

Issue 202 EUROPEAN, ASIAN AND
BRITISH BUILT MACHINES

THE WORLD'S LARGEST RANGE OF PREMIUM REPLACEMENT MOTORCYCLE BRAKES

77
RYDE

Kyle Ryde,
2019 British
GP2 Champion.



MH Motorsport Photography

EBC[®] BRAKES

Brake pads, rotors, braided stainless brake lines, clutches and much more, with four manufacturing plants in the UK and USA producing over 10 million components each year.

www.ebcbrakes.com



Welcome to your new catalogue from EBC Brakes with all of the new brakes and clutches you need for your customers

New for 2020

With nearly 40 years in the motorcycle aftermarket, we can only thank again our thousands of loyal customers for their support through the years. Carrying EBC as an alternative product line to genuine parts continues to make good commercial sense, increases sales and offers a truly long-term solution to stocking aftermarket parts.

Our range of products for US built motorcycles has been updated and included once again in this catalogue.

2019 saw a change in the way that we produce and distribute our catalogues. This is a full catalogue, in 2021 we will produce an "update only" catalogue which will supplement this edition. An up to date full catalogue will always be available on our website on the catalogues page.

WHAT ARE THE HOT PRODUCTS FOR 2020?

OVERSIZE DISC CONVERSIONS FOR US BUILT MACHINES

Brackets for oversize discs also available, complete with required hardware. See page 10 for fitment information and page 11 for model-specific product images.

Once again **THANK YOU** and have a great 2020 selling season.



CATALOGUE COPYRIGHT

This catalogue forms a copyright under international law.

This includes, but is not limited to, the series of brake pad, brake shoe, clutch and brake rotor design numbers with or without the prefixes FA, EPFA, GPFA, GPFAX, MXS, or suffixes R, HH, TT, SV. These design numbers, prefixes and suffixes form the toils of many years of work and set EBC products apart and easily distinguished from other manufacturers brands or numbers.

Any copying, imitation, in full or in part, by any third party, will result in prosecution to the fullest extent of the law.

Also included within this catalogue are registered or applied for individual trademarks, such as

- EBC
- Double-H
- Pro-lite
- SD-System
- Dirt Racer
- Street Racer
- DRC
- DRCF
- SRC
- SRK
- SV Series
- VLD Series
- VR Series
- UTVX
- SXR

All of the above are active trademarks and/or brands used by EBC Brakes licencees.

CONTENTS

BRAKE APPLICATIONS

American Produced Motorcycles	2-33	Pads for Aftermarket Calipers	150-153
Japanese Built Motorcycles.....	34-149	Non-Japanese Built Motorcycles	154-419
Road Racing Motorcycles	150		

BRAKE
APPLICATIONS

DISC PAD BUYERS GUIDE

Buyers Guide - Disc Brake Pads	420-638
--------------------------------------	---------

DISC PADS
BUYERS GUIDE

SHOE BUYERS GUIDE

Buyers Guide - Brake Shoes	639-665
Brake Shoe Illustrations.....	666-672
Diameter Chart - Brake Shoes.....	672

SHOE
BUYERS GUIDE

DISC BUYERS GUIDE

Buyers Guide - Streetbike Discs	673-715
Buyers Guide - Off Road Discs.....	716-732

DISC
BUYERS GUIDE

CLUTCH APPLICATIONS

Clutch Introduction Page	733
EBC Coil Spring Kits/Spring Tension Measuring Machine/EBC Diaphragm Clutch Springs.....	734
CKF Clutch Kits/DRC-F Clutch Kits/Clutch Removal Tools	735
Clutch Applications	736-779

CLUTCH
APPLICATIONS

BUYERS GUIDE CLUTCH

Buyers Guide - CK/CKF Clutch Kits	780-802
Buyers Guide - DRC/DRCF Kits	803-811
Buyers Guide - SRC Kits	812-819
Buyers Guide - SRK Kits	820-827
Buyers Guide - Clutch Removal Tools	828-845

CLUTCH
BUYERS GUIDE

BRAKE LINES

Brake Lines	846-860
-------------------	---------

BRAKE
LINES

ACCESSORY PAGES

Pilot Jets	861-863	Baffle Pac Silencer Wool	867
Main Jets	864-865	Brake Fluid/Brake Caliper Lube.....	867
S & B Filters	865	Galindo & Baja Grips, Ledar Nozzles & Racing Reeds	868
Hy-Tech Racing Reeds.....	866	Promotional Items	869-871

ACCESSORY
PAGES

MOTORCYCLE BRAKE PADS

Aramid Fiber Organic FA Series Pads

"TT" Pads

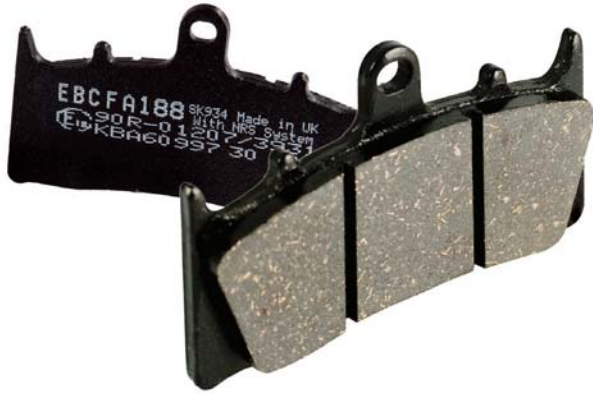

FA series organic brake pads will deliver fingertip stopping power and superb brake feel and control, the preferred choice for many sportbike riders. This compound has low disc attack characteristics and gives medium lifetime.

"TT" series moto-x sport and enduro pads, cool running based pad compound for sport use in moto-x and ATV applications. For mud, sand or wet conditions requiring longer life, use our sintered range below.

Double-H™ Pads

MXS Series Pads

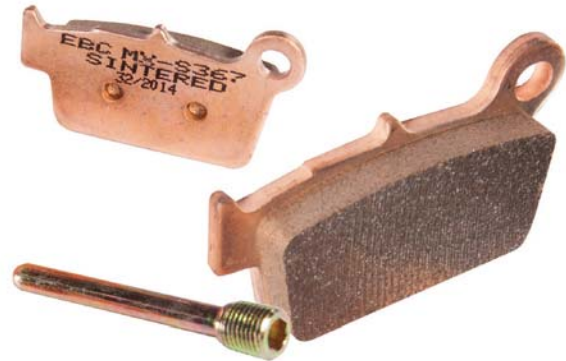
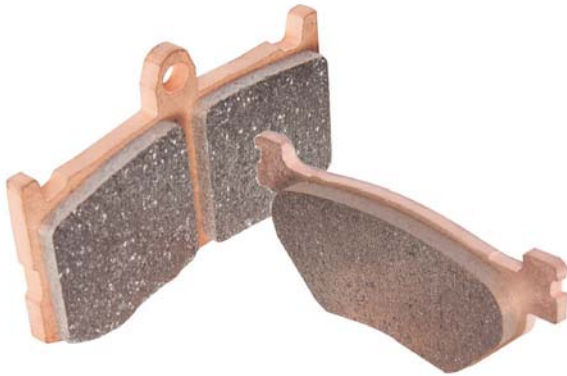

FA series with HH suffix, EBC's American-made ultra high friction Double-H™ sintered copper alloy brake pads for maximum stopping power and lifetime. With stainless steel radiator plates to reduce heat transfer and double compact for wider pads.

"MXS" moto-x race pads, ultra high friction American-made sintered copper alloy with diamond ground surface finish for fast brake-in. With external hex drive slider pins, these pads are suitable for all fast moto-x riding.

"R" Series Pads



"R" series American-made sintered copper alloy ATV and Moto-X replacement pads for sport and utility off road riding.

ii Part numbers, prefixes, suffixes, photos and illustrations shown in this catalogue are trademarks and/or copyrights of EBC Brakes or the trademark owner A C Freeman Investments Ltd and use without express written permission of the owners is punishable by law.

MOTORCYCLE BRAKE PADS

EPFA Trackday Pads

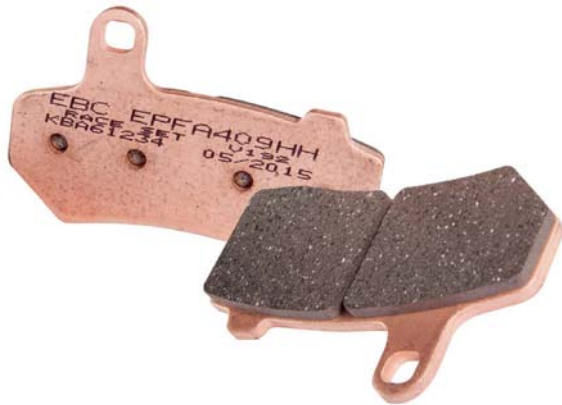

EPFA trackday pads give long life in street use with improved fade resistance and heat cycling plus improved noise characteristics, making this a great pad for heavy streetbikes and cruisers as well as faster superbikes. Great for intermittent track use.

GPFX Race Series Pads

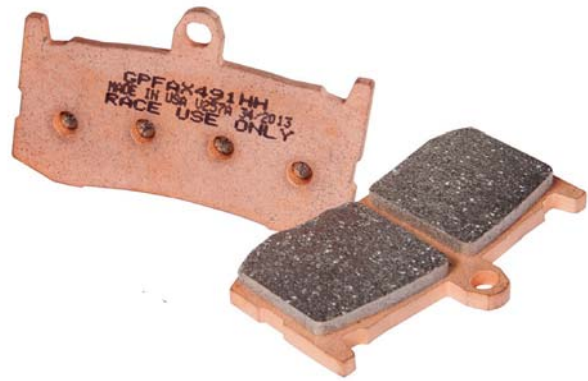

GPFX vacuum sintered ultra-high friction race pads are for sportbike asphalt racing and have been refined over the years to deliver one of the best brake race materials ever made. See page xii for full details.

SFA Organic Scooter Pads



A superb general replacement pad for urban use on scooter mopeds, mopeds and mopeds. Made using aramid fibres, these pads give above average lifetime, reduced disc wear characteristics and offer great value for money.

SFA-HH Sintered Scooter Pads

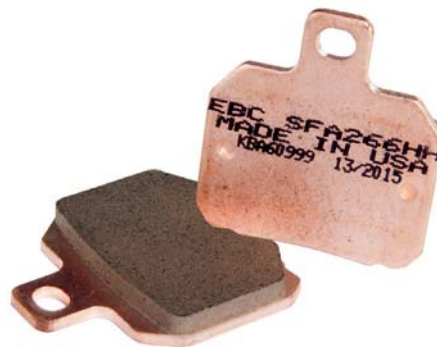

These American-made sintered scooter pads are long lasting with high performance HH rated stopping power for perfect braking - wet or dry. The HH pads target the faster and heavier scooter market and work well with stainless steel brake discs.

MOTORCYCLE BRAKE DISCS

X and XC Series Sportbike Discs



X and XC series discs feature mill hard stainless steel high friction rotor blades for maximum brake effect and are direct size for size replacements for OEM discs. These lightweight discs feature our patented SD system square drive button system.

VMD Classic Style Discs



These lightweight, black anodised vintage discs are new to our range. The vintage fitment benefits from billet aluminium construction; lightweight, less unsprung weight enables better handling and stopping power. Perfect for the Café racer scene.

Sportbike VR Series Discs

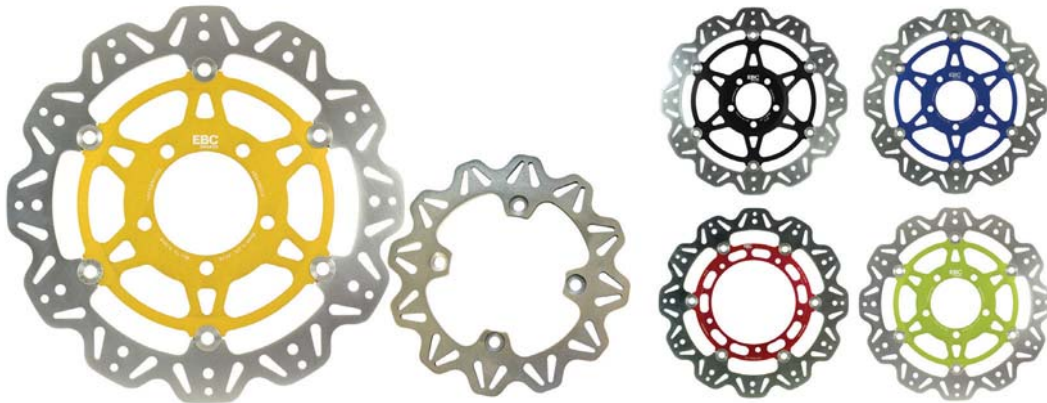

Vee profile lightweight discs with alloy hubs and ground stainless steel rotor blades for fast street bikes. Choose from black or coloured hub options as shown above. To order prefix with VR and suffix with chosen color BLK, RED, BLU, GRN, GLD. For rear discs just the VR number.

Custom Finish VR Series Discs

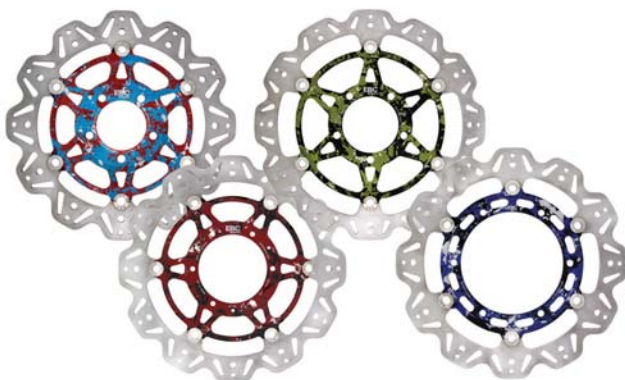

Special edition splatter anodised custom finish is applied to the centre hubs of our VR series discs by hand. The coating has the same resilience as other EBC disc finishes but with a radical and unique aesthetic. Colour options available: Light Blue, Red & White; Red, White & Black; Green, White & Black; Dark Blue, White & Black.

Supermoto Brake Disc

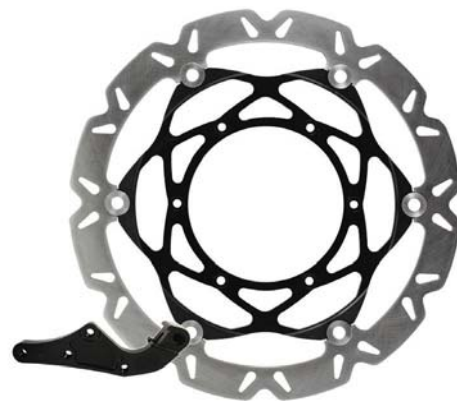

SMX rotor with vee design contoured disc, 320mm disc upgrade kits complete with relocation bracket.

MOTORCYCLE BRAKE DISCS

MD Series Stainless Scooter Discs



Made from mill hard rolled steel, these discs are machined to match the original units, mechanically de-stressed to avoid rotor distortion, surface finished for precise smoothness and then zinc coated to prevent corrosion or rusting.

VR Series Stainless Scooter Discs



Made in the UK using German mill rolled heat treated and precision ground stainless steel, the new VR series stainless profiled scooter sport discs are the lightest and best looking on the market and can be used with any type of brake pad.

UTVX Rotors for ATV/Quad/4x4



These discs look great and give an improved brake performance. Made in our British manufacturing facility using durable, tough German mill rolled stainless steel, heat treated & diamond ground to give great braking for less than OEM prices.

CX Extreme Off Road Discs



CX Extreme self-cleaning lightweight stainless discs are a size-for-size replacement/upgrade for front and rear fitment on all modern motocross machines.

Oversize MX Discs



250 or 280mm motocross oversize disc kit complete with billet aluminum relocation brackets for improved brake power and control with vee design disc.

Rear Brake Discs



Made from stainless steel and available in full circle or contoured profile, suitable for performance street use or racing with new lightweight hole pattern construction.

MOTORCYCLE CLUTCH OPTIONS

CK/CKF Series Clutch Kits



CK complete engine sets of stack height controlled friction plates feature the EBC Brakes' unique alloy particle impregnated clutch facings that prevent burn up or slippage. CKF carbon fibre impregnated kits for ATV and moto-x use are built to last longer, grip and feel better than cork kits.

DRC/DRCF Series Clutch Kits



DRC is the ultimate clutch rebuild kit for your ATV and Moto-X machine. The DRCF kit swaps the stock type cork friction plates for a set of severe duty carbon fibre lined friction plates for better heat and wear abilities.

SRC/SRK Series Clutch Kits



SRC is an aramid fibre lined plate set with heavy duty clutch springs (diaphragm type springs included where required). Ideal for heavy sport bikes, faster riders and production based race use. SRK series includes a full engine set of aramid lined friction plates with clutch springs and steel separator plates.

CSK Coil & Diaphragm Clutch Kits



CSK sets include either coiled springs or diaphragm springs where appropriate. Coil springs are spiral wound with 4 to 8 pieces per set, made from heat treated high carbon steel delivering the right tension for your bike. Diaphragm springs are dish shaped flat steel pressure rings.

Clutch Removal Tools



NOW BEING MADE
IN STAINLESS
STEEL FINISH

Made in the UK by EBC Brakes, these laser cut clutch tools make clutch removal, loosening of the drive shaft bolts and re-tightening a breeze, without any fear of damage to your expensive clutch basket. Tools can be extended to create more leverage if required with any simple workshop tool or tube. EBC Brakes produce a clutch tool for almost every clutch plate design known.

SXS Products from EBC BRAKES

The longest lasting, highest performing aftermarket pads and rotors for the SxS industry yet ...

All EBC Brakes pads for SxS fitments, both sintered and carbon X pads, are made with beefed-up pad thickness and DO NOT REQUIRE or accommodate the fitting of noise shims, offering even more available pad life for this tough application.

UTVX DISCS

- Lightweight • Profiled
- UK made • Heat treated stainless steel

NEW SXR PADS

- Vacuum sintered • Maximum grip
- Race performance • Longest wear life

SXR sintered pads are MADE IN THE USA using vacuum furnace sintering to deliver a refined and much longer lasting material blend.

SPORT CARBON TT PADS

also available for fast, dry riding using ENHANCED LIFE MATERIAL and enhanced pad thickness.

All parts are in stock at your favourite EBC Brakes distributor NOW for immediate delivery.

GO FAST STOP FAST

STEP UP FROM STOCK

Choose from our carbon graphite X pads, high-friction SXR Race Pads or severe duty SV Series pads.

Add these to our new stainless-steel UTVX Rotors for a great set of brakes to suit all of your riding styles.



Boost brake response even further with EBC Brakes' British-made Stainless Steel Braided Brake Lines.































EBC
BRAKES

The World's No. 1 Name in Brakes www.ebcbrakes.com

Part #	Make/Model	Year	Pad Position	EAN	Matching UTVX Disc		
					Front	Rear	
SXR135HH	CAN AM			5050953856174			
	Commander 800 R/XT/DPS/1000 STD/DPS/LTD/X/XT/XT-P	11-15	Front Right & Rear		UTVX6366	UTVX6366	
	Maverick 1000 STD/XRS	13	Front Left		UTVX6370	UTVX6370	
SXR159HH	POLARIS			5050953856198			
	570 Sportsman	11-15	Front		UTVX6202	UTVX6275	
	RZR 570	12-13	Rear		UTVX6312	UTVX6275	
	600/700/800 Sportsman 4 x 4	02-13	Front		MD6201D	MD6201D	
	700/800 Sportsman EFI/X 2	07-14	Front		UTVX6202	UTVX6275	
	Ranger	99	Front		MD6149D	TBA	
	PPS/PTV 4 x 4/Series 10		Front		UTVX6202	MD6200D	
	PPS/PTV 6 x 6/Series 10		Front		MD6149D	MD6200D	
	PPS LUH 6 x 6	02	Front		MD6149D	MD6170D	
SXR165HH	CAN AM			5050953856235			
	Commander 800 R/XT/DPS	11-15	Front Left		UTVX6366	UTVX6366	
	Commander 1000 STD/DPS/LTD/X/XT/XT-P	11-15	Front Left		UTVX6366	UTVX6366	
	Maverick 1000 STD/XRS	13	Front Left		UTVX6366	UTVX6370	
SXR307HH	BOMBARDIER			5050953856259			
	Outlander 300 HO/400/400 Max HO	03-06	Front Left		UTVX6222	UTVX6223	
	Outlander 650 HO Efi 4 x 4/HO Efi XT 4 x 4	06	Front Left		UTVX6222	UTVX6223	
	Outlander Max 650 HO Efi 4 x 4 HO Efi XT 4 x 4	06	Front Left		UTVX6222	UTVX6223	
	Outlander 800 (All models)	06	Front Left		UTVX6222	UTVX6223	
	Traxter (4 x 4)/XL (4 x 4)/XT (4 x 4)	01-04	Front Left		MD6229D	MD6230D	
	Traxter Autoshift	01-05	Front Left		MD6225D	MD6224D	
	Traxter Footshift	01	Front Left		MD6229D	MD6230D	
	Quest 500 (4 x 4)	02-04	Front Left		MD6224D	MD6225D	
	Traxter Max	03-05	Front Left		MD6245D	MD6225D	
	Quest 500/650 (2 x 4)/650 (4 x 4)/650 XT (4 x 4)	02-04	Front Left		MD6224D	MD6225D	
	Quest Max 650	03-	Front Left		MD6224D	MD6225D	
	DS 650/650 Baja/X	00-06	Front Left		MD6171D	MD6172D	
	Traxter Max 650/XL/Quest Max/STD/XT	04-05	Front Left		MD6245D	MD6225D	
		CAN AM					
	Maverick 1000 STD/XRS	13	Rear Left & Rear		UTVX6366	UTVX6370	
	Outlander 400/500/650/800/Max 400/500/650/800	07-15	Front Left & Rear		UTVX6222	UTVX6223	
	Renegade 500/800	07-12	Front Left & Rear		UTVX6223	UTVX6223	
	DS 650 X (3B7A/B)	07	Front Left & Rear		MD6171D	MD6172D	
	Renegade 800	08-11	Front Left & Rear		TBA	TBA	
	Buck/Trail Buck 500/650 EX/EXT	04-08	Rear Left		MD6245D	MD6225D	
	Commander 1000 R EFI	18-19	Rear Left		UTVX6411	UTVX6366	
	Commander Max 1000 - DPS/XT/LTD	14-15	Rear Left		TBA	UTVX6370	
Maverick 1000 - STD/XRS/XRS/XDS - DPS/XMR/XXC	14-15	Rear Left		UTVX6411	UTVX6370		
Maverick Max 1000 Std/1000 - XRS/XDS - DPS	14-17	Rear Left		UTVX6411	UTVX6370		
SXR317HH	BOMBARDIER			5050953856273			
	Outlander 300 HO/400/400 Max HO	03-06	Front Right		UTVX6222	UTVX6223	
	Outlander 650 HO Efi 4 x 4/HO Efi XT 4 x 4	06	Front Right		UTVX6222	UTVX6223	
	Outlander Max 650 HO Efi 4 x 4 HO Efi XT 4 x 4	06	Front Right		UTVX6222	UTVX6223	
	Outlander 800 (All models)	06	Front Right		UTVX6222	UTVX6223	
	Traxter (4 x 4) /XL (4 x 4)/XT (4 x 4)	01-04	Front Right		MD6229D	MD6230D	
	Traxter Autoshift	01-05	Front Right		MD6225D	MD6224D	
	Traxter Footshift	01	Front Right		MD6229D	MD6230D	
	Quest 500 (4 x 4)	02-04	Front Right		MD6224D	MD6225D	
	Traxter Max	03-05	Front Right		MD6245D	MD6225D	
	Quest 500/650 (2 x 4)/650 (4 x 4)/650 XT (4 x 4)	02-04	Front Right		MD6224D	MD6225D	
	Quest Max 650	03-	Front Right		MD6224D	MD6225D	
	DS 650/650 Baja/X	00-06	Front Right		MD6171D	MD6172D	
	Traxter Max 650/XL/Quest Max/STD/XT	04-05	Front Right		MD6245D	MD6225D	
		CAN AM					
	Maverick 1000 STD/XRS	13	Rear Right		UTVX6366	UTVX6370	
	Outlander 400/500/650/800/Max 400/500/650/800	07-15	Front Right & Rear		UTVX6222	UTVX6223	
	Renegade 500/800	07-12	Front Right & Rear		UTVX6223	UTVX6223	
	DS 650 X (3B7A/B)	07	Front Right & Rear		MD6171D	MD6172D	
	Renegade 800	08-11	Front Right & Rear		TBA	TBA	
	Buck/Trail Buck 500/650 EX/EXT	04-08	Front Right & Rear Right		MD6245D	MD6225D	
	Commander 1000 R EFI	18-19	Rear Right		UTVX6411	UTVX6366	
	Commander Max 1000 - DPS/XT/LTD	14-15	Rear Right		TBA	UTVX6370	
Maverick 1000 - STD/XRS/XRS/XDS - DPS/XMR/XXC	14-15	Rear Right		UTVX6411	UTVX6370		
Maverick Max 1000 Std/1000 - XRS/XDS - DPS	14-17	Rear Right		UTVX6411	UTVX6370		
SXR354HH	POLARIS			5050953856297			
	570 Sportsman Ace/Ace Euro	15-20	Rear		UTVX6202	UTVX6275	
	800 Ranger Crew	10-14	Rear		UTVX6338	UTVX6275	
SXR395HH	ARCTIC CAT			5050953856334			
	550 H1 Efi Prowler/650 H1 Prowler/650 Prowler 4 x 4/M4	07-09	Front		UTVX6271	N/A	
	HDX 500 LTD Prowler/Prowler/XT Prowler	14	Front		UTVX6271	N/A	
	XT 550/550 Prowler/650 H1 Prowler	06-14	Front		UTVX6271	N/A	
	HDX 700 Prowler/LTD Prowler/Trail	11-14	Front		UTVX6271	UTVX6173	
	Wildcat Trail 700 XT inc LTD	15-19	Front		UTVX6384	UTVX6384	
	XTX 700 H1 EFI/LE Prowler/700 Prowler	08-14	Front		UTVX6271	N/A	
	1000 H2 Mudpro EFI	10	Front		UTVX6173	UTVX6173	
	1000 Mudpro	10-13	Front		UTVX6271	UTVX6271	
	1000 TRV Cruiser/TRV H2 EFI/H2 EFI Cruiser	09-11	Front		UTVX6173	UTVX6173	
	Thundercat 1000 H2/H2 LE	08-10	Front		UTVX6173	UTVX6173	
	Wildcat 1000 GT	11-12	Front		UTVX6271	UTVX6173	
	Wildcat 1000 GT/LTD/X-LTD/XT-LTD-EPS	13-16	Front		TBA	TBA	
	Wildcat X 1000/X-SE-EPS 1000	14-16	Front		TBA	UTVX6383	
		XTZ 1000 Prowler	10-14	Front		UTVX6271	UTVX6173
SXR452HH	POLARIS			5050953856358			
	500 Ranger (4 x 4 EFI)/(Carb) 2 x 4/Ranger Crew	08-13	Front		UTVX6202	UTVX6275	
	500 Ranger (EFI) 4 x 4 H.O.	09-11	Front		UTVX6338	UTVX6275	
	RGR 570, Full Size (R06)	16	Front		UTVX6202	UTVX6275	
	700 Ranger Crew (EFI) 4 x 4/6 x 4 EFI/XP 4 x 4	08-09	Front		UTVX6202	UTVX6275	
	700 Ranger 4 x 4 EFI	09	Front		UTVX6338	UTVX6275	
	800 Ranger/EFI/XP/Crew	10-14	Front		UTVX6338	UTVX6275	
	800 Ranger 6 x 6	10-17	Front & Rear		UTVX6338	UTVX6275	
	RZR-4 800 EPS	12	Front		UTVX6338	UTVX6275	

Part #	Make/Model	Year	Pad Position	EAN	Matching UTVX Disc	
					Front	Rear
	Ranger EV (Electric)	10-15	Front		UTVX6202	UTVX6275
	900 D Crew Ranger Diesel/Crew Ranger Diesel	11-14	Front		UTVX6338	UTVX6275
	900 (Ranger XP 900)	15-19	Front		UTVX6338	UTVX6275
	900 (Ranger XP 900)	13-14	Front		UTVX6338	UTVX6374
	Ranger Crew 900 All Options (R07)	16-19	Front & Rear		UTVX6338	UTVX6275
	1000 General EPS (2 Seat)	16	Front		UTVX6338	UTVX6338
	1000 General EPS PS MD (R09, R13, 2 Seat)	17-20	Front		UTVX6408	UTVX6408
	1000 General 4 EPS PS XP DLX (R01, R14, R18, 4 Seat)	17-20	Front		UTVX6338	UTVX6408
	1000 Ranger Diesel Crew	15	Front		UTVX6338	UTVX6275
	RZR XP 1000 (R11 EU/MD,R12, R14)	16-17	Front		UTVX6380	UTVX6380
	Brutus HD HDPTO (R03)	13-17	Front		UTVX6338	UTVX6275
SXR456HH	POLARIS			5050953856372		
	RZR 570/RZR 800 (Inc EPS Models)	08-14	Front		UTVX6312	UTVX6275
	RZR 570 S/EU/MD (R05)	14-19	Front		UTVX6338	UTVX6275
SXR610HH	ARCTIC CAT			5050953856396		
	Wildcat 4X/4X-LTD/4/4 LTD 1000	13-16	Front		UTVX6384	UTVX6384
SXR642HH	CAN AM			5050953856419		
	Commander 1000 R EFI	18-19	Front Left		UTVX6411	UTVX6366
	Commander Max 1000 - DPS/XT/LTD	14-15	Front Left		TBA	UTVX6370
	Maverick 1000 - STD/XRS/XRS/XDS - DPS/XMR/XXC	14-15	Front Left		UTVX6411	UTVX6370
	Maverick Max 1000 Std/1000 - XRS/XDS - DPS	14-17	Front Left		UTVX6411	UTVX6370
SXR645HH	CAN AM			5050953856433		
	Commander 1000 R EFI	18-19	Front Right		UTVX6411	UTVX6366
	Commander Max 1000 - DPS/XT/LTD	14-15	Front Right		TBA	UTVX6370
	Maverick 1000 - STD/XRS/XRS/XDS - DPS/XMR/XXC	14-15	Front Right		UTVX6411	UTVX6370
	Maverick Max 1000 - Std/1000 - XRS/XDS - DPS	14-17	Front Right		UTVX6411	UTVX6370
SXR651HH	CF MOTO (Side x Side)					
	1000 Z-Force	17-19	Rear		TBA	TBA
SXR656HH	POLARIS			5050953856457		
	570 Sportsman Ace/Ace Euro	15-20	Front		UTVX6202	UTVX6275
	570 Ranger Crew EFI	14-15	Front		UTVX6202	UTVX6275
	RGR 570, Full Size (R12/R06/R03)	17-20	Front		UTVX6202	UTVX6275
	RGR CRW 570 FS (R08/R05/R03)	16-20	Front		UTVX6202	UTVX6275
	RGR 570 EPS CRW MD (R04)/EFI CRW (R10/R03/R02)	17-20	Front		UTVX6202	UTVX6275
	RGR EV MD (R02)/EV LILION (R08/R03)/EV (R12/R03/R02)	16-19	Front		UTVX6202	TBA
	RGR 800 6X6 MD Poland (R02)	17-20	Front		UTVX6202	TBA
	RGR CRW 900 XP 6P SP (R10)/900 EPS (R03)/6P SP (R14)	17-19	Front		UTVX6338	TBA
	Ranger 902D EU Tractor R07	19-20	Front		UTVX6380	UTVX6338
	RZR XP 1000 S4 R02	18-20	Front		UTVX6380	UTVX6338
	900 Ranger Crew	10-15	Front		UTVX6338	UTVX6275
	1000 Ranger Diesel EU (R12)	15-20	Front		UTVX6338	UTVX6275
	RGR CRW 1000 XP PS MD (R08)/PS All Options (R32/R09)	17-18	Front		UTVX6338	UTVX6275
	RGR CRW 1000 XP 6P, PS, NB, MD (R08)/PS (R10)	17-20	Front		UTVX6338	UTVX6275
	RGR 1000 D Poland (R07)/D EU (R14) D Crew (R16)	17-18	Front		UTVX6338	UTVX6275
	Ranger Crew 1000 (R04, R06, R08, R11)	18-20	Front		UTVX6338	UTVX6275
	Ranger 1000 XP PS Crew Inc EU, EPS, HD, MD (R03, R09, R13, R20)	18-20	Front		UTVX6338	UTVX6275
	Ranger 1000 XP PS NSTR, Crew Mud (R15, R17, R18)	18-20	Front		UTVX6338	UTVX6275
	RGR 1000D (R17/R13)	17-18	Front		UTVX6338	UTVX6275
	MIL RZR2 XP MV 1000 TD (R01/R04)/TD NELO (R01)	17-18	Front		TBA	TBA
	RZR XP 900 (Inc EPS Models)/4 XP 900 All Options Inc Military/4 900 (R05)	11-17	Front		UTVX6338	MD6374D
	RZR 4 900 (R05, R12)	16-18	Front		UTVX6338	TBA
	RZR XP 1000 R35	12-19	Front		UTVX6380	UTVX6380
	RZR RS1/XP 4 1000/4 1000 MD	16-20	Front & Rear		UTVX6380	UTVX6380
	RZR XP/XP 4 Turbo/Turbo 4	16-20	Rear		UTVX6397	UTVX6397
	RZR XP Turbo/Latin/MD/S/Tractor/Turbo S/XP4 Turbo/Turbo Intl/Turbo MD	17-20	Rear		UTVX6380	UTVX6397
SXR657HH	POLARIS			5050953856471		
	RZR/RZR-S 900 (50"/60" All Options)	15-20	Front		UTVX6338	UTVX6338
	RZR 1000 60" PS EU/Tractor/Zug (R01, R06, R07, R09)	17-20	Front		UTVX6338	UTVX6338
SXR676HH	YAMAHA			5050953856495		
	YZZ 1000 R All Models	16-17	Front		UTVX6395	UTVX6395
SXR677HH	YAMAHA			5050953856518		
	YZZ 1000 R All Models	16-17	Rear		UTVX6395	UTVX6395
SXR680HH	POLARIS			5050953856532		
	RZR XP/XP 4 Turbo/Turbo 4	16-20	Front		UTVX6397	UTVX6397
	RZR XP/XP4	17-20	Front		UTVX6380	UTVX6397
SXR682HH	CAN AM			5050953856556		
	Defender 500cc/799cc/Max/976cc	16-19	Front Left		UTVX6396	UTVX6396
	Maverick Trail 800cc/1000cc EFI	18	Front Left		UTVX6396	UTVX6412
	Maverick X3/X3 Max	17-18	Front Left		UTVX6411	UTVX6412
SXR683HH	CAN AM			5050953856570		
	Defender 500cc/799cc/Max/976cc	16-19	Front Right		UTVX6396	UTVX6396
	Maverick Trail 800cc/1000cc EFI	18	Front Right		UTVX6396	UTVX6412
	Maverick X3/X3 Max	17-18	Front Right		UTVX6411	UTVX6412
SXR684HH	CAN AM			5050953856594		
	Defender 799cc/976cc	16-19	Rear Left		UTVX6396	UTVX6396
SXR685HH	CAN AM			5050953856617		
	Defender 799cc/976cc	16-19	Rear Right		UTVX6396	UTVX6396
SXR701HH	HONDA			5050953856631		
	Pioneer 1000 SXS (2/4 seat)	16-18	Front Left		UTVX6410	UTVX6410
	SXS Talon 1000 R	19-20	Front Left		UTVX6397	UTVX6425
SXR702HH	HONDA			5050953856655		
	Pioneer 1000 SXS (2/4 seat)	16-18	Front Right		UTVX6410	UTVX6410
	SXS Talon 1000 R	19-20	Front Right		UTVX6397	UTVX6425
SXR703HH	HONDA			5050953856679		
	Pioneer 1000 SXS (2/4 seat)	16-18	Rear Left		UTVX6410	UTVX6410
	SXS Talon 1000 R	19-20	Rear Left		UTVX6397	UTVX6425
SXR704HH	HONDA			5050953856693		
	Pioneer 1000 SXS (2/4 seat)	16-18	Rear Right		UTVX6410	UTVX6410
	SXS Talon 1000 R	19-20	Rear Right		UTVX6397	UTVX6425
SXR726HH	CF MOTO (Side x Side)					
	1000 Z-Force	17-19	Front		TBA	TBA
SXR728HH	POLARIS			5050953868986		
	RZR XP4 Turbo S/XP Turbo S Velocity	19-20	Front		UTVX6380	UTVX6397

 <p>SXR135HH - 77.3/96.7mm wide</p>	 <p>SXR159HH - 97mm wide</p>	 <p>SXR165HH - 77.3/96.7mm wide</p>	 <p>SXR307HH - 82/62mm wide</p>
 <p>SXR317HH - 82/62mm wide</p>	 <p>SXR354HH - 97mm wide</p>	 <p>SXR395HH - 95mm wide</p>	 <p>SXR452HH - 121mm wide</p>
 <p>SXR456HH - 97.1mm wide</p>	 <p>SXR610HH - 135.6mm wide</p>	 <p>SXR642HH - 104/88mm wide</p>	 <p>SXR645HH - 104/88mm wide</p>
 <p>SXR651HH - 72.73mm wide</p>	<p>Hardened Steel Backplate</p>  <p>SXR656HH - 121mm wide</p>	 <p>SXR657HH - 98mm wide</p>	 <p>SXR676HH - 113.8mm wide</p>
 <p>SXR677HH - 104mm wide</p>	 <p>SXR680HH - 158mm wide</p>	 <p>SXR682HH - 117.35/95.2mm wide</p>	 <p>SXR683HH - 117.35/95.2mm wide</p>
 <p>SXR684HH - 101.5/83.05mm wide</p>	 <p>SXR685HH - 101.5/83.05mm wide</p>	 <p>SXR701HH - 115.1mm wide</p>	 <p>SXR702HH - 115.1mm wide</p>
 <p>SXR703HH - 81.8mm wide</p>	 <p>SXR704HH - 81.8mm wide</p>	 <p>SXR726HH - 101.5mm wide</p>	 <p>SXR728HH - 163.6mm wide</p>



UTVX6173 / MD6173 202mm/7.95"



UTVX6202 / MD6202 228mm/8.98"



UTVX6271 / MD6271 252mm/9.92"



UTVX6275 / MD6275 218mm/8.58"

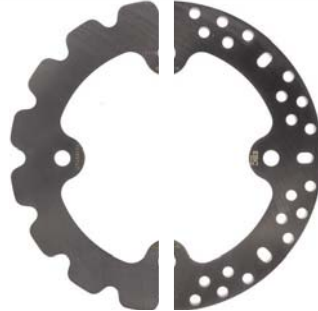

UTVX6312 / MD6312 235mm/9.25"



UTVX6338 / MD6338 220mm/8.93"



UTVX6366 / MD6366 215mm/8.46"

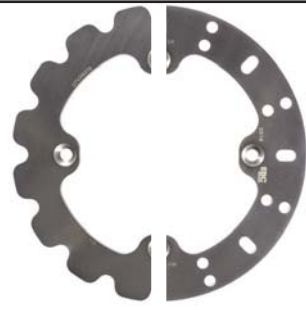

UTVX6370 / MD6370 215mm/8.46"



UTVX6374 / MD6374 218mm/8.58"



UTVX6380 / MD6380 245mm/9.64"



UTVX6384 / MD6384 252mm/9.92"



UTVX6395 / MD6395 245mm/9.64"



UTVX6408 / MD6408 227mm/8.94"



UTVX6410 / MD6410 210mm/8.27"



UTVX6411 / MD6411 260mm/10.23"



UTVX6412 / MD6412 247.5mm/9.74"

GPFX Full Race Pads

PART #	BRIEF FITMENT
GPFX016HH	AP/LOCKHEED CALIPERS / DUCATI 750 Sport / TRIUMPH (MERIDEN MODELS)
GPFX184HH	ISR AFTERMARKET CALIPERS
GPFX197HH	KAWASAKI Ninja 300 & 400
GPFX218HH	BREMBO CALIPERS
GPFX244HH	BREMBO CALIPERS / APRILIA early Dosoduro, RSV & Tuono models / DUCATI 748, 848, 916, 996, 998 models
GPFX263HH	AP LOCKHEED CALIPERS / PFM CALIPERS
GPFX295HH	BREMBO CALIPERS
GPFX296HH	HONDA CBR600 all F & RR3/4 models, CB1000R / KAWASAKI ZX6-R (636cc) Ninja 13-20
GPFX347HH	HONDA RS125 Radial caliper, NSF250R Moto3 / KAWASAKI ZX9-R & Z900 / MORIWAKI MD250H 08-13 / YAMAHA TZ250 Radial Caliper 02-10
GPFX379HH	KAWASAKI ZX10R 08-15, Ninja H2-SX 18-20 / SUZUKI GSXR 600/750 04-10, GSXR 1000 04-11
GPFX380HH	YAMAHA YZ-R6/R1 04-20
GPFX390HH	HONDA CBR 600 RR5 on Radial Caliper 05-16, CBR 1000 RR 05-16, CB 1000 R 09-15
GPFX417/4HH	KAWASAKI ZX6R (600cc) 07-16, ZZR1400 06-20
GPFX435/4HH	AP LOCKHEED CALIPERS / BREMBO RADIAL CALIPERS / PVM REAR CALIPERS
GPFX442/4HH	YAMAHA YZ-R1 Six Piston Radial Caliper 07-14
GPFX447HH	BREMBO CALIPERS / APRILIA RSV410-20, Tuono 17-20 / BENELLI Tornado, Bimota DB8, 9&11 / BMW HP2 Sport, HP4 13-20 / DUCATI Desmodici 2008, 1098, 1198, 1199 & 1299 Panigale / ENERGICA Electric / HONDA CBR1000RR SP 14-20, RC213V-S 15-18 / KAWASAKI H2 Ninja 15-16, ZX-10R 16-20, Ninja H2 17-20, ZX-10RR 17 / KTM RC8 08-15 / MV AUGUSTA 998/1000/1078 F4R/RR / SUZUKI GSXR600/750/1000 11-20 / TRIUMPH 675R
GPFX491HH	TRIUMPH Daytona 675 09-17
GPFX604/4HH	BMW S 1000 RR 10-18 / TRIUMPH Daytona 765 Moto2
GPFX611HH	BREMBO CALIPERS
GPFX630HH	DUCATI 899, V2 955cc, 959 Panigale models / KAWASAKI Z H2 / KTM 890 Duke R / INDIAN FTR1200
GPFX646HH	BREMBO CALIPERS
GPFX662HH	YAMAHA YZ-F R3 Rear 15-20
GPFX663HH	YAMAHA YZ-F R3 Front 15-20
GPFX673HH	BREMBO CALIPERS
GPFX700HH	HONDA CBR600RR 17-20, CBR1000R/RR Tokico Caliper 17-20
GPFX724HH	BMW S1000 R/RR Sport & M Sport 18-20
GPFX730HH	BREMBO CALIPERS

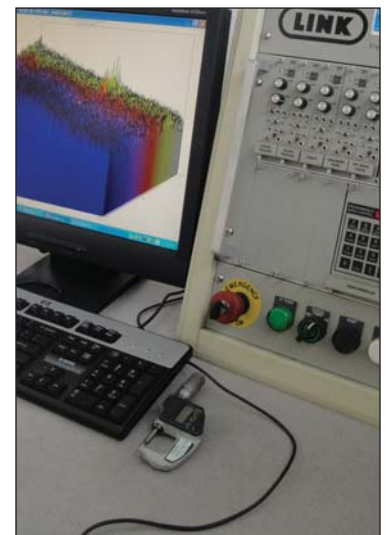
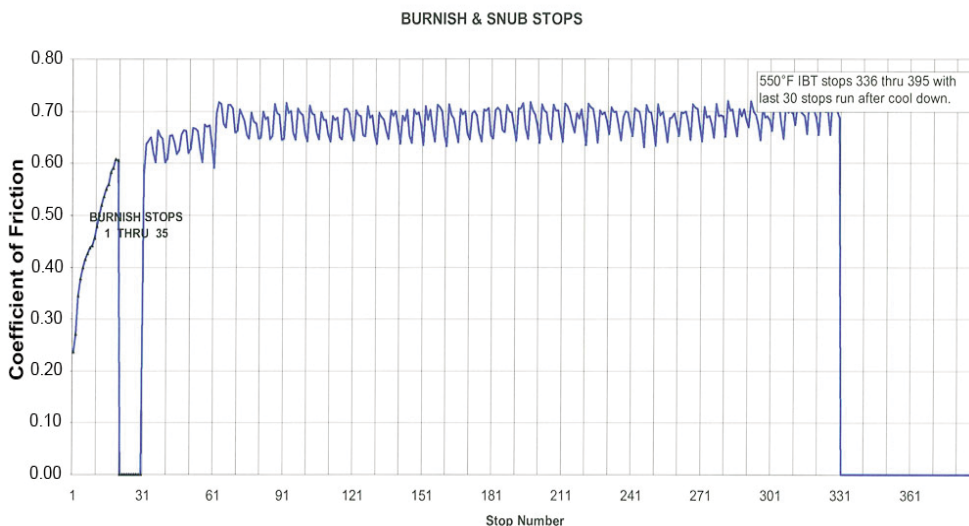

These pads bed in fast and deliver extremely high friction linear performance in track use. GPFX pads are high friction but highly stable in stop. This means pads are powerful and predictable time after time when the brake is applied in race use. The “in-stop” friction fall off is almost zero and can hardly be noticed at the lever meaning the brakes offer superb control. The EBC dyno is set to duplicate race conditions at the Road America race track and represents a true simulation of race brake demand. The number of race teams using GPFX grows annually and for 2020 the exact same formulation developed thru 2019 is used again.

EBC pads are developed in our own laboratory and tested using this race track simulator dynamometer to guarantee perfection before being thoroughly field tested on dozens of race teams.



Catalogue - Issue 202

**AMERICAN, EUROPEAN, ASIAN AND
BRITISH BUILT MACHINES**

FRONT: AMERICAN PRODUCED MOTORCYCLES

APPLICATIONS

BRAKE

⚡ This symbol indicates a disc made of billet steel, and should be only used with EBC FA Kevlar® Organic or Vee pads.

SUFFIX OR PREFIX PAD MATERIALS AND DESCRIPTION		FRONT					DISCS		Line #
		PADS	PADS	PADS	PADS	DESIGN NO.			
		FA	V	HH	EPFA	NARROW BAND	WIDE BAND		
HARLEY-DAVIDSON® ELECTRIC									
Livewire	18-20	FA630*	FA630V*	FA630HH*				1	
HARLEY-DAVIDSON® SPORTSTER								2	
XL, XLH, XLCH, XLS, XLX	54-78							3	
XLH, XLCH (Rivet Type)	73-77	FA26						4	
79-81 (Twin fronts)	79-81	FA71*	FA71V*					5	
82-83 (Twin fronts) (Girling caliper)	82-83	FA71*	FA71V*					6	
84-Early 87 (Girling caliper)	84-Early 87	FA94	FA94V	FA94HH	EPFA94HH		008	7	
Late 87-99	Late 87-99	FA94	FA94V	FA94HH	EPFA94HH		008	8	
XL 50 50th Anniversary Sportster	07	FA381	FA381V	FA381HH	EPFA381HH	002	008	9	
XLH883 Sportster	00-03	FA400	FA400V	FA400HH	EPFA400HH	002	008	10	
XLH883r Sportster Flat Track	00-03	FA400	FA400V	FA400HH	EPFA400HH	002	008	11	
XL883 Sportster Hugger	00-03	FA400	FA400V	FA400HH	EPFA400HH	002	008	12	
XL53c Sportster Custom (883cc)	00-03	FA400	FA400V	FA400HH	EPFA400HH	002	008	13	
XL883 Sportster Standard	04-08	FA381	FA381V	FA381HH	EPFA381HH	002	008	14	
XL883 C Sportster Custom	04-10	FA381	FA381V	FA381HH	EPFA381HH	002	008	15	
XL883 L 883 Low	04-10	FA381	FA381V	FA381HH	EPFA381HH	002	008	16	
XL883 L Superlow	11-13	FA381	FA381V	FA381HH	EPFA381HH	002	008	17	
XL883 L Super Low (Cast Wheel)	14-20	FA640	FA640V	FA640HH	EPFA640HH	026		18	
XL883 N Iron	09-10	FA381	FA381V	FA381HH	EPFA381HH	002	008	19	
XL883 N Iron (Cast Wheel)	11-13	FA381	FA381V	FA381HH	EPFA381HH	002	008	20	
XL883 N Iron (Cast Wheel)	14-15	FA640	FA640V	FA640HH	EPFA640HH	026		21	
XL883 N Iron	16-20	FA640	FA640V	FA640HH	EPFA640HH	030		22	
XL883 R 100th Anniversary Edition	03	FA400*	FA400V*	FA400HH*	EPFA400HH*	002	008	23	
XL883 R Sportster R	05-13	FA381*	FA381V*	FA381HH*	EPFA381HH*	002	008	24	
XL883 R Roadster	10	FA381*	FA381V*	FA381HH*	EPFA381HH*	002	008	25	
XL883 R Roadster (Cast Wheel)	11-13	FA381*	FA381V*	FA381HH*	EPFA381HH*	002	008	26	
XL883 R Roadster (Cast Wheel)	14-15	FA640	FA640V	FA640HH	EPFA640HH	026		27	
XL1200c Sportster Custom	00-03	FA400	FA400V	FA400HH	EPFA400HH	002	008	28	
XL1200s Sportster Sport	00-03	FA400*	FA400V*	FA400HH*	EPFA400HH*	002	008	29	
XL1200 R Sportster Roadster	04-08	FA381*	FA381V*	FA381HH*	EPFA381HH*	002	008	30	
XL1200 C Sportster Custom	04-13	FA381	FA381V	FA381HH	EPFA381HH	002	008	31	
XL1200 C Custom/Custom Ltd (Spoke Wheel)	14-20	FA640	FA640V	FA640HH	EPFA640HH	026		32	
XL1200 CX Roadster	16-20	FA640*	FA640V*	FA640HH*	EPFA640HH*	030		33	
XL1200 L Sportster Low (Spoke Wheel)	07-11	FA381	FA381V	FA381HH	EPFA381HH	002	008	34	
XL1200 L Sportster Low (Cast Wheel)	07-11	FA381	FA381V	FA381HH	EPFA381HH	002	008	35	
XL1200 N Nightster (Spoke wheel)	08-12	FA381	FA381V	FA381HH	EPFA381HH	002	008	36	
XL1200 NS Iron	18	FA640	FA640V	FA640HH	EPFA640HH			37	
XL1200 T Superlow	14-20	FA640	FA640V	FA640HH	EPFA640HH	026		38	
XL1200 V Seventy Two	12-13	FA381	FA381V	FA381HH	EPFA381HH	002	008	39	
XL1200 V Seventy Two	14-16	FA640	FA640V	FA640HH	EPFA640HH	026		40	
XL1200 X Forty Eight	10-13	FA381	FA381V	FA381HH	EPFA381HH	002	008	41	
XL1200 X Forty Eight	14-17	FA640	FA640V	FA640HH	EPFA640HH	026		42	
XL1200 X Forty Eight	18	FA640	FA640V	FA640HH	EPFA640HH	030		43	
XL1200 Forty Eight Anniv.	18	FA640	FA640V	FA640HH	EPFA640HH	030		44	
XL1200 XS Forty Eight Special	18	FA640	FA640V	FA640HH	EPFA640HH	030		45	
XR1200	08-10			FA296HH*	EPFA296HH*	023		46	
XR1200 X	10-13			FA296HH*	EPFA296HH*	023		47	
HARLEY-DAVIDSON® STREET								48	
XG 500 Street (494cc)	14-15	FA643	FA643V	FA643HH		031		49	
XG 500 Street (300mm Discs)	16-20	FA209/2	FA209/2V	FA209/2HH	EPFA209/2HH	035		50	
XG 750 Street (749cc)	14-15	FA643	FA643V	FA643HH		031		51	
XG 750 Street (300mm Discs)	16-20	FA209/2	FA209/2V	FA209/2HH	EPFA209/2HH	035		52	
XG 750 A Street Rod (300mm Discs)	17-20	FA209/2*	FA209/2V*	FA209/2HH*	EPFA209/2HH*	035		53	
FX, FXE (Rivet Type)	73-77	FA26						54	
FX, FXE, FXS	Late 78-83	FA71	FA71V					55	
FX, FXE, FXS	84-86	FA94*	FA94V*	FA94HH*	EPFA94HH*		008	56	
FXWG, FXSB	83	FA71	FA71V					57	

*-2 Sets Required. ■ - Also available in MX-S race compound. **SAFETY WARNING:- DO NOT USE HH PADS ON REAR UNLESS ALSO USED ON FRONT TO AVOID BRAKE IMBALANCE**

REAR: AMERICAN PRODUCED MOTORCYCLES

Line #	SUFFIX OR PREFIX PAD MATERIALS AND DESCRIPTION	YEAR	REAR				
			PADS	PADS	PADS	PADS	DISCS
			FA	V	HH	EPFA	DESIGN NO.
			Kevlar Organic Pads	Semi-Sintered V-Pads™	Double-H™ USA-Made Sintered Pads	Premium Low Noise Street Sintered Pads	See Buyers Guide for disc style & finish options. Part nos for ordering & sizing.
					NARROW BAND	WIDE BAND	
HARLEY-DAVIDSON® ELECTRIC							
1	Livewire	18-20	FA266		FA266HH		
HARLEY-DAVIDSON® SPORTSTER							
4	XL, XLH, XLCH, XLS, XLX	54-78					
5	XLH, XLCH (Rivet Type)	73-77	FA72	FA72V			
6	79-81 (Twin fronts)	79-81	FA72	FA72V			
7	82-83 (Twin fronts) (Girling caliper)	82-83	FA78	FA78V			
8	84-Early 87 (Girling caliper)	84-Early 87	FA78	FA78V	FA78HH		
9	Late 87-99	Late 87-99	FA200	FA200V	FA200HH	EPFA200HH	011
10	XL 50 50th Anniversary Sportster	07	FA387	FA387V	FA387HH	EPFA387HH	009 010
11	XLH883 Sportster	00-03	FA400	FA400V	FA400HH	EPFA400HH	009 010
12	XLH883r Sportster Flat Track	00-03	FA400	FA400V	FA400HH	EPFA400HH	009 010
13	XL883 Sportster Hugger	00-03	FA400	FA400V	FA400HH	EPFA400HH	009 010
14	XL53c Sportster Custom (883cc)	00-03	FA400	FA400V	FA400HH	EPFA400HH	009 010
15	XL883 Sportster Standard	04-08	FA387	FA387V	FA387HH	EPFA387HH	009 010
16	XL883 C Sportster Custom	04-10	FA387	FA387V	FA387HH	EPFA387HH	009 010
17	XL883 L 883 Low	04-10	FA387	FA387V	FA387HH	EPFA387HH	009 010
18	XL883 L Superlow	11-13	FA387	FA387V	FA387HH	EPFA387HH	024
19	XL883 L Super Low (Cast Wheel)	14-20	FA254	FA254V	FA254HH	EPFA254HH	024
20	XL883 N Iron	09-10	FA387	FA387V	FA387HH	EPFA387HH	009 010
21	XL883 N Iron (Cast Wheel)	11-13	FA387	FA387V	FA387HH	EPFA387HH	024
22	XL883 N Iron (Cast Wheel)	14-15	FA254	FA254V	FA254HH	EPFA254HH	024
23	XL883 N Iron	16-20	FA254	FA254V	FA254HH	EPFA254HH	024
24	XL883 R 100th Anniversary Edition	03	FA400	FA400V	FA400HH	EPFA400HH	009 010
25	XL883 R Sportster R	05-13	FA387	FA387V	FA387HH	EPFA387HH	009 010
26	XL883 R Roadster	10	FA387	FA387V	FA387HH	EPFA387HH	009 010
27	XL883 R Roadster (Cast Wheel)	11-13	FA387	FA387V	FA387HH	EPFA387HH	024
28	XL883 R Roadster (Cast Wheel)	14-15	FA254	FA254V	FA254HH	EPFA254HH	024
29	XL1200c Sportster Custom	00-03	FA400	FA400V	FA400HH	EPFA400HH	009 010
30	XL1200s Sportster Sport	00-03	FA400	FA400V	FA400HH	EPFA400HH	009 010
31	XL1200 R Sportster Roadster	04-08	FA387	FA387V	FA387HH	EPFA387HH	009 010
32	XL1200 C Sportster Custom	04-10	FA387	FA387V	FA387HH	EPFA387HH	009 010
33	XL1200 C Custom/Custom Ltd (Spoke Wheel)	14-20	FA254	FA254V	FA254HH	EPFA254HH	024
34	XL1200 CX Roadster	16-20	FA254	FA254V	FA254HH	EPFA254HH	024
35	XL1200 L Sportster Low (Spoke Wheel)	07-11	FA387	FA387V	FA387HH	EPFA387HH	009 010
36	XL1200 L Sportster Low (Cast Wheel)	07-11	FA387	FA387V	FA387HH	EPFA387HH	024
37	XL1200 N Nightster (Spoke wheel)	08-12	FA387	FA387V	FA387HH	EPFA387HH	009 010
38	XL1200 NS Iron	18	FA254	FA254V	FA254HH	EPFA254HH	024
39	XL1200 T Superlow	14-20	FA254	FA254V	FA254HH	EPFA254HH	024
40	XL1200 V Seventy Two	12-13	FA387	FA387V	FA387HH	EPFA387HH	009 010
41	XL1200 V Seventy Two	14-16	FA254	FA254V	FA254HH	EPFA254HH	024
42	XL1200 X Forty Eight	10-13	FA387	FA387V	FA387HH	EPFA387HH	009 010
43	XL1200 X Forty Eight	14-17	FA254	FA254V	FA254HH	EPFA254HH	024
44	XL1200 X Forty Eight	18	FA254	FA254V	FA254HH	EPFA254HH	024
45	XL1200 Forty Eight Anniv.	18	FA254	FA254V	FA254HH	EPFA254HH	024
46	XL1200 XS Forty Eight Special	18	FA254	FA254V	FA254HH	EPFA254HH	024
47	XR1200	08-10	FA387	FA387V	FA387HH	EPFA387HH	024
48	XR1200 X	10-13	FA387	FA387V	FA387HH	EPFA387HH	024
HARLEY-DAVIDSON® STREET							
51	XG 500 Street (494cc)	14-15	FA643	FA643V	FA643HH		031
52	XG 500 Street (300mm Discs)	16-20	FA181X	FA181V	FA181HH		036
53	XG 750 Street (749cc)	14-15	FA643	FA643V	FA643HH		031
54	XG 750 Street (300mm Discs)	16-20	FA181X	FA181V	FA181HH		036
55	XG 750 A Street Rod (300mm Discs)	17-20	FA181X	FA181V	FA181HH		036
56	FX, FXE (Rivet Type)	73-77	FA24/2	FA24/2V			
57	FX, FXE, FXS	Late 78-83	FA24/2	FA24/2V			
58	FX, FXE, FXS	84-86	FA78	FA78V	FA78HH		
59	FXWG, FXSB	83	FA78	FA78V	FA78HH		

All names & numbers are for reference purposes only. © Registered trademarks of Harley—Davidson® Motor Corp or Buell.

Recommended Fittings: FA400 for use on polished chrome show discs. FA400HH recommended fitting as replacement for OE.

NOTE: — Some models may have a second disc fitted as an optional extra. Please double check with your customer exactly which side the front disc is fitted and if twin disc or single.

BRAKE APPLICATIONS

*-2 Sets Required. ■ - Also available in MX-S race compound. **SAFETY WARNING:- DO NOT USE HH PADS ON REAR UNLESS ALSO USED ON FRONT TO AVOID BRAKE IMBALANCE**

FRONT: AMERICAN PRODUCED MOTORCYCLES

APPLICATIONS

BRAKE

This symbol indicates a disc made of billet steel, and should be only used with EBC FA Kevlar® Organic or Vee pads.

SUFFIX OR PREFIX PAD MATERIALS AND DESCRIPTION		FRONT					Line #	
		PADS	PADS	PADS	PADS	DISCS		
		FA	V	HH	EPFA	DESIGN NO.		
HARLEY-DAVIDSON® STREET								
FL, FLH	49-71						1	
FL, FLH	58-62						2	
FL, FLH (Banana caliper)	72-84	FA24/2	FA24/2V				3	
FL, FLH (Banana caliper)	72-80	FA24/2	FA24/2V				4	
FL, FLH	81-84	FA24/2	FA24/2V				5	
FXD, FXDL, FXDWG, FXR, FXRS, FXRT, FXRD, FXLR	82-83	FA71	FA71V				6	
FXD, FXDL, FXDWG, FXR, FXRS, FXRT, FXRD, FXLR	84-Early 87	FA94*	FA94V*	FA94HH*	EPFA94HH*	008	7	
FXD, FXDL, FXDWG, FXR, FXRS, FXRT, FXRD, FXLR	Late 87-99	FA94*	FA94V*	FA94HH*	EPFA94HH*	008	8	
FLD Switchback	12-16		FA457V	FA457HH	EPFA457HH	016	9	
FXD Super Glide	00-03	FA400	FA400V	FA400HH	EPFA400HH	002	008	10
FXD Super Glide (Cast wheel)	08-10		FA457V	FA457HH	EPFA457HH	016	11	
FXDF Fat Bob (Cast wheel)	08-17		FA457V*	FA457HH*	EPFA457HH*	018	12	
FXDX Super Glide Sport	00-03	FA400*	FA400V*	FA400HH*	EPFA400HH*	002	008	13
FXDL Low Rider	00-03	FA400*	FA400V*	FA400HH*	EPFA400HH*	002	008	14
FXDWG Wide Glide	00-03	FA400*	FA400V*	FA400HH*	EPFA400HH*	002	008	15
FXDWG Wide Glide (Spoke wheel)	08		FA457V	FA457HH	EPFA457HH	018	16	
FXDS-CON Dyna Convertible	00-02	FA400*	FA400V*	FA400HH*	EPFA400HH*	002	008	17
FXDXT Superglide T-Sport	01-03	FA400*	FA400V*	FA400HH*	EPFA400HH*	002	008	18
FXDi Super Glide 1450	04-05	FA400	FA400V	FA400HH	EPFA400HH	002	008	19
FXDi 35 35th Anniversary Super Glide (Spoke wheels)	06	FA400	FA400V	FA400HH	EPFA400HH	018	20	
FXDXi Super Glide Sport	04-05	FA400*	FA400V*	FA400HH*	EPFA400HH*	002	008	21
FXDLi Low Rider 1450	04-05	FA400	FA400V	FA400HH	EPFA400HH	002	008	22
FXDLi Dyna Low Rider (Spoke wheels)	06	FA400	FA400V	FA400HH	EPFA400HH	018	23	
FXDWGi Wide Glide 1450	04-05	FA400	FA400V	FA400HH	EPFA400HH	002	008	24
FXDWGi Dyna Wide Glide (Spoke wheels)	06-07	FA400	FA400V	FA400HH	EPFA400HH	018	25	
FXDWG Dyna Wide Glide (Spoke Wheels)	08-20		FA457V	FA457HH	EPFA457HH	018	26	
FXDC/FXDCi Super Glide Custom	05	FA400	FA400V	FA400HH	EPFA400HH	002	008	27
FXDCi Dyna Superglide Custom (Spoke wheels)	06-07	FA400	FA400V	FA400HH	EPFA400HH	018	28	
FXDC Super Glide Custom (Spoke wheel)	08-14		FA457V	FA457HH	EPFA457HH	018	29	
FXDBi Street Bob (Spoke wheels)	06-07	FA400	FA400V	FA400HH	EPFA400HH	018	30	
FXDB Street Bob (Spoke wheel)	08-20		FA457V	FA457HH	EPFA457HH	018	31	
FXDBC Street Bob LTD	16		FA457V*	FA457HH*	EPFA457HH*	018	32	
FXDi Super Glide (Cast wheel)	06-07	FA400	FA400V	FA400HH	EPFA400HH	016	33	
FXDLi Low Rider (Cast wheel)	06-07	FA400	FA400V	FA400HH	EPFA400HH	016	34	
FXDLi Low Rider (Spoke wheel)	06-07	FA400	FA400V	FA400HH	EPFA400HH	018	35	
FXDL Low Rider (Cast wheel)	08-13		FA457V	FA457HH	EPFA457HH	016	36	
FXDL Low Rider (Spoke wheel)	08-09		FA457V	FA457HH	EPFA457HH	018	37	
FXDL Low Rider (Cast wheel)	14-17		FA457V*	FA457HH*	EPFA457HH*	016	38	
FXDL Low Rider (Spoke wheel)	14-17		FA457V*	FA457HH*	EPFA457HH*	018	39	
FXDCi Superglide Custom (Cast wheel)	06	FA400	FA400V	FA400HH	EPFA400HH	016	40	
HARLEY-DAVIDSON® SOFTAIL							41	
FXST, FXSTB, FXSTC, FXSTS, FLST, FLSTC, FLSTF, FLSTS, FLSTN	84-Early 87	FA94	FA94V	FA94HH	EPFA94HH	008	42	
FXST, FXSTB, FXSTC, FXSTS, FLST, FLSTC, FLSTF, FLSTS, FLSTN	Late 87-99	FA94	FA94V	FA94HH	EPFA94HH	008	43	
FXST/FXSTi Softail Standard	00-05	FA400	FA400V	FA400HH	EPFA400HH	002	008	44
FXSTB/FXSTBi Night Train	00-05	FA400	FA400V	FA400HH	EPFA400HH	002	008	45
FXSTDI/FXSTD Softail Deuce/i	00-07	FA400	FA400V	FA400HH	EPFA400HH	002	008	46
FXSTS/FXSTSi Softail Springer	00-05	FA94	FA94V	FA94HH	EPFA94HH	008	47	
FLSTF/FLSTFi Fat Boy	00-06	FA400	FA400V	FA400HH	EPFA400HH	002	008	48
FLSTFi Fat Boy 15th Anniversary Edition	05	FA400	FA400V	FA400HH	EPFA400HH	002	008	49
FLSTF/FLSTFi Fat Boy	07	FA400	FA400V	FA400HH	EPFA400HH	002	008	50
FLSTF Fat Boy	08-14		FA457V	FA457HH	EPFA457HH	002	008	51
FLSTF Fat Boy	15-17			FA296HH	EPFA296HH	030	52	
FLSTFB Fat Boy LO	10-14		FA457V	FA457HH	EPFA457HH	002	008	53
FLSTFB Fat Boy LO	15-17			FA296HH	EPFA296HH	030	54	
FLFB Fat Boy	18			FA296HH	EPFA296HH	030	55	
FLFBS Fat boy 114	18			FA296HH	EPFA296HH	030	56	
FLFBS Fat Boy 114 Anniv	18			FA296HH	EPFA296HH	030	57	
FLSTCi/FLSTC Heritage Classic/i	00-07	FA400	FA400V	FA400HH	EPFA400HH	002	008	58
							59	

*-2 Sets Required. ■ - Also available in MX-S race compound. **SAFETY WARNING:- DO NOT USE HH PADS ON REAR UNLESS ALSO USED ON FRONT TO AVOID BRAKE IMBALANCE**

REAR: AMERICAN PRODUCED MOTORCYCLES

Line #	SUFFIX OR PREFIX PAD MATERIALS AND DESCRIPTION	YEAR	REAR				
			PADS	PADS	PADS	PADS	DISCS
			FA	V	HH	EPFA	DESIGN NO.
			Kevlar Organic Pads	Semi-Sintered V-Pads™	Double-H™ USA-Made Sintered Pads	Premium Low Noise Street Sintered Pads	See Buyers Guide for disc style & finish options. Part nos for ordering & sizing.
					NARROW BAND	WIDE BAND	
HARLEY-DAVIDSON® STREET							
1	FL, FLH	49-71					
2	FL, FLH	58-62					
3	FL, FLH (Banana caliper)	72-84	FA24/2	FA24/2V			
4	FL, FLH (Banana caliper)	72-80	FA24/2	FA24/2V			
5	FL, FLH	81-84	FA79	FA79V			
6	FXD, FXDL, FXDWG, FXR, FXRS, FXRT, FXRD, FXLR	82-83	FA78	FA78V			
7	FXD, FXDL, FXDWG, FXR, FXRS, FXRT, FXRD, FXLR	84-Early 87	FA78	FA78V	FA78HH		
8	FXD, FXDL, FXDWG, FXR, FXRS, FXRT, FXRD, FXLR	Late 87-99	FA200	FA200V	FA200HH	EPFA200HH	011
9	FLD Switchback	12-16		FA458V	FA458HH	EPFA458HH	009 010
10	FXD Super Glide	00-03	FA400	FA400V	FA400HH	EPFA400HH	009 010
11	FXD Super Glide (Cast wheel)	08-10		FA458V	FA458HH	EPFA458HH	009 010
12	FXDF Fat Bob (Cast wheel)	08-17		FA458V	FA458HH	EPFA458HH	009 010
13	FXDX Super Glide Sport	00-03	FA400	FA400V	FA400HH	EPFA400HH	009 010
14	FXDL Low Rider	00-03	FA400	FA400V	FA400HH	EPFA400HH	009 010
15	FXDWG Wide Glide	00-03	FA400	FA400V	FA400HH	EPFA400HH	009 010
16	FXDWG Wide Glide (Spoke wheel)	08		FA458V	FA458HH	EPFA458HH	009 010
17	FXDS-CON Dyna Convertible	00-02	FA400	FA400V	FA400HH	EPFA400HH	009 010
18	FXDXT Superglide T-Sport	01-03	FA400	FA400V	FA400HH	EPFA400HH	009 010
19	FXDi Super Glide 1450	04-05	FA400	FA400V	FA400HH	EPFA400HH	009 010
20	FXDi 35 35th Anniversary Super Glide (Spoke wheels)	06	FA400	FA400V	FA400HH	EPFA400HH	009 010
21	FXDXi Super Glide Sport	04-05	FA400	FA400V	FA400HH	EPFA400HH	009 010
22	FXDLi Low Rider 1450	04-05	FA400	FA400V	FA400HH	EPFA400HH	009 010
23	FXDLi Dyna Low Rider (Spoke wheels)	06	FA400	FA400V	FA400HH	EPFA400HH	009 010
24	FXDWGi Wide Glide 1450	04-05	FA400	FA400V	FA400HH	EPFA400HH	009 010
25	FXDWGi Dyna Wide Glide (Spoke wheels)	06-07	FA400	FA400V	FA400HH	EPFA400HH	009 010
26	FXDWG Dyna Wide Glide (Spoke Wheels)	08-20		FA458V	FA458HH	EPFA458HH	009 010
27	FXDC/FXDCi Super Glide Custom	05	FA400	FA400V	FA400HH	EPFA400HH	009 010
28	FXDCi Dyna Superglide Custom (Spoke wheels)	06-07	FA400	FA400V	FA400HH	EPFA400HH	009 010
29	FXDC Super Glide Custom (Spoke wheel)	08-14		FA458V	FA458HH	EPFA458HH	009 010
30	FXDBi Street Bob (Spoke wheels)	06-07	FA400	FA400V	FA400HH	EPFA400HH	009 010
31	FXDB Street Bob (Spoke wheel)	08-20		FA458V	FA458HH	EPFA458HH	009 010
32	FXDBC Street Bob LTD	16		FA458V	FA458HH	EPFA458HH	009 010
33	FXDi Super Glide (Cast wheel)	06-07	FA400	FA400V	FA400HH	EPFA400HH	009 010
34	FXDLi Low Rider (Cast wheel)	06-07	FA400	FA400V	FA400HH	EPFA400HH	009 010
35	FXDLi Low Rider (Spoke wheel)	06-07	FA400	FA400V	FA400HH	EPFA400HH	009 010
36	FXDL Low Rider (Cast wheel)	08-13		FA458V	FA458HH	EPFA458HH	009 010
37	FXDL Low Rider (Spoke wheel)	08-09		FA458V	FA458HH	EPFA458HH	009 010
38	FXDL Low Rider (Cast wheel)	14-17		FA458V	FA458HH	EPFA458HH	009 010
39	FXDL Low Rider (Spoke wheel)	14-17		FA458V	FA458HH	EPFA458HH	009 010
40	FXDCi Superglide Custom (Cast wheel)	06	FA400	FA400V	FA400HH	EPFA400HH	009 010
HARLEY-DAVIDSON® SOFTAIL							
43	FXST, FXSTB, FXSTC, FXSTS, FLST, FLSTC, FLSTF, FLSTS, FLSTN	84-Early 87	FA78	FA78V	FA78HH		
44	FXST, FXSTB, FXSTC, FXSTS, FLST, FLSTC, FLSTF, FLSTS, FLSTN	Late 87-99	FA200	FA200V	FA200HH	EPFA200HH	009 010
45	FXST/FXSTi Softail Standard	00-05	FA400	FA400V	FA400HH	EPFA400HH	009 010
46	FXSTB/FXSTBi Night Train	00-05	FA400	FA400V	FA400HH	EPFA400HH	009 010
47	FXSTDi/FXSTDi Softail Deuce/i	00-07	FA400	FA400V	FA400HH	EPFA400HH	009 010
48	FXSTS/FXSTSi Softail Springer	00-05	FA400	FA400V	FA400HH	EPFA400HH	009 010
49	FLSTF/FLSTFi Fat Boy	00-06	FA400	FA400V	FA400HH	EPFA400HH	009 010
50	FLSTFi Fat Boy 15th Anniversary Edition	05	FA400	FA400V	FA400HH	EPFA400HH	009 010
51	FLSTF/FLSTFi Fat Boy	07	FA434	FA434V	FA434HH	EPFA434HH	009 010
52	FLSTF Fat Boy	08-14		FA458V	FA458HH	EPFA458HH	009 010
53	FLSTF Fat Boy	15-17		FA458V	FA458HH	EPFA458HH	009 010
54	FLSTFB Fat Boy LO	10-14		FA458V	FA458HH	EPFA458HH	009 010
55	FLSTFB Fat Boy LO	15-17		FA458V	FA458HH	EPFA458HH	009 010
56	FLFB Fat Boy	18		FA710V	FA710HH	EPFA710HH	027
57	FLFBS Fat boy 114	18		FA710V	FA710HH	EPFA710HH	027
58	FLFBS Fat Boy 114 Anniv	18		FA710V	FA710HH	EPFA710HH	027
59	FLSTCi/FLSTC Heritage Classic/i	00-07	FA400	FA400V	FA400HH	EPFA400HH	009 010

All names & numbers are for reference purposes only. © Registered trademarks of Harley—Davidson® Motor Corp or Buell.

Recommended Fittings: FA400 for use on polished chrome show discs. FA400HH recommended fitting as replacement for OE.

NOTE: — Some models may have a second disc fitted as an optional extra. Please double check with your customer exactly which side the front disc is fitted and if twin disc or single.

BRAKE APPLICATIONS

*-2 Sets Required. ■ - Also available in MX-S race compound. **SAFETY WARNING:- DO NOT USE HH PADS ON REAR UNLESS ALSO USED ON FRONT TO AVOID BRAKE IMBALANCE**

FRONT: AMERICAN PRODUCED MOTORCYCLES

APPLICATIONS

BRAKE

This symbol indicates a disc made of billet steel, and should be only used with EBC FA Kevlar® Organic or Vee pads.

SUFFIX OR PREFIX PAD MATERIALS AND DESCRIPTION		FRONT						Line #
		PADS	PADS	PADS	PADS	DISCS		
		FA	V	HH	EPFA	DESIGN NO.		
HARLEY-DAVIDSON® SOFTAIL	YEAR	Kevlar Organic Pads	Semi-Sintered V-Pads™	Double-H™ USA-Made Sintered Pads	Premium Low Noise Street Sintered Pads	See Buyers Guide for disc style & finish options. Part nos for ordering & sizing.		
						NARROW BAND	WIDE BAND	
FLSTS Heritage Springer	00-03	FA94	FA94V	FA94HH	EPFA94HH	002	008	1
FLSTN/FLSTNi Softail Deluxe	05-07	FA400	FA400V	FA400HH	EPFA400HH	002	008	2
FLSTSC/FLSTSci Springer Classic	05-07	FA94	FA94V	FA94HH	EPFA94HH	002	008	3
FLST/FLSTI Heritage Softail	06	FA400	FA400V	FA400HH	EPFA400HH	002	008	4
FLSTSB Softail Cross Bones	08-11	FA94	FA94V	FA94HH	EPFA94HH		008	5
FXST/FXSTI Softail Standard	06-07	FA400	FA400V	FA400HH	EPFA400HH	002	008	6
FXST Softail Standard	08-14		FA457V	FA457HH	EPFA457HH	002	008	7
FXST Softail Standard	15			FA296HH	EPFA296HH	026		8
FXSTB/FXSTBi Night Train Softail	06-07	FA400	FA400V	FA400HH	EPFA400HH	002	008	9
FXSTB Night Train (Spoke wheel)	08-09		FA457V	FA457HH	EPFA457HH	002	008	10
FXSTC Softail Custom	07	FA400	FA400V	FA400HH	EPFA400HH	002	008	11
FXSTC Softail Custom (Spoke wheel)	08-10		FA457V	FA457HH	EPFA457HH	002	008	12
FLSTSC/FLSTSci Springer Softail Classic	06-07	FA94	FA94V	FA94HH	EPFA94HH		008	13
FLSTC Heritage Softail Classic	07	FA400	FA400V	FA400HH	EPFA400HH	002	008	14
FLSTC Heritage Softail Classic	08-14		FA457V	FA457HH	EPFA457HH	002	008	15
FLSTC Heritage Softail Classic	15-17			FA296HH	EPFA296HH	026		16
FLHC Heritage Classic	18			FA296HH	EPFA296HH	026		17
FLHCS Heritage Classic 114	18			FA296HH	EPFA296HH	026		18
FLHCS Heritage Classic 114 Anniv.	18			FA296HH	EPFA296HH	026		19
FLSTN Softail Deluxe (Spoke wheel)	08-14		FA457V	FA457HH	EPFA457HH	002	008	20
FLSTN Softail Deluxe	15-17			FA296HH	EPFA296HH	026		21
FLS Softail Slim	12-14		FA457V	FA457HH	EPFA457HH	002	008	22
FLS Softail Slim	15-17			FA296HH	EPFA296HH	026		23
FLSL Softail Slim	18			FA296HH	EPFA296HH	026		24
FXCW Rocker (Cast wheel)	08-09		FA457V	FA457HH	EPFA457HH	002	008	25
FXCWC Rocker C (Cast wheel)	08-11		FA457V	FA457HH	EPFA457HH	002	008	26
FXS Blackline	11-13		FA457V	FA457HH	EPFA457HH	002	008	27
FXSB Breakout	13-14		FA457V	FA457HH	EPFA457HH	002	008	28
FXSB Breakout	15-17			FA296HH	EPFA296HH	030		29
FXBR Breakout	18-20			FA296HH	EPFA296HH	030		30
FXBRS Breakout 114	18-20			FA296HH	EPFA296HH	030		31
FXBRS Breakout 114 Anniv	18-20			FA296HH	EPFA296HH	030		32
FLDE Deluxe	18-20			FA296HH	EPFA296HH	026		33
FXBB Street Bob	18-20			FA296HH	EPFA296HH	026		34
FXFB Fat Bob	18-20			FA296HH*	EPFA296HH*	030		35
FXBS Fat Bob	18-20			FA296HH*	EPFA296HH*	030		36
FXLR Low Rider	18-20			FA296HH	EPFA296HH	026		37
FXDR 114	18-20	FA196*	FA196V*	FA196HH*	EPFA196HH*	035	035	38
								39
HARLEY-DAVIDSON® SOFTAIL S SERIES								40
FLSS Softail Slim S	16-20			FA296HH	EPFA296HH	030		41
FLSTFBS Fat Boy S	16-18			FA296HH	EPFA296HH	030		42
								43
HARLEY-DAVIDSON® S SERIES								44
FXDLS Dyna Low Rider S	17		FA457V*	FA457HH*	EPFA457HH*	016		45
								46
HARLEY-DAVIDSON® TOURING								47
FLT, FLHT, FLHTCi (Ultraglide®, Electraglide®, Electraglide Classic®/Ultra Classic®)	80-83	FA72*	FA72V*					48
	84-85	FA94*	FA94V*	FA94HH*	EPFA94HH*			49
	86-99	FA94*	FA94V*	FA94HH*	EPFA94HH*		008	50
FLHR, FLHRCi (Road King®, Road King Classic®)	94-99	FA94*	FA94V*	FA94HH*	EPFA94HH*		008	51
FLHRCi Road King	00-07	FA400*	FA400V*	FA400HH*	EPFA400HH*	002	008	52
FLHRCi Road King Classic	00-07	FA400*	FA400V*	FA400HH*	EPFA400HH*	002	008	53
FLHR Road King (Spoke Wheel Type)	08-16	FA409*	FA409V*	FA409HH*	EPFA409HH*	020		54
FLHR Road King (Cast Wheel Type)	15-20	FA409*	FA409V*	FA409HH*	EPFA409HH*	028		55
FLHRC Road King Classic	08-20	FA409*	FA409V*	FA409HH*	EPFA409HH*	020		56
FLHT/FLHTi Electra Glide Standard	00-07	FA400*	FA400V*	FA400HH*	EPFA400HH*	002	008	57
FLTR/FLTR-i Road Glide	00-07	FA400*	FA400V*	FA400HH*	EPFA400HH*	002	008	58
								59

*-2 Sets Required. ■ - Also available in MX-S race compound. **SAFETY WARNING:- DO NOT USE HH PADS ON REAR UNLESS ALSO USED ON FRONT TO AVOID BRAKE IMBALANCE**

6 Part numbers, prefixes, suffixes, photos and illustrations shown in this catalogue are trademarks and/or copyrights of EBC Brakes or the trademark owner A C Freeman Investments Ltd and use without express written permission of the owners is punishable by law.

REAR: AMERICAN PRODUCED MOTORCYCLES

Line #	SUFFIX OR PREFIX PAD MATERIALS AND DESCRIPTION	YEAR	REAR					DISCS	
			PADS	PADS	PADS	PADS	DESIGN NO.		
			FA	V	HH	EPFA	See Buyers Guide for disc style & finish options. Part nos for ordering & sizing.		
			Kevlar Organic Pads	Semi-Sintered V-Pads™	Double-H™ USA-Made Sintered Pads	Premium Low Noise Street Sintered Pads	NARROW BAND	WIDE BAND	
HARLEY-DAVIDSON® SOFTAIL									
1	FLSTS Heritage Springer	00-03	FA400	FA400V	FA400HH	EPFA400HH	009	010	
2	FLSTN/FLSTNi Softail Deluxe	05-07	FA400	FA400V	FA400HH	EPFA400HH	009	010	
3	FLSTSC/FLSTSCI Springer Classic	05-07	FA400	FA400V	FA400HH	EPFA400HH	009	010	
4	FLST/FLSTI Heritage Softail	06	FA400	FA400V	FA400HH	EPFA400HH	009	010	
5	FLSTSB Softail Cross Bones	08-11		FA458V	FA458HH	EPFA458HH	009	010	
6	FXST/FXSTI Softail Standard	06-07	FA434	FA434V	FA434HH	EPFA434HH	009	010	
7	FXST Softail Standard	08-14		FA458V	FA458HH	EPFA458HH	009	010	
8	FXST Softail Standard	15		FA458V	FA458HH	EPFA458HH	009	010	
9	FXSTB/FXSTBi Night Train Softail	06-07	FA434	FA434V	FA434HH	EPFA434HH	009	010	
10	FXSTB Night Train (Spoke wheel)	08-09		FA458V	FA458HH	EPFA458HH	009	010	
11	FXSTC Softail Custom	07	FA434	FA434V	FA434HH	EPFA434HH	009	010	
12	FXSTC Softail Custom (Spoke wheel)	08-10		FA458V	FA458HH	EPFA458HH	009	010	
13	FLSTSC/FLSTSCI Springer Softail Classic	06-07	FA400	FA400V	FA400HH	EPFA400HH	009	010	
14	FLSTC Heritage Softail Classic	07	FA400	FA400V	FA400HH	EPFA400HH	009	010	
15	FLSTC Heritage Softail Classic	08-14		FA458V	FA458HH	EPFA458HH	009	010	
16	FLSTC Heritage Softail Classic	15-17		FA458V	FA458HH	EPFA458HH	009	010	
17	FLHC Heritage Classic	18		FA710V	FA710HH	EPFA710HH	027		
18	FLHCS Heritage Classic 114	18		FA710V	FA710HH	EPFA710HH	027		
19	FLHCS Heritage Classic 114 Anniv.	18		FA710V	FA710HH	EPFA710HH	027		
20	FLSTN Softail Deluxe (Spoke wheel)	08-14		FA458V	FA458HH	EPFA458HH	009	010	
21	FLSTN Softail Deluxe	15-17		FA458V	FA458HH	EPFA458HH	009	010	
22	FLS Softail Slim	12-14		FA458V	FA458HH	EPFA458HH	009	010	
23	FLS Softail Slim	15-17		FA458V	FA458HH	EPFA458HH	009	010	
24	FLSL Softail Slim	18		FA710V	FA710HH	EPFA710HH	027		
25	FXCW Rocker (Cast wheel)	08-09		FA458V	FA458HH	EPFA458HH	009	010	
26	FXCWC Rocker C (Cast wheel)	08-11		FA458V	FA458HH	EPFA458HH	009	010	
27	FXS Blackline	11-13		FA458V	FA458HH	EPFA458HH	009	010	
28	FXSB Breakout	13-14		FA458V	FA458HH	EPFA458HH	009	010	
29	FXSB Breakout	15-17		FA458V	FA458HH	EPFA458HH	027		
30	FXBR Breakout	18-20		FA710V	FA710HH	EPFA710HH	027		
31	FXBRS Breakout 114	18-20		FA710V	FA710HH	EPFA710HH	027		
32	FXBRS Breakout 114 Anniv	18-20		FA710V	FA710HH	EPFA710HH	027		
33	FLDE Deluxe	18-20		FA710V	FA710HH	EPFA710HH	027		
34	FXBB Street Bob	18-20		FA710V	FA710HH	EPFA710HH	027		
35	FXFB Fat Bob	18-20		FA710V	FA710HH	EPFA710HH	027		
36	FXBS Fat Bob	18-20		FA710V	FA710HH	EPFA710HH	027		
37	FXLR Low Rider	18-20		FA710V	FA710HH	EPFA710HH	027		
38	FXDR 114	18-20	FA387	FA387V	FA387HH	EPFA387HH	028		
HARLEY-DAVIDSON® SOFTAIL S SERIES									
41	FLSS Softail Slim S	16-20		FA458V	FA458HH	EPFA458HH	027		
42	FLSTFBS Fat Boy S	16-18		FA458V	FA458HH	EPFA458HH	027		
HARLEY-DAVIDSON® S SERIES									
45	FXDLS Dyna Low Rider S	17		FA458V	FA458HH	EPFA458HH	009	010	
HARLEY-DAVIDSON® TOURING									
48	FLT, FLHT, FLHTCi (Ultraglide®, Electraglide®,								
49	Electraglide Classic®/Ultra Classic®)	80-83	FA79	FA79V					
50		84-85	FA79	FA79V					
51		86-99	FA201	FA201V	FA201HH	EPFA201HH		MD509SR ⚡	
52	FLHR, FLHRCi (Road King®, Road King Classic®)	94-99	FA201	FA201V	FA201HH	EPFA201HH		MD509SR ⚡	
53	FLHRCi/FLHR Road King	00-07	FA400	FA400V	FA400HH	EPFA400HH	009	010	
54	FLHRCi Road King Classic	00-07	FA400	FA400V	FA400HH	EPFA400HH	009	010	
55	FLHR Road King (Spoke Wheel Type)	08-16	FA409	FA409V	FA409HH	EPFA409HH	021 ⚡		
56	FLHR Road King (Cast Wheel Type)	15-20	FA409	FA409V	FA409HH	EPFA409HH	021 ⚡		
57	FLHRC Road King Classic	08-20	FA409	FA409V	FA409HH	EPFA409HH	021 ⚡		
58	FLHT/FLHTi Electra Glide Standard	00-07	FA400	FA400V	FA400HH	EPFA400HH	009	010	
59	FLTR/FLTR-i Road Glide	00-07	FA400	FA400V	FA400HH	EPFA400HH	009	010	

All names & numbers are for reference purposes only. © Registered trademarks of Harley—Davidson® Motor Corp or Buell.

Recommended Fittings: FA400 for use on polished chrome show discs. FA400HH recommended fitting as replacement for OE.

NOTE: — Some models may have a second disc fitted as an optional extra. Please double check with your customer exactly which side the front disc is fitted and if twin disc or single.

BRAKE APPLICATIONS

*-2 Sets Required. ■ - Also available in MX-S race compound. **SAFETY WARNING:- DO NOT USE HH PADS ON REAR UNLESS ALSO USED ON FRONT TO AVOID BRAKE IMBALANCE**

FRONT: AMERICAN PRODUCED MOTORCYCLES

APPLICATIONS

BRAKE

⚡ This symbol indicates a disc made of billet steel, and should be only used with EBC FA Kevlar® Organic or Vee pads.

SUFFIX OR PREFIX PAD MATERIALS AND DESCRIPTION	YEAR	FRONT					DISCS		Line #
		PADS	PADS	PADS	PADS	DESIGN NO.			
		FA	V	HH	EPFA	See Buyers Guide for disc style & finish options. Part nos for ordering & sizing.			
		Kevlar Organic Pads	Semi-Sintered V-Pads™	Double-H™ USA-Made Sintered Pads	Premium Low Noise Street Sintered Pads	NARROW BAND	WIDE BAND		
HARLEY-DAVIDSON® TOURING									
FLTR Road Glide	08-09	FA409*	FA409V*	FA409HH*	EPFA409HH*	020		1	
FLTRX Road Glide	15-20	FA409*	FA409V*	FA409HH*	EPFA409HH*	028		2	
FLTRX Road Glide Custom	10-12	FA409*	FA409V*	FA409HH*	EPFA409HH*	020		3	
FLTRXS Road Glide Special	15-17	FA409*	FA409V*	FA409HH*	EPFA409HH*	028		4	
FLTRXS Road Glide Special	18	FA409*	FA409V*	FA409HH*	EPFA409HH*	030		5	
FLTRU Road Glide Ultra	11-12	FA409*	FA409V*	FA409HH*	EPFA409HH*	020		6	
FLTRU Road Glide Ultra	16-20	FA409*	FA409V*	FA409HH*	EPFA409HH*	028		7	
FLHTCU-I Electra Glide Ultra Classic	00-07	FA400*	FA400V*	FA400HH*	EPFA400HH*	002	008	8	
FLHRS/FLHRSi Road King Custom	04-07	FA400*	FA400V*	FA400HH*	EPFA400HH*	002	008	9	
FLHTC/FLHTCi Electra Glide Classic	04-07	FA400*	FA400V*	FA400HH*	EPFA400HH*	002	008	10	
FLHTC Electra Glide Classic	08-12	FA409*	FA409V*	FA409HH*	EPFA409HH*	020		11	
FLHTCU Ultra Classic Electra Glide	08-13	FA409*	FA409V*	FA409HH*	EPFA409HH*	020		12	
FLHTCU Ultra Classic Electra Glide	14-20	FA409*	FA409V*	FA409HH*	EPFA409HH*	028		13	
FLHTCUL Ultra Classic Electra Glide Low	15-16	FA409*	FA409V*	FA409HH*	EPFA409HH*	028		14	
FLHT Electra Glide Standard	08-10	FA409*	FA409V*	FA409HH*	EPFA409HH*	020		15	
FLHTK Electra Glide Ultra LTD	10-13	FA409*	FA409V*	FA409HH*	EPFA409HH*	028		16	
FLHTK Electra Glide Ultra LTD	15-20	FA409*	FA409V*	FA409HH*	EPFA409HH*	028		17	
FLHTK Electra Glide Ultra LTD Anniv.	18	FA409*	FA409V*	FA409HH*	EPFA409HH*	028		18	
FLHTK Electra Glide Ultra LTD Shrine Edition	18	FA409*	FA409V*	FA409HH*	EPFA409HH*	028		19	
FLHTKL Electra Glide Ultra LTD Low	15-20	FA409*	FA409V*	FA409HH*	EPFA409HH*	028		20	
FLHRXS Road King Special	17-20	FA409*	FA409V*	FA409HH*	EPFA409HH*	030		21	
FLHX/FLHXi Street Glide	06-07	FA400*	FA400V*	FA400HH*	EPFA400HH*	002	008	22	
FLHX Street Glide	08-13	FA409*	FA409V*	FA409HH*	EPFA409HH*	020		23	
FLHX Street Glide	14-20	FA409*	FA409V*	FA409HH*	EPFA409HH*	028		24	
FLHXS Street Glide Special	15-20	FA409*	FA409V*	FA409HH*	EPFA409HH*	028		25	
FLHXS Street Glide Special	18	FA409*	FA409V*	FA409HH*	EPFA409HH*	028		26	
FLHX Street Glide Anniv.	18	FA409*	FA409V*	FA409HH*	EPFA409HH*	028		27	
FLHXS Street Glide Special Anniv.	18	FA409*	FA409V*	FA409HH*	EPFA409HH*	030		28	
HARLEY-DAVIDSON® TRIKE									
FLHTCUTG Tri Glide Ultra Classic Trike	09-13	FA409*	FA409V*	FA409HH*	EPFA409HH*	020		31	
FLHXXX Street Glide Trike	10-11	FA409*	FA409V*	FA409HH*	EPFA409HH*	020		32	
FLRT Freewheeler Trike	15-20	FA638*	FA638V*	FA638HH*	EPFA638HH*	030		33	
FLHTCUTG Tri Glide Ultra Trike	14-20	FA638*	FA638V*	FA638HH*	EPFA638HH*	030		34	
FLHTCUTG Tri Glide Ultra Trike Anniv.	18	FA638*	FA638V*	FA638HH*	EPFA638HH*	030		35	
HARLEY-DAVIDSON® V-ROD									
V-Rod VRSCA/VRSCB (Hayes Caliper)	02-05	FA400*	FA400V*	FA400HH*	EPFA400HH*	015		39	
V-Rod VRSCA (Brembo Caliper)	06	FA409*	FA409V*	FA409HH*	EPFA409HH*	016		40	
VRSCAW V-Rod	07	FA409*	FA409V*	FA409HH*	EPFA409HH*	016		41	
VRSCAW V-Rod (Spoke wheel)	08-10	FA409*	FA409V*	FA409HH*	EPFA409HH*	018		42	
VRSCR Street Rod	06-07	FA409*	FA409V*	FA409HH*	EPFA409HH*	016		43	
VRSCD Night Rod (Cast Wheel)	06-08	FA409*	FA409V*	FA409HH*	EPFA409HH*	016		44	
VRSCDX Night Rod Special (Cast Wheel)	07-17	FA409*	FA409V*	FA409HH*	EPFA409HH*	016		45	
VRSC 10th Anniversary V Rod	12	FA409*	FA409V*	FA409HH*	EPFA409HH*	016		46	
VRSCX V-Rod	07	FA409*	FA409V*	FA409HH*	EPFA409HH*	018		47	
VRSCF V-Rod Muscle	09-17	FA409*	FA409V*	FA409HH*	EPFA409HH*	016		48	
								49	
								50	
								51	
								52	
								53	
								54	
								55	
								56	
								57	
								58	
								59	

*-2 Sets Required. ■ - Also available in MX-S race compound. **SAFETY WARNING:- DO NOT USE HH PADS ON REAR UNLESS ALSO USED ON FRONT TO AVOID BRAKE IMBALANCE**

REAR: AMERICAN PRODUCED MOTORCYCLES

Line #	SUFFIX OR PREFIX PAD MATERIALS AND DESCRIPTION	YEAR	REAR					DISCS	
			PADS	PADS	PADS	PADS	DESIGN NO.		
			FA	V	HH	EPFA	See Buyers Guide for disc style & finish options. Part nos for ordering & sizing.		
			Kevlar Organic Pads	Semi-Sintered V-Pads™	Double-H™ USA-Made Sintered Pads	Premium Low Noise Street Sintered Pads	NARROW BAND	WIDE BAND	
HARLEY-DAVIDSON® TOURING									
1	FLTR Road Glide	08-09	FA409	FA409V	FA409HH	EPFA409HH	021	☼	
2	FLTRX Road Glide	15-20	FA409	FA409V	FA409HH	EPFA409HH	021	☼	
3	FLTRX Road Glide Custom	10-12	FA409	FA409V	FA409HH	EPFA409HH	021	☼	
4	FLTRXS Road Glide Special	15-17	FA409	FA409V	FA409HH	EPFA409HH	021	☼	
5	FLTRXS Road Glide Special	18	FA409	FA409V	FA409HH	EPFA409HH	021	☼	
6	FLTRU Road Glide Ultra	11-12	FA409	FA409V	FA409HH	EPFA409HH	021	☼	
7	FLTRU Road Glide Ultra	16-20	FA409	FA409V	FA409HH	EPFA409HH	021	☼	
8	FLHTCU-I Electra Glide Ultra Classic	00-07	FA400	FA400V	FA400HH	EPFA400HH	009	010	
9	FLHRS/FLHRSI Road King Custom	04-07	FA400	FA400V	FA400HH	EPFA400HH	009	010	
10	FLHTC/FLHTCi Electra Glide Classic	04-07	FA400	FA400V	FA400HH	EPFA400HH	009	010	
11	FLHTC Electra Glide Classic	08-12	FA409	FA409V	FA409HH	EPFA409HH	021	☼	
12	FLHTCU Ultra Classic Electra Glide	08-13	FA409	FA409V	FA409HH	EPFA409HH	021	☼	
13	FLHTCU Ultra Classic Electra Glide	14-20	FA409	FA409V	FA409HH	EPFA409HH	021	☼	
14	FLHTCUL Ultra Classic Electra Glide Low	15-16	FA409	FA409V	FA409HH	EPFA409HH	021	☼	
15	FLHT Electra Glide Standard	08-10	FA409	FA409V	FA409HH	EPFA409HH	021	☼	
16	FLHTK Electra Glide Ultra LTD	10-13	FA409	FA409V	FA409HH	EPFA409HH	021	☼	
17	FLHTK Electra Glide Ultra LTD	15-20	FA409	FA409V	FA409HH	EPFA409HH	021	☼	
18	FLHTK Electra Glide Ultra LTD Anniv.	18	FA409	FA409V	FA409HH	EPFA409HH	021	☼	
19	FLHTK Electra Glide Ultra LTD Shrine Edition	18	FA409	FA409V	FA409HH	EPFA409HH	021	☼	
20	FLHTKL Electra Glide Ultra LTD Low	15-20	FA409	FA409V	FA409HH	EPFA409HH	021	☼	
21	FLHRXS Road King Special	17-20	FA409	FA409V	FA409HH	EPFA409HH	021	☼	
22	FLHX/FLHXi Street Glide	06-07	FA409	FA409V	FA409HH	EPFA409HH	009	010	
23	FLHX Street Glide	08-13	FA409	FA409V	FA409HH	EPFA409HH	021	☼	
24	FLHX Street Glide	14-20	FA409	FA409V	FA409HH	EPFA409HH	021	☼	
25	FLHXS Street Glide Special	15-20	FA409	FA409V	FA409HH	EPFA409HH	021	☼	
26	FLHXS Street Glide Special	18	FA409	FA409V	FA409HH	EPFA409HH	021	☼	
27	FLHX Street Glide Anniv.	18	FA409	FA409V	FA409HH	EPFA409HH	021	☼	
28	FLHXS Street Glide Special Anniv.	18	FA409	FA409V	FA409HH	EPFA409HH	021	☼	
HARLEY-DAVIDSON® TRIKE									
31	FLHTCUTG Tri Glide Ultra Classic Trike	09-13		FA605/4V▲	FA605/4HH▲		043		
32	FLHXX Street Glide Trike	10-11		FA605/4V▲	FA605/4HH▲		043		
33	FLRT Freewheeler Trike	15-20	FA641/4▲	FA641/4V▲	FA641/4HH▲		044		
34	FLHTCUTG Tri Glide Ultra Trike	14-20	FA641/4▲	FA641/4V▲	FA641/4HH▲		044		
35	FLHTCUTG Tri Glide Ultra Trike Anniv.	18	FA641/4▲	FA641/4V▲	FA641/4HH▲		044		
▲ PADS ARE SOLD IN AXLE SETS - 4 PADS PER SET									
HARLEY-DAVIDSON® V-ROD									
39	V-Rod VRSCA/VRSCB (Hayes Caliper)	02-05	FA400	FA400V	FA400HH	EPFA400HH	015		
40	V-Rod VRSCA (Brembo Caliper)	06	FA409	FA409V	FA409HH	EPFA409HH	017		
41	VRSCAW V-Rod	07	FA409	FA409V	FA409HH	EPFA409HH	017		
42	VRSCAW V-Rod (Spoke wheel)	08-10	FA409	FA409V	FA409HH	EPFA409HH	017		
43	VRSCR Street Rod	06-07	FA409	FA409V	FA409HH	EPFA409HH	017		
44	VRSCD Night Rod (Cast Wheel)	06-08	FA409	FA409V	FA409HH	EPFA409HH	017		
45	VRSCDX Night Rod Special (Cast Wheel)	07-17	FA409	FA409V	FA409HH	EPFA409HH	017		
46	VRSC 10th Anniversary V Rod	12	FA409	FA409V	FA409HH	EPFA409HH	017		
47	VRSCX V-Rod	07	FA409	FA409V	FA409HH	EPFA409HH	017		
48	VRSCF V-Rod Muscle	09-17	FA409	FA409V	FA409HH	EPFA409HH	025	☼	
49									
50									
51									
52									
53									
54									
55									
56									
57									
58									
59									

All names & numbers are for reference purposes only. © Registered trademarks of Harley—Davidson® Motor Corp or Buell.

Recommended Fittings: FA400 for use on polished chrome show discs. FA400HH recommended fitting as replacement for OE.

NOTE: — Some models may have a second disc fitted as an optional extra. Please double check with your customer exactly which side the front disc is fitted and if twin disc or single.

BRAKE APPLICATIONS

*-2 Sets Required. ■ - Also available in MX-S race compound. **SAFETY WARNING:- DO NOT USE HH PADS ON REAR UNLESS ALSO USED ON FRONT TO AVOID BRAKE IMBALANCE**

AMERICAN PRODUCED MOTORCYCLES

APPLICATIONS

BRAKE

NEW OVERSIZE DISC OPTIONS FOR HARLEY-DAVIDSON® - SEE OPPOSITE FOR IMAGES

* This symbol indicates a disc made of billet steel, and should be only used with EBC FA Kevlar® Organic or Vee pads.

DYNA MODELS

	YEAR	Bobbin Vee Style Oversize Disc (Left)	Bobbin Vee Style Oversize Disc (Right)	Oversize Bracket Left	Oversize Bracket Left	Line #
Models with hub mounted disc	00-05	OSVR516-15	OSVR516-15	BRK711	BRK712	1
Models with hub mounted 11.5" disc and 18" or larger wheel (Except Springer Models)	00-05	OSVR516-15	OSVR516-15	BRK711	BRK712	2
Models with hub mounted disc with 11.8" disc and 18" or larger wheel (Except Springer models)	00-05	OSVR004-15BLK	OSVR004-15BLK	BRK709	BRK710	3
Models with hub mounted disc	06-17	OSVR516-15	OSVR516-15	BRK711	BRK712	4
Models with 11.5" disc and 18" or larger wheel	06-17	OSVR516-15	OSVR516-15	BRK711	BRK712	5
Models with 11.5" factory discs		OSVR516-14		BRK703		6
Models with 11.8" factory discs		OSVR516-14		BRK704		7

SOFTAIL MODELS

Models with hub mounted 11.5 disc and 18" or larger wheel (Except Springer Models)	00-14	OSVR516-15	OSVR516-15	BRK711	BRK712	10
Models with 11.5" disc and 18" or larger wheel (Except Springer models)	00-14	OSVR004-15BLK	OSVR004-15BLK	BRK709	BRK710	11
Models with 11.8" disc and 18" or larger wheel	00-14	OSVR516-15	OSVR516-15	BRK711	BRK712	12
Models with 11.5" disc and 18" or larger wheel	15-17	OSVR516-15	OSVR516-15	BRK711	BRK712	13
Models with 11.8" disc and 18" or larger wheel	15-17	OSVR516-15	OSVR516-15	BRK711	BRK712	14
Models with 11.5" factory discs		OSVR516-14		BRK703		15
Models with 11.8" factory discs		OSVR516-14		BRK704		16

SPORTSTER MODELS

Models with 19" or larger wheel with hub mounted discs	00-13	OSVR516-15	OSVR516-15	BRK711	BRK712	19
Models with 17" or larger wheel with hub mounted discs	14-18	OSVR516-15	OSVR516-15	BRK711	BRK712	20

TOURING MODELS

Touring frame (FLT) models	00-07	OSVR004-14BLK	OSVR004-14BLK	BRK701	BRK702	23
Touring frame (FLT) models	08-18	OSVR529-14	OSVR529-14	BRK705	BRK706	24

						25
						26
						27
						28
						29
						30
						31
						32
						33
						34
						35
						36
						37
						38
						39
						40
						41
						42
						43
						44
						45
						46
						47
						48
						49
						50
						51
						52
						53
						54
						55
						56
						57
						58
						59

*-2 Sets Required. ■ - Also available in MX-S race compound. **SAFETY WARNING:- DO NOT USE HH PADS ON REAR UNLESS ALSO USED ON FRONT TO AVOID BRAKE IMBALANCE**

10 Part numbers, prefixes, suffixes, photos and illustrations shown in this catalogue are trademarks and/or copyrights of EBC Brakes or the trademark owner A C Freeman Investments Ltd and use without express written permission of the owners is punishable by law.

REAR: AMERICAN PRODUCED MOTORCYCLES













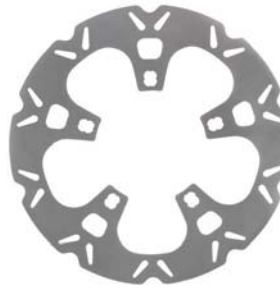

BRAKE APPLICATIONS

All names & numbers are for reference purposes only. © Registered trademarks of Harley—Davidson® Motor Corp or Buell.

Recommended Fittings: FA400 for use on polished chrome show discs. FA400HH recommended fitting as replacement for OE.

NOTE: — Some models may have a second disc fitted as an optional extra. Please double check with your customer exactly which side the front disc is fitted and if twin disc or single.

OVERSIZE DISCS AND BRACKETS FOR HARLEY-DAVIDSON®

<p>Type: Floater Finish: Stainless with Black Chromed Hub Dimensions: OD: 355.6mm(14") Bore: 170.2mm(6.7") Thickness: 5mm(0.19")</p>  <p>OSVR516-14 Fits EBC pads:</p>	<p>Type: Floater Finish: Stainless with Black Chromed Hub Dimensions: OD: 355.6mm(14") Bore: 170.2mm(6.7") Thickness: 5mm(0.19")</p>  <p>OSVR516-15 Fits EBC pads:</p>	<p>Type: Solid Finish: Ground Stainless Steel Dimensions: OD: 355.6mm(14") Bore: 139.2mm(5.48") Thickness: 5mm(0.19")</p>  <p>OSVR529-14 Fits EBC pads:</p>	<p>Type: Floater Finish: Stainless with Black Chromed Hub Dimensions: OD: 355.6mm(14") Bore: 56.4mm(2.22") Thickness: 5mm(0.19")</p>  <p>OSVR004-14BLK Fits EBC pads:</p>
<p>Type: Floater Finish: Stainless with Black Chromed Hub Dimensions: OD: 355.6mm(14") Bore: 56.4mm(2.22") Thickness: 5mm(0.19")</p>  <p>OSVR004-15BLK Fits EBC pads:</p>	 <p>BRK701 Use with OSVR004-14BLK</p>	 <p>BRK703 Use with OSVR516-14</p>	 <p>BRK705 Use with OSVR529-14</p>
 <p>BRK702 Use with OSVR004-14BLK</p>	 <p>BRK704 Use with OSVR516-14</p>	 <p>BRK706 Use with OSVR529-14</p>	
 <p>BRK709 Use with OSVR004-15BLK</p>	 <p>BRK711 Use with OSVR516-15</p>		
 <p>BRK710 Use with OSVR004-15BLK</p>	 <p>BRK712 Use with OSVR516-15</p>		

*-2 Sets Required. ■ - Also available in MX-S race compound. **SAFETY WARNING:- DO NOT USE HH PADS ON REAR UNLESS ALSO USED ON FRONT TO AVOID BRAKE IMBALANCE**

Part numbers, prefixes, suffixes, photos and illustrations shown in this catalogue are trademarks and/or copyrights of EBC Brakes or the trademark owner A C Freeman Investments Ltd and use without express written permission of the owners is punishable by law.

FRONT: AMERICAN PRODUCED MOTORCYCLES

APPLICATIONS

BRAKE

This symbol indicates a disc made of billet steel, and should be only used with EBC FA Kevlar® Organic or Vee pads.

SUFFIX OR PREFIX PAD MATERIALS AND DESCRIPTION		FRONT					DISCS		Line #
		PADS	PADS	PADS	PADS	DESIGN NO.			
		FA	V	HH	EPFA	See Buyers Guide for disc style & finish options. Part nos for ordering & sizing.			
ATK	YEAR	Kevlar Organic Pads	Semi-Sintered V-Pads™	Double-H™ USA-Made Sintered Pads	Premium Low Noise Street Sintered Pads	NARROW BAND	WIDE BAND		
GT 250 R V-Twin Sport	11	FA86*		FA86HH*		MD690	MD690	1	
GV 250 V-Twin Cruiser	11	FA86		FA86HH				2	
GT 650 R V-Twin Sport	11	FA86*		FA86HH*		MD690	MD690	3	
GV 650 V-Twin Cruiser	11	FA86*		FA86HH*		MD691	MD691	4	
BUELL									
M2 Cyclone® (Disc has Countersunk bolt holes)	94-97	FA210	FA210V				MD719RS	7	
S1 Lightning® (Disc has Countersunk bolt holes)	94-97	FA210	FA210V				MD719RS	8	
S2 Thunderbolt® (Disc has Countersunk bolt holes)	94-97	FA210	FA210V				MD719RS	9	
S3 Thunderbolt® (Disc has Countersunk bolt holes)	94-97	FA210	FA210V				MD719RS	10	
M2 Cyclone® (Disc has Countersunk bolt holes)	98-00	FA424		FA424HH	EPFA424HH		MD719RS	11	
S1 Lightning® (Disc has Countersunk bolt holes)	98-00	FA424		FA424HH	EPFA424HH		MD719RS	12	
S1 White Lightning® (Disc has Countersunk bolt holes)	98-00	FA424		FA424HH	EPFA424HH		MD719RS	13	
S3 Thunderbolt® (Disc has Countersunk bolt holes)	98-00	FA424		FA424HH	EPFA424HH		MD719RS	14	
S3T Thunderbolt® (Disc has Countersunk bolt holes)	98-00	FA424		FA424HH	EPFA424HH		MD719RS	15	
X1 Lightning (Disc has Countersunk bolt holes)	98-00	FA424		FA424HH	EPFA424HH		MD719RS	16	
M2 Cyclone (Disc has Counterbored bolt holes)	00-05	FA424		FA424HH	EPFA424HH		MD734RS	17	
X1 Lightning (Disc has Counterbored bolt holes)	00-05	FA424		FA424HH	EPFA424HH		MD734RS	18	
Blast	00-07	FA196	FA196V	FA196HH	EPFA196HH		045	19	
Firebolt XB9R	02-07			FA345HH	EPFA345HH		MD735RS	20	
XB9S Lightning	03-04			FA345HH	EPFA345HH		MD735RS	21	
XB9SX Lightning City X	05-09			FA345HH	EPFA345HH		MD735RS	22	
XB9SX Lightning	08-10			FA345HH	EPFA345HH		MD735RS	23	
XB12 S Lightning	04-08			FA345HH	EPFA345HH		MD735RS	24	
XB12 X Ulysses	06-10			FA345HH	EPFA345HH		MD735RS	25	
XB12 XT Ulysses	08-10			FA345HH	EPFA345HH		MD735RS	26	
XB12 SCG Lightning	06-08			FA345HH	EPFA345HH		MD735RS	27	
XB12 Ss Lightning Long	06-08			FA345HH	EPFA345HH		MD735RS	28	
XB12 Ss Lightning	09-10			FA454/4HH	EPFA454/4HH		MD735RS	29	
XB12 STT Lightning	08			FA345HH	EPFA345HH		MD735RS	30	
XB12 SCG Lightning	09-10			FA454/4HH	EPFA454/4HH		MD735RS	31	
XB12 R Firebolt	04-08			FA345HH	EPFA345HH		MD735RS	32	
XB12 R Firebolt	09-10			FA454/4HH	EPFA454/4HH		MD735RS	33	
1125R	08-10			FA454/4HH	EPFA454/4HH		MD735RS	34	
1125CR	09-10			FA454/4HH	EPFA454/4HH		MD735RS	35	
CAN-AM									
Spyder RS SE5	08-09	FA474*	FA474V*				039	38	
Spyder RS SM5	08-09	FA474*	FA474V*				039	39	
Spyder RS Phantom Black	09	FA474*	FA474V*				039	40	
Spyder RT	10-12	FA474*	FA474V*				039	41	
Spyder RT LTD	10-12	FA474*	FA474V*				039	42	
Spyder RT-S	10-12	FA474*	FA474V*				039	43	
Spyder RS	10-12	FA474*	FA474V*				039	44	
Spyder RS-S	10-12	FA474*	FA474V*				039	45	
Spyder RS (Brembo Caliper)	13-16	FA630*	FA630V*	FA630HH*	EPFA630HH*		041	46	
Spyder RS-S (Brembo Caliper)	13-16	FA630*	FA630V*	FA630HH*	EPFA630HH*		041	47	
Spyder RT (3 Cyl Eng/ 6 Speed)	13-17	FA630*	FA630V*	FA630HH*	EPFA630HH*		041	48	
Spyder RT LTD (3 Cyl Eng/ 6 Speed)	13-19	FA630*	FA630V*	FA630HH*	EPFA630HH*		041	49	
Spyder RT-S (3 Cyl Eng/ 6 Speed)	13-15	FA630*	FA630V*	FA630HH*	EPFA630HH*		041	50	
Spyder RT-S (Special Series)	16-17	FA630*	FA630V*	FA630HH*	EPFA630HH*		041	51	
Spyder ST (Brembo Calipers)	13-16	FA630*	FA630V*	FA630HH*	EPFA630HH*		041	52	
Spyder ST LTD (Brembo Calipers)	13-15	FA630*	FA630V*	FA630HH*	EPFA630HH*		041	53	
Spyder ST-S (Brembo Calipers)	13-16	FA630*	FA630V*	FA630HH*	EPFA630HH*		041	54	
Spyder F3 (SE6/SM6)	15-19	FA630*	FA630V*	FA630HH*	EPFA630HH*		041	55	
Spyder F3 LTD	16-19	FA630*	FA630V*	FA630HH*	EPFA630HH*		041	56	
Spyder F3-S (SE6/SM6)	15-19	FA630*	FA630V*	FA630HH*	EPFA630HH*		041	57	
Spyder F3-S (Special Series)	16	FA630*	FA630V*	FA630HH*	EPFA630HH*		041	58	
Spyder F3-S Daytona 500	17	FA630*	FA630V*	FA630HH*	EPFA630HH*		041	59	

*-2 Sets Required. ■ - Also available in MX-S race compound. **SAFETY WARNING:- DO NOT USE HH PADS ON REAR UNLESS ALSO USED ON FRONT TO AVOID BRAKE IMBALANCE**

REAR: AMERICAN PRODUCED MOTORCYCLES

Line #	ATK	SUFFIX OR PREFIX PAD MATERIALS AND DESCRIPTION	YEAR	REAR						
				PADS	PADS	PADS	PADS	DISCS		
				FA	V	HH	EPFA	DESIGN NO.		
				Kevlar Organic Pads	Semi-Sintered V-Pads™	Double-H™ USA-Made Sintered Pads	Premium Low Noise Street Sintered Pads	See Buyers Guide for disc style & finish options. Part nos for ordering & sizing.		
				NARROW BAND	WIDE BAND					
1	GT 250 R V-Twin Sport		11	FA86			FA86HH		MD689	
2	GV 250 V-Twin Cruiser		11	606						
3	GT 650 R V-Twin Sport		11	FA86			FA86HH		MD689	
4	GV 650 V-Twin Cruiser		11	FA86			FA86HH			
5										
6	BUELL									
7	M2 Cyclone® (Disc has Countersunk bolt holes)		94-97	FA251					MD511	
8	S1 Lightning® (Disc has Countersunk bolt holes)		94-97	FA251					MD511	
9	S2 Thunderbolt® (Disc has Countersunk bolt holes)		94-97	FA251					MD511	
10	S3 Thunderbolt® (Disc has Countersunk bolt holes)		94-97	FA251					MD511	
11	M2 Cyclone® (Disc has Countersunk bolt holes)		98-00	FA140	FA140V	FA140HH			MD511	
12	S1 Lightning® (Disc has Countersunk bolt holes)		98-00	FA140	FA140V	FA140HH			MD511	
13	S1 White Lightning® (Disc has Countersunk bolt holes)		98-00	FA140	FA140V	FA140HH			MD511	
14	S3 Thunderbolt® (Disc has Countersunk bolt holes)		98-00	FA140	FA140V	FA140HH			MD511	
15	S3T Thunderbolt® (Disc has Countersunk bolt holes)		98-00	FA140	FA140V	FA140HH			MD511	
16	X1 Lightning (Disc has Countersunk bolt holes)		98-00	FA140	FA140V	FA140HH			MD511	
17	M2 Cyclone (Disc has Counterbored bolt holes)		00-05	FA140	FA140V	FA140HH			MD511	
18	X1 Lightning (Disc has Counterbored bolt holes)		00-05	FA140	FA140V	FA140HH			MD511	
19	Blast		00-07	FA140	FA140V	FA140HH			046	
20	Firebolt XB9R		02-07	FA140	FA140V	FA140HH			MD522	
21	XB9S Lightning		03-04	FA140	FA140V	FA140HH			MD522	
22	XB9SX Lightning City X		05-09	FA140	FA140V	FA140HH			MD522	
23	XB9SX Lightning		08-10	FA140	FA140V	FA140HH			MD522	
24	XB12 S Lightning		04-08	FA140	FA140V	FA140HH			MD522	
25	XB12 X Ulysses		06-10	FA140	FA140V	FA140HH			MD522	
26	XB12 XT Ulysses		08-10	FA140	FA140V	FA140HH			MD522	
27	XB12 SCG Lightning		06-08	FA140	FA140V	FA140HH			MD522	
28	XB12 Ss Lightning Long		06-08	FA140	FA140V	FA140HH			MD522	
29	XB12 Ss Lightning		09-10	FA140	FA140V	FA140HH			MD522	
30	XB12 STT Lightning		08	FA140	FA140V	FA140HH			MD522	
31	XB12 SCG Lightning		09-10	FA140	FA140V	FA140HH			MD522	
32	XB12 R Firebolt		04-08	FA140	FA140V	FA140HH			MD522	
33	XB12 R Firebolt		09-10	FA140	FA140V	FA140HH			MD522	
34	1125R		08-10			FA460HH				
35	1125CR		09-10			FA460HH				
36										
37	CAN-AM									
38	Spyder RS SE5		08-09	FA473	FA473V				040	
39	Spyder RS SM5		08-09	FA473	FA473V				040	
40	Spyder RS Phantom Black		09	FA473	FA473V				040	
41	Spyder RT		10-12	FA473	FA473V				040	
42	Spyder RT LTD		10-12	FA473	FA473V				040	
43	Spyder RT-S		10-12	FA473	FA473V				040	
44	Spyder RS		10-12	FA473	FA473V				040	
45	Spyder RS-S		10-12	FA473	FA473V				040	
46	Spyder RS (Brembo Caliper)		13-16	FA631	FA631V	FA631HH			042	
47	Spyder RS-S (Brembo Caliper)		13-16	FA631	FA631V	FA631HH			042	
48	Spyder RT (3 Cyl Eng/ 6 Speed)		13-17	FA631	FA631V	FA631HH			042	
49	Spyder RT LTD (3 Cyl Eng/ 6 Speed)		13-19	FA631	FA631V	FA631HH			042	
50	Spyder RT-S (3 Cyl Eng/ 6 Speed)		13-15	FA631	FA631V	FA631HH			042	
51	Spyder RT-S (Special Series)		16-17	FA631	FA631V	FA631HH			042	
52	Spyder ST (Brembo Calipers)		13-16	FA631	FA631V	FA631HH			042	
53	Spyder ST LTD (Brembo Calipers)		13-15	FA631	FA631V	FA631HH			042	
54	Spyder ST-S (Brembo Calipers)		13-16	FA631	FA631V	FA631HH			042	
55	Spyder F3 (SE6/SM6)		15-19	FA631	FA631V	FA631HH			042	
56	Spyder F3 LTD		16-19	FA631	FA631V	FA631HH			042	
57	Spyder F3-S (SE6/SM6)		15-19	FA631	FA631V	FA631HH			042	
58	Spyder F3-S (Special Series)		16	FA631	FA631V	FA631HH			042	
59	Spyder F3-S Daytona 500		17	FA631	FA631V	FA631HH			042	

All names & numbers are for reference purposes only. © Registered trademarks of Harley—Davidson® Motor Corp or Buell.

Recommended Fittings: FA400 for use on polished chrome show discs. FA400HH recommended fitting as replacement for OE.

NOTE: — Some models may have a second disc fitted as an optional extra. Please double check with your customer exactly which side the front disc is fitted and if twin disc or single.

BRAKE APPLICATIONS

*-2 Sets Required. ■ - Also available in MX-S race compound. **SAFETY WARNING:- DO NOT USE HH PADS ON REAR UNLESS ALSO USED ON FRONT TO AVOID BRAKE IMBALANCE**

FRONT: AMERICAN PRODUCED MOTORCYCLES

APPLICATIONS

BRAKE

⚠ This symbol indicates a disc made of billet steel, and should be only used with EBC FA Kevlar® Organic or Vee pads.

CAN-AM EBC INDIAN MOTUS	SUFFIX OR PREFIX PAD MATERIALS AND DESCRIPTION YEAR	FRONT					DISCS		Line #
		PADS FA	PADS V	PADS HH	PADS EPFA	DESIGN NO.			
		Kevlar Organic Pads	Semi-Sintered V-Pads™	Double-H™ USA-Made Sintered Pads	Premium Low Noise Street Sintered Pads	See Buyers Guide for disc style & finish options. Part nos for ordering & sizing.			
					NARROW BAND	WIDE BAND			
Spyder F3-T	16-19	FA630*	FA630V*	FA630HH*	EPFA630HH*	041		1	
								2	
								3	
1190 RS (Sport)	14-15			FA454/4HH	EPFA454/4HH		MD735RS	4	
1190 RX (Sport)	14-15			FA454/4HH	EPFA454/4HH		MD735RS	5	
1190 SX (Naked)	14-15			FA454/4HH	EPFA454/4HH		MD735RS	6	
								7	
Chief All models Chief/Deluxe/Springfield/Road Master/Vintage	02-08	FA216/3	FA216/3V	FA216/3HH	EPFA216/3HH	007		9	
Spirit All models Deluxe/Springfield/Roadblaster	02-08	FA216/3	FA216/3V	FA216/3HH	EPFA216/3HH	007		10	
Scout All models Scout/Deluxe/Springfield	02-08	FA216/3	FA216/3V	FA216/3HH	EPFA216/3HH	007		11	
Chief Blackhawk (Brembo calipers)	11	FA95*	FA95V*	FA95HH*	EPFA95HH*	034		12	
Chief Blackhawk Dark (Brembo calipers)	11	FA95*	FA95V*	FA95HH*	EPFA95HH*	034		13	
Chief Classic (Brembo calipers)	11-13	FA95*	FA95V*	FA95HH*	EPFA95HH*	034		14	
Chief Standard (Brembo calipers)	09-11	FA95*	FA95V*	FA95HH*	EPFA95HH*	034		15	
Chief Deluxe (Brembo calipers)	09	FA95*	FA95V*	FA95HH*	EPFA95HH*	034		16	
Chief Roadmaster (Brembo calipers)	09-11	FA95*	FA95V*	FA95HH*	EPFA95HH*	034		17	
Chief Vintage (Brembo calipers)	09-13	FA95*	FA95V*	FA95HH*	EPFA95HH*	034		18	
Bomber (Brembo calipers)	10-11	FA95*	FA95V*	FA95HH*	EPFA95HH*	034		19	
Dark Horse (Brembo calipers)	10-13	FA95*	FA95V*	FA95HH*	EPFA95HH*	034		20	
Chief Classic (Nissin calipers)	14-18			FA347HH*	EPFA347HH*	037		21	
Chief Dark Horse (Nissin calipers)	16-20			FA347HH*	EPFA347HH*	037		22	
Chief Vintage (Nissin calipers)	14-20			FA347HH*	EPFA347HH*	037		23	
Chieftain (Nissin Calipers)	14-20			FA347HH*	EPFA347HH*	037		24	
Chieftain Dark Horse (Nissin Calipers)	16-20			FA347HH*	EPFA347HH*	037		25	
Chieftain Limited (Nissin Calipers)	17-20			FA347HH*	EPFA347HH*	037		26	
FTR 1200	19-20		FA630V*	FA630HH*				27	
FTR 1200 S	19-20		FA630V*	FA630HH*				28	
FTR 1200 S Race Replica	19-20		FA630V*	FA630HH*				29	
FTR 1200 Rally	19-20		FA630V*	FA630HH*				30	
Roadmaster (Nissin Calipers/Cast Wheels)	15-20			FA347HH*	EPFA347HH*	037		31	
Roadmaster Classic (Nissin Calipers)	17-18			FA347HH*	EPFA347HH*	037		32	
Roadmaster Elite (Nissin Calipers)	17-20			FA347HH*	EPFA347HH*	037		33	
Scout (Toso Calipers/Cast Wheels)	15-16	FA672	FA672V	FA672HH	EPFA672HH	033		34	
Scout 1200	17-20	FA209/2	FA209/2V	FA209/2HH	EPFA209/2HH	033		35	
Scout Bobber	18-20	FA209/2	FA209/2V	FA209/2HH	EPFA209/2HH	033		36	
Scout Bobber Twenty	19-20	FA209/2	FA209/2V	FA209/2HH	EPFA209/2HH	033		37	
Scout Sixty (Toso Calipers/Cast Wheels)	16	FA672	FA672V	FA672HH	EPFA672HH	033		38	
Scout Sixty	17-20	FA209/2	FA209/2V	FA209/2HH	EPFA209/2HH	033		39	
Springfield	16-18			FA347HH*	EPFA347HH*	037		40	
Springfield Dark Horse	18-20			FA347HH*	EPFA347HH*	037		41	
								42	
								43	
MST-01	12-13			FA322/4HH*	EPFA322/4HH*			44	
MST	14-18	FA244*		FA244HH*	EPFA244HH*			45	
MSTR-01	12-13			FA322/4HH*	EPFA322/4HH*			46	
MSTR	14-18			FA447HH*	EPFA447HH*			47	
								48	
								49	
								50	
								51	
								52	
								53	
								54	
								55	
								56	
								57	
								58	
								59	

*-2 Sets Required. ■ - Also available in MX-S race compound. **SAFETY WARNING:- DO NOT USE HH PADS ON REAR UNLESS ALSO USED ON FRONT TO AVOID BRAKE IMBALANCE**

REAR: AMERICAN PRODUCED MOTORCYCLES

BRAKE APPLICATIONS

Line #	SUFFIX OR PREFIX PAD MATERIALS AND DESCRIPTION YEAR	REAR					DISCS	
		PADS FA	PADS V	PADS HH	PADS EPFA	DESIGN NO.		
		Kevlar Organic Pads	Semi-Sintered V-Pads™	Double-H™ USA-Made Sintered Pads	Premium Low Noise Street Sintered Pads	See Buyers Guide for disc style & finish options. Part nos for ordering & sizing.		
						NARROW BAND	WIDE BAND	
1	CAN-AM Spyder F3-T	16-19	FA631	FA631V	FA631HH		042	
2								
3	EBR							
4	1190 RS (Sport)	14-15			FA460HH			
5	1190 RX (Sport)	14-15			FA460HH			
6	1190 SX (Naked)	14-15			FA460HH			
7								
8	INDIAN							
9	Chief All models Chief/Deluxe/Springfield/Road Master/Vintage	02-08	FA216/3	FA216/3V	FA216/3HH	EPFA216/3HH	007	
10	Spirit All models Deluxe/Springfield/Roadblaster	02-08	FA216/3	FA216/3V	FA216/3HH	EPFA216/3HH	007	
11	Scout All models Scout/Deluxe/Springfield	02-08	FA216/3	FA216/3V	FA216/3HH	EPFA216/3HH	007	
12	Chief Blackhawk (Brembo calipers)	11	FA696	FA696V	FA696HH	EPFA696HH	034	
13	Chief Blackhawk Dark (Brembo calipers)	11	FA696	FA696V	FA696HH	EPFA696HH	034	
14	Chief Classic (Brembo calipers)	11-13	FA696	FA696V	FA696HH	EPFA696HH	034	
15	Chief Standard (Brembo calipers)	09-11	FA696	FA696V	FA696HH	EPFA696HH	034	
16	Chief Deluxe (Brembo calipers)	09	FA696	FA696V	FA696HH	EPFA696HH	034	
17	Chief Roadmaster (Brembo calipers)	09-11	FA696	FA696V	FA696HH	EPFA696HH	034	
18	Chief Vintage (Brembo calipers)	09-13	FA696	FA696V	FA696HH	EPFA696HH	034	
19	Bomber (Brembo calipers)	10-11	FA696	FA696V	FA696HH	EPFA696HH	034	
20	Dark Horse (Brembo calipers)	10-13	FA696	FA696V	FA696HH	EPFA696HH	034	
21	Chief Classic (Nissin calipers)	14-18	FA196	FA196V	FA196HH	EPFA196HH	037A	
22	Chief Dark Horse (Nissin calipers)	16-20	FA196	FA196V	FA196HH	EPFA196HH	037A	
23	Chief Vintage (Nissin calipers)	14-20	FA196	FA196V	FA196HH	EPFA196HH	037A	
24	Chieftain (Nissin Calipers)	14-20	FA196	FA196V	FA196HH	EPFA196HH	037A	
25	Chieftain Dark Horse (Nissin Calipers)	16-20	FA196	FA196V	FA196HH	EPFA196HH	037A	
26	Chieftain Limited (Nissin Calipers)	17-20	FA196	FA196V	FA196HH	EPFA196HH	037A	
27	FTR 1200	19-20	FA266	FA266V	FA266HH			
28	FTR 1200 S	19-20	FA266	FA266V	FA266HH			
29	FTR 1200 S Race Replica	19-20	FA266	FA266V	FA266HH			
30	FTR 1200 Rally	19-20	FA266	FA266V	FA266HH			
31	Roadmaster (Nissin Calipers/Cast Wheels)	15-20	FA196	FA196V	FA196HH	EPFA196HH	037A	
32	Roadmaster Classic (Nissin Calipers)	17-18	FA196	FA196V	FA196HH	EPFA196HH	037A	
33	Roadmaster Elite (Nissin Calipers)	17-20	FA196	FA196V	FA196HH	EPFA196HH	037A	
34	Scout (Toso Calipers/Cast Wheels)	15-16	FA377	FA377V	FA377HH		033	
35	Scout 1200	17-20	FA213	FA213V	FA213HH	EPFA213HH	033	
36	Scout Bobber	18-20	FA213	FA213V	FA213HH	EPFA213HH	033	
37	Scout Bobber Twenty	19-20	FA213	FA213V	FA213HH	EPFA213HH	033	
38	Scout Sixty (Toso Calipers/Cast Wheels)	16	FA377	FA377V	FA377HH		033	
39	Scout Sixty	17-20	FA213	FA213V	FA213HH	EPFA213HH	033	
40	Springfield	16-18	FA196	FA196V	FA196HH	EPFA196HH	037A	
41	Springfield Dark Horse	18-20	FA196	FA196V	FA196HH	EPFA196HH	037A	
42								
43	MOTUS							
44	MST-01	12-13	FA266	FA266V	FA266HH			
45	MST	14-18	FA266	FA266V	FA266HH			
46	MSTR-01	12-13	FA266	FA266V	FA266HH			
47	MSTR	14-18	FA266	FA266V	FA266HH			
48								
49								
50								
51								
52								
53								
54								
55								
56								
57								
58								
59								

All names & numbers are for reference purposes only. © Registered trademarks of Harley—Davidson® Motor Corp or Buell.

Recommended Fittings: FA400 for use on polished chrome show discs. FA400HH recommended fitting as replacement for OE.

NOTE: — Some models may have a second disc fitted as an optional extra. Please double check with your customer exactly which side the front disc is fitted and if twin disc or single.

FRONT: AMERICAN PRODUCED MOTORCYCLES

APPLICATIONS

BRAKE

* This symbol indicates a disc made of billet steel, and should be only used with EBC FA Kevlar® Organic or Vee pads.

SUFFIX OR PREFIX PAD MATERIALS AND DESCRIPTION		FRONT					DISCS		Line #
		PADS	PADS	PADS	PADS	DESIGN NO.			
		FA	V	HH	EPFA	See Buyers Guide for disc style & finish options. Part nos for ordering & sizing.			
POLARIS	YEAR	Kevlar Organic Pads	Semi-Sintered V-Pads™	Double-H™ USA-Made Sintered Pads	Premium Low Noise Street Sintered Pads	NARROW BAND	WIDE BAND		
Slingshot Base (Front pads sold as an axle set of 4 pads)	15-17	FA669/4	FA4669/4*			MD533**	MD533**	1	
Slingshot S (Front pads sold as an axle set of 4 pads)	18	FA669/4	FA4669/4*			MD533**	MD533**	2	
Slingshot SL (Front pads sold as an axle set of 4 pads)	15-18	FA669/4	FA4669/4*			MD533**	MD533**	3	
Slingshot SL SE (Front pads sold as an axle set of 4 pads)	15-18	FA669/4	FA4669/4*			MD533**	MD533**	4	
* - FA4669/4 and FA4670 are yellow coded upgrade pads for faster driving.									
** - MD533 is also available with a BSD slotted design. Order MD533BSDF for front and MD533BSDR for rear.									
Money saving complete brake kits are available for all above models.									
Order MDK533STD - this kit includes 1 set of organic front pads, 1 set of organic rear pads,									
2 standard front brake discs and 1 standard rear brake disc.									
Order MDK533BSD - this kit includes 1 set of yellow coded upgrade front pads, 1 set of yellow coded upgrade									
rear pads, 2 BSD slotted design front brake discs and 1 BSD slotted design rear brake disc									
Slingshot SLR	17-18	FA669/4	FA4669/4*					12	
VICTORY									
V92C (Standard Cruiser)	98-00	FA244	FA244V	FA244HH	EPFA244HH	038		15	
V92C (Standard Cruiser)	01-02	FA244	FA244V	FA244HH	EPFA244HH			16	
V92DH (Deluxe Cruiser)	01-02	FA244	FA244V	FA244HH	EPFA244HH			17	
V92SC (Sport Cruiser)	00	FA244*	FA244V*	FA244HH*	EPFA244HH*	038		18	
V92SC (Sport Cruiser)	01	FA244	FA244V	FA244HH	EPFA244HH			19	
V92SE (Special Edition)	00	FA244	FA244V	FA244HH	EPFA244HH	038		20	
V92TC (Special Edition)	03-06	FA244*	FA244V*	FA244HH*	EPFA244HH*			21	
Broadwalk (Spoke Wheels)	13-15			FA347HH	EPFA347HH	037		22	
Cross Country	10-17			FA347HH*	EPFA347HH*	037		23	
Cross Country 8-Ball	15-16			FA347HH*	EPFA347HH*	037		24	
Cross Country Touring	13-17			FA347HH*	EPFA347HH*	037		25	
Cory Ness Victory Cross Country	11-12			FA347HH*	EPFA347HH*	037		26	
Cross Roads	10-12			FA347HH*	EPFA347HH*	037		27	
Cross Roads Classic	13-14			FA347HH*	EPFA347HH*	037		28	
Cross Roads 8-Ball	14-15			FA347HH*	EPFA347HH*	037		29	
Empulse TT	16	FA244*	FA244V*	FA244HH*	EPFA244HH*			30	
Gunner	15-17			FA347HH	EPFA347HH	037		31	
Hammer	05-07	FA244*	FA244V*	FA244HH*	EPFA244HH*	037		32	
Hammer	08-11			FA347HH*	EPFA347HH*	037		33	
Hammer 8 Ball	10-15			FA347HH	EPFA347HH	037		34	
Hammer 8 Ball	16			FA347HH*	EPFA347HH*	037		35	
Hammer S	07	FA244*	FA244V*	FA244HH*	EPFA244HH*	037		36	
Hammer S	08-17			FA347HH*	EPFA347HH*	037		37	
Hard Ball	12-13			FA347HH*	EPFA347HH*	037		38	
High Ball	12-17			FA347HH	EPFA347HH	037		39	
Jackpot	07-10			FA347HH	EPFA347HH	037		40	
Jackpot	11-16			FA347HH	EPFA347HH	037		41	
Cory Ness Jackpot	08-10			FA347HH	EPFA347HH	037		42	
Judge	13-17			FA347HH	EPFA347HH	037		43	
King Pin	04-07	FA244	FA244V	FA244HH	EPFA244HH	037		44	
King Pin	08-12			FA347HH	EPFA347HH	037		45	
King Pin Tour	04-07	FA244	FA244V	FA244HH	EPFA244HH	037		46	
King Pin Tour	08-09			FA347HH	EPFA347HH	037		47	
King Pin 8-Ball	08-11			FA347HH	EPFA347HH	037		48	
King Pin Low	09			FA347HH	EPFA347HH	037		49	
Magnum	15-17			FA347HH*	EPFA347HH*	037		50	
Magnum X-1	15-17			FA347HH*	EPFA347HH*	037		51	
Ness Signature Series	05-07	FA244	FA244V	FA244HH	EPFA244HH	037		52	
Octane 1200cc	17	FA209/2	FA209/2V	FA209/2HH	EPFA209/2HH	033		53	
Vegas	03-07	FA244	FA244V	FA244HH	EPFA244HH	037		54	
Vegas	08-12			FA347HH	EPFA347HH	037		55	
Vegas	16-17			FA347HH	EPFA347HH	037		56	
Vegas 8-Ball	05-07	FA244	FA244V	FA244HH	EPFA244HH	037		57	
Vegas 8-Ball	08-10			FA347HH	EPFA347HH	037		58	
Vegas 8-Ball	11-17			FA347HH	EPFA347HH	037		59	

*-2 Sets Required. ■ - Also available in MX-S race compound. **SAFETY WARNING:- DO NOT USE HH PADS ON REAR UNLESS ALSO USED ON FRONT TO AVOID BRAKE IMBALANCE**

REAR: AMERICAN PRODUCED MOTORCYCLES

Line #	SUFFIX OR PREFIX PAD MATERIALS AND DESCRIPTION YEAR	REAR					DISCS	
		PADS	PADS	PADS	PADS	DESIGN NO.		
		FA	V	HH	EPFA	See Buyers Guide for disc style & finish options. Part nos for ordering & sizing.		
		Kevlar Organic Pads	Semi-Sintered V-Pads™	Double-H™ USA-Made Sintered Pads	Premium Low Noise Street Sintered Pads	NARROW BAND	WIDE BAND	
POLARIS								
1	Slingshot Base (Front pads sold as an axle set of 4 pads)	15-17	FA670	FA4670*			MD533**	MD533**
2	Slingshot S (Front pads sold as an axle set of 4 pads)	18	FA670	FA4670*			MD533**	MD533**
3	Slingshot SL (Front pads sold as an axle set of 4 pads)	15-18	FA670	FA4670*			MD533**	MD533**
4	Slingshot SL SE (Front pads sold as an axle set of 4 pads)	15-18	FA670	FA4670*			MD533**	MD533**
5								
6								
7								
8								
9								
10								
11								
12	Slingshot SLR	17-18	FA670	FA4670*				
13								
VICTORY								
15	V92C (Standard Cruiser)	98-00	FA209/2	FA209/2V	FA209/2HH	EPFA209/2HH	038	
16	V92C (Standard Cruiser)	01-02	FA209/2	FA209/2V	FA209/2HH	EPFA209/2HH		
17	V92DH (Deluxe Cruiser)	01-02	FA209/2	FA209/2V	FA209/2HH	EPFA209/2HH		
18	V92SC (Sport Cruiser)	00	FA209/2	FA209/2V	FA209/2HH	EPFA209/2HH	038	
19	V92SC (Sport Cruiser)	01	FA209/2	FA209/2V	FA209/2HH	EPFA209/2HH		
20	V92SE (Special Edition)	00	FA209/2	FA209/2V	FA209/2HH	EPFA209/2HH	038	
21	V92TC (Special Edition)	03-06	FA209/2	FA209/2V	FA209/2HH	EPFA209/2HH		
22	Broadwalk (Spoke Wheels)	13-15	FA196	FA196V	FA196HH	EPFA196HH	037	
23	Cross Country	10-17	FA196	FA196V	FA196HH	EPFA196HH	037	
24	Cross Country 8-Ball	15-16	FA196	FA196V	FA196HH	EPFA196HH	037	
25	Cross Country Touring	13-17	FA196	FA196V	FA196HH	EPFA196HH	037	
26	Cory Ness Victory Cross Country	11-12	FA196	FA196V	FA196HH	EPFA196HH	037	
27	Cross Roads	10-12	FA196	FA196V	FA196HH	EPFA196HH	037	
28	Cross Roads Classic	13-14	FA196	FA196V	FA196HH	EPFA196HH	037	
29	Cross Roads 8-Ball	14-15	FA196	FA196V	FA196HH	EPFA196HH	037	
30	Empulse TT	16	FA266*	FA266V*	FA266HH*			
31	Gunner	15-17	FA196	FA196V	FA196HH	EPFA196HH	037	
32	Hammer	05-07	FA209/2	FA209/2V	FA209/2HH	EPFA209/2HH	037	
33	Hammer	08-11	FA196	FA196V	FA196HH	EPFA196HH	037	
34	Hammer 8 Ball	10-15	FA196	FA196V	FA196HH	EPFA196HH	037	
35	Hammer 8 Ball	16	FA196	FA196V	FA196HH	EPFA196HH	037	
36	Hammer S	07	FA209/2	FA209/2V	FA209/2HH	EPFA209/2HH	037	
37	Hammer S	08-17	FA196	FA196V	FA196HH	EPFA196HH	037	
38	Hard Ball	12-13	FA196	FA196V	FA196HH	EPFA196HH	037	
39	High Ball	12-17	FA196	FA196V	FA196HH	EPFA196HH	037	
40	Jackpot	07-10	FA196	FA196V	FA196HH	EPFA196HH	037	
41	Jackpot	11-16	FA196	FA196V	FA196HH	EPFA196HH	037	
42	Cory Ness Jackpot	08-10	FA196	FA196V	FA196HH	EPFA196HH	037	
43	Judge	13-17	FA196	FA196V	FA196HH	EPFA196HH	037	
44	King Pin	04-07	FA209/2	FA209/2V	FA209/2HH	EPFA209/2HH	037	
45	King Pin	08-12	FA196	FA196V	FA196HH	EPFA196HH	037	
46	King Pin Tour	04-07	FA209/2	FA209/2V	FA209/2HH	EPFA209/2HH	037	
47	King Pin Tour	08-09	FA196	FA196V	FA196HH	EPFA196HH	037	
48	King Pin 8-Ball	08-11	FA196	FA196V	FA196HH	EPFA196HH	037	
49	King Pin Low	09	FA196	FA196V	FA196HH	EPFA196HH	037	
50	Magnum	15-17	FA196	FA196V	FA196HH	EPFA196HH	037	
51	Magnum X-1	15-17	FA196	FA196V	FA196HH	EPFA196HH	037	
52	Ness Signature Series	05-07	FA209/2	FA209/2V	FA209/2HH	EPFA209/2HH	037	
53	Octane 1200cc	17	FA213	FA213V	FA213HH	EPFA213HH	033	
54	Vegas	03-07	FA209/2	FA209/2V	FA209/2HH	EPFA209/2HH	037	
55	Vegas	08-12	FA196	FA196V	FA196HH	EPFA196HH	037	
56	Vegas	16-17	FA196	FA196V	FA196HH	EPFA196HH	037	
57	Vegas 8-Ball	05-07	FA209/2	FA209/2V	FA209/2HH	EPFA209/2HH	037	
58	Vegas 8-Ball	08-10	FA196	FA196V	FA196HH	EPFA196HH	037	
59	Vegas 8-Ball	11-17	FA196	FA196V	FA196HH	EPFA196HH	037	

All names & numbers are for reference purposes only. © Registered trademarks of Harley—Davidson® Motor Corp or Buell.

Recommended Fittings: FA400 for use on polished chrome show discs. FA400HH recommended fitting as replacement for OE.

NOTE: — Some models may have a second disc fitted as an optional extra. Please double check with your customer exactly which side the front disc is fitted and if twin disc or single.

BRAKE APPLICATIONS

*-2 Sets Required. ■ - Also available in MX-S race compound. **SAFETY WARNING:- DO NOT USE HH PADS ON REAR UNLESS ALSO USED ON FRONT TO AVOID BRAKE IMBALANCE**

FRONT: AMERICAN PRODUCED MOTORCYCLES

APPLICATIONS

BRAKE

⚠ This symbol indicates a disc made of billet steel, and should be only used with EBC FA Kevlar® Organic or Vee pads.

VICTORY

SUFFIX OR PREFIX PAD MATERIALS AND DESCRIPTION	YEAR	FRONT						Line #
		PADS	PADS	PADS	PADS	DISCS		
		FA	V	HH	EPFA	DESIGN NO.		
		Kevlar Organic Pads	Semi-Sintered V-Pads™	Double-H™ USA-Made Sintered Pads	Premium Low Noise Street Sintered Pads	See Buyers Guide for disc style & finish options. Part nos for ordering & sizing.		
						NARROW BAND	WIDE BAND	
Vegas Jackpot	06-07	FA244	FA244V	FA244HH	EPFA244HH	037		1
Vegas Jackpot	08-12			FA347HH	EPFA347HH	037		2
Vegas Jackpot	13-14			FA347HH	EPFA347HH	037		3
Zach Ness Vegas	11			FA347HH	EPFA347HH	037		4
Vegas Low	08-09			FA347HH	EPFA347HH	037		5
Vision 8 Ball	10-11			FA261HH*	EPFA261HH*	037		6
Vision Street	08-09			FA261HH*	EPFA261HH*	037		7
Vision Tour (All models)	08-15			FA261HH*	EPFA261HH*	037		8
Arlen Ness Victory Vision	10-12			FA261HH*	EPFA261HH*	037		9
								10
								11
								12
								13
								14
								15
								16
								17
								18
								19
								20
								21
								22
								23
								24
								25
								26
								27
								28
								29
								30
								31
								32
								33
								34
								35
								36
								37
								38
								39
								40
								41
								42
								43
								44
								45
								46
								47
								48
								49
								50
								51
								52
								53
								54
								55
								56
								57
								58
								59

*-2 Sets Required. ■ - Also available in MX-S race compound. **SAFETY WARNING:- DO NOT USE HH PADS ON REAR UNLESS ALSO USED ON FRONT TO AVOID BRAKE IMBALANCE**

REAR: AMERICAN PRODUCED MOTORCYCLES

Line #	VICTORY	SUFFIX OR PREFIX PAD MATERIALS AND DESCRIPTION YEAR	REAR					DISCS	
			PADS	PADS	PADS	PADS	DESIGN NO.		
			FA	V	HH	EPFA	See Buyers Guide for disc style & finish options. Part nos for ordering & sizing.		
			Kevlar Organic Pads	Semi-Sintered V-Pads™	Double-H™ USA-Made Sintered Pads	Premium Low Noise Street Sintered Pads	NARROW BAND	WIDE BAND	
1	Vegas Jackpot	06-07	FA209/2	FA209/2V	FA209/2HH	EPFA209/2HH	037		
2	Vegas Jackpot	08-12	FA196	FA196V	FA196HH	EPFA196HH	037		
3	Vegas Jackpot	13-14	FA196	FA196V	FA196HH	EPFA196HH	037		
4	Zach Ness Vegas	11	FA196	FA196V	FA196HH	EPFA196HH	037		
5	Vegas Low	08-09	FA196	FA196V	FA196HH	EPFA196HH	037		
6	Vision 8 Ball	10-11	FA196	FA196V	FA196HH	EPFA196HH	037		
7	Vision Street	08-09	FA196	FA196V	FA196HH	EPFA196HH	037		
8	Vision Tour (All models)	08-15	FA196	FA196V	FA196HH	EPFA196HH	037		
9	Arlen Ness Victory Vision	10-12	FA196	FA196V	FA196HH	EPFA196HH	037		
10									
11									
12									
13									
14									
15									
16									
17									
18									
19									
20									
21									
22									
23									
24									
25									
26									
27									
28									
29									
30									
31									
32									
33									
34									
35									
36									
37									
38									
39									
40									
41									
42									
43									
44									
45									
46									
47									
48									
49									
50									
51									
52									
53									
54									
55									
56									
57									
58									
59									

All names & numbers are for reference purposes only. © Registered trademarks of Harley—Davidson® Motor Corp or Buell.

Recommended Fittings: FA400 for use on polished chrome show discs. FA400HH recommended fitting as replacement for OE.

NOTE: — Some models may have a second disc fitted as an optional extra. Please double check with your customer exactly which size the front disc is fitted and if twin disc or single.

BRAKE APPLICATIONS

*-2 Sets Required. ■ - Also available in MX-S race compound. **SAFETY WARNING:- DO NOT USE HH PADS ON REAR UNLESS ALSO USED ON FRONT TO AVOID BRAKE IMBALANCE**

EBC DISC DESIGNS AND DIMENSIONS

Type: Solid No Speedo Slot
Finish: Ground Stainless Steel
Dimensions: OD: 290mm(11.5")
Bore: 56.4mm(2.22")
Thickness: 5mm(0.19")



FSD002 Fits EBC pads: 381, 400, 457

Type: Solid No Speedo Slot
Finish: Ground Stainless Steel
Dimensions: OD: 290mm(11.5")
Bore: 56.4mm(2.22")
Thickness: 5mm(0.19")



VR002 Fits EBC pads: 381, 400, 457

Type: Floater
Finish: Stainless with Polished Centre Hub
Dimensions: OD: 290mm(11.5")
Bore: 56.4mm(2.22")
Thickness: 5mm(0.19")



FSD004 Fits EBC pads: 381, 400, 457

Type: Floater
Finish: Stainless with Black Chromed Hub
Dimensions: OD: 290mm(11.5")
Bore: 56.4mm(2.22")
Thickness: 5mm(0.19")



FSD004BLK Fits EBC pads: 381, 400, 457

Type: Floater
Finish: Stainless with Black Chromed Hub
Dimensions: OD: 290mm(11.5")
Bore: 56.4mm(2.22")
Thickness: 5mm(0.19")



FSD004CBLK Fits EBC pads: 381, 400, 457

Type: Floater
Finish: Stainless with Black Chromed Hub
Dimensions: OD: 290mm(11.5")
Bore: 56.4mm(2.22")
Thickness: 5mm(0.19")



VR004BLK Fits EBC pads: 381, 400, 457

Type: Floater
Finish: Stainless with Polished Centre Hub
Dimensions: OD: 290mm(11.5")
Bore: 56.4mm(2.22")
Thickness: 5mm(0.19")



FSD006C Fits EBC pads: 381, 400, 457

Type: Floater
Finish: Stainless with Polished Centre Hub
Dimensions: OD: 290mm(11.5")
Bore: 56.4mm(2.22")
Thickness: 5mm(0.19")



FSD021 Fits EBC pads: 381, 400, 457

Type: Floater
Finish: Stainless with Polished Centre Hub
Dimensions: OD: 290mm(11.5")
Bore: 56.4mm(2.22")
Thickness: 5mm(0.19")



FSD025C Fits EBC pads: 381, 400, 457

Type: Floater
Finish: Stainless with Black Chromed Hub
Dimensions: OD: 290mm(11.5")
Bore: 56.4mm(2.22")
Thickness: 5mm(0.19")



FSD025BLK Fits EBC pads: 381, 400, 457

Type: Floater
Finish: Stainless with Black Chromed Hub
Dimensions: OD: 290mm(11.5")
Bore: 56.4mm(2.22")
Thickness: 5mm(0.19")



FSD025CBLK Fits EBC pads: 381, 400, 457

Type: Floater
Finish: Stainless with Black Chromed Hub
Dimensions: OD: 290mm(11.5")
Bore: 56.4mm(2.22")
Thickness: 5mm(0.19")



VR025BLK Fits EBC pads: 381, 400, 457

EBC DISC DESIGNS AND DIMENSIONS

DESIGN NO. 007 - WIDE BAND OPTION - FRONT/REAR

Type: Solid With Speedo Slot
Finish: Ground Stainless Steel
Dimensions: OD: 290mm(11.5")
Bore: 50.6mm(1.99")
Thickness: 5mm(0.19")



FSD007 Fits EBC pads: 216/3

Type: Solid With Speedo Slot
Finish: Ground Stainless Steel
Dimensions: OD: 290mm(11.5")
Bore: 50.6mm(1.99")
Thickness: 5mm(0.19")



VR007 Fits EBC pads: 216/3

Type: Floater With Speedo Slot
Finish: Stainless with Polished Centre Hub
Dimensions: OD: 290mm(11.5")
Bore: 50.6mm(1.99")
Thickness: 5mm(0.19")



FSD009 Fits EBC pads: 216/3

Type: Floater With Speedo Slot
Finish: Stainless with Black Chromed Hub
Dimensions: OD: 290mm(11.5")
Bore: 50.6mm(1.99")
Thickness: 5mm(0.19")



FSD009BLK Fits EBC pads: 216/3

Type: Floater With Speedo Slot
Finish: Stainless with Polished Centre Hub
Dimensions: OD: 290mm(11.5")
Bore: 50.6mm(1.99")
Thickness: 5mm(0.19")



FSD011C Fits EBC pads: 216/3

Type: Floater With Speedo Slot
Finish: Stainless with Black Chromed Hub
Dimensions: OD: 290mm(11.5")
Bore: 50.6mm(1.99")
Thickness: 5mm(0.19")



FSD011CBLK Fits EBC pads: 216/3

Type: Floater With Speedo Slot
Finish: Stainless with Black Chromed Hub
Dimensions: OD: 290mm(11.5")
Bore: 50.6mm(1.99")
Thickness: 5mm(0.19")



VR011BLK Fits EBC pads: 216/3

Type: Floater With Speedo Slot
Finish: Stainless with Polished Centre Hub
Dimensions: OD: 290mm(11.5")
Bore: 50.6mm(1.99")
Thickness: 5mm(0.19")



FSD022 Fits EBC pads: 216/3

Type: Floater With Speedo Slot
Finish: Stainless with Black Chromed Hub
Dimensions: OD: 290mm(11.5")
Bore: 50.6mm(1.99")
Thickness: 5mm(0.19")



FSD022BLK Fits EBC pads: 216/3

Type: Floater With Speedo Slot
Finish: Stainless with Polished Centre Hub
Dimensions: OD: 290mm(11.5")
Bore: 50.6mm(1.99")
Thickness: 5mm(0.19")



FSD026C Fits EBC pads: 216/3

Type: Floater With Speedo Slot
Finish: Stainless with Black Chromed Hub
Dimensions: OD: 290mm(11.5")
Bore: 50.6mm(1.99")
Thickness: 5mm(0.19")



FSD026CBLK Fits EBC pads: 216/3

Type: Solid With Speedo Slot
Finish: Ground Stainless Steel
Dimensions: OD: 290mm(11.5")
Bore: 50.6mm(1.99")
Thickness: 5mm(0.19")



RSD007 Fits EBC pads: 216/3

NOTE: Speedo slot is unused and sits empty when fitting any discs in group 007 to vehicles and does not interfere with its fit or function.

EBC DISC DESIGNS AND DIMENSIONS

DESIGN NO. 008 - WIDE BAND OPTION - FRONT

Type: Solid No Speedo Slot
Finish: Ground Stainless Steel
Dimensions: OD: 290mm(11.5")
Bore: 56.4mm(2.22")
Thickness: 5mm(0.19")



FSD008 Fits EBC pads: 94, 381, 400, 457

Type: Solid No Speedo Slot
Finish: Ground Stainless Steel
Dimensions: OD: 290mm(11.5")
Bore: 56.4mm(2.22")
Thickness: 5mm(0.19")



VR009 Fits EBC pads: 94, 381, 400, 457

Type: Floater
Finish: Stainless with Polished Centre Hub
Dimensions: OD: 290mm(11.5")
Bore: 56.4mm(2.22")
Thickness: 5mm(0.19")



FSD010 Fits EBC pads: 94, 381, 400, 457

Type: Floater
Finish: Stainless with Black Chromed Hub
Dimensions: OD: 290mm(11.5")
Bore: 56.4mm(2.22")
Thickness: 5mm(0.19")



FSD010BLK Fits EBC pads: 94, 381, 400, 457

Type: Floater
Finish: Stainless with Black Chromed Hub
Dimensions: OD: 290mm(11.5")
Bore: 56.4mm(2.22")
Thickness: 5mm(0.19")



VR010BLK Fits EBC pads: 94, 381, 400, 457

Type: Floater
Finish: Stainless with Polished Centre Hub
Dimensions: OD: 290mm(11.5")
Bore: 56.4mm(2.22")
Thickness: 5mm(0.19")



FSD012C Fits EBC pads: 94, 381, 400, 457

Type: Floater
Finish: Stainless with Black Chromed Hub
Dimensions: OD: 290mm(11.5")
Bore: 56.4mm(2.22")
Thickness: 5mm(0.19")



FSD012CBLK Fits EBC pads: 94, 381, 400, 457

Type: Floater
Finish: Stainless with Polished Centre Hub
Dimensions: OD: 290mm(11.5")
Bore: 56.4mm(2.22")
Thickness: 5mm(0.19")



FSD023 Fits EBC pads: 94, 381, 400, 457

Type: Floater
Finish: Stainless with Black Chromed Hub
Dimensions: OD: 290mm(11.5")
Bore: 56.4mm(2.22")
Thickness: 5mm(0.19")



FSD023BLK Fits EBC pads: 94, 381, 400, 457

Type: Floater
Finish: Stainless with Black Chromed Hub
Dimensions: OD: 290mm(11.5")
Bore: 56.4mm(2.22")
Thickness: 5mm(0.19")



VR023BLK Fits EBC pads: 94, 381, 400, 457

Type: Floater
Finish: Stainless with Polished Centre Hub
Dimensions: OD: 290mm(11.5")
Bore: 56.4mm(2.22")
Thickness: 5mm(0.19")



FSD027C Fits EBC pads: 94, 381, 400, 457

Type: Floater
Finish: Stainless with Black Chromed Hub
Dimensions: OD: 290mm(11.5")
Bore: 56.4mm(2.22")
Thickness: 5mm(0.19")



FSD027CBLK Fits EBC pads: 94, 381, 400, 457

EBC DISC DESIGNS AND DIMENSIONS

DESIGN NO. 009 - NARROW BAND OPTION - REAR

Type: Solid No Speedo Slot
Finish: Ground Stainless Steel
Dimensions: OD: 290mm(11.5")
Bore: 56.4mm(2.22")
Thickness: 6mm(0.24")



RSD008 Fits EBC pads: 387, 400, 434, 458, 710

Type: Solid No Speedo Slot
Finish: Ground Stainless Steel
Dimensions: OD: 290mm(11.5")
Bore: 56.4mm(2.22")
Thickness: 6mm(0.24")



VR008 Fits EBC pads: 387, 400, 434, 458, 710

Type: Floater
Finish: Stainless with Polished Centre Hub
Dimensions: OD: 290mm(11.5")
Bore: 56.4mm(2.22")
Thickness: 6mm(0.24")



RSD018C Fits EBC pads: 400, 434, 458, 710

Type: Floater
Finish: Stainless with Black Chromed Hub
Dimensions: OD: 290mm(11.5")
Bore: 56.4mm(2.22")
Thickness: 6mm(0.24")



RSD018CBLK Fits EBC pads: 400, 434, 458, 710

Type: Floater
Finish: Stainless with Polished Centre Hub
Dimensions: OD: 290mm(11.5")
Bore: 56.4mm(2.22")
Thickness: 6mm(0.24")



RSD020 Fits EBC pads: 387, 400, 434, 458, 710

Type: Floater
Finish: Stainless with Black Chromed Hub
Dimensions: OD: 290mm(11.5")
Bore: 56.4mm(2.22")
Thickness: 6mm(0.24")



RSD020BLK Fits EBC pads: 387, 400, 434, 458, 710

Type: Floater
Finish: Stainless with Black Chromed Hub
Dimensions: OD: 290mm(11.5")
Bore: 56.4mm(2.22")
Thickness: 6mm(0.24")



VR020BLK Fits EBC pads: 387, 400, 434, 458, 710

DESIGN NO. 010 - WIDE BAND OPTION - REAR

Type: Floater
Finish: Stainless with Polished Centre Hub
Dimensions: OD: 290mm(11.5")
Bore: 56.4mm(2.22")
Thickness: 6mm(0.24")



RSD014C Fits EBC pads: 387, 400, 434, 458

Type: Floater
Finish: Stainless with Black Chromed Hub
Dimensions: OD: 290mm(11.5")
Bore: 56.4mm(2.22")
Thickness: 6mm(0.24")



RSD014CBLK Fits EBC pads: 387, 400, 434, 458

Type: Solid No Speedo Slot
Finish: Ground Stainless Steel
Dimensions: OD: 290mm(11.5")
Bore: 56.4mm(2.22")
Thickness: 6mm(0.24")



VR014 Fits EBC pads: 387, 400, 434, 458

Type: Floater
Finish: Stainless with Black Chromed Hub
Dimensions: OD: 290mm(11.5")
Bore: 56.4mm(2.22")
Thickness: 6mm(0.24")



VR014BLK Fits EBC pads: 387, 400, 434, 458

Type: Floater
Finish: Stainless with Polished Centre Hub
Dimensions: OD: 290mm(11.5")
Bore: 56.4mm(2.22")
Thickness: 6mm(0.24")



RSD016 Fits EBC pads: 387, 400, 434, 458

Type: Floater
Finish: Stainless with Black Chromed Hub
Dimensions: OD: 290mm(11.5")
Bore: 56.4mm(2.22")
Thickness: 6mm(0.24")



RSD016BLK Fits EBC pads: 387, 400, 434, 458

EBC DISC DESIGNS AND DIMENSIONS

BRAKE
APPLICATIONS

GROUP NO. 011 - WIDE BAND - REAR

Type: Floater
Finish: Stainless with Black Chromed Hub
Dimensions: OD: 290mm(11.5")
Bore: 50.6mm(1.96")
Thickness: 6mm(0.24")



RSD017CBLK Fits EBC pads: 200

Type: Floater
Finish: Stainless with Polished Centre Hub
Dimensions: OD: 290mm(11.5")
Bore: 50.6mm(1.96")
Thickness: 6mm(0.24")



RSD019 Fits EBC pads: 200

Type: Floater
Finish: Stainless with Polished Centre Hub
Dimensions: OD: 290mm(11.5")
Bore: 50.6mm(1.96")
Thickness: 6mm(0.24")



RSD019C Fits EBC pads: 200

Type: Floater
Finish: Stainless with Black Chromed Hub
Dimensions: OD: 290mm(11.5")
Bore: 50.6mm(1.96")
Thickness: 6mm(0.24")



RSD019BLK Fits EBC pads: 200

Type: Floater
Finish: Stainless with Black Chromed Hub
Dimensions: OD: 290mm(11.5")
Bore: 50.6mm(1.96")
Thickness: 6mm(0.24")



VR019BLK Fits EBC pads: 200

Type: Solid No Speedo Slot
Finish: Ground Stainless Steel
Dimensions: OD: 290mm(11.5")
Bore: 50.6mm(1.96")
Thickness: 6mm(0.24")



RSD007 Fits EBC pads: 200

DESIGN NO. 014 - REAR

Type: Solid No Speedo Slot
Finish: Ground Stainless Steel
Dimensions: OD: 240mm(9.44")
Bore: 105.2mm(4.1")
Thickness: 5mm(0.19")



MD511 Fits EBC pads: 140, 251

NO. 015 - FRONT/REAR

Type: Solid No Speedo Slot
Finish: Ground Stainless Steel
Dimensions: OD: 292mm(11.5")
Bore: 172mm(6.7")
Thickness: 5mm(0.19")



MD514LS Fits EBC pads: 400

Type: Solid No Speedo Slot
Finish: Ground Stainless Steel
Dimensions: OD: 292mm(11.5")
Bore: 172mm(6.7")
Thickness: 5mm(0.19")



MD514RS Fits EBC pads: 400

Type: Solid No Speedo Slot
Finish: Ground Stainless Steel
Dimensions: OD: 292mm(11.5")
Bore: 172mm(6.7")
Thickness: 5mm(0.19")















VR514 Fits EBC pads: 400

Type: Solid No Speedo Slot
Finish: Ground Stainless Steel
Dimensions: OD: 292mm(11.5")
Bore: 101.4mm(4")
Thickness: 5.8mm(0.23")













MD515 Fits EBC pads: 400











EBC DISC DESIGNS AND DIMENSIONS

DESIGN NO. 016 - FRONT	<p>Type: Solid No Speedo Slot Finish: Ground Stainless Steel Dimensions: OD: 300mm(11.8") Bore: 171mm(6.7") Thickness: 5mm(0.19")</p>  <p>MD516 Fits EBC pads: 400, 409, 457</p>	<p>Type: Floater Finish: Stainless with Polished Centre Hub Dimensions: OD: 300mm(11.8") Bore: 171mm(6.7") Thickness: 5mm(0.19")</p>  <p>MD516X Fits EBC pads: 400, 409, 457</p>	<p>Type: Solid No Speedo Slot Finish: Ground Stainless Steel Dimensions: OD: 300mm(11.8") Bore: 171mm(6.7") Thickness: 5mm(0.19")</p>  <p>VR516 Fits EBC pads: 400, 409, 457</p>	<p>Type: Floater Finish: Stainless with Black Chromed Hub Dimensions: OD: 300mm(11.8") Bore: 171mm(6.7") Thickness: 5mm(0.19")</p>  <p>VR516BLK Fits EBC pads: 400, 409, 457</p>		
	DESIGN NO. 017 - REAR	<p>Type: Solid No Speedo Slot Finish: Ground Stainless Steel Dimensions: OD: 300mm(11.8") Bore: 101.6mm(4") Thickness: 7mm(0.27")</p>  <p>MD517 Fits EBC pads: 409</p>	<p>Type: Solid No Speedo Slot Finish: Ground Stainless Steel Dimensions: OD: 300mm(11.8") Bore: 101.6mm(4") Thickness: 7mm(0.27")</p>  <p>VR517 Fits EBC pads: 409</p>	<p>Type: Floater Finish: Stainless with Black Chromed Hub Dimensions: OD: 300mm(11.8") Bore: 101.6mm(4") Thickness: 7mm(0.27")</p>  <p>VR517BLK Fits EBC pads: 409</p>		
		DESIGN NO. 018 - NARROW BAND - FRONT	<p>Type: Floater Finish: Stainless with Polished Centre Hub Dimensions: OD: 300mm(11.8") Bore: 56.4mm(2.22") Thickness: 5mm(0.19")</p>  <p>MD518 Fits EBC pads: 400, 409, 457</p>	<p>Type: Solid No Speedo Slot Finish: Ground Stainless Steel Dimensions: OD: 300mm(11.8") Bore: 56.4mm(2.22") Thickness: 7mm(0.27")</p>  <p>VR518 Fits EBC pads: 400, 409, 457</p>	<p>Type: Floater Finish: Stainless with Black Chromed Hub Dimensions: OD: 300mm(11.8") Bore: 56.4mm(2.22") Thickness: 5mm(0.19")</p>  <p>VR518BLK Fits EBC pads: 400, 409, 457</p>	<p>Type: Floater Finish: Stainless with Black Chromed Hub Dimensions: OD: 300mm(11.8") Bore: 56.4mm(2.22") Thickness: 5mm(0.19")</p>  <p>MD518/5 Fits EBC pads: 400, 409, 457</p>
			<p>Type: Floater Finish: Stainless with Black Chromed Hub Dimensions: OD: 300mm(11.8") Bore: 56.4mm(2.22") Thickness: 5mm(0.19")</p>  <p>MD518/5BLK Fits EBC pads: 400, 409, 457</p>			

EBC DISC DESIGNS AND DIMENSIONS

DESIGN NO. 020 - FRONT	<p>Type: Floater Finish: Stainless with Polished Centre Hub Dimensions: OD: 300mm(11.8") Bore: 56.4mm(2.22") Thickness: 5mm(0.19")</p>  <p>MD520 Fits EBC pads: 409</p>	<p>Type: Solid Finish: Ground Stainless Steel Dimensions: OD: 300mm(11.8") Bore: 56.4mm(2.22") Thickness: 5mm(0.19")</p>  <p>VR520BLK Fits EBC pads: 409</p>	<p>Type: Solid No Speedo Slot Finish: Ground Stainless Steel Dimensions: OD: 300mm(11.8") Bore: 56.4mm(2.22") Thickness: 5mm(0.19")</p>  <p>VR520 Fits EBC pads: 409</p>	<p>Type: Solid No Speedo Slot Finish: Ground Stainless Steel Dimensions: OD: 300mm(11.8") Bore: 56.4mm(2.22") Thickness: 5mm(0.19")</p>  <p>MD541 Fits EBC pads: 409</p>		
	DESIGN NO. 021 - REAR	<p>Type: Floater Finish: Stainless with Polished Centre Hub Dimensions: OD: 300mm(11.8") Bore: 56.4mm(2.22") Thickness: 7mm(0.27")</p>  <p>MD521 Fits EBC pads: 409</p>	<p>Type: Floater Finish: Stainless with Polished Centre Hub Dimensions: OD: 300mm(11.8") Bore: 56.4mm(2.22") Thickness: 7mm(0.27")</p>  <p>MD521C Fits EBC pads: 409</p>	<p>Type: Floater Finish: Stainless with Black Chromed Hub Dimensions: OD: 300mm(11.8") Bore: 56.4mm(2.22") Thickness: 7mm(0.27")</p>  <p>MD521BLK Fits EBC pads: 409</p>	<p>Type: Solid No Speedo Slot Finish: Ground Stainless Steel Dimensions: OD: 300mm(11.8") Bore: 56.4mm(2.22") Thickness: 7mm(0.27")</p>  <p>VR521 Fits EBC pads: 409</p>	
		DESIGN NO. 022 - REAR	<p>Type: Floater Finish: Stainless with Black Chromed Hub Dimensions: OD: 300mm(11.8") Bore: 56.4mm(2.22") Thickness: 7mm(0.27")</p>  <p>VR521BLK Fits EBC pads: 409</p>			
			<p>Type: Solid No Speedo Slot Finish: Ground Stainless Steel Dimensions: OD: 240mm(9.44") Bore: 70.6mm(2.77") Thickness: 5mm(0.19")</p>  <p>MD522 Fits EBC pads: 140</p>			

EBC DISC DESIGNS AND DIMENSIONS

DESIGN NO. 023 - FRONT	<p>Type: Solid No Speedo Slot Finish: Ground Stainless Steel Dimensions: OD: 290mm(11.5") Bore: 56.4mm(2.22") Thickness: 5.2mm(0.2")</p>  <p>MD523 Fits EBC pads: 296</p>	<p>Type: Floater Finish: Stainless with Gold Centre Hub Dimensions: OD: 290mm(11.5") Bore: 56.4mm(2.22") Thickness: 5.2mm(0.2")</p>  <p>MD523X Fits EBC pads: 296</p>	<p>Type: Floater Finish: Stainless with Black Chromed Hub Dimensions: OD: 290mm(11.5") Bore: 56.4mm(2.22") Thickness: 5.2mm(0.2")</p>  <p>VR523BLK Fits EBC pads: 296</p>	<p>Type: Floater Finish: Stainless with Polished Centre Hub Dimensions: OD: 290mm(11.5") Bore: 56.4mm(2.22") Thickness: 5.2mm(0.2")</p>  <p>FSD523 Fits EBC pads: 296</p>		
	DESIGN NO. 024 - REAR	<p>Type: Solid no speedo slot Finish: Ground Stainless Steel Dimensions: OD: 260mm(10.23") Bore: 56.4mm(2.2") Thickness: 7mm(0.27")</p>  <p>MD524 Fits EBC pads: 254, 387</p>	<p>Type: Floater Finish: Stainless with Gold Center Hub Dimensions: OD: 260mm(10.23") Bore: 56.4mm(2.2") Thickness: 7mm(0.27")</p>  <p>MD524X Fits EBC pads: 254, 387</p>	<p>Type: Floater Finish: Stainless with Black Chromed Hub Dimensions: OD: 260mm(10.23") Bore: 56.4mm(2.2") Thickness: 7mm(0.27")</p>  <p>VR524BLK Fits EBC pads: 254, 387</p>	<p>Type: Floater Finish: Stainless with Polished Centre Hub Dimensions: OD: 260mm(10.23") Bore: 56.4mm(2.2") Thickness: 7mm(0.27")</p>  <p>FSD524 Fits EBC pads: 254, 387</p>	
		DESIGN NO. 025 - REAR	<p>Type: Floater Finish: Stainless with Polished Centre Hub Dimensions: OD: 300mm(11.8") Bore: 101.4mm(4") Thickness: 7mm(0.27")</p>  <p>MD525 Fits EBC pads: 409</p>	<p>Type: Floater Finish: Stainless with Black Chromed Hub Dimensions: OD: 300mm(11.8") Bore: 101.4mm(4") Thickness: 7mm(0.27")</p>  <p>VR525BLK Fits EBC pads: 409</p>		

EBC DISC DESIGNS AND DIMENSIONS

DESIGN NO. 026 - NARROW BAND - FRONT

Type: Solid No Speedo Slot
Finish: Ground Stainless Steel
Dimensions: OD: 300mm(11.8")
Bore: 56.4mm(2.22")
Thickness: 5mm(0.19")



MD526 Fits EBC pads: 296, 640

Type: Floater
Finish: Stainless with Polished Centre Hub
Dimensions: OD: 300mm(11.8")
Bore: 56.4mm(2.22")
Thickness: 5mm(0.19")



MD526X Fits EBC pads: 296, 640

Type: Floater
Finish: Stainless with Black Chromed Hub
Dimensions: OD: 300mm(11.8")
Bore: 56.4mm(2.22")
Thickness: 5mm(0.19")



MD526XBLK Fits EBC pads: 296, 640

Type: Solid No Speedo Slot
Finish: Ground Stainless Steel
Dimensions: OD: 300mm(11.8")
Bore: 56.4mm(2.22")
Thickness: 5mm(0.19")



VR526 Fits EBC pads: 296, 640

Type: Floater
Finish: Stainless with Black Chromed Hub
Dimensions: OD: 300mm(11.8")
Bore: 56.4mm(2.22")
Thickness: 5mm(0.19")



VR526BLK Fits EBC pads: 296, 640

DESIGN NO. 027 - REAR

Type: Floater
Finish: Stainless with Polished Centre Hub
Dimensions: OD: 290mm(11.5")
Bore: 56.4mm(2.22")
Thickness: 6mm(0.23")



MD528 Fits EBC pads: 458, 710

Type: Floater
Finish: Stainless with Polished Centre Hub
Dimensions: OD: 290mm(11.5")
Bore: 56.4mm(2.22")
Thickness: 6mm(0.23")



MD528C Fits EBC pads: 458, 710

Type: Floater
Finish: Stainless with Black Chromed Hub
Dimensions: OD: 290mm(11.5")
Bore: 56.4mm(2.22")
Thickness: 6mm(0.23")



VR528BLK Fits EBC pads: 458, 710

Type: Solid No Speedo Slot
Finish: Ground Stainless Steel
Dimensions: OD: 290mm(11.5")
Bore: 56.4mm(2.22")
Thickness: 6mm(0.23")



VR528 Fits EBC pads: 458, 710

DESIGN NO. 028 - FRONT

Type: Solid No Speedo Slot
Finish: Ground Stainless Steel
Dimensions: OD: 300mm(11.8")
Bore: 139.2mm(5.48")
Thickness: 5mm(0.22")



MD529 Fits EBC pads: 409

Type: Solid No Speedo Slot
Finish: Ground Stainless Steel
Dimensions: OD: 300mm(11.8")
Bore: 139.2mm(5.48")
Thickness: 5mm(0.22")















VR529 Fits EBC pads: 409









EBC DISC DESIGNS AND DIMENSIONS

DESIGN NO. 030 - FRONT	<p>Type: Floater Finish: Stainless with Polished Centre Hub Dimensions: OD: 300mm(11.8") Bore: 56.4mm(2.2") Thickness: 5mm(0.19")</p>  <p>MD530 Fits EBC pads: 296, 409, 638, 640</p>	<p>Type: Floater Finish: Stainless with Black Chromed Hub Dimensions: OD: 300mm(11.8") Bore: 56.4mm(2.2") Thickness: 5mm(0.19")</p>  <p>MD530BLK Fits EBC pads: 296, 409, 638, 640</p>	<p>Type: Floater Finish: Stainless with Black Chromed Hub Dimensions: OD: 300mm(11.8") Bore: 56.4mm(2.2") Thickness: 5mm(0.19")</p>  <p>VR530BLK Fits EBC pads: 296, 409, 638, 640</p>	<p>Type: Solid No Speedo Slot Finish: Ground Stainless Steel Dimensions: OD: 300mm(11.8") Bore: 56.4mm(2.2") Thickness: 5mm(0.19")</p>  <p>VR530 Fits EBC pads: 296, 409, 638, 640</p>	
	NO. 031 - FRONT/REAR	<p>Type: Solid No Speedo Slot Finish: Ground Stainless Steel Dimensions: OD: 292mm(11.5") Bore: 56.4mm(2.2") Thickness: 5.2mm(0.2")</p>  <p>MD531 Fits EBC pads: 643</p>			
		DESIGN NO. 032 - FRONT	<p>Type: Cast Iron Auto Style Disc Finish: Cast Iron Dimensions: OD: 299mm(11.77") Bore: 68mm(2.67") Thickness: 21mm(0.82")</p>  <p>MD533 Fits EBC pads: 669/4, 670</p>	<p>Type: Cast Iron Auto Style Disc Finish: Cast Iron Dimensions: OD: 299mm(11.77") Bore: 68mm(2.67") Thickness: 21mm(0.82")</p>  <p>MD533BSD Fits EBC pads: 669/4, 670</p>	
	NO. 033 - FRONT/REAR		<p>Type: Solid No Speedo Slot Finish: Ground Stainless Steel Dimensions: OD: 298mm(11.73") Bore: 64.2mm(2.5") Thickness: 5mm(0.19")</p>  <p>MD534 Fits EBC pads: 213, 209/2, 377, 672</p>	<p>Type: Floater Finish: Stainless with Black Chromed Hub Dimensions: OD: 298mm(11.73") Bore: 64.2mm(2.5") Thickness: 5mm(0.19")</p>  <p>VR534BLK Fits EBC pads: 213, 209/2, 377, 672</p>	







EBC DISC DESIGNS AND DIMENSIONS

NO. 034 - FRONT/REAR	<p>Type: Floater Finish: Stainless with Polished Centre Hub Dimensions: OD: 292mm(11.5") Bore: 56.6mm(2.22") Thickness: 5mm(0.19")</p>  <p>MD535 Fits EBC pads: 95, 696</p>	<p>Type: Floater Finish: Stainless with Black Chromed Hub Dimensions: OD: 292mm(11.5") Bore: 56.6mm(2.22") Thickness: 5mm(0.19")</p>  <p>VR535BLK Fits EBC pads: 95, 696</p>				
	DESIGN NO. 035 - FRONT	<p>Type: Solid No Speedo Slot Finish: Ground Stainless Steel Dimensions: OD: 300mm(11.8") Bore: 56.4mm(2.22") Thickness: 6mm(0.24")</p>  <p>MD536 Fits EBC pads: 209/2</p>	<p>Type: Solid No Speedo Slot Finish: Ground Stainless Steel Dimensions: OD: 300mm(11.8") Bore: 56.4mm(2.22") Thickness: 6mm(0.24")</p>  <p>MD536X Fits EBC pads: 209/2</p>	<p>Type: Floater Finish: Stainless with Polished Centre Hub Dimensions: OD: 300mm(11.8") Bore: 56.4mm(2.22") Thickness: 6mm(0.24")</p>  <p>MD536XBLK Fits EBC pads: 209/2</p>	<p>Type: Solid No Speedo Slot Finish: Ground Stainless Steel Dimensions: OD: 300mm(11.8") Bore: 56.4mm(2.22") Thickness: 6mm(0.24")</p>  <p>VR536 Fits EBC pads: 209/2</p>	
DESIGN NO. 036 - REAR		<p>Type: Solid No Speedo Slot Finish: Ground Stainless Steel Dimensions: OD: 300mm(11.8") Bore: 56.4mm(2.22") Thickness: 6mm(0.24")</p>  <p>MD537 Fits EBC pads: 181</p>	<p>Type: Floater Finish: Stainless with Polished Centre Hub Dimensions: OD: 300mm(11.8") Bore: 56.4mm(2.22") Thickness: 6mm(0.24")</p>  <p>MD537X Fits EBC pads: 181</p>	<p>Type: Floater Finish: Stainless with Black Chromed Hub Dimensions: OD: 300mm(11.8") Bore: 56.4mm(2.22") Thickness: 6mm(0.24")</p>  <p>MD537XBLK Fits EBC pads: 181</p>	<p>Type: Solid No Speedo Slot Finish: Ground Stainless Steel Dimensions: OD: 300mm(11.8") Bore: 56.4mm(2.22") Thickness: 6mm(0.24")</p>  <p>VR537 Fits EBC pads: 181</p>	
		NO. 037 - FRONT/REAR	<p>Type: Floater Finish: Stainless with Natural Finish Alum. Hub Dimensions: OD: 299mm(11.77") Bore: 64.2mm(2.52") Thickness: 5mm(0.19")</p>  <p>MD678 Fits EBC pads: 196, 244, 347</p>	<p>Type: Floater Finish: Stainless with Black Anodised Alloy Hub Dimensions: OD: 299mm(11.77") Bore: 64.2mm(2.52") Thickness: 5mm(0.19")</p>  <p>MD678BLK Fits EBC pads: 196, 244, 347</p>	<p>Type: Floater Finish: Stainless with Black Chromed Hub Dimensions: OD: 299mm(11.77") Bore: 64.2mm(2.52") Thickness: 5mm(0.19")</p>  <p>VR678BLK Fits EBC pads: 196, 244, 347</p>	

EBC DISC DESIGNS AND DIMENSIONS

<p>NO. 037A - REAR</p>	<p>Type: Floater Finish: Stainless with Black Chromed Hub Dimensions: OD: 299mm(11.77") Bore: 64.2mm(2.52") Thickness: 7mm(0.27")</p>  <p>MD887BLK Fits EBC pads: 196</p>	<p>Type: Floater Finish: Stainless with Black Chromed Hub Dimensions: OD: 299mm(11.77") Bore: 64.2mm(2.52") Thickness: 7mm(0.27")</p>  <p>VR887BLK Fits EBC pads: 196</p>		
<p>NO. 038 - FRONT/REAR</p>	<p>Type: Floater Finish: Stainless with Natural Finish Alum. Hub Dimensions: OD: 299mm(11.77") Bore: 50.6mm(1.99") Thickness: 5mm(0.19")</p>  <p>MD727 Fits EBC pads: 209/2, 244</p>	<p>Type: Floater Finish: Stainless with Black Chromed Hub Dimensions: OD: 299mm(11.77") Bore: 50.6mm(1.99") Thickness: 5mm(0.19")</p>  <p>VR727BLK Fits EBC pads: 209/2, 244</p>		
<p>DESIGN NO. 039 - FRONT</p>	<p>Type: Solid No Speedo Slot Finish: Ground Stainless Steel Dimensions: OD: 250mm(9.8") Bore: 66.2mm(2.6") Thickness: 6mm(0.24")</p>  <p>MD801 Fits EBC pads: 474</p>	<p>Type: Solid No Speedo Slot Finish: Ground Stainless Steel Dimensions: OD: 250mm(9.8") Bore: 66.2mm(2.6") Thickness: 6mm(0.24")</p>  <p>VR801 Fits EBC pads: 474</p>		
<p>DESIGN NO. 040 - REAR</p>	<p>Type: Solid No Speedo Slot Finish: Ground Stainless Steel Dimensions: OD: 250mm(9.8") Bore: 66.2mm(2.6") Thickness: 6mm(0.24")</p>  <p>MD802 Fits EBC pads: 473</p>	<p>Type: Solid No Speedo Slot Finish: Ground Stainless Steel Dimensions: OD: 250mm(9.8") Bore: 66.2mm(2.6") Thickness: 6mm(0.24")</p>  <p>VR802 Fits EBC pads: 473</p>		

EBC DISC DESIGNS AND DIMENSIONS

<p>DESIGN NO. 041 - FRONT</p> <p>Type: Solid No Speedo Slot Finish: Ground Stainless Steel Dimensions: OD: 270mm(10.6") Bore: 62.6mm(2.46") Thickness: 7mm(0.27")</p>  <p>MD853 Fits EBC pads: 630</p>	<p>Type: Solid No Speedo Slot Finish: Ground Stainless Steel Dimensions: OD: 270mm(10.6") Bore: 62.6mm(2.46") Thickness: 7mm(0.27")</p>  <p>VR853 Fits EBC pads: 630</p>		
<p>DESIGN NO. 042 - REAR</p> <p>Type: Solid No Speedo Slot Finish: Ground Stainless Steel Dimensions: OD: 270mm(10.6") Bore: 62.6mm(2.46") Thickness: 7mm(0.27")</p>  <p>MD854 Fits EBC pads: 631</p>	<p>Type: Solid No Speedo Slot Finish: Ground Stainless Steel Dimensions: OD: 270mm(10.6") Bore: 62.6mm(2.46") Thickness: 7mm(0.27")</p>  <p>VR854 Fits EBC pads: 631</p>		
<p>DESIGN NO. 045 - FRONT</p> <p>Type: Solid No Speedo Slot Finish: Ground Stainless Steel Dimensions: OD: 320mm(12.6") Bore: 225mm(8.86") Thickness: 5mm(0.19)</p>  <p>MD737 Fits EBC pads: 196</p>	<p>Type: Solid No Speedo Slot Finish: Ground Stainless Steel Dimensions: OD: 320mm(12.6") Bore: 225mm(8.86") Thickness: 5mm(0.19)</p>  <p>VR737 Fits EBC pads: 196</p>		
<p>DESIGN NO. 046 - REAR</p> <p>Type: Solid No Speedo Slot Finish: Ground Stainless Steel Dimensions: OD: 220mm(8.66") Bore: 50.6mm(2.0") Thickness: 5mm(0.19)</p>  <p>MD738 Fits EBC pads: 140</p>	<p>Type: Solid No Speedo Slot Finish: Ground Stainless Steel Dimensions: OD: 220mm(8.66") Bore: 50.6mm(2.0") Thickness: 5mm(0.19)</p>  <p>VR738 Fits EBC pads: 140</p>		

EBC DISC DESIGNS AND DIMENSIONS

MD509SR

Type: Solid No Speedo Slot
Finish: Ground Stainless Steel
Dimensions: OD: 290mm(11.5")
Bore: 101.8mm(4")
Thickness: 7.8mm(0.3)



MD509SR Fits EBC pads: 201

JAPANESE Built Motorcycles



HONDA

C 50 All Models	75-93
C 50 N (Single seat model)	95
C 50 P/S/N/X/Y/1/2 (Single seat model)	96-02
CB 50 J	81
CB 50 V/W Dream 50	97-98
CD 50 ST/SV/SW/SX Benley 50 S	96-99
CF 50 Chaly	79
CHF 50-1/Scoopy 50 (Drum brake model)	01-05
CL 50 V/X Benley CL50	97-99
CR 50 RE/RF	84-85
CRF 50 F	04-20
CRM 50 RV/RP/RR/RT	93-96
MB 5 S	80-82
MBX 50 SD/SF	83-85
MG 50 S/X/1/3 Magna 50 (AC13-)	95-03
MP 50 3/DX3 (AC17) Solo	03
MRX 50	88-
MT 50 SA/SE/SG/SJ/SL	80-93
MTX 50 SC	83-84
NB 50 ME Aero	84
NB 50 MF/MG/TH Vision	86-88
NC 50 K1/Z Express	79-82
NC 50 C Express 2	82
NC 50 A/B Express 3 Delux	82
NCX 50 E/G/J - Dunk 50	14-17
NE 50 MF/MG Vision	86-87
NH 50 Lead 50 SS	84
NH 50 Lead AF01/D716	84-85
NJ 50 MDY/M2/MD2 (TD01) Gyro-X	00-02
NP 50 D Melody Mini	83
NPC 50 2/3 (AF59) Bite	02-03
NPS 50 1/2/3/5/6/7/8/9 (AF58) Zoomer	01-12
NS 50 Melody	82
NS 50 MSB Melody Delux	82
NSC 50 WHC/T2E/F - Vision 50 14 Inch Wheels	12-16
NSC 50 MPDC/E/F/G/H/J - Vision 50 16 Inch Wheels	12-18
NSC 50 R - 14 Inch Wheels	12-16
NSR 50 FP/FR/FS	93-95
NSR 50 RV/RW/RX/RY	97-00
NSR 50 SK/SP/SR/SS	89-95
NSR 50 V (AC10-180)	97
NSR 50 V (AC10-180) - Floating disc option	97
NSR 50 X (AC10-190)	99
NSR 50 X (AC10-190) - Floating disc option	99
NT 50 F/G/H Melody Mini	85-87
NU 50 MC Runaway	82
NV 50 MSD Stream	84
NVS 50 1SH2/Today 50	01-05
NX 50 A/B/MB Caren	80-82
PA 50 Camino (Spoke wheels)	79-86
PA 50 Camino (Cast wheels)	88-89
PC 50 K1	79
PF 50 M Novio	75
PK 50 Wallaro All models	90-01
PX 50	82-83
PX 50	84
PXR 50	84
SA 50 J/M/P/R/S Vision Metin	88-95
SFX 50 S/T/W/X/Y/1	95-04
SGX 50 V/W/X/Y/1 Sky/Sky Deluxe	97-03

FA, SFA, TT Pad or Brake Shoe	DISC PAD CHOICES - FRONT			BRAKE DISC CHOICES - FRONT						Line #
	SFAC Carbon Scooter Pads	Speciality Pads - SXR / Vee / MXS	Sintered/HH Pads/ Grooved Shoes	Left / Gauche / Links Standard Replacement Disc	Right / Droite / Rechts Standard Replacement Disc	Contour Disc Universal left and right fitment	Custom Disc Universal left and right fitment	Vee-Discs Black † See note below	CX Extreme MX Race Disc/ UTVX Disc	
H303										1
H303										2
H303										3
FA040										4
FA197			FA197HH							5
H304										6
H303										7
H333										8
H304										9
H333			H333G							10
H301										11
FA125TT		MXS125	FA125R	MD6001D		MD6001C			MD6001CX	12
SFA054	SFAC054		FA054HH							13
FA086			FA086HH							14
SFA054	SFAC054	MXS054	FA054HH							15
H304										16
FA054TT										17
H304			H304G							18
H304			H304G							19
H301										20
H301										21
H301										22
H301										23
H301										24
SFA708				MD923D						25
H301										26
SFA176										27
SFA176										28
H333										29
H301										30
H333										31
H333										32
H301										33
H301										34
SFA603	SFAC603		SFA603HH	MD9134D				VR9134		35
SFA603	SFAC603		SFA603HH	MD9134D				VR9134		36
SFA603	SFAC603		SFA603HH	MD9134D				VR9134		37
FA086			FA086HH							38
FA197			FA197HH		MD1142RS					39
FA086										40
FA197			FA197HH			MD1169C				41
FA197			FA197HH			MD1169CF				42
FA197			FA197HH			MD1169C				43
FA197			FA197HH			MD1169CF				44
H301										45
H333										46
H302										47
H333										48
H301										49
H322										50
H335										51
H301										52
H322										53
H333										54
H322										55
H322										56
H335										57
H333										58
SFA193	SFAC193		SFA193HH	MD906D				VR906		59
SFA193	SFAC193		SFA193HH	MD931D				VR931		60

FRONT / AVANT / VORN / FRENTE / ANTERIORE

R Suffix = High Durability Sintered Pad. HH Suffix = High Performance Sintered Pad. TT Suffix = Hard Wearing Off Road Pad. V Suffix = Semi Sintered Pad. G Suffix = Grooved Shoe.
 D Suffix = Drilled Disc. X Suffix = Universal Left or Right Disc. XC Suffix = Contoured Disc. LS Suffix = Left/Steel Disc. RS = Right/Steel Disc.

*-2 Sets Required. † For Vee disc colours add RED, BLU, GRN, GLD, ORG suffix to part number. For Custom Finish Options for Vee-Rotors™ including Splatter discs add suffix CHR, CHGR, CHBL, CHBR - available in various colours see page iv. ☼ - Also available as a Vintage Motorcycle Disc.

JAPANESE Built Motorcycles

Line #	BRAKE DISC CHOICES - FRONT						DISC PAD CHOICES - REAR				BRAKE DISC CHOICES - REAR			
	Oversize 250 /280mm Disc Kit	OSX Oversize 250/280mm Disc Kit	Relocating Bracket for 250/ 280mm Disc	Oversize 320mm Disc Kit	SMX Oversize 320mm Disc Kit	Relocating Bracket for 320mm Disc	FA, SFA, TT Pad or Brake Shoe	SFAC Carbon Scooter Pads	Speciality Pads - SXR / Vee / MXS	Sintered/ HH Pads/ Grooved Shoes	Standard Replacement Disc	Contour Disc Rear fitment	Vee Discs CONTOUR	CX Extreme MX Race Disc
1							H303							
2							H304							
3							H304							
4							H304							
5							FA131TT							
6							H304							
7							H303							
8							H333							
9							H304							
10							H333		H333G					
11							H301							
12							H304							
13							H304							
14							H304							
15							H304							
16							H304							
17							H304							
18							H304		H304G					
19							H304		H304G					
20							H302							
21							H302							
22							H301							
23							H302							
24							H302							
25							H353							
26							H302							
27							H302							
28							H302							
29							H333*							
30							H302							
31							H333							
32							H333							
33							H302							
34							H302							
35							H352							
36							H352							
37							H352							
38							H304							
39							SFA131/3		SFA131/3HH	MD1143				
40							H304							
41							SFA131/3		SFA131/3HH		MD1170C			
42							SFA131/3		SFA131/3HH		MD1170C			
43							SFA131/2		SFA131/2HH		MD1170C			
44							SFA131/2		SFA131/2HH		MD1170C			
45							H301							
46							H302							
47							H302							
48														
49							H302							
50							H322							
51							H335							
52							H301							
53							H322							
54							H303							
55							H302							
56							H337							
57							H334							
58							H333							
59							H303							
60							H303							

REAR / ARRIÈRE / HINTEN / POSTERIOR / POSTERIORE

BRAKE APPLICATIONS

*-2 Sets Required. † For Vee disc colours add RED, BLU, GRN, GLD, ORG suffix to part number. For Custom Finish Options for Vee-Rotors™ including Splatter discs add suffix CHR, CHGR, CHBL, CHBR - available in various colours see page iv. ☼ - Also available as a Vintage Motorcycle Disc.

R Suffix = High Durability Sintered Pad. HH Suffix = High Performance Sintered Pad. TT Suffix = Hard Wearing Off Road Pad. V Suffix = Semi Sintered Pad. G Suffix = Grooved Shoe. D Suffix = Drilled Disc. X Suffix = Universal Left or Right Disc. XC Suffix = Contoured Disc. LS Suffix = Left/Steel Disc. RS = Right/Steel Disc.

JAPANESE Built Motorcycles



HONDA Contd.

SH 50 E/H/K/M/P/DP City Express	85-96
SH 50 T Fifty/Scoopy W/XY/1	97-03
SJ 50 P/R/S/T/V/W/X Bali	93-99
SK 50 MM/MM-YA/MM-YC/MN/MN-YA/MN-YB/MP /MP-YA/MMR/MMT (AF27) DIO Drum Front & Rear	
SK 50 MM-II/MM-YD/MN-II/MP-II (AF28) DIO SR	
SK 50 MNIII/MPIII/MP-IV (AF28) DIO-ZX	
SK 50 MR-II/MMT-II DIO XR (AF28)	
SN 50 N/R/S Giorno	94
SS 50 ZK2	75-77
SS 50 ZB2	77-80
SRX 50 T/W/X Joker/Shadow	97-99
ST 50 J/K Dax	78-93
SXR 50 W/SW/X/SX	98-99
X8R-S Super Sport Scooter (SZX 50 SW/SX/SY/S1)	98-04
X8R-X Cross Sport Scooter (SZX 50 XW/XX/XY/X1)	98-04
Tact 50	
TC 50 M/P/V Gyro Canopy (TA02)	96-00
TC 50 Y/2 (TA02) Gyro Canopy	00-02
TLM 50 F	85
QR 50 D/E/F	83-87
QR 50 M/R/N/W/Y	93-03
XR 50 R1/R2/R3	01-03
XR 50 M5 (AD14) Motard	05
XZ 50 1/2 APE-AC16	01-02
Z 50 R All Models	79-86
CR 60 RF/RG	85-86
ATC 70 All Models	78-85
C 70 All Models	75-85
CF 70 C	77-78
CRF 70 F4/F5/F6/F7/F8/F9/FA/FB/FC/FD	04-13
TRX 70 Fourtrax	86-87
XR 70 RV/RW/RX/R1/R2/R3	97-03
CRM 75 RK/RL/RM/RR	89-94
NF 75	79
NSR 75 N/P/R/X/Y (NS-1)	92-00
SA 75 Vision	89-
SH 75 Scoopy H/K/M/P/DP/S/DS	87-95
XR 75 K4	75-78
XR 75 K5	79
CR 80 RA/RB	80-81
CR 80 RC	82
CR 80 RD/RE	83-84
CR 80 RF	85
CR 80 R2F/R2G	85-86
CR 80 RG/RH/RJ/RK/RL/RM	86-91
CR 80 RN/RR/RS	92-95
CR 80 RT/RBT/RV/RBV/RW/RBW/RX/RBX/R1/RB2	96-02
CRE 80	98-
CRF 80 F4/F5/F6/F7/F8/F9/FB/FC/FD	04-13
MB 80 (MB8)	80-
MBX 80 FWDD/FWDF	83-86
MCX 80	82-
MTX 80 RFD/RFF	83-84
NH 80 MD-D/MD-G	83-86
NH 80 Lead 80	85
NH 80 Lead 80 SS	85
NH 80 MDR	94-

FA, SFA, TT Pad or Brake Shoe	SFAC Carbon Scooter Pads	Speciality Pads - SXR / Vee / MXS	Sintered/ HH Pads/ Grooved Shoes	BRAKE DISC CHOICES - FRONT							Line #
				Left / Gauche / Links Standard Replacement Disc	Right / Droite / Rechts Standard Replacement Disc	Contour Disc Universal left and right fitment	Custom Disc Universal left and right fitment	Vee-Discs Black † See note below	CX Extreme MX Race Disc/ UTVX Disc		
H303											1
SFA193	SFAC193		SFA193HH	MD918D							2
SFA256	SFAC256		SFA256HH	MD923D					VR923		3
H333											4
SFA257	SFAC257			MD919D							5
SFA257	SFAC257			MD919D							6
SFA257	SFAC257			MD919D							7
H333											8
H303											9
FA040											10
SFA131/3			SFA131/3HH	MD931D						VR931	11
H303											12
SFA193	SFAC193		SFA193HH	MD906D						VR906	13
SFA193	SFAC193		SFA193HH	MD920D						VR920	14
SFA193	SFAC193		SFA193HH	MD920D						VR920	15
SFA257	SFAC257										16
H303											17
H304											18
H333			H333G								19
H301											20
H301											21
H301											22
H301											23
FA197			FA197HH								24
H304											25
H301											26
H333			H333G								27
None											28
H303											29
H303											30
H333			H333G								31
H346*			H346G*								32
H333			H333G								33
FA125TT		MXS125	FA125R	MD6001D			MD6001C			MD6001CX	34
H303											35
FA197			FA197HH				MD1142RS				36
H303											37
H303											38
H304			H304G								39
H303			H303G								40
H304			H304G								41
H304			H304G								42
H333			H333G								43
H333			H333G								44
H304			H304G								45
FA084TT		MXS084	FA084R	MD6004D							46
FA084TT		MXS084	FA084R	MD6004D							47
FA084TT		MXS084	FA084R	MD6058D			MD6058C			MD6058CX	48
FA084TT		MXS084	FA084R	MD6058D			MD6058C			MD6058CX	49
H333			H333G								50
FA083/2TT											51
SFA054*	SFAC054*		FA054HH*								52
FA083/2TT											53
H304			H304G								54
H303											55
SFA176											56
SFA176											57
H303											58
H303											59
H303											60

FRONT / AVANT / VORN / FRENTE / ANTERIORE

R Suffix = High Durability Sintered Pad. HH Suffix = High Performance Sintered Pad. TT Suffix = Hard Wearing Off Road Pad. V Suffix = Semi-Sintered Pad. G Suffix = Grooved Shoe.
D Suffix = Drilled Disc. X Suffix = Universal Left or Right Disc. XC Suffix = Contoured Disc. LS Suffix = Left/Steel Disc. RS = Right/Steel Disc.

*-2 Sets Required. † For Vee disc colours add RED, BLU, GRN, GLD, ORG suffix to part number. For Custom Finish Options for Vee-Rotors™ including Splatter discs add suffix CHR, CHGR, CHBL, CHBR - available in various colours see page iv. ☼ - Also available as a Vintage Motorcycle Disc.

JAPANESE Built Motorcycles

Line #	BRAKE DISC CHOICES - FRONT						DISC PAD CHOICES - REAR				BRAKE DISC CHOICES - REAR			
	Oversize 250 /280mm Disc Kit	OSX Oversize 250/280mm Disc Kit	Relocating Bracket for 250/ 280mm Disc	Oversize 320mm Disc Kit	SMX Oversize 320mm Disc Kit	Relocating Bracket for 320mm Disc	FA, SFA, TT Pad or Brake Shoe	SFAC Carbon Scooter Pads	Speciality Pads - SXR / Vee / MXS	Sintered/ HH Pads/ Grooved Shoes	Standard Replacement Disc	Contour Disc Rear fitment	Vee Discs CONTOUR	CX Extreme MX Race Disc
1							H336							
2							H303							
3							H303							
4														
5							H333							
6							H333							
7							H333							
8							H333							
9							H333							
10							H303							
11							H303							
12							H303							
13							H303							
14							H303							
15							SFA234			MD921D		VR921		
16							SFA234			MD921D		VR921		
17							H333		H333G					
18							H333							
19							H333							
20							H333		H333G					
21							H302							
22							H333							
23							H301							
24							FA131TT							
25							H304							
26							H301							
27							H333		H333G					
28							H310		H310G					
29							H303							
30							H303							
31							H333		H333G					
32							H306		H306G					
33							H333		H333G					
34							H304		H304G					
35							H303							
36							SFA131/2		SFA131/2HH	MD1143				
37							H333							
38							H336							
39							H303		H303G					
40							H303		H303G					
41							H304		H304G					
42							H333		H333G					
43							H333		H333G					
44							H338		H338G					
45							H304		H304G					
46							H338		H338G					
47							FA131TT	MXS131	FA131R	MD6005D	MD6005C			
48														
49	OS6058C	OSX6058	BRK026				FA131TT	MXS131	FA131R	MD6005D	MD6005C		MD6005CX	
50	OS6058C	OSX6058	BRK026				FA131TT	MXS131	FA131R	MD6005D	MD6005C		MD6005CX	
51							H333		H333G					
52							H304							
53							H304							
54							H304							
55							H304		H304G					
56							H302							
57							H302							
58							H333							
59							H333							
60														

REAR / ARRIÈRE / HINTEN / POSTERIOR / POSTERIORE

R Suffix = High Durability Sintered Pad. **HH** Suffix = High Performance Sintered Pad. **TT** Suffix = Hard Wearing Off Road Pad. **V** Suffix = Semi Sintered Pad. **G** Suffix = Grooved Shoe.
D Suffix = Drilled Disc. **X** Suffix = Universal Left or Right Disc. **XC** Suffix = Contoured Disc. **LS** Suffix = Left/Steel Disc. **RS** = Right/Steel Disc.

BRAKE APPLICATIONS

*-2 Sets Required. † For Vee disc colours add RED, BLU, GRN, GLD, ORG suffix to part number. For Custom Finish Options for Vee-Rotors™ including Splatter discs add suffix CHR, CHGR, CHBL, CHBR - available in various colours see page iv. ☼ - Also available as a Vintage Motorcycle Disc.

JAPANESE Built Motorcycles



HONDA Contd.



R Suffix = High Durability Sintered Pad. HH Suffix = High Performance Sintered Pad. TT Suffix = Hard Wearing Off Road Pad. V Suffix = Semi-Sintered Pad. G Suffix = Grooved Shoe.

D Suffix = Drilled Disc. X Suffix = Universal Left or Right Disc. XC Suffix = Contoured Disc. LS Suffix = Left/Steel Disc. RS = Right/Steel Disc.

NSR 80 J-2/K/L/N (HC06)	88-92
NSR 80 J-2/K/L/N (HC06) - Floating disc option	88-92
NSR 80 P/R/S (HC06)	93-95
NSR 80 P/R/S (HC06) - Floating disc option	93-95
NSR 80 V (HC06-170)	97
NSR 80 V (HC06-170) - Floating disc option	97
NSR 80 X (HC06-180)	99
NSR 80 X (HC06-180) - Floating disc option	99
XR 80 Z/A/B	80-81
XR 80 R	87-88
CR 85 R3/RB3/R4/RB4/R5/RB5/R6/RB6/R7/RB7	03-07
C 90 All Models	75-92
C 90 All Models	93-03
EZ 90 Cub	91-95
Lead 90	88-
NH 90 M/P/R Yuppy	91-94
SRX 90 Shadow T/W/X	97-99
TRX 90 Fourtrax/Sportrax P/R/S/T/V/W/X/Y/1-6	93-06
TRX 90 EX	07-08
TRX 90 X9/XB/XC	09-14
Astrea Supra NF 100	99
Astrea Grand/Supra (Drum Model)	97-98
CB 100 N	78-80
CRF 100 F4/F5/F6/F7/F8/F9/FA/FB/FC/FD	04-13
H 100 A/SD/SG/SJ	82-92
SCV 100-3/F5 Lead	03-08
SH 100 T/W/X/Y/1 Scoopy	96-01
SJ 100 T/W/X Bali Ex	96-99
XL 100 All models	78-82
XR 100 RP/RR/RS/RT/RV/RW/RX/RY/R1-R3	93-03
XR 100 M5 (HD13) Motard	05
XZ 100 2 APE-HC07	02
ACB 110 CBB/CSB - Vario 110	10
ACD 110 CSB/SCB - Scoopy 110 Fi	11-16
ACC 110 SCB/SCC - ANC 110 Icon	11-12
AFS 110 2SHC/CSFF Wave	12-16
ATC 110 All models	79-84
CRF 110 F	13-20
CT 110 A/B/C/D/K/M	80-88
CT 110 P	89-04
CT 110 X	05-09
NSC 110 CSD/CSE - Spacy 110	12-14
NSC 110 CBFF/CBFH - Dio 110	15-17
NSC 110 WHB/E - Vision 110 14 Inch Wheels	11-16
NSC 110 MPDC/E Vision (16 Inch Wheels)	12-14
NSC 110 MPDH Vision (16 Inch Wheels)	17-18
SCV 110 Lead (NHX 110-WH8 - 3 Bolt Front Disc Fixing)	08-09
SCV 110 Lead (NHX 110-WHA - 4 Bolt Front Disc Fixing)	10-12
ACA 125 CBFE - Air Blade 125	14-16
ANF 125 3/5/T5/6/T6/7/A Innova	03-11
ATC 125 ME/MG	84-85
CA 125 S/T Rebel	95-97
CA 125 V/W/X Rebel	98-00
CB 125 F (GLR 125 1WHF)	15-16
CB 125 F (GLR 125 1WHH)	17-18
CB 125 K1-K5	72-76
CB 125 K6/S2	76
CB 125 S	75-79
CB 125 J	79
CB 125 T	78

FRONT / AVANT / VORN / FRENTE / ANTERIORE

DISC PAD CHOICES - FRONT				BRAKE DISC CHOICES - FRONT						Line #
FA, SFA, TT Pad or Brake Shoe	SFAC Carbon Scooter Pads	Speciality Pads - SXR / Vee / MXS	Sintered/HH Pads/ Grooved Shoes	Left / Gauche / Links Standard Replacement Disc	Right / Droite / Rechts Standard Replacement Disc	Contour Disc Universal left and right fitment	Custom Disc Universal left and right fitment	Vee-Discs Black † See note below	CX Extreme MX Race Disc/ UTVX Disc	Line #
FA086			FA086HH			MD1169C				1
FA086			FA086HH			MD1169CF				2
FA197			FA197HH			MD1169C				3
FA197			FA197HH			MD1169CF				4
FA197			FA197HH			MD1169C				5
FA197			FA197HH			MD1169CF				6
FA197			FA197HH			MD1169C				7
FA197			FA197HH			MD1169CF				8
H304			H304G							9
H333			H333G							10
FA084TT		MXS084	FA084R	MD6058D		MD6058C			MD6058CX	11
H303										12
H304										13
H303										14
SFA131/3			SFA131/3HH							15
SFA131/3			SFA131/3HH							16
SFA131/3			SFA131/3HH	MD931D						17
H303*			H303G*							18
H303*			H303G*							19
H303*			H303G*							20
SFA197			FA197HH							21
H303										22
FA052										23
H333			H333G							24
H303										25
H352										26
SFA193	SFAC193		SFA193HH	MD918D						27
SFA256	SFAC256		SFA256HH	MD923D				VR923		28
H304			H304G							29
H333			H333G							30
FA197			FA197HH							31
H304										32
SFA708				MD9134D				VR9134		33
SFA708				MD9134D				VR9134		34
SFA708				MD9134D				VR9134		35
SFA625					MD9134D			VR9134		36
None										37
H333			H333G							38
H303										39
H304										40
H304										41
SFA708				MD9134D				VR9134		42
SFA708				MD9134D				VR9134		43
SFA603	SFAC603		SFA603HH	MD9134D				VR9134		44
SFA603	SFAC603		SFA603HH	MD9134D				VR9134		45
SFA708				MD9134D				VR9134		46
SFA323	SFAC323		SFA323HH	MD923D				VR923		47
SFA603	SFAC603		SFA603HH	MD9140D				VR9140		48
SFA708				MD9134D				VR9134		49
SFA375										50
H303			H303G							51
FA228			FA228HH	MD1030						52
FA256			FA256HH	MD1030						53
FA197			FA197HH		MD1030					54
FA716					MD1030					55
H308										56
H303										57
H303										58
FA040										59
FA040										60

*-2 Sets Required. † For Vee disc colours add RED, BLU, GRN, GLD, ORG suffix to part number. For Custom Finish Options for Vee-Rotors™ including Splatter discs add suffix CHR, CHGR, CHBL, CHBR - available in various colours see page iv. ☼ - Also available as a Vintage Motorcycle Disc.

JAPANESE Built Motorcycles

Line #	BRAKE DISC CHOICES - FRONT						DISC PAD CHOICES - REAR				BRAKE DISC CHOICES - REAR			
	Oversize 250 /280mm Disc Kit	OSX Oversize 250/280mm Disc Kit	Relocating Bracket for 250/ 280mm Disc	Oversize 320mm Disc Kit	SMX Oversize 320mm Disc Kit	Relocating Bracket for 320mm Disc	FA, SFA, TT Pad or Brake Shoe	SFAC Carbon Scooter Pads	Speciality Pads - SXR / Vee / MXS	Sintered/ HH Pads/ Grooved Shoes	Standard Replacement Disc	Contour Disc Rear fitment	Vee Discs CONTOUR	CX Extreme MX Race Disc
1							SFA131/3			SFA131/3HH		MD1170C		
2							SFA131/3			SFA131/3HH		MD1170C		
3							SFA131/3			SFA131/3HH		MD1170C		
4							SFA131/3			SFA131/3HH		MD1170C		
5							SFA131/3			SFA131/3HH		MD1170C		
6							SFA131/3			SFA131/3HH		MD1170C		
7							SFA131/3			SFA131/3HH		MD1170C		
8							SFA131/3			SFA131/3HH		MD1170C		
9							H304			H304G				
10							H333			H333G				
11	OS6058C	OSX6058	BRK026				FA131TT		MXS131	FA131R	MD6005D	MD6005C		MD6005CX
12							H303							
13							H304							
14							H303							
15							H336							
16							H303							
17							H303							
18							H306			H306G				
19							H306			H306G				
20							H306			H306G				
21							H303							
22							H303							
23							H304							
24							H333			H333G				
25							H303							
26							H352							
27							H303							
28							H303							
29							H304			H304G				
30							H333			H333G				
31							FA131TT							
32							H304							
33							H352							
34							H352							
35							H352							
36							H353							
37							H306			H306G				
38							H333			H333G				
39							H304							
40							H304							
41							H352							
42							H352							
43							H352							
44							H352							
45							H352							
46							H352							
47							H352							
48							H352							
49							H352							
50							H353							
51							H306			H306G				
52							H318							
53							H318							
54							H352							
55							H352							
56							H310			H310G				
57							H310			H310G				
58							H303							
59							H304							
60							H310			H310G				

REAR / ARRIÈRE / HINTEN / POSTERIOR / POSTERIORE

R Suffix = High Durability Sintered Pad. **HH** Suffix = High Performance Sintered Pad. **TT** Suffix = Hard Wearing Off Road Pad. **V** Suffix = Semi Sintered Pad. **G** Suffix = Grooved Shoe.
D Suffix = Drilled Disc. **X** Suffix = Universal Left or Right Disc. **XC** Suffix = Contoured Disc. **LS** Suffix = Left/Steel Disc. **RS** = Right/Steel Disc.

BRAKE APPLICATIONS

*-2 Sets Required. † For Vee disc colours add RED, BLU, GRN, GLD, ORG suffix to part number. For Custom Finish Options for Vee-Rotors™ including Splatter discs add suffix CHR, CHGR, CHBL, CHBR - available in various colours see page iv. ☼ - Also available as a Vintage Motorcycle Disc.



HONDA Contd.

JAPANESE Built Motorcycles

DISC PAD CHOICES - FRONT

BRAKE DISC CHOICES - FRONT

CB 125 T2	79
CB 125 TDC/TDE/TDJ	83-89
CB 125 RS	83
CB 125 R	18-19
CBF 125 6 Stunner	06
CBF 125 M7 Stunner	07
CBF 125 M9/MA/MB/MD/ME	09-15
CB 125 F	17-20
CB 125 R	18-20
CBR 125 R4/R5/RS5/RW5/RS6/RW6	
(6 Bolt Front Disc Fixing)	04-06
CBR 125 RW7/RW8/RW9/RWA (6 Bolt Front Disc Fixing)	07-10
CBR 125 RWB/RC/RD/RF/RG (6 Bolt Front Disc Fitting)	11-16
CBX 125 TS Custom	82-
CBX 125 F	84-
CBX 125 Custom	88-
CD 125 TC	78
CG 125 Cargo	09-10
CG 125 K1/B/C/E	77-84
CG 125 BR-K/BR-T/95	85-97
CG 125 TAN/M1/1	98-03
CG 125 ES4-ES8	04-08
CG 125 Job	05
CH 125 D/E/G Spacy	84-86
CH 125 J/K/L/M/P/R/T Spacy	88-96
CLR 125 W City Fly	99-03
CM 125 CC/CF	82-85
CR 125 M2-M4	76-78
CR 125 RZ/RA/RB	79-81
CR 125 RC	82
CR 125 RD	83
CR 125 RE/RF	84-85
CR 125 RG	86
CR 125 RH/RJ	87-88
CR 125 RK	89
CR 125 RL/RM	90-91
CR 125 RN/RP/RR	92-94
CR 125 RS/RT/RV	95-97
CR 125 RW/RX/RV/R1	98-01
CR 125 R2/R3	02-03
CR 125 R4/R5/R6/R7	04-07
CRF 125 F (Small wheel FR 17 Inch/RR 14 Inch Wheels)	14-20
CRF 125 FB (Big wheel FR 19 Inch/RR 16 Inch Wheels)	14-20
CRM 125 RL/RM/R/PP/RR/RV/RX	90-99
CT 125 C	85
FES 125 W/Y/1/2 Pantheon	98-02
FES 125 3/4/5 Pantheon	03-06
FES 125 7/9/A/B S-Wing (Non ABS Model)	07-13
FES 125 A7/A9/AA/AB S-Wing (ABS Model)	07-15
FS 125 Sonic	03-04
LS 125 RY	00-
MBX 125 FE	84-86
Monkey Z 125 M AC	18-20
MSX 125 D/E/F/G/H Grom (Non ABS)	13-20
MSX 125 AG/AH GROM (ABS)	18-20
MTX 125 RWD	83-84
MTX 125 RWE/RWF/RWH/RWL	85-95
NES 125 Y/1/2/3/4/5/6 (@ 125 Scooter)	00-06
NH 125 MD-D Lead	83

FRONT / AVANT / VORN / FRENTE / ANTERIORE

FA, SFA, TT Pad or Brake Shoe	SFAC Carbon Scooter Pads	Speciality Pads - SXR / Vee / MXS	Sintered/HH Pads/ Grooved Shoes	Left / Gauche / Links Standard Replacement Disc	Right / Droite / Rechts Standard Replacement Disc	Contour Disc Universal left and right fitment	Custom Disc Universal left and right fitment	Vee-Discs Black † See note below	CX Extreme MX Race Disc/ UTVX Disc
FA052									
FA069			FA069HH						
SFA054	SFAC054		FA054HH						
FA715		FA715V	FA715HH		MD1030	TBA			
FA715		FA715V	FA715HH		MD1030				
FA375			FA375HH		MD1030				
FA716									
			FA679HH						
FA375			FA375HH		MD644				
FA375			FA375HH		MD644				
FA375			FA375HH		MD1166RS				
SFA054	SFAC054		FA054HH						
FA069			FA069HH						
FA086			FA086HH						
H312									
H352									
H303									
H330									
H330									
SFA054	SFAC054		FA054HH						
H352									
H303									
H303									
FA256			FA256HH	MD1147LS					
H312									
H304			H304G						
H324			H324G						
H319			H319G						
H331			H331G						
FA092TT			FA092R	MD6087D					
FA092TT			FA092R	MD6087D					
FA125TT		MXS125	FA125R	MD6087D					
FA125TT		MXS125	FA125R	MD6008D					
FA125TT		MXS125	FA125R	MD6003D					
FA125TT		MXS125	FA125R	MD6001D		MD6001C		MD6001CX	
FA185TT		MXS185	FA185R	MD6037D		MD6037C		MD6037CX	
FA185TT		MXS185	FA185R	MD6037D		MD6037C		MD6037CX	
FA185TT		MXS185	FA185R	MD6037D		MD6037C		MD6037CX	
FA185TT		MXS185	FA185R	MD6037D		MD6037C		MD6037CX	
FA185TT		MXS185	FA185R	MD6037D		MD6037C		MD6037CX	
FA185TT		MXS185	FA185R	MD6390D		MD6390C			
FA185TT		MXS185	FA185R	MD6390D		MD6390C			
FA256TT			FA256HH	MD1147LS					
H304									
SFA281			SFA281HH	MD922D				VR922	
SFA281			SFA281HH	MD922D				VR922	
SFA388	SFAC388		SFA388HH	MD922D				VR922	
SFA388	SFAC388		SFA388HH	MD922D				VR922	
SFA086	SFAC086		SFA086HH						
FA086			FA086HH						
FA086			FA086HH						
FA375					MD1191	MD1191C		VR1191	
FA375			FA375HH		MD1183			VR1183	
FA375			FA375HH		MD1191	MD1191C		VR1191	
H304									
FA092TT			FA092R	MD6087D					
SFA323	SFAC323		SFA323HH	MD970D				VR970	
H303									

Line #
1
2
3
4
5
6
7
8
9
10
11
12
13
14
15
16
17
18
19
20
21
22
23
24
25
26
27
28
29
30
31
32
33
34
35
36
37
38
39
40
41
42
43
44
45
46
47
48
49
50
51
52
53
54
55
56
57
58
59
60

R Suffix = High Durability Sintered Pad. HH Suffix = High Performance Sintered Pad. TT Suffix = Hard Wearing Off Road Pad. V Suffix = Semi Sintered Pad. G Suffix = Grooved Shoe.

D Suffix = Drilled Disc. X Suffix = Universal Left or Right Disc. XC Suffix = Contoured Disc. LS Suffix = Left/Steel Disc. RS = Right/Steel Disc.

*-2 Sets Required. † For Vee disc colours add RED, BLU, GRN, GLD, ORG suffix to part number. For Custom Finish Options for Vee-Rotors™ including Splatter discs add suffix CHR, CHGR, CHBL, CHBR - available in various colours see page iv. Ⓢ - Also available as a Vintage Motorcycle Disc.

JAPANESE Built Motorcycles

Line #	BRAKE DISC CHOICES - FRONT						DISC PAD CHOICES - REAR				BRAKE DISC CHOICES - REAR			
	Oversize 250 /280mm Disc Kit	OSX Oversize 250/280mm Disc Kit	Relocating Bracket for 250/ 280mm Disc	Oversize 320mm Disc Kit	SMX Oversize 320mm Disc Kit	Relocating Bracket for 320mm Disc	FA, SFA, TT Pad or Brake Shoe	SFAC Carbon Scooter Pads	Speciality Pads - SXR / Vee / MXS	Sintered/ HH Pads/ Grooved Shoes	Standard Replacement Disc	Contour Disc Rear fitment	Vee Discs CONTOUR	CX Extreme MX Race Disc
1							H310			H310G				
2							H310			H310G				
3							H310			H310G				
4							FA629				TBA			
5							H352							
6							H352							
7							H352							
8							FA629			FA629HH				
9							FA629			FA629HH				
10														
11							FA343			FA343HH	MD1151			
12							FA343			FA343HH	MD1151			
13							FA629			FA629HH	MD1151			
14							H310			H310G				
15							H318							
16							H304							
17							H310			H310G				
18							H352							
19							H303							
20							H303							
21							H304							
22							H352							
23							H353							
24							H303							
25							H303							
26							H304							
27							H310			H310G				
28							H304			H304G				
29							H330			H330G				
30							H330			H330G				
31							H331			H331G				
32							H331			H331G				
33							H344			H344G				
34							FA131TT	MXS131	FA131R	MD6009D				
35							FA131TT	MXS131	FA131R	MD6002D				
36							FA131TT	MXS131	FA131R	MD6002D				
37	OSX6001EC	OSX6001E	BRK004				FA131TT	MXS131	FA131R	MD6002D				
38	OSX6037C	OSX6037	BRK004	SM6037C	SMX6037	BRK009	FA131TT	MXS131	FA131R	MD6002D				
39	OSX6037C	OSX6037	BRK004	SM6037C	SMX6037	BRK009	FA131TT	MXS131	FA131R	MD6124D	MD6124C		MD6124CX	
40	OSX6037C	OSX6037	BRK004	SM6037C	SMX6037	BRK009	FA346TT	MXS346	FA346R	MD6191D	MD6191C♦		MD6191CX	
41	OSX6437C	OSX6437	BRK005	SM6437C	SMX6437	BRK006	FA346TT	MXS346	FA346R	MD6191D	MD6191C♦		MD6191CX	
42							H333			H333G				
43							H333			H333G				
44							FA047/3							
45							H304							
46							H351							
47							SFA140	SFAC140	SFA140HH	MD9135D		VR9135		
48							SFA415	SFAC415	SFA415HH	MD9135D		VR9135		
49							SFA415	SFAC415	SFA415HH	MD9135D		VR9135		
50							SFA375							
51							FA197		FA197HH					
52							H304							
53							FA343		FA343HH	MD1184	MD1184C	VR1184		
54	OSX1183		BRK037				FA629		FA629HH	MD1184	MD1184C	VR1184		
55							FA629		FA629HH	MD1184	MD1184C	VR1184		
56							H304							
57							H304		H304G					
58							H352							
59							H303							
60														

REAR / ARRIÈRE / HINTEN / POSTERIOR / POSTERIORE

*-2 Sets Required. † For Vee disc colours add RED, BLU, GRN, GLD, ORG suffix to part number. For Custom Finish Options for Vee-Rotors™ including Splatter discs add suffix CHR, CHGR, CHBL, CHBR - available in various colours see page iv. ♦ - Also available as a Vintage Motorcycle Disc.

R Suffix = High Durability Sintered Pad. HH Suffix = High Performance Sintered Pad. TT Suffix = Hard Wearing Off Road Pad. V Suffix = Semi Sintered Pad. G Suffix = Grooved Shoe. D Suffix = Drilled Disc. X Suffix = Universal Left or Right Disc. XC Suffix = Contoured Disc. LS Suffix = Left/Steel Disc. RS = Right/Steel Disc.

Part numbers, prefixes, suffixes, photos and illustrations shown in this catalogue are trademarks and/or copyrights of EBC Brakes or the trademark owner A C Freeman Investments Ltd and use without express written permission of the owners is punishable by law.

JAPANESE Built Motorcycles



HONDA Contd.



R Suffix = High Durability Sintered Pad. HH Suffix = High Performance Sintered Pad. TT Suffix = Hard Wearing Off Road Pad. V Suffix = Semi-Sintered Pad. G Suffix = Grooved Shoe.

D Suffix = Drilled Disc. X Suffix = Universal Left or Right Disc. XC Suffix = Contoured Disc. LS Suffix = Left/Steel Disc. RS = Right/Steel Disc.

NH 125 Lead	86-87
NS 125 FG/FH/RH	86-87
NSR 125 FJ/FK/FL/FM/FN	88-92
NSR 125 RK/RL/RM/RN	89-92
NSR 125 RR/RS/RV/RW/RX/RY/R1	93-01
NSS 125 Forza (2 Piston Caliper)	15-18
NX 125 K/S/F Transcity	89-97
NXR 125 Bros ES/KS	05
PCX 125 (WW 125 EX2 C/D/F/H/J)	12-18
PCX 125S (WW 125 AK)	18-20
PCX 125	18-20
PES 125 6/7/8/9/A (PS125)	06-09
PES 125 R8/R9/RA (PS125)	08-09
SES 125 2/3/4 Dylan	02-07
SH 125 1/3 (Carb/Rear drum model)	01-03
SH 125i 4/5/6/7/8 (Fuel Injection/Rear Drum Model)	04-08
SH 125i 9/A/B (Fuel Injection/Rear Disc Model)	09-12
SH 125i D9 (Fuel Injection/Rear Drum Model)	09
SH 125i R8 (Fuel Injection/Rear Drum Model)	08
SH 125i RA (Fuel Injection/Rear Disc Model)	10-14
SH 125i S7/S8 (Fuel Injection/Rear Drum Model)	07-08
SH 125i Mode (ANC 125 E)	14-18
SH 125i (2 Piston Caliper)	14-18
SH 125i (3 Piston Caliper/ABS)	14-16
SL 125 KIA	76
SL 125 KID/E/F/G/K2A	76-80
Super Cub C 125 (ABS)	18-20
Super Cub C 125 (ABS) 007	18-20
TL 125	76
TRX 125 J	88
VT 125 CX-C8 Shadow	99-08
XL 125 K2	78
XL 125 K3/K4	79
XL 125 SZ/SA/SB/SC/RC	79-82
XL 125 Paris-Dakar	85
XL 125 RF/RH	85-86
XL 125 V1-VA Varadero	01-16
XLR 125 RW	98-01
XR 125 L3/L4/L5/L6/L7/L8	03-08
CBF 150 5	05
CBF 150 M5 Unicorn	05
CBF 150 6 (Spoke Wheels)	06
CBF 150 M6/M7 Unicorn (Spoke Wheels)	06-07
CBF 150 M7/M9/MA Unicorn (Cast Wheels)	07-10
CBF 150 MB/MC Unicorn (Cast Wheels)	11-12
CBR 150 R	00-03
CG 150 ESD Titan	04-05
CG 150 KS/ES Titan	04-05
CRF 150 F3/F4/F5/F6/F7/F8/F9	03-20
CRF 150 R (Small wheel FR 17 Inch/RR 14 Inch)	03-20
CRF 150 RB (Big wheel FR 19 Inch/RR 16 Inch)	03-20
FES 150 W/Y/1/2 Pantheon	98-02
FES 150 3/4/5 Pantheon	03-06
FES 150 7/9 S-Wing (Non ABS Model)	07-13
FES 150 A7/A9 S-Wing (ABS Model)	07-13
NES 150 Y/1/2/3/4/5/6 @ 150 Scooter	01-06
NSR 150 RR (Malaysian Market)	
PCX 150 (WW 150 EX2)	12-20
PCX 150 (ABS)	18-20
PES 150 6/7/8/9/A (PS150)	06-10

FRONT / AVANT / VORN / FRENTE / ANTERIORE

DISC PAD CHOICES - FRONT					BRAKE DISC CHOICES - FRONT						Line #
FA, SFA, TT Pad or Brake Shoe	SFAC Carbon Scooter Pads	Speciality Pads - SXR / Vee / MXS	Sintered/HH Pads/ Grooved Shoes	Left / Gauche / Links Standard Replacement Disc	Right / Droite / Rechts Standard Replacement Disc	Contour Disc Universal left and right fitment	Custom Disc Universal left and right fitment	Vee-Discs Black † See note below	CX Extreme MX Race Disc/ UTVX Disc	Line #	
SFA176										1	
FA256			FA256HH	MD1084LS						2	
FA256			FA256HH	MD1088LS						3	
FA256			FA256HH	MD1088LS						4	
FA256			FA256HH	MD1109LS						5	
SFA196	SFAC196		SFA196HH							6	
FA256TT			FA256HH	MD1147LS						7	
H352										8	
SFA603	SFAC603		SFA603HH	MD9134D				VR9134		9	
SFA693	SFAC693		SFA693HH	MD9134D						10	
SFA723										11	
SFA323	SFAC323		SFA323HH	MD970D				VR970		12	
SFA323	SFAC323		SFA323HH	MD970D				VR970		13	
SFA323	SFAC323		SFA323HH	MD970D				VR970		14	
SFA323	SFAC323		SFA323HH	MD970D				VR970		15	
SFA323	SFAC323		SFA323HH	MD970D				VR970		16	
SFA388	SFAC388		SFA388HH	MD922D				VR922		17	
SFA323	SFAC323		SFA323HH	MD922D				VR922		18	
SFA323	SFAC323		SFA323HH	MD970D				VR970		19	
SFA388	SFAC388		SFA388HH	MD922D				VR922		20	
SFA323	SFAC323		SFA323HH	MD970D				VR970		21	
SFA603	SFAC603		SFA603HH	MD9134D						22	
SFA196	SFAC196		SFA196HH	MD922D				VR922		23	
SFA388	SFAC388		SFA388HH	MD922D				VR922		24	
H303										25	
H304										26	
FA691			FA691HH							27	
FA691			FA691HH							28	
H304			H304G							29	
H303*			H303G*							30	
FA197			FA197HH		MD1030					31	
H304			H304G							32	
H303			H303G							33	
H304			H304G							34	
FA256TT			FA256HH							35	
FA092TT			FA092R	MD6087D						36	
FA197			FA197HH		MD1150RS					37	
FA185TT		MXS185	FA185R	MD6001D		MD6001C			MD6001CX	38	
FA185TT		MXS185	FA185R							39	
FA715		FA715V	FA715HH			N/A				40	
FA715		FA715V	FA715HH			N/A				41	
FA715		FA715V	FA715HH		MD1030					42	
FA715		FA715V	FA715HH		MD1030					43	
FA715		FA715V	FA715HH		MD1030					44	
FA715		FA715V	FA715HH		MD1030					45	
FA375			FA375HH		MD644					46	
FA054TT		MXS054	FA054R							47	
FA054TT		MXS054	FA054R							48	
FA185TT		MXS185	FA185R	MD6317D						49	
FA084TT		MXS084	FA084R	MD6314D		MD6314C			MD6314CX	50	
FA084TT		MXS084	FA084R	MD6314D		MD6314C			MD6314CX	51	
SFA281			SFA281HH	MD922D				VR922		52	
SFA281			SFA281HH	MD922D				VR922		53	
SFA388	SFAC388		SFA388HH	MD922D				VR922		54	
SFA388	SFAC388		SFA388HH	MD922D				VR922		55	
SFA323	SFAC323		SFA323HH	MD970D				VR970		56	
FA197			FA197HH							57	
SFA603	SFAC603		SFA603HH	MD9134D				VR9134		58	
SFA693	SFAC603		SFA693HH	MD9134D				VR9134		59	
SFA323	SFAC323		SFA323HH	MD970D				VR970		60	

*-2 Sets Required. † For Vee disc colours add RED, BLU, GRN, GLD, ORG suffix to part number. For Custom Finish Options for Vee-Rotors™ including Splatter discs add suffix CHR, CHGR, CHBL, CHBR - available in various colours see page iv. ☼ - Also available as a Vintage Motorcycle Disc.

JAPANESE Built Motorcycles

Line #	BRAKE DISC CHOICES - FRONT						DISC PAD CHOICES - REAR				BRAKE DISC CHOICES - REAR			
	Oversize 250 /280mm Disc Kit	OSX Oversize 250/280mm Disc Kit	Relocating Bracket for 250/ 280mm Disc	Oversize 320mm Disc Kit	SMX Oversize 320mm Disc Kit	Relocating Bracket for 320mm Disc	FA, SFA, TT Pad or Brake Shoe	SFAC Carbon Scooter Pads	Speciality Pads - SXR / Vee / MXS	Sintered/ HH Pads/ Grooved Shoes	Standard Replacement Disc	Contour Disc Rear fitment	Vee Discs CONTOUR	CX Extreme MX Race Disc
1							H303							
2							H303							
3							FA047/3							
4							FA047/3							
5							FA047/3							
6							SFA415	SFAC415	SFA415HH					
7							H303							
8							H353							
9							H352							
10							H352							
11							H352							
12							H352							
13							H352							
14							H352							
15							H352							
16							H352							
17							SFA415	SFAC415	SFA415HH	MD9139D		VR9139		
18							H352							
19							H352							
20							SFA415	SFAC415	SFA415HH	MD9139D		VR9139		
21							H352							
22							H352							
23							SFA415	SFAC415	SFA415HH	MD9139D		VR9139		
24							SFA415	SFAC415	SFA415HH	MD9139D		VR9139		
25							H303							
26							H304							
27							H352							
28							H352							
29							H304		H304G					
30							H306		H306G					
31							H318							
32							H304		H304G					
33							H304		H304G					
34							H304		H304G					
35							H303							
36							H304		H304G					
37							FA343		FA343HH	MD1151				
38							H304		H304G					
39							H304		H304G					
40							H352							
41							H352							
42							H352							
43							H352							
44							H352							
45							FA629		FA629HH	MD1151				
46							FA343		FA343HH	MD1151				
47							H352							
48							H352							
49		OSX6317	BRK009				H304		H304G					
50		OSX6314	BRK026				FA346TT	MXS346	FA346R	MD6316D	MD6316C		MD6316CX	
51		OSX6314	BRK026				FA346TT	MXS346	FA346R	MD6316D	MD6316C		MD6316CX	
52							H351							
53							SFA140	SFAC140	SFA140HH	MD9135D		VR9135		
54							SFA415	SFAC415	SFA415HH	MD9135D		VR9135		
55							SFA415	SFAC415	SFA415HH	MD9135D		VR9135		
56							H352							
57							FA197		FA197HH					
58							H352							
59							H352							
60							H352							

REAR / ARRIÈRE / HINTEN / POSTERIOR / POSTERIORE

R Suffix = High Durability Sintered Pad. **HH** Suffix = High Performance Sintered Pad. **TT** Suffix = Hard Wearing Off Road Pad. **V** Suffix = Semi Sintered Pad. **G** Suffix = Grooved Shoe.
D Suffix = Drilled Disc. **X** Suffix = Universal Left or Right Disc. **XC** Suffix = Contoured Disc. **LS** Suffix = Left/Steel Disc. **RS** = Right/Steel Disc.

BRAKE APPLICATIONS

*-2 Sets Required. † For Vee disc colours add RED, BLU, GRN, GLD, ORG suffix to part number. For Custom Finish Options for Vee-Rotors™ including Splatter discs add suffix CHR, CHGR, CHBL, CHBR - available in various colours see page iv. ☺ - Also available as a Vintage Motorcycle Disc.

JAPANESE Built Motorcycles



HONDA Contd.

R Suffix = High Durability Sintered Pad. **HH** Suffix = High Performance Sintered Pad. **TT** Suffix = Hard Wearing Off Road Pad. **V** Suffix = Semi Sintered Pad. **G** Suffix = Grooved Shoe.

D Suffix = Drilled Disc. **X** Suffix = Universal Left or Right Disc. **XC** Suffix = Contoured Disc. **LS** Suffix = Left/Steel Disc. **RS** = Right/Steel Disc.

PES 150 R8/R9/RA (PS150)	08-11
SES 150 2/3/4 Dylan	02-06
SH 150 1/3 (CARB/Rear Drum Model)	01-03
SH 150i 4/5/6/7/8 (Fuel Injection/Rear Drum Model)	04-08
SH 150i 9/A/B (Fuel Injection/Rear Disc Model)	09-12
SH 150 i-D9 (Fuel Injection/Rear Drum Model)	09
SH 150i R8 (Fuel Injection/Rear Drum Model)	08
SH 150i RA (Fuel Injection/Rear Disc Model)	10-14
SH 150i S7/S8 (Fuel Injection/Rear Drum Model)	07-08
SH 150i (2 Piston Caliper/ABS)	14-18
SH 150i (3 Piston Caliper/ABS)	14-16
CB 175 All models	74-76
CD 175 All models	67-79
ATC 185 A/SB	80-81
CD 185 T	78
XL 185 SZ/SA/SB	80-82
ATC 200 B/ESE/ESF/SE	81-84
ATC 200 XD	83
TRX 200 L/M/DM/DN	90-93
CB 200 B	76-79
CBX 200 Strada	97-01
CD 200 TA/TB	79-80
CM 200 TA/TB	79-80
CTX 200/CTX 200 A Bushlander	04-16
MTX 200 RWD	83-84
MTX 200 RWF	85
TA 200 (TA Shadow)	02-05
TL 200 J/Y Colin Seeley	76-78
TLR 200 D/E	83-85
TLR 200 G/H	86-87
TRX 200 L/M	90-91
TRX 200 D	91-97
TRX 200 SX	86-87
XL 200 L	85
XL 200 R	85
XR 200	80-84
XR 200 R	81-02
TLM 220 R	88-92
FTR 223 Y/2/A2 (MC34)	00-02
CRF 230 F AC	04-20
CRF 230 L	08-10
CRF 230 M (Supermoto)	09-10
SL 230 Free Landsports (MD33) V/W/X/1	97-01
XL 230 2 (MC36)	02
ATC 250 RB	81
ATC 250 RC	82
ATC 250 RD	83-84
ATC 250 RF/RG	85-86
ATC 250 ESF/ESG/ESH/ESJ	85-88
AX-1 (NX 250 J/K/R/R3)	89-94
CB 250 K3-K5	73-75
CB 250 G5	75
CB 250 T	78
CB 250 N/NA/NB/NDB/NDC	78-82
CB 250 RSA/RSD	81-84
CB 250 FT/FV/FX/FY/F1 Hornet	96-01
CB 250 N/T/W/X/Y/1/4 Two Fifty	92-05
CBF 250 4/6	04-06
CBR 250 FG/FGYA (MC14)	86
CBR 250 RH (MC17)	87

FRONT / AVANT / VORN / FRENTE / ANTERIORE

DISC PAD CHOICES - FRONT				BRAKE DISC CHOICES - FRONT						Line #
FA, SFA, TT Pad or Brake Shoe	SFAC Carbon Scooter Pads	Speciality Pads - SXR / Vee / MXS	Sintered/HH Pads/ Grooved Shoes	Left / Gauche / Links Standard Replacement Disc	Right / Droite / Rechts Standard Replacement Disc	Contour Disc Universal left and right fitment	Custom Disc Universal left and right fitment	Vee-Discs Black † See note below	CX Extreme MX Race Disc/ UTVX Disc	Line #
SFA323	SFAC323		SFA323HH	MD970D				VR970		1
SFA323	SFAC323		SFA323HH	MD970D				VR970		2
SFA323	SFAC323		SFA323HH	MD970D				VR970		3
SFA323	SFAC323		SFA323HH	MD970D				VR970		4
SFA388	SFAC388		SFA388HH	MD922D				VR922		5
SFA323	SFAC323		SFA323HH	MD922D				VR922		6
SFA323	SFAC323		SFA323HH	MD970D				VR970		7
SFA388	SFAC388		SFA388HH	MD922D				VR922		8
SFA323	SFAC323		SFA323HH	MD970D				VR970		9
SFA196	SFAC196		SFA196HH	MD922D				VR922		10
SFA388	SFAC388		SFA388HH	MD922D				VR922		11
H308										12
H306										13
H303			H303G							14
H312										15
H304			H304G							16
H303			H303G							17
				MD6059D						18
H345*			H345G*							19
SFA054	SFAC054		SFA054HH							20
H312										21
H312										22
FA185TT		MXS185	FA185R	MD6001D		MD6001C			MD6001CX	23
H304			H304G							24
FA092TT			FA092R	MD6087D						25
FA197			FA197HH		MD1030					26
H304			H304G							27
H333			H333G							28
H304			H304G							29
H345*			H345G*							30
H345*			H345G*							31
H345*			H345G*							32
H345*			H345G*							33
FA256TT			FA256HH							34
FA092TT			FA092R							35
H304			H304G							36
H304			H304G							37
FA624TT										38
FA092TT			FA092R							39
FA185TT		MXS185	FA185R	MD6001D		MD6001C			MD6001CX	40
FA185TT		MXS185	FA185R	MD6001D		MD6001C			MD6001CX	41
FA185TT		MXS185	FA185R	MD6001D		MD6001C			MD6001CX	42
FA185TT		MXS185	FA185R	MD6001D		MD6001C			MD6001CX	43
H352										44
FA054TT		MXS054	FA054R		MD6060D					45
FA084TT		MXS084	FA084R		MD6060D					46
FA084TT		MXS084	FA084R		MD6059D					47
FA092TT			FA092R	MD6059D						48
H306			H306G							49
FA125TT		MXS125	FA125R	MD6001D		MD6001C			MD6001CX	50
H314										51
FA013										52
FA045										53
FA045				MD1036LS						54
FA045										55
FA187			FA187HH		MD1144RS					56
FA196			FA196HH	MD1089LS						57
FA197			FA197HH		MD1166RS					58
FA121*			FA121HH*	MD1006	MD1006	MD1006C*				59
FA121*			FA121HH*	MD1006	MD1006	MD1006C*				60

*-2 Sets Required. † For Vee disc colours add RED, BLU, GRN, GLD, ORG suffix to part number. For Custom Finish Options for Vee-Rotors™ including Splatter discs add suffix CHR, CHGR, CHBL, CHBR - available in various colours see page iv. Ⓢ - Also available as a Vintage Motorcycle Disc.

JAPANESE Built Motorcycles

Line #	BRAKE DISC CHOICES - FRONT						DISC PAD CHOICES - REAR				BRAKE DISC CHOICES - REAR			
	Oversize 250 /280mm Disc Kit	OSX Oversize 250/280mm Disc Kit	Relocating Bracket for 250/ 280mm Disc	Oversize 320mm Disc Kit	SMX Oversize 320mm Disc Kit	Relocating Bracket for 320mm Disc	FA, SFA, TT Pad or Brake Shoe	SFAC Carbon Scooter Pads	Speciality Pads - SXR / Vee / MXS	Sintered/ HH Pads/ Grooved Shoes	Standard Replacement Disc	Contour Disc Rear fitment	Vee Discs CONTOUR	CX Extreme MX Race Disc
1							H352							
2							H352							
3							H352							
4							H352							
5							SFA415	SFAC415		SFA415HH	MD9139D		VR9139	
6							H352							
7							H352							
8							SFA415	SFAC415		SFA415HH	MD9139D		VR9139	
9							H352							
10							SFA415	SFAC415		SFA415HH	MD9139D		VR9139	
11							SFA415	SFAC415		SFA415HH	MD9139D		VR9139	
12							H309							
13							H307							
14							H306			H306G				
15							H310			H310G				
16							H304			H304G				
17							H306			H306G				
18										FA084/2R	MD6059D			
19							H306			H306G				
20							H309							
21							H352							
22							H310			H310G				
23							H310			H310G				
24							H304			H304G				
25							H304			H304G				
26							H304			H304G				
27							H304			H304G				
28							FA197			FA197HH				
29							H304			H304G				
30							H333			H333G				
31							H333			H333G				
32							H306			H306G				
33							H306			H306G				
34							H306			H306G				
35							H303							
36							H303							
37							H304			H304G				
38							H304			H304G				
39							H304			H304G				
40	OS6001C	OSX6001	BRK008		SMX6001	BRK009	H304			H304G				
41	OS6001C	OSX6001	BRK008		SMX6001	BRK009	FA131TT	MXS131	FA131R	MD6013D	MD6013C		MD6013CX	
42	OS6001C	OSX6001	BRK008		SMX6001	BRK009	FA131TT	MXS131	FA131R	MD6013D	MD6013C		MD6013CX	
43							FA131TT	MXS131	FA131R	MD6013D	MD6013C		MD6013CX	
44							H352							
45							H306			H306G				
46							H306			H306G				
47							FA084TT	MXS084	FA084R	MD6059D				
48							FA092TT		FA092R	MD6007D				
49							H315			H315G				
50							FA153			MD6198D				
51							H315							
52							H315							
53							H313							
54							H313							
55							H309							
56							FA140	FA140V	FA140HH	MD1004	MD1004C			
57							H310			H310G				
58							H352							
59							H309							
60							FA140	FA140V	FA140HH	MD1002				

REAR / ARRIÈRE / HINTEN / POSTERIOR / POSTERIORE

R Suffix = High Durability Sintered Pad. **HH** Suffix = High Performance Sintered Pad. **TT** Suffix = Hard Wearing Off Road Pad. **V** Suffix = Semi Sintered Pad. **G** Suffix = Grooved Shoe.
D Suffix = Drilled Disc. **X** Suffix = Universal Left or Right Disc. **XC** Suffix = Contoured Disc. **LS** Suffix = Left/Steel Disc. **RS** = Right/Steel Disc.

BRAKE APPLICATIONS

*-2 Sets Required. † For Vee disc colours add RED, BLU, GRN, GLD, ORG suffix to part number. For Custom Finish Options for Vee-Rotors™ including Splatter discs add suffix CHR, CHGR, CHBL, CHBR - available in various colours see page iv. Ⓢ - Also available as a Vintage Motorcycle Disc.

JAPANESE Built Motorcycles



HONDA Contd.



R Suffix = High Durability Sintered Pad. HH Suffix = High Performance Sintered Pad. TT Suffix = Hard Wearing Off Road Pad. V Suffix = Semi-Sintered Pad. G Suffix = Grooved Shoe.
 D Suffix = Drilled Disc. X Suffix = Universal Left or Right Disc. XC Suffix = Contoured Disc. LS Suffix = Left/Steel Disc. RS = Right/Steel Disc.

CBR 250 RJ/RK/RK2 (MC19)	88-89
CBR 250 RRL/RRN/RRR (MC22)	90-94
CBR 250 RB/RC (Non ABS Model)	11-13
CBR 250 RAB/RAC (ABS Model)	11-13
CBX 250 RSE	84
CBX 250 Twister	
CBX 250	84-98
CD 250 UJ	88-92
CH 250 F/G Spacy	85-86
CJ 250 T	77
C 250 SC	81
CM 250 TB	81
CMX 250 CT Rebel (Nissin Caliper)	96
CMX 250 CV/CW/CX Rebel (Grimeca Caliper)	97-00
CN 250 H/J/K/L/M/P/R/S/T/V/X Spazio/Helix	87-98
CN 250 3 (MF02) Fusion/Fusion X/Fusion X Special	03
CR 250 RZ/RA	79-80
CR 250 RB	81
CR 250 RC/RD	82-83
CR 250 RE/RF	84-85
CR 250 RG	86
CR 250 RH/RJ	87-88
CR 250 RK	89
CR 250 RL/RM	90-91
CR 250 RN/RR	92-94
CR 250 RS/RT	95-96
CR 250 RV/RW/RX/RY/R1	97-01
CR 250 R2/R3	02-03
CR 250 R4/R5/R6/R7	04-07
CRF 250 LD/LF	13-20
CRF 250 LH (ABS)	17-20
CRF 250 ME Supermoto	14-16
CRF 250 R4/R5/R6/R7	04-07
CRF 250 R8/R9/RA/RB/RC/RD/RE/RF/RG	08-16
CRF 250 RF/RG/RH/RJ (260mm F/Disc)	15-20
CRF 250 RE (Limited Road Use)	16
CRF 250 Rally (CRF 250 RLA Rally ABS)	17-20
CRF 250 Rally (CRF 250 RL Rally Non ABS)	17-20
CRF 250 X	04-20
CRF 250 RX	08-20
CRF 250 XRL (Road Legal)	14-20
CRM 250 R (RK) MK1 MD24 (100001-1008385)	89-90
CRM 250 R (RM) MK2 MD24 (1200001-1211634)	91-92
CRM 250 R (RP/RP-II) MK2/2 MD24 (1300001-)	93
CRM 250 (MD24) 140 (MK3) RR-RR-II	94-96
CRM 250 ARV/ARW Active Radical (MD32)	97-98
FES 250 W/X Foresight	98-99
FES 250 Y/1/2/5 Foresight	00-05
FES 250 Y/1/2/5 Foresight - Parking Brake	00-05
FL 250 Odyssey	77-84
GB 250 E/H Clubman (MC10 101-110)	84-87
GB 250 J/L/P/S/V Clubman (MC 10-120-150)	89-97
MXV 250 F (MC92)	83-88
NS 250 FE/RE (MCII-100)	84
NS 250 RG (MCII-102)	86
NSF 250 R (Moto 3)	18-20
NSR 250 RG (MC16-100)	86
NSR 250 R2J (MC18-100) R4J (MC18-100)	88
NSR 250 R5K/R5K-2 (MC18-110)	89

◆ Plain undrilled disc for enduro use MD6191CE

FRONT / AVANT / VORN / FRENTE / ANTERIORE

DISC PAD CHOICES - FRONT				BRAKE DISC CHOICES - FRONT							Line #
FA, SFA, TT Pad or Brake Shoe	SFAC Carbon Scooter Pads	Speciality Pads - SXR / Vee / MXS	Sintered/HH Pads/ Grooved Shoes	Left / Gauche / Links Standard Replacement Disc	Right / Droite / Rechts Standard Replacement Disc	Contour Disc Universal left and right fitment	Custom Disc Universal left and right fitment	Vee-Discs Black † See note below	CX Extreme MX Race Disc/ UTVX Disc	Line #	
FA142		FA142V	FA142HH							1	
FA142*		FA142V*	FA142HH*	MD1145LS	MD1145RS					2	
FA142		FA142V	FA142HH		MD1180X	MD1180XC				3	
FA388			FA388HH		MD1180X	MD1180XC				4	
FA069			FA069HH	MD1090LS						5	
										6	
FA086			FA086HH		MD1030					7	
FA124/2			FA124/2HH	MD1090LS						8	
SFA323/2			SFA323/2HH	MD913D						9	
FA013										10	
H312										11	
FA045				MD1036LS						12	
FA228			FA228HH	MD1030						13	
FA256			FA256HH	MD1030						14	
FA069/2				MD908D				VR908		15	
SFA196	SFAC196		SFA196HH	MD908D				VR908		16	
H324			H324G							17	
H327			H327G							18	
H328			H328G							19	
FA092TT			FA092R	MD6087D						20	
FA092TT			FA092R	MD6087D						21	
FA125TT		MXS125	FA125R	MD6087D						22	
FA125TT		MXS125	FA125R	MD6008D						23	
FA125TT		MXS125	FA125R	MD6003D						24	
FA125TT		MXS125	FA125R	MD6001D		MD6001C			MD6001CX	25	
FA185TT		MXS185	FA185R	MD6037D		MD6037C			MD6037CX	26	
FA185TT		MXS185	FA185R	MD6037D		MD6037C			MD6037CX	27	
FA185TT		MXS185	FA185R	MD6037D		MD6037C			MD6037CX	28	
FA185TT		MXS185	FA185R	MD6037D		MD6037C			MD6037CX	29	
FA185TT		MXS185	FA185R	MD6037D		MD6037C			MD6037CX	30	
FA465TT		MXS465	FA465R			MD6372C			MD6372CX	31	
FA465TT		MXS465	FA465R			MD6372C			MD6372CX	32	
FA465TT		MXS465	FA465R							33	
FA185TT		MXS185	FA185R	MD6037D		MD6037C			MD6037CX	34	
FA185TT		MXS185	FA185R			MD6037C			MD6037CX	35	
FA185TT		MXS185	FA185R			MD6389C			MD6389CX	36	
FA185TT		MXS185	FA185R			MD6389C			MD6389CX	37	
FA465TT		MXS465	FA465R			MD6409C				38	
FA465TT		MXS465	FA465R			MD6409C				39	
FA185TT		MXS185	FA185R	MD6037D		MD6037C			MD6037CX	40	
FA185TT		MXS185	FA185R			MD6037C			MD6037CX	41	
FA185TT		MXS185	FA185R			MD6037C			MD6037CX	42	
FA125TT		MXS125	FA125R	MD6087D						43	
FA125TT		MXS125	FA125R	MD6001D		MD6001C			MD6001CX	44	
FA125TT		MXS125	FA125R	MD6001D		MD6001C			MD6001CX	45	
FA185TT		MXS185	FA185R	MD6001D		MD6001C			MD6001CX	46	
FA185TT		MXS185	FA185R	MD6001D		MD6001C			MD6001CX	47	
SFA281			SFA281HH	MD922D				VR922		48	
SFA281			SFA281HH	MD922D				VR922		49	
H351										50	
FA040										51	
FA069/2										52	
FA124/2			FA124/2HH							53	
FA080/2										54	
FA069/2*				MD1006	MD1006	MD1006C*				55	
FA069/2*				MD1006	MD1006	MD1006C*				56	
			FA347HH*							57	
FA121*			FA121HH*	MD1129LS	MD1129RS					58	
FA187*			FA187HH*	MD1117LS	MD1117RS					59	
FA187*			FA187HH*	MD1117LS	MD1117RS					60	

*-2 Sets Required. † For Vee disc colours add RED, BLU, GRN, GLD, ORG suffix to part number. For Custom Finish Options for Vee-Rotors™ including Splatter discs add suffix CHR, CHGR, CHBL, CHBR - available in various colours see page iv. Ⓢ - Also available as a Vintage Motorcycle Disc.

JAPANESE Built Motorcycles

Line #	BRAKE DISC CHOICES - FRONT						DISC PAD CHOICES - REAR				BRAKE DISC CHOICES - REAR			
	Oversize 250 /280mm Disc Kit	OSX Oversize 250/280mm Disc Kit	Relocating Bracket for 250/ 280mm Disc	Oversize 320mm Disc Kit	SMX Oversize 320mm Disc Kit	Relocating Bracket for 320mm Disc	FA, SFA, TT Pad or Brake Shoe	SFAC Carbon Scooter Pads	Speciality Pads - SXR / Vee / MXS	Sintered/ HH Pads/ Grooved Shoes	Standard Replacement Disc	Contour Disc Rear fitment	Vee Discs CONTOUR	CX Extreme MX Race Disc
1							FA140		FA140V	FA140HH	MD1002			
2							FA140		FA140V	FA140HH	MD1004	MD1004C		
3							FA496		FA496V	FA496HH	MD1004	MD1004C		
4							FA496		FA496V	FA496HH	MD1181			
5							H318							
6							H352							
7							H304							
8							H310			H310G				
9							H341							
10							H315							
11							H309							
12							H313							
13							H318							
14							H318							
15							H350							
16							H350							
17							H325			H325G				
18							H330			H330G				
19							H331			H331G				
20							H331			H331G				
21							H344			H344G				
22							FA131TT	MXS131	FA131R		MD6009D			
23							FA131TT	MXS131	FA131R		MD6002D			
24							FA131TT	MXS131	FA131R		MD6002D			
25	OS6001EC	OSX6001E	BRK004				FA131TT	MXS131	FA131R		MD6002D			
26	OS6037C	OSX6037	BRK008	SM6037C	SMX6037	BRK009	FA131TT	MXS131	FA131R		MD6002D			
27	OS6037C	OSX6037	BRK008	SM6037C	SMX6037	BRK009	FA131TT	MXS131	FA131R	MD6124D	MD6124C		MD6124CX	
28	OS6037C	OSX6037	BRK008	SM6037C	SMX6037	BRK009	FA346TT	MXS346	FA346R	MD6191D	MD6191C		MD6191CX	
29	OS6437C	OSX6437	BRK005	SM6437C	SMX6437	BRK006	FA346TT	MXS346	FA346R	MD6191D	MD6191C		MD6191CX	
30							FA629TT		FA629R		MD6373C		MD6373CX	
31							FA629TT		FA629R		MD6373C		MD6373CX	
32							FA629TT		FA629R		MD6373C		MD6373CX	
33	OS6437C	OSX6437	BRK005	SM6437C	SMX6437	BRK006	FA346TT	MXS346	FA346R	MD6191D	MD6191C		MD6191CX	
34	OS6437C	OSX6437	BRK005	SM6437C	SMX6437	BRK006	FA346TT	MXS346	FA346R		MD6191C		MD6191CX	
35		OSX6389	BRK042		SMX6389	BRK041	FA346TT	MXS346	FA346R		MD6191C		MD6191CX	
36		OSX6389	BRK042		SMX6389	BRK041	FA346TT	MXS346	FA346R		MD6191C		MD6191CX	
37							FA629TT		FA629R		MD6373C		MD6373CX	
38							FA629TT		FA629R		MD6373C		MD6373CX	
39	OS6437C	OSX6437	BRK005	SM6437C	SMX6437	BRK006	FA346TT	MXS346	FA346R	MD6191D	MD6191C		MD6191CX	
40	OS6437C	OSX6437	BRK005	SM6437C	SMX6437	BRK006	FA346TT	MXS346	FA346R		MD6191C		MD6191CX	
41	OS6437C	OSX6437	BRK005	SM6437C	SMX6437	BRK006	FA346TT	MXS346	FA346R		MD6191C		MD6191CX	
42							FA153				MD6165D			
43	OS6001EC	OSX6001E	BRK004				FA131TT	MXS131	FA131R	MD6013D	MD6013C		MD6013CX	
44	OS6001EC	OSX6001E	BRK004				FA131TT	MXS131	FA131R	MD6013D	MD6013C		MD6013CX	
45	OS6001C	OSX6001	BRK008		SMX6001	BRK009	FA131TT	MXS131	FA131R	MD6013D	MD6013C		MD6013CX	
46	OS6001C	OSX6001	BRK008		SMX6001	BRK009	FA131TT	MXS131	FA131R	MD6013D	MD6013C		MD6013CX	
47							H351							
48							SFA140		SFA140HH	MD1004		VR1004		
49														
50							H306		H306G					
51							H318							
52							H318							
53							H315							
54							FA069/3				MD1002			
55							FA069/3				MD1002			
56														
57							FA069/3		FA069/3HH	MD1002				
58							FA140		FA140HH	MD1002				
59							FA140		FA140HH	MD1002				
60														

REAR / ARRIÈRE / HINTEN / POSTERIOR / POSTERIORE

BRAKE APPLICATIONS

R Suffix = High Durability Sintered Pad. HH Suffix = High Performance Sintered Pad. TT Suffix = Hard Wearing Off Road Pad. V Suffix = Semi Sintered Pad. G Suffix = Grooved Shoe.
D Suffix = Drilled Disc. X Suffix = Universal Left or Right Disc. XC Suffix = Contoured Disc. LS Suffix = Left/Steel Disc. RS = Right/Steel Disc.

*-2 Sets Required. † For Vee disc colours add RED, BLU, GRN, GLD, ORG suffix to part number. For Custom Finish Options for Vee-Rotors™ including Splatter discs add suffix CHR, CHGR, CHBL, CHBR - available in various colours see page iv. Ⓢ - Also available as a Vintage Motorcycle Disc.

JAPANESE Built Motorcycles



HONDA Contd.

NSR 250 R6K/R6K-2 (MC18-110)	89
NSR 250 R7L/R7N (MC21-106)	90
NSR 250 R8L-3 (MC21-101) R9L (MC21-102) R8N/R8N-3 (MC21-106)	90-92
NSR 250 R9N (MC21-106)	92
NSR 250 RR (MC28-100)	94
NSR 250 R2R/R3R (MC28-110) R2T/R3T (MC28-120)	94
NSS 250 Y/AY/1/A1/A3/3 Forza/Forza-ST/S/T /Jazz/Reflex (MF04/MF06)	00-04
NSS 250 EX5/EX7/EX8 Forza EX (ABS)	05-08
NSS 250 EX5/EX7/EX8 Forza EX (ABS) - Parking Brake	05-08
NSS 250 AX5/AX6 Forza Z (ABS)	05-06
NSS 250 AX5/AX6 Forza Z (ABS) - Parking Brake	05-06
NSS 250 X5/X7/X8 Forza X	05-08
NSS 250 X5/X7/X8 Forza X - Parking Brake	05-08
NX 250 J/K (MD21)	87-90
NX 250 2L/M/P/2P (MD25)	90-93
PS 250 5/6 Big Ruckus	05-06
RTL 250 SG	86
RTL 250 S	88-89
TL 250 K1	79
TLR 250 F	85
TLM 250 RJ	89
TRX 250 F/G/H	85-87
TRX 250 RG/RH	86-87
TRX 250 RJ/RK	88-89
TRX 250 V/W/X/Y/1/TM2 Re Con (Manual Shift)	97-14
TRX 250 TE2 Re Con ES (Electric Shift)	02-14
TRX 250 EX1/2/3/4/5/6/7/8	01-08
TRX 250 X9/XA/XB	09-11
VT 250 FL Spada/Castel	88-90
XL 250 K3/K4	78-79
XL 250 S/SZ/SA	78-81
XL 250 SB	82
XL 250 RE/RF	84-85
XL 250 RC	82
XL 250 RL	90
XL 250 Degree (MD26)	
XR 250 SZ/SA	79-80
XR 250 RB/RC/RD	81-83
XR 250 RE/RF	84-85
XR 250 RG/RH	86-87
XR 250 RJ/RK	88-89
XR 250 RL	90
XR 250 RM/RN/RP/RR/RS	91-95
XR 250 RT/RV/RW/RX/RY/R1/R2/R3/R4	96-04
XR 250 Y/3 (MD30)	00-03
XR 250 3/5 (MD30) Motard	03-05
XR 250 Tornado	05
XR 250 III Y/3 Baja	00-03
XLR 250 Baja MK1 RF/R2F/RH (MD22)	
XLR 250 Baja MK2 R3 (MD22)	
XLR 250 R/R3J/RK/RL/R3L/R3M/RN (MD22)	88-90
XLR 250 RM/R3N/RP/RR/R3R (MD22)	91-
VT 250 FD	83
VT 250 CR/CT/CV Magna	95-97
VTR 250 W/Y/1-7 (MC33)	98-07
VTR 250 9	09-10
VTZ 250 H/J/K	86-88
TLM 260	89-93

FA, SFA, TT Pad or Brake Shoe	SFAC Carbon Scooter Pads	Speciality Pads - SXR / Vee / MXS	Sintered/HH Pads/ Grooved Shoes	BRAKE DISC CHOICES - FRONT				Vee-Discs Black † See note below	CX Extreme MX Race Disc/ UTVX Disc
				Left / Gauche / Links Standard Replacement Disc	Right / Droite / Rechts Standard Replacement Disc	Contour Disc Universal left and right fitment	Custom Disc Universal left and right fitment		
FA187*			FA187HH*	MD1117LS	MD1117RS				
FA187*			FA187HH*	MD1117LS	MD1117RS				
FA187*			FA187HH*	MD1117LS	MD1117RS				
FA187*			FA187HH*	MD1117LS	MD1117RS				
FA187*			FA187HH*	MD1117LS	MD1117RS				
FA187*			FA187HH*	MD1117LS	MD1117RS				
SFA281			SFA281HH	MD922D			VR922		
SFA388	SFAC388		SFA388HH	MD922D			VR922		
H333									
SFA388	SFAC388		SFA388HH	MD922D			VR922		
H333									
SFA388	SFAC388		SFA388HH	MD922D			VR922		
H333									
FA125TT		MXS125	FA125R	MD6008D					
FA125TT		MXS125	FA125R	MD6001D		MD6001C		MD6001CX	
SFA388	SFAC388		SFA388HH	MD922D			VR922		
H304			H304G						
FA624TT									
H304			H304G						
H304			H304G						
H304			H304G						
H339*			H339G*						
FA125TT*		MXS125*	FA125R*	MD6046D	MD6046D				
FA125TT*		MXS125*	FA125R*	MD6006D	MD6006D				
H345*			H345G*						
H345*			H345G*						
FA084TT*		MXS084*	FA084R*	MD6006D	MD6006D				
FA084TT*		MXS084*	FA084R*	MD6006D	MD6006D				
FA142			FA142HH						
H311			H311G						
H312			H312G						
H312			H312G						
H330			H330G						
H330			H330G						
FA125TT		MXS125	FA125R	MD6001D		MD6001C		MD6001CX	
FA185TT		MXS185	FA185R	MD6001D		MD6001C		MD6001CX	
H312			H312G						
H327			H327G						
FA092TT			FA092R	MD6001D		MD6001C		MD6001CX	
FA092TT			FA092R	MD6087D					
FA125TT		MXS125	FA125R	MD6087D					
FA125TT		MXS125	FA125R	MD6087D					
FA125TT		MXS125	FA125R	MD6001D		MD6001C		MD6001CX	
FA185TT		MXS185	FA185R	MD6001D		MD6001C		MD6001CX	
FA185TT		MXS185	FA185R	MD6001D		MD6001C		MD6001CX	
FA185TT		MXS185	FA185R	MD6001D		MD6001C		MD6001CX	
FA185TT		MXS185	FA185R	MD6001D		MD6001C		MD6001CX	
FA185TT		MXS185	FA185R	MD6001D		MD6001C		MD6001CX	
FA092TT			FA092R	MD6001D		MD6001C		MD6001CX	
FA185TT		MXS185	FA185R	MD6001D		MD6001C		MD6001CX	
FA092TT			FA092R	MD6087D					
FA185TT		MXS185	FA185R	MD6001D		MD6001C		MD6001CX	
FA080/2									
FA196			FA196HH	MD1021LS					
FA196			FA196HH		MD1144RS				
FA196			FA196HH						
FA124/2			FA124/2HH						
FA624TT									

Line #
1
2
3
4
5
6
7
8
9
10
11
12
13
14
15
16
17
18
19
20
21
22
23
24
25
26
27
28
29
30
31
32
33
34
35
36
37
38
39
40
41
42
43
44
45
46
47
48
49
50
51
52
53
54
55
56
57
58
59
60

R Suffix = High Durability Sintered Pad. HH Suffix = High Performance Sintered Pad. TT Suffix = Hard Wearing Off Road Pad. V Suffix = Semi-Sintered Pad. G Suffix = Grooved Shoe.
D Suffix = Drilled Disc. X Suffix = Universal Left or Right Disc. XC Suffix = Contoured Disc. LS Suffix = Left/Steel Disc. RS = Right/Steel Disc.

FRONT / AVANT / VORN / FRENTE / ANTERIORE

*-2 Sets Required. † For Vee disc colours add RED, BLU, GRN, GLD, ORG suffix to part number. For Custom Finish Options for Vee-Rotors™ including Splatter discs add suffix CHR, CHGR, CHBL, CHBR - available in various colours see page iv. ☼ - Also available as a Vintage Motorcycle Disc.

JAPANESE Built Motorcycles

Line #	BRAKE DISC CHOICES - FRONT						DISC PAD CHOICES - REAR				BRAKE DISC CHOICES - REAR			
	Oversize 250 /280mm Disc Kit	OSX Oversize 250/280mm Disc Kit	Relocating Bracket for 250/ 280mm Disc	Oversize 320mm Disc Kit	SMX Oversize 320mm Disc Kit	Relocating Bracket for 320mm Disc	FA, SFA, TT Pad or Brake Shoe	SFAC Carbon Scooter Pads	Speciality Pads - SXR / Vee / MXS	Sintered/ HH Pads/ Grooved Shoes	Standard Replacement Disc	Contour Disc Rear fitment	Vee Discs CONTOUR	CX Extreme MX Race Disc
1							FA140			FA140HH	MD1002			
2							FA140			FA140HH	MD1002			
3														
4							FA140			FA140HH	MD1002			
5							FA140			FA140HH	MD1002			
6							FA143				MD1111			
7							FA143				MD1111			
8														
9							SFA358			SFA358HH	MD1004		VR1004	
10							SFA415	SFAC415		SFA415HH	MD1020	MD1020C	VR1020	
11														
12							SFA415	SFAC415		SFA415HH	MD1020	MD1020C	VR1020	
13														
14							SFA415	SFAC415		SFA415HH	MD1020	MD1020C	VR1020	
15														
16							H323			H323G				
17							H323			H323G				
18							H351							
19							H304			H304G				
20							FA153							
21							H304			H304G				
22							H304			H304G				
23							H304			H304G				
24							H315			H315G				
25							FA092TT			FA092R	MD6007D			
26							FA092TT			FA092R	MD6007D			
27							H340			H340G				
28							H340			H340G				
29							H340			H340G				
30							H340			H340G				
31							FA140	FA140V		FA140HH	MD1002			
32							H312			H312G				
33							H323			H323G				
34							H318			H318G				
35							H323			H323G				
36							H323			H323G				
37							FA131TT		MXS131	FA131R	MD6013D	MD6013C	MD6013CX	
38							H323			H323G				
39							H323			H323G				
40							H323			H323G				
41							H304			H304G				
42							H304			H304G				
43							H304			H304G				
44							FA131TT		MXS131	FA131R	MD6013D	MD6013C	MD6013CX	
45	OS6001EC	OSX6001E	BRK004				FA131TT		MXS131	FA131R	MD6013D	MD6013C	MD6013CX	
46	OS6001C	OSX6001	BRK008		SMX6001	BRK009	FA131TT		MXS131	FA131R	MD6013D	MD6013C	MD6013CX	
47							FA131TT		MXS131	FA131R	MD6013D	MD6013C	MD6013CX	
48							FA131TT		MXS131	FA131R	MD6013D	MD6013C	MD6013CX	
49							H352							
50							FA131TT		MXS131	FA131R	MD6013D	MD6013C	MD6013CX	
51							H323			H323G				
52							FA153				MD6013D	MD6013C	MD6013CX	
53							FA153				MD6013D	MD6013C	MD6013CX	
54							FA131TT		MXS131	FA131R	MD6013D	MD6013C	MD6013CX	
55							H309							
56							H321							
57							FA140	FA140V		FA140HH	MD1004	MD1004C		
58							FA140	FA140V		FA140HH				
59							H309							
60							FA153							

REAR / ARRIÈRE / HINTEN / POSTERIOR / POSTERIORE

*-2 Sets Required. † For Vee disc colours add RED, BLU, GRN, GLD, ORG suffix to part number. For Custom Finish Options for Vee-Rotors™ including Splatter discs add suffix CHR, CHGR, CHBL, CHBR - available in various colours see page iv. ☼ - Also available as a Vintage Motorcycle Disc.

R Suffix = High Durability Sintered Pad. HH Suffix = High Performance Sintered Pad. TT Suffix = Hard Wearing Off Road Pad. V Suffix = Semi Sintered Pad. G Suffix = Grooved Shoe. D Suffix = Drilled Disc. X Suffix = Universal Left or Right Disc. XC Suffix = Contoured Disc. LS Suffix = Left/Steel Disc. RS = Right/Steel Disc.

JAPANESE Built Motorcycles



HONDA Contd.



R Suffix = High Durability Sintered Pad. HH Suffix = High Performance Sintered Pad. TT Suffix = Hard Wearing Off Road Pad. V Suffix = Semi-Sintered Pad. G Suffix = Grooved Shoe.

D Suffix = Drilled Disc. X Suffix = Universal Left or Right Disc. XC Suffix = Contoured Disc. LS Suffix = Left/Steel Disc. RS = Right/Steel Disc.

Model	Year
CB 300 R10	10
CB 300 F AC (ABS)	15-17
CB 300 FA AC ABS	18-20
CB 300 R AC	18-20
CBR 300 RAE (ABS Model)	14
CBR 300 RA (ABS)	14-20
CBR 300 R (Non ABS Model)	18-20
CMX 300 Rebel	18-20
CMX 300 Rebel ABS	18-20
NSS 300 AD Forza (ABS)	13-17
NSS 300 D Forza (Non ABS)	13-15
NSS 300 D Forza (ABS)	18-20
SH 300i 7/8/9/A/B (Non ABS Model)	07-12
SH 300i A7/A8/A9/AA/AB/AC (ABS Model)	07-13
SH 300i R8/R9/RA (Non ABS Model)	08-10
SH 300i AR8/AR9/ARA (ABS Model)	08-10
SH 300i (ABS Model)	14
SH 300i (2 Piston Caliper/ABS)	16-18
TRX 300 JK/L/T/W/X/Y (2WD)	88-00
TRX 300 FW/J/K/L/T/V/W/X/Y (4WD)	88-00
TRX 300 EX P/R/S/T/V/W/X/Y/1-8	93-08
TRX 300 X9	09
XR 300 R10	10
CB 350 K4	74
CB 350 SG/SJ	86-90
CBR 300 RAE (ABS Model)	14
FL 350 R Odyssey	85-87
SL 350 K0	69-70
SL 350 K1/K2	70-73
TRX 350 G/H/J/K/L/M/N	86-93
TRX 350 Rancher ES 4 x 4/2 x 4 (FMY/1/2/3) /Rancher 4 x 4 & 2 x 4 (FEY/1/2/3)	00-03
XR 350 RD	83
XR 350 RE	84
CB 360 G5	75
CJ 360 T	78
CB-1 (CB 400 F)	89-90
CB 400 SF (F2N/F2R/F2S/F2T/F3S) Superfour (NC31)	92-95
CB 400 SF (F2V/F3T) Superfour (NC31)	96-97
CB 400 SF (F3V) Superfour (NC31)	97
CB 400 F/F1/F2	75-79
CB 400 A Honda-Matic	79
CB 400 T	78
CB 400 N/NA/NB	78-81
CB 400 NC	82
CB 400 Four VV-II/W/W-II (NC36)	97-98
CB 400 SFX/SFY/SF1/SF2/SF3 Superfour (NC39 - Superfour/Superfour Bol D'Or)	99-03
CB 400 SS (SS2-NC41)	01-05
CB 400 SF4/5/S5 (NC39 - Superfour/Superfour Bol D'Or)	04-05
CBR 400 RG (NC23) 100	86
CBR 400 RH-YA (NC23) 101	86
CBR 400 RRJ/RRK (NC23) Tri-Arm (102/109)	87-89
CBR 400 RRL/RRN/RRR (NC29) Gull Arm	90-94
CL 400 (NC38)	98-03
FJS 400 Silverwing D6/D7/D8 Non ABS 256mm front disc	06-08
FJS 400 Silverwing D6/D7/D8 Non ABS 256mm front disc - Parking Brake	06-08
FL 400 R RK/RL Pilot	89-93

FRONT / AVANT / VORN / FRENTE / ANTERIORE

DISC PAD CHOICES - FRONT				BRAKE DISC CHOICES - FRONT						Line #
FA, SFA, TT Pad or Brake Shoe	SFAC Carbon Scooter Pads	Speciality Pads - SXR / Vee / MXS	Sintered/HH Pads/ Grooved Shoes	Left / Gauche / Links Standard Replacement Disc	Right / Droite / Rechts Standard Replacement Disc	Contour Disc Universal left and right fitment	Custom Disc Universal left and right fitment	Vee-Discs Black † See note below	CX Extreme MX Race Disc/ UTVX Disc	Line #
FA197			FA197HH			MD1166RS				1
FA226			FA226HH			MD1180X				2
FA226			FA226HH			MD1180X	MD1180XC			3
			FA679HH			MD1180X	MD1180XC			4
FA142			FA142HH			MD1180X	MD1180XC			5
FA196			FA196HH			MD1180X	MD1180XC			6
FA196			FA196HH			MD1180X	MD1180XC			7
FA196			FA196HH			TBA				8
FA196			FA196HH			TBA				9
SFA388	SFAC388		SFA388HH							10
SFA388	SFAC388		SFA388HH							11
SFA196			SFA196HH							12
SFA388	SFAC388		SFA388HH	MD9118D				VR9118		13
SFA388	SFAC388		SFA388HH	MD9118D				VR9118		14
SFA388	SFAC388		SFA388HH	MD9118D				VR9118		15
SFA388	SFAC388		SFA388HH	MD9118D				VR9118		16
SFA388	SFAC388		SFA388HH							17
SFA196	SFAC196		SFA196HH							18
H345*			H345G*							19
H347*			H347G*							20
FA084TT*		MXS084*	FA084R*	MD6006D	MD6006D					21
FA084TT*		MXS084*	FA084R*	MD6006D	MD6006D					22
FA185TT		MXS185	FA185R	MD6010D					MD6010CX	23
H314										24
FA121*			FA121HH*	MD1005LS	MD1005RS					25
FA142		FA142V	FA142HH		MD1180X					26
H339*			H339G*							27
H314										28
H308										29
H342*			H342G*							30
H347S*			H347SG*							31
H331			H331G							32
FA092TT			FA092R	MD6087D						33
FA013										34
FA013										35
FA142			FA142HH		MD1038RS					36
FA142*		FA142V*	FA142HH*	MD1132	MD1132	MD1132C*				37
FA187*			FA187HH*	MD1132	MD1132	MD1132C*				38
FA244*			FA244HH*	MD1132	MD1132	MD1132C*				39
FA013										40
FA045										41
FA045										42
FA030*										43
FA069/2*										44
FA142*		FA142V*	FA142HH*							45
			FA296HH*							46
			FA196HH							47
			FA296HH*							48
FA121*			FA121HH*	MD1001	MD1001					49
FA121*			FA121HH*	MD1001	MD1001					50
FA142*		FA142V*	FA142HH*	MD1003X	MD1003X	MD1003XC*	MD1003CC*	VR1003BLK*†		51
FA142*		FA142V*	FA142HH*	MD1003X	MD1003X	MD1003XC*	MD1003CC*	VR1003BLK*†		52
FA196			FA196HH							53
SFA281			SFA281HH	MD1006		MD1006C				54
SFA257/2										55
H339*			H339G*							56

*-2 Sets Required. † For Vee disc colours add RED, BLU, GRN, GLD, ORG suffix to part number. For Custom Finish Options for Vee-Rotors™ including Splatter discs add suffix CHR, CHGR, CHBL, CHBR - available in various colours see page iv. ☼ - Also available as a Vintage Motorcycle Disc.

JAPANESE Built Motorcycles

Line #	BRAKE DISC CHOICES - FRONT						DISC PAD CHOICES - REAR				BRAKE DISC CHOICES - REAR			
	Oversize 250 /280mm Disc Kit	OSX Oversize 250/280mm Disc Kit	Relocating Bracket for 250/ 280mm Disc	Oversize 320mm Disc Kit	SMX Oversize 320mm Disc Kit	Relocating Bracket for 320mm Disc	FA, SFA, TT Pad or Brake Shoe	SFAC Carbon Scooter Pads	Speciality Pads - SXR / Vee / MXS	Sintered/ HH Pads/ Grooved Shoes	Standard Replacement Disc	Contour Disc Rear fitment	Vee Discs CONTOUR	CX Extreme MX Race Disc
1							H352							
2							FA496			FA496HH	MD1181	MD1181C		
3							FA496			FA496HH	TBA			
4							FA496			FA496HH	TBA			
5														
6							FA496		FA496V	FA496HH				
7							FA496		FA496V	FA496HH	TBA			
8							FA496		FA496V	FA496HH	TBA			
9							FA496		FA496V	FA496HH	TBA			
10							SFA415	SFAC415		SFA415HH				
11							SFA415	SFAC415		SFA415HH				
12							SFA415	SFAC415		SFA415HH				
13							SFA415	SFAC415		SFA415HH	MD9119D	VR9119		
14							SFA415	SFAC415		SFA415HH	MD9119D	VR9119		
15							SFA415	SFAC415		SFA415HH	MD9119D	VR9119		
16							SFA415	SFAC415		SFA415HH	MD9119D	VR9119		
17							SFA415	SFAC415		SFA415HH				
18							SFA415	SFAC415		SFA415HH				
19							H315			H315G				
20							H315			H315G				
21							FA084TT		MXS084	FA084R	MD6064D			
22							FA084TT		MXS084	FA084R	MD6064D			
23				SM6010C	SMX6010C	BRK009	FA131TT		MXS131	FA131R	MD6013D		MD6013CX	
24							H315							
25							H313							
26							FA496		FA496V	FA496HH	MD1181			
27							FA111			FA111R				
28							H315							
29							H309							
30							H343			H343G				
31														
32							H351			H351G				
33							H304			H304G				
34							H304			H304G				
35							H315							
36							H315							
37							FA140		FA140V	FA140HH	MD1020			
38							FA140		FA140V	FA140HH	MD1020	MD1020C	VR1020	
39							FA140		FA140V	FA140HH	MD1020	MD1020C	VR1020	
40							FA140		FA140V	FA140HH	MD1020	MD1020C	VR1020	
41							H315							
42							H313							
43							H313							
44							H313							
45							H313							
46							FA140		FA140V	FA140HH	MD1020			
47														
48							FA254		FA254V	FA254HH				
49							H351							
50							FA174		FA174V	FA174HH				
51							FA069/3		FA069/3V	FA069/3HH	MD1002			
52							FA069/3		FA069/3V	FA069/3HH	MD1002			
53							FA140		FA140V	FA140HH	MD1002			
54							FA140		FA140V	FA140HH	MD1004	MD1004C	VR1004	
55							H351							
56														
57							SFA196			FA196HH	MD1149	MD1149C		
58														
59														
60							FA111			FA111R	MD6144D			

REAR / ARRIÈRE / HINTEN / POSTERIOR / POSTERIORE

BRAKE APPLICATIONS

R Suffix = High Durability Sintered Pad. **HH** Suffix = High Performance Sintered Pad. **TT** Suffix = Hard Wearing Off Road Pad. **V** Suffix = Semi Sintered Pad. **G** Suffix = Grooved Shoe.
D Suffix = Drilled Disc. **X** Suffix = Universal Left or Right Disc. **XC** Suffix = Contoured Disc. **LS** Suffix = Left/Steel Disc. **RS** = Right/Steel Disc.

*-2 Sets Required. † For Vee disc colours add RED, BLU, GRN, GLD, ORG suffix to part number. For Custom Finish Options for Vee-Rotors™ including Splatter discs add suffix CHR, CHGR, CHBL, CHBR - available in various colours see page iv. ☼ - Also available as a Vintage Motorcycle Disc.

JAPANESE Built Motorcycles



HONDA Contd.



NS 400 RF/RG	85-87
NT 400 Bros (NC25)	
NV 400 CJ/CK Steed	92-93
NV 400 CS/CV Steed	95-97
NV 400 DCY/DC1/DC2 (NC40) Shadow Slasher	00-02
NX 4 Falcon	02-05
RVF 400 RR/RR-II/RT/RT-II (NC35)	94-96
SW-T 400 (FJS 400 D9)	09
SW-T 400 (FJS 400 D9) - Parking Brake	09
SW-T 400 (FJS 400 A9/AB)	09-16
SW-T 400 (FJS 400 A9/AB) - Parking Brake	09-16
TRX 400 FWS/TN/W/X/Y	95-00
TRX 400 EXX/EXY/EX1-EX8	99-08
TRX 400 FA4/5/6/7 Fourtrax AT	04-07
TRX 400 FGA4/5/6/7 Fourtrax Rancher at Gscape	04-07
TRX 400 X9	09
VF 400 FD	83-85
VFR 400 ZG/ZH/RG/RG-YA (NC21)	85-87
VFR 400 RH2/RJ (NC24)	87-88
VFR 400 R3K/R3N (NC30)	89-92
VFR 400 R3L/R3M (NC30)	90-91
VRX 400 T (NC33)	96
XL 400 R	82
XR 400 RT/RV/RW/RX/RY/R1/R2/R3/R4	96-04
XR 400 M Supermotard (ND08/NC38E)	06-08
TRX 420 FE7/FE8/FE9/FEA/FEB 4WD Fourtrax ES	07-11
TRX 420 FM7/FM8/FM9/FMA/FMB 4WD Fourtrax Auto	07-11
TRX 420 FPA9/FPA4/FPA8	
Fourtrax Auto - Power Steering	09-11
TRX 420 FA9/FAA/FAB Fourtrax Auto 4WD	09-11
TRX 420 FPM9/FPMA/FPMB Fourtrax 4WD	
- Power Steering	09-11
TRX 420 TE7/TE8/TE9 Fourtrax ES 2WD	07-09
TRX 420 TM7/TM8/TM9/TMA/TMB	07-11
TRX 420 All models	14-19
CB 450 SG/SJ	86-88
CB 450 DX-K	89-92
CMX 450 CH/CJ Rebel	87-88
CR 450 RB	81
CRF 450 R2/R3	02-03
CRF 450 R4/R5/R6/R7	04-07
CRF 450 R8/R9/RA/RB/RC/RD/RE	08-18
CRF 450 R (260mm F/Disc)	15-20
CRF 450 RE (Limited Road Use)	16
CRF 450 X5/X6/X7	05-07
CRF 450 X	08-20
CRF 450 XRL (Road Legal)	14-16
CRF 450 RX (18 Inch Rear Wheel)	17-20
CRF 450 L (18" Rear Wheel)	18-20
TRX 450 ESW/ESX/ESY/ES1	98-01
TRX 450 R4/R5/R6/ER6/R7/ER7/R8/ER8/R9/ER9	04-09
CR 480 RC	82
CR 480 RD	83
CB 500 FD/FE/FF (Non ABS)	13-16
CB 500 T (Twin)	75-77
CB 500 K1/K2/F (Four)	75-77
CB 500 R/T (Twin)	94-96
CB 500 V/W/SW/X/SX/Y/SY/2/S2 (Twin)	97-03
CB 500 X (Twin/Non ABS)	14-15

◆ Plain undrilled disc for enduro use MD6191CE

DISC PAD CHOICES - FRONT

BRAKE DISC CHOICES - FRONT

FA, SFA, TT Pad or Brake Shoe	SFAC Carbon Scooter Pads	Speciality Pads - SXR / Vee / MXS	Sintered/HH Pads/ Grooved Shoes	Left / Gauche / Links Standard Replacement Disc	Right / Droite / Rechts Standard Replacement Disc	Contour Disc Universal left and right fitment	Custom Disc Universal left and right fitment	Vee-Discs Black † See note below	CX Extreme MX Race Disc/ UTVX Disc
FA069*			FA069HH*	MD1006	MD1006	MD1006C*			
FA187			FA187HH	MD1124LS					
FA124/2			FA124/2HH						
FA142		FA142V	FA142HH						
FA196			FA196HH	MD1159					
FA185TT		MXS185	FA185R						
FA187*			FA187HH*	MD1003X	MD1003X	MD1003XC*	MD1003CC*	VR1003BLK*†	
SFA388	SFAC388		SFA388HH	MD1172LS					
SFA257/2									
SFA388	SFAC388		SFA388HH	MD1172LS					
SFA257/2									
H347*			H347C*						
FA084TT*		MXS084*	FA084R*	MD6006D	MD6006D				
H347*			H347C*						
H347*			H347C*						
FA084TT*		MXS084*	FA084R*	MD6006D	MD6006D				
FA080/2									
FA121*			FA121HH*	MD1006	MD1006	MD1006C*			
FA121*			FA121HH*	MD1001	MD1001				
FA187*			FA187HH*	MD1003X	MD1003X	MD1003XC*	MD1003CC*	VR1003BLK*†	
FA187*			FA187HH*	MD1003X	MD1003X	MD1003XC*	MD1003CC*	VR1003BLK*†	
FA196			FA196HH						
H332			H332G						
FA185TT		MXS185	FA185R	MD6001D		MD6001C			MD6001CX
FA142			FA142HH						
FA084TT*		MXS084*	FA084R*	MD6302D	MD6302D				
FA084TT*		MXS084*	FA084R*	MD6302D	MD6302D				
FA084TT*		MXS084*	FA084R*	MD6302D	MD6302D				
FA084TT*		MXS084*	FA084R*	MD6302D	MD6302D				
FA084TT*		MXS084*	FA084R*	MD6302D	MD6302D				
FA084TT*		MXS084*	FA084R*	MD6302D	MD6302D				
FA084TT*		MXS084*	FA084R*	MD6302D	MD6302D				
FA084TT*		MXS084*	FA084R*	MD6302D	MD6302D				
FA084TT*		MXS084*	FA084R*	MD6302D	MD6302D				
FA121*			FA121HH*	MD1005LS	MD1005RS				
FA122*									
FA069			FA069HH	MD1041LS					
H327			H327G						
FA185TT		MXS185	FA185R	MD6037D		MD6037C			MD6037CX
FA185TT		MXS185	FA185R	MD6037D		MD6037C			MD6037CX
FA185TT		MXS185	FA185R			MD6037C			MD6037CX
FA185TT		MXS185	FA185R			MD6389C			MD6389CX
FA185TT		MXS185	FA185R			MD6389C			MD6389CX
FA185TT		MXS185	FA185R	MD6037D		MD6037C			MD6037CX
FA185TT		MXS185	FA185R			MD6037C			MD6037CX
FA185TT		MXS185	FA185R			MD6037C			MD6037CX
FA185TT		MXS185	FA185R			MD6037C			MD6037CX
FA185TT		MXS185	FA185R			MD6389C			MD6389CX
FA185TT		MXS185	FA185R			MD6389C			MD6389CX
H347S*			H347SG*						
FA185TT*		MXS185*	FA185R*	MD6006D	MD6006D				
H327			H327G						
H328			H328G						
FA196		FA196V	FA196HH						
FA013									
FA013									
FA196			FA196HH		MD1008				
FA209/2			FA209/2HH		MD1008				
FA196		FA196V	FA196HH						

Line #
1
2
3
4
5
6
7
8
9
10
11
12
13
14
15
16
17
18
19
20
21
22
23
24
25
26
27
28
29
30
31
32
33
34
35
36
37
38
39
40
41
42
43
44
45
46
47
48
49
50
51
52
53
54
55
56
57
58
59
60

R Suffix = High Durability Sintered Pad. HH Suffix = High Performance Sintered Pad. TT Suffix = Hard Wearing Off Road Pad. V Suffix = Semi-Sintered Pad. G Suffix = Grooved Shoe.

D Suffix = Drilled Disc. X Suffix = Universal Left or Right Disc. XC Suffix = Contoured Disc. LS Suffix = Left/Steel Disc. RS Suffix = Right/Steel Disc.

*-2 Sets Required. † For Vee disc colours add RED, BLU, GRN, GLD, ORG suffix to part number. For Custom Finish Options for Vee-Rotors™ including Splatter discs add suffix CHR, CHGR, CHBL, CHBR - available in various colours see page iv. ☼ - Also available as a Vintage Motorcycle Disc.

JAPANESE Built Motorcycles

Line #	BRAKE DISC CHOICES - FRONT						DISC PAD CHOICES - REAR				BRAKE DISC CHOICES - REAR			
	Oversize 250 /280mm Disc Kit	OSX Oversize 250/280mm Disc Kit	Relocating Bracket for 250/ 280mm Disc	Oversize 320mm Disc Kit	SMX Oversize 320mm Disc Kit	Relocating Bracket for 320mm Disc	FA, SFA, TT Pad or Brake Shoe	SFAC Carbon Scooter Pads	Speciality Pads - SXR / Vee / MXS	Sintered/ HH Pads/ Grooved Shoes	Standard Replacement Disc	Contour Disc Rear fitment	Vee Discs CONTOUR	CX Extreme MX Race Disc
1							FA069		FA069V	FA069HH	MD1002			
2							FA140		FA140V	FA140HH	MD1022			
3							H321							
4							H321							
5							H343							
6							FA131TT		MXS131	FA131R	MD1004			
7							FA143				MD1111			
8							SFA196	SFAC196		SFA196HH	MD1149			
9														
10							SFA196	SFAC196		SFA196HH	MD1149			
11														
12							H351			H351G				
13							FA084TT			FA084R	MD6164D			
14							H351			H351G				
15							H351			H351G				
16							FA084TT			FA084R	MD6164D			
17							FA080/2							
18							FA069/3		FA069/3V	FA069/3HH	MD1002			
19							FA140		FA140V	FA140HH	MD1022			
20							FA143				MD1111			
21							FA143				MD1111			
22							FA174		FA174V	FA174HH				
23							H318			H318G				
24	OS6001C	OSX6001	BRK008		SMX6001	BRK009	FA131TT		MXS131	FA131R	MD6013D	MD6013C	MD6013CX	
25							FA131TT		MXS131	FA131R				
26							H351			H351G				
27							H351			H351G				
28														
29							FA373TT			FA373R	MD6217D			
30							FA373TT			FA373R	MD6217D			
31														
32							H351			H351G				
33							H351			H351G				
34							H351			H351G				
35							FA373TT			FA373R	MD1195			
36							H313							
37							FA122							
38							H313							
39							H319			H319G				
40	OS6037C	OSX6037	BRK008	SM6037C	SMX6037	BRK009	FA346TT		MXS346	FA346R	MD6191D	MD6191C♦	MD6191CX	
41	OS6437C	OSX6437	BRK005	SM6437C	SMX6437	BRK006	FA346TT		MXS346	FA346R	MD6191D	MD6191C♦	MD6191CX	
42	OS6437C	OSX6437	BRK005	SM6437C	SMX6437	BRK006	FA346TT		MXS346	FA346R	MD6191C♦		MD6191CX	
43		OSX6389	BRK042		SMX6389	BRK041	FA346TT		MXS346	FA346R	MD6191C♦		MD6191CX	
44		OSX6389	BRK042		SMX6389	BRK041	FA346TT		MXS346	FA346R	MD6191C♦		MD6191CX	
45	OS6437C	OSX6437	BRK005	SM6437C	SMX6437	BRK006	FA346TT		MXS346	FA346R	MD6191D	MD6191C♦	MD6191CX	
46	OS6437C	OSX6437	BRK005	SM6437C	SMX6437	BRK006	FA346TT		MXS346	FA346R	MD6191C♦		MD6191CX	
47	OS6437C	OSX6437	BRK005	SM6437C	SMX6437	BRK006	FA346TT		MXS346	FA346R	MD6191C♦		MD6191CX	
48		OSX6389	BRK042		SMX6389	BRK041	FA346TT		MXS346	FA346R	MD6191C♦		MD6191CX	
49														
50							H351			H351G				
51							FA373TT			FA373R	MD6233D			
52							H330			H330G				
53							H331			H331G				
54							FA496		FA496V	FA496HH				
55							H316							
56							H316							
57							H321							
58							FA213			FA213HH	MD1020			
59							FA140		FA140V	FA140HH				
60														

REAR / ARRIÈRE / HINTEN / POSTERIOR / POSTERIORE

*-2 Sets Required. † For Vee disc colours add RED, BLU, GRN, GLD, ORG suffix to part number. For Custom Finish Options for Vee-Rotors™ including Splatter discs add suffix CHR, CHGR, CHBL, CHBR - available in various colours see page iv. Ⓢ - Also available as a Vintage Motorcycle Disc.

R Suffix = High Durability Sintered Pad. HH Suffix = High Performance Sintered Pad. TT Suffix = Hard Wearing Off Road Pad. V Suffix = Semi Sintered Pad. G Suffix = Grooved Shoe. D Suffix = Drilled Disc. X Suffix = Universal Left or Right Disc. XC Suffix = Contoured Disc. LS Suffix = Left/Steel Disc. RS = Right/Steel Disc.

JAPANESE Built Motorcycles



HONDA Contd.



R Suffix = High Durability Sintered Pad. HH Suffix = High Performance Sintered Pad. TT Suffix = Hard Wearing Off Road Pad. V Suffix = Semi-Sintered Pad. G Suffix = Grooved Shoe.

D Suffix = Drilled Disc. X Suffix = Universal Left or Right Disc. XC Suffix = Contoured Disc. LS Suffix = Left/Steel Disc. RS = Right/Steel Disc.

CBF 500 A4/A5/A6/A7 (ABS Model)	04-07
CBF 500 4 (Non ABS Model)	04
CBR 500 FH/FJ/FK/FL (Four)	87-90
CB 500 F (Non ABS)	13-20
CB 500 FA (ABS)	13-20
CB 500 X (Non ABS)	13-20
CB 500 XA (ABS)	13-20
CBR 500 R (Non ABS)	13-20
CBR 500 RA (ABS)	13-20
CMX 500 Rebel (Non ABS)	18-20
CMX 500 Rebel (ABS)	18-20
CR 500 RE/RF	84-85
CR 500 RG	86
CR 500 RH/RJ	87-88
CR 500 RK	89
CR 500 RL/RM	90-91
CR 500 RN/RP/RR	92-94
CR 500 RS/RT/RV/RW/RX/RV/R1	95-01
CX 500 CA/CB/Z/A/B	79-81
CX 500 CC	82
CX 500 EC	82
FT 500 C	82
GL 500 DC	82
CX 500 TCC Turbo	83
NX 500 J/K/L/M Dominator	88-91
NX 500 N/P/R/S/T	92-96
NX 500 V/W/X Dominator	97-99
SXS 500 M2 Pioneer (2 Seat)	15-17
TRX 500 FA1/FA2/FA3/FA4/FA5/FA6/FA7/FA8/FA9	
/FAA/FAB Fourtrax Foreman - Auto	01-04
TRX 500 FA5/FA6/FA7/FA8/FA9/FAA/FAB	
Fourtrax Foreman - Auto	05-11
TRX 500 FAC Fourtrax Foreman AT 2/4 WD	12
TRX 500 FE5/FE6/FE7/FE8/FE9/FAA/FAB	
Fourtrax Foreman 4WD/ES	05-11
TRX 500 FEC Fourtrax Foreman ES 2/4 WD	12
TRX 500 FM5/FM6/FM7/FM8/FM9/FMA/FMB	
Fourtrax Foreman 4 x 4	05-11
TRX 500 FMC Fourtrax Foreman S 2/4 WD	12
TRX 500 FPE8/FPE9/FPEA/FPEB	
Fourtrax Foreman - Power Steering	05-11
TRX 500 FPAC Fourtrax Foreman 2/4 WD	12
TRX 500 TM5/TM6 Fourtrax Foreman	05-06
TRX 500 All models	14-19
VF 500 FE/F2E/FF/F2F	84-85
VT 500 ED/EF	83-85
XL 500 SZ	80
XL 500 SB	81
XL 500 RC	82
XR 500 SZ/SA	79-80
XR 500 RB	81
XR 500 RD/RE	84-85
XBR 500 F/G/H/SJ	85-89
CB 550 F/F1/F2/K3	78-80
CBX 550 FC/F2C/FD/F2D	82-84
CB 600 FW/FX Hornet (16 Inch wheel)	98-99
CB 600 FY/F1/F2/F3/F4/F5/F6 Hornet (17 Inch wheel)	00-06
CB 600 F7/F8/F9/FA/FB/FC Hornet	07-13
CB 600 FA7/FA7/FA8/FA9/FAA/FAB/FAC Hornet (ABS)	07-13
CB 600 F2Y/F21/F22 Hornet S (17 Inch wheel)	00-04

FA, SFA, TT Pad or Brake Shoe	SFAC Carbon Scooter Pads	Speciality Pads - SXR / Vee / MXS	Sintered/HH Pads/Grooved Shoes	BRAKE DISC CHOICES - FRONT				CX Extreme MX Race Disc/ UTVX Disc	Line #
				Left / Gauche / Links Standard Replacement Disc	Right / Droite / Rechts Standard Replacement Disc	Contour Disc Universal left and right fitment	Custom Disc Universal left and right fitment		
FA388			FA388HH		MD1155RS				1
FA196			FA196HH		MD1155RS				2
FA121*			FA121HH*	MD1001	MD1001				3
FA196			FA196HH						4
FA196			FA196HH						5
FA196			FA196HH						6
FA196			FA196HH						7
FA196			FA196HH						8
FA196			FA196HH						9
FA196			FA196HH						10
FA196			FA196HH						11
FA092TT			FA092R	MD6087D					12
FA092TT			FA092R	MD6087D					13
FA125TT		MXS125	FA125R	MD6087D					14
FA125TT		MXS125	FA125R	MD6008D					15
FA125TT		MXS125	FA125R	MD6003D					16
FA125TT		MXS125	FA125R	MD6001D		MD6001C		MD6001CX	17
FA185TT		MXS185	FA185R	MD6037D		MD6037C		MD6037CX	18
FA029*									19
FA069*			FA069HH*						20
FA069*			FA069HH*	MD1036LS	MD1036RS				21
FA069			FA069HH	MD1131LS					22
FA069*			FA069HH*						23
FA069*			FA069HH*						24
FA124/2			FA124/2HH	MD6010D				MD6010CX	25
FA124/2			FA124/2HH	MD6010D				MD6010CX	26
FA209/2			FA209/2HH	MD6010D				MD6010CX	27
FA712TT*			FA712R*	MD6341D	MD6341D				28
									29
H347*			H347C*						30
									31
FA410TT*			FA410R*	MD6251D	MD6251D				32
FA084TT*			FA084R*	MD6365D	MD6365D				33
									34
FA410TT*			FA410R*	MD6251D	MD6251D				35
FA084TT*			FA084R*	MD6365D	MD6365D				36
									37
FA410TT*			FA410R*	MD6251D	MD6251D				38
FA084TT*			FA084R*	MD6365D	MD6365D				39
									40
FA410TT*			FA410R*	MD6251D	MD6251D				41
FA084TT*			FA084R*	MD6365D	MD6365D				42
									43
FA410TT*			FA410R*	MD6251D	MD6251D				44
FA084TT*		MXS084*	FA084R*	MD6302D	MD6302D				45
FA069*			FA069HH*	MD1006	MD1006	MD1006C*		VR1006*	46
FA080/2									47
H312			H312G						48
H325			H325G						49
H332			H332G						50
H324			H324G						51
H327			H327G						52
FA092TT			FA092R	MD6001D				MD6001CX	53
FA069			FA069HH	MD1001					54
FA013									55
FA080*									56
FA226*			FA226HH*	MD1132	MD1132	MD1132C*			57
FA226*			FA226HH*	MD1139	MD1139	MD1139C*			58
FA226*			FA226HH*	MD1168X	MD1168X	MD1168XC*			59
FA388*			FA388HH*	MD1168X	MD1168X	MD1168XC*			60
FA226*			FA226HH*	MD1139	MD1139	MD1139C*			60

FRONT / AVANT / VORN / FRENTE / ANTERIORE

*-2 Sets Required. † For Vee disc colours add RED, BLU, GRN, GLD, ORG suffix to part number. For Custom Finish Options for Vee-Rotors™ including Splatter discs add suffix CHR, CHGR, CHBL, CHBR - available in various colours see page iv. Ⓢ - Also available as a Vintage Motorcycle Disc.

JAPANESE Built Motorcycles

Line #	BRAKE DISC CHOICES - FRONT						DISC PAD CHOICES - REAR				BRAKE DISC CHOICES - REAR			
	Oversize 250 /280mm Disc Kit	OSX Oversize 250/280mm Disc Kit	Relocating Bracket for 250/ 280mm Disc	Oversize 320mm Disc Kit	SMX Oversize 320mm Disc Kit	Relocating Bracket for 320mm Disc	FA, SFA, TT Pad or Brake Shoe	SFAC Carbon Scooter Pads	Speciality Pads - SXR / Vee / MXS	Sintered/ HH Pads/ Grooved Shoes	Standard Replacement Disc	Contour Disc Rear fitment	Vee Discs CONTOUR	CX Extreme MX Race Disc
1							FA174		FA174HH	MD1156				
2							FA174		FA174HH	MD1156				
3							FA069/3	FA069/3V	FA069/3HH	MD1002				
4							FA140		FA140HH					
5							FA140		FA140HH					
6							FA140		FA140HH					
7							FA140		FA140HH					
8							FA140		FA140HH					
9							FA140		FA140HH					
10							FA140		FA140HH					
11							FA140		FA140HH					
12							H331		H331G					
13							H344		H344G					
14							FA131TT	MXS131	FA131R	MD6009D				
15							FA131TT	MXS131	FA131R	MD6002D				
16							FA131TT	MXS131	FA131R	MD6002D				
17	OS6001EC	OSX6001E	BRK004				FA131TT	MXS131	FA131R	MD6002D				
18	OS6037C	OSX6037	BRK008	SM6037C	SMX6037	BRK009	FA131TT	MXS131	FA131R	MD6002D				
19							H321							
20							H321							
21							FA069	FA069V	FA069HH					
22							FA069	FA069V	FA069HH	MD1048				
23							H321							
24							FA069	FA069V	FA069HH					
25				SM6010C	SMX6010C	BRK009	FA140		FA140HH	MD6013D			MD6013CX	
26				SM6010C	SMX6010C	BRK009	FA140		FA140HH	MD6099D				
27				SM6010C	SMX6010C	BRK009	FA213		FA213HH	MD6099D				
28							FA714TT		FA714R	MD6217D				
29														
30							H343		H343G					
31														
32							H343		H343G					
33							H343		H343G					
34														
35							H343		H343G					
36							H343		H343G					
37														
38							H343		H343G					
39							H343		H343G					
40														
41							H343		H343G					
42							H343		H343G					
43							H343		H343G					
44							FA373TT		FA373R	MD1195				
45							FA069	FA069V	FA069HH	MD1006	MD1006C	VR1006		
46							H313							
47							H318		H318G					
48							H309							
49							H318		H318G					
50							H318		H318G					
51							H318		H318G					
52							H304		H304G					
53							H340							
54							H316							
55							FA080/2							
56							FA174		FA174HH	MD1004	MD1004C			
57							FA174		FA174HH	MD1004	MD1004C			
58							FA436	FA436V	FA436HH	MD1156				
59							FA174		FA174HH	MD1156				
60							FA174		FA174HH	MD1004	MD1004C			

REAR / ARRIÈRE / HINTEN / POSTERIOR / POSTERIORE

R Suffix = High Durability Sintered Pad. HH Suffix = High Performance Sintered Pad. TT Suffix = Hard Wearing Off Road Pad. V Suffix = Semi Sintered Pad. G Suffix = Grooved Shoe.
D Suffix = Drilled Disc. X Suffix = Universal Left or Right Disc. XC Suffix = Contoured Disc. LS Suffix = Left/Steel Disc. RS = Right/Steel Disc.

BRAKE APPLICATIONS

*-2 Sets Required. † For Vee disc colours add RED, BLU, GRN, GLD, ORG suffix to part number. For Custom Finish Options for Vee-Rotors™ including Splatter discs add suffix CHR, CHGR, CHBL, CHBR - available in various colours see page iv. ☼ - Also available as a Vintage Motorcycle Disc.

JAPANESE Built Motorcycles



HONDA Contd.

CBF 600 N4/S4/N5/N6	04-06
CBF 600 N8/N9/NA (Non ABS)	08-11
CBF 600 NA4/NA5/NA6 (ABS Model)	04-06
CBF 600 NA8/NA9/NAA (ABS)	08-11
CBF 600 S4/S5 (Non ABS)	04-05
CBF 600 S8/S9 (Non ABS)	08-09
CBF 600 SA4/SA5/SA6/SA7 (ABS Model)	04-08
CBF 600 SA8/SA9/SAA (ABS)	08-12
CBR 600 FH/FJ/FK/FL	87-90
CBR 600 FM/FN/FP/FR	91-94
CBR 600 FM/FN/FP/FR - Floating Disc Conversion Option	91-94
CBR 600 FS/FT/FV/FW	95-98
CBR 600 FX/FY	99-00
CBR 600 F1/F2/ CBR 600 FS1/FS2 Sport	01-02
CBR 600 F3/F4/F5/F6	03-06
CBR 600 FB/FC (Non ABS Model)	11-13
CBR 600 FAB/FAC (ABS Model)	11-13
CBR 600 RR3/RR4	03-04
CBR 600 RR5/RR6 (Radial Caliper)	05-06
CBR 600 RR7/RR8/RR9/RAA/RRB/RRC/RRD /RRE/RRF/RRG (Radial Caliper)	07-16
CBR 600 RR Hannspree	08
CBR 600 RR RA9/RAA/RAB/RAC/RAD/RAG (C-ABS)	09-16
CBR 600 RR	17-20
CBR 600 RR ABS	17-20
FJS 600 1/2/D3/D4/D5/D6 Silverwing (Non ABS 256mm front disc)	01-06
FJS 600 1/2/D3/D4/D5/D6 Silverwing (Non ABS 256mm front disc) - Parking Brake	01-06
FJS 600 A3-A7/D7 Silverwing (ABS Model 276mm front disc)	03-09
FJS 600 A3-A7/D7 Silverwing (ABS Model 276mm front disc) - Parking Brake	03-09
NTV 600 JK/M Revere	88-92
SW-T 600 Silverwing (FJS 600 AB)	11-16
SW-T 600 Silverwing (FJS 600 AB) - Parking Brake	11-16
VT 600 CN Shadow Custom	93
VT 600 CR/CS/CT/CV/CW/CX Shadow Custom	94-00
XL 600 RD/LD/RE/LE/RF/RG/RH	83-87
XL 600 LMF/RMG/LMH	85-87
XL 600 VH/VJ/VK Trans Alp	87-90
XL 600 VM/VN/VP Trans Alp	91-93
XL 600 VR/VT Trans Alp	94-96
XL 600 W/WV/WX Trans Alp	97-99
XR 600 RF/RG/RH	85-87
XR 600 RJ/RK/RL	88-90
XR 600 RM/RN	91-92
XR 600 RP/RR/RS/RT/RV/RW/RX/RY	93-00
CB 650 FE/FG	14-16
CB 650 F ABS	14-20
CB 650 R AC/ RA AC	19-20
CB 650 Z/B	79-81
CB 650 SCC Nighthawk	82
CBR 650 F (Non ABS)	14-20
CBR 650 F ABS	14-20
CBR 650 R 2AC/RA 2AC	18-20
CX 650 ED	83
CX 650 TD Turbo	83
FMX 650 5/6	05-08

DISC PAD CHOICES - FRONT				BRAKE DISC CHOICES - FRONT						Line #
FA, SFA, TT Pad or Brake Shoe	SFAC Carbon Scooter Pads	Speciality Pads - SXR / Vee / MXS	Sintered/HH Pads/ Grooved Shoes	Left / Gauche / Links Standard Replacement Disc	Right / Droite / Rechts Standard Replacement Disc	Contour Disc Universal left and right fitment	Custom Disc Universal left and right fitment	Vee-Discs Black † See note below	CX Extreme MX Race Disc/ UTVX Disc	Line #
FA226*			FA226HH*	MD1008	MD1008					1
FA226*			FA226HH*	MD1160	MD1160					2
FA226*			FA226HH*	MD1008	MD1008					3
FA388*			FA388HH*	MD1160	MD1160					4
FA226*			FA226HH*	MD1008	MD1008					5
FA226*			FA226HH*	MD1160	MD1160					6
FA226*			FA226HH*	MD1008	MD1008					7
FA388*			FA388HH*	MD1160	MD1160					8
FA121*			FA121HH*	MD1001	MD1001					9
FA203*			FA203HH*	MD1001	MD1001					10
										11
FA203*			FA203HH*	MD601LS	MD601RS					12
FA226*			FA226HH*	MD1003X	MD1003X	MD1003XC*	MD1003CC*	VR1003BLK*†		13
			FA296HH*	MD1014X	MD1014X	MD1014XC*	MD1014CC*	VR1014BLK*†		14
			FA296HH*	MD1141X	MD1141X	MD1141XC*	MD1141CC*	VR1141BLK*†		15
			FA296HH*	MD1141X	MD1141X	MD1141XC*	MD1141CC*	VR1141BLK*†		16
FA226*			FA226HH*	MD1168X	MD1168X	MD1168XC*				17
FA388*			FA388HH*	MD1168X	MD1168X	MD1168XC*				18
			FA296HH*	MD1152X	MD1152X	MD1152XC*	MD1152CC*	VR1152BLK*†		19
			FA390HH*	MD1152X	MD1152X	MD1152XC*	MD1152CC*	VR1152BLK*†		20
										21
			FA390HH*	MD1152X	MD1152X	MD1152XC*	MD1152CC*	VR1152BLK*†		22
			FA390HH*	MD1152X	MD1152X	MD1152XC*	MD1152CC*	VR1152BLK*†		23
			FA390HH*	MD1152X	MD1152X	MD1152XC*	MD1152CC*	VR1152BLK*†		24
			FA700HH*	MD1152X	MD1152X	MD1152XC*	MD1152CC*	VR1152BLK*†		25
			FA700HH*	MD1152X	MD1152X	MD1152XC*	MD1152CC*	VR1152BLK*†		26
										27
SFA281			SFA281HH	MD1006		MD1006C				28
										29
SFA257/2										30
										31
SFA281			SFA281HH	MD1172LS						32
										33
SFA257/2										34
FA142		FA142V	FA142HH	MD1021LS						35
SFA388	SFAC388		SFA388HH	MD1172LS						36
SFA257/2										37
FA124/2		FA124/2V	FA124/2HH	MD1047LS						38
FA142		FA142V	FA142HH	MD1047LS						39
FA092TT			FA092R	MD6087D						40
FA069			FA069HH	MD6096D						41
FA069			FA069HH	MD6044D						42
FA124/2			FA124/2HH	MD6044D						43
FA196			FA196HH	MD6044D						44
FA185TT*		MXS185*	FA185R*	MD6010D	MD6010D				MD6010CX*	45
FA092TT			FA092R	MD6087D						46
FA125TT		MXS125	FA125R	MD6087D						47
FA125TT		MXS125	FA125R	MD6001D		MD6001C			MD6001CX	48
FA185TT		MXS185	FA185R	MD6001D		MD6001C			MD6001CX	49
FA142*		FA142V*	FA142HH*			TBA				50
FA142*		FA142V*	FA142HH*			TBA				51
			FA679HH*		TBA	TBA	TBA			52
FA045*		FA045V*								53
FA090*		FA090V*		MD1036LS	MD1036RS					54
FA142*		FA142V*	FA142HH*							55
FA142*		FA142V*	FA142HH*							56
			FA679HH*		TBA	TBA	TBA			57
FA069/2*				MD1036LS	MD1036RS					58
FA069/2*										59
FA196			FA196HH	MD6300D						60

FRONT / AVANT / VORN / FRENTE / ANTERIORE

R Suffix = High Durability Sintered Pad. HH Suffix = High Performance Sintered Pad. TT Suffix = Hard Wearing Off Road Pad. V Suffix = Semi-Sintered Pad. G Suffix = Grooved Shoe.

D Suffix = Drilled Disc. X Suffix = Universal Left or Right Disc. XC Suffix = Contoured Disc. LS Suffix = Left/Steel Disc. RS = Right/Steel Disc.

*-2 Sets Required. † For Vee disc colours add RED, BLU, GRN, GLD, ORG suffix to part number. For Custom Finish Options for Vee-Rotors™ including Splatter discs add suffix CHR, CHGR, CHBL, CHBR - available in various colours see page iv. Ⓢ - Also available as a Vintage Motorcycle Disc.

JAPANESE Built Motorcycles

Line #	BRAKE DISC CHOICES - FRONT						DISC PAD CHOICES - REAR				BRAKE DISC CHOICES - REAR			
	Oversize 250 /280mm Disc Kit	OSX Oversize 250/280mm Disc Kit	Relocating Bracket for 250/ 280mm Disc	Oversize 320mm Disc Kit	SMX Oversize 320mm Disc Kit	Relocating Bracket for 320mm Disc	FA, SFA, TT Pad or Brake Shoe	SFAC Carbon Scooter Pads	Speciality Pads - SXR / Vee / MXS	Sintered/ HH Pads/ Grooved Shoes	Standard Replacement Disc	Contour Disc Rear fitment	Vee Discs CONTOUR	CX Extreme MX Race Disc
1							FA174			FA174HH	MD1156			
2							FA174			FA174HH	MD1156			
3							FA174			FA174HH	MD1156			
4							FA174			FA174HH	MD1156			
5							FA174			FA174HH	MD1156			
6							FA174			FA174HH	MD1156			
7							FA174			FA174HH	MD1156			
8							FA174			FA174HH	MD1156			
9							FA069/3			FA069/3HH	MD1002			
10							FA174			FA174HH	MD1004	MD1004C		
11														
12						BRK15S	FA174			FA174HH	MD1004	MD1004C		
13							FA174			FA174HH	MD1004	MD1004C	VR1004	
14							FA174			FA174HH	MD1004	MD1004C	VR1004	
15							FA174			FA174HH	MD1004	MD1004C	VR1004	
16							FA174			FA174HH	MD1004	MD1004C	VR1004	
17							FA436	FA436V		FA436HH	MD1156			
18							FA174			FA174HH	MD1156			
19							FA174			FA174HH	MD1004	MD1004C	VR1004	
20							FA174			FA174HH	MD1004	MD1004C	VR1004	
21														
22							FA436			FA436HH	MD1004	MD1004C	VR1004	
23							FA436			FA436HH	MD1004	MD1004C	VR1004	
24							FA436			FA436HH	MD1173	MD1173C	VR1173	
25							FA436			FA436HH	MD1004	MD1004C	VR1004	
26							FA436			FA436HH	MD1004	MD1004C	VR1004	
27														
28							SFA196			FA196HH	MD1149	MD1149C		
29														
30														
31														
32							SFA196			FA196HH	MD1149			
33														
34														
35							FA140	FA140V		FA140HH	MD1025			
36							SFA196	SFAC196		SFA196HH	MD1149			
37														
38														
39							H321							
40							H321							
41							H318			H318G				
42							H318			H318G				
43							H318			H318G				
44							FA140			FA140HH	MD6097D			
45							FA140			FA140HH	MD6097D			
46						SM6010C*	SMX6010*			FA140HH	MD6097D			
47							H304			H304G				
48	OS6001C	OSX6001	BRK004		SMX6001	BRK009	FA131TT	MXS131		FA131R	MD6013D	MD6013C	MD6013CX	
49	OS6001C	OSX6001	BRK008		SMX6001	BRK009	FA131TT	MXS131		FA131R	MD6013D	MD6013C	MD6013CX	
50							FA496	FA496V		FA496HH	TBA			
51							FA496	FA496V		FA496HH				
52							FA496			FA496HH				
53							H320							
54							H320							
55							FA496	FA496V		FA496HH				
56							FA496	FA496V		FA496HH				
57							FA496			FA496HH	TBA			
58							FA069	FA069V						
59							FA069	FA069V						
60							FA140			FA140HH	MD6099D			

REAR / ARRIÈRE / HINTEN / POSTERIOR / POSTERIORE

*-2 Sets Required. † For Vee disc colours add RED, BLU, GRN, GLD, ORG suffix to part number. For Custom Finish Options for Vee-Rotors™ including Splatter discs add suffix CHR, CHGR, CHBL, CHBR - available in various colours see page iv. ☺ - Also available as a Vintage Motorcycle Disc.

R Suffix = High Durability Sintered Pad. HH Suffix = High Performance Sintered Pad. TT Suffix = Hard Wearing Off Road Pad. V Suffix = Semi Sintered Pad. G Suffix = Grooved Shoe.
D Suffix = Drilled Disc. X Suffix = Universal Left or Right Disc. XC Suffix = Contoured Disc. LS Suffix = Left/Steel Disc. RS = Right/Steel Disc.

BRAKE APPLICATIONS

JAPANESE Built Motorcycles



HONDA Contd.

FX 650 X/Y Vigor	99-03
GL 650 D2-E	84
NT 650 J/K/L (Bros)	88-92
NT 650 VW/VX/VY/V1 Deauville	98-01
NT 650 V2/V3/V4/V5 Deauville (Note - linked brake system. Fit all three sets at pad change)	02-05
NTV 650 J/K/L/M/P/S/T/V	88-97
NX 650 J/K/L/LII/M Dominator	88-91
NX 650 N/P/R/S/T Dominator	92-96
NX 650 VW/X Dominator	97-02
SLR 650 V/W	97-98
TRX 650 FA3/FA4/FA5 Rincon	03-05
XL 650 VY/V1-V7 Transalp	00-07
XR 650 L	93-20
XR 650 RY/R1-R7	00-07
XRV 650 J/K Africa Twin	88-89
DN-01 (680cc) (NSA 700 A8/A9)	08-11
DN-01 (680cc) (NSA 700 A8/A9) - Parking Brake	08-11
TRX 680 FA6/FA7/FA8/FA9/FAA/FAB/FAC Rubicon 4 x 4 Auto	06-14
CTX 700 DE-DCT	14-19
CTX 700 DE-DCT - Parking Brake	14-19
CTX 700 N-DCT	14-19
CTX 700 N-DCT - Parking Brake	14-19
NC 700 DC-700 Integra Scooter	12-14
NC 700 DC-700 Integra Scooter - Parking Brake	12-14
NC 700 SA (ABS)	12-13
NC 700 SD (ABS/DCT)	12-14
NC 700 SD (ABS/DCT) - Parking Brake	12-14
NC 700 S (Non ABS)	12-13
NC 700 XA (ABS)	12-13
NC 700 XA (ABS) - Parking Brake	12-13
NC 700 XD (ABS/DCT)	12-14
NC 700 XD (ABS/DCT) - Parking Brake	12-14
NC 700 X (Non ABS)	12-13
NT 700 V6/V7/V8/VA Deauville	06-13
NT 700 VA6/VA7/VA8/VAA Deauville	07-13
MUV 700-9 Big Red Side x Side	Left Right 09
SXS 700 M2 Pioneer (2 Seat)	16-18
SXS 700 M4 Pioneer (4 Seat)	16-18
TRX 700 XX8/XX9/XXB	08-12
XL 700 V8/V9/VA (Transalp/2 Piston Front Caliper /ABS on Rear Disc)	08-11
XL 700 VA8/VA9/VAA (Transalp/3 Piston Front Caliper /ABS Front & Rear wheels)	08-11
ADV 750 H (X-ADV DCT)	17-18
ADV 750 H (X-ADV DCT) - Parking Brake	17-18
CB 750 F/F1	76-77
CB 750 F2	78
CB 750 FZ/FA/FB	78-82
CB 750 FC/F2C/FD/F2D	83-84
CB 750 F2N/F2R/F2S/F2T/F2V/F2W/F2X/F2Y/F21 CB Seven Fifty	92-02
CB 750 KO-K5	69-75
CB 750 K6	76
CB 750 K7	78
CB 750 KZ	80
CBR 750 FH Superaero (RC27)	87
CBR 750 FJ Superaero (RC27)	88

FA, SFA, TT Pad or Brake Shoe	SFAC Carbon Scooter Pads	Speciality Pads - SXR / Vee / MXS	Sintered/HH Pads/ Grooved Shoes	BRAKE DISC CHOICES - FRONT				Vee-Discs Black † See note below	CX Extreme MX Race Disc/ UTVX Disc
				Left / Gauche / Links Standard Replacement Disc	Right / Droite / Rechts Standard Replacement Disc	Contour Disc Universal left and right fitment	Custom Disc Universal left and right fitment		
FA209/2			FA209/2HH	MD6044D					
FA069/2				MD1040LS	MD1040RS				
FA187			FA187HH	MD1124LS					
FA209/2*			FA209/2HH*	MD1008	MD1008				
			FA261HH*	MD1008	MD1008				
FA142		FA142V	FA142HH	MD1021LS					
FA124/2			FA124/2HH	MD6010D				MD6010CX	
FA124/2			FA124/2HH	MD6010D				MD6010CX	
FA209/2			FA209/2HH	MD6010D				MD6010CX	
FA209/2			FA209/2HH	MD6044D					
H347*			H347C*						
FA185TT*		MXS185*	FA185R*	MD6346D	MD6346D				
FA185TT		MXS185	FA185R	MD6010D				MD6010CX	
FA185TT		MXS185	FA185R	MD6001D		MD6001C		MD6001CX	
FA124/2			FA124/2HH	MD6168D					
FA388*			FA388HH*						
SFA257/2									
FA410TT*			FA410R*	MD6251D	MD6251D				
FA196		FA196V	FA196HH			MD1187C			
SFA257/2									
FA196		FA196V	FA196HH			MD1186C			
SFA257/2									
SFA388	SFAC388		SFA388HH			MD1187C			
SFA257/2									
FA388			FA388HH			MD1187C			
FA388			FA388HH			MD1187C			
SFA257/2									
FA196		FA196V	FA196HH			MD1186C			
FA388			FA388HH			MD1187C			
SFA257/2									
FA388			FA388HH			MD1187C			
SFA257/2									
FA196		FA196V	FA196HH			MD1186C			
			FA388HH*	MD1008	MD1008				
			FA388HH*	MD1008	MD1008				
FA476TT				MD6341D					
FA477TT					MD6341D				
FA712TT*		MXS712*	FA712R*	MD6341D	MD6341D				
FA712TT*		MXS712*	FA712R*	MD6341D	MD6341D				
FA185TT*			FA185R*	MD6006D	MD6006D				
FA185TT*		MXS185	FA185R*	MD6346D	MD6346D				
FA388*			FA388HH*	MD6346D	MD6346D				
			FA679HH*						
SFA257/2									
FA013		FA013V							
FA031*		FA031V*							
FA031*		FA031V*		MD1036LS	MD1036RS				
FA069/2*		FA069/2V*		MD1036LS	MD1036RS				
FA142*		FA142V*	FA142HH*	MD1008	MD1008				
FA012		FA012V							
FA012		FA012V		MD1062LS					
FA013		FA013V		MD1062LS					
FA045*		FA045V*		MD1036LS	MD1036RS				
FA124*			FA124HH*	MD1001	MD1001				
FA142*		FA142V*	FA142HH*	MD1162LS	MD1162RS				

Line #
1
2
3
4
5
6
7
8
9
10
11
12
13
14
15
16
17
18
19
20
21
22
23
24
25
26
27
28
29
30
31
32
33
34
35
36
37
38
39
40
41
42
43
44
45
46
47
48
49
50
51
52
53
54
55
56
57
58
59
60

R Suffix = High Durability Sintered Pad. HH Suffix = High Performance Sintered Pad. TT Suffix = Hard Wearing Off Road Pad. V Suffix = Semi-Sintered Pad. G Suffix = Grooved Shoe.
D Suffix = Drilled Disc. X Suffix = Universal Left or Right Disc. XC Suffix = Contoured Disc. LS Suffix = Left/Steel Disc. RS = Right/Steel Disc.

*-2 Sets Required. † For Vee disc colours add RED, BLU, GRN, GLD, ORG suffix to part number. For Custom Finish Options for Vee-Rotors™ including Splatter discs add suffix CHR, CHGR, CHBL, CHBR - available in various colours see page iv. ☼ - Also available as a Vintage Motorcycle Disc.

JAPANESE Built Motorcycles

Line #	BRAKE DISC CHOICES - FRONT						DISC PAD CHOICES - REAR				BRAKE DISC CHOICES - REAR			
	Oversize 250 /280mm Disc Kit	OSX Oversize 250/280mm Disc Kit	Relocating Bracket for 250/ 280mm Disc	Oversize 320mm Disc Kit	SMX Oversize 320mm Disc Kit	Relocating Bracket for 320mm Disc	FA, SFA, TT Pad or Brake Shoe	SFAC Carbon Scooter Pads	Speciality Pads - SXR / Vee / MXS	Sintered/ HH Pads/ Grooved Shoes	Standard Replacement Disc	Contour Disc Rear fitment	Vee Discs CONTOUR	CX Extreme MX Race Disc
1							FA213			FA213HH	MD6099D			
2							H321							
3							FA140		FA140V	FA140HH	MD1022			
4							FA140			FA140HH	MD1016			
5														
6									FA261HH	MD1016				
7							FA140			FA140HH	MD1025			
8				SM6010C	SMX6010	BRK009	FA140			FA140HH	MD6013D	MD6013C	MD6013CX	
9				SM6010C	SMX6010	BRK009	FA140			FA140HH	MD6099D			
10				SM6010C	SMX6010	BRK009	FA213			FA213HH	MD6099D			
11							FA213			FA213HH	MD6099D			
12							FA373TT			FA373R	MD6217D			
13							FA140			FA140HH	MD6097D			
14				SM6010C	SMX6010	BRK009	FA131TT		MXS131	FA131R	MD6045D		MD6045CX	
15	OS6001C	OSX6001	BRK008		SMX6001	BRK009	FA131TT		MXS131	FA131R	MD6181D	MD6181C	MD6181CX	
16							FA140			FA140HH	MD6097D			
17							FA196		FA196V	FA196HH				
18														
19														
20							FA373TT			FA373R	MD6217D			
21							FA140		FA140V	FA140HH		MD1185C		
22														
23							FA140		FA140V	FA140HH		MD1185C		
24														
25							FA174		FA174V	FA174HH		MD1185C		
26														
27							FA174		FA174V	FA174HH		MD1185C		
28							FA174		FA174V	FA174HH		MD1185C		
29														
30							FA140		FA140V	FA140HH		MD1185C		
31							FA174		FA174V	FA174HH		MD1185C		
32														
33							FA174		FA174V	FA174HH		MD1185C		
34														
35							FA140		FA140V	FA140HH		MD1185C		
36									FA261HH	MD1016				
37									FA261HH	MD1016				
38							FA478TT				MD6341D			
39							FA479TT				MD6341D			
40							FA714TT			FA714R	MD6217D			
41							FA714TT			FA714R	MD6217D			
42							FA410TT			FA410R	MD6331D			
43														
44							FA140			FA140HH	MD6345D			
45														
46							FA174			FA174HH	MD6345D			
47							FA496			FA496HH	MD1156			
48														
49							FA032		FA032V		MD1064			
50							FA030		FA030V		MD1064			
51							FA031		FA031V		MD1071			
52							FA069		FA069V		MD1082			
53														
54							FA174		FA174V	FA174HH	MD1020			
55							H320							
56							H320							
57							H320							
58							H320							
59							FA069/3		FA069/3V	FA069/3HH	MD1006			
60							FA196		FA196V	FA196HH	MD1006			

REAR / ARRIÈRE / HINTEN / POSTERIOR / POSTERIORE

R Suffix = High Durability Sintered Pad. **HH** Suffix = High Performance Sintered Pad. **TT** Suffix = Hard Wearing Off Road Pad. **V** Suffix = Semi Sintered Pad. **G** Suffix = Grooved Shoe.
D Suffix = Drilled Disc. **X** Suffix = Universal Left or Right Disc. **XC** Suffix = Contoured Disc. **LS** Suffix = Left/Steel Disc. **RS** = Right/Steel Disc.

BRAKE APPLICATIONS

*-2 Sets Required. † For Vee disc colours add RED, BLU, GRN, GLD, ORG suffix to part number. For Custom Finish Options for Vee-Rotors™ including Splatter discs add suffix CHR, CHGR, CHBL, CHBR - available in various colours see page iv. Ⓢ - Also available as a Vintage Motorcycle Disc.

JAPANESE Built Motorcycles



HONDA Contd.



CBX 750 FE	84
NM 4 Vultus (NC750J)	15-19
NM 4 Vultus (NC750J) - Parking Brake	15-19
NC 750 S	14-15
NC 750 S - Parking brake	14-15
NC 750 S ABS	14-18
NC 750 S ABS DCT	14-18
NC 750 S ABS DCT - Parking Brake	14-18
NC 750 X	14-18
NC 750 X ABS	14-15
NC 750 X ABS DCT	14-18
NC 750 X ABS DCT - Parking Brake	14-18
NC 750 D Integra Scooter DCT	14-18
NC 750 D Integra Scooter DCT - Parking Brake	14-18
NR 750 N	92
RVF 750 RR/RS RC45	94-98
VF 750 C Shadow	83
VF 750 CH	87
VF 750 CP/CR/CS/CT/CV/CW/CX	93-99
VF 750 FD/FE	83-84
VF 750 SC (V45 Sabre)	82
VFR 750 FG/FH	86-87
VFR 750 FJ/FK	88-89
VFR 750 FL/FM/FV/FP	90-93
VFR 750 FR/FS/FT/FV	94-97
VFR 750 RJ/RK/RL RC30	88-90
VT 750 CV/C2V/CW/C2W/CX/C2X/CY/C2Y/C21/C1 /C31/C4/C5/C6/C7/C8 Shadow	97-09
VT 750 C2BA/C2BB/C2BC/C2BE Shadow Black Spirit	10-16
VT 750 C2SA/C2SB Shadow (3 Piston Caliper /17 Inch Front Wheel/ABS/Rear Disc)	10-12
VT 750 DC1/DC2 Black Widow	01-04
VT 750 DC7/DC8 Shadow Spirit	07-09
VT 750 S (VT 750 SA/SB)	10-12
VT 750 C Shadow Aero	18-20
VT 750 C Shadow Aero ABS	18-20
XLV 750 R (RD/RF)	83-88
XRV 750 L/M/N Africa Twin	90-93
XRV 750 P/R/S/T/N/W/X/Y Africa Twin	94-03
PC 800 Pacific Coast	89-97
VFR 800 FIW/FIX	98-99
VFR 800 FV/F1/2/3/4/5	00-05
VFR 800 6/8/9	06-09
VFR 800 A2/A3/A4/A5 (ABS Model)	02-05
VFR 800 A6/A8/A9 (ABS Model)	06-13
VFR 800 F (ABS Model)	14-18
VFR 800 XB/XC/XD (Crossrunner/ABS)	11-13
VFR 800 XF/XG (Crossrunner/ABS)	15-16
VFR 800 XH/XJ (Crossrunner/ABS)	17-18
CB 900 FZ/FA	80-81
CB 900 FB/F2B	82-83
CB 900 FC/F2C/FD/F2D	84-85
CB 900 F2/F3/F4/F5/F6/F7 Hornet	02-07
CBR 900 RR/RP Fireblade (893cc)	92-93
CBR 900 RRR/RPS Fireblade (893cc)	94-95
CBR 900 RRT/RRV Fireblade (918cc)	96-97
CBR 900 RRW/RRX Fireblade (918cc)	98-99
CBR 900 Evolution Blade	99
CBR 900 RRV/RR1 (929cc) Fireblade	00-01
CBR 900 RR2/RR3 (954cc) Fireblade	02-03

FA, SFA, TT Pad or Brake Shoe	SFAC Carbon Scooter Pads	Speciality Pads - SXR / Vee / MXS	Sintered/ HH Pads/ Grooved Shoes	DISC PAD CHOICES - FRONT		BRAKE DISC CHOICES - FRONT						Line #
				Left / Gauche / Links Standard Replacement Disc	Right / Droite / Rechts Standard Replacement Disc	Contour Disc Universal left and right fitment	Custom Disc Universal left and right fitment	Vee-Discs Black † See note below	CX Extreme MX Race Disc/ UTVX Disc			
FA069*			FA069HH*	MD1001	MD1001							1
FA196		FA196V	FA196HH									2
FA196												3
		FA196V	FA196HH			MD1186C						4
SFA257/2												5
FA196		FA196V	FA196HH			MD1187C						6
FA196		FA196V	FA196HH			MD1187C						7
SFA257/2												8
FA196		FA196V	FA196HH			MD1186C						9
FA196		FA196V	FA196HH			MD1187C						10
FA196		FA196V	FA196HH			MD1187C						11
SFA257/2												12
SFA196	SFAC196		SFA196HH			MD1187C						13
SFA257/2												14
FA187*			FA187HH*									15
FA187*			FA187HH*	MD1012LS	MD1012RS							16
FA069		FA069V	FA069HH	MD1047LS								17
FA069/3		FA069/3V	FA069/3HH	MD1059LS								18
FA196		FA196V	FA196HH	MD1021LS								19
FA069*			FA069HH*	MD1083LS	MD1083RS							20
FA069*		FA069V*	FA069HH*	MD1001	MD1001							21
FA124*			FA124HH*	MD1001	MD1001							22
FA142*		FA142V*	FA142HH*	MD1008	MD1008							23
FA142*		FA142V*	FA142HH*	MD1008	MD1008							24
FA142*		FA142V*	FA142HH*	MD1003X	MD1003X	MD1003XC*	MD1003CC*	VR1003BLK*†				25
FA187*			FA187HH*	MD1010LS	MD1010RS							26
												27
FA196		FA196V	FA196HH	MD1159								28
FA196		FA196V	FA196HH		MD1159							29
												30
FA388			FA388HH									31
FA196		FA196V	FA196HH	MD1159								32
FA196		FA196V	FA196HH	MD1159								33
FA196		FA196V	FA196HH	MD1159								34
FA388		FA388V	FA388HH									35
FA388		FA388V	FA388HH									36
FA069			FA069HH	MD6044D								37
FA121*			FA121HH*	MD6102	MD6102							38
FA185TT*		MXS185*	FA185R*	MD6102	MD6102							39
FA142*		FA142V*	FA142HH*	MD1001	MD1001							40
			FA261HH*	MD1014X	MD1014X	MD1014XC*	MD1014CC*	VR1014BLK*†				41
			FA261HH*	MD1014X	MD1014X	MD1014XC*	MD1014CC*	VR1014BLK*†				42
			FA388HH*	MD1157X	MD1157X	MD1157XC*						43
			FA261HH*	MD1157X	MD1157X	MD1157XC*						44
			FA388HH*	MD1157X	MD1157X	MD1157XC*						45
			FA390HH*	MD1188X	MD1188X							46
			FA388HH*	MD1188X	MD1188X							47
			FA390HH*	MD1188X	MD1188X							48
			FA700HH*	MD1188X	MD1188X							49
FA031*				MD1036LS	MD1036RS							50
FA069/2*				MD1036LS	MD1036RS							51
FA069*			FA069HH*	MD1036LS	MD1036RS							52
FA187*			FA187HH*	MD1141X	MD1141X	MD1141XC*	MD1141CC*	VR1141BLK*†				53
FA187*			FA187HH*	MD1014X	MD1014X	MD1014XC*	MD1014CC*	VR1014BLK*†				54
FA187*			FA187HH*	MD1003X	MD1003X	MD1003XC*	MD1003CC*	VR1003BLK*†				55
FA187*			FA187HH*	MD1003X	MD1003X	MD1003XC*	MD1003CC*	VR1003BLK*†				56
			FA265HH*	MD1134X	MD1134X	MD1134XC*	MD1134CC*	VR1134BLK*†				57
FA095*			FA095HH*									58
			FA265HH*	MD1137X	MD1137X	MD1137XC*	MD1137CC*	VR1137BLK*†				59
			FA265HH*	MD1137X	MD1137X	MD1137XC*	MD1137CC*	VR1137BLK*†				60

FRONT / AVANT / VORN / FRENTE / ANTERIORE

R Suffix = High Durability Sintered Pad. HH Suffix = High Performance Sintered Pad. TT Suffix = Hard Wearing Off Road Pad. V Suffix = Semi-Sintered Pad. G Suffix = Grooved Shoe.
D Suffix = Drilled Disc. X Suffix = Universal Left or Right Disc. XC Suffix = Contoured Disc. LS Suffix = Left/Steel Disc. RS = Right/Steel Disc.

*-2 Sets Required. † For Vee disc colours add RED, BLU, GRN, GLD, ORG suffix to part number. For Custom Finish Options for Vee-Rotors™ including Splatter discs add suffix CHR, D, CHGR, CHBL, CHBR - available in various colours see page iv. Ⓢ - Also available as a Vintage Motorcycle Disc.

JAPANESE Built Motorcycles

Line #	BRAKE DISC CHOICES - FRONT						DISC PAD CHOICES - REAR				BRAKE DISC CHOICES - REAR			
	Oversize 250 /280mm Disc Kit	OSX Oversize 250/280mm Disc Kit	Relocating Bracket for 250/ 280mm Disc	Oversize 320mm Disc Kit	SMX Oversize 320mm Disc Kit	Relocating Bracket for 320mm Disc	FA, SFA, TT Pad or Brake Shoe	SFAC Carbon Scooter Pads	Speciality Pads - SXR / Vee / MXS	Sintered/ HH Pads/ Grooved Shoes	Standard Replacement Disc	Contour Disc Rear fitment	Vee Discs CONTOUR	CX Extreme MX Race Disc
1							FA069/3		FA069/3V	FA069/3HH	MD1079			
2							FA140		FA140V	FA140HH				
3							FA496		FA496V	FA496HH				
4							FA496		FA496V	FA496HH		MD1185C		
5														
6							FA496		FA496V	FA496HH		MD1185C		
7							FA496		FA496V	FA496HH		MD1185C		
8														
9							FA496		FA496V	FA496HH		MD1185C		
10							FA496		FA496V	FA496HH		MD1185C		
11							FA496		FA496V	FA496HH		MD1185C		
12														
13							FA496		FA496V	FA496HH		MD1185C		
14														
15							FA143							
16							FA143				MD1013			
17							H343							
18							H343							
19							H343							
20							FA069/3		FA069/3V	FA069/3HH	MD1068			
21							H321							
22							FA069/3		FA069/3V	FA069/3HH	MD1006			
23							FA196		FA196V	FA196HH	MD1006			
24							FA196		FA196V	FA196HH	MD1007			
25							FA196		FA196V	FA196HH	MD1007	MD1007C		
26							FA143				MD1011			
27														
28							H343							
29							H343							
30														
31							FA254		FA254V	FA254HH				
32							H343							
33							H343							
34							H343							
35							TBA							
36							FA254		FA254V	FA254HH				
37							H340			H340G				
38							FA140			FA140HH	MD6103D			
39							FA140				MD6103D			
40							H343							
41									FA261HH		MD1165	MD1165C		
42									FA261HH		MD1165	MD1165C		
43									FA261HH		MD1165	MD1165C		
44									FA261HH		MD1164	MD1164C		
45									FA261HH		MD1164	MD1164C		
46									FA488HH		MD1190			
47									FA488HH		MD1189			
48									FA488HH		MD1190			
49									FA488HH		MD1190			
50							FA031		FA031V		MD1071			
51							FA069		FA069V		MD1082			
52							FA069		FA069V	FA069HH	MD1082			
53							FA174		FA174V	FA174HH	MD1020	MD1020C	VR1020	
54							FA174		FA174V	FA174HH	MD1004	MD1004C	VR1004	
55							FA174		FA174V	FA174HH	MD1004	MD1004C	VR1004	
56							FA174		FA174V	FA174HH	MD1004	MD1004C	VR1004	
57							FA174		FA174V	FA174HH	MD1004	MD1004C	VR1004	
58							FA047			FA047HH				
59							FA174		FA174V	FA174HH	MD1004	MD1004C	VR1004	
60							FA174		FA174V	FA174HH	MD1004	MD1004C	VR1004	

REAR / ARRIÈRE / HINTEN / POSTERIOR / POSTERIORE

R Suffix = High Durability Sintered Pad. **HH** Suffix = High Performance Sintered Pad. **TT** Suffix = Hard Wearing Off Road Pad. **V** Suffix = Semi Sintered Pad. **G** Suffix = Grooved Shoe.
D Suffix = Drilled Disc. **X** Suffix = Universal Left or Right Disc. **XC** Suffix = Contoured Disc. **LS** Suffix = Left/Steel Disc. **RS** = Right/Steel Disc.

BRAKE APPLICATIONS

*-2 Sets Required. † For Vee disc colours add RED, BLU, GRN, GLD, ORG suffix to part number. For Custom Finish Options for Vee-Rotors™ including Splatter discs add suffix CHR, CHGR, CHBL, CHBR - available in various colours see page iv. Ⓢ - Also available as a Vintage Motorcycle Disc.

JAPANESE Built Motorcycles



HONDA Contd.

CB 1000 FP/FR/FS/FT/FV	93-97
CB 1000 R (Non ABS Model)	09-15
CB 1000 R (ABS Model)	09-16
CB 1000 R (ABS Model)	17-20
CBF 1000 6/7/8/9/A (2 Piston Front Calipers /Non ABS Model)	06-11
CBF 1000 A A6/A7/A8/A9/AA (3 Piston Front Caliper /ABS Model)	06-10
CBF 1000 S S7/S8/S9/SA (3 Piston Front Caliper /ABS Model)	07-11
CBF 1000 T T7/T8/T9/TA - GT (3 Piston Front Caliper /ABS Model)	07-16
CBF 1000 F FA (2 Piston Front Caliper/Non ABS)	10-15
CBF 1000 FA FAA (3 Piston Front Caliper/ABS Model)	10-15
CBF 1000 FS FSA (3 Piston Front Caliper/ABS Model)	10-11
CBF 1000 FT FTA (3 Piston Front Caliper/ABS Model)	10-11
CBR 1000 FH/FJ	87-88
CBR 1000 FK/FL/FM/FN	89-92
CBR 1000 FP/FR/FS/FT/FV/FW/FX (Note - linked brake system. Fit all three sets at pad change)	93-99
CBR 1000 RR4/RR5 Fireblade	04-05
CBR 1000 RR6/RR7	06-07
CBR 1000 RR8/RR9/RAA/RRB/RRC/RRD/RRE/RRF /RRG Fireblade Non ABS	08-16
CBR 1000 RA9/RAA/RAB/RAC/RAD/RAE/RAF/RAG Fireblade (C-ABS)	09-16
CBR 1000 RAH/RAJ Fireblade (C-ABS/ Tokico Front Caliper)	17-20
CBR 1000 RRH/RRJ Fireblade (C-ABS/ Tokico Front Caliper)	17-20
CBR 1000 RR-SP ABS Fireblade (CBR 1000 SAE/SAF/SAG /SAH/SAJ/SAK - Brembo Front Caliper)	14-20
CBR 1000 RR-SP Non ABS Fireblade (CBR 1000 SE/SF/SG)	14-16
CBR 1000 Fireblade 8 Ball ABS	20
CBR 1000 RR-SP ABS-TT Edition	16
CBX 1000 Z	79-80
CBX 1000 B/C	81-82
CRF 1000 Africa Twin ABS	16-17
CRF 1000 Africa Twin ABS DCT	16-17
CRF 1000 Africa Twin ABS DCT	18-20
CRF 1000 Africa Twin ABS DCT Parking Brake	16-20
GL 1000 K/K1/K2 Goldwing (6 Bolt disc fixing)	75-77
GL 1000 K3 Goldwing	78
GL 1000 Z Goldwing (5 Bolt disc fixing)	79
RC 213 V-S	15-17
PVT 1000 RS Pursuer	17-18
SXS 1000 M3 Pioneer (3 Seater)	Left 16-20
	Right
SXS 1000 M3P Pioneer (3 Seater)	Left 16-20
	Right
SXS 1000 M5D Pioneer (5 Seater)	Left 16-20
	Right
SXS 1000 M5L Pioneer (5 Seater)	Left 17-20
	Right
SXS 1000 M5P Pioneer (5 Seater)	Left 16-20
	Right
SXS 1000 S2R Talon (2 Seater)	Left 19-20
	Right
VF 1000 FE/FF/FG/F2F/F2G	84-86

FA, SFA, TT Pad or Brake Shoe	DISC PAD CHOICES - FRONT			BRAKE DISC CHOICES - FRONT						Line #
	SFAC Carbon Scooter Pads	Speciality Pads - SXR / Vee / MXS	Sintered/HH Pads/ Grooved Shoes	Left / Gauche / Links Standard Replacement Disc	Right / Droite / Rechts Standard Replacement Disc	Contour Disc Universal left and right fitment	Custom Disc Universal left and right fitment	Vee-Discs Black † See note below	CX Extreme MX Race Disc/ UTVX Disc	
FA187*			FA187HH*	MD1056	MD1056					1
			FA390HH*	MD1152X	MD1152X	MD1152XC*	MD1152CC*	VR1152BLK*†		2
			FA388HH*	MD1152X	MD1152X	MD1152XC*	MD1152CC*	VR1152BLK*†		3
			FA700HH*							4
FA226*			FA226HH*	MD1160	MD1160					5
			FA388HH*	MD1160	MD1160					6
			FA388HH*	MD1160	MD1160					7
			FA388HH*	MD1160	MD1160					8
			FA388HH*	MD1160	MD1160					9
			FA388HH*	MD1160	MD1160					10
FA226*			FA226HH*	MD1160	MD1160					11
			FA388HH*	MD1160	MD1160					12
			FA388HH*	MD1160	MD1160					13
			FA388HH*	MD1160	MD1160					14
			FA388HH*	MD1160	MD1160					15
FA124*			FA124HH*	MD1008	MD1008					16
FA142*		FA142V*	FA142HH*	MD1008	MD1008					17
										18
FA189*			FA189HH*	MD1008	MD1008					19
			FA390HH*	MD1153X	MD1153X	MD1153XC*	MD1153CC*	VR1153BLK*†		20
			FA390HH*	MD1161X	MD1161X	MD1161XC*	MD1161CC*	VR1161BLK*†		21
			FA390HH*	MD1171X	MD1171X	MD1171XC*		VR1171BLK*†		22
			FA390HH*	MD1171X	MD1171X	MD1171XC*		VR1171BLK*†		23
			FA390HH*	MD1171X	MD1171X	MD1171XC*		VR1171BLK*†		24
			FA390HH*	MD1171X	MD1171X	MD1171XC*		VR1171BLK*†		25
			FA390HH*	MD1171X	MD1171X	MD1171XC*		VR1171BLK*†		26
			FA390HH*	MD1171X	MD1171X	MD1171XC*		VR1171BLK*†		27
			FA390HH*	MD1171X	MD1171X	MD1171XC*		VR1171BLK*†		28
			FA390HH*	MD1171X	MD1171X	MD1171XC*		VR1171BLK*†		29
			FA390HH*	MD1171X	MD1171X	MD1171XC*		VR1171BLK*†		30
			FA390HH*	MD1171X	MD1171X	MD1171XC*		VR1171BLK*†		31
			FA390HH*	MD1171X	MD1171X	MD1171XC*		VR1171BLK*†		32
			FA390HH*	MD1171X	MD1171X	MD1171XC*		VR1171BLK*†		33
			FA390HH*	MD1171X	MD1171X	MD1171XC*		VR1171BLK*†		34
			FA390HH*	MD1171X	MD1171X	MD1171XC*		VR1171BLK*†		35
			FA390HH*	MD1171X	MD1171X	MD1171XC*		VR1171BLK*†		36
FA031*				MD1036LS	MD1036RS					37
FA069/2*										38
			FA679HH*	MD1198X	MD1198X					39
			FA679HH*	MD1198X	MD1198X					40
			FA679HH*	MD1198X	MD1198X					41
SFA257/2										42
FA030*		FA030V*		MD1074LS	MD1074RS					43
FA029*		FA029V*								44
FA029*		FA029V*		MD1036LS	MD1036RS					45
			FA447HH*							46
FA700*			FA700HH*	MD1186X	MD1186X	MD1186XC*				47
FA701TT		SXR701HH	FA701R	MD6410D					UTVX6410	48
FA702TT		SXR702HH	FA702R		MD6410D				UTVX6410	49
FA701TT		SXR701HH	FA701R	MD6410D					UTVX6410	50
FA702TT		SXR702HH	FA702R		MD6410D				UTVX6410	51
FA701TT		SXR701HH	FA701R	MD6410D					UTVX6410	52
FA702TT		SXR702HH	FA702R		MD6410D				UTVX6410	53
FA701TT		SXR701HH	FA701R	MD6410D					UTVX6410	54
FA702TT		SXR702HH	FA702R		MD6410D				UTVX6410	55
FA701TT		SXR701HH	FA701R	MD6410D					UTVX6410	56
FA702TT		SXR702HH	FA702R		MD6410D				UTVX6410	57
FA701TT		SXR701HH	FA701R	MD6425					UTVX6410	58
FA701TT		SXR702HH	FA702R		MD6425				UTVX6410	59
FA069*			FA069HH*	MD1001	MD1001					60

FRONT / AVANT / VORN / FRENTE / ANTERIORE

R Suffix = High Durability Sintered Pad. HH Suffix = High Performance Sintered Pad. TT Suffix = Hard Wearing Off Road Pad. V Suffix = Semi Sintered Pad. G Suffix = Grooved Shoe.

D Suffix = Drilled Disc. X Suffix = Universal Left or Right Disc. XC Suffix = Contoured Disc. LS Suffix = Left/Steel Disc. RS = Right/Steel Disc.

*-2 Sets Required. † For Vee disc colours add RED, BLU, GRN, GLD, ORG suffix to part number. For Custom Finish Options for Vee-Rotors™ including Splatter discs add suffix CHR, CHGR, CHBL, CHBR - available in various colours see page iv. Ⓢ - Also available as a Vintage Motorcycle Disc.

JAPANESE Built Motorcycles

Line #	BRAKE DISC CHOICES - FRONT						DISC PAD CHOICES - REAR				BRAKE DISC CHOICES - REAR			
	Oversize 250 /280mm Disc Kit	OSX Oversize 250/280mm Disc Kit	Relocating Bracket for 250/ 280mm Disc	Oversize 320mm Disc Kit	SMX Oversize 320mm Disc Kit	Relocating Bracket for 320mm Disc	FA, SFA, TT Pad or Brake Shoe	SFAC Carbon Scooter Pads	Speciality Pads - SXR / Vee / MXS	Sintered/ HH Pads/ Grooved Shoes	Standard Replacement Disc	Contour Disc Rear fitment	Vee Discs CONTOUR	CX Extreme MX Race Disc
1							FA174		FA174V	FA174HH	MD1016			
2										FA488HH	MD1177	MD1177C		
3										FA488HH	MD1177	MD1177C		
4							FA196		FA196V	FA196HH				
5														
6							FA174		FA174V	FA174HH	MD1156			
7														
8										FA388HH	MD1178			
9														
10										FA388HH	MD1178			
11														
12										FA388HH	MD1178			
13							FA174		FA174V	FA174HH	MD1156			
14							FA174		FA174V	FA174HH	MD1178			
15							FA174		FA174V	FA174HH	MD1178			
16							FA174		FA174V	FA174HH	MD1178			
17							FA069/3		FA069/3V	FA069/3HH	MD1001			
18							FA196		FA196V	FA196HH	MD1016			
19														
20							FA189			FA189HH	MD1006			
21							FA174		FA174V	FA174HH	MD1004	MD1004C	VR1004	
22							FA436		FA436V	FA436HH	MD1004	MD1004C	VR1004	
23														
24							FA436		FA436V	FA436HH	MD1173	MD1173C	VR1173	
25														
26							FA436		FA436V	FA436HH	MD1173	MD1173C	VR1173	
27														
28							FA436		FA436V	FA436HH				
29														
30							FA436		FA436V	FA436HH				
31														
32							FA436		FA436V	FA436HH	MD1173	MD1173C	VR1173	
33														
34							FA436		FA436V	FA436HH	MD1173	MD1173C		
35							FA436		FA436V	FA436HH		MD1173C		
36							FA436		FA436V	FA436HH		MD1173C		
37							FA031		FA031V		MD1071			
38							FA069		FA069V		MD1071			
39							FA174		FA174V	FA174HH	MD1196			
40							FA174		FA174V	FA174HH	MD1196			
41							FA174		FA174V	FA174HH	MD1196			
42														
43							FA032		FA032V		MD1064			
44							FA032		FA032V		MD1064			
45							FA032		FA032V		MD1064			
46							FA266		FA266V	FA266HH				
47							FA109				MD1079			
48							FA703TT			FA703R	MD6410D			UTVX6410
49							FA704TT			FA704R	MD6410D			UTVX6410
50							FA703TT			FA703R	MD6410D			UTVX6410
51							FA704TT			FA704R	MD6410D			UTVX6410
52							FA703TT			FA703R	MD6410D			UTVX6410
53							FA704TT			FA704R	MD6410D			UTVX6410
54							FA703TT			FA703R	MD6410D			UTVX6410
55							FA704TT			FA704R	MD6410D			UTVX6410
56							FA703TT			FA703R	MD6410D			UTVX6410
57							FA704TT			FA704R	MD6410D			UTVX6410
58							FA703TT			FA703R	MD6425			
59							FA704TT			FA704R	MD6425			
60							FA069/3		FA069/3V	FA069/3HH	MD1079			

REAR / ARRIÈRE / HINTEN / POSTERIOR / POSTERIORE

BRAKE APPLICATIONS

*-2 Sets Required. † For Vee disc colours add RED, BLU, GRN, GLD, ORG suffix to part number. For Custom Finish Options for Vee-Rotors™ including Splatter discs add suffix CHR, CHGR, CHBL, CHBR - available in various colours see page iv. ☼ - Also available as a Vintage Motorcycle Disc.

R Suffix = High Durability Sintered Pad. HH Suffix = High Performance Sintered Pad. TT Suffix = Hard Wearing Off Road Pad. V Suffix = Semi Sintered Pad. G Suffix = Grooved Shoe. D Suffix = Drilled Disc. X Suffix = Universal Left or Right Disc. XC Suffix = Contoured Disc. LS Suffix = Left/Steel Disc. RS = Right/Steel Disc.

JAPANESE Built Motorcycles



HONDA Contd.

VF 1000 RE/RF/RG	84-86
VTR 1000 FV/FW/FX/FY/F1-F6 Firestorm	97-06
VTR 1000 SP-Y/SP-1 (SC45) (SP1)	00-01
VTR 1000 SP-2/SP-3/SP-4/SP-5/SP-6 (SP2)	02-07
XL 1000 VX/XY/V1/V2 Varadero - Non ABS Model	
(Note - linked brake system.	
Fit all three sets at pad change)	99-02
XL 1000 V3/V4/V5/V6 Varadero - Non ABS Model	
(Note - linked brake system.	
Fit all three sets at pad change)	03-06
XL 1000 V7/V8/V9/VA/VB Varadero - Non ABS Model	
(Note - linked brake system.	
Fit all three sets at pad change)	07-11
XL 1000 VA4/VA5/VA6/VA7/VA8/VA9/VAA/VB Varadero - ABS Model (Note - linked brake system.	
Fit all three sets at pad change)	04-11
CB 1100 RB2/RC2/RD2	80-83
CB 1100 SFY/SF1 X11	00-03
CB 1100 AD (Cast Wheels/3 Piston Caliper)	13
CB 1100 AE (Cast Wheels/4 Piston Calipers)	14
CB 1100 EX (SAE)	14-18
CB 1100 RS	17
CB 1100 RS	18
CBR 1100 XXV/XXW Blackbird (Note - linked brake system.	
Fit all three sets at pad change)	97-98
CBR 1100 XXX/XXY/XX1-XX6 Blackbird	
(Note - linked brake system.	
Fit all three sets at pad change)	99-08
CRF 1100 Africa Twin Adventure Sport ES ABS (Manual)	18-20
CRF 1100 Africa Twin Adventure Sport ES ABS (DCT)	18-20
GL 1100 AD Goldwing Aspencade	83
GL 1100 A/DA/B/DB (SC02)	80-82
GL 1100 C/DC Goldwing	82
ST 1100 L/M/N/P/R/S/T/V/W/X/Y/1/2 Pan European - Non ABS Model	90-02
ST 1100 AN/AP/AR/AS (Pan European - ABS Model) (Note - linked brake system.	
Fit all three sets at pad change)	92-95
ST 1100 AT/AV/AW/AX/AY/A1/A2 (Pan European - ABS Model) (Note - linked brake system.	
Fit all three sets at pad change)	96-02
VT 1100 CH/CJ/CV/CP Shadow	87-93
VT 1100 CR/CS/CT/CW/CV Shadow	94-98
VT 1100 C2 (S/T/V)	95-97
VT 1100 C2 (W/X/Y/1/2/3/4/5)	98-05
VT 1100 C3 (W/X/Y)	98-00
GL 1200 DE/DF/DG Goldwing (4.7mm front disc)	84-86
GL 1200 AE/AF/AG Goldwing (10mm vented front disc)	84-86
VFR 1200 FA	10-16
VFR 1200 FAD DCT	10-17
VFR 1200 FAD DCT - Parking Brake	10-17
VFR 1200 FA GT	14-15
VFR 1200 FAD GT/DCT	14-15
VFR 1200 FAD GT/DCT - Parking Brake	14-15
VFR 1200 XAC/XAD/XAE/XAF/XAH/XAJ Crosstourer (Manual G/Box)	12-18
VFR 1200 XDC/XDCD/XDE/XDF/XDG/XDH/XDJ DCT Crosstourer	12-18
VFR 1200 XDC/XDCD/XDE/XDF/XDG/XDH/XDJ DCT Crosstourer - Parking Brake	12-18

FA, SFA, TT Pad or Brake Shoe	SFAC Carbon Scooter Pads	Speciality Pads - SXR / Vee / MXS	Sintered/HH Pads/ Grooved Shoes	DISC PAD CHOICES - FRONT				BRAKE DISC CHOICES - FRONT				Line #
				Left / Gauche / Links Standard Replacement Disc	Right / Droite / Rechts Standard Replacement Disc	Contour Disc Universal left and right fitment	Custom Disc Universal left and right fitment	Vee-Discs Black † See note below	CX Extreme MX Race Disc/ UTVX Disc			
FA069*			FA069HH*	MD1146	MD1146							1
FA187*			FA187HH*	MD1003X	MD1003X	MD1003XC*	MD1003CC*	VR1003BLK*†				2
			FA265HH*	MD1161X	MD1161X	MD1161XC*	MD1161CC*	VR1161BLK*†				3
			FA265HH*	MD1161X	MD1161X	MD1161XC*	MD1161CC*	VR1161BLK*†				4
												5
												6
			FA261HH*	MD1014X	MD1014X	MD1014XC*	MD1014CC*	VR1014BLK*†				7
												8
												9
			FA261HH*	MD1014X	MD1014X	MD1014XC*	MD1014CC*	VR1014BLK*†				10
												11
												12
			FA388HH*	MD1014X	MD1014X	MD1014XC*	MD1014CC*	VR1014BLK*†				13
												14
												15
			FA388HH*	MD1157X	MD1157X	MD1157XC*						16
FA069*			FA069HH*									17
			FA261HH*	MD1136X	MD1136X	MD1136XC*		VR1136BLK*†				18
			FA388HH*									19
			FA296HH*									20
			FA296HH*									21
			FA390HH*									22
			FA700HH*									23
												24
			FA261HH*	MD1120X	MD1120X	MD1120XC*		VR1120BLK*†				25
												26
												27
			FA261HH*	MD1136X	MD1136X	MD1136XC*		VR1136BLK*†				28
			FA679HH*	MD1198X	MD1198X							29
			FA679HH*	MD1198X	MD1198X							30
FA069/2*		FA069/2V*		MD1133	MD1133							31
FA030*		FA030V*		MD1036LS	MD1036RS							32
FA069/2*		FA069/2V*		MD1036LS	MD1036RS							33
												34
FA142*		FA142V*	FA142HH*	MD1101	MD1101							35
												36
												37
FA142*		FA142V*	FA142HH*	MD1101	MD1101							38
												39
												40
			FA261HH*	MD1008	MD1008							41
FA069/3		FA069/3V	FA069/3HH		MD1080RS							42
FA196		FA196V	FA196HH		MD1167RS							43
FA196		FA196V	FA196HH	MD1021RS								44
FA196		FA196V	FA196HH	MD1179								45
FA196		FA196V	FA196HH	MD1179								46
FA069/3*		FA069/3V*	FA069/3HH*	MD1083LS	MD1083RS							47
FA069/3*		FA069/3V*	FA069/3HH*	MD1125	MD1125							48
			FA499/4HH*	MD1176X	MD1176X							49
			FA499/4HH*	MD1176X	MD1176X							50
SFA257/2												51
			FA499/4HH*	MD1176X	MD1176X							52
			FA499/4HH*	MD1176X	MD1176X							53
SFA257/2												54
												55
			FA388HH*	MD1197	MD1197							56
												57
			FA388HH*	MD1197	MD1197							58
												59
SFA257/2												60

FRONT / AVANT / VORN / FRENTE / ANTERIORE

R Suffix = High Durability Sintered Pad. HH Suffix = High Performance Sintered Pad. TT Suffix = Hard Wearing Off Road Pad. V Suffix = Semi-Sintered Pad. G Suffix = Grooved Shoe.

D Suffix = Drilled Disc. X Suffix = Universal Left or Right Disc. XC Suffix = Contoured Disc. LS Suffix = Left/Steel Disc. RS = Right/Steel Disc.

*-2 Sets Required. † For Vee disc colours add RED, BLU, GRN, GLD, ORG suffix to part number. For Custom Finish Options for Vee-Rotors™ including Splatter discs add suffix CHR, D, HGR, CHBL, CHBR - available in various colours see page iv. Ⓢ - Also available as a Vintage Motorcycle Disc.

JAPANESE Built Motorcycles

Line #	BRAKE DISC CHOICES - FRONT						DISC PAD CHOICES - REAR				BRAKE DISC CHOICES - REAR			
	Oversize 250 /280mm Disc Kit	OSX Oversize 250/280mm Disc Kit	Relocating Bracket for 250/ 280mm Disc	Oversize 320mm Disc Kit	SMX Oversize 320mm Disc Kit	Relocating Bracket for 320mm Disc	FA, SFA, TT Pad or Brake Shoe	SFAC Carbon Scooter Pads	Speciality Pads - SXR / Vee / MXS	Sintered/ HH Pads/ Grooved Shoes	Standard Replacement Disc	Contour Disc Rear fitment	Vee Discs CONTOUR	CX Extreme MX Race Disc
1							FA109							
2							FA174		FA174V	FA174HH	MD1004	MD1004C	VR1004	
3							FA174		FA174V	FA174HH	MD1004	MD1004C	VR1004	
4							FA174		FA174V	FA174HH	MD1004	MD1004C	VR1004	
5														
6														
7									FA261HH	MD6103D				
8														
9														
10									FA261HH	MD1006	MD1006C	VR1006		
11														
12														
13									FA261HH	MD1006	MD1006C	VR1006		
14														
15														
16									FA261HH	MD1006	MD1006C			
17							FA069/3		FA069/3V	FA069/3HH	MD1116			
18									FA261HH	MD1006	MD1006C	VR1006		
19							FA174		FA174V	FA174HH				
20							FA174		FA174V	FA174HH				
21							FA174		FA174V	FA174HH				
22							FA174		FA174V	FA174HH	MD1174			
23							FA174		FA174V	FA174HH	MD1174			
24														
25									FA261HH	MD1006	MD1006C	VR1006		
26														
27														
28									FA261HH	MD1006	MD1006C	VR1006		
29							FA174		FA174V	FA174HH	MD1196			
30							FA174		FA174V	FA174HH	MD1196			
31							FA069		FA069V		MD1082			
32							FA030		FA030V		MD1071 ⚙			
33							FA069		FA069V		MD1071 ⚙			
34														
35							FA196		FA196V	FA196HH	MD1077			
36														
37														
38							FA196		FA196V	FA196HH	MD1077			
39														
40														
41									FA261HH	MD1135				
42							H343							
43							H343							
44							FA174		FA174V	FA174HH	MD1016			
45							FA174		FA174V	FA174HH	MD1016			
46							FA174		FA174V	FA174HH	MD1016			
47							FA069/3		FA069/3V	FA069/3HH	MD1082			
48							FA069/3		FA069/3V	FA069/3HH	MD1082			
49									FA488HH	MD1175				
50								FA636V	FA636HH	MD1175				
51														
52									FA488HH	MD1175				
53								FA636V	FA636HH	MD1175				
54														
55									FA636HH	MD1175				
56														
57									FA636HH	MD1175				
58														
59									FA636HH	MD1175				
60														

REAR / ARRIÈRE / HINTEN / POSTERIORE

R Suffix = High Durability Sintered Pad. **HH** Suffix = High Performance Sintered Pad. **TT** Suffix = Hard Wearing Off Road Pad. **V** Suffix = Semi Sintered Pad. **G** Suffix = Grooved Shoe.
D Suffix = Drilled Disc. **X** Suffix = Universal Left or Right Disc. **XC** Suffix = Contoured Disc. **LS** Suffix = Left/Steel Disc. **RS** = Right/Steel Disc.

BRAKE APPLICATIONS

*-2 Sets Required. † For Vee disc colours add RED, BLU, GRN, GLD, ORG suffix to part number. For Custom Finish Options for Vee-Rotors™ including Splatter discs add suffix CHR, CHGR, CHBL, CHBR - available in various colours see page iv. ⚙ - Also available as a Vintage Motorcycle Disc.

JAPANESE Built Motorcycles



HONDA Contd.

VFR 1200 Crosstourer Highlander T/DCT	15-16
X4 CB 1300 DCV/DCW/DCX/DCY (SC38)	97-00
CB 1300 FW/FX/FY (SC40)	98-00
CB 1300 F1 (SC40)	01
CB 1300 F3/F13 Superfour	03-04
CB 1300 5/6/7/8/9 (Superfour)	05-09
CB 1300 A5/A6/A7/A8/A9 (Superfour ABS)	05-09
CB 1300 S5/S6/S7/S8/S9	05-09
CB 1300 SA5-SAA	05-11
CTX 1300 AE	14-17
ST 1300 2/3/4/6 Pan European - Non ABS Model (Note - linked brake system.)	
Fit all three sets at pad change)	02-07
ST 1300 8/9 Pan European - Non ABS Model (Note - linked brake system.)	
Fit all three sets at pad change)	08-09
ST 1300 A2/A3/A4/A6 Pan European - ABS Model (Note - linked brake system.)	
Fit all three sets at pad change)	02-07
ST 1300 A8/A9/AA-AE Pan European - ABS Model (Note - linked brake system.)	
Fit all three sets at pad change)	08-17
VT 1300 CTA Interstate	11-13
VT 1300 CXA (Fury/Chopper/Non ABS /9 Spoke Cast Wheel)	10-20
VT 1300 CXAA (Fury/Chopper/ABS /9 Spoke Cast Wheel)	10-20
VTX 1300 S (Spoke Wheel Models Only)	03-08
VTX 1300 C/T (Cast Wheel Models Only)	03-08
GL 1500 J/K Goldwing	88-89
GL 1500 L/SEM/SEN/SEP/SER/SES/SEV/SEW /SEY/SEY Goldwing	90-00
GL 1500 CV/CW/CX (F6C)	97-99
GL 1500 CY/C1/C2 (F6C)	00-03
F6B Goldwing (GLF6BA)	13-17
F6C Goldwing (GLF6CA)	14-17
GL 1800 A1/A2/A3/A4/A5 Goldwing	01-05
GL 1800 6/7/8/9/A/C/D/E/F/G/H Goldwing	06-17
GL 1800 B Goldwing J (Manual)	18-20
GL 1800 Goldwing Tour J (Manual)	18-20
GL 1800 BD Goldwing J (DCT)	18-20
GL 1800 J Goldwing DCT - Parking Brake	18-20
GL 1800 D Goldwing Tour J (DCT)	18-20
GL 1800 D Goldwing Tour J (DCT) - Parking Brake	18-20
GL 1800 DA Goldwing Tour Airbag J (DCT)	18-20
GL 1800 DA Goldwing Tour Airbag J (DCT) - Parking Brake	18-20
VTX 1800 C2/C3/C4/C15/CA6/CA7 (Note - linked brake system. Fit all three sets at pad change)	02-08

FRONT / AVANT / VORN / FRENTE / ANTERIORE

DISC PAD CHOICES - FRONT				BRAKE DISC CHOICES - FRONT						Line #	
FA, SFA, TT Pad or Brake Shoe	SFAC Carbon Scooter Pads	Speciality Pads - SXR / Vee / MXS	Sintered/ HH Pads/ Grooved Shoes	Left / Gauche / Links Standard Replacement Disc	Right / Droite / Rechts Standard Replacement Disc	Contour Disc Universal left and right fitment	Custom Disc Universal left and right fitment	Vee-Discs Black † See note below	CX Extreme MX Race Disc/ UTVX Disc	Line #	
			FA388HH*		MD1197	MD1197				1	
FA187*			FA187HH*							2	
FA424*			FA424HH*	MD1136X	MD1136X	MD1136XC*		VR1136BLK*†		3	
			FA265HH*							4	
			FA296HH*							5	
			FA296HH*	MD1152X	MD1152X	MD1152XC*	MD1152CC*	VR1152BLK*†		6	
			FA296HH*	MD1152X	MD1152X	MD1152XC*	MD1152CC*	VR1152BLK*†		7	
			FA296HH*	MD1152X	MD1152X	MD1152XC*	MD1152CC*	VR1152BLK*†		8	
			FA296HH*	MD1152X	MD1152X	MD1152XC*	MD1152CC*	VR1152BLK*†		9	
			FA388HH*							10	
										11	
			FA261HH*	MD1154X	MD1154X	MD1154XC*				12	
										13	
			FA388HH*	MD1154X	MD1154X	MD1154XC*				14	
										15	
			FA388HH*	MD1154X	MD1154X	MD1154XC*				16	
										17	
			FA261HH*	MD1154X	MD1154X	MD1154XC*				18	
										19	
			FA388HH*	MD1154X	MD1154X	MD1154XC*				20	
			FA388HH							21	
										22	
			FA196V	FA196V	FA196HH					23	
										24	
			FA388		FA388HH					25	
			FA196	FA196V	FA196HH		MD1158RS			26	
			FA196	FA196V	FA196HH		MD1182RS			27	
			FA124/2*	FA124/2V*	FA124/2HH*	MD1126	MD1126			28	
										29	
			FA124/2*	FA124/2V*	FA124/2HH*	MD1126	MD1126			30	
			FA142*	FA142V*	FA142HH*	MD1014X	MD1014X	MD1014XC*	MD1014CC*	VR1014BLK*†	31
			FA142*	FA142V*	FA142HH*	MD1014X	MD1014X	MD1014XC*	MD1014CC*	VR1014BLK*†	32
					FA261HH*					33	
					FA296HH*					34	
					FA261HH*	MD1014X	MD1014X	MD1014XC*	MD1014CC*	VR1014BLK*†	35
					FA261HH*	MD1014X	MD1014X	MD1014XC*	MD1014CC*	VR1014BLK*†	36
					FA717HH*					37	
					FA717HH*					38	
					FA717HH*					39	
					FA717HH*					40	
					FA717HH*					41	
					FA257/2					42	
										43	
					FA257/2					44	
										45	
					FA257/2					46	
										47	
					FA261HH*	MD1141X	MD1141X	MD1141XC*	MD1141CC*	VR1141BLK*†	48
										49	
										50	
										51	
										52	
										53	
										54	
										55	
										56	
										57	
										58	
										59	
										60	

*-2 Sets Required. † For Vee disc colours add RED, BLU, GRN, GLD, ORG suffix to part number. For Custom Finish Options for Vee-Rotors™ including Splatter discs add suffix CHR, CHGR, CHBL, CHBR - available in various colours see page iv. Ⓢ - Also available as a Vintage Motorcycle Disc.

JAPANESE Built Motorcycles

Line #	BRAKE DISC CHOICES - FRONT						DISC PAD CHOICES - REAR				BRAKE DISC CHOICES - REAR			
	Oversize 250 /280mm Disc Kit	OSX Oversize 250/280mm Disc Kit	Relocating Bracket for 250/ 280mm Disc	Oversize 320mm Disc Kit	SMX Oversize 320mm Disc Kit	Relocating Bracket for 320mm Disc	FA, SFA, TT Pad or Brake Shoe	SFAC Carbon Scooter Pads	Speciality Pads - SXR / Vee / MXS	Sintered/ HH Pads/ Grooved Shoes	Standard Replacement Disc	Contour Disc Rear fitment	Vee Discs CONTOUR	CX Extreme MX Race Disc
1									FA636HH					
2							FA254	FA254V	FA254HH	MD1001				
3							FA254	FA254V	FA254HH	MD1016				
4							FA254	FA254V	FA254HH	MD1016				
5							FA174	FA174V	FA174HH	MD1006				
6							FA174	FA174V	FA174HH	MD1174	MD1174C			
7							FA174	FA174V	FA174HH	MD1174	MD1174C			
8							FA174	FA174V	FA174HH	MD1174	MD1174C			
9							FA174	FA174V	FA174HH	MD1174	MD1174C			
10								FA261V	FA261HH					
11														
12														
13									FA261HH	MD1163				
14														
15														
16									FA261HH	MD1163				
17														
18														
19									FA261HH	MD1163				
20														
21														
22									FA261HH	MD1163				
23								FA216/2V	FA261/2HH					
24														
25							FA174	FA174V	FA174HH					
26														
27							FA174	FA174V	FA174HH					
28							FA174	FA174V	FA174HH	MD1159				
29							FA174	FA174V	FA174HH	MD1159				
30							FA069/3	FA069/3V	FA069/3HH	MD1127				
31														
32							FA069/3	FA069/3V	FA069/3HH	MD1077				
33							FA196	FA196V	FA196HH	MD1077				
34							FA196	FA196V	FA196HH	MD1148				
35								FA261/2V	FA261/2HH					
36								FA261/2V	FA261/2HH					
37								FA261/2V	FA261/2HH					
38								FA261/2V	FA261/2HH					
39									FA388/2HH					
40									FA388/2HH					
41									FA388/2HH					
42														
43									FA388/2HH					
44														
45									FA388/2HH					
46														
47														
48														
49									FA261HH	MD1148				
50														
51														
52														
53														
54														
55														
56														
57														
58														
59														
60														

REAR / ARRIÈRE / HINTEN / POSTERIOR / POSTERIORE

BRAKE APPLICATIONS

*-2 Sets Required. † For Vee disc colours add RED, BLU, GRN, GLD, ORG suffix to part number. For Custom Finish Options for Vee-Rotors™ including Splatter discs add suffix CHR, CHGR, CHBL, CHBR - available in various colours see page iv. ☼ - Also available as a Vintage Motorcycle Disc.

R Suffix = High Durability Sintered Pad. HH Suffix = High Performance Sintered Pad. TT Suffix = Hard Wearing Off Road Pad. V Suffix = Semi Sintered Pad. G Suffix = Grooved Shoe.
D Suffix = Drilled Disc. X Suffix = Universal Left or Right Disc. XC Suffix = Contoured Disc. LS Suffix = Left/Steel Disc. RS = Right/Steel Disc.

JAPANESE Built Motorcycles



KAWASAKI



R Suffix = High Durability Sintered Pad. **HH** Suffix = High Performance Sintered Pad. **TT** Suffix = Hard Wearing Off Road Pad. **V** Suffix = Semi Sintered Pad. **G** Suffix = Grooved Shoe.

D Suffix = Drilled Disc. **X** Suffix = Universal Left or Right Disc. **XC** Suffix = Contoured Disc. **LS** Suffix = Left/Steel Disc. **RS** = Right/Steel Disc.

AE 50 A1/A2	81-82
AR 50 A1/C2-C10	81-97
KDX 50 A1/A2/A3	03-05
KFX 50 (KSF 50 A1/A2/A3)	03-05
KFX 50 (KSF 50 B7F/B8F/B9F/BDF/BEF/BFF/BGF/BHF)	07-09
KFX 50 (KSF 50 B7F/B8F/B9F/BDF/BEF/BFF/BGF/BHF)	13-17
KSR1 (KMX 50 B1/B2)	90-91
KX 60 A1/A2/B1-B19	83-03
KX 65	00-20
AE 80 A1/B1	81-82
AR 80 A1/C1-C8	81-91
KFX 80 (KSF 80 A1/A2/A3/A6F)	03-06
KX 80 B1/B2/D1/D2	79-83
KX 80 E1	83
KX 80 E2/E3/G1/G2/J1/J2	84-87
KX 80 L1/L2/N2/L3/N3/R1/T1	88-91
KX 80 R2/T2/R3/T3/R4/T4/R5/T5/R6/T6	92-96
KX 80 R7/W1/W2/W3	97-00
KX 85 (17 Inch Front/14 Inch Rear Wheel)	01-20
KX 85 (19 Inch Front/16 Inch Rear Wheel)	01-20
KFX 90 (KSF 90 A7F/A8F/A9F/AA/ABF/ACF/ADF/AEF /AFF/AGF/AHF)	07-17
KSR II (KMX 80 B1/B2)	90-91
KC 100 C1-C4	80-83
KE 100 A7-A10/B1-B15	79-98
KH 100 A2-A4	78-81
KH 100 G2/G3	81-83
KH 100 G4	83
KH 100 G5-G8 (EX)	84-87
KM 100 A4-A6	78-81
KX 100 A1/A2/B1	89-91
KX 100 B2-B6	92-96
KX 100 B7/C1/C2/C3	97-00
Max 100	
KLF 110 B1-B2 Mojave	87-88
KLX 110 R	02-20
KLX 110 L	10-20
Kaze-r 112cc	04
AR 125 A1-A7/B1-B8	82-94
BN 125 A1/A2 Eliminator	98-99
BN 125 A3/A4/A5/A6/A7F Eliminator	00-07
J 125 ABS (SC125 AGF/BGF/CGF/CHF/CJF)	16-18
J 125 SE/ABS (SC125 AGFA/BGFA/CGFA/CHFA/CJFA)	16-18
KDX 125 A1/A2/B1/B2	90-94
KE 125 A4-A12	76-85
KH 125 A1-A4	77-81
KH 125 K1	83
KH 125 K2-K10	82-98
KH 125 L1 (EX)	84
KLX 125 A1/A2/A3/A6F	03-06
KLX 125 L (B1/B2/B3/B6F)	03-06
KLX 125 CAF/CBF/CCF/CDS/CDF/CES/CEF/CFF/CGF	10-16
KLX 125 DAF/DBF/DCF/DDF/DEF (D-Tracker)	10-14
KMX 125 A1-A5/B1-B9	86-98
KMX 125 B2-B12 (From E/No MX AE 013437)	87-03
KX 125 A3-A7	74-80
KX 125 B1	82
KX 125 B2/C1	83-84
KX 125 D1	85
KX 125 E1	86

FA, SFA, TT Pad or Brake Shoe	SFAC Carbon Scooter Pads	Speciality Pads - SXR / Vee / MXS	Sintered/HH Pads/ Grooved Shoes	BRAKE DISC CHOICES - FRONT							Line #
				Left / Gauche / Links Standard Replacement Disc	Right / Droite / Rechts Standard Replacement Disc	Contour Disc Universal left and right fitment	Custom Disc Universal left and right fitment	Vee-Discs Black † See note below	CX Extreme MX Race Disc/ UTVX Disc		
S603			S603G								1
FA083TT			FA083HH	MD4040LS							2
S613			S613G								3
S614*			S614G*								4
H338*			H338G*								5
H338*			H338G*								6
FA083/2TT											7
K715			K715G								8
FA302TT			FA302R	MD6166D						MD6166CX	9
S603			S603G								10
FA083TT			FA083HH	MD4040LS							11
S614*			S614G*								12
K701			K701G								13
K714			K714G								14
FA083TT			FA083R	MD6027D							15
FA083TT			FA083R	MD6027D							16
FA083TT			FA083R	MD6026D							17
FA258TT			FA258R	MD6026D							18
FA258TT			FA258R	MD6186D		MD6186C				MD6186CX	19
FA258TT			FA258R	MD6186D		MD6186C				MD6186CX	20
H338*			H338G*								21
H338*			H338G*								22
FA083/2TT											23
S603											24
S603			S603G								25
S602											26
FA048				MD4116LS							27
FA067			FA067HH	MD4116LS							28
FA067			FA067HH	MD4105LS							29
S603			S603G								30
FA083TT			FA083R	MD6027D							31
FA083TT			FA083R	MD6026D							32
FA258TT			FA258R	MD6026D							33
S603											34
S603			S603G								35
K715			K715G								36
K715			K715G								37
FA197			FA197HH								38
FA067			FA067HH	MD4099							39
FA054TT			FA054HH		MD4137RS						40
FA197			FA197HH		MD4137RS						41
SFA142	SFAC142		SFA142HH								42
SFA142	SFAC142		SFA142HH								43
FA083TT			FA083R	MD6083D						MD6083CX	44
K704			K704G								45
FA039											46
FA054TT			FA054HH								47
FA067			FA067HH								48
FA067			FA067HH	MD4105LS							49
S604			S604G								50
FA230TT			FA230R	MD6212D							51
FA135TT		MXS135	FA135R			MD6363C					52
FA135TT		MXS135	FA135R			MD6363C					53
FA083TT			FA083R	MD6106D							54
FA230TT			FA230R	MD6106D							55
K704			K704G								56
FA083TT			FA083R								57
FA067TT			FA067R								58
FA067TT			FA067R	MD6036D							59
FA067TT			FA067R	MD6036D							60

FRONT / AVANT / VORN / FREITE / ANTERIORE

*-2 Sets Required. † For Vee disc colours add RED, BLU, GRN, GLD, ORG suffix to part number. For Custom Finish Options for Vee-Rotors™ including Splatter discs add suffix CHR, CHGR, CHBL, CHBR - available in various colours see page iv. ☼ - Also available as a Vintage Motorcycle Disc.

JAPANESE Built Motorcycles

Line #	BRAKE DISC CHOICES - FRONT						DISC PAD CHOICES - REAR				BRAKE DISC CHOICES - REAR			
	Oversize 250 /280mm Disc Kit	OSX Oversize 250/280mm Disc Kit	Relocating Bracket for 250/ 280mm Disc	Oversize 320mm Disc Kit	SMX Oversize 320mm Disc Kit	Relocating Bracket for 320mm Disc	FA, SFA, TT Pad or Brake Shoe	SFAC Carbon Scooter Pads	Speciality Pads - SXR / Vee / MXS	Sintered/ HH Pads/ Grooved Shoes	Standard Replacement Disc	Contour Disc Rear fitment	Vee Discs CONTOUR	CX Extreme MX Race Disc
1							S603			S603G				
2							S603							
3							S613			S613G				
4							S604			S604G				
5							FA305TT			FA305R	MD6267D			
6							FA305TT			FA305R	MD6267D			
7							FA067TT							
8							K715			K715G				
9							FA054TT	MXS054		FA054R	MD6166D			MD6166CX
10							S603			S603G				
11							S603							
12							S618			S618G				
13							K701			K701G				
14							K715			K715G				
15							K715			K715G				
16							FA084TT			FA084R	MD6025D			
17							FA084TT			FA084R	MD6025D			
18							FA084TT			FA084R	MD6025D			
19	OS6186C		BRK025				FA084TT			FA084R	MD6187D	MD6187C		MD6187CX
20	OS6186C		BRK025				FA084TT			FA084R	MD6187D	MD6187C		MD6187CX
21														
22							FA305TT			FA305R	MD6267D			
23							FA067TT							
24							S603							
25							S603			S603G				
26							S603							
27							S603							
28							S603							
29							S602							
30							S603			S603G				
31							FA084TT			FA084R	MD6025D			
32							FA084TT			FA084R	MD6025D			
33							FA084TT			FA084R	MD6025D			
34							S603							
35							S602			S602G				
36							S603			S603G				
37							S603			S603G				
38							S603							
39							S602							
40							S602							
41							S602							
42							SFA498	SFAC498		SFA498HH				
43							SFA498	SFAC498		SFA498HH				
44							FA152TT	MXS152		FA152R	MD6105D			MD6105CX
45							S602			S602G				
46							K702							
47							S602							
48							S602							
49							S602							
50							S604			S604G				
51							S604			S604G				
52							FA054TT	MXS054		FA054R		MD6362C		
53							FA054TT	MXS054		FA054R		MD6362C		
54							FA067			FA067R	MD6107D			
55							FA067			FA067R	MD6107D			
56							S602			S602G				
57							S602			S602G				
58							K702			K702G				
59							K702			K702G				
60							FA067TT			FA067R	MD6161D			

REAR / ARRIÈRE / HINTEN / POSTERIOR / POSTERIORE

R Suffix = High Durability Sintered Pad. **HH** Suffix = High Performance Sintered Pad. **TT** Suffix = Hard Wearing Off Road Pad. **V** Suffix = Semi Sintered Pad. **G** Suffix = Grooved Shoe.
D Suffix = Drilled Disc. **X** Suffix = Universal Left or Right Disc. **XC** Suffix = Contoured Disc. **LS** Suffix = Left/Steel Disc. **RS** = Right/Steel Disc.

BRAKE APPLICATIONS

*-2 Sets Required. † For Vee disc colours add RED, BLU, GRN, GLD, ORG suffix to part number. For Custom Finish Options for Vee-Rotors™ including Splatter discs add suffix CHR, CHGR, CHBL, CHBR - available in various colours see page iv. ☼ - Also available as a Vintage Motorcycle Disc.

JAPANESE Built Motorcycles



KAWASAKI Contd.

KX 125 E2/F1	87-88
KX 125 G1/H1/H2/J1/J2	89-93
KX 125 K1	94
KX 125 K2/K3/K4/K5/L1/L2/L3/L4	95-02
KX 125 M1/M2/M3	03-05
KX 125 M6F/M7F/M8F	06-08
Ninja 125 ABS	19-20
Z 125 (BR 125 GGF/GHF Auto G/Box)	16-20
Z 125 PRO (BR 125 HGF/JHF Manual G/Box)	16-20
Z 125 Pro SE (BR 125 JFJS Manual G/Box)	18-20
ZX 130 R	08-10
KLX 140 (17" front/14" rear)	08-20
KLX 140 L (19" front/16" rear)	08-20
KLX 140 G (21" front/18" rear)	17-20
KLX 150 L (KLX 150 EFF)	14-15
KLX 150 D-Tracker (KLX 150 HGF)	16
SC 150 A1 (Epsilon 150)	02
BN 175 Boss 175	02
KDX 175 A1-A3	80-82
KE 175 B1-B3	76-78
KE 175 D2-D5	79-83
KLF 185 A1	87
KDX 200 A1-A3	83-85
KDX 200 C1/C2/C3	86-88
KDX 200 E1/E2/E3/E4	89-92
KDX 200 E5/E6	93-94
KDX 200 H1/H2/H3/H4/H5	95-99
KDX 200 SR (DX 200 G)	
KLT 200 A1/A4A/C1/C2	81-84
KMX 200 A2/A3	88-92
Z 200 A1-A5	77-82
Z 200 A6	83
KLF 220 A1-A15	88-02
KDX 220 R A4-A12/A6F	97-06
KDX 220 SR (DX 220 B)	
KLX 230	19-20
KLX 230 R	19-20
250 SIB	75
ER 250 B1/B2/B3 (Z 250 T Scorpion)	83-88
EL 250 D1-D5	90-94
EL 252 (EL 250 F2/F3/F5/F6)	96-03
EL 250 Eliminator	87-89
BJ 250 B1-B7A Estrella	92-99
BJ 250 C1-C7 Estrella RS	99-02
BJ 250 D1-D7 Estrella Custom	96-02
BJ 250 E1-E4A Estrella RS Custom	96-99
BJ 250 F1/F2 (250 TR)	02-03
EX 250 K8F/K9F/KAF/KBF/KBFA/KCF Ninja 250R	08-12
EX 250 K8F/K9F/KAF/KBF/KBFA/KCF Ninja 250R	
- Floating disc option	08-12
GPX 250 R (ZX 250 F2-F9)	88-95
GPX 250 R (EX 250 E)	86
GPX 250 R (EX 250 F)	87
GPX 250 RIII (EX 250 G)	88
KDX 250 B1	79
KDX 250 B2/B3	80-84
KDX 250 D1	91-93
KH 250 B1-B5	77-82
KDX 250 SR (KDX 250 F1)	91

◆ Plain undrilled disc for enduro use MD6208CE

DISC PAD CHOICES - FRONT				BRAKE DISC CHOICES - FRONT						Line #
FA, SFA, TT Pad or Brake Shoe	SFAC Carbon Scooter Pads	Speciality Pads - SXR / Vee / MXS	Sintered/HH Pads/ Grooved Shoes	Left / Gauche / Links Standard Replacement Disc	Right / Droite / Rechts Standard Replacement Disc	Contour Disc Universal left and right fitment	Custom Disc Universal left and right fitment	Vee-Discs Black † See note below	CX Extreme MX Race Disc/ UTVX Disc	Line #
FA130TT			FA130R	MD6036D						1
FA135TT		MXS135	FA135R	MD6015D		MD6015C			MD6015CX	2
FA185TT		MXS185	FA185R	MD6015D		MD6015C			MD6015CX	3
FA185TT		MXS185	FA185R	MD6015D		MD6015C			MD6015CX	4
FA185TT		MXS185	FA185R	MD6213D		MD6213C			MD6213CX	5
FA185TT		MXS185	FA185R	MD6264D		MD6264C			MD6264CX	6
FA691			FA691HH			MD4171C				7
FA691			FA691HH			MD4171C				8
FA691			FA691HH			MD4171C				9
FA691			FA691HH			MD4171C				10
SFA197	SFAC197		SFA197HH							11
FA135TT		MXS135	FA135R	MD6328C						12
FA135TT		MXS135	FA135R	MD6328C						13
FA135TT		MXS135	FA135R	MD6328C						14
FA135TT		MXS135	FA135R							15
FA135TT		MXS135	FA135R							16
SFA396			SFA396HH	MD934D						17
K704			K704G							18
K704			K704G							19
K704			K704G							20
None										21
K703			K703G							22
FA067TT			FA067R	MD6036D						23
FA067TT			FA067R	MD6036D						24
FA135TT		MXS135	FA135R	MD6015D		MD6015C			MD6015CX	25
FA185TT		MXS185	FA185R	MD6083D					MD6083CX	26
FA135TT		MXS135	FA135R	MD6036D						27
S603			S603G							28
FA083TT			FA083R	MD6057D						29
FA039										30
FA067			FA067HH							31
K705*			K705G*							32
FA185TT		MXS185	FA185R	MD6083D					MD6083CX	33
FA185TT		MXS185	FA185R	MD6083D					MD6083CX	34
FA135X		MXS135	FA135R							35
FA135X		MXS135	FA135R							36
K711										37
FA085			FA085HH	MD4099						38
FA085			FA085HH	MD4002LS						39
FA085			FA085HH		MD4002RS					40
FA085			FA085HH		MD4002RS					41
FA067			FA067HH							42
FA067			FA067HH							43
S612										44
S612										45
FA231			FA231HH							46
FA197			FA197HH			MD4162C				47
FA197			FA197HH			MD4162XC				48
FA129			FA129HH		MD4041RS					49
FA085			FA085HH	MD4002LS						50
FA129			FA129HH		MD4041RS					51
FA141*										52
K705			K705G							53
K705			K705G							54
FA135TT		MXS135	FA135R	MD6083D					MD6083CX	55
FA033										56
FA135TT		MXS135	FA135R	MD6083D					MD6083CX	57

*-2 Sets Required. † For Vee disc colours add RED, BLU, GRN, GLD, ORG suffix to part number. For Custom Finish Options for Vee-Rotors™ including Splatter discs add suffix CHR, CHGR, CHBL, CHBR - available in various colours see page iv. ☼ - Also available as a Vintage Motorcycle Disc.

JAPANESE Built Motorcycles

Line #	BRAKE DISC CHOICES - FRONT						DISC PAD CHOICES - REAR				BRAKE DISC CHOICES - REAR			
	Oversize 250 /280mm Disc Kit	OSX Oversize 250/280mm Disc Kit	Relocating Bracket for 250/ 280mm Disc	Oversize 320mm Disc Kit	SMX Oversize 320mm Disc Kit	Relocating Bracket for 320mm Disc	FA, SFA, TT Pad or Brake Shoe	SFAC Carbon Scooter Pads	Speciality Pads - SXR / Vee / MXS	Sintered/ HH Pads/ Grooved Shoes	Standard Replacement Disc	Contour Disc Rear fitment	Vee Discs CONTOUR	CX Extreme MX Race Disc
1							FA067TT			FA067R	MD6161D			
2							FA152TT			FA152R	MD6024D			MD6024CX
3	OS6015C	OSX6015	BRK023		SMX6015	BRK024	FA152TT		MXS152	FA152R	MD6024D	MD6024C		MD6024CX
4	OS6015C	OSX6015	BRK023		SMX6015	BRK024	FA131TT		MXS131	FA131R	MD6024D	MD6024C		MD6024CX
5	OS6213C	OSX6015	BRK023	SM6213C	SMX6015	BRK024	FA131TT		MXS131	FA131R	MD6208D	MD6208C		MD6208CX
6	OS6264C	OSX6015	BRK023		SMX6015	BRK024	FA131TT		MXS131	FA131R	MD6208D	MD6208C		MD6208CX
7	OS4171		BRK040				FA054TT			FA054HH		MD4172C		
8							FA054TT			FA054HH		MD4172C		
9							FA054TT			FA054HH		MD4172C		
10							FA054TT			FA054HH		MD4172C		
11							S603							
12							FA054TT		MXS054	FA054R				
13							FA054TT		MXS054	FA054R				
14							FA054TT		MXS054	FA054R				
15							FA054TT		MXS054	FA054R				
16							FA054TT		MXS054	FA054R				
17							S635							
18														
19							S602			S602G				
20							S602			S602G				
21							K703			K703G				
22							K706			K706G				
23							K702			K702G				
24							K702			K702G				
25							FA152TT		MXS152	FA152R	MD6024D			
26							FA152TT		MXS152	FA152R	MD6024D	MD6024C		MD6024CX
27							FA152TT		MXS152	FA152R	MD6105D			MD6015CX
28							FA152TT		MXS152	FA152R	MD6105D			
29							K705			K705G				
30							FA067TT			FA067R	MD6108D			
31							S602							
32							S602							
33							K706			K706G				
34							FA152TT		MXS152	FA152R	MD6105D			MD6105CX
35							FA152TT		MXS152	FA152R	MD6105D			MD6105CX
36							FA54X		MXS54	FA54R				
37							FA54X		MXS54	FA54R				
38							K708							
39							K706							
40							K706							
41							K706							
42							K706							
43							FA067			FA067HH				
44							FA067			FA067HH				
45							K706							
46							K706							
47							K706							
48							FA197			FA197HH		MD4163C		
49														
50							FA197			FA197HH		MD4163C		
51							FA141				MD4042			
52							FA085		FA085V	FA085HH	MD4032			
53							FA141				MD4042			
54							FA141				MD4042			
55							S605			S605G				
56							S602			S602G				
57							FA152TT		MXS152	FA152R	MD6105D			MD6105CX
58							K708							
59							FA152TT		MXS152	FA152R	MD6105D			MD6105CX
60														

REAR / ARRIÈRE / HINTEN / POSTERIOR / POSTERIORE

R Suffix = High Durability Sintered Pad. HH Suffix = High Performance Sintered Pad. TT Suffix = Hard Wearing Off Road Pad. V Suffix = Semi Sintered Pad. G Suffix = Grooved Shoe.
D Suffix = Drilled Disc. X Suffix = Universal Left or Right Disc. XC Suffix = Contoured Disc. LS Suffix = Left/Steel Disc. RS = Right/Steel Disc.

BRAKE APPLICATIONS

*-2 Sets Required. † For Vee disc colours add RED, BLU, GRN, GLD, ORG suffix to part number. For Custom Finish Options for Vee-Rotors™ including Splatter discs add suffix CHR, CHGR, CHBL, CHBR - available in various colours see page iv. ⚙ - Also available as a Vintage Motorcycle Disc.

JAPANESE Built Motorcycles



KAWASAKI Contd.



R Suffix = High Durability Sintered Pad. HH Suffix = High Performance Sintered Pad. TT Suffix = Hard Wearing Off Road Pad. V Suffix = Semi Sintered Pad. G Suffix = Grooved Shoe.

D Suffix = Drilled Disc. X Suffix = Universal Left or Right Disc. XC Suffix = Contoured Disc. LS Suffix = Left/Steel Disc. RS = Right/Steel Disc.

KL 250 A1/A2	78-79
KL 250 A3/A4/C1/C2	80-84
KL 250 J1/J3 Stockman	
KL 250 G1/G1A Super Sherpa	97-00
KLE 250 A2 Anhele	95
KLE 250 A3	97
KLE 250 A5/A6	00-01
KLX 250 H1 Super Sherpa	98
KLF 250 A1/A2/A3/A6F-A9F/AAF/ABF (Bayou 250)	03-11
KLR 250 D2-D22	84-05
KLT 250 C1-C3 Prairie	83-85
KLX 250 R D1/D2	93-94
KLX 250 F1-F4 (KLX 250 ES)	94-97
KLX 250 G1	94
KLX 250 J1-J6 D-Tracker	98-03
KLX 250 S H6F/H7F (If installing oversize disc kit, longer brake hose is required - Goodridge ref 62024)	06-07
KLX 250 SF	09-20
KLX 250 SF	09-20
KR-1 (KR 250 B2)	89
KR-1S (KR 250 C2/C3)	90-92
KR 250 A1/A2	84-86
KSF 250 A1-A18 (KFX 250 Mojave)	87-04
KT 250 All models	75-80
KX 250	74
KX 250 A/A3/A4/A5	75-79
KX 250 A6/A7	80-81
KX 250 B1	82
KX 250 C1/C2	83-84
KX 250 D1	85
KX 250 D2	86
KX 250 E1/F1	87-88
KX 250 G1/H1/H2/J1/J2	89-93
KX 250 K1	94
KX 250 K2/K3/K4/K5/L1/L2/L3/L4	95-02
KX 250 M1/M2/R1 (2T)	03-05
KX 250 R6F/R7F/R8F (2T)	06-08
KX 250 F (KX 250 N1/N2) (4T)	04-05
KX 250 F (T6F/T7F/T8F) (4T)	06-08
KX 250 F (KX 250 W9F/XAFB/YBF/YCF/ZDF/ZEF) (4T)	09-14
KX 250 F	15-20
KXF 250 A1/A2 Tecate 4	87-88
KXT 250 A1 Tecate - 3 Wheel Model	84
KXT 250 A2 Tecate - 3 Wheel Model	85
KXT 250 B1 Tecate - 3 Wheel Model	86
KXT 250 B2 Tecate - 3 Wheel Model	87
SC 250 A1 (Epsilon 250)	02
S1-A/B/C (250cc)	73-75
Z 250 A1/A2	78-80
Z 250 A3	81
Z 250 B1/B2	80-83
Z 250 C1/C2/G1/G2	81-83
Z 250 SL (Naked Non ABS) (BR 250 EFF/EGF/FHF)	15-17
Z 250 SL (Naked ABS) (BR 250 FFF/FGF)	15-16
Ninja 250 SL (BX 250 AFF/AFS/AFSA KRT Edition Non ABS)	15
Ninja 250 SL (BX 250 BFF/BFS/BGF/BGFS ABS)	15-16
Ninja 250 SL (BX 250 BFS/BGSA KRT/ABS Edition)	15-16
ZR 250 A1-A5 Ballus	91-95

FRONT / AVANT / VORN / FRENTE / ANTERIORE

DISC PAD CHOICES - FRONT				BRAKE DISC CHOICES - FRONT							Line #
FA, SFA, TT Pad or Brake Shoe	SFAC Carbon Scooter Pads	Speciality Pads - SXR / Vee / MXS	Sintered/HH Pads/ Grooved Shoes	Left / Gauche / Links Standard Replacement Disc	Right / Droite / Rechts Standard Replacement Disc	Contour Disc Universal left and right fitment	Custom Disc Universal left and right fitment	Vee-Discs Black † See note below	CX Extreme MX Race Disc/ UTVX Disc	Line #	
K705			K705G							1	
K704			K704G							2	
FA258TT			FA258R	MD6239D						3	
FA258TT			FA258R	MD6239D						4	
FA129			FA129R							5	
FA129			FA129R							6	
FA129			FA129R							7	
FA258TT			FA258R	MD6239D						8	
K705*			K705G*							9	
FA067			FA067R	MD6057D						10	
S603			S603G							11	
FA185TT		MXS185	FA185R	MD6015D		MD6015C			MD6015CX	12	
FA185TT		MXS185	FA185R	MD6091D						13	
FA185TT		MXS185	FA185R	MD6091D						14	
FA185TT		MXS185	FA185R	MD6240D		MD6240C				15	
FA185TT		MXS185	FA185R	MD6330D		MD6330C			MD6330CX	16	
FA135TT		MXS135	FA135R			MD6351C				17	
FA135TT		MXS135	FA135R			MD6351C				18	
FA141*				MD4095X	MD4095X					19	
FA158*			FA158HH*	MD4008X	MD4008X	MD4008XC*	MD4008CC*	VR4008BLK†		20	
FA067*			FA067HH*							21	
FA128TT*			FA128R*	MD6133D	MD6133D					22	
K704			K704G							23	
S602			S602G							24	
K705			K705G							25	
K705			K705G							26	
FA083TT			FA083R							27	
FA067TT			FA067R							28	
FA067TT			FA067R	MD6036D						29	
FA067TT			FA067R	MD6036D						30	
FA130TT			FA130R	MD6036D						31	
FA135TT		MXS135	FA135R	MD6015D		MD6015C			MD6015CX	32	
FA185TT		MXS185	FA185R	MD6015D		MD6015C			MD6015CX	33	
FA185TT		MXS185	FA185R	MD6015D		MD6015C			MD6015CX	34	
FA185TT		MXS185	FA185R	MD6213D		MD6213C			MD6213CX	35	
FA185TT		MXS185	FA185R	MD6264D		MD6264C			MD6264CX	36	
FA185TT		MXS185	FA185R	MD6213D		MD6213C			MD6213CX	37	
FA185TT		MXS185	FA185R	MD6264D		MD6264C			MD6264CX	38	
FA185TT		MXS185	FA185R			MD6264C			MD6264CX	39	
FA185TT		MXS185	FA185R			MD6264C			MD6264CX	40	
FA185TT		MXS185	FA185R			MD6388C			MD6388CX	41	
FA128TT*			FA128R*	MD6133D	MD6133D					42	
K705			K705G							43	
FA067TT			FA067R							44	
FA067TT			FA067R	MD6138D						45	
FA067TT			FA067R	MD6138D						46	
SFA283/4	SFAC283/4		SFA283/4HH	MD929D				VR929		47	
K711										48	
FA073										49	
FA068			FA068HH	MD4010LS						50	
K711										51	
K711										52	
FA197			FA197HH							53	
FA197			FA197HH							54	
FA197			FA197HH							55	
FA197			FA197HH							56	
FA197			FA197HH							57	
FA197			FA197HH							58	
FA129			FA129HH		MD4008X	MD4008XC	MD4008CC	VR4008BLK†		59	

♦ Plain undrilled disc for enduro use MD6208CE

*-2 Sets Required. † For Vee disc colours add RED, BLU, GRN, GLD, ORG suffix to part number. For Custom Finish Options for Vee-Rotors™ including Splatter discs add suffix CHR, CHGR, CHBL, CHBR - available in various colours see page iv. ☼ - Also available as a Vintage Motorcycle Disc.

JAPANESE Built Motorcycles

Line #	BRAKE DISC CHOICES - FRONT						DISC PAD CHOICES - REAR				BRAKE DISC CHOICES - REAR			
	Oversize 250 /280mm Disc Kit	OSX Oversize 250/280mm Disc Kit	Relocating Bracket for 250/ 280mm Disc	Oversize 320mm Disc Kit	SMX Oversize 320mm Disc Kit	Relocating Bracket for 320mm Disc	FA, SFA, TT Pad or Brake Shoe	SFAC Carbon Scooter Pads	Speciality Pads - SXR / Vee / MXS	Sintered/ HH Pads/ Grooved Shoes	Standard Replacement Disc	Contour Disc Rear fitment	Vee Discs CONTOUR	CX Extreme MX Race Disc
1							S605			S605G				
2							K703			K703G				
3							FA067TT			FA067R	MD6107D			
4							FA067TT			FA067R	MD6107D			
5							FA067/3							
6							FA067/3							
7							FA067/3							
8							FA067TT			FA067R	MD6107D			
9							K706			K706G				
10							K703			K703G				
11							K705			K705G				
12							FA152TT	MXS152	FA152R	MD6085D				
13							FA152TT	MXS152	FA152R	MD6085D				
14							FA152TT	MXS152	FA152R	MD6085D				
15	OS6240C	OSX6240	BRK023		SMX6240	BRK024	FA131TT	MXS131	FA131R	MD6105D				
16														
17		OSX6330C	BRK021	SM6330C	SMX6330C	BRK022	FA131TT	MXS131	FA131R	MD6105D				MD6105CX
18		OSX6330C	BRK021		SMX6330C	BRK022	FA131TT	MXS131	FA131R		MD6352C			
19		OSX6330C	BRK021		SMX6330C	BRK022	FA131TT	MXS131	FA131R		MD6326C			
20							FA141				MD4096			
21							FA141				MD4096			
22							FA085	FA085V	FA085HH					
23							FA084TT		FA084R	MD6132D				
24							S602		S602G					
25							S605		S605G					
26							S605		S605G					
27							S605		S605G					
28							S602		S602G					
29							S602		S602G					
30							S602		S602G					
31							FA067TT		FA067R	MD6161D				
32							FA067TT		FA067R	MD6161D				
33							FA152TT	MXS152	FA152R	MD6024D	MD6024C			MD6024CX
34	OS6015C	OSX6015	BRK023		SMX6015	BRK024	FA152TT	MXS152	FA152R	MD6024D	MD6024C			MD6024CX
35	OS6015C	OSX6015	BRK023		SMX6015	BRK024	FA131TT	MXS131	FA131R	MD6024D	MD6024C			MD6024CX
36	OS6213C	OSX6213	BRK023	SM6213C	SMX6213	BRK024	FA131TT	MXS131	FA131R	MD6208D	MD6208C			MD6208CX
37	OS6264C	OSX6264	BRK023		SMX6264	BRK024	FA131TT	MXS131	FA131R	MD6208D	MD6208C			MD6208CX
38	OS6213C	OSX6213	BRK023	SM6213C	SMX6213	BRK024	FA367TT	MXS367	FA367R	MD6208D	MD6208C			MD6208CX
39	OS6264C	OSX6264	BRK023		SMX6264	BRK024	FA367TT	MXS367	FA367R	MD6208D	MD6208C			MD6208CX
40	OS6264C	OSX6264	BRK023		SMX6264	BRK024	FA367TT	MXS367	FA367R	MD6208D	MD6208C			MD6208CX
41							FA367TT	MXS367	FA367R	MD6208D	MD6208C			MD6208CX
42							FA083TT		FA083R	MD6136D				
43							FA083TT		FA083R					
44							FA067TT		FA067R					
45							FA067TT		FA067R	MD6138D				
46							FA084TT		FA084R	MD6134D				
47							SFA323/3		SFA323/3HH	MD930D	MD930C	VR930		
48							K708							
49							FA161							
50							FA161		FA161HH					
51							K706							
52							S602							
53							FA197		FA197HH					
54							FA197		FA197HH					
55														
56							FA197		FA197HH					
57							FA197		FA197HH					
58							FA197		FA197HH					
59							FA067/3			MD4051	MD4051C			
60														

REAR / ARRIÈRE / HINTEN / POSTERIOR / POSTERIORE

*-2 Sets Required. † For Vee disc colours add RED, BLU, GRN, GLD, ORG suffix to part number. For Custom Finish Options for Vee-Rotors™ including Splatter discs add suffix CHR, CHGR, CHBL, CHBR - available in various colours see page iv. Ⓢ - Also available as a Vintage Motorcycle Disc.

R Suffix = High Durability Sintered Pad. HH Suffix = High Performance Sintered Pad. TT Suffix = Hard Wearing Off Road Pad. V Suffix = Semi Sintered Pad. G Suffix = Grooved Shoe. D Suffix = Drilled Disc. X Suffix = Universal Left or Right Disc. XC Suffix = Contoured Disc. LS Suffix = Left/Steel Disc. RS = Right/Steel Disc.

JAPANESE Built Motorcycles



KAWASAKI Contd.



R Suffix = High Durability Sintered Pad. HH Suffix = High Performance Sintered Pad. TT Suffix = Hard Wearing Off Road Pad. V Suffix = Semi-Sintered Pad. G Suffix = Grooved Shoe.

D Suffix = Drilled Disc. X Suffix = Universal Left or Right Disc. XC Suffix = Contoured Disc. LS Suffix = Left/Steel Disc. RS = Right/Steel Disc.

ZR 250 B6 Balius-II	02
ZZR 250 (EX 250 H1-H13)	90-01
ZXR 250 (ZX 250 A1/A2)	89-90
ZXR 250 R (ZX 250 B1/B2)	89-90
ZXR 250 C1-C3 (ZX 250 C1-C3)	91-95
ZXR 250 R (ZX 250 D1)	91
ZX-25 Ninja	20
EX 300 ADF/AEF/AFF Ninja 300 (Non ABS)	13-15
EX 300 ADF/AEF/AFF Ninja 300 (Non ABS)	
- Floating disc option	13-15
EX 300 AEFA/AFFA/AGFA Ninja 300 (Non ABS)	14-16
EX 300 AEFA/AFFA/AGFA Ninja 300 (Non ABS)	
- Floating disc option	14-16
EX 300 BDF/BEF/BFF/BGF Ninja 300 (ABS)	13-16
EX 300 BDF/BEF/BFF/BGF Ninja 300 (ABS)	
- Floating disc option	13-16
EX 300 BEFA/BFFA/BGFA Ninja 300 (ABS)	14-16
EX 300 BEFA/BFFA/BGFA Ninja 300 (ABS)	
- Floating disc option	14-16
J300 AEF/AFF/AGF (Non ABS)	14-16
J300 AEFA/AFFA/AGFA Special Edition (Non ABS)	14-16
J300 (ABS)	14-20
J300 Special Edition (ABS)	14-20
KAF 300 A1/B1/B2 (Mule 500)	
KAF 300 C1/C2/C3/C4/C6/C7/D1 (Mule 550)	
KEF 300 B1/B2/B3 Lakota Sport	01-03
KLE 300 CHF/CJF Versys-X 300 ABS	17-20
KLE 300 BHF/Versys-X 300 Non ABS	17-20
KLF 300 A1/A2 Bayou	86-87
KLF 300 B1-B17 Bayou	88-04
KLF 300 C1-C17 Bayou	Left 89-05
	Right
KLX 300 A2-A10/A6F/A7F	97-07
KLX 300 R	19-20
KVF 300 A1/A2/A3/A4 (Prairie 4 x 4)	99-02
KVF 300 B1/B2/B3/B4 (Prairie 2 x 4)	99-02
KVF 300 CCF/CDF/CEF/CFF/CGF/CHF Brute Force	12-17
Z 300 Non ABS (ER 300 AFF/AGF)	15-16
Z 300 Non ABS (ER 300 AFF/AGF) - Floating disc option	15-16
Z 300 ABS (ER 300 BFF/BGF/BGFA) Ninja 300 (ABS)	15-16
Z 300 ABS (ER 300 BFF/BGF/BGFA) Ninja 300 (ABS)	
- Floating Disc Conversion	15-16
GPZ 305 A1/B1-B10	83-96
S2 (350cc)	72-73
S2-A (350cc)	72-73
KVF 360 A1-A3/A6F/A7F/A8F/A9F/AAF/ABF/ACF/ADF	03-13
KVF 360 B1-B3/B6F/B7F/B8F/B9F	03-09
KVF 360 C1-C3/C6F/C7F/C8F Prairie All models	03-08
KAF 400 A6F/A7F/A8F/A9F/AAF (Mule 610 4 x 4)	06-10
KAF 400 ABF/ACF/ADF/AEF (Mule 610 4 x 4)	11-14
KAF 400 B6F/B7F/B8F/B9F/BAF/BBF/BCF/BDF/BEF (Mule 600)	06-14
KAF 400 JHF (Mule SX)	17
KAF 400 HHF (Mule SX 4 x 4)	17
KAF 400 NHF (Mule SX 4 x 4 SE)	17
KAF 400 KHf (Mule SX 4 x 4 XC)	17
KAF 400 LHF (Mule SX 4 x 4 XC Camo)	17
KAF 400 MHF (Mule SX 4 x 4 XC SE)	17
KH 400 A3/A4/A5	76-78
KLF 400 B1-B7 Bayou	Left 93-99
	Right

FRONT / AVANT / VORN / FRENTE / ANTERIORE

DISC PAD CHOICES - FRONT				BRAKE DISC CHOICES - FRONT						Line #
FA, SFA, TT Pad or Brake Shoe	SFAC Carbon Scooter Pads	Speciality Pads - SXR / Vee / MXS	Sintered/HH Pads/ Grooved Shoes	Left / Gauche / Links Standard Replacement Disc	Right / Droite / Rechts Standard Replacement Disc	Contour Disc Universal left and right fitment	Custom Disc Universal left and right fitment	Vee-Discs Black † See note below	CX Extreme MX Race Disc/ UTVX Disc	Line #
FA231			FA231HH		MD4008X	MD4008XC	MD4008CC	VR4008BLK†		1
FA129			FA129HH			MD4008X	MD4008CC	VR4008BLK†		2
FA141*				MD4008X	MD4008X	MD4008XC*	MD4008CC*	VR4008BLK†		3
FA141*				MD4008X	MD4008X	MD4008XC*	MD4008CC*	VR4008BLK†		4
FA141*				MD4149LS	MD4149RS					5
FA141*				MD4149LS	MD4149RS					6
FA379			FA379HH							7
FA197			FA197HH				MD4166C	VR4166BLK†		8
										9
FA197			FA197HH			MD4166XC		VR4166BLK†		10
FA197			FA197HH			MD4166C		VR4166BLK†		11
										12
FA197			FA197HH			MD4166XC		VR4166BLK†		13
FA197			FA197HH			MD4166C		VR4166BLK†		14
										15
FA197			FA197HH			MD4166XC		VR4166BLK†		16
FA197			FA197HH			MD4166C		VR4166BLK†		17
FA197			FA197HH			MD4166XC		VR4166BLK†		18
SFA142	SFAC142		SFA142HH							19
SFA142	SFAC142		SFA142HH							20
SFA142	SFAC142		SFA142HH							21
SFA142	SFAC142		SFA142HH							22
S628*			S628G*							23
S628*			S628G*							24
FA128TT*			FA128R*	MD6133D	MD6133D					25
FA142			FA142HH			MD4166XC		VR4166BLK†		26
FA142			FA142HH			MD4166XC		VR4166BLK†		27
K717*			K717C*							28
FA067*			FA067R*	MD6133D	MD6133D					29
FA165TT	MXS165		FA165R	MD6131D						30
FA135TT	MXS135		FA135R		MD6131D					31
FA185TT	MXS185		FA185R	MD6015D					MD6015CX	32
FA135TT	MXS135		FA135R							33
FA054TT*	MXS054*		FA054R*	MD6131D	MD6131D					34
FA054TT*	MXS054*		FA054R*	MD6131D	MD6131D					35
FA377TT*			FA377R*	MD6267D	MD6267D					36
FA197			FA197HH			MD4166C		VR4166BLK†		37
FA197			FA197HH			MD4166XC		VR4166BLK†		38
FA197			FA197HH			MD4166C		VR4166BLK†		39
										40
FA197			FA197HH			MD4166XC		VR4166BLK†		41
FA067*			FA067HH*	MD4105LS	MD4105RS					42
K711										43
FA033										44
FA054TT*	MXS054*		FA054R*	MD6188D	MD6188D					45
FA054TT*	MXS054*		FA054R*	MD6188D	MD6188D					46
FA054TT*	MXS054*		FA054R*	MD6188D	MD6188D					47
K718*										48
K718*										49
										50
K718*										51
K718*										52
K718*										53
K718*										54
K718*										55
K718*										56
K718*										57
FA033				VMD4123						58
FA165TT	MXS165		FA165R	MD6131D						59
FA135TT	MXS135		FA135R		MD6131D					60

*-2 Sets Required. † For Vee disc colours add RED, BLU, GRN, GLD, ORG suffix to part number. For Custom Finish Options for Vee-Rotors™ including Splatter discs add suffix CHR, CHGR, CHBL, CHBR - available in various colours see page iv. ☼ - Also available as a Vintage Motorcycle Disc.

JAPANESE Built Motorcycles

Line #	BRAKE DISC CHOICES - FRONT						DISC PAD CHOICES - REAR				BRAKE DISC CHOICES - REAR			
	Oversize 250 /280mm Disc Kit	OSX Oversize 250/280mm Disc Kit	Relocating Bracket for 250/ 280mm Disc	Oversize 320mm Disc Kit	SMX Oversize 320mm Disc Kit	Relocating Bracket for 320mm Disc	FA, SFA, TT Pad or Brake Shoe	SFAC Carbon Scooter Pads	Speciality Pads - SXR / Vee / MXS	Sintered/ HH Pads/ Grooved Shoes	Standard Replacement Disc	Contour Disc Rear fitment	Vee Discs CONTOUR	CX Extreme MX Race Disc
1							FA067			FA067HH	MD4051	MD4051C		
2							FA067/3				MD4117			
3							FA141				MD4051	MD4051C		
4							FA141				MD4051	MD4051C		
5							FA067/3				MD4051	MD4051C		
6							FA067/3				MD4051	MD4051C		
7							FA174			FA174HH				
8							FA197			FA197HH		MD4163C	VR4163	
9														
10							FA197			FA197HH		MD4163C	VR4163	
11							FA197			FA197HH		MD4163C	VR4163	
12														
13							FA197			FA197HH		MD4163C	VR4163	
14							FA197			FA197HH				
15														
16							FA197			FA197HH				
17							FA197			FA197HH				
18							FA197			FA197HH				
19							SFA498	SFAC498		SFA498HH				
20							SFA498	SFAC498		SFA498HH				
21							SFA498	SFAC498		SFA498HH				
22							SFA498	SFAC498		SFA498HH				
23							K718*							
24							K718*							
25							FA084TT			FA084R	MD6132D			
26							FA197			FA197HH				
27							FA197			FA197HH				
28							K706			K706G				
29							K706			K706G				
30							K710			K710G				
31														
32							FA131TT		MXS131	FA131R	MD6105D			MD6105CX
33							FA131TT		MXS131	FA131R				
34							K710			K710G				
35							K710			K710G				
36							FA377TT			FA377R	MD6267D			
37							FA197			FA197HH				
38							FA197			FA197HH				
39							FA197			FA197HH				
40														
41							FA197			FA197HH				
42							K706							
43							K708							
44							K708							
45														
46														
47														
48							K718*							
49							K719*							
50														
51							K718*							
52							K718*							
53							K718*							
54							K718*							
55							K718*							
56							K718*							
57							K718*							
58							K708							
59							K710			K710G				
60														

REAR / ARRIÈRE / HINTEN / POSTERIOR / POSTERIORE

R Suffix = High Durability Sintered Pad. **HH** Suffix = High Performance Sintered Pad. **TT** Suffix = Hard Wearing Off Road Pad. **V** Suffix = Semi Sintered Pad. **G** Suffix = Grooved Shoe.
D Suffix = Drilled Disc. **X** Suffix = Universal Left or Right Disc. **XC** Suffix = Contoured Disc. **LS** Suffix = Left/Steel Disc. **RS** = Right/Steel Disc.

BRAKE APPLICATIONS

*-2 Sets Required. † For Vee disc colours add RED, BLU, GRN, GLD, ORG suffix to part number. For Custom Finish Options for Vee-Rotors™ including Splatter discs add suffix CHR, CHGR, CHBL, CHBR - available in various colours see page iv. Ⓢ - Also available as a Vintage Motorcycle Disc.

JAPANESE Built Motorcycles



KAWASAKI Contd.

KSF 400 A1/A2/A3/A6F (KFX 400)	03-06
KVF 400 A1/A2/B1 Prairie	97-98
KVF 400 C1/C2/C3/C4 (Prairie 4 x 4)	99-02
KVF 400 D1/D2/D3 (Prairie 2 x 4)	99-01
S3/S3-A (400cc)	74-75
Z 400 B1/B2	78-80
Z 400 G1	79
Z 400 J1	80
Z 400 J2/J3	81-83
ZR 400 A1/B1 (Z 400 F)	83-84
Z 400 C2/C3 (Z 400 F2)	85-87
ZL 400 A Eliminator	86-87
ZL 400 B Eliminator 400 SE	88
ZL 400 D1/D2	94-95
FX 400 R (ZX 400 E1-E3)	86-88
GPZ 400 R (ZX 400 D/D3/D3A)	85-87
GPZ 400 R D4	88
GPX 400 R (ZX 400 F1)	87
KLX 400 R (KLX 400 B1/B2)	03-04
Ninja 400 (EX 400 GJF/GJFA- ABS)	17-20
Ninja 400 (EX 400 GJF/GJFA - ABS KRT)	18-20
Z 400 ABS	18-20
ZR 400 D1/D3/D4 Xanthus	92-95
ZR 400 Zephyr (G2/G3/G3A/G4/G5)	97-01
ZRX 400 (ZR 400 E1/E2)	94-95
ZRX 400 E3 (ZR 400 E3)	Left 96 Right 96
ZRX 400 (ZX 400 E4/5/6/7)	98-01
ZX-4 (ZX 400 G1/G1A/G1B)	88
ZXR 400 H1/H2	89-90
ZXR 400 R (ZXR 400 J1)	89
ZXR 400 R (ZX 400 J2)	90
ZXR 400 R (ZX 400 M1-M4)	91-94
ZXR 400 L1-L9	91-03
ZZ-R 400 (ZX 400 K1/K2/K3)	90-92
ZZ-R 400 (ZX 400 N1-N7)	93-99
KX 420 A1/A2	80-81
Z 440 A2 LTD	79
Z 440 C1	80
Z 440 C2	81
Z 440 D4 LTD	82
Z 440 D5/D6 LTD	83-84
Z 440 H1/H2	82-83
LTD 454 (EN 450 A1-A5)	86-89
KAF 450 B1 (Mule 1000)	
KFX 450 R Quad (KSF 450 B8F/B9F/BAF/BBF /BCS/BFD/BEF)	08-14
KFX 450 R Quad (KSF 450 B8F/B9F/BAF/BBF /BCS/BFD/BEF) - Plain undrilled disc for enduro use	08-14
KLX 450 R (A8F/A9F/AAF/ABF/ACF/ADF/AEF/AFF/AGF/AHF/AJF)	08-18
KX 450 F (D6F/D7F/D8F/E9F/EAF/EBF/FCF/FDF/FEF)	06-14
KX 450 F (FFF/HGF/HHF/HJF)	15-18
KX 450 F (4T) 270mm Front 250mm Rear Rotor	19-20
KX 450 F Tomac (JKF) (4T) 270mm Front 250mm Rear Rotor	19
EN 500 A1-A3	90-93
EN 500 B1-B2/C1-C9	94-04
ER-5 (ER 500 A1/A2/A3/A4)	97-00
ER-5 (ER 500 C1/C3/C4/C5P)	01-07
GPZ 500 S (EX 500 A1-A6)	87-93

◆ Plain undrilled disc for enduro use MD6208CE

*-2 Sets Required. For Vee disc colours add RED, BLU, GRN, GLD, ORG suffix to part number. ■ - Also available in MX-S race compound.

⊗ - Also available as a Vintage Motorcycle Disc.

FA, SFA, TT Pad or Brake Shoe	SFAC Carbon Scooter Pads	Speciality Pads - SXR / Vee / MXS	Sintered/HH Pads/ Grooved Shoes	DISC PAD CHOICES - FRONT		BRAKE DISC CHOICES - FRONT					Line #
				Left / Gauche / Links Standard Replacement Disc	Right / Droite / Rechts Standard Replacement Disc	Contour Disc Universal left and right fitment	Custom Disc Universal left and right fitment	Vee-Discs Black † See note below	CX Extreme MX Race Disc/ UTVX Disc		
FA084TT*		MXS084*	FA084R*	MD6210D	MD6210D						1
FA054TT*		MXS054*	FA054R*	MD6131D	MD6131D						2
FA054TT*		MXS054*	FA054R*	MD6131D	MD6131D						3
FA054TT*		MXS054*	FA054R*	MD6131D	MD6131D						4
FA033											5
FA048											6
FA033											7
FA073*				MD4047LS	MD4047RS						8
FA068*			FA068HH*	MD4010LS	MD4010RS						9
FA067*			FA067HH*	MD4108LS	MD4108RS						10
FA067*			FA067HH*	MD4028	MD4028						11
FA085			FA085HH	MD4016							12
FA067*			FA067HH*	MD4135LS	MD4135RS						13
FA129			FA129HH		MD4008X	MD4008XC	MD4008CC	VR4008BLK†			14
FA067*			FA067HH*	MD4135LS	MD4135RS						15
FA067*			FA067HH*	MD4135LS	MD4135RS						16
FA141*				MD4143LS	MD4143RS						17
FA141*				MD4140LS	MD4140RS						18
FA185TT		MXS185	FA185R	MD6017D		MD6017C				MD6017CX	19
FA197			FA197HH		MD4174X	MD4174XC		VR4174BLK†			20
FA197			FA197HH		MD4174X	MD4174XC		VR4174BLK†			21
FA197			FA197HH		MD4174X	MD4174XC		VR4174BLK†			22
FA141*											23
FA158*			FA158HH*								24
FA129*			FA129HH*	MD4008X	MD4008X	MD4008XC*	MD4008CC*	VR4008BLK†			25
FA229			FA229HH	MD4008X		MD4008XC	MD4008CC	VR4008BLK†			26
FA231			FA231HH		MD4008X	MD4008XC	MD4008CC	VR4008BLK†			27
			FA294HH*	MD4008X	MD4008X	MD4008XC*	MD4008CC*	VR4008BLK†			28
FA141*				MD4134	MD4134						29
FA158*			FA158HH*	MD4008X	MD4008X	MD4008XC*	MD4008CC*	VR4008BLK†			30
FA158*			FA158HH*	MD4008X	MD4008X	MD4008XC*	MD4008CC*	VR4008BLK†			31
FA158*			FA158HH*	MD4008X	MD4008X	MD4008XC*	MD4008CC*	VR4008BLK†			32
FA158*			FA158HH*	MD4005	MD4005						33
FA180*			FA180HH*	MD4005	MD4005						34
FA158*			FA158HH*	MD4008X	MD4008X	MD4008XC*	MD4008CC*	VR4008BLK†			35
FA158*			FA158HH*	MD4008X	MD4008X	MD4008XC*	MD4008CC*	VR4008BLK†			36
K705			K705G								37
FA073				MD4047LS							38
FA073											39
FA068			FA068HH	MD4010LS							40
FA073				MD4047LS							41
FA068			FA068HH	MD4010LS							42
FA068			FA068HH	MD4010LS							43
FA085			FA085HH	MD4006LS							44
K719*											45
											46
											47
											48
											49
FA185TT		MXS185	FA185R	MD6264D		MD6264C				MD6264CX	50
FA185TT		MXS185	FA185R	MD6264D		MD6264C				MD6264CX	51
FA185TT		MXS185	FA185R			MD6388C				MD6388CX	52
FA185TT		MXS185	FA185R			MD6388C				MD6388CX	53
FA185TT		MXS185	FA185R			MD6388C				MD6388CX	54
FA085			FA085HH	MD4006LS							55
FA085			FA085HH	MD4124LS							56
FA129			FA129HH	MD4016							57
FA229			FA229HH	MD4016							58
FA129			FA129HH	MD4016							59

JAPANESE Built Motorcycles

Line #	BRAKE DISC CHOICES - FRONT						DISC PAD CHOICES - REAR				BRAKE DISC CHOICES - REAR			
	Oversize 250 /280mm Disc Kit	OSX Oversize 250/280mm Disc Kit	Relocating Bracket for 250/ 280mm Disc	Oversize 320mm Disc Kit	SMX Oversize 320mm Disc Kit	Relocating Bracket for 320mm Disc	FA, SFA, TT Pad or Brake Shoe	SFAC Carbon Scooter Pads	Speciality Pads - SXR / Vee / MXS	Sintered/ HH Pads/ Grooved Shoes	Standard Replacement Disc	Contour Disc Rear fitment	Vee Discs CONTOUR	CX Extreme MX Race Disc
1							FA137TT			FA137R	MD6211D			
2							K710			K710G				
3							K710			K710G				
4							K710			K710G				
5							K708							
6							K706							
7							K706							
8							K709							
9							K709							
10							K706							
11							FA085	FA085V	FA085HH	MD4001				
12							K709							
13							K709							
14							K709							
15							FA085	FA085V	FA085HH	MD4015				
16							FA085	FA085V	FA085HH	MD4015				
17							FA129							
18							FA129			MD4027				
19	OS6017C	OSX6017	BRK023	SM6017C	SMX6017	BRK024	FA131TT	MXS131	FA131R	MD6014D	MD6014C		MD6014CX	
20							FA197		FA197HH					
21							FA197		FA197HH					
22							FA197		FA197HH					
23							FA067/3							
24							FA192	FA192V	FA192HH	MD4009				
25							FA192	FA192V	FA192HH					
26							FA192	FA192V	FA192HH					
27														
28							FA192	FA192V	FA192HH					
29							FA141			MD4009				
30							FA161	FA161V	FA161HH	MD4009	MD4009C	VR4009		
31							FA161	FA161V	FA161HH	MD4009	MD4009C	VR4009		
32							FA161	FA161V	FA161HH	MD4009	MD4009C	VR4009		
33							FA161	FA161V	FA161HH	MD4009				
34							FA161	FA161V	FA161HH	MD4009				
35							FA129	FA129V	FA129HH	MD4007		VR4007		
36							FA192	FA192V	FA192HH	MD4009	MD4009C	VR4009		
37							S605		S605G					
38							K706							
39							K706							
40							K706							
41							K706							
42							K706							
43							K706							
44							K709							
45							K720*							
46														
47											MD6304C			
48														
49							FA084TT		FA084R					
50	OS6264C	OSX6264	BRK023		SMX6264	BRK024	FA367TT	MXS367	FA367R	MD6208D	MD6208C♦		MD6208CX	
51	OS6264C	OSX6264	BRK023		SMX6264	BRK024	FA367TT	MXS367	FA367R	MD6208D	MD6208C♦		MD6208CX	
52					SMX6264	BRK024	FA367TT	MXS367	FA367R		MD6208C♦		MD6208CX	
53							FA367TT	MXS367	FA367R	TBA	TBA	TBA		
54							FA367TT	MXS367	FA367R	TBA	TBA	TBA		
55							K709							
56							K709							
57							K706							
58							K706							
59							K706							
60														

REAR / ARRIÈRE / HINTEN / POSTERIOR / POSTERIORE

R Suffix = High Durability Sintered Pad. HH Suffix = High Performance Sintered Pad. TT Suffix = Hard Wearing Off Road Pad. V Suffix = Semi Sintered Pad. G Suffix = Grooved Shoe.
D Suffix = Drilled Disc. X Suffix = Universal Left or Right Disc. XC Suffix = Contoured Disc. LS Suffix = Left/Steel Disc. RS = Right/Steel Disc.

BRAKE APPLICATIONS

*-2 Sets Required. † For Vee disc colours add RED, BLU, GRN, GLD, ORG suffix to part number. For Custom Finish Options for Vee-Rotors™ including Splatter discs add suffix CHR, CHGR, CHBL, CHBR - available in various colours see page iv. ♦ - Also available as a Vintage Motorcycle Disc.

JAPANESE Built Motorcycles



KAWASAKI Contd.



R Suffix = High Durability Sintered Pad. HH Suffix = High Performance Sintered Pad. TT Suffix = Hard Wearing Off Road Pad. V Suffix = Semi-Sintered Pad. G Suffix = Grooved Shoe.

D Suffix = Drilled Disc. X Suffix = Universal Left or Right Disc. XC Suffix = Contoured Disc. LS Suffix = Left/Steel Disc. RS = Right/Steel Disc.

GPZ 500 S (EX 500 B1-B5)	88-93
GPZ 500 S (EX 500 D1-D7)	94-01
GPZ 500 S (EX 500 E1-E10)	94-04
H1 500 Mach III	69-70
H1-A 500 S Mach III	71
H1-B/C 500 Mach III	72
H1-D/E/F 500	73-75
KH 500 A8	76
KLE 500 A1-A12	91-04
KLE 500 B1P/B6F/B7F	05-07
KX 500 A1/A2	83-84
KX 500 B1	85
KX 500 B2	86
KX 500 C1/D1	87-88
KX 500 E1-E5	89-93
KX 500 E6/E7	94-95
KX 500 E8-E16	96-04
Z 500 B1-B2	79-80
KAF 540 C1 (Mule 2010)	
KAF 540 D1 (Mule 2020)	
KAF 540 E1 (Mule 2030)	
GPZ 550 D1	82
GPZ 550 H1/H2	82-83
GPZ 550 A1-A4 (ZX 550 A1-A4)	84-87
GT 550 G1-G9	83-01
Z 550 A1	80
Z 550 A2/A3	81-82
Z 550 C1/C2 LTD	82-84
ZR 550 A1/A2 (Z 550 F)	83-84
ZR 550 B2/B3 Zephyr	91-93
ZR 550 B4-B6 Zephyr	94-99
GPX 600 R (ZX 600 C1-C7)	88-96
GPZ 600 R A1-A5A	85-89
KLR 600 A1/B2/B1-B4/B6-B9	84-94
ZL 600 B1 Eliminator	95-97
ZZR 600 (ZX 600 D1-D3)	90-93
ZZR 600 (ZX 600 E1-E13)	93-05
ZR 600 (ZX 600 E6F)	06-07
ZX-6R (ZX 600 F1-F3)	95-97
ZX-6R (ZX 600 G1/G2/J1/J2)	98-01
ZX-6R (ZX 600 P7F/P8F)	07-08
ZX-6R (ZX 600 R9F/RAF/RBF/RCF/RDF/REF/RFF /RGF 599cc)	09-16
ZX-6R (ZX 636 A1P 636cc)	02
ZX-6R (ZX 636 B1/B2)	03-04
ZX-6R (ZX 636 C1/C6F)	05-06
Ninja ZX-6R (Non ABS - 636cc)	13-20
Ninja ZX-6R KRT (Non ABS - 636cc)	16-20
ZX-6R 30th Anniversary Edition (ZX 636 EFFA - Non ABS - 636cc)	15
Ninja ZX-6R ABS (636cc)	13-20
Ninja ZX-6R KRT ABS (636cc)	16-20
ZX-6R 30th Anniversary Edition (ZX 636 FFFA - ABS - 636cc)	15
ZX-6RR (ZX 600 K1/M1)	03-04
ZX-6RR (ZX 600 N1/N6F)	05-06
KAF 620 A1/A2/A3/A6 (Mule 2510)	
KAF 620 B1/B2/B6 (Mule 2520)	
KAF 620 C1/C2/C3/C6 (Mule 2500)	
KAF 620 E1/E2/E3/E4/E5 Mule 3010	

FRONT / AVANT / VORN / FRENTE / ANTERIORE

FA, SFA, TT Pad or Brake Shoe	SFAC Carbon Scooter Pads	Speciality Pads - SXR / Vee / MXS	Sintered/HH Pads/ Grooved Shoes	DISC PAD CHOICES - FRONT		BRAKE DISC CHOICES - FRONT						Line #
				Left / Gauche / Links Standard Replacement Disc	Right / Droite / Rechts Standard Replacement Disc	Contour Disc Universal left and right fitment	Custom Disc Universal left and right fitment	Vee-Discs Black † See note below	CX Extreme MX Race Disc/ UTVX Disc			
FA067*			FA067HH*	MD4144	MD4144							1
FA129			FA129HH		MD4016							2
FA141*				MD4144	MD4144							3
												4
												5
												6
FA055				MD4069LS								7
FA033				MD4052LS								8
FA129			FA129R	MD6093D								9
FA129			FA129HH	MD6093D								10
FA067TT			FA067R									11
FA067TT			FA067R	MD6036D								12
FA067TT			FA067R	MD6036D								13
FA130TT			FA130R	MD6036D								14
FA135TT		MXS135	FA135R	MD6015D		MD6015C				MD6015CX		15
FA185TT		MXS185	FA185R	MD6015D		MD6015C				MD6015CX		16
FA185TT		MXS185	FA185R	MD6015D		MD6015C				MD6015CX		17
FA073*				MD4047LS	MD4047RS							18
K719*												19
K719*												20
K719*												21
FA068*			FA068HH*	MD4010LS	MD4010RS							22
FA068*			FA068HH*	MD4099	MD4099							23
FA085*			FA085HH*	MD4002LS	MD4002RS							24
FA067*			FA067HH*	MD4006LS	MD4006RS							25
FA073*				MD4047LS	MD4047RS							26
FA068*			FA068HH*	MD4010LS	MD4010RS							27
FA068*			FA068HH*	MD4010LS	MD4010RS							28
FA067*			FA067HH*	MD4108LS	MD4108RS							29
FA129*			FA129HH*	MD4008X	MD4008X	MD4008XC*	MD4008CC*	VR4008BLK*†				30
FA129*			FA129HH*	MD4008X	MD4008X	MD4008XC*	MD4008CC*	VR4008BLK*†				31
FA129*			FA129HH*	MD4026LS	MD4026RS							32
FA085*			FA085HH*	MD4028	MD4028							33
FA067			FA067R	MD6080D								34
FA129		FA129V	FA129HH		MD4008X	MD4008XC	MD4008CC	VR4008BLK*†				35
FA158*			FA158HH*	MD4141X	MD4141X	MD4141XC*	MD4141CC*					36
FA158*			FA158HH*	MD4153X	MD4153X	MD4153XC*	MD4153CC*	VR4153BLK*†				37
FA158*			FA158HH*	MD4153X	MD4153X	MD4153XC*	MD4153CC*	VR4153BLK*†				38
FA158*			FA158HH*	MD4008X	MD4008X	MD4008XC*	MD4008CC*	VR4008BLK*†				39
FA188*			FA188HH*	MD4136X	MD4136X	MD4136XC*	MD4136CC*	VR4136BLK*†				40
			FA417/4HH*			MD4152XC*	MD4152CC*	VR4152BLK*†				41
						MD4152XC*	MD4152CC*	VR4152BLK*†				42
FA188*			FA188HH*	MD4136X	MD4136X	MD4136XC*	MD4136CC*	VR4136BLK*†				43
			FA369/4HH*	MD4151X	MD4151X	MD4151XC*						44
			FA369/4HH*			MD4152XC*	MD4152CC*	VR4152BLK*†				45
			FA296HH*			MD4155XC*		VR4155BLK*†				46
			FA296HH*			MD4155XC*		VR4155BLK*†				47
			FA296HH*			MD4155XC*		VR4155BLK*†				48
			FA296HH*			MD4155XC*		VR4155BLK*†				49
			FA296HH*			MD4155XC*		VR4155BLK*†				50
			FA296HH*			MD4155XC*		VR4155BLK*†				51
			FA296HH*			MD4155XC*		VR4155BLK*†				52
			FA296HH*			MD4155XC*		VR4155BLK*†				53
			FA296HH*			MD4155XC*		VR4155BLK*†				54
			FA369/4HH*	MD4151X	MD4151X	MD4151XC*						55
			FA369/4HH*			MD4152XC*	MD4152CC*	VR4155BLK*†				56
K719*												57
K719*												58
K719*												59
K719*												60

*-2 Sets Required. † For Vee disc colours add RED, BLU, GRN, GLD, ORG suffix to part number. For Custom Finish Options for Vee-Rotors™ including Splatter discs add suffix CHR, D, CHGR, CHBL, CHBR - available in various colours see page iv. Ⓢ - Also available as a Vintage Motorcycle Disc.

JAPANESE Built Motorcycles

Line #	BRAKE DISC CHOICES - FRONT						DISC PAD CHOICES - REAR				BRAKE DISC CHOICES - REAR			
	Oversize 250 /280mm Disc Kit	OSX Oversize 250/280mm Disc Kit	Relocating Bracket for 250/ 280mm Disc	Oversize 320mm Disc Kit	SMX Oversize 320mm Disc Kit	Relocating Bracket for 320mm Disc	FA, SFA, TT Pad or Brake Shoe	SFAC Carbon Scooter Pads	Speciality Pads - SXR / Vee / MXS	Sintered/ HH Pads/ Grooved Shoes	Standard Replacement Disc	Contour Disc Rear fitment	Vee Discs CONTOUR	CX Extreme MX Race Disc
1							K706							
2							FA067/3				MD4051	MD4051C		
3							FA067				MD4051	MD4051C		
4														
5														
6														
7							K710							
8							K710							
9							FA067/3				MD6082D			
10							FA067/3				MD6082D			
11							S602		S602G					
12							S602		S602G					
13							FA067TT		FA067R		MD6161D			
14							FA067		FA067R		MD6161D			
15							FA152TT	MXS152	FA152R	MD6024D	MD6024C		MD6024CX	
16	OSG015C	OSX6015	BRK023		SMX6015	BRK024	FA152TT	MXS152	FA152R	MD6024D	MD6024C		MD6024CX	
17	OSG015C	OSX6015	BRK023		SMX6015	BRK024	FA131TT	MXS131	FA131R	MD6024D	MD6024C		MD6024CX	
18							FA036							
19							K720*							
20							K720*							
21							K720*							
22							FA068	FA068V	FA068HH	MD4169				
23							FA068	FA068V	FA068HH	MD4024				
24							FA085	FA085V	FA085HH	MD4001				
25							K709							
26							K709							
27							K709							
28							K709							
29							K706							
30							FA141			MD4009	MD4009C	VR4009		
31							FA192	FA192V	FA192HH	MD4009	MD4009C	VR4009		
32							FA129	FA129V	FA129HH	MD4027				
33							FA085	FA085V	FA085HH	MD4015				
34							S602		S602G					
35							K709							
36							FA129	FA129V	FA129HH	MD4007	MD4007C			
37							FA192	FA192V	FA192HH	MD4009	MD4009C	VR4009		
38							FA192	FA192V	FA192HH	MD4009	MD4009C	VR4009		
39							FA192	FA192V	FA192HH	MD4023	MD4023C	VR4023		
40							FA192	FA192V	FA192HH	MD4138	MD4138C	VR4138		
41							FA192	FA192V	FA192HH		MD4138C	VR4138		
42														
43							FA192	FA192V	FA192HH		MD4138C	VR4138		
44							FA192	FA192V	FA192HH	MD4138	MD4138C	VR4138		
45							FA192	FA192V	FA192HH	MD4138	MD4138C			
46							FA192	FA192V	FA192HH	MD4138	MD4138C	VR4138		
47							FA436		FA436HH		MD4165C	VR4165		
48							FA436		FA436HH		MD4165C	VR4165		
49														
50							FA436		FA436HH		MD4165C	VR4165		
51							FA436		FA436HH		MD4165C	VR4165		
52							FA436		FA436HH		MD4165C	VR4165		
53														
54							FA436		FA436HH		MD4165C	VR4165		
55							FA192	FA192V	FA192HH	MD4138	MD4138C			
56							FA192	FA192V	FA192HH		MD4138C	VR4138		
57							K720*							
58							K720*							
59							K720*							
60							K720*							

REAR / ARRIÈRE / HINTEN / POSTERIOR / POSTERIORE

R Suffix = High Durability Sintered Pad. HH Suffix = High Performance Sintered Pad. TT Suffix = Hard Wearing Off Road Pad. V Suffix = Semi Sintered Pad. G Suffix = Grooved Shoe.
D Suffix = Drilled Disc. X Suffix = Universal Left or Right Disc. XC Suffix = Contoured Disc. LS Suffix = Left/Steel Disc. RS = Right/Steel Disc.

*-2 Sets Required. † For Vee disc colours add RED, BLU, GRN, GLD, ORG suffix to part number. For Custom Finish Options for Vee-Rotors™ including Splatter discs add suffix CHR, CHGR, CHBL, CHBR - available in various colours see page iv. Ⓢ - Also available as a Vintage Motorcycle Disc.

BRAKE APPLICATIONS

JAPANESE Built Motorcycles



KAWASAKI Contd.

KAF 620 F1/F2 Mule 3020	
KAF 620 G1/G2/G3/G4/G5 Mule 3000	
KAF 620 H1/H2/H3 (Mule 3010 4 x 4)	
KAF 620 J1/K1/K6F/K7F (Mule 3010 Trans 4 x 4)	05-07
KAF 620 M9F/MAF/MBF/MCF/MDF/MEF/MFF/MGF/MHF (Mule 4010 4 x 4)	09-17
KAF 620 N9F (Mule 4010 4 x 4 Hardwoods Green)	09
KAF 620 P9F/PAF/PBF/PCF/PDF/PEF/PFF/PGF/PHF (Mule 4000)	09-17
KAF 620 R9F/RAF/RBF/RCF/RDF/REF/RFF/RFFA/RGF/RHF (Mule 4010 Trans 4 x 4)	09-17
KAF 620 S9F/SAF/SBF/SCF/SDF/SEF/SFF/SGF/SHF (Mule 4010 Trans 4 x 4 Hardwoods Green HD)	09-17
KAF 620 TGF/TGF (Mule 4010 4 x 4 SE)	16-17
KAF 620 VGF/VHF (Mule 4010 Trans 4 x 4 SE)	16-17
EN 650 Vulcan S	15-20
EN 650 Vulcan S ABS	15-20
EN 650 Vulcan S Café ABS	18-20
EN 650 Vulcan SE ABS	18-20
ER-6f Non ABS Model	Left 06-11
(EX 650 A6F/A7F/A8F/C9F/CAF/CBF) Right	
ER-6f (ABS Model)	Left 06-11
(EX 650 B6F/B7F/B8F/D9F/DAF/DBF) Right	
ER-6f ECF/EDS/EEF/EFF/EGF (Non ABS Model)	Left 12-16
Right	
ER-6f FCF/FDS/FEF/FFF/FGF (ABS Model)	Left 12-16
Right	
ER-6n (Non ABS Model)	Left 06-11
(ER 650 A6F/A7F/A8F/C9F/CAF/CBF) Right	
ER-6n (ABS Model)	Left 06-11
(ER 650 B6F/B7F/B8F/D9F/DAF/DBF) Right	
ER-6n ECF/EDS/EEF/EFF/EGF (Non ABS Model)	Left 12-16
Right	
ER-6n FCF/FDS/FEF/FFF/FGF (ABS Model)	Left 12-16
Right	
KLR 650 A1-A3	87-89
KL 650 B1-B3 Tengai	89-92
KLE 650 A7F/A8F/A9F/CAF Versys	Left 07-10
Right	
KLE 650 B7F/B8F/B9F/DAF Versys ABS	Left 07-10
Right	
KLE 650 CBF/CCF/CDF/CEF Versys/Non ABS	Left 11-14
Right	
KLE 650 Versys (KLE 650 EFF/Non ABS)	15
KLE 650 DBF/DCF/DDF/DEF Versys/ABS	Left 11-14
Right	
KLE 650 Versys (KLE 650 FFF/ABS)	Left 15
Right	
KLE 650 Versys (Non ABS) KLE 650 EGF	16
KLE 650 Versys (ABS)	Left 16-20
Right	
KLR 650 C1-C10	95-04
KLR 650 (KL 650 E8F/E9F)	08-09
KLX 650 C1/C2/C3	93-97
KVF 650 A1/A2 Prairie	Left 02-03
Right	
KVF 650 D1/D6F/D7F/D8F/D9F /DAF/DBF Brute Force 4 x 4	Left 05-11
Right	
KVF 650 E1/E6F/E7F/E8F/E9F Brute Force 4 x 4 Hardwoods Green HD	Left 05-09
Right	

FA, SFA, TT Pad or Brake Shoe	SFAC Carbon Scooter Pads	Speciality Pads - SXR / Vee / MXS	Sintered/HH Pads/ Grooved Shoes	BRAKE DISC CHOICES - FRONT				CX Extreme MX Race Disc/ UTVX Disc	Line #
				Left / Gauche / Links Standard Replacement Disc	Right / Droite / Rechts Standard Replacement Disc	Contour Disc Universal left and right fitment	Custom Disc Universal left and right fitment		
									1
									2
									3
									4
									5
									6
									7
									8
									9
									10
									11
									12
									13
									14
									15
			FA281HH						16
			FA281HH						17
			FA281HH						18
			FA281HH						19
						MD4159XC		VR4159BLK†	20
			FA229HH			MD4159XC		VR4159BLK†	21
			FA229HH			MD4156AXC			22
			FA229HH			MD4156XC			23
			FA229HH			MD4159XC		VR4159BLK†	24
			FA229HH			MD4159XC		VR4159BLK†	25
			FA229HH			MD4156AXC			26
			FA229HH			MD4156XC			27
			FA229HH			MD4159XC		VR4159BLK†	28
			FA229HH			MD4159XC		VR4159BLK†	29
			FA229HH			MD4156AXC			30
			FA229HH			MD4159XC		VR4159BLK†	31
			FA229HH			MD4159XC		VR4159BLK†	32
			FA229HH			MD4159XC		VR4159BLK†	33
			FA229HH			MD4156AXC			34
			FA229HH			MD4156XC			35
		FA130V	FA130R	MD6042D					36
			FA129R	MD6081D					37
			FA229HH			MD4159XC		VR4159BLK†	38
			FA229HH			MD4159XC		VR4159BLK†	39
			FA229HH			MD4156AXC			40
			FA229HH			MD4156XC			41
			FA229HH			MD4159XC		VR4159BLK†	42
			FA229HH			MD4159XC		VR4159BLK†	43
			FA142HH*						44
			FA229HH			MD4156AXC			45
			FA229HH			MD4156XC			46
			FA142HH			MD4156AXC			47
			FA142HH			MD4156XC			48
			FA142HH*						49
			FA142HH			MD4156AXC			50
			FA142HH			MD4156XC			51
			FA229HH	MD6081D					52
			FA228HH			MD6309C			53
		MXS185	FA185R	MD6086D					54
			FA342R	MD6188D					55
			FA349R		MD6188D				56
			FA342R	MD6188D					57
			FA349R		MD6188D				58
			FA342R	MD6188D					59
			FA349R		MD6188D				60

FRONT / AVANT / VORN / FRENTE / ANTERIORE

R Suffix = High Durability Sintered Pad. HH Suffix = High Performance Sintered Pad. TT Suffix = Hard Wearing Off Road Pad. V Suffix = Semi Sintered Pad. G Suffix = Grooved Shoe.

D Suffix = Drilled Disc. X Suffix = Universal Left or Right Disc. XC Suffix = Contoured Disc. LS Suffix = Left/Steel Disc. RS = Right/Steel Disc.

*-2 Sets Required. † For Vee disc colours add RED, BLU, GRN, GLD, ORG suffix to part number. For Custom Finish Options for Vee-Rotors™ including Splatter discs add suffix CHR, CHGR, CHBL, CHBR - available in various colours see page iv. ☼ - Also available as a Vintage Motorcycle Disc.

JAPANESE Built Motorcycles

Line #	BRAKE DISC CHOICES - FRONT						DISC PAD CHOICES - REAR				BRAKE DISC CHOICES - REAR			
	Oversize 250 /280mm Disc Kit	OSX Oversize 250/280mm Disc Kit	Relocating Bracket for 250/ 280mm Disc	Oversize 320mm Disc Kit	SMX Oversize 320mm Disc Kit	Relocating Bracket for 320mm Disc	FA, SFA, TT Pad or Brake Shoe	SFAC Carbon Scooter Pads	Speciality Pads - SXR / Vee / MXS	Sintered/ HH Pads/ Grooved Shoes	Standard Replacement Disc	Contour Disc Rear fitment	Vee Discs CONTOUR	CX Extreme MX Race Disc
1							K720*							
2							K720*							
3							K720*							
4							K720*							
5														
6							K720*							
7							K720*							
8														
9							K720*							
10														
11							K720*							
12														
13							K720*							
14							K720*							
15							K720*							
16							FA174		FA174HH					
17							FA174		FA174HH					
18							FA174		FA174HH					
19							FA174		FA174HH					
20							FA192	FA192V	FA192HH		MD4138C	VR4138		
21														
22							FA192	FA192V	FA192HH		MD4164AC			
23														
24											MD4138C	VR4138		
25							FA192		FA192HH					
26											MD4164AC			
27							FA192		FA192HH					
28							FA192	FA192V	FA192HH		MD4138C	VR4138		
29														
30							FA192	FA192V	FA192HH		MD4164AC			
31														
32											MD4138C	VR4138		
33							FA192		FA192HH					
34											MD4164AC			
35							FA192		FA192HH					
36				SM6042C	SMX6042	BRK017	FA067/3			MD6082D			MD6082CX	
37							FA067		FA067R	MD6082D				
38							FA192		FA192HH		MD4138C	VR4138		
39														
40							FA192		FA192HH		MD4164AC			
41														
42							FA192		FA192HH		MD4138C	VR4138		
43														
44							FA140		FA140HH					
45							FA192		FA192HH		MD4164AC			
46														
47														
48							FA140		FA140HH					
49							FA174		FA174HH					
50							FA174		FA174HH					
51														
52							FA067		FA067R	MD6082D				
53				SM6309C	SMX6309	BRK018	FA197		FA197HH		MD6310C			
54							FA152TT	MXS152	FA152R	MD6085D				
55														
56														
57														
58														
59														
60														

REAR / ARRIÈRE / HINTEN / POSTERIOR / POSTERIORE

R Suffix = High Durability Sintered Pad. HH Suffix = High Performance Sintered Pad. TT Suffix = Hard Wearing Off Road Pad. V Suffix = Semi Sintered Pad. G Suffix = Grooved Shoe.
D Suffix = Drilled Disc. X Suffix = Universal Left or Right Disc. XC Suffix = Contoured Disc. LS Suffix = Left/Steel Disc. RS = Right/Steel Disc.

BRAKE APPLICATIONS

*-2 Sets Required. † For Vee disc colours add RED, BLU, GRN, GLD, ORG suffix to part number. For Custom Finish Options for Vee-Rotors™ including Splatter discs add suffix CHR, CHGR, CHBL, CHBR - available in various colours see page iv. Ⓢ - Also available as a Vintage Motorcycle Disc.

JAPANESE Built Motorcycles



KAWASAKI Contd.

Model	Side	Year
KVF 650 E8FA Brute Force	Left	08
4 x 4 Hardwoods Green HD	Right	
KVF 650 F7F/F8F Brute Force	Left	07-08
4 x 4i Hardwoods Green	Right	
KVF 650 H7F/H8F Brute Force	Left	07-08
4 x 4i Hardwoods Green	Right	
KVF 650 FCF/FCS/FDF/FEF	Left	12-14
	Right	
KVF 650 G7F/G8F Brute Force	Left	07-08
4 x 4i Hardwoods Green	Right	
KVF 650 G7F/G8F Brute Force	Left	12-13
4 x 4i Hardwoods Green	Right	
Ninja 650 (EX 650)		17-20
Ninja 650 ABS (EX 650)		17-20
Ninja 650 KRT (EX 650 KRT)		17-20
W 650 (EJ 650 A1/C3/C4/C5/C6/C7)		99-05
Z 650 B1/B2/B3		77-79
Z 650 C1/C2		77-78
Z 650 C3		79
Z 650 D2/D3 (SR)		79-80
Z 650 F1		80
Z 650 F2/F3/F4		81-83
Z 650 (ER 650)		17-20
Z 650 (ER 650 ABS)		17-20
KSV 700 A1/A2/A6F/A7F/A8F	Left	04-11
/A9F/ABF (KFX 700) V-Force	Right	
KVF 700 B1/B6F/A7F/A8F 4 x 4	Left	04-08
(Prairie) (KVF 700 A1/A2/A6F/B2)	Right	
KVF 700 D1 Team Green	Left	05
	Right	
ST 700 Stallion		14-18
Z 700 A1 LTD		84
VN 700 A1 Vulcan		85
ZN 700 A1/A2 LTD		84-85
GPX 750 R (ZX 750 F1-F3)		87-89
GT 750 P1-P9		82-96
GPZ 750 R1		82
GPZ 750 A1-A5		83-87
GPZ 750 E1/E2 Turbo		84-87
GPZ 750 R G2/G3		85-86
H2/H2-A (750cc) Mach IV		72-73
H2-B/H2-C (750cc) Mach IV		74-75
KRF 750 A8F/B8F	Left	08
Teryx 750 4 x 4 (RUV)	Right	
KRF 750 C8F/D8F	Left	08
Teryx 750 4 x 4 LE (RUV)	Right	
KRF 750 F8F Teryx 750	Left	08
4 x 4 NRA Outdoors (RUV)	Right	
KRF 750 G9F/NAF/NBF/NCS/NDF	Left	09-13
Teryx 750 Fi 4 x 4	Right	
KRF 750 J9FA/K9F/PAF/RAF/PBF/RBF	Left	09-13
/RCS/PDF/RDF Teryx 750 Fi 4 x 4 LE	Right	
KRF 750 L9F Teryx 750 Fi	Left	09
4 x 4 LE Sport	Right	
KRF 750 M9F Teryx 750 Fi	Left	09
4 x 4 NRA Outdoors	Right	
KRF 750 SAF/SAFA/SBF/SBFASCS/SCSA	Left	10-13
/SDF Teryx 750 Fi 4 x 4 Sport LE	Right	
KRF 750 TAF/VBF	Left	10-11
Teryx 750 Fi 4 x 4 SGE	Right	

FA, SFA, TT Pad or Brake Shoe	SFAC Carbon Scooter Pads	Speciality Pads - SXR / Vee / MXS	Sintered/HH Pads/ Grooved Shoes	DISC PAD CHOICES - FRONT		BRAKE DISC CHOICES - FRONT					Line #
				Left / Gauche / Links Standard Replacement Disc	Right / Droite / Rechts Standard Replacement Disc	Contour Disc Universal left and right fitment	Custom Disc Universal left and right fitment	Vee-Discs Black † See note below	CX Extreme MX Race Disc/ UTVX Disc		
FA165TT		MXS165	FA165R	MD6188D							1
FA135TT		MXS135	FA135R		MD6188D						2
FA165TT		MXS165	FA165R	MD6188D							3
FA135TT		MXS135	FA135R		MD6188D						4
FA165TT		MXS165	FA165R	MD6188D							5
FA135TT		MXS135	FA135R		MD6188D						6
FA165TT		MXS165	FA165R	MD6188D							7
FA135TT		MXS135	FA135R		MD6188D						8
FA165TT		MXS165	FA165R	MD6188D							9
FA135TT		MXS135	FA135R		MD6188D						10
FA165TT		MXS165	FA165R	MD6188D							11
FA135TT		MXS135	FA135R		MD6188D						12
FA226*			FA226HH*								13
FA226*			FA226HH*								14
FA226*			FA226HH*								15
FA231			FA231HH			MD4008X	MD4008XC	MD4008CC	VR4008BLK†		16
FA033				MD4052LS							17
FA033*				MD4059LS	MD4059RS						18
FA073*				MD4059LS	MD4059RS						19
FA073*				MD4059LS	MD4059RS						20
FA073*				MD4052LS	MD4052RS						21
FA068*	FA068V*	FA068HH*	FA068HH*	MD4010LS	MD4010RS						22
FA142*	FA142V*	FA142HH*	FA142HH*								23
FA142*	FA142V*	FA142HH*	FA142HH*								24
			FA342R	MD6137D							25
			FA349R		MD6137D						26
			FA342R	MD6188D							27
			FA349R		MD6188D						28
			FA342R	MD6188D							29
			FA349R		MD6188D						30
			FA380HH*	MD4155X	MD4155X	MD4155XC*					31
FA068*	FA068V*	FA068HH*	FA068HH*	MD4010LS	MD4010RS						32
FA085*	FA085V*	FA085HH*	FA085HH*	MD4010LS	MD4010RS						33
FA085*	FA085V*	FA085HH*	FA085HH*	MD4067LS	MD4067RS						34
FA129*		FA129HH*	FA129HH*	MD4071LS	MD4071RS						35
FA068*	FA068V*	FA068HH*	FA068HH*	MD4010LS	MD4010RS						36
FA068*	FA068V*	FA068HH*	FA068HH*	MD4010LS	MD4010RS						37
FA085*		FA085HH*	FA085HH*	MD4028	MD4028						38
FA085*		FA085HH*	FA085HH*	MD4016	MD4016						39
FA085*		FA085HH*	FA085HH*	MD4016	MD4016						40
FA055				MD4069LS							41
FA055				MD4069LS							42
FA165TT		MXS165	FA165R	MD6325D							43
FA135TT		MXS135	FA135R		MD6325D						44
FA165TT		MXS165	FA165R	MD6325D							45
FA135TT		MXS135	FA135R		MD6325D						46
FA165TT		MXS165	FA165R	MD6325D							47
FA135TT		MXS135	FA135R		MD6325D						48
FA165TT		MXS165	FA165R	MD6325D							49
FA135TT		MXS135	FA135R		MD6325D						50
FA165TT		MXS165	FA165R	MD6325D							51
FA135TT		MXS135	FA135R		MD6325D						52
FA165TT		MXS165	FA165R	MD6325D							53
FA135TT		MXS135	FA135R		MD6325D						54
FA165TT		MXS165	FA165R	MD6325D							55
FA135TT		MXS135	FA135R		MD6325D						56
FA165TT		MXS165	FA165R	MD6325D							57
FA135TT		MXS135	FA135R		MD6325D						58
FA165TT		MXS165	FA165R	MD6325D							59
FA135TT		MXS135	FA135R		MD6325D						60

FRONT / AVANT / VORN / FRENTE / ANTERIORE

R Suffix = High Durability Sintered Pad. HH Suffix = High Performance Sintered Pad. TT Suffix = Hard Wearing Off Road Pad. V Suffix = Semi-Sintered Pad. G Suffix = Grooved Shoe.

D Suffix = Drilled Disc. X Suffix = Universal Left or Right Disc. XC Suffix = Contoured Disc. LS Suffix = Left/Steel Disc. RS = Right/Steel Disc.

*-2 Sets Required. † For Vee disc colours add RED, BLU, GRN, GLD, ORG suffix to part number. For Custom Finish Options for Vee-Rotors™ including Splatter discs add suffix CHR, CHGR, CHBL, CHBR - available in various colours see page iv. ☼ - Also available as a Vintage Motorcycle Disc.

JAPANESE Built Motorcycles

Line #	BRAKE DISC CHOICES - FRONT						DISC PAD CHOICES - REAR				BRAKE DISC CHOICES - REAR			
	Oversize 250 /280mm Disc Kit	OSX Oversize 250/280mm Disc Kit	Relocating Bracket for 250/ 280mm Disc	Oversize 320mm Disc Kit	SMX Oversize 320mm Disc Kit	Relocating Bracket for 320mm Disc	FA, SFA, TT Pad or Brake Shoe	SFAC Carbon Scooter Pads	Speciality Pads - SXR / Vee / MXS	Sintered/ HH Pads/ Grooved Shoes	Standard Replacement Disc	Contour Disc Rear fitment	Vee Discs CONTOUR	CX Extreme MX Race Disc
1														
2														
3														
4														
5														
6														
7														
8														
9														
10														
11														
12														
13							FA174	FA174V	FA174HH					
14							FA174		FA174HH					
15							FA174	FA174V	FA174HH					
16							K706							
17							K709							
18							FA037			MD4062				
19							FA036	FA036V						
20							FA036	FA036V		MD4063				
21							K709							
22							K709							
23							FA174	FA174V	FA174HH					
24							FA174	FA174V	FA174HH					
25														
26														
27														
28														
29														
30														
31							FA196	FA196V	FA196HH	MD4169				
32							FA068	FA068V	FA068HH	MD4169				
33							K709							
34							FA085	FA085V	FA085HH	MD4068				
35							FA129	FA129V	FA129HH	MD4007				
36							FA068	FA068V	FA068HH	MD4169				
37							FA068	FA068V	FA068HH	MD4169				
38							FA085	FA085V	FA085HH	MD4019				
39							FA085	FA085V	FA085HH	MD4017				
40							FA085	FA085V	FA085HH	MD4017				
41							K713							
42							K713							
43														
44														
45														
46														
47														
48														
49														
50														
51														
52														
53														
54														
55														
56														
57														
58														
59														
60														

REAR / ARRIÈRE / HINTEN / POSTERIOR / POSTERIORE

*-2 Sets Required. † For Vee disc colours add RED, BLU, GRN, GLD, ORG suffix to part number. For Custom Finish Options for Vee-Rotors™ including Splatter discs add suffix CHR, CHGR, CHBL, CHBR - available in various colours see page iv. Ⓢ - Also available as a Vintage Motorcycle Disc.

R Suffix = High Durability Sintered Pad. **HH** Suffix = High Performance Sintered Pad. **TT** Suffix = Hard Wearing Off Road Pad. **V** Suffix = Semi Sintered Pad. **G** Suffix = Grooved Shoe.
D Suffix = Drilled Disc. **X** Suffix = Universal Left or Right Disc. **XC** Suffix = Contoured Disc. **LS** Suffix = Left/Steel Disc. **RS** = Right/Steel Disc.

BRAKE APPLICATIONS



KAWASAKI Contd.

JAPANESE Built Motorcycles

DISC PAD CHOICES - FRONT

BRAKE DISC CHOICES - FRONT

			FA, SFA, TT Pad or Brake Shoe	SFAC Carbon Scooter Pads	Speciality Pads - SXR / Vee / MXS	Sintered/ HH Pads/ Grooved Shoes	Left / Gauche / Links Standard Replacement Disc	Right / Droite / Rechts Standard Replacement Disc	Contour Disc Universal left and right fitment	Custom Disc Universal left and right fitment	Vee-Discs Black † See note below	CX Extreme MX Race Disc/ UTVX Disc	Line #
KRT 750 ACF/ADF (Teryx 4 750 4 x 4)	Left	12-13	FA165TT			FA165R	MD6399D					UTVX6399	1
	Right		FA135TT			FA135R		MD6399D				UTVX6399	2
KRT 750 ACFA/ADFA	Left	12-13	FA165TT			FA165R	MD6399D					UTVX6399	3
(Teryx 4 750 4 x 4 EPS)	Right		FA135TT			FA135R		MD6399D				UTVX6399	4
KRT 750 CCF/CDF	Left	12-13	FA165TT			FA165R	MD6399D					UTVX6399	5
(Teryx 4 750 4 x 4 EPS LE)	Right		FA135TT			FA135R		MD6399D				UTVX6399	6
KVF 750 D8F/D9F/DBF	Left	08-11	FA165TT			FA165R	MD6188D						7
	Right		FA135TT		MXS135	FA135R		MD6188D					8
KVF 750 GCF/GDF/GEF/GFF/GGF/GHF	Left	12-17	FA165TT		MXS165	FA165R	MD6188D						9
Brute Force 4 x 4i EPS	Right		FA135TT		MXS135	FA135R		MD6188D					10
KVF 750 HCF/HDF/HEF/HFF/HGF/HHF	Left	12-17	FA165TT		MXS165	FA165R	MD6188D						11
Brute Force 4 x 4i EPS/CamO	Right		FA135TT		MXS135	FA135R		MD6188D					12
KVF 750 JCF/JDF/JEF/JFF/JGF	Left	12-17	FA165TT		MXS165	FA165R	MD6188D						13
/JHF Brute Force 4 x 4i EPS	Right		FA135TT		MXS135	FA135R		MD6188D					14
KVF 750 LCF/LDF/LEF/LFF/LGF/LHF	Left	12-17	FA165TT		MXS165	FA165R	MD6188D						15
Brute Force 4 x 4i	Right		FA135TT		MXS135	FA135R		MD6188D					16
VN 750 A2-A5/A10		86-94	FA085*		FA085V*	FA085HH*	MD4010LS	MD4010RS					17
Z 750 E1		80	FA068*		FA068V*	FA068HH*	MD4010LS	MD4010RS					18
Z 750 H1/H2 LTD		80-81	FA068*		FA068V*	FA068HH*	MD4010LS	MD4010RS					19
Z 750 L1-L4		81-84	FA068*		FA068V*	FA068HH*	MD4010LS	MD4010RS					20
Z 750 Y1 LTD		82	FA068*		FA068V*	FA068HH*	MD4043LS	MD4043RS					21
Z 750 B1/B2		77-78	FA033										22
Z 750 D1		76	FA033										23
Z 750 N1/N2 Spectre		82-83	FA068*		FA068V*	FA068HH*	MD4010LS	MD4010RS					24
Z 750 S (ZR 750 K1/K6F)	Left	05-07	FA229		FA229V	FA229HH	MD4141X		MD4141XC	MD4141CC			25
	Right		FA231		FA231V	FA231HH		MD4141X	MD4141XC	MD4141CC			26
Z 750 (ZR 750 J1/J2/J6F)	Left	04-06	FA229		FA229V	FA229HH	MD4141X		MD4141XC	MD4141CC			27
	Right		FA231		FA231V	FA231HH		MD4141X	MD4141XC	MD4141CC			28
Z 750 (ZR 750 L7F/L8F/L9F/LAF)		07-11	FA142*		FA142V*	FA142HH*			MD4159XC*		VR4159BLK*†		29
Z 750 ABS (ZR 750 M7F/M8F/M9F/MAF/MBF)		07-11	FA142*		FA142V*	FA142HH*			MD4156XC*				30
Z 750 R Non ABS (ZR 750 NBF/NCF)		11-12				FA417/4HH*			MD4152XC*	MD4152CC*	VR4152BLK*†		31
Z 750 R Black Edition (ZR 750 NBFA)		12				FA417/4HH*			MD4152XC*	MD4152CC*	VR4152BLK*†		32
Z 750 R ABS (ZR 750 PBF/PCF)		11-12				FA417/4HH*			MD4152XC*	MD4152CC*	VR4152BLK*†		33
ZR 750 C1-C5 Zephyr		91-95	FA129*		FA129V*	FA129HH*	MD4008X	MD4008X	MD4008XC*	MD4008CC*	VR4008BLK*†		34
ZR 750 D1 Zephyr	Left	96-98	FA229		FA229V	FA229HH	MD4008X		MD4008XC*	MD4008CC*	VR4008BLK*†		35
	Right		FA231		FA231V	FA231HH		MD4008X	MD4008XC*	MD4008CC*	VR4008BLK*†		36
ZR-7 (ZR 750 F1/F3/F5)	Left	99-04	FA229		FA229V	FA229HH	MD4141X		MD4141XC	MD4141CC			37
	Right		FA231		FA231V	FA231HH		MD4141X	MD4141XC	MD4141CC			38
ZR-7S (ZR 750 H1/H3)	Left	01-04	FA229		FA229V	FA229HH	MD4141X		MD4141XC	MD4141CC			39
	Right		FA231		FA231V	FA231HH		MD4141X	MD4141XC	MD4141CC			40
ZXR 750 H1/H2		89-90	FA158*			FA158HH*	MD4012X	MD4012X	MD4012XC*	MD4012CC*	VR4012BLK*†		41
ZXR 750 K1/K2/J1/J2		91-92	FA158*			FA158HH*	MD4022X	MD4022X	MD4022XC*	MD4022CC*	VR4022BLK*†		42
ZXR 750 M1/M2/L1-L3		93-95	FA158*			FA158HH*	MD4022X	MD4022X	MD4022XC*	MD4022CC*	VR4022BLK*†		43
ZX7-R (ZX 750 P1/P2/P3/P4/P5/P6/P7)		96-03	FA188*			FA188HH*	MD4022X	MD4022X	MD4022XC*	MD4022CC*	VR4022BLK*†		44
ZX7-RR (ZX 750 N1/N2)		96-99	FA424*			FA424HH*	MD4022X	MD4022X	MD4022XC*	MD4022CC*	VR4022BLK*†		45
KRF 800 BEF/BFF/FGF/FHF/FJF (Teryx)	Left	14-18	FA165TT			FA165R	MD6399D					UTVX6399	46
	Right		FA135TT			FA135R		MD6399D				UTVX6399	47
KRF 800 CEF/CFE/GGF/GHF/GJF	Left	14-18	FA165TT			FA165R	MD6399D					UTVX6399	48
(Teryx LE)	Right		FA135TT			FA135R		MD6399D				UTVX6399	49
KRF 800 DEF/DFE/HGF/HFF/HJF	Left	14-18	FA165TT			FA165R	MD6399D					UTVX6399	50
(Teryx Camo)	Right		FA135TT			FA135R		MD6399D				UTVX6399	51
KRT 800 BEF/BFF/FGF/FHF/FJF	Left	14-18	FA165TT			FA165R	MD6399D					UTVX6399	52
(Teryx 4)	Right		FA135TT			FA135R		MD6399D				UTVX6399	53
KRT 800 CEF/CFE/GGF/GHF/GJF	Left	14-18	FA165TT			FA165R	MD6399D					UTVX6399	54
(Teryx 4 LE)	Right		FA135TT			FA135R		MD6399D				UTVX6399	55
KRT 800 DEF/DFE/HGF/HFF/HJF	Left	14-18	FA165TT			FA165R	MD6399D					UTVX6399	56
(Teryx 4 Camo)	Right		FA135TT			FA135R		MD6399D				UTVX6399	57
VN 800 A1/A2/A3		95-99	FA085		FA085V	FA085HH	MD4124LS						58
VN 800 B1-B10/B6F Classic		96-06	FA229		FA229V	FA229HH	MD4125LS						59
VN 800 C1/C2/E1/E2/E3 Drifter		99-04	FA229		FA229V	FA229HH	MD4125LS						60

FRONT / AVANT / VORN / FRENTE / ANTERIORE

R Suffix = High Durability Sintered Pad. HH Suffix = High Performance Sintered Pad. TT Suffix = Hard Wearing Off Road Pad. V Suffix = Semi-Sintered Pad. G Suffix = Grooved Shoe.

D Suffix = Drilled Disc. X Suffix = Universal Left or Right Disc. XC Suffix = Contoured Disc. LS Suffix = Left/Steel Disc. RS = Right/Steel Disc.

*-2 Sets Required. † For Vee disc colours add RED, BLU, GRN, GLD, ORG suffix to part number. For Custom Finish Options for Vee-Rotors™ including Splatter discs add suffix CHR, CHGR, CHBL, CHBR - available in various colours see page iv. ☼ - Also available as a Vintage Motorcycle Disc.

JAPANESE Built Motorcycles

Line #	BRAKE DISC CHOICES - FRONT						DISC PAD CHOICES - REAR				BRAKE DISC CHOICES - REAR			
	Oversize 250 /280mm Disc Kit	OSX Oversize 250/280mm Disc Kit	Relocating Bracket for 250/ 280mm Disc	Oversize 320mm Disc Kit	SMX Oversize 320mm Disc Kit	Relocating Bracket for 320mm Disc	FA, SFA, TT Pad or Brake Shoe	SFAC Carbon Scooter Pads	Speciality Pads - SXR / Vee / MXS	Sintered/ HH Pads/ Grooved Shoes	Standard Replacement Disc	Contour Disc Rear fitment	Vee Discs CONTOUR	CX Extreme MX Race Disc
1														
2														
3														
4														
5														
6														
7														
8														
9														
10														
11														
12														
13														
14														
15														
16														
17							K709							
18							FA068	FA068V	FA068HH	MD4169				
19							FA068	FA068V	FA068HH	MD4169				
20							FA068	FA068V	FA068HH	MD4169				
21							K709							
22							FA037							
23							FA037							
24							FA068	FA068V	FA068HH	MD4169				
25														
26							FA192	FA192V	FA192HH	MD4138	MD4138C			
27														
28							FA192	FA192V	FA192HH	MD4138	MD4138C			
29							FA174	FA174V	FA174HH		MD4157C	VR4157		
30							FA174	FA174V	FA174HH		MD4157C			
31							FA140	FA140V	FA140HH		MD4157C	VR4157		
32							FA140	FA140V	FA140HH		MD4157C	VR4157		
33							FA140	FA140V	FA140HH		MD4157C	VR4157		
34							FA129	FA129V	FA129HH	MD4007	MD4007C	VR4007		
35							FA129	FA129V	FA129HH	MD4007	MD4007C	VR4007		
36														
37							FA231		FA231HH	MD4142	MD4142C			
38														
39							FA231		FA231HH	MD4142	MD4142C			
40														
41							FA161	FA161V	FA161HH	MD4013	MD4013C	VR4013		
42							FA161	FA161V	FA161HH	MD4013	MD4013C	VR4013		
43							FA161	FA161V	FA161HH	MD4013	MD4013C	VR4013		
44							FA161	FA161V	FA161HH	MD4013	MD4013C	VR4013		
45							FA254	FA254V	FA254HH	MD4013	MD4013C	VR4013		
46														
47														
48														
49														
50														
51														
52														
53														
54														
55														
56														
57														
58							K709							
59							K709							
60							FA231	FA231V	FA231HH	MD4148				

REAR / ARRIÈRE / HINTEN / POSTERIOR / POSTERIORE

R Suffix = High Durability Sintered Pad. HH Suffix = High Performance Sintered Pad. TT Suffix = Hard Wearing Off Road Pad. V Suffix = Semi Sintered Pad. G Suffix = Grooved Shoe.
D Suffix = Drilled Disc. X Suffix = Universal Left or Right Disc. XC Suffix = Contoured Disc. LS Suffix = Left/Steel Disc. RS = Right/Steel Disc.

BRAKE APPLICATIONS

*-2 Sets Required. † For Vee disc colours add RED, BLU, GRN, GLD, ORG suffix to part number. For Custom Finish Options for Vee-Rotors™ including Splatter discs add suffix CHR, CHGR, CHBL, CHBR - available in various colours see page iv. ☼ - Also available as a Vintage Motorcycle Disc.

JAPANESE Built Motorcycles



KAWASAKI Contd.



W 800 (Solid Front Disc)	11-12
W 800 Café (Cockpit Fairing)	11
W 800 Special (Black Exhaust)	12
W 800 ABS	13-16
W 800 Special	13-16
Z 800 ADS/AEF/AF/AGF (Non ABS)	13-16
Z 800 BDS/BEF/BFF/BGF (ABS Model)	13-16
Z 800 E CDS/CEF/CFF/CGF (Non ABS)	13-16
Z 800 E DDS/DEF/DF/DFG (ABS Model)	13-16
KAF 820 AFF/AGF/AHF/AJF	Left 15-18
Mule Pro FXT	Right
KAF 820 BFF/BGF/BHF/BJF	Left 15-18
Mule Pro FXT/EP/PS	Right
KAF 820 CFF/CGF/CHF/CJF	Left 15-18
Mule Pro FXT/EP/PS LE	Right
KAF 820 DFF/DGF/DHF/DJF	Left 15-18
Mule Pro FXT/EP/PS Camo	Right
KAF 820 EGF/EHF/EJF Mule Pro FX	Left 16-18
	Right
KAF 820 FGF/FHF/FJF	Left 16-18
Mule Pro FX/EP/PS	Right
KAF 820 GGF/GHF/GJF	Left 16-18
Mule Pro FX/EP/PS LE	Right
KAF 820 HGF/HHF	Left 16-17
Mule Pro FX/EP/PS Camo	Right
KAF 820 JGF/JHF	Left 16-17
Mule Pro FXT Ranch Edition	Right
ZL 900 A1/A2 Eliminator	85-86
GPZ 900 R A1-A6	84-89
GPZ 900 R A7/A8	90-96
GPZ 900 R (ZX 900 A11)	98
GPZ 900 R (ZX 900 A12-A15)	99-02
VN 900 A6F Classic	06
Vulcan Classic LT (Spoke wheels & Screen)	07-20
Vulcan Classic (Spoke Wheels)	11-20
Vulcan Custom (Cast Wheels)	07-20
Z 900 ZIA/ZIB	74-76
Z 900 A4	77
Z 900	17-18
Z 900 (ZR 900 ABS)	17-20
Z 900 RS	18-20
Z 900 RS ABS	18-20
Z 900 RS Café	18-20
ZX 9 R (ZX 900 B1/B2)	94-95
ZX 9 R (ZX 900 B3/B4)	96-97
ZX 9 R (ZX 900 C1/C2)	98-99
ZX 9 R (ZX 900 E1/E2)	00-01
ZX 9 R (ZX 900 F1/F2)	02-04
KAF 950 A1/A2/A3 (Mule 2510 Diesel)	
KAF 950 B1/B2/B3 (Mule 3010 Diesel)	
KAF 950 D8F Mule 3010 Diesel 4 x 4	08
KAF 950 E8F Mule 3010 Trans Diesel 4 x 4	08
KAF 950 F9F/FAF/FBF/FCF/FDF (Mule 4010 Diesel 4 x 4)	09-13
KAF 950 G9F/GAF/GBF/GCF/GDF (Mule 4010 Trans 4 x 4 Diesel)	09-13
GPZ 1000 RX (A1-A3)	86-88
H2 Ninja (ZX 1000 NFF/NGF)	15-16
H2 R Ninja (ZX 1000 PFF/PGF)	15-16
KAF 1000 AGF/AHF/AJF	Left 16-18
Mule Pro DXT/Diesel	Right

DISC PAD CHOICES - FRONT				BRAKE DISC CHOICES - FRONT						Line #
FA, SFA, TT Pad or Brake Shoe	SFAC Carbon Scooter Pads	Speciality Pads - SXR / Vee / MXS	Sintered/HH Pads/ Grooved Shoes	Left / Gauche / Links Standard Replacement Disc	Right / Droite / Rechts Standard Replacement Disc	Contour Disc Universal left and right fitment	Custom Disc Universal left and right fitment	Vee-Discs Black † See note below	CX Extreme MX Race Disc/ UTVX Disc	Line #
FA231		FA231V	FA231HH			MD4158				1
FA231		FA231V	FA231HH			MD4008X	MD4008XC	MD4008CC	VR4008BLK†	2
FA231		FA231V	FA231HH			MD4008X	MD4008XC	MD4008CC	VR4008BLK†	3
FA231		FA231V	FA231HH			MD4008X	MD4008XC	MD4008CC	VR4008BLK†	4
FA231		FA231V	FA231HH			MD4008X	MD4008XC	MD4008CC	VR4008BLK†	5
			FA347HH*				MD4155XC*	MD4155CC*	VR4155BLK*†	6
			FA347HH*				MD4155XC*	MD4155CC*	VR4155BLK*†	7
FA142*		FA142V*	FA142HH*				MD4155XC*	MD4155CC*	VR4155BLK*†	8
			FA347HH*				MD4155XC*	MD4155CC*	VR4155BLK*†	9
FA165TT			FA165R	MD6398D					UTVX6398	10
FA135TT			FA135R		MD6398D				UTVX6398	11
FA165TT			FA165R	MD6398D					UTVX6398	12
FA135TT			FA135R		MD6398D				UTVX6398	13
FA165TT			FA165R	MD6398D					UTVX6398	14
FA135TT			FA135R		MD6398D				UTVX6398	15
FA165TT			FA165R	MD6398D					UTVX6398	16
FA135TT			FA135R		MD6398D				UTVX6398	17
FA165TT			FA165R	MD6398D					UTVX6398	18
FA135TT			FA135R		MD6398D				UTVX6398	19
FA165TT			FA165R	MD6398D					UTVX6398	20
FA135TT			FA135R		MD6398D				UTVX6398	21
FA165TT			FA165R	MD6398D					UTVX6398	22
FA135TT			FA135R		MD6398D				UTVX6398	23
FA165TT			FA165R	MD6398D					UTVX6398	24
FA135TT			FA135R		MD6398D				UTVX6398	25
FA165TT			FA165R	MD6398D					UTVX6398	26
FA135TT			FA135R		MD6398D				UTVX6398	27
FA085*		FA085V*	FA085HH*	MD4016	MD4016					28
FA085*			FA085HH*	MD4016	MD4016					29
FA158*			FA158HH*	MD4008X	MD4008X	MD4008XC*	MD4008CC*	VR4008BLK*†		30
FA158*			FA158HH*	MD4008X	MD4008X	MD4008XC*	MD4008CC*	VR4008BLK*†		31
FA188*			FA188HH*							32
FA229		FA229V	FA229HH	MD4158						33
FA229		FA229V	FA229HH	MD4158						34
FA229		FA229V	FA229HH	MD4158						35
FA229		FA229V	FA229HH	MD4158						36
FA055*				MD4069LSⓈ	MD4069RSⓈ					37
FA033*				MD4052LSⓈ	MD4052RSⓈ					38
			FA347HH*							39
			FA347HH*							40
			FA379HH*							41
			FA379HH*							42
			FA379HH*							43
FA158*			FA158HH*	MD4022X	MD4022X	MD4022XC*	MD4022CC*	VR4022BLK†		44
FA188*			FA188HH*	MD4022X	MD4022X	MD4022XC*	MD4022CC*	VR4022BLK†		45
FA188*			FA188HH*	MD4167X	MD4167X	MD4167XC*				46
FA188*			FA188HH*	MD4012X	MD4012X	MD4012XC*	MD4012CC*	VR4012BLK*†		47
			FA347HH*	MD4022X	MD4022X	MD4022XC*	MD4022CC*	VR4022BLK*†		48
K719*										49
K719*										50
K719*										51
K719*										52
K719*										53
										54
K719*										55
FA085*			FA085HH*	MD4016	MD4016					56
			FA447HH*							57
			FA447HH*							58
FA165TT			FA165R	MD6398D					UTVX6398	59
FA135TT			FA135R		MD6398D				UTVX6398	60

FRONT / AVANT / VORN / FRENTE / ANTERIORE

R Suffix = High Durability Sintered Pad. HH Suffix = High Performance Sintered Pad. TT Suffix = Hard Wearing Off Road Pad. V Suffix = Semi-Sintered Pad. G Suffix = Grooved Shoe.

D Suffix = Drilled Disc. X Suffix = Universal Left or Right Disc. XC Suffix = Contoured Disc. LS Suffix = Left/Steel Disc. RS = Right/Steel Disc.

*-2 Sets Required. † For Vee disc colours add RED, BLU, GRN, GLD, ORG suffix to part number. For Custom Finish Options for Vee-Rotors™ including Splatter discs add suffix CHR, CHGR, CHBL, CHBR - available in various colours see page iv. Ⓢ - Also available as a Vintage Motorcycle Disc.

JAPANESE Built Motorcycles

Line #	BRAKE DISC CHOICES - FRONT						DISC PAD CHOICES - REAR				BRAKE DISC CHOICES - REAR			
	Oversize 250 /280mm Disc Kit	OSX Oversize 250/280mm Disc Kit	Relocating Bracket for 250/ 280mm Disc	Oversize 320mm Disc Kit	SMX Oversize 320mm Disc Kit	Relocating Bracket for 320mm Disc	FA, SFA, TT Pad or Brake Shoe	SFAC Carbon Scooter Pads	Speciality Pads - SXR / Vee / MXS	Sintered/ HH Pads/ Grooved Shoes	Standard Replacement Disc	Contour Disc Rear fitment	Vee Discs CONTOUR	CX Extreme MX Race Disc
1							K706							
2							K706							
3							K706							
4							K706							
5							K706							
6							FA140		FA140V	FA140HH		MD4157C	VR4157	
7							FA140		FA140V	FA140HH		MD4157C	VR4157	
8							FA140		FA140V	FA140HH		MD4157C	VR4157	
9							FA140		FA140V	FA140HH		MD4157C	VR4157	
10							FA686TT			FA686R	MD6398D			UTVX6398
11							FA686TT			FA686R	MD6398D			UTVX6398
12							FA686TT			FA686R	MD6398D			UTVX6398
13							FA686TT			FA686R	MD6398D			UTVX6398
14							FA686TT			FA686R	MD6398D			UTVX6398
15							FA686TT			FA686R	MD6398D			UTVX6398
16							FA686TT			FA686R	MD6398D			UTVX6398
17							FA686TT			FA686R	MD6398D			UTVX6398
18							FA686TT			FA686R	MD6398D			UTVX6398
19							FA686TT			FA686R	MD6398D			UTVX6398
20							FA686TT			FA686R	MD6398D			UTVX6398
21							FA686TT			FA686R	MD6398D			UTVX6398
22							FA686TT			FA686R	MD6398D			UTVX6398
23							FA686TT			FA686R	MD6398D			UTVX6398
24							FA686TT			FA686R	MD6398D			UTVX6398
25							FA686TT			FA686R	MD6398D			UTVX6398
26							FA686TT			FA686R	MD6398D			UTVX6398
27							FA686TT			FA686R	MD6398D			UTVX6398
28							FA085		FA085V	FA085HH	MD4017			
29							FA085		FA085V	FA085HH	MD4017			
30							FA129		FA129V	FA129HH	MD4015	MD4015C	VR4015	
31							FA129		FA129V	FA129HH	MD4015	MD4015C	VR4015	
32							FA129		FA129V	FA129HH	MD4015	MD4015C	VR4015	
33							FA231		FA231/2V	FA231HH	MD4085			
34							FA231		FA231/2V	FA231HH	MD4085			
35							FA231		FA231/2V	FA231HH	MD4085			
36							FA231		FA231/2V	FA231HH	MD4085			
37							K713							
38							K713							
39							FA140		FA140V	FA140HH				
40							FA140		FA140V	FA140HH				
41							FA140		FA140V	FA140HH				
42							FA140		FA140V	FA140HH				
43							FA140		FA140V	FA140HH				
44							FA192		FA192V	FA192HH	MD4013	MD4013C	VR4013	
45							FA192		FA192V	FA192HH	MD4013	MD4013C	VR4013	
46							FA192		FA192V	FA192HH	MD4138	MD4138C		
47							FA192		FA192V	FA192HH	MD4138	MD4138C	VR4138	
48							FA192		FA192V	FA192HH	MD4138	MD4138C	VR4138	
49							K720*							
50							K720*							
51							K720*							
52							K720*							
53							K720*							
54														
55							K720*							
56							FA085		FA085V	FA085HH	MD4019			
57							FA266		FA266V	FA266HH				
58							FA266		FA266V	FA266HH				
59							FA686TT			FA686R	MD6398D			UTVX6398
60							FA686TT			FA686R	MD6398D			UTVX6398

REAR / ARRIÈRE / HINTEN / POSTERIOR / POSTERIORE

R Suffix = High Durability Sintered Pad. **HH** Suffix = High Performance Sintered Pad. **TT** Suffix = Hard Wearing Off Road Pad. **V** Suffix = Semi Sintered Pad. **G** Suffix = Grooved Shoe.
D Suffix = Drilled Disc. **X** Suffix = Universal Left or Right Disc. **XC** Suffix = Contoured Disc. **LS** Suffix = Left/Steel Disc. **RS** = Right/Steel Disc.

BRAKE APPLICATIONS

*-2 Sets Required. † For Vee disc colours add RED, BLU, GRN, GLD, ORG suffix to part number. For Custom Finish Options for Vee-Rotors™ including Splatter discs add suffix CHR, CHGR, CHBL, CHBR - available in various colours see page iv. Ⓢ - Also available as a Vintage Motorcycle Disc.

JAPANESE Built Motorcycles



KAWASAKI Contd.



Model	Side	Year
KAF 1000 BGF/BHF/BJF	Left	16-18
Mule Pro DXT/Diesel EPS	Right	
KAF 1000 CGF/CHF	Left	16-17
Mule Pro DXT EPS LE/Diesel	Right	
KAF 1000 DGF/DHF	Left	16-17
Mule Pro DX/Diesel	Right	
KAF 1000 EGF/EHFEJF	Left	16-18
Mule Pro DX EPS/Diesel	Right	
KAF 1000 FGF/FHF	Left	16-17
Mule Pro DX EPS LE/Diesel	Right	
KLV 1000 (LV 1000 A1H/A2H)	Left	04-05
	Right	
KLZ 1000 ACF/ADF/AEF Versys		12-14
KLZ 1000 BFF/BGF/BHF/BJF/BJFA Versys		15-18
KLX 1000 Versys LT ABS		18-20
KLX 1000 Versys SE LT ABS		18-20
KLX 1000 Versys SE LT+ ABS		18-20
KRX 1000 Teryx		20
Z 1000 A1/A2		77-78
Z 1000 A3/A4		79-80
Z 1000 D1 (ZIR)		78-
Z 1000 D3 (ZIR)		79
Z 1000 ST (E1-E2 Shaft)		79-82
Z 1000 H1		80
Z 1000 J1/J2		81-82
Z 1000 J3		83
Z 1000 K1/K2 LTD		81-83
Z 1000 R2		83
Z 1000 (ZR 1000 A1/A2/A3/A6F)		03-06
Z 1000 (ZR 1000 B7F/B8F/B9F)		07-09
Z 1000 ABS (ZR 1000 C7F/C8F/C9F)		07-09
Z 1000 (ZR 1000 DAF/DBF/DCF/DDF/FEF/FFF)		10-15
Z 1000 (ZR 1000 DCFA/DDFA/FEFA)		12-14
Z 1000 DAF/DAS/DBF/DCF/DCFA/DDF/DDFA (Non ABS/300mm Disc)		10-13
Z 1000 EAF/EBF/ECF/ECFA/EDF/EDFA (ABS/300mm Discs)		10-13
Z 1000 FEF/FEFA/FFF/FGF (Non ABS/310mm Discs)		14-16
Z 1000 (ABS/310mm Contour Discs)		14-20
Z 1000 R (ABS/310mm Round Discs)		17-20
Z 1000 Special Edition (ZR 1000 GEFA)		14
Z 1000 SX (ZX 1000 HBF/HCF/HDF) ABS Model		11-13
Z 1000 SX (ZX 1000 GBF/GCF/GDF) Non ABS Model		11-13
Z 1000 SX Non ABS (ZX 1000 LEF/LFF/LGF)		14-16
Z 1000 SX ABS		14-20
Z 1000 SX Tourer		14
Z H2		20
ZL 1000 A1		87
ZX 1000 B1-B3 (ZX-10)		88-90
ZG 1000 A1-A7 (1000 GTR)		86-93
ZG 1000 A9-A18 (1000 GTR)		94-03
ZX10 R Ninja (ZX 1000 A1/A2)		86-87
ZX10 R Ninja (ZX 1000 B1/B2/B3)		88-90
ZX10 R Ninja (ZX 1000 C1/C2/D6F/D7F)		04-07
ZX10 R Ninja (ZX 1000 E8F/E9F/FAF)		08-10
ZX10 R Ninja (ZX 1000 GBF/GCF/GDF)		11-13
ZX10 R Ninja (ZX 1000 JBF/JCF/JDF/JEF/JFF)		11-15
ZX10 R Ninja ABS (ZX 1000 KBF/KCF/KDF/KEF/KFF)		11-15
ZX10 R Ninja ABS (ZX 1000 HCF/HDF)		12-13
ZX10 R Ninja ABS (ZX 1000 MEF/MFF)		14-19

FRONT / AVANT / VORN / FRENTE / ANTERIORE

DISC PAD CHOICES - FRONT				BRAKE DISC CHOICES - FRONT					Line #	
FA, SFA, TT Pad or Brake Shoe	SFAC Carbon Scooter Pads	Speciality Pads - SXR / Vee / MXS	Sintered/HH Pads/ Grooved Shoes	Left / Gauche / Links Standard Replacement Disc	Right / Droite / Rechts Standard Replacement Disc	Contour Disc Universal left and right fitment	Custom Disc Universal left and right fitment	Vee-Discs Black † See note below	CX Extreme MX Race Disc/ UTVX Disc	Line #
FA165TT			FA165R	MD6398D					UTVX6398	1
FA135TT			FA135R		MD6398D				UTVX6398	2
FA165TT			FA165R	MD6398D					UTVX6398	3
FA135TT			FA135R		MD6398D				UTVX6398	4
FA165TT			FA165R	MD6398D					UTVX6398	5
FA135TT			FA135R		MD6398D				UTVX6398	6
FA165TT			FA165R	MD6398D					UTVX6398	7
FA135TT			FA135R		MD6398D				UTVX6398	8
FA165TT			FA165R	MD6398D					UTVX6398	9
FA135TT			FA135R		MD6398D				UTVX6398	10
FA229		FA229V	FA229HH	MD3088X	MD3088X	MD3088XC	MD3088CC	VR3088BLK†		11
FA231		FA231V	FA231HH			MD3088XC	MD3088CC	VR3088BLK†		12
FA158*			FA158HH*							13
FA158*			FA158HH*							14
			FA158HH*	MD4155X	MD4155X					15
			FA379HH*	MD4155X	MD4155X					16
			FA379HH*	MD4155X	MD4155X					17
			FA738R*							18
FA033*				MD4064LS	MD4064RS					19
FA073*				MD4064LS	MD4064RS					20
FA033*				MD4076LS	MD4076RS					21
FA073*				MD4076LS	MD4076RS					22
FA062*				MD4078LS	MD4078RS					23
FA033*				MD4064LS	MD4064RS					24
FA068*			FA068HH*	MD4006LS	MD4006RS					25
FA068*			FA068HH*	MD4038	MD4038					26
FA068*		FA068V*	FA068HH*	MD4006LS	MD4006RS					27
FA068*			FA068HH*	MD4038	MD4038					28
			FA347HH*	MD4154X	MD4154X	MD4154XC*	MD4154CC*	VR4154BLK†		29
			FA417/4HH*			MD4152XC*	MD4152CC*	VR4152BLK†		30
			FA417/4HH*			MD4152XC*	MD4152CC*	VR4152BLK†		31
			FA379HH*			MD4152XC*	MD4152CC*	VR4152BLK†		32
			FA379HH*			MD4152XC*	MD4152CC*	VR4152BLK†		33
						MD4152XC*	MD4152CC*	VR4152BLK†		34
						MD4152XC*	MD4152CC*	VR4152BLK†		35
						MD4152XC*	MD4152CC*	VR4152BLK†		36
			FA379HH*			MD4152XC*	MD4152CC*	VR4152BLK†		37
			FA379HH*							38
			FA379HH*							39
			FA447HH*							40
			FA379HH*			MD4152XC*	MD4152CC*	VR4152BLK†		41
			FA379HH*			MD4152XC*	MD4152CC*	VR4152BLK†		42
			FA379HH*			MD4152XC*	MD4152CC*	VR4152BLK†		43
			FA379HH*			MD4152XC*	MD4152CC*	VR4152BLK†		44
			FA379HH*			MD4152XC*	MD4152CC*	VR4152BLK†		45
			FA379HH*			MD4152XC*	MD4152CC*	VR4152BLK†		46
			FA630HH*	TBA	TBA					47
FA085*		FA085V*	FA085HH*	MD4016	MD4016					48
FA129*			FA129HH*	MD4021	MD4021					49
FA085*		FA085V*	FA085HH*	MD4028	MD4028					50
FA129*		FA129V*	FA129HH*	MD4008X	MD4008X	MD4008XC*	MD4008CC*	VR4008BLK†		51
FA085*			FA085HH*	MD4016	MD4016					52
FA129*			FA129HH*	MD4021	MD4021					53
			FA369/4HH*			MD4152XC*	MD4152CC*	VR4152BLK†		54
			FA379HH*			MD4161XC*		VR4161BLK†		55
			FA379HH*			TBA*		VR4161BLK†		56
			FA379HH*			MD4161XC*		VR4161BLK†		57
			FA379HH*			MD4161XC*		VR4161BLK†		58
			FA379HH*			TBA*		VR4161BLK†		59
			FA379HH*			TBA*		VR4161BLK†		60

*-2 Sets Required. † For Vee disc colours add RED, BLU, GRN, GLD, ORG suffix to part number. For Custom Finish Options for Vee-Rotors™ including Splatter discs add suffix CHR, CHGR, CHBL, CHBR - available in various colours see page iv. ☼ - Also available as a Vintage Motorcycle Disc.

JAPANESE Built Motorcycles

Line #	BRAKE DISC CHOICES - FRONT						DISC PAD CHOICES - REAR				BRAKE DISC CHOICES - REAR			
	Oversize 250 /280mm Disc Kit	OSX Oversize 250/280mm Disc Kit	Relocating Bracket for 250/ 280mm Disc	Oversize 320mm Disc Kit	SMX Oversize 320mm Disc Kit	Relocating Bracket for 320mm Disc	FA, SFA, TT Pad or Brake Shoe	SFAC Carbon Scooter Pads	Speciality Pads - SXR / Vee / MXS	Sintered/ HH Pads/ Grooved Shoes	Standard Replacement Disc	Contour Disc Rear fitment	Vee Discs CONTOUR	CX Extreme MX Race Disc
1							FA686TT			FA686R	MD6398D			UTVX6398
2							FA686TT			FA686R	MD6398D			UTVX6398
3							FA686TT			FA686R	MD6398D			UTVX6398
4							FA686TT			FA686R	MD6398D			UTVX6398
5							FA686TT			FA686R	MD6398D			UTVX6398
6							FA686TT			FA686R	MD6398D			UTVX6398
7							FA686TT			FA686R	MD6398D			UTVX6398
8							FA686TT			FA686R	MD6398D			UTVX6398
9							FA686TT			FA686R	MD6398D			UTVX6398
10							FA686TT			FA686R	MD6398D			UTVX6398
11														
12							FA174		FA174V	FA174HH	MD6232D			MD6232CX
13							FA174		FA174V	FA174HH		MD4157C		
14							FA174		FA174V	FA174HH				
15							FA174			FA174HH				
16							FA174			FA174HH				
17							FA174			FA174HH				
18										FA739R*				
19							FA036		FA036V		MD4077 ⚙			
20							FA036		FA036V		MD4077 ⚙			
21							FA036		FA036V		MD4077 ⚙			
22							FA036		FA036V		MD4077 ⚙			
23							FA036		FA036V		MD4090			
24							FA036		FA036V		MD4077 ⚙			
25							FA068		FA068V	FA068HH	MD4054			
26							FA068		FA068V	FA068HH	MD4054			
27							FA068		FA068V	FA068HH	MD4054			
28							FA068		FA068V	FA068HH	MD4054			
29							FA192		FA192V	FA192HH	MD4138	MD4138C	VR4138	
30							FA174		FA174V	FA174HH		MD4157C	VR4157	
31							FA174		FA174V	FA174HH		MD4157C	VR4157	
32							FA192		FA192V	FA192HH		MD4157C	VR4157	
33							FA192		FA192V	FA192HH		MD4157C	VR4157	
34														
35							FA192		FA192V	FA192HH		MD4157C	VR4157	
36														
37							FA192		FA192V	FA192HH		MD4157C	VR4157	
38							FA192		FA192V	FA192HH		MD4157C	VR4157	
39							FA192		FA192V	FA192HH		MD4157C	VR4157	
40							FA192		FA192V	FA192HH				
41							FA192		FA192V	FA192HH		MD4157C	VR4157	
42							FA192		FA192V	FA192HH		MD4157C	VR4157	
43							FA192		FA192V	FA192HH		MD4157C	VR4157	
44							FA192		FA192V	FA192HH		MD4157C	VR4157	
45							FA192		FA192V	FA192HH		MD4157C	VR4157	
46							FA192		FA192V	FA192HH		MD4157C	VR4157	
47														
48							FA085		FA085V	FA085HH	MD4017			
49							FA129		FA129V	FA129HH	MD4015			
50							FA085		FA085V	FA085HH	MD4082			
51							FA085		FA085V	FA085HH	MD4082			
52							FA085		FA085V	FA085HH	MD4019			
53							FA129		FA129V	FA129HH	MD4015			
54							FA192		FA192V	FA192HH		MD4138C	VR4138	
55							FA192		FA192V	FA192HH		MD4138C	VR4138	
56							FA192		FA192V	FA192HH		MD4157C		
57							FA436		FA436V	FA436HH		MD4165C	VR4165	
58							FA436		FA436V	FA436HH		MD4165C	VR4165	
59							FA192		FA192V	FA192HH		MD4157C		
60							FA192		FA192V	FA192HH		MD4157C		

REAR / ARRIÈRE / HINTEN / POSTERIOR / POSTERIORE

BRAKE APPLICATIONS

R Suffix = High Durability Sintered Pad. HH Suffix = High Performance Sintered Pad. TT Suffix = Hard Wearing Off Road Pad. V Suffix = Semi Sintered Pad. G Suffix = Grooved Shoe. D Suffix = Drilled Disc. X Suffix = Universal Left or Right Disc. XC Suffix = Contoured Disc. LS Suffix = Left/Steel Disc. RS = Right/Steel Disc.

*-2 Sets Required. † For Vee disc colours add RED, BLU, GRN, GLD, ORG suffix to part number. For Custom Finish Options for Vee-Rotors™ including Splatter discs add suffix CHR, CHGR, CHBL, CHBR - available in various colours see page iv. ⚙ - Also available as a Vintage Motorcycle Disc.

JAPANESE Built Motorcycles



KAWASAKI Contd.



ZX10 R Ninja 30th Anniversary Edition (ZX 1000 JFFA)	15
ZX10 R Ninja 30th Anniversary Edition ABS (ZX 1000 KFFA)	15
ZX 10 R Winter Test Edition (ZX 1000 SGFB)	16
ZX10 R Ninja ABS (ZX 1000 RGF/SGF/RHF/SHF/RJF/SJF)	16-18
ZX10 R Ninja ABS KRT Edition (ZX 1000 RGFA/SGFA/RHFA/SHFA/RJFA/SJFA)	16-18
ZX10 R Ninja ABS (ZX 1002 EKF/FKF)	19-20
ZX10 R Ninja SE ABS (ZX 1002 EKF/FKF)	19-20
ZX10 R Ninja ABS KRT Edition (ZX 1002 EKFA/FKFA)	19-20
ZX10 RR Ninja (ZX 1000 ZHF/ZJF)	17-18
ZX10 RR Ninja (ZX 1002 GKF)	19-20
Ninja H2/Carbon (ZX 1000 NFF/NGF/XHF/XHFA)	15-18
Ninja H2/Carbon (ZX 1002 JFK/JKFA)	19-20
Ninja H2R (ZX 1000 P)	15-18
Ninja H2R (ZX 1000 P)	19-20
Ninja H2 SX (ZX 1002 AJF)	18-20
Ninja H2 SX SE (ZX 1002 BJF)	18-20
Ninja H2 SX SE+ (ZX 1002 DKF)	19-20
GPZ 1100 B1	82
GPZ 1100 B2	83
Z 1100 D1/D2 Spectre	82-83
GPZ 1100 A1-A3	83-85
Z 1100 A1-A3	81-83
Z 1100 R1 Lawson Replica	84
ZR 1100 A1-A4 Zephyr	92-95
ZR 1100 B1 Zephyr	Left 96-97
	Right
ZR 1100 B5 (Zephyr 1100 RS)	Left 02
	Right
ZRX 1100 (ZR 1100 C1/C2/C3/C4)	97-00
ZZR 1100 (ZX 1100 C1-C3)	90-92
ZZR 1100 (ZX 1100 D1-D9)	93-01
GPZ 1100 E1/E2	Left 95-97
	Right
GPZ 1100 F1 (ABS Model)	Left 96-98
	Right
ZX 12 R (ZX 1200 A1/A2/B1/B2)	00-03
ZX 12 R (ZX 1200 B3/B4/B6F)	04-06
ZRX 1200 R (ZR 1200 A1/A2/A3/A4/A5/A6F)	01-08
ZRX 1200 S (ZR 1200 B1/B2/B3)	01-07
ZZR 1200 C1H/C2H	02-04
Z 1300 A1-A5	79-83
ZG 1300 A1-A3	84-86
GTR 1400 (ZG 1400 A8F/A9F/CAF/CBF) ABS	08-11
GTR 1400 ABS (ZG 1400 CCF/CDF/CEF/EEF /EGF/EHF/EJF/EKF)	12-18
ZZR 1400 (ZX 1400 A6F/A7F)	06-07
ZZR 1400 ABS (ZX 1400 B6F/B7F)	06-07
ZZR 1400 ABS	08-11
ZZR 1400 ABS	12-20
ZZR 1400 ABS Performance	12-20
ZZR 1400 ABS Performance Sport	14-20
VN 1500 B2-B6 (VN 15 SE)	88-92
VN 1500 A6 (VN15)	92
VN 1500 C1/C2 (VN15)	94-95
VN 1500 D1/D2/E1/E2 Classic	96-99

FA, SFA, TT Pad or Brake Shoe	SFAC Carbon Scooter Pads	Speciality Pads - SXR / Vee / MXS	Sintered/HH Pads/ Grooved Shoes	DISC PAD CHOICES - FRONT		BRAKE DISC CHOICES - FRONT						Line #	
				Left / Gauche / Links Standard Replacement Disc	Right / Droite / Rechts Standard Replacement Disc	Contour Disc Universal left and right fitment	Custom Disc Universal left and right fitment	Vee-Discs Black † See note below	CX Extreme MX Race Disc/ UTVX Disc				
			FA379HH*					MD4161XC*					1
			FA379HH*					MD4161XC*					2
			FA447HH*	MD4170X	MD4170X					VR4170CHGR*			3
			FA447HH*	MD4170X	MD4170X								4
			FA447HH*	MD4170X	MD4170X								5
			FA447HH*	MD4170X	MD4170X								6
			FA447HH*	MD4170X	MD4170X								7
			FA447HH*	MD4170X	MD4170X								8
			FA447HH*	MD4170X	MD4170X								9
			FA447HH*	MD4170X	MD4170X								10
			FA447HH*	MD4170X	MD4170X								11
			FA447HH*	MD4170X	MD4170X								12
			FA447HH*	MD4175X	MD4175X								13
			FA447HH*	MD4175X	MD4175X								14
			FA447HH*	TBA	TBA								15
			FA447HH*	TBA	TBA								16
			FA447HH*	TBA	TBA								17
			FA447HH*	TBA	TBA								18
			FA379HH*	TBA	TBA								19
			FA379HH*	TBA	TBA								20
			FA447HH*										21
FA068*			FA068HH*	MD4006LS	MD4006RS								22
FA068*			FA068HH*	MD4038	MD4038								23
FA068*		FA068V*	FA068HH*	MD4006LS	MD4006RS								24
FA085*			FA085HH*	MD4016	MD4016								25
FA068*		FA068V*	FA068HH*	MD4006LS	MD4006RS								26
FA085*			FA085HH*	MD4038	MD4038								27
FA158*			FA158HH*	MD4012X	MD4012X	MD4012XC*	MD4012CC*	VR4012BLK†					28
FA229			FA229HH	MD4012X		MD4012XC	MD4012CC	VR4012BLK†					29
FA231			FA231HH		MD4012X	MD4012XC	MD4012CC	VR4012BLK†					30
FA229			FA229HH	MD4012X		MD4012XC	MD4012CC	VR4012BLK†					31
FA231			FA231HH		MD4012X	MD4012XC	MD4012CC	VR4012BLK†					32
FA188*			FA188HH*	MD4012X	MD4012X	MD4012XC*	MD4012CC*	VR4012BLK†					33
FA158*			FA158HH*	MD4012X	MD4012X	MD4012XC*	MD4012CC*	VR4012BLK†					34
FA158*			FA158HH*	MD4022X	MD4022X	MD4022XC*	MD4022CC*	VR4022BLK†					35
FA229			FA229HH	MD4008X		MD4008XC	MD4008CC	VR4008BLK†					36
FA231			FA231HH		MD4008X	MD4008XC	MD4008CC	VR4008BLK†					37
FA229			FA229HH	MD4008X		MD4008XC		VR4008BLK†					38
FA231			FA231HH		MD4132X	MD4132XC		VR4008BLK†					39
FA188*			FA188HH*	MD4022X	MD4022X	MD4022XC*	MD4022CC*	VR4022BLK†					40
			FA369/4HH†	MD4154X	MD4154X	MD4154XC*	MD4154CC*	VR4154BLK†					41
FA188*			FA188HH*	MD4012X	MD4012X	MD4012XC*	MD4012CC*	VR4012BLK†					42
FA188*			FA188HH*	MD4012X	MD4012X	MD4012XC*	MD4012CC*	VR4012BLK†					43
FA158*			FA158HH*	MD4022X	MD4022X	MD4022XC*	MD4022CC*	VR4022BLK†					44
FA062*				MD4089LS	MD4089RS								45
FA062*				MD4089LS	MD4089RS								46
			FA417/4HH*			MD4155XC*	MD4155CC*	VR4155BLK†					47
			FA417/4HH*			MD4155XC*	MD4155CC*	VR4155BLK†					48
			FA417/4HH*			MD4155XC*	MD4155CC*	VR4155BLK†					49
			FA417/4HH*			MD4155XC*	MD4155CC*	VR4155BLK†					50
			FA417/4HH*			MD4155XC*	MD4155CC*	VR4155BLK†					51
			FA417/4HH*			MD4155XC*	MD4155CC*	VR4155BLK†					52
			FA417/4HH*			MD4155XC*	MD4155CC*	VR4155BLK†					53
			FA447HH										54
			FA447HH										55
FA085		FA085V	FA085HH	MD4094LS									56
FA085		FA085V	FA085HH	MD4124LS									57
FA085		FA085V	FA085HH	MD4124LS									58
FA229		FA229V	FA229HH	MD4131LS									59
													60

FRONT / AVANT / VORN / FRENTE / ANTERIORE

R Suffix = High Durability Sintered Pad. HH Suffix = High Performance Sintered Pad. TT Suffix = Hard Wearing Off Road Pad. V Suffix = Semi-Sintered Pad. G Suffix = Grooved Shoe.

D Suffix = Drilled Disc. X Suffix = Universal Left or Right Disc. XC Suffix = Contoured Disc. LS Suffix = Left/Steel Disc. RS = Right/Steel Disc.

*-2 Sets Required. † For Vee disc colours add RED, BLU, GRN, GLD, ORG suffix to part number. For Custom Finish Options for Vee-Rotors™ including Splatter discs add suffix CHR, CHGR, CHBL, CHBR - available in various colours see page iv. Ⓢ - Also available as a Vintage Motorcycle Disc.

JAPANESE Built Motorcycles

Line #	BRAKE DISC CHOICES - FRONT						DISC PAD CHOICES - REAR				BRAKE DISC CHOICES - REAR			
	Oversize 250 /280mm Disc Kit	OSX Oversize 250/280mm Disc Kit	Relocating Bracket for 250/ 280mm Disc	Oversize 320mm Disc Kit	SMX Oversize 320mm Disc Kit	Relocating Bracket for 320mm Disc	FA, SFA, TT Pad or Brake Shoe	SFAC Carbon Scooter Pads	Speciality Pads - SXR / Vee / MXS	Sintered/ HH Pads/ Grooved Shoes	Standard Replacement Disc	Contour Disc Rear fitment	Vee Discs CONTOUR	CX Extreme MX Race Disc
1							FA436			FA436HH		MD4165C	VR4165	
2												MD4165C	VR4165	
3							FA436			FA346HH				
4							FA436			FA346HH	MD4165			
5														
6							FA436			FA346HH	MD4165			
7														
8							FA436			FA346HH	MD4165			
9							FA436			FA346HH	MD4166			
10							FA436			FA346HH	MD4166			
11														
12							FA436			FA346HH	MD4166			
13							FA436			FA346HH	MD4165			
14							FA436			FA346HH	MD4165			
15							FA266			FA266HH				
16														
17							FA266			FA266HH				
18							FA266			FA266HH				
19							FA228			FA228HH				
20							FA228			FA228HH				
21							FA228			FA228HH				
22							FA068	FA068V		FA068HH	MD4054			
23							FA068	FA068V		FA068HH	MD4054			
24							FA068	FA068V		FA068HH	MD4054			
25							FA085	FA085V		FA085HH	MD4017			
26							FA068	FA068V		FA068HH	MD4054			
27							FA068	FA068V		FA068HH	MD4054			
28							FA129	FA129V	FA129HH	MD4027	MD4027C	VR4027		
29							FA129	FA129V	FA129HH	MD4027	MD4027C	VR4027		
30														
31							FA129	FA129V	FA129HH	MD4027	MD4027C	VR4027		
32														
33							FA161	FA161V	FA161HH	MD4133	MD4133C	VR4133		
34							FA129	FA129V	FA129HH	MD4015	MD4015C	VR4015		
35							FA161	FA161V	FA161HH	MD4014	MD4014C	VR4014		
36							FA192	FA192V	FA192HH	MD4130	MD4130C	VR4130		
37														
38							FA192	FA192V	FA192HH	MD4130	MD4130C	VR4130		
39														
40							FA161			FA161HH	MD4023	MD4023C	VR4023	
41							FA161			FA161HH	MD4023	MD4023C	VR4023	
42							FA161	FA161V	FA161HH	MD4133	MD4133C	VR4133		
43							FA161	FA161V	FA161HH	MD4133	MD4133C	VR4133		
44							FA161			FA161HH	MD4133	MD4133C	VR4133	
45							FA036	FA036V			MD4090			
46							FA036	FA036V			MD4090			
47							FA254					MD4160C	VR4160	
48														
49							FA254			FA254HH		MD4160C	VR4160	
50							FA254			FA254HH	MD4157	MD4157C	VR4157	
51							FA254			FA254HH	MD4157	MD4157C	VR4157	
52							FA254			FA254HH	MD4157	MD4157C	VR4157	
53							FA254			FA254HH	MD4157	MD4157C	VR4157	
54							FA254			FA254HH	MD4157	MD4157C	VR4157	
55							FA254			FA254HH	MD4157	MD4157C	VR4157	
56							FA085	FA085V		FA085HH	MD4054			
57							FA085	FA085V		FA085HH	MD4054			
58							FA085	FA085V		FA085HH	MD4128			
59							FA085	FA085V		FA085HH	MD4128			
60														

REAR / ARRIÈRE / HINTEN / POSTERIOR / POSTERIORE

BRAKE APPLICATIONS

*-2 Sets Required. † For Vee disc colours add RED, BLU, GRN, GLD, ORG suffix to part number. For Custom Finish Options for Vee-Rotors™ including Splatter discs add suffix CHR, CHGR, CHBL, CHBR - available in various colours see page iv. ☼ - Also available as a Vintage Motorcycle Disc.

R Suffix = High Durability Sintered Pad. HH Suffix = High Performance Sintered Pad. TT Suffix = Hard Wearing Off Road Pad. V Suffix = Semi Sintered Pad. G Suffix = Grooved Shoe. D Suffix = Drilled Disc. X Suffix = Universal Left or Right Disc. XC Suffix = Contoured Disc. LS Suffix = Left/Steel Disc. RS = Right/Steel Disc.

JAPANESE Built Motorcycles



KAWASAKI Contd.

Model	Side	Year
VN 1500 G1/G2 Classic Tourer	Left	98-99
	Right	
VN 1500 J1/J2/R1/R2/R3 Drifter		99-04
VN 1500 N1/N2/N3 Classic Fi		00-04
VN 1500 L1/L2/L3/L4 Classic Tourer Fi	Left	00-03
	Right	
VN 1500 P1/P2 Mean Streak		02-04
VN 1600 A1/A2/A3/A6F Classic	Left	03-08
	Right	
VN 1600 B1 Mean Streak		04
VN 1600 B2H/B6F/B7F Mean Streak		05-08
VN 1600 D1H/D6F Classic Tourer	Left	05-08
	Right	
VN 1700 Voyager ABS		09-20
VN 1700 C9F Classic Tourer	Left	09
	Right	
VN 1700 DAF/DBF/DCF/DDF/DEF Classic Tourer ABS		10-14
VN 1700 DFF/DGF Vulcan 1700 Nomad		15-16
VN 1700 E9F Classic	Left	09
	Right	
VN 1700 FAF/FBF/FCF/FDF/FEF Classic ABS		10-14
VN 1700 KBF/KCF/KDF/KEF Voyager Custom		11-14
VN 2000 A1/A2/A6F		04-07
VN 2000 H8F/H9F Classic		08-09

FRONT / AVANT / VORN / FRENTE / ANTERIORE

DISC PAD CHOICES - FRONT					BRAKE DISC CHOICES - FRONT					
FA, SFA, TT Pad or Brake Shoe	SFAC Carbon Scooter Pads	Speciality Pads - SXR / Vee / MXS	Sintered/HH Pads/ Grooved Shoes	Left / Gauche / Links Standard Replacement Disc	Right / Droite / Rechts Standard Replacement Disc	Contour Disc Universal left and right fitment	Custom Disc Universal left and right fitment	Vee-Discs Black † See note below	CX Extreme MX Race Disc/ UTVX Disc	
FA229		FA229V	FA229HH	MD4150						
FA231		FA231V	FA231HH		MD4150					
FA229		FA229V	FA229HH	MD4125LS						
FA229		FA229V	FA229HH	MD4125LS						
FA229		FA229V	FA229HH	MD4150						
FA231		FA231V	FA231HH		MD4150					
FA188*			FA188HH*	MD4022X	MD4022X	MD4022XC*	MD4022CC*	VR4022BLK*†		
FA229		FA229V	FA229HH	MD4158						
FA231		FA231V	FA231HH		MD4158					
FA188*			FA188HH*	MD4022X	MD4022X	MD4022XC*	MD4022CC*	VR4022BLK*†		
			FA369/4HH*	MD4022X	MD4022X	MD4022XC*	MD4022CC*	VR4022BLK*†		
FA229		FA229V	FA229HH	MD4158						
FA231		FA231V	FA231HH		MD4158					
FA158*			FA158HH*	MD4158	MD4158					
FA229		FA229V	FA229HH	MD4158						
FA231		FA231V	FA231HH		MD4158					
FA158*			FA158HH*	MD4158						
FA158*			FA158HH*		MD4158					
FA229		FA229V	FA229HH	MD4158						
FA231		FA231V	FA231HH		MD4158					
FA158*			FA158HH*	MD4158	MD4158					
FA158*			FA158HH*	MD4158	MD4158					
FA158*			FA158HH*	MD4158	MD4158					
FA158*			FA158HH*	MD4158	MD4158					

Line #
1
2
3
4
5
6
7
8
9
10
11
12
13
14
15
16
17
18
19
20
21
22
23
24
25
26
27
28
29
30
31
32
33
34
35
36
37
38
39
40
41
42
43
44
45
46
47
48
49
50
51
52
53
54
55
56
57
58
59
60

R Suffix = High Durability Sintered Pad. HH Suffix = High Performance Sintered Pad. TT Suffix = Hard Wearing Off Road Pad. V Suffix = Semi-Sintered Pad. G Suffix = Grooved Shoe.

D Suffix = Drilled Disc. X Suffix = Universal Left or Right Disc. XC Suffix = Contoured Disc. LS Suffix = Left/Steel Disc. RS = Right/Steel Disc.

*-2 Sets Required. † For Vee disc colours add RED, BLU, GRN, GLD, ORG suffix to part number. For Custom Finish Options for Vee-Rotors™ including Splatter discs add suffix CHR, CHGR, CHBL, CHBR - available in various colours see page iv. Ⓢ - Also available as a Vintage Motorcycle Disc.

JAPANESE Built Motorcycles

Line #	BRAKE DISC CHOICES - FRONT						DISC PAD CHOICES - REAR				BRAKE DISC CHOICES - REAR			
	Oversize 250 /280mm Disc Kit	OSX Oversize 250/280mm Disc Kit	Relocating Bracket for 250/ 280mm Disc	Oversize 320mm Disc Kit	SMX Oversize 320mm Disc Kit	Relocating Bracket for 320mm Disc	FA, SFA, TT Pad or Brake Shoe	SFAC Carbon Scooter Pads	Speciality Pads - SXR / Vee / MXS	Sintered/ HH Pads/ Grooved Shoes	Standard Replacement Disc	Contour Disc Rear fitment	Vee Discs CONTOUR	CX Extreme MX Race Disc
1							FA085		FA085V	FA085HH	MD4147			
2														
3							FA231		FA231V	FA231HH	MD4148			
4							FA231		FA231V	FA231HH	MD4148			
5							FA231		FA231/3V	FA231HH	MD4147			
6														
7							FA231		FA231/3V	FA231HH	MD4146			
8							FA231		FA231/3V	FA231HH	MD4146			
9														
10							FA231		FA231/3V	FA231HH	MD4146			
11							FA231		FA231/2V	FA231HH	MD4146			
12							FA231		FA231/2V	FA231HH	MD4146			
13														
14							FA231		FA231/2V	FA231HH				
15							FA231		FA231/2V	FA231HH				
16														
17							FA231		FA231/2V	FA231HH				
18									FA231/2V	FA231HH				
19							FA231		FA231/2V	FA231HH				
20														
21							FA231		FA231/2V	FA231HH				
22							FA231		FA231/2V	FA231HH				
23							FA231		FA231/2V	FA231HH				
24							FA231		FA231/2V	FA231HH				
25														
26														
27														
28														
29														
30														
31														
32														
33														
34														
35														
36														
37														
38														
39														
40														
41														
42														
43														
44														
45														
46														
47														
48														
49														
50														
51														
52														
53														
54														
55														
56														
57														
58														
59														
60														

REAR / ARRIÈRE / HINTEN / POSTERIOR / POSTERIORE

R Suffix = High Durability Sintered Pad. **HH** Suffix = High Performance Sintered Pad. **TT** Suffix = Hard Wearing Off Road Pad. **V** Suffix = Semi Sintered Pad. **G** Suffix = Grooved Shoe.
D Suffix = Drilled Disc. **X** Suffix = Universal Left or Right Disc. **XC** Suffix = Contoured Disc. **LS** Suffix = Left/Steel Disc. **RS** = Right/Steel Disc.

*-2 Sets Required. † For Vee disc colours add RED, BLU, GRN, GLD, ORG suffix to part number. For Custom Finish Options for Vee-Rotors™ including Splatter discs add suffix CHR, CHGR, CHBL, CHBR - available in various colours see page iv. Ⓢ - Also available as a Vintage Motorcycle Disc.

BRAKE APPLICATIONS

JAPANESE Built Motorcycles



SUZUKI



A 50	71-76
AD 50 T/Tune/V-Tune	88
AE 50 R	
AE 50 L/N/T Style	90-96
AH 50 N Address (CA1GA)	92-95
AH 50 N Address (CA1GA) Italian Market	92-95
AJ 50 ZZ/RS Sepia	92-
AP 50	75-78
AP 50 R/S/T/V/W	96-02
AY 50 V/W/VW/WRW/K1-K4 Katana	97-04
AY 50 WRX/WX/WRY/WY/WRK1/WRK2/WRK3/WRK4 Katana (Grimeca caliper)	99-04
AY 50 WRK1/WRK2/WRK3/WRK4/AK5 (AJP Caliper)	01-05
AZ 50 X/LX/UX/Y/LY/UY/K2/UK2 (LETS II)	
AZ 50 RY/RK2 (ZZ Inch Up Sport)	00-02
AZ 50 7/8 Let 4/G (CA45A)	07-08
CL 50 D Suzi/Love	83
CP 50 CHF (CA14C)	85
CP 50 C	
CR 50 DC	
CS 50 Z/D Roadie	83-84
CX 50 DF (CA15A)	85
DR-Z 50	18-20
F 50	71-73
FR 50	74-81
FS 50 T/X Snip	81-82
FZ 50 N/X/Z/G/K/L/P Suzy	80-96
GS 50 K5 (NA41A)	05
GT 50 KB/KEN	77-80
JR 50 (All models)	78-07
LT 50 G/H/J/K/L/X/Y/K1	86-02
LT-A 50 K2/K3/K4/K5 Quadmaster	02-05
LT-Z 50 K6/K7/K8/K9/L0/L4/L5/L6/L7/L8 Quadport	06-18
OR 50 ET	80
RB 50 H GSXR 50	87
RG 50 EW	
RM 50 C/N/T	78-80
RM 50 X/Z	81-82
RMX 50	
TR 50 SW/SX Street Magic	98-00
TS 50 W	
TS 50 KN	79
TS 50 ERKT/X/Z/D	80-83
TS 50 XKE/XKG/XKH/XKJ/XKM/XKR	84-02
UF 50 Y Estilete	00-02
UR 50 W/Y/K1/K2/K3 (CA1MA/B) Verde	99-03
UX 50 WX/WY Zillion	99-02
X5K3/BK3/DK3/DBK3 (CZ41A) Choinori	03
ZR 50 KEN/KEX X1	79-83
ZR 50 SLKX	81
ZR 50 SKX/SKE/SKH	83-87
RM 60 K3	03
RM 65 K3/K4/K5	03-05
DR-Z 70 K8/K9/L0/L2/L4/L5/L6/L7	08-17
FR 70	74-76
AH 80 Address	92-94
CP 80 CHF	85-93
CS 80 CD	83
DS 80 T/X/Z/D/F/G/H/J/K/L/MN/P/R/S/T/V/W/X/Y	80-00
FR 80 M/B/N/X/Z/D	76-83

DISC PAD CHOICES - FRONT				BRAKE DISC CHOICES - FRONT						Line #
FA, SFA, TT Pad or Brake Shoe	SFAC Carbon Scooter Pads	Speciality Pads - SXR / Vee / MXS	Sintered/HH Pads/ Grooved Shoes	Left / Gauche / Links Standard Replacement Disc	Right / Droite / Rechts Standard Replacement Disc	Contour Disc Universal left and right fitment	Custom Disc Universal left and right fitment	Vee-Discs Black † See note below	CX Extreme MX Race Disc/ UTVX Disc	Line #
S603										1
SFA083	SFAC083		SFA083HH							2
SFA083	SFAC083		SFA083HH							3
S632										4
S624										5
SFA083	SFAC083		SFA083HH							6
SFA083	SFAC083		SFA083HH							7
S603										8
SFA193	SFAC193		SFA193HH	MD937D						9
SFA193	SFAC193		SFA193HH	MD938D				VR938		10
SFA193	SFAC193		SFA193HH	MD938D				VR938		11
SFA115	SFAC115		SFA115HH	MD938D				VR938		12
S632										13
SFA396			SFA396HH							14
S632										15
S614										16
S624										17
SFA083	SFAC083		SFA083HH							18
SFA083	SFAC083		SFA083HH							19
S613										20
S614										21
H301			H301G							22
S603										23
S603										24
S614										25
S601										26
S604										27
FA039										28
S613			S613G							29
None										30
S614*			S614G*							31
S614*			S614G*							32
FA067										33
FA067				MD3010LS						34
FA067										35
S603			S603G							36
S604			S604G							37
FA115			FA115R							38
SFA396			SFA396HH	MD911D				VR911		39
S617										40
S603			S603G							41
S603			S603G							42
S617			S617G							43
SFA115			SFA115HH	MD938D				VR938		44
S632										45
SFA193			SFA193HH	MD938D				VR938		46
S632										47
S632										48
FA039										49
FA067			FA067HH							50
FA067			FA067HH							51
K715			K715G							52
FA302TT			FA302R	MD6166D					MD6166CX	53
H301										54
S603										55
SFA083	SFAC083		SFA083HH	MD939D						56
S624										57
S601										58
S604			S604G							59
S603										60

FRONT / AVANT / VORN / FRENTE / ANTERIORE

R Suffix = High Durability Sintered Pad. HH Suffix = High Performance Sintered Pad. TT Suffix = Hard Wearing Off Road Pad. V Suffix = Semi Sintered Pad. G Suffix = Grooved Shoe.

D Suffix = Drilled Disc. X Suffix = Universal Left or Right Disc. XC Suffix = Contoured Disc. LS Suffix = Left/Steel Disc. RS = Right/Steel Disc.

*-2 Sets Required. † For Vee disc colours add RED, BLU, GRN, GLD, ORG suffix to part number. For Custom Finish Options for Vee-Rotors™ including Splatter discs add suffix CHR, CHGR, CHBL, CHBR - available in various colours see page iv. ☼ - Also available as a Vintage Motorcycle Disc.

JAPANESE Built Motorcycles

Line #	BRAKE DISC CHOICES - FRONT						DISC PAD CHOICES - REAR				BRAKE DISC CHOICES - REAR			
	Oversize 250 /280mm Disc Kit	OSX Oversize 250/280mm Disc Kit	Relocating Bracket for 250/ 280mm Disc	Oversize 320mm Disc Kit	SMX Oversize 320mm Disc Kit	Relocating Bracket for 320mm Disc	FA, SFA, TT Pad or Brake Shoe	SFAC Carbon Scooter Pads	Speciality Pads - SXR / Vee / MXS	Sintered/ HH Pads/ Grooved Shoes	Standard Replacement Disc	Contour Disc Rear fitment	Vee Discs CONTOUR	CX Extreme MX Race Disc
1							S603							
2							S632							
3							S632							
4							S632							
5							S624							
6							S624							
7							S624							
8							S603							
9							S624							
10							S624							
11														
12							SFA115	SFAC115		SFA115HH	MD940D		VR940	
13							SFA115	SFAC115		SFA115HH	MD940D		VR940	
14							S624							
15														
16							S624							
17							S613							
18							S624							
19							S631							
20							S632							
21							S613							
22							S614							
23							H301			H301G				
24							S603							
25							S603							
26							S614							
27							S601							
28							S604							
29							S603							
30							S613			S613G				
31							S613			S613G				
32							S604			S604G				
33							S604			S604G				
34							S604							
35							S604							
36							S601							
37							S603			S603G				
38							S604			S604G				
39							FA115			FA115R				
40							897							
41							S601							
42							S603			S603G				
43							S604			S604G				
44							S601							
45							S624							
46							S624							
47							S624							
48							S632							
49							S603							
50							S604							
51							S604							
52							K715			K715G				
53							FA054TT			FA054R	MD6166D		MD6166CX	
54							H301							
55							S603							
56							S624							
57							S624							
58							S601							
59							S604			S604G				
60							S603							

REAR / ARRIÈRE / HINTEN / POSTERIOR / POSTERIORE

R Suffix = High Durability Sintered Pad. **HH** Suffix = High Performance Sintered Pad. **TT** Suffix = Hard Wearing Off Road Pad. **V** Suffix = Semi Sintered Pad. **G** Suffix = Grooved Shoe.
D Suffix = Drilled Disc. **X** Suffix = Universal Left or Right Disc. **XC** Suffix = Contoured Disc. **LS** Suffix = Left/Steel Disc. **RS** = Right/Steel Disc.

BRAKE APPLICATIONS

*-2 Sets Required. † For Vee disc colours add RED, BLU, GRN, GLD, ORG suffix to part number. For Custom Finish Options for Vee-Rotors™ including Splatter discs add suffix CHR, CHGR, CHBL, CHBR - available in various colours see page iv. ☺ - Also available as a Vintage Motorcycle Disc.

JAPANESE Built Motorcycles



SUZUKI Contd.

JR 80 K1/K2/K3/K4/K5/K6/K7	01-07
LT 80 L/M/N/P/R/S/T/V/W/X/Y/K1-K6	87-06
RM 80 B/C/N	77-79
RM 80 XT/XX	80-81
RM 80 XZ/XD/XE/XF	82-85
RM 80 HD/HF	83-85
RM 80 XG/XH/XJ/XK (RC12A)	86-89
RM 80 XL/XM/XN/XP/XR/XS (RC12A)	90-95
RM 80 T/V/W/X/Y/K1	96-01
RM 85 K2/LK2/K3/LK3/K4/LK4	02-04
RM 85 (Small Wheel F 17 Inch/R 14 Inch)	05-20
RM 85 (Big Wheel F 19 Inch/R 16 Inch)	05-20
FB 90 K1 (BD42A)	01
LT-Z 90 K7/K8/K9/L0/L4/L5/L6/L7 QuadSport	07-17
TS 90 R/J	71-73
ASS 100	69-71
ACC 100	70-72
A 100 All Models	74-80
AH 100 Address	92-94
AH 100 P Address (CE12A)	95-96
GP 100 C/N/X/DED	78-87
GP 100 UN/UX/UD/UL	79-92
RM 100 A/B/C	76-78
RM 100 N/T/X	79-81
RM 100 K3	03
TS 100 K/L/M	73-75
TS 100 A/B/C/ERN/ERT/ERX	75-81
TS 100 ERZ/ERH	82-87
DR-Z 110 K3/K4/K5	03-05
110cc Smash	03
FX 110 Shogun	
UG 110 W/SW/Y/SY/SK1 Hokuto/Address	98-02
UK 110 L5/L6/L7/L8 Address	15-18
Shogun-R FD-112	04
B 120	71-77
AN 125 S/T/N/W/X	95-00
AN 125 HKK5	06-08
CS 125 D	83
DF 125	
DR 125 SZ/SD/SE	82-84
DR 125 SF/SH/SJ	85-94
DR 125 SEX/SEY	99-01
DR 125 SMK8/SMK9/SML0	08-12
DR-Z 125 K3/K4/K5/K6/K7/K8/K9/L0-L5	03-15
DR-Z 125 L	03-20
EN 125-2	05
EN 125-2A	05
FL 125 SDWK7/SDWK8 Address/Underbone	07-10
FX 125	
GN 125 R/V/W/X/Y/K1 (NF41A)	94-01
GN 125 ER/EV/EW/EX/EY/EK1 (NF41A)	94-01
GN 125 Z/D/K (NF41A/Cast wheel/Aisin Caliper)	82-90
GN 125 HS (LC6PCJB1/Chinese production)	00-10
GP 125 C/N/X/D	78-84
GS 125 Z/D	82-84
GS 125 ESZ	82
GS 125 ESD/ESF/ESK/ESM	83-94
GS 125 ESR/ESX	95-00
GSX-R 125	17-20
GSX-S 125	17-20

FRONT / AVANT / VORN / FRENTE / ANTERIORE

DISC PAD CHOICES - FRONT				BRAKE DISC CHOICES - FRONT						Line #
FA, SFA, TT Pad or Brake Shoe	SFAC Carbon Scooter Pads	Speciality Pads - SXR / Vee / MXS	Sintered/HH Pads/ Grooved Shoes	Left / Gauche / Links Standard Replacement Disc	Right / Droite / Rechts Standard Replacement Disc	Contour Disc Universal left and right fitment	Custom Disc Universal left and right fitment	Vee-Discs Black † See note below	CX Extreme MX Race Disc/ UTVX Disc	Line #
S604			S604G							1
S614*			S614G*							2
S603			S603G							3
S604			S604G							4
S615			S615G							5
S602			S602G							6
FA083TT			FA083R	MD6018D		MD6018C				7
FA083TT			FA083R	MD6018D		MD6018C				8
FA230TT			FA230R	MD6018D		MD6018C				9
FA230TT			FA230R	MD6018D		MD6018C				10
FA258TT			FA258R	MD6030D		MD6030C			MD6030CX	11
FA258TT			FA258R	MD6030D		MD6030C			MD6030CX	12
S602										13
S604*			S604G*							14
S603			S603G							15
S602										16
S602										17
S603										18
SFA083	SFAC083		SFA083HH	MD939D						19
SFA083	SFAC083		SFA083HH	MD912D						20
FA046										21
S602										22
S603			S603G							23
S603			S603G							24
FA258TT			FA258R	MD6186D		MD6186C			MD6186CX	25
S603			S603G							26
S602			S602G							27
S602			S602G							28
K715			K715G							29
S603										30
S603										31
SFA652				MD911D				VR911		32
SFA396			SFA396HH							33
FA197			FA197HH							34
S602										35
SFA396			SFA396HH	MD911D				VR911		36
SFA083/2			SFA083/2HH	MD911D				VR911		37
S603										38
FA054TT		MXS054	FA054R	MD6073D						39
S602			S602G							40
FA054TT		MXS054	FA054R	MD6073D						41
FA054TT		MXS054	FA054R	MD6073D						42
FA185TT		MXS185	FA185R	MD6017D		MD6017C			MD6017CX	43
S604										44
FA230TT			FA230R	MD6212D						45
FA135TT										46
FA135TT										47
SFA197			SFA197HH		MD9120D					48
FA197			FA197HH							49
FA067			FA067HH							50
FA067			FA067HH							51
FA093										52
FA067			FA067HH							53
FA056										54
S602										55
FA067			FA067HH							56
FA093										57
FA067			FA067HH							58
FA715		FA715V	FA715HH			MD3110C				59
FA715		FA715V	FA715HH			MD3110C				60

*-2 Sets Required. † For Vee disc colours add RED, BLU, GRN, GLD, ORG suffix to part number. For Custom Finish Options for Vee-Rotors™ including Splatter discs add suffix CHR, CHGR, CHBL, CHBR - available in various colours see page iv. ☼ - Also available as a Vintage Motorcycle Disc.

JAPANESE Built Motorcycles

Line #	BRAKE DISC CHOICES - FRONT						DISC PAD CHOICES - REAR				BRAKE DISC CHOICES - REAR			
	Oversize 250 /280mm Disc Kit	OSX Oversize 250/280mm Disc Kit	Relocating Bracket for 250/ 280mm Disc	Oversize 320mm Disc Kit	SMX Oversize 320mm Disc Kit	Relocating Bracket for 320mm Disc	FA, SFA, TT Pad or Brake Shoe	SFAC Carbon Scooter Pads	Speciality Pads - SXR / Vee / MXS	Sintered/ HH Pads/ Grooved Shoes	Standard Replacement Disc	Contour Disc Rear fitment	Vee Discs CONTOUR	CX Extreme MX Race Disc
1							S604			S604G				
2							S618			S618G				
3							S603			S603G				
4							S604			S604G				
5							Y502			Y502G				
6							S604			S604G				
7							Y502			Y502G				
8							FA083TT			FA083R	MD6025D	MD6025C		
9	OS6018C	OSX6018	BRK001				FA083TT			FA083R	MD6025D	MD6025C		
10	OS6018C	OSX6018	BRK001				FA083TT			FA083R	MD6025D	MD6025C		
11	OSS6030C	OSXS6030	BRK029				FA401TT			FA401R	MD6246D	MD6246C		MD6246CX
12	OSS6030C	OSXS6030	BRK029				FA401TT			FA401R	MD6246D	MD6246C		MD6246CX
13							S602							
14							S618			S618G				
15							S602			S602G				
16							S603							
17							S602							
18							S603							
19							S624							
20							S624							
21							S603							
22							S603							
23							S602			S602G				
24							S617			S617G				
25	OS6186C	OSX6186	BRK025				FA084TT			FA084R	MD6187D	MD6187C		MD6187CX
26							S602			S602G				
27							S602			S602G				
28							S604			S604G				
29							S603			S603G				
30							S603							
31							S603							
32							897							
33							S624							
34							S603							
35							S602							
36							S624							
37							S624							
38							S603							
39							S602							
40							S602			S602G				
41							S602			S602G				
42							S602			S602G				
43							FA131TT	MXS131		FA131R	MD6014D	MD6014C		MD6014CX
44							S604							
45							S604							
46							S602							
47							S602							
48							H353							
49							S603							
50							S602							
51							S602							
52							S602							
53							S602							
54							S602							
55							S602							
56							S602							
57							S602							
58							S602							
59							FA629			FA629HH		MD3111C		
60							FA629			FA629HH		MD3111C		

REAR / ARRIÈRE / HINTEN / POSTERIOR / POSTERIORE

R Suffix = High Durability Sintered Pad. **HH** Suffix = High Performance Sintered Pad. **TT** Suffix = Hard Wearing Off Road Pad. **V** Suffix = Semi Sintered Pad. **G** Suffix = Grooved Shoe.
D Suffix = Drilled Disc. **X** Suffix = Universal Left or Right Disc. **XC** Suffix = Contoured Disc. **LS** Suffix = Left/Steel Disc. **RS** = Right/Steel Disc.

BRAKE APPLICATIONS

*-2 Sets Required. † For Vee disc colours add RED, BLU, GRN, GLD, ORG suffix to part number. For Custom Finish Options for Vee-Rotors™ including Splatter discs add suffix CHR, CHGR, CHBL, CHBR - available in various colours see page iv. Ⓢ - Also available as a Vintage Motorcycle Disc.

JAPANESE Built Motorcycles



SUZUKI Contd.



R Suffix = High Durability Sintered Pad. HH Suffix = High Performance Sintered Pad. TT Suffix = Hard Wearing Off Road Pad. V Suffix = Semi-Sintered Pad. G Suffix = Grooved Shoe.

D Suffix = Drilled Disc. X Suffix = Universal Left or Right Disc. XC Suffix = Contoured Disc. LS Suffix = Left/Steel Disc. RS = Right/Steel Disc.

GT 125 L/M/A/B	74-77
GT 125 C/EC/EN	78-79
GX 125 (SJ 125)	03
GZ 125 W/X/Y/K1-K9 Marauder	98-11
LT 125 D	83
LT 125 E	84
LT 125 F/G/H	85-87
RG 125 CG/CH/J (NF12A)	
(Gamma/Rear Drum Brake Model)	86-90
RG 125 UCG/UCH/UCJ/J/BUJ (NF12B)	
(Gamma/Rear Drum Model)	86-90
RG 125 FN/FP/FR Gamma (NF13A/Rear Disc Model)	92-94
RG 125 FUN/FUP/FUR Gamma (NF13B/Rear Disc Model)	92-94
RG 125 UN Wolf (NF13E/Naked)	92-94
RM 125 M/A/B/C	75-78
RM 125 N/T	79-80
RM 125 X/Z/D	81-83
RM 125 E	84
RM 125 F/G	85-86
RM 125 H	87
RM 125 J	88
RM 125 K/L/M	89-91
RM 125 N/P/R/S (RF14A)	92-95
RM 125 T/V/W	96-98
RM 125 X/Y/K1/K2/K3/K4/K5	99-05
RM 125 K6/K7/K8/K9	06-12
RM 125 XCK8	09
RV 125 K	73
RV 125 L/M/A	74-76
RV 125 K2-K9/L0/L3/L4/L5/L6/L7/L8 Van-Van	02-18
T 125/125 II/125 R Stinger	69-71
TF 125 Farm Bike (All models)	78-05
TS 125 K	72
TS 125 L/M/A/B/C/CZ/ERN/ERT/ERX	73-81
TS 125 ERZ	82
TS 125 N	84
TS 125 XE	84
TS 125 XUF/XUG/XUH/XUJ	86-90
TS 125 RK/RL/RM/RN/RP/RR (SF15A)	90-96
TU 125 XXTUX/XTX	99
UC 125 X/Y Epicuro	99-02
UE 125 CTK1	01-03
UH 125 K2/K3/K4/K5/K6 Burgman	02-06
UH 125 K2/K3/K4/K5/K6 Burgman - Parking Brake	02-06
UH 125 K7/K8/K9/L0/L1/L3 Burgman	07-13
UH 125 L4/L5/L6 Burgman (Non ABS)	14-16
UH 125 AL4/AL5/AL6/AL7/AL8 Burgman (ABS)	14-18
UX 125 K8/K9/L0/L1 Sixteen	08-14
UZ 125 K5/GK5 (CF46A) (V 125 G)	05
VL 125 Y/K1-K7 Intruder	00-08
X4 125	
GSX 150 L6 Gixxer	16-18
GSX 150 Gixxer	16-18
GSX-R 150	16-17
GSX-S 150	16-17
GSX-R 150	18-20
GSX-S 150	18-20
UE 150 CTK1	01
UX 150 K8/K9/L0/L1 Sixteen	08-14
LT 160 EK/EL/EM/EN	89-92

FRONT / AVANT / VORN / FRENTE / ANTERIORE

DISC PAD CHOICES - FRONT				BRAKE DISC CHOICES - FRONT						Line #
FA, SFA, TT Pad or Brake Shoe	SFAC Carbon Scooter Pads	Speciality Pads - SXR / Vee / MXS	Sintered/HH Pads/ Grooved Shoes	Left / Gauche / Links Standard Replacement Disc	Right / Droite / Rechts Standard Replacement Disc	Contour Disc Universal left and right fitment	Custom Disc Universal left and right fitment	Vee-Discs Black † See note below	CX Extreme MX Race Disc/ UTVX Disc	Line #
FA055										1
FA038		FA038V								2
FA093										3
FA106TT		FA106V								4
None										5
None										6
None										7
FA110				MD3048LS						9
FA110				MD3048LS						11
FA158			FA158HH		MD3045					12
FA158			FA158HH		MD3045					13
FA129			FA129HH		MD3045					14
S602			S602G							15
S602			S602G							16
S602			S602G							17
S622			S622G							18
FA106TT			FA106R	MD6163D						19
FA135TT		MXS135	FA135R	MD6163D						20
FA135TT		MXS135	FA135R	MD6163D						21
FA135TT		MXS135	FA135R	MD6017D		MD6017C			MD6017CX	22
FA135TT		MXS135	FA135R	MD6017D		MD6017C			MD6017CX	23
FA185TT		MXS185	FA185R	MD6017D		MD6017C			MD6017CX	24
FA185TT		MXS185	FA185R	MD6017D		MD6017C			MD6017CX	25
FA185TT		MXS185	FA185R	MD6017D		MD6017C			MD6017CX	26
FA185TT		MXS185	FA185R	MD6017D		MD6017C			MD6017CX	27
S603			S603G							28
S602			S602G							29
FA231			FA231HH		MD6281D					30
S602										31
S602			S602G							32
S603			S603G							33
S602			S602G							34
S602			S602G							35
S602			S602G							36
S602			S602G							37
FA054TT		MXS054	FA054R	MD6073D						38
FA135TT		MXS135	FA135R	MD6109D						39
FA067			FA067HH							40
SFA396			SFA396HH	MD934D						41
SFA083	SFAC083		SFA083HH	MD911D				VR911		42
SFA181	SFAC181		SFA181HH	MD976D				VR976		43
S602										44
SFA388	SFAC388		SFA388HH		MD9117D			VR9117		45
SFA197	SFAC197		SFA197HH							46
SFA197	SFAC197		SFA197HH							47
SFA388	SFAC388		SFA388HH		MD9142D					48
SFA396			SFA396HH							49
FA106TT										50
FA067			FA067HH							51
FA715		FA715V	FA715HH		TBA					52
FA715		FA715V	FA715HH		TBA					53
FA715		FA715V	FA715HH		TBA					54
FA715		FA715V	FA715HH			MD3110C				55
FA715		FA715V	FA715HH			MD3110C				56
FA715		FA715V	FA715HH			MD3110C				57
SFA083	SFAC083		SFA083HH		MD9117D			VR9117		58
SFA388	SFAC388		SFA388HH		MD9142D					59
S624			S624G							60

*-2 Sets Required. † For Vee disc colours add RED, BLU, GRN, GLD, ORG suffix to part number. For Custom Finish Options for Vee-Rotors™ including Splatter discs add suffix CHR, CHGR, CHBL, CHBR - available in various colours see page iv. ☼ - Also available as a Vintage Motorcycle Disc.

JAPANESE Built Motorcycles

Line #	BRAKE DISC CHOICES - FRONT						DISC PAD CHOICES - REAR				BRAKE DISC CHOICES - REAR			
	Oversize 250 /280mm Disc Kit	OSX Oversize 250/280mm Disc Kit	Relocating Bracket for 250/ 280mm Disc	Oversize 320mm Disc Kit	SMX Oversize 320mm Disc Kit	Relocating Bracket for 320mm Disc	FA, SFA, TT Pad or Brake Shoe	SFAC Carbon Scooter Pads	Speciality Pads - SXR / Vee / MXS	Sintered/ HH Pads/ Grooved Shoes	Standard Replacement Disc	Contour Disc Rear fitment	Vee Discs CONTOUR	CX Extreme MX Race Disc
1							S602							
2							S602							
3							S602							
4							S602							
5							S621		S621G					
6							S605		S605G					
7							S621		S621G					
8														
9							S602							
10														
11							S602							
12							FA157			MD3059				
13							FA157			MD3059				
14							FA157			MD3059				
15							S602		S602G					
16							S617		S617G					
17							S616		S616G					
18							S616		S616G					
19							S616		S616G					
20							S616		S616G					
21														
22	OS6017EC	OSX6017E	BRK031				FA152TT	MXS084/3	FA084/3R	MD6014D	MD6014C			
23	OS6017EC	OSX6017E	BRK031				FA152/2TT	MXS152	FA152R	MD6014D	MD6014C		MD6014CX	
24	OS6017C	OSX6017	BRK023	SM6017C	SMX6017	BRK024	FA131TT	MXS131	FA131R	MD6014D	MD6014C		MD6014CX	
25	OS6017C	OSX6017	BRK023	SM6017C	SMX6017	BRK024	FA131TT	MXS131	FA131R	MD6157D	MD6157C		MD6157CX	
26	OS6017C	OSX6017	BRK023	SM6017C	SMX6017	BRK024	FA131TT	MXS131	FA131R	MD6305D	MD6305C		MD6305CX	
27	OS6017C	OSX6017	BRK023	SM6017C	SMX6017	BRK024	FA131TT	MXS131	FA131R	MD6305D	MD6305C		MD6305CX	
28							S602		S602G					
29							S602		S602G					
30							S603							
31							S602							
32							S602		S602G					
33							S602		S602G					
34							S602		S602G					
35							S604		S604G					
36							S602		S602G					
37							S627							
38							S627							
39							FA152TT	MXS152	FA152R	MD6038D				
40							S602							
41							S635							
42							S624							
43							SFA266	SFAC266	SFA266HH	MD975D		VR975		
44														
45							SFA413	SFAC413	SFA413HH	MD9117D		VR9117		
46							SFA413	SFAC413	SFA413HH					
47							SFA413	SFAC413	SFA413HH					
48							SFA307		SFA307HH	MD9142D				
49														
50							S602							
51							S602							
52														
53														
54							FA629		FA629HH	MD3111				
55							FA629		FA629HH	MD3111	MD3111C			
56							FA629		FA629HH	MD3111	MD3111C			
57							FA629		FA629HH	MD3111	MD3111C			
58							S624							
59							SFA307		SFA307HH	MD9142D				
60							S605		S605G					

REAR / ARRIÈRE / HINTEN / POSTERIOR / POSTERIORE

*-2 Sets Required. † For Vee disc colours add RED, BLU, GRN, GLD, ORG suffix to part number. For Custom Finish Options for Vee-Rotors™ including Splatter discs add suffix CHR, CHGR, CHBL, CHBR - available in various colours see page iv. ☺ - Also available as a Vintage Motorcycle Disc.

R Suffix = High Durability Sintered Pad. HH Suffix = High Performance Sintered Pad. TT Suffix = Hard Wearing Off Road Pad. V Suffix = Semi Sintered Pad. G Suffix = Grooved Shoe. D Suffix = Drilled Disc. X Suffix = Universal Left or Right Disc. XC Suffix = Contoured Disc. LS Suffix = Left/Steel Disc. RS = Right/Steel Disc.

JAPANESE Built Motorcycles



SUZUKI Contd.



LT-F 160 L/M/N/P/R/S/T/W/XY/K1-K3	90-03
LT 160 K3/K4 Quadsport	03-04
PE 175 C/N	78-79
PE 175 T/X	80-81
PE 175 Z	82
GT 185 K	73
GT 185 L/M/A/B/C/EC	74-79
LT 185 E/F	84-85
TS 185 K	73
TS 185 L/M/B/C/ERN/ERT/ERX	74-81
DF 200 EV/EW/EY (SH42A)	98-00
DR 200 G/H/J	86-89
DR 200 SEP/SER/SES/SEV/SEW/SEX/SEY (SH42A) Djebel	93-00
DR 200 SEK1-SEK9	01-09
DR 200 SE Trojan	96-13
GT 200 EN/EX X5	79-82
RV 200 K2/K3	02-03
RV 200 L6/L7/L8/L9 Van-Van	16-19
SB 200 IX	79-81
SX 200 R/R-2/RJ/RM (SH41A)	90-91
TS 200 RK/RL/RM/RN/RP/RR	89-94
UH 200 K7/K8/K9/L0/L1/L3 Burgman	07-13
UH 200 L4/L5/L6 Burgman (Non ABS)	14-16
UH 200 Burgman ABS	14-20
LT 230 GEF/GEG	85-86
LT-F 230 G/H	86-87
LT-F4WDX H/J/K/L/M/N/P/R/S/T/W	87-98
250 SBK 2 (LX 250 L)	02
AN 250 W/XY Burgman/Skywave	98-02
AN 250 K1/K2 Burgman/Skywave	01-02
AN 250 K3-K6 Burgman (CJ43A)	03-06
AN 250 Skywave Type M (BA-CJ45A)	Left 07-08
	Right
AN 250 Skywave Type S (BA-CJ44A)	Left 07-08
	Right
AN 250 8 Skywave SS	Left 08
	Right
DL 250 V-Strom ABS	18-20
DR 250 SL/SM/SN/SEP/SER/SES (SJ 44A)	90-95
DR 250 RS/RLS/RT/RV/RLV/RLW/RW/RY (SJ45A/DOHC)	95-00
DR 250 RXT/RXLT/RXV/RXLV/RXW/RXLW/RXGW/RXGLW /RXV/RXGY (Djebel 250 XC/GPS (SJ45A))	96-98
DR-Z 250 K1-K7 (SJ 44 A)	01-07
GN 250 F/J/M/R/T (NJ41A)	85-97
GT 250 K/L/M/N/A/B/C	73-78
GT 250 EN/ET/EX X7	78-81
GS 250 TT/TX	80-81
GSF 250 N/ZM/P/NP/ZP/R/NR Bandit (GJ74A)	92-96
GSF 250 VS/VT/W/WZ/WV/WX/WY Bandit (GJ77A)	95-00
GSX 250 ET/EX/EZ	80-82
GSX 250 FL/FM/FV/FP/FR/FS/FT/FV/FW Across	90-98
GSX 250 RCH/H (GJ72A)	87
GSX 250 SSM Katana (GJ76A)	91
GSX 250 FXK2/K3/K4/K5 (ZR 250 C)	02-05
GSX 250 RL7/RL8	17-18
GSXR 250 CJ (GJ72A)	88
GSXR 250 CK (GJ72A)	89
GSXR 250 RK (GJ73A)	89
GW 250 L3/ZL5 Inazuma	13-15
GW 250 FL5 Inazuma	15

FA, SFA, TT Pad or Brake Shoe	SFAC Carbon Scooter Pads	Speciality Pads - SXR / Vee / MXS	Sintered/HH Pads/ Grooved Shoes	BRAKE DISC CHOICES - FRONT							Line #
				Left / Gauche / Links Standard Replacement Disc	Right / Droite / Rechts Standard Replacement Disc	Contour Disc Universal left and right fitment	Custom Disc Universal left and right fitment	Vee-Discs Black † See note below	CX Extreme MX Race Disc/ UTVX Disc		
S624			S624G							1	
S624			S624G							2	
S602			S602G							3	
S602			S602G							4	
S618			S618G							5	
										6	
FA055										7	
None										8	
S603			S603G							9	
S602			S602G							10	
FA054TT		MXS054	FA054R	MD6073D						11	
FA054TT		MXS054	FA054R	MD6073D						12	
FA054TT		MXS054	FA054R	MD6073D						13	
FA054TT		MXS054	FA054R	MD6073D						14	
FA054TT		MXS054	FA054R	MD6073D						15	
FA038										16	
FA231			FA231HH		MD6281D					17	
FA231			FA231HH		MD6281D					18	
S605										19	
FA054TT		MXS054	FA054R	MD6073D						20	
FA135TT		MXS135	FA135R	MD6109D						21	
SFA388	SFAC388		SFA388HH		MD9117D			VR9117		22	
SFA197	SFAC197		SFA197HH							23	
SFA197	SFAC197		SFA197HH							24	
S625*			S625G*							25	
S625*			S625G*							26	
S633*			S633G*							27	
FA185TT		MXS185	FA185R	MD6240D		MD6240C				28	
SFA283/4	SFAC283/4		SFA283/4HH	MD929D				VR929		29	
SFA283/4	SFAC283/4		SFA283/4HH	MD929D				VR929		30	
SFA283/4	SFAC283/4		SFA283/4HH	MD994D				VR994		31	
SFA228	SFAC228		SFA228HH	MD994D				VR994		32	
SFA197	SFAC197		SFA197HH		MD994D			VR994		33	
SFA228	SFAC228		SFA228HH	MD994D				VR994		34	
SFA197	SFAC197		SFA197HH		MD994D			VR994		35	
SFA228	SFAC228		SFA228HH	MD994D				VR994		36	
SFA197	SFAC197		SFA197HH		MD994D			VR994		37	
FA226			FA226HH			MD3112C				38	
FA135TT		MXS135	FA135R	MD6040D					MD6040CX	39	
FA185TT		MXS185	FA185R	MD6017D		MD6017C			MD6017CX	40	
										41	
FA185TT		MXS185	FA185R	MD6017D		MD6017C			MD6017CX	42	
FA185TT		MXS185	FA185R	MD6017D		MD6017C			MD6017CX	43	
FA051				MD3014LS						44	
FA055					MD3014RS					45	
FA038		FA038V								46	
FA051				MD3014LS						47	
FA129			FA129HH	MD3006X		MD3006XC	MD3006CC	VR3006BLK†		48	
FA229			FA229HH	MD3006X		MD3006XC	MD3006CC	VR3006BLK†		49	
FA051				MD3014LS						50	
FA129			FA129HH	MD3006X		MD3006XC	MD3006CC	VR3006BLK†		51	
FA103*			FA103HH*	MD3074	MD3074					52	
FA129			FA129HH	MD3006X		MD3006XC	MD3006CC	VR3006BLK†		53	
FA231			FA231HH		MD4008X	MD4008XC	MD4008CC	VR3006BLK†		54	
FA226			FA226HH			MD3112C				55	
FA103*			FA103HH*	MD3074	MD3074					56	
FA103*			FA103HH*	MD3074	MD3074					57	
FA158*			FA158HH*	MD3003X	MD3003X	MD3003XC*	MD3003CC*	VR3006BLK†		58	
FA142		FA142V	FA142HH	MD3105LS						59	
FA142		FA142V	FA142HH	MD3105LS						60	

FRONT / AVANT / VORN / FRENTE / ANTERIORE

R Suffix = High Durability Sintered Pad. HH Suffix = High Performance Sintered Pad. TT Suffix = Hard Wearing Off Road Pad. V Suffix = Semi-Sintered Pad. G Suffix = Grooved Shoe.

D Suffix = Drilled Disc. X Suffix = Universal Left or Right Disc. XC Suffix = Contoured Disc. LS Suffix = Left/Steel Disc. RS = Right/Steel Disc.

*-2 Sets Required. † For Vee disc colours add RED, BLU, GRN, GLD, ORG suffix to part number. For Custom Finish Options for Vee-Rotors™ including Splatter discs add suffix CHR, D, H, L, M, N, P, R, S, T, W, X, Y, Z - available in various colours see page iv. ☼ - Also available as a Vintage Motorcycle Disc.

JAPANESE Built Motorcycles

Line #	BRAKE DISC CHOICES - FRONT						DISC PAD CHOICES - REAR				BRAKE DISC CHOICES - REAR			
	Oversize 250 /280mm Disc Kit	OSX Oversize 250/280mm Disc Kit	Relocating Bracket for 250/ 280mm Disc	Oversize 320mm Disc Kit	SMX Oversize 320mm Disc Kit	Relocating Bracket for 320mm Disc	FA, SFA, TT Pad or Brake Shoe	SFAC Carbon Scooter Pads	Speciality Pads - SXR / Vee / MXS	Sintered/ HH Pads/ Grooved Shoes	Standard Replacement Disc	Contour Disc Rear fitment	Vee Discs CONTOUR	CX Extreme MX Race Disc
1							S605							
2							S605							
3							S602							
4							S619							
5							S619							
6							S602							
7							S602							
8							S605							
9							S602							
10							S602							
11							S602							
12							S602							
13							S602							
14							S602							
15							S602							
16							S602							
17							S603							
18							S603							
19							S602							
20							S605							
21							FA152TT		MXS152		FA152R	MD6038D		
22							SFA413	SFAC413			SFA413HH	MD9117D		VR9117
23							SFA413	SFAC413			SFA413HH			
24							SFA413	SFAC413			SFA413HH			
25							S605				S605G			
26							S605				S605G			
27							S634				S634G			
28	OSG6240C	OSX6240	BRK023		SMX6240	BRK024	FA131TT		MXS131		FA131R	MD6105D		
29							SFA323/3				SFA323/3HH	MD930D	MD930C	VR930
30							SFA411	SFAC411			SFA411HH	MD930D	MD930C	VR930
31							SFA411	SFAC411			SFA411HH			
32							SFA412	SFAC412			SFA412HH	MD9109D		VR9109
33														
34							SFA412	SFAC412			SFA412HH	MD9109D		VR9109
35														
36							SFA412	SFAC412			SFA412HH	MD9109D		VR9109
37														
38							FA496				FA496HH		MD3113C	
39	OSG6040C	OSX6040	BRK031				FA152TT		MXS152		FA152R	MD6038D		
40	OSG6017C	OSX6017	BRK023	SM6017C	SMX6017	BRK024	FA152/2TT		MXS152		FA152/2R	MD6110D		
41														
42	OSG6017C	OSX6017	BRK023	SM6017C	SMX6017	BRK024	FA152TT		MXS152		FA152R	MD6110D		
43	OSG6017C	OSX6017	BRK023	SM6017C	SMX6017	BRK024	FA152/2TT		MXS152		FA152/2R	MD6110D		
44							S602							
45							S609							
46							S606							
47							S606							
48							FA063		FA063V		FA063HH	MD3002	MD3002C	VR3002
49							FA063		FA063V		FA063HH	MD3084		
50							S606							
51							FA063		FA063V		FA063HH	MD3002	MD3002C	VR3002
52							FA063		FA063V		FA063HH	MD3064		
53							FA063		FA063V		FA063HH	MD3002	MD3002C	VR3002
54							FA067				FA067HH	MD4051	MD4051C	VR4015
55							FA496		FA496V		FA496HH		MD3113C	
56							FA063		FA063V		FA063HH	MD3081		
57							FA063		FA063V		FA063HH	MD3081		
58							FA063		FA063V		FA063HH			
59							FA496		FA496V		FA496HH	MD3093		
60							FA496		FA496V		FA496HH	MD3093		

REAR / ARRIÈRE / HINTEN / POSTERIOR / POSTERIORE

*-2 Sets Required. † For Vee disc colours add RED, BLU, GRN, GLD, ORG suffix to part number. For Custom Finish Options for Vee-Rotors™ including Splatter discs add suffix CHR, CHGR, CHBL, CHBR - available in various colours see page iv. ☼ - Also available as a Vintage Motorcycle Disc.

R Suffix = High Durability Sintered Pad. HH Suffix = High Performance Sintered Pad. TT Suffix = Hard Wearing Off Road Pad. V Suffix = Semi Sintered Pad. G Suffix = Grooved Shoe. D Suffix = Drilled Disc. X Suffix = Universal Left or Right Disc. XC Suffix = Contoured Disc. LS Suffix = Left/Steel Disc. RS = Right/Steel Disc.

BRAKE APPLICATIONS

JAPANESE Built Motorcycles



SUZUKI Contd.



R Suffix = High Durability Sintered Pad. HH Suffix = High Performance Sintered Pad. TT Suffix = Hard Wearing Off Road Pad. V Suffix = Semi-Sintered Pad. G Suffix = Grooved Shoe.

D Suffix = Drilled Disc. X Suffix = Universal Left or Right Disc. XC Suffix = Contoured Disc. LS Suffix = Left/Steel Disc. RS = Right/Steel Disc.

GZ 250 X/Y/K1	99-01
GZ 250 K2-K8 Marauder	02-08
LT 250 EFF/EFK	85-86
LT 250 RH/RJ/RK/RL	87-90
LT-F 250 J/K/L/M/N/P/R/S/T/V/W/X/Y/K1	88-01
LT-F 250 FX/FY/FK1/FK2	99-02
LT-F 250 K2/K3/K4/K5/K6/K7/K8/K9/L2/L3/L4 Ozark	02-14
LT-Z 250 K4/K5/K6/K7/K8/K9/LO Quadport	04-12
LT-F4WD H/J/K/L/M/N/P/S/T/V/W	87-98
PE 250 B/C/N	77-79
PE 250 T/X/Z	80-82
RL 250 L/M	74-75
RL 250 Beamish Model Reed Valve Engine	78-82
RM 250 A/B/C	76-78
RM 250 N	79
RM 250 T	80
RM 250 X/Z	81-82
RM 250 D	83
RM 250 E	84
RM 250 F/G	85-86
RM 250 H/J	87-88
RM 250 K/L/M	89-91
RM 250 N/P/R/S (RJ16A)	92-95
RM 250 T/V/W	96-98
RM 250 X/Y/K1/K2/K3/K4/K5/K6/K7	99-05
RM 250 K6/K7/K8/K9	06-12
RM 250 XCK8	09
RMX 250 K/M/N/P	89-93
RMX 250 R/S	94-95
RMX 250 T/V/W	96-98
RMX 250 ST/SV/SW/SX (SJ14A)	96-99
RMX 250 SN/SR/SS (SJ13A)	95-97
RMZ 250 K4/K5/K6	04-06
RMZ 250 K7	07
RM-Z 250	08-20
RG 250 WD Gamma	83
RG 250 WE	84
RG 250 FG/CH/FCH/FH Gamma (GJ21B)	85-88
RGV 250 J	88
RGV 250 K/L (VJ21A)	89-90
RGV 250 M/N/P/R/S (VJ22A)	91-95
RGV 250 T (RGVR 250 SP VJ23A)	96
SW-1 (NJ45A)	92
T 20 Super Six	66-68
T 250 I/R/J	70-72
TS 250 L/M/A/B/C/ERN/ERT/ERX	74-82
TS 250 XE/XG/XH/XJ/XK	85-89
TU 250 S/T/XS/XT/X-ST/XSV/XT-W Volty (NJ47A 100001-115972)	92-97
TU 250 XV/XW	97-00
TU 250 XTX/XTY (NJ47A-115-) Volty	99-00
TU 250 GY/GBK1 Grass Tracker Big Boy (NJ47A-117/123)	00-01
TV 250 J/K/AK/L (VJ21A) Wolf	88-90
VL 250 Y/K1/K5/K6/K7 Intruder	00-01
VL 250 Y/K1/K5/K6/K7 Intruder	05-07
LT-F 300 J/K	88-89
LT-F 300 FX/FY/FK1	99-01
LT-F 300 FK2	Left 02
	Right

◆ Plain undrilled disc for enduro use MD6255CE

FRONT / AVANT / VORN / FRENTE / ANTERIORE

DISC PAD CHOICES - FRONT				BRAKE DISC CHOICES - FRONT						Line #
FA, SFA, TT Pad or Brake Shoe	SFAC Carbon Scooter Pads	Speciality Pads - SXR / Vee / MXS	Sintered/HH Pads/ Grooved Shoes	Left / Gauche / Links Standard Replacement Disc	Right / Droite / Rechts Standard Replacement Disc	Contour Disc Universal left and right fitment	Custom Disc Universal left and right fitment	Vee-Discs Black † See note below	CX Extreme MX Race Disc/ UTVX Disc	Line #
FA106TT		FA106V								1
FA106TT		FA106V								2
S625*			S625G*							3
FA128TT*			FA128R*	MD6020D	MD6020D					4
S628*			S628G*							5
S628*			S628G*							6
FA054TT*			FA054R*	MD6207D	MD6207D					7
FA084TT*		MXS084*	FA084R*	MD6210D	MD6210D					8
S628*			S628G*							9
S605			S605G							10
S605			S605G							11
S603			S603G							12
S603			S603G							13
S602			S602G							14
S605			S605G							15
S618			S618G							16
S621			S621G							17
S622			S622G							18
S622			S622G							19
FA106TT			FA106R	MD6163D						20
FA135TT		MXS135	FA135R	MD6163D						21
FA135TT		MXS135	FA135R	MD6017D		MD6017C			MD6017CX	22
FA135TT		MXS135	FA135R	MD6017D		MD6017C			MD6017CX	23
FA185TT		MXS185	FA185R	MD6017D		MD6017C			MD6017CX	24
FA185TT		MXS185	FA185R	MD6017D		MD6017C			MD6017CX	25
FA185TT		MXS185	FA185R	MD6017D		MD6017C			MD6017CX	26
FA185TT		MXS185	FA185R	MD6017D		MD6017C			MD6017CX	27
FA135TT		MXS135	FA135R	MD6017D		MD6017C			MD6017CX	28
FA135TT		MXS135	FA135R	MD6017D		MD6017C			MD6017CX	29
FA185TT		MXS185	FA185R	MD6017D		MD6017C			MD6017CX	30
FA185TT		MXS185	FA185R	MD6017D		MD6017C			MD6017CX	31
FA135TT		MXS135	FA135R	MD6017D		MD6017C			MD6017CX	32
FA185TT		MXS185	FA185R	MD6213D		MD6213C			MD6213CX	33
FA185TT		MXS185	FA185R	MD6254D		MD6254C			MD6254CX	34
FA185TT		MXS185	FA185R			MD6254C			MD6254CX	35
FA063			FA063HH	MD3014LS						36
FA102				MD3014LS						37
FA102*										38
FA158*			FA158HH*	MD3003X	MD3003X	MD3003XC*	MD3003CC*	VR3003BLK†		39
FA158*			FA158HH*	MD3003X	MD3003X	MD3003XC*	MD3003CC*	VR3003BLK†		40
FA158*			FA158HH*	MD3045	MD3045					41
FA180*			FA180HH*	MD3082LS	MD3082RS					42
FA129			FA129HH							43
S608										44
S608										45
S605			S605G							46
FA054TT		MXS054	FA054R	MD6075D						47
FA106TT		FA106V								48
FA106TT		FA106V								49
FA229			FA229HH							50
FA229			FA229HH							51
FA158			FA158HH		MD3007X	MD3007XC		VR3007BLK†		52
FA106TT		FA106V								53
FA106TT		FA106V								54
S625*			S625G*							55
S633*			S633G*							56
FA165TT		MXS165	FA165R	MD6206D						57
FA135TT		MXS135	FA135R		MD6206D					58
										59
										60

*-2 Sets Required. † For Vee disc colours add RED, BLU, GRN, GLD, ORG suffix to part number. For Custom Finish Options for Vee-Rotors™ including Splatter discs add suffix CHR, CHGR, CHBL, CHBR - available in various colours see page iv. Ⓢ - Also available as a Vintage Motorcycle Disc.

JAPANESE Built Motorcycles

Line #	BRAKE DISC CHOICES - FRONT						DISC PAD CHOICES - REAR				BRAKE DISC CHOICES - REAR			
	Oversize 250 /280mm Disc Kit	OSX Oversize 250/280mm Disc Kit	Relocating Bracket for 250/ 280mm Disc	Oversize 320mm Disc Kit	SMX Oversize 320mm Disc Kit	Relocating Bracket for 320mm Disc	FA, SFA, TT Pad or Brake Shoe	SFAC Carbon Scooter Pads	Speciality Pads - SXR / Vee / MXS	Sintered/ HH Pads/ Grooved Shoes	Standard Replacement Disc	Contour Disc Rear fitment	Vee Discs CONTOUR	CX Extreme MX Race Disc
1							S602							
2							S602							
3							S634		S634G					
4							FA137TT		FA137R	MD6021D				
5							S629		S629G					
6							S629		S629G					
7							S636		S636G					
8							S636		S636G					
9							S629		S629G					
10							S605		S605G					
11							S605		S605G					
12							S602		S602G					
13							S602		S602G					
14							S605		S605G					
15							S620		S620G					
16							S620		S620G					
17							S616		S616G					
18							S616		S616G					
19							S602		S602G					
20							S602		S602G					
21														
22	OS6017EC	OSX6017E	BRK031				FA152TT	MXS084/3	FA084/3R	MD6014D				
23	OS6017EC	OSX6017E	BRK031				FA152/2TT	MXS152	FA152R	MD6014D	MD6014C		MD6014CX	
24	OS6017C	OSX6017	BRK023	SM6017C	SMX6017	BRK024	FA131TT	MXS152	FA152/2R	MD6014D	MD6014C		MD6014CX	
25	OS6017C	OSX6017	BRK023	SM6017C	SMX6017	BRK024	FA131TT	MXS131	FA131R	MD6014D	MD6014C		MD6014CX	
26	OS6017C	OSX6017	BRK023	SM6017C	SMX6017	BRK024	FA131TT	MXS131	FA131R	MD6157D	MD6157C		MD6157CX	
27	OS6017C	OSX6017	BRK023	SM6017C	SMX6017	BRK024	FA131TT	MXS131	FA131R	MD6305D	MD6305C		MD6305CX	
28	OS6017C	OSX6017	BRK023	SM6017C	SMX6017	BRK024	FA131TT	MXS131	FA131R	MD6305D	MD6305C		MD6305CX	
29	OS6017EC	OSX6017E	BRK031				FA152TT	MXS152	FA152R	MD6014D	MD6014C		MD6014CX	
30	OS6017EC	OSX6017E	BRK031				FA152/2TT	MXS152	FA152/2R	MD6014D	MD6014C		MD6014CX	
31	OS6017C	OSX6017	BRK023	SM6017C	SMX6017	BRK024	FA152TT	MXS152	FA152R	MD6014D	MD6014C		MD6014CX	
32	OS6017C	OSX6017	BRK023	SM6017C	SMX6017	BRK024	FA131TT	MXS131	FA131R	MD6014D	MD6014C		MD6014CX	
33	OS6017EC	OSX6017E	BRK031				FA152/2TT	MXS152	FA152/2R	MD6014D	MD6014C		MD6014CX	
34	OS6213C	OSX6213	BRK023	SM6213C	SMX6213	BRK024	FA367TT	MXS367	FA367R	MD6208D	MD6208C		MD6208CX	
35	OS6254C	OSX6254	BRK023	SM6254C	SMX6254	BRK024	FA367TT	MXS367	FA367R	MD6255D	MD6255C		MD6255CX	
36	OS6254C	OSX6254	BRK023	SM6254C	SMX6254	BRK024	FA367TT	MXS367	FA367R	MD6255C	MD6255C		MD6255CX	
37							FA063	FA063V	FA063HH	MD3064				
38							FA063	FA063V		MD3064				
39							FA063	FA063V		MD3064				
40							FA063	FA063V	FA063HH	MD3081				
41							FA063	FA063V	FA063HH	MD3081				
42							FA141			MD3059				
43							FA141			MD3059				
44							S606							
45							S609							
46							S609							
47							S605		S605G					
48							S627							
49							S602							
50							S602							
51							S602							
52							S602							
53							FA063	FA063V	FA063HH	MD3081				
54							S602							
55							S602							
56							S634		S634G					
57							S634		S634G					
58							S634		S634G					
59														
60														

REAR / ARRIÈRE / HINTEN / POSTERIORE

R Suffix = High Durability Sintered Pad. **HH** Suffix = High Performance Sintered Pad. **TT** Suffix = Hard Wearing Off Road Pad. **V** Suffix = Semi Sintered Pad. **G** Suffix = Grooved Shoe.
D Suffix = Drilled Disc. **X** Suffix = Universal Left or Right Disc. **XC** Suffix = Contoured Disc. **LS** Suffix = Left/Steel Disc. **RS** = Right/Steel Disc.

*-2 Sets Required. † For Vee disc colours add RED, BLU, GRN, GLD, ORG suffix to part number. For Custom Finish Options for Vee-Rotors™ including Splatter discs add suffix CHR, CHGR, CHBL, CHBR - available in various colours see page iv. Ⓢ - Also available as a Vintage Motorcycle Disc.

BRAKE APPLICATIONS

JAPANESE Built Motorcycles



SUZUKI Contd.



LT-F 4WD XH/J/K/L/M/N/P/R/S/T/V/W	87-98
RL 325	
DR 350 SL/SM/SN/SP (4 Bolt Front Disc/Kick Start)	90-93
DR 350 SER/SES (Electric Start/4 Bolt Front Disc)	94-95
DR 350 SET/SEV/SEW/SEX (Electric Start /4 Bolt Front Disc/UK/Europe)	96-99
DR 350 SEW/SEX (Electric Start/6 Bolt Front Disc /USA Only)	98-99
RL 350 Beamish Model Reed Valve Engine	78-82
SG 350 N Goose	92
T 350 1/2/R/J	69-72
SP 370 C/N	77-80
GT 380 J	72
GT 380 K/L/M/A/B	73-77
AN 400 X/Y Burgman	99-00
AN 400 K1/K2	01-02
AN 400 K3-K6	03-06
AN 400 K7/ZK7/K8/ZK8/K9/L0/L1/L2/L3/L4 Burgman /Skywave (Non ABS)	Left 07-15 Right
AN 400 Burgman/Skywave (ABS)	Left 07-20 Right
DR 400 ST/SX	79-81
DR-Z 400 SY/EY/Y/SEK1/EK1/K1/SK2/EK2/K2/K3/SK3/EK3 /K4/SK4/EK4/SK5/EK5/K5/EK5/EK6/SK6/K6/SK7 /EK7/K7/SK8	00-08
DR-Z 400 SMK5/SMK6/SMK7/SMK8/SMK9	05-09
GN 400 TT	80
GS 400 B/C	77-78
GS 400 LX	81
GS 400 TX	81
GSF 400 K/NK/Z/NM/VZM/P/NP/NP/NZP/NR Bandit (GK75A)	89-94
GSF 400 M/N/P Bandit	91-95
GSF 400 S/V/S/V-VZ-V Bandit (GK7AA)	95-97
GSR 400 K6	06
GSX 400 ET/EX/EZ	81-83
GSX 400 FW/FWS/FWS-2	
GSX 400 R2 (GK 7IB)	
GSX 400 R3 (GK 7IF)	
GSX 400 FX/FZ/FD	81-83
GSX 400 FJ/FK/FAK/FL (GK74A)	88-90
GSX 400 X/XA/XS Impulse	
GSX 400 SSN (GK77A) Katana	92
GSX 400 R/S/T/ZR/ZS/ZT (GK79A) Impulse Type S	94-96
GSX 400 X (GK79A) Impulse	99
GSX 400 FSV/FSK1 (GK7B) Inazuma	00
GSXR 400 H	87
GSXR 400 J/RR/RAK (GK73A)	88-90
GSXR 400 RL/RM/RN/RP/RS (GK76A)	90-95
LT-A 400 FK2-FK7 Eiger 4WD	02-07
LT-A 400 K2/K3/K4 Eiger	02-04
LT-A 400 FK8/FK9/FL0/FL1	Left 08-12
King Quad Auto 4WD	Right
LT-F 400 FK8/FK9/FL0/FL1	Left 08-12
King Quad 4WD	Right
LT-F 400 FK2/FK3/FK4/FK5/FK6/FK7 (Eiger 4WD)	02-07
LT-F 400 K2-K7 Eiger	02-07
LT-Z 400 K3/K4/K5/K6/K7/K8/K9/L0/L1/L2/L3	03-15
PE 400 T/X	79-81

DISC PAD CHOICES - FRONT				BRAKE DISC CHOICES - FRONT							Line #
FA, SFA, TT Pad or Brake Shoe	SFAC Carbon Scooter Pads	Speciality Pads - SXR / Vee / MXS	Sintered/HH Pads/ Grooved Shoes	Left / Gauche / Links Standard Replacement Disc	Right / Droite / Rechts Standard Replacement Disc	Contour Disc Universal left and right fitment	Custom Disc Universal left and right fitment	Vee-Discs Black † See note below	CX Extreme MX Race Disc/ UTVX Disc	Line #	
S633*			S633G*							1	
S603			S603G							2	
FA135TT		MXS135	FA135R	MD6040D					MD6040CX	3	
FA135TT		MXS135	FA135R	MD6040D					MD6040CX	4	
FA135TT		MXS135	FA135R	MD6040D					MD6040CX	6	
FA185TT		MXS185	FA185R	MD6017D					MD6017CX	8	
S603			S603G							9	
FA158			FA158HH		MD3080RS					10	
S608										11	
S605			S605G							12	
S608										13	
FA055					MD3014RS					14	
SFA283/4	SFAC283/4		SFA283/4HH	MD929D				VR929		15	
SFA283/4	SFAC283/4		SFA283/4HH	MD929D				VR929		16	
SFA283/4	SFAC283/4		SFA283/4HH	MD994D				VR994		17	
SFA228	SFAC228		SFA228HH	MD994D				VR994		19	
SFA197	SFAC197		SFA197HH		MD994D			VR994		20	
SFA228	SFAC228		SFA228HH	MD994D				VR994		21	
SFA197	SFAC197		SFA197HH		MD994D			VR994		22	
S605			S605G							23	
FA185TT		MXS185	FA185R	MD6017D		MD6017C			MD6017CX	26	
FA185TT		MXS185	FA185R	MD6247D		MD6247C				27	
FA051				MD3014LS						28	
FA035				MD3014LS						29	
FA051				MD3014LS						30	
FA051				MD3014LS						31	
FA158*			FA158HH*	MD3003X	MD3003X	MD3003XC*	MD3003CC*	VR3003BLK*†		33	
FA129			FA129HH	MD3006X		MD3006XC	MD3006CC*	VR3006BLK†		34	
FA158*			FA158HH*	MD3003X	MD3003X	MD3003XC*	MD3003CC*	VR3003BLK*†		35	
FA158*			FA158HH*	MD3092X	MD3092X	MD3092XC*	MD3092CC*	VR3092BLK*†		36	
FA051				MD3014LS						37	
FA063*			FA063HH*	MD3024LS	MD3024RS					38	
FA102*										39	
FA103*			FA103HH*	MD3001	MD3001					40	
FA067*			FA067HH*	MD3066LS	MD3066RS					41	
FA146*			FA146HH*	MD3003X	MD3003X	MD3003XC*	MD3003CC*	VR3003BLK*†		42	
FA103*			FA103HH*	MD3001	MD3001					43	
FA158*			FA158HH*	MD3003X	MD3003X	MD3003XC*	MD3003CC*	VR3003BLK*†		44	
FA142*		FA142V*	FA142HH*	MD3003X	MD3003X	MD3003XC*	MD3003CC*	VR3003BLK*†		45	
FA244*			FA244HH*	MD3003X	MD3003X	MD3003XC*	MD3003CC*	VR3003BLK*†		46	
FA244*			FA244HH*	MD3003X	MD3003X	MD3003XC*	MD3003CC*	VR3003BLK*†		47	
FA103*			FA103HH*	MD3001	MD3001					48	
FA158*			FA158HH*	MD3003X	MD3003X	MD3003XC*	MD3003CC*	VR3003BLK*†		49	
FA145*			FA145HH*	MD3045	MD3045					50	
FA054TT*		MXS054*	FA054R*	MD6195D	MD6195D					51	
FA054TT*		MXS054*	FA054R*	MD6195D	MD6195D					52	
FA413TT			FA413R	MD6195D						53	
FA414TT			FA414R		MD6195D					54	
FA413TT			FA413R	MD6195D						55	
FA414TT			FA414R		MD6195D					56	
FA054TT*		MXS054*	FA054R*	MD6195D	MD6195D					57	
FA054TT*		MXS054*	FA054R*	MD6195D	MD6195D					58	
FA084TT*		MXS084*	FA084R*	MD6210D	MD6210D					59	
S605			S605G							60	

FRONT / AVANT / VORN / FRENTE / ANTERIORE

R Suffix = High Durability Sintered Pad. HH Suffix = High Performance Sintered Pad. TT Suffix = Hard Wearing Off Road Pad. V Suffix = Semi Sintered Pad. G Suffix = Grooved Shoe.
D Suffix = Drilled Disc. X Suffix = Universal Left or Right Disc. XC Suffix = Contoured Disc. LS Suffix = Left/Steel Disc. RS = Right/Steel Disc.

*-2 Sets Required. † For Vee disc colours add RED, BLU, GRN, GLD, ORG suffix to part number. For Custom Finish Options for Vee-Rotors™ including Splatter discs add suffix CHR, D, CHGR, CHBL, CHBR - available in various colours see page iv. ☼ - Also available as a Vintage Motorcycle Disc.

JAPANESE Built Motorcycles

Line #	BRAKE DISC CHOICES - FRONT						DISC PAD CHOICES - REAR				BRAKE DISC CHOICES - REAR			
	Oversize 250 /280mm Disc Kit	OSX Oversize 250/280mm Disc Kit	Relocating Bracket for 250/ 280mm Disc	Oversize 320mm Disc Kit	SMX Oversize 320mm Disc Kit	Relocating Bracket for 320mm Disc	FA, SFA, TT Pad or Brake Shoe	SFAC Carbon Scooter Pads	Speciality Pads - SXR / Vee / MXS	Sintered/ HH Pads/ Grooved Shoes	Standard Replacement Disc	Contour Disc Rear fitment	Vee Discs CONTOUR	CX Extreme MX Race Disc
1							S634		S634G					
2							S602		S602G					
3	OS6040C	OSX6040	BRK031				FA152TT	MXS152	FA152R	MD6038D			MD6038CX	
4	OS6040C	OSX6040	BRK031				FA152TT	MXS152	FA152R	MD6038D			MD6038CX	
5														
6	OS6040C	OSX6040	BRK031				FA152TT	MXS152	FA152R	MD6110D			MD6110CX	
7														
8	OS6017C	OSX6017	BRK023	SM6017C	SMX6017	BRK024	FA152TT	MXS152	FA152R	MD6110D			MD6110CX	
9														
10							FA063	FA063V	FA063HH	MD3081				
11							S609							
12							S605		S605G					
13							S609							
14							S609							
15							SFA323/3		SFA323/3HH	MD930D	MD930C	VR930		
16							SFA411	SFAC411	SFA411HH	MD930D	MD930C	VR930		
17							SFA411	SFAC411	SFA411HH					
18														
19														
20							SFA412	SFAC412	SFA412HH	MD9109D		VR9109		
21														
22							SFA412	SFAC412	SFA412HH	MD9109D		VR9109		
23							S605		S605G					
24														
25														
26	OS6017C	OSX6017	BRK023		SMX6017/1	BRK038	FA131TT	MXS131	FA131R	MD6014D	MD6014C		MD6014CX	
27							FA131TT	MXS131	FA131R	MD6157D	MD6157C			
28							S606							
29							S609							
30							S606							
31							S609							
32														
33							FA063	FA063V	FA063HH	MD3002	MD3002C	VR3002		
34							FA063	FA063V	FA063HH	MD3002	MD3002C	VR3002		
35							FA063	FA063V	FA063HH	MD3084				
36							FA419	FA419V	FA419HH	MD3093	MD3093C	VR3093		
37							S606							
38							FA063	FA063V	FA063HH	MD3025				
39							FA063	FA063V		MD3064				
40							FA063	FA063V	FA063HH	MD3064				
41							FA036	FA036V		MD3025				
42							FA063	FA063V	FA063HH	MD3002	MD3002C	VR3002		
43							FA063	FA063V	FA063HH	MD3064				
44							FA063	FA063V	FA063HH	MD3002	MD3002C	VR3002		
45							FA063	FA063V	FA063HH	MD3002	MD3002C	VR3002		
46							FA063	FA063V	FA063HH	MD3002	MD3002C	VR3002		
47							FA063	FA063V	FA063HH	MD3008	MD3008C	VR3008		
48							FA063	FA063V	FA063HH	MD3064				
49							FA063	FA063V	FA063HH	MD3081				
50							FA063	FA063V	FA063HH	MD3081				
51							S606		S606G					
52							S606		S606G					
53							S626		S626G					
54														
55							S626		S626G					
56														
57							S606		S606G					
58							S606		S606G					
59							FA137TT		FA137R	MD6211D				
60							S605		S605G					

REAR / ARRIÈRE / HINTEN / POSTERIOR / POSTERIORE

R Suffix = High Durability Sintered Pad. HH Suffix = High Performance Sintered Pad. TT Suffix = Hard Wearing Off Road Pad. V Suffix = Semi Sintered Pad. G Suffix = Grooved Shoe.
D Suffix = Drilled Disc. X Suffix = Universal Left or Right Disc. XC Suffix = Contoured Disc. LS Suffix = Left/Steel Disc. RS = Right/Steel Disc.

BRAKE APPLICATIONS

*-2 Sets Required. † For Vee disc colours add RED, BLU, GRN, GLD, ORG suffix to part number. For Custom Finish Options for Vee-Rotors™ including Splatter discs add suffix CHR, CHGR, CHBL, CHBR - available in various colours see page iv. ☺ - Also available as a Vintage Motorcycle Disc.

JAPANESE Built Motorcycles



SUZUKI Contd.

RF 400 RP/RR/RV/RT/RVT/RV-V (GK78A)		93-97
RG 400 EWF/EW-2G/EWH Walter Wolf (Type 1 & 2)		85-87
RM 400 C		78
RM 400 N		79
RM 400 T		80
SP 400 T		80
ST 400 V/W/X/Y/K1/K2/K3 Tempter		97-03
SV 400 N (VK53A)		98
SV 400 X/Y/K1/K2	Left	99-02
	Right	
SV 400 K3/K4/K5	Left	03-05
	Right	
SV 400 SN (VK53A)		98
SV 400 SX/SY/SK1/SK2	Left	99-02
	Right	
SV 400 SK3/SK4/SK5	Left	03-05
	Right	
VS 400 VR/FR/VTR/FTRV-T/F-T Intruder		94-
GS 425 EN		79
RM-X 450 ZL0/ZL2		10-15
RM-Z 450 K5/K6/K7		05-07
RM-Z 450		08-17
RM-Z 450		18-20
GS 450 ET/EG/EJ		80-88
LT-A 450 XK7/XK8/XK9	Left	07-10
	Right	
LT-R 450 K6/K7/K8/K9/L0/L1	Left	06-12
	Right	
RM 465 X/Z		81-82
DR 500 X/Z/D		81-83
DR 500 S/SA		84-88
GS 500 EK/EL/EM/EN/EP/ER/ES (GM51A)		89-95
GS 500 ET/EV/EW/EX/EY/K1/K2/K3		96-03
GS 500 FK4/K4/FK5/K5/FK6/K6/FK7/K7/K8/FK8		04-08
T 500 1/2/3/R/J/K/L/M		68-75
GT 500 A/B		76-77
RE 5 M/A		75-77
RG 500 G/CH		85-87
RM 500 D/E		83-84
LT 500 RL		90
LT-A 500 FY/FK1	Left	00-01
	Right	
LT-A 500 FK2 Vision 4WD		02
LT-A 500 FK3/FK4/FK5/FK6/FK7 Vinson 4WD Auto		03-07
LT-A 500 XPK9/XPZK9/XPL0	Left	09-15
/XPL1-XPL5 (Power Steering)	Right	
LT-F 500 FW/FX/FY/FK1/FK2	Left	98-02
	Right	
LT-F 500 FK3-FK7 Vinson Quadrunner		03-07
GT 550 J (4 Shoe type front brake)		72
GT 550 K/L/M		73-75
GT 550 A/B		76-77
GS 550 DB/DC		77-78
GS 550 EC/EN		78-79
GS 550 ET/EX/EZ/LT/LX/MX/MZ		80-84
GSX 550 ESD/ESE/EFE/EF/ESH/EF/EG (GN71D)		84-87
DR 600 RG/RH/RJ (SN41A) (Rear drum model)		86-88
DR 600 RK (SN41A) (Rear disc model)		89
DR 600 SF/SG/SH/SJ/SK (SN41A)		85-89

◆ Plain undrilled disc for enduro use MD6255CE

FRONT / AVANT / VORN / FRENTE / ANTERIORE

DISC PAD CHOICES - FRONT				BRAKE DISC CHOICES - FRONT						Line #
FA, SFA, TT Pad or Brake Shoe	SFAC Carbon Scooter Pads	Speciality Pads - SXR / Vee / MXS	Sintered/HH Pads/ Grooved Shoes	Left / Gauche / Links Standard Replacement Disc	Right / Droite / Rechts Standard Replacement Disc	Contour Disc Universal left and right fitment	Custom Disc Universal left and right fitment	Vee-Discs Black † See note below	CX Extreme MX Race Disc/ UTVX Disc	Line #
FA142*		FA142V*	FA142HH*	MD3003X	MD3003X	MD3003XC*	MD3003CC*	VR3003BLK†		1
FA103*			FA103HH*	MD3070LS	MD3070RS					2
S602			S602G							3
S605			S605G							4
S618			S618G							5
S605			S605G							6
										7
FA231			FA231HH		MD3006X	MD3006XC		VR3006BLK†		8
FA229		FA229V	FA229HH	MD3003X		MD3003XC	MD3003CC	VR3003BLK†		9
FA231		FA231V	FA231HH		MD3003X	MD3003XC	MD3003CC	VR3003BLK†		10
FA229		FA229V	FA229HH	MD3090X		MD3090XC	MD3090CC	VR3090BLK†		11
FA231		FA231V	FA231HH		MD3090X	MD3090XC	MD3090CC	VR3090BLK†		12
					MD3006X	MD3006XC	MD3006CC	VR3006BLK†		13
FA229		FA229V	FA229HH	MD3003X		MD3003XC	MD3003CC	VR3003BLK†		14
FA231		FA231V	FA231HH		MD3003X	MD3003XC	MD3003CC	VR3003BLK†		15
FA229		FA229V	FA229HH	MD3090X		MD3090XC	MD3090CC	VR3090BLK†		16
FA231		FA231V	FA231HH		MD3090X	MD3090XC	MD3090CC	VR3090BLK†		17
FA103			FA103HH		MD3032RS					18
FA035				MD3014LS						19
FA185TT		MXS185	FA185R			MD6254C			MD6254CX	20
FA185TT		MXS185	FA185R	MD6254D		MD6254C			MD6254CX	21
FA185TT		MXS185	FA185R			MD6254C			MD6254CX	22
FA185TT		MXS185	FA185R	TBA						23
FA051				MD3014LS						24
FA413TT			FA413R	MD6261D						25
FA414TT			FA414R		MD6261D					26
FA165TT		MXS165	FA165R	MD6277D						27
FA135TT		MXS135	FA135R		MD6277D					28
S621			S621G							29
S602			S602G							30
S605			S605G							31
FA129			FA129HH		MD3006X	MD3006XC	MD3006CC	VR3006BLK†		32
FA231			FA231HH		MD3006X	MD3006XC	MD3006CC	VR3006BLK†		33
FA231			FA231HH		MD3006X	MD3006XC	MD3006CC	VR3006BLK†		34
S612										35
FA055					MD3019RS					36
FA055*				MD3019LS	MD3019RS					37
FA103*			FA103HH*	MD3070LS	MD3070RS					38
S622			S622G							39
FA128TT*			FA128R*	MD6022D	MD6022D					40
FA165TT		MXS165	FA165R	MD6145D						41
FA135TT		MXS135	FA135R		MD6145D					42
FA054TT*		MXS054*	FA054R*	MD6195D	MD6195D					43
FA054TT*		MXS054*	FA054R*	MD6195D	MD6195D					44
FA413TT			FA413R	MD6355D						45
FA414TT			FA414R		MD6355D					46
FA165TT		MXS165	FA165R	MD6145D						47
FA135TT		MXS135	FA135R		MD6145D					48
FA054TT*		MXS054*	FA054R*	MD6195D	MD6195D					49
										50
FA055					MD3019RS					51
FA055					MD3019RS					52
FA038*		FA038V*		MD3014LS	MD3014RS					53
FA038*		FA038V*		MD3014LS	MD3014RS					54
FA065*				MD3014LS	MD3014RS					55
FA063*			FA063HH*	MD3024LS	MD3024RS					56
FA106/2TT			FA106/2R	MD6075D						57
FA106/2TT			FA106/2R	MD6075D						58
FA106/2TT			FA106/2R	MD6075D						59

*-2 Sets Required. † For Vee disc colours add RED, BLU, GRN, GLD, ORG suffix to part number. For Custom Finish Options for Vee-Rotors™ including Splatter discs add suffix CHR, CHGR, CHBL, CHBR - available in various colours see page iv. Ⓢ - Also available as a Vintage Motorcycle Disc.

JAPANESE Built Motorcycles

Line #	BRAKE DISC CHOICES - FRONT						DISC PAD CHOICES - REAR				BRAKE DISC CHOICES - REAR			
	Oversize 250 /280mm Disc Kit	OSX Oversize 250/280mm Disc Kit	Relocating Bracket for 250/ 280mm Disc	Oversize 320mm Disc Kit	SMX Oversize 320mm Disc Kit	Relocating Bracket for 320mm Disc	FA, SFA, TT Pad or Brake Shoe	SFAC Carbon Scooter Pads	Speciality Pads - SXR / Vee / MXS	Sintered/ HH Pads/ Grooved Shoes	Standard Replacement Disc	Contour Disc Rear fitment	Vee Discs CONTOUR	CX Extreme MX Race Disc
1							FA063		FA063V	FA063HH	MD3008	MD3008C	VR3008	
2							FA063		FA063V	FA063HH	MD3064			
3							S605			S605G				
4							S620			S620G				
5							S620			S620G				
6							S605			S605G				
7							S606							
8							FA063		FA063V	FA063HH	MD3008	MD3008C	VR3008	
9							FA063		FA063V	FA063HH	MD3008	MD3008C	VR3008	
10														
11							FA174		FA174V	FA174HH	MD3060	MD3060C	VR3060	
12														
13							FA063		FA063V	FA063HH	MD3008	MD3008C	VR3008	
14							FA063		FA063V	FA063HH	MD3008	MD3008C	VR3008	
15														
16							FA174		FA174V	FA174HH	MD3060	MD3060C	VR3060	
17														
18							S626							
19							S606							
20	OS6254C	OSX6254	BRK023	SM6254C	SMX6254	BRK024	FA367TT		MXS367	FA367R		MD6255C♦		MD6255CX
21	OS6254C	OSX6254	BRK023	SM6254C	SMX6254	BRK024	FA367TT		MXS367	FA367R	MD6255D	MD6255C♦		MD6255CX
22	OS6254C	OSX6254	BRK023	SM6254C	SMX6254	BRK024	FA367TT		MXS367	FA367R		MD6255C♦		MD6255CX
23							FA367TT		MXS367	FA367R	MD6255D	MD6255C♦		MD6255CX
24							S606							
25														
26														
27							FA137TT			FA137R	MD6278D			
28														
29							S602			S602G				
30							S605			S605G				
31							S605			S605G				
32							FA063		FA063V	FA063HH	MD3002	MD3002C	VR3002	
33							FA063		FA063V	FA063HH	MD3002	MD3002C	VR3002	
34							FA063		FA063V	FA063HH	MD3002	MD3002C	VR3002	
35							S609							
36							S609							
37							S634							
38							FA063		FA063V	FA063HH	MD3064			
39							S602			S602G				
40							FA137TT			FA137R	MD6023D			
41							S634			S634G				
42														
43							FA317TT			FA317R	MD6196D			
44							FA372TT			FA372R	MD6196D			
45														
46														
47							S634			S634G				
48														
49							FA372TT			FA372R	MD6196D			
50							S609							
51							S609							
52							S611							
53							S611							
54							FA036		FA036V		MD3014RS ☼			
55							FA036		FA036V		MD3014RS ☼			
56							FA063		FA063V	FA063HH	MD3025			
57							S602			S602G				
58							FA157			FA157R	MD6077D			
59							S602			S602G				
60														

REAR / ARRIÈRE / HINTEN / POSTERIOR / POSTERIORE

BRAKE APPLICATIONS

R Suffix = High Durability Sintered Pad. HH Suffix = High Performance Sintered Pad. TT Suffix = Hard Wearing Off Road Pad. V Suffix = Semi Sintered Pad. G Suffix = Grooved Shoe. D Suffix = Drilled Disc. X Suffix = Universal Left or Right Disc. XC Suffix = Contoured Disc. LS Suffix = Left/Steel Disc. RS = Right/Steel Disc.

*-2 Sets Required. † For Vee disc colours add RED, BLU, GRN, GLD, ORG suffix to part number. For Custom Finish Options for Vee-Rotors™ including Splatter discs add suffix CHR, CHGR, CHBL, CHBR - available in various colours see page iv. ☼ - Also available as a Vintage Motorcycle Disc.



SUZUKI Contd.

GSF 600 S/T/V/W/X (Naked Bandit)	95-99
GSF 600 ST/SV/SW/SX (Faired Bandit)	96-99
GSF 600 Y/K1/K2/K3/K4 (Naked Bandit)	Left 00-04 Right
GSF 600 SY/K1/K2/K3/K4 (Faired Bandit)	Left 00-04 Right
GSR 600 K6/K7/K8	06-08
GSX 600 FJ (GN72A)	88
GSX 600 FK/FL/FM/FN/FP/FR/FS/FT/FV (GN72A)	89-97
GSX 600 FW/FX/FY/FK1/FK2	Left 98-02 Right
GSX 600 FK3/FK4/FK5/FK6	Left 03-04 Right
GSXR 600 V/W/X/Y (SRAD)	97-00
GSXR 600 K1/K2/K3/ZK3	01-03
GSXR 600 K4/K5	04-05
GSXR 600 K6/K7	06-07
GSXR 600 K8/K9/L0	08-10
GSXR 600 L1/L2/L3/L4/L5/L6/L7/L8 (Brembo Calipers)	11-1
RF 600 RP/RR/RS/RT/RV (GN76A)	93-97
VS 600 GLS/GLT/GLV	95-97
UV 620 FK5 Side x Side	05
AN 650 K3 Burgman (4 Bolt Fixing Front/Rear Discs)	03
AN 650 K4/K5/K6/K7/K8/K9/L0/L1/L2 Burgman/Skywave (Non ABS) (5 Bolt Fixing Front/Rear Discs)	04-11
AN 650 AK4/AK5/AK6/AK7/AK8/AK9/ALO/AL1/AL2 Burgman/Skywave (ABS) (5 Bolt F/R Discs)	04-12
AN 650 L3/L4/L5/L6 Burgman Non ABS	13-16
AN 650 ZL3/ZL4/ZL5/ZL6/ZL7/ZL8 Burgman ABS Executive	13-18
DL 650 K4/K5/K6 V-Strom	Left 04-06 Right
DL 650 XK7/XK8/XK9/XAO V-Strom X	Left 07-11 Right
DL 650 AK7/AK8/AK9/ALO V-Strom ABS	Left 07-11 Right
DL 650 AL1XP V-Strom Xpedition	Left 11 Right
DL 650 AK9GT V-Strom Traveller/ABS	Left 07-11 Right
DL 650 V-Strom ABS	Left 12-20 Right
DL 650 XTV-Strom ABS	Left 15-20 Right
DL 650 XT V-Strom Touring ABS	Left 18-20 Right
DR 650 RL/RM (SP41A)	90-91
DR 650 RSL/RSM (SP42A)	90-91
DR 650 RSEM/RSEN/RSEP (SP43A/B)	91-93
DR 650 RER/RES (SP45A/B)	94-95
DR 650 RUN/RN/RUP/RP (SP44A/B)	92-93
DR 650 SET/SEV (SP46A/B)	96-97
GR 650 D/XD Tempter	83
GS 650 GTX/GTZ/GTD/GX/GZ	81-83
GSF 650 K5/K6 (Naked Bandit - Non ABS)	Left 05-06 Right
GSF 650 SK5/SK6 (Faired Bandit - Non ABS)	Left 05-06 Right
GSF 650 AK5/AK6 (Naked Bandit - ABS)	Left 05-06 Right

DISC PAD CHOICES - FRONT

BRAKE DISC CHOICES - FRONT

FA, SFA, TT Pad or Brake Shoe	SFAC Carbon Scooter Pads	Speciality Pads - SXR / Vee / MXS	Sintered/HH Pads/ Grooved Shoes	Left / Gauche / Links Standard Replacement Disc	Right / Droite / Rechts Standard Replacement Disc	Contour Disc Universal left and right fitment	Custom Disc Universal left and right fitment	Vee-Discs Black † See note below	CX Extreme MX Race Disc/ UTVX Disc
FA142*		FA142V*	FA142HH*	MD3003X	MD3003X	MD3003XC*	MD3003CC*	VR3003BLK*†	
FA142*		FA142V*	FA142HH*	MD3003X	MD3003X	MD3003XC*	MD3003CC*	VR3003BLK*†	
FA229			FA229HH	MD3003X			MD3003CC	VR3003BLK*†	
FA231			FA231HH		MD3003X	MD3003XC	MD3003CC	VR3003BLK*†	
FA229			FA229HH	MD3003X			MD3003CC	VR3003BLK*†	
FA231			FA231HH		MD3003X	MD3003XC	MD3003CC	VR3003BLK*†	
FA158*			FA158HH*	MD3092X	MD3092X	MD3092XC*	MD3092CC	VR3003BLK*†	
FA146*			FA146HH*	MD3001	MD3001				
FA146*			FA146HH*	MD3003X	MD3003X	MD3003XC*	MD3003CC*	VR3003BLK*†	
FA229			FA229HH	MD3003X			MD3003CC	VR3003BLK*†	
FA231			FA231HH		MD3003X	MD3003XC	MD3003CC	VR3003BLK*†	
FA229			FA229HH	MD3090X			MD3090CC	VR3090BLK*†	
FA231			FA231HH		MD3090X	MD3090XC	MD3090CC	VR3090BLK*†	
FA158*			FA158HH*	MD3058X	MD3058X	MD3058XC*	MD3058CC*	VR3058BLK*†	
FA158*			FA158HH*	MD3058X	MD3058X	MD3058XC*	MD3058CC*	VR3058BLK*†	
			FA379HH*	MD3104X	MD3104X	MD3104XC*		VR3104BLK*†	
			FA379HH*	MD3091X	MD3091X	MD3091XC*	MD3091CC*	VR3091BLK*†	
			FA379HH*	MD3100X	MD3100X	MD3100XC*		VR3100BLK*†	
			FA447HH*	MD3100X	MD3100X	MD3100XC*		VR3100BLK*†	
FA142*		FA142V*	FA142HH*	MD3003X	MD3003X	MD3003XC*	MD3003CC*	VR3003BLK*†	
FA103		FA103V	FA103HH		MD3032RS				
K719*									
SFA142*	SFAC142*		SFA142HH*	MD987D	MD987D			VR987*	
SFA142*	SFAC142*		SFA142HH*	MD994D	MD994D			VR994*	
SFA142*	SFAC142*		SFA142HH*	MD994D	MD994D			VR994*	
SFA142*	SFAC142*		SFA142HH*	MD9144D	MD9144D			VR9144BLK*	
SFA142*	SFAC142*		SFA142HH*	MD9144D	MD9144D			VR9144BLK*	
FA229			FA229HH	MD3088X		MD3088XC	MD3088CC	VR3088BLK*†	
FA231			FA231HH		MD3088X	MD3088XC	MD3088CC	VR3088BLK*†	
FA229			FA229HH	MD3092X		MD3092XC	MD3092CC	VR3092BLK*†	
FA231			FA231HH		MD3092X	MD3092XC	MD3092CC	VR3092BLK*†	
FA229			FA229HH	MD3092X		MD3092XC	MD3092CC	VR3092BLK*†	
FA231			FA231HH		MD3092X	MD3092XC	MD3092CC	VR3092BLK*†	
FA229			FA229HH	MD3092X		MD3092XC	MD3092CC	VR3092BLK*†	
FA231			FA231HH		MD3092X	MD3092XC	MD3092CC	VR3092BLK*†	
FA229			FA229HH	MD3092X		MD3092XC	MD3092CC	VR3092BLK*†	
FA231			FA231HH		MD3092X	MD3092XC	MD3092CC	VR3092BLK*†	
FA229			FA229HH	MD3092X		MD3092XC	MD3092CC	VR3092BLK*†	
FA231			FA231HH		MD3092X	MD3092XC	MD3092CC	VR3092BLK*†	
FA229			FA229HH	MD3092X		MD3092XC	MD3092CC	VR3092BLK*†	
FA231			FA231HH		MD3092X	MD3092XC	MD3092CC	VR3092BLK*†	
FA147			FA147R	MD6076D					
FA147			FA147R	MD6076D					
FA147			FA147R	MD6078D					
FA147			FA147R	MD6078D					
FA147			FA147R	MD6078D					
FA185TT		MXS185	FA185R	MD6094D					MD6094CX
FA065		FA065V		MD3014LS					
FA065*		FA065V*		MD3014LS	MD3014RS				
FA229		FA229V	FA229HH	MD3090X		MD3090XC	MD3090CC	VR3090BLK*†	
FA231		FA231V	FA231HH		MD3090X	MD3090XC	MD3090CC	VR3090BLK*†	
FA229		FA229V	FA229HH	MD3090X		MD3090XC	MD3090CC	VR3090BLK*†	
FA231		FA231V	FA231HH		MD3090X	MD3090XC	MD3090CC	VR3090BLK*†	
FA229		FA229V	FA229HH	MD3101X		MD3101XC			
FA231		FA231V	FA231HH		MD3101X	MD3101XC			

Line #
1
2
3
4
5
6
7
8
9
10
11
12
13
14
15
16
17
18
19
20
21
22
23
24
25
26
27
28
29
30
31
32
33
34
35
36
37
38
39
40
41
42
43
44
45
46
47
48
49
50
51
52
53
54
55
56
57
58
59
60

R Suffix = High Durability Sintered Pad. HH Suffix = High Performance Sintered Pad. TT Suffix = Hard Wearing Off Road Pad. V Suffix = Semi-Sintered Pad. G Suffix = Grooved Shoe.
D Suffix = Drilled Disc. X Suffix = Universal Left or Right Disc. XC Suffix = Contoured Disc. LS Suffix = Left/Steel Disc. RS = Right/Steel Disc.

FRONT / AVANT / VORN / FRENTE / ANTERIORE

*-2 Sets Required. † For Vee disc colours add RED, BLU, GRN, GLD, ORG suffix to part number. For Custom Finish Options for Vee-Rotors™ including Splatter discs add suffix CHR, CHGR, CHBL, CHBR - available in various colours see page iv. Ⓢ - Also available as a Vintage Motorcycle Disc.

JAPANESE Built Motorcycles

Line #	BRAKE DISC CHOICES - FRONT						DISC PAD CHOICES - REAR				BRAKE DISC CHOICES - REAR			
	Oversize 250 /280mm Disc Kit	OSX Oversize 250/280mm Disc Kit	Relocating Bracket for 250/ 280mm Disc	Oversize 320mm Disc Kit	SMX Oversize 320mm Disc Kit	Relocating Bracket for 320mm Disc	FA, SFA, TT Pad or Brake Shoe	SFAC Carbon Scooter Pads	Speciality Pads - SXR / Vee / MXS	Sintered/ HH Pads/ Grooved Shoes	Standard Replacement Disc	Contour Disc Rear fitment	Vee Discs CONTOUR	CX Extreme MX Race Disc
1							FA063		FA063V	FA063HH	MD3008	MD3008C	VR3008	
2							FA063		FA063V	FA063HH	MD3008	MD3008C	VR3008	
3							FA063		FA063V	FA063HH	MD3008	MD3008C	VR3008	
4														
5							FA063		FA063V	FA063HH	MD3008	MD3008C	VR3008	
6														
7							FA419		FA419V	FA419HH	MD3093	MD3093C	VR3093	
8							FA063		FA063V	FA063HH	MD3002	MD3002C	VR3002	
9							FA063		FA063V	FA063HH	MD3002	MD3002C	VR3002	
10							FA063		FA063V	FA063HH	MD3008	MD3008C	VR3008	
11														
12							FA063		FA063V	FA063HH	MD3008	MD3008C	VR3008	
13														
14							FA063		FA063V	FA063HH	MD3060	MD3060C	VR3060	
15							FA063		FA063V	FA063HH	MD3060	MD3060C	VR3060	
16							FA254		FA254V	FA254HH	MD3060	MD3060C	VR3060	
17							FA419		FA419V	FA419HH	MD3060	MD3060C	VR3060	
18							FA419		FA419V	FA419HH	MD3060	MD3060C	VR3060	
19							FA436		FA436V	FA436HH	MD3060	MD3060C	VR3060	
20							FA063		FA063V	FA063HH	MD3008	MD3008C	VR3008	
21							S626							
22							K720*							
23							SFA412	SFAC412		SFA412HH	MD988D		VR988	
24														
25							SFA412	SFAC412		SFA412HH	MD998D		VR998	
26														
27							SFA412	SFAC412		SFA412HH	MD998D		VR998	
28							SFA412	SFAC412		SFA412HH	MD998D		VR998	
29														
30							SFA412	SFAC412		SFA412HH	MD998D		VR998	
31														
32							FA174			FA174HH	MD6232D			MD6232CX
33														
34							FA174			FA174HH	MD6232D			MD6232CX
35														
36							FA174			FA174HH	MD6232D			MD6232CX
37														
38							FA174			FA174HH	MD6232D			MD6232CX
39														
40							FA174			FA174HH	MD6232D			MD6232CX
41														
42							FA174			FA174HH	MD6232D			MD6232CX
43														
44							FA174			FA174HH	MD6232D			MD6232CX
45							FA174			FA174HH	MD6232D			MD6232CX
46														
47							FA157			FA157R	MD6077D			
48							FA157			FA157R	MD6077D			
49							FA157			FA157R	MD6077D			
50							FA157			FA157R	MD6077D			
51							FA157			FA157R	MD6077D			
52				SM6094C	SMX6094	BRK003	FA152TT		MXS152	FA152R	MD6095D			MD6059CX
53							S606							
54							FA036		FA036V		MD3027			
55														
56							FA254		FA254V	FA254HH	MD3008	MD3008C	VR3008	
57														
58							FA254		FA254V	FA254HH	MD3008	MD3008C	VR3008	
59														
60							FA174		FA174V	FA174HH	MD3093	MD3093C	VR3093	

REAR / ARRIÈRE / HINTEN / POSTERIOR / POSTERIORE

BRAKE APPLICATIONS

R Suffix = High Durability Sintered Pad. HH Suffix = High Performance Sintered Pad. TT Suffix = Hard Wearing Off Road Pad. V Suffix = Semi Sintered Pad. G Suffix = Grooved Shoe.
D Suffix = Drilled Disc. X Suffix = Universal Left or Right Disc. XC Suffix = Contoured Disc. LS Suffix = Left/Steel Disc. RS = Right/Steel Disc.

*-2 Sets Required. † For Vee disc colours add RED, BLU, GRN, GLD, ORG suffix to part number. For Custom Finish Options for Vee-Rotors™ including Splatter discs add suffix CHR, CHGR, CHBL, CHBR - available in various colours see page iv. ☼ - Also available as a Vintage Motorcycle Disc.

JAPANESE Built Motorcycles



SUZUKI Contd.



Model	Side	Year
GSF 650 SAK5/SAK6	Left	05-06
(Faired Bandit - ABS)	Right	
GSF 650 K7/K8/K9/L0/L1/L2 (Naked Bandit - Non ABS)		07-11
GSF 650 AK7/AK8/AK9/AL0/AL1/AL2 (Naked Bandit - ABS)		07-11
GSF 650 SK7/SK8/SK9/SLO/SL1/SL2		
(Faired Bandit - Non ABS)		07-11
GSF 650 SAK7/SAK8/SAK9/SAL0/SAL1/SAL2		
(Faired Bandit - ABS)		07-15
GSX 650 FK8/FK9/FLO/FL1/FL2 (Non ABS)		08-11
GSX 650 FAK8/FAK9/FAL0/FAL1/FAL2 (ABS)		08-15
XN 85 Turbo		83
LS 650 FG/PK/PM/PR/PG/PT/PV/PW/PX Savage NP41A		87-99
SFV 650 K9/L0/L1/L2/L3/L4/L5	Left	09-15
Gladius (Non ABS)	Right	
SFV 650 AK9/AL0/AL1/AL2/AL3/AL4	Left	09-15
/AL5 Gladius (ABS)	Right	
SV 650 X/Y/K1/K2 (Naked - Non ABS)	Left	99-02
	Right	
SV 650 SX/SY/SK1/SK2	Left	99-02
(Top Fairing - Non ABS)	Right	
SV 650 K3/K4/K5/K6/K7/K8/K9/L0	Left	03-10
(Naked - Non ABS)	Right	
SV 650 SK3/SK4/SK5/SK6/SK7/SK8	Left	03-15
/SK9/SLO (Top Fairing - Non ABS)	Right	
SV 650 AK7/AK8/AK9/AL0	Left	07-10
(Naked - ABS)	Right	
SV 650 SAK7/SAK8/SAK9/SAL0	Left	07-15
(Top Fairing - ABS)	Right	
SV 650 ABS	Left	16-18
	Right	
SV 650 ABS		19-20
SV 650 X ABS		18-20
XF 650 V/W/X/Y Freewind		97-02
GS 700 EF/ESF		85
LT-A 700 XK5/XCK6/XK6/XK7	Left	05-07
King Quad	Right	
LT-V 700 FK4/FK5 Twin Peaks	Left	04-05
	Right	
VS 700 GLEFG/GLEPG/GLEFH/GLEPH (Cast wheel 5 bolt)		86-87
VS 700 GLFG/GLPG (Spoke wheel 5 bolt)		86
VS 700 GLFH/GLPH (Spoke wheel 6 bolt)		87
DR 750 SJ (SR41A)		88
DR 750 SK (SR41A)		89
GT 750 J (4 Shoe type front brake)		72
GT 750 K/L/M/A/B		73-77
GS 750 B		77
GS 750 DB/DC/EC/EN		77-80
GSR 750 L1/L2/L3/L4/L5/L6 (Non ABS)	Left	11-16
	Right	
GSR 750 AL2/AL/AL4/AL5/AL6 (ABS)	Left	11-16
	Right	
GSX 750 ET/EX		80-81
GSX 750 ESD/EFE/ESG/ESE/ESH/EFF		82-86
GSX 750 S/SS (GS75X-106815-)		84
GSX 750 S-2/S-2C Katana (FS75X-114747-)		84
GSX 750 SE Katana (GR72A)		85
GSXR 750 F/G/H (GR75A)		85-87
GSXR 750 RG		86
GSXR 750 J/K/L/M/WN/WP		88-93
GSXR 750 WR/WS		94-95

FA, SFA, TT Pad or Brake Shoe	SFAC Carbon Scooter Pads	Speciality Pads - SXR / Vee / MXS	Sintered/HH Pads/ Grooved Shoes	DISC PAD CHOICES - FRONT				BRAKE DISC CHOICES - FRONT				Line #
				Left / Gauche / Links Standard Replacement Disc	Right / Droite / Rechts Standard Replacement Disc	Contour Disc Universal left and right fitment	Custom Disc Universal left and right fitment	Vee-Discs Black † See note below	CX Extreme MX Race Disc/ UTVX Disc			
FA229		FA229V	FA229HH	MD3101X		MD3101XC					1	
FA231		FA231V	FA231HH		MD3101X	MD3101XC					2	
FA158*			FA158HH*	MD3092X	MD3092X	MD3092XC*	MD3092CC*	VR3092BLK*†			3	
FA158*			FA158HH*	MD3092X	MD3092X	MD3092XC*	MD3092CC*	VR3092BLK*†			4	
											5	
FA158*			FA158HH*	MD3092X	MD3092X	MD3092XC*	MD3092CC*	VR3092BLK*†			6	
											7	
FA158*			FA158HH*	MD3092X	MD3092X	MD3092XC*	MD3092CC*	VR3092BLK*†			8	
FA158*			FA158HH*	MD3092X	MD3092X	MD3092XC*	MD3092CC*	VR3092BLK*†			9	
FA158*			FA158HH*	MD3092X	MD3092X	MD3092XC*	MD3092CC*	VR3092BLK*†			10	
FA065*		FA065V*		MD3028LS	MD3028RS						11	
FA106TT		FA106V		MD3017LS							12	
FA229		FA229V	FA229HH	MD3103X		MD3103XC					13	
FA231		FA231V	FA231HH		MD3103X	MD3103XC					14	
FA229		FA229V	FA229HH	MD3103X		MD3103XC					15	
FA231		FA231V	FA231HH		MD3103X	MD3103XC					16	
FA229		FA229V	FA229HH	MD3003X		MD3003XC	MD3003CC	VR3003BLK*†			17	
FA231		FA231V	FA231HH		MD3003X	MD3003XC	MD3003CC	VR3003BLK*†			18	
FA229		FA229V	FA229HH	MD3003X		MD3003XC	MD3003CC	VR3003BLK*†			19	
FA231		FA231V	FA231HH		MD3003X	MD3003XC	MD3003CC	VR3003BLK*†			20	
FA229		FA229V	FA229HH	MD3090X		MD3090XC	MD3090CC	VR3090BLK*†			21	
FA231		FA231V	FA231HH		MD3090X	MD3090XC	MD3090CC	VR3090BLK*†			22	
FA229		FA229V	FA229HH	MD3090X		MD3090XC	MD3090CC	VR3090BLK*†			23	
FA231		FA231V	FA231HH		MD3090X	MD3090XC	MD3090CC	VR3090BLK*†			24	
FA229		FA229V	FA229HH	MD3103X		MD3103XC					25	
FA231		FA231V	FA231HH		MD3103X	MD3103XC					26	
FA229		FA229V	FA229HH	MD3103X		MD3103XC					27	
FA231		FA231V	FA231HH		MD3103X	MD3103XC					28	
FA229		FA229V	FA229HH	MD3103X		MD3103XC					29	
FA231		FA231V	FA231HH		MD3103X	MD3103XC					30	
FA158*			FA158HH*	MD3103X	MD3103X	MD3103XC*					31	
FA158*			FA158HH*	MD3103X	MD3103X	MD3103XC*					32	
FA231		FA231V	FA231HH		MD6113D						33	
FA051*		FA051V*		MD3028LS	MD3028RS						34	
FA413TT			FA413R	MD6261D							35	
FA414TT			FA414R		MD6261D						36	
			FA342R	MD6188D							37	
			FA349R		MD6188D						38	
											39	
FA103		FA103V	FA103HH	MD3073LS							40	
FA103		FA103V	FA103HH	MD3031LS							41	
FA103		FA103V	FA103HH	MD3032LS							42	
FA147			FA147R	MD6076D							43	
FA147			FA147R	MD6076D							44	
											45	
FA055*				MD3019LS	MD3019RS						46	
FA035				MD3019LS							47	
FA035*				MD3014LS	MD3014RS						48	
FA229			FA229HH	MD3092X		MD3092XC	MD3092CC	VR3092BLK*†			49	
FA231			FA231HH		MD3092X	MD3092XC	MD3092CC	VR3092BLK*†			50	
FA229			FA229HH	MD3092X		MD3092XC	MD3092CC	VR3092BLK*†			51	
FA231			FA231HH		MD3092X	MD3092XC	MD3092CC	VR3092BLK*†			52	
FA051*		FA051V*		MD3014LS	MD3014RS						53	
FA051*		FA051V*		MD3028LS	MD3028RS						54	
FA065*		FA065V*		MD3028LS	MD3028RS						55	
FA065*		FA065V*		MD3028LS	MD3028RS						56	
FA063*		FA063V*	FA063HH*	MD3014LS	MD3014RS						57	
FA103*			FA103HH*	MD3005	MD3005						58	
FA145*			FA145HH*	MD3005	MD3005						59	
FA145*			FA145HH*	MD3007X	MD3007X	MD3007XC*		VR3007BLK*†			60	
FA188*			FA188HH*	MD3007X	MD3007X	MD3007XC*		VR3007BLK*†			60	

FRONT / AVANT / VORN / FRENTE / ANTERIORE

R Suffix = High Durability Sintered Pad. HH Suffix = High Performance Sintered Pad. TT Suffix = Hard Wearing Off Road Pad. V Suffix = Semi-Sintered Pad. G Suffix = Grooved Shoe.

D Suffix = Drilled Disc. X Suffix = Universal Left or Right Disc. XC Suffix = Contoured Disc. LS Suffix = Left/Steel Disc. RS = Right/Steel Disc.

*-2 Sets Required. † For Vee disc colours add RED, BLU, GRN, GLD, ORG suffix to part number. For Custom Finish Options for Vee-Rotors™ including Splatter discs add suffix CHR, CHGR, CHBL, CHBR - available in various colours see page iv. Ⓢ - Also available as a Vintage Motorcycle Disc.

JAPANESE Built Motorcycles

Line #	BRAKE DISC CHOICES - FRONT						DISC PAD CHOICES - REAR				BRAKE DISC CHOICES - REAR			
	Oversize 250 /280mm Disc Kit	OSX Oversize 250/280mm Disc Kit	Relocating Bracket for 250/ 280mm Disc	Oversize 320mm Disc Kit	SMX Oversize 320mm Disc Kit	Relocating Bracket for 320mm Disc	FA, SFA, TT Pad or Brake Shoe	SFAC Carbon Scooter Pads	Speciality Pads - SXR / Vee / MXS	Sintered/ HH Pads/ Grooved Shoes	Standard Replacement Disc	Contour Disc Rear fitment	Vee Discs CONTOUR	CX Extreme MX Race Disc
1														
2							FA174		FA174V	FA174HH	MD3093	MD3093C	VR3093	
3							FA174		FA174V	FA174HH	MD3093	MD3093C	VR3093	
4							FA174		FA174V	FA174HH	MD3093	MD3093C	VR3093	
5														
6							FA174		FA174V	FA174HH	MD3093	MD3093C	VR3093	
7														
8							FA174		FA174V	FA174HH	MD3093	MD3093C	VR3093	
9							FA174		FA174V	FA174HH	MD3093	MD3093C	VR3093	
10							FA174		FA174V	FA174HH	MD3093	MD3093C	VR3093	
11							FA036		FA036V		MD3014RS			
12							S606							
13														
14							FA496		FA496V	FA496HH	MD3093	MD3093C		
15														
16							FA496		FA496V	FA496HH	MD3093	MD3093C		
17														
18							FA063		FA063V	FA063HH	MD3008	MD3008C	VR3008	
19														
20							FA063		FA063V	FA063HH	MD3008	MD3008C	VR3008	
21														
22							FA174		FA174V	FA174HH	MD3060	MD3060C	VR3060	
23														
24							FA174		FA174V	FA174HH	MD3060	MD3060C	VR3060	
25														
26							FA174		FA174V	FA174HH	MD3093	MD3093C		
27														
28							FA174		FA174V	FA174HH	MD3093	MD3093C		
29														
30							FA496			FA496HH	MD3093	MD3093C		
31							FA496			FA496HH	MD3093	MD3093C		
32							FA496			FA496HH	MD3093	MD3093C		
33							FA140		FA140V	FA140HH	MD6095D			
34							FA036		FA036V		MD3029			
35														
36														
37														
38														
39														
40							S626							
41							S626							
42							S606							
43							FA157			FA157R	MD6077D			
44							S634							
45							S634							
46							FA036		FA036V		MD3014RS			
47							FA036		FA036V		MD3014RS			
48														
49							FA174		FA174V	FA174HH	MD3093	MD3093C	VR3093	
50														
51							FA174		FA174V	FA174HH	MD3093	MD3093C	VR3093	
52							FA036		FA036V		MD3014RS			
53							FA036		FA036V		MD3029			
54							FA036		FA036V		MD3014RS			
55							FA036		FA036V		MD3014RS			
56							FA036		FA036V		MD3029			
57							FA063		FA063V	FA063HH	MD3009			
58							FA063		FA063V	FA063HH	MD3009			
59							FA063		FA063V	FA063HH	MD3008	MD3008C	VR3008	
60							FA063		FA063V	FA063HH	MD3008	MD3008C	VR3008	

REAR / ARRIÈRE / HINTEN / POSTERIOR / POSTERIORE

BRAKE APPLICATIONS

R Suffix = High Durability Sintered Pad. HH Suffix = High Performance Sintered Pad. TT Suffix = Hard Wearing Off Road Pad. V Suffix = Semi Sintered Pad. G Suffix = Grooved Shoe.
D Suffix = Drilled Disc. X Suffix = Universal Left or Right Disc. XC Suffix = Left/Steel Disc. RS = Right/Steel Disc.

*-2 Sets Required. † For Vee disc colours add RED, BLU, GRN, GLD, ORG suffix to part number. For Custom Finish Options for Vee-Rotors™ including Splatter discs add suffix CHR, CHGR, CHBL, CHBR - available in various colours see page iv. Ⓢ - Also available as a Vintage Motorcycle Disc.



JAPANESE Built Motorcycles

SUZUKI Contd.



GSXR 750 T/V/W/X (SRAD)	96-99
GSXR 750 Y/K1/K2/K3	00-03
GSXR 750 K4/K5	04-05
GSXR 750 K6/K7	06-07
GSXR 750 K8/K9/L0	08-10
GSXR 750 ABS (Brembo Caliper)	11-20
GSX-S 750 ABS	17-20
GSX-S 750 Y	18-20
GSX-S 750 Z	18-20
GSX-S 750 ZL	18-20
GSX 750 W/X/Y/K1	Left 98-03
	Right
GSX 750 FK/FL/FM/FN/FP/FR/FS/FT/FV (GR78A)	89-97
GSX 750 FW/FX/FY/FK1/FK2	Left 98-02
	Right
GSX 750 FK3/FK4/FK5/FK6	Left 03-06
	Right
LT-A 750 XK8/XZK8/XK9/XZK9/XL0	Left 08-10
King Quad	Right
LT-A 750 XPK9/XPZK9/XPLO	Left 10-15
/XPL1-XPL5 (Power Steering)	Right
VS 750 GLF/GLFG/GLPG Intruder	
(Spoke Wheel 5 bolt) (VR51A)	85-90
VS 750 GLFH/GLPH Intruder (Spoke Wheel 6 bolt) (VR51A)	87
VS 750 GLEFH/GLEPH Intruder (Cast Wheel 5 bolt) (VR51A)	87
VS 750 GLPK/GLPL/GLPM Intruder	
(Spoke Wheel 6 bolt) (VR51A)	88-91
DR 800 SL (SR43A)	90
DR 800 SM/SN/SP/SR/SS (SR43B)	91-95
DR 800 ST/SV (SR43B)	96-97
VL 800 K1/K2/K3/K4/K5 Intruder Volusia	01-05
C 800 Intruder - Spoke Wheels	
(VL 800 K6/K7/K8/K9/L0/L1/L2/L3/L5)	05-15
C 800 C Intruder - Cast Wheels	
(VL 800 CK7/CK8/CK9/CL0/CL1/CL2/CL3)	07-13
VS 800 GLN/GLP/GLR/GLS/GLT/GLV/GLW/GLX Intruder	
(VS52A)	92-99
VX 800 L/M/N/P/R	90-95
VX 800 T	96
VZ 800 V/W/X/Y/K1/K2 Marauder	97-03
M 800 (VZ 800 K5-K9/L0/L1/L3 Intruder M800)	05-13
M 800 Z (VZ 800 K9Z M800 Intruder)	09-10
M 800/T (VZ 800 L4/L5 M800/T Intruder)	14-15
GS 850 GN/GT/GX	79-81
GS 850 GZ/GE/GG	82-85
DL 900 Migrator	14-17
RF 900 RR/RS/RS2	94-95
RF 900 RT/RV/RW	96-99
DL 1000 K2-K9/L0 V-Strom	Left 02-10
	Right
DL 1000 V-Strom (ABS)	14-20
DL 1000XT V-Strom (ABS)	18-20
GS 1000 HC/EC/EN/SN	78-80
GS 1000 ET	81
GS 1000 GT/GX	81-82
GSX 1000 SZ Katana	82
GSX 1000 Katana	19-20
GSXR 1000 K1/K2	01-02
GSXR 1000 K3	03
GSXR 1000 K4	04

DISC PAD CHOICES - FRONT				BRAKE DISC CHOICES - FRONT					
FA, SFA, TT Pad or Brake Shoe	SFAC Carbon Scooter Pads	Speciality Pads - SXR / Vee / MXS	Sintered/HH Pads/ Grooved Shoes	Left / Gauche / Links Standard Replacement Disc	Right / Droite / Rechts Standard Replacement Disc	Contour Disc Universal left and right fitment	Custom Disc Universal left and right fitment	Vee-Discs Black † See note below	CX Extreme MX Race Disc/ UTVX Disc
FA188*			FA188HH*	MD3058X	MD3058X	MD3058XC*	MD3058CC*	VR3058BLK*†	
FA158*			FA158HH*	MD3058X	MD3058X	MD3058XC*	MD3058CC*	VR3058BLK*†	
			FA379HH*	MD3104X	MD3104X	MD3104XC*		VR3104BLK*†	
			FA379HH*	MD3091X	MD3091X	MD3091XC*	MD3091CC*	VR3091BLK*†	
			FA379HH*	MD3100X	MD3100X	MD3100XC*		VR3100BLK*†	
			FA447HH*	MD3100X	MD3100X	MD3100XC*		VR3100BLK*†	
			FA347HH*	MD3100X	MD3100X	MD3100XC*		VR3100BLK*†	
			FA347HH*	MD3100X	MD3100X	MD3100XC*		VR3100BLK*†	
			FA347HH*	MD3100X	MD3100X	MD3100XC*		VR3100BLK*†	
			FA347HH*	MD3100X	MD3100X	MD3100XC*		VR3100BLK*†	
FA229			FA229HH	MD3045					
FA231			FA231HH		MD3045				
FA146*		FA146V*	FA146HH*	MD3003X	MD3003X	MD3003XC*	MD3003CC*	VR3003BLK*†	
FA229			FA229HH	MD3003X		MD3003CC*	MD3003CC	VR3003BLK*†	
FA231			FA231HH		MD3003X	MD3003CC*	MD3003CC	VR3003BLK*†	
FA229			FA229HH	MD3090X		MD3090CC*	MD3090CC	VR3090BLK*†	
FA231			FA231HH		MD3090X	MD3090CC*	MD3090CC	VR3090BLK*†	
FA413TT			FA413R	MD6261D					
FA414TT			FA414R		MD6261D				
FA413TT			FA413R	MD6355D					
FA414TT			FA414R		MD6355D				
FA103		FA103V	FA103HH	MD3031LS					
FA103		FA103V	FA103HH	MD3032LS					
FA103		FA103V	FA103HH	MD3073LS					
FA103		FA103V	FA103HH			MD3032RS			
FA147			FA147R	MD6076D					
FA129			FA129R	MD6113D					
FA229		FA229V	FA229HH	MD6113D					
FA231		FA231V	FA231HH			MD3095RS			
FA231		FA231V	FA231HH			MD3095RS			
FA231		FA231V	FA231HH			MD3095RS			
FA103		FA103V	FA103HH			MD3032RS			
FA129		FA129V	FA129HH	MD3033LS					
FA229		FA229V	FA229HH	MD3033LS					
FA231		FA231V	FA231HH			MD3045			
FA231		FA231V	FA231HH			MD3096RS			
FA231		FA231V	FA231HH			MD3096RS			
FA231		FA231V	FA231HH			MD3096RS			
FA038*		FA038V*		MD3014LS	MD3014RS				
FA051*		FA051V*		MD3014LS	MD3014RS				
FA229			FA229HH	MD3014LS		MD3014C			
FA145*			FA145HH*	MD3006X	MD3006X	MD3006XC*	MD3006CC*	VR3006BLK*†	
FA145*			FA145HH*	MD3006X	MD3006X	MD3006XC*	MD3006CC*	VR3006BLK*†	
FA229		FA229V	FA229HH	MD3088X		MD3088XC*	MD3088CC	VR3088BLK*†	
FA231		FA231V	FA231HH			MD3088XC*	MD3088CC	VR3088BLK*†	
			FA379HH*						
			FA379HH*						
FA038*		FA038V*		MD3014LS	MD3014RS				
FA065*				MD3014LS	MD3014RS				
FA051*				MD3014LS	MD3014RS				
FA065*				MD3014LS	MD3014RS				
			FA447HH*	MD3109X	MD3109X	MD3109XC*		VR3109BLK*†	
FA188*			FA188HH*	MD3058X	MD3058X	MD3058XC*	MD3058CC*	VR3058BLK*†	
			FA369/4HH*	MD3089X	MD3089X	MD3089XC*	MD3089CC*	VR3089BLK*†	
			FA379HH*	MD3104X	MD3104X	MD3104XC*		VR3104BLK*†	

Line #

1

2

3

4

5

6

7

8

9

10

11

12

13

14

15

16

17

18

19

20

21

22

23

24

25

26

27

28

29

30

31

32

33

34

35

36

37

38

39

40

41

42

43

44

45

46

47

48

49

50

51

52

53

54

55

56

57

58

59

60

R Suffix = High Durability Sintered Pad. HH Suffix = High Performance Sintered Pad. TT Suffix = Hard Wearing Off Road Pad. V Suffix = Semi Sintered Pad. G Suffix = Grooved Shoe.

D Suffix = Drilled Disc. X Suffix = Universal Left or Right Disc. XC Suffix = Contoured Disc. LS Suffix = Left/Steel Disc. RS = Right/Steel Disc.

*-2 Sets Required. † For Vee disc colours add RED, BLU, GRN, GLD, ORG suffix to part number. For Custom Finish Options for Vee-Rotors™ including Splatter discs add suffix CHR, CHGR, CHBL, CHBR - available in various colours see page iv. ☼ - Also available as a Vintage Motorcycle Disc.

JAPANESE Built Motorcycles

Line #	BRAKE DISC CHOICES - FRONT						DISC PAD CHOICES - REAR				BRAKE DISC CHOICES - REAR			
	Oversize 250 /280mm Disc Kit	OSX Oversize 250/280mm Disc Kit	Relocating Bracket for 250/ 280mm Disc	Oversize 320mm Disc Kit	SMX Oversize 320mm Disc Kit	Relocating Bracket for 320mm Disc	FA, SFA, TT Pad or Brake Shoe	SFAC Carbon Scooter Pads	Speciality Pads - SXR / Vee / MXS	Sintered/ HH Pads/ Grooved Shoes	Standard Replacement Disc	Contour Disc Rear fitment	Vee Discs CONTOUR	CX Extreme MX Race Disc
1							FA063		FA063V	FA063HH	MD3060	MD3060C	VR3060	
2							FA063		FA063V	FA063HH	MD3060	MD3060C	VR3060	
3							FA254		FA254V	FA254HH	MD3060	MD3060C	VR3060	
4							FA419		FA419V	FA419HH	MD3060	MD3060C	VR3060	
5							FA419		FA419V	FA419HH	MD3060	MD3060C	VR3060	
6							FA436		FA436V	FA436HH	MD3060	MD3060C	VR3060	
7							FA174		FA174V	FA174HH	MD3060	MD3060C	VR3060	
8							FA174		FA174V	FA174HH	MD3060	MD3060C	VR3060	
9							FA174		FA174V	FA174HH	MD3060	MD3060C	VR3060	
10							FA174		FA174V	FA174HH	MD3060	MD3060C	VR3060	
11							FA063		FA063V	FA063HH	MD3008	MD3008C		
12														
13							FA063		FA063V	FA063HH	MD3002	MD3002C	VR3002	
14							FA063		FA063V	FA063HH	MD3008	MD3008C	VR3008	
15														
16							FA063		FA063V	FA063HH	MD3008	MD3008C	VR3008	
17														
18														
19														
20														
21														
22														
23							S626							
24							S626							
25							S626							
26														
27							S626							
28							FA157			FA157R	MD6077D			
29							FA165/2TT			FA165/2R	MD6077D			
30							FA165/2TT			FA165/2R	MD6077D			
31							S626							
32														
33							S626							
34														
35							S626							
36														
37							S626							
38							FA146		FA146V	FA146HH	MD3061			
39							FA146		FA146V	FA146HH	MD3061			
40							S626							
41							S626							
42							S626							
43							S626							
44							FA036		FA036V		MD3014RS ☼			
45							FA036		FA036V		MD3027			
46							FA174			FA174HH	MD6232D			
47							FA222				MD3008	MD3008C	VR3008	
48							FA063		FA063V	FA063HH	MD3008	MD3008C	VR3008	
49											MD6232D			MD6232CX
50							FA174		FA174V	FA174HH				
51							FA419		FA419V	FA419HH	MD6232D			MD6232CX
52							FA419		FA419V	FA419HH	MD6232D			MD6232CX
53							FA036		FA036V		MD3014RS ☼			
54							FA036		FA036V		MD3014RS ☼			
55							FA036		FA036V		MD3014RS ☼			
56							FA036		FA036V		MD3014RS ☼			
57							FA174			FA174HH	MD3108	MD3108C	VR3108	
58							FA254			FA254HH	MD3060	MD3060C	VR3060	
59							FA254			FA254HH	MD3060	MD3060C	VR3060	
60							FA254			FA254HH	MD3060	MD3060C	VR3060	

REAR / ARRIÈRE / HINTEN / POSTERIOR / POSTERIORE

*-2 Sets Required. † For Vee disc colours add RED, BLU, GRN, GLD, ORG suffix to part number. For Custom Finish Options for Vee-Rotors™ including Splatter discs add suffix CHR, CHGR, CHBL, CHBR - available in various colours see page iv. ☼ - Also available as a Vintage Motorcycle Disc.

R Suffix = High Durability Sintered Pad. HH Suffix = High Performance Sintered Pad. TT Suffix = Hard Wearing Off Road Pad. V Suffix = Semi Sintered Pad. G Suffix = Grooved Shoe.
D Suffix = Drilled Disc. X Suffix = Universal Left or Right Disc. XC Suffix = Contoured Disc. LS Suffix = Left/Steel Disc. RS = Right/Steel Disc.

JAPANESE Built Motorcycles



SUZUKI Contd.

GSXR 1000 K5/K6	05-06
GSXR 1000 K7/K8	07-08
GSXR 1000 K9/L0/L1	09-11
GSXR 1000 L2/L3/ZL3/L4/ZL4/L5/L6/L7 (Brembo Caliper)	12-17
GSXR 1000 AL5/AL6	
(Brembo Caliper/310mm Disc ABS)	15-16
GSXR 1000 A (Brembo Caliper/320mm Disc ABS)	17-20
GSXR 1000 R (Brembo Caliper/320mm Disc ABS)	17-20
GSX-S 1000 L	16-20
GSX-S 1000 A ABS	16-20
GSX-S 1000 F	16-20
GSX-S 1000 F ABS	16-20
SV 1000 K3/K4/K5/K6/K7 (Naked)	03-07
SV 1000 SK3/SK4/SK5/SK6/SK7 (Faired)	03-07
TL 1000 SV/SW/SX/SY/SK1	97-01
TL 1000 RW/RX/RV/RK1	98-02
GSX 1100 ET/EX/EZ	80-82
GSX 1100 ESD	83
GSX 1100 SZ/SD Katana	82-83
GS 1100 GZ	82
GSX 1100 EFE/EFF/ESE	84-86
GSX 1100 FJ/FK/FL/FM/FN/FP/FR (GV72A)	88-94
GSXR 1100 G/H/J (GV74B)	86-88
GSXR 1100 K/L/M/N (GV73B)	89-92
GSXR 1100 WP/WR/WS/WT (GU75A)	93-96
GSX 1100 GM/GN/GR	91-96
GS 1200 SSK1/ZK1 (GV78A)	01
GSF 1200 T/V/W/X/Y (Naked Bandit - 4 Piston Caliper)	96-00
GSF 1200 ST/SV/SW/SX/SY	
(Faired Bandit - 4 Piston Caliper)	96-00
GSF 1200 SAV (Faired Bandit - ABS Model - 4 Piston Caliper)	97
GSF 1200 K1/K2/K3/K4/K5	
(Naked Bandit - 6 Piston Caliper)	01-05
GSF 1200 S SK1/SK2/SK3/SK4/SK5	
(Faired Bandit - 6 Piston Caliper)	01-05
GSF 1200 K6/AK6 (Naked Bandit /Non & ABS Models/4 Piston Caliper)	06
GSF 1200 SK6/SAK6 (Faired Bandit /Non & ABS Models/4 Piston Caliper)	06
GSX 1200 FSW/FSX Inazuma	98-99
GV 1200 GLF/GLF2/GLG Madura	85-86
GSF 1250 K7/K8/K9/OLO (Naked Bandit - Non ABS - 4 Piston Caliper)	07-11
GSF 1250 AK7/AK8 (Naked Bandit - ABS Model - 4 Piston Caliper)	07-10
GSF 1250 SK7/SK8/SK9/SLO	
(Faired Bandit - ABS Model - 4 Piston Caliper)	07-10
GSF 1250 SAK7/SAK8/SAK9/SAZK9/SALO/SAL1 /SAL2/SAL4/SAL5/SAL6	
(Faired Bandit - ABS Model - 4 Piston Caliper)	07-16
GSX 1250 FAL0/FAL1/FAL2/FAL4/FAL5/FAL6	10-16
GSX 1250 FAL0ST/FAL1ST Sports Touring	10-14
GSX 1300 RX/RV/RK1/RK2/RK3/RZK3/RK4	
/RK5/K6/K7 Hayabusa	99-07
GSX 1300 RK8/RK9/RL0/RL1/RL2 Hayabusa	08-12
GSX 1300 Hayabusa (Brembo Calipers)	13-20
GSX 1300 BKK8/BKK9/BKL0/BKL1 B-King	08-12
GSX 1400 K1/K2/K3/K4/K5/K6/K7/FE	01-07
GV 1400 GDG/GTG Cavalcade (Up to F/No 103764)	86

FA, SFA, TT Pad or Brake Shoe	SFAC Carbon Scooter Pads	Speciality Pads - SXR / Vee / MXS	Sintered/HH Pads/ Grooved Shoes	DISC PAD CHOICES - FRONT				BRAKE DISC CHOICES - FRONT				Line #
				Left / Gauche / Links Standard Replacement Disc	Right / Droite / Rechts Standard Replacement Disc	Contour Disc Universal left and right fitment	Custom Disc Universal left and right fitment	Vee-Discs Black † See note below	CX Extreme MX Race Disc/ UTVX Disc			
			FA379HH*	MD3091X	MD3091X	MD3091XC*	MD3091CC*	VR3091BLK*†			1	
			FA379HH*	MD3091X	MD3091X	MD3091XC*	MD3091CC*	VR3091BLK*†			2	
			FA379HH*	MD3102X	MD3102X	MD3102XC*		VR3102BLK*†			3	
			FA447HH*	MD3102X	MD3102X	MD3102XC*		VR3102BLK*†			4	
											5	
			FA447HH*	MD3102X	MD3102X	MD3102XC*		VR3102BLK*†			6	
			FA447HH*	MD3107X	MD3107X	MD3107XC*		VR3107BLK*†			7	
			FA447HH*	MD3107X	MD3107X	MD3107XC*		VR3107BLK*†			8	
			FA447HH*	MD3109X	MD3109X	MD3109XC*		VR3109BLK*†			9	
			FA447HH*	MD3109X	MD3109X	MD3109XC*		VR3109BLK*†			10	
			FA447HH*	MD3109X	MD3109X	MD3109XC*		VR3109BLK*†			11	
			FA447HH*	MD3109X	MD3109X	MD3109XC*		VR3109BLK*†			12	
FA158*			FA158HH*	MD3088X	MD3088X	MD3088XC*	MD3088CC*	VR3088BLK*†			13	
FA158*			FA158HH*	MD3088X	MD3088X	MD3088XC*	MD3088CC*	VR3088BLK*†			14	
FA158*			FA158HH*	MD3058X	MD3058X	MD3058XC*	MD3058CC*	VR3058BLK*†			15	
FA188*			FA188HH*	MD3058X	MD3058X	MD3058XC*	MD3058CC*	VR3058BLK*†			16	
FA065*				MD3014LS	MD3014RS						17	
FA065*				MD3014LS	MD3014RS						18	
FA065*				MD3014LS	MD3014RS						19	
FA051*				MD3014LS	MD3014RS						20	
FA103*			FA103HH*	MD3039LS	MD3039RS						21	
FA146*			FA146HH*	MD3039LS	MD3039RS						22	
FA103*			FA103HH*	MD3004	MD3004						23	
FA145*			FA145HH*	MD3007X	MD3007X	MD3007XC*		VR3007BLK*†			24	
FA188*			FA188HH*	MD3007X	MD3007X	MD3007XC*		VR3007BLK*†			25	
FA129*			FA129HH*	MD3037LS	MD3037RS						26	
FA188*			FA188HH*	MD3006X	MD3006X	MD3006XC*	MD3006CC*	VR3006BLK*†			27	
FA145*			FA145HH*	MD3006X	MD3006X	MD3006XC*	MD3006CC*	VR3006BLK*†			28	
											29	
FA145*			FA145HH*	MD3006X	MD3006X	MD3006XC*	MD3006CC*	VR3006BLK*†			30	
											31	
FA145*			FA145HH*	MD3075LS	MD3075RS						32	
											33	
FA188*			FA188HH*	MD3006X	MD3006X	MD3006XC*	MD3006CC*	VR3006BLK*†			34	
											35	
FA188*			FA188HH*	MD3006X	MD3006X	MD3006XC*	MD3006CC*	VR3006BLK*†			36	
											37	
FA158*			FA158HH*	MD3092X	MD3092X	MD3092XC*	MD3092CC*	VR3092BLK*†			38	
											39	
FA158*			FA158HH*	MD3092X	MD3092X	MD3092XC*	MD3092CC*	VR3092BLK*†			40	
FA244*			FA244HH*	MD3006X	MD3006X	MD3006XC*	MD3006CC*	VR3006BLK*†			41	
FA051*		FA051V*		MD3030LS	MD3030RS						42	
											43	
FA158*			FA158HH*	MD3092X	MD3092X	MD3092XC*	MD3092CC*	VR3092BLK*†			44	
											45	
FA158*			FA158HH*	MD3092X	MD3092X	MD3092XC*	MD3092CC*	VR3092BLK*†			46	
											47	
FA158*			FA158HH*	MD3092X	MD3092X	MD3092XC*	MD3092CC*	VR3092BLK*†			48	
											49	
											50	
FA158*			FA158HH*	MD3092X	MD3092X	MD3092XC*	MD3092CC*	VR3092BLK*†			51	
FA158*			FA158HH*	MD3092X	MD3092X	MD3092XC*	MD3092CC*	VR3092BLK*†			52	
FA158*			FA158HH*	MD3092X	MD3092X	MD3092XC*	MD3092CC*	VR3092BLK*†			53	
											54	
FA188*			FA188HH*	MD3058X	MD3058X	MD3058XC*	MD3058CC*	VR3058BLK*†			55	
											56	
GSX 1300 RK8/RK9/RL0/RL1/RL2 Hayabusa			FA379HH*	MD3098X	MD3098X	MD3098XC*	MD3098CC*	VR3098BLK*†			56	
GSX 1300 Hayabusa (Brembo Calipers)			FA447HH*	MD3098X	MD3098X	MD3098XC*	MD3098CC*	VR3098BLK*†			57	
GSX 1300 BKK8/BKK9/BKL0/BKL1 B-King			FA347HH*	MD3098X	MD3098X	MD3098XC*	MD3098CC*	VR3098BLK*†			58	
GSX 1400 K1/K2/K3/K4/K5/K6/K7/FE			FA188*	MD3058X	MD3058X	MD3058XC*	MD3058CC*	VR3058BLK*†			59	
GV 1400 GDG/GTG Cavalcade (Up to F/No 103764)			FA103*	FA103V*	FA103HH*	MD3042	MD3042				60	

FRONT / AVANT / VORN / FRENTE / ANTERIORE

R Suffix = High Durability Sintered Pad. HH Suffix = High Performance Sintered Pad. TT Suffix = Hard Wearing Off Road Pad. V Suffix = Semi-Sintered Pad. G Suffix = Grooved Shoe.

D Suffix = Drilled Disc. X Suffix = Universal Left or Right Disc. XC Suffix = Contoured Disc. LS Suffix = Left/Steel Disc. RS = Right/Steel Disc.

*-2 Sets Required. † For Vee disc colours add RED, BLU, GRN, GLD, ORG suffix to part number. For Custom Finish Options for Vee-Rotors™ including Splatter discs add suffix CHR, CHGR, CHBL, CHBR - available in various colours see page iv. ☼ - Also available as a Vintage Motorcycle Disc.

JAPANESE Built Motorcycles

Line #	BRAKE DISC CHOICES - FRONT						DISC PAD CHOICES - REAR				BRAKE DISC CHOICES - REAR			
	Oversize 250 /280mm Disc Kit	OSX Oversize 250/280mm Disc Kit	Relocating Bracket for 250/ 280mm Disc	Oversize 320mm Disc Kit	SMX Oversize 320mm Disc Kit	Relocating Bracket for 320mm Disc	FA, SFA, TT Pad or Brake Shoe	SFAC Carbon Scooter Pads	Speciality Pads - SXR / Vee / MXS	Sintered/ HH Pads/ Grooved Shoes	Standard Replacement Disc	Contour Disc Rear fitment	Vee Discs CONTOUR	CX Extreme MX Race Disc
1							FA254			FA254HH	MD3060	MD3060C	VR3060	
2							FA419			FA419HH	MD3060	MD3060C	VR3060	
3							FA436			FA436HH	MD3060	MD3060C	VR3060	
4							FA436			FA436HH	MD3060	MD3060C	VR3060	
5														
6							FA436			FA436HH	MD3106	MD3106C	VR3106	
7							FA436			FA436HH	MD3106	MD3106C	VR3106	
8							FA436			FA436HH	MD3106	MD3106C	VR3106	
9							FA174			FA174HH	MD3108	MD3108C	VR3108	
10							FA174			FA174HH	MD3108	MD3108C	VR3108	
11							FA174			FA174HH	MD3108	MD3108C	VR3108	
12							FA174			FA174HH	MD3108	MD3108C	VR3108	
13							FA174			FA174HH	MD3060	MD3060C	VR3060	
14							FA174			FA174HH	MD3060	MD3060C	VR3060	
15							FA063			FA063HH	MD3060	MD3060C	VR3060	
16							FA063			FA063HH	MD3060	MD3060C	VR3060	
17							FA036		FA036V		MD3014RS Ⓞ			
18							FA036		FA036V		MD3014RS Ⓞ			
19							FA036		FA036V		MD3014RS Ⓞ			
20							FA036		FA036V		MD3027			
21							FA103		FA103V	FA103HH	MD3039			
22							FA103		FA103V	FA103HH	MD3036			
23							FA063		FA063V	FA063HH	MD3009			
24							FA063		FA063V	FA063HH	MD3008	MD3008C	VR3008	
25							FA063		FA063V	FA063HH	MD3008	MD3008C	VR3008	
26							FA146		FA146V	FA146HH	MD3038			
27							FA254		FA254V	FA254HH	MD3008	MD3008C	VR3008	
28							FA063		FA063V	FA063HH	MD3008	MD3008C	VR3008	
29														
30							FA063		FA063V	FA063HH	MD3008	MD3008C		
31														
32							FA063		FA063V	FA063HH	MD3076			
33														
34							FA063		FA063V	FA063HH	MD3008	MD3008C	VR3008	
35														
36							FA063		FA063V	FA063HH	MD3008	MD3008C	VR3008	
37														
38							FA174		FA174V	FA174HH	MD3093	MD3093C	VR3093	
39														
40							FA174		FA174V	FA174HH	MD3093	MD3093C	VR3093	
41							FA063		FA063V	FA063HH	MD3008	MD3008C	VR3008	
42							FA036		FA036V		MD3041			
43														
44							FA174		FA174V	FA174HH	MD3093	MD3093C	VR3093	
45														
46							FA174		FA174V	FA174HH	MD3093	MD3093C	VR3093	
47														
48							FA174		FA174V	FA174HH	MD3093	MD3093C	VR3093	
49														
50														
51							FA174		FA174V	FA174HH	MD3093	MD3093C	VR3093	
52							FA174		FA174V	FA174HH	MD3093	MD3093C	VR3093	
53							FA174		FA174V	FA174HH	MD3093	MD3093C	VR3093	
54														
55							FA063		FA063V	FA063HH	MD3008	MD3008C	VR3008	
56							FA419		FA419V	FA419HH	MD3099	MD3099C	VR3099	
57							FA419		FA419V	FA419HH	MD3099	MD3099C	VR3099	
58							FA419		FA419V	FA419HH	MD3099	MD3099C	VR3099	
59							FA254		FA254V	FA254HH	MD3083	MD3083C		
60							FA103		FA103V	FA103HH	MD3043			

REAR / ARRIÈRE / HINTEN / POSTERIOR / POSTERIORE

*-2 Sets Required. † For Vee disc colours add RED, BLU, GRN, GLD, ORG suffix to part number. For Custom Finish Options for Vee-Rotors™ including Splatter discs add suffix CHR, CHGR, CHBL, CHBR - available in various colours see page iv. Ⓞ - Also available as a Vintage Motorcycle Disc.

R Suffix = High Durability Sintered Pad. HH Suffix = High Performance Sintered Pad. TT Suffix = Hard Wearing Off Road Pad. V Suffix = Semi Sintered Pad. G Suffix = Grooved Shoe.
D Suffix = Drilled Disc. X Suffix = Universal Left or Right Disc. XC Suffix = Contoured Disc. LS Suffix = Left/Steel Disc. RS = Right/Steel Disc.

BRAKE APPLICATIONS

JAPANESE Built Motorcycles



SUZUKI Contd.

GV 1400 GDG/GCG/GDH/GDJ/GCH Cavalcade (From f/no 103765)	86-88
VS 1400 GLPH/GLFH/GLPJ/GLFJ/GLPR/GLPT/GLPV/GLPW /GLPX/GLPY/GLPK1/GLPK2 Intruder (VX51L)	87-03
VL 1500 W/X Intruder Legendary Classic	98-99
VL 1500 Y/K1 Intruder Legendary Classic	00-01
VL 1500 K2/K3 Intruder	02-03
Legendary Classic	Left
Right	
VL 1500 K5/K6/K7/K8/K9 (C 1500 Intruder)	05-09
Left	
Right	
VL 1500 BTL3/BTL4/BLT5 (CT 1500 BT Intruder)	13-15
M 1500 VZ 1500 K9/LO (M 1500 Intruder)	09-13
Left	
Right	
M 1600 (VZ 1600 K4 M1600 Marauder)	04
M 1600 (VZ 1600 K5 M1600 Intruder)	05
C 1800 R (VLR 1800 K8/K9/L0/L1) (C 1800 R Intruder)	08-13
C 1800 RT (VLR 1800 8RT/K9RT) (C 1800 RT Intruder)	08-09
M 1800 R (VZR 1800 K6/K7/K8/K9) (M 1800 R Intruder - With handlebar cowling)	06-09
M 1800 R2 (VZR 1800 NK8/NK9 Intruder - M 1800 RZ - No handlebar cowling)	08-09
M 1800 RZ (VZR 1800 ZK7/ZK8/ZL1/ZL2/ZL3 - M 1800 RZ - With handlebar cowling)	07-13
M 1800 RB (VZR 1800 BZL4/BZL5/BZL6/BZL7/BZL8 - M 1800 RB)	14-18

FRONT / AVANT / VORN / FRENTE / ANTERIORE

DISC PAD CHOICES - FRONT				BRAKE DISC CHOICES - FRONT						
FA, SFA, TT Pad or Brake Shoe	SFAC Carbon Scooter Pads	Speciality Pads - SXR / Vee / MXS	Sintered/ HH Pads/ Grooved Shoes	Left / Gauche / Links Standard Replacement Disc	Right / Droite / Rechts Standard Replacement Disc	Contour Disc Universal left and right fitment	Custom Disc Universal left and right fitment	Vee-Discs Black † See note below	CX Extreme MX Race Disc/ UTVX Disc	
FA146*		FA146V*	FA146HH*	MD3042	MD3042					
FA103		FA103V	FA103HH		MD3032RS					
FA103		FA103V	FA103HH		MD3078RS					
FA103		FA103V	FA103HH		MD3078RS					
FA229		FA229V	FA229HH	MD3087LS						
FA231		FA231V	FA231HH		MD3087RS					
FA229		FA229V	FA229HH	MD3087LS						
FA231		FA231V	FA231HH		MD3087RS					
FA196		FA196V	FA196HH							
FA229		FA229V	FA229HH	MD3090X			MD3090CC			
FA231		FA231V	FA231HH		MD3090X		MD3090CC			
FA188*			FA188HH*	MD4022X	MD4022X	MD4022XC*	MD4022CC*	VR4022BLK*†		
			FA369/4HH*	MD4022X	MD4022X	MD4022XC*	MD4022CC*	VR4022BLK*†		
FA388*			FA388HH*	MD3090X	MD3090X	MD3090XC*	MD3090CC*	VR3090BLK*†		
FA388*			FA388HH*	MD3090X	MD3090X	MD3090XC*	MD3090CC*	VR3090BLK*†		
			FA379HH*	MD3091X	MD3091X	MD3091XC*	MD3091CC*	VR3091BLK*†		
			FA379HH*	MD3091X	MD3091X	MD3091XC*	MD3091CC*	VR3091BLK*†		
			FA379HH*	MD3091X	MD3091X	MD3091XC*	MD3091CC*	VR3091BLK*†		
			FA379HH*	MD3091X	MD3091X	MD3091XC*	MD3091CC*	VR3091BLK*†		

Line #
1
2
3
4
5
6
7
8
9
10
11
12
13
14
15
16
17
18
19
20
21
22
23
24
25
26
27
28
29
30
31
32
33
34
35
36
37
38
39
40
41
42
43
44
45
46
47
48
49
50
51
52
53
54
55
56
57
58
59
60

R Suffix = High Durability Sintered Pad. HH Suffix = High Performance Sintered Pad. TT Suffix = Hard Wearing Off Road Pad. V Suffix = Semi-Sintered Pad. G Suffix = Grooved Shoe.
D Suffix = Drilled Disc. X Suffix = Universal Left or Right Disc. XC Suffix = Contoured Disc. LS Suffix = Left/Steel Disc. RS = Right/Steel Disc.

*-2 Sets Required. † For Vee disc colours add RED, BLU, GRN, GLD, ORG suffix to part number. For Custom Finish Options for Vee-Rotors™ including Splatter discs add suffix CHR, CHGR, CHBL, CHBR - available in various colours see page iv. ☼ - Also available as a Vintage Motorcycle Disc.

JAPANESE Built Motorcycles

Line #	BRAKE DISC CHOICES - FRONT						DISC PAD CHOICES - REAR				BRAKE DISC CHOICES - REAR			
	Oversize 250 /280mm Disc Kit	OSX Oversize 250/280mm Disc Kit	Relocating Bracket for 250/ 280mm Disc	Oversize 320mm Disc Kit	SMX Oversize 320mm Disc Kit	Relocating Bracket for 320mm Disc	FA, SFA, TT Pad or Brake Shoe	SFAC Carbon Scooter Pads	Speciality Pads - SXR / Vee / MXS	Sintered/ HH Pads/ Grooved Shoes	Standard Replacement Disc	Contour Disc Rear fitment	Vee Discs CONTOUR	CX Extreme MX Race Disc
1														
2							FA150		FA150V	FA150HH	MD3043			
3														
4							FA103		FA103V	FA103HH	MD3044			
5							FA103		FA103V	FA103HH	MD3079			
6							FA103		FA103V	FA103HH	MD3086			
7							FA366TT		FA366V	FA366HH	MD3086			
8														
9							FA366TT		FA366V	FA366HH	MD3086			
10														
11								FA231/2V	FA231HH					
12								FA231/2V	FA231HH	MD3097				
13														
14								FA231/3V	FA231HH	MD4146				
15								FA231/3V	FA231HH	MD4146				
16								FA231/2V	FA231HH	MD3097				
17								FA231/2V	FA231HH	MD3097				
18														
19								FA231/3V	FA231HH	MD3097				
20														
21								FA231/3V	FA231HH	MD3097				
22														
23								FA231/3V	FA231HH	MD3097				
24														
25								FA231/3V	FA231HH	MD3097				
26														
27														
28														
29														
30														
31														
32														
33														
34														
35														
36														
37														
38														
39														
40														
41														
42														
43														
44														
45														
46														
47														
48														
49														
50														
51														
52														
53														
54														
55														
56														
57														
58														
59														
60														

REAR / ARRIÈRE / HINTEN / POSTERIOR / POSTERIORE

R Suffix = High Durability Sintered Pad. **HH** Suffix = High Performance Sintered Pad. **TT** Suffix = Hard Wearing Off Road Pad. **V** Suffix = Semi Sintered Pad. **G** Suffix = Grooved Shoe.
D Suffix = Drilled Disc. **X** Suffix = Universal Left or Right Disc. **XC** Suffix = Contoured Disc. **LS** Suffix = Left/Steel Disc. **RS** = Right/Steel Disc.

*-2 Sets Required. † For Vee disc colours add RED, BLU, GRN, GLD, ORG suffix to part number. For Custom Finish Options for Vee-Rotors™ including Splatter discs add suffix CHR, CHGR, CHBL, CHBR - available in various colours see page iv. Ⓢ - Also available as a Vintage Motorcycle Disc.

BRAKE APPLICATIONS

JAPANESE Built Motorcycles



YAMAHA



DISC PAD CHOICES - FRONT

BRAKE DISC CHOICES - FRONT

Aerox 50 2T All Models (See lines for NS 50/YQ 50)	97-16
Aerox 4 50	14-20
BA 50 C (4KNH) Gear-C (UA03J)	04-08
BA 50 S/V (UA03J)	08
BWs (3TX/4CA) CW 50 T Bi-Wizz	90-94
BWs 50 Next Generation (Twin headlight model)	
(190mm disc)	99-07
BWs 50 Original (180mm disc)	99-02
BWs 50 (5WW1)	04
BWs 50 (5WW4/6/8/9/B/D/F/H/K/M/P)	05-15
BWs Easy (2DW)	13-15
BWs 50 Naked (1D11/2B71)	03-04
BWs 50 Naked (2B7B/D/F/H)	09-15
BWs 50 R (5SX1)	01
CA 50 Sallient	83-85
CG 50 Jog	88-92
CR-Z 50 (3WN)	91-95
CS 50 Jog R	02-05
CS 50 Jog R	06-15
CS 50 Z (Jog RR)	03-05
CS 50 Z (Jog RR)	06-12
CT 50 S (3NT6)	90-95
CT 50 SS (3NTC)	92-95
CV 50 Jog (5KN1/2) (Coolstyle)	00-02
CV 50 ZR Evolution (5PT1)	01-02
CV 50 A/R Jog (5SU2/1)/SA/EJ	03-08
CW 50 RS (4YA1/2/BWs) (180mm front disc)	96-97
CW 50 RSP (5CC1/3/4YA BWs Spy) (180mm front disc)	97-98
CW 50 RS (4YA4/BWs NG) (180mm front disc)	98
CW 50 RS (5FXA/VG5SA BWs) (190mm front disc)	99
CW 50 RS (5FXJ/VG5SA BWs) (190mm front disc)	00
CW 50 RS (5FXM/VG5SA BWs) (190mm front disc)	01-05
CW 50 (5MS2/4G54R)	02
CW 50 (5WW4/BWs)	04-07
CY 50 Jog-in	91-95
DT 50 LC	98-
DT 50 M/MX	78-86
DT 50 MX	87-91
DT 50 MX	92-95
DT 50 R	97-01
DT 50 R	02-08
DT 50 X (Supermotard)	04-08
DT 50 R-L (SM-5VB1/VG55BK)	02-03
EC-03 (Electric Bike)	11-15
EW 50 Slider	00-05
FS1E	74-76
FS1E DX	77-79
FS1 DX	79-80
FS1 SE	81-82
FS1	87-90
CY 50 RS Jog R	96-
LC 50 M Bop	80
MA 50 M QT 50	80-86
MJ 50 M Towny	82
MS 50	85-86
NS 50 Aerox (2T)	13-16
NS 50 N Aerox Naked (2T)	13-16
PW 50	80-20
RD 50 M	78
RD 50 M	79-80

FRONT / AVANT / VORN / FRENTE / ANTERIORE

FA, SFA, TT Pad or Brake Shoe	SFAC Carbon Scooter Pads	Speciality Pads - SXR / Vee / MXS	Sintered/HH Pads/ Grooved Shoes	Left / Gauche / Links Standard Replacement Disc	Right / Droite / Rechts Standard Replacement Disc	Contour Disc Universal left and right fitment	Custom Disc Universal left and right fitment	Vee-Discs Black † See note below	CX Extreme MX Race Disc/ UTVX Disc
SFA193	SFAC193		SFA193HH	MD923D				VR923	
SFA193	SFAC193		SFA193HH	MD923D				VR923	
Y531									
Y531									
Y518									
SFA193	SFAC193		SFA193HH	MD923D				VR923	
SFA193	SFAC193		SFA193HH	MD916D					
SFA193	SFAC193		SFA193HH	MD916D					
SFA193	SFAC193		SFA193HH	MD916D					
Y530									
SFA193	SFAC193		SFA193HH	MD916D					
SFA193	SFAC193		SFA193HH	MD916D					
SFA193	SFAC193		SFA193HH	MD916D					
Y501									
Y501									
SFA169	SFAC169		SFA169HH	MD904D				VR904	
SFA193	SFAC193		SFA193HH	MD943D		MD943C		VR943	
SFA193	SFAC193		SFA193HH	MD943D		MD943C		VR943	
SFA193	SFAC193		SFA193HH	MD943D		MD943C		VR943	
SFA193	SFAC193		SFA193HH	MD943D		MD943C		VR943	
Y503									
Y503									
SFA336				MD965D					
SFA336				MD965D					
SFA384				MD965D					
SFA193	SFAC193		SFA193HH	MD916D					
SFA193	SFAC193		SFA193HH	MD916D					
SFA193	SFAC193		SFA193HH	MD916D					
SFA193	SFAC193		SFA193HH	MD923D				VR923	
SFA193	SFAC193		SFA193HH	MD923D				VR923	
SFA193	SFAC193		SFA193HH	MD923D				VR923	
SFA193	SFAC193		SFA193HH	MD923D				VR923	
SFA193	SFAC193		SFA193HH	MD916D					
Y519									
FA119TT			FA119R	MD6158D		MD6158C			
Y504			Y504G						
Y518			Y518G						
Y503			Y503G						
FA116				MD6214D					
FA350			FA350HH	MD6297D					
FA194			FA194HH	MD6279D					
FA116				MD6214D					
Y519									
SFA268	SFAC268		SFA268HH	MD923D				VR923	
Y504									
FA028									
FA042									
Y504									
Y518									
SFA169	SFAC169		SFA169HH	MD904D				VR904	
Y519									
Y501									
Y501									
Y501									
SFA193	SFAC193		SFA193HH	MD923D				VR923	
SFA193	SFAC193		SFA193HH	MD923D				VR923	
Y501									
FA028									
FA042									

Line #
1
2
3
4
5
6
7
8
9
10
11
12
13
14
15
16
17
18
19
20
21
22
23
24
25
26
27
28
29
30
31
32
33
34
35
36
37
38
39
40
41
42
43
44
45
46
47
48
49
50
51
52
53
54
55
56
57
58
59
60

R Suffix = High Durability Sintered Pad. HH Suffix = High Performance Sintered Pad. TT Suffix = Hard Wearing Off Road Pad. V Suffix = Semi-Sintered Pad. G Suffix = Grooved Shoe.

D Suffix = Drilled Disc. X Suffix = Universal Left or Right Disc. XC Suffix = Contoured Disc. LS Suffix = Left/Steel Disc. RS = Right/Steel Disc.

*-2 Sets Required. † For Vee disc colours add RED, BLU, GRN, GLD, ORG suffix to part number. For Custom Finish Options for Vee-Rotors™ including Splatter discs add suffix CHR, CHGR, CHBL, CHBR - available in various colours see page iv. ☼ - Also available as a Vintage Motorcycle Disc.

JAPANESE Built Motorcycles

Line #	BRAKE DISC CHOICES - FRONT						DISC PAD CHOICES - REAR				BRAKE DISC CHOICES - REAR			
	Oversize 250 /280mm Disc Kit	OSX Oversize 250/280mm Disc Kit	Relocating Bracket for 250/ 280mm Disc	Oversize 320mm Disc Kit	SMX Oversize 320mm Disc Kit	Relocating Bracket for 320mm Disc	FA, SFA, TT Pad or Brake Shoe	SFAC Carbon Scooter Pads	Speciality Pads - SXR / Vee / MXS	Sintered/ HH Pads/ Grooved Shoes	Standard Replacement Disc	Contour Disc Rear fitment	Vee Discs CONTOUR	CX Extreme MX Race Disc
1							SFA268	SFAC268		SFA268HH	MD923D		VR923	
2							SFA268	SFAC268		SFA268HH	MD923D		VR923	
3							Y530							
4							Y530							
5							Y518							
6														
7							Y503							
8							Y503							
9							Y503							
10							Y530							
11							Y530							
12							Y503							
13							Y530							
14							Y503							
15							Y519							
16							Y519							
17							Y503							
18							Y503							
19							Y530							
20							Y503							
21							Y530							
22							Y503							
23							Y503							
24							Y530							
25							Y530							
26							Y530							
27							Y503							
28							Y503							
29							Y503							
30							Y503							
31							Y503							
32							Y503							
33							Y503							
34							Y530							
35							Y518							
36							Y503							
37							Y504		Y504G					
38							Y518		Y518G					
39							Y503		Y503G					
40							Y503							
41							FA350		FA350HH	MD6280D				
42							FA350		FA350HH	MD6280D				
43							FA382			MD6286D				
44														
45							Y503							
46							Y504							
47							Y504							
48							Y504							
49							Y504							
50							Y518							
51							Y503							
52							Y519							
53							Y501							
54							Y501							
55							Y519							
56							SFA268	SFAC268	SFA268HH	MD923D		VR923		
57							SFA268	SFAC268	SFA268HH	MD923D		VR923		
58							Y501							
59							Y504							
60							Y504							

REAR / ARRIÈRE / HINTEN / POSTERIOR / POSTERIORE

R Suffix = High Durability Sintered Pad. **HH** Suffix = High Performance Sintered Pad. **TT** Suffix = Hard Wearing Off Road Pad. **V** Suffix = Semi Sintered Pad. **G** Suffix = Grooved Shoe.
D Suffix = Drilled Disc. **X** Suffix = Universal Left or Right Disc. **XC** Suffix = Contoured Disc. **LS** Suffix = Left/Steel Disc. **RS** = Right/Steel Disc.

BRAKE APPLICATIONS

*-2 Sets Required. † For Vee disc colours add RED, BLU, GRN, GLD, ORG suffix to part number. For Custom Finish Options for Vee-Rotors™ including Splatter discs add suffix CHR, CHGR, CHBL, CHBR - available in various colours see page iv. Ⓢ - Also available as a Vintage Motorcycle Disc.

JAPANESE Built Motorcycles



YAMAHA Contd.



R Suffix = High Durability Sintered Pad. **HH** Suffix = High Performance Sintered Pad. **TT** Suffix = Hard Wearing Off Road Pad. **V** Suffix = Semi-Sintered Pad. **G** Suffix = Grooved Shoe.

D Suffix = Drilled Disc. **X** Suffix = Universal Left or Right Disc. **XC** Suffix = Contoured Disc. **LS** Suffix = Left/Steel Disc. **RS** = Right/Steel Disc.

FRONT / AVANT / VORN / FRENTE / ANTERIORE

FA, SFA, TT Pad or Brake Shoe	SFAC Carbon Scooter Pads	Speciality Pads - SXR / Vee / MXS	Sintered/HH Pads/ Grooved Shoes	BRAKE DISC CHOICES - FRONT							Line #
				Left / Gauche / Links Standard Replacement Disc	Right / Droite / Rechts Standard Replacement Disc	Contour Disc Universal left and right fitment	Custom Disc Universal left and right fitment	Vee-Discs Black † See note below	CX Extreme MX Race Disc/ UTVX Disc		
RD 50/RD 50 MX											1
RZ 50 (5FC1/2)			FA275HH								2
SA 50 M/ME Passola			Y501								3
T 50 Townmate			Y518								4
TT-R 50 E			H301								5
TY 50/50 M			Y504	Y504G							6
TZR 50 Thunderkid (41V21) (5DU1/3)			FA197	FA197HH		MD2067					7
TZR 50			FA194	FA194HH	MD672LS						8
V 50 M/P			Y504								9
V 50 M			Y518								10
XC 50 X Vino Classic (SA26J)			Y530								11
XF 50 Giggle/Vox			Y530								12
YA 50 R Axis (4PC)	SFA193	SFAC193	SFA193HH		MD904D		MD904C		VR904		13
YA 50 ZA Jog Z (4SC1)	SFA169	SFAC169	SFA169HH								14
Yamy 50 (2T)			Y525								15
YB-1 (50cc) (5JE1/3)			Y531								16
YFM 50 S/T/RV/RW/RX Raptor			Y503*	Y503G*							17
YSR 50 T			FA101								18
YJ 50 R (5AU1-3) Vino			Y519	Y519G							19
YZ 50 G/H/J/K			Y502	Y502G							20
YE 50 Zest	SFA193	SFAC193	SFA193HH		MD904D		MD904C		VR904		21
YFZ 50 Quad			TBA								22
YH 50 Why	SFA193	SFAC193	SFA193HH		MD928D						23
YM 50 Breeze (4KH)	SFA193	SFAC193	SFA193HH		MD904D		MD904C		VR904		24
YN 50 R Neos (5AD/5MR/5RN3)	SFA193	SFAC193	SFA193HH		MD943D		MD943C		VR943		25
YN 50 Neos (5RN/1P9)	SFA193	SFAC193	SFA193HH		MD943D		MD943C		VR943		26
YN 50 Neos (2T) (1F5C2/1H5C2)	SFA193	SFAC193	SFA193HH		MD943D		MD943C		VR943		27
YN 50 Neos F (4T)	SFA193	SFAC193	SFA193HH		MD943D		MD943C		VR943		28
YN 50 Neos Easy (2T)			Y530								29
YV 50 (5BM2) Jog Space Innovation			Y519	Y519G							30
YQ 50 Aerox/Aerox-R	SFA193	SFAC193	SFA193HH		MD923D		MD923C		VR923		31
YT 60 Tri Zinger			None								32
YF 60 S			None								33
YZ 65 J			FA119TT	FA119R							34
V 70 A			Y504								35
V 75 A			Y504								36
CV 80 Beluga			Y503								37
DT 80 LC (37A)			FA081								38
DT 80 LC-2 (53V)			FA101TT	FA101R							39
DT 80 MX			Y504	Y504G							40
DT 80 MX 36N Type/MXS			Y518	Y518G							41
LB2/80 Bop 2			Y504								42
PW 80 K/S/91			Y502	Y502G							43
PW 80			Y502	Y502G							44
RD 80 (Air cooled)			FA070								45
RD 80 LC			FA081								46
T 80 Townmate			Y518								47
TY 80			Y502	Y502							48
TY 80			Y502	Y502							49
V 80			Y504								50
V 80 DL			Y518								51
YFM 80 S			None								52
YFM 80 D/E/F/G/H/J/K/L/M/N Badger			Y503*	Y503G*							53
YFM 80 WP/WR/WS/RT/RV/RW/RX Raptor			Y503*	Y503G*							54
YFM 80 GT/GV/GW/GX Grizzly			Y503*	Y503G*							55
YZ 80 D/E/F			Y502	Y502G							56
YZ 80 G/H/J/K/L/N			Y502	Y502G							57
YZ 80 S/T/U/W			FA119TT	FA119R	MD6029D						58
YZ 80 E/F/LWF/LWG/G/LWH/H/LWJ/J/LWK/K/L/LWL/M /LWM/N/LWN			FA119TT	FA119R	MD6030D		MD6030C			MD6030CX	60

*-2 Sets Required. † For Vee disc colours add RED, BLU, GRN, GLD, ORG suffix to part number. For Custom Finish Options for Vee-Rotors™ including Splatter discs add suffix CHR, CHGR, CHBL, CHBR - available in various colours see page iv. ☼ - Also available as a Vintage Motorcycle Disc.

JAPANESE Built Motorcycles

Line #	BRAKE DISC CHOICES - FRONT						DISC PAD CHOICES - REAR				BRAKE DISC CHOICES - REAR			
	Oversize 250 /280mm Disc Kit	OSX Oversize 250/280mm Disc Kit	Relocating Bracket for 250/ 280mm Disc	Oversize 320mm Disc Kit	SMX Oversize 320mm Disc Kit	Relocating Bracket for 320mm Disc	FA, SFA, TT Pad or Brake Shoe	SFAC Carbon Scooter Pads	Speciality Pads - SXR / Vee / MXS	Sintered/ HH Pads/ Grooved Shoes	Standard Replacement Disc	Contour Disc Rear fitment	Vee Discs CONTOUR	CX Extreme MX Race Disc
1							Y504							
2							Y503							
3							Y519		Y519G					
4							Y518							
5							H301							
6							Y504		Y504G					
7							FA101			MD2077				
8							FA115		FA115HH	MD2113				
9							Y504							
10							Y518							
11							Y530							
12							Y530							
13							Y503							
14							Y503							
15							Y525							
16							Y531							
17							Y527		Y527G					
18							Y503							
19							Y503							
20							Y502		Y502G					
21							Y518							
22							H307							
23							Y503							
24							Y503							
25							Y503							
26							Y503							
27							Y530							
28							Y530							
29							Y530							
30							Y503							
31							SFA268	SFAC268	SFA268HH	MD923D	MD923C	VR923		
32							Y518		Y518G					
33							Y518		Y518G					
34							FA084/3TT	MXS084/3	FA084/3R					
35							Y504							
36							Y504							
37							Y503							
38							Y506							
39							Y506							
40							Y504		Y504G					
41							Y518		Y518G					
42							Y504							
43							Y518		Y518G					
44							Y503		Y503G					
45							Y504							
46							Y504							
47							Y518							
48							Y504		Y504G					
49							Y503		Y503G					
50							Y504							
51							Y518							
52							Y506		Y506G					
53							Y527		Y527G					
54							Y527		Y527G					
55							Y527		Y527G					
56							Y504		Y504G					
57							Y502		Y502G					
58							Y502		Y502G					
59														
60	OSY6030C	OSXY6030	BRK036				FA084/3TT	MXS084/3	FA084/3R	MD6031D	MD6031C		MD6031CX	

REAR / ARRIÈRE / HINTEN / POSTERIOR / POSTERIORE

R Suffix = High Durability Sintered Pad. **HH** Suffix = High Performance Sintered Pad. **TT** Suffix = Hard Wearing Off Road Pad. **V** Suffix = Semi Sintered Pad. **G** Suffix = Grooved Shoe.
D Suffix = Drilled Disc. **X** Suffix = Universal Left or Right Disc. **XC** Suffix = Contoured Disc. **LS** Suffix = Left/Steel Disc. **RS** = Right/Steel Disc.

BRAKE APPLICATIONS

*-2 Sets Required. † For Vee disc colours add RED, BLU, GRN, GLD, ORG suffix to part number. For Custom Finish Options for Vee-Rotors™ including Splatter discs add suffix CHR, CHGR, CHBL, CHBR - available in various colours see page iv. ☺ - Also available as a Vintage Motorcycle Disc.

JAPANESE Built Motorcycles



YAMAHA Contd.



DISC PAD CHOICES - FRONT

BRAKE DISC CHOICES - FRONT

		FA, SFA, TT Pad or Brake Shoe	SFAC Carbon Scooter Pads	Speciality Pads - SXR / Vee / MXS	Sintered/ HH Pads/ Grooved Shoes	Left / Gauche / Links Standard Replacement Disc	Right / Droite / Rechts Standard Replacement Disc	Contour Disc Universal left and right fitment	Custom Disc Universal left and right fitment	Vee-Discs Black † See note below	CX Extreme MX Race Disc/ UTVX Disc	Line #
YZ 85 (Small wheel model Front 17 Inch												1
/Rear 14 Inch)	02-15	FA119TT			FA119R			MD6030D			MD6030CX	2
YZ 85 (Big Wheel - 19" Front/16" Rear)	02-20	FA119TT			FA119R			MD6030D			MD6030CX	3
T 90 N (4NM1/2/3/6)	94-99	Y530										4
T 90 D (4NM4/5/7)	97-99	Y530										5
T 90 D (4NM8/UB02J)	00-08	Y530										6
T 90 N (4NM9/UB02J)	00-08	Y530										7
TT-R 90 M/N/P/R/ES/S/T/ET/EV/EW	00-07	Y502			Y502G							8
V 90	78	Y504										9
YFM 90 RY Raptor (No Rear Parking Brake)	09	Y536*			Y536G*							10
YFM 90 RZ/RA/RB/RD Raptor (With Rear Parking Brake)	10-13	Y536*			Y536G*							11
YFM 90 (Raptor 90)	16-20	H346*			H346G*							12
AG 100 J (3HAA)	82	Y503			Y503G							13
AG 100 E Farm Bike	93	Y503			Y503G							14
DT 100	76-80	Y504			Y504G							15
FIZ	97-	SFA275	SFAC275		SFA275HH							16
RT 100 E/F/K	93-03	Y503			Y503G							17
RS 100 (478)	75-76	Y504										18
RS 100 (1Y8/Europe) (Front Disc Model/Round Type Pad)	77-78	FA028										19
RS 100 (1Y8/UK)	77-78	Y504										20
RS 100 (1Y9/UK)	79-81	Y504										21
RS 100 DX (1Y8 Europe) (Front Disc Model/ Round Type Pad)	79	FA028										22
RS 100 (1Y8/Europe) (Front Disc Model/Square Type Pad)	80-82	FA028										23
RXS 100	83-97	Y518										24
YB 100	78-81	Y504										25
YB 100	82-86	Y504										26
YB 100	87-92	Y503										27
YN 100 Neos 100	99-03	SFA193	SFAC193		SFA193HH	MD943D		MD943C		VR943		28
YQ 100 Aerox 100	00-04	SFA193	SFAC193		SFA193HH	MD923D		MD923C		VR923		29
YW 100 T Booster BWS	96	SFA169			SFA169HH							30
YZ 100 E/F/G/H	78-81	Y504			Y504G							31
YZ 100 J/K	82-83	Y503			Y503G							32
T 105/105 E Crypton	96	Y518										33
T 105 E (5ER1/2) Crypton-R	99	SFA275	SFAC275		SFA275HH	MD963D						34
T 105 SE Crypton (SER3)	02	SFA275	SFAC275		SFA275HH	MD963D						35
Alba (106cc 4T) (Cast wheel)	08											36
G5 Libero (106cc 4T) (Cast wheel)	08											37
Crux (106cc 4T) (Spoke wheel)	08											38
Crypton 110cc	04	SFA197	SFAC197		SFA197HH							39
TT-R 110 E	08-20	Y502			Y502G							40
V 110 ZE/ZK/ZHE/ZHK FIZR/FIZR Sporty	96	SFA275	SFAC275		SFA275HH	MD963D						41
MIO (113cc)	05-07	SFA336										42
MIO Sporty (113cc)	05-07	SFA336										43
Nouvo-Z (113cc)	06-07	SFA336										44
AT 115 (2B81/2/3) Neo (Brasil)	05-07	SFA275	SFAC275		SFA275HH			MD963D				45
AT 115 (15S1) (Neo CVT/Brasil)	08	SFA275	SFAC275		SFA275HH			MD963D				46
Crypton S 115	18-19											47
RX 115 (5FS3)	99	FA081										48
XC 115 S D'elight	14-16	SFA464	SFAC464									49
AS3 125	71-72	Y522										50
BL 125 Beluga	85	Y521										51
BWs 125 - See YW 125	10-13											52
Cygnus X (5ML) 220mm O/D Disc - See NXC 125	04-06											53
Cygnus X (4P9) 240mm O/D Disc - See NXC 125	07-13											54
D'elight 125	17-20	SFA694	SFAC694									55
DT 125 E/MX/LC	74-85	Y506			Y506							56
DT 125 LC	86-87	FA101TT		MXS101	FA101R	MD6067D						57
DT 125 R	88-03	FA101TT		MXS101	FA101R	MD6039D						58
DT 125 RE	04	FA101TT		MXS101	FA101R	MD6039D						59
												60

FRONT / AVANT / VORN / FRENTE / ANTERIORE

R Suffix = High Durability Sintered Pad. HH Suffix = High Performance Sintered Pad. TT Suffix = Hard Wearing Off Road Pad. V Suffix = Semi-Sintered Pad. G Suffix = Grooved Shoe.
D Suffix = Drilled Disc. X Suffix = Universal Left or Right Disc. XC Suffix = Contoured Disc. LS Suffix = Left/Steel Disc. RS = Right/Steel Disc.

*-2 Sets Required. † For Vee disc colours add RED, BLU, GRN, GLD, ORG suffix to part number. For Custom Finish Options for Vee-Rotors™ including Splatter discs add suffix CHR, CHGR, CHBL, CHBR - available in various colours see page iv. ☺ - Also available as a Vintage Motorcycle Disc.

JAPANESE Built Motorcycles

Line #	BRAKE DISC CHOICES - FRONT						DISC PAD CHOICES - REAR				BRAKE DISC CHOICES - REAR			
	Oversize 250 /280mm Disc Kit	OSX Oversize 250/280mm Disc Kit	Relocating Bracket for 250/ 280mm Disc	Oversize 320mm Disc Kit	SMX Oversize 320mm Disc Kit	Relocating Bracket for 320mm Disc	FA, SFA, TT Pad or Brake Shoe	SFAC Carbon Scooter Pads	Speciality Pads - SXR / Vee / MXS	Sintered/ HH Pads/ Grooved Shoes	Standard Replacement Disc	Contour Disc Rear fitment	Vee Discs CONTOUR	CX Extreme MX Race Disc
1														
2	OSY6030C	OSXY6030	BRK036				FA084/3TT							
3	OSY6030C	OSXY6030	BRK036				FA084/3TT	MXS084/3	FA084/3R	MD6031D	MD6031C		MD6031CX	
4							Y530	MXS084/3	FA084/3R	MD6031D	MD6031C		MD6031CX	
5							Y530							
6							Y530							
7							Y530							
8							Y503		Y503G					
9							Y504							
10							FA083TT		FA083R	MD6282D				
11							FA067TT		FA067R	MD6282D				
12							H307*		H307G*					
13							Y527		Y527G					
14							Y527		Y527G					
15							Y506		Y506G					
16							Y503							
17							Y503		Y503G					
18							Y504							
19							Y504							
20							Y504							
21							Y504							
22														
23							Y504							
24							Y504							
25							Y518							
26							Y504							
27							Y503							
28							Y503							
29							Y527							
30							Y527							
31							Y527							
32							Y506		Y506G					
33							Y506		Y506G					
34							Y518							
35							Y518							
36							Y518							
37														
38														
39														
40							Y518							
41							Y503		Y503G					
42							Y518							
43														
44														
45														
46							Y531							
47							Y531							
48														
49							Y518							
50							Y531							
51							Y506							
52							Y506							
53														
54														
55														
56														
57							Y506		Y506G					
58							Y506		Y506G					
59							FA101TT	MXS101	FA101R	MD6115D				
60							FA101TT	MXS101	FA101R	MD6115D				

REAR / ARRIÈRE / HINTEN / POSTERIOR / POSTERIORE

R Suffix = High Durability Sintered Pad. **HH** Suffix = High Performance Sintered Pad. **TT** Suffix = Hard Wearing Off Road Pad. **V** Suffix = Semi Sintered Pad. **G** Suffix = Grooved Shoe.
D Suffix = Drilled Disc. **X** Suffix = Universal Left or Right Disc. **XC** Suffix = Contoured Disc. **LS** Suffix = Left/Steel Disc. **RS** = Right/Steel Disc.

BRAKE APPLICATIONS

*-2 Sets Required. † For Vee disc colours add RED, BLU, GRN, GLD, ORG suffix to part number. For Custom Finish Options for Vee-Rotors™ including Splatter discs add suffix CHR, CHGR, CHBL, CHBR - available in various colours see page iv. Ⓢ - Also available as a Vintage Motorcycle Disc.

JAPANESE Built Motorcycles



YAMAHA Contd.



R Suffix = High Durability Sintered Pad. HH Suffix = High Performance Sintered Pad. TT Suffix = Hard Wearing Off Road Pad. V Suffix = Semi-Sintered Pad. G Suffix = Grooved Shoe.

D Suffix = Drilled Disc. X Suffix = Universal Left or Right Disc. XC Suffix = Contoured Disc. LS Suffix = Left/Steel Disc. RS = Right/Steel Disc.

DT 125 RE	05-07
DT-Z 125 Tenere/Tenere Scout	89-90
DT 125 Chesterfield Scout	89-90
DT 125 (3TT4)	96
DT 125 X	05-06
GT 125 Hammerhead	12-18
IT 125 G/H/J	80-82
XQ 125/150 N Maxster - See XQ 125/150 N	01-03
Majesty 125 - See YP 125	98-00
Majesty 125 - See YP 125	01-06
Majesty 125 FA (SCA9) (Taiwan Production) - See YP125	02
Majesty 125 - See YP125	04-09
Majesty S 125 - See XC 125 R	15
MT 125 (Non ABS)	14-16
MT 125 A (ABS)	14-20
N-Max 125	15-20
NCX 125 K Cygnus X Cab (4C6-1)	07-10
NCX 125 L Cygnus X Injection (4C6-2)	07-10
NXC 125 Cygnus X (5ML) 220mm O/D Disc	04-06
NXC 125 Cygnus X (4P9) 240mm O/D Disc	07-13
RD 125 DX	75-77
RD 125 DX	78-81
RD 125 LC	82-84
RD 125 LC (MK2/3)	85-87
RD 125	73-74
RS 125	75
RS 125 DX	76-80
RS 125 DX	81
RZ 125 (1GV 030101-)	85
SR 125 SE	82
SR 125 (3MW2 Type)	89-91
SR 125 SE	92-96
SR 125	97-03
TDR 125 (4GW/GX1/2/3/4)	93-03
TDR 125 (3HS1/3XD0/3SH3/3XD1)	89-93
TDR 125 R (3SH2/3XE2) Lightburner	93-94
Tricity 125	Left 14-16 Right
Tricity 125 ABS	Left 17-20 Right
TT-R 125 M/N/P/R/S/ES/T/ET/EV/EW/EX/EY	00-09
TT-R 125 LW	00-20
TW 125 (5EK)	99-02
TW 125 (5RS)	03-04
TY 125	82
TZR 125 (2RK/3PC1)	87-89
TZR 125 (3PC2/3PC3)	90-92
TZR 125 (3JB/4JB/4HW/4HX)	93-95
TZR 125 R (4DL1/4DL2) Brembo caliper	91-93
TZR 125 RR (4DL3) Brembo caliper	94-95
Vity 125 - See XC 125E	08-13
VP 125 X-City (16P)	08-15
WR 125 X (Supernoto)	09-18
WR 125 R	09-15
X-City - See VP 125 X-City	08-15
XC 125 Beluga	92
XC 125 Beluga	93-95
XC 125 T Cygnus	95-98
XC 125 TR Cygnus	96-03
XC 125 E Vity (4P7)	08-13

FRONT / AVANT / VORN / FRENTE / ANTERIORE

DISC PAD CHOICES - FRONT				BRAKE DISC CHOICES - FRONT						Line #
FA, SFA, TT Pad or Brake Shoe	SFAC Carbon Scooter Pads	Speciality Pads - SXR / Vee / MXS	Sintered/HH Pads/ Grooved Shoes	Left / Gauche / Links Standard Replacement Disc	Right / Droite / Rechts Standard Replacement Disc	Contour Disc Universal left and right fitment	Custom Disc Universal left and right fitment	Vee-Discs Black † See note below	CX Extreme MX Race Disc/ UTVX Disc	
FA101TT		MXS101	FA101R	MD6039D						1
FA166										2
FA166										3
Y527			Y527G							4
FA209/2			FA209/2HH	MD6235D						5
FA181TT				MD6158D		MD6158C				6
Y504			Y504G							7
										8
										9
										10
										11
										12
SFA142	SFAC142		SFA142HH					VR9145		13
FA432			FA432HH	MD2121X						14
FA432			FA432HH	MD2121X						15
SFA694	SFAC694					MD9156D				16
SFA632						MD9133D		VR9133		17
SFA632						MD9133D		VR9133		18
SFA393	SFAC393					MD986D		VR986		19
SFA393	SFAC393					MD9133D		VR9133		20
FA028										21
FA042										22
FA081										23
FA104			FA104HH			MD2053RS				24
Y522										25
Y510										26
FA028										27
FA042										28
FA104			FA104HH			MD2053RS				29
Y506										30
Y506/Y527										31
FA081										32
FA199			FA199HH	MD2085LS						33
FA199			FA199HH	MD6116D						34
FA134				MD2003X		MD2003XC	MD2003CC	VR2003BLK†		35
FA134				MD2003X		MD2003XC	MD2003CC	VR2003BLK†		36
SFA652				MD9146D	MD9146D					37
SFA655										38
SFA652										39
SFA655										40
Y503			Y503G							41
FA119TT			FA119R	MD6158D		MD6158C				42
FA275TT			FA275HH	MD6067D						43
FA275TT			FA275HH	MD6067D						44
Y504			Y504G							45
FA104			FA104HH			MD2053RS				46
FA088			FA088HH			MD2056RS				47
FA252			FA252HH			MD2022RS				48
FA095			FA095HH			MD2003X	MD2003XC	MD2003CC	VR2003BLK†	49
FA095			FA095HH			MD2003X	MD2003XC	MD2003CC	VR2003BLK†	50
										51
SFA196	SFAC196		SFA196HH	MD9130D						52
FA142			FA142HH	MD6235D						53
FA142			FA142HH			MD6347C				54
										55
Y521										56
Y521										57
Y527										58
SFA101	SFAC101		SFA101HH							59
SFA464	SFAC464					MD9127D		VR9127		60

*-2 Sets Required. † For Vee disc colours add RED, BLU, GRN, GLD, ORG suffix to part number. For Custom Finish Options for Vee-Rotors™ including Splatter discs add suffix CHR, D, HGR, CHBL, CHBR - available in various colours see page iv. ☼ - Also available as a Vintage Motorcycle Disc.

JAPANESE Built Motorcycles

Line #	BRAKE DISC CHOICES - FRONT						DISC PAD CHOICES - REAR				BRAKE DISC CHOICES - REAR			
	Oversize 250 /280mm Disc Kit	OSX Oversize 250/280mm Disc Kit	Relocating Bracket for 250/ 280mm Disc	Oversize 320mm Disc Kit	SMX Oversize 320mm Disc Kit	Relocating Bracket for 320mm Disc	FA, SFA, TT Pad or Brake Shoe	SFAC Carbon Scooter Pads	Speciality Pads - SXR / Vee / MXS	Sintered/ HH Pads/ Grooved Shoes	Standard Replacement Disc	Contour Disc Rear fitment	Vee Discs CONTOUR	CX Extreme MX Race Disc
1							FA152TT		MXS152	FA152R	MD6121D			
2							FA157							
3							FA157							
4							Y527			Y527G				
5							FA152TT		MXS152	FA152R	MD6121D			
6							FA152TT		MXS152	FA152R	MD6011D			
7							Y506			Y506G				
8														
9														
10														
11														
12														
13							SFA213			SFA213HH		VR9133		
14							FA377			FA377HH	MD2122			
15							FA377			FA377HH	MD2122			
16							SFA464	SFAC464			MD9157D			
17							Y533							
18							Y533							
19							Y533							
20							Y533							
21							Y506							
22							Y510							
23							Y506							
24							Y506							
25							Y506							
26							Y506							
27							Y506							
28							Y506							
29							Y506							
30							Y503							
31							Y503/Y518							
32							Y518							
33							Y503							
34							FA101TT				MD6115D			
35							FA173							
36							FA047				MD2021	MD2021C	VR2021	
37							SFA343				MD9147D			
38														
39							SFA464							
40														
41							Y503			Y503G				
42							Y503			Y503G				
43							Y503			Y503G				
44							Y531							
45							Y506			Y506G				
46							Y506							
47							FA104			FA104HH	MD2021			
48							FA104			FA104HH	MD2021			
49							FA047			FA047HH	MD2021	MD2021C	VR2021	
50							FA047			FA047HH	MD2021	MD2021C	VR2021	
51														
52							SFA266	SFAC266		SFA266HH	MD9104D			
53							FA213			FA213HH	MD6121D			
54							FA213			FA213HH		MD6121C		
55														
56							Y506							
57							Y527							
58							Y503							
59							Y503							
60							Y530							

REAR / ARRIÈRE / HINTEN / POSTERIOR / POSTERIORE

R Suffix = High Durability Sintered Pad. **HH** Suffix = High Performance Sintered Pad. **TT** Suffix = Hard Wearing Off Road Pad. **V** Suffix = Semi Sintered Pad. **G** Suffix = Grooved Shoe.
D Suffix = Drilled Disc. **X** Suffix = Universal Left or Right Disc. **XC** Suffix = Contoured Disc. **LS** Suffix = Left/Steel Disc. **RS** = Right/Steel Disc.

BRAKE APPLICATIONS

*-2 Sets Required. † For Vee disc colours add RED, BLU, GRN, GLD, ORG suffix to part number. For Custom Finish Options for Vee-Rotors™ including Splatter discs add suffix CHR, CHGR, CHBL, CHBR - available in various colours see page iv. ☼ - Also available as a Vintage Motorcycle Disc.

JAPANESE Built Motorcycles



YAMAHA Contd.

XC 125 R Majesty S 125	15
Xenter 125	12-20
X-Max 125 (2DM/Brembo R/Caliper)	
- See YP 125 R X-Max	14-16
X-Max 125 (2DM/Heng Tong R/Caliper)	
- See YP 125 R X-Max	14
X-Max 125 R (1B9/Brembo F/Caliper) - See YP 125 R	06-09
X-Max 125 Non ABS (39D1/5/Nissin F/Caliper)	
- See YP 125 R	10-15
X-Max 125 R Sport Non ABS (Nissin F/Caliper)	
- See YP 125 R Sport	11-12
X-Max 125 ABS (39D2/Nissin F/Caliper) - See YP 125 RA	11-17
X-Max 125 ABS	18-20
X-Max 125 ABS Tech Max	19-20
X-Max 125 R Business ABS - See YP 125 R	11
X-Max 125 Momo Design inc ABS	15
XN 125 N Teos	00-03
XP 125 RA X-Max - Iron-Max (ABS)	16
XT 125	82
XT 125 R (3D61/3D63) 21 Inch/18 Inch Wheels	05-06
XT 125 R (13D1) 21 Inch/18 Inch Wheels	07
XT 125 R (13D3/13D5) 21 Inch/18 Inch Wheels	07-11
XT 125 X (3D62/3D64) 17 Inch Wheels	05-06
XT 125 X (13D2) 17 Inch Wheels	07
XT 125 X (13D4/13D6) 17 Inch Wheels	07-11
XTZ 125 (5RM)	03-10
XV 125 Virago	97-00
XVS 125 Dragstar	00-04
XQ 125/150 N Maxster	01-03
YFA1W/A/B Breeze	89-91
YFA1D/F/G/H/J/K/L/M/N/P/R Breeze	92-03
YBA 125 Enticer (3P01/3P41)	05-06
YBR 125 E/K (5HH1/2/C/G/J/SLX/SLX9)	
(Drum front/Brasil)	00-08
YBR 125 ED (5HHB/F/H) (Disc front/Brasil)	06-08
YBR 125 Custom	08-16
YBR 125 ED (3D91)	05-06
YBR 125 (3D92/9)	07-09
YBR 125 (51D1/2)	10-16
YFM 125 S/GT/GV/GW/GX/GY/GZ/GA/GB/GD Grizzly	04-14
YP 125 Majesty	98-00
YP 125 Majesty	01-06
YP 125 Majesty FA (SCA9) (Taiwan Production)	02
YP 125 Majesty	04-09
YS 125	17-20
YW 125 (BWs 125/1CE1)	10-13
YW 125 X (1DN1/2)	10-13
YZ 125 C/D/E/F/G/H/J (2T)	76-82
YZ 125 K (2T)	83
YZ 125 L (2T)	84
YZ 125 N (2T)	85
YZ 125 S (2T)	86
YZ 125 T (2T)	87
YZ 125 U (2T)	88
YZ 125 W (2T)	89
YZ 125 D/E/F/G/H/J (2T)	92-97
YZ 125 K/L/M (2T)	98-00
YZ 125 N (2T)	01
YZ 125 P (2T)	02

◆ Plain undrilled disc for enduro use MD6190CE

DISC PAD CHOICES - FRONT				BRAKE DISC CHOICES - FRONT							Line #
FA, SFA, TT Pad or Brake Shoe	SFAC Carbon Scooter Pads	Speciality Pads - SXR / Vee / MXS	Sintered/HH Pads/ Grooved Shoes	Left / Gauche / Links Standard Replacement Disc	Right / Droite / Rechts Standard Replacement Disc	Contour Disc Universal left and right fitment	Custom Disc Universal left and right fitment	Vee-Discs Black † See note below	CX Extreme MX Race Disc/ UTVX Disc	Line #	
SFA142	SFAC142		SFA142HH	MD9145D				VR9145BLK		1	
SFA492	SFAC492			MD9154D						2	
SFA196	SFAC196		SFA196HH	MD9102D						3	
SFA196	SFAC196		SFA196HH	MD9102D						4	
SFA430	SFAC430		SFA430HH		MD9102D			VR9102		5	
SFA196	SFAC196		SFA196HH		MD9102D			VR9102		6	
SFA196	SFAC196		SFA196HH		MD9102D			VR9102		7	
SFA196	SFAC196		SFA196HH		MD9102D			VR9102		8	
SFA196	SFAC196		SFA196HH		MD9102D			VR9102		9	
SFA196	SFAC196		SFA196HH		MD9102D			VR9102		10	
SFA196	SFAC196		SFA196HH		MD9102D			VR9102		11	
SFA196	SFAC196		SFA196HH		MD9102D			VR9102		12	
SFA705	SFAC705		SFA705HH		MD9169D					13	
SFA705	SFAC705		SFA705HH		MD9169D					14	
SFA196	SFAC196		SFA196HH		MD9102D			VR9102		15	
SFA196	SFAC196		SFA196HH		MD9102D					16	
SFA193	SFAC193		SFA193HH	MD907D				VR907		17	
SFA196	SFAC196		SFA196HH	MD9102D						18	
Y506			Y506G							19	
FA350			FA350HH	MD6297D						20	
FA350			FA350HH	MD6297D						21	
FA350			FA350HH	MD6297D						22	
FA194			FA194HH	MD6279D						23	
FA194			FA194HH	MD6279D						24	
FA194			FA194HH	MD6279D						25	
FA135TT			FA135R	MD6067D						26	
FA199			FA199HH	MD2067						27	
FA199			FA199HH		MD2067					28	
SFA181	SFAC181		SFA181HH	MD957D				VR957		29	
Y503*			Y503G*							30	
Y503*			Y503G*							31	
SFA181	SFAC181		SFA181HH							32	
Y527										33	
FA228			FA228HH							34	
FA464										35	
FA101					MD2104RS					36	
FA464					MD2097RS					37	
FA464					MD2104RS					38	
FA464					MD2104RS					39	
Y503*			Y503G*							40	
SFA181	SFAC181		SFA181HH	MD907D				VR907		41	
SFA181	SFAC181		SFA181HH	MD907D				VR907		42	
SFA196	SFAC196		SFA196HH		MD979D					43	
SFA181	SFAC181		SFA181HH	MD907D				VR907		44	
FA464					MD2104RS					45	
SFA492	SFAC492			MD986D				VR986		46	
SFA632								VR9133		47	
Y507			Y507G							48	
Y507			Y507G							49	
Y508			Y508G							50	
FA105TT			FA105R	MD6324D						51	
FA105TT			FA105R	MD6067D						52	
FA105TT			FA105R	MD6067D						53	
FA105TT			FA105R	MD6039D						54	
FA135TT		MXS135	FA135R	MD6016D						55	
FA135TT		MXS135	FA135R	MD6028D		MD6028C			MD6028CX	56	
FA185TT		MXS185	FA185R	MD6028D		MD6028C			MD6028CX	57	
FA185TT		MXS185	FA185R	MD6356D		MD6356C			MD6356CX	58	
FA185TT		MXS185	FA185R	MD6356D		MD6356C			MD6356CX	59	

*-2 Sets Required. † For Vee disc colours add RED, BLU, GRN, GLD, ORG suffix to part number. For Custom Finish Options for Vee-Rotors™ including Splatter discs add suffix CHR, CHGR, CHBL, CHBR - available in various colours see page iv. ☼ - Also available as a Vintage Motorcycle Disc.

126 Part numbers, prefixes, suffixes, photos and illustrations shown in this catalogue are trademarks and/or copyrights of EBC Brakes or the trademark owner A C Freeman Investments Ltd and use without express written permission of the owners is punishable by law.

JAPANESE Built Motorcycles

Line #	BRAKE DISC CHOICES - FRONT						DISC PAD CHOICES - REAR				BRAKE DISC CHOICES - REAR			
	Oversize 250 /280mm Disc Kit	OSX Oversize 250/280mm Disc Kit	Relocating Bracket for 250/ 280mm Disc	Oversize 320mm Disc Kit	SMX Oversize 320mm Disc Kit	Relocating Bracket for 320mm Disc	FA, SFA, TT Pad or Brake Shoe	SFAC Carbon Scooter Pads	Speciality Pads - SXR / Vee / MXS	Sintered/ HH Pads/ Grooved Shoes	Standard Replacement Disc	Contour Disc Rear fitment	Vee Discs CONTOUR	CX Extreme MX Race Disc
1							SFA213			SFA213HH			VR9133	
2							Y533							
3														
4							SFA266	SFAC266		SFA266HH	MD9153D			
5														
6							SFA678	SFAC678		SFA678HH	MD9153D			
7							SFA266	SFAC266		SFA266HH	MD9104D		VR9104	
8														
9							SFA266	SFAC266		SFA266HH	MD9104D		VR9104	
10														
11							SFA266	SFAC266		SFA266HH	MD9104D		VR9104	
12							SFA275	SFAC275		SFA275HH	MD9108D			
13							SFA706	SFAC706		SFA706HH	MD9168D			
14							SFA706	SFAC706		SFA706HH	MD9168D			
15							SFA275	SFAC275		SFA275HH	MD9108D			
16							SFA275	SFAC275		SFA275HH	MD9108D			
17							Y527							
18							SFA275	SFAC275		SFA275HH	MD9108D			
19							Y503			Y503G				
20							FA350			FA350HH	MD6280D			
21							FA350			FA350HH	MD6280D			
22							FA350			FA350HH	MD6280D			
23							FA350			FA350HH	MD6280D			
24							FA350			FA350HH	MD6280D			
25							FA350			FA350HH	MD6280D			
26							Y527			Y527G				
27							Y527							
28							Y527							
29							SFA266	SFAC266		SFA266HH	MD958D		VR958	
30							Y506			Y506G				
31							Y527			Y527G				
32							Y506							
33														
34							Y527							
35							Y527							
36							Y535							
37							Y527							
38							Y535							
39							Y535							
40							Y527			Y527G				
41							Y527							
42							SFA266	SFAC266		SFA266HH	MD962D		VR962	
43							Y527							
44							SFA266	SFAC266		SFA266HH	MD962D		VR962	
45							Y535							
46							Y533							
47							Y533							
48							Y506			Y506G				
49							Y517			Y517G				
50							Y517			Y517G				
51							Y517			Y517G				
52							Y517			Y517G				
53							Y506			Y506G				
54							FA101TT		MXS101	FA101R	MD6011D			
55									MXS084/3	FA084/3R	MD6011D			
56	OS6028EC	OSX6028E	BRK035				FA152/2TT		MXS152	FA152/2R	MD6011D			
57	OS6028C	OSX6028	BRK008		SMX6028	BRK009	FA131TT		MXS131	FA131R	MD6135D	MD6135C		MD6135CX
58	OS6028C	OSX6028	BRK008		SMX6028	BRK009	FA131TT		MXS131	FA131R	MD6135D	MD6135C		MD6135CX
59	OS6028C	OSX6028	BRK008		SMX6028	BRK009	FA131TT		MXS131	FA131R	MD6190D	MD6190C		MD6190CX
60														

REAR / ARRIÈRE / HINTEN / POSTERIOR / POSTERIORE

R Suffix = High Durability Sintered Pad. HH Suffix = High Performance Sintered Pad. TT Suffix = Hard Wearing Off Road Pad. V Suffix = Semi Sintered Pad. G Suffix = Grooved Shoe.
D Suffix = Drilled Disc. X Suffix = Universal Left or Right Disc. XC Suffix = Contoured Disc. LS Suffix = Left/Steel Disc. RS = Right/Steel Disc.

BRAKE APPLICATIONS

*-2 Sets Required. † For Vee disc colours add RED, BLU, GRN, GLD, ORG suffix to part number. For Custom Finish Options for Vee-Rotors™ including Splatter discs add suffix CHR, CHGR, CHBL, CHBR - available in various colours see page iv. Ⓢ - Also available as a Vintage Motorcycle Disc.

JAPANESE Built Motorcycles



YAMAHA Contd.

YZ 125 R/S/T/V/W (2T)	03-07
YZ 125 X/Y/Z/A/B/D/E/F/G (2T)	08-16
YZ 125 (2T)	17-20
YZF-R 125 (Standard Mount Front Caliper)	08-13
YZF-R 125 (Radial Mount Front Caliper/Non ABS)	14-16
YZF-R 125 A (Radial Mount Front Caliper/ABS)	14-18
YZF-R 125	19-20
YZF-R 125 Monster Energy MotoGP Edition	19-20
RX 135 (13X)	81
T135 HC/S (2S61) Crypton X/Jupiter MX/Spark 135 /Exciter/135LC Sniper	06-08
T135 SE (1S71) Crypton X/Jupiter MX/Spark 135 /Exciter/135LC Sniper (Automatic clutch)	06-08
GPD 150 A - N-Max/2DP4	15-17
HW 150 - Xenter 150	12-16
N-Max 150 - See GPD150 A	15-17
TZR 150 R (4AP2)	00
Xenter 150 - See HW 150	12-16
N-Max 155	19-20
Tricity 155 ABS	19-20
XC 155 F/G SMAX	15-16
DT 175 All models	74-83
DT 175 (3TS4)	96
IT 175 G/H/J	80-82
TY 175	77-80
XC 180 Riva Scooter	83-85
AG 200 E (3GX6)	93
DT 200 (2LR)	87
DT 200 R	93
DT 200 WR (3XP)	92-93
IT 200 L	84
RD 200 DX	75-78
RD 200 DX	78-80
RS 200	79
SDR 200 (2TV)	87-89
TW 200 (2JL/4CS1/2/3/5)	91-98
TW 200 (4CS4/6/5LB1/2)	98-01
XC 200 Riva Scooter	87-91
YFM 200 N	85
YFM 200 DXW/DX/DXA	89-90
YFS 200 B/F/G/H/J/K/L/M/N/P Blaster	91-02
YFS 200 R/S/T/V Blaster	03-06
YTM 200 EL/DX	89
WR 200 D/E/F	92-94
ST 225 (5BT) Bronco	97
TDM 225	05
TW 225 E (5VC1/2)	02-03
YFM 225 S/T/U	86-89
YTM 225 DRN	85
XT 225 (2LN) (1KH 020101- Serrow)	86-87
XT 225 (3RW1-5 Serrow) (1KH 034101 - 132000)	89-93
XT 225 S (3RW3) (1KH 102101- 109000 Serrow)	92
XT 225 (3RW4) (1KH 080101- Serrow)	92
XT 225 W (4JG1/2/3/4 Serrow)	93-96
XT 225 WE (4JG5/6 Serrow)	97-98
XT 225 (4VW1/3/5/7/9) (4VWA/B/D/G/J/L) (Brasil)	97-06
DT 230 (4TP1/2) Lanza	97-98
YFU1W/YFU1TW Pro Hauler Pro 4 (230cc)	89
CP 250 (1B71) Maxam/Morphus	05-08

FRONT / AVANT / VORN / FRENTE / ANTERIORE

DISC PAD CHOICES - FRONT				BRAKE DISC CHOICES - FRONT					Line #
FA, SFA, TT Pad or Brake Shoe	SFAC Carbon Scooter Pads	Speciality Pads - SXR / Vee / MXS	Sintered/HH Pads/ Grooved Shoes	Left / Gauche / Links Standard Replacement Disc	Right / Droite / Rechts Standard Replacement Disc	Contour Disc Universal left and right fitment	Custom Disc Universal left and right fitment	Vee-Discs Black † See note below	CX Extreme MX Race Disc/ UTVX Disc
FA185TT		MXS185	FA185R	MD6356D		MD6356C			MD6356CX
FA450TT		MXS450	FA450R			MD6356C			MD6356CX
FA450TT		MXS405	FA450R			MD6392C			MD6392CX
FA181TT			FA181HH	MD2110LS					
FA432			FA432HH	MD2121X					
FA432			FA432HH	MD2121X					
FA432			FA432HH	MD2121X					
FA432			FA432HH	MD2121X					
FA081									
SFA464	SFAC464			MD963D					
SFA464	SFAC464			MD963D					
SFA694	SFAC694				MD9156D				
SFA492	SFAC492			MD9154D					
SFA694	SFAC694				MD9156D				
FA199			FA199HH						
SFA492	SFAC492			MD9154D					
SFA694	SFAC694				MD9156D				
SFA196	SFAC196		SFA196HH					VR9145BLK	
Y506			Y506G						
Y527			Y527G						
Y507			Y507G						
Y504			Y504G						
Y521									
Y503			Y503G						
FA101TT		MXS101	FA101R	MD6067D					
FA101TT		MXS101	FA101R	MD6039D					
FA135TT		MXS135	FA135R	MD6066D					
Y517			Y517G						
FA028									
FA042									
Y510									
FA104			FA104HH		MD2056RS				
FA275TT			FA275HH	MD6067D					
FA275TT			FA275HH	MD6067D					
Y521									
Y503*			Y503G*						
Y503*			Y503G*						
Y503*			Y503G*						
FA054TT*			FA054R*	MD6054D	MD6054D				
Y503			Y503G						
FA135TT		MXS135	FA135R		MD6066D				
FA275TT			FA275HH	MD6067D					
FA275TT			FA275HH	MD6067D					
Y503*			Y503G*						
Y503			Y503G						
FA101TT		MXS101	FA101R	MD6067D					
FA101TT		MXS101	FA101R	MD6067D					
FA101TT		MXS101	FA101R	MD6067D					
FA101TT		MXS101	FA101R	MD6067D					
FA101TT		MXS101	FA101R	MD6067D					
FA275TT		MXS275	FA275HH	MD6067D					
FA101TT		MXS101	FA101R	MD6067D					
FA135TT		MXS135	FA135R	MD6066D					
Y528*			Y528G*						
SFA199	SFAC199		SFA199HH		MD9107D				

R Suffix = High Durability Sintered Pad. HH Suffix = High Performance Sintered Pad. TT Suffix = Hard Wearing Off Road Pad. V Suffix = Semi Sintered Pad. G Suffix = Grooved Shoe.
D Suffix = Drilled Disc. X Suffix = Universal Left or Right Disc. XC Suffix = Contoured Disc. LS Suffix = Left/Steel Disc. RS = Right/Steel Disc.

*-2 Sets Required. † For Vee disc colours add RED, BLU, GRN, GLD, ORG suffix to part number. For Custom Finish Options for Vee-Rotors™ including Splatter discs add suffix CHR, CHGR, CHBL, CHBR - available in various colours see page iv. ☼ - Also available as a Vintage Motorcycle Disc.

JAPANESE Built Motorcycles

Line #	BRAKE DISC CHOICES - FRONT					DISC PAD CHOICES - REAR				BRAKE DISC CHOICES - REAR				
	Oversize 250 /280mm Disc Kit	OSX Oversize 250/280mm Disc Kit	Relocating Bracket for 250/ 280mm Disc	Oversize 320mm Disc Kit	SMX Oversize 320mm Disc Kit	Relocating Bracket for 320mm Disc	FA, SFA, TT Pad or Brake Shoe	SFAC Carbon Scooter Pads	Speciality Pads - SXR / Vee / MXS	Sintered/ HH Pads/ Grooved Shoes	Standard Replacement Disc	Contour Disc Rear fitment	Vee Discs CONTOUR	CX Extreme MX Race Disc
1	OS6028C	OSX6028	BRK008		SMX6028	BRK009	FA367TT		MXS367	FA367R	MD6190D	MD6190C		MD6190CX
2	OS6728C	OSX6728	BRK002		SMX6728	BRK034	FA367TT		MXS367	FA367R		MD6190C		MD6190CX
3							FA367TT		MXS367	FA367R		MD6190C		MD6190CX
4							FA377		FA377V	FA377HH	MD2111			
5							FA377		FA377V	FA377HH	MD2122			
6							FA377		FA377V	FA377HH	MD2122			
7							FA152			FA152R	MD2122			
8							FA152			FA152R	MD2122			
9							Y506							
10														
11							Y531							
12														
13							Y531							
14							SFA464	SFAC464			MD9157D			
15							Y533							
16							SFA464	SFAC464			MD9157D			
17							FA104			FA104HH	MD2021			
18							Y533							
19							SFA464	SFAC464			MD9157D			
20														
21							SFA213			SFA213HH			VR9133	
22							Y506			Y506G				
23							Y527			Y527G				
24							Y506			Y506G				
25							Y506			Y506G				
26							Y537							
27							Y527			Y527G				
28							Y506			Y506G				
29							FA101TT		MXS101	FA101R	MD6115D			
30							FA152/2TT		MXS152	FA152/2R	MD6121D			
31							Y517			Y517G				
32							Y510							
33							Y510							
34							Y510							
35							FA104			FA104HH	MD2021			
36							Y503			Y503G				
37							Y503			Y503G				
38							Y537							
39							FA021			FA021R				
40							FA021			FA021R				
41							FA155			FA155R	MD6050D			
42							FA084TT			FA084R	MD6237D			
43							FA021			FA021R				
44							FA152TT		MXS152	FA152R	MD6121D			
45							Y503			Y503G				
46														
47							Y531							
48							FA021			FA021R				
49							FA021			FA021R				
50							Y503			Y503G				
51							Y503			Y503G				
52							Y503			Y503G				
53							Y503			Y503G				
54							FA152/2TT		MXS152	FA152/2R	MD6244D			
55							FA152/2TT		MXS152	FA152/2R	MD6244D			
56							Y527							
57							FA152/2TT		MXS152	FA152/2R	MD6121D			
58							Y523*			Y523G*				
59							SFA408	SFAC408		SFA408HH	MD9108D			
60														

REAR / ARRIÈRE / HINTEN / POSTERIOR / POSTERIORE

R Suffix = High Durability Sintered Pad. **HH** Suffix = High Performance Sintered Pad. **TT** Suffix = Hard Wearing Off Road Pad. **V** Suffix = Semi Sintered Pad. **G** Suffix = Grooved Shoe.
D Suffix = Drilled Disc. **X** Suffix = Universal Left or Right Disc. **XC** Suffix = Contoured Disc. **LS** Suffix = Left/Steel Disc. **RS** = Right/Steel Disc.

BRAKE APPLICATIONS

*-2 Sets Required. † For Vee disc colours add RED, BLU, GRN, GLD, ORG suffix to part number. For Custom Finish Options for Vee-Rotors™ including Splatter discs add suffix CHR, CHGR, CHBL, CHBR - available in various colours see page iv. Ⓢ - Also available as a Vintage Motorcycle Disc.

JAPANESE Built Motorcycles



YAMAHA Contd.



R Suffix = High Durability Sintered Pad. HH Suffix = High Performance Sintered Pad. TT Suffix = Hard Wearing Off Road Pad. V Suffix = Semi-Sintered Pad. G Suffix = Grooved Shoe.

D Suffix = Drilled Disc. X Suffix = Universal Left or Right Disc. XC Suffix = Contoured Disc. LS Suffix = Left/Steel Disc. RS = Right/Steel Disc.

DT 250 All models	75-80
FZR 250	87
FZR 250 R (3LN)	
FZX 250 (3YX1/2/4) Zeal	91-92
IT 250 G	80
IT 250 H/J	81-82
IT 250 L	84
Majesty - See YP 250 Majesty	96-98
Majesty - See YP 250 DX/A Majesty	98-99
Majesty - See YP 250 Majesty	00-03
RD 250 A	73-74
RD 250 B/C	75-76
RD 250 D	77
RD 250 E/F	78-79
RD 250 LC	80
RD 250 LC	80-83
RZ 250 R (1AR/1XG)	
RZ 250 R (29L)	
RZ 250 RR (5IL)	
RZ 250 (4L3)	
RI-Z (250cc/3XC)	90-92
Serrow 250 (3C51/52)	05
SR 250 SE (3Y8)	81-83
SR 250 (4GR1/2/3/4)	93-94
SR 250 (Classic/21L)	96-00
SRV 250 Soulfultwin/Renaissa (4DN1-6)	92-97
SRX 250 (51Y/52E/1JA)	
TDR 250 (3CK1/3CK2 Europe - Eng/Frame 3CK-)	88-92
TT 250	90
TT 250 R (4GY Japan)	93-94
TT 250 R (4RR1/2 Japan)	95-97
TT 250 R (4GV3/4GV5/4WA1 - Japan - Raid)	94-96
TT 250 R (4MR2 UK)	96
TT 250 RL (4PX5)	99
TT 250 RM (4PX6)	00
TY 250 D/E	77-78
TY 250 H	81
TY 250 S/R	84-90
TY 250 R	91-92
TY 250 R	93-94
TY 250 Z	93-96
TZR 250 (1KT/2AW Japan - Eng/Frame # 1KT)	87
TZR 250 (2MA/2XW1/2XW2 Europe - Eng/Frame # 2MA-)	87-92
TZR 250 (3MA1 Reverse Cylinder - Eng/Frame # 3MA-)	89
TZR 250 (3MA3/3MA5 Reverse Cylinder - Eng/Frame # 3MA -046/058-)	90
TZR 250 SP (3MA4 - Eng/Frame # 3MA 055)	90
TZR 250 R (3XV1/3XV4/3XV6 V-Twin - Eng/Frame # 3XV 000101-08600)	91-93
TZR 250 RS (3XV8/3XV9/3XVA - V-Twin - Eng/Frame # 3XV 08080101-08200/088-)	92-94
TZR 250 SPR (3XVC V-Twin 3XV 107101-)	95
VP 250 X-City (5B2)	07-16
WR 250 ZB	91
WR 250 ZD/ZE/ZF/ZG/ZH/ZJ (2T)	92-97
WR 250 ZK (5EN1) (2T)	98
WR 250 FN (4T)	01
WR 250 FP (4T)	02
WR 250 FR/FS/FT/FV (4T)	03-06

◆ Plain undrilled disc for enduro use MD6190CE

FRONT / AVANT / VORN / FRENTE / ANTERIORE

FA, SFA, TT Pad or Brake Shoe	SFAC Carbon Scooter Pads	Speciality Pads - SXR / Vee / MXS	Sintered/HH Pads/ Grooved Shoes	BRAKE DISC CHOICES - FRONT							Line #
				Left / Gauche / Links Standard Replacement Disc	Right / Droite / Rechts Standard Replacement Disc	Contour Disc Universal left and right fitment	Custom Disc Universal left and right fitment	Vee-Discs Black † See note below	CX Extreme MX Race Disc/ UTVX Disc		
Y528			Y528G								1
FA123			FA123HH			MD2003X	MD2003XC	MD2003CC	VR2003BLK†		2
FA220*					MD2022LS	MD2022RS					3
FA179			FA179HH								4
Y507			Y507G								5
Y507			Y507G								6
Y508			Y508G								7
											8
											9
											10
			Y513								11
FA011											12
FA011											13
FA041						MD2025RS					14
FA064						MD2019RS					15
FA070						MD2019RS					16
FA104*			FA104HH*	MD2011	MD2011	MD2011C*			VR2011*		17
FA081*				MD2011	MD2011	MD2011C*			VR2011*		18
FA104*			FA104HH*	MD2011	MD2011	MD2011C*			VR2011*		19
FA070						MD2019RS					20
FA220*					MD2022LS	MD2022RS					21
FA275TT			FA275HH	MD6067D							22
Y522											23
Y522											24
FA081						MD2019RS					25
FA179			FA179HH	MD2067							26
FA104			FA104HH			MD2056RS					27
FA123			FA123HH			MD2003X	MD2003XC	MD2003CC	VR2003BLK†		28
FA105TT			FA105R	MD6039D							29
FA135TT		MXS135	FA135R	MD6066D							30
FA135TT		MXS135	FA135R	MD6066D							31
FA135TT		MXS135	FA135R	MD6066D							32
FA135TT		MXS135	FA135R	MD6066D							33
FA135TT		MXS135	FA135R	MD6066D							34
FA135TT		MXS135	FA135R	MD6066D							35
Y504			Y504G								36
Y507			Y507G								37
Y517			Y517G								38
FA115TT		MXS115	FA115R								39
FA115TT		MXS115	FA115R								40
FA115TT		MXS115	FA115R								41
FA123			FA123HH			MD2003X	MD2003XC	MD2003CC	VR2003BLK†		42
FA123			FA123HH			MD2003X	MD2003XC	MD2003CC	VR2003BLK†		43
FA252*			FA252HH*	MD2001X	MD2001X	MD2001XC*	MD2001CC*	VR2001BLK†			44
											45
FA252*			FA252HH*								46
FA252*			FA252HH*								47
											48
FA252*			FA252HH*								49
											50
FA252*			FA252HH*								51
FA252*			FA252HH*								52
SFA196	SFAC196		SFA196HH	MD9130D							53
FA135TT		MXS135	FA135R	MD6012D							54
FA135TT		MXS135	FA135R	MD6028D			MD6028C			MD6028CX	55
FA185TT		MXS185	FA185R	MD6028D			MD6028C			MD6028CX	56
FA185TT		MXS185	FA185R	MD6356D			MD6356C			MD6356CX	57
FA185TT		MXS185	FA185R	MD6356D			MD6356C			MD6356CX	58
FA185TT		MXS185	FA185R	MD6356D			MD6356C			MD6356CX	59

*-2 Sets Required. † For Vee disc colours add RED, BLU, GRN, GLD, ORG suffix to part number. For Custom Finish Options for Vee-Rotors™ including Splatter discs add suffix CHR, CHGR, CHBL, CHBR - available in various colours see page iv. Ⓢ - Also available as a Vintage Motorcycle Disc.

JAPANESE Built Motorcycles

Line #	BRAKE DISC CHOICES - FRONT						DISC PAD CHOICES - REAR				BRAKE DISC CHOICES - REAR			
	Oversize 250 /280mm Disc Kit	OSX Oversize 250/280mm Disc Kit	Relocating Bracket for 250/ 280mm Disc	Oversize 320mm Disc Kit	SMX Oversize 320mm Disc Kit	Relocating Bracket for 320mm Disc	FA, SFA, TT Pad or Brake Shoe	SFAC Carbon Scooter Pads	Speciality Pads - SXR / Vee / MXS	Sintered/ HH Pads/ Grooved Shoes	Standard Replacement Disc	Contour Disc Rear fitment	Vee Discs CONTOUR	CX Extreme MX Race Disc
1							Y510		Y510G					
2							FA104		FA104HH	MD2021	MD2021C	VR2021		
3							FA104			MD2021				
4							FA104	FA104V	FA104HH	MD2021				
5							Y528		Y528G					
6							Y510		Y510G					
7							Y510		Y510G					
8														
9														
10														
11							Y514							
12							Y514							
13							FA011							
14							FA041			MD2025RS				
15							Y514							
16							Y514							
17							FA104	FA104V	FA104HH	MD2011	MD2011C	VR2011		
18							FA104	FA104V		MD2011	MD2011C	VR2011		
19							FA104	FA104V	FA104HH	MD2011	MD2011C	VR2011		
20							Y514							
21							FA104	FA104V		MD2021				
22							FA152TT		FA152R	MD6244D				
23							Y506							
24							Y527							
25							Y527							
26							Y527							
27							Y510							
28							FA104	FA104V	FA104HH	MD2021	MD2021C	VR2021		
29							Y506		Y506G					
30							FA152/2TT	MXS152	FA152/2R	MD6121D				
31							FA152/2TT	MXS152	FA152/2R	MD6121D				
32							FA152/2TT	MXS152	FA152/2R	MD6121D				
33							FA152/2TT	MXS152	FA152/2R	MD6121D				
34							FA152/2TT	MXS152	FA152/2R	MD6121D				
35							FA152/2TT	MXS152	FA152/2R	MD6121D				
36							Y506		Y506G					
37							Y510		Y510G					
38							Y504		Y504G					
39							Y504		Y504G					
40							FA115TT	MXS115	FA115R					
41							FA115TT	MXS115	FA115R					
42							FA104	FA104V	FA104HH	MD2021	MD2021C	VR2021		
43							FA104	FA104V	FA104HH	MD2021	MD2021C	VR2021		
44							FA104	FA104V	FA104HH	MD2021	MD2021C	VR2021		
45														
46							FA104	FA104V	FA104HH	MD2021	MD2021C			
47							FA104	FA104V	FA104HH	MD2021	MD2021C			
48														
49							FA104	FA104V	FA104HH	MD2021	MD2021C			
50														
51							FA104	FA104V	FA104HH	MD2021	MD2021C			
52							FA104	FA104V	FA104HH	MD2021	MD2021C			
53							SFA275	SFAC275	SFA275HH	MD9104D				
54							FA152TT	MXS152	FA152R	MD6011D				
55	OSG6028EC	OSX6028E	BRK035				FA152TT	MXS152	FA152R	MD6011D				
56	OSG6028C	OSX6028	BRK008		SMX6028	BRK009	FA131TT	MXS131	FA131R	MD6135D	MD6135C		MD6135CX	
57	OSG6028C	OSX6028	BRK008		SMX6028	BRK009	FA131TT	MXS131	FA131R	MD6135D	MD6135C		MD6135CX	
58	OSG6028C	OSX6028	BRK008		SMX6028	BRK009	FA131TT	MXS131	FA131R	MD6190D	MD6190C		MD6190CX	
59	OSG6028C	OSX6028	BRK008		SMX6028	BRK009	FA367TT	MXS367	FA367R	MD6190D	MD6190C		MD6190CX	
60														

REAR / ARRIÈRE / HINTEN / POSTERIOR / POSTERIORE

R Suffix = High Durability Sintered Pad. **HH** Suffix = High Performance Sintered Pad. **TT** Suffix = Hard Wearing Off Road Pad. **V** Suffix = Semi Sintered Pad. **G** Suffix = Grooved Shoe.
D Suffix = Drilled Disc. **X** Suffix = Universal Left or Right Disc. **XC** Suffix = Contoured Disc. **LS** Suffix = Left/Steel Disc. **RS** = Right/Steel Disc.

BRAKE APPLICATIONS

*-2 Sets Required. † For Vee disc colours add RED, BLU, GRN, GLD, ORG suffix to part number. For Custom Finish Options for Vee-Rotors™ including Splatter discs add suffix CHR, CHGR, CHBL, CHBR - available in various colours see page iv. Ⓢ - Also available as a Vintage Motorcycle Disc.

JAPANESE Built Motorcycles



YAMAHA Contd.



WR 250 FW/FX/FY/FZ/FA/FB/FD (4T)	07-13
WR 250 FF/FG (4T/Reverse Cylinder)	15-16
WR 250 F (4T/Reverse Cylinder)	17-20
WR 250 RX/RX (32D-)	08-18
WR 250 RX/RX (32D-) For upgrade disc from 250mm to 280mm when using WR 250 X wheel and caliper bracket.	
Disc only supplied by EBC.	08-15
WR 250 XX/XY (Supermoto) (32D-)	08-15
X-City - See VP 250 X-City (5B2)	07-16
XG 250 Tricker (5XT1)	04-06
X-Max (Brembo F/Caliper/Non ABS/1CO)	
See YP 250 R X-Max (Brembo F/Caliper/Non ABS/1CO)	05-09
X-Max (37P1/Nissin F/Caliper/Non ABS)	
See YP 250 R X-Max (37P1/Nissin F/Caliper/Non ABS)	10-13
X-Max (ABS) See YP 250 R X-Max (ABS)	11-16
X-Max Sport - See YP 250 X-Max Sport	11-12
X-Max 250 Momo Design	15
X-Max 250 (Non ABS/Heng Tong R/Caliper/2DL)	
See YP250 R X-Max	14-16
XP 250 RA X-Max - Iron-Max (ABS)	16
XS 250 C	78
XS 250 D/E	79-81
XS 250 SE/SF	79-81
XS 250 C	81
XT 250	80
XT 250 Serow (3C51/2)	05-08
XTZ 250 (4B41/2/3) Lander (Brasil)	07-09
XV 250 Virago	89-94
XV 250 S Virago	95-00
XVS 250 Dragstar	01-04
YBR 250 (5D11/3/4)	07-11
YDS7 250cc	72
YFB 250 D/E/F Timberwolf	92-94
YFB 250 G/H/UH/J/UJ/UK/K Timberwolf	95-98
YFB 250 FWF/FWG/FWH/FWJ/FWK/FWL/FWK Timberwolf	94-00
YFM 250 W/A/B	90-92
YFM 250 XLC/XL/X Bear Tracker	99-00
YFM 250 XN/XP/XR/XS Bear Tracker	01-04
YFM 250 BT/BV Bruin	05-06
YFM 250 BW/BX/BY Big Bear	07-10
YFM 250 RX/RX Raptor	Left 08-09
	Right
YFM 250 R (33B)	Left 09-11
	Right
YFM 250 R (1BT)	Left 12-13
	Right
YFU1W/YFU1-T (230cc)	89-90
YP 250 Majesty	96-98
YP 250 DX/A Majesty	98-99
YP 250 Majesty	00-03
YP 250 R X-Max (1CO) Non ABS (Brembo F/Caliper)	05-09
YP 250 R X-Max (37P1) Non ABS (Nissin Front Caliper)	10-13
YP 250 R X-Max (ABS)	11-16
YP 250 R X-Max Sport	11-12
YP 250 R X-Max ABS (Nissin Front /Brembo Rear Calipers)	14-15
YP 250 R X-Max (2PL1) Non ABS (Nissin Front /Brembo Rear Calipers)	14-15
◆ Plain undrilled disc for enduro use MD6190CE	

FRONT / AVANT / VORN / FRENTE / ANTERIORE

DISC PAD CHOICES - FRONT				BRAKE DISC CHOICES - FRONT						Line #
FA, SFA, TT Pad or Brake Shoe	SFAC Carbon Scooter Pads	Speciality Pads - SXR / Vee / MXS	Sintered/HH Pads/ Grooved Shoes	Left / Gauche / Links Standard Replacement Disc	Right / Droite / Rechts Standard Replacement Disc	Contour Disc Universal left and right fitment	Custom Disc Universal left and right fitment	Vee-Discs Black † See note below	CX Extreme MX Race Disc/ UTVX Disc	Line #
FA185TT		MXS185	FA185R			MD6356C			MD6356CX	1
FA185TT		MXS185	FA185R			MD6356C			MD6356CX	2
FA450TT		MXS450	FA450R			MD6392C			MD6392CX	3
FA185TT		MXS185	FA185R			MD6320C				4
										5
										6
						MD6320CSPEC				7
FA142		FA142V	FA142HH			MD6323C				8
										9
FA275TT			FA275HH	MD6067D						10
										11
										12
										13
										14
										15
SFA196	SFAC196		SFA196HH	MD9102D						16
										17
SFA196	SFAC196		SFA196HH	MD9102D						18
SFA196	SFAC196		SFA196HH	MD9102D						19
FA034		FA034V			MD2019RS					20
FA034					MD2019RS					21
FA041					MD2019RS					22
Y513										23
Y506			Y506G							24
FA275TT			FA275HH	MD6068D						25
FA135TT			FA135R							26
FA081					MD2019RS					27
FA199			FA199HH	MD2067						28
FA199			FA199HH		MD2067					29
FA197			FA197HH		MD2106RS					30
Y513										31
Y503*			Y503G*							32
Y528*			Y528G*							33
Y528*			Y528G*							34
Y528*			Y528G*							35
Y528*			Y528G*							36
Y528*			Y528G*							37
FA054TT*			FA054R*	MD6054D	MD6054D					38
FA054TT*			FA054R*	MD6054D	MD6054D					39
FA054TT*		MXS054*	FA054R*	MD6054D	MD6054D					40
FA443TT			FA443R	MD6054D						41
FA444TT			FA444R		MD6054D					42
FA443TT			FA443R	MD6054D						43
FA444TT			FA444R		MD6054D					44
FA443TT			FA443R	MD6054D						45
FA444TT			FA444R		MD6054D					46
Y528*			Y528G*							47
SFA199	SFAC199		SFA199HH		MD903D			VR903		48
SFA199	SFAC199		SFA199HH		MD903D			VR903		49
SFA199	SFAC199		SFA199HH		MD903D			VR903		50
SFA430	SFAC430		SFA430HH		MD9102D			VR9102		51
SFA196	SFAC196		SFA196HH		MD9102D			VR9102		52
SFA196	SFAC196		SFA196HH		MD9102D			VR9102		53
SFA196	SFAC196		SFA196HH		MD9102D			VR9102		54
SFA196	SFAC196		SFA196HH		MD9102D			VR9102		55
SFA196	SFAC196		SFA196HH		MD9102D			VR9102		56
SFA196	SFAC196		SFA196HH		MD9102D			VR9102		57
SFA196	SFAC196		SFA196HH		MD9102D			VR9102		58
										59
										60

*-2 Sets Required. † For Vee disc colours add RED, BLU, GRN, GLD, ORG suffix to part number. For Custom Finish Options for Vee-Rotors™ including Splatter discs add suffix CHR, CHGR, CHBL, CHBR - available in various colours see page iv. ☼ - Also available as a Vintage Motorcycle Disc.

JAPANESE Built Motorcycles

Line #	BRAKE DISC CHOICES - FRONT						DISC PAD CHOICES - REAR				BRAKE DISC CHOICES - REAR			
	Oversize 250 /280mm Disc Kit	OSX Oversize 250/280mm Disc Kit	Relocating Bracket for 250/ 280mm Disc	Oversize 320mm Disc Kit	SMX Oversize 320mm Disc Kit	Relocating Bracket for 320mm Disc	FA, SFA, TT Pad or Brake Shoe	SFAC Carbon Scooter Pads	Speciality Pads - SXR / Vee / MXS	Sintered/ HH Pads/ Grooved Shoes	Standard Replacement Disc	Contour Disc Rear fitment	Vee Discs CONTOUR	CX Extreme MX Race Disc
1	OS6028C	OSX6028	BRK008		SMX6028	BRK009	FA367TT		MXS367	FA367R		MD6190C		MD6190CX
2		OSX6028	BRK008		SMX6028	BRK009	FA367TT		MXS367	FA367R		MD6190C		MD6190CX
3							FA367TT		MXS367	FA367R		MD6190C		MD6190CX
4							FA367TT		MXS367	FA367R		MD6319C		
5														
6														
7														
8							FA367TT		MXS367	FA367R		MD6319C		
9														
10							FA152TT		MXS152	FA152R	MD6244D			
11														
12														
13														
14														
15														
16														
17							SFA213			SFA213HH				
18							SFA678	SFAC678		SFA678HH	MD9153D			
19							SFA275	SFAC275		SFA275HH	MD9108D			
20							FA034		FA034V		MD2019RS			
21							Y516							
22							Y516							
23							Y516							
24							Y506			Y506G				
25							FA152TT			FA152R	MD6244D			
26							FA152TT			FA152R	MD6244D			
27							Y527							
28							Y527							
29							Y527							
30							Y535							
31							Y514							
32							Y528			Y528G				
33							Y528			Y528G				
34							Y528			Y528G				
35							FA021			FA021R				
36							Y528			Y528G				
37							Y528			Y528G				
38							Y532			Y532G				
39							Y532			Y532G				
40							FA084TT			FA084R	MD6236D			
41														
42							FA084TT			FA084R	MD6236D			
43														
44							FA084TT			FA084R	MD6236D			
45														
46							Y523*			Y523G*				
47							Y516							
48							SFA275	SFAC275		SFA275HH	MD927D		VR927	
49							SFA275	SFAC275		SFA275HH	MD953D	MD953C	VR953	
50							SFA275	SFAC275		SFA275HH	MD9104D		VR9104	
51							SFA275	SFAC275		SFA275HH	MD9104D		VR9104	
52							SFA275	SFAC275		SFA275HH	MD9108D			
53							SFA275	SFAC275		SFA275HH	MD9104D		VR9104	
54														
55							SFA213			SFA213HH				
56														
57							SFA213			SFA213HH				
58														
59														
60														

REAR / ARRIÈRE / HINTEN / POSTERIOR / POSTERIORE

*-2 Sets Required. † For Vee disc colours add RED, BLU, GRN, GLD, ORG suffix to part number. For Custom Finish Options for Vee-Rotors™ including Splatter discs add suffix CHR, CHGR, CHBL, CHBR - available in various colours see page iv. Ⓢ - Also available as a Vintage Motorcycle Disc.

R Suffix = High Durability Sintered Pad. HH Suffix = High Performance Sintered Pad. TT Suffix = Hard Wearing Off Road Pad. V Suffix = Semi Sintered Pad. G Suffix = Grooved Shoe. D Suffix = Drilled Disc. X Suffix = Universal Left or Right Disc. XC Suffix = Contoured Disc. LS Suffix = Left/Steel Disc. RS = Right/Steel Disc.

JAPANESE Built Motorcycles



YAMAHA Contd.



R Suffix = High Durability Sintered Pad. HH Suffix = High Performance Sintered Pad. TT Suffix = Hard Wearing Off Road Pad. V Suffix = Semi-Sintered Pad. G Suffix = Grooved Shoe.

D Suffix = Drilled Disc. X Suffix = Universal Left or Right Disc. XC Suffix = Contoured Disc. LS Suffix = Left/Steel Disc. RS = Right/Steel Disc.

YP 250 R X-Max (2DL) Non ABS	
(Heng Tong Rear Calipers)	14-16
YS 250 (1S41/2/3) Fazer (Brasil)	06-08
YTZ 250 N/S TR1-Z	85-86
YZ 250 D/E/F (2T)	77-79
YZ 250 G (2T)	80
YZ 250 J/K/L (2T)	81-84
YZ 250 N (2T)	85
YZ 250 S/T (2T)	86-87
YZ 250 U (2T)	88
YZ 250 W/WRW (2T)	89
YZ 250 A/WRA/B (2T)	90-91
YZ 250 D/E/F/G/H/J (2T)	92-97
YZ 250 K/L/M (2T)	98-00
YZ 250 N (2T)	01
YZ 250 P (2T)	02
YZ 250 R/S/T/V/W (2T)	03-07
YZ 250 X/Y/Z/A/B/D/E/F/G (2T)	08-16
YZ 250 H/J (270mm Disc)	17-18
YZ 250 FN (4T)	01
YZ 250 FP (4T)	02
YZ 250 FR/FS/FT/FV (4T)	03-06
YZ 250 FW/FX/FY/FZ/FA/FB/FD/FE/FF (4T)	07-15
YZ 250 F	16-20
YZ 250 FGY (60th Anniversary Edition/270mm Disc)	16
Tricity 300 ABS	19-20
VP 300 Versity	03-05
XC 300 Versity	06
X-Max 300 (CZD300A) ABS	17-20
X-Max 300 ABS Tech Max	19-20
YFM 300 B/D Grizzly	12-13
MT-03 ABS	16-20
YZF-R3 ABS	15-20
R5/5A/5B 350cc	70-72
RD 350 A/B	73-75
RD 350 LC	80
RD 350 LC	81-82
RD 350 YPVS	83-84
RD 350 F/F2	85-92
RD 350 N	85
RD 350 R	92-95
TT 350 A (3GJ)	90-95
TT 350 (1TJ)	85-89
XT 350	85-90
XT 350	91-95
YFM 350 FWT/FWU Big Bear	87-88
YFM 350 FWW/FWA/FWA/FWB/FWD/FWE/FWF/FWG	89-95
YFM 350 FWH/FWJ/FWK Big Bear	96-98
YFM 350 XD/XE/XF/XG/XH/XJ/XK/XL/XM/XN	
/XP/XR/XS (Warrior)	92-04
YFM 350 ERD	92
YFM 350 ERE/ERF/ERG	93-95
YFM 350 FXG/FXH/FXJ/FXK/FXL/FXM/FXN	
/FXP/FXR/FXS Wolverine	95-04
YFM 350 UH/UJ/UK	96-98
YFM 350 L Big Bear	99
YFM 350 FAS/FAT/FAV Bruin 4 x 4	04-06
YFM 350 ANS/ANT/ANV Bruin 2 x 4	04-06
YFM 350 S/T/V/RW/RX/RV Raptor	04-09

FRONT / AVANT / VORN / FRENTE / ANTERIORE

DISC PAD CHOICES - FRONT				BRAKE DISC CHOICES - FRONT							Line #
FA, SFA, TT Pad or Brake Shoe	SFAC Carbon Scooter Pads	Speciality Pads - SXR / Vee / MXS	Sintered/HH Pads/ Grooved Shoes	Left / Gauche / Links Standard Replacement Disc	Right / Droite / Rechts Standard Replacement Disc	Contour Disc Universal left and right fitment	Custom Disc Universal left and right fitment	Vee-Discs Black † See note below	CX Extreme MX Race Disc/ UTVX Disc		
SFA196	SFAC196		SFA196HH	MD9102D						1	
FA197			FA197HH							2	
FA101TT		MXS101	FA101R	MD6047D						3	
Y507										4	
Y507			Y507G							5	
Y508			Y508G							6	
FA105TT			FA105R	MD6324D						7	
FA105TT			FA105R	MD6067D						8	
FA105TT			FA105R	MD6039D						9	
FA135TT		MXS135	FA135R	MD6016D						10	
FA135TT		MXS135	FA135R	MD6012D						11	
FA135TT		MXS135	FA135R	MD6028D		MD6028C			MD6028CX	12	
FA185TT		MXS185	FA185R	MD6028D		MD6028C			MD6028CX	13	
FA185TT		MXS185	FA185R	MD6356D		MD6356C			MD6356CX	14	
FA185TT		MXS185	FA185R	MD6356D		MD6356C			MD6356CX	15	
FA185TT		MXS185	FA185R	MD6356D		MD6356C			MD6356CX	16	
FA185TT		MXS185	FA185R	MD6356D		MD6356C			MD6356CX	17	
FA450TT		MXS450	FA450R			MD6356C			MD6356CX	18	
FA450TT		MXS450	FA450R			MD6392C			MD6392CX	19	
FA185TT		MXS185	FA185R	MD6356D		MD6356C			MD6356CX	20	
FA185TT		MXS185	FA185R	MD6356D		MD6356C			MD6356CX	21	
FA185TT		MXS185	FA185R	MD6356D		MD6356C			MD6356CX	22	
FA450TT		MXS450	FA450R			MD6356C			MD6356CX	23	
FA450TT		MXS450	FA450R			MD6392C			MD6392CX	24	
FA450TT		MXS450	FA450R			MD6392C			MD6392CX	25	
SFA694	SFAC694									26	
SFA181	SFAC181		SFA181HH		MD995D			VR995		27	
SFA196	SFAC196		SFA196HH		MD995D			VR995		28	
SFA705	SFAC705		SFA705HH		MD9169D					29	
SFA705	SFAC705		SFA705HH		MD9169D					30	
FA083TT*			FA083R*	MD6283D	MD6283D					31	
FA663			FA663HH		MD2119X	MD2119XC		VR2119BLK†		32	
FA663			FA663HH		MD2119X	MD2119XC		VR2119BLK†		33	
Y513										34	
FA011										35	
FA064*				MD2019LS	MD2019RS					36	
FA070*				MD2019LS	MD2019RS					37	
FA081*				MD2011	MD2011	MD2011C*		VR2011*		38	
FA104*			FA104HH*	MD2011	MD2011	MD2011C*		VR2011*		39	
FA104*			FA104HH*	MD2011	MD2011	MD2011C*		VR2011*		40	
FA104*			FA104HH*	MD2011	MD2011	MD2011C*		VR2011*		41	
FA105TT			FA105R	MD6039D						42	
FA105TT			FA105R	MD6039D						43	
FA101TT			FA101R	MD6068D						44	
FA101TT			FA101R	MD6068D						45	
Y520*			Y520C*							46	
Y524*			Y524G*							47	
Y524*			Y524G*							48	
FA054TT*		MXS054*	FA054R*	MD6054D	MD6054D					49	
Y528*			Y528G*							50	
Y528*			Y528G*							51	
FA054TT*		MXS054*	FA054R*	MD6123D	MD6123D					52	
Y524*			Y524G*							53	
FA054TT*		MXS054*	FA054R*	MD6123D	MD6123D					54	
FA054TT*		MXS054*	FA054R*	MD6215D	MD6215D					55	
FA054TT*		MXS054*	FA054R*	MD6215D	MD6215D					56	
FA054TT*		MXS054*	FA054R*	MD6215D	MD6215D					57	
FA084TT*		MXS084*	FA084R*	MD6054D	MD6054D					58	
FA084TT*		MXS084*	FA084R*	MD6054D	MD6054D					59	

♦ Plain undrilled disc for enduro use MD6190CE

*-2 Sets Required. † For Vee disc colours add RED, BLU, GRN, GLD, ORG suffix to part number. For Custom Finish Options for Vee-Rotors™ including Splatter discs add suffix CHR, CHGR, CHBL, CHBR - available in various colours see page iv. ☼ - Also available as a Vintage Motorcycle Disc.

JAPANESE Built Motorcycles

Line #	BRAKE DISC CHOICES - FRONT						DISC PAD CHOICES - REAR				BRAKE DISC CHOICES - REAR			
	Oversize 250 /280mm Disc Kit	OSX Oversize 250/280mm Disc Kit	Relocating Bracket for 250/ 280mm Disc	Oversize 320mm Disc Kit	SMX Oversize 320mm Disc Kit	Relocating Bracket for 320mm Disc	FA, SFA, TT Pad or Brake Shoe	SFAC Carbon Scooter Pads	Speciality Pads - SXR / Vee / MXS	Sintered/ HH Pads/ Grooved Shoes	Standard Replacement Disc	Contour Disc Rear fitment	Vee Discs CONTOUR	CX Extreme MX Race Disc
1														
2							SFA678	SFAC678		SFA678HH	MD9153D			
3							Y531							
4							FA101TT		MXS101	FA101R				
5							Y528			Y528G				
6							Y506			Y506G				
7							Y506			Y506G				
8							Y506			Y506G				
9							Y506			Y506G				
10							FA101TT		MXS101	FA101R	MD6011D			
11							FA084/3TT		MXS084/3	FA084/3R	MD6011D			
12							FA152TT		MXS152	FA152R	MD6011D			
13	OS6028EC	OSX6028E	BRK035				FA152/2TT		MXS152	FA152/2R	MD6011D			
14	OS6028C	OSX6028	BRK008		SMX6028	BRK009	FA131TT		MXS131	FA131R	MD6135D	MD6135C		MD6135CX
15	OS6028C	OSX6028	BRK008		SMX6028	BRK009	FA131TT		MXS131	FA131R	MD6135D	MD6135C		MD6135CX
16	OS6028C	OSX6028	BRK008		SMX6028	BRK009	FA131TT		MXS131	FA131R	MD6190D	MD6190C		MD6190CX
17	OS6028C	OSX6028	BRK008		SMX6028	BRK009	FA367TT		MXS367	FA367R	MD6190D	MD6190C		MD6190CX
18	OS6728C	OSX6728	BRK002		SMX6728	BRK034	FA367TT		MXS367	FA367R	MD6190D	MD6190C		MD6190CX
19							FA367TT		MXS367	FA367R		MD6190C		MD6190CX
20	OS6028C	OSX6028	BRK008		SMX6028	BRK009	FA131TT		MXS131	FA131R	MD6135D	MD6135C		MD6135CX
21	OS6028C	OSX6028	BRK008		SMX6028	BRK009	FA131TT		MXS131	FA131R	MD6190D	MD6190C		MD6190CX
22	OS6028C	OSX6028	BRK008		SMX6028	BRK009	FA367TT		MXS367	FA367R	MD6190D	MD6190C		MD6190CX
23	OS6728C	OSX6728	BRK002		SMX6728	BRK034	FA367TT		MXS367	FA367R	MD6190D	MD6190C		MD6190CX
24							FA367TT		MXS367	FA367R		MD6190C		MD6190CX
25							FA367TT		MXS367	FA367R		MD6190C		MD6190CX
26														
27							SFA181	SFAC181		SFA181HH	MD9104D		VR9104	
28							SFA181	SFAC181		SFA181HH	MD9104D		VR9104	
29							SFA706	SFAC706		SFA706HH	MD9168D			
30							SFA706	SFAC706		SFA706HH	MD9168D			
31							FA067TT			FA067R	MD6369D			
32							FA662			FA662HH	MD2123	MD2123C	VR2123	
33							FA662			FA662HH	MD2123	MD2123C	VR2123	
34							Y514							
35							Y514							
36							Y514							
37							Y514							
38							FA088				MD2011	MD2011C	VR2011	
39							FA104		FA104V	FA104HH	MD2011	MD2011C	VR2011	
40							FA104		FA104V	FA104HH	MD2011	MD2011C	VR2011	
41							FA104		FA104V	FA104HH	MD2011	MD2011C	VR2011	
42							Y527			Y527G				
43							Y527			Y527G				
44							Y506			Y506G				
45							Y527			Y527G				
46							FA021			FA021R				
47							FA021			FA021R				
48							Y516							
49														
50							FA084TT			FA084R	MD6055D			
51							FA021			FA021R				
52							FA021			FA021R				
53														
54							FA084TT			FA084R	MD6053D			
55							Y528			Y528G				
56							Y516			Y516G				
57							Y532			Y532G				
58							Y532			Y532G				
59							FA084TT		MXS084	FA084R	MD6236D			
60														

REAR / ARRIÈRE / HINTEN / POSTERIOR / POSTERIORE

BRAKE APPLICATIONS

R Suffix = High Durability Sintered Pad. HH Suffix = High Performance Sintered Pad. TT Suffix = Hard Wearing Off Road Pad. V Suffix = Semi Sintered Pad. G Suffix = Grooved Shoe.
D Suffix = Drilled Disc. X Suffix = Universal Left or Right Disc. XC Suffix = Contoured Disc. LS Suffix = Left/Steel Disc. RS = Right/Steel Disc.

*-2 Sets Required. † For Vee disc colours add RED, BLU, GRN, GLD, ORG suffix to part number. For Custom Finish Options for Vee-Rotors™ including Splatter discs add suffix CHR, CHGR, CHBL, CHBR - available in various colours see page iv. Ⓢ - Also available as a Vintage Motorcycle Disc.

JAPANESE Built Motorcycles



YAMAHA Contd.



YFM 350 XV/XW/XX/XY 2WD Wolverine	06-09
YFM 350 GW/GX/GY/GZ Grizzly 2WD	08-10
YFM 350 FWA Grizzly 4WD	04-14
YFM 350 FG1W/FG1X/FG1Y/FG1Z Grizzly 4WD IRS	07-10
YZF 350 T/U/W Banshee	87-89
YZF 350 A/B/D/E/F/G/H/J/K/L/M/N/P/R/S/T Banshee	90-09
XS 360 B	75
XS 360 C	76
DT 400 All models	75-77
FZ 400 N (KF/46K/33M)	85
FZ 400 (4YR1)	96
FZR 400 Genesis (1WG) F/No 1WG 000101-0305100	86
FZR 400 RSP (2TK-EXUP) F/No 1WG 0305101-043100	87
FZR 400 (3EN1) F/No 1WG 043101-080100	88
FZR 400 R (3EN2) F/No 1WG 080101-	89
FZR 400 RR (3TJ1)	
FZR 400 RRSP (3TJ2/6/7) (ITJ)	
FZR 400 RR (4DX)	92
Majesty - See YP 400 Majesty	04
Majesty - See YP 400 Majesty	05-12
RD 400 C/D	76-77
RD 400 E/F	78-79
SR 400 (3HT1)	88
SR 400 (2RD)	14-17
SRX 400 (1JL)	85
SRX 400 (3VN1/3VN2/3VN5)	90-96
XJR 400 (4HM1/4HM2/4HM4/4HM7)	93-96
XJR 400 (4HM3/4HM5/4HM6/4HM9/4HMA/4HMB)	
Brembo calipers	95-99
XP 400 RA T-Max - Iron Max (ABS)	16
XS 400 C	78
XS 400	79
XS 400 SE	80-81
XS 400	82
XVS 400	96
YFM 400 FWE/FWF/FWG/FWH/FWJ/FWK/FWL Kodiak	93-99
YFM 400 FAM/FAN	00-01
YFM 400 FWP Big Bear 4 x 4	02
YFM 400 FPR/FPS Big Bear	03-04
YFM 400 FAR/FAS Kodiak Auto	03-04
YFM 400 AR Kodiak (5VH3/4)	03
YFM 400 FAT/FAV (Big Bear)	05-06
YFM 400 FGW/FGX Grizzly	07-08
YP 400 Majesty (5RU1/3 - Non ABS)	04
YP 400 Majesty (5RU6/8 - Non ABS)	05-13
YP 400 Majesty (ABS)	05-13
YP 400 R X-Max (Non ABS)	13-16
YP 400 X-Max ABS	13-20
YP 400 X-Max ABS Tech Max	13-20
YP 400 X-Max Momo Design ABS	15
YZ 400 D/E/F (2T)	77-79
YZ 400 FK (4T)	98
YZ 400 FL (4T)	99
WR 400 FK (4T)	98
WR 400 FL/FM (4T)	99-00
WR 400 FN (4T)	01
IT 425 G	80
WR 426 FN (4T)	01
WR 426 FP (4T)	02

FRONT / AVANT / VORN / FRENTE / ANTERIORE

DISC PAD CHOICES - FRONT				BRAKE DISC CHOICES - FRONT						Line #
FA, SFA, TT Pad or Brake Shoe	SFAC Carbon Scooter Pads	Speciality Pads - SXR / Vee / MXS	Sintered/HH Pads/ Grooved Shoes	Left / Gauche / Links Standard Replacement Disc	Right / Droite / Rechts Standard Replacement Disc	Contour Disc Universal left and right fitment	Custom Disc Universal left and right fitment	Vee-Discs Black † See note below	CX Extreme MX Race Disc/ UTVX Disc	Line #
FA054TT*		MXS054*	FA054R*	MD6215D	MD6215D					1
FA054TT*		MXS054*	FA054R*	MD6215D	MD6215D					2
FA054TT*		MXS054*	FA054R*	MD6215D	MD6215D					3
FA054TT*		MXS054*	FA054R*	MD6215D	MD6215D					4
FA101TT*			FA101R*	MD6051D	MD6051D					5
FA054TT*		MXS054*	FA054R*	MD6054D	MD6054D					6
FA011										7
FA034		FA034V			MD2019RS					8
Y528			Y528G							9
FA088*			FA088HH*	MD2011	MD2011					10
FA244*			FA244HH*	MD2001X	MD2001X	MD2001XC*	MD2001CC*	VR2001BLK*†		11
FA088*			FA088HH*	MD2020LS	MD2020RS					12
FA123*			FA123HH*	MD2022LS	MD2022RS					13
FA123*			FA123HH*	MD2022LS	MD2022RS					14
FA123*			FA123HH*	MD2001X	MD2001X	MD2001XC*	MD2001CC*	VR2001BLK*†		15
FA252*			FA252HH*	MD2001X	MD2001X	MD2001XC*	MD2001CC*	VR2001BLK*†		16
FA252*			FA252HH*	MD2001X	MD2001X	MD2001XC*	MD2001CC*	VR2001BLK*†		17
FA252*			FA252HH*	MD2001X	MD2001X	MD2001XC*	MD2001CC*	VR2001BLK*†		18
FA011										19
FA041					MD2025RS					20
Y526										21
FA179			FA179HH		MD2076					22
FA088			FA088HH		MD2011					23
FA123			FA123HH		MD2003X	MD2003XC	MD2003CC	VR2003BLK*†		24
FA199*			FA199HH*	MD2001X	MD2001X	MD2001XC*	MD2001CC*	VR2003BLK*†		25
FA244*			FA244HH*	MD2001X	MD2001X	MD2001XC*	MD2001CC*	VR2003BLK*†		26
SFA196*	SFAC196*		SFA196HH*							27
FA034		FA034V			MD2019RS					28
FA034					MD2019RS					29
FA041					MD2019RS					30
FA081					MD2011					31
FA179			FA179HH		MD2076					32
Y524*			Y524G*							33
FA054TT*		MXS054*	FA054R*	MD6123D	MD6123D					34
FA084TT*		MXS084*	FA084R*	MD6123D	MD6123D					35
FA054TT*		MXS054*	FA054R*	MD6123D	MD6123D					36
FA054TT*		MXS054*	FA054R*	MD6215D	MD6215D					37
FA054TT*		MXS054*	FA054R*	MD6215D	MD6215D					38
FA054TT*		MXS054*	FA054R*	MD6215D	MD6215D					39
FA054TT*		MXS054*	FA054R*	MD6215D	MD6215D					40
FA054TT*		MXS054*	FA054R*	MD6215D	MD6215D					41
FA054TT*		MXS054*	FA054R*	MD6215D	MD6215D					42
FA054TT*		MXS054*	FA054R*	MD6054D	MD6054D					43
SFA179	SFAC179		SFA179HH	MD9102D				VR9102		44
SFA199*	SFAC199*		SFA199HH*	MD9136D	MD9136D			VR9136*		45
SFA199*	SFAC199*		SFA199HH*	MD9136D	MD9136D			VR9136*		46
SFA196*	SFAC196*		SFA196HH*							47
SFA196*	SFAC196*		SFA196HH*							48
SFA196*	SFAC196*		SFA196HH*							49
SFA196*	SFAC196*		SFA196HH*							50
Y507			Y507G							51
FA185TT		MXS185	FA185R	MD6028D		MD6028C			MD6028CX	52
FA185TT		MXS185	FA185R	MD6028D		MD6028C			MD6028CX	53
FA185TT		MXS185	FA185R	MD6028D		MD6028C			MD6028CX	54
FA185TT		MXS185	FA185R	MD6028D		MD6028C			MD6028CX	55
FA185TT		MXS185	FA185R	MD6356D		MD6356C			MD6356CX	56
Y507			Y507G							57
FA185TT		MXS185	FA185R	MD6356D		MD6356C			MD6356CX	58
FA185TT		MXS185	FA185R	MD6356D		MD6356C			MD6356CX	59

♦ Plain undrilled disc for enduro use MD6190CE

*-2 Sets Required. † For Vee disc colours add RED, BLU, GRN, GLD, ORG suffix to part number. For Custom Finish Options for Vee-Rotors™ including Splatter discs add suffix CHR, CHGR, CHBL, CHBR - available in various colours see page iv. Ⓢ - Also available as a Vintage Motorcycle Disc.

JAPANESE Built Motorcycles

Line #	BRAKE DISC CHOICES - FRONT						DISC PAD CHOICES - REAR				BRAKE DISC CHOICES - REAR			
	Oversize 250 /280mm Disc Kit	OSX Oversize 250/280mm Disc Kit	Relocating Bracket for 250/ 280mm Disc	Oversize 320mm Disc Kit	SMX Oversize 320mm Disc Kit	Relocating Bracket for 320mm Disc	FA, SFA, TT Pad or Brake Shoe	SFAC Carbon Scooter Pads	Speciality Pads - SXR / Vee / MXS	Sintered/ HH Pads/ Grooved Shoes	Standard Replacement Disc	Contour Disc Rear fitment	Vee Discs CONTOUR	CX Extreme MX Race Disc
1							Y532			Y532G				
2							Y532			Y532G				
3							Y532			Y532G				
4														
5							FA084TT			FA084R	MD6053D			
6							FA084TT		MXS084	FA084R	MD6237D			
7							Y514							
8							FA034		FA034V		MD2019RS			
9							Y510			Y510G				
10							FA104		FA104V	FA104HH	MD2002			
11							FA104		FA104V	FA104HH	MD2002	MD2002C	VR2002	
12							FA104		FA104V	FA104HH	MD2021			
13							FA104		FA104V	FA104HH	MD2021			
14							FA104		FA104V	FA104HH	MD2021			
15							FA104		FA104V	FA104HH	MD2021	MD2021C	VR2021	
16							FA104		FA104V	FA104HH	MD2021	MD2021C	VR2021	
17							FA104		FA104V	FA104HH	MD2021	MD2021C	VR2021	
18							FA104		FA104V	FA104HH	MD2021	MD2021C	VR2021	
19														
20														
21							FA011							
22							FA041				MD2025RS			
23							Y510							
24							Y510							
25							FA104		FA104V	FA104HH	MD2002			
26							FA104		FA104V	FA104HH	MD2002	MD2002C	VR2002	
27							FA104		FA104V	FA104HH	MD2002	MD2002C	VR2002	
28														
29							FA104		FA104V	FA104HH	MD2002	MD2002C	VR2002	
30							SFA275	SFAC275		SFA275HH				
31							FA034		FA034V		MD2019RS			
32							Y516							
33							Y516							
34							Y516							
35							Y515							
36							Y516			Y516G				
37							FA307TT			FA307R	MD6174D			
38							Y516			Y516G				
39							Y516			Y516G				
40							Y516			Y516G				
41							Y532			Y532G				
42							FA307TT			FA307R	MD6252D			
43							FA307TT			FA307R	MD6252D			
44							SFA408	SFAC408		SFA408HH	MD9103D		VR9103	
45							SFA408	SFAC408		SFA408HH	MD9103D		VR9103	
46							SFA408	SFAC408		SFA408HH	MD9103D		VR9103	
47							SFA275	SFAC275		SFA275HH				
48							SFA275	SFAC275		SFA275HH				
49							SFA275	SFAC275		SFA275HH				
50							SFA607			SFA607HH				
51							Y528			Y528G				
52	OS6028C	OSX6028	BRK008		SMX6028	BRK009	FA152/2TT		MXS152	FA152/2R	MD6011D			
53	OS6028C	OSX6028	BRK008		SMX6028	BRK009	FA131TT		MXS131	FA131R	MD6135D	MD6135C		MD6135CX
54	OS6028C	OSX6028	BRK008		SMX6028	BRK009	FA152/2TT		MXS152	FA152/2R	MD6011D			
55	OS6028C	OSX6028	BRK008		SMX6028	BRK009	FA131TT		MXS131	FA131R	MD6135D	MD6135C		MD6135CX
56	OS6028C	OSX6028	BRK008		SMX6028	BRK009	FA131TT		MXS131	FA131R	MD6135D	MD6135C		MD6135CX
57							Y528			Y528G				
58	OS6028C	OSX6028	BRK008		SMX6028	BRK009	FA131TT		MXS131	FA131R	MD6135D	MD6135C		MD6135CX
59	OS6028C	OSX6028	BRK008		SMX6028	BRK009	FA131TT		MXS131	FA131R	MD6190D	MD6190C		MD6190CX
60														

REAR / ARRIÈRE / HINTEN / POSTERIOR / POSTERIORE

R Suffix = High Durability Sintered Pad. **HH** Suffix = High Performance Sintered Pad. **TT** Suffix = Hard Wearing Off Road Pad. **V** Suffix = Semi Sintered Pad. **G** Suffix = Grooved Shoe.
D Suffix = Drilled Disc. **X** Suffix = Universal Left or Right Disc. **XC** Suffix = Contoured Disc. **LS** Suffix = Left/Steel Disc. **RS** = Right/Steel Disc.

BRAKE APPLICATIONS

*-2 Sets Required. † For Vee disc colours add RED, BLU, GRN, GLD, ORG suffix to part number. For Custom Finish Options for Vee-Rotors™ including Splatter discs add suffix CHR, CHGR, CHBL, CHBR - available in various colours see page iv. Ⓢ - Also available as a Vintage Motorcycle Disc.

JAPANESE Built Motorcycles



YAMAHA Contd.

YZ 426 FM (4T)		00
YZ 426 FN (4T)		01
YZ 426 FP (4T)		02
WR 450 FR/FS/FT/FV (4T)		03-06
WR 450 FW/FX/FY/FZ/FA/FB/FD/FE/FF (4T)		07-15
WR 450 F (270mm F/Disc/4T)		16-20
YFM 450 FAR/FAS Kodiak (5ND3/4)		03-04
YFM 450 FAT/FAHT/FAV (Kodiak)		05-06
YFM 450 FXV/FXW/FXX/FXY/FXZ Wolverine		06-10
YFM 450 FWAD Grizzly IRS		11-16
YFM 450 FWAD Grizzly EPS (Power Steering)		11-14
YZ 450 S/T/R (Quad)	Left	04-05
	Right	
YZ 450 V/W/X (Quad)	Left	06-08
	Right	
YZ 450 B/D		13-14
YZ 450 RY/RZ (Quad)	Left	09-10
	Right	
YZ 450 RSEA/RSEB/RSED/RSE	Left	11-14
	Right	
YZ 450 FR/FSFT/FV		03-06
YZ 450 FW (4T)		07
YZ 450 FX/FY/FZ/FA/FB/FD/FE/FF (4T)		08-15
YZ 450 F (270mm Disc)		16-20
YZ 450 F (270mm Disc, 240mm rear disc)		19-20
YZ 450 FGY (60th Anniversary Edition/270mm Disc)		16
IT 465 H/J		81-82
YZ 465 G		80
YZ 465 H		81
IT 490 L		84
YZ 490 H/J		81-82
YZ 490 K		83
YZ 490 L		84
YZ 490 N		85
YZ 490 S/T		86-87
YZ 490 U		88
IT 500 G/H		80-81
RD 500 LC		84-86
RVZ 500 R (51X)		85
SR 500		78-82
SR 500 (3GW1/3/4/6/7)		96-98
SR 500 S (3GW5)		98
TX/XS 500 B		75-77
XP 500 N/P/R T-Max		01-03
XP 500 S/T/V T-Max (5VU1/2)		04-07
XP 500 T-Max (Non ABS Models)		08-11
XP 500 T-Max (ABS Models)		08-11
XP 500 T-Max (530cc Engine/Non ABS Models)		12-16
XP 500 T-Max (530cc Engine/Non ABS Models)		
- Parking Brake		12-16
XP 500 A T-Max (530cc Engine/ABS Models)		12-16
XP 500 A T-Max (530cc Engine/ABS Models)		
- Parking Brake		12-16
XP 500 (530cc Engine - Black & Bronze Max		
- Non & ABS Models)		13-15
XP 500 (530cc Engine - Black & Bronze Max		
- Non & ABS Models) - Parking Brake		13-15
XP 530 A - Iron Max (530cc Engine - ABS Model)		15-16
◆ Plain undrilled disc for enduro use MD6190CE		

DISC PAD CHOICES - FRONT					BRAKE DISC CHOICES - FRONT					Line #
FA, SFA, TT Pad or Brake Shoe	SFAC Carbon Scooter Pads	Speciality Pads - SXR / Vee / MXS	Sintered/HH Pads/ Grooved Shoes	Left / Gauche / Links Standard Replacement Disc	Right / Droite / Rechts Standard Replacement Disc	Contour Disc Universal left and right fitment	Custom Disc Universal left and right fitment	Vee-Discs Black † See note below	CX Extreme MX Race Disc/ UTVX Disc	Line #
FA185TT		MXS185	FA185R	MD6028D		MD6028C			MD6028CX	1
FA185TT		MXS185	FA185R	MD6356D		MD6356C			MD6356CX	2
FA185TT		MXS185	FA185R	MD6356D		MD6356C			MD6356CX	3
FA185TT		MXS185	FA185R	MD6356D		MD6356C			MD6356CX	4
FA185TT		MXS185	FA185R			MD6356C			MD6356CX	5
FA450TT		MXS450	FA450R			MD6392C			MD6392CX	6
FA054TT*		MXS054*	FA054R*	MD6215D	MD6215D					7
FA054TT*		MXS054*	FA054R*	MD6215D	MD6215D					8
FA054TT*		MXS054*	FA054R*	MD6215D	MD6215D					9
FA054TT*		MXS054*	FA054R*	MD6215D	MD6215D					10
FA054TT*		MXS054*	FA054R*	MD6215D	MD6215D					11
FA165TT		MXS165	FA165R	MD6054D						12
FA135TT		MXS135	FA135R		MD6054D					13
FA165TT		MXS165	FA165R	MD6054D						14
FA135TT		MXS135	FA135R		MD6054D					15
FA054TT*		MXS054*	FA054R*	MD6054D	MD6054D					16
FA165TT		MXS165	FA165R	MD6054D						17
FA135TT		MXS135	FA135R		MD6054D					18
FA165TT		MXS165	FA165R	MD6054D						19
FA135TT		MXS135	FA135R		MD6054D					20
FA185TT		MXS185	FA185R	MD6356D		MD6356C			MD6356CX	21
FA185TT		MXS185	FA185R			MD6356C			MD6356CX	22
FA450TT		MXS450	FA450R			MD6356C			MD6356CX	23
FA450TT		MXS450	FA450R			MD6392C			MD6392CX	24
FA450TT		MXS450	FA450R			MD6392C			MD6392CX	25
FA450TT		MXS450	FA450R			MD6392C			MD6392CX	26
Y508			Y508G							27
Y508			Y508G							28
Y508			Y508G							29
Y508			Y508G							30
Y508			Y508G							31
Y508			Y508G							32
Y508			Y508G							33
FA105TT			FA105R	MD6324D						34
FA105TT			FA105R	MD6067D						35
FA105TT			FA105R	MD6039D						36
Y507			Y507G							37
FA088*			FA088HH*	MD2069	MD2069					38
FA088*			FA088HH*	MD2069	MD2069					39
FA034				MD2023LS						40
Y526										41
Y526										42
FA011										43
SFA179	SFAC179		SFA179HH	MD2087LS						44
SFA199*	SFAC199*		SFA199HH*	MD2098	MD2098	MD2098C*				45
SFA252*	SFAC252*		SFA252HH*	MD2107	MD2107	MD2107C*				46
SFA252*	SFAC252*		SFA252HH*	MD2107	MD2107	MD2107C*				47
SFA252*			SFA252HH*	MD2098	MD2098	MD2098C*				48
										49
SFA621V										50
SFA252*			SFA252HH*	MD2098	MD2098	MD2098C*				51
										52
SFA621V										53
										54
SFA252*			SFA252HH*	MD2098	MD2098	MD2098C*				55
										56
SFA621V										57
SFA252*			SFA252HH*	MD2098	MD2098	MD2098C*				58
										59
										60

FRONT / AVANT / VORN / FRENTE / ANTERIORE

R Suffix = High Durability Sintered Pad. HH Suffix = High Performance Sintered Pad. TT Suffix = Hard Wearing Off Road Pad. V Suffix = Semi Sintered Pad. G Suffix = Grooved Shoe.

D Suffix = Drilled Disc. X Suffix = Universal Left or Right Disc. XC Suffix = Contoured Disc. LS Suffix = Left/Steel Disc. RS = Right/Steel Disc.

*-2 Sets Required. † For Vee disc colours add RED, BLU, GRN, GLD, ORG suffix to part number. For Custom Finish Options for Vee-Rotors™ including Splatter discs add suffix CHR, CHGR, CHBL, CHBR - available in various colours see page iv. Ⓢ - Also available as a Vintage Motorcycle Disc.

JAPANESE Built Motorcycles

Line #	BRAKE DISC CHOICES - FRONT						DISC PAD CHOICES - REAR				BRAKE DISC CHOICES - REAR			
	Oversize 250 /280mm Disc Kit	OSX Oversize 250/280mm Disc Kit	Relocating Bracket for 250/ 280mm Disc	Oversize 320mm Disc Kit	SMX Oversize 320mm Disc Kit	Relocating Bracket for 320mm Disc	FA, SFA, TT Pad or Brake Shoe	SFAC Carbon Scooter Pads	Speciality Pads - SXR / Vee / MXS	Sintered/ HH Pads/ Grooved Shoes	Standard Replacement Disc	Contour Disc Rear fitment	Vee Discs CONTOUR	CX Extreme MX Race Disc
1	OS6028C	OSX6028	BRK008		SMX6028	BRK009	FA131TT		MXS131	FA131R	MD6135D	MD6135C		MD6135CX
2	OS6028C	OSX6028	BRK008		SMX6028	BRK009	FA131TT		MXS131	FA131R	MD6135D	MD6135C		MD6135CX
3	OS6028C	OSX6028	BRK008		SMX6028	BRK009	FA131TT		MXS131	FA131R	MD6190D	MD6190C		MD6190CX
4	OS6028C	OSX6028	BRK008		SMX6028	BRK009	FA367TT		MXS367	FA367R	MD6190D	MD6190C		MD6190CX
5	OS6028C	OSX6028	BRK008		SMX6028	BRK009	FA367TT		MXS367	FA367R		MD6190C		MD6190CX
6							FA367TT		MXS367	FA367R		MD6190C		MD6190CX
7							FA307TT			FA307R	MD6174D			
8							FA307TT			FA307R	MD6252D			
9							FA307TT			FA307R	MD6174D			
10														
11														
12														
13							FA084TT			FA084R	MD6236D			
14														
15							FA323TT			FA323R	MD6263D			
16							FA323TT			FA323R	MD6263D			
17														
18							FA323TT			FA323R		MD6263C		
19														
20							FA323TT			FA323R		MD6263C		
21	OS6028C	OSX6028	BRK008		SMX6028	BRK009	FA367TT		MXS367	FA367R	MD6190D	MD6190C		MD6190CX
22	OS6028C	OSX6028	BRK008		SMX6028	BRK009	FA367TT		MXS367	FA367R		MD6190C		MD6190CX
23	OS6728C	OSX6728	BRK002		SMX6728	BRK034	FA367TT		MXS367	FA367R		MD6190C		MD6190CX
24							FA367TT		MXS367	FA367R		MD6190C		MD6190CX
25							FA367TT		MXS367	FA367R		MD6190C		MD6190CX
26							FA367TT		MXS367	FA367R		MD6190C		MD6190CX
27							Y510			Y510G				
28							Y528			Y528G				
29							Y510			Y510G				
30							Y510			Y510G				
31							Y510			Y510G				
32							Y506			Y506G				
33							Y510			Y510G				
34							Y510			Y510G				
35							Y510			Y510G				
36							Y510			Y510G				
37							Y528			Y528G				
38							FA104		FA104V	FA104HH	MD2070			
39							FA104		FA104V	FA104HH	MD2070			
40							Y510							
41							Y510							
42							Y510							
43							Y512							
44							SFA319	SFAC319		SFA319HH	MD2011	MD2011C		
45							SFA408	SFAC408		SFA408HH	MD2011	MD2011C		
46							SFA408	SFAC408		SFA408HH	MD2011	MD2011C		
47							SFA408	SFAC408		SFA408HH	MD2011	MD2011C		
48							SFA319			SFA319HH	MD9143D		VR9143	
49														
50														
51							SFA319			SFA319HH	MD9143D		VR9143	
52														
53														
54							SFA319			SFA319HH	MD9143D		VR9143	
55														
56														
57														
58							SFA319			SFA319HH	MD9143D		VR9143	
59														
60														

REAR / ARRIÈRE / HINTEN / POSTERIOR / POSTERIORE

R Suffix = High Durability Sintered Pad. **HH** Suffix = High Performance Sintered Pad. **TT** Suffix = Hard Wearing Off Road Pad. **V** Suffix = Semi Sintered Pad. **G** Suffix = Grooved Shoe.
D Suffix = Drilled Disc. **X** Suffix = Universal Left or Right Disc. **XC** Suffix = Contoured Disc. **LS** Suffix = Left/Steel Disc. **RS** = Right/Steel Disc.

BRAKE APPLICATIONS

*-2 Sets Required. † For Vee disc colours add RED, BLU, GRN, GLD, ORG suffix to part number. For Custom Finish Options for Vee-Rotors™ including Splatter discs add suffix CHR, CHGR, CHBL, CHBR - available in various colours see page iv. ⚡ - Also available as a Vintage Motorcycle Disc.

JAPANESE Built Motorcycles



YAMAHA Contd.



R Suffix = High Durability Sintered Pad. HH Suffix = High Performance Sintered Pad. TT Suffix = Hard Wearing Off Road Pad. V Suffix = Semi-Sintered Pad. G Suffix = Grooved Shoe.

D Suffix = Drilled Disc. X Suffix = Universal Left or Right Disc. XC Suffix = Contoured Disc. LS Suffix = Left/Steel Disc. RS = Right/Steel Disc.

XP 530 A - Iron Max (530cc Engine - ABS Model)		
- Parking Brake	15-16	
XP 500 A T-Max - Lux Max (ABS)	16	
XP 500 A T-Max - Lux Max (ABS) - Parking Brake	16	
XP 530E-A T-Max (530cc Engine - ABS Model)	17-20	
XP 530E-A T-Max (530cc Engine - ABS Model)		
- Parking Brake	17-20	
XP 530-A T-Max SX (530cc Engine - ABS Model)	17-20	
XP 530-A T-Max SX (530cc Engine - ABS Model)		
- Parking Brake	17-20	
XP 530D-A T-Max DX (530cc Engine - ABS Model)	17-20	
XP 530D-A T-Max DX (530cc Engine - ABS Model)		
- Parking Brake	17-20	
XS 500 C/D	78-79	
WR 500 ZD	92	
XT 500	76-80	
XV 535 Virago	88-94	
XV 535/535 S Virago	95-03	
XJ 550	81-84	
XJ 550 H/J/K Maxim	81-83	
XJ 550 RH/RJ/RK Seca	81-83	
XT 550	82-83	
XZ 550	82-84	
YFM 550 FWA Grizzly IRS	Left 11-14	
	Right	
YFM 550 FWAD Grizzly EPS	Left 11-14	
(Power Steering)	Right	
T-Max 560 ABS	19-20	
T-Max 560 ABS Tech Max	19-20	
FZ 600	87-88	
FZR 600	89	
FZR 600	90-93	
FZR 600 R	94-95	
FZS 600 Fazer	98-03	
FZ6 Naked - Non ABS/2 Piston Caliper (1B3/1B3D)	04-07	
FZ6 NS - Naked/Non ABS/2 Piston Caliper (1B35/1B6)	05-06	
FZ6 S2 - Naked/Non ABS/4 Piston Caliper (5S51/5S5)	07-09	
FZ6 Fazer - Half Fairing/Non ABS/2 Piston Caliper (5VX/5VXL)	04-07	
FZ6 Fazer - Half Fairing/ABS/2 Piston Caliper (4P5)	06-07	
FZ6 Fazer S2 - Half Fairing/Non ABS /4 Piston Caliper (4S81/4S8)	07-09	
FZ6 Fazer S2 - Half Fairing/ABS/4 Piston Caliper (5S2)	08	
SRX 600 (1JK)	85	
SRX 600 (3SX)	90	
SRX 600	86-87	
TT 600 L	84	
TT 600 N (59X) Frame # 59X 000101 -007852	85-88	
TT 600 W (2JT/3SW1) Frame # 59X 007853 Onwards	89-92	
TT 600 E (4LW3/4LW4/4GV4/4GV5)	94-01	
TT 600 E (4GV2)	94-95	
TT 600 K (4LW1/4GV1/4LW2) Up to 4GV 003403 (Nissin rear caliper)	93-95	
TT 600 K From 4GV 003404 (Brembo rear caliper)	95-96	
TT 600 R (5CH1)	97	
TT 600 R (5CH2)	98-99	
TT 600 R (5CH3)	00-02	
TT 600 RE (5CH5)	04	
XJ 600	84-91	
XJ 600 S Diversion	92-97	

FRONT / AVANT / VORN / FRENTE / ANTERIORE

DISC PAD CHOICES - FRONT				BRAKE DISC CHOICES - FRONT							Line #
FA, SFA, TT Pad or Brake Shoe	SFAC Carbon Scooter Pads	Speciality Pads - SXR / Vee / MXS	Sintered/HH Pads/ Grooved Shoes	Left / Gauche / Links Standard Replacement Disc	Right / Droite / Rechts Standard Replacement Disc	Contour Disc Universal left and right fitment	Custom Disc Universal left and right fitment	Vee-Discs Black † See note below	CX Extreme MX Race Disc/ UTVX Disc	Line #	
SFA621V										1	
SFA252*			SFA252HH*	MD2098	MD2098	MD2098C*				2	
SFA621V										3	
SFA252*			SFA252HH*	MD2098	MD2098	MD2098C*				4	
SFA621V										5	
SFA252*			SFA252HH*	MD2098	MD2098	MD2098C*				6	
SFA621V										7	
SFA252*			SFA252HH*	MD2098	MD2098	MD2098C*				8	
SFA621V										9	
SFA252*			SFA252HH*	MD2098	MD2098	MD2098C*				10	
SFA621V										11	
SFA252*			SFA252HH*	MD2098	MD2098	MD2098C*				12	
FA034		FA034V					MD2024			13	
FA135TT		MXS135	FA135R	MD6016D						14	
Y528			Y528G							15	
FA136						MD2023RS				16	
FA179		FA179V	FA179HH			MD2076				17	
FA070*				MD2019LS		MD2019RS				18	
FA070				MD2023LS						19	
FA070						MD2023RS				20	
Y510			Y510G							21	
FA081*				MD2011	MD2011	MD2011C*		VR2011*		22	
FA443TT			FA443R	MD6291D						23	
FA444TT			FA444R			MD6291D				24	
FA443TT			FA443R	MD6291D						25	
FA444TT			FA444R			MD6291D				26	
SFA252*			SFA252HH*	MD2098	MD2098	MD2098C*				27	
SFA252*			SFA252HH*	MD2098	MD2098	MD2098C*				28	
FA088*			FA088HH*	MD2011	MD2011	MD2011C*		VR2011*		29	
FA088*			FA088HH*	MD2001X	MD2001X	MD2001XC*	MD2001CC*	VR2001BLK*†		30	
FA160*			FA160HH*	MD2001X	MD2001X	MD2001XC*	MD2001CC*	VR2001BLK*†		31	
FA160*			FA160HH*	MD2001X	MD2001X	MD2001XC*	MD2001CC*	VR2001BLK*†		32	
FA252*			FA252HH*	MD2001X	MD2001X	MD2001XC*	MD2001CC*	VR2001BLK*†		33	
FA199*			FA199HH*	MD2082X	MD2082X	MD2082XC*	MD2082CC*	VR2082BLK*†		34	
FA199*			FA199HH*	MD2082X	MD2082X	MD2082XC*	MD2082CC*	VR2082BLK*†		35	
FA252*			FA252HH*	MD2082X	MD2082X	MD2082XC*	MD2082CC*	VR2082BLK*†		36	
FA199*			FA199HH*	MD2082X	MD2082X	MD2082XC*	MD2082CC*	VR2082BLK*†		37	
FA199*			FA199HH*	MD2082X	MD2082X	MD2082XC*	MD2082CC*	VR2082BLK*†		38	
FA252*			FA252HH*	MD2082X	MD2082X	MD2082XC*	MD2082CC*	VR2082BLK*†		39	
FA252*			FA252HH*	MD2082X	MD2082X	MD2082XC*	MD2082CC*	VR2082BLK*†		40	
FA104*			FA104HH*	MD2011	MD2011	MD2011C*		VR2011*		41	
FA123			FA123HH		MD2003X	MD2003XC	MD2003CC	VR2003BLK†		42	
FA104*			FA104HH*	MD2011	MD2011	MD2011C*		VR2011*		43	
Y508			Y508G							44	
FA101TT		MXS101	FA101R	MD6039D						45	
FA105TT			FA105R	MD6039D						46	
FA181TT		MXS181	FA181R	MD6182D						47	
FA181TT		MXS181	FA181R	MD6182D						48	
FA181TT		MXS181	FA181R	MD6182D						49	
FA181TT		MXS181	FA181R	MD6182D						50	
FA181TT		MXS181	FA181R	MD6182D						51	
FA181TT		MXS181	FA181R	MD6182D						52	
FA181TT		MXS181	FA181R	MD6182D						53	
FA181TT		MXS181	FA181R	MD6182D						54	
FA181TT		MXS181	FA181R	MD6182D						55	
FA181TT		MXS181	FA181R	MD6182D						56	
FA181TT		MXS181	FA181R	MD6182D						57	
FA181TT		MXS181	FA181R	MD6182D						58	
FA088*			FA088HH*	MD2011	MD2011	MD2011C*		VR2011*		59	
FA179			FA179HH	MD2031LS						60	

*-2 Sets Required. † For Vee disc colours add RED, BLU, GRN, GLD, ORG suffix to part number. For Custom Finish Options for Vee-Rotors™ including Splatter discs add suffix CHR, CHGR, CHBL, CHBR - available in various colours see page iv. Ⓢ - Also available as a Vintage Motorcycle Disc.

JAPANESE Built Motorcycles

Line #	BRAKE DISC CHOICES - FRONT						DISC PAD CHOICES - REAR				BRAKE DISC CHOICES - REAR			
	Oversize 250 /280mm Disc Kit	OSX Oversize 250/280mm Disc Kit	Relocating Bracket for 250/ 280mm Disc	Oversize 320mm Disc Kit	SMX Oversize 320mm Disc Kit	Relocating Bracket for 320mm Disc	FA, SFA, TT Pad or Brake Shoe	SFAC Carbon Scooter Pads	Speciality Pads - SXR / Vee / MXS	Sintered/ HH Pads/ Grooved Shoes	Standard Replacement Disc	Contour Disc Rear fitment	Vee Discs CONTOUR	CX Extreme MX Race Disc
1														
2														
3							SFA319		SFA319HH	MD9143D		VR9143		
4							SFA319		SFA319HH	MD9143D		VR9143		
5							SFA319		SFA319HH	MD9143D		VR9143		
6														
7														
8							SFA319		SFA319HH	MD9143D		VR9143		
9														
10														
11							SFA319		SFA319HH	MD9143D		VR9143		
12														
13														
14							FA034	FA034V		MD2025RS ☼				
15							FA152TT	MXS152	FA152R	MD6011D				
16							Y510		Y510G					
17							Y515							
18							Y515							
19							Y512							
20							Y512							
21							Y516							
22							Y510		Y510G					
23							Y512							
24							FA445TT		FA445R	MD6292D				
25							FA446TT		FA446R	MD6292D				
26							FA445TT		FA445R	MD6292D				
27							FA446TT		FA446R	MD6292D				
28							SFA319		SFA319HH	MD9143D		VR9143		
29							SFA319		SFA319HH	MD9143D		VR9143		
30							FA104	FA104V	FA104HH	MD2002	MD2002C	VR2002		
31							FA088	FA088V	FA088HH	MD2002	MD2002C	VR2002		
32							FA088	FA088V	FA088HH	MD2002	MD2002C	VR2002		
33							FA088	FA088V	FA088HH	MD2002	MD2002C	VR2002		
34							FA104	FA104V	FA104HH	MD2002	MD2002C	VR2002		
35							FA174	FA174V	FA174HH	MD2093	MD2093C	VR2093		
36							FA174	FA174V	FA174HH	MD2093	MD2093C	VR2093		
37							FA174	FA174V	FA174HH	MD2093	MD2093C	VR2093		
38														
39							FA174	FA174V	FA174HH	MD2093	MD2093C	VR2093		
40							FA174	FA174V	FA174HH	MD2093	MD2093C	VR2093		
41														
42							FA174	FA174V	FA174HH	MD2093	MD2093C	VR2093		
43							FA174	FA174V	FA174HH	MD2093	MD2093C	VR2093		
44							FA104	FA104V	FA104HH	MD2002	MD2002C	VR2002		
45							FA104	FA104V	FA104HH	MD2002	MD2002C	VR2002		
46							FA104	FA104V	FA104HH	MD2002	MD2002C	VR2002		
47							Y506		Y506G					
48							Y527		Y527G					
49							Y527		Y527G					
50							FA208TT	MXS208	FA208R	MD6183D				
51							FA152/2TT	MXS152	FA152/2R	MD6183D				
52														
53							FA152TT	MXS152	FA152R	MD6183D				
54							FA208TT	MXS208	FA208R	MD6183D				
55							FA208TT	MXS208	FA208R	MD6183D				
56							FA208TT	MXS208	FA208R	MD6183D				
57							FA208TT	MXS208	FA208R	MD6183D				
58							FA208TT	MXS208	FA208R	MD6183D				
59							FA088	FA088V	FA088HH	MD2011	MD2011C	VR2011		
60							FA104	FA104V	FA104HH	MD2002	MD2002C			

REAR / ARRIÈRE / HINTEN / POSTERIOR / POSTERIORE

BRAKE APPLICATIONS

R Suffix = High Durability Sintered Pad. **HH** Suffix = High Performance Sintered Pad. **TT** Suffix = Hard Wearing Off Road Pad. **V** Suffix = Semi Sintered Pad. **G** Suffix = Grooved Shoe.
D Suffix = Drilled Disc. **X** Suffix = Universal Left or Right Disc. **XC** Suffix = Contoured Disc. **LS** Suffix = Left/Steel Disc. **RS** = Right/Steel Disc.

*-2 Sets Required. † For Vee disc colours add RED, BLU, GRN, GLD, ORG suffix to part number. For Custom Finish Options for Vee-Rotors™ including Splatter discs add suffix CHR, CHGR, CHBL, CHBR - available in various colours see page iv. ☼ - Also available as a Vintage Motorcycle Disc.



YAMAHA Contd.

JAPANESE Built Motorcycles

DISC PAD CHOICES - FRONT

BRAKE DISC CHOICES - FRONT

XJ 600 S Diversion	98-03
XJ 600 N	95-97
XJ 600 N	98-03
XJ6-N Diversion 600 (Naked Diversion - Non ABS & ABS Models - 20S)	09-13
XJ6-N Diversion 600 (Naked Diversion - Non ABS & ABS Models)	13-15
XJ6-F Diversion 600 (Full Fairing Diversion - Non ABS & ABS Models - 1CW)	10-13
XJ6-F Diversion 600 (Full Fairing Diversion - Non ABS & ABS Models)	13-15
XJ6-S Diversion 600 (Top Fairing Diversion - Non ABS & ABS Models-36C)	09-13
XJ6-S Diversion 600 (Top Fairing Diversion - Non ABS & ABS Models)	13-15
XJ6-SP Diversion 600 (Non ABS & ABS Models)	13
XT 600	84-86
XT 600	87
XT 600 Z Tenere	84
XT 600 Z Tenere	85-88
XT 600/600 Z Tenere	88-90
XT 600 E	92-94
XT 600 E	95-03
YFM 600 FWAK/FWAL/FWAM/FWAN Grizzly	98-01
YFM 600 HM Grizzly Hunting	00
YX 600 S/SC/TT/UC/UW/WC/A/AC Radian	86-90
YZF 600 R Thundercat	96-03
YZF-R6	99-02
YZF-R6	03-04
YZF-R6	05-07
YZF-R6	08-16
YZF-R6	17-20
XJ 650 G/H/J/K Maxim	80-83
XJ 650 LH Midnight	81
XJ 650 RJ Seca	82
XJ 650 LK Seca	83
XJ 650	80-84
XJ 650 Turbo	82
XS 650	75
XS 650	77-81
XS 650 SE	79-80
XS 650 SE	81
XVS 650 Drag Star	97-04
XVS 650 A Drag Star Classic	98-07
MT-03 (660cc)	06-12
SZR 660	96-97
XT 660 X Supermoto	04-16
XT 660 R	04-16
XT 660 Z Tenere (Non ABS)	08-16
XT 660 ZA Tenere (ABS)	11-16
XTZ 660 Tenere	91-98
YFM 660 RW/RP/RR/RS/RT Raptor	01-05
YFM 660 FR/FS/FT Grizzly	03-05
YFM 660 FWAP/FWAR/FWAS/FWAT/FWAV /FGW/FGX Grizzly	02-08
YXR 66 FAS/FAT/FAV Rhino	Left 04-06
4 x 4 Side x Side	Right
MT-07 Non ABS (689cc/2Cyl)	14-16
MT-07A ABS (689cc/2Cyl)	14-20
MT-07A Moto Cage (ABS)	15-17

FRONT / AVANT / VORN / FRENTE / ANTERIORE

FA, SFA, TT Pad or Brake Shoe	SFAC Carbon Scooter Pads	Speciality Pads - SXR / Vee / MXS	Sintered/HH Pads/ Grooved Shoes	Left / Gauche / Links Standard Replacement Disc	Right / Droite / Rechts Standard Replacement Disc	Contour Disc Universal left and right fitment	Custom Disc Universal left and right fitment	Vee-Discs Black † See note below	CX Extreme MX Race Disc/ UTVX Disc
FA199*			FA199HH*	MD2074X	MD2074X	MD2074XC*	MD2074CC*	VR2074BLK*†	
FA179			FA179HH	MD2031LS				VR2074BLK*†	
FA199*			FA199HH*	MD2074X	MD2074X	MD2074XC*	MD2074CC*	VR2074BLK*†	
FA199*			FA199HH*	MD2082X	MD2082X	MD2082XC*	MD2082CC*	VR2082BLK*†	
FA199*			FA199HH*	MD2082X	MD2082X	MD2082XC*	MD2082CC*	VR2082BLK*†	
FA199*			FA199HH*	MD2082X	MD2082X	MD2082XC*	MD2082CC*	VR2082BLK*†	
FA199*			FA199HH*	MD2082X	MD2082X	MD2082XC*	MD2082CC*	VR2082BLK*†	
FA199*			FA199HH*	MD2082X	MD2082X	MD2082XC*	MD2082CC*	VR2082BLK*†	
FA199*			FA199HH*	MD2082X	MD2082X	MD2082XC*	MD2082CC*	VR2082BLK*†	
FA199*			FA199HH*	MD2082X	MD2082X	MD2082XC*	MD2082CC*	VR2082BLK*†	
FA199*			FA199HH*	MD2082X	MD2082X	MD2082XC*	MD2082CC*	VR2082BLK*†	
FA081				MD6070D					
FA118				MD6070D					
FA081				MD6070D					
FA118				MD6070D					
FA118				MD6070D					
FA172TT			FA172R	MD6070D					
FA172TT			FA172R	MD6116D					
FA084TT*			FA084R*	MD6140D	MD6140D				
FA084TT*			FA084R*	MD6140D	MD6140D				
FA088*			FA088HH*	MD2011	MD2011	MD2011C*		VR2011*	
FA252*			FA252HH*	MD2074X	MD2074X	MD2074XC*	MD2074CC*	VR2074BLK*†	
FA252*			FA252HH*	MD2074X	MD2074X	MD2074XC*	MD2074CC*	VR2074BLK*†	
FA252*			FA252HH*	MD2082X	MD2082X	MD2082XC*	MD2082CC*	VR2082BLK*†	
			FA380HH*	MD2095X	MD2095X	MD2095XC*	MD2095CC*	VR2095BLK*†	
			FA380HH*	MD2105X	MD2105X	MD2105XC*		VR2105BLK*†	
			FA380HH*	MD2124X	MD2124X	MD2124XC*		VR2124BLK*†	
FA061				MD2023LS					
FA061				MD2023LS					
FA034*				MD2019LS	MD2019RS				
FA081*				MD2011	MD2011	MD2011C*		VR2011*	
FA034*				MD2019LS	MD2019RS				
FA081*				MD2011	MD2011	MD2011C*		VR2011*	
FA011*									
FA034					MD2025RS				
FA034					MD2024				
FA034					MD2024				
FA179			FA179HH		MD2076				
FA179			FA179HH		MD2076				
FA199*			FA199HH*	MD2082X	MD2082X	MD2082XC*	MD2082CC*	VR2082BLK*†	
FA095			FA095HH		MD2003X	MD2003XC	MD2003CC	VR2003BLK*†	
FA244			FA244HH	MD6226D					
FA209/2			FA209/2HH	MD6235D					
FA181TT*		MXS181*	FA181R*	MD6235D	MD6235D				
FA181TT*		MXS181*	FA181R*	MD6235D	MD6235D				
FA172TT			FA172R	MD6116D					
FA084TT*		MXS084*	FA084R*	MD6054D	MD6054D				
FA084TT*		MXS084*	FA084R*	MD6189D	MD6189D				
FA084TT*		MXS084*	FA084R*	MD6189D	MD6189D				
FA135TT		MXS135	FA135R	MD6241D					UTVX6241
FA165TT		MXS165	FA165R	MD6241D					UTVX6241
FA252*			FA252HH*	MD2127X	MD2127X	MD2127XC*		VR2127BLK*†	
FA252*			FA252HH*	MD2127X	MD2127X	MD2127XC*		VR2127BLK*†	
FA252*			FA252HH*	MD2127X	MD2127X	MD2127XC*		VR2127BLK*†	

Line #
1
2
3
4
5
6
7
8
9
10
11
12
13
14
15
16
17
18
19
20
21
22
23
24
25
26
27
28
29
30
31
32
33
34
35
36
37
38
39
40
41
42
43
44
45
46
47
48
49
50
51
52
53
54
55
56
57
58
59
60

R Suffix = High Durability Sintered Pad. HH Suffix = High Performance Sintered Pad. TT Suffix = Hard Wearing Off Road Pad. V Suffix = Semi-Sintered Pad. G Suffix = Grooved Shoe.
D Suffix = Drilled Disc. X Suffix = Universal Left or Right Disc. XC Suffix = Contoured Disc. LS Suffix = Left/Steel Disc. RS = Right/Steel Disc.

*-2 Sets Required. † For Vee disc colours add RED, BLU, GRN, GLD, ORG suffix to part number. For Custom Finish Options for Vee-Rotors™ including Splatter discs add suffix CHR, CHGR, CHBL, CHBR - available in various colours see page iv. Ⓢ - Also available as a Vintage Motorcycle Disc.

JAPANESE Built Motorcycles

Line #	BRAKE DISC CHOICES - FRONT						DISC PAD CHOICES - REAR				BRAKE DISC CHOICES - REAR			
	Oversize 250 /280mm Disc Kit	OSX Oversize 250/280mm Disc Kit	Relocating Bracket for 250/ 280mm Disc	Oversize 320mm Disc Kit	SMX Oversize 320mm Disc Kit	Relocating Bracket for 320mm Disc	FA, SFA, TT Pad or Brake Shoe	SFAC Carbon Scooter Pads	Speciality Pads - SXR / Vee / MXS	Sintered/ HH Pads/ Grooved Shoes	Standard Replacement Disc	Contour Disc Rear fitment	Vee Discs CONTOUR	CX Extreme MX Race Disc
1							FA104		FA104V	FA104HH	MD2002	MD2002C	VR2002	
2							FA104		FA104V	FA104HH	MD2002	MD2002C	VR2002	
3							FA104		FA104V	FA104HH	MD2002	MD2002C	VR2002	
4														
5							FA140		FA140V	FA140HH	MD2117		VR2117	
6														
7							FA174			FA174HH	MD2117		VR2117	
8														
9							FA140			FA140HH	MD2117		VR2117	
10														
11							FA174			FA174HH	MD2117		VR2117	
12														
13							FA140			FA140HH	MD2117		VR2117	
14														
15							FA174			FA174HH	MD2117		VR2117	
16							FA174		FA174V	FA174HH	MD2117		VR2117	
17							Y510			Y510G				
18							FA101TT			FA101R	MD6072D			
19							Y510			Y510G				
20							Y510			Y510G				
21							FA101TT			FA101R	MD6072D			
22							FA101TT			FA101R	MD6072D			
23							FA101TT			FA101R	MD6072D			
24							Y516			Y516G				
25							Y516			Y516G				
26							Y512							
27							FA088		FA088V	FA088HH	MD2002	MD2002C	VR2002	
28							FA275			FA275HH	MD2084	MD2084C	VR2084	
29							FA174			FA174HH	MD2091	MD2091C	VR2091	
30							FA174			FA174HH	MD2091	MD2091C	VR2091	
31							FA174			FA174HH	MD2091	MD2091C	VR2091	
32							FA436			FA436HH	MD2091	MD2091C	VR2091	
33							Y512							
34							Y512							
35							Y515							
36							Y515							
37							Y515							
38							Y515							
39							Y514							
40							Y514							
41							FA034				MD2025RS			
42							Y514							
43							Y515							
44							Y515							
45							FA213			FA213HH	MD2093	MD2093C	VR2093	
46							FA047			FA047HH	MD2021	MD2021C	VR2021	
47							FA213			FA213HH	MD6234D			
48							FA213			FA213HH	MD6234D			
49							FA208TT		MXS208	FA208R	MD6234D			
50							FA208TT		MXS208	FA208R	MD6234D			
51							FA101TT			FA101R	MD6072D			
52							FA084TT			FA084R	MD6237D			
53							FA344TT			FA344R	MD6197D			
54														
55							FA344TT			FA344R	MD6197D			
56							FA428TT			FA428R	MD6242D			UTVX6242
57														
58							FA174		FA174V	FA174HH		MD2120C	VR2120	
59							FA174		FA174V	FA174HH		MD2120C	VR2120	
60							FA174		FA174V	FA174HH		MD2120C	VR2120	

REAR / ARRIÈRE / HINTEN / POSTERIOR / POSTERIORE

R Suffix = High Durability Sintered Pad. **HH** Suffix = High Performance Sintered Pad. **TT** Suffix = Hard Wearing Off Road Pad. **V** Suffix = Semi Sintered Pad. **G** Suffix = Grooved Shoe.
D Suffix = Drilled Disc. **X** Suffix = Universal Left or Right Disc. **XC** Suffix = Contoured Disc. **LS** Suffix = Left/Steel Disc. **RS** = Right/Steel Disc.

BRAKE APPLICATIONS

*-2 Sets Required. † For Vee disc colours add RED, BLU, GRN, GLD, ORG suffix to part number. For Custom Finish Options for Vee-Rotors™ including Splatter discs add suffix CHR, CHGR, CHBL, CHBR - available in various colours see page iv. ☼ - Also available as a Vintage Motorcycle Disc.

JAPANESE Built Motorcycles



YAMAHA Contd.

MT-07A Moto Cage (Non ABS)	14-16
FZX 700 S/SC/T/TC Fazer	86-87
XT 700 Z Tenere	18-20
Tracer 700 (MTT 690)	16-20
Tracer 700 GT	19-20
XSR 700 ABS	16-20
XSR 700 ABS XTribute	19-20
YFM 700 RV/RW/RAA/R	Left 06-12
	Right
YFM 700 RD/RE	Left 13-14
	Right
YFM 700 RSE	Left 13-18
	Right
YFM 700 FWAD Grizzly EPS	Left 07-18
	Right
YXM 700 E Viking EPS Como	Left 16
(YXM70VPHG)	Right
YXM 700 E Viking EPS Como (YXM70VPHG)	
- Parking Brake	16
YXM 700 E Wolverine R (YXE70WPHG)	Left 16
	Right
YXM 700 E Wolverine R (YXE70WPHG) - Parking Brake	16
YXM 700 ES Viking EPS SE	Left 14-16
(YXM700PSE)	Right
YXM 700 ES Viking EPS SE (YXM700PSE)	
- Parking Brake	14-16
YXC 700 E Viking VI EP	Left 15-18
(YXC700PF/PXG/PXH/PXJ)	Right
YXC 700 E Viking VI EP (YXC700PF/PXG/PXH/PXJ)	
- Parking Brake	15-18
YXP 700 AS/AT/AV Pro Hauler 700 Side x Side	04-06
YXR 700 Rhino 4 x 4 SE	Left 09
	Right
YXR 700 Rhino 4 x 4 SE - Parking Brake	09
YXR 700 FA/FB/FD Rhino Side x Side	Left 11-13
	Right
YXR 700 FA/FB/FD Rhino Side x Side - Parking Brake	11-13
FZ 750	85-86
FZ 750	87-88
FZ 750	89-91
FZX 750	87
FZR 750 Genesis	87
FZR 750 R OW01	89-90
XJ 750 RF/RJ/RK Seca	81-83
XJ 750	82-84
XS 750	77-79
XS 750 SE	Left 79-80
	Right
XTZ 750 Super Tenere	Left 89-95
	Right
XV 750 SE	81
XV 750 Virago	92-93
XV 750 Virago	94-97
YZF 750 R/SP	93-97
YZF-R7 750 OW02 (Race Version)	99-01
YZF-R7 750 OW02 (Road Version) (5FL1)	99-01
FZ 8 N-800cc (Naked/Single Headlight/Non ABS)	11-15
FZ 8 NA-800cc (Naked/Single Headlight/ABS)	11-15
Fazer 8 S-800cc (Top Fairing/Twin Headlight/Non ABS)	11-15
Fazer 8 SA-800cc (Top Fairing/Twin Headlight/ABS)	11-15

DISC PAD CHOICES - FRONT				BRAKE DISC CHOICES - FRONT						Line #
FA, SFA, TT Pad or Brake Shoe	SFAC Carbon Scooter Pads	Speciality Pads - SXR / Vee / MXS	Sintered/HH Pads/ Grooved Shoes	Left / Gauche / Links Standard Replacement Disc	Right / Droite / Rechts Standard Replacement Disc	Contour Disc Universal left and right fitment	Custom Disc Universal left and right fitment	Vee-Discs Black † See note below	CX Extreme MX Race Disc/ UTVX Disc	Line #
FA252*			FA252HH*	MD2127X	MD2127X	MD2127XC*		VR2127BLK†		1
FA088*		FA088V*	FA088HH*	MD2011	MD2011	MD2011C*		VR2011*		2
FA181TT*		MXS181*	FA181HH*							3
FA252*			FA252HH*			MD2127XC*		VR2127BLK†		4
FA252*			FA252HH*			MD2127XC*		VR2127BLK†		5
FA252*			FA252HH*			MD2127XC*		VR2127BLK†		6
FA252*			FA252HH*			MD2127XC*		VR2127BLK†		7
FA165TT		MXS165	FA165R	MD6054D						8
FA135TT		MXS135	FA135R		MD6054D					9
FA165TT		MXS165	FA165R	MD6054D						10
FA135TT		MXS135	FA135R		MD6054D					11
FA165TT		MXS165	FA165R	MD6054D						12
FA135TT		MXS135	FA135R		MD6054D					13
FA443TT			FA443R	MD6291D						14
FA444TT			FA444R		MD6291D					15
FA642TT			FA642R	MD6382D					UTVX6382	16
FA645TT			FA645R		MD6382D				UTVX6382	17
FA497TT				MD6381D						18
FA642TT			FA642R	MD6382D					UTVX6382	19
FA645TT			FA645R		MD6382D				UTVX6382	20
FA497TT				MD6381D						21
FA642TT			FA642R	MD6382D					UTVX6382	22
FA645TT			FA645R		MD6382D				UTVX6382	23
FA497TT				MD6381D						24
FA642TT			FA642R	MD6382D					UTVX6382	25
FA645TT			FA645R		MD6382D				UTVX6382	26
FA497TT				MD6381D						27
FA642TT			FA642R	MD6382D					UTVX6382	28
FA645TT			FA645R		MD6382D				UTVX6382	29
FA497TT				MD6381D						30
FA165TT			FA165R	MD6241D					UTVX6241	31
FA135TT			FA135R		MD6241D				UTVX6241	32
FA497TT										33
FA165TT			FA165R	MD6241D					UTVX6241	34
FA135TT			FA135R		MD6241D				UTVX6241	35
FA497TT										36
FA088*			FA088HH*	MD2069	MD2069					37
FA088*			FA088HH*	MD2011	MD2011	MD2011C*		VR2011*		38
FA123*			FA123HH*	MD2001X	MD2001X	MD2001XC*	MD2001CC*	VR2001BLK†		39
FA088*			FA088HH*	MD2011	MD2011	MD2011C*		VR2011*		40
FA123*			FA123HH*	MD2003X	MD2003X	MD2003XC*	MD2003CC*	VR2003BLK†		41
FA145*			FA145HH*	MD2009LS	MD2009RS					42
FA070*		FA070V*		MD2023LS	MD2023RS					43
FA070*		FA070V*		MD2023LS	MD2023RS					44
FA034*		FA034V*		MD2025LS	MD2025RS					45
FA061		FA061V		MD2025LS						46
FA041		FA041V			MD2025RS					47
FA135TT		MXS135	FA135R	MD6118D						48
FA165TT		MXS165	FA165R		MD6118D					49
FA061		FA061V		MD2024						50
FA088*		FA088V*	FA088HH*	MD2011	MD2011	MD2011C*		VR2011*		51
FA179*		FA179V*	FA179HH*	MD2067	MD2067					52
FA190*			FA190HH*	MD2003X	MD2003X	MD2003XC*	MD2003CC*	VR2003BLK†		53
FA424*			FA424HH*							54
FA252*			FA252HH*	MD2083	MD2083					55
			FA380HH*	MD2095X	MD2095X	MD2095XC*	MD2095CC*	VR2095BLK†		56
			FA380HH*	MD2095X	MD2095X	MD2095XC*	MD2095CC*	VR2095BLK†		57
			FA380HH*	MD2095X	MD2095X	MD2095XC*	MD2095CC*	VR2095BLK†		58
			FA380HH*	MD2095X	MD2095X	MD2095XC*	MD2095CC*	VR2095BLK†		59
			FA380HH*	MD2095X	MD2095X	MD2095XC*	MD2095CC*	VR2095BLK†		60

FRONT / AVANT / VORN / FRENTE / ANTERIORE

R Suffix = High Durability Sintered Pad. HH Suffix = High Performance Sintered Pad. TT Suffix = Hard Wearing Off Road Pad. V Suffix = Semi-Sintered Pad. G Suffix = Grooved Shoe.

D Suffix = Drilled Disc. X Suffix = Universal Left or Right Disc. XC Suffix = Contoured Disc. LS Suffix = Left/Steel Disc. RS = Right/Steel Disc.

*-2 Sets Required. † For Vee disc colours add RED, BLU, GRN, GLD, ORG suffix to part number. For Custom Finish Options for Vee-Rotors™ including Splatter discs add suffix CHR, CHGR, CHBL, CHBR - available in various colours see page iv. ☼ - Also available as a Vintage Motorcycle Disc.

JAPANESE Built Motorcycles

Line #	BRAKE DISC CHOICES - FRONT						DISC PAD CHOICES - REAR				BRAKE DISC CHOICES - REAR			
	Oversize 250 /280mm Disc Kit	OSX Oversize 250/280mm Disc Kit	Relocating Bracket for 250/ 280mm Disc	Oversize 320mm Disc Kit	SMX Oversize 320mm Disc Kit	Relocating Bracket for 320mm Disc	FA, SFA, TT Pad or Brake Shoe	SFAC Carbon Scooter Pads	Speciality Pads - SXR / Vee / MXS	Sintered/ HH Pads/ Grooved Shoes	Standard Replacement Disc	Contour Disc Rear fitment	Vee Discs CONTOUR	CX Extreme MX Race Disc
1							FA174		FA174V	FA174HH		MD2120C	VR2120	
2							FA088		FA088V	FA088HH	MD2069			
3							FA208TT		MXS208	FA208R				
4							FA174		FA174V	FA174HH		MD2120C	VR2120	
5							FA174		FA174V	FA174HH		MD2120C	VR2120	
6							FA174		FA174V	FA174HH		MD2120C	VR2120	
7							FA174		FA174V	FA174HH		MD2120C	VR2120	
8							FA428TT			FA428R	MD6263D			
9														
10							FA323TT			FA323R	MD6236D			
11														
12							FA323TT			FA323R	MD6236D			
13														
14							FA445TT			FA445R	MD6292D			
15							FA446TT			FA446R	MD6292D			
16							FA674TT			FA674R	MD6382D			UTVX6382
17							FA675TT			FA675R	MD6382D			UTVX6382
18														
19														
20							FA674TT			FA674R	MD6382D			UTVX6382
21							FA675TT			FA675R	MD6382D			UTVX6382
22														
23							FA674TT			FA674R	MD6382D			UTVX6382
24							FA675TT			FA675R	MD6382D			UTVX6382
25														
26														
27							FA674TT			FA674R	MD6382D			UTVX6382
28							FA675TT			FA675R	MD6382D			UTVX6382
29														
30														
31							Y534			Y534G				
32							FA165TT			FA165R	MD6332D			UTVX6332
33							FA135TT			FA135R	MD6332D			UTVX6332
34														
35							FA165TT			FA165R	MD6332D			UTVX6332
36							FA135TT			FA135R	MD6332D			UTVX6332
37														
38							FA088		FA088V	FA088HH	MD2069			
39							FA088		FA088V	FA088HH	MD2011	MD2011C	VR2011	
40							FA088		FA088V	FA088HH	MD2011	MD2011C	VR2011	
41							FA088		FA088V	FA088HH	MD2069			
42							FA088		FA088V	FA088HH	MD2011	MD2011C	VR2011	
43							FA088		FA088V	FA088HH	MD2008			
44							Y515							
45							Y515							
46							FA034		FA034V		MD2025RS ☼			
47														
48							FA034		FA034V		MD2025RS ☼			
49							FA165/2TT			FA165/2R	MD6119D			
50														
51							Y512							
52							Y512							
53							Y515							
54							FA088		FA088V	FA088HH	MD2002	MD2002C		
55														
56							FA267			FA267HH	MD2086	MD2086C	VR2086	
57							FA174		FA174V	FA174HH	MD2116	MD2116C	VR2116	
58							FA174		FA174V	FA174HH	MD2116	MD2116C	VR2116	
59							FA174		FA174V	FA174HH	MD2116	MD2116C	VR2116	
60							FA174		FA174V	FA174HH	MD2116	MD2116C	VR2116	

REAR / ARRIÈRE / HINTEN / POSTERIOR / POSTERIORE

R Suffix = High Durability Sintered Pad. **HH** Suffix = High Performance Sintered Pad. **TT** Suffix = Hard Wearing Off Road Pad. **V** Suffix = Semi Sintered Pad. **G** Suffix = Grooved Shoe.
D Suffix = Drilled Disc. **X** Suffix = Universal Left or Right Disc. **XC** Suffix = Contoured Disc. **LS** Suffix = Left/Steel Disc. **RS** = Right/Steel Disc.

*-2 Sets Required. † For Vee disc colours add RED, BLU, GRN, GLD, ORG suffix to part number. For Custom Finish Options for Vee-Rotors™ including Splatter discs add suffix CHR, CHGR, CHBL, CHBR - available in various colours see page iv. ☼ - Also available as a Vintage Motorcycle Disc.

BRAKE APPLICATIONS

JAPANESE Built Motorcycles



YAMAHA Contd.



DISC PAD CHOICES - FRONT

BRAKE DISC CHOICES - FRONT

TDM 850	91-95
TDM 850	96-01
TRX 850	96-99
XS 850	80
MT-09 (1RC/Non ABS 847cc/3 Cyl Engine)	14-16
MT-09 A (2DR/ABS 847cc/3 Cyl Engine)	14-16
MT-09 A Sport Tracker ABS (847cc/3 Cyl Engine)	14-16
MT-09 A Street Rally ABS (847cc/3 Cyl Engine)	14-16
MT-09 ABS (MT850-A 847cc/3 Cyl Engine)	17-20
MT-09 SP ABS (MT850-D 847cc/3 Cyl Engine)	18-20
MT-09 Tracer 900 ABS (847cc/3 Cyl Engine)	15-20
MT-09 Tracer 900 GT ABS (847cc/3 Cyl Engine)	18-20
Niken ABS (847cc/3 Cyl Engine)	18-20
Niken GT ABS (847cc/3 Cyl Engine)	19-20
TDM 900 (5PS/Non ABS)	02-14
TDM 900 A (2B0/ABS)	05-13
XJ 900/900 F	83-86
XJ 900/900 F	87-94
XJ 900 S Diversion	95-03
XSR 900 ABS (MTM 850)	16-20
XSR 900 Abarth ABS (MTM 850)	17-18
SCR 950 (XVS 950XR-A)	17-20
XV 950 Racer (Remote Reservoir Rear Shocks)	15-16
XVS 950 A Midnight Star	09-13
XV 950 - XVS 950 (Non ABS/Standard Rear Shocks)	14
XV 950 CU - XVS 950 (1XC1/ABS/Standard Rear Shocks)	14-16
XV 950 R - XVS 950 R (2DE/Remote Reservoir Rear Shocks)	14-20
FZR 1000 Genesis	87-88
FZR 1000 EX UP (STD Forks)	89-90
FZR 1000 EX UP (USD Forks)	91-93
FZR 1000 EX UP (6 piston caliper)	94-95
FZS 1000 Fazer	01-05
FZ1 (Naked) (2D1) (1000cc)	06-09
FZ1 N/NA (Naked) (Non ABS & ABS)	10-15
FZ1 Fazer (3C3) (Half fairing/Non ABS)	06-15
FZ1 Fazer (Half fairing/ABS - 5D0)	08-15
GTS 1000	93-99
MT-10 (MTN1000/998cc)	16-20
MT-10 Tourer Edition (998cc)	18-20
MT-10 SP (MTN 1000D/998cc)	17-20
XV 1000 TR1	81
XV 1000 Virago	86
XV 1000 SE Virago	88
YZF 1000 R Thunderace	96-01
YZF-R1	98-01
YZF-R1	02-03
YZF-R1	04-06
YZF-R1 SP (4B1)	06
YZF-R1 (6 piston radial caliper)	07-08
YZF-R1	09-14
YZF-R1	15-20
YZF-R1M	15-20
YZF-R1M Mission	20
YZF-R1 (60th Anniversary Edition)	16
YXP 1000 AS/AT Pro Hauler 1000 Side x Side	04-05
YZX 1000 R EPS (Side x Side) YZX10PXG	16
YZX 1000 R EPS (Side x Side) YZX10PXG - Parking Brake	16
YZX 1000 R SE (Side x Side)	16

FRONT / AVANT / VORN / FRENTE / ANTERIORE

FA, SFA, TT Pad or Brake Shoe	SFAC Carbon Scooter Pads	Speciality Pads - SXR / Vee / MXS	Sintered/HH Pads/ Grooved Shoes	Left / Gauche / Links Standard Replacement Disc	Right / Droite / Rechts Standard Replacement Disc	Contour Disc Universal left and right fitment	Custom Disc Universal left and right fitment	Vee-Discs Black † See note below	CX Extreme MX Race Disc/ UTVX Disc
FA123*		FA123V*	FA123HH*	MD2001X	MD2001X	MD2001XC*	MD2001CC*	VR2001BLK*†	
FA160*			FA160HH*	MD2001X	MD2001X	MD2001XC*	MD2001CC*	VR2001BLK*†	
FA123*		FA123V*	FA123HH*	MD2001X	MD2001X	MD2001XC*	MD2001CC*	VR2001BLK*†	
FA034*		FA034V*		MD2024 ☼	MD2024 ☼				
FA252*			FA252HH*	MD2119X	MD2119X	MD2119XC*		VR2119BLK*†	
FA252*			FA252HH*	MD2119X	MD2119X	MD2119XC*		VR2119BLK*†	
FA252*			FA252HH*	MD2119X	MD2119X	MD2119XC*		VR2119BLK*†	
FA252*			FA252HH*	MD2119X	MD2119X	MD2119XC*		VR2119BLK*†	
FA252*			FA252HH*	MD2119X	MD2119X	MD2119XC*		VR2119BLK*†	
FA252*			FA252HH*	MD2119X	MD2119X	MD2119XC*		VR2119BLK*†	
FA252*			FA252HH*	MD2119X	MD2119X	MD2119XC*		VR2119BLK*†	
FA252*			FA252HH*	MD2119X	MD2119X	MD2119XC*		VR2119BLK*†	
			FA380HH*						
			FA380HH*						
FA252*			FA252HH*	MD2074X	MD2074X	MD2074XC*	MD2074CC*	VR2074BLK*†	
FA252*			FA252HH*	MD2074X	MD2074X	MD2074XC*	MD2074CC*	VR2074BLK*†	
FA088*			FA088HH*	MD2069	MD2069				
FA088*			FA088HH*	MD2011	MD2011	MD2011C*		VR2011*	
FA179*		FA179V*	FA179HH*	MD2012	MD2012				
			FA380HH*	MD2119X	MD2119X	MD2119XC*		VR2119BLK*†	
			FA380HH*	MD2119X	MD2119X	MD2119XC*		VR2119BLK*†	
FA179		FA179V	FA179HH						
FA179		FA179V	FA179HH						
FA179		FA179V	FA179HH	MD2089X		MD2089XC	MD2089CC	VR2089BLK†	
FA179		FA179V	FA179HH						
FA179		FA179V	FA179HH			MD2074XC			
FA123*			FA123HH*	MD2003X	MD2003X	MD2003XC*	MD2003CC*	VR2003BLK*†	
FA160*			FA160HH*	MD2003X	MD2003X	MD2003XC*	MD2003CC*	VR2003BLK*†	
FA182*			FA182HH*	MD2003X	MD2003X	MD2003XC*	MD2003CC*	VR2003BLK*†	
FA190*			FA190HH*	MD2003X	MD2003X	MD2003XC*	MD2003CC*	VR2003BLK*†	
FA252*			FA252HH*	MD2074X	MD2074X	MD2074XC*	MD2074CC*	VR2074BLK*†	
			FA380HH*	MD2101X	MD2101X	MD2101XC*		VR2101BLK*†	
			FA380HH*	MD2101X	MD2101X	MD2101XC*		VR2101BLK*†	
			FA380HH*	MD2101X	MD2101X	MD2101XC*		VR2101BLK*†	
			FA380HH*	MD2101X	MD2101X	MD2101XC*		VR2101BLK*†	
FA191									
			FA380HH*	MD2124X	MD2124X	MD2124XC*		VR2124BLK*†	
			FA380HH*	MD2124X	MD2124X	MD2124XC*		VR2124BLK*†	
			FA380HH*	MD2124X	MD2124X	MD2124XC*		VR2124BLK*†	
FA034*		FA034V*		MD2019LS	MD2019RS				
FA088*		FA088V*	FA088HH*	MD2011	MD2011	MD2011C*		VR2011*	
FA088*		FA088V*	FA088HH*	MD2011	MD2011	MD2011C*		VR2011*	
FA252*			FA252HH*	MD2074X	MD2074X	MD2074XC*	MD2074CC*	VR2074BLK*†	
FA252*			FA252HH*	MD2074X	MD2074X	MD2074XC*	MD2074CC*	VR2074BLK*†	
FA252*			FA252HH*	MD2074X	MD2074X	MD2074XC*	MD2074CC*	VR2074BLK*†	
			FA380HH*	MD2094X	MD2094X	MD2094XC*	MD2094CC*	VR2094BLK*†	
			FA380HH*	MD2112X	MD2112X				
FA442/4*			FA442/4HH*†	MD2102X	MD2102X	MD2102XC*	MD2102CC*	VR2102BLK*†	
FA442/4*			FA442/4HH*†	MD2102X	MD2102X	MD2102XC*		VR2102BLK*†	
			FA380HH*	MD2124X	MD2124X	MD2124XC*		VR2124BLK*†	
			FA380HH*	MD2124X	MD2124X	MD2124XC*		VR2124BLK*†	
			FA380HH*	MD2124X	MD2124X	MD2124XC*		VR2124BLK*†	
			FA380HH*	MD2124X	MD2124X	MD2124XC*		VR2124BLK*†	
			FA380HH*	MD2124X	MD2124X	MD2124XC*		VR2124BLK*†	
Y534*			Y534G*						
FA676TT*			FA676R*	MD6382D	MD6382D				UTVX6382*
FA497TT				MD6381D					
FA676TT*			FA676R*	MD6395D	MD6395D				UTVX6395*

Line #

1

2

3

4

5

6

7

8

9

10

11

12

13

14

15

16

17

18

19

20

21

22

23

24

25

26

27

28

29

30

31

32

33

34

35

36

37

38

39

40

41

42

43

44

45

46

47

48

49

50

51

52

53

54

55

56

57

58

59

60

R Suffix = High Durability Sintered Pad. HH Suffix = High Performance Sintered Pad. TT Suffix = Hard Wearing Off Road Pad. V Suffix = Semi-Sintered Pad. G Suffix = Grooved Shoe.

D Suffix = Drilled Disc. X Suffix = Universal Left or Right Disc. XC Suffix = Contoured Disc. LS Suffix = Left/Steel Disc. RS = Right/Steel Disc.

*-2 Sets Required. † For Vee disc colours add RED, BLU, GRN, GLD, ORG suffix to part number. For Custom Finish Options for Vee-Rotors™ including Splatter discs add suffix CHR, CHGR, CHBL, CHBR - available in various colours see page iv. ☼ - Also available as a Vintage Motorcycle Disc.

JAPANESE Built Motorcycles

Line #	BRAKE DISC CHOICES - FRONT						DISC PAD CHOICES - REAR				BRAKE DISC CHOICES - REAR			
	Oversize 250 /280mm Disc Kit	OSX Oversize 250/280mm Disc Kit	Relocating Bracket for 250/ 280mm Disc	Oversize 320mm Disc Kit	SMX Oversize 320mm Disc Kit	Relocating Bracket for 320mm Disc	FA, SFA, TT Pad or Brake Shoe	SFAC Carbon Scooter Pads	Speciality Pads - SXR / Vee / MXS	Sintered/ HH Pads/ Grooved Shoes	Standard Replacement Disc	Contour Disc Rear fitment	Vee Discs CONTOUR	CX Extreme MX Race Disc
1							FA088		FA088V	FA088HH	MD2002	MD2002C	VR2002	
2							FA088		FA088V	FA088HH	MD2002	MD2002C	VR2002	
3							FA088		FA088V	FA088HH	MD2002	MD2002C	VR2002	
4							FA034		FA034V		MD2024 Ⓞ			
5							FA174		FA174V	FA174HH	MD2120	MD2120C	VR2120	
6							FA174		FA174V	FA174HH	MD2120	MD2120C	VR2120	
7							FA174		FA174V	FA174HH	MD2120	MD2120C	VR2120	
8							FA174		FA174V	FA174HH	MD2120	MD2120C	VR2120	
9							FA174		FA174V	FA174HH	MD2120	MD2120C	VR2120	
10							FA174		FA174V	FA174HH	MD2120	MD2120C	VR2120	
11							FA174		FA174V	FA174HH	MD2120	MD2120C	VR2120	
12							FA174		FA174V	FA174HH	MD2120	MD2120C	VR2120	
13							FA436			FA436HH				
14							FA436			FA436HH				
15							FA319/2		FA319/2V	FA319/2HH	MD2002	MD2002C	VR2002	
16							FA319/2		FA319/2V	FA319/2HH	MD2002	MD2002C	VR2002	
17							FA088		FA088V	FA088HH	MD2069			
18							FA088		FA088V	FA088HH	MD2069			
19							FA088		FA088V	FA088HH	MD2011			
20							FA174		FA174V	FA174HH	MD2120	MD2120C	VR2120	
21							FA174		FA174V	FA174HH	MD2120	MD2120C	VR2120	
22							FA319/2		FA319/2V	FA319/2HH		MD2130C		
23							FA319/2		FA319/2V	FA319/2HH		MD2130C		
24							FA319/2		FA319/2V	FA319/2HH	MD2103	MD2103C	VR2103	
25							FA319/2		FA319/2V	FA319/2HH		MD2130C		
26														
27							FA319/2		FA319/2V	FA319/2HH		MD2130C		
28														
29							FA319/2		FA319/2V	FA319/2HH		MD2130C		
30							FA088		FA088V	FA088HH	MD2011	MD2011C	VR2011	
31							FA088		FA088V	FA088HH	MD2011	MD2011C	VR2011	
32							FA088		FA088V	FA088HH	MD2011	MD2011C	VR2011	
33							FA088		FA088V	FA088HH	MD2011	MD2011C	VR2011	
34							FA348			FA348HH	MD2011	MD2011C	VR2011	
35							FA174		FA174V	FA174HH	MD2093	MD2093C	VR2093	
36							FA174		FA174V	FA174HH	MD2093	MD2093C	VR2093	
37							FA174		FA174V	FA174HH	MD2093	MD2093C	VR2093	
38							FA174		FA174V	FA174HH	MD2093	MD2093C	VR2093	
39							FA088		FA088V		MD2075			
40							FA174		FA174V	FA174HH	MD2091	MD2091C	VR2091	
41							FA174		FA174V	FA174HH	MD2091	MD2091C	VR2091	
42							FA174		FA174V	FA174HH	MD2091	MD2091C	VR2091	
43							Y515							
44							Y515							
45							Y515							
46							FA088		FA088V	FA088HH	MD2002	MD2002C	VR2002	
47							FA267			FA267HH	MD2086	MD2086C	VR2086	
48							FA275			FA275HH	MD2084	MD2084C	VR2084	
49							FA174		FA174V	FA174HH	MD2091	MD2091C	VR2091	
50							FA174		FA174V	FA174HH	MD2091	MD2091C	VR2091	
51							FA174		FA174V	FA174HH	MD2091	MD2091C	VR2091	
52							FA174		FA174V	FA174HH	MD2091	MD2091C	VR2091	
53							FA436		FA436V	FA436HH	MD2125	MD2125C	VR2125	
54							FA436		FA436V	FA436HH	MD2125	MD2125C	VR2125	
55							FA436		FA436V	FA436HH	MD2125	MD2125C	VR2125	
56							FA436		FA436V	FA436HH	MD2125	MD2125C	VR2125	
57							Y534			Y534G				
58							FA677TT*			FA677R*	MD6395D*			UTVX6395*
59														
60							FA677TT*			FA677R*	MD6395D*			UTVX6395*

REAR / ARRIÈRE / HINTEN / POSTERIOR / POSTERIORE

BRAKE APPLICATIONS

R Suffix = High Durability Sintered Pad. HH Suffix = High Performance Sintered Pad. TT Suffix = Hard Wearing Off Road Pad. V Suffix = Semi Sintered Pad. G Suffix = Grooved Shoe.
D Suffix = Drilled Disc. X Suffix = Universal Left or Right Disc. XC Suffix = Contoured Disc. LS Suffix = Left/Steel Disc. RS = Right/Steel Disc.

*-2 Sets Required. † For Vee disc colours add RED, BLU, GRN, GLD, ORG suffix to part number. For Custom Finish Options for Vee-Rotors™ including Splatter discs add suffix CHR, CHGR, CHBL, CHBR - available in various colours see page iv. Ⓞ - Also available as a Vintage Motorcycle Disc.

JAPANESE Built Motorcycles



YAMAHA Contd.

YZZ 1000 R SE (Side x Side) - Parking Brake	16
YZZ 1000 R SS (Side x Side)	17-18
YZZ 1000 R SS (Side x Side) - Parking Brake	17-18
BT 1100 P/R/S/T/V Bulldog	02-06
FJ 1100	84-85
XS 1100	78-80
XS 1100 S	81
XV 1100 Virago	89-93
XV 1100 Virago	94-98
XV 1100 Virago	99
XVS 1100 Drag Star	99-04
XVS 1100 A Dragstar Classic	00-06
FJ 1200 (ITX Type)	86-87
FJ 1200 (3CV/3XW Type)	88-95
FJ 1200 A (ABS Model)	91-95
XJR 1200	95-98
XT 1200 Z Super Tenere (ABS/UBS Brake System)	10-18
XT 1200 ZE Super Tenere (ABS/UBS Brake System)	14-18
XT 1200 ZE Super Tenere Raid Edition (ABS/UBS Brake System)	18
XVZ 12 TD	85
V-Max 12	91-92
V-Max 12	93-03
FJR 1300 (Non ABS/5JW)	01-04
FJR 1300 A (ABS/2 Pad Front Caliper)	03-05
FJR 1300 A (ABS/4 Pad Front Caliper)	06-20
FJR 1300 AE (Electronic Suspension Adjustment /USD Forks)	14-20
FJR 1300 AS (ABS - Electric G/Shift)	06-20
XJR 1300 L 5EA2/5EA3/5EA4	99
XJR 1300 M 5EAA/5EAB/5EAC	00
XJR 1300 (5EA1/5EA7) (320mm front discs) (Brembo calipers)	98-99
XJR 1300 (5EA9/5EAG) (298mm front disc)	00
XJR 1300 C/Racer	15-16
XJR 1300 N/P (5EAP/5EAR/5EAS/5EAT/5EAW/5EAW/5EAY) (298mm front discs)	01-02
XJR 1300 R/S (5WM1/5WM3/5WM5 /5WM6/5WM7/5WM9)	03-04
XJR 1300 T/V/W/X 5WMA/5WMC/5WMD /5WMFY	05-14
XJR 1300 SP (L) (5EA5/5EA6/5EA8)	99
XJR 1300 SP (M) (5EAD/5EAE/5EAF)	00
XJR 1300 SP (N) 5EAL/5EAM/5EAN)	01
XVS 1300 A Midnight Star	07-16
XVS 1300 CU Custom	14-17
XVS 1300 ACFD Midnight Star/Casual Full Dresser (With Handbar Faring)	14-16
XVZ 13 AH/ATH Royal Star/Royal Star Tour Classic	96-01
XVZ 1300 TF Venture Star	99-01
XV 1600 A Wildstar	99-04
MT-01 (1670cc) (4 piston caliper)	05-06
MT-01 (6 piston radial caliper)	07-09
MT-01 S (6 piston radial caliper/5YUR)	09
XV 1700 PCR Road Star Warrior	03-05
XV 1700 V-Max	09-20
XV 1900 A Midnight Star	06-08
XV 1900 A Midnight Star	11-13
XV 1900 ACFD Midnight Star/Casual Full Dresser (With Handlebar Faring)	14-16

FA, SFA, TT Pad or Brake Shoe	SFAC Carbon Scooter Pads	Speciality Pads - SXR / Vee / MXS	Sintered/HH Pads/ Grooved Shoes	DISC PAD CHOICES - FRONT				BRAKE DISC CHOICES - FRONT				Line #
				Left / Gauche / Links Standard Replacement Disc	Right / Droite / Rechts Standard Replacement Disc	Contour Disc Universal left and right fitment	Custom Disc Universal left and right fitment	Vee-Discs Black † See note below	CX Extreme MX Race Disc/ UTVX Disc			
FA497TT						MD6381D						1
FA676TT*			FA676R*			MD6395D	MD6395D				UTVX6395*	2
FA497TT						MD6381D						3
FA252*			FA252HH*		MD2074X	MD2074X	MD2074XC*	MD2074CC*		VR2074BLK*†		4
FA088*			FA088HH*		MD2068	MD2068						5
FA034*					MD2024 ☼	MD2024 ☼						6
FA070*					MD2024 ☼	MD2024 ☼						7
FA088*		FA088V*	FA088HH*		MD2011	MD2011	MD2011C*			VR2011*		8
FA179*		FA179V*	FA179HH*		MD2067	MD2067						9
FA199*		FA199V*	FA199HH*		MD2067	MD2067						10
FA199*		FA199V*	FA199HH*		MD2076	MD2076						11
FA199*		FA199V*	FA199HH*		MD2076	MD2076						12
FA088*			FA088HH*		MD2068	MD2068						13
FA123*			FA123HH*		MD2001X	MD2001X	MD2001XC*	MD2001CC*		VR2001BLK*†		14
FA160*			FA160HH*		MD2046	MD2046						15
FA123*			FA123HH*		MD2003X	MD2003X	MD2003XC*	MD2003CC*		VR2003BLK*†		16
			FA380HH*				MD2095XC*	MD2095CC*		VR2095BLK*†		17
			FA380HH*				MD2095XC*	MD2095CC*		VR2095BLK*†		18
			FA380HH*				MD2095XC*	MD2095CC*		VR2095BLK*		20
FA088*		FA088V*	FA088HH*		MD2081	MD2081						21
FA088*			FA088HH*		MD2068	MD2068						22
FA160*			FA160HH*		MD2129X	MD2129X	MD2129XC*					23
FA252*			FA252HH*		MD2074X	MD2074X	MD2074XC*	MD2074CC*		VR2074BLK*†		24
FA252*			FA252HH*		MD2089X	MD2089X	MD2089XC*	MD2089CC*		VR2089BLK*†		25
			FA423/4HH*		MD2089X	MD2089X	MD2089XC*	MD2089CC*		VR2089BLK*		26
			FA423/4HH*		MD2089X	MD2089X	MD2089XC*	MD2089CC*		VR2089BLK*		28
			FA423/4HH*		MD2089X	MD2089X	MD2089XC*	MD2089CC*		VR2089BLK*†		29
FA252*			FA252HH*		MD2074X	MD2074X	MD2074XC*	MD2074CC*		VR2074BLK*†		30
FA252*			FA252HH*		MD2074X	MD2074X	MD2074XC*	MD2074CC*		VR2074BLK*†		31
												32
FA244*			FA244HH*		MD2003X	MD2003X	MD2003XC*	MD2003CC*		VR2003BLK*†		33
FA252*			FA252HH*		MD2074X	MD2074X	MD2074XC*	MD2074CC*		VR2074BLK*†		34
FA252*			FA252HH*		MD2074X	MD2074X	MD2074XC*	MD2074CC*		VR2074BLK*†		35
												36
FA252*			FA252HH*		MD2074X	MD2074X	MD2074XC*	MD2074CC*		VR2074BLK*†		37
												38
FA252*			FA252HH*		MD2074X	MD2074X	MD2074XC*	MD2074CC*		VR2074BLK*†		39
												40
FA252*			FA252HH*		MD2074X	MD2074X	MD2074XC*	MD2074CC*		VR2074BLK*†		41
FA252*			FA252HH*		MD2074X	MD2074X	MD2074XC*	MD2074CC*		VR2074BLK*†		42
FA252*			FA252HH*		MD2074X	MD2074X	MD2074XC*	MD2074CC*		VR2074BLK*†		43
FA252*			FA252HH*		MD2074X	MD2074X	MD2074XC*	MD2074CC*		VR2074BLK*†		44
FA199*		FA199V*	FA199HH*		MD2074X	MD2074X	MD2074XC*	MD2074CC*		VR2074BLK*†		45
FA179		FA179V	FA179HH									46
												47
FA199*		FA199V*	FA199HH*		MD2074X	MD2074X	MD2074XC*	MD2074CC*		VR2074BLK*†		48
FA123*		FA123V*	FA123HH*		MD2076	MD2076						49
FA179*		FA179V*	FA179HH*		MD2076	MD2076						50
FA179*		FA179V*	FA179HH*		MD2076	MD2076						51
			FA380HH*		MD2126X	MD2126X	MD2126XC*			VR2126BLK*†		52
FA442/4*			FA442/4HH*		MD2128X	MD2128X	MD2128XC*			VR2128BLK*†		53
FA442/4*			FA442/4HH*		MD2128X	MD2128X	MD2128XC*			VR2128BLK*†		54
FA252*			FA252HH*		MD2074X	MD2074X	MD2074XC*	MD2074CC*		VR2074BLK*†		55
FA442/4*			FA442/4HH*				MD2109XC*					56
FA252*			FA252HH*		MD2074X	MD2074X	MD2074XC*	MD2074CC*		VR2074BLK*†		57
			FA423/4HH*									58
			FA423/4HH*									59
			FA423/4HH*									60

*-2 Sets Required. † For Vee disc colours add RED, BLU, GRN, GLD, ORG suffix to part number. For Custom Finish Options for Vee-Rotors™ including Splatter discs add suffix CHR, CHGR, CHBL, CHBR - available in various colours see page iv. ☼ - Also available as a Vintage Motorcycle Disc.

JAPANESE Built Motorcycles

Line #	BRAKE DISC CHOICES - FRONT						DISC PAD CHOICES - REAR				BRAKE DISC CHOICES - REAR			
	Oversize 250 /280mm Disc Kit	OSX Oversize 250/280mm Disc Kit	Relocating Bracket for 250/ 280mm Disc	Oversize 320mm Disc Kit	SMX Oversize 320mm Disc Kit	Relocating Bracket for 320mm Disc	FA, SFA, TT Pad or Brake Shoe	SFAC Carbon Scooter Pads	Speciality Pads - SXR / Vee / MXS	Sintered/ HH Pads/ Grooved Shoes	Standard Replacement Disc	Contour Disc Rear fitment	Vee Discs CONTOUR	CX Extreme MX Race Disc
1														
2							FA677TT*		FA677R*	MD6395D*			UTVX6395*	
3														
4							FA088		FA088HH	MD2011	MD2011C	VR2011		
5							FA088	FA088V	FA088HH	MD2068				
6							FA034	FA034V		MD2024 Ⓞ				
7							FA034	FA034V		MD2024 Ⓞ				
8							Y515							
9							Y515							
10							FA088	FA088V	FA088HH	MD2011				
11							FA088	FA088V	FA088HH	MD2092				
12							FA088	FA088V	FA088HH	MD2092				
13							FA088	FA088V	FA088HH	MD2068				
14							FA088	FA088V	FA088HH	MD2068				
15							FA088	FA088V	FA088HH	MD2068				
16							FA088	FA088V	FA088HH	MD2011	MD2011C	VR2011		
17							FA319/2		FA319/2HH		MD2115C			
18							FA319/2		FA319/2HH		MD2115C			
19														
20							FA319/2		FA319/2HH		MD2115C			
21							FA088	FA088V	FA088HH	MD2081				
22							FA088	FA088V	FA088HH	MD2068				
23							FA088	FA088V	FA088HH	MD2068				
24							FA319/2	FA319/2V	FA319/2HH	MD2092	MD2092C	VR2092		
25							FA319/2	FA319/2V	FA319/2HH	MD2092	MD2092C	VR2092		
26							FA319/2	FA319/2V	FA319/2HH	MD2100	MD2100C	VR2100		
27														
28							FA319/2	FA319/2V	FA319/2HH	MD2100	MD2100C	VR2100		
29							FA319/2	FA319/2V	FA319/2HH	MD2100	MD2100C	VR2100		
30							FA088	FA088V	FA088HH	MD2011	MD2011C	VR2011		
31							FA088	FA088V	FA088HH	MD2011	MD2011C	VR2011		
32														
33							FA088	FA088V	FA088HH	MD2011	MD2011C	VR2011		
34							FA267		FA267HH	MD2011	MD2011C	VR2011		
35							FA348		FA348HH	MD2011	MD2011C	VR2011		
36														
37							FA348		FA348HH	MD2011	MD2011C	VR2011		
38														
39							FA348		FA348HH	MD2011	MD2011C	VR2011		
40														
41							FA348		FA348HH	MD2011	MD2011C	VR2011		
42							FA088	FA088V	FA088HH	MD2011	MD2011C	VR2011		
43							FA088	FA088V	FA088HH	MD2011	MD2011C	VR2011		
44							FA088	FA088V	FA088HH	MD2011	MD2011C	VR2011		
45							FA319/2	FA319/2V	FA319/2HH	MD2103	MD2103C	VR2103		
46							FA319/2	FA319/2V	FA319/2HH	MD2103				
47														
48							FA319/2	FA319/2V	FA319/2HH	MD2103	MD2103C	VR2103		
49							FA123	FA123V	FA123HH	MD2078				
50							FA123	FA123V	FA123HH	MD2078				
51							FA123	FA123V	FA123HH	MD2088				
52							FA196	FA196V	FA196HH	MD2011				
53							FA196	FA196V	FA196HH	MD2011				
54							FA196	FA196V	FA196HH	MD2011				
55							FA319/2	FA319/2V	FA319/2HH	MD2092	MD2092C	VR2092		
56							FA319/2	FA319/2V	FA319/2HH		MD2108C			
57							FA319/2	FA319/2V	FA319/2HH	MD2099				
58							FA319/2	FA319/2V	FA319/2HH	MD2099				
59														
60							FA319/2	FA319/2V	FA319/2HH	MD2099				

REAR / ARRIÈRE / HINTEN / POSTERIOR / POSTERIORE

*-2 Sets Required. † For Vee disc colours add RED, BLU, GRN, GLD, ORG suffix to part number. For Custom Finish Options for Vee-Rotors™ including Splatter discs add suffix CHR, CHGR, CHBL, CHBR - available in various colours see page iv. Ⓞ - Also available as a Vintage Motorcycle Disc.

R Suffix = High Durability Sintered Pad. HH Suffix = High Performance Sintered Pad. TT Suffix = Hard Wearing Off Road Pad. V Suffix = Semi Sintered Pad. G Suffix = Grooved Shoe.
D Suffix = Drilled Disc. X Suffix = Universal Left or Right Disc. XC Suffix = Contoured Disc. LS Suffix = Left/Steel Disc. RS = Right/Steel Disc.

ROAD RACING APPLICATIONS

BRAKE APPLICATIONS

Make & Model	Year	FRONT				REAR		
		Organic Pads	Sintered/HH Pads	Brake Rotor Left	Brake Rotor Right	Custom Chrome Rotor	Organic Pads	Brake Rotor
HONDA								
RS 125	88-89	FA124	FA124HH		N/A		FA151	MD713
RS 125	90-94	FA226	EPFA226HH		MD1003X	MD1003CC	FA151	MD713
RS 125	95-03	FA239	EPFA239HH		MD1003X	MD1003CC	FA151	MD713
RS 125 (Radial caliper)	04-07		GPFA347HH		MD1003X	MD1003CC	FA151	MD713
NSF 250 R	12-19		GPFA347HH		N/A		FA151	N/A
RS 250	88-89	FA124*	FA124HH*	MD1003X	MD1003X	MD1003CC	FA151	MD724
RS 250	90-94	FA226*	EPFA226HH*	MD1003X	MD1003X	MD1003CC	FA151	MD724
RS 250	95-02	FA239*	EPFA239HH*	MD1003X	MD1003X	MD1003CC	FA151	MD724
MORIWAKI								
MD 250 H	08-13		GPFA347HH		N/A		FA151	N/A
YAMAHA								
TZ 125	94-97	FA145	EPFA145HH		MD711RD		FA162	MD732
TZ 250	89-90	FA145*	EPFA145HH*	MD711LD	MD711RD		FA162	MD732
TZ 250	91	FA145*	EPFA145HH*	MD711LD	MD711RD		FA162	MD2021
TZ 250	92-96	FA145*	EPFA145HH*	MD711LD	MD711RD		FA162	MD732
TZ 250	97-01	FA145*	EPFA145HH*	MD730LD	MD730RD		FA162	MD732
TZ 250 (Radial Caliper)	02-10		GPFA347HH*	MD730LD	MD730RD		FA162	MD732
TZ 350			GPFA743HH*	MD-TZ350/500	MD-TZ350/500			
TZ 500				MD-TZ350/500	MD-TZ350/500			

PADS FOR AFTERMARKET CALIPERS

AMERICAN SUSPENSION	Standard Organic Pad	Optional Organic Pad	Semi-Sintered Pad	Fully Sintered Pad	Fully Sintered Pad Track Day /Race Pad	Fully Sintered Race Pad
B17 Phantom 2 piston brake caliper	FA018		FA018V			
B17 Mach 8 Radial mount 4 Piston caliper	N/A		N/A			
B17 Mach 8 Standard mount 2 Piston caliper	FA018		FA018V			
P26 2 Piston Caliper	FA018		FA018V			
AP LOCKHEED						
2 Piston/2 Pin (CP2195/CP2696 -38E0)	FA016	FA016S		FA016HH	EPFA016HH	GPFA016HH
2 Piston Sidecar Caliper (CP2576/2577/3176/3177/3178)						
2 Piston/1 Pin (CP4226 - 2S0)	FA272					
2 Piston/1 Pin (CP4227 - 2S0)	FA272					
6 Piston/No Pins (CP3366/67)	FA217					
6 Piston/2 Pins (CP4466)					EPFA263HH	
4 Piston (CP3086/CP3369/CP4484 D27)	FA107A					
4 Piston (CP4485/CP4679)	FA107/2A					
4 Piston Radial 2 Piece (CP4488)						
4 Piston (CP4680) 1 Piece Pad						
4 Piston Radial Mount/4 Separate Pads (CP6688 - 8EOM/9EOM)				FA435/4HH	EPFA435/4HH	
2 Piston/1 Pin (CP7003-2S0) Radial mount	FA272					
4 Piston Sidecar Caliper (CP7030-3S0/5S0)						
4 Piston Radial Monobloc 1 Piece Pad (CP7853 D27 2E0/3E0)						
BERINGER						
2 Piston Quad Caliper						
4 Piston (Old Design)	FA158			FA158HH	EPFA158HH	
4 Piston (Radial)				MXS405		
6 Piston (Old Design)	FA249			FA249HH	EPFA249HH	
6 Piston (Old design/2 piston)	FA047	FA047S		FA047HH		
6 Piston (Old Design/Endurance)	FA249/2					
6 Piston (New Design)				MXS406		
BREMBO						
20 5161 43 or 81 - 2 Piston P 2/32 Rear caliper (Single Pad Fixing Pin/With Anti Rattle Shim)	FA047	FA047S		FA047HH		
20 6950 51 - 2 Piston P2/32 Rear Caliper (Single Pad Fixing Pin/With Wire Clip)	FA266		FA266V	FA266HH		
20 6951 12/50/63 - P2/34 Rear Caliper (Single Pad Fixing Pin/With Wire Clip)	FA266		FA266V	FA266HH		
20 7850 11/21 - 4 Piston P4/34 @ 65mm Spacing (Wire clip pad retention Only)				FA322/4HH	EPFA322/4HH	
20 8343 11/21 or 35/45 - 4 Piston P4/34 @ 100mm Spacing (Wire clip pad retention Only)				FA322/4HH	EPFA322/4HH	
220B01010 - GP4-RX 4 Piston Radial Mount @ 108mm Spacing				FA447HH	EPFA447HH	GPFA447HH
X20-60-01 - 2 Piston P2/24 Rear Caliper Rear caliper @ 64mm Spacing						
X20-61-01 - 4 Piston P4/24 Rear Caliper Rear caliper @ 64mm Spacing						
X98-88-70 - 2 Piston P2/34 Rear Caliper Rear caliper @ 64mm Spacing						
X97.37.60/61 - 4 Piston Monobloc 32/36 Radial mount @ 108mm (Single Pin Fixing)				FA218HH	EPFA218HH	GPFA218HH
20 5165 55/68 - Goldline 4 piston P4 30/34 @ 40mm Spacing (Single Pin pad Fixing)	FA095		FA095V	FA095HH	EPFA095HH	
20 6800 10/20 - Goldline 4 piston P4 30/34 @ 65mm Spacing (Two Pin Pad Fixing)	FA244		FA244V	FA244HH	EPFA244HH	GPFA244HH
20 4756 52/62 - 4 Piston P4 30/34 @ 40mm Spacing (Single pin pad fixing)	FA095		FA095V	FA095HH	EPFA095HH	
X99.C04 60/61 - 4 Piston P34/34 Radial Mount Caliper @ 108mm Spacing (4 Pad Set)					EPFA435/4HH	

PADS FOR AFTERMARKET CALIPERS

	Standard Organic Pad	Optional Organic Pad	Semi-Sintered Pad	Fully Sintered Pad	Fully Sintered Pad Track Day /Race Pad	Fully Sintered Race Pad
BREMBO						
XA3.B8.30/31 - 4 Piston P32/36 Radial Mount Caliper @ 108mm Spacing (Titanium Pistons)					EPFA218/2HH	GPFA218/2HH
XA3.B8.60/61 - 4 Piston P32/36 Radial Mount Caliper @ 108mm Spacing (Aluminium Pistons)					EPFA218/2HH	GPFA218/2HH
XA3.J7.50/51 - 4 Piston P34/38 Radial Mount @ 108mm Spacing (Pinless Fixing)						GPFA218/2HH
XA3.J7.60/61 - 4 Piston P34/38 Radial Mount @ 108mm Spacing (Pinless Fixing/Lithium Body)						GPFA218/2HH
XA8.Y3.310/111 - 4 Piston P34/38 Radial Mount @ 130mm Spacing (Pinless Fixing)						GPFA218/2HH
XA9.33.10/11 - 4 Piston P32/36 Radial mount Monobloc @ 108mm Spacing (Single Pin Pad Fixing)					EPFA218/2HH	GPFA218/2HH
XA07680 - 2 Piston P2 34 Radial Mount (Note Only Sold As Set Of 4 Pads)				FA435/4HH	EPFA435/4HH	
X1017.40/41 - 4 Piston/40mm Axial Monobloc Caliper					EPFA218/2HH	GPFA218/2HH
XA7G2.40/41 - 4 Piston/100mm CNC Monobloc Caliper					EPFA218/2HH	GPFA218/2HH
XA32950 P4/34 Axial Radial Mount 65mm - 4 Pad Set				FA322/4HH	EPFA322/4HH	
XA1K480 Motocross Radial Caliper						
XQ21361 P2/28 Off Road Caliper	FA181TT			FA181R	EPFA181HH	
122A99021 P2/24 Off Road Caliper	FA181TT			FA181R	EPFA181HH	
XQ21390 PF 26 Off Road Rear Caliper	FA368TT				EPFA368HH	
120A44110 P2/34 Supersport Rear Caliper	FA266		FA266V	FA266HH		
206121 P4/24 Rear Caliper						
XA1J040 P2/30 Rear Caliper				FA730HH	EPFA730HH	GPFA730HH
XA69510 P4 30/34 Motard Radial Mount 108mm 2 Pin Pad Fixing	FA244		FA244V	FA244HH	EPFA244HH	GPFA244HH
XA78910 P4 30/34 Motard Radial Caliper 100mm Mount 2 Pin Pad Fixing	FA244		FA244V	FA244HH	EPFA244HH	GPFA244HH
220A80310 P4 30/34 Radial Mount 100mm 2 Pin Pad Fixing	FA244		FA244V	FA244HH	EPFA244HH	GPFA244HH
220A16820 P30/34 Yamaha R1 07-10 Radial Mount	FA244		FA244V	FA244HH	EPFA244HH	GPFA244HH
XA7G2 10/11 P4 32/36 Radial Mount Caliper 100mm					EPFA218/2HH	GPFA218/2HH
X97C4 60/61 P4/34 Radial Monobloc 108mm 4 Pad Type Caliper				FA435/4HH	EPFA435/4HH	
X9737 80/81 Radial Mount 108mm Endurance Caliper					EPFA295HH	
220A39710 P4/34 Radial Mount 108mm Monobloc Caliper				FA447HH	EPFA447HH	GPFA447HH
220988530 P4/34 Radial Mount 100mm Monobloc Caliper				FA447HH	EPFA447HH	GPFA447HH
220A0610 P4 30/34 Radial Mount Caliper 108mm 2 Pin Pad Fixing	FA244		FA244V	FA244HH	EPFA244HH	GPFA244HH
220A80210 P4 30/34 Radial Mount Caliper 108mm 2 Pin Pad Fixing	FA244		FA244V	FA244HH	EPFA244HH	GPFA244HH
220A16810 P4 30/34 Radial Mount Caliper 100mm 2 Pin Pad Fixing	FA244		FA244V	FA244HH	EPFA244HH	GPFA244HH
20.9883 Radial Mount Caliper 100mm				FA447HH	EPFA447HH	GPFA447HH
XB2P710/XB2P711 Endurance Caliper						
XB0B1 30/31 P4 30/34						GPFA673HH
EBC						
4 Piston	FA216/2				FA216/2HH	
FTE						
4 Piston Radial Supermoto					MXS405	
6 Piston Radial Supermoto					MXS406	
GMA						
2 Piston rear (large) caliper model A (CCI #09-997)	FA036		FA036V			
2 Piston (small) caliper model B (CCI # 09-996)	FA076		FA076V	FA076HH		
4 Piston model F	FA115		FA115V	FA115HH		
HARRISON BILLET						
Big 4 Piston (1296033)	FA047	FA047S		FA047HH		
Big 6 Piston (1296033)	FA047	FA047S		FA047HH		
2 Piston (1296040)	FA175			FA175HH	EPFA175HH	
Slim Design	FA175			FA175HH	EPFA175HH	
Mini 6	FA175			FA175HH	EPFA175HH	
HHI - HAWG HALTERS						
4 Piston - All Types	FA216/3		FA216/3V	FA216/3HH		
4 Piston - Sprocket Brake	FA623			FA623HH		
6 Piston - All Types	FA424			FA424HH	EPFA424HH	
IRON PEGASUS						
Small caliper (Single Pin Fixing)	FA047	FA047S		FA047HH		
Small caliper (2 Pin Fixing)	FA115		FA115V	FA115HH		
ISR						
22-023-0A (2 Piston)	FA011					
22-025-XX (4 Piston)	FA047	FA047S		FA047HH		
22-026-0A (Sprocket Caliper)	FA011					
22-027 (2 Piston Rear)	FA047	FA047S		FA047HH		
22-028 (2 Piston)	FA047	FA047S		FA047HH		
22-029 (Rear 2 Piston)	FA047	FA047S		FA047HH		
22-030 (2 Piston Rear)	FA016	FA016S		FA016HH	EPFA016HH	GPFA016HH
22-032 (6 Piston Large)	FA175			FA175HH		
22-033 (2 Piston HD)	FA016	FA016S		FA016HH	EPFA016HH	GPFA016HH
22-034 (6 Piston Small)	FA184					GPFA184HH
22-036 (2 Piston)	FA184					GPFA184HH

PADS FOR AFTERMARKET CALIPERS

	Standard Organic Pad	Optional Organic Pad	Semi-Sintered Pad	Fully Sintered Pad	Fully Sintered Pad Track Day /Race Pad	Fully Sintered Race Pad
ISR						
R22-042 (6 Piston Racing)	FA175			FA175HH	EPFA175HH	
22-043 (4 Piston)	FA184					GPFA184HH
radial 6 Piston Monoblock	FA184					GPFA184HH
JAYBRAKE						
Dual 7 Quad (300-04) (2 & 4 Piston)	FA115		FA115V	FA115HH		
J-Four (300-44) (4 Piston)	FA188			FA188HH	EPFA188HH	
J-Six (300-64) (6 Piston)	FA243			FA243HH		
6 PF-L (6 Piston/ 13" Disc - Full Height Friction)	N/A			FA455HH		
6 PF-L (6 Piston/ 11.5" Disc - Lower Height Friction)	N/A			FA649HH		
Early Design 2 Piston	FA076		FA076V	FA076HH		
MAGURA						
4 Piston	FA158			FA158HH	EPFA158HH	
MOTOMASTER						
4 Piston	FA158	N/A	N/A	FA158HH	EPFA158HH	N/A
NOVA/LEGENDS						
4 Piston	FA216/3		FA216/3V	FA216/3HH		
OMP						
4 Piston Caliper (Front or Rear)	FA095		FA095V	FA095HH	EPFA095HH	
6 Piston	FA116					
Sprocket caliper	FA116					
PERFORMANCE MACHINE						
112 X 6B	FA249			FA249HH	EPFA249HH	
112 X 6QC	FA249			FA249HH	EPFA249HH	
112 X 6RSB	FA190		FA190V	FA190HH	EPFA190HH	
112 X 6SSB	FA190		FA190V	FA190HH	EPFA190HH	
124 X 4HR	FA216/2			FA216/2HH		
125 X 2	FA115		FA115V	FA115HH		
125 X 4R	FA216/3		FA216/3V	FA216/3HH		
125 X 4RSPH	FA216/3		FA216/3V	FA216/3HH		
125 X 4S	FA115		FA115V	FA115HH		
125 X 4SL	FA115		FA115V	FA115HH		
125 X 6	FA210		FA210V			
125 X 6QC	FA190		FA190V	FA190HH	EPFA190HH	
137 X 4	FA216/2			FA216/2HH		
137 X 4 (2006)				FA420HH		
137 X 4B	FA216/3		FA216/3V	FA216/3HH		
137 X 6	FA210		FA210V			
162 X 2	FA032		FA032V			
PFM						
6 Piston Superbike caliper					EPFA263HH	
PRE TECH						
4 Piston (Uni P401)	FA180			FA180HH		
4 Piston (P402) Lockheed Replacement Caliper	FA158			FA158HH	EPFA158HH	
6 Piston	FA190		FA190V	FA190HH	EPFA190HH	
6 Piston (Radial Mount)	FA249			FA249HH	EPFA249HH	
PRO-ONE						
2 Piston	FA047	FA047S		FA047HH		
4 Piston	FA158			FA158HH	EPFA158HH	
P.V.M.						
2 Piston Rear Caliper (Note Only 2 Pads Required)				FA435/4HH	EPFA435/4HH	
4 Piston Radial Mount Caliper				FA435/4HH	EPFA435/4HH	
4 Piston Race Caliper (Old Design)	FA211/2	FA211				
6 Piston (old large design)						GFA183HH
6 Piston (new small design)						
REVTECH						
CCI Polished Caliper (Front/Rear)	FA095		FA095V	FA095HH	EPFA095HH	
New Black 4 Piston Caliper	FA216/3		FA216/3V	FA216/3HH		
6 Piston VR1000 Race Caliper	FA217					
SPONDON						
4 Piston Caliper	FA107A					
4 Piston Caliper	FA107/2A					

PADS FOR AFTERMARKET CALIPERS

	Standard Organic Pad	Optional Organic Pad	Semi-Sintered Pad	Fully Sintered Pad	Fully Sintered Pad Track Day /Race Pad	Fully Sintered Race Pad
SPIEGLER						
4 Piston Caliper S4B						
8 Piston Caliper S8B						
THUNDERHEART						
4 Piston Caliper	FA216/3		FA216/3V	FA216/3HH		
6 Piston Caliper	FA249			FA249HH		
WILWOOD						
PS1 Caliper (Part # 150-4091K)	FA271TT			FA271R		
GP300/310 (Part # 150-8733-2)	FA095		FA095V	FA095HH	EPFA095HH	
GP320 (Part # 154-8596K)	N/A					

NOTES

Non-JAPANESE Built Motorcycles

APPLICATIONS

BRAKE



ACCOSSATO



-50 Cross Mini	82-
50/80 Cross/Enduro	83-
C 50 Cross/Enduro/Competition	84-
CE 80/125 Cross/Enduro H 20	84-
CE 50/80/KR 80	87-
Enduro Codice 50	89-

ADIVA SCOOTERS

AD 125	09-11
AD1 125/150 (3 Wheel Type)	14-15
AD 200	09-11
AD 400	09-11
AD2 300 (2 Wheel Type)	14-15
AD3 300 (3 Wheel Type)	14-15
AR 125	10-11
AR 200	10-11

ADLY

AT 50 Air Tech 1	08-09
50 RS Supersonic	06-08
Jet 50/100 (X-1)	
City Bird	
Predator 50/100	
Fox 50	
NB 50 Noble 50	08-10
P50 Panther 50	02-09
Cosy 50/80	02-06
RT 50/100	
Road Tracer 50/90/100	04-06
SF 50 Silver Fox 50	06-09
SS 50 Supersonic	04-05
TB 50 Thunderbike	08-09
SS 100 Supersonic	04-05
Thunderbike 125 (Rear Drum Model)	
Thunderbike 125 (Rear Disc Model)	
GK 125 Buggy	03-07
NB 125 B Noble 125 (Rear Drum Model)	08-09
NB 125 D Noble 125 (Rear Disc Model)	08-10
SS 125 B/D Supersonic	04-05
150 Crusader Quad	06
150 Interceptor	06
Crossroad 150 Quad	07-09
Sport 150 Quad	08-09
Crossroad 220 Sentinal Quad	
Hurricane 280 Quad	08-09
Canyon 280 Quad	08-09
Canyon 320 Quad	08-09
Crossroad 300 Sentinal Quad	08-09
Hurricane 300 Quad	08-09
Interceptor 300	05-07
Interceptor 300 Quad	
300 Crusader Quad	05-07
300 RS Quad	07-08
300 XS Quad	07-08
Utility 300	05-07
320 S Quad	08
Hurricane 320 Quad	08-09
500 S	08

FA, SFA, TT Pad or Brake Shoe	SFAC Carbon Scooter Pads	Speciality Pads SXR / Vee / MXS	Sintered/HH Pads/ Grooved Shoes	BRAKE DISC CHOICES - FRONT							Line #
				Left / Gauche / Links Standard Replacement Disc	Right / Droite / Rechts Standard Replacement Disc	Contour Disc Universal left and right fitment	Universal Custom Disc	Vee-Discs Black † See note below	CX Extreme MX Race Disc/ UTVX Disc		
			926G								1
			841G								2
			841G								3
			940G								4
FA047			FA047R	N/A							5
FA047			FA047R	N/A							6
											7
											8
SFA264	SFAC264		SFA264HH	N/A							9
SFA260*	SFAC260*		SFA260HH*	N/A	N/A						10
SFA264	SFAC264		SFA264HH	N/A							11
SFA266*	SFAC266*		SFA266HH*	N/A	N/A						12
SFA266*	SFAC266*		SFA266HH*	N/A	N/A						13
SFA260*	SFAC260*		SFA260HH*	N/A	N/A						14
SFA264	SFAC264		SFA264HH	N/A							15
SFA264	SFAC264		SFA264HH	N/A							16
											17
											18
SFA083	SFAC083		SFA083HH	TBA							19
SFA083*	SFAC083*		SFA083HH*	N/A	N/A						20
SFA083	SFAC083		SFA083HH	MD904D				VR904			21
SFA169	SFAC169		SFA169HH	TBA							22
SFA083*	SFAC083*		SFA083HH*	MD923D	MD923D			VR923*			23
SFA169	SFAC169		SFA169HH	MD904D				VR904			24
SFA083	SFAC083		SFA083HH	N/A							25
SFA083	SFAC083		SFA083HH	TBA							26
SFA083	SFAC083		SFA083HH	TBA							27
SFA083	SFAC083		SFA083HH	TBA							28
SFA169	SFAC169		SFA169HH	MD904D				VR904			29
SFA083	SFAC083		SFA083HH	N/A							30
SFA083	SFAC083		SFA083HH	MD923D				VR923			31
SFA083	SFAC083		SFA083HH	N/A							32
SFA083	SFAC083		SFA083HH	MD923D				VR923			33
SFA083	SFAC083		SFA083HH	MD923D				VR923			34
SFA083	SFAC083		SFA083HH	MD923D				VR923			35
H346*			H346G*								36
SFA083	SFAC083		SFA083HH	N/A							37
SFA083	SFAC083		SFA083HH	N/A							38
SFA083	SFAC083		FA083HH	MD923D				VR923			39
FA083TT*			FA083R*	N/A	N/A						40
FA083TT*			FA083R*	N/A	N/A						41
FA083TT*			FA083R*	N/A	N/A						42
FA083TT*			FA083R*	N/A	N/A						43
FA377TT*			FA377R*	N/A	N/A						44
FA377TT*			FA377R*	N/A	N/A						45
FA377TT*			FA377R*	N/A	N/A						46
FA377TT*			FA377R*	N/A	N/A						47
FA377TT*			FA377R*	N/A	N/A						48
FA377TT*			FA377R*	N/A	N/A						49
FA083TT*			FA083R*	N/A	N/A						50
FA416TT*			FA416R*	N/A	N/A						51
FA083TT*			FA083R*	N/A	N/A						52
FA377TT*			FA377R*	TBA	TBA						53
FA377TT*			FA377R*	TBA	TBA						54
FA377TT*			FA377R*	N/A	N/A						55
FA377TT*			FA377R*	TBA	TBA						56
FA377TT*			FA377R*	N/A	N/A						57
FA377TT*			FA377R*	N/A	N/A						58
											59
											60

FRONT / AVANT / VORN / FREITE / ANTERIORE

R Suffix = High Durability Sintered Pad. HH Suffix = High Performance Sintered Pad. TT Suffix = Hard Wearing Off Road Pad. V Suffix = Semi Sintered Pad. G Suffix = Grooved Shoe.

D Suffix = Drilled Disc. X Suffix = Universal Left or Right Disc. XC Suffix = Contoured Disc. LS Suffix = Left/Steel Disc. RS Suffix = Right/Steel Disc.

*-2 Sets Required. † For Vee disc colours add RED, BLU, GRN, GLD, ORG suffix to part number.

⊗ - Also available as a Vintage Motorcycle Disc.

Non-JAPANESE Built Motorcycles

Line #	BRAKE DISC CHOICES - FRONT						DISC PAD CHOICES - REAR				BRAKE DISC CHOICES - REAR			
	Oversize 250 /280mm Disc Kit	OSX Oversize 250/280mm Disc Kit	Relocating Bracket for 250/ 280mm Disc	Oversize 320mm Disc Kit	SMX Oversize 320mm Disc Kit	Relocating Bracket for 320mm Disc	FA, SFA, TT Pad or Brake Shoe	SFAC Carbon Scooter Pads	Speciality Pads - SXR / Vee / MXS	Sintered/ HH Pads/ Grooved Shoes	Standard Replacement Disc	Contour Disc Rear fitment	Vee-Discs™ CONTOUR	CX Extreme MX Race Disc/ UTVX Disc
1									926G					
2									841G					
3									841G					
4									841G					
5							FA116			N/A				
6							FA116			N/A				
7														
8														
9							SFA199	SFAC199	SFA199HH	N/A				
10							SFA260	SFAC260	SFA260HH	N/A				
11							SFA199	SFAC199	SFA199HH	N/A				
12							SFA266	SFAC266	SFA266HH	N/A				
13							SFA427	SFAC427	SFA427HH	N/A				
14							SFA427	SFAC427	SFA427HH	N/A				
15							SFA199	SFAC199	SFA199HH	N/A				
16							SFA199	SFAC199	SFA199HH	N/A				
17														
18														
19							TBA							
20							SFA083	SFAC083	SFA083HH	N/A				
21							Y503							
22							Y503							
23							Y503							
24							Y503							
25							TBA							
26							Y503							
27							Y503							
28							897							
29							Y503							
30							Y503							
31							Y503							
32							TBA							
33							Y503							
34							TBA							
35							SFA083	SFAC083	SFA083HH	MD982D				
36							FA083TT		FA083R	MD6354D				
37							TBA							
38							SFA083	SFAC083	SFA083HH	N/A				
39							SFA083	SFAC083	SFA083HH	MD982D				
40							FA083TT		FA083R	N/A				
41							FA083TT		FA083R	N/A				
42							FA083TT		FA083R	N/A				
43							FA083TT		FA083R	N/A				
44							FA431TT		FA431R	N/A				
45							FA431TT		FA431R	N/A				
46							FA431TT		FA431R	N/A				
47							FA431TT		FA431R	N/A				
48							FA431TT		FA431R	N/A				
49							FA431TT		FA431R	N/A				
50							FA083TT		FA083R	N/A				
51							FA431TT		FA431R	N/A				
52							FA083TT		FA083R	N/A				
53							FA431TT		FA431R	TBA				
54							FA431TT		FA431R	TBA				
55							FA431TT		FA431R	N/A				
56							FA431TT		FA431R	TBA				
57							FA431TT		FA431R	N/A				
58							FA431TT		FA431R	N/A				
59														
60														

REAR / ARRIÈRE / HINTEN / POSTERIOR / POSTERIORE

*-2 Sets Required. † For Vee disc colours add RED, BLU, GRN, GLD, ORG suffix to part number.

⊗ - Also available as a Vintage Motorcycle Disc.

R Suffix = High Durability Sintered Pad. HH Suffix = High Performance Sintered Pad. TT Suffix = Hard Wearing Off Road Pad. V Suffix = Semi Sintered Pad. G Suffix = Grooved Shoe.

D Suffix = Drilled Disc. X Suffix = Universal Left or Right Disc. XC Suffix = Contoured Disc. LS Suffix = Left/Steel Disc. RS = Right/Steel Disc.

Non-JAPANESE Built Motorcycles

APPLICATIONS

BRAKE



AEON

Aero 50/100 (Scooter)	06
Argon 50 (Scooter)	04-06
Boy X 50 (Bike)	04-06
Cobra 50	06-15
CO-IN ECO (Electric)	13
Echo 50 (Scooter)	04-06
Minikoit 50 (AT06 Type) (Quad)	03-15
Nox 50/100/125/150 Scooter	06
Regal 50/90 (Scooter)	06
Revo R50 Cobra 2 (AT34 Type) (Quad)	04-06
X-Fast 50	06
Cobra 60 (AT30 Type) (Quad)	04-11
Cobra 100 (AT30 Type) (Quad)	04-06
Pulsar 100/125/150 (Scooter)	06
Revo R100 Cobra 2 (AT34 Type) (Quad)	04-11
X-Fast 110 (Bike)	06
CO-IN 125 (4T)	13
Elite 125 (4T)	12-13
MY 125	12-13
Urban 125 (Scooter)	11
Urban 125 (4T)	12-13
Overland 125 (AT08) (Quad)	02-06
OZ 125 (4T)	13
Sporty 125 (AT05 Type) (Quad)	01-05
OZ 150 (4T)	13
Cobra RS 180 (Quad)	06
Overland 180 (AT08) (Quad)	02-11
Sporty 180 (AT05 Type) (Quad)	04-05
Elite 200 i (Scooter)	11
200 Two Hundred Quad	06
Cobra 220 (Quad)	06-11
Cobra S 300	12-15
Cube 300 - Side x Side	11
Overland 300 (Quad) (AT20)	06-07
Cobra 350 (Quad)	10-11
Cube 350 - Side x Side	13-15
Elite 350i (4T)	12-13
Urban 350i (4T)	12-13
Cube X4 400 - Side x Side	11-13
Crossland RX 350	11
Crossland X4 350	11
Urban 350 i (Scooter)	11
Cobra 400 (Quad)	10-15
Cobra 400 Supermoto Quad	13-15
Crossland 400 (2 x 4)	12-15
Crossland 400 (2 x 4) - Parking brake	12-15
Crossland 400 (4 x 4)	12-15
Crossland 400 (4 x 4) - Parking brake	12-15
Elite 400i (ABS)	14-15
Overland 600 (Quad)	11
Crossland 600i	14-15

AGRALE

Elefantre 30	
--------------	--

AJP

PR3 125 Enduro	08-12
PR3 125 Enduro	13-15
PR3 125 Enduro Pro	08-12
PR3 125 Enduro Pro	13-15

DISC PAD CHOICES - FRONT

BRAKE DISC CHOICES - FRONT

FA, SFA, TT Pad or Brake Shoe	SFAC Carbon Scooter Pads	Speciality Pads - SXR / Vee / MXS	Sintered/HH Pads/ Grooved Shoes	Left / Gauche / Links Standard Replacement Disc	Right / Droite / Rechts Standard Replacement Disc	Contour Disc Universal left and right fitment	Universal Custom Disc	Vee-Discs Black † See note below	CX Extreme MX Race Disc/ UTVX Disc
SFA083	SFAC083		SFA083HH	N/A					
TBA				N/A					
TBA									
TBA*									
SFA384						N/A			
TBA				N/A					
TBA*									
SFA083	SFAC083		SFA083HH	N/A					
SFA083	SFAC083		SFA083HH	N/A					
TBA*									
TBA				N/A					
H346*			H346G*						
TBA*									
SFA083	SFAC083		SFA083HH	N/A					
TBA*									
TBA				N/A					
SFA384						N/A			
SFA228	SFAC228		SFA228HH	N/A					
FA228			FA228HH	N/A					
SFA228			SFA228HH	N/A					
SFA228	SFAC228		SFA228HH	N/A					
TBA									
SFA384				N/A					
TBA*									
SFA384				N/A					
TBA*									
TBA*									
TBA*									
SFA228			SFA228HH	N/A					
FA083TT*			FA083R*	N/A	N/A				
FA083TT*			FA083R*	MD6274D	MD6274D				
FA083TT*			FA083R*	N/A	N/A				
FA083TT*			FA083R*	N/A	N/A				
FA083TT*			FA083R*	MD6274D	MD6274D				
FA083TT*			FA083R*	MD6274D	MD6274D				
FA083TT*			FA083R*	N/A	N/A				
SFA228	SFAC228		SFA228HH	N/A					
SFA228	SFAC228		SFA228HH	N/A					
TBA*			TBA*	TBA	TBA				
FA083TT*			FA083R*	TBA	TBA				
TBA*			TBA*	TBA	TBA				
SFA228	SFAC228		SFA228HH	N/A					
FA083TT*			FA083R*	MD6274D	MD6274D				
FA083TT*			FA083R*	N/A	N/A				
FA083TT*			FA083R*	N/A	N/A				
FA083TT									
FA083TT*			FA083R*	N/A	N/A				
FA083TT									
SFA627			SFA627HH	N/A					
FA377TT*			FA377R*	N/A	N/A				
FA083TT*			FA083R*	N/A	N/A				
FA047			FA047R	N/A					
FA194			FA194HH	N/A					
FA465TT		MXS465	FA465R	N/A					
FA194			FA194HH	N/A					
FA465TT		MXS465	FA465R	N/A					

Line #
1
2
3
4
5
6
7
8
9
10
11
12
13
14
15
16
17
18
19
20
21
22
23
24
25
26
27
28
29
30
31
32
33
34
35
36
37
38
39
40
41
42
43
44
45
46
47
48
49
50
51
52
53
54
55
56
57
58
59
60

R Suffix = High Durability Sintered Pad. HH Suffix = High Performance Sintered Pad. TT Suffix = Hard Wearing Off Road Pad. V Suffix = Semi Sintered Pad. G Suffix = Grooved Shoe.

D Suffix = Drilled Disc. X Suffix = Universal Left or Right Disc. XC Suffix = Contoured Disc. LS Suffix = Left/Steel Disc. RS Suffix = Right/Steel Disc.

*-2 Sets Required. † For Vee disc colours add RED, BLU, GRN, GLD, ORG suffix to part number.

⊗ - Also available as a Vintage Motorcycle Disc.

156 Part numbers, prefixes, suffixes, photos and illustrations shown in this catalogue are trademarks and/or copyrights of EBC Brakes or the trademark owner A C Freeman Investments Ltd and use without express written permission of the owners is punishable by law.

Non-JAPANESE Built Motorcycles

Line #	BRAKE DISC CHOICES - FRONT						DISC PAD CHOICES - REAR				BRAKE DISC CHOICES - REAR			
	Oversize 250 /280mm Disc Kit	OSX Oversize 250/280mm Disc Kit	Relocating Bracket for 250/ 280mm Disc	Oversize 320mm Disc Kit	SMX Oversize 320mm Disc Kit	Relocating Bracket for 320mm Disc	FA, SFA, TT Pad or Brake Shoe	SFAC Carbon Scooter Pads	Speciality Pads - SXR / Vee / MXS	Sintered/ HH Pads/ Grooved Shoes	Standard Replacement Disc	Contour Disc Rear fitment	Vee-Discs™ CONTOUR	CX Extreme MX Race Disc/ UTVX Disc
1							TBA							
2							TBA							
3							TBA							
4							TBA							
5							H303							
6							TBA							
7							TBA							
8							TBA							
9							TBA							
10							FA083TT			FA083R	N/A			
11							TBA							
12							FA083TT			FA083R	N/A			
13							TBA							
14							TBA							
15							FA083TT			FA083R	N/A			
16							TBA							
17							H303							
18							SFA067	SFAC067		SFA067HH	N/A			
19							FA067			FA067HH	N/A			
20							SFA083			SFA083HH	N/A			
21							SFA067	SFAC067		SFA067HH	N/A			
22							FA165TT			FA165R	N/A			
23							H303							
24							FA083TT			FA083R	N/A			
25							H303							
26							FA165TT			FA165R	N/A			
27							FA165TT			FA165R	N/A			
28							FA083TT			FA083R	N/A			
29							SFA083			SFA083HH	N/A			
30							FA083TT			FA083R	N/A			
31							FA067TT			FA067R	N/A			
32							FA067TT			FA067R	N/A			
33							FA067TT			FA067R	N/A			
34							FA067TT			FA067R	N/A			
35							FA067TT			FA067R	TBA			
36							FA067TT			FA067R	N/A			
37							SFA067	SFAC067		SFA067HH	N/A			
38							SFA067	SFAC067		SFA067HH	N/A			
39							TBA			TBA	TBA			
40							FA165TT			FA165R	TBA			
41							TBA			TBA	TBA			
42							SFA083	SFAC083		SFA083HH	N/A			
43							FA067TT			FA067R	TBA			
44							FA067TT			FA067R	N/A			
45							FA135TT			FA135R	N/A			
46														
47							FA135TT			FA135R	N/A			
48														
49							SFA197	SFAC197		SFA197HH	N/A			
50							FA067TT			FA067R	N/A			
51							FA159TT*			FA159R*	N/A*			
52														
53														
54							845							
55														
56														
57							FA303TT				N/A			
58							FA634TT				N/A			
59							FA303TT				N/A			
60							FA634TT				N/A			

REAR / ARRIÈRE / HINTEN / POSTERIOR / POSTERIORE

*-2 Sets Required. † For Vee disc colours add RED, BLU, GRN, GLD, ORG suffix to part number.

⊗ - Also available as a Vintage Motorcycle Disc.

R Suffix = High Durability Sintered Pad. **HH** Suffix = High Performance Sintered Pad. **TT** Suffix = Hard Wearing Off Road Pad. **V** Suffix = Semi Sintered Pad. **G** Suffix = Grooved Shoe.
D Suffix = Drilled Disc. **X** Suffix = Universal Left or Right Disc. **XC** Suffix = Contoured Disc. **LS** Suffix = Left/Steel Disc. **RS** = Right/Steel Disc.

Non-JAPANESE Built Motorcycles

APPLICATIONS

BRAKE



AJP Contd.

		DISC PAD CHOICES - FRONT			BRAKE DISC CHOICES - FRONT						Line #		
		FA, SFA, TT Pad or Brake Shoe	SFAC Carbon Scooter Pads	Speciality Pads SXR / Vee / MXS	Sintered/HH Pads/ Grooved Shoes	Left / Gauche / Links Standard Replacement Disc	Right / Droite / Rechts Standard Replacement Disc	Contour Disc Universal left and right fitment	Universal Custom Disc	Vee-Discs Black † See note below		CX Extreme MX Race Disc/ UTVX Disc	
PR3 125 Extreme	13-15	FA465TT		MXS465	FA465R	N/A						1	
PR3 125 Supermoto	08-12	FA194			FA194HH	N/A						2	
PR3 125 Supermoto	13-15	FA465TT		MXS465	FA465R	N/A						3	
PR3 125 Supermoto Pro	10-11	FA194			FA194HH	N/A						4	
PR3 125 Trial	11-12	FA194			FA194HH	N/A						5	
PR4 125 Trail	13-15	FA465TT		MXS465	FA465R	N/A						6	
PR4 125 Enduro	04-09	FA167			FA167HH	N/A						7	
PR4 125 Enduro	10-12	FA194			FA194HH	N/A						8	
PR4 125 Enduro	13-15	FA465TT		MXS465	FA465R	N/A						9	
PR4 125 Enduro Pro	10-12	FA194			FA194HH	N/A						10	
PR4 125 Enduro Pro	13-15	FA465TT		MXS465	FA465R	N/A						11	
PR4 125 Supermoto	04-09	FA167			FA167HH	N/A						12	
PR4 125 Supermoto	10-12	FA194			FA194HH	N/A						13	
PR4 125 Supermoto	13-15	FA465TT		MXS465	FA465R	N/A						14	
PR4 125 Supermoto Pro	10-11	FA194			FA194HH	N/A						15	
PR3 200 Enduro	08-11	FA194			FA194HH	N/A						16	
PR3 200 Enduro	12-14	FA194			FA194HH	N/A						17	
PR3 200 Enduro Pro	10-11	FA194			FA194HH	N/A						18	
PR3 200 Enduro Pro	12-14	FA194			FA194HH	N/A						19	
PR3 200 M/X	10-11	FA194			FA194HH	N/A						20	
PR3 200 M/X Pro	10-11	FA194			FA194HH	N/A						21	
PR3 200 M/X Pro	12-14	FA194			FA194HH	N/A						22	
PR3 240 MX Pro	13-15	FA465TT		MXS465	FA465R	N/A						23	
PR3 200 Supermoto	08-11	FA194			FA194HH	N/A						24	
PR3 200 Supermoto	12-14	FA194			FA194HH	N/A						25	
PR3 200 Supermotard Pro	10-11	FA194			FA194HH	N/A						26	
PR4 200 Enduro	04-09	FA167			FA167HH	N/A						27	
PR4 200 Enduro	10-11	FA194			FA194HH	N/A						28	
PR4 200 Enduro	12-14	FA194			FA194HH	N/A						29	
PR4 Enduro Pro 200	10-11	FA194			FA194HH	N/A						30	
PR4 200 Enduro Pro	12-14	FA194			FA194HH	N/A						31	
PR4 200 Extreme	12-14	FA194			FA194HH	N/A						32	
PR4 200 Supermoto	04-09	FA167			FA167HH	N/A						33	
PR4 200 Supermoto	10-11	FA194			FA194HH	N/A						34	
PR4 200 Supermoto	12-14	FA194			FA194HH	N/A						35	
PR4 200 Supermoto Pro	10-11	FA194			FA194HH	N/A						36	
PR4 240 Extreme	13-15	FA465TT		MXS465	FA465R	N/A						37	
PR5 250 Enduro	09	FA185TT		MXS185	FA185R	N/A						38	
PR5 250 Enduro	10-15	FA465TT		MXS465	FA465R	N/A						39	
PR5 250 Extreme	12-15	FA465TT		MXS465	FA465R	N/A						40	
PR5 250 Supermoto	09	FA185TT		MXS185	FA185R	N/A						41	
PR5 250 Supermoto	10-15	FA465TT		MXS465	FA465R	N/A						42	
												43	
												44	
AJS													
Crazy 50 Naked	13-14	SFA264	SFAC264		SFA264HH			N/A				45	
Digita 50	13-15	SFA235	SFAC235					N/A				46	
Exactly 50 Scooter	08-11	SFA235	SFAC235					N/A				47	
Firefox 50	13-15	SFA235	SFAC235					N/A				48	
Regal Raptor DD 50 E	04-06	SFA054	SFAC054		FA054HH							49	
JSM 50 Motard	13-15	FA086			FA086HH			N/A				50	
Modena 50 (4T)	14-15	TBA					N/A					51	
Regal Raptor DD 100 E	04-06	TBA										52	
Bobber 125 (Custom)	10-15	FA086*			FA086HH*			N/A*				53	
Cadwell 125	19	FA722										54	
Cadwell Clubman 125	19	FA722										55	
Daytona 125 E	10	FA086			FA086HH			N/A				56	
125 Daytona	13-15	FA086*			FA086HH*			N/A*				57	
EOS 125-Regal Raptor	09-15	FA086*			FA086HH*			N/A*				58	
Exactly 125 Scooter (4T)	08-15	SFA235	SFAC235					N/A				59	
JS 125-6C Custom	12-15	SFA086			FA086HH		N/A					60	

FRONT / AVANT / VORN / FRENTE / ANTERIORE

R Suffix = High Durability Sintered Pad. HH Suffix = High Performance Sintered Pad. TT Suffix = Hard Wearing Off Road Pad. V Suffix = Semi-Sintered Pad. G Suffix = Grooved Shoe.

D Suffix = Drilled Disc. X Suffix = Universal Left or Right Disc. XC Suffix = Contoured Disc. LS Suffix = Left/Steel Disc. RS Suffix = Right/Steel Disc.

*-2 Sets Required. † For Vee disc colours add RED, BLU, GRN, GLD, ORG suffix to part number.

⊗ - Also available as a Vintage Motorcycle Disc.

158 Part numbers, prefixes, suffixes, photos and illustrations shown in this catalogue are trademarks and/or copyrights of EBC Brakes or the trademark owner A C Freeman Investments Ltd and use without express written permission of the owners is punishable by law.

Non-JAPANESE Built Motorcycles

Line #	BRAKE DISC CHOICES - FRONT						DISC PAD CHOICES - REAR				BRAKE DISC CHOICES - REAR			
	Oversize 250 /280mm Disc Kit	OSX Oversize 250/280mm Disc Kit	Relocating Bracket for 250/ 280mm Disc	Oversize 320mm Disc Kit	SMX Oversize 320mm Disc Kit	Relocating Bracket for 320mm Disc	FA, SFA, TT Pad or Brake Shoe	SFAC Carbon Scooter Pads	Speciality Pads - SXR / Vee / MXS	Sintered/ HH Pads/ Grooved Shoes	Standard Replacement Disc	Contour Disc Rear fitment	Vee-Discs™ CONTOUR	CX Extreme MX Race Disc/ UTVX Disc
1							FA634TT				N/A			
2							FA303TT				N/A			
3							FA634TT				N/A			
4							FA303TT				N/A			
5							FA303TT				N/A			
6							FA634TT				N/A			
7							FA303TT				N/A			
8							FA093				N/A			
9							FA634TT				N/A			
10							FA093				N/A			
11							FA634TT				N/A			
12							FA303TT				N/A			
13							FA093				N/A			
14							FA634TT				N/A			
15							FA093				N/A			
16							FA303TT				N/A			
17							FA634TT				N/A			
18							FA303TT				N/A			
19							FA634TT				N/A			
20							FA303TT				N/A			
21							FA303TT				N/A			
22							FA634TT				N/A			
23							FA634TT				N/A			
24							FA303TT				N/A			
25							FA634TT				N/A			
26							FA303TT				N/A			
27							FA303TT				N/A			
28							FA093				N/A			
29							FA634TT				N/A			
30							FA093				N/A			
31							FA634TT				N/A			
32							FA634TT				N/A			
33							FA303TT				N/A			
34							FA093				N/A			
35							FA634TT				N/A			
36							FA093				N/A			
37							FA634TT				N/A			
38							FA131TT		MXS131	FA131R	N/A			
39							FA634TT				N/A			
40							FA634TT				N/A			
41							FA131TT		MXS131	FA131R	N/A			
42							FA634TT				N/A			
43														
44														
45							FA453TT				N/A			
46							TBA							
47							TBA							
48							TBA							
49							TBA							
50							FA054TT			FA054HH	N/A			
51							TBA							
52							TBA							
53							FA197			FA197HH	N/A			
54							TBC							
55							TBC							
56							FA197			FA197HH	N/A			
57							FA197			FA197HH	N/A			
58							FA197			FA197HH	N/A			
59							Y527							
60							TBA							

REAR / ARRIÈRE / HINTEN / POSTERIOR / POSTERIORE

*-2 Sets Required. † For Vee disc colours add RED, BLU, GRN, GLD, ORG suffix to part number.

⊗ - Also available as a Vintage Motorcycle Disc.

R Suffix = High Durability Sintered Pad. **HH** Suffix = High Performance Sintered Pad. **TT** Suffix = Hard Wearing Off Road Pad. **V** Suffix = Semi Sintered Pad. **G** Suffix = Grooved Shoe.
D Suffix = Drilled Disc. **X** Suffix = Universal Left or Right Disc. **XC** Suffix = Contoured Disc. **LS** Suffix = Left/Steel Disc. **RS** = Right/Steel Disc.

BRAKE APPLICATIONS

Non-JAPANESE Built Motorcycles

APPLICATIONS

BRAKE



AJS Contd.

		DISC PAD CHOICES - FRONT				BRAKE DISC CHOICES - FRONT						Line #
		FA, SFA, TT Pad or Brake Shoe	SFAC Carbon Scooter Pads	Speciality Pads SXR / Vee / MXS	Sintered/HH Pads/ Grooved Shoes	Left / Gauche / Links Standard Replacement Disc	Right / Droite / Rechts Standard Replacement Disc	Contour Disc Universal left and right fitment	Universal Custom Disc	Vee-Discs Black † See note below	CX Extreme MX Race Disc/ UTVX Disc	
JS 125-E (ECO 125)	07-09	SFA054	SFAC054		FA054HH		N/A					1
JS 125-E (ECO-2 125)	09-15	SFA054	SFAC054		FA054HH		N/A					2
JSM 125 Motard	10-15	FA086			FA086HH			N/A				3
JSM 125 Trail	13-14	FA086			FA086HH			N/A				4
Modena 125 (4T)	14-15	TBA				N/A						5
NAC 12 (125cc)	09-15	FA086*			FA086HH*			N/A*				6
NKT1 125 Naked	08-10	FA197			FA197HH		N/A					7
Regal Raptor DD 125 E	04-06	FA197			FA197HH		N/A					8
Regal Raptor DD 125 E (Cast Wheels)	09-15	FA086			FA086HH			N/A				9
Regal Raptor CR3-125	06	FA375			FA375HH							10
Regal Raptor CR3-125 - Floating Disc Conversion Option	06	FA375			FA375HH	MD644						11
R7 125 (4T) Sport	14-15	TBA*				N/A	N/A					12
Tempest Roadster 125	19	FA722										13
Tempest Scrambler 125	19	FA722										14
NKT2 250 Naked	08-09	FA197			FA197HH		N/A					15
Regal Raptor DD 250 E	04-09	FA197			FA197HH		N/A					16
350 E-9B	13-14	FA086*			FA086HH*			N/A*				17
EOS 350	13-15	FA086*			FA086HH*			N/A*				18
SPT 350	13-14	TBA						N/A*				19
												20
												21
												22
												23
												24
												25
												26
												27
												28
												29
												30
												31
												32
												33
												34
												35
												36
												37
												38
												39
												40
												41
												42
												43
												44
												45
												46
												47
												48
												49
												50
												51
												52
												53
												54
												55
												56
												57
												58
												59
												60

*-2 Sets Required. † For Vee disc colours add RED, BLU, GRN, GLD, ORG suffix to part number.

⊗ - Also available as a Vintage Motorcycle Disc.

R Suffix = High Durability Sintered Pad. HH Suffix = High Performance Sintered Pad. TT Suffix = Hard Wearing Off Road Pad. V Suffix = Semi-Sintered Pad. G Suffix = Grooved Shoe.

D Suffix = Drilled Disc. X Suffix = Universal Left or Right Disc. XC Suffix = Contoured Disc. LS Suffix = Left/Steel Disc. RS Suffix = Right/Steel Disc.

Non-JAPANESE Built Motorcycles

Line #	BRAKE DISC CHOICES - FRONT						DISC PAD CHOICES - REAR				BRAKE DISC CHOICES - REAR			
	Oversize 250 /280mm Disc Kit	OSX Oversize 250/280mm Disc Kit	Relocating Bracket for 250/ 280mm Disc	Oversize 320mm Disc Kit	SMX Oversize 320mm Disc Kit	Relocating Bracket for 320mm Disc	FA, SFA, TT Pad or Brake Shoe	SFAC Carbon Scooter Pads	Speciality Pads - SXR / Vee / MXS	Sintered/ HH Pads/ Grooved Shoes	Standard Replacement Disc	Contour Disc Rear fitment	Vee-Discs™ CONTOUR	CX Extreme MX Race Disc/ UTVX Disc
1							TBA							
2							Y531							
3							FA054TT			FA054HH		N/A		
4							FA197			FA197HH		N/A		
5														
6							FA086			FA086HH		N/A		
7							FA197			FA197HH	N/A			
8							TBA							
9							FA197			FA197HH		N/A		
10							FA343			FA343HH	N/A			
11							FA343			FA343HH	N/A			
12							TBA							
13							TBC							
14							TBC							
15							FA197			FA197HH	N/A			
16							TBA							
17							FA197			FA197HH		N/A		
18							FA197			FA197HH		N/A		
19							TBA					N/A		
20														
21														
22							FA115TT			FA115R	N/A			
23							N/A							
24							FA047TT			FA047R	N/A			
25							FA208TT			FA208R	N/A			
26							FA067TT			FA067R	N/A			
27							FA208TT			FA208R	N/A			
28							FA208TT			FA208R	N/A			
29							N/A							
30							FA047TT			FA047R	N/A			
31							FA047TT			FA047R	N/A			
32							N/A							
33							FA047TT			FA047R	N/A			
34							FA208TT			FA208R	N/A			
35							N/A							
36							FA047TT			FA047R	N/A			
37														
38														
39							FA368TT	MXS368		FA368R		TBA		
40							FA368TT			FA368R		TBA		
41														
42														
43										841G				
44										843G				
45														
46														
47							FA232TT			FA232R	N/A			
48							H307			H307G				
49							FA083TT			FA083R	N/A			
50							FA083TT			FA083R	N/A			
51							FA083TT			FA083R	N/A			
52							FA067TT			FA067R	N/A			
53							FA067TT			FA067R	N/A			
54							FA165TT			FA165R	N/A			
55							FA135TT			FA135R	N/A			
56							FA135TT			FA135R	N/A			
57							FA067TT			FA067R	N/A			
58							FA067TT			FA067R	N/A			
59							FA067TT			FA067R	N/A			
60														

REAR / ARRIÈRE / HINTEN / POSTERIOR / POSTERIORE

*-2 Sets Required. † For Vee disc colours add RED, BLU, GRN, GLD, ORG suffix to part number.

⊗ - Also available as a Vintage Motorcycle Disc.

R Suffix = High Durability Sintered Pad. **HH** Suffix = High Performance Sintered Pad. **TT** Suffix = Hard Wearing Off Road Pad. **V** Suffix = Semi Sintered Pad. **G** Suffix = Grooved Shoe.
D Suffix = Drilled Disc. **X** Suffix = Universal Left or Right Disc. **XC** Suffix = Contoured Disc. **LS** Suffix = Left/Steel Disc. **RS** = Right/Steel Disc.

Part numbers, prefixes, suffixes, photos and illustrations shown in this catalogue are trademarks and/or copyrights of EBC Brakes or the trademark owner A C Freeman Investments Ltd and use without express written permission of the owners is punishable by law.

Non-JAPANESE Built Motorcycles

APPLICATIONS

BRAKE



APRILIA

(Inc Scarabeo Models up to 2009/ See separate Scarabeo section for 2010 models onwards)

AF1 Futura 50	90-92
Amico (All models)	96-98
Area 51	98-02
Classic 50	92-01
Europa 50	90-92
Habana 50/Habana Custom	99-02
Gulliver (All models)	95-98
Mini RX 50 Experience	04
Mini RX 50 Challenge/Entry	04
MX 50	03-05
Mojito Custom 50 (120mm Diameter Rear Drum)	99-03
Mojito Custom 50 (110mm Diameter Rear Drum)	04-12
Mojito Retro 50 (120mm Diameter Rear Drum)	99-03
Pegaso 50	92-94
(2 pads both same shape modification A)	
Pegaso 50	92-94
(Pad with hook on one side modification B)	
Quad 50 cc (2 stroke)	04
Rally (All models) A/C	95-02
Rally 50 All models L/C	96-00
RS 50 (6 bolt disc fixing front & rear)	93-98
RS 50 (5 bolt fixing front & rear)	99-05
RS 50 (Radial Caliper - 6 bolt fixing front & rear)	06-11
RS4 50 (4T) (AJP Calipers)	11-14
RS4 50 (4T) (J.Juan Calipers)	11-20
RX 3-5 Marce (M/N) (50cc)	91-92
RX 3-5 Marce (P/R) (50cc)	93-94
RX 50 C/CD	95-04
RX 50 Racing	03-06
RX 50 Factory	06-20
Scarabeo 50 (2T) (HS/HL) Front drum model	93-97
Scarabeo 50 (2T) (H2/HL) Front disc model	93-97
Scarabeo 50 (2T) (PFO100) (Rear drum model)	98-99
Scarabeo 50 (2T) (Rear disc model) (PFO100)	98-99
Scarabeo 50 (2T) (Rear drum model) (PFG00/TH000)	00-05
Scarabeo 50 (2T) (Rear disc model) (PFG00/TH000)	00-05
Scarabeo 50 Classic 2T (PFO100) (Rear drum model)	98-99
Scarabeo Classic (2T) (PFO100) (Rear disc model)	98-99
Scarabeo 50 (Ditech) (2T) (SCA00)	02-06
Scarabeo 50 Street (2T) (TH00/THE00)	05-09
Scarabeo 50 (4T) (TG000)	02-06
Scarabeo 50 (4T) (TGA00/TGB00)	06-09
Scarabeo 50 (4T)	14-17
Sonic (All models)	98-08
Sport City One 50 (2T)	08-11
Sport City One 50 (4T)	08-09
SR 50 Ditech (LC) (RLD 100)	02-03
SR 50 WWW (A/C) (LYH00)	97-01
SR 50 Street (LC/2T) (TE00/TEA00)	03-15
SR 50 R/Factory (LC/2T) (VFB00/VFD00)	04-18
SR 50 R SBK/SBK Alitalia Replica (LC)	10-11
SR 50 H20 (Ditech) (RLA1/RLB1) (Rear disc model)	00-03
SR 50 H20 (Ditech) (RLA1/RLB1) (Rear drum model)	00-03
SR 50 (A/C) GP/LB/LF	93-96
SR 50 (LC)	94-96
SR 50 Motard (2T)	12-15

DISC PAD CHOICES - FRONT				BRAKE DISC CHOICES - FRONT						Line #
FA, SFA, TT Pad or Brake Shoe	SFAC Carbon Scooter Pads	Speciality Pads SXR / Vee / MXS	Sintered/HH Pads/ Grooved Shoes	Left / Gauche / Links Standard Replacement Disc	Right / Droite / Rechts Standard Replacement Disc	Contour Disc Universal left and right fitment	Universal Custom Disc	Vee-Discs Black † See note below	CX Extreme MX Race Disc/ UTVX Disc	Line #
										1
										2
FA116				MD625LS						3
SFA193	SFAC193		SFA193HH	MD904D				VR904		4
SFA193	SFAC193		SFA193HH	MD936D				VR936		5
FA116				N/A						6
FA116				MD625LS						7
SFA193	SFAC193		SFA193HH	MD943D		MD943C		VR943		8
SFA193	SFAC193		SFA193HH	MD943D		MD943C		VR943		9
FA351TT				N/A						10
TBA										11
FA194			FA194HH	MD6214D						12
SFA193	SFAC193		SFA193HH	MD943D		MD943C		VR943		13
SFA193	SFAC193		SFA193HH	MD943D		MD943C		VR943		14
SFA193	SFAC193		SFA193HH	MD943D		MD943C		VR943		15
FA256TT			FA256HH	MD6214D						16
										17
FA194			FA194HH	MD6214D						18
										19
TBA*										20
SFA193	SFAC193		SFA193HH	MD943D		MD943C		VR943		21
SFA193	SFAC193		SFA193HH	MD943D		MD943C		VR943		22
FA047			FA047HH	MD639LS						23
FA194			FA194HH	MD672LS						24
FA266			FA266HH	MD685LS						25
FA399				MD685LS						26
FA095			FA095HH	MD685LS						27
FA167			FA167HH	MD6214D						28
FA167			FA167HH	MD6214D						29
FA194			FA194HH	MD6214D						30
FA194			FA194HH	TBA						31
FA194			FA194HH	MD811						32
805										33
SFA193	SFAC193		SFA193HH	MD917D						34
SFA193	SFAC193		SFA193HH	MD945D				VR945		35
SFA193	SFAC193		SFA193HH	MD945D				VR945		36
SFA193	SFAC193		SFA193HH	MD945D				VR945		37
SFA193	SFAC193		SFA193HH	MD945D				VR945		38
SFA193	SFAC193		SFA193HH	MD990D				VR990		39
SFA193	SFAC193		SFA193HH	MD990D				VR990		40
SFA193	SFAC193		SFA193HH	MD945D				VR945		41
SFA193	SFAC193		SFA193HH	MD945D				VR945		42
SFA193	SFAC193		SFA193HH	MD945D				VR945		43
SFA193	SFAC193		SFA193HH	MD945D				VR945		44
SFA193	SFAC193		SFA193HH	MD945D				VR945		45
SFA193	SFAC193		SFA193HH	MD935D						46
SFA353	SFAC353		SFA353HH	MD924D				VR924		47
SFA353	SFAC353		SFA353HH	MD924D				VR924		48
SFA193	SFAC193		SFA193HH	MD943D		MD943C		VR943		49
SFA193	SFAC193		SFA193HH	MD943D		MD943C		VR943		50
SFA193	SFAC193		SFA193HH	MD943D		MD943C		VR943		51
										52
SFA193	SFAC193		SFA193HH	MD943D		MD943C		VR943		53
										54
SFA193	SFAC193		SFA193HH			MD943C		VR943		55
SFA193	SFAC193		SFA193HH	MD943D		MD943C		VR943		56
SFA193	SFAC193		SFA193HH	MD943D		MD943C		VR943		57
SFA193	SFAC193		SFA193HH	MD943D		MD943C		VR943		58
SFA193	SFAC193		SFA193HH	MD943D		MD943C		VR943		59
SFA353	SFAC353		SFA353HH	MD924D				VR924		60

*-2 Sets Required. † For Vee disc colours add RED, BLU, GRN, GLD, ORG suffix to part number.

⊗ - Also available as a Vintage Motorcycle Disc.

R Suffix = High Durability Sintered Pad. HH Suffix = High Performance Sintered Pad. TT Suffix = Hard Wearing Off Road Pad. V Suffix = Semi-Sintered Pad. G Suffix = Grooved Shoe.

D Suffix = Drilled Disc. X Suffix = Universal Left or Right Disc. XC Suffix = Contoured Disc. LS Suffix = Left/Steel Disc. RS Suffix = Right/Steel Disc.

Non-JAPANESE Built Motorcycles

Line #	BRAKE DISC CHOICES - FRONT						DISC PAD CHOICES - REAR				BRAKE DISC CHOICES - REAR			
	Oversize 250 /280mm Disc Kit	OSX Oversize 250/280mm Disc Kit	Relocating Bracket for 250/ 280mm Disc	Oversize 320mm Disc Kit	SMX Oversize 320mm Disc Kit	Relocating Bracket for 320mm Disc	FA, SFA, TT Pad or Brake Shoe	SFAC Carbon Scooter Pads	Speciality Pads - SXR / Vee / MXS	Sintered/ HH Pads/ Grooved Shoes	Standard Replacement Disc	Contour Disc Rear fitment	Vee-Discs™ CONTOUR	CX Extreme MX Race Disc/ UTVX Disc
1														
2														
3							FA060							
4							893							
5							SFA193	SFAC193		SFA193HH	MD943D		VR943	
6							995							
7							FA060							
8							817							
9							893							
10							TBA							
11							TBA							
12							FA060							
13							817				MD6286D			
14							899							
15							817							
16							FA337TT							
17											MD6286D			
18							FA337TT							
19											MD6286D			
20							TBA							
21							893							
22							SFA193	SFAC193		SFA193HH	MD943D	MD943C	VR943	
23							FA060							
24							FA060							
25							FA115			FA115HH	MD686			
26							FA093				MD833			
27							FA083TT				MD833			
28							FA060				MD6286D			
29							FA060				MD6286D			
30							FA060				MD6286D			
31							FA060				MD6286D			
32							FA115			FA115HH	MD6248D			
33							893							
34							893							
35							893							
36							SFA193	SFAC193		SFA193HH	MD943D		VR943	
37							893							
38							SFA193	SFAC193		SFA193HH	MD943D		VR943	
39							893							
40							SFA193	SFAC193		SFA193HH	MD943D		VR943	
41							SFA298	SFAC298		SFA298HH	MD943D		VR943	
42							816							
43							816							
44							816							
45							816							
46							893							
47							816							
48							816							
49							SFA298	SFAC298		SFA298HH	MD943D	MD943C	VR943	
50							893							
51							SFA298	SFAC298		SFA298HH	MD996D		VR996	
52														
53							SFA298	SFAC298		SFA298HH	Note - Rear disc mounts onto a spacer carrier hub MD996D		VR996	
54														
55							SFA298	SFAC298		SFA298HH	Note - Rear disc mounts onto a spacer carrier hub			
56							SFA298	SFAC298		SFA298HH		TBA		
57							817				MD943D	MD943C	VR943	
58							893							
59							893							
60							816							

REAR / ARRIÈRE / HINTEN / POSTERIOR / POSTERIORE

*-2 Sets Required. † For Vee disc colours add RED, BLU, GRN, GLD, ORG suffix to part number.

⊗ - Also available as a Vintage Motorcycle Disc.

R Suffix = High Durability Sintered Pad. **HH** Suffix = High Performance Sintered Pad. **TT** Suffix = Hard Wearing Off Road Pad. **V** Suffix = Semi Sintered Pad. **G** Suffix = Grooved Shoe.
D Suffix = Drilled Disc. **X** Suffix = Universal Left or Right Disc. **XC** Suffix = Contoured Disc. **LS** Suffix = Left/Steel Disc. **RS** = Right/Steel Disc.

Non-JAPANESE Built Motorcycles

APPLICATIONS

BRAKE



APRILIA Contd.

SR 50 Motard (4T/4V)	13-15
SR 50 Stealth/Racing (LC) (Drum rear brake) (MZCO)	97-99
SR 50 Stealth/Racing (LC) (Disc rear brake) (MZCO)	97-99
SX 50	06-20
SX 50 Limited Edition	14-16
SX 50 Factory	19-20
Tuono 50	04
Scarabeo 100 (2T) (Yamaha Engine - RE00)	00
Scarabeo 100 (2T) (Minarelli Engine - REA0)	00
Scarabeo 100 (4T) (SA000/VA000)	01-09
Quad 100cc (2 stroke)	04
AF1 125	87
AF1 125	88-89
AF1 125	90-91
Atlantic 125	03-08
Atlantic 125	10
Classic 125	95-01
ETX 125	99-01
Habana 125/Habana Custom	00-02
Leonardo 125/150	96-98
Leonardo 125/150 ST/SP	99-04
Leonardo 125	05-06
Mojito/Mojito Custom 125	03-12
MX 125	04-06
RS 125 (6 bolt rear disc/2T)	92-98
RS 125 (5 bolt rear disc/2T)	99-05
RS 125 (Radial Caliper/2T)	06-12
RS 125 (4T)	17-18
RS 125 (4T) GP Replica	18-20
RS4 125 (4T) (AJP Calipers)	11-20
RS4 125 (4T) (J.Juan Calipers)	11-20
Scarabeo 125/150	99-02
Scarabeo 125/200	03
Scarabeo 125/150 GT	04-06
Scarabeo 125	07-10
Tuareg Rally 125 (N)	-93
RX 125	92-99
RX 125	00-01
RX 125 (Brembo Front & Grimeca Rear caliper)	08-12
RX 125 (AJP Calipers Front & Rear)	08-12
RX 125	18-20
Pegaso 125	91
Pegaso 125 Kat	94-95
Red Rose 125 (Cast wheel)	87
Red Rose 125 (Spoke wheel)	88-94
Sport City 125	04-08
Sport City Cube 125	08-12
Sport City One - 125cc	08-11
SR 125/150	99-02
SR 125 Motard (4T)	12-15
SR 125 Max (4T)	11-15
SX 125	08-13
SX 125	18-20
Tuareg Rally 125	89
Tuareg Rally 125 (L/M)	90-91
Tuono 125	03-04
Tuono 125	17-20
TX 125/240/311	86-88
Quad 180 Sport (4 stroke)	04
Quad 180 Grip (4 stroke)	04

DISC PAD CHOICES - FRONT				BRAKE DISC CHOICES - FRONT							Line #
FA, SFA, TT Pad or Brake Shoe	SFAC Carbon Scooter Pads	Speciality Pads SXR / Vee / MXS	Sintered/HH Pads/ Grooved Shoes	Left / Gauche / Links Standard Replacement Disc	Right / Droite / Rechts Standard Replacement Disc	Contour Disc Universal left and right fitment	Universal Custom Disc	Vee-Discs Black † See note below	CX Extreme MX Race Disc/ UTVX Disc	Line #	
SFA353	SFAC353		SFA353HH	MD924D				VR924		1	
SFA193	SFAC193		SFA193HH	MD943D		MD943C		VR943		2	
SFA193	SFAC193		SFA193HH	MD943D		MD943C		VR943		3	
FA194			FA194HH	MD811						4	
FA194			FA194HH	MD811						5	
FA194			FA194HH	MD811						6	
FA194			FA194HH	MD672LS						7	
SFA301	SFAC301		SFA301HH	MD945D				VR945		8	
SFA301	SFAC301		SFA301HH	MD945D				VR945		9	
SFA301	SFAC301		SFA301HH	MD945D				VR945		10	
TBA*										11	
FA134					MD635RS					12	
FA126			FA126HH		MD635RS					13	
FA126			FA126HH		MD612RS					14	
SFA324	SFAC324		SFA324HH	MD997D				VR997		15	
SFA324	SFAC324		SFA324HH	MD997D				VR997		16	
FA167			FA167HH		MD628RS					17	
FA194			FA194HH	N/A						18	
SFA301	SFAC301		SFA301HH	MD943D		MD943C		VR943		19	
SFA193	SFAC193		SFA193HH	MD942D				VR942		20	
SFA301	SFAC301		SFA301HH	MD942D				VR942		21	
SFA301	SFAC301		SFA301HH	MD942D				VR942		22	
SFA301	SFAC301		SFA301HH	MD943D		MD943C		VR943		23	
FA181TT			FA181R	MD2003X			MD2003CC	VR2003BLK		24	
FA126			FA126HH		MD2003X	MD2003XC	MD2003CC	VR2003BLK		25	
FA126			FA126HH		MD2003X	MD2003XC	MD2003CC	VR2003BLK		26	
FA432			FA432HH		MD621X	MD621XC		VR621BLK		27	
FA399				MD685LS						28	
FA399				MD685LS						29	
FA399				MD685LS						30	
FA095			FA095HH	MD685LS						31	
SFA256	SFAC256		SFA256HH	MD952D				VR952		32	
SFA256	SFAC256		SFA256HH	MD952D				VR952		33	
SFA324	SFAC324		SFA324HH	MD952D				VR952		34	
SFA324	SFAC324		SFA324HH	MD952D				VR952		35	
FA167			FA167HH		N/A					36	
FA194			FA194HH		N/A					37	
FA181TT			FA181R	N/A						38	
FA181TT		MXS181	FA181R	TBA						39	
FA181TT		MXS181	FA181R	TBA						40	
TBA										41	
FA167			FA167HH		N/A					42	
FA194			FA194HH		N/A					43	
FA256			FA256HH		N/A					44	
FA256			FA256HH		MD628RS					45	
SFA256	SFAC256		SFA256HH	MD952D				VR952		46	
SFA256	SFAC256		SFA256HH	MD952D				VR952		47	
SFA353	SFAC353		SFA353HH	MD924D				VR924		48	
SFA301	SFAC301		SFA301HH	MD943D		MD943C		VR943		49	
SFA353	SFAC353		SFA353HH	MD924D				VR924		50	
SFA353	SFAC353		SFA353HH	MD983D				VR983		51	
FA181TT		MXS181	FA181R	TBA						52	
TBA				TBA						53	
FA163				N/A						54	
FA256TT			FA256HH	N/A						55	
FA126			FA126HH		MD2003X	MD2003XC	MD2003CC	VR2003BLK		56	
FA399				MD685						57	
FA115TT			FA115R		N/A					58	
TBA										59	
TBA										60	

FRONT / AVANT / VORN / FRENTE / ANTERIORE

R Suffix = High Durability Sintered Pad. HH Suffix = High Performance Sintered Pad. TT Suffix = Hard Wearing Off Road Pad. V Suffix = Semi-Sintered Pad. G Suffix = Grooved Shoe.

D Suffix = Drilled Disc. X Suffix = Universal Left or Right Disc. XC Suffix = Contoured Disc. LS Suffix = Left/Steel Disc. RS Suffix = Right/Steel Disc.

*-2 Sets Required. † For Vee disc colours add RED, BLU, GRN, GLD, ORG suffix to part number.

⊗ - Also available as a Vintage Motorcycle Disc.

Non-JAPANESE Built Motorcycles

Line #	BRAKE DISC CHOICES - FRONT						DISC PAD CHOICES - REAR				BRAKE DISC CHOICES - REAR			
	Oversize 250 /280mm Disc Kit	OSX Oversize 250/280mm Disc Kit	Relocating Bracket for 250/ 280mm Disc	Oversize 320mm Disc Kit	SMX Oversize 320mm Disc Kit	Relocating Bracket for 320mm Disc	FA, SFA, TT Pad or Brake Shoe	SFAC Carbon Scooter Pads	Speciality Pads - SXR / Vee / MXS	Sintered/ HH Pads/ Grooved Shoes	Standard Replacement Disc	Contour Disc Rear fitment	Vee-Discs™ CONTOUR	CX Extreme MX Race Disc/ UTVX Disc
1							816							
2							893							
3							SFA193	SFAC193		SFA193HH	MD943D	MD943C	VR943	
4							FA115			FA115HH	MD6248D			
5							FA083TT			FA083HH	MD833			
6							FA083TT			FA083HH	MD833			
7							FA060				MD664			
8							Y527							
9							Y527							
10							816							
11							TBA							
12							FA047				MD658			
13							FA047			FA047HH	MD658			
14							FA047			FA047HH	MD658			
15							SFA298	SFAC298		SFA298HH	MD996D		VR996	
16							SFA298	SFAC298		SFA298HH	MD996D		VR996	
17							921							
18							FA173				N/A			
19							816							
20							SFA193	SFAC193		SFA193HH	MD943D		VR943	
21							SFA301	SFAC301		SFA301HH	MD943D		VR943	
22							SFA301	SFAC301		SFA301HH	MD990D		VR990	
23							816							
24							FA382				MD6315D			
25							FA047			FA047HH	MD659			
26							FA047			FA047HH	MD664	MD664C		
27							FA298			SFA298HH	MD664	MD664C		
28							FA083TT				MD833			
29							FA083TT				MD833			
30							FA093				MD833			
31							FA083TT				MD833			
32							SFA298	SFAC298		SFA298HH	MD942D		VR942	
33							SFA298	SFAC298		SFA298HH	MD942D		VR942	
34							SFA298	SFAC298		SFA298HH	MD942D		VR942	
35							SFA298	SFAC298		SFA298HH	TBA			
36							FA382				N/A			
37							FA382				MD6315D			
38							FA382				MD6315D			
39							FA067			FA067R	TBA			
40							FA093				TBA			
41							FA083TT				TBA			
42							FA382				N/A			
43							FA382				N/A			
44							FA047			FA047HH				
45							921							
46							SFA298	SFAC298		SFA298HH	MD942D		VR942	
47							SFA298	SFAC298		SFA298HH	MD942D		VR942	
48							816							
49							816							
50							816							
51							SFA353	SFAC353		SFA353HH	MD960D		VR960	
52							FA067			FA067R	TBA			
53							FA083TT				TBA			
54							FA382				MD6315D			
55							FA382				MD6315D			
56							FA047			FA047HH	MD664	MD664C		
57							FA083TT				MD833			
58										841G				
59							TBA				TBA			
60							TBA				TBA			

REAR / ARRIÈRE / HINTEN / POSTERIOR / POSTERIORE

*-2 Sets Required. † For Vee disc colours add RED, BLU, GRN, GLD, ORG suffix to part number.

⊗ - Also available as a Vintage Motorcycle Disc.

R Suffix = High Durability Sintered Pad. **HH** Suffix = High Performance Sintered Pad. **TT** Suffix = Hard Wearing Off Road Pad. **V** Suffix = Semi Sintered Pad. **G** Suffix = Grooved Shoe.
D Suffix = Drilled Disc. **X** Suffix = Universal Left or Right Disc. **XC** Suffix = Contoured Disc. **LS** Suffix = Left/Steel Disc. **RS** = Right/Steel Disc.

Non-JAPANESE Built Motorcycles

APPLICATIONS

BRAKE



APRILIA Contd.

R Suffix = High Durability Sintered Pad. HH Suffix = High Performance Sintered Pad. TT Suffix = Hard Wearing Off Road Pad. V Suffix = Semi Sintered Pad. G Suffix = Grooved Shoe.

D Suffix = Drilled Disc. X Suffix = Universal Left or Right Disc. XC Suffix = Contoured Disc. LS Suffix = Left/Steel Disc. RS = Right/Steel Disc.

FRONT / AVANT / VORN / FRENTE / ANTERIORE

		DISC PAD CHOICES - FRONT				BRAKE DISC CHOICES - FRONT						Line #
Model	Year	FA, SFA, TT Pad or Brake Shoe	SFAC Carbon Scooter Pads	Speciality Pads SXR / Vee / MXS	Sintered/HH Pads/ Grooved Shoes	Left / Gauche / Links Standard Replacement Disc	Right / Droite / Rechts Standard Replacement Disc	Contour Disc Universal left and right fitment	Universal Custom Disc	Vee-Discs Black † See note below	CX Extreme MX Race Disc/ UTVX Disc	
Atlantic 200	03-05	SFA324	SFAC324		SFA324HH	MD997D				VR997		1
Scarabeo 200	07-09	SFA324	SFAC324		SFA324HH	MD952D				VR952		2
Sport City 200	04-08	SFA256	SFAC256		SFA256HH	MD952D				VR952		3
Sport City Cube 200	08-09	SFA256	SFAC256		SFA256HH	MD952D				VR952		4
TRX 240 M	89	FA099						N/A				5
250	86	FA047			FA047R			N/A				6
Atlantic 250 ie	06-08	SFA324	SFAC324		SFA324HH	MD997D				VR997		7
Atlantic 250	03-05	SFA324	SFAC324		SFA324HH	MD997D				VR997		8
Leonardo 250 SP/ST Models	00-04	SFA256	SFAC256		SFA256HH	MD942D				VR942		9
RS 250	95-97	FA095*			FA095HH*	MD660LS	MD660RS					10
RS 250	98-02	FA244*			FA244HH*	MD660LS	MD660RS					11
Scarabeo 250 ie	07-10	SFA324	SFAC324		SFA324HH	MD952D				VR952		12
Sport City 250 ie	06-08	SFA256*	SFAC256*		SFA256HH*	MD952D	MD952D			VR952*		13
Sport City Cube 250	08-09	SFA256*	SFAC256*		SFA256HH*	MD952D	MD952D			VR952*		14
280 R Climber	92-93	FA115TT			FA115R			N/A				15
280 Climber	94-96	FA115TT			FA115R			N/A				16
Scarabeo 250	06	SFA324	SFAC324		SFA324HH	MD952D				VR952		17
Atlantic 300	10-11	SFA324	SFAC324		SFA324HH	MD997D				VR997		18
Leonardo 300	05-06	SFA256	SFAC256		SFA256HH	MD942D				VR942		19
Scarabeo 300 S	09-10	SFA324	SFAC324		SFA324HH	MD952D				VR952		20
Sport City Cube 300	08-12	SFA256*	SFAC256*		SFA256HH*	MD952D	MD952D			VR952*		21
Sport City Cube 300 Blackline	11	SFA256*	SFAC256*		SFA256HH*	MD952D	MD952D			VR952*		22
SR 300 Max (4T)	11-15	SFA353	SFAC353		SFA353HH	MD983D				VR983		23
TX 311	88	FA115TT			FA115R			N/A				24
Atlantic 400 Sprint	05-08	SFA324	SFAC324		SFA324HH	TBA						25
Atlantic Sprint 400	05-08	SFA324	SFAC324		SFA324HH	TBA						26
Scarabeo 400 ie	07-08	SFA256*	SFAC256*		SFA256HH*	MD952D	MD952D			VR952*		27
MXV 450	09-13	FA185TT		MXS185	FA185R			TBA				28
RXV 450/550 Enduro	06-13	FA185TT		MXS185	FA185R	TBA		TBA				29
SXV 450/550 Supermoto	06-13				MXS405	TBA		TBA				30
Atlantic 500	02-04	SFA256*	SFAC256*		SFA256HH*	MD952D	MD952D			VR952*		31
Atlantic Sprint 500	05-08	SFA324	SFAC324		SFA324HH	TBA						32
Scarabeo 500/500 ABS	03-06	SFA256*	SFAC256*		SFA256HH*	MD952D	MD952D			VR952*		33
Scarabeo 500 Light	06	SFA256*	SFAC256*		SFA256HH*	MD952D	MD952D			VR952*		34
Scarabeo 500 ie	07-09	SFA256*	SFAC256*		SFA256HH*	MD952D	MD952D			VR952*		35
Pegaso 600	91	FA167			FA167HH			N/A				36
Tuareg Wind 600	89	FA163				MD6180D						37
Pegaso 650	91-96	FA177				MD6129D						38
Pegaso 650	97-00	FA209/2		FA209/2V	FA209/2HH	MD6129D						39
Pegaso 650 ie	01-04	FA209/2		FA209/2V	FA209/2HH	MD6129D						40
Pegaso Strada 650	05-06	FA244		FA244V	FA244HH	MD621X		MD621XC		VR621BLK		41
Pegaso 650 Trial	06-08	FA209/2		FA209/2V	FA209/2HH	MD6129D						42
Pegaso 650	07-08	FA244			FA244HH	MD621X		MD621XC		VR621BLK		43
Pegaso 650 Factory	06-08				MXS405	MD621X		MD621XC		VR621BLK		44
Moto 6.5	95-01	FA209/2		FA209/2V	FA209/2HH	MD673LS						45
Shiver 750 (RA000)	07-10	FA432*			FA432HH*	MD621X	MD621X	MD621XC*		VR621BLK*		46
Shiver 750 (RAE00/STD & ABS)	10-16	FA432*			FA432HH*			MD870XC*				47
Shiver 750 GT	09-10	FA432*			FA432HH*	MD621X	MD621X	MD621XC*		VR621BLK*		48
Shiver 750 GT ABS	10-12	FA432*			FA432HH*			MD621XC*		VR621BLK*		49
Dorsoduro 750 (ABS)	08-16	FA432*			FA432HH*			MD870XC*				50
Dorsoduro Factory 750	10-13	FA244*		FA244V*	FA244HH*			MD870XC*				51
Dorsoduro Factory 750 (ABS)	10-12	FA244*		FA244V*	FA244HH*			MD870XC*				52
NA 850 Mana (Non ABS)	08-11	FA432*			FA432HH*	MD621X	MD621X	MD621XC*		VR621BLK*		53
NA 850 Mana (Non ABS) - Parking brake	08-11	SFA257/2										54
NA 850 Mana (ABS)	08-13	FA432*			FA432HH*	MD621X	MD621X	MD621XC*		VR621BLK*		55
NA 850 Mana (ABS) - Parking brake	08-13	SFA257/2										56
NA 850 Mana GT (ABS Model)	09-16	FA432*			FA432HH*	MD621X	MD621X	MD621XC*		VR621BLK*		57
NA 850 Mana GT (ABS Model) - Parking brake	09-16	SFA257/2										58
SRV 850	12-14	SFA181*	SFAC181*		SFA181HH*	MD9125D	MD9125D					59
SRV 850 - Parking brake	12-14	SFA257/2										60

*-2 Sets Required. † For Vee disc colours add RED, BLU, GRN, GLD, ORG suffix to part number.

⊗ - Also available as a Vintage Motorcycle Disc.

Non-JAPANESE Built Motorcycles

Line #	BRAKE DISC CHOICES - FRONT						DISC PAD CHOICES - REAR				BRAKE DISC CHOICES - REAR			
	Oversize 250 /280mm Disc Kit	OSX Oversize 250/280mm Disc Kit	Relocating Bracket for 250/ 280mm Disc	Oversize 320mm Disc Kit	SMX Oversize 320mm Disc Kit	Relocating Bracket for 320mm Disc	FA, SFA, TT Pad or Brake Shoe	SFAC Carbon Scooter Pads	Speciality Pads - SXR / Vee / MXS	Sintered/ HH Pads/ Grooved Shoes	Standard Replacement Disc	Contour Disc Rear fitment	Vee-Discs™ CONTOUR	CX Extreme MX Race Disc/ UTVX Disc
1							SFA298	SFAC298		SFA298HH	MD996D		VR996	
2							SFA298	SFAC298		SFA298HH	TBA			
3							SFA298	SFAC298		SFA298HH	MD942D		VR942	
4							SFA298	SFAC298		SFA298HH	MD942D		VR942	
5							FA099			FA099R	N/A			
6										841G				
7							SFA298	SFAC298		SFA298HH	MD996D		VR996	
8							SFA298	SFAC298		SFA298HH	MD996D		VR996	
9							SFA298	SFAC298		SFA298HH	MD990D		VR990	
10							FA047			FA047HH	MD665			
11							FA047			FA047HH	MD665			
12							SFA298	SFAC298		SFA298HH	TBA			
13							SFA298	SFAC298		SFA298HH	MD942D		VR942	
14							SFA298	SFAC298		SFA298HH	MD942D		VR942	
15							FA337TT			FA337R	N/A			
16							FA156				N/A			
17							SFA298	SFAC298		SFA298HH	TBA			
18							SFA298	SFAC298		SFA298HH	MD996D		VR996	
19							SFA298	SFAC298		SFA298HH	MD990D		VR990	
20							SFA298	SFAC298		SFA298HH	TBA			
21							SFA298	SFAC298		SFA298HH	MD942D		VR942	
22							SFA298	SFAC298		SFA298HH	MD942D		VR942	
23							SFA353	SFAC353		SFA353HH	MD960D		VR960	
24							FA115TT			FA115R	N/A			
25							SFA298	SFAC298		SFA298HH	MD990D			
26							SFA298	SFAC298		SFA298HH	MD990D			
27							SFA298	SFAC298		SFA298HH	TBA			
28							FA367TT		MXS367	FA367R		TBA		
29							FA367TT		MXS367	FA367R		TBA		
30							FA367TT		MXS367	FA367R		TBA		
31							SFA298	SFAC298		SFA298HH	MD990D		VR990	
32							SFA298	SFAC298		SFA298HH	MD990D			
33							SFA298	SFAC298		SFA298HH	MD990D		VR990	
34							SFA298	SFAC298		SFA298HH	TBA			
35							SFA298	SFAC298		SFA298HH	TBA			
36							FA382				N/A			
37							FA382				N/A			
38							FA173				MD6128D			
39							FA173				MD6128D			
40							FA208TT			FA208R	TBA			
41							FA213		FA213V	FA213HH	TBA			
42							FA213		FA213V	FA213HH	TBA			
43							FA213		FA213V	FA213HH	TBA			
44							FA213		FA213V	FA213HH	TBA			
45							FA173				MD674			
46							FA213		FA213V	FA213HH	TBA			
47							FA213		FA213V	FA213HH	TBA			
48							FA213		FA213V	FA213HH	TBA			
49							FA213		FA213V	FA213HH	TBA			
50							FA213		FA213V	FA213HH		TBA		
51							FA213		FA213V	FA213HH		TBA		
52							FA213		FA213V	FA213HH		TBA		
53							FA256			FA256HH	MD858	MD858C	VR858	
54														
55							FA256			FA256HH	MD872	MD872C	VR872	
56														
57							FA256			FA256HH	MD872	MD872C	VR872	
58														
59							SFA353	SFAC353		SFA353HH	MD9124D			
60														

REAR / ARRIÈRE / HINTEN / POSTERIOR / POSTERIORE

*-2 Sets Required. † For Vee disc colours add RED, BLU, GRN, GLD, ORG suffix to part number.

⊗ - Also available as a Vintage Motorcycle Disc.

R Suffix = High Durability Sintered Pad. **HH** Suffix = High Performance Sintered Pad. **TT** Suffix = Hard Wearing Off Road Pad. **V** Suffix = Semi Sintered Pad. **G** Suffix = Grooved Shoe.
D Suffix = Drilled Disc. **X** Suffix = Universal Left or Right Disc. **XC** Suffix = Contoured Disc. **LS** Suffix = Left/Steel Disc. **RS** = Right/Steel Disc.

Non-JAPANESE Built Motorcycles



APRILIA Contd.

Dorsoduro 900 (ABS)	17-20
Shiver 900 (ABS)	17-20
ETV 1000 Caponord (Non ABS - Bolt fixing)	01-03
ETV 1000 Caponord Rally (Non ABS - Bush fixing)	03
ETV 1000 Caponord (ABS - Bush fixing)	04-07
RST Futura 1000	01-04
RSV 1000 Mille	98-00
RSV 1000 Mille	01-02
RSV 1000 Mille (Radial caliper)	03
RSV 1000 Mille R	00
RSV 1000 R Mille	01-02
RSV 1000 R Mille (Radial caliper)	03
RSV 1000 R Racing/Factory (Radial caliper/4 pad)	04-08
RSV 1000 R Tuono (Radial caliper/2 pin pad fixing)	07-08
RSV 1000 SP	99-00
RSV 1000 R Factory	04-08
RSV 1000 R	04-08
RSV 1000 R Tuono	02-06
RSV4R	10
RSV4R APRC	11-13
RSV4R APRC ABS	13-14
RSV4 Factory	09-10
RSV4 Factory APRC	11-13
RSV4 Factory APRC ABS	13-14
RSV4 RF 1000	15-18
RSV4 RR 1000	15-18
SL 1000 Falco	00-04
Tuono R 1000 Radial caliper/4 pad type	02-05
Tuono R Factory 1000 Radial caliper/4 pad type	06-10
Tuono R 1000 Radial caliper/2 pad type	02-10
Tuono V4R	11-12
Tuono V4R - APRC	11-13
Tuono V4R - APRC ABS	13-14
RSV4 1100 Factory	19-20
RSV4 1100 RR	19-20
Tuono Factory 1100 V4	15-16
Tuono Factory 1100 V4	17-18
Tuono 1100 RR V4	15-16
Tuono 1100 RR	19-20
Tuono V4 1100 Factory	19-20
Caponord 1200 (Cast Wheels)	13-16
Caponord Rally 1200 (Spoke Wheels)	15-19
Dorsoduro 1200	11-12
Dorsoduro 1200 ATC/ABS	11-14

ARCTIC CAT (ATV)

50 2 x 4 Youth (2T)	04-06
50 DVX Sport (4T)	06-08
50 4 x 4 Auto Youth	06-08
90 2 x 4 Youth (2T) Rear Drum Model	02-04
90 2 x 4 Youth (4T) Rear Drum Model	04-05
90 2 x 4 Youth (4T) Rear Disc Model	06
Alterra 90	17-19
90 DVX	06-14
90 DVX	18
90 DVX SE	09
90 Reverse Gear Model	10-14
150 Utility 2x4	09-14
150 Utility 2x4	15-18
250 2 x 4 Utility	99-04

DISC PAD CHOICES - FRONT				BRAKE DISC CHOICES - FRONT						Line #
FA, SFA, TT Pad or Brake Shoe	SFAC Carbon Scooter Pads	Speciality Pads SXR / Vee / MXS	Sintered/HH Pads/ Grooved Shoes	Left / Gauche / Links Standard Replacement Disc	Right / Droite / Rechts Standard Replacement Disc	Contour Disc Universal left and right fitment	Universal Custom Disc	Vee-Discs Black † See note below	CX Extreme MX Race Disc/ UTVX Disc	Line #
FA432*			FA432HH*							1
FA432*			FA432HH*							2
FA209/2*		FA209/2V*	FA209/2HH*	MD6307D	MD6307D					3
FA209/2*		FA209/2V*	FA209/2HH*	MD6406D	MD6406D					4
FA209/2*		FA209/2V*	FA209/2HH*	MD6406D	MD6406D					5
FA244*			FA244HH*	MD2001X	MD2001X	MD2001XC*	MD2001CC*	VR2001BLK*		6
FA244*			FA244HH*	MD666X	MD666X	MD666XC*				7
			FA322/4HH*	MD621X	MD621X	MD621XC*		VR621BLK*		8
			FA322/4HH*	MD621X	MD621X	MD621XC*		VR621BLK*		9
FA244*			FA244HH*	MD666X	MD666X	MD666XC*				10
			FA322/4HH*	MD621X	MD621X	MD621XC*		VR621BLK*		11
			FA322/4HH*	MD621X	MD621X	MD621XC*		VR621BLK*		12
			FA322/4HH*	MD621X	MD621X	MD621XC*		VR621BLK*		13
FA244*			FA244HH*	MD621X	MD621X	MD621XC*		VR621BLK*		14
FA244*			FA244HH*	MD621X	MD621X	MD621XC*		VR621BLK*		15
			FA322/4HH*	MD621X	MD621X	MD621XC*		VR621BLK*		16
			FA322/4HH*	MD621X	MD621X	MD621XC*		VR621BLK*		17
FA244*			FA244HH*	MD621X	MD621X	MD621XC*		VR621BLK*		18
			FA447HH*	MD2003X	MD2003X	MD2003XC*	MD2003CC*	VR2003BLK*		19
			FA447HH*	MD2003X	MD2003X	MD2003XC*	MD2003CC*	VR2003BLK*		20
			FA447HH*	MD2003X	MD2003X	MD2003XC*	MD2003CC*	VR2003BLK*		21
			FA447HH*	MD2003X	MD2003X	MD2003XC*	MD2003CC*	VR2003BLK*		22
			FA447HH*	MD2003X	MD2003X	MD2003XC*	MD2003CC*	VR2003BLK*		23
			FA447HH*	MD2003X	MD2003X	MD2003XC*	MD2003CC*	VR2003BLK*		24
			FA447HH*	N/A	N/A					25
			FA447HH*	N/A	N/A					26
FA244*			FA244HH*	MD666X	MD666X	MD666XC*				27
			FA322/4HH*	MD621X	MD621X	MD621XC*		VR621BLK*		28
			FA322/4HH*	MD621X	MD621X	MD621XC*		VR621BLK*		29
FA244*			FA244HH*	MD621X	MD621X	MD621XC*		VR621BLK*		30
FA244*			FA244HH*	TBA	TBA	TBA*				31
FA244*			FA244HH*	TBA	TBA	TBA*				32
			FA630HH*	TBA	TBA					33
			FA447HH*							34
			FA447HH*							35
			FA630HH*	N/A	N/A					36
			FA447HH*	N/A	N/A					37
			FA630HH*	N/A	N/A					38
			FA447HH*							39
			FA447HH*							40
		FA630V*	FA630HH*	TBA	TBA					41
		FA630V*	FA630HH*	TBA	TBA					42
FA244*			FA244HH*	TBA	TBA					43
FA244*			FA244HH*	TBA	TBA					44
										45
										46
H338*			H338G*							47
H338*			H338G*							48
H338*			H338G*							49
H338*			H338G*							50
H338*			H338G*							51
H338*			H338G*							52
H338*			H338G*							53
H338*			H338G*							54
H338*			H338G*							55
H338*			H338G*							56
H338*			H338G*							57
H303*			H303G*							58
H303*			H303G*							59
FA271TT*			FA271R*	MD6173D	MD6173D				UTVX6173*	60

*-2 Sets Required. † For Vee disc colours add RED, BLU, GRN, GLD, ORG suffix to part number.

⊗ - Also available as a Vintage Motorcycle Disc.

Non-JAPANESE Built Motorcycles

Line #	BRAKE DISC CHOICES - FRONT						DISC PAD CHOICES - REAR				BRAKE DISC CHOICES - REAR			
	Oversize 250 /280mm Disc Kit	OSX Oversize 250/280mm Disc Kit	Relocating Bracket for 250/ 280mm Disc	Oversize 320mm Disc Kit	SMX Oversize 320mm Disc Kit	Relocating Bracket for 320mm Disc	FA, SFA, TT Pad or Brake Shoe	SFAC Carbon Scooter Pads	Speciality Pads - SXR / Vee / MXS	Sintered/ HH Pads/ Grooved Shoes	Standard Replacement Disc	Contour Disc Rear fitment	Vee-Discs™ CONTOUR	CX Extreme MX Race Disc/ UTVX Disc
1							FA213		FA213V	FA213HH				
2							FA213		FA213V	FA213HH				
3							FA266		FA266V	FA266HH	MD6308D			
4							FA266		FA266V	FA266HH	MD6308D			
5							FA266		FA266V	FA266HH	MD6308D			
6							FA181TT			FA181HH	MD697	MD697C		
7							FA266			FA266HH	MD613	MD613C		
8							FA266			FA266HH	MD613	MD613C		
9							FA266			FA266HH	MD613	MD613C		
10							FA266			FA266HH	MD613	MD613C		
11							FA266			FA266HH	MD613	MD613C		
12							FA266			FA266HH	MD613	MD613C		
13							FA266			FA266HH	MD613	MD613C		
14							FA266			FA266HH	MD613	MD613C		
15							FA266			FA266HH	MD613	MD613C		
16							FA266			FA266HH	MD613	MD613C		
17							FA266			FA266HH	MD613	MD613C		
18							FA266			FA266HH	MD613	MD613C		
19							FA266			FA266HH	MD613	MD613C		
20							FA266			FA266HH	MD613	MD613C		
21							FA266			FA266HH	MD613	MD613C		
22							FA266			FA266HH	MD613	MD613C		
23							FA266			FA266HH	MD613	MD613C		
24							FA266			FA266HH	MD613	MD613C		
25							FA266			FA266HH	N/A			
26							FA266			FA266HH	N/A			
27							FA266			FA266HH	MD613	MD613C		
28							FA266			FA266HH	MD613	MD613C		
29							FA266			FA266HH	MD613	MD613C		
30							FA266			FA266HH	MD613	MD613C		
31							FA266			FA266HH	MD613	TBA		
32							FA266			FA266HH	MD613	TBA		
33							FA266			FA266HH	MD613			
34							FA266			FA266HH				
35							FA266			FA266HH				
36							FA266			FA266HH	N/A			
37							FA266			FA266HH	N/			
38							FA266			FA266HH	N/A			
39							FA266			FA266HH	TBA			
40							FA266			FA266HH				
41							FA213		FA213V	FA213HH	TBA			
42							FA213		FA213V	FA213HH	TBA			
43							FA213		FA213V	FA213HH	TBA			
44							FA213		FA213V	FA213HH	TBA			
45														
46														
47							N/A							
48							FA305TT			FA305R	MD6267D			
49							FA305TT			FA305R	MD6267D			
50							H307			H307G				
51							H307			H307G				
52							FA305TT			FA305R	MD6267D			
53							FA377TT			FA377R	MD6267D			
54							FA305TT			FA305R	MD6267D			
55							FA377TT			FA377R	MD6267D			
56							FA305TT			FA305R	MD6267D			
57							FA305TT			FA305R	MD6267D			
58							FA305TT			FA305R	MD6267D			
59							FA377TT			FA377R	MD6267D			
60							FA271TT			FA271R	MD6173D			UTVX6173

REAR / ARRIÈRE / HINTEN / POSTERIOR / POSTERIORE

*-2 Sets Required. † For Vee disc colours add RED, BLU, GRN, GLD, ORG suffix to part number.

⊗ - Also available as a Vintage Motorcycle Disc.

R Suffix = High Durability Sintered Pad. **HH** Suffix = High Performance Sintered Pad. **TT** Suffix = Hard Wearing Off Road Pad. **V** Suffix = Semi Sintered Pad. **G** Suffix = Grooved Shoe.
D Suffix = Drilled Disc. **X** Suffix = Universal Left or Right Disc. **XC** Suffix = Contoured Disc. **LS** Suffix = Left/Steel Disc. **RS** = Right/Steel Disc.

Non-JAPANESE Built Motorcycles

APPLICATIONS

BRAKE



ARCTIC CAT (ATV) Contd.



R Suffix = High Durability Sintered Pad. HH Suffix = High Performance Sintered Pad. TT Suffix = Hard Wearing Off Road Pad. V Suffix = Semi Sintered Pad. G Suffix = Grooved Shoe.

D Suffix = Drilled Disc. X Suffix = Universal Left or Right Disc. XC Suffix = Contoured Disc. LS Suffix = Left/Steel Disc. RS Suffix = Right/Steel Disc.

Model	Year
250 2 x 4 Utility	05-09
250 4 x 4 Utility	01-04
250 4 x 4 Utility	05/08
250 DVX Sport	06-08
300 4 x 4	98-04
300 4 x 4 Utility	05
300 Alterra	17-19
300 ATV	10-12
300 2 x 4 Utility (Mid Size)	10-16
300 DVX	09-14
350 ATV	12
366 4 x 4 Auto Utility	08-09
366 SE	10
400 4 x 4 ACT	04
400 4 x 4 Auto ACT	04
400 2 x 4 Utility	98-04
400 2 x 4 Auto Utility	04
400 4 x 4 Utility	00-04
400 4 x 4 Utility	05-07
400 4 x 4 VP Utility	05-06
400 4 x 4 Auto Utility	04
400 4 x 4 Auto Utility	05-08
400 4 x 4 Auto LE Utility	05-07
400 4 x 4 Auto VP Utility	05-06
400 DVX Sport	04-08
400 DVX TS Sport	06-07
400 4 x 4 Auto TBX Utility	04
400 4 x 4 Auto TBX Utility	05-06
Alterra 400	16-18
400 ATV (Mid Size)	13-14
400 TRV	09
400 TRV	13
400 TRV H1	10
400 4 x 4 Auto TRV Multirider	06
400 4 x 4 Auto TRV Plus Multirider	07
425i	12
425i SE	12
450 H1 EFI	10
450i	11-12
450i GT	12
450 TRV	11-12
450i TRV	11
Alterra 450	16
XC 450i	11-12
450i XC	13-14
450i XC	15-17
500 ATV (Mid Size)	13-14
454 Bearcat 2 x 4	97-98
454 Bearcat 4 x 4	96-98
500 4 x 4 Auto Utility	98-04
500 4 x 4 Auto Utility	05-08
500 4 x 4 Auto LE Utility	05-06
500 4 x 4 Manual G/Box Utility	98-04
500 4 x 4 Manual G/Box Utility	05-09
500 4 x 4 Auto TBX Utility	04
500 4 x 4 Auto TBX Utility	05-06
500 4 x 4 Auto TRV Utility	04
500 4 x 4 Auto TRV Multirider	05-06/08
500 ATV (Mid Size)	13-14
500 ATV XT (Mid Size)	13-14

FRONT / AVANT / VORN / FRENTE / ANTERIORE

DISC PAD CHOICES - FRONT				BRAKE DISC CHOICES - FRONT						Line #
FA, SFA, TT Pad or Brake Shoe	SFAC Carbon Scooter Pads	Speciality Pads SXR / Vee / MXS	Sintered/HH Pads/ Grooved Shoes	Left / Gauche / Links Standard Replacement Disc	Right / Droite / Rechts Standard Replacement Disc	Contour Disc Universal left and right fitment	Universal Custom Disc	Vee-Discs Black † See note below	CX Extreme MX Race Disc/ UTVX Disc	Line #
FA395TT*			FA395R*	MD6173D	MD6173D				UTVX6173*	1
FA271TT*			FA271R*	MD6173D	MD6173D				UTVX6173*	2
FA395TT*			FA395R*	MD6173D	MD6173D				UTVX6173*	3
FA377TT*			FA377R*	MD6267D	MD6267D					4
FA271TT*			FA271R*	MD6173D	MD6173D				UTVX6173*	5
FA395TT*			FA395R*	MD6173D	MD6173D				UTVX6173*	6
FA377TT*			FA377R*	MD6267D	MD6267D					7
FA395TT*			FA395R*	MD6173D	MD6173D				UTVX6173*	8
FA377TT*			FA377R*	MD6267D	MD6267D					9
FA377TT*			FA377R*	MD6267D	MD6267D					10
FA395TT*			FA395R*	MD6173D	MD6173D				UTVX6173*	11
FA395TT*			FA395R*	MD6173D	MD6173D				UTVX6173*	12
FA395TT*			FA395R*	MD6173D	MD6173D				UTVX6173*	13
FA271TT*			FA271R*	MD6173D	MD6173D				UTVX6173*	14
FA271TT*			FA271R*	MD6173D	MD6173D				UTVX6173*	15
FA271TT*			FA271R*	MD6173D	MD6173D				UTVX6173*	16
FA271TT*			FA271R*	MD6173D	MD6173D				UTVX6173*	17
FA271TT*			FA271R*	MD6173D	MD6173D				UTVX6173*	18
FA395TT*			FA395R*	MD6173D	MD6173D				UTVX6173*	19
FA395TT*			FA395R*	MD6173D	MD6173D				UTVX6173*	20
FA271TT*			FA271R*	MD6173D	MD6173D				UTVX6173*	21
FA395TT*			FA395R*	MD6173D	MD6173D				UTVX6173*	22
FA395TT*			FA395R*	MD6173D	MD6173D				UTVX6173*	23
FA395TT*			FA395R*	MD6173D	MD6173D				UTVX6173*	24
FA084TT*			FA084R*	MD6210D	MD6210D					25
FA084TT*			FA084R*	MD6210D	MD6210D					26
FA271TT*			FA271R*	MD6173D	MD6173D				UTVX6173*	27
FA395TT*			FA395R*	MD6173D	MD6173D				UTVX6173*	28
FA395TT*			FA395R*	MD6383D	MD6383D					29
FA395TT*			FA395R*	MD6383D	MD6383D					30
FA395TT*			FA395R*	MD6173D	MD6173D				UTVX6173*	31
FA395TT*			FA395R*	TBA	TBA					32
FA395TT*			FA395R*	MD6173D	MD6173D				UTVX6173*	33
FA395TT*			FA395R*	MD6173D	MD6173D				UTVX6173*	34
FA395TT*			FA395R*	MD6173D	MD6173D				UTVX6173*	35
FA395TT*			FA395R*	MD6173D	MD6173D				UTVX6173*	36
FA395TT*			FA395R*	MD6173D	MD6173D				UTVX6173*	37
FA395TT*			FA395R*	MD6173D	MD6173D				UTVX6173*	38
FA395TT*			FA395R*	MD6173D	MD6173D				UTVX6173*	39
FA395TT*			FA395R*	MD6173D	MD6173D				UTVX6173*	40
FA395TT*			FA395R*	MD6173D	MD6173D				UTVX6173*	41
FA395TT*			FA395R*	MD6173D	MD6173D				UTVX6173*	42
FA395TT*			FA395R*	MD6173D	MD6173D				UTVX6173*	43
FA395TT*			FA395R*	MD6173D	MD6173D				UTVX6173*	44
FA395TT*			FA395R*	TBA	TBA					45
FA395TT*			FA395R*	MD6173D	MD6173D				UTVX6173*	46
FA395TT*			FA395R*	MD6375D	MD6375D					47
FA271TT*			FA271R*	MD6173D	MD6173D				UTVX6173*	48
FA271TT*			FA271R*	MD6173D	MD6173D				UTVX6173*	49
FA271TT*			FA271R*	MD6173D	MD6173D				UTVX6173*	50
FA395TT*			FA395R*	MD6173D	MD6173D				UTVX6173*	51
FA395TT*			FA395R*	MD6173D	MD6173D				UTVX6173*	52
FA271TT*			FA271R*	MD6173D	MD6173D				UTVX6173*	53
FA395TT*			FA395R*	MD6173D	MD6173D				UTVX6173*	54
FA271TT*			FA271R*	MD6173D	MD6173D				UTVX6173*	55
FA395TT*			FA395R*	MD6173D	MD6173D				UTVX6173*	56
FA271TT*			FA271R*	MD6173D	MD6173D				UTVX6173*	57
FA395TT*			FA395R*	MD6173D	MD6173D				UTVX6173*	58
FA395TT*			FA395R*	MD6383D	MD6383D					59
FA395TT*			FA395R*	MD6383D	MD6383D					60

*-2 Sets Required. † For Vee disc colours add RED, BLU, GRN, GLD, ORG suffix to part number.

⊗ - Also available as a Vintage Motorcycle Disc.

Non-JAPANESE Built Motorcycles

Line #	BRAKE DISC CHOICES - FRONT						DISC PAD CHOICES - REAR				BRAKE DISC CHOICES - REAR			
	Oversize 250 /280mm Disc Kit	OSX Oversize 250/280mm Disc Kit	Relocating Bracket for 250/ 280mm Disc	Oversize 320mm Disc Kit	SMX Oversize 320mm Disc Kit	Relocating Bracket for 320mm Disc	FA, SFA, TT Pad or Brake Shoe	SFAC Carbon Scooter Pads	Speciality Pads - SXR / Vee / MXS	Sintered/ HH Pads/ Grooved Shoes	Standard Replacement Disc	Contour Disc Rear fitment	Vee-Discs™ CONTOUR	CX Extreme MX Race Disc/ UTVX Disc
1							FA395TT			FA395R	MD6173D			UTVX6173
2							FA271TT			FA271R	MD6173D			UTVX6173
3							FA395TT			FA395R	MD6173D			UTVX6173
4							FA355/4TT			FA355/4R	MD6268D			
5							FA271TT			FA271R	MD6173D			UTVX6173
6							FA395TT			FA395R	MD6173D			UTVX6173
7							FA377TT			FA377R	MD6267D			
8							FA395TT			FA395R	MD6173D			UTVX6173
9							FA377TT*			FA377R*	TBA			
10							FA355/4TT			FA355/4R	MD6268D			
11							FA395TT			FA395R	MD6173D			UTVX6173
12							FA395TT			FA395R	MD6173D			UTVX6173
13							FA395TT			FA395R	MD6173D			UTVX6173
14							FA271TT			FA271R	MD6173D			UTVX6173
15							FA271TT			FA271R	MD6173D			UTVX6173
16							FA271TT			FA271R	MD6173D			UTVX6173
17							FA271TT			FA271R	MD6173D			UTVX6173
18							FA271TT			FA271R	MD6173D			UTVX6173
19							FA395TT			FA395R	MD6173D			UTVX6173
20							FA395TT			FA395R	MD6173D			UTVX6173
21							FA271TT			FA271R	MD6173D			UTVX6173
22							FA395TT			FA395R	MD6173D			UTVX6173
23							FA395TT			FA395R	MD6173D			UTVX6173
24							FA395TT			FA395R	MD6173D			UTVX6173
25							FA137TT			FA137R	MD6211D			
26							FA137TT			FA137R	MD6211D			
27							FA271TT			FA271R	MD6173D			UTVX6173
28							FA395TT			FA395R	MD6173D			UTVX6173
29							FA395TT			FA395R	MD6383D			
30							FA395TT			FA395R	MD6383D			
31							FA395TT			FA395R	MD6173D			UTVX6173
32							FA395TT			FA395R	TBA			
33							FA395TT			FA395R	MD6173D			UTVX6173
34							FA395TT			FA395R	MD6173D			UTVX6173
35							FA395TT			FA395R	MD6173D			UTVX6173
36							FA395TT			FA395R	MD6173D			UTVX6173
37							FA395TT			FA395R	MD6173D			UTVX6173
38							FA395TT			FA395R	MD6173D			UTVX6173
39							FA395TT			FA395R	MD6173D			UTVX6173
40							FA395TT			FA395R	MD6173D			UTVX6173
41							FA395TT			FA395R	MD6173D			UTVX6173
42							FA395TT			FA395R	MD6173D			UTVX6173
43							FA395TT			FA395R	MD6173D			UTVX6173
44							FA395TT			FA395R	MD6173D			UTVX6173
45							FA395TT			FA395R	TBA			
46							FA395TT			FA395R	MD6173D			UTVX6173
47							FA395TT			FA395R	MD6375D			
48							FA271TT			FA271R	MD6173D			UTVX6173
49							FA271TT			FA271R	MD6173D			UTVX6173
50							FA271TT			FA271R	MD6173D			UTVX6173
51							FA395TT			FA395R	MD6173D			UTVX6173
52							FA395TT			FA395R	MD6173D			UTVX6173
53							FA271TT			FA271R	MD6173D			UTVX6173
54							FA395TT			FA395R	MD6173D			UTVX6173
55							FA271TT			FA271R	MD6173D			UTVX6173
56							FA395TT			FA395R	MD6173D			UTVX6173
57							FA271TT			FA271R	MD6173D			UTVX6173
58							FA395TT			FA395R	MD6173D			UTVX6173
59							FA395TT			FA395R	MD6383D			
60							FA395TT			FA395R	MD6383D			

REAR / ARRIÈRE / HINTEN / POSTERIOR / POSTERIORE

*-2 Sets Required. † For Vee disc colours add RED, BLU, GRN, GLD, ORG suffix to part number.
 ⦿ - Also available as a Vintage Motorcycle Disc.

R Suffix = High Durability Sintered Pad. **HH** Suffix = High Performance Sintered Pad. **TT** Suffix = Hard Wearing Off Road Pad. **V** Suffix = Semi Sintered Pad. **G** Suffix = Grooved Shoe.
D Suffix = Drilled Disc. **X** Suffix = Universal Left or Right Disc. **XC** Suffix = Contoured Disc. **LS** Suffix = Left/Steel Disc. **RS** = Right/Steel Disc.

BRAKE APPLICATIONS

Non-JAPANESE Built Motorcycles

APPLICATIONS

BRAKE



ARCTIC CAT (ATV) Contd.



R Suffix = High Durability Sintered Pad. HH Suffix = High Performance Sintered Pad. TT Suffix = Hard Wearing Off Road Pad. V Suffix = Semi-Sintered Pad. G Suffix = Grooved Shoe.

D Suffix = Drilled Disc. X Suffix = Universal Left or Right Disc. XC Suffix = Contoured Disc. LS Suffix = Left/Steel Disc. RS Suffix = Right/Steel Disc.

Model	Year
500 TRV (Core/2 Up)	13-14
Alterra 500	16-19
550 HI EFI	09-10
550 HI EFI LE	09-10
550 TRV	11
550 TRV Cruiser	11
550 TRV EFI	09-10
550 TRV EFI LE	09-10
550i	11-12
550i LTD	11-12
550i GT	11-12
550i GT TRV	11
550i TRV Cruiser	11
550 GT TRV	11-12
550 GT S TRV	10
550 S	10
550 S LTD	10
550 ATV (Mid Size)	13-14
550 ATV LTD (Mid Size)	13-14
550 ATV XT (Mid Size)	13-14
550 TRV LTD/2 Up	13-14
Alterra TRV 550 XT	16-19
Alterra 570	19
650 H1 4 x 4 Auto Utility	04
650 H1 4 x 4 Auto Utility	05/08
650 H1 4 x 4 Auto LE Utility	07
650 H1 4 x 4 SE Auto Utility	06
650 H1	10
650 H1 Mudpro	10-11
650 H1 TRV	09
650 H1 TBX 4 x 4 Auto Utility	07
650 H1 TRV 4 x 4 Auto Plus Multirider	07
650 H1 TRV 4 x 4 Auto Plus LE Multirider	07
650 H1 TRV 4 x 4 Auto	08
650 TBX	09
650 V2 4 x 4 Auto Utility	04-06
650 V2 4 x 4 Auto LE Utility	04-05
650 V2 4 x 4 Auto LE TS Utility	06
700 Diesel Utility	07-08
700i GT	11-12
700 TRV H2 EFI Cruiser	09-10
700 TRV	11-12
700 TRV Cruiser	11-12
700 TRV GT	11-12
700 EFI 4 x 4 Utility	07-08
700 EFI 4 x 4 LE Utility	06
700 EFI 4 x 4 SE Utility	06
700 EFI Cruiser	11
700 EFI 4 x 4 Auto M4	08
700 EFI 4 x 4 Auto TRV LE	08
700 H1 EFI	09-10
700 H1 EFI LE	09-10
700 H1 EFI 4 x 4 Auto SE	08-09
700 H1 TBX EFI	10
700 Super Duty Diesel	10-11
700 Mudpro	10-11
700 H1 EFI Mudpro	09-11
700i	11-12
700i LTD	11-12
700i Mudpro	11-12

FRONT / AVANT / VORN / FRENTE / ANTERIORE

DISC PAD CHOICES - FRONT				BRAKE DISC CHOICES - FRONT						Line #
FA, SFA, TT Pad or Brake Shoe	SFAC Carbon Scooter Pads	Speciality Pads SXR / Vee / MXS	Sintered/HH Pads/ Grooved Shoes	Left / Gauche / Links Standard Replacement Disc	Right / Droite / Rechts Standard Replacement Disc	Contour Disc Universal left and right fitment	Universal Custom Disc	Vee-Discs Black † See note below	CX Extreme MX Race Disc/ UTVX Disc	Line #
FA395TT*			FA395R*	MD6383D	MD6383D					1
FA395TT*			FA395R*	MD6383D	MD6383D					2
FA395TT*			FA395R*	MD6173D	MD6173D				UTVX6173*	3
FA395TT*			FA395R*	MD6173D	MD6173D				UTVX6173*	4
FA395TT*			FA395R*	MD6173D	MD6173D				UTVX6173*	5
FA395TT*			FA395R*	MD6173D	MD6173D				UTVX6173*	6
FA395TT*			FA395R*	MD6173D	MD6173D				UTVX6173*	7
FA395TT*			FA395R*	MD6173D	MD6173D				UTVX6173*	8
FA395TT*			FA395R*	MD6173D	MD6173D				UTVX6173*	9
FA395TT*			FA395R*	MD6173D	MD6173D				UTVX6173*	10
FA395TT*			FA395R*	MD6173D	MD6173D				UTVX6173*	11
FA395TT*			FA395R*	MD6173D	MD6173D				UTVX6173*	12
FA395TT*			FA395R*	MD6173D	MD6173D				UTVX6173*	13
FA395TT*			FA395R*	MD6173D	MD6173D				UTVX6173*	14
FA395TT*			FA395R*	MD6173D	MD6173D				UTVX6173*	15
FA395TT*			FA395R*	MD6173D	MD6173D				UTVX6173*	16
FA395TT*			FA395R*	MD6173D	MD6173D				UTVX6173*	17
FA395TT*			FA395R*	MD6383D	MD6383D					18
FA395TT*			FA395R*	MD6383D	MD6383D					19
FA395TT*			FA395R*	MD6383D	MD6383D					20
FA395TT*			FA395R*	TBA	TBA					21
FA395TT*			FA395R*	MD6383D	MD6383D					22
FA395TT*			FA395R*	MD6383D	MD6383D					23
FA271TT*			FA271R*	MD6173D	MD6173D				UTVX6173*	24
FA271TT*			FA271R*	MD6173D	MD6173D				UTVX6173*	25
FA271TT*			FA271R*	MD6173D	MD6173D				UTVX6173*	26
FA271TT*			FA271R*	MD6173D	MD6173D				UTVX6173*	27
FA395TT*			FA395R*	MD6173D	MD6173D				UTVX6173*	28
FA395TT*			FA395R*	MD6173D	MD6173D				UTVX6173*	29
FA395TT*			FA395R*	MD6173D	MD6173D				UTVX6173*	30
FA395TT*			FA395R*	MD6173D	MD6173D				UTVX6173*	31
FA395TT*			FA395R*	MD6173D	MD6173D				UTVX6173*	32
FA395TT*			FA395R*	MD6173D	MD6173D				UTVX6173*	33
FA395TT*			FA395R*	MD6173D	MD6173D				UTVX6173*	34
FA395TT*			FA395R*	MD6173D	MD6173D				UTVX6173*	35
FA395TT*			FA395R*	MD6173D	MD6173D				UTVX6173*	36
FA395TT*			FA395R*	MD6173D	MD6173D				UTVX6173*	37
FA395TT*			FA395R*	MD6173D	MD6173D				UTVX6173*	38
FA395TT*			FA395R*	MD6173D	MD6173D				UTVX6173*	39
FA395TT*			FA395R*	MD6173D	MD6173D				UTVX6173*	40
FA395TT*			FA395R*	MD6173D	MD6173D				UTVX6173*	41
FA395TT*			FA395R*	MD6173D	MD6173D				UTVX6173*	42
FA395TT*			FA395R*	MD6173D	MD6173D				UTVX6173*	43
FA395TT*			FA395R*	MD6173D	MD6173D				UTVX6173*	44
FA395TT*			FA395R*	MD6173D	MD6173D				UTVX6173*	45
FA395TT*			FA395R*	MD6173D	MD6173D				UTVX6173*	46
FA395TT*			FA395R*	MD6173D	MD6173D				UTVX6173*	47
FA395TT*			FA395R*	MD6173D	MD6173D				UTVX6173*	48
FA395TT*			FA395R*	MD6173D	MD6173D				UTVX6173*	49
FA395TT*			FA395R*	MD6173D	MD6173D				UTVX6173*	50
FA395TT*			FA395R*	MD6173D	MD6173D				UTVX6173*	51
FA395TT*			FA395R*	MD6173D	MD6173D				UTVX6173*	52
FA395TT*			FA395R*	MD6173D	MD6173D				UTVX6173*	53
FA395TT*			FA395R*	MD6173D	MD6173D				UTVX6173*	54
FA395TT*			FA395R*	MD6173D	MD6173D				UTVX6173*	55
FA395TT*			FA395R*	MD6173D	MD6173D				UTVX6173*	56
FA395TT*			FA395R*	MD6173D	MD6173D				UTVX6173*	57
FA395TT*			FA395R*	MD6173D	MD6173D				UTVX6173*	58
FA395TT*			FA395R*	MD6173D	MD6173D				UTVX6173*	59
FA395TT*			FA395R*	MD6173D	MD6173D				UTVX6173*	60

*-2 Sets Required. † For Vee disc colours add RED, BLU, GRN, GLD, ORG suffix to part number.

⊗ - Also available as a Vintage Motorcycle Disc.

Non-JAPANESE Built Motorcycles

Line #	BRAKE DISC CHOICES - FRONT						DISC PAD CHOICES - REAR				BRAKE DISC CHOICES - REAR			
	Oversize 250 /280mm Disc Kit	OSX Oversize 250/280mm Disc Kit	Relocating Bracket for 250/ 280mm Disc	Oversize 320mm Disc Kit	SMX Oversize 320mm Disc Kit	Relocating Bracket for 320mm Disc	FA, SFA, TT Pad or Brake Shoe	SFAC Carbon Scooter Pads	Speciality Pads - SXR / Vee / MXS	Sintered/ HH Pads/ Grooved Shoes	Standard Replacement Disc	Contour Disc Rear fitment	Vee-Discs™ CONTOUR	CX Extreme MX Race Disc/ UTVX Disc
1							FA395TT			FA395R	MD6383D			
2							FA395TT			FA395R	MD6383D			
3							FA395TT			FA395R	MD6173D			UTVX6173
4							FA395TT			FA395R	MD6173D			UTVX6173
5							FA395TT			FA395R	MD6173D			UTVX6173
6							FA395TT			FA395R	MD6173D			UTVX6173
7							FA395TT			FA395R	MD6173D			UTVX6173
8							FA395TT			FA395R	MD6173D			UTVX6173
9							FA395TT			FA395R	MD6173D			UTVX6173
10							FA395TT			FA395R	MD6173D			UTVX6173
11							FA395TT			FA395R	MD6173D			UTVX6173
12							FA395TT			FA395R	MD6173D			UTVX6173
13							FA395TT			FA395R	MD6173D			UTVX6173
14							FA395TT			FA395R	MD6173D			UTVX6173
15							FA395TT			FA395R	MD6173D			UTVX6173
16							FA395TT			FA395R	MD6173D			UTVX6173
17							FA395TT			FA395R	MD6173D			UTVX6173
18							FA395TT			FA395R	MD6383D			
19							FA395TT			FA395R	MD6383D			
20							FA395TT			FA395R	MD6383D			
21							FA395TT			FA395R	TBA			
22							FA395TT			FA395R	MD6383D			
23							FA395TT			FA395R	MD6383D			
24							FA271TT			FA271R	MD6173D			UTVX6173
25							FA271TT			FA271R	MD6173D			UTVX6173
26							FA271TT			FA271R	MD6173D			UTVX6173
27							FA271TT			FA271R	MD6173D			UTVX6173
28							FA395TT			FA395R	MD6173D			UTVX6173
29							FA395TT			FA395R	MD6173D			UTVX6173
30							FA395TT			FA395R	MD6173D			UTVX6173
31							FA395TT			FA395R	MD6173D			UTVX6173
32							FA395TT			FA395R	MD6173D			UTVX6173
33							FA395TT			FA395R	MD6173D			UTVX6173
34							FA395TT			FA395R	MD6173D			UTVX6173
35							FA395TT			FA395R	MD6173D			UTVX6173
36							FA395TT			FA395R	MD6173D			UTVX6173
37							FA395TT			FA395R	MD6173D			UTVX6173
38							FA395TT			FA395R	MD6173D			UTVX6173
39							FA395TT			FA395R	MD6173D			UTVX6173
40							FA395TT			FA395R	MD6173D			UTVX6173
41							FA395TT			FA395R	MD6173D			UTVX6173
42							FA395TT			FA395R	MD6173D			UTVX6173
43							FA395TT			FA395R	MD6173D			UTVX6173
44							FA395TT			FA395R	MD6173D			UTVX6173
45							FA395TT			FA395R	MD6173D			UTVX6173
46							FA395TT			FA395R	MD6173D			UTVX6173
47							FA395TT			FA395R	MD6173D			UTVX6173
48							FA395TT			FA395R	MD6173D			UTVX6173
49							FA395TT			FA395R	MD6173D			UTVX6173
50							FA395TT			FA395R	MD6173D			UTVX6173
51							FA395TT			FA395R	MD6173D			UTVX6173
52							FA395TT			FA395R	MD6173D			UTVX6173
53							FA395TT			FA395R	MD6173D			UTVX6173
54							FA395TT			FA395R	MD6173D			UTVX6173
55							FA395TT			FA395R	MD6173D			UTVX6173
56							FA395TT			FA395R	MD6173D			UTVX6173
57							FA395TT			FA395R	MD6173D			UTVX6173
58							FA395TT			FA395R	MD6173D			UTVX6173
59							FA395TT			FA395R	MD6173D			UTVX6173
60							FA395TT			FA395R	MD6173D			UTVX6173

REAR / ARRIÈRE / HINTEN / POSTERIOR / POSTERIORE

R Suffix = High Durability Sintered Pad. **HH** Suffix = High Performance Sintered Pad. **TT** Suffix = Hard Wearing Off Road Pad. **V** Suffix = Semi Sintered Pad. **G** Suffix = Grooved Shoe.
D Suffix = Drilled Disc. **X** Suffix = Universal Left or Right Disc. **XC** Suffix = Contoured Disc. **LS** Suffix = Left/Steel Disc. **RS** = Right/Steel Disc.

*-2 Sets Required. † For Vee disc colours add RED, BLU, GRN, GLD, ORG suffix to part number.
 ⦿ - Also available as a Vintage Motorcycle Disc.

BRAKE APPLICATIONS

Non-JAPANESE Built Motorcycles

APPLICATIONS

BRAKE



ARCTIC CAT (ATV) Contd.



700i Mudpro LTD	11
700 S	10
700 S LTD	10
700 TBX LTD	11
700 ATV/Core	13-14
700 ATV Diesel	12-14
700 ATV LTD	12-14
700 ATV XT	13-14
700 TRV XT	13-14
Alterra 700 inc XT, inc Mudpro	16-19
Alterra TBX 700	17-18
Alterra VLX 700	17-18
XR 700 LTD/XT	15
1000 GT	11-12
1000 Mudpro LTD	12-13
Alterra 1000 TRV XT EPS	17
1000 H2 Mudpro EFI	11-12
1000 Mudpro SE EPS	16
1000 TRV Cruiser	11
1000 TRV H2 EFI Cruiser	09-10
Thundercat 1000 H2	08-10
Thundercat 1000 H2 LE	10
1000 TRV H2 EFI	10
1000 XT	13-14

ARCTIC CAT (SIDE X SIDE)

500 Prowler	18-19
HDX 500 Prowler	14
HDX 500 Prowler LTD	14
HDX 500 Prowler XT	14-19
550 Hi EFI Prowler	09
XT 550	10-11
XT 550 i Prowler	11-15
XT 650 H1 Prowler	06-09
650 H1 Prowler	07
650 Prowler 4 x 4/M4	08
XTX 700 Hi LE Prowler	08
XTX 700 Hi EFI Prowler	09
XTX 700	10-11
XTX 700 i Prowler	11-17
HDX 700 Prowler	11-14
HDX 700 Prowler LTD	14
Wildcat Sport 700	15
Wildcat Sport XT 700	15
Wildcat Sport LTD	16
Wildcat Sport 700 XT inc LTD	18-19
Wildcat Trail 700 XT inc LTD	15-19
Stampede 900 inc XT, XTR and LTD	17-19
Stampede 900 inc 4 Inferno and TT Kanati	18
Havoc X EPS	18
Wildcat 1000i G.T.	12
Wildcat 1000	13-14
Wildcat 1000 4 and 4X	13-16
Wildcat 1000 X	13
Wildcat 1000 X	14-16
Wildcat 1000 4X	14-16
Wildcat 1000 LTD	13-14
Wildcat 1000 4 LTD	14
Wildcat X, XT and LTD	19
Prowler Pro Crew and XT	19-20

FA, SFA, TT Pad or Brake Shoe	DISC PAD CHOICES - FRONT			BRAKE DISC CHOICES - FRONT						Line #
	SFAC Carbon Scooter Pads	Speciality Pads SXR / Vee / MXS	Sintered/HH Pads/ Grooved Shoes	Left / Gauche / Links Standard Replacement Disc	Right / Droite / Rechts Standard Replacement Disc	Contour Disc Universal left and right fitment	Universal Custom Disc	Vee-Discs Black † See note below	CX Extreme MX Race Disc/ UTVX Disc	
FA395TT*			FA395R*	MD6173D	MD6173D				UTVX6173*	1
FA395TT*			FA395R*	MD6173D	MD6173D				UTVX6173*	2
FA395TT*			FA395R*	MD6173D	MD6173D				UTVX6173*	3
FA395TT*			FA395R*	MD6173D	MD6173D				UTVX6173*	4
FA395TT*			FA395R*	TBA	TBA					5
FA395TT*			FA395R*	MD6383D	MD6383D					6
FA395TT*			FA395R*	MD6383D	MD6383D					7
FA395TT*			FA395R*	MD6383D	MD6383D					8
FA395TT*			FA395R*	TBA	TBA					9
FA395TT*			FA395R*	MD6383D	MD6383D					10
FA395TT*			FA395R*	MD6383D	MD6383D					11
FA395TT*			FA395R*	MD6383D	MD6383D					12
FA395TT*			FA395R*	MD6383D	MD6383D					13
FA395TT*			FA395R*	MD6173D	MD6173D				UTVX6173*	14
FA395TT*			FA395R*	MD6173D	MD6173D				UTVX6173*	15
FA395TT*			FA395R*	MD6383D	MD6383D					16
FA395TT*			FA395R*	MD6173D	MD6173D				UTVX6173*	17
FA395TT*			FA395R*	MD6383D	MD6383D					18
FA395TT*			FA395R*	MD6173D	MD6173D				UTVX6173*	19
FA395TT*			FA395R*	MD6173D	MD6173D				UTVX6173*	20
FA395TT*			FA395R*	MD6173D	MD6173D				UTVX6173*	21
FA395TT*			FA395R*	MD6173D	MD6173D				UTVX6173*	22
FA395TT*			FA395R*	MD6173D	MD6173D				UTVX6173*	23
FA395TT*			FA395R*	TBA	TBA					24
										25
										26
FA377TT*			FA377R*	MD6267D	MD6267D					27
FA395TT*		SXR395HH*	FA395R*	MD6271D	MD6271D				UTVX6271*	28
FA395TT*		SXR395HH*	FA395R*	MD6271D	MD6271D				UTVX6271*	29
FA395TT*		SXR395HH*	FA395R*	MD6271D	MD6271D				UTVX6271*	30
FA395TT*		SXR395HH*	FA395R*	MD6271D	MD6271D				UTVX6271*	31
FA395TT*		SXR395HH*	FA395R*	MD6271D	MD6271D				UTVX6271*	32
FA395TT*		SXR395HH*	FA395R*	MD6271D	MD6271D				UTVX6271*	33
FA395TT*		SXR395HH*	FA395R*	MD6271D	MD6271D				UTVX6271*	34
FA395TT*		SXR395HH*	FA395R*	MD6271D	MD6271D				UTVX6271*	35
FA395TT*		SXR395HH*	FA395R*	MD6271D	MD6271D				UTVX6271*	36
FA395TT*		SXR395HH*	FA395R*	MD6271D	MD6271D				UTVX6271*	37
FA395TT*		SXR395HH*	FA395R*	MD6271D	MD6271D				UTVX6271*	38
FA395TT*		SXR395HH*	FA395R*	MD6271D	MD6271D				UTVX6271*	39
FA395TT*		SXR395HH*	FA395R*	MD6271D	MD6271D				UTVX6271*	40
FA395TT*		SXR395HH*	FA395R*	MD6271D	MD6271D				UTVX6271*	41
FA395TT*		SXR395HH*	FA395R*	MD6271D	MD6271D				UTVX6271*	42
FA741TT*			FA741R*							43
FA741TT*			FA741R*							44
FA741TT*			FA741R*							45
FA741TT*			FA741R*							46
FA395TT*		SXR395HH*	FA395R*	MD6384D	MD6384D					47
TBA*			TBA*							48
TBA*										49
TBA										50
FA395TT*		SXR395HH*	FA395R*	MD6271D	MD6271D				UTVX6271*	51
FA395TT*		SXR395HH*	FA395R*	MD6271D	MD6271D				UTVX6271*	52
FA395TT*		SXR610HH*	FA395R*	MD6384D	MD6384D				UTVX6384*	53
FA395TT*		SXR395HH*	FA395R*	MD6271D	MD6271D				UTVX6271*	54
			TBA*	MD6271D	MD6271D				UTVX6271*	55
		SXR610HH*	FA610R*	MD6384D	MD6384D				UTVX6384*	56
FA395TT*		SXR395HH*	FA395R*	MD6271D	MD6271D				UTVX6271*	57
			TBA*	MD6271D	MD6271D				UTVX6271*	58
FA740TT*			FA740R*							59
FA740TT*			FA740R*							60

FRONT / AVANT / VORN / FRENTE / ANTERIORE

R Suffix = High Durability Sintered Pad. HH Suffix = High Performance Sintered Pad. TT Suffix = Hard Wearing Off Road Pad. V Suffix = Semi Sintered Pad. G Suffix = Grooved Shoe.

D Suffix = Drilled Disc. X Suffix = Universal Left or Right Disc. XC Suffix = Contoured Disc. LS Suffix = Left/Steel Disc. RS Suffix = Right/Steel Disc.

*-2 Sets Required. † For Vee disc colours add RED, BLU, GRN, GLD, ORG suffix to part number.

⊗ - Also available as a Vintage Motorcycle Disc.

Non-JAPANESE Built Motorcycles

Line #	BRAKE DISC CHOICES - FRONT						DISC PAD CHOICES - REAR				BRAKE DISC CHOICES - REAR			
	Oversize 250 /280mm Disc Kit	OSX Oversize 250/280mm Disc Kit	Relocating Bracket for 250/ 280mm Disc	Oversize 320mm Disc Kit	SMX Oversize 320mm Disc Kit	Relocating Bracket for 320mm Disc	FA, SFA, TT Pad or Brake Shoe	SFAC Carbon Scooter Pads	Speciality Pads - SXR / Vee / MXS	Sintered/ HH Pads/ Grooved Shoes	Standard Replacement Disc	Contour Disc Rear fitment	Vee-Discs™ CONTOUR	CX Extreme MX Race Disc/ UTVX Disc
1							FA395TT			FA395R	MD6173D			UTVX6173
2							FA395TT			FA395R	MD6173D			UTVX6173
3							FA395TT			FA395R	MD6173D			UTVX6173
4							FA395TT			FA395R	MD6173D			UTVX6173
5							FA395TT			FA395R	TBA			
6							FA395TT			FA395R	MD6383D			
7							FA395TT			FA395R	MD6383D			
8							FA395TT			FA395R	MD6383D			
9							FA395TT			FA395R	TBA			
10							FA395TT			FA395R	MD6383D			
11							FA395TT			FA395R	MD6383D			
12							FA395TT			FA395R	MD6383D			
13							FA395TT			FA395R	MD6383D			
14							FA395TT			FA395R	MD6173D			UTVX6173
15							FA395TT			FA395R	MD6173D			UTVX6173
16							FA395TT			FA395R	MD6383D			
17							FA395TT			FA395R	MD6173D			UTVX6173
18							FA395TT			FA395R	MD6383D			
19							FA395TT			FA395R	MD6173D			UTVX6173
20							FA395TT			FA395R	MD6173D			UTVX6173
21							FA395TT			FA395R	MD6173D			UTVX6173
22							FA395TT			FA395R	MD6173D			UTVX6173
23							FA395TT			FA395R	MD6173D			UTVX6173
24							FA395TT			FA395R	MD6173D			UTVX6173
25														
26														
27							FA377TT			FA377R	MD6267D			
28							FA395TT	SXR395HH		FA395R	N/A			
29							FA395TT	SXR395HH		FA395R	N/A			
30							FA395TT	SXR395HH		FA395R	N/A			
31							FA395TT	SXR395HH		FA395R	N/A			
32							FA395TT	SXR395HH		FA395R	N/A			
33							FA395TT	SXR395HH		FA395R	N/A			
34							FA395TT	SXR395HH		FA395R	N/A			
35							FA395TT	SXR395HH		FA395R	N/A			
36							FA395TT	SXR395HH		FA395R	N/A			
37							FA395TT	SXR395HH		FA395R	N/A			
38							FA395TT	SXR395HH		FA395R	N/A			
39							FA395TT	SXR395HH		FA395R	N/A			
40							FA395TT	SXR395HH*		FA395R	N/A			
41							FA395TT*	SXR395HH*		FA395R*	MD6173D*			UTVX6173*
42							FA395TT*	SXR395HH*		FA395R*	MD6173D*			UTVX6173*
43							FA395TT*	SXR395HH*		FA395R*				
44							FA395TT*	SXR395HH*		FA395R*				
45							FA395TT*	SXR395HH*		FA395R*				
46							FA395TT*	SXR395HH*		FA395R*				
47							FA395TT*	SXR395HH*		FA395R*	MD6384D*			
48							FA395TT*	SXR395HH*		FA395R*				
49							FA395TT*	SXR395HH*		FA395R*				
50														
51							FA395TT*	SXR395HH*		FA395R*	MD6173D*			UTVX6173*
52							FA395TT*	SXR395HH*		FA395R*	TBA*			
53							FA395TT*	SXR395HH*		FA395R*	MD6384D*			
54							FA395TT*	SXR395HH*		FA395R*	TBA*			
55							FA395TT*	SXR395HH*		FA395R*	MD6173D*			UTVX6173*
56							FA395TT*	SXR395HH*		FA395R*	MD6384D*			
57							FA395TT*	SXR395HH*		FA395R*	TBA*			
58							FA395TT*	SXR395HH*		FA395R*	MD6173D*			UTVX6173*
59							FA742TT*			FA742R*				
60							FA742TT*			FA742R*				

REAR / ARRIÈRE / HINTEN / POSTERIOR / POSTERIORE

*-2 Sets Required. † For Vee disc colours add RED, BLU, GRN, GLD, ORG suffix to part number.
 Ⓢ - Also available as a Vintage Motorcycle Disc.

R Suffix = High Durability Sintered Pad. **HH** Suffix = High Performance Sintered Pad. **TT** Suffix = Hard Wearing Off Road Pad. **V** Suffix = Semi Sintered Pad. **G** Suffix = Grooved Shoe.
D Suffix = Drilled Disc. **X** Suffix = Universal Left or Right Disc. **XC** Suffix = Contoured Disc. **LS** Suffix = Left/Steel Disc. **RS** = Right/Steel Disc.

BRAKE APPLICATIONS

Non-JAPANESE Built Motorcycles

APPLICATIONS

BRAKE



ARCTIC CAT (SIDE X SIDE)

XTZ 1000 H2 Prowler	09
XTZ 1000	10-16
Cushman Hauler 4x4 Diesel	19
Cushman Hauler 4x4 Crew and EPS Diesel	19

ARMSTRONG

250 Trial/320 Trial	
---------------------	--

ASPES

50 Navaho	
50 Vega Hybrid	10-14
CS 75 Navaho/125 Juma/Hopi	
CM 180	
RCL 80	
125 Duma	
Vega 125 Hybrid	11-14
Perseus Hybrid 150	11-14

ATALA

Hacker LC	97
Hacker Racing	97
Byte AT10	97
Hacker	97

AUSA QUADS

M 50 Task - Side x Side	
-------------------------	--

BAJAJ

Pulsar 180 (UG4)	12-16
Pulsar 150	07-16
Pulsar 220 F	15-16
Pulsar 220 S	15-16
Pulsar Adventure AS 150	15-16
Pulsar Adventure AS 200	15-17
XCD 125 (Drum Brake)	
XCD 125 (Disc Brake)	
Pulsar RS 200 (inc Lower Fairing)	15-16
Pulsar 200 NS	14-16
Boxer 150	12-15
Pulsar 135 LS	12-16
Discover 100 T	13-15
Discover 125 ST	13-15
Discover 150 S (Disc Brake)	14-16
Discover 150 F (Disc Brake)	14-16
Discover 125 M	14-16
Discover 150 S (Drum Brake)	14-16
Discover 125 (Disc Model)	14-16
Discover 125 (Drum Model)	14-16
Platina 100 ES	16
CT100	16
Avenger 150 Street (Cast Wheel)	15-16
Avenger Cruise 220 DTS-i (Spoke Wheel)	15-16
Avenger Cruise 220 DTS-i (Spoke Wheel)	08-14
Avenger 220 Street (Cast Wheel)	15-16

BAOTIAN

BT 49 QT-7	06-07
BT 49 QT-9 (Speedy 50-4T)	10-11
BT 50 QT-11 (Retro 50-4T)	06-11
BT 49 QT-12 (Rebel-4T)	06-11

DISC PAD CHOICES - FRONT

BRAKE DISC CHOICES - FRONT

FA, SFA, TT Pad or Brake Shoe	SFAC Carbon Scooter Pads	Speciality Pads - SXR / Vee / MXS	Sintered/HH Pads/ Grooved Shoes	Left / Gauche / Links Standard Replacement Disc	Right / Droite / Rechts Standard Replacement Disc	Contour Disc Universal left and right fitment	Universal Custom Disc	Vee-Discs Black † See note below	CX Extreme MX Race Disc/ UTVX Disc
FA395TT*		SXR395HH*	FA395R*	MD6271D	MD6271D				UTVX6271*
FA395TT*		SXR395HH*	FA395R*	MD6271D	MD6271D				UTVX6271*
FA740TT*			FA740R*						
FA740TT*			FA740R*						
			841G						
			926G						
SFA228	SFAC228		SFA228HH	N/A					
			841G						
			841G						
941									
FA076			FA076HH	N/A					
SFA086	SFAC086		SFA086HH		N/A				
SFA054	SFAC054		SFA054HH	N/A					
SFA193	SFAC193		SFA193HH	MD901D				VR901	
SFA193	SFAC193		SFA193HH	MD901D				VR901	
SFA193	SFAC193		SFA193HH	TBA					
SFA193	SFAC193		SFA193HH	MD901D				VR901	
N/A*			FA266R*	N/A	N/A				
FA181TT			FA181HH		TBA				
FA181TT			FA181HH		TBA				
FA181TT			FA181HH		TBA				
FA181TT			FA181HH		TBA				
FA181TT			FA181HH		TBA				
FA181TT			FA181HH		TBA				
FA181TT			FA181HH		TBA				
TBA									
FA181TT			FA181HH		TBA				
FA181TT			FA181HH		TBA				
FA181TT			FA181HH		TBA				
FA181TT			FA181HH		TBA				
FA181TT			FA181HH		TBA				
FA181TT			FA181HH		TBA				
TBA									
FA197			FA197HH		TBA				
TBA									
TBA									
FA197			FA197HH		TBA				
FA197			FA197HH		TBA				
FA197			FA197HH		TBA				
FA197			FA197HH		TBA				
TBA				N/A					
SFA169	SFAC169		SFA169HH	N/A					
SFA169	SFAC169		SFA169HH	N/A					
SFA235	SFAC235			N/A					

Line #
1
2
3
4
5
6
7
8
9
10
11
12
13
14
15
16
17
18
19
20
21
22
23
24
25
26
27
28
29
30
31
32
33
34
35
36
37
38
39
40
41
42
43
44
45
46
47
48
49
50
51
52
53
54
55
56
57
58
59
60

R Suffix = High Durability Sintered Pad. HH Suffix = High Performance Sintered Pad. TT Suffix = Hard Wearing Off Road Pad. V Suffix = Semi Sintered Pad. G Suffix = Grooved Shoe.
D Suffix = Drilled Disc. X Suffix = Universal Left or Right Disc. XC Suffix = Contoured Disc. LS Suffix = Left/Steel Disc. RS Suffix = Right/Steel Disc.

*-2 Sets Required. † For Vee disc colours add RED, BLU, GRN, GLD, ORG suffix to part number.

⊗ - Also available as a Vintage Motorcycle Disc.

Non-JAPANESE Built Motorcycles

Line #	BRAKE DISC CHOICES - FRONT						DISC PAD CHOICES - REAR				BRAKE DISC CHOICES - REAR			
	Oversize 250 /280mm Disc Kit	OSX Oversize 250/280mm Disc Kit	Relocating Bracket for 250/ 280mm Disc	Oversize 320mm Disc Kit	SMX Oversize 320mm Disc Kit	Relocating Bracket for 320mm Disc	FA, SFA, TT Pad or Brake Shoe	SFAC Carbon Scooter Pads	Speciality Pads - SXR / Vee / MXS	Sintered/ HH Pads/ Grooved Shoes	Standard Replacement Disc	Contour Disc Rear fitment	Vee-Discs™ CONTOUR	CX Extreme MX Race Disc/ UTVX Disc
1							FA395TT*		SXR395HH*	FA395R*	MD6173D*		UTVX6173*	
2							FA395TT*		SXR395HH*	FA395R*	MD6173D*		UTVX6173*	
3							FA742TT*			FA742R*				
4							FA742TT*			FA742R*				
5														
6														
7									841G					
8														
9														
10									926G					
11							TBA							
12									843G					
13									841G					
14							941							
15									843G					
16							TBA							
17							SFA086	SFAC086	SFA086HH	N/A				
18														
19														
20							S624							
21							S624							
22							S624							
23							S624							
24														
25														
26									FA266R*	N/A*				
27														
28														
29							TBA							
30							TBA							
31							FA213		FA213HH	TBA				
32							FA213		FA213HH	TBA				
33							TBA							
34							TBA							
35							TBA							
36							TBA							
37							FA213		FA213HH	TBA				
38							FA213		FA213HH	TBA				
39							TBA							
40							TBA							
41							TBA							
42							TBA							
43							TBA							
44							TBA							
45							TBA							
46							TBA							
47							TBA							
48							TBA							
49							TBA							
50							TBA							
51							TBA							
52							TBA							
53							TBA							
54							TBA							
55														
56														
57							H303			TBA				
58							H303							
59							H303							
60							H303							

REAR / ARRIÈRE / HINTEN / POSTERIOR / POSTERIORE

*-2 Sets Required. † For Vee disc colours add RED, BLU, GRN, GLD, ORG suffix to part number.

⊗ - Also available as a Vintage Motorcycle Disc.

R Suffix = High Durability Sintered Pad. **HH** Suffix = High Performance Sintered Pad. **TT** Suffix = Hard Wearing Off Road Pad. **V** Suffix = Semi Sintered Pad. **G** Suffix = Grooved Shoe.
D Suffix = Drilled Disc. **X** Suffix = Universal Left or Right Disc. **XC** Suffix = Contoured Disc. **LS** Suffix = Left/Steel Disc. **RS** = Right/Steel Disc.

BRAKE APPLICATIONS

Non-JAPANESE Built Motorcycles

Line #	BRAKE DISC CHOICES - FRONT						DISC PAD CHOICES - REAR				BRAKE DISC CHOICES - REAR			
	Oversize 250 /280mm Disc Kit	OSX Oversize 250/280mm Disc Kit	Relocating Bracket for 250/ 280mm Disc	Oversize 320mm Disc Kit	SMX Oversize 320mm Disc Kit	Relocating Bracket for 320mm Disc	FA, SFA, TT Pad or Brake Shoe	SFAC Carbon Scooter Pads	Speciality Pads - SXR / Vee / MXS	Sintered/ HH Pads/ Grooved Shoes	Standard Replacement Disc	Contour Disc Rear fitment	Vee-Discs™ CONTOUR	CX Extreme MX Race Disc/ UTVX Disc
1							H303							
2							H303							
3							TBA				N/A			
4							TBA							
5							TBA							
6							TBA				N/A			
7							Y506							
8							TBA				N/A			
9							TBA							
10														
11														
12							H302			H302G				
13							TBA							
14							TBA							
15							820							
16							FA135TT			FA135R	N/A			
17							FA135TT			FA135R	N/A			
18							FA067TT			FA067R	N/A			
19							FA067TT			FA067R	N/A			
20							FA135TT			FA135R	N/A			
21														
22														
23							Y503							
24							Y503							
25														
26														
27							TBA							
28							931			931G				
29							965							
30							FA099			FA099R	N/A			
31							816							
32							908							
33							893							
34							893							
35							816							
36							816							
37							Y503							
38							Y503							
39							FA099			FA099R	N/A			
40							Y503							
41							SFA235	SFAC235			N/A	TBA		
42							FA099			FA099R	N/A			
43							893							
44							SFA193	SFAC193		SFA193HH	MD943D	MD943C	VR943	
45							893							
46							Y527							
47							893							
48							893							
49														
50							929							
51							929							
52							816							
53							SFA321	SFAC321		SFA321HH	MD9106D			
54							SFA213							
55							FA629							
56							SFA228	SFAC228		SFA228HH				
57							SFA228	SFAC228		SFA228HH	N/A			
58							FA698							
59							SFA228	SFAC228		SFA228HH	TBA			
60							N/A							

REAR / ARRIÈRE / HINTEN / POSTERIOR / POSTERIORE

*-2 Sets Required. † For Vee disc colours add RED, BLU, GRN, GLD, ORG suffix to part number.

⊗ - Also available as a Vintage Motorcycle Disc.

R Suffix = High Durability Sintered Pad. HH Suffix = High Performance Sintered Pad. TT Suffix = Hard Wearing Off Road Pad. V Suffix = Semi Sintered Pad. G Suffix = Grooved Shoe.

D Suffix = Drilled Disc. X Suffix = Universal Left or Right Disc. XC Suffix = Contoured Disc. LS Suffix = Left/Steel Disc. RS = Right/Steel Disc.

BRAKE APPLICATIONS

Non-JAPANESE Built Motorcycles

APPLICATIONS

BRAKE



BENELLI Contd.

TN 125 (Tornado Naked T 125cc)	17-20
TRK125	18-20
X 125	12-14
Velvet 125 (13" front wheel)	99-07
Velvet 125 (13" Front Wheel/Touring)	08-12
Worx 125	17-18
TNT 135 (Tornado Naked T 135cc)	18
Adiva 150 (12" front wheel/rear drum model)	00
Adiva 150 (13" front wheel/rear disc model)	01-04
Caffe Nero 150	11-16
Hobby 151 (4T)	13
Macis 150	10-16
UNOC 150 (Single Cyl)	13
Velvet 150 (13" front wheel)	99-07
Velvet 150 (13" Front Wheel/Touring)	08-12
X 150	12-14
TNT 200 (Tornado Naked T 200cc)	17-18
BX Motard (250cc)	12
BX 250 Motard	16-18
Caffe Nero 250	Left 08-14 Right
UNOC 250 (Single Cyl)	13
Velvet 250	99-12
250 C/TS, 250/4	76-
666 Scooter Born in Hell 125cc	98-99
Leoncino 250	18-20
BN251	14-16
BN251	17-18
TRK 251	18-20
254	83
302R	17-20
302S	18-20
BN302	15-16
BN302	17-18
TNT 300 (Tornado Naked 300cc)	16-18
304	83
Zenzero 350	12-16
354	-82
354 Sport 2	83
Velvet 400 Dusk	03-04
Imperiale 400	18-20
402S	18
BX Cross (449cc)	07-12
500 4	76-
Leoncino (500cc)	17-20
Leoncino Trail (500cc)	17-20
TRE-K 502	16
TRK 502	17-20
TRK 502 X	17-20
BX Enduro (505cc)	08-12
BN 600 GT	14-17
BN 600i	14-17
BN 600 R	14-16
BN 600 S	14-15
654 Sport	83
750 SEI (6 Cyl)	75-
2UE 750	09-10
752S	18-20
Café Racer 899	10-12

DISC PAD CHOICES - FRONT				BRAKE DISC CHOICES - FRONT						Line #
FA, SFA, TT Pad or Brake Shoe	SFAC Carbon Scooter Pads	Speciality Pads SXR / Vee / MXS	Sintered/HH Pads/ Grooved Shoes	Left / Gauche / Links Standard Replacement Disc	Right / Droite / Rechts Standard Replacement Disc	Contour Disc Universal left and right fitment	Universal Custom Disc	Vee-Discs Black † See note below	CX Extreme MX Race Disc/ UTVX Disc	Line #
FA711		FA711V								1
FA658										2
SFA228	SFAC228		SFA228HH			N/A				3
SFA193	SFAC193		SFA193HH	MD9101D						4
SFA194	SFAC194		SFA194HH	MD9101D						5
FA711		FA711V								6
FA711		FA711V								7
SFA193	SFAC193		SFA193HH	MD924D				VR924		8
SFA193	SFAC193		SFA193HH	MD9101D						9
SFA228	SFAC228		SFA228HH	N/A						10
SFA228	SFAC228		SFA228HH	N/A						11
SFA228	SFAC228		SFA228HH	TBA						12
FA244			FA244HH			N/A				13
SFA193	SFAC193		SFA193HH	MD9101D						14
SFA194	SFAC194		SFA194HH	MD9101D						15
SFA228	SFAC228		SFA228HH			N/A				16
FA658		FA658V	FA658HH							17
FA181TT		MXS181	FA181R			TBA				18
FA181TT		MXS181	FA181R							19
SFA197	SFAC197		SFA197HH	TBA	TBA					20
SFA228	SFAC228		SFA228HH							21
FA244			FA244HH			N/A				22
SFA194	SFAC194		SFA194HH	MD997D				VR997		23
FA047			FA047HH	N/A						24
FA095			FA095HH	N/A						25
FA658		FA658V	FA658HH							26
FA658		FA658V		N/A						27
FA658		FA658V	FA658HH							28
FA658		FA658V	FA658HH							29
N/A				N/A						30
FA658*		FA658V*	FA658HH*							31
FA658*		FA658V*	FA658HH*							32
FA658*		FA658V*	FA658HH*	N/A	N/A	N/A*				33
FA658*		FA658V*	FA658HH*							34
FA658*		FA658V*	FA658HH*							35
FA047			FA047HH	N/A						36
SFA228	SFAC228		SFA228HH	N/A						37
FA047*			FA047HH*	N/A	N/A					38
FA047*			FA047HH*	N/A	N/A					39
SFA194	SFAC194		SFA194HH	TBA						40
FA196			FA196HH							41
FA658*		FA658V*	FA658HH*							42
FA181TT		MXS181	FA181R			TBA				43
FA047*			FA047HH*	N/A	N/A					44
			FA322/4HH*							45
			FA322/4HH*							46
FA244*			FA244HH*							47
			FA322/4HH*							48
FA209/2			FA209/2HH							49
FA181TT		MXS181	FA181R	TBA						50
			FA322/4HH	TBA						51
			FA322/4HH*	N/A	N/A					52
			FA322/4HH*	N/A	N/A					53
			FA630HH*	N/A	N/A					54
			FA630HH*	N/A	N/A					55
FA047*			FA047HH*	N/A	N/A					56
FA018*		FA018V*	FA018HH*	MD837	MD837					57
FA244*			FA244HH*	MD614X	MD614X	MD614XC*		VR614BLK*		58
			FA322/4HH*							59
			FA322/4HH*			TBA*				60

FRONT / AVANT / VORN / FRENTE / ANTERIORE

R Suffix = High Durability Sintered Pad. HH Suffix = High Performance Sintered Pad. TT Suffix = Hard Wearing Off Road Pad. V Suffix = Semi Sintered Pad. G Suffix = Grooved Shoe.

D Suffix = Drilled Disc. X Suffix = Universal Left or Right Disc. XC Suffix = Contoured Disc. LS Suffix = Left/Steel Disc. RS Suffix = Right/Steel Disc.

*-2 Sets Required. † For Vee disc colours add RED, BLU, GRN, GLD, ORG suffix to part number.

⊗ - Also available as a Vintage Motorcycle Disc.

180 Part numbers, prefixes, suffixes, photos and illustrations shown in this catalogue are trademarks and/or copyrights of EBC Brakes or the trademark owner A C Freeman Investments Ltd and use without express written permission of the owners is punishable by law.

Non-JAPANESE Built Motorcycles

Line #	BRAKE DISC CHOICES - FRONT						DISC PAD CHOICES - REAR				BRAKE DISC CHOICES - REAR			
	Oversize 250 /280mm Disc Kit	OSX Oversize 250/280mm Disc Kit	Relocating Bracket for 250/ 280mm Disc	Oversize 320mm Disc Kit	SMX Oversize 320mm Disc Kit	Relocating Bracket for 320mm Disc	FA, SFA, TT Pad or Brake Shoe	SFAC Carbon Scooter Pads	Speciality Pads - SXR / Vee / MXS	Sintered/ HH Pads/ Grooved Shoes	Standard Replacement Disc	Contour Disc Rear fitment	Vee-Discs™ CONTOUR	CX Extreme MX Race Disc/ UTVX Disc
1							FA629							
2							FA698							
3							SFA228	SFAC228		SFA228HH		N/A		
4							SFA193	SFAC193		SFA193HH	MD966D			
5							SFA298	SFAC298		SFA298HH	MD966D			
6														
7							FA629							
8							816							
9							SFA321	SFAC321		SFA321HH	MD9106D			
10							SFA228	SFAC228		SFA228HH	N/A			
11							SFA228	SFAC228		SFA228HH	N/A			
12							SFA228	SFAC228		SFA228HH	TBA			
13							FA047			FA047HH		N/A		
14							SFA193	SFAC193		SFA193HH	MD966D			
15							SFA298	SFAC298		SFA298HH	MD966D			
16							SFA228	SFAC228		SFA228HH		N/A		
17							FA629			FA629HH				
18							FA047TT			FA047R		TBA		
19							FA298							
20							SFA413	SFAC413		SFA413HH	TBA			
21														
22							FA047			FA047HH		N/A		
23							SFA298	SFAC298		SFA298HH	MD966D		VR966	
24							929							
25							FA047			FA047HH	TBA			
26							FA698			FA698HH				
27							FA298				N/A			
28							FA698			FA698HH				
29							FA698			FA698HH				
30							929							
31							FA698			FA698HH				
32							FA698			FA698HH				
33							FA298				N/A			
34							FA698			FA698HH				
35							FA698			FA698HH				
36							929							
37							SFA083	SFAC083		SFA083HH	N/A			
38							FA018			FA018HH				
39							FA047			FA047HH	N/A			
40							SFA298	SFAC298		SFA298HH	TBA			
41							FA698			FA698HH				
42							FA698			FA698HH				
43							FA208TT		MXS208	FA208R		TBA		
44							929							
45							FA698			FA698HH				
46							FA698			FA698H				
47							FA266			FA266HH				
48							FA698			FA698HH				
49							FA698			FA698HH				
50							FA208TT		MXS208	FA208R	TBA			
51							FA208TT		MXS208	FA208R	TBA			
52							FA266			FA266HH	N/A			
53							FA266			FA266HH	N/A			
54							FA266			FA266HH	N/A			
55							FA266			FA266HH	N/A			
56							FA047			FA047HH	N/A			
57							N/A							
58							FA266	FA266V		FA266HH	TBA			
59							FA698	FA698V		FA698HH				
60							FA266	FA266V		FA266HH		TBA		

REAR / ARRIÈRE / HINTEN / POSTERIOR / POSTERIORE

*-2 Sets Required. † For Vee disc colours add RED, BLU, GRN, GLD, ORG suffix to part number.

⊗ - Also available as a Vintage Motorcycle Disc.

R Suffix = High Durability Sintered Pad. HH Suffix = High Performance Sintered Pad. TT Suffix = Hard Wearing Off Road Pad. V Suffix = Semi Sintered Pad. G Suffix = Grooved Shoe.

D Suffix = Drilled Disc. X Suffix = Universal Left or Right Disc. XC Suffix = Contoured Disc. LS Suffix = Left/Steel Disc. RS = Right/Steel Disc.

Non-JAPANESE Built Motorcycles

APPLICATIONS

BRAKE



BENELLI Contd.

Century Racer 899	11-12
TNT 899 Tornado Naked Tre	07-16
TNT 899 S Tornado Naked Tre	07-11
TRE-K 899	07-16
900 SEI (6 Cyl)	83
Tornado 900	02
Tornado Tre Novecento/LE/RS	03-05
TNT 1130 Cafe Racer	05
TNT 1130 Cafe Racer	06-12
TNT 1130 Sport/Sport Evo	04-09
TNT 1130 Titanium	05
TNT 1130 Titanium	06
Tornado TRE 1130 (Radial caliper)	06-10
Tornado Naked TRE R 160	09-12
Tornado Naked Tre TNT 1130	06-07
Tornado Naked Tre TNT 1130 R	13-16
TRE-K 1130	06-17
TRE-K 1130 Amazonas	07-15

BETA

Electric 16	18-19
Electric 20	18-19
Electric 20XL	18-19
Minicross Pro Race 12/10	04-06
R 150 (Minicross /4T/49cc)	10-13
ARK (Air Cooled Models)	96-14
ARK (LC Models)	97-14
Pro Race 50	05
Quadra 50	97-01
Rev 50	00-08
50 RR Supermoto/Enduro	99-05
RR Enduro Alu 50/Motard Alu 50	04-08
RR 50 Standard	05-08
RR 50 Enduro Racing	09-11
RR 50 Enduro	04-07
RR 50 Enduro	08-20
RR 50 Enduro Factory	12-20
RR 50 Enduro Standard	09-14
RR 50 Motard Standard	09-12
RR 50 Motard (Spoke Wheel)	09-12
RR 50 Motard Skull	11
RR Motard 50 Track (Cast Wheels)	08-14
RR Motard 50 Track/Racing (Spoke Wheels)	14-20
RR 50 Motard Standard (5 Spoke Cast Wheel)	13-14
RR 50 Motard Sport (5 Spoke Cast Wheel)	14-20
RR 50 Motard 50 (Spoke Wheel)	12-13
RK6	93-96
Tempo 16	94-97
Eickon 50	99-06
Minitrial 50 (A/C)	09-12
Minitrial LC (Hydraulic Brakes)	13-15
Minitrial Electric 20XL/20/16	14-20
RK 50cc Enduro	97-02
Tempo 50	98-02
Evo 80 Junior	09-20
Evo 80 Senior	09-20
Rev 80	00-07
Rev 80	08
124 TR	80-83
ALP 125 4T	98-04

FRONT / AVANT / VORN / FRENTE / ANTERIORE

DISC PAD CHOICES - FRONT				BRAKE DISC CHOICES - FRONT						Line #
FA, SFA, TT Pad or Brake Shoe	SFAC Carbon Scooter Pads	Semi-Sintered V-Pads™	Sintered/HH Pads/ Grooved Shoes	Left / Gauche / Links Standard Replacement Disc	Right / Droite / Rechts Standard Replacement Disc	Contour Disc Universal left and right fitment	Universal Custom Disc	Vee-Discs Black † See note below	CX Extreme MX Race Disc	Line #
			FA322/4HH*			TBA*				1
FA244*			FA244HH*	MD614X	MD614X	MD614XC*		VR614BLK*		2
FA244*			FA244HH*	MD614X	MD614X	MD614XC*		VR614BLK*		3
FA244*			FA244HH*	MD614X	MD614X	MD614XC*		VR614BLK*		4
FA018*		FA018V*	FA018HH*	MD837	MD837					5
FA244*			FA244HH*	TBA	TBA					6
			FA322/4HH*	MD621X	MD621X	MD621XC*		VR621BLK*		7
FA244*			FA244HH*	MD621X	MD621X	MD621XC*		VR621BLK*		8
			FA322/4HH*	MD621X	MD621X	MD621XC*		VR621BLK*		9
			FA322/4HH*	MD621X	MD621X	MD621XC*		VR621BLK*		10
FA244*			FA244HH*	MD621X	MD621X	MD621XC*		VR621BLK*		11
			FA322/4HH*	MD621X	MD621X	MD621XC*		VR621BLK*		12
			FA322/4HH*	MD621X	MD621X	MD621XC*		VR621BLK*		13
			FA322/4HH*			TBA*				14
FA244*			FA244HH*	MD621X	MD621X	MD621XC*		VR621BLK*		15
			FA447HH*			TBA*				16
FA244*			FA244HH*	MD614X	MD614X	MD614XC*		VR614BLK*		17
FA244*			FA244HH*			TBA*				18
										19
										20
			CFA327			CFA327R				21
			CFA327			CFA327R				22
			CFA327			CFA327R				23
			FA351TT		N/A					24
			FA086		N/A					25
	SFA193	SFAC193	SFA193HH	MD901D				VR901		26
	SFA193	SFAC193	SFA193HH	MD901D				VR901		27
	FA115		FA115HH	N/A						28
	SFA193	SFAC193	SFA193HH	MD901D				VR901		29
	FA115		FA115R	N/A						30
	FA115		FA115HH	N/A						31
	FA194		FA194HH	N/A						32
	FA194		FA194HH	N/A						33
	FA194		FA194HH	N/A						34
	FA194		FA194HH	N/A						35
	FA194		FA194HH	N/A						36
	FA194		FA194HH	N/A						37
	FA115TT		FA115R	N/A						38
	FA115TT		FA115R	N/A						39
	FA194		FA194HH	N/A						40
	FA194		FA194HH	N/A						41
	FA194		FA194HH	N/A						42
	FA194		FA194HH	N/A						43
	FA194		FA194HH			N/A				44
	FA194		FA194HH			N/A				45
	FA194		FA194HH			N/A				46
	FA167		FA167HH	MD6296D						47
	SFA116			N/A						48
	SFA115	SFAC115	SFA115HH	MD901D				VR901		49
	FA351TT			N/A						50
	FA351TT			N/A						51
	CFA327	CFA327R	CFA327HH	N/A						52
	FA167		FA167HH	N/A						53
	SFA193	SFAC193	SFA193HH	MD901D				VR901		54
	FA115TT		FA115R	N/A						55
	FA303TT			N/A						56
	FA115		FA115R	N/A						57
	FA303TT			N/A						58
			841G							59
	FA115TT		FA115R	N/A						60

*-2 Sets Required. † For Vee disc colours add RED, BLU, GRN, GLD, ORG suffix to part number.

⊗ - Also available as a Vintage Motorcycle Disc.

182 Part numbers, prefixes, suffixes, photos and illustrations shown in this catalogue are trademarks and/or copyrights of EBC Brakes or the trademark owner A C Freeman Investments Ltd and use without express written permission of the owners is punishable by law.

Non-JAPANESE Built Motorcycles

Line #	BRAKE DISC CHOICES - FRONT						DISC PAD CHOICES - REAR				BRAKE DISC CHOICES - REAR			
	Oversize 250 /280mm Disc Kit	OSX Oversize 250/280mm Disc Kit	Relocating Bracket for 250/ 280mm Disc	Oversize 320mm Disc Kit	SMX Oversize 320mm Disc Kit	Relocating Bracket for 320mm Disc	FA, SFA, TT Pad or Brake Shoe	SFAC Carbon Scooter Pads	Speciality Pads - SXR / Vee / MXS	Sintered/ HH Pads/ Grooved Shoes	Standard Replacement Disc	Contour Disc Rear fitment	Vee-Discs™ CONTOUR	CX Extreme MX Race Disc/ UTVX Disc
1							FA266		FA266V	FA266HH		TBA		
2							FA266		FA266V	FA266HH	MD651			
3							FA266		FA266V	FA266HH	MD651			
4							FA266		FA266V	FA266HH	MD651			
5							FA077		FA077V		N/A			
6							FA266		FA266V	FA266HH	MD651			
7							FA266		FA266V	FA266HH	MD651			
8							FA266		FA266V	FA266HH	MD651			
9							FA266		FA266V	FA266HH	MD651			
10							FA266		FA266V	FA266HH	MD651			
11							FA266		FA266V	FA266HH	MD651			
12							FA266		FA266V	FA266HH	MD651			
13							FA266		FA266V	FA266HH	MD651			
14							FA266		FA266V	FA266HH		TBA		
15							FA266		FA266V	FA266HH	MD651			
16							FA266		FA266V	FA266HH		TBA		
17							FA266		FA266V	FA266HH	MD651			
18							FA266		FA266V	FA266HH		TBA		
19														
20														
21							CFA327			CFA327R				
22							CFA327			CFA327R				
23							CFA327			CFA327R				
24							FA351TT				N/A			
25							FA337TT			FA337R	N/A			
26							893							
27							SFA193HH	SFAC193		SFA193HH	MD901D		VR901	
28							FA351TT				N/A			
29							893							
30							FA115			FA115R	N/A			
31							FA115			FA115HH	N/A			
32							FA115			FA115HH	N/A			
33							FA115			FA115HH	N/A			
34							FA367/2TT			FA367/2R	N/A			
35							FA115			FA115HH	N/A			
36							FA367/2TT			FA367/2R	N/A			
37							FA367/2TT			FA367/2R	N/A			
38							FA367/2TT			FA367/2R	N/A			
39							FA367/2TT			FA367/2R	N/A			
40							FA367/2TT			FA367/2R	N/A			
41							FA367/2TT			FA367/2R	N/A			
42							FA367/2TT			FA367/2R	N/A			
43							FA367/2TT			FA367/2R	N/A			
44							FA367/2TT			FA367/2R		N/A		
45							FA367/2TT			FA367/2R		N/A		
46							FA367/2TT			FA367/2R		N/A		
47							FA116				N/A			
48							893							
49							SFA115	SFAC115		SFA115HH	MD901D			
50							N/A				N/A			
51							N/A				N/A			
52							CFA327	CFA327R		CFA327HH	N/A			
53							FA115			FA115HH	N/A			
54							893							
55							FA115TT			FA115R	N/A			
56							FA403				N/A			
57							FA115			FA115R	N/A			
58							FA403				N/A			
59										841G				
60							FA115TT			FA115R	N/A			

REAR / ARRIÈRE / HINTEN / POSTERIOR / POSTERIORE

*-2 Sets Required. † For Vee disc colours add RED, BLU, GRN, GLD, ORG suffix to part number.

⊗ - Also available as a Vintage Motorcycle Disc.

R Suffix = High Durability Sintered Pad. **HH** Suffix = High Performance Sintered Pad. **TT** Suffix = Hard Wearing Off Road Pad. **V** Suffix = Semi Sintered Pad. **G** Suffix = Grooved Shoe.
D Suffix = Drilled Disc. **X** Suffix = Universal Left or Right Disc. **XC** Suffix = Contoured Disc. **LS** Suffix = Left/Steel Disc. **RS** = Right/Steel Disc.

Non-JAPANESE Built Motorcycles

APPLICATIONS

BRAKE



BETA Contd.



DISC PAD CHOICES - FRONT

BRAKE DISC CHOICES - FRONT

		FA, SFA, TT Pad or Brake Shoe	SFAC Carbon Scooter Pads	Speciality Pads SXR / Vee / MXS	Sintered/ HH Pads/ Grooved Shoes	Left / Gauche / Links Standard Replacement Disc	Right / Droite / Rechts Standard Replacement Disc	Contour Disc Universal left and right fitment	Universal Custom Disc	Vee-Discs Black † See note below	CX Extreme MX Race Disc/ UTVX Disc	Line #
ALP 125 4T	05-15	FA194			FA194HH	N/A						1
Evo 125 (2T)	09-15	FA303TT			FA164R	N/A						2
Trial Evo 125 (2T) MY20	20	FA164										3
Rev 3 125/200	00-05	FA303TT			N/A	N/A						4
Rev 3 125/200	06-08	FA303TT										5
R 125 4T Mini Cross		SFA169	SFAC169		SFA169HH	N/A						6
RE 125 4T Enduro	09-10	FA194			FA194HH	N/A						7
RE 125 4T Enduro	10-14	FA115TT			FA115R	N/A						8
Enduro RR 125 LC (2T) MY20	20	FA185TT		MXS185	FA185R							9
RR 125 4T Enduro (A/C)	09-14	FA194			FA194HH	N/A						10
RR 125 4T Enduro (L/C)	11-20	FA194			FA194HH	N/A						11
RR 125 4T Motard (A/C - Spoke Wheel)	08-14	FA194			FA194HH	N/A						12
RR 125 4T Motard (L/C - Cast Wheel)	11-20	FA194			FA194HH	N/A						13
RR 2T 125 RC	18-20	FA185TT		MXS185	FA185HH							14
TR 125	80-83				841G							15
TR 125 32/33	86-87	FA099				N/A						16
125 TR 34	88	FA115			FA115R	N/A						17
125 TR 34	89	FA115			FA115R	N/A						18
Eurotek/Techno 125/250	96-98	FA115			FA115R	N/A						19
Urban 125	08-15	FA194			FA194HH	N/A						20
Urban 125 Special	09-15	FA194			FA194HH	N/A						21
Eikon 125/150	00-06	SFA047			SFA047HH	MD924D				VR924		22
Jonathan 125	00-01	FA095			FA095HH		MD813					23
Jonathan 125	02-05	FA095			FA095HH		MD813					24
ALP 200 4T	00-04	FA115TT			FA115R	N/A						25
ALP 200 4T	05-20	FA194			FA194HH	N/A						26
Evo 200 (2T)	09-20	FA303TT				N/A						27
Trial Evo 200 (2T) MY20	20	FA164			FA164R							28
RR Enduro 200 (2T) MY20	20	FA185TT		MXS185	FA185R							29
Urban 200	08-15	FA194			FA194HH	N/A						30
Urban 200 Special	09-15	FA194			FA194HH		N/A					31
240 TR	80-83				841G							32
240 TR 32	84-85				939G							33
240 TR 33	86	FA099				N/A						34
Evo 250 (2T)/Factory	09-20	FA303TT				N/A						35
Evo 250 (4T)	09-20	FA303TT				N/A						36
Rev 3 250/270	00-04	FA303TT			N/A	N/A						37
Rev 3 250/270	05-08	FA303TT			N/A	N/A						38
Rev 4T 250	07-08	FA303TT				N/A						39
RR 250 4T Enduro	05-07	FA185TT		MXS185	FA185R			MD6367C◆				40
RR 250 Enduro (2T)	13-14	FA185TT		MXS185	FA185R			N/A				41
RR 250 Enduro (2T) RC	18-20	FA185TT		MXS185	FA185R							42
Enduro RR 250 (2T) MY20	20	FA185TT		MXS185	FA185R							43
Trial Evo 250 (2T) MY20	20	FA164			FA164R							44
Trial Evo 250 (2T) MY20 GB	20	FA164			FA164R							45
RR 250 Racing (2T)	15	FA185TT		MXS185	FA185R			N/A				46
TR 34	86-88	FA099				N/A						47
TR 34	86	FA099				N/A						48
TR 34 260	89-91	FA099				N/A						49
SYNT	92	FA115TT			FA115R	N/A						50
Zero	92	FA115TT			FA115R	N/A						51
SYNT/GARA	93-95	FA115TT			FA115R	N/A						52
Super Trial ST	94	FA115TT			FA115R	N/A						53
Techno	95	FA115TT			FA115R	N/A						54
Enduro RR 300 (2T) MY20	20	FA185TT		MXS185	FA185R							55
Evo 300 (2T)	09-20	FA303TT				N/A						56
Evo 300 (4T)	09-20	FA303TT				N/A						57
Trial Evo 300 (2T) MY20 Inc GB and SS	20	FA164			FA164R							58
RR 300 Enduro (2T)	13-14	FA185TT		MXS185	FA185R			N/A				59

FRONT / AVANT / VORN / FRENTE / ANTERIORE

R Suffix = High Durability Sintered Pad. HH Suffix = High Performance Sintered Pad. TT Suffix = Hard Wearing Off Road Pad. V Suffix = Semi Sintered Pad. G Suffix = Grooved Shoe.

D Suffix = Drilled Disc. X Suffix = Universal Left or Right Disc. XC Suffix = Contoured Disc. LS Suffix = Left/Steel Disc. RS = Right/Steel Disc.

◆ Remove old speedo pick up magnet from old disc and refit to new EBC disc.

*-2 Sets Required. † For Vee disc colours add RED, BLU, GRN, GLD, ORG suffix to part number.

◆ - Also available as a Vintage Motorcycle Disc.

184 Part numbers, prefixes, suffixes, photos and illustrations shown in this catalogue are trademarks and/or copyrights of EBC Brakes or the trademark owner A C Freeman Investments Ltd and use without express written permission of the owners is punishable by law.

Non-JAPANESE Built Motorcycles

Line #	BRAKE DISC CHOICES - FRONT						DISC PAD CHOICES - REAR				BRAKE DISC CHOICES - REAR			
	Oversize 250 /280mm Disc Kit	OSX Oversize 250/280mm Disc Kit	Relocating Bracket for 250/ 280mm Disc	Oversize 320mm Disc Kit	SMX Oversize 320mm Disc Kit	Relocating Bracket for 320mm Disc	FA, SFA, TT Pad or Brake Shoe	SFAC Carbon Scooter Pads	Speciality Pads - SXR / Vee / MXS	Sintered/ HH Pads/ Grooved Shoes	Standard Replacement Disc	Contour Disc Rear fitment	Vee-Discs™ CONTOUR	CX Extreme MX Race Disc/ UTVX Disc
1							FA367/2TT			FA367/2R	N/A			
2							FA495				N/A			
3							FA495							
4							FA303TT			N/A	N/A			
5							FA403				N/A			
6							FA115			FA115HH	N/A			
7							FA367/2TT			FA367/2R	N/A			
8							FA367/2TT			FA367/2R	N/A			
9							FA367/2TT			FA367/2R				
10							FA367/2TT			FA367/2R	N/A			
11							FA367/2TT			FA367/2R	N/A			
12							FA367/2TT			FA367/2R	N/A			
13							FA367/2TT			FA367/2R	N/A			
14							FA367/2TT			FA367/2R				
15										841G				
16										841G				
17							FA116			N/A	N/A			
18							FA115			FA115R				
19							FA115			FA115R	N/A			
20							FA367/2TT			FA367/2R	N/A			
21							FA367/2TT			FA367/2R		N/A		
22							SFA298			SFA298HH	MD909D			
23							FA213			FA213HH	N/A			
24							FA173				N/A			
25							FA115TT			FA115R	N/A			
26							FA367/2TT			FA367/2R	N/A			
27							FA495				N/A			
28							FA495							
29							FA367/2TT			FA367/2R				
30							FA367/2TT			FA367/2R	N/A			
31							FA367/2TT			FA367/2R		N/A		
32										841G				
33										841G				
34										841G				
35							FA495				N/A			
36							FA495				N/A			
37							FA303TT			N/A	N/A			
38							FA403			N/A	N/A			
39							FA403				N/A			
40							FA367/2TT			FA367/2R		MD6368C		
41							FA367/2TT			FA367/2R		N/A		
42							FA367/2TT			FA367/2R				
43							FA367/2TT			FA367/2R				
44							FA495TT							
45							FA495TT							
46							FA367/2TT			FA367/2R		N/A		
47							FA116			N/A	N/A			
48							FA116			N/A	N/A			
49							FA164			FA164R	N/A			
50							FA164			FA164R	N/A			
51							FA164			FA164R	N/A			
52							FA156			N/A	N/A			
53							FA164			FA164R	N/A			
54							FA156			N/A	N/A			
55							FA367/2TT			FA367/2R				
56							FA495				N/A			
57							FA495				N/A			
58							FA495TT							
59							FA367/2TT			FA367/2R		N/A		
60														

REAR / ARRIÈRE / HINTEN / POSTERIOR / POSTERIORE

*-2 Sets Required. † For Vee disc colours add RED, BLU, GRN, GLD, ORG suffix to part number.

⊗ - Also available as a Vintage Motorcycle Disc.

R Suffix = High Durability Sintered Pad. **HH** Suffix = High Performance Sintered Pad. **TT** Suffix = Hard Wearing Off Road Pad. **V** Suffix = Semi Sintered Pad. **G** Suffix = Grooved Shoe.
D Suffix = Drilled Disc. **X** Suffix = Universal Left or Right Disc. **XC** Suffix = Contoured Disc. **LS** Suffix = Left/Steel Disc. **RS** = Right/Steel Disc.

Part numbers, prefixes, suffixes, photos and illustrations shown in this catalogue are trademarks and/or copyrights of EBC Brakes or the trademark owner A C Freeman Investments Ltd and use without express written permission of the owners is punishable by law.

Non-JAPANESE Built Motorcycles

APPLICATIONS

BRAKE



BETA Contd.

RR 300 Enduro (2T) RC	18-20
RR 300 Racing (2T)	15
300 X-Trainer (2T)	15-20
ALP 4.0 (4T/349cc)	05-15
Enduro RR 350 (4T) MY20	20
Euro 350	00-01
Euro 350	02
Euro 350	03-06
Jonathan 350	03-06
M4 350 Supermotard	04-06
M4 350 Motard	07-15
RR 350 4T Enduro	11
RR 350 4T Enduro	12-14
RR 350 EFI (4T)	15
RR 350 4T Enduro Racing	13-20
RR 350 4T Racing	15
Enduro RR 390 (4T) MY20	20
RR 390 (4T)	15-20
RR 400 4T Enduro	05-11
RR 400 4T Enduro	12-14
Enduro RR 430 (4T) MY20	20
RR 430 (4T)	15
RR 430 4T Racing	15
RR 450 4T Enduro	05-11
RR 450 4T Enduro	12-14
RR 450 4T Enduro Racing	13-20
RR 450 4T Cross Country	12
Enduro RR 480 (4T) MY20	20
RR 480 (4T)	15-20
RR 480 4T Racing	15-20
RR 498 4T Enduro	12-14
RR 498 4T Enduro Racing	13-14
RR 520 4T Enduro	10-11
RR 525 4T Enduro	05-09

BETTER

BT 125-20	06-09
-----------	-------

BIMOTA

All early models	-88
All models (Single pin fixing)	89-
Later models (Twin pin fixing)	98/99-
Delirio	06
DB5 (All models)	06-07
DB5 Desiderio (1078cc)	12-14
DB5R	06-13
DB6 Delirio (992cc) Ducati engine	07
SB8K Gobert (Suzuki Engine) (996cc)	06
SB8K Santamonica (Suzuki Engine) (996cc)	
Tesi 2D (Ducati) 992cc	04-06
Tesi-3D (1078cc)	09-13
DB5R/S (1078cc)	08-09
DB6 (1078cc)	08-09
DB6 (1100cc)	08
DB6 (1100cc)	12-13
DB6/R (1078cc)	08-09
DB6R Delirio (1100cc)	08
DB7 (1098cc)	08
DB7 (1099cc)	09-14

DISC PAD CHOICES - FRONT	BRAKE DISC CHOICES - FRONT				Line #					
	SFAC Carbon Scooter Pads	Semi-Sintered V-Pads™	Sintered/HH Pads/ Grooved Shoes	Left / Gauche / Links		Right / Droite / Rechts	Contour Disc Universal left and right fitment	Universal Custom Disc	Vee-Discs Black **See note below	CX Extreme MX Race Disc
FA185TT		MXS185	FA185R							1
FA185TT		MXS185	FA185R			N/A				2
FA185TT		MXS185	FA185R			N/A				3
FA194			FA194HH	N/A						4
FA185TT		MXS185	FA185R							5
FA126			FA126HH		MD813					6
FA126			FA126HH		MD813					7
FA095			FA095HH		MD813					8
FA095			FA095HH		N/A					9
FA426				N/A						10
FA426				N/A						11
FA185TT		MXS185	FA185R			MD6367C♦				12
FA185TT		MXS185	FA185R			N/A				13
FA185TT		MXS185	FA185R			N/A				14
FA185TT		MXS185	FA185R			N/A				15
FA185TT		MXS185	FA185R			N/A				16
FA185TT		MXS185	FA185R			N/A				17
FA185TT		MXS185	FA185R			N/A				18
FA185TT		MXS185	FA185R			MD6367C♦				19
FA185TT		MXS185	FA185R			N/A				20
FA185TT		MXS185	FA185R			N/A				21
FA185TT		MXS185	FA185R			N/A				22
FA185TT		MXS185	FA185R			N/A				23
FA185TT		MXS185	FA185R			MD6367C♦				24
FA185TT		MXS185	FA185R			N/A				25
FA185TT		MXS185	FA185R			N/A				26
FA185TT		MXS185	FA185R			N/A				27
FA185TT		MXS185	FA185R			N/A				28
FA185TT		MXS185	FA185R			N/A				29
FA185TT		MXS185	FA185R			N/A				30
FA185TT		MXS185	FA185R			N/A				31
FA185TT		MXS185	FA185R			N/A				32
FA185TT		MXS185	FA185R			MD6367C♦				33
FA185TT		MXS185	FA185R			MD6367C♦				34
										35
										36
FA486				N/A						37
										38
										39
FA018*			FA018HH*	N/A	N/A					40
FA095*			FA095HH*	N/A	N/A					41
FA244*			FA244HH*	N/A	N/A					42
			FA322/4HH*	N/A	N/A					43
			FA322/4HH*	N/A	N/A					44
			FA322/4HH*	N/A	N/A					45
			FA322/4HH*	TBA	TBA					46
			FA322/4HH*	TBA	TBA					47
FA244*			FA244HH*	TBA	TBA					48
			FA322/4HH*	MD621X	MD621X	MD621XC*		VR621BLK*		49
FA095*			FA095HH*	N/A	N/A					50
			FA322/4HH*	N/A	N/A					51
			FA322/4HH*	N/A	N/A					52
			FA322/4HH*	N/A	N/A					53
			FA322/4HH*	N/A	N/A					54
			FA322/4HH*			N/A				55
			FA322/4HH*	N/A	N/A					56
			FA322/4HH*	TBA	TBA					57
			FA322/4HH*	TBA	TBA					58
			FA447HH*	N/A	N/A					59

FRONT / AVANT / VORN / FRENTE / ANTERIORE

♦ Remove old speedo pick up magnet from old disc and refit to new EBC disc.

*-2 Sets Required. † For Vee disc colours add RED, BLU, GRN, GLD, ORG suffix to part number.

⊗ - Also available as a Vintage Motorcycle Disc.

186 Part numbers, prefixes, suffixes, photos and illustrations shown in this catalogue are trademarks and/or copyrights of EBC Brakes or the trademark owner A C Freeman Investments Ltd and use without express written permission of the owners is punishable by law.

Non-JAPANESE Built Motorcycles

Line #	BRAKE DISC CHOICES - FRONT						DISC PAD CHOICES - REAR				BRAKE DISC CHOICES - REAR			
	Oversize 250 /280mm Disc Kit	OSX Oversize 250/280mm Disc Kit	Relocating Bracket for 250/ 280mm Disc	Oversize 320mm Disc Kit	SMX Oversize 320mm Disc Kit	Relocating Bracket for 320mm Disc	FA, SFA, TT Pad or Brake Shoe	SFAC Carbon Scooter Pads	Speciality Pads - SXR / Vee / MXS	Sintered/ HH Pads/ Grooved Shoes	Standard Replacement Disc	Contour Disc Rear fitment	Vee-Discs™ CONTOUR	CX Extreme MX Race Disc/ UTVX Disc
1							FA367/2TT			FA367/2R				
2							FA367/2TT			FA367/2R		N/A		
3							FA367/2TT			FA367/2R		N/A		
4							FA367/2TT			FA367/2R	N/A			
5							FA367/2TT			FA367/2R				
6							FA213			FA213HH	N/A			
7							FA173				N/A			
8							FA101				N/A			
9							FA101				N/A			
10							FA337TT				N/A			
11							FA367/2TT				N/A			
12							FA367/2TT			FA367/2R		MD6368C		
13							FA367/2TT			FA367/2R		N/A		
14							FA367/2TT			FA367/2R		N/A		
15							FA367/2TT			FA367/2R		N/A		
16							FA367/2TT			FA367/2R		N/A		
17							FA367/2TT			FA367/2R		N/A		
18							FA367/2TT			FA367/2R		N/A		
19							FA367/2TT			FA367/2R		MD6368C		
20							FA367/2TT			FA367/2R		N/A		
21							FA367/2TT			FA367/2R				
22							FA367/2TT			FA367/2R		N/A		
23							FA367/2TT			FA367/2R		N/A		
24							FA367/2TT			FA367/2R		MD6368C		
25							FA367/2TT			FA367/2R		N/A		
26							FA367/2TT			FA367/2R		N/A		
27							FA367/2TT			FA367/2R		N/A		
28							FA367/2TT			FA367/2R		N/A		
29							FA367/2TT			FA367/2R		N/A		
30							FA367/2TT			FA367/2R		N/A		
31							FA367/2TT			FA367/2R		N/A		
32							FA367/2TT			FA367/2R		N/A		
33							FA367/2TT			FA367/2R		MD6368C		
34							FA367/2TT			FA367/2R		MD6368C		
35														
36														
37							TBA							
38														
39														
40							FA018			FA018HH	N/A			
41							FA047			FA047HH	N/A			
42							FA047			FA047HH	N/A			
43							FA266	FA266V		FA266HH	N/A			
44							FA266	FA266V		FA266HH	N/A			
45							FA266	FA266V		FA266HH	N/A			
46							FA266	FA266V		FA266HH	TBA			
47							FA266	FA266V		FA266HH	TBA			
48							FA047			FA047HH	TBA			
49							FA047			FA047HH	TBA			
50							FA047			FA047HH	N/A			
51							FA047			FA047HH	N/A			
52							FA047			FA047HH	N/A			
53							FA047			FA047HH	N/A			
54							FA266	FA266V		FA266HH	TBA			
55							FA047			FA047HH		N/A		
56							FA047			FA047HH	N/A			
57							FA266	FA266V		FA266HH	TBA			
58							FA266	FA266V		FA266HH	TBA			
59							FA047			FA047HH	N/A			

REAR / ARRIÈRE / HINTEN / POSTERIOR / POSTERIORE

*-2 Sets Required. † For Vee disc colours add RED, BLU, GRN, GLD, ORG suffix to part number.

⊗ - Also available as a Vintage Motorcycle Disc.

R Suffix = High Durability Sintered Pad. **HH** Suffix = High Performance Sintered Pad. **TT** Suffix = Hard Wearing Off Road Pad. **V** Suffix = Semi Sintered Pad. **G** Suffix = Grooved Shoe.
D Suffix = Drilled Disc. **X** Suffix = Universal Left or Right Disc. **XC** Suffix = Contoured Disc. **LS** Suffix = Left/Steel Disc. **RS** = Right/Steel Disc.

Non-JAPANESE Built Motorcycles

APPLICATIONS
BRAKE



BIMOTA Contd.

DB8 (1198cc)	10-14
DB8 SP (1198cc)	10-13
DB9 Brivido (1198cc)	12-14
DB9 Brivido S (6 Piston BCA Caliper/1198cc)	12-14
DB10 Motard (1078cc)	12-14
DB11 VLX (1198cc)	12-14
DBX 1100	12-14
DB12 B. Tourist (1198cc)	12-13

BLANEY (Quads)

FX50	03-04
FX90	03-04
XC 125 Trojan	03-04
XL 200 Trooper	03-04

BLATA

Enduro 125	07-08
Motard 125	07-08

BMW

C Evolution Electric	18-20
C1 125	99-03
C1 200	01-03
G 310 R	17-20
G 310 GS	17-20
C 400 X	18-20
C 400 GT	18-20
G 450 X	08-11
C 600 Sport Scooter	12-15
C 600 Sport Scooter - Parking brake	13-15
C 600 Sport Highline Scooter	13-15
C 600 Sport Highline Scooter - Parking brake	13-15
C 600 Evolution Scooter	14-20
C 600 Evolution Scooter - Parking brake	14-20
C 650 GT Scooter	12-18
C 650 GT Scooter - Parking brake	12-20
C 650 GT Highline Scooter	13-18
C 650 GT Highline Scooter - Parking brake	13-18
C 650 Sport Scooter	16-20
C 650 Sport Scooter - Parking brake	16-20
G 650 Xchallenge	07-09
G 650 Xmoto (Cast wheel)	07-09
G 650 Xcountry	07-09
G 650 GS (R131/Single cylinder/chain drive/Cast Wheels)	09-15
G 650 GS Sertao (Single cylinder/chain drive/Spoke Wheels)	12-14
F 650 (E169/0161/Standard)	09/93-96
F 650 (E169/0162/Funduro /High Screen/19" Front Wheel)	97-00
F 650 CS/Scarver K14/0174/0184 /Belt drive/17" Cast Wheels)	00-03
F 650 CS/Scarver K14/0177/0187 /Belt drive/17" Cast Wheels)	04-07
F 650 GS (R13/0172/0182/Single Cylinder/19" Front Wheel)	99-03
F 650 GS (R13/0175/0185 /Single Cylinder/19" Front Wheel)	04-07

DISC PAD CHOICES - FRONT

FA, SFA, TT Pad or Brake Shoe	SFAC Carbon Scooter Pads	Speciality Pads - SXR / Vee / MXS	Sintered/ HH Pads/ Grooved Shoes
--	-----------------------------------	--	---

BRAKE DISC CHOICES - FRONT

Left / Gauche / Links Standard Replacement Disc	Right / Droite / Rechts Standard Replacement Disc	Contour Disc Universal left and right fitment	Universal Custom Disc	Vee-Discs Black † See note below	CX Extreme MX Race Disc/ UTVX Disc
---	---	---	-----------------------------	---	---

FRONT / AVANT / VORN / FRENTE / ANTERIORE

Line #

⊗ - Remove ABS ring from old rotor and refit to new EBC rotor. Ensure all mounting surfaces are clean and when refitting bolts use a thread lock cement to hold them in place.

*-2 Sets Required. † For Vee disc colours add RED, BLU, GRN, GLD, ORG suffix to part number.

⊙ - Also available as a Vintage Motorcycle Disc.

188 Part numbers, prefixes, suffixes, photos and illustrations shown in this catalogue are trademarks and/or copyrights of EBC Brakes or the trademark owner A C Freeman Investments Ltd and use without express written permission of the owners is punishable by law.

R Suffix = High Durability Sintered Pad. HH Suffix = High Performance Sintered Pad. TT Suffix = Hard Wearing Off Road Pad. V Suffix = Semi-Sintered Pad. G Suffix = Grooved Shoe.
D Suffix = Drilled Disc. X Suffix = Universal Left or Right Disc. XC Suffix = Contoured Disc. LS Suffix = Left/Steel Disc. RS Suffix = Right/Steel Disc.

Non-JAPANESE Built Motorcycles

Line #	BRAKE DISC CHOICES - FRONT						DISC PAD CHOICES - REAR				BRAKE DISC CHOICES - REAR			
	Oversize 250 /280mm Disc Kit	OSX Oversize 250/280mm Disc Kit	Relocating Bracket for 250/ 280mm Disc	Oversize 320mm Disc Kit	SMX Oversize 320mm Disc Kit	Relocating Bracket for 320mm Disc	FA, SFA, TT Pad or Brake Shoe	SFAC Carbon Scooter Pads	Speciality Pads - SXR / Vee / MXS	Sintered/ HH Pads/ Grooved Shoes	Standard Replacement Disc	Contour Disc Rear fitment	Vee-Discs™ CONTOUR	CX Extreme MX Race Disc/ UTVX Disc
1							FA266		FA266V	FA266HH	N/A			
2							FA047			FA047HH	N/A			
3							FA266		FA266V	FA266HH	N/A			
4							FA266		FA266V	FA266HH	N/A			
5							FA047			FA047HH		N/A		
6							FA266		FA266V	FA266HH		N/A		
7							FA209/2			FA209/2HH		N/A		
8							FA266		FA266V	FA266HH		N/A		
9														
10														
11							TBA							
12							TBA							
13							FA083TT			FA083R	N/A			
14							FA165TT			FA165R	N/A			
15														
16														
17							FA115				TBA			
18							FA115				TBA			
19														
20														
21							SFA196			SFA196HH				
22							SFA213			SFA213HH	MD968D	VR968		
23							SFA213			SFA213HH	MD968D	VR968		
24							FA213			FA213HH	MD882			
25							FA213			FA213HH	MD882			
26							FA213			FA213HH				
27							FA213			FA213HH				
28	OS6343C	OSX6343	BRK011	SM6343C	SMX6343	BRK012	FA368TT		MXS368	FA368R	MD6342D	MD6342C		
29							SFA196	SFAC196		SFA196HH	TBA			
30														
31							SFA196	SFAC196		SFA196HH	TBA			
32														
33							SFA196	SFAC196		SFA196HH	TBA			
34														
35							SFA196	SFAC196		SFA196HH	TBA			
36														
37							SFA196	SFAC196		SFA196HH	TBA			
38														
39							SFA196	SFAC196		SFA196HH				
40														
41							FA213		FA213V	FA213HH	MD810	MD810C		
42							FA213		FA213V	FA213HH	MD845			
43							FA213		FA213V	FA213HH	MD810	MD810C		
44														
45							FA213		FA213V	FA213HH	MD651			
46														
47							FA213		FA213V	FA213HH	MD651			
48							FA213		FA213V	FA213HH	MD651			
49														
50							FA213		FA213V	FA213HH	MD651			
51														
52							FA213		FA213V	FA213HH	MD651			
53														
54							FA213		FA213V	FA213HH	MD651			
55														
56							FA213		FA213V	FA213HH	MD651			
57														
58							FA213		FA213V	FA213HH	MD651			
59														
60														

REAR / ARRIÈRE / HINTEN / POSTERIOR / POSTERIORE

*-2 Sets Required. † For Vee disc colours add RED, BLU, GRN, GLD, ORG suffix to part number.

⊗ - Also available as a Vintage Motorcycle Disc.

R Suffix = High Durability Sintered Pad. **HH** Suffix = High Performance Sintered Pad. **TT** Suffix = Hard Wearing Off Road Pad. **V** Suffix = Semi Sintered Pad. **G** Suffix = Grooved Shoe.
D Suffix = Drilled Disc. **X** Suffix = Universal Left or Right Disc. **XC** Suffix = Contoured Disc. **LS** Suffix = Left/Steel Disc. **RS** = Right/Steel Disc.

Part numbers, prefixes, suffixes, photos and illustrations shown in this catalogue are trademarks and/or copyrights of EBC Brakes or the trademark owner A C Freeman Investments Ltd and use without express written permission of the owners is punishable by law.

Non-JAPANESE Built Motorcycles

APPLICATIONS

BRAKE



BMW Contd.

F 650 GS (K72/0218/0228 /Twin cylinder 798cc/Cast wheel)	07-12
F 650 GS (30 Years GS/Twin cylinder 798cc/Cast wheel)	11
F 650 GS Dakar (R13/0173/0183 /Single Cylinder/ 21" front wheel)	99-03
F 650 GS Dakar (R13/0176/0186 /Single Cylinder/ 21" front wheel)	04-07
F 650 ST (E169/0163/0168/Strada /Low Screen/18" Front Wheel)	97-00
F 700 GS	13-18
F 750 GS	16-20
F 800 GT	13-20
F 800 GS	08-18
F 800 GS Adventure	12-18
F 800 GS (30 Years GS)	11
F 800 GS Triple Black	12
F 800 GS Trophy	12-18
F 800 R (Disc has fixed bobbins)	09-14
F 800 R (Disc has fixed bobbins)	15-20
F 800 R Sport (Disc has fixed bobbins)	15
F 800 R Chris Pfeiffer Edition (Disc has fixed bobbins)	09-11
F 800 S (Half fairing/Disc has loose bobbins)	06-08
F 800 S (Half fairing/Disc has fixed bobbins)	08-17
F 800 ST (Full fairing/Disc has loose bobbins)	06-08
F 800 ST (Full fairing/Disc has fixed bobbins)	08-12
F 800 ST (Touring/Disc has fixed bobbins)	10-17
F 850 GS	16-20
F 850 GS Adventure	16-20
F900 R	20
F900 XR	20
HP2 Enduro	05-09
HP2 Megamoto (Disc has fixed bobbins)	07-10
HP2 Sport (Disc has fixed bobbins)	08-11
HP4	13-14
HP4 Carbon	13-14
HP4 Race	19-20
K75/75-S (Non ABS)	84-08/88
K75/75-2 (Non ABS)	84-07/90
K75/75-2 (Non ABS)	09/88-96
K75/75-S (ABS Model)	08/90-96
K75 C	85-08/88
K75 C	09/88-90
K75 RT (Non ABS)	89-96
K75 RT (ABS Model)	89-96
K75 S (Non ABS)	85-09/88
K75 S (Non ABS Model)	09/88-95
K75 S (ABS Model)	85-09/88
K75 S (ABS Model)	09/88-95
K1000 (Non ABS - 8 valve model)	82-09/88
K100/2 (Non ABS - 8 valve model)	87-08/88
K100/2 (Non ABS - 8 valve model)	09/88-90
K100/2 (ABS - 8 valve model)	87-08/88
K100/2 (ABS - 8 valve model)	09/88-90
K100 LT (Non ABS - 8 valve model)	86-08/88
K100 LT (Non ABS - 8 valve model)	09/88-91
K100 LT (ABS - 8 valve model)	86-/8/88
K100 LT (ABS - 8 valve model)	09/88-91
K100 RS (Non ABS - 8 valve)	83-09/88
K100 RS (Non ABS - 8 valve)	10/88-89

FRONT / AVANT / VORN / FRENTE / ANTERIORE

DISC PAD CHOICES - FRONT				BRAKE DISC CHOICES - FRONT				Line #		
FA, SFA, TT Pad or Brake Shoe	SFAC Carbon Scooter Pads	Speciality Pads SXR / Vee / MXS	Sintered/HH Pads/ Grooved Shoes	Left / Gauche / Links Standard Replacement Disc	Right / Droite / Rechts Standard Replacement Disc	Contour Disc Universal left and right fitment	Universal Custom Disc	Vee-Discs Black † See note below	CX Extreme MX Race Disc/ UTVX Disc	Line #
FA209/2		FA209/2V	FA209/2HH	MD834X	MD834X					1
FA209/2		FA209/2V	FA209/2HH		MD834Ⓣ					2
FA209/2		FA209/2V	FA209/2HH	MD834Ⓣ						3
FA209/2		FA209/2V	FA209/2HH	MD834Ⓣ						4
FA209/2		FA209/2V	FA209/2HH	MD834Ⓣ						5
FA209/2		FA209/2V	FA209/2HH	MD834Ⓣ						6
FA209/2		FA209/2V	FA209/2HH	MD650Ⓣ						7
FA209/2*		FA209/2V*	FA209/2HH*	MD834X	MD834X					8
FA181TT*		FA181V*	FA181HH*							9
FA244*		FA244V*	FA244HH*	N/A	N/A					10
FA209/2*		FA209/2V*	FA209/2HH*	MD834X	MD834X					11
FA209/2*		FA209/2V*	FA209/2HH*	MD834X	MD834X					12
FA209/2*		FA209/2V*	FA209/2HH*	MD834X	MD834X					13
FA209/2*		FA209/2V*	FA209/2HH*	MD834X	MD834X					14
FA209/2*		FA209/2V*	FA209/2HH*	MD834X	MD834X					15
FA209/2*		FA209/2V*	FA209/2HH*	MD834X	MD834X					16
FA209/2*		FA209/2V*	FA209/2HH*	MD834X	MD834X					17
FA244*		FA244V*	FA244HH*	N/A	N/A					18
			FA630HH*	N/A	N/A					19
			FA630HH*	N/A	N/A					20
FA244*		FA244V*	FA244HH*	N/A	N/A					21
FA244*		FA244V*	FA244HH*	MD803	MD803					22
FA244*		FA244V*	FA244HH*	N/A	N/A					23
FA244*		FA244V*	FA244HH*	MD803	MD803					24
FA244*		FA244V*	FA244HH*	N/A	N/A					25
FA244*		FA244V*	FA244HH*	N/A	N/A					26
FA181TT*		FA181V*	FA181HH*							27
FA181TT*		FA181V*	FA181HH*							28
			FA630HH*							29
			FA630HH*							30
FA209/2		FA209/2V	FA209/2HH	MD687						31
			FA335HH*	N/A	N/A					32
			FA447HH*	N/A	N/A					33
			FA447HH*	MD862X	MD862X					34
			FA447HH*	MD862X	MD862X					35
			FA447HH*							36
FA018*		FA018V*	FA018HH*	MD604LS	MD604RS					37
FA018*		FA018V*	FA018HH*	MD603LS	MD603RS					38
FA171*		FA171V*	FA171HH*	MD604LS	MD604RS					39
FA171*		FA171V*	FA171HH*	MD603LSⓉ	MD603RSⓉ					40
FA018*		FA018V*	FA018HH*	MD604LS	MD604RS					41
FA171*		FA171V*	FA171HH*	MD604LS	MD604RS					42
FA171*		FA171V*	FA171HH*	MD604LS	MD604RS					43
FA171*		FA171V*	FA171HH*	MD603LSⓉ	MD603RSⓉ					44
FA018*		FA018V*	FA018HH*	MD604LS	MD604RS					45
FA171*		FA171V*	FA171HH*	MD604LS	MD604RS					46
FA018*		FA018V*	FA018HH*	MD603LSⓉ	MD603RSⓉ					47
FA171*		FA171V*	FA171HH*	MD603LSⓉ	MD603RSⓉ					48
FA018*		FA018V*	FA018HH*	MD604LS	MD604RS					49
FA018*		FA018V*	FA018HH*	MD604LS	MD604RS					50
FA171*		FA171V*	FA171HH*	MD604LS	MD604RS					51
FA018*		FA018V*	FA018HH*	MD603LSⓉ	MD603RSⓉ					52
FA171*		FA171V*	FA171HH*	MD603LSⓉ	MD603RSⓉ					53
FA018*		FA018V*	FA018HH*	MD604LS	MD604RS					54
FA171*		FA171V*	FA171HH*	MD604LS	MD604RS					55
FA018*		FA018V*	FA018HH*	MD603LSⓉ	MD603RSⓉ					56
FA171*		FA171V*	FA171HH*	MD603LSⓉ	MD603RSⓉ					57
FA018*		FA018V*	FA018HH*	MD604LS	MD604RS					58
FA171*		FA171V*	FA171HH*	MD604LS	MD604RS					59

Ⓣ - Remove ABS ring from old rotor and refit to new EBC rotor. Ensure all mounting surfaces are clean and when refitting bolts use a thread lock cement to hold them in place.

*-2 Sets Required. † For Vee disc colours add RED, BLU, GRN, GLD, ORG suffix to part number.

Ⓣ - Also available as a Vintage Motorcycle Disc.

190 Part numbers, prefixes, suffixes, photos and illustrations shown in this catalogue are trademarks and/or copyrights of EBC Brakes or the trademark owner A C Freeman Investments Ltd and use without express written permission of the owners is punishable by law.

Non-JAPANESE Built Motorcycles

Line #	BRAKE DISC CHOICES - FRONT						DISC PAD CHOICES - REAR				BRAKE DISC CHOICES - REAR			
	Oversize 250 /280mm Disc Kit	OSX Oversize 250/280mm Disc Kit	Relocating Bracket for 250/ 280mm Disc	Oversize 320mm Disc Kit	SMX Oversize 320mm Disc Kit	Relocating Bracket for 320mm Disc	FA, SFA, TT Pad or Brake Shoe	SFAC Carbon Scooter Pads	Speciality Pads - SXR / Vee / MXS	Sintered/ HH Pads/ Grooved Shoes	Standard Replacement Disc	Contour Disc Rear fitment	Vee-Discs™ CONTOUR	CX Extreme MX Race Disc/ UTVX Disc
1														
2							FA213		FA213V	FA213HH	MD671			
3							FA213		FA213V	FA213HH	MD671			
4														
5							FA213		FA213V	FA213HH	MD651			
6														
7							FA213		FA213V	FA213HH	MD651			
8														
9							FA213		FA213V	FA213HH	MD651			
10							FA213		FA213V	FA213HH	MD671			
11							FA213		FA213V	FA213HH	MD671			
12							FA213		FA213V	FA213HH	MD671			
13							FA213		FA213V	FA213HH	MD671			
14							FA213		FA213V	FA213HH	MD671			
15							FA213		FA213V	FA213HH	MD671			
16							FA213		FA213V	FA213HH	MD671			
17							FA213		FA213V	FA213HH	MD671			
18							FA213		FA213V	FA213HH	MD671			
19							FA213		FA213V	FA213HH	MD671			
20							FA213		FA213V	FA213HH	MD671			
21							FA213		FA213V	FA213HH	MD671			
22							FA213		FA213V	FA213HH	MD671			
23							FA213		FA213V	FA213HH	MD671			
24							FA213		FA213V	FA213HH	MD671			
25							FA213		FA213V	FA213HH	MD671			
26							FA213		FA213V	FA213HH	MD671			
27							FA213		FA213V	FA213HH	MD671			
28							FA213		FA213V	FA213HH	MD671			
29							FA213		FA213V	FA213HH	MD671			
30							FA213		FA213V	FA213HH	MD671			
31							FA363		FA363V	FA363HH	MD671			
32							FA363		FA363V	FA363HH	MD671			
33							FA363		FA363V	FA363HH	MD671			
34							FA213		FA213V	FA213HH	MD832			
35							FA213		FA213V	FA213HH	MD832			
36							FA213		FA213V	FA213HH	MD832			
37							863							
38							861							
39							861							
40							FA018		FA018V	FA018HH	MD611Ⓞ			
41							861							
42							861							
43							FA018		FA018V	FA018HH	MD611			
44							FA018		FA018V	FA018HH	MD661Ⓞ			
45							FA018		FA018V	FA018HH	MD611			
46							FA018		FA018V	FA018HH	MD611			
47							FA018		FA018V	FA018HH	MD661Ⓞ			
48							FA018		FA018V	FA018HH	MD661Ⓞ			
49							FA018		FA018V	FA018HH	MD611			
50							FA018		FA018V	FA018HH	MD611			
51							FA018		FA018V	FA018HH	MD611			
52							FA018		FA018V	FA018HH	MD661Ⓞ			
53							FA018		FA018V	FA018HH	MD661Ⓞ			
54							FA018		FA018V	FA018HH	MD611			
55							FA018		FA018V	FA018HH	MD611			
56							FA018		FA018V	FA018HH	MD661Ⓞ			
57							FA018		FA018V	FA018HH	MD661Ⓞ			
58							FA018		FA018V	FA018HH	MD611			
59							FA018		FA018V	FA018HH	MD611			
60							FA018		FA018V	FA018HH	MD611			

REAR / ARRIÈRE / HINTEN / POSTERIOR / POSTERIORE

*-2 Sets Required. † For Vee disc colours add RED, BLU, GRN, GLD, ORG suffix to part number.

Ⓞ - Also available as a Vintage Motorcycle Disc.

R Suffix = High Durability Sintered Pad. HH Suffix = High Performance Sintered Pad. TT Suffix = Hard Wearing Off Road Pad. V Suffix = Semi Sintered Pad. G Suffix = Grooved Shoe.

D Suffix = Drilled Disc. X Suffix = Universal Left or Right Disc. XC Suffix = Contoured Disc. LS Suffix = Left/Steel Disc. RS = Right/Steel Disc.

BRAKE APPLICATIONS

Non-JAPANESE Built Motorcycles

APPLICATIONS

BRAKE



BMW Contd.



K100 RS (ABS Model - 8 valve)	83-09/88
K100 RS (ABS Model - 8 valve)	10/88-89
K100 RT (Non ABS - 8 valve)	83-09/88
K100 RT (Non ABS - 8 valve)	10/88-89
K100 RT (ABS - 8 valve)	83-09/88
K100 RT (ABS - 8 valve)	10/88-89
K100 RS (16 valve - Non ABS)	89-92
K100 RS (16 valve - ABS Models)	89-92
K1 (16 valve - Non ABS)	88-93
K1 (16 valve - ABS models)	88-93
K1100 LT (Non ABS)	89-07/93
K1100 LT (ABS Model)	89-07/93
K1100 LT (Non ABS)	08/93-99
K1100 LT (ABS Model)	08/93-99
K1100 RS (Non ABS Model)	92-96
K1100 RS (ABS Model)	92-96
K1200 RS (Non ABS & ABS Models)	96-00
K1200 RS (With & Without Integral ABS)	01-04
K1200 LT (Integral ABS & STD ABS Models)	97-10/00
K1200 LT	11/00-07
(Evo-Integral ABS/Disc Has Loose Bobbins)	
K1200 LT (Evo-Integral ABS/Disc Has Fixed Bobbins)	08-09
(Evo-Integral ABS/Disc Has Loose Bobbins)	
K1200 GT (2 pin rear pad K41) Disc has loose bobbins	03-06
K1200 GT (K44) Disc has fixed bobbins	06-08
Bike is fitted with pad wear sensors. These are not available from BMW. EBC Part No. for these are as follows (you will need to order 1 kit for the front RH pad and 1 kit for the rear pad set)	
K1200 R (K27/0378/Tokico Caliper	
- Disc has loose bobbins	11/05-11/07
K1200 R (K27/0378/Tokico Caliper	
- Disc has fixed bobbins	12/07-10
K1200 S (K40)	05-08
K1300 GT (Disc has fixed bobbins)	09-11
K1300 GT SE (Disc has fixed bobbins)	10-11
K1300 R (Disc has fixed bobbins)	09-12
K1300 R Carbon (Disc has fixed bobbins)	12
K1300 R Dynamic (Disc has fixed bobbins)	11-15
K1300 S (Fixed bobbins - Non and ABS Models)	09-15
K1300 S HP (Fixed bobbins - Non and ABS Models)	12
K1300 S Sport (Fixed bobbins - Non and ABS Models)	12-15
K1600 B Bagger	17-20
K1600 B Grand America	18-20
K1600 GT (Disc has fixed bobbins)	11-20
K1600 GTSE (Disc has fixed bobbins)	12-15
K1600 GT Sport (Disc has fixed bobbins)	15
K1600 GTL (Disc has fixed bobbins)	11-20
K1600 GTL-Exclusive (Disc has fixed bobbins)	13-16
R45/45 N (Single rotor with ATE caliper)	78-09/80
R45/45 N (Twin rotor with ATE caliper)	78-09/80
R45/45 N (Single rotor with ATE caliper)	10/80-85
R45/45 N (Twin rotor with ATE caliper)	10/80-85
R45/45 N (Single rotor with Brembo caliper)	78-09/80
R45/45 N (Twin rotor with Brembo caliper)	78-09/80
R45/45 N (Single rotor with Brembo caliper)	10/80-85
R45/45 N (Twin rotor with Brembo caliper)	10/80-85
R45 T	80-85
R50/5 / 60/5 / 60/6 / 75/5	69-76

FRONT / AVANT / VORN / FREITE / ANTERIORE

DISC PAD CHOICES - FRONT				BRAKE DISC CHOICES - FRONT						Line #
FA, SFA, TT Pad or Brake Shoe	SFAC Carbon Scooter Pads	Semi-Sintered V-Pads™	Sintered/HH Pads/Grooved Shoes	Left / Gauche / Links Standard Replacement Disc	Right / Droite / Rechts Standard Replacement Disc	Contour Disc Universal left and right fitment	Universal Custom Disc	Vee-Discs Black **See note below	CX Extreme MX Race Disc	Line #
FA018*		FA018V*	FA018HH*	MD603LSⓉ	MD603RSⓉ					1
FA171*		FA171V*	FA171HH*	MD603LSⓉ	MD603RSⓉ					2
FA018*		FA018V*	FA018HH*	MD604LS	MD604RS					3
FA171*		FA171V*	FA171HH*	MD604LS	MD604RS					4
FA018*		FA018V*	FA018HH*	MD603LSⓉ	MD603RSⓉ					5
FA171*		FA171V*	FA171HH*	MD603LSⓉ	MD603RSⓉ					6
FA407*			FA407HH*	MD607LS	MD607RS					7
FA407*			FA407HH*	MD607LSⓉ	MD607RSⓉ					8
FA407*			FA407HH*	MD607LS	MD607RS					9
FA407*			FA407HH*	MD607LSⓉ	MD607RSⓉ					10
FA407*			FA407HH*	MD607LS	MD607RS					11
FA407*			FA407HH*	MD607LSⓉ	MD607RSⓉ					12
FA407*			FA407HH*	MD607LS	MD607RS					13
FA407*			FA407HH*	MD607LSⓉ	MD607RSⓉ					14
FA407*			FA407HH*	MD607LS	MD607RS					15
FA407*			FA407HH*	MD607LSⓉ	MD607RSⓉ					16
FA407*			FA407HH*	MD652Ⓣ	MD652Ⓣ	MD652C*				17
			FA335HH*	MD620Ⓣ	MD620Ⓣ					18
FA407*			FA407HH*	MD652Ⓣ	MD652Ⓣ	MD652C*				19
			FA294HH*	MD616Ⓣ	MD616Ⓣ					20
										21
			FA294HH*	N/A	N/A					22
										23
			FA335HH*	MD620	MD620					24
			FA335HH*	N/A	N/A					25
										26
										27
										28
			MWL001							29
										30
			FA294HH*	MD616	MD616					31
										32
			FA294HH*	N/A	N/A					33
			FA335HH*	MD620	MD620					34
			FA335HH*	N/A	N/A					35
			FA335HH*	N/A	N/A					36
			FA294HH*	N/A	N/A					37
			FA294HH*	N/A	N/A					38
			FA294HH*	N/A	N/A					39
			FA335HH*	N/A	N/A					40
			FA335HH*	N/A	N/A					41
			FA335HH*	N/A	N/A					42
			FA613HH*							43
			FA613HH*							44
			FA613HH*	N/A	N/A					45
			FA613HH*	N/A	N/A					46
			FA613HH*	N/A	N/A					47
			FA613HH*	N/A	N/A					48
			FA613HH*	N/A	N/A					49
FA057		FA057V		MD606LS						50
FA057*		FA057V*		MD606LS	MD606RS					51
FA057		FA057V		MD606LS						52
FA057*		FA057V*		MD606LS	MD606RS					53
FA018		FA018V	FA018HH	MD606LS						54
FA018*		FA018V*	FA018HH*	MD606LS	MD606RS					55
FA018*		FA018V*	FA018HH*	MD606LS						56
FA018*		FA018V*	FA018HH*	MD606LS	MD606RS					57
FA057		FA057V		MD606LS						58
864										59

Ⓣ - Remove ABS ring from old rotor and refit to new EBC rotor. Ensure all mounting surfaces are clean and when refitting bolts use a thread lock cement to hold them in place.

*-2 Sets Required. † For Vee disc colours add RED, BLU, GRN, GLD, ORG suffix to part number.

Ⓣ - Also available as a Vintage Motorcycle Disc.

Non-JAPANESE Built Motorcycles

Line #	BRAKE DISC CHOICES - FRONT						DISC PAD CHOICES - REAR				BRAKE DISC CHOICES - REAR			
	Oversize 250 /280mm Disc Kit	OSX Oversize 250/280mm Disc Kit	Relocating Bracket for 250/ 280mm Disc	Oversize 320mm Disc Kit	SMX Oversize 320mm Disc Kit	Relocating Bracket for 320mm Disc	FA, SFA, TT Pad or Brake Shoe	SFAC Carbon Scooter Pads	Speciality Pads - SXR / Vee / MXS	Sintered/ HH Pads/ Grooved Shoes	Standard Replacement Disc	Contour Disc Rear fitment	Vee-Discs™ CONTOUR	CX Extreme MX Race Disc/ UTVX Disc
1							FA018		FA018V	FA018HH	MD661			
2							FA018		FA018V	FA018HH	MD661			
3							FA018		FA018V	FA018HH	MD611			
4							FA018		FA018V	FA018HH	MD661			
5							FA018		FA018V	FA018HH	MD661			
6							FA018		FA018V	FA018HH	MD661			
7							FA018		FA018V	FA018HH	MD611			
8							FA018		FA018V	FA018HH	MD661			
9							FA018		FA018V	FA018HH	MD611			
10							FA018		FA018V	FA018HH	MD661			
11							FA018		FA018V	FA018HH	MD611			
12							FA018		FA018V	FA018HH	MD661			
13							FA018		FA018V	FA018HH	MD661			
14							FA018		FA018V	FA018HH	MD661			
15							FA018		FA018V	FA018HH	MD661			
16							FA018		FA018V	FA018HH	MD661			
17							FA018		FA018V	FA018HH	MD661			
18							FA018		FA018V	FA018HH	MD661			
19							FA304		FA304V	FA304HH	MD615			
20							FA304		FA304V	FA304HH	MD615			
21														
22							FA304		FA304V	FA304HH	MD615			
23														
24							FA018		FA018V	FA018HH	MD661			
25									FA438HH	MD688				
26														
27														
28														
29									MWL002					
30														
31							FA671		FA671V	FA671HH	MD671			
32														
33							FA671		FA671V	FA671HH	MD671			
34							FA671		FA671V	FA671HH	MD671			
35							FA363		FA363V	FA363HH	MD688			
36							FA363		FA363V	FA363HH	MD688			
37							FA671		FA671V	FA671HH	MD671			
38							FA671		FA671V	FA671HH	MD671			
39							FA671		FA671V	FA671HH	MD671			
40							FA671		FA671V	FA671HH	MD671			
41							FA363		FA363V	FA363HH	MD671			
42							FA671		FA671V	FA671HH	MD671			
43							N/A		FA209/2V	FA209/2HH	TBA			
44							N/A		FA209/2V	FA209/2HH	TBA			
45							N/A		FA209/2V	FA209/2HH	TBA			
46							N/A		FA209/2V	FA209/2HH	TBA			
47							N/A		FA209/2V	FA209/2HH	TBA			
48							N/A		FA209/2V	FA209/2HH	TBA			
49							N/A		FA209/2V	FA209/2HH	TBA			
50							860							
51							860							
52							861							
53							861							
54							860							
55							860							
56							861							
57							861							
58							861							
59							860							
60														

REAR / ARRIÈRE / HINTEN / POSTERIOR / POSTERIORE

*-2 Sets Required. † For Vee disc colours add RED, BLU, GRN, GLD, ORG suffix to part number.

⊗ - Also available as a Vintage Motorcycle Disc.

R Suffix = High Durability Sintered Pad. HH Suffix = High Performance Sintered Pad. TT Suffix = Hard Wearing Off Road Pad. V Suffix = Semi Sintered Pad. G Suffix = Grooved Shoe.

D Suffix = Drilled Disc. X Suffix = Universal Left or Right Disc. XC Suffix = Contoured Disc. LS Suffix = Left/Steel Disc. RS = Right/Steel Disc.

Non-JAPANESE Built Motorcycles

APPLICATIONS

BRAKE



BMW Contd.



DISC PAD CHOICES - FRONT

BRAKE DISC CHOICES - FRONT

R60/7 (Single rotor)	76-80
R60/7 (Double rotor model)	76-80
R60 TIC (Single rotor)	78-82
R60 TIC (Double rotor model)	78-82
R65 (Single rotor)	07/88-08/89
R65 (Double rotor model)	07/88-08/89
R65 GS	87-92
R65 LS (ATE Caliper)	81-85
R65 LS (Brembo Caliper)	81-85
R65 T (Brembo Caliper)	80-85
R65 RT	85-88
R65 T (ATE caliper)	80-85
R75/6 (Single rotor) 75/7	73-79
R75/6 (Twin rotor) 75/7	73-79
R80 (Single rotor)	77-09/80
R80 (Double rotor)	77-09/80
R80 (Single rotor)	10/80-84
R80 (Double rotor)	10/80-84
R80/R 80 RT (Single rotor)	84-07/90
R80 RT (Double rotor)	82-84
R80/R 80 RT (Double rotor)	84-08/88
R80/R 80 RT (Single rotor)	08/90-95
R80/R 80 RT (Double rotor)	09/88-95
R80 GS	80-87
R80 GS	87-95
R80 PD/CH	90-95
R80 ST	82-84
R80 TIC	78-08/80
R80 TIC	09/80-85
R80 Mystic	94-95
R80 R	91-94
R850 C (Cast wheel/ABS)	97-00
R850 C (Spoke wheel/ABS)	97-00
R850 GS	96
R850 GS (Std & ABS models)	96-00
R850 R (Cast wheel/ABS)	94-02
R850 R (Spoke wheel)	94-05/96
R850 R	04-06
R850 RT (Cast wheel/ABS)	96-01
R850 RT (Spoke wheel)	96-01
R850 RT	06
R90 S	73-76
R90/6 (Single rotor)	73-76
R90/6 (Twin rotor)	73-76
R100 (Single rotor)	76-77
R100 (Twin rotor)	76-77
R100 GS	86-94
R100 PD	89-96
R100/7T (Single rotor)	77-09/80
R100/7T (Twin rotor)	77-09/80
R100/7T (Spoke wheel)	09/80-84
R100/7T (Cast wheel)	09/80-84
R100 S	76-80
R100 RS	76-09/80
R100 RS	10/80-84
R100 RS	86-08/88
R100 RS	09/88-08/89
R100 RS	90-9/92
R100 RT	78-09/80

FRONT / AVANT / VORN / FRENTE / ANTERIORE

FA, SFA, TT Pad or Brake Shoe	SFAC Carbon Scooter Pads	Speciality Pads - SXR / Vee / MXS	Sintered/HH Pads/ Grooved Shoes	Left / Gauche / Links Standard Replacement Disc	Right / Droite / Rechts Standard Replacement Disc	Contour Disc Universal left and right fitment	Universal Custom Disc	Vee-Discs Black † See note below	CX Extreme MX Race Disc/ UTVX Disc
FA022		FA022V		MD602LS					
FA022*		FA022V*		MD602LS	MD602RS				
FA022		FA022V		MD602LS					
FA022*		FA022V*		MD602LS	MD602RS				
FA077		FA077V		MD605LS					
FA018*		FA018V*	FA018HH*	MD605LS	MD605RS				
FA018		FA018V	FA018HH		MD606RS				
FA057*		FA057V*		MD606LS	MD606RS				
FA018*		FA018V*	FA018HH*	MD606LS	MD606RS				
FA018		FA018V	FA018HH	MD606LS					
FA018*		FA018V*	FA018HH*	MD605LS	MD605RS				
FA057		FA057V		MD606LS					
FA022		FA022V		MD602LS					
FA022*		FA022V*		MD602LS	MD602RS				
FA022		FA022V		MD602LS					
FA022*		FA022V*		MD602LS	MD602RS				
FA077		FA077V		MD605LS					
FA018*		FA018V*	FA018HH*	MD602LS	MD602RS				
FA018*		FA018V*	FA018HH*	MD605LS	MD605RS				
FA077		FA077V			MD605RS				
FA171*		FA171V*	FA171HH*	MD605LS	MD605RS				
FA018		FA018V	FA018HH		MD606RS				
FA077		FA077V			MD605RS				
FA077		FA077V			MD605RS				
FA018		FA018V	FA018HH		MD606RS				
FA022*		FA022V*		MD602LS	MD602RS				
FA018*		FA018V*	FA018HH*	MD602LS	MD602RS				
FA407*			FA407HH*	MD605LS	MD605RS				
FA407*			FA407HH*	MD605LS	MD605RS				
FA407*			FA407HH*	MD652⊗	MD652⊗	MD652C*			
FA407*			FA407HH*	MD652⊗	MD652⊗	MD652C*			
FA077		FA077V			MD605RS				
FA407*			FA407HH*	MD652⊗	MD652⊗	MD652C*			
FA407*			FA407HH*	MD607LS⊗	MD607RS⊗				
FA407*			FA407HH*	MD652	MD652	MD652C*			
FA294HH*			FA294HH*	MD616	MD616				
FA407*			FA407HH*	MD607LS⊗	MD607RS⊗				
FA407*			FA407HH*	MD652	MD652	MD652C*			
			FA335HH*	MD620	MD620				
FA022*		FA022V*		MD602LS	MD602RS				
FA022		FA022V		MD602LS					
FA022*		FA022V*		MD602LS	MD602RS				
FA022		FA022V		MD602LS					
FA022*		FA022V*		MD602LS	MD602RS				
FA077		FA077V			MD605RS				
FA077		FA077V			MD605RS				
FA022		FA022V		MD602LS					
FA022*		FA022V*		MD602LS	MD602RS				
FA018*		FA018V*	FA018HH*	MD606LS	MD606RS				
FA018*		FA018V*	FA018HH*	MD602LS	MD602RS				
FA022*		FA022V*		MD602LS	MD602RS				
FA022*		FA022V*		MD602LS	MD602RS				
FA018*		FA018V*	FA018HH*	MD602LS	MD602RS				
FA018*		FA018V*	FA018HH*	MD605LS	MD605RS				
FA171*		FA171V*	FA171HH*	MD605LS	MD605RS				
FA171*		FA171V*	FA171HH*	MD605LS	MD605RS				
FA022*		FA022V*		MD602LS	MD602RS				

Line #
1
2
3
4
5
6
7
8
9
10
11
12
13
14
15
16
17
18
19
20
21
22
23
24
25
26
27
28
29
30
31
32
33
34
35
36
37
38
39
40
41
42
43
44
45
46
47
48
49
50
51
52
53
54
55
56
57
58
59
60

R Suffix = High Durability Sintered Pad. HH Suffix = High Performance Sintered Pad. TT Suffix = Hard Wearing Off Road Pad. V Suffix = Semi Sintered Pad. G Suffix = Grooved Shoe.

D Suffix = Drilled Disc. X Suffix = Universal Left or Right Disc. XC Suffix = Contoured Disc. LS Suffix = Left/Steel Disc. RS Suffix = Right/Steel Disc.

⊗ - Remove ABS ring from old rotor and refit to new EBC rotor. Note: Ensure all mounting surfaces are clean and when refitting bolts use a thread lock cement to hold them in place.

*-2 Sets Required. † For Vee disc colours add RED, BLU, GRN, GLD, ORG suffix to part number.

⊗ - Also available as a Vintage Motorcycle Disc.

Non-JAPANESE Built Motorcycles

Line #	BRAKE DISC CHOICES - FRONT						DISC PAD CHOICES - REAR				BRAKE DISC CHOICES - REAR			
	Oversize 250 /280mm Disc Kit	OSX Oversize 250/280mm Disc Kit	Relocating Bracket for 250/ 280mm Disc	Oversize 320mm Disc Kit	SMX Oversize 320mm Disc Kit	Relocating Bracket for 320mm Disc	FA, SFA, TT Pad or Brake Shoe	SFAC Carbon Scooter Pads	Speciality Pads - SXR / Vee / MXS	Sintered/ HH Pads/ Grooved Shoes	Standard Replacement Disc	Contour Disc Rear fitment	Vee-Discs™ CONTOUR	CX Extreme MX Race Disc/ UTVX Disc
1							860							
2							860							
3							860							
4							860							
5							861							
6							861							
7							861							
8							862							
9							862							
10							861							
11							861							
12							861							
13							860							
14							860							
15							860							
16							860							
17							861							
18							861							
19							861							
20							861							
21							861							
22							861							
23							859							
24							861							
25							859							
26							859							
27							861							
28							860							
29							861							
30							859							
31							859							
32							FA363	FA363V	FA363HH	N/A				
33							FA363	FA363V	FA363HH	N/A				
34							859							
35							FA363	FA363V	FA363HH	MD653Ⓢ	MD653C			
36							FA363	FA363V	FA363HH	MD653Ⓢ				
37							FA363	FA363V	FA363HH	MD653	MD653C			
38							FA363	FA363V	FA363HH	MD653				
39							FA363	FA363V	FA363HH	MD653Ⓢ				
40							FA363	FA363V	FA363HH	MD653	MD653C			
41							FA363	FA363V	FA363HH	MD653				
42							860							
43							860							
44							860							
45							860							
46							860							
47							859							
48							859							
49							860							
50							860							
51							861							
52							861							
53							860							
54							860							
55							FA018	FA018V	FA018HH	MD602LS				
56							861							
57							861							
58							859							
59							860							

REAR / ARRIÈRE / HINTEN / POSTERIOR / POSTERIORE

*-2 Sets Required. † For Vee disc colours add RED, BLU, GRN, GLD, ORG suffix to part number.

Ⓢ - Also available as a Vintage Motorcycle Disc.

R Suffix = High Durability Sintered Pad. HH Suffix = High Performance Sintered Pad. TT Suffix = Hard Wearing Off Road Pad. V Suffix = Semi Sintered Pad. G Suffix = Grooved Shoe. D Suffix = Drilled Disc. X Suffix = Universal Left or Right Disc. XC Suffix = Contoured Disc. LS Suffix = Left/Steel Disc. RS = Right/Steel Disc.

Non-JAPANESE Built Motorcycles

APPLICATIONS

BRAKE



BMW Contd.

R100 RT	10/80-84
R100 RT	87-08/88
R100 RT	09/88-08/89
R100 RT	09/89-95
R100 Mystic	93-96
R100 R	91-95
R1100 GS (STD & ABS)	93-99
R1100 R (Spoke wheel)	93-05/96
R1100 R (Spoke wheel)	06/96
R1100 R (Cast wheel)	93-01
R1100 RS	92-01
R1100 S (ABS)	96-11/00
R1100 S (With integral ABS)	12/00-06
R1100 S (Without integral ABS)	12/00-03
R1100 RT (Cast wheel/ABS)	94-01
R1100 RT (Spoke wheel)	94-01
R1150 GS (R21/0415/0495)	98-10/01
R1150 GS (Evo R21/0415/0495)	11/01-03
R1150 GS-Adventure (Evo R21A 0441/0492)	07/01-06
R1150 R	01-06
R1150 RS (Integral ABS)	01-04
R1150 RT (Integral ABS)	00-06
R1150 R Rockster	03-06
R1150 R Rockster Edition 80	04
R Nine T (K21/1170cc)	14-20
R Nine T Pure (K22/1170cc)	16-20
R Nine T Scrambler (K21/1170cc)	16-20
R Nine T Café Racer (K32/1170cc)	16-20
R Nine T Urban GS (K33/1170cc)	17-20
R1200 (Independence/Cast Wheel)	00-02
R1200 (Independence/Spoke Wheel)	00-02
R1200 C (Cast Wheel/ABS)	96-02
R1200 C (Spoke Wheel/ABS)	96-02
R1200 C Independent (Cast Wheel)	03-04
R1200 C Montauk	04
R1200 C Classic	03-04
R1200 CL	02-04
R1200 GS (K25/0307) (Discs have loose bobbins)	02-11/07
R1200 GS Adventure (K25/0382/Spoke Wheel)	
(Disc has fixed bobbins)	05-11/07
R1200 GS Adventure/M (K25/0380/Spoke wheel)	
(Disc has fixed bobbins)	06-09
R1200 GS/M (K25/0303 Cast/Spoke wheel)	
(Disc has fixed bobbins)	06-09
R1200 GS (Cast wheels/Disc has fixed bobbins)	10-11
R1200 GS (30 Years GS/Spoke wheels	
/Disc has fixed bobbins)	11
R1200 GS (Triple Black/Spoke wheels	
/Disc has fixed bobbins)	11-13
R1200 GS Adventure (Spoke wheels	
/Disc has fixed bobbins)	10-13
R1200 GS Adventure (30 Years GS/Spoke wheels	
/Disc has fixed bobbins)	11
R1200 GS Adventure	
(Triple Black/Disc has fixed bobbins)	12
R1200 GS Rallye (Disc has fixed bobbins)	12
R1200 GS (K50/Liquid Cooled/Radial Calipers)	13-18
R1200 GS Adventure (K51/Inc TE/XE Models	
/LC/Radial Calipers)	14-18

DISC PAD CHOICES - FRONT				BRAKE DISC CHOICES - FRONT						Line #
FA, SFA, TT Pad or Brake Shoe	SFAC Carbon Scooter Pads	Speciality Pads SXR / Vee / MXS	Sintered/HH Pads/ Grooved Shoes	Left / Gauche / Links Standard Replacement Disc	Right / Droite / Rechts Standard Replacement Disc	Contour Disc Universal left and right fitment	Universal Custom Disc	Vee-Discs Black † See note below	CX Extreme MX Race Disc/ UTVX Disc	Line #
FA018*		FA018V*	FA018HH*	MD602LS	MD602RS					1
FA018*		FA018V*	FA018HH*	MD605LS	MD605RS					2
FA171*		FA171V*	FA171HH*	MD605LS	MD605RS					3
FA171*		FA171V*	FA171HH*	MD605LS	MD605RS					4
FA407*			FA407HH*	MD605LS	MD605RS					5
FA407*			FA407HH*	MD605LS	MD605RS					6
FA407*			FA407HH*	MD652	MD652	MD652C*				7
FA407*			FA407HH*	MD652	MD652	MD652C*				8
FA407*			FA407HH*	MD652	MD652	MD652C*				9
FA407*			FA407HH*	MD607LS	MD607RS					10
FA407*			FA407HH*	MD607LS	MD607RS					11
FA407*			FA407HH*	MD652	MD652	MD652C*				12
			FA294HH*	MD616	MD616					13
			FA335HH*	MD803	MD803					14
FA407*			FA407HH*	MD607LS	MD607RS					15
FA407*			FA407HH*	MD652	MD652	MD652C*				16
FA407*			FA407HH*	MD652	MD652	MD652C*				17
			FA294HH*	MD652	MD652	MD652C*				18
			FA294HH*	MD652	MD652	MD652C*				19
			FA294HH*	MD616	MD616					20
			FA294HH*	MD616	MD616					21
			FA335HH*	MD620	MD620					22
			FA294HH*	MD616	MD616					23
			FA294HH*	MD616	MD616					24
			FA630HH*	N/A	N/A					25
FA244*		FA244V*	FA244HH*							26
FA244*		FA244V*	FA244HH*							27
FA244*		FA244V*	FA244HH*							28
FA244*		FA244V*	FA244HH*							29
FA407*			FA407HH*	MD652	MD652	MD652C*				30
FA407*			FA407HH*	MD652	MD652	MD652C*				31
FA407*			FA407HH*	MD652	MD652	MD652C*				32
FA407*			FA407HH*	MD652	MD652	MD652C*				33
			FA294HH*	MD652	MD652	MD652C*				34
			FA294HH*	MD652	MD652	MD652C*				35
			FA294HH*	MD652	MD652	MD652C*				36
			FA294HH*	MD652	MD652	MD652C*				37
			FA335HH*	MD687	MD687					38
										39
			FA335HH*	MD687	MD687					40
										41
			FA335HH*	MD687	MD687					42
										43
			FA335HH*	MD687	MD687					44
			FA335HH*	MD687	MD687					45
										46
			FA335HH*	MD687	MD687					47
										48
			FA335HH*	MD687	MD687					49
										50
			FA335HH*	MD687	MD687					51
										52
			FA335HH*	MD687	MD687					53
										54
			FA335HH*	MD687	MD687					55
			FA335HH*	MD687	MD687					56
			FA630HH*	MD687	MD687					57
										58
			FA630HH*	MD687	MD687					59

FRONT / AVANT / VORN / FRENTE / ANTERIORE

R Suffix = High Durability Sintered Pad. HH Suffix = High Performance Sintered Pad. TT Suffix = Hard Wearing Off Road Pad. V Suffix = Semi Sintered Pad. G Suffix = Grooved Shoe.

D Suffix = Drilled Disc. X Suffix = Universal Left or Right Disc. XC Suffix = Contoured Disc. LS Suffix = Left/Steel Disc. RS = Right/Steel Disc.

⊙ - Remove ABS ring from old rotor and refit to new EBC rotor. Note: Ensure all mounting surfaces are clean and when refitting bolts use a thread lock cement to hold them in place.

*-2 Sets Required. † For Vee disc colours add RED, BLU, GRN, GLD, ORG suffix to part number.

⊙ - Also available as a Vintage Motorcycle Disc.

Non-JAPANESE Built Motorcycles

Line #	BRAKE DISC CHOICES - FRONT						DISC PAD CHOICES - REAR				BRAKE DISC CHOICES - REAR			
	Oversize 250 /280mm Disc Kit	OSX Oversize 250/280mm Disc Kit	Relocating Bracket for 250/ 280mm Disc	Oversize 320mm Disc Kit	SMX Oversize 320mm Disc Kit	Relocating Bracket for 320mm Disc	FA, SFA, TT Pad or Brake Shoe	SFAC Carbon Scooter Pads	Speciality Pads - SXR / Vee / MXS	Sintered/ HH Pads/ Grooved Shoes	Standard Replacement Disc	Contour Disc Rear fitment	Vee-Discs™ CONTOUR	CX Extreme MX Race Disc/ UTVX Disc
1							FA018		FA018V	FA018HH	MD602LS			
2							861							
3							861							
4							859							
5							859							
6							859							
7							FA363		FA363V	FA363HH	MD653Ⓞ	MD653C		
8							FA363		FA363V	FA363HH	MD653	MD653C		
9							FA363		FA363V	FA363HH	MD653	MD653C		
10							FA363		FA363V	FA363HH	MD653Ⓢ			
11							FA018		FA018V	FA018HH	MD661			
12							FA363		FA363V	FA363HH	MD653	MD653C		
13							FA363		FA363V	FA363HH	MD653Ⓞ			
14							FA363		FA363V	FA363HH	MD653			
15							FA363		FA363V	FA363HH	MD653Ⓞ			
16							FA363		FA363V	FA363HH	MD653	MD653C		
17							FA363		FA363V	FA363HH	MD653Ⓞ	MD653C		
18							FA363		FA363V	FA363HH	MD653Ⓞ	MD653C		
19							FA363		FA363V	FA363HH	MD653Ⓞ	MD653C		
20							FA363		FA363V	FA363HH	MD653			
21							FA363		FA363V	FA363HH	MD653Ⓞ			
22							FA363		FA363V	FA363HH	MD653Ⓞ			
23							FA363		FA363V	FA363HH	MD653			
24							FA363		FA363V	FA363HH	MD653			
25							FA363		FA363V	FA363HH	MD671			
26							FA363		FA363V	FA363HH	MD671			
27							FA363		FA363V	FA363HH	MD671			
28							FA363		FA363V	FA363HH	MD671			
29							FA363		FA363V	FA363HH	MD671			
30							FA363		FA363V	FA363HH	N/A			
31							FA363		FA363V	FA363HH	N/A			
32							FA363		FA363V	FA363HH	N/A			
33							FA363		FA363V	FA363HH	N/A			
34							FA363		FA363V	FA363HH	N/A			
35							FA363		FA363V	FA363HH	N/A			
36							FA363		FA363V	FA363HH	N/A			
37							FA304		FA304V	FA304HH	MD615Ⓞ			
38							FA363			FA363HH	MD671			
39														
40							FA363			FA363HH	MD671			
41														
42							FA363			FA363HH	MD671			
43														
44							FA363			FA363HH	MD671			
45							FA363			FA363HH	MD671			
46														
47							FA363			FA363HH	MD671			
48														
49							FA363			FA363HH	MD671			
50														
51							FA363			FA363HH	MD671			
52														
53							FA363			FA363HH	MD671			
54														
55							FA363			FA363HH	MD671			
56							FA363			FA363HH	MD671			
57							N/A			FA209/2HH	MD8001			
58														
59							N/A			FA209/2HH	MD8001			
60														

REAR / ARRIÈRE / HINTEN / POSTERIOR / POSTERIORE

*-2 Sets Required. † For Vee disc colours add RED, BLU, GRN, GLD, ORG suffix to part number.

Ⓞ - Also available as a Vintage Motorcycle Disc.

R Suffix = High Durability Sintered Pad. HH Suffix = High Performance Sintered Pad. TT Suffix = Hard Wearing Off Road Pad. V Suffix = Semi Sintered Pad. G Suffix = Grooved Shoe.

D Suffix = Drilled Disc. X Suffix = Universal Left or Right Disc. XC Suffix = Contoured Disc. LS Suffix = Left/Steel Disc. RS = Right/Steel Disc.

Non-JAPANESE Built Motorcycles

APPLICATIONS

BRAKE



BMW Contd.

R1200 RS (Disc has fixed bobbins)	15-18
R1200 RS Sport (Disc has fixed bobbins)	15-18
R1200 RT (K26/0368) (Brembo caliper)	
/Disc has loose buttons)	05-11/07
R1200 RT (K26/0368) (Disc has fixed bobbins)	12/07-09
R1200 RT (Disc has fixed bobbins)	10-13
R1200 RT-SE (Disc has fixed bobbins)	10-13
R1200 RT (K52/LC/Radial Calipers)	14-18
R1200 ST (K28/0328) (Disc has loose bobbins)	03-11/07
R1200 ST (K28/0328) (Disc has fixed bobbins)	12/07-08
R1200 S (K29/0366) (Disc has loose bobbins)	06-11/07
R1200 S (K29/0366) (Disc has fixed bobbins)	12/07-08
R1200 R (K27/0378) (Disc has loose bobbins)	06-07
R1200 R (K27/0378) (Disc has fixed bobbins)	12/07-14
R1200 R Classic (Disc has fixed bobbins)	11-14
R1200 R (Disc has fixed bobbins)	15-18
R1200 R SE (Disc has fixed bobbins)	10-11
R1200 R Sport (Disc has fixed bobbins)	15-18
R1250 GS (Disc has fixed bobbins)	19-20
R 1250 GS TE (Disc has fixed bobbins)	19-20
R 1250 GS Exclusive TE (Disc has fixed bobbins)	19-20
R 1250 GS Rallye (Disc has fixed bobbins)	19-20
R 1250 GS Rallye TE (Disc has fixed bobbins)	19-20
R 1250 RT (Disc has fixed bobbins)	19-20
R 1250 RT SE (Disc has fixed bobbins)	19-20
R 1250 RT LE (Disc has fixed bobbins)	19-20
S1000 R Naked (K47)	14-18
S1000 RR (K46) (Disc has fixed bobbins)	10-18
S1000 R/RR (Models fitted)	
with Forged race wheels - 7 Spoke type)	10-18
S1000 XR (Disc has fixed bobbins)	15-18
S1000 XR	19-20
S1000 R	18-20
S1000 RR/RR Sport/RR M Sport	18-20

BOMBARDIER/BRP (See Can-Am For 2007 Models)

DS 50 (2 stroke)	02-06
Quest 50	03-04
DS 90 (2 stroke/4 stroke)	02-06
DS 250	06
Quest 90 (2 stroke/4 stroke)	03-04
Rally 200 (7550/7551/7552/7553)	03-04
Rally 200	05-07
Outlander 330 HO	Left 04-05
	Right
Outlander 400 (7535/7716)	Left 03-04
	Right
Outlander 400 Max HO	Left 03-06
	Right
Outlander 650 HO Efi 4x4/HO Efi XT 4x4	Left 06
	Right
Outlander Max 650 HO Efi 4x4/HO Efi XT 4x4	Left 06
	Right
Outlander 800 (All models)	Left 06
	Right
Traxter (4x4) (Model types 7400-7408 /7413-7422/7425-7428/7455/7456)	99-00
Traxter (4x4) (Model types 7459/7460)	Left 01
	Right

FA, SFA, TT Pad or Brake Shoe	SFAC Carbon Scooter Pads	Speciality Pads SXR / Vee / MXS	Sintered/HH Pads/ Grooved Shoes	BRAKE DISC CHOICES - FRONT						Line #
				Left / Gauche / Links Standard Replacement Disc	Right / Droite / Rechts Standard Replacement Disc	Contour Disc Universal left and right fitment	Universal Custom Disc	Vee-Discs Black † See note below	CX Extreme MX Race Disc/ UTVX Disc	
			FA630HH*	MD687	MD687					1
			FA630HH*	MD687	MD687					2
										3
			FA335HH*	MD803	MD803					4
			FA335HH*	N/A	N/A					5
			FA335HH*	N/A	N/A					6
			FA335HH*	N/A	N/A					7
			FA335HH*	N/A	N/A					8
			FA335HH*	MD803	MD803					9
			FA335HH*	N/A	N/A					10
			FA335HH*	MD803	MD803					11
			FA335HH*	N/A	N/A					12
			FA294HH*	MD804	MD804					13
			FA294HH*	N/A	N/A					14
			FA294HH*	N/A	N/A					15
			FA294HH*	N/A	N/A					16
			FA294HH*	N/A	N/A					17
			FA630HH*	N/A	N/A					18
			FA294HH*	N/A	N/A					19
			FA724HH*	MD687	MD687					20
			FA724HH*	MD687	MD687					21
			FA724HH*	MD687	MD687					22
			FA724HH*	MD687	MD687					23
			FA724HH*	MD687	MD687					24
			FA724HH*	MD687	MD687					25
			FA724HH*	MD687	MD687					26
			FA604/4HH*	MD804	MD804					27
			FA604/4HH*	MD804	MD804					28
										29
			FA604/4HH*	MD862X	MD862X					30
			FA630HH*	N/A	N/A					31
			FA724HH*							32
			FA724HH*							33
			FA724HH*							34
			FA724HH*							35
										36
										37
		H346*	H346G*							38
		H346*	H346G*							39
		H346*	H346G*							40
		FA377TT*	FA377R*	MD6283D	MD6283D					41
		H346*	H346G*							42
		FA083TT*	FA083R*	MD6220D	MD6220D					43
		FA083TT*	FA083R*	MD6220D	MD6220D					44
		FA307TT	FA307R	MD6222D	MD6222D					45
		FA317TT	FA317R							46
		FA307TT	FA307R	MD6222D	MD6222D					47
		FA317TT	FA317R							48
		FA307TT	FA307R	MD6222D	MD6222D					49
		FA317TT	FA317R							50
		FA307TT	FA307R	MD6222D	MD6222D					51
		FA317TT	FA317R							52
		FA307TT	FA307R	MD6222D	MD6222D					53
		FA317TT	FA317R							54
		FA307TT	FA307R	MD6222D	MD6222D					55
		FA317TT	FA317R							56
		FA266	FA266R	MD6229D	MD6229D					57
		FA307TT	FA307R	MD6229D	MD6229D					58
		FA317TT	FA317R							59
										60

*-2 Sets Required. † For Vee disc colours add RED, BLU, GRN, GLD, ORG suffix to part number.

⊗ - Also available as a Vintage Motorcycle Disc.

198 Part numbers, prefixes, suffixes, photos and illustrations shown in this catalogue are trademarks and/or copyrights of EBC Brakes or the trademark owner A C Freeman Investments Ltd and use without express written permission of the owners is punishable by law.

Non-JAPANESE Built Motorcycles

Line #	BRAKE DISC CHOICES - FRONT						DISC PAD CHOICES - REAR				BRAKE DISC CHOICES - REAR			
	Oversize 250 /280mm Disc Kit	OSX Oversize 250/280mm Disc Kit	Relocating Bracket for 250/ 280mm Disc	Oversize 320mm Disc Kit	SMX Oversize 320mm Disc Kit	Relocating Bracket for 320mm Disc	FA, SFA, TT Pad or Brake Shoe	SFAC Carbon Scooter Pads	Speciality Pads - SXR / Vee / MXS	Sintered/ HH Pads/ Grooved Shoes	Standard Replacement Disc	Contour Disc Rear fitment	Vee-Discs™ CONTOUR	CX Extreme MX Race Disc/ UTVX Disc
1									FA209/2HH	MD8001				
2									FA209/2HH	MD8001				
3														
4							FA363	FA363V	FA363HH	MD671				
5							FA363	FA363V	FA363HH	MD671				
6							FA363	FA363V	FA363HH	MD671				
7							FA363	FA363V	FA363HH	MD671				
8							N/A	FA209/2V	FA209/2HH	MD8001				
9							FA363	FA363V	FA363HH	MD671				
10							FA363	FA363V	FA363HH	MD671				
11							FA363	FA363V	FA363HH	MD671				
12							FA363	FA363V	FA363HH	MD671				
13							FA363	FA363V	FA363HH	MD671				
14							FA363	FA363V	FA363HH	MD671				
15							FA363	FA363V	FA363HH	MD671				
16								FA209/2V	FA209/2HH	MD8001				
17							FA363	FA363V	FA363HH	MD671				
18								FA209/2V	FA209/2HH	MD8001				
19									FA209/2HH	MD8001				
20									FA209/2HH	MD8001				
21									FA209/2HH	MD8001				
22									FA209/2HH	MD8001				
23									FA209/2HH	MD8001				
24									FA209/2HH	MD8001				
25									FA209/2HH	MD8001				
26									FA209/2HH	MD8001				
27							FA213		FA213HH	MD832				
28							FA213		FA213HH	MD832				
29														
30							FA213		FA213HH	MD832				
31							FA363		FA363HH	MD671				
32							FA363		FA363HH	MD671				
33							FA213		FA213HH	MD832				
34							FA213		FA213HH	MD832				
35														
36														
37														
38							H330		H330G					
39							H330		H330G					
40							H330		H330G					
41							FA377TT		FA377R	MD6282D				
42							H330		H330G					
43							N/A			MD6221D				
44							FA165/2TT		FA165/2R	MD6285D				
45							FA307TT		FA307R	MD6223D				
46														
47							FA307TT		FA307R	MD6223D				
48														
49							FA307TT		FA307R	MD6223D				
50														
51							FA307TT		FA307R	MD6223D				
52														
53							FA307TT		FA307R	MD6223D				
54														
55							FA307TT		FA307R	MD6223D				
56														
57														
58							FA266		FA266R	MD6230D				
59							FA307TT		FA307R	MD6230D				
60														

REAR / ARRIÈRE / HINTEN / POSTERIOR / POSTERIORE

*-2 Sets Required. † For Vee disc colours add RED, BLU, GRN, GLD, ORG suffix to part number.

⊗ - Also available as a Vintage Motorcycle Disc.

R Suffix = High Durability Sintered Pad. **HH** Suffix = High Performance Sintered Pad. **TT** Suffix = Hard Wearing Off Road Pad. **V** Suffix = Semi Sintered Pad. **G** Suffix = Grooved Shoe.
D Suffix = Drilled Disc. **X** Suffix = Universal Left or Right Disc. **XC** Suffix = Contoured Disc. **LS** Suffix = Left/Steel Disc. **RS** = Right/Steel Disc.

Part numbers, prefixes, suffixes, photos and illustrations shown in this catalogue are trademarks and/or copyrights of EBC Brakes or the trademark owner A C Freeman Investments Ltd and use without express written permission of the owners is punishable by law.

Non-JAPANESE Built Motorcycles

APPLICATIONS

BRAKE



BOMBARDIER/BRP Contd.



Model	Side	Part No.
Traxter Auto Std/XL	Left	04
	Right	
Traxter CVT (500/650/650XT)	Left	05
	Right	
Traxter Max Std/XT	Left	04-05
	Right	
Traxter Max CVT 650	Left	05
	Right	
Traxter Max	Left	03-05
	Right	
Traxter XL (4x4) Up to SN V000708 (Model type 7448)		01
Traxter XL (4x4) (Model types 7448 from SN V000709/7458/7477/7489/7565/7571)	Left	01-04
	Right	
Traxter XL	Left	04-05
	Right	
Traxter XT (4x4) (Model types 7423/7424)		00
Traxter XT (4x4) (Model types 7446/7452 /7467/7468/7472/7481/7493/7494)	Left	01
	Right	
Traxter XT	Left	05
	Right	
Traxter Autoshift (Model types 7431/7432/7433/7434)		01
Traxter Autoshift (Model types 7453/7454/7461/7462/7469/7470/7471 /7475/7480/7495/7496/7497/7560/7561/7562/7563/7564/7566 /7567/7568/7569/7570/7595/7596/ 7597/7598/7599)	Left	01-05
	Right	
Traxter Footshift (Model types 7439/7440/7441/7442)		01
Traxter Footshift (Model types 7473/7474)	Left	01
	Right	
Traxter 5 Speed	Left	05
	Right	
Quest 500 (4x4) (Model types 7478/7515/7525/7539 /7540/7546/7547/7583/7584 /7713/7724/7725/7731)	Left	02-04
	Right	
Quest 500 (2x4) (Model types 7541/7542/7548/7549 /7585/7586/7714/7726)	Left	02
	Right	
Quest 650 (2x4) (Model type 7582)	Left	02
Quest 650 (2x4) (Model type 7582)	Right	
Quest 650 (4x4) (Model types 7443/7445/7516/7517 /7523/7536/7537/7543/7544/7580 /7581/7730)	Left	02-04
	Right	
Quest 650 XT (4x4) (Model types 7522/7523/7534 /7545/7715/7727/7728)	Left	02
	Right	
Quest Max 650	Left	03-
	Right	
DS 650 (Model types 7404/7409/7463/ 7482/7518/7519/7587/7588-7483)	Left	00-05
	Right	
DS 650 Baja/X	Left	01-06
	Right	
Traxter Max 650	Left	04-05
	Right	
Sarasota 1000 Side x Side		05
Traxter XL (7920/7921)	Left	04
	Right	
Quest Max/STD/XT	Left	04
	Right	

FA, SFA, TT Pad or Brake Shoe	SFAC Carbon Scooter Pads	Speciality Pads SXR / Vee / MXS	Sintered/ HH Pads/ Grooved Shoes	DISC PAD CHOICES - FRONT		BRAKE DISC CHOICES - FRONT					Line #
				Left / Gauche / Links Standard Replacement Disc	Right / Droite / Rechts Standard Replacement Disc	Contour Disc Universal left and right fitment	Universal Custom Disc	Vee-Discs Black † See note below	CX Extreme MX Race Disc/ UTVX Disc		
FA307TT			FA307R	MD6245D	MD6245D						1
FA317TT			FA317R								2
FA307TT			FA307R	MD6245D	MD6245D						3
FA317TT			FA317R								4
FA307TT			FA307R	MD6245D	MD6245D						5
FA317TT			FA317R								6
FA307TT			FA307R	MD6245D	MD6245D						7
FA317TT			FA317R								8
FA307TT			FA307R	MD6245D	MD6245D						9
FA317TT			FA317R								10
FA266		FA266V	FA266R	MD6229D	MD6229D						11
FA307TT			FA307R	MD6229D	MD6229D						12
FA317TT			FA317R								13
FA307TT			FA307R	MD6245D	MD6245D						14
FA317TT			FA317R								15
FA266		FA266V	FA266R	MD6229D	MD6229D						16
FA307TT			FA307R	MD6229D	MD6229D						17
FA317TT			FA317R								18
FA307TT			FA307R	MD6245D	MD6245D						19
FA317TT			FA317R								20
FA266		FA266V	FA266R	MD6229D	MD6229D						21
											22
											23
FA307TT			FA307R	MD6225D	MD6225D						24
FA317TT			FA317R								25
FA266		FA266V	FA266R	MD6229D	MD6229D						26
FA307TT			FA307R	MD6229D	MD6229D						27
FA317TT			FA317R								28
FA307TT			FA307R	MD6245D	MD6245D						29
FA317TT			FA317R								30
											31
FA307TT			FA307R	MD6224D	MD6224D						32
FA317TT			FA317R								33
											34
FA307TT			FA307R	MD6224D	MD6224D						35
FA317TT			FA317R								36
FA307TT			FA307R	MD6224D	MD6224D						37
FA317TT			FA317R								38
											39
FA307TT			FA307R	MD6224D	MD6224D						40
FA317TT			FA317R								41
											42
FA307TT			FA307R	MD6224D	MD6224D						43
FA317TT			FA317R								44
FA307TT			FA307R	MD6224D	MD6224D						45
FA317TT			FA317R								46
FA307TT			FA307R	MD6171D	MD6171D						47
FA317TT			FA317R								48
FA307TT			FA307R	MD6171D	MD6171D						49
FA317TT			FA317R								50
FA307TT			FA307R	MD6245D	MD6245D						51
FA317TT			FA317R								52
N/A											53
FA307TT			FA307R	MD6245D	MD6245D						54
FA317TT			FA317R								55
FA307TT			FA307R	MD6245D	MD6245D						56
FA317TT			FA317R								57
											58
											59
											60

FRONT / AVANT / VORN / FREITE / ANTERIORE

R Suffix = High Durability Sintered Pad. HH Suffix = High Performance Sintered Pad. TT Suffix = Hard Wearing Off Road Pad. V Suffix = Semi Sintered Pad. G Suffix = Grooved Shoe.
D Suffix = Drilled Disc. X Suffix = Universal Left or Right Disc. XC Suffix = Contoured Disc. LS Suffix = Left/Steel Disc. RS = Right/Steel Disc.

*-2 Sets Required. † For Vee disc colours add RED, BLU, GRN, GLD, ORG suffix to part number.
⊗ - Also available as a Vintage Motorcycle Disc.

Non-JAPANESE Built Motorcycles

Line #	BRAKE DISC CHOICES - FRONT						DISC PAD CHOICES - REAR				BRAKE DISC CHOICES - REAR			
	Oversize 250 /280mm Disc Kit	OSX Oversize 250/280mm Disc Kit	Relocating Bracket for 250/ 280mm Disc	Oversize 320mm Disc Kit	SMX Oversize 320mm Disc Kit	Relocating Bracket for 320mm Disc	FA, SFA, TT Pad or Brake Shoe	SFAC Carbon Scooter Pads	Speciality Pads - SXR / Vee / MXS	Sintered/ HH Pads/ Grooved Shoes	Standard Replacement Disc	Contour Disc Rear fitment	Vee-Discs™ CONTOUR	CX Extreme MX Race Disc/ UTVX Disc
1							FA317TT			FA317R	MD6225D			
2														
3							FA317TT			FA317R	MD6225D			
4														
5							FA317TT			FA317R	MD6225D			
6														
7							FA317TT			FA317R	MD6225D			
8														
9							FA317TT			FA317R	MD6225D			
10														
11							FA266	FA266V	FA266R	MD6230D				
12							FA317TT			FA317R	MD6230D			
13														
14							FA317TT			FA317R	MD6225D			
15														
16							FA266	FA266V	FA266R	MD6230D				
17							FA317TT			FA317R	MD6230D			
18														
19							FA317TT			FA317R	MD6225D			
20														
21							FA266	FA266V	FA266R	MD6230D				
22														
23														
24							FA317TT			FA317R	MD6224D			
25														
26							FA266	FA266V	FA266R	MD6230D				
27							FA317TT			FA317R	MD6230D			
28														
29							FA317TT			FA317R	MD6225D			
30														
31														
32							FA317TT			FA317R	MD6225D			
33														
34														
35							FA317TT			FA317R	MD6225D			
36														
37							FA317TT			FA317R	MD6225D			
38														
39														
40							FA317TT			FA317R	MD6225D			
41														
42														
43							FA317TT			FA317R	MD6225D			
44														
45							FA317TT			FA317R	MD6225D			
46														
47							FA307TT			FA307R	MD6172D			
48														
49							FA307TT			FA307R	MD6172D			
50														
51							FA317TT			FA317R	MD6225D			
52														
53							N/A							
54							FA317TT			FA317R	MD6225D			
55														
56							FA317TT			FA317R	MD6225D			
57														
58														
59														
60														

REAR / ARRIÈRE / HINTEN / POSTERIOR / POSTERIORE

*-2 Sets Required. † For Vee disc colours add RED, BLU, GRN, GLD, ORG suffix to part number.

⊗ - Also available as a Vintage Motorcycle Disc.

R Suffix = High Durability Sintered Pad. **HH** Suffix = High Performance Sintered Pad. **TT** Suffix = Hard Wearing Off Road Pad. **V** Suffix = Semi Sintered Pad. **G** Suffix = Grooved Shoe.
D Suffix = Drilled Disc. **X** Suffix = Universal Left or Right Disc. **XC** Suffix = Contoured Disc. **LS** Suffix = Left/Steel Disc. **RS** = Right/Steel Disc.

Part numbers, prefixes, suffixes, photos and illustrations shown in this catalogue are trademarks and/or copyrights of EBC Brakes or the trademark owner A C Freeman Investments Ltd and use without express written permission of the owners is punishable by law.

Non-JAPANESE Built Motorcycles

APPLICATIONS

BRAKE



BORILE

B 500 CR	02-04
B 500 MT	02

BRAMMO (ELECTRIC BIKES)

Empulse R	12-13
Enerzia	12-13

BRANSON

BS 50 Cuba	08
BS 50 Sting	08
BS 50 Snooker	08
BC 125 Street Rider	08
BM 125	08
BM 125 Retro	08
BM 125 Sport	08
BS 125 Snooker	08
BS 125 Boulevard	08
BT 125 Ardennes	08
Town Runner 125	08
Andes 200	08
BM 200	08
BM 250 Cruiser	08

BSA

Bantam D7	858
-----------	-----

BSM

TB 100	
TB 125	
FT 125	

BULTACO

Astro SM 50	
Lobito 125 and 250cc	
Sherpa 250/350 N/A/I	
Sherpa (91-250cc & 92-350cc)	
Sherpa (124-250cc, 125-350cc), (150-250cc, 151)	
Sherpa (198-250cc & 199-350cc)	
Frontera 250/360/370 all models	
Pursang MK6 125/175/200/250/350	
Pursang MK7 and MK8 125/250/360	
Pursang MK9 125/200	
Pursang MK9 250/370	
Pursang MK10 250cc	
Pursang MK10 370cc	
Pursang MK11 250cc	
Pursang MK11 370cc	
Pursang MK12 250cc	
Pursang MK12 370cc	
Brinco (Electric Trials Bike- C/R/RE/S Models)	15-17

CAGIVA

Cucciolo 50	98-99
Stella 50	97
Blues 50	93-95
Mantis 50	99
Nag 50 Scooter	08
Nuvola 50	00
Progress 50	97-99
Super City 50/80	93-95

DISC PAD CHOICES - FRONT

BRAKE DISC CHOICES - FRONT

FA, SFA, TT Pad or Brake Shoe	SFAC Carbon Scooter Pads	Speciality Pads - SXR / Vee / MXS	Sintered/HH Pads/ Grooved Shoes	Left / Gauche / Links Standard Replacement Disc	Right / Droite / Rechts Standard Replacement Disc	Contour Disc Universal left and right fitment	Universal Custom Disc	Vee-Discs Black † See note below	CX Extreme MX Race Disc/ UTVX Disc
FA095			FA095HH	N/A					
FA095			FA095HH	N/A					
FA244*		FA244V*	FA244HH*	MD614X	MD614X	MD614XC*		VR614BLK*	
FA209/2		FA209/2V	FA209/2HH	N/A					
SFA235	SFAC235			MD923D				VR923	
SFA235	SFAC235			MD923D				VR923	
TBA				TBA					
TBA									
SFA093				N/A					
SFA093				N/A					
FA093				N/A					
SFA257	SFAC257				N/A				
SFA257	SFAC257				N/A				
TBA				N/A					
TBA					N/A				
TBA				N/A					
TBA				N/A					
TBA				N/A					
TBA				N/A					
SFA083*	SFAC083*		SFA083HH*	MD923D	MD923D			VR923*	
SFA083*	SFAC083*		SFA083HH*	MD923D	MD923D			VR923*	
FA056				N/A					
FA167			FA167HH	N/A					
			831G						
			831G						
			831G						
			831G						
			831G						
			833G						
			831G						
			831G						
			831G						
			833G						
			831G						
			833G						
			831G						
			833G						
CFA689				N/A					
SFA047			SFA047HH	TBA					
SFA264	SFAC264		SFA264HH	TBA					
FA156					N/A				
SFA193	SFAC193		SFA193HH	TBA					
SFA235	SFAC235			N/A					
SFA193	SFAC193		SFA193HH	TBA					
SFA115	SFAC115		SFA115HH	N/A					
FA156					N/A				

Line #
1
2
3
4
5
6
7
8
9
10
11
12
13
14
15
16
17
18
19
20
21
22
23
24
25
26
27
28
29
30
31
32
33
34
35
36
37
38
39
40
41
42
43
44
45
46
47
48
49
50
51
52
53
54
55
56
57
58
59
60

FRONT / AVANT / VORN / FRENTE / ANTERIORE

R Suffix = High Durability Sintered Pad. HH Suffix = High Performance Sintered Pad. TT Suffix = Hard Wearing Off Road Pad. V Suffix = Semi-Sintered Pad. G Suffix = Grooved Shoe.

D Suffix = Drilled Disc. X Suffix = Universal Left or Right Disc. XC Suffix = Contoured Disc. LS Suffix = Left/Steel Disc. RS = Right/Steel Disc.

*-2 Sets Required. † For Vee disc colours add RED, BLU, GRN, GLD, ORG suffix to part number.

⊗ - Also available as a Vintage Motorcycle Disc.

Non-JAPANESE Built Motorcycles

Line #	BRAKE DISC CHOICES - FRONT						DISC PAD CHOICES - REAR				BRAKE DISC CHOICES - REAR			
	Oversize 250 /280mm Disc Kit	OSX Oversize 250/280mm Disc Kit	Relocating Bracket for 250/ 280mm Disc	Oversize 320mm Disc Kit	SMX Oversize 320mm Disc Kit	Relocating Bracket for 320mm Disc	FA, SFA, TT Pad or Brake Shoe	SFAC Carbon Scooter Pads	Speciality Pads - SXR / Vee / MXS	Sintered/ HH Pads/ Grooved Shoes	Standard Replacement Disc	Contour Disc Rear fitment	Vee-Discs™ CONTOUR	CX Extreme MX Race Disc/ UTVX Disc
1							FA213			FA213HH	N/A			
2							FA213			FA213HH	N/A			
3														
4														
5							FA266		FA266V	FA266HH	N/A			
6							FA266		FA266V	FA266HH	N/A			
7														
8														
9							TBA							
10							TBA							
11							TBA			N/A				
12							TBA							
13							TBA							
14							TBA							
15							TBA							
16							TBA							
17							TBA			N/A				
18							TBA			N/A				
19							TBA							
20							TBA			N/A				
21							TBA			N/A				
22							TBA							
23														
24														
25							858							
26														
27														
28							Y503							
29							SFA083	SFAC083		FA083HH	MD923D	VR923		
30							S602							
31														
32														
33							FA115			FA115HH	N/A			
34										831G				
35										831G				
36										N/A				
37										833G				
38										831G				
39										833G				
40										N/A				
41										833G				
42										831G				
43										833G				
44										833G				
45										833G				
46										833G				
47										833G				
48										833G				
49										833G				
50							CFA619				N/A			
51														
52														
53							S624							
54							SFA264	SFAC264			TBA			
55							SFA186				N/A			
56							TBA							
57							TBA							
58							TBA							
59							S624							
60							SFA186				MD805			

REAR / ARRIÈRE / HINTEN / POSTERIOR / POSTERIORE

R Suffix = High Durability Sintered Pad. **HH** Suffix = High Performance Sintered Pad. **TT** Suffix = Hard Wearing Off Road Pad. **V** Suffix = Semi Sintered Pad. **G** Suffix = Grooved Shoe.
D Suffix = Drilled Disc. **X** Suffix = Universal Left or Right Disc. **XC** Suffix = Contoured Disc. **LS** Suffix = Left/Steel Disc. **RS** = Right/Steel Disc.

BRAKE APPLICATIONS

*-2 Sets Required. † For Vee disc colours add RED, BLU, GRN, GLD, ORG suffix to part number.
 Ⓢ - Also available as a Vintage Motorcycle Disc.

Non-JAPANESE Built Motorcycles

APPLICATIONS

BRAKE



CAGIVA Contd.



DISC PAD CHOICES - FRONT

BRAKE DISC CHOICES - FRONT

	FA, SFA, TT Pad or Brake Shoe	SFAC Carbon Scooter Pads	Speciality Pads SXR / Vee / MXS	Sintered/ HH Pads/ Grooved Shoes	Left / Gauche / Links Standard Replacement Disc		Right / Droite / Rechts Standard Replacement Disc		Contour Disc Universal left and right fitment	Universal Custom Disc	Vee-Discs Black † See note below	CX Extreme MX Race Disc/ UTVX Disc	Line #
Prima 50	92-94												1
W4 50	91-95			FA047HH	N/A								2
City 50	91-94	SFA257			MD933D					VR933			3
Mito 50	98-99			FA167HH	MD806LS								4
Brillio 125	08			FA086	N/A								5
Cruiser 125	87			FA134	N/A								6
125 Elefant RE	87			FA047TT	FA047R	N/A							7
Elafant 125	88-90			FA163	N/A								8
Tamanaco 125	88-89			FA163	TBA								9
WSXT 125 Aletta Rossa	83-84			FA060	N/A								10
XSST 125	-80			N/A	N/A								11
XSST 125	81-82			FA060	N/A								12
SXT 125	82			FA060	N/A								13
Blues 125	92-95			FA256	FA256HH	N/A							14
Cucciolo 125	00			SFA047	SFA047HH	MD9110D				VR9110			15
Mito 125	91-92			FA163		MD614X	MD614XC			VR614BLK			16
Mito 125 All models	93-07			FA095	FA095HH	MD614X	MD614XC			VR614BLK			17
Mito 125 (SP525)	08-10			FA095	FA095HH	MD614X	MD614XC			VR614BLK			18
Passing 125	93-97	SFA264	SFAC264	SFA264HH	N/A								19
Raptor 125	03-10			FA095	FA095HH	MD614X	MD614XC			VR614BLK			20
Roadster 125 (521 1A Model)	92-94			FA256	FA256HH		N/A						21
Roadster 125 (1AA Model)	95-99			FA256	FA256HH		N/A						22
Super City 125	92-00			FA163		MD614X	MD614XC			VR614BLK			23
Freccia 125 SY	89			FA163		N/A							24
Nuvola 125	00	SFA193	SFAC193	SFA193HH	N/A								25
Planet 125 (3 Spoke Wheels Model/6 Bolt Rear Disc)	99-03			FA095	FA095HH	MD614X	MD614XC			VR614BLK			26
Planet 125 (6 Spoke Wheels Model - 1st Series/3 Bolt Rear Disc)	99-03			FA095	FA095HH	MD614X	MD614XC			VR614BLK			28
Planet 125 (6 Spoke Wheels Model - 2nd Series/ 6 Bolt Rear Disc)	99-03			FA095	FA095HH	MD614X	MD614XC			VR614BLK			30
WMX 125 (Rimoldi Hub)	-85				944G								31
WMX 125	86			FA047	FA047R	N/A							32
WM 125	87-88			FA134	FA134R	N/A							33
WMX 125	89			FA134	FA134R	N/A							34
W8 125	93-98			FA163			N/A						35
N1 125	97			FA095	FA095HH	MD614X	MD614XC			VR614BLK			36
SST 250	-80			N/A		N/A							37
SST 250/350	80-82			FA047	FA047HH	N/A							38
SX 250/350	-82				842G								39
SX 250	82			FA047	FA047HH	N/A							40
WMX 250	-85			FA047	FA047R	N/A							41
WMX 250	86-88			FA134	FA134R	N/A							42
WMX 250	89			FA134	FA134R	N/A							43
WMX 500	84-86			FA047	FA047R	N/A							44
W12 350	93-95			FA163		N/A							45
Canyon 500	96-00			FA124/2	FA124/2HH	MD6168D							46
Mito 500 (4T)	07			FA095	FA095HH	MD614X	MD614XC			VR614BLK			47
Mito 500 (4T)	08				FA322/4HH	MD614X	MD614XC			VR614BLK			48
Excaliber 501 RLX	92			FA134		N/A							49
W16 600	94-98			FA163		N/A							50
River 600	95-99			FA095	FA095HH	MD614X	MD614XC			VR614BLK			51
Canyon 600	96-99			FA124/2	FA124/2HH	MD6168D							52
650 Elefant	85					N/A							53
650 Elefant	88-89					MD6265D							54
V-Raptor/Raptor 650	01-07			FA244*	FA244V* FA244HH*	MD660LS	MD660RS						55
750 Elefant	90-92			FA134		MD6265D							56
E 750 Elefant	93-95			FA124/2	FA124/2HH	MD6168D							57
900 IE Canyon/Gran Canyon	98-00			FA142*		MD6168D	MD6168D						58
E 900 Elefant Dakar Rep (300mm front disc)	90			FA124/2	FA124/2HH	TBA							59
E 900 ie Lucky Explorer (296mm front disc)	91-92			FA124/2	FA124/2HH	MD6168D							60

FRONT / AVANT / VORN / FRENTE / ANTERIORE

R Suffix = High Durability Sintered Pad. HH Suffix = High Performance Sintered Pad. TT Suffix = Hard Wearing Off Road Pad. V Suffix = Semi Sintered Pad. G Suffix = Grooved Shoe.

D Suffix = Drilled Disc. X Suffix = Universal Left or Right Disc. XC Suffix = Contoured Disc. LS Suffix = Left/Steel Disc. RS Suffix = Right/Steel Disc.

*-2 Sets Required. † For Vee disc colours add RED, BLU, GRN, GLD, ORG suffix to part number.

⊗ - Also available as a Vintage Motorcycle Disc.

204 Part numbers, prefixes, suffixes, photos and illustrations shown in this catalogue are trademarks and/or copyrights of EBC Brakes or the trademark owner A C Freeman Investments Ltd and use without express written permission of the owners is punishable by law.

Non-JAPANESE Built Motorcycles

Line #	BRAKE DISC CHOICES - FRONT						DISC PAD CHOICES - REAR				BRAKE DISC CHOICES - REAR			
	Oversize 250 /280mm Disc Kit	OSX Oversize 250/280mm Disc Kit	Relocating Bracket for 250/ 280mm Disc	Oversize 320mm Disc Kit	SMX Oversize 320mm Disc Kit	Relocating Bracket for 320mm Disc	FA, SFA, TT Pad or Brake Shoe	SFAC Carbon Scooter Pads	Speciality Pads - SXR / Vee / MXS	Sintered/ HH Pads/ Grooved Shoes	Standard Replacement Disc	Contour Disc Rear fitment	Vee-Discs™ CONTOUR	CX Extreme MX Race Disc/ UTVX Disc
1							SFA186				MD805			
2							FA060				N/A			
3							893							
4							FA115			FA115HH	MD805			
5							FA101				N/A			
6							FA060				N/A			
7							953							
8							FA060				MD861			
9							FA060				MD861			
10							845							
11							844			844G				
12							844			844G				
13										841G				
14							FA047			FA047HH	N/A			
15							816							
16							FA047				MD638			
17							FA047			FA047HH	MD638			
18							FA047			FA047HH	MD638			
19							H303							
20							FA047			FA047HH	MD638			
21							949							
22							949							
23							FA047				MD638			
24							FA047				N/A			
25							816							
26							FA047			FA047HH	MD638			
27														
28							FA047			FA047HH	MD839			
29														
30							FA047			FA047HH	MD638			
31										841G				
32										977G				
33										977G				
34							FA067			FA067R	N/A			
35							FA060				MD659			
36							FA047			FA047HH	TBA			
37							844			844G				
38										842G				
39										842G				
40										842G				
41										841G				
42										977G				
43							FA067			FA067R	N/A			
44										982G				
45							FA173				N/A			
46							FA165/2TT				MD6160D			
47							FA047			FA047HH	MD638			
48							FA047			FA047HH	MD638			
49							FA047				N/A			
50							FA173				N/A			
51							FA047			FA047HH	MD638			
52							FA165/2TT				MD6160D			
53							FA047				N/A			
54							FA047				MD6259D			
55							FA266	FA266V	FA266HH		MD617			
56							FA163				MD6259D			
57							FA181TT		FA181HH		MD1020			
58							FA165/2TT				MD6160D			
59							FA165/2TT				MD6160D			
60							FA165/2TT				MD6160D			

REAR / ARRIÈRE / HINTEN / POSTERIOR / POSTERIORE

*-2 Sets Required. † For Vee disc colours add RED, BLU, GRN, GLD, ORG suffix to part number.

⊗ - Also available as a Vintage Motorcycle Disc.

R Suffix = High Durability Sintered Pad. **HH** Suffix = High Performance Sintered Pad. **TT** Suffix = Hard Wearing Off Road Pad. **V** Suffix = Semi Sintered Pad. **G** Suffix = Grooved Shoe.
D Suffix = Drilled Disc. **X** Suffix = Universal Left or Right Disc. **XC** Suffix = Contoured Disc. **LS** Suffix = Left/Steel Disc. **RS** = Right/Steel Disc.

Part numbers, prefixes, suffixes, photos and illustrations shown in this catalogue are trademarks and/or copyrights of EBC Brakes or the trademark owner A C Freeman Investments Ltd and use without express written permission of the owners is punishable by law.

Non-JAPANESE Built Motorcycles



CAGIVA Contd.

E 900 ie GT (296mm front disc)	91-92
E 900 C Elefant (282mm front discs/USD forks /Brembo front calipers/rear)	93-97
E 900 C ie Lucky Explorer (282mm front discs)	95-97
Navigator 1000	00-05
Raptor/V-Raptor/X-tra	00-05
Raptor X3 1000	03-04

CAN AM (ATV)

DS 70 (2x4/4T) Mini	08-19
DS 90 (2x4/4T)	07-19
DS 90 X (2x4/4T)	08-15
Rally 200 (4A7A/B/C/D/E/F)	07
DS 250 (3J7A/B/C)	07-19
Outlander 400 (4x4 STD)	Left 07-14
(2D7A/B/C/D/E/F/G/H)	Right
Outlander 400 (XT 4x4) (2E7A/B/C/D/E/F)	Left 07-14
	Right
Outlander Max 400 (STD 4x4)	Left 07-15
(2F7B/C/D/E/F/G/H/J)	Right
Outlander Max 400 (XT 4x4) (2G7A/B/C/D/E)	Left 07-13
	Right
Outlander 400 EFI, STD (International only)	Left 15
	Right
DS 450 (2x4/EFI)	08-15
DS 450 X (2x4/EFI)	08-09
DS 450 Xxc/Xxm	09-15
Outlander 450 EFI, inc MAX and T3	Left 18-19
	Right
Outlander 6X6 inc Max and T3	Left 19
	Right
Outlander 500 (STD 4x4) (2T7A/B/C/D)	Left 07-12
	Right
Outlander L 500 EFI STD inc MAX	Left 13-15
	Right
Outlander 500 (XT 4x4) (2U7A/B/C/D)	Left 07-12
	Right
Outlander 500 (XT)	Left 13-14
	Right
Outlander Max 500 (STD 4x4) (2W7A/B/C)	Left 07-12
	Right
Outlander Max 500 (XT 4x4) (2X7A/B/C)	Left 07-12
	Right
Outlander 500 4 x 4 (DPS)	Left 13-14
	Right
Outlander Max 500 4 x 4 (DPS)	Left 13-14
	Right
Outlander Max 500 EFI (XT)	Left 13-15
	Right
Renegade 500 (4x4/EFI)	Left 07-15
	Right
Renegade 500 (STD)	Left 12-15
	Right
Outlander MAX 570 Pro	Left 17
	Right
Outlander 570 T3 EFI inc (3FJD)	Left 18
	Right
Outlander MAX 570 EFI T3 PRO inc DPS XT	Left 18-19
	Right

FA, SFA, TT Pad or Brake Shoe	SFAC Carbon Scooter Pads	Speciality Pads SXR / Vee / MXS	Sintered/HH Pads/ Grooved Shoes	DISC PAD CHOICES - FRONT		BRAKE DISC CHOICES - FRONT					Line #
				Left / Gauche / Links Standard Replacement Disc	Right / Droite / Rechts Standard Replacement Disc	Contour Disc Universal left and right fitment	Universal Custom Disc	Vee-Discs Black † See note below	CX Extreme MX Race Disc/ UTVX Disc		
FA124/2			FA124/2HH	MD6168D							1
FA181TT*		MXS181	FA181R*	MD6303D	MD6303D						2
FA181TT*		MXS181	FA181R*	MD6303D	MD6303D						3
FA142*			FA142HH*	MD6168D	MD6168D						4
FA244*			FA244HH*	MD660LS	MD660RS						5
			FA322/4HH*	MD666X	MD666X	MD666XC*					6
											7
											8
											9
H346*			H346G*								10
H346*			H346G*								11
FA083TT*			FA083R*	MD6335D	MD6335D						12
FA083TT*			FA083R*	MD6220D	MD6220D						13
FA377TT*			FA377R*	MD6283D	MD6283D						14
FA307TT			FA307R	MD6222D							15
FA317TT			FA317R		MD6222D						16
FA307TT			FA307R	MD6222D							17
FA317TT			FA317R		MD6222D						18
FA307TT			FA307R	MD6222D							19
FA317TT			FA317R		MD6222D						20
FA307TT			FA307R	MD6222D							21
FA317TT			FA317R		MD6222D						22
FA307TT			FA307R	MD6222D							23
FA317TT			FA317R		MD6222D						24
			FA468R*			MD6322C*					25
			FA468R*			MD6322C*					26
			FA468R*			MD6322C*					27
FA618TT			FA618R	MD6370D						UTVX6370	28
FA617TT			FA617R		MD6370D					UTVX6370	29
FA618TT			FA618R	MD6370D						UTVX6370	30
FA617TT			FA617R		MD6370D					UTVX6370	31
FA307TT			FA307R	MD6222D							32
FA317TT			FA317R		MD6222D						33
FA618TT			FA618R	MD6370D						UTVX6370	34
FA617TT			FA617R		MD6370D					UTVX6370	35
FA307TT			FA307R	MD6222D							36
FA317TT			FA317R		MD6222D						37
FA618TT			FA618R	MD6370D						UTVX6370	38
FA617TT			FA617R		MD6370D					UTVX6370	39
FA307TT			FA307R	MD6222D							40
FA317TT			FA317R		MD6222D						41
FA307TT			FA307R	MD6222D							42
FA317TT			FA317R		MD6222D						43
FA618TT			FA618R	MD6370D						UTVX6370	44
FA617TT			FA617R		MD6370D					UTVX6370	45
FA618TT			FA618R	MD6370D						UTVX6370	46
FA617TT			FA617R		MD6370D					UTVX6370	47
FA618TT			FA618R	MD6370D						UTVX6370	48
FA617TT			FA617R		MD6370D					UTVX6370	49
FA307TT			FA307R	MD6223D							50
FA317TT			FA317R		MD6223D						51
FA618TT			FA618R	MD6370D						UTVX6370	52
FA617TT			FA617R		MD6370D					UTVX6370	53
FA618TT			FA618R	MD6370D						UTVX6370	54
FA617TT			FA617R		MD6370D					UTVX6370	55
FA618TT			FA618R	MD6370D						UTVX6370	56
FA617TT			FA617R		MD6370D					UTVX6370	57
FA618TT			FA618R	MD6370D						UTVX6370	58
FA617TT			FA617R		MD6370D					UTVX6370	59
											60

FRONT / AVANT / VORN / FREITE / ANTERIORE

R Suffix = High Durability Sintered Pad. HH Suffix = High Performance Sintered Pad. TT Suffix = Hard Wearing Off Road Pad. V Suffix = Semi Sintered Pad. G Suffix = Grooved Shoe.
D Suffix = Drilled Disc. X Suffix = Universal Left or Right Disc. XC Suffix = Contoured Disc. LS Suffix = Left/Steel Disc. RS = Right/Steel Disc.

*-2 Sets Required. † For Vee disc colours add RED, BLU, GRN, GLD, ORG suffix to part number.

⊗ - Also available as a Vintage Motorcycle Disc.

Non-JAPANESE Built Motorcycles

Line #	BRAKE DISC CHOICES - FRONT						DISC PAD CHOICES - REAR				BRAKE DISC CHOICES - REAR			
	Oversize 250 /280mm Disc Kit	OSX Oversize 250/280mm Disc Kit	Relocating Bracket for 250/ 280mm Disc	Oversize 320mm Disc Kit	SMX Oversize 320mm Disc Kit	Relocating Bracket for 320mm Disc	FA, SFA, TT Pad or Brake Shoe	SFAC Carbon Scooter Pads	Speciality Pads - SXR / Vee / MXS	Sintered/ HH Pads/ Grooved Shoes	Standard Replacement Disc	Contour Disc Rear fitment	Vee-Discs™ CONTOUR	CX Extreme MX Race Disc/ UTVX Disc
1							FA165/2TT				MD6160D			
2														
3							FA181TT		MXS181	FA181R	MD1020			
4							FA181TT		MXS181	FA181R	MD1020			
5							FA165/2TT				MD6160D			
6							FA266		FA266V	FA266HH	MD617			
7							FA266		FA266V	FA266HH	MD617			
8														
9														
10							H307			H307G				
11							H307			H307G				
12							FA083TT			FA083R	MD6334D			
13							FA307TT			FA307R	MD6285D			
14							FA377TT			FA377R	MD6282D			
15							FA307TT			FA307R	MD6223D			
16														
17							FA307TT			FA307R	MD6223D			
18														
19							FA307TT			FA307R	MD6223D			
20														
21							FA307TT			FA307R	MD6223D			
22														
23							FA307TT			FA307R	MD6223D			
24														
25										FA398R		MD6321C		
26										FA398R		MD6321C		
27										FA398R		MD6321C		
28							FA618TT			FA618R	MD6370D			UTVX6370
29							FA617TT			FA617R	MD6370D			UTVX6370
30							FA618TT			FA617R	MD6370D			UTVX6370
31							FA617TT			FA617R	MD6370D			UTVX6370
32							FA307TT			FA307R	MD6223D			
33														
34							FA617TT			FA617R	MD6370D			UTVX6370
35														
36							FA307TT			FA307R	MD6223D			
37														
38							FA617TT			FA617R	MD6370D			UTVX6370
39														
40							FA307TT			FA307R	MD6223D			
41														
42							FA307TT			FA307R	MD6223D			
43														
44							FA617TT			FA617R	MD6370D			UTVX6370
45														
46							FA617TT			FA617R	MD6370D			UTVX6370
47														
48							FA617TT			FA617R	MD6370D			UTVX6370
49														
50							FA307TT			FA307R	MD6223D			
51														
52							FA617TT			FA617R	MD6370D			
53														
54							FA618TT			FA618R	MD6370D			UTVX6370
55							FA617TT			FA617R	MD6370D			UTVX6370
56							FA618TT			FA618R	MD6370D			UTVX6370
57							FA617TT			FA617R	MD6370D			UTVX6370
58							FA618TT			FA618R	MD6370D			UTVX6370
59							FA617TT			FA617R	MD6370D			UTVX6370
60														

REAR / ARRIÈRE / HINTEN / POSTERIOR / POSTERIORE

*-2 Sets Required. † For Vee disc colours add RED, BLU, GRN, GLD, ORG suffix to part number.

⊗ - Also available as a Vintage Motorcycle Disc.

R Suffix = High Durability Sintered Pad. **HH** Suffix = High Performance Sintered Pad. **TT** Suffix = Hard Wearing Off Road Pad. **V** Suffix = Semi Sintered Pad. **G** Suffix = Grooved Shoe.
D Suffix = Drilled Disc. **X** Suffix = Universal Left or Right Disc. **XC** Suffix = Contoured Disc. **LS** Suffix = Left/Steel Disc. **RS** = Right/Steel Disc.

Non-JAPANESE Built Motorcycles

APPLICATIONS

BRAKE



CAN AM (ATV) Contd.

Model	Side	Line #
Renegade 570 EFI	Left	19
	Right	
DS 650 X (3B7A/B)	Left	07
	Right	
Outlander 650 (4x4 STD)	Left	07-12
(2N7A/B/C/D/E/F/G/H)	Right	
Outlander 650 (XT 4x4) (2P7A/B/C/D/E/F)	Left	07-12
	Right	
Outlander Max 650 (STD 4x4)	Left	07-12
(2R7A/B/C/D/E/F/G/H/J/K)	Right	
Outlander Max 650 (XT 4x4)	Left	07-12
(2S7A/B/C/D/E/F)	Right	
Outlander 650 4 x 4 (STD/DPS/XT)	Left	13-15
	Right	
Outlander Max 650 X-TP	Left	12
	Right	
Outlander 650 Max 4 x 4 (STD/DPS/XT)	Left	13-14
	Right	
Outlander MAX 650 Pro	Left	17
	Right	
Outlander 650 T3 EFI inc	Left	18
	Right	
Outlander MAX 650 EFI T3 PRO inc DPS XT	Left	18-19
	Right	
Outlander MAX 6X6 650 EFI T3	Left	19
	Right	
Renegade 650 EFI T3	Left	19
	Right	
Outlander 800 (STD 4x4)	Left	07-08
(2H7A/B/C/D/E/F/G/H)	Right	
Outlander 800 (XT 4x4) (2J7A/B/C/D/E/F)	Left	07-08
	Right	
Outlander 800 R EFI	Left	09
	Right	
Outlander 800 R XT	Left	09-10
	Right	
Outlander 800 R STD	Left	12-15
	Right	
Outlander 800 R 4 x 4 (DPS)	Left	13
	Right	
Outlander Max 800 R EFI	Left	09-12
	Right	
Outlander Max 800 R XT	Left	09-12
	Right	
Outlander 800 R XT	Left	12-14
	Right	
Outlander Max 800 (Ltd 4x4) (2M7A/B/C)	Left	07-12
	Right	
Outlander Max 800 (STD 4x4)	Left	07-12
(2K7A/B/C/D/E/F/G/H/J)	Right	
Outlander Max 800 (XT 4x4)	Left	07-08
(2L7A/B/C/D/E/F)	Right	
Outlander 800 Max R 4x4	Left	13-14
(STD/DPS/XT-P)	Right	
Outlander 800 R Xmr	Left	11-12
	Right	
Outlander 800 R Xxc	Left	11
	Right	
Outlander Max 800 R X-TP	Left	12
	Right	

FA, SFA, TT Pad or Brake Shoe	SFAC Carbon Scooter Pads	Speciality Pads SXR / Vee / MXS	Sintered/HH Pads/ Grooved Shoes	BRAKE DISC CHOICES - FRONT							Line #
				Left / Gauche / Links Standard Replacement Disc	Right / Droite / Rechts Standard Replacement Disc	Contour Disc Universal left and right fitment	Universal Custom Disc	Vee-Discs Black † See note below	CX Extreme MX Race Disc/ UTVX Disc		
FA618TT			FA618R	MD6370D						UTVX6370	1
FA617TT			FA617R		MD6370D					UTVX6370	2
FA307TT			FA307R	MD6171D							3
FA317TT			FA317R		MD6171D						4
FA307TT			FA307R	MD6222D							5
FA317TT			FA317R		MD6222D						6
FA307TT			FA307R	MD6222D							7
FA317TT			FA317R		MD6222D						8
FA307TT			FA307R	MD6222D							9
FA317TT			FA317R		MD6222D						10
FA307TT			FA307R	MD6222D							11
FA317TT			FA317R		MD6222D						12
FA618TT			FA618R	MD6370D						UTVX6370	13
FA617TT			FA617R		MD6370D					UTVX6370	14
FA307TT			FA307R	MD6222D							15
FA317TT			FA317R		MD6222D						16
FA618TT			FA618R	MD6370D						UTVX6370	17
FA617TT			FA617R		MD6370D					UTVX6370	18
FA618TT			FA618R	MD6370D						UTVX6370	19
FA617TT			FA617R		MD6370D					UTVX6370	20
FA618TT			FA618R	MD6370D						UTVX6370	21
FA617TT			FA617R		MD6370D					UTVX6370	22
FA618TT			FA618R	MD6370D						UTVX6370	23
FA617TT			FA617R		MD6370D					UTVX6370	24
FA618TT			FA618R	MD6370D						UTVX6370	25
FA617TT			FA617R		MD6370D					UTVX6370	26
FA618TT			FA618R	MD6370D						UTVX6370	27
FA617TT			FA617R		MD6370D					UTVX6370	28
FA307TT			FA307R	MD6222D							29
FA317TT			FA317R		MD6222D						30
FA307TT			FA307R	MD6222D							31
FA317TT			FA317R		MD6222D						32
FA307TT			FA307R	MD6222D							33
FA317TT			FA317R		MD6222D						34
FA307TT			FA307R	MD6222D							35
FA317TT			FA317R		MD6222D						36
FA618TT			FA618R	MD6370D						UTVX6370	37
FA617TT			FA617R		MD6370D					UTVX6370	38
FA618TT			FA618R	MD6370D						UTVX6370	39
FA617TT			FA617R		MD6370D					UTVX6370	40
FA307TT			FA307R	MD6222D							41
FA317TT			FA317R		MD6222D						42
FA307TT			FA307R	MD6222D							43
FA317TT			FA317R		MD6222D						44
FA618TT			FA618R	MD6370D						UTVX6370	45
FA617TT			FA617R		MD6370D					UTVX6370	46
FA307TT			FA307R	MD6222D							47
FA317TT			FA317R		MD6222D						48
FA307TT			FA307R	MD6222D							49
FA317TT			FA317R		MD6222D						50
FA307TT			FA307R	MD6222D							51
FA317TT			FA317R		MD6222D						52
FA618TT			FA618R	MD6370D						UTVX6370	53
FA617TT			FA617R		MD6370D					UTVX6370	54
FA307TT			FA307R	MD6222D							55
FA317TT			FA317R		MD6222D						56
FA307TT			FA307R	MD6222D							57
FA317TT			FA317R		MD6222D						58
FA307TT			FA307R	MD6222D							59
FA317TT			FA317R		MD6222D						60

FRONT / AVANT / VORN / FRENTE / ANTERIORE

R Suffix = High Durability Sintered Pad. HH Suffix = High Performance Sintered Pad. TT Suffix = Hard Wearing Off Road Pad. V Suffix = Semi Sintered Pad. G Suffix = Grooved Shoe.

D Suffix = Drilled Disc. X Suffix = Universal Left or Right Disc. XC Suffix = Contoured Disc. LS Suffix = Left/Steel Disc. RS = Right/Steel Disc.

*-2 Sets Required. † For Vee disc colours add RED, BLU, GRN, GLD, ORG suffix to part number.

⊗ - Also available as a Vintage Motorcycle Disc.

Non-JAPANESE Built Motorcycles

Line #	BRAKE DISC CHOICES - FRONT						DISC PAD CHOICES - REAR				BRAKE DISC CHOICES - REAR			
	Oversize 250 /280mm Disc Kit	OSX Oversize 250/280mm Disc Kit	Relocating Bracket for 250/ 280mm Disc	Oversize 320mm Disc Kit	SMX Oversize 320mm Disc Kit	Relocating Bracket for 320mm Disc	FA, SFA, TT Pad or Brake Shoe	SFAC Carbon Scooter Pads	Speciality Pads - SXR / Vee / MXS	Sintered/ HH Pads/ Grooved Shoes	Standard Replacement Disc	Contour Disc Rear fitment	Vee-Discs™ CONTOUR	CX Extreme MX Race Disc/ UTVX Disc
1							FA618TT			FA618R	MD6370D			UTVX6370
2							FA617TT			FA617R	MD6370D			UTVX6370
3							FA307TT			FA307R	MD6172D			
4														
5							FA307TT			FA307R	MD6223D			
6														
7							FA307TT			FA307R	MD6223D			
8														
9							FA307TT			FA307R	MD6223D			
10														
11							FA307TT			FA307R	MD6223D			
12														
13							FA617TT			FA617R	MD6370D			UTVX6370
14														
15							FA307TT			FA317R	MD6223D			
16														
17														
18							FA617TT			FA617R	MD6370D			UTVX6370
19							FA618TT			FA618R	MD6370D			UTVX6370
20							FA617TT			FA617R	MD6370D			UTVX6370
21							FA618TT			FA618R	MD6370D			UTVX6370
22							FA617TT			FA617R	MD6370D			UTVX6370
23							FA618TT			FA618R	MD6370D			UTVX6370
24							FA617TT			FA617R	MD6370D			UTVX6370
25							FA618TT			FA618R	MD6370D			UTVX6370
26							FA617TT			FA617R	MD6370D			UTVX6370
27							FA618TT			FA618R	MD6370D			UTVX6370
28							FA617TT			FA617R	MD6370D			UTVX6370
29							FA307TT			FA307R	MD6223D			
30														
31							FA307TT			FA307R	MD6223D			
32														
33							FA307TT			FA307R	MD6223D			
34														
35							FA307TT			FA307R	MD6223D			
36														
37							FA617TT			FA617R	MD6370D			UTVX6370
38														
39							FA617TT			FA617R	MD6370D			UTVX6370
40														
41							FA307TT			FA307R	MD6223D			
42														
43							FA307TT			FA307R	MD6223D			
44														
45							FA617TT			FA617R	MD6370D			UTVX6370
46														
47							FA307TT			FA307R	MD6223D			
48														
49							FA307TT			FA307R	MD6223D			
50														
51							FA307TT			FA307R	MD6223D			
52														
53							FA617TT			FA617R	MD6370D			UTVX6370
54														
55							FA307TT			FA307R	MD6223D			
56														
57							FA307TT			FA307R	MD6223D			
58														
59							FA307TT			FA317R	MD6223D			
60														

REAR / ARRIÈRE / HINTEN / POSTERIOR / POSTERIORE

*-2 Sets Required. † For Vee disc colours add RED, BLU, GRN, GLD, ORG suffix to part number.

⊗ - Also available as a Vintage Motorcycle Disc.

R Suffix = High Durability Sintered Pad. **HH** Suffix = High Performance Sintered Pad. **TT** Suffix = Hard Wearing Off Road Pad. **V** Suffix = Semi Sintered Pad. **G** Suffix = Grooved Shoe.
D Suffix = Drilled Disc. **X** Suffix = Universal Left or Right Disc. **XC** Suffix = Contoured Disc. **LS** Suffix = Left/Steel Disc. **RS** = Right/Steel Disc.

Non-JAPANESE Built Motorcycles

APPLICATIONS

BRAKE



CAN AM (ATV) Contd.

Model	Side	Year
Renegade 800 X (4x4/EFI)	Left	08
	Right	
Renegade 800 (4x4/EFI)	Left	07-08
	Right	
Renegade 800 R EFI	Left	09-11
	Right	
Renegade 800 R STD	Left	12-15
	Right	
Renegade 800 R X	Left	09-10
	Right	
Renegade 800 R Xxc	Left	11
	Right	
Renegade 800 R Xxc	Left	12-14
	Right	
Outlander 850 EFI	Left	18
	Right	
Outlander MAX 850	Left	17
	Right	
Renegade 850 EFI	Left	19
	Right	
Outlander 1000 STD	Left	12-14
	Right	
Outlander 1000 4 x 4 (DPS/XT/XT-P/LTD/STD)	Left	13-14
	Right	
Outlander 1000 4 x 4 (LTD)	Left	13
	Right	
Outlander 1000 4 x 4 (XMR)	Left	13-14
	Right	
Outlander 1000 XT/XT-P	Left	12-14
	Right	
Outlander Max 1000 4 x 4 (DPS/XT/XT-P)	Left	13
	Right	
Outlander MAX 1000 EFI T3 L and R	Left	17-19
	Right	
Outlander 1000 EFI T3 and R	Left	17-19
	Right	
Outlander 6X6 1000 EFI T3	Left	18-19
	Right	
Renegade 1000 EFI T3 and R	Left	19
	Right	
Renegade 1000 STD	Left	12-14
	Right	
Renegade 1000 Xxc	Left	12-14
	Right	
Commander Electric 9KW		15

CAN AM (SIDE X SIDE)

Model	Side	Year
Commander 800 R STD EFI	Left	11-19
	Right	
Commander 800 (R XT)	Left	11-14
	Right	
Commander 800 (XT/DPS)	Left	11-15
	Right	
Commander 1000R EFI	Left	18-19
	Right	
Commander 1000 (STD)	Left	11-15
	Right	
Commander 1000 (DPS)	Left	13-15
	Right	

FA, SFA, TT Pad or Brake Shoe	SFAC Carbon Scooter Pads	Speciality Pads - SXR / Vee / MXS	Sintered/ HH Pads/ Grooved Shoes	DISC PAD CHOICES - FRONT		BRAKE DISC CHOICES - FRONT					Line #
				Left / Gauche / Links Standard Replacement Disc	Right / Droite / Rechts Standard Replacement Disc	Contour Disc Universal left and right fitment	Universal Custom Disc	Vee-Discs Black † See note below	CX Extreme MX Race Disc/ UTVX Disc		
FA307TT			FA307R	MD6223D							1
FA317TT			FA317R		MD6223D						2
FA307TT			FA307R	MD6223D							3
FA317TT			FA317R		MD6223D						4
FA307TT			FA307R	MD6222D							5
FA317TT			FA317R		MD6222D						6
FA618TT			FA618R	MD6370D						UTVX6370	7
FA617TT			FA617R		MD6370D					UTVX6370	8
FA307TT			FA307R	MD6222D							9
FA317TT			FA317R		MD6222D						10
FA307TT			FA307R	MD6222D							11
FA317TT			FA317R		MD6222D						12
FA618TT			FA618R	MD6370D						UTVX6370	13
FA617TT			FA617R		MD6370D					UTVX6370	14
FA618TT			FA618R	MD6370D						UTVX6370	15
FA617TT			FA617R		MD6370D					UTVX6370	16
FA618TT			FA618R	MD6370D						UTVX6370	17
FA617TT			FA617R		MD6370D					UTVX6370	18
FA618TT			FA618R	MD6370D						UTVX6370	19
FA617TT			FA617R		MD6370D					UTVX6370	20
FA618TT			FA618R	MD6370D						UTVX6370	21
FA617TT			FA617R		MD6370D					UTVX6370	22
FA618TT			FA618R	MD6370D						UTVX6370	23
FA617TT			FA617R		MD6370D					UTVX6370	24
FA618TT			FA618R	MD6370D						UTVX6370	25
FA617TT			FA617R		MD6370D					UTVX6370	26
FA618TT			FA618R	MD6370D						UTVX6370	27
FA617TT			FA617R		MD6370D					UTVX6370	28
FA618TT			FA618R	MD6370D						UTVX6370	29
FA617TT			FA617R		MD6370D					UTVX6370	30
FA618TT			FA618R	MD6370D						UTVX6370	31
FA617TT			FA617R		MD6370D					UTVX6370	32
FA618TT			FA618R	MD6370D						UTVX6370	33
FA617TT			FA617R		MD6370D					UTVX6370	34
FA618TT			FA618R	MD6370D						UTVX6370	35
FA617TT			FA617R		MD6370D					UTVX6370	36
FA618TT			FA618R	MD6370D						UTVX6370	37
FA617TT			FA617R		MD6370D					UTVX6370	38
FA618TT			FA618R	MD6370D						UTVX6370	39
FA617TT			FA617R		MD6370D					UTVX6370	40
FA618TT			FA618R	MD6370D						UTVX6370	41
FA617TT			FA617R		MD6370D					UTVX6370	42
FA618TT			FA618R	MD6370D						UTVX6370	43
FA617TT			FA617R		MD6370D					UTVX6370	44
			FA468R*	MD6222D	MD6222D						45
											46
											47
FA165TT		SXR165HH	FA165R	MD6366D						UTVX6366	48
FA135TT		SXR135HH	FA135R		MD6366D					UTVX6366	49
FA165TT		SXR165HH	FA165R	MD6366D						UTVX6366	50
FA135TT		SXR135HH	FA135R		MD6366D					UTVX6366	51
FA165TT		SXR165HH	FA165R	MD6366D						UTVX6366	52
FA135TT		SXR135HH	FA135R		MD6366D					UTVX6366	53
FA642TT		SXR642HH	FA642R	MD6411D						UTVX6411	54
FA645TT		SXR645HH	FA645R		MD6411D					UTVX6411	55
FA165TT		SXR165HH	FA165R	MD6366D						UTVX6366	56
FA135TT		SXR135HH	FA135R		MD6366D					UTVX6366	57
FA165TT		SXR165HH	FA165R	MD6366D						UTVX6366	58
FA135TT		SXR135HH	FA135R		MD6366D					UTVX6366	59
											60

FRONT / AVANT / VORN / FRENTE / ANTERIORE

*-2 Sets Required. † For Vee disc colours add RED, BLU, GRN, GLD, ORG suffix to part number.

⊗ - Also available as a Vintage Motorcycle Disc.

R Suffix = High Durability Sintered Pad. HH Suffix = High Performance Sintered Pad. TT Suffix = Hard Wearing Off Road Pad. V Suffix = Semi-Sintered Pad. G Suffix = Grooved Shoe.

D Suffix = Drilled Disc. X Suffix = Universal Left or Right Disc. XC Suffix = Contoured Disc. LS Suffix = Left/Steel Disc. RS Suffix = Right/Steel Disc.

Non-JAPANESE Built Motorcycles

Line #	BRAKE DISC CHOICES - FRONT						DISC PAD CHOICES - REAR				BRAKE DISC CHOICES - REAR			
	Oversize 250 /280mm Disc Kit	OSX Oversize 250/280mm Disc Kit	Relocating Bracket for 250/ 280mm Disc	Oversize 320mm Disc Kit	SMX Oversize 320mm Disc Kit	Relocating Bracket for 320mm Disc	FA, SFA, TT Pad or Brake Shoe	SFAC Carbon Scooter Pads	Speciality Pads - SXR / Vee / MXS	Sintered/ HH Pads/ Grooved Shoes	Standard Replacement Disc	Contour Disc Rear fitment	Vee-Discs™ CONTOUR	CX Extreme MX Race Disc/ UTVX Disc
1							FA307TT			FA307R	MD6223D			
2														
3							FA307TT			FA307R	MD6223D			
4														
5							FA307TT			FA307R	MD6223D			
6														
7							FA617TT			FA617R	MD6370D			UTVX6370
8														
9							FA307TT			FA307R	MD6223D			
10														
11							FA307TT			FA307R	MD6223D			
12														
13							FA618TT			FA618R	MD6370D			UTVX6370
14							FA617TT			FA617R	MD6370D			UTVX6370
15							FA618TT			FA618R	MD6370D			UTVX6370
16							FA617TT			FA617R	MD6370D			UTVX6370
17							FA618TT			FA618R	MD6370D			UTVX6370
18							FA617TT			FA617R	MD6370D			UTVX6370
19							FA618TT			FA618R	MD6370D			UTVX6370
20							FA617TT			FA617R	MD6370D			UTVX6370
21							FA618TT			FA618R	MD6370D			UTVX6370
22							FA617TT			FA617R	MD6370D			UTVX6370
23							FA617TT			FA617R	MD6370D			UTVX6370
24														
25							FA617TT			FA617R	MD6370D			UTVX6370
26														
27							FA617TT			FA617R	MD6370D			UTVX6370
28														
29							FA618TT			FA618R	MD6370D			UTVX6370
30							FA617TT			FA617R	MD6370D			UTVX6370
31							FA617TT			FA617R	MD6370D			UTVX6370
32														
33							FA618TT			FA618R	MD6370D			UTVX6370
34							FA617TT			FA617R	MD6370D			UTVX6370
35							FA618TT			FA618R	MD6370D			UTVX6370
36							FA617TT			FA617R	MD6370D			UTVX6370
37							FA618TT			FA618R	MD6370D			UTVX6370
38							FA617TT			FA617R	MD6370D			UTVX6370
39							FA618TT			FA618R	MD6370D			UTVX6370
40							FA617TT			FA617R	MD6370D			UTVX6370
41							FA618TT			FA618R	MD6370D			UTVX6370
42							FA617TT			FA617R	MD6370D			UTVX6370
43							FA618TT			FA618R	MD6370D			UTVX6370
44							FA617TT			FA617R	MD6370D			UTVX6370
45							N/A*			N/A*				
46														
47														
48							FA135TT		SXR135HH	FA135R	MD6366D			UTVX6366
49														
50							FA135TT		SXR135HH	FA135R	MD6366D			UTVX6366
51														
52							FA135TT		SXR135HH	FA135R	MD6366D			UTVX6366
53														
54							FA135TT		SXR135HH	FA135R	MD6366D			UTVX6366
55														
56							FA135TT		SXR135HH	FA135R	MD6366D			UTVX6366
57														
58							FA135TT		SXR135HH	FA135R	MD6366D			UTVX6366
59														
60														

REAR / ARRIÈRE / HINTEN / POSTERIOR / POSTERIORE

*-2 Sets Required. † For Vee disc colours add RED, BLU, GRN, GLD, ORG suffix to part number.

⊗ - Also available as a Vintage Motorcycle Disc.

R Suffix = High Durability Sintered Pad. **HH** Suffix = High Performance Sintered Pad. **TT** Suffix = Hard Wearing Off Road Pad. **V** Suffix = Semi Sintered Pad. **G** Suffix = Grooved Shoe.
D Suffix = Drilled Disc. **X** Suffix = Universal Left or Right Disc. **XC** Suffix = Contoured Disc. **LS** Suffix = Left/Steel Disc. **RS** = Right/Steel Disc.

Non-JAPANESE Built Motorcycles

APPLICATIONS

BRAKE



CAN AM (SIDE X SIDE) Contd.

Model	Side	Year
Commander 1000 (LTD)	Left	12-15
	Right	
Commander 1000 X	Left	11-13
	Right	
Commander 1000 XT	Left	11-15
	Right	
Commander 1000 XT-P	Left	14-15
	Right	
Commander Max 1000 - XT/DPS	Left	14-17
	Right	
Defender HD5 500cc	Left	17-19
	Right	
Defender HD8 799cc	Left	17-19
	Right	
Defender HD10 976cc	Left	17-19
	Right	
Defender 799cc	Left	16
	Right	
Defender 976cc	Left	16
	Right	
Defender DPS 799cc	Left	16
	Right	
Defender DPS 976cc	Left	16
	Right	
Defender Max	Left	17
	Right	
Defender Max HD8 799cc	Left	18-19
	Right	
Defender Max HD10 976cc inc XMR	Left	18-19
	Right	
Defender T	Left	17
	Right	
Defender XT 976cc	Left	16
	Right	
Defender XT 799cc	Left	16
	Right	
Defender XT Cab 976cc	Left	16
	Right	
Defender XT Cab 799cc	Left	16
	Right	
Maverick 1000 R - XMR	Left	14-15
	Right	
Maverick 1000 R - XXC	Left	14-15
	Right	
Maverick 1000 R - XRS	Left	14-15
	Right	
Maverick 1000 R - XRS/DPS	Left	14-15
	Right	
Maverick 1000 R - STD	Left	14-15
	Right	
Maverick Max 1000 - STD/XRS/DPS	Left	15-16
	Right	
Maverick Max 1000	Left	16-17
	Right	
Maverick Trail 800R EFI	Left	18
	Right	
Maverick Trail 1000 EFI	Left	18
	Right	
Maverick X3	Left	17
	Right	

DISC PAD CHOICES - FRONT

BRAKE DISC CHOICES - FRONT

FA, SFA, TT Pad or Brake Shoe	SFAC Carbon Scooter Pads	Speciality Pads SXR / Vee / MXS	Sintered/HH Pads/Grooved Shoes	Left / Gauche / Links Standard Replacement Disc	Right / Droite / Rechts Standard Replacement Disc	Contour Disc Universal left and right fitment	Universal Custom Disc	Vee-Discs Black † See note below	CX Extreme MX Race Disc/ UTVX Disc
FA165TT		SXR165HH	FA165R	MD6366D					UTVX6366
FA135TT		SXR135HH	FA135R		MD6366D				UTVX6366
FA165TT		SXR165HH	FA165R	MD6366D					UTVX6366
FA135TT		SXR135HH	FA135R		MD6366D				UTVX6366
FA165TT		SXR165HH	FA165R	MD6366D					UTVX6366
FA135TT		SXR135HH	FA135R		MD6366D				UTVX6366
FA165TT		SXR165HH	FA165R	MD6366D					UTVX6366
FA135TT		SXR135HH	FA135R		MD6366D				UTVX6366
FA642TT		SXR642HH	FA642R	TBA	TBA				
FA645TT		SXR645HH	FA645R						
FA682TT		SXR682HH	FA682R	MD6396D					UTVX6396
FA683TT		SXR683HH	FA683R		MD6396D				UTVX6396
FA682TT		SXR682HH	FA682R	MD6396D					UTVX6396
FA683TT		SXR683HH	FA683R		MD6396D				UTVX6396
FA682TT		SXR682HH	FA682R	MD6396D					UTVX6396
FA683TT		SXR683HH	FA683R		MD6396D				UTVX6396
FA682TT		SXR682HH	FA682R	MD6396D					UTVX6396
FA683TT		SXR683HH	FA683R		MD6396D				UTVX6396
FA682TT		SXR682HH	FA682R	MD6396D					UTVX6396
FA683TT		SXR683HH	FA683R		MD6396D				UTVX6396
FA682TT		SXR682HH	FA682R	MD6396D					UTVX6396
FA683TT		SXR683HH	FA683R		MD6396D				UTVX6396
FA682TT		SXR682HH	FA682R	MD6396D					UTVX6396
FA683TT		SXR683HH	FA683R		MD6396D				UTVX6396
FA682TT		SXR682HH	FA682R	MD6396D					UTVX6396
FA683TT		SXR683HH	FA683R		MD6396D				UTVX6396
FA682TT		SXR682HH	FA682R	MD6396D					UTVX6396
FA683TT		SXR683HH	FA683R		MD6396D				UTVX6396
FA682TT		SXR682HH	FA682R	MD6396D					UTVX6396
FA683TT		SXR683HH	FA683R		MD6396D				UTVX6396
FA165TT		SXR165HH	FA165R	MD6366D					UTVX6366
FA135TT		SXR135HH	FA135R		MD6366D				UTVX6366
FA165TT		SXR165HH	FA165R	MD6366D					UTVX6366
FA135TT		SXR135HH	FA135R		MD6366D				UTVX6366
FA165TT		SXR165HH	FA165R	MD6366D					UTVX6366
FA135TT		SXR135HH	FA135R		MD6366D				UTVX6366
FA165TT		SXR165HH	FA165R	MD6366D					UTVX6366
FA135TT		SXR135HH	FA135R		MD6366D				UTVX6366
FA165TT		SXR165HH	FA165R	MD6366D					UTVX6366
FA135TT		SXR135HH	FA135R		MD6366D				UTVX6366
FA642TT		SXR642HH	FA642R	TBA					
FA645TT		SXR645HH	FA645R		TBA				
FA642TT		SXR642HH	FA642R	MD6411D					UTVX6411
FA645TT		SXR645HH	FA645R		MD6411D				UTVX6411
FA682TT		SXR682HH	FA682R	MD6396D					UTVX6396
FA683TT		SXR683HH	FA683R		MD6396D				UTVX6396
FA682TT		SXR682HH	FA682R	MD6396D					UTVX6396
FA683TT		SXR683HH	FA683R		MD6396D				UTVX6396
FA682TT		SXR682HH	FA682R	MD6411D					UTVX6411
FA683TT		SXR683HH	FA683R		MD6411D				UTVX6411

FRONT / AVANT / VORN / FRENTE / ANTERIORE

Line #

R Suffix = High Durability Sintered Pad. **HH** Suffix = High Performance Sintered Pad. **TT** Suffix = Hard Wearing Off Road Pad. **V** Suffix = Semi Sintered Pad. **G** Suffix = Grooved Shoe. **D** Suffix = Drilled Disc. **X** Suffix = Universal Left or Right Disc. **XC** Suffix = Contoured Disc. **LS** Suffix = Left/Steel Disc. **RS** = Right/Steel Disc.

*-2 Sets Required. † For Vee disc colours add RED, BLU, GRN, GLD, ORG suffix to part number.

⊗ - Also available as a Vintage Motorcycle Disc.

Non-JAPANESE Built Motorcycles

Line #	BRAKE DISC CHOICES - FRONT						DISC PAD CHOICES - REAR				BRAKE DISC CHOICES - REAR			
	Oversize 250 /280mm Disc Kit	OSX Oversize 250/280mm Disc Kit	Relocating Bracket for 250/ 280mm Disc	Oversize 320mm Disc Kit	SMX Oversize 320mm Disc Kit	Relocating Bracket for 320mm Disc	FA, SFA, TT Pad or Brake Shoe	SFAC Carbon Scooter Pads	Speciality Pads - SXR / Vee / MXS	Sintered/ HH Pads/ Grooved Shoes	Standard Replacement Disc	Contour Disc Rear fitment	Vee-Discs™ CONTOUR	CX Extreme MX Race Disc/ UTVX Disc
1							FA135TT		SXR135HH	FA135R	MD6366D		UTVX6366	
2														
3							FA135TT		SXR135HH	FA135R	MD6366D		UTVX6366	
4														
5							FA135TT		SXR135HH	FA135R	MD6366D		UTVX6366	
6														
7							FA135TT		SXR135HH	FA135R	MD6366D		UTVX6366	
8														
9							FA307TT		SXR307HH	FA307R	MD6370D		UTVX6370	
10							FA317TT		SXR317HH	FA317R	MD6370D		UTVX6370	
11														
12							FA683TT		SXR683HH	FA683R	MD6396D		UTVX6396	
13							FA684TT		SXR684HH	FA684R	MD6396D		UTVX6396	
14							FA685TT		SXR685HH	FA685R	MD6396D		UTVX6396	
15							FA684TT		SXR684HH	FA684R	MD6396D		UTVX6396	
16							FA685TT		SXR685HH	FA685R	MD6396D		UTVX6396	
17							FA684TT		SXR684HH	FA684R	MD6396D		UTVX6396	
18							FA685TT		SXR685HH	FA685R	MD6396D		UTVX6396	
19							FA684TT		SXR684HH	FA684R	MD6396D		UTVX6396	
20							FA685TT		SXR685HH	FA685R	MD6396D		UTVX6396	
21							FA684TT		SXR684HH	FA684R	MD6396D		UTVX6396	
22							FA685TT		SXR685HH	FA685R	MD6396D		UTVX6396	
23							FA684TT		SXR684HH	FA684R	MD6396D		UTVX6396	
24							FA685TT		SXR685HH	FA685R	MD6396D		UTVX6396	
25							FA682TT		SXR682HH	FA682R	MD6396D		UTVX6396	
26							FA683TT		SXR683HH	FA683R	MD6396D		UTVX6396	
27							FA684TT		SXR684HH	FA684R	MD6396D		UTVX6396	
28							FA685TT		SXR685HH	FA685R	MD6396D		UTVX6396	
29							FA682TT		SXR682HH	FA682R	MD6396D		UTVX6396	
30							FA683TT		SXR683HH	FA683R	MD6396D		UTVX6396	
31							FA682TT		SXR682HH	FA682R	MD6396D		UTVX6396	
32							FA683TT		SXR683HH	FA683R	MD6396D		UTVX6396	
33							FA684TT		SXR684HH	FA684R	MD6396D		UTVX6396	
34							FA685TT		SXR685HH	FA685R	MD6396D		UTVX6396	
35							FA684TT		SXR684HH	FA684R	MD6396D		UTVX6396	
36							FA685TT		SXR685HH	FA685R	MD6396D		UTVX6396	
37							FA684TT		SXR684HH	FA684R	MD6396D		UTVX6396	
38							FA685TT		SXR685HH	FA685R	MD6396D		UTVX6396	
39							FA684TT		SXR684HH	FA684R	MD6396D		UTVX6396	
40							FA685TT		SXR685HH	FA685R	MD6396D		UTVX6396	
41							FA307TT		SXR307HH	FA307R	MD6370D		UTVX6370	
42							FA317TT		SXR317HH	FA317R	MD6370D		UTVX6370	
43							FA307TT		SXR307HH	FA307R	MD6370D		UTVX6370	
44							FA317TT		SXR317HH	FA317R	MD6370D		UTVX6370	
45							FA307TT		SXR307HH	FA307R	MD6370D		UTVX6370	
46							FA317TT		SXR317HH	FA317R	MD6370D		UTVX6370	
47							FA307TT		SXR307HH	FA307R	MD6370D		UTVX6370	
48							FA317TT		SXR317HH	FA317R	MD6370D		UTVX6370	
49							FA307TT		SXR307HH	FA307R	MD6370D		UTVX6370	
50							FA317TT		SXR317HH	FA317R	MD6370D		UTVX6370	
51							FA307TT		SXR307HH	FA307R	MD6370D		UTVX6370	
52							FA317TT		SXR317HH	FA317R	MD6370D		UTVX6370	
53							FA307TT		SXR307HH	FA307R	MD6370D		UTVX6370	
54							FA317TT		SXR317HH	FA317R	MD6370D		UTVX6370	
55							FA682TT		SXR682HH	FA682R	MD6396D		UTVX6396	
56							FA683TT		SXR683HH	FA683R	MD6396D		UTVX6396	
57							FA682TT		SXR682HH	FA682R	MD6396D		UTVX6396	
58							FA683TT		SXR683HH	FA683R	MD6396D		UTVX6396	
59							FA682TT		SXR682HH	FA682R	MD6412D		UTVX6412	
60							FA683TT		SXR683HH	FA683R	MD6412D		UTVX6412	

REAR / ARRIÈRE / HINTEN / POSTERIOR / POSTERIORE

*-2 Sets Required. † For Vee disc colours add RED, BLU, GRN, GLD, ORG suffix to part number.

⊗ - Also available as a Vintage Motorcycle Disc.

R Suffix = High Durability Sintered Pad. **HH** Suffix = High Performance Sintered Pad. **TT** Suffix = Hard Wearing Off Road Pad. **V** Suffix = Semi Sintered Pad. **G** Suffix = Grooved Shoe.
D Suffix = Drilled Disc. **X** Suffix = Universal Left or Right Disc. **XC** Suffix = Contoured Disc. **LS** Suffix = Left/Steel Disc. **RS** = Right/Steel Disc.

Non-JAPANESE Built Motorcycles



CAN AM (SIDE X SIDE) Contd.

Model	Side	Year
Maverick X3 Max Turbo	Left	17
Maverick X3 Max Turbo	Right	
Maverick X3 Turbo	Left	18
Maverick X3 Turbo	Right	
Maverick X3 Max Turbo	Left	18
Maverick X3 Max Turbo	Right	
Maverick X3 Turbo R	Left	18
Maverick X3 Turbo R	Right	
Maverick X3 Max Turbo R	Left	18
Maverick X3 Max Turbo R	Right	
Traxter HD5	Left	17-19
Traxter HD5	Right	
Traxter HD8	Left	17-19
Traxter HD8	Right	
Traxter HD10	Left	17-19
Traxter HD10	Right	
Traxter Max HD10	Left	18-19
Traxter Max HD10	Right	
Traxter T HD5	Left	18-19
Traxter T HD5	Right	
Traxter T HD8	Left	18-19
Traxter T HD8	Right	
Traxter T HD10	Left	18-19
Traxter T HD10	Right	

CAN AM (STREET)

Model	Side	Year
Ryker 600 Ace	Left	18-19
Ryker 600 Ace	Right	
Ryker 900 Ace	Left	18-19
Ryker 900 Ace	Right	

CANNONDALE

Model	Side	Year
FX 400	Left	01
FX 400	Right	
Cannibal 440	Left	02-03
Cannibal 440	Right	
Speed/Glamis 440	Left	02-03
Speed/Glamis 440	Right	
Blaze 440	Left	02-03
Blaze 440	Right	
Moto 440	Left	02-03
Moto 440	Right	

CASAL

Model	Year
All disc models	FA050
Mofas	875
Boss	875
Mofas drum dia. 110mm	894
Mofas drum dia. 140mm	895
50 Ciclomotori (140mm drum)	895

CCM

Model	Year
CR 40 S Cafe Racer (Full Fairing)	07-08
CR 40 Cafe Racer (Handlebar Fairing)	07-08
SR 40 Street Scrambler	07-09
C-XR 125 M	07-09
C-XR 125 E	08-09
C-XR 125 S	08-09
RL 125	08-09
SM 125	08-09

DISC PAD CHOICES - FRONT

BRAKE DISC CHOICES - FRONT

FA, SFA, TT Pad or Brake Shoe	SFAC Carbon Scooter Pads	Speciality Pads - SXR / Vee / MXS	Sintered/HH Pads/ Grooved Shoes	Left / Gauche / Links Standard Replacement Disc	Right / Droite / Rechts Standard Replacement Disc	Contour Disc Universal left and right fitment	Universal Custom Disc	Vee-Discs Black † See note below	CX Extreme MX Race Disc/ UTVX Disc
FA682TT		SXR682HH	FA682R	MD6411D					UTVX6411
FA683TT		SXR683HH	FA683R		MD6411D				UTVX6411
FA682TT		SXR682HH	FA682R	MD6411D					UTVX6411
FA683TT		SXR683HH	FA683R		MD6411D				UTVX6411
FA682TT		SXR682HH	FA682R	MD6411D					UTVX6411
FA683TT		SXR683HH	FA683R		MD6411D				UTVX6411
FA682TT		SXR682HH	FA682R	MD6411D					UTVX6411
FA683TT		SXR683HH	FA683R		MD6411D				UTVX6411
FA682TT		SXR682HH	FA682R	MD6411D					UTVX6411
FA683TT		SXR683HH	FA683R		MD6411D				UTVX6411
FA682TT		SXR682HH	FA682R	MD6396D					UTVX6396
FA683TT		SXR683HH	FA683R		MD6396D				UTVX6396
FA682TT		SXR682HH	FA682R	MD6396D					UTVX6396
FA683TT		SXR683HH	FA683R		MD6396D				UTVX6396
FA682TT		SXR682HH	FA682R	MD6396D					UTVX6396
FA683TT		SXR683HH	FA683R		MD6396D				UTVX6396
FA682TT		SXR682HH	FA682R	MD6396D					UTVX6396
FA683TT		SXR683HH	FA683R		MD6396D				UTVX6396
FA682TT		SXR682HH	FA682R	MD6396D					UTVX6396
FA683TT		SXR683HH	FA683R		MD6396D				UTVX6396
FA682TT		SXR682HH	FA682R	MD6396D					UTVX6396
FA683TT		SXR683HH	FA683R		MD6396D				UTVX6396
FA682TT		SXR682HH	FA682R	MD6396D					UTVX6396
FA683TT		SXR683HH	FA683R		MD6396D				UTVX6396
FA682TT		SXR682HH	FA682R	MD6396D					UTVX6396
FA683TT		SXR683HH	FA683R		MD6396D				UTVX6396
FA682TT		SXR682HH	FA682R	MD6396D					UTVX6396
FA683TT		SXR683HH	FA683R		MD6396D				UTVX6396
FA682TT		SXR682HH	FA682R	MD6396D					UTVX6396
FA683TT		SXR683HH	FA683R		MD6396D				UTVX6396
FA682TT		SXR682HH	FA682R	MD6396D					UTVX6396
FA683TT		SXR683HH	FA683R		MD6396D				UTVX6396
FA682TT		SXR682HH	FA682R	MD6396D					UTVX6396
FA683TT		SXR683HH	FA683R		MD6396D				UTVX6396
FA682TT		SXR682HH	FA682R	MD6396D					UTVX6396
FA683TT		SXR683HH	FA683R		MD6396D				UTVX6396
FA682TT		SXR682HH	FA682R	MD6396D					UTVX6396
FA683TT		SXR683HH	FA683R		MD6396D				UTVX6396
FA682TT		SXR682HH	FA682R	MD6396D					UTVX6396
FA683TT		SXR683HH	FA683R		MD6396D				UTVX6396
FA682TT		SXR682HH	FA682R	MD6396D					UTVX6396
FA683TT		SXR683HH	FA683R		MD6396D				UTVX6396
FA682TT		SXR682HH	FA682R	MD6396D					UTVX6396
FA683TT		SXR683HH	FA683R		MD6396D				UTVX6396
FA682TT		SXR682HH	FA682R	MD6396D					UTVX6396
FA683TT		SXR683HH	FA683R		MD6396D				UTVX6396
FA682TT		SXR682HH	FA682R	MD6396D					UTVX6396
FA683TT		SXR683HH	FA683R		MD6396D				UTVX6396
FA682TT		SXR682HH	FA682R	MD6396D					UTVX6396
FA683TT		SXR683HH	FA683R		MD6396D				UTVX6396
FA682TT		SXR682HH	FA682R	MD6396D					UTVX6396
FA683TT		SXR683HH	FA683R		MD6396D				UTVX6396
FA682TT		SXR682HH	FA682R	MD6396D					UTVX6396
FA683TT		SXR683HH	FA683R		MD6396D				UTVX6396
FA682TT		SXR682HH	FA682R	MD6396D					UTVX6396
FA683TT		SXR683HH	FA683R		MD6396D				UTVX6396
FA682TT		SXR682HH	FA682R	MD6396D					UTVX6396
FA683TT		SXR683HH	FA683R		MD6396D				UTVX6396
FA682TT		SXR682HH	FA682R	MD6396D					UTVX6396
FA683TT		SXR683HH	FA683R		MD6396D				UTVX6396
FA682TT		SXR682HH	FA682R	MD6396D					UTVX6396
FA683TT		SXR683HH	FA683R		MD6396D				UTVX6396
FA682TT		SXR682HH	FA682R	MD6396D					UTVX6396
FA683TT		SXR683HH	FA683R		MD6396D				UTVX6396
FA682TT		SXR682HH	FA682R	MD6396D					UTVX6396
FA683TT		SXR683HH	FA683R		MD6396D				UTVX6396
FA682TT		SXR682HH	FA682R	MD6396D					UTVX6396
FA683TT		SXR683HH	FA683R		MD6396D				UTVX6396
FA682TT		SXR682HH	FA682R	MD6396D					UTVX6396
FA683TT		SXR683HH	FA683R		MD6396D				UTVX6396
FA682TT		SXR682HH	FA682R	MD6396D					UTVX6396
FA683TT		SXR683HH	FA683R		MD6396D				UTVX6396
FA682TT		SXR682HH	FA682R	MD6396D					UTVX6396
FA683TT		SXR683HH	FA683R		MD6396D				UTVX6396
FA682TT		SXR682HH	FA682R	MD6396D					UTVX6396
FA683TT		SXR683HH	FA683R		MD6396D				UTVX6396
FA682TT		SXR682HH	FA682R	MD6396D					UTVX6396
FA683TT		SXR683HH	FA683R		MD6396D				UTVX6396
FA682TT		SXR682HH	FA682R	MD6396D					UTVX6396
FA683TT		SXR683HH	FA683R		MD6396D				UTVX6396
FA682TT		SXR682HH	FA682R	MD6396D					UTVX6396
FA683TT		SXR683HH	FA683R		MD6396D				UTVX6396
FA682TT		SXR682HH	FA682R	MD6396D					UTVX6396
FA683TT		SXR683HH	FA683R		MD6396D				UTVX6396
FA682TT		SXR682HH	FA682R	MD6396D					UTVX6396
FA683TT		SXR683HH	FA683R		MD6396D				UTVX6396
FA682TT		SXR682HH	FA682R	MD6396D					UTVX6396
FA683TT		SXR683HH	FA683R		MD6396D				UTVX6396
FA682TT		SXR682HH	FA682R	MD6396D					UTVX6396
FA683TT		SXR683HH	FA683R		MD6396D				UTVX6396
FA682TT		SXR682HH	FA682R	MD6396D					UTVX6396
FA683TT		SXR683HH	FA683R		MD6396D				UTVX6396
FA682TT		SXR682HH	FA682R	MD6396D					UTVX6396
FA683TT		SXR683HH	FA683R		MD6396D				UTVX6396
FA682TT		SXR682HH	FA682R	MD6396D					UTVX6396
FA683TT		SXR683HH	FA683R		MD6396D				UTVX6396
FA682TT		SXR682HH	FA682R	MD6396D					UTVX6396
FA683TT		SXR683HH	FA683R		MD6396D				UTVX6396
FA682TT		SXR682HH	FA682R	MD6396D					UTVX6396
FA683TT		SXR683HH	FA683R		MD6396D				UTVX6396
FA682TT		SXR682HH	FA682R	MD6396D					UTVX6396
FA683TT		SXR683HH	FA683R		MD6396D				UTVX6396
FA682TT		SXR682HH	FA682R	MD6396D					UTVX6396
FA683TT		SXR683HH	FA683R		MD6396D				UTVX6396
FA682TT		SXR682HH	FA682R	MD6396D					UTVX6396
FA683TT		SXR683HH	FA683R		MD6396D				UTVX6396
FA682TT		SXR682HH	FA682R	MD6396D					UTVX6396
FA683TT		SXR683HH	FA683R		MD6396D				UTVX6396
FA682TT		SXR682HH	FA682R	MD6396D					UTVX6396
FA683TT		SXR683HH	FA683R		MD6396D				UTVX6396
FA682TT		SXR682HH	FA682R	MD6396D					UTVX6396
FA683TT		SXR683HH	FA683R		MD6396D				UTVX6396
FA682TT		SXR682HH	FA682R	MD6396D					UTVX6396
FA683TT		SXR683HH	FA683R		MD6396D				UTVX6396
FA682TT		SXR682HH	FA682R	MD6396D					UTVX6396
FA683TT		SXR683HH	FA683R		MD6396D				UTVX6396
FA682TT		SXR682HH	FA682R	MD6396D					UTVX6396
FA683TT		SXR683HH	FA683R		MD6396D				UTVX6396
FA682TT		SXR682HH	FA682R	MD6396D					UTVX6396
FA683TT		SXR683HH	FA683R		MD6396D				UTVX6396
FA682TT		SXR682HH	FA682R	MD6396D					UTVX6396
FA683TT		SXR683HH	FA683R		MD6396D				UTVX6396
FA682TT		SXR682HH	FA682R	MD6396D					UTVX6396
FA683TT		SXR683HH	FA683R		MD6396D				UTVX6396
FA682TT		SXR682HH	FA682R	MD6396D					UTVX6396
FA683TT		SXR683HH	FA683R		MD6396D				UTVX6396

Non-JAPANESE Built Motorcycles

Line #	BRAKE DISC CHOICES - FRONT						DISC PAD CHOICES - REAR				BRAKE DISC CHOICES - REAR			
	Oversize 250 /280mm Disc Kit	OSX Oversize 250/280mm Disc Kit	Relocating Bracket for 250/ 280mm Disc	Oversize 320mm Disc Kit	SMX Oversize 320mm Disc Kit	Relocating Bracket for 320mm Disc	FA, SFA, TT Pad or Brake Shoe	SFAC Carbon Scooter Pads	Speciality Pads - SXR / Vee / MXS	Sintered/ HH Pads/ Grooved Shoes	Standard Replacement Disc	Contour Disc Rear fitment	Vee-Discs™ CONTOUR	CX Extreme MX Race Disc/ UTVX Disc
1							FA682TT		SXR682HH	FA682R	MD6412D		UTVX6412	
2							FA683TT		SXR683HH	FA683R	MD6412D		UTVX6412	
3							FA682TT		SXR682HH	FA682R	MD6411D		UTVX6412	
4							FA683TT		SXR683HH	FA683R	MD6411D		UTVX6412	
5							FA682TT		SXR682HH	FA682R	MD6412D		UTVX6412	
6							FA683TT		SXR683HH	FA683R	MD6412D		UTVX6412	
7							FA682TT		SXR682HH	FA682R	MD6412D		UTVX6412	
8							FA683TT		SXR683HH	FA683R	MD6412D		UTVX6412	
9							FA682TT		SXR682HH	FA683R	MD6412D		UTVX6412	
10							FA683TT		SXR683HH	FA682R	MD6412D		UTVX6412	
11														
12							FA683TT		SXR683HH	FA683R	MD6396D		UTVX6396	
13														
14							FA683TT		SXR683HH	FA683R	MD6396D		UTVX6396	
15														
16							FA683TT		SXR683HH	FA683R	MD6396D		UTVX6396	
17														
18							FA683TT		SXR683HH	FA683R	MD6396D		UTVX6396	
19														
20							FA683TT		SXR683HH	FA683R	MD6396D		UTVX6396	
21														
22							FA683TT		SXR683HH	FA683R	MD6396D		UTVX6396	
23														
24							FA683TT		SXR683HH	FA683R	MD6396D		UTVX6396	
25														
26														
27							FA317TT			FA317R				
28														
29							FA317TT			FA317R				
30														
31														
32														
33							FA307TT			FA307R	N/A			
34														
35							FA307TT			FA307R	N/A			
36														
37							FA307TT			FA307R	N/A			
38														
39							FA307TT			FA307R	N/A			
40														
41							FA307TT			FA307R	N/A			
42														
43														
44														
45							N/A							
46							875							
47							875							
48							894							
49							895							
50							895							
51														
52														
53							FA213	FA213V	FA213HH	MD6276D				
54							FA213	FA213V	FA213HH	TBA				
55							FA213	FA213V	FA213HH	TBA				
56							FA054TT		FA054HH	TBA				
57							FA054TT		FA054HH	TBA				
58							FA054TT		FA054HH	TBA				
59							TBA							
60							FA197		FA197HH	TBA				

REAR / ARRIÈRE / HINTEN / POSTERIOR / POSTERIORE

*-2 Sets Required. † For Vee disc colours add RED, BLU, GRN, GLD, ORG suffix to part number.

⊗ - Also available as a Vintage Motorcycle Disc.

R Suffix = High Durability Sintered Pad. HH Suffix = High Performance Sintered Pad. TT Suffix = Hard Wearing Off Road Pad. V Suffix = Semi Sintered Pad. G Suffix = Grooved Shoe.

D Suffix = Drilled Disc. X Suffix = Universal Left or Right Disc. XC Suffix = Contoured Disc. LS Suffix = Left/Steel Disc. RS = Right/Steel Disc.

BRAKE APPLICATIONS

Non-JAPANESE Built Motorcycles

APPLICATIONS

BRAKE



CCM Contd.

TL 125	08-09
C-XR 230 E	07-09
C-XR 230 S	07-09
C-XR 230 M	07-09
XTR 250	09
LX 350-4A Quad	08-09
FT 35 S (400cc) (DRZ 400 Motor)	07-09
404 E (Front disc has 260mm O/D)	03-04
404 DS (Front disc has 260mm O/D)	03-04
404 DS Supermoto (Front disc has 320mm O/D)	03-04
404 DS Supermoto	07-09
404 DS Trail	07-09
CMX 450 (MX)	08
450 DS Trail	07-09
GP 450 (4T)	13-15
600 Spitfire	19
600 Spitfire Scrambler	19
Spitfire Bobber	19-20
Spitfire Bobber Stealth Edition	19-20
Spitfire Foggy Edition	19-20
Spitfire Foggy Edition S	19-20
Spiritfire Foggy Stealth Edition	19-20
Spitfire RABFB 100	19-20
Spitfire Six	19-20
Spitfire Six Stealth Edition	19-20
Spitfire Stealth	19-20
604 E DS (Dual Sport/Trail) (Front disc has 260mm O/D)	98-03
604 E Supermoto (Front disc has 320mm O/D)	99-03
604 RS Roadster (Front disc has 320mm O/D)	00-03
644 DS Supermoto (Front disc has 320mm O/D)	04
644 DS (Front disc has 320mm O/D)	04
R 30 (Spoke wheel) (604/644) (Front disc has 320mm O/D)	02-04
R 30 (Mag wheel) (604/644) (Front disc has 320mm O/D)	02-04
R 35/R 35 S	07-09
R 45	07-09
FT 650	08
LX 700-4A Quad	08-09
FT 710 S Flat Tracker	08-09

FRONT / AVANT / VORN / FRENTE / ANTERIORE

DISC PAD CHOICES - FRONT				BRAKE DISC CHOICES - FRONT							Line #
FA, SFA, TT Pad or Brake Shoe	SFAC Carbon Scooter Pads	Speciality Pads SXR / Vee / MXS	Sintered/HH Pads/ Grooved Shoes	Left / Gauche / Links Standard Replacement Disc	Right / Droite / Rechts Standard Replacement Disc	Contour Disc Universal left and right fitment	Universal Custom Disc	Vee-Discs Black † See note below	CX Extreme MX Race Disc/ UTVX Disc	Line #	
FA086			FA086HH							1	
FA086			FA086HH	TBA						2	
FA086			FA086HH	TBA						3	
FA086			FA086HH	TBA						4	
FA086			FA086HH	N/A						5	
FA054TT*			FA054R*	TBA	TBA					6	
FA181TT		MXS181	FA181R	TBA						7	
FA181TT		MXS181	FA181R	MD6260D						8	
FA181TT		MXS181	FA181R	MD6260D						9	
FA181TT		MXS181	FA181R	MD6209D						10	
FA181TT		MXS181	FA181R	TBA						11	
FA181TT		MXS181	FA181R	TBA						12	
FA181TT		MXS181	FA181R	N/A						13	
FA181TT		MXS181	FA181R	TBA						14	
FA209/2			FA209/2HH			N/A				15	
			FA630HH							16	
FA209/2			FA209/2HH							17	
			FA630HH							18	
			FA630HH							19	
			FA630HH							20	
			FA630HH							21	
			FA630HH							22	
			FA630HH							23	
			FA630HH							24	
			FA630HH							25	
			FA630HH							26	
FA181TT		MXS181	FA181R	MD6260D						27	
FA181TT		MXS181	FA181R	MD6209D						28	
FA181TT		MXS181	FA181R	MD6209D						29	
FA181TT		MXS181	FA181R	MD6209D						30	
FA181TT		MXS181	FA181R	MD6209D						31	
FA181TT		MXS181	FA181R	MD6209D						32	
FA181TT		MXS181	FA181R	MD6306D						33	
FA181TT		MXS181	FA181R	TBA						34	
FA181TT		MXS181	FA181R	TBA						35	
FA181TT		MXS181	FA181R	TBA						36	
FA054TT*			FA054R*	TBA	TBA					37	
FA181TT		MXS181	FA181R	TBA						38	
										39	
										40	
FA484TT*			FA484R*	N/A	N/A					41	
FA377TT*			FA377R*	N/A	N/A					42	
FA484TT*			FA484R*	N/A	N/A					43	
FA484TT*			FA484R*	N/A	N/A					44	
										45	
										46	
SFA228	SFAC228		SFA228HH	N/A						47	
SFA228	SFAC228		SFA228HH	N/A						48	
SFA228	SFAC228		SFA228HH	N/A						49	
SFA228	SFAC228		SFA228HH	N/A						50	
FA658			FA658HH		N/A					51	
FA093				N/A						52	
TBA					N/A					53	
FA179			FA179HH	N/A						54	
SFA086*	SFAC086*		SFA086HH*	N/A	N/A					55	
		SXR726HH*	FA726R*							56	
		SXR726HH*	FA726R*							57	
FA135TT			FA135R	N/A	N/A					58	
FA165TT			FA165R							59	
FA232TT										60	

*-2 Sets Required. † For Vee disc colours add RED, BLU, GRN, GLD, ORG suffix to part number.

⊗ - Also available as a Vintage Motorcycle Disc.

216 Part numbers, prefixes, suffixes, photos and illustrations shown in this catalogue are trademarks and/or copyrights of EBC Brakes or the trademark owner A C Freeman Investments Ltd and use without express written permission of the owners is punishable by law.

Non-JAPANESE Built Motorcycles

Line #	BRAKE DISC CHOICES - FRONT						DISC PAD CHOICES - REAR				BRAKE DISC CHOICES - REAR			
	Oversize 250 /280mm Disc Kit	OSX Oversize 250/280mm Disc Kit	Relocating Bracket for 250/ 280mm Disc	Oversize 320mm Disc Kit	SMX Oversize 320mm Disc Kit	Relocating Bracket for 320mm Disc	FA, SFA, TT Pad or Brake Shoe	SFAC Carbon Scooter Pads	Speciality Pads - SXR / Vee / MXS	Sintered/ HH Pads/ Grooved Shoes	Standard Replacement Disc	Contour Disc Rear fitment	Vee-Discs™ CONTOUR	CX Extreme MX Race Disc/ UTVX Disc
1							FA197			FA197HH	TBA			
2							FA054TT			FA054HH	TBA			
3							FA054TT			FA054HH	TBA			
4							FA054TT			FA054HH	TBA			
5							FA101				N/A			
6							FA083TT			FA083R	TBA			
7							FA208TT		MXS208	FA208R	TBA			
8							FA208TT		MXS208	FA208R	MD6276D			
9							FA208TT		MXS208	FA208R	MD6276D			
10							FA208TT		MXS208	FA208R	MD6276D			
11							FA208TT		MXS208	FA208R	TBA			
12							FA208TT		MXS208	FA208R	TBA			
13							FA208TT		MXS208	FA208R	N/A			
14							FA208TT		MXS208	FA208R	TBA			
15							FA213			FA213HH		N/A		
16							FA208TT			FA208R				
17							FA368TT		MXS368	FA368R				
18							FA208TT			FA208R				
19							FA208TT			FA208R				
20							FA208TT			FA208R				
21							FA208TT			FA208R				
22							FA208TT			FA208R				
23							FA208TT			FA208R				
24							FA208TT			FA208R				
25							FA208TT			FA208R				
26							FA208TT			FA208R				
27							FA208TT		MXS208	FA208R	MD6276D			
28							FA208TT		MXS208	FA208R	MD6276D			
29							FA208TT		MXS208	FA208R	MD6276D			
30							FA208TT		MXS208	FA208R	MD6276D			
31							FA208TT		MXS208	FA208R	MD6276D			
32							FA208TT		MXS208	FA208R	MD6276D			
33							FA208TT		MXS208	FA208R	N/A			
34							FA208TT		MXS208	FA208R	TBA			
35							FA208TT		MXS208	FA208R	MD6276D			
36							FA208TT		MXS208	FA208R	TBA			
37							FA344TT			FA344R	TBA			
38							FA208TT		MXS208	FA208R	MD6276D			
39														
40														
41							FA067TT*			FA067R*	N/A			
42							FA067TT*			FA067R*	N/A			
43							FA067TT*			FA067R*	N/A			
44							FA067TT*			FA067R*	N/A			
45														
46														
47							TBA				N/A			
48							TBA				N/A			
49							TBA				N/A			
50							TBA				N/A			
51							TBA				N/A			
52							S602							
53							TBA				N/A			
54							FA101TT				N/A			
55							TBA				N/A			
56									SXR651HH*	FA651R*				
57									SXR651HH*	FA651R*				
58							FA344TT			FA344R	N/A			
59														
60														

REAR / ARRIÈRE / HINTEN / POSTERIOR / POSTERIORE

*-2 Sets Required. † For Vee disc colours add RED, BLU, GRN, GLD, ORG suffix to part number.

⊗ - Also available as a Vintage Motorcycle Disc.

R Suffix = High Durability Sintered Pad. **HH** Suffix = High Performance Sintered Pad. **TT** Suffix = Hard Wearing Off Road Pad. **V** Suffix = Semi Sintered Pad. **G** Suffix = Grooved Shoe.
D Suffix = Drilled Disc. **X** Suffix = Universal Left or Right Disc. **XC** Suffix = Contoured Disc. **LS** Suffix = Left/Steel Disc. **RS** = Right/Steel Disc.

Non-JAPANESE Built Motorcycles

APPLICATIONS

BRAKE



CF MOTO Contd.

CF 500 5B/5C - C/Force 500 Classic	14-15
CF 500 5B/5C - C/Force 500 Classic - Parking brake	14-15
CF 500- AU-6L C/Force 550 ATV	15
CF 500- C/Force (X5 Terralander)	11-15
CF 500- C/Force (X5 Terralander) - Parking brake	11-15
CF 500 US Z-Force 550 (Side x Side)	Left 15
	Right
CF 500 UU-A U-Force 550	Left 15
(Side x Side)	Right
600 C-Force	20
600 C-Force EPS	18-19
CF 600 Z-Force Z6 EX (Side x Side)	Left 13-15
	Right
CF 625 - C/Force (X6 Terralander)	11-15
CF 625 - C/Force (X6 Terralander) - Parking brake	11-15
650 NK	Left 12-15
	Right
650 TR	Left 13-14
	Right
650 TK	Left 13-15
	Right
CF 800-2 - C/Force ATV	14-15
CF 800 UU-A U-Force 800	Left 14-16
(Side x Side)	Right
CF 800 Z-Force Z8 (Side x Side)	Left 13-15
	Right
CF 800 Z-Force Z8-EX (Side x Side)	Left 14-15
	Right
950 Z-Force	20
1000 U-Force	20
1000 Z-Force	18-19

CH RACING

WXE 50 Enduro	05
WSM 50 Motard	05
WXE 125 Enduro	05
WSM 125 Motard	05

CIMATTI

Gringo	-85
Gringo	85-

CONTI

RX 356 V3 (12" wheels)	05-06
RX 356 V3 (17" wheels)	05-06

CPI

Aragon 50	07-09
Aragon GP50	07-12
Aragon GP Paddock	08-12
Aragon Club 50	07-12
Aragon S-Line 50	07-12
Baby J 50	02
Bravo 50	12
Formula 50 Basic	07-08
Formula 50 R	07-08
Freaky 50	07
GTR 50 (2 Pin Pad Fixing Front Caliper)	02
GTR 50 (1 Pin Pad Fixing Front Caliper)	03-13
GTS 50/125/200	02-03

DISC PAD CHOICES - FRONT

BRAKE DISC CHOICES - FRONT

FA, SFA, TT Pad or Brake Shoe	SFAC Carbon Scooter Pads	Speciality Pads - SXR / Vee / MXS	Sintered/HH Pads/ Grooved Shoes	Left / Gauche / Links Standard Replacement Disc	Right / Droite / Rechts Standard Replacement Disc	Contour Disc Universal left and right fitment	Universal Custom Disc	Vee-Discs Black † See note below	CX Extreme MX Race Disc/ UTVX Disc
FA453TT*			FA453R*	N/A	N/A				
FA232TT									
FA453TT*			FA453R*	N/A	N/A				
FA453TT*			FA453R*	N/A	N/A				
FA232TT									
FA135TT		SXR135HH	FA135R	N/A	N/A				
FA165TT		SXR165HH	FA165R						
FA135TT		SXR135HH	FA135R	N/A	N/A				
FA165TT		SXR165HH	FA165R						
		SXR726HH*	FA726R*						
		SXR726HH*	FA726R*						
FA135TT		SXR135HH	FA135R	N/A	N/A				
FA165TT		SXR165HH	FA165R						
FA453TT*			FA453R*	N/A	N/A				
FA232TT									
FA229			FA229HH			N/A*			
FA231			FA231HH						
FA229			FA229HH			N/A*			
FA231			FA231HH						
FA229			FA229HH			N/A*			
FA231			FA231HH						
FA453TT*			FA453R*	N/A	N/A				
FA135TT		SXR135HH	FA135R	N/A	N/A				
FA165TT		SXR165HH	FA165R						
FA135TT		SXR135HH	FA135R	N/A	N/A				
FA165TT		SXR165HH	FA165R						
FA135TT		SXR135HH	FA135R	N/A	N/A				
FA165TT		SXR165HH	FA165R						
		SXR726HH*	FA726R*						
		SXR726HH*	FA726R*						
		SXR726HH*	FA726R*						
FA167			FA167HH	N/A					
FA167			FA167HH	N/A					
FA167			FA167HH	N/A					
FA167			FA167HH	N/A					
FA050				N/A					
FA099				N/A					
FA399				N/A					
FA399				N/A					
SFA235	SFAC235			TBA					
SFA235	SFAC235			TBA					
SFA235	SFAC235			N/A					
SFA235	SFAC235			TBA					
SFA235	SFAC235			TBA					
SFA083	SFAC083		SFA083HH	MD923D				VR923	
SFA086	SFAC086		SFA086HH		TBA				
SFA235	SFAC235			TBA					
SFA235	SFAC235			TBA					
SFA235	SFAC235			TBA					
SFA194	SFAC194		SFA194HH	N/A					
SFA266	SFAC266		SFA266HH	N/A					
SFA194	SFAC194		SFA194HH	N/A					

Line #
1
2
3
4
5
6
7
8
9
10
11
12
13
14
15
16
17
18
19
20
21
22
23
24
25
26
27
28
29
30
31
32
33
34
35
36
37
38
39
40
41
42
43
44
45
46
47
48
49
50
51
52
53
54
55
56
57
58
59
60

R Suffix = High Durability Sintered Pad. HH Suffix = High Performance Sintered Pad. TT Suffix = Hard Wearing Off Road Pad. V Suffix = Semi Sintered Pad. G Suffix = Grooved Shoe.
D Suffix = Drilled Disc. X Suffix = Universal Left or Right Disc. XC Suffix = Contoured Disc. LS Suffix = Left/Steel Disc. RS = Right/Steel Disc.

*-2 Sets Required. † For Vee disc colours add RED, BLU, GRN, GLD, ORG suffix to part number.

⊗ - Also available as a Vintage Motorcycle Disc.

218 Part numbers, prefixes, suffixes, photos and illustrations shown in this catalogue are trademarks and/or copyrights of EBC Brakes or the trademark owner A C Freeman Investments Ltd and use without express written permission of the owners is punishable by law.

Non-JAPANESE Built Motorcycles

Line #	BRAKE DISC CHOICES - FRONT						DISC PAD CHOICES - REAR				BRAKE DISC CHOICES - REAR			
	Oversize 250 /280mm Disc Kit	OSX Oversize 250/280mm Disc Kit	Relocating Bracket for 250/ 280mm Disc	Oversize 320mm Disc Kit	SMX Oversize 320mm Disc Kit	Relocating Bracket for 320mm Disc	FA, SFA, TT Pad or Brake Shoe	SFAC Carbon Scooter Pads	Speciality Pads - SXR / Vee / MXS	Sintered/ HH Pads/ Grooved Shoes	Standard Replacement Disc	Contour Disc Rear fitment	Vee-Discs™ CONTOUR	CX Extreme MX Race Disc/ UTVX Disc
1							FA344TT			FA344R	N/A			
2														
3							FA135TT			FA135R	N/A			
4							FA344TT			FA344R	N/A			
5														
6							FA651TT		SXR651HH	FA651R	N/A			
7							FA651TT		SXR651HH	FA651R	N/A			
8							FA651TT		SXR651HH	FA651R	N/A			
9							FA651TT		SXR651HH	FA651R	N/A			
10									SXR651HH*	FA651R*				
11									SXR651HH*	FA651R*				
12							FA651TT		SXR651HH	FA651R	N/A			
13							FA651TT		SXR651HH	FA651R	N/A			
14							FA344TT			FA344R	N/A			
15														
16							FA192		FA192V	FA192HH		N/A		
17														
18												N/A		
19														
20							FA192		FA192V	FA192HH		N/A		
21														
22							FA344TT			FA344R	N/A			
23							FA067TT			FA067R	N/A			
24							FA067TT			FA067R	N/A			
25							FA651TT		SXR651HH	FA651R	N/A			
26							FA651TT		SXR651HH	FA651R	N/A			
27							FA651TT		SXR651HH	FA651R	N/A			
28							FA651TT		SXR651HH	FA651R	N/A			
29									SXR651HH*	FA651R*				
30									SXR651HH*	FA651R*				
31									SXR651HH*	FA651R*				
32														
33														
34							FA115			FA115HH	N/A			
35							FA115			FA115HH	N/A			
36							FA115			FA115HH	N/A			
37							FA115			FA115HH	N/A			
38														
39														
40							N/A							
41							N/A							
42														
43														
44							FA115				N/A			
45							FA115				N/A			
46														
47														
48							Y503							
49							Y503							
50							Y503							
51							Y503							
52							Y503							
53							Y503							
54							Y503							
55							Y503							
56							Y503							
57							Y503							
58							SFA260	SFAC260		SFA260HH	N/A			
59							SFA298	SFAC298		SFA298HH	N/A			
60							SFA260	SFAC260		SFA260HH	N/A			

REAR / ARRIÈRE / HINTEN / POSTERIOR / POSTERIORE

*-2 Sets Required. † For Vee disc colours add RED, BLU, GRN, GLD, ORG suffix to part number.

⊗ - Also available as a Vintage Motorcycle Disc.

R Suffix = High Durability Sintered Pad. HH Suffix = High Performance Sintered Pad. TT Suffix = Hard Wearing Off Road Pad. V Suffix = Semi Sintered Pad. G Suffix = Grooved Shoe.

D Suffix = Drilled Disc. X Suffix = Universal Left or Right Disc. XC Suffix = Contoured Disc. LS Suffix = Left/Steel Disc. RS = Right/Steel Disc.

BRAKE APPLICATIONS

Non-JAPANESE Built Motorcycles

APPLICATIONS

BRAKE



CPI Contd.

R Suffix = High Durability Sintered Pad. HH Suffix = High Performance Sintered Pad. TT Suffix = Hard Wearing Off Road Pad. V Suffix = Semi Sintered Pad. G Suffix = Grooved Shoe.
 D Suffix = Drilled Disc. X Suffix = Universal Left or Right Disc. XC Suffix = Contoured Disc. LS Suffix = Left/Steel Disc. RS = Right/Steel Disc.

50 Hussar	01-02
Hussar 50	03-05
50 Mars	01-02
Oliver 50 (All models)	03-12
Popcorn 50	02
Popcorn 50	03-06
Quad 50/100cc (Crab)	03-04
Supermoto 50 SMX	03-08
Supermoto 50 (Low level exhaust)	06-09
Supercross 50	03-09
SM 50	11-12
SM 50 Black Tiger	08-09
SX 50	06-07
SX 50	11-12
Vogue 50 EFI	12
XT 50 Quad	06-09
Aragon S-Line 125	07-12
Aragon GP 125	07-08
Bravo 125	12
GTR 125 (2 Pin Pad Fixing Front Caliper)	02
GTR 125 (1 Pin Pad Fixing Front Caliper)	03-13
125 Prince	01
Oliver 125	06-12
SM 125	11-12
SX 125	11-12
Vogue 125 EFI	12
X-Large 125/150/200	02-03
X-Large 125/300	11-12
XR 125 Sprint	12
Sauel 125	
GTR 150 (2 Pin Pad Fixing Front Caliper)	02
GTR 150 (1 Pin Pad Fixing Front Caliper)	03-13
X-Large 250	11-12
SM 250	09-12
SX 250	09-12
XR 250	12
XS 250 Quad	06-09
X-Large 300	11-12
CQR	
DN 50	
DN 50 E	
DN 50/50 E	05
Mini Adventure	
DN 100	06
DN 100/100 E	05
DN 150	
DN 150 Extreme	
DN 150/150 E	05
DN 250/Hammel	06
DN 250 Dolphin	06
DN 250	05
Utility 250	06
RX 260	06
CSR	
Ona 125 (4T)	04-06
Scoo 125 (4T)	04-06
Moped	

FA, SFA, TT Pad or Brake Shoe	SFAC Carbon Scooter Pads	Speciality Pads - SXR / Vee / MXS	Sintered/HH Pads/ Grooved Shoes	BRAKE DISC CHOICES - FRONT					Line #
				Left / Gauche / Links Standard Replacement Disc	Right / Droite / Rechts Standard Replacement Disc	Contour Disc Universal left and right fitment	Universal Custom Disc	Vee-Discs Black † See note below	
SFA083	SFAC083		SFA083HH	MD923D				VR923	1
SFA235	SFAC235			MD923D				VR923	2
SFA083	SFAC083		SFA083HH	MD923D				VR923	3
SFA235	SFAC235			MD923D				VR923	4
SFA083	SFAC083		SFA083HH	MD923D				VR923	5
SFA235	SFAC235			MD923D				VR923	6
H338*			H338G*						7
FA115			FA115R	N/A					8
FA115			FA115HH	N/A					9
FA115			FA115R	N/A					10
FA115TT			FA115R	N/A					11
FA115			FA115HH	N/A					12
FA194			FA194HH	N/A					13
FA115TT			FA115R	N/A					14
TBA					N/A				15
Y503*			Y503G*						16
SFA235	SFAC235			TBA					17
SFA235	SFAC235			TBA					18
SFA086	SFAC086		SFA086HH		TBA				19
SFA194	SFAC194		SFA194HH	N/A					20
SFA266	SFAC266		SFA266HH	N/A					21
FA197			FA197HH	N/A					22
SFA235	SFAC235			N/A					23
FA115TT			FA115R	N/A					24
FA115TT			FA115R	N/A					25
TBA					N/A				26
SFA266*	SFAC266*		SFA266HH*	N/A	N/A				27
SFA197	SFAC197		SFA197HH		N/A				28
FA086			FA086HH	N/A					29
FA185TT		MXS185	FA185R	MD6087D					30
SFA194	SFAC194		SFA194HH	N/A					31
SFA266	SFAC266		SFA266HH	N/A					32
SFA086	SFAC086		SFA086HH		N/A				33
FA115						N/A			34
FA115						N/A			35
FA086			FA086HH	N/A					36
FA377TT*			FA377R*	N/A	N/A				37
SFA197	SFAC197		SFA197HH		N/A				38
									39
									40
TBA*									41
TBA*									42
TBA*									43
TBA*									44
TBA*									45
TBA*									46
TBA*									47
TBA*									48
TBA*									49
FA083TT*			FA083R*	N/A	N/A				50
TBA*									51
TBA*									52
FA083TT*			FA083R*	N/A	N/A				53
FA083TT*			FA083R*	N/A	N/A				54
									55
									56
SFA235	SFAC235			N/A					57
SFA235	SFAC235			N/A					58
804									59
									60

*-2 Sets Required. † For Vee disc colours add RED, BLU, GRN, GLD, ORG suffix to part number.

⊗ - Also available as a Vintage Motorcycle Disc.

220 Part numbers, prefixes, suffixes, photos and illustrations shown in this catalogue are trademarks and/or copyrights of EBC Brakes or the trademark owner A C Freeman Investments Ltd and use without express written permission of the owners is punishable by law.

Non-JAPANESE Built Motorcycles

Line #	BRAKE DISC CHOICES - FRONT						DISC PAD CHOICES - REAR				BRAKE DISC CHOICES - REAR			
	Oversize 250 /280mm Disc Kit	OSX Oversize 250/280mm Disc Kit	Relocating Bracket for 250/ 280mm Disc	Oversize 320mm Disc Kit	SMX Oversize 320mm Disc Kit	Relocating Bracket for 320mm Disc	FA, SFA, TT Pad or Brake Shoe	SFAC Carbon Scooter Pads	Speciality Pads - SXR / Vee / MXS	Sintered/ HH Pads/ Grooved Shoes	Standard Replacement Disc	Contour Disc Rear fitment	Vee-Discs™ CONTOUR	CX Extreme MX Race Disc/ UTVX Disc
1							Y503							
2							Y503							
3							Y503							
4							Y503							
5							Y503							
6							Y504							
7							FA083TT			FA083R	N/A			
8							FA115			FA115R	N/A			
9							FA115			FA115HH	N/A			
10							FA115			FA115R	N/A			
11							FA115TT			FA115R	N/A			
12							FA115			FA115HH	N/A			
13							FA115			FA115HH	N/A			
14							FA115TT			FA115R	N/A			
15							TBA				N/A			
16							FA165TT			FA165R	N/A			
17							Y503							
18							Y527							
19							Y503							
20							SFA260	SFAC260		SFA260HH	N/A			
21							SFA298	SFAC298		SFA298HH	N/A			
22							TBA							
23							Y506							
24							FA115TT			FA115R	N/A			
25							FA115TT			FA115R	N/A			
26							TBA				N/A			
27							SFA266	SFAC266		SFA266HH	N/A			
28							SFA197	SFAC197		SFA197HH	N/A			
29							TBA							
30							FA131TT		MXS131	FA131R	MD6013D			
31							SFA260	SFAC260		SFA260HH	N/A			
32							SFA298	SFAC298		SFA298HH	N/A			
33							SFA086	SFAC086		SFA086HH	N/A			
34							FA665				N/A			
35							FA665				N/A			
36							FA086			FA086HH	N/A			
37							FA431TT			FA431R	N/A			
38							SFA197	SFAC197		SFA197HH	N/A			
39														
40														
41							TBA							
42							TBA				TBA			
43							FA083TT			FA083R	N/A			
44							N/A				N/A			
45							FA083TT			FA083R	TBA			
46							FA083TT			FA083R	N/A			
47							FA083TT			FA083R	N/A			
48							FA083TT			FA083R	TBA			
49							FA083TT			FA083R	N/A			
50							FA083TT			FA083R	N/A			
51							FA083TT			FA083R	TBA			
52							FA083TT			FA083R	N/A			
53							FA083TT			FA083R	N/A			
54							FA083TT			FA083R	N/A			
55														
56														
57							SFA235	SFAC235			N/A			
58							SFA235	SFAC235			N/A			
59							TBA							
60														

REAR / ARRIÈRE / HINTEN / POSTERIOR / POSTERIORE

*-2 Sets Required. † For Vee disc colours add RED, BLU, GRN, GLD, ORG suffix to part number.

⊗ - Also available as a Vintage Motorcycle Disc.

R Suffix = High Durability Sintered Pad. HH Suffix = High Performance Sintered Pad. TT Suffix = Hard Wearing Off Road Pad. V Suffix = Semi Sintered Pad. G Suffix = Grooved Shoe.

D Suffix = Drilled Disc. X Suffix = Universal Left or Right Disc. XC Suffix = Contoured Disc. LS Suffix = Left/Steel Disc. RS = Right/Steel Disc.

BRAKE APPLICATIONS

Non-JAPANESE Built Motorcycles

APPLICATIONS

BRAKE



C.Z./JAWA



50 Minarelli	03-04
50/100 Robby	03-04
Scrambler Cross 125-380 (Single & twin port models)	65-76
125 Sport	03-04
125 Dandy	03-04
125 Travel	03-04
125 Chopper	03-04
125/175/250/350	-74
125/175/250/350	75-
250/380 (Models 513/514) Full width front hub models	77-79
Jawa 250/400 Cross	65-76
350	
350 Chopper	03-04
350 Tramp	03-04
350 Californian	03-04
350 Californian	09-10
350 Classic	03-04
350 New Classic	13-14

DAELIM

A-Four (50cc) (SJ 50 R)	06-09
Bonita 50 (SE50C)	09-12
Cordi 50/SE 50 R	05-12
DX 50 D Camper	03
GZ 50 Message	97-02
M 50 D/MD Millenium	03
Tapo Message 50	04
E-Five (SJ50A)	03-06
S-Four (ES 50)	10-12
S-Five (SJ50)	01-12
ST 90 Pro Monkey	03
Delfino 100 (SH100)	01-04
Citi Ace 110	03-11
Altino 125/125 ES	01-04
Besbi 125 (SC125)	08-13
B-Bone 125 (SN125)	09-14
History 125 (SL 125)	01-06
History 125 (SL 125) - Parking brake	01-06
Otello 125 (NS 125) DLX	00-02
Roadwin (VJ125)	04-13
Roadwin R 125 Fi (VJF 125)	08-14
SL 125 Otello Fi	07-09
SQ 125 S2 Freewing	07-09
ST 125	03
SU 125 Delfino	07-11
S1 125 (SL125)	07-14
S3 125 (SV125)	10-11
S3 125 (SV125)	12-14
VL 125 Daystar/L	03-14
VS 125 Evolution	01-04
VT 125 Evolution	03
NS 125 DLX/III Trans Eagle	03-07
SQ 125 Freewing S2	06
ET 250 Quad	05-08
Roadsport 250 (VJF 250)	10-14
Roadwin R 250 Fi (VJF 250)	08-10
SQ 250 Freeway S2	06
S3 250 (SV250)	12-14
ST 250 Sector Quad	05-06
VL 250 Daystar	13-14

FA, SFA, TT Pad or Brake Shoe	DISC PAD CHOICES - FRONT			BRAKE DISC CHOICES - FRONT						Line #
	SFAC Carbon Scooter Pads	Speciality Pads - SXR / Vee / MXS	Sintered/HH Pads/ Grooved Shoes	Left / Gauche / Links Standard Replacement Disc	Right / Droite / Rechts Standard Replacement Disc	Contour Disc Universal left and right fitment	Universal Custom Disc	Vee-Discs Black † See note below	CX Extreme MX Race Disc/ UTVX Disc	
FA115			FA115HH		N/A					1
FA115			FA115HH	N/A						2
950										3
FA115			FA115HH		N/A					4
FA115			FA115HH		N/A					5
FA115			FA115HH		N/A					6
FA198					N/A					7
949										8
951										9
N/A										10
950										11
FA198				N/A						12
FA198					N/A					13
FA198					N/A					14
FA198					N/A					15
FA142			FA142HH		TBA					16
FA198					N/A					17
FA142		FA142V	FA142HH		N/A					18
										19
										20
SFA228	SFAC228		SFA228HH	N/A						21
SFA257	SFAC257			N/A						22
SFA257	SFAC257			N/A						23
SFA169	SFAC169		SFA169HH	MD904D				VR904		24
SFA257	SFAC257			TBA						25
SFA169	SFAC169		SFA169HH	MD904D				VR904		26
SFA054	SFAC054		SFA054HH	N/A						27
SFA257	SFAC257			N/A						28
SFA197	SFAC197		SFA197HH		N/A					29
SFA257	SFAC257			TBA						30
SFA169	SFAC169		SFA169HH	MD904D				VR904		31
SFA257	SFAC257			TBA						32
SFA086	SFAC086		SFA086HH		N/A					33
SFA054	SFAC054		SFA054HH		N/A					34
SFA233				TBA						35
SFA661/4	SFAC661/4			N/A						36
SFA054	SFAC054		SFA054HH		MD814					37
H303										38
SFA054	SFAC054		SFA054HH		N/A					39
FA196			FA196HH	N/A						40
FA196			FA196HH	TBA						41
SFA661/4	SFAC661/4			TBA						42
SFA661/4	SFAC661/4			TBA						43
FA194			FA194HH	N/A						44
SFA197	SFAC197		SFA197HH		N/A					45
SFA661/4	SFAC661/4			N/A						46
SFA661/4	SFAC661/4			N/A		N/A				47
SFA661/4	SFAC661/4			N/A		N/A				48
FA196			FA196HH		N/A					49
FA196			FA196HH	N/A						50
FA196			FA196HH	N/A						51
SFA054	SFAC054		SFA054HH	N/A						52
SFA142	SFAC142		SFA142HH							53
FA083TT*			FA083R*	N/A	N/A					54
FA142*			FA142HH*	N/A	N/A					55
FA142*			FA142HH*	N/A	N/A					56
SFA142	SFAC142		SFA142HH	N/A						57
SFA661/4	SFAC661/4			N/A		N/A				58
FA083TT*			FA083R*	N/A	N/A					59
FA142*		FA142V*	FA142HH*	N/A	N/A					60

FRONT / AVANT / VORN / FRENTE / ANTERIORE

R Suffix = High Durability Sintered Pad. HH Suffix = High Performance Sintered Pad. TT Suffix = Hard Wearing Off Road Pad. V Suffix = Semi Sintered Pad. G Suffix = Grooved Shoe.

D Suffix = Drilled Disc. X Suffix = Universal Left or Right Disc. XC Suffix = Contoured Disc. LS Suffix = Left/Steel Disc. RS = Right/Steel Disc.

*-2 Sets Required. † For Vee disc colours add RED, BLU, GRN, GLD, ORG suffix to part number.

⊗ - Also available as a Vintage Motorcycle Disc.

222 Part numbers, prefixes, suffixes, photos and illustrations shown in this catalogue are trademarks and/or copyrights of EBC Brakes or the trademark owner A C Freeman Investments Ltd and use without express written permission of the owners is punishable by law.

Non-JAPANESE Built Motorcycles

Line #	BRAKE DISC CHOICES - FRONT						DISC PAD CHOICES - REAR				BRAKE DISC CHOICES - REAR			
	Oversize 250 /280mm Disc Kit	OSX Oversize 250/280mm Disc Kit	Relocating Bracket for 250/ 280mm Disc	Oversize 320mm Disc Kit	SMX Oversize 320mm Disc Kit	Relocating Bracket for 320mm Disc	FA, SFA, TT Pad or Brake Shoe	SFAC Carbon Scooter Pads	Speciality Pads - SXR / Vee / MXS	Sintered/ HH Pads/ Grooved Shoes	Standard Replacement Disc	Contour Disc Rear fitment	Vee-Discs™ CONTOUR	CX Extreme MX Race Disc/ UTVX Disc
1							TBA							
2							TBA							
3							950							
4							FA115			FA115HH	N/A			
5							FA115			FA115HH	N/A			
6							FA115			FA115HH	N/A			
7							949							
8							949							
9							949							
10							950							
11							950							
12							949							
13							949							
14							949							
15							949							
16							949							
17							949							
18							949							
19														
20														
21							H303							
22							TBA							
23							TBA							
24							Y503							
25							TBA							
26							Y503							
27							TBA							
28							H303							
29							TBA							
30							H303							
31							Y503							
32							H303							
33							TBA							
34							TBA							
35							TBA							
36							SFA054	SFAC054			N/A			
37							SFA054	SFAC054		SFA054HH	N/A			
38														
39							H303							
40							FA197			FA197HH	TBA			
41							FA197			FA197HH	TBA			
42							SFA054	SFAC054			TBA			
43							SFA054	SFAC054			TBA			
44							FA115			FA115HH	N/A			
45							TBA							
46							SFA054	SFAC054			N/A			
47							SFA197	SFAC197			N/A			
48							SFA427	SFAC427			N/A			
49							H310	H310G						
50							H310	H310G						
51							TBA							
52							SFA054	SFAC054		SFA054HH	N/A			
53							SFA197	SFAC197		SFA197HH	N/A			
54							FA427TT			FA427R	N/A			
55							FA197			FA197HH	N/A			
56							FA197			FA197HH	N/A			
57							SFA197	SFAC197		SFA197HH	N/A			
58							SFA608				N/A			
59							FA427TT			FA427R	N/A			
60							FA197			FA197HH	N/A			

REAR / ARRIÈRE / HINTEN / POSTERIOR / POSTERIORE

*-2 Sets Required. † For Vee disc colours add RED, BLU, GRN, GLD, ORG suffix to part number.

⊗ - Also available as a Vintage Motorcycle Disc.

R Suffix = High Durability Sintered Pad. **HH** Suffix = High Performance Sintered Pad. **TT** Suffix = Hard Wearing Off Road Pad. **V** Suffix = Semi Sintered Pad. **G** Suffix = Grooved Shoe.
D Suffix = Drilled Disc. **X** Suffix = Universal Left or Right Disc. **XC** Suffix = Contoured Disc. **LS** Suffix = Left/Steel Disc. **RS** = Right/Steel Disc.

Part numbers, prefixes, suffixes, photos and illustrations shown in this catalogue are trademarks and/or copyrights of EBC Brakes or the trademark owner A C Freeman Investments Ltd and use without express written permission of the owners is punishable by law.

Non-JAPANESE Built Motorcycles

APPLICATIONS

BRAKE



DAELIM Contd.

ET 300 Quad 07-09

DAYTONA

DY 125 RS Euro 4 17

DERBI

Atlantis 50 (AC/2T) 99-01

Atlantis 50 (AC/2T) 02

Atlantis 50 Bullet (AC/2T) 03-05

Atlantis 50 City (AC/2T) 03-06

Atlantis 50 Red Bullet (AC/2T) 03

Atlantis 50 Two Chic (AC/2T) 05

Atlantis 50 (4T) (13" - 3 spoke wheels) 04-06

Atlantis 50 (2T) Upto ref no. 8G253171 12"/5

spoke wheels/190mm disc 3 bolt 07

Atlantis 50 (2T/AC) (12"/5 spoke wheels/200mm

disc From ref no. 8G253172/5 bolt) 07-11

Atlantis 50 (4T) 07-09

Atlantis 50 LC (4T) 99-01

Boulevard 50 (2T) 09-12

Boulevard 50 (4T) 09

Hunter 96-99

DFW 50 Quad 04-07

DRD 50 Supermoto/Racer 03-04

GP1 50cc 01-03

GP1 50 Open 06-11

GP1 50 Euro 2 Chain driven/radial caliper

/5 bolt fixing front disc 05

GP1 50 Race Chain driven/radial caliper

/5 bolt fixing front disc 05-07

GP1 50cc 01-03

GPR 50 R (218mm Rear Disc) 97-01

GPR 50 Replica Racing (218mm Rear Disc) 99-03

GPR 50 (40mm Forks/180mm Rear Disc/Radial Caliper) 04-07

GPR 50 Racing (40mm Forks/180mm

Rear Disc/Radial Caliper) 08-10

GPR 50 2T (41mm Forks/218mm Rear Disc/Radial Caliper) 09-11

GPR 50 Nude (Radial caliper/180mm Rear Disc) 04-09

Paddock 50 (AC/2T) 98-99

Predator 50 (AC/2T) 98-01

Predator 50 (LC/2T) 3 bolt front disc/USD Showa forks 98-03

Predator 50 (LC/2T) 5 bolt front disc/STD Paioli forks 98-03

Red Bullet 50 04-05

Senda-R 96-99

Senda-R 00-02

Senda SM DRD 50 (Double disc model/SDR1DB) 02-03

Senda SM DRD 50 (Double disc model/SR3A1A) 05

Senda SM DRD 50 Black Edition 03

Senda SM DRD 50 Black Edition 05

Senda SM DRD Racing LTD (SR2A2B Model/Cast Wheels) 05-07

Senda R DR 02

Senda DRD X Treme 50 R (21" Spoke Front Wheel

/260mm disc) 11-14

Senda DRD X Treme 50 SM

(17" Cast Front Wheel/260mm disc) 11-14

Senda DRD Racing 50 SM

(300mm disc/Std mounted caliper) 04-10

Senda DRD Racing 50 R

(300mm disc/Std mounted caliper) 04-10

DISC PAD CHOICES - FRONT

BRAKE DISC CHOICES - FRONT

FA, SFA, TT Pad or Brake Shoe	SFAC Carbon Scooter Pads	Speciality Pads SXR / Vee / MXS	Sintered/HH Pads/ Grooved Shoes	Left / Gauche / Links Standard Replacement Disc	Right / Droite / Rechts Standard Replacement Disc	Contour Disc Universal left and right fitment	Universal Custom Disc	Vee-Discs Black † See note below	CX Extreme MX Race Disc/ UTVX Disc
FA083TT*			FA083R*	TBA	TBA				
SFA709	SFAC709		SFA709HH						
SFA115	SFAC115		SFA115HH	MD964D					
SFA115	SFAC115		SFA115HH	MD964D					
SFA115	SFAC115		SFA115HH	MD964D					
SFA115	SFAC115		SFA115HH	MD964D					
SFA115	SFAC115		SFA115HH	MD964D					
SFA115	SFAC115		SFA115HH	MD964D					
SFA115	SFAC115		SFA115HH	MD964D					
SFA115	SFAC115		SFA115HH	MD991D					
SFA115	SFAC115		SFA115HH	MD964D					
SFA093				MD910D		MD910C		VR910	
SFA093				MD910D		MD910C		VR910	
SFA115	SFAC115		SFA115HH	MD964D					
SFA353	SFAC353		SFA353HH	MD910D		MD910C		VR910	
SFA353	SFAC353		SFA353HH	MD910D		MD910C		VR910	
SFA115	SFAC115		SFA115HH	MD964D					
H338*			H338G*						
FA115TT*			FA115R*	N/A	N/A				
SFA194	SFAC194		SFA194HH	MD956D				VR956	
SFA266	SFAC266		SFA266HH	MD9113D					
SFA266	SFAC266		SFA266HH	MD9113D					
SFA115	SFAC115		SFA115HH	MD991D					
FA167			FA167HH	MD806LS					
FA167			FA167HH	MD806LS					
FA266			FA266HH	MD685LS					
FA266			FA266HH	MD685LS					
FA399				MD685LS					
FA266			FA266HH	MD685LS					
SFA115	SFAC115		SFA115HH	MD964D					
SFA115	SFAC115		SFA115HH	MD964D					
SFA115	SFAC115		SFA115HH	MD964D					
SFA115	SFAC115		SFA115HH	MD991D					
SFA115	SFAC115		SFA115HH	MD964D					
FA115TT			FA115R	MD6175D					
FA115TT			FA115R	MD6250D					
FA167*			FA167HH*	MD6361D	MD6361D				
FA115*			FA115HH*	MD6361D	MD6361D				
FA167			FA167HH	TBA					
FA115TT*			FA115R*	MD6361D	MD6361D				
FA115*			FA115HH*			MD836C*			
FA194			FA194HH	TBA					
FA083TT			FA083R	TBA					
FA266			FA266HH	TBA					
FA194			FA194HH	MD811					
FA194			FA194HH	MD811					

Line #
1
2
3
4
5
6
7
8
9
10
11
12
13
14
15
16
17
18
19
20
21
22
23
24
25
26
27
28
29
30
31
32
33
34
35
36
37
38
39
40
41
42
43
44
45
46
47
48
49
50
51
52
53
54
55
56
57
58
59
60

R Suffix = High Durability Sintered Pad. HH Suffix = High Performance Sintered Pad. TT Suffix = Hard Wearing Off Road Pad. V Suffix = Semi Sintered Pad. G Suffix = Grooved Shoe.

D Suffix = Drilled Disc. X Suffix = Universal Left or Right Disc. XC Suffix = Contoured Disc. LS Suffix = Left/Steel Disc. RS Suffix = Right/Steel Disc.

*-2 Sets Required. † For Vee disc colours add RED, BLU, GRN, GLD, ORG suffix to part number.

⊗ - Also available as a Vintage Motorcycle Disc.

Non-JAPANESE Built Motorcycles

Line #	BRAKE DISC CHOICES - FRONT						DISC PAD CHOICES - REAR				BRAKE DISC CHOICES - REAR			
	Oversize 250 /280mm Disc Kit	OSX Oversize 250/280mm Disc Kit	Relocating Bracket for 250/ 280mm Disc	Oversize 320mm Disc Kit	SMX Oversize 320mm Disc Kit	Relocating Bracket for 320mm Disc	FA, SFA, TT Pad or Brake Shoe	SFAC Carbon Scooter Pads	Speciality Pads - SXR / Vee / MXS	Sintered/ HH Pads/ Grooved Shoes	Standard Replacement Disc	Contour Disc Rear fitment	Vee-Discs™ CONTOUR	CX Extreme MX Race Disc/ UTVX Disc
1							FA427TT			FA427R	TBA			
2														
3														
4														
5														
6														
7							S624							
8							899							
9							899							
10							899							
11							899							
12							899							
13							816							
14														
15							899							
16														
17							899							
18							816							
19							S624							
20							816							
21							816							
22							S624							
23							H330		H330G					
24							FA115TT		FA115R	N/A				
25														
26							SFA115	SFAC115	SFA115HH	MD932D		VR932		
27														
28							SFA115	SFAC115	SFA115HH	MD9123D				
29														
30							SFA115	SFAC115	SFA115HH	MD9123D				
31							SFA115	SFAC115	SFA115HH	MD932D				
32							FA115		FA115HH	MD805				
33							FA115		FA115HH	MD805				
34							FA115		FA115HH	MD686				
35														
36							FA115		FA115HH	MD686				
37							FA115		FA115HH	MD833				
38							FA115		FA115HH	MD686				
39							S624							
40							S624							
41							SFA115	SFAC115	SFA115HH	MD964D				
42							SFA115	SFAC115	SFA115HH	MD964D				
43							S624							
44							FA115TT		FA115R	N/A				
45							FA115TT		FA115R	MD6248D				
46							FA115		FA115HH	MD6248D				
47							FA115		FA115HH	MD6248D				
48							FA115		FA115HH	N/A				
49							FA115TT		FA115R	TBA				
50							FA115		FA115HH	MD805C				
51							FA115		FA115HH	TBA				
52														
53							FA083TT		FA083R	TBA				
54														
55							FA083TT		FA083R	TBA				
56														
57							FA115		FA115HH	MD808				
58														
59							FA115		FA115HH	MD808				
60														

REAR / ARRIÈRE / HINTEN / POSTERIOR / POSTERIORE

*-2 Sets Required. † For Vee disc colours add RED, BLU, GRN, GLD, ORG suffix to part number.

⊗ - Also available as a Vintage Motorcycle Disc.

R Suffix = High Durability Sintered Pad. **HH** Suffix = High Performance Sintered Pad. **TT** Suffix = Hard Wearing Off Road Pad. **V** Suffix = Semi Sintered Pad. **G** Suffix = Grooved Shoe.
D Suffix = Drilled Disc. **X** Suffix = Universal Left or Right Disc. **XC** Suffix = Contoured Disc. **LS** Suffix = Left/Steel Disc. **RS** = Right/Steel Disc.

Part numbers, prefixes, suffixes, photos and illustrations shown in this catalogue are trademarks and/or copyrights of EBC Brakes or the trademark owner A C Freeman Investments Ltd and use without express written permission of the owners is punishable by law.

Non-JAPANESE Built Motorcycles

APPLICATIONS

BRAKE



DERBI Contd.



DISC PAD CHOICES - FRONT

BRAKE DISC CHOICES - FRONT

		FA, SFA, TT Pad or Brake Shoe	SFAC Carbon Scooter Pads	Speciality Pads SXR / Vee / MXS	Sintered/ HH Pads/ Grooved Shoes	Left / Gauche / Links Standard Replacement Disc	Right / Droite / Rechts Standard Replacement Disc	Contour Disc Universal left and right fitment	Universal Custom Disc	Vee-Discs Black † See note below	CX Extreme MX Race Disc/ UTVX Disc	Line #
Senda DRD Racing 50 SM												1
(260mm disc/Std mounted caliper)	11-12	FA194			FA194HH	MD811						2
Senda DRD Racing 50 R (260mm disc/Std mounted caliper)	11-12	FA194			FA194HH	MD811						3
Senda DRD Pro 50 R Radial Caliper/260mm disc	05-13	FA266			FA266HH	TBA						4
SendaDRD Pro 50 SM Radial Caliper/300mm disc	05-14	FA266			FA266HH	MD811						5
Senda DRD 50 Evo SM (Cast wheels)	08-11	FA266			FA266HH	N/A						6
Senda X-treme 50 R (240mm disc)	03-11	FA115			FA115HH	MD6250D						7
Senda X-treme 50 SM (260mm disc)	03-11	FA115			FA115HH	TBA						8
Senda X Race 50 R (240mm disc)	05-11	FA115			FA115HH	MD6250D						9
Senda X-Race 50 SM (260mm disc)	06-11	FA115			FA115HH	TBA						10
Sonar 50 (2T)	10-11	SFA260	SFAC260		SFA260HH	TBA						11
Vamos 50	93-95	S624										12
Vamos/Vamos FL	96-99	SFA115	SFAC115		SFA115HH	N/A						13
Variant Sport 50 (2T)	12	SFA353	SFAC353		SFA353HH	MD924D				VR924		14
X Race 50	06	FA115			FA115HH	TBA						15
GPR 80 Cup Radial Caliper	04-05	FA266			FA266HH	N/A						16
Atlantis 100 (AC/2T)	00-01	SFA115	SFAC115		SFA115HH	MD964D						17
Atlantis 100 (4T) (13" - 3 spoke wheels)	04-06	SFA115	SFAC115		SFA115HH	MD991D						18
Boulevard 125	03-07	SFA350	SFAC350		SFA350HH	MD924D		MD924C		VR924		19
Boulevard S 125	07	SFA256	SFAC256		SFA256HH	MD952D				VR952		20
Boulevard 125 (4T)	08-12	SFA353	SFAC353		SFA353HH	MD910D				VR910		21
Cross City 125	07-08	FA194			FA194HH	MD807LS						22
Cross City 125	09-14	FA465TT		MXS465	FA465R	MD807LS						23
GP1 125cc Scooter Full height seat/5 bolt fixing front disc	06	SFA266	SFAC266		SFA266HH	MD9113D						24
GP1 125cc Racing Low Seat/Radial Caliper												25
/6 bolt disc fixing	07-09	FA399				MD9122D						26
GPR 125 Racing (Radial caliper) (2T)	04-07	FA399				MD685LS						27
GPR 125 Nude (Radial caliper) (2T)	04-08	FA399				MD685LS						28
GPR 125 (4T) 4V	09-14	FA399				MD685LS						29
Mulhacen 125 (4T) Up to ref no.: 7N001790												30
Spoke wheel/2 pin pad fixing	07	FA194			FA194HH	MD807LS						31
Mulhacen 125 (4T) From ref no.: 7N001791												32
Spoke wheel/Single pin fixing	07-10	FA465TT		MXS465	FA465R	MD807LS						33
Mulhacen 125 Cafe Cast wheel/radial caliper	08-11	FA266			FA266HH	MD685LS						34
Rambla 125	08-12	SFA256	SFAC256		SFA256HH	MD952D				VR952		35
Senda 125 R Vin # SCB1A	04	FA167			FA167HH	MD698LS						36
Senda 125 R Vin # SCA1A	04	FA194			FA194HH	MD698LS						37
Senda 125 SM (Twin headlight)	04-07	FA194			FA194HH	MD698LS						38
Senda 125 Baja R (4T) (260mm disc)	06-12	FA194			FA194HH	TBA						39
Senda 125 Baja SM (4T) (300mm disc)	06-12	FA194			FA194HH	MD698LS						40
Senda DRD 125 R	10-12	FA266			FA266HH			TBA				41
Senda DRD 125 SM	10-14	FA266			FA266HH	TBA						42
Sonar 125 (4T)	10-11	SFA260	SFAC260		SFA260HH	TBA						43
Terra 125 Adventure	07-14	FA465TT		MXS465	FA465R	MD807LS						44
Terra 125 Euro (Single pin pad fixing)	07-11	FA465TT		MXS465	FA465R	MD807LS						45
Variant Sport 125 (4T)	12	SFA353	SFAC353		SFA353HH	MD924D				VR924		46
Boulevard 150	03-07	SFA350	SFAC350		SFA350HH	MD924D				VR924		47
Sonar 150 (4T)	09-10	SFA260	SFAC260		SFA260HH	TBA						48
Boulevard 200	05	SFA350	SFAC350		SFA350HH	MD924D				VR924		49
DXR 200 Quad (Front drum model)	04	Y503*			Y503G*							50
DXR 200 Quad (Front drum model)	04-05	Y503*			Y503G*							51
DXR 200 Quad (Front disc model)	04-07	FA083TT*			FA083R*	MD6054D	MD6054D					52
DXR 250 Quad (Front drum model)	04-05	Y503*			Y503G*							53
DXR 250 Quad (Front disc model)	04-07	FA083TT*			FA083R*	MD6054D	MD6054D					54
GP1 250cc Scooter	06-07	SFA266*	SFAC266*		SFA266HH*	MD9113D	MD9113D					55
GP1 250cc Racing Low Seat/Radial Caliper												56
/6 bolt disc fixing	07-09	FA399				MD9122D						57
Rambla 250 i	08-09	SFA256*	SFAC256*		SFA256HH*	MD952D	MD952D			VR952*		58
Rambla 300 i	10-12	SFA256*	SFAC256*		SFA256HH*	MD952D	MD952D			VR952*		59
Mulhacen 659	06-08				FA322/4HH	TBA						60

FRONT / AVANT / VORN / FREITE / ANTERIORE

R Suffix = High Durability Sintered Pad. HH Suffix = High Performance Sintered Pad. TT Suffix = Hard Wearing Off Road Pad. V Suffix = Semi Sintered Pad. G Suffix = Grooved Shoe.

D Suffix = Drilled Disc. X Suffix = Universal Left or Right Disc. XC Suffix = Contoured Disc. LS Suffix = Left/Steel Disc. RS Suffix = Right/Steel Disc.

*-2 Sets Required. † For Vee disc colours add RED, BLU, GRN, GLD, ORG suffix to part number.

⊗ - Also available as a Vintage Motorcycle Disc.

226 Part numbers, prefixes, suffixes, photos and illustrations shown in this catalogue are trademarks and/or copyrights of EBC Brakes or the trademark owner A C Freeman Investments Ltd and use without express written permission of the owners is punishable by law.

Non-JAPANESE Built Motorcycles

Line #	BRAKE DISC CHOICES - FRONT						DISC PAD CHOICES - REAR				BRAKE DISC CHOICES - REAR			
	Oversize 250 /280mm Disc Kit	OSX Oversize 250/280mm Disc Kit	Relocating Bracket for 250/ 280mm Disc	Oversize 320mm Disc Kit	SMX Oversize 320mm Disc Kit	Relocating Bracket for 320mm Disc	FA, SFA, TT Pad or Brake Shoe	SFAC Carbon Scooter Pads	Speciality Pads - SXR / Vee / MXS	Sintered/ HH Pads/ Grooved Shoes	Standard Replacement Disc	Contour Disc Rear fitment	Vee-Discs™ CONTOUR	CX Extreme MX Race Disc/ UTVX Disc
1														
2							FA083TT		FA083R	MD805				
3							FA083TT		FA083R	MD805				
4							FA350		SFA350HH	TBA				
5							FA350		SFA350HH	MD808				
6							FA350		SFA350HH	N/A				
7							FA115		FA115HH	MD6248D				
8							FA115		FA115HH	MD6248D				
9							FA115		FA115HH	MD6248D				
10							FA115		FA115HH	MD6248D				
11							816							
12							S624							
13							S624							
14							816							
15							FA115		FA115HH	TBA				
16							FA115		FA115HH	N/A				
17							S624							
18							816							
19							816							
20							SFA298	SFAC298	SFA298HH	MD942D		VR942		
21							816							
22							FA350		FA350HH	MD808				
23							FA350TT			MD808				
24							SFA266	SFAC266	SFA266HH	MD944D				
25														
26							SFA350			MD956D				
27							FA115			MD686				
28							FA115			MD686				
29							FA093			MD833				
30														
31							FA093			MD808				
32														
33							FA093			MD808				
34							FA093			MD833				
35							SFA298	SFAC298	SFA298HH	MD942D		VR942		
36							FA350		FA350HH	MD808				
37							FA350		FA350HH	MD808				
38							FA350		FA350HH	MD808				
39							FA350		FA350HH	MD808				
40							FA350		FA350HH	MD808				
41							FA093				TBA			
42							FA093			TBA				
43							816							
44							FA093			MD808				
45							FA093			MD808				
46							816							
47							816							
48							816							
49							816							
50							FA135TT		FA135R	N/A				
51							FA067TT		FA067R	MD6053D				
52							FA067TT		FA067R	MD6053D				
53							FA135TT		FA135R	MD6053D				
54							FA067TT		FA067R	MD6053D				
55							SFA266	SFAC266	SFA266HH	MD944D				
56														
57							SFA350	SFAC350		MD956D				
58							SFA298	SFAC298	SFA298HH	MD942D		VR942		
59							SFA298	SFAC298	SFA298HH	MD942D		VR942		
60							FA266	FA266V	FA266HH	TBA				

REAR / ARRIÈRE / HINTEN / POSTERIOR / POSTERIORE

*-2 Sets Required. † For Vee disc colours add RED, BLU, GRN, GLD, ORG suffix to part number.

⊗ - Also available as a Vintage Motorcycle Disc.

R Suffix = High Durability Sintered Pad. **HH** Suffix = High Performance Sintered Pad. **TT** Suffix = Hard Wearing Off Road Pad. **V** Suffix = Semi Sintered Pad. **G** Suffix = Grooved Shoe.
D Suffix = Drilled Disc. **X** Suffix = Universal Left or Right Disc. **XC** Suffix = Contoured Disc. **LS** Suffix = Left/Steel Disc. **RS** = Right/Steel Disc.

Part numbers, prefixes, suffixes, photos and illustrations shown in this catalogue are trademarks and/or copyrights of EBC Brakes or the trademark owner A C Freeman Investments Ltd and use without express written permission of the owners is punishable by law.

Non-JAPANESE Built Motorcycles

APPLICATIONS

BRAKE



DINLI

QZ 150 CUV (Front drum model)	
QZ 150 CUV (Front disc model)	
DL 450 RS (DL901)	06-09

DUCATI

250/350/450 Desmo/Single	-76
250/350/450 Desmo/Single (4 bolt disc fixing)	74-77
Supersport 400 (Single disc)	93-97
Supersport 400 (Twin disc)	93-97
400 Monster	95-97
Monster 400 (Single disc)	00-02
Monster 400 (Twin disc)	03-04
400 Monster (Japan)	00-04
Monster Dark ie 400 (Japan)	05-06
Monster Dark ie 400 (Single disc)	05
Monster 400 ie (Japan)	07-08
400 Scrambler Sixty 2	16-20
500 GTL	75
500 GTV Pantah	77
500 Sport Desmo	77
500 Pantah	79
(549cc) Supermono	93-95
600 Pantah	81
Monster 600 (Twin disc)	93-97
600 Monster (Single disc)	93-99
600 Monster Dark	98-99
600 Monster City/City Dark	99
600 Monster	00-01
600 Supersport (Single disc)	91-97
Monster 620 ie (Single disc)	03-04
620 IE Monster (First series)	02-05
620 IE Monster (Second series)	03-05
620 Sport	03
Monster 620	05-06
620 Multistrada (Twin Disc/Single Pin Pad Fixing)	06
620 Multistrada Dark (Single Disc/Twin Pin Pad Fixing)	06
650 Pantah	-84
695 Monster	07-08
696 Monster	08-14
696+ Monster (Inc ABS Models)	09-12
748 R (2 pad caliper)	00
748 R (4 pad caliper)	01
748 R (4 pad caliper)	02
748 Biposto	95-98
748 Biposto	99-02
748 SP	95-97
748 SP	98
748 SP/Monoposto	99-02
748 S (Biposto)	00-02
748 S (Monoposto)	00-02
748 SPS	98-99
748 Testa Bassa (Mono/Biposto)	01
749 Dark (Monoposto/Biposto)	04-06
749 R (Radial caliper)	04-06
749 S (Monoposto/Biposto)	03-06
749 (Monoposto/Biposto)	03-06
750 Sport (4 bolt disc fixing)	74
750 SS (4 bolt disc fixing) (Note thinner pad version for shaved down caliper)	75-76
751 F1	98

DISC PAD CHOICES - FRONT

BRAKE DISC CHOICES - FRONT

FA, SFA, TT Pad or Brake Shoe	SFAC Carbon Scooter Pads	Speciality Pads SXR / Vee / MXS	Sintered/HH Pads/ Grooved Shoes	Left / Gauche / Links Standard Replacement Disc	Right / Droite / Rechts Standard Replacement Disc	Contour Disc Universal left and right fitment	Universal Custom Disc	Vee-Discs Black † See note below	CX Extreme MX Race Disc/ UTVX Disc
Y503*			Y503G*						
TBA*				N/A	N/A				
FA067TT*			FA067R*	N/A	N/A				
928									
FA018			FA018HH	MD634LS					
FA095			FA095HH	MD2003X		MD2003XC	MD2003CC	VR2003BLK†	
FA095*			FA095HH*	MD2003X	MD2003X	MD2003XC*	MD2003CC*	VR2003BLK*†	
FA095			FA095HH	MD633X		MD633XC			
FA244			FA244HH	MD614X		MD614XC		VR614BLK†	
FA244*			FA244HH*	MD614X	MD614X	MD614XC*		VR614BLK*†	
FA244			FA244HH	MD614X		MD614XC		VR614BLK†	
FA244*			FA244HH*	MD614X	MD614X	MD614XC*		VR614BLK*†	
FA244			FA244HH	MD614X		MD614XC		VR614BLK†	
FA181TT*			FA181HH*	MD626X	MD626X	MD626XC*		VR626BLK*†	
FA209/2			FA209/2HH	TBA					
FA047*			FA047HH*	N/A	N/A				
FA047*			FA047HH*	N/A	N/A				
FA047*			FA047HH*	N/A	N/A				
FA047*			FA047HH*	MD657LS	MD657RS				
FA095*			FA095HH*	N/A	N/A				
FA018*			FA018HH*	MD657LS	MD657RS				
FA095*			FA095HH*	MD633X	MD633X	MD633XC*			
FA095			FA095HH	MD633X		MD633XC			
FA095			FA095HH	MD633X		MD633XC			
FA095			FA095HH	MD614X		MD614XC		VR614BLK†	
FA244			FA244HH	MD614X		MD614XC		VR614BLK†	
FA095			FA095HH	MD2003X		MD2003XC	MD2003CC	VR2003BLK†	
FA244			FA244HH	MD614X		MD614XC		VR614BLK†	
FA244*			FA244HH*	MD614X	MD614X	MD614XC*		VR614BLK*†	
FA181TT*			FA181HH*	MD626X	MD626X	MD626XC*		VR626BLK*†	
FA244*			FA244HH*	MD614X	MD614X	MD614XC*		VR614BLK*†	
FA181TT*			FA181HH*	MD626X	MD626X	MD626XC*		VR626BLK*†	
FA181TT*			FA181HH*	MD626X	MD626X	MD626XC*		VR626BLK*†	
FA244			FA244HH	MD2003X		MD2003XC	MD2003CC	VR2003BLK†	
FA018*			FA018HH*	N/A	N/A				
FA181TT*			FA181HH*	MD626X	MD626X	MD626XC*		VR626BLK*†	
FA244*			FA244HH*	MD614X	MD614X	MD614XC*		VR614BLK*†	
FA244*			FA244HH*	MD614X	MD614X	MD614XC*		VR614BLK*†	
FA244*			FA244HH*	MD624	MD624				
			FA322/4HH*	MD636X	MD636X	MD636XC*			
			FA322/4HH*	MD636X	MD636X	MD636XC*			
FA095			FA095HH	MD2003X	MD2003X	MD2003XC*	MD2003CC*	VR2003BLK*†	
FA244*			FA244HH*	MD614X	MD614X	MD614XC*		VR614BLK*†	
FA095*			FA095HH*	TBA	TBA				
FA095*			FA095HH*	MD633X	MD633X	MD633XC*			
FA244*			FA244HH*	MD614X	MD614X	MD614XC*		VR614BLK*†	
FA244*			FA244HH*	TBA	TBA				
FA244*			FA244HH*	TBA	TBA				
FA244			FA244HH	MD633X	MD633X	MD633XC*			
FA244*			FA244HH*	MD614X	MD614X	MD614XC*		VR614BLK*†	
			FA322/4HH*	MD622X	MD622X	MD622XC*		VR622BLK*†	
			FA322/4HH*	MD622X	MD622X	MD622XC*		VR622BLK*†	
			FA322/4HH*	MD622X	MD622X	MD622XC*		VR622BLK*†	
FA016			FA016HH	MD634LS					
FA019*			FA019HH*	MD634LS	MD634RS				
FA018*			FA018HH*	N/A	N/A				

Line #
1
2
3
4
5
6
7
8
9
10
11
12
13
14
15
16
17
18
19
20
21
22
23
24
25
26
27
28
29
30
31
32
33
34
35
36
37
38
39
40
41
42
43
44
45
46
47
48
49
50
51
52
53
54
55
56
57
58
59
60

R Suffix = High Durability Sintered Pad. HH Suffix = High Performance Sintered Pad. TT Suffix = Hard Wearing Off Road Pad. V Suffix = Semi Sintered Pad. G Suffix = Grooved Shoe.

D Suffix = Drilled Disc. X Suffix = Universal Left or Right Disc. XC Suffix = Contoured Disc. LS Suffix = Left/Steel Disc. RS Suffix = Right/Steel Disc.

FRONT / AVANT / VORN / FRENTE / ANTERIORE

*-2 Sets Required. † For Vee disc colours add RED, BLU, GRN, GLD, ORG suffix to part number.

⊗ - Also available as a Vintage Motorcycle Disc.

228 Part numbers, prefixes, suffixes, photos and illustrations shown in this catalogue are trademarks and/or copyrights of EBC Brakes or the trademark owner A C Freeman Investments Ltd and use without express written permission of the owners is punishable by law.

Non-JAPANESE Built Motorcycles

Line #	BRAKE DISC CHOICES - FRONT						DISC PAD CHOICES - REAR				BRAKE DISC CHOICES - REAR			
	Oversize 250 /280mm Disc Kit	OSX Oversize 250/280mm Disc Kit	Relocating Bracket for 250/ 280mm Disc	Oversize 320mm Disc Kit	SMX Oversize 320mm Disc Kit	Relocating Bracket for 320mm Disc	FA, SFA, TT Pad or Brake Shoe	SFAC Carbon Scooter Pads	Speciality Pads - SXR / Vee / MXS	Sintered/ HH Pads/ Grooved Shoes	Standard Replacement Disc	Contour Disc Rear fitment	Vee-Discs™ CONTOUR	CX Extreme MX Race Disc/ UTVX Disc
1							TBA							
2							TBA							
3							FA067TT			FA067R	MD6348D			
4														
5														
6							929							
7							921							
8							FA047		FA047V	FA047HH	MD2002	MD2002C	VR2002	
9							FA047		FA047V	FA047HH	MD2002	MD2002C	VR2002	
10							FA047		FA047V	FA047HH	MD2002	MD2002C		
11							FA047		FA047V	FA047HH	MD2002	MD2002C	VR2002	
12							FA047		FA047V	FA047HH	MD2002	MD2002C	VR2002	
13							FA047		FA047V	FA047HH	MD2002	MD2002C	VR2002	
14							FA047		FA047V	FA047HH	MD2002	MD2002C	VR2002	
15							FA047		FA047V	FA047HH	MD2002	MD2002C	VR2002	
16							FA047		FA047V	FA047HH	MD2002	MD2002C	VR2002	
17							FA213			FA213HH	MD899			
18							N/A							
19							FA047		FA047V	FA047HH	N/A			
20							FA047		FA047V	FA047HH				
21							FA047			FA047HH	MD657RS			
22							FA115			FA115HH	N/A			
23							FA047		FA047V	FA047HH	N/A			
24							FA047		FA047V	FA047HH	MD2002	MD2002C		
25							FA047		FA047V	FA047HH	MD2002	MD2002C		
26							FA047		FA047V	FA047HH	MD2002	MD2002C		
27							FA047		FA047V	FA047HH	MD2002	MD2002C	VR2002	
28							FA047		FA047V	FA047HH	MD2002	MD2002C	VR2002	
29							FA047		FA047V	FA047HH	MD2002	MD2002C	VR2002	
30							FA047		FA047V	FA047HH	MD2002	MD2002C	VR2002	
31							FA047		FA047V	FA047HH	MD2002	MD2002C	VR2002	
32							FA047		FA047V	FA047HH	MD2002	MD2002C	VR2002	
33							FA047		FA047V	FA047HH	MD2002	MD2002C	VR2002	
34							FA047		FA047V	FA047HH	MD2002	MD2002C	VR2002	
35							FA047			FA047HH	MD2002	MD2002C	VR2002	
36							FA047			FA047HH	MD2002	MD2002C	VR2002	
37							FA018			FA018HH	N/A			
38							FA047		FA047V	FA047HH	MD899			
39							FA266		FA266V	FA266HH	MD899			
40							FA266		FA266V	FA266HH	MD899			
41							FA047			FA047HH	MD632			
42							FA047			FA047HH	MD632	MD632C		
43							FA047			FA047HH	MD632	MD632C		
44							FA047			FA047HH	MD632	MD632C	VR632	
45							FA047			FA047HH	MD899			
46							FA047			FA047HH	MD632	MD632C		
47							FA047			FA047HH	MD632	MD632C		
48							FA047			FA047HH	MD2002	MD2002C	VR2002	
49							FA047			FA047HH	MD632			
50							FA047			FA047HH	MD632			
51							FA047			FA047HH	MD632	MD632C		
52							FA047			FA047HH	MD632	MD632C	VR632	
53							FA266			FA266HH	MD618		VR618	
54							FA266			FA266HH	MD618		VR618	
55							FA266			FA266HH	MD618		VR618	
56							FA266			FA266HH	MD618		VR618	
57							N/A							
58														
59							FA019			FA019HH	N/A			
60							FA018			FA018HH	N/A			

REAR / ARRIÈRE / HINTEN / POSTERIOR / POSTERIORE

*-2 Sets Required. † For Vee disc colours add RED, BLU, GRN, GLD, ORG suffix to part number.

⊗ - Also available as a Vintage Motorcycle Disc.

R Suffix = High Durability Sintered Pad. **HH** Suffix = High Performance Sintered Pad. **TT** Suffix = Hard Wearing Off Road Pad. **V** Suffix = Semi Sintered Pad. **G** Suffix = Grooved Shoe.
D Suffix = Drilled Disc. **X** Suffix = Universal Left or Right Disc. **XC** Suffix = Contoured Disc. **LS** Suffix = Left/Steel Disc. **RS** = Right/Steel Disc.

Non-JAPANESE Built Motorcycles

APPLICATIONS

BRAKE



DUCATI Contd.

		DISC PAD CHOICES - FRONT				BRAKE DISC CHOICES - FRONT						Line #
		FA, SFA, TT Pad or Brake Shoe	SFAC Carbon Scooter Pads	Speciality Pads SXR / Vee / MXS	Sintered/HH Pads/ Grooved Shoes	Left / Gauche / Links Standard Replacement Disc	Right / Droite / Rechts Standard Replacement Disc	Contour Disc Universal left and right fitment	Universal Custom Disc	Vee-Discs Black † See note below	CX Extreme MX Race Disc/ UTVX Disc	
750 Paso	87-90				FA018HH*	MD630LS	MD630RS					1
750 Sport	88-90				FA018HH*	MD630LS	MD630RS					2
750 Supersport (Single disc)	91-98				FA095HH	MD633X		MD633XC				3
Supersport 750 (Twin disc)	91-98				FA095*	FA095HH*	MD633X	MD633X	MD633XC*			4
750 Supersport	99				FA244*	FA244HH*	MD2003X	MD2003X	MD2003XC*	MD2003CC*	VR2003BLK*†	5
750 Supersport IE	00-02				FA244*	FA244HH*	MD614X	MD614X	MD614XC*		VR614BLK*†	6
750 Sport	01-02				FA244*	FA244HH*	MD614X	MD614X	MD614XC*		VR614BLK*†	7
750 Monster (Single disc)	96-97				FA095	FA095HH	MD2003X		MD2003XC	MD2003CC	VR2003BLK†	8
750 Monster (Twin disc)	96-98				FA095*	FA095HH*	MD2003X	MD2003X	MD2003XC*	MD2003CC*	VR2003BLK*†	9
750 Monster City/City Dark	99				FA095*	FA095HH*	MD2003X	MD2003X	MD2003XC*	MD2003CC*	VR2003BLK*†	10
750 Monster/Monster Dark	99				FA095*	FA095HH*	MD633X	MD633X	MD633XC*			11
750 Monster	00-01				FA244*	FA244HH*	MD614X	MD614X	MD614XC*		VR614BLK*†	12
750 ie Monster	02				FA244*	FA244HH*	MD614X	MD614X	MD614XC*		VR614BLK*†	13
796 Hypermotard	10-13				FA244*	FA244HH*	MD865X	MD865X	MD865XC*			14
796 Monster (Non ABS Models)	10-13				FA244*	FA244HH*	MD841X	MD841X	MD841XC*		VR841BLK*†	15
796 Monster (ABS Models)	10-14				FA244*	FA244HH*	MD841X	MD841X	MD841XC*		VR841BLK*†	16
796 Monster 20th Anniversary Model (Non ABS Models)	13				FA244*	FA244HH*	MD841X	MD841X	MD841XC*		VR841BLK*†	17
796 Monster 20th Anniversary Model (ABS Models)	13				FA244*	FA244HH*	MD841X	MD841X	MD841XC*		VR841BLK*†	18
797 Monster	17-20					FA630HH*	MD841X	MD841X	MD841XC*		VR841BLK*†	19
797+ Monster	18-20					FA630HH*	MD841X	MD841X	MD841XC*		VR841BLK*†	20
Monster 800	03-04				FA244*	FA244HH*	MD614X	MD614X	MD614XC*		VR614BLK*†	21
Monster S2R (803cc)	05-07				FA181TT*	FA181HH*	MD626X	MD626X	MD626XC*		VR626BLK*†	22
Monster S2R Dark (803cc)	05-06				FA181TT*	FA181HH*	MD626X	MD626X	MD626XC*		VR626BLK*†	23
800 Sport	03				FA244*	FA244HH*	MD614X	MD614X	MD614XC*		VR614BLK*†	24
800 Supersport	03-05				FA244*	FA244HH*	MD614X	MD614X	MD614XC*		VR614BLK*†	25
803 Scrambler Café Racer (Cast Wheels)	17-20					FA630HH	MD868X		MD868XC			26
803 Scrambler Classic (Spoke Wheels)	15-20					FA630HH	MD868X		MD868XC			27
803 Scrambler Desert Sled (Spoke Wheels)	17-20					FA630HH	MD868X		MD868XC			28
803 Scrambler Flat Track Pro	16					FA630HH	MD868X		MD868XC			29
803 Scrambler Full Throttle (Cast Wheels)	15-20					FA630HH	MD868X		MD868XC			30
803 Scrambler Icon (Cast Wheels)	15-20					FA630HH	MD868X		MD868XC			31
803 Scrambler Mach 2 (Cast Wheels)	18-20					FA630HH	MD868X		MD868XC			32
803 Scrambler Street Classic (Spoke Wheels)	18-20					FA630HH	MD868X		MD868XC			33
803 Scrambler Urban Enduro (Spoke Wheels)	15-16					FA630HH	MD868X		MD868XC			34
821 Hypermotard	13-16					FA630HH*	MD841X	MD841X	MD841XC*		VR841BLK*†	35
821 Hypermotard SP	13-16					FA630HH*	MD841X	MD841X	MD841XC*		VR841BLK*†	36
821 Hyperstrada	13-16					FA630HH*	MD841X	MD841X	MD841XC*		VR841BLK*†	37
821 Monster	15-16					FA630HH*	MD841X	MD841X	MD841XC*		VR841BLK*†	38
821 Monster Dark	15-20					FA630HH*	MD841X	MD841X	MD841XC*		VR841BLK*†	39
821 Monster Stripe	15-20					FA630HH*	MD841X	MD841X	MD841XC*		VR841BLK*†	40
848 (Radial 2 pad caliper)	08-10				FA244*	FA244HH*	MD843X	MD843X	MD843XC*		VR843BLK*†	41
848 Evo (Monobloc front calipers)	10-13					FA447HH*	MD843X	MD843X	MD843XC*		VR843BLK*†	42
848 Evo Corse SE	12-13					FA447HH*	N/A	N/A				43
848 Evo Dark	12					FA447HH*	MD843X	MD843X	MD843XC*			44
848 Streetfighter	11-15				FA244*	FA244HH*	N/A	N/A	N/A*		N/A*	45
851 Superbike Biposto	89-92				FA095*	FA095HH*	MD633X	MD633X	MD633XC*			46
860 GT/GTS	75-76				FA018*	FA018HH*	MD634LS	MD634RS				47
888 SP4/SP5	92-93				FA095*	FA095HH*	MD633X	MD633X	MD633XC*			48
888 Superbike Strada	94-95				FA095*	FA095HH*	MD633X	MD633X	MD633XC*			49
899 Panigale	14-15					FA630HH*	MD843X	MD843X	MD843XC*		VR843BLK*†	50
900 GTS (4 bolt disc fixing) (front & rear)	75-76				FA018*	FA018HH*	MD634LS	MD634RS				51
900 Hailwood Replica (6 bolt disc fixing)	79				FA018*	FA018HH*	MD609LS	MD609RS				52
900 SS (Note thinner pad version for shaved down caliper)	75-76				FA019*	FA019HH*	MD634LS	MD634RS				53
900 Supersport	89-90				FA095*	FA095HH*	MD2001X	MD2001X	MD2001XC*	MD2001CC*	VR2001BLK*†	54
900 Supersport/Superlight	91-97				FA095*	FA095HH*	MD633X	MD633X	MD633XC*			55
900 Supersport	98-99				FA244*	FA244HH*	MD633X	MD633X	MD633XC*			56
900 Supersport CR USA	98				FA095*	FA095HH*	MD633X	MD633X	MD633XC*			57
900 Supersport FE	98				FA095*	FA095HH*	MD633X	MD633X	MD633XC*			58
900 Supersport IE	00-01				FA244*	FA244HH*	MD614X	MD614X	MD614XC*		VR614BLK*†	59
900 Sport	02				FA244*	FA244HH*	MD614X	MD614X	MD614XC*		VR614BLK*†	60

FRONT / AVANT / VORN / FRENTE / ANTERIORE

R Suffix = High Durability Sintered Pad. HH Suffix = High Performance Sintered Pad. TT Suffix = Hard Wearing Off Road Pad. V Suffix = Semi Sintered Pad. G Suffix = Grooved Shoe.

D Suffix = Drilled Disc. X Suffix = Universal Left or Right Disc. XC Suffix = Contoured Disc. LS Suffix = Left/Steel Disc. RS Suffix = Right/Steel Disc.

*-2 Sets Required. † For Vee disc colours add RED, BLU, GRN, GLD, ORG suffix to part number.

⊗ - Also available as a Vintage Motorcycle Disc.

Non-JAPANESE Built Motorcycles

Line #	BRAKE DISC CHOICES - FRONT						DISC PAD CHOICES - REAR				BRAKE DISC CHOICES - REAR			
	Oversize 250 /280mm Disc Kit	OSX Oversize 250/280mm Disc Kit	Relocating Bracket for 250/ 280mm Disc	Oversize 320mm Disc Kit	SMX Oversize 320mm Disc Kit	Relocating Bracket for 320mm Disc	FA, SFA, TT Pad or Brake Shoe	SFAC Carbon Scooter Pads	Speciality Pads - SXR / Vee / MXS	Sintered/ HH Pads/ Grooved Shoes	Standard Replacement Disc	Contour Disc Rear fitment	Vee-Discs™ CONTOUR	CX Extreme MX Race Disc/ UTVX Disc
1							FA047		FA047V	FA047HH	MD631			
2							FA018			FA018HH	MD631			
3							FA047		FA047V	FA047HH	MD2002	MD2002C		
4							FA047		FA047V	FA047HH	MD2002	MD2002C		
5							FA266		FA266V	FA266HH	MD2002	MD2002C	VR2002	
6							FA266		FA266V	FA266HH	MD2002	MD2002C	VR2002	
7							FA266		FA266V	FA266HH	MD2002	MD2002C	VR2002	
8							FA047		FA047V	FA047HH	MD2002	MD2002C	VR2002	
9							FA047		FA047V	FA047HH	MD2002	MD2002C	VR2002	
10							FA047		FA047V	FA047HH	MD2002	MD2002C	VR2002	
11							FA047		FA047V	FA047HH	MD2002	MD2002C	VR2002	
12							FA047		FA047V	FA047HH	MD2002	MD2002C	VR2002	
13							FA047		FA047V	FA047HH	MD2002	MD2002C	VR2002	
14							FA266		FA266V	FA266HH	MD627			
15							FA266		FA266V	FA266HH	MD627	MD627C	VR627	
16							FA266		FA266V	FA266HH	MD878	MD878C	VR878	
17							FA266		FA266V	FA266HH	MD627	MD627C	VR627	
18							FA266		FA266V	FA266HH	MD878	MD878C	VR878	
19							FA213		FA213V	FA213HH	MD899			
20							FA213		FA213V	FA213HH	MD899			
21							FA047		FA047V	FA047HH	MD2002	MD2002C	VR2002	
22							FA047		FA047V	FA047HH	MD627	MD627C	VR627	
23							FA047		FA047V	FA047HH	MD627	MD627C	VR627	
24							FA047		FA047V	FA047HH	MD2002	MD2002C	VR2002	
25							FA266		FA266V	FA266HH	MD2002	MD2002C	VR2002	
26							FA213		FA213V	FA213HH	MD899			
27							FA213		FA213V	FA213HH	MD899			
28							FA213		FA213V	FA213HH	MD899			
29							FA213		FA213V	FA213HH	MD899			
30							FA213		FA213V	FA213HH	MD899			
31							FA213		FA213V	FA213HH	MD899			
32							FA213		FA213V	FA213HH	MD899			
33							FA213		FA213V	FA213HH	MD899			
34							FA213		FA213V	FA213HH	MD899			
35							FA266		FA266V	FA266HH	MD878	MD878C	VR878	
36							FA266		FA266V	FA266HH	MD878	MD878C	VR878	
37							FA266		FA266V	FA266HH	MD878	MD878C	VR878	
38							FA266		FA266V	FA266HH	MD899			
39							FA266		FA266V	FA266HH	MD899			
40							FA266		FA266V	FA266HH	MD899			
41							FA266		FA266V	FA266HH	MD627	MD627C	VR627	
42							FA266		FA266V	FA266HH	MD627	MD627C	VR627	
43							FA266		FA266V	FA266HH	MD627	MD627C	VR627	
44							FA266		FA266V	FA266HH	MD627	MD627C	VR627	
45							FA266		FA266V	FA266HH	MD627	MD627C	VR627	
46							FA047		FA047V	FA047HH	MD2002	MD2002C		
47							FA018		FA018V	FA018HH	MD634LS			
48							FA047		FA047V	FA047HH	MD2002	MD2002C		
49							FA047		FA047V	FA047HH	MD2002	MD2002C		
50							FA266		FA266V	FA266HH	MD2002	MD2002C	VR2002	
51							FA018			FA018HH	MD634LS			
52							FA018			FA018HH	MD609LS			
53							FA019			FA019HH	N/A			
54							FA047		FA047V	FA047HH	MD2002	MD2002C	VR2002	
55							FA047		FA047V	FA047HH	MD2002	MD2002C		
56							FA266		FA266V	FA266HH	MD2002	MD2002C		
57							FA047		FA047V	FA047HH	MD2002	MD2002C		
58							FA047		FA047V	FA047HH	MD2002	MD2002C		
59							FA266		FA266V	FA266HH	MD2002	MD2002C	VR2002	
60							FA266		FA266V	FA266HH	MD2002	MD2002C	VR2002	

REAR / ARRIÈRE / HINTEN / POSTERIOR / POSTERIORE

*-2 Sets Required. † For Vee disc colours add RED, BLU, GRN, GLD, ORG suffix to part number.

⊗ - Also available as a Vintage Motorcycle Disc.

R Suffix = High Durability Sintered Pad. **HH** Suffix = High Performance Sintered Pad. **TT** Suffix = Hard Wearing Off Road Pad. **V** Suffix = Semi Sintered Pad. **G** Suffix = Grooved Shoe.
D Suffix = Drilled Disc. **X** Suffix = Universal Left or Right Disc. **XC** Suffix = Contoured Disc. **LS** Suffix = Left/Steel Disc. **RS** = Right/Steel Disc.

Non-JAPANESE Built Motorcycles

APPLICATIONS

BRAKE



DUCATI Contd.

R Suffix = High Durability Sintered Pad. HH Suffix = High Performance Sintered Pad. TT Suffix = Hard Wearing Off Road Pad. V Suffix = Semi-Sintered Pad. G Suffix = Grooved Shoe.
D Suffix = Drilled Disc. X Suffix = Universal Left or Right Disc. XC Suffix = Contoured Disc. LS Suffix = Left/Steel Disc. RS Suffix = Right/Steel Disc.

		DISC PAD CHOICES - FRONT				BRAKE DISC CHOICES - FRONT						Line #
		FA, SFA, TT Pad or Brake Shoe	SFAC Carbon Scooter Pads	Speciality Pads SXR / Vee / MXS	Sintered/HH Pads/ Grooved Shoes	Left / Gauche / Links Standard Replacement Disc	Right / Droite / Rechts Standard Replacement Disc	Contour Disc Universal left and right fitment	Universal Custom Disc	Vee-Discs Black † See note below	CX Extreme MX Race Disc/ UTVX Disc	
900 Monster	93-99	FA095*			FA095HH*	MD633X	MD633X	MD633XC*				1
900 Monster Cromo/Special	98	FA095*			FA095HH*	MD633X	MD633X	MD633XC*				2
900 Monster City/City Dark	99	FA095*			FA095HH*	MD633X	MD633X	MD633XC*				3
900 IE Monster	00-01	FA244*			FA244HH*	MD614X	MD614X	MD614XC*		VR614BLK*†		4
900 MH Evoluzione	00-01	FA244*			FA244HH*	MD614X	MD614X	MD614XC*		VR614BLK*†		5
900 SD Darmah (4 bolt front and rear disc fixing)	77	FA018*			FA018HH*	MD634LS	MD634RS					6
900 SD Darmah (6 bolt front disc fixing /4 bolt rear disc fixing)	78	FA018*			FA018HH*	MD609LS	MD609RS					7
900 SD Darmah (6 bolt disc fixing front & rear)	78	FA018*			FA018HH*	MD609LS	MD609RS					8
906 Paso	88-89	FA018*			FA018HH*	TBA	TBA					9
907 IE	90-91	FA095*			FA095HH*	MD2001X	MD2001X	MD2001XC*	MD2001CC*	VR2001BLK*†		10
907 IE	92-93	FA095*			FA095HH*	MD633X	MD633X	MD633XC*				11
Monster S4 Foggy (916cc)	02	FA244*			FA244HH*	MD624	MD624			VR624BLK†		12
Monster S4 (916cc)	01-02	FA244*			FA244HH*	MD624	MD624			VR624BLK†		13
ST4 (916cc)	99-00	FA244*			FA244HH*	MD633X	MD633X	MD633XC*				14
ST4 (916cc)	01-02	FA244*			FA244HH*	MD614X	MD614X	MD614XC*		VR614BLK*†		15
916 (Biposto)	94-96	FA095*			FA095HH*	MD633X	MD633X	MD633XC*				16
916 Senna	94-98	FA095*			FA095HH*	MD633X	MD633X	MD633XC*				17
916 SP	94-96	FA095*			FA095HH*	MD633X	MD633X	MD633XC*				18
Supersport (936cc)	17-20				FA630HH*	MD841X	MD841X	MD841XC*		VR841BLK*†		19
Supersport S (936cc)	17-20				FA630HH*	MD841X	MD841X	MD841XC*		VR841BLK*†		20
939 Hypermotard	16-20				FA630HH*					VR841BLK*†		21
939 Hypermotard SP	16-20				FA630HH*	MD841X	MD841X	MD841XC*		VR841BLK*†		22
939 Hyperstrada	16-17				FA630HH*	MD841X	MD841X	MD841XC*		VR841BLK*†		23
ST2 (944cc)	97-99	FA244*			FA244HH*	MD633X	MD633X	MD633XC*				24
ST2 (944cc)	00-03	FA244			FA244HH*	MD614X	MD614X	MD614XC*		VR614BLK*†		25
950 Multistrada (936cc)	17-20				FA630HH*	MD841X	MD841X	MD841XC*		VR841BLK*†		26
950 Multistrada S (936cc)	19-20				FA630HH*	MD841X	MD841X	MD841XC*		VR841BLK*†		27
959 Panigale (ABS)	16-19				FA630HH*	MD843X	MD843X	MD843XC*		VR843BLK*†		28
959 Panigale Corse (ABS)	18-19				FA630HH*	MD843X	MD843X	MD843XC*		VR843BLK*†		29
Panigale V2 (955cc)	19-20				FA630HH*	MD843X	MD843X	MD843XC*		VR843BLK*†		30
Panigale V2 Bomber (955cc)	19-20				FA630HH*	MD843X	MD843X	MD843XC*		VR843BLK*†		31
ST3 (Non ABS) (992cc)	04-07	FA244*			FA244HH*	MD614X	MD614X	MD614XC*		VR614BLK*†		32
ST3S (ABS Model) (992cc)	06-07	FA244*			FA244HH*	MD624	MD624			VR624BLK*†		33
916 SPS (996cc)	97-98	FA095*			FA095HH*	TBA	TBA					34
Monster S4R (996cc) (2 pad caliper)	05-06	FA244*			FA244HH*	MD624	MD624			VR624BLK*†		35
996 SPS (996cc)	99	FA244*			FA244HH*	MD624	MD624			VR624BLK*†		36
996 (996cc) (Monoposto/Biposto)	99-01	FA244*			FA244HH*	MD624	MD624			VR624BLK*†		37
996 R	01				FA322/4HH*	MD636X	MD636X	MD636XC*				38
996 S	01	FA244*			FA244HH*	MD624	MD624			VR624BLK*†		39
Monster S4R (996cc)	03-06	FA244*			FA244HH*	MD624	MD624			VR624BLK*†		40
S4RS Monster (998cc) (Radial 4 pad caliper)	06				FA322/4HH*	MD843X	MD843X	MD843XC*		VR843BLK*†		41
S4R Testastretta Monster (998cc) (Radial 4 pad caliper)	07-08				FA322/4HH*	MD843X	MD843X	MD843XC*		VR843BLK*†		42
S4RS Testastretta Monster (998cc) (Radial 4 pad caliper)	07-				FA322/4HH*	MD843X	MD843X	MD843XC*		VR843BLK*†		43
S4RS (Tricolore/Monster Testastretta) (998cc) (Radial 4 pad caliper)	08				FA322/4HH*	MD843X	MD843X	MD843XC*		VR843BLK*†		44
ST4S (Non ABS/996cc)	01-05	FA244*			FA244HH*	MD624	MD624			VR624BLK*†		45
ST4S (ABS Model/996cc)	03-05	FA244*			FA244HH*	MD624	MD624			VR624BLK*†		46
Desmosedici RR (D16RR/989cc)	08				FA447HH*	MD694X	MD694X	MD694XC*		VR694BLK*†		47
998 Matrix (998cc)	04	FA244*			FA244HH*	MD633X	MD633X	MD633XC*				48
998 R (998cc)	02				FA322/4HH*	TBA	TBA					49
998 S Bayliss/Bostrom	02				FA322/4HH*	MD633X	MD633X	MD633XC*				50
998 S (998cc) (4 pad caliper)	02-04				FA322/4HH*	MD633X	MD633X	MD633XC*				51
998 (998cc) (2 pad caliper) (Monoposto/Biposto)	02-03	FA244			FA244HH*	MD633X	MD633X	MD633XC*				52
999 S (Std Caliper Mount) (Monoposto/Biposto)	03-04				FA322/4HH*	MD622X	MD622X	MD622XC*		VR622BLK*†		53
999 (Std mount caliper)	03-06				FA322/4HH*	MD622X	MD622X	MD622XC*		VR622BLK*†		54
999 R (Radial mount caliper)	03-06				FA322/4HH*	MD622X	MD622X	MD622XC*		VR622BLK*†		55
999 R Fila (Radial mount caliper)	03-				FA322/4HH*	MD622X	MD622X	MD622XC*		VR622BLK*†		56
999 R Xerox	06				FA322/4HH*	MD622X	MD622X	MD622XC*		VR622BLK*†		57
999 S (Radial caliper) Monoposto/Biposto	05-06				FA322/4HH*	MD622X	MD622X	MD622XC*		VR622BLK*†		58

*-2 Sets Required. † For Vee disc colours add RED, BLU, GRN, GLD, ORG suffix to part number.

⊗ - Also available as a Vintage Motorcycle Disc.

Non-JAPANESE Built Motorcycles

Line #	BRAKE DISC CHOICES - FRONT						DISC PAD CHOICES - REAR				BRAKE DISC CHOICES - REAR			
	Oversize 250 /280mm Disc Kit	OSX Oversize 250/280mm Disc Kit	Relocating Bracket for 250/ 280mm Disc	Oversize 320mm Disc Kit	SMX Oversize 320mm Disc Kit	Relocating Bracket for 320mm Disc	FA, SFA, TT Pad or Brake Shoe	SFAC Carbon Scooter Pads	Speciality Pads - SXR / Vee / MXS	Sintered/ HH Pads/ Grooved Shoes	Standard Replacement Disc	Contour Disc Rear fitment	Vee-Discs™ CONTOUR	CX Extreme MX Race Disc/ UTVX Disc
1							FA047		FA047V	FA047HH	MD2002	MD2002C		
2							FA047		FA047V	FA047HH	MD2002	MD2002C		
3							FA047		FA047V	FA047HH	MD2002	MD2002C		
4							FA047		FA047V	FA047HH	MD2002	MD2002C	VR2002	
5							FA266		FA266V	FA266HH	MD632	MD632C	VR632	
6							FA018			FA018HH	MD634LS			
7														
8							FA018			FA018HH	MD634LS			
9							FA018			FA018HH	MD609LS			
10							FA018			FA018HH	MD631			
11							FA047			FA047HH	MD2002	MD2002C	VR2002	
12							FA047			FA047HH	MD2002	MD2002C		
13							FA047			FA047HH	MD2002		VR2002	
14							FA047			FA047HH	MD2002		VR2002	
15							FA266		FA266V	FA266HH	MD2002	MD2002C		
16							FA266		FA266V	FA266HH	MD2002	MD2002C	VR2002	
17							FA047			FA047HH	MD632	MD632C		
18							FA047			FA047HH	MD632			
19							FA047			FA047HH	MD632	MD632C		
20							FA266		FA266V	FA266HH	MD880			
21							FA266		FA266V	FA266HH	MD880			
22							FA266		FA266V	FA266HH	MD878	MD878C	VR878	
23							FA266		FA266V	FA266HH	MD878	MD878C	VR878	
24							FA266		FA266V	FA266HH	MD878	MD878C	VR878	
25							FA266		FA266V	FA266HH	MD2002	MD2002C		
26							FA266		FA266V	FA266HH	MD2002	MD2002C	VR2002	
27							FA181TT			FA181HH				
28							FA181TT			FA181HH				
29							FA266			FA266HH	MD899			
30							FA266			FA266HH	MD899			
31							FA266			FA266HH	MD899			
32							FA266			FA266HH	MD899			
33							FA266		FA266V	FA266HH	MD2002	MD2002C	VR2002	
34							FA266		FA266V	FA266HH	MD2002		VR2002	
35							FA047			FA047HH	MD632			
36							FA047			FA047HH	MD627		VR627	
37							FA047			FA047HH	MD632		VR632	
38							FA047			FA047HH	MD632		VR632	
39							FA047			FA047HH	MD632	MD632C		
40							FA047			FA047HH	MD632		VR632	
41							FA047			FA047HH	MD627		VR627	
42							FA047			FA047HH	MD627	MD627C	VR627	
43							FA047			FA047HH	MD627	MD627C	VR627	
44							FA047			FA047HH	MD627	MD627C	VR627	
45														
46							FA047			FA047HH	MD627	MD627C	VR627	
47							FA266		FA266V	FA266HH	MD2002		VR2002	
48							FA266		FA266V	FA266HH	MD2002		VR2002	
49							FA266		FA266V	FA266HH	MD618	MD618C	VR618	
50							FA047			FA047HH	MD632	MD632C		
51							FA047			FA047HH	MD632			
52							FA047			FA047HH	MD632	MD632C		
53							FA047			FA047HH	MD632	MD632C		
54							FA047			FA047HH	MD632	MD632C		
55							FA266		FA266V	FA266HH	MD618		VR618	
56							FA266		FA266V	FA266HH	MD618		VR618	
57							FA266		FA266V	FA266HH	MD618		VR618	
58							FA266		FA266V	FA266HH	MD618		VR618	
59							FA266		FA266V	FA266HH	MD618		VR618	
60							FA266		FA266V	FA266HH	MD618		VR618	

REAR / ARRIÈRE / HINTEN / POSTERIOR / POSTERIORE

*-2 Sets Required. † For Vee disc colours add RED, BLU, GRN, GLD, ORG suffix to part number.

⊗ - Also available as a Vintage Motorcycle Disc.

R Suffix = High Durability Sintered Pad. **HH** Suffix = High Performance Sintered Pad. **TT** Suffix = Hard Wearing Off Road Pad. **V** Suffix = Semi Sintered Pad. **G** Suffix = Grooved Shoe.
D Suffix = Drilled Disc. **X** Suffix = Universal Left or Right Disc. **XC** Suffix = Contoured Disc. **LS** Suffix = Left/Steel Disc. **RS** = Right/Steel Disc.

Part numbers, prefixes, suffixes, photos and illustrations shown in this catalogue are trademarks and/or copyrights of EBC Brakes or the trademark owner A C Freeman Investments Ltd and use without express written permission of the owners is punishable by law.

Non-JAPANESE Built Motorcycles

APPLICATIONS

BRAKE



DUCATI Contd.

		DISC PAD CHOICES - FRONT				BRAKE DISC CHOICES - FRONT					Line #	
		FA, SFA, TT Pad or Brake Shoe	SFAC Carbon Scooter Pads	Speciality Pads SXR / Vee / MXS	Sintered/HH Pads/ Grooved Shoes	Left / Gauche / Links Standard Replacement Disc	Right / Droite / Rechts Standard Replacement Disc	Contour Disc Universal left and right fitment	Universal Custom Disc	Vee-Discs Black † See note below		CX Extreme MX Race Disc/ UTVX Disc
1000 R1 Hailwood Replica (6 bolt disc)	84	FA018*			FA018HH*	MD609LS	MD609RS					1
GT 1000 (992cc)	07-10	FA209/2*			FA209/2HH*	MD614X	MD614X	MD614XC*		VR614BLK*†		2
GT 1000 Touring (992cc)	09	FA209/2*			FA209/2HH*	MD614X	MD614X	MD614XC*		VR614BLK*†		3
Monster 1000 Dark	03	FA244*			FA244HH*	MD614X	MD614X	MD614XC*		VR614BLK*†		4
Monster 1000 ie (992cc)	04-05	FA244*			FA244HH*	MD614X	MD614X	MD614XC*		VR614BLK*†		5
Monster 1000 S ie (992cc)	03-05	FA244*			FA244HH*	MD614X	MD614X	MD614XC*		VR614BLK*†		6
Monster S2R 1000 (992cc)	06-08	FA244*			FA244HH*	MD614X	MD614X	MD614XC*		VR614BLK*†		7
Multistrada 1000 DS (992cc)	03-05	FA244*			FA244HH*	MD682	MD682					8
Multistrada S 1000 DS (992cc)	05-06	FA244*			FA244HH*	MD682	MD682					9
Paul Smart 1000 LE (992cc)	06	FA209/2*			FA209/2HH*	MD614X	MD614X	MD614XC*		VR614BLK*†		10
Sport 1000 S	07-09	FA209/2*			FA209/2HH*	MD614X	MD614X	MD614XC*		VR614BLK*†		11
Sport Classic 1000 (992cc) (Monoposto - Japan/Biposto - Europe)	06-08	FA209/2*			FA209/2HH*	MD614X	MD614X	MD614XC*		VR614BLK*†		12
Supersport 1000 DS (992cc)	03-06	FA244*			FA244HH*	MD614X	MD614X	MD614XC*		VR614BLK*†		13
1098	07-08				FA447HH*	MD694X	MD694X	MD694XC*		VR694BLK*†		14
1098 S Tricolore	07				FA447HH*	MD694X	MD694X	MD694XC*		VR694BLK*†		15
1098 S	07-08				FA447HH*	MD694X	MD694X	MD694XC*		VR694BLK*†		16
1098 R	08-09				FA447HH*	N/A	N/A					17
1100 Hypermotard	07-09	FA244*			FA244HH*	MD865X	MD865X	MD865XC*				18
1100 S Hypermotard	07-09				FA447HH*	MD865X	MD865X	MD865XC*				19
1100 EVO Hypermotard	10-12	FA244*			FA244HH*	MD865X	MD865X	MD865XC*				20
1100 EVO SP Hypermotard	10-12				FA447HH*	MD865X	MD865X	MD865XC*				21
1100 Monster (Non ABS)	09-10	FA244*			FA244HH*	MD841X	MD841X	MD841XC*		VR841BLK*†		22
1100 Monster (ABS)	09-10	FA244*			FA244HH*	MD841X	MD841X	MD841XC*		VR841BLK*†		23
1100 S Monster (Non ABS)	09-10	FA244*			FA244HH*	MD843X	MD843X	MD843XC*		VR843BLK*†		24
1100 S Monster (ABS)	09-10	FA244*			FA244HH*	MD843X	MD843X	MD843XC*		VR843BLK*†		25
1100 Monster EVO	11-13	FA244*			FA244HH*	MD841X	MD841X	MD841XC*		VR841BLK*†		26
1100 Monster EVO 20th Anniversary Model	13	FA244*			FA244HH*	MD841X	MD841X	MD841XC*		VR841BLK*†		27
1100 Monster Diesel	13	FA244*			FA244HH*	MD841X	MD841X	MD841XC*		VR841BLK*†		28
1100 Multistrada (1078cc)	07-09	FA244*			FA244HH*	MD682	MD682					29
1100 S Multistrada (1078cc)	07-09	FA244*			FA244HH*	MD682	MD682					30
1100 Scrambler (1079cc)	18-20				FA630HH*							31
1100 Scrambler Special (1079cc)	18-20				FA630HH*							32
1100 Scrambler Sport (1079cc)	18-20				FA630HH*							33
1100 Streetfighter (1099cc)	09-10				FA447HH*	MD694X	MD694X	MD694XC*		VR694BLK*†		34
1100 S Streetfighter (1099cc)	09-13				FA447HH*							35
Panigale V4 (1103cc)	18-20				FA447HH*							36
Panigale V4 S (1103cc)	18-20				FA447HH*							37
Streetfighter V4 (1103cc)	19-20				FA447HH*	MD694X	MD694X	MD694XC*		VR694BLK*†		38
Streetfighter V4 S (1103cc)	19-20				FA447HH*	MD694X	MD694X	MD694XC*		VR694BLK*†		39
198	09-11				FA447HH*	N/A	N/A					40
1198 R Corse	10				FA447HH*	N/A	N/A					41
1198 S	09-10				FA447HH*	N/A	N/A					42
1198 S Corse	10				FA447HH*	N/A	N/A					43
1198 SP	11				FA447HH*	N/A	N/A					44
1199 Panigale	12-13				FA447HH*	TBA	TBA					45
1199 Panigale ABS	12-15				FA447HH*	TBA	TBA					46
1199 Panigale S ABS	12-15				FA447HH*	TBA	TBA					47
1199 Panigale S Tricolore	12-13				FA447HH*	TBA	TBA					48
1199 Panigale R	13-16				FA447HH*	TBA	TBA					49
1199 Superleggera	14				FA447HH*	N/A	N/A					50
Diavel ABS	11-18				FA447HH*	MD841X	MD841X	MD841XC*		VR841BLK*†		51
Diavel AMG	11-12				FA447HH*	MD841X	MD841X	MD841XC*		VR841BLK*†		52
Diavel Carbon ABS	11-19				FA447HH*	MD841X	MD841X	MD841XC*		VR841BLK*†		53
Diavel Chromo ABS	12				FA447HH*	MD841X	MD841X	MD841XC*		VR841BLK*†		54
Diavel Dark	13-14				FA447HH*	MD841X	MD841X	MD841XC*		VR841BLK*†		55
Diavel Diesel (1200cc)	17-18				FA447HH*	MD841X	MD841X	MD841XC*		VR841BLK*†		56
Diavel Strada	13-14				FA447HH*	MD841X	MD841X	MD841XC*		VR841BLK*†		57
1200 Multistrada Standard Edition	10-11	FA244*			FA244HH*	MD841X	MD841X	MD841XC*		VR841BLK*†		58
1200 Multistrada ABS	10-14	FA244*			FA244HH*	MD841X	MD841X	MD841XC*		VR841BLK*†		59

*-2 Sets Required. † For Vee disc colours add RED, BLU, GRN, GLD, ORG suffix to part number.

⊗ - Also available as a Vintage Motorcycle Disc.

R Suffix = High Durability Sintered Pad. HH Suffix = High Performance Sintered Pad. TT Suffix = Hard Wearing Off Road Pad. V Suffix = Semi-Sintered Pad. G Suffix = Grooved Shoe.
D Suffix = Drilled Disc. X Suffix = Universal Left or Right Disc. XC Suffix = Contoured Disc. LS Suffix = Left/Steel Disc. RS Suffix = Right/Steel Disc.

Non-JAPANESE Built Motorcycles

Line #	BRAKE DISC CHOICES - FRONT						DISC PAD CHOICES - REAR				BRAKE DISC CHOICES - REAR			
	Oversize 250 /280mm Disc Kit	OSX Oversize 250/280mm Disc Kit	Relocating Bracket for 250/ 280mm Disc	Oversize 320mm Disc Kit	SMX Oversize 320mm Disc Kit	Relocating Bracket for 320mm Disc	FA, SFA, TT Pad or Brake Shoe	SFAC Carbon Scooter Pads	Speciality Pads - SXR / Vee / MXS	Sintered/ HH Pads/ Grooved Shoes	Standard Replacement Disc	Contour Disc Rear fitment	Vee-Discs™ CONTOUR	CX Extreme MX Race Disc/ UTVX Disc
1							FA018		FA018HH	MD609LS				
2							FA213		FA213HH	MD899				
3							FA213	FA213V	FA213HH	MD899				
4							FA047	FA047V	FA047HH	MD2002	MD2002C	VR2002		
5							FA047	FA047V	FA047HH	MD2002	MD2002C	VR2002		
6							FA047	FA047V	FA047HH	MD2002	MD2002C	VR2002		
7							FA047	FA047V	FA047HH	MD627	MD627C	VR627		
8							FA266		FA266HH	MD627				
9							FA266	FA266V	FA266HH	MD627				
10							FA213	FA213V	FA213HH	MD2002	MD2002C	VR2002		
11							FA213	FA213V	FA213HH	MD2002	MD2002C	VR2002		
12														
13							FA213	FA213V	FA213HH	MD2002	MD2002C	VR2002		
14							FA266	FA266V	FA266HH	MD2002	MD2002C	VR2002		
15							FA266	FA266V	FA266HH	MD695	MD695C	VR695		
16							FA266	FA266V	FA266HH	MD695	MD695C	VR695		
17							FA266	FA266V	FA266HH	MD695	MD695C	VR695		
18							FA266	FA266V	FA266HH	MD695	MD695C	VR695		
19							FA266	FA266V	FA266HH	MD627				
20							FA266	FA266V	FA266HH	MD627				
21							FA266	FA266V	FA266HH	MD627				
22							FA266	FA266V	FA266HH	MD627				
23							FA266	FA266V	FA266HH	MD627	MD627C	VR627		
24							FA266	FA266V	FA266HH	MD878	MD878C	VR878		
25							FA266	FA266V	FA266HH	MD627	MD627C	VR627		
26							FA266	FA266V	FA266HH	MD878	MD878C	VR878		
27							FA266	FA266V	FA266HH	MD878	MD878C	VR878		
28							FA266	FA266V	FA266HH	MD878	MD878C	VR878		
29							FA266	FA266V	FA266HH	MD878	MD878C	VR878		
30							FA266	FA266V	FA266HH	MD627				
31							FA266	FA266V	FA266HH	MD627				
32							FA213	FA213V	FA213HH	MD899				
33							FA213	FA213V	FA213HH	MD899				
34							FA213	FA213V	FA213HH	MD899				
35							FA266		FA266HH	MD695	MD695C	VR695		
36							FA266		FA266HH	MD695	MD695C	VR695		
37							FA266		FA266HH	MD878	MD878C	VR878		
38							FA266		FA266HH	MD878	MD878C	VR878		
39							FA266		FA266HH	MD878	MD878C	VR878		
40							FA266		FA266HH	MD878	MD878C	VR878		
41							FA266		FA266HH	MD695	MD695C	VR695		
42							FA266		FA266HH	MD695	MD695C	VR695		
43							FA266		FA266HH	MD695	MD695C	VR695		
44							FA266		FA266HH	MD695	MD695C	VR695		
45							FA266		FA266HH	MD695	MD695C	VR695		
46							FA266		FA266HH	TBA				
47							FA266		FA266HH	TBA				
48							FA266		FA266HH	TBA				
49							FA266		FA266HH	TBA				
50							FA266		FA266HH	TBA				
51							FA266		FA266HH	N/A				
52									FA209/2HH	MD879				
53									FA209/2HH	TBA				
54									FA209/2HH	MD879				
55									FA209/2HH	TBA				
56									FA209/2HH	TBA				
57									FA209/2HH	TBA				
58									FA209/2HH	TBA				
59							FA266		FA266HH	TBA				
60							FA266		FA266HH	TBA				

REAR / ARRIÈRE / HINTEN / POSTERIOR / POSTERIORE

*-2 Sets Required. † For Vee disc colours add RED, BLU, GRN, GLD, ORG suffix to part number.

⊗ - Also available as a Vintage Motorcycle Disc.

R Suffix = High Durability Sintered Pad. HH Suffix = High Performance Sintered Pad. TT Suffix = Hard Wearing Off Road Pad. V Suffix = Semi Sintered Pad. G Suffix = Grooved Shoe.

D Suffix = Drilled Disc. X Suffix = Universal Left or Right Disc. XC Suffix = Contoured Disc. LS Suffix = Left/Steel Disc. RS = Right/Steel Disc.

Part numbers, prefixes, suffixes, photos and illustrations shown in this catalogue are trademarks and/or copyrights of EBC Brakes or the trademark owner A C Freeman Investments Ltd and use without express written permission of the owners is punishable by law.

Non-JAPANESE Built Motorcycles

APPLICATIONS

BRAKE



DUCATI Contd.

Model	Year	DISC PAD CHOICES - FRONT				BRAKE DISC CHOICES - FRONT						Line #
		FA, SFA, TT Pad or Brake Shoe	SFAC Carbon Scooter Pads	Speciality Pads SXR / Vee / MXS	Sintered/HH Pads/ Grooved Shoes	Left / Gauche / Links Standard Replacement Disc	Right / Droite / Rechts Standard Replacement Disc	Contour Disc Universal left and right fitment	Universal Custom Disc	Vee-Discs Black † See note below	CX Extreme MX Race Disc/ UTVX Disc	
1200 Multistrada ABS (Single Pin F/Caliper)	15-18				FA630HH*	MD841X	MD841X	MD841XC*		VR841BLK*†		1
1200 Multistrada Granturismo	13	FA244*			FA244HH*	MD841X	MD841X	MD841XC*		VR841BLK*†		2
1200 Multistrada DVT	15-17				FA630HH*	MD841X	MD841X	MD841XC*		VR841BLK*†		3
1200 Multistrada Enduro	16				FA630HH*	MD841X	MD841X	MD841XC*		VR841BLK*†		4
1200 Multistrada Enduro	17-18				FA630HH*	MD841X	MD841X	MD841XC*		VR841BLK*†		5
1200 Multistrada Enduro Pro	18-19				FA630HH*	MD841X	MD841X	MD841XC*		VR841BLK*†		6
1200 S Multistrada DVT	15-17				FA447HH*	TBA	TBA					7
1200 S Multistrada Sports Edition	10-12	FA244*			FA244HH*	MD841X	MD841X	MD841XC*		VR841BLK*†		8
1200 S Multistrada Touring Edition	10-14	FA244*			FA244HH*	MD841X	MD841X	MD841XC*		VR841BLK*†		9
1200 Multistrada Touring	15-17	FA244*			FA244HH*	TBA	TBA					10
1200 S Multistrada Touring	15-18	FA244*			FA244HH*	TBA	TBA					11
1200 S Multistrada	15-18				FA447HH*	MD841X	MD841X	MD841XC*		VR841BLK*†		12
1200 S Multistrada D air	15-17				FA447HH*	MD841X	MD841X	MD841XC*		VR841BLK*†		13
1200 S Multistrada D air DVT	15-17				FA447HH*	MD841X	MD841X	MD841XC*		VR841BLK*†		14
1200 S Multistrada Pikes Peak	11-14	FA244*			FA244HH*	MD841X	MD841X	MD841XC*		VR841BLK*†		15
1200 S Multistrada Pikes Peak	16-17				FA447HH*	MD841X	MD841X	MD841XC*		VR841BLK*†		16
1200 Monster	14-20				FA630HH*	MD841X	MD841X	MD841XC*		VR841BLK*†		17
1200 S Monster	14-20				FA447HH*	MD841X	MD841X	MD841XC*		VR841BLK*†		18
1200 S Monster Stripe	15-19				FA447HH*	TBA	TBA					19
1200 R Monster	16-18				FA447HH*	MD841X	MD841X	MD841XC*		VR841BLK*†		20
1260 Multistrada	18-20				FA630HH*	MD841X	MD841X	MD841XC*		VR841BLK*†		21
1260 Multistrada Touring	18				FA630HH*	MD841X	MD841X	MD841XC*		VR841BLK*†		22
1260 S Multistrada	18-20				FA447HH*	TBA	TBA					23
1260 S Multistrada D air	18-20				FA447HH*	TBA	TBA					24
1260 S Multistrada Pikes Peak	18-20				FA447HH*	TBA	TBA					25
1260 Multistrada Enduro	18-20				FA447HH*							26
1260 Multistrada S Grand Tour	19-20				FA447HH*							27
Diavel Diesel (1262cc)	17-18				FA447HH*	MD841X	MD841X	MD841XC*		VR841BLK*†		28
1262 XDiavel	16-20				FA630HH*	MD841X	MD841X	MD841XC*		VR841BLK*†		29
1262 XDiavel S	16-20				FA447HH*	MD841X	MD841X	MD841XC*		VR841BLK*†		30
1299 Panigale	15-18				FA447HH*	MD694X	MD694X	MD691XC*		VR691BLK*†		31
1299 Panigale S	15-18				FA447HH*	MD694X	MD694X	MD691XC*		VR691BLK*†		32
1299 Panigale R	15-17					MD694X	MD694X	MD691XC*		VR691BLK*†		33
1299 Panigale V4 Corse/ Speciale	18-20				FA447HH*	MD694X	MD694X	MD691XC*		VR691BLK*†		34
1299 Panigale V4 R	19-20				FA447HH*	MD694X	MD694X	MD691XC*		VR691BLK*†		35
1299 Panigale R Final Edition	18				FA447HH*	MD694X	MD694X	MD691XC*		VR691BLK*†		36
1299 Superleggera	17				FA447HH*	MD694X	MD694X	MD691XC*		VR691BLK*†		37
												38
												39
												40
												41
												42
												43
												44
												45
												46
												47
												48
												49
												50
												51
												52
												53
												54
												55
												56
												57
												58
												59
												60

R Suffix = High Durability Sintered Pad. HH Suffix = High Performance Sintered Pad. TT Suffix = Hard Wearing Off Road Pad. V Suffix = Semi Sintered Pad. G Suffix = Grooved Shoe.
D Suffix = Drilled Disc. X Suffix = Universal Left or Right Disc. XC Suffix = Contoured Disc. LS Suffix = Left/Steel Disc. RS Suffix = Right/Steel Disc.

EASYRIDER

CJ 50 F	98	TBA										40
Teeny Blazer/II	98	TBA										41
QM 50 E	98	TBA										42
M 50 Monkey/Monkey O.R.	98	H303										43
CJ 70 Holiday	98	TBA										44
JH 125 L Trail Blazer	98	TBA										45
JC 125/8 Dragon	98	FA093										46

ECO

Bushman 150 (LX 150 GY)		FA135TT										47
-------------------------	--	---------	--	--	--	--	--	--	--	--	--	----

ELSTARS

Various models (Check parts before fitting)		FA448										48
---	--	-------	--	--	--	--	--	--	--	--	--	----

E-MAX

90 S	08	TBA										49
100 L	08	TBA										50
110 S	08	TBA										51
120 L	08	TBA										52
140 L	08	TBA										53
190 L	08	TBA										54

*-2 Sets Required. † For Vee disc colours add RED, BLU, GRN, GLD, ORG suffix to part number.

⊗ - Also available as a Vintage Motorcycle Disc.

Non-JAPANESE Built Motorcycles

Line #	BRAKE DISC CHOICES - FRONT						DISC PAD CHOICES - REAR				BRAKE DISC CHOICES - REAR			
	Oversize 250 /280mm Disc Kit	OSX Oversize 250/280mm Disc Kit	Relocating Bracket for 250/ 280mm Disc	Oversize 320mm Disc Kit	SMX Oversize 320mm Disc Kit	Relocating Bracket for 320mm Disc	FA, SFA, TT Pad or Brake Shoe	SFAC Carbon Scooter Pads	Speciality Pads - SXR / Vee / MXS	Sintered/ HH Pads/ Grooved Shoes	Standard Replacement Disc	Contour Disc Rear fitment	Vee-Discs™ CONTOUR	CX Extreme MX Race Disc/ UTVX Disc
1							FA209/2			FA209/2HH	MD879			
2							FA266			FA266HH	TBA			
3							FA181TT			FA181HH	TBA			
4							FA209/2			FA209/2HH	TBA			
5							FA181TT			FA181HH	TBA			
6							FA181TT			FA181HH	TBA			
7							FA181TT			FA181HH	TBA			
8							FA266			FA266HH	TBA			
9							FA266			FA266HH	TBA			
10							FA181TT			FA181HH	TBA			
11							FA181TT			FA181HH	TBA			
12							FA209/2			FA209/2HH	MD879			
13							FA209/2			FA209/2HH	MD879			
14							FA209/2			FA209/2HH	MD879			
15							FA266			FA266HH	TBA			
16							FA209/2			FA209/2HH	MD879			
17							FA266	FA266V	FA266HH	MD880	MD880C	VR880		
18							FA266	FA266V	FA266HH	MD880	MD880C	VR880		
19							FA266	FA266V	FA266HH	TBA				
20							FA266	FA266V	FA266HH	MD880	MD880C	VR880		
21							FA181TT		FA181HH	MD879				
22							FA181TT		FA181HH	MD879				
23							FA181TT		FA181HH	MD879				
24							FA181TT		FA181HH	MD879				
25							FA181TT		FA181HH	MD879				
26							FA181TT		FA181HH	MD879				
27							FA181TT		FA181HH	MD879				
28									FA209/2HH	MD879				
29							FA209/2		FA209/2HH	MD879				
30							FA209/2		FA209/2HH	MD879				
31							FA266		FA266HH	MD880	MD880C	VR880		
32							FA266		FA266HH	MD880	MD880C	VR880		
33							FA266		FA266HH	MD880	MD880C	VR880		
34									FA266HH	MD880				
35									FA266HH	MD880				
36							FA266		FA266HH	MD880	MD880C	VR880		
37							FA266		FA266HH	MD880	MD880C	VR880		
38														
39														
40														
41							TBA							
42							TBA							
43							TBA							
44							H303							
45							TBA							
46							TBA							
47														
48														
49							FA115TT			N/A				
50														
51														
52							FA448			N/A				
53														
54														
55							TBA			N/A				
56							TBA			N/A				
57							TBA			N/A				
58							TBA			N/A				
59							TBA			N/A				
60							TBA			N/A				

REAR / ARRIÈRE / HINTEN / POSTERIOR / POSTERIORE

*-2 Sets Required. † For Vee disc colours add RED, BLU, GRN, GLD, ORG suffix to part number.

⊗ - Also available as a Vintage Motorcycle Disc.

R Suffix = High Durability Sintered Pad. HH Suffix = High Performance Sintered Pad. TT Suffix = Hard Wearing Off Road Pad. V Suffix = Semi Sintered Pad. G Suffix = Grooved Shoe.

D Suffix = Drilled Disc. X Suffix = Universal Left or Right Disc. XC Suffix = Contoured Disc. LS Suffix = Left/Steel Disc. RS = Right/Steel Disc.

Non-JAPANESE Built Motorcycles

APPLICATIONS

BRAKE



ENERGICA

Electric EVA	20
Electric EGO	20
Electric EVA Esse Esse 9	20

E-TON

IXL 40 Rascal	98-01	N/A								
RXL-40 E Viper Junior	01-07	N/A								
Viper 40 E	99-00	N/A								
AXL-50 Lightning 50	99-00	H338*			H338G*					
BXL-50 Draco	05-06	H338*			H338G*					
EXL 50 Viper 50	90	H338*			H338G*					
NXL 50 Lightning 50	01-02	H338*			H338G*					
TXL 50 Wizz 50	98-99	H338*			H338G*					
Viper 50 Mini RXL 50M	03-07	N/A								
Viper 50 RXL 50	03-07	N/A								
Viper 70 RXL 70	05-07	H338			H338G					
AXL 90 Thunder	99-00	H338			H338G					
DXL-90 Sierra	99-03	S614*			S614G*					
NXL-90 Thunder	01-02	H338*			H338G*					
RXL 90 Viper 90	03-07	H338*			H338G*					
RXL 90 R Viper 90 R Reverse	03-07	H338*			H338G*					
BXL 100 Draco	05-06	H338*			H338G*					
CXL 150 Challenger (Rear disc)	02-07	H303*			H303G*					
CXL 150 Challenger (Drum brake model)	02-07	H303*			H303G*					
EXL 150 Yukon S.T. (Rear drum)	05-07	FA083TT*			FA083R*	N/A	N/A			
EXL 150 Eukon ST (Drum front/disc rear)	05-07	S614*			S614G*					
RXL 150 Viper	05-06	H303*			H303G*					
RXL 150 Viper	07	H303*			H303G*					
Viper EXL 150 ST Quad	05-07	FA083TT*			FA083R*	N/A	N/A			
YXL 150 Yukon	00-02	H303*			H303G*					
RXL 150 Viper R	05	H303*			H303G*					
VXL 250 ST Vector	06-07	FA083TT*			FA083R*	N/A	N/A			
VXL Vector 250	06-07	FA083TT*			FA083R*	N/A	N/A			
VXL 300 Vector	07	FA083TT*			FA083R*	TBA	TBA			
VXL 300 ST Vector ST	07	FA083TT*			FA083R*	TBA	TBA			
VTX 300 Vortex	07	FA083TT*			FA083R*	TBA	TBA			
VTX 300 ST Vortex ST	07	FA083TT*			FA083R*	TBA	TBA			

E-TROPOLIS (ELECTRIC SCOOTERS)

Bel-Air	13-14	SFA086	SFAC086				N/A			
Bel-Air Lithium	14	SFA086	SFAC086				N/A			
Future	13	SFA086	SFAC086				N/A			
Miami	13	SFA086	SFAC086			N/A				
Milano	14	SFA086	SFAC086				N/A			
Retro	13-14	SFA086	SFAC086				N/A			
Retro Lithium	14	SFA086	SFAC086				N/A			

EXPLORER

KBR 200	05	FA167			FA167HH	N/A				
Stinger 250	08-09	TBA*				N/A	N/A			
Ranger 300 2x4/4x4	08-09	FA416TT*			FA416R*	N/A	N/A			
Stinger 300	08-09	TBA*				N/A	N/A			
Taurus 300	08-09	TBA*				N/A	N/A			
Titan 300	08-09	TBA*				N/A	N/A			
Trasher 450	08-09	FA067TT*			FA067R*	N/A	N/A			
Atlas 500/4x4	08-09	FA453TT*			FA453R*	N/A	N/A			
Everest 500 L/4x4	08-09	FA453TT*			FA453R*	N/A	N/A			
Side x Side 500	08-09	TBA*				N/A	N/A			

DISC PAD CHOICES - FRONT

BRAKE DISC CHOICES - FRONT

FA, SFA, TT Pad or Brake Shoe	SFAC Carbon Scooter Pads	Speciality Pads - SXR / Vee / MXS	Sintered/HH Pads/ Grooved Shoes	Left / Gauche / Links Standard Replacement Disc	Right / Droite / Rechts Standard Replacement Disc	Contour Disc Universal left and right fitment	Universal Custom Disc	Vee-Discs Black † See note below	CX Extreme MX Race Disc/ UTVX Disc	Line #
			FA447HH*							1
			FA447HH*							2
			FA447HH*							3
										4
										5
										6
										7
										8
										9
										10
										11
										12
										13
										14
										15
										16
										17
										18
										19
										20
										21
										22
										23
										24
										25
										26
										27
										28
										29
										30
										31
										32
										33
										34
										35
										36
										37
										38
										39
										40
										41
										42
										43
										44
										45
										46
										47
										48
										49
										50
										51
										52
										53
										54
										55
										56
										57
										58
										59
										60

*-2 Sets Required. † For Vee disc colours add RED, BLU, GRN, GLD, ORG suffix to part number.

⊗ - Also available as a Vintage Motorcycle Disc.

238 Part numbers, prefixes, suffixes, photos and illustrations shown in this catalogue are trademarks and/or copyrights of EBC Brakes or the trademark owner A C Freeman Investments Ltd and use without express written permission of the owners is punishable by law.

Non-JAPANESE Built Motorcycles

Line #	BRAKE DISC CHOICES - FRONT						DISC PAD CHOICES - REAR				BRAKE DISC CHOICES - REAR			
	Oversize 250 /280mm Disc Kit	OSX Oversize 250/280mm Disc Kit	Relocating Bracket for 250/ 280mm Disc	Oversize 320mm Disc Kit	SMX Oversize 320mm Disc Kit	Relocating Bracket for 320mm Disc	FA, SFA, TT Pad or Brake Shoe	SFAC Carbon Scooter Pads	Speciality Pads - SXR / Vee / MXS	Sintered/ HH Pads/ Grooved Shoes	Standard Replacement Disc	Contour Disc Rear fitment	Vee-Discs™ CONTOUR	CX Extreme MX Race Disc/ UTVX Disc
1							FA266		FA266V	FA266HH				
2							FA266		FA266V	FA266HH				
3							FA266		FA266V	FA266HH				
4														
5														
6							H330			H330G				
7							H330			H330G				
8							H330			H330G				
9														
10							FA083TT			FA083R	N/A			
11							FA083TT			FA083R	TBA			
12							TBA							
13							TBA							
14							FA083TT			FA083R	N/A			
15							FA083TT			FA083R	N/A			
16							FA083TT			FA083R	N/A			
17							H330			H330G				
18							H330			H330G				
19							H330			H330G				
20							FA083TT			FA083R	N/A			
21							FA083TT			FA083R	N/A			
22							FA083TT			FA083R	N/A			
23							FA165TT			FA165R	N/A			
24							H330			H330G				
25							H330			H330G				
26							FA165TT			FA165R	TBA			
27							FA165TT			FA165R	N/A			
28							FA427TT			FA427R	TBA			
29							H330			H330G				
30							H330			H330G				
31							FA165TT			FA165R	N/A			
32							FA427TT			FA427R	N/A			
33							FA427TT			FA427R	N/A			
34							FA427TT			FA427R	TBA			
35							FA427TT			FA427R	TBA			
36							FA427TT			FA427R	TBA			
37							FA427TT			FA427R	TBA			
38														
39														
40							SFA086	SFAC086			N/A			
41							SFA086	SFAC086			N/A			
42							SFA086	SFAC086			N/A			
43							SFA086	SFAC086			N/A			
44							SFA086	SFAC086			N/A			
45							SFA086	SFAC086			N/A			
46							SFA086	SFAC086			N/A			
47														
48														
49							FA115			FA115HH	N/A			
50							TBA				N/A			
51							FA431TT			FA431R	N/A			
52							TBA				N/A			
53							TBA							
54							TBA				N/A			
55							FA067TT			FA067R	N/A			
56							FA344TT			FA344R	N/A			
57							FA344TT			FA344R	N/A			
58							TBA				N/A			
59														
60														

REAR / ARRIÈRE / HINTEN / POSTERIOR / POSTERIORE

*-2 Sets Required. † For Vee disc colours add RED, BLU, GRN, GLD, ORG suffix to part number.

⊗ - Also available as a Vintage Motorcycle Disc.

R Suffix = High Durability Sintered Pad. **HH** Suffix = High Performance Sintered Pad. **TT** Suffix = Hard Wearing Off Road Pad. **V** Suffix = Semi Sintered Pad. **G** Suffix = Grooved Shoe.
D Suffix = Drilled Disc. **X** Suffix = Universal Left or Right Disc. **XC** Suffix = Contoured Disc. **LS** Suffix = Left/Steel Disc. **RS** = Right/Steel Disc.

Part numbers, prefixes, suffixes, photos and illustrations shown in this catalogue are trademarks and/or copyrights of EBC Brakes or the trademark owner A C Freeman Investments Ltd and use without express written permission of the owners is punishable by law.

Non-JAPANESE Built Motorcycles

APPLICATIONS

BRAKE



FACTORY

Chrono SM 50	04
Phantom R14 Agua	04
RP 50	05
YM 50	05
YR 50 Desert	02-03
YR 50 Desert	04-05
YR 125 4T	05
YR 250 Desert	03

FANTIC

50 Issimo spoke wheel	
50 Issimo Alu wheel	
50 Trial	-83
50 Strada Super Six	73-
50 Strada	-82
50 Strada	82-
50 Repl./Enduro Repl.	-85
50 Enduro Competition	-82
50 Enduro	83-
50 Sprinter/3V.R	83-
50 Casa/Competition	75-
50 Caballero	-83
50 Caballero/Caballero RC	91-
Caballero 50 Regularita Competizione	06-09
Caballero Regularita Competizione Mini 50	08-09
Caballero 50 Regularita Casa	06-09
Caballero 50 Supersei Competizione	07-08
Caballero 50 Supersei Motard	06-09
50/50.1 Raider	81-
50.1 Oasis	86-
50.1 Oasis KS/Rally	86-
50.1 Oasis E.S.	87-
50.1 Oasis Kick	87-
50.1 Trial	86-
50.1 Trial H 20	87-
50.5 Trial	89
50.7 Trial	90
50.9 Trial	91-
50 Fast	88-
50 Joy	92-
50 Koala	
50 Clubman	95-
Trial 50 Junior	87-
Trial 50	06
TX 180 E (49cc/2T) Regularita Casa 50E	12-15
TX 180 ER (49cc/2T) Regularita Competizione 50ER	12-15
TX 180 ES (49cc/2T) Regularita Scuderia 50ES	12-15
TX 180 M (49cc/2T) Motard Casa 50M	12-15
TX 180 MR (49cc/2T) Motard Competizione 50MR	12-15
80 Trial	-83
80 Trial	83-
80 Enduro	80-
80 Caballero/Caballero RC	91-
80 Cross Competition	-81
80 Cross Competition	81-
80 Kaloa	
80 Clubman	95-
Caballero 125 Regularita Competizione	07-09
Caballero 50 Regularita Casa	07-08
Caballero 125 Supersei Motard	07-09

FA, SFA, TT Pad or Brake Shoe	SFAC Carbon Scooter Pads	Speciality Pads - SXR / Vee / MXS	Sintered/ HH Pads/ Grooved Shoes	BRAKE DISC CHOICES - FRONT							Line #
				Left / Gauche / Links Standard Replacement Disc	Right / Droite / Rechts Standard Replacement Disc	Contour Disc Universal left and right fitment	Universal Custom Disc	Vee-Discs Black † See note below	CX Extreme MX Race Disc/ UTVX Disc		
FA194			FA194HH	N/A						1	
FA351TT				N/A						2	
FA194			FA194HH	N/A						3	
FA194			FA194HH	N/A						4	
FA115			FA115HH	N/A						5	
FA194			FA194HH	N/A						6	
FA194			FA194HH	N/A						7	
FA181TT		MXS181	FA181R	N/A						8	
										9	
										10	
945										11	
945										12	
			926G							13	
FA050				N/A						14	
			841G							15	
FA067/2				N/A						16	
			841G							17	
			841G							18	
			922G							19	
909										20	
			841G							21	
			922G							22	
FA047			FA047R	N/A						23	
FA181TT		MXS181	FA181R	TBA						24	
FA181TT		MXS181	FA181R	N/A						25	
FA194			FA194HH	TBA						26	
FA181TT		MXS181	FA181R	TBA						27	
FA194			FA194HH	TBA						28	
FA067/2				N/A						29	
FA116				N/A						30	
FA116				N/A						31	
FA116				N/A						32	
FA099				N/A						33	
FA099				N/A						34	
FA099				N/A						35	
FA115			FA115R	N/A						36	
FA115			FA115R	N/A						37	
FA115			FA115R	N/A						38	
FA116				N/A						39	
945										40	
FA060				N/A						41	
FA115			FA115R	N/A						42	
			930G							43	
FA291				N/A						44	
FA465TT		MXS465	FA465R			N/A				45	
FA465TT		MXS465	FA465R			N/A				46	
FA465TT		MXS465	FA465R			N/A				47	
FA465TT		MXS465	FA465R			N/A				48	
FA465TT		MXS465	FA465R			N/A				49	
		MXS922	922G							50	
		MXS930	930G							51	
		MXS841	841G							52	
FA047			FA047R	N/A						53	
			841G							54	
			841G							55	
FA060				N/A						56	
FA115			FA115R	N/A						57	
FA181TT		MXS181	FA181R	TBA						58	
FA194			FA194HH	TBA						59	
FA194			FA194HH	TBA						60	

FRONT / AVANT / VORN / FRENTE / ANTERIORE

R Suffix = High Durability Sintered Pad. HH Suffix = High Performance Sintered Pad. TT Suffix = Hard Wearing Off Road Pad. V Suffix = Semi Sintered Pad. G Suffix = Grooved Shoe.
D Suffix = Drilled Disc. X Suffix = Universal Left or Right Disc. XC Suffix = Contoured Disc. LS Suffix = Left/Steel Disc. RS Suffix = Right/Steel Disc.

*-2 Sets Required. † For Vee disc colours add RED, BLU, GRN, GLD, ORG suffix to part number.

⊗ - Also available as a Vintage Motorcycle Disc.

240 Part numbers, prefixes, suffixes, photos and illustrations shown in this catalogue are trademarks and/or copyrights of EBC Brakes or the trademark owner A C Freeman Investments Ltd and use without express written permission of the owners is punishable by law.

Non-JAPANESE Built Motorcycles

Line #	BRAKE DISC CHOICES - FRONT						DISC PAD CHOICES - REAR				BRAKE DISC CHOICES - REAR			
	Oversize 250 /280mm Disc Kit	OSX Oversize 250/280mm Disc Kit	Relocating Bracket for 250/ 280mm Disc	Oversize 320mm Disc Kit	SMX Oversize 320mm Disc Kit	Relocating Bracket for 320mm Disc	FA, SFA, TT Pad or Brake Shoe	SFAC Carbon Scooter Pads	Speciality Pads - SXR / Vee / MXS	Sintered/ HH Pads/ Grooved Shoes	Standard Replacement Disc	Contour Disc Rear fitment	Vee-Discs™ CONTOUR	CX Extreme MX Race Disc/ UTVX Disc
1							FA115			FA115HH	N/A			
2							FA115				N/A			
3							FA115			FA115HH	N/A			
4							FA115			FA115HH	N/A			
5							FA115			FA115HH	N/A			
6							FA115			FA115HH	N/A			
7							FA115			FA115HH	N/A			
8							FA208TT	MXS208	FA208R	FA208R	N/A			
9														
10														
11							945							
12							945							
13									922G					
14									843G					
15									841G					
16									843G					
17									841G					
18									841G					
19									922G					
20							909							
21									841G					
22									922G					
23							FA060				N/A			
24							FA367TT	MXS367	FA367R	FA367R	TBA			
25							FA367TT	MXS367	FA367R	FA367R	N/A			
26							FA382				TBA			
27							FA367TT	MXS367	FA367R	FA367R	TBA			
28							FA382				TBA			
29							930G							
30							FA060				N/A			
31							930G							
32							FA060				N/A			
33							995							
34							930G							
35							995							
36							FA115		FA115R	FA115R	N/A			
37							FA115		FA115R	FA115R	N/A			
38							FA115		FA115R	FA115R	N/A			
39									841G					
40							945							
41							FA060				N/A			
42							FA115		FA115R	FA115R	N/A			
43									930G					
44							FA291				N/A			
45							FA346TT		FA346R	FA346R	N/A			
46							FA346TT		FA346R	FA346R	N/A			
47							FA346TT		FA346R	FA346R	N/A			
48							FA346TT		FA346R	FA346R	N/A			
49							FA346TT		FA346R	FA346R	N/A			
50									922G					
51									930G					
52									843G					
53							FA060				N/A			
54									841G					
55									843G					
56							FA060							
57							FA115		FA115R	FA115R				
58							FA367TT	MXS367	FA367R	FA367R	TBA			
59							FA382				TBA			
60							FA382				TBA			

REAR / ARRIÈRE / HINTEN / POSTERIOR / POSTERIORE

*-2 Sets Required. † For Vee disc colours add RED, BLU, GRN, GLD, ORG suffix to part number.

⊗ - Also available as a Vintage Motorcycle Disc.

R Suffix = High Durability Sintered Pad. **HH** Suffix = High Performance Sintered Pad. **TT** Suffix = Hard Wearing Off Road Pad. **V** Suffix = Semi Sintered Pad. **G** Suffix = Grooved Shoe.
D Suffix = Drilled Disc. **X** Suffix = Universal Left or Right Disc. **XC** Suffix = Contoured Disc. **LS** Suffix = Left/Steel Disc. **RS** = Right/Steel Disc.

Non-JAPANESE Built Motorcycles

APPLICATIONS

BRAKE



FANTIC Contd.

R Suffix = High Durability Sintered Pad. HH Suffix = High Performance Sintered Pad. TT Suffix = Hard Wearing Off Road Pad. V Suffix = Semi Sintered Pad. G Suffix = Grooved Shoe.
 D Suffix = Drilled Disc. X Suffix = Universal Left or Right Disc. XC Suffix = Contoured Disc. LS Suffix = Left/Steel Disc. RS = Right/Steel Disc.

Model	Year
Trial 125	
Trial 125/2	
Section 125/249 R	-95
TR 125 CR (2T) Cross Competizione	13
TR 125 MR (2T) Motard Competizione	13
TZ 125 CS (2T) Caballero Cross	11-12
TZ 125 ES (2T) Regularita Scuderia	11-12
TZ 125 SM (2T) Caballero Motard	11-12
TZ 170 E (125 E/4T) Regularita Casa	11-15
TZ 170 ER (125 ER/4T) Caballero Regularita Competizione	11-15
TZ 170 M (125 SM/4T) Motard Casa	11-15
TZ 170 MR (125 SM/4T) Motard Competizione	11-15
200	
TZ 200 ER (200 ER/4T) Caballero Regularita Competizione	11-15
TZ 200 MR (200 MR/4T) Motard	11-15
201 Monoshock	86
240	
Trial 243	87-
TF 250 ES (4T)	11-13
TR 250 ES (2T) Enduro Six Day	13
TR 300 ES (2T) Enduro Six Day	13
TZ 300 ES Regularita Scuderia	11-12
300 Trial	
301 Monoshock	86
303 Monoshock	87
125.5/245/305	89
All series 7 models	90
309	92
K-R00 All Models	92-95
Section 125/249 R	95-
FB MINARELLI (SPAIN)	
Rieju Marathon	74-
MR 80	
FONTA	
Hawk 50	06
FK 125/17	06
FT 125-T	06
FYM/X-SPORT	
Mini-XRC 50 F	06
CR 90 E	06-07
Xtreme CR 90 E Auto	06
110 ES R X-Sport	06-07
110 ES	06-07
CR 110 X Sport 110	06-07
CR 110	06-07
CR 110 ESR	06-07
X-Sport 110	06
X-Sport CR3	06
X-Sport Sand Blaster	06
CR 125 Sand Bike	06-07
CR 125 R	06-07
CR3 125	06-07
FYM 125 EY-5 (X Sport CR3/CR125)	06-07
X-Sport Typhoon 125 Quad	06-07
X-Trail 150	06-07

FRONT / AVANT / VORN / FRENTE / ANTERIORE

DISC PAD CHOICES - FRONT				BRAKE DISC CHOICES - FRONT							Line #
FA, SFA, TT Pad or Brake Shoe	SFAC Carbon Scooter Pads	Speciality Pads SXR / Vee / MXS	Sintered/HH Pads/ Grooved Shoes	Left / Gauche / Links Standard Replacement Disc	Right / Droite / Rechts Standard Replacement Disc	Contour Disc Universal left and right fitment	Universal Custom Disc	Vee-Discs Black † See note below	CX Extreme MX Race Disc/ UTVX Disc	Line #	
			841G							1	
FA099				N/A						2	
FA115			FA115R	N/A						3	
FA465TT		MXS465	FA465R			N/A				4	
FA465TT		MXS465	FA465R			N/A				5	
FA465TT		MXS465	FA465R			N/A				6	
FA465TT		MXS465	FA465R			N/A				7	
FA095			FA095HH							8	
FA465TT		MXS465	FA465R			N/A				9	
FA465TT		MXS465	FA465R			N/A				10	
FA465TT		MXS465	FA465R			N/A				11	
FA465TT		MXS465	FA465R			N/A				12	
			841G							13	
FA465TT		MXS465	FA465R			N/A				14	
FA465TT		MXS465	FA465R			N/A				15	
FA099				N/A						16	
			841G							17	
FA099				N/A						18	
FA465TT		MXS465	FA465R			N/A				19	
FA465TT		MXS465	FA465R			N/A				20	
FA465TT		MXS465	FA465R			N/A				21	
FA465TT		MXS465	FA465R			N/A				22	
			939G							23	
FA099				N/A						24	
FA099				N/A						25	
FA115			FA115R	N/A						26	
FA115			FA115R	N/A						27	
FA115			FA115R	N/A						28	
FA115			FA115R	N/A						29	
FA115			FA115R	N/A						30	
										31	
										32	
985										33	
FA115			FA115R	N/A						34	
										35	
										36	
TBA				TBA						37	
TBA				TBA						38	
TBA				TBA						39	
										40	
										41	
N/A										42	
SFA169	SFAC169		SFA169HH	N/A						43	
TBA				N/A						44	
SFA169	SFAC169		SFA169HH	N/A						45	
SFA169	SFAC169		SFA169HH	N/A						46	
TBA				N/A						47	
SFA169	SFAC169		SFA169HH	N/A						48	
SFA169	SFAC169		SFA169HH	N/A						49	
TBA				N/A						50	
TBA				N/A						51	
TBA				N/A						52	
TBA				N/A						53	
SFA169	SFAC169		SFA169HH	N/A						54	
SFA169	SFAC169		SFA169HH	N/A						55	
SFA169	SFAC169		SFA169HH	N/A						56	
SFA169*	SFAC169*		SFA169HH*	N/A	N/A					57	
TBA				N/A						58	
										59	
										60	

*-2 Sets Required. † For Vee disc colours add RED, BLU, GRN, GLD, ORG suffix to part number.

⊗ - Also available as a Vintage Motorcycle Disc.

242 Part numbers, prefixes, suffixes, photos and illustrations shown in this catalogue are trademarks and/or copyrights of EBC Brakes or the trademark owner A C Freeman Investments Ltd and use without express written permission of the owners is punishable by law.

Non-JAPANESE Built Motorcycles

Line #	BRAKE DISC CHOICES - FRONT						DISC PAD CHOICES - REAR				BRAKE DISC CHOICES - REAR			
	Oversize 250 /280mm Disc Kit	OSX Oversize 250/280mm Disc Kit	Relocating Bracket for 250/ 280mm Disc	Oversize 320mm Disc Kit	SMX Oversize 320mm Disc Kit	Relocating Bracket for 320mm Disc	FA, SFA, TT Pad or Brake Shoe	SFAC Carbon Scooter Pads	Speciality Pads - SXR / Vee / MXS	Sintered/ HH Pads/ Grooved Shoes	Standard Replacement Disc	Contour Disc Rear fitment	Vee-Discs™ CONTOUR	CX Extreme MX Race Disc/ UTVX Disc
1									841G					
2							FA099		FA099R	N/A				
3							FA115		FA115R	N/A				
4							FA346TT		FA346R		N/A			
5							FA346TT		FA346R		N/A			
6							FA346TT		FA346R		N/A			
7							FA346TT		FA346R		N/A			
8							FA346TT		FA346R		N/A			
9							FA346TT		FA346R		N/A			
10							FA346TT		FA346R		N/A			
11							FA346TT		FA346R		N/A			
12							FA346TT		FA346R		N/A			
13									841G					
14							FA346TT		FA346R		N/A			
15							FA346TT		FA346R		N/A			
16									841G					
17									841G					
18							FA099		FA099R	N/A				
19							FA346TT		FA346R		N/A			
20							FA346TT		FA346R		N/A			
21							FA346TT		FA346R		N/A			
22							FA346TT		FA346R		N/A			
23									841G					
24									841G					
25							FA099		FA099R	N/A				
26							FA115		FA115R	N/A				
27							FA115		FA115R	N/A				
28							FA115		FA115R	N/A				
29							FA115		FA115R	N/A				
30							FA115		FA115R	N/A				
31														
32														
33							985							
34									936G					
35														
36														
37							TBA			TBA				
38							TBA							
39							TBA							
40														
41														
42							N/A							
43							H338		H338G					
44							N/A							
45							SFA115	SFAC115	SFA115HH	N/A				
46							H338		H338G					
47							TBA			N/A				
48							SFA115	SFAC115	SFA115HH	N/A				
49							SFA115	SFAC115	SFA115HH	N/A				
50							TBA			N/A				
51							SFA115	SFAC115	SFA115HH	N/A				
52							TBA			N/A				
53							TBA							
54							SFA115	SFAC115	SFA115HH	N/A				
55							SFA115	SFAC115	SFA115HH	N/A				
56							SFA115	SFAC115	SFA115HH	N/A				
57							SFA115	SFAC115	SFA115HH	N/A				
58							TBA			N/A				
59														
60														

REAR / ARRIÈRE / HINTEN / POSTERIOR / POSTERIORE

*-2 Sets Required. † For Vee disc colours add RED, BLU, GRN, GLD, ORG suffix to part number.

⊗ - Also available as a Vintage Motorcycle Disc.

R Suffix = High Durability Sintered Pad. HH Suffix = High Performance Sintered Pad. TT Suffix = Hard Wearing Off Road Pad. V Suffix = Semi Sintered Pad. G Suffix = Grooved Shoe.

D Suffix = Drilled Disc. X Suffix = Universal Left or Right Disc. XC Suffix = Contoured Disc. LS Suffix = Left/Steel Disc. RS = Right/Steel Disc.

BRAKE APPLICATIONS

Non-JAPANESE Built Motorcycles

APPLICATIONS

BRAKE



GARELLI

		DISC PAD CHOICES - FRONT				BRAKE DISC CHOICES - FRONT						Line #
		FA, SFA, TT Pad or Brake Shoe	SFAC Carbon Scooter Pads	Speciality Pads SXR / Vee / MXS	Sintered/HH Pads/ Grooved Shoes	Left / Gauche / Links Standard Replacement Disc	Right / Droite / Rechts Standard Replacement Disc	Contour Disc Universal left and right fitment	Universal Custom Disc	Vee-Discs Black † See note below	CX Extreme MX Race Disc/ UTVX Disc	
Queenie	95-	SFA083	SFAC083		SFA083HH	MD904D				VR904		1
Grinta	95-	SFA083	SFAC083		SFA083HH	MD904D				VR904		2
Capri 50 (DF50QT-7)	06	SFA169	SFAC169		SFA169HH	TBA						3
Capri LX 50	06-08	SFA169	SFAC169		SFA169HH	TBA						4
Ciclone 50	07	SFA169	SFAC169		SFA169HH	TBA						5
Ciclone	08	TBA				N/A						6
Flexi 50	09-12	SFA235	SFAC235			TBA						7
FLO 50		SFA193	SFAC193		SFA193HH	MD916D						8
FX 50		SFA169	SFAC169		SFA169HH	MD923D				VR923		9
GSP 50 (2T)	09-12	SFA235	SFAC235					TBA				10
KRS 50		SFA264	SFAC264		SFA264HH	MD923D				VR923		11
Tiesse 50 (2T)	08-10	SFA235	SFAC235			N/A						12
Tiesse 50 (4T)	08-10	SFA235	SFAC235			N/A						13
VIP 50		TBA										14
VIP 50	07	SFA235	SFAC235			TBA						15
VIP 50	08	SFA169	SFAC169		SFA169HH	N/A						16
XO 50	09	SFA235	SFAC235			TBA						17
XO 50 (2T/4T - TM50QT-31)	10-12	SFA235	SFAC235			TBA						18
XO 50'e (Electric)	12	SFA086	SFAC086		SFA086HH	TBA						19
Comfort 125	07	SFA086	SFAC086		SFA086HH			N/A				20
Freeland 125/150		SFA264	SFAC264		SFA264HH	MD923D				VR923		21
Joker 125/150	02	SFA264	SFAC264		SFA264HH	N/A						22
Panther 125/150/250	02	SFA257	SFAC257			N/A						23
Skyнет 250/400	02	SFA281			SFA281HH	N/A						24
Eureka, Gulp		908										25
50 Ciclone/KL 50 SV					926G							26
50 Vip/Noi/Basic spoke wheel		908										27
50 Vip/Noi/Basic Alu Wheel		931			931G							28
Junior Turismo		909										29
Gran Turismo					926G							30
50 Tiger XLE	86-	FA256				N/A						31
Formuno 50 till chassis no. 2701551	87-	N/A										32
Formuno 50 from chassis no. 2701552	87-	N/A										33
50 Team Matic	88-	877										34
Sahel 50	91-	FA116				N/A						35
Urka 50	91-	FA047			FA047R	N/A						36
Sahel 80	91-	FA116										37
Flexi 125	09-12	SFA235	SFAC235			TBA						38
RSX 125	81-				821G							39
Strada/Sport 125		N/A				N/A						40
TSR 125	-83	FA076			FA076HH	N/A						41
TSR 125	83-	N/A				N/A						42
125 XR/XRD Tiger	83-	FA047			FA047R	N/A						43
125 Tiger XLE	86-	FA256				N/A						44
Tiger 125	07	FA197			FA197HH	N/A						45
GTA 125	85	FA060*				N/A						46
GTA 125	86-	FA060*				N/A						47
XO 125i (TM 125 T)	09-12	SFA086	SFAC086		SFA086HH	N/A						48
Fashion 150	07	SFA054	SFAC054		FA054HH			N/A				49
Mosquito 150	07	FA086			FA086HH	N/A						50
XO 150i (TM 150 T)	09-12	SFA086	SFAC086		SFA086HH	N/A						51
XO 200i (TM 200 T)	10-12	SFA086	SFAC086		SFA086HH	N/A						52
Trial 320	-85				841G							53
Trial 323	86-	FA115			FA115R	N/A						54
												55
												56
												57
												58
												59
												60

FRONT / AVANT / VORN / FRENTE / ANTERIORE

R Suffix = High Durability Sintered Pad. HH Suffix = High Performance Sintered Pad. TT Suffix = Hard Wearing Off Road Pad. V Suffix = Semi Sintered Pad. G Suffix = Grooved Shoe.

D Suffix = Drilled Disc. X Suffix = Universal Left or Right Disc. XC Suffix = Contoured Disc. LS Suffix = Left/Steel Disc. RS Suffix = Right/Steel Disc.

*-2 Sets Required. † For Vee disc colours add RED, BLU, GRN, GLD, ORG suffix to part number.

⊗ - Also available as a Vintage Motorcycle Disc.

244 Part numbers, prefixes, suffixes, photos and illustrations shown in this catalogue are trademarks and/or copyrights of EBC Brakes or the trademark owner A C Freeman Investments Ltd and use without express written permission of the owners is punishable by law.

Non-JAPANESE Built Motorcycles

Line #	BRAKE DISC CHOICES - FRONT						DISC PAD CHOICES - REAR				BRAKE DISC CHOICES - REAR			
	Oversize 250 /280mm Disc Kit	OSX Oversize 250/280mm Disc Kit	Relocating Bracket for 250/ 280mm Disc	Oversize 320mm Disc Kit	SMX Oversize 320mm Disc Kit	Relocating Bracket for 320mm Disc	FA, SFA, TT Pad or Brake Shoe	SFAC Carbon Scooter Pads	Speciality Pads - SXR / Vee / MXS	Sintered/ HH Pads/ Grooved Shoes	Standard Replacement Disc	Contour Disc Rear fitment	Vee-Discs™ CONTOUR	CX Extreme MX Race Disc/ UTVX Disc
1							Y503							
2							Y503							
3							TBA							
4							TBA							
5							TBA							
6							TBA							
7							TBA							
8							TBA							
9							Y503							
10							SFA115	SFAC115				TBA		
11							S624							
12							Y503							
13							Y503							
14							TBA							
15							TBA							
16							TBA							
17							Y503							
18							SFA235	SFAC235			N/A			
19							SFA101	SFAC101		SFA101HH	N/A			
20							TBA							
21							S624							
22							TBA							
23							TBA							
24							SFA193			SFA193HH	N/A			
25							908							
26										926G				
27							908							
28							931			931G				
29							909							
30										926G				
31							FA099				N/A			
32							931			931G				
33							931			931G				
34							931			931G				
35							FA115			FA115R	N/A			
36							N/A							
37							FA115			FA115R	N/A			
38							TBA							
39										821G				
40							921							
41							921							
42							921							
43							N/A							
44							FA060				N/A			
45							FA197			FA197HH	N/A			
46														
47							FA060				N/A			
48							SFA101	SFAC101		SFA101HH	N/A			
49							TBA							
50							TBA							
51							SFA101	SFAC101		SFA101HH	N/A			
52							SFA101	SFAC101		SFA101HH	N/A			
53										841G				
54										930G				
55														
56														
57							FA351TT				N/A			
58							FA291				N/A			
59							FA351TT				N/A			
60							FA351TT				N/A			

REAR / ARRIÈRE / HINTEN / POSTERIOR / POSTERIORE

*-2 Sets Required. † For Vee disc colours add RED, BLU, GRN, GLD, ORG suffix to part number.

⊗ - Also available as a Vintage Motorcycle Disc.

R Suffix = High Durability Sintered Pad. HH Suffix = High Performance Sintered Pad. TT Suffix = Hard Wearing Off Road Pad. V Suffix = Semi Sintered Pad. G Suffix = Grooved Shoe.

D Suffix = Drilled Disc. X Suffix = Universal Left or Right Disc. XC Suffix = Contoured Disc. LS Suffix = Left/Steel Disc. RS = Right/Steel Disc.

BRAKE APPLICATIONS

Non-JAPANESE Built Motorcycles

APPLICATIONS

BRAKE



GAS-GAS Contd.

R Suffix = High Durability Sintered Pad. **HH** Suffix = High Performance Sintered Pad. **TT** Suffix = Hard Wearing Off Road Pad. **V** Suffix = Semi Sintered Pad. **G** Suffix = Grooved Shoe.

D Suffix = Drilled Disc. **X** Suffix = Universal Left or Right Disc. **XC** Suffix = Contoured Disc. **LS** Suffix = Left/Steel Disc. **RS** = Right/Steel Disc.

		DISC PAD CHOICES - FRONT				BRAKE DISC CHOICES - FRONT						Line #
		FA, SFA, TT Pad or Brake Shoe	SFAC Carbon Scooter Pads	Speciality Pads - SXR / Vee / MXS	Sintered/HH Pads/ Grooved Shoes	Left / Gauche / Links Standard Replacement Disc	Right / Droite / Rechts Standard Replacement Disc	Contour Disc Universal left and right fitment	Universal Custom Disc	Vee-Discs Black † See note below	CX Extreme MX Race Disc/ UTVX Disc	
EC 50 (Rookie)	01-04	FA167			FA167HH	N/A						1
EC 50	05	FA194			FA194HH	N/A						2
EC 50	06-07	FA115TT			FA115R	N/A						3
K1 Quad	06	TBA*										4
J50 Quad	06	TBA*										5
Quad Wild HP 50	04-07	FA181TT*		MXS181	FA181R*	N/A						6
SM 50 (Rookie)	01-04	FA167			FA167HH	N/A						7
SM 50	05	FA194			FA194HH	N/A						8
TXT 50 (Boy)	01	FA291				N/A						9
TXT 50 (Boy)	04-15	FA115TT		MXS115	FA115R	N/A						10
TXT 50 (Rookie)	02-03	FA291				N/A						11
TXT 50 (Rookie)	04-08	FA303TT				N/A						12
TXT 50 (Cadet)	06-09	FA115TT		MXS115	FA115R	N/A						13
TXE (Electric Bike)	20	FA291										14
Cross MC 65	06	FA351TT				N/A						15
MX 65 (MC)	05-08	FA351TT				N/A						16
TXT 80 (Rookie)	02-03	FA291				N/A						17
TXT 80 (Rookie)	04-09	FA303TT				N/A						18
TXT 80 Cadet	06	FA351TT				N/A						19
TXT 80 Cadet	07-09	FA303TT				N/A						20
TXT 80 Pro Racing (2T)	15	FA303TT				N/A						21
Enduro EC 125/200/250/300 (Brembo)	97-99	FA181TT		MXS181	FA181R	N/A						22
EC 125/200/250/300 (Nissin/2T)	00-08	FA185TT		MXS185	FA185R	MD6289D		MD6289C				23
EC 125/200/250/300 (Nissin/2T)	09-10	FA185TT		MXS185	FA185R	MD6289D		MD6289C				24
EC 125/200/250/300 (All Models/2T)	11-15	FA185TT		MXS185	FA185R			MD6289C				25
EC 200-250-300 XC 250-300 Euro4	18-20	FA185TT		MXS185	FA185R							26
EC Ranger 200/300	18-20	FA185TT		MXS185	FA185R							27
JTX 125/200/270/320	95-98	FA115TT		MXS115	FA115R	N/A						28
MX 125/250 (MC)	01-08	FA185TT		MXS185	FA185R	MD6289D						29
MX 125/250 (MC)	09-11	FA185TT		MXS185	FA185R	MD6289D						30
Pampera 125/250/370	96-97	FA115TT		MXS115	FA115R	N/A						31
Pampera 125/250/280	04	FA194			FA194HH	N/A						32
Pampera 125 (2T)	05-08	FA194			FA194HH	TBA						33
SM 125 (2T) Supermotard	03-06	FA095			FA095HH	MD6209D						34
SM Halley 125cc	09	FA095			FA095HH	N/A						35
Trail Halley 125cc	09	FA185TT		MXS185	FA185R	N/A						36
TXT 125 Randonne (4T)	11-15	FA303TT				N/A						37
TXT 125/200/249/280/321	00-03	FA291				N/A						38
TXT 125/200/250/280/300 (TXT Pro)	04-11	FA303TT				N/A						39
TXT 125/250/280/300												40
(For All models with AJP caliper/2 pin pad fixing)	12-13	FA303TT				N/A						41
TXT 125/250/280/300 (For All models with Formula caliper/1 pin pad fixing)	12-14	FA612TT			FA612R	N/A						42
TXT 125/250/280/300 Replica Factory Models (2T Monobloc Caliper)	13-14	FA644TT						N/A				43
TXT 125/250/280/300 Racing Models (2T Monobloc Caliper)	14-19	FA644TT						N/A				44
TXT-E (Full Size Electric Bike)	12-14	FA303TT				N/A						45
MX 200/250/300	99-00	FA185TT		MXS185	FA185R	N/A						46
TX 200/270/320	98	FA115TT		MXS115	FA115R	N/A						47
TXT 200/270/321	99	FA291				N/A						48
TXT 200 Randonne (4T)	11-15	FA303TT				N/A						49
XC 200/250/300	20	FA185TT		MXS185	FA185R	N/A						50
Contact JT25 (238cc)	93-94	FA115TT		MXS115	FA115R	N/A						51
Contact RR 250/280	20	FA303TT										52
EC Six Days 250/300	19	FA185TT		MXS185	FA185R							53
EC Cami 250F (4T)	14-15	FA465TT		MXS465	FA465R			N/A				54
EC 250 F (All Models/4T)	12-15	FA185TT		MXS185	FA185R			N/A				55
Quad HP 240	04-06	FA181TT*		MXS181	FA181R*	N/A	N/A					56

*-2 Sets Required. † For Vee disc colours add RED, BLU, GRN, GLD, ORG suffix to part number.

⊗ - Also available as a Vintage Motorcycle Disc.

Non-JAPANESE Built Motorcycles

Line #	BRAKE DISC CHOICES - FRONT						DISC PAD CHOICES - REAR				BRAKE DISC CHOICES - REAR			
	Oversize 250 /280mm Disc Kit	OSX Oversize 250/280mm Disc Kit	Relocating Bracket for 250/ 280mm Disc	Oversize 320mm Disc Kit	SMX Oversize 320mm Disc Kit	Relocating Bracket for 320mm Disc	FA, SFA, TT Pad or Brake Shoe	SFAC Carbon Scooter Pads	Speciality Pads - SXR / Vee / MXS	Sintered/ HH Pads/ Grooved Shoes	Standard Replacement Disc	Contour Disc Rear fitment	Vee-Discs™ CONTOUR	CX Extreme MX Race Disc/ UTVX Disc
1							FA291				N/A			
2							FA291				N/A			
3							FA351TT				N/A			
4							TBA							
5							FA115TT		FA115R		N/A			
6							FA181TT	MXS181	FA181R		N/A			
7							FA291				N/A			
8							FA291				N/A			
9							FA291				N/A			
10							FA115TT	MXS115	FA115R		N/A			
11							FA291				N/A			
12							FA351TT				N/A			
13							FA351TT				N/A			
14							FA351TT				N/A			
15							FA351TT				N/A			
16							FA115				N/A			
17							FA291				N/A			
18							FA351TT				N/A			
19							FA351TT				N/A			
20							FA351TT				N/A			
21							FA351TT				N/A			
22							FA208TT	MXS208	FA208R	MD6253D				
23							FA131TT	MXS131	FA131R	MD6253D	MD6253C			
24							FA367TT	MXS367	FA367R	MD6253D	MD6253C			
25							FA367TT	MXS367	FA367R		MD6253C			
26							FA367TT	MXS367	FA367R					
27							FA367TT	MXS367	FA367R					
28							FA115TT	MXS115	FA115R	N/A				
29							FA131TT	MXS131	FA131R	MD6253D				
30							FA367TT	MXS367	FA367R	MD6253D				
31							FA115TT	MXS115	FA115R	N/A				
32							FA291			N/A				
33							FA131TT	MXS131	FA131R	TBA				
34							FA131TT	MXS131	FA131R	MD6253D				
35							FA131TT	MXS131	FA131R	N/A				
36							FA131TT	MXS131	FA131R	N/A				
37							FA351TT				N/A			
38							FA291			N/A				
39							FA351TT			N/A				
40														
41							FA351TT			N/A				
42														
43							FA351TT			N/A				
44														
45							FA351TT				N/A			
46														
47							FA351TT				N/A			
48							FA351TT				N/A			
49							FA131TT	MXS131	FA131R	MD6253D				
50							FA115TT	MXS115	FA115R	N/A				
51							FA291			N/A				
52							FA351TT				N/A			
53							FA367TT	MXS367	FA367R					
54							FA115TT	MXS115	FA115R	N/A				
55							FA351TT							
56							FA367TT	MXS367	FA367R					
57							FA093				N/A			
58							FA367TT	MXS367	FA367R		N/A			
59							FA181TT	MXS181	FA181R	N/A				
60														

REAR / ARRIÈRE / HINTEN / POSTERIOR / POSTERIORE

*-2 Sets Required. † For Vee disc colours add RED, BLU, GRN, GLD, ORG suffix to part number.

⊗ - Also available as a Vintage Motorcycle Disc.

R Suffix = High Durability Sintered Pad. **HH** Suffix = High Performance Sintered Pad. **TT** Suffix = Hard Wearing Off Road Pad. **V** Suffix = Semi Sintered Pad. **G** Suffix = Grooved Shoe.
D Suffix = Drilled Disc. **X** Suffix = Universal Left or Right Disc. **XC** Suffix = Contoured Disc. **LS** Suffix = Left/Steel Disc. **RS** = Right/Steel Disc.

Part numbers, prefixes, suffixes, photos and illustrations shown in this catalogue are trademarks and/or copyrights of EBC Brakes or the trademark owner A C Freeman Investments Ltd and use without express written permission of the owners is punishable by law.

BRAKE APPLICATIONS

Non-JAPANESE Built Motorcycles

APPLICATIONS

BRAKE



GAS GAS Contd.

	Left	Right	06
KS 250 RV Quad			
Pampera 250/320			98-99
Pampera 250			02-03
TXT 250 Contact (4T)			15
EC 300 F (All Models/4T)			13-15
Quad HP 300 RV			03-06
Pampera 400			06
SM 400 FSE (2T)			01-02
EC 450 FSR (4T) Enduro/FSE			05-09
EC 450 F (All Models/4T)			13-15
EC 450 Raid (4T)			14
Pampera 450 (4T)			07-08
SM 450 FSR (4T) Supermotard			07-09
SM Halley 450cc			09
Trail Halley 450cc			09
Wild HP 450 Quad			04-09
EC 515 FSR/FSE (4T) Enduro			05-09
SM 515 FSR (4T) Supermotard			07-09
Wild HP 515cc Quad			09

GENERIC / KSR

TTX (Electric)			16-18
Vionis (Electric)			18
Classic 50			17-18
Cracker 50 (2T/4T)			09-18
Demonio 50			17-18
50 GT Race Explorer			09
Epico 50 (2T)			10-18
Epico Electric			12-13
Ideo 50			05-14
Mini Trigger SM 50			08-09
Mini Trigger X 50			08-09
Moped 50			13-14
Pandora 50 (2T/4T)			13-18
Jump 50 (2T)			12-18
Onyx 50 (2T/4T)			10-18
Race 2 50 (2T/4T)			10-14
Roc 50			08-11
Sirion 50 (2T/4T)			12-20
Toxic 50			07-08
Toxic 50 Sport (2T)			12-18
Trigger SM50 (All Models)			06-18
Trigger X50 (All Models/TR X 50)			06-18
Vendetta 50 (2T)			12-13
Vertigo 50 (4T)			12-14
XOR 50 (2T)			05-14
Moped 100			13-14
Vulcan 100			13-14
N'Joy 110 (4T)			13-14
Madison 110 (4T)			13-14
Venos 110 (4T)			13-14
Inox 125 (4T)			12-14
Classic 125			17-18
Code 125			17-20
Code S 125/150/200 (4T)			12-16
Code X 125/150/200 (4T)			12-16
Demonio 125			17-18
GRS 125			13-16
GRS 125			17-20

FA, SFA, TT Pad or Brake Shoe	SFAC Carbon Scooter Pads	Speciality Pads SXR / Vee / MXS	Sintered/HH Pads/ Grooved Shoes	BRAKE DISC CHOICES - FRONT						Line #
				Left / Gauche / Links Standard Replacement Disc	Right / Droite / Rechts Standard Replacement Disc	Contour Disc Universal left and right fitment	Universal Custom Disc	Vee-Discs Black † See note below	CX Extreme MX Race Disc/ UTVX Disc	
FA135TT			FA135R	N/A	N/A					1
FA165TT			FA165R							2
FA115TT		MXS115	FA115R	N/A	N/A					3
FA194			FA194HH	N/A						4
FA303TT						N/A				5
FA185TT		MXS185	FA185R			N/A				6
FA181TT*		MXS181	FA181R*	N/A	N/A					7
FA181TT		MXS181	FA181R	N/A						8
FA095			FA095HH	MD6209D						9
FA185TT		MXS185	FA185R	MD6289D		N/A				10
FA185TT		MXS185	FA185R			N/A				11
FA185TT		MXS185	FA185R							12
FA185TT		MXS185	FA185R	MD6289D						13
FA095			FA095HH	MD6209D						14
FA185TT		MXS185	FA185R	N/A						15
FA185TT		MXS185	FA185R	N/A						16
FA181TT*		MXS181	FA181R*	TBA	TBA					17
FA185TT		MXS185	FA185R	MD6289D						18
FA095			FA095HH	MD6209D						19
FA181TT		MXS181	FA181R	N/A	N/A					20
										21
										22
SFA086										23
SFA086										24
SFA086	SFAC086		SFA086HH							25
SFA235	SFAC235			MD923D				VR923		26
FA707										27
SFA235	SFAC235			MD971D				VR971		28
SFA235	SFAC235			TBA						29
SFA235	SFAC235			TBA						30
SFA235	SFAC235			MD923D				VR923		31
FA448				N/A						32
FA448				N/A						33
TBA										34
SFA235	SFAC235			N/A						35
SFA083	SFAC083		SFA083HH	TBA						36
SFA193	SFAC193		SFA193HH	TBA						37
SFA235	SFAC235			TBA						38
SFA235	SFAC235			MD923D				VR923		39
SFA235	SFAC235							VR923		40
FA194			FA194HH	N/A						41
SFA235	SFAC235			TBA						42
FA194			FA194HH	TBA						43
FA194			FA194HH	TBA						44
SFA264	SFAC264		SFA264HH	TBA						45
SFA086	SFAC086			N/A						46
SFA235	SFAC235			MD923D				VR923		47
TBA										48
TBA										49
TBA										50
SFA086	SFAC086		SFA086HH		N/A					51
SFA086	SFAC086		SFA086HH		N/A					52
SFA228	SFAC228		SFA228HH		N/A	N/A				53
FA707										54
FA707										55
FA658			FA658HH			N/A				56
FA658			FA658HH							57
FA707										58
FA658			FA658HH			N/A				59
FA707										60

*-2 Sets Required. † For Vee disc colours add RED, BLU, GRN, GLD, ORG suffix to part number.

⊗ - Also available as a Vintage Motorcycle Disc.

248 Part numbers, prefixes, suffixes, photos and illustrations shown in this catalogue are trademarks and/or copyrights of EBC Brakes or the trademark owner A C Freeman Investments Ltd and use without express written permission of the owners is punishable by law.

Non-JAPANESE Built Motorcycles

Line #	BRAKE DISC CHOICES - FRONT						DISC PAD CHOICES - REAR				BRAKE DISC CHOICES - REAR			
	Oversize 250 /280mm Disc Kit	OSX Oversize 250/280mm Disc Kit	Relocating Bracket for 250/ 280mm Disc	Oversize 320mm Disc Kit	SMX Oversize 320mm Disc Kit	Relocating Bracket for 320mm Disc	FA, SFA, TT Pad or Brake Shoe	SFAC Carbon Scooter Pads	Speciality Pads - SXR / Vee / MXS	Sintered/ HH Pads/ Grooved Shoes	Standard Replacement Disc	Contour Disc Rear fitment	Vee-Discs™ CONTOUR	CX Extreme MX Race Disc/ UTVX Disc
1							TBA							
2														
3							FA115TT		MXS115	FA115R	N/A			
4							FA291				N/A			
5							FA351TT					N/A		
6							FA367TT		MXS367	FA367R		N/A		
7							FA181TT		MXS181	FA181R	N/A			
8							FA131TT		MXS131	FA131R	N/A			
9							FA131TT		MXS131	FA131R	MD6253D			
10							FA131TT		MXS131	FA131R	TBA			
11							FA367TT		MXS367	FA367R		N/A		
12							FA367TT		MXS367	FA367R		N/A		
13							FA131TT		MXS131	FA131R	TBA			
14							FA131TT		MXS131	FA131R	MD6253D			
15							FA131TT		MXS131	FA131R	N/A			
16							FA131TT		MXS131	FA131R	N/A			
17							FA181TT		MXS181	FA181R	TBA			
18							FA131TT		MXS131	FA131R	TBA			
19							FA131TT		MXS131	FA131R	MD6253D			
20							FA181TT		MXS181	FA181R	N/A			
21														
22														
23							SFA086							
24							Y503							
25							Y503							
26							Y503							
27							SFA083							
28							Y503							
29							Y503							
30							Y503							
31							Y503							
32							FA448				N/A			
33							FA448				N/A			
34							TBA							
35							Y503							
36							Y503							
37							Y503							
38							Y503							
39							Y503							
40							Y503							
41							FA060				N/A			
42							Y503				N/A			
43							FA060				TBA			
44							FA060				TBA			
45							Y503							
46							Y503							
47							Y503							
48							TBA							
49							TBA							
50							TBA							
51							TBA							
52							TBA							
53							TBA							
54							SFA415							
55							FA197							
56							FA298					N/A		
57							FA298					N/A		
58							SFA083							
59							FA060					N/A		
60							FA298							

REAR / ARRIÈRE / HINTEN / POSTERIOR / POSTERIORE

*-2 Sets Required. † For Vee disc colours add RED, BLU, GRN, GLD, ORG suffix to part number.

⊗ - Also available as a Vintage Motorcycle Disc.

R Suffix = High Durability Sintered Pad. HH Suffix = High Performance Sintered Pad. TT Suffix = Hard Wearing Off Road Pad. V Suffix = Semi Sintered Pad. G Suffix = Grooved Shoe.

D Suffix = Drilled Disc. X Suffix = Universal Left or Right Disc. XC Suffix = Contoured Disc. LS Suffix = Left/Steel Disc. RS = Right/Steel Disc.

BRAKE APPLICATIONS

Non-JAPANESE Built Motorcycles

APPLICATIONS

BRAKE



GENERIC / KSR Contd.

R Suffix = High Durability Sintered Pad. HH Suffix = High Performance Sintered Pad. TT Suffix = Hard Wearing Off Road Pad. V Suffix = Semi Sintered Pad. G Suffix = Grooved Shoe.
 D Suffix = Drilled Disc. X Suffix = Universal Left or Right Disc. XC Suffix = Contoured Disc. LS Suffix = Left/Steel Disc. RS Suffix = Right/Steel Disc.

Model	Year
Nimbus 125	13-14
OJ 126-6K Mercury 125	13-14
Race 2 125 (4T)	10-14
Race 2 125 (4T) GT	18
Rumbler 125	13-14
Sirion 125 (4T) Rear Drum	12-18
Sirion 125 (4T) Rear Disc	18-20
Soho 125/150	06-15
TR 125 SM (4T)	12-16
TR 125 SM (4T)	17-18
Trigger 125 SM	08-09
Trigger 125 X	08-09
TR 125 X	17-18
TW 125 SM	13-16
TW 125 SM	17-20
Versus 125 (4T)	14
Vertigo 125	13-18
Worx 125	17-18
Worx 125/150 (4T)	12-16
XOR 125	05-11
Zion 125/150 (Rear Drum Model)	08-10
Zion 125/150 (Rear Disc Model)	11-16
Dayton 150	13-14
GRS 150	13-15
Torano 150	13-14
Revolver 250 Classic	13-14
Revolver 250 Lowrider	13-14
Urano 275 Quad	07-08
GRS 600	13-14

GILERA

Built 50	90-
CBA 50	
ec1 50	
ECO 50	
503 50cc	91-
50 GR 2	
50 GSA/Vale	
50 Rally	87-
SMT 50 Supermotard	03-06
R1/50	90-
50 RC Top Rally	90-
50 Trend	89-
50 Trial/Enduro	
DNA 50 (Grimeca Caliper)	01-06
DNA 50 (Heng Tong Caliper)	01-05
Eaglet 50	96
Easy Moving 50	95-96
GSM 50	99-01
GSM 50	02-03
H@K 50	00-02
Zulu 50	01-02
Ice 50cc	01-02
Runner 50 (5 Bolt Fixing On Front Disc)	98
Runner/Purejet 50 DD/SP (5 Bolt Fixing On Front Disc)	99-05
Runner 50 P.J/SP (6 Bolt Fixing On Front Disc)	06-14
Stalker 50 (Rear disc models) (Grimeca calipers)	97-06
Stalker 50 (Rear Drum Model) (Grimeca calipers)	97-06
Stalker 50 (Rear disc model) (Heng Tong caliper)	03-06
Stalker 50 (Rear drum model) (Heng Tong caliper)	03-11

FA, SFA, TT Pad or Brake Shoe	DISC PAD CHOICES - FRONT				BRAKE DISC CHOICES - FRONT						Line #
	SFAC Carbon Scooter Pads	Speciality Pads - SXR / Vee / MXS	Sintered/HH Pads/ Grooved Shoes	Left / Gauche / Links Standard Replacement Disc	Right / Droite / Rechts Standard Replacement Disc	Contour Disc Universal left and right fitment	Universal Custom Disc	Vee-Discs Black † See note below	CX Extreme MX Race Disc/ UTVX Disc		
TBA										1	
TBA					N/A					2	
SFA235	SFAC235				TBA					3	
SFA707										4	
TBA					N/A					5	
SFA235	SFAC235							VR923		6	
SFA707										7	
SFA235	SFAC235				TBA		N/A			8	
FA228			FA228HH							9	
FA707										10	
FA194			FA194HH	N/A						11	
FA194			FA194HH	N/A						12	
FA707										13	
TBA							N/A			14	
FA707										15	
TBA				N/A						16	
SFA086	SFAC086		SFA086HH	N/A						17	
FA711		FA711V								18	
FA197			FA197HH		N/A					19	
SFA235	SFAC235			MD923D				VR923		20	
SFA228	SFAC228		SFA228HH	N/A						21	
SFA228	SFAC228		SFA228HH	N/A						22	
TBA										23	
FA658			FA658HH				N/A			24	
TBA				N/A						25	
TBA				N/A						26	
TBA				N/A						27	
TBA*				N/A	N/A					28	
			FA322/4HH*	N/A	N/A					29	
										30	
FA099				N/A						31	
908										32	
908										33	
908										34	
908										35	
FA099				N/A						36	
922										37	
909										38	
FA047/2				N/A						39	
FA115			FA115HH	N/A						40	
FA047/2				N/A						41	
FA173				N/A						42	
909										43	
909										44	
SFA194	SFAC194		SFA194HH	MD944D				VR944		45	
SFA353	SFAC353		SFA353HH	MD944D				VR944		46	
FA099				N/A						47	
SFA193	SFAC193		SFA193HH	MD904D				VR904		48	
FA115			FA115HH	N/A						49	
FA115			FA115HH	N/A						50	
FA115			FA115HH	N/A						51	
FA115			FA115HH	N/A						52	
SFA193	SFAC193		SFA193HH	MD910D		MD910C		VR910		53	
SFA193	SFAC193		SFA193HH	MD924D				VR924		54	
SFA193	SFAC193		SFA193HH	MD924D				VR924		55	
SFA353	SFAC353		SFA353HH	MD956D				VR956		56	
SFA193	SFAC193		SFA193HH	MD9126D						57	
SFA193	SFAC193		SFA193HH	MD9126D						58	
SFA083/2			SFA083/2HH	MD9126D						59	
SFA083/2			SFA083/2HH	MD9126D						60	

FRONT / AVANT / VORN / FREITE / ANTERIORE

*-2 Sets Required. † For Vee disc colours add RED, BLU, GRN, GLD, ORG suffix to part number.

⊗ - Also available as a Vintage Motorcycle Disc.

250 Part numbers, prefixes, suffixes, photos and illustrations shown in this catalogue are trademarks and/or copyrights of EBC Brakes or the trademark owner A C Freeman Investments Ltd and use without express written permission of the owners is punishable by law.

Non-JAPANESE Built Motorcycles

Line #	BRAKE DISC CHOICES - FRONT						DISC PAD CHOICES - REAR				BRAKE DISC CHOICES - REAR			
	Oversize 250 /280mm Disc Kit	OSX Oversize 250/280mm Disc Kit	Relocating Bracket for 250/ 280mm Disc	Oversize 320mm Disc Kit	SMX Oversize 320mm Disc Kit	Relocating Bracket for 320mm Disc	FA, SFA, TT Pad or Brake Shoe	SFAC Carbon Scooter Pads	Speciality Pads - SXR / Vee / MXS	Sintered/ HH Pads/ Grooved Shoes	Standard Replacement Disc	Contour Disc Rear fitment	Vee-Discs™ CONTOUR	CX Extreme MX Race Disc/ UTVX Disc
1							TBA							
2							TBA							
3							Y503							
4							SFA083							
5							TBA							
6							Y503							
7							SFA083							
8							Y527							
9							FA298		SFA298HH		N/A			
10							FA298							
11							FA060			N/A				
12							FA060			N/A				
13							FA298							
14							FA298					N/A		
15							FA298							
16							TBA							
17							Y503							
18							FA197							
19							FA298							
20							Y527							
21							Y527							
22							SFA228	SFAC228	SFA228HH	N/A				
23							TBA							
24							FA060				N/A			
25							TBA							
26							TBA			N/A				
27							TBA			N/A				
28							TBA			TBA				
29							FA266	FA266V	FA266HH	N/A	N/A			
30														
31														
32							883							
33							V907							
34							V907							
35							V907							
36							FA099			N/A				
37							N/A							
38							924							
39							845							
40							FA115		FA115HH	MD6248D				
41							N/A							
42							FA173			N/A				
43							909							
44							909							
45							SFA260	SFAC260	SFA260HH	MD910D		VR910		
46							SFA260	SFAC260	SFA260HH	MD910D		VR910		
47							FA382			N/A				
48							806							
49							FA115		FA115HH	MD6394D				
50							FA115		FA115HH	N/A				
51							FA115		FA115HH	N/A				
52							FA115		FA115HH	MD6394D				
53							899							
54							899							
55							SFA260	SFAC260	SFA260HH	MD932D		VR932		
56							SFA260	SFAC260	SFA260HH	MD932D		VR932		
57							SFA260	SFAC260	SFA260HH	MD932D				
58							899							
59							SFA260		SFA260HH	MD932D				
60							899							

REAR / ARRIÈRE / HINTEN / POSTERIOR / POSTERIORE

*-2 Sets Required. † For Vee disc colours add RED, BLU, GRN, GLD, ORG suffix to part number.

⊗ - Also available as a Vintage Motorcycle Disc.

R Suffix = High Durability Sintered Pad. HH Suffix = High Performance Sintered Pad. TT Suffix = Hard Wearing Off Road Pad. V Suffix = Semi Sintered Pad. G Suffix = Grooved Shoe.

D Suffix = Drilled Disc. X Suffix = Universal Left or Right Disc. XC Suffix = Contoured Disc. LS Suffix = Left/Steel Disc. RS = Right/Steel Disc.

Part numbers, prefixes, suffixes, photos and illustrations shown in this catalogue are trademarks and/or copyrights of EBC Brakes or the trademark owner A C Freeman Investments Ltd and use without express written permission of the owners is punishable by law.

BRAKE APPLICATIONS

Non-JAPANESE Built Motorcycles

APPLICATIONS

BRAKE



GILERA Contd.



R Suffix = High Durability Sintered Pad. HH Suffix = High Performance Sintered Pad. TT Suffix = Hard Wearing Off Road Pad. V Suffix = Semi Sintered Pad. G Suffix = Grooved Shoe.

D Suffix = Drilled Disc. X Suffix = Universal Left or Right Disc. XC Suffix = Contoured Disc. LS Suffix = Left/Steel Disc. RS = Right/Steel Disc.

Model	Year
RCR 50 Enduro	03-06
RK 50 Cannibal	96-98
RV 50 NGR	88
SKP 50	98
SKP 50	99-01
SMT 50 Supermotard	03-06
SMT 50	07
Storm 50	94-95
Typhoon 50 All models	93-95
Typhoon 50	96-
80 TG 36191	
98 Giubileo	
124 Giubileo	
125 Apache	91-
125 Arcore	
125 CX	91-
125 GR 1	
125 E 1/E 1 Competition	
125 TG 36191	
125 HX LC	83-
125 RX	84-
125 MX1/MXR	89-
125 SP 01/SP 2	89-
125 XR1/XR2	89-
DNA 125/180	01-03
DNA 125/180 (Heng Tong Caliper)	01-03
FX/FXR 125/180 Runner (Rear drum brake model /Grimeca front caliper)	97-02
FX/FXR 125/180 Runner (Rear drum brake model /Heng Tong front caliper)	97-02
GFR 125	94
Nexus 125	07-12
RC 125 Rally	87-88
RC 125 Top Rally	89-92
RV 125	88
RX 125 Arizona	88
Coguar 125	99-02
Runner 125/180 FX/FXR/SP 2 stroke (Grimeca caliper)	99-02
Runner 125/180 FX/FXR/SP 2 stroke (Heng Tong caliper)	99-02
SC 125	06-07
Typhoon 125	95-98
Typhoon 125 X-XR	99-00
125 VX4T/180 VXR4T Runner 4 stroke (Grimeca Caliper)	01-04
125 VX4T/180 VXR4T Runner 4 stroke (Heng Tong Caliper)	01-04
VX 125 Runner/ST (4T)	05-14
150 Arcore	
RX 200/Arizona/Enduro	85-
200 Arizona Hawk	85-
200 RTX	85-
200 T4/T4 C/T4 S	
200 ER	87-
200 Fast Bike	87-
RV 200	85-86
RV 200 ES	87-
VXR 200 Runner (4T) (6 bolt rear disc) Heng Tong caliper	02-04
VXR 200 Runner (4T) (6 bolt rear disc) Grimeca caliper	02-04
VX 200 Runner/ST (4T) (6 bolt rear disc) Heng Tong caliper	05-11
HX 250 LC	83-
Nexus 250 ie	07

FRONT / AVANT / VORN / FRENTE / ANTERIORE

DISC PAD CHOICES - FRONT				BRAKE DISC CHOICES - FRONT							Line #
FA, SFA, TT Pad or Brake Shoe	SFAC Carbon Scooter Pads	Speciality Pads SXR / Vee / MXS	Sintered/HH Pads/ Grooved Shoes	Left / Gauche / Links Standard Replacement Disc	Right / Droite / Rechts Standard Replacement Disc	Contour Disc Universal left and right fitment	Universal Custom Disc	Vee-Discs Black † See note below	CX Extreme MX Race Disc/ UTVX Disc	Line #	
FA115			FA115HH	N/A						1	
FA115			FA115HH	N/A						2	
FA060*				N/A	N/A					3	
SFA193	SFAC193		SFA193HH	MD943D		MD943C		VR943		4	
SFA193	SFAC193		SFA193HH	MD943D		MD943C		VR943		5	
FA115			FA115HH	N/A						6	
FA115			FA115HH	N/A						7	
SFA193	SFAC193		SFA193HH	MD943D		MD943C		VR943		8	
SFA193	SFAC193		SFA193HH	MD901D				VR901		9	
SFA193	SFAC193		SFA193HH	MD901D				VR901		10	
FA076			FA076HH							11	
			821G							12	
			821G							13	
FA134			FA134R	N/A						14	
			843G							15	
FA126			FA126R	N/A						16	
FA076			FA076HH	N/A						17	
			841G							18	
FA076			FA076HH							19	
FA047			FA047R	N/A						20	
FA047			FA047R	N/A						21	
FA126			FA126R	N/A						22	
FA126			FA126R	N/A						23	
FA256			FA256HH	N/A						24	
SFA194	SFAC194		SFA194HH	MD944D				VR944		25	
SFA353	SFAC353		SFA353HH	MD944D				VR944		26	
SFA194	SFAC194		SFA194HH	MD924D				VR924		28	
SFA353	SFAC353		SFA353HH	MD924D				VR924		30	
FA126			FA126HH	N/A						31	
SFA353	SFAC353		SFA353HH	MD983D				VR983		32	
FA256			FA256HH	MD6359D						33	
FA134			FA134R	MD6378D						34	
N/A				N/A						35	
FA047			FA047R	N/A						36	
FA256			FA256HH	MD983D				VR983		37	
SFA194	SFAC194		SFA194HH	MD924D				VR924		38	
SFA353	SFAC353		SFA353HH	MD924D				VR924		39	
FA399				MD685LS						40	
SFA193	SFAC193		SFA193HH	MD9126D						41	
SFA193	SFAC193		SFA193HH	MD9126D						42	
SFA194	SFAC194		SFA194HH	MD924D				VR924		43	
SFA353	SFAC353		SFA353HH	MD924D				VR924		44	
SFA353	SFAC353		SFA353HH	MD9112D				VR9112		45	
925										46	
FA047			FA047R	N/A						47	
FA256			FA256HH	N/A						48	
FA256			FA256HH	N/A						49	
FA076			FA076HH	N/A						50	
FA256			FA256HH	N/A						51	
FA256			FA256HH	N/A						52	
N/A				N/A						53	
FA256			FA256HH	N/A						54	
SFA353	SFAC353		SFA353HH	MD924D				VR924		55	
SFA194	SFAC194		SFA194HH	MD924D				VR924		56	
SFA353	SFAC353		SFA353HH	MD9112D				VR9112		57	
FA047			FA047R	N/A						58	
SFA353	SFAC353		SFA353HH	MD961D				VR961		59	

* See SFA681 if rear pad SFA321 is incorrect shape - ONLY AVAILABLE AS SFA ORGANIC VERSION

*-2 Sets Required. † For Vee disc colours add RED, BLU, GRN, GLD, ORG suffix to part number.

⊗ - Also available as a Vintage Motorcycle Disc.

252 Part numbers, prefixes, suffixes, photos and illustrations shown in this catalogue are trademarks and/or copyrights of EBC Brakes or the trademark owner A C Freeman Investments Ltd and use without express written permission of the owners is punishable by law.

Non-JAPANESE Built Motorcycles

Line #	BRAKE DISC CHOICES - FRONT						DISC PAD CHOICES - REAR				BRAKE DISC CHOICES - REAR			
	Oversize 250 /280mm Disc Kit	OSX Oversize 250/280mm Disc Kit	Relocating Bracket for 250/ 280mm Disc	Oversize 320mm Disc Kit	SMX Oversize 320mm Disc Kit	Relocating Bracket for 320mm Disc	FA, SFA, TT Pad or Brake Shoe	SFAC Carbon Scooter Pads	Speciality Pads - SXR / Vee / MXS	Sintered/ HH Pads/ Grooved Shoes	Standard Replacement Disc	Contour Disc Rear fitment	Vee-Discs™ CONTOUR	CX Extreme MX Race Disc/ UTVX Disc
1							FA115			FA115HH	MD6248D			
2							FA115			FA115HH	MD6394D			
3							FA047				N/A			
4							899							
5							SFA260	SFAC260		SFA260HH	MD932D	MD932C	VR932	
6							FA115			FA115HH	MD6248D			
7							FA115			FA115HH	MD6248D			
8							806							
9							886							
10							806							
11										843G				
12							922							
13							922							
14							FA101TT			FA101R	N/A			
15							922							
16							FA047			FA047R	N/A			
17										843G				
18										843G				
19							921							
20							N/A							
21							954							
22							FA047			FA047R	N/A			
23							FA047			FA047R	N/A			
24							FA047				N/A			
25							SFA321★	SFAC321		SFA321HH	MD944D		VR944	
26							SFA321★	SFAC321		SFA321HH	MD944D		VR944	
27														
28							816							
29														
30							816							
31							FA047			FA047HH	N/A			
32							SFA353	SFAC353		SFA353HH	MD960D		VR960	
33							954							
34							FA101TT			FA101R	N/A			
35							921							
36							954							
37							921							
38							SFA260	SFAC260		SFA260HH	MD944D		VR944	
39							SFA260	SFAC260		SFA260HH	MD944D		VR944	
40							FA115				MD686			
41							899							
42							899							
43							SFA321★	SFAC321		SFA321HH	MD910D			
44							SFA321★	SFAC321		SFA321HH	MD910D			
45							SFA321★	SFAC321		SFA321HH	MD956D		VR956	
46										843G				
47							954							
48							954							
49							954							
50							921							
51							954							
52							FA047				N/A			
53							FA047				N/A			
54							FA047				N/A			
55							SFA321★	SFAC321		SFA321HH	MD956D		VR956	
56							SFA321★	SFAC321		SFA321HH	MD956D		VR956	
57							SFA321★	SFAC321		SFA321HH	MD956D		VR956	
58							N/A							
59							SFA353	SFAC353		SFA353HH	MD960D		VR960	
60														

REAR / ARRIÈRE / HINTEN / POSTERIOR / POSTERIORE

*-2 Sets Required. † For Vee disc colours add RED, BLU, GRN, GLD, ORG suffix to part number.

⊛ - Also available as a Vintage Motorcycle Disc.

R Suffix = High Durability Sintered Pad. **HH** Suffix = High Performance Sintered Pad. **TT** Suffix = Hard Wearing Off Road Pad. **V** Suffix = Semi Sintered Pad. **G** Suffix = Grooved Shoe.
D Suffix = Drilled Disc. **X** Suffix = Universal Left or Right Disc. **XC** Suffix = Contoured Disc. **LS** Suffix = Left/Steel Disc. **RS** = Right/Steel Disc.

Part numbers, prefixes, suffixes, photos and illustrations shown in this catalogue are trademarks and/or copyrights of EBC Brakes or the trademark owner A C Freeman Investments Ltd and use without express written permission of the owners is punishable by law.

BRAKE APPLICATIONS

Non-JAPANESE Built Motorcycles

APPLICATIONS

BRAKE



GILERA Contd.



NGR 250	85-
250 RX Arizona Rally	86-
Oregon 250 Quad	07
RC 250 Rally	87-88
Nexus 300i	08-12
350 Dakota	85-
ER 350	87-
Saturno 350 Bialbero	90-
XRT 350	90-
500 Dakota	87-
ER 500	87-
Fuoco 500 RC/ie	07-13
Fuoco 500 RC/ie - Parking brake	07-13
Fuoco 500 LT (4V/4T)	13-15
Fuoco 500 LT (4V/4T) - Parking brake	13-15
Saturno 500 S/Bialbero/Piuma	90-
Nexus 500	03-12
Nexus 500 SP	06-07
Nordwest 600	90-
RC 600	89-90
R 600	91-92
RC 600 Cobra	91-93
XRT 600	88-
GP 800 (Chain drive)	08-14
GP 800 (Chain drive) - Parking brake	08-14

GOCCIA (Electric Scooters)

E-Gora (Li/SI)	12-15
Sunday	12-15

GOES

50 XS (Quad)	05-14
50 S (Quad)	07-11
G 50 CL (Scooter)	13-14
G 50 RT (Scooter)	13-14
GS 50 X	08-09
Slam 50 (Scooter)	10-12
G 55 R Scooter	08-14
G 90 XS	10-13
G 125 M	08-14
G 125 CL (Scooter)	13-14
G 125 L (Scooter)	13-14
G 125 Max (Scooter)	13-14
G 125 RT Retro (Scooter)	10-14
G 125 XM	08-09
G 125 X	08-09
SPR 125 (Motorcycle)	10-12
W1K1 125 (Scooter)	10-11
180 S (Quad)	10-14
220 (Quad)	06-08
220 UTS (Side X Side)	10-14
G 225 S	12-13
G 250 XM	08-09
G 250 Max (Scooter)	13-14
300 S (Quad)	07-08
320 Max (Quad)	07-08
G 350 S (Quad)	08-14
360 Max (Quad)	08-14
450 X (Quad)	07-12
G 520 (Quad)	07-13

DISC PAD CHOICES - FRONT					BRAKE DISC CHOICES - FRONT						Line #
FA, SFA, TT Pad or Brake Shoe	SFAC Carbon Scooter Pads	Speciality Pads - SXR / Vee / MXS	Sintered/ HH Pads/ Grooved Shoes	Left / Gauche / Links Standard Replacement Disc	Right / Droite / Rechts Standard Replacement Disc	Contour Disc Universal left and right fitment	Universal Custom Disc	Vee-Discs Black † See note below	CX Extreme MX Race Disc/ UTVX Disc		
FA060*				N/A	N/A					1	
FA047			FA047R	N/A						2	
FA101TT*			FA101R*	TBA	TBA					3	
FA256			FA256HH	N/A						4	
SFA353	SFAC353		SFA353HH	MD983D				VR983		5	
FA256			FA256HH	N/A						6	
FA256			FA256HH	N/A						7	
FA095			FA095HH	N/A						8	
FA256			FA256HH	N/A						9	
FA256			FA256HH	N/A						10	
FA256			FA256HH	N/A						11	
SFA260*	SFAC260*		SFA260HH*	MD9112D	MD9112D			VR9112*		12	
SFA257/2										13	
SFA260*	SFAC260*		SFA260HH*	MD9112D	MD9112D			VR9112*		14	
SFA257/2										15	
FA095			FA095HH	N/A						16	
SFA181*	SFAC181*		SFA181HH*	MD983D	MD983D			VR983*		17	
SFA181*	SFAC181*		SFA181HH*	MD983D	MD983D			VR983*		18	
FA126*			FA126HH*	MD869	MD869					19	
FA134				N/A						20	
FA134				N/A						21	
FA134				N/A						22	
FA256			FA256HH	N/A						23	
SFA181*	SFAC181*		SFA181HH*	MD9125D	MD9125D					24	
SFA257/2										25	
										26	
										27	
SFA086	SFAC086		SFA086HH		N/A					28	
SFA151	SFAC151			N/A						29	
										30	
										31	
TBA*										32	
TBA*										33	
TBA						N/A				34	
TBA				N/A		N/A				35	
FA167			FA167HH	N/A						36	
SFA235	SFAC235					N/A				37	
SFA086	SFAC086		SFA086HH	N/A						38	
TBA*										39	
FA086			FA086HH	N/A						40	
TBA							N/A			41	
TBA							N/A			42	
TBA							N/A			43	
SFA235	SFAC235			N/A						44	
FA185TT		MXS185	FA185R	N/A						45	
FA086			FA086HH	N/A						46	
FA086			FA086HH				N/A			47	
SFA235	SFAC235			N/A						48	
TBA*			TBA*	N/A	N/A					49	
TBA*			TBA*	N/A	N/A					50	
FA453TT*			FA453R*	N/A	N/A					51	
FA083TT*			FA083R*	N/A	N/A					52	
FA185TT		MXS185	FA185R	N/A						53	
TBA*						N/A				54	
TBA*				N/A	N/A					55	
TBA*			TBA*	N/A	N/A					56	
FA083TT*			FA083R*	N/A	N/A					57	
FA453TT*			FA453R*	N/A	N/A					58	
TBA*				N/A	N/A					59	
FA453TT*			FA453R*	N/A	N/A					60	

FRONT / AVANT / VORN / FRENTE / ANTERIORE

R Suffix = High Durability Sintered Pad. HH Suffix = High Performance Sintered Pad. TT Suffix = Hard Wearing Off Road Pad. V Suffix = Semi Sintered Pad. G Suffix = Grooved Shoe.

D Suffix = Drilled Disc. X Suffix = Universal Left or Right Disc. XC Suffix = Contoured Disc. LS Suffix = Left/Steel Disc. RS Suffix = Right/Steel Disc.

*-2 Sets Required. † For Vee disc colours add RED, BLU, GRN, GLD, ORG suffix to part number.

⊗ - Also available as a Vintage Motorcycle Disc.

254 Part numbers, prefixes, suffixes, photos and illustrations shown in this catalogue are trademarks and/or copyrights of EBC Brakes or the trademark owner A C Freeman Investments Ltd and use without express written permission of the owners is punishable by law.

Non-JAPANESE Built Motorcycles

Line #	BRAKE DISC CHOICES - FRONT						DISC PAD CHOICES - REAR				BRAKE DISC CHOICES - REAR			
	Oversize 250 /280mm Disc Kit	OSX Oversize 250/280mm Disc Kit	Relocating Bracket for 250/ 280mm Disc	Oversize 320mm Disc Kit	SMX Oversize 320mm Disc Kit	Relocating Bracket for 320mm Disc	FA, SFA, TT Pad or Brake Shoe	SFAC Carbon Scooter Pads	Speciality Pads - SXR / Vee / MXS	Sintered/ HH Pads/ Grooved Shoes	Standard Replacement Disc	Contour Disc Rear fitment	Vee-Discs™ CONTOUR	CX Extreme MX Race Disc/ UTVX Disc
1							FA047				N/A			
2									N/A					
3							FA355/4TT		FA355/4R	TBA				
4							FA047		FA047HH	N/A				
5							SFA353	SFAC353	SFA353HH	MD960D		VR960		
6							987							
7							987							
8							FA047		FA047HH	N/A				
9							FA047		FA047HH	N/A				
10							987							
11							987							
12							SFA353	SFAC353	SFA353HH	MD960D		VR960		
13														
14							SFA353	SFAC353	SFA353HH	MD960D		VR960		
15														
16							FA047		FA047R	N/A				
17							SFA266	SFAC266	SFA266HH	MD960D		VR960		
18							SFA266	SFAC266	SFA266HH	MD960D		VR960		
19							FA047		FA047HH					
20							FA101TT			N/A				
21							FA101TT			N/A				
22							FA101TT			N/A				
23							FA047		FA047HH	N/A				
24							SFA353	SFAC353	SFA353HH	MD9124D				
25														
26														
27														
28							H303							
29							H303							
30														
31														
32							TBA			N/A				
33							TBA			TBA				
34							TBA				N/A			
35							TBA			N/A				
36							FA167		FA167HH	N/A				
37							TBA							
38							TBA							
39							FA083TT		FA083R	N/A				
40							FA197		FA197HH	N/A				
41							TBA				N/A			
42							TBA				N/A			
43							TBA				N/A			
44							TBA			N/A				
45							FA131TT	MXS131	FA131R	N/A				
46							FA086		FA086HH	N/A				
47							FA197		FA197HH		N/A			
48							TBA							
49							TBA		TBA	N/A				
50							TBA		TBA	N/A				
51							TBA		TBA	N/A				
52							FA067TT		FA067R	N/A				
53							FA131TT	MXS131	FA131R	N/A				
54							TBA				N/A			
55							TBA			N/A				
56							TBA		TBA	N/A				
57							FA067TT		FA067R	N/A				
58										N/A				
59							TBA			N/A				
60							FA344TT		FA344R	N/A				

REAR / ARRIÈRE / HINTEN / POSTERIOR / POSTERIORE

*-2 Sets Required. † For Vee disc colours add RED, BLU, GRN, GLD, ORG suffix to part number.

⊗ - Also available as a Vintage Motorcycle Disc.

R Suffix = High Durability Sintered Pad. **HH** Suffix = High Performance Sintered Pad. **TT** Suffix = Hard Wearing Off Road Pad. **V** Suffix = Semi Sintered Pad. **G** Suffix = Grooved Shoe.
D Suffix = Drilled Disc. **X** Suffix = Universal Left or Right Disc. **XC** Suffix = Contoured Disc. **LS** Suffix = Left/Steel Disc. **RS** = Right/Steel Disc.

Part numbers, prefixes, suffixes, photos and illustrations shown in this catalogue are trademarks and/or copyrights of EBC Brakes or the trademark owner A C Freeman Investments Ltd and use without express written permission of the owners is punishable by law.

Non-JAPANESE Built Motorcycles

APPLICATIONS

BRAKE



GOES Contd.

520 Max (Quad)		07-12
G 520 UTX (Side x Side)	Left	10-12
	Right	
G 525 (4X4)		12-13
G 525 MAX (4X4)		12-13
G 620 i		11-12
G 625i (4X4)		12-14
G 625i MAX (4X4)		12-14
G 625i MAX (4X4) UTX 4 X 4 (Side x Side)		12-14
625i UTS (Side x Side)		13-14
820i Max		14
GE - SSV Electric (Side x Side)		12-13

GOGORO (E Scooter)

Smart Scooter		15-17
---------------	--	-------

GOVECS (Electric Scooters)

GO S 1.2		11-14
GO S 1.4		11-14
GO S 2.4		11-14
GO S 3.4		11-14
GO T 1.2		11-14
GO T 1.4		13-14
GO T 2.4		11-14
GO T 3.4		11-14

HAMMERHEAD BUGGIES

Mini (45cc)		08-09
80T		08-09
150 Supersport ES 150 11 R		08-09

HARTFORD/HRD

VR-125 Z Velo Sport		00-03
VR-125 X/H Velo-Cross		00-03
VR-125/150 H/X/Z		04
HD 125 L/150 L		00-04
Cabriolet 125		01

HERO HONDA

Nipster 50		06
CD Dawn (100cc 4T) (Spoke wheel)		08
CD Deluxe (100cc 4T) (Cast wheel)		08
Passion Plus (100cc 4T) (Cast wheel)		08
Passion Plus (100cc 4T) (Spoke wheel)		08
Splendor NXG (100cc 4T) (Cast wheel)		08
Splendor+ (100cc 4T) (Front drum model)		08
Splendor+ (100cc 4T) (Front disc model)		08
Pleasure (102cc 4T)		08
Super Splendor (125cc 4T)		08
Glamour PGM Fi (125cc 4T) (Cast wheel)		08
Glamour (125cc 4T) (Cast wheel)		08
Magellan 125		06
Punto 125		06
Quickster 125		06
Slickster 125		06
Achiever (150cc 4T) (Cast Wheel)		08
CBZ X-treme (Cast wheel)		08
Hunk (150cc 4T) (Cast wheel)		08
Karizma (223cc 4T)		08

DISC PAD CHOICES - FRONT

BRAKE DISC CHOICES - FRONT

FA, SFA, TT Pad or Brake Shoe	SFAC Carbon Scooter Pads	Speciality Pads SXR / Vee / MXS	Sintered/HH Pads/ Grooved Shoes	Left / Gauche / Links Standard Replacement Disc	Right / Droite / Rechts Standard Replacement Disc	Contour Disc Universal left and right fitment	Universal Custom Disc	Vee-Discs Black † See note below	CX Extreme MX Race Disc/ UTVX Disc
FA453TT*			FA453R*	N/A	N/A				
FA165TT			FA165R	N/A	N/A				
FA135TT			FA135R						
FA453TT*			FA453R*	N/A	N/A				
FA453TT*			FA453R*	N/A	N/A				
FA453TT*			FA453R*	N/A	N/A				
FA453TT*			FA453R*	N/A	N/A				
FA453TT*			FA453R*	N/A	N/A				
FA453TT*			FA453R*	N/A	N/A				
FA453TT*			FA453R*	N/A	N/A				
TBA*				N/A	N/A				
FA453TT*			FA453R*	N/A	N/A				
SFA266	SFAC266		SFA266HH	MD9162D				VR9162	
SFA193	SFAC193		SFA193HH					VR901	
SFA193	SFAC193		SFA193HH					VR901	
SFA193	SFAC193		SFA193HH					VR901	
SFA193	SFAC193		SFA193HH					VR901	
SFA193	SFAC193		SFA193HH	MD901D				VR901	
SFA193	SFAC193		SFA193HH	MD901D				VR901	
SFA193	SFAC193		SFA193HH	MD901D				VR901	
SFA193	SFAC193		SFA193HH	MD901D				VR901	
N/A									
N/A									
FA416TT*			FA416R*	N/A	N/A				
FA228			FA228HH	N/A					
FA228			FA228HH	N/A					
FA228			FA228HH	N/A					
FA093				N/A					
FA167			FA167HH	N/A					
SFA169	SFAC169		SFA169HH	TBA					
TBA									
TBA									
TBA									
TBA									
TBA									
TBA									
TBA									
TBA									
TBA									
TBA									
FA197			FA197HH						
FA197			FA197HH						
FA101									
FA086			FA086HH						
TBA									
TBA									
TBA									
TBA									
TBA									
TBA									
TBA									
TBA									
TBA									
TBA									

Line #

R Suffix = High Durability Sintered Pad. HH Suffix = High Performance Sintered Pad. TT Suffix = Hard Wearing Off Road Pad. V Suffix = Semi-Sintered Pad. G Suffix = Grooved Shoe.

D Suffix = Drilled Disc. X Suffix = Universal Left or Right Disc. XC Suffix = Contoured Disc. LS Suffix = Left/Steel Disc. RS = Right/Steel Disc.

*-2 Sets Required. † For Vee disc colours add RED, BLU, GRN, GLD, ORG suffix to part number.

⊗ - Also available as a Vintage Motorcycle Disc.

Non-JAPANESE Built Motorcycles

Line #	BRAKE DISC CHOICES - FRONT						DISC PAD CHOICES - REAR				BRAKE DISC CHOICES - REAR			
	Oversize 250 /280mm Disc Kit	OSX Oversize 250/280mm Disc Kit	Relocating Bracket for 250/ 280mm Disc	Oversize 320mm Disc Kit	SMX Oversize 320mm Disc Kit	Relocating Bracket for 320mm Disc	FA, SFA, TT Pad or Brake Shoe	SFAC Carbon Scooter Pads	Speciality Pads - SXR / Vee / MXS	Sintered/ HH Pads/ Grooved Shoes	Standard Replacement Disc	Contour Disc Rear fitment	Vee-Discs™ CONTOUR	CX Extreme MX Race Disc/ UTVX Disc
1							FA344TT			FA344R	N/A			
2							FA344TT			FA344R	N/A			
3														
4							FA344TT			FA344R	N/A			
5							FA344TT			FA344R	N/A			
6							FA344TT			FA344R	N/A			
7							FA344TT			FA344R	N/A			
8							FA344TT			FA344R	N/A			
9							FA344TT			FA344R	N/A			
10							TBA				N/A			
11							TBA				N/A			
12							FA344TT			FA344R	N/A			
13														
14														
15							SFA067	SFAC067		SFA067HH	MD9163D		VR9163	
16														
17														
18							SFA083	SFAC083		SFA083HH		TBA		
19							SFA083	SFAC083		SFA083HH		TBA		
20							SFA083	SFAC083		SFA083HH		TBA		
21							SFA083	SFAC083		SFA083HH		TBA		
22							SFA083	SFAC083		SFA083HH	TBA	TBA		
23							SFA083	SFAC083		SFA083HH	TBA	TBA		
24							SFA083	SFAC083		SFA083HH	TBA	TBA		
25							SFA083	SFAC083		SFA083HH	TBA	TBA		
26														
27														
28							FA485TT				N/A			
29							FA416TT			FA416R	N/A			
30							FA431TT			FA431R	N/A			
31														
32														
33							H304							
34							H304							
35							FA197				N/A			
36							S602							
37							FA115				N/A			
38														
39														
40							TBA							
41							TBA							
42							TBA							
43							TBA							
44														
45							TBA							
46							TBA							
47							TBA							
48							TBA							
49							TBA							
50							TBA							
51							TBA							
52							TBA							
53							TBA							
54							TBA							
55							TBA							
56							TBA							
57							TBA							
58							TBA							
59							TBA							
60														

REAR / ARRIÈRE / HINTEN / POSTERIOR / POSTERIORE

*-2 Sets Required. † For Vee disc colours add RED, BLU, GRN, GLD, ORG suffix to part number.

⊗ - Also available as a Vintage Motorcycle Disc.

R Suffix = High Durability Sintered Pad. **HH** Suffix = High Performance Sintered Pad. **TT** Suffix = Hard Wearing Off Road Pad. **V** Suffix = Semi Sintered Pad. **G** Suffix = Grooved Shoe.
D Suffix = Drilled Disc. **X** Suffix = Universal Left or Right Disc. **XC** Suffix = Contoured Disc. **LS** Suffix = Left/Steel Disc. **RS** = Right/Steel Disc.

Part numbers, prefixes, suffixes, photos and illustrations shown in this catalogue are trademarks and/or copyrights of EBC Brakes or the trademark owner A C Freeman Investments Ltd and use without express written permission of the owners is punishable by law.

Non-JAPANESE Built Motorcycles

APPLICATIONS

BRAKE



HERO

Splendor NXG 100	11-12
Splendor Pro 100	11-12
Pleasure 102	11-12
Glamour 125 (PGM Fi)	11-12
Super Splendor 125	11-12
Hunk 150	11-12
Karizma ZMR 230	11-12

HIGHLAND

950 V2 Outback	00-04
950 V2 Motard	00-04

HONDA DALL-ARA

XR 125 SM	04
XR 250 R	04
XR 250 SM	04
XR 400/440 R	04
XR 400/440 SM	04
XR 650 R	04
XR 650 R	04

HONDA-HM (ITALY)

Baja 10/10 JR & SR	99-07
Baja 12/14 MX	99-09
CRE 50 Six/Baja/Derapage Brembo caliper twin pin/41mm Paioli forks	95-02
CRE 50 Six/Baja/Derapage Brembo caliper single pin/Kayaba forks	95-02
CRE 50 Six/Baja/Derapage Grimeca caliper twin pin/Kayaba forks	95-02
CRE 50 Six/Baja/Derapage Grimeca	95-02
CRE 50 Six	01-02
CRE 50 Baja/Derapage	01-02
CRE 50 Baja/Six/Derapage	03-09
CRE 50 Six Competition	07-12
CRE 50 Baja RR Up to ZEN50XACEA7700324	07-09
CRE 50 Baja RR From ZEN50XACEA7700325	07-09
CRE 50 Baja RR	10-12
CRE 50 Derapage RR Up to ZEN50XACMA7700384	07-09
CRE 50 Derapage RR From ZEN50XACMA7700385	07-09
CRE 50 Six Competition	07-08
CRM 50 Derapage Competition	07-08
CRM 50 Derapage Competition	09-12
CRE 80	98-02
CR 85 R/R2	03-07
CRE 125	95-07
CRE 125	98-01
CRE 125 R Supermotard	02-06
CRE 125 R Enduro	02-03
CRE 125 R Enduro	04-07
CRE 125 Baja RR 2T	11
CRE 125 (Six Competition 2T)	11
CRE F 125 X	09
CRE F 125 X Six (4T)	11-12
CR 125 Motard	04-06
CRM 125 R Supermoto	07
CRM 125 (Derapage Competition 2T)	11-12
CRM 125 (Derapage RR 2T)	11
CRM F 125 X	09

DISC PAD CHOICES - FRONT

BRAKE DISC CHOICES - FRONT

FA, SFA, TT Pad or Brake Shoe	SFAC Carbon Scooter Pads	Speciality Pads - SXR / Vee / MXS	Sintered/ HH Pads/ Grooved Shoes	Left / Gauche / Links Standard Replacement Disc	Right / Droite / Rechts Standard Replacement Disc	Contour Disc Universal left and right fitment	Universal Custom Disc	Vee-Discs Black † See note below	CX Extreme MX Race Disc/ UTVX Disc
H353									
H353									
H353									
TBA					MD1030				
TBA					MD1030				
TBA					MD1030				
FA375			FA375HH		N/A				
FA181TT		MXS181	FA181R	N/A					
FA181TT		MXS181	FA181R	N/A					
FA185TT		MXS185	FA185R	TBA					
FA185TT		MXS185	FA185R	MD6001D		MD6001C			MD6001CX
FA185TT		MXS185	FA185R	TBA					
FA185TT		MXS185	FA185R	MD6037D		MD6037C			MD6037CX
FA185TT		MXS185	FA185R	TBA					
FA185TT		MXS185	FA185R	MD6001D		MD6001C			MD6001CX
FA185TT		MXS185	FA185R	TBA					
FA351TT				N/A					
FA351TT				N/A					
FA194			FA194HH	N/A					
FA134			FA134R	N/A					
FA166				N/A					
FA382				N/A					
FA181TT		MXS181	FA181R	N/A					
FA181TT		MXS181	FA181R	N/A					
FA194			FA194HH	N/A					
FA654				N/A					
FA194			FA194HH	N/A					
FA194			FA194HH	N/A					
FA194			FA194HH	N/A		N/A			
FA194			FA194HH	N/A					
FA194			FA194HH	N/A					
FA194			FA194HH	N/A					
FA194			FA194HH	N/A					
FA654				N/A					
FA084TT		MXS084	FA084R	MD6058D		MD6058C			MD6058CX
FA084TT		MXS084	FA084R	MD6058D		MD6058C			MD6058CX
FA185TT		MXS185	FA185R	MD6037D		MD6037C			MD6037CX
FA185TT		MXS185	FA185R	MD6037D		MD6037C			MD6037CX
FA185TT		MXS185	FA185R	N/A		MD6037C			MD6037CX
FA185TT		MXS185	FA185R	MD6037D		MD6037C			MD6037CX
FA185TT		MXS185	FA185R	MD6037D		MD6037C			MD6037CX
FA465TT		MXS465	FA465R			N/A			
FA185TT		MXS185	FA185R	N/A					
FA194			FA194HH	N/A					
FA654						N/A			
FA185TT		MXS185	FA185R			SM6437C			
FA433/4			FA433/4HH	N/A					
FA654						N/A			
FA185TT		MXS185	FA185R			N/A			
FA194			FA194HH	N/A					

Line #
1
2
3
4
5
6
7
8
9
10
11
12
13
14
15
16
17
18
19
20
21
22
23
24
25
26
27
28
29
30
31
32
33
34
35
36
37
38
39
40
41
42
43
44
45
46
47
48
49
50
51
52
53
54
55
56
57
58
59
60

R Suffix = High Durability Sintered Pad. HH Suffix = High Performance Sintered Pad. TT Suffix = Hard Wearing Off Road Pad. V Suffix = Semi Sintered Pad. G Suffix = Grooved Shoe.
D Suffix = Drilled Disc. X Suffix = Universal Left or Right Disc. XC Suffix = Contoured Disc. LS Suffix = Left/Steel Disc. RS Suffix = Right/Steel Disc.

Ⓢ Note choice of 3 different pads on rear caliper - check shape in buyers guide - FA47 / FA101 / FA382.

*-2 Sets Required. † For Vee disc colours add RED, BLU, GRN, GLD, ORG suffix to part number.

Ⓢ - Also available as a Vintage Motorcycle Disc.

258 Part numbers, prefixes, suffixes, photos and illustrations shown in this catalogue are trademarks and/or copyrights of EBC Brakes or the trademark owner A C Freeman Investments Ltd and use without express written permission of the owners is punishable by law.

Non-JAPANESE Built Motorcycles

Line #	BRAKE DISC CHOICES - FRONT						DISC PAD CHOICES - REAR				BRAKE DISC CHOICES - REAR			
	Oversize 250 /280mm Disc Kit	OSX Oversize 250/280mm Disc Kit	Relocating Bracket for 250/ 280mm Disc	Oversize 320mm Disc Kit	SMX Oversize 320mm Disc Kit	Relocating Bracket for 320mm Disc	FA, SFA, TT Pad or Brake Shoe	SFAC Carbon Scooter Pads	Speciality Pads - SXR / Vee / MXS	Sintered/ HH Pads/ Grooved Shoes	Standard Replacement Disc	Contour Disc Rear fitment	Vee-Discs™ CONTOUR	CX Extreme MX Race Disc/ UTVX Disc
1							H353							
2							H353							
3							H353							
4							H352							
5							H352							
6							H352							
7							FA343		FA343HH	N/A				
8														
9														
10							FA208TT	MXS208	FA208R	N/A				
11							FA208TT	MXS208	FA208R	N/A				
12														
13														
14							FA115	MXS115	FA115R	TBA				
15							FA131TT	MXS131	FA131R	MD6013D	MD6013C		MD6013CX	
16							FA346TT	MXS346	FA346R	MD6013D	MD6013C			
17							FA346TT	MXS346	FA346R	MD6013D	MD6013C		MD6013CX	
18							FA346TT	MXS346	FA346R	MD6013D	MD6013C			
19							FA131TT	MXS131	FA131R	MD6181D			MD6181CX	
20							FA131TT	MXS131	FA131R	MD6181D				
21														
22														
23							FA351TT			N/A				
24							FA351TT			N/A				
25														
26							FA047 / FA101 / FA382 Ⓡ			N/A				
27														
28							FA047 / FA101 / FA382 Ⓡ			N/A				
29														
30							FA047 / FA101 / FA382 Ⓡ			N/A				
31							FA047 / FA101 / FA382 Ⓡ			N/A				
32							FA382			N/A				
33							FA115TT	MXS115	FA115R	N/A				
34							FA350		FA350HH	N/A				
35							FA346TT			N/A				
36							FA350		FA350HH	N/A				
37							FA346TT		FA346R	N/A				
38							FA346TT		FA346R		N/A			
39							FA350		FA350HH	N/A				
40							FA346TT		FA346R	N/A				
41							FA346TT		FA346R	N/A				
42							FA346TT		FA346R	N/A				
43							FA346TT		FA346R	N/A				
44							FA131TT	MXS131	FA131R	MD6005D	MD6005C		MD6005CX	
45							FA131TT	MXS131	FA131R	MD6005D	MD6005C		MD6005CX	
46							FA131TT	MXS131	FA131R	MD6002D			MD6002CX	
47							FA131TT	MXS131	FA131R	MD6124D	MD6124C		MD6124CX	
48							FA346TT	MXS346	FA346R	MD6191D	MD6191C		MD6191CX	
49							FA346TT	MXS346	FA346R	MD6191D	MD6191C		MD6191CX	
50							FA346TT	MXS346	FA346R	MD6191D	MD6191C		MD6191CX	
51							FA346TT		FA346R		N/A			
52							FA346TT	MXS346	FA346R		N/A			
53							FA346TT		FA346R	N/A				
54							FA346TT				N/A			
55							FA346TT	MXS346	FA346R		MD6191C		MD6191CX	
56							FA346TT		FA346R	MD6191D	MD6191C			
57							FA346TT				N/A			
58							FA346TT		FA346R		N/A			
59							FA346TT		FA346R	N/A				
60														

REAR / ARRIÈRE / HINTEN / POSTERIOR / POSTERIORE

*-2 Sets Required. † For Vee disc colours add RED, BLU, GRN, GLD, ORG suffix to part number.

Ⓡ - Also available as a Vintage Motorcycle Disc.

R Suffix = High Durability Sintered Pad. **HH** Suffix = High Performance Sintered Pad. **TT** Suffix = Hard Wearing Off Road Pad. **V** Suffix = Semi Sintered Pad. **G** Suffix = Grooved Shoe.
D Suffix = Drilled Disc. **X** Suffix = Universal Left or Right Disc. **XC** Suffix = Contoured Disc. **LS** Suffix = Left/Steel Disc. **RS** = Right/Steel Disc.

Non-JAPANESE Built Motorcycles

APPLICATIONS

BRAKE



HONDA-HM (ITALY) Contd.

R Suffix = High Durability Sintered Pad. HH Suffix = High Performance Sintered Pad. TT Suffix = Hard Wearing Off Road Pad. V Suffix = Semi Sintered Pad. G Suffix = Grooved Shoe.
 D Suffix = Drilled Disc. X Suffix = Universal Left or Right Disc. XC Suffix = Contoured Disc. LS Suffix = Left/Steel Disc. RS = Right/Steel Disc.

Model	Year
CRM F 125 X Derapage Competition (4T)	10-11
CRF 150 R/R2	07-09
CRF 230 Easy Trail	04-07
CRF 230 Easy Enduro	04-07
CRF 230 Easy Motard	04-07
CRF 230 F Easy Trial (All models)	04-07
CRE 250	97-01
CRE 250	02
CRE 250 R Supermotard	02-03
CRE 250 R Enduro	02-07
CR 250 R Moto	04
CREF 250 R	04-09
CREF 250 R	08-09
CREF 250 X	08-11
CRE 250 R Enduro	04-07
CRF 250 Motard	04-06
CRF 250 F	04-08
CRF 250 R	08-09
CRM 250 X Supermoto	07
CRE 260	95-96
CRE 260	97-98
CREF 290 C	07
CREF 300 X	08-09
CRE 450 F	02
CRE 450 R Enduro	02-07
CREF 450 R Enduro	04-08
CRE 450 F Supermoto	02-03
CREF 450 X	04-09
CRF 450 Motard	04-06
CRF 450 R	04-09
CRMF 450 R Supermoto	07-08
CRMF 450 X Supermoto	07-09
CREF 490 X	07
CRMF 490 X Supermoto	07
CREF 500 X	08-09
CRMF 500 X	11
♦ Plain undrilled disc for enduro use MD6191CE	
HONGDOU	
CTM 125 Chituma	04
HD 125-7	05-07
GY 125	
HONLEY	
Classic 125	16-17
HD1 125	14-15
HD2 125	16-17
HD3 SE 125	16-17
HD3 125	16-17
Oliver 125	15-16
RX-3 Venture 250	15-17
HOREX	
Rebell 80 N	
Rebell 80 T	
Sport 80 L	
HRD 600	85
500/600 Columbus	88-
644 Osca	92-
VR6 Classic	13-14

FA, SFA, TT Pad or Brake Shoe	SFAC Carbon Scooter Pads	Speciality Pads SXR / Vee / MXS	Sintered/HH Pads/ Grooved Shoes	BRAKE DISC CHOICES - FRONT					Line #
				Left / Gauche / Links Standard Replacement Disc	Right / Droite / Rechts Standard Replacement Disc	Contour Disc Universal left and right fitment	Universal Custom Disc	Vee-Discs Black † See note below	
FA654						N/A			1
FA084TT			FA084R	MD6314D		MD6314C			2
FA185TT		MXS185	FA185R	MD6037D		MD6037C			3
FA185TT		MXS185	FA185R	MD6037D		MD6037C			4
FA185TT		MXS185	FA185R	MD6037D		MD6037C			5
FA185TT		MXS185	FA185R	MD6037D		MD6037C			6
FA185TT		MXS185	FA185R	MD6037D		MD6037C			7
FA185TT		MXS185	FA185R	MD6037D		MD6037C			8
FA185TT		MXS185	FA185R	MD6037D		MD6037C			9
FA185TT		MXS185	FA185R	MD6037D		MD6037C			10
FA185TT		MXS185	FA185R	MD6037D		MD6037C			11
FA185TT		MXS185	FA185R	MD6037D		MD6037C			12
FA185TT		MXS185	FA185R	MD6037D		MD6037C			13
FA185TT		MXS185	FA185R	MD6037D		MD6037C			14
FA185TT		MXS185	FA185R	MD6037D		MD6037C			15
FA185TT		MXS185	FA185R	MD6037D		MD6037C			16
FA185TT		MXS185	FA185R	MD6037D		MD6037C			17
FA185TT		MXS185	FA185R	MD6037D		MD6037C			18
FA433/4			FA433/4HH	N/A					19
FA185TT		MXS185	FA185R	MD6001D		MD6001C			20
FA185TT		MXS185	FA185R	MD6001D		MD6001C			21
FA185TT		MXS185	FA185R	MD6037D		MD6037C			22
FA185TT		MXS185	FA185R	MD6037D		MD6037C			23
FA185TT		MXS185	FA185R	MD6037D		MD6037C			24
FA185TT		MXS185	FA185R	MD6037D		MD6037C			25
FA185TT		MXS185	FA185R	MD6037D		MD6037C			26
FA185TT		MXS185	FA185R	MD6037D		MD6037C			27
FA185TT		MXS185	FA185R	MD6037D		MD6037C			28
FA185TT		MXS185	FA185R	MD6037D		MD6037C			29
FA185TT		MXS185	FA185R	MD6037D		MD6037C			30
FA433/4			FA433/4HH	N/A					31
FA433/4			FA433/4HH	N/A					32
FA185TT		MXS185	FA185R	MD6037D		MD6037C			33
FA433/4			FA433/4HH	N/A					34
FA185TT		MXS185	FA185R	MD6037D		MD6037C			35
FA433/4			FA433/4HH	N/A					36
FA433/4			FA433/4HH	N/A					37
									38
									39
FA086			FA086HH		N/A				40
FA486				TBA					41
TBA				N/A					42
									43
									44
H303									45
FA464						MD2104RS			46
FA464						MD2104RS			47
FA464						MD2104RS			48
FA464						MD2104RS			49
SFA151						N/A			50
FA664						N/A			51
									52
									53
FA050				N/A					54
FA050*				N/A	N/A				55
FA050*				N/A	N/A				56
FA018*			FA018HH*	N/A	N/A				57
FA018*			FA018HH*	N/A	N/A				58
									59
FA244*			FA244HH*			N/A*			60

FRONT / AVANT / VORN / FRENTE / ANTERIORE

*-2 Sets Required. † For Vee disc colours add RED, BLU, GRN, GLD, ORG suffix to part number.

⊗ - Also available as a Vintage Motorcycle Disc.

Non-JAPANESE Built Motorcycles

Line #	BRAKE DISC CHOICES - FRONT						DISC PAD CHOICES - REAR				BRAKE DISC CHOICES - REAR			
	Oversize 250 /280mm Disc Kit	OSX Oversize 250/280mm Disc Kit	Relocating Bracket for 250/ 280mm Disc	Oversize 320mm Disc Kit	SMX Oversize 320mm Disc Kit	Relocating Bracket for 320mm Disc	FA, SFA, TT Pad or Brake Shoe	SFAC Carbon Scooter Pads	Speciality Pads - SXR / Vee / MXS	Sintered/ HH Pads/ Grooved Shoes	Standard Replacement Disc	Contour Disc Rear fitment	Vee-Discs™ CONTOUR	CX Extreme MX Race Disc/ UTVX Disc
1							FA346TT					N/A		
2							FA346TT		MXS346	FA346R	MD6316D	MD6316C		MD6316CX
3							FA346TT		MXS346	FA346R	MD6191D	MD6191C		MD6191CX
4							FA346TT		MXS346	FA346R	MD6191D	MD6191C		MD6191CX
5							FA346TT		MXS346	FA346R	MD6191D	MD6191C		MD6191CX
6							H304							
7							FA131TT		MXS131	FA131R	MD6124D	MD6124C		MD6124CX
8							FA346TT		MXS346	FA346R	MD6191D	MD6191C		MD6191CX
9							FA346TT		MXS346	FA346R	MD6191D	MD6191C		MD6191CX
10							FA346TT		MXS346	FA346R	MD6191D	MD6191C		MD6191CX
11							FA346TT		MXS346	FA346R	MD6191D	MD6191C		MD6191CX
12							FA346TT		MXS346	FA346R	MD6191D	MD6191C		MD6191CX
13							FA131TT		MXS131	FA131R	MD6191D	MD6191C		MD6191CX
14							FA346TT		MXS346	FA346R	MD6191D	MD6191C		MD6191CX
15							FA346TT		MXS346	FA346R	MD6191D	MD6191C		MD6191CX
16							FA346TT		MXS346	FA346R	MD6191D	MD6191C		MD6191CX
17							FA346TT		MXS346	FA346R	MD6191D	MD6191C		MD6191CX
18							FA346TT		MXS346	FA346R	MD6191D	MD6191C		MD6191CX
19							FA346TT		MXS346	FA346R	MD6191D	MD6191C		MD6191CX
20							FA131TT		MXS131	FA131R	MD6002D			MD6002CX
21							FA131TT		MXS131	FA131R	MD6124D	MD6124C		MD6124CX
22							FA346TT		MXS346	FA346R	MD6191D	MD6191C		MD6191CX
23							FA346TT		MXS346	FA346R	MD6191D	MD6191C		MD6191CX
24							FA346TT		MXS346	FA346R	MD6191D	MD6191C		MD6191CX
25							FA346TT		MXS346	FA346R	MD6191D	MD6191C		MD6191CX
26							FA346TT		MXS346	FA346R	MD6191D	MD6191C		MD6191CX
27							FA346TT		MXS346	FA346R	MD6191D	MD6191C		MD6191CX
28							FA346TT		MXS346	FA346R	MD6191D	MD6191C		MD6191CX
29							FA346TT		MXS346	FA346R	MD6191D	MD6191C		MD6191CX
30							FA346TT		MXS346	FA346R	MD6191D	MD6191C		MD6191CX
31							FA346TT		MXS346	FA346R	MD6191D	MD6191C		MD6191CX
32							FA346TT		MXS346	FA346R	MD6191D	MD6191C		MD6191CX
33							FA346TT		MXS346	FA346R	MD6191D	MD6191C		MD6191CX
34							FA346TT		MXS346	FA346R	MD6191D	MD6191C		MD6191CX
35							FA346TT		MXS346	FA346R	MD6191D	MD6191C		MD6191CX
36							FA346TT			FA346R	N/A			
37														
38														
39														
40							Y516							
41							TBA							
42							H304							
43														
44														
45							H303							
46							Y535							
47							Y535							
48							Y535							
49							Y535							
50							TBA							
51							FA086							
52														
53														
54							N/A							
55							N/A							
56							N/A							
57							FA018			FA018HH	N/A			
58							FA018			FA018HH	N/A			
59														
60							FA266			FA266HH		N/A		

REAR / ARRIÈRE / HINTEN / POSTERIOR / POSTERIORE

*-2 Sets Required. † For Vee disc colours add RED, BLU, GRN, GLD, ORG suffix to part number.
 ⦿ - Also available as a Vintage Motorcycle Disc.

R Suffix = High Durability Sintered Pad. **HH** Suffix = High Performance Sintered Pad. **TT** Suffix = Hard Wearing Off Road Pad. **V** Suffix = Semi Sintered Pad. **G** Suffix = Grooved Shoe.
D Suffix = Drilled Disc. **X** Suffix = Universal Left or Right Disc. **XC** Suffix = Contoured Disc. **LS** Suffix = Left/Steel Disc. **RS** = Right/Steel Disc.

BRAKE APPLICATIONS

Non-JAPANESE Built Motorcycles



HOREX Contd.

VR6 Roadster	11-14
H. P. POWER	
Copper 50 (4T)	10-12
Facile 50 (4T)	10-12
Iron 50 (2T)	10-12
Tin 50 (4T/4V)	10-12
Chromel 125 (4T/LC)	11-12
Lithium 125 (2T/LC)	10-12
Chromel 150 (4T/LC)	11-12
Lithium 150 (4T/2V/LC)	10-12
Nickel 150 (4T/2V)	10-11
Barum 260 (4T/2V/LC)	10-12
Radium 300	11-12
Pantera 600	11

HRD (Also see Sherco section)

GS 50	
RP 50 Cross	
Sonic 2 Trail 50	
Sonic 2 Supermotard 50	
SX 50 Mini Cross	
RP 80 Cross	83-
Cabriole Trail 125	
Cabriole Supermotard 125	
WH 125 Road/Red Horse	85-

HUSABERG

Enforcer Four	00-03
All models (central fixing pin in pad)	89-92
All models (fixing pin at end of brake pad)	93-94
All models (fixing pin at end of brake pad)	95-99
All MX/Enduro models	
(Brembo 2 piston caliper 260mm front disc)	00-05
All Supermotard models (Beringer 4 piston caliper central in fixing 310mm front disc)	00-03
TE 125 (2T)	12-14
TE 250 (2T)	11-14
TE 300 (2T)	11-14
FE 250 (4T)	13-14
FE 350 (4T)	13-14
FE 390 (New 70° Engine)	10-12
FE 450 E	06-08
FE 450 (New 70° Engine)	09-13
FS 450 C	06
FS 450 E	06-08
FX 450 (New 70° Engine)	10-11
FE 501 (4T)	13-14
FE 550 E	06-08
FE 550 E Supermoto	05-07
FE 570 (New 70° Engine)	09-12
FS 570 (Supermoto)	10-11
FE 650 E	06-08
FS 650 C Supermoto	06-08
FS 650 E Supermoto	05-08
FS Supermotard Models (Beringer/FTE 6 piston caliper 310mm front disc)	04
FS Supermotard Models (FTE 4 piston radial caliper)	05
◆ Plain undrilled disc for enduro use MD6035CE	

FA, SFA, TT Pad or Brake Shoe	SFAC Carbon Scooter Pads	Speciality Pads SXR / Vee / MXS	Sintered/HH Pads/ Grooved Shoes	BRAKE DISC CHOICES - FRONT						Line #
				Left / Gauche / Links Standard Replacement Disc	Right / Droite / Rechts Standard Replacement Disc	Contour Disc Universal left and right fitment	Universal Custom Disc	Vee-Discs Black † See note below	CX Extreme MX Race Disc/ UTVX Disc	
FA244*			FA244HH*			N/A*				1
										2
										3
SFA086	SFAC086		SFA086HH		N/A					4
TBA										5
SFA047			SFA047HH			N/A				6
SFA235	SFAC235			N/A						7
SFA086	SFAC086		SFA086HH		N/A					8
SFA086	SFAC086		SFA086HH	N/A						9
SFA086	SFAC086		SFA086HH		N/A					10
SFA086	SFAC086		SFA086HH	N/A						11
SFA086	SFAC086		SFA086HH		N/A					12
SFA197	SFAC197		SFA197HH		N/A					13
SFA086	SFAC086		SFA086HH		N/A					14
FA231		FA231V	FA231HH		N/A					15
										16
										17
FA194				N/A						18
944			944G							19
FA167			FA167HH	N/A						20
FA167			FA167HH	N/A						21
FA293				N/A						22
944			944G							23
FA167			FA167HH	N/A						24
FA167			FA167HH	N/A						25
FA047			FA047R	N/A						26
										27
										28
FA181TT*		MXS181*	FA181R*	MD6141D	MD6141D					29
FA134			FA134R	N/A						30
FA181TT		MXS181	FA181R	MD6125D						31
FA181TT		MXS181	FA181R	MD6125D						32
										33
FA181TT		MXS181	FA181R	MD6032D		MD6032C			MD6032CX	34
										35
FA158			FA158HH	N/A						36
FA181TT		MXS181	FA181R			MD6032C			MD6032CX	37
FA181TT		MXS181	FA181R			MD6032C			MD6032CX	38
FA181TT		MXS181	FA181R			MD6032C			MD6032CX	39
FA181TT		MXS181	FA181R			MD6032C			MD6032CX	40
FA181TT		MXS181	FA181R			MD6032C			MD6032CX	41
FA181TT		MXS181	FA181R			MD6032C			MD6032CX	42
FA181TT		MXS181	FA181R	MD6032D		MD6032C			MD6032CX	43
FA181TT		MXS181	FA181R			MD6032C			MD6032CX	44
		MXS405		N/A						45
		MXS405		N/A						46
FA181TT		MXS181	FA181R			MD6032C			MD6032CX	47
FA181TT		MXS181	FA181R			MD6032C			MD6032CX	48
FA181TT		MXS181	FA181R	MD6032D		MD6032C			MD6032CX	49
		MXS405		MD6270D		MD6270C				50
FA181TT		MXS181	FA181R			MD6032C			MD6032CX	51
FA433/4			FA433/4HH			TBA				52
FA181TT		MXS181	FA181R	MD6032D		MD6032C			MD6032CX	53
		MXS405		MD6270D		MD6270C				54
		MXS405		MD6270D		MD6270C				55
										56
		MXS406		MD6270D		MD6270C				57
		MXS405		MD6270D		MD6270C				58
										59
										60

*-2 Sets Required. † For Vee disc colours add RED, BLU, GRN, GLD, ORG suffix to part number.

◆ - Also available as a Vintage Motorcycle Disc.

R Suffix = High Durability Sintered Pad. HH Suffix = High Performance Sintered Pad. TT Suffix = Hard Wearing Off Road Pad. V Suffix = Semi-Sintered Pad. G Suffix = Grooved Shoe.

D Suffix = Drilled Disc. X Suffix = Universal Left or Right Disc. XC Suffix = Contoured Disc. LS Suffix = Left/Steel Disc. RS Suffix = Right/Steel Disc.

Non-JAPANESE Built Motorcycles

Line #	BRAKE DISC CHOICES - FRONT						DISC PAD CHOICES - REAR				BRAKE DISC CHOICES - REAR			
	Oversize 250 /280mm Disc Kit	OSX Oversize 250/280mm Disc Kit	Relocating Bracket for 250/ 280mm Disc	Oversize 320mm Disc Kit	SMX Oversize 320mm Disc Kit	Relocating Bracket for 320mm Disc	FA, SFA, TT Pad or Brake Shoe	SFAC Carbon Scooter Pads	Speciality Pads - SXR / Vee / MXS	Sintered/ HH Pads/ Grooved Shoes	Standard Replacement Disc	Contour Disc Rear fitment	Vee-Discs™ CONTOUR	CX Extreme MX Race Disc/ UTVX Disc
1							FA266			FA266HH		N/A		
2														
3														
4							SFA115			SFA115HH	N/A			
5							TBA							
6							SFA298			SFA298HH		N/A		
7							TBA							
8							SFA086	SFAC086		SFA086HH	N/A			
9							SFA086	SFAC086		SFA086HH	N/A			
10							SFA086	SFAC086		SFA086HH	N/A			
11							SFA086	SFAC086		SFA086HH	N/A			
12							SFA197	SFAC197		SFA197HH	N/A			
13							SFA427	SFAC427		SFA427HH	N/A			
14							SFA086	SFAC086		SFA086HH	N/A			
15							FA213		FA213V	FA213HH	N/A			
16														
17														
18							FA208TT				N/A			
19							944			944G				
20							FA115			FA115R	N/A			
21							FA115			FA115R	N/A			
22							FA293				N/A			
23							944			944G				
24							FA115			FA115R	N/A			
25							FA115			FA115R	N/A			
26							N/A							
27														
28														
29							FA181TT		MXS181	FA181R	MD6142D			
30							FA067TT			FA067R	N/A			
31	OS6125C	OSX6125	BRK010	SM6125C	SMX6125	BRK007	FA067TT			FA067R	MD6126D			
32	OS6125C	OSX6125	BRK010	SM6125C	SMX6125	BRK007	FA208TT		MXS208	FA208R	MD6126D			
33														
34	OS6032C	OSX6032	BRK011	SM6032C	SMX6032	BRK012	FA208TT		MXS208	FA208R	MD6035D ♦	MD6035C		MD6035CX
35														
36														
37	OS6932C	OSX6932	BRK013	SM6932C	SMX6932	BRK014	FA208TT		MXS208	FA208R	MD6035D			
38	OS6932C	OSX6932	BRK013	SM6932C	SMX6932	BRK014	FA368TT		MXS368	FA368R	MD6035CE ♦	MD6035C		MD6035CX
39	OS6932C	OSX6932	BRK013	SM6932C	SMX6932	BRK014	FA368TT		MXS368	FA368R	MD6035CE ♦	MD6035C		MD6035CX
40	OS6932C	OSX6932	BRK013	SM6932C	SMX6932	BRK014	FA368TT		MXS368	FA368R	MD6035CE ♦	MD6035C		MD6035CX
41	OS6932C	OSX6932	BRK013	SM6932C	SMX6932	BRK014	FA368TT		MXS368	FA368R	MD6035CE ♦	MD6035C		MD6035CX
42	OS6932C	OSX6932	BRK013	SM6932C	SMX6932	BRK014	FA368TT		MXS368	FA368R	MD6035CE ♦	MD6035C		MD6035CX
43	OS6032C	OSX6032	BRK011	SM6032C	SMX6032	BRK012	FA208TT		MXS368	FA208R	MD6035D ♦	MD6035C		MD6035CX
44	OS6932C	OSX6932	BRK013	SM6932C	SMX6932	BRK014	FA368TT		MXS368	FA368R	MD6035CE ♦	MD6035C		MD6035CX
45							FA208TT		MXS208	FA208R	MD6035D ♦	MD6035C		
46							FA208TT		MXS208	FA208R	MD6035D ♦	MD6035C		
47	OS6932C	OSX6932	BRK013	SM6932C	SMX6932	BRK014	FA368TT		MXS368	FA368R	MD6035CE ♦	MD6035C		MD6035CX
48	OS6932C	OSX6932	BRK013	SM6932C	SMX6932	BRK014	FA368TT		MXS368	FA368R	MD6035CE ♦	MD6035C		MD6035CX
49	OS6032C	OSX6032	BRK011	SM6032C	SMX6032	BRK012	FA208TT		MXS208	FA208R	MD6035D ♦	MD6035C		MD6035CX
50							FA208TT		MXS208	FA208R	MD6035D ♦	MD6035C		
51	OS6932C	OSX6932	BRK013	SM6932C	SMX6932	BRK014	FA368TT		MXS368	FA368R	MD6035CE ♦	MD6035C		MD6035CX
52							FA368TT		MXS368	FA368R	MD6035CE ♦	MD6035C		
53	OS6032C	OSX6032	BRK011	SM6032C	SMX6032	BRK012	FA208TT		MXS208	FA208R	MD6035D ♦	MD6035C		MD6035CX
54							FA208TT		MXS208	FA208R	MD6035D ♦	MD6035C		
55							FA208TT		MXS208	FA208R	MD6035D ♦	MD6035C		
56														
57							FA208TT		MXS208	FA208R	MD6035D ♦	MD6035C		
58							FA208TT		MXS208	FA208R	MD6035D	MD6035C		
59														
60														

R Suffix = High Durability Sintered Pad. HH Suffix = High Performance Sintered Pad. TT Suffix = Hard Wearing Off Road Pad. V Suffix = Semi Sintered Pad. G Suffix = Grooved Shoe.
D Suffix = Drilled Disc. X Suffix = Universal Left or Right Disc. XC Suffix = Contoured Disc. LS Suffix = Left/Steel Disc. RS = Right/Steel Disc.

BRAKE APPLICATIONS

*-2 Sets Required. † For Vee disc colours add RED, BLU, GRN, GLD, ORG suffix to part number.
♦ - Also available as a Vintage Motorcycle Disc.

Non-JAPANESE Built Motorcycles

APPLICATIONS

BRAKE



HUSQVARNA



DISC PAD CHOICES - FRONT

BRAKE DISC CHOICES - FRONT

		FA, SFA, TT Pad or Brake Shoe	SFAC Carbon Scooter Pads	Speciality Pads - SXR / Vee / MXS	Sintered/ HH Pads/ Grooved Shoes	Left / Gauche / Links Standard Replacement Disc	Right / Droite / Rechts Standard Replacement Disc	Contour Disc Universal left and right fitment	Universal Custom Disc	Vee-Discs Black † See note below	CX Extreme MX Race Disc/ UTVX Disc	Line #
Husky Boy	98-99				FA282R							1
Husky Boy Racing S	00	H301										2
Husky Boy Drum front & rear	00-02	H301										3
Husky Boy Racing J	00	H301										4
Husky Boy J	01-02	FA115TT		MXS115	FA115R							5
Husky Boy R	01	FA115TT		MXS115	FA115R							6
Husky Boy S	01-02	FA115TT		MXS115	FA115R							7
CR 50 Junior	05	FA351TT										8
CR 50 Junior Basic	05	TBA										9
CR 50 Senior Pro	05	FA351TT										10
CR 50	11-13	FA325TT			FA325R							11
SM 50	02	FA167										12
SM 50	11-13	FA325TT			FA325R							13
TC 50/ Mini	18-20	FA325TT			FA325R							14
TE 50 Boy	05	TBA										15
WR 50	02	FA167			FA167HH							16
WRS 50 Scooter	98-00	SFA115	SFAC115		SFA115HH		MD964D					17
CR 65	11-13	FA357TT			FA357R							18
TC65	18-20	FA357TT			FA357R							19
TC 85 (2T/17 Inch/14 Inch Wheels)	14-16	FA612TT			FA612R			MD6258C				20
TC 85 (2T/17 Inch/14 Inch Wheels)	17-20	FA612TT			FA612R			MD6379C				21
TC 85 (2T/19 Inch/16 Inch Wheels)	14-20	FA612TT			FA612R			MD6379C				22
TE 100	05	FA351TT										23
CR 125	73-77	N/A										24
CR 125	78				801G							25
CR 125	79-81				801G							26
CR 125	82-84				803G							27
CR 125	85-86	FA047TT			FA047R							28
CR 125	91	FA134			FA134R							29
CR 125	92-94	FA135TT		MXS135	FA135R	MD6125D						30
CR 125	95-99	FA181TT		MXS181	FA181R	MD6125D						31
CR 125 (45mm diameter Marzocchi forks with 60mm caliper mount centres)	00-01	FA181TT		MXS181	FA181R	MD6184D		MD6184C				32
CR 125 (48mm diameter Marzocchi forks or 48mm diameter Kayaba forks with 95mm caliper mount centres)	00-01	FA181TT		MXS181	FA181R	MD6184D		MD6184C				33
CR 125 (45mm diameter Marzocchi forks with 60mm caliper mount centres)	02-04	FA181TT		MXS181	FA181R	MD6184D		MD6184C				34
CR 125 (48mm diameter Marzocchi forks or 48mm diameter Kayaba forks with 95mm caliper mount centres)	02-04	FA181TT		MXS181	FA181R	MD6184D		MD6184C				35
CR 125 (45mm diameter Marzocchi forks with 60mm caliper mount centres)	05	FA181TT		MXS181	FA181R	MD6184D		MD6184C				36
CR 125 (48mm diameter Marzocchi forks or 48mm diameter Kayaba forks with 95mm caliper mount centres)	05	FA181TT		MXS181	FA181R	MD6184D		MD6184C				37
CR 125 (45mm diameter Marzocchi forks with 60mm caliper mount centres)	06-08	FA181TT		MXS181	FA181R	MD6184D		MD6184C				38
CR 125 (48mm diameter Marzocchi forks or 48mm diameter Kayaba forks with 95mm caliper mount centres)	06-08	FA181TT		MXS181	FA181R	MD6184D		MD6184C				39
CR 125 (45mm diameter Marzocchi forks with 60mm caliper mount centres)	09-13	FA181TT		MXS181	FA181R	MD6184D		MD6184C				40
CR 125 (48mm diameter Marzocchi forks or 48mm diameter Kayaba forks with 95mm caliper mount centres)	09-13	FA181TT		MXS181	FA181R	MD6184D		MD6184C				41
SC 125	73-74	N/A										42
SM 125 (6 bolt fixing)	98-99	FA181TT		MXS181	FA181R	MD6125D						43
SM 125 (4 bolt fixing) (45mm diameter Marzocchi forks with 60mm caliper mount centres)	00	FA181TT		MXS181	FA181R	MD6184D		MD6184C				44
												45
												46
												47
												48
												49
												50
												51
												52
												53
												54
												55
												56
												57
												58
												59
												60

FRONT / AVANT / VORN / FRENTE / ANTERIORE

R Suffix = High Durability Sintered Pad. HH Suffix = High Performance Sintered Pad. TT Suffix = Hard Wearing Off Road Pad. V Suffix = Semi Sintered Pad. G Suffix = Grooved Shoe.

D Suffix = Drilled Disc. X Suffix = Universal Left or Right Disc. XC Suffix = Contoured Disc. LS Suffix = Left/Steel Disc. RS Suffix = Right/Steel Disc.

*-2 Sets Required. † For Vee disc colours add RED, BLU, GRN, GLD, ORG suffix to part number.

⊗ - Also available as a Vintage Motorcycle Disc.

264 Part numbers, prefixes, suffixes, photos and illustrations shown in this catalogue are trademarks and/or copyrights of EBC Brakes or the trademark owner A C Freeman Investments Ltd and use without express written permission of the owners is punishable by law.

Non-JAPANESE Built Motorcycles

Line #	BRAKE DISC CHOICES - FRONT						DISC PAD CHOICES - REAR				BRAKE DISC CHOICES - REAR			
	Oversize 250 /280mm Disc Kit	OSX Oversize 250/280mm Disc Kit	Relocating Bracket for 250/ 280mm Disc	Oversize 320mm Disc Kit	SMX Oversize 320mm Disc Kit	Relocating Bracket for 320mm Disc	FA, SFA, TT Pad or Brake Shoe	SFAC Carbon Scooter Pads	Speciality Pads - SXR / Vee / MXS	Sintered/ HH Pads/ Grooved Shoes	Standard Replacement Disc	Contour Disc Rear fitment	Vee-Discs™ CONTOUR	CX Extreme MX Race Disc/ UTVX Disc
1									FA282R					
2							H301							
3							H301							
4							H301							
5							984							
6							984							
7							984							
8														
9							TBA							
10							FA325TT							
11							FA325TT		FA325R					
12							FA115		FA115HH					
13							FA325TT		FA325R					
14							FA325TT		FA325R					
15							TBA							
16							FA115		FA115HH					
17							S624							
18							FA602TT		FA602R					
19							FA357TT		FA357R					
20		OSX6258	BRK028				FA602TT		FA602R		MD6360C			
21							FA602TT		FA602R		MD6360C			
22							FA602TT		FA602R		MD6360C			
23														
24							N/A							
25														
26									801G					
27									801G					
28								802G						
29							FA251			MD6126D				
30							FA084TT		FA084R	MD6126D				
31	OS6125C	OSX6125	BRK010	SM6125C	SMX6125	BRK007	FA208TT	MXS208	FA208R	MD6126D				
32														
33	OS6184HC	OSX6184HC	BRK010		SMX6184H	BRK007	FA208TT	MXS208	FA208R	MD6287D				
34														
35														
36	OS6184KC	OSX6184K	BRK011		SMX6184K	BRK012	FA208TT	MXS208	FA208R	MD6287D				
37														
38	OS6184HC	OSX6184HC	BRK010		SMX6184H	BRK007	FA208TT	MXS208	FA208R	MD6295D				
39														
40														
41	OS6184KC	OSX6184K	BRK011		SMX6184K	BRK012	FA208TT	MXS208	FA208R	MD6295D				
42														
43	OS6184HC	OSX6184HC	BRK010		SMX6184H	BRK007	FA368TT	MXS368	FA368R	MD6295D				
44														
45														
46	OS6184KC	OSX6184K	BRK011		SMX6184K	BRK012	FA368TT	MXS368	FA368R	MD6295D				
47														
48	OS6184HC	OSX6184HC	BRK010		SMX6184H	BRK007	FA368TT	MXS368	FA368R	MD6288D				
49														
50														
51	OS6184KC	OSX6184K	BRK011		SMX6184K	BRK012	FA368TT	MXS368	FA368R	MD6288D				
52														
53	OS6184HC	OSX6184HC	BRK010		SMX6184H	BRK007	FA368TT	MXS368	FA368R					
54														
55														
56	OS6184KC	OSX6184K	BRK011		SMX6184K	BRK012	FA368TT	MXS368	FA368R					
57							N/A							
58	OS6125C	OSX6125	BRK010	SM6125C	SMX6125	BRK007	FA208TT	MXS208	FA208R	MD6126D				
59														
60	OS6184HC	OSX6184HC	BRK010		SMX6184H	BRK007	FA208TT	MXS208	FA208R	MD6287D				

REAR / ARRIÈRE / HINTEN / POSTERIOR / POSTERIORE

*-2 Sets Required. † For Vee disc colours add RED, BLU, GRN, GLD, ORG suffix to part number.

⊗ - Also available as a Vintage Motorcycle Disc.

R Suffix = High Durability Sintered Pad. **HH** Suffix = High Performance Sintered Pad. **TT** Suffix = Hard Wearing Off Road Pad. **V** Suffix = Semi Sintered Pad. **G** Suffix = Grooved Shoe.
D Suffix = Drilled Disc. **X** Suffix = Universal Left or Right Disc. **XC** Suffix = Contoured Disc. **LS** Suffix = Left/Steel Disc. **RS** = Right/Steel Disc.

Part numbers, prefixes, suffixes, photos and illustrations shown in this catalogue are trademarks and/or copyrights of EBC Brakes or the trademark owner A C Freeman Investments Ltd and use without express written permission of the owners is punishable by law.

Non-JAPANESE Built Motorcycles

APPLICATIONS

BRAKE



HUSQVARNA Contd.



R Suffix = High Durability Sintered Pad. HH Suffix = High Performance Sintered Pad. TT Suffix = Hard Wearing Off Road Pad. V Suffix = Semi-Sintered Pad. G Suffix = Grooved Shoe.

D Suffix = Drilled Disc. X Suffix = Universal Left or Right Disc. XC Suffix = Contoured Disc. LS Suffix = Left/Steel Disc. RS Suffix = Right/Steel Disc.

	DISC PAD CHOICES - FRONT			BRAKE DISC CHOICES - FRONT							Line #
	FA, SFA, TT Pad or Brake Shoe	SFAC Carbon Scooter Pads	Speciality Pads - SXR / Vee / MXS	Sintered/HH Pads/ Grooved Shoes	Left / Gauche / Links Standard Replacement Disc	Right / Droite / Rechts Standard Replacement Disc	Contour Disc Universal left and right fitment	Universal Custom Disc	Vee-Discs Black † See note below	CX Extreme MX Race Disc/ UTVX Disc	
SM 125 (4 bolt fixing) (48mm diameter Marzocchi forks or 48mm diameter Kayaba forks with 95mm caliper mount centres) 00	FA181TT		MXS181	FA181R	MD6184D		MD6184C				1
SM 125 S (4 bolt fixing/2T) (45mm diameter Marzocchi forks with 60mm caliper mount centres) 02-13	FA181TT		MXS181	FA181R	MD6184D		MD6184C				2
SM 125 S (4 bolt fixing/2T) (48mm diameter Marzocchi forks or 48mm diameter Kayaba forks with 95mm caliper mount centres) 02-13	FA181TT		MXS181	FA181R	MD6184D		MD6184C				3
SMS4 125 (4T) (45mm diameter Marzocchi forks with 60mm caliper mount centres) 11	FA181TT		MXS181	FA181R	MD6184D		MD6184C				4
SMS4 125 (4T) (48mm diameter Marzocchi forks or 48mm diameter Kayaba forks with 95mm caliper mount centres) 11	FA181TT		MXS181	FA181R	MD6184D		MD6184C				5
TC 125 (2T) 14-20	FA181TT		MXS181	FA181R			MD6032C			MD6032CX	6
TE 125 (4T) (45mm diameter Marzocchi forks with 60mm caliper mount centres) 11-13	FA181TT		MXS181	FA181R	MD6184D		MD6184C				7
TE 125 (4T) (48mm diameter Marzocchi forks or 48mm diameter Kayaba forks with 95mm caliper mount centres) 11-13	FA181TT		MXS181	FA181R	MD6184D		MD6184C				8
TE 125 (2T) 14-19	FA181TT		MXS181	FA181R			MD6032C			MD6032CX	9
TX 125 (2T) 18-19	FA181TT		MXS181	FA181R							10
WR 125 73-74	N/A										11
WR 125 79				801G							12
WR 125 80-81				802G							13
WR 125 82-84				803G							14
WR 125 87-88	FA134			FA134R							15
WR 125 91	FA134			FA134R							16
WR 125 93-94	FA135TT		MXS135	FA135R	MD6125D						17
WR 125 95-99	FA181TT		MXS181	FA181R	MD6125D						18
WR 125 (45mm diameter Marzocchi forks with 60mm caliper mount centres) 00-01	FA181TT		MXS181	FA181R	MD6184D		MD6184C				19
WR 125 (48mm diameter Marzocchi forks or 48mm diameter Kayaba forks with 95mm caliper mount centres) 00-01	FA181TT		MXS181	FA181R	MD6184D		MD6184C				20
WR 125 (45mm diameter Marzocchi forks with 60mm caliper mount centres) 02-05	FA181TT		MXS181	FA181R	MD6184D		MD6184C				21
WR 125 (48mm diameter Marzocchi forks or 48mm diameter Kayaba forks with 95mm caliper mount centres) 02-05	FA181TT		MXS181	FA181R	MD6184D		MD6184C				22
WR 125 (45mm diameter Marzocchi forks with 60mm caliper mount centres) 06-08	FA181TT		MXS181	FA181R	MD6184D		MD6184C				23
WR 125 (48mm diameter Marzocchi forks or 48mm diameter Kayaba forks with 95mm caliper mount centres) 06-08	FA181TT		MXS181	FA181R	MD6184D		MD6184C				24
WR 125 (45mm diameter Marzocchi forks with 60mm caliper mount centres) 09-13	FA181TT		MXS181	FA181R			MD6184C				25
WR 125 (48mm diameter Marzocchi forks or 48mm diameter Kayaba forks with 95mm caliper mount centres) 09-13	FA181TT		MXS181	FA181R			MD6184C				26
WRE 125 93-99	FA181TT		MXS181	FA181R	MD6125D						27
WRE 125 (45mm diameter Marzocchi forks with 60mm caliper mount centres) 00	FA181TT		MXS181	FA181R	MD6184D		MD6184C				28
WRE 125 (48mm diameter Marzocchi forks or 48mm diameter Kayaba forks with 95mm caliper mount centres) 00	FA181TT		MXS181	FA181R	MD6184D		MD6184C				29
WRE 125 (45mm diameter Marzocchi forks with 60mm caliper mount centres) 02-13	FA181TT		MXS181	FA181R	MD6184D		MD6184C				30
◆ Plain undrilled disc for enduro use MD6035CE											31

FRONT / AVANT / VORN / FRENTE / ANTERIORE

*-2 Sets Required. † For Vee disc colours add RED, BLU, GRN, GLD, ORG suffix to part number.

⊗ - Also available as a Vintage Motorcycle Disc.

Non-JAPANESE Built Motorcycles

Line #	BRAKE DISC CHOICES - FRONT						DISC PAD CHOICES - REAR				BRAKE DISC CHOICES - REAR			
	Oversize 250 /280mm Disc Kit	OSX Oversize 250/280mm Disc Kit	Relocating Bracket for 250/ 280mm Disc	Oversize 320mm Disc Kit	SMX Oversize 320mm Disc Kit	Relocating Bracket for 320mm Disc	FA, SFA, TT Pad or Brake Shoe	SFAC Carbon Scooter Pads	Speciality Pads - SXR / Vee / MXS	Sintered/ HH Pads/ Grooved Shoes	Standard Replacement Disc	Contour Disc Rear fitment	Vee-Discs™ CONTOUR	CX Extreme MX Race Disc/ UTVX Disc
1														
2														
3	OS6184KC	OSX6184K	BRK011		SMX6184K	BRK012	FA208TT		MXS208	FA208R	MD6287D			
4														
5	OS6184HC	OSX6184HC	BRK010		SMX6184H	BRK007	FA208TT		MXS208	FA208R	MD6287D			
6														
7														
8	OS6184KC	OSX6184K	BRK011		SMX6184K	BRK012	FA208TT		MXS208	FA208R	MD6287D			
9														
10	OS6184HC	OSX6184HC	BRK010		SMX6184H	BRK007	FA208TT		MXS208	FA208R	MD6287D			
11														
12														
13	OS6184KC	OSX6184K	BRK011		SMX6184K	BRK012	FA208TT		MXS208	FA208R	MD6287D			
14	OS6932C	OSX6932	BRK013		SMX6932	BRK014	FA368TT		MXS368	FA368R		MD6035C	MD6035CX	
15														
16	OS6184HC	OSX6184HC	BRK010		SMX6184H	BRK007	FA208TT		MXS208	FA208R	MD6287D			
17														
18														
19	OS6184KC	OSX6184K	BRK011		SMX6184K	BRK012	FA208TT		MXS208	FA208R	MD6287D			
20	OS6932C	OSX6932	BRK013		SMX6932	BRK014	FA368TT		MXS368	FA368R	MD6035CE ♦	MD6035C	MD6035CX	
21							FA368TT		MXS368	FA368R				
22							N/A							
23														
24									801G					
25									802G					
26									802G					
27									802G					
28							FA251				MD6126D			
29	OS6125C	OSX6125	BRK010	SM6125C	SMX6125	BRK007	FA084TT		MXS084	FA084R	MD6126D			
30							FA208TT		MXS208	FA208R	MD6126D			
31	OS6184HC	OSX6184HC	BRK010		SMX6184H	BRK007	FA208TT		MXS208	FA208R	MD6287D			
32														
33														
34	OS6184KC	OSX6184K	BRK011		SMX6184K	BRK012	FA208TT		MXS208	FA208R	MD6287D			
35														
36	OS6184HC	OSX6184HC	BRK010		SMX6184H	BRK007	FA208TT		MXS208	FA208R	MD6295D			
37														
38														
39	OS6184KC	OSX6184K	BRK011		SMX6184K	BRK012	FA208TT		MXS208	FA208R	MD6295D			
40														
41	OS6184HC	OSX6184HC	BRK010		SMX6184H	BRK007	FA368TT		MXS368	FA368R	MD6288D			
42														
43														
44	OS6184KC	OSX6184K	BRK011		SMX6184K	BRK012	FA368TT		MXS368	FA368R	MD6288D			
45														
46	OS6184HC	OSX6184HC	BRK010		SMX6184H	BRK007	FA368TT		MXS368	FA368R				
47														
48														
49	OS6184KC	OSX6184K	BRK011		SMX6184K	BRK012	FA368TT		MXS368	FA368R				
50	OS6125C	OSX6125	BRK010	SM6125C	SMX6125	BRK007	FA208TT		MXS208	FA208R	MD6126D			
51														
52	OS6184HC	OSX6184HC	BRK010		SMX6184H	BRK007	FA208TT		MXS208	FA208R	MD6287D			
53														
54														
55	OS6184KC	OSX6184K	BRK011		SMX6184K	BRK012	FA208TT		MXS208	FA208R	MD6287D			
56														
57	OS6184HC	OSX6184HC	BRK010		SMX6184H	BRK007	FA208TT		MXS208	FA208R	MD6287D			
58														
59														
60														

REAR / ARRIÈRE / HINTEN / POSTERIOR / POSTERIORE

R Suffix = High Durability Sintered Pad. **HH** Suffix = High Performance Sintered Pad. **TT** Suffix = Hard Wearing Off Road Pad. **V** Suffix = Semi Sintered Pad. **G** Suffix = Grooved Shoe.
D Suffix = Drilled Disc. **X** Suffix = Universal Left or Right Disc. **XC** Suffix = Contoured Disc. **LS** Suffix = Left/Steel Disc. **RS** = Right/Steel Disc.

*-2 Sets Required. † For Vee disc colours add RED, BLU, GRN, GLD, ORG suffix to part number.
 ♦ - Also available as a Vintage Motorcycle Disc.

BRAKE APPLICATIONS

Non-JAPANESE Built Motorcycles

APPLICATIONS

BRAKE



HUSQVARNA Contd.



		DISC PAD CHOICES - FRONT			BRAKE DISC CHOICES - FRONT						
FA, SFA, TT Pad or Brake Shoe	SFAC Carbon Scooter Pads	Speciality Pads SXR / Vee / MXS	Sintered/ HH Pads/ Grooved Shoes	Left / Gauche / Links Standard Replacement Disc	Right / Droite / Rechts Standard Replacement Disc	Contour Disc Universal left and right fitment	Universal Custom Disc	Vee-Discs Black † See note below	CX Extreme MX Race Disc/ UTVX Disc		
WRE 125 (48mm diameter Marzocchi forks or 48mm diameter Kayaba forks with 95mm caliper mount centres)	02-13										
WRE 125 (45mm diameter Marzocchi forks with 60mm caliper mount centres)	07										
WRE 125 (48mm diameter Marzocchi forks or 48mm diameter Kayaba forks with 95mm caliper mount centres)	07										
XC 125	82-84										
XC 125	85-86										
TE 150 (2T)	18-20										
CR 240	81-81										
CR 240	82-84										
CR 240	85-86										
CR 240	87-88										
WR 240	78										
WR 240	80-81										
WR 240	82-84										
WR 240	87-88										
WR 240	90-91										
CR 250	71-74										
CR 250	75-79										
CR 250	80-81										
CR 250	82-84										
CR 250	85-86										
CR 250	87-88										
CR 250	91										
CR 250	92-94										
CR 250	95-99										
CR 250 (45mm diameter Marzocchi forks with 60mm caliper mount centres)	00-01										
CR 250 (48mm diameter Marzocchi forks or 48mm diameter Kayaba forks with 95mm caliper mount centres)	00-01										
CR 250 (45mm diameter Marzocchi forks with 60mm caliper mount centres)	02-04										
CR 250 (48mm diameter Marzocchi forks or 48mm diameter Kayaba forks with 95mm caliper mount centres)	02-04										
CR 250 (45mm diameter Marzocchi forks with 60mm caliper mount centres)	05-07										
CR 250 (48mm diameter Marzocchi forks or 48mm diameter Kayaba with 95mm caliper mount centres)	05-07										
FC 250 (4T)	14-20										
FE 250 (4T)	14-20										
TC 250 (45mm diameter Marzocchi forks with 60mm caliper mount centres)	02-03										
TC 250 (48mm diameter Marzocchi forks or 48mm diameter Kayaba forks with 95mm caliper mount centres)	02-03										
TC 250 (45mm diameter Marzocchi forks with 60mm caliper mount centres)	05-08										
TC 250 (48mm diameter Marzocchi forks or 48mm diameter Kayaba forks with 95mm caliper mount centres)	05-08										
TC 250 (4T)	09-13										
TC 250 (2T)	14-20										
◆ Plain undrilled disc for enduro use MD6035CE											

FRONT / AVANT / VORN / FRENTE / ANTERIORE

Line #

R Suffix = High Durability Sintered Pad. **HH** Suffix = High Performance Sintered Pad. **TT** Suffix = Hard Wearing Off Road Pad. **V** Suffix = Semi Sintered Pad. **G** Suffix = Grooved Shoe.

D Suffix = Drilled Disc. **X** Suffix = Universal Left or Right Disc. **XC** Suffix = Contoured Disc. **LS** Suffix = Left/Steel Disc. **RS** = Right/Steel Disc.

*-2 Sets Required. † For Vee disc colours add RED, BLU, GRN, GLD, ORG suffix to part number.

⊙ - Also available as a Vintage Motorcycle Disc.

Non-JAPANESE Built Motorcycles

Line #	BRAKE DISC CHOICES - FRONT						DISC PAD CHOICES - REAR				BRAKE DISC CHOICES - REAR			
	Oversize 250 /280mm Disc Kit	OSX Oversize 250/280mm Disc Kit	Relocating Bracket for 250/ 280mm Disc	Oversize 320mm Disc Kit	SMX Oversize 320mm Disc Kit	Relocating Bracket for 320mm Disc	FA, SFA, TT Pad or Brake Shoe	SFAC Carbon Scooter Pads	Speciality Pads - SXR / Vee / MXS	Sintered/ HH Pads/ Grooved Shoes	Standard Replacement Disc	Contour Disc Rear fitment	Vee-Discs™ CONTOUR	CX Extreme MX Race Disc/ UTVX Disc
1														
2														
3	OS6184KC	OSX6184K	BRK011		SMX6184K	BRK012	FA208TT		MXS208	FA208R	MD6287D			
4														
5	OS6184HC	OSX6184HC	BRK010		SMX6184H	BRK007	FA131TT		MXS131	FA131R				
6														
7														
8	OS6184KC	OSX6184K	BRK011		SMX6184K	BRK012	FA131TT		MXS131	FA131R				
9										802G				
10										801G				
11		OSX6032E	BRK013				FA368TT		MXS368	FA368R	MD6035C			
12										801G				
13										801G				
14										802G				
15										802G				
16										801G				
17										802G				
18										802G				
19														
20							FA251				MD6126D			
21										801G				
22										801G				
23										801G				
24										801G				
25										802G				
26										802G				
27							FA251				MD6126D			
28							FA084TT			FA084R	MD6126D			
29	OS6125C	OSX6125	BRK010	SM6125C	SMX6125	BRK007	FA208TT		MXS208	FA208R	MD6126D			
30														
31	OS6184HC	OSX6184HC	BRK010		SMX6184H	BRK007	FA208TT		MXS208	FA208R	MD6287D			
32														
33														
34	OS6184KC	OSX6184K	BRK011		SMX6184K	BRK012	FA208TT		MXS208	FA208R	MD6287D			
35														
36	OS6184HC	OSX6184HC	BRK010		SMX6184H	BRK007	FA208TT		MXS208	FA208R	MD6295D			
37														
38														
39	OS6184KC	OSX6184K	BRK011		SMX6184K	BRK012	FA208TT		MXS208	FA208R	MD6295D			
40														
41	OS6184HC	OSX6184HC	BRK010		SMX6184H	BRK007	FA368TT		MXS368	FA368R	MD6295D			
42														
43														
44	OS6184KC	OSX6184K	BRK011		SMX6184K	BRK012	FA368TT		MXS368	FA368R	MD6295D			
45	OS6932C	OSX6032E	BRK013		SMX6932	BRK014	FA368TT		MXS368	FA368R	MD6035C		MD6035CX	
46	OS6932C	OSX6032E	BRK013		SMX6932	BRK014	FA368TT		MXS368	FA368R	MD6035C		MD6035CX	
47														
48	OS6184HC	OSX6184HC	BRK010		SMX6184H	BRK007	FA208TT		MXS208	FA208R	MD6295D			
49														
50														
51	OS6184KC	OSX6184K	BRK011		SMX6184K	BRK012	FA208TT		MXS208	FA208R	MD6295D			
52														
53	OS6184HC	OSX6184HC	BRK010		SMX6184H	BRK007	FA368TT		MXS368	FA368R	MD6288D			
54														
55														
56	OS6184KC	OSX6184K	BRK011		SMX6184K	BRK012	FA368TT		MXS368	FA368R	MD6288D			
57	OS6184CK9	OSX6184K9	BRK013	SM6184CK9	SMX6184K9	BRK014	FA368TT		MXS368	FA368R				
58	OS6932C	OSX6032E	BRK013		SMX6932	BRK014	FA368TT		MXS368	FA368R	MD6035C		MD6035CX	
59														
60														

REAR / ARRIÈRE / HINTEN / POSTERIOR / POSTERIORE

R Suffix = High Durability Sintered Pad. **HH** Suffix = High Performance Sintered Pad. **TT** Suffix = Hard Wearing Off Road Pad. **V** Suffix = Semi Sintered Pad. **G** Suffix = Grooved Shoe.
D Suffix = Drilled Disc. **X** Suffix = Universal Left or Right Disc. **XC** Suffix = Contoured Disc. **LS** Suffix = Left/Steel Disc. **RS** = Right/Steel Disc.

*-2 Sets Required. † For Vee disc colours add RED, BLU, GRN, GLD, ORG suffix to part number.
 ⦿ - Also available as a Vintage Motorcycle Disc.

BRAKE APPLICATIONS

Non-JAPANESE Built Motorcycles

Line #	BRAKE DISC CHOICES - FRONT						DISC PAD CHOICES - REAR				BRAKE DISC CHOICES - REAR			
	Oversize 250 /280mm Disc Kit	OSX Oversize 250/280mm Disc Kit	Relocating Bracket for 250/ 280mm Disc	Oversize 320mm Disc Kit	SMX Oversize 320mm Disc Kit	Relocating Bracket for 320mm Disc	FA, SFA, TT Pad or Brake Shoe	SFAC Carbon Scooter Pads	Speciality Pads - SXR / Vee / MXS	Sintered/ HH Pads/ Grooved Shoes	Standard Replacement Disc	Contour Disc Rear fitment	Vee-Discs™ CONTOUR	CX Extreme MX Race Disc/ UTVX Disc
1														
2	OS6184HC	OSX6184HC	BRK010		SMX6184H	BRK007	FA208TT		MXS208	FA208R	MD6295D			
3														
4														
5	OS6184KC	OSX6184K	BRK011		SMX6184K	BRK012	FA208TT		MXS208	FA208R	MD6295D			
6														
7	OS6184HC	OSX6184HC	BRK010		SMX6184H	BRK007	FA368TT		MXS368	FA368R	MD6288D			
8														
9														
10	OS6184KC	OSX6184K	BRK011		SMX6184K	BRK012	FA368TT		MXS368	FA368R	MD6288D			
11	OS6184CK9	OSX6184K9	BRK013	SM6184CK9	SMX6184K9	BRK014	FA368TT		MXS368	FA368R		MD6288C		
12	OS6184CK9	OSX6184K9	BRK013	SM6184CK9	SMX6184K9	BRK014	FA368TT		MXS368	FA368R		MD6377C		
13	OS6184CK9	OSX6184K9	BRK013	SM6184CK9	SMX6184K9	BRK014	FA368TT		MXS368	FA368R		MD6377C		
14	OS6184CK9	OSX6184K9	BRK013	SM6184CK9	SMX6184K9	BRK014	FA368TT		MXS368	FA368R		MD6377C		
15	OS6932C	OSX6032E	BRK013		SMX6932	BRK014	FA368TT		MXS368	FA368R	MD6035CE ♦	MD6035C	MD6035CX	
16	OS6932C	OSX6032E	BRK013		SMX6932	BRK014	FA368TT		MXS368	FA368R	MD6035CE ♦	MD6035C	MD6035CX	
17														
18									801G					
19									802G					
20									802G					
21									802G					
22							FA251				MD6126D			
23							FA084TT		MXS084	FA084R	MD6126D			
24	OS6125C	OSX6125	BRK010	SM6125C	SMX6125	BRK007	FA208TT		MXS208	FA208R	MD6126D			
25														
26	OS6184HC	OSX6184HC	BRK010		SMX6184H	BRK007	FA208TT		MXS208	FA208R	MD6287D			
27														
28														
29	OS6184KC	OSX6184K	BRK011		SMX6184K	BRK012	FA208TT		MXS208	FA208R	MD6287D			
30														
31	OS6184HC	OSX6184HC	BRK010		SMX6184H	BRK007	FA208TT		MXS208	FA208R	MD6295D			
32														
33														
34	OS6184KC	OSX6184K	BRK011		SMX6184K	BRK012	FA208TT		MXS208	FA208R	MD6295D			
35														
36	OS6184HC	OSX6184HC	BRK010		SMX6184H	BRK007	FA208TT		MXS208	FA208R	MD6295D			
37														
38														
39	OS6184KC	OSX6184K	BRK011		SMX6184K	BRK012	FA208TT		MXS208	FA208R	MD6295D			
40														
41	OS6184HC	OSX6184HC	BRK010		SMX6184H	BRK007	FA208TT		MXS208	FA208R	MD6295D			
42														
43														
44	OS6184KC	OSX6184K	BRK011		SMX6184K	BRK012	FA208TT		MXS208	FA208R	MD6295D			
45									802G					
46									802G					
47									801G					
48									802G					
49							FA251				MD6126D			
50														
51	OS6184HC	OSX6184HC	BRK010		SMX6184H	BRK007	FA208TT		MXS208	FA208R	MD6295D			
52														
53														
54	OS6184KC	OSX6184K	BRK011		SMX6184K	BRK012	FA208TT		MXS208	FA208R	MD6295D			
55	OS6932C	OSX6032E	BRK013		SMX6932	BRK014	FA368TT		MXS368	FA368R	MD6035CE ♦	MD6035C	MD6035CX	
56	OS6932C	OSX6032E	BRK013		SMX6932	BRK014	FA368TT		MXS368	FA368R	MD6035CE ♦	MD6035C	MD6035CX	
57	OS6932C	OSX6032E	BRK013		SMX6932	BRK014	FA368TT		MXS368	FA368R	MD6035CE ♦	MD6035C	MD6035CX	
58							FA368TT		MXS368	FA368R	MD6035CE ♦	MD6035C	MD6035CX	
59	OS6184CK9	OSX6184K9	BRK013	SM6184CK9	SMX6184K9	BRK014	FA368TT		MXS368	FA368R		MD6288C		
60														

REAR / ARRIÈRE / HINTEN / POSTERIOR / POSTERIORE

*-2 Sets Required. † For Vee disc colours add RED, BLU, GRN, GLD, ORG suffix to part number.

⊗ - Also available as a Vintage Motorcycle Disc.

R Suffix = High Durability Sintered Pad. **HH** Suffix = High Performance Sintered Pad. **TT** Suffix = Hard Wearing Off Road Pad. **V** Suffix = Semi Sintered Pad. **G** Suffix = Grooved Shoe.
D Suffix = Drilled Disc. **X** Suffix = Universal Left or Right Disc. **XC** Suffix = Contoured Disc. **LS** Suffix = Left/Steel Disc. **RS** = Right/Steel Disc.

Non-JAPANESE Built Motorcycles

APPLICATIONS

BRAKE



HUSQVARNA Contd.

TE 310 (4T)	11-13
TE 310 R (4T)	13
FC 350 (4T)	14-20
FE 350 (4T) inc S model	14-20
FX 350 (4T)	18-20
TE 350	90-91
TE 350	92-94
TE 350	95-97
360 Automatic	75-77
CR 360	75-78
CR 360	92-94
WR 360	75-78
WR 360	92-94
WR 360	95-99
WR 360 (45mm diameter Marzocchi forks with 60mm caliper mount centres)	00-01
WR 360 (48mm diameter Marzocchi forks or 48mm diameter Kayaba forks with 95mm caliper mount centres)	00-01
WR 360 (45mm diameter Marzocchi forks with 60mm caliper mount centres)	02
WR 360 (48mm diameter Marzocchi forks or 48mm diameter Kayaba forks with 95mm caliper mount centres)	02
ACC 390	80-81
ACCE 390	80-81
CR 390	75-79
CR 390	80-81
CR 390 Automatic	78
WR 390	78
CR 400	71-74
SM 400 R	02
TE 400 (45mm diameter Marzocchi forks with 60mm caliper mount centres)	02
TE 400 (48mm diameter Marzocchi forks or 48mm diameter Kayaba forks with 95mm caliper mount centres)	02
WR 400	75-78
WR 400	87-88
Svartpilen 401 (4T)	18-20
Vitpilen 401 (4T)	18-20
TE 410	95-99
TE 410 (45mm diameter Marzocchi forks with 60mm caliper mount centres)	00
TE 410 (48mm diameter Marzocchi forks or 48mm diameter Kayaba forks with 95mm caliper mount centres)	00
TE 410 (45mm diameter Marzocchi forks with 60mm caliper mount centres)	06
TE 410 (48mm diameter Marzocchi forks or 48mm diameter Kayaba forks with 95mm caliper mount centres)	06
TE 410 E (45mm diameter Marzocchi forks with 60mm caliper mount centres)	00
TE 410 E (48mm diameter Marzocchi forks or 48mm diameter Kayaba forks with 95mm caliper mount centres)	00
430 Automatic	87-88
CR 430	80-81

FA, SFA, TT Pad or Brake Shoe	SFAC Carbon Scooter Pads	Speciality Pads SXR / Vee / MXS	Sintered/ HH Pads/ Grooved Shoes	BRAKE DISC CHOICES - FRONT							Line #
				Left / Gauche / Links Standard Replacement Disc	Right / Droite / Rechts Standard Replacement Disc	Contour Disc Universal left and right fitment	Universal Custom Disc	Vee-Discs Black † See note below	CX Extreme MX Race Disc/ UTVX Disc		
FA181TT		MXS181	FA181R				MD6184C				1
FA181TT		MXS181	FA181R				MD6184C				2
FA181TT		MXS181	FA181R				MD6032C			MD6032CX	3
FA181TT		MXS181	FA181R				MD6032C			MD6032CX	4
FA181TT		MXS181	FA181R				MD6032C			MD6032CX	5
FA134			FA134R								6
FA135TT		MXS135	FA135R	MD6125D							7
FA181TT		MXS181	FA181R	MD6125D							8
N/A											9
			801G								10
FA135TT		MXS135	FA135R	MD6125D							11
			801G								12
FA135TT		MXS135	FA135R	MD6125D							13
FA181TT		MXS181	FA181R	MD6125D							14
FA181TT		MXS181	FA181R	MD6184D			MD6184C				15
											16
											17
FA181TT		MXS181	FA181R	MD6184D			MD6184C				18
											19
FA181TT		MXS181	FA181R	MD6184D			MD6184C				20
											21
											22
FA181TT		MXS181	FA181R	MD6184D			MD6184C				23
											24
			801G								25
			801G								26
			801G								27
			801G								28
			801G								29
			801G								30
			801G								31
FA095			FA095HH	MD6293D							32
											33
FA181TT		MXS181	FA181R	MD6184D			MD6184C				34
											35
											36
FA181TT		MXS181	FA181R	MD6184D			MD6184C				37
			801G								38
FA134			FA134R								39
FA606			FA606HH								40
FA606			FA606HH								41
FA181TT		MXS181	FA181R	MD6125D							42
											43
FA181TT		MXS181	FA181R	MD6184D			MD6184C				44
											45
FA181TT		MXS181	FA181R	MD6184D			MD6184C				46
											47
FA181TT		MXS181	FA181R	MD6184D			MD6184C				48
											49
FA181TT		MXS181	FA181R	MD6184D			MD6184C				50
											51
FA181TT		MXS181	FA181R	MD6184D			MD6184C				52
											53
FA181TT		MXS181	FA181R	MD6184D			MD6184C				54
											55
FA181TT		MXS181	FA181R	MD6184D			MD6184C				56
											57
FA134			FA134R								58
			802G								59
											60

FRONT / AVANT / VORN / FRENTE / ANTERIORE

R Suffix = High Durability Sintered Pad. HH Suffix = High Performance Sintered Pad. TT Suffix = Hard Wearing Off Road Pad. V Suffix = Semi Sintered Pad. G Suffix = Grooved Shoe.

D Suffix = Drilled Disc. X Suffix = Universal Left or Right Disc. XC Suffix = Contoured Disc. LS Suffix = Left/Steel Disc. RS Suffix = Right/Steel Disc.

*-2 Sets Required. † For Vee disc colours add RED, BLU, GRN, GLD, ORG suffix to part number.

⊗ - Also available as a Vintage Motorcycle Disc.

272 Part numbers, prefixes, suffixes, photos and illustrations shown in this catalogue are trademarks and/or copyrights of EBC Brakes or the trademark owner A C Freeman Investments Ltd and use without express written permission of the owners is punishable by law.

Non-JAPANESE Built Motorcycles

Line #	BRAKE DISC CHOICES - FRONT						DISC PAD CHOICES - REAR				BRAKE DISC CHOICES - REAR			
	Oversize 250 /280mm Disc Kit	OSX Oversize 250/280mm Disc Kit	Relocating Bracket for 250/ 280mm Disc	Oversize 320mm Disc Kit	SMX Oversize 320mm Disc Kit	Relocating Bracket for 320mm Disc	FA, SFA, TT Pad or Brake Shoe	SFAC Carbon Scooter Pads	Speciality Pads - SXR / Vee / MXS	Sintered/ HH Pads/ Grooved Shoes	Standard Replacement Disc	Contour Disc Rear fitment	Vee-Discs™ CONTOUR	CX Extreme MX Race Disc/ UTVX Disc
1	OS6184CK9	OSX6184K9	BRK013	SM6184CK9	SMX6184K9	BRK014	FA368TT		MXS368	FA368R		MD6377C		
2	OS6184CK9	OSX6184K9	BRK013	SM6184CK9	SMX6184K9	BRK014	FA368TT		MXS368	FA368R		MD6377C		
3	OS6932C	OSX6932	BRK013		SMX6932	BRK014	FA368TT		MXS368	FA368R		MD6035C		MD6035CX
4	OS6932C	OSX6932	BRK013		SMX6932	BRK014	FA368TT		MXS368	FA368R	MD6035CE ⬇	MD6035C		MD6035CX
5							FA368TT		MXS368	FA368R	MD6035CE ⬆	MD6035C		MD6035CX
6							FA251				MD6126D			
7							FA084TT		MXS084	FA084R	MD6126D			
8	OS6125C	OSX6125	BRK010	SM6125C	SMX6125	BRK007	FA208TT		MXS208	FA208R	MD6126D			
9										801G				
10										801G				
11							FA084TT		MXS084	FA084R	MD6126D			
12										801G				
13							FA084TT		MXS084	FA084R	MD6126D			
14	OS6125C	OSX6125	BRK010	SM6125C	SMX6125	BRK007	FA208TT		MXS208	FA208R	MD6126D			
15														
16	OS6184HC	OSX6184HC	BRK010		SMX6184H	BRK007	FA208TT		MXS208	FA208R	MD6287D			
17														
18														
19	OS6184KC	OSX6184K	BRK011		SMX6184K	BRK012	FA208TT		MXS208	FA208R	MD6287D			
20														
21	OS6184HC	OSX6184HC	BRK010		SMX6184H	BRK007	FA208TT		MXS208	FA208R	MD6295D			
22														
23														
24	OS6184KC	OSX6184K	BRK011		SMX6184K	BRK012	FA208TT		MXS208	FA208R	MD6295D			
25										801G				
26										801G				
27										801G				
28										801G				
29										801G				
30										801G				
31										801G				
32							FA208TT		MXS208	FA208R	MD6295D			
33														
34	OS6184HC	OSX6184HC	BRK010		SMX6184H	BRK007	FA208TT		MXS208	FA208R	MD6295D			
35														
36														
37	OS6184KC	OSX6184K	BRK011		SMX6184K	BRK012	FA208TT		MXS208	FA208R	MD6295D			
38										801G				
39										802G				
40							FA208TT			FA208R				
41							FA208TT			FA208R				
42	OS6125C	OSX6125	BRK010	SM6125C	SMX6125	BRK007	FA208TT		MXS208	FA208R	MD6126D			
43														
44	OS6184HC	OSX6184HC	BRK010		SMX6184H	BRK007	FA208TT		MXS208	FA208R	MD6287D			
45														
46														
47	OS6184KC	OSX6184K	BRK011		SMX6184K	BRK012	FA208TT		MXS208	FA208R	MD6287D			
48														
49	OS6184HC	OSX6184HC	BRK010		SMX6184H	BRK007	FA368TT		MXS368	FA368R	MD6288D			
50														
51														
52	OS6184KC	OSX6184K	BRK011		SMX6184K	BRK012	FA368TT		MXS368	FA368R	MD6288D			
53														
54	OS6184HC	OSX6184HC	BRK010		SMX6184H	BRK007	FA208TT		MXS208	FA208R	MD6126D			
55														
56														
57	OS6184KC	OSX6184K	BRK011		SMX6184K	BRK012	FA208TT		MXS208	FA208R	MD6126D			
58										802G				
59										801G				
60														

REAR / ARRIÈRE / HINTEN / POSTERIOR / POSTERIORE

*-2 Sets Required. † For Vee disc colours add RED, BLU, GRN, GLD, ORG suffix to part number.

⊗ - Also available as a Vintage Motorcycle Disc.

R Suffix = High Durability Sintered Pad. **HH** Suffix = High Performance Sintered Pad. **TT** Suffix = Hard Wearing Off Road Pad. **V** Suffix = Semi Sintered Pad. **G** Suffix = Grooved Shoe.
D Suffix = Drilled Disc. **X** Suffix = Universal Left or Right Disc. **XC** Suffix = Contoured Disc. **LS** Suffix = Left/Steel Disc. **RS** = Right/Steel Disc.

Non-JAPANESE Built Motorcycles

APPLICATIONS

BRAKE



HUSQVARNA Contd.

R Suffix = High Durability Sintered Pad. HH Suffix = High Performance Sintered Pad. TT Suffix = Hard Wearing Off Road Pad. V Suffix = Semi-Sintered Pad. G Suffix = Grooved Shoe.

D Suffix = Drilled Disc. X Suffix = Universal Left or Right Disc. XC Suffix = Contoured Disc. LS Suffix = Left/Steel Disc. RS = Right/Steel Disc.

Model	Year
CR 430	87-88
WR 430	80-81
WR 430	87-88
WR-E 430	80-81
WR-E 430	82-84
WRU 430	82-84
XC 430	80-81
XC 430	87-88
SMR 449 (4T)	11
TC 449 (4T)	11-13
TE 449 (4T)	11-13
CR 450	71-74
FC 450 (4T)	14-20
FC 450 Rockstar Edition (4T)	19-20
FE 450 (4T)	14-20
FR 450 Rally (4T)	16-20
FS 450 (4T)	15-20
FX 450 (4T)	17-19
SM 450 R	03-06
SMR 450 RR (Radial caliper)	06-07
SM 450 R Radial caliper	07-10
SM 450 RR	08-10
TC 450 (45mm diameter Marzocchi forks with 60mm caliper mount centres)	03-04
TC 450 (48mm diameter Marzocchi forks or 48mm diameter Kayaba forks with 95mm caliper mount centres)	03-04
TC 450 (45mm diameter Marzocchi forks with 60mm caliper mount centres)	05-08
TC 450 (48mm diameter Marzocchi forks or 48mm diameter Kayaba forks with 95mm caliper mount centres)	05-08
TC 450 (45mm diameter Marzocchi forks with 60mm caliper mount centres)	09-10
TC 450 (48mm diameter Marzocchi forks or 48mm diameter Kayaba forks with 95mm caliper mount centres)	09-10
TE 450 (45mm diameter Marzocchi forks with 60mm caliper mount centres)	03-05
TE 450 (48mm diameter Marzocchi forks or 48mm diameter Kayaba forks with 95mm caliper mount centres)	03-05
TE 450 (45mm diameter Marzocchi forks with 60mm caliper mount centres)	06-08
TE 450 (48mm diameter Marzocchi forks or 48mm diameter Kayaba forks with 95mm caliper mount centres)	06-08
TE 450 (4T) (45mm diameter Marzocchi forks with 60mm caliper mount centres)	09-10
TE 450 (4T) (48mm diameter Marzocchi forks or 48mm diameter Kayaba forks with 95mm caliper mount centres)	09-10
WR 450	71-72
AE 500	82-84
CR 500	82-84
CR 500	85-86
CR 500	87-88
XC 500	82-84
XC 500	85-86

◆ Plain undrilled disc for enduro use MD6035CE

*-2 Sets Required. † For Vee disc colours add RED, BLU, GRN, GLD, ORG suffix to part number.

⊗ - Also available as a Vintage Motorcycle Disc.

FA, SFA, TT Pad or Brake Shoe	SFAC Carbon Scooter Pads	Speciality Pads SXR / Vee / MXS	Sintered/HH Pads/ Grooved Shoes	BRAKE DISC CHOICES - FRONT							Line #
				Left / Gauche / Links Standard Replacement Disc	Right / Droite / Rechts Standard Replacement Disc	Contour Disc Universal left and right fitment	Universal Custom Disc	Vee-Discs Black † See note below	CX Extreme MX Race Disc/ UTVX Disc		
FA134			FA134R								1
			802G								2
FA134			FA134R								3
			802G								4
			803G								5
			803G								6
			802G								7
FA134			FA134R								8
			FA322/4HH								9
FA181TT		MXS181	FA181R			MD6184C					10
FA181TT		MXS181	FA181R			MD6184C					11
			801G								12
FA181TT		MXS181	FA181R			MD6032C				MD6032CX	13
FA181TT		MXS181	FA181R			MD6032C				MD6032CX	14
FA181TT		MXS181	FA181R			MD6032C				MD6032CX	15
FA209/2			FA209/2HH	MD6032D		MD6032C				MD6032CX	16
			FA447HH	MD6032D		MD6032C				MD6032CX	17
FA181TT		MXS181	FA181R	MD6032D		MD6032C				MD6032CX	18
FA095			FA095HH	MD6293D							19
			FA322/4HH	MD6293D							20
			FA322/4HH	MD6293D							21
			FA322/4HH								22
											23
FA181TT		MXS181	FA181R	MD6184D		MD6184C					24
											25
FA181TT		MXS181	FA181R	MD6184D		MD6184C					26
											27
FA181TT		MXS181	FA181R	MD6184D		MD6184C					28
											29
FA181TT		MXS181	FA181R	MD6184D		MD6184C					30
											31
FA181TT		MXS181	FA181R	MD6184D		MD6184C					32
											33
FA181TT		MXS181	FA181R			MD6184C					34
											35
FA181TT		MXS181	FA181R			MD6184C					36
											37
FA181TT		MXS181	FA181R	MD6184D		MD6184C					38
											39
FA181TT		MXS181	FA181R	MD6184D		MD6184C					40
											41
FA181TT		MXS181	FA181R	MD6184D		MD6184C					42
											43
FA181TT		MXS181	FA181R	MD6184D		MD6184C					44
											45
FA181TT		MXS181	FA181R	MD6184D		MD6184C					46
											47
FA181TT		MXS181	FA181R			MD6184C					48
											49
FA181TT		MXS181	FA181R			MD6184C					50
											51
FA181TT		MXS181	FA181R			MD6184C					52
			801G								53
			803G								54
			803G								55
FA047TT			FA047R								56
FA134			FA134R								57
			803G								58
FA047TT			FA047R								59
											60

Non-JAPANESE Built Motorcycles

Line #	BRAKE DISC CHOICES - FRONT						DISC PAD CHOICES - REAR				BRAKE DISC CHOICES - REAR			
	Oversize 250 /280mm Disc Kit	OSX Oversize 250/280mm Disc Kit	Relocating Bracket for 250/ 280mm Disc	Oversize 320mm Disc Kit	SMX Oversize 320mm Disc Kit	Relocating Bracket for 320mm Disc	FA, SFA, TT Pad or Brake Shoe	SFAC Carbon Scooter Pads	Speciality Pads - SXR / Vee / MXS	Sintered/ HH Pads/ Grooved Shoes	Standard Replacement Disc	Contour Disc Rear fitment	Vee-Discs™ CONTOUR	CX Extreme MX Race Disc/ UTVX Disc
1									802G					
2									802G					
3									802G					
4									802G					
5									802G					
6									802G					
7									802G					
8									802G					
9							FA368TT	MXS368	FA368R					
10	OS6184CK9	OSX6184K9	BRK013	SM6184CK9	SMX6184K9	BRK014	FA368TT	MXS368	FA368R					
11	OS6184CK9	OSX6184K9	BRK013	SM6184CK9	SMX6184K9	BRK014	FA368TT	MXS368	FA368R					
12									801G					
13	OS6932C	OSX6932	BRK013		SMX6932	BRK014	FA368TT	MXS368	FA368R		MD6035C		MD6035CX	
14	OS6932C	OSX6032E	BRK013		SMX6932	BRK014	FA368TT	MXS368	FA368R		MD6035C		MD6035CX	
15	OS6932C	OSX6032E	BRK013		SMX6932	BRK014	FA368TT	MXS368	FA368R	MD6035CE ⬇	MD6035C		MD6035CX	
16	OS6932C	OSX6932	BRK013		SMX6932	BRK014	FA368TT	MXS368	FA368R		MD6035C		MD6035CX	
17	OS6932C	OSX6932	BRK013		SMX6932	BRK014	FA368TT	MXS368	FA368R		MD6035C		MD6035CX	
18	OS6932C	OSX6932	BRK013		SMX6932	BRK014	FA368TT	MXS368	FA368R		MD6035C		MD6035CX	
19							FA208TT	MXS208	FA208R	MD6295D				
20							FA368TT	MXS368	FA368R	MD6288D				
21							FA368TT	MXS368	FA368R	MD6288D				
22							FA368TT	MXS368	FA368R					
23														
24	OS6184HC	OSX6184HC	BRK010		SMX6184H	BRK007	FA208TT	MXS208	FA208R	MD6295D				
25														
26														
27	OS6184KC	OSX6184K	BRK011		SMX6184K	BRK012	FA208TT	MXS208	FA208R	MD6295D				
28														
29	OS6184HC	OSX6184HC	BRK010		SMX6184H	BRK007	FA368TT	MXS368	FA368R	MD6288D				
30														
31														
32	OS6184KC	OSX6184K	BRK011		SMX6184K	BRK012	FA368TT	MXS368	FA368R	MD6288D				
33														
34	OS6184HC	OSX6184HC	BRK010		SMX6184H	BRK007	FA368TT	MXS368	FA368R		MD6288C			
35														
36														
37	OS6184KC	OSX6184K	BRK011		SMX6184K	BRK012	FA368TT	MXS368	FA368R		MD6288C			
38														
39	OS6184HC	OSX6184HC	BRK010		SMX6184H	BRK007	FA208TT	MXS208	FA208R	MD6295D				
40														
41														
42	OS6184KC	OSX6184K	BRK011		SMX6184K	BRK012	FA208TT	MXS208	FA208R	MD6295D				
43														
44	OS6184HC	OSX6184HC	BRK010		SMX6184H	BRK007	FA368TT	MXS368	FA368R	MD6288D				
45														
46														
47	OS6184KC	OSX6184K	BRK011		SMX6184K	BRK012	FA368TT	MXS368	FA368R	MD6288D				
48														
49	OS6184HC	OSX6184HC	BRK010		SMX6184H	BRK007	FA368TT	MXS368	FA368R		MD6288C			
50														
51														
52	OS6184KC	OSX6184K	BRK011		SMX6184K	BRK012	FA368TT	MXS368	FA368R	MD6288C				
53									801G					
54									802G					
55									801G					
56									802G					
57									802G					
58									802G					
59									801G					
60														

REAR / ARRIÈRE / HINTEN / POSTERIOR / POSTERIORE

*-2 Sets Required. † For Vee disc colours add RED, BLU, GRN, GLD, ORG suffix to part number.

⊗ - Also available as a Vintage Motorcycle Disc.

R Suffix = High Durability Sintered Pad. HH Suffix = High Performance Sintered Pad. TT Suffix = Hard Wearing Off Road Pad. V Suffix = Semi Sintered Pad. G Suffix = Grooved Shoe.

D Suffix = Drilled Disc. X Suffix = Universal Left or Right Disc. XC Suffix = Contoured Disc. LS Suffix = Left/Steel Disc. RS = Right/Steel Disc.

Non-JAPANESE Built Motorcycles

APPLICATIONS

BRAKE



HUSQVARNA Contd.

		DISC PAD CHOICES - FRONT				BRAKE DISC CHOICES - FRONT						Line #	
		FA, SFA, TT Pad or Brake Shoe	SFAC Carbon Scooter Pads	Speciality Pads - SXR / Vee / MXS	Sintered/ HH Pads/ Grooved Shoes	Left / Gauche / Links Standard Replacement Disc	Right / Droite / Rechts Standard Replacement Disc	Contour Disc Universal left and right fitment	Universal Custom Disc	Vee-Discs Black † See note below	CX Extreme MX Race Disc/ UTVX Disc		
XC 500	87-88	FA134			FA134R								1
FE 501 (4T)	14-20	FA181TT		MXS181	FA181R			MD6032C				MD6032CX	2
SM 510 R	05	FA095			FA095HH	MD6293D							3
SM 510 R (Radial caliper)	06-10				FA322/4HH	MD6293D							4
TC 510	87-88	FA047TT			FA047R								5
TC 510	89-	FA134			FA134R								6
TC 510	1990	FA134			FA134R								7
TC 510 (45mm diameter Marzocchi forks with 60mm caliper mount centres)	04	FA181TT		MXS181	FA181R	MD6184D		MD6184C					8
TC 510 (48mm diameter Marzocchi forks or 48mm diameter Kayaba forks with 95mm caliper mount centres)	04	FA181TT		MXS181	FA181R	MD6184D		MD6184C					9
TC 510 (45mm diameter Marzocchi forks with 60mm caliper mount centres)	05-08	FA181TT		MXS181	FA181R	MD6184D		MD6184C					10
TC 510 (48mm diameter Marzocchi forks or 48mm diameter Kayaba forks with 95mm caliper mount centres)	05-08	FA181TT		MXS181	FA181R	MD6184D		MD6184C					11
TC 510	09	FA181TT		MXS181	FA181R								12
TE 510	87-88	FA047TT			FA047R								13
TE 510	89-	FA134			FA134R								14
TE 510	90	FA134			FA134R								15
TE 510 (45mm diameter Marzocchi forks with 60mm caliper mount centres)	04-05	FA181TT		MXS181	FA181R			MD6184C					16
TE 510 (48mm diameter Marzocchi forks or 48mm diameter Kayaba forks with 95mm caliper mount centres)	04-05	FA181TT		MXS181	FA181R	MD6184D		MD6184C					17
TE 510 (45mm diameter Marzocchi forks with 60mm caliper mount centres)	06-08	FA181TT		MXS181	FA181R	MD6184D		MD6184C					18
TE 510 (48mm diameter Marzocchi forks or 48mm diameter Kayaba forks with 95mm caliper mount centres)	06-08	FA181TT		MXS181	FA181R	MD6184D		MD6184C					19
TE 510 (45mm diameter Marzocchi forks with 60mm caliper mount centres)	09-10	FA181TT		MXS181	FA181R			MD6184C					20
TE 510 (48mm diameter Marzocchi forks or 48mm diameter Kayaba forks with 95mm caliper mount centres)	09-10	FA181TT		MXS181	FA181R			MD6184C					21
TX 510	87-88	FA047TT			FA047R								22
WMX 510	89	FA134			FA134R								23
WXE 510	89	FA134			FA134R								24
SMR 511	11-13				FA322/4HH								25
TE 511 (4T)	11-12	FA181TT		MXS181	FA181R								26
M 530 RR	08-10				FA322/4HH	MD6293D							27
SM 570 R (4 bolt front disc)	01	FA095			FA095HH	MD6293D							28
SM 570 R	02-04	FA095			FA095HH	MD6293D							29
TC 570 (45mm diameter Marzocchi forks with 60mm caliper mount centres)	02-03	FA181TT		MXS181	FA181R	MD6184D		MD6184C					30
TC 570 (48mm diameter Marzocchi forks or 48mm diameter Kayaba forks with 95mm caliper mount centres)	02-03	FA181TT		MXS181	FA181R	MD6184D		MD6184C					31
TE 570 (45mm diameter Marzocchi forks with 60mm caliper mount centres)	01	FA181TT		MXS181	FA181R	MD6184D		MD6184C					32
TE 570 (48mm diameter Marzocchi forks or 48mm diameter Kayaba forks with 95mm caliper mount centres)	01	FA181TT		MXS181	FA181R	MD6184D		MD6184C					33
TE 570 (45mm diameter Marzocchi forks with 60mm caliper mount centres)	02-04	FA181TT		MXS181	FA181R	MD6184D		MD6184C					34
TE 570 (48mm diameter Marzocchi forks or 48mm diameter Kayaba forks with 95mm caliper mount centres)	02-04	FA181TT		MXS181	FA181R	MD6184D		MD6184C					35
LT 610 (6 bolt front disc)	00	FA244			FA244HH	MD6294D							36
SM 610 (6 bolt front disc)	98-99	FA244			FA244HH	MD6294D							37

FRONT / AVANT / VORN / FREITE / ANTERIORE

R Suffix = High Durability Sintered Pad. HH Suffix = High Performance Sintered Pad. TT Suffix = Hard Wearing Off Road Pad. V Suffix = Semi Sintered Pad. G Suffix = Grooved Shoe.

D Suffix = Drilled Disc. X Suffix = Universal Left or Right Disc. XC Suffix = Contoured Disc. LS Suffix = Left/Steel Disc. RS Suffix = Right/Steel Disc.

*-2 Sets Required. † For Vee disc colours add RED, BLU, GRN, GLD, ORG suffix to part number.

⊗ - Also available as a Vintage Motorcycle Disc.

276 Part numbers, prefixes, suffixes, photos and illustrations shown in this catalogue are trademarks and/or copyrights of EBC Brakes or the trademark owner A C Freeman Investments Ltd and use without express written permission of the owners is punishable by law.

Non-JAPANESE Built Motorcycles

Line #	BRAKE DISC CHOICES - FRONT						DISC PAD CHOICES - REAR				BRAKE DISC CHOICES - REAR			
	Oversize 250 /280mm Disc Kit	OSX Oversize 250/280mm Disc Kit	Relocating Bracket for 250/ 280mm Disc	Oversize 320mm Disc Kit	SMX Oversize 320mm Disc Kit	Relocating Bracket for 320mm Disc	FA, SFA, TT Pad or Brake Shoe	SFAC Carbon Scooter Pads	Speciality Pads - SXR / Vee / MXS	Sintered/ HH Pads/ Grooved Shoes	Standard Replacement Disc	Contour Disc Rear fitment	Vee-Discs™ CONTOUR	CX Extreme MX Race Disc/ UTVX Disc
1									802G					
2	OS6932C	OSX6932	BRK013		SMX6932	BRK014	FA368TT		MXS368	FA368R	MD6035CE ⬇	MD6035C		MD6035CX
3							FA208TT		MXS208	FA208R	MD6295D			
4							FA368TT		MXS368	FA368R	MD6288D			
5									801G					
6									801G					
7							FA251				MD6126D			
8														
9	OS6184HC	OSX6184HC	BRK010		SMX6184H	BRK007	FA208TT		MXS208	FA208R	MD6295D			
10														
11														
12	OS6184KC	OSX6184K	BRK011		SMX6184K	BRK012	FA208TT		MXS208	FA208R	MD6295D			
13														
14	OS6184HC	OSX6184HC	BRK010		SMX6184H	BRK007	FA368TT		MXS208	FA368R	MD6288D			
15														
16														
17	OS6184KC	OSX6184K	BRK011		SMX6184K	BRK012	FA368TT		MXS368	FA368R	MD6288D			
18							FA368TT		MXS368	FA368R				
19									801G					
20									801G					
21							FA251				MD6126D			
22														
23	OS6184HC	OSX6184HC	BRK010		SMX6184H	BRK007	FA208TT		MXS208	FA208R	MD6295D			
24														
25														
26	OS6184KC	OSX6184K	BRK011		SMX6184K	BRK012	FA208TT		MXS208	FA208R	MD6295D			
27														
28	OS6184HC	OSX6184HC	BRK010		SMX6184H	BRK007	FA368TT		MXS368	FA368R	MD6288D			
29														
30	OS6184KC	OSX6184K	BRK011		SMX6184K	BRK012	FA368TT		MXS368	FA368R	MD6288D			
31														
32	OS6184HC	OSX6184HC	BRK010		SMX6184H	BRK007	FA368TT		MXS368	FA368R				
33														
34														
35	OS6184KC	OSX6184K	BRK011		SMX6184K	BRK012	FA368TT		MXS368	FA368R				
36									801G					
37									801G					
38									801G					
39							FA368TT		MXS368	FA368R				
40	OS6184CK9	OSX6184K9	BRK013	SM6184CK9	SMX6184K9	BRK014	FA368TT		MXS368	FA368R				
41							FA368TT		MXS368	FA368R				
42							FA368TT		MXS368	FA368R				
43							FA208TT		MXS208	FA208R	MD6287D			
44							FA208TT		MXS208	FA208R	MD6295D			
45	OS6184HC	OSX6184HC	BRK010		SMX6184H	BRK007	FA208TT		MXS208	FA208R	MD6295D			
46														
47														
48	OS6184KC	OSX6184K	BRK011		SMX6184K	BRK012	FA208TT		MXS208	FA208R	MD6295D			
49														
50	OS6184HC	OSX6184HC	BRK010		SMX6184H	BRK007	FA208TT		MXS208	FA208R	MD6287D			
51														
52														
53	OS6184KC	OSX6184K	BRK011		SMX6184K	BRK012	FA208TT		MXS208	FA208R	MD6287D			
54														
55	OS6184HC	OSX6184HC	BRK010		SMX6184H	BRK007	FA208TT		MXS208	FA208R	MD6287D			
56														
57														
58	OS6184KC	OSX6184K	BRK011		SMX6184K	BRK012	FA208TT		MXS208	FA208R	MD6287D			
59							FA208TT		MXS208	FA208R	MD6295D			
60							FA208TT		MXS208	FA208R	MD6126D			

REAR / ARRIÈRE / HINTEN / POSTERIOR / POSTERIORE

*-2 Sets Required. † For Vee disc colours add RED, BLU, GRN, GLD, ORG suffix to part number.

⬇ - Also available as a Vintage Motorcycle Disc.

R Suffix = High Durability Sintered Pad. HH Suffix = High Performance Sintered Pad. TT Suffix = Hard Wearing Off Road Pad. V Suffix = Semi Sintered Pad. G Suffix = Grooved Shoe.

D Suffix = Drilled Disc. X Suffix = Universal Left or Right Disc. XC Suffix = Contoured Disc. LS Suffix = Left/Steel Disc. RS = Right/Steel Disc.

BRAKE APPLICATIONS

Non-JAPANESE Built Motorcycles

APPLICATIONS

BRAKE



HUSQVARNA Contd.

SM 610 R (45mm diameter Marzocchi forks with 60mm caliper mount centres)	00
SM 610 R (48mm diameter Marzocchi forks or 48mm diameter Kayaba forks with 95mm caliper mount centres)	00
SM 610/S (4 bolt front disc)	02-06
SM 610 S (Radial caliper)	05
SM 610 IE	07-09
TC 610	91
TC 610	92-94
TC 610/E	95-99
TC 610 (45mm diameter Marzocchi forks with 60mm caliper mount centres)	00
TC 610 (48mm diameter Marzocchi forks or 48mm diameter Kayaba forks with 95mm caliper mount centres)	00
TE 610	91
TE 610	92-94
TE 610 (6 bolt fixing)	00
TE 610/E (6 bolt fixing)	95-99
TE 610/E (6 bolt fixing)	00
TE 610/E (6 bolt fixing)	03-04
TE 610/IE (45mm diameter Marzocchi forks with 60mm caliper mount centres)	06-09
TE 610/IE (48mm diameter Marzocchi forks or 48mm diameter Kayaba forks with 95mm caliper mount centres)	06-09
SMR 630	06
SMR 630 (4T)	10-12
STR 650 CRC	07
TE 630 (45mm diameter Marzocchi forks with 60mm caliper mount centres)	10-12
TE 630 (48mm diameter Marzocchi forks or 48mm diameter Kayaba forks with 95mm caliper mount centres)	10-12
TR 650 Terra (Spoke Wheel)	12-13
TR 650 Strada (Cast Wheel)	12-13
701 Enduro	16-20
701 Enduro LR	19-20
701 Supermoto	16-20
701 Vitpilen	18-20
701 Svartpilen	18-20
Nuda 900 (Inc ABS)	12-13
Nuda R 900 (Inc ABS)	12-13
HYOSUNG	
Eva Electric Scooter	13-14
50 Newtee Up (4T)	14-15
Super Cab/Cab Plus/Sense 50/Prima Avanti	99-06
SD 50	00-06
SF 50 R Rally Prima/Racing	00-06
STE3 (Electric Scooter)	10-11
TE 50	05-07
TE 90	05-07
EZ 100	99-05
SF 100 R	05-06
TE 100	05-07
FX 110 Midas - ECO/STD	99-02
FX 110 DLX Midas	99-04
KR 110 Master	04-05

DISC PAD CHOICES - FRONT				BRAKE DISC CHOICES - FRONT						Line #
FA, SFA, TT Pad or Brake Shoe	SFAC Carbon Scooter Pads	Speciality Pads SXR / Vee / MXS	Sintered/HH Pads/ Grooved Shoes	Left / Gauche / Links Standard Replacement Disc	Right / Droite / Rechts Standard Replacement Disc	Contour Disc Universal left and right fitment	Universal Custom Disc	Vee-Discs Black † See note below	CX Extreme MX Race Disc/ UTVX Disc	
FA244			FA244HH	MD6184D		MD6184C				1
										2
										3
										4
FA244			FA244HH	MD6184D		MD6184C				5
FA244			FA244HH	MD6293D						6
			FA322/4HH	MD6293D						7
			FA322/4HH	MD6293D						8
FA134			FA134R							9
FA135TT		MXS135	FA135R	MD6125D						10
FA181TT		MXS181	FA181R	MD6125D						11
										12
FA181TT		MXS181	FA181R	MD6184D		MD6184C				13
										14
FA181TT		MXS181	FA181R	MD6184D		MD6184C				15
FA134			FA134R							16
FA135TT		MXS135	FA135R	MD6125D						17
FA181TT		MXS181	FA181R	MD6125D						18
FA181TT		MXS181	FA181R	MD6125D						19
FA181TT		MXS181	FA181R	MD6125D						20
FA181TT		MXS181	FA181R	MD6125D						21
FA181TT		MXS181	FA181R	MD6125D						22
										23
FA181TT		MXS181	FA181R	MD6184D		MD6184C				24
										25
FA181TT		MXS181	FA181R	MD6184D		MD6184C				26
FA095			FA095HH	MD6293D						27
			FA322/4HH	MD6293D						28
			FA322/4HH	MD6293D						29
										30
FA181TT		MXS181	FA181R	MD6184D		MD6184C				31
										32
										33
FA181TT		MXS181	FA181R	MD6184D		MD6184C				34
FA209/2			FA209/2HH	MD834						35
FA209/2			FA209/2HH	MD834						36
FA209/2		FA209/2V	FA209/2HH	MD6299D		MD6299C				37
FA209/2			FA209/2HH	MD6299D		MD6299C				38
			FA322/4HH	MD6414D		MD6414C				39
FA244			FA244HH							40
FA244			FA244HH							41
FA244*			FA244HH*							42
			FA447HH*							43
										44
										45
SFA083	SFAC083		SFA083HH	TBA						46
SFA169	SFAC169		SFA169HH	MD904D						47
SFA083	SFAC083		SFA083HH	TBA						48
SFA083	SFAC083		SFA083HH	TBA						49
SFA083	SFAC083		SFA083HH	TBA						50
SFA083	SFAC083		SFA083HH	TBA						51
938*										52
938*										53
SFA083	SFAC083		SFA083HH	TBA						54
SFA083	SFAC083		SFA083HH	N/A						55
938*										56
S603										57
SFA083	SFAC083		SFA083HH	TBA						58
SFA083	SFAC083		SFA083HH	N/A						59
SFA083	SFAC083		SFA083HH	N/A						60

FRONT / AVANT / VORN / FRENTE / ANTERIORE

R Suffix = High Durability Sintered Pad. HH Suffix = High Performance Sintered Pad. TT Suffix = Hard Wearing Off Road Pad. V Suffix = Semi Sintered Pad. G Suffix = Grooved Shoe.

D Suffix = Drilled Disc. X Suffix = Universal Left or Right Disc. LS Suffix = Left/Steel Disc. RS = Right/Steel Disc.

*-2 Sets Required. † For Vee disc colours add RED, BLU, GRN, GLD, ORG suffix to part number.

⊗ - Also available as a Vintage Motorcycle Disc.

278 Part numbers, prefixes, suffixes, photos and illustrations shown in this catalogue are trademarks and/or copyrights of EBC Brakes or the trademark owner A C Freeman Investments Ltd and use without express written permission of the owners is punishable by law.

Non-JAPANESE Built Motorcycles

Line #	BRAKE DISC CHOICES - FRONT						DISC PAD CHOICES - REAR				BRAKE DISC CHOICES - REAR			
	Oversize 250 /280mm Disc Kit	OSX Oversize 250/280mm Disc Kit	Relocating Bracket for 250/ 280mm Disc	Oversize 320mm Disc Kit	SMX Oversize 320mm Disc Kit	Relocating Bracket for 320mm Disc	FA, SFA, TT Pad or Brake Shoe	SFAC Carbon Scooter Pads	Speciality Pads - SXR / Vee / MXS	Sintered/ HH Pads/ Grooved Shoes	Standard Replacement Disc	Contour Disc Rear fitment	Vee-Discs™ CONTOUR	CX Extreme MX Race Disc/ UTVX Disc
1														
2	OS6184HC	OSX6184HC	BRK010		SMX6184H	BRK007	FA208TT		MXS208	FA208R	MD6287D			
3														
4														
5	OS6184KC	OSX6184K	BRK011		SMX6184K	BRK012	FA208TT		MXS208	FA208R	MD6287D			
6							FA208TT		MXS208	FA208R	MD6287D			
7							FA208TT		MXS208	FA208R	MD6288D			
8							FA208TT		MXS208	FA208R	MD6295D			
9							FA251				MD6126D			
10							FA084TT	MXS084	FA084R		MD6126D			
11	OS6125C	OSX6125	BRK010	SM6125C	SMX6125	BRK007	FA208TT		MXS208	FA208R	MD6126D			
12														
13	OS6184HC	OSX6184HC	BRK010		SMX6184H	BRK007	FA208TT		MXS208	FA208R	MD6287D			
14														
15														
16	OS6184KC	OSX6184K	BRK011		SMX6184K	BRK012	FA208TT		MXS208	FA208R	MD6287D			
17							FA251				MD6126D			
18							FA084TT	MXS084	FA084R		MD6126D			
19	OS6125C	OSX6125	BRK010	SM6125C	SMX6125	BRK007	FA208TT		MXS208	FA208R	MD6287D			
20	OS6125C	OSX6125	BRK010	SM6125C	SMX6125	BRK007	FA208TT		MXS208	FA208R	MD6126D			
21	OS6125C	OSX6125	BRK010	SM6125C	SMX6125	BRK007	FA208TT		MXS208	FA208R	MD6126D			
22	OS6125C	OSX6125	BRK010	SM6125C	SMX6125	BRK007	FA208TT		MXS208	FA208R	MD6287D			
23														
24	OS6184HC	OSX6184HC	BRK010		SMX6184H	BRK007	FA208TT		MXS208	FA208R				
25														
26														
27	OS6184KC	OSX6184K	BRK011		SMX6184K	BRK012	FA208TT		MXS208	FA208R	MD6295D			
28							FA208TT		MXS208	FA208R	MD6295D			
29							FA208TT		MXS208	FA208R	MD6287D			
30							FA208TT		MXS208	FA208R	MD6295D			
31														
32	OS6184HC	OSX6184HC	BRK010		SMX6184H	BRK007	FA208TT		MXS208	FA208R	MD6287D			
33														
34														
35	OS6184KC	OSX6184K	BRK011		SMX6184K	BRK012	FA208TT		MXS208	FA208R	MD6287D			
36							FA213			FA213HH	MD651			
37							FA213	FA213V		FA213HH	MD651			
38							FA208TT		MXS208	FA208R		MD6417C		
39							FA208TT		MXS208	FA208R		MD6417C		
40							FA208TT		MXS208	FA208R	MD6415D	MD6415C		
41							FA208TT			FA208R				
42							FA208TT			FA208R				
43							FA213	FA213V	FA213HH		MD671			
44							FA213	FA213V	FA213HH		MD671			
45														
46														
47							SFA083	SFAC083		SFA083HH	TBA			
48							TBA							
49							TBA							
50							TBA							
51							TBA							
52							N/A							
53										FA282R	MD6301D			
54										FA282R	MD6301D			
55							TBA							
56							TBA							
57										FA282R	MD6301D			
58							S603							
59							S603							
60							S603							

REAR / ARRIÈRE / HINTEN / POSTERIORE

*-2 Sets Required. † For Vee disc colours add RED, BLU, GRN, GLD, ORG suffix to part number.

⊗ - Also available as a Vintage Motorcycle Disc.

R Suffix = High Durability Sintered Pad. HH Suffix = High Performance Sintered Pad. TT Suffix = Hard Wearing Off Road Pad. V Suffix = Semi Sintered Pad. G Suffix = Grooved Shoe. D Suffix = Drilled Disc. X Suffix = Universal Left or Right Disc. XC Suffix = Contoured Disc. LS Suffix = Left/Steel Disc. RS = Right/Steel Disc.

Non-JAPANESE Built Motorcycles

APPLICATIONS

BRAKE



HYOSUNG Contd.

GPS 125 Grand Prix/Hyper Rear drum model	99-04
GPS 125 Grand Prix Plus Rear disc model	00-04
Cruise II GA 125 F	99-06
Boomer/Exceed 125	02-03
Comet 125/250	04
Exceed 125 (MS1-125/150)	02-04
Comet GT 125 (Naked)	04-06
GT 125 Naked	03-06
GT 125 Naked	07-12
GT 125 i (Naked)	13-15
GT 125 R	06-14
GV 125 Aquilia	01-06
GV 125 Classic	07-15
RT Karion 125	02-07
RT 125 D Karion	08-15
MS1 125/150	05
MS3 (125cc)	07-09
RX 125	01-07
RX 125 D (XR)	08-11
RX 125 D (Karion)	07-11
XR 125 Enduro	00-06
XR 125 Supermoto	07-11
XR 125 LC Enduro	14-15
XR 125 LC Supermoto	14-15
Comet 250	02
Comet GT 250 (Naked)	04-05
GD 250 i Naked	13-15
GT 250 (Naked)	06-12
GT 250 i (Naked)	13-15
GT 250 R (Carbs)	05-07
GT 250 i R	08-13
GT 250 i R	14-15
GV 250 Aquilia	04-07
GV 250 i Classic	08-15
MS3 250i	07-09
RX 400	05
TE 450 Quad Rapier	06-09
Comet 600	02
Comet GT 650 (Naked)	04-06
Comet GT 650 (Naked)	07-08
GT 650 (Naked)	09-11
GT 650 i (Naked)	12-15
GT 650 R	07-08
GT 650 i R	09-13
GT 650 i R	14-15
GT 650 X	07
GT 650 S	05-08
GV 650 Aquilia (Carb)	04-06
GV 650 (EFI)	07-12
GV 650 i Pro (Naked)	12-15
GV 700 C	06-09
ST7 (ST 700 i)	10-15
ST7 Deluxe (ST 700 i)	12-15

FRONT / AVANT / VORN / FRENTE / ANTERIORE

DISC PAD CHOICES - FRONT				BRAKE DISC CHOICES - FRONT							Line #
FA, SFA, TT Pad or Brake Shoe	SFAC Carbon Scooter Pads	Speciality Pads SXR / Vee / MXS	Sintered/HH Pads/ Grooved Shoes	Left / Gauche / Links Standard Replacement Disc	Right / Droite / Rechts Standard Replacement Disc	Contour Disc Universal left and right fitment	Universal Custom Disc	Vee-Discs Black † See note below	CX Extreme MX Race Disc/ UTVX Disc	Line #	
SFA047			SFA047HH		N/A					1	
SFA047			SFA047HH		N/A					2	
FA056				N/A						3	
SFA047			SFA047HH		N/A					4	
FA086			FA086HH	N/A						5	
FA047			FA047HH	N/A						6	
FA086/2			FA086/2HH	MD690		MD690C				7	
FA086/2			FA086/2HH	MD690		MD690C				8	
FA086/2			FA086/2HH	MD690		MD690C				9	
FA086/2			FA086/2HH	MD690		MD690C				10	
FA086/2			FA086/2HH	MD690		MD690C				11	
FA086			FA086HH	N/A						12	
FA086/2			FA086/2HH	N/A						13	
FA086			FA086HH	TBA						14	
FA086/2			FA086/2HH	TBA						15	
SFA047			SFA047HH	N/A						16	
SFA197*	SFAC197*		SFA197HH*	MD9152D	MD9152D					17	
FA086			FA086HH	N/A						18	
FA086/2			FA086/2HH	N/A						19	
FA086/2			FA086/2HH	N/A						20	
FA086			FA086HH	N/A						21	
FA086/2			FA086/2HH	N/A						22	
FA054TT			FA054R							23	
FA054TT			FA054R							24	
FA129			FA129HH	N/A						25	
FA086			FA086HH	MD690		MD690C				26	
			FA296HH			N/A				27	
FA086/2			FA086/2HH	MD690		MD690C				28	
FA086/2			FA086/2HH	N/A						29	
FA086/2*			FA086/2HH*	MD690	MD690	MD690C*				30	
FA086/2*			FA086/2HH*	MD690	MD690	MD690C*				31	
FA086/2*			FA086/2HH*	MD690	MD690	MD690C*				32	
FA086			FA086HH	N/A						33	
FA086/2			FA086/2HH	N/A						34	
SFA197*	SFAC197*		SFA197HH*	MD9152D	MD9152D					35	
FA086			FA086HH	N/A						36	
FA054TT*		MXS054	FA054R*	N/A	N/A					37	
FA129			FA129HH	N/A						38	
FA086*			FA086HH*	TBA	TBA					39	
FA086/2*			FA086/2HH*	MD690	MD690	MD690C*				40	
			FA296HH*	MD690	MD690	MD690C*				41	
			FA296HH*	MD690	MD690	MD690C*				42	
FA086/2*			FA086/2HH*	MD690	MD690	MD690C*				43	
			FA296HH*	MD690	MD690	MD690C*				44	
			FA296HH*	MD690	MD690	MD690C*				45	
FA086*			FA086HH*	TBA	TBA					46	
FA086*			FA086HH*	MD690	MD690	MD690C*				47	
FA086*			FA086HH*	TBA	TBA					48	
FA086/2*			FA086/2HH*	MD691	MD691					49	
FA086/2*			FA086/2HH*	MD691	MD691					50	
FA086/2*			FA086/2HH*	MD691						51	
			FA296HH	MD691						52	
			FA296HH	MD691						53	
										54	
										55	
SFA115	SFAC115		SFA115HH	MD941D				VR941		56	
SFA115	SFAC115		SFA115HH	MD941D				VR941		57	
SFA115	SFAC115		SFA115HH	MD941D				VR941		58	
TBA						TBA				59	
SFA197	SFAC197		SFA197HH		N/A					60	

ITALJET

Dragster 50 LC	98-12
Formula 50 LC	96-03
Formula Air 50	99-03
IT 50 (4T)	08
50 it Scooter	09

*-2 Sets Required. † For Vee disc colours add RED, BLU, GRN, GLD, ORG suffix to part number.

⊗ - Also available as a Vintage Motorcycle Disc.

280 Part numbers, prefixes, suffixes, photos and illustrations shown in this catalogue are trademarks and/or copyrights of EBC Brakes or the trademark owner A C Freeman Investments Ltd and use without express written permission of the owners is punishable by law.

Non-JAPANESE Built Motorcycles

Line #	BRAKE DISC CHOICES - FRONT						DISC PAD CHOICES - REAR				BRAKE DISC CHOICES - REAR			
	Oversize 250 /280mm Disc Kit	OSX Oversize 250/280mm Disc Kit	Relocating Bracket for 250/ 280mm Disc	Oversize 320mm Disc Kit	SMX Oversize 320mm Disc Kit	Relocating Bracket for 320mm Disc	FA, SFA, TT Pad or Brake Shoe	SFAC Carbon Scooter Pads	Speciality Pads - SXR / Vee / MXS	Sintered/ HH Pads/ Grooved Shoes	Standard Replacement Disc	Contour Disc Rear fitment	Vee-Discs™ CONTOUR	CX Extreme MX Race Disc/ UTVX Disc
1							897							
2							SFA086			SFA086HH	N/A			
3							S602							
4							TBA				N/A			
5							FA086			FA086HH	N/A			
6							FA086			FA086HH	N/A			
7							FA086/2			FA086/2HH	MD689	MD689C		
8							FA086/2			FA086/2HH	MD689	MD689C		
9							FA086/2			FA086/2HH	MD689	MD689C		
10							FA086/2			FA086/2HH	MD689	MD689C		
11							FA086/2			FA086/2HH	MD689	MD689C		
12							S602							
13							S602							
14							S602							
15							S602							
16							TBA							
17							SFA197	SFAC197		SFA197HH	TBA			
18							S602							
19							S602							
20							S602							
21							S602							
22							FA165/2TT			FA165/2R	N/A			
23							FA083TT			FA083R				
24							FA083TT			FA083R				
25							FA063			FA063HH	TBA			
26							FA086			FA086HH	MD689	MD689C		
27							FA298			SFA298HH		N/A		
28							FA086/2			FA086/2HH	MD689	MD689C		
29							FA298			SFA298HH	N/A			
30							FA086/2			FA086/2HH	MD689	MD689C		
31							FA086/2			FA086/2HH	MD689	MD689C		
32							FA298			SFA298HH	MD689	MD689C		
33							S606							
34							S606							
35							SFA197	SFAC197		SFA197HH	N/A			
36							FA131TT				N/A			
37							FA054TT			FA054R	N/A			
38							FA063			FA063HH	TBA			
39							FA086			FA086HH	MD689			
40							FA086/2			FA086/2HH	MD689	MD689C		
41							FA086/2			FA086/2HH	MD689	MD689C		
42							FA086/2			FA086/2HH	MD689	MD689C		
43							FA086/2			FA086/2HH	MD689	MD689C		
44							FA086/2			FA086/2HH	MD689	MD689C		
45							FA298			SFA298HH	MD689	MD689C		
46							FA086			FA086HH	MD689	MD689C		
47							FA086			FA086HH	MD689	MD689C		
48							FA319/2			FA319/2HH	N/A			
49							FA086/2			FA086/2HH	N/A			
50							FA086/2			FA086/2HH	N/A			
51							FA086/2			FA086/2HH	TBA			
52							FA086/2			FA086/2HH	N/A			
53							FA086/2			FA086/2HH	N/A			
54														
55														
56							SFA115	SFAC115		SFA115HH	MD948D			
57							SFA115	SFAC115		SFA115HH	MD950D			
58							S624							
59							TBA							
60							TBA							

REAR / ARRIÈRE / HINTEN / POSTERIOR / POSTERIORE

*-2 Sets Required. † For Vee disc colours add RED, BLU, GRN, GLD, ORG suffix to part number.

⊗ - Also available as a Vintage Motorcycle Disc.

R Suffix = High Durability Sintered Pad. HH Suffix = High Performance Sintered Pad. TT Suffix = Hard Wearing Off Road Pad. V Suffix = Semi Sintered Pad. G Suffix = Grooved Shoe.

D Suffix = Drilled Disc. X Suffix = Universal Left or Right Disc. XC Suffix = Contoured Disc. LS Suffix = Left/Steel Disc. RS = Right/Steel Disc.

BRAKE APPLICATIONS

Non-JAPANESE Built Motorcycles

Line #	BRAKE DISC CHOICES - FRONT						DISC PAD CHOICES - REAR				BRAKE DISC CHOICES - REAR			
	Oversize 250 /280mm Disc Kit	OSX Oversize 250/280mm Disc Kit	Relocating Bracket for 250/ 280mm Disc	Oversize 320mm Disc Kit	SMX Oversize 320mm Disc Kit	Relocating Bracket for 320mm Disc	FA, SFA, TT Pad or Brake Shoe	SFAC Carbon Scooter Pads	Speciality Pads - SXR / Vee / MXS	Sintered/ HH Pads/ Grooved Shoes	Standard Replacement Disc	Contour Disc Rear fitment	Vee-Discs™ CONTOUR	CX Extreme MX Race Disc/ UTVX Disc
1							816							
2							FA448				N/A			
3							TBA							
4							TBA							
5							TBA							
6							S624							
7							S624							
8							965		965G					
9							816							
10							SFA115	SFAC115		SFA115HH	MD949D			
11							SFA115	SFAC115		SFA115HH	MD950D			
12							SFA260	SFAC260		SFA260HH	N/A			
13							SFA323	SFAC323		SFA323HH	TBA			
14							816							
15							SFA275	SFAC275		SFA275HH	MD953D			
16							Y527							
17							Y527							
18							FA448				N/A			
19							FA115				N/A			
20							816							
21							S624							
22							SFA115	SFAC115		SFA115HH	MD949D			
23							SFA374				MD953D			
24							SFA298	SFAC298		SFA298HH	N/A			
25							FA086			FA086HH	N/A			
26							FA086			FA086HH	N/A			
27							FA209/2		FA209/2V		TBA			
28														
29														
30														
31														
32							N/A*			FA609R*	N/A			
33							N/A*			FA609R*	N/A			
34							N/A*			FA609R*	N/A			
35							N/A*			FA609R*	N/A			
36							N/A*			FA609R*	N/A			
37							N/A*			FA609R*	N/A			
38														
39														
40														
41							TBA							
42							TBA							
43							TBA							
44							TBA							
45							TBA							
46							TBA							
47														
48														
49							FA337TT			FA337R	N/A			
50														
51														
52							FA115			FA115R	N/A			
53							N/A							
54														
55														
56							FA317TT			FA317R	MD6225D			
57														
58							FA317TT			FA317R	MD6225D			
59														
60										FA398R*	N/A*			

REAR / ARRIÈRE / HINTEN / POSTERIOR / POSTERIORE

*-2 Sets Required. † For Vee disc colours add RED, BLU, GRN, GLD, ORG suffix to part number.

⊗ - Also available as a Vintage Motorcycle Disc.

R Suffix = High Durability Sintered Pad. **HH** Suffix = High Performance Sintered Pad. **TT** Suffix = Hard Wearing Off Road Pad. **V** Suffix = Semi Sintered Pad. **G** Suffix = Grooved Shoe.
D Suffix = Drilled Disc. **X** Suffix = Universal Left or Right Disc. **XC** Suffix = Contoured Disc. **LS** Suffix = Left/Steel Disc. **RS** = Right/Steel Disc.

Non-JAPANESE Built Motorcycles

Line #	BRAKE DISC CHOICES - FRONT						DISC PAD CHOICES - REAR				BRAKE DISC CHOICES - REAR			
	Oversize 250 /280mm Disc Kit	OSX Oversize 250/280mm Disc Kit	Relocating Bracket for 250/ 280mm Disc	Oversize 320mm Disc Kit	SMX Oversize 320mm Disc Kit	Relocating Bracket for 320mm Disc	FA, SFA, TT Pad or Brake Shoe	SFAC Carbon Scooter Pads	Speciality Pads - SXR / Vee / MXS	Sintered/ HH Pads/ Grooved Shoes	Standard Replacement Disc	Contour Disc Rear fitment	Vee-Discs™ CONTOUR	CX Extreme MX Race Disc/ UTVX Disc
1									FA398R*	N/A*				
2									FA398R*	N/A*				
3									FA398R*	N/A*				
4									FA398R*	N/A*				
5									FA398R*	N/A*				
6									FA398R*	N/A*				
7														
8									FA609R*	N/A*				
9									FA609R*	N/A*				
10									FA609R*	N/A*				
11									FA609R*	N/A*				
12									FA609R*	N/A*				
13									FA609R*	N/A*				
14														
15														
16							TBA							
17							TBA							
18							TBA							
19							TBA							
20							TBA							
21							TBA							
22							TBA							
23							TBA							
24							TBA							
25							FA165TT		FA165R	N/A				
26							FA165TT		FA165R	N/A				
27							SFA086	SFAC086	SFA086HH	N/A				
28							FA165TT		FA165R	N/A				
29							SFA086	SFAC086	SFA086HH	N/A				
30							TBA			TBA				
31														
32														
33							Y503							
34							FA232TT		FA232R	N/A				
35							FA232TT		FA232R	N/A				
36							TBA			TBA				
37							TBA			TBA				
38														
39														
40							TBA							
41							TBA							
42							TBA							
43							TBA							
44														
45														
46							FA416TT		FA416R	N/A				
47							H330		H330G					
48														
49														
50							Y503							
51							Y503							
52							Y503							
53							Y503							
54							Y503							
55							SFA083	SFAC083			N/A			
56							Y503							
57							Y503							
58							Y503							
59							Y503							
60							Y503							

REAR / ARRIÈRE / HINTEN / POSTERIOR / POSTERIORE

*-2 Sets Required. † For Vee disc colours add RED, BLU, GRN, GLD, ORG suffix to part number.

⊗ - Also available as a Vintage Motorcycle Disc.

R Suffix = High Durability Sintered Pad. **HH** Suffix = High Performance Sintered Pad. **TT** Suffix = Hard Wearing Off Road Pad. **V** Suffix = Semi Sintered Pad. **G** Suffix = Grooved Shoe.
D Suffix = Drilled Disc. **X** Suffix = Universal Left or Right Disc. **XC** Suffix = Contoured Disc. **LS** Suffix = Left/Steel Disc. **RS** = Right/Steel Disc.

Non-JAPANESE Built Motorcycles

APPLICATIONS

BRAKE



KEEWAY Contd.



R Suffix = High Durability Sintered Pad. HH Suffix = High Performance Sintered Pad. TT Suffix = Hard Wearing Off Road Pad. V Suffix = Semi Sintered Pad. G Suffix = Grooved Shoe.

D Suffix = Drilled Disc. X Suffix = Universal Left or Right Disc. XC Suffix = Contoured Disc. LS Suffix = Left/Steel Disc. RS = Right/Steel Disc.

Model	Year
Flash 50 Electric	09-10
Goccia 50 (2T/4T)	08-15
Hacker 50	08-09
Hurricane 50	07-14
Hurricane 50 Base	07
Matrix 50 (2T)	06-12
Matrix V4 50 (25/45)	10-11
Milan 50	10-11
Pixel 50	08-12
RY6 50cc (25/45)	10-15
RY8 50cc (All models)	07-09
RY8 Racing 50cc (25/45)	10-11
RY8 SP 50cc (25/45)	10-11
Swan 50 (25/45)	10-11
TX 50	10-12
X-Ray 50 Supermoto	07-09
50 Zahara (2T/4T)	13-14
110 Kee	12-14
Partner 110	06-07
110 Target	13-14
ARN 125	06-12
Cityblade 125	13-14
Cityblade 125 Euro 4	16-19
F-Act 125	07-11
Focus 125	06-07
Hacker 125	08-10
Hacker 125	11-12
K2 125/150/250	07
125 Link	13-14
125 Logjik	13-14
125 Logjik	17-19
Matrix 125	06
Matrix 125	07-10
Outlook 125/150	07-10
Outlook Sport 125	10-11
RKS 125	10-11
RKS 125	12-15
RKV 125	10-15
RKV 125 Euro 4	16-19
Silverblade 125/150/250	07
Silverblade 125	10-11
125i Silverblade	Left 13-15
	Right 13-15
Speed 125/150	07-12
125 New Strike	13-14
125 Strike	13-14
Superlight Ltd 125	07-15
Superlight 125 Euro 4	17-19
125 Target	13-15
TX 125	10-12
TX 125 TXM	16-19
TX 125 SM (17" F/Wheel)	13-14
125 Zahara (2T/4T)	13-15
ARN 150	06-09
Cityblade 150	13-15
F-Act 150	07-10
Hacker 150	08-10
150 Link	13-14
150 Logjik	13-15
Matrix 150	07-10

FRONT / AVANT / VORN / FRENTE / ANTERIORE

DISC PAD CHOICES - FRONT				BRAKE DISC CHOICES - FRONT							Line #
FA, SFA, TT Pad or Brake Shoe	SFAC Carbon Scooter Pads	Speciality Pads SXR / Vee / MXS	Sintered/HH Pads/ Grooved Shoes	Left / Gauche / Links Standard Replacement Disc	Right / Droite / Rechts Standard Replacement Disc	Contour Disc Universal left and right fitment	Universal Custom Disc	Vee-Discs Black † See note below	CX Extreme MX Race Disc/ UTVX Disc	Line #	
SFA235	SFAC235				TBA					1	
SFA193	SFAC193		SFA193HH		N/A					2	
SFA047			SFA047HH		N/A					3	
SFA083	SFAC083		SFA083HH		TBA					4	
SFA083	SFAC083		SFA083HH		TBA					5	
SFA235	SFAC235				N/A					6	
SFA235	SFAC235				N/A					7	
TBA										8	
SFA083	SFAC083		SFA083HH		N/A					9	
SFA235	SFAC235					N/A				10	
SFA235	SFAC235				TBA					11	
SFA235	SFAC235					N/A				12	
SFA235	SFAC235					N/A				13	
SFA235	SFAC235				N/A					14	
FA194			FA194HH			N/A				15	
FA194			FA194HH		N/A					16	
SFA086	SFAC086		SFA086HH		N/A					17	
SFA086	SFAC086		SFA086HH			N/A				18	
SFA228	SFAC228		SFA228HH			N/A				19	
TBA						N/A				20	
SFA047			SFA047HH		TBA					21	
SFA228	SFAC228		SFA228HH			N/A				22	
FA707		FA707V								23	
SFA235	SFAC235				N/A					24	
SFA235	SFAC235				TBA					25	
SFA047			SFA047HH		N/A					26	
TBA					N/A					27	
SFA353	SFAC353		SFA353HH		TBA					28	
SFA086	SFAC086		SFA086HH		N/A					29	
SFA228	SFAC228		SFA228HH		N/A					30	
FA707		FA707V								31	
SFA083	SFAC083		SFA083HH		N/A					32	
SFA235	SFAC235				TBA					33	
SFA228	SFAC228		SFA228HH		N/A					34	
TBA					N/A					35	
FA086			FA086HH			N/A				36	
FA197			FA197HH			N/A				37	
FA658		FA658V	FA658HH			N/A				38	
FA707		FA707V								39	
SFA181*	SFAC181*		SFA181HH*		TBA	TBA				40	
SFA197	SFAC197		SFA197HH			N/A				41	
SFA228	SFAC228		SFA228HH		N/A	N/A				42	
SFA197	SFAC197		SFA197HH							43	
SFA093					N/A					44	
Y506										45	
FA086			FA086HH		N/A					46	
FA228			FA228HH		TBA					47	
FA707		FA707V								48	
TBA						N/A				49	
FA194			FA194HH			N/A				50	
FA707		FA707V								51	
FA194			FA194HH				N/A			52	
SFA086	SFAC086		SFA086HH		N/A					53	
SFA047			SFA047HH		N/A					54	
SFA228	SFAC228		SFA228HH			N/A				55	
SFA235	SFAC235				N/A					56	
SFA047			SFA047HH		N/A					57	
SFA086	SFAC086		SFA086HH		N/A					58	
SFA228	SFAC228		SFA228HH		N/A					59	
SFA235	SFAC235				N/A					60	

*-2 Sets Required. † For Vee disc colours add RED, BLU, GRN, GLD, ORG suffix to part number.

⊗ - Also available as a Vintage Motorcycle Disc.

286 Part numbers, prefixes, suffixes, photos and illustrations shown in this catalogue are trademarks and/or copyrights of EBC Brakes or the trademark owner A C Freeman Investments Ltd and use without express written permission of the owners is punishable by law.

Non-JAPANESE Built Motorcycles

Line #	BRAKE DISC CHOICES - FRONT						DISC PAD CHOICES - REAR				BRAKE DISC CHOICES - REAR			
	Oversize 250 /280mm Disc Kit	OSX Oversize 250/280mm Disc Kit	Relocating Bracket for 250/ 280mm Disc	Oversize 320mm Disc Kit	SMX Oversize 320mm Disc Kit	Relocating Bracket for 320mm Disc	FA, SFA, TT Pad or Brake Shoe	SFAC Carbon Scooter Pads	Speciality Pads - SXR / Vee / MXS	Sintered/ HH Pads/ Grooved Shoes	Standard Replacement Disc	Contour Disc Rear fitment	Vee-Discs™ CONTOUR	CX Extreme MX Race Disc/ UTVX Disc
1							Y503							
2							Y503							
3							Y503							
4							Y503							
5							Y503							
6							Y503							
7							Y503							
8							TBA							
9							Y503							
10							Y503							
11							Y503							
12							TBA				N/A			
13							Y503							
14							Y503							
15							FA060			N/A				
16							FA060			N/A				
17							Y503							
18							Y506							
19							TBA							
20							Y506							
21							Y503							
22							SFA298	SFAC298		SFA298HH		N/A		
23							FA298							
24							Y503							
25							Y506							
26							TBA							
27							TBA			TBA				
28							SFA353	SFAC353		SFA353HH	TBA			
29							SFA086	SFAC086		SFA086HH	N/A			
30							SFA228	SFAC228		SFA228HH	N/A			
31							TBA							
32							Y506							
33							Y506							
34							SFA228	SFAC228		SFA228HH	N/A			
35							TBA			TBA				
36							Y506							
37							Y506							
38							FA298				N/A			
39							FA197							
40							SFA266	SFAC266		SFA266HH	TBA			
41							SFA197	SFAC197		SFA197HH	N/A			
42							SFA197	SFAC197		SFA197HH	N/A			
43														
44							SFA093				N/A			
45							Y506							
46							Y506							
47							Y516							
48							FA698		FA698V					
49							Y506							
50							FA060			N/A				
51							FA298							
52							FA298			SFA298HH		N/A		
53							Y503							
54							Y506							
55							SFA260	SFAC260		SFA260HH		N/A		
56							Y506							
57							TBA							
58							SFA086	SFAC086		SFA086HH	N/A			
59							SFA228	SFAC228		SFA228HH	N/A			
60							Y506							

REAR / ARRIÈRE / HINTEN / POSTERIOR / POSTERIORE

*-2 Sets Required. † For Vee disc colours add RED, BLU, GRN, GLD, ORG suffix to part number.

⊗ - Also available as a Vintage Motorcycle Disc.

R Suffix = High Durability Sintered Pad. **HH** Suffix = High Performance Sintered Pad. **TT** Suffix = Hard Wearing Off Road Pad. **V** Suffix = Semi Sintered Pad. **G** Suffix = Grooved Shoe.
D Suffix = Drilled Disc. **X** Suffix = Universal Left or Right Disc. **XC** Suffix = Contoured Disc. **LS** Suffix = Left/Steel Disc. **RS** = Right/Steel Disc.

Part numbers, prefixes, suffixes, photos and illustrations shown in this catalogue are trademarks and/or copyrights of EBC Brakes or the trademark owner A C Freeman Investments Ltd and use without express written permission of the owners is punishable by law.

Non-JAPANESE Built Motorcycles



KEEWAY Contd.



R Suffix = High Durability Sintered Pad. **HH** Suffix = High Performance Sintered Pad. **TT** Suffix = Hard Wearing Off Road Pad. **V** Suffix = Semi-Sintered Pad. **G** Suffix = Grooved Shoe.

D Suffix = Drilled Disc. **X** Suffix = Universal Left or Right Disc. **XC** Suffix = Contoured Disc. **LS** Suffix = Left/Steel Disc. **RS** = Right/Steel Disc.

RKS 150	12-14
RKX 150	13-14
RKV 150	13-15
Superlight 150	07-12
150 New Strike	13-14
150 Strike	13-14
KXM 200	14
KXV 200	14
200 Link	13-14
RKS 200	12-14
RKX 200	13-14
RKV 200S	14
RKV 200S Factory	14
200 New Strike	13-14
TX 200 (19" F/Wheel)	13-14
250i Blackster	14-15
Cruiser 250i	09-14
Dragon 250 Quad	07-09
250i Silverblade	Left 13-15 Right 13-15
GTX 300 Quad	10-11
350i Index	13-15
KIOTI/MECHRON (Side x Side)	
2200 UTV (Side x Side)	09-14
2200 UTV (Side x Side) - Parking brake	09-14
2200 PS UTV (Side x Side)	14-15
2200 PS UTV (Side x Side) - Parking brake	14-15
2210 UTV (Side x Side)	11-14
2210 UTV (Side x Side) - Parking brake	11-14
2240 UTV (Side x Side)	14-15
2240 UTV (Side x Side) - Parking brake	14-15
K.M. (Keemotorbikes)	
Badboy 50 CX	05
Badboy 100 CX	05
KRAM-IT (KRAMER)	
MC 125 LC	
EP 250/EC 250	
GS 250	00-
MC 250/MC 250 LC	
SM 250	00-
SMR 250	00-
EC 450/MC 450	
MC 500	
ER 125/250/300 RV3	88-
ER 500/600	96-
KREIDLER	
e-Florett 3.00 (4.0KW)	14-15
e-Florett 1.00 (3.0KW)	14-15
Florett City (50cc/2T/A-C)	14-15
Florett 2.1 RS (50cc/2T/A-C)	14-15
Galactica 3.0 LC (50cc/2T/L-C)	14-15
Galactica 3.0 RS (50cc/2T/A-C)	14-15
50 MF2	
50 MF4 Early Models	
50 MF4 Later Models	
50 Flory MF 40147	

FA, SFA, TT Pad or Brake Shoe	DISC PAD CHOICES - FRONT			BRAKE DISC CHOICES - FRONT						Line #
	SFAC Carbon Scooter Pads	Semi-Sintered V-Pads™	Sintered/HH Pads/Grooved Shoes	Left / Gauche / Links Standard Replacement Disc	Right / Droite / Rechts Standard Replacement Disc	Contour Disc Universal left and right fitment	Universal Custom Disc	Vee-Discs Black † See note below	CX Extreme MX Race Disc	
FA197			FA197HH		N/A					1
FA658		FA658V	FA658HH			N/A				2
FA658		FA658V	FA658HH			N/A				3
FA228			FA228HH	TBA						4
Y506										5
FA086			FA086HH	N/A						6
FA181TT			FA181R							7
FA181TT			FA181R							8
SFA086	SFAC086		SFA086HH	N/A						9
FA197			FA197HH		N/A					10
FA658		FA658V	FA658HH			N/A				11
FA658		FA658V	FA658HH			N/A				12
FA658		FA658V	FA658HH			N/A				13
Y506										14
FA194			FA194HH			N/A				15
FA228			FA228HH	N/A						16
FA228			FA228HH	TBA						17
FA083TT*			FA083R*	N/A	N/A					18
SFA228	SFAC228		SFA228HH	N/A	N/A					19
SFA197	SFAC197		SFA197HH							20
FA483TT*			FA483R*	N/A	N/A					21
SFA228	SFAC228		SFA228HH	N/A						22
										23
										24
FA622TT*			FA622R*	TBA	TBA					25
FA659TT										26
FA622TT*			FA622R*	TBA	TBA					27
FA659TT										28
FA622TT*			FA622R*	TBA	TBA					29
FA659TT										30
FA622TT*			FA622R*	TBA	TBA					31
FA659TT										32
										33
										34
SFA235	SFAC235			N/A						35
SFA235	SFAC235			N/A						36
										37
										38
										39
										40
FA181TT		MXS181	FA181R	N/A						41
										42
FA181TT		MXS181	FA181R	N/A						43
TBA										44
										45
										46
FA134			FA134R	N/A						47
FA134			FA134R	N/A						48
										49
										50
SFA086	SFAC086		SFA086HH	N/A						51
SFA086	SFAC086		SFA086HH	N/A						52
SFA235	SFAC235			MD943D		MD943C		VR943		53
SFA235	SFAC235			MD943D		MD943C		VR943		54
SFA086	SFAC086		SFA086HH			N/A				55
SFA086	SFAC086		SFA086HH			N/A				56
H322										57
908										58
H322										59
932										60

FRONT / AVANT / VORN / FRENTE / ANTERIORE

*-2 Sets Required. † For Vee disc colours add RED, BLU, GRN, GLD, ORG suffix to part number. ■ - Also available in MX-S race compound. ● - Also available as a Vintage Motorcycle Disc.

Non-JAPANESE Built Motorcycles

Line #	BRAKE DISC CHOICES - FRONT						DISC PAD CHOICES - REAR				BRAKE DISC CHOICES - REAR			
	Oversize 250 /280mm Disc Kit	OSX Oversize 250/280mm Disc Kit	Relocating Bracket for 250/ 280mm Disc	Oversize 320mm Disc Kit	SMX Oversize 320mm Disc Kit	Relocating Bracket for 320mm Disc	FA, SFA, TT Pad or Brake Shoe	SFAC Carbon Scooter Pads	Speciality Pads - SXR / Vee / MXS	Sintered/ HH Pads/ Grooved Shoes	Standard Replacement Disc	Contour Disc Rear fitment	Vee-Discs™ CONTOUR	CX Extreme MX Race Disc/ UTVX Disc
1							Y506							
2							FA298					N/A		
3							FA298					N/A		
4							Y516							
5							Y506							
6							Y506							
7							FA298		SFA298HH			N/A		
8							FA298		SFA298HH			N/A		
9							FA086		FA086HH	N/A				
10							Y506							
11							FA298					N/A		
12							FA298					N/A		
13							FA298					N/A		
14							Y506							
15							FA298		SFA298HH			N/A		
16							FA197		FA197HH	N/A				
17							TBA							
18							FA054TT		FA054R	N/A				
19							SFA197	SFAC197	SFA197HH	N/A				
20														
21							FA482TT		FA482R	N/A				
22							SFA083	SFAC083	SFA083HH			N/A		
23														
24														
25							FA622TT*		FA622R*	TBA*				
26														
27							FA622TT*		FA622R*	TBA*				
28														
29							FA622TT*		FA622R*	TBA*				
30														
31							FA622TT*		FA622R*	TBA*				
32														
33														
34														
35							H303							
36							H303							
37														
38														
39														
40									843G					
41							FA208TT	MXS208	FA208R	N/A				
42									843G					
43							FA208TT	MXS208	FA208R	N/A				
44							FA208TT		FA208R	N/A				
45									843G					
46									843G					
47							FA067/3		FA067R	N/A				
48							FA067/3		FA067R	N/A				
49														
50														
51							SFA083	SFAC083	SFA083HH	N/A				
52							SFA083	SFAC083	SFA083HH	N/A				
53							Y503							
54							Y503							
55							SFA260	SFAC260	SFA260HH			N/A		
56							SFA260	SFAC260	SFA260HH			N/A		
57							H322							
58							908							
59							H322							
60							932							

REAR / ARRIÈRE / HINTEN / POSTERIOR / POSTERIORE

*-2 Sets Required. † For Vee disc colours add RED, BLU, GRN, GLD, ORG suffix to part number.

⊗ - Also available as a Vintage Motorcycle Disc.

R Suffix = High Durability Sintered Pad. **HH** Suffix = High Performance Sintered Pad. **TT** Suffix = Hard Wearing Off Road Pad. **V** Suffix = Semi Sintered Pad. **G** Suffix = Grooved Shoe.
D Suffix = Drilled Disc. **X** Suffix = Universal Left or Right Disc. **XC** Suffix = Contoured Disc. **LS** Suffix = Left/Steel Disc. **RS** = Right/Steel Disc.

Non-JAPANESE Built Motorcycles

APPLICATIONS

BRAKE



KREIDLER Contd.

50 Flory MF 20/22		
50 Flory MF 23/24/25		
50 Flory Classic (50cc/4T/A-C)	14-15	
50 MP1 Early Models		
50 MP1 Later Models		
50 RM		
50 LH/LF/LFF		
50 RMC/RMC-BG		
50 Supermoto (2T)	14-15	
RS Typ K 54/53		
RSH Typ K54/53H		
50 RS-G/RSH-G and GS		
80E/L Florett		
Mustang 125		
125		
125 RS		
125 Enduro (4T)	14-15	
125 Insignio (4T)	Left 14-15	
	Right 14-15	
125 Supermoto (4T)	14-15	
250 Insignio (4T)	Left 14-15	
	Right 14-15	

KSR (SEE GENERIC SECTION)

KTM

SX-E 5 Electric	20	
Freeride E-SM (Electric Powered)	15-17	
Freeride E-SX (Electric Powered)	14-17	
Freeride E-XC (Electric Powered)	15-20	
50 Supermoto	06	
50 SX/SXR Pro Junior/Senior/Adventure	96-03	
50 SX Mini Adventure	04-07	
50 SX Pro Senior LC	02-03	
50 SX Senior Adventure	02-07	
50 SX Pro Senior LC (12" Front Wheel)	04-20	
50 SX	06-20	
50 SX Mini (10" Wheels)	08-20	
60 SX	98-99	
60 SX	00	
65 SX	98-99	
65 SX	00-01	
65 SX	02-03	
65 SX	04-08	
SX 65	09-20	
80 MX	86-92	
SX 85 (17"/14" wheels)	03-10	
SX 85 (19"/16" wheels)	03-10	
SX 85 (17"/14" wheels)	11	
SX 85 (19"/16" wheels)	11	
SX 85 (17"/14" wheels - 220mm F/Disc/Radial Caliper)	12-15	
SX 85 (19"/16" wheels - 220mm F/Disc/Radial Caliper)	12	
SX 85 (17"/14" wheels - 240mm F/Disc/Radial Caliper)	16-20	
SX 85 (19"/16" wheels - 240mm F/Disc/Radial Caliper)	13-20	
SX 85 (220mm Oversize Rear disc only)		
& Rear pads for aftermarket kit	03-17	
125/175	-84	
125 GS	83	
125 Duke (280mm F/Disc)	11-12	

FA, SFA, TT Pad or Brake Shoe	SFAC Carbon Scooter Pads	Semi-Sintered V-Pads™	Sintered/HH Pads/Grooved Shoes	BRAKE DISC CHOICES - FRONT							Line #
				Left / Gauche / Links Standard Replacement Disc	Right / Droite / Rechts Standard Replacement Disc	Contour Disc Universal left and right fitment	Universal Custom Disc	Vee-Discs Black † See note below	CX Extreme MX Race Disc		
H322											1
932											2
SFA086	SFAC086		SFA086HH	N/A							3
908											4
H322											5
966											6
932											7
932											8
FA228			FA228HH				N/A				9
N/A											10
N/A											11
FA056						N/A					12
FA056						N/A					13
FA076			FA076HH	N/A							14
N/A											15
FA056						N/A					16
FA228			FA228HH				N/A				17
SFA197	SFAC197		SFA197HH	N/A	N/A						18
SFA228	SFAC228		SFA228HH								19
FA228			FA228HH				N/A				20
SFA197	SFAC197		SFA197HH	N/A	N/A						21
SFA228	SFAC228		SFA228HH								22
											23
											24
											25
											26
FA325TT			FA325R								27
FA612TT			FA612R				TBA				28
FA612TT			FA612R				TBA				29
FA612TT			FA612R				TBA				30
FA325TT			FA325R	N/A							31
H322											32
H322											33
FA325TT			FA325R	N/A							34
FA325TT			FA325R	N/A							35
FA325TT			FA325R	N/A							36
FA325TT			FA325R								37
FA325TT			FA325R								38
FA115TT			FA115R	MD6192D			MD6192C				39
FA115TT			FA115R	MD6192D			MD6192C				40
FA115TT			FA115R	MD6192D			MD6192C				41
FA115TT			FA115R	MD6192D			MD6192C				42
FA357TT			FA357R	MD6192D			MD6192C				43
FA357TT			FA357R	MD6243D			MD6243C			MD6243CX	44
FA357TT			FA357R				MD6243C			MD6243CX	45
FA047/2				N/A							46
FA357TT			FA357R				MD6258C				47
FA357TT			FA357R				MD6258C				48
FA357TT			FA357R				MD6258C				49
FA357TT			FA357R				MD6258C				50
FA612TT			FA612R				MD6407C				51
FA612TT			FA612R				MD6407C				52
FA612TT			FA612R				MD6379C				53
FA612TT			FA612R				MD6379C				54
											55
											56
			812G								57
			811G								58
FA606			FA606HH	MD849							59

NOTE: Most KTM models changed the caliper bracket design in 2009. O/E BRACKET REF 770 13 14 0 type is used in the OS/SM6932C type disc.

*-2 Sets Required. † For Vee disc colours add RED, BLU, GRN, GLD, ORG suffix to part number.

⊗ - Also available as a Vintage Motorcycle Disc.

290 Part numbers, prefixes, suffixes, photos and illustrations shown in this catalogue are trademarks and/or copyrights of EBC Brakes or the trademark owner A C Freeman Investments Ltd and use without express written permission of the owners is punishable by law.

Non-JAPANESE Built Motorcycles

Line #	BRAKE DISC CHOICES - FRONT						DISC PAD CHOICES - REAR				BRAKE DISC CHOICES - REAR			
	Oversize 250 /280mm Disc Kit	OSX Oversize 250/280mm Disc Kit	Relocating Bracket for 250/ 280mm Disc	Oversize 320mm Disc Kit	SMX Oversize 320mm Disc Kit	Relocating Bracket for 320mm Disc	FA, SFA, TT Pad or Brake Shoe	SFAC Carbon Scooter Pads	Speciality Pads - SXR / Vee / MXS	Sintered/ HH Pads/ Grooved Shoes	Standard Replacement Disc	Contour Disc Rear fitment	Vee-Discs™ CONTOUR	CX Extreme MX Race Disc/ UTVX Disc
1							H322							
2							932							
3							Y503							
4							908							
5							H322							
6							966							
7							932							
8							932							
9							FA197		FA197HH		N/A			
10							N/A							
11							N/A							
12							TBA							
13							966							
14							932							
15							932							
16							932							
17							FA054TT		FA054HH		N/A			
18							TBA			N/A				
19														
20							FA054TT		FA054HH		N/A			
21							TBA			N/A				
22														
23														
24														
25														
26														
27							FA325TT		FA325R					
28							FA602TT		FA602R		TBA			
29							FA602TT		FA602R		TBA			
30							FA602TT		FA602R		TBA			
31							FA325TT		FA325R	N/A				
32							H322							
33							H322							
34							H322							
35							H322							
36							FA325TT		FA325R	N/A				
37							FA325TT		FA325R					
38							FA325TT		FA325R					
39														
40							FA337TT		FA337R	MD6216D				
41							873							
42							FA337TT		FA337R	MD6216D				
43							FA337TT		FA337R	MD6216D				
44							FA325TT		FA325R		MD6249C		MD6249CX	
45							FA357TT		FA357R		MD6249C		MD6249CX	
46							814G							
47	OS6258C	OSX6258	BRK028ORG	N/A		N/A	FA357TT		FA357R		MD6257C			
48	OS6258C	OSX6258	BRK028ORG	N/A		N/A	FA357TT		FA357R		MD6257C			
49	OS6258C	OSX6258	BRK028ORG	N/A		N/A	FA602TT		FA602R		MD6360C			
50	OS6258C	OSX6258	BRK028ORG	N/A		N/A	FA602TT		FA602R		MD6360C			
51	N/A	OSX6407	BRK027	N/A		N/A	FA602TT		FA602R		MD6360C			
52	N/A	OSX6407	BRK027	N/A		N/A	FA602TT		FA602R		MD6360C			
53	N/A		N/A	N/A		N/A	FA602TT		FA602R		MD6360C			
54	N/A		N/A	N/A		N/A	FA602TT		FA602R		MD6360C			
55														
56							FA367/2TT		FA367/2R		MD6360COS			
57								812G						
58								812G						
59							FA213	FA213V	FA213HH	MD850				
60														

REAR / ARRIÈRE / HINTEN / POSTERIOR / POSTERIORE

*-2 Sets Required. † For Vee disc colours add RED, BLU, GRN, GLD, ORG suffix to part number.

⊗ - Also available as a Vintage Motorcycle Disc.

R Suffix = High Durability Sintered Pad. **HH** Suffix = High Performance Sintered Pad. **TT** Suffix = Hard Wearing Off Road Pad. **V** Suffix = Semi Sintered Pad. **G** Suffix = Grooved Shoe.
D Suffix = Drilled Disc. **X** Suffix = Universal Left or Right Disc. **XC** Suffix = Contoured Disc. **LS** Suffix = Left/Steel Disc. **RS** = Right/Steel Disc.

Part numbers, prefixes, suffixes, photos and illustrations shown in this catalogue are trademarks and/or copyrights of EBC Brakes or the trademark owner A C Freeman Investments Ltd and use without express written permission of the owners is punishable by law.

BRAKE APPLICATIONS

Non-JAPANESE Built Motorcycles

APPLICATIONS

BRAKE



KTM Contd.

R Suffix = High Durability Sintered Pad. HH Suffix = High Performance Sintered Pad. TT Suffix = Hard Wearing Off Road Pad. V Suffix = Semi Sintered Pad. G Suffix = Grooved Shoe.

D Suffix = Drilled Disc. X Suffix = Universal Left or Right Disc. XC Suffix = Contoured Disc. LS Suffix = Left/Steel Disc. RS Suffix = Right/Steel Disc.

125 Duke (300mm F/Disc)	13-19
D-XC/E-XC/E-GS 125	90-91
D-XC/E-XC/E-GS 125 Grimeca Calipers	90-91
D-XC/E-XC/E-GS 125 Brembo Calipers	92-93
D-XC/E-XC/E-GS 125 Grimeca Calipers	92-93
EXC 125	87
EXC 125	88
EXC 125 Brembo Calipers	89
EXC 125 Grimeca Calipers	89
EXC/EGS 125 (Standard forks)	94
EXC 125 (Standard forks)	95-99
EXC 125 (Upside down forks)	00-03
EXC 125 (Upside down forks)	04-08
EXC 125 (Upside down forks)	09-17
EXC 125 Six Days (Upside down forks)	11-17
EXE 125	00
GSXC/GS 125	85
LC2 125	96-98
Sting 125	97-99
MX 125	83
MX 125	84
MX/MXC 125	85
MX/MXC/GS 125	86
MX 125	87
MX 125	88
MX 125 Brembo Calipers	89
MX 125 Grimeca Calipers	89
MX 125 Brembo Calipers	90-91
MX 125 Grimeca Calipers	90-91
MX 125 Brembo Calipers	92-93
MX 125 Grimeca Calipers	92-93
RC 125	14-19
SM 125 Supermoto	00
SX 125 (Standard forks)	94-99
SX 125 (Upside down forks)	00-03
SX 125 (Upside down forks)	04-08
SX 125 (Upside down forks)	09-20
XC-W 125 (2T)	17-19
SX 150 (Upside Down Forks)	08
SX 150 (Upside Down Forks)	09-20
XC 150 (Upside Down Forks)	11-13
XC-W 150 (2T) inc Tpi	17-20
200 Duke (280mm F/Disc)	12
200 Duke (300mm F/Disc)	13-15
EXC/EGS 200 (Standard forks)	98-99
EXC/EGS 200 (Upside down forks)	00-03
EXC 200 (Upside down forks)	04-08
EXC 200 (Upside down forks/Inc Six Days)	09-16
RC 200	14-15
250	-82
250 Duke	15-20
250 MX Leleu	82
250 MX	83
250 XC/GS	83
DXC/EXC 250 Grimeca Calipers	90
D-XC/E-XC/E-GS 250 Brembo Calipers	91
D-XC/E-XC/E-GS 250	91
D-XC/E-XC/T-XC/E-GS 250 (Grimeca calipers)	92-93

FRONT / AVANT / VORN / FRENTE / ANTERIORE

DISC PAD CHOICES - FRONT				BRAKE DISC CHOICES - FRONT						Line #
FA, SFA, TT Pad or Brake Shoe	SFAC Carbon Scooter Pads	Semi-Sintered V-Pads™ or SXR Race Pads	Sintered/HH Pads/ Grooved Shoes	Left / Gauche / Links Standard Replacement Disc	Right / Droite / Rechts Standard Replacement Disc	Contour Disc Universal left and right fitment	Universal Custom Disc	Vee-Discs Black † See note below	CX Extreme MX Race Disc/ UTVX Disc	Line #
FA606			FA606HH	MD864		MD864XC				1
FA067TT			FA067R	MD6034D						2
FA132			FA132R	MD6034D						3
FA181TT		MXS181	FA181R	MD6034D						4
FA132			FA132R	MD6034D						5
FA126TT			FA126R	N/A						6
FA132			FA132R	N/A						7
FA067TT			FA067R	MD6034D						8
FA132			FA132R	MD6034D						9
FA181TT		MXS181	FA181R	MD6032D		MD6032C			MD6032CX	10
FA181TT		MXS181	FA181R	MD6032D		MD6032C			MD6032CX	11
FA181TT		MXS181	FA181R	MD6032D		MD6032C			MD6032CX	12
FA181TT		MXS181	FA181R	MD6032D		MD6032C			MD6032CX	13
FA181TT		MXS181	FA181R	MD6032D		MD6032C			MD6032CX	14
FA181TT		MXS181	FA181R	MD6032D		MD6032C			MD6032CX	15
FA181TT		MXS181	FA181R	MD6032D		MD6032C			MD6032CX	16
FA047TT			FA047R	N/A						17
FA181TT		MXS181	FA181R	MD6032D		MD6032C			MD6032CX	18
FA095			FA095HH	N/A						19
			811G							20
			814G							21
FA047TT			FA047R	N/A						22
FA047TT			FA047R	N/A						23
FA126TT			FA126R	N/A						24
FA132			FA132R	N/A						25
FA067TT			FA067R	N/A						26
FA132			FA132R	N/A						27
FA067TT			FA067R	N/A						28
FA132			FA132R	N/A						29
FA181TT		MXS181	FA181R	MD6032D		MD6032C			MD6032CX	30
FA132			FA132R	MD6032D		MD6032C			MD6032CX	31
FA606			FA606HH	MD864		MD864XC				32
FA181TT		MXS181	FA181R	TBA						33
FA181TT		MXS181	FA181R	MD6032D		MD6032C			MD6032CX	34
FA181TT		MXS181	FA181R	MD6032D		MD6032C			MD6032CX	35
FA181TT		MXS181	FA181R			MD6032C			MD6032CX	36
FA181TT		MXS181	FA181R			MD6032C			MD6032CX	37
FA181TT		MXS181	FA181R			MD6032C			MD6032CX	38
FA181TT		MXS181	FA181R			MD6032C			MD6032CX	39
FA181TT		MXS181	FA181R			MD6032C			MD6032CX	40
FA181TT		MXS181	FA181R			MD6032C			MD6032CX	41
FA181TT		MXS181	FA181R			MD6032C			MD6032CX	42
FA606			FA606HH	MD849						43
FA606			FA606HH	MD864		MD864XC				44
FA181TT		MXS181	FA181R	MD6032D		MD6032C			MD6032CX	45
FA181TT		MXS181	FA181R	MD6032D		MD6032C			MD6032CX	46
FA181TT		MXS181	FA181R	MD6032D		MD6032C			MD6032CX	47
FA181TT		MXS181	FA181R	MD6032D		MD6032C			MD6032CX	48
FA606			FA606HH	MD864		MD864XC				49
			812G							50
FA606			FA606HH	MD864						51
			811G							52
			TBA							53
			811G							54
FA132			FA132R	MD6034D						55
FA067TT			FA067R	MD6034D						56
FA132			FA132R	MD6034D						57
FA132			FA132R	MD6032D		MD6032C			MD6032CX	58

NOTE: Most KTM models changed the caliper bracket design in 2009. O/E BRACKET REF 770 13 14 0 type is used in the OS/SM6932C type disc.

♦ Plain undrilled disc for enduro use MD6035CE

*-2 Sets Required. † For Vee disc colours add RED, BLU, GRN, GLD, ORG suffix to part number.

⊗ - Also available as a Vintage Motorcycle Disc.

Non-JAPANESE Built Motorcycles

Line #	BRAKE DISC CHOICES - FRONT						DISC PAD CHOICES - REAR				BRAKE DISC CHOICES - REAR			
	Oversize 250 /280mm Disc Kit	OSX Oversize 250/280mm Disc Kit	Relocating Bracket for 250/ 280mm Disc	Oversize 320mm Disc Kit	SMX Oversize 320mm Disc Kit	Relocating Bracket for 320mm Disc	FA, SFA, TT Pad or Brake Shoe	SFAC Carbon Scooter Pads	Speciality Pads - SXR / Vee / MXS	Sintered/ HH Pads/ Grooved Shoes	Standard Replacement Disc	Contour Disc Rear fitment	Vee-Discs™ CONTOUR	CX Extreme MX Race Disc/ UTVX Disc
1							FA213		FA213V	FA213HH	MD850			
2							FA067TT			FA067R	N/A			
3							FA132			FA132R	N/A			
4							FA067TT			FA067R	N/A			
5							FA067TT			FA067R	N/A			
6							FA126TT			FA126R	N/A			
7							FA132			FA132R	MD6227D			
8							FA067TT			FA067R	MD6227D			
9							FA132			FA132R	MD6227D			
10	OS6032EC	OSX6032EORG	BRK015ORG	SM6032EC	SMX6032EORG	BRK016ORG	FA208TT		MXS208	FA208R	MD6035D	MD6035C ♦	MD6035CX	
11	OS6032EC	OSX6032EORG	BRK015ORG	SM6032EC	SMX6032EORG	BRK016ORG	FA208TT		MXS208	FA208R	MD6035D	MD6035C ♦	MD6035CX	
12	OS6032C	OSX6032ORG	BRK011ORG	SM6032C	SMX6032ORG	BRK012ORG	FA208TT		MXS208	FA208R	MD6035D	MD6035C ♦	MD6035CX	
13	OS6032C	OSX6032ORG	BRK011ORG	SM6032C	SMX6032ORG	BRK012ORG	FA368TT		MXS368	FA368R	MD6035D	MD6035C ♦	MD6035CX	
14	OS6932C	OSX6932ORG	BRK013ORG	SM6932C	SMX6932ORG	BRK014ORG	FA368TT		MXS368	FA368R	MD6035D	MD6035C ♦	MD6035CX	
15	OS6932C	OSX6932ORG	BRK013ORG	SM6932C	SMX6932ORG	BRK014ORG	FA368TT		MXS368	FA368R	MD6035D	MD6035C ♦	MD6035CX	
16	OS6032C	OSX6032ORG	BRK011ORG	SM6032C	SMX6032ORG	BRK012ORG	FA208TT		MXS208	FA208R	MD6035D	MD6035C ♦	MD6035CX	
17									814G					
18							FA208TT		MXS208	FA208R	MD6035D	MD6035C ♦		
19							FA208TT			FA208R	N/A			
20									812G					
21									814G					
22									814G					
23							FA047TT			FA047R	MD6227D			
24							FA126TT			FA126R	N/A			
25							FA132			FA132R	MD6227D			
26							FA067TT			FA067R	MD6227D			
27							FA132			FA132R	MD6227D			
28							FA067TT			FA067R	N/A			
29							FA132			FA132R	N/A			
30	OS6032EC	OSX6032EORG	BRK015ORG	SM6032EC	SMX6032EORG	BRK016ORG	FA067TT			FA067R	N/A			
31	N/A		N/A	N/A		N/A	FA067TT			FA067R	N/A			
32							FA213		FA213V	FA213HH	MD850			
33							FA208TT		MXS208	FA208R	MD6035D	MD6035C		
34	OS6032C	OSX6032ORG	BRK011ORG	SM6032C	SMX6032ORG	BRK012ORG	FA208TT		MXS208	FA208R	MD6035D	MD6035C	MD6035CX	
35	OS6032EC	OSX6032EORG	BRK015ORG		SMX6032EORG	BRK016ORG	FA208TT		MXS208	FA208R	MD6035D	MD6035C	MD6035CX	
36	OS6032C	OSX6032ORG	BRK011ORG	SM6032C	SMX6032ORG	BRK012ORG	FA368TT		MXS368	FA368R	MD6035C		MD6035CX	
37	OS6932C	OSX6932ORG	BRK013ORG	SM6932C	SMX6932ORG	BRK014ORG	FA368TT		MXS368	FA368R	MD6035C		MD6035CX	
38	OS6932C	OSX6932ORG	BRK013ORG	SM6932C	SMX6932ORG	BRK014ORG	FA368TT		MXS368	FA368R	MD6035C		MD6035CX	
39	OS6032C	OSX6032ORG	BRK011ORG	SM6032C	SMX6032ORG	BRK012ORG	FA368TT		MXS368	FA368R	MD6035C		MD6035CX	
40	OS6932C	OSX6932ORG	BRK013ORG	SM6932C	SMX6932ORG	BRK014ORG	FA368TT		MXS368	FA368R	MD6035C		MD6035CX	
41	OS6932C	OSX6932ORG	BRK013ORG	SM6932C	SMX6932ORG	BRK014ORG	FA368TT		MXS368	FA368R	MD6035C		MD6035CX	
42	OS6932C	OSX6932ORG	BRK013ORG	SM6932C	SMX6932ORG	BRK014ORG	FA368TT		MXS368	FA368R	MD6035C		MD6035CX	
43							FA213		FA213V	FA213HH	MD850			
44							FA213		FA213V	FA213HH	MD850			
45	OS6032EC	OSX6032EORG	BRK015ORG		SMX6032EORG	BRK016ORG	FA208TT		MXS208	FA208R	MD6035D	MD6035C ♦	MD6035CX	
46	OS6032C	OSX6032ORG	BRK011ORG	SM6032C	SMX6032ORG	BRK012ORG	FA208TT		MXS208	FA208R	MD6035D	MD6035C ♦	MD6035CX	
47	OS6032C	OSX6032ORG	BRK011ORG	SM6032C	SMX6032ORG	BRK012ORG	FA368TT		MXS368	FA368R	MD6035D	MD6035C ♦	MD6035CX	
48	OS6932C	OSX6932ORG	BRK013ORG	SM6932C	SMX6932ORG	BRK014ORG	FA368TT		MXS368	FA368R	MD6035D	MD6035C ♦	MD6035CX	
49							FA213		FA213V	FA213HH	MD850			
50									813G					
51							FA213		FA213V	FA213HH	MD850			
52									813G					
53									TBA					
54									813G					
55							FA132			FA132R	N/A			
56							FA067			FA067R	N/A			
57							FA132			FA132R	N/A			
58							FA067			FA067R	N/A			
59														
60														

REAR / ARRIÈRE / HINTEN / POSTERIOR / POSTERIORE

*-2 Sets Required. † For Vee disc colours add RED, BLU, GRN, GLD, ORG suffix to part number.

♦ - Also available as a Vintage Motorcycle Disc.

R Suffix = High Durability Sintered Pad. **HH** Suffix = High Performance Sintered Pad. **TT** Suffix = Hard Wearing Off Road Pad. **V** Suffix = Semi Sintered Pad. **G** Suffix = Grooved Shoe.
D Suffix = Drilled Disc. **X** Suffix = Universal Left or Right Disc. **XC** Suffix = Contoured Disc. **LS** Suffix = Left/Steel Disc. **RS** = Right/Steel Disc.

Non-JAPANESE Built Motorcycles

APPLICATIONS

BRAKE



KTM Contd.



DISC PAD CHOICES - FRONT

BRAKE DISC CHOICES - FRONT

	FA, SFA, TT Pad or Brake Shoe	SFAC Carbon Scooter Pads	Speciality Pads - SXR / Vee / MXS	Sintered/HH Pads/ Grooved Shoes	BRAKE DISC CHOICES - FRONT						Line #
					Left / Gauche / Links Standard Replacement Disc	Right / Droite / Rechts Standard Replacement Disc	Contour Disc Universal left and right fitment	Universal Custom Disc	Vee-Discs Black † See note below	CX Extreme MX Race Disc/ UTVX Disc	
EXC/EGS 250	FA132			FA132R	N/A						1
EXC/EGS 250 Brembo Calipers	FA067TT			FA067R	MD6034D						2
EXC/EGS 250 Grimeca Calipers	FA132			FA132R	MD6034D						3
EXC/EGS 250 (Standard forks)	FA181TT		MXS181	FA181R	MD6032D		MD6032C			MD6032CX	4
EXC 250 (Standard forks)	FA181TT		MXS181	FA181R	MD6032D		MD6032C			MD6032CX	5
EXC 250 (Upside down forks)	FA181TT		MXS181	FA181R	MD6032D		MD6032C			MD6032CX	6
EXC 250 (Upside down forks) (2T)	FA181TT		MXS181	FA181R	MD6032D		MD6032C			MD6032CX	7
EXC 250 (Upside down forks) (2T) Inc Tpi	FA181TT		MXS181	FA181R	MD6032D		MD6032C			MD6032CX	8
EXC 250 Six Days (Upside down forks) (2T) Inc Tpi	FA181TT		MXS181	FA181R	MD6032D		MD6032C			MD6032CX	9
EXC 250 Racing	FA181TT		MXS181	FA181R	MD6032D		MD6032C			MD6032CX	10
EXC-F 250 (4T)	FA181TT		MXS181	FA181R	MD6032D		MD6032C			MD6032CX	11
EXC-F 250 (4T)	FA181TT		MXS181	FA181R	MD6032D		MD6032C			MD6032CX	12
EXC-F 250 Six Days (4T)	FA181TT		MXS181	FA181R	MD6032D		MD6032C			MD6032CX	13
250 R Freeride (2T)	FA612TT			FA612R			TBA				14
GS 250	FA047TT			FA047R	N/A						15
GSXC/GS 250	FA047TT			FA047R	N/A						16
MX 250	FA132			FA132R	N/A						17
MX 250 Grimeca Calipers	FA132			FA132R	N/A						18
MX 250 Brembo Calipers	FA067TT			FA067R	N/A						19
MX 250 Brembo Calipers	FA067TT			FA067R	N/A						20
MX 250 Brembo Calipers	FA067TT			FA067R	N/A						21
MX 250 Grimeca Calipers	FA132			FA132R	N/A						22
MX 250 Brembo Calipers	FA181TT		MXS181	FA181R	MD6032D		MD6032C			MD6032CX	23
MX/EXC 250	FA126			FA126R	N/A						24
MX/MXC/GS 250				814G							25
MX/MXC 250	FA047TT			FA047R	N/A						26
MX/MXC 250	FA047TT			FA047R	N/A						27
SX 250 (2T/Standard Forks)	FA181TT		MXS181	FA181R	MD6032D		MD6032C			MD6032CX	28
SX 250 (2T/Upside down forks)	FA181TT		MXS181	FA181R			MD6032C			MD6032CX	29
SX 250 (2T/Upside down forks)	FA181TT		MXS181	FA181R			MD6032C			MD6032CX	30
SX 250 (2T/Upside down forks)	FA181TT		MXS181	FA181R			MD6032C			MD6032CX	31
SX-F 250 (4T/Upside Down Forks)	FA181TT		MXS181	FA181R			MD6032C			MD6032CX	32
SX-F 250 (4T/Upside Down Forks)	FA181TT		MXS181	FA181R			MD6032C			MD6032CX	33
SX-F 250 (4T) Prado	FA181TT		MXS181	FA181R			MD6032C			MD6032CX	34
SX-F 250 (Ken Roczen Edition)	FA181TT		MXS181	FA181R			MD6032C			MD6032CX	35
SX 250 (2T/Upside down forks)	FA181TT		MXS181	FA181R			MD6032C			MD6032CX	36
XC 250 (2T/Upside down forks)	FA181TT		MXS181	FA181R			MD6032C			MD6032CX	37
XC 250 (2T) Tpi	FA181TT		MXS181	FA181R			MD6032C			MD6032CX	38
XC-F 250 (4T/Upside Down Forks)	FA181TT		MXS181	FA181R			MD6032C			MD6032CX	39
EXC 300 (Upside down forks)	FA181TT		MXS181	FA181R	MD6032D		MD6032C			MD6032CX	40
EXC 300 (Upside down forks)	FA181TT		MXS181	FA181R	MD6032D		MD6032C			MD6032CX	41
EXC 300 (Upside down forks)	FA181TT		MXS181	FA181R	MD6032D		MD6032C			MD6032CX	42
EXC 300 Six Days (Upside down forks)	FA181TT		MXS181	FA181R	MD6032D		MD6032C			MD6032CX	43
EXC-E 300 (2T) (USD/Electric start)	FA181TT		MXS181	FA181R	MD6032D		MD6032C			MD6032CX	44
XC 300 (2T) Inc Tpi	FA181TT		MXS181	FA181R	MD6032D		MD6032C			MD6032CX	45
GSXC/GS 300	FA047TT			FA047R	N/A						46
MX/MXC 300	FA047TT			FA047R	N/A						47
MX/MXC/GS 300	FA047TT			FA047R	N/A						48
350				812G							49
350 Four Stroke	FA047TT			FA047R	N/A						50
350 Freeride (4T)	FA612TT			FA612R			TBA				51
DXC/EXC/EGS 350 Brembo Calipers	FA067TT			FA067R	MD6034D						52
DXC/EXC/EGS 350 Grimeca Calipers	FA132			FA132R	MD6034D						53
EXC 350 Brembo Calipers	FA067TT			FA067R	MD6034D						54
EXC 350 Grimeca Calipers	FA132			FA132R	MD6034D						55
EXC 350 LC4 (Standard forks)	FA181TT		MXS181	FA181R	MD6032D		MD6032C			MD6032CX	56
MX/MXC/GS 350	FA047TT			FA047R	N/A						57
MX/EXC 350	FA126TT			FA126R	N/A						58

FRONT / AVANT / VORN / FRENTE / ANTERIORE

NOTE: Most KTM models changed the caliper bracket design in 2009. O/E BRACKET REF 770 13 14 0 type is used in the OS/SM6932C type disc.

♦ Plain undrilled disc for enduro use MD6035CE

*-2 Sets Required. † For Vee disc colours add RED, BLU, GRN, GLD, ORG suffix to part number.

⊗ - Also available as a Vintage Motorcycle Disc.

294 Part numbers, prefixes, suffixes, photos and illustrations shown in this catalogue are trademarks and/or copyrights of EBC Brakes or the trademark owner A C Freeman Investments Ltd and use without express written permission of the owners is punishable by law.

R Suffix = High Durability Sintered Pad. HH Suffix = High Performance Sintered Pad. TT Suffix = Hard Wearing Off Road Pad. V Suffix = Semi Sintered Pad. G Suffix = Grooved Shoe.
D Suffix = Drilled Disc. X Suffix = Universal Left or Right Disc. XC Suffix = Contoured Disc. LS Suffix = Left/Steel Disc. RS Suffix = Right/Steel Disc.

Non-JAPANESE Built Motorcycles

Line #	BRAKE DISC CHOICES - FRONT						DISC PAD CHOICES - REAR				BRAKE DISC CHOICES - REAR			
	Oversize 250 /280mm Disc Kit	OSX Oversize 250/280mm Disc Kit	Relocating Bracket for 250/ 280mm Disc	Oversize 320mm Disc Kit	SMX Oversize 320mm Disc Kit	Relocating Bracket for 320mm Disc	FA, SFA, TT Pad or Brake Shoe	SFAC Carbon Scooter Pads	Speciality Pads - SXR / Vee / MXS	Sintered/ HH Pads/ Grooved Shoes	Standard Replacement Disc	Contour Disc Rear fitment	Vee-Discs™ CONTOUR	CX Extreme MX Race Disc/ UTVX Disc
1							FA132			FA132R	MD6227D			
2							FA067			FA067R	MD6227D			
3							FA132			FA132R	MD6227D			
4	OS6032EC	OSX6032EORG	BRK015ORG		SMX6032EORG	BRK016ORG	FA208TT		MXS208	FA208R	MD6035D	MD6035C		MD6035CX
5	OS6032EC	OSX6032EORG	BRK015ORG		SMX6032EORG	BRK016ORG	FA208TT		MXS208	FA208R	MD6035D	MD6035C ♦		MD6035CX
6	OS6032C	OSX6032ORG	BRK011ORG	SM6032C	SMX6032ORG	BRK012ORG	FA208TT		MXS208	FA208R	MD6035D	MD6035C ♦		MD6035CX
7	OS6032C	OSX6032ORG	BRK011ORG	SM6032C	SMX6032ORG	BRK012ORG	FA368TT		MXS368	FA368R	MD6035D	MD6035C ♦		MD6035CX
8	OS6932C	OSX6932ORG	BRK013ORG	SM6932C	SMX6932ORG	BRK014ORG	FA368TT		MXS368	FA368R	MD6035D	MD6035C ♦		MD6035CX
9	OS6932C	OSX6932ORG	BRK013ORG	SM6932C	SMX6932ORG	BRK014ORG	FA368TT		MXS368	FA368R	MD6035D	MD6035C ♦		MD6035CX
10	OS6032C	OSX6032ORG	BRK011ORG	SM6032C	SMX6032ORG	BRK012ORG	FA368TT		MXS368	FA368R	MD6035D	MD6035C ♦		MD6035CX
11	OS6032C	OSX6032ORG	BRK011ORG	SM6032C	SMX6032ORG	BRK012ORG	FA368TT		MXS368	FA368R	MD6035D	MD6035C		MD6035CX
12	OS6932C	OSX6932ORG	BRK013ORG	SM6932C	SMX6932ORG	BRK014ORG	FA368TT		MXS368	FA368R	MD6035D	MD6035C		MD6035CX
13	OS6932C	OSX6932ORG	BRK013ORG	SM6932C	SMX6932ORG	BRK014ORG	FA368TT		MXS368	FA368R	MD6035D	MD6035C		MD6035CX
14							FA602TT			FA602R		MD6360C		
15							FA047TT			FA047R	MD6227D			
16										814G				
17							FA132			FA132R	MD6227D			
18							FA132			FA132R	MD6227D			
19							FA067TT			FA067R	MD6227D			
20							FA067TT			FA067R	N/A			
21							FA067TT			FA067R	N/A			
22							FA132			FA132R	N/A			
23	OS6032EC	OSX6032EORG	BRK015ORG		SMX6032EORG	BRK016ORG	FA067TT			FA067R	N/A			
24							FA126			FA126R	N/A			
25										814G				
26										814G				
27							FA047TT			FA047R	MD6227D			
28	OS6032EC	OSX6032EORG	BRK015ORG		SMX6032EORG	BRK016ORG	FA208TT		MXS208	FA208R	MD6035D	MD6035C		MD6035CX
29	OS6032C	OSX6032ORG	BRK011ORG	SM6032C	SMX6032ORG	BRK012ORG	FA208TT		MXS208	FA208R	MD6035D	MD6035C		MD6035CX
30	OS6032C	OSX6032ORG	BRK011ORG	SM6032C	SMX6032ORG	BRK012ORG	FA368TT		MXS368	FA368R	MD6035D	MD6035C		MD6035CX
31	OS6932C	OSX6932ORG	BRK013ORG	SM6932C	SMX6932ORG	BRK014ORG	FA368TT		MXS368	FA368R	MD6035D	MD6035C		MD6035CX
32	OS6032C	OSX6032ORG	BRK011ORG	SM6032C	SMX6032ORG	BRK012ORG	FA368TT		MXS368	FA368R	MD6035D	MD6035C		MD6035CX
33	OS6932C	OSX6932ORG	BRK013ORG	SM6932C	SMX6932ORG	BRK014ORG	FA368TT		MXS368	FA368R	MD6035D	MD6035C		MD6035CX
34	OS6932C	OSX6932ORG	BRK013ORG	SM6932C	SMX6932ORG	BRK014ORG	FA368TT		MXS368	FA368R	MD6035D	MD6035C		MD6035CX
35	OS6932C	OSX6932ORG	BRK013ORG	SM6932C	SMX6932ORG	BRK014ORG	FA368TT		MXS368	FA368R	MD6035D	MD6035C		MD6035CX
36	OS6032C	OSX6032ORG	BRK011ORG	SM6032C	SMX6032ORG	BRK012ORG	FA368TT		MXS368	FA368R	MD6035D	MD6035C		MD6035CX
37	OS6932C	OSX6932ORG	BRK013ORG	SM6932C	SMX6932ORG	BRK014ORG	FA368TT		MXS368	FA368R	MD6035D	MD6035C ♦		MD6035CX
38	OS6932C	OSX6932ORG	BRK013ORG	SM6932C	SMX6932ORG	BRK014ORG	FA368TT		MXS368	FA368R	MD6035D	MD6035C		MD6035CX
39	OS6932C	OSX6932ORG	BRK013ORG	SM6932C	SMX6932ORG	BRK014ORG	FA368TT		MXS368	FA368R	MD6035D	MD6035C ♦		MD6035CX
40	OS6032C	OSX6032ORG	BRK011ORG	SM6032C	SMX6032ORG	BRK012ORG	FA208TT		MXS208	FA208R	MD6035D	MD6035C ♦		MD6035CX
41	OS6032C	OSX6032ORG	BRK011ORG	SM6032C	SMX6032ORG	BRK012ORG	FA368TT		MXS368	FA368R	MD6035D	MD6035C ♦		MD6035CX
42	OS6932C	OSX6932ORG	BRK013ORG	SM6932C	SMX6932ORG	BRK014ORG	FA368TT		MXS368	FA368R	MD6035D	MD6035C ♦		MD6035CX
43	OS6932C	OSX6932ORG	BRK013ORG	SM6932C	SMX6932ORG	BRK014ORG	FA368TT		MXS368	FA368R	MD6035D	MD6035C ♦		MD6035CX
44	OS6032C	OSX6032ORG	BRK011ORG	SM6032C	SMX6032ORG	BRK012ORG	FA368TT		MXS368	FA368R	MD6035D	MD6035C ♦		MD6035CX
45	OS6932C	OSX6932ORG	BRK013ORG	SM6932C	SMX6932ORG	BRK014ORG	FA368TT		MXS368	FA368R	MD6035D	MD6035C		MD6035CX
46										814G				
47										814G				
48							FA047TT			FA047R	MD6227D			
49										813G				
50										813G				
51							FA602TT			FA602R		MD6360C		
52							FA067TT			FA067R	N/A			
53							FA132			FA132R	N/A			
54							FA067TT			FA067R	MD6227D			
55							FA132			FA132R	MD6227D			
56	OS6032EC	OSX6032EORG	BRK015ORG		SMX6032EORG	BRK016ORG	FA208TT		MXS208	FA208R	MD6371D	MD6371C		
57							FA047TT			FA047R	MD6227D			
58							FA126TT			FA126R	N/A			
59														
60														

REAR / ARRIÈRE / HINTEN / POSTERIOR / POSTERIORE

*-2 Sets Required. † For Vee disc colours add RED, BLU, GRN, GLD, ORG suffix to part number.

⦿ - Also available as a Vintage Motorcycle Disc.

R Suffix = High Durability Sintered Pad. **HH** Suffix = High Performance Sintered Pad. **TT** Suffix = Hard Wearing Off Road Pad. **V** Suffix = Semi Sintered Pad. **G** Suffix = Grooved Shoe.
D Suffix = Drilled Disc. **X** Suffix = Universal Left or Right Disc. **XC** Suffix = Contoured Disc. **LS** Suffix = Left/Steel Disc. **RS** = Right/Steel Disc.

Non-JAPANESE Built Motorcycles

APPLICATIONS

BRAKE



KTM Contd.

		DISC PAD CHOICES - FRONT				BRAKE DISC CHOICES - FRONT						Line #
		FA, SFA, TT Pad or Brake Shoe	SFAC Carbon Scooter Pads	Speciality Pads - SXR / Vee / MXS	Sintered/HH Pads/ Grooved Shoes	Left / Gauche / Links Standard Replacement Disc	Right / Droite / Rechts Standard Replacement Disc	Contour Universal Left and right fitment	Universal Custom Disc	Vee-Discs Black † See note below	CX Extreme MX Race Disc/ UTVX Disc	
MX/EXC/EGS 350	88	FA132			FA132R	N/A						1
MX 350 Brembo Calipers	90-91	FA067TT			FA067R	N/A						2
MX 350 Grimeca Calipers	90-91	FA132			FA132R	N/A						3
MX 350 Brembo Calipers	89	FA067TT			FA067R	N/A						4
MX 350 Grimeca Calipers	89	FA132			FA132R	N/A						5
EXC 350 (Standard forks)	96-97	FA181TT		MXS181	FA181R	MD6032D		MD6032C			MD6032CX	6
EXC-F 350 (4T/Upside down forks)	11-20	FA181TT		MXS181	FA181R			MD6032C			MD6032CX	7
EXC-F 350 (4T/Six Days)	12-20	FA181TT		MXS181	FA181R			MD6032C			MD6032CX	8
SX-F 350 (4T/Upside down forks)	11-20	FA181TT		MXS181	FA181R			MD6032C			MD6032CX	9
SX-F 350 (Tony Cairoli Edition)	12	FA181TT		MXS181	FA181R			MD6032C			MD6032CX	10
XC-F 350 (4T)	12-18	FA181TT		MXS181	FA181R			MD6032C			MD6032CX	11
EXC 360	96-97	FA181TT		MXS181	FA181R	MD6032D		MD6032C			MD6032CX	12
SX 360 (Standard forks)	96-97	FA181TT		MXS181	FA181R	MD6032D		MD6032C			MD6032CX	13
EXC 380 (Standard forks)	98-99	FA181TT		MXS181	FA181R	MD6032D		MD6032C			MD6032CX	14
EXC 380 (Upside down forks)	00-03	FA181TT		MXS181	FA181R	MD6032D		MD6032C			MD6032CX	15
SX 380 (Standard forks)	98-99	FA181TT		MXS181	FA181R	MD6032D		MD6032C			MD6032CX	16
SX 380 (Upside down forks)	00-03	FA181TT		MXS181	FA181R	MD6032D		MD6032C			MD6032CX	17
390 Adventure	19-20	FA606			FA606HH							18
390 Duke (300mm F/Disc)	13-17	FA606			FA606HH	MD864		MD864XC				19
390 Duke (320mm F/Disc)	18-20	FA606			FA606HH	TBA						20
390 Duke (4T)	15	FA606			FA606HH							21
RC 390	14-16	FA606			FA606HH							22
RC 390	17-20	FA606			FA606HH	MD864		MD864XC				23
Duke 400 LC4	94-98	FA095			FA095HH	MD6199D		MD6199C				24
EGS 400/EGS-E/LSE (LC4 Enduro)	96-99	FA181TT		MXS181	FA181R	MD6130D †						25
EXC/EGS 400 (USD)	00-03	FA181TT		MXS181	FA181R	MD6032D		MD6032C			MD6032CX	26
EXC 400 Racing (USD)	00	FA181TT		MXS181	FA181R	MD6032D		MD6032C			MD6032CX	27
EXC 400 Racing	04-07	FA181TT		MXS181	FA181R	MD6032D		MD6032C			MD6032CX	28
LC4-E 400 Enduro	00-01	FA181TT		MXS181	FA181R	MD6130D †						29
SC 400 (Supercompetition LC4)	96-99	FA181TT		MXS181	FA181R	MD6032D		MD6032C			MD6032CX	30
SX 400 (Upside down forks)	00-02	FA181TT		MXS181	FA181R	MD6032D		MD6032C			MD6032CX	31
420 GS	85				812G							32
EXC 440	94-95	FA181TT		MXS181	FA181R	MD6032D		MD6032C			MD6032CX	33
EXC 450 (4T)	03	FA181TT		MXS181	FA181R	MD6032D		MD6032C			MD6032CX	34
EXC 450 (4T)	04-08	FA181TT		MXS181	FA181R	MD6032D		MD6032C			MD6032CX	35
EXC 450 (4T)	09-20	FA181TT		MXS181	FA181R	MD6032D		MD6032C			MD6032CX	36
EXC 450 Six Days (4T)	11-20	FA181TT		MXS181	FA181R	MD6032D		MD6032C			MD6032CX	37
EXC 450 Racing	06-07	FA181TT		MXS181	FA181R	MD6032D		MD6032C			MD6032CX	38
EXC-R 450 (4T)	08	FA181TT		MXS181	FA181R	MD6032D		MD6032C			MD6032CX	39
450 Rally	17-20	FA209/2TT			FA209/2HH	TBA						40
SMR 450 (6 piston caliper)	04				MXS406	MD6270D		MD6270C				41
SMR 450 (4 piston caliper)	05-06				MXS405	MD6270D		MD6270C				42
SMR 450 (Magura caliper)	07-13	FA433/4			FA433/4HH			MD6313C				43
SMR 450 (Brembo caliper)	14				FA447HH			MD6270C				44
SX 440	94-95	FA181TT		MXS181	FA181R	MD6032D		MD6032C			MD6032CX	45
SX 450 (4T)	03-06	FA181TT		MXS181	FA181R			MD6032C			MD6032CX	46
SX-F 450 (4T)	07-08	FA181TT		MXS181	FA181R			MD6032C			MD6032CX	47
SX-F 450 (4T) Inc Cairoli	09-20	FA181TT		MXS181	FA181R			MD6032C			MD6032CX	48
450 SX-F (Quad)	09				FA462R*			MD6336C*				49
XC 450 (Quad)	08-10				FA462R*			MD6336C*				50
495	-82				812G							51
495 MX Leleu	82				811G							52
EXC 500 (4T)	12-20	FA181TT		MXS181	FA181R	MD6032D		MD6032C			MD6032CX	53
EXC 500 Six Days (4T)	12-20	FA181TT		MXS181	FA181R	MD6032D		MD6032C			MD6032CX	54
LC-4 MX/EXC 500	89	FA132			FA132R	MD6034D						55
LC-4 MX 500 Brembo Calipers	90-91	FA067TT			FA067R	N/A						56
LC-4 EXC 500 Brembo Calipers	90-91	FA067TT			FA067R	MD6034D						57

FRONT / AVANT / VORN / FRENTE / ANTERIORE

NOTE: Most KTM models changed the caliper bracket design in 2009. O/E BRACKET REF 770 13 14 0 type is used in the OS/SM6932C type disc.

♦ Plain undrilled disc for enduro use MD6035CE

† - Choice of MD6130D = Solid. MD6130DF = Pro-lite. MD6130CF = Contour Profile.

*-2 Sets Required. † For Vee disc colours add RED, BLU, GRN, GLD, ORG suffix to part number.

⊗ - Also available as a Vintage Motorcycle Disc.

296 Part numbers, prefixes, suffixes, photos and illustrations shown in this catalogue are trademarks and/or copyrights of EBC Brakes or the trademark owner A C Freeman Investments Ltd and use without express written permission of the owners is punishable by law.

R Suffix = High Durability Sintered Pad. HH Suffix = High Performance Sintered Pad. TT Suffix = Hard Wearing Off Road Pad. V Suffix = Semi-Sintered Pad. G Suffix = Grooved Shoe.

D Suffix = Drilled Disc. X Suffix = Universal Left or Right Disc. XC Suffix = Contoured Disc. LS Suffix = Left/Steel Disc. RS Suffix = Right/Steel Disc.

Non-JAPANESE Built Motorcycles

Line #	BRAKE DISC CHOICES - FRONT						DISC PAD CHOICES - REAR				BRAKE DISC CHOICES - REAR			
	Oversize 250 /280mm Disc Kit	OSX Oversize 250/280mm Disc Kit	Relocating Bracket for 250/ 280mm Disc	Oversize 320mm Disc Kit	SMX Oversize 320mm Disc Kit	Relocating Bracket for 320mm Disc	FA, SFA, TT Pad or Brake Shoe	SFAC Carbon Scooter Pads	Speciality Pads - SXR / Vee / MXS	Sintered/ HH Pads/ Grooved Shoes	Standard Replacement Disc	Contour Disc Rear fitment	Vee-Discs™ CONTOUR	CX Extreme MX Race Disc/ UTVX Disc
1							FA132			FA132R	MD6227D			
2							FA067TT			FA067R	N/A			
3							FA132			FA132R	N/A			
4							FA067TT			FA067R	MD6227D			
5							FA132			FA132R	MD6227D			
6	OS6032EC	OSX6032EORG	BRK0150RG		SMX6032EORG	BRK0160RG	FA208TT		MXS208	FA208R	MD6035D	MD6035C ♦	MD6035CX	
7	OS6932C	OSX6932ORG	BRK0130RG	SM6932C	SMX6932ORG	BRK0140RG	FA368TT		MXS368	FA368R		MD6035C	MD6035CX	
8	OS6932C	OSX6932ORG	BRK0130RG	SM6932C	SMX6932ORG	BRK0140RG	FA368TT		MXS368	FA368R		MD6035C	MD6035CX	
9	OS6932C	OSX6932ORG	BRK0130RG	SM6932C	SMX6932ORG	BRK0140RG	FA368TT		MXS368	FA368R		MD6035C	MD6035CX	
10	OS6932C	OSX6932ORG	BRK0130RG	SM6932C	SMX6932ORG	BRK0140RG	FA368TT		MXS368	FA368R		MD6035C	MD6035CX	
11	OS6932C	OSX6932ORG	BRK0130RG	SM6932C	SMX6932ORG	BRK0140RG	FA368TT		MXS368	FA368R		MD6035C	MD6035CX	
12	OS6032EC	OSX6032EORG	BRK0150RG		SMX6032EORG	BRK0160RG	FA208TT		MXS208	FA208R	MD6035D	MD6035C	MD6035CX	
13	OS6032EC	OSX6032EORG	BRK0150RG		SMX6032EORG	BRK0160RG	FA208TT		MXS208	FA208R	MD6035D	MD6035C	MD6035CX	
14	OS6032EC	OSX6032EORG	BRK0150RG		SMX6032EORG	BRK0160RG	FA208TT		MXS208	FA208R	MD6035D	MD6035C ♦	MD6035C	
15	OS6032C	OSX6032ORG	BRK0110RG	SM6032C	SMX6032ORG	BRK0120RG	FA208TT		MXS208	FA208R	MD6035D	MD6035C ♦	MD6035CX	
16	OS6032EC	OSX6032EORG	BRK0150RG		SMX6032EORG	BRK0160RG	FA208TT		MXS208	FA208R	MD6035D	MD6035C	MD6035CX	
17	OS6032C	OSX6032ORG	BRK0110RG	SM6032C	SMX6032ORG	BRK0120RG	FA208TT		MXS208	FA208R	MD6035D	MD6035C	MD6035CX	
18							FA213			FA213HH				
19							FA213			FA213HH	MD850			
20							FA213			FA213HH	MD850			
21							FA213			FA213HH	MD850			
22							FA213			FA213HH	MD850			
23							FA213			FA213HH	MD850			
24	N/A		N/A	N/A		N/A	FA208TT		MXS208	FA208R	MD6371D	MD6371C		
25	N/A		N/A	N/A		N/A	FA208TT		MXS208	FA208R	MD6371D			
26	OS6032C	OSX6032ORG	BRK0110RG	SM6032C	SMX6032ORG	BRK0120RG	FA208TT		MXS208	FA208R	MD6371D	MD6371C		
27	OS6032C	OSX6032ORG	BRK0110RG	SM6032C	SMX6032ORG	BRK0120RG	FA208TT		MXS208	FA208R	MD6035D	MD6035C ♦	MD6035CX	
28	OS6032C	OSX6032ORG	BRK0110RG	SM6032C	SMX6032ORG	BRK0120RG	FA368TT		MXS368	FA368R	MD6035D	MD6035C	MD6035CX	
29	N/A		N/A	N/A		N/A	FA208TT		MXS208	FA208R	MD6035D	MD6035C	MD6035CX	
30	OS6032EC	OSX6032EORG	BRK0150RG		SMX6032EORG	BRK0160RG	FA208TT		MXS208	FA208R	MD6371D	MD6371C		
31	OS6032C	OSX6032ORG	BRK0110RG	SM6032C	SMX6032ORG	BRK0120RG	FA208TT		MXS208	FA208R	MD6035D	MD6035C	MD6035CX	
32										812G				
33	OS6032C	OSX6032ORG	BRK0110RG	SM6032C	SMX6032ORG	BRK0120RG	FA208TT		MXS208	FA208R	MD6371D	MD6371C		
34	OS6032C	OSX6032ORG	BRK0110RG	SM6032C	SMX6032ORG	BRK0120RG	FA208TT		MXS208	FA208R	MD6035D	MD6035C ♦	MD6035CX	
35	OS6032C	OSX6032ORG	BRK0110RG	SM6032C	SMX6032ORG	BRK0120RG	FA368TT		MXS368	FA368R	MD6035D	MD6035C ♦	MD6035CX	
36	OS6932C	OSX6932ORG	BRK0130RG	SM6932C	SMX6932ORG	BRK0140RG	FA368TT		MXS368	FA368R	MD6035D	MD6035C ♦	MD6035CX	
37	OS6932C	OSX6932ORG	BRK0130RG	SM6932C	SMX6932ORG	BRK0140RG	FA368TT		MXS368	FA368R	MD6035D	MD6035C ♦	MD6035CX	
38	OS6032C	OSX6032ORG	BRK0110RG	SM6032C	SMX6032ORG	BRK0120RG	FA368TT		MXS368	FA368R	MD6035D	MD6035C ♦	MD6035CX	
39	OS6032C	OSX6032ORG	BRK0110RG	SM6032C	SMX6032ORG	BRK0120RG	FA368TT		MXS368	FA368R	MD6035D	MD6035C ♦	MD6035CX	
40							FA208TT		MXS208	FA208R	TBA			
41							FA368TT		MXS368	FA368R	MD6035D	MD6035C		
42							FA368TT		MXS368	FA368R	MD6035D	MD6035C		
43							FA368TT		MXS368	FA368R		MD6035C		
44							FA368TT		MXS368	FA368R		MD6035C		
45	OS6032EC	OSX6032EORG	BRK0150RG		SMX6032EORG	BRK0160RG	FA208TT		MXS208	FA208R	MD6371D	MD6371C		
46	OS6032C	OSX6032ORG	BRK0110RG	SM6032C	SMX6032ORG	BRK0120RG	FA368TT		MXS368	FA368R		MD6035C	MD6035CX	
47	OS6032C	OSX6032ORG	BRK0110RG	SM6032C	SMX6032ORG	BRK0120RG	FA368TT		MXS368	FA368R		MD6035C	MD6035CX	
48	OS6932C	OSX6932ORG	BRK0130RG	SM6932C	SMX6932ORG	BRK0140RG	FA368TT		MXS368	FA368R		MD6035C	MD6035CX	
49										FA463R	MD6337D			
50										FA463R	MD6337D			
51										813G				
52										813G				
53	OS6932C	OSX6932ORG	BRK0130RG	SM6932C	SMX6932ORG	BRK0140RG	FA368TT		MXS368	FA368R	MD6035D	MD6035C ♦	MD6035CX	
54	OS6932C	OSX6932ORG	BRK0130RG	SM6932C	SMX6932ORG	BRK0140RG	FA368TT		MXS368	FA368R	MD6035D	MD6035C ♦	MD6035CX	
55							FA132			FA132R	N/A			
56							FA067TT			FA067R	MD6035D	MD6035C		
57							FA067TT			FA067R	MD6035D	MD6035C ♦		
58														
59														
60														

REAR / ARRIÈRE / HINTEN / POSTERIOR / POSTERIORE

*-2 Sets Required. † For Vee disc colours add RED, BLU, GRN, GLD, ORG suffix to part number.

♦ - Also available as a Vintage Motorcycle Disc.

R Suffix = High Durability Sintered Pad. **HH** Suffix = High Performance Sintered Pad. **TT** Suffix = Hard Wearing Off Road Pad. **V** Suffix = Semi Sintered Pad. **G** Suffix = Grooved Shoe.
D Suffix = Drilled Disc. **X** Suffix = Universal Left or Right Disc. **XC** Suffix = Contoured Disc. **LS** Suffix = Left/Steel Disc. **RS** = Right/Steel Disc.

Non-JAPANESE Built Motorcycles

APPLICATIONS

BRAKE



KTM Contd.

R Suffix = High Durability Sintered Pad. HH Suffix = High Performance Sintered Pad. TT Suffix = Hard Wearing Off Road Pad. V Suffix = Semi Sintered Pad. G Suffix = Grooved Shoe.
 D Suffix = Drilled Disc. X Suffix = Universal Left or Right Disc. XC Suffix = Contoured Disc. LS Suffix = Left/Steel Disc. RS Suffix = Right/Steel Disc.

LC-4 MX 500 Grimeca Calipers	90-91
LC-4 EXC 500 Grimeca Calipers	90-91
MX/MXC/XC-GS 500	85
MX 500	92-94
MX 500	95
SX-F 505	07-08
SX-F 505	09
505 SX-F (Quad)	09-12
EXC 520	01-03
SX 520	01-03
EXC 525	03
EXC 525	04-05
EXC 525 Racing	06
MXC 525 (Desert Racing)	03
MXC 525 (Desert Racing)	04
SMR 525 (6 piston caliper)	04
SMR 525 (4 piston caliper)	05
SX 525	03-06
XC 525 Racing	06-07
XC 525 (Quad)	08-12
EXC 530 (4T)	09-10
EXC 530 Six Days (4T)	11
EXC-R 530 (4T)	08
MXC 550	96
SMR 560 Supermoto	06
SMR 560	07
LC4 MX/EXC 600	89
LC4 MX 600 Brembo Calipers	90-91
LC4 EXC 600 Brembo Calipers	90-91
LC4 MX 600 Grimeca Calipers	90-91
LC4 EXC 600 Grimeca Calipers	90-91
LC4 EXC 600	92-93
EGS-E 620 Adventure/Rallye	99
EGS 620 Enduro/EGS-E/LSE	96-99
LC4 620 SC Supermoto	00
SC 620 Supercompetition	96-00
SX 620/EXC/EGS	94
SX EXC/EGS 620	95
SX 620	96-99
LC4 625 SC Supermoto	02
LC4 625 SC Supercompetition	02
SMC 625	04-06
SXC 625	03-04
SXC 625	05-06
Duke-E 640 (Single pin pad fixing/zero offset disc)	98
Duke II 640 (2 pin pad fixing disc/zero offset)	99-02
Duke II 640 (2 pin pad fixing disc/zero offset)	03-07
LC4-E 640 Enduro	00-04
LC4-E 640 Supermoto	
(Single Pin Pad Fixing At End Of Pad)	99-02
LC4-E 640 Supermoto (Central Single Pin Fixing)	03
LC4-E 640 Supermoto (2 Pin Fixing)	04-06
LC-4 640 Adventure	01-02
LC-4 640 Adventure R	99-02
LC-4 640 Adventure	03
LC-4 640 Adventure R	04
LC4 640 Adventure	05-07

FA, SFA, TT Pad or Brake Shoe	SFAC Carbon Scooter Pads	Speciality Pads - SXR / Vee / MXS	Sintered/HH Pads/ Grooved Shoes	BRAKE DISC CHOICES - FRONT				Universal Custom Disc	Vee-Discs Black † See note below	CX Extreme MX Race Disc/ UTVX Disc
				Left / Gauche / Links Standard Replacement Disc	Right / Droite / Rechts Standard Replacement Disc	Contour Disc Universal left and right fitment				
FA132			FA132R	N/A						
FA132			FA132R	MD6034D						
FA047TT				N/A						
FA181TT		MXS181	FA181R	N/A						
FA181TT		MXS181	FA181R	N/A						
FA181TT		MXS181	FA181R	MD6032D		MD6032C			MD6032CX	
FA181TT		MXS181	FA181R	MD6032D		MD6032C			MD6032CX	
			FA462R*			MD6336C*				
FA181TT		MXS181	FA181R	MD6032D		MD6032C			MD6032CX	
FA181TT		MXS181	FA181R	MD6032D		MD6032C			MD6032CX	
FA181TT		MXS181	FA181R	MD6032D		MD6032C			MD6032CX	
FA181TT		MXS181	FA181R	MD6032D		MD6032C			MD6032CX	
FA181TT		MXS181	FA181R	MD6032D		MD6032C			MD6032CX	
FA181TT		MXS181	FA181R	MD6032D		MD6032C			MD6032CX	
			MXS406	MD6270D		MD6270C				
			MXS405	MD6270D		MD6270C				
FA181TT		MXS181	FA181R	MD6032D		MD6032C			MD6032CX	
FA181TT		MXS181	FA181R	MD6032D		MD6032C			MD6032CX	
			FA462R*			MD6336C*				
FA181TT		MXS181	FA181R			MD6032C			MD6032CX	
FA181TT		MXS181	FA181R			MD6032C			MD6032CX	
FA181TT		MXS181	FA181R	MD6032D		MD6032C			MD6032CX	
FA181TT		MXS181	FA181R	MD6032D		MD6032C			MD6032CX	
			MXS405	N/A						
FA433/4			FA433/4HH	TBA						
FA132			FA132R	MD6034D						
FA067TT			FA067R	N/A						
FA067TT			FA067R	MD6034D						
FA132			FA132R	N/A						
FA132			FA132R	MD6034D						
FA132			FA132R	MD6034D						
FA181TT		MXS181	FA181R	MD6032D		MD6032C			MD6032CX	
FA181TT		MXS181	FA181R	MD6130D †						
FA181TT		MXS181	FA181R	MD6199D		MD6199C				
FA181TT		MXS181	FA181R	MD6032D		MD6032C			MD6032CX	
FA181TT		MXS181	FA181R	MD6032D		MD6032C			MD6032CX	
FA181TT		MXS181	FA181R	MD6032D		MD6032C			MD6032CX	
FA181TT		MXS181	FA181R	MD6199D		MD6199C				
FA181TT		MXS181	FA181R	MD6032D		MD6032C			MD6032CX	
FA244			FA244HH			MD6199C				
FA181TT		MXS181	FA181R	MD6032D		MD6032C			MD6032CX	
FA181TT		MXS181	FA181R	MD6032D		MD6032C			MD6032CX	
FA095			FA095HH	MD6199D		MD6199C				
FA244			FA244HH	MD6199D		MD6199C				
FA244			FA244HH	MD633X		MD633XC		VR633ORG		
FA181TT		MXS181	FA181R	MD6130D †						
FA181TT		MXS181	FA181R	MD6199D		MD6199C				
FA095			FA095HH	MD6199D		MD6199C				
FA244			FA244HH	MD6199D		MD6199C				
FA181TT		MXS181	FA181R	MD6199D		MD6199C				
FA181TT		MXS181	FA181R	MD6199D		MD6199C				
FA181TT*		MXS181	FA181R*	MD6199D	MD6199D	MD6199C*				
FA209/2*			FA209/2HH*	MD6266D*						
FA209/2*			FA209/2HH*	MD6266D*						

FRONT / AVANT / VORN / FRENTE / ANTERIORE

NOTE: Most KTM models changed the caliper bracket design in 2009. O/E BRACKET REF 770 13 14 0 type is used in the OS/SM6932C type disc.

† Plain undrilled disc for enduro use MD6035CE

† Choice of MD6130D(Solid), MD6130DF(Pro-line), MD6130CF (Contour Profile)

*-2 Sets Required. † For Vee disc colours add RED, BLU, GRN, GLD, ORG suffix to part number.

⊗ - Also available as a Vintage Motorcycle Disc.

298 Part numbers, prefixes, suffixes, photos and illustrations shown in this catalogue are trademarks and/or copyrights of EBC Brakes or the trademark owner A C Freeman Investments Ltd and use without express written permission of the owners is punishable by law.

Line #
1
2
3
4
5
6
7
8
9
10
11
12
13
14
15
16
17
18
19
20
21
22
23
24
25
26
27
28
29
30
31
32
33
34
35
36
37
38
39
40
41
42
43
44
45
46
47
48
49
50
51
52
53
54
55
56
57
58
59
60

Non-JAPANESE Built Motorcycles

Line #	BRAKE DISC CHOICES - FRONT						DISC PAD CHOICES - REAR				BRAKE DISC CHOICES - REAR			
	Oversize 250 /280mm Disc Kit	OSX Oversize 250/280mm Disc Kit	Relocating Bracket for 250/ 280mm Disc	Oversize 320mm Disc Kit	SMX Oversize 320mm Disc Kit	Relocating Bracket for 320mm Disc	FA, SFA, TT Pad or Brake Shoe	SFAC Carbon Scooter Pads	Speciality Pads - SXR / Vee / MXS	Sintered/ HH Pads/ Grooved Shoes	Standard Replacement Disc	Contour Disc Rear fitment	Vee-Discs™ CONTOUR	CX Extreme MX Race Disc/ UTVX Disc
1							FA132			FA132R	MD6035D	MD6035C		
2							FA132			FA132R	MD6035D	MD6035C	◆	
3									814G					
4							FA067TT			FA067R	N/A			
5							FA208TT			FA208R	N/A			
6	OS6032C	OSX6032ORG	BRK011ORG	SM6032C	SMX6032ORG	BRK012ORG	FA368TT		MXS368	FA368R	MD6035D	MD6035C		MD6035CX
7	OS6932C	OSX6932ORG	BRK013ORG	SM6932C	SMX6932ORG	BRK014ORG	FA368TT		MXS368	FA368R	MD6035D	MD6035C		MD6035CX
8										FA463R	MD6337D			
9	OS6032C	OSX6032ORG	BRK011ORG	SM6032C	SMX6032ORG	BRK012ORG	FA208TT		MXS208	FA208R	MD6035D	MD6035C	◆	MD6035CX
10	OS6032C	OSX6032ORG	BRK011ORG	SM6032C	SMX6032ORG	BRK012ORG	FA208TT		MXS208	FA208R	MD6035D	MD6035C		MD6035CX
11	OS6032C	OSX6032ORG	BRK011ORG	SM6032C	SMX6032ORG	BRK012ORG	FA208TT		MXS208	FA208R	MD6035D	MD6035C	◆	MD6035CX
12	OS6032C	OSX6032ORG	BRK011ORG	SM6032C	SMX6032ORG	BRK012ORG	FA368TT		MXS368	FA368R	MD6035D	MD6035C	◆	MD6035CX
13	OS6032C	OSX6032ORG	BRK011ORG	SM6032C	SMX6032ORG	BRK012ORG	FA368TT		MXS368	FA368R	MD6035D	MD6035C	◆	MD6035CX
14	OS6032C	OSX6032ORG	BRK011ORG	SM6032C	SMX6032ORG	BRK012ORG	FA208TT		MXS208	FA208R	MD6035D	MD6035C		MD6035CX
15	OS6032C	OSX6032ORG	BRK011ORG	SM6032C	SMX6032ORG	BRK012ORG	FA208TT		MXS208	FA208R	MD6035D	MD6035C		MD6035CX
16							FA368TT		MXS368	FA368R	MD6035D	MD6035C		
17							FA368TT		MXS368	FA368R	MD6035D	MD6035C		
18	OS6032C	OSX6032ORG	BRK011ORG	SM6032C	SMX6032ORG	BRK012ORG	FA368TT		MXS368	FA368R	MD6035D	MD6035C		MD6035CX
19	OS6032C	OSX6032ORG	BRK011ORG	SM6032C	SMX6032ORG	BRK012ORG	FA368TT		MXS368	FA368R	MD6035D	MD6035C		MD6035CX
20										FA463R	MD6337D			
21	OS6032C	OSX6032ORG	BRK011ORG	SM6032C	SMX6032ORG	BRK012ORG	FA368TT		MXS368	FA368R		MD6035C	◆	MD6035CX
22	OS6932C	OSX6932ORG	BRK013ORG	SM6932C	SMX6932ORG	BRK014ORG	FA368TT		MXS368	FA368R		MD6035C	◆	MD6035CX
23	OS6032C	OSX6032ORG	BRK011ORG	SM6032C	SMX6032ORG	BRK012ORG	FA368TT		MXS368	FA368R	MD6035D	MD6035C	◆	MD6035CX
24	OS6032EC	OSX6032EORG	BRK015ORG		SMX6032EORG	BRK016ORG	FA208TT		MXS208	FA208R	MD6035D	MD6035C		MD6035CX
25							FA368TT		MXS368	FA368R	MD6035D	MD6035C		
26							FA368TT		MXS368	FA368R	MD6035D	MD6035C		
27							FA132			FA132R	N/A			
28							FA067TT			FA067R	MD6371D			
29							FA067TT			FA067R	MD6371D			
30							FA132			FA132R	MD6371D			
31							FA132			FA132R	MD6371D			
32							FA067TT			FA067R	MD6371D			
33	OS6032EC	OSX6032EORG	BRK015ORG		SMX6032EORG	BRK016ORG	FA208TT		MXS208	FA208R	MD6371D	MD6371C		
34							FA208TT		MXS208	FA208R	MD6371D			
35	N/A		N/A	N/A		N/A	FA208TT		MXS208	FA208R	MD6371D	MD6371C		
36	OS6032EC	OSX6032EORG	BRK015ORG		SMX6032EORG	BRK016ORG	FA208TT		MXS208	FA208R	MD6371D	MD6371C		
37	OS6032EC	OSX6032EORG	BRK015ORG		SMX6032EORG	BRK016ORG	FA067TT			FA067R	MD6371D	MD6371C		
38	OS6032EC	OSX6032EORG	BRK015ORG		SMX6032EORG	BRK016ORG	FA208TT		MXS208	FA208R	MD6371D	MD6371C		
39	OS6032EC	OSX6032EORG	BRK015ORG		SMX6032EORG	BRK016ORG	FA208TT		MXS208	FA208R	MD6371D	MD6371C		
40	N/A		N/A	N/A		N/A	FA208TT		MXS208	FA208R	MD6371D	MD6371C		
41	OS6032C	OSX6032ORG	BRK011ORG	SM6032C	SMX6032ORG	BRK012ORG	FA208TT		MXS208	FA208R	MD6371D	MD6371C		
42	N/A		N/A	N/A		N/A	FA208TT		MXS208	FA208R	MD6371D	MD6371C		
43	OS6032C	OSX6032ORG	BRK011ORG	SM6032C	SMX6032ORG	BRK012ORG	FA208TT		MXS208	FA208R	MD6371D	MD6371C		
44	OS6032C	OSX6032ORG	BRK011ORG	SM6032C	SMX6032ORG	BRK012ORG	FA368TT		MXS368	FA368R	MD6371D	MD6371C		
45	N/A		N/A	N/A		N/A	FA213		FA213V	FA213HH	MD6371D	MD6371C		
46	N/A		N/A	N/A		N/A	FA213		FA213V	FA213HH	MD6371D	MD6371C		
47	N/A		N/A	N/A		N/A	FA213		FA213V	FA213HH	MD6371D	MD6371C		
48	N/A		N/A	N/A		N/A	FA208TT		MXS208	FA208R	MD6371D			
49														
50	N/A		N/A	N/A		N/A	FA208TT		MXS208	FA208R	MD6371D	MD6371C		
51	N/A		N/A	N/A		N/A	FA208TT		MXS208	FA208R	MD6371D	MD6371C		
52	N/A		N/A	N/A		N/A	FA208TT		MXS208	FA208R	MD6371D	MD6371C		
53	N/A		N/A	N/A		N/A	FA208TT		MXS208	FA208R	MD6371D	MD6371C		
54	N/A		N/A	N/A		N/A	FA208TT		MXS208	FA208R	MD6371D	MD6371C		
55							FA208TT		MXS208	FA208R	MD6371D	MD6371C		
56							FA208TT		MXS208	FA208R	MD6371D	MD6371C		
57							FA208TT		MXS208	FA208R	MD6371D	MD6371C		
58														
59														
60														

REAR / ARRIÈRE / HINTEN / POSTERIOR / POSTERIORE

*-2 Sets Required. † For Vee disc colours add RED, BLU, GRN, GLD, ORG suffix to part number.
 ◆ - Also available as a Vintage Motorcycle Disc.

R Suffix = High Durability Sintered Pad. **HH** Suffix = High Performance Sintered Pad. **TT** Suffix = Hard Wearing Off Road Pad. **V** Suffix = Semi Sintered Pad. **G** Suffix = Grooved Shoe.
D Suffix = Drilled Disc. **X** Suffix = Universal Left or Right Disc. **XC** Suffix = Contoured Disc. **LS** Suffix = Left/Steel Disc. **RS** = Right/Steel Disc.

BRAKE APPLICATIONS

Non-JAPANESE Built Motorcycles

APPLICATIONS

BRAKE



KTM Contd.

SMC 640 LC4	05
SMC 660 Supermoto	03-04
SMC 660 Supermoto	05-06
690 Duke	08-11
690 Duke (2 Pin Pad Fixing/5 Spoke Cast Wheels)	12
690 Duke (2 Pin Pad Fixing/Multi Spoke Cast Wheels)	13-20
690 Duke R (5 Spoke Cast Wheels)	10-11
690 Duke R (Multi Spoke Cast Wheels)	13-18
690 Enduro	08-20
690 R Enduro	09-20
690 R Enduro (ABS)	14-20
690 Rally Factory Replica	07-09
690 SM (2 pin pad fixing/spoke wheel)	07-09
690 SM - LE (Limited Edition)	10-11
690 SMC (4 pad type caliper/spoke wheel)	08-10
690 SMC R	12-13
690 SMC R (ABS)	14-20
790 Duke	18-20
790 Adventure R	18-20
890 Duke R	20
950 Adventure	02-06
950 Adventure S	03-06
950 R Superenduro	06-08
950 Supermoto	05-07
990 Adventure S (Non ABS)	06-08
990 Adventure R (Non ABS)	09-12
990 Adventure (ABS Model)	Left 07-12
	Right
990 Adventure Dakar Edition (ABS Model)	Left 11
	Right
990 Superduke	05-11
990 Superduke R	07-13
990 Supermoto T (SM-T)	09-13
990 Supermoto R (SM-R)	08-09
990 Supermoto R (SM-R)	10-13
1050 Adventure	15-16
1090 Adventure	17-19
1090 Adventure R	17-20
RC8 (1190cc)	08-11
RC8R/Track (1190cc)	09-16
1190 Adventure	13-16
1190 Adventure R	13-16
1290 Super Duke R	14-20
1290 Super Duke R SE	16-17
1290 Super Duke GT	16-20
1290 Super Adventure	15-19
1290 Super Adventure R	17-20
1290 Super Adventure S	17-20
1290 Super Adventure T	17

DISC PAD CHOICES - FRONT				BRAKE DISC CHOICES - FRONT							Line #
FA, SFA, TT Pad or Brake Shoe	SFAC Carbon Scooter Pads	Semi-Sintered V-Pads™	Sintered/HH Pads/ Grooved Shoes	Left / Gauche / Links Standard Replacement Disc	Right / Droite / Rechts Standard Replacement Disc	Contour Disc Universal left and right fitment	Universal Custom Disc	Vee-Discs Black † See note below	CX Extreme MX Race Disc		
FA244			FA244HH	TBA						1	
FA095			FA095HH	TBA						2	
FA244			FA244HH	TBA						3	
			FA322/4HH	MD614X		MD614XC		VR614BLK†		4	
FA244			FA244HH	MD614X		MD614XC		VR614BLK†		5	
			FA244HH	MD856X		MD856XC		VR856ORG		6	
			FA322/4HH	MD614X		MD614XC		VR614BLK†		7	
			FA447HH	MD856X		MD856XC		VR856ORG		8	
FA209/2			FA209/2HH			MD6299C				9	
FA209/2			FA209/2HH			MD6299C				10	
FA209/2			FA209/2HH			MD6299C				11	
FA209/2			FA209/2HH	MD6299D		MD6299C				12	
FA244			FA244HH	MD6199D		MD6199C				13	
FA244			FA244HH	MD6199D		MD6199C				14	
			FA322/4HH	MD6199D		MD6199C				15	
			FA322/4HH	MD6199D		MD6199C				16	
			FA322/4HH	MD6414D		MD6414C				17	
FA244*		FA244V*	FA244HH*							18	
FA244*		FA244V*	FA244HH*							19	
			FA630HH*							20	
FA209/2*		FA209/2V*	FA209/2HH*	MD6266D	MD6266D					21	
FA209/2*		FA209/2V*	FA209/2HH*	MD6266D	MD6266D					22	
FA209/2		FA209/2V	FA209/2HH	MD6299D						23	
			FA322/4HH*	MD680	MD680	MD680C*				24	
FA209/2*		FA209/2V*	FA209/2HH*	MD6299D	MD6299D					25	
FA209/2*		FA209/2V*	FA209/2HH*	MD6299D	MD6299D					26	
FA209/2		FA209/2V	FA209/2HH	MD844X		MD844XC				27	
FA209/2		FA209/2V	FA209/2HH		MD848X	MD848XC				28	
FA209/2		FA209/2V	FA209/2HH	MD844X	MD848X	MD844XC				29	
FA209/2		FA209/2V	FA209/2HH		MD848X	MD848XC				30	
			FA322/4HH*	MD633X	MD633X	MD633XC*		VR633ORG*		31	
			FA322/4HH*	MD633X	MD633X	MD633XC*		VR633ORG*		32	
			FA322/4HH*	MD680	MD680	MD680C*				33	
			FA322/4HH*	MD680	MD680	MD680C*				34	
			FA447HH*	MD680	MD680	MD680C*				35	
FA244*		FA244V*	FA244HH*	TBA	TBA					36	
FA244*		FA244V*	FA244HH*	TBA	TBA					37	
FA244*		FA244V*	FA244HH*	TBA	TBA					38	
			FA447HH*	MD633X	MD633X	MD633XC*		VR633ORG*		39	
			FA447HH*	MD633X	MD633X	MD633XC*		VR633ORG*		40	
FA244*		FA244V*	FA244HH*	TBA	TBA					41	
FA244*		FA244V*	FA244HH*	TBA	TBA					42	
			FA447HH*	TBA	TBA					43	
			FA447HH*	TBA	TBA					44	
			FA447HH*	TBA	TBA					45	
FA244*			FA244HH*	TBA	TBA					46	
FA244*		FA244V*	FA244HH*	TBA	TBA					47	
FA244*		FA244V*	FA244HH*	TBA	TBA					48	
FA244*		FA244V*	FA244HH*	TBA	TBA					49	

FRONT / AVANT / VORN / FRENTE / ANTERIORE

NOTE: Most KTM models changed the caliper bracket design in 2009. O/E BRACKET REF 770 13 14 0 type is used in the OS/SM6932C type disc.

KYMCO

Activ 50	05-06
Active SR 50cc	08-11
Agility 50 (KG10SA)	05-08
Agility 50 Basic	07
Agility 50 Carry (4T)	11-18
Agility City+ 50 (4T)	18-20
Agility 50 R10 (4T) (CV 50 QT S) 10" wheels	06-14
Agility 50 R12 (4T) (CK 50 QT S) 12" wheels	06-20

										50
										51
										52
SFA197	SFAC197		SFA197HH		N/A					53
SFA086	SFAC086		SFA086HH		N/A					54
SFA228	SFAC228		SFA228HH	MD971D		MD971C		VR971		55
H303										56
SFA305	SFAC305		SFA305HH			TBA				57
SFA228	SFAC228		SFA228HH	MD971D		MD971C		VR971		58
SFA228	SFAC228		SFA228HH	MD971D		MD971C		VR971		59
SFA228	SFAC228		SFA228HH	MD971D		MD971C		VR971		60

*-2 Sets Required. † For Vee disc colours add RED, BLU, GRN, GLD, ORG suffix to part number.

⊗ - Also available as a Vintage Motorcycle Disc.

Non-JAPANESE Built Motorcycles

Line #	BRAKE DISC CHOICES - FRONT						DISC PAD CHOICES - REAR				BRAKE DISC CHOICES - REAR			
	Oversize 250 /280mm Disc Kit	OSX Oversize 250/280mm Disc Kit	Relocating Bracket for 250/ 280mm Disc	Oversize 320mm Disc Kit	SMX Oversize 320mm Disc Kit	Relocating Bracket for 320mm Disc	FA, SFA, TT Pad or Brake Shoe	SFAC Carbon Scooter Pads	Speciality Pads -SXR / Vee / MXS	Sintered/ HH Pads/ Grooved Shoes	Standard Replacement Disc	Contour Disc Rear fitment	Vee-Discs™ CONTOUR	CX Extreme MX Race Disc/ UTVX Disc
1							FA208TT		MXS208	FA208R	MD6371D			
2							FA208TT		MXS208	FA208R	MD6371D			
3							FA208TT		MXS208	FA208R	MD6371D			
4							FA213		FA213V	FA213HH	MD681	MD681C	VR681	
5							FA213		FA213V	FA213HH	MD681	MD681C	VR681	
6							FA213			FA213HH	MD857	MD857C		
7							FA213		FA213V	FA213HH	MD681	MD681C	VR681	
8							FA213			FA213HH	MD857	MD857C		
9							FA208TT		MXS208	FA208R		MD6269C		
10							FA208TT		MXS208	FA208R	MD6269D	MD6269C		
11							FA208TT		MXS208	FA208R	MD6415D		MD6415C	
12							FA213		FA213V	FA213HH	MD6269D	MD6269C		
13							FA213		FA213V	FA213HH	MD6269D			
14							FA213		FA213V	FA213HH	MD6269D			
15							FA213		FA213V	FA213HH	MD6298D			
16							FA213		FA213V	FA213HH	MD6298D			
17							FA208TT		MXS208	FA208R	MD6415D		MD6415C	
18							FA213		FA213V	FA213HH				
19							FA213		FA213V	FA213HH				
20							FA213			FA213HH				
21							FA181TT			FA181HH	MD6269D			
22							FA181TT			FA181HH	MD6269D			
23							FA181TT			FA181HH	MD6298D			
24							FA181TT			FA181HH	MD681	MD681C	VR681	
25							FA181TT			FA181HH	MD6298D			
26							FA181TT			FA181HH	MD6298D			
27							FA181TT			FA181HH	MD6298D			
28														
29							FA181TT			FA181HH	MD6298D			
30														
31							FA213			FA213HH	MD681	MD681C	VR681	
32							FA213			FA213HH	MD681	MD681C	VR681	
33							FA181TT			FA181HH	MD681	MD681C	VR681	
34							FA181TT			FA181HH	MD681	MD681C	VR681	
35							FA181TT			FA181HH	MD681	MD681C	VR681	
36							FA181TT			FA181HH	TBA			
37							FA181TT			FA181HH	TBA			
38							FA181TT			FA181HH	TBA			
39							FA266			FA266HH	MD812			
40							FA266			FA266HH	MD812			
41							FA181TT			FA181HH	TBA			
42							FA181TT			FA181HH	TBA			
43							FA266			FA266HH	TBA			
44							FA266			FA266HH	TBA			
45							FA266			FA266HH	TBA			
46							FA181TT			FA181HH	TBA			
47							FA181TT			FA181HH	TBA			
48							FA181TT			FA181HH	TBA			
49							FA181TT			FA181HH	TBA			
50														
51														
52														
53							H303							
54							H303							
55							H303							
56							H303							
57							H303							
58							H303							
59							H303							
60							H303							

REAR / ARRIÈRE / HINTEN / POSTERIOR / POSTERIORE

*-2 Sets Required. † For Vee disc colours add RED, BLU, GRN, GLD, ORG suffix to part number.

⊗ - Also available as a Vintage Motorcycle Disc.

R Suffix = High Durability Sintered Pad. HH Suffix = High Performance Sintered Pad. TT Suffix = Hard Wearing Off Road Pad. V Suffix = Semi Sintered Pad. G Suffix = Grooved Shoe.

D Suffix = Drilled Disc. X Suffix = Universal Left or Right Disc. XC Suffix = Contoured Disc. LS Suffix = Left/Steel Disc. RS = Right/Steel Disc.

Non-JAPANESE Built Motorcycles

APPLICATIONS

BRAKE



KYMCO Contd.



R Suffix = High Durability Sintered Pad. HH Suffix = High Performance Sintered Pad. TT Suffix = Hard Wearing Off Road Pad. V Suffix = Semi Sintered Pad. G Suffix = Grooved Shoe.

D Suffix = Drilled Disc. X Suffix = Universal Left or Right Disc. XC Suffix = Contoured Disc. LS Suffix = Left/Steel Disc. RS Suffix = Right/Steel Disc.

Model	Year
Agility 50 R16 (2T/16" wheels)	08-15
Agility 50 R16 (4T/16" wheels)	08-15
Agility RS 50 (2T/12" Wheels) Naked	10-15
Bet & Win 50/Dink Sports 50	02-06
Candy 2.0 EV E Scooter	13-15
Calypso 50/125	99
Cobra 50 Cross	00-06
Cobra Racer (SF10AG)	00-06
CX 50 (PR50AE)	93
CX 50 Super (PR50AC)	94-97
Dink 50/Spacer 50/Yager 50 (SH10)	98-10
Dink 50 (4T)	07-14
Dink Classic Euro 2 50 (T8000)	03
DJ 50 S	12-15
DJW 50 World (PR50AD)	95-97
DJX 50 (KA50A)	91-92
DJY 50 Refined (PR50A)	93-06
Filly 50 (SD10AC)	98-00
Filly LX 50 (S210)	00-06
Grand Dink 50 (2T)	04-15
Heroism 50 (SE10BA)	95-97
K-Pipe 50	12-13
KB 50 (SE10CA)	95-00
K12 Sport 50 (SE10CA)	95-00
KXR 50 Mongoose	04-06
Kymcosento 50 i	13
Like 50 (2T)	09
Like 50 (2T)	10-20
Like 50 (4T)	09
Like 50 LX (4T)	10-15
Looker 50 (BA10AD (JP)	07-08
Looping 50	98
Jetix 50	10-15
Newsento 50 i	13
Maxxer 50 (2T)	05-14
MXer 50 (Quad)	00-07
MXU 50 (2T)	05-13
Nexxon 50	08-09
People S 50 2T (5 bolt fixing)	05-15
People S 50 (4T) (B91000) 5 Bolt fixing disc	06-20
People 50 (2T) (3 bolt fixing disc - BA10AD)	99-11
Queen 3.0 EV E Scooter	13-15
Sento 50	08-15
Sniper 50 (PR50B)	93
Sniper 50 DD (PR50BB)	94-96
Super 8 (50cc) 2T	07-15
Super 8 (50cc) 4T	07-20
Super 9 50 (LC) (SH10DA)	00-07
Super 9 (A/C)	00-07
Visa R 50	11-15
Vitality 50 (4T) (U31000)	04-09
Vitality 50 (2T) (SF10FA)	04-09
Yup 50	02-09
ZX 50 Super Fever/Scout (SC10AS) (ZX12)	99-06
Top Boy 50 (On road & off road models) (SF10GG)	97-06
Yager 50	07
KXR 90/S Mongoose Quad	04-20
Maxxer 90	05-06
AS 100/125	99
Cobra 100 Racer	99-03

FRONT / AVANT / VORN / FRENTE / ANTERIORE

DISC PAD CHOICES - FRONT				BRAKE DISC CHOICES - FRONT							Line #
FA, SFA, TT Pad or Brake Shoe	SFAC Carbon Scooter Pads	Speciality Pads - SXR / Vee / MXS	Sintered/HH Pads/ Grooved Shoes	Left / Gauche / Links Standard Replacement Disc	Right / Droite / Rechts Standard Replacement Disc	Contour Disc Universal left and right fitment	Universal Custom Disc	Vee-Discs Black † See note below	CX Extreme MX Race Disc/ UTVX Disc		
SFA305	SFAC305		SFA305HH	MD9100D				VR9100		1	
SFA305	SFAC305		SFA305HH	TBA						2	
SFA228	SFAC228		SFA228HH			MD971C		VR971		3	
SFA197	SFAC197		SFA197HH		MD973D			VR973		4	
TBA										5	
SFA235	SFAC235			TBA						6	
SFA233				MD971D		MD971C		VR971		7	
SFA233				MD971D		MD971C		VR971		8	
H303										9	
SFA233				MD933D				VR933		10	
SFA197	SFAC197		SFA197HH		MD971D	MD971C		VR971		11	
SFA197	SFAC197		SFA197HH		TBA					12	
SFA197	SFAC197		SFA197HH		MD973D			VR973		13	
SFA305	SFAC305		SFA305HH	TBA						14	
SFA235	SFAC235			MD933D				VR933		15	
H303										16	
H303										17	
H303										18	
SFA228	SFAC228		SFA228HH	TBA						19	
SFA197	SFAC197		SFA197HH		MD973D			VR973		20	
SFA235	SFAC235			MD933D				VR933		21	
FA197			FA197HH			N/A				22	
SFA233				MD933D				VR933		23	
SFA233				MD933D				VR933		24	
H346*			H346G*							25	
SFA197	SFAC197		SFA197HH	TBA						26	
SFA305	SFAC305		SFA305HH	TBA						27	
SFA228	SFAC228		SFA228HH	TBA						28	
SFA305	SFAC305		SFA305HH	TBA						29	
SFA228	SFAC228		SFA228HH	TBA						30	
SFA305	SFAC305		SFA305HH	MD989D						31	
SFA233				TBA						32	
SFA086	SFAC086		SFA086HH			N/A				33	
SFA197	SFAC197		SFA197HH	TBA						34	
H346*			H346G*							35	
H303*			H303G*							36	
H303*			H303G*							37	
SFA086	SFAC086		SFA086HH		N/A					38	
SFA305	SFAC305		SFA305HH	MD9100D				VR9100		39	
SFA305	SFAC305		SFA305HH	MD9100D				VR9100		40	
SFA305	SFAC305		SFA305HH	MD989D						41	
TBA										42	
SFA228	SFAC228		SFA228HH	TBA						43	
SFA233				MD933D				VR933		44	
SFA233				MD933D				VR933		45	
SFA305	SFAC305		SFA305HH			TBA				46	
SFA305	SFAC305		SFA305HH			TBA				47	
SFA197	SFAC197		SFA197HH		MD981D			VR981		48	
SFA197	SFAC197		SFA197HH		MD981D			VR981		49	
SFA067	SFAC067		SFA067HH		N/A					50	
SFA228	SFAC228		SFA228HH	MD971D		MD971C		VR971		51	
SFA228	SFAC228		SFA228HH	MD971D		MD971C		VR971		52	
SFA228	SFAC228		SFA228HH	MD971D		MD971C		VR971		53	
SFA233				MD971D		MD971C		VR971		54	
SFA233				MD971D		MD971C		VR971		55	
SFA197	SFAC197		SFA197HH		MD971D	MD971C		VR971		56	
H346*			H346G*							57	
H346*			H346G*							58	
TBA										59	
SFA228	SFAC228		SFA228HH	TBA						60	

*-2 Sets Required. † For Vee disc colours add RED, BLU, GRN, GLD, ORG suffix to part number.

⊗ - Also available as a Vintage Motorcycle Disc.

302 Part numbers, prefixes, suffixes, photos and illustrations shown in this catalogue are trademarks and/or copyrights of EBC Brakes or the trademark owner A C Freeman Investments Ltd and use without express written permission of the owners is punishable by law.

Non-JAPANESE Built Motorcycles

Line #	BRAKE DISC CHOICES - FRONT						DISC PAD CHOICES - REAR				BRAKE DISC CHOICES - REAR			
	Oversize 250 /280mm Disc Kit	OSX Oversize 250/280mm Disc Kit	Relocating Bracket for 250/ 280mm Disc	Oversize 320mm Disc Kit	SMX Oversize 320mm Disc Kit	Relocating Bracket for 320mm Disc	FA, SFA, TT Pad or Brake Shoe	SFAC Carbon Scooter Pads	Speciality Pads - SXR / Vee / MXS	Sintered/ HH Pads/ Grooved Shoes	Standard Replacement Disc	Contour Disc Rear fitment	Vee-Discs™ CONTOUR	CX Extreme MX Race Disc/ UTVX Disc
1							818							
2							818							
3							H303							
4							H303							
5							TBA							
6							H303							
7							H303							
8							H303							
9							H333							
10							H333							
11							H303							
12							H303							
13							H303							
14							H303							
15							H303							
16							H333							
17							H333							
18							H303							
19							H303							
20							H303							
21							H303							
22							H340							
23							H303							
24							H303							
25							H307		H307G					
26							H303							
27							H303							
28							H303							
29							H303							
30							H303							
31							818							
32							H303							
33							SFA197		SFA197HH		N/A			
34							H303							
35							H307		H307G					
36							FA305TT		FA305R	MD6267D				
37							FA305TT		FA305R	MD6267D				
38							SFA086		SFA086HH	N/A				
39							818							
40							818							
41							818							
42							TBA							
43							H303							
44							H303							
45							SFA234			MD926D				
46							818							
47							818							
48							SFA305	SFAC305	SFA305HH	MD971D		VR971		
49							H303							
50							H303							
51							H303							
52							H303							
53							H303							
54							H303							
55							H303							
56							H303							
57							FA305TT		FA305R	MD6267D				
58							FA305TT		FA305R	MD6267D				
59							TBA							
60							H303							

REAR / ARRIÈRE / HINTEN / POSTERIOR / POSTERIORE

*-2 Sets Required. † For Vee disc colours add RED, BLU, GRN, GLD, ORG suffix to part number.

⊗ - Also available as a Vintage Motorcycle Disc.

R Suffix = High Durability Sintered Pad. **HH** Suffix = High Performance Sintered Pad. **TT** Suffix = Hard Wearing Off Road Pad. **V** Suffix = Semi Sintered Pad. **G** Suffix = Grooved Shoe.
D Suffix = Drilled Disc. **X** Suffix = Universal Left or Right Disc. **XC** Suffix = Contoured Disc. **LS** Suffix = Left/Steel Disc. **RS** = Right/Steel Disc.

BRAKE APPLICATIONS

Non-JAPANESE Built Motorcycles

APPLICATIONS

BRAKE



KYMCO Contd.

		DISC PAD CHOICES - FRONT				BRAKE DISC CHOICES - FRONT					Line #	
		FA, SFA, TT Pad or Brake Shoe	SFAC Carbon Scooter Pads	Speciality Pads - SXR / Vee / MXS	Sintered/HH Pads/ Grooved Shoes	Left / Gauche / Links Standard Replacement Disc	Right / Droite / Rechts Standard Replacement Disc	Contour Disc Universal left and right fitment	Universal Custom Disc	Vee-Discs Black † See note below		CX Extreme MX Race Disc/ UTVX Disc
KB 100 Manboy	97-00	SFA233				MD933D				VR933		1
Spike 100/125	00-06	SFA086	SFAC086		SFA086HH		N/A					2
Top Boy 100 (On road & off road models)	97	SFA233				TBA						3
Activ 110/125	04-06	SFA197	SFAC197		SFA197HH		N/A					4
Visa - R 110	11-15	SFA067	SFAC067		SFA067HH		N/A					5
Agility 125 Carry (4T)	11-15	SFA305	SFAC305		SFA305HH			TBA				6
Agility 125 4T (U62000/1 - 12" Wheels/3 Spoke)	06-14	SFA228	SFAC228		SFA228HH	MD971D		MD971C		VR971		7
Agility 125 (C20000 - 16" Wheels)	08-15	SFA305	SFAC305		SFA305HH	MD9100D				VR9100		8
Agility City 125	18-20	SFA305	SFAC305		SFA305HH	MD9100D				VR9100		9
Agility City+ 125	18-20	SFA305	SFAC305		SFA305HH	MD9100D				VR9100		10
Agility RS 125 (2T-12" wheels/5 Spoke)	09-13	SFA305	SFAC305		SFA305HH		TBA					11
Agility RS 125 (4T-12" wheels/5 Spoke)	10-15	SFA228	SFAC228		SFA228HH			N/A				12
Bet & Win 125/150 (SH25CA/30C)	00-06	SFA197	SFAC197		SFA197HH		MD973D			VR973		13
CK1 125 (4T/KT25AA)	14-15	FA197			FA197HH		N/A					14
CK 125 Pulsar	99-00	FA486					N/A					15
CK 125 Pulsar (KJ25CB)	01-07	FA197			FA197HH		N/A					16
CK 125 Pulsar 11 (KE25RF)	08-10	FA197			FA197HH		N/A					17
CK 125 Pulsar S	11-15	FA197			FA197HH		N/A					18
Cruiser 125	99	FA197			FA197HH		TBA					19
Dink Classic 125/150 (SH25BB/30B)	02	SFA197	SFAC197		SFA197HH		MD973D			VR973		20
Dink/Spacer 125/150 (SH25/30)	97-04	SFA197	SFAC197		SFA197HH		MD971D	MD971C		VR971		21
Dink LX 125/150 (SH25BA/30B)	98-00	SFA197	SFAC197		SFA197HH	MD971D		MD971C		VR971		22
Dink 125i (T90000)	06-15	SFA197	SFAC197		SFA197HH		TBA					23
Downtown 125 i/Super Dink (V21000)	09-15	SFA142	SFAC142		SFA142HH			N/A		VR9128		24
New Downtown 125i	15-19	SFA324	SFAC324		SFA324HH			N/A				25
DJ 125 S	12-13	SFA305	SFAC305		SFA305HH	TBA						26
Grand Dink/Miler 125/150 (S40000-00)	01-07	SFA197	SFAC197		SFA197HH		MD973D			VR973		27
Grand Dink 125	12-15	SFA142	SFAC142		SFA142HH		TBA					28
Heroism 125 (SE25BA)	95-97	SFA235	SFAC235			MD933D				VR933		29
Heroism 150 (SE30AD)	95-97	SFA235	SFAC235			MD933D				VR933		30
Hipster 125/150	99-06	FA197			FA197HH		N/A					31
K-Pipe 125	12-15	FA197			FA197HH		TBA					32
K-XCT 125 i	12-15	SFA124	SFAC124		SFA124HH			N/A				33
KR 125 Quannon Naked	10-15	FA197			FA197HH		N/A					34
KR 125 Quannon Sport	07-13	FA197			FA197HH		N/A					35
Like 125	09	SFA305	SFAC305		SFA305HH	TBA						36
Like 125 LX	10-20	SFA228	SFAC228		SFA228HH	TBA		N/A				37
Looker 125 S (BA25BA (JP))	07-08	SFA305	SFAC305		SFA305HH	MD989D						38
Jetix 125	10-15	SFA086	SFAC086		SFA086HH			N/A				39
Movie 125 (SL25AA)	99-00	SFA228	SFAC228		FA228HH	MD972D						40
Movie XL 125/150 (S510/500)	01-09	SFA197	SFAC197		SFA197HH		MD973D			VR973		41
Movie 125 i	12-13	SFA197	SFAC197		SFA197HH		TBA					42
MXer 125/150 Quad (LA35AD/LA30AD)	02-07	H303*			H303G*							43
Nexxon 125	07-08	SFA086	SFAC086		SFA086HH		N/A					44
People GT 125 i	10-20	SFA324	SFAC324		SFA324HH		TBA					45
People S 125 (BA25BA) (5 bolt disc fixing)	05-06	SFA305	SFAC305		SFA305HH	MD9100D				VR9100		46
People S 125 DD (D1000 rear disc model) (5 bolt fixing)	07-20	SFA305	SFAC305		SFA305HH	MD9100D				VR9100		47
People 125 (B20000/10/11) (3 bolt disc fixing)	99-14	SFA305	SFAC305		SFA305HH	MD989D						48
People One 125i	13-15	SFA305	SFAC305		SFA305HH	N/A						49
People One 125i	16-19	SFA603										50
Sector 125	98-01	FA197			FA197HH		N/A					51
Spike 125 R	04-06	SFA197	SFAC197		SFA197HH	N/A						52
Straight 125	05-06	FA197			FA197HH	N/A						53
Stryker 125 (DA25BB) On Road/Off Road	01-06	FA228			FA228HH	N/A						54
Super 8 4T (125cc)	08-15	SFA305	SFAC305		SFA305HH			TBA				55
V-Link 125 SRC-V (SD125 LD (JP))	07-08	TBA				TBA						56
V-Link 125 S (SD 25QA (JP))	07-08	TBA				TBA						57
X Town 125i ABS	16-20	SFA324	SFAC324		SFA324HH							58
Yager 125	00	SFA197	SFAC197		SFA197HH		MD971D	MD971C		VR971		59
Yager GT 125	07-13	SFA197	SFAC197		SFA197HH		TBA					60

FRONT / AVANT / VORN / FRENTE / ANTERIORE

R Suffix = High Durability Sintered Pad. HH Suffix = High Performance Sintered Pad. TT Suffix = Hard Wearing Off Road Pad. V Suffix = Semi Sintered Pad. G Suffix = Grooved Shoe.

D Suffix = Drilled Disc. X Suffix = Universal Left or Right Disc. XC Suffix = Contoured Disc. LS Suffix = Left/Steel Disc. RS = Right/Steel Disc.

*-2 Sets Required. † For Vee disc colours add RED, BLU, GRN, GLD, ORG suffix to part number.

⊗ - Also available as a Vintage Motorcycle Disc.

304 Part numbers, prefixes, suffixes, photos and illustrations shown in this catalogue are trademarks and/or copyrights of EBC Brakes or the trademark owner A C Freeman Investments Ltd and use without express written permission of the owners is punishable by law.

Non-JAPANESE Built Motorcycles

Line #	BRAKE DISC CHOICES - FRONT						DISC PAD CHOICES - REAR				BRAKE DISC CHOICES - REAR			
	Oversize 250 /280mm Disc Kit	OSX Oversize 250/280mm Disc Kit	Relocating Bracket for 250/ 280mm Disc	Oversize 320mm Disc Kit	SMX Oversize 320mm Disc Kit	Relocating Bracket for 320mm Disc	FA, SFA, TT Pad or Brake Shoe	SFAC Carbon Scooter Pads	Speciality Pads - SXR / Vee / MXS	Sintered/ HH Pads/ Grooved Shoes	Standard Replacement Disc	Contour Disc Rear fitment	Vee-Discs™ CONTOUR	CX Extreme MX Race Disc/ UTVX Disc
1							H303							
2							TBA				N/A			
3							H303							
4							H303							
5							H303							
6							H303							
7							818							
8							SFA067	SFAC067		SFA067HH	TBA			
9							SFA067	SFAC067		SFA067HH				
10							SFA067	SFAC067		SFA067HH				
11							818							
12							818							
13							SFA197	SFAC197		SFA197HH	MD974D		VR974	
14							H307							
15							H310							
16							H340							
17							H307							
18							H307							
19							TBA							
20							SFA197	SFAC197		SFA197HH	MD971D		VR971	
21							SFA197	SFAC197		SFA197HH	MD971D	MD971C	VR971	
22							SFA197	SFAC197		SFA197HH	MD971D	MD971C	VR971	
23							SFA197	SFAC197		SFA197HH	MD974D		VR974	
24							SFA498	SFAC498		SFA498HH	MD9129D		VR9129	
25							SFA607			SFA607HH	MD9129D		VR9129	
26							H303							
27							SFA197	SFAC197		SFA197HH	MD974D		VR974	
28							SFA197	SFAC197		SFA197HH	TBA			
29							H303							
30							SFA234				MD926D			
31							H340							
32							H340							
33							SFA607			SFA607HH		N/A		
34							FA197			FA197HH	N/A			
35							FA197			FA197HH	N/A			
36							SFA197	SFAC197		SFA197HH	TBA			
37							SFA197	SFAC197		SFA197HH	TBA			
38							818							
39							SFA197	SFAC197		SFA197HH		N/A		
40							818							
41							818							
42							TBA							
43							FA305TT			FA305R	MD6267D			
44							SFA086	SFAC086		SFA086HH	N/A			
45							SFA607			SFA607HH	SFA607HH			
46							818							
47							SFA607			SFA607HH	MD9100D			
48							818							
49							818							
50														
51							TBA							
52							SFA197	SFAC197		SFA197HH	MD971D			
53							N/A							
54							H340							
55							818							
56							TBA							
57							TBA							
58							SFA607			SFA607HH	MD9129D		VR9129	
59							SFA197	SFAC197		SFA197HH	MD971D	MD971C	VR971	
60							SFA197	SFAC197		SFA197HH	MD974D			

REAR / ARRIÈRE / HINTEN / POSTERIOR / POSTERIORE

*-2 Sets Required. † For Vee disc colours add RED, BLU, GRN, GLD, ORG suffix to part number.

⊗ - Also available as a Vintage Motorcycle Disc.

R Suffix = High Durability Sintered Pad. HH Suffix = High Performance Sintered Pad. TT Suffix = Hard Wearing Off Road Pad. V Suffix = Semi Sintered Pad. G Suffix = Grooved Shoe.

D Suffix = Drilled Disc. X Suffix = Universal Left or Right Disc. XC Suffix = Contoured Disc. LS Suffix = Left/Steel Disc. RS = Right/Steel Disc.

BRAKE APPLICATIONS

Non-JAPANESE Built Motorcycles

APPLICATIONS

BRAKE



KYMCO Contd.



DISC PAD CHOICES - FRONT

BRAKE DISC CHOICES - FRONT

	FA, SFA, TT Pad or Brake Shoe	SFAC Carbon Scooter Pads	Speciality Pads SXR / Vee / MXS	Sintered/ HH Pads/ Grooved Shoes	BRAKE DISC CHOICES - FRONT						Line #
					Left / Gauche / Links Standard Replacement Disc	Right / Droite / Rechts Standard Replacement Disc	Contour Disc Universal left and right fitment	Universal Custom Disc	Vee-Discs Black † See note below	CX Extreme MX Race Disc/ UTVX Disc	
MXU 150	H303*			H303G*							1
Stryker 150 (Off road)	FA228			FA228HH	N/A						2
Visar - R 125	SFA067	SFAC067		SFA067HH		N/A					3
Vivio 125/150 (SL25BA/30AC)	SFA228	SFAC228		SFA228HH		MD972D					4
Zing 125/150 Custom Style (RF25/30)	FA197			FA197HH		N/A					5
Agility 150 R16 (C30000)	SFA305	SFAC305		SFA305HH	MD9100D				VR9100		6
Jetix 150	SFA086	SFAC086		SFA086HH			N/A				7
People 150 (B200001/20) (3 bolt disc fixing)	SFA305	SFAC305		SFA305HH		MD989D					8
Agility 200 i R16	SFA305	SFAC305		SFA305HH	MD9100D				VR9100		9
Dink 200i (T91000)	SFA197	SFAC197		SFA197HH		TBA					10
Downtown 200 i	SFA142	SFAC142		SFA142HH			N/A		VR9128		11
People GT 200 i	SFA324	SFAC324		SFA324HH		TBA					12
Like 200i	SFA305	SFAC305		SFA305HH	TBA						13
Like 200i LX	SFA228	SFAC228		SFA228HH	TBA						14
People S 200 (D11000) (5 bolt fixing disc)	SFA305	SFAC305		SFA305HH	MD9100D				VR9100		15
People S 200i DD (D12000) (5 bolt fixing disc F/Disc - Rear Disc Model)	SFA305	SFAC305		SFA305HH	MD9100D				VR9100		16
Yager 200i	SFA197	SFAC197		SFA197HH		TBA					17
Bet & Win 250 (S7000)	SFA197	SFAC197		SFA197HH		MD973D			VR973		18
Grand Dink 250 (S400)	SFA355*	SFAC355*		SFA355HH*		MD973D			VR973		19
KXR 250 Mongoose Quad	FA377TT*			FA377R*	MD6267D	MD6267D					20
Maxxer 250	FA377TT*			FA377R*	MD6267D	MD6267D					21
MXU 250	FA377TT*			FA377R*	MD6267D	MD6267D					22
MXU 250 R	FA377TT*			FA377R*	MD6267D	MD6267D					23
People 250 (BC50AA)	SFA197	SFAC197		SFA197HH		MD9100D			VR9100		24
People 250 Si DD	SFA228	SFAC228		SFA228HH	MD9100D	MD9100D			VR9100		25
	SFA197	SFAC197		SFA197HH					VR9100		26
Urban Quad 250	FA377TT*			FA377R*	TBA	TBA					27
Xciting 250 (T71000)	SFA142*	SFAC142*		SFA142HH*	TBA	TBA					28
Xciting 250 i (T71010)	SFA142*	SFAC142*		SFA142HH*	TBA	TBA					29
Venox 250 (R20010/RA50AA/Carb Model)	FA196			FA196HH	MD1101						30
Venox 250 (RFBR20011/RA500AD/Carb Model)	FA196			FA196HH	MD1101						31
Venox 250 (R20012/EFI Model)	FA196			FA196HH	MD1101						32
Yup 250 (W2000)	SFA197	SFAC197		SFA197HH		MD973D			VR973		33
Agility Maxi 300i ABS	SFA324	SFAC324		SFA324HH			TBA				34
AK 300i ABS			FA630V*	FA630HH*							35
Downtown 300 i/Super Dink (V20000)	SFA142	SFAC142		SFA142HH			N/A		VR9128		36
Downtown 300i/ABS	SFA142	SFAC142		SFA142HH			N/A		VR9128		37
Grand Dink 300 i	SFA142	SFAC142		SFA142HH		MD973D			VR973		38
K-XCT 300 i	SFA324	SFAC324		SFA324HH			N/A				39
Maxxer 300	FA377TT*			FA377R*	MD6267D	MD6267D					40
MXU 300	FA377TT*			FA377R*	MD6267D	MD6267D					41
MXU 300 R	FA377TT*			FA377R*	MD6267D	MD6267D					42
People GT 300 i	SFA324	SFAC324		SFA324HH		TBA					43
People GT 300i ABS Euro 4	SFA324	SFAC324		SFA324HH							44
People S 300i	SFA228	SFAC228		SFA228HH	MD9100D	MD9100D			VR9100		45
	SFA197	SFAC197		SFA197HH					VR9100		46
People S 300i ABS Euro 4	SFA324	SFAC324		SFA324HH		MD9100D					47
Xciting 300i (T72000 - EFI Model)	SFA142*	SFAC142*		SFA142HH*	TBA	TBA					48
Xciting 300i R (T72001/T72011)	SFA142*	SFAC142*		SFA142HH*			TBA*				49
X Town 300i ABS	SFA324	SFAC324		SFA324HH							50
Downtown 350i	SFA324	SFAC324		SFA324HH			N/A				51
Maxxer 400	FA395TT*			FA395R*	MD6173D	MD6173D					52
Maxxer 400 - Parking brake	SFA257/2										53
MXU 400 (A40000)	FA395TT*			FA395R*	MD6173D	MD6173D					54
MXU 400 (A40000) - Parking brake	SFA257/2										55
UXV 450i (Side X Side)	FA377TT*			FA377R*	N/A	N/A					56
Xciting 400i	SFA432*			SFA432HH*			TBA*				57
Xciting S 400i	SFA432*			SFA432HH*			TBA*				58
Maxxer 450 i (4T/On & Off Road Models)	FA395TT*			FA395R*	MD6173D	MD6173D					59

FRONT / AVANT / VORN / FRENTE / ANTERIORE

R Suffix = High Durability Sintered Pad. HH Suffix = High Performance Sintered Pad. TT Suffix = Hard Wearing Off Road Pad. V Suffix = Semi Sintered Pad. G Suffix = Grooved Shoe.

D Suffix = Drilled Disc. X Suffix = Universal Left or Right Disc. XC Suffix = Contoured Disc. LS Suffix = Left/Steel Disc. RS Suffix = Right/Steel Disc.

*-2 Sets Required. † For Vee disc colours add RED, BLU, GRN, GLD, ORG suffix to part number.

⊗ - Also available as a Vintage Motorcycle Disc.

306 Part numbers, prefixes, suffixes, photos and illustrations shown in this catalogue are trademarks and/or copyrights of EBC Brakes or the trademark owner A C Freeman Investments Ltd and use without express written permission of the owners is punishable by law.

Non-JAPANESE Built Motorcycles

Line #	BRAKE DISC CHOICES - FRONT						DISC PAD CHOICES - REAR				BRAKE DISC CHOICES - REAR			
	Oversize 250 /280mm Disc Kit	OSX Oversize 250/280mm Disc Kit	Relocating Bracket for 250/ 280mm Disc	Oversize 320mm Disc Kit	SMX Oversize 320mm Disc Kit	Relocating Bracket for 320mm Disc	FA, SFA, TT Pad or Brake Shoe	SFAC Carbon Scooter Pads	Speciality Pads - SXR / Vee / MXS	Sintered/ HH Pads/ Grooved Shoes	Standard Replacement Disc	Contour Disc Rear fitment	Vee-Discs™ CONTOUR	CX Extreme MX Race Disc/ UTVX Disc
1							FA305TT			FA305R	MD6267D			
2							H340							
3							H303							
4							818							
5							H340							
6							SFA197	SFAC197		SFA197HH	TBA			
7							SFA197	SFAC197		SFA197HH		N/A		
8							818							
9							SFA197	SFAC197		SFA197HH	TBA			
10							SFA197	SFAC197		SFA197HH	MD974D			
11							SFA498	SFAC498		SFA498HH	MD9129D		VR9129	
12							SFA607			SFA607HH	TBA			
13							SFA197	SFAC197		SFA197HH	TBA			
14							SFA197	SFAC197		SFA197HH	TBA			
15							818							
16														
17							SFA607			SFA607HH	MD9100D			
18							SFA197	SFAC197		SFA197HH	MD974D			
19							SFA197	SFAC197		SFA197HH	MD974D		VR974	
20							SFA356			SFA356HH	MD974D		VR974	
21							FA355/4TT			FA355/4R	MD6268D			
22							FA377TT			FA377R	MD6267D			
23							FA355/4TT			FA355/4R	MD6268D			
24							FA377TT			FA377R	MD6267D			
25							SFA142	SFAC142		SFA142HH	MD9100D			
26							SFA607			SFA607HH	MD9100D			
27														
28							FA355/4TT			FA355/4R	TBA			
29							SFA607			SFA607HH	TBA			
30							SFA607			SFA607HH	TBA			
31							H321							
32							H321							
33							H321							
34							SFA197	SFAC197		SFA197HH	MD974D		VR974	
35							SFA607			SFA607HH		TBA		
36							SFA719			SFA719HH				
37							SFA498	SFAC498		SFA498HH	MD9129D		VR9129	
38							SFA498	SFAC498		SFA498HH	MD9129D		VR9129	
39							SFA607			SFA607HH		N/A		
40							SFA607			SFA607HH		N/A		
41							FA355/4TT			FA355/4R	MD6268D			
42							FA377TT*			FA377R*	MD6267D			
43							FA377TT			FA377R	MD6267D			
44							SFA607			SFA607HH	TBA			
45							SFA607			SFA607HH				
46							SFA607			SFA607HH	MD9100D			
47														
48														
49							SFA607			SFA607HH	TBA			
50							SFA607			SFA607HH		N/A		
51							SFA607			SFA607HH	MD9129D		VR9129	
52							SFA607			SFA607HH	MD9129D		VR9129	
53							FA395TT			FA395R	MD6173D			
54														
55							FA395TT			FA395R	MD6173D			
56														
57							FA377TT*			FA377R*	N/A			
58							SFA608			SFA608HH		N/A		
59							SFA608			SFA608HH		N/A		
60							FA395TT			FA395R	MD6173D			

REAR / ARRIÈRE / HINTEN / POSTERIOR / POSTERIORE

*-2 Sets Required. † For Vee disc colours add RED, BLU, GRN, GLD, ORG suffix to part number.

⊗ - Also available as a Vintage Motorcycle Disc.

R Suffix = High Durability Sintered Pad. HH Suffix = High Performance Sintered Pad. TT Suffix = Hard Wearing Off Road Pad. V Suffix = Semi Sintered Pad. G Suffix = Grooved Shoe.

D Suffix = Drilled Disc. X Suffix = Universal Left or Right Disc. XC Suffix = Contoured Disc. LS Suffix = Left/Steel Disc. RS = Right/Steel Disc.

Non-JAPANESE Built Motorcycles

APPLICATIONS

BRAKE



KYMCO Contd.

Maxxer 450 i (4T/On & Off Road Models) - Parking brake	10-18
MXU 450 i IRS	11-12
MXU 450 i	13-15
MXU 450 i - Parking brake	13-15
MXU 500 (L70000/Carb Model/4x4)	05-09
MXU 500 i DX	12-13
MXU 500 i DX - Parking brake	12-13
MXU 500 i IRS (4x4 - IRS) (LAAOCD/CM)	09-14
MXU 500 i IRS (4x4 - IRS) (LAAOCD/CM) - Parking brake	09-14
UXV 500 (Side x Side/4x4/U10000)	08-09
UXV 500 i (Side x Side/4x4/U10100)	10-15
Xciting 500 (T70000 - Carb Model)	05
Xciting 500 i (T70020 - EFI Model)	06-08
Xciting 500i R (T70030 - EFI Model)	07-09
Xciting 500i R (T70021 - EFI Model)	07-15
Xciting Evo 500i ABS	13
AK 550	17-20
MXU 550 i	12-15
MXU 550 i - Parking brake	12-15
MXU 550 I (4x4 LoF)	13-15
MXU 550 I (4x4 LoF) - Parking brake	13-15
My Road 700 i	11-15
MXU 700 i (4x4 LoF)	13-18
MXU 700 i (4x4 LoF) - Parking brake	13-15
UXV 700 i (Turf)	14-18
UXV 700 i (Turf) - Parking brake	14-15

LAMBRETTA

LJ 50	12-13
LT 50	12-13
50 N Pato	08-10
125 N Pato	08-10
125/150/175 L1	
125/150/200 DL	
125/150 D-LD	
LN 125 (4T)	11-13
LN 151 (4T)	11-13
151 N Pato	08-10
175 TV II	

LAVERDA

CR 50 Atlas	87-
Quasar 50	02-04
Quasar 100	02-04
Mini Quasar	02-04
GS 125 Lesmo	86-89
LB 125 Custom/Sabbia Strada/Sport	85-87
LZ 125 Sport Brembo Caliper	80-82
LZ 125 Sport Grimeca Caliper	80-82
Phoenix 125/150/200	01-04
Quasar 125 HP Grip	02-04
Quasar 125 HP	02-04
Quasar 180 HP Grip	04
Quasar 180 HP	04
Quasar 4x4 400	04
Montjuic	76
Alpino 500	76
Quasar 4x4 500C	04
Quasar 4x4 500	04
650 All models	94-95

DISC PAD CHOICES - FRONT

BRAKE DISC CHOICES - FRONT

FA, SFA, TT Pad or Brake Shoe	SFAC Carbon Scooter Pads	Speciality Pads SXR / Vee / MXS	Sintered/HH Pads/ Grooved Shoes	Left / Gauche / Links Standard Replacement Disc	Right / Droite / Rechts Standard Replacement Disc	Contour Disc Universal left and right fitment	Universal Custom Disc	Vee-Discs Black † See note below	CX Extreme MX Race Disc/ UTVX Disc
SFA257/2									
FA395TT*			FA395R*	MD6173D	MD6173D				
FA395TT*			FA395R*	TBA	TBA				
SFA257/2									
FA377TT*			FA377R*	MD6195D	MD6195D				
FA600TT*			FA600R*	MD6173D	MD6173D				
FA377									
FA600TT*			FA600R*	MD6173D	MD6173D				
FA377TT									
FA377TT*			FA377R*	TBA	TBA				
FA377TT*			FA377R*	TBA	TBA				
SFA142*	SFAC142*		SFA142HH*	TBA	TBA				
SFA142*	SFAC142*		SFA142HH*	TBA	TBA				
SFA142*	SFAC142*		SFA142HH*	TBA	TBA				
SFA142*	SFAC142*		SFA142HH*			TBA*			
SFA142*	SFAC142*		SFA142HH*			N/A*			
FA630*		FA630V*	FA630HH*	MD9174D	MD9174D				
FA600TT*			FA600R*	MD6173D	MD6173D				
FA377TT									
FA600TT*			FA600R*	MD6173D	MD6173D				
FA377TT									
SFA142*	SFAC142*		SFA142HH*	N/A	N/A				
FA600TT*			FA600R*	N/A	N/A				
FA377TT									
FA600TT*			FA600R*	MD6173D	MD6173D				
FA377TT									
SFA264	SFAC264		SFA264HH	TBA					
SFA264	SFAC264		SFA264HH	TBA					
SFA086	SFAC086		SFA086HH	TBA					
SFA086	SFAC086		SFA086HH	TBA					
958									
959									
N/A									
SFA264	SFAC264		SFA264HH	TBA					
SFA264	SFAC264		SFA264HH	TBA					
SFA086	SFAC086		SFA086HH	TBA					
FA100				N/A					
FA047			FA047HH	N/A					
H338*			H338G*						
H338*			H338G*						
TBA*									
FA047*			FA047HH*	N/A	N/A				
FA060				N/A					
FA047			FA047HH	N/A					
FA076			FA076HH	N/A					
SFA306	SFAC306			N/A					
TBA*									
TBA*									
TBA*									
TBA*									
FA271TT*			FA271R*	MD6173D	MD6173D				
FA047*			FA047HH*	N/A	N/A				
FA047*			FA047HH*	N/A	N/A				
FA271TT*			FA271R*	MD6173D	MD6173D				
FA271TT*			FA271R*	MD6173D	MD6173D				
FA095*		FA095V*	FA095HH*	MD2003X	MD2003X	MD2003XC*	MD2003CC*	VR2003BLK*	

Line #
1
2
3
4
5
6
7
8
9
10
11
12
13
14
15
16
17
18
19
20
21
22
23
24
25
26
27
28
29
30
31
32
33
34
35
36
37
38
39
40
41
42
43
44
45
46
47
48
49
50
51
52
53
54
55
56
57
58
59
60

R Suffix = High Durability Sintered Pad. HH Suffix = High Performance Sintered Pad. TT Suffix = Hard Wearing Off Road Pad. V Suffix = Semi-Sintered Pad. G Suffix = Grooved Shoe.

D Suffix = Drilled Disc. X Suffix = Universal Left or Right Disc. XC Suffix = Contoured Disc. LS Suffix = Left/Steel Disc. RS Suffix = Right/Steel Disc.

*-2 Sets Required. † For Vee disc colours add RED, BLU, GRN, GLD, ORG suffix to part number.

⊗ - Also available as a Vintage Motorcycle Disc.

308 Part numbers, prefixes, suffixes, photos and illustrations shown in this catalogue are trademarks and/or copyrights of EBC Brakes or the trademark owner A C Freeman Investments Ltd and use without express written permission of the owners is punishable by law.

Non-JAPANESE Built Motorcycles

Line #	BRAKE DISC CHOICES - FRONT						DISC PAD CHOICES - REAR				BRAKE DISC CHOICES - REAR			
	Oversize 250 /280mm Disc Kit	OSX Oversize 250/280mm Disc Kit	Relocating Bracket for 250/ 280mm Disc	Oversize 320mm Disc Kit	SMX Oversize 320mm Disc Kit	Relocating Bracket for 320mm Disc	FA, SFA, TT Pad or Brake Shoe	SFAC Carbon Scooter Pads	Speciality Pads - SXR / Vee / MXS	Sintered/ HH Pads/ Grooved Shoes	Standard Replacement Disc	Contour Disc Rear fitment	Vee-Discs™ CONTOUR	CX Extreme MX Race Disc/ UTVX Disc
1														
2							FA395TT			FA395R	MD6173D			
3							FA395TT			FA395R	TBA			
4														
5							FA377TT*			FA377R*	TBA			
6							FA600/2TT			FA600/2R	TBA			
7														
8							FA600/2TT			FA600/2R	TBA			
9														
10							FA377TT			FA377R	MD6376D			UTVX6376
11							FA377TT			FA377R	MD6376D			UTVX6376
12							SFA608			SFA608HH	TBA			
13							SFA608			SFA608HH	TBA			
14							SFA608			SFA608HH	TBA			
15							SFA608			SFA608HH		TBA		
16							SFA608			SFA608HH		N/A		
17							SFA719			SFA719HH	MD9173D			
18							FA600/2TT			FA600/2R	TBA			
19														
20							FA600/2TT			FA600/2R	TBA			
21														
22							SFA608			SFA608HH		N/A		
23							FA600/2TT*			FA600/2R*	N/A			
24														
25							FA600/2TT			FA600/2R	TBA			
26														
27														
28														
29							TBA							
30							TBA							
31							SFA086	SFAC086		SFA086HH	TBA			
32							SFA086	SFAC086		SFA086HH	TBA			
33							958							
34							959							
35							N/A							
36							TBA							
37							TBA							
38							SFA086	SFAC086		SFA086HH	TBA			
39							958							
40														
41														
42							FA047			FA047HH	N/A			
43							H330			H330G				
44							H330			H330G				
45							TBA							
46														
47							921							
48							921							
49							921							
50							SFA305	SFAC305			TBA			
51							TBA							
52							TBA							
53							TBA							
54							TBA							
55							FA271TT			FA271R	MD6173D			
56							FA047			FA047HH	N/A			
57							FA047			FA047HH	N/A			
58							FA271TT			FA271R	MD6173D			
59							FA271TT			FA271R	MD6173D			
60							FA047			FA047HH	MD2002	MD2002C		

REAR / ARRIÈRE / HINTEN / POSTERIOR / POSTERIORE

R Suffix = High Durability Sintered Pad. **HH** Suffix = High Performance Sintered Pad. **TT** Suffix = Hard Wearing Off Road Pad. **V** Suffix = Semi Sintered Pad. **G** Suffix = Grooved Shoe.
D Suffix = Drilled Disc. **X** Suffix = Universal Left or Right Disc. **XC** Suffix = Contoured Disc. **LS** Suffix = Left/Steel Disc. **RS** = Right/Steel Disc.

*-2 Sets Required. † For Vee disc colours add RED, BLU, GRN, GLD, ORG suffix to part number.
 Ⓢ - Also available as a Vintage Motorcycle Disc.

BRAKE APPLICATIONS

Non-JAPANESE Built Motorcycles

Line #	BRAKE DISC CHOICES - FRONT						DISC PAD CHOICES - REAR				BRAKE DISC CHOICES - REAR			
	Oversize 250 /280mm Disc Kit	OSX Oversize 250/280mm Disc Kit	Relocating Bracket for 250/ 280mm Disc	Oversize 320mm Disc Kit	SMX Oversize 320mm Disc Kit	Relocating Bracket for 320mm Disc	FA, SFA, TT Pad or Brake Shoe	SFAC Carbon Scooter Pads	Speciality Pads - SXR / Vee / MXS	Sintered/ HH Pads/ Grooved Shoes	Standard Replacement Disc	Contour Disc Rear fitment	Vee-Discs™ CONTOUR	CX Extreme MX Race Disc/ UTVX Disc
1							FA047			FA047HH	MD2002	MD2002C		
2							N/A							
3							FA018		FA018V	FA018HH	MD609LS			
4							FA018		FA018V	FA018HH	MD609LS			
5							FA047			FA047HH	MD2002	MD2002C		
6							FA018		FA018V	FA018HH	MD609LS			
7							FA018		FA018V	FA018HH	MD609LS			
8							FA018		FA018V	FA018HH	MD609LS			
9							FA018		FA018V	FA018HH	MD609LS			
10							FA018		FA018V	FA018HH	MD609LS			
11							FA018		FA018V	FA018HH	MD609LS			
12							FA018		FA018V	FA018HH	MD609ALS			
13							FA018		FA018V	FA018HH	MD609LS			
14							FA266		FA266V	FA266HH	MD613	MD613C		
15							FA018		FA018V	FA018HH	MD609LS			
16							FA018		FA018V	FA018HH	MD609LS			
17											MD670			
18														
19														
20														
21										FA325R		N/A		
22							FA115			FA115HH	N/A			
23							FA325TT			FA325R	N/A			
24							FA325TT			FA325R	N/A			
25							FA325TT			FA325R	N/A			
26														
27														
28							FA197			FA197HH		N/A		
29							FA197			FA197HH		N/A		
30							FA197			FA197HH		N/A		
31							FA197			FA197HH		N/A		
32							FA197			FA197HH		N/A		
33							FA197			FA197HH		N/A		
34							FA197			FA197HH		N/A		
35														
36														
37														
38							H303			H303G				
39							SFA054	SFAC054		SFA054HH				
40							H303			H303G				
41							H303			H303G				
42							SFA054	SFAC054		SFA054HH				
43							SFA054	SFAC054		SFA054HH				
44							SFA464	SFAC464						
45							H303			H303G				
46							H303			H303G				
47							SFA197	SFAC197		SFAC197HH				
48							SFA054	SFAC054		SFA054HH				
49							Y527			Y527G				
50							S602			S602G				
51							SFA197	SFAC197		SFAC197HH				
52														
53							SFA197	SFAC197		SFAC197HH				
54							H303			H303G				
55							FA135TT			FA135TT				
56							SFA054	SFAC054		SFA054HH				
57							H303			H303G				
58							SFA086	SFAC086		SFA086HH				
59							FA140							
60							FA140							

REAR / ARRIÈRE / HINTEN / POSTERIOR / POSTERIORE

*-2 Sets Required. † For Vee disc colours add RED, BLU, GRN, GLD, ORG suffix to part number.

⊗ - Also available as a Vintage Motorcycle Disc.

R Suffix = High Durability Sintered Pad. HH Suffix = High Performance Sintered Pad. TT Suffix = Hard Wearing Off Road Pad. V Suffix = Semi Sintered Pad. G Suffix = Grooved Shoe.

D Suffix = Drilled Disc. X Suffix = Universal Left or Right Disc. XC Suffix = Contoured Disc. LS Suffix = Left/Steel Disc. RS = Right/Steel Disc.

Part numbers, prefixes, suffixes, photos and illustrations shown in this catalogue are trademarks and/or copyrights of EBC Brakes or the trademark owner A C Freeman Investments Ltd and use without express written permission of the owners is punishable by law.

Non-JAPANESE Built Motorcycles

APPLICATIONS

BRAKE



LIFAN

Lifan Electric LF 1200 DT E3	17-20
Lifan Electric LF 1200 DT E3 Deluxe	17-20
LF 50 QGY	
LF 50 QGY 39844	
Smart 50/125	
LF 100 5	
LF 100 A	
LF 125 Off Road	07
LT 125 T-2D	
LT 125 3A	

LINHAI

LH 50 Prince (Scooter)	07-09
ATV 80	13
Drive-in City Walker 125/150 Scooter	08-09
Eggy 125cc (Scooter)	07-09
Monarch 125/150 T	06-07
ATV 150	13
Goon 260cc (ATV) 2x4/4x4	07-09
Goon 260 (ATV) (2x4/4x4)	07-09
Goon 260 (ATV) (2x4/4x4) - Parking brake	07-09
CUV Carry 300 (ATV)	07-09
Main Street 300cc (Scooter)	07-09
Main Street 300cc Scooter	08-09
Muddy 300 4x4 (ATV)	07-09
Muddy 300 4x4 (ATV) - Parking brake	07-09
Muddy 300 4x4 (ATV)	07-09
Muddy 300 4x4 (ATV) - Parking brake	07-09
ATV 310 (4 X 2)	13
ATV 320 (4 X 4/Carrier)	13
ATV 420 (4 X 2/LoF)	13
ATV 420 (4 X 4/LoF)	13
ATV 420 (4 X 4/Carrier LoF)	13
CUV Jobber 4 x 4	13
520 Quad	08-09
ATV 600 Efi 4 X 4/LoF	13

LML

Star Deluxe 125 (2T/Drum model)	01-03
Star Deluxe 125 (2T/Disc model)	01-03
Star Deluxe 150 (2T/Drum model)	01-03
Star Deluxe 150 (2T/Disc model)	01-03
Star 125 (2T) All Models	10-14
Star 125i (4T) All Models	10-15
Star 150 (2T) All Models	10-14
Star 150 (4T) All Models	10-14
Star 151i (4T) All Models	10-15
Star 200i (4T) All Models	10-15

MAGNI

Sport 1200 S	01
--------------	----

MAICO

All models	-84
All models	85
All models	86-88
All models	89-93
250 MX	94-98
500 MX	94-98
500 MX/Enduro	99

DISC PAD CHOICES - FRONT

BRAKE DISC CHOICES - FRONT

FA, SFA, TT Pad or Brake Shoe	SFAC Carbon Scooter Pads	Speciality Pads SXR / Vee / MXS	Sintered/HH Pads/ Grooved Shoes	Left / Gauche / Links Standard Replacement Disc	Right / Droite / Rechts Standard Replacement Disc	Contour Disc Universal left and right fitment	Universal Custom Disc	Vee-Discs Black † See note below	CX Extreme MX Race Disc/ UTVX Disc
SFA708	SFAC708								
SFA708	SFAC708								
SFA169	SFAC169		SFA169HH	N/A					
H303/H304									
FA375			FA375HH	N/A					
S603									
FA086			FA086HH	N/A					
FA448				N/A					
TBA									
FA056					N/A				
SFA101	SFAC101		SFA101HH	N/A					
N/A*									
TBA				N/A					
SFA101	SFAC101		SFA101HH	N/A					
SFA199	SFAC199		SFA199HH		TBA				
N/A*									
FA453TT*			FA453R*	N/A	N/A				
FA453TT*			FA453R*	N/A	N/A				
FA270TT									
FA453TT*			FA453R*	N/A	N/A				
SFA199	SFAC199		SFA199HH		TBA				
TBA					TBA				
FA453TT*			FA453R*	N/A	N/A				
FA270TT			FA270R	N/A					
FA453TT*			FA453R*	N/A	N/A				
FA453TT*			FA453R*	N/A	N/A				
FA453TT*			FA453R*	N/A	N/A				
FA453TT*			FA453R*	N/A	N/A				
FA482TT*			FA482R*	N/A	N/A				
TBA*				N/A	N/A				
TBA*				N/A	N/A				
V903									
SFA186	SFAC186				MD910D	MD910C		VR910	
V903									
SFA186	SFAC186				MD910D	MD910C		VR910	
SFA186	SFAC186				MD910D	MD910C		VR910	
SFA186	SFAC186				MD910D	MD910C		VR910	
SFA186	SFAC186				MD910D	MD910C		VR910	
SFA186	SFAC186				MD910D	MD910C		VR910	
SFA186	SFAC186				MD910D	MD910C		VR910	
SFA186	SFAC186				MD910D	MD910C		VR910	
SFA186	SFAC186				MD910D	MD910C		VR910	
SFA186	SFAC186				MD910D	MD910C		VR910	
SFA186	SFAC186				MD910D	MD910C		VR910	
FA244*			FA244HH*	N/A	N/A				
821G									
FA047			FA047R	N/A					
FA106TT			FA106R	N/A					
FA132			FA132R	N/A					
FA132			FA132R	N/A					
FA132			FA132R	N/A					
FA181TT		MXS181	FA181R		N/A				

Line #
1
2
3
4
5
6
7
8
9
10
11
12
13
14
15
16
17
18
19
20
21
22
23
24
25
26
27
28
29
30
31
32
33
34
35
36
37
38
39
40
41
42
43
44
45
46
47
48
49
50
51
52
53
54
55
56
57
58
59
60

R Suffix = High Durability Sintered Pad. HH Suffix = High Performance Sintered Pad. TT Suffix = Hard Wearing Off Road Pad. V Suffix = Semi-Sintered Pad. G Suffix = Grooved Shoe.

D Suffix = Drilled Disc. X Suffix = Universal Left or Right Disc. XC Suffix = Contoured Disc. LS Suffix = Left/Steel Disc. RS Suffix = Right/Steel Disc.

*-2 Sets Required. † For Vee disc colours add RED, BLU, GRN, GLD, ORG suffix to part number.

⊗ - Also available as a Vintage Motorcycle Disc.

Non-JAPANESE Built Motorcycles

Line #	BRAKE DISC CHOICES - FRONT						DISC PAD CHOICES - REAR				BRAKE DISC CHOICES - REAR			
	Oversize 250 /280mm Disc Kit	OSX Oversize 250/280mm Disc Kit	Relocating Bracket for 250/ 280mm Disc	Oversize 320mm Disc Kit	SMX Oversize 320mm Disc Kit	Relocating Bracket for 320mm Disc	FA, SFA, TT Pad or Brake Shoe	SFAC Carbon Scooter Pads	Speciality Pads - SXR / Vee / MXS	Sintered/ HH Pads/ Grooved Shoes	Standard Replacement Disc	Contour Disc Rear fitment	Vee-Discs™ CONTOUR	CX Extreme MX Race Disc/ UTVX Disc
1														
2														
3														
4							H303/H304							
5							H303/H304							
6							H304							
7							S603							
8							H304							
9							FA480				N/A			
10							TBA							
11							S602							
12														
13							TBA							
14							FA067TT			FA067R	N/A			
15							TBA				TBA			
16							TBA							
17							SFA275	SFAC275		SFA275HH	N/A			
18							FA067TT			FA067R	N/A			
19							FA270TT			FA270R	N/A			
20							FA453TT			FA453R	N/A			
21														
22							FA453TT*			FA453R*	N/A			
23							SFA275	SFAC275		SFA275HH	TBA			
24							TBA				TBA			
25							FA453TT			FA453R	N/A			
26														
27							FA453TT			FA453R	N/A			
28														
29							FA453TT			FA453R	N/A			
30							FA453TT			FA453R	N/A			
31							FA453TT			FA453R	N/A			
32							FA453TT			FA453R	N/A			
33							FA453TT			FA453R	N/A			
34							FA453TT*			FA453R*	N/A			
35							TBA*				N/A			
36							FA453TT*			FA453R*	N/A			
37														
38														
39							V903							
40							V903							
41							V903							
42							V903							
43							V903							
44							V903							
45							V903							
46							V903							
47							V903							
48							V903							
49														
50														
51							FA063			FA063HH	N/A			
52														
53														
54														
55										822G				
56										822G				
57							FA106TT			FA106R	N/A			
58							FA132			FA132R	N/A			
59							FA132			FA132R	N/A			
60							FA067			FA067R	N/A			
							FA208TT		MXS208	FA208R	N/A			

REAR / ARRIÈRE / HINTEN / POSTERIOR / POSTERIORE

*-2 Sets Required. † For Vee disc colours add RED, BLU, GRN, GLD, ORG suffix to part number.

⊗ - Also available as a Vintage Motorcycle Disc.

R Suffix = High Durability Sintered Pad. **HH** Suffix = High Performance Sintered Pad. **TT** Suffix = Hard Wearing Off Road Pad. **V** Suffix = Semi Sintered Pad. **G** Suffix = Grooved Shoe.
D Suffix = Drilled Disc. **X** Suffix = Universal Left or Right Disc. **XC** Suffix = Contoured Disc. **LS** Suffix = Left/Steel Disc. **RS** = Right/Steel Disc.

Part numbers, prefixes, suffixes, photos and illustrations shown in this catalogue are trademarks and/or copyrights of EBC Brakes or the trademark owner A C Freeman Investments Ltd and use without express written permission of the owners is punishable by law.

Non-JAPANESE Built Motorcycles

APPLICATIONS

BRAKE



MALAGUTI



DISC PAD CHOICES - FRONT

BRAKE DISC CHOICES - FRONT

	FA, SFA, TT Pad or Brake Shoe	SFAC Carbon Scooter Pads	Speciality Pads - SXR / Vee / MXS	Sintered/ HH Pads/ Grooved Shoes	Left / Gauche / Links Standard Replacement Disc	Right / Droite / Rechts Standard Replacement Disc	Contour Disc Universal left and right fitment	Universal Custom Disc	Vee-Discs Black † See note below	CX Extreme MX Race Disc/ UTVX Disc	Line #
Chopper 25/40	FA050				N/A						1
50 LX Sport	FA050				N/A						2
50 Ronco RCW	FA050				N/A						3
50 Fifty HF	FA050				N/A						4
VA Olympique	FA050				N/A						5
50 Watercooled	FA050				N/A						6
50 Enduro RCX-W/Sahib	FA099				N/A						7
50 Fifty Full/CX	FA099				N/A						8
50 RGT Strada	FA099				N/A						9
50 Enduro Dune	FA099				N/A						10
50 MDX Gold Enduro	FA067/2				N/A						11
50 Enduro MEX	FA047			FA047R	N/A						12
50 Enduro MEX	FA067/2				N/A						13
50 Enduro MGX				922G							14
50 Enduro MLX	FA116				N/A						15
50 Enduro MSX	FA067/2				N/A						16
50 Fifty Top	FA099				N/A						17
50 RGT Sport	FA099				N/A						18
50 Custom Fox	931			931G							19
50 Dribbling	931			931G							20
50 Fifty HF/NL 4 gears				922G							21
50 Fifty RV	931			931G							22
50 Grizzly RCX 10 (Round pad with tag)	N/A				N/A						23
50 Grizzly RCX 12	931			931G							24
Grizzly RCW4	N/A				N/A						25
Grizzly 10 50 (Round pad with tag)	N/A				N/A						26
Grizzly 10 CE 50 (Round pad with tag)	N/A										27
Grizzly 12	931			931G							28
Grizzly 12 CE	931			931G							29
Grizzly Quad	FA050				N/A						30
50 Ranocchio 3 Wheels	931			931G							31
50 RST Sport	FA099				N/A						32
50 MXR	FA060				N/A						33
50 America	SFA173				N/A						34
50 Evolution	FA099				N/A						35
50 Raid	FA099				N/A						36
Centro SL/SL Cat 50	SFA116					MD902D			VR902		37
Centro Base 50 (Drum front model)				926G							38
Centro Base (Front disc model)	SFA116					MD902D			VR902		39
Centro 50/SL (4T)	SFA083	SFAC083		SFA083HH	TBA						40
Ciak 50	SFA193	SFAC193		SFA193HH		MD955D					41
Ciak 50 Twin Disc	SFA193	SFAC193		SFA193HH	MD955D						42
Ciak 50 (4T) Master	SFA193	SFAC193		SFA193HH	MD955D						43
Drakon S	FA266			FA266HH		N/A					44
F10 Jetline 50	SFA173				MD915D				VR915		45
F10 Jetline 50	SFA193	SFAC193		SFA193HH	MD915D				VR915		46
F10 Tribal	SFA193	SFAC193		SFA193HH	MD915D				VR915		47
F10 Jetline WAP	SFA193	SFAC193		SFA193HH	MD915D				VR915		48
F10 WAP	SFA083	SFAC083		SFA083HH	TBA						49
Phantom F12 (Front brake pad with two pin holes)	SFA099				MD901D				VR901		50
F12 Phantom 50 (Front brake pad with one pin hole)	SFA116										51
F12 50 Phantom	SFA116				MD901D				VR901		52
F12 50 Phantom	SFA116				MD946D						53
F12 Phantom (Air cooled) all models	SFA193	SFAC193		SFA193HH	MD946D						54
F12 Phantom All liquid cooled models	SFA193	SFAC193		SFA193HH	MD946D						55
Phantom F12R 50 A/C (All air cooled models)	SFA193	SFAC193		SFA193HH	TBA		TBA				56
Phantom F12R 50 L/C (All liquid cooled models)	SFA193	SFAC193		SFA193HH	TBA		TBA				57
Malbo Line - DVD	SFA169	SFAC169		SFA169HH	MD904D					VR904	58
NKD 50 Drakon	FA266			FA266HH		N/A					59
XSM 50 Super Motard	FA194			FA194HH	MD6279D						60

FRONT / AVANT / VORN / FREITE / ANTERIORE

R Suffix = High Durability Sintered Pad. HH Suffix = High Performance Sintered Pad. TT Suffix = Hard Wearing Off Road Pad. V Suffix = Semi Sintered Pad. G Suffix = Grooved Shoe.

D Suffix = Drilled Disc. X Suffix = Universal Left or Right Disc. XC Suffix = Contoured Disc. LS Suffix = Left/Steel Disc. RS Suffix = Right/Steel Disc.

*-2 Sets Required. † For Vee disc colours add RED, BLU, GRN, GLD, ORG suffix to part number.

⊗ - Also available as a Vintage Motorcycle Disc.

Non-JAPANESE Built Motorcycles

Line #	BRAKE DISC CHOICES - FRONT						DISC PAD CHOICES - REAR				BRAKE DISC CHOICES - REAR			
	Oversize 250 /280mm Disc Kit	OSX Oversize 250/280mm Disc Kit	Relocating Bracket for 250/ 280mm Disc	Oversize 320mm Disc Kit	SMX Oversize 320mm Disc Kit	Relocating Bracket for 320mm Disc	FA, SFA, TT Pad or Brake Shoe	SFAC Carbon Scooter Pads	Speciality Pads - SXR / Vee / MXS	Sintered/ HH Pads/ Grooved Shoes	Standard Replacement Disc	Contour Disc Rear fitment	Vee-Discs™ CONTOUR	CX Extreme MX Race Disc/ UTVX Disc
1							908							
2							908							
3							908							
4									926G					
5							908							
6									926G					
7									930G					
8									926G					
9							931		931G					
10							FA099			N/A				
11									922G					
12									922G					
13									922G					
14									922G					
15									922G					
16									922G					
17							926							
18									922G					
19							931		931G					
20							931		931G					
21									922G					
22							931		931G					
23							931		931G					
24							931		931G					
25							931		931G					
26							931		931G					
27							931		931G					
28							931		931G					
29							931		931G					
30							931		931G					
31							931		931G					
32							FA099			N/A				
33														
34							893							
35							N/A							
36							893							
37							893							
38							893							
39							893							
40							816							
41							893							
42							SFA193	SFAC193	SFA193HH	MD901D				
43							816							
44							FA115		FA115HH	N/A				
45							893							
46							893							
47							893							
48							893							
49							893							
50							893							
51							893							
52							SFA193			MD901D	MD901C			
53							SFA193			MD901D				
54							893							
55							SFA193	SFAC193	SFA193HH	MD901D				
56							893							
57							SFA193	SFAC193	SFA193HH	TBA				
58							Y503							
59							FA115		FA115HH	N/A				
60							FA115		FA115HH	N/A				

REAR / ARRIÈRE / HINTEN / POSTERIOR / POSTERIORE

*-2 Sets Required. † For Vee disc colours add RED, BLU, GRN, GLD, ORG suffix to part number.

⊗ - Also available as a Vintage Motorcycle Disc.

R Suffix = High Durability Sintered Pad. **HH** Suffix = High Performance Sintered Pad. **TT** Suffix = Hard Wearing Off Road Pad. **V** Suffix = Semi Sintered Pad. **G** Suffix = Grooved Shoe.
D Suffix = Drilled Disc. **X** Suffix = Universal Left or Right Disc. **XC** Suffix = Contoured Disc. **LS** Suffix = Left/Steel Disc. **RS** = Right/Steel Disc.

Part numbers, prefixes, suffixes, photos and illustrations shown in this catalogue are trademarks and/or copyrights of EBC Brakes or the trademark owner A C Freeman Investments Ltd and use without express written permission of the owners is punishable by law.

Non-JAPANESE Built Motorcycles

APPLICATIONS

BRAKE



MALAGUTI Contd.

		DISC PAD CHOICES - FRONT				BRAKE DISC CHOICES - FRONT						Line #
		FA, SFA, TT Pad or Brake Shoe	SFAC Carbon Scooter Pads	Speciality Pads SXR / Vee / MXS	Sintered/HH Pads/ Grooved Shoes	Left / Gauche / Links Standard Replacement Disc	Right / Droite / Rechts Standard Replacement Disc	Contour Disc Universal left and right fitment	Universal Custom Disc	Vee-Discs Black † See note below	CX Extreme MX Race Disc/ UTVX Disc	
XTM 50	03-11	FA115			FA115HH	N/A						1
Chopper 80	-82	FA050										2
Enduro MDX 80	84-	FA047			FA047R							3
Ciak 100	99-03	SFA193	SFAC193		SFA193HH	MD955D						4
Phantom 100 F12	99-03	SFA193	SFAC193		SFA193HH	MD946D						5
Firefox F15 50	96-98	SFA116				MD901D			VR901			6
F15 50 Firefox	98-00	SFA116				MD901D			VR901			7
F15 Firefox (All liquid cooled models)	01-08	SFA193	SFAC193		SFA193HH	MD946D						8
Firefox F15 (Air cooled models)	99-08	SFA193	SFAC193		SFA193HH	MD946D						9
F69 Phantom 70cc	98	SFA193	SFAC193		SFA193HH	MD936D			VR936			10
Crosser CR1 (Front brake pad with two pin holes)	95-98	SFA099				MD901D			VR901			11
Crosser CR1	95-98	SFA116				MD901D			VR901			12
Yesterday	98-03	SFA116				MD915D			VR915			13
Blog 125 ie	09-11	SFA228	SFAC228		SFA228HH	TBA						14
Ciak 125/150	01-08	SFA047			SFA047HH	MD955D						15
Centro 125 ie/SL	07-11	SFA228	SFAC228		SFA228HH	TBA						16
Madison T 125/150/180	99-03	SFA194	SFAC194		SFA194HH	MD966D			VR966			17
Madison 125-3	06-09	SFA194	SFAC194		SFA194HH	TBA						18
Phantom Max 125/200	04-08	SFA194	SFAC194		SFA194HH	MD966D			VR966			19
R 125 Madison	03-07	SFA194	SFAC194		SFA194HH	MD966D			VR966			20
X3M Enduro (Spoke wheel) 125	08-10	FA350			FA350HH	N/A						21
X3M Motard (Cast wheels) 125	08-10	FA194			FA194HH	N/A						22
Blog 160 ie	09-11	SFA228	SFAC228		SFA228HH	TBA						23
Centro 160 ie/SL	07-11	SFA228	SFAC228		SFA228HH	TBA						24
Ciak 200	06-08	SFA047			SFA047HH	MD955D						25
Madison S 200	04	SFA194	SFAC194		SFA194HH	MD966D			VR966			26
Madison S 250	99-03	SFA324	SFAC324		SFA324HH	MD967D						27
Madison 250ie 3	06-10	SFA194	SFAC194		SFA194HH	TBA						28
Password 250	05-11	SFA194	SFAC194		SFA194HH	TBA						29
RS 250 Madison	04-07	SFA194	SFAC194		SFA194HH	MD966D			VR966			30
Phantom Max 250	04-08	SFA194	SFAC194		SFA194HH	MD966D			VR966			31
F18 Warrior 125/150	00-03	SFA047			SFA047HH	TBA						32
Madison K 400	02-06	SFA324	SFAC324		SFA324HH	MD969D						33
Spider Max GT 500	04-10	SFA256*	SFAC256*		SFA256HH*	TBA	TBA					34
Spider Max RS 500	04-11	SFA256*	SFAC256*		SFA256HH*	TBA	TBA					35
Ciak (Electric Power)	00-05	SFA193	SFAC193		SFA193HH	MD946D						36
												37
												38
												39
												40
												41
												42
												43
												44
												45
												46
												47
												48
												49
												50
												51
												52
												53
												54
												55
												56
												57
												58
												59
												60

FRONT / AVANT / VORN / FRENTE / ANTERIORE

R Suffix = High Durability Sintered Pad. HH Suffix = High Performance Sintered Pad. TT Suffix = Hard Wearing Off Road Pad. V Suffix = Semi-Sintered Pad. G Suffix = Grooved Shoe.

D Suffix = Drilled Disc. X Suffix = Universal Left or Right Disc. XC Suffix = Contoured Disc. LS Suffix = Left/Steel Disc. RS = Right/Steel Disc.

*-2 Sets Required. † For Vee disc colours add RED, BLU, GRN, GLD, ORG suffix to part number.

⊗ - Also available as a Vintage Motorcycle Disc.

Non-JAPANESE Built Motorcycles

Line #	BRAKE DISC CHOICES - FRONT						DISC PAD CHOICES - REAR				BRAKE DISC CHOICES - REAR			
	Oversize 250 /280mm Disc Kit	OSX Oversize 250/280mm Disc Kit	Relocating Bracket for 250/ 280mm Disc	Oversize 320mm Disc Kit	SMX Oversize 320mm Disc Kit	Relocating Bracket for 320mm Disc	FA, SFA, TT Pad or Brake Shoe	SFAC Carbon Scooter Pads	Speciality Pads - SXR / Vee / MXS	Sintered/ HH Pads/ Grooved Shoes	Standard Replacement Disc	Contour Disc Rear fitment	Vee-Discs™ CONTOUR	CX Extreme MX Race Disc/ UTVX Disc
1							FA115			FA115HH	N/A			
2							908							
3														
4							SFA193	SFAC193		SFA193HH	MD901D			
5							SFA193	SFAC193		SFA193HH	MD901D			
6							893							
7							SFA193				MD901D	MD901C		
8							SFA193	SFAC193		SFA193HH	MD901D			
9							893			SFA193HH				
10							893							
11							807							
12							807							
13							893							
14							SFA101	SFAC101		SFA101HH	TBA			
15							818							
16							SFA101	SFAC101		SFA101HH	TBA			
17							SFA298	SFAC298		SFA298HH	MD966D	VR966		
18							SFA266	SFAC266		SFA266HH	TBA			
19							SFA298	SFAC298		SFA298HH	MD966D	VR966		
20							SFA298	SFAC298		SFA298HH	MD966D	VR966		
21							FA115			FA115HH	N/A			
22							FA115			FA115HH	N/A			
23							SFA101	SFAC101		SFA101HH	TBA			
24							SFA101	SFAC101		SFA101HH	TBA			
25							818							
26							SFA298	SFAC298		SFA298HH	MD966D	VR966		
27							SFA298	SFAC298		SFA298HH	MD966D			
28							SFA266	SFAC266		SFA266HH	TBA			
29							SFA298	SFAC298		SFA298HH	TBA			
30							SFA298	SFAC298		SFA298HH	MD966D	VR966		
31							SFA298	SFAC298		SFA298HH	MD966D	VR966		
32							SFA298	SFAC298		SFA298HH	MD946D			
33							SFA298	SFAC298		SFA298HH	MD967D			
34							SFA266	SFAC266		SFA266HH	TBA			
35							SFA266	SFAC266		SFA266HH	TBA			
36							TBA							
37														
38														
39							FA047			FA047R	N/A			
40							FA047			FA047R	N/A			
41							N/A							
42							N/A							
43							FA060				N/A			
44							FA060				N/A			
45										841G				
46														
47														
48							FA232TT			FA232R	N/A			
49							FA232TT			FA232R	N/A			
50							TBA				N/A			
51							FA083TT			FA083R	N/A			
52							TBA				N/A			
53							FA355/4TT			FA355/4R	N/A			
54							FA355/4TT			FA355/4R	N/A			
55														
56														
57							806							
58							806							
59							FA086	SFAC086		SFA086HH				
60														

REAR / ARRIÈRE / HINTEN / POSTERIOR / POSTERIORE

*-2 Sets Required. † For Vee disc colours add RED, BLU, GRN, GLD, ORG suffix to part number.

⊗ - Also available as a Vintage Motorcycle Disc.

R Suffix = High Durability Sintered Pad. **HH** Suffix = High Performance Sintered Pad. **TT** Suffix = Hard Wearing Off Road Pad. **V** Suffix = Semi Sintered Pad. **G** Suffix = Grooved Shoe.
D Suffix = Drilled Disc. **X** Suffix = Universal Left or Right Disc. **XC** Suffix = Contoured Disc. **LS** Suffix = Left/Steel Disc. **RS** = Right/Steel Disc.

Non-JAPANESE Built Motorcycles

Line #	BRAKE DISC CHOICES - FRONT						DISC PAD CHOICES - REAR				BRAKE DISC CHOICES - REAR			
	Oversize 250 /280mm Disc Kit	OSX Oversize 250/280mm Disc Kit	Relocating Bracket for 250/ 280mm Disc	Oversize 320mm Disc Kit	SMX Oversize 320mm Disc Kit	Relocating Bracket for 320mm Disc	FA, SFA, TT Pad or Brake Shoe	SFAC Carbon Scooter Pads	Speciality Pads - SXR / Vee / MXS	Sintered/ HH Pads/ Grooved Shoes	Standard Replacement Disc	Contour Disc Rear fitment	Vee-Discs™ CONTOUR	CX Extreme MX Race Disc/ UTVX Disc
1														
2							FA054TT							
3							FA054TT							
4							FA054TT		FA054HH	N/A				
5							FA054TT							
6							FA086	SFAC086	SFAC086HH					
7							FA054TT							
8							TBA							
9							H303							
10							H303							
11							FA054TT		FA054HH	N/A				
12							FA054TT							
13							FA054TT							
14							FA054TT		FA054HH					
15														
16							FA350			N/A				
17							FA054TT		FA054HH					
18							FA086		FA086HH					
19							H351							
20														
21														
22														
23														
24							FA271TT		FA271R	MD6173D				
25							FA271TT		FA271R	MD6173D				
26							FA271TT		FA271R	MD6173D				
27							FA271TT		FA271R	MD6173D				
28							FA395TT		FA395R	MD6173D				
29							FA271TT		FA271R	MD6173D				
30							FA271TT		FA271R	MD6173D				
31							FA271TT		FA271R	MD6173D				
32							FA395TT		FA395R	MD6173D				
33							FA395TT		FA395R	MD6173D				
34							FA395TT		FA395R	MD6173D				
35							FA395TT		FA395R	MD6173D				
36														
37														
38							Y503							
39							Y503							
40							Y530							
41							Y503							
42							Y530							
43							Y503							
44							Y503							
45							Y503							
46							Y503							
47							Y503							
48							Y503							
49							Y503							
50							Y503							
51							Y503							
52							Y503							
53							Y503							
54							Y503							
55							Y503							
56							Y503							
57							Y503							
58							Y503							
59							Y503							
60							Y503							

REAR / ARRIÈRE / HINTEN / POSTERIOR / POSTERIORE

*-2 Sets Required. † For Vee disc colours add RED, BLU, GRN, GLD, ORG suffix to part number.

⊗ - Also available as a Vintage Motorcycle Disc.

R Suffix = High Durability Sintered Pad. **HH** Suffix = High Performance Sintered Pad. **TT** Suffix = Hard Wearing Off Road Pad. **V** Suffix = Semi Sintered Pad. **G** Suffix = Grooved Shoe.
D Suffix = Drilled Disc. **X** Suffix = Universal Left or Right Disc. **XC** Suffix = Contoured Disc. **LS** Suffix = Left/Steel Disc. **RS** = Right/Steel Disc.

Part numbers, prefixes, suffixes, photos and illustrations shown in this catalogue are trademarks and/or copyrights of EBC Brakes or the trademark owner A C Freeman Investments Ltd and use without express written permission of the owners is punishable by law.

Non-JAPANESE Built Motorcycles

APPLICATIONS

BRAKE



MBK Contd.

CW 50 Booster Spirit	09
CW 50 Naked Booster (12" Wheels)	09
CY 50 Forte/Forte Mufa	96-97
EW 50 Stunt	00-06
EW 50 Stunt Naked	05-10
TZR 50 X-Power	00
TZR 50 X Power	03-10
X Limit Enduro 50cc	03-10
X Limit Supermoto 50cc	03-10
XF 50 Booster X	07-10
YA 50 R Forte	94-95
YA 50 TA Sorriso	95-96
YE 50 Evolis	92-95
YH 50 Flipper	98-10
YM 50 Fizz	94-95
YN 50 R Ovetto (2T)	98-10
YN 50 Ovetto (4T)	09-10
YQ 50 Nitro	97-10
YQ 50 Nitro Naked	06-10
CV 80 Evolis	97
YN 100 Ovetto	99-02
YQ 100 Nitro	01-03
YW 100 Booster 100	99-02
XC 125 T Flame	95-96
XC 125 Flame 125	96-03
XC 125 WAAP	08-10
XN 125/150 Doo Do	00-05
XQ 125/150 Thunder	01-03
YP 125 D Skyliner	98-00
YP 125 D Skyliner	01-10
YP 125 Skycruiser	06-10
YP 125 Cityliner	08-10
YW 125 Z X-Over	10
NXC 125 Flame X (220mm Front Disc)	04-06
NXC 125 Flame X (240mm Front Disc)	07-12
XC 150 Vertex	97
YP 250 Skyliner	96-98
YP 250 Skyliner	98-99
YP 250 Skyliner 250	00-02
VP 300 R Kilibre	03-04
YP 400 Skyliner	04

FRONT / AVANT / VORN / FRENTE / ANTERIORE

DISC PAD CHOICES - FRONT					BRAKE DISC CHOICES - FRONT						Line #
FA, SFA, TT Pad or Brake Shoe	SFAC Carbon Scooter Pads	Speciality Pads SXR / Vee / MXS	Sintered/HH Pads/ Grooved Shoes	Left / Gauche / Links Standard Replacement Disc	Right / Droite / Rechts Standard Replacement Disc	Contour Disc Universal left and right fitment	Universal Custom Disc	Vee-Discs Black † See note below	CX Extreme MX Race Disc/ UTVX Disc		
SFA193	SFAC193		SFA193HH	MD916D						1	
SFA193	SFAC193		SFA193HH	MD916D						2	
SFA169	SFAC169		SFA169HH	MD904D				VR904		3	
SFA268	SFAC268		SFA268HH	MD923D				VR923		4	
SFA268	SFAC268		SFA268HH	MD923D				VR923		5	
FA165TT			FA165HH		MD2067					6	
FA194			FA194HH	MD672LS						7	
FA350			FA350HH	MD6297D						8	
FA194			FA194HH	MD6297D						9	
Y530										10	
SFA193	SFAC193		SFA193HH	MD904D				VR904		11	
Y503										12	
SFA193	SFAC193		SFA193HH	MD904D				VR904		13	
SFA193	SFAC193		SFA193HH	MD928D						14	
SFA193	SFAC193		SFA193HH	MD904D				VR904		15	
SFA193	SFAC193		SFA193HH	MD943D		MD943C		VR943		16	
SFA193	SFAC193		SFA193HH	MD943D		MD943C		VR943		17	
SFA193	SFAC193		SFA193HH	MD923D				VR923		18	
SFA193	SFAC193		SFA193HH	MD923D				VR923		19	
SFA193	SFAC193		SFA193HH	MD904D				VR904		20	
SFA193	SFAC193		SFA193HH	MD943D		MD943C		VR943		21	
SFA193	SFAC193		SFA193HH	MD923D				VR923		22	
SFA169	SFAC169		SFA169HH	N/A						23	
Y527										24	
SFA101	SFAC101		SFA101HH	N/A						25	
SFA464	SFAC464				MD9127D			VR9127		26	
SFA193	SFAC193		SFA193HH	MD907D				VR907		27	
SFA181	SFAC181		SFA181HH	MD957D				VR957		28	
SFA181	SFAC181		SFA181HH	MD907D				VR907		29	
SFA181	SFAC181		SFA181HH	MD907D				VR907		30	
SFA430	SFAC430		SFA430HH		MD9102D					31	
SFA196	SFAC196		SFA196HH	MD9130D						32	
SFA492	SFAC492			MD986D				VR986		33	
SFA393	SFAC393				MD986D			VR986		34	
SFA393	SFAC393				MD9133D			VR9133		35	
SFA181	SFAC181		SFA181HH		N/A					36	
SFA199	SFAC199		SFA199HH		MD903D	N/A		VR903		37	
SFA199	SFAC199		SFA199HH		MD903D	N/A		VR903		38	
SFA199	SFAC199		SFA199HH		MD903D	N/A		VR903		39	
SFA181	SFAC181		SFA181HH		MD995D			VR995		40	
SFA199	SFAC199		SFA199HH	MD9102D				VR9102		41	
										42	
										43	
										44	
										45	
FA086			FA086HH	TBA						46	
FA086			FA086HH	TBA						47	
FA086			FA086HH	TBA						48	
										49	
										50	
TBA				N/A						51	
FA399				N/A						52	
										53	
										54	
FA399						N/A				55	
FA416TT						N/A				56	
FA416TT						N/A				57	
FA416TT						N/A				58	
FA416TT						N/A				59	
FA416TT						N/A				60	

MECHRON- See KIOTI

MEGELLI

125 M (Supermoto)	08-10
125 R (Sportbike)	08-10
125 S (Naked Sport Bike)	08-10

METRAKIT

XL 80 Mini GP	09
Pre GP 125	09

MH/MOTORHISPANIA

Kn 250 (50cc)	12-13
MH 10 50 Enduro	13-14
MH 10 50 Pro Enduro	13-14
MH 10 50 Eco Urban 50	14
MH 10 50 Pro Urban 50	14
MH 10 50 SM	13

*-2 Sets Required. † For Vee disc colours add RED, BLU, GRN, GLD, ORG suffix to part number.

⊗ - Also available as a Vintage Motorcycle Disc.

320 Part numbers, prefixes, suffixes, photos and illustrations shown in this catalogue are trademarks and/or copyrights of EBC Brakes or the trademark owner A C Freeman Investments Ltd and use without express written permission of the owners is punishable by law.

Non-JAPANESE Built Motorcycles

Line #	BRAKE DISC CHOICES - FRONT						DISC PAD CHOICES - REAR				BRAKE DISC CHOICES - REAR			
	Oversize 250 /280mm Disc Kit	OSX Oversize 250/280mm Disc Kit	Relocating Bracket for 250/ 280mm Disc	Oversize 320mm Disc Kit	SMX Oversize 320mm Disc Kit	Relocating Bracket for 320mm Disc	FA, SFA, TT Pad or Brake Shoe	SFAC Carbon Scooter Pads	Speciality Pads - SXR / Vee / MXS	Sintered/ HH Pads/ Grooved Shoes	Standard Replacement Disc	Contour Disc Rear fitment	Vee-Discs™ CONTOUR	CX Extreme MX Race Disc/ UTVX Disc
1							Y503							
2							Y503							
3							Y503							
4							Y503							
5							Y503							
6							FA101TT				MD2077			
7							FA115		FA115HH	MD2113				
8							FA350		FA350HH	MD6280D				
9							FA350		FA350HH	MD6280D				
10							Y530							
11							Y503							
12							Y503							
13							Y503							
14							Y503							
15							Y503							
16							Y503							
17							Y503							
18							SFA268	SFAC268	SFA268HH	MD923D		VR923		
19							SFA268	SFAC268	SFA268HH	MD923D		VR923		
20							Y503							
21							Y527							
22							Y527							
23							Y527							
24							Y503							
25							Y503							
26							Y530							
27							Y527							
28							SFA266	SFAC266	SFA266HH	MD958D		VR958		
29							Y527							
30							SFA266	SFAC266	SFA266HH	MD962D		VR962		
31							SFA266	SFAC266	SFA266HH	MD9104D		VR9104		
32							SFA275	SFAC275	SFA275HH	MD9104D		VR9104		
33							Y533							
34							Y533							
35							Y533							
36							Y527							
37							Y516							
38							SFA275	SFAC275	SFA275HH	MD927D		VR927		
39							SFA275	SFAC275	SFA275HH	MD953D	MD953C	VR953		
40							SFA181	SFAC181	SFA181HH	MD9104D		VR9104		
41							SFA408	SFAC408	SFA408HH	MD9103D		VR9103		
42														
43														
44														
45														
46							FA346TT		FA346R	TBA				
47							FA346TT		FA346R	TBA				
48							FA346TT		FA346R	TBA				
49														
50														
51							FA351TT			N/A				
52							FA351TT			N/A				
53														
54														
55							FA416TT				N/A			
56							FA083TT				N/A			
57							FA083TT				N/A			
58							FA083TT				N/A			
59							FA083TT				N/A			
60							FA083TT				N/A			

REAR / ARRIÈRE / HINTEN / POSTERIOR / POSTERIORE

*-2 Sets Required. † For Vee disc colours add RED, BLU, GRN, GLD, ORG suffix to part number.

⊗ - Also available as a Vintage Motorcycle Disc.

R Suffix = High Durability Sintered Pad. **HH** Suffix = High Performance Sintered Pad. **TT** Suffix = Hard Wearing Off Road Pad. **V** Suffix = Semi Sintered Pad. **G** Suffix = Grooved Shoe.
D Suffix = Drilled Disc. **X** Suffix = Universal Left or Right Disc. **XC** Suffix = Contoured Disc. **LS** Suffix = Left/Steel Disc. **RS** = Right/Steel Disc.

Part numbers, prefixes, suffixes, photos and illustrations shown in this catalogue are trademarks and/or copyrights of EBC Brakes or the trademark owner A C Freeman Investments Ltd and use without express written permission of the owners is punishable by law.

Non-JAPANESE Built Motorcycles

APPLICATIONS

BRAKE



MH/MOTORHISPANIA Contd.



MH 10 50 Pro SM	13
RX 50 Super Racing	06-07
RX 50 R	08-14
Furia Max Supermoto	07-10
Furia Max Enduro 50	06-10
RYZ 50 Enduro	06-10
RYZ 50 Enduro	13-14
RYZ 50 Supermotard	06-10
RYZ SM 50	06-10
RYZ 50 Pro Racing Enduro	14
RYZ 50 Pro Racing Supermotard	06-14
RYZ Pro SM 50	06-10
RYZ 50 Urban Bike	06-10
RYZ 50 Pro Racing Urban Bike	06-10
RYZ 50 Pro Racing Enduro	06-10
Custom 125	12
Duna 125 Hard Road Enduro	
(21" front wheel/18" rear wheel)	08-14
Duna 125 Dual Plus Trail (19" wheels)	08-14
Duna 125 Sports City Supermotard (17" wheels)	08-14
Duna 125	13-14
Duna Plus 125	14
Duna 125 Pro	13-14
Duna Supermotard 125	14
Kn1 125 (125cc) AC/LC	09-14
Kn2 125 (125cc)	12-14
Ranger 125 Enduro	13-14
RX 125 R	08-14
MH7 Naked (125cc/Air cooled)	08-14
MH7 Naked (125cc/Liquid cooled)	08-14
MH 10 125 Pro Enduro	13-14
MH 10 125 SM	13
125 LC Hard Road SM	12

MINIMOTO

Polini/Pasini/GRC Calipers (Round Type)
Polini/Pasini/GRC Calipers (Square Two Pin Type)

MODENAS

Kriss 110	00-02
Kriss 115	

MONDIAL

Piega 1000	02
Piega 1000	03-04
Evo	04

MONTESA/HONDA

Old Models	
Cota 123/290/349	-83
Cota 123/200/242/349	84
250 4RT Cota	05-10
260 4RT Cota (STD Version ED/3E)	14-18
260 4RT Cota (Repsol Edition 2E/4E)	14-18
4 Ride Enduro (260cc/4T)	16-18
Cota 300 RR (4T)	16
Cota 307/335	88
348 Trial Enduro	
Honda 311 260cc	92-93
Honda 314 R	94-96

DISC PAD CHOICES - FRONT

FA, SFA, TT
Pad or
Brake
Shoe

SFAC
Carbon
Scooter
Pads

Speciality
Pads
SXR / Vee
/ MXS

Sintered/
HH Pads/
Grooved
Shoes

Left / Gauche
/ Links
Standard
Replacement
Disc

Right / Droite
/ Rechts
Standard
Replacement
Disc

Contour
Disc
Universal left
and right
fitment

Universal
Custom
Disc

Vee-Discs
Black
† See note
below

CX Extreme
MX Race
Disc/ UTVX
Disc

FRONT / AVANT / VORN / FRENTE / ANTERIORE

FA416TT										
FA167			FA167HH	MD6318D						
FA399							N/A			
FA115			FA115HH	N/A						
FA115			FA115HH	N/A						
FA115			FA115HH	N/A						
FA416TT							N/A			
FA194			FA194HH	N/A						
FA416TT							N/A			
FA194			FA194HH	N/A			TBA			
FA194			FA194HH	N/A			TBA			
FA416TT							N/A			
FA167			FA167HH	MD6318D						
FA194			FA194HH	N/A			TBA			
FA167			FA167HH	N/A			TBA			
FA093							N/A			
FA093							N/A			
FA194			FA194HH	N/A						
FA194			FA194HH	N/A						
FA416TT							N/A			
FA194			FA194HH				N/A			
FA416TT							N/A			
FA465TT			MXS465				N/A			
FA399							N/A			
FA399							N/A			
FA465TT			MXS465				N/A			
FA399							N/A			
FA399							N/A			
FA399							N/A			
FA399							N/A			
FA416TT							N/A			
FA416TT							N/A			
FA399							N/A			
FA293							N/A			
FA352							N/A			
S603										
FA165TT							N/A			
FA424*			FA424HH*	N/A	N/A					
			FA322/4HH*	MD621X	MD621X	MD621XC*		VR621BLK*		
			FA322/4HH*	MD621X	MD621X	MD621XC*		VR621BLK*		
N/A										
933			933G							
			937G							
FA303TT							N/A			
FA303TT							N/A			
FA644TT							N/A			
FA644TT								N/A		
FA644TT								N/A		
FA115TT			FA115R	N/A						
933			933G							
FA115TT			FA115R	N/A						
FA115TT			FA115R	N/A						

Line #
1
2
3
4
5
6
7
8
9
10
11
12
13
14
15
16
17
18
19
20
21
22
23
24
25
26
27
28
29
30
31
32
33
34
35
36
37
38
39
40
41
42
43
44
45
46
47
48
49
50
51
52
53
54
55
56
57
58
59
60

R Suffix = High Durability Sintered Pad. HH Suffix = High Performance Sintered Pad. TT Suffix = Hard Wearing Off Road Pad. V Suffix = Semi-Sintered Pad. G Suffix = Grooved Shoe.
D Suffix = Drilled Disc. X Suffix = Universal Left or Right Disc. XC Suffix = Contoured Disc. LS Suffix = Left/Steel Disc. RS Suffix = Right/Steel Disc.

*-2 Sets Required. † For Vee disc colours add RED, BLU, GRN, GLD, ORG suffix to part number.

⊗ - Also available as a Vintage Motorcycle Disc.

322 Part numbers, prefixes, suffixes, photos and illustrations shown in this catalogue are trademarks and/or copyrights of EBC Brakes or the trademark owner A C Freeman Investments Ltd and use without express written permission of the owners is punishable by law.

Non-JAPANESE Built Motorcycles

Line #	BRAKE DISC CHOICES - FRONT						DISC PAD CHOICES - REAR				BRAKE DISC CHOICES - REAR			
	Oversize 250 /280mm Disc Kit	OSX Oversize 250/280mm Disc Kit	Relocating Bracket for 250/ 280mm Disc	Oversize 320mm Disc Kit	SMX Oversize 320mm Disc Kit	Relocating Bracket for 320mm Disc	FA, SFA, TT Pad or Brake Shoe	SFAC Carbon Scooter Pads	Speciality Pads - SXR / Vee / MXS	Sintered/ HH Pads/ Grooved Shoes	Standard Replacement Disc	Contour Disc Rear fitment	Vee-Discs™ CONTOUR	CX Extreme MX Race Disc/ UTVX Disc
1							FA083TT					N/A		
2							FA115		FA115HH	N/A				
3							FA093				N/A			
4							FA115		FA115HH	N/A				
5							FA115		FA115HH	N/A				
6							FA115		FA115HH	N/A				
7							FA083TT				N/A			
8							FA115		FA115HH	N/A				
9							FA083TT				N/A			
10							FA115		FA115HH	N/A	TBA			
11							FA115		FA115HH	N/A	TBA			
12							FA083TT				N/A			
13							FA115		FA115HH	N/A				
14							FA115		FA115HH	N/A	TBA			
15							FA115		FA115HH	N/A	TBA			
16							TBA							
17														
18							FA115		FA115HH	N/A				
19							FA115		FA115HH	N/A				
20							FA093			N/A				
21							FA083TT			N/A				
22														
23							FA083TT			N/A				
24							FA093				N/A			
25							FA093				N/A			
26							FA416TT				N/A			
27							TBA				N/A			
28							FA093				N/A			
29							FA093			N/A				
30							FA093			N/A				
31							FA083TT				N/A			
32							FA083TT				N/A			
33							FA416TT				N/A			
34														
35														
36							FA293			N/A				
37							FA352			N/A				
38														
39														
40														
41							S603							
42							S603							
43														
44							FA095	FA095V	FA095HH	N/A				
45							FA266	FA266V	FA266HH	TBA				
46							FA266	FA266V	FA266HH	TBA				
47														
48														
49							889							
50							933		933G					
51							933		933G					
52							FA351TT			N/A				
53							FA351TT			N/A				
54							FA351TT			N/A				
55							FA351TT				N/A			
56							FA351TT				N/A			
57							FA115TT		FA115R	N/A				
58							933		933G					
59							FA047TT		FA047R	N/A				
60							FA047TT		FA047R	N/A				

REAR / ARRIÈRE / HINTEN / POSTERIOR / POSTERIORE

*-2 Sets Required. † For Vee disc colours add RED, BLU, GRN, GLD, ORG suffix to part number.

⊗ - Also available as a Vintage Motorcycle Disc.

R Suffix = High Durability Sintered Pad. HH Suffix = High Performance Sintered Pad. TT Suffix = Hard Wearing Off Road Pad. V Suffix = Semi Sintered Pad. G Suffix = Grooved Shoe.

D Suffix = Drilled Disc. X Suffix = Universal Left or Right Disc. XC Suffix = Contoured Disc. LS Suffix = Left/Steel Disc. RS = Right/Steel Disc.

BRAKE APPLICATIONS

Non-JAPANESE Built Motorcycles

APPLICATIONS

BRAKE



MONTESA/HONDA Contd.



Honda 315 R	97-00
Honda 315 R	01-04

MOTOBECANE

40 AE/41 AE	
50 all mod. Atom hub	88-
50 all mod. Leleu hub	88-
50 A/E/AE	
51 SA/SAE/SV/SVE	
51 SUE	
51 VLM	
or 51 VLM	
Rock/Rock A	
Magnum/A/Racing	

MOTO GUZZI

350 V 35 (12 Spoke Cast Wheels/Electronic Ignition)	77-79
350 V 35 II (12 Spoke Cast Wheels)	80-85
350 V 35 III (10 Spoke Cast Wheels)	85-87
350 V 35 C Custom (10 Spoke Cast Wheel/Points Ignition)	82-86
350 V 35 Florida	86-90
350 NTX 350	87-90
350 Nevada	92-97
350 Nevada Club	98-99
500 V 50 (12 Spoke Cast Wheels/Electronic Ignition)	77-79
500 V 50 III (12 Spoke Cast Wheels)	85-87
500 V 50 C Custom (10 Spoke Cast Wheel/Points Ignition)	82-86
650 65 GT	88-89
650 NTX 650	87-90
650 V 65 C Custom (10 Spoke Cast Wheel)	83-86
650 V 65 Florida (Spoke & Cast Wheel Models)	85-92
750 Brevia ie (3 Spoke Cast Wheel)	03-11
750 SP (10 Spoke Cast Wheels)	90-92
750 Targa	90-93
750 Nevada 750	91-01
750 Nevada 750	02-11
750 Nevada Club (Up To LK112433)	98-01
750 Nevada Club (From LK112434)	98-01
750 Nevada Classic 750 ie (Spoke Wheels)	04-11
750 Nevada Classic 750 ie (Spoke Wheels)	12-15
750 Strada/T Roadster	93-95
750 V 75 (10 Spoke Cast Wheels/Solid front discs)	92-96
750 V 75 (10 Spoke Cast Wheels/Solid floating discs)	96-01
750 V7 Classic	08-12
750 V7 Cafe Classic	09-12
750 V7 Racer	10-11
750 V7 Racer	12-14
750 V7 Racer II (ABS/Spoke Wheel)	15
750 V7 Special	12-14
750 V7 Special II (ABS/Spoke Wheel)	15
750 V7 Special III (ABS/Spoke Wheel)	17-20
750 V7 Stone	12-14
750 V7 Stone II (ABS/Cast Wheel)	15-17
750 V7 Stone III (ABS/Cast Wheel)	17-20
750 V7 II Stornello	16-17
850 Le Mans I	76-77
850 Le Mans II	78-80
850 Le Mans III	81-84
850 T	74
850 T3	75-79

FRONT / AVANT / VORN / FRENTE / ANTERIORE

DISC PAD CHOICES - FRONT				BRAKE DISC CHOICES - FRONT							Line #
FA, SFA, TT Pad or Brake Shoe	SFAC Carbon Scooter Pads	Speciality Pads - SXR / Vee / MXS	Sintered/HH Pads/ Grooved Shoes	Left / Gauche / Links Standard Replacement Disc	Right / Droite / Rechts Standard Replacement Disc	Contour Disc Universal left and right fitment	Universal Custom Disc	Vee-Discs Black † See note below	CX Extreme MX Race Disc/ UTVX Disc	Line #	
FA115TT			FA115R	N/A						1	
FA303TT				N/A						2	
										3	
										4	
N/A										5	
H322										6	
H322										7	
N/A										8	
N/A										9	
877										10	
N/A										11	
N/A										12	
877										13	
877										14	
										15	
										16	
FA047*		FA047V*	FA047HH*	N/A	N/A					17	
FA047*		FA047V*	FA047HH*	N/A	N/A					18	
FA047*		FA047V*	FA047HH*	N/A	N/A					19	
FA047*		FA047V*	FA047HH*	N/A	N/A					20	
FA047*		FA047V*	FA047HH*	N/A	N/A					21	
FA047*		FA047V*	FA047HH*	N/A	N/A					22	
FA047*		FA047V*	FA047HH*	N/A	N/A					23	
FA047*		FA047V*	FA047HH*	N/A	N/A					24	
FA047*		FA047V*	FA047HH*	N/A	N/A					25	
FA047*		FA047V*	FA047HH*	N/A	N/A					26	
FA047*		FA047V*	FA047HH*	N/A	N/A					27	
FA047*		FA047V*	FA047HH*	N/A	N/A					28	
FA047*		FA047V*	FA047HH*	N/A	N/A					29	
FA047*		FA047V*	FA047HH*	N/A	N/A					30	
FA047*		FA047V*	FA047HH*	N/A	N/A					31	
FA244		FA244V	FA244HH	MD614X		MD614XC		VR614BLK		32	
FA047*		FA047V*	FA047HH*	MD693LS	MD693RS					33	
FA047*		FA047V*	FA047HH*	N/A	N/A					34	
FA047		FA047V	FA047HH	MD693LS						35	
FA047		FA047V	FA047HH	MD693LS						36	
FA047*		FA047V*	FA047HH*	N/A	N/A					37	
FA047*		FA047V*	FA047HH*	N/A	N/A					38	
FA244		FA244V	FA244HH	MD614X		MD614XC		VR614BLK		39	
FA244		FA244V	FA244HH	MD614X		MD614XC		VR614BLK		40	
FA047*		FA047V*	FA047HH*	N/A	N/A					41	
FA047*		FA047V*	FA047HH*	N/A	N/A					42	
FA047*		FA047V*	FA047HH*	N/A	N/A					43	
FA244		FA244V	FA244HH	MD614X		MD614XC		VR614BLK		44	
FA244		FA244V	FA244HH	MD614X		MD614XC		VR614BLK		45	
FA244		FA244V	FA244HH	MD614X		MD614XC		VR614BLK		46	
FA244		FA244V	FA244HH	MD614X		MD614XC		VR614BLK		47	
FA244		FA244V	FA244HH	TBA						48	
FA244		FA244V	FA244HH	MD614X		MD614XC		VR614BLK		49	
FA244		FA244V	FA244HH	TBA						50	
FA244		FA244V	FA244HH	TBA						51	
FA244		FA244V	FA244HH	MD614X		MD614XC		VR614BLK		52	
FA244		FA244V	FA244HH	TBA						53	
FA244		FA244V	FA244HH	TBA						54	
FA244		FA244V	FA244HH	TBA		TBA		TBA		55	
FA018*		FA018V*	FA018HH*	N/A	N/A					56	
FA018*		FA018V*	FA018HH*	N/A	N/A					57	
FA018*		FA018V*	FA018HH*	N/A	N/A					58	
FA018		FA018V	FA018HH	N/A	N/A					59	
FA018*		FA018V*	FA018HH*	N/A	N/A					60	

*-2 Sets Required. † For Vee disc colours add RED, BLU, GRN, GLD, ORG suffix to part number.

⊗ - Also available as a Vintage Motorcycle Disc.

324 Part numbers, prefixes, suffixes, photos and illustrations shown in this catalogue are trademarks and/or copyrights of EBC Brakes or the trademark owner A C Freeman Investments Ltd and use without express written permission of the owners is punishable by law.

Non-JAPANESE Built Motorcycles

Line #	BRAKE DISC CHOICES - FRONT						DISC PAD CHOICES - REAR				BRAKE DISC CHOICES - REAR			
	Oversize 250 /280mm Disc Kit	OSX Oversize 250/280mm Disc Kit	Relocating Bracket for 250/ 280mm Disc	Oversize 320mm Disc Kit	SMX Oversize 320mm Disc Kit	Relocating Bracket for 320mm Disc	FA, SFA, TT Pad or Brake Shoe	SFAC Carbon Scooter Pads	Speciality Pads - SXR / Vee / MXS	Sintered/ HH Pads/ Grooved Shoes	Standard Replacement Disc	Contour Disc Rear fitment	Vee-Discs™ CONTOUR	CX Extreme MX Race Disc/ UTVX Disc
1							FA047TT			FA047R	N/A			
2							FA351TT				N/A			
3														
4														
5							N/A							
6							873							
7							873							
8							N/A							
9							N/A							
10							877							
11							N/A							
12							H322							
13							877							
14							877							
15														
16														
17							FA047		FA047V	FA047HH	N/A			
18							FA047		FA047V	FA047HH	N/A			
19							FA047		FA047V	FA047HH	N/A			
20							FA047		FA047V	FA047HH	N/A			
21							FA047		FA047V	FA047HH	N/A			
22							FA047		FA047V	FA047HH	N/A			
23							FA047		FA047V	FA047HH	N/A			
24							FA047		FA047V	FA047HH	N/A			
25							FA047		FA047V	FA047HH	N/A			
26							FA047		FA047V	FA047HH	N/A			
27							FA047		FA047V	FA047HH	N/A			
28							FA047		FA047V	FA047HH	N/A			
29							FA047		FA047V	FA047HH	N/A			
30							FA047		FA047V	FA047HH	N/A			
31							FA047		FA047V	FA047HH	N/A			
32							FA266		FA266V	FA266HH	MD871			
33							FA047		FA047V	FA047HH	N/A			
34							FA047		FA047V	FA047HH	N/A			
35							FA047		FA047V	FA047HH	N/A			
36							FA266		FA266V	FA266HH	MD871			
37							FA047		FA047V	FA047HH	N/A			
38							FA266		FA266V	FA266HH	MD871			
39							FA266		FA266V	FA266HH	MD871			
40							FA266		FA266V	FA266HH	N/A			
41							FA047		FA047V	FA047HH	N/A			
42							FA047		FA047V	FA047HH	N/A			
43							FA047		FA047V	FA047HH	N/A			
44							FA266		FA266V	FA266HH	MD871			
45							FA266		FA266V	FA266HH	MD871			
46							FA266		FA266V	FA266HH	MD871			
47							FA256			FA256HH	N/A			
48							FA256			FA256HH	N/A			
49							FA256			FA256HH	N/A			
50							FA256			FA256HH	N/A			
51							FA256			FA256HH	N/A			
52							FA256			FA256HH	N/A			
53							FA256			FA256HH	N/A			
54							FA256			FA256HH	N/A			
55							FA256			FA256HH	N/A			
56							FA018		FA018V	FA018HH	N/A			
57							FA018		FA018V	FA018HH	N/A			
58							FA077		FA077V		N/A			
59							N/A							
60							FA018		FA018V	FA018HH	N/A			

REAR / ARRIÈRE / HINTEN / POSTERIOR / POSTERIORE

*-2 Sets Required. † For Vee disc colours add RED, BLU, GRN, GLD, ORG suffix to part number.

⊗ - Also available as a Vintage Motorcycle Disc.

R Suffix = High Durability Sintered Pad. HH Suffix = High Performance Sintered Pad. TT Suffix = Hard Wearing Off Road Pad. V Suffix = Semi Sintered Pad. G Suffix = Grooved Shoe.

D Suffix = Drilled Disc. X Suffix = Universal Left or Right Disc. XC Suffix = Contoured Disc. LS Suffix = Left/Steel Disc. RS = Right/Steel Disc.

Non-JAPANESE Built Motorcycles

Line #	BRAKE DISC CHOICES - FRONT						DISC PAD CHOICES - REAR				BRAKE DISC CHOICES - REAR			
	Oversize 250 /280mm Disc Kit	OSX Oversize 250/280mm Disc Kit	Relocating Bracket for 250/ 280mm Disc	Oversize 320mm Disc Kit	SMX Oversize 320mm Disc Kit	Relocating Bracket for 320mm Disc	FA, SFA, TT Pad or Brake Shoe	SFAC Carbon Scooter Pads	Speciality Pads - SXR / Vee / MXS	Sintered/ HH Pads/ Grooved Shoes	Standard Replacement Disc	Contour Disc Rear fitment	Vee-Discs™ CONTOUR	CX Extreme MX Race Disc/ UTVX Disc
1							FA018		FA018V	FA018HH	N/A			
2							FA018		FA018V	FA018HH	N/A			
3							FA018		FA018V	FA018HH	N/A			
4							FA018		FA018V	FA018HH	N/A			
5							FA181TT			FA181HH	MD840			
6							FA181TT			FA181HH	MD840	MD840C		
7							FA181TT			FA181HH	MD840			
8							FA256			FA256HH				
9							FA256			FA256HH	MD871			
10							FA256			FA256HH				
11							FA256			FA256HH	MD871			
12							FA181TT			FA181HH	MD840	MD840C		
13							FA047		FA047V	FA047HH	N/A			
14							FA047		FA047V	FA047HH	MD692			
15							N/A				N/A			
16							FA018		FA018V	FA018HH	N/A			
17							FA018		FA018V	FA018HH	N/A			
18							FA018		FA018V	FA018HH	MD693LS			
19							FA077		FA077V		N/A			
20							FA077		FA077V		N/A			
21							FA077		FA077V		MD693LS			
22							FA018		FA018V	FA018HH	N/A			
23														
24							FA018		FA018V	FA018HH	MD693LS			
25							FA018		FA018V	FA018HH	MD693LS			
26														
27							FA018		FA018V	FA018HH	MD693LS			
28							FA018		FA018V	FA018HH	MD693LS			
29							FA018		FA018V	FA018HH	MD693LS			
30							FA018		FA018V	FA018HH				
31							FA163				N/A			
32							FA047		FA047V	FA047HH	MD692	MD692C		
33							FA047		FA047V	FA047HH	MD692	MD692C		
34							FA181TT			FA181HH	MD840			
35							FA181TT			FA181HH	MD840			
36							FA018			FA018HH	MD693LS			
37							FA209/2		FA209/2V	FA209/2HH	MD692	MD692C		
38							FA209/2		FA209/2V	FA209/2HH	MD692	MD692C		
39							FA209/2		FA209/2V	FA209/2HH	MD692	MD692C		
40							FA209/2		FA209/2V	FA209/2HH	MD692	MD692C		
41							FA209/2		FA209/2V	FA209/2HH	MD692	MD692C		
42							FA209/2		FA209/2V	FA209/2HH	MD692	MD692C		
43														
44							FA209/2		FA209/2V	FA209/2HH	MD692	MD692C		
45							FA209/2		FA209/2V	FA209/2HH	MD692	MD692C		
46														
47							FA209/2		FA209/2V	FA209/2HH	MD692	MD692C		
48							FA209/2		FA209/2V	FA209/2HH	MD692	MD692C		
49							FA209/2		FA209/2V	FA209/2HH	MD692	MD692C		
50							FA209/2		FA209/2V	FA209/2HH	MD692	MD692C		
51							FA209/2		FA209/2V	FA209/2HH	MD692	MD692C		
52							FA209/2		FA209/2V	FA209/2HH	MD692	MD692C		
53							FA209/2		FA209/2V	FA209/2HH	MD692	MD692C		
54							FA209/2		FA209/2V	FA209/2HH	MD692	MD692C		
55							FA181TT			FA181HH	MD840	MD840C		
56							FA047		FA047V	FA047HH	N/A			
57							FA047		FA047V	FA047HH	N/A			
58							FA047		FA047V	FA047HH	N/A			
59							FA181TT			FA181HH	N/A			
60							FA047		FA047V	FA047HH	MD692	MD692C		

REAR / ARRIÈRE / HINTEN / POSTERIOR / POSTERIORE

*-2 Sets Required. † For Vee disc colours add RED, BLU, GRN, GLD, ORG suffix to part number.

⊗ - Also available as a Vintage Motorcycle Disc.

R Suffix = High Durability Sintered Pad. **HH** Suffix = High Performance Sintered Pad. **TT** Suffix = Hard Wearing Off Road Pad. **V** Suffix = Semi Sintered Pad. **G** Suffix = Grooved Shoe.
D Suffix = Drilled Disc. **X** Suffix = Universal Left or Right Disc. **XC** Suffix = Contoured Disc. **LS** Suffix = Left/Steel Disc. **RS** = Right/Steel Disc.

Part numbers, prefixes, suffixes, photos and illustrations shown in this catalogue are trademarks and/or copyrights of EBC Brakes or the trademark owner A C Freeman Investments Ltd and use without express written permission of the owners is punishable by law.

Non-JAPANESE Built Motorcycles

APPLICATIONS

BRAKE



MOTO GUZZI Contd.

1100 V11 Le Mans	01-05
1100 V11 Naked	02-03
1100 V11 Scura	01-03
1100 V11 Sport	99-01
1200 Brevia	08-09
1200 Griso 8V (Standard/Cast Wheel/Radial Caliper)	07-12
1200 Griso 8V (Special Edition/Spoke Wheel/Radial Caliper)	07-15
Norge 1200	06-07
1200 Norge GT 8V (ABS)	08-15
1200 Sport (4V)	06-07
1200 Sport (8V)	08-13
1200 Stelvio	08-11
1200 Stelvio 8V (ABS)	11-15
1200 Stelvio NTX ABS	09-10
1200 Stelvio 8V NTX (ABS)	11-15
1400 California Custom	13-15
1400 California Touring	13-20
1400 California Touring SE	15-17
1400 Audace	15-16
1400 Audace Carbon	16-17
1400 Eldorado	15-17
MGX 21 1400	16-20

MOTOM

Ana 50	08-09	SFA086	SFAC086	SFA086HH	N/A				
Gypsy 50	08-09	SFA235	SFAC235		TBA				
Spasso 50	08-09	FA448			TBA				
Dolcevita 125/151	08-09	SFA235	SFAC235		TBA				
Transcity 125/250	08-09	SFA179	SFAC179	SFA179HH	N/A				
Ana 151	08-09	SFA086	SFAC086	SFA086HH		N/A			

MOTO MORINI

125 Monocilindro	79-	FA076		FA076HH	N/A				
125 KJ/T/KT/Kanguro	84-	N/A			N/A				
250 All Models	71-	FA076		FA076HH	N/A				
350 Coguaro	90-	FA134		FA134R	N/A				
350 Sport	-79	FA076*		FA076HH*	N/A				
350 Sport	80	FA076		FA076HH	N/A				
350 Sport	81	FA076		FA076HH	N/A				
350 Sport	82-	N/A			N/A				
350 FT/Turismo	80-	FA076		FA076HH	N/A				
350 Kanguro	-83			927G					
350 Kanguro	84-86	N/A			N/A				
350 Kanguro	87	FA256		FA256HH	N/A				
Excalibur 350/501 RLX	93	FA134			N/A				
Dart 350	87	FA134			N/A				
350 K2		N/A*			N/A	N/A			
9 1/2 (1200cc)	06-10	FA244*		FA244HH*	MD633X	MD633X	MD633XC*		
Corsaro 1200	05-10	FA244*		FA244HH*	MD633X	MD633X	MD633XC*		
Corsaro 1200 Veloce	07-09	FA244*		FA244HH*	MD633X	MD633X	MD633XC*		
Granpasso 1200	08-10	FA209/2*	FA209/2V*	FA209/2HH*	N/A	N/A			
Corsaro Avio	08-09	FA244		FA244HH	MD633X	MD633X	MD633XC*		
1200 Sport	08-10	FA244*		FA244HH*	MD633X	MD633X	MD633XC*		
Scrambler 1200	08-09	FA244*		FA244HH*	N/A	N/A			
Scrambler 1200	10-13	FA209/2*	FA209/2V*	FA209/2HH*	N/A	N/A			
Rebello 1200 Giubileo	12-13			FA322/4HH*	N/A	N/A			

MOTOROMA

Bee 50	04-05	SFA169	SFAC169	SFA169HH	TA				
Blazer 50/100/110 Quad	99-04	H338*		H338G*					

DISC PAD CHOICES - FRONT

BRAKE DISC CHOICES - FRONT

FA, SFA, TT Pad or Brake Shoe	SFAC Carbon Scooter Pads	Speciality Pads SXR / Vee / MXS	Sintered/HH Pads/Grooved Shoes	Left / Gauche / Links Standard Replacement Disc	Right / Droite / Rechts Standard Replacement Disc	Contour Disc Universal left and right fitment	Universal Custom Disc	Vee-Discs Black † See note below	CX Extreme MX Race Disc/ UTVX Disc
FA244*			FA244HH*	MD614X	MD614X	MD614XC*		VR614BLK*	
FA244*			FA244HH*	MD614X	MD614X	MD614XC*		VR614BLK*	
FA244*			FA244HH*	MD614X	MD614X	MD614XC*		VR614BLK*	
FA244*			FA244HH*	MD614X	MD614X	MD614XC*		VR614BLK*	
FA244*			FA244HH*	MD624	MD624			VR624BLK*	
FA244*			FA244HH*			MD614XC*		VR614BLK*	
FA244*			FA244HH*	MD614X	MD614X	MD614XC*		VR614BLK*	
FA244*			FA244HH*	MD624	MD624			VR624BLK*	
FA244*			FA244HH*	MD624	MD624			VR624BLK*	
FA244*			FA244HH*	MD624	MD624			VR624BLK*	
FA244*			FA244HH*	TBA	TBA			VR624BLK*	
FA244*			FA244HH*	MD624	MD624			VR624BLK*	
FA244*			FA244HH*	TBA	TBA				
FA244*			FA244HH*	MD624	MD624			VR624BLK*	
FA244*			FA244HH*	TBA	TBA			VR624BLK*	
FA244*			FA244HH*	TBA	TBA				
FA244*			FA244HH*	TBA	TBA				
FA244*			FA244HH*	TBA	TBA				
FA244*			FA244HH*	TBA	TBA				
FA244*			FA244HH*	TBA	TBA				
FA244*			FA244HH*	TBA	TBA				
FA244*			FA244HH*	TBA	TBA				
SFA086	SFAC086		SFA086HH		N/A				
SFA235	SFAC235			TBA					
FA448				TBA					
SFA235	SFAC235			TBA					
SFA179	SFAC179		SFA179HH	N/A					
SFA086	SFAC086		SFA086HH		N/A				
FA076			FA076HH	N/A					
N/A				N/A					
FA076			FA076HH	N/A					
FA134			FA134R	N/A					
FA076*			FA076HH*	N/A					
FA076			FA076HH	N/A					
FA076			FA076HH	N/A					
N/A				N/A					
FA076			FA076HH	N/A					
N/A			927G						
N/A				N/A					
FA256			FA256HH	N/A					
FA134				N/A					
FA134				N/A					
N/A*				N/A	N/A				
FA244*			FA244HH*	MD633X	MD633X	MD633XC*			
FA244*			FA244HH*	MD633X	MD633X	MD633XC*			
FA244*			FA244HH*	MD633X	MD633X	MD633XC*			
FA209/2*	FA209/2V*	FA209/2HH*	N/A	N/A					
FA244		FA244HH	MD633X	MD633X	MD633XC*				
FA244*		FA244HH*	MD633X	MD633X	MD633XC*				
FA244*		FA244HH*	N/A	N/A					
FA209/2*	FA209/2V*	FA209/2HH*	N/A	N/A					
		FA322/4HH*	N/A	N/A					
SFA169	SFAC169		SFA169HH	TA					
H338*			H338G*						

Line #

1
2
3
4
5
6
7
8
9
10
11
12
13
14
15
16
17
18
19
20
21
22
23
24
25
26
27
28
29
30
31
32
33
34
35
36
37
38
39
40
41
42
43
44
45
46
47
48
49
50
51
52
53
54
55
56
57
58
59
60

R Suffix = High Durability Sintered Pad. HH Suffix = High Performance Sintered Pad. TT Suffix = Hard Wearing Off Road Pad. V Suffix = Semi Sintered Pad. G Suffix = Grooved Shoe.
D Suffix = Drilled Disc. X Suffix = Universal Left or Right Disc. XC Suffix = Contoured Disc. LS Suffix = Left/Steel Disc. RS Suffix = Right/Steel Disc.

*-2 Sets Required. † For Vee disc colours add RED, BLU, GRN, GLD, ORG suffix to part number.

⊗ - Also available as a Vintage Motorcycle Disc.

328 Part numbers, prefixes, suffixes, photos and illustrations shown in this catalogue are trademarks and/or copyrights of EBC Brakes or the trademark owner A C Freeman Investments Ltd and use without express written permission of the owners is punishable by law.

Non-JAPANESE Built Motorcycles

Line #	BRAKE DISC CHOICES - FRONT						DISC PAD CHOICES - REAR				BRAKE DISC CHOICES - REAR			
	Oversize 250 /280mm Disc Kit	OSX Oversize 250/280mm Disc Kit	Relocating Bracket for 250/ 280mm Disc	Oversize 320mm Disc Kit	SMX Oversize 320mm Disc Kit	Relocating Bracket for 320mm Disc	FA, SFA, TT Pad or Brake Shoe	SFAC Carbon Scooter Pads	Speciality Pads - SXR / Vee / MXS	Sintered/ HH Pads/ Grooved Shoes	Standard Replacement Disc	Contour Disc Rear fitment	Vee-Discs™ CONTOUR	CX Extreme MX Race Disc/ UTVX Disc
1							FA047		FA047V	FA047HH	MD692	MD692C		
2							FA047		FA047V	FA047HH	MD692	MD692C		
3							FA047		FA047V	FA047HH	MD692	MD692C		
4							FA047		FA047V	FA047HH	MD692	MD692C		
5							FA181TT			FA181HH	MD840			
6							FA181TT			FA181HH	MD840	MD840C		
7							FA181TT			FA181HH	MD840	MD840C		
8							FA181TT			FA181HH	MD840			
9							FA181TT			FA181HH	MD840			
10							FA181TT			FA181HH	MD840			
11							FA181TT			FA181HH	MD840			
12							FA181TT			FA181HH	MD840			
13							FA181TT			FA181HH	MD840			
14							FA181TT			FA181HH	MD840			
15							FA181TT			FA181HH	MD840			
16							FA209/2		FA209/2V	FA209/2HH	MD840			
17							FA209/2		FA209/2V	FA209/2HH	MD840			
18							FA209/2		FA209/2V	FA209/2HH	MD840			
19							FA209/2		FA209/2V	FA209/2HH	MD840			
20							FA209/2		FA209/2V	FA209/2HH	MD840			
21							FA209/2		FA209/2V	FA209/2HH	MD840			
22							FA209/2		FA209/2V	FA209/2HH	MD840			
23														
24														
25							SFA197	SFAC197		FA197HH	N/A			
26							TBA							
27							TBA							
28							SFA086	SFAC086			N/A			
29							SFA086	SFAC086		SFA086HH	N/A			
30							SFA197	SFAC197		SFA197HH	N/A			
31														
32														
33										821G				
34										821G				
35							921							
36							FA047			FA047HH	N/A			
37							FA076				N/A			
38							921							
39							N/A							
40							N/A				N/A			
41							921							
42										927G				
43										927G				
44							FA047				N/A			
45							FA047				N/A			
46							FA047				N/A			
47							FA047				N/A			
48							FA266		FA266V	FA266HH	N/A			
49							FA266		FA266V	FA266HH	N/A			
50							FA266		FA266V	FA266HH	N/A			
51							FA181TT			FA181HH	N/A			
52							FA266		FA266V	FA266HH	N/A			
53							FA266		FA266V	FA266HH	N/A			
54							FA266		FA266V	FA266HH	N/A			
55							FA181TT		FA181V	FA181HH	N/A			
56							FA266			FA266HH	N/A			
57														
58														
59							TBA							
60							H330			H330G				

REAR / ARRIÈRE / HINTEN / POSTERIOR / POSTERIORE

*-2 Sets Required. † For Vee disc colours add RED, BLU, GRN, GLD, ORG suffix to part number.

⊗ - Also available as a Vintage Motorcycle Disc.

R Suffix = High Durability Sintered Pad. **HH** Suffix = High Performance Sintered Pad. **TT** Suffix = Hard Wearing Off Road Pad. **V** Suffix = Semi Sintered Pad. **G** Suffix = Grooved Shoe.
D Suffix = Drilled Disc. **X** Suffix = Universal Left or Right Disc. **XC** Suffix = Contoured Disc. **LS** Suffix = Left/Steel Disc. **RS** = Right/Steel Disc.

Part numbers, prefixes, suffixes, photos and illustrations shown in this catalogue are trademarks and/or copyrights of EBC Brakes or the trademark owner A C Freeman Investments Ltd and use without express written permission of the owners is punishable by law.

Non-JAPANESE Built Motorcycles

Line #	BRAKE DISC CHOICES - FRONT						DISC PAD CHOICES - REAR				BRAKE DISC CHOICES - REAR			
	Oversize 250 /280mm Disc Kit	OSX Oversize 250/280mm Disc Kit	Relocating Bracket for 250/ 280mm Disc	Oversize 320mm Disc Kit	SMX Oversize 320mm Disc Kit	Relocating Bracket for 320mm Disc	FA, SFA, TT Pad or Brake Shoe	SFAC Carbon Scooter Pads	Speciality Pads - SXR / Vee / MXS	Sintered/ HH Pads/ Grooved Shoes	Standard Replacement Disc	Contour Disc Rear fitment	Vee-Discs™ CONTOUR	CX Extreme MX Race Disc/ UTVX Disc
1							Y503							
2							Y503							
3							Y503							
4							Y503							
5							Y503							
6							Y503							
7							Y503							
8							H330		H330G					
9							H330		H330G					
10							S603							
11							TBA							
12							SFA083	SFAC083	SFA083HH	MD982D				
13							FA083TT		FA083R	MD6354D				
14							Y503							
15							S602							
16							TBA			N/A				
17							TBA							
18							S602							
19							FA115		FA115HH	N/A				
20							S602							
21							FA165TT		FA165R	N/A				
22														
23														
24							TBA							
25							TBA							
26							TBA							
27														
28														
29							FA266	FA266V	FA266HH	MD885	MD885C			
30							FA266	FA266V	FA266HH	MD885	MD885C			
31							FA266	FA266V	FA266HH	MD885	MD885C			
32							FA266	FA266V	FA266HH	MD885	MD885C			
33									FA320HH	MD696				
34									FA320HH	MD696				
35									FA320HH	MD696				
36									FA320HH	MD696				
37									FA320HH	MD696				
38									FA320HH	MD696				
39							FA266	FA266V	FA266HH	MD885	MD885C			
40							FA266	FA266V	FA266HH	MD885	MD885C			
41							FA266	FA266V	FA266HH	MD885	MD885C			
42							FA266	FA266V	FA266HH	MD885	MD885C			
43							FA266	FA266V	FA266HH	MD885	MD885C			
44							FA266	FA266V	FA266HH	MD885	MD885C			
45							FA266	FA266V	FA266HH	MD885	MD885C			
46							FA266	FA266V	FA266HH	MD885	MD885C			
47							FA266	FA266V	FA266HH	MD885	MD885C			
48							FA266	FA266V	FA266HH	MD885	MD885C			
49							FA266	FA266V	FA266HH	MD885	MD885C			
50							FA266	FA266V	FA266HH	MD885	MD885C			
51							FA266	FA266V	FA266HH	MD885	MD885C			
52							FA266	FA266V	FA266HH	MD885	MD885C			
53							FA266	FA266V	FA266HH	MD885	MD885C			
54							FA266	FA266V	FA266HH	MD885	MD885C			
55							FA266	FA266V	FA266HH	MD885	MD885C			
56							FA266	FA266V	FA266HH	MD885	MD885C			
57							FA266	FA266V	FA266HH	MD885	MD885C			
58									FA320HH	MD696				
59									FA320HH	MD696				
60									FA320HH	MD696				

REAR / ARRIÈRE / HINTEN / POSTERIOR / POSTERIORE

*-2 Sets Required. † For Vee disc colours add RED, BLU, GRN, GLD, ORG suffix to part number.

⊗ - Also available as a Vintage Motorcycle Disc.

R Suffix = High Durability Sintered Pad. HH Suffix = High Performance Sintered Pad. TT Suffix = Hard Wearing Off Road Pad. V Suffix = Semi Sintered Pad. G Suffix = Grooved Shoe.

D Suffix = Drilled Disc. X Suffix = Universal Left or Right Disc. XC Suffix = Contoured Disc. LS Suffix = Left/Steel Disc. RS = Right/Steel Disc.

Part numbers, prefixes, suffixes, photos and illustrations shown in this catalogue are trademarks and/or copyrights of EBC Brakes or the trademark owner A C Freeman Investments Ltd and use without express written permission of the owners is punishable by law.



Non-JAPANESE Built Motorcycles



MV Contd.

989 Brutale	08-09
990 Brutale R	10-11
998 Freccie Tricolori	10
998 F4	10-15
998 F4 R	12-15
998 F4 RR	10-15
998 F4 RR Corsa Corta	12
1000 F4 Ago	05
1000 F4 S (Mono Posto)	04-06
1000 F4 Ss 1+1 (Bi Posto)	04-06
1000 F4 Tamburini	05
1000 F4 R	06-07
1000 F4 R 312 (Brembo 4 Pad Caliper Up To VIN # 008064)	07
1000 F4 R 312 (Brembo 4 Pad Caliper From VIN # 008065)	08-09
1000 F4 R 312 1+1	07-08
1078 Brutale RR	08-09
1078 F4 100 CC Claudio Castlioni	07-08
1078 F4 RR 312	09
1090 Brutale	13-15
1090 Brutale R	12-15
1090 Brutale RR	10-15

MZ/MUZ

Simpson	80-94
Moskito 50	02
Moskito FB 50	97-03
Moskito SX JP50	00-03
VRS 50	05
VRS 100	05
Saxon 125	93-97
ETZ 125/150	85-92
Mantizz 125 S	05-07
Moskito 125	02
RT 125 (All models)	02-07
SM 125 (All models)	02-07
SX 125 (All models)	02-07
TS 125/150	
VRT 125 Quad	05
Saxon 150	95
VRS 150 Quad	05
VRT 175 Quad	05
TS 250	
251 Fun	95-96
ETZ 250/300	85-92
Saxon Tour 251/301	93-98
Saxon 500 All models	93-98
Skorpion Tour/Traveller	95-02
Skorpion Sport/Cup	95-01
Skorpion Replica	95-01
Baghira Black Panther - 17" Front wheel/Spoke wheel	96-03
Baghira Forest/Forest HR - 21" Front wheel/Spoke wheel	96-05
Baghira Street Moto 17" Front wheel/Spoke wheel	96-05
Baghira 21" Front wheel/Spoke wheel	99-05
Mastiff 21" Front wheel/Spoke wheel	96-05
Mastiff 17" Front wheel/Cast wheel	99-05
1000 S	03-07
1000 SF	05-07
1000 SFX	07
1000 ST	07

FA, SFA, TT Pad or Brake Shoe	SFAC Carbon Scooter Pads	Speciality Pads SXR / Vee / MXS	Sintered/ HH Pads/ Grooved Shoes	BRAKE DISC CHOICES - FRONT				Line #
				Left / Gauche / Links Standard Replacement Disc	Right / Droite / Rechts Standard Replacement Disc	Contour Disc Universal left and right fitment	Universal Custom Disc	
			FA244HH*	N/A	N/A			1
			FA244HH*	N/A	N/A			2
			FA447HH*	N/A	N/A			3
			FA447HH*	N/A	N/A			4
			FA447HH*	N/A	N/A			5
			FA447HH*	N/A	N/A			6
			FA447HH*	N/A	N/A			7
			FA424HH*	N/A	N/A			8
			FA424HH*	N/A	N/A			9
			FA424HH*	N/A	N/A			10
			FA424HH*	N/A	N/A			11
			FA322/4HH*	N/A	N/A			12
			FA322/4HH*	N/A	N/A			13
			FA447HH*	N/A	N/A			14
			FA322/4HH*	N/A	N/A			15
			FA447HH*	N/A	N/A			16
			FA322/4HH*	N/A	N/A			17
			FA447HH*	N/A	N/A			18
			FA244HH*	N/A	N/A			19
			FA244HH*	N/A	N/A			20
			FA447HH*	N/A	N/A			21
								22
								23
								24
	980							25
	SFA083	SFAC083	SFA083HH	N/A				26
	SFA169	SFAC169	SFA169HH	MD904D			VR904	27
	SFA169	SFAC169	SFA169HH	MD904D			VR904	28
	TBA*							29
	TBA*							30
	FA018		FA018HH		MD623RS			31
	FA018		FA018HH		N/A			32
	SFA323	SFAC323	SFA323HH		TBA			33
	SFA083	SFAC083	SFA083HH	N/A				34
	FA197		FA197HH	N/A				35
	FA228		FA228HH	N/A				36
	FA228		FA228HH	N/A				37
	978							38
	TBA*							39
	FA018		FA018HH		MD623RS			40
	TBA*							41
	TBA*							42
	978							43
	FA018		FA018HH		MD623RS			44
	FA018		FA018HH		N/A			45
	FA018		FA018HH		MD623RS			46
	FA018		FA018HH		MD623RS			47
	FA095		FA095HH		MD619RS			48
	FA095		FA095HH		MD619RS			49
	FA095*		FA095HH*	TBA	TBA			50
	FA177			TBA				51
	FA177			N/A				52
	FA177			TBA				53
	FA177			N/A				54
	FA177			TBA				55
	FA095		FA095HH	TBA				56
	FA145*		FA145HH*	MD855X	MD855X	MD855XC*		57
	FA145*		FA145HH*	MD855X	MD855X	MD855XC*		58
	FA145*		FA145HH*	MD855X	MD855X	MD855XC*		59
	FA145*		FA145HH*	MD855X	MD855X	MD855XC*		60

FRONT / AVANT / VORN / FRENTE / ANTERIORE

R Suffix = High Durability Sintered Pad. **HH** Suffix = High Performance Sintered Pad. **TT** Suffix = Hard Wearing Off Road Pad. **V** Suffix = Semi Sintered Pad. **G** Suffix = Grooved Shoe.
D Suffix = Drilled Disc. **X** Suffix = Universal Left or Right Disc. **XC** Suffix = Contoured Disc. **LS** Suffix = Left/Steel Disc. **RS** Suffix = Right/Steel Disc.

*-2 Sets Required. † For Vee disc colours add RED, BLU, GRN, GLD, ORG suffix to part number.
 * - Also available as a Vintage Motorcycle Disc.

Non-JAPANESE Built Motorcycles

Line #	BRAKE DISC CHOICES - FRONT						DISC PAD CHOICES - REAR				BRAKE DISC CHOICES - REAR			
	Oversize 250 /280mm Disc Kit	OSX Oversize 250/280mm Disc Kit	Relocating Bracket for 250/ 280mm Disc	Oversize 320mm Disc Kit	SMX Oversize 320mm Disc Kit	Relocating Bracket for 320mm Disc	FA, SFA, TT Pad or Brake Shoe	SFAC Carbon Scooter Pads	Speciality Pads - SXR / Vee / MXS	Sintered/ HH Pads/ Grooved Shoes	Standard Replacement Disc	Contour Disc Rear fitment	Vee-Discs™ CONTOUR	CX Extreme MX Race Disc/ UTVX Disc
1									FA320HH	MD696				
2									FA320HH	MD696				
3									FA320HH	MD696				
4									FA320HH	MD696				
5									FA320HH	MD696				
6									FA320HH	MD696				
7									FA320HH	MD696				
8									FA320HH	MD696				
9									FA320HH	MD696				
10									FA320HH	MD696				
11									FA320HH	MD696				
12									FA320HH	MD696				
13									FA320HH	MD696				
14									FA320HH	MD696				
15									FA320HH	MD696				
16									FA320HH	MD696				
17									FA320HH	MD696				
18									FA320HH	MD696				
19									FA320HH	MD696				
20									FA320HH	MD696				
21									FA320HH	MD696				
22														
23														
24							980							
25							TBA							
26							Y503							
27							Y503							
28							TBA							
29							TBA							
30							979							
31							979							
32							TBA							
33							TBA							
34							FA197		FA197HH	N/A				
35							FA197		FA197HH	N/A				
36							FA197		FA197HH	N/A				
37							979							
38							FA165/2TT		FA165/2R	N/A				
39							979							
40							FA083TT		FA083R	N/A				
41							FA165/2TT		FA165/2R	N/A				
42							978							
43							978							
44							978							
45							978							
46							978							
47							FA047		FA047HH	MD637				
48							FA047		FA047HH	MD637				
49							FA047		FA047HH	MD637				
50							FA173			MD6284D				
51							FA173			MD6284D				
52							FA173			MD6284D				
53							FA173			MD6284D				
54							FA173			MD6284D				
55							FA047		FA047HH	TBA				
56							FA254	FA254V	FA254HH	N/A				
57							FA254	FA254V	FA254HH	TBA				
58							FA254	FA254V	FA254HH	TBA				
59							FA254	FA254V	FA254HH	TBA				
60														

REAR / ARRIÈRE / HINTEN / POSTERIOR / POSTERIORE

*-2 Sets Required. † For Vee disc colours add RED, BLU, GRN, GLD, ORG suffix to part number.

⊗ - Also available as a Vintage Motorcycle Disc.

R Suffix = High Durability Sintered Pad. **HH** Suffix = High Performance Sintered Pad. **TT** Suffix = Hard Wearing Off Road Pad. **V** Suffix = Semi Sintered Pad. **G** Suffix = Grooved Shoe.
D Suffix = Drilled Disc. **X** Suffix = Universal Left or Right Disc. **XC** Suffix = Contoured Disc. **LS** Suffix = Left/Steel Disc. **RS** = Right/Steel Disc.

Part numbers, prefixes, suffixes, photos and illustrations shown in this catalogue are trademarks and/or copyrights of EBC Brakes or the trademark owner A C Freeman Investments Ltd and use without express written permission of the owners is punishable by law.

Non-JAPANESE Built Motorcycles



NEWFORCE QUADS

Most models	
NIPPONIA	
Brio 50 (4T)	12-13
Ezio 50 (4T)	12-14
Neon 50 (2T)	12-15
Miro 100 (4T)	12-13
Arte 125 (4T)	12-13
Brio 125 (4T)	12-15
Dion 125 (4T)	13-15
Duel 125 (4T)	12-13
Eclipse 125 (4T)	12-13
Ezio 125 (4T)	12-13
Inter 125 (4T)	12-13
Miro 125 (4T)	12-14
U2L 125 (4T)	12-13
Vorrei 125 (4T)	12-13
Arte 150 (4T)	12-13
Inter 150 (4T)	12-13
Vorrei 150 (4T)	12-13
Eclipse 180 (4T)	12-13

NORTON

Commando (Drum Brake Models)	68-70
750 MK V Commando Roadster/Interstate	73
850 MK 1 Commando Hi Rider/Interstate	73
850 MK 1A Commando Roadster/Interstate	73
850 MK 11/11A Commando Roadster/Hi Rider/Interstate	74
850 MK 111 Commando Roadster/Hi Rider/Interstate	75
Classic (Rotary)	89
Interpol 2 (Rotary)	89
Commander (Rotary)	90
F1 (Rotary) P55 Model	90
F1 (Rotary) P55 B Model	90-91
961 Commando Sport	10-20
961 Commando Cafe Racer	10-14
961 Commando Cafe Racer	15-20
961 Commando Dominator SS	15-20
961 Commando SE	10-11
961 Commando SF	13-14
961 Commando SF	15

NVT

Easy Rider	908
125/175 Rambler	FA076

OSSA

125 Cross	74-
TR 125i	13-15
250 Cross/Fuego/Super Pioneer	74-
Enduro 250i	12
Explorer 250i	14-15
TR 250i	14-15
Explorer 280i	12-15
TR 280i	10-15
Enduro 300i	12
TR 300i	14-15
350 Tu-Yo	
pre 1980 models	
81 onwards	

DISC PAD CHOICES - FRONT

BRAKE DISC CHOICES - FRONT

FA, SFA, TT Pad or Brake Shoe	SFAC Carbon Scooter Pads	Speciality Pads SXR / Vee / MXS	Sintered/ HH Pads/ Grooved Shoes	Left / Gauche / Links Standard Replacement Disc	Right / Droite / Rechts Standard Replacement Disc	Contour Disc Universal left and right fitment	Universal Custom Disc	Vee-Discs Black † See note below	CX Extreme MX Race Disc/ UTVX Disc
FA453TT*			FA453R*	N/A	N/A				
SFA086	SFAC086		SFA086HH			N/A			
SFA086	SFAC086		SFA086HH		N/A				
TBA				N/A					
SFA101	SFA101		SFA101HH		N/A				
SFA197	SFAC197		SFA197HH	N/A					
SFA086	SFAC086		SFA086HH			N/A			
SFA086	SFAC086		SFA086HH	N/A					
FA228			FA228HH	N/A					
TBA					N/A				
SFA086	SFAC086		SFA086HH		N/A				
TBA					TBA				
SFA101	SFAC101		SFA101HH		N/A				
TBA					N/A				
TBA				N/A					
SFA197	SFAC197		SFA197HH	N/A					
TBA					TBA				
TBA				N/A					
TBA					N/A				
852									
FA027				N/A					
FA027				N/A					
FA027				N/A					
FA027				N/A					
FA027				N/A					
FA027				N/A					
FA018*			FA018HH*	N/A	N/A				
FA018*			FA018HH*	N/A	N/A				
FA088*			FA088HH*	MD2011	MD2011	MD2011C*		VR2011*	
FA095*			FA095HH*	MD684	MD684				
FA095*			FA095HH*	MD684	MD684				
FA244*			FA244HH*	MD614X	MD614X	MD614XC*		VR614BLK*	
			FA322/4HH*	MD614X	MD614X	MD614XC*		VR614BLK*	
			FA630HH*	MD614X	MD614X	MD614XC*		VR614BLK*	
			FA630HH*	MD614X	MD614X	MD614XC*		VR614BLK*	
			FA322/4HH*	MD614X	MD614X	MD614XC*		VR614BLK*	
			FA322/4HH*	MD614X	MD614X	MD614XC*		VR614BLK*	
			FA630HH*	MD614X	MD614X	MD614XC*		VR614BLK*	
908									
FA076			FA076HH	N/A					
			934G						
FA303TT				N/A					
			934G						
FA181TT		MXS181	FA181R			N/A			
FA303TT						N/A			
FA303TT				N/A					
FA303TT						N/A			
FA303TT				N/A					
FA181TT		MXS181	FA181R			N/A			
FA303TT				N/A					
FA050				N/A					
			934G						
			935G						

FRONT / AVANT / VORN / FRENTE / ANTERIORE

Line #

1
2
3
4
5
6
7
8
9
10
11
12
13
14
15
16
17
18
19
20
21
22
23
24
25
26
27
28
29
30
31
32
33
34
35
36
37
38
39
40
41
42
43
44
45
46
47
48
49
50
51
52
53
54
55
56
57
58
59
60

*-2 Sets Required. † For Vee disc colours add RED, BLU, GRN, GLD, ORG suffix to part number.

⊗ - Also available as a Vintage Motorcycle Disc.

Non-JAPANESE Built Motorcycles

Line #	BRAKE DISC CHOICES - FRONT						DISC PAD CHOICES - REAR				BRAKE DISC CHOICES - REAR			
	Oversize 250 /280mm Disc Kit	OSX Oversize 250/280mm Disc Kit	Relocating Bracket for 250/ 280mm Disc	Oversize 320mm Disc Kit	SMX Oversize 320mm Disc Kit	Relocating Bracket for 320mm Disc	FA, SFA, TT Pad or Brake Shoe	SFAC Carbon Scooter Pads	Speciality Pads - SXR / Vee / MXS	Sintered/ HH Pads/ Grooved Shoes	Standard Replacement Disc	Contour Disc Rear fitment	Vee-Discs™ CONTOUR	CX Extreme MX Race Disc/ UTVX Disc
1									FA453R	N/A				
2														
3														
4							TBA							
5							TBA							
6							TBA							
7							TBA							
8							SFA197	SFAC197	SFA197HH	N/A				
9							SFA197	SFAC197	SFA197HH	N/A				
10							SFA197	SFAC197	SFA197HH	N/A				
11							TBA							
12							TBA							
13							TBA							
14							TBA							
15							Y527							
16							TBA							
17							TBA							
18							SFA197	SFAC197	SFA197HH	N/A				
19							TBA							
20							TBA							
21							TBA							
22														
23														
24							851							
25							FA027			N/A				
26							FA027			N/A				
27							FA027			N/A				
28							FA027			N/A				
29							FA027			N/A				
30							FA018	FA018V	FA018HH	N/A				
31							FA018	FA018V	FA018HH	N/A				
32							FA088		FA088HH	MD2069				
33							FA047		FA047HH	MD816				
34							FA095		FA095HH	MD816				
35							FA266	FA266V	FA266HH	N/A				
36							FA266	FA266V	FA266HH	N/A				
37							FA266	FA266V	FA266HH	N/A				
38							FA266	FA266V	FA266HH	N/A				
39							FA266	FA266V	FA266HH	N/A				
40							FA266	FA266V	FA266HH	N/A				
41							FA266	FA266V	FA266HH	N/A				
42														
43														
44							908							
45									821G					
46														
47														
48									990G					
49							FA351TT			N/A				
50									990G					
51							FA368TT	MXS368	FA368R		N/A			
52							FA351TT				N/A			
53							FA351TT				N/A			
54							FA351TT				N/A			
55							FA351TT				N/A			
56							FA368TT	MXS368	FA368R		N/A			
57							FA351TT				N/A			
58							FA050				N/A			
59									934G					
60									936G					

REAR / ARRIÈRE / HINTEN / POSTERIOR / POSTERIORE

*-2 Sets Required. † For Vee disc colours add RED, BLU, GRN, GLD, ORG suffix to part number.

⊗ - Also available as a Vintage Motorcycle Disc.

R Suffix = High Durability Sintered Pad. **HH** Suffix = High Performance Sintered Pad. **TT** Suffix = Hard Wearing Off Road Pad. **V** Suffix = Semi Sintered Pad. **G** Suffix = Grooved Shoe.
D Suffix = Drilled Disc. **X** Suffix = Universal Left or Right Disc. **XC** Suffix = Contoured Disc. **LS** Suffix = Left/Steel Disc. **RS** = Right/Steel Disc.

Non-JAPANESE Built Motorcycles

APPLICATIONS

BRAKE



OSSA Contd.

500	92
560	92

PEUGEOT

Most Mofas/Mopeds	
E-Powered by GenZe	18
Fox/Fox L 50	94-98
103 Pro, SP 3	
Buxy M/Buxy RM (50cc) (Counterbored disc - Leleu Wheels) - Grimeca Caliper	94-97
Buxy M/Buxy RM (50cc) (Counterbored disc - Leleu Wheels) - Hengtong caliper - check pad shape before ordering)	94-97
Buxy M/Buxy RM (50cc) (Counterbored disc - Leleu Wheels) - AJP Caliper - check pad shape before ordering)	94-97
Buxy M/Buxy RM (50cc) (Countersunk disc - Grimeca Wheels) - Grimeca Caliper	94-97
Buxy M/Buxy RM (50cc) (Countersunk disc - Grimeca Wheels) - Hengtong caliper - check pad shape before ordering)	94-97
Buxy M/Buxy RM (50cc) (Countersunk disc - Grimeca Wheels) - AJP Caliper - check pad shape before ordering)	94-97
Blastrer RS 12 50 (2T)	10-11
Blastrer Iceblade 50 (2T/12" Wheels)	10-12
Django 50 Allure (2T)	14-18
Django 50 Allure (4T)	14-18
Django 50 Evasion (2T)	14-20
Django 50 Evasion (4T)	14-18
Django 50 Heritage (2T)	14-18
Django 50 Heritage (4T)	14-18
Django 50 S (2T)	14-18
Django 50 S (4T)	14-18
Django 50 Sport (2T)	14-20
Django 50 Sport (4T)	14-18
Elyseo 50	98-02
Elyseo 50 (Hengtong caliper - check pad shape before ordering)	98-02
Elyseo 50 (AJP Caliper - check pad shape before ordering)	98-02
Elyseo 50	03
Elystar 50 TSDi	02-07
Elystar 50 Advantage	02-07
Jet Force 50/Jet-C (All models)	03-10
Jet C Tech 50	11-12
Jet Darkside 50 (2T)	11-13
Jet Iceblade 50 (2T)	11-13
Jet H2i 50 (2T - Air Cooled)	11-12
Jet H2i 50 (2T-L/C)	11-12
Kisbee 50 (2T)	10-18
Kisbee 50 (4T)	10-20
Kisbee RS 50 (2T)	10-18
Kisbee RS 50 (4T)	10-20
LooXoR 50 (AJP Caliper/Rear Drum)	01-06
LooXoR 50 (Heng Tong Caliper/Rear Drum)	01-06
LooXoR 50 TSDi (Rear disc)	06
Ludix One (10" wheels) 50cc	04-12
Ludix Snake (10" wheels) 50cc	04-09
Ludix Bullet (10" wheels) 50cc	04

DISC PAD CHOICES - FRONT				BRAKE DISC CHOICES - FRONT							Line #
FA, SFA, TT Pad or Brake Shoe	SFAC Carbon Scooter Pads	Speciality Pads - SXR / Vee / MXS	Sintered/ HH Pads/ Grooved Shoes	Left / Gauche / Links Standard Replacement Disc	Right / Droite / Rechts Standard Replacement Disc	Contour Disc Universal left and right fitment	Universal Custom Disc	Vee-Discs Black † See note below	CX Extreme MX Race Disc/ UTVX Disc	Line #	
FA132			FA132R	N/A						1	
FA067			FA067R	N/A						2	
										3	
										4	
H322										5	
SFA083	SFAC083									6	
H322										7	
H322										8	
										9	
SFA193	SFAC193		SFA193HH	MD909D						10	
										11	
SFA083	SFAC083		SFA083HH	MD909D						12	
										13	
SFA115	SFAC115		SFA115HH	MD909D						14	
										15	
SFA193	SFAC193		SFA193HH	MD901D				VR901		16	
										17	
SFA083	SFAC083		SFA083HH	MD901D				VR901		18	
										19	
										20	
SFA115	SFAC115		SFA115HH	MD901D				VR901		21	
										22	
SFA115	SFAC115		SFA115HH					VR9105		23	
										24	
SFA115	SFAC115		SFA115HH					VR9105		25	
										26	
SFA603	SFAC603		SFA603HH	MD9141D						27	
										28	
SFA603	SFAC603		SFA603HH	MD9141D						29	
										30	
SFA603	SFAC603		SFA603HH	MD9141D						31	
										32	
SFA228	SFAC228		SFA228HH	MD9141D						33	
										34	
SFA603	SFAC603		SFA603HH	MD9141D						35	
										36	
SFA603	SFAC603		SFA603HH	MD9141D						37	
										38	
SFA193	SFAC193		SFA193HH	MD901D				VR901		39	
										40	
SFA83	SFAC083		SFA083HH	MD901D				VR901		41	
										42	
SFA115	SFAC115		SFA115HH	MD901D				VR901		43	
										44	
SFA115	SFAC115		SFA115HH	MD947D				VR947		45	
										46	
SFA115	SFAC115		SFA115HH	MD947D				VR947		47	
										48	
SFA115	SFAC115		SFA115HH	MD985D				VR985		49	
										50	
SFA115	SFAC115		SFA115HH	MD985D				VR985		51	
										52	
SFA115	SFAC115		SFA115HH	MD985D				VR985		53	
										54	
SFA115	SFAC115		SFA115HH	MD985D				VR985		55	
										56	
SFA115	SFAC115		SFA115HH	MD985D				VR985		57	
										58	
SFA115	SFAC115		SFA115HH	MD954D				VR954		59	
										60	
SFA083	SFAC083		SFA083HH	MD954D				VR954		61	
										62	
SFA115	SFAC115		SFA115HH	MD954D				VR954		63	
										64	
H303										65	
SFA115	SFAC115		SFA115HH	MD992D				VR992		66	
										67	
SFA115	SFAC115		SFA115HH	MD992D				VR992		68	

*-2 Sets Required. † For Vee disc colours add RED, BLU, GRN, GLD, ORG suffix to part number.

⊗ - Also available as a Vintage Motorcycle Disc.

336 Part numbers, prefixes, suffixes, photos and illustrations shown in this catalogue are trademarks and/or copyrights of EBC Brakes or the trademark owner A C Freeman Investments Ltd and use without express written permission of the owners is punishable by law.

Non-JAPANESE Built Motorcycles

Line #	BRAKE DISC CHOICES - FRONT						DISC PAD CHOICES - REAR				BRAKE DISC CHOICES - REAR			
	Oversize 250 /280mm Disc Kit	OSX Oversize 250/280mm Disc Kit	Relocating Bracket for 250/ 280mm Disc	Oversize 320mm Disc Kit	SMX Oversize 320mm Disc Kit	Relocating Bracket for 320mm Disc	FA, SFA, TT Pad or Brake Shoe	SFAC Carbon Scooter Pads	Speciality Pads - SXR / Vee / MXS	Sintered/ HH Pads/ Grooved Shoes	Standard Replacement Disc	Contour Disc Rear fitment	Vee-Discs™ CONTOUR	CX Extreme MX Race Disc/ UTVX Disc
1							FA067			FA067R	N/A			
2							FA067			FA067R	N/A			
3														
4														
5							H322							
6							SFA083	SFAC083						
7							H303							
8							H322							
9														
10							H303							
11														
12														
13							H303							
14														
15														
16							H303							
17														
18							H303							
19														
20														
21							H303							
22														
23														
24							H303							
25							SFA115	SFAC115		SFA115HH		N/A		
26							SFA115	SFAC115		SFA115HH		N/A		
27							H303							
28							H303							
29							893							
30							893							
31							H303							
32							H303							
33							H303							
34							H303							
35							893							
36							893							
37							H303							
38														
39							H303							
40														
41							H303							
42							SFA115	SFAC115		SFA115HH	MD925D		VR925	
43							SFA350	SFAC350		SFA350HH	MD978D	MD978C	VR978	
44							SFA115	SFAC115		SFA115HH	MD925D		VR925	
45							SFA115	SFAC115		SFA115HH	MD984D		VR984	
46							SFA115	SFAC115		SFA115HH	MD984D		VR984	
47							SFA115	SFAC115		SFA115HH	MD984D		VR984	
48							SFA115	SFAC115		SFA115HH	MD984D		VR984	
49							H303							
50							SFA115	SFAC115		SFA115HH		N/A		
51							H353							
52							H353							
53							H353							
54							H353							
55							H303							
56							H303							
57							SFA115	SFAC115		SFA115HH	MD901D		VR901	
58							H303							
59							H303							
60							H303							

REAR / ARRIÈRE / HINTEN / POSTERIOR / POSTERIORE

*-2 Sets Required. † For Vee disc colours add RED, BLU, GRN, GLD, ORG suffix to part number.

⊗ - Also available as a Vintage Motorcycle Disc.

R Suffix = High Durability Sintered Pad. **HH** Suffix = High Performance Sintered Pad. **TT** Suffix = Hard Wearing Off Road Pad. **V** Suffix = Semi Sintered Pad. **G** Suffix = Grooved Shoe.
D Suffix = Drilled Disc. **X** Suffix = Universal Left or Right Disc. **XC** Suffix = Contoured Disc. **LS** Suffix = Left/Steel Disc. **RS** = Right/Steel Disc.

Part numbers, prefixes, suffixes, photos and illustrations shown in this catalogue are trademarks and/or copyrights of EBC Brakes or the trademark owner A C Freeman Investments Ltd and use without express written permission of the owners is punishable by law.

Non-JAPANESE Built Motorcycles

APPLICATIONS

BRAKE



PEUGEOT Contd.

	DISC PAD CHOICES - FRONT				BRAKE DISC CHOICES - FRONT						Line #
	FA, SFA, TT Pad or Brake Shoe	SFAC Carbon Scooter Pads	Speciality Pads SXR / Vee / MXS	Sintered/HH Pads/ Grooved Shoes	Left / Gauche / Links Standard Replacement Disc	Right / Droite / Rechts Standard Replacement Disc	Contour Disc Universal left and right fitment	Universal Custom Disc	Vee-Discs Black † See note below	CX Extreme MX Race Disc/ UTVX Disc	
Ludix Trend (10" wheels) 50cc	SFA115	SFAC115		SFA115HH	MD992D				VR992		1
Ludix Elegance (14" wheels) 50cc	SFA115	SFAC115		SFA115HH	MD993D						2
Ludix Classic (14" wheels)	H303										3
Ludix Urban Track	SFA115	SFAC115		SFA115HH	MD992D				VR992		4
Ludix Red Zone	SFA115	SFAC115		SFA115HH	MD992D				VR992		5
Ludix Acid	SFA115	SFAC115		SFA115HH	MD992D				VR992		6
Ludix Blaster (10" Wheels)	SFA115	SFAC115		SFA115HH					VR9105		7
Ludix 2 Trend 50cc (2T/12" wheels)	SFA115	SFAC115		SFA115HH					VR9105		8
Ludix Pro (4T/14" Wheels/AJP Caliper)	SFA115	SFAC115		SFA115HH					VR901		9
Ludix Pro (4T/14" Wheels/J.Juan Caliper)	SFA193	SFAC193		SFA193HH					VR901		10
Ludix 2 Bipoosto 50cc (2T/10" wheels)	H303										11
Ludix 2 One Bipoosto (2T/10" Wheels)	H303										12
Ludix 2 One Monoposoto (2T/12" Wheels)	H303										13
Metal-X 50 (All models)	SFA115	SFAC115		SFA115HH	MD984D				VR984		14
Vivacity 50 (AJP Caliper/12" Wheels/190mm Disc)	SFA115	SFAC115		SFA115HH	MD901D				VR901		15
Vivacity 50 (Heng Tong Caliper/12" Wheels/190mm Disc)	SFA083	SFAC083		SFA083HH	MD901D				VR901		16
Vivacity 2 50 (AJP Caliper/10" Wheels/190mm Disc)	SFA115	SFAC115		SFA115HH	MD901D				VR901		17
Vivacity 2 50 (Heng Tong Caliper/10" Wheels/190mm Disc)	SFA083	SFAC083		SFA083HH	MD901D				VR901		18
E-Vivacity (Electric)	SFA235	SFAC235			TBA						19
E-Vivacity (Electric)	SFA228	SFAC228		SFA228HH	MD9141D				VR9141		20
New Vivacity (50cc/2T/12" Wheels/200mm Disc)	SFA054	SFAC054		SFA054HH	MD9141D				VR9141		21
New Vivacity (50cc/4T/12" Wheels/200mm Disc)	SFA054	SFAC054		SFA054HH	MD9141D				VR9141		22
New Vivacity Sixties (50cc/4T/12" Wheels/200mm Disc)	SFA054	SFAC054		SFA054HH	MD9141D				VR9141		23
Speedake 50cc (Counterbored disc)											24
- Leleu Wheels - Hengtong caliper											25
- check pad shape before ordering)	SFA083	SFAC083		SFA083HH	MD909D						26
Speedake 50cc (Counterbored disc)											27
- Leleu Wheels - AJP Caliper											28
- check pad shape before ordering)	SFA115	SFAC115		SFA115HH	MD909D						29
Speedake 50cc (Countersunk disc)											30
- Grimeca Wheels - Hengtong caliper											31
- check pad shape before ordering)	SFA083	SFAC083		SFA083HH	MD901D				VR901		32
Speedake 50cc (Countersunk disc)											33
- Grimeca Wheels - AJP Caliper											34
- check pad shape before ordering)	SFA115	SFAC115		SFA115HH	MD901D				VR901		35
Speedfight 50 1/2 (Air Cooled) Rear Drum Models											36
- AJP Calipers	SFA115	SFAC115		SFA115HH	MD925D		MD925C		VR925		37
Speedfight 50 1/2 (Air Cooled) Rear Drum Models											38
- Heng Tong Calipers	SFA083	SFAC083		SFA083HH	MD925D		MD925C		VR925		39
Speedfight 50 1/2 (LC) Front & Rear Disc Models											40
- AJP Calipers	SFA115	SFAC115		SFA115HH	MD925D		MD925C		VR925		41
Speedfight 50 1/2 (LC) Front & Rear Disc Models											42
- Heng Tong Calipers	SFA083	SFAC083		SFA083HH	MD925D		MD925C		VR925		43
Speedfight 3 (50cc A/C - 2T)	SFA086	SFAC086		SFA086HH			N/A				44
Speedfight 3 (50cc L/C - 2T)	SFA086	SFAC086		SFA086HH			N/A				45
Speedfight 3 RS (50cc A/C - 2T)	SFA086	SFAC086		SFA086HH			N/A				46
Speedfight 3 RS (50cc L/C - 2T)	SFA086	SFAC086		SFA086HH			N/A				47
Speedfight 3 Darkside (50cc A/C - 2T)	SFA086	SFAC086		SFA086HH			N/A				48
Speedfight 3 Darkside (50cc L/C - 2T)	SFA086	SFAC086		SFA086HH			N/A				49
Speedfight Furious 3 (50cc L/C - 2T)	SFA086	SFAC086		SFA086HH			N/A				50
Speedfight 3 Iceblade (50cc A/C - 2T)	SFA086	SFAC086		SFA086HH			N/A				51
Speedfight 3 Iceblade (50cc L/C - 2T)	SFA086	SFAC086		SFA086HH			N/A				52
Speedfight 4 Classic (50cc/AC/2T & 4T)	SFA086	SFAC086		SFA086HH			N/A				53
Speedfight 4 Classic (50cc/LC/2T & 4T)	SFA086	SFAC086		SFA086HH			N/A				54
Speedfight 4 Darkside (50cc/AC/2T & 4T)	SFA086	SFAC086		SFA086HH			N/A				55
Speedfight 4 Darkside (50cc/LC/2T & 4T)	SFA086	SFAC086		SFA086HH			N/A				56
Speedfight 4 Iceblade (50cc/AC/2T & 4T)	SFA086	SFAC086		SFA086HH			N/A				57
Speedfight 4 Iceblade (50cc/LC/2T & 4T)	SFA086	SFAC086		SFA086HH			N/A				58
Speedfight 4 Pure (50cc/AC/2T & 4T)	SFA086	SFAC086		SFA086HH			N/A				59
Speedfight 4 Pure (50cc/LC/2T & 4T)	SFA086	SFAC086		SFA086HH			N/A				60

FRONT / AVANT / VORN / FRENTE / ANTERIORE

R Suffix = High Durability Sintered Pad. HH Suffix = High Performance Sintered Pad. TT Suffix = Hard Wearing Off Road Pad. V Suffix = Semi Sintered Pad. G Suffix = Grooved Shoe.

D Suffix = Drilled Disc. X Suffix = Universal Left or Right Disc. XC Suffix = Contoured Disc. LS Suffix = Left/Steel Disc. RS = Right/Steel Disc.

*-2 Sets Required. † For Vee disc colours add RED, BLU, GRN, GLD, ORG suffix to part number.

⊗ - Also available as a Vintage Motorcycle Disc.

338 Part numbers, prefixes, suffixes, photos and illustrations shown in this catalogue are trademarks and/or copyrights of EBC Brakes or the trademark owner A C Freeman Investments Ltd and use without express written permission of the owners is punishable by law.

Non-JAPANESE Built Motorcycles

Line #	BRAKE DISC CHOICES - FRONT						DISC PAD CHOICES - REAR				BRAKE DISC CHOICES - REAR			
	Oversize 250 /280mm Disc Kit	OSX Oversize 250/280mm Disc Kit	Relocating Bracket for 250/ 280mm Disc	Oversize 320mm Disc Kit	SMX Oversize 320mm Disc Kit	Relocating Bracket for 320mm Disc	FA, SFA, TT Pad or Brake Shoe	SFAC Carbon Scooter Pads	Speciality Pads - SXR / Vee / MXS	Sintered/ HH Pads/ Grooved Shoes	Standard Replacement Disc	Contour Disc Rear fitment	Vee-Discs™ CONTOUR	CX Extreme MX Race Disc/ UTVX Disc
1							H303							
2							H303							
3							H303							
4							H303							
5							H303							
6							H303							
7							H303							
8							H303							
9							H303							
10							H303							
11							H303							
12							H303							
13							H303							
14							H303							
15							H303							
16							H303							
17							H303							
18							H303							
19							H303							
20							H353							
21							H353							
22							H353							
23							H353							
24														
25														
26							H303							
27														
28														
29							H303							
30														
31														
32							H303							
33														
34														
35							H303							
36														
37							H303							
38														
39							SFA260	SFAC260	SFA260HH	MD925D	MD925C	VR925		
40														
41							SFA115	SFAC115	SFA115HH	MD925D	MD925C	VR925		
42														
43							SFA260	SFAC260	SFA260HH	MD925D	MD925C	VR925		
44							H353							
45							SFA266	SFAC266	SFA266HH		N/A			
46							SFA266	SFAC266	SFA266HH		N/A			
47							SFA266	SFAC266	SFA266HH		N/A			
48							H353							
49							SFA266	SFAC266	SFA266HH		N/A			
50							SFA266	SFAC266	SFA266HH		N/A			
51							H353							
52							SFA266	SFAC266	SFA266HH		N/A			
53							H353							
54							SFA266	SFAC266	SFA266HH		N/A			
55							H353							
56							SFA266	SFAC266	SFA266HH		N/A			
57							H353							
58							SFA266	SFAC266	SFA266HH		N/A			
59							H353							
60							SFA266	SFAC266	SFA266HH		N/A			

REAR / ARRIÈRE / HINTEN / POSTERIOR / POSTERIORE

*-2 Sets Required. † For Vee disc colours add RED, BLU, GRN, GLD, ORG suffix to part number.

⊗ - Also available as a Vintage Motorcycle Disc.

R Suffix = High Durability Sintered Pad. **HH** Suffix = High Performance Sintered Pad. **TT** Suffix = Hard Wearing Off Road Pad. **V** Suffix = Semi Sintered Pad. **G** Suffix = Grooved Shoe.
D Suffix = Drilled Disc. **X** Suffix = Universal Left or Right Disc. **XC** Suffix = Contoured Disc. **LS** Suffix = Left/Steel Disc. **RS** = Right/Steel Disc.

Part numbers, prefixes, suffixes, photos and illustrations shown in this catalogue are trademarks and/or copyrights of EBC Brakes or the trademark owner A C Freeman Investments Ltd and use without express written permission of the owners is punishable by law.

Non-JAPANESE Built Motorcycles

APPLICATIONS

BRAKE



PEUGEOT Contd.

		DISC PAD CHOICES - FRONT				BRAKE DISC CHOICES - FRONT					Line #	
		FA, SFA, TT Pad or Brake Shoe	SFAC Carbon Scooter Pads	Speciality Pads SXR / Vee / MXS	Sintered/HH Pads/ Grooved Shoes	Left / Gauche / Links Standard Replacement Disc	Right / Droite / Rechts Standard Replacement Disc	Contour Disc Universal left and right fitment	Universal Custom Disc	Vee-Discs Black † See note below		CX Extreme MX Race Disc/ UTVX Disc
Speedfight 4 R-Cup (50cc/LC/2T)	18-20	SFA086	SFAC086		SFA086HH			N/A				1
Speedfight 4 20 Ans Edition (50cc/AC/2T)	18	SFA086	SFAC086		SFA086HH			N/A				2
Squab 50cc (Counterbored disc												3
- Leleu Wheels - Hengtong caliper												4
- check pad shape before ordering)	95-01	SFA083	SFAC083		SFA083HH	MD909D						5
Squab 50cc (Counterbored disc												6
- Leleu Wheels - AJP Caliper												7
- check pad shape before ordering)	95-01	SFA115	SFAC115		SFA115HH	MD909D						8
Squab 50cc (Countersunk disc												9
- Grimeca Wheels - Hengtong caliper												10
- check pad shape before ordering)	95-01	SFA083	SFAC083		SFA083HH	MD901D			VR901			11
Squab 50cc (Countersunk disc												12
- Grimeca Wheels - AJP Caliper												13
- check pad shape before ordering)	95-01	SFA115	SFAC115		SFA115HH	MD901D			VR901			14
Streetzone 12 (50cc/2T)	14-18	SFA115	SFAC115		SFA115HH			TBA				15
SV 50/80/125 (Geo) (Counterbored disc												16
- Leleu Wheels - Nissin Caliper												17
- check pad shape before ordering)	91-92	SFA131/2			SFA131/2HH	MD909D						18
SV 50/80/125 (Geo) (Counterbored disc												19
- Leleu Wheels - Hengtong Caliper												20
- check pad shape before ordering)	91-92	SFA083			SFA083HH	MD909D						21
SV 50/80/125 (Geo) (Countersunk disc												22
- Grimeca Wheels - Nissin Caliper												23
- check pad shape before ordering)	93-	SFA131/3			SFA131/3HH	MD901D			VR901			24
SV 50/80/125 (Geo) (Countersunk disc												25
- Grimeca Wheels - Hengtong Caliper												26
- check pad shape before ordering)	93-	SFA083			SFA083HH	MD901D			VR901			27
SV 50 J (Front drum model) (Geo)	91-95	H303										28
Trekker (2T) AJP Caliper	98-00	SFA115	SFAC115		SFA115HH	MD901D			VR901			29
Trekker (2T) Heng Tong Caliper	98-00	SFA083	SFAC083		SFA083HH	MD901D			VR901			30
TRK 2WRC 50 (2T) (AJP Caliper												31
- check pad shape before ordering)	99-08	SFA115	SFAC115		SFA115HH	MD901D			VR901			32
TRK 2WRC 50 (2T) (Hengtong Caliper												33
- check pad shape before ordering)	99-08	SFA083	SFAC083		SFA083HH	MD901D			VR901			34
TRK 50 (2T/10" Wheels)	09-12	SFA115	SFAC115		SFA115HH	MD901D			VR901			35
TRK 50 12 (2T/12" Wheels)	09-12	SFA115	SFAC115		SFA115HH	MD901D			VR901			36
Tweet 50 (4T/Rear Drum Model)	10-13	SFA264	SFAC264		SFA264HH	MD9148D						37
Tweet 50 RS (4T/Rear Disc Model)	10-13	SFA264	SFAC264		SFA264HH			N/A				38
New Tweet Evo 50 (4T/Rear Drum Model)	14-20	SFA264	SFAC264		SFA264HH	MD9148D						39
New Tweet Evo 50 RS (4T/Rear Disc Model)	14-15	SFA264	SFAC264		SFA264HH			N/A				40
V-Clic 50 (4T) (155mm F/disc)	08-13	SFA169	SFAC169		SFA169HH	MD904D			VR904			41
V-Clic 50 (4T) (160mm F/disc)	08-11	SFA169	SFAC169		SFA169HH	TBA						42
Vogue 50 (2T)	08-09	TBA										43
XP6 Enduro/Top Road 21" front wheel	03-10	FA115			FA115HH	N/A						44
XP6 Supermoto (17" front wheel/240mm disc)	03-09	FA115			FA115HH	N/A						45
XR6 (2T) 50	03-07	FA167			FA167HH	MD6318D						46
XPS 50 SM	09	FA093				N/A						47
XPS Enduro	03-09	FA115			FA115HH	N/A						48
XPS Supermoto (17" front wheel/260mm disc)	03-10	FA194			FA194HH	N/A						49
XPS Street (17" front wheel/280mm disc)	03-09	FA194			FA194HH	N/A						50
XPS 50 Track (21" F/Wheel)	11-12	FA093				N/A						51
XPS 50 Top Road (17" F/Wheel)	10-12	FA093				N/A						52
NK7 (50cc) Naked	09-12	FA399				N/A						53
XR7 (50cc) Full Fairing	08-12	FA399				N/A						54
Zenith LS 50cc (Counterbored disc												55
- Leleu Wheels - AJP Caliper												56
- check pad shape before ordering)	96-99	SFA115	SFAC115		SFA115HH				VR904			57
Zenith LS 50cc (Counterbored disc												58
- Leleu Wheels - Hengtong Caliper												59
- check pad shape before ordering)	96-99	SFA083	SFAC083		SFA083HH				VR904			60

FRONT / AVANT / VORN / FRENTE / ANTERIORE

R Suffix = High Durability Sintered Pad. HH Suffix = High Performance Sintered Pad. TT Suffix = Hard Wearing Off Road Pad. V Suffix = Semi Sintered Pad. G Suffix = Grooved Shoe.

D Suffix = Drilled Disc. X Suffix = Universal Left or Right Disc. XC Suffix = Contoured Disc. LS Suffix = Left/Steel Disc. RS = Right/Steel Disc.

*-2 Sets Required. † For Vee disc colours add RED, BLU, GRN, GLD, ORG suffix to part number.

⊗ - Also available as a Vintage Motorcycle Disc.

340 Part numbers, prefixes, suffixes, photos and illustrations shown in this catalogue are trademarks and/or copyrights of EBC Brakes or the trademark owner A C Freeman Investments Ltd and use without express written permission of the owners is punishable by law.

Non-JAPANESE Built Motorcycles

Line #	BRAKE DISC CHOICES - FRONT						DISC PAD CHOICES - REAR				BRAKE DISC CHOICES - REAR			
	Oversize 250 /280mm Disc Kit	OSX Oversize 250/280mm Disc Kit	Relocating Bracket for 250/ 280mm Disc	Oversize 320mm Disc Kit	SMX Oversize 320mm Disc Kit	Relocating Bracket for 320mm Disc	FA, SFA, TT Pad or Brake Shoe	SFAC Carbon Scooter Pads	Speciality Pads - SXR / Vee / MXS	Sintered/ HH Pads/ Grooved Shoes	Standard Replacement Disc	Contour Disc Rear fitment	Vee-Discs™ CONTOUR	CX Extreme MX Race Disc/ UTVX Disc
1							SFA266	SFAC266		SFA266HH		N/A		
2							H353							
3														
4														
5							H303							
6														
7														
8							H303							
9														
10														
11							H303							
12														
13														
14							H303							
15							H353							
16														
17														
18							H303							
19														
20														
21							H303							
22														
23														
24							H303							
25														
26														
27							H303							
28							H303							
29							H303							
30							H303							
31														
32							H303							
33														
34							H303							
35							H303							
36							H303							
37							H307							
38							SFA260	SFAC260		SFA260HH		N/A		
39							H307							
40							SFA260	SFAC260		SFA260HH		N/A		
41							H303							
42							H303							
43							TBA							
44							FA115			FA115HH	N/A			
45							FA115			FA115HH	N/A			
46							FA115			FA115HH	N/A			
47							FA093				N/A			
48							FA115			FA115HH	N/A			
49							FA115			FA115HH	N/A			
50							FA115			FA115HH	N/A			
51							FA115				N/A			
52							FA115				N/A			
53							FA093				N/A			
54							FA093				N/A			
55														
56														
57							H303							
58														
59														
60							H303							

REAR / ARRIÈRE / HINTEN / POSTERIOR / POSTERIORE

*-2 Sets Required. † For Vee disc colours add RED, BLU, GRN, GLD, ORG suffix to part number.

⊗ - Also available as a Vintage Motorcycle Disc.

R Suffix = High Durability Sintered Pad. **HH** Suffix = High Performance Sintered Pad. **TT** Suffix = Hard Wearing Off Road Pad. **V** Suffix = Semi Sintered Pad. **G** Suffix = Grooved Shoe.
D Suffix = Drilled Disc. **X** Suffix = Universal Left or Right Disc. **XC** Suffix = Contoured Disc. **LS** Suffix = Left/Steel Disc. **RS** = Right/Steel Disc.

BRAKE APPLICATIONS

Non-JAPANESE Built Motorcycles

APPLICATIONS

BRAKE



PEUGEOT Contd.

		DISC PAD CHOICES - FRONT				BRAKE DISC CHOICES - FRONT						Line #
		FA, SFA, TT Pad or Brake Shoe	SFAC Carbon Scooter Pads	Speciality Pads SXR / Vee / MXS	Sintered/HH Pads/ Grooved Shoes	Left / Gauche / Links Standard Replacement Disc	Right / Droite / Rechts Standard Replacement Disc	Contour Disc Universal left and right fitment	Universal Custom Disc	Vee-Discs Black † See note below	CX Extreme MX Race Disc/ UTVX Disc	
Zenith LS 50cc (Countersunk disc												1
- Grimeca Wheels - AJP Caliper												2
- check pad shape before ordering)	96-99	SFA115	SFAC115		SFA115HH	MD914D						3
Zenith LS 50cc (Countersunk disc												4
- Grimeca Wheels - Hengtong Caliper												5
- check pad shape before ordering)	96-99	SFA083	SFAC083		SFA083HH	MD914D						6
Zenith M/N 50cc	96-00	H303										7
Elyseo 100	98-02	SFA115	SFAC115		SFA115HH	MD947D				VR947		8
Elyseo 100	03	SFA115	SFAC115		SFA115HH	MD947D				VR947		9
LooXoR 100 (All models)	01-04	SFA115	SFAC115		SFA115HH	MD954D				VR954		10
Kissbee 100 (4T)	12-14	SFA083	SFAC083		SFA083H	TBA						11
Speedfight 100 39844 (AJP Calipers Front & Rear All models)	97-07	SFA115	SFAC115		SFA115HH	MD925D		MD925C		VR925		12
Streetzone 100 (4T)	14-15	SFA115	SFAC115		SFA115HH			TBA				13
SV 100 L		SFA116				MD901D				VR901		14
Trekker 100 (2T) AJP Caliper	98-00	SFA115	SFAC115		SFA115HH	MD901D				VR901		15
VOX 110 (4T)	12-13	SFA635						N/A				16
Belville 125 Allure	18-20	SFA264	SFAC264		SFA164HH							17
Belville 125 RS	18-20	SFA264	SFAC264		SFA164HH							18
City Star 125 (AC/Carb)	11-15	SFA228	SFAC228		SFA228HH	TBA						19
City Star 125 i (LC)	13-19	SFA228	SFAC228		SFA228HH	TBA						20
City Star 125 Blue Line (AC/Carb)	15	SFA228	SFAC228		SFA228HH	TBA						21
Django 125 Allure (4T/190mm Rear Disc)	14-20	SFA603	SFAC603		SFA603HH	MD9141D						22
Django 125 Allure SBC (4T/190mm Rear Disc)	14-20	SFA603	SFAC603		SFA603HH	MD9141D						23
Django 125 Evasion (4T/190mm Rear Disc)	14-20	SFA603	SFAC603		SFA603HH	MD9141D						24
Django 125 Evasion SBC (4T/190mm Rear Disc)	14-20	SFA603	SFAC603		SFA603HH	MD9141D						25
Django 125 Heritage (4T/190mm Rear Disc)	14-20	SFA603	SFAC603		SFA603HH	MD9141D						26
Django 125 Heritage SBC (4T/190mm Rear Disc)	14-20	SFA603	SFAC603		SFA603HH	MD9141D						27
Django 125 S (4T/190mm Rear Disc)	14-20	SFA603	SFAC603		SFA603HH	MD9141D						28
Django 125 Sport (4T/190mm Rear Disc)	14-20	SFA603	SFAC603		SFA603HH	MD9141D						29
Django 125 Sport SBC (4T/190mm Rear Disc)	14-20	SFA603	SFAC603		SFA603HH	MD9141D						30
E-Metropolis Electric	19											31
Elyseo 125/150 (Drum Rear model)												32
(AJP Caliper - check pad shape before ordering)	98-01	SFA115	SFAC115		SFA115HH	MD947D				VR947		33
Elyseo 125/150 (Drum Rear model) (Hengtong Caliper												34
- check pad shape before ordering)	98-01	SFA083	SFAC083		SFA083HH	MD947D				VR947		35
Elyseo 125/150 Rear Disc Model	03	SFA194	SFAC194		SFA194HH	MD977D						36
Elystar 125/150 (3 bolt fixing front disc)	02-05	SFA194	SFAC194		SFA194HH	MD977D						37
Elystar 125/150 (5 bolt fixing front disc)	06-07	SFA194	SFAC194		SFA194HH	MD980D						38
Geo RS 125 (Nissan Calipers)	07-12	SFA228	SFAC228		SFA228HH	MD9111D				VR9111		39
Geopolis 125 Executive (AJP Caliper/Non ABS)	07-12	SFA194	SFAC194		SFA194HH	MD9111D				VR9111		40
Geopolis 125 Premium (Nissan Caliper/Non ABS)	07-12	SFA228	SFAC228		SFA228HH	MD9111D				VR9111		41
Geopolis 125 Urban (AJP Caliper/ABS)	07-12	SFA194	SFAC194		SFA194HH	TBA						42
Geopolis 125 (AJP Caliper/ABS)	07-12	SFA194	SFAC194		SFA194HH	MD9111D				VR9111		43
Jet Force 125 (All models)	03-07	SFA194	SFAC194		SFA194HH	MD980D						44
LooXoR 125/150	03-06	SFA324	SFAC324		SFA324HH	MD954D				VR954		45
Ludix Ambition (14" wheels) 125cc												46
(Counterbored disc - Leleu Wheels)	04	SFA115	SFAC115		SFA115HH	MD909D						47
Ludix Ambition (14" wheels) 125cc												48
(Countersunk disc - Grimeca Wheels)	04	SFA115	SFAC115		SFA115HH	MD901D				VR901		49
LXR 125 (4T)	10-13	SFA264	SFAC264		SFA264HH	TBA						50
Pulsion Active 125	19											51
Pulsion Allure 125	19											52
Pulsion RS 125	19											53
E-Vivacity (Electric)	10	SFA235	SFAC235			TBA						54
e-Satelis	11-13	SFA228	SFAC228		SFA228HH	TBA						55
Satelis 125 4V Executive/Premium/City (4 stroke/4 valve)	06-09	SFA194	SFAC194		SFA194HH	MD9111D				VR9111		56
Satelis 125 Blacksats (AJP Calipers)	10-11	SFA194	SFAC194		SFA194HH	N/A						57
Satelis 125 Compressor (4T)	06-11	SFA194	SFAC194		SFA194HH	MD9111D				VR9111		58
Satelis 125 Urban (AJP Caliper/ABS)	07-11	SFA194	SFAC194		SFA194HH	N/A						59
Satelis 125 RS (AJP Caliper)	07-13	SFA194	SFAC194		SFA194HH	N/A						60

FRONT / AVANT / VORN / FRENTE / ANTERIORE

R Suffix = High Durability Sintered Pad. HH Suffix = High Performance Sintered Pad. TT Suffix = Hard Wearing Off Road Pad. V Suffix = Semi-Sintered Pad. G Suffix = Grooved Shoe.

D Suffix = Drilled Disc. X Suffix = Universal Left or Right Disc. XC Suffix = Contoured Disc. LS Suffix = Left/Steel Disc. RS = Right/Steel Disc.

*-2 Sets Required. † For Vee disc colours add RED, BLU, GRN, GLD, ORG suffix to part number.

⊗ - Also available as a Vintage Motorcycle Disc.

Non-JAPANESE Built Motorcycles

Line #	BRAKE DISC CHOICES - FRONT						DISC PAD CHOICES - REAR				BRAKE DISC CHOICES - REAR			
	Oversize 250 /280mm Disc Kit	OSX Oversize 250/280mm Disc Kit	Relocating Bracket for 250/ 280mm Disc	Oversize 320mm Disc Kit	SMX Oversize 320mm Disc Kit	Relocating Bracket for 320mm Disc	FA, SFA, TT Pad or Brake Shoe	SFAC Carbon Scooter Pads	Speciality Pads - SXR / Vee / MXS	Sintered/ HH Pads/ Grooved Shoes	Standard Replacement Disc	Contour Disc Rear fitment	Vee-Discs™ CONTOUR	CX Extreme MX Race Disc/ UTVX Disc
1														
2														
3							H303							
4														
5														
6							H303							
7							H303							
8							H303							
9							SFA115	SFAC115		SFA115HH	MD925D		VR925	
10							SFA115	SFAC115		SFA115HH	MD901D		VR901	
11							H307							
12							SFA115	SFAC115		SFA115HH	MD925D	MD925C	VR925	
13							H307							
14							H303							
15							H303							
16							H303							
17							SFA260	SFAC260		SFA260HH	TBA			
18							SFA260	SFAC260		SFA260HH	TBA			
19							SFA260	SFAC260		SFA260HH	TBA			
20							SFA260	SFAC260		SFA260HH	TBA			
21							SFA067	SFAC067		SFA067HH	TBA			
22							SFA067	SFAC067		SFA067HH	MD9167D			
23							SFA067	SFAC067		SFA067HH	MD9167D			
24							SFA067	SFAC067		SFA067HH	MD9167D			
25							SFA067	SFAC067		SFA067HH	MD9167D			
26							SFA266	SFAC266		SFA266HH	MD9170D			
27							SFA067	SFAC067		SFA067HH	MD9167D			
28							SFA067	SFAC067		SFA067HH	MD9167D			
29							SFA067	SFAC067		SFA067HH	MD9167D			
30							SFA067	SFAC067		SFA067HH	MD9167D			
31														
32														
33							857							
34														
35							857							
36							SFA350	SFAC350		SFA350HH	MD978D	MD978C		
37							SFA350	SFAC350		SFA350HH	MD978D	MD978C		
38							SFA350	SFAC350		SFA350HH	MD978D	MD978C		
39							SFA228	SFAC228		SFA228HH	N/A			
40							SFA350	SFAC350		SFA350HH	TBA			
41							SFA228	SFAC228		SFA228HH	TBA			
42							SFA350	SFAC350		SFA350HH	TBA			
43							SFA350	SFAC350		SFA350HH	TBA			
44							SFA350	SFAC350		SFA350HH	MD978D	MD978C		
45							SFA115	SFAC115		SFA115HH	MD9121D			
46														
47							H303							
48														
49							H303							
50							SFA427	SFAC427		SFA427HH	TBA			
51														
52														
53														
54							H303							
55							SFA228	SFAC228		SFA228HH	TBA			
56							SFA350	SFAC350		SFA350HH	MD978D	MD978C	VR978	
57							SFA350	SFAC350		SFA350HH	MD978D	MD978C		
58							SFA350	SFAC350		SFA350HH	MD978D	MD978C	VR978	
59							SFA350	SFAC350		SFA350HH	MD978D	MD978C		
60							SFA350	SFAC350		SFA350HH	MD978D	MD978C		

REAR / ARRIÈRE / HINTEN / POSTERIOR / POSTERIORE

*-2 Sets Required. † For Vee disc colours add RED, BLU, GRN, GLD, ORG suffix to part number.

⊗ - Also available as a Vintage Motorcycle Disc.

R Suffix = High Durability Sintered Pad. HH Suffix = High Performance Sintered Pad. TT Suffix = Hard Wearing Off Road Pad. V Suffix = Semi Sintered Pad. G Suffix = Grooved Shoe.

D Suffix = Drilled Disc. X Suffix = Universal Left or Right Disc. XC Suffix = Contoured Disc. LS Suffix = Left/Steel Disc. RS = Right/Steel Disc.

Non-JAPANESE Built Motorcycles

APPLICATIONS

BRAKE



PEUGEOT Contd.

		DISC PAD CHOICES - FRONT			BRAKE DISC CHOICES - FRONT						Line #	
		FA, SFA, TT Pad or Brake Shoe	SFAC Carbon Scooter Pads	Speciality Pads SXR / Vee / MXS	Sintered/HH Pads/ Grooved Shoes	Left / Gauche / Links Standard Replacement Disc	Right / Droite / Rechts Standard Replacement Disc	Contour Disc Universal left and right fitment	Universal Custom Disc	Vee-Discs Black † See note below		CX Extreme MX Race Disc/ UTVX Disc
Satelis 125 Whitesat (AJP Calipers)	10-11	SFA194	SFAC194		SFA194HH	N/A						1
Satelis 125 Avenue (Nissin Calipers)	08-09	SFA228	SFAC228		SFA228HH	TBA						2
Satelis 125	13	SFA603	SFAC603		SFA603HH	N/A						3
Satelis 125 RS (4T)	13	SFA228	SFAC228		SFA228HH	TBA						4
Satelis 125 Blue Line	15	SFA228	SFAC228		SFA228HH	N/A						5
Speedfight 125 (4T)	14-15	SFA086	SFAC086		SFA086HH	N/A						6
Speedfight 125 Darkside (4T)	14-15	SFA086	SFAC086		SFA086HH			N/A				7
Speedfight 125 Iceblade (4T)	14-15	SFA086	SFAC086		SFA086HH			N/A				8
Speedfight 125 Team (4T)	14-15	SFA086	SFAC086		SFA086HH			N/A				9
Speedfight 4 125 (4T)	17-18	SFA603	SFAC603		SFA603HH							10
Sum-Up (125cc)	08-11	SFA054	SFAC054		SFA054HH		N/A					11
Tweet 125 (4T/Rear Drum Model)	10-12	SFA264	SFAC264		SFA264HH	MD9137D				VR9137		12
Tweet 125 (4T/Rear Disc Model)	12-13	SFA264	SFAC264		SFA264HH	MD9148D		TBA				13
Tweet 125 RS (4T/Rear Disc Model)	10-13	SFA264	SFAC264		SFA264HH			TBA				14
New Tweet Evo 125 (4T)	14-20	SFA264	SFAC264		SFA264HH	MD9148D						15
New Tweet Evo RS 125 (4T)	14-20	SFA264	SFAC264		SFA264HH			N/A				16
WTR 125	08	FA197			FA197HH		TBA					17
XPS 125 CT	05-07	FA115			FA115HH	N/A						18
XP 125 Street Evo 2	05	FA167			FA167HH	N/A						19
Vivacity 125 (4T)	10-15	SFA228	SFAC228		SFA228HH	MD9141D				VR9141		20
Vivacity Sixties 125 (4T)	11-12	SFA228	SFAC228		SFA228HH	MD9141D				VR9141		21
City Star One 150	13-14	SFA228	SFAC228		SFA228HH	TBA						22
Django 150 Allure (4T/190mm Rear Disc)	14-18	SFA603	SFAC603		SFA603HH	MD9141D						23
Django 150 Evasion (4T/190mm Rear Disc)	14-20	SFA603	SFAC603		SFA603HH	MD9141D						24
Django 150 Heritage (4T/196mm Rear Disc)	14-20	SFA228	SFAC228		SFA228HH	MD9141D						25
Django 150 S (4T) (4T/190mm Rear Disc)	14-20	SFA603	SFAC603		SFA603HH	MD9141D						26
Django 150 Sport (4T/190mm Rear Disc)	14-20	SFA603	SFAC603		SFA603HH	MD9141D						27
Tweet 150 (4T/Rear Drum Model)	10-12	SFA264	SFAC264		SFA264HH	MD9137D				VR9137		28
Tweet 150 RS (4T/Rear Disc Model)	10-12	SFA264	SFAC264		SFA264HH			TBA				29
City Star 150 (AC/Carb)	11-15	SFA228	SFAC228		SFA228HH	TBA						30
City Star 150 i (LC)	13-15	SFA228	SFAC228		SFA228HH	TBA						31
New Tweet Evo 150 (4T)	14-19	SFA264	SFAC264		SFA264HH	MD9148D						32
New Tweet Evo RS 150 (4T)	14-19	SFA264	SFAC264		SFA264HH			N/A				33
Belville 200 Allure	18-20	SFA264	SFAC264		SFA264HH			N/A				34
Belville 200 RS	18-20	SFA264	SFAC264		SFA264HH			N/A				35
City Star 200 i	12-18	SFA228	SFAC228		SFA228HH	TBA						36
LXR 200i (4T)	10-11	SFA264	SFAC264		SFA264HH	TBA						37
Geo 250 (Nissin Caliper)	07-11	SFA228	SFAC228		SFA228HH	MD9111D				VR9111		38
Geopolis 250 Executive (AJP caliper/Non ABS)	07-11	SFA194	SFAC194		SFA194HH	MD9111D				VR9111		39
Geopolis 250 Premium (Nissin caliper/Non ABS)	07-11	SFA228	SFAC228		SFA228HH	MD9111D				VR9111		40
Geopolis 250 Urban (AJP caliper/ABS)	07-11	SFA194	SFAC194		SFA194HH	MD9111D				VR9111		41
Satelis 250 Premium (Nissin Calipers)	07-12	SFA228	SFAC228		SFA228HH	TBA						42
Satelis 250 Urban (AJP Caliper/ABS)	07-12	SFA194	SFAC194		SFA194HH	N/A						43
Satelis 250 RS (Nissin Calipers)	07-12	SFA228	SFAC228		SFA228HH	TBA						44
SV 250	01-02	SFA281			SFA281HH	MD922D				VR922		45
SV 250 - Parking brake	01-02	H351										46
Geo RS 300 (Nissin Calipers)	10-12	SFA228	SFAC228		SFA228HH	MD9111D				VR9111		47
Geopolis 300	10-15	SFA228	SFAC228		SFA228HH	MD9111D				VR9111		48
Geostyle 300 (Nissin Calipers)	10-12	SFA228	SFAC228		SFA228HH	MD9111D				VR9111		49
Geopolis 300 GT	14	SFA142*	SFAC142*		SFA142HH*	TBA	TBA					50
Satelis 300 (4T)	13	SFA228	SFAC228		SFA228HH	N/A						51
Satelis 2 300 (4T)	14-15	SFA228	SFAC228		SFA228HH	N/A						52
Geo RS 400 (Nissin Calipers)	08-12	SFA228	SFAC228		SFA228HH	MD9111D				VR9111		53
Geopolis 400 Premium (Nissin Caliper/Non ABS)	07-12	SFA228	SFAC228		SFA228HH	MD9111D				VR9111		54
Geopolis 400 Urban (AJP Caliper/ABS)	07-12	SFA194	SFAC194		SFA194HH	MD9111D				VR9111		55
Metropolis 400T (3 Wheel Model)	14-16	SFA650*	SFAC650*		SFA650HH*	N/A	N/A					56
Metropolis 400T (3 Wheel Model) - Parking brake	14-16	SFA083										57
Metropolis 400T-RS (3 Wheel Model)	14-16	SFA650*	SFAC650*		SFA650HH*	N/A	N/A					58
Metropolis 400T-RS (3 Wheel Model) - Parking brake	14-16	SFA083										59
Metropolis 400 Blue Line (3 Wheel Model)	15-16	SFA650*	SFAC650*		SFA650HH*	N/A	N/A					60

FRONT / AVANT / VORN / FRENTE / ANTERIORE

R Suffix = High Durability Sintered Pad. HH Suffix = High Performance Sintered Pad. TT Suffix = Hard Wearing Off Road Pad. V Suffix = Semi-Sintered Pad. G Suffix = Grooved Shoe.

D Suffix = Drilled Disc. X Suffix = Universal Left or Right Disc. XC Suffix = Contoured Disc. LS Suffix = Left/Steel Disc. RS = Right/Steel Disc.

*-2 Sets Required. † For Vee disc colours add RED, BLU, GRN, GLD, ORG suffix to part number.

⊗ - Also available as a Vintage Motorcycle Disc.

Non-JAPANESE Built Motorcycles

Line #	BRAKE DISC CHOICES - FRONT						DISC PAD CHOICES - REAR				BRAKE DISC CHOICES - REAR			
	Oversize 250 /280mm Disc Kit	OSX Oversize 250/280mm Disc Kit	Relocating Bracket for 250/ 280mm Disc	Oversize 320mm Disc Kit	SMX Oversize 320mm Disc Kit	Relocating Bracket for 320mm Disc	FA, SFA, TT Pad or Brake Shoe	SFAC Carbon Scooter Pads	Speciality Pads - SXR / Vee / MXS	Sintered/ HH Pads/ Grooved Shoes	Standard Replacement Disc	Contour Disc Rear fitment	Vee-Discs™ CONTOUR	CX Extreme MX Race Disc/ UTVX Disc
1							SFA350	SFAC350		SFA350HH	MD978D	MD978C		
2							SFA228	SFAC228		SFA228HH	MD978D	MD978C		
3							SFA260			SFA260HH	N/A			
4							SFA260			SFA260HH	N/A			
5							SFA260			SFA260HH	N/A			
6							SFA266	SFAC266		SFA266HH	N/A			
7							SFA266	SFAC266		SFA266HH		N/A		
8							SFA266	SFAC266		SFA266HH		N/A		
9							SFA266	SFAC266		SFA266HH		N/A		
10							SFA083			SFA083HH				
11							Y506							
12							Y506							
13							SFA260	SFAC260		SFA260HH	MD9149D	TBA		
14							SFA260	SFAC260		SFA260HH	TBA	TBA		
15							SFA260	SFAC260		SFA260HH	MD9149D			
16							SFA260	SFAC260		SFA260HH		N/A		
17							TBA							
18							FA115			FA115HH	N/A			
19							FA115			FA115HH	N/A			
20							Y506							
21							Y506							
22							SFA260	SFAC260		SFA260HH	TBA			
23							SFA067	SFAC067		SFA067HH	MD9167D		VR9167	
24							SFA067	SFAC067		SFA067HH	MD9167D		VR9167	
25							SFA266	SFAC266		SFA266HH	MD9170D		VR9170	
26							SFA067	SFAC067		SFA067HH	MD9167D		VR9167	
27							SFA067	SFAC067		SFA067HH	MD9167D		VR9167	
28							Y506							
29							SFA260	SFAC260		SFA260HH	TBA	TBA		
30							SFA260	SFAC260		SFA260HH	TBA			
31							SFA260	SFAC260		SFA260HH	TBA			
32							SFA260	SFAC260		SFA260HH	MD9149D			
33							SFA260	SFAC260		SFA260HH		N/A		
34							SFA260	SFAC260		SFA260HH		N/A		
35							SFA260	SFAC260		SFA260HH		N/A		
36							SFA260	SFAC260		SFA260HH	TBA			
37							SFA427	SFAC427		SFA427HH	TBA			
38							SFA228	SFAC228		SFA228HH	N/A			
39							SFA350	SFAC350		SFA350HH	N/A			
40							SFA228	SFAC228		SFA228HH	N/A			
41							SFA350	SFAC350		SFA350HH	N/A			
42							SFA228	SFAC228		SFA228HH	N/A			
43							SFA350	SFAC350		SFA350HH	N/A			
44							SFA228	SFAC228		SFA228HH	N/A			
45							SFA140			SFA140HH	MD1004		VR1004	
46														
47							SFA228	SFAC228		SFA228HH	N/A			
48							SFA228	SFAC228		SFA228HH	N/A			
49							SFA228	SFAC228		SFA228HH	N/A			
50							SFA228	SFAC228		SFA228HH	TBA			
51							SFA228	SFAC228		SFA228HH	N/A			
52							SFA228	SFAC228		SFA228HH	N/A			
53							SFA228	SFAC228		SFA228HH	N/A			
54							SFA228	SFAC228		SFA228HH	N/A			
55							SFA350	SFAC350		SFA350HH	N/A			
56							SFA650	SFAC650		SFA650HH	N/A			
57														
58							SFA650	SFAC650		SFA650HH	N/A			
59														
60							SFA650	SFAC650		SFA650HH	N/A			

REAR / ARRIÈRE / HINTEN / POSTERIOR / POSTERIORE

*-2 Sets Required. † For Vee disc colours add RED, BLU, GRN, GLD, ORG suffix to part number.

⊗ - Also available as a Vintage Motorcycle Disc.

R Suffix = High Durability Sintered Pad. **HH** Suffix = High Performance Sintered Pad. **TT** Suffix = Hard Wearing Off Road Pad. **V** Suffix = Semi Sintered Pad. **G** Suffix = Grooved Shoe.
D Suffix = Drilled Disc. **X** Suffix = Universal Left or Right Disc. **XC** Suffix = Contoured Disc. **LS** Suffix = Left/Steel Disc. **RS** = Right/Steel Disc.

Part numbers, prefixes, suffixes, photos and illustrations shown in this catalogue are trademarks and/or copyrights of EBC Brakes or the trademark owner A C Freeman Investments Ltd and use without express written permission of the owners is punishable by law.

BRAKE APPLICATIONS

Non-JAPANESE Built Motorcycles

APPLICATIONS

BRAKE



PEUGEOT Contd.

Metropolis 400 Blue Line (3 Wheel Model) - Parking brake	15-16
Metropolis 400 RS (3 Wheel Model/Nissin Caliper)	17-18
Metropolis 400 RX-R (3 Wheel Model/Nissin Caliper)	17-18
Metropolis 400 Allure (3 Wheel Model/Nissin Caliper)	17-18
Satelis 400 Premium (Nissin Calipers)	08-11
Satelis 400 Urban (Nissin Calipers)	08-12
Satelis 400 RS (Nissin Calipers)	08-12
Satelis 2 400 (4T)	14-15
Satelis 2 400 RS	14-15
Geopolis 500	08-11
Satelis 500	07-12
Satelis 500 RS (Nissin Calipers)	08-12

PETRONAS

FP1	05
-----	----

PHB

500	92
560	92

PGO

idep Electric Scooter	09
Big Max 50	94-06
Big Max 50 S	03-04
Big Max 50 (Front wave disc)	07-09
Big Max 50 Naked (Round disc/No Cover on handlebars)	07-09
Bugrider 50 (Buggie)	06
EPS	97
Galaxy 50	94-
G-Max 50	05-07
G-Max 50 Naked (Wave disc)	09
G-Max 50 (Wave disc)	08-12
Libra 50 (2T)	09
Ligero 50 (2T)	08-12
Mega 50	94-
My Bubu 50	03
PMX 50	00-07
PMX 50 Naked	
Rodo Show 50	00-09
T-Rex 50	99-12
T-Rex 3 (50cc) (3 wheeler)	03-04
Tornado 50/125	97
X Rider 50/90/110	04-05
XL-Rider 50	07-08
XL-Rider	07-08
Bubu 100/125	03-08
My Bubu 100/125	03-05
PMX 110	00-07
T-Rex 110	99-06
Charge 125 A/B	01-02
G-Max 125	06-08
G-Max 125 (Wave disc)	09-12
i-Charge 125	03-05
Libra 125 EFI (4T)	09-12
Ligero 125	06-08
Ligero 125 (4T)	08-12
Tigra 125 (4T/4V)	12
T/Rex 125	99-07
T-Rex 125 (Wave disc)	08-12
Bugrider 150	

DISC PAD CHOICES - FRONT				BRAKE DISC CHOICES - FRONT						Line #
FA, SFA, TT Pad or Brake Shoe	SFAC Carbon Scooter Pads	Speciality Pads SXR / Vee / MXS	Sintered/HH Pads/ Grooved Shoes	Left / Gauche / Links Standard Replacement Disc	Right / Droite / Rechts Standard Replacement Disc	Contour Disc Universal left and right fitment	Universal Custom Disc	Vee-Discs Black † See note below	CX Extreme MX Race Disc/ UTVX Disc	Line #
SFA083										1
SFA415*	SFAC415*		SFA415HH*	N/A						2
SFA415*	SFAC415*		SFA415HH*	N/A						3
SFA415*	SFAC415*		SFA415HH*	N/A						4
SFA142*	SFAC142*		SFA142HH*	N/A	N/A					5
SFA142*	SFAC142*		SFA142HH*	N/A	N/A					6
SFA142*	SFAC142*		SFA142HH*	N/A	N/A					7
SFA142*	SFAC142*		SFA142HH*	N/A	N/A					8
SFA142*	SFAC142*		SFA142HH*	N/A	N/A					9
SFA142*	SFAC142*		SFA142HH*	MD9111D	MD9111D			VR9111*		10
SFA142*	SFAC142*		SFA142HH*	TBA	TBA					11
SFA142*	SFAC142*		SFA142HH*	TBA	TBA					12
										13
										14
			FA322/4HH*	TBA	TBA					15
										16
										17
FA132			FA132R	N/A						18
FA067			FA067R	N/A						19
										20
										21
SFA264	SFAC264		SFA264HH	N/A						22
SFA169	SFAC169		SFA169HH	MD904D				VR904		23
SFA264	SFAC264		SFA264HH	TBA						24
SFA264	SFAC264		SFA264HH			N/A				25
SFA264	SFAC264		SFA264HH	N/A						26
FA416TT*			FA416R*	N/A	N/A					27
SFA169	SFAC169		SFA169HH	MD904D				VR904		28
SFA083	SFAC083		SFA083HH	MD939D						29
SFA264	SFAC264		SFA264HH	N/A						30
SFA264	SFAC264		SFA264HH			N/A				31
SFA264	SFAC264		SFA264HH			N/A				32
SFA264	SFAC264		SFA264HH	N/A						33
SFA264	SFAC264		SFA264HH	N/A						34
SFA083	SFAC083		SFA083HH	TBA						35
SFA193	SFAC193		SFA193HH	MD904D				VR904		36
SFA264	SFAC264		SFA264HH	MD923D				VR923		37
SFA264	SFAC264		SFA264HH	TBA						38
SFA193	SFAC193		SFA193HH	TBA						39
SFA264	SFAC264		SFA264HH	MD923D				VR923		40
SFA264	SFAC264		SFA264HH	TBA						41
SFA169	SFAC169		SFA169HH	MD904D				VR904		42
TBA*										43
TBA*										44
TBA*										45
SFA264	SFAC264		SFA264HH	MD923D				VR923		46
SFA264	SFAC264		SFA264HH	N/A						47
SFA264	SFAC264		SFA264HH	MD923D				VR923		48
SFA264	SFAC264		SFA264HH	MD923D				VR923		49
SFA264	SFAC264		SFA264HH	MD923D				VR923		50
FA095			FA095HH	N/A						51
FA095			FA095HH			N/A				52
SFA264	SFAC264		SFA264HH	N/A						53
SFA264	SFAC264		SFA264HH	N/A						54
SFA264	SFAC264		SFA264HH	MD923D				VR923		55
SFA264	SFAC264		SFA264HH	N/A						56
SFA264	SFAC264		SFA264HH			N/A				57
SFA264	SFAC264		SFA264HH	MD923D				VR923		58
SFA264	SFAC264		SFA264HH			N/A				59
FA416TT*			FA416R*	N/A	N/A					60

FRONT / AVANT / VORN / FRENTE / ANTERIORE

R Suffix = High Durability Sintered Pad. HH Suffix = High Performance Sintered Pad. TT Suffix = Hard Wearing Off Road Pad. V Suffix = Semi Sintered Pad. G Suffix = Grooved Shoe.

D Suffix = Drilled Disc. X Suffix = Universal Left or Right Disc. XC Suffix = Contoured Disc. LS Suffix = Left/Steel Disc. RS Suffix = Right/Steel Disc.

*-2 Sets Required. † For Vee disc colours add RED, BLU, GRN, GLD, ORG suffix to part number.

⊗ - Also available as a Vintage Motorcycle Disc.

346 Part numbers, prefixes, suffixes, photos and illustrations shown in this catalogue are trademarks and/or copyrights of EBC Brakes or the trademark owner A C Freeman Investments Ltd and use without express written permission of the owners is punishable by law.

Non-JAPANESE Built Motorcycles

Line #	BRAKE DISC CHOICES - FRONT						DISC PAD CHOICES - REAR				BRAKE DISC CHOICES - REAR			
	Oversize 250 /280mm Disc Kit	OSX Oversize 250/280mm Disc Kit	Relocating Bracket for 250/ 280mm Disc	Oversize 320mm Disc Kit	SMX Oversize 320mm Disc Kit	Relocating Bracket for 320mm Disc	FA, SFA, TT Pad or Brake Shoe	SFAC Carbon Scooter Pads	Speciality Pads - SXR / Vee / MXS	Sintered/ HH Pads/ Grooved Shoes	Standard Replacement Disc	Contour Disc Rear fitment	Vee-Discs™ CONTOUR	CX Extreme MX Race Disc/ UTVX Disc
1														
2							SFA228	SFAC228		SFA228HH	N/A			
3							SFA228	SFAC228		SFA228HH	N/A			
4							SFA228	SFAC228		SFA228HH	N/A			
5							SFA228	SFAC228		SFA228HH	N/A			
6							SFA228	SFAC228		SFA228HH	N/A			
7							SFA228	SFAC228		SFA228HH	N/A			
8							SFA228	SFAC228		SFA228HH	N/A			
9							SFA228	SFAC228		SFA228HH	N/A			
10							SFA228	SFAC228		SFA228HH	TBA			
11							SFA228	SFAC228		SFA228HH	TBA			
12							SFA228	SFAC228		SFA228HH	TBA			
13														
14														
15							FA266		FA266V	FA266HH	TBA			
16														
17														
18							FA067			FA067R	N/A			
19							FA067			FA067R	N/			
20														
21														
22							SFA264	SFAC264			N/A			
23							897							
24							897							
25							897							
26							897							
27							FA054TT			FA054R	N/A			
28							897							
29							897							
30							897							
31							897							
32							897							
33							TBA							
34							897							
35							897							
36							Y503							
37							897							
38							897							
39							897							
40							897							
41							TBA*							
42							897							
43							FA083TT			FA083R	N/A			
44							FA083TT			FA083R	N/A			
45							FA083TT			FA083R	N/A			
46							S602							
47							S602							
48							897							
49							897							
50							S624							
51							FA197			FA197HH	N/A			
52							FA197			FA197HH	N/A			
53							S602							
54							TBA							
55							S624							
56							S624							
57							SFA260			SFA260HH		N/A		
58							S602							
59							S602							
60							FA054TT			FA054R	N/A			

REAR / ARRIÈRE / HINTEN / POSTERIOR / POSTERIORE

*-2 Sets Required. † For Vee disc colours add RED, BLU, GRN, GLD, ORG suffix to part number.

⊗ - Also available as a Vintage Motorcycle Disc.

R Suffix = High Durability Sintered Pad. HH Suffix = High Performance Sintered Pad. TT Suffix = Hard Wearing Off Road Pad. V Suffix = Semi Sintered Pad. G Suffix = Grooved Shoe.

D Suffix = Drilled Disc. X Suffix = Universal Left or Right Disc. XC Suffix = Contoured Disc. LS Suffix = Left/Steel Disc. RS = Right/Steel Disc.

BRAKE APPLICATIONS

Non-JAPANESE Built Motorcycles

APPLICATIONS

BRAKE



PGO Contd.

Bugxter BR 150 A	05-07
Libra 150 (4T)	09
TR-3 150cc (3 wheeler)	03-09
X Rider 150	04-05
BR-200 Bug Rider	07-12
250 Bug	
BR 250 Bugrider E	05-12
Bugrider 250 SS (Single seat)	
Bugrider 250	
G-Max 250	06-08
500 Bug	08-09
500 Bug - Parking brake	08-09
BR 500i Racer	07-09
BR 600i Racer	12

PIAGGIO

Boss 50	88-89
Bravo 50 Alloy Wheels	73-81
Bravo 50 Spoke Wheels	73-81
Bravo 3	87-90
Ciao All models	71-99
Ciao Mix Teen 50	96-01
Ciao 50 Catalitico	99-05
Diesis 50	01-05
FL 250 HP	91-97
Fly 50 (2T)	05-18
Fly 50 (4T)	05-18
Free 50	92-00
Free 50 (Disc model)	95-00
Free Delivery 50	00-01
Free 50	02
Grillo 50	89-93
Liberty 50 (Grimeca Caliper) (2T/5 Spoke Wheels)	97-08
Liberty 50 (Heng Tong Caliper) (2T/5 Spoke Wheels)	97-08
Liberty 50 4T (Grimeca Caliper) (5 Spoke Wheels)	00-08
Liberty 50 4T (Heng Tong Caliper/5 Spoke Wheels)	00-08
Liberty 50 (2T/10 Spoke Cast Wheels)	09-14
Liberty 50 (4T/10 Spoke Cast Wheels)	09-14
Liberty i-get 50 (3V/4T)	15-20
Liberty S 50 (2T)	07-08
Liberty S 50 (4T)	07-08
Liberty Elettrico	11-12
New Fly 50 (4T/4V)	12-13
NRG 50	94-96
NRG 50 RST (DT/DD) MC2 (Rear drum)	96-97
NRG 50 RST (DT/DD) MC2 (Rear drum)	98
NRG 50 RST (DD/DT) MC2 (Rear disc)	98
NRG 50 Extreme (Rear Drum Model)	99-01
NRG 50 Extreme (Rear Disc Model)	99-01
NRG 50 DT MC3 (Rear Drum Model)	01-05
NRG 50 MC3 DD (Rear Disc Model)	01-05
NRG 50 Power DD	05-20
NRG 50 Power Pure Jet	04-10
NRG 50 Power DT	05-13
NRG 50 Silver Bullet	10
NTT 50	95-96
Quartz 50	92-96
S 150 Alloy Wheels	79-88
S 150 Spoke Wheels	79-88
S 150 FL2	91-97

DISC PAD CHOICES - FRONT				BRAKE DISC CHOICES - FRONT						Line #
FA, SFA, TT Pad or Brake Shoe	SFAC Carbon Scooter Pads	Speciality Pads - SXR / Vee / MXS	Sintered/HH Pads/ Grooved Shoes	Left / Gauche / Links Standard Replacement Disc	Right / Droite / Rechts Standard Replacement Disc	Contour Disc Universal left and right fitment	Universal Custom Disc	Vee-Discs Black † See note below	CX Extreme MX Race Disc/ UTVX Disc	Line #
FA416TT*			FA416R*	N/A	N/A					1
SFA264	SFAC264		SFA264HH	N/A						2
SFA264	SFAC264		SFA264HH	N/A						3
H338*			H338C*							4
FA416TT*			FA416R*	TBA	TBA					5
FA416TT*			FA416R*	N/A	N/A					6
FA416TT*			FA416R*	TBA	TBA					7
FA416TT			FA416R	N/A	N/A					8
FA416TT			FA416R	N/A	N/A					9
FA095			FA095HH	N/A						10
FA484TT*			FA484R*	N/A	N/A					11
FA232TT			FA232R							12
FA484TT*			FA484R*	TBA	TBA					13
FA484TT*			FA484R*	TBA	TBA					14
										15
										16
909										17
909										18
N/A										19
909										20
909										21
808										22
909										23
SFA115	SFAC115		SFA115HH	MD943D		MD943C		VR943		24
V903										25
SFA353	SFAC353		SFA353HH	MD910D		MD910C		VR910		26
SFA353	SFAC353		SFA353HH	MD910D		MD910C		VR910		27
908										28
SFA116					MD910D	MD910C		VR910		29
SFA116				MD910D		MD910C		VR910		30
SFA193	SFAC193		SFA193HH	MD910D		MD910C		VR910		31
909										32
SFA260	SFAC260		SFA260HH	MD956D				VR956		33
SFA260	SFAC260		SFA260HH	MD956D				VR956		34
SFA260	SFAC260		SFA260HH	MD956D				VR956		35
SFA260	SFAC260		SFA260HH	MD956D				VR956		36
SFA353	SFAC353		SFA353HH	MD959D				VR959		37
SFA353	SFAC353		SFA353HH	MD959D				VR959		38
SFA693	SFAC693		SFA693HH	MD9165D						39
SFA260	SFAC260		SFA260HH	MD956D				VR956		40
SFA260	SFAC260		SFA260HH	MD956D				VR956		41
SFA260	SFAC260		SFA260HH	MD956D				VR956		42
SFA353	SFAC353		SFA353HH	MD9151D				VR9151		43
SFA193	SFAC193		SFA193HH	MD943D		MD943C		VR943		44
SFA193	SFAC193		SFA193HH	MD943D		MD943C		VR943		45
SFA193	SFAC193		SFA193HH	MD943D		MD943C		VR943		46
SFA193	SFAC193		SFA193HH	MD943D		MD943C		VR943		47
SFA193	SFAC193		SFA193HH	MD924D				VR924		48
SFA193	SFAC193		SFA193HH	MD924D				VR924		49
SFA193	SFAC193		SFA193HH	MD924D				VR924		50
SFA193	SFAC193		SFA193HH	MD924D				VR924		51
SFA083/2			SFA083/2HH	MD956D				VR956		52
SFA083/2			SFA083/2HH	MD956D				VR956		53
SFA083/2			SFA083/2HH	MD956D				VR956		54
SFA083/2			SFA083/2HH	MD956D				VR956		55
SFA193	SFAC193		SFA193HH	MD943D		MD943C		VR943		56
SFA186	SFAC186			MD902D				VR902		57
909										58
N/A										59
909										60

FRONT / AVANT / VORN / FREITE / ANTERIORE

R Suffix = High Durability Sintered Pad. HH Suffix = High Performance Sintered Pad. TT Suffix = Hard Wearing Off Road Pad. V Suffix = Semi Sintered Pad. G Suffix = Grooved Shoe.

D Suffix = Drilled Disc. X Suffix = Universal Left or Right Disc. XC Suffix = Contoured Disc. LS Suffix = Left/Steel Disc. RS = Right/Steel Disc.

*-2 Sets Required. † For Vee disc colours add RED, BLU, GRN, GLD, ORG suffix to part number.

⊗ - Also available as a Vintage Motorcycle Disc.

348 Part numbers, prefixes, suffixes, photos and illustrations shown in this catalogue are trademarks and/or copyrights of EBC Brakes or the trademark owner A C Freeman Investments Ltd and use without express written permission of the owners is punishable by law.

Non-JAPANESE Built Motorcycles

Line #	BRAKE DISC CHOICES - FRONT						DISC PAD CHOICES - REAR				BRAKE DISC CHOICES - REAR			
	Oversize 250 /280mm Disc Kit	OSX Oversize 250/280mm Disc Kit	Relocating Bracket for 250/ 280mm Disc	Oversize 320mm Disc Kit	SMX Oversize 320mm Disc Kit	Relocating Bracket for 320mm Disc	FA, SFA, TT Pad or Brake Shoe	SFAC Carbon Scooter Pads	Speciality Pads - SXR / Vee / MXS	Sintered/ HH Pads/ Grooved Shoes	Standard Replacement Disc	Contour Disc Rear fitment	Vee-Discs™ CONTOUR	CX Extreme MX Race Disc/ UTVX Disc
1							FA054TT			FA054R	N/A			
2							TBA							
3							TBA*							
4							FA083TT			FA083R	N/A			
5							FA431TT			FA431R	TBA			
6							FA431TT			FA431R	N/A			
7							FA431TT			FA431R	TBA			
8							FA054TT			FA054R	N/A			
9							FA054TT			FA054R	N/A			
10							SFA197			FA197HH	N/A			
11							FA377TT							
12														
13							FA377TT*			FA377R*	TBA*			
14							FA377TT*			FA377R*	TBA*			
15														
16														
17							V907							
18							V907							
19							V907							
20							N/A							
21							V907							
22							V907							
23							V907							
24							899							
25							V903							
26							816							
27							816							
28							806							
29							806							
30							899							
31							899							
32							V907							
33							816							
34							816							
35							816							
36							816							
37							816							
38							816							
39							816							
40							816							
41							816							
42							816							
43							816							
44							806							
45							806							
46							899							
47							SFA260	SFAC260		SFA260HH	MD932D	MD932C	VR932	
48							899							
49							SFA260	SFAC260		SFA260HH	MD932D		VR932	
50							899							
51							SFA260	SFAC260		SFA260HH	MD932D		VR932	
52							SFA260			SFA260HH	MD932D		VR932	
53							SFA260			SFA260HH	MD932D		VR932	
54							899							
55							SFA260			SFA260HH	MD932D		VR932	
56							806							
57							886							
58							V907							
59							V907							
60							V907							

REAR / ARRIÈRE / HINTEN / POSTERIOR / POSTERIORE

*-2 Sets Required. † For Vee disc colours add RED, BLU, GRN, GLD, ORG suffix to part number.

⊗ - Also available as a Vintage Motorcycle Disc.

R Suffix = High Durability Sintered Pad. HH Suffix = High Performance Sintered Pad. TT Suffix = Hard Wearing Off Road Pad. V Suffix = Semi Sintered Pad. G Suffix = Grooved Shoe. D Suffix = Drilled Disc. X Suffix = Universal Left or Right Disc. XC Suffix = Contoured Disc. LS Suffix = Left/Steel Disc. RS = Right/Steel Disc.

BRAKE APPLICATIONS

Non-JAPANESE Built Motorcycles

APPLICATIONS

BRAKE



PIAGGIO Contd.



DISC PAD CHOICES - FRONT

BRAKE DISC CHOICES - FRONT

	FA, SFA, TT Pad or Brake Shoe	SFAC Carbon Scooter Pads	Speciality Pads - SXR / Vee / MXS	Sintered/ HH Pads/ Grooved Shoes	Left / Gauche / Links Standard Replacement Disc	Right / Droite / Rechts Standard Replacement Disc	Contour Disc Universal left and right fitment	Universal Custom Disc	Vee-Discs Black † See note below	CX Extreme MX Race Disc/ UTVX Disc	Line #
S1 Mix 50	808										1
Scatto 50	890										2
Sfera Base 50	885										3
Sfera 50 Maquillage 2	885										4
Sfera 50 RST	SFA255				MD910D		MD910C		VR910		5
Superbravo 50	896										6
Typhoon	SFA193	SFAC193		SFA193HH	MD9126D						7
Typhoon 50 X	SFA193	SFAC193		SFA193HH	MD9126D						8
Typhoon 50 XR	SFA193	SFAC193		SFA193HH	MD9126D						9
Typhoon 50 (2T) (Heng Tong Caliper/10" Wheels)	SFA193	SFAC193		SFA193HH	MD9126D						10
Typhoon 50 (2T) (Grimeca Caliper/10" wheels)	SFA193	SFAC193		SFA193HH	MD9126D						11
Typhoon 50 (2T/12" Wheels)	SFA353	SFAC353		SFA353HH	MD9151D				VR9151		12
Typhoon 50 (2T/12 Inch Wheels) Euro 4	SFA732	SFAC732									13
Velofax 50	899										14
Zip 50 Base (Drum Model)	909										15
Zip Fast Rider	SFA193	SFAC193		SFA193HH	MD904D				VR904		16
Zip & Zip 50 Bimodale	896										17
Zip 50 Base (Disc model)	SFA193	SFAC193		SFA193HH	MD904D				VR904		18
Zip 50 RST	808										19
Zip 50 RST	SFA260	SFAC260		SFA260HH	MD904D				VR904		20
Zip 50 (Grimeca Caliper) (Heng Tong Caliper) (A/C) 4T	SFA260	SFAC260		SFA260HH	MD932D				VR932		21
Zip 50 Elettrico	SFA193	SFAC193		SFA193HH	MD904D				VR904		22
Zip 50 (2T)	SFA260	SFAC260		SFA260HH	MD932D				VR932		23
Zip 50 (4T)	SFA260	SFAC260		SFA260HH	MD932D				VR932		24
Zip 50 SP (Liquid Cooled)	SFA260	SFAC260		SFA260HH	MD910D		MD910C		VR910		25
Zip 50 SP (2T)	SFA260	SFAC260		SFA260HH	MD932D				VR932		26
SKR 80 City	885										27
Diesis 100	SFA115	SFAC115		SFA115HH	MD943D		MD943C		VR943		28
Fly 100 (4T)	SFA353	SFAC353		SFA353HH	MD910D		MD910C		VR910		29
Free 100	SFA193	SFAC193		SFA193HH	MD910D		MD910C		VR910		30
Zip 100	SFA260	SFAC260		SFA260HH	MD932D				VR932		31
125 GTR (VNL2)	V901										32
Beverly B 125/200 (Heng Tong Caliper)	SFA353	SFAC353		SFA353HH	MD961D				VR961		33
Beverly B 125/200 (Grimeca Caliper)	SFA194	SFAC194		SFA194HH	MD961D				VR961		34
Beverly 125	SFA353	SFAC353		SFA353HH	MD961D				VR961		35
Beverly Tourer 125	SFA353	SFAC353		SFA353HH	MD961D				VR961		36
Beverly 125 (Multi Spoke cast Type Wheels/4T)	SFA353	SFAC353		SFA353HH	MD9172D				VR9172		37
Beverly S 125	SFA353	SFAC353		SFA353HH	MD961D				VR961		38
Beverly 125 ie S	SFA353	SFAC353		SFA353HH	MD9172D				VR9172		39
Carnaby 125	SFA353	SFAC353		SFA353HH	MD961D				VR961		40
Cosa CL/CLX 125/200	882										41
Cosa 2 125	882										42
Fly 125 (2V/4T)	SFA353	SFAC353		SFA353HH	MD910D		MD910C		VR910		43
Fly 125i (3V/4T)	SFA353	SFAC353		SFA353HH	MD9151D				VR9151		44
Hexagon 125/150	SFA193	SFAC193		SFA193HH	MD905D						45
Hexagon LX4 125	SFA194	SFAC194		SFA194HH	MD910D		MD910C		VR910		46
Liberty 125 (5 Spoke Wheels)	SFA260	SFAC260		SFA260HH	MD956D				VR956		47
Liberty 125 (4T/2V/10 Spoke Cast Wheels)	SFA260	SFAC260		SFA260HH	TBA						48
Liberty 125 (3V/4T/10 Spoke Cast Wheels)	SFA260	SFAC260		SFA260HH	TBA						49
Liberty 125 (Full Optional/4T/10 Spoke Cast Wheels)	SFA260	SFAC260		SFA260HH	TBA						50
Liberty i-get 125 (3V/4T)	SFA693	SFAC693		SFA693HH	MD9165D						51
Liberty S 125	SFA260	SFAC260		SFA260HH	MD956D				VR956		52
Medley 125 (ABS)	SFA693	SFAC693		SFA693HH							53
Medley S 125 (ABS)	SFA693	SFAC693		SFA693HH							54
MP3 125 (Carb models) (12" rear wheel)	SFA260*	SFAC260*		SFA260HH*	MD9112D	MD9112D			VR9112*		55
MP3 125 (Carb models) (12" rear wheel) - Parking brake	SFA257/2										56
MP3 125 ie (EFI models) (14" rear wheel)	SFA260*	SFAC260*		SFA260HH*	MD9112D	MD9112D			VR9112*		57
MP3 125 ie (EFI models) (14" rear wheel) - Parking brake	SFA257/2										58
MP3 125 (Hybrid/125cc) (14" rear wheel)	SFA260*	SFAC260*		SFA260HH*	MD9112D	MD9112D			VR9112*		59
MP3 125 (Hybrid/125cc) (14" rear wheel) - Parking brake	SFA257/2										60

FRONT / AVANT / VORN / FRENTE / ANTERIORE

R Suffix = High Durability Sintered Pad. HH Suffix = High Performance Sintered Pad. TT Suffix = Hard Wearing Off Road Pad. V Suffix = Semi Sintered Pad. G Suffix = Grooved Shoe.

D Suffix = Drilled Disc. X Suffix = Universal Left or Right Disc. XC Suffix = Contoured Disc. LS Suffix = Left/Steel Disc. RS Suffix = Right/Steel Disc.

*-2 Sets Required. † For Vee disc colours add RED, BLU, GRN, GLD, ORG suffix to part number.

⊗ - Also available as a Vintage Motorcycle Disc.

350 Part numbers, prefixes, suffixes, photos and illustrations shown in this catalogue are trademarks and/or copyrights of EBC Brakes or the trademark owner A C Freeman Investments Ltd and use without express written permission of the owners is punishable by law.

Non-JAPANESE Built Motorcycles

Line #	BRAKE DISC CHOICES - FRONT						DISC PAD CHOICES - REAR				BRAKE DISC CHOICES - REAR			
	Oversize 250 /280mm Disc Kit	OSX Oversize 250/280mm Disc Kit	Relocating Bracket for 250/ 280mm Disc	Oversize 320mm Disc Kit	SMX Oversize 320mm Disc Kit	Relocating Bracket for 320mm Disc	FA, SFA, TT Pad or Brake Shoe	SFAC Carbon Scooter Pads	Speciality Pads - SXR / Vee / MXS	Sintered/ HH Pads/ Grooved Shoes	Standard Replacement Disc	Contour Disc Rear fitment	Vee-Discs™ CONTOUR	CX Extreme MX Race Disc/ UTVX Disc
1							V907							
2							890							
3							806							
4							806							
5							806							
6							V907							
7							806							
8							806							
9							899							
10							899							
11							899							
12							816							
13														
14							809							
15							806							
16							806							
17							806							
18							806							
19							899							
20							899							
21							899							
22							806							
23							899							
24							899							
25							899							
26							899							
27							806							
28							S624							
29							816							
30							816							
31							899							
32							V903							
33							SFA353	SFAC353		SFA353HH	MD961D		VR961	
34							SFA194	SFAC194		SFA194HH	MD961D		VR961	
35											MD961D		VR961	
36							SFA353	SFAC353		SFA353HH	MD961D		VR961	
37							SFA418	SFAC418		SFA418HH	MD9155D		VR9155	
38							SFA353	SFAC353		SFA353HH	MD961D		VR961	
39							SFA418	SFAC418		SFA418HH	MD9155D		VR9155	
40							SFA353	SFAC353		SFA353HH	MD961D		VR961	
41							881							
42							881							
43							816							
44							816							
45							899							
46							816							
47							816							
48							816							
49							816							
50							816							
51							816							
52							816							
53							SFA418	SFAC418		SFA418HH	MD9164D		VR9164	
54							SFA418	SFAC418		SFA418HH	MD9164D		VR9164	
55							SFA425	SFAC425		SFA425HH	MD960D		VR960	
56														
57							SFA418	SFAC418		SFA418HH	MD960D		VR960	
58														
59							SFA418	SFAC418		SFA418HH	MD960D		VR960	
60														

REAR / ARRIÈRE / HINTEN / POSTERIOR / POSTERIORE

*-2 Sets Required. † For Vee disc colours add RED, BLU, GRN, GLD, ORG suffix to part number.

⊗ - Also available as a Vintage Motorcycle Disc.

R Suffix = High Durability Sintered Pad. **HH** Suffix = High Performance Sintered Pad. **TT** Suffix = Hard Wearing Off Road Pad. **V** Suffix = Semi Sintered Pad. **G** Suffix = Grooved Shoe.
D Suffix = Drilled Disc. **X** Suffix = Universal Left or Right Disc. **XC** Suffix = Contoured Disc. **LS** Suffix = Left/Steel Disc. **RS** = Right/Steel Disc.

Part numbers, prefixes, suffixes, photos and illustrations shown in this catalogue are trademarks and/or copyrights of EBC Brakes or the trademark owner A C Freeman Investments Ltd and use without express written permission of the owners is punishable by law.

Non-JAPANESE Built Motorcycles

APPLICATIONS

BRAKE



PIAGGIO Contd.

125 ie MP3 Yourban	11-12
125 ie MP3 Yourban - Parking brake	11-12
New Fly 125 ie (3V)	12-13
Fly 125 (4T/3V) Rear Disc Model	12-15
Skipper LX 125/150	98-99
Skipper 125/150	94-97
Skipper ST 125/150 4T (Grimeca Caliper)	00-04
Skipper ST 125/150 4T (Heng Tong Caliper)	00-04
Sfera 125	95-97
Super Hexagon GTX 125/180 (11" wheels) (Grimeca calipers)	00
Super Hexagon GTX 125/180 (11" wheels) (Heng Tong Calipers)	00
Super Hexagon GTX 125/180 (12" wheels)	01-03
Typhoon 125	99-03
Typhoon 125 (4T/12" Wheels)	10-15
Xevo 125	07-16
X7 125cc	08-09
X7 Evo 125 ie (Efi)	09-12
X8 125 (Brembo Rear Caliper)	04-05
X8 125 (Heng Tong Rear Caliper)	05-06
X8 125 ie (Heng Tong Rear Caliper)	07
X8 125/Street	06-07
X9 125	00-02
X9 125 Evolution (Brembo/Single pin fixing)	03-04
X9 125 Evolution (Heng Tong/2 Pin Fixing)	Left 05-07 Right
X10 125 (4V/4T/Efi/All Models)	Left 12-15 Right
Zip 125 (4T - 200mm F/Disc)	00-01
Zip 125 (4T - 175mm F/Disc)	02-04
Fly 150 (4T)	05-12
150 Sprint Veloce (VLB1)	74
Cosa CL/CLX 150	88-91
Cosa 2 150	91-97
150 Super (VBC1)	74
Liberty 150 (5 Spoke Wheels)	08
Liberty 150 (4T/2V/10 Spoke Cast Wheels)	09-12
Liberty 150 (3V/4T/10 Spoke Cast Wheels)	13-15
Liberty 150 (Full Optional/4T/3V/10 Spoke Cast Wheels)	13-15
Liberty i-get 150 (3V/4T)	15-20
Medley 150 (ABS)	16-20
Medley S 150 (ABS)	16-20
X8 150 Street	06-08
Hexagon LX 180	98-99
Hexagon LXT 180	98-99
X9 180 Amalfi	00-03
Carnaby 200	07-09
Cosa CL/CLX 200	88-91
Cosa 2 200	91-97
Liberty 200	98-07
Liberty S 200	07-08
Rally 200 (VSE1)	74
X8 200 (Brembo Rear Caliper)	04-05
X8 200 (Heng Tong Rear Caliper)	04-05
X9 200	02-03
X9 200 Evolution	03-04
Beverly 250 (Carb Model)	04-07
Beverly 250 ie	06-07

DISC PAD CHOICES - FRONT				BRAKE DISC CHOICES - FRONT							Line #
FA, SFA, TT Pad or Brake Shoe	SFAC Carbon Scooter Pads	Speciality Pads SXR / Vee / MXS	Sintered/HH Pads/ Grooved Shoes	Left / Gauche / Links Standard Replacement Disc	Right / Droite / Rechts Standard Replacement Disc	Contour Disc Universal left and right fitment	Universal Custom Disc	Vee-Discs Black † See note below	CX Extreme MX Race Disc/ UTVX Disc	Line #	
SFA260*	SFAC260*		SFA260HH*	MD9112D	MD9112D			VR9112*		1	
SFA257/2										2	
SFA353	SFAC353		SFA353HH	MD9151D				VR9151		3	
SFA353	SFAC353		SFA353HH	MD9151D				VR9151		4	
SFA194	SFAC194		SFA194HH	MD924D				VR924		5	
SFA186	SFAC186			MD902D				VR902		6	
SFA194	SFAC194		SFA194HH	MD924D				VR924		7	
SFA353	SFAC353		SFA353HH	MD924D				VR924		8	
SFA255				MD910D		MD910C		VR910		9	
SFA194	SFAC194		SFA194HH	MD910D		MD910C		VR910		10	
SFA353	SFAC353		SFA353HH	MD910D		MD910C		VR910		11	
SFA353	SFAC353		SFA353HH	MD960D				VR960		12	
SFA193	SFAC193		SFA193HH	MD9126D						13	
SFA353	SFAC353		SFA353HH	MD9151D				VR9151		14	
SFA353	SFAC353		SFA353HH	MD983D				VR983		15	
SFA353	SFAC353		SFA353HH	MD983D				VR983		16	
SFA353	SFAC353		SFA353HH	MD983D				VR983		17	
SFA353	SFAC353		SFA353HH	MD983D				VR983		18	
SFA353	SFAC353		SFA353HH	MD983D				VR983		19	
SFA353	SFAC353		SFA353HH	MD983D				VR983		20	
SFA353	SFAC353		SFA353HH	MD983D				VR983		21	
SFA353	SFAC353		SFA353HH	MD961D				VR961		22	
SFA353	SFAC353		SFA353HH	MD961D				VR961		23	
SFA266*	SFAC266*		SFA266HH*	MD959D	MD959D			VR959*		24	
SFA266*	SFAC266*		SFA266HH*	MD959D	MD959D			VR959*		25	
SFA353	SFAC353		SFA353HH	MD959D				VR959*		26	
SFA418	SFAC418		SFA418HH		MD959D					27	
SFA353	SFAC353		SFA353HH	TBA						28	
SFA418	SFAC418		SFA418HH		TBA					29	
SFA260	SFAC260		SFA260HH	MD910D		MD910C		VR910		30	
SFA260	SFAC260		SFA260HH	MD932D				VR932		31	
SFA353	SFAC353		SFA353HH	MD910D		MD910C		VR910		32	
V901										33	
882										34	
882										35	
V905										36	
SFA260	SFAC260		SFA260HH	MD956D						37	
SFA260	SFAC260		SFA260HH	TBA						38	
SFA260	SFAC260		SFA260HH	TBA						39	
SFA260	SFAC260		SFA260HH	TBA				TBA		40	
SFA693	SFAC693		SFA693HH	MD9165D						41	
SFA693	SFAC693		SFA693HH							42	
SFA693	SFAC693		SFA693HH							43	
SFA353	SFAC353		SFA353HH	MD961D				VR961		44	
SFA194	SFAC194		SFA194HH	MD910D		MD910C		VR910		45	
SFA194	SFAC194		SFA194HH	MD910D		MD910C		VR910		46	
SFA266*	SFAC266*		SFA266HH*	MD959D	MD959D			VR959*		47	
SFA353	SFAC353		SFA353HH	MD961D				VR961		48	
882										49	
882										50	
SFA260	SFAC260		SFA260HH	MD956D				VR956		51	
SFA260	SFAC260		SFA260HH	MD956D				VR956		52	
V901										53	
SFA353	SFAC353		SFA353HH	MD983D				VR983		54	
SFA353	SFAC353		SFA353HH	MD983D				VR983		55	
SFA266*	SFAC266*		SFA266HH*	MD959D	MD959D			VR959*		56	
SFA266*	SFAC266*		SFA266HH*	MD959D	MD959D			VR959*		57	
SFA353	SFAC353		SFA353HH	MD961D				VR961		58	
SFA353	SFAC353		SFA353HH	MD961D				VR961		59	

* See SFA681 if rear pad SFA321 is incorrect shape - ONLY AVAILABLE AS SFA ORGANIC VERSION.

*-2 Sets Required. † For Vee disc colours add RED, BLU, GRN, GLD, ORG suffix to part number.

⊗ - Also available as a Vintage Motorcycle Disc.

R Suffix = High Durability Sintered Pad. HH Suffix = High Performance Sintered Pad. TT Suffix = Hard Wearing Off Road Pad. V Suffix = Semi-Sintered Pad. G Suffix = Grooved Shoe.

D Suffix = Drilled Disc. X Suffix = Universal Left or Right Disc. XC Suffix = Contoured Disc. LS Suffix = Left/Steel Disc. RS Suffix = Right/Steel Disc.

Non-JAPANESE Built Motorcycles

Line #	BRAKE DISC CHOICES - FRONT						DISC PAD CHOICES - REAR				BRAKE DISC CHOICES - REAR			
	Oversize 250 /280mm Disc Kit	OSX Oversize 250/280mm Disc Kit	Relocating Bracket for 250/ 280mm Disc	Oversize 320mm Disc Kit	SMX Oversize 320mm Disc Kit	Relocating Bracket for 320mm Disc	FA, SFA, TT Pad or Brake Shoe	SFAC Carbon Scooter Pads	Speciality Pads - SXR / Vee / MXS	Sintered/ HH Pads/ Grooved Shoes	Standard Replacement Disc	Contour Disc Rear fitment	Vee-Discs™ CONTOUR	CX Extreme MX Race Disc/ UTVX Disc
1							SFA418	SFAC418		SFA418HH	MD960D		VR960	
2														
3							SFA321 ★	SFAC321		SFA321HH	MD956D		VR956	
4							SFA321 ★	SFAC321		SFA321HH	MD956D		VR956	
5							816							
6							899							
7							816							
8							816							
9							899							
10														
11							SFA321 ★	SFAC321		SFA321HH	MD910D	MD910C	VR910	
12														
13							SFA321 ★	SFAC321		SFA321HH	MD910D	MD910C	VR910	
14							SFA321 ★	SFAC321		SFA321HH	MD956D		VR956	
15							899							
16							816							
17							SFA418	SFAC418		SFA418HH	MD960D		VR960	
18							SFA418	SFAC418		SFA418HH	MD960D		VR960	
19							SFA418	SFAC418		SFA418HH	MD960D		VR960	
20							SFA266	SFAC266		SFA266HH	MD960D		VR960	
21							SFA425	SFAC425		SFA425HH	MD960D		VR960	
22							SFA425	SFAC425		SFA425HH	MD960D		VR960	
23							816							
24							SFA266	SFAC266		SFA266HH	MD959D		VR959	
25							SFA266	SFAC266		SFA266HH	MD959D		VR959	
26							SFA266	SFAC266		SFA266HH	MD959D		VR959	
27														
28							SFA418	SFAC418		SFA418HH	TBA			
29														
30							899							
31							899							
32							816							
33							V903							
34							881							
35							881							
36							V902							
37							816							
38							816							
39							816							
40							816							
41							816							
42							SFA418	SFAC418		SFA418HH	MD9164D			
43							SFA418	SFAC418		SFA418HH	MD9164D			
44							816							
45							816							
46							816							
47							SFA266	SFAC266		SFA266HH	MD959D		VR959	
48							SFA353	SFAC353		SFA353HH	MD961D		VR961	
49							881							
50							881							
51							816							
52							816							
53							V903							
54							SFA266	SFAC266		SFA266HH	MD960D		VR960	
55							SFA425	SFAC425		SFA425HH	MD960D		VR960	
56							SFA266	SFAC266		SFA266HH	MD959D		VR959	
57							SFA266	SFAC266		SFA266HH	MD959D		VR959	
58							SFA353	SFAC353		SFA353HH	MD961D		VR961	
59							SFA353	SFAC353		SFA353HH	MD961D		VR961	
60														

REAR / ARRIÈRE / HINTEN / POSTERIOR / POSTERIORE

*-2 Sets Required. † For Vee disc colours add RED, BLU, GRN, GLD, ORG suffix to part number.

⊗ - Also available as a Vintage Motorcycle Disc.

R Suffix = High Durability Sintered Pad. HH Suffix = High Performance Sintered Pad. TT Suffix = Hard Wearing Off Road Pad. V Suffix = Semi Sintered Pad. G Suffix = Grooved Shoe. D Suffix = Drilled Disc. X Suffix = Universal Left or Right Disc. XC Suffix = Contoured Disc. LS Suffix = Left/Steel Disc. RS = Right/Steel Disc.

Part numbers, prefixes, suffixes, photos and illustrations shown in this catalogue are trademarks and/or copyrights of EBC Brakes or the trademark owner A C Freeman Investments Ltd and use without express written permission of the owners is punishable by law.

Non-JAPANESE Built Motorcycles

APPLICATIONS

BRAKE



PIAGGIO Contd.



R Suffix = High Durability Sintered Pad. HH Suffix = High Performance Sintered Pad. TT Suffix = Hard Wearing Off Road Pad. V Suffix = Semi Sintered Pad. G Suffix = Grooved Shoe.

D Suffix = Drilled Disc. X Suffix = Universal Left or Right Disc. XC Suffix = Contoured Disc. LS Suffix = Left/Steel Disc. RS = Right/Steel Disc.

Model	Year
Beverly S 250 ie	07
Beverly Cruiser 250 ie	07-08
Beverly Tourer 250 ie	08-09
Carnaby 250 ie	08-09
Hexagon GT 250	98-99
MP3 250 EFI (12" rear wheel)	06-08
MP3 250 EFI (12" rear wheel) - Parking brake	06-08
MP3 250 MIC/EFI (14" rear wheel)	08-09
MP3 250 MIC/EFI (14" rear wheel) - Parking brake	08-09
MP3 LT 250 ie (14" rear wheel)	09
MP3 LT 250 ie (14" rear wheel) - Parking brake	09
Super Hexagon GTX 250	00-02
Xevo 250 ie	07-10
X7 250 ie	08-09
X8 250 ie	05-06
X8 250 ie	07
X9 250 (13" rear wheel)	00-04
X9 250 (Linked brake F & R wheel 14" dia)	04
X9 250 Left	05-06
X9 250 Right	05-06
Beverly 300 (278cc/4T/Multi Spoke Wheel)	10-18
Beverly 300 ie S	14-20
Beverly Police 300 ABS ASR (278cc)	16-18
Carnaby Cruiser 300	08-11
Carnaby 300 ie	12
MP3 LT 300 ie	10
MP3 LT 300 ie - Parking brake	10
MP3 Business LT 300 ie	13
MP3 Business LT 300 ie - Parking brake	13
MP3 Business LT 300 ie ABS (13" Front Wheel/14" Rear Wheel)	14-18
MP3 Business LT 300 ie ABS (13" Front Wheel/14" Rear Wheel) - Parking brake	14-18
MP3 Hybrid 300 ie	11-15
MP3 Hybrid 300 ie - Parking brake	11-15
MP3 Hybrid LT 300 ie	11-12
MP3 Hybrid LT 300 ie - Parking brake	11-12
MP3 Touring 300 ie	11-12
MP3 Touring 300 ie - Parking brake	11-12
MP3 Touring LT 300 ie	11-12
MP3 Touring LT 300 ie - Parking brake	11-12
MP3 Sport LT 300 ie	13
MP3 Sport LT 300 ie - Parking brake	13
MP3 Sport LT 300 ie ABS (13" Front Wheel/14" Rear Wheel)	14-18
MP3 Sport LT 300 ie ABS (13" Front Wheel/14" Rear Wheel) - Parking brake	14-18
300 ie MP3 Yourban	11-16
300 ie MP3 Yourban - Parking brake	11-16
MP3 Yourban LT RL 300	17-18
MP3 Yourban LT RL 300 - Parking brake	17-18
X7 EVO 300 ie	10-12
Beverly 350 ie Sport Touring Non (330cc/4T)	11-15
Beverly 350 ie Sport Touring ABS (330cc/4T)	11-15
Beverly 350 ie Sport Touring ABS (330cc/4T)	16-20
MP3 Maxi Sport-Business E4 ABS (350cc)	18-19
MP3 Maxi Sport-Business E4 ABS (350cc) - Parking Brake	
X10 350 (4V/4T/EFI/All Models) Left	12-15
X10 350 (4V/4T/EFI/All Models) Right	

FRONT / AVANT / VORN / FRENTE / ANTERIORE

DISC PAD CHOICES - FRONT				BRAKE DISC CHOICES - FRONT							Line #
FA, SFA, TT Pad or Brake Shoe	SFAC Carbon Scooter Pads	Speciality Pads - SXR / Vee / MXS	Sintered/HH Pads/ Grooved Shoes	Left / Gauche / Links Standard Replacement Disc	Right / Droite / Rechts Standard Replacement Disc	Contour Disc Universal left and right fitment	Universal Custom Disc	Vee-Discs Black † See note below	CX Extreme MX Race Disc/ UTVX Disc	Line #	
SFA353	SFAC353		SFA353HH	MD961D				VR961		1	
SFA353	SFAC353		SFA353HH	MD961D				VR961		2	
SFA353	SFAC353		SFA353HH	MD961D				VR961		3	
SFA353	SFAC353		SFA353HH	MD961D				VR961		4	
SFA194	SFAC194		SFA194HH	MD910D		MD910C		VR910		5	
SFA260*	SFAC260*		SFA260HH*	MD9112D	MD9112D			VR9112*		6	
SFA257/2										7	
SFA260*	SFAC260*		SFA260HH*	MD9112D	MD9112D			VR9112*		8	
SFA257/2										9	
SFA260*	SFAC260*		SFA260HH*	MD9112D	MD9112D			VR9112*		10	
SFA257/2										11	
SFA194	SFAC194		SFA194HH	MD910D		MD910C		VR910		12	
SFA353	SFAC353		SFA353HH	MD983D				VR983		13	
SFA353	SFAC353		SFA353HH	MD983D				VR983		14	
SFA353	SFAC353		SFA353HH	MD983D				VR983		15	
SFA353	SFAC353		SFA353HH	MD961D				VR961		16	
SFA266*	SFAC266*		SFA266HH*	MD959D	MD959D			VR959*		17	
SFA181*	SFAC181*		SFA181HH*	MD983D	MD983D			VR983*		18	
SFA353	SFAC353		SFA353HH	MD959D				VR959		19	
SFA418	SFAC418		SFA418HH		MD959D			VR959		20	
SFA353	SFAC353		SFA353HH	MD9172D				VR9172		21	
SFA353	SFAC353		SFA353HH	MD9172D				VR9172		22	
SFA353	SFAC353		SFA353HH	TBA						23	
SFA353	SFAC353		SFA353HH	MD961D				VR961		24	
SFA353	SFAC353		SFA353HH	MD961D				VR961		25	
SFA260*	SFAC260*		SFA260HH*	MD9112D	MD9112D			VR9112*		26	
SFA257/2										27	
SFA260*	SFAC260*		SFA260HH*	MD9112D	MD9112D			VR9112*		28	
SFA257/2										29	
SFA681*	SFAC681*		SFA681HH*	MD9158D	MD9158D			TBA		30	
SFA257/2										31	
SFA257/2										32	
SFA260*	SFAC260*		SFA260HH*	MD9112D	MD9112D			VR9112*		33	
SFA257/2										34	
SFA260*	SFAC260*		SFA260HH*	MD9112D	MD9112D			VR9112*		35	
SFA257/2										36	
SFA260*	SFAC260*		SFA260HH*	MD9112D	MD9112D			VR9112*		37	
SFA257/2										38	
SFA260*	SFAC260*		SFA260HH*	MD9112D	MD9112D			VR9112*		39	
SFA257/2										40	
SFA260*	SFAC260*		SFA260HH*	MD9112D	MD9112D			VR9112*		41	
SFA257/2										42	
SFA260*	SFAC260*		SFA260HH*	MD9112D	MD9112D			VR9112*		43	
SFA257/2										44	
SFA681*	SFAC681*		SFA681HH*	MD9158D	MD9158D			TBA*		45	
SFA257/2										46	
SFA257/2										47	
SFA260*	SFAC260*		SFA260HH*	MD9112D	MD9112D			VR9112*		48	
SFA257/2										49	
SFA260*	SFAC260*		SFA260HH*	MD9112D	MD9112D			VR9112*		50	
SFA257/2										51	
SFA353	SFAC353		SFA353HH	MD983D				VR983		52	
SFA324	SFAC324		SFA324HH	MD9172D				VR9172		53	
SFA324	SFAC324		SFA324HH	MD9172D				VR9172		54	
SFA353	SFAC353		SFA353HH	MD9172D				VR9172		55	
SFA681*	SFAC681*		SFA681HH*	MD9158D	MD9158D					56	
SFA257/2										57	
SFA353	SFAC353		SFA353HH	TBA						58	
SFA418	SFAC418		SFA418HH		TBA					59	

* See SFA681 if rear pad SFA321 is incorrect shape - ONLY AVAILABLE AS SFA ORGANIC VERSION.

*-2 Sets Required. † For Vee disc colours add RED, BLU, GRN, GLD, ORG suffix to part number.

⊗ - Also available as a Vintage Motorcycle Disc.

354 Part numbers, prefixes, suffixes, photos and illustrations shown in this catalogue are trademarks and/or copyrights of EBC Brakes or the trademark owner A C Freeman Investments Ltd and use without express written permission of the owners is punishable by law.

Non-JAPANESE Built Motorcycles

Line #	BRAKE DISC CHOICES - FRONT						DISC PAD CHOICES - REAR				BRAKE DISC CHOICES - REAR			
	Oversize 250 /280mm Disc Kit	OSX Oversize 250/280mm Disc Kit	Relocating Bracket for 250/ 280mm Disc	Oversize 320mm Disc Kit	SMX Oversize 320mm Disc Kit	Relocating Bracket for 320mm Disc	FA, SFA, TT Pad or Brake Shoe	SFAC Carbon Scooter Pads	Speciality Pads - SXR / Vee / MXS	Sintered/ HH Pads/ Grooved Shoes	Standard Replacement Disc	Contour Disc Rear fitment	Vee-Discs™ CONTOUR	CX Extreme MX Race Disc/ UTVX Disc
1							SFA353	SFAC353		SFA353HH	MD961D		VR961	
2							SFA353	SFAC353		SFA353HH	MD961D		VR961	
3							SFA353	SFAC353		SFA353HH	MD961D		VR961	
4							SFA353	SFAC353		SFA353HH	MD961D		VR961	
5							H350							
6							SFA425	SFAC425		SFA425HH	MD960D		VR960	
7														
8							SFA418	SFAC418		SFA418HH	MD960D		VR960	
9														
10							SFA418	SFAC418		SFA418HH	MD960D		VR960	
11														
12							SFA321★	SFAC321		SFA321HH	MD910D	MD910C	VR910	
13							SFA418	SFAC418		SFA418HH	MD960D		VR960	
14							SFA418	SFAC418		SFA418HH	MD960D		VR960	
15							SFA425	SFAC425		SFA425HH	MD960D		VR960	
16							SFA425	SFAC425		SFA425HH	MD960D		VR960	
17							SFA266	SFAC266		SFA266HH	MD959D		VR959	
18							SFA266	SFAC266		SFA266HH	MD960D		VR960	
19							SFA425	SFAC425		SFA425HH	MD959D		VR959	
20														
21							SFA418	SFAC418		SFA418HH	MD9155D		VR9155	
22							SFA418	SFAC418		SFA418HH	MD9155D		VR9155	
23							SFA418	SFAC418		SFA418HH	TBA			
24							SFA353	SFAC353		SFA353HH	MD961D		VR961	
25							SFA353	SFAC353		SFA353HH	MD961D		VR961	
26							SFA418	SFAC418		SFA418HH	MD960D		VR960	
27														
28							SFA418	SFAC418		SFA418HH	MD960D		VR960	
29														
30														
31							SFA418	SFAC418		SFA418HH	MD960D			
32														
33														
34							SFA418	SFAC418		SFA418HH	MD960D		VR960	
35														
36							SFA418	SFAC418		SFA418HH	MD960D		VR960	
37														
38							SFA418	SFAC418		SFA418HH	MD960D		VR960	
39														
40							SFA418	SFAC418		SFA418HH	MD960D		VR960	
41														
42							SFA418	SFAC418		SFA418HH	MD960D		VR960	
43														
44														
45							SFA418	SFAC418		SFA418HH	MD960D			
46														
47														
48							SFA418	SFAC418		SFA418HH	MD960D		VR960	
49														
50							SFA418	SFAC418		SFA418HH	MD960D		VR960	
51														
52							SFA418	SFAC418		SFA418HH	MD960D		VR960	
53							SFA418	SFAC418		SFA418HH	MD9164D			
54							SFA418	SFAC418		SFA418HH	MD9164D			
55							SFA418	SFAC418		SFA418HH	MD9164D			
56							SFA418	SFAC418		SFA418HH	MD960D			
57														
58							SFA418	SFAC418		SFA418HH	TBA			
59														
60														

REAR / ARRIÈRE / HINTEN / POSTERIOR / POSTERIORE

*-2 Sets Required. † For Vee disc colours add RED, BLU, GRN, GLD, ORG suffix to part number.

⊗ - Also available as a Vintage Motorcycle Disc.

R Suffix = High Durability Sintered Pad. HH Suffix = High Performance Sintered Pad. TT Suffix = Hard Wearing Off Road Pad. V Suffix = Semi Sintered Pad. G Suffix = Grooved Shoe.

D Suffix = Drilled Disc. X Suffix = Universal Left or Right Disc. XC Suffix = Contoured Disc. LS Suffix = Left/Steel Disc. RS = Right/Steel Disc.

Non-JAPANESE Built Motorcycles

APPLICATIONS

BRAKE



PIAGGIO Contd.

X10 350 (4V/4T/Efi/All Models) - Parking brake	12-15
Beverly 400 ie	07
Beverly Tourer 400 ie	08-09
Trackmaster 400 Quad	06
Trackmaster 400 Quad - Parking brake	06
MP3 400 ie	07-10
MP3 400 ie - Parking brake	07-10
MP3-LT 400 ie	09-10
MP3-LT 400 ie - Parking brake	09-10
MP3 Touring 400 ie	11-12
MP3 Touring 400 ie - Parking brake	11-12
MP3 Touring LT 400 ie	11-12
MP3 Touring LT 400 ie - Parking brake	
Xevo 400 ie	07-10
	Left
	Right
X8 400 ie	06-08
	Left
	Right
Beverly B 500	02-05
Beverly 500	06
Beverly Cruiser 500 ie	07-11
Beverly 500 ie	12
MP3 500 Efi	09-10
MP3 500 Efi - Parking brake	
MP3 Touring Business 500 ie	11-12
MP3 Touring Business 500 ie - Parking brake	
MP3 500 LT Business	11-15
MP3 500 LT Business - Parking brake	11-15
MP3 500 LT Business ABS (13 Inch Front Wheel /14 Inch Rear Wheel)	14-20
MP3 500 LT Business ABS (13 Inch Front Wheel /14 Inch Rear Wheel) - Parking brake	14-18
MP3 Touring Sport 500 ie	11-12
MP3 Touring Sport 500 ie - Parking brake	
MP3 500 LT Sport	11-15
MP3 500 LT Sport - Parking brake	11-15
MP3 500 LT Sport ABS (13 Inch Front Wheel /14 Inch Rear Wheel)	14-18
MP3 500 LT Sport ABS (13 Inch Front Wheel /14 Inch Rear Wheel)	14-18
X9 500/500 SL	00-02
X9 500 cc Evolution (inc ABS)	03-06
X9 500 ie	07
X10 - 500 i (4V/4T/Efi/All Models)	12-15
	Left
	Right
X10 - 500 i (4V/4T/Efi/All Models) - Parking brake	12-15

PIZZA PEDS

125cc 4T Pizza Delivery Scooter	12-15
---------------------------------	-------

POLARIS (ATV)

50 Outlaw	08-18
50 Predator (2 stroke)	04-07
Scrambler (3 Wheeler)	85-86
50 Scrambler	01-03
90 Outlaw	07-16
90 Predator	03-06
90 Scrambler X	01-03
90 Sportsman	01-16
110 Sportsman	16-18
110 Outlaw	16-18

DISC PAD CHOICES - FRONT

BRAKE DISC CHOICES - FRONT

FA, SFA, TT Pad or Brake Shoe	SFAC Carbon Scooter Pads	Speciality Pads SXR / Vee / MXS	Sintered/HH Pads/ Grooved Shoes	Left / Gauche / Links Standard Replacement Disc	Right / Droite / Rechts Standard Replacement Disc	Contour Disc Universal left and right fitment	Universal Custom Disc	Vee-Discs Black † See note below	CX Extreme MX Race Disc/ UTVX Disc
SFA257/2									
SFA181	SFAC181		SFA181HH	MD961D	MD961D			VR961*	
SFA266	SFAC266		SFA266HH	MD961D	MD961D			VR961*	
FA395TT*			FA395R*	MD6173D	MD6173D				
FA271TT									
SFA260*	SFAC260*		SFA260HH*	MD9112D	MD9112D			VR9112*	
SFA257/2									
SFA260*	SFAC260*		SFA260HH*	MD9112D	MD9112D			VR9112*	
SFA257/2									
SFA260*	SFAC260*		SFA260HH*	MD9112D	MD9112D			VR9112*	
SFA257/2									
SFA260*	SFAC260*		SFA260HH*	MD9112D	MD9112D			VR9112*	
SFA257/2									
SFA353	SFAC353		SFA353HH	MD959D	MD959D			VR959*	
SFA418	SFAC418		SFA418HH						
SFA353	SFAC353		SFA353HH	MD961D	MD961D			VR961*	
SFA418	SFAC418		SFA418HH						
SFA266*	SFAC266*		SFA266HH*	MD961D	MD961D			VR961*	
SFA266*	SFAC266*		SFA266HH*	MD961D	MD961D			VR961*	
SFA266*	SFAC266*		SFA266HH*	MD961D	MD961D			VR961*	
SFA266*	SFAC266*		SFA266HH*	MD961D	MD961D			VR961*	
SFA260*	SFAC260*		SFA260HH*	MD9112D	MD9112D			VR9112*	
SFA257/2									
SFA260*	SFAC260*		SFA260HH*	MD9112D	MD9112D			VR9112*	
SFA257/2									
SFA260*	SFAC260*		SFA260HH*	MD9112D	MD9112D			VR9112*	
SFA257/2									
SFA681*	SFAC681*		SFA681HH*	MD9158D	MD9158D			TBA*	
SFA257/2									
SFA260*	SFAC260*		SFA260HH*	MD9112D	MD9112D			VR9112*	
SFA257/2									
SFA260*	SFAC260*		SFA260HH*	MD9112D	MD9112D			VR9112*	
SFA257/2									
SFA681*	SFAC681*		SFA681HH*	MD9158D	MD9158D			TBA*	
SFA257/2									
SFA266*	SFAC266*		SFA266HH*	MD961D	MD961D			VR961*	
SFA181*	SFAC181*		SFA181HH*	MD983D	MD983D			VR983*	
SFA181*	SFAC181*		SFA181HH*	MD961D	MD961D			VR961*	
SFA353	SFAC353		SFA353HH	TBA	TBA				
SFA418	SFAC418		SFA418HH						
SFA257/2									
SFA054	SFAC054		SFA054HH			N/A			
H346*			H346G*						
H346*			H346G*						
Y503			Y503G						
H346*			H346G*						
H346*			H346G*						
H346*			H346G*						
H346*			H346G*						
H346*			H346G*						
H338*			H338G*						
H338*			H338G*						

Line #
1
2
3
4
5
6
7
8
9
10
11
12
13
14
15
16
17
18
19
20
21
22
23
24
25
26
27
28
29
30
31
32
33
34
35
36
37
38
39
40
41
42
43
44
45
46
47
48
49
50
51
52
53
54
55
56
57
58
59
60

R Suffix = High Durability Sintered Pad. HH Suffix = High Performance Sintered Pad. TT Suffix = Hard Wearing Off Road Pad. V Suffix = Semi-Sintered Pad. G Suffix = Grooved Shoe.
D Suffix = Drilled Disc. X Suffix = Universal Left or Right Disc. XC Suffix = Contoured Disc. LS Suffix = Left/Steel Disc. RS Suffix = Right/Steel Disc.

*-2 Sets Required. † For Vee disc colours add RED, BLU, GRN, GLD, ORG suffix to part number.

⊗ - Also available as a Vintage Motorcycle Disc.

Non-JAPANESE Built Motorcycles

Line #	BRAKE DISC CHOICES - FRONT						DISC PAD CHOICES - REAR				BRAKE DISC CHOICES - REAR			
	Oversize 250 /280mm Disc Kit	OSX Oversize 250/280mm Disc Kit	Relocating Bracket for 250/ 280mm Disc	Oversize 320mm Disc Kit	SMX Oversize 320mm Disc Kit	Relocating Bracket for 320mm Disc	FA, SFA, TT Pad or Brake Shoe	SFAC Carbon Scooter Pads	Speciality Pads - SXR / Vee / MXS	Sintered/ HH Pads/ Grooved Shoes	Standard Replacement Disc	Contour Disc Rear fitment	Vee-Discs™ CONTOUR	CX Extreme MX Race Disc/ UTVX Disc
1														
2							SFA353	SFAC353		SFA353HH	MD960D		VR960	
3							SFA266	SFAC266		SFA266HH	MD959D		VR959	
4							FA395TT			FA395R	MD6173D			
5														
6							SFA353	SFAC353		SFA353HH	MD960D		VR960	
7														
8							SFA353	SFAC353		SFA353HH	MD960D		VR960	
9														
10							SFA353	SFAC353		SFA353HH	MD960D		VR960	
11														
12							SFA353	SFAC353		SFA353HH	MD960D		VR960	
13														
14							SFA353	SFAC353		SFA353HH	MD960D		VR960	
15														
16							SFA353	SFAC353		SFA353HH	MD960D		VR960	
17														
18							SFA266	SFAC266		SFA266HH	MD960D		VR960	
19							SFA425	SFAC425		SFA425HH	MD960D		VR960	
20							SFA266	SFAC266		SFA266HH	MD960D		VR960	
21							SFA266	SFAC266		SFA266HH	MD960D		VR960	
22							SFA418	SFAC418		SFA418HH	MD960D		VR960	
23														
24							SFA353	SFAC353		SFA353HH	MD960D		VR960	
25														
26							SFA353	SFAC353		SFA353HH	MD960D		VR960	
27														
28														
29							SFA353	SFAC353		SFA353HH	MD960D		VR960	
30														
31														
32							SFA353	SFAC353		SFA353HH	MD960D		VR960	
33														
34							SFA353	SFAC353		SFA353HH	MD960D		VR960	
35														
36														
37							SFA353	SFAC353		SFA353HH	MD960D		VR960	
38														
39														
40							SFA266	SFAC266		SFA266HH	MD960D		VR960	
41							SFA266	SFAC266		SFA266HH	MD960D		VR960	
42							SFA266	SFAC266		SFA266HH	MD960D		VR960	
43							SFA418	SFAC418		SFA418HH	TBA			
44														
45														
46														
47														
48							820							
49														
50														
51							H307			H307G				
52							H307			H307G				
53							FA040				N/A			
54							H307			H307G				
55							H307			H307G				
56							H307			H307G				
57							H307			H307G				
58							H307			H307G				
59							H307			H307G				
60							H307			H307G				

REAR / ARRIÈRE / HINTEN / POSTERIOR / POSTERIORE

*-2 Sets Required. † For Vee disc colours add RED, BLU, GRN, GLD, ORG suffix to part number.

⊗ - Also available as a Vintage Motorcycle Disc.

R Suffix = High Durability Sintered Pad. HH Suffix = High Performance Sintered Pad. TT Suffix = Hard Wearing Off Road Pad. V Suffix = Semi Sintered Pad. G Suffix = Grooved Shoe.

D Suffix = Drilled Disc. X Suffix = Universal Left or Right Disc. XC Suffix = Contoured Disc. LS Suffix = Left/Steel Disc. RS = Right/Steel Disc.

Part numbers, prefixes, suffixes, photos and illustrations shown in this catalogue are trademarks and/or copyrights of EBC Brakes or the trademark owner A C Freeman Investments Ltd and use without express written permission of the owners is punishable by law.

Non-JAPANESE Built Motorcycles

APPLICATIONS

BRAKE



POLARIS (ATV) Contd.

200 Phoenix (AA/AB Model/Rear Drum Model)	05
200 Phoenix (AC/AD Model and Following /Rear Drum Model)	06-09
200 Phoenix (Rear Drum Model)	10-14
200 Phoenix Quadricycle Model (EA/EB/Rear disc model)	05
200 Phoenix Quadricycle Model (EC/ED Models /Rear disc model)	05-09
200 Phoenix Quadricycle Model (Rear disc model)	10
200 Sawtooth (Rear Drum Model)	06-08
200 Sawtooth Quadricycle (Rear Disc Model)	06/08
250 2x4/4x4	90
250 2x4/4x4	93
250 Cyclone X	87
250 Big Boss 4 x 6	89-90
250 Big Boss 4 x 6 - Middle Axle Brake	89-90
250 Big Boss 4 x 6	91-92
250 Big Boss 4 x 6 - Middle Axle Brake	91-92
250 Big Boss 6 x 6	91
250 Big Boss 6 x 6 - Middle Axle Brake	91
250 Big Boss 6 x 6	92-93
250 Big Boss 6 x 6 - Middle Axle Brake	92-93
250 Trail Blazer	90
250 Trail Blazer	91-93
250 Trail Blazer	94-98
250 Trail Blazer	99-00
250 Trail Blazer (Freedom)	01-04
250 Trail Blazer	05-06
Trail Boss 2 x 4	85-87
Trail Boss	88-90
250 Trail Boss	91-99
Trail Boss 4 x 4	87
Trail Boss 2 x 4/4 x 4	88-89
250 Trail Boss 2 x 4/4 x 4	91-92
250 Xplorer (4 x 4)	00
300 2 x 4/4 x 4	94-95
300 Big Boss 6 x 6	94
300 Big Boss 6 x 6 - Middle Axle Brake	94
300 Hawkeye 2 x 4	06
300 Hawkeye 2 x 4	08-09
300 Hawkeye 4 x 4	06
Hawkeye 2 x 4/4 x 4	07
300 Sportsman (4 x 4)	08-10
300 Xplorer 4 x 4	96-00
300/400 Xpress L	96-97
300 Xpress 2 x 4	98-00
325 Hawkeye 2x4	15
325 Magnum (4 x 4) (2 x 4)	00
325 Magnum 2 x 4/4 x 4 Moose	01
325 Magnum (2 x 4) HDS	02
325 Magnum 4 x 4 (A02CD32AA/AB/AC)	02
325 Magnum 4 x 4 HDS (A02CD32FB)	02
325 Sportsman Ace	14
325 Sportsman Ace Efi	15
325 Sportsman Ace Euro	15
325 Sportsman Ace HD	15
325 Trail Boss	00-02
325 Xpedition	00
325 Xpedition	02
330 ATP (4x4)	04-05

FA, SFA, TT Pad or Brake Shoe	SFAC Carbon Scooter Pads	Speciality Pads SXR / Vee / MXS	Sintered/ HH Pads/ Grooved Shoes	DISC PAD CHOICES - FRONT		BRAKE DISC CHOICES - FRONT					Line #
				Left / Gauche / Links Standard Replacement Disc	Right / Droite / Rechts Standard Replacement Disc	Contour Disc Universal left and right fitment	Universal Custom Disc	Vee-Discs Black † See note below	CX Extreme MX Race Disc/ UTVX Disc		
FA159TT*			FA159R*	MD6219D	MD6219D						1
FA083TT*			FA083R*	MD6274D	MD6274D						2
FA159TT*			FA490R*	MD6274D	MD6274D						3
FA159TT*			FA159R*	MD6219D	MD6219D						4
FA083TT*			FA083R*	MD6219D	MD6219D						5
FA083TT*			FA490R*	MD6274D	MD6274D						6
FA083TT*			FA083R*	MD6274D	MD6274D						7
FA083TT*			FA083R*	MD6274D	MD6274D						8
FA159TT*			FA159R*	MD6149D	MD6149D						9
FA159TT*			FA159R*	MD6150D	MD6150D						10
Y503*			Y503G*								11
FA159TT*			FA159R*	MD6147D	MD6147D						12
FA159TT*			FA159R*	MD6149D	MD6149D						13
FA159TT*			FA159R*	MD6150D	MD6150D						14
FA159TT*			FA159R*	MD6149D	MD6149D						15
FA159TT*			FA159R*	MD6149D	MD6149D						16
FA159TT*			FA159R*	MD6149D	MD6149D						17
FA159TT*			FA159R*	MD6149D	MD6149D						18
FA159TT*			FA159R*	MD6150D	MD6150D						19
FA159TT*			FA159R*	MD6149D	MD6149D						20
FA159TT*			FA159R*	MD6147D	MD6147D						21
FA159TT*			FA159R*	MD6150D	MD6150D						22
FA159TT*			FA159R*	MD6150D	MD6150D						23
FA159TT*			FA159R*	MD6155D	MD6155D						24
FA159TT*			FA159R*	MD6155D♣	MD6155D♣						25
FA159TT*			FA159R*	MD6262D	MD6262D						26
Y503*			Y503G*								27
FA159TT*			FA159R*	MD6147D	MD6147D						28
FA159TT*			FA159R*	MD6150D	MD6150D						29
FA054TT*			FA054R*	MD6147D	MD6147D						30
FA159TT*			FA159R*	MD6147D	MD6147D						31
FA159TT*			FA159R*	MD6150D	MD6150D						32
FA159TT*			FA159R*	MD6150D	MD6150D						33
FA159TT*			FA159R*	MD6155D♣	MD6155D♣						34
FA159TT*			FA159R*	MD6150D	MD6150D						35
FA159TT*			FA159R*	MD6150D	MD6150D						36
FA159TT*			FA159R*	MD6149D	MD6149D						37
FA395TT*			FA395R*	MD6272D	MD6272D						38
FA159TT*			FA159R*	MD6272D	MD6272D						39
FA395TT*			FA395R*	MD6272D	MD6272D						40
FA159TT*			FA159R*	MD6272D	MD6272D						41
FA159TT*			FA159R*	MD6272D	MD6272D						42
FA159TT*			FA159R*	MD6150D	MD6150D						43
FA159TT*			FA159R*	MD6150D	MD6150D						44
FA159TT*			FA159R*	MD6150D	MD6150D						45
FA159TT*			FA159R*	MD6202D	MD6202D					UTVX6202	46
FA159TT*			FA159R*	MD6150D	MD6150D						47
FA159TT*			FA159R*	MD6155D	MD6155D						48
FA159TT*			FA159R*	MD6155D	MD6155D						49
FA159TT*			FA159R*	MD6155D	MD6155D						50
FA159TT*			FA159R*	MD6202D	MD6202D						51
FA656TT*			FA656R*	MD6202D	MD6202D					UTVX6202	52
FA656TT*			FA656R*	MD6202D	MD6202D					UTVX6202	53
FA656TT*			FA656R*	MD6202D	MD6202D					UTVX6202	54
FA656TT*			FA656R*	MD6202D	MD6202D					UTVX6202	55
FA159TT*			FA159R*	MD6155D♣	MD6155D♣						56
FA159TT*			FA159R*	MD6155D♣	MD6155D♣						57
FA159TT*			FA159R*	MD6155D♣	MD6155D♣						58
FA159TT*			FA159R*	MD6202D	MD6202D						59

FRONT / AVANT / VORN / FRENTE / ANTERIORE

R Suffix = High Durability Sintered Pad. HH Suffix = High Performance Sintered Pad. TT Suffix = Hard Wearing Off Road Pad. V Suffix = Semi Sintered Pad. G Suffix = Grooved Shoe.

D Suffix = Drilled Disc. X Suffix = Universal Left or Right Disc. XC Suffix = Contoured Disc. LS Suffix = Left/Steel Disc. RS Suffix = Right/Steel Disc.

♣NOTE: Plain edged rotor will not allow fitment of optional speedo pick up.

*-2 Sets Required. † For Vee disc colours add RED, BLU, GRN, GLD, ORG suffix to part number.

♣ - Also available as a Vintage Motorcycle Disc.

358 Part numbers, prefixes, suffixes, photos and illustrations shown in this catalogue are trademarks and/or copyrights of EBC Brakes or the trademark owner A C Freeman Investments Ltd and use without express written permission of the owners is punishable by law.

Non-JAPANESE Built Motorcycles

Line #	BRAKE DISC CHOICES - FRONT						DISC PAD CHOICES - REAR				BRAKE DISC CHOICES - REAR			
	Oversize 250 /280mm Disc Kit	OSX Oversize 250/280mm Disc Kit	Relocating Bracket for 250/ 280mm Disc	Oversize 320mm Disc Kit	SMX Oversize 320mm Disc Kit	Relocating Bracket for 320mm Disc	FA, SFA, TT Pad or Brake Shoe	SFAC Carbon Scooter Pads	Speciality Pads - SXR / Vee / MXS	Sintered/ HH Pads/ Grooved Shoes	Standard Replacement Disc	Contour Disc Rear fitment	Vee-Discs™ CONTOUR	CX Extreme MX Race Disc/ UTVX Disc
1							H306			H306G				
2														
3							H306			H306G				
4							H306			H306G				
5							FA067TT			FA067R	MD6311D			
6														
7							FA067TT			FA067R	MD6311D			
8							FA067TT			FA067R	MD6311D			
9							H306			H306G				
10							FA067TT			FA067R	MD6311D			
11							FA232TT			FA232R	N/A			
12							FA232TT			FA232R	N/A			
13							FA040				N/A			
14							FA232TT			FA232R	N/A			
15														
16							FA232TT			FA232R	N/A			
17														
18							FA232TT			FA232R	N/A			
19														
20							FA232TT			FA232R	N/A			
21														
22							FA232TT			FA232R	N/A			
23							FA232TT			FA232R	N/A			
24							FA232TT			FA232R	N/A			
25							FA270TT			FA270R	MD6156D			
26							FA270TT			FA270R	MD6156D			
27							N/A			FA314R	MD6256D			
28							FA040				N/A			
29							FA232TT			FA232R	N/A			
30							FA232TT			FA232R	N/A			
31							FA232TT			FA232R	N/A			
32							FA232TT			FA232R	N/A			
33							FA232TT			FA232R	N/A			
34							FA270TT			FA270R	N/A			
35							FA232TT			FA232R	N/A			
36							FA232TT			FA232R	N/A			
37														
38							FA395TT*			FA395R*	MD6273D*			
39							FA159TT			FA159R	MD6273D			
40							FA395TT*			FA395R*	MD6273D*			
41							FA159TT*			FA159R*	MD6273D*			
42							FA159TT			FA159R	MD6273D			
43							FA232TT			FA232R	N/A			
44							FA232TT			FA232R	N/A			
45							FA232TT			FA232R	N/A			
46							FA475TT			FA475R	MD6275D			UTVX6275
47							FA270TT			FA270R	MD6156D			
48							FA270TT			FA270R	MD6156D			
49							N/A			FA314R	MD6200D			
50							N/A			FA314R	MD6200D			
51							N/A			FA314R	MD6200D			
52							N/A*			FA354R*	MD6275D*			UTVX6275*
53							N/A*			FA354R*	MD6275D*			UTVX6275*
54							N/A*			FA354R*	MD6275D*			UTVX6275*
55							N/A*			FA354R*	MD6275D*			UTVX6275*
56							FA270TT			FA270R	MD6156D			
57							FA270TT			FA270R	MD6156D			
58							N/A			FA314R	MD6200D			
59							FA159TT*			FA159R*	MD6200D			
60														

REAR / ARRIÈRE / HINTEN / POSTERIOR / POSTERIORE

*-2 Sets Required. † For Vee disc colours add RED, BLU, GRN, GLD, ORG suffix to part number.

⊗ - Also available as a Vintage Motorcycle Disc.

R Suffix = High Durability Sintered Pad. **HH** Suffix = High Performance Sintered Pad. **TT** Suffix = Hard Wearing Off Road Pad. **V** Suffix = Semi Sintered Pad. **G** Suffix = Grooved Shoe.
D Suffix = Drilled Disc. **X** Suffix = Universal Left or Right Disc. **XC** Suffix = Contoured Disc. **LS** Suffix = Left/Steel Disc. **RS** = Right/Steel Disc.

Part numbers, prefixes, suffixes, photos and illustrations shown in this catalogue are trademarks and/or copyrights of EBC Brakes or the trademark owner A C Freeman Investments Ltd and use without express written permission of the owners is punishable by law.

Non-JAPANESE Built Motorcycles

APPLICATIONS

BRAKE



POLARIS (ATV) Contd.

R Suffix = High Durability Sintered Pad. HH Suffix = High Performance Sintered Pad. TT Suffix = Hard Wearing Off Road Pad. V Suffix = Semi-Sintered Pad. G Suffix = Grooved Shoe.

D Suffix = Drilled Disc. X Suffix = Universal Left or Right Disc. XC Suffix = Contoured Disc. LS Suffix = Left/Steel Disc. RS = Right/Steel Disc.

330 Magnum (2x4/HDS)	03-06
330 Magnum (4x4/HDS)	03-04
330 Trail Boss	03-04
330 Trail Boss	05-09
330 Trail Boss	10-13
330 Trail Blazer	08-09
330 Trail Blazer	10-13
335 Sportsman 4 x 4	99-00
335 Sportsman/Worker 4 x 4	99-00
350L 2 x 4	90
350L 4 x 4	90
350L 4 x 4	93
350 Big Boss L	93
350 Big Boss L - Middle Axle Brake	93
350 Sportsman 4 x 4	93
350 Trail Boss L 2 x 4	91-93
350 Trail Boss L 4 x 4	91
400 L 2 x 4	94-95
400 L 4 x 4	94
400 Big Boss L 6 x 6	94-95
400 Big Boss L 6 x 6 - Middle Axle Brake	94-95
400 Big Boss L 6 x 6	96
400 Big Boss L 6 x 6 - Middle Axle Brake	96
400 Big Boss L 6 x 6	97
400 Big Boss L 6 x 6 - Middle Axle Brake	97
400 Hawkeye H.O. (2x4)	11-14
400 Scrambler L 4 x 4	95-97
400 Scrambler (2 x 4/4 x 4)	00
400 Scrambler 4 x 4	98-02
400 Scrambler 2 x 4	02
400 Sport L	94-98
400 Sport	99-00
400 Sportsman L 4 x 4	94-97
400 Sportsman	01-02
400 Sportsman 400	03-05
400 Sportsman HO 4x4	08-10
400 Sportsman HO 4x4	11-14
400 Trail Blazer	03
400 Xplorer L 4 x 4	95-98
400 Xplorer L 4 x 4	99-00
400 Xplorer 4 x 4	01-02
400 Xplorer	01-02
425 Magnum 2 x 4	95-98
425 Magnum 4 x 4	95-98
425 Magnum 6 x 6	96
425 Magnum 6 x 6 - Middle Axle Brake	96
425 Magnum 6 x 6	97
425 Magnum 6 x 6 - Middle Axle Brake	97
425 Xpedition (4 x 4)	00
450 S Outlaw	08
450 Outlaw MXR	09-10
450 Sportsman	06
450 Sportsman	07
455cc Diesel 4 x 4 EBS	99-00
455cc Diesel	01
500 ATP HO (4x4)	04-05
500 ATV Pro 4x4 PPS	02
500 Big Boss 6 x 6	98-99
500 Big Boss 6 x 6 - Middle Axle Brake	98-99

FRONT / AVANT / VORN / FRENTE / ANTERIORE

DISC PAD CHOICES - FRONT				BRAKE DISC CHOICES - FRONT						Line #
FA, SFA, TT Pad or Brake Shoe	SFAC Carbon Scooter Pads	Speciality Pads SXR / Vee / MXS	Sintered/HH Pads/Grooved Shoes	Left / Gauche / Links Standard Replacement Disc	Right / Droite / Rechts Standard Replacement Disc	Contour Disc Universal left and right fitment	Universal Custom Disc	Vee-Discs Black † See note below	CX Extreme MX Race Disc/ UTVX Disc	Line #
			FA159R*	MD6149D	MD6149D					1
			FA159R*	MD6202D	MD6202D					2
FA159TT*			FA159R*	MD6155D	MD6155D					3
			FA159R*	MD6262D	MD6262D					4
			FA159R*	MD6202D	MD6202D					5
			FA159R*	MD6262D	MD6262D					6
			FA159R*	MD6202D	MD6202D					7
FA159TT*			FA159R*	MD6150D	MD6150D					8
FA159TT*			FA159R*	MD6149D	MD6149D					9
FA159TT*			FA159R*	MD6150D	MD6150D					10
FA159TT*			FA159R*	MD6149D	MD6149D					11
FA159TT*			FA159R*	MD6150D	MD6150D					12
FA159TT*			FA159R*	MD6149D	MD6149D					13
FA159TT			FA159R	MD6149D	MD6149D					14
FA159TT*			FA159R*	MD6149D	MD6149D					15
FA159TT*			FA159R*	MD6150D	MD6150D					16
FA159TT*			FA159R*	MD6149D	MD6149D					17
FA159TT*			FA159R*	MD6150D	MD6150D					18
FA159TT*			FA159R*	MD6149D	MD6149D					19
FA159TT*			FA159R*	MD6149D	MD6149D					20
FA159TT*			FA159R*	MD6149D	MD6149D					21
FA159TT*			FA159R*	MD6149D	MD6149D					22
FA273R				MD6153D	MD6153D					23
FA159TT*			FA159R*	MD6149D	MD6149D					24
FA159TT*			FA159R*	MD6149D	MD6149D					25
FA159TT*			FA159R*	MD6202D	MD6202D					26
FA159TT*			FA159R*	MD6150D	MD6150D					27
FA159TT*			FA159R*	MD6155D	MD6155D					28
FA159TT*			FA159R*	MD6155D❖	MD6155D❖					29
FA159TT*			FA159R*	MD6155D❖	MD6155D❖					30
FA159TT*			FA159R*	MD6150D	MD6150D					31
FA159TT*			FA159R*	MD6150D	MD6150D					32
FA159TT*			FA159R*	MD6150D	MD6150D					33
FA159TT*			FA159R*	MD6149D	MD6149D					34
FA159TT*			FA159R*	MD6149D	MD6149D					35
FA159TT*			FA159R*	MD6149D	MD6149D					36
FA159TT*			FA159R*	MD6272D	MD6272D					37
FA159TT*			FA159R*	MD6202D	MD6202D				UTVX6202	38
FA159TT*			FA159R*	MD6155D	MD6155D					39
FA159TT*			FA159R*	MD6149D	MD6149D					40
FA159TT*			FA159R*	MD6155D	MD6155D					41
FA159TT*			FA159R*	MD6149D	MD6149D					42
FA159TT*			FA159R*	MD6150D	MD6150D					43
FA159TT*			FA159R*	MD6149D	MD6149D					44
FA159TT*			FA159R*	MD6149D	MD6149D					45
FA273R				MD6153D	MD6153D					46
FA159TT*			FA159R*	MD6149D	MD6149D					47
FA159TT*			FA159R*	MD6149D	MD6149D					48
FA159TT*			FA159R*	MD6149D	MD6149D					49
FA456TT*			FA456R*	MD6219D	MD6219D					50
FA456TT*			FA456R*	MD6219D	MD6219D					51
			FA159R*	MD6202D	MD6202D					52
			FA159R*	MD6202D	MD6202D					53
FA159TT*			FA159R*	MD6149D	MD6149D				UTVX6202	54
FA159TT*			FA159R*	MD6149D	MD6149D					55
FA159TT*			FA159R*	MD6202D	MD6202D					56
			FA159R*	MD6202D	MD6202D					57
FA159TT*			FA159R*	MD6149D	MD6149D					58
FA159TT*			FA159R*	MD6149D	MD6149D					59

❖NOTE: Plain edged rotor will not allow fitment of optional speedo pick up.

*-2 Sets Required. † For Vee disc colours add RED, BLU, GRN, GLD, ORG suffix to part number.

❖ - Also available as a Vintage Motorcycle Disc.

360 Part numbers, prefixes, suffixes, photos and illustrations shown in this catalogue are trademarks and/or copyrights of EBC Brakes or the trademark owner A C Freeman Investments Ltd and use without express written permission of the owners is punishable by law.

Non-JAPANESE Built Motorcycles

Line #	BRAKE DISC CHOICES - FRONT						DISC PAD CHOICES - REAR				BRAKE DISC CHOICES - REAR			
	Oversize 250 /280mm Disc Kit	OSX Oversize 250/280mm Disc Kit	Relocating Bracket for 250/ 280mm Disc	Oversize 320mm Disc Kit	SMX Oversize 320mm Disc Kit	Relocating Bracket for 320mm Disc	FA, SFA, TT Pad or Brake Shoe	SFAC Carbon Scooter Pads	Speciality Pads - SXR / Vee / MXS	Sintered/ HH Pads/ Grooved Shoes	Standard Replacement Disc	Contour Disc Rear fitment	Vee-Discs™ CONTOUR	CX Extreme MX Race Disc/ UTVX Disc
1							N/A		FA314R	MD6200D				
2							N/A		FA314R	MD6200D				
3							FA270TT		FA270R	MD6156D				
4							N/A		FA314R	MD6256D				
5							N/A		FA314R	MD6256D				
6							N/A		FA314R	MD6256D				
7							N/A		FA314R	MD6256D				
8							FA270TT		FA270R	N/A				
9							FA270TT		FA270R	N/A				
10							FA232TT		FA232R	N/A				
11							FA232TT		FA232R	N/A				
12							FA232TT		FA232R	N/A				
13							FA232TT		FA232R	N/A				
14														
15							FA232TT		FA232R	N/A				
16							FA232TT		FA232R	N/A				
17							FA232TT		FA232R	N/A				
18							FA232TT		FA232R	N/A				
19							FA232TT		FA232R	N/A				
20							FA232TT		FA232R	N/A				
21														
22							FA232TT		FA232R	N/A				
23														
24							FA232TT		FA232R	N/A				
25														
26							FA475TT		FA475R	MD6274D				
27							FA232TT		FA232R	N/A				
28							FA270TT		FA270R	MD6156D				
29							FA270TT		FA270R	MD6156D				
30							FA270TT		FA270R	MD6156D				
31							FA232TT		FA232R	N/A				
32							FA270TT		FA270R	MD6156D				
33							FA232TT		FA232R	N/A				
34							FA270TT		FA270R	N/A				
35							N/A		FA314R	N/A				
36							FA159TT		FA159R	MD6273D				
37							FA475TT		FA475R	MD6275D			UTVX6275	
38							FA270TT		FA270R	MD6156D				
39							FA232TT		FA232R	N/A				
40							FA270TT		FA270R	MD6169D				
41							FA270TT		FA270R	MD6156D				
42							FA270TT		FA270R	MD6169D				
43							FA232TT		FA232R	N/A				
44							FA232TT		FA232R	N/A				
45							FA232TT		FA232R	N/A				
46														
47							FA232TT		FA232R	N/A				
48														
49							FA270TT		FA270R	MD6156D				
50							FA159TT		FA159R	MD6218D				
51							FA159TT		FA159R	MD6290D				
52							N/A		FA314R	MD6201D				
53							N/A		FA314R	MD6275D			UTVX6275	
54							FA270TT		FA270R	N/A				
55							FA270TT		FA270R	N/A				
56							FA159TT*		FA159R*	MD6200D				
57							N/A		FA314R	MD6200D				
58							FA232TT		FA232R	N/A				
59														
60														

REAR / ARRIÈRE / HINTEN / POSTERIOR / POSTERIORE

*-2 Sets Required. † For Vee disc colours add RED, BLU, GRN, GLD, ORG suffix to part number.

⊗ - Also available as a Vintage Motorcycle Disc.

R Suffix = High Durability Sintered Pad. HH Suffix = High Performance Sintered Pad. TT Suffix = Hard Wearing Off Road Pad. V Suffix = Semi Sintered Pad. G Suffix = Grooved Shoe.

D Suffix = Drilled Disc. X Suffix = Universal Left or Right Disc. XC Suffix = Contoured Disc. LS Suffix = Left/Steel Disc. RS = Right/Steel Disc.

Non-JAPANESE Built Motorcycles

APPLICATIONS

BRAKE



POLARIS (ATV) Contd.



R Suffix = High Durability Sintered Pad. HH Suffix = High Performance Sintered Pad. TT Suffix = Hard Wearing Off Road Pad. V Suffix = Semi Sintered Pad. G Suffix = Grooved Shoe.

D Suffix = Drilled Disc. X Suffix = Universal Left or Right Disc. XC Suffix = Contoured Disc. LS Suffix = Left/Steel Disc. RS Suffix = Right/Steel Disc.

		DISC PAD CHOICES - FRONT				BRAKE DISC CHOICES - FRONT						Line #
		FA, SFA, TT Pad or Brake Shoe	SFAC Carbon Scooter Pads	Speciality Pads - SXR / Vee / MXS	Sintered/HH Pads/ Grooved Shoes	Left / Gauche / Links Standard Replacement Disc	Right / Droite / Rechts Standard Replacement Disc	Contour Disc Universal left and right fitment	Universal Custom Disc	Vee-Discs Black † See note below	CX Extreme MX Race Disc/ UTVX Disc	
500 Magnum (4 x 4)	99-00	FA159TT*			FA159R*	MD6149D	MD6149D					1
500 Magnum	01	FA159TT*			FA159R*	MD6149D	MD6149D					2
500 Magnum (2 x 39906 x 4 HDS)	02				FA159R*	MD6149D	MD6149D					3
500 Magnum 4x4 HDS	02-03				FA159R*	MD6202D	MD6202D					4
500 Outlaw	06-07	FA159TT*			FA159R*	MD6219D	MD6219D					5
500 Predator/TLD	03-07	FA159TT*			FA159R*	MD6219D	MD6219D					6
500 Scrambler 2 x 4	01-02	FA159TT*			FA159R*	MD6155D♣	MD6155D♣					7
500 Scrambler 2 x 4	07-08				FA159R*	MD6262D	MD6262D					8
500 Scrambler 4 x 4	97	FA159TT*			FA159R*	MD6150D	MD6150D					9
500 Scrambler 4 x 4	98-04	FA159TT*			FA159R*	MD6155D♣	MD6155D♣					10
500 Scrambler 4 x 4	05-09	FA159TT*			FA159R*	MD6155D♣	MD6155D♣					11
500 Scrambler 4 x 4	10-12				FA159R	MD6202D	MD6202D					12
500 Sportsman 4 x 4	96	FA159TT*			FA159R*	MD6149D	MD6149D					13
500 Sportsman 4 x 4	97	FA159TT*			FA159R*	MD6149D	MD6149D					14
500 Sportsman/Worker 4 x 4 EBS/500 RSE	98-02	FA159TT*			FA159R*	MD6149D	MD6149D					15
500 Sportsman HO/EFI Demand Drive	03-04				FA159R*	MD6149D	MD6149D					16
500 Sportsman HO/EFI	04-06				FA159R*	MD6202D	MD6202D					17
500 Sportsman EFI/HO	07-08				FA159R*	MD6202D	MD6202D					18
500 Sportsman X2	06-08				FA159R*	MD6202D	MD6202D					19
500 Sportsman 6 x 6	00-08				FA159R*	MD6149D	MD6149D					20
500 Sportsman X2 EFI	07-09	FA159TT*			FA159R*	MD6202D	MD6202D					21
500 Sportsman Forest	12	FA159TT*			FA159R*	MD6202D	MD6202D					22
500 Sportsman Touring H.O.	08-11	FA159TT*			FA159R*	MD6202D	MD6202D					23
500 Sportsman Touring H.O.	11-13	FA159TT*			FA159R*	MD6202D	MD6202D					24
500 Sportsman EFI Quad H.O.	08-13				FA159R*	MD6202D	MD6202D					25
500 XP Sportsman	09	FA475TT*			FA475R*	MD6339D	MD6339D					26
500 Xplorer 4 x 4	97	FA159TT*			FA159R*	MD6149D	MD6149D					27
525 S Outlaw	08-10	FA456TT*			FA456R*	MD6219D	MD6219D					28
525 Outlaw IRS	08-11	FA456TT*			FA456R*	MD6219D	MD6219D					29
550 Sportsman	11-13	FA475TT*			FA475R*	MD6339D	MD6339D					30
550 Sportsman XP	09-13	FA475TT*			FA475R*	MD6339D	MD6339D					31
550 Sportsman EPS	10-14	FA475TT*			FA475R*	MD6339D	MD6339D					32
550 Sportsman Forest	10-14	FA475TT*			FA475R*	MD6339D	MD6339D					33
550 Sportsman XP EPS	09-14	FA475TT*			FA475R*	MD6339D	MD6339D					34
550 Sportsman XP Touring EPS	12	FA475TT*			FA475R*	MD6339D	MD6339D					35
550 Sportsman X2	10-14	FA475TT*			FA475R*	MD6339D	MD6339D					36
550 Sportsman X2 EPS	14	FA475TT*			FA475R*	MD6339D	MD6339D					37
550 Sportsman Touring EPS	10-14	FA475TT*			FA475R*	MD6339D	MD6339D					38
570 Forest Tractor Efi/EPS	15	FA159TT*			FA159R*	MD6202D	MD6202D					39
570 Sportsman EFI (Inc EPS)	11-15	FA159TT*			FA159R*	MD6202D	MD6202D					40
570 Sportsman Touring EFI EPS	14-15	FA159TT*			FA159R*	MD6202D	MD6202D					41
570 Sportsman Touring Tractor EFI EPS	16-18	FA159TT*			FA159R*	MD6202D	MD6202D					42
570 Sportsman EFI HD	14-18	FA159TT*			FA159R*	MD6202D	MD6202D					43
570 Sportsman EFI UTE	14-18	FA159TT*			FA159R*	MD6202D	MD6202D					44
570 Sportsman EFI X2 EPS	14-18	FA159TT*			FA159R*	MD6202D	MD6202D					45
570 Sportsman SP	15-18	FA159TT*			FA159R*	MD6202D	MD6202D					46
570 Sportsman SP Touring	15-18	FA159TT*			FA159R*	MD6202D	MD6202D					47
570 Sportsman 6x6	17-18	FA159TT*			FA159R*	MD6202D	MD6202D					48
570 Sportsman 6x6 Tractor	17-18	FA159TT*			FA159R*	MD6202D	MD6202D					49
570 Sportsman Ace	15-20	FA656TT*		SXR656HH*	FA656R*	MD6202D	MD6202D				UTVX6202*	50
570 Sportsman Ace Euro	15-20	FA656TT*		SXR656HH*	FA656R*	MD6202D	MD6202D				UTVX6202*	51
600 Sportsman 4 x 4	03-05			SXR159HH*	FA159R*	MD6202D	MD6202D				UTVX6202*	52
700 Sportsman (4 x 4)/EFI	02-06			SXR159HH*	FA159R*	MD6202D	MD6202D				UTVX6202*	53
700 Sportsman MV	05-06			SXR159HH*	FA159R*	MD6202D	MD6202D				UTVX6202*	54
700 Sportsman EFI	07			SXR159HH*	FA159R*	MD6202D	MD6202D				UTVX6202*	55
700 Sportsman X2	08	FA159TT*		SXR159HH*	FA159R*	MD6202D	MD6202D				UTVX6202*	56
800 Sportsman EFI	05-06			SXR159HH*	FA159R*	MD6202D	MD6202D				UTVX6202*	57
800 Sportsman EFI (Built up to 15/12/2008)	08			SXR159HH*	FA159R*	MD6202D	MD6202D				UTVX6202*	58
800 Sportsman EFI (Built up after 16/12/2008)	09			SXR159HH*	FA159R*	MD6202D	MD6202D				UTVX6202*	59

FRONT / AVANT / VORN / FRENTE / ANTERIORE

♣NOTE: Plain edged rotor will not allow fitment of optional speedo pick up.

*-2 Sets Required. † For Vee disc colours add RED, BLU, GRN, GLD, ORG suffix to part number.

♣ - Also available as a Vintage Motorcycle Disc.

Non-JAPANESE Built Motorcycles

Line #	BRAKE DISC CHOICES - FRONT						DISC PAD CHOICES - REAR				BRAKE DISC CHOICES - REAR			
	Oversize 250 /280mm Disc Kit	OSX Oversize 250/280mm Disc Kit	Relocating Bracket for 250/ 280mm Disc	Oversize 320mm Disc Kit	SMX Oversize 320mm Disc Kit	Relocating Bracket for 320mm Disc	FA, SFA, TT Pad or Brake Shoe	SFAC Carbon Scooter Pads	Speciality Pads - SXR / Vee / MXS	Sintered/ HH Pads/ Grooved Shoes	Standard Replacement Disc	Contour Disc Rear fitment	Vee-Discs™ CONTOUR	CX Extreme MX Race Disc/ UTVX Disc
1							FA270TT			FA270R	MD6156D			
2							FA270TT			FA270R	MD6156D			
3							N/A			FA314R	MD6200D			
4							N/A			FA314R	MD6200D			
5							FA159TT			FA159R	MD6290D			
6							FA159TT			FA159R	MD6218D			
7							FA270TT			FA270R	MD6156D			
8							N/A			FA314R	MD6256D			
9							FA232TT			FA232R	N/A			
10							FA270TT			FA270R	MD6156D			
11							N/A			FA314R	MD6256D			
12							N/A			FA314R	MD6256D			
13							FA232TT			FA232R	MD6201D			
14							FA232TT			FA232R	MD6154D			
15							FA270TT			FA270R	N/A			
16										FA314R*	MD6201D*			
17										FA314R*	MD6201D*			
18							N/A			FA314R*	MD6275D			
19							N/A			FA314R*	MD6275D*			
20							N/A			FA313R	MD6170D			
21							FA159TT			FA159R	MD6275D			
22							N/A*			FA314R*	MD6275D*			
23							FA159TT*			FA159R*	MD6275D*			
24										FA354R*	MD6275D*			
25							N/A*			FA314R*	MD6275D*			
26							FA475TT			FA475R	MD6339D			
27							FA232TT			FA232R	N/A			
28							FA159TT			FA159R	MD6218D			
29							FA159TT			FA159R	MD6290D			
30							FA475TT			FA475R	MD6339D			
31							FA475TT			FA475R	MD6339D			
32							FA475TT			FA475R	MD6339D			
33							FA475TT			FA475R	MD6339D			
34							FA475TT			FA475R	MD6339D			
35							FA475TT			FA475R	MD6339D			
36							FA475TT			FA475R	MD6339D			
37							FA475TT			FA475R	MD6339D			
38							FA475TT			FA475R	MD6339D			
39							FA475TT			FA475R	MD6275D			
40							FA475TT			FA475R	MD6275D			
41							FA475TT			FA475R	MD6275D			
42							FA475TT			FA475R	MD6275D			
43							FA475TT			FA475R	MD6275D			
44							FA475TT			FA475R	MD6275D			
45							FA475TT			FA475R	MD6275D			
46							FA475TT			FA475R	MD6275D			
47							FA475TT			FA475R	MD6275D			
48							FA475TT			FA475R	MD6275D			
49							FA475TT			FA475R	MD6275D			
50							N/A*	SXR354HH*	FA354R*	MD6275D*			UTVX6275*	
51							N/A*	SXR354HH*	FA354R*	MD6275D*			UTVX6275*	
52							N/A	SXR314HH	FA314R	MD6201D			UTVX6201	
53							N/A	SXR314HH	FA314R	MD6201D			UTVX6201	
54							N/A	SXR314HH	FA314R	MD6201D			UTVX6201	
55							N/A	SXR314HH	FA314R	MD6275D			UTVX6275	
56							FA159TT	SXR314HH	FA159R	MD6275D			UTVX6275	
57							N/A	SXR314HH	FA314R	MD6201D			UTVX6201	
58							N/A	SXR314HH	FA314R	MD6275D			UTVX6275	
59							N/A	SXR314HH	FA314R	MD6275D			UTVX6275	
60														

REAR / ARRIÈRE / HINTEN / POSTERIOR / POSTERIORE

*-2 Sets Required. † For Vee disc colours add RED, BLU, GRN, GLD, ORG suffix to part number.

⊗ - Also available as a Vintage Motorcycle Disc.

R Suffix = High Durability Sintered Pad. HH Suffix = High Performance Sintered Pad. TT Suffix = Hard Wearing Off Road Pad. V Suffix = Semi Sintered Pad. G Suffix = Grooved Shoe.

D Suffix = Drilled Disc. X Suffix = Universal Left or Right Disc. XC Suffix = Contoured Disc. LS Suffix = Left/Steel Disc. RS = Right/Steel Disc.

BRAKE APPLICATIONS

Non-JAPANESE Built Motorcycles

Line #	BRAKE DISC CHOICES - FRONT						DISC PAD CHOICES - REAR				BRAKE DISC CHOICES - REAR			
	Oversize 250 /280mm Disc Kit	OSX Oversize 250/280mm Disc Kit	Relocating Bracket for 250/ 280mm Disc	Oversize 320mm Disc Kit	SMX Oversize 320mm Disc Kit	Relocating Bracket for 320mm Disc	FA, SFA, TT Pad or Brake Shoe	SFAC Carbon Scooter Pads	Speciality Pads - SXR / Vee / MXS	Sintered/ HH Pads/ Grooved Shoes	Standard Replacement Disc	Contour Disc Rear fitment	Vee-Discs™ CONTOUR	CX Extreme MX Race Disc/ UTVX Disc
1							FA475TT		SXR475HH	FA475R	MD6275D			UTVX6275
2							FA159TT*		SXR159HH*	FA159R*	MD6275D*			UTVX6275*
3							N/A	SXR314HH	FA314R	MD6275D				UTVX6275
4							FA475TT		FA475R					
5							FA159TT*		FA159R*	MD6275D*				
6								SXR314HH	FA314R	MD6275D				UTVX6275
7							FA475TT*	SXR475HH	FA475R*	MD6275D*				UTVX6275*
8							FA475TT*		FA475R*	MD6339D*				
9							FA475TT		FA475R	MD6339D				
10							FA475TT		FA475R	MD6339D				
11							FA475TT*		FA475R*	MD6339D*				
12							FA475TT		FA475R	MD6339D				
13							FA475TT		FA475R	MD6339D				
14							FA475TT		FA475R	MD6339D				
15							FA475TT		FA475R	MD6339D				
16							FA475TT		FA475R	MD6339D				
17							FA475TT*		FA475R*	MD6275D*				
18							FA475TT*		FA475R*	MD6339D*				
19							FA475TT*		FA475R*	MD6339D*				
20							FA456TT*		FA456R*	MD6339D*				
21							FA475TT*		FA475R*	MD6339D*				
22							FA475TT*		FA475R*	MD6339D*				
23							FA475TT*		FA475R*	MD6339D*				
24							FA475TT*		FA475R*	MD6339D*				
25							FA475TT*		FA475R*	MD6339D*				
26														
27														
28								SXR354HH*	FA354R*	MD6275D*				UTVX6275*
29														
30														
31							N/A*		FA314R	MD6200D				
32							N/A*		FA313R	MD6200D				
33							N/A*		FA354R	MD6201D				
34							N/A*		FA354R	MD6201D				
35							N/A*		FA354R	MD6201D				
36							N/A*		FA313R	MD6170D				
37							N/A*		FA354R*	MD6201D*				
38							N/A*		FA354R*	MD6201D*				
39							N/A*		FA354R*	MD6201D*				
40							N/A*		FA354R*	MD6201D*				
41							N/A*		FA354R*	MD6201D*				
42							N/A*		FA354R	MD6201D				
43							N/A*		FA354R*	MD6201D*				
44							N/A*		FA354R*	MD6275D*				
45							N/A*		FA354R*	MD6201D*				
46							N/A*		FA354R*	MD6275D*				
47							N/A*		FA354R	MD6201D				
48							N/A*		FA273R	N/A				
49							N/A*		FA354R*	MD6275D*				
50							N/A*		FA354R*	MD6275D*				
51							N/A*		FA354R*	MD6275D*				
52							N/A*		FA354R*	MD6275D*				
53							N/A*		FA354R*	MD6275D*				
54							N/A*		FA354R*	MD6275D*				
55							N/A*		FA354R*	MD6275D*				
56							FA475TT		FA475R	MD6339D				
57							N/A*		FA354R*	MD6275D*				
58							FA656TT	SXR656HH*	FA656R*	MD6275D*				UTVX6275*
59							FA656TT	SXR656HH*	FA656R*	MD6275D*				UTVX6275*
60														

REAR / ARRIÈRE / HINTEN / POSTERIOR / POSTERIORE

*-2 Sets Required. † For Vee disc colours add RED, BLU, GRN, GLD, ORG suffix to part number.
 Ⓢ - Also available as a Vintage Motorcycle Disc.

R Suffix = High Durability Sintered Pad. HH Suffix = High Performance Sintered Pad. TT Suffix = Hard Wearing Off Road Pad. V Suffix = Semi Sintered Pad. G Suffix = Grooved Shoe.
 D Suffix = Drilled Disc. X Suffix = Universal Left or Right Disc. XC Suffix = Contoured Disc. LS Suffix = Left/Steel Disc. RS = Right/Steel Disc.

BRAKE APPLICATIONS

Non-JAPANESE Built Motorcycles

Line #	BRAKE DISC CHOICES - FRONT						DISC PAD CHOICES - REAR				BRAKE DISC CHOICES - REAR			
	Oversize 250 /280mm Disc Kit	OSX Oversize 250/280mm Disc Kit	Relocating Bracket for 250/ 280mm Disc	Oversize 320mm Disc Kit	SMX Oversize 320mm Disc Kit	Relocating Bracket for 320mm Disc	FA, SFA, TT Pad or Brake Shoe	SFAC Carbon Scooter Pads	Speciality Pads - SXR / Vee / MXS	Sintered/ HH Pads/ Grooved Shoes	Standard Replacement Disc	Contour Disc Rear fitment	Vee-Discs™ CONTOUR	CX Extreme MX Race Disc/ UTVX Disc
1							FA656TT		SXR656HH*	FA656R*	MD6275D*		UTVX6275*	
2							FA656TT		SXR656HH*	FA656R*	MD6275D*		UTVX6275*	
3							FA656TT		SXR656HH*	FA656R*	MD6275D*		UTVX6275*	
4							N/A*		FA354R*	FA656R*	MD6275D*		UTVX6275*	
5							N/A*		FA354R*	FA656R*	MD6275D*		UTVX6275*	
6							N/A*		FA354R*	FA656R*	MD6275D*		UTVX6275*	
7							N/A*		FA354R*	FA656R*	MD6275D*		UTVX6275*	
8							FA452TT*		SXR452HH*	FA452R*	MD6275D*		UTVX6275*	
9							N/A*		FA354R*	FA656R*	MD6275D*		UTVX6275*	
10							N/A*		FA354R*	FA656R*	MD6275D*		UTVX6275*	
11							N/A*		FA354R*	FA656R*	MD6275D*		UTVX6275*	
12							N/A*		FA354R*	FA656R*	MD6275D*		UTVX6275*	
13							N/A*		FA354R*	FA656R*	MD6275D*		UTVX6275*	
14							FA452TT*		SXR452HH*	FA452R*	MD6275D*		UTVX6275*	
15							FA452TT*		SXR452HH*	FA452R*	MD6275D*		UTVX6275*	
16							N/A*		FA354R*	FA656R*	MD6275D*		UTVX6275*	
17							N/A*		FA354R*	FA656R*	MD6275D*		UTVX6275*	
18							N/A*		FA354R*	FA656R*	MD6275D*		UTVX6275*	
19							N/A*		FA354R*	FA656R*	MD6275D*		UTVX6275*	
20							N/A*		FA354R*	FA656R*	MD6275D*		UTVX6275*	
21							FA456TT*		SXR456HH*	FA456R*	MD6338D*		UTVX6338*	
22							FA456TT*		SXR456HH*	FA456R*	MD6408D*		UTVX6408*	
23							FA456TT*		SXR456HH*	FA456R*	MD6408D*		UTVX6408*	
24							N/A*		FA354R*	FA656R*	MD6275D*		UTVX6275*	
25														
26														
27														
28							N/A		FA489R	MD6344D				
29							FA159TT*		SXR159HH*	FA159R*	MD6275D*		UTVX6275*	
30							FA159TT*		SXR159HH*	FA159R*	MD6275D*		UTVX6275*	
31							FA159TT*		SXR159HH*	FA159R*	MD6275D*		UTVX6275*	
32									FA354R*	MD6275D*			UTVX6275*	
33									FA354R*	MD6275D*			UTVX6275*	
34							FA456TT*		SXR456HH*	FA456R*	MD6338D*		UTVX6338*	
35							FA456TT*		SXR456HH*	FA456R*	MD6338D*		UTVX6338*	
36							FA452TT*		SXR452HH*	FA452R*	MD6374D*			
37							FA452TT*		SXR452HH*	FA452R*	MD6380D*			
38							FA456TT*		SXR456HH*	FA456R*	MD6338D*		UTVX6338*	
39							FA656TT*		SXR656HH*	FA656R*	MD6397D*		UTVX6397*	
40							FA656TT*		SXR656HH*	FA656R*	MD6397D*		UTVX6397*	
41							FA656TT*		SXR656HH*	FA656R*				
42														
43														
44							FA352			N/A				
45														
46							FA293/293S			N/A				
47							FA325TT		FA325R	N/A				
48							FA351TT			N/A				
49							FA351TT			N/A				
50							FA352			N/A				
51							FA352			N/A				
52							FA351TT			N/A				
53							FA351TT			N/A				
54														
55														
56							FA208TT		MXS208	FA208R	N/A			
57							FA208TT		MXS208	FA208R	N/A			
58							FA208TT				N/A			
59														
60														

REAR / ARRIÈRE / HINTEN / POSTERIOR / POSTERIORE

*-2 Sets Required. † For Vee disc colours add RED, BLU, GRN, GLD, ORG suffix to part number.

⊗ - Also available as a Vintage Motorcycle Disc.

R Suffix = High Durability Sintered Pad. HH Suffix = High Performance Sintered Pad. TT Suffix = Hard Wearing Off Road Pad. V Suffix = Semi Sintered Pad. G Suffix = Grooved Shoe.

D Suffix = Drilled Disc. X Suffix = Universal Left or Right Disc. XC Suffix = Contoured Disc. LS Suffix = Left/Steel Disc. RS = Right/Steel Disc.

Non-JAPANESE Built Motorcycles

APPLICATIONS

BRAKE



PUCH

Magnum 50cc Automatic Kids Bike	78-80
Maxi 50 (N/NK) Spoke Wheels/1 Speed automatic/Solid rear frame	73-80
Maxi 50 (SW/SKW) Spoke Wheels/1 Speed automatic/with rear suspension	73-80
Maxi 50 Spoke Wheels/2 Speed automatic/with rear suspension	73-80
Maxi 50 Executive (Cast Wheels/1 Speed automatic)	
Maxi S 50 Sport (Cast Wheels/1 Speed automatic)	
Maxi 50 Super (Cast Wheels/2 Speed automatic)	
Maxi 50 Executive (Cast Wheels with screwed in hub/1 speed automatic)	
Maxi S 50 Sport (Cast Wheels with screwed in hub/1 speed automatic)	
Maxi 50 Super (Cast Wheels with screwed in hub/2 Speed automatic)	
M 250cc Sport	74
M 350cc Sport	75
MS 50/50 L	
M 50 Sport	73-74
M 50 Grand Prix	74-77
M 50 SDP Spoke Wheel/Grand Prix Special	75-77
M 50 SDP Cast Wheel/Grand Prix Supreme	75-77
VS/DS/DZS/DSK 50	
50 KA/K2/K25/K3T/MSP	
Monza 4 SL/GP	
Imola X/GX	
Cobra 80/80-8/80-6 GT/GTL	
PUZEY	
MTD 300 (4T/4V)	11-12
MX 300 (4T/4V)	11-12
QUADRO	
350 D	11-15
350 D - Parking brake	11-15
350 S	13-15
350 S - Parking brake	13-15
350 4	14-15
350 4 - Parking brake	14-15
QUADZILLA (inc. White Knuckle Models)	
Buzz 50	03-07
Micro Buggy MK11/111 (RV 50)	05-09
R50 (Rear disc model)	03-06
R50 (Rear drum model)	
WK 50 White Knuckle (Pit Bike)	06-08
WK ONE 50	10-11
WK GP 50	10-11
WK GTR 50	10-11
X50	
ZR50	07-09
WK 70 White Knuckle (Pit Bike) (Front drum model)	06-09
WK 70 White Knuckle (Pit Bike) (Front disc model)	06-09
Black Max M100 (S.E.)	06
Pro Shark 100 (RMX) (Front disc models)	
Pro Shark (Double A Arms)	
Pro Shark 100 (Single A Arms)	
Ram R100	03-05
Ram R100 E	03-05

DISC PAD CHOICES - FRONT				BRAKE DISC CHOICES - FRONT							Line #
FA, SFA, TT Pad or Brake Shoe	SFAC Carbon Scooter Pads	Speciality Pads - SXR / Vee / MXS	Sintered/HH Pads/ Grooved Shoes	Left / Gauche / Links Standard Replacement Disc	Right / Droite / Rechts Standard Replacement Disc	Contour Disc Universal left and right fitment	Universal Custom Disc	Vee-Discs Black † See note below	CX Extreme MX Race Disc/ UTVX Disc	Line #	
			931G							1	
										2	
			H322							3	
										4	
			H322							5	
										6	
			H322							7	
		931G								8	
		931G								9	
		931G								10	
										11	
			H322							12	
										13	
			H322							14	
										15	
			H322							16	
		856								17	
		856								18	
		970								19	
			843G							20	
		932								21	
		FA050			MD866					22	
		FA050			MD866					23	
		856								24	
		972								25	
		932								26	
		FA050		N/A						27	
		FA050		N/A						28	
										29	
										30	
		FA135TT	MXS135	FA135R	N/A					31	
		FA135TT	MXS135	FA135R	N/A					32	
										33	
										34	
		SFA193*	SFAC193*	SFA193HH*	N/A	N/A				35	
		SFA083								36	
		SFA193*	SFAC193*	SFA193HH*	N/A	N/A				37	
		SFA083								38	
		SFA193*	SFAC193*	SFA193HH*	N/A	N/A				39	
		SFA083								40	
										41	
										42	
		N/A								43	
		H346*		H346G*						44	
		S614*		S614G*						45	
		S614*		S614G*						46	
		S614		S614G						47	
		TBA			TBA					48	
		TBA			TBA					49	
		TBA			TBA					50	
		H346*		H346G*						51	
		H346		H346G						52	
		S614		S614G						53	
		SFA169	SFAC169	SFA169HH	N/A					54	
		Y503*		Y503G*						55	
		FA067*		FA067R*	N/A	N/A				56	
		Y503*		Y503G*						57	
		H346*		H346G*						58	
		TBA*								59	
		TBA*								60	

FRONT / AVANT / VORN / FRENTE / ANTERIORE

R Suffix = High Durability Sintered Pad. HH Suffix = High Performance Sintered Pad. TT Suffix = Hard Wearing Off Road Pad. V Suffix = Semi Sintered Pad. G Suffix = Grooved Shoe.

D Suffix = Drilled Disc. X Suffix = Universal Left or Right Disc. XC Suffix = Contoured Disc. LS Suffix = Left/Steel Disc. RS = Right/Steel Disc.

*-2 Sets Required. † For Vee disc colours add RED, BLU, GRN, GLD, ORG suffix to part number.

⊗ - Also available as a Vintage Motorcycle Disc.

368 Part numbers, prefixes, suffixes, photos and illustrations shown in this catalogue are trademarks and/or copyrights of EBC Brakes or the trademark owner A C Freeman Investments Ltd and use without express written permission of the owners is punishable by law.

Non-JAPANESE Built Motorcycles

Line #	BRAKE DISC CHOICES - FRONT						DISC PAD CHOICES - REAR				BRAKE DISC CHOICES - REAR			
	Oversize 250 /280mm Disc Kit	OSX Oversize 250/280mm Disc Kit	Relocating Bracket for 250/ 280mm Disc	Oversize 320mm Disc Kit	SMX Oversize 320mm Disc Kit	Relocating Bracket for 320mm Disc	FA, SFA, TT Pad or Brake Shoe	SFAC Carbon Scooter Pads	Speciality Pads - SXR / Vee / MXS	Sintered/ HH Pads/ Grooved Shoes	Standard Replacement Disc	Contour Disc Rear fitment	Vee-Discs™ CONTOUR	CX Extreme MX Race Disc/ UTVX Disc
1							931		931G					
2														
3							H322							
4														
5							H322							
6														
7							H322							
8							945							
9							945							
10							945							
11														
12							H322							
13														
14							H322							
15														
16							H322							
17							856							
18							856							
19							970							
20									843G					
21							932							
22							932							
23									843G					
24							856							
25							972							
26							932							
27							932							
28							932							
29														
30														
31							FA346TT	MXS346	FA346R	N/A				
32							FA346TT	MXS346	FA346R	N/A				
33														
34														
35							SFA083	SFAC083	SFA083HH	N/A				
36														
37							SFA083	SFAC083	SFA083HH	N/A				
38														
39							SFA083*	SFAC083*	SFA083HH*	N/A*				
40														
41														
42														
43							H302		H302G					
44							FA485TT			N/A				
45							FA232TT		FA232R	N/A				
46							Y527		Y527G					
47							S614		S614G					
48							TBA							
49							TBA							
50							TBA							
51							FA083TT		FA083R	N/A				
52							FA083TT		FA083R	N/A				
53							S614		S614G					
54							S614		S614G					
55							FA083TT		FA083R	N/A				
56							FA083TT		FA083R	N/A				
57							FA083TT		FA083R	N/A				
58							FA083TT		FA083R	N/A				
59							FA083TT		FA083R	N/A				
60							FA083TT		FA083R	N/A				

REAR / ARRIÈRE / HINTEN / POSTERIOR / POSTERIORE

*-2 Sets Required. † For Vee disc colours add RED, BLU, GRN, GLD, ORG suffix to part number.

⊗ - Also available as a Vintage Motorcycle Disc.

R Suffix = High Durability Sintered Pad. HH Suffix = High Performance Sintered Pad. TT Suffix = Hard Wearing Off Road Pad. V Suffix = Semi Sintered Pad. G Suffix = Grooved Shoe.

D Suffix = Drilled Disc. X Suffix = Universal Left or Right Disc. XC Suffix = Contoured Disc. LS Suffix = Left/Steel Disc. RS = Right/Steel Disc.

BRAKE APPLICATIONS

Non-JAPANESE Built Motorcycles

APPLICATIONS

BRAKE



QUADZILLA
(inc. White Knuckle Models) Contd



DISC PAD CHOICES - FRONT

BRAKE DISC CHOICES - FRONT

R100 (Rear disc model)	06-09
R100 (Rear drum model)	
Magmax	03-05
Magmax	
X100 E (XLC)	06-07
X100	
WK 110 White Knuckle (Pit Bike)	06-08
RV 125 Midi RV Bug	
WK 125 White Knuckle (Pit Bike)	06-09
WK 125 S - Efi	10-11
WK 125 SC - Efi	10-11
WK 125 R	10-11
WK 140 White Knuckle (Pit Bike)	06-08
BR 150 E Bugrider	04-06
CVT 150 E	10-11
RV 150 Midi RV Buggy	
Ram R170	03-05
Ram R170 E Stinger	03-05
Stinger R170E	06
4 Cross 200 E SUV	06-07
4 Cross 200cc	
BR 200	07-08
QZ 200 (Front disc model)	
R200 E Stinger	06-07
ST 200 E (Automatic)	06-07
ST 200 E (5 speed manual)	06-07
250e	06-11
BR 250 E Bugrider	05-08
BR 250	
QZ 250 (Front disc model)	
Ram R250	03-05
Ram R250E Stinger	03-05
Stinger R250E	06
XRV 250 (Off Road)	06
XRV 250 E	06-07
XRV 250	
QZ 270	
300e XLC Stinger	07-08
300e XLC	07-08
300e Stinger	09-11
300e SUV (Automatic)	06
300e (4x4) (Auto)	06-07
300e XLC	06-07
300SE 4 Valve	06-07
300e SUV (Manual)	06-07
CUV 300 (4x4 Super Utility Side x Side)	08
CUV 300 E 4x4 Side x Side	08-09
CUV 300 E 4x4 Side x Side - Parking brake	08-09
Jow 300	07-08
Quadzilla 300	04-05
QZ 300 XLC	
QZ 300 E 4x4	
QZ 300 E 4x4 - Parking brake	
RL 300 Buggy	07-08
RL 300 Buggy	09-11
WK 300 White Knuckle (Pit Bike)	06-08
XL 300	
320e 4x4	07-08
320e 4x4 - Parking brake	07-08
320 CUV	

FRONT / AVANT / VORN / FRENTE / ANTERIORE

FA, SFA, TT Pad or Brake Shoe	SFAC Carbon Scooter Pads	Speciality Pads SXR / Vee / MXS	Sintered/HH Pads/ Grooved Shoes	Left / Gauche / Links Standard Replacement Disc	Right / Droite / Rechts Standard Replacement Disc	Contour Disc Universal left and right fitment	Universal Custom Disc	Vee-Discs Black † See note below	CX Extreme MX Race Disc/ UTVX Disc
S614*			S614G*						
S614*			S614G*						
TBA*									
H346*			H346G*						
Y503*			Y503G*						
H346*			H346G*						
SFA169	SFAC169		SFA169HH						
FA416TT*			FA416R*	N/A	N/A				
SFA169	SFAC169		SFA169HH	N/A					
TBA									
TBA				N/A					
TBA				N/A					
FA448				N/A					
FA416TT*			FA416R*	N/A	N/A				
FA453TT*			FA453R*	N/A	N/A				
FA416TT*			FA416R*	N/A	N/A				
Y503*			Y503G*						
Y503*			Y503G*						
Y503*			Y503G*						
FA083TT*			FA083R*	N/A	N/A				
H307*			H307G*						
FA416TT*			FA416R*	N/A	N/A				
FA067TT*			FA067R*	N/A	N/A				
TBA*				N/A	N/A				
Y503*			Y503G*						
FA083TT*			FA083R*	N/A	N/A				
FA067TT*			FA067R*	N/A	N/A				
FA416TT*			FA416R*	N/A	N/A				
FA416TT*			FA416R*	N/A	N/A				
FA416TT*			FA416R*	N/A	N/A				
FA067TT*			FA067R*	N/A	N/A				
FA067TT*			FA067R*	N/A	N/A				
FA067TT*			FA067R*	N/A	N/A				
FA067TT*			FA067R*	N/A	N/A				
FA083TT*			FA083R*	N/A	N/A				
FA416TT*			FA416R*	N/A	N/A				
FA416TT*			FA416R*	N/A	N/A				
FA416TT*			FA416R*	N/A	N/A				
FA067TT*			FA067R*	N/A	N/A				
FA067TT*			FA067R*	N/A	N/A				
FA067TT*			FA067R*	N/A	N/A				
FA453TT*			FA453R*	N/A	N/A				
FA453TT*			FA453R*	N/A	N/A				
FA083TT*			FA083R*	N/A	N/A				
FA083TT*			FA083R*	N/A	N/A				
FA453TT*			FA453R*	N/A	N/A				
FA453TT*			FA453R*	N/A	N/A				
FA482TT*			FA482R*	N/A	N/A				
FA482TT*			FA482R*	N/A	N/A				
FA481									
FA067TT*			FA067R*	N/A	N/A				
FA453TT*			FA453R*	N/A	N/A				
FA067TT*			FA067R*	N/A	N/A				
FA483TT*			FA483R*	N/A	N/A				
FA431TT									
FA416TT*			FA416R*	N/A	N/A				
FA067TT*			FA067R*	N/A	N/A				
FA228			FA228HH	N/A					
FA416TT*			FA416R*	N/A	N/A				
FA453TT*			FA453R*	N/A	N/A				
FA270TT			FA270R						
FA067TT*			FA067R*	N/A	N/A				

Line #
1
2
3
4
5
6
7
8
9
10
11
12
13
14
15
16
17
18
19
20
21
22
23
24
25
26
27
28
29
30
31
32
33
34
35
36
37
38
39
40
41
42
43
44
45
46
47
48
49
50
51
52
53
54
55
56
57
58
59
60

R Suffix = High Durability Sintered Pad. HH Suffix = High Performance Sintered Pad. TT Suffix = Hard Wearing Off Road Pad. V Suffix = Semi Sintered Pad. G Suffix = Grooved Shoe.

D Suffix = Drilled Disc. X Suffix = Universal Left or Right Disc. XC Suffix = Contoured Disc. LS Suffix = Left/Steel Disc. RS = Right/Steel Disc.

*-2 Sets Required. † For Vee disc colours add RED, BLU, GRN, GLD, ORG suffix to part number.

⊗ - Also available as a Vintage Motorcycle Disc.

370 Part numbers, prefixes, suffixes, photos and illustrations shown in this catalogue are trademarks and/or copyrights of EBC Brakes or the trademark owner A C Freeman Investments Ltd and use without express written permission of the owners is punishable by law.

Non-JAPANESE Built Motorcycles

Line #	BRAKE DISC CHOICES - FRONT						DISC PAD CHOICES - REAR				BRAKE DISC CHOICES - REAR			
	Oversize 250 /280mm Disc Kit	OSX Oversize 250/280mm Disc Kit	Relocating Bracket for 250/ 280mm Disc	Oversize 320mm Disc Kit	SMX Oversize 320mm Disc Kit	Relocating Bracket for 320mm Disc	FA, SFA, TT Pad or Brake Shoe	SFAC Carbon Scooter Pads	Speciality Pads - SXR / Vee / MXS	Sintered/ HH Pads/ Grooved Shoes	Standard Replacement Disc	Contour Disc Rear fitment	Vee-Discs™ CONTOUR	CX Extreme MX Race Disc/ UTVX Disc
1							FA083TT			FA083R	N/A			
2							Y527			Y527G				
3							FA083TT			FA083R	N/A			
4							FA083TT			FA083R	N/A			
5							FA083TT			FA083R	N/A			
6							FA083TT			FA083R	N/A			
7							FA086			FA086HH	N/A			
8							FA054TT			FA054R	N/A			
9							FA086			FA086HH	N/A			
10														
11														
12							TBA			TBA	N/A			
13							FA480				N/A			
14							FA054TT			FA054R	N/A			
15							FA431TT			FA431R	N/A			
16							FA054TT			FA054R	N/A			
17							FA135TT			FA135R	N/A			
18							FA135TT			FA135R	N/A			
19							FA135TT			FA135R	N/A			
20							FA067TT			FA067R	N/A			
21							FA165TT			FA165R	N/A			
22							FA054TT			FA054R	N/A			
23							FA067TT			FA067R	N/A			
24							TBA				N/A			
25							FA135TT			FA135R	N/A			
26							FA067TT			FA067R	N/A			
27							FA067TT			FA067R	N/A			
28							FA431TT			FA431R	N/A			
29							FA054TT			FA054R	N/A			
30							FA067TT			FA067R	N/A			
31							FA135TT			FA135R	N/A			
32							FA135TT			FA135R	N/A			
33							FA067TT			FA067R	N/A			
34							FA431TT			FA431R	N/A			
35							FA431TT			FA431R	N/A			
36							FA054TT			FA054R	N/A			
37							FA067TT			FA067R	N/A			
38							FA067TT			FA067R	N/A			
39							FA067TT			FA067R	N/A			
40							FA067TT			FA067R	N/A			
41							FA270TT			FA270R	N/A			
42							FA270TT			FA270R	N/A			
43							FA067TT			FA067R	N/A			
44							FA067TT			FA067R	N/A			
45							FA270TT			FA270R	N/A			
46							FA453TT*			FA453R*	N/A*			
47							FA270TT			FA270R	N/A			
48														
49							FA067TT			FA067R	N/A			
50							FA270TT			FA270R	N/A			
51							FA067TT			FA067R	N/A			
52							FA270TT			FA270R	N/A			
53														
54							FA431TT			FA431R	N/A			
55							FA067TT			FA067R	N/A			
56							FA197			FA197HH	N/A			
57							FA054TT			FA054R	N/A			
58							FA431TT			FA431R	N/A			
59														
60							FA067TT			FA067R	N/A			

REAR / ARRIÈRE / HINTEN / POSTERIOR / POSTERIORE

*-2 Sets Required. † For Vee disc colours add RED, BLU, GRN, GLD, ORG suffix to part number.

⊗ - Also available as a Vintage Motorcycle Disc.

R Suffix = High Durability Sintered Pad. **HH** Suffix = High Performance Sintered Pad. **TT** Suffix = Hard Wearing Off Road Pad. **V** Suffix = Semi Sintered Pad. **G** Suffix = Grooved Shoe.
D Suffix = Drilled Disc. **X** Suffix = Universal Left or Right Disc. **XC** Suffix = Contoured Disc. **LS** Suffix = Left/Steel Disc. **RS** = Right/Steel Disc.

Non-JAPANESE Built Motorcycles

APPLICATIONS

BRAKE



QUADZILLA

(inc. White Knuckle Models) Contd



CVT 320e	07-11
CVT 320e - Parking brake	07-11
QZ 320e 4x4	09
QZ 320e 4x4 - Parking brake	09
325 4 x 4 Quad	10-11
QZ 450 RS	06-09
QZ 450 Sport	08-09
500 4 x 4	06-07
CUV 500 Side x Side	10-11
CUV 500 Side x Side - Parking brake	10-11
QZ 500 E/ES 4x4	09-11
QZ 500 E/ES 4x4 - Parking brake	09-11
RL 500 Buggie	08-09
RL 500 MK 11 Buggie	10-11
RS5 4WD	10-11
RS5 4WD - Parking brake	10-11
XLC 500	10-15
RS6 4WD	Left 10-11
	Right
RS7 4WD	10-11
X7R	10-11
RS8	10-11
Z6 4 x 4	10-13
X8 (4 x 4/Efi)	12-15
Z8 (4 x 4/Side X Side)	Left 14-15
	Right

RIEJU

MIUS-Electric	12-15
MRT 50 (Single piston caliper)	09-20
MRT-Pro 50 (Radial/double piston caliper)	09-20
MRT Supermotard 50 (Cast wheel/single piston caliper)	09-20
MRT-Pro Supermotard (Radial caliper/cast wheel)	09-20
MRT 50 Competizione (Spoke Wheel)	11-14
MRX 50 Castrol	01-02
MRX 50	03-08
MRX 50 Pro/Top	04-08
RS2 NKD	05
NKD 50	07
NKD 50	08-10
Pacific 50 (4T)	08
Urban Blast (50cc)	13-15
RS1 50cc	97-00
RS1 50cc	01-04
RR 50cc Thunderfire	97-02
RR 50 Castrol	00-02
RR 50 Sport	03-06
RRX 50 Spike (17" wheel/spoke wheel)	03-08
RRX 50 Spike (17" cast wheel)	06-09
RRX 50	06-09
RS2 50 FR	09-10
RS2 Matrix (50cc) (AJP Caliper)	02-08
RS2 50cc Matrix (J. Juan Caliper)	07-09
RS2 50cc Pro (J. Juan Caliper)	07-10
RS2 50cc Pro (AJP Caliper)	06-10
RS3 50cc	11-20
RS3 NKD 50	12-20
RS3 Pro 50cc	11-15
RS NKD 50 (Scooter)	13-15
RS Sport 50 (Scooter)	12-15

DISC PAD CHOICES - FRONT				BRAKE DISC CHOICES - FRONT						Line #
FA, SFA, TT Pad or Brake Shoe	SFAC Carbon Scooter Pads	Speciality Pads SXR / Vee / MXS	Sintered/HH Pads/ Grooved Shoes	Left / Gauche / Links Standard Replacement Disc	Right / Droite / Rechts Standard Replacement Disc	Contour Disc Universal left and right fitment	Universal Custom Disc	Vee-Discs Black † See note below	CX Extreme MX Race Disc/ UTVX Disc	
FA453TT*			FA453R*	N/A	N/A					1
FA270TT			FA270R							2
FA483TT*			FA483R*	N/A	N/A					3
FA431TT			FA431R							4
FA483TT*			FA483R*	N/A	N/A					5
FA067TT*			FA067R*	N/A	N/A					6
FA067TT*			FA067R*	N/A	N/A					7
FA453TT*			FA453R*	N/A	N/A					8
FA453TT*			FA453R*	N/A						9
FA232TT	FA232R									10
FA453TT*			FA453R*	N/A	N/A					11
FA232TT	FA232R									12
FA171*			FA171HH*	N/A	N/A					13
FA453TT*			FA453R*	N/A	N/A					14
FA453TT*			FA453R*	N/A	N/A					15
FA232TT	FA232R									16
FA067TT*			FA067R*	N/A	N/A					17
FA135TT			FA135R	N/A	N/A					18
FA165TT			FA165R							19
FA377TT*			FA377R*	N/A	N/A					20
FA377TT*			FA377R*	N/A	N/A					21
FA377TT*			FA377R*	N/A	N/A					22
FA453TT*			FA453R*	N/A	N/A					23
FA453TT*			FA453R*	N/A	N/A					24
FA135TT			FA135R	N/A	N/A					25
FA165TT			FA165R							26
										27
										28
SFA083	SFAC083		SFA083HH		N/A					29
FA093				N/A						30
FA266			FA266HH			N/A				31
FA093				N/A						32
FA266			FA266HH			N/A				33
FA465TT		MXS465	FA465R			N/A				34
FA167			FA167HH	N/A						35
FA115			FA115R	N/A						36
FA194			FA194HH	N/A						37
FA194			FA194HH		N/A					38
FA374				N/A						39
FA375			FA375HH		N/A					40
SFA235	SFAC235			N/A						41
SFA083	SFAC083		SFA083HH	N/A						42
FA115			FA115HH	N/A						43
FA167			FA167HH	N/A						44
FA115			FA115HH	N/A						45
FA167			FA167HH	N/A						46
FA115			FA115HH	N/A						47
FA115			FA115HH	N/A						48
FA115			FA115HH	N/A						49
FA115			FA115HH	N/A						50
FA375			FA375HH		N/A					51
FA374					N/A					52
FA375			FA375HH		N/A					53
FA375			FA375HH			N/A				54
FA194			FA194HH			N/A				55
FA374					N/A					56
FA266		FA266V	FA266HH			N/A				57
FA086			FA086HH		N/A					58
SFA083	SFAC083		SFA083HH			N/A				59
SFA083	SFAC083		SFA083HH			N/A				60

FRONT / AVANT / VORN / FRENTE / ANTERIORE

R Suffix = High Durability Sintered Pad. HH Suffix = High Performance Sintered Pad. TT Suffix = Hard Wearing Off Road Pad. V Suffix = Semi Sintered Pad. G Suffix = Grooved Shoe.

D Suffix = Drilled Disc. X Suffix = Universal Left or Right Disc. XC Suffix = Contoured Disc. LS Suffix = Left/Steel Disc. RS = Right/Steel Disc.

*-2 Sets Required. † For Vee disc colours add RED, BLU, GRN, GLD, ORG suffix to part number.

⊗ - Also available as a Vintage Motorcycle Disc.

372 Part numbers, prefixes, suffixes, photos and illustrations shown in this catalogue are trademarks and/or copyrights of EBC Brakes or the trademark owner A C Freeman Investments Ltd and use without express written permission of the owners is punishable by law.

Non-JAPANESE Built Motorcycles

Line #	BRAKE DISC CHOICES - FRONT						DISC PAD CHOICES - REAR				BRAKE DISC CHOICES - REAR			
	Oversize 250 /280mm Disc Kit	OSX Oversize 250/280mm Disc Kit	Relocating Bracket for 250/ 280mm Disc	Oversize 320mm Disc Kit	SMX Oversize 320mm Disc Kit	Relocating Bracket for 320mm Disc	FA, SFA, TT Pad or Brake Shoe	SFAC Carbon Scooter Pads	Speciality Pads - SXR / Vee / MXS	Sintered/ HH Pads/ Grooved Shoes	Standard Replacement Disc	Contour Disc Rear fitment	Vee-Discs™ CONTOUR	CX Extreme MX Race Disc/ UTVX Disc
1							FA431TT			FA431R	N/A			
2														
3							FA270TT			FA270R	N/A			
4														
5							FA482TT			FA482R	N/A			
6							FA067TT			FA067R	MD6348D			
7							FA067TT			FA067R	MD6348D			
8							FA270TT			FA270R	N/A			
9							FA344TT			FA344R	N/A			
10														
11							FA344TT			FA344R	N/A			
12														
13							FA171*			FA171HH*	N/A*			
14							FA344TT			FA344R	N/A			
15							FA344TT			FA344R	N/A			
16														
17							FA067TT			FA067R	N/A			
18							TBA*			TBA*	N/A*			
19														
20							FA067TT			FA067R	N/A			
21							FA067TT			FA067R	N/A			
22							FA067TT			FA067R	N/A			
23							FA344TT			FA344R	N/A			
24							FA344TT			FA344R	N/A			
25							FA651TT			FA651R	N/A*			
26							FA651TT			FA651R				
27														
28														
29							SFA083	SFAC083		SFA083HH	N/A			
30							FA093				N/A			
31							FA093					N/A		
32							FA093				N/A			
33							FA093		N/A			N/A		
34							FA367/2TT			FA367/2R		N/A		
35							FA115			FA115HH	N/A			
36							FA115			FA115R	N/A			
37							FA115			FA115HH	N/A			
38							FA115			FA115HH	N/A			
39							FA115			FA115HH	TBA			
40							FA093				N/A			
41							TBA							
42							Y530							
43							FA115			FA115HH	N/A			
44							FA115			FA115HH	N/A			
45							FA115			FA115HH	N/A			
46							FA115			FA115HH	N/A			
47							FA115			FA115HH	N/A			
48							FA115			FA115HH	N/A			
49							FA115			FA115HH	N/A			
50							FA115			FA115HH	N/A			
51							FA093				N/A			
52							FA350			FA350HH	N/A			
53							FA093				N/A			
54							FA093					N/A		
55							FA350			FA350HH		N/A		
56							FA093				N/A			
57							FA083TT			FA083HH		N/A		
58							FA093				N/A			
59							SFA193	SFAC193		SFA193HH		N/A		
60							SFA193	SFAC193		SFA193HH		N/A		

REAR / ARRIÈRE / HINTEN / POSTERIOR / POSTERIORE

*-2 Sets Required. † For Vee disc colours add RED, BLU, GRN, GLD, ORG suffix to part number.

⊗ - Also available as a Vintage Motorcycle Disc.

R Suffix = High Durability Sintered Pad. **HH** Suffix = High Performance Sintered Pad. **TT** Suffix = Hard Wearing Off Road Pad. **V** Suffix = Semi Sintered Pad. **G** Suffix = Grooved Shoe.
D Suffix = Drilled Disc. **X** Suffix = Universal Left or Right Disc. **XC** Suffix = Contoured Disc. **LS** Suffix = Left/Steel Disc. **RS** = Right/Steel Disc.

Non-JAPANESE Built Motorcycles

APPLICATIONS

BRAKE



RIEJU Contd.



Model	Year
SMX 50	02-06
SMX 50 Pro Supermotard/Top	04-07
SMX 50 Pro Street (Cast wheel)	06-08
SMX 50 (Cast Wheel)	07-08
Spike 50	04-06
Spike 50 Pro	04
Spike X50	06-07
Tango 50 (Spoke Wheel)	11
Tango 50 Motard	09-10
Tango 50 Motard (Cast Wheel)	11
Tango 50 (2T)	07-12
Tango 50 (2T)	13-15
Toreo 50 (4T)	07-08
Cityline 125 ie	13-15
Marathon 125 (Air Cooled)	10-15
Marathon 125 SM (Air Cooled)	10-15
Marathon Pro 125 (Radial/double piston caliper/Spoke Wheel)	09-20
Marathon Pro 125 Competizione (Spoke Wheel)	11-14
Marathon Pro Supermotard 125 (Cast wheel/radial caliper)	09-20
MRX 125	02-08
NKD 125	06-07
NKD 125	08-10
Pacific 125 (4T)	08
Pacific 125 Scooter	09
RS2 125 (AJP Caliper)	06-10
RS2 125 (J. Juan Caliper)	07-10
RS2 125 Pro (J. Juan Caliper)	07-10
RS3 NKD 125cc	11-20
RS3 125cc (Sport)	11-20
SMX 125	02-07
SMX 125 (Cast wheel)	07-08
Tango 125	06-10
Tango 125 (4T)	11-20
Tango 125 Motard (Cast wheel)	08-09
Tango Pro 125	07-10
Marathon 200 Pro SM	11-15
Marathon 250	09-10
Tango 250	08-11
Tango 250 (4T)	12-15
Cityline 300 ie	14-15
Marathon 450	09-10

ROXON

Duel 50 SM	06
Duel 50 SM	06
Duel 50 TT	06
Fox 50 (Quad)	04-06
Go-Kart Enfant X-Cube	06
Silver Fox 50 (Quad)	04-06
Fox 100 (Quad)	04-06
RX 150 (Quad)	04-06
Sport Spirit NFS 150 (Quad)	04-06

ROVIGO

Spoletto 50cc	04-05
Tempesta 50cc	04-05
Tempesta 90cc	04-05

DISC PAD CHOICES - FRONT

BRAKE DISC CHOICES - FRONT

FA, SFA, TT Pad or Brake Shoe	SFAC Carbon Scooter Pads	Speciality Pads - SXR / Vee / MXS	Sintered/HH Pads/ Grooved Shoes	BRAKE DISC CHOICES - FRONT							Line #
				Left / Gauche / Links Standard Replacement Disc	Right / Droite / Rechts Standard Replacement Disc	Contour Disc Universal left and right fitment	Universal Custom Disc	Vee-Discs Black † See note below	CX Extreme MX Race Disc/ UTVX Disc		
FA115			FA115R	N/A						1	
FA194			FA194HH	N/A						2	
FA194			FA194HH	N/A						3	
FA115			FA115HH	N/A						4	
FA115			FA115HH	N/A						5	
FA167			FA167HH	N/A						6	
FA115			FA115HH	N/A						7	
FA093				N/A						8	
FA093				N/A						9	
FA093				N/A						10	
FA266			FA266HH	N/A						11	
FA465TT		MXS465	FA465R	N/A						12	
SFA235	SFAC235			N/A						13	
SFA353	SFAC353		SFA353HH			N/A				14	
FA093						N/A				15	
FA093						N/A				16	
FA266			FA266HH			N/A				17	
FA465TT		MXS465	FA465R			N/A				18	
FA266			FA266HH			N/A				19	
FA167			FA167HH	N/A						20	
FA374					N/A					21	
FA375			FA375HH		N/A					22	
SFA235	SFAC235			N/A						23	
SFA235	SFAC235			TBA						24	
FA374					N/A					25	
FA375			FA375HH		N/A					26	
FA375			FA375HH			N/A				27	
FA266		FA266V	FA266HH			N/A				28	
FA374					N/A					29	
FA167			FA167HH	N/A						30	
FA266			FA266HH	N/A						31	
FA266			FA266HH	N/A						32	
FA465TT		MXS465	FA465R	N/A						33	
FA266			FA266HH	N/A						34	
FA266			FA266HH			N/A				35	
FA266			FA266HH			N/A				36	
FA181TT		MXS181	FA181R			N/A				37	
FA266			FA266HH	N/A						38	
FA465TT		MXS465	FA465R	N/A						39	
SFA353	SFAC353		SFA353HH			N/A				40	
FA181TT		MXS181	FA181R			N/A				41	
										42	
										43	
FA115			FA115HH	N/A						44	
FA115			FA115HH	N/A						45	
FA115			FA115HH	N/A						46	
H338*			H338C*							47	
N/A										48	
TBA*										49	
TBA*										50	
TBA*										51	
TBA*										52	
										53	
										54	
TBA				N/A						55	
TBA				N/A						56	
TBA				N/A						57	
										58	
										59	
										60	

*-2 Sets Required. † For Vee disc colours add RED, BLU, GRN, GLD, ORG suffix to part number.

⊗ - Also available as a Vintage Motorcycle Disc.

Non-JAPANESE Built Motorcycles

Line #	BRAKE DISC CHOICES - FRONT						DISC PAD CHOICES - REAR				BRAKE DISC CHOICES - REAR			
	Oversize 250 /280mm Disc Kit	OSX Oversize 250/280mm Disc Kit	Relocating Bracket for 250/ 280mm Disc	Oversize 320mm Disc Kit	SMX Oversize 320mm Disc Kit	Relocating Bracket for 320mm Disc	FA, SFA, TT Pad or Brake Shoe	SFAC Carbon Scooter Pads	Speciality Pads - SXR / Vee / MXS	Sintered/ HH Pads/ Grooved Shoes	Standard Replacement Disc	Contour Disc Rear fitment	Vee-Discs™ CONTOUR	CX Extreme MX Race Disc/ UTVX Disc
1							FA115			FA115R	N/A			
2							FA115			FA115HH	N/A			
3							FA115			FA115HH	N/A			
4							FA115			FA115HH	N/A			
5							FA115			FA115HH	N/A			
6							FA115			FA115HH	N/A			
7							FA115			FA115HH	N/A			
8							FA093				N/A			
9							FA350			FA350HH	N/A			
10							FA350			FA350HH	N/A			
11							FA350			FA350HH	N/A			
12							FA350			FA350HH	N/A			
13							TBA							
14							SFA266	SFAC266		SFA266HH		N/A		
15							FA093				N/A			
16							FA093				N/A			
17							FA093					N/A		
18							FA367/2TT			FA367/2R		N/A		
19							FA093					N/A		
20							FA115			FA115HH	N/A			
21							FA350			FA350HH	N/A			
22							FA093				N/A			
23							TBA							
24							TBA							
25							FA350			FA350HH	N/A			
26							FA093				N/A			
27							FA093					N/A		
28							FA083TT			FA083HH		N/A		
29							FA083TT			FA083HH	N/A			
30							FA350			FA350HH	N/A			
31							FA350			FA350HH	N/A			
32							FA350			FA350HH	N/A			
33							FA350TT				N/A			
34							FA093				N/A			
35							FA350			FA350HH		N/A		
36							FA093					N/A		
37							FA368TT		MXS368	FA368R		N/A		
38							FA350			FA350HH	N/A			
39							FA350TT				N/A			
40							SFA266	SFAC266		SFA266HH		N/A		
41							FA368TT		MXS368	FA368R		N/A		
42														
43														
44							FA115			FA115HH	N/A			
45							FA115			FA115HH	N/A			
46							FA115			FA115HH	N/A			
47							H307			H307G				
48							TBA				N/A			
49							TBA							
50							TBA							
51							FA083TT			FA083R	N/A			
52							FA083TT			FA083R	N/A			
53														
54														
55							TBA							
56							TBA							
57							TBA							
58														
59														
60														

REAR / ARRIÈRE / HINTEN / POSTERIOR / POSTERIORE

*-2 Sets Required. † For Vee disc colours add RED, BLU, GRN, GLD, ORG suffix to part number.

⊗ - Also available as a Vintage Motorcycle Disc.

R Suffix = High Durability Sintered Pad. **HH** Suffix = High Performance Sintered Pad. **TT** Suffix = Hard Wearing Off Road Pad. **V** Suffix = Semi Sintered Pad. **G** Suffix = Grooved Shoe.
D Suffix = Drilled Disc. **X** Suffix = Universal Left or Right Disc. **XC** Suffix = Contoured Disc. **LS** Suffix = Left/Steel Disc. **RS** = Right/Steel Disc.

Non-JAPANESE Built Motorcycles

Line #	BRAKE DISC CHOICES - FRONT						DISC PAD CHOICES - REAR				BRAKE DISC CHOICES - REAR			
	Oversize 250 /280mm Disc Kit	OSX Oversize 250/280mm Disc Kit	Relocating Bracket for 250/ 280mm Disc	Oversize 320mm Disc Kit	SMX Oversize 320mm Disc Kit	Relocating Bracket for 320mm Disc	FA, SFA, TT Pad or Brake Shoe	SFAC Carbon Scooter Pads	Speciality Pads - SXR / Vee / MXS	Sintered/ HH Pads/ Grooved Shoes	Standard Replacement Disc	Contour Disc Rear fitment	Vee-Discs™ CONTOUR	CX Extreme MX Race Disc/ UTVX Disc
1							N/A							
2							FA213		FA213V	FA213HH				
3							N/A							
4							N/A							
5							N/A							
6							N/A							
7							N/A							
8							FA213		FA213V	FA213HH				
9							FA213		FA213V	FA213HH				
10							N/A							
11							N/A							
12							N/A							
13							FA213		FA213V	FA213HH	MD894	MD894C		
14							N/A							
15							N/A							
16							FA213		FA213V	FA213HH	MD651			
17							FA213		FA213V	FA213HH	MD877			
18							FA213		FA213V	FA213HH	MD894	MD894C		
19							FA213		FA213V	FA213HH	MD894	MD894C		
20														
21														
22							N/A							
23							TBA							
24							N/A							
25							922							
26							N/A							
27							921							
28							TBA							
29							FA115		FA115HH	N/A				
30							N/A			N/A				
31							FA054TT		FA054HH	N/A				
32							TBA							
33							TBA							
34							TBA							
35							TBA							
36							Y503							
37							921							
38							921							
39							922							
40							922							
41														
42							Y506							
43							FA351TT			N/A				
44							TBA							
45							FA086		FA086HH	N/A				
46							FA054TT		FA054HH	N/A				
47							SFA260	SFAC260			N/A			
48							Y506							
49							TBA							
50							FA382			MD860				
51							FA382			MD815				
52							FA382			MD815				
53							FA382			N/A				
54							FA382			N/A				
55							TBA							
56							SFA260		SFA260HH	TBA				
57							FA382			MD659				
58							FA101			MD659				
59							S626							
60							S626							

REAR / ARRIÈRE / HINTEN / POSTERIOR / POSTERIORE

*-2 Sets Required. † For Vee disc colours add RED, BLU, GRN, GLD, ORG suffix to part number.

⊗ - Also available as a Vintage Motorcycle Disc.

R Suffix = High Durability Sintered Pad. **HH** Suffix = High Performance Sintered Pad. **TT** Suffix = Hard Wearing Off Road Pad. **V** Suffix = Semi Sintered Pad. **G** Suffix = Grooved Shoe.
D Suffix = Drilled Disc. **X** Suffix = Universal Left or Right Disc. **XC** Suffix = Contoured Disc. **LS** Suffix = Left/Steel Disc. **RS** = Right/Steel Disc.

Part numbers, prefixes, suffixes, photos and illustrations shown in this catalogue are trademarks and/or copyrights of EBC Brakes or the trademark owner A C Freeman Investments Ltd and use without express written permission of the owners is punishable by law.

Non-JAPANESE Built Motorcycles

APPLICATIONS

BRAKE



SCARABEO

See Aprilia Section For Pre-2010 Models



50 (2T/Street)	10-15
50 Net (4T/4V)	10-11
50 (4T/4V)	10-15
50 YourZ (4T/4V)	10-11
100 (4T)	10-15
125ie	10-15
125 Net	10-11
200ie	10-15
200 Net	10-11
300S ie	09-12
500ie	10-12

SCOMADI

TL 50 Air Cooled	15-18
TL 125 Air Cooled	15-18
TL200 Liquid Cooled	15-18

SCORPA

SR 125 (2T) (Rear pad with large friction area)	10-13
SR 125 (2T) (Rear pad with small friction area)	10-13
SR 125 Long Ride (2T) (Rear pad with large friction area)	10-11
SR 125 Long Ride (2T) (Rear pad with small friction area)	10-11
SY 125 F (4T) (Rear pad with large friction area)	03-10
SY 125 F (4T) (Rear pad with small friction area)	03-10
SY 125 FR (4T) (Rear pad with large friction area)	03-11
SY 125 FR (4T) (Rear pad with small friction area)	03-11
SY 125 (4T) Long Ride (Rear pad with large friction area)	09-10
SY 125 (4T) Long Ride (Rear pad with small friction area)	09-10
T-Ride 125 F (Enduro)	10
T-Ride 125 (2T/Enduro)	12-15
TY 125 (4T) (Rear pad with large friction area)	11-15
TY-S 125 F Enduro	03-05
TY-S 125 F (Rear pad with large friction area)	06-07
TY-S 125 F (Rear pad with small friction area)	06-07
TY-S 125 F Long Ride (Rear pad with large friction area)	06-08
TY-S 125 F Long Ride (Rear pad with small friction area)	06-08
Twenty 125 (2T)	15
SY 175 F (Rear pad with large friction area)	06
SY 175 F (Rear pad with small friction area)	06
TY-S 175 F (Rear pad with large friction area)	06
TY-S 175 F (Rear pad with small friction area)	06
SY 200 F (4T) (163cc) (Rear pad with large friction area)	08
SY 200 F (4T) (163cc) (Rear pad with small friction area)	08
250 Easy	96-99
SY 250 (2T) (Rear pad with large friction area)	00-05
SY 250 (2T) (Rear pad with small friction area)	00-05
SY 250 R (2T) (Rear pad with large friction area)	00-05
SY 250 R (2T) (Rear pad with small friction area)	00-05
SY 250 (2T) (Rear pad with large friction area)	06-09
SY 250 (2T) (Rear pad with small friction area)	06-09
SY 250 R (2T) (Rear pad with large friction area)	06-09
SY 250 R (2T) (Rear pad with small friction area)	06-09
SY 250 Long Ride (2T) (Rear pad with large friction area)	04-06
SY 250 Long Ride (2T) (Rear pad with small friction area)	04-06
SY 250 F (4T) (Rear pad with large friction area)	06-10
SY 250 F (4T) (Rear pad with small friction area)	06-10
SY 250 FR (4T) (Rear pad with large friction area)	06-10
SY 250 FR (4T) (Rear pad with small friction area)	06-10
SY 250 F (4T) Long Ride (Rear pad with large friction area)	07-08
SY 250 F (4T) Long Ride (Rear pad with small friction area)	07-08

FRONT / AVANT / VORN / FRENTE / ANTERIORE

DISC PAD CHOICES - FRONT					BRAKE DISC CHOICES - FRONT						Line #
FA, SFA, TT Pad or Brake Shoe	SFAC Carbon Scooter Pads	Speciality Pads - SXR / Vee / MXS	Sintered/ HH Pads/ Grooved Shoes	Left / Gauche / Links Standard Replacement Disc	Right / Droite / Rechts Standard Replacement Disc	Contour Disc Universal left and right fitment	Universal Custom Disc	Vee-Discs Black † See note below	CX Extreme MX Race Disc/ UTVX Disc		
SFA083/2			SFA083/2HH	MD945D				VR945		1	
SFA083/2			SFA083/2HH	MD945D				VR945		2	
SFA083/2			SFA083/2HH	MD945D				VR945		3	
SFA083/2			SFA083/2HH	MD945D				VR945		4	
SFA083/2			SFA083/2HH	MD945D				VR945		5	
SFA324	SFAC324		SFA324HH	MD960D				VR960		6	
SFA324	SFAC324		SFA324HH	MD960D				VR960		7	
SFA324	SFAC324		SFA324HH	MD960D				VR960		8	
SFA324	SFAC324		SFA324HH	MD960D				VR960		9	
SFA324	SFAC324		SFA324HH	MD952D				VR952		10	
SFA256*	SFAC256*		SFA256HH*	MD952D	MD952D			VR952*		11	
										12	
										13	
SFA086										14	
SFA086										15	
SFA086										16	
										17	
										18	
										19	
FA303TT				N/A						20	
FA303TT				N/A						21	
FA303TT				N/A						22	
FA303TT				N/A						23	
FA303TT				N/A						24	
FA303TT				N/A						25	
FA303TT				N/A						26	
FA303TT				N/A						27	
FA303TT				N/A						28	
FA465TT		MXS465	FA465R	N/A						29	
FA083TT			FA083R			N/A				30	
FA303TT				N/A						31	
FA115TT		MXS115	FA115R	N/A						32	
FA115TT		MXS115	FA115R	N/A						33	
FA115TT		MXS115	FA115R	N/A						34	
FA115TT		MXS115	FA115R	N/A						35	
FA115TT		MXS115	FA115R	N/A						36	
FA303TT				N/A						37	
FA303TT				N/A						38	
FA303TT				N/A						39	
FA115TT		MXS115	FA115R	N/A						40	
FA115TT		MXS115	FA115R	N/A						41	
FA303TT				N/A						42	
FA303TT				N/A						43	
FA115TT		MXS115	FA115R	N/A						44	
FA303TT				N/A						45	
FA303TT				N/A						46	
FA303TT				N/A						47	
FA303TT				N/A						48	
FA303TT				N/A						49	
FA303TT				N/A						50	
FA303TT				N/A						51	
FA303TT				N/A						52	
FA303TT				N/A						53	
FA303TT				N/A						54	
FA303TT				N/A						55	
FA303TT				N/A						56	
FA303TT				N/A						57	
FA303TT				N/A						58	
FA303TT				N/A						59	
FA303TT				N/A						60	

*-2 Sets Required. † For Vee disc colours add RED, BLU, GRN, GLD, ORG suffix to part number.

⊗ - Also available as a Vintage Motorcycle Disc.

378 Part numbers, prefixes, suffixes, photos and illustrations shown in this catalogue are trademarks and/or copyrights of EBC Brakes or the trademark owner A C Freeman Investments Ltd and use without express written permission of the owners is punishable by law.

R Suffix = High Durability Sintered Pad. HH Suffix = High Performance Sintered Pad. TT Suffix = Hard Wearing Off Road Pad. V Suffix = Semi-Sintered Pad. G Suffix = Grooved Shoe.
D Suffix = Drilled Disc. X Suffix = Universal Left or Right Disc. XC Suffix = Contoured Disc. LS Suffix = Left/Steel Disc. RS Suffix = Right/Steel Disc.

Non-JAPANESE Built Motorcycles

Line #	BRAKE DISC CHOICES - FRONT						DISC PAD CHOICES - REAR				BRAKE DISC CHOICES - REAR			
	Oversize 250 /280mm Disc Kit	OSX Oversize 250/280mm Disc Kit	Relocating Bracket for 250/ 280mm Disc	Oversize 320mm Disc Kit	SMX Oversize 320mm Disc Kit	Relocating Bracket for 320mm Disc	FA, SFA, TT Pad or Brake Shoe	SFAC Carbon Scooter Pads	Speciality Pads - SXR / Vee / MXS	Sintered/ HH Pads/ Grooved Shoes	Standard Replacement Disc	Contour Disc Rear fitment	Vee-Discs™ CONTOUR	CX Extreme MX Race Disc/ UTVX Disc
1							816							
2							816							
3							816							
4							816							
5							816							
6							SFA298	SFAC298		SFA298HH	TBA			
7							SFA298	SFAC298		SFA298HH	TBA			
8							SFA298	SFAC298		SFA298HH	TBA			
9							SFA298	SFAC298		SFA298HH	TBA			
10							SFA298	SFAC298		SFA298HH	TBA			
11							SFA298	SFAC298		SFA298HH	TBA			
12														
13														
14							TBA							
15							TBA							
16							SFA264							
17														
18														
19							FA351TT				N/A			
20							FA471				N/A			
21							FA351TT				N/A			
22							FA471				N/A			
23							FA351TT				N/A			
24							FA471				N/A			
25							FA351TT				N/A			
26							FA471				N/A			
27							FA351TT				N/A			
28							FA471				N/A			
29							FA350TT				N/A			
30							FA083TT		FA083R		N/A			
31							FA351TT				N/A			
32							FA115TT	MXS115	FA115R		N/A			
33							FA351TT				N/A			
34							FA471				N/A			
35							FA351TT				N/A			
36							FA471				N/A			
37							FA351TT				N/A			
38							FA351TT				N/A			
39							FA471				N/A			
40							FA351TT				N/A			
41							FA471				N/A			
42							FA351TT				N/A			
43							FA471				N/A			
44							FA115TT	MXS115	FA115R		N/A			
45							FA351TT				N/A			
46							FA471				N/A			
47							FA351TT				N/A			
48							FA471				N/A			
49							FA351TT				N/A			
50							FA471				N/A			
51							FA351TT				N/A			
52							FA471				N/A			
53							FA351TT				N/A			
54							FA471				N/A			
55							FA351TT				N/A			
56							FA471				N/A			
57							FA351TT				N/A			
58							FA471				N/A			
59							FA351TT				N/A			
60							FA471				N/A			

REAR / ARRIÈRE / HINTEN / POSTERIOR / POSTERIORE

*-2 Sets Required. † For Vee disc colours add RED, BLU, GRN, GLD, ORG suffix to part number.

⊗ - Also available as a Vintage Motorcycle Disc.

R Suffix = High Durability Sintered Pad. **HH** Suffix = High Performance Sintered Pad. **TT** Suffix = Hard Wearing Off Road Pad. **V** Suffix = Semi Sintered Pad. **G** Suffix = Grooved Shoe.
D Suffix = Drilled Disc. **X** Suffix = Universal Left or Right Disc. **XC** Suffix = Contoured Disc. **LS** Suffix = Left/Steel Disc. **RS** = Right/Steel Disc.

Part numbers, prefixes, suffixes, photos and illustrations shown in this catalogue are trademarks and/or copyrights of EBC Brakes or the trademark owner A C Freeman Investments Ltd and use without express written permission of the owners is punishable by law.

Non-JAPANESE Built Motorcycles

APPLICATIONS

BRAKE



SCORPA Contd.

SY 250 FR (4T) Long Ride (Rear pad with large friction area)	10
SY 250 FR (4T) Long Ride (Rear pad with small friction area)	10
Twenty 250 (2T)	15
SR 280 (2T) (Rear pad with large friction area)	09-14
SR 280 (2T) (Rear pad with small friction area)	09-14
SR 280 (2T) Long Ride (Rear pad with large friction area)	09-11
SR 280 (2T) Long Ride (Rear pad with small friction area)	09-11
T-Ride 250 F (Enduro)	08-11
T-Ride 280 (2T/Enduro)	12-15
Twenty 300 (2T)	15
Raidster 660 (Rear pad with large friction area)	07
Raidster 660 (Rear pad with small friction area)	07

SFM

Bee 50 (2T)	14-15
Speedjet 50 (2T)	14-15
Speedjet RS3 50 (2T)	14-15
Speedjet R 50 (2T)	14-15
Bee 125 (4T)	14-15
SFM 125 8A Roadster	13-15
ZX 125 Enduro (Spoke Wheels/Matching Pads)	13-15
ZX 125 Enduro (Spoke Wheels/Hooked Pad)	13-15
ZZ 125 SM (Cast Wheel/Matching Pads)	13-15
ZZ 125 SM (Cast Wheel/Hooked Pad)	13-15

SHERCO

Trials 0.5 (50cc 2T)	02
Enduro 50cc (2T)	02-07
Enduro 50c (2T) (Urban/SU - Spoke wheel models)	08-13
50 SE-R	14-15
Supermotard 50cc (2T)	02-07
Supermotard 50cc (2T)	08-13
SU 50 (2T) (Urban Base - Cast wheel model)	10
SM 0.5cc Black Panther	08-10
50 SM-R	14-15
50cc Americas SM-RS	19-20
50cc Americas SM-R	19-20
50cc Factory SE-RS	19-20
50cc Factory SE-R	19-20
50cc Factory SM-RS	19-20
50cc Factory SM-R	19-20
Trials 0.8 (2T)	01-04
Trials 0.8 (2T)	05-10
ST 80 (2T/Formula Calipers)	13-14
ST 80 (2T/Braktec Calipers)	14-15
City Corp 125 (All models)	03-07
City Corp 125 (All models)	08
FST 125	18-19
Trials 1.25cc (2T)	99-05
Trials 1.25cc (2T/AJP Calipers)	06-12
SE 1.25 F Enduro (4T)	10-12
SM 1.25 i F Black Panther (4T)	10-12
ST 125 (2T/Formula Calipers)	13-14
ST 125 (2T/Braktec Calipers)	14-15
125 ST-R	18-19
125 TY Classic	18-19
125 SC-Factory	19-20
125 SE-R	19-20
125 X-Ride	19-20
X-Ride 125	12-15

DISC PAD CHOICES - FRONT

FA, SFA, TT
Pad or
Brake
Shoe

SFAC
Carbon
Scooter
Pads

Specialty
Pads
SXR / Vee
/ MXS

Sintered/
HH Pads/
Grooved
Shoes

Left / Gauche
/ Links
Standard
Replacement
Disc

Right / Droite
/ Rechts
Standard
Replacement
Disc

Contour
Disc
Universal left
and right
fitment

Universal
Custom
Disc

Vee-Discs
Black
† See note
below

CX Extreme
MX Race
Disc/ UTVX
Disc

FRONT / AVANT / VORN / FRENTE / ANTERIORE

Line #

FA303TT				N/A						
FA303TT				N/A						
FA303TT				N/A						
FA303TT				N/A						
FA303TT				N/A						
FA303TT				N/A						
FA303TT				N/A						
FA465TT		MXS465	FA465R	N/A						
FA083TT			FA083R			N/A				
FA303TT				N/A						
FA244			FA244HH	TBA						
FA244			FA244HH	TBA						
SFA101	SFAC101		SFA101HH	N/A		N/A				
SFA235	SFAC235					N/A				
SFA235	SFAC235					N/A				
SFA235	SFAC235					N/A				
SFA101	SFAC101		SFA101HH	N/A		N/A				
FA228			FA228HH	N/A						
FA086			FA086HH			N/A				
FA228			FA228HH							
FA086			FA086HH							
FA228			FA228HH							
TBA										
FA167			FA167HH	N/A						
FA194			FA194HH	N/A						
FA083TT			FA083R			N/A				
FA167			FA167HH	N/A						
FA194			FA194HH	N/A						
FA093						N/A				
FA194			FA194HH			N/A				
FA083TT			FA083R			N/A				
FA083TT			FA083R							
FA083TT			FA083R							
FA083TT			FA083R							
FA083TT			FA083R							
FA083TT			FA083R							
FA083TT			FA083R							
FA083TT			FA083R							
FA115TT		MXS115	FA115R	N/A						
FA303TT				N/A						
FA612TT			FA612R	N/A						
FA303TT				N/A						
FA167			FA167HH	N/A						
FA194			FA194HH	N/A						
FA303TT										
FA115TT		MXS115	FA115R	N/A						
FA303TT				N/A						
FA194			FA194HH	N/A						
FA194			FA194HH	N/A						
FA612TT			FA612R	N/A						
FA303TT				N/A						
FA303TT										
FA303TT										
FA181TT		MXS181	FA181R							
FA181TT		MXS181	FA181R							
FA083TT			FA083R							
FA083TT			FA083R			N/A				

*-2 Sets Required. † For Vee disc colours add RED, BLU, GRN, GLD, ORG suffix to part number.

⊗ - Also available as a Vintage Motorcycle Disc.

380 Part numbers, prefixes, suffixes, photos and illustrations shown in this catalogue are trademarks and/or copyrights of EBC Brakes or the trademark owner A C Freeman Investments Ltd and use without express written permission of the owners is punishable by law.

Non-JAPANESE Built Motorcycles

Line #	BRAKE DISC CHOICES - FRONT						DISC PAD CHOICES - REAR				BRAKE DISC CHOICES - REAR			
	Oversize 250 /280mm Disc Kit	OSX Oversize 250/280mm Disc Kit	Relocating Bracket for 250/ 280mm Disc	Oversize 320mm Disc Kit	SMX Oversize 320mm Disc Kit	Relocating Bracket for 320mm Disc	FA, SFA, TT Pad or Brake Shoe	SFAC Carbon Scooter Pads	Speciality Pads - SXR / Vee / MXS	Sintered/ HH Pads/ Grooved Shoes	Standard Replacement Disc	Contour Disc Rear fitment	Vee-Discs™ CONTOUR	CX Extreme MX Race Disc/ UTVX Disc
1							FA351TT				N/A			
2							FA471				N/A			
3							FA351TT				N/A			
4							FA351TT				N/A			
5							FA471				N/A			
6							FA351TT				N/A			
7							FA471				N/A			
8							FA350TT				N/A			
9							FA083TT		FA083R		N/A			
10							FA351TT				N/A			
11							FA351TT				TBA			
12							FA471				TBA			
13														
14														
15							TBA							
16							TBA							
17							SFA260	SFAC260	SFA260HH		N/A			
18							TBA							
19							TBA							
20							Y527							
21							FA197		FA197HH		N/A			
22							FA197		FA197HH					
23							FA197		FA197HH					
24							FA197		FA197HH					
25														
26														
27							TBA							
28							FA115		FA115HH	N/A				
29							FA350		FA350HH	N/A				
30							FA083TT		FA083R		N/A			
31							FA115		FA115HH	N/A				
32							FA350		FA350HH	N/A				
33							FA350				N/A			
34							FA350		FA350HH		N/A			
35							FA083TT		FA083R		N/A			
36							FA083TT		FA083R					
37							FA083TT		FA083R					
38							FA083TT		FA083R					
39							FA083TT		FA083R					
40							FA083TT		FA083R					
41							FA083TT		FA083R					
42							FA351TT				N/A			
43							FA351TT				N/A			
44							FA351TT				N/A			
45							FA351TT				N/A			
46							FA115		FA115HH	N/A				
47							FA350		FA350HH	N/A				
48							FA351TT							
49							FA115TT	MXS115	FA115R	N/A				
50							FA351TT				N/A			
51							FA350		FA350HH	N/A				
52							FA350		FA350HH	N/A				
53							FA351TT				N/A			
54							FA351TT				N/A			
55							FA351TT							
56							FA351TT							
57							FA368TT	MXS368	FA368R					
58							FA368TT	MXS368	FA368R					
59							FA083TT		FA083R					
60							FA083TT		FA083R		N/A			

REAR / ARRIÈRE / HINTEN / POSTERIOR / POSTERIORE

*-2 Sets Required. † For Vee disc colours add RED, BLU, GRN, GLD, ORG suffix to part number.
 Ⓢ - Also available as a Vintage Motorcycle Disc.

R Suffix = High Durability Sintered Pad. **HH** Suffix = High Performance Sintered Pad. **TT** Suffix = Hard Wearing Off Road Pad. **V** Suffix = Semi Sintered Pad. **G** Suffix = Grooved Shoe.
D Suffix = Drilled Disc. **X** Suffix = Universal Left or Right Disc. **XC** Suffix = Contoured Disc. **LS** Suffix = Left/Steel Disc. **RS** = Right/Steel Disc.

BRAKE APPLICATIONS

Non-JAPANESE Built Motorcycles

APPLICATIONS

BRAKE



SHERCO Contd.



DISC PAD CHOICES - FRONT

BRAKE DISC CHOICES - FRONT

		FA, SFA, TT Pad or Brake Shoe	SFAC Carbon Scooter Pads	Speciality Pads SXR / Vee / MXS	Sintered/ HH Pads/ Grooved Shoes	Left / Gauche / Links Standard Replacement Disc	Right / Droite / Rechts Standard Replacement Disc	Contour Disc Universal left and right fitment	Universal Custom Disc	Vee-Discs Black † See note below	CX Extreme MX Race Disc/ UTVX Disc	Line #
XY 125 (4T)	14-15	FA303TT				N/A						1
Trials 2.0cc (2T)	99-05	FA115TT		MXS115	FA115R	N/A						2
Trials 2.5 (2T)	99-05	FA115TT		MXS115	FA115R	N/A						3
Trials 2.5 (2T/AJP Calipers)	06-12	FA303TT				N/A						4
Enduro 2.5i (4T) Inc. SE Models	08-11	FA181TT		MXS181	FA181R	N/A		N/A				5
SE 250 i (2T/Brembo Rear Caliper)	12-15	FA181TT		MXS181	FA181R			N/A				6
SE-R 250 (2T)	12-15	FA181TT		MXS181	FA181R			N/A				7
SEF 250 (4T)	13-15	FA181TT		MXS181	FA181R			N/A				8
SEF-R 250 (4T)	13-15	FA181TT		MXS181	FA181R			N/A				9
250 SC-Factory	19-20	FA181TT		MXS181	FA181R							10
250 SCF-Factory	19-20	FA181TT		MXS181	FA181R							11
250 SE-R	19-20	FA181TT		MXS181	FA181R							12
250 SE-Factory	19-20	FA181TT		MXS181	FA181R							13
250 SEF-R	19-20	FA181TT		MXS181	FA181R							14
250 SEF-Factory	19-20	FA181TT		MXS181	FA181R							15
SM 2.5i Supermotard (4T)	08	FA181TT		MXS181	FA181R	N/A						16
ST 250 (2T/Formula Calipers)	13-14	FA612TT			FA612R	N/A						17
ST 250 (2T/Braktec Calipers)	14-15	FA303TT				N/A						18
250 ST Factory	18-19	FA303TT										19
250 ST-R	18-19	FA303TT										20
SX 2.5 i F Moto Cross	10	FA181TT		MXS181	FA181R			N/A				21
ST 290 (2T) Cabestany - Formula Calipers	12	FA612TT			FA612R	N/A						22
ST 290 (2T/Formula Calipers)	13-14	FA612TT			FA612R	N/A						23
ST 290 (2T/Braktec Calipers)	14-15	FA303TT				N/A						24
Trials 2.9 (2T)	99-05	FA115TT		MXS115	FA115R	N/A						25
Trials 2.9 (2T/AJP Calipers)	06-12	FA303TT				N/A						26
X-Ride 290	12-15	FA083TT			FA083R			N/A				27
Enduro SE 3.0i (4T)	10-11	FA181TT		MXS181	FA181R			N/A				28
300 FST	18-19	FA303TT			FA303R							29
300 ST-R	18-19	FA303TT			FA303R							30
300 SC-Factory	19-20	FA181TT		MXS181	FA181R							31
300 SCF-Factory	19-20	FA181TT		MXS181	FA181R							32
300 SE-R	19-20	FA181TT		MXS181	FA181R							33
300 SE-Factory	19-20	FA181TT		MXS181	FA181R							34
300 SEF-R	19-20	FA181TT		MXS181	FA181R							35
300 SEF-Factory	19-20	FA181TT		MXS181	FA181R							36
SE 300 i (2T/Brembo Rear Caliper)	12-15	FA181TT		MXS181	FA181R			N/A				37
SE-R 300 (2T)	12-15	FA181TT		MXS181	FA181R			N/A				38
SEF 300 (4T)	13-15	FA181TT		MXS181	FA181R			N/A				39
SEF-R 300 (4T)	13-15	FA181TT		MXS181	FA181R			N/A				40
ST 305 (2T/Formula Calipers)	13-15	FA612TT			FA612R	N/A						41
ST 305 (2T/Braktec Calipers)	14-15	FA303TT				N/A						42
Trials 3.2cc (4T/AJP Calipers)	05-12	FA303TT				N/A						43
Enduro 4.5 i (4T) Inc SE Models	04-11	FA181TT		MXS181	FA181R	N/A		N/A				44
SE 450 i R (Nissin Rear Caliper)	12-13	FA181TT		MXS181	FA181R			N/A				45
SEF 450 (4T)	14-15	FA181TT		MXS181	FA181R			N/A				46
SEF-R 450 (4T)	14-15	FA181TT		MXS181	FA181R			N/A				47
SM 4.5 i F (Supermotard)	04-10	FA181TT		MXS181	FA181R	N/A						48
SM 4.5 i F (Black Panther)	08-12				FA322/4HH			N/A				49
450 SCF-Factory	19-20	FA181TT		MXS181	FA181R							50
450 SE-R	19-20	FA181TT		MXS181	FA181R							51
450 SEF-Factory	19-20	FA181TT		MXS181	FA181R							52
500 SCF-Factory	19-20	FA181TT		MXS181	FA181R							53
500 SEF-R	19-20	FA181TT		MXS181	FA181R							54
500 SEF-Factory	19-20	FA181TT		MXS181	FA181R							55
Enduro 5.1 i F Inc SE Models	07-11	FA181TT		MXS181	FA181R			N/A				56
SE 510 i R (Nissin Rear Caliper)	12-13	FA181TT		MXS181	FA181R			N/A				57
SM 5.1 i F Supermotard	07	FA181TT		MXS181	FA181R			N/A				58
SM 5.1 i F Black Panther	08-12				FA322/4HH			N/A				59
												60

FRONT / AVANT / VORN / FRENTE / ANTERIORE

R Suffix = High Durability Sintered Pad. HH Suffix = High Performance Sintered Pad. TT Suffix = Hard Wearing Off Road Pad. V Suffix = Semi Sintered Pad. G Suffix = Grooved Shoe.

D Suffix = Drilled Disc. X Suffix = Universal Left or Right Disc. XC Suffix = Contoured Disc. LS Suffix = Left/Steel Disc. RS = Right/Steel Disc.

*-2 Sets Required. † For Vee disc colours add RED, BLU, GRN, GLD, ORG suffix to part number.

⊗ - Also available as a Vintage Motorcycle Disc.

382 Part numbers, prefixes, suffixes, photos and illustrations shown in this catalogue are trademarks and/or copyrights of EBC Brakes or the trademark owner A C Freeman Investments Ltd and use without express written permission of the owners is punishable by law.

Non-JAPANESE Built Motorcycles

Line #	BRAKE DISC CHOICES - FRONT						DISC PAD CHOICES - REAR				BRAKE DISC CHOICES - REAR			
	Oversize 250 /280mm Disc Kit	OSX Oversize 250/280mm Disc Kit	Relocating Bracket for 250/ 280mm Disc	Oversize 320mm Disc Kit	SMX Oversize 320mm Disc Kit	Relocating Bracket for 320mm Disc	FA, SFA, TT Pad or Brake Shoe	SFAC Carbon Scooter Pads	Speciality Pads - SXR / Vee / MXS	Sintered/ HH Pads/ Grooved Shoes	Standard Replacement Disc	Contour Disc Rear fitment	Vee-Discs™ CONTOUR	CX Extreme MX Race Disc/ UTVX Disc
1							FA351TT				N/A			
2							FA115TT		MXS115	FA115R	N/A			
3							FA115TT		MXS115	FA115R	N/A			
4							FA351TT				N/A			
5							FA367TT		MXS367	FA367R	N/A	N/A		
6							FA368TT		MXS368	FA368R		N/A		
7							FA368TT		MXS368	FA368R		N/A		
8							FA368TT		MXS368	FA368R		N/A		
9							FA368TT		MXS368	FA368R		N/A		
10							FA368TT		MXS368	FA368R				
11							FA368TT		MXS368	FA368R				
12							FA368TT		MXS368	FA368R				
13							FA368TT		MXS368	FA368R				
14							FA368TT		MXS368	FA368R				
15							FA368TT		MXS368	FA368R				
16							FA367TT		MXS367	FA367R	N/A			
17							FA351TT				N/A			
18							FA351TT				N/A			
19							FA351TT							
20							FA351TT							
21							FA367TT		MXS367	FA367R		N/A		
22							FA351TT				N/A			
23							FA351TT				N/A			
24							FA351TT				N/A			
25							FA115TT		MXS115	FA115R	N/A			
26							FA351TT				N/A			
27							FA083TT			FA083R		N/A		
28							FA367TT		MXS367	FA367R		N/A		
29							FA351TT			FA351R				
30							FA351TT			FA351R				
31							FA368TT		MXS368	FA368R				
32							FA368TT		MXS368	FA368R				
33							FA368TT		MXS368	FA368R				
34							FA368TT		MXS368	FA368R				
35							FA368TT		MXS368	FA368R				
36							FA368TT		MXS368	FA368R				
37							FA368TT		MXS368	FA368R		N/A		
38							FA368TT		MXS368	FA368R		N/A		
39							FA368TT		MXS368	FA368R		N/A		
40							FA368TT		MXS368	FA368R		N/A		
41							FA351TT				N/A			
42							FA351TT				N/A			
43							FA351TT				N/A			
44							FA367TT		MXS367	FA367R	N/A	N/A		
45							FA367TT		MXS367	FA367R		N/A		
46							FA368TT		MXS368	FA368R		N/A		
47							FA368TT		MXS368	FA368R		N/A		
48							FA367TT		MXS367	FA367R	N/A			
49							FA367TT		MXS367	FA367R		N/A		
50							FA368TT		MXS368	FA368R				
51							FA368TT		MXS368	FA368R				
52							FA368TT		MXS368	FA368R				
53							FA368TT		MXS368	FA368R				
54							FA368TT		MXS368	FA368R				
55							FA368TT		MXS368	FA368R				
56							FA367TT		MXS367	FA367R		N/A		
57							FA367TT		MXS367	FA367R		N/A		
58							FA367TT		MXS367	FA367R		N/A		
59							FA367TT		MXS367	FA367R		N/A		
60							FA367TT		MXS367	FA367R		N/A		

REAR / ARRIÈRE / HINTEN / POSTERIOR / POSTERIORE

*-2 Sets Required. † For Vee disc colours add RED, BLU, GRN, GLD, ORG suffix to part number.

⊗ - Also available as a Vintage Motorcycle Disc.

R Suffix = High Durability Sintered Pad. **HH** Suffix = High Performance Sintered Pad. **TT** Suffix = Hard Wearing Off Road Pad. **V** Suffix = Semi Sintered Pad. **G** Suffix = Grooved Shoe.
D Suffix = Drilled Disc. **X** Suffix = Universal Left or Right Disc. **XC** Suffix = Contoured Disc. **LS** Suffix = Left/Steel Disc. **RS** = Right/Steel Disc.

Part numbers, prefixes, suffixes, photos and illustrations shown in this catalogue are trademarks and/or copyrights of EBC Brakes or the trademark owner A C Freeman Investments Ltd and use without express written permission of the owners is punishable by law.

Non-JAPANESE Built Motorcycles

Line #	BRAKE DISC CHOICES - FRONT						DISC PAD CHOICES - REAR				BRAKE DISC CHOICES - REAR			
	Oversize 250 /280mm Disc Kit	OSX Oversize 250/280mm Disc Kit	Relocating Bracket for 250/ 280mm Disc	Oversize 320mm Disc Kit	SMX Oversize 320mm Disc Kit	Relocating Bracket for 320mm Disc	FA, SFA, TT Pad or Brake Shoe	SFAC Carbon Scooter Pads	Speciality Pads - SXR / Vee / MXS	Sintered/ HH Pads/ Grooved Shoes	Standard Replacement Disc	Contour Disc Rear fitment	Vee-Discs™ CONTOUR	CX Extreme MX Race Disc/ UTVX Disc
1							TBA							
2							TBA							
3							TBA							
4							TBA							
5							TBA							
6							TBA							
7							TBA							
8							TBA							
9							TBA							
10							FA115		FA115HH	N/A				
11							S602							
12														
13														
14							H303							
15							SFA054	SFAC054			MD923D	VR923		
16							897							
17							H303							
18							H303							
19							897							
20							H303							
21							H303							
22							FA054TT		FA054R		MD6358C			
23							FA054TT		FA054R		MD6358C			
24							FA054TT		FA054R					
25														
26							Y506							
27							Y506							
28							H310		H310G					
29							SFA266	SFAC266	SFA266HH	MD9132D				
30							Y516							
31							FA140		FA140HH	MD827				
32														
33							Y506							
34							Y506							
35							Y506							
36							Y506							
37							Y506							
38							S602							
39							FA054TT		FA054R		MD6358C			
40							FA054TT		FA054R		N/A			
41							H310		H310G					
42							FA496		FA496HH					
43							FA496		FA496HH					
44							Y506							
45							TBA							
46							Y506							
47							Y506							
48							H310		H310G					
49							FA165TT		FA165R		N/A			
50														
51														
52							FA086		FA086HH	N/A				
53							FA086		FA086HH	N/A				
54							FA086		FA086HH	N/A				
55														
56														
57							FA480			N/A				
58														
59														
60							TBA							

REAR / ARRIÈRE / HINTEN / POSTERIOR / POSTERIORE

*-2 Sets Required. † For Vee disc colours add RED, BLU, GRN, GLD, ORG suffix to part number.

⊗ - Also available as a Vintage Motorcycle Disc.

R Suffix = High Durability Sintered Pad. **HH** Suffix = High Performance Sintered Pad. **TT** Suffix = Hard Wearing Off Road Pad. **V** Suffix = Semi Sintered Pad. **G** Suffix = Grooved Shoe.
D Suffix = Drilled Disc. **X** Suffix = Universal Left or Right Disc. **XC** Suffix = Contoured Disc. **LS** Suffix = Left/Steel Disc. **RS** = Right/Steel Disc.

Non-JAPANESE Built Motorcycles

APPLICATIONS

BRAKE



SUPERBYKE Contd.



CQ 50 Road Classic	
M-Ped 50 Road Classic	
RFX 50 Road Trail	
CU 125 Road Classic	
M-Ped 125 Road Classic	
Powerband 125	07-08
RFX 125 Road Trail	
RMR 125	07-09
RMX 125 4V	05-07
RMX 125	07-08
R-SR 125 4V	
SB 125-4	
SBS 125	07-08
RFX 200	05-07
RMR 200 SM	07-08
R-SR 250	
ZS 250-5	07-08

SVM (SWM)

50/80 TR/TL Trial	-83
50/80 MK/GS/RBS Enduro	83-
50/80 MK/MC Cross	83-
125/175/250/347/440 Enduro	-83
125/250/440 Cross	-83
125/240/320/350 HM/MW/TL Trial	-83
125/250 S1/S2	83-
323 Trial	85-
323 Trial	85-
350 XP Sahara	83-
XN 506 Enduro	84-

S.W.M.

MC 125 R	18
RS 125 R	16-17
RS 125 R	18
SM 125 R	16-17
SM 125 R	18-20
MC 250 S	16
FT 300 R (RS 300 R Flat Track)	17
RS 300 R (4T)	15-18
RS 340 S	16
Ace of Spades 500	18-20
Gran Milano (4T)	15
Gran Milano (4T)	16-18
Gran Milano Boggi SE	18
Gran Milano Outlaw 500	18-20
Gran Milano Special (4T)	15
Gran Turismo 440 (4T)	15
Gran Turismo 440 (4T)	18
Silver Vase 440 (4T)	15
Silver Vase 440 (4T)	18
Six Days	18-20
SM 450 R (4T)	15-18
RS 500 R (4T)	15-18
SM 500 R (4T)	16-20
Super Dual T 600	16-20
Super Dual X 600	16-20
MC 650 R	18
RS 650 R	16-18
SM 650 R	16-18

DISC PAD CHOICES - FRONT				BRAKE DISC CHOICES - FRONT						Line #
FA, SFA, TT Pad or Brake Shoe	SFAC Carbon Scooter Pads	Speciality Pads - SXR / Vee / MXS	Sintered/HH Pads/ Grooved Shoes	Left / Gauche / Links Standard Replacement Disc	Right / Droite / Rechts Standard Replacement Disc	Contour Disc Universal left and right fitment	Universal Custom Disc	Vee-Discs Black † See note below	CX Extreme MX Race Disc/ UTVX Disc	Line #
FA375			FA375HH		N/A					1
SFA169	SFAC169		SFA169HH	MD904D				VR904		2
FA093				N/A						3
FA375			FA375HH		N/A					4
FA086			FA086HH		MD904D			VR904		5
TBA				N/A						6
FA093				N/A						7
FA135TT			FA135R	N/A						8
TBA				N/A						9
FA086			FA086HH	N/A						10
FA056					N/A					11
FA086			FA086HH		N/A					12
TBA				N/A						13
TBA				N/A						14
TBA				N/A						15
FA086			FA086HH	MD690		MD690C				16
TBA				TBA						17
										18
										19
			926G							20
			841G							21
			841G							22
			843G							23
			843G							24
			841G							25
FA047			FA047R	N/A						26
			841G							27
FA047			FA047R	N/A						28
FA018			FA018HH	N/A						29
			843G							30
										31
										32
FA181TT			FA181R							33
FA181TT			FA181R	MD6184D						34
										35
FA181TT			FA181R							36
										37
FA181TT			FA181R							38
FA181TT		MXS181	FA181R	MD6184D						39
FA181TT		MXS181	FA181R	MD6184D						40
FA181TT	FA181R									41
			FA322/4HH							42
FA142		FA142V	FA142HH	N/A						43
			FA322/4HH							44
			FA322/4HH							45
			FA322/4HH							46
			FA218HH	N/A						47
FA142		FA142V	FA142HH	N/A						48
FA664										49
FA142		FA142V	FA142HH	N/A						50
FA664										51
FA664										52
			FA322/4HH	N/A						53
FA181TT		MXS181	FA181R	MD6184D						54
			FA322/4HH	N/A						55
FA209/2			FA209/2HH							56
FA209/2			FA209/2HH							57
FA357TT			FA357R							58
FA181TT			FA181R	MD6184D						59
			FA322/4HH	N/A						60

FRONT / AVANT / VORN / FRENTE / ANTERIORE

R Suffix = High Durability Sintered Pad. HH Suffix = High Performance Sintered Pad. TT Suffix = Hard Wearing Off Road Pad. V Suffix = Semi Sintered Pad. G Suffix = Grooved Shoe.

D Suffix = Drilled Disc. X Suffix = Universal Left or Right Disc. XC Suffix = Contoured Disc. LS Suffix = Left/Steel Disc. RS = Right/Steel Disc.

*-2 Sets Required. † For Vee disc colours add RED, BLU, GRN, GLD, ORG suffix to part number.

⊗ - Also available as a Vintage Motorcycle Disc.

386 Part numbers, prefixes, suffixes, photos and illustrations shown in this catalogue are trademarks and/or copyrights of EBC Brakes or the trademark owner A C Freeman Investments Ltd and use without express written permission of the owners is punishable by law.

Non-JAPANESE Built Motorcycles

Line #	BRAKE DISC CHOICES - FRONT						DISC PAD CHOICES - REAR				BRAKE DISC CHOICES - REAR			
	Oversize 250 /280mm Disc Kit	OSX Oversize 250/280mm Disc Kit	Relocating Bracket for 250/ 280mm Disc	Oversize 320mm Disc Kit	SMX Oversize 320mm Disc Kit	Relocating Bracket for 320mm Disc	FA, SFA, TT Pad or Brake Shoe	SFAC Carbon Scooter Pads	Speciality Pads - SXR / Vee / MXS	Sintered/ HH Pads/ Grooved Shoes	Standard Replacement Disc	Contour Disc Rear fitment	Vee-Discs™ CONTOUR	CX Extreme MX Race Disc/ UTVX Disc
1							FA086			FA086HH	N/A			
2							TBA							
3							TBA							
4							FA086			FA086HH	N/A			
5							TBA							
6							TBA							
7							TBA							
8							FA054TT			FA054R	N/A			
9							TBA							
10							FA086			FA086HH	N/A			
11							TBA							
12							H303							
13							TBA							
14							TBA			N/A				
15							TBA							
16							FA086			FA086HH	MD689	MD689C		
17							TBA							
18														
19														
20										926G				
21										841G				
22										841G				
23										843G				
24										843G				
25										841G				
26										841G				
27										841G				
28										841G				
29										841G				
30										843G				
31														
32														
33							FA368TT			FA368R				
34							FA213			FA213HH				
35							FA697							
36							FA213			FA213HH				
37							FA697							
38							FA368TT			FA368R				
39							FA368TT		MXS368	FA368R				
40							FA368TT		MXS368	FA368R	N/A			
41							FA368TT			FA368R				
42							FA697			FA697HH				
43							TBA							
44							FA697							
45							FA697							
46							FA697			FA697HH				
47							FA368TT		MXS368	FA368R	N/A			
48							TBA							
49							FA697							
50							TBA							
51							FA697							
52							FA697							
53							FA368TT		MXS368	FA368R	N/A			
54							FA368TT		MXS368	FA368R	N/A			
55							FA368TT			FA368R				
56							FA208TT			FA208R				
57							FA208TT			FA208R				
58							FA602TT			FA602R				
59							FA208TT			FA208R				
60							FA208TT			FA208R				

REAR / ARRIÈRE / HINTEN / POSTERIOR / POSTERIORE

*-2 Sets Required. † For Vee disc colours add RED, BLU, GRN, GLD, ORG suffix to part number.

⊗ - Also available as a Vintage Motorcycle Disc.

R Suffix = High Durability Sintered Pad. HH Suffix = High Performance Sintered Pad. TT Suffix = Hard Wearing Off Road Pad. V Suffix = Semi Sintered Pad. G Suffix = Grooved Shoe. D Suffix = Drilled Disc. X Suffix = Universal Left or Right Disc. XC Suffix = Contoured Disc. LS Suffix = Left/Steel Disc. RS = Right/Steel Disc.

Non-JAPANESE Built Motorcycles

APPLICATIONS

BRAKE



S.W.M. Contd.

Super Dual 650 (4T) 15

SYM

Allo 50 (4T)	11-15
Allo GT 50 (4T)	13-15
Cinderella 50/100	99-00
City Hopper 50	99-02
Crox 50 (4T)	15-20
DD 50 (2T)	02-12
Evie (Electric Scooter)	10
E-Woo Electric	11
Symmetry Electric	11
E-Symmetry (Electric)	12-13
E-Virid (Electric)	12-15
E-Virid Deluxe (Electric)	12-15
Fiddle 50	99-05
Fiddle II 50	08-15
Fiddle III 50 (4T)	14-20
Jet Basix 50	06-09
Jet 50/Euro X S	99-05
Jet Euro X 50	06-14
Jet Evo 50 (2T)	13-15
Jet Sport 50	14-15
Jet Sport 50 S	14-15
Jet Sport X 50 SR	06-15
Jet 4 (50cc/4T)	10-15
Jet 4 Naked (50cc/4T)	13-15
Jet 4 R (50cc/2T)	11-15
Jungle 50/100	99-02
Mask 50	00-05
Mio 50	15-20
Orbit 50	08-09
Orbit 11 50 (4T)	12-15
Orbit 11 50 Naked (4T)	12-15
Orbit 11 50 TS (4T)	12-15
Red Devil 50	99-09
RS 50	04-09
Shark 50	99-03
Super Fancy 50	96-06
Symphony 50 (4T/Rear drum model)	09
Symphony S 50 (4T/Rear disc model)	10-20
Symphony 50 SR (4T/Rear disc model)	10-15
Symply 50	07-08
Symply 11 50	09-14
Tonik 50 (4T)	11-15
X'Pro 50	13-15
Jet 100 (G100P-6)	99-00
Mio 100	05-15
SR 100 Sunrise	97
Symba 100	11-12
Tonik 110 (4T)	11-13
Allo 125 (4T)	11-15
Attila 125	99-00
Cevalo B9A (125cc -4T)	10
City Com 125	08-13
Com Biz 125	11-15
Crox 125 (4T)	15-20
CT 125	03-04
Euro MX 125 (HF12-W6 Euro 1) (Rear drum model)	02-07
Euro MX 125 (HF12W3-6 Euro 2) (Rear disc model)	06-09

DISC PAD CHOICES - FRONT				BRAKE DISC CHOICES - FRONT							Line #
FA, SFA, TT Pad or Brake Shoe	SFAC Carbon Scooter Pads	Speciality Pads - SXR / Vee / MXS	Sintered/HH Pads/ Grooved Shoes	Left / Gauche / Links Standard Replacement Disc	Right / Droite / Rechts Standard Replacement Disc	Contour Disc Universal left and right fitment	Universal Custom Disc	Vee-Discs Black † See note below	CX Extreme MX Race Disc/ UTVX Disc	Line #	
			FA322/4HH	N/A						1	
										2	
										3	
SFA264	SFAC264		SFA264HH	N/A						4	
SFA264	SFAC264		SFA264HH	N/A						5	
SFA151	SFAC151			MD933D				VR933		6	
SFA257	SFAC257			MD933D				VR933		7	
SFA264	SFAC264		SFA264HH	N/A						8	
SFA151	SFAC151			MD9138D				VR9138		9	
H303										10	
SFA151	SFAC151			MD933D				VR933		11	
H303										12	
SFA151	SFAC151			MD933D						13	
H303										14	
SFA151	SFAC151			MD933D						15	
H303										16	
SFA264	SFAC264		SFA264HH	MD923D				VR923		17	
SFA264	SFAC264		SFA264HH	MD923D						18	
SFA264	SFAC264		SFA264HH	MD9116D				VR9116		19	
SFA264	SFAC264		SFA264HH	MD9116D				VR9116		20	
SFA264	SFAC264		SFA264HH	MD9116D				VR9116		21	
SFA264	SFAC264		SFA264HH	N/A						22	
SFA264	SFAC264		SFA264HH			N/A				23	
SFA264	SFAC264		SFA264HH			N/A				24	
SFA264	SFAC264		SFA264HH			TBA				25	
SFA264	SFAC264		SFA264HH	TBA						26	
SFA264	SFAC264		SFA264HH	N/A						27	
SFA264	SFAC264		SFA264HH			MD9137C		VR9137		28	
SFA264	SFAC264		SFA264HH	MD9116D				VR9116		29	
SFA264	SFAC264		SFA264HH	MD9116D				VR9116		30	
SFA151	SFAC151			MD933D				VR933		31	
SFA257	SFAC257			MD923D				VR923		32	
SFA264	SFAC264		SFA264HH	N/A						33	
SFA264	SFAC264		SFA264HH	N/A						34	
SFA264	SFAC264		SFA264HH	N/A						35	
SFA264	SFAC264		SFA264HH	MD9116D				VR9116		36	
SFA306	SFAC306			N/A						37	
SFA306	SFAC306			N/A						38	
SFA257	SFAC257			MD933D				VR933		39	
SFA264	SFAC264		SFA264HH	MD9137D		MD9137C		VR9137		40	
SFA264	SFAC264		SFA264HH	MD9137D		MD9137C		VR9137		41	
SFA264	SFAC264		SFA264HH					VR9149		42	
SFA264	SFAC264		SFA264HH	MD923D				VR923		43	
SFA264	SFAC264		SFA264HH	MD923D				VR923		44	
SFA151	SFAC151			TBA						45	
SFA264	SFAC264		SFA264HH	N/A						46	
SFA264	SFAC264		SFA264HH	MD9116D				VR9116		47	
SFA151	SFAC151			MD933D				VR933		48	
SFA131/2			SFA131/2HH	N/A						49	
H303										50	
SFA151	SFAC151			N/A						51	
SFA264	SFAC264		SFA264HH	N/A				VR923		52	
SFA264	SFAC264		SFA264HH	MD933D				VR933		53	
FA196			FA196HH		N/A					54	
SFA264	SFAC264		SFA264HH	N/A		N/A				55	
SFA305	SFAC305		SFA305HH	N/A						56	
SFA264	SFAC264		SFA264HH	N/A						57	
FA297						N/A				58	
SFA306	SFAC306			N/A						59	
SFA306	SFAC306			N/A						60	

FRONT / AVANT / VORN / FRENTE / ANTERIORE

R Suffix = High Durability Sintered Pad. HH Suffix = High Performance Sintered Pad. TT Suffix = Hard Wearing Off Road Pad. V Suffix = Semi Sintered Pad. G Suffix = Grooved Shoe.

D Suffix = Drilled Disc. X Suffix = Universal Left or Right Disc. XC Suffix = Contoured Disc. LS Suffix = Left/Steel Disc. RS Suffix = Right/Steel Disc.

*-2 Sets Required. † For Vee disc colours add RED, BLU, GRN, GLD, ORG suffix to part number.

⊗ - Also available as a Vintage Motorcycle Disc.

388 Part numbers, prefixes, suffixes, photos and illustrations shown in this catalogue are trademarks and/or copyrights of EBC Brakes or the trademark owner A C Freeman Investments Ltd and use without express written permission of the owners is punishable by law.

Non-JAPANESE Built Motorcycles

Line #	BRAKE DISC CHOICES - FRONT						DISC PAD CHOICES - REAR				BRAKE DISC CHOICES - REAR			
	Oversize 250 /280mm Disc Kit	OSX Oversize 250/280mm Disc Kit	Relocating Bracket for 250/ 280mm Disc	Oversize 320mm Disc Kit	SMX Oversize 320mm Disc Kit	Relocating Bracket for 320mm Disc	FA, SFA, TT Pad or Brake Shoe	SFAC Carbon Scooter Pads	Speciality Pads - SXR / Vee / MXS	Sintered/ HH Pads/ Grooved Shoes	Standard Replacement Disc	Contour Disc Rear fitment	Vee-Discs™ CONTOUR	CX Extreme MX Race Disc/ UTVX Disc
1							FA208TT							
2														
3														
4							820							
5							820							
6							H303							
7							H303							
8							820							
9							H333							
10							H303							
11							H303							
12							H303							
13							H303							
14							H303							
15							H303							
16							H302							
17							H303							
18							H303							
19							H303							
20							H303							
21							H303							
22							H303							
23							H303							
24							H303							
25							SFA234					TBA		
26							H303							
27							H303							
28							H303							
29							H303							
30							H303							
31							H303							
32							H303							
33							H303							
34							H303							
35							H303							
36							H303							
37							H303							
38							820							
39							H303							
40							H307							
41							SFA260	SFAC260		SFA260HH	TBA			
42							SFA260	SFAC260		SFA260HH			VR9149	
43							H303							
44							H303							
45							H303							
46							H307							
47							H303							
48							H303							
49														
50							H303							
51							H307							
52							820							
53							H307							
54							TBA							
55							SFA427	SFAC427		SFA427HH	N/A			
56							820							
57							820							
58							819							
59							820							
60							SFA197	SFAC197			TBA			

REAR / ARRIÈRE / HINTEN / POSTERIOR / POSTERIORE

*-2 Sets Required. † For Vee disc colours add RED, BLU, GRN, GLD, ORG suffix to part number.

⊗ - Also available as a Vintage Motorcycle Disc.

R Suffix = High Durability Sintered Pad. **HH** Suffix = High Performance Sintered Pad. **TT** Suffix = Hard Wearing Off Road Pad. **V** Suffix = Semi Sintered Pad. **G** Suffix = Grooved Shoe.
D Suffix = Drilled Disc. **X** Suffix = Universal Left or Right Disc. **XC** Suffix = Contoured Disc. **LS** Suffix = Left/Steel Disc. **RS** = Right/Steel Disc.

Non-JAPANESE Built Motorcycles

APPLICATIONS

BRAKE



SYM Contd.



DISC PAD CHOICES - FRONT

BRAKE DISC CHOICES - FRONT

		FA, SFA, TT Pad or Brake Shoe	SFAC Carbon Scooter Pads	Speciality Pads SXR / Vee / MXS	Sintered/ HH Pads/ Grooved Shoes	Left / Gauche / Links Standard Replacement Disc	Right / Droite / Rechts Standard Replacement Disc	Contour Disc Universal left and right fitment	Universal Custom Disc	Vee-Discs Black † See note below	CX Extreme MX Race Disc/ UTVX Disc	Line #
Fiddle II 125	08-15	SFA264	SFAC264		SFA264HH	MD923D		MD923C		VR923		1
Fiddle III 125 (4T)	08-20	SFA264	SFAC264		SFA264HH	N/A						2
GTS 125 Joymax/Voyager	06-09	SFA427	SFAC427		SFA427HH	N/A						3
GTS 125 i Joymax (All Models)	10-15	SFA355	SFAC355		SFA355HH	TBA						4
GTS 125 i Sport(All Models)	14-15	SFA355	SFAC355		SFA355HH	TBA						5
HD 125/200	04-07	SFA305	SFAC305		SFA305HH	N/A						6
HD 125 S Evo	07	SFA264	SFAC264		SFA264HH	N/A						7
HD Evo 125 (Carb & EFi Models/4T/Single Headlight)	03-13	SFA264	SFAC264		SFA264HH	TBA						8
HD2-125i (Twin H/Lights/4T)	10-15	SFA264	SFAC264		SFA264HH	N/A						9
Huskey 125/150	99-05	FA297				N/A						10
JET 4 (125cc/4T)	10-15	SFA264	SFAC264		SFA264HH	MD9137D		MD9137C		VR9137		11
JET V (125cc/4T)	12-13	SFA067	SFAC067		SFA067HH			MD9137C		VR9137		12
Joyride 125	01-06	SFA306	SFAC306			N/A						13
Joyride 125 i	07-09	SFA306	SFAC306			N/A						14
Joyride EVO 125 i (Twin Headlights)	09-20	SFA306	SFAC306			N/A						15
Megalo 125	00-07	SFA264	SFAC264		SFA264HH	MD933D				VR933		16
Orbit 125	08-09	SFA257	SFAC257			TBA						17
Orbit 11/Symply 125 (4T)	09-15	SFA264	SFAC264		SFA264HH	MD923D				VR923		18
RS 125	04-06	SFA306	SFAC306			N/A						19
SB 125 N - Wolf (Carb Model/Drum Rear Brake)	11-15	FA179			FA179HH		TBA					20
SB 125 Ni - Wolf (EFi Model)	11-15	SFA427			SFA427HH		TBA					21
Shark 125/150 (Drum rear model)	99-02	SFA306	SFAC306			N/A						22
Shark 4VR 125/150 R (Rear disc model)	00-02	SFA306	SFAC306			N/A						23
SK 125	03-04	SFA306	SFAC306			N/A						24
Super Duke 125/150	99-02	SFA264	SFAC264		SFA264HH	MD933D				VR933		25
Symphony 125 (4T/Rear drum)	09	SFA264	SFAC264		SFA264HH	MD9137D		MD9137C		VR9137		26
Symphony S 125 (4T/Rear disc model)	10-20	SFA264	SFAC264		SFA264HH	MD9137D		MD9137C		VR9137		27
Symphony 125 SR (4T/Rear disc model)	10-15	SFA264	SFAC264		SFA264HH	MD9149D				VR9149		28
Symply 125	07-08	SFA264	SFAC264		SFA264HH	MD923D				VR923		29
Symply 11 125	09-14	SFA264	SFAC264		SFA264HH	MD923D				VR923		30
Tonik 125 (4T)	11-15	SFA151	SFAC151			TBA						31
VS 125	06-15	SFA306	SFAC306			N/A						32
Wolf Legend	04-05	FA086			FA086HH		N/A					33
Wolf 125/150 Scooter (Type 125M/P125M/P150M)	00	H306										34
XS 125 K	07-15	FA197			FA197HH		N/A					35
X'Pro 125	13-15	SFA264	SFAC264		SFA264HH	N/A						36
Allo 150 (4T)	11-15	SFA264	SFAC264		SFA264HH		N/A					37
Crox 150 (4T)	11-15	SFA264	SFAC264		SFA264HH	N/A						38
Jet 4 (150cc/4T)	13-15	SFA264	SFAC264		SFA264HH			N/A				39
Joyride 150	01-06	SFA306	SFAC306			N/A						40
RS 150	06	SFA306	SFAC306			N/A						41
Fiddle II 151	08-15	SFA264	SFAC264		SFA264HH	TBA						42
Symphony S 151 (4T/Rear disc model)	10-15	SFA264	SFAC264		SFA264HH	MD9137D		MD9137C		VR9137		43
Symphony 151 SR (4T/Rear disc model)	10-15	SFA264	SFAC264		SFA264HH	MD9149D				VR9149		44
VS 150	06-15	SFA306	SFAC306			N/A						45
Neo VF185		TBA	TBA									46
Fiddle III 200i (4T)	14-20	SFA264	SFAC264		SFA264HH	N/A						47
H 200 SE	06	SFA264	SFAC264		SFA264HH	TBA						48
HD 200 S Evo	07	SFA264	SFAC264		SFA264HH	TBA						49
HD Evo 200 (Carb & EFi Models/4T/Single Headlight)	03-13	SFA264	SFAC264		SFA264HH	TBA						50
HD 2-200i (Twin H/Lights/4T)	10-15	SFA264	SFAC264		SFA264HH	N/A						51
Joyride 200	03-07	SFA306	SFAC306			N/A						52
Joyride 200 i	07-09	SFA306	SFAC306			N/A						53
Joyride EVO 200 i	09-20	SFA306	SFAC306			N/A						54
Trackrunner 200 Quad	05-09	FA377TT*			FA377R*	N/A	N/A					55
Quadlander 200	12-13	FA377TT*			FA377R*	N/A	N/A					56
GTS 250	07-08	SFA355/4*	SFAC355/4*		SFA355/4HH*	N/A						57
GTS 250i/Joymax (All Models)	09-14	SFA355/4*	SFAC355/4*		SFA355/4HH*			N/A				58
Joymax 250	06	SFA355/4*	SFAC355/4*		SFA355/4HH*	N/A						59
Joymax 250 i	07-08	SFA355/4*	SFAC355/4*		SFA355/4HH*	TBA						60

FRONT / AVANT / VORN / FRENTE / ANTERIORE

R Suffix = High Durability Sintered Pad. HH Suffix = High Performance Sintered Pad. TT Suffix = Hard Wearing Off Road Pad. V Suffix = Semi-Sintered Pad. G Suffix = Grooved Shoe.

D Suffix = Drilled Disc. X Suffix = Universal Left or Right Disc. XC Suffix = Contoured Disc. LS Suffix = Left/Steel Disc. RS Suffix = Right/Steel Disc.

*-2 Sets Required. † For Vee disc colours add RED, BLU, GRN, GLD, ORG suffix to part number.

⊗ - Also available as a Vintage Motorcycle Disc.

390 Part numbers, prefixes, suffixes, photos and illustrations shown in this catalogue are trademarks and/or copyrights of EBC Brakes or the trademark owner A C Freeman Investments Ltd and use without express written permission of the owners is punishable by law.

Non-JAPANESE Built Motorcycles

Line #	BRAKE DISC CHOICES - FRONT						DISC PAD CHOICES - REAR				BRAKE DISC CHOICES - REAR			
	Oversize 250 /280mm Disc Kit	OSX Oversize 250/280mm Disc Kit	Relocating Bracket for 250/ 280mm Disc	Oversize 320mm Disc Kit	SMX Oversize 320mm Disc Kit	Relocating Bracket for 320mm Disc	FA, SFA, TT Pad or Brake Shoe	SFAC Carbon Scooter Pads	Speciality Pads - SXR / Vee / MXS	Sintered/ HH Pads/ Grooved Shoes	Standard Replacement Disc	Contour Disc Rear fitment	Vee-Discs™ CONTOUR	CX Extreme MX Race Disc/ UTVX Disc
1							H307							
2							H307							
3							SFA427	SFAC427		SFA427HH	N/A			
4							SFA427	SFAC427		SFA427HH	TBA			
5							SFA427	SFAC427		SFA427HH	TBA			
6							820							
7							820							
8							SFA427	SFAC427		SFA427HH	TBA			
9							SFA427	SFAC427		SFA427HH	TBA			
10							819							
11							H307							
12							H307							
13							SFA305	SFAC305			N/A			
14							SFA427	SFAC427			TBA			
15							SFA427	SFAC427			TBA			
16							820							
17							820							
18							H303							
19							TBA							
20							TBA							
21							FA377		FA377V	FA377HH	TBA			
22							820							
23							SFA197	SFAC197			N/A			
24							SFA305	SFAC305			N/A			
25							H303							
26							H307							
27							SFA260	SFAC260		SFA260HH	TBA			
28							SFA260	SFAC260		SFA260HH		TBA		
29							H307							
30							H307							
31							820							
32							820							
33							819							
34							H307							
35							H310							
36							H307							
37							820							
38							820							
39							820							
40							SFA305	SFAC305			N/A			
41							SFA228	SFAC228			N/A			
42							H307							
43							SFA260	SFAC260		SFA260HH	TBA			
44							SFA260	SFAC260		SFA260HH		TBA		
45							820							
46							FA377	TBA						
47							SFA264	SFAC264		SFA264HH	N/A			
48							SFA427	SFAC427		SFA427HH	TBA			
49							SFA427	SFAC427		SFA427HH	TBA			
50							SFA427	SFAC427		SFA427HH	TBA			
51							SFA427	SFAC427		SFA427HH	TBA			
52							SFA305	SFAC305			N/A			
53							SFA427	SFAC427			TBA			
54							SFA427	SFAC427			TBA			
55							FA427TT			FA427R	N/A			
56							FA427TT			FA427R	N/A			
57							SFA427	SFAC427		SFA427HH	N/A			
58							SFA427	SFAC427		SFA427HH		N/A		
59							SFA427	SFAC427		SFA427HH	N/A			
60							SFA427	SFAC427		SFA427HH	TBA			

REAR / ARRIÈRE / HINTEN / POSTERIOR / POSTERIORE

*-2 Sets Required. † For Vee disc colours add RED, BLU, GRN, GLD, ORG suffix to part number.

⊗ - Also available as a Vintage Motorcycle Disc.

R Suffix = High Durability Sintered Pad. HH Suffix = High Performance Sintered Pad. TT Suffix = Hard Wearing Off Road Pad. V Suffix = Semi Sintered Pad. G Suffix = Grooved Shoe.

D Suffix = Drilled Disc. X Suffix = Universal Left or Right Disc. XC Suffix = Contoured Disc. LS Suffix = Left/Steel Disc. RS = Right/Steel Disc.

BRAKE APPLICATIONS

Non-JAPANESE Built Motorcycles

APPLICATIONS

BRAKE



SYM Contd.



		DISC PAD CHOICES - FRONT				BRAKE DISC CHOICES - FRONT						Line #
		FA, SFA, TT Pad or Brake Shoe	SFAC Carbon Scooter Pads	Speciality Pads SXR / Vee / MXS	Sintered/HH Pads/ Grooved Shoes	Left / Gauche / Links Standard Replacement Disc	Right / Droite / Rechts Standard Replacement Disc	Contour Disc Universal left and right fitment	Universal Custom Disc	Vee-Discs Black † See note below	CX Extreme MX Race Disc/ UTVX Disc	
Quadlander 250	05-09	FA377TT*			FA377R*	N/A	N/A					1
SB 250 Ni (Wolf SB)	12-15	SFA627			SFA627HH			N/A				2
Voyager 250	05	SFA355/4*	SFAC355*		SFA355HH*	N/A						3
GTS 300/Joymax (All Models)	08-14	SFA355/4*	SFAC355*		SFA355HH*	N/A						4
GTS 300 Sport (All Models)	14-15	SFA355/4*	SFAC355*		SFA355HH*	N/A						5
City Com 300 i	08-14	SFA264	SFAC264		SFA264HH	N/A						6
City Com S 300 I CBS	15	SFA264	SFAC264		SFA264HH	N/A						7
Citymax 300 Quad	06	FA377*			FA377R*	TBA	TBA					8
Cruisym 300 ABS	17-20	SFA355/4	SFAC355/4		SFA355/4HH							9
Joymax Z 300 ABS	17-20	SFA355/4	SFAC355/4		SFA355/4HH							10
Quadlander 300	08-10	FA377TT*			FA377R*	TBA	TBA					11
Quadlander 300 S	07-15	FA377TT*			FA377R*	TBA	TBA					12
Max Sym 400i	11-20	SFA627*			SFA627HH*	TBA	TBA	N/A*				13
GT 500	04	SFA283/4	SFAC283/4		SFA283/4HH	N/A						14
XP 500	04	TBA			N/A							15
Quadraider 600	06-07	FA054TT*		MXS054	FA054R*	TBA	TBA					16
Quadraider 600	08-15	FA377TT*			FA377R*	N/A	N/A					17
Quadraider 600 LE	10-15	FA377TT*			FA377R*	N/A	N/A					18
Max Sym 600i (ABS)	14-15	SFA627*			SFA627HH*	TBA		N/A*				19
TAISHAN (Project Quads)												
Commuter 50	03-05	S632										22
XT 50	03-04	FA054TT			FA054HH	N/A						23
Sport 50 (Drum front)	03-05	S632				N/A						24
Panther 50 Quad	03-04	FA054TT			FA054HH	N/A						25
Desert Cat 100	04-05	TBA*										26
Desert Cat Extreme 100	04-05	TBA*										27
Hurricane 125 Quad	04-05	TBA*										28
XT 125 Sport	04-05	FA054TT			FA054HH	N/A						29
Explorer 150 Quad	04-05	TBA*										30
Tornado 200 Quad	04	TBA*										31
TAMORETTI												
Retro 50		SFA086	SFAC086		SFA086HH	MD901D				VR901		34
Retro 125		SFA086	SFAC086		SFA086HH	MD901D				VR901		35
Stealth 125		SFA235	SFAC235			MD901D				VR901		36
TERRAMOTO												
TDX 125 F	07	SFA169	SFAC169		SFA169HH	N/A						39
TDX 125 F Krusha	07	SFA169	SFAC169		SFA169HH	N/A						40
TDX 125 F Street Rippa	07	SFA169	SFAC169		SFA169HH	N/A						41
TGB												
Bullet 2 50 (2T)	11-12	SFA083	SFAC083		SFA083HH			N/A				44
Bull& T 50 RS (2T)	11-12	SFA083	SFAC083		SFA083HH			N/A				45
Bull& T 50 RR (2T)	11-12	SFA083	SFAC083		SFA083HH			N/A				46
City 50cc (2T)	07-08	SFA083	SFAC083		SFA083HH	MD923D				VR923		47
City 50cc (4T)	07-11	SFA083	SFAC083		SFA083HH	MD923D				VR923		48
Delivery 50 Scooter (Up to E/F no 609099)	04-06	SFA264	SFAC264		SFA264HH	MD923D				VR923		49
Delivery/Express 50 (From F/E No 609100)	06-12	SFA083	SFAC083		SFA083HH	MD923D				VR923		50
Akros Tec -50	03-04	SFA264	SFAC264		SFA264HH	MD923D				VR923		51
High Wheel 50	02-03	SFA083	SFAC083		SFA083HH	MD923D				VR923		52
Hornet 50/90 Quad	04-05	H338*			H338G*							53
R50 X Bullet	06-10	SFA093				MD9115D						54
R50 X Bullet	10-14	SFA093						N/A				55
Tapo RS 50 (2T)	10-12	SFA083	SFAC083		SFA083HH			N/A				56
Tapo RR 50 (2T)	10-12	SFA083	SFAC083		SFA083HH			N/A				57
Trigger 50	02-03	SFA083	SFAC083		SFA083HH	MD923D				VR923		58
X Race 50 (2T)	11-12	SFA083	SFAC083		SFA083HH					VR923		59
101R (50cc)	04-09	SFA264	SFAC264		SFA264HH	MD923D				VR923		60

FRONT / AVANT / VORN / FRENTE / ANTERIORE

R Suffix = High Durability Sintered Pad. HH Suffix = High Performance Sintered Pad. TT Suffix = Hard Wearing Off Road Pad. V Suffix = Semi Sintered Pad. G Suffix = Grooved Shoe.

D Suffix = Drilled Disc. X Suffix = Universal Left or Right Disc. XC Suffix = Contoured Disc. LS Suffix = Left/Steel Disc. RS = Right/Steel Disc.

*-2 Sets Required. † For Vee disc colours add RED, BLU, GRN, GLD, ORG suffix to part number.

⊗ - Also available as a Vintage Motorcycle Disc.

Non-JAPANESE Built Motorcycles

Line #	BRAKE DISC CHOICES - FRONT						DISC PAD CHOICES - REAR				BRAKE DISC CHOICES - REAR			
	Oversize 250 /280mm Disc Kit	OSX Oversize 250/280mm Disc Kit	Relocating Bracket for 250/ 280mm Disc	Oversize 320mm Disc Kit	SMX Oversize 320mm Disc Kit	Relocating Bracket for 320mm Disc	FA, SFA, TT Pad or Brake Shoe	SFAC Carbon Scooter Pads	Speciality Pads - SXR / Vee / MXS	Sintered/ HH Pads/ Grooved Shoes	Standard Replacement Disc	Contour Disc Rear fitment	Vee-Discs™ CONTOUR	CX Extreme MX Race Disc/ UTVX Disc
1							FA427TT			FA427R	N/A			
2							FA377		FA377V	FA377HH		N/A		
3							SFA319			SFA319HH	N/A			
4							SFA427	SFAC427		SFA427HH	N/A			
5							SFA427	SFAC427		SFA427HH	N/A			
6							SFA264	SFAC264		SFA264HH	N/A			
7							SFA264	SFAC264		SFA264HH	N/A			
8							FA427TT			FA427R	TBA			
9							SFA427	SFAC427		SFA427HH				
10							SFA427	SFAC427		SFA427HH				
11							FA377TT			FA377R	TBA			
12							FA377TT			FA377R	TBA			
13							SFA628			SFA628HH		N/A		
14							SFA305	SFAC305		SFA305HH	N/A			
15							TBA				N/A			
16							FA377TT			FA377R	TBA			
17							FA377TT			FA377R	N/A			
18							FA377TT			FA377R	N/A			
19							SFA628			SFA628HH		N/A		
20														
21														
22							H303							
23							TBA							
24							H303							
25							TBA							
26							TBA				TBA			
27							TBA				TBA			
28							FA165TT			FA165R	N/A			
29							TBA							
30							FA165TT			FA165R	N/A			
31							FA165TT			FA165R	N/A			
32														
33														
34							H303							
35							H303							
36							H307							
37														
38														
39							SFA169	SFAC169		SFA169HH	N/A			
40							SFA169	SFAC169		SFA169HH	N/A			
41							SFA169	SFAC169		SFA169HH	N/A			
42														
43														
44							897							
45							SFA083	SFAC083		SFA083HH		N/A		
46							SFA083	SFAC083		SFA083HH		N/A		
47							897							
48							897							
49							897							
50							897							
51							897							
52							897							
53							FA083TT			FA083R	N/A			
54							SFA083				MD9115D			
55							SFA083					N/A		
56							897							
57							897							
58							897							
59							897							
60							897							

REAR / ARRIÈRE / HINTEN / POSTERIOR / POSTERIORE

*-2 Sets Required. † For Vee disc colours add RED, BLU, GRN, GLD, ORG suffix to part number.

⊗ - Also available as a Vintage Motorcycle Disc.

R Suffix = High Durability Sintered Pad. **HH** Suffix = High Performance Sintered Pad. **TT** Suffix = Hard Wearing Off Road Pad. **V** Suffix = Semi Sintered Pad. **G** Suffix = Grooved Shoe.
D Suffix = Drilled Disc. **X** Suffix = Universal Left or Right Disc. **XC** Suffix = Contoured Disc. **LS** Suffix = Left/Steel Disc. **RS** = Right/Steel Disc.

Non-JAPANESE Built Motorcycles

APPLICATIONS

BRAKE



TGB Contd.

		DISC PAD CHOICES - FRONT			BRAKE DISC CHOICES - FRONT					Line #	
		FA, SFA, TT Pad or Brake Shoe	SFAC Carbon Scooter Pads	Speciality Pads SXR / Vee / MXS	Sintered/ HH Pads/ Grooved Shoes	Left / Gauche / Links Standard Replacement Disc	Right / Droite / Rechts Standard Replacement Disc	Contour Disc Universal left and right fitment	Universal Custom Disc		Vee-Discs Black † See note below
Bellavita 125 i (4T)	12-14	SFA264	SFAC264		SFA264HH		N/A				1
Delivery/Express (125cc)	04-14	SFA093				MD9115D					2
X-Motion 125	08-14	SFA484				N/A					3
X-Motion 125 R i	11-12	SFA484				N/A					4
R125 X Bullet	08-09	SFA093				MD9115D					5
R125 X Bullet	10-14	SFA093						N/A			6
202 Classic (50cc)	03-14	SFA083	SFAC083		SFA083HH	MD923D				VR923	7
204 Classic (125cc)	03-04	SFA083	SFAC083		SFA083HH	TBA					8
250 Blade/Congo ATV	06-07	FA067TT*			FA067R*	N/A	N/A				9
X-Motion 250i	08-10	SFA484				N/A					10
302 Sport (50cc)	03-09	SFA093				MD9115D					11
303R Hawk/Laser (50cc)	04-14	SFA083	SFAC083		SFA083HH	MD923D				VR923	12
303R Hawk/Laser (125/150cc)	04-08	SFA093				MD9115D					13
303R Hawk/Laser (125/150cc)	09-14	SFA093						N/A			14
303 Revolution (50/125cc)	02-03	SFA083			SFA083HH	MD923D				VR923	15
304 Sport (125cc)	03-09	SFA093				MD9115D					16
F409 Cruise 50/125	02-05	SFA083	SFAC083		SFA083HH	MD923D				VR923	17
309RS 50	02-03	SFA093				MD923D				VR923	18
Bellavita 300 i (4T)	12-14	SFA264	SFAC264		SFA264HH		N/A				19
X-Motion 300 Efi	10-12	SFA484				N/A					20
Blade 325 Quad (4x2)	07-11	FA083TT*			FA083R*	TBA	TBA				21
Blade 325 LE Quad (4x2)	08-10	FA083TT*			FA083R*	TBA	TBA				22
Blade 325 SL Quad (4x2)	11-12	FA083TT*			FA083R*	TBA	TBA				23
Target 325 (4x2)	09-12	FA083TT*			FA083R*	N/A	N/A				24
Avenger 400 Quad (4x2)	07-09	FA377TT*			FA377R*	TBA	TBA				25
Avenger 400 LE Quad (4x2)	09-10	FA377TT*			FA377R*	TBA	TBA				26
Target 400 (4x2)	09-10	FA083TT*			FA083R*	N/A	N/A				27
404 Executive	03-04	SFA093				TBA					28
Blade (4x4) 425 Quad	07-09	FA377TT*			FA377R*	N/A	N/A				29
Blade SE (4x4) 425 Quad	09-10	FA377TT*			FA377R*	N/A	N/A				30
Target 425 (4X4)	09-11	FA083TT*			FA083R*	N/A	N/A				31
Blade 450 SE (4x4)	10-11	FA377TT*			FA377R*	N/A	N/A				32
Blade 460 R Target	12	FA083TT*			FA083R*	N/A	N/A				33
Blade 460 IRS Target	12	FA083TT*			FA083R*	N/A	N/A				34
Blade 460 SL IRS 4x4	12	FA377TT*			FA377R*	N/A	N/A				35
Avenger 500 R Quad (4x2)	09-10	FA377TT*			FA377R*	TBA	TBA				36
Target 500 (4x2)	09-10	FA083TT*			FA083R*	N/A	N/A				37
Blade 510 LE	11-12	FA377TT*			FA377R*	N/A	N/A				38
Blade 525 SE 4x4	09-10	FA377TT*			FA377R*	N/A	N/A				39
Blade 525 SL 4x4	09-10	FA377TT*			FA377R*	N/A	N/A				40
525 SE 4x4	09	FA377TT*			FA377R*	N/A	N/A				41
Target 525 (4x4)	09-11	FA083TT*			FA083R*	N/A	N/A				42
Blade 550 LT 4x4	10-11	FA377TT*			FA377R*	N/A	N/A				43
Blade 550 SE 4x4	09-11	FA377TT*			FA377R*	N/A	N/A				44
Blade 550 SL 4x4	09-10	FA377TT*			FA377R*	N/A	N/A				45
Gunner 550 4x4 Target	10-12	FA377TT*			FA377R*	N/A	N/A				46
Blade 550 IRS Target	11-12	FA377TT*			FA377R*	N/A	N/A				47
550 IRS Blade LT	10-12	FA377TT*			FA377R*	N/A	N/A				48
											49
											50
THUMPSTAR											
Thumpstar Junior 90cc	04-06	SFA169	SFAC169		SFA169HH	N/A					51
Thumpstar Supa 110cc	04-06	SFA169	SFAC169		SFA169HH	N/A					52
Thumpstar Expert 125	06	SFA169	SFAC169		SFA169HH	N/A					53
Thumpstar Pro 125	05-06	SFA169	SFAC169		SFA169HH	N/A					54
Thumpstar 125 Road Ripper	06	SFA169	SFAC169		SFA169HH	N/A					55
											56
											57
T.M.											
Junior 80/85/100 Cross (Small wheel)	02-04	FA181TT		MXS181	FA181R	N/A					58
Junior 80/85/100	05-07	FA181TT		MXS181	FA181R	N/A					59
80/85/100 (Big wheel)	02-04	FA181TT		MXS181	FA181R	N/A					60

*-2 Sets Required. † For Vee disc colours add RED, BLU, GRN, GLD, ORG suffix to part number.

⊗ - Also available as a Vintage Motorcycle Disc.

R Suffix = High Durability Sintered Pad. HH Suffix = High Performance Sintered Pad. TT Suffix = Hard Wearing Off Road Pad. V Suffix = Semi Sintered Pad. G Suffix = Grooved Shoe.
D Suffix = Drilled Disc. X Suffix = Universal Left or Right Disc. XC Suffix = Contoured Disc. LS Suffix = Left/Steel Disc. RS = Right/Steel Disc.

FRONT / AVANT / VORN / FRENTE / ANTERIORE

Non-JAPANESE Built Motorcycles

Line #	BRAKE DISC CHOICES - FRONT						DISC PAD CHOICES - REAR				BRAKE DISC CHOICES - REAR			
	Oversize 250 /280mm Disc Kit	OSX Oversize 250/280mm Disc Kit	Relocating Bracket for 250/ 280mm Disc	Oversize 320mm Disc Kit	SMX Oversize 320mm Disc Kit	Relocating Bracket for 320mm Disc	FA, SFA, TT Pad or Brake Shoe	SFAC Carbon Scooter Pads	Speciality Pads - SXR / Vee / MXS	Sintered/ HH Pads/ Grooved Shoes	Standard Replacement Disc	Contour Disc Rear fitment	Vee-Discs™ CONTOUR	CX Extreme MX Race Disc/ UTVX Disc
1							SFA298	SFAC298		SFA298HH	N/A			
2							820							
3							SFA427				N/A			
4							SFA427				N/A			
5							SFA083				MD9115D			
6							SFA083					N/A		
7							897							
8							TBA							
9							FA083TT			FA083R	N/A			
10							SFA427				N/A			
11							897							
12							897							
13							820							
14							820							
15							897							
16							897							
17							897							
18							897							
19							SFA298	SFAC298		SFA298HH	N/A			
20							SFA427				N/A			
21							FA067TT			FA067R	TBA			
22							FA067TT			FA067R	TBA			
23							FA067TT			FA067R	TBA			
24							FA067TT			FA067R	N/A			
25							FA377TT*			FA377R*	TBA*			
26							FA377TT*			FA377R*	TBA*			
27							FA067TT			FA067R	N/A			
28							TBA							
29							FA377TT*			FA377R*	N/A*			
30							FA377TT*			FA377R*	N/A*			
31							FA067TT			FA067R	N/A			
32							FA067TT			FA067R	N/A			
33							FA067TT			FA067R	N/A			
34							FA067TT			FA067R	N/A			
35							FA067TT			FA067R	N/A			
36							FA377TT*			FA377R*	TBA*			
37							FA067TT			FA067R	N/A			
38							FA067TT			FA067R	N/A			
39							FA377TT*			FA377R*	N/A*			
40							FA067TT			FA067R	N/A			
41							FA067TT			FA067R	N/A			
42							FA067TT			FA067R	N/A			
43							FA067TT			FA067R	N/A			
44							FA067TT			FA067R	N/A			
45							FA067TT			FA067R	N/A			
46							FA377TT*			FA377R*	N/A*			
47							FA067TT			FA067R	N/A			
48							FA067TT			FA067R	N/A			
49														
50														
51							SFA169	SFAC169		SFA169HH	N/A			
52							SFA169	SFAC169		SFA169HH	N/A			
53							SFA169	SFAC169		SFA169HH	N/A			
54							SFA169	SFAC169		SFA169HH	N/A			
55							SFA169	SFAC169		SFA169HH	N/A			
56														
57														
58							FA208TT		MXS208	FA208R	N/A			
59							FA367TT		MXS367	FA367R	N/A			
60							FA208TT		MXS208	FA208R	N/A			

REAR / ARRIÈRE / HINTEN / POSTERIOR / POSTERIORE

*-2 Sets Required. † For Vee disc colours add RED, BLU, GRN, GLD, ORG suffix to part number.

⊗ - Also available as a Vintage Motorcycle Disc.

R Suffix = High Durability Sintered Pad. HH Suffix = High Performance Sintered Pad. TT Suffix = Hard Wearing Off Road Pad. V Suffix = Semi Sintered Pad. G Suffix = Grooved Shoe. D Suffix = Drilled Disc. X Suffix = Universal Left or Right Disc. XC Suffix = Contoured Disc. LS Suffix = Left/Steel Disc. RS = Right/Steel Disc.

BRAKE APPLICATIONS

Non-JAPANESE Built Motorcycles

APPLICATIONS

BRAKE



T.M. Contd.

R Suffix = High Durability Sintered Pad. HH Suffix = High Performance Sintered Pad. TT Suffix = Hard Wearing Off Road Pad. V Suffix = Semi Sintered Pad. G Suffix = Grooved Shoe.

D Suffix = Drilled Disc. X Suffix = Universal Left or Right Disc. XC Suffix = Contoured Disc. LS Suffix = Left/Steel Disc. RS = Right/Steel Disc.

Model	Year
80 Enduro	96-00
80/85 Minicross/Junior	96-00
80/85 Cross	96-01
MX 85 JR (Small Wheel)	02-04
MX 85 JR (Small Wheel)	05-09
MX 85 JR (Small Wheel)	10-15
MX 85 (Big Wheel)	02-04
MX 85 (Big Wheel)	05-09
MX 85 (Big Wheel)	10-15
125 Cross	95-00
MX 125 (2T)	01-04
MX 125 (2T)	05-09
MX 125 (2T)	10-15
125 Enduro	95-00
Enduro EN 125 (2T)	01-04
Enduro EN 125 (2T)	05-09
Enduro EN 125 (2T)	10-15
SMM 125 Black Dream (Rim brake)	04-07
SMM 125 (2T) Black Dream (320mm front disc)	08-15
SMR 125 (2T)	05-14
SMR 125 (2T)	15
SMX 125 (2T)	15
EN 144 (2T)	08-09
EN 144 (2T)	10-15
MX 144 (2T)	08-09
MX 144 (2T)	10-15
250 Enduro	95-00
EN 250 F (4T) Enduro	04
EN 250 F (4T) Enduro	05-09
EN 250 F (4T) Enduro	10-15
Enduro EN 250 (2T)	01-04
Enduro EN 250 (2T)	05-09
Enduro EN 250 (2T)	10-15
SME 250 (4T)	04
250 Cross	95-00
MX 250 (2T)	01-04
MX 250 (2T)	05-09
MX 250 (2T)	10-15
MX 250 (4T) Cross	02-04
MX 250 (4T) Cross	05-09
MX 250 Fi (4T)	10-15
SM 250	02
SMM 250 (2T)	05-14
SMM 250 (2T)	15
SMM 250 F (4T)	10-15
SMR 250 (2T)	05-14
SMR 250 (2T)	15
SMR 250 F (4T)	10-15
SMX 250 (2T)	15
SMX 250 F (4T)	12-15
300 Enduro (2T)	95-00
Enduro EN 300 (2T)	01-04
Enduro EN 300 (2T)	05-09
Enduro EN 300 (2T)	10-15
300 Cross	95-00
MX 300 (2T)	01-04
MX 300 (2T)	05-09
MX 300 (2T)	10-15
SMM 300 (2T)	05-14
SMM 300 (2T)	15

FRONT / AVANT / VORN / FRENTE / ANTERIORE

DISC PAD CHOICES - FRONT				BRAKE DISC CHOICES - FRONT						Line #
FA, SFA, TT Pad or Brake Shoe	SFAC Carbon Scooter Pads	Speciality Pads SXR / Vee / MXS	Sintered/HH Pads/ Grooved Shoes	Left / Gauche / Links Standard Replacement Disc	Right / Droite / Rechts Standard Replacement Disc	Contour Disc Universal left and right fitment	Universal Custom Disc	Vee-Discs Black † See note below	CX Extreme MX Race Disc/ UTVX Disc	Line #
FA181TT		MXS181	FA181R	N/A						1
FA083TT			FA083R	N/A						2
FA181TT		MXS181	FA181R	N/A						3
FA181TT		MXS181	FA181R			MD6349C				4
FA181TT		MXS181	FA181R			MD6349C				5
FA181TT		MXS181	FA181R			N/A				6
FA181TT		MXS181	FA181R			MD6349C				7
FA181TT		MXS181	FA181R			MD6349C				8
FA181TT		MXS181	FA181R			N/A				9
FA181TT		MXS181	FA181R	N/A						10
FA181TT		MXS181	FA181R			MD6349C				11
FA181TT		MXS181	FA181R			MD6349C				12
FA181TT		MXS181	FA181R			N/A				13
FA181TT		MXS181	FA181R	N/A						14
FA181TT		MXS181	FA181R			MD6349C				15
FA181TT		MXS181	FA181R			MD6349C				16
FA181TT		MXS181	FA181R			N/A				17
N/A				N/A						18
			FA322/4HH	N/A						19
FA095			FA095HH	N/A						20
			FA322/4HH			N/A				21
			FA322/4HH			N/A				22
FA181TT		MXS181	FA181R			MD6349C				23
FA181TT		MXS181	FA181R			N/A				24
FA181TT		MXS181	FA181R			MD6349C				25
FA181TT		MXS181	FA181R			N/A				26
FA181TT		MXS181	FA181R	N/A						27
FA181TT		MXS181	FA181R			MD6349C				28
FA181TT		MXS181	FA181R			MD6349C				29
FA181TT		MXS181	FA181R			N/A				30
FA181TT		MXS181	FA181R			MD6349C				31
FA181TT		MXS181	FA181R			MD6349C				32
FA181TT		MXS181	FA181R			N/A				33
FA095		MXS181	FA095HH	N/A						34
FA181TT		MXS181	FA181R	N/A						35
FA181TT		MXS181	FA181R			MD6349C				36
FA181TT		MXS181	FA181R			MD6349C				37
FA181TT		MXS181	FA181R			N/A				38
FA181TT		MXS181	FA181R			MD6349C				39
FA181TT		MXS181	FA181R			MD6349C				40
FA181TT		MXS181	FA181R			N/A				41
FA095			FA095HH	N/A						42
FA095			FA095HH	N/A						43
			FA322/4HH			N/A				44
			FA322/4HH	N/A						45
FA095			FA095HH	N/A						46
			FA322/4HH			N/A				47
			FA322/4HH	N/A						48
			FA322/4HH			N/A				49
			FA322/4HH	N/A						50
FA181TT		MXS181	FA181R	N/A						51
FA181TT		MXS181	FA181R			MD6349C				52
FA181TT		MXS181	FA181R			MD6349C				53
FA181TT		MXS181	FA181R			N/A				54
FA181TT		MXS181	FA181R	N/A						55
FA181TT		MXS181	FA181R			MD6349C				56
FA181TT		MXS181	FA181R			MD6349C				57
FA181TT		MXS181	FA181R			N/A				58
FA095			FA095HH			N/A				59
			FA322/4HH			N/A				60

*-2 Sets Required. † For Vee disc colours add RED, BLU, GRN, GLD, ORG suffix to part number.

⊗ - Also available as a Vintage Motorcycle Disc.

396 Part numbers, prefixes, suffixes, photos and illustrations shown in this catalogue are trademarks and/or copyrights of EBC Brakes or the trademark owner A C Freeman Investments Ltd and use without express written permission of the owners is punishable by law.

Non-JAPANESE Built Motorcycles

Line #	BRAKE DISC CHOICES - FRONT						DISC PAD CHOICES - REAR				BRAKE DISC CHOICES - REAR			
	Oversize 250 /280mm Disc Kit	OSX Oversize 250/280mm Disc Kit	Relocating Bracket for 250/ 280mm Disc	Oversize 320mm Disc Kit	SMX Oversize 320mm Disc Kit	Relocating Bracket for 320mm Disc	FA, SFA, TT Pad or Brake Shoe	SFAC Carbon Scooter Pads	Speciality Pads -SXR / Vee / MXS	Sintered/ HH Pads/ Grooved Shoes	Standard Replacement Disc	Contour Disc Rear fitment	Vee-Discs™ CONTOUR	CX Extreme MX Race Disc/ UTVX Disc
1							FA208TT		MXS208	FA208R	N/A			
2							FA084/3TT		MXS084/3	FA084/3R	N/A			
3							FA208TT		MXS208	FA208R	N/A			
4							FA131TT		MXS131	FA131R		MD6350C		
5							FA367TT		MXS367	FA367R		MD6350C		
6							FA367TT		MXS367	FA367R		N/A		
7							FA131TT		MXS131	FA131R		MD6350C		
8							FA367TT		MXS367	FA367R		MD6350C		
9							FA367TT		MXS367	FA367R		N/A		
10							FA208TT		MXS208	FA208R	N/A			
11							FA131TT		MXS131	FA131R		MD6350C		
12							FA367TT		MXS367	FA367R		MD6350C		
13							FA367TT		MXS367	FA367R		N/A		
14							FA208TT		MXS208	FA208R	N/A			
15							FA131TT		MXS131	FA131R		MD6350C		
16							FA367TT		MXS367	FA367R		MD6350C		
17							FA367TT		MXS367	FA367R		N/A		
18							FA047			FA047HH	N/A			
19							FA047			FA047HH	N/A			
20							FA367TT		MXS367	FA367R	N/A			
21							FA367TT		MXS367	FA367R		N/A		
22							FA367TT		MXS367	FA367R		N/A		
23							FA367TT		MXS367	FA367R		MD6350C		
24							FA367TT		MXS367	FA367R		N/A		
25							FA367TT		MXS367	FA367R		MD6350C		
26							FA367TT		MXS367	FA367R		N/A		
27							FA208TT		MXS208	FA208R	N/A			
28							FA131TT		MXS131	FA131R		MD6350C		
29							FA367TT		MXS367	FA367R		MD6350C		
30							FA367TT		MXS367	FA367R		N/A		
31							FA131TT		MXS131	FA131R		MD6350C		
32							FA367TT		MXS367	FA367R		MD6350C		
33							FA367TT		MXS367	FA367R		N/A		
34							FA131TT		MXS131	FA131R	N/A			
35							FA208TT		MXS208	FA208R	N/A			
36							FA131TT		MXS131	FA131R		MD6350C		
37							FA367TT		MXS367	FA367R		MD6350C		
38							FA367TT		MXS367	FA367R		N/A		
39							FA131TT		MXS131	FA131R		MD6350C		
40							FA367TT		MXS367	FA367R		MD6350C		
41							FA367TT		MXS367	FA367R		N/A		
42							FA131TT		MXS131	FA131R	N/A			
43							FA047			FA047HH	N/A			
44							FA047			FA047HH	N/A			
45							FA367TT		MXS367	FA367R	N/A			
46							FA367TT		MXS367	FA367R	N/A			
47							FA367TT		MXS367	FA367R	N/A			
48							FA367TT		MXS367	FA367R	N/A			
49							FA367TT		MXS367	FA367R	N/A			
50							FA367TT		MXS367	FA367R	N/A			
51							FA208TT		MXS208	FA208R	N/A			
52							FA131TT		MXS131	FA131R		MD6350C		
53							FA367TT		MXS367	FA367R		MD6350C		
54							FA367TT		MXS367	FA367R		N/A		
55							FA208TT		MXS208	FA208R	N/A			
56							FA131TT		MXS131	FA131R		MD6350C		
57							FA367TT		MXS367	FA367R		MD6350C		
58							FA367TT		MXS367	FA367R		N/A		
59							FA047			FA047HH	N/A			
60							FA047			FA047HH	N/A			

REAR / ARRIÈRE / HINTEN / POSTERIORE

*-2 Sets Required. † For Vee disc colours add RED, BLU, GRN, GLD, ORG suffix to part number.

⊗ - Also available as a Vintage Motorcycle Disc.

R Suffix = High Durability Sintered Pad. HH Suffix = High Performance Sintered Pad. TT Suffix = Hard Wearing Off Road Pad. V Suffix = Semi Sintered Pad. G Suffix = Grooved Shoe.

D Suffix = Drilled Disc. X Suffix = Universal Left or Right Disc. XC Suffix = Contoured Disc. LS Suffix = Left/Steel Disc. RS = Right/Steel Disc.

Non-JAPANESE Built Motorcycles

APPLICATIONS

BRAKE



T.M. Contd.

R Suffix = High Durability Sintered Pad. HH Suffix = High Performance Sintered Pad. TT Suffix = Hard Wearing Off Road Pad. V Suffix = Semi Sintered Pad. G Suffix = Grooved Shoe.

D Suffix = Drilled Disc. X Suffix = Universal Left or Right Disc. XC Suffix = Contoured Disc. LS Suffix = Left/Steel Disc. RS = Right/Steel Disc.

Model	Year	FA, SFA, TT Pad or Brake Shoe	SFAC Carbon Scooter Pads	Speciality Pads SXR / Vee / MXS	Sintered/HH Pads/ Grooved Shoes	Left / Gauche / Links Standard Replacement Disc	Right / Droite / Rechts Standard Replacement Disc	Contour Disc Universal left and right fitment	Universal Custom Disc	Vee-Discs Black † See note below	CX Extreme MX Race Disc/ UTVX Disc
SMR 300 (2T)	05-14	FA095			FA095HH	N/A					
SMR 300 (2T)	15				FA322/4HH			N/A			
SMX 300 (2T)	15				FA322/4HH			N/A			
400 (4T) MX Cross	02-03	FA181TT		MXS181	FA181R	N/A					
400 Cross (4T)	95-00	FA181TT		MXS181	FA181R	N/A					
SME 400 (4T)	04	FA095			FA095HH	N/A					
SMM 400 (4T) (Rim brake)	04	N/A				N/A					
SM 400	02-03	FA095			FA095HH	N/A					
EN 450 F (4T)	04	FA181TT		MXS181	FA181R			MD6349C			
EN 450 Fi (4T)	05-09	FA181TT		MXS181	FA181R			MD6349C			
EN 450 Fi (4T)	10-15	FA181TT		MXS181	FA181R			N/A			
MX 450 F (4T)	04	FA181TT		MXS181	FA181R			MD6349C			
MX 450 Fi (4T)	05-09	FA181TT		MXS181	FA181R			MD6349C			
MX 450 Fi (4T)	10-15	FA181TT		MXS181	FA181R			N/A			
SMM 450 F Black Dream ES (320mm front disc)	08-10				FA322/4HH	N/A					
SMM 450 F	11-15				FA322/4HH	N/A					
SMR 450 FES	05-09	FA095			FA095HH	N/A					
SMR 450 F (4T)	10-15				FA322/4HH	N/A					
SMX 450 Fi	05-15				FA322/4HH	N/A					
530 Cross (4T)	98-00	FA181TT		MXS181	FA181R	N/A					
EN 530 F (4T)	04	FA181TT		MXS181	FA181R			MD6349C			
EN 530 F (4T)	05-09	FA181TT		MXS181	FA181R			MD6349C			
EN 530 F (4T)	10-15	FA181TT		MXS181	FA181R			N/A			
530 (4T) Cross	02-03	FA095			FA095HH	N/A					
MX 530 F	05-09	FA181TT		MXS181	FA181R			MD6349C			
MX 530 F	10-15	FA181TT		MXS181	FA181R			N/A			
SMM 530 F Black Dream (Rim brake)	04-07	N/A				N/A					
SM 530	02-03	FA095			FA095HH	N/A					
SME 530 (4T)	04	FA095			FA095HH	N/A					
SMM 530 F Black Dream ES (320mm front disc)	08-10				FA322/4HH	N/A					
SMR 530 F ES	05-09	FA095			FA095HH	N/A					
SMR 530 F	10-15				FA322/4HH	N/A					
SMX 530 F	05-14				FA322/4HH	N/A					
SMX 660 F	04	FA095			FA095HH	N/A					
SMX 660 F	05-10				FA322/4HH	N/A					

FRONT / AVANT / VORN / FRENTE / ANTERIORE

TOMOS

Moped with spoke wheels	908										
Moped with cast wheels	931				931G						
Alpino 45 (Drum Brakes)	909										
Alpino 45 (Front Disc Brake)	SFA115	SFAC115			SFA115HH	N/A					
APN 6	SFA115	SFAC115			SFA115HH	N/A					
Classic XL	909										
Flexer EX 25	909										
Flexer XL	909										
Funsport R 25	909										
Funtastic 25	SFA115	SFAC115			SFA115HH	N/A					
Hip Hop	SFA115	SFAC115			SFA115HH	N/A					
Luxe	909										
Luxe EX 25	909										
Nitro 50	TBA										
Revival TS	03-04	SFA116				N/A					
Revival TS		SFA115	SFAC115		SFA115HH	N/A					
Standard		909									
Standard XL		909									
Streetmate		SFA116				N/A					
Streetmate R		SFA116				N/A					
Twister 50		SFA264	SFAC264		SFA264HH	N/A					
MC 36	05-07	TBA									
MC 50 Junior	05-07	TBA									

*-2 Sets Required. † For Vee disc colours add RED, BLU, GRN, GLD, ORG suffix to part number.

⊗ - Also available as a Vintage Motorcycle Disc.

398 Part numbers, prefixes, suffixes, photos and illustrations shown in this catalogue are trademarks and/or copyrights of EBC Brakes or the trademark owner A C Freeman Investments Ltd and use without express written permission of the owners is punishable by law.

Line #
1
2
3
4
5
6
7
8
9
10
11
12
13
14
15
16
17
18
19
20
21
22
23
24
25
26
27
28
29
30
31
32
33
34
35
36
37
38
39
40
41
42
43
44
45
46
47
48
49
50
51
52
53
54
55
56
57
58
59
60

Non-JAPANESE Built Motorcycles

Line #	BRAKE DISC CHOICES - FRONT						DISC PAD CHOICES - REAR				BRAKE DISC CHOICES - REAR			
	Oversize 250 /280mm Disc Kit	OSX Oversize 250/280mm Disc Kit	Relocating Bracket for 250/ 280mm Disc	Oversize 320mm Disc Kit	SMX Oversize 320mm Disc Kit	Relocating Bracket for 320mm Disc	FA, SFA, TT Pad or Brake Shoe	SFAC Carbon Scooter Pads	Speciality Pads - SXR / Vee / MXS	Sintered/ HH Pads/ Grooved Shoes	Standard Replacement Disc	Contour Disc Rear fitment	Vee-Discs™ CONTOUR	CX Extreme MX Race Disc/ UTVX Disc
1							FA367TT		MXS367	FA367R	N/A			
2							FA367TT		MXS367	FA367R		N/A		
3							FA367TT		MXS367	FA367R		N/A		
4							FA131TT		MXS131	FA131R	N/A			
5							FA208TT		MXS208	FA208R	N/A			
6							FA131TT		MXS131	FA131R	N/A			
7							FA047			FA047HH	N/A			
8							FA131TT		MXS131	FA131R	N/A			
9							FA131TT		MXS131	FA131R		MD6350C		
10							FA367TT		MXS367	FA367R		MD6350C		
11							FA367TT		MXS367	FA367R		N/A		
12							FA131TT		MXS131	FA131R		MD6350C		
13							FA367TT		MXS367	FA367R		MD6350C		
14							FA367TT		MXS367	FA367R		N/A		
15							FA047			FA047HH	N/A			
16							FA047			FA047HH	N/A			
17							FA367TT		MXS367	FA367R	N/A			
18							FA367TT		MXS367	FA367R	N/A			
19							FA367TT		MXS367	FA367R	N/A			
20							FA208TT		MXS208	FA208R	N/A			
21							FA131TT		MXS131	FA131R		MD6350C		
22							FA367TT		MXS367	FA367R		MD6350C		
23							FA367TT		MXS367	FA367R		N/A		
24							FA131TT		MXS131	FA131R	N/A			
25							FA367TT		MXS367	FA367R		MD6350C		
26							FA367TT		MXS367	FA367R		N/A		
27							FA047			FA047HH	N/A			
28							FA131TT		MXS131	FA131R	N/A			
29							FA131TT		MXS131	FA131R	N/A			
30							FA047			FA047HH	N/A			
31							FA367TT		MXS367	FA367R	N/A	N/A		
32							FA367TT		MXS367	FA367R		N/A		
33							FA367TT		MXS367	FA367R	N/A			
34							FA131TT		MXS131	FA131R	N/A			
35							FA367TT		MXS367	FA367R	N/A			
36														
37														
38							908							
39							931		931G					
40							909							
41							909							
42							909							
43							909							
44							909							
45							909							
46							909							
47							909							
48							909							
49							909							
50							909							
51							TBA							
52							TBA							
53							909							
54							909							
55							909							
56							TBA							
57							909							
58							H307							
59							TBA							
60							TBA							

REAR / ARRIÈRE / HINTEN / POSTERIOR / POSTERIORE

*-2 Sets Required. † For Vee disc colours add RED, BLU, GRN, GLD, ORG suffix to part number.

⊗ - Also available as a Vintage Motorcycle Disc.

R Suffix = High Durability Sintered Pad. HH Suffix = High Performance Sintered Pad. TT Suffix = Hard Wearing Off Road Pad. V Suffix = Semi Sintered Pad. G Suffix = Grooved Shoe.

D Suffix = Drilled Disc. X Suffix = Universal Left or Right Disc. XC Suffix = Contoured Disc. LS Suffix = Left/Steel Disc. RS = Right/Steel Disc.

BRAKE APPLICATIONS

Non-JAPANESE Built Motorcycles

Line #	BRAKE DISC CHOICES - FRONT						DISC PAD CHOICES - REAR				BRAKE DISC CHOICES - REAR			
	Oversize 250 /280mm Disc Kit	OSX Oversize 250/280mm Disc Kit	Relocating Bracket for 250/ 280mm Disc	Oversize 320mm Disc Kit	SMX Oversize 320mm Disc Kit	Relocating Bracket for 320mm Disc	FA, SFA, TT Pad or Brake Shoe	SFAC Carbon Scooter Pads	Speciality Pads - SXR / Vee / MXS	Sintered/ HH Pads/ Grooved Shoes	Standard Replacement Disc	Contour Disc Rear fitment	Vee-Discs™ CONTOUR	CX Extreme MX Race Disc/ UTVX Disc
1							FA325TT			FA325R	N/A			
2							TBA							
3							FA351TT				N/A			
4							909							
5							909							
6							909							
7							909							
8							909							
9							TBA							
10							FA115			FA115HH	N/A			
11							FA115			FA115HH	N/A			
12							TBA							
13							H307							
14							TBA							
15														
16														
17							858							
18							853							
19							N/A							
20							FA016			FA016HH	MD656 ☉			
21							FA016			FA016HH	MD656 ☉			
22							FA016			FA016HH	MD656 ☉			
23							FA016			FA016HH	MD838			
24							FA016			FA016HH	MD656 ☉			
25							FA016			FA016HH	N/A			
26							FA016			FA016HH	MD656 ☉			
27							FA016			FA016HH	MD656 ☉			
28														
29							FA018		FA018V	FA018HH	N/A			
30														
31														
32							FA196		FA196V	FA196HH	MD643			
33							FA196		FA196V	FA196HH	MD643			
34							FA214/2		FA214/2V	FA214/2HH	MD643		VR643	
35														
36							FA214/2		FA214/2V	FA214/2HH	MD643		VR643	
37							FA214/2		FA214/2V	FA214/2HH	MD643			
38														
39							FA214/2		FA214/2V	FA214/2HH	MD643			
40							FA214/2		FA214/2V	FA214/2HH	MD643			
41														
42							FA214/2		FA214/2V	FA214/2HH	MD643			
43							FA214/2		FA214/2V	FA214/2HH	MD643		VR643	
44														
45							FA214/2		FA214/2V	FA214/2HH	MD643		VR643	
46							FA214/2		FA214/2V	FA214/2HH	MD663		VR663	
47							FA214/2		FA214/2V	FA214/2HH	MD663		VR663	
48							FA214/2		FA214/2V	FA214/2HH	MD663	MD663C		
49														
50							FA214/2		FA214/2V	FA214/2HH	MD663	MD663C		
51							FA214/2		FA214/2V	FA214/2HH	MD663	MD663C		
52														
53							FA214/2		FA214/2V	FA214/2HH	MD663	MD663C		
54							FA214/2		FA214/2V	FA214/2HH	MD663	MD663C		
55														
56							FA214/2		FA214/2V	FA214/2HH	MD663	MD663C		
57							FA214/2		FA214/2V	FA214/2HH	MD663			
58														
59							FA214/2		FA214/2V	FA214/2HH	MD663			
60							FA214/2		FA214/2V	FA214/2HH	MD663		VR663	

REAR / ARRIÈRE / HINTEN / POSTERIOR / POSTERIORE

*-2 Sets Required. † For Vee disc colours add RED, BLU, GRN, GLD, ORG suffix to part number.
 ☉ - Also available as a Vintage Motorcycle Disc.

R Suffix = High Durability Sintered Pad. **HH** Suffix = High Performance Sintered Pad. **TT** Suffix = Hard Wearing Off Road Pad. **V** Suffix = Semi Sintered Pad. **G** Suffix = Grooved Shoe.
D Suffix = Drilled Disc. **X** Suffix = Universal Left or Right Disc. **XC** Suffix = Contoured Disc. **LS** Suffix = Left/Steel Disc. **RS** = Right/Steel Disc.

BRAKE APPLICATIONS

Non-JAPANESE Built Motorcycles

APPLICATIONS

BRAKE



TRIUMPH Contd.
(HINCKLEY PRODUCED MACHINES)



R Suffix = High Durability Sintered Pad. HH Suffix = High Performance Sintered Pad. TT Suffix = Hard Wearing Off Road Pad. V Suffix = Semi Sintered Pad. G Suffix = Grooved Shoe.

D Suffix = Drilled Disc. X Suffix = Universal Left or Right Disc. XC Suffix = Contoured Disc. LS Suffix = Left/Steel Disc. RS = Right/Steel Disc.

Model	Year
Bonneville/Bonneville Black (865cc)	
- Floating Disc Conversion Option	07-08
Bonneville T100 (790cc)	02-04
Bonneville T100 (790cc) - Floating Disc Conversion Option	02-04
Bonneville T100 (865cc)	05-09
Bonneville T100 (865cc) - Floating Disc Conversion Option	05-09
Bonneville T100 (865cc/Air Cooled/Spoke Wheel)	10-16
Bonneville T100 (865cc/Air Cooled/Spoke Wheel) - Floating Disc Conversion Option	10-16
Bonneville T100 Black (865cc/Air Cooled/Spoke Wheel)	14-16
Bonneville T100 Black (865cc/Air Cooled/Spoke Wheel) - Floating Disc Conversion Option	14-16
Bonneville T100 (900cc/Liquid Cooled/Spoke Wheel)	16-20
Bonneville T100 Black (900cc/Liquid Cooled/Spoke Wheel)	16-20
Bonneville T214 (865cc/Spoke Wheel)	15
Bonneville T214 (865cc/Spoke Wheel) - Floating Disc Conversion Option	15
Bonneville Steve McQueen SE (865cc/Spoke Wheel)	12
Bonneville Steve McQueen SE (865cc/Spoke Wheel) - Floating Disc Conversion Option	12
Bonneville T120 (1200cc Liquid Cooled)	16-20
Bonneville T120 (1200cc Liquid Cooled) - Floating Disc Conversion Option	16-20
Bonneville T120 Black (1200cc Liquid Cooled)	16-20
Bonneville T120 Black (1200cc Liquid Cooled) - Floating Disc Conversion Option	16-20
Bonneville Bobber (1200cc Liquid Cooled)	17-20
Bonneville Bobber (1200cc Liquid Cooled) - Floating Disc Conversion Option	17-20
Bonneville Bobber Black (1200cc Liquid Cooled)	18-20
Bonneville Bobber Black (1200cc Liquid Cooled) - Floating Disc Conversion Option	18-20
Bonneville Speedmaster (1200cc Liquid Cooled)	18
Bonneville Speedmaster (1200cc Liquid Cooled) - Floating Disc Conversion Option	18
Bonneville Speedtwin (1200cc Liquid Cooled)	19-20
Daytona 600	03-04
TT 600	00-03
Daytona 650	05
Daytona 675	06-08
Daytona 675 Black Monobloc radial caliper - flat look to outer body	09-12
Daytona 675 (Nissin F/Brembo R Calipers)	13-17
Daytona 675 R (Brembo F/Nissin R Caliper)	11-12
Daytona 675 R (Brembo Calipers F&R)	13-17
Street Triple S 765 ABS (Nissin 2 piston front calipers, Brembo single piston rear caliper)	18-20
Street Triple R 765 ABS (Brembo 4 piston radial front calipers, Brembo single piston rear caliper)	18-20
Street Triple RS 765 ABS (Brembo 4 piston radial monobloc front calipers, Brembo single piston rear caliper)	18-20
Daytona 765 Moto2	20
T595 Daytona (6 bolt) Front disc	97
Daytona 955i (6 bolt) Front disc (single sided swinging arm)	98-00
Daytona 955i (from VIN132513) (5 bolt Front disc) (Single sided s/arm)	01-04
Daytona 955i (from VIN132513) (5 bolt Front disc) (Double sided s/arm)	01-04
Daytona 955i	05-06
Daytona 750 (3 cyl)	92

FRONT / AVANT / VORN / FRENTE / ANTERIORE

DISC PAD CHOICES - FRONT				BRAKE DISC CHOICES - FRONT						
FA, SFA, TT Pad or Brake Shoe	SFAC Carbon Scooter Pads	Speciality Pads SXR / Vee / MXS	Sintered/HH Pads/ Grooved Shoes	Left / Gauche / Links Standard Replacement Disc	Right / Droite / Rechts Standard Replacement Disc	Contour Disc Universal left and right fitment	Universal Custom Disc	Vee-Discs Black † See note below	CX Extreme MX Race Disc/ UTVX Disc	
FA142		FA142V	FA142HH	MD822X					MD649CX	
FA142		FA142V	FA142HH	MD822					MD649CX	
FA142		FA142V	FA142HH	MD822X					MD649CX	
FA142		FA142V	FA142HH	MD822					MD649CX	
FA142		FA142V	FA142HH	MD822X					MD649CX	
FA142		FA142V	FA142HH	MD822						
FA142		FA142V	FA142HH	MD822X			MD822XC			
FA142		FA142V	FA142HH	MD822						
FA142		FA142V	FA142HH	MD822X			MD822XC			
FA142		FA142V	FA142HH	MD886X			TBA			
FA142		FA142V	FA142HH	MD886X			TBA			
FA142		FA142V	FA142HH	MD822						
FA142		FA142V	FA142HH	MD822X			MD822XC			
FA142		FA142V	FA142HH	MD822						
FA142		FA142V	FA142HH	MD822X			MD822XC			
FA142*			FA142HH*	MD873	MD873					
FA142*			FA142HH*	MD873X	MD873X					
FA142*			FA142HH*	MD873	MD873					
FA142*			FA142HH*	MD873X	MD873X					
FA181TT*		FA181V*	FA181HH*	MD873	MD873					
FA181TT*		FA181V*	FA181HH*	MD873X	MD873X					
FA181TT*		FA181V*	FA181HH*	MD873	MD873					
FA181TT*		FA181V*	FA181HH*	MD873X	MD873X					
FA236*			FA236HH*	MD662X	MD662X	MD662XC*		VR662BLK*		
FA236*			FA236HH*	MD662X	MD662X	MD662XC*		VR662BLK*		
FA236*			FA236HH*	MD662X	MD662X	MD662XC*		VR662BLK*		
			FA347HH*	MD800X	MD800X	MD800XC*		VR800BLK*		
			FA491HH*	MD800X	MD800X	MD800XC*		VR800BLK*		
			FA491HH*	MD852X	MD852X	MD852XC*				
			FA447HH*	TBA	TBA					
			FA447HH*	TBA	TBA					
FA266*			FA266HH*							
			FA447HH*							
			FA447HH*							
			FA604/4HH*	TBA	TBA					
FA236*			FA236HH*	MD647X	MD647X	MD647XC*		VR647BLK*		
FA236*			FA236HH*	MD647X	MD647X	MD647XC*		VR647BLK*		
FA236*			FA236HH*	MD669X	MD669X	MD669XC*		VR669BLK*		
FA236*			FA236HH*	MD669X	MD669X	MD669XC*		VR669BLK*		
FA236*			FA236HH*	MD669X	MD669X	MD669XC*		VR669BLK*		
FA236*			FA236HH*	MD640	MD640			VR640BLK*		

Line #
1
2
3
4
5
6
7
8
9
10
11
12
13
14
15
16
17
18
19
20
21
22
23
24
25
26
27
28
29
30
31
32
33
34
35
36
37
38
39
40
41
42
43
44
45
46
47
48
49
50
51
52
53
54
55
56
57
58
59
60

*-2 Sets Required. † For Vee disc colours add RED, BLU, GRN, GLD, ORG suffix to part number.

⊗ - Also available as a Vintage Motorcycle Disc.

Non-JAPANESE Built Motorcycles

Line #	BRAKE DISC CHOICES - FRONT						DISC PAD CHOICES - REAR				BRAKE DISC CHOICES - REAR			
	Oversize 250 /280mm Disc Kit	OSX Oversize 250/280mm Disc Kit	Relocating Bracket for 250/ 280mm Disc	Oversize 320mm Disc Kit	SMX Oversize 320mm Disc Kit	Relocating Bracket for 320mm Disc	FA, SFA, TT Pad or Brake Shoe	SFAC Carbon Scooter Pads	Speciality Pads - SXR / Vee / MXS	Sintered/ HH Pads/ Grooved Shoes	Standard Replacement Disc	Contour Disc Rear fitment	Vee-Discs™ CONTOUR	CX Extreme MX Race Disc/ UTVX Disc
1														
2							FA214/2		FA214/2V	FA214/2HH	MD663		VR663	
3							FA214/2		FA214/2V	FA214/2HH	MD663		VR663	
4							FA214/2		FA214/2V	FA214/2HH	MD663		VR663	
5							FA214/2		FA214/2V	FA214/2HH	MD663		VR663	
6							FA214/2		FA214/2V	FA214/2HH	MD663		VR663	
7							FA214/2		FA214/2V	FA214/2HH	MD663			
8														
9							FA214/2		FA214/2V	FA214/2HH	MD663			
10							FA214/2		FA214/2V	FA214/2HH	MD663			
11														
12							FA214/2		FA214/2V	FA214/2HH	MD663			
13							FA214/2		FA214/2V	FA214/2HH	MD874			
14							FA214/2		FA214/2V	FA214/2HH	MD874			
15							FA214/2		FA214/2V	FA214/2HH	MD663			
16														
17							FA214/2		FA214/2V	FA214/2HH	MD663			
18							FA214/2		FA214/2V	FA214/2HH	MD663			
19														
20							FA214/2		FA214/2V	FA214/2HH	MD663			
21							FA214/2		FA214/2V	FA214/2HH	MD874			
22														
23							FA214/2		FA214/2V	FA214/2HH	MD874			
24							FA214/2		FA214/2V	FA214/2HH	MD874			
25														
26							FA214/2		FA214/2V	FA214/2HH	MD874			
27							FA140		FA140V	FA140HH	MD874			
28														
29							FA140		FA140V	FA140HH	MD874			
30							FA140		FA140V	FA140HH	MD874			
31														
32							FA140		FA140V	FA140HH	MD874			
33							FA140		FA140V	FA140HH	MD874			
34														
35							FA140		FA140V	FA140HH	MD874			
36							FA215/2			FA215/2HH				
37							FA140		FA140V	FA140HH	MD648	MD648C	VR648	
38							FA140		FA140V	FA140HH	MD648	MD648C	VR648	
39							FA140		FA140V	FA140HH	MD648	MD648C	VR648	
40							FA140		FA140V	FA140HH	MD648	MD648C	VR648	
41														
42							FA140		FA140V	FA140HH	MD648	MD648C	VR648	
43							FA213		FA213V	FA213HH	MD851	MD851C		
44							FA140		FA140V	FA140HH	MD648	MD648C	VR648	
45							FA213		FA213V	FA213HH	MD851	MD851C		
46														
47							FA213			FA213HH				
48														
49							FA213			FA213HH				
50														
51							FA213			FA213HH				
52							FA213			FA213HH				
53							FA214/2		FA214/2V	FA214/2HH	MD648	MD648C	VR648	
54							FA214/2		FA214/2V	FA214/2HH	MD648	MD648C	VR648	
55														
56							FA214/2		FA214/2V	FA214/2HH	MD648	MD648C	VR648	
57														
58							FA140		FA140V	FA140HH	MD648	MD648C	VR648	
59							FA214/2		FA214/2V	FA214/2HH	MD648	MD648C	VR648	
60							FA215/2		FA215/2V	FA215/2HH	MD641		VR641	

REAR / ARRIÈRE / HINTEN / POSTERIOR / POSTERIORE

*-2 Sets Required. † For Vee disc colours add RED, BLU, GRN, GLD, ORG suffix to part number.

⊗ - Also available as a Vintage Motorcycle Disc.

R Suffix = High Durability Sintered Pad. HH Suffix = High Performance Sintered Pad. TT Suffix = Hard Wearing Off Road Pad. V Suffix = Semi Sintered Pad. G Suffix = Grooved Shoe.

D Suffix = Drilled Disc. X Suffix = Universal Left or Right Disc. XC Suffix = Contoured Disc. LS Suffix = Left/Steel Disc. RS = Right/Steel Disc.

Non-JAPANESE Built Motorcycles



TRIUMPH Contd.
(HINCKLEY PRODUCED MACHINES)



R Suffix = High Durability Sintered Pad. HH Suffix = High Performance Sintered Pad. TT Suffix = Hard Wearing Off Road Pad. V Suffix = Semi Sintered Pad. G Suffix = Grooved Shoe.

D Suffix = Drilled Disc. X Suffix = Universal Left or Right Disc. XC Suffix = Contoured Disc. LS Suffix = Left/Steel Disc. RS = Right/Steel Disc.

Daytona 1000 (4 cyl)	92
Daytona 900 (3 cyl)	93-96
Daytona Super III (3 cyl)	94-97
Daytona 1200 (4 cyl)	93-98
Legend TT	98-01
Legend TT - Floating Disc Conversion Option	98-01
Rocket III 2300cc	04-09
Rocket III Classic	07-09
Rocket III Roadster ABS	10-18
Rocket III Touring	08-17
Rocket X	15-16
Rocket III R	19-20
Rocket III GT	19-20
Scrambler (865cc)	06-09
Scrambler (865cc) - Floating Disc Conversion Option	06-09
Scrambler (865cc)	10-15
Scrambler (865cc) - Floating Disc Conversion Option	10-15
Speed Triple 750/900 (Carb Models)	94-96
Speed Triple T509 - (EFI 885cc - 6 Bolt Front Disc)	97-98
Speed Triple (EFI 955cc - 6 Bolt Front Disc)	99-04
Speed Triple (1050cc - Nissin Radial F/Caliper/220mm R/Disc)	05-06
Speed Triple (1050cc - 4 Pad Brembo F/Caliper /220mm R/Disc/Non ABS Model- To VIN 461331)	07-11
Speed Triple (1050cc - 4 Pad Brembo F/Caliper /220mm R/Disc/ABS Model- To VIN 461331)	07-11
Speed Triple (1050cc - 4 Pad Brembo F/Caliper /255mm R/Disc/Non ABS Model- From VIN461332)	11-16
Speed Triple (1050cc - 4 Pad Brembo F/Caliper /255mm R/Disc/ABS Model- To VIN 461331)	11-16
Speed Triple S (1050cc/ABS Model)	17-18
Speed Triple R (1050cc - 2 Pad Brembo F/Caliper /255mm R/Disc/Non ABS /5 Spoke wheels)	12-13
Speed Triple R (1050cc - 2 Pad Brembo F/Caliper /255mm R/Disc ABS /5 Spoke wheels)	12-13
Speed Triple R (1050cc - 2Pad Brembo F/Caliper /Non ABS Model/ 10 Spoke wheels)	14-16
Speed Triple R (1050cc - 2Pad Brembo F/Caliper /ABS Model/ 10 Spoke wheels)	14-16
Speed Triple R (1050cc/ABS)	17
Speed Triple RS (1050cc/ABS)	18
Speedfour 600	02-05
Speedmaster (790cc/Carbs)	03-04
Speedmaster (790cc/Carbs) - Floating Disc Conversion Option	03-04
Speedmaster (865cc/Carbs)	05-07
Speedmaster (865cc/Carbs) - Floating Disc Conversion Option	05-07
Speedmaster (865cc/EFI)	08-09
Speedmaster (865cc/EFI) - Floating Disc Conversion Option	08-09
Speedmaster (865cc/EFI)	10-16
Speedmaster (865cc/EFI) - Floating Disc Conversion Option	10-16
Sprint (All carb models) Left	93
Up to VIN 9082 Right	
Sprint (All carb models from VIN 9083)	94-98
Sprint RS (up to VIN 139276) (6 bolt front disc) (double sided swing arm)	99-01

FRONT / AVANT / VORN / FRENTE / ANTERIORE

DISC PAD CHOICES - FRONT				BRAKE DISC CHOICES - FRONT							Line #
FA, SFA, TT Pad or Brake Shoe	SFAC Carbon Scooter Pads	Speciality Pads SXR / Vee / MXS	Sintered/ HH Pads/ Grooved Shoes	Left / Gauche / Links Standard Replacement Disc	Right / Droite / Rechts Standard Replacement Disc	Contour Disc Universal left and right fitment	Universal Custom Disc	Vee-Discs Black † See note below	CX Extreme MX Race Disc/ UTVX Disc	Line #	
FA236*			FA236HH*	MD640	MD640			VR640BLK*		1	
FA236*			FA236HH*	MD640	MD640			VR640BLK*		2	
FA190*			FA190HH*	MD640	MD640			VR640BLK*		3	
FA236*			FA236HH*	MD640	MD640			VR640BLK*		4	
FA196		FA196V	FA196HH	MD642LS						5	
FA196		FA196V	FA196HH	MD629						6	
			FA236HH*	MD669X	MD669X	MD669XC*		VR669BLK*		7	
			FA236HH*	MD669X	MD669X	MD669XC*		VR669BLK*		8	
			FA236HH*	MD669X	MD669X	MD669XC*		VR669BLK*		9	
			FA236HH*	TBA	TBA					10	
			FA236HH*	MD669X	MD669X	MD669XC*		VR669BLK*		11	
			FA477HH*							12	
			FA477HH*							13	
FA142		FA142V	FA142HH	MD822					MD649CX	14	
FA142		FA142V	FA142HH	MD822X					MD649CX	15	
FA142		FA142V	FA142HH	MD822						16	
FA142		FA142V	FA142HH	MD822X		MD822XC				17	
FA236*			FA236HH*	MD640	MD640					18	
FA236*			FA236HH*	MD647X	MD647X	MD647XC*		VR647BLK*		19	
FA236*			FA236HH*	MD647X	MD647X	MD647XC*		VR647BLK*		20	
										21	
			FA347HH*	MD679X	MD679X	MD679XC*		VR679BLK*		22	
										23	
			FA322/4HH*	MD817X	MD817X	MD817XC*		VR817BLK*		24	
										25	
			FA322/4HH*	MD817X	MD817X	MD817XC*		VR817BLK*		26	
										27	
			FA604/4HH*	MD817X	MD817X	MD817XC*		VR817BLK*		28	
										29	
			FA604/4HH*	MD817X	MD817X	MD817XC*		VR817BLK*		30	
			FA447HH*	MD817X	MD817X	MD817XC*		VR817BLK*		31	
										32	
			FA447HH*	MD679X	MD679X	MD679XC*		VR679BLK*		33	
										34	
			FA447HH*	MD679X	MD679X	MD679XC*		VR679BLK*		35	
										36	
			FA447HH*	MD817X	MD817X	MD817XC*		VR817BLK*		37	
										38	
			FA447HH*	MD817X	MD817X	MD817XC*		VR817BLK*		39	
			FA447HH*	MD817X	MD817X	MD817XC*		VR817BLK*		40	
			FA447HH*	MD679X	MD679X	MD679XC*		VR679BLK*		41	
FA236*			FA236HH*	MD662X	MD662X	MD662XC*		VR662BLK*		42	
FA196		FA196V*	FA196HH*	MD649	MD649				MD649CX*	43	
										44	
FA196*		FA196V*	FA196HH*	MD649	MD649				MD649CX*	45	
FA196*		FA196V*	FA196HH*	MD649	MD649				MD649CX*	46	
										47	
FA196*		FA196V*	FA196HH*	MD601LS	MD601RS				MD649CX*	48	
FA142*		FA142V*	FA142HH*	MD822	MD822				MD649CX*	49	
										50	
FA142*		FA142V*	FA142HH*	MD822X	MD822X				MD649CX*	51	
FA196*		FA196V*	FA196HH*	MD821						52	
										53	
FA196*		FA196V*	FA196HH*	MD821X		MD821XC				54	
FA214		FA214V	FA214HH	MD646LS	MD646RS			VR646BLK*		55	
FA215		FA215V	FA215HH							56	
FA236*			FA236HH*	MD640	MD640			VR640BLK*		57	
										58	
FA236*			FA236HH*	MD647X	MD647X	MD647XC*		VR647BLK*		59	
										60	

*-2 Sets Required. † For Vee disc colours add RED, BLU, GRN, GLD, ORG suffix to part number.

⊗ - Also available as a Vintage Motorcycle Disc.

Non-JAPANESE Built Motorcycles

Line #	BRAKE DISC CHOICES - FRONT						DISC PAD CHOICES - REAR				BRAKE DISC CHOICES - REAR			
	Oversize 250 /280mm Disc Kit	OSX Oversize 250/280mm Disc Kit	Relocating Bracket for 250/ 280mm Disc	Oversize 320mm Disc Kit	SMX Oversize 320mm Disc Kit	Relocating Bracket for 320mm Disc	FA, SFA, TT Pad or Brake Shoe	SFAC Carbon Scooter Pads	Speciality Pads - SXR / Vee / MXS	Sintered/ HH Pads/ Grooved Shoes	Standard Replacement Disc	Contour Disc Rear fitment	Vee-Discs™ CONTOUR	CX Extreme MX Race Disc/ UTVX Disc
1							FA215/2		FA215/2V	FA215/2HH	MD641		VR641	
2							FA215/2		FA215/2V	FA215/2HH	MD641		VR641	
3							FA215/2		FA215/2V	FA215/2HH	MD641		VR641	
4							FA215/2		FA215/2V	FA215/2HH	MD641		VR641	
5							FA196		FA196V	FA196HH	MD643			
6							FA196		FA196V	FA196HH	MD643			
7									FA209/2V	FA209/2HH	MD699			
8									FA209/2V	FA209/2HH	MD699			
9									FA209/2V	FA209/2HH	MD699			
10									FA209/2V	FA209/2HH	MD699			
11									FA209/2V	FA209/2HH	MD699			
12									FA630HH					
13									FA630HH					
14							FA214/2		FA214/2V	FA214/2HH	MD663		VR663	
15							FA214/2		FA214/2V	FA214/2HH	MD663		VR663	
16							FA214/2		FA214/2V	FA214/2HH	MD663			
17							FA214/2		FA214/2V	FA214/2HH	MD663			
18							FA215/2		FA215/2V	FA215/2HH	MD641		VR641	
19							FA214/2		FA214/2V	FA214/2HH	MD648	MD648C	VR648	
20							FA214/2		FA214/2V	FA214/2HH	MD648	MD648C	VR648	
21														
22							FA214/2		FA214/2V	FA214/2HH	MD648	MD648C	VR648	
23														
24							FA214/2		FA214/2V	FA214/2HH	MD648	MD648C	VR648	
25														
26							FA214/2		FA214/2V	FA214/2HH	MD648	MD648C	VR648	
27														
28							FA214/2		FA214/2V	FA214/2HH	MD663	MD663C	VR663	
29														
30							FA214/2		FA214/2V	FA214/2HH	MD820	MD820C	VR820	
31							FA214/2		FA214/2V	FA214/2HH	MD874			
32														
33							FA214/2		FA214/2V	FA214/2HH	MD663	MD663C	VR663	
34														
35							FA214/2		FA214/2V	FA214/2HH	MD820	MD820C	VR820	
36														
37							FA214/2		FA214/2V	FA214/2HH	MD663	MD663C	VR663	
38														
39							FA214/2		FA214/2V	FA214/2HH	MD820	MD820C	VR820	
40							FA214/2		FA214/2V	FA214/2HH	MD874			
41							FA214/2		FA214/2V	FA214/2HH	MD874			
42							FA140		FA140V	FA140HH	MD648	MD648C	VR648	
43							FA214/2		FA214/2V	FA214/2HH	MD643		VR643	
44														
45							FA214/2		FA214/2V	FA214/2HH	MD643		VR643	
46							FA214/2		FA214/2V	FA214/2HH	MD643		VR643	
47														
48							FA214/2		FA214/2V	FA214/2HH	MD643		VR643	
49							FA214/2		FA214/2V	FA214/2HH	MD643		VR643	
50														
51							FA214/2		FA214/2V	FA214/2HH	MD643		VR643	
52							FA214/2		FA214/2V	FA214/2HH	MD643			
53														
54							FA214/2		FA214/2V	FA214/2HH	MD643			
55							FA215/2		FA215/2V	FA215/2HH	MD641		VR641	
56														
57							FA215/2		FA215/2V	FA215/2HH	MD641		VR641	
58														
59							FA215/2		FA215/2V	FA215/2HH	MD663	MD663C	VR663	
60														

REAR / ARRIÈRE / HINTEN / POSTERIOR / POSTERIORE

*-2 Sets Required. † For Vee disc colours add RED, BLU, GRN, GLD, ORG suffix to part number.

⊗ - Also available as a Vintage Motorcycle Disc.

R Suffix = High Durability Sintered Pad. **HH** Suffix = High Performance Sintered Pad. **TT** Suffix = Hard Wearing Off Road Pad. **V** Suffix = Semi Sintered Pad. **G** Suffix = Grooved Shoe.
D Suffix = Drilled Disc. **X** Suffix = Universal Left or Right Disc. **XC** Suffix = Contoured Disc. **LS** Suffix = Left/Steel Disc. **RS** = Right/Steel Disc.

Non-JAPANESE Built Motorcycles

APPLICATIONS

BRAKE



TRIUMPH Contd.
(HINCKLEY PRODUCED MACHINES)



R Suffix = High Durability Sintered Pad. HH Suffix = High Performance Sintered Pad. TT Suffix = Hard Wearing Off Road Pad. V Suffix = Semi Sintered Pad. G Suffix = Grooved Shoe.

D Suffix = Drilled Disc. X Suffix = Universal Left or Right Disc. XC Suffix = Contoured Disc. LS Suffix = Left/Steel Disc. RS = Right/Steel Disc.

Model	Year
Sprint RS (from VIN 139277) (6 bolt front disc) Note: up to VIN 161317 double sided swing arm	02
Sprint RS (from VIN 139277) (Single sided swing arm up to VIN 161317) (6 bolt front disc)	
Note: from VIN 161318 double sided swing arm	03-04
Sprint ST 955i (Front Disc With Offset/6 Bolt Fixing)	99-04
Sprint ST 1050 (5 Spoke wheel/Non ABS/F Disc With Offset/5 Bolt Fixing) Vin 208167>	05-10
Sprint ST 1050 (5 Spoke wheel/ABS/F Disc With Offset/5 Bolt Fixing)	05-10
Sprint ST 1050i (Non ABS/Front Disc With Zero Offset/5 Bolt Fixing)	11-12
Sprint ST 1050i (ABS/Front Disc With Zero Offset/5 Bolt Fixing)	11-12
Sprint GT 1050/SE (ABS)	10-20
Street Cup (900cc Liquid Cooled)	16-20
Street Scrambler (900cc Liquid Cooled)	16-20
Street Triple S 660 (Nissin F/Brembo R Calipers)	17-20
Street Triple 675 (Naked)	07-12
Street Triple 675 (Nissin F/Brembo R Calipers)	13-16
Street Triple S 765 (Nissin F/Brembo R Calipers)	17-20
Street Triple R 675	09-12
Street Triple 675 R (Nissin F/Brembo R Calipers)	13-16
Street Triple R 765 (Brembo F&R Calipers)	17-20
Street Triple RS 765 (Brembo F&R Calipers)	17-20
Street Triple RX 675 (Nissin F/Brembo R Calipers)	15-16
Street Twin (900cc Liquid Cooled)	16-20
Street Twin (900cc Liquid Cooled) - Floating Disc Conversion Option	16-20
Thunderbird	95-03
Thunderbird - Floating Disc Conversion Option	95-03
Thunderbird Sport	98-04
Thunderbird Sport - Floating Disc Conversion Option	98-04
Thunderbird (1597cc)	09-18
Thunderbird Commander (1699cc)	14-18
Thunderbird LT (1699cc)	14-18
Thunderbird Storm (1699cc)	11-18
Thunderbird Nightstorm (1699cc)	15-18
Thruxton 900	04-16
Thruxton Ace 900	15-16
Tiger 800 (Non ABS)	11-14
Tiger 800 (With ABS)	11-14
Tiger 800 XC (Non ABS)	11-14
Tiger 800 XC (With ABS)	11-20
Tiger 800 XCa (ABS) up to VIN 855531	15-18
Tiger 800 XCa (ABS) from VIN 855532	18-20
Tiger 800 XCx (ABS) up to VIN 855531	15-18
Tiger 800 XCx (ABS) from VIN 855532	18-20
Tiger 800 XR (ABS)	15-18
Tiger 800 XRt (ABS) up to VIN 855531	15-18
Tiger 800 XRt (ABS) from VIN 855532	18-20
Tiger 800 XRx (ABS) up to VIN 855531	15-18
Tiger 800 XRx (ABS) from VIN 855532	18-20
Tiger 885cc (Carbs) (Up to VIN 71698) Left	92-97
Right	
Tiger 885i (From VIN 71699)	98-99
Tiger 885i (From VIN 71699) - Floating Disc Conversion	98-99
Tiger 900	20
Tiger 900 GT	20
Tiger 900 GT Low	20

FRONT / AVANT / VORN / FRENTE / ANTERIORE

DISC PAD CHOICES - FRONT				BRAKE DISC CHOICES - FRONT						Line #
FA, SFA, TT Pad or Brake Shoe	SFAC Carbon Scooter Pads	Speciality Pads SXR / Vee / MXS	Sintered/HH Pads/ Grooved Shoes	Left / Gauche / Links Standard Replacement Disc	Right / Droite / Rechts Standard Replacement Disc	Contour Disc Universal left and right fitment	Universal Custom Disc	Vee-Discs Black † See note below	CX Extreme MX Race Disc/ UTVX Disc	Line #
FA236*			FA236HH*	MD647X	MD647X	MD647XC*		VR647BLK*		1
										2
										3
										4
FA236*			FA236HH*	MD647X	MD647X	MD647XC*		VR647BLK*		5
FA236*			FA236HH*	MD647X	MD647X	MD647XC*		VR647BLK*		6
										7
FA236*			FA236HH*	MD669X	MD669X	MD669XC*		VR669BLK*		8
										9
FA236*			FA236HH*	MD669X	MD669X	MD669XC*		VR669BLK*		10
										11
FA236*			FA236HH*	MD817X	MD817X	MD817XC*		VR817BLK*		12
										13
FA236*			FA236HH*	MD817X	MD817X	MD817XC*		VR817BLK*		14
FA236*			FA236HH*	MD817X	MD817X	MD817XC*		VR817BLK*		15
FA142		FA142V	FA142HH	MD886X						16
FA142		FA142V	FA142HH	MD873		MD873X				17
FA226*			FA226HH*		TBA					18
FA226*			FA226HH*	MD800X	MD800X	MD800XC*		VR800BLK*		19
FA226*			FA226HH*	MD852X	MD852X	MD852XC*				20
FA226*			FA226HH*		TBA					21
			FA347HH*	MD800X	MD800X	MD800XC		VR800BLK*		22
			FA347HH*	MD852X	MD852X	MD852XC*				23
			FA447HH*		TBA					24
			FA447HH*		TBA					25
			FA347HH*	MD852X	MD852X	MD852XC*				26
FA142		FA142V	FA142HH	MD873						27
										28
FA142		FA142V	FA142HH	MD873X						29
FA196		FA196V	FA196HH	MD642LS						30
FA196		FA196V	FA196HH	MD629						31
FA196*		FA196V*	FA196HH*	MD649	MD649				MD649CX*	32
FA196*		FA196V*	FA196HH*	MD601LS	MD601RS				MD649CX*	33
FA236*			FA236HH*	MD825	MD825					34
FA236*			FA236HH*	MD825	MD825					35
FA236*			FA236HH*	MD825	MD825					36
FA236*			FA236HH*	MD825	MD825					37
FA236*			FA236HH*	MD825	MD825					38
FA142			FA142HH	MD629X		MD629XC		VR629BLK		39
FA142			FA142HH	MD629X		MD629XC		VR629BLK		40
FA226*			FA226HH*	MD842X	MD842X	MD842XC*		VR842BLK*		41
FA226*			FA226HH*	MD842X	MD842X	MD842XC*		VR842BLK*		42
FA226*			FA226HH*	MD842X	MD842X	MD842XC*		VR842BLK*		43
FA226*			FA226HH*	MD842X	MD842X	MD842XC*		VR842BLK*		44
FA226*			FA226HH*	MD842X	MD842X	MD842XC*		VR842BLK*		45
FA181TT*		FA181V*	FA181HH*	MD842X	MD842X	MD842XC*		VR842BLK		46
FA226*			FA226HH*	MD842X	MD842X	MD842XC*		VR842BLK*		47
FA181TT*		FA181V*	FA181HH*	MD842X	MD842X	MD842XC*		VR842BLK		48
FA226*			FA226HH*	MD842X	MD842X	MD842XC*		VR842BLK*		49
FA226*			FA226HH*	MD842X	MD842X	MD842XC*		VR842BLK*		50
FA181TT*		FA181V*	FA181HH*	MD842X	MD842X	MD842XC*		VR842BLK		51
FA226*			FA226HH*	MD842X	MD842X	MD842XC*		VR842BLK*		52
FA181TT*		FA181V*	FA181HH*	MD842X	MD842X	MD842XC*		VR842BLK		53
FA214		FA214V	FA214HH	MD644						54
FA215		FA215V	FA215HH		MD644					55
FA196*			FA196HH*	MD649	MD649				MD649CX*	56
FA196*			FA196HH*	MD601LS	MD601RS				MD649CX*	57
			FA447HH*	MD842X	MD842X	MD842XC*				58
			FA447HH*	MD842X	MD842X	MD842XC*				59
			FA447HH*	MD842X	MD842X	MD842XC*				60

*-2 Sets Required. † For Vee disc colours add RED, BLU, GRN, GLD, ORG suffix to part number.

⊗ - Also available as a Vintage Motorcycle Disc.

Non-JAPANESE Built Motorcycles

Line #	BRAKE DISC CHOICES - FRONT						DISC PAD CHOICES - REAR				BRAKE DISC CHOICES - REAR			
	Oversize 250 /280mm Disc Kit	OSX Oversize 250/280mm Disc Kit	Relocating Bracket for 250/ 280mm Disc	Oversize 320mm Disc Kit	SMX Oversize 320mm Disc Kit	Relocating Bracket for 320mm Disc	FA, SFA, TT Pad or Brake Shoe	SFAC Carbon Scooter Pads	Speciality Pads - SXR / Vee / MXS	Sintered/ HH Pads/ Grooved Shoes	Standard Replacement Disc	Contour Disc Rear fitment	Vee-Discs™ CONTOUR	CX Extreme MX Race Disc/ UTVX Disc
1														
2							FA215/2		FA215/2HH	MD663	MD663C	VR663		
3														
4														
5							FA214/2	FA214/2V	FA214/2HH	MD663	MD663C	VR663		
6							FA214/2	FA214/2V	FA214/2HH	MD663	MD663C	VR663		
7														
8							FA214/2	FA214/2V	FA214/2HH	MD663	MD663C	VR663		
9														
10							FA214/2	FA214/2V	FA214/2HH	MD820	MD820C			
11														
12							FA214/2	FA214/2V	FA214/2HH	MD663	MD663C	VR663		
13														
14							FA214/2	FA214/2V	FA214/2HH	MD820	MD820C			
15							FA214/2	FA214/2V	FA214/2HH	MD820	MD820C			
16							FA214/2	FA214/2V	FA214/2HH	MD874				
17							FA214/2	FA214/2V	FA214/2HH	MD874				
18							FA213	FA213V	FA213HH	MD851	MD851C			
19							FA140	FA140V	FA140HH	MD648	MD648C	VR648		
20							FA213	FA213V	FA213HH	MD851	MD851C			
21							FA213	FA213V	FA213HH	MD851	MD851C			
22							FA140	FA140V	FA140HH	MD648	MD648C	VR648		
23							FA213	FA213V	FA213HH	MD851	MD851C			
24							FA213	FA213V	FA213HH	MD851	MD851C			
25							FA213	FA213V	FA213HH	MD851	MD851C			
26							FA213	FA213V	FA213HH	MD851	MD851C			
27							FA214/2	FA214/2V	FA214/2HH	MD874				
28														
29							FA214/2	FA214/2V	FA214/2HH	MD874				
30							FA196	FA196V	FA196HH	MD643				
31							FA196	FA196V	FA196HH	MD643				
32							FA196	FA196V	FA196HH	MD643		VR643		
33							FA196	FA196V	FA196HH	MD643		VR643		
34							FA209/2	FA209/2V	FA209/2HH	MD831				
35							FA209/2	FA209/2V	FA209/2HH	MD831				
36							FA209/2	FA209/2V	FA209/2HH	MD831				
37							FA209/2	FA209/2V	FA209/2HH	MD831				
38							FA209/2	FA209/2V	FA209/2HH	MD831				
39							FA214/2	FA214/2V	FA214/2HH	MD663	MD663C	VR663		
40							FA214/2	FA214/2V	FA214/2HH	MD663	MD663C	VR663		
41							FA140	FA140V	FA140HH	MD663	MD663C	VR663		
42							FA140	FA140V	FA140HH	MD820	MD820C			
43							FA140	FA140V	FA140HH	MD663	MD663C	VR663		
44							FA140	FA140V	FA140HH	MD820	MD820C			
45							FA140	FA140V	FA140HH	MD820	MD820C			
46							FA140	FA140V	FA140HH	MD820	MD820C			
47							FA140	FA140V	FA140HH	MD820	MD820C			
48							FA140	FA140V	FA140HH	MD820	MD820C			
49							FA140	FA140V	FA140HH	MD820	MD820C			
50							FA140	FA140V	FA140HH	MD820	MD820C			
51							FA140	FA140V	FA140HH	MD820	MD820C			
52							FA140	FA140V	FA140HH	MD820	MD820C			
53							FA140	FA140V	FA140HH	MD820	MD820C			
54							FA215/2	FA215/2V	FA215/2HH	MD645				
55														
56							FA196	FA196V	FA196HH	MD643		VR643		
57							FA196	FA196V	FA196HH	MD643		VR643		
58							FA140	FA140V	FA140HH	MD820	MD820C			
59							FA140	FA140V	FA140HH	MD820	MD820C			
60							FA140	FA140V	FA140HH	MD820	MD820C			

REAR / ARRIÈRE / HINTEN / POSTERIOR / POSTERIORE

*-2 Sets Required. † For Vee disc colours add RED, BLU, GRN, GLD, ORG suffix to part number.
 Ⓢ - Also available as a Vintage Motorcycle Disc.

R Suffix = High Durability Sintered Pad. **HH** Suffix = High Performance Sintered Pad. **TT** Suffix = Hard Wearing Off Road Pad. **V** Suffix = Semi Sintered Pad. **G** Suffix = Grooved Shoe.
D Suffix = Drilled Disc. **X** Suffix = Universal Left or Right Disc. **XC** Suffix = Contoured Disc. **LS** Suffix = Left/Steel Disc. **RS** = Right/Steel Disc.

BRAKE APPLICATIONS

Non-JAPANESE Built Motorcycles

APPLICATIONS

BRAKE



TRIUMPH Contd.
(HINCKLEY PRODUCED MACHINES)



Tiger 900 GT Pro	20
Tiger 900 Rally	20
Tiger 900 Rally Pro	20
Tiger 955cc (Spoke wheel) up to VIN 198874	00-04
Tiger 955cc (Spoke wheel) up to VIN 198874	
- Floating Disc Conversion	00-04
Tiger 955 (Cast wheel) from VIN 198875	04-06
Tiger 1050 (Radial caliper)	07-11
Tiger Sport (ABS) 1050cc	13-15
Tiger Sport (ABS) 1050cc	16-18
Tiger SE (ABS) 1050cc	10-13
Tiger 1200 XR	18-20
Tiger 1200 XRx	18-20
Tiger 1200 XRx Low	18-20
Tiger 1200 XRt	18-20
Tiger 1200 Xca	18-20
Tiger 1200 XCx	18-20
Tiger Explorer 1200	12-15
Tiger Explorer XC 1200	13-15
Tiger Explorer XC (1215cc)	16-17
Tiger Explorer XCx/XCx Low (1215cc)	16-17
Tiger Explorer XCa (1215cc)	16-17
Tiger Explorer XR(1215cc)	16-17
Tiger Explorer XRx/XRx Low (1215cc)	16-17
Tiger Explorer XRt (1215cc)	16-17
Trident 750	Left 92-98
	Right
Trident 900	Left 92-98
	Right
Trophy 900 (3 cyl) (up to VIN 9082)	Left 92-93
	Right
Trophy 900 (3 cyl) (From VIN 9083)	94-01
Trophy 1200 (4 cyl) (up to VIN 4901)	Left 92-93
	Right
Trophy 1200 (4 cyl) (From VIN 4902)	94-01
Thruxton R 1200 (Liquid Cooled)	16-20
Thruxton 1200 (Liquid Cooled)	16-20
Thruxton 1200 (Liquid Cooled)	
- Floating Disc Conversion	16-20
Thruxton TFC 1200 (Liquid Cooled)	19-20
Trophy 1215	12-16
Trophy SE 1215	12-17

URAL

Cross With Sidecar (Brembo 2 Pin Pad Fixing)	11-12
Ranger With Sidecar (Brembo 2 Pin Pad Fixing)	11-12
Retro With Sidecar (Brembo 2 Pin Pad Fixing)	11-12
Sportsman With Sidecar (Brembo 2 Pin Pad Fixing)	11-12
Tourist With Sidecar (Brembo 2 Pin Pad Fixing)	11-12
Ural T With Sidecar (Brembo 2 Pin Pad Fixing)	11-12
All Sidecar Models With Drum Brakes	All Years
Retro Solo (Brembo 2 Pin Pad Fixing)	11-12
Solo ST (Brembo 2 Pin Pad Fixing)	11-12
Wolf Solo (Brembo 2 Pin Pad Fixing)	11-12

VECTRIX

VT-1	14
VX-1 (Li/NiMh)	07-14
VX-2	12-14
VX-3 (3 Wheel Model)	12-13

DISC PAD CHOICES - FRONT

BRAKE DISC CHOICES - FRONT

FA, SFA, TT Pad or Brake Shoe	SFAC Carbon Scooter Pads	Speciality Pads SXR / Vee / MXS	Sintered/HH Pads/Grooved Shoes	Left / Gauche / Links Standard Replacement Disc	Right / Droite / Rechts Standard Replacement Disc	Contour Disc Universal left and right fitment	Universal Custom Disc	Vee-Discs Black † See note below	CX Extreme MX Race Disc/ UTVX Disc	Line #
			FA447HH*	MD842X	MD842X	MD842XC*				1
			FA447HH*	MD842X	MD842X	MD842XC*				2
			FA447HH*	MD842X	MD842X	MD842XC*				3
FA196*			FA196HH*	MD649	MD649				MD649CX*	4
										5
FA196*			FA196HH*	MD601LS	MD601RS				MD649CX*	6
FA196*		FA196V*	FA196HH*	MD676	MD676					7
			FA347HH*	MD679X	MD679X	MD679XC*		VR679BLK*		8
			FA347HH*	MD679X	MD679X	MD679XC*		VR679BLK*		9
			FA347HH*	MD679X	MD679X	MD679XC*		VR679BLK*		10
			FA347HH*	MD679X	MD679X	MD679XC*		VR679BLK*		11
		FA630V*	FA630HH*	MD842X	MD842X	MD842XC*		VR842BLK*		12
		FA630V*	FA630HH*	MD842X	MD842X	MD842XC*		VR842BLK*		13
		FA630V*	FA630HH*	MD842X	MD842X	MD842XC*		VR842BLK*		14
		FA630V*	FA630HH*	MD842X	MD842X	MD842XC*		VR842BLK*		15
		FA630V*	FA630HH*	MD842X	MD842X	MD842XC*		VR842BLK*		16
		FA630V*	FA630HH*	MD842X	MD842X	MD842XC*		VR842BLK*		17
FA236*			FA236HH*	MD842X	MD842X	MD842XC*		VR842BLK*		18
FA236*			FA236HH*	MD842X	MD842X	MD842XC*		VR842BLK*		19
		FA630V*	FA630HH*	MD842X	MD842X	MD842XC*		VR842BLK*		20
		FA630V*	FA630HH*	MD842X	MD842X	MD842XC*		VR842BLK*		21
		FA630V*	FA630HH*	MD842X	MD842X	MD842XC*		VR842BLK*		22
		FA630V*	FA630HH*	MD842X	MD842X	MD842XC*		VR842BLK*		23
		FA630V*	FA630HH*	MD842X	MD842X	MD842XC*		VR842BLK*		24
		FA630V*	FA630HH*	MD842X	MD842X	MD842XC*		VR842BLK*		25
		FA214V	FA214HH	MD646LS				VR646BLK*		26
		FA215V	FA215HH		MD646RS					27
		FA214V	FA214HH	MD646LS				VR646BLK*		28
		FA215V	FA215HH		MD646RS					29
		FA214V	FA214HH	MD646LS				VR646BLK*		30
		FA215V	FA215HH		MD646RS					31
			FA236HH*	MD640	MD640			VR640BLK*		32
		FA214V	FA214HH	MD646LS				VR646BLK*		33
		FA215V	FA215HH		MD646RS					34
			FA236HH*	MD640	MD640			VR640BLK*		35
			FA447HH*	MD883X	MD883X	MD883XC*				36
			FA142HH*	MD873	MD873					37
										38
			FA142HH*	MD873X	MD873X					39
			FA447HH*	MD883X	MD883X	MD883XC*				40
			FA423/4HH*	MD817X	MD817X	MD817XC*		VR817BLK*		41
			FA423/4HH*	MD817X	MD817X	MD817XC*		VR817BLK*		42
										43
										44
			FA244HH		N/A					45
			FA244HH		N/A					46
			FA244HH		N/A					47
			FA244HH		N/A					48
			FA244HH		N/A					49
			FA244HH		N/A					50
										51
			FA244HH		N/A					52
			FA244HH		N/A					53
			FA244HH		N/A					54
										55
										56
SFA228	SFAC228		SFA228HH		N/A					57
SFA181	SFAC181		SFA181HH		MD995D			VR995		58
SFA086	SFAC086		SFA086HH		N/A					59
SFA266*	SFAC266*		SFA266HH*	N/A	N/A					60

*-2 Sets Required. † For Vee disc colours add RED, BLU, GRN, GLD, ORG suffix to part number.

⊗ - Also available as a Vintage Motorcycle Disc.

408 Part numbers, prefixes, suffixes, photos and illustrations shown in this catalogue are trademarks and/or copyrights of EBC Brakes or the trademark owner A C Freeman Investments Ltd and use without express written permission of the owners is punishable by law.

Non-JAPANESE Built Motorcycles

Line #	BRAKE DISC CHOICES - FRONT						DISC PAD CHOICES - REAR				BRAKE DISC CHOICES - REAR			
	Oversize 250 /280mm Disc Kit	OSX Oversize 250/280mm Disc Kit	Relocating Bracket for 250/ 280mm Disc	Oversize 320mm Disc Kit	SMX Oversize 320mm Disc Kit	Relocating Bracket for 320mm Disc	FA, SFA, TT Pad or Brake Shoe	SFAC Carbon Scooter Pads	Speciality Pads - SXR / Vee / MXS	Sintered/ HH Pads/ Grooved Shoes	Standard Replacement Disc	Contour Disc Rear fitment	Vee-Discs™ CONTOUR	CX Extreme MX Race Disc/ UTVX Disc
1							FA140		FA140V	FA140HH	MD820	MD820C		
2							FA140		FA140V	FA140HH	MD820	MD820C		
3							FA140		FA140V	FA140HH	MD820	MD820C		
4							FA196		FA196V	FA196HH	MD643		VR643	
5														
6							FA196		FA196V	FA196HH	MD643		VR643	
7							FA215/2		FA215/2V	FA215/2HH	MD677			
8							FA215/2		FA215/2V	FA215/2HH	MD663	MD663C	VR663	
9							FA214/2		FA214/2V	FA214/2HH	MD820	MD820C		
10							FA214/2		FA214/2V	FA214/2HH	MD820	MD820C		
11							FA215/2		FA215/2V	FA215/2HH	MD663	MD663C	VR663	
12							FA228			FA228HH	MD863			
13							FA228			FA228HH	MD863			
14							FA228			FA228HH	MD863			
15							FA228			FA228HH	MD863			
16							FA228			FA228HH	MD863			
17							FA228			FA228HH	MD863			
18							FA214/2		FA214/2V	FA214/2HH	MD863			
19							FA214/2		FA214/2V	FA214/2HH	MD863			
20							FA228			FA228HH	MD863			
21							FA228			FA228HH	MD863			
22							FA228			FA228HH	MD863			
23							FA228			FA228HH	MD863			
24							FA228			FA228HH	MD863			
25							FA228			FA228HH	MD863			
26							FA215/2		FA215/2V	FA215/2HH	MD641		VR641	
27														
28							FA215/2		FA215/2V	FA215/2HH	MD641		VR641	
29														
30							FA215/2		FA215/2V	FA215/2HH	MD641		VR641	
31														
32							FA215/2		FA215/2V	FA215/2HH	MD641		VR641	
33							FA215/2		FA215/2V	FA215/2HH	MD641		VR641	
34														
35							FA215/2		FA215/2V	FA215/2HH	MD641		VR641	
36							FA214/2		FA214/2V	FA214/2HH	MD851	MD851C		
37							FA214/2		FA214/2V	FA214/2HH	MD851			
38														
39							FA214/2		FA214/2V	FA214/2HH	MD851			
40							FA214/2		FA214/2V	FA214/2HH	MD851			
41							FA228			FA228HH	MD863			
42							FA228			FA228HH	MD863			
43														
44														
45							N/A							
46							N/A							
47							N/A							
48							N/A							
49							N/A							
50							N/A							
51							N/A							
52							N/A							
53							N/A							
54							N/A							
55														
56														
57							SFA067	SFAC067		SFA067HH	N/A			
58							SFA181	SFAC181		SFA181HH	MD9139D		VR9139	
59							SFA083	SFAC083		SFA083HH	N/A			
60							SFA181	SFAC181		SFA181HH	N/A			

REAR / ARRIÈRE / HINTEN / POSTERIOR / POSTERIORE

*-2 Sets Required. † For Vee disc colours add RED, BLU, GRN, GLD, ORG suffix to part number.
 Ⓜ - Also available as a Vintage Motorcycle Disc.

R Suffix = High Durability Sintered Pad. **HH** Suffix = High Performance Sintered Pad. **TT** Suffix = Hard Wearing Off Road Pad. **V** Suffix = Semi Sintered Pad. **G** Suffix = Grooved Shoe.
D Suffix = Drilled Disc. **X** Suffix = Universal Left or Right Disc. **XC** Suffix = Contoured Disc. **LS** Suffix = Left/Steel Disc. **RS** = Right/Steel Disc.

BRAKE APPLICATIONS

Non-JAPANESE Built Motorcycles

APPLICATIONS

BRAKE



VECTRIX Contd.

VX-3 (3 Wheel Model) - Parking brake 12-13

VERTEMATI

All models with 2 piston Brembo calipers 99-04

All models with 4 piston Beringher/Ergal calipers 99-04

VESPA

S50 (2T) 07-13

S50 (4T/4V) 08-13

S50 Sport (2T) 11-13

S50 Sport (4T/4V) 11-13

50 R 70-83

50 S 75-83

50 Special Edition 91

50 S 68

LX 50 (2T) 05-13

LX 50 (4T/4V) 05-13

LXV 50 07-09

PK 50 82-85

PK 50 S 82-85

PK 50 SS 83-85

PK 50 S Automotica 84-89

PK 50 XL 85-88

PK 50 XL 88-89

Primavera 50 (2T) 13-20

Primavera 50 Touring (2T) 15

Primavera 50 (4T/4V) 13-15

Primavera 50 Touring (4T/4V) 15

50 N 89-90

FL 50 90

FL2 Automatica 90-91

ET 2 (50cc) 97-05

ET 4 (50cc) (Grimeca Caliper) 00-04

ET 4 (50cc) (Heng Tong Caliper) 00-04

Sprint 50 (2T) 14-15

Sprint 50 (4T/3V) 14-20

Sprint S 50 (2T) 15

GT 60 (Special Anniversary Model) (GTV 250) 06

LX 60 (Special Anniversary Model) 06

PK 100 XL 78-83

FL 125 89-00

GT 125 Granturismo (Grimeca caliper) 03-06

GT 125 Granturismo (Heng Tong caliper) 03-06

GTS 125 07-11

GTS 125 Super ie (inc ABS Models) 10-20

GTS 125 Supersport ie (inc ABS Models) 13-15

GTS 4V ABS/Super Sport/Touring 18-19

GTS 4V ABS 18-20

GTV 125 07-09

LXV 125 07-12

S 125 (4T/3V) 07-13

S 125 Sport (4T/3V) 11-13

ET4 125 96-99

ET4 125/150 99-05

125 Primavera 67-83

125 ET3 76-83

LX 125 (4T/3V) 05-13

LX 125 (Serie Speciali/4T) 12

Primavera 125 (4T/3V/ABS) 13-20

DISC PAD CHOICES - FRONT

BRAKE DISC CHOICES - FRONT

FA, SFA, TT Pad or Brake Shoe	SFAC Carbon Scooter Pads	Speciality Pads - SXR / Vee / MXS	Sintered/HH Pads/ Grooved Shoes	Left / Gauche / Links Standard Replacement Disc	Right / Droite / Rechts Standard Replacement Disc	Contour Disc Universal left and right fitment	Universal Custom Disc	Vee-Discs Black † See note below	CX Extreme MX Race Disc/ UTVX Disc
SFA257/2									
FA181TT		MXS181	FA181R	N/A					
FA158			FA158HH	N/A					
SFA260	SFAC260		SFA260HH	MD910D		MD910C		VR910	
SFA260	SFAC260		SFA260HH	MD910D		MD910C		VR910	
SFA260	SFAC260		SFA260HH	MD910D		MD910C		VR910	
SFA260	SFAC260		SFA260HH	MD910D		MD910C		VR910	
V905									
V905									
V905									
SFA260	SFAC260		SFA260HH	MD910D		MD910C		VR910	
SFA260	SFAC260		SFA260HH	MD910D		MD910C		VR910	
SFA260	SFAC260		SFA260HH	MD956D				VR956	
V905									
V905									
V905									
SFA353	SFAC353		SFA353HH	MD910D		MD910C		VR910	
SFA353	SFAC353		SFA353HH	MD910D		MD910C		VR910	
SFA353	SFAC353		SFA353HH	MD910D		MD910C		VR910	
SFA353	SFAC353		SFA353HH	MD910D		MD910C		VR910	
V903									
V903									
SFA260	SFAC260		SFA260HH	MD910D		MD910C		VR910	
SFA260	SFAC260		SFA260HH	MD910D		MD910C		VR910	
SFA260	SFAC260		SFA260HH	MD910D		MD910C		VR910	
SFA353	SFAC353		SFA353HH	MD910D				VR910	
SFA353	SFAC353		SFA353HH	MD910D				VR910	
SFA353	SFAC353		SFA353HH	MD910D				VR910	
SFA353	SFAC353		SFA353HH	MD910D				VR910	
SFA353	SFAC353		SFA353HH	MD956D				VR956	
SFA186	SFAC186			MD910D		MD910C		VR910	
V905									
V903									
SFA194	SFAC194		SFA194HH	MD956D				VR956	
SFA353	SFAC353		SFA353HH	MD956D				VR956	
SFA353	SFAC353		SFA353HH	MD956D				VR956	
SFA353	SFAC353		SFA353HH	MD956D				VR956	
SFA353	SFAC353		SFA353HH	MD956D				VR956	
SFA353	SFAC353		SFA353HH	MD956D				VR956	
SFA353	SFAC353		SFA353HH	MD956D				VR956	
SFA353	SFAC353		SFA353HH	MD956D				VR956	
SFA353	SFAC353		SFA353HH	MD956D				VR956	
SFA260	SFAC260		SFA260HH	MD956D				VR956	
SFA260	SFAC260		SFA260HH	MD910D		MD910C		VR910	
SFA260	SFAC260		SFA260HH	MD910D		MD910C		VR910	
SFA260	SFAC260		SFA260HH	MD910D		MD910C		VR910	
SFA260	SFAC260		SFA260HH	MD910D		MD910C		VR910	
V905									
V905									
SFA260	SFAC260		SFA260HH	MD910D		MD910C		VR910	
SFA260	SFAC260		SFA260HH	MD910D		MD910C		VR910	
SFA353	SFAC353		SFA353HH	TBA					

FRONT / AVANT / VORN / FRENTE / ANTERIORE

Line # 1 2 3 4 5 6 7 8 9 10 11 12 13 14 15 16 17 18 19 20 21 22 23 24 25 26 27 28 29 30 31 32 33 34 35 36 37 38 39 40 41 42 43 44 45 46 47 48 49 50 51 52 53 54 55 56 57 58 59 60

R Suffix = High Durability Sintered Pad. HH Suffix = High Performance Sintered Pad. TT Suffix = Hard Wearing Off Road Pad. V Suffix = Semi Sintered Pad. G Suffix = Grooved Shoe.

D Suffix = Drilled Disc. X Suffix = Universal Left or Right Disc. XC Suffix = Contoured Disc. LS Suffix = Left/Steel Disc. RS Suffix = Right/Steel Disc.

★ See SFA681 if rear pad SFA321 is incorrect shape - ONLY AVAILABLE AS SFA ORGANIC VERSION.

*-2 Sets Required. † For Vee disc colours add RED, BLU, GRN, GLD, ORG suffix to part number.

⊗ - Also available as a Vintage Motorcycle Disc.

Non-JAPANESE Built Motorcycles

Line #	BRAKE DISC CHOICES - FRONT						DISC PAD CHOICES - REAR				BRAKE DISC CHOICES - REAR			
	Oversize 250 /280mm Disc Kit	OSX Oversize 250/280mm Disc Kit	Relocating Bracket for 250/ 280mm Disc	Oversize 320mm Disc Kit	SMX Oversize 320mm Disc Kit	Relocating Bracket for 320mm Disc	FA, SFA, TT Pad or Brake Shoe	SFAC Carbon Scooter Pads	Speciality Pads - SXR / Vee / MXS	Sintered/ HH Pads/ Grooved Shoes	Standard Replacement Disc	Contour Disc Rear fitment	Vee-Discs™ CONTOUR	CX Extreme MX Race Disc/ UTVX Disc
1														
2														
3														
4							FA208TT	MXS208	FA208R	N/A				
5							FA208TT	MXS208	FA208R	N/A				
6														
7														
8							899							
9							899							
10							899							
11							899							
12							V906							
13							V904							
14							V906							
15							V906							
16							899							
17							899							
18							899							
19							V903							
20							V903							
21							V903							
22							V942							
23							V903							
24							V903							
25							816							
26							816							
27							816							
28							816							
29							V903							
30							V903							
31							V942							
32							899							
33							899							
34							899							
35							816							
36							816							
37							816							
38							SFA321 ★	SFAC321	SFA321HH	MD956D		VR956		
39							V903							
40							V906							
41							V903							
42							SFA321 ★	SFAC321	SFA321HH	MD956D		VR956		
43							SFA321 ★	SFAC321	SFA321HH	MD956D		VR956		
44							SFA321 ★	SFAC321	SFA321HH	MD956D		VR956		
45							SFA321 ★	SFAC321	SFA321HH	MD956D		VR956		
46							SFA321 ★	SFAC321	SFA321HH	MD956D		VR956		
47							SFA321 ★	SFAC321	SFA321HH					
48							SFA321 ★	SFAC321	SFA321HH			SFA321HH		
49							SFA321 ★	SFAC321	SFA321HH	MD956D		VR956		
50							899							
51							899							
52							899							
53							899							
54							899							
55							V904							
56							V904							
57							899							
58							899							
59							816							

REAR / ARRIÈRE / HINTEN / POSTERIOR / POSTERIORE

*-2 Sets Required. † For Vee disc colours add RED, BLU, GRN, GLD, ORG suffix to part number.

⊗ - Also available as a Vintage Motorcycle Disc.

R Suffix = High Durability Sintered Pad. **HH** Suffix = High Performance Sintered Pad. **TT** Suffix = Hard Wearing Off Road Pad. **V** Suffix = Semi Sintered Pad. **G** Suffix = Grooved Shoe.
D Suffix = Drilled Disc. **X** Suffix = Universal Left or Right Disc. **XC** Suffix = Contoured Disc. **LS** Suffix = Left/Steel Disc. **RS** = Right/Steel Disc.

Non-JAPANESE Built Motorcycles

APPLICATIONS

BRAKE



VESPA Contd.



R Suffix = High Durability Sintered Pad. HH Suffix = High Performance Sintered Pad. TT Suffix = Hard Wearing Off Road Pad. V Suffix = Semi-Sintered Pad. G Suffix = Grooved Shoe.

D Suffix = Drilled Disc. X Suffix = Universal Left or Right Disc. XC Suffix = Contoured Disc. LS Suffix = Left/Steel Disc. RS = Right/Steel Disc.

Model	Year
Primavera 125 (4T/3V/Non ABS)	13-15
Primavera 125 Touring (4T/3V/Non ABS)	15
Primavera 125 Touring (4T/3V/ABS)	15
PX 125 E/EFL	81-97
PK 125	82-85
PK 125 S	82-85
PK 125 S Automatica	84-89
PX 125 T5	85-00
PX 125 (Disc Brake Model/2T)	98-30/04/11
PX 125 (Disc Brake Model/2T)	01/05/11-16
PX 125 Touring	15
946 Special - (125cc/4T/3V)	13-15
Sprint 125 (4T/3V/ABS)	15-20
Sprint S 125 (4T/3V/ABS)	15-20
Sprint S 125 (4T/3V/Non ABS)	15-20
LX 150 (4T/3V)	05-13
LX 150 (Serie Speciali/4T)	12
Primavera 150 (4T/3V/ABS)	13-20
Primavera 150 (4T/3V/Non ABS)	13-15
Primavera 150 Touring (4T/3V/Non ABS)	15
Primavera 150 Touring (4T/3V/ABS)	15
PX 150 E/EFL	81-97
PX 150 (Disc Brake Model)	98-15
PX 150 Touring	15
S 150 (4T)	07-12
S 150 Sport (4T)	11-12
Sprint S 150 (4T/3V/ABS)	15-20
GT 200 L Granturismo (Grimeca Caliper)	03-06
GT 200 L Granturismo (Heng Tong Caliper)	03-06
PX 200 E/EFL	81-97
PX 200 (Disc Brake Model)	98-07
GTS 250 ie/ABS	05-11
GTV 250 ie	07-09
GTS 300 ie (Non ABS Models)	08-15
GTS 300 ie (ABS Models)	08-20
GTS 300 ie Super (Non ABS Models)	08-15
GTS 300 ie Super (ABS Models)	08-20
GTS 300 ie Super Sport (ABS Models)	10-15
GTS 300 ie Super Sport (ABS Models)	08-18
GTS 300 ie Touring (Non ABS)	11-16
GTS 300 ie Touring (ABS Models)	11-17
GTV 300 (4T/4V)	10-13
Cargo 50	06
DXB 50	06
Fireforce 50	06
FXR Sport 50	06
Jupiter 50	06
RX Sport 50	06
Truro 50	06
All models with 2 piston Brembo calipers	99-02
All models with 4 piston Ergal calipers	02
EN 450/530 Enduro	03-04
EN-E 450/530 Enduro	03-04
SM-E 450/530	03-04
MX 450/530	03-04

DISC PAD CHOICES - FRONT				BRAKE DISC CHOICES - FRONT						Line #
FA, SFA, TT Pad or Brake Shoe	SFAC Carbon Scooter Pads	Speciality Pads - SXR / Vee / MXS	Sintered/HH Pads/ Grooved Shoes	Left / Gauche / Links Standard Replacement Disc	Right / Droite / Rechts Standard Replacement Disc	Contour Disc Universal left and right fitment	Universal Custom Disc	Vee-Discs Black † See note below	CX Extreme MX Race Disc/ UTVX Disc	Line #
SFA353	SFAC353		SFA353HH	MD910D		MD910C		VR910		1
SFA353	SFAC353		SFA353HH	MD910D		MD910C		VR910		2
SFA353	SFAC353		SFA353HH	MD910D		MD910C		VR910		3
V903										4
V903										5
V903										6
V903										7
V903										8
SFA186	SFAC186				MD910D			VR910		9
SFA260	SFAC260		SFA260HH		MD910D			VR910		10
SFA186	SFAC186				MD910D	MD910C		VR910		11
SFA353	SFAC353		SFA353HH	TBA						12
SFA353	SFAC353		SFA353HH	TBA						13
SFA353	SFAC353		SFA353HH	MD910D				VR910		14
SFA353	SFAC353		SFA353HH	MD910D				VR910		15
SFA260	SFAC260		SFA260HH	MD910D		MD910C		VR910		16
SFA260	SFAC260		SFA260HH	MD910D		MD910C		VR910		17
SFA353	SFAC353		SFA353HH	TBA						18
SFA353	SFAC353		SFA353HH	MD910D		MD910C		VR910		19
SFA353	SFAC353		SFA353HH	MD910D		MD910C		VR910		20
SFA353	SFAC353		SFA353HH	MD910D		MD910C		VR910		21
V903										22
SFA186	SFAC186				MD910D	MD910C		VR910		23
SFA186	SFAC186				MD910D	MD910C		VR910		24
SFA260	SFAC260		SFA260HH	MD910D		MD910C		VR910		25
SFA260	SFAC260		SFA260HH	MD910D		MD910C		VR910		26
SFA353	SFAC353		SFA353HH	MD910D				VR910		27
SFA194	SFAC194		SFA194HH	MD956D				VR956		28
SFA353	SFAC353		SFA353HH	MD956D				VR956		29
V903										30
SFA186	SFAC186				MD910D	MD910C		VR910		31
SFA353	SFAC353		SFA353HH	MD956D				VR956		32
SFA353	SFAC353		SFA353HH	MD956D				VR956		33
SFA353	SFAC353		SFA353HH	MD956D				VR956		34
SFA418	SFAC418		SFA418HH	MD956D				VR956		35
SFA353	SFAC353		SFA353HH	MD956D				VR956		36
SFA418	SFAC418		SFA418HH	MD956D				VR956		37
SFA353	SFAC353		SFA353HH	MD956D				VR956		38
SFA418	SFAC418		SFA418HH	MD956D				VR956		39
SFA353	SFAC353		SFA353HH	MD956D				VR956		40
SFA418	SFAC418		SFA418HH	MD956D				VR956		41
SFA353	SFAC353		SFA353HH	MD956D				VR956		42
★ See SFA681 if rear pad SFA321 is incorrect shape - ONLY AVAILABLE AS SFA ORGANIC VERSION.										
										43
										44
										45
SFA169	SFAC169		SFA169HH	TBA						46
SFA228	SFAC228		SFA228HH	TBA						47
SFA228	SFAC228		SFA228HH	TBA						48
SFA169	SFAC169		SFA169HH	TBA						49
SFA169	SFAC169		SFA169HH	TBA						50
SFA083	SFAC083		SFA083HH	TBA						51
SFA086	SFAC086		SFA086HH		TBA					52
										53
										54
FA181TT		MXS181	FA181R	N/A						55
TBA			TBA	N/A						56
FA181TT		MXS181	FA181R	N/A						57
FA181TT		MXS181	FA181R	N/A						58
FA095			FA095HH	N/A						59
FA181TT		MXS181	FA181R	N/A						60

*-2 Sets Required. † For Vee disc colours add RED, BLU, GRN, GLD, ORG suffix to part number.

⊗ - Also available as a Vintage Motorcycle Disc.

Non-JAPANESE Built Motorcycles

Line #	BRAKE DISC CHOICES - FRONT						DISC PAD CHOICES - REAR				BRAKE DISC CHOICES - REAR			
	Oversize 250 /280mm Disc Kit	OSX Oversize 250/280mm Disc Kit	Relocating Bracket for 250/ 280mm Disc	Oversize 320mm Disc Kit	SMX Oversize 320mm Disc Kit	Relocating Bracket for 320mm Disc	FA, SFA, TT Pad or Brake Shoe	SFAC Carbon Scooter Pads	Speciality Pads - SXR / Vee / MXS	Sintered/ HH Pads/ Grooved Shoes	Standard Replacement Disc	Contour Disc Rear fitment	Vee-Discs™ CONTOUR	CX Extreme MX Race Disc/ UTVX Disc
1							816							
2							816							
3							816							
4							V903							
5							V903							
6							V903							
7							V942							
8							V903							
9							V903							
10							V903							
11							V903							
12							SFA321 ★	SFAC321		SFA321HH	TBA			
13							816							
14							816							
15							816							
16							899							
17							899							
18							816							
19							816							
20							816							
21							816							
22							V903							
23							V903							
24							V903							
25							899							
26							899							
27							816							
28							SFA321 ★	SFAC321		SFA321HH	MD956D	VR956		
29							SFA321 ★	SFAC321		SFA321HH	MD956D	VR956		
30							V903							
31							V903							
32							SFA321 ★	SFAC321		SFA321HH	MD956D	VR956		
33							SFA321 ★	SFAC321		SFA321HH	MD956D	VR956		
34							SFA321 ★	SFAC321		SFA321HH	MD956D	VR956		
35							SFA321 ★	SFAC321		SFA321HH	MD956D	VR956		
36							SFA321 ★	SFAC321		SFA321HH	MD956D	VR956		
37							SFA321 ★	SFAC321		SFA321HH	MD956D	VR956		
38							SFA321 ★	SFAC321		SFA321HH	MD956D	VR956		
39							SFA321 ★	SFAC321		SFA321HH	MD956D	VR956		
40							SFA321 ★	SFAC321		SFA321HH	MD956D	VR956		
41							SFA321 ★	SFAC321		SFA321HH	MD956D	VR956		
42							SFA321 ★	SFAC321		SFA321HH	MD956D	VR956		
43														
44														
45														
46							TBA							
47							TBA							
48							TBA							
49							TBA							
50							TBA							
51							TBA							
52							TBA							
53														
54														
55							FA208TT		MXS208	FA208R	N/A			
56							FA208TT		MXS208	FA208R	N/A			
57							FA208TT		MXS208	FA208R	N/A			
58							FA208TT		MXS208	FA208R	N/A			
59							FA208TT		MXS208	FA208R	N/A			
60							FA208TT		MXS208	FA208R	N/A			

REAR / ARRIÈRE / HINTEN / POSTERIOR / POSTERIORE

*-2 Sets Required. † For Vee disc colours add RED, BLU, GRN, GLD, ORG suffix to part number.

⊗ - Also available as a Vintage Motorcycle Disc.

R Suffix = High Durability Sintered Pad. HH Suffix = High Performance Sintered Pad. TT Suffix = Hard Wearing Off Road Pad. V Suffix = Semi Sintered Pad. G Suffix = Grooved Shoe.

D Suffix = Drilled Disc. X Suffix = Universal Left or Right Disc. XC Suffix = Contoured Disc. LS Suffix = Left/Steel Disc. RS = Right/Steel Disc.

Part numbers, prefixes, suffixes, photos and illustrations shown in this catalogue are trademarks and/or copyrights of EBC Brakes or the trademark owner A C Freeman Investments Ltd and use without express written permission of the owners is punishable by law.

Non-JAPANESE Built Motorcycles

APPLICATIONS

BRAKE



VOXAN

Black Magic	04-08
Street Scrambler	03-05
Street Scrambler	07-08
VB1 Evo	03-04
Cyclope 1000	02
Scrambler 1000	06
Café Racer 1000	02-05
Café Racer	06-08
Roadster 1000	02-05
Roadster	06-08
Charade Racing	06
Charade Racing (Beringer Caliper)	07-08
GTV 1200	08

WK BIKES

Bellisima 50 (4T)	13-15
Mii 50 (4T)	13-15
SM 50	11-12
SP 50 (4T)	13
WK Go 50 (4T)	11-15
WK One 50 (2T)	10-12
WK GP 2 (2T/50cc)	10-14
WK GTR 50 (2T)	10-14
VS 50 (4T/Scooter)	13-15
Wasp R 50 (2T)	13-15
Bellisima 125 (4T)	13-15
Trail 125	11-15
GP 125 (4T/Scooter)	13-14
VS 125 (4T/Scooter)	13-15
Wasp 125 (4T)	13-15
WK 125 Cruiser	15
WK 125 C (4T/16" Wheels)	10-15
WK 125 SC (4T/14" Wheels)	10-14
WK 125 R (4T)	10-15
WK 125 Sport (4T)	11-15
125 RR	12-13
RT 125	15
SP 125 N (4T)	13-15
Tomcat 125 (4T)	15
150 NK	15
SP 250 N (4T)	15
WK Jetmax 250 (4T)	Left 10-14
	Right
GTR 300 (Scooter)	13-15
WK 400 Trail	15-17
450 RX Enduro	14
450 RX Supermoto	14
650i (Naked)	Left 13-15
	Right
650 TR (Touring)	Left 13-15
	Right

W.T. MOTORS

Bilbao 50 (4T)	08-09
WT 500 Alaska Quad	08-09

WUYANG

WY 50 QT	06-07
WY 125-12	06-07
WY 125-16C	06-07

DISC PAD CHOICES - FRONT

BRAKE DISC CHOICES - FRONT

FA, SFA, TT Pad or Brake Shoe	SFAC Carbon Scooter Pads	Speciality Pads - SXR / Vee / MXS	Sintered/HH Pads/ Grooved Shoes	Left / Gauche / Links Standard Replacement Disc	Right / Droite / Rechts Standard Replacement Disc	Contour Disc Universal left and right fitment	Universal Custom Disc	Vee-Discs Black † See note below	CX Extreme MX Race Disc/ UTVX Disc
FA244*			FA244HH*	MD614X	MD614X	MD614XC*		VR614BLK*	
FA095*			FA095HH*	MD614X	MD614X	MD614XC*		VR614BLK*	
FA244			FA244HH	MD614X	MD614X	MD614XC*		VR614BLK*	
FA244*			FA244HH*	MD614X	MD614X	MD614XC*		VR614BLK*	
FA095*			FA095HH*	N/A	N/A				
FA142*			FA142HH*	N/A	N/A				
FA095*			FA095HH*	MD614X	MD614X	MD614XC*		VR614BLK*	
FA244*			FA244HH*	MD614X	MD614X	MD614XC*		VR614BLK*	
FA095*			FA095HH*	MD614X	MD614X	MD614XC*		VR614BLK*	
FA244*			FA244HH*	MD614X	MD614X	MD614XC*		VR614BLK*	
			FA322/4HH*	N/A	N/A				
TBA*				N/A	N/A				
			FA322/4HH*	TBA	TBA				
SFA086	SFAC086		SFA086HH	N/A					
SFA235	SFAC235					N/A			
FA115			FA115HH			N/A			
TBA						N/A			
SFA086	SFAC086		SFA086HH			N/A			
SFA235	SFAC235					N/A			
SFA235	SFAC235					N/A			
SFA266	SFAC266		SFA266HH	N/A					
SFA086	SFAC086		SFA086HH	N/A					
SFA086	SFAC086		SFA086HH			N/A			
FA197			FA197HH			N/A			
TBA				N/A					
SFA086	SFAC086		SFA086HH	N/A					
SFA086	SFAC086		SFA086HH	N/A					
FA086*		FA086V*	FA086HH*	N/A	N/A				
SFA228	SFAC228		SFA228HH	N/A					
SFA228	SFAC228		SFA228HH	N/A					
FA196			FA196HH	N/A					
FA196			FA196HH	N/A					
TBA*						N/A*			
FA093				N/A					
FA095		FA095V	FA095HH			N/A			
FA086		FA086V	FA086HH	N/A					
FA658		FA658V	FA658HH	N/A					
FA095*		FA095V*	FA095HH*			N/A*			
SFA228	SFAC228		SFA228HH	N/A	N/A				
SFA197	SFAC197		SFA197HH						
SFA086	SFAC086		SFA086HH	N/A					
FA664						N/A			
TBA						N/A			
TBA						N/A			
FA229			FA229HH			N/A*			
FA231			FA231HH						
FA229			FA229HH			N/A*			
FA231			FA231HH						
SFA086	SFAC086		SFA086HH	N/A					
FA453TT*			FA453R*	N/A	N/A				
SFA169	SFAC169		SFA169HH	N/A					
SFA093				N/A					
SFA093				N/A					

Line #

R Suffix = High Durability Sintered Pad. HH Suffix = High Performance Sintered Pad. TT Suffix = Hard Wearing Off Road Pad. V Suffix = Semi Sintered Pad. G Suffix = Grooved Shoe.

D Suffix = Drilled Disc. X Suffix = Universal Left or Right Disc. XC Suffix = Contoured Disc. LS Suffix = Left/Steel Disc. RS Suffix = Right/Steel Disc.

*-2 Sets Required. † For Vee disc colours add RED, BLU, GRN, GLD, ORG suffix to part number.

⊗ - Also available as a Vintage Motorcycle Disc.

414 Part numbers, prefixes, suffixes, photos and illustrations shown in this catalogue are trademarks and/or copyrights of EBC Brakes or the trademark owner A C Freeman Investments Ltd and use without express written permission of the owners is punishable by law.

Non-JAPANESE Built Motorcycles

Line #	BRAKE DISC CHOICES - FRONT						DISC PAD CHOICES - REAR				BRAKE DISC CHOICES - REAR			
	Oversize 250 /280mm Disc Kit	OSX Oversize 250/280mm Disc Kit	Relocating Bracket for 250/ 280mm Disc	Oversize 320mm Disc Kit	SMX Oversize 320mm Disc Kit	Relocating Bracket for 320mm Disc	FA, SFA, TT Pad or Brake Shoe	SFAC Carbon Scooter Pads	Speciality Pads - SXR / Vee / MXS	Sintered/ HH Pads/ Grooved Shoes	Standard Replacement Disc	Contour Disc Rear fitment	Vee-Discs™ CONTOUR	CX Extreme MX Race Disc/ UTVX Disc
1							FA266		FA266V	FA266HH	MD2002	MD2002C	VR2002	
2							FA266		FA266V	FA266HH	MD2002	MD2002C	VR2002	
3							FA266		FA266V	FA266HH	MD2002	MD2002C	VR2002	
4							FA266		FA266V	FA266HH	MD2002	MD2002C	VR2002	
5							FA266		FA266V	FA266HH	N/A			
6							FA165/2TT				N/A			
7							FA266		FA266V	FA266HH	MD2002	MD2002C	VR2002	
8							FA266		FA266V	FA266HH	MD2002	MD2002C	VR2002	
9							FA266		FA266V	FA266HH	MD2002	MD2002C	VR2002	
10							FA266		FA266V	FA266HH	MD2002	MD2002C	VR2002	
11							FA047			FA047HH	N/A			
12							TBA				N/A			
13							FA266		FA266V	FA266HH	TBA			
14														
15														
16							Y503							
17							Y503							
18							FA115			FA115HH		N/A		
19							TBA					N/A		
20							Y503							
21							Y503							
22							Y503							
23							SFA260	SFAC260		SFA260HH	N/A			
24							TBA							
25							SFA115	SFAC115		SFA115HH				
26							Y503							
27							TBA			FA367R		N/A		
28							TBA							
29							TBA							
30							SFA197	SFAC197		SFA197HH				
31							FA086		FA086V	FA086HH		N/A		
32							SFA101	SFAC101		SFA101HH	N/A			
33							SFA266	SFAC266		SFA266HH	N/A			
34							FA197			FA197HH	N/A			
35							FA197			FA197HH	N/A			
36							FA256			FA256HH		N/A		
37							TBA					N/A		
38							TBA					N/A		
39							TBA							
40							TBA				N/A			
41							TBA				N/A			
42							SFA266	SFAC266		SFA266HH	N/A			
43														
44							SFA197	SFAC197		SFA197HH	N/A			
45							FA697					N/A		
46							TBA					N/A		
47							TBA					N/A		
48							FA192		FA192V	FA192HH		N/A		
49														
50							FA192		FA192V	FA192HH		N/A		
51														
52														
53														
54							TBA							
55							FA344TT			FA344R	N/A			
56														
57														
58							TBA							
59							TBA							
60							TBA							

REAR / ARRIÈRE / HINTEN / POSTERIOR / POSTERIORE

*-2 Sets Required. † For Vee disc colours add RED, BLU, GRN, GLD, ORG suffix to part number.

⊗ - Also available as a Vintage Motorcycle Disc.

R Suffix = High Durability Sintered Pad. HH Suffix = High Performance Sintered Pad. TT Suffix = Hard Wearing Off Road Pad. V Suffix = Semi Sintered Pad. G Suffix = Grooved Shoe.

D Suffix = Drilled Disc. X Suffix = Universal Left or Right Disc. XC Suffix = Contoured Disc. LS Suffix = Left/Steel Disc. RS = Right/Steel Disc.

BRAKE APPLICATIONS

Non-JAPANESE Built Motorcycles

Line #	BRAKE DISC CHOICES - FRONT						DISC PAD CHOICES - REAR				BRAKE DISC CHOICES - REAR			
	Oversize 250 /280mm Disc Kit	OSX Oversize 250/280mm Disc Kit	Relocating Bracket for 250/ 280mm Disc	Oversize 320mm Disc Kit	SMX Oversize 320mm Disc Kit	Relocating Bracket for 320mm Disc	FA, SFA, TT Pad or Brake Shoe	SFAC Carbon Scooter Pads	Speciality Pads - SXR / Vee / MXS	Sintered/ HH Pads/ Grooved Shoes	Standard Replacement Disc	Contour Disc Rear fitment	Vee-Discs™ CONTOUR	CX Extreme MX Race Disc/ UTVX Disc
1							TBA							
2							TBA							
3														
4														
5							FA351TT				N/A			
6							FA351TT				N/A			
7							FA351TT				N/A			
8														
9														
10							SFA197	SFAC197		SFA197HH	N/A			
11							SFA197	SFAC197		SFA197HH	N/A			
12							TBA*							
13														
14														
15							FA367TT			FA367R				
16							FA367TT			FA367R				
17							FA367TT			FA367R				
18							FA213		FA213V	FA213HH				
19							FA213		FA213V	FA213HH				
20							FA213		FA213V	FA213HH				
21							FA367TT			FA367R				
22							FA367TT			FA367R				
23							FA208TT			FA208R				
24							FA208TT			FA208R				
25							FA208TT			FA208R				
26							FA208TT			FA208R				
27							FA213		FA213V	FA213HH				
28							FA083TT			FA083HH				
29							FA213		FA213V	FA213HH				
30							FA213		FA213V	FA213HH				
31							FA213		FA213V	FA213HH				
32							FA213		FA213V	FA213HH				
33							FA213		FA213V	FA213HH				
34							FA213		FA213V	FA213HH				
35							FA213		FA213V	FA213HH				
36							FA208TT			FA208R				
37							FA213		FA213V	FA213HH				
38							FA213		FA213V	FA213HH				
39							FA083TT			FA083HH				
40							FA083TT			FA083HH				
41							FA213		FA213V	FA213HH				
42							FA213		FA213V	FA213HH				
43							FA083TT			FA083HH				
44							FA083TT			FA083HH				
45														
46														
47														
48														
49														
50														
51														
52							FA197				N/A			
53							FA197				N/A			
54														
55														
56														
57							FA140							
58							FA140							
59							FA140							
60							FA140							

REAR / ARRIÈRE / HINTEN / POSTERIOR / POSTERIORE

*-2 Sets Required. † For Vee disc colours add RED, BLU, GRN, GLD, ORG suffix to part number.

⊗ - Also available as a Vintage Motorcycle Disc.

R Suffix = High Durability Sintered Pad. **HH** Suffix = High Performance Sintered Pad. **TT** Suffix = Hard Wearing Off Road Pad. **V** Suffix = Semi Sintered Pad. **G** Suffix = Grooved Shoe.
D Suffix = Drilled Disc. **X** Suffix = Universal Left or Right Disc. **XC** Suffix = Contoured Disc. **LS** Suffix = Left/Steel Disc. **RS** = Right/Steel Disc.

Non-JAPANESE Built Motorcycles

Line #	BRAKE DISC CHOICES - FRONT						DISC PAD CHOICES - REAR				BRAKE DISC CHOICES - REAR			
	Oversize 250 /280mm Disc Kit	OSX Oversize 250/280mm Disc Kit	Relocating Bracket for 250/ 280mm Disc	Oversize 320mm Disc Kit	SMX Oversize 320mm Disc Kit	Relocating Bracket for 320mm Disc	FA, SFA, TT Pad or Brake Shoe	SFAC Carbon Scooter Pads	Speciality Pads - SXR / Vee / MXS	Sintered/ HH Pads/ Grooved Shoes	Standard Replacement Disc	Contour Disc Rear fitment	Vee-Discs™ CONTOUR	CX Extreme MX Race Disc/ UTVX Disc
1							976							
2							976							
3							976							
4							976							
5							976							
6							976							
7							976							
8							976							
9							976							
10							976							
11							975							
12							N/A							
13							N/A							
14							N/A							
15							975							
16							N/A							
17							N/A							
18														
19														
20														
21														
22														
23														
24														
25														
26														
27														
28														
29														
30														
31														
32														
33														
34														
35														
36														
37														
38														
39														
40														
41														
42														
43														
44														
45														
46														
47														
48														
49														
50														
51														
52														
53														
54														
55														
56														
57														
58														
59														
60														

REAR / ARRIÈRE / HINTEN / POSTERIOR / POSTERIORE

R Suffix = High Durability Sintered Pad. HH Suffix = High Performance Sintered Pad. TT Suffix = Hard Wearing Off Road Pad. V Suffix = Semi Sintered Pad. G Suffix = Grooved Shoe.
D Suffix = Drilled Disc. X Suffix = Universal Left or Right Disc. XC Suffix = Contoured Disc. LS Suffix = Left/Steel Disc. RS = Right/Steel Disc.

*-2 Sets Required. † For Vee disc colours add RED, BLU, GRN, GLD, ORG suffix to part number.
⊗ - Also available as a Vintage Motorcycle Disc.

BRAKE APPLICATIONS

DISC PAD BUYERS GUIDE

NOTE:- Size identification is shown as follows

Dimension 1=Length or Diameter, Dimension 2= Height or Diameter, Dimension 3= Thickness (Material and backplate)

DISC PADS
BUYERS GUIDE

DO NOT REFIT ANY SHIMS/INSULATORS TO EBC PADS FROM ORIGINAL PADS UNLESS INSTRUCTED
ON NOTE ON PAD PACKAGING AND ON FA DRAWING ASSOCIATED WITH THAT PAD.

FA011 48 x 9mm

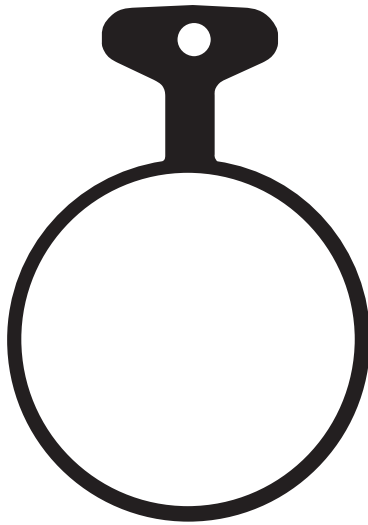

YAMAHA

RD 250 B/C	75-76	F
RD 250 D	77	F&R
RD 350/A/B	73-75	F
XS 360 B	75	F
RD 400 C/D	76-77	F&R
TX/XS 500 B	75-77	F
XS 650	75	F

ISR

22-023-0A (2 Piston)
22-026-0A (Sprocket caliper)

Equivalents OE #		
1A1 W0045 00	306 25811 03	409 W0045 00
306 25811 00	306 25811 04	409 25811 00
306 25811 01	306 25811 05	409 25811 01
306 25811 02	306 25811 06	

MATERIAL AVAILABILITY AND PART NO.					
STD	OPTIONS				
FA	HH	R	MXS	EPFA	
FA011	-	-	-	-	

FA012 50 x 13/20mm

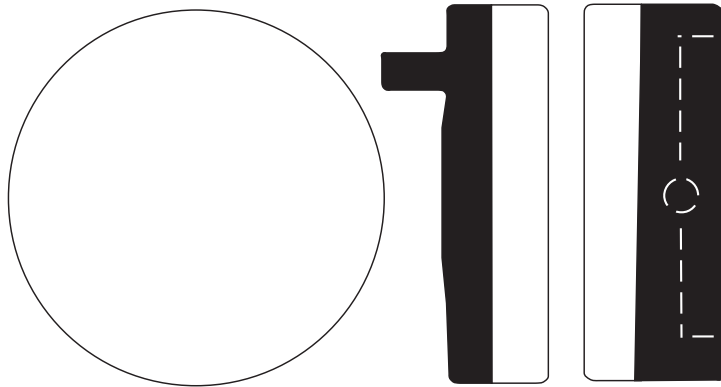

HONDA

CB 750 K0-K6	69-77	F
--------------	-------	---

Equivalents OE #	
45105 300 040	45106 341 000
45105 341 000	45106 341 003
45105 341 003	45106 300 004
45105 341 305	45106 341 305

MATERIAL AVAILABILITY AND PART NO.					
STD	OPTIONS				
FA	V	HH	R	MXS	EPFA
FA012	FA012V	-	-	-	-

FA013 52 x 13/20mm

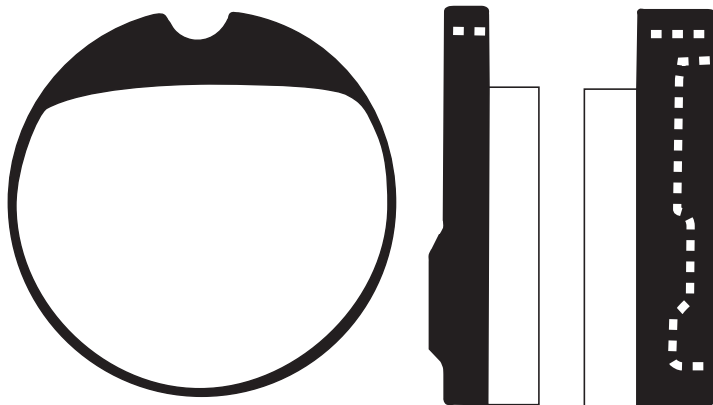

HONDA

CB 250 G5	75	F
CJ 250 T	77	F
CB 360 G5	75	F
CJ 360 T	78	F
CB 400 F/F1/F2	75-79	F
CB 500 T	75-77	F
CB 500 K1/K2/F	75-77	F
CB 550 F/F1/F2/F3	78-80	F
CB 750 F/F1	76-77	F
CB 750 K7	78	F

Equivalents OE #	
45102 393 700	45105 390 305
45105 323 006	45106 323 013
45105 323 013	45106 323 016
45105 323 016	45106 323 023
45105 323 023	45106 323 036
45105 323 036	45106 323 043
45105 323 043	45106 390 003
45105 390 003	45106 390 006
45105 390 006	45106 390 305

MATERIAL AVAILABILITY AND PART NO.					
STD	OPTIONS				
FA	V	HH	R	MXS	EPFA
FA013	FA013V	-	-	-	-

FA016 59.7 x 51.6 x 10mm



AP/LOCKHEED

2 Piston / 2 Pin (CP2195/CP2696 - 38EO)
220-30 (2 Piston Rear)
22-033 (2 Piston HD)

DUCATI

750 Sport	74	F
TRIUMPH (MERIDEN MODELS)		
T 140 V Bonneville 5 Speed Gearbox/Drum Rear Brake	73-74	F
T 140 V Bonneville Disc All Round/5 Speed Gearbox	75-78	F&R
T 140 Silver Jubilee Bonneville	77	F&R
T 140 E Bonneville	78-83	F&R
T 140 D Bonneville (Lester Alloy wheels)	79-81	F&R
T 140 ES (750cc) (Electric Start)	80-81	F&R
T 140 E/ES (750cc) (Executive/Alloy Wheels)	81-83	F&R
T 150V (Trident 3 cyl)	73-74	F&R
T 160V (Trident 3 cyl)	75	F&R
TSS 750 (8 valve)	83	F&R
TSX 750	83	F&R

MATERIAL AVAILABILITY AND PART NO.

STD	OPTIONS				
FA	HH	R	MXS	EPFA	GPFA
FA016	FA016HH	-	-	EPFA016HH	GPFA016HH
FA016'S' (Green)					

Equivalents OE

4741 537	99-2769
----------	---------

FA018 55.7 x 55 x 9mm

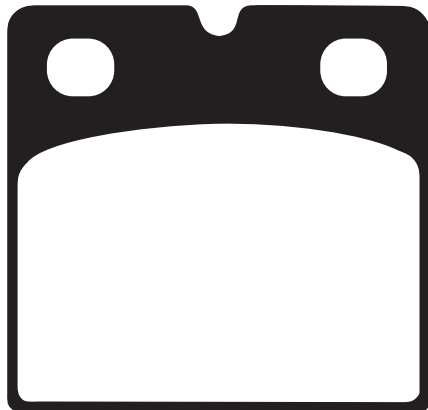

AMERICAN SUSPENSION AFTERMARKET CALIPERS

B17 Phantom 2 piston brake caliper
B17 Mach 8 Standard mount 2 Piston caliper
P26 2 Piston Caliper

BENELLI

354 -82 R
750 SEi (6 cyl) 75- F
900 SEi (6 cyl) 83 F

BIMOTA

All early models -83 F&R

BMW

K 75/75-S 84-90 F
K 75/75-S 08/90-96 R
K 75 C 85-08/88 F
K 75 RT 89-96 R
K 75 S 85-09/88 F&R
K 75 S 09/88-95 R
K 75 S 85-09/88 F&R
K 75 S 09/88-85 R
K 1000 82-09/88 F&R
K 100/2 87-08/88 F&R
K 100/2 09/88-90 R
K 100/2 87-08/88 F&R
K 100/2 09/88-90 R
K 100 LT 86-08/88 F&R
K 100 LT 09/88-91 R
K 100 LT 86/08-88 F&R
K 100 LT 09/88-91 R
K 100 RS 83-09/88 F&R
K 100 RS 10/88-89 R
K 100 RS 83-09/88 F&R
K 100 RS 10/88-89 R
K 100 RS 83-09/88 F&R
K 100 RT 10/88-89 R
K 100 RT 83-09/88 F&R
K 100 RT 10/88-89 R
K 100 RS 89-92 R
K 100 RS 89-92 R
K1 88-93 R
K 1100 LT 89-07/93 R

BMW Contd.

KL 1100 LT
KL 1100 LT
KL 1100 LT
K 1100 RS
K 1100 RS
K 1200 RS
K 1200 RS
K 1200 GT
R 45/45N
R 65
R 65 T (Brembo Caliper)
R 65 LS (Brembo Caliper)
R 65 GS
R 65 RT
R 80 RT
R 80 RT
R 80 RT
R 80 GS
R 80 ST
R 80 TIC
R 100/7T
R 100 RS
R 100 RS
R 100 RT
R 100 RT
R 100 RS
DUCATI
250/350/450 Desmo
600 Pantah
650 Pantah
751 F1
750 Paso
750 Sport
860 GT/GTS
900 GTS
900 Hailwood Replica
900 SD Darmah
(4 bolt front and rear disc fixing)
900 SD Darmah (6 bolt front disc fixing/4 bolt rear disc fixing)
R

89-07/93 R
08/93-99 R
08/93-99 R
92-96 R
92-96 R
96-00 R
01-04 R
03-06 R
78-85 F
07/88-92 F
80-85 F
81-85 F
87-92 F
85-88 F
82-84 F
84-08/88 F
80-87 F
82-84 F
09/80-85 F
09/80-84 F
10/80-84 F&R
86-08/88 F
10/80-84 F&R
87-08/88 F
92-01 R
-76 F
81 F&R
-84 F&R
98 F&R
87-90 F
88-90 F&R
75-76 F&R
75-76 F&R
79 F&R
77 F&R
78 F&R
900 SD Darmah (6 bolt disc fixing front & rear) 78 F&R
906 Paso 88-89 F&R
1000 R1 Hailwood Replica 84 F&R
HOREX
HRD 600 85 F&R
500/600 Columbus 88- F&R
LAVERDA
750 SF2 74 F
750 SFC 74 F&R
750 SF3 76-77 F&R
1000 3C 74-75 F&R
1000 3CL 76-78 F&R
1000 3CL Jarama/Jota 79-81 F&R
1000 RGS 82 F&R
1000 RGA/RGS Exec 83 F&R
1000 RGS Corsa 84 R
1000 SFC 85-86 F&R
1200 78-79 F&R
1200 TS/Mirage 81 F&R
MOTO GUZZI
850 Le Mans I 76-77 F&R
850 Le Mans II 78-80 F&R
850 Le Mans III
(12 spoke cast wheel) 81-84 F
850 T 74 F
850 T3 75-79 F&R
850 T3 California
(with screen/panniers) 75-79 F&R
850 T4 80-82 F&R
850 T5 83-85 F&R
850 T5 California
(with screen/panniers) 83-85 F&R
1000 GT 1st Series Alloy
Wheels & Cast 87-91 F&R
1000 GT 2nd Series Alloy
Wheels & Cast 87-91 F&R
1000 - 1000 S 89-94 F&R
1000 - 1000 SP (12 spoke cast
wheels/dished front discs) 79-83 F

DISC PADS
BUYERS GUIDE

DO NOT REFIT ANY SHIMS/INSULATORS TO EBC PADS FROM ORIGINAL PADS UNLESS INSTRUCTED
ON NOTE ON PAD PACKAGING AND ON FA DRAWING ASSOCIATED WITH THAT PAD.

FA018 Contd.

MOTO GUZZI Contd.

1000 - 1000 SP II (10 spoke cast wheels/solid front discs)	84-87	F&R
1000 - 1000 SP III (No spoke cast wheels/flat floating front discs)	89-94	F&R
1000 California II (12 spoke cast wheels/screen & luggage)	81-87	F&R
1000 California III Carbs (VY Chassis code/full fairing /cast & spoke wheels)	88-90	F&R
1000 California III Carbs (VW Chassis code/screen only)	87-93	F&R
1000 California III - EFi (VY Chassis Code/Full fairing /cast & spoke wheels)	90-93	F&R
1000 Le Mans 1V/V (10 spoke cast wheel)	84-93	F&R
1000 Strada	93-94	F&R
1100 California - Carbs (KC/KD Chassis codes)	94-97	F&R
G5 V1000	78-83	F&R

MZ

ETZ 125/150/250/300
Saxon 125/251/301/500
Saxon 150
Saxon Tour 251/301
251 Fun
Saxon 500 All models

85-92	F
93-97	F
95	F
93-98	F
95-96	F
93-98	F

NORTON

Classic (Rotary)	89	F&R
Interpol 2 (Rotary)	89	F&R
TRIUMPH (MERIDEN MODELS)		
T 140 Bonneville (L.F. Harris Made Machine/Brembo Calipers)	85-88	F&R

MATERIAL AVAILABILITY AND PART NO.						
STD	OPTIONS					
FA	V	HH	R	MXS	EPFA	
FA018	FA018V	FA018HH	-	-	-	

Equivalents OE #		
510	34 21 2 332 988	00 1865 4660
34 11 1 451 995	14654601	00 2865 4601
34 11 1 454 724	14654650	
34 11 1 458 388	0795 39 856	
34 1 2 301 360	0979 39 856	
34 21 7 657 025	0960 39 656	
34 21 1 236 221	61654630	

FA019 55.7 x 55 x 7.5mm

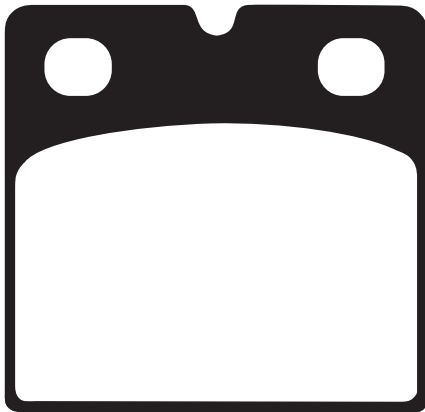

DUCATI

750 SS (4 bolt disc fixing) Note thinner pad version for shaved down caliper	75-76	F&R
900 SS Note thinner pad version for shaved down caliper	75-76	F&R

MATERIAL AVAILABILITY AND PART NO.						
STD	OPTIONS					
FA	V	HH	R	MXS	EPFA	
FA019	-	FA019HH	-	-	-	

Equivalents OE #
0797 39656

FA021 47 x 16.2mm

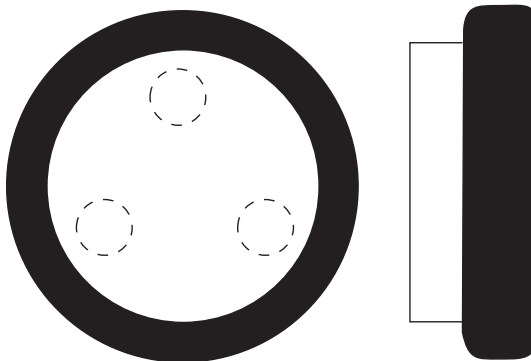

YAMAHA

YFM 200 N/DXW/DX/DXA	85-90	R
YTM 200 EL/DX	89	R
YTM 225 DRN	85	R
YFM 225 S/T/U	86-89	R
YFM 250 W/A/B	90-92	R
YFM 350 FWT/FWU/FWW/FWA/FWB/FWD/FWE/FWF/FWG "Big Bear"	87-95	R
YFM 350 ERD/ERE/ERF/ERG	92-95	R

MATERIAL AVAILABILITY AND PART NO.						
STD	OPTIONS					
FA	V	HH	R	MXS	EPFA	
FA021	-	-	FA021R	-	-	

Equivalents OE #		
2HR W0045 00	5V6 W0045 00	5V6 W0045 01

DISC PADS
BUYERS GUIDE

DO NOT REFIT ANY SHIMS/INSULATORS TO EBC PADS FROM ORIGINAL PADS UNLESS INSTRUCTED ON NOTE ON PAD PACKAGING AND ON FA DRAWING ASSOCIATED WITH THAT PAD.

FA022 71.8 X 35mm

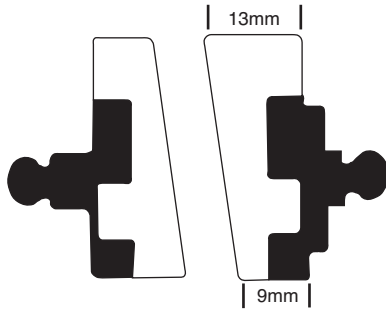

**Note: 1 pad left
1 pad right
Tapered finish**

BMW		
R 60/7	76-80	F
R 60 TIC	78-82	F
R 75/6/75/7	73-79	F
R 80	77-84	F
R 80 TIC	78-08/80	F
R 90 S	73-76	F
R 90/6	73-76	F
R 100	76-77	F
R 100/7T	77-09/80	F
R 100 S	76-80	F
R 100 RS	76-09/80	F
R 100 RT	78-09/80	F

MATERIAL AVAILABILITY AND PART NO.					
STD	OPTIONS				
FA	V	HH	R	MXS	EPFA
FA022	FA022V	-	-	-	-

Equivalents OE #	
34 11 2 301 358	34 11 1 233 319

FA027 44.4 x 55.4 x 9.5mm



NORTON		
750 Mk V Commando / Roadster / Interstate	73	F&R
850 Mk I Commando / Hi Rider / Interstate	73	F&R
850 Mk I A Commando Roadster / Interstate	73	F&R
850 Mk II / II A Commando Roadster/ Hi Rider / Interstate	74	F&R
850 Mk III Commando Roadster / Hi Rider / Interstate	75	F&R

Equivalents OE #
06 6005
06 1894
06 6186

MATERIAL AVAILABILITY AND PART NO.					
STD	OPTIONS				
FA	V	HH	R	MXS	EPFA
FA027	-	-	-	-	-

FA028 45.3 x 12/15.5mm

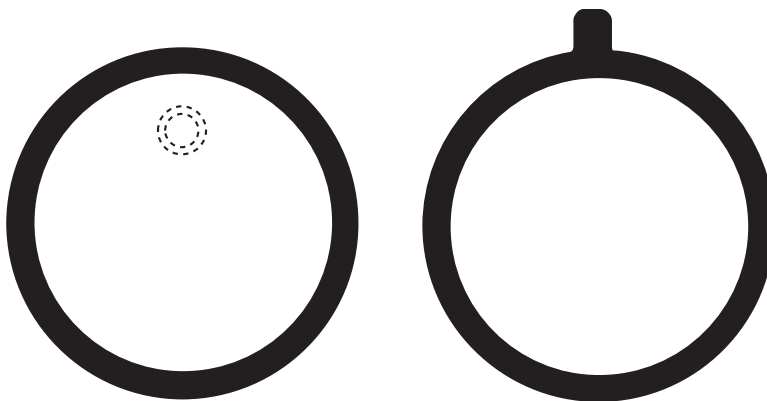

YAMAHA		
FSIE DX	77-79	F
RD 50 M	78	F
RS 100 DX	77-80	F
RS 100 (IY8 Europe)	77-78	F
RS 100 DX (IY8 Europe)	79	F
RD 125 DX	75-77	F
RS 125 DX	76-80	F
RD 200 DX	75-78	F

MATERIAL AVAILABILITY AND PART NO.					
STD	OPTIONS				
FA	V	HH	R	MXS	EPFA
FA028	-	-	-	-	-

Equivalents OE #	
1V1 W0045 00	404 W0045 12
404 2000 11	464 20000 11
404 2000 12	464 20000 12

FA029 67 x 49.2 x 11mm
FA030 67 x 49.2 x 10mm
FA031 67 x 49.2 x 9mm

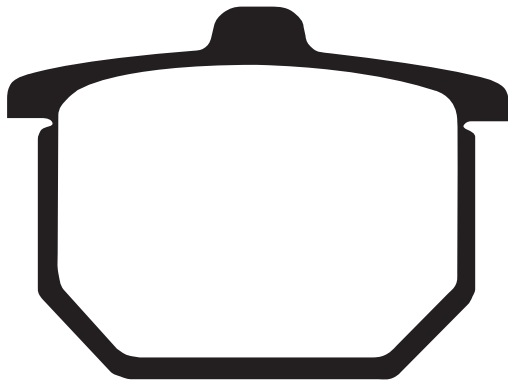

FA029 - HONDA		
CX 500 CA/CB/Z/AB	79-81	F
GL 1000 K3/KZ "Goldwing"	78-79	F
FA030 - HONDA		
CB 400 N/NA/NB	78-81	F
CB 750 F2	79	R
CBX 1000 Z	79-80	R
GL 1000 K/K1/K2/KZ 'Goldwing'	75-77	F
GL 1100 A/DA/B/DB (SC02)	80-81	F&R
FA031 - HONDA		
CB 750 F2	79	F
CB 750 FZ/FA/FB	78-82	F&R
CB 900 FZ/FA	80-81	F&R
CBX 1000 Z	79-80	F&R

Equivalents OE # FA029	
43105 461 305	45105 410 006
43105 461 771	45105 410 007
43105 461 772	45105 410 016
45105 415 006	45105 410 026
45105 415 770	45105 410 305
45105 415 772	45105 415 004
45105 410 004	45105 415 305

MATERIAL AVAILABILITY AND PART NO.					
STD	OPTIONS				
FA	V	HH	R	MXS	EPFA
FA029	FA029V	-	-	-	-

Equivalents OE # FA030		
45105 461 771	45105 438 000	45105 438 008
45105 461 772	45105 438 004	
45105 415 006	45105 438 007	

MATERIAL AVAILABILITY AND PART NO.					
STD	OPTIONS				
FA	V	HH	R	MXS	EPFA
FA030	FA030V	-	-	-	-

Equivalents OE # FA031		
43105 461 770	06435 761 405	
45105 371 000	06455 371 405	

MATERIAL AVAILABILITY AND PART NO.					
STD	OPTIONS				
FA	V	HH	R	MXS	EPFA
FA031	FA031V	-	-	-	-

FA032 57.8 x 65.3 x 11mm

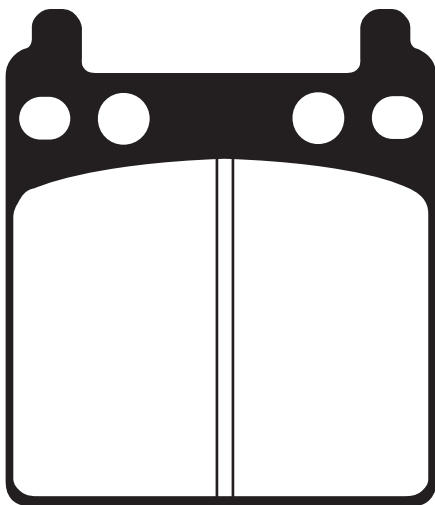

HONDA		
CB 750 F/F1	76-77	R
GL 1000 K/K1/K2/K3/KZ 'Goldwing'	75-79	R

MATERIAL AVAILABILITY AND PART NO.					
STD	OPTIONS				
FA	V	HH	R	MXS	EPFA
FA032	FA032V	-	-	-	-

Equivalents OE #		
431A0 431 673	43211 392 016	43211 431 673
43211 371 006	43211 431 671	
43211 392 006	43211 431 672	

DO NOT REFIT ANY SHIMS/INSULATORS TO EBC PADS FROM ORIGINAL PADS UNLESS INSTRUCTED ON NOTE ON PAD PACKAGING AND ON FA DRAWING ASSOCIATED WITH THAT PAD.

FA033 A. 51.3 x 12.3mm B. 50 x 12.5mm



KAWASAKI		
KH 250 B1-B5	77-82	F
S2-A (350cc)	72-73	F
KH 400 A3/A4/A5	76-78	F
S3/S3-A (400cc)	74-75	F
Z 400 G1	79	F
KH 500 A8	76	F
Z 650 B1/B2/B3	79-81	F
Z 650 C1/C2	76-78	F
Z 750 B1/B2/D1	76-78	F
Z 900 A4	77-78	F
Z 1000 A1-A2	74-82	F
Z 1000 D1 (Z1-R)	78-	F
Z 1000 H1	80	F

Equivalents OE #	
43050 002	43050 5002
43050 005	43050 5003
43050 006	43051 001
43050 007	43051 006
43050 008	43051 007
43050 009	43051 008
43050 011	43051 011
43050 1006	43082 001
43050 1021	43082 1001
43050 5001	43082 1005

MATERIAL AVAILABILITY AND PART NO.					
STD	OPTIONS				
FA	V	HH	R	MXS	EPFA
FA033	-	-	-	-	-

FA034 57.8 x 65.3 x 11mm

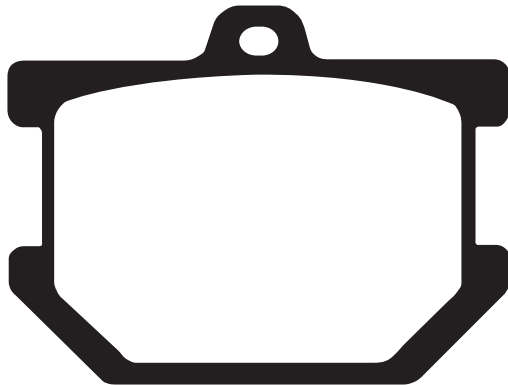

YAMAHA		
XS 250 C	78	F&R
XS 250 D/E	79-81	F
XS 360 C	76	F&R
XS 400 C	78	F&R
XS 400	79	F
SR 500	78-82	F
XS 500 C/D	78-79	F&R
XJ 650	80-84	F
XJ 650 LH Midnight	81	F
XJ 650 RJ 'Seca'	82	F
XS 650	77-81	F
XS 650 SE	79-80	F&R
XS 650 SE	81	F
XS 750	77-79	F&R
XS 750 SE	79-80	R
XS 850	80	F&R
XV 1000 TRI	81	F
XS 1100	78-80	F&R
XS 1100 S	81	R

Equivalents OE #		
1J3 20000 11	1L9 W0045 00	3G1 W0046 00
1J3 20000 13	1L9 W0046 00	3H5 W0045 00
1J3 20000 63	1U4 W0046 01	3H5 W0045 01
1J3 20000 64	1U4 W0046 02	4K0 W0045 00
1J3 20000 70	2J2 W0046 00	4K0 W0045 01
1J3 W0045 00	2J2 W0046 01	4K0 W0045 02
1J3 W0046 00	2M0 W0046 00	
1J9 20000 02	2M0 W0046 01	

MATERIAL AVAILABILITY AND PART NO.					
STD	OPTIONS				
FA	V	HH	R	MXS	EPFA
FA034	FA034V	-	-	-	-

FA035 51 x 11/12mm

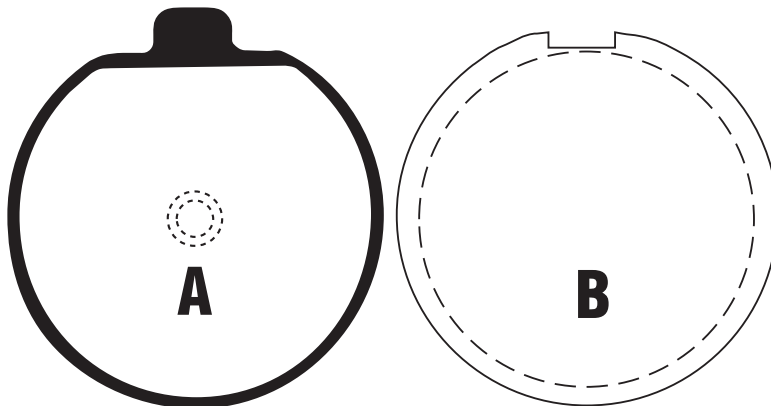

SUZUKI		
GS 400 B/C	77-78	F
GS 425 EN	78-80	F
GS 750 B/DB/DC/EC/EN	77-80	F

Equivalents OE #	
59100 45820	59300 44822
59100 45821	59300 44860
59300 44810	59300 45890
59300 44820	59300 45891
59300 44821	59302 45830

MATERIAL AVAILABILITY AND PART NO.					
STD	OPTIONS				
FA	V	HH	R	MXS	EPFA
FA035	-	-	-	-	-

DISC PADS BUYERS GUIDE

DO NOT REFIT ANY SHIMS/INSULATORS TO EBC PADS FROM ORIGINAL PADS UNLESS INSTRUCTED ON NOTE ON PAD PACKAGING AND ON FA DRAWING ASSOCIATED WITH THAT PAD.

FA036 57.6 x 52.8 x 9mm

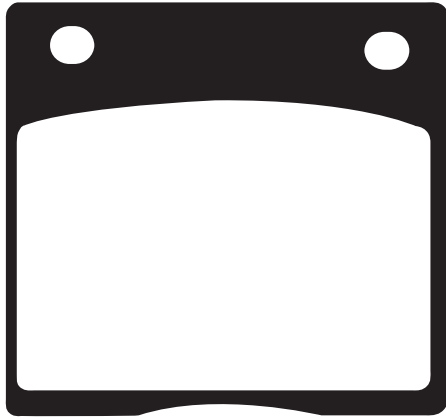

KAWASAKI

Z 500 B1/B2	79-80	R
Z 650 C3	79	R
Z 650 D2/D3 (SR)	79-80	R
Z 1000 D1/D3 (Z1R)	78-79	R
Z 1000 A1-A4	77-80	R
Z 1000 ST (E1-E2 shaft)	79-82	R
Z 1000 H1	80	R
Z 1300 A1-A5	79-83	R
ZG 1300 A1-A3	84-86	R

SUZUKI

GSX 400 FX/FZ/FD	81-83	R
GS 550 EC/EN	78-79	R
GS 550 ET/EX/EZ/LT/LX/MX/MZ	80-84	R
XN 85 Turbo	83	R
GS 650 GTX/GTZ/GTD/GX/GZ	81-83	R
GS 700 EF/ESF	85	R
GS 750 B/DB/DC/EC/EN	77-80	R
GSX 750 ET/EX/ESD/EFE/ESG/ESE/ESH/ESF	82-86	R
GSX 750 SE Katana	85	R
GSX 750 S/SS (G57SX-106815-) Katana	84	R
GSX 750 S-2/S-2C (GS75X-114747-) Katana	84	R
GS 850 GN/GT/GX/GZ/GE/GG	79-85	R
GS 1000 HC/EC/EN/SN	78-80	R
GS 1000 ET/GT/GX	81-82	R
GSX 1000 SZ "Katana"	82	R
GSX 1100 ET/EX/EZ/ESD	80-83	R
GS 1100 GZ	82	R
GSX 1100 SZ/SD Katana	82-83	R
GV 1200 GLF/GLF2/GLG Madura	85-86	R

GMA

2 Piston Rear (Large) Caliper model A (CCI # 09-997)

Equivalents OE

43050 010	69130 45010	69101 45820
43050 1013	69130 45020	69101 45830
43082 1059	69130 45021	69101 45840
69130 34220	69130 45100	69101 45850 XNA
69130 34240	69130 45101	69101 45860 XNA
69130 45000	69130 45990	69130 45030
69130 45001	69100 34870	

MATERIAL AVAILABILITY AND PART NO.

STD	OPTIONS				
FA	V	HH	R	MXS	EPFA
FA036	FA036V	-	-	-	-

FA037 51.5 x 13/12mm

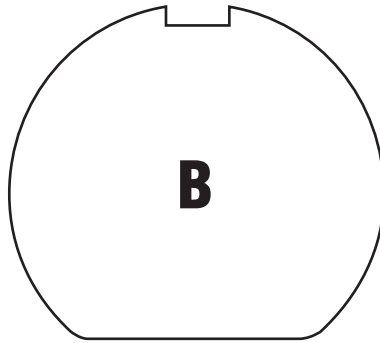
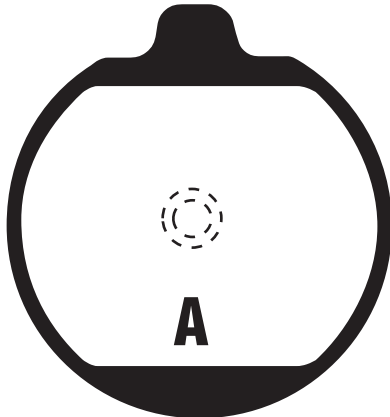

KAWASAKI

Z 650 C1/C2	77-78	R
Z 750 B1/B2	77-78	R
Z 750 D1	76	R

MATERIAL AVAILABILITY AND PART NO.

STD	OPTIONS			
FA	HH	R	MXS	EPFA
FA037	-	-	-	-

Equivalents OE

43051 009	43050 1006
43050 1008	43050 5002

FA038 A. 50 x 12mm B. 50 x 11.9mm

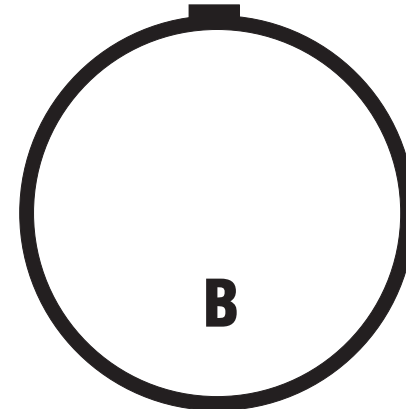
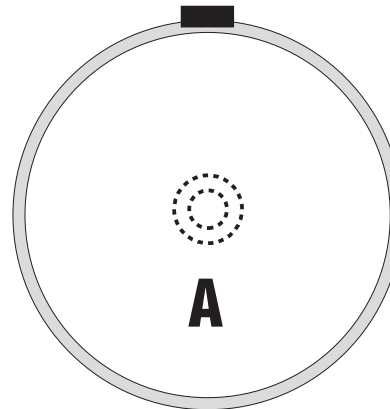

SUZUKI

GT 125 C/EC/EN	78-79	F
GT 200 EN/EX "X5"	79-82	F
GT 250 EN/ET/EX "X7"	78-81	F
GS 550 DB/DC/EC/EN	77-79	F
GS 850 GN/GT/GX	79-81	F
GS 1000 HC/EC/EN/SN	78-80	F

MATERIAL AVAILABILITY AND PART NO.

STD	OPTIONS				
FA	V	HH	R	MXS	EPFA
FA038	FA038V	-	-	-	-

Equivalents OE

59100 11850	59300 47830
59100 34820	59300 47840
59300 45820	59300 47850
59300 47810	59300 47870
59300 47820	59300 47880

DISC PADS
BUYERS GUIDE

DO NOT REFIT ANY SHIMS/INSULATORS TO EBC PADS FROM ORIGINAL PADS UNLESS INSTRUCTED ON NOTE ON PAD PACKAGING AND ON FA DRAWING ASSOCIATED WITH THAT PAD.

FA039 43.50ø x 12/10mm

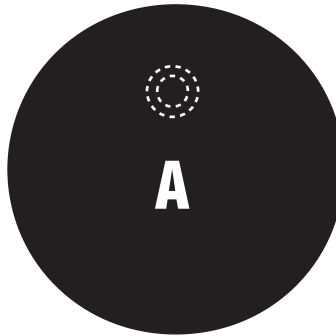
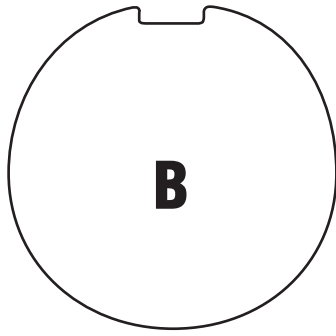

KAWASAKI			
KH 125 A1-A4	77-81	F	
Z 200 A1-A5	77-82	F	
SUZUKI			
GT 50 KB/KEN	77-80	F	
ZR 50 KEN/KEX "X1"	79-83	F	

MATERIAL AVAILABILITY AND PART NO.					
STD	OPTIONS				
FA	V	HH	R	MXS	EPFA
FA039	-	-	-	-	-

Equivalents OE #	
43050 1009	59300 46811
43050 1010	59300 46820
59300 46810	

FA040 41 x 21/11mm

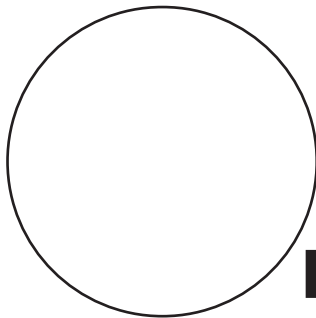

HONDA			
CB 50 J	81	F	
SS 50 ZB2	77-80	F	
CB 125 J/T	78-79	F	
FL 250 Odyssey	77-84	R	
POLARIS			
Trail Boss 2 x 4	85-87	R	
Scrambler 3 wheeler	85-86	R	
Cyclone '250 X'	87	R	

MATERIAL AVAILABILITY AND PART NO.					
STD	OPTIONS				
FA	V	HH	R	MXS	EPFA
FA040	-	-	-	-	-

Equivalents OE #	
45340 107 720 A	45345 107 721 B
45340 107 721 A	45345 107 722 B
45340 107 722 A	45345 149 000 B
45340 149 000 A	45345 149 003 B
45340 149 003 A	45345 149 720 B
45340 149 720 A	45350 107 720
45340 950 000 A	45350 107 720 B
45345 950 000 B	45350 950 000
45345 107 720 B	

FA041 94.5 x 56mm

MARKED WITH BLUE TAG TO AVOID CONFUSION WITH FA061



YAMAHA			
RD 250 E/F	78-79	F&R	
XS 250 SE/SF	79-81	F	
RD 400 E/F	78-79	F&R	
XS 400 SE	80-81	F	
XS 750 SE	79-80	F (Right)	

MATERIAL AVAILABILITY AND PART NO.					
STD	OPTIONS				
FA	V	HH	R	MXS	EPFA
FA041	FA041V	-	-	-	-

Equivalents OE #	
2G2 W0045 00	3J6 W0045 01
2R8 W0045 003	4W1 W0046 00
3H6 W0045 00	

FA042 45 x 45 x 10/16mm

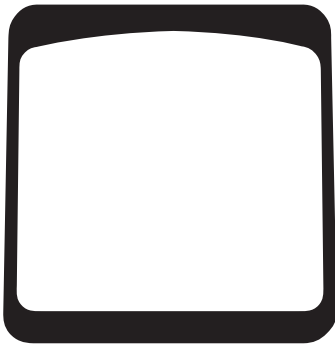

YAMAHA		
FS 1 DX	79-80	F
RD 50 M	79-80	F
RS 100 (IY8 Europe)	80-82	F
RD 125 DX	78-81	F
RS 125 DX	81	F
RD 200 DX	78-80	F

MATERIAL AVAILABILITY AND PART NO.					
STD	OPTIONS				
FA	V	HH	R	MXS	EPFA
FA042	-	-	-	-	-

Equivalents OE #	
2R6 W0045 00	2R6 W0045 11
2R6 W0045 10	2R6 W0045 12

FA045 54 x 53 x 11mm

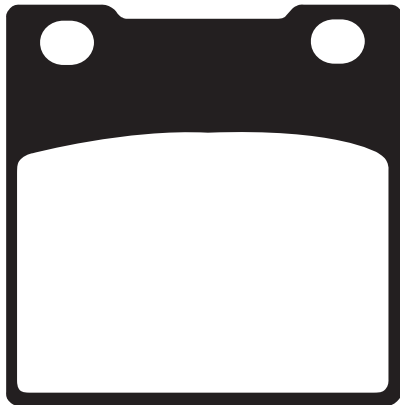

HONDA		
CB 250 T/N/NA/NB/NDB/NDC	78-82	F
CB 250 RSA/RSD	81-84	F
CM 250 TB	81	F
CB 400 A 'Honda-matic'	79	F
CB 400 T	78	F
CB 650 Z/B	79-81	F
CB 750 KZ	80	F

MATERIAL AVAILABILITY AND PART NO.					
STD	OPTIONS				
FA	V	HH	R	MXS	EPFA
FA045	FA045V	-	-	-	-

Equivalents OE #		
45105 413 003	45105 425 003	45105 MA5 671
45105 413 305	45105 425 006	06455 425 405
45105 413 871	45105 471 006	

FA046 44 x 11.5/13mm

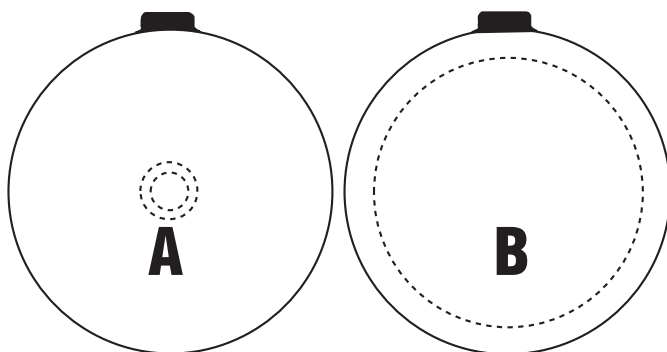

SUZUKI		
GP 100 C/N/X/DED	78-87	F

MATERIAL AVAILABILITY AND PART NO.				
STD	OPTIONS			
FA	HH	R	MXS	EPFA
FA046	-	-	-	-

Equivalents OE #
59300 39840

DO NOT REFIT ANY SHIMS/INSULATORS TO EBC PADS FROM ORIGINAL PADS UNLESS INSTRUCTED ON NOTE ON PAD PACKAGING AND ON FA DRAWING ASSOCIATED WITH THAT PAD.

FA047 40 x 50 x 7mm

FA047/2 40 x 50 x 5.5mm

FA047/3 40 x 50 x 9.3mm

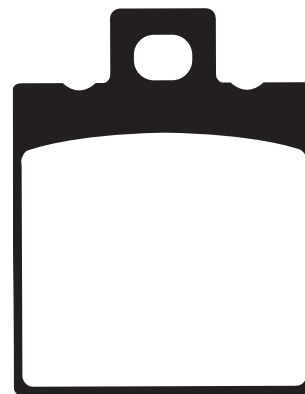

Model	Year	Caliper	Disc Size	Disc Type	Disc Part No.	Disc Type	Disc Size	Disc Type	Disc Part No.
FA047									
ACCOSSATO									
CE 50/80/KR 80	87-	F	500 GTL		03-04	R			
Enduro Codice 50	89-	F	500 GTV Pantah		93-97	R			
AGRALE									
Elefantre 30.0		F	500 Sport Desmo		75	F			
ALFER									
80 MC	87-	F	500 Pantah		77	F&R			
125 MC	87	F	500 Monster (Twin disc)		77	F&R			
125 MC	88-	R	600 Monster		79	F&R			
250 MC	85-86	F	600 Monster Dark		93-97	R			
250 MC	87	F&R	600 Monster City/City Dark		93-99	R			
250 MC	88-	R	600 Monster		98-99	R			
250 GR/Enduro	85-87	F	620 Super		99	R			
250 GR/Enduro	88-	R	620 Sport		00-01	R			
300 GR Enduro	88-	R	620 Multiestrada		01-97	R			
APRILIA									
RS 50	93-98	F	620 Multiestrada		02-04	R			
AF1 125	89-91	R	620 Multiestrada		03	R			
RS 125 (All models)	92-05	R	620 Multiestrada		03-04	R			
AF 125	90-91	R	620 Multiestrada		05-06	R			
Red Rose 125	87	R	620 Multiestrada		06	R			
Tuono 125	03-04	R	620 Multiestrada		06	R			
250	86	F	620 Multiestrada		06	R			
RS 250 (All models)	95-02	R	620 Multiestrada		06	R			
BENELLI									
124/125 2C/125 2T/2CSE	76-	F	620 Multiestrada		06	R			
125 T	83	F	620 Multiestrada		06	R			
Uno C 150 (Single Cyl)	13	R	620 Multiestrada		06	R			
250 C/TS, 250/4	76-	F	620 Multiestrada		06	R			
BX 250 Motard	12	R	620 Multiestrada		06	R			
Uno C 250 (Single)	13	R	620 Multiestrada		06	R			
304	83	F	620 Multiestrada		06	R			
354	-82	F	620 Multiestrada		06	R			
354 Sport 2	83	F&R	620 Multiestrada		06	R			
500/4	76-	F	620 Multiestrada		06	R			
654 Sport	83	F&R	620 Multiestrada		06	R			
666 Scooter "Born in Hell"	98-99	R	620 Multiestrada		06	R			
BERINGER									
6 Piston (Old design / 2 piston)			620 Multiestrada		06	R			
BETA									
Eikon 125/150	00-06	F	620 Multiestrada		06	R			
BIMOTA									
All models	89-03	R	620 Multiestrada		06	R			
DB5R/S (1078cc)	08-09	R	620 Multiestrada		06	R			
DB6 (1078cc)	08-09	R	620 Multiestrada		06	R			
DB6/R (1078cc)	08-09	R	620 Multiestrada		06	R			
DB6 Delirio (1078cc)	12-13	R	620 Multiestrada		06	R			
DB7 (1099cc)	09	R	620 Multiestrada		06	R			
DB8 SP (1078cc)	12-13	R	620 Multiestrada		06	R			
DB10 Motard (1078cc)	12-13	R	620 Multiestrada		06	R			
Tesi 2D	04-06	R	620 Multiestrada		06	R			
Tesi 3D (1078cc)	09-13	R	620 Multiestrada		06	R			
SB8K Gobert (996cc Suzuki engine)	06	R	620 Multiestrada		06	R			
SB8K Santamonica (992cc Suzuki engine)		R	620 Multiestrada		06	R			
BREMO									
20 5161 43 or 81 - 2 Piston P 2/32 Rear caliper (Single pad fixing pin / with anti rattle shim)			620 Multiestrada		06	R			
CAGIVA									
Cucciolo 50	97	F	620 Multiestrada		06	R			
W4 50	91-95	F	620 Multiestrada		06	R			
Blues 125	92-95	R	620 Multiestrada		06	R			
Cucciolo 125	00	F	620 Multiestrada		06	R			
125 Elefant RE	87	F	620 Multiestrada		06	R			
Freccia 125 SY	89	R	620 Multiestrada		06	R			
NI 125	97	R	620 Multiestrada		06	R			
Supercity 125	92	R	620 Multiestrada		06	R			
Mito 125 (all models)	91-10	R	620 Multiestrada		06	R			
Planet 125 (3 Spoke Wheels)	98-03	R	620 Multiestrada		06	R			
Planet 125 (6 Spoke Wheels/ST Series)	98-03	R	620 Multiestrada		06	R			
Planet 125 (6 Spoke Wheels 2nd Series)	98-03	R	620 Multiestrada		06	R			
Raptor 125	03-10	R	620 Multiestrada		06	R			
SST 250/350	80-82	F	620 Multiestrada		06	R			
SX 250	82	F	620 Multiestrada		06	R			
WMX 125	86	F	620 Multiestrada		06	R			
WMX 250	-85	F	620 Multiestrada		06	R			
Mito 500	91-92	R	620 Multiestrada		06	R			
Mito 500 (4T)	08	R	620 Multiestrada		06	R			
WMX 500	84-86	F	620 Multiestrada		06	R			
Excaliber 501 RX	92-	R	620 Multiestrada		06	R			
River 600	95-99	R	620 Multiestrada		06	R			
650 Elephant	85-	R	620 Multiestrada		06	R			
650 Elefant	88-89	R	620 Multiestrada		06	R			
DERBI									
GPI 250	05	R	620 Multiestrada		06	R			
DUCATI									
Supersport 400	93-97	R	620 Multiestrada		06	R			
400 Monster/Dark	95-04	R	620 Multiestrada		06	R			
Monster 400 ie (Japan)	07-08	R	620 Multiestrada		06	R			
Monster Dark ie 400 (Japan)	05-06	R	620 Multiestrada		06	R			
Monster Darkie 400 (Single disc)	05	R	620 Multiestrada		06	R			
Monster 400 (Single disc)	00-02	R	620 Multiestrada		06	R			
DUCATI Contd.									
Monster 400 (Twin disc)	03-04	R	620 Multiestrada		06	R			
Supersport 400 (Twin disc)	93-97	R	620 Multiestrada		06	R			
500 GTL	75	F	620 Multiestrada		06	R			
500 GTV Pantah	77	F&R	620 Multiestrada		06	R			
500 Sport Desmo	77	F&R	620 Multiestrada		06	R			
500 Pantah	79	F&R	620 Multiestrada		06	R			
Monster 600 (Twin disc)	93-97	R	620 Multiestrada		06	R			
600 Monster	93-99	R	620 Multiestrada		06	R			
600 Monster Dark	98-99	R	620 Multiestrada		06	R			
600 Monster City/City Dark	99	R	620 Multiestrada		06	R			
600 Monster	00-01	R	620 Multiestrada		06	R			
600 Supersport	91-97	R	620 Multiestrada		06	R			
620/IE/SIE Monster	02-04	R	620 Multiestrada		06	R			
620 Sport	03	R	620 Multiestrada		06	R			
Monster 620 ie (Single disc)	03-04	R	620 Multiestrada		06	R			
Monster 620	05-06	R	620 Multiestrada		06	R			
S4RS (998cc)	06	R	620 Multiestrada		06	R			
Monster 620 Dark	03-06	R	620 Multiestrada		06	R			
695 Monster	07-08	R	620 Multiestrada		06	R			
620 Multiestrada			620 Multiestrada		06	R			
(Twin disc/single pin pad fixing)			620 Multiestrada		06	R			
620 Multiestrada Dark			620 Multiestrada		06	R			
(Single disc/twin pin pad fixing)			620 Multiestrada		06	R			
748 S (Biposto)	00-02	R	620 Multiestrada		06	R			
748 S (Monoposto)	00-02	R	620 Multiestrada		06	R			
748 SPS	98-99	R	620 Multiestrada		06	R			
748 Testa Bassa (Mono/Biposto)	07	R	620 Multiestrada		06	R			
748 Biposto	95-02	R	620 Multiestrada		06	R			
748 SP/Monoposto	99-02	R	620 Multiestrada		06	R			
748 SP	95-98	R	620 Multiestrada		06	R			
748 R (2 pad caliper)	00	R	620 Multiestrada		06	R			
748 R (4 pad caliper)	01-02	R	620 Multiestrada		06	R			
750 Paso	87-90	R	620 Multiestrada		06	R			
750 Supersport	91-98	R	620 Multiestrada		06	R			
750 Monster	96-98	R	620 Multiestrada		06	R			
750 Monster City/City Dark	99	R	620 Multiestrada		06	R			
750 Monster/Monster Dark	99	R	620 Multiestrada		06	R			
750 Monster	00-01	R	620 Multiestrada		06	R			
Monster ie 750	02	R	620 Multiestrada		06	R			
Supersport 750 (Twin disc)	91-98	R	620 Multiestrada		06	R			
Monster 800	03-04	R	620 Multiestrada		06	R			
800 Supersport	03-05	R	620 Multiestrada		06	R			
851 Superbike Biposto	89-92	R	620 Multiestrada		06	R			
888 SP4/SP5	92-93	R	620 Multiestrada		06	R			
888 Superbike Strada	94-95	R	620 Multiestrada		06	R			
900 Supersport	89-90	R	620 Multiestrada		06	R			
900 Supersport/Superlight	91-97	R	620 Multiestrada		06	R			
900 Supersport CR USA	98	R	620 Multiestrada		06	R			
900 Supersport FE	98	R	620 Multiestrada		06	R			
900 Monster	93-99	R	620 Multiestrada		06	R			
900 Monster Cromo/Special	98	R	620 Multiestrada		06	R			
900 Monster City/City Dark	99	R	620 Multiestrada		06	R			
900 IE Monster	00-01	R	620 Multiestrada		06	R			
907 IE	90-93	R	620 Multiestrada		06	R			
916 SPS (996cc)	97-98	R	620 Multiestrada		06	R			
Monster S2R Dark (803cc)	05-06	R	620 Multiestrada		06	R			
Monster S4 Foggy (916cc)	02	R	620 Multiestrada		06	R			
Monster S4 (916cc)	01-02	R	620 Multiestrada		06	R			
916 (Biposto)	94-98	R	620 Multiestrada		06	R			
916 Senna	94-98	R	620 Multiestrada		06	R			
916 SP	94-96	R	620 Multiestrada		06	R			
S4 RS Monster (998cc)			620 Multiestrada		06	R			
(Radial 4 pad caliper)			620 Multiestrada		06	R			
S4RS Monster Testastretta (998cc)	07-08	R	620 Multiestrada		06	R			
(Radial 4 pad caliper)			620 Multiestrada		06	R			

FA047 Contd. 40 x 50 x 7mm

FA047/2 Contd. 40 x 50 x 5.5mm

FA047/3 Contd. 40 x 50 x 9.3mm

DISC PADS BUYERS GUIDE

DO NOT REFIT ANY SHIMS/INSULATORS TO EBC PADS FROM ORIGINAL PADS UNLESS INSTRUCTED ON NOTE ON PAD PACKAGING AND ON FA DRAWING ASSOCIATED WITH THAT PAD.

MALAGUTI Contd.

Enduro MDX 80
Ciak 125/150/200
F18 125/150 Warrior

84- F
01-08 F
00-03 F

MALANCA

E2 C80/CS
125 GTI
125 Mark Enduro
Ciak 200

F&R
F&R
-84 F
06 F

MONTESA

311 (Honda) 260cc
314R (Honda)
315R (Honda)
(350) V35 Florida
350 V35 II (12 spoke cast wheels)
350 V35 III (10 spoke cast wheels)
350 V35C Custom (10 spoke cast wheels/points ignition)
350 V35 (12 spoke cast wheels/electronic ignition)
NTX 350
350 Nevada
350 Nevada Club
500 V50 (12 spoke cast wheels/electronic ignition)
500 V50 C Custom (10 spoke cast wheels/points ignition)
500 V50 III (12 spoke cast wheel)
650 65 GT
650 V65 C Custom (10 spoke cast wheels)
650 V65 Florida
(Spoke/cast wheel models)
NTX 650
750 Nevada Club (Up to LK112433)
750 Nevada Club (From LK112433)
750 SP (10 spoke cast wheels)
750 Strada/T Roadster

92-93 R
94-96 R
97-00 R
86-90 F&R
80-85 F&R
85-87 F&R
82-86 F&R
77-79 F&R
87-90 F&R
92-97 F&R
98-99 F&R
77-79 F&R
82-86 F&R
80-84 F&R
88-89 F&R
83-86 F&R
85-91 F&R
87-90 F&R
98-00 F&R
00-01 F
90-92 F&R
93-95 F&R

MONTESA Contd.

750 Targa
750 Nevada
750 V75 (10 spoke cast wheel/solid front disc)
750 V75 (10 spoke cast wheel/floating front discs)
1000 Daytona
1000 Daytona RS
1000 V10 Centauro GT
1000 V10 Centauro Sport
1100 Sport Carbs
1100 Sport EFi
1100 Sport Corsa
1100 V11 Ballabio
1100 V11 Le Mans
1100 V11 Sport
1100 V11 Scura
1100 V11 Naked

90-93 F&R
91-01 F&R
92-96 F&R
96-01 F&R
92-95 R
97-98 R
97-99 R
97-99 R
94-96 R
96-99 R
98-99 R
03-05 R
01-05 R
99-01 R
01-03 R
02-03 R

MOTO MORINI

Dart 350
350 Kanguro
Excaliber 350/501 RLX

87 R
87 R
93- R

MZ/MUZ

Mastiff - 17" front wheel/cast wheel
Tour/Traveller
Skorpion Sport/Replica/Cup

99-05 R
95-02 R
95-01 R

PRO-ONE

2 Piston

TM

SMM 125 Black Dream (Rim brake)
SMM 250 (2T)
SMM 250 F (4T)
SMM 300 (2T)
SMM 400 (4T) Rim brake
SMM 450 F Black Dream E-S
SMM 530 F Black Dream Rim brake

04-10 R
05-15 R
10 R
05-15 R
04- R
08 R
04-10/15 R

VOXAN

Charade Racing

06 R

YAMAHA

TDR 125 R Lightburner (3SH2/3XE2)
TZR 125 RR
TZR 125 R Brembo Caliper (4DL1/4DL2)
SZR 660

93-94 R
96- R
91-93 R
96-97 R

FA047/2 GARELLI

Urka 50
125 XR/XRD Tiger

91- F
83- F

GILERA

50 Rally

87- F

R1/50

90- F

KTM

80 MX

86-92 F

FA047/3 HONDA

CRM 125 RL/RM/RN/RP/RR/RV/RX
NSR 125 FJ/FK/FL/FM/FN
NSR 125 RK/RL/RM/RN/RR/RS/RV /RW/RX/RY/R1

90-99 R
88-92 R
89-01 R

Equivalents OE # - FA047

8103662	8000 39730	8A00 46147	00276546100
8113016	323 627	8000 46147	107 28 86 30
8113064	326 446	03613 9666	107 5365 13
8113118	341 170	61340 311A	KA3496535
8113196	19654600	61340 281A	9021038000
8113222	19654601	04700 2000037	12906040
8113323	491 13 409 044	119 52200	1296006
8113638	3SH F5811 20	9021035000	GU27654610
8113651	613 4008 1A	252524000	211021022
8113662	613 4007 71A	000276546100	211082010
8213197	43105 NN2 600	613 4 0541A	61340731A
8213200	8000 46147	2547/F/S	
19654600	8000 90156	211082010	
8000 29070	2525 242000	000316546650	

Equivalents OE # - FA047/3

43105 KBS 405
43105 KBS W00
43105 KY4 901
43105 KY4 902
43105 NW2 610

MATERIAL AVAILABILITY AND PART NO.

OPTIONS								
STD	SFA	V	TT	HH	SFA-HH	R	MXS	EPFA
FA047	SFA047	FA047V	FA047TT	FA047HH	SFA047HH	-	-	-

MATERIAL AVAILABILITY AND PART NO.

OPTIONS				
STD	HH	R	MXS	EPFA
FA047/2	-	-	-	-

MATERIAL AVAILABILITY AND PART NO.

OPTIONS				
STD	HH	R	MXS	EPFA
FA047/3	-	-	-	-

FA048 46 x 44 x 16/11mm

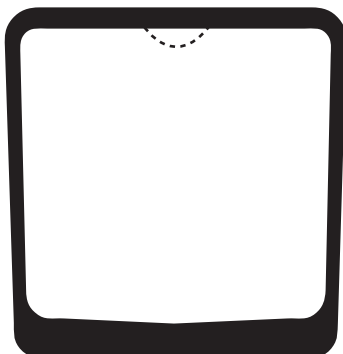

KAWASAKI

KH 100 G2/G3
Z 400 B1/B2

81-83 F
78-80 F

Equivalents OE

43050 1007 A	43050 5004
43050 1007 B	

MATERIAL AVAILABILITY AND PART NO.

OPTIONS					
STD	V	HH	R	MXS	EPFA
FA048	-	-	-	-	-

FA050 31.5 x 49 x 5.5mm



CASAL
All disc models
CIMATTI
Gringo
FANTIC
50 Strada Super Six
HERCULES (SACHS)
Diff. older models with disc brake
50 KX 5
50 Ultra, RS Ultra
80 Ultra, F Ultra, RS Ultra
80 Ultra Chopper
80 Ultra AC
80 Ultra AC Chopper
80 XE 9
HOREX
Rebell 80 N
Rebell 80 T
Sport 80 L

MALAGUTI
F Chopper 25/40 -82 F
50 LX Sport -82 F
50 Ronco RCW -82 F
50 Fity HF -82 F
73- VA Olympique -82 F
50 Watercooled -82 F
F Chopper 80 -82 F
MALANCA
F 125/ST 54/GT 5 F
F PUCH
F M 50 SDP Spoke Wheel
F /Grand Prix Special 75-77 F
F M 50 SDP Cast Wheel
F /Grand Prix Supreme 75-77 F
F
F
F

MATERIAL AVAILABILITY AND PART NO.					
STD	OPTIONS				
FA	V	HH	R	MXS	EPFA
FA050	-	-	-	-	-

Equivalents OE #
359 1 40 280 0
359 1 40 283 1

FA051 78 x 50 x 11.5mm



SUZUKI
GN 250 F/J/M/R/T 85-97 F
GS 250 TT/TX 80-81 F
GSX 250 ET/EX/EZ 80-82 F
GN 400 TT 80 F
GSX 400 ET/EX/EZ 81-83 F
GSX 400 LX/TX 81 F
GS 450 ET/EG/EJ 80-88 F
GS 700 EF/ESF 85 F
GSX 750 ESD/EFE/ESG/ESE/ESH/EFF 82-86 F
GSX 750 ET/EX 80-81 F
GS 850 GZ/GE/GG 82-85 F
GS 1000 GT/GX 81-82 F
GS 1100 GZ 82 F
GV 1200 GLF/GLF2/GLG Madura 85-86 F

MATERIAL AVAILABILITY AND PART NO.					
STD	OPTIONS				
FA	V	HH	R	MXS	EPFA
FA051	FA051V	-	-	-	-

Equivalents OE #	
59130 45230	59300 05810
59301 45810	59330 38300
59301 45811	59330 38310
59301 45850	

FA052 41 x 21/11mm



HONDA
CB 100 N 78-80 F
CB 125 T2 79 F

MATERIAL AVAILABILITY AND PART NO.					
STD	OPTIONS				
FA	V	HH	R	MXS	EPFA
FA052	-	-	-	-	-

Equivalents OE #	
45340 399 700	45345 399 700
45340 399 701	45345 399 701
45340 399 702	45345 399 702

DISC PADS
BUYERS GUIDE

DO NOT REFIT ANY SHIMS/INSULATORS TO EBC PADS FROM ORIGINAL PADS UNLESS INSTRUCTED
ON NOTE ON PAD PACKAGING AND ON FA DRAWING ASSOCIATED WITH THAT PAD.

FA054 39.5 x 45 x 7.5mm

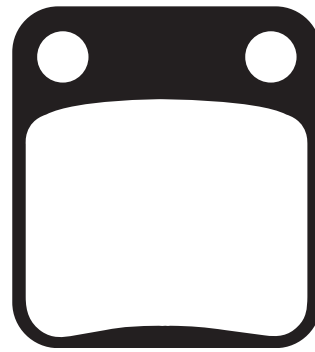

AJS	JSM 50 Motard	13-15	R	KREIDLER	125 Enduro (4T)	14-15	R
	JSM 125 Motard	10-15	R		125 Supermoto (4T)	14-15	
	Regal Raptor DD 50 E/E2	04-06	F	LEXMOTO			
	JS 125-E/E2 (Eco 125)	07-09	F		LSM 50 (STR50)	12-16	R
	JS 125-E (Eco-2 125)	09-15	F		Adrenaline 125 XFLM125GY-2B	13-18	
					Adrenaline 125 EFI (XFLM125GY-2B-E4)	15-18	
ASPES	Perseus Hybrid 150	11-14	F		FMX 125 (WY125T-108)	15-18	R
					LSM 125 (STR125YB)	12-18	R
CCM				MASH			
	C-XR 125 E	08-09	R		Black Seven 125cc	17-20	R
	C-XR 125 M	07-09	R		Brown Edition 125cc	18-20	R
	C-XR 125 S	08-09	R		Café Racer 125	14-20	R
	C-XR 230 E	07-09	R		Dirt Track 125cc	18-20	R
	C-XR 230 M	07-09	R		Seventy Five 125	14-16	R
	C-XR 230 S	07-09	R		Seventy Five 125 (Classic)	17-20	R
	LX 350-4A Quad	08-09	F		Black Seven 250cc	17-20	R
	LX 700-4A Quad	08-09	F		Café Racer 250cc	17-18	R
DAELIM					Two Fifty 250	17-20	R
	Tapo Message 50	04	F	PEUGEOT			
	Altino 125	01-04	F		New Vivacity (50cc/2T)		
	B-Bone 125 (SN125)	09-14			(12" wheels/200mm dia disc)	08-14	F
	History 125	01-06	F&R		New Vivacity (50cc/4T)		
	NS 125 DLX/III	03-07	F&R		(12" wheels/200mm dia disc)	08-14	F
	Otello 125 (NS 125 DLX)	00-02	F		New Vivacity Sixties (50cc/4T)		
	S1 125 (SL125)	07-14	R		(12" wheels/200mm disc)	10-13	F
	SL 125 Otello Fi	07-09	R		Sum-up (125cc)	08-11	F
	SQ 125 S2 Freewing	07-09	R	PGO			
GARELLI					Bugrider 50 (Buggie)	05-07	R
	Fashion F150	07	F		BR 150 A Bugxter	04-06	R
HONDA					Bugrider 150		
	MB 5 S	80-82	F		Bugrider 250 SS (Single seat)		
	MG 50 S/X/1/3 Magna 50	95-03	F		Bugrider 250		
	MRX 50	88-	F	PIZZA PEDS			
	MBX 80 FWDD/FWDF	83-86	F		125cc 4T Pizza Delivery Scooter	12-15	F
	CB 125 RS	83	F	POLARIS			
	CBX 125 TS Custom	82	F		Trail Boss 4x4	87	F
	CG 125 ES4-ES8	04-08	F	QUADZILLA			
	CG 150 ESD Titan	04-05	F		RV 125 Midi RV Bug		
	CG 150 KS/ES Titan	04-05	F		BR 150 E Bugrider	04-06	R
	CBX 200 Strada	97-01	F		RV 150 Midi RV Buggie		
	ATC 250 RB	81	F		BR 200	07-08	R
					BR 250		
HYOSUNG					XR 250		
	XR 125 LC Enduro	14-15	F		XL 300		
	XR 125 LC Supermoto	14-15	F	SACHS			
	TE 450 Quad Rapier	06-09	F&R		Mad Ass 50 (4T)	06-09	R
					Mad Ass 125 (4T)	06-09	R
JIALING							
	JH 125 B Roadstar	98	F	SINNIS			
KAWASAKI					LJ 50 QT-H (Rear disc model)	12-14	R
	KX 65 A1/A2/A3/A4/A5/A6/A6F/A7F				Apache 125 QM 125 GY-2B(A)		
	/A8F/A9F/AAF/ABF/ACF/ADF/AEF				(Rear disc model)	09-14	R
	/AFF/AGF/AHF/AJF	00-18	R		Apache SM/SMR 125	15-20	R
	KH 125 K1	83	F		Blade 125 QM 125 GY-2B	09-14	R
	BN 125 A1/A2 'Eliminator'	98-99	F		Blade X 125	15-20	R
	KLX 125 CAF/CBF/CCF/CCS/CDS				Eagle 125 QM 125 T-10R	10-14	F
	/CDF/CEF/CFF/CGF	10-16	R		JS 125-6H ST125	13-14	F
	KLX 125 DAF/DBF/DCF/DDF/DEF				Matrix II 125 QM 125 T-10H	10-14	F
	D-Tracker	10-14	R		Matrix 125	10	F
	Ninja 125 ABS	19-20	R		Ecogity 125 (125T-86)	07-14	F
	Z 125 (BR125 GGF/GHF Auto G/Box)	16-20	R	SUPERBYKE			
	Z 125 PRO (BR125 HGF/JHF				RMR 125	07-09	R
	Manual G/Box)	16-20	R	SUZUKI			
	KLX 150 L (KLX 150 EFF)	14-15	R		RM 65 K3/K4/K5	03-05	R
	KLX 150 D-Tracker (KLX150 HGF)	16	R		DF 125		
	KVF 300 A1/A2/A3/A4/B1/B2/B3/B4	99-02	F		DR 125 SF/SH/SJ	85-94	F
	(Prairie 4x4/2x4)				DR 125 SEX/SEY	99-01	F
	KVF 360 A1-A3/A6F/A7F/A8F/A9F				TS 125 XUF/XUG/XUH/XUJ	86-90	F
	/AAF/ABF/ACF/ADF Prairie	03-13	F		DF 200 EV/EV/EY (SH42A)	98-00	F
	KVF 360 B1-B3/B6F/B7F/B8F/B9F	03-09	F		DR 200 G/H/J	86-89	F
	KVF 360 C1-C3/C6F/C7F/C8F				DR 200 SEP/SER/SES/SEV/SEW		
	Prairie All models	03-08	F		/SEX/SEY Djebel (SH42A)	93-00	F
	KVF 400 A1/A2/B1 'Prairie'	97-98	F		DR 200 SE Trojan	96-13	F
	KVF 400 C1/C2/C3/C4/D1/D2/D3/D4				DR 200 SEK1-SEK9	01-09	F
	(Prairie 4x4/2x4)	99-02	F		SX 200 R/R2/RJ/RM	90-91	F
KEEWAY					LT-F 250 K2/K3/K4/K5/K6/K7/K8		
	Dragon 250 Quad	07-09	R		/K9/L2/L3/L4 Ozark	02-14	F

SUZUKI Contd.

TS 250 XE/XG/XH/XJ/XK	85-89	F
LT-A 400 FK2/FK3/FK4/FK5/FK6		
/FK7 Eiger 4WD	02-07	F
LT-F 400 FK2/FK3/FK4/FK5/FK6		
/FK7 (Eiger 4WD)	02-07	F
LT-F 400 K2-K7	02-07	F
LT-A 500 FK2/FK3/FK4		
Vinson 4WD Auto	02-07	F
LT-F 500 FK3/FK4/FK5/FK6/FK7		
Vinson	03-07	F
SYM		
Quadraider 600	06-07	F
TAISHAN		
Panther 50 Quad	03-04	F
XT 50	03-04	F
XT 125 Sport	04-05	F
YAMAHA		
YFS 200 R/S/T/V Blaster	03-06	F
YFM 250 XN/XP/XR/XS	01-04	F
YFM 250 BT/BV Bruin	05-06	F
YFM 250 BW/BX/BY Big Bear	07-10	F
YFM 350 XD/XE/XF/XG/XH/XJ/XK		
/XL/XM/XN/XP/XR	92-04	F
YFZ 350 A/B/D/E/F/G/H/J/K/L/M/N		
/P/R/S/T/V Banshee	90-09	F
YFM 350 FXG/FXH/FXJ/FXK/FXL		
/FXM/FXN/FXP/FXR/FXS Wolverine	95-04	F
YFM 350 FWA Grizzly 4WD	04-14	F
YFM 350 FGW/FGIX/FGIY/FGIZ		
Grizzly 4WD IRS	07-10	F
YFM 350 L Big Bear	99	F
YFM 350 FAS/FAT/FAV Bruin 4x4	04-06	F
YFM 350 ANS/ANT/ANV Bruin 2x4	04-06	F
YFM 350 XV/XXW/XX/XY		
2WD Wolverine	06-09	F
YFM 350 GW/GX/GY/GZ		
Grizzly 2WD	08-10	F
YFM 400 AR Kodiak (5VH3/4)	2003	F
YFM 400 FAM/FAN	00-01	F
YFM 400 FWT (Big Bear)	05	F
YFM 400 FGW/FGX Grizzly	07-08	F
YFM 450 FAR/FAS	03-04	F
YFM 450 FAT/FAH/FAV (Kodiak)	05-06	F
YFM 450 FXV/FXW/FXX/FXY/FXZ		
Wolverine	06-10	F
YFM 450 FWAD		
Grizzly EPS (Power Steering)	11-14	F
YFM 450 FWA Grizzly IRS	11-16	F
YFZ 450 B/D	13-14	F

Equivalents OE

43082 1241	45105 GBF 405	59340 13A00	59101 38820
43082 0043	45112 GC4 601	59340 22A00	59101 38850
43235-FYBQ-300	45112 GC4 831	59340 42A10	59101 38860
44203 OSB 0000	800070854	59340 44A00	K4308 21241
45105 166 007	43082 1028	3GD W0045 00	06455 KEH 900
45105 GE3 601	43082 1201	06455 GBF J01	06455 GBZ 701
45105 GE3 602	54074-10000	5LP W0045 00	06455 KRM 861
45105 GC4 601	59300 44870	59100 38870	55100 23044 08
45105 GC4 602/603	59300 42810	59100 38880	PE774896
45105 GW6 004	59300 42850	59101 38810	

MATERIAL AVAILABILITY AND PART NO.

STD	OPTIONS							
FA	SFA	SFAC	TT	HH	SFA-HH	R	MXS	EPFA
-	SFA054	SFAC054	FA054TT	FA054HH	SFA054HH	FA054R	MXS054	-

DISC PADS
BUYERS GUIDE

DO NOT REFIT ANY SHIMS/INSULATORS TO EBC PADS FROM ORIGINAL PADS UNLESS INSTRUCTED
ON NOTE ON PAD PACKAGING AND ON FA DRAWING ASSOCIATED WITH THAT PAD.

FA055 50 x 12/9mm

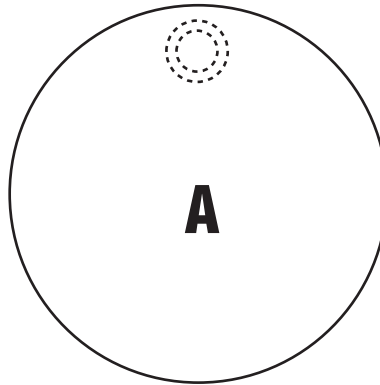
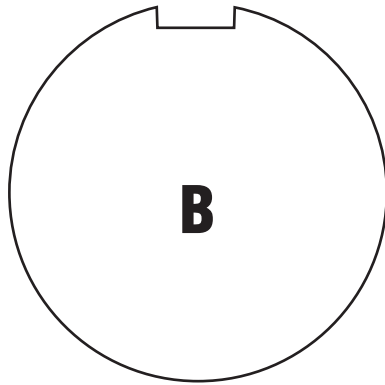

KAWASAKI		
HI-D/E/F 500	73-75	F
H2/H20A Mach IV (750cc)	72-73	F
H2-B/H2-C Mach IV (750cc)	74-75	F
Z 900 Z1A/Z1B	74-76	F
SUZUKI		
GT 125 L/M/A/B	74-77	F
GT 185 L/M/A/B	74-79	F
GT 250 L/M/A/B	74-79	F
GT 380 L/M/A/B	74-79	F
RE5 M/A	75-77	F
GT 500 A/B	75-77	F
GT 550 K/L/M/A/B	73-77	F
GT 750 K/L/M/A/B	73-77	F

MATERIAL AVAILABILITY AND PART NO.					
STD	OPTIONS				
FA	V	HH	R	MXS	EPFA
FA055	-	-	-	-	-

Equivalents OE #	
59100 18840	43050 002
59100 18841	43051 001
59100 36830/1	43071 001
59100 39810	43082 001
59100 31830	59300 18810
59100 31831	59300 36840
43050 001	

FA056 43.5 x 8mm

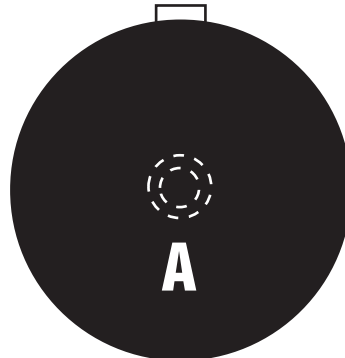
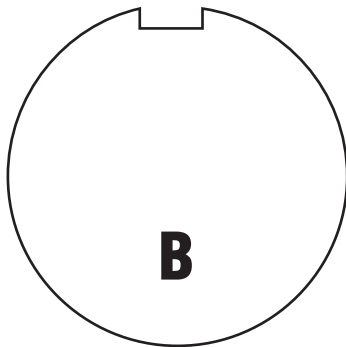

SUZUKI		
GP 125 C/N/X/D	78-84	F
HYOSUNG		
GF/A 125 'Speed'	99-06	F
Cruise II GA 125 F	99-04	F
KREIDLER		
50 RS-G/RSH-G and GS		F
80 E/L Florett		F
125 RS		F
LIFAN		
LT 125-3A		F
MOTO ROMA		
MXR 125	03	F
SUPERBYKE		
R-SR125 4V		F

MATERIAL AVAILABILITY AND PART NO.					
STD	OPTIONS				
FA	V	HH	R	MXS	EPFA
FA056	-	-	-	-	-

Equivalents OE #	
59300 39820	59340 39100
59300 39821	59330 39100
59302 39870	

FA057 55.7 x 53 x 9mm

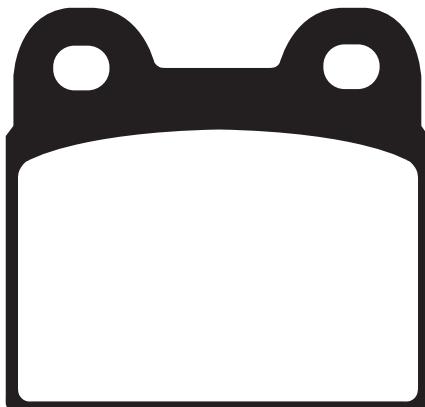

BMW		
R 45/45 N	78-85	F
R 45 T	80-85	F
R 65 LS	81-85	F
R 65 T	80-85	F

Equivalents OE #
34 71 2 301 359
34 11 1 238 083

MATERIAL AVAILABILITY AND PART NO.					
STD	OPTIONS				
FA	V	HH	R	MXS	EPFA
FA057	FA057V	-	-	-	-

DISC PADS BUYERS GUIDE

DO NOT REFIT ANY SHIMS/INSULATORS TO EBC PADS FROM ORIGINAL PADS UNLESS INSTRUCTED ON NOTE ON PAD PACKAGING AND ON FA DRAWING ASSOCIATED WITH THAT PAD.

FA060 35.2 x 51.5 x 6mm

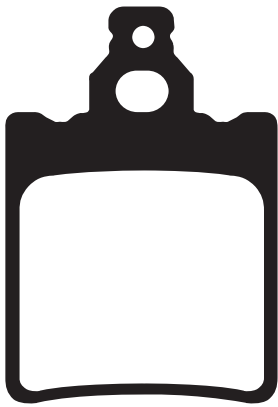

APRILIA					
Europa 50	90-92	R			
AF1 Futura 50	90-92	R			
MX 50	03-05	R			
RS 50	93-06	R			
RX 50 C/CD	93-04	R			
RS 50 (6 bolt disc fixing front & rear)	93-98	R			
RS 50 (5 bolt fixing front & rear)	99-05	R			
Tuorno 50	03-04	R			
RX 50 Raing	03-06	R			
RX3-5 Marce (M/N/P/R)	91-94	R			
KEEWAY					
X Ray 50 Supermoto	07-09	R			
TX 50	10-12	R			
TX 125	10-12	R			
MOTO GUZZI					
250 (All Models)	75-	F			
CAGIVA					
W4 50	91-95	R			
Cruiser 125	87	R			
Elefant 125	88-90	R			
WSXT 125 "Aletta Rossa"	83-84	F			
XSST 125	81-82	F			
SXT 125	82-	F			
Tamanaco 125	88-89	R			
W8 125	93-98	R			
FANTIC					
50 Caballero/Caballero RC	91-	R			

FANTIC Contd.					
50.1 Oasis	86-	R			
50.1 Oasis E.S.	87-	R			
50 Kaloa			F&R		
80 Caballero/Caballero RC	91-	R			
80 Kaloa			F&R		
GARELLI					
125 Tiger XLE	86-	R			
GTA 125	85	F			
GTA 125	86-	F&R			
GENERIC/KSR					
Toxic 50	07-08	R			
Trigger X 50 (All Models/TR X 50)	06-18	R			
Trigger SM 50 (All Models)	06-18	R			
GRS 125	14-16	R			
Trigger 125 SM	08-09	R			
Trigger 125 X	08-09	R			
TW 125 SM	13-16	R			
GILERA					
RV 50 NGR	88-	F			
NGR 250	85-	F			
LAVERDA					
LB 125 Custom/Sarbia/Strada Sport	85-87	F			
MALAGUTI					
50 MXR	89-	F			
MALANCA					
125 ob one M6	85-	F&R			
125 ob one M6 Racing	85-	F&R			
125 Mark Enduro	85-	F			

MATERIAL AVAILABILITY AND PART NO.					
STD	OPTIONS				
FA	V	HH	R	MXS	EPFA
FA060	-	-	-	-	-

Equivalents OE #	
8113104	8213104
8000 33545	238 076570
8000 37009	245 07 6340
8000 40413	326 478
8213051	8000 40413

FA061 94.5 x 56mm Tapered 1 Left/1Right

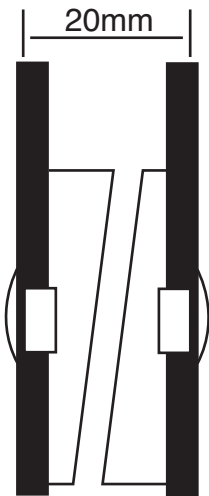

MARKED WITH GREEN TAG TO AVOID CONFUSION WITH FA041

YAMAHA			
XJ 650 G/H/J/K Maxim	80-83	F	
XJ 650 LH Midnight	81	F	
XS 750 SE	79-80	F(left)	
XV 750 SE	81	F	

MATERIAL AVAILABILITY AND PART NO.					
STD	OPTIONS				
FA	V	HH	R	MXS	EPFA
FA061	FA061V	-	-	-	-

Equivalents OE #	
2G2 W0045 01	4H7 W0045 00
2G2 W0045 10	4H7 W0045 10
3J6 W0045 10	4H7 W0045 12
3J6 W0045 11	4W5 W0045 00

FA062 51.3 x 11mm

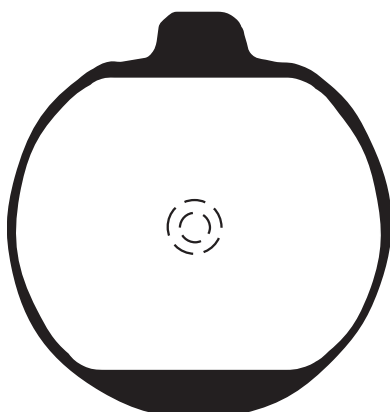

KAWASAKI			
Z 1000 ST (E1/E2 shaft)	79-82	F	
Z 1300 A1-A5	79-83	F	
ZG 1300 A1-A3	84-86	F	

Equivalents OE #
43082 1004
43082 1058

MATERIAL AVAILABILITY AND PART NO.					
STD	OPTIONS				
FA	V	HH	R	MXS	EPFA
FA062	-	-	-	-	-

DISC PADS
BUYERS GUIDE

DO NOT REFIT ANY SHIMS/INSULATORS TO EBC PADS FROM ORIGINAL PADS UNLESS INSTRUCTED ON NOTE ON PAD PACKAGING AND ON FA DRAWING ASSOCIATED WITH THAT PAD.

FA063 52.6 x 53 x 9mm

HYOSUNG			
Comet 250/600	02	R	
MAGNI			
Sport 1200 'S'	01	R	
SUZUKI			
GSF 250 N/ZM/P/NP/ZP/N/NR	92-96	R	
GSF 250 VS/VT/VV/VVZ/VW/VX/VY			
Bandit (GJ77)	95-00	R	
GSX 250 R CH/H (GJ72A)		R	
GSX 250 SSM Katana (GJ76A)	91	R	
GSX 250 FL/FM/FN/FP/FR/FS/FT			
/FV/FW Across	90-98	R	
GSXR 250 J (GJ72A)		R	
GSXR 250 CK		R	
GSXR 250 RK (GJ73A)	89	R	
RG 250 WD 'Gamma'	83	F&R	
RG 250 WE/FG/CH/FCH/FH 'Gamma'	84-88	R	
RGV 250 J/K/L	88-90	R	
TV 250 J/K/AK/L (VJ21A) Wolf	88-90	R	
SG 350 N 'Goose'	92	R	
GSXR 400 H	87	R	
GSXR 400 J/RR/RAK (GK73A)	88-90	R	
GSXR 400 RL/RM/RN/RS (GK76A)	90-95	R	
GSF 400 All models (Bandit)	89-97	R	
GSX 400 R2/RG (GK71B/F)		R	
GSX 400 X/XA/XS Impulse		R	
GSX 400 FJ/FK/FAK/FL (GK74A)	88-90	R	
GSX 400 R/S/T/ZR/ZS/ZT/X			
Impulse Type S	94-99	R	
GSX 400 FW/FWS/FWS-2		F&R	
GSX 400 SSN (GK77A) Katana	92	R	
GSX 400 FSV/FSK1 (GK7B) Inazuma	00	R	
RF 400 RP/RR/VR/RT/RVT/RV-V			
(GK78A)	93-97	R	
RG 400 EWF/EW-2G/EWH Walter Wolf			
(Type 1&2)	85-87	R	
SV 400 N (VK53A)	98	R	
SV 400 SV (VK53A)	98	R	
SV 400 X/Y/K1/K2	00-02	R	
SV 400 SX/SY/SK1/SK2	00-02	R	
GS 500 EK/EL/EM/EN/EP/ER/ES/ET/EV			
/EW/EX/EY/K1/K2/K3/FK4/K4/FK5/K5			
/FK6/K6/K7/FK7/K8/FK8	89-08	R	
RG 500 G/CH	85-87	R	
GSX 550 ESD/ESE/EFE/EFF /ESH/EPG	84-87	F&R	
GSF 600 Y/K1/K2/K3/K4 (Naked Bandit)	00-04	R	
GSF 600 SY/SK1/SK2/SK3/SK4			
(Faired Bandit)	00-04	R	

SUZUKI Contd.			
GSX 600 FJ/FK/FL/FM/FN/FP/FR			
/FS/FT/FV	88-97	R	
GSX 600 FW/FX/FY/FK1/FK2/FK3			
/FK4/FK5/FK6	98-06	R	
RF 600 RP/RR/RS/RT/RV	93-97	R	
GSXR 600 V/W/X/Y/K1/K2/K3/ZK3	97-03	R	
GSF 650 S/T/N/M/X Naked Bandit	95-99	R	
GSX 650 ST/SV/SW/SX Faired Bandit	95-99	R	
SV 650 A/Y/K1/K2 Naked - Non ABS	99-02	R	
SV 650 SX/SY/SK1/SK2			
Top Fairing Non ABS	99-02	R	
GSX 750 SE "Katana"	85	F	
GSX 750 FK/FL/FM/FN/FP/FR/FS/FT/FV	89-97	R	
GSX 750 RG	89	R	
GSX 750 FW/FX/FY/FK1/FK2/FK3			
/FK4/FK5/FK6	98-06	R	
GSX 750 W/X/Y/K1	98-03	R	
GSXR 750 F/G/H/J/K/L/M/WN/WP			
/WR/WS/T/V/W/X/Y/K1/K2/K3	85-00	R	
GSXR 750 RG	86	R	
RF 900 RT/RV/RW	96-98	R	
TL 1000 SV/SW/SX/RW/RX/SY			
/RY/SK1/RK1	97-02	R	
GSXR 1100 G/H/J/K/L/M/N	86-92	R	
GSXR 1100 WP/WR/WS/WT	93-96	R	
GSF 1200 T/ST/V/SV/SW/X/SX			
/SY/SK1/K1/K2/SK2/K3/SK3/K4	96-05	R	
/SK4/K5/SK5 'Bandit'	97	R	
GSF 1200 SAV ABS-Bandit			
GSF 1200 K1/K2/K3/K4/K5			
(Naked Bandit - 6 piston caliper)	01-05	R	
GSF 1200 SK1/SK2/SK3/SK4/SK5			
(Faired Bandit - 6 piston caliper)	01-05	R	
GSF 1200 T/V/W/X/Y (Naked Bandit)			
4 Piston Caliper	96-00	R	
GSF 1200 ST/SV/SW/SX/SY			
(Faired Bandit) 4 Piston Caliper	96-00	R	
GSX 1200 FSW/FSX 'Inazuma'	98-99	R	
GSX 1300 RX/RV/RK1/RK2/RZK3/RK3			
/RK4/RK5/K6/K7 'Hayabusa'	99-07	R	

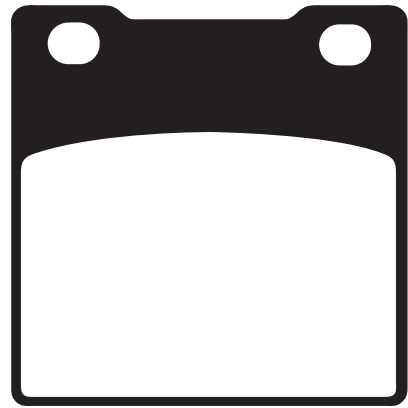

Equivalents OE #	
59100 16820	69100 05830
59130 16700	69100 05860
59130 16720	69100 05890
59130 16730	69100 06810
59130 16740	69100 20810
59130 16750	69100 21820
59130 16810	69130 27A10
59130 30B00	69130 30B21
59130 30B10	69130 33C00
59130 30B20	69130 21820
59130 30B21	69130 34C00
69100 05870	69100 34860
69130 16700	69101 05820
69130 16740	69100 05890
69130 20A10	69100 0BE00
69130 21E00	

MATERIAL AVAILABILITY AND PART NO.					
STD	OPTIONS				
FA	V	HH	R	MXS	EPFA
FA063					

FA064 65.3 x 59 x 10mm

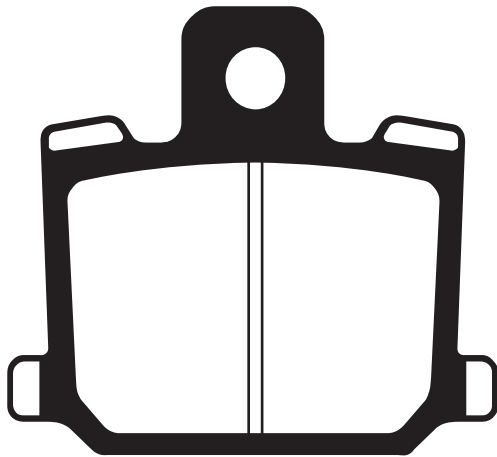

YAMAHA
RD 250/350 LC 80 F

Equivalents OE #
4LO W0045 00
4LO W0045 10
4KO W0045 00
4KO W0045 10

MATERIAL AVAILABILITY AND PART NO.					
STD	OPTIONS				
FA	V	HH	R	MXS	EPFA
FA064					

FA065 71.6 x 45.2 x 11.5mm

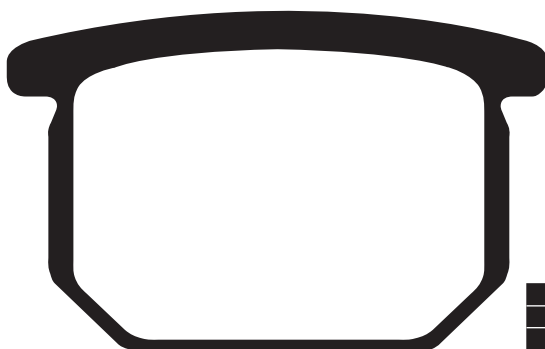

SUZUKI			
GS 550 ET/EX/EZ/LT/LX/MX/MZ	80-84	F	
GR 650 D/XD Tempter	83	F	
GS 650 GTX/GTZ/GTD/GX/GZ	81-83	F	
GSX 750 S/SS			
(G57SX-106815-) Katana	84	F	
GSX 750 S-2/S-2C (GS75X-114747-)			
Katana	84	F	
XN 85 Turbo	83	F	
GS 1000 ET	81	F	
GSX 1000 SZ 'Katana'	82	F	
GSX 1100 ET/EX/EZ/ESD	80-83	F	
GSX 1100 SZ/SD 'Katana'	82-83	F	

Equivalents OE #
59300 49820
59300 49821
59300 49850

MATERIAL AVAILABILITY AND PART NO.					
STD	OPTIONS				
FA	V	HH	R	MXS	EPFA
FA065					

FA067 B. 85 x 43 x 8mm A. 55.5 x 37 x 10mm

FA067/2 B. 85 x 43 x 6.2mm A. 55.5 x 37 x 8.5mm

FA067/3 B. 85 x 43 x 7mm A. 55.5 x 37 x 9mm

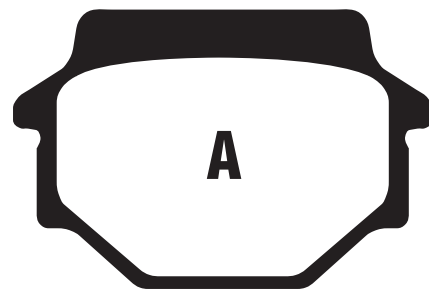
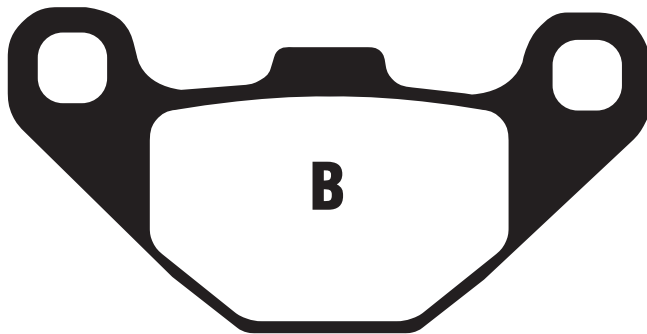

**DISC PADS
BUYERS GUIDE**

**DO NOT REFIT ANY SHIMS/INSULATORS TO EBC PADS FROM ORIGINAL PADS UNLESS INSTRUCTED
ON NOTE ON PAD PACKAGING AND ON FA DRAWING ASSOCIATED WITH THAT PAD.**

FA067

AEON

MY 125		R
Cobra 220 Quad	06-11	R
Overland 300 (Quad) (AT20)	06-07	R
Cobra S 300	12-15	R
Cube 300 Side X Side	11	R
Cobra 350 (Quad)	10-11	R
Cube 350 Side X Side	13-15	R
Cobra 400 (Quad)	10-15	R
Cobra 400 Supermoto Quad	13-15	R
Overland 600 (Quad)	10-11	R

ALFER

AR 250	93-	R
--------	-----	---

APACHE

F 100		F&R
ZX 100		F
RLX 250 S (MK1) Rear Disc Model		F
RLX 250 SX (MK1) Rear Disc Model		F
RLX 320 S		F&R
RLX 320 Utility		F&R
RLX 450 S		F&R

APRILIA

RX 125 (Brembo Front & Grimeca Rear caliper)		R
08-12		R
SX 125	08-13	R

BAROSSA

170 Cheetah	03-06	R
250 Cheetah	03-06	R

CAGIVA

WMX 125	89	R
WMX 250	89	R

CECTEK

500 EFI King Cobra	09-10	R
500 EFI Gladiator	09-10	R
500 EFI Quadrifit	09-10	R
500i Estoc	10	R

C F MOTO

CF800 UU-A UForce 800 (Side x Side)	14-16	R
-------------------------------------	-------	---

DERBI

DXR 200 Quad (Front drum model)	04-05	R
DXR 200 Quad (Front disc model)	04-07	R
DXR 250 Quad (Front disc model)	04-07	R

DINLI

DL 450 RS (DL901)	06-09	F&R
-------------------	-------	-----

EXPLORER

Trasher 450	08-09	F&R
-------------	-------	-----

GOES

G 225 S	12-13	R
C 350 S (Quad)	08-13	R

GOGORO (E SCOOTER)

Smart Scooter	15-17	R
---------------	-------	---

HUSABERG

All models (central fixing pin in pad)	89-92	R
All models (fixing pin at end of brake pad)	93-94	R

KAWASAKI

KSR1 (KMX 50 B1/B2)	90-91	R
KSR II (KMX 80 B1/B2)	90-91	R
KH 100 G4	83	F
KH 100 G5-G8 (EX)	84-87	F
AR 125 A1-A7/B1-B8	82-94	F
KH 125 K2-K10	82-98	F
KH 125 L1 (EX)	84	F
KMX 125 A1-A5/B1-B9	86-98	R
KMX 125 B2-B12		R
(From E/No MX AE 013437)	87-03	R
KX 125 B2/C1	83-84	F
KX 125 D1	85	F
KX 125 E1	86	F&R
KX 125 E2/F1	87-88	R
KDX 200 C1/C2/C3	86-88	F

KAWASAKI Contd.

KDX 200 E1/E2/E3/E4	89-92	F
KMX 200 A2/A3	88-92	R
Z 200 A6	83	F
BJ 250 B1-B7A Estrella	92-99	F&R
BJ 250 C1-C7 Estrella RS	99-02	F&R
KL 250 J1/J3 Stockman		R
KL 250 G1/G1A Super Sherpa	97	R
KL 250 D2-D22	84-05	F
KLX 250 H1 Super Sherpa	98	R
KR 250 A1/A2	84-86	F
KX 250 C1/C2	83-84	F
KX 250 D1	85	F
KX 250 D2	86	F&R
KX 250 E1/F1	87-88	R
KXT 250 A2 Tecate - 3 Wheel Model	85	F&R
KXT 250 B1 Tecate - 3 Wheel Model	86	F&R
KXT 250 B2 Tecate - 3 Wheel Model	87	F
ZR 250 B6 Balius-II	02	R
KLF 300 B1-B17 Bayou	88-04	F
GPZ 305 A1/B1-B10	83-96	F
ZR 400 A1/B1 (Z 400 F)	83-84	F
Z 400 C2/C3 (Z 400 F2)	85-87	F
ZL 400 B Eliminator 400 SE	88	F
FX 400 R (ZX 400 E1-E3)	86-88	F
GPZ 400 R (ZX 400 D/D3/D3A)	85-87	F
GPZ 500 S (EX 500 B1-B5)	88-93	F
GPZ 500 S (EX 500 E1-E10)	94-04	R
KX 500 A1/A2	83-84	F
KX 500 B1	85	F
KX 500 B2	86	F&R
KX 500 C1/D1	87-88	R
GT 550 G1-G9	83-01	F
ZR 550 A1/A2 (Z 550 F)	83-84	F
KLR 600 A1/B2/B1-B4/B6-B9	84-94	F
KL 650 B1-B3 Tengai	89-92	R
KLR 650 C1-C10	95-04	R

KTM

D-XC/E-XC/E-GS 125 Brembo Calipers	92-93	R
D-XC/E-XC/E-GS 125 Grimeca Calipers	92-93	R
MX 125 Brembo Calipers	92-93	R
MX 125 Grimeca Calipers	92-93	R
D-XC/E-XC/E-GS 125	90-91	F&R
EXC 125 Brembo Calipers	89	F&R
MX 125 Brembo Calipers	89	F&R
MX 125 Brembo Calipers	90-91	F&R
D-XC/E-XC/E-GS 250 (Brembo Calipers)	91	F&R
D-XC/E-XC/T-XC/E-GS 250		R
(Grimeca calipers)	92-93	R
EXC/EGS 250 (Brembo Calipers)	89	F&R
MX 250 (Brembo Calipers)	89	F&R
MX 250 (Brembo Calipers)	90	F&R
MX 250 (Brembo Calipers)	91	F&R
MX 250 (Brembo Calipers)	92-93	R
DXC/EXC/EGS 350 (Brembo Calipers)	90-91	F&R
EXC 350 (Brembo Calipers)	89	F&R
MX 350 (Brembo Calipers)	90-91	F&R
MX 350 (Brembo Calipers)	89	F&R
LC-4 MX 500 (Brembo Calipers)	90-91	F&R
LC-4 EXC 500 (Brembo Calipers)	90-91	F&R
MX 500	92-94	R
LC4 MX 600 (Brembo Calipers)	90-91	F&R
LC4 EXC 600	92-93	R
LC4 EXC 600 (Brembo Calipers)	90-91	F&R
SX 620/EXC/EGS	94	R

KYMCO

Agility 125 (C20000 - 16 Inch Wheels)	08-15	R
Visa R 50	11-15	F
Visa R 110	11-15	F
Visar R 125	11-15	F

LINHAI

ATV 80	13	R
ATV 150	13	R

MAICO

500 MX	94-98	R
--------	-------	---

OSSA

560	92	F&R
500	92	R

PEUGEOT

City Star 125 Blue Line (AC/Carb)	15	R
Django 125 Allure (4T/190mm Rear Disc)	14-19	R
Django 125 Allure SBC		R
(4T/190mm Rear Disc)	14-19	R
Django 125 Evasion		R
(4T/190mm Rear Disc)	14-19	R
Django 125 Evasion SBC		R
(4T/190mm Rear Disc)	14-19	R
Django 125 Heritage SBC		R
(4T/190mm Rear Disc)	14-19	R
Django 125 S (4T/190mm Rear Disc)	14-18	R
Django 125 Sport		R
(4T/190mm Rear Disc)	14-19	R
Django 125 Sport SBC		R
(4T/190mm Rear Disc)	14-19	R
Django 150 Allure		R
(4T/190mm Rear Disc)	14-19	R
Django 150 Evasion		R
(4T/190mm Rear Disc)	14-19	R
Django 150 Sport		R
(4T/190mm Rear Disc)	14-19	R

PHB

500	92	R
560	92	F&R

POLARIS

200 Phoenix Quadricycle Model (EA/EB/Rear disc model)	05	R
200 Phoenix Quadricycle Model (EC/ED Models/Rear disc model)	05-09	R
200 Phoenix Quadricycle Model (Rear disc model)	10	R
200 Sawtooth Quadricycle (Rear Disc Model)	06	R
200 Sawtooth Quadricycle (Rear Disc Model)	08	R
QUADZILLA (inc. White Knuckle Models)		
Pro Shark 100 (RMX) (Front disc models)		F
4 Cross 200 E SUV	06-07	R
ST 200 E (5 speed manual)	06-07	R
QZ 200 (Front disc model)		F&R
250e	06-11	F&R
Stinger R250E	06	R
QZ 250 (Front disc model)		F&R
QZ 270		F&R
300e XLC	06-07	R
300e Stinger	09-11	F&R
300e XLC	07-08	F&R
300e XLC Stinger	07-08	F&R
300SE 4 Valve	06-07	R
Jow 300	07-08	F&R
QZ 300 XLC		F&R
RL 300 Buggie	09-11	F&R
320 CUV		F&R
RS7 4WD	10-11	R
RS8	10-11	R
QZ 450 RS	06-09	F&R
QZ 450 Sport	08-09	F&R
X7R	10-11	R
XLC 500	10-15	F&R

FA067, FA067/2, FA067/3 Contd.

SUZUKI

OR 50 ET	1980	F
RB 50 H GSXR 50	1987	F
RG 50 EW		F
ZR 50 SLKX	1981	F
ZR 50 SKX/SKE/SKH	83-87	F
GN 125 R/V/W/X/Y/K1 (NF41A)	94-01	F
GN 125 ER/EV/EW/EX/EY/EK1 (NF41A)	94-01	F
GN 125 HS (LC6PCJB1 /Chinese production)	00-10	F
GS 125 ESZ	82	F
GS 125 ESR/ESX	95-00	F
TU 125 X/XTUX/XTX	99	F
GSX 400 FX/FZ/FD	81-83	F
X4 125		F
GSX 250 FXK2/K3/K4/K5 (ZR 250 C)	02-05	R
SYM		
JET V (125cc/4T)	12-13	F
TGB		
250 Blade/Congo ATV	06-07	F
Blade 325 Quad (4x2)	07-11	R
Blade 325 LE Quad (4x2)	08-10	R
Blade 325 SL Quad (4x2)	11-12	R
Target 325 (4x2)	09-12	R
Target 400 (4x2)	09-10	R
Target 425 (4 x 4)	09-11	R

TGB Contd.

Blade 450 SE (4 x 4)	10-11	R
Blade 460 R Target	12	R
Blade 460 IRS Target	12	R
Blade 460 SL IRS 4 x 4	12	R
Target 500 (4x2)	09-10	R
Blade 510 LE	11-12	R
Blade 525 SL 4 x 4	09-10	R
525 SE 4 x 4	09	R
Target 525 (4 x 4)	09-11	R
Blade 550 LT 4 x 4	10-11	R
Blade 550 SE 4 x 4	09-11	R
Blade 550 SL 4 x 4	09-10	R
Blade 550 IRS Target	11-12	R
550 IRS Blade LT	10-12	R
VECTRIX		
VT-1	14	R
YAMAHA		
YFM 90 RZ/RA/RB/RD Raptor (With Rear Parking Brake)	10-13	R
YFM 300 B/D Grizzly	12-13	R

FA067/2

FANTIC		
50 Strada	82	F
50/50.1 Raider	81	F
MALAGUTI		
50 MDX Gold Enduro	87-	F
50 Enduro MEX	87-	F
50 Enduro MSX	85-	F
SACHS (HERCULES) Also see SFM section		
50 Supra 4 GP		F

FA067/3

KAWASAKI		
KLE 250 A2 Anhelu	95	R
KLE 250 A3	97	R
KLE 250 A5/A6	00-01	R
ZZR 250 (EX 250 H1-H13)	90-01	R
ZXR 250 C1-C3 (ZX 250 C1-C3)	91-95	R
ZXR 250 R (ZX 250 D1)	91	R
ZR 250 A1-A5 Balius	91-95	R
ZR 400 D1/D3/D4 Xanthus	92-95	R
GPZ 500 S (EX 500 D1-D7)	94-01	R
KLE 500 A1-A12	91-04	R
KLE 500 B1P/B6F/B7F	05-07	R
KLR 650 A1-A3	87-89	R
KRAM-IT (KRAMER)		
ER 125/250/300 RV3	88-	R
ER 500/600	96-	R

Equivalents OE # - FA67					
43050 1063	43082 1073	45815 RAM 01	59300 36820	00Q25001198	
43050 1064	43082 1084	59100 33810	59300 36821	890304	
43050 1073	43082 1086	59100 33812	59300 36822	1SC F5806 00	
43050 1082	43082 1092	59100 33820	59300 36871	43D F5906 01	
43082 1027	43082 1096	59130 26820	59301 39810	0453200	
430821031	43082 1163	59300 04830	59301 39811	0452883	
43082 1051	43082 1191	59300 04831	59301 39812	0453201	
43082 1056	43082 1204	59300 26820	59301 33810	45120 211 000	
43082 1063	43082 120	59300 33810	545 13209 044	PE803444	
43082 1064	45105 LFC3 305	59300 36810	K4308 21204	7030 081520	
43082 1070	45815 RAM 000	59300 36811	513506	7030 0855A0	

Equivalents OE # - FA067/2
238 07 6340
240 07 6340

Equivalents OE # - FA067/3
43082 1116

MATERIAL AVAILABILITY AND PART NO.								
STD	OPTIONS							
FA	SFA	SFAC	TT	SFA-HH	HH	R	MXS	EPFA
FA067	SFA067	SFAC067	FA067TT	SFA067HH	FA067HH	FA067R	-	-

MATERIAL AVAILABILITY AND PART NO.				
STD	OPTIONS			
FA	V	HH	R	MXS
FA067/2	-	-	-	-

MATERIAL AVAILABILITY AND PART NO.				
STD	OPTIONS			
FA	V	HH	R	MXS
FA067/3	-	-	-	-

FA068 67.8 x 40.7 x 9.5mm



KAWASAKI

Z 250 A3	81	F
Z 400 J2/J3	81-83	F
Z 440 C2	81	F
Z 440 D5/D6 (LTD)	83-84	F
Z 440 H1/H2	82-83	F
GPZ 550 H1/H2	82-83	F&R
GPZ 550 D1	82	F&R
Z 550 A2/A3/C1/C2/LTD	81-84	F
Z 650 F2/F3/F4	80-83	F
Z 700 A1 'Ltd'	84	F&R
Z 750 E1	80	F&R
Z 750 H1/H2/LTD	80-81	F&R
Z 750 L1/L2/L3/L4	81-84	F&R
Z 750 N1/N2 'Spectre'	82-83	F&R
GT 750 P1-P9	82-96	F&R
GPz 750 R1	82	F&R
Z 750 Y1 (LTD)	82	F
Z 1000 R1/R2 (Eddie Lawson Replica)	82-83	F&R
Z 1000 J1/J2/J3	81-83	F&R
Z 1000 K1/K2 LTD	81-82	F&R
Z 1100 A1-A3	81-83	F&R
GPz 1100 B1/B2	82-83	F&R
Z 1100 D1/D2 'Spectre'	82-83	F&R

MATERIAL AVAILABILITY AND PART NO.					
STD	OPTIONS				
FA	V	HH	R	MXS	EPFA
FA068	FA068V	FA068HH	-	-	-

Equivalents OE #	
43082 1007	43082 1022
43082 1008	43082 1025
43082 1021	43082 1026

FA069 90 x 49 x 10mm

FA069/2 90 x 49 x 9mm

FA069/3 90 x 49 x 11.3mm

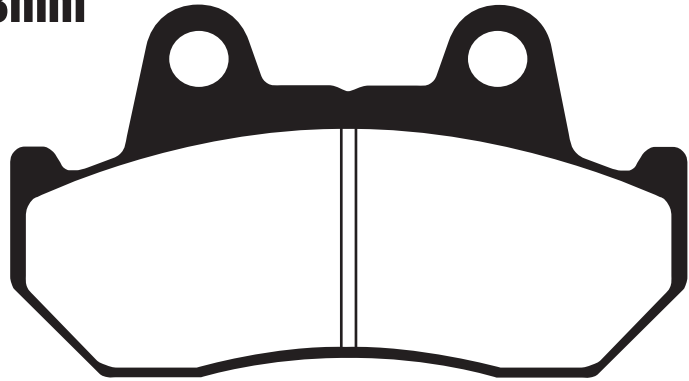

DO NOT REFIT ANY SHIMS/INSULATORS TO EBC PADS FROM ORIGINAL PADS UNLESS INSTRUCTED ON NOTE ON PAD PACKAGING AND ON FA DRAWING ASSOCIATED WITH THAT PAD.

FA069 - HONDA

CB 125 TDC/TDE/TDJ	83-89	F
CBX 125 F	84-	F
CBX 250 RSE	84	F
NS 400 RF/RG	85-87	F&R
CMX 450 CH/CJ Rebel	87-88	F
CX 500 CC	82	F
CX 500 EC	82	F&R
CX 500 TCC 'Turbo'	83	F&R
FT 500 C	82	F&R
GL 500 DC	82	F
VF 500 FE/F2E/FF/F2F	84-85	F&R
XBR 500 F/G/H/SJ	85-89	F
XL 600 LMF/RMG/RMH	85-87	F
XL 600 VH/VJ/VK 'Transalp'	87-90	F
CX 650 ED	83	R
CB 750 FC/F2C/FD/F2D	83-84	R
CBX 750 FE	84	F
VF 750 C Shadow	83	F
VF 750 FD/FE	83-84	F
VF 750 SC (V45 Sabre)	82	F
XLV 750 R (RD/RF)	83-88	R
CB 900 FB/F2B	82-85	R
CB 900 FC/F2C/FD/F2D	84-85	F&R
CBX 1000 B/C	81-82	R
VF 1000 FE/FF/FG/F2F/F2G	84-86	F
VF 1000 RE/RF/RG	84-86	F
CB 1100 RBII/RCII/RDII	80-83	F&R
GL 1100 C/DC/AD 'Goldwing'	82-83	R

FA069/2 - HONDA

CN 250 H/J/L/M/P/R/S/T/V/X	87-98	F
SPAZIO/Helix	84-87	F
GB 250 E/H 'Clutman'	84	F
NS 250 FE/RE (MC11-100)	86	F
NS 250 RG (MC11-102)	86	F
CB 400 NC	82	F
CX 650 TD 'Turbo'	83	F
CX 650 ED	83	F
GL 650 D2-E	84	F
CB 750 FC/F2C/FD/F2D	83-84	F
CB 900 FB/F2B	82-88	F
CBX 1000 B/C	81-82	F
GL 1100 C/DC/1C Interstate 'Goldwing'	82	F
GL 1100 AC Aspencade 'Goldwing'	82	F
GL 1100 C/DC/AD	82	F

FA069/3 - HONDA

NS 250 FE/RE (MC11-100)	84	R
NS 250 RG (MC11-102)	86	R
NSR 250 RG (MC16-100)	86	R
CBR 400 RG/RHYA (NC23)	86-87	R
VFR 400 ZG/ZH/RG-YA (NC21)	85-87	R
CBR 500 FH/FJ/FK/FL	87-90	R
CBR 600 FH/FJ/FK/FL	87-90	R
CBR 750 FH Superaero	87	R
CBX 750 FE	84	R
VF 750 FD/FE	83-84	R
VF 750 CH	87	F
VFR 750 FG/FH	86-87	R
VF 1000 FE/FF/FG/F2F/F2G	84-86	R
CBR 1000 FH/FJ	87-88	R
CB 1100 RB2/RC2/RD2	80-83	R
VT 1100 CH/CJ/CN/CP Shadow	87-93	F
GL 1200 DE/DF/DG/AE/AF/AG	84-86	F&R
GL 1500 J/K/L/SEM/SEN/SEP /SER/SES/SEV/SEW/SEX /SEY 'Goldwing'	88-00	R

Equivalents OE #- FA069

06435 MT8 405	43105 KE7 702	43105 MJ6 007	45105 MB1 702	45105 MK7 671
06455 MA3 405	43105 MA3 004	43105 MJ6 014	45105 MC4 004	45105 MK7 672
451A0 MM9 670	43105 MA3 007	45105 MA6 671	45105 MF2 670	
431A0 MC7 024	43105 MC7 004/007/024	45105 MBO 007	45105 MJ1 672	
431A0 MC7 305	43105 MC7 014	45105 MBO 008	45105 MK4 004	
451A0 MM9 670	43105 MJ6 004	45105 MB1 701	45105 MK6 671	

Equivalents OE #- FA069/2

06455 443 405	43105 KN8 007	45105 KL8 004	45105 006/016/026	45105 MC7 024
06455 KN8 405	43105 MJ6 721/722/723	45105 KL8 007	45105 KN8 712	45105 MM9 670
431A0 MC7 024	43105 MJ6 724	45105 KL8 014	45105 MC7 004	45105 MM9 781
45105 KL8 405	45105 443 761	45105 KL8 712	45105 MC7 007	45105 MM9 782
45105 KL8 405	45105 443 762	45105 KN8 007	45105 MC7 014	

Equivalents OE #- FA069/3

06435 MT8 405	43105 MB4 008	43105 ML7 006	43105 MN5 008
06435 ML7 405	43105 MB4 305	43105 ML7 007	43105 MT8 008
06435 ML7 415	43105 MB6 018/008	43105 ML7 017	431A0 MN5 670
43105 MB4 007/017	43105 MG9 007/017	43105 ML7 027	451A0 MM8 670

MATERIAL AVAILABILITY AND PART NO.

OPTIONS					
STD	V	HH	R	MXS	EPFA
FA	FA069V	FA069HH	-	-	-
FA069	FA069V	FA069HH	-	-	-

MATERIAL AVAILABILITY AND PART NO.

OPTIONS					
STD	V	HH	R	MXS	EPFA
FA	FA069/2V	-	-	-	-
FA069/2	FA069/2V	-	-	-	-

MATERIAL AVAILABILITY AND PART NO.

OPTIONS					
STD	V	HH	R	MXS	EPFA
FA	FA069/3V	FA069/3HH	-	-	-
FA069/3	FA069/3V	FA069/3HH	-	-	-

FA070 66.5 x 59 x 10mm

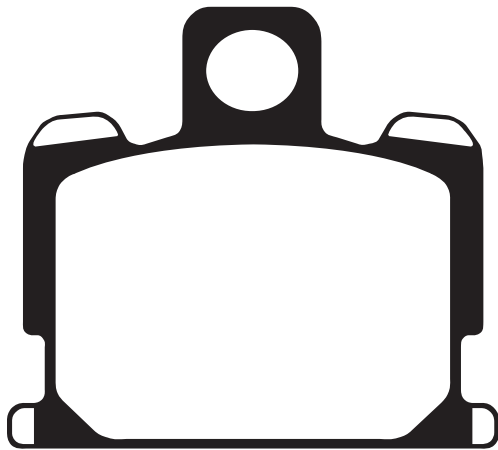

YAMAHA		
RD 50 MX/RD 50	81-87	F
RD 80 (Air Cooled)	82	F
RD 250	80-83	F
RZ 250 (4L3)		F
RD 350 LX	81-82	F
XJ 550	81-84	F
XJ 550 H/J/K Maxim	81-83	F
XJ 550 RH/RJ/RK Seca	81-83	F
XJ 750	82-84	F
XJ 750 RF/RJ/RK Seca	81-83	F
XS 1100 S	81	F

Equivalents OE #	
23W W0045 01	4W1 W0045 00
23W W0045 10	4W1 W0045 00
4L3 W0045 00	4W1 W0045 20
4L3 W0045 10	4W1 W0045 30

MATERIAL AVAILABILITY AND PART NO.					
STD	OPTIONS				
FA	V	HH	R	MXS	EPFA
FA070	FA070V	-	-	-	-

FA073 A. 51.3 x 9.4mm B. 50 x 8mm

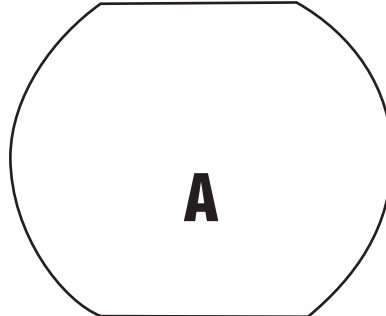

KAWASAKI		
Z 250 A1/A2	78-80	F
Z 400 J1	80	F
Z 440 A2/C1	79-80	F
Z 440 D4 (LTD)	82	F
Z 500 B1/B2	79-80	F
Z 550 A1	80	F
Z 650 (D2/D-SR)	79-80	F
Z 650 C3	79	F
Z 650 F1	80	F
Z 650 D2/D3 (SR)	79-80	F
Z 1000 A3/A4	79-80	F
Z 1000 H1/H2	74-75	F
Z 1000 D3 (ZIR)	79	F

MATERIAL AVAILABILITY AND PART NO.					
STD	OPTIONS				
FA	V	HH	R	MXS	EPFA
FA073	-	-	-	-	-

Equivalents OE #
43082 1001
43082 1005

FA076 43.95 x 59 x 7.1mm

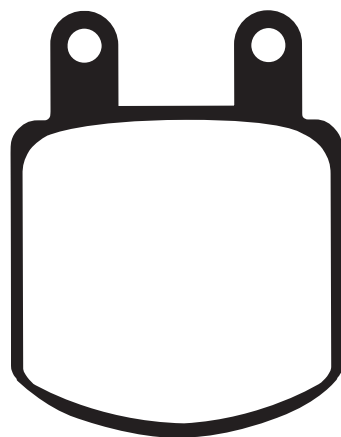

ASPES	125 Duma	F
GARELLI	TSR 125	-83
GILERA	80 TG 1/2/3	F
	125 GR 1	F
	125 TG 1/2/3	F
	200 T4/T4 C/T4 S	F
GMA	2 Piston (Small) Caliper model B (CCI # 09-996)	F
JAYBRAKE	Early Design 2 Piston	
KREIDLER	Mustang 125	F

LAVERDA	LZ 125 Sport (Grimeca Caliper)	80-82	F
MOTO MORINI	125 Monocilindro	79-	F
	250 All models	71-	F
	350 Sport	-79	F&R
	350 Sport	80-81	F
	350 FT/Turismo	80-	F
NVT	125/175 Rambler		F

MATERIAL AVAILABILITY AND PART NO.					
STD	OPTIONS				
FA	V	HH	R	MXS	EPFA
FA076	FA076V	FA076HH	-	-	-

Equivalents OE #
310 292
43 09 11

FA077 60 x 58 x 9mm

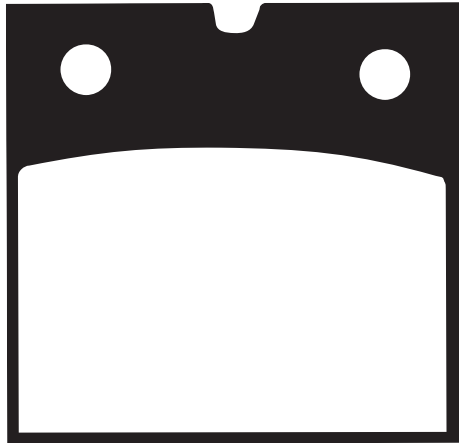

BENELLI
900 SE1 (6 cyl) 83 R
BMW
R 65 07/88-08/89 F
R 80/R 80 RT 84-07/95 F
R 80 GS 87-95 F
R 80 PD/CH 90-95 F
R 850 GS 96 F
R 100 GS 86-94 F
R 100 PD 89-96 F

LAVERDA
1000 RGS Corsa 84 F
MOTO GUZZI
850 Le Mans III
(12 spoke cast wheel) 81-84 R
1000 - 1000 SP (12 spoke
cast wheels/dished front discs) 79-83 R

Equivalents OE #		
34 11 1 354 720	34 11 2 314 545	18654660
34 11 2 331 177	34 11 2 310 601	GV18654660

MATERIAL AVAILABILITY AND PART NO.					
STD	OPTIONS				
FA	V	HH	R	MXS	EPFA
FA077	FA077V	-	-	-	-

FA080 92 x 53 x 8mm

FA080/2 92 x 53 x 9.5mm

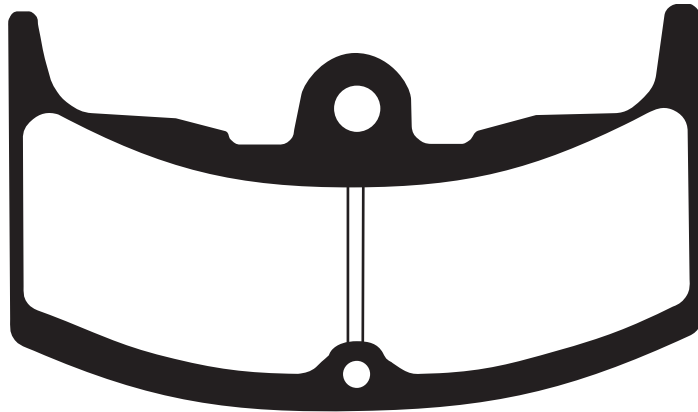

FA080 - HONDA
CBX 550 FC/F2C/FD/F2D 82-84 F
FA080/2 - HONDA
MXV 250 F (MC92) 83-88 F
VT 250 FD 83 F
VF 400 FD 83-85 F&R
VT 500 ED/EF 83-85 F
CBX 550 FC/F2C/F2D/FD 82-84 R

Equivalents OE #FA080	Equivalents OE #FA080/2
45105 MA7 007	45105 MA6 004
45105 MA7 004	45105 MA6 007
45105 MA7 305	45105 MA6 305

MATERIAL AVAILABILITY AND PART NO.					
STD	OPTIONS				
FA	V	HH	R	MXS	
FA080	-	-	-	-	-

MATERIAL AVAILABILITY AND PART NO.					
STD	OPTIONS				
FA	V	HH	R	MXS	
FA080/2	-	-	-	-	-

FA081 68 x 60 x 10.5mm

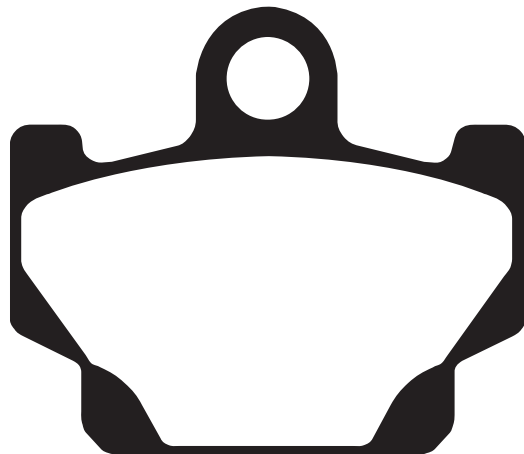

YAMAHA
DT 80 LC (37A) 81-84 F
RD 80 LC 82 F
RX 115 (5FS3) 99 F
RD 125 LC 82-84 F
SR 125 SE 92-96 F
RX 135 (13X) 81 F
RZ 250 R (29L) F
SR 250 Classic (21L) 96-00 F

YAMAHA Contd.
XV 250 Virago 89-94 F
RD 350 YPVS 83-84 F
XS 400 82 F
XZ 550 82-84 F
XT 600 84-86 F
XT 600 (Z Tenere) 84 F
XJ 650 Turbo 82 F
XJ 650 LK 'Seca' 83 F

Equivalents OE #		
11H W0045 00	29L W0045 00	43F W0045 01
11H W0045 01	29L W0045 10	4X8 W0045 00
11H W0045 11	2KJ W0045 00	52R W0045 00
11L W0045 00	2UJ W0045 00	5R2 W0045 00
11U W0045 00	2UJ W0045 01	3XL W0045 00
11U W0045 10	34L W0045 10	
22U W0045 10	43F W0045 00	

MATERIAL AVAILABILITY AND PART NO.					
STD	OPTIONS				
FA	V	HH	R	MXS	EPFA
FA081	-	-	-	-	-

DO NOT REFIT ANY SHIMS/INSULATORS TO EBC PADS FROM ORIGINAL PADS UNLESS INSTRUCTED ON NOTE ON PAD PACKAGING AND ON FA DRAWING ASSOCIATED WITH THAT PAD.

FA083 A. 47.5 x 37 x 9mm B. 85 x 42.5 x 7mm

FA083/2 A. 47.5 x 37 x 10mm B. 85 x 42.5 x 7.8mm

SFA083/2 A. 47.5 x 37 x 10mm B. 85 x 42.5 x 7.8mm

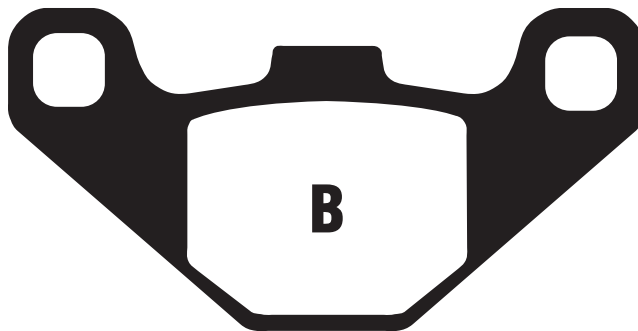
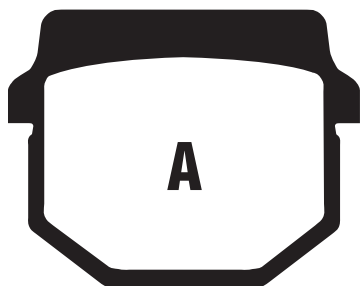

FA083

KAWASAKI

AR 50 A1/C2-C10	81-97
AH 80 Address	92-94
AR 80 A1/C1-C8	81-91
KX 80 E2/E3/G1/G2/J1/J2/L1-L3/N2/N3/R1-R6/T1-T6	84-96
AH 100 Address	92-94
KX 100 A1/A2/B1-B6	89-96
KMX 125 A1-A5/B1-B9	86-98
KX 125 B1	82
KDX 125 A1/A2/B1/B2	90-94
KMX 200 A2/A3	88-92
KX 250 B1	82
KXT 250 A1 Tecate	84
KXF 250 A1/A2 'Tecate 4'	87-88

ADLY

50 RS Supersonic	06-08
AT 50 Air Tech 1	08-09
Silver Fox 50/SF50	06-09
Thunderbike 125	
Jet 50/100	
NB 50 Noble 50	08-10
Predator 50/100	
Panther 50/P50	02-09
Cosy 50/80	02-06
TB 50 Thunderbike	08-10
RT 50/100	
SS 50 1/11 Supersonic	04-05
SS 100 1/11 Supersonic	04-05
GK 125 Buggie	03-07
NB 125 Noble 125	08-09
Noble 125 B (Rear drum model)	08-10
TB 125 B (Rear drum model)	
SS 125 B/D Supersonic	04-05
150 Crusader Quad	06
150 Interceptor	06
Crossroad 150 Quad	07-09
Sport 150 Quad	08-09
Interceptor 300	05-07
300 Crusader Quad	05-07

AEON

Aero 50/100 (Scooter)	06
Cobra 50	06-15
Nox 50/100/125/150 Scooter	06
Regal 50/90 (Scooter)	06
Revo R50 Cobra 2 (AT34 Type) (Quad)	04-06
Cobra 60 (AT30 Type) (Quad)	04-11
Revo R100 Cobra 2 (AT34 Type) (Quad)	04-11
Pulsar 100/125/150 (Scooter)	06
Sporty 125 (AT05 type) (Quad)	01-05
Urban 125 (Scooter)	11
Sporty 180 (AT05 type) (Quad)	04-05
200 Two Hundred Quad	05
Elite 200 i (Scooter)	11
Cobra 220 (Quad)	06-11
Cube 300 Side X Side	11
Overland 300 (Quad) (AT20)	06-07
Cobra 350	10-11
Crossland RX 350	11
Urban 350i (Scooter)	11
Cobra 400 (Quad)	10-15
Cobra 400 Supermoto Quad	13-15
Crossland 400 (2x4)	12-15
Crossland 400 (4x4)	12-15
Crosslander 600i	14-15

ALFER

VR 125 Raider	12-13
VX 125 Explorer	12-13
VX 200 Explorer	12-13

APACHE

RLX 50			R
F RLX 100			R
F RLX 110			R
F APRILIA			
F RS4 50 (4T) (J. Juan Calipers)	11-14		R
SX 50 Limited Edition	14-16		R
F RS4 125 (4T/J. Juan Caliper)	11-15		R
F RS 125 (4T)	17-18		R
F RS 125 (4T) GP Replica	18		R
F RX 125	18		R
F SX 125	18		R
F Tuono 125	17-18		R
R BENELLI			
R Zenzero 350	12-16		R
R BLANEY (Quads)			
F&R XC 125 Trojan	03-04		R
F BOMBARDIER			
F Rally 200	03-06		F
F&R BSM			
F TB 100			F
F TB 125			F&R
F CAN-AM			
F DS 90 X (4T)	08-15		F&R
F Rally 200 (4A7A/B/C/D/E/F)	07		F
F CCM			
F LX 350-4A Quad	08-09		R
F CECTEK			
F 500 EFI King Cobra	09-10		R
R 500 EFI Gladiator	09-10		R
F&R 500 EFI Quadrift	09-10		R
F 500i Estoc	10		R
F CF MOTO			
F&R CF 500 UU U-Force (Side x Side)	15	R Left & R Right	
F&R CF 800 UU-A U-Force (Side x Side)	13-15	R Left & R Right	
F&R COR QUADS			
F&R DN 50/50 E	05		R
F&R DN 100/100 E	05		R
F&R DN 150/150 E	05		R
F&R DN 250	05		R
F CPI			
F 50 Hussar	01-03		F
R 50 Mars	01		F
R Baby J 50	02		F
F Quad	03		R
R Popcorn 50	02-03		F
R ST 250 Sector Quad	05-06		F
R CQR			
F DN 250/Hammel	06		F&R
R DN 100	06		R
R DN 250 Dolphin	06		R
R RX 260	06		F&R
F&R Utility 250	06		F&R
R DN 150			R
F DN 150 Extreme			R
F DAELIM			
F ET 250 Quad	05-08		F
F ET 300 Quad	07-09		F
F DERBI			
R Senda DRD Racing 50 R (Spoke wheel/260mm F/disc)	11-12		R
R Senda DRD Racing 50 SM (Cast wheel/260mm f/disc)	11-12		R
F & PB Senda DRD X-Treme 50R (Spoke wheel/260mm f disc/21" front wheel)	11-14		F&R
F & PB Senda DRD X-Treme 50 SM (Cast Wheel/260mm F disc/17" front wheel)	11-14		R
R DXR 200	04-07		F
R DXR 250	04-07		F

DISC PADS
BUYERS GUIDE

DO NOT REFIT ANY SHIMS/INSULATORS TO EBC PADS FROM ORIGINAL PADS UNLESS INSTRUCTED
ON NOTE ON PAD PACKAGING AND ON FA DRAWING ASSOCIATED WITH THAT PAD.

FA083, FA083/2, SFA083/2 Contd.

E-TON QUADS

BXL 50 Draco	05-06
EXL 50 Viper 50	07
Viper 50 Mini RXL 50 M	03-07
Viper 50 RXL 50	03-06
Viper 70 RXL 70	05-07
BXL 100 Draco	05-06
RXL 90 Viper 90	03-07
RXL 90 R Viper 90 R Reverse	03-07
Viper EXL 150 ST Quad	05-07
EXL 150 Yukon ST	05-06
VXL 250 Vector	06
Vector VXL 250 ST Quad	06-07
VXL 300 Vector	07
VXL 300 ST Vector ST	07
VTX 300 Vortex	07
VTX 300 ST Vortex ST	07

EVA

Electric Scooter	13-14
------------------	-------

GARELLI

Queenie	95-
Grinta	95-

GENERIC/KSR

Demonio 50	17-18
Epico 50 (2T)	10-16
Jump 50	12-18
Demonio 125	17-18
Race 2 125 GT (4T)	18
Sirion 125 (4T/ Rear Disc Model)	18-20

GOES

G 90 XS	10-13
G 350 S (Quad)	08-14

GOVECS (ELECTRIC SCOOTERS)

GO S 1.2	11-14
GO S 1.4	11-14
GO S 2.4	11-14
GO S 3.4	11-14
GO T 1.2	11-14
GO T 1.4	13-14
GO T 2.4	11-14
GO T 3.4	11-14

HYOSUNG

Eva Electric Scooter (ST-E3)	13-14
Super Cab/Cab Plus/Sense 50/Prima 50/Avanti	99-06
SF 50 R Rally Prima	00-06
SD 50	00-06
EZ 100	99-02
SF 100 R	05-06
FX 110 DLX Midas	99-04
Krillo Master	04
ST E3 (Electric Scooter)	10-11
XRX 125 LC Enduro	14-15
XRX 125 LC Supermoto	14-15

KEEWAY

F-Act 50 Cty (2T)	09-15
Focus 50	06-07
Flash 50	07-10
Hurricane 50	07-14
Hurricane 50-Base	07
Pixel 50	08-12
Focus 125	06-07
Dragon 250 Quad	07-09
350i Index	13-14

KREIDLER

e-Florett 3.0 (4.0KW)	14-15
-----------------------	-------

MALAGUTI

Centro 50 (4T)/SL	08-11
F10 WAP	10-11

MASAI

L 150	05-07
A 300 Quad	05-07
A 450 Quad	05-07

MH

MH10 50 Enduro	13-14
MH10 50 SM	13
MH10 Eco Urban	14
MH10 Pro 50 Enduro	13-14
MH10 Pro 50 SM	13
MH10 Pro Urban 50	14
RYZ 50 Enduro	13-14
RYZ SM 50	13
RYZ Pro SM 50	13
Duna 125	13-14
Duna Pro 125	13-14
MH10 125 Enduro	13-14
MH10 125 SM	13

MOTO-ROMA

Grand Prix 50/100	99-03
Grand Prix 125	02
Lazer 125 Buggie	03-07
Geko 300 Quad	04-06

MZ/MUZ

Moskito 50/50 SX	02
Moskito 125	02
VRS 150 Quad	05

PEUGEOT (Heng Tong calipers)

Various Scooter models (Check pad shape)		F
E-Powered by GenZe	18	F&R
Kisbee 50 (2T/4T)	10-20	F
Kisbee 50 RS (2T/4T)	10-20	F
Looxo 50 (Heng Tong Caliper/Drum rear)	01-06	F
Trekker 50 (2T) Heng Tong Caliper	98-00	F
Speedfight 50 LC Darkside	13	R
Speedfight 50 1/2	97-08	F
Vivacity 50 (12" wheels/190mm disc)	92-07	F
Vivacity 2 (50cc) (10" wheels/190mm disc)	08-11	F
Kisbee 100 (4T)	12-15	F
Speedfight 4 125 (4T)	17-19	F
Metropolis 400 T (3 Wheel Model - Parking brake)	14-16	F
Metropolis 400 T- RS (3 Wheel Mode - Parking brake)	14-16	F
Metropolis 400 Blue Line (3 Wheel Mode - Parking brake)	15-16	F
Metropolis 400 RS (3 Wheel Model/Nissin Caliper - Parking Brake)	17-18	F&R
Metropolis 400 RX-R (3 Wheel Model/Nissin Caliper - Parking Brake)	17-18	F
Metropolis 400 Allure (3 Wheel Model/Nissin Caliper - Parking Brake)	17-18	F

PGO

Galaxy 50	93-00	F
Mega 50	94-	F
XL_Rider 50	07-08	R
XL Rider	07-08	R
Rider 150 50/90/110	04-05	R

POLARIS

200 Phoenix (AC/AD Model and following/rear drum model)	06-09	F
200 Phoenix Quadricycle Model (EC/ED Models/Rear disc model)	05-09	F
200 Sawtooth (Rear drum model)	06-08	F
200 Sawtooth Quadricycle (Rear disc model)	06/08	F

QUADZILLA

ZR 50	07-09	R
X 50		R
R 100 (Rear disc model)	06-09	R
X 100		R
Magmax		R
Black Max M100 (SE)	06	R
Pro Shark 100 (RMX) (Front disc model)		R
Pro Shark 100 (Single 4 Arms)		R
Pro Shark (Double 4 arms)		R
Stinger R 250 E	06	F
300 E XLC	06-07	F
300 SE 4 Valve	06-07	F
4 Cross 200 E SUV	06-07	F
X 100 E (XLC)	06-07	R
Pro Shark-E	06	R
ST 200 E (5 Speed Manual)	06-07	F

QUADRA

350 D	11-15	R
350 S	13-15	R
350 4	14-15	R
350 D Parking Brake	11-15	PB
350 S Parking Brake	13-15	PB
350 4 Parking Brake	14-15	PB

RIEJU

MIUS-Electric	12-15	F & R
RS NKD 50 (Scooter)	13-15	F
RS Sport 50 (Scooter)	12-15	F
Urban Blast (50)	13-15	F
RS3 NKD 50	12-20	R
RS3 125 (Sport)	11-20	R
RS3 NKD 125	11-20	R

ROXON

RX 150 (Quad)	04-06	R
Sport Spirit NFS 150 (Quad)	04-06	R

SCARABEO

50 Yourz (4T)	12-14	F
---------------	-------	---

SCORPA

T-Ride 125 (2T)	12-15	F&R
T-Ride 280 (2T)	12-15	F&R

SHERCO

50 SE-R	14-15	F&R
50 SM-R	14-15	F&R
X-Ride 125	12-20	F&R
X-Ride 290	12-15	F&R
50cc Americas SM-RS	19-20	F&R
50cc Americas SM-R	19-20	F&R
50cc Factory SE-RS	19-20	F&R
50cc Factory SE-R	19-20	F&R
50cc Factory SM-RS	19-20	F&R
50cc Factory SM-R	19-20	F&R

SUZUKI

AD 50 T/Tune/V-Tune	88	F
AE 50 R		F
AJ 50 ZZ/RS Sepia	92-	F
CP 50 C		F
CR 50 DC		F
RM 80 XG/XH/XJ/XK	86-89	F
RM 80 XL/XM/XN/XP/XR/XS	90-95	F&R

DISC PADS
BUYERS GUIDE

DO NOT REFIT ANY SHIMS/INSULATORS TO EBC PADS FROM ORIGINAL PADS UNLESS INSTRUCTED
ON NOTE ON PAD PACKAGING AND ON FA DRAWING ASSOCIATED WITH THAT PAD.

FA083, FA083/2, SFA083/2 Contd.

SUZUKI Contd.

RM 80 T/V/W/X/Y/K1	96-01
RM 85 K2/LK2/K3/LK3/K4/LK4	02-04
AH 100 P Address	95-96
UE 125 CTK1	01-03
UE 150 CTK1	01
TGB	
Bullet 2 50 (2T)	11-12
Bullet 50 RS (2T)	11-12
Bullet 50 RR	11-12
City 50cc (2T)	07-08
City 50cc (4T)	07-11
202 Classic (50cc)	03-14
Delivery 50 (From FE no 609100)	06-12
Hornet 50/90 Quad	04-05
Tapo RR 50 2T	10-12
Tapo RS 50 (2T)	10-12
Trigger 50	02-03
X Race 50 (2T)	11-12
High Wheel 50	02-03
F409 Cruise 50/125	02-05
R 125 X Bullet	08-09
250 Blade/Congo ATV	06-07
303 Revolution (50/125cc)	02-03
303 R Hawk/Laser (50cc)	04-14
204 Classic (125cc)	03-04
R 50 X Bullet	06-10
R 50 X Bullet	10-14
R 125 X Bullet	10-14
Blade 325 Quad (4x2)	07-11
Blade 325 SL 4x2	11-12
Target 325 (4x2)	09-11
Target 400 (4x2)	09-10
Target 425 (4x4)	09-11
Blade 460 R Target	12
Blade 460 IRS Target	12
Target 500 (4x2)	09-10
Target 525 (4x4)	09-11

TM			
R 80/85 Minicross/Junior	96-00	F	
VECTRIX			
F VX2	12-14	R	
VIALLI			
F RX Sport 50	06	F	
YAMAHA			
F YFM 90 RY	09	R	
F&R YFM 300 B/D Grizzly	12-14	F	
FA083/2TT			
HONDA			
F MB 80 (MB8)	80-	F	
F MCX 80	82-	F	
KAWASAKI			
F KSR1 (KMX50 B1/B2)	90-91	F	
F KSR11 (KMX80 B1/B2)	90-91	F	
GILERA			
F Stalker 50	03-11	F	
GOES			
F G 90 XS	10-13	R	
F G 225 S	12-13	F	
PIAGGIO			
F NRG 50 DD	06-18	F	
F NRG 50 Pure Jet	06-09	F	
F NRG 50 Power DT	05-15	F	
F NRG 50 Silver Bullet	10	F	
SCARABEO			
R 50 (2T) Street	10-15	F	
F 50 Net (4T/4V)	10-11	F	
F 50 (4T/4V)	10-15	F	
F 100 (4T)	10-14	F	
SUZUKI			
F AN 125 HKK5	06-08	F	

Equivalents OE #- FA083					
43050 1040	43082 1081	59100 02821	752818	610143	B044224
43050 1043	43082 1083	59100 02830	GF5359902	45110 JHFT 000	4084 43D F5906 00
43050 1044	43082 1115	59300 09810	705 600 285	45120 168000	QCA0648860010
43050 1048	43082 1164	59300 09811	45815RAM00/01	45120 169000	R800277
43050 1051	4312016900B	59300 03870	610113 497417	G71315EE00000	0454293
43050 1126	45120 119 00	59330 46F00	514069	0453036	4084
43050 1169	45815 NAF00	59340 46F00	67131 5EE0 0000	PE802452	PS 2012 02001
43082 1065	69100 02821	736502	59300 03860	ISC F5805 00	
43082 1079	59100 02820	752426	45110 B20T 000	B044223	

MATERIAL AVAILABILITY AND PART NO.					
STD	OPTIONS				
FA	SFA	SFAC	HH	SFA-HH	R
FA083TT	SFA083	SFAC083	FA083HH	SFA083HH	FA083R

Equivalents OE #- FA083/2
497417
647171
59300 37810
59302 20820

MATERIAL AVAILABILITY AND PART NO.					
STD	OPTIONS				
FA	SFA	SFAC	HH	SFA-HH	R
FA083/2TT	SFA083/2	-	-	SFA083/2HH	-

DISC PADS BUYERS GUIDE

DO NOT REFIT ANY SHIMS/INSULATORS TO EBC PADS FROM ORIGINAL PADS UNLESS INSTRUCTED ON NOTE ON PAD PACKAGING AND ON FA DRAWING ASSOCIATED WITH THAT PAD.

FA084 46 x 45 x 7.8mm

FA084/2 46 x 45 x 6.5/7.8mm (1 piece each size per set)

FA084/3 46 x 45 x 6.5mm



FA084

ARCTIC CAT

400 DVX (2x4) Sport	04-08	F
400 DVX TS Sport	06-07	F

HONDA

CR 80 RG/RH/RJ/RK/RL/RM/RN/RP/RR/RS/RT/RBT/RV /RBV/RW/RBW/RX/RBX/RY/RBY/R1/RB1/RB2/R2	86-02	F
CR 85 R3/RB3/R4/RB4/R5/RB5/R6/RB6/R7/RS7	03-07	F
CRF 150 R Small wheel (FR 17"/RR 14")	07-20	F
CRF 150 RB Big wheel (FR 19"/RR 16")	07-20	F
ATC 200 XD	83	F&R
ATC 250 RD	83-84	F&R
ATC 250 RC	82	F
TRX 250 EX1/2/3/4/5/6/7/8	01-08	F
TRX 250 X9/XA/XB	09-11	F
TRX 300 EX P/R/S/T/V/W/X/Y1/2/3/4/5/6/7/8	93-08	F&R
TRX 300 X9	09	F&R
TRX 400 EXX/EXY/EX1/EX8	99-08	F&R
TRX 400 X9	09	F&R
TRX 420 FE7/FE8/FE9/FEA/FEB 4WD Fourtrax ES	07-11	F
TRX 420 FA9/FAA/FAB Fourtrax - Auto 4WD	09-11	F
TRX 420 FM7/FM8/FM9/FMA/FMB 4WD Fourtrax	07-11	F
TRX 420 FPA9/FPAA/FPAB Fourtrax Auto Power Steering	09-11	F
TRX 420 FPM9/FPMA/FPMB Fourtrax 4WW Power Steering	09-11	F
TRX 420 TE7/TE8/TE9 Fourtrax ES 2WD	07-09	F
TRX 420 TM7/TM8/TM9/TMA/TMB Fourtrax 2WD	07-10	F
TRX 500 FEC Fourtrax Foreman ES 2x4 HD	12	F
TRX 500 FMC Fourtrax Foreman S 2/4WD	12	F
TRX 500 FPC Fourtrax Foreman 2/4WD	12	F
TRX 500 FAC Fourtrax Foreman AT 2/4WD	12	F

HONDA HM (Italy)

CR 85 R/R2	03-07	F
CR 150 R/R2	07-09	F

HUSQVARNA

CR 125	92-94	R
WR 125	93-94	R
CR 250	92-94	R
WR 250	92-94	R
TE 350	92-94	R
CR 360	92-94	R
WR 360	92-94	R
TC 610	92-94	R
TE 610	92-94	R

KAWASAKI

KX 80 L1-L3/N2/N3/R1-R7/T1-T6/W1/W2/W3	88-00	R
KX 85 (17" front wheel/14" rear wheel)	01-20	R
KX 85 (19" front wheel/16" rear wheel)	01-20	R
KX 100 A1/A2/B1-B7/C1/C2/C3	89-00	R
KSF 250 A1-A18	87-04	R
KXT 250 B2 Tecate 3 Wheel Model	87	R
KEF 300 B1/B2/B3 Lakota Sport	01-03	R
KVF 400 A1/A2/A3 (KFX 400)	03-05	F
KFX 450 R Quad (KSF 450 B8F/B9F/BAF/BCS/BDF/BEF)	08-14	R

SUZUKI

RM 100 K3	03	R
RM 125 J	88	R
RM 250 H J	87-88	R
LT-Z 250 K4/K5/K6/K7/K8/K9/L0 QuadSport	04-12	F
LT-Z 400 K3/K4/K5/K6/K7/K8/K9/L0/L1/L2/L3	03-15	F

YAMAHA

YZ80	93-01	R
YZ85 Small wheel	02-15	R
YZ85 Big wheel	02-20	R
YZ125W	89	R
YZ250W	89	R
YFS 200 R/S/T/V Blaster	03-06	R
YFM 250 RX/RV Raptor	08-09	R
YFM 250 R (33B)	09-11	R
YFM 250 R (IBT)	12-13	R
YFZ 350 T/U/W/A/B/D/E/F/G/H/J/K/L/M/N/P/R/S/T/V Banshee	87-09	R
YFM 350 XD/XE/XF/XG/XH/XJ/XK/XL/XM/XN/XP/XR/XS	92-04	R
YFM 350 FXG/FXH/FXJ/FXK/FXL/FXM/FXN/FXP/FXR/FXS Wolverine	95-04	R
YFM 350 S/T/V/R-WV/RW/RX/RV/RZ Raptor	04-10	F&R
YFM 400 FWP Big Bear 4x4	02	F
YFZ 450 S/T	04-05	R
YFM 600 FWAK/FWAL/FWAM/FWAN 'Grizzly'	98-01	F
YFM 600 HM "Grizzly Hunting"	00	F
YFM 660 RN/RP/RR/RS Raptor	01-04	F&R
YFM 660 FWAP/FWAR/FWAS/FWAT/FWAV/FGW/FGX Grizzly	02-08	F
YFM 660 FR/FS/FT Grizzly	03-05	F

FA084/2

HONDA

ATC 200 XD	83	F&R
------------	----	-----

FA084/3

SUZUKI

RM 125 J	88	R
RM 250 H/J	87-88	R
TM		
80/85 Minicross/Junior	96-00	R
HONDA		
CRF 150 FB (Big Wheel FR 19"/RR16")	07-16	R
YAMAHA		
YZ 65	18-20	R
YZ 80 E/F/LWF/LWG/G/LWH/H/LWJ/J/LWK/K/L/LWL /LWM/M/LWN/N	93-01	R
YZ 85 (2T - Small Wheel F17" / R 14")	02-20	R
YZ 85 (2T - Big Wheel F19" / R 16")	02-17	R
YZ 125 W	89	R
YZ 250 W/WRW	89	R

Equivalents OE #- FA084

06435 HA5 405	43120 HA5 670	5LP W0046 50
06435 HA5 670	69140 19A00	K4308 21205
1UY W0046 00	69140 19A01	59300 42850
43082 5006	69140 19A11	3406 031
43082 1205	69140 19A10	3406 032
43106 961 006	4WV W0045 00	59300 42860
45105 961 000	45105 GC4 601	59300 42870
45110 HB7 007	45105 GC4 602/603	800070854
451A0 HB5 670	45105 GBF 405	800071451
43082 1066	45112 GC4 601	06435 HP5 602
43082 1082	45112 GC4 831	06455 KSE 006
431A0 HA5 670	06455 GBF J01	06455 KSE 016
43120 HA5 305	5LP W0046 00	

Equivalents OE #- FA084/2

431A0 965 000	43120 HC0 007	43120 965 000
431A0 965 670	45105 961 006	

MATERIAL AVAILABILITY AND PART NO.				
STD	OPTIONS			
FA	HH	R	MXS	EPFA
FA084TT	-	FA084R	MXS084	-

MATERIAL AVAILABILITY AND PART NO.				
STD	OPTIONS			
FA	HH	R	MXS	EPFA
FA084/2TT	-	FA084/2R	-	-

MATERIAL AVAILABILITY AND PART NO.				
STD	OPTIONS			
FA	HH	R	MXS	EPFA
FA084/3TT	-	FA084/3R	MXS084/3	-

69140 26C00	3JD W0046 00	BR8 25806 00
3JD W0046 01	4ES W0046 00	
3JD W0046 10	5PA W0046 00	

DISC PADS
BUYERS GUIDE

DO NOT REFIT ANY SHIMS/INSULATORS TO EBC PADS FROM ORIGINAL PADS UNLESS INSTRUCTED
ON NOTE ON PAD PACKAGING AND ON FA DRAWING ASSOCIATED WITH THAT PAD.

FA085 A. 111 x 50 x 9.5mm B. 69x 43.5x 9.8mm

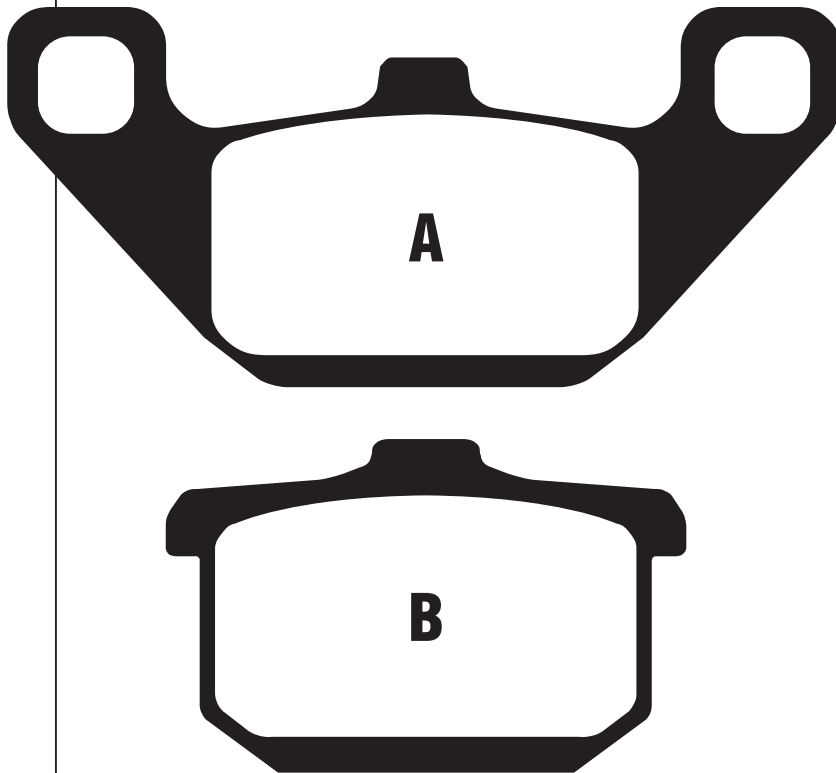

Model	Year	Fit
GENERIC		
Vertigo 125 (4T)	12-13	F
KAWASAKI		
EL 250 'Eliminator'	87-89	F
EL 250 D1-D5	90-94	F
EL 252 (EL 250 F2/F3/F5/F6)	96-03	F
ER 250 B1-B3 (Z250T Scorpion)	83-88	F
GPZ 250 R (EX 250 E)	86	F&R
KR 250 A1/A2	84-86	R
Z 400 C2/C3 (Z 400 F2)	85-87	R
ZL 400 A 'Eliminator'	86-87	F
FX 400 R (ZX400 E1-E3)	86-88	R
GPX 400 R (ZX 400 D1/D3/D3A)	85-87	R
LTD 454 (EN 450 A1-A5)	86-89	F
EN 500 A1-A3/B1-B2/C1-C9	90-04	F
GPz 550 A1-A4 (ZX 550 A1-A4)	84-87	F&R
GPz 600 R A1-A5A	85-89	F&R
VN 700 A1 'Vulcan'	85	F
ZN 700 A1/A2 'Ltd'	84-85	F&R
GPz 750 A1-A5	83-87	F&R
GPz 750 E1-E2 (Turbo)	84-87	F&R
GPz 750 R G2/G3	85-86	F&R
VN 750 A2-A5/A10	86-94	F
VN 800 A1-A3	95-99	F
GPz 900 R (A1-A6)	84-89	F&R
ZL 900 A1/A2 'Eliminator'	85-86	F&R
GPz 1000 RX (A1-A3)	86-88	F&R
ZL 1000 A1	87	F&R
1000 GTR (ZG 1000 A1-A7)	86-93	F&R
1000 GTR (ZR 1000 A9-A14)	94-99	R
GPz 1100 A1-A3	83-85	F&R
Z 1100 R1	84	F
VN 1500 B2-B6 (VN15SE)	88-92	F&R
VN 1500 A6 (VN15)	92	F&R
VN 1500 C1/C2 (VN15)	94-95	F&R
VN 1500 D1/D2/E1/E2 'Classic'	96-99	R
VN 1500 G1/G2 'Classic Tourer'	98-99	R

MATERIAL AVAILABILITY AND PART NO.					
STD	OPTIONS				
FA	V	HH	R	MXS	EPFA
FA085	FA085V	FA085HH	-	-	-

Equivalents OE #		
43082 1029	43082 1061	43082 1167
43082 1031	43082 1062	43082 1194
43082 1057	43082 1080	

FA086 77.3 x 42.2 x 7.2mm FA086/2 77.3 x 42.2 x 8.4mm

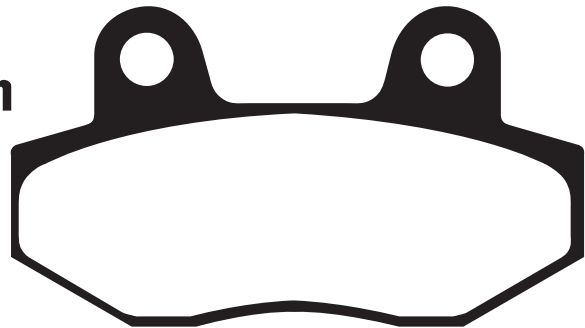

FA086

AJS			
JSM 50 Motard	12-15	F	
Daytona 125 E	10	F	
Daytona 125	13-15	F	
DD 125 E Mk2			
Regal Raptor (Cast wheels)	10-14	F	
EOS 125 Regal Raptor	09-15	F	
NAC 12 (125cc)	09-14	F&R	
Bobber 125 (Custom)	10-15	F	
JSM 125 Motard	10-14	F	
JSM 125 Trail	13-14	F	
JS 125 6C Eco Custom	12-14	F	
EOS 350	13-14	F	
350 E-9PB	13-14	F	
ASPES			
Vega 125 Hybrid	11-14	F	
Perseus Hybrid 150	11-14	R	
BENELLI			
Aurak MY 125 (BJ 125 10A)	16-17	F	
BETA			
R150 (Minicross/4T/49cc)	10-13	F	
CCM			
C-XR 125 E	08-09	F	
C-XR 125 M	07-09	F	
C-XR 125 S	08-09	F	
TL 125	08-09	F	
C-XR 230 E	07-09	F	
C-XR 230 M	07-09	F	
C-XR 230 S	07-09	F	
XTR 250	09	F	
CAGIVA			
Brillio 125	08	F	
CF MOTO			
CF 250 T - 6A (Scooter) Jetmax	12-15	F	
CPI			
Bravo 50	12	F	
Bravo 125	12	F	
SUV 125	11-12	F	
XR 125 Sprint	11-12	F	
X-Large 250	11-12	F&R	
XR 250	11-12	F&R	

DAELIM			
Citi Ace 110	03-11	F	
GARELLI			
Comfort 125	07	F	
XO 125i (TM 125 T)	09-12	F	
Mosquito 150	07	F	
XO 150i (TM 150 T)	09-12	F	
XO 200i (TM 200 T)	10-12	F	
XO'E (Electric)	12	F	
GENERIC/KSR			
TTX (Electric)	16-18	F&R	
Vionis (Electric)	18	F	
Classic 50	17-18	F	
Madison 110 (4T)	13-14	F	
Venos 110 (4T)	13-14	F	
Vertigo 50 (4T)	12-14	F	
Vertigo 125	13-18	F	
GOCCIA (ELECTRIC SCOOTERS)			
E-Gora (Li/Si)	12-15	F	
FA086 Contd.			
GOES			
G 55 R Scooter	08-14	F	
G 125 M	08-14	F	
G 125 X	08-09	F&R	
SP R 125 (Motorcycle)	10-12	F	
HERO HONDA			
Slickster 125	06	F	

HONDA			
MBX 50 SD/SF	03-11	F	83-85
NSR 50 FP/FR/FS		F	93-95
NSR 50 SK/SP/SR/SS	07	F	89-95
NSR 80 J-2/K/L/N (HC06)	09-12	F	88-92
CBX 125 Custom	07	F	88
FS 125 Sonic	09-12	F	03-04
LS 125 RY	10-12	F	00
MBX 125 FE	12	F	84-86
CBX 250		F	84-98
HONGDOU			
CTM 125 Chituma	18	F	04
HONLEY			
RX3 Venture 250	13-14	F	15-17
HP POWER			
Copper 50 (4T)	12-14	F	10-12
Chromel 125 (4T/LC)	13-18	F	11-12
Lithium 125 (2T/LC)		F	10-12
Chromel 150 (4T/LC)	12-15	F	11-12
Lithium 150 (4T/2V/LC)		F	10-12
Nickel 150 (4T/2V)		F	10-12
Radium 300 (4T/4V)		F	11-12
HYOSUNG			
Comet GT 125 (Naked)	08-14	F	04-06
RX 125	08-09	F	01-02
RT Karion 125	10-12	F	02-06
Exceed 125 (MS 125/150)		R	02-04
GPS 125 Grand Prix Plus		F	
Rear disc model		R	00-04
XRX 125 Enduro		R	00-06
GV 125 Aquilla		F	01-06

FA086, FA086/2 Contd.

HYOSUNG Contd.

Comet GT 250	04-05	F&R
Comet GT 250 (Naked)	04-06	F&R
GV 250 Aquilla	01-09	F
RX 400	05	F
Comet GT 650 (Naked)	04-06	F&R
Comet GT 650 R	04-06	F&R
Comet GT 650 S	05-06	F&R
GV 650 Aquilla	04-06	F&R
GT 650 S	05-08	F&R
GT 650	06-08	F&R
GT 650 X	07	F&R

E-TROPOLIS (ELECTRIC SCOOTERS)

Bel Air	13	F&R
Bel Air Lithium	14	F&R
Future	13	F&R
Miami	13	F&R
Milano	14	F&R
Retro	13	F&R
Retro Lithium	14	F&R

ITALJET

Formula 125 (4T/Single Cyl)	14-15	F
Grifon #59 (650cc)	06	F&R
Bazooka (650cc)	06	F&R

JIALING

JE 125 E Dragon	98	F
-----------------	----	---

JONWAY

YY 50 QT-6 (2T) Agility	07-09	F
YY 50 QT-6 (4T) Agility	07-09	F
YY 50 QT-10 (2T) Viper	07-09	F
YY 50 QT-10 (4T) Viper	07-09	F
YY 50 QT-28 (2T) Raptor	07-09	F
YY 50 QT-28 (4T) Raptor	07-09	F
YY 80 QT-6 (4T) Agility	07-09	F
YY 150 T-19	08-09	F&R
YY 250 T-19	08-09	F&R

KEEWAY

Agora 50 (4T)	10-15	F
50 Zahara (2T/4T)	13-15	F
110 Kee	12-14	F
125 Link	13-14	F&R
125 Strike	13-14	F
125 Zahara (2T/4T)	13-15	F
150 Strike	13-14	F
200i Link	13-14	F&R

KREIDLER

50 Flory Classic (50cc/4T/A-C)	14-15	F
e- Florett 3.0 (4.0KW)	14-15	F
50 Galactica 3.0 LC (50cc/2T/L-C)	14-15	F

KYMCO

Active SR 50cc	08-11	F
Jetix 50	10-15	F
Nexxon 50	08-09	F&R
Jetix 125	10-15	F
Nexxon 125	07-08	F&R
Spike 100/125	00-06	F
Jetix 150	10	F

LAMBRETTA

50 N Pato	08-10	F&R
125 N Pato	08-10	F&R
151 N Pato	08-10	F&R

LEONART

Bobber 125	13-14	F
Daytona 125	13-14	F
Raptor 125	13-14	F
Spyder 125	13-14	F
Raptor 250	13-14	F
Bobber 350	13-14	F
Daytona 350	13-14	F
Spyder 350	13-14	F

LEXMOTO

FMR 50 (WY50QT-58R)	15-18	F
LSM 50 (STR50)	12-16	F
Milano 50 (FT50QT-27)	16-18	F
Aspire 125 TD125-43	12-16	F
FMR 125 (WY125T-74R)	14-18	F
FMR 125 EFI (WY125T-74R-E4)	14-18	F
FMS 125 (ZN125T-7H)	15-18	F
Matador 125 (ZS125T-40)	13-18	F
Milano 125 (FT125T-27)	16-18	F
Milano 125 EFI (FT125T-27-E4)	12-20	F
LSM 125 (STR125YB)	12-18	F
Tommy 125 (ZN125T-E)	11-17	F
XTR-S 125	13-18	F

LIFAN

LF 100 A	18	F&R
----------	----	-----

MASH

City 50cc	18	F&R
City 125cc	18-20	F&R
Sixty Five 125	13-15	F
Black Seven 250cc	17-20	F
Café Racer 250cc	17-18	F
Two Fifty 250	14-20	F
Family Side 400cc Side Car Outfit	18-20	R

MEGELLI

125 M	08-10	F
-------	-------	---

MOTOM

ANA 50	08-09	F
ANA 151	08-09	F
Dolcevit 125/151	08-09	R
Transcity 125/250	08-09	R

NIPPONIA

Brio 50 (4T)	12-13	F
EZio 50 (4T)	12-14	F
Brio 125 (4T)	12-15	F
Dion 125 (4T)	13-15	F
EZio 125 (4T)	12-14	F
Dion 150 (4T)		

PEUGEOT

Speedfight 3 (50cc/AC 2T)	09-15	F
Speedfight 3 (50cc/LC 2T)	09-15	F
Speedfight 3-RS (50cc-L 2T)	09-12	F
Speedfight 3 RS (50cc/ AC/2T)	10-12	F
Speedfight 3 Darkside (50cc/LC/2T)	13-15	F
Speedfight 3 Furious (50cc/LC/2T)	13	F
Speedfight 3 Iceblade (50cc/LC/2T)	13-15	F
Speedfight 4 Classic (50cc/AC/2T & 4T)	15-19	F
Speedfight 4 Darkside (50cc/LC/2T & 4T)	15-18	F
Speedfight 4 Iceblade (50cc/AC/2T & 4T)	15-18	F
Speedfight 4 Pure (50cc/AC/2T & 4T)	15-18	F
Speedfight 4 Classic (50cc/LC/2T & 4T)	15-19	F
Speedfight 4 Darkside (50cc/LC/2T & 4T)	15-18	F
Speedfight 4 Iceblade (50cc/LC/2T & 4T)	15-18	F
Speedfight 4 Pure (50cc/LC/2T & 4T)	15-18	F
Speedfight 4 R-Cup (50cc/LC/2T)	18-19	F
Speedfight 4 20 Ans Edition (50cc/AC/2T)	18	F
Speedfight 3 125 (4T)	14-15	F
Speedfight 3 125 Darkside (4T)	14-15	F
Speedfight 3 125 Iceblade (4T)	14-15	F
Speedfight 3 125 Team (4T)	14-15	F

QUADZILLA

WK 110	06-08	R
WK 125	06-09	R

SACHS

Madass 50 (4 stroke)	04-05	F
Madass 50 (2 stroke)	04-05	F
Mad Ass 50 (4T)	06-09	F
Madass 125	05	F&R
Mad Ass 125 (4T)	06-09	F

SCOMADI

TL 50 Air Cooled	15-19	F
TL 125 Air Cooled	15-19	F
TL200 Liquid Cooled	15-19	F

SFM

ZX 125 Enduro (Spoke Wheels)	13-15	F
ZZ 125 SM (Cast Wheels)	13-15	F

SINNIS

Nitro 125 (WY 125 T-56A)	09-10	F
--------------------------	-------	---

SMC

YB 125	09	F&R
YB 150	09	F&R
YB 250	09	F&R

SUPERBYKE

CQ 50 Road Classic		R
CU 125 Road Classic		R
M-Ped 125 Road Classic		F
RMX 125	07-08	F&R
R-SR 250		F&R

SYM

Wolf Legend	04-05	F
-------------	-------	---

TAMORETTI

Retro 50		F
Retro 125		F

VECTRIX

VX2	12-14	F
-----	-------	---

VIALLI

Truro 50	06	F
----------	----	---

WK BIKES

Bellissima 50 (4T)	13-15	F
WK Go 50 (4T)	11-15	F
VS 50 (4T/Scooter)	13-15	F
Wasp R 50 (2T)	13-15	F
Bellissima 125 (4T)	13-15	F
Tomcat 125 (4T)	15	F
Wasp 125 (4T)	13-15	F
WK 125 Cruiser (4T)	15	F&R
GTR 300	13-15	F

W.T. MOTORS

Bilbao 50 (4T)	08-09	F
----------------	-------	---

FA086/2

HYOSUNG

GT 125 Naked	07-12	F&R
GT 125 i (Naked)	13-15	F&R
GT 125 R	06-14	F&R
GV 125 Classic	07-15	F
RT 125 D Karion	07-15	F
RX 125 D (XRX)	08-11	F
XRX 125 Supermoto	07-11	F
GT 250 i (Naked)	13-15	F
GT 250 R (Carbs)	05-07	F&R
GT 250 i R	08-13	F&R
GT 250 i R	14-15	F
GT 250 (Naked)	06-12	F&R
GV 250 I Classic	08-15	F
GT 650 R	07-08	F&R
GT 650 Naked	07-08	F&R
GT 650 (Naked)	09-11	R
GT 650 I R	09-13	R
GT 650 i (Naked)	12-15	R
GV 650 (EFI)	07-12	F&R
GV 650 i Pro	12-15	F&R
GT 650 S	05-08	F&R
GT 650 X	07	F&R
GV 700 C	06-09	F&R
ST7 (ST 700 i)	10-15	R
ST7 Deluxe (ST 700 i)	12-15	R

Equivalents OE # - FA086/2

59301 HP9 500
5190-080256

Equivalents OE # - FA086

451A0 KR3 603	45105 KR3 007	251 0037 A
45105 GE2 004	45105 KR3 014	59300 HG5 800
45105 GE2 006	45105 KR3 601	PE776170
45105 GE2 305	45105 KR3 602	P67660000116700
45105 KK4 004	45105 KR3 603	14140001000E
45105 KK4 007	45105 KW7 405	5190-080256
45105 KK4 014	46630 FYBQ 000	
45105 KR3 004	P4064905001002640	

MATERIAL AVAILABILITY AND PART NO.

STD	OPTIONS			
FA	SFA	SFAC	SFA-HH	HH
FA086	SFA086	SFAC086	SFA086HH	FA086HH

MATERIAL AVAILABILITY AND PART NO.

STD	OPTIONS			
FA	SFA	SFAC	SFA-HH	HH
FA086/2	-	-	-	FA086/2HH

DISC PADS
BUYERS GUIDE

DO NOT REFIT ANY SHIMS/INSULATORS TO EBC PADS FROM ORIGINAL PADS UNLESS INSTRUCTED
ON NOTE ON PAD PACKAGING AND ON FA DRAWING ASSOCIATED WITH THAT PAD.

FA088 64 x 55 x 9mm



NORTON
Commander (Rotary)

YAMAHA
TZR 125
RD 350 YPVS
FZ 400 N (IFK/46X/33M)
FZR 400 Genesis (1WG)
SRX 400 (1JL)
XJR 400
RD 500 LC
RZV 500 R (SIX)
FZ 600
FZR 600
FZR 600
FZR 600 R
YZF 600 R "Thundercat"
XJ 600
YX 600 S/SC/T/TC/UC/UW/WC
/A/AC "Radian"
FZX 700 S/SC/T/TC Fazer
FZ 750
FZ 750
FZX 750
FZR 750 'Genesis'
FZR 750 R "OWOI"
XV 750 Virago
YZF 750 R/SP
TDM 850
TRX 850
XJ 900/900 F
XJ 900 S "Diversion"
GTS 1000
FZR 1000 Genesis
FZR 1000 'EX UP'
YZF 1000 R "Thunderace"
XV 1000/1000 SE "Virago"
BT 1100 P/R/S/T/V Bulldog

YAMAHA Contd.
FJ 1100 84-85 F&R
XV 1100 Virago 89-93 F
XV 1100 Virago 99 R
XVS 1100 Dragstar 99-04 R
XVS 1100 A "Dragstar Classic" 00-07 R
FJ 1200 (ITX Type) 86-87 F&R
FJ1200 (3CV/3XW Type) 88-95 R
FJ 1200 A (ABS model) 91-95 R
XVZ 12 TD 85 F&R
V-MAX 12 91-92 F&R
V-MAX 12 93-03 R
XJR 1200 95-98 R
XJR 1300 (5EA1/5EA7) Brembo calipers (320mm front discs) 98-99 R
XJR 1300 L 5EA2/5EA3/5EA4 99 R
XJR 1300 M 5EAA/5EAB/5EAC 00 R
XJR 1300/1300 SP 99-01 R
XJR 1300 SP (L) 5EA5/5EA6/5EA8 99 R
XJR 1300 SP (M) 5EAD/5EAE/5EAF 00 R
XJR 1300 SP (N) 5EAL/5EAM/5EAN 01 R

MATERIAL AVAILABILITY AND PART NO.					
STD	OPTIONS				
FA	V	HH	R	MXS	EPFA
FA088	FA088V	FA088HH	-	-	EPFA088HH

Equivalents OE #	
1FK W0045 00	33M W0045 01
1FK W0045 10	33M W0045 10
1FK W0046 02	36H W0046 01
1FK W0046 01	37A W0045 00
1UF W0045 00	38A W0045 01
1UF W0045 01	3HE W0045 00
26H W0045 00	3HE W0045 11
26H W0045 01	3XF W0045 00
26H W0045 10	43F W0045 00
26H W0046 00	47X W0045 00
26H W0046 01	47X W0045 01
26H W0045 11	4FM W0046 00
29L W0045 10	4FM W0045 10
29L W0046 01	4FM W0045 20
31A W0046 00	4FM W0045 30
31A W0046 10	4SV W0045 50

FA090 91 x 51 x 10mm

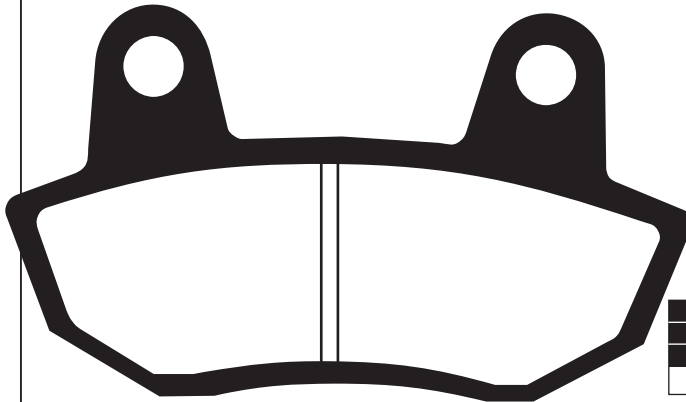

HONDA
CB 650 SCC "Nighthawk" 82 F

Equivalents OE #
45105 MA5 771
45105 MA5 772
45105 MC9 305

MATERIAL AVAILABILITY AND PART NO.					
STD	OPTIONS				
FA	V	HH	R	MXS	
FA090	FA090V	-	-	-	-

FA092 81 x 42 x 7.5mm

FA092/2 Use SFA323/2

FA092/3 Use SFA323/3

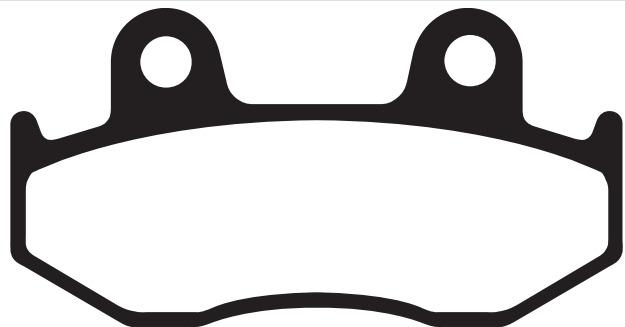

HONDA
CR 125 RE/RF/RG 84-86 F
MTX 125 RWE/RWF/RWH/RWL 85-95 F
XL 125 RF/RH 85-86 F
XL 200 R 85 F
MTX 200 RWF 85 F
FTR 223 (MC34) Y/2/A2 00-02 F
ATC 250 RF/RG 85-86 F&R
CR 250 RE/RF/RG 84-86 F
XR 250 RE/RF/RG/RH 84-87 F
XLR 250 R (MD22) 88-90 F
TRX 250 RG/RH/RJ/RK 86-89 R
XR 350 RE 84 F
CR 500 RE/RF/RG 84-86 F
XR 500 RD/RE 84-85 F
XL 600 RD/LD/RE/LE/RF/RG/RH 83-87 F
XR 600 RF-RH 85-87 F

Equivalents OE #		
43105 HB9 008	45105 HA2 671	45105 KE1 744
431A0 HB9 008	45105 HB9 008	45105 KS5 004
451A0 MG3 670	45105 KA3 731	45105 KS5 006
451A0 KA3 731	45105 KE1 742	45105 MG3 006
45105 G04 601	45105 KE1 743	06455 KPM 006

MATERIAL AVAILABILITY AND PART NO.					
STD	OPTIONS				
FA	V	HH	R	MXS	EPFA
FA092TT	-	-	FA092R	-	-

FA093 A. 88 x 48 x 7.8mm B. 56 x 36.6 x 10.2mm

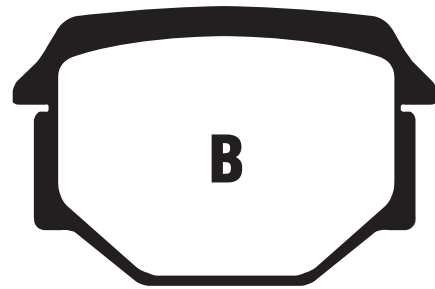
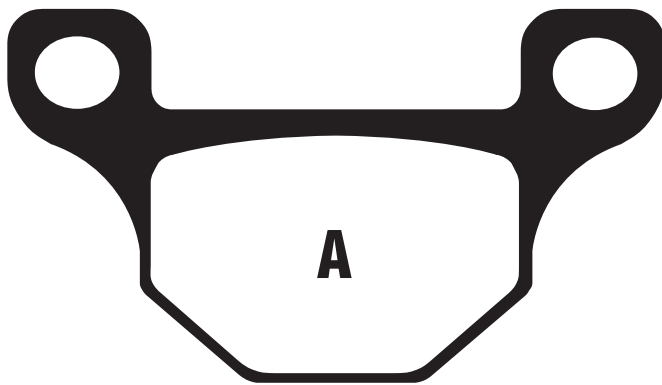

DISC PADS BUYERS GUIDE

DO NOT REFIT ANY SHIMS/INSULATORS TO EBC PADS FROM ORIGINAL PADS UNLESS INSTRUCTED ON NOTE ON PAD PACKAGING AND ON FA DRAWING ASSOCIATED WITH THAT PAD.

SUZUKI

GN 125 Z/D/K Gold Coloured Cast Wheels/Aisin Caliper 82-90 F
 GS 125 ESD/ESF/ESK/ESM 83-94 F
 GX 125 (SJ 125) 03 F

AJP

PR4 125 Enduro 10-12 R
 PR4 125 Enduro Pro 10-12 R
 PR4 125 Supermoto 10-12 R
 PR4 125 Supermoto Pro 10-11 R
 PR4 200 Enduro Pro 10-11 R
 PR4 200 Supermoto 10-11 R
 PR4 200 SM Pro 10-11 R

APRILIA

RS4 50 (4T) (AJP Rear Caliper) 11-14 R
 RX 125 (AJP Rear Caliper) 08-12 R
 RS4 125 (4T) (AJP Rear Caliper) 11-15 R

BRANSON

BM 125 Retro 08 F
 BM 125 08 F
 BM 125 Sport 08 F

CF MOTO

CF 150 Leader 10-11 F

DERBI

Atlantis 50 (4T) 07-09 F
 Atlantis 50 (2T/AC) 12"/5 spoke wheels/200mm disc
 /5 bolt From Ref No8G253172 07-11 F
 GPR 50 (2T) 41mm Forks (218mm rear disc) 09-12 R
 Terra 125 Euro (Single pin pad fixing) 07-11 R
 Terra 125 Adventure 07-12 R
 GPR 125 (4T) 4V 09-14 R

Mulhacen 125 (4T) Up to ref no. 7N001790
 Spoke wheel/2 pin pad fixing 07 R
 Mulhacen 125 (4T) From Ref no. 7N001791

Spoke wheel/single pin fixing 07-11 R
 Mulhacen 125 Cafe Cast wheel/radial caliper 08-11 R
 Senda DRD 125 R 10-12 R
 Senda DRD 125 SM 10-14 R

EASY RIDER

JC 125/8 Dragon 98 F

GAS GAS

EC Cami 250 F (4T) 14-15 R

HARTFORD

HD 125 L/150 L 00-04 F

KEEWAY

Speed 125/150 07-12 F&R

MASH

Dirt Track 50cc 18-20 F
 Fifty 50cc (Roadstar 50) 18-20 F
 Scrambler 125 14-16 F
 Seventy 125 14-20 F

MH/MOTORHISPANIA

RX 50 R 08-14 R
 125 Custom 12 F
 Duna 125 Supermotard 13-14 R
 RX 125 R 08-14 R
 MH7 Naked (125cc/Air cooled) 08-14 R
 MH7 Naked (125cc/Liquid Cooled) 08-14 R
 Duna 125 Hard Road Enduro 08-12 F
 Duna 125 Sports City Supermotard 08-09 R
 KN1 (125cc) 09-10 R

MOTO-ROMA

SK 125 (Cast Wheel) 10-12 F
 Virage 125 01 F

PEUGEOT

XR7 (50cc) 08-12 R
 NK7 "Naked" 50cc 09-12 R
 XPS 50 SM 09 F&R
 XPS 50 Track (21" front wheel) 11-12 F
 XPS 50 Top Road (17" front wheel) 10-12 F

RIEJU

MRT 50 (Single piston caliper) 09-20 F&R
 MRT Pro Supermotard (Radial caliper/cast wheel) 09-20 R
 MRT Supermotard 50 (Cast wheel/single piston caliper) 09-20 F&R
 MRT-Pro 50 (Radial/double piston caliper) 09-15 R
 NKD 50 08-10 R
 RS2 50cc Matrix/Pro 07-10 R
 RS3 50 11-20 R
 RS3 50 Pro 11-15 R
 Tango 50 Motard 09-10 F
 Tango 50 (Spoke Wheel) 11 F
 Tango 50 Motard (Cast Wheel) 11 F
 Marathon Pro Supermotard 125 (Cast wheel/radial caliper) 09-20 R
 Marathon Pro 125 (Radial/double piston caliper) 09-20 R
 Marathon 125 (Air Cooled) 10-15 F&R
 Marathon 125 SM (Air Cooled/Cast Wheel) 10-15 F&R
 NKD 125 08-10 R
 RS2 125/Pro 07-10 R
 Tango 125 Motard (Cast wheel) 08-10 R
 Marathon 200 Pro SM 11-15 R

SHERCO

SE 0.5 11 F
 SM 0.5 11 F
 SU 50cc (2T) Urban Base (Cast Wheels) 10 F
 SE 1.25 F 11 F
 SM 1.25 F Black Panther 11 F

SINNIS

QM 125 2V2 Max II 125 12-14 F
 QM 125 GY-2XR Retro Star 125 12-14 F
 QM 125 GY-2X Cafe 125 12-14 F
 Trackstar 125 (4T) 10-12 F
 Vista 125 QM 125 2C 08-10 F

SUPERBYKE

RFX 50 Road Trail F
 RFX 125 Road Trail F

TGB

R 50 X Bullet 06-14 F
 Delivery/Express 125cc 04-14 F
 R 125 X Bullet 08-14 F
 302 Sport (50cc) 03-08 F
 303R Hawk/Laser (125/150cc) 04-08 F
 303R Hawk/Laser (125/150) 09-14 F
 304 Sport (125cc) 03-04 F
 309 RS 50 02-03 F
 404 Executive 03-08 F

WK BIKES

RT125 15 F

WUYANG

WY 125-12 06-07 F
 WY 125 16C 06-07 F

ZONTES

Tiger 50 (4T) 14-15 F
 ZT125-3A Tiger 09-15 F
 ZT125-8A Panther 09-15 F

MATERIAL AVAILABILITY AND PART NO.					
STD	OPTIONS				
FA	SFA	HH	R	MXS	EPFA
FA093	SFA093	-	-	-	-

Equivalents OE #		
59301 39841	866692	B044221
59300 29820	894051	K01310073
45120 128 000	413610	0/000 930 0090
864121	45110 J00 P001	114100100000E
864428	00TRS01A0068	

FA095 69.2 x 51 x 8.2mm

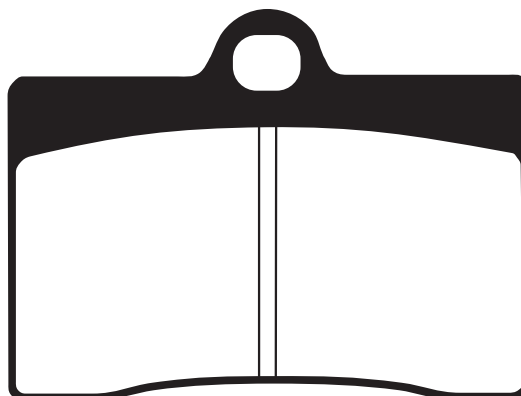

DISC PADS BUYERS GUIDE

APRILIA		
RS4 50 (J. Juan F Caliper)	11-14	F
RS4 125 (J. Juan F Caliper)	11-14	F
RS 250 All models	95-97	F
B 500 CR	02	F
B 500 MT	02	F
BENELLI		
666 Scooter "Born in Hell"	98-99	F
BETA		
Jonathan 125	00-05	F
Euro 350	03-06	F
Jonathan 350	03-06	F
BIMOTA		
Various models	89-03	F
Tesi 2D	05-06	F
BORILE		
B 500 CR	02-04	F
B 500 MT	02	F
BREMBO		
20 5165 55/68 Goldline 4 Piston P4 30/34		
@ 40mm Spacing (Single pin pad fixing)		
20 4756 52/62 - 4 Piston P4 30/34		
@ 40mm Spacing (Single pin pad fixing)		
CAGIVA		
Mito 125/SP525	93-10	F
N1 125	97	F
Planet 125 (3 Spoke Wheels)	98-03	F
Planet 125 (6 Spoke Wheels/ST Series)	98-03	F
Planet 125 (6 Spoke Wheels 2nd Series)	98-03	F
Raptor 125	03-10	F
Mito 500	07	F
River 600	95-99	F
CCM		
CR 40 S Cafe Racer (Full Fairing)	07-09	F
CR 40 Cafe Racer (Handlebar Fairing)	07-08	F
DUCATI		
Supersport 400	93-97	F
400 Monster	95-97	F
(549cc) Supermono	93-95	F
600 Monster	93-99	F
600 Monster Dark	98-99	F
600 Monster City/City Dark	99	F
600 Supersport	91-97	F
748 SP	95-98	F
749 Biposto	95-98	F
750 Supersport	91-98	F
Supersport 750 (Twin disc)	91-98	F
750 Monster	96-98	F
750 Monster City/City Dark	99	F
750 Monster/Monster Dark	99	F
851 Superbike Biposto	89-92	F
884 SP4/SP5	92-93	F
888 Superbike Strada	94-95	F
900 Supersport	89-90	F
900 Supersport/Superlight	91-97	F
900 Supersport CR USA	98	F
900 Supersport FE	98	F
900 Monster	93-99	F
900 Monster Cromo/Special	98	F
900 Monster City/City Dark	99	F
907 IE	90-93	F
916 SPS (996cc)	97-98	F
916 Biposto	94-98	F
916 Senna	94-98	F
916 SP	94-96	F
FANTIC		
TZ 125 SM Caballero Motard (2T)	11-12	F
TZ 125 MR (2T) Motard Competizione	13	F
GAS GAS		
SM 125/250/400 FSE	02	F
SM 125/250 (2T)	01-06	F
SM 125 (2T) Supermotard	03-06	F
SM Halley 125cc	09	F
SM 400 FSE (2T)	01-04	F
SM 450 FSR (4T) Supermotard	07-09	F
SM 515 FSR (4T) Supermotard	07-09	F

GILERA		
Saturno 350 Bialbero	90-	F
Saturno 500 S/Bialbero/Piuma	90-	F
HONDA		
CBR 900 'Evolution Blade'	99	F
HUSQVARNA		
SM 400 R	02	F
SM 450 R	03-06	F
SM 510 R	05	F
SM 570 R	01-04	F
SMR 630	06	F
KTM		
Sting 125	97-99	F
Duke 400 LC4	94-98	F
Duke 620 LC4	94-98	F
Duke-E 640 (Single pin pad fixing/zero offset disc)	98	F
LC4-E 640 (Central single pin fixing)	03	F
SMC 660 Supermoto	03-04	F
LAVERDA		
650 All models	94-95	F
668 All models	96-98	F
750 All models	98-01	F
MASH		
TT40 400cc (Trackstar)	17-20	F
MONDIAL		
Piega 1000	02	F
MOTO GUZZI		
1000 Daytona	92-95	F
1000 Daytona RS	97-98	F
1000 V10 Centauro GT	97-99	F
1000 V10 Centauro Sport	97-99	F
Sport V11	98-99	F
California 1100 EV (Single pad pin fixing)	97-00	F
California 1100 Jackal (Single pin pad fixing)	99-01	F
California 1100 Special (Single pin pad fixing)	99-00	F
1100 California EV (Up to KD115426/Single pin pad fixing)	97-00	F
1100 California Jackal (Up to KD152328 Single pin pad fixing)	94-01	F
1100 California Special (Up to KD131644/single pin pad fixing)	99-00	F
1100 Sport Carbs	94-96	F
1100 Sport EFi	96-99	F
1100 Sport Corsa	98-99	F
MZ/MUZ		
Skorpion/Tour/Sport/Traveller/Cup	95-02	F
Mastiff -17" front wheel/cast wheel	99-05	F
OMP		
4 Piston	F&R	
PGO		
G Max 125	06-08	F
G Max 125 (Wave disc)	09-12	F
G Max 250	06-08	F
REVTECH		
CCI Polished Caliper (Front/Rear)		

SACHS		
XTC 125 Supersport	00-07	F
XTC 125 N	00-07	F
X Road 125	06-07	F
Roadster 650	05	F
Roadster 800	01-05	F
B-805	03-04	F
TM		
SMR 125 (2T)	05-14	F
SM 250	02	F
SME 250 (4T)	04	F
SMM 250 (2T)	05-14	F
SMR 250 (2T)	05-14	F
SMM 300 (2T)	05-14	F
SMR 300 (2T)	05-14	F
SM 400	02-03	F
SME 400 (4T)	04	F
SMR 450 FES	05-09	F
EN 530 F-ES	03-04	F
SM 530	02-03	F
SME 530 (4T)	04	F
SMR 530 FES	05-09	F
530 (4T) Cross	02-03	F
SMX 660 F	04	F
VOR		
SM-E 450/530	03-04	F
VOXAN		
Cyclope 1000	02	F
Cafe Racer 1000	02-05	F
Roadster 1000	02-05	F
Street Scrambler	03-05	F
WILWOOD		
GP300/310 (Part # 150-8733-2)		
WK BIKES		
SP125N	13-15	F
SP250N	15	F
YAMAHA		
TZR 125 R Brembo Caliper (4DL1/4DL2)	91-93	F
TZR 125 RR	96-	F
SZR 660	96-97	F

Equivalents OE #			
4SU F5811 00	047 00 2000036	27 69173	211082009
613 4 004 24	573 V3 030 000	800078331	07009R
613 4 009 1A	90210 55000	GU30654600	B044201
613 4 0041 A	BE250122065SM	GU30654602	B044202
8113585	800094411	107 A486 53	53182 ABE1 9000
8000 78331	211041010	211021021	N50025061

MATERIAL AVAILABILITY AND PART NO.				
STD	OPTIONS			
FA	V	HH	R	EPFA
FA095	FA095V	FA095HH	-	EPFA095HH

DO NOT REFIT ANY SHIMS/INSULATORS TO EBC PADS FROM ORIGINAL PADS UNLESS INSTRUCTED ON NOTE ON PAD PACKAGING AND ON FA DRAWING ASSOCIATED WITH THAT PAD.

FA099 31.5 x 52 x 5.5mm



APRILIA TRX 240 M	89	F&R	GARELLI 50 Tiger XLE	86-	R
BENELLI Devil 50	92-	R	GILERA Eaglet 50	96	F
Spring 50	93-	R	Built 50	90-	F
Devil 80	92-	R	503 50cc	91-	F&R
BETA TR 32/33 125	86-87	F	MALAGUTI Phantom F12	94-98	F
TR 33 240	86	F	Crosser CR1	97	F
TR 34 260	89-91	F	50 Enduro RCX-W/Sahib	83-	F
TR 34	86-88	F	50 Fifty Full/CX	83-	F
CIMATTI Gringo	85-	F	50 RGT Strada	83-	F
FANTIC 50.1 Oasis Kick	87-	F	50 Enduro Dune	87-	F&R
50.1 Trial	86-	F	50 Fifty Top	85-	F
50.1 Trial H 20	87-	F	50 RGT Sport	85-	F
Trial 125/2		F&R	50 RST Sport	87-	F&R
201/301 Monoshock	86	F	50 Evolution	91-	F
243 Trial	87-	F&R	50 Raid	91-	F
303 Monoshock	87	F&R			

MATERIAL AVAILABILITY AND PART NO.					
STD	OPTIONS				
FA	SFA	HH	R	MXS	EPFA
FA099	SFA099	-	-	-	-

Equivalents OE #
266 07 6340
510 362 4 282
464143
11933400

FA100 39 x 9mm

LAMBRETTA
175 TV II F

Equivalents OE #
14744200

MATERIAL AVAILABILITY AND PART NO.					
STD	OPTIONS				
FA	V	HH	R	MXS	EPFA
FA100	-	-	-	-	-

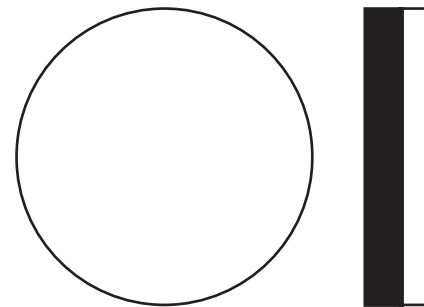

FA101 71 x 36 x 9.2mm

BETA Euro 350	03-06	R						
Jonathan 350	03-06	R						
CCM XTR 250	09	R						
CF MOTO CF 125 T-21A E-Charm	10-11	R						
CF 150 T-Si	10-11	R						
CF 250 T-5 V5 Custom	11-12	R						
GARELLI XO 125i (TM 125 T)	09-12	R	MZ 660 SSR	95	R	XC 125 TR "Cygnus"	96-03	F
XO 150i (TM 150 T)	09-12	R	NIPPONIA Miro 100 (4T)	12-13	F	DT 200 (2LR)	87	F
XO 200i (TM 200 T)	10-12	R	Miro 125 (4T)	12-14	F	XT 225 (2LN) Serrow (1KH 020101-)	86-87	F
XO'E Electric	12	R	SACHS Bee 50	08-10	F	XT 225 (3RW1-5 Serrow)	89-93	F
GILERA 125 Apache	91-	R	Bee 125	08-09	F	(1KH 034101-132000)	93-96	F
RC 125 Top Rally	89-92	R	Roadster 650	05	R	XT 225 W (4JG1/2/3/4) Serrow		
Oregon 250 Quad	07	F	SFM Bee 50 (2T)	14-15	F	XT 225 (4VW1/3/5/7/9)		
RC 600	89-90	R	Bee 125 (4T)	14-15	F	(4VWA/B/D/G/J/L) (Brasil)	97-06	F
HERO HONDA Quickster 125	06	F	SIAMOTO KD 125	00-04	F	YZ 250 U	88	R
HONDA HM (Italy) CRE 50 Six/Baja/Derapage	95-02	R	W.K. BIKES WK 125 C (4T) (16" wheel)	10-13	R	YZ 250 N/S "TRI-Z"	85-86	F&R
ITALJET Millennium 100/125/150	00-01	F	YAMAHA TZR 50 "Thunderkid" (5DU1/3)	97-00	R	YFZ 350 T/U/W	87-89	F
LINHAI Eggy 125cc (Scooter)	07-09	F	YSR 50 T	87	F	XT 350	85-95	F
LH50 Police (Scooter)	07-09	F	DT 80 LC-2 (53V)	85-92	F	TT 600 N (59X) Frame	85-88	F
MALAGUTI Blog 125 ie	09-11	R	DT 125 LC	86-87	F	#59X000101-59X007852	87	R
Centro 125 ie/SL	07-11	R	DT 125 R	88-03	F&R	XT 600 Z "Tenere"	88-90	R
Blog 160 ie	09-11	R	DT 125 RE	04	F&R	XT 600 E	92-03	R
Centro 160 ie/SL	07-11	R	DT 125 RE	05-07	F	XTZ 660 E "Tenere"	91-98	R
MBK TZR 50 X-Power	00	R	TDR 125 (4GW/GX 1/2/3/4)	93-03	R			
XC 125 Flame 125	96-03	F	YBR 125 ED (3D91)	05-06	F			
XC 150 Vertex	97	F	YZ 125 U	88	R			

Equivalents OE #					
1UY W0045 00	2VN W0046 00	34X W0046 02	3BN W0045 01	3JH W0045 00	4KL F5811 00
1UY W0045 01	2VN W0046 01	38W W0045 00	3FY W0045 00	3UH W0045 00	KA3495506
1UY W0045 02	34X W0046 00	38W W0045 01	3XP W0045 00	344 840	11969900
1UY W0045 03	34X W0046 01	3BN W0045 00	3XP W0046 00	48 7100 7	605 08 02 50

MATERIAL AVAILABILITY AND PART NO.								
STD	OPTIONS							
FA	SFA	SFAC	TT	SFA-HH	HH	R	MXS	EPFA
FA101	SFA101	SFAC101	FA101TT	SFA101HH	-	FA101R	MXS101	-

DISC PADS
BUYERS GUIDE

DO NOT REFIT ANY SHIMS/INSULATORS TO EBC PADS FROM ORIGINAL PADS UNLESS INSTRUCTED
ON NOTE ON PAD PACKAGING AND ON FA DRAWING ASSOCIATED WITH THAT PAD.

FA102 58 x 48 x 8.7mm

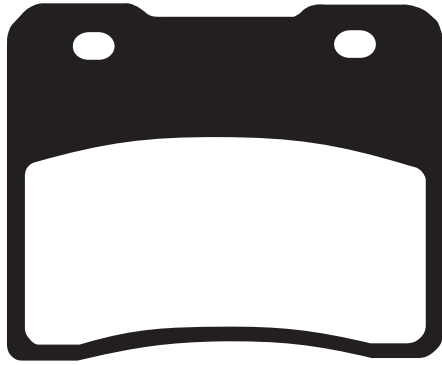

SUZUKI

RG 250 WE/FG/CH/FCH/FH 'Gamma' 84-88 F
 GSX 400 R2 (GK71B) F

Equivalents OE #		
59130 04A00	59130 04A10	59100 04830

MATERIAL AVAILABILITY AND PART NO.					
STD	OPTIONS				
FA	V	HH	R	MXS	EPFA
FA102	-	-	-	-	-

FA103 58 x 53.5 x 8.7mm

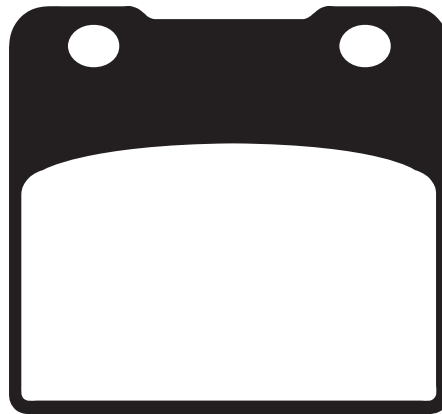

SUZUKI

GSX 250 R CH/H (GJ72A) F
 GSXR 250 J (GJ72A) F
 GSXR 250 CK F
 GSXR 400 H 87 F
 GSX 400 X/XA/XS "Impulse" F
 GSX 400 R3 (GK71F) F
 RG 400 F
 RG 400 EWF/EW-2G/EWH Walter Wolf (Type 1&2) 85-87 F
 VS 400 VR/FR/VTR/FTR/V-T/F-T 94- F
 RG 500 G/CH 85-87 F
 VS 600 GLS/GLT/GLV 95-97 F
 VS 700 GLEFG/GLEPG/GLEFH/GLEPH 86-87 F
 VS 700 GLFH/GLPH/GLFG/GLPG 86-87 F
 GSXR 750 F/G/H 85-87 F
 VS 750 All models 85-91 F
 VS 800 GLN/GLP/GLR/GLT/GLS/GLV/GLW/GLX 92-99 F
 GSX 1100 EFE/EFF/ESF 84-86 F&R
 GSX 1100 FJ/FK/FL/FM/FN/FP/FR 88-94 F
 GSXR 1100 G/H/J 86-88 F
 GV 1400 GDG/GTG Cavalcade (Up to F/No 103764) 86 F&R
 VS 1400 GLPH/GLFH/GLPJ/GLFJ/GLPR/GLPT F
 /GLPV/GLPW/GLPX/GLPY/GLPK1 F
 /GLPK2 Intruder 87-03 F&R
 VL 1500 W/X/Y/K1 98-01 F&R

MATERIAL AVAILABILITY AND PART NO.				
STD	OPTIONS			
FA	V	HH	R	MXS
FA103	FA103V	FA103HH	-	-

Equivalents OE #					
59100 10810	59100 30820	59130 06B20	59130 30B00	69100 38840	69130 38B00
59100 20810	59100 38820	59130 00810	59130 30B01	69100 38860	69130 48B00
59100 20820	59130 00A00	59130 24A00	59130 30B21	69100 38870	69130 38820
59100 30810	59130 00A10	59130 27A00	69100 38810	69100 48810	69130 48810
59100 06820	59130 06B10	59130 27A10	69100 38820	69130 38B10	

DISC PADS
BUYERS GUIDE

DO NOT REFIT ANY SHIMS/INSULATORS TO EBC PADS FROM ORIGINAL PADS UNLESS INSTRUCTED
 ON NOTE ON PAD PACKAGING AND ON FA DRAWING ASSOCIATED WITH THAT PAD.

FA104 68 x 56.2 x 8.8mm

YAMAHA

RD 125 LC (MK 2-3)	85-87	F
RZ 125 (1GV 030101-)	85	F
TZR 125	87-89	F
TZR 125	90-92	R
TZR 125 R	93-	R
TZR 150 R (4AP2)	00	R
SDR 200 (2TV)	87-89	F&R
FZR 250 R		R
FZR 250	87	R
FZX 250 Zeal (3YX1/2/4)	91-92	R
RZ 250 R (1AR/1XG)		F&R
RZ 250 R (29L)		R
RZ 250 RR (51L)		F&R
R1-Z (250CC/3XC)	90-92	R
SRX 250		F
TDR 250 (3CK1/3CK2 Europe) (Eng Frame # 3CK-)	88-92	R
TZR 250 (2MA/2XW1/2XW2 Europe) (Eng Frame # 2MA-)	87-92	R
TZR 250 (1KT/2AW Japan) (Eng Frame # 1KT-000/056)	87	R
TZR 250 (2XT1 Japan) (Eng Frame 1KT-09)	88	R
TZR 250 (3MA1 - Reverse Cylinders) (Eng Frame # 3MA-0001)	89	R
TZR 250 (3MA3/3MA5) (Eng Frame # 3MA-046/058)	90	R
TZR 250 SP (3MA4) (Eng Frame # 3MA055)	90	R
TZR 250 R (3XV1/3X4/3XV6) V-Twin (Eng Frame # 3XV000101-08600)	91-93	R
TZR 250 RS (3XV8/3XV9/3XVA) V-Twin (Eng Frame # 3XV080101/08200 088-)	92-94	R
TZR 250 SPR (3XVC) V-Twin (Eng Frame # 3XV 107101-)	95	R
RD 350 N	85	F&R
RD 350 F/F2	85-92	F&R
RD 350 R	92-95	F&R
FZ 400 (4YR1)	96	R
FZ 400 N (IFK 146X 133M)	85	R
FZR 400 RR (4DX)	92	R
FZR 400 (3TJ1/2/6/7)		R
FZR 400 Genesis (1WG)	86	R

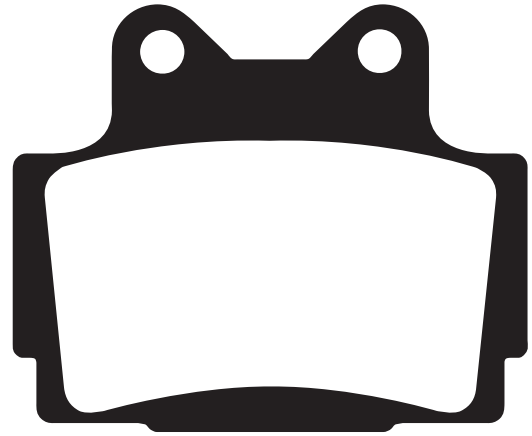

YAMAHA

FZR 400 RSP (2TK EX-UP)	87	R
FZR 400 (3EN1/2)	88-89	R
SRX 400 (1JL)	85	R
SRX 400 (3VN1/3VN2/3VN5)	90-96	R
XJR 400 (4HM1/4HM2/4HM4/4HM7)	93-96	R
XJR 400 (4HM3/4HM5/4HM6/4HM9 /4HMA/4HMB) Brembo caliper	95-99	R
RD 500 LC	84-86	R
RZV 500 R(SIX)	85	R
FZ 600	87-88	R
FZS 600 Fazer	98-03	R
SRX 600	86-87	F&R
SRX 600 (1JK)	85	F&R
SRX 600 (3SX)	90-91	R
XJ 600 N	95-03	R
XJ 600 S "Diversion"	92-03	R

MATERIAL AVAILABILITY AND PART NO.				
STD	OPTIONS			
FA	V	HH	R	MXS
FA104	FA104V	FA104HH	-	-

Equivalents OE #	
1KT W0046 50	51L W0046 00
1KT W0046 51	51L W0046 01
1KT W0046 52	51L W0046 02
3TJ W0046 00	4AP W0046 00

FA105 91 x 30.4 x 8mm



YAMAHA

YZ 125 N/S/T/U	85-88	F
TT 250	90	F
YZ 250 N/S/T/U	85-88	F
TT 350 (ITJ)	85-89	F
TT 350 A (3GJ)	90-95	F
YZ 490 N/S/T/U	85-88	F
TT 600 W (2JT/3SW1) (Frame # 59X007853-)	89-92	F

MATERIAL AVAILABILITY AND PART NO.					
STD	OPTIONS				
FA	V	R	HH	MXS	EPFA
FA105TT	-	FA105R	-	-	-

Equivalents OE #		
56A W0046 00	1LX W0045 00	2HH W0045 01
1LN W0045 01	2HH W0045 00	

FA106 77 x 54 x 8mm

FA106/2 77 x 54 x 9.5mm

SUZUKI

GZ 125 W/X/Y/K1-K9 "Marauder"	98-10	F
RM 125/250 F/G	85-86	F
VL 125 Y/K1/K2/K3/K4/K5/K6/K7 Intruder	00-08	F
GZ 250 K2-K8 Marauder	02-08	F
GZ 250 X/Y/K1	99-01	F
TU 250 XV/XW	97-00	F
TU 250 S/T/XS/XT/X-ST/XSV/XT-W (NJ47A 10001-115972)	92-97	F
VL 250 Y/K1/K5/K6/K7 Intruder	00-01/05-07	F
LS 650 "Savage" FG/PK/PM/PR/PG/PT/PV/PW/PX	87-99	F

SIAMOTO

Geco 250	04	F
----------	----	---

MAICO

All Models	86-88	F&R
------------	-------	-----

FA106/2 - SUZUKI

DR 600 RG/RH/RJ (SN41A) (Rear drum model)	86-88	F
DR 600 RK (SN41A) (Rear disc model)	89	F
DR 600 SF/SG/SH/SJ/SK (SN41A)	85-89	F

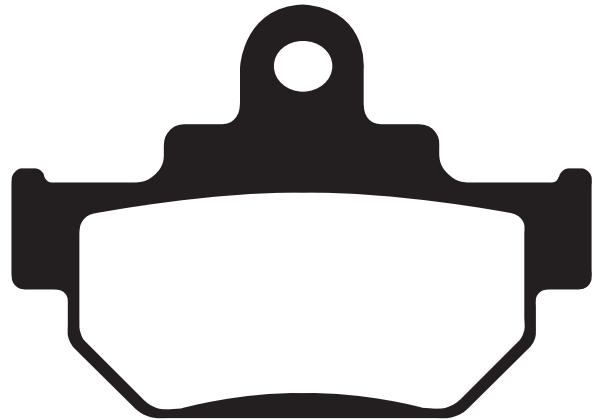

MATERIAL AVAILABILITY AND PART NO.				
STD	OPTIONS			
FA	V	HH	R	EPFA
FA106TT	FA106V	-	FA106R	-

MATERIAL AVAILABILITY AND PART NO.				
STD	OPTIONS			
FA	V	R	HH	EPFA
FA106/2TT	-	FA106/2R	-	-

Equivalents OE # - FA106
59300 24830
59340 14600
59340 24B00
59340 24B10

Equivalents OE # - FA106/2
59300 14830
59340 14500
59340 14501
59340 14510

DISC PADS
BUYERS GUIDE

DO NOT REFIT ANY SHIMS/INSULATORS TO EBC PADS FROM ORIGINAL PADS UNLESS INSTRUCTED
ON NOTE ON PAD PACKAGING AND ON FA DRAWING ASSOCIATED WITH THAT PAD.

FA107A 82 x 54 x 8mm

FA107/2A 82 x 54 x 7mm

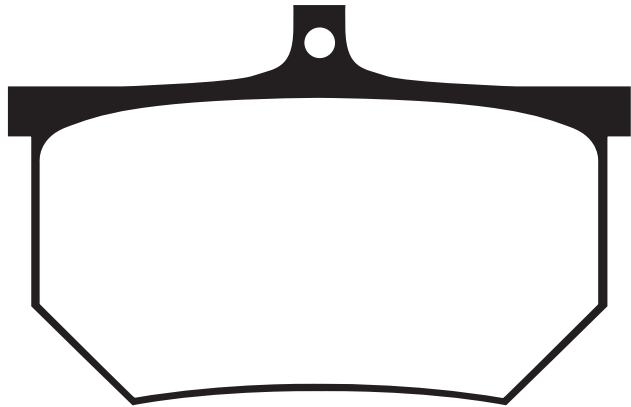

FA107A - AP/LOCKHEED
4 Piston Caliper (CP3086/CP3369/CP4484 D27)
SPONDON
4 Piston Caliper

FA107/2A - AP/LOCKHEED
4 Piston Caliper (CP4485/CP4679)
SPONDON
4 Piston Caliper

MATERIAL AVAILABILITY AND PART NO.					
STD	OPTIONS				
FA	V	R	HH	EPFA	
FA107/2A	-	-	-	-	

MATERIAL AVAILABILITY AND PART NO.					
STD	OPTIONS				
FA	V	HH	R	EPFA	
FA107A	-	-	-	-	

DISC PADS
BUYERS GUIDE

FA109 50 x 55 x 11.3mm

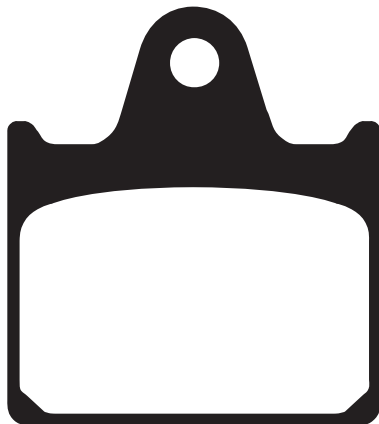

HONDA
VF 1000 RE/RF/RG 84-86 R

Equivalents OE #
43105 MJ4 007
43105 MJ4 008

MATERIAL AVAILABILITY AND PART NO.					
STD	OPTIONS				
FA	V	HH	R	MXS	EPFA
FA109	-	-	-	-	-

FA110 52.5 x 44.5 x 7.2mm



SUZUKI
RG 125 CG/CH/J (NF12A) Gamma/Rear drum brake model 86-90 F
RG 125 UCG/UJ/UJJ/UJJ/BUJ (NF12B) Gamma/Rear drum model 86-90 F

Equivalents OE #
59100 36850
59130 36A00
59130 36A01

MATERIAL AVAILABILITY AND PART NO.					
STD	OPTIONS				
FA	V	HH	R	MXS	EPFA
FA110	-	-	-	-	-

FA111 64 x 57 x 9mm

HONDA
FL 350 R Odyssey 85-87 R
FL 400 R/RK/RL "Pilot" 89-93 R

Equivalents OE #	
43105 HEO 305	431A0 HEO 670
43105 VMO 008	431A0 VMO 008
43105 VMO 771	

MATERIAL AVAILABILITY AND PART NO.					
STD	OPTIONS				
FA	V	HH	R	MXS	EPFA
FA111	-	-	FA111R	-	-

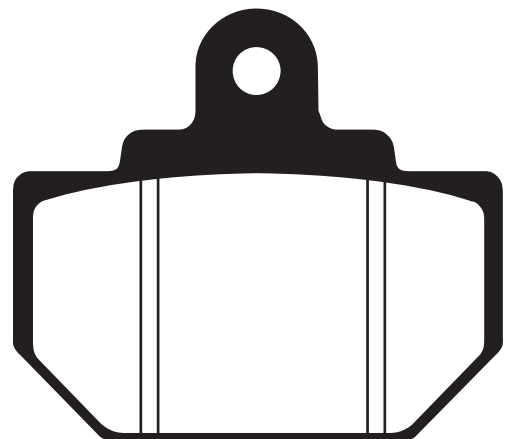

DO NOT REFIT ANY SHIMS/INSULATORS TO EBC PADS FROM ORIGINAL PADS UNLESS INSTRUCTED
ON NOTE ON PAD PACKAGING AND ON FA DRAWING ASSOCIATED WITH THAT PAD.

FA115 36 x 45 x 6mm

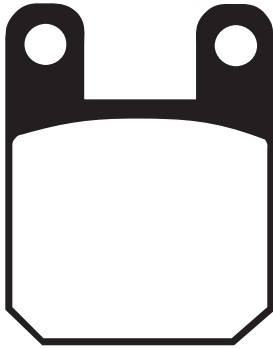

DISC PADS
BUYERS GUIDE

DO NOT REFIT ANY SHIMS/INSULATORS TO EBC PADS FROM ORIGINAL PADS UNLESS INSTRUCTED
ON NOTE ON PAD PACKAGING AND ON FA DRAWING ASSOCIATED WITH THAT PAD.

AJP									
PR4 Supermotard 200	04-09	R							
ALFER									
80 MC	87-	R							
APRILIA									
RS 50 (Radial Caliper)	06-11	R							
RX 50	06-14	R							
SM 50	11-12	F&R							
SX 50	06-13	R							
SX 50	11-14	F&R							
SM 125	11-12	F&R							
SX 125	11-12	F&R							
TX 125/240/311	86-88	F							
SM 250	11-12	F							
TX 311	88	F&R							
280 Climber	94-96	F							
280 R Climber	92-93	F							
BETA									
RR 50 Supermoto/Enduro	98-05	F&R							
RR Enduro Alu 50/Motard Alu 50	04-08	R							
RR Enduro 50	04-07	R							
Eickon 50	99-06	F&R							
50 RR Enduro	97-04	F&R							
RR 50 Standard	05-08	R							
RR Enduro 50 Standard	09-14	F							
RR 50 Enduro Racing	09-10	R							
RR 50 Motard Standard	09-14	F							
Pro race 50	05	F							
Synt/Gara	93-95	F							
Zero	92	F							
Super Trial ST	94	F							
Techno	95	F							
REV 50	00-08	F&R							
Minirial 70cc 2T	13-14	F&R							
Evo 80 Junior	09-19	F&R							
REV 80	00-07	F&R							
Alp 125 (4T)	98-04	F&R							
Eurotek/Techno 125/250	96-98	F&R							
125 TR 34		F&R							
R 125 4T Mini Cross		R							
RE 125 4T Enduro	10-14	F							
Synt	92	F							
RK6 50cc Enduro	97-02	R							
Alp 200 (4T)	00-04	F&R							
BLATA									
Enduro 125	07-08	R							
Motard 125	07-08	R							
BULTACO									
Astro SM 50		R							
CAGIVA									
Mito 50	99-00	R							
Progress 50	97-99	F							
CH RACING									
WXE 50 Enduro	05	R							
WSM 50 Motard	05	R							
WXE 125 Enduro	05	R							
WSM 125 Motard	05	R							
CONTI									
RX 356 V3 (12" wheels)	05-06	R							
RX 356 V3 (17" wheels)	05-06	R							
CPI									
Supermoto 50 SMX	03-08	F&R							
Supermoto 50 (Low level exhaust)	06-09	F&R							
Supercross 50	03-09	F&R							
SM 50 Black Tiger	08-09	F&R							
SX 50	06-07	R							
SM 250	09-12	F							
SX 250	09-12	F							
CZ/JAWA									
50 Minarelli	03-04	F							
125 Sport	03-04	F&R							
125 Dandy	03-04	F&R							
50/100 Robby	03-04	F							
DAELIM									
S 125	03	R							
DERBI									
Atlantis 50 (AC/2T)	99-01	F							
Atlantis 50 Bullet (AC/2T)	03-05	F							
Atlantis 50 City (AC/2T)	03-06	F							
Atlantis 50 Red Bullet (AC/2T)	03	F							
Atlantis 50 Two Chic (AC/2T)	05	F							
Atlantis 50 (AC/2T)	02	F							
Atlantis 50 (4T) (13" 3 spoke wheels)	04-06	F							
Atlantis 50 (2T) Up to Ref No. 8G253171 12"/5 spoke wheels/190mm disc 3 bolt	07	F							
Atlantis 50 LC (2T)	99-01	F							
GP1 50 Open	06-11	R							
GP1 50 Euro 2 Chain Driven /Radial caliper									
/5 bolt fixing front disc	05	R							
GP1 50 Race Chain Driven/Radial caliper/5 bolt fixing front disc	05-07	R							
GP1 50 50cc	01-03	F&R							
GPR 50 R	97-01	R							
GPR 50 Replica Racing	99-03	R							
GPR 50 (2T) 41mm Forks /218mm rear disc	09-11	R							
GPR 50 Racing 40mm forks /180mm rear disc/radial caliper	08-10	R							
GPR 50 40mm forks/180mm rear disc/radial caliper	04-07	R							
Paddock 50 (AC/2T)	98-99	F							
Predator 50 (AC/2T)	98-01	F							
Predator 50 (LC/2T) 5 bolt front disc/STD Paioli forks	98-03	F&R							
Predator 50 (LC/2T) 3 bolt front disc/USD Showa forks	98-03	F&R							
Red Bullet 50	04-05	F							
GPR 50 Nude (Radial caliper)	04-09	R							
Senda SM DRD Super Motard	04-11	F&R							
Senda-R	96-02	F&R							
Senda X Race 50 R (240mm disc)	05-09	F&R							
Senda R DRD	02	R							
Senda DRD Racing 50 SM (300mm disc/Std mounted caliper)	04-11	R							
Senda DRD Racing 50 R (260mm disc/Std mounted caliper)	04-11	R							
Senda SM DRD 50 (Double disc model) SDR1DB	02-03	R							
Senda SM DRD 50 (Double disc model/SR3A1A)	05	F&R							
Senda SM DRD Racing Ltd (Cast Wheels/Double F Disc)	05-07	F&R							
Senda 50 SM DRD Black Edition	05	F&R							
Senda 50 Black Edition	03	R							
Senda X-treme 50 R (240mm disc)	03-11	F&R							
Senda X-treme 50 SM (260mm disc)	03-09	F&R							
Senda X-Race 50 SM (260mm disc)	06-11	F&R							
Vamos/Vamos FL	96-99	F							
Hunter	96-99	F							
Atlantis 100 (AC/2T)	00-01	F							
Atlantis 100 (4T) (13" 3 spoke wheels)	04-06	F							
GPR 125 Racing (Radial caliper)	04-07	R							
GPR 125 Nude (Radial caliper)	04-08	R							
DUCATI									
(549cc) Supermono	93-95	R							
ECO									
Bushman 150 (LX 150 GY)		R							
EXPLORER									
KBR 200	05	R							
FACTORY									
RP 50	05	R							
YM 50	05	R							
YR 50 Desert	02-03	F&R							
YR 50 Desert	04-05	R							
Chrono SM 50	04	R							
YR 125 4T	05	R							
FANTIC									
50.5 Trial	89	F&R							
50.7 Trial	90	F&R							
50.9 Trial	91-	F&R							
50 Clubman	95-	F&R							
80 Clubman	95-	F&R							
125/5/245/305	89	F&R							
Series 7 Models	90	F&R							
K-Roo (All Models)	92-95	F&R							
309	92	F&R							
Section 125/249 R	95-	F&R							
FB MINARELLI (SPAIN)									
MR 80		F							
FYM/X-Sport									
CR 110	06-07	R							
CR 110 ESR	06-07	R							
CR3 125	06-07	R							
CR 125 R	06-07	R							
X Sport Typhoon 125 Quad	06-07	R							
GARELLI									
GSP 50 (2T)	09-12	R							
Sahel 50	91-	R							
Sahel 80	91-	R							
Trial 323	86-	F							
GAS-GAS									
EC 50 Boy (Air cooled)	05	F							
K 50 Quad	06	R							
TXT 50 (Boy)	04-15	F&R							
TXT 50 (Cadet)	06-09	F							
MX 65	05-08	R							
Contact Models	93-95	F&R							
JTX 125/200/270/320	95-98	F&R							
Pampera 125/250/370	96-97	F&R							
TX 200/270/320	98	F&R							

FA115 Contd.

ITALJET

Formula 50 LC	96-03	F&R
Formula Air 50	99-03	F
Torpedo 50	98-03	F
Torpedo 125 4T	99-03	F
Formula 125 LC (2T/Twin Cyl)	96-03	F&R
Dragster 50	98-07	F&R
Dragster 125/180 LC	00-08	F&R
Pit Jet 125 (4T)	07-09	R
Dragster 250	07-08	F&R

JAYBRAKE

Dual 7 Quad (300-04) (2 & 4 Piston)

JCM

240 Europa	89	F
------------	----	---

KTM

60 SX	98-00	F
65 SX	98-99	F
65 SX	00-01	F

LEM

Four X Pro		R
------------	--	---

MALAGUTI

NDK 50 Drakon	05-09	R
XTM 50	03-11	F&R
XSM 50	03-11	R
Drakon S	06	R
X3M Enduro (Cast wheel)	08-10	R
X3M Motard (Cast wheels)	08-10	R

MBK

TZR 50 X Power	03-09	R
----------------	-------	---

MH/MOTORHISPANIA

Furia Max Supermoto	07-10	F&R
Furia Max Enduro 50	06-10	F&R
RYZ 50 Enduro	06-10	F&R
RYZ 50 Pro Racing Enduro	06-10	R
RYZ 50 Pro Racing Supermotard	06-10	R
RYZ 50 Pro Racing Urban Bike	06-10	R
RYZ 50 Supermotard	06-10	R
RYZ 50 Urban Bike	06-10	R
RYZ 50 Pro Racing Enduro	13-14	R
RX 50 Super Racing	06-07	R
Duna 125 Hard Road Enduro	08-12	R
Duna 125 Dual Plus Trail	08-10	R
Duna Plus 125	14	R

MONTESA

Cota 307/335	88	F&R
311 (Honda)	92-93	F
314 R (Honda)	94-96	F
315 R (Honda)	97-00	F

MOTO ROMA

SMX 125	04-06	R
---------	-------	---

SUZUKI

RMX 50		F&R
AY 50 WRX/WX/WRY/WY		
/WRK1-WRK4"Katana"	99-04	R
AY 50 WRK1/WRK2/K3/WRK3		
/WRK4/AK5 (AJP Caliper)	01-05	F
UF 50 Y "Estilete"	00-02	F

PERFORMANCE MACHINE

125 X 2		
125 X 4S		
125 X 4SL		

PEUGEOT (AJP CALIPER)

Blaster RS12 50 (2T)	10-11	F
Blaster Ice Blade 50 (2T/12" wheels)	10-12	F&R
Elyseo 50	98-02	F
Elyseo 50	03	F&R
Elystar 50 TSDi	02-07	F
Elystar 50 Advantage	02-07	F&R
Jet C Tech 50	11-12	F&R
Jet Darkside 50 (2T)	11-13	F&R
Jet Force 50 H2i (2T/Air Cooled)	11-12	F
Jet Iceblade 50 (2T)	11-13	F&R
Jet H2i 50 (LC)	11-12	F&R
Looxor 50	01-06	F
Ludix Blaster (10" wheels)	05-09	F
Ludix 2 Trend 50cc (2T)	07-11	F
Ludix Snake 50cc	04-09	F

PEUGEOT (AJP CALIPER) Contd.

Ludix Bullet 50cc	04	F
Ludix Trend 50cc	04-07	F
Ludix Elegance 50cc	04-09	F
Ludix Pro (14" wheels/4T)		
(AJP caliper)	11-13	F
Speedfight 50 1/2	97-08	F&R
Streetzone 50 (2T)	14-18	F
TRK 50 (2T) (10" wheels)	09-12	F
TRK2 WRC 50 (2T)	04-06	F
Trekker 50 (2T) AJP Caliper	98-00	F
TRK 50 (2T/12" wheels)	09-12	F
Vivacity 50 (12" wheels/190mm disc)		
(AJP Caliper)	92-07	F
Vivacity 2 (50cc) AJP Caliper		
(10" wheels/190mm disc)	08-11	F
XP6 Track	03-08	F&R
XR6 (2T) 50	03-07	R
XPS 50 Track (21" front wheel)	11-12	R
XPS 50 Top Road (17" front wheel)	10-12	R
Elyseo 100	98-02	F
Speedfight 100 1/2	97-09	F&R
Trekker 100 (2T)	98	F
Elyseo 125/150	98-02	F
Ludix Ambition 125cc	04	F
Squab		F
Vivacity 50/100 (All models)	99-07	F
LOOXOR 100	01-04	F&R
Metal X 50	02-03	F
Elyseo 100	03	F&R
Streetzone 100 (4T)	14-15	F
LOOXOR 125/150	03-06	R
Elystar 50 TSDI	02-05	F
Jet Force 50/Jet-C	03-10	F&R
Ludix Urban Track	06-07	F
Ludix Red Zone	06	F
Ludix Acid	06	F
Looxor 50 TSDI (Rear disc)	06	F&R
XPS 125 CT	05-07	F&R
Ludix Blaster	05-09	F
XP 125 Street Evo 2	05	R
XP6 Enduro/Top Road 21" front wheel	03-10	F&R
XPS Enduro	03-09	F&R
XP6 Supermoto (17" front wheel		
/240mm disc)	03-09	F&R
XPS Supermoto (17" front wheel		
/260mm disc)	03-10	R
XPS Street (17" front wheel		
/280mm disc)	03-09	R
PIAGGIO		
Diesis 50	01-05	F
Diesis 100	01-03	F
RIEJU		
MRX 50	03-08	F&R
NKD 50	07	R
RS1 50cc	97-00	F&R
RS2 NKD	05	R
RR 50 cc Thunderfire	97-02	F&R
RR 50 Castrol	00-02	R
RR 50 Sport	03-06	F&R
RRX 50 Spike (17" wheel		
/spoke wheel)	03-08	F&R
RRX 50 Spike (17" cast wheel)	06-09	F&R
MRX 50 Pro	04-08	R
Spike 50	04-06	F&R
Spike 50 Pro	04	R
SMX 50 Pro Supermotard/Top	04-07	R
RS1 50cc	01-04	R
SMX 50	02-06	F&R
SMX 50 Pro Street	06-08	R
SMX 50 (Cast wheel)	07-08	F&R
MRX 50 Castrol/SMX 50	01-02	R
RRX 50	06-09	F&R
RRX 50	06-08	F&R
Spike X50	06-07	F&R
Tango 50 Motard (Cast wheel)	11	R
Tango 50 (4T)	07-08	R
MRX 125	02-08	R

ROXON

Duel 50 SM	06	F&R
Duel 50 TT	06	F&R

SACHS

Madass 50 (2 stroke) (Hydraulic rear brake)	04-05	R
---	-------	---

SCORPA

250 Easy	96	F&R
TY-S 125 F Enduro	03-05	F&R
TY-S 125 F	06-08	F
TY-S 175 F	06	F

SHERCO

All models 0.5-2.0	01-05	F
All models 1.2-2.0	01-05	R
SM 50 Supermotard	03-07	R
SE 0.5	11	R
SM 0.5	11	R
Supermotard 50cc (2T)	02-07	R
Enduro 50 (EN 50)	03-07	R
Enduro 50cc (2T)	02-07	R
SE 1.25 F	11	R
SM 1.25 F Black Panther	11	R
SM 125/125 City Corp	03-06	R
City Corp 125 (All models)	03-07	R
0.8	01-05	F
Trials 0.8 (2T)	01-04	F
Trials 1.25 (2T)	99-05	F&R
Trials 2.0 (2T)	99-05	F&R
Trials 2.5 (2T)	99-05	F&R
Trials 2.9 (2T)	99-05	F&R

SIAMOTO

SX1 125	04	R
---------	----	---

TOMOS

Alpino (Front Disc)		F
APN6		F
Fantastic 25		F
Hip Hop		F
Racing		F
Revival TS		F
SM 125 F	05-08	R
SE 125 F	05-08	R
Youngst'r 50	05-08	F

WK

SM 50	11-12	F&R
Wasp R 50 (2T)	13-15	R

YAMAHA

TZR 50 Power	03-16	R
TY 250 R	91-92	F
TY 250 R	93-94	F&R
TYZ 250 R	93-96	F&R

Equivalents OE # - FA069

3380925	753200	00H01301931	5WX W0045 10	00H01303551
3380928	757215	00D01210221	R051	R051
3499074	59330 06E00	213307100003	460 13 016 000	11966900
8113181	45105 NN2 900	P150442	00009300060	61340051A
510 015 4 282	ODN00G04700141	2525350000	0009307001	R235000
4AJ W0045 00	812732	2525241000	EJ29099074	GA121001T
737786	2525241000	59300 06E00	11955600	D06-45230-00-00
752816	2525350000	KA3497506	2133071000019	
753092	00G04700141	K00996315	K00996315	

MATERIAL AVAILABILITY AND PART NO.

STD		OPTIONS							
FA	V	SFA	SFAC	TT	SFA-HH	HH	R	MXS	EPFA
FA115	FA115V	SFA115	SFAC115	FA115TT	SFA115HH	FA115HH	FA115R	MXS115	-

FA116 31.5 x 57.2 x 5.5mm

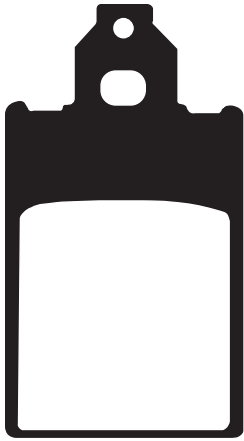

ACCOSSATO

CE 50/80/KR 80 87- R
Enduro Codice 50 89- R

APRILIA

Classic 50 92-01 F
AF1 Futura 40 90-92 F
Europa 50 90-92 F

BETA

TR34 86-88 R
TR34 125 86- R
Tempo 16" 94-97 F
Tempo 98 F
RK6 93-96 R

CAGIVA

W4 50 91-95 F

FANTIC

50.1 Oasis 86- F
50.1 Oasis KS/Rally 86- F
50.1 Oasis E.S. 87- F
50 Fast 88- F

GARELLI

Sahel 50 91- F
Sahel 80 91- F

MALAGUTI

50 Enduro MLX 87- F
Yesterday 98-03 F
FI5 Firefox 96-00 F
Centro SL/SL Cat 94-00 F
CRI Crosser 95-98 F
Centro Base F
F12 Phantom 50 94-03 F

OMP

6 Piston R
Sprocket Brake F

PEUGEOT

SV 100 L R F

PIAGGIO

Free 50 (Disc Model) 95-00 F
Free Delivery 50 00-01 F

TOMOS

Streetmate 03-04 F
Streetmate R F
Revival/Revival TS 03-04 F

YAMAHA

DT 50 R 97-01 F
DR 50 R-L (SM-5VB1/VG55BK) 02-03 F

MATERIAL AVAILABILITY AND PART NO.						
STD	OPTIONS					
FA	SFA	HH	R	MXS	EPFA	
FA116	SFA116	-	-	-	-	

Equivalents OE #		
119 363 00	119 468 000	8213145
5BK F5811 00	119 419 000	07010R
821 3145	752817	
498840	2525250000	

FA118 71 x 38.8 x 10mm

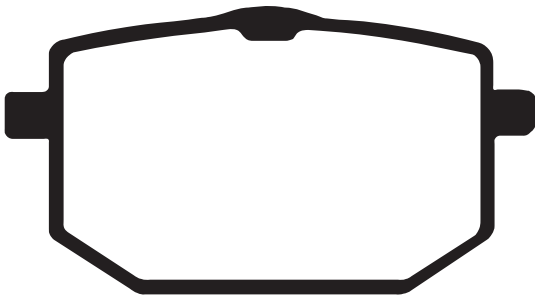

ALFER

VRE 125 4T 98- F
Divertida 250 Super Motard 01- F
Diferente Enduro 01- F
VR 250 98- F

YAMAHA

XT 600 87 F
XT 600 (Z Tenere) 85-90 F

MATERIAL AVAILABILITY AND PART NO.						
STD	OPTIONS					
FA	V	HH	R	MXS	EPFA	
FA118	-	-	-	-	-	

Equivalents OE #
55W W0045 00
55W W0045 01

FA119 82.6 x 21.8 x 7.1mm

YAMAHA

DT 50 LC 98- F
YZ 65 18-20 F
YZ 80 S/T/U/W/E/F/LWF/LWG/G/LWH/H
/LWJ/J/LWK/K/L/LWL/LWM/MN/LWN 86-01 F
YZ 85 (2T - Small Wheel F 17" / R 14") 02-20 F
YZ 85 (2T - Big Wheel F 19" / R 16") 02-17 F
TT-R 125 00-20 F



MATERIAL AVAILABILITY AND PART NO.						
STD	OPTIONS					
FA	V	HH	R	MXS	EPFA	
FA119TT	-	FA119R	-	-	-	

Equivalents OE #	
1LR W0046 00	3UN W0045 00
2HF W0046 00	4ES W0045 00
5PA W0045 00	4P1 W0045 00
2HF W0046 02	

DISC PADS
BUYERS GUIDE

DO NOT REFIT ANY SHIMS/INSULATORS TO EBC PADS FROM ORIGINAL PADS UNLESS INSTRUCTED
ON NOTE ON PAD PACKAGING AND ON FA DRAWING ASSOCIATED WITH THAT PAD.

FA121 81.2 x 42 x 8mm

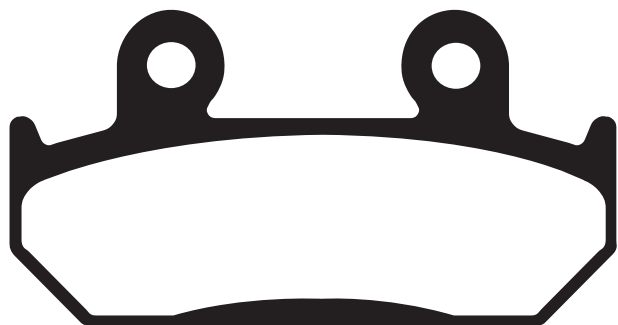

**SAME AS FA203 EXCEPT
REDUCED THICKNESS**

MATERIAL AVAILABILITY AND PART NO.				
STD	OPTIONS			
FA	V	HH	R	MXS
FA121	-	FA121HH	-	-

HONDA		
CBR 250 FG/FGYA (MC14)	86	F
CBR 250 RH (MC17)	87	F
NSR 250 RG (MC16-100)	86	F
CB 350 SG/SJ	86-90	F
CBR 400 RG (NC23)	86	F
CBR 400 RHYA (NC23)	87	F
CB 450 SG/SJ	86-88	F
CBR 500 FH/FJ/FK/FL	87-90	F
CBR 600 FH/FJ/FK/FL	87-90	F
VFR 400 ZG/ZH/RG/RG-YA (NC21)	85-87	F
VFR 400 RH2/RJ (NC24)	87-88	F
XRV 750 L/M/N 'Africa Twin'	90-93	F

Equivalents OE #		
06455 ML4 P00	45105 ML4 000	45105 ML7 017
06455 ML7 P10	45105 ML4 004	45105 MLO 007
451A0 MN4 670	45105 ML4 006	45105 MN4 007
45105 KT7 751	45105 ML4 008	45105 MN4 008
45105 KT7 761	45105 ML4 014	
45105 KT8 004	45105 ML4 024	

FA122 55 x 52.6 x 9.4mm

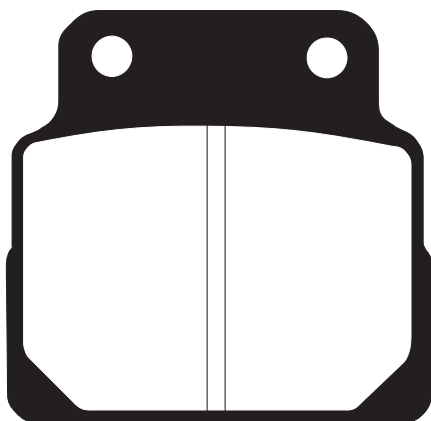

MATERIAL AVAILABILITY AND PART NO.					
STD	OPTIONS				
FA	V	HH	R	MXS	EPFA
FA122	-	-	-	-	-

HONDA		
CB 450 DX-K	89-92	F&R

Equivalents OE #
43105 KK9 691

**DISC PADS
BUYERS GUIDE**

**DO NOT REFIT ANY SHIMS/INSULATORS TO EBC PADS FROM ORIGINAL PADS UNLESS INSTRUCTED
ON NOTE ON PAD PACKAGING AND ON FA DRAWING ASSOCIATED WITH THAT PAD.**

FA123 74.8 x 54 x10mm

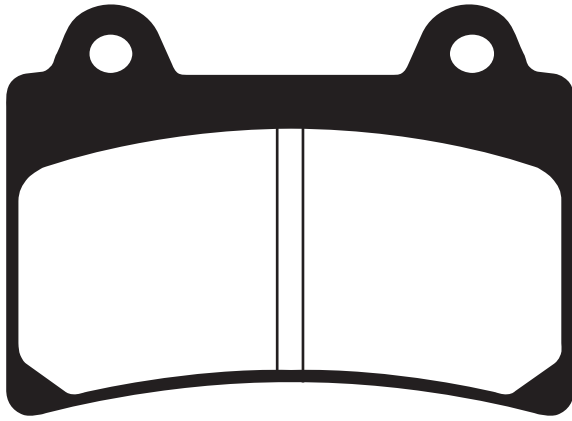

YAMAHA

FZR 250	87	F
TDR 250 (3CK1/3CK2 Europe) (Eng Frame # 3CK-)	88-92	F
TZR 250 (2MA/2XW1/2XW2 Europe) (Eng Frame # 2MA-)	87-92	F
TZR 250 (1KT/2AW Japan) (Eng Frame # 1KT-000/056)	87	F
TZR 250 (2XT1 Japan) (Eng Frame 1KT-09)	88	F
FZR 400 (3EN1/3EN2)	88-89	F
FZR 400 RSP (2TK-EX-UP)	87	F
SRX 400 (3VN1/3VN2/3VN5)	90-96	F
SRX 600 (3SX)	90-91	F
FZ 750	89-91	F
FZR 750 'Genesis'	87	F
TDM 850	91-95	F
TRX 850	96-99	F
FZR 1000 Genesis	87-88	F
FJ 1200 (3CV/3XW type)	88-95	F
FJ 1200 A (ABS model)	91-95	F
XJR 1200	95-98	F
XVZ 13 AH/ATH "Royal Star" Royal Star Classic	96-00	F&R
XVZ 1300 TF Venture Star	99-01	R
XV 1600 Wildstar	99-04	R

Equivalents OE

1NL W0045 00	2GH W0045 01
1NL W0045 01	3EN W0045 00
1RK W0045 00	4KG W0045 00
1RK W0045 50	4NK W0046 00
1RK W0046 00	4NK W0045 00
2GH W0045 00	4WM W0046 00

MATERIAL AVAILABILITY AND PART NO.

STD	OPTIONS				
	V	HH	R	MXS	EPFA
FA123	FA123V	FA123HH	-	-	-

FA124 87.9 x 41.1 x 8.8mm

FA124/2 87.9 x 41.1 x 9.8mm

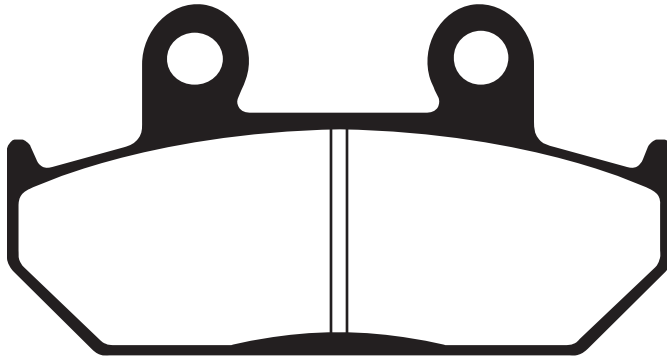

FA124

HONDA

RS 125/250	88-89	F
CBR 750 FH Superaero	87-88	F
VFR 750 FG/FH	86-87	F
CBR 1000 FH/FJ	87-88	F

FA124/2

CAGIVA

Canyon 500	96-00	F
Canyon 600	96-99	F
E 750 Elefant	93-95	F
E 900 Elefant Dakar Rep (300mm front disc)	90	F
E 900 ie Lucky Explorer (296mm front disc)	90	F
E 900 ie GT (296mm front disc)	91-92	F

HONDA

CD 250 UJ	88-92	F
GB 250 J/L/P/S/V 'Clubman'	89-97	F
VTZ 250 H/J/K	86-88	F
NV 400 C/J/CK 'Steed'	92-93	F
NX 500 J/K/L/M/N/P/R/S/T Dominator	92-96	F
XL 600 VM/VN/VP Trans Alp	91-93	F
VT 600 C/N "Shadow Custom"	93	F
NX 650 J/K/L/LI/M/N/P/R/S/T "Dominator"	88-96	F
XRV 650 J Africa Twin	88-89	F
GL1500 J/K/SEM/SEN/SEP/SER/SES/SEV/SEW/SEX/SEY "Goldwing"	88-00	F

Equivalents OE #- FA124

45105 ML7 006	45105 MM5 008	45105 MM5 017
45105 ML7 007	45105 NF4 000	06455 MM5 P00
45105 MM5 007	451A0 ML7 670	

Equivalents OE #- FA124/2

06455 MT8 405	45105 MN5 018	45105 MT8 008
06455 MS8 405	45105 MN9 008	45106 MW3 671
06455 MV4	45105 MR1 671	451A0 MT8 670
06455 MS8 405	45105 MS6 901	451A0 MT2 670
06455 MS6 P00	45105 MS8 008	8000 66796
45105 KV0 701	45105 MT2 007	
45105 MN5 008	45105 MT2 008	

MATERIAL AVAILABILITY AND PART NO.

STD	OPTIONS				
	V	HH	R	MXS	EPFA
FA124	-	FA124HH	-	-	-

MATERIAL AVAILABILITY AND PART NO.

STD	OPTIONS				
	V	HH	R	MXS	EPFA
FA124/2	FA124/2V	FA124/2HH	-	-	-

DO NOT REFIT ANY SHIMS/INSULATORS TO EBC PADS FROM ORIGINAL PADS UNLESS INSTRUCTED ON NOTE ON PAD PACKAGING AND ON FA DRAWING ASSOCIATED WITH THAT PAD.

FA125 94.2 x 32 x 7.3mm



1 Left/1Right

ALSO SEE FA185 FOR OVERSIZE PAD

HONDA

CRM 50 RN/RP/RR/RT	93-96	F
CRM 75 RK/RL/RM/RP/RR	89-94	F
CR 125 RH/RJ/RK/RL/RM/RN/RP/RR	87-94	F
AX-1 (NX 250 J/K/R/R3)	89-94	F
CR 250 RH/RJ/RK/RL/RM/RN/RP/RR	87-94	F
CRM 250 R (RK) MK1/MD24 (100001-1008385)	89-90	F
CRM 250 R (RM) MK2/MD24 (1200001-1211634)	91-92	F
CRM 250 R (RP-RP-11) MK2/2 MD24 (1300001-)	93	F
NX 250 J/K/L/ZL/M/P/2P	87-93	F
TRX 250 RG/RH/RJ/RK	86-89	F
XL 250 RL	90	F
XR 250 RJ/RK/RL/RM/RN/RP/RR/RS	88-95	F
CR 500 RH/RJ/RK/RL/RM/RN/RP/RR	87-94	F
XR 600 RJ/RK/RL/RM/RN	88-92	F

Equivalents OE

45105 HA5 671A	45105 KW3 681	45106 KY7 008
45105 HA5 672A	45105 KY7 008	45106 KW3 681
45105 HA5 672B	45106 HA5 671B	451A0 HB9 670
45105 KS6 831A	45106 HA5 672B	
45105 KT0 405	45106 KS6 701A	
45105 KZ1 405	45106 KS6 701B	
45105 KW3 405	45106 KS6 831B	

MATERIAL AVAILABILITY AND PART NO.					
STD	OPTIONS				
FA	V	HH	R	MXS	
FA125TT	-	FA125R	-	MXS125	

FA126 67.5 x 51 x 7mm



ALFER

125 MC	88-	F	GFR 125	94	F
250 MC	88-	F	Nordwest	94-96	F
250 GR/Enduro	88-	F	125 CX	91-	F
300 GR/Enduro	88-	F	125 MX1/MXR	89-	F
APRILIA			125 SP 01/SP 02	89-	F
AF-1 125	88-91	F	Nord-West 350	94-	F
RS 125 All models	92-05	F	KTM		
Tuono 125	03-04	F	Most Models	87	F&R
BENELLI			MALAGUTI		
Devil 50	92-	F	Madison 125	99	R
Spring 50	93-	F	MOTO GUZZI		
Devil 80	92-	F	Quota 100 D	93-95	F
Tamo 125	89-	F	1000 Quota	92-97	F
BETA			MZ		
Euro 350	00-02	F	Skorpion replica	95-96	F

MATERIAL AVAILABILITY AND PART NO.					
STD	OPTIONS				
FA	TT	HH	R	MXS	EPFA
FA126	FA126TT	FA126HH	FA126R	-	-

Equivalents OE #	
8113489	90214 01000
000306546310	GU30654631

FA128 A. 35 x 85 x 8mm B. 37 x 55.5 x 9.8mm

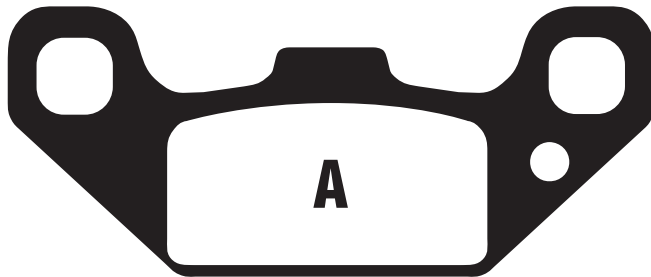

A

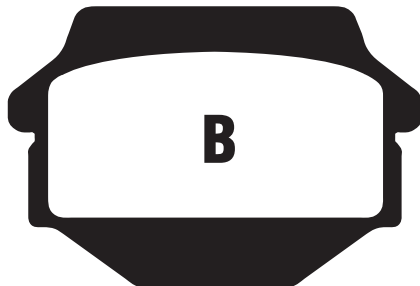

B

KAWASAKI

KXF 250 A1/A2 Tecate 4	87-88	F
KSF 250 A1-A18	87-04	F
KEF 300 B1/B2 Lakota Sport	01-02	F
SUZUKI		
LT 250 RH/RJ/RK/RL	87-90	F
LT 500 RL	90	F

MATERIAL AVAILABILITY AND PART NO.					
STD	OPTIONS				
FA	V	HH	R	MXS	EPFA
FA128TT	-	FA128R	-	-	-

Equivalents OE #	
43082 1067	
59100 43810	
59300 03840	

FA129 A. 141 x 41.5 x 9.7mm B. 95 x 34.5 x 9.7mm

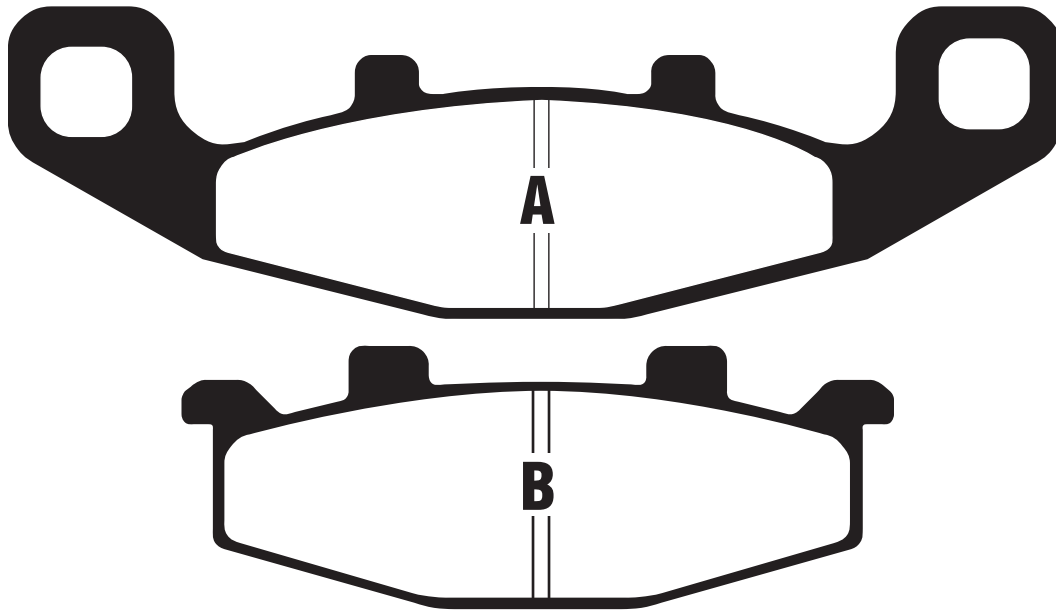

HYOSUNG

Comet 250/600

KAWASAKI

GPX 250 R (ZX 250 F2-F9)

GPX 250 R (EX 250 F)

KLE 250 A2 (Anhelo)

KLE 250 A3/A5/A6

ZZR 250 (EX 250 H1-H13)

ZR 250 A1-A5

GPX 400 R (ZX 400 F1)

GPZ 400 R 'D4'

ZL 400 D1/D2

ZRX 400 (ZR 400 E1/E2)

ZZR 400 (ZX 400 K1/K2/K3)

ER-5 (ER500 A1/A2/A3/A4)

GPz 500 S (EX 500 A1-A6/D1-D7)

KLE 500 A1-A12

KLE 500 B1P/B6F/B7F

ZR 550 B2-B6 "Zephyr"

02 F

88-95 F

87 F

95 F

97/00-01 F

90-03 F

91-95 F

87 R

88 R

94-95 F

94-95 F

90-92 R

97-00 F

87-01 F

91-04 F

05-07 F

91-99 F

KAWASAKI Contd.

GPx 600 R (ZX 600 C1-C7)

ZL 600 B1 "Eliminator"

ZZ-R 600 (ZX 600 D1-D3)

KL 650 B1-B3 "Tengai"

GPX 750 R (ZX 750 F1-F3)

ZR 750 C1-C5 'Zephyr'

ZR 750 D1 'Zephyr'

GPz 900R A7-A8

GPZ 900 R (ZX 900 A11)

GPZ 900 R (ZX 900 A12-15)

ZX 100 B1-B3 (ZX-10)

ZG 1000 A9-A18 (1000 GTR)

ZZR 1100 (ZX 1100 C1-C3)

ZR 1100 A1-A4 'Zephyr'

ZR 1100 B1 'Zephyr'

ZR 1100 B5 (Zephyr 1100 RS)

SUZUKI

88-96 F&R

95-97 F

90-93 R

89-92 F

87-89 F&R

91-95 F&R

96- R

90-96 R

98 R

99-02 R

88-90 F&R

94-03 F

90-92 R

92-95 R

96-97 R

02 R

RG 125 UN "Wolf"

RG 125 UN "Wolf" (NF13E) Naked

GSF 250 N/ZM/P/NP/ZP/N/NR

GSX 250 SSM Katana (GJ76A)

GSX 250 FL/FM/FN/FP/FR/FS/FT

/FV/FW Across

SW-1 250 (NJ45A)

GSF 400 M/N/P Bandit

GS 500 EK/EL/EM/EN/EP/ER/ES

DR 800 SM/SN/SP/SR/SS (SR43B)

VX 800 L/M/N/P/R

GSX 1100 GM/GN

92-94 F

92-94 F

92-96 F

91 F

90-98 F

92 F

91-95 F

89-95 F

91-95 F

90-95 F

91-94 F

MATERIAL AVAILABILITY AND PART NO.					
STD	OPTIONS				
FA	V	HH	R	EPFA	
FA129	FA129V	FA129HH	FA129R	EPFA129HH	

Equivalents OE #		
43082 1068	43082 1114	59100 01820
43082 1069	43082 1123	59100 26810
43082 1074	43082 1124	59100 45860
43082 1077	43082 1134	59301 45860
43082 1088	43082 1139	59302 45810
43082 1095	43082 1161	
43082 1104	43082 1189	

FA130 A. 73.3 x 49.3 x 7mm B. 60.8 x 62.8 x 9mm

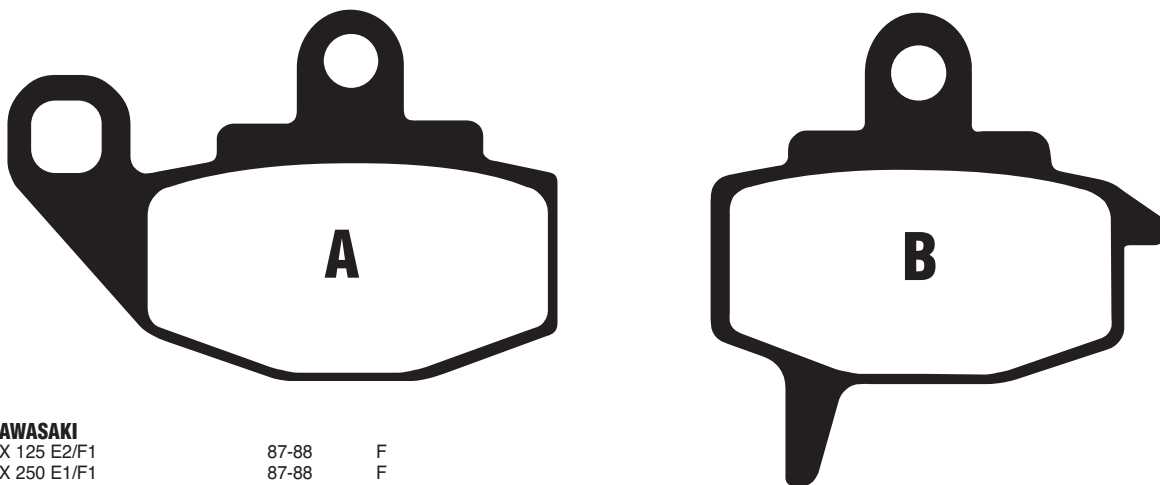

KAWASAKI

KX 125 E2/F1

KX 250 E1/F1

KX 500 C1/D1

KLR 650 A1-A3

87-88 F

87-88 F

87-88 F

87-89 F

MATERIAL AVAILABILITY AND PART NO.					
STD	OPTIONS				
FA	V	HH	R	MXS	EPFA
FA130TT	FA130V	-	FA130R	-	-

Equivalents OE #
43082 1072
43082 1078

DO NOT REFIT ANY SHIMS/INSULATORS TO EBC PADS FROM ORIGINAL PADS UNLESS INSTRUCTED ON NOTE ON PAD PACKAGING AND ON FA DRAWING ASSOCIATED WITH THAT PAD.

FA131 75 x 36 x 10.5mm

*FA131R/MXS 75 x 36 x 9.5mm

FA131/2 75 x 36 x 7.5mm

FA131/3 75 x 36 x 9.5mm



* This pad is made to a thinner dimension to allow fitting of radiator shims to the back of pads if required.

FA131TT

AJP

PR5 Supermoto 250cc 09 R
PR5 Enduro 250cc 09 R

CPI

Sauel 125 R

GAS-GAS

EC 125/200/250/300 00-08 R
Pampera 125 (2T) 05-08 R
Enduro EC 200/250/300 99-00 R
MX 125/250 (MC) 01-08 R
MX 200/250/300 99-00 R
SM 125/250/400 FSE 02 R
SM 125/250 (2T) 01-06 R
SM 125 (2T) Supermotard 03-06 R
SM Halley 125cc 09 R
Trail Halley 125cc 09 R
Pampera 400 06 R
SM 400 FSE (2T) 01-02 R
EC 450 FSR/FSE Enduro (4T) 05-09 R
Pampera 450 (4T) 07-08 R
SM 450 FSR (4T) Supermotard 07-09 R
SM Halley 450cc 09 R
Trail Halley 450cc 09 R
EC 515 FSR/FSE Enduro (4T) 05-09 R
SM 515 FSR (4T) Supermotard 07-09 R

GOES

G 125 XM 08-09 R
G 250 XM 08-09 R

HONDA

CB 50 V/W Dream 50 97-98 R
XR 50 M5 (AD14) Motard 05 R
CR 80 RN/RP/RR/RS/RT/RBT/RV/RBV /RW/RBW/RX/RBX/RV/RBY/R1/RB1 /R2/RB2 92-02 R
CR 85 R3/RB3/R4/RB4/R5/RB5/R6 /RB6/R7/RB7 03-07 R
NH 90 M/P/R Yuppy 95-97 F
XR 100 MS (HD13) Motard 05 R
CR 125/250/500 RH/RJ/RK/RL/RM/RN /RP/RR/RS/RT/RV/RW/RX/RV/R1 87-01 R
CRF 230 L 08-10 R
CRF 230 M Supermoto 09-10 R
SL 230 'Free Landports' (MD33) V/W/X/1 97-01 R
CRM 250 R (RM) MK2/MD24 (120001-1211634) 91-92 R
CRM 250 R (RP-RP-11) MK2/2 (MD 24 1300001-) 93 R

HONDA Contd.

CRM 250 'Active Radial' (MD32) 97-98 R
ARV/ARW 90 R
XL 250 RL 91- R
XLR 250 RM/R3N/RP/RR/R3R (MD22) 90-95 R
XR 250 RL/RM/RN/RP/RR/RS 96-04 R
XR 250 RT/RV/RW/RX/RV/R1/R2/R3/R4 00-03 R
XR 250 Y/3 (MD30) 03-05 R
XR 250 3/5 (MD30) Motard 00-03 R
XR 250 III Y/3 Baja 10 R
XR 300 R10 02-05 R
NX4 Falcon 96-05 R
XR 400 RT/RV/RW/RX/RV/R1-R5 06-08 R
XR 400 M (ND08/NC38E) Supermotard 91-00 R
XR 600 RM/RP/RR/RS/RT/RV/RW/RX/RV 00-06 R
XR 650 RY/R1-R6 93-20 R
XR 650 L 04 R
HONDA DALL'ARA
XR 250 R 04 R
XR 650 R 04 R
HONDA HM (Italy)
CRE 80 98-02 R
CR 85 R/R2 03-07 R
CRE 125 95-97 R
CRE 125 98-01 R
HYOSUNG
RX 400 05 R
HUSQVARNA
WXE 125 07 R
KAWASAKI
KX 125 K2-K5/L1/L2/L3/L4/M1/M2/M3 /M6F-M8F 95-08 R
KLX 250 J1-J6 D-Tracker 98-03 R
KLX 250 H6F/H7F 06-07 R
KLX 250 F 09-20 R
K 250 K2-K5/L1/L2/L3/L4/M1/M2/R1 /R6F-R8F 95-08 R
KLX 300 A2/A3/A4/A5/A6/A7/A8/A9 /A10/A6F/A7F 97-07 R
KLX 400 R (KLX 400 B1/B2) 03-04 R
KX 500 E8-A16 96-04 R
SUZUKI
DR 125 SMK8/SMK9/SML0 08-12 R
RM 125 T/V/W/X/Y/K1-K9 96-12 R
RM 125 XCK8 09 R
RM 250 T/V/W/X/Y/K1-K9 96-12 R
RM 250 XCK8 09 R
RMX 250 ST/SV/SW/SX (Sj14A) 96-99 R
250 SBK2 (LX 250 L) 02 R

SUZUKI Contd.

DR-Z 400 SEY/EY/Y/SEK1/EK1/K2/SEK2 /EK2/K3/SEK3/EK3/K4/SEK4/EK4/EK5 /SK5/SK6/K6/SK7/K7/EK7/SK8/SK9 00-09 R
DR-Z 400 SMK5/SMK6/SMK7/SMK8 /SMK9 05-09 R

TM

MX 85 JR 02-04 R
MX 85 (Big Wheel) 02-04 R
MX 125 (2T) 01-04 R
Enduro EN 125 (2T) 01-04 R
MX 250 (2T) 01-04 R
Enduro EN 250 (2T) 01-04 R
EN 250 F (4T) Enduro 04 R
SM 250 02 R
SME 250 (4T) 04 R
MX 250 (4T) 02-04 R
MX 300 (2T) 01-04 R
Enduro EN 300 (2T) 01-04 R
400 (4T) MX Cross 02-03 R
SM 400 02-03 R
SME 400 (4T) 04 R
EN 450 F (4T) 04- R
MX 450 F (4T) 04- R
530 (4T) Cross 02-03 R
EN 530 F (4T) 04- R
SM 530 02-03 R
SME 530 (4T) 04 R

YAMAHA

YZ 125 K/L/M/N/P 98-02 R
YZ 250 K/L/M/N/P/R/S/T/V/W 98-02 R
YZ 250 FN/FP (4T) 01-02 R
WR 250 ZK 98 R
WR 250 FN/FP (4T) 01-02 R
WR 400 FL/FM/FN 99-01 R
YZ 400 FL 99 R
WR 426 FN/FP 01-02 R
YZ 426 FM/FN/FP 00-02 R

SFA131/2

PEUGEOT
SV 50 80/125 Geo 91-92 F
SYM (SANYANG)
SR 100 Sunrise 97- F
HONDA
NSR 50 X (AC10-190) 99 R
NS-1 75 92- R

SFA131/3

HONDA
NSR 50 RV/RW/RX/RV 97-00 R
NSR 50 V (AC10-180) 97 R
SRX 50 T/W/X 'Joker/Shadow' 97-99 F
NSR 75 N/P/R/X/Y (NS-1/NSR 80) 92-00 R
NSR 80 J-2/K/L/N/P/R/S (HC06) 88-93 R
NSR 80 V (HC06-170) 97 R
NSR 80 X (HC06-180) 99 R
Lead 90 88- F
NH 90 M/P/R 91-94 F
SRX 90 T/W/X 'Shadow' 97-99 F
PEUGEOT
SV 50 80/125 Geo 93- F

Equivalents OE # - FA131				
06435 KCZ 000	43105 KZ1 405	5ET W0046 00	43082 1267	69100 37830
06455 6CK 006	43105 MY6 415	5GR W0046 00	5MV W0046 00	69095
43082 0090	43106 GT4 004B	69100 36820	43082 5010	69096
43082 1228	43106 GW2 004B	69100 36830	43082 5012	00TRS01A0075
43105 GT4 004A	43106 KS6 701B	69100 36840	43082 1292	
43105 GW2 004A	43106 KS6 702B	69100 36850	69100 37810	
43105 KS6 701A	43082 1173	69100 36860	BE2500 22068	
43105 KS6 702A	5DH WD0046 00	69100 36870	69400 37820	

MATERIAL AVAILABILITY AND PART NO. OPTIONS				
STD	HH	R	MXS	EPFA
FA131TT	-	FA131R	MXS131	EPFA131HH

Equivalents OE # - SFA131/2
752394
752071
752391

Equivalents OE # - SFA131/3
06435 GT4 405
06431 GW2 405

MATERIAL AVAILABILITY AND PART NO. OPTIONS				
STD	HH	R	MXS	EPFA
SFA131/2	SFA131/2HH	-	-	-

MATERIAL AVAILABILITY AND PART NO. OPTIONS				
STD	HH	R	MXS	EPFA
SFA131/3	SFA131/3HH	-	-	-

FA132 79.6 x 46.5 x 9mm

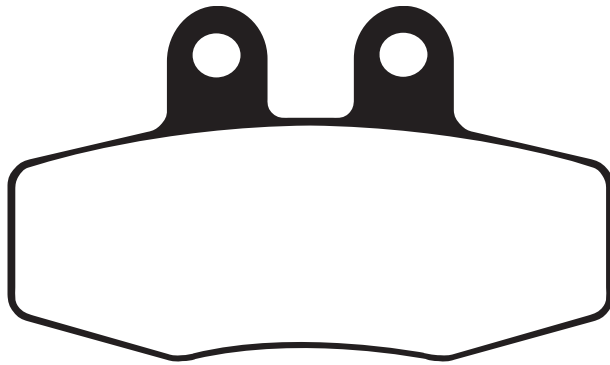

KTM		
Most 1988 Models	88	F&R
Enduro Models	89-91	F&R
250/300 E/XC/GS	90-91	F
125/350 E/XL/GS	90-91	F&R
125/250/300/600 Enduro	92-93	F
125/250/400/600 LC Models	89-91	F&R
MX 125	89-91	F&R
MX 125	92-93	F
EXC 125	89	F&R
D-XC/E-XC/E-GS 125	90-91	F&R
D-XC/E-XC/E-GS 125	92-93	F
MX 250	88-91	F&R
EXC/EGS 250	88-89	F&R
DXC/EXC 5-0	90	F&R
D-XC/EXC/E-GS 250	91	F&R
D-XC/E-XC/T-XC/E-GS 250	92-93	F
MX/EXC/EGS 350	88	F&R
MX 350	89-91	F&R
DXC/EXC/EGS 350	90-91	F&R
EXC 350	89	F&R
LC-4 MX/EXC 500	89-91	F&R
LC-4 MX/EXC 600	89-91	F&R
LC-4 EXC 600	92-93	F
MAICO		
All Models	89-93	F&R
250 MX	94-98	F&R
500 MX	94-98	F
OSSA		
500	92	F
PHB		
500	92	F

MATERIAL AVAILABILITY AND PART NO.					
STD	OPTIONS				
FA	V	HH	R	MXS	EPFA
FA132	-	-	FA132R	-	-

Equivalents OE #
565 13209544
565 13209323

FA134 99.8 x 46.7 x 8.5mm

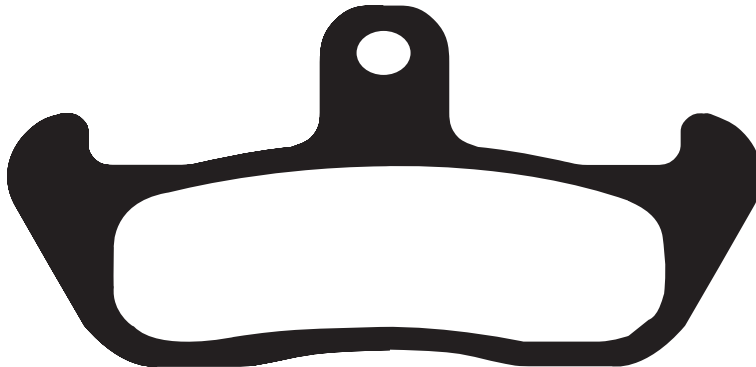

NOTE

EBC pads are supplied with close tolerance slider pin holes and do not therefore require use of original anti-rattle clip slider pin hole.

APRILIA					
AF1 125	87	F			
CAGIVA					
Cruiser 125	87	F			
WMX 125	89	F			
Excaliber 501 RLX	92	F			
WMX 250	86-89	F			
WM 125	87-88	F			
750 Elefant	90-92	F			
GILERA					
125 Apache	91-	F			
RC 125 Top Rally	89-92	F			
RC 600	89-90	F			
HONDA HM (Italy)					
CRE 50 Six/Baja/Derapage Brembo caliper/Kayaba forks	95-02	F			
HUSQVARNA					
CR 125	91	F			
WR 125	87-88/91	F			
CR 240	87-88	F			
WR 240	87-88/90-91	F			
CR 250	87-88/91	F			
WR 250	87-88/90-91	F			
XC 250	87-88	F			
WR 260	90-91	F			
TE 350	90-91	F			
WR 400	87-88	F			
CR 430	87-88	F			
WR 430	87-88	F			
HUSQVARNA Contd					
XC 430	87-88	F			
430 Automatic	87-88	F			
CR 500	87-88	F			
XC 500	87-88	F			
TC 510	89-90	F			
TE 510	89-90	F			
WMX 510	89	F			
WXE 510	89	F			
TC 610	91	F			
TE 610	91	F			
KRAM-IT (KRAMER)					
ER 125/250/300 RV3	88-	F			
ER 500/600	96-	F			
MOTO MORINI					
Excaliber 350/501 RLX	93-	F			
Dart 350	87	F			
YAMAHA					
TDR 125 (3HS1/3XDO/3HS3/3XD01)	89-93	F			
TDR 125 R Lightburner (3SH2/3XE2)	93-94	F			

MATERIAL AVAILABILITY AND PART NO.					
STD	OPTIONS				
FA	V	HH	R	MXS	EPFA
FA134	-	-	FA134R	-	-

Equivalents OE #
341878
2VW F0047 00
K00946315

DISC PADS
BUYERS GUIDE

DO NOT REFIT ANY SHIMS/INSULATORS TO EBC PADS FROM ORIGINAL PADS UNLESS INSTRUCTED ON NOTE ON PAD PACKAGING AND ON FA DRAWING ASSOCIATED WITH THAT PAD.

FA135 A. 96.7 x 42.7 x 7.4mm B. 77 x 42.2 x 7.4mm

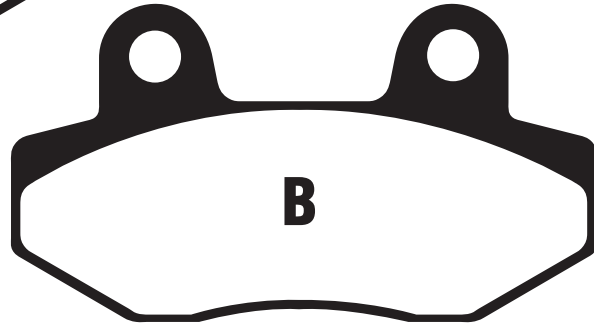
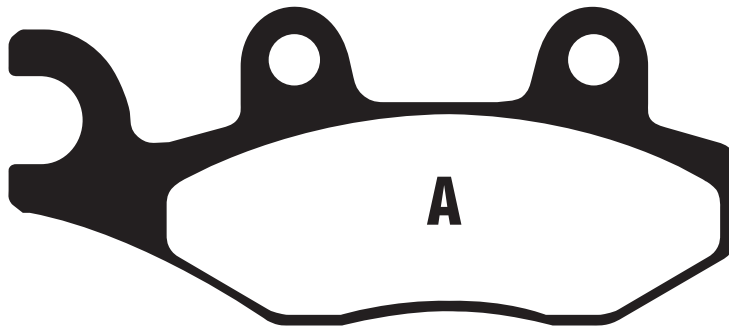

AEON

Crossland 400 (2x4) 12-15 R
Crossland 400 (4x4) 12-15 R

APACHE

RLX 250 S/SX (Mk1) Rear disc model R

BAROSSA QUADS

170 Sport 03-04 R
170 Cheetah/Magna 03-05 R
Quarterback 250 05 R

CAN AM (SIDE X SIDE)

Commander 800 (XT/DPS) 11-15 F(right)&R
Commander 800 R (STD) 11-15 F(right)&R
Commander 800 R XT 11-14 F(right)&R
Commander 1000 (STD) 11-15 F(right)&R
Commander 1000 X 11-13 F(right)&R
Commander 1000 XT 11-15 F(right)&R
Commander 1000 XT-P 14-15 F(right)&R
Commander 1000 (DPS) 13-15 F(right)&R
Commander 1000 LTD 12-15 F(right)&R
Maverick 1000 R STD 13-14 F(right)
Maverick 1000 R-XRS 13-14 F(right)
Maverick 1000 R-XRS/DPS 14 F(right)
Maverick 1000 R XMR 14 F(right)
Maverick 1000 R XXC 14 F(right)

CF MOTO

CF 500 3
(Rancher 500 Side x Side) 10-11 F(left)
CF 500 AU-6L - C Force 550 (ATV) 15 R
CF 500 US - Z Force 550
(Side x Side) 15 F(left)
CF 500 UU U Force 550
(Side x Side) 15 F(left)
CF 600 Z Force Z8 (Side x Side) 13-15 F(left)
CF 600 Z Force Z8-EX
(Side x Side) 13-15 F(left)
CF 625 3 (Z6 Terra Cross) 11-12 F(left)
CF 800 Z Force Z8 (Side x Side) 13-15 F(left)
CF 800 Z Force Z8-EX
(Side x Side) 14-15 F(left)
CF 800-3 (Tracker 800 Side x Side) 13 F(left)
CF 800 UU-AA U-Force 800 14-16 F(left)
U Force 800 (Side x Side) 14-16 F(left)

ECO

Bushman 150 (LX 150 GY) F

GAS GAS

KZ 250 RV Quad 06 F(left)

GOES

G 520 UTX (Side x Side) 10-11 F(right)

HUSQVARNA

CR 125 92-94 F
WR 125 93-94 F
CR 250 92-94 F
WR 250 92-94 F
TE 350 92-94 F
CR 360 92-94 F
WR 360 92-94 F
TE 610 92-94 F
TC 610 92-94 F

KAWASAKI

KLX 125 CAF/CBF/CCF/CCS
/CDS/CDF/CEF/CFE/CGF
KLX 125 DAF/DBF/DCF/DDF
/DEF D-Tracker 10-14 F
KX 125 G1/H1/H2/J1/J2 89-93 F
KLX 150 L (KLX 150 EFF) 14-15 F
KLX 150 D-Tracker (KLX150 HGF) 16 F
KDX 200 E5/E6 93-94 F

KAWASAKI Contd.

KDX 200 SR (DX200G) 89-93 F
KX 250 G1/H1/H2/J1/J2 91 F
KDX 250 SR (KDX 250 F1) 91 F
KDX 250 D1 91-93 F
KLX 250 F 09-20 F
KLF 300 C1-C17 "Bayou" 89-05 F(right)
KLX 300 R 19-20 F
KVF 650 FCF/FCS/FDF 12-13 F(right)
KLF 400 B1-B7 Bayou 93-99 F(right)
KX 500 E1-E5 89-93 F
KVF 650 F7F/F8F Brute Force
4x4i Hardwoods Green 07-08 F(right)
KVF 650 H7F/H8F
Brute Force 4x4i 07-08 F(right)
KVF 650 67F/68F Brute Force
4x4i Hardwoods Green 07-08 F(right)
KVF 750 A1/B1/A2/B2
Brute Force 4x4 05-06 F(right)
KVF 750 E8FA Brute Force 4x4
Hardwoods Green HD 08 F(right)
KVF 750 D8F/D9F/DAF/DBF 08-11 F(right)
KVF 750 GCF/GDF/GEF/GFF
/GGF/GHF Brute Force
4X4i EPS 12-17 F(right)
KVF 750 HCF/HDF/HEF/HFF
/HGF/HHF Brute Force
4X4i EPS/Camo 12-17 F(right)
KVF 750 JCF/JDF/JEF/JFF/JGF
/JHF Brute Force 4x4i EPS 12-17 F(right)
KVF 750 LCF/LDF/LEF/LFF/LGF
/LHF Brute Force 4x4i 12-17 F(right)
KRF 750 Teryx 750 4x4 (RUV)
A8F/B8F 08 F(right)
KRF 750 Teryx 750 4x4 LE (RUV)
C8F/D8F 08 F(right)
KRF 750 TAF/VBP
Teryx 750 Fi 4x4 SGO 10-11 F(right)
KRT 750 ACF/ADF
(Tyrex 4 750 4X4) 12-13 F(right)
KRT 750 ACF/ADF
(Tyrex 4 750 4X4 EPS) 12-13 F(right)
KRT 750 CCF/CDF
(Tyrex 4 750 4X4 EPS LE) 12-13 F(right)
KRF 750 G9F/NAF/NBF/NCS/NDF
Teryx 750 Fi 4x4 09-12 F(right)
KRF 750 J9FA/K9F/PAF/RAF/PBF
/RBF/RCS/PDF/RDF
Teryx 750 Fi 4x4 LE 09-13 F(right)
KRF 750 L9F Teryx 750 Fi
4x4 LE Sport 09 F(right)
KRF 750 M9F Teryx 750 Fi 4x4
NRA Outdoors 09 F(right)
KRF 750 SAF/SAFA/SBF/SBFA
/SCS/SCSA Teryx 750 Fi
4x4 Sport LE 10-12 F(right)
Teryx 750 4x4 NRA Outdoors (RUV)
KRF 750 F8F 08 F(right)
KRF 800 BEF/BFF/FGF/FHF/FJF
(Teryx) 14-18 F(right)
KRF 800 CEF/CFE/CGF/GHF/GJF
(Teryx LE) 14-18 F(right)
KRF 800 DEF/DFE/DGF/HGF/HJF
(Teryx Camo) 14-18 F(right)
KRT 800 BEF/BFF/FGF/FHF/FJF
(Teryx 4) 14-18 F(right)

KAWASAKI Contd.

KRT 800 CEF/CFE/CGF/GHF/GJF
(Teryx 4 LE) 14-18 F(right)
KRT 800 DEF/DFE/DGF/HGF/HJF
(Teryx 4 Camo) 14-18 F(right)
KAF 820 AFF/AGF/AHF/AJF
Mule Pro FXT 15-18 F(right)
KAF 820 BFF/BGF/BHF/BJF
Mule Pro FXT/EPSS 15-18 F(right)
KAF 820 CFF/CGF/CHF/CJF
Mule Pro FXT/EPSS LE 15-18 F(right)
KAF 820 DFF/DGF/DHF/DJF
Mule Pro FXT/EPSS Camo 15-18 F(right)
KAF 820 EGF/EHF/EJF
Mule Pro FX 16-18 F(right)
KAF 820 FGF/FHF/FJF
Mule Pro FX/EPSS 16-18 F(right)
KAF 820 GGF/GHF/GJF
Mule Pro FX/EPSS LE 16-18 F(right)
KAF 820 HGF/HHF Mule
PRO - FX/EPSS Camo 16-17 F(right)
KAF 820 JGF/JHF Mule PRO
- FXT Ranch Edition 16-17 F(right)
KAF 1000 AGF/AHF/AJF
Mule Pro DXT/Diesel 16-18 F(right)
KAF 1000 BGF/BHF/BJF
Mule Pro DXT/Diesel EPS 16-18 F(right)
KAF 1000 CGF/CHF -
Mule Pro DXT EPS LE/Diesel 16-17 F(right)
KAF 1000 DGF/DHF -
Mule Pro DX /Diesel 16-17 F(right)
KAF 1000 EGF/EHF/EJF -
Mule Pro DX EPS/Diesel 16-18 F(right)
KAF 1000 FGF/FHF -
Mule Pro DX EPS LE/Diesel 16-17 F(right)
KAF 1000 DGF Mule Pro DX Diesel 16 F(right)
KAF 1000 BGF Mule Pro DXT Diesel 16 F(right)

KREIDLER

125 DD Supermoto 12-13 F

LEXMOTO

Milano 125 EFI (FT125T-27-E4) 16-20 R
Adrenaline 125 XFLM125GY-2B 13-18 F
Michigan 125 (ZS125-79) 13-20 F

MOTO ROMA

Road Runner 125 04-05 F

PUZEY

MTD 300 (4T/4V) (Motard model) 11-12 F
MX 300 (4T/4V) (Enduro model) 11-12 F

QUADZILLA

Stingr R170E 06 R
ST 200 E (Automatic) 06 R
Z8 4X4 (Side X Side/800cc) 14-15 F (Left)

SINNIS

Apache 125 QM 125 GY-2B(A)
(Rear disc model) 09-10 F
Apache (Rear drum model) 09-10 F
Apache SM/SMR 125 15-20 F
Blade 125 QM 125 GY-2B 08-10 F
Blade X 125 15-20 F
QM 250 GY-D Apache 250 13-14 F

SUPERBYKE

RMR 125 07-09 F

SUZUKI

EN 125-2/125-2A 05 F
TS 125 RK/RL/RM/RN/RP/RR 90-96 F
RM 125/250 H/J/K/L/M/N/P/R/S 87-95 F
TS 200 RK/RL/RM/RN/RP/RR 89-94 F

DO NOT REFIT ANY SHIMS/INSULATORS TO EBC PADS FROM ORIGINAL PADS UNLESS INSTRUCTED
ON NOTE ON PAD PACKAGING AND ON FA DRAWING ASSOCIATED WITH THAT PAD.

FA135 Contd.

SUZUKI Contd.

DR 250 SL/SM/SN/SEP /SER/SES (SJ448)	90-95	F
RMX 250 K/M/N/P/R/S	89-95	F
RMX 250 SN/SR/SS (SJ13A)	95-97	F
LT-F 300 FK2	02	F(right)
DR 350 SL/SM/SN/SP 4 bolt front disc/kick start	90-93	F
DR 350 SER/SES (Electric start /4 bolt front disc)	94-95	F
DR 350 SET/SEV (Electric start /4 bolt front disc)	96-97	F
LT-R 450 K6/K7/K8/K9/L0/L1	06-12	F(right)
LT-A 500 FY/FK1	00-01	F(right)
LT-F 500 FW/FX/FY/FK1/FK2	98-02	F(right)

YAMAHA

XTZ 125 K/E	05-10	F
XTZ 125 (5RM)	03-10	F

YAMAHA Contd.

YZ 125 W/A/B/D/E/F/G/H/J	89-97	
DT 200 WR (3XP)	92-93	
WR 200 D/E/F	92-94	
DT 230 (4TP1/2) Lanza	91-98	
TT 250 R (4GY) Raid/4MR2	96	
TT 250 R RL/RM/RN/RP/RR/RS	99-04	
TT 250 R (4GY1 Japan)	93-94	
TT 250 R (4RR1/2 Japan)	95-97	
TT 250 RL (4PX5)	99	
TT 250 RM (4PX6)	00	
TT 250 R (4GY3/4GY5/4WA1) Raid	94-96	
WR 250 ZB/ZD/ZE/ZF/ZG/ZH/ZJ	91-97	
XTZ 250 Lander (Brasil) (4B41/2/3)	07-09	
YZ 250 D/E/F/G/H/J	92-97	
YZ 250 W/WRW	89	

YAMAHA Contd.

YZ 250 A/WRA/B	90-91	F
YZ 250 A/WRA/B	90-91	F
YFZ 450 S/T/V/W/X	04-08	F(right)
YFZ 450 RY/RZ (Quad)	09-10	F(right)
YFZ 450 R	11-14	F(right)
YFZ 450 RSEA/RSEB/RSED/RSE	11-14	F(right)
WR 500 ZD	92	F
YXR 66 FAS/FAT		
Rhino 4x4 Side x Side	04-05	F(right)
YFM 700 RV/RW/RX/RV/RA/RB Raptor	06-12	F(right)
YFM 700 RD Raptor	13	F(right)
YFM 700 RSE	13-18	F(right)
YXR 700 Rhino 4x4 SE	09	F(right)&R
YXR 700 FA/FB/FS		
Rhino Side x Side	11-13	F&R(right)
XTZ 750 "Super Tenere"	89-95	F(right)

MATERIAL AVAILABILITY AND PART NO.

STD	OPTIONS				
FA	V	HH	R	MXS	EPFA
FA135TT	-	-	FA135R	MXS135	-

Equivalents OE

43082 0082	59300 08810	4EW W0045 00	59100 09840	715500336
43082 0087	59300 26830	4EW W0045 01	59100 09850	715500336
43082 0099	59300 27830	4GY W0045 01	59100 09870	1XD 25806 10
43082 0100	59300 27810	4MX W0045 00	59100 09890	43082 0146
43082 1089	59300 27850	4TP W0045 00	IS3 W0045 00	9060 080910
43082 1093	59300 27860	5B4 W0045 10	5RM W0045 10	7030 081420
43082 1117	3JD W0045 00	5GF W0045 00	800070858	
43082 1129	3SP W0045 00	800070888	903 08 08 70	
59100 39850	3XP W0045 00	800071450	903 08 08 80	

FA136 80 x 40 x 9.8mm

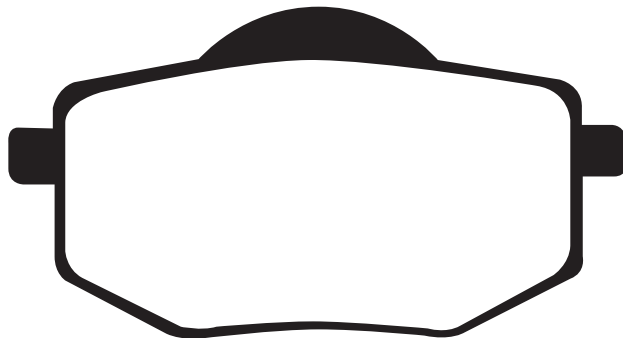

YAMAHA

XV 535 Virago

88-94

F

MATERIAL AVAILABILITY AND PART NO.

STD	OPTIONS				
FA	V	HH	R	MXS	EPFA
FA136	-	-	-	-	-

Equivalents OE

3JB W0045 00

FA137 47 x 45.1 x 7.5mm

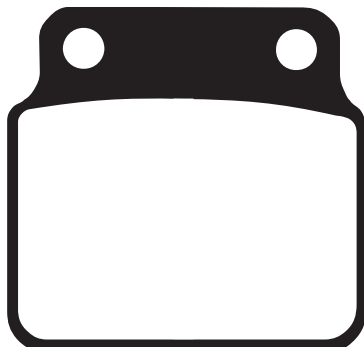

ARCTIC CAT

400 DVX (2x4) Sport

04-08

R

400 DVX TS Sport

06-07

R

KAWASAKI

KSF 400 A1/A2/A3 (KFX 400)

03-05

R

SUZUKI

LT 250 RH/RJ/RK/RL

87-90

R

LT-Z 400 K3/K4/K5/K6/K7/K8/K9/L0/L1

03-12

R

LT-R 450 K6/K7/K8/K9/L0/L1/L2/L3

06-13

R

LT 500 RL

90

R

MATERIAL AVAILABILITY AND PART NO.

STD	OPTIONS				
FA	V	HH	R	MXS	EPFA
FA137TT	-	-	FA137R	-	-

Equivalents OE

43082 S007	69140 43B10
69100 07810	3406-075
69140 35B00	69100 01810
69140 43B00	

DISC PADS
BUYERS GUIDE

DO NOT REFIT ANY SHIMS/INSULATORS TO EBC PADS FROM ORIGINAL PADS UNLESS INSTRUCTED ON NOTE ON PAD PACKAGING AND ON FA DRAWING ASSOCIATED WITH THAT PAD.

FA140 86 x 40 x 10.2mm

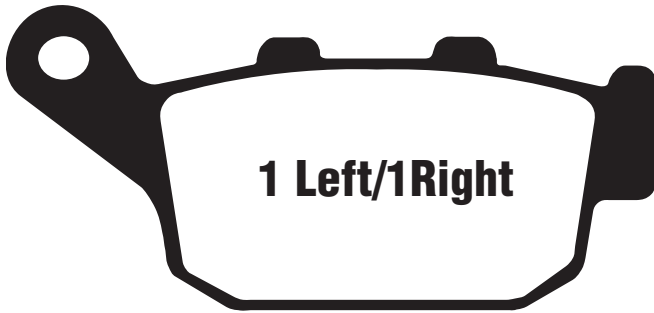

HONDA

FES 125 3/4/5 Pantheon	03-06	R
FES 150 3/4/5 Phantom	03-06	R
CB 250 FT/FV/FX/FY/F1 'Hornet'	96-01	R
CBR 250 RH (MC17)	87	R
CBR 250 RJ/RK/RK2 (MC19)	88-89	R
FES 250 Y/1/2/5 Foreight	00-05	R
NSR 250 R6K/R6K-2 (MC18-110)	89	R
NSR 250 R7L/R7N (MC21-100/106)	90	R
NSR 250 R8L-3/R9L/R8N/R8N-3 (MC21-101/102/106)	90-92	R
NSR 250 R9N (MC21-106)	92	R
NSR 250 R2J (MC18-100)/R4J (MC18-100)	88	R
NSR 250 R5K/R5K-2 (MC18-110)	89	R
VT 250 FL Spada/Castec	88-90	R
VTR 250 W/Y/1-7 (MC33)	98-07	R
VTR 250-9	09-10	R
CB-1 (CB 400 F)	89-90	R
NT 400 'Bros' NC25		R
CB 400 SF (F2N/F2R) "Superfour" (NC31)	92-	R
CB 400 SF (F2V/F3T) Superfour (NC31)	96-97	R
CB 400 SF (F3V) Superfour (NC31)	97	R
CB 400 Four V/V-II/W/W-II (NC36)	97-98	R
CBR 400 RRJ/K (NC23 Tri-arm)	92-93	R
CBR 400 RRL/RRN/RRR (NC29 Gull-arm)	90-94	R
VFR 400 RH2/RJ (NC24)	87-88	R
CB 500 X (Non ABS/Twin)	14-20	R
CB 500 XA (Twin/ABS)	14-20	R
CBR 500 R (Non ABS/Twin)	13-20	R
CBR 500 RA (ABS/Twin)	13-20	R
NX 500 J/K/L/M/N/P/R/S/T Dominator	92-96	R
NTV 600 J/K/M Revere	88-92	R
XL 600 VM/VN/VP/VR/VT/VV/VW/VX "Trans Alp"	91-00	R
FMX 650 5/6	05-08	R
NT 650 J/K/L 'Bros'	88-92	R
NT 650 V/W	98	R
NTV 650 J/K/L/M/P/S/T/V	88-97	R
NX 650 J/K/L/LII/M/N/P/R/S/T "Dominator"	88-	R
NT 650 VW/VX/VY/V1 "Deauville"	98-01	R
XL 650 VY/V1-V7 Transalp	00-07	R
XRV 650 J Africa Twin	88-89	R
CTX 700 DE-DCT	14-20	R
CTX 700 N-DCT	14-20	R
NC 700 S (Non ABS)	12-13	R
NC 700 X (Non ABS)	12-13	R
NM4 Vultus (NC 750 J)	15-20	R
XL 700 V8/V9/VA (Transalp/2 piston front caliper/ABS on rear disc)	08-11	R
XRV 750 L/M/N/P/R/S/T/V/W/X/Y "Africa Twin"	90-03	R

Equivalents OE #		
06435 KFG J21	43105 KV3 831	754804
06435 KFK 016	43105 MN8 006	H0301 T
06435 KT7 405	43106 KV3 831	06435 MY9 405
06435 KV3 405	43106 MN8 006	06435 KFK 006
42385 98Y	43105 MY1 405	06435 MFF D01
43082 0117	43106 KT7 762B	20S W0046 00
43105 KT7 761A	69100 04830	06345 MGZ J01
43105 KT7 762A	T2020602	43082 0151
43106 KT7 761B	06435 KFG J21	T2025016

MATERIAL AVAILABILITY AND PART NO.								
STD	OPTIONS							
FA	SFA	V	SFAC	HH	SFA-HH	R	MXS	EPFA
FA140	SFA140	FA140V	SFAC140	FA140HH	SFA140HH	-	-	-

KREIDLER

125 Street DD	12-13	R
---------------	-------	---

PEUGEOT

SV 250	01-02	R
--------	-------	---

SINNIS

Stealth 125 QM125-2D	08-10	R
----------------------	-------	---

SUZUKI

XF 650 V/W/X/Y Freewind	97-02	R
-------------------------	-------	---

TRIUMPH

Daytona 600	03-04	R
Street Triple R 675	02-05	R
Speedfour 600	09-12	R
TT 600	00-03	R
Daytona 650	05	R
Daytona 675	06-12	R
Daytona 675 R (Brembo calipers)	11-12	R
Street Triple 675 (Naked)	07-12	R
Street Triple R 675	09-12	R
Tiger 800 (Non ABS)	11-14	R
Tiger 800 (With ABS)	11-14	R
Tiger 800 XC (Non ABS)	11-14	R
Tiger 800 XC (ABS)	11-20	R
Tiger 800 XCa (ABS)	15-20	R
Tiger 800 XCx (ABS)	15-20	R
Tiger 800 XR (ABS)	15-20	R
Tiger 800 XRt (ABS)	15-20	R
Tiger 800 XRx (ABS)	15-20	R
Tiger 900	20	R
Tiger 900 GT	20	R
Tiger 900 GT low	20	R
Tiger 900 GT Pro	20	R
Tiger 900 Rally	20	R
Tiger 900 Rally Pro	20	R
Daytona 955i	01-04	R
Bonneville Bobber (1200cc Liquid Cooled)	17-20	R
Bonneville Bobber Black (1200cc Liquid Cooled)	18-20	R
Bonneville Speedmaster (1200cc Liquid Cooled)	18-20	R

YAMAHA

XJ6-N (600cc) (Naked - 20S) ABS/Non ABS	09-12	R
XJ6-S Diversion (600cc) (Top fairing - 36C)		
ABS and Non ABS version	09-12	R
XJ6-F Diversion (600cc) (Full Fairing - 1CW)		
(Non ABS/ABS)	10-12	R
XSR 700 ABS (MTM 690-U)	16	R

ZONTES

R 310	20	R
X 310	20	R
T 310	20	R
V 310	20	R

Part numbers, prefixes, suffixes, photos and illustrations shown in this catalogue are trademarks and/or copyrights of EBC Brakes or the trademark owner A C Freeman Investments Limited and use without express written permission of the owners is punishable by law.

DO NOT REFIT ANY SHIMS/INSULATORS TO EBC PADS FROM ORIGINAL PADS UNLESS INSTRUCTED ON NOTE ON PAD PACKAGING AND ON FA DRAWING ASSOCIATED WITH THAT PAD.

DISC PADS BUYERS GUIDE

FA141 A. 106 x 38.2 x 9mm B. 76.4 x 27 x 10.7mm

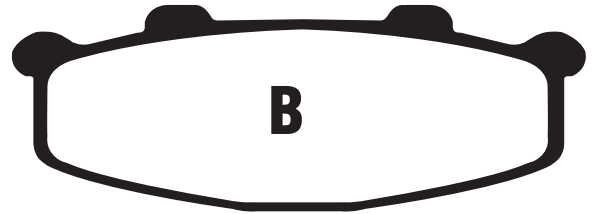
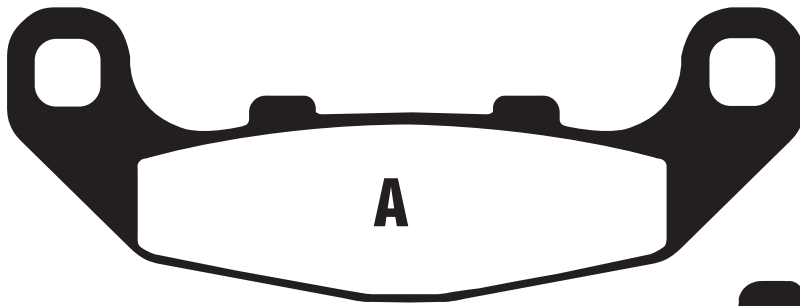

KAWASAKI

KR-1 (KR 250 B2)	89	F&R
KR1S (KR 250C2/C3)	90-92	R
GPX 250 R (ZX 250 F2-F9)	88-95	R
GPX 250 R (EX 250 F)	87	R
GPX 250 R II (EX 250 G)	88	F&R
ZXR 250 C1-C5 (ZX 250 C1-C5)	91-95	F
ZXR 250 R (ZX 250 D1)	91	F
ZXR 250 (ZX 250 A1/A2)	89/90	F&R
ZXR 250 R (ZX 250 B1/B2)	89-90	F&R
GPX 400 R (ZX 400 F1)	87	F
GPZ 400 R 'D4'	88	F
ZR 400 D1/D3/D4 'Zanhus'	92-95	F
ZX-4 (ZX 400 G1/G1A/G1B)	88	F&R
GPZ 500 S (EX 500 E1-E10)	94-04	F
ZR 550 B2/B3 'Zephyr'	91-93	R
SUZUKI		
RGV 250 M/N/P/R/S/T	91-96	R
RGV 250 T (RGVR 250 SP VJ23A)	96	R

MATERIAL AVAILABILITY AND PART NO.					
STD	OPTIONS				
FA	V	HH	R	MXS	EPFA
FA141	-	-	-	-	-

Equivalents OE #		
43082 1075	43082 1125	69100 22820
43082 1076	43082 1127	69100 22830
43082 1085	43082 1144	69100 22850
43082 1087	43082 1147	43082 0151
43082 1101	43082 1162	

FA142 102 x 38 x 9mm

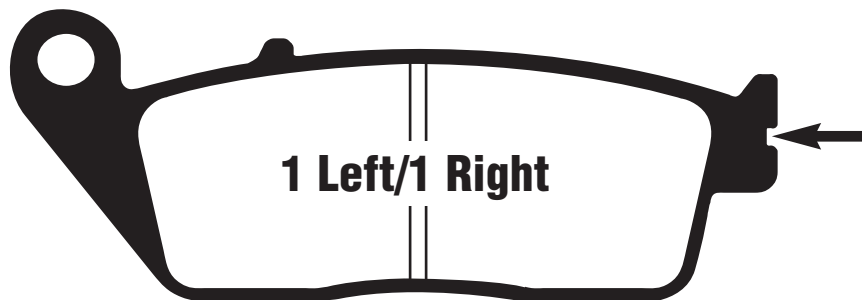

NOTE

Later supplies have clip notch. Both designs ok for front brake use

BENELLI

Leoncino 500 Trail 18-19 F

BMW

C Evolution Electric 18-20 F
 C 600 Sport Scooter 12-15 F
 C 600 Sport Highline 13-15 F
 C 650 GT Scooter 12-18 F
 C 650 GT Highline 13-18 F
 C 650 Sport Scooter 16-18 F
 C Evolution (Scooter) 14-18 F

CAGIVA

900 IE Canyon/Gran Canyon' 98-00 F
 Navigator 1000 00-05 F

DAELIM

SQ 125 Freewing S2 06 F
 Roadwin R 250 Fi (VJF 250) 08-11 F
 Roadsport 250 (VJF 250) 10-14 F
 SQ 250 Freeway S2 06 F
 VL 250 Daystar 13-14 F

HONDA

CBR 250 RB/RC (Non ABS) 11-13 F
 CBR 250 RJ/RK/RK2 (MC19) 88-89 F
 CBR 250 RRL/RRN/RRR (MC22) 90-94 F
 VT 250 FL Spada/Castec 88-90 F
 CBR 300 RAE (ABS) 14 F
 CB-1 (CB 400 F) 89-90 F
 CB 400 SF "Superfour" (NC31) (F2N/F2R/F2S/F2T/F3S) 92-95 F
 CB 400 Four V/II/III/IV (NC36) 97-98 F
 CBR 400 RRJ/K (NC23 Tri-Arm) 92-93 F
 CBR 400 RRL/RRN/RRR (NC29 Gull Arm) 90-94 F
 NV 400 CS/CV 'Steed' 95-97 F
 XR 400 M (ND08/NC38E) Supermotard 06-08 F
 NTV 600 J/K/M Revere 88-92 F
 VT 600 CR/CS/CT/CV/CW/CX 'Shadow Custom' 94-99 F
 CB 650 FE/FG/FH/FJ 14-20 F

HONDA Contd.

CB 650 FAE/FAF/FAG/FAH (ABS) 14-20 F
 CBR 650 FE/FG/FH/FJ (Non ABS) 14-20 F
 CBR 650 FAE/FAF/FAG/FAH/FAJ (ABS) 14-20 F
 NTV 650 J/K/L/M/P/S/T/V 88-97 F
 NX 650 J/K/L/M/N/P/R/S/T/V 88-97 R
 CBR 750 FJ "Superaero" 88 F
 VFR 750 FJ/FK/FL/FM/FN/FP/FR/FS/FT/FV 88-97 F
 CB 750 F2N/F2R/F2S/F2T/F2V/F2W/F2X /F2Y/F21 'CB Seven fifty' 92-02 F
 PC 800 'Pacific Coast' 89-97 F
 Z 800 E (Z 800 CDS - Non ABS) 13 F
 CBR 1000 FK/FL/FM/FN 89-92 F
 ST 1100 AN/AP/AR/AS Pan European (ABS Model) 92-95 F
 ST 1100 L/M/N/P/R/S/T/V/W/X/Y/1/2 Pan European - Non ABS 90-02 F
 GL 1500 'CV/CW/CX/1/CY/1/C2' (F6C) 97-03 F

GENERIC/KSR

TW 125 SM 13-15 F
ITALJET
 Marco Polo 400xx Scooter 07-09 F
CZ/JAWA
 350 Classic F
 350 New Classic 13-14 F

KAWASAKI

J 125 ABS (SC125 AGF/BGF/CGF/CHF/CJF) 16-18 F
 J 125 SE/ABS (SC125 AGFA/BGFA/CGFA/CHFA/CJFA) 16-18 F
 J300 AEF/AFF/AGF (Non ABS) 14-16 F
 J300 AEF/AFF/AGFA Special Edition (Non ABS) 14-16 F
 J300 BEF/BFF/BGF/CHF/CJF (ABS) 14-20 F
 J300 BEFA/BFFA/BGFA/CHFA/CJFA Special Edition (ABS) 14-20 F
 KLE 300 CHF/CJF Versys-X 300 ABS 17-20 F
 KLE 300 BHF Versys-X 300 Non ABS 17-20 F
 EN 650 AFF - Vulcan S - Non ABS 15 R
 EN 650 BFF - Vulcan S - ABS 15 R

DO NOT REFIT ANY SHIMS/INSULATORS TO EBC PADS FROM ORIGINAL PADS UNLESS INSTRUCTED ON NOTE ON PAD PACKAGING AND ON FA DRAWING ASSOCIATED WITH THAT PAD.

FA142 Contd.

KAWASAKI Contd.

KLE 650 Versys (KLE 650 EFF Non ABS)	15
KLE 650 Versys (KLE 650 FFF ABS)	15
KLE 650 Versys (Non ABS) KLE650 EGF	16-20
KLE 650 Versys (ABS) KLE 650 FGF/FHF/FHFA/FJF/FJA	16-20
Z 650 (ER 650 GHF Non ABS)	17-20
Z 650 (ER 650 HHF/HJF - ABS)	17-20
Z 750 (ZR 750 L7F/L8F/L9F/LAF/LBF)	07-11
Z 750 ABS (ZR 750 M7F/M8F/M9F/MAF/MBF)	07-11
Z 800 E CDS/CEF/CFF (Non ABS)	13-16

KYMGCO

Downtown/Super Dink 125i (C21000)	09-15
Grand Dink 125	12-15
K-XCT 125i	12-15
Downtown 200i	10-15
People 250	03-06
Xciting 250/250i	05-07
Xciting 250	05
Xciting 250i	06-08
Downtown/Super Dink 300i (V20000)	09-12
Downtown 300i (ABS/C20010)	10-15
Grand Dink 300i	12-20
Xciting 300i (T72000) (EFI Model)	08
Xciting 300i R (T72001/72011)	08-15
Xciting 500 Ri (T70021) (EFI Model)	09-15
Xciting 500i (T70020) (EFI Model)	06-08
Xciting 500 (T70000) (Carb Model)	05
Xciting Evo 500i ABS	13
My Road 700i	12-15

MASH

Family Side 400cc Side Car Outfit	18-20
Scrambler 400cc (Dirtstar 400)	17-20
400 Roadstar (Five Hundred)	14-20

PEUGEOT

Geopolis 300 GT	14
Satelis 400 Premium (Nissin Calipers)	08-11
Satelis 400 Urban (Nissin Calipers/ABS)	08-12
Satellis 400 RS (Nissin Calipers)	08-14
Geopolis 500	08-11
Satelis 500	07-12
Satelis 500 RS (Nissin Calipers)	08-12

SACHS

Quattrocento 400	08
------------------	----

SUZUKI

GW 250 L3/ZL5 Inazuma	13-15
GW 250 FL5 Inazuma	15
GSX 400 R/S/T/ZR/ZS/ZT "Impulse Type"	94-96
RF 400 RP/RR/VR/RT/RTV (GK78A)	93-97
RF 600 RP/RR/RS/RT/RV	93-97
AN 650 K3/K4/K5/K6/K7/K8/K9/L0 Burgman/Non ABS	04-11

SUZUKI contd

AN 650 AK4/AK5/AK6/AK7/AK8/AZK8/AK8/AK9/ALO			
Burgman/ABS	04-12	F	
AN 650 ZL3/ZL4/ZL5/ZL6/ZL7/ZL8 Burgman ABS Executive	13-19	F	
AN 650 L3/L4/L5/L6 Burgman Non ABS	13-16	F	
GSF 650 S/T/V/W/X Naked Bandit	95-99	F	
GSX 650 ST/SV/SW/SX Faired Bandit	95-99	F	
S.W.M.			
Gran Milano 440 (4T)	15	F	
Gran Turismo 440 (4T)	15	F	
Silver Vase 440 (4T)	15	F	
TRIUMPH			
Speedmaster (865cc/EFI)	08-10	F	
Street Scrambler (900cc Liquid Cooled)	16-20	F	
Street Twin (900cc Liquid Cooled)	16-20	F	
Street Cup (900cc Liquid Cooled)	16-20	F	
Thruxton 900	04-16	F	
Thruxton Ace 900	15-16	F	
Thruxton 1200 (Liquid Cooled)	16-20	F	
Bonneville T120 (1200cc Liquid Cooled)	16-20	F	
Bonneville T120 Black (1200cc Liquid Cooled)	16-20	F	
Bonneville Bobber (1200cc Liquid Cooled)	17-20	F	
America (6 spoke cast wheel)	07-09	F	
America (12 spoke cast wheel - 865cc)	10-17	F	
America LT (12 spoke cast wheels/865cc)	14-17	F	
Bonneville America	02-06	F	
Bonneville 800	01-06	F	
Bonneville/Bonneville Black (865cc)	07-08	F	
Bonneville T214 (Spoke wheel/865cc)	15	F	
Bonneville Spirit (Spoke wheel/865cc)	15	F	
Bonneville T100 (790cc)	02-04	F	
Bonneville T100 (865cc)	05-09	F	
Bonneville T100 (865cc/Air Cooled/Spoke wheel)	10-16	F	
Bonneville T100 Black (865cc/Air Cooled/Spoke wheel)	14-16	F	
Bonneville Steve McQueen SE	12	F	
Scrambler (865cc)	06-15	F	
Bonneville T100 (900cc/Liquid Cooled/Spoke Wheel)	16-20	F	
Bonneville T100 Black (900cc/Liquid Cooled/Spoke Wheel)	16-20	F	
VOXAN			
Scrambler 1000	06	F	
YAMAHA			
Majesty S 125 XC 125 R	14-15	F	
WR 125 X (Supermoto)	09-18	F	
WR 125 R	09-15	F	
WR 250 XX/XY (Supermoto) (32D2/4)	08-15	F	
ZONTES			
R 310	20	F	
X 310	20	F	
T 310	20	F	
V 310	20	F	

Equivalents OE

06455 MR1 405	45105 LCA7 305	45105 LEA7 305	06455 MBE 006	1DK W0045 00
06455 MR4 405	45105 LLJ3 305	45106 ML7 922	59100 21860	06455 MJE D02
06455 MW3 405	45105 ML7 921/922	45106 ML7 922B	59100 21870	59101 26820
06455 MV4 405	45105 MS9 612	45106 MR4 901	06455 KFR 701	T2027535
06455 MZ0 760	45105 MT4 651/405	45106 MS9 612	T2020543	T2027545
43082 0079	45105 KAZ 004	45106 MT4 651/405	3D7 W0045 10	43082 0173
43082 0150	45105 MV4 008	59300 21820	22B FS811 00	43082 0165
43082 Y005	45105 ML7 405	59300 21840	5AP W0045 00	
43082 Y007	45105 ML7 P10	59300 21850	59301 48811	
451A0 MT4 670	45105 LBA2 305	8000 88482	55120315	

MATERIAL AVAILABILITY AND PART NO.

OPTIONS								
STD	SFA	SFAC	V	HH	SFA-HH	R	MXS	EPFA
FA142	SFA142	SFAC142	FA142V	FA142HH	SFA142HH	-	-	-

FA143 94.2 x 32 x 10mm

HONDA

NSR 250 R2R/R3R (MC28-110) R2T/R3T (MC28-120)	94	R
NSR 250 RR (MC28-100)	94	R
RVF 400 RR/RR-II/RT/RT-II (NC35)	94-96	R
VFR 400 RK/R3L/R3M/R3N (NC30)	89-92	R

HONDA Contd.

NR 750 N	92	R
VFR 750 RJ/RK/RL (RC30)	88-90	R
RVF 750 RR/RS 'RC45'	94-98	R



MATERIAL AVAILABILITY AND PART NO.

OPTIONS				
STD	V	HH	R	MXS
FA143	-	-	-	-

Equivalents OE

06435 MR7 P00	43105 MT7 405
43105 MR7 007A	43106 MR7 007B
43105 MR7 017A	43106 MR7 017B

FA145 70 x 55.5 x 8mm

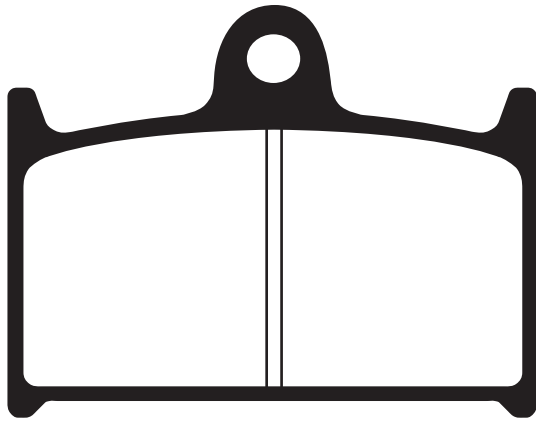

SUZUKI			
GSXR 400 RL/RM/RN/RP/RS (GK76A)		90-95	F
GSXR 750 J/K/L/M/WN/WP		88-93	F
GSXR 750 RG		86	F
RF 900 RR/RS/RS2/RT/RV/RW		94-98	F
GSXR 1100 K/L/M/N		89-92	F
GSF 1200 T/ST/V/SV/W/SW/X/SX/S/SY 'Bandit'		96-00	F
GSF 1200 SAV ABS Bandit		97	F
YAMAHA			
TZ 125		94-97	F
TZ 250		89-02	F
FZR 750 R "OWO!"		89-90	F
MZ/MUZ			
1000 S		03-07	F
1000 SF		05-07	F
1000 SFX		07	F
1000 ST		07	F

Equivalents OE #		
59100 33830	59130 40C00	3MW W0045 00
59100 40810	59300 17810	3TC W0045 00
59130 17C00	59300 17811	9024020000
59130 33C00	3FV W0045 00	
59130 33C10	3LC 25811 00	

MATERIAL AVAILABILITY AND PART NO.					
STD	OPTIONS				
FA	V	HH	R	EPFA	
FA145	-	FA145HH	-	EPFA145HH	

FA146 58.8 x 57.1 x 9mm

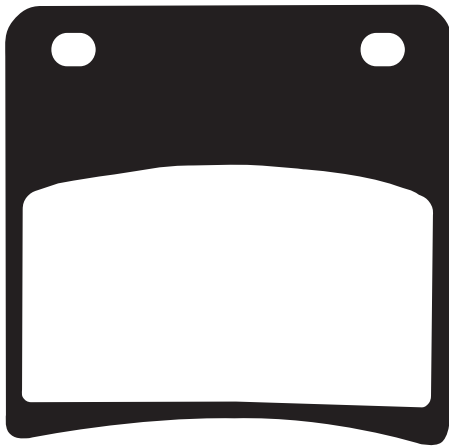

SUZUKI			
GW 250 L3 Inazuma		13	F
GSX 400 FJ/FK/FAK/FL (GK74A)		88-90	F
GSX 600 FJ/FK/FL/FM/FN/FP/FR/FS/FT/FV		88-97	F
GSX 750 FK/FL/FM/FN/FP/FR/FS/FT/FV		89-97	F
VX 800 L/M/N/P/R/T		90-96	R
GSX 1100 FJ/FK/FL/FM/FN/FP/FR		88-94	F
GSX 1100 GM/GN		91-94	R
GV 1400 GDG/GCG/GDH/GDJ "Cavalcade"		86-88	F

Equivalents OE #		
59100 19820	59130 45C10	69130 45C10
59100 24810	59130 48B00	69130 26D00
59130 19C00	69100 34860	69100 26810
59130 20C00	69100 45890	
59130 24A10	69130 34C00	
59130 26D00	69130 45C00	

MATERIAL AVAILABILITY AND PART NO.					
STD	OPTIONS				
FA	V	HH	R	MXS	EPFA
FA146	FA146V	FA146HH	-	-	-

FA147 A. 118 x 48 x 8.6mm B. 97.5 x 57 x 10.8mm

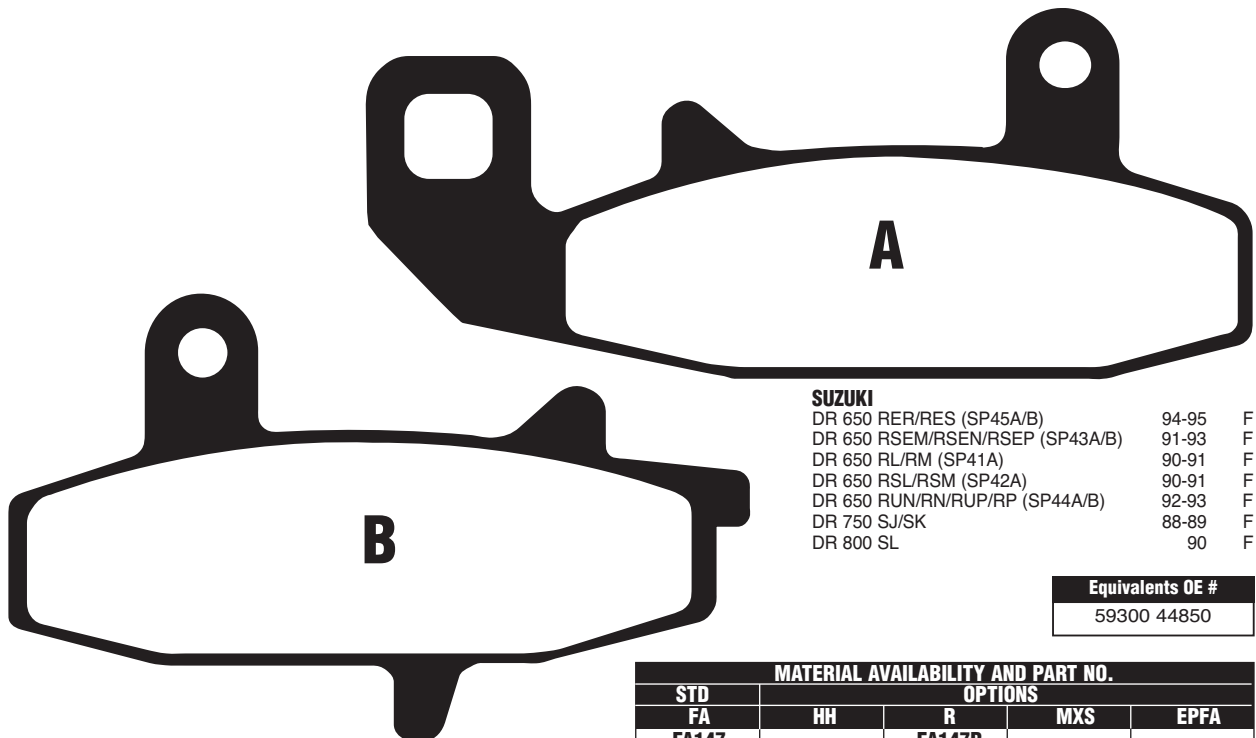

SUZUKI			
DR 650 RER/RES (SP45A/B)		94-95	F
DR 650 RSEM/RSEN/RSEP (SP43A/B)		91-93	F
DR 650 RL/RM (SP41A)		90-91	F
DR 650 RSL/RSM (SP42A)		90-91	F
DR 650 RUN/RN/RUP/RP (SP44A/B)		92-93	F
DR 750 SJ/SK		88-89	F
DR 800 SL		90	F

Equivalents OE #
59300 44850

MATERIAL AVAILABILITY AND PART NO.				
STD	OPTIONS			
FA	HH	R	MXS	EPFA
FA147	-	FA147R	-	-

DO NOT REFIT ANY SHIMS/INSULATORS TO EBC PADS FROM ORIGINAL PADS UNLESS INSTRUCTED ON NOTE ON PAD PACKAGING AND ON FA DRAWING ASSOCIATED WITH THAT PAD.

FA150 57.3 x 59 x 9mm

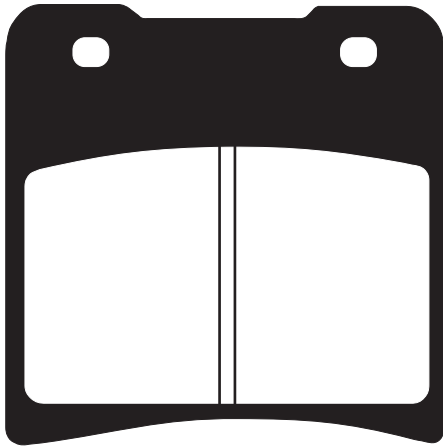

SUZUKI

GV 1400 GDG/GCG/GDH/GDJ/GCH
'Cavalcade' (from f.no -103765) 86-88

R

MATERIAL AVAILABILITY AND PART NO.					
STD	OPTIONS				
FA	V	HH	R	MXS	EPFA
FA150	FA0150V	FA150HH	-	-	-

Equivalents OE #	
69100 24860	69130 24A03
69130 24A02	69130 24A04

FA151 51 x 36.5 x 8.3mm



FA151

HONDA

RS 125/250
NSF 250 R

MORIWAKI/HONDA

MD 250 H/S

88-07

12-20

08-13

SFA151

GOCCIA (ELECTRIC SCOOTER)

R Sunday

R HONLEY

Oliver 125

R SYM

Cinderella 50/100

DD 50 (2T)

Mio 50

Tonik 50 (4T)

Mio 100

E W00 Electrico

Tonik 110 (4T)

Tonik 125 (4T)

E-Virid (Electric) Deluxe

E-Symmetry

12-15

15-16

99-00

02-12

05-20

11-15

05-15

11

11-13

11-14

12-15

12-13

F

F

F

F

F

F

F

F

F

F

MATERIAL AVAILABILITY AND PART NO.					
STD	OPTIONS				
FA	SFA	SFAC	HH	R	MXS
FA151	SFA151	SFAC151	-	-	-

Equivalents OE #		
43105 NF5 611	45105 GM9 741	45105 GM9 743A
43105 NF5 612	45105 GM9 742	
45105 GH9 710	45105 GM9 743	

FA152 62 x 40.8 x 9mm

FA152/2 62 x 40.8 x 11mm

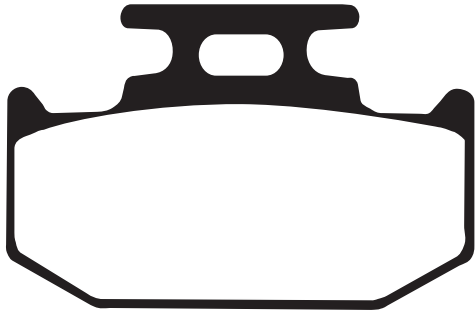

NOTE:
ANTI RATTLE SHIMS MUST BE DISCARDED TO USE THICKER PAD

YAMAHA

DT 125 RE	05-07	R
DT 125 X	05-06	R
GT 125 Hammerhead	12-18	R
YZF-R 125 Inc Monster Energy Edition	19-20	R
YZ 125 A/B	90-91	R
TT 250 RL/RM/RN/RR/RS	99-04	R
XG 250 Tricker (5XT1)	04-06	R
XT 250 X (3C51/2)	05-08	R
XTZ 250 Lander (Brasil) (4B41/2)	07-08	R
YZ 250 A/WRA/B	90-91	R
WR 200 D/E/F	92-94	R
WR 250 ZB/ZD/ZE/ZF/ZG/ZH/ZJ	91-97	R
YZ 400 FK	98	R
WR 500 ZD	92	R
TT 600 RES	04	R
TT 600 K (4LW1/4GV1/4LW2)		
Up to 4GV 003403 (Nissan rear caliper)	93-95	R

FA152/2

SUZUKI

RM 125 N/P/R/S	92-95	R
DR-Z 250 K1-K7 (DJ43A)	01-07	R
RM 250 N/P/R/S	92-95	R
RMX 250 R/S	94-95	R
RMX 250 SN/SR/SS (SJ13A)	95-97	R

YAMAHA

YZ 125 D/E/F/G/H/J	92-97	R
DT 200 WR (3XP)	92-93	R
XT 225 WE (4JG5/6) Serrow	97-98	R
DT 230 (4TP1/2) Lanza	97-96	R
TT 250 R (4GY) Raid/4MR2	96	R
TT 250 R (4GY1 Japan)	93-94	R
TT 250 R (4RR1/2 Japan)	95-97	R
TT 250 RL (4PX5)	99	R
TT 250 RM (4PX6)	00	R
TT 250 R (4GY3/4GY5/4WA1) Raid	94-96	R
YZ 250 D/E/F/G/H/J	92-97	R
YZ 400 FK/WR 400 FK	98	R
WR 400 FK	98	R
TT 600 E (4GV2)	94-95	R

FA152 CANNONDALE

MX 400 00 R

KAWASAKI

KX 125 G1/H1/H2/J1/J2/K1	89-94	R
KDX 125 A1/A2/B1/B2	90-94	R
KDX 200 E1-E6	89-94	R
KDX 200 H1-H5	95-99	R
KDX 200 SR (DX 200 G)		
KDX 220 R A4-A12/A6F	97-06	R
KDX 220 SR (DX 220 B)		
KDX 250 SR (KDX 250 F1)	91	R
KX 250 G1/H1/H2/J1/J2/K1	89-94	R
KDX 250 D1	91-93	R
KLX 250 R D1/D2/G1	93-97	R
KLX 250 F1-F4	94-97	R
KX 500 E1-E7	89-95	R
KLX 650 C1-C3	93-97	R

SUZUKI

TS 125 RK/RL/RM/RN/RR	90-96	R
RM 125/250 K/L/M	89-91	R
TS 200 RK/RL/RM/RN/RR	89-94	R
DR 250 RS/RLS/RT/RV/RLV/RLW/RW/RX (SJ45A/DOHC)	95-00	R
DR 250 RXT/RXLT/RXV/RXLV/RXW/RXLW/RXGW		
/RXGLW/RXY/RXGY (Dejbel 250 XC/GPS Ver (SJ45A)		R
DR 250 SL/SM/SN/SEP/SER/SES (SJ44A)	90-95	R
RMX 250 K/M/N/P	89-93	R
RMX 250 T/V/W	96-98	R
DR 350 SL/SM/SN/SP 4 bolt front disc/kick start	90-93	R
DR 350 SER/SES (Electric start/4 bolt front disc)	94-95	R
DR 350 SET/SEV (Electric start/4 bolt front disc)	96-97	R
DR 350 SEW/SEX (Electric start/6 bolt front disc)	98-99	R
DR 650 SET/SEV	96-20	R

Equivalents OE #-FA152	
43082 1090	69100 15810
43082 1118	69140 03D00
43082 1131	69140 15D00
43082 1137	69140 28C00
43082 1151	5XT W0046 50

Equivalents OE #-FA152/2		
69100 43820	69140 27C10	3XP W0046 00
69100 43840	69140 27C20	4DA W0046 00
69100 43850	69140 43D00	4GV FS811 00
69140 05D00	69140 43840	4GY W0046 00
69140 26C00	3SP W0046 00	5GF W0046 00

MATERIAL AVAILABILITY AND PART NO.				
STD	OPTIONS			
FA	V	HH	R	MXS
FA152TT	-	-	FA152R	MXS152

MATERIAL AVAILABILITY AND PART NO.				
STD	OPTIONS			
FA	V	HH	R	MXS
FA152/2TT	-	-	FA152/2R	MXS152/2

FA153 75 x 40 x 8mm



HONDA

AX-1 (NX 250 J/K/R/R3)	89-94	R
CRM 250 R (RK) MK1 MD24 (100001-1008385)	89-90	R
RTL 250 S	88-89	R
XLR 250 R (MD22)	88-90	R
XLR 250 Baja MK2 (MD22)		R
TLM 260	89-93	R

MATERIAL AVAILABILITY AND PART NO.				
STD	OPTIONS			
FA	V	HH	R	MXS
FA153	-	-	-	-

Equivalents OE #	
43106 KW3 006B	
43106 KZ9 006B	

DISC PADS BUYERS GUIDE

DO NOT REFIT ANY SHIMS/INSULATORS TO EBC PADS FROM ORIGINAL PADS UNLESS INSTRUCTED ON NOTE ON PAD PACKAGING AND ON FA DRAWING ASSOCIATED WITH THAT PAD.

FA155 40 x 23/7.8mm

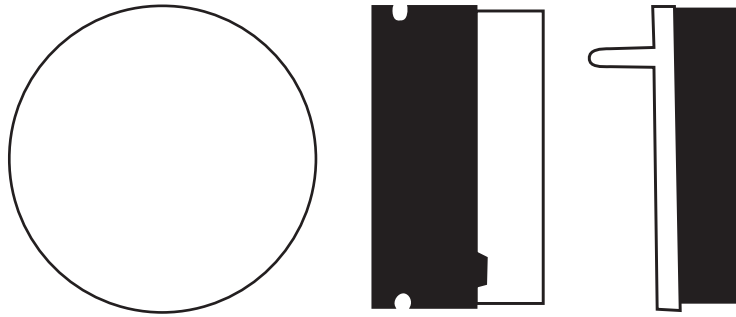

YAMAHA
YFS 200 B/F/G/H/J/K/L/M/N/P "Blaster" 91-02 R

MATERIAL AVAILABILITY AND PART NO.				
STD	OPTIONS			
FA	HH	R	MXS	EPFA
FA155	-	FA155R	-	-

Equivalents OE #
2XJ 25811 00

FA156 55.8 x 45.5 x 6mm



APRILIA
280 Climber 94-96 R
BETA
Synt/Gara 93-95 R
Techno 95 R
CAGIVA
Blues 50 93-95 F
Super City 50/80 93-95 F
Prima 50 92-94 F

MATERIAL AVAILABILITY AND PART NO.				
STD	OPTIONS			
FA	HH	R	MXS	EPFA
FA156	-	-	-	-

Equivalents OE #
800066937

FA157 A. 99.3 x 44 x 7.4mm B. 47.7 x 83.3 x 9.7mm

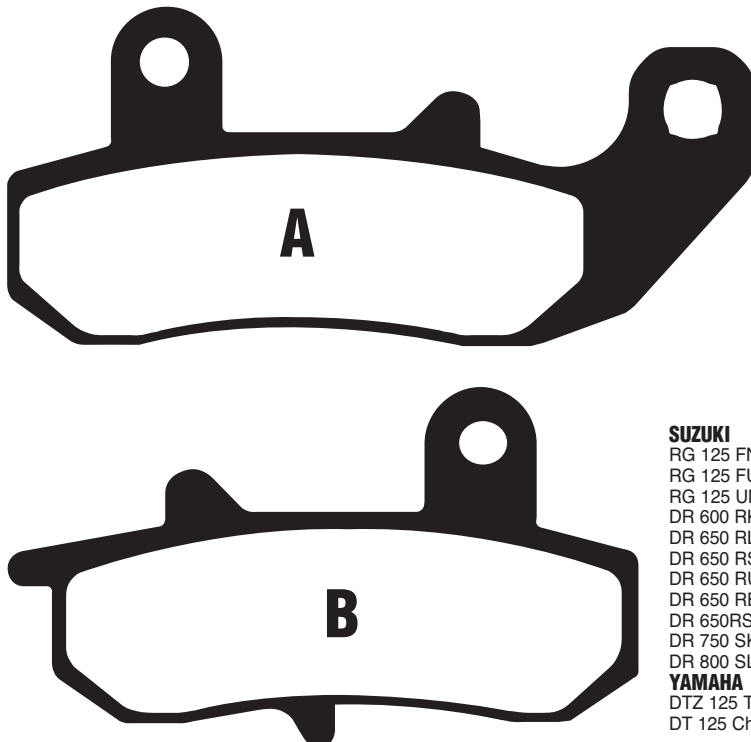

SUZUKI
RG 125 FN/FP/FR (NF13A) Gamma/Rear Disc Model 92-94 R
RG 125 FUN/FUP/FUR (NF13B) Gamma/Rear Disc Model 92-94 R
RG 125 UN "Wolf" (ND13E) Naked 92-94 R
DR 600 RK (SN41A) (Rear disc model) 89 R
DR 650 RL/RM (SP41A) 90-91 R
DR 650 RSL/RSM (SP42A) 90-91 R
DR 650 RUN/RN/RUP/RP (SP44A/B) 92-93 R
DR 650 RER/RES (SPA45A/B) 94-95 R
DR 650RSEM/RSEN/RSEP (SP43A/B) 91-93 R
DR 750 SK 89 R
DR 800 SL 90 R
YAMAHA
DTZ 125 Tenere/Tenere 89-90 R
DT 125 Chesterfield Scout 89-90 R

MATERIAL AVAILABILITY AND PART NO.				
STD	OPTIONS			
FA	HH	R	MXS	EPFA
FA157	-	FA157R	-	-

Equivalents OE #
69100 44860
69100 12810

DO NOT REFIT ANY SHIMS/INSULATORS TO EBC PADS FROM ORIGINAL PADS UNLESS INSTRUCTED
ON NOTE ON PAD PACKAGING AND ON FA DRAWING ASSOCIATED WITH THAT PAD.

FA158 46.7 x 69.8 x 8mm

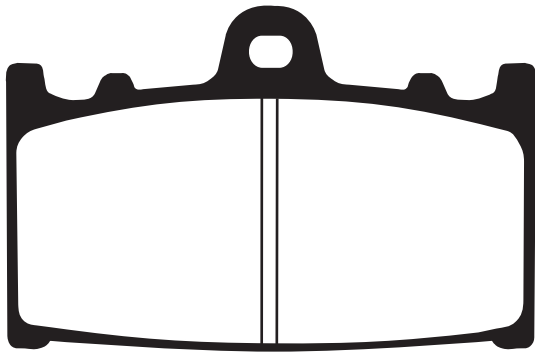

DISC PADS
BUYERS GUIDE

DO NOT REFIT ANY SHIMS/INSULATORS TO EBC PADS FROM ORIGINAL PADS UNLESS INSTRUCTED
ON NOTE ON PAD PACKAGING AND ON FA DRAWING ASSOCIATED WITH THAT PAD.

KAWASAKI

KRIS (KR 250 C2/C3)	90-92	F
ZR 400 Zephyr (G2/G3/G3A/G4/G5)	97-01	F
ZXR 400 H1/H2	89-90	F
ZXR 400 J1/J2	89-90	F
ZXR 400 R (ZX 400 M1-M4)	91-94	F
ZZR 400 (ZX 400 K1/K2/K3)	90-92	F
ZZR 400 (ZX 400 N1/N2/N3/N4/N5/N6/N7)	93-99	F
ZZR 600 (ZX 600 D1-D3)(E1-E13)	90-05	F
ZZR 600 (ZX 600 E6F)	06-07	F
ZX6 R (ZX 600 F1/F2/F3)	95-97	F
ZXR 750 H1/H2/J1/J2/K1/K2/L1/L2/L3/M1/M2	89-95	F
GPz 900 R A7/A8	90-96	F
GPZ 900 R (ZX 900 A11)	98	F
ZX9 R (ZX 900 B1/B2)	94-95	F
KLZ 1000 ACF/ADF/AEF/BFF/BGF/BHF/BJF/BJFA Versys	12-18	F
KLZ 1000 Versys SE LT (BJF - ABS)	18-20	F
ZZR 1100 (ZX 1100 C1-C3) (D1-D9)	90-01	F
ZR 1100 A1-A4 'Zephyr'	92-95	F
ZZR 1200 C1H/C2H	02-04	F
VN 1700 B9F/BAF/BBF/BCF/BDF/BEF/BFF		
/BGF/BHF/BJF Voyager ABS	09-20	F
VN 1700 KBF/KCF/KDF/KEF Voyager Custom	11-14	F
VN 1700 DAF/DBF/DCF/DDF/DEF Classic Tourer ABS	10-14	F
VN 1700 DFF/DGF - Vulcan 1700 Nomad	15-16	R
VN 1700 FAF/FBF/FCF/FDF/FEF Classic ABS	10-14	F
VN 2000 A1/A2/A6F	04-08	F
VN 2000 H8F/H9F Classic	08-09	F

SUZUKI

RG 125 FN/FP/FR (NF13A) Gamma/Rear disc	92-94	F
RG 125 FUN/FUP/FUR (NF13B) Gamma/Rear disc	92-94	F
GSXR 250 RK (GJ73A)		F
RGV 250 J/K/L/M/N/P/R/S	88-95	F
TV 250 J/K/AK/L (VJ21A) Wolf	88-90	F
SG 350 N 'Goose'	92	F
GSF 400 K/NK/Z/VN/VZM/P/NP/VP		
/NZP/VR (GK75A) "Bandit"	89-94	F
GSF 400 S/VN/V-VZ-V Bandit (GK7AA)	95-97	F

MATERIAL AVAILABILITY AND PART NO.					
STD	OPTIONS				
FA	V	HH	R	MXS	EPFA
FA158	-	FA158HH	-	-	EPFA158HH

SUZUKI Contd.

GSXR 400 J/RR/RAK (GK73A)	88-90	F
GSXR 400 K6/K7/K8	06-08	F
GSX 400 SSN (GK77A) Katana	92	F
GSR 600 K6/K7/K8	06-10	F
GSXR 600 V/M/X/Y/K1/K2/K3/ZK3	97-03	F
GSF 650 AK7/AK8/AK9/ALS/AL1/AL2 Naked Bandit - ABS	07-11	F
GSF 650 SAK7/SAK8/SAK9/SALO/SAL1/SAL2		
Faired Bandit - ABS	07-15	F
GSF 650 K7/K8/K9/L0/L1/L2 (Naked Bandit/Non ABS)	07-11	F
GSX 650 FK8/FK9/FL0/FL1/FL2	08-14	F
GSX 650 SK7/SK8/SK9 (Faired Bandit/Non ABS)	07-09	F
GSX 650 FAK8/FAK9/FAL0/FAL1/FAL2 (ABS Model)	08-15	F
GSXR 750 Y/K1/K2/K3	00-02	F
SV 1000 K3/K4/K5/K6/K7	03-07	F
SV 1000 SK3/SK4/SK5/SK6/SK7 (Faired model)	03-07	F
TL 1000 SV/SW/SX/SY/SK1	97-01	F
GSF 1200 SK6/SAK6 ABS & Non ABS Faired Bandit		
4 Piston Caliper	06	F
GSF 1200 SK7/SK8/SK9/SLO Faired Bandit		
- Non ABS 4 Piston Caliper	07-10	F
GSF 1250 K6/AK6 ABS & Non ABS		
Naked Bandit 4 Piston Caliper	06	F
GSF 1250 K7/K8/K9/OLO Non ABS Naked Bandit		
4 Piston Caliper	07-11	F
GSF 1250 AK7/AK8 ABS Model Naked Bandit		
4 Piston Caliper	07-08	F
GSF 1250 SAK7/SAK8/SAK9/SAZK9/SALO/SAL1/SAL2/SAL4/SAL5/SAL6		
(Faired Bandit - ABS Model - 4 Piston Caliper)	07-16	F
GSX 1250 FAL0/FAL1/FAL2/FAL4/FAL5/FAL6	10-16	F
GSX 1250 FAL0ST/FAL1ST Sports Touring	10-14	F

BERINGER

4 Piston (Old Design)

MOTOMASTER

4 Piston

PRE TECH

4 Piston (P402) Lockheed Replacement Caliper

PRO ONE

4 Piston

VERTEMATI

4 Piston Caliper

Equivalents OE #		
43082 1097	59100 32820	59130 32C20
43082 1102	59100 34830	59130 38C00
43082 1110	59100 35880	59300 34830
43082 1111	59101 35810	59100 35830
43082 1113	59130 06C00	59100 35850
43082 1120	59130 22D00	43082 0015
43082 1142	59130 32000	43082 0016
43082 1208	59130 32020	43082 1169
43082 1288	59130 32C00	2654F/S/R2
59100 22810	59130 32C10	43082 0153

FA159 97 x 40 x 7.9mm



SEE MAIN CATALOGUE FOR APPLICATIONS

DANGER MUST BE FITTED IN COMPLETE FRONT AXLE SETS TO AVOID PULLING LEFT OR RIGHT

AEON

Crosslander 600i

14-15

R

POLARIS

Most Models

89-19

F&R

MATERIAL AVAILABILITY AND PART NO.					
STD	OPTIONS				
FA	V	R	HH	MXS	EPFA
FA159TT	-	FA159R	-	-	

Equivalents OE #		
1910036	1930731	2202412
1910042	1930815	2203452
1910129	2200465	2203792
1910333	2200901	2201149
1930643	2201398	1911171

FA160 74.8 x 53.9 x 10mm

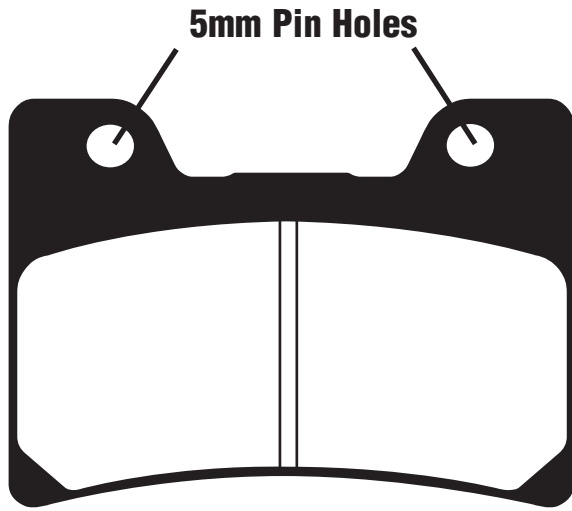

For later pad FZR 1000 92-93 with 6mm pin holes use FA182

MZ			
850 KBT		95	F
YAMAHA			
FZR 600		90-93	F
FZR 600 R		94-95	F
TDM 850		96-01	F
FZR 1000 EX UP (Std Forks)		89-90	F
V-MAX 12		93-03	F
FJ 1200 A (ABS Model)		91-95	F

MATERIAL AVAILABILITY AND PART NO.					
STD	OPTIONS				
FA	HH	R	MXS	EPFA	
FA160	FA160HH	-	-	-	

Equivalents OE #	
3GM W0045 00	
3GM W0045 01	
3GM W0045 11	

FA161 52.6 x 52.7 x 8mm

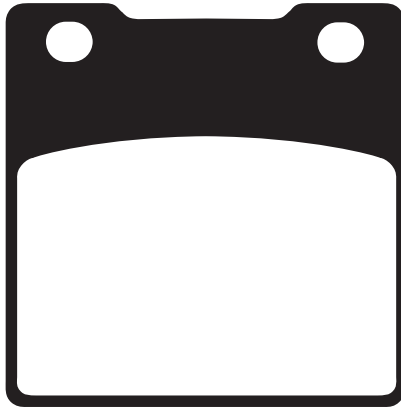

KAWASAKI			
Z 250 A1/A2/A3		78-81	R
ZXR 400 (L1-L9)		91-03	R
ZXR 400 H1/H2		89-90	R
ZXR 400 J1/J2		89-90	R
ZXR 400 R (ZX 400 M1-M4)		91-94	R
ZXR 750 H1/H2/J1/J2/K1/K2/L1/L2L3/M1/M2		89-95	R
ZX-7R (ZX 750 P1/P2/P3/P4/P5/P6/P7)		96-03	R
ZZR 1100 D1-D9		93-01	R
ZRX 1100 (ZR 1100 C1/C2/C3/C4)		97-00	R
ZX12R (ZX 1200 A1/A2/B1/B2)		00-03	R
ZRX 1200 R(A1/A2/A3/A4/A5/A6F)		01-08	R
ZRX 1200 S (B1-B3)		01-04	R
ZZR 1200 C1H/C2H		02-04	R
ZX 12R (ZX 1200 B3/B4/B6F)		04-06	R

MATERIAL AVAILABILITY AND PART NO.					
STD	OPTIONS				
FA	V	HH	R	MXS	EPFA
FA161	FA161V	FA161HH	-	-	-

Equivalents OE #		
43082 1003	43082 1141	43082 1257
43082 1098	43082 1180	43082 1291
43082 1103	43082 1200	

FA162 47.8 x 48.6 x 7.2mm

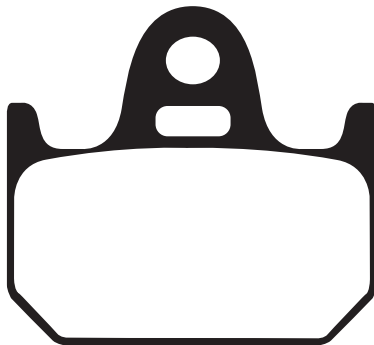

YAMAHA			
TZ 125		94-97	R
TZ 250		89-01	R
TZ 250 (Radial Caliper)		02-10	R

MATERIAL AVAILABILITY AND PART NO.					
STD	OPTIONS				
FA	V	HH	R	MXS	EPFA
FA162	-	-	-	-	-

Equivalents OE #	
3CL W0046 00	3LC W0046 00
3LC 25811 50	4TW W0046 00

DO NOT REFIT ANY SHIMS/INSULATORS TO EBC PADS FROM ORIGINAL PADS UNLESS INSTRUCTED
ON NOTE ON PAD PACKAGING AND ON FA DRAWING ASSOCIATED WITH THAT PAD.

FA163 99.5 x 52 x 7.8mm

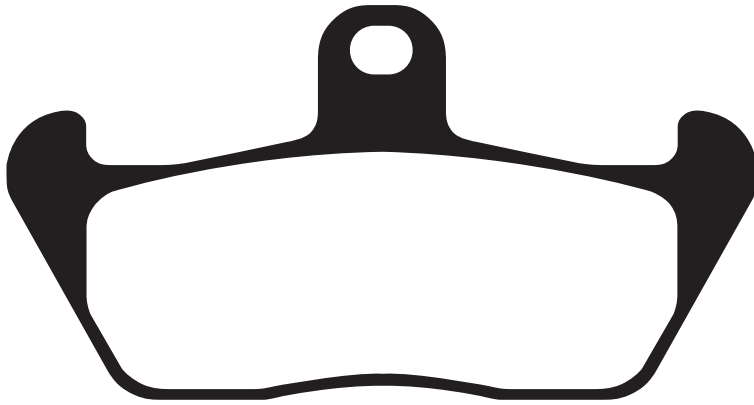

CAGIVA		
Mito 125	91-92	F
W8 125	93-98	F
Elefant 125	88-90	F
Freccia 125 SY	89	F
Supercity 125	92-	F
Tamanaco 125	88-89	F
W12 "350"	93-95	F
W16 "600"	94-98	F
750 Elefant	90-92	R
APRILIA		
Tuareg Rally 215	89	F
Tuareg Wind 600	89	F
GILERA		
Nord-West 350	94-	F
MOTO GUZZI		
1000 Quota	92-97	R

MATERIAL AVAILABILITY AND PART NO.					
STD	OPTIONS				
FA	V	HH	R	MXS	EPFA
FA163	-	-	-	-	-

Equivalents OE #	
8000 59214	8113283
000306546300	GU30654630

FA164 74.2 x 40.5 x 6.7mm



BETA		
Trial Evo 125 (2T) MY20	20	F
Trial Evo 200 (2T) MY20	20	F
Trial Evo 250 (2T) MY20 Inc GB	20	F
Trial Evo 300 (2T) MY20 Inc GB and SS	20	F
TR34 260	89-91	R
Synt	92	R
Zero	92	R
Supertrial ST	94	R

MATERIAL AVAILABILITY AND PART NO.				
STD	OPTIONS			
FA	V	HH	R	MXS
FA164	-	-	FA164R	-

Equivalents OE #
N/A

FA165 A. 96.7 x 42 x 7.4mm B. 77.3 x 42 x 7.4mm

FA165/2 A. 96.7 x 42 x 9.7mm B. 77.3 x 42 x 8mm

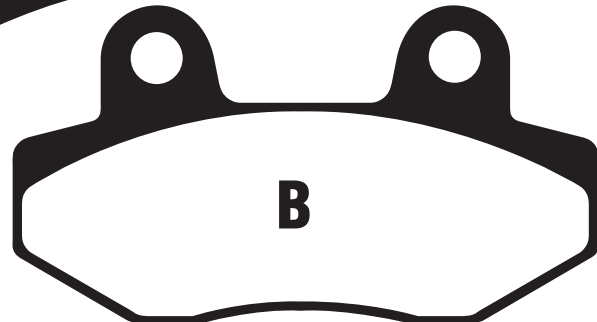
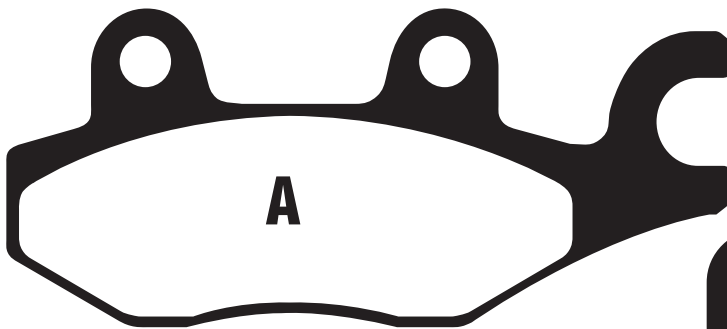

FA165		
AEON		
Cobra RS 180 (Quad)	06	R
Overland 125 (AT08) (Quad)	02-06	R
Overland 180 (AT08) (Quad)	02-11	R
Crossland RX 350	11	R
APACHE		
RLX 150 S		R
BLANEY (Quads)		
XL 200 Trooper	03-04	R
CAN AM (SIDE X SIDE)		
CCommander 800 R (STD)	11-15	F (Left)
Commander 800 R XT	11-14	F (Left)
Commander 800 (XT/DPS)	11-15	F (Left)
Commander 1000 (STD)	11-15	F (Left)
Commander 1000 LTD	12-15	F (Left)
Commander 1000 X	11-13	F (Left)
Commander 1000 XT	11-15	F (Left)
Commander 1000 XT-P	14-15	F (Left)

CAN AM (SIDE X SIDE) Contd.		
Commander 1000 (DPS)	13-15	F (Left)
Maverick 1000 R STD	13-14	F (Left)
Maverick 1000 R XRS	13-14	F (Left)
Maverick 1000 R XRS/DPS	14	F (Left)
Maverick 1000 R XMR	14	F (Left)
Maverick 1000 R XXC	14	F (Left)

CF MOTO		
CF 500-5 (Rancher UTV)	11-14	F (Left)
CF 500 US - Z Force 550		
(Side x Side)	15	F(Right)
CF 600 Z Force Z6		
(Side x Side)	13-15	F (Left)
CF 600 Z Force Z6 EX		
(Side x Side)	13-15	F (Left)
CF 625-3 (Z6 Terra Cross)	11-12	F(left)&R(left)

FA165 Contd.

FA165/2 Contd.

CF MOTO Contd.

CF 800 UU-A - U Force 800 (Side x Side)	13-15	F(Right)
CF 800 Z Force Z8 (Side x Side)	13-15	F (Left)
CF 800 Z Force Z8 EX (Side x Side)	14-15	F (Left)
CF 800-3 (Tracker 800 Side x Side)	13	F (Left)
U Force 800 (Side x Side)	14-16	F (Left)

CPI

XT 50 Quad	06-09	R
------------	-------	---

E-TON QUADS

RXL 150 Viper R	05	R
CXL 150 Yukon II/Challenger	02-	R
EXL 150 Eukon St	05-07	R
RXL 150 Viper	05-06	R

GOES

G 520 UTX (Side x Side)	10-11	F(Left)
-------------------------	-------	---------

JONWAY

YY 125	08-09	F&R
YY 150	08-09	F&R
YY 250/250 A	08-09	F&R

KAWASAKI

Kazer 115		F
KLF 300 C1-C17 "Bayou"	89-05	F(left)
KLF 400 B1-B7 Bayou	93-99	F(left)
KVF 650 F7F/F8F Brute Force 4x4i Hardwoods Green	07-08	F(left)
KVF 650 FCF/FCS/FDF	12-13	F(left)
KVF 650 H7F/H8F Brute Force 4x4i	07-08	F(left)
KVF 650 G7F/G8F Brute Force 4x4i Hardwoods Green	07-08	F(left)
KVF 750 A1/A6F/B1/B6F Brute Force 4x4	05-06	F(left)
KVF 750 E8FA Brute Force 4x4 Hardwoods Green HD	08	F(left)
KVF 750 D8F/D9F/DAF/DBF	08-11	F(left)
KVF 750 GCF/GDF/GEF/GFF /GGF/GHF Brute Force 4X4i EPS	12-17	F(left)
KVF 750 HCF/HDF/HEF/HFF /HGF/HHF Brute Force 4X4i EPS/Camo	12-17	F(left)
KVF 750 JCF/JDF/JEF/JFF /JGF/JHF Brute Force 4x4i EPS	12-17	F(left)
KVF 750 LCF/LDF/LEF/LFF /LGF/LHF Brute Force 4x4i	12-17	F(left)
KRF 750 A8F/B8F Teryx 750 4x4 (RUV)	08	F(left)
KRF 750 C8F/D8F Teryx 750 4x4 LE (RUV)	08	F(left)
KRF 750 F8F Teryx 750 4x4 NRA Outdoors (RUV)	08	F(left)
KRF 750 TAF Teryx 750 Fi 4x4 SGE	10-11	F(left)
KRF 750 G9F/NAF/NBF/NC5 /NDF Teryx 750 Fi 4x4	09-13	F(right)
KRF 750 J9FA/K9F/PAF/RAF /PBF/RBF/RCS/PDF/RDF Teryx 750 Fi 4x4 LE	09-13	F(right)
KRF 750 L9F Teryx 750 Fi 4x4 LE Sport	09	F(right)
KRF 750 M9F Teryx 750 Fi 4x4 NRA Outdoors	09	F(right)
KRF 750 SAF/SAFA/SBF/SBFA /SCS/SCSA/SDF Teryx 750 Fi 4x4 Sport LE	10-13	F(right)
KRT 750 ACF/ADF (Tyrex 4 750 4X4)	12-13	F(left)

KAWASAKI Contd.

KRT 750 ACFA/ADFA (Tyrex 4 750 4X4 EPS)	12-13	F(left)
KRT 750 CCF/CDF (Tyrex 4 750 4X4 EPS LE)	12-13	F(left)
KRF 800 BEF/BFF/FGF/FHF /FJF (Teryx)	14-18	F(left)
KRF 800 CEF/CFE/GGF/GHF /GJF (Teryx LE)	14-18	F(left)
KRF 800 DEF/DFE/HGF/HFF /HJF (Teryx Camo)	14-18	F(left)
KRT 800 BEF/BFF/FGF/FHF /FJF (Teryx 4)	14-18	F(left)
KRT 800 CEF/CFE/GGF/GHF /GJF (Teryx 4 LE)	14-18	F(left)
KRT 800 DEF/DFE/HGF/HHF /HJF (Teryx 4 Camo)	14-18	F(left)
KAF 820 AFF/AGF/AHF/AJF Mule Pro FXT	15-18	F(left)
KAF 820 BFF/BGF/BHF/BJF Mule Pro FXT/EP5	15-18	F(left)
KAF 820 CFF/CGF/CHF/CJF Mule Pro FXT/EP5 LE	15-18	F(left)
KAF 820 DFF/DGF/DHF/DJF Mule Pro FXT/EP5 Camo	15-18	F(left)
KAF 820 EGF/EHF/EJF Mule Pro FX	16-18	F(left)
KAF 820 FGF/FHF/FJF Mule Pro FX/EP5	16-18	F(left)
KAF 820 GGF/GHF/GJF Mule Pro FX/EP5 LE	16-18	F(left)
KAF 820 HGF/HHF Mule PRO - FX/EP5 Camo	16-17	F(left)
KAF 820 JGF/JHF Mule PRO - FXT Ranch Edition	16-17	F(left)
KAF 1000 AGF/AHF/AJF Mule Pro DXT/Diesel	16-18	F(left)
KAF 1000 BGF/BHF/BJF Mule Pro DXT/Diesel EPS	16-18	F(left)
KAF 1000 CGF/CHF - Mule Pro DXT EPS LE/Diesel	16-17	F(left)
KAF 1000 DGF/DHF - Mule Pro DX /Diesel	16-17	F(left)
KAF 1000 EGF/EHF/EJF Mule Pro DX EPS/Diesel	16-18	F(left)
KAF 1000 FGF/FHF - Mule Pro DX EPS LE/Diesel	16-17	F(left)
KAF 1000 DGF Mule Pro DX Diesel	16	F(left)
KAF 1000 BGF Mule Pro DXT Diesel	16	F(left)
MBK TZR 50 'X-Blazer'	00	F
MOTO-ROMA Go-Go 110	02	F
Geko 300 Quad	04-06	R
QUADZILLA 4 Cross 200cc		R
Z8 4X4 (Side X Side/800cc)	14-15	F (Right)
SINNIS QM 250 GY-D Apache 250	13-14	R
SUZUKI LT-F 300 FK2	02	R(left)
LT-R 450 K6/K7/K8/K9/L0/L1	06-12	F(left)
LTA 500 FY/FK1	00-01	F(left)
LT-F 500 FW/FX/FY/FK1/FK2	98-02	F(left)
TAISHAN Panther 90 Quad	04	R
Hurricane 125 Quad	04	R
Explorer 150 Quad	04	R
Tornado 200 Quad	04	R

YAMAHA

YZF 450 S/T/V/W/X	04-08	F(left)
YZF 450 RY/RZ (Quad)	09-10	F(left)
YZF 450 R	11-14	F(left)
YZF 450 RSEA /RSEB/RSED/RSE	11-14	F(left)
YXR 66 FAS/FAT Rhino 4x4 Side x Side	04-05	F(left)
YFM 700 RV/RW/RX/RY /RA/RB Raptor	06-12	F(left)
YFM 700 RD Raptor	13	F(left)
YFM 700 RSE	13-18	F(left)
YXR 700 Rhino 4x4 SE	09	F(left)
YXR 700 FA/FB/FD Rhino Side x Side	11-13	F&R(left)
XTZ 750 "Super Tenere"	89-95	F&R(left)

FA165/2

BOMBARDIER Rally 200	05-06	R
CAGIVA Canyon 600 E	96-99	R
Canyon 500	96-00	R
900 IE Canyon/Gran Canyon	97-00	R
E 900 Elefant Dakar Rep (300mm front disc)	90	R
E 900 ie Lucky Explorer (296mm front disc)	90	R
E 900 ie GT (296mm front disc)	91-92	R
Navigator 1000	00-05	R
HYOSUNG XR125 Supermoto	07-11	R
MZ/MUZ VRT 125 Quad	05	R
VRT 175 Quad	05	R
SUZUKI DR 800 SM/SN/SP/SR/SS (SR43B)	91-95	R
DR 800 ST/SV (SR43B)	96-97	R
YAMAHA XTZ 750 "Super Tenere"	89-95	R
VOXAN Scrambler 1000	02-06	R

Equivalents OE # - FA165		
43020 CEK 000	59100 09880	903 08 08 80
43082 0069	810183	903 08 08 90
43082 0080	67131 BCAA 0000	1XD 25806 00
43082 1094	5B4 W0045 00	9060 080810
3JD W0045 10	59300 09840	43082 0138
59100 09840	59300 09850	153 W0045 10
7 020 016	715500325	43082 0126
IS3 W0046 10	715500335	7030 0853A0
59100 09860	705601150	

Equivalents OE # - FA165/2		
69100 31820	A45120 168 000	59401 HP7 600
3LD W0046 01	59312 HP7 600	
8000 66785	59400 HP7 600	

MATERIAL AVAILABILITY AND PART NO.				
STD	OPTIONS			
FA	HH	R	MXS	SXR
FA165TT	FA165HH	FA165R	MXS165	SXR165HH

MATERIAL AVAILABILITY AND PART NO.				
STD	OPTIONS			
FA	HH	R	MXS	EPFA
FA165/2TT	-	FA165/2R	-	-

FA166 100 x 46.7 x 7.5mm

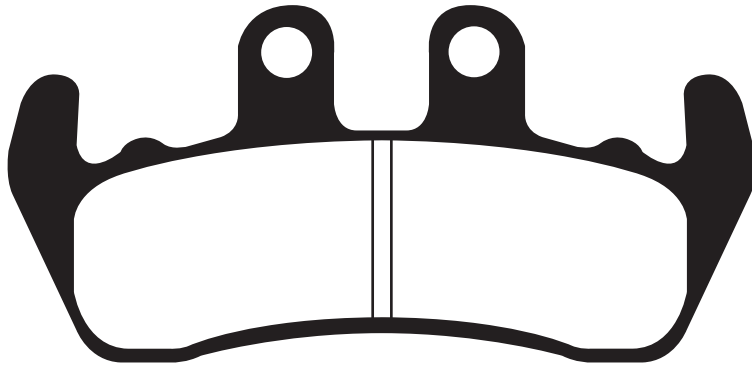

HONDA HM (Italy)

CRE 50 Six/Baja/Derapage Grimeca
caliper twin pin Kayaba forks 95-02 F

YAMAHA

DT-Z 125 'Tenere/Tenere Scout' 89-90 F
DT 125 Chesterfield Scout 89-90 F

MATERIAL AVAILABILITY AND PART NO.

STD	OPTIONS				
FA	V	HH	R	MXS	EPFA
FA166	-	-	-	-	-

Equivalents OE

K009463415

FA167 77 x 42 x 7.5mm

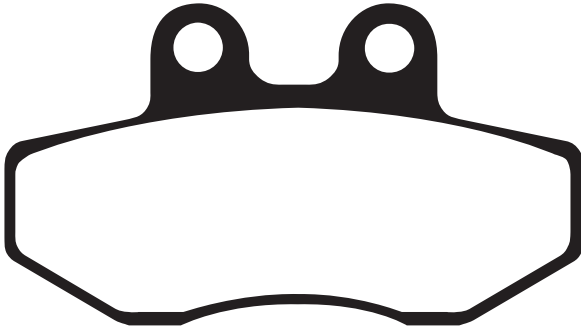

AJP

PR4-Enduro 125 04-09 F
PR4-Supermotard 125 04-09 F
PR4 Enduro 200 04-09 F
PR4 Supermotard 200 04-09 F

APRILIA

RX3-5 Marce (M/N/P/R) 91-94 F
Classic 125 95-01 F
Tuareg Rally 125 (N) 93 F
Pegaso 125 91 F
Pegaso 600 91 F
Classic 125 99 F

BETA

RK6 93-96 F
RK6 50cc Enduro 97-02 F

BULTACO

Astro SM50 F

CH RACING

WXE 50 Enduro 05 F
WSM 50 Motard 05 F
WXE 125 Enduro 05 F
WSM 125 Motard 05 F

DERBI

GPR 50 R 97-01 F
GPR 50 Replica Racing 99-03 F
Senda SM DRD 50 (Double disc model) (SDR1DB) 02-03 F
Senda 50 Black Edition 03 F
Senda R 125 Vin# SCB1A 04 F

EXPLORER

KBR 200 05 F

GAS-GAS

EC 50 Rookie 01-04 F
SM 50 Rookie 01-04 F

GOES

G 50 X 08-09 F&R

HRD

Cabriole 125 01 F
Sonic 2 Trail 50 F
Sonic 2 Supermotard 50 F
Cabriolett Trail 125 F
Cabriolett Supermotard 125 F

HUSQVARNA

SM 50 02 F
WR 50 02 F
WXE 125 07 F

MH/MOTORHISPANIA

RX 50 Super Racing 06-07 F
RYZ 50 Urban Bike 06-10 F
RYZ 50 Pro Racing Enduro 06-10 F

MOTO ROMA

SMX 125 04-06 F

PEUGEOT

XP 125 Street Evo 2 05 F
XR6 (2T) 50 03-07 F

RIEJU

RR 50 Castrol 50 00-02 F
RS1 50cc 01-04 F
MRX 50 Castrol/SMX 50 01-02 F
Spike 50 Pro 04 F

SMX 125

02-07 F

MRX 125

02-08 F

SACHS

Roadster 125 00-03 F

SHERCO

SM 50 Supermotard 03-07 F
Enduro 50 (50 EN) 03-07 F
Enduro 50cc (2T) 02-07 F
Supermotard 50cc (2T) 02-07 F
City Corp 125 (All models) 03-07 F
SM 125/125 City Corp 03-06 F

TOMOS

SE 125 F 05-08 F

MATERIAL AVAILABILITY AND PART NO.

STD	OPTIONS			
FA	V	HH	R	MXS
FA167	-	FA167HH	-	-

Equivalents OE

8113373	00009300065
8113478	00RTS01A0015
8113604	2525230000
P00 927 020 64 07 000	R351
214 007 1000002	00H04702141

DO NOT REFIT ANY SHIMS/INSULATORS TO EBC PADS FROM ORIGINAL PADS UNLESS INSTRUCTED ON NOTE ON PAD PACKAGING AND ON FA DRAWING ASSOCIATED WITH THAT PAD.

SFA169 61.1 x 27.1 x 7.3mm

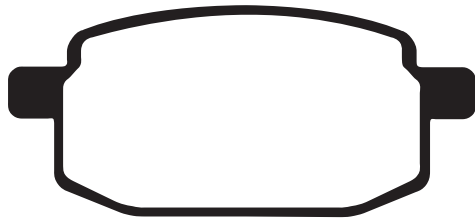

ADLY

City Bird
Fox 50
Road Tracer 50/90/100 04-06

BAOTIAN

BT49 QT-9 Speedy 50 (4T) 10-11
BT49 QT-11 Retro 50 (4T) 06-11

BETA

R 125 4T Mini Cross 03

DAELIM

M 50 D/MD Millenium 03
DX 50 D Camper 03
ST 90 Pro Monkey 03

FYM/X-Sport

CR 90 E 06-07
110 ES 06-07
CR 110 06-07
CR 110 ESR 06-07
X-Sport Typhoon 125 Quad 06-07
CR 3 125 06-07
CR 125 R 06-07

GARELLI

FX 50
Capri LX 50 06-08
Capri (DF 50 QT-7) 06
Ciclone 50 07
Vip 50 08

HERO HONDA

Nipster 50 06

HYOSUNG

50 Newtee (4T) 14-15

JORDAN

Easy 50/100 03-04

KAWARA

Fever 50/90 99
Stinger 90 99

LEM

Four X Pro

LEXMOTO

Molly 50 (DFE50QT-3) 15-18

LIFAN

LF 50 QGY

MALAGUTI

Malbo Line - DVD 50 (2T) 10-11

MOTO-ROMA

Bee 50 04-05
Go-Go 50/110 97-05
Stinger 50 01-05
Scrambler 50 01
Road Runner 50/100 01-02
Grand Prix 125 01

MBK

CY 50 Forte/Forte Mufa 96-97
CR 50 Z Target 91-95

MZ/MUZ

Moskito FB50 97-03
Moskito SX/JP50 00-03

PEUGEOT

V-Clic 50 (4T) (155mm dia. disc) 08-13
V-Clic 50 (4T) (160mm dia. disc) 08-11

P.G.O

Big Max 50 94-06
EPS 97
Tornado 50/125 97

QUADZILLA

WK 70 (Front disc model) 06-09
WK 110 06-08
WK 125 06-09

SIAMOTO

Birdie 50 02-04
Favorite 02-04

SINNIS

Falcon 50 QM 50 QT-2T 08-10
Jet 50 QM 50 QT-6A 08-10

SUPERBYKE

M-Ped 50 Road Classic
TERRA MOTO

TDX 125 F 07 F&R
TDX 125 F Krusha 07 F&R
TDX 125 F Street Ripa 07 F&R

THUMPSTAR

Thumpstar Junior 90cc 04-06
Thumpstar Supa 110cc 04-06
Thumpstar Expert 125 06
Thumpstar Pro 125 05-06
Thumpstar 125 Road Ripper 06 F&R

VIALLI

Cargo 50 06
FXR Sport 50 06
Jupiter 50 06

WUYANG

WY 50 QT 06-07

YAMAHA

CR-Z 50 (3WN) 91-95
CY 50 RS Jog R 96-
YA 50 ZA Jog Z (4SC1) 95
YW 100 T Booster BWs 96

Equivalents OE #	
2NA W0045 01	802 567 1000
5CP W0045 00	T01H000101
45120 107 000	64098800
3XG W0045 00	140330
5JU W0045 00	

MATERIAL AVAILABILITY AND PART NO.

STD	OPTIONS								
	FA	SFA	SFAC	TT	HH	SFA-HH	R	MXS	EPFA
-	SFA169	SFAC169	-	-	SFA169HH	-	-	-	-

FA171 57.7 x 53.7 x 8.9mm

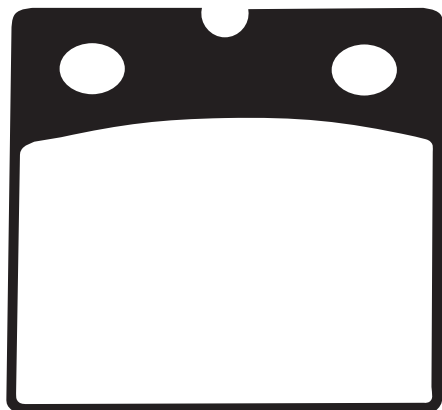

BMW

K 75/75-2 09/88-96
K 75/75-S 08/90-96
K 75 C 09/88-90
K 75 RT 89-96
K 75 RT 89-96
K 75 S 09/88-95
K 75 S 09/88-95
K 100/2 09/88-90
K 100 LT 09/88-91

BMW Contd.

K 100 RS 10/88-89
K 100 RT 10/88-89
R 80/R 80 RT 09/88-95
R 100 RS 9/9-92
R 100 RT 09/88-95
QUADZILLA
RL 500 Buggie 08-09 F&R

Equivalents OE #	
34 11 2 310 494	34 11 2 331 175
34 11 2 311 175	34 11 2 314 546

MATERIAL AVAILABILITY AND PART NO.

STD	OPTIONS					
	FA	V	HH	R	MXS	EPFA
FA171	FA171V	FA171HH	-	-	-	-

FA172 A. 104 x 45.6 x 9.8mm B. 88 x 42 x 9.8mm

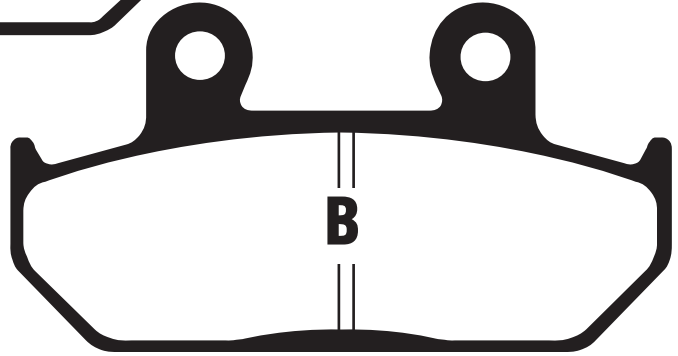
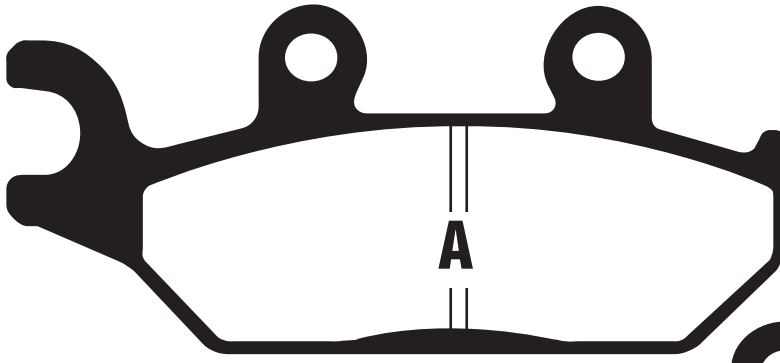

YAMAHA
 XT 600 E 92-03 F
 XTZ 660 "Tenere" 91-98 F

MATERIAL AVAILABILITY AND PART NO.				
STD	OPTIONS			
FA	V	HH	R	MXS
FA172TT	-	-	FA172R	-

Equivalents OE #	
3YF W0045 00	4PT W0045 00
3TB W0045 00	1XD 25805 10

FA173 A. 85 x 42.5 x 7.3mm B. 56 x 35 x 9.7mm

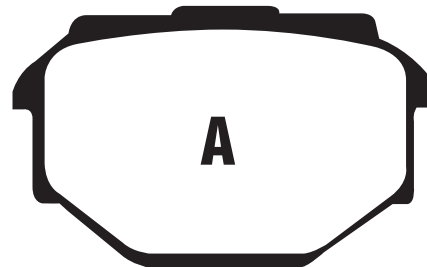
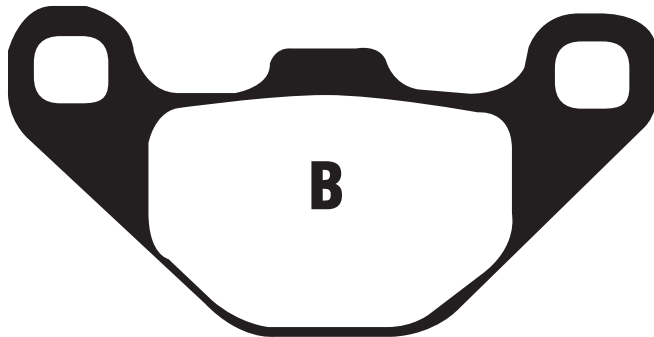

APRILIA
 ETX 125 99-01 R
 Moto 6.5 95-01 R
 Pegaso 650 91-00 R
BETA
 Jonathan 125 02-05 R
 Euro 350 02 R
CAGIVA
 W12 "350" 93-95 R
 W16 "600" 94-98 R
GILERA
 Eaglet 50 96 R
 50 RC Top Rally 90- F&R
MALAGUTI
 F10 Jetline 91-93 F
 50 America 91- F

MBK
 X-Limit 50 02 R
MZ/MUZ
 Baghira - Forest/Forest HR
 - 21" front wheel/spoke wheel 96-05 R
 Baghira - Street Moto
 - 17" front wheel/spoke wheel 96-05 R
 Baghira - 21" front wheel/spoke wheel 99-05 R
 Baghira - Black Panther
 - 17" front wheel/spoke wheel 96-03 R
 Mastiff - 21" front wheel/spoke wheel 96-05 R
YAMAHA
 TDR 125 (3HS1/3XD0/3SH3/3XD01) 89-93 R

MATERIAL AVAILABILITY AND PART NO.				
STD	OPTIONS			
FA	SFA	HH	R	MXS
FA173	SFA173	-	-	-

Equivalents OE #	
34 11 2 310 494	902203100
8113595	3SH F5811 00
8000 68794	5VB W0045 00
11940100	

DO NOT REFIT ANY SHIMS/INSULATORS TO EBC PADS FROM ORIGINAL PADS UNLESS INSTRUCTED ON NOTE ON PAD PACKAGING AND ON FA DRAWING ASSOCIATED WITH THAT PAD.

FA174 86.3 x 41.4 x 10.2mm

DO NOT REFIT SHIMS



HONDA

CB 400 SF4/5/S5 (NC39)	04-05	R
VRX 400 T (NC33)	96	R
CB 500 A4/A5/A6/A7	04-07	R
CBF 500 4 (Non ABS Model)	04-	R
CB 600 FW/FX/ "Hornet"	98-00	R
CB 600 FY/F2Y/F1/F21/F2/F22/F3/F4/F5/F6/FA7/FA8/FA9 /FAA/FAB Hornet	00-12	R
CBF 600 N8/N9 (Non ABS)	08-09	R
CBF 600 S4/S5/S6/S8/S9 (Non ABS)	04-06/08-09	R
CBF 600 SA4/SA5/SA6/SA8/SA9/SAA (ABS)	04-06/08-12	R
CBF 600 NA8/NA9 (ABS)	08-09	R
CBF 600 N4/N5/N6 (Non ABS)	04-06	R
CBF 600 NA4/NA5/NA6 (ABS)	04-06	R
CBR 600 FM/FN/FP/FR/FS/FT/FV/FW/FX/FY	91-00	R
CBR 600 F1/F2/ CBR 600 FS1/FS2 'Sport'	01-02	R
CBR 600 F3/F4/F5/F6	03-06	R
CBR 600 RR3/RR4/RR5/RR6	03-06	R
CBR 600 FAB/FAC (ABS Model)	11-13	R
700 Integra Scooter NC 700 DC	12-14	R
NC 700 XA (ABS)	12-13	R
NC 700 XD (ABS/DCT)	12-13	R
NC 700 SA (ABS)	12-13	R
NC 700 SD (ABS/DCT)	12-14	R
XL 700 VA8/VA9/VAA (Transalp/3 piston front caliper/ABS front & rear wheels)	08-11	R
CB 750 F2N/F2R/F2S/F2T/F2V/F2W/F2X/F2Y/F21 CB Seven Fifty	92-02	R
750 Integra Scooter - DCT (NC 750 D)	14-16	R
NM4 Vultus (NC 750 J)	15	R
CBR 900 RRR/RRP/RRR/RRS/RRT/RRV/RRW/RRX /RRY/RR1/RR2/RR3 Fireblade	92-03	R
CB 900 F2/F3/F4/F5/F6/F7 Hornet	02-07	R
CB 1000 FP/FR/FS/FT/FV	93-97	R
CBF 1000 6/7/8/9/A (Non ABS Model)	06-10	R
CBF 1000 F (FA) (2 piston front calipers/non ABS)	10-15	R
CBF 1000 FA FAA (3 Piston Front Caliper/ABS Model)	10-15	R
CBF 1000 FS FSA (3 Piston Front Caliper/ABS Model)	10-11	R
CBF 1000 FT FTA (3 Piston Front Caliper/ABS Model)	10-11	R
CBF 1000 6/7/8/9/A (2 piston front caliper/Non ABS)	06-11	R
CBR 1000 RR4/RR5 Fireblade	04-05	R
CRF 1000 LAG/LAH (Manual Clutch/ABS)	16-17	R
CRF 1000 LAG/LAH (DCT/ABS)	16-17	R
CRF 1000 LAJ (DCT/ABS) Africa Twin (inc Adventure Sport)	18-19	R
CRF 1100 Africa Twin Adventure Sport ES ABS Manual	19-20	R
CRF 1100 Africa Twin Adventure Sport ES ABS DCT	19-20	R
VTR 1000 FV/FW/FX/FY/F1-F6 'Firestorm'	97-06	R
VT-R 1000 SPY/SP1 (SC45)	00-01	R
VTR 1000 SP2/SP3/SP4/SP5/SP6	02-07	R
CB 1100 AD	13	R
CB 1100 AE (Cast Wheels/2 Piston Caliper)	13	R
CB 1100 EX (SAE)	14-18	R
CB 1100 RS	17-18	R
VT 1100 C2 (W/X/Y/1/2/3/4/5)	98-05	R
VT 1100 C2 (S/T/V)	95-97	R
VT 1100 C3 (W/X/Y)	98-00	R
CB 1300 F3/F13	03-04	R
CB 1300 5/6/7/8/9 (Superfour)	05-09	R
CB 1300 A5/A6/A7/A8/A9 (Superfour ABS)	05-09	R
CB 1300 SA5/SA6/SA7/SA8/SA9/SAA	05-12	R
CB 1300 S5/S6/S7/S8/S9	05-09	R
VT 1300 CXA Chopper (9 spoke cast wheel/non ABS)	10-12	R
VT 1300 CXAA "Chopper" (9 spoke cast wheel/ABS model)	10-11	R
VTX 1300 S3/S4/S5/S6/S7/S8	03-08	R

KAWASAKI

EN 650 AFF/AGF/AGFA/CHF Vulcan S - Non ABS	15-20	R
EN 650 BFF/BGF/BGFA/BGFB/DHF/DHFA/EHF/ DJF/DJFA/EJF Vulcan S - ABS	15-20	R
EN 650 Vulcan S Café ABS	18-20	R
EN 650 Vulcan S SE ABS	18-20	R
Ninja 650 (EX 650 KHf/KHFA/KJF/KJFA - ABS)	17-20	R
Ninja 650 (EX 650 JHf/JJF - Non ABS)	17-20	R
KLE 650 Versys (Non ABS) KLE650 EGF	16	R
KLE 650 Versys (ABS) KLE 650 FGF/FHF/FHFA/FJF/FJFA	16-20	R
Z 650 (ER650GHF Non ABS)	17-20	R
Z 650 (ER650HHF/HJF - ABS)	17-20	R
Z 750 (ZR 750 L7F/L8F/L9F/LAF/LBF)	07-11	R
Z 750 ABS (ZR 750 M7F/M8F/M9F/MAF/MBF)	07-11	R
KLV 1000 (LV 1000 A1H/A2H)	04-05	R
KLZ 1000 ACF/ADF/AEF/BFF/BGF/BHF/BJF/BJFA Versys	12-18	R
KLZ 1000 Versys SE LT (BJF - ABS)	18-20	R
KLZ 1000 Versys SE LT+ ABS Inc DKF	19-20	R
Z 1000 (ZR 1000 B7F/B8F/B9F)	07-09	R
Z 1000 ABS (ZR 1000 C7F/C8F/C9F)	07-09	R

SUZUKI

SV 400 K3/K4/K5	03-05	R
SV 400 SK3/SK4/SK5	03-05	R
DL 650 AK9 GT V-Strom Traveller ABS	09-11	R
DL 650 K4/K5/K6 V-Strom	04-06	R
DL 650 XK7/XK8/XK9/XL0 V-Strom X	07-11	R
DL 650 AK7/AK8/AK9/AL0 V-Strom ABS	07-11	R
DL 650 AL1 XP V-Strom Xpedition	11	R
DL 650 AL2/AL3/AL4/AL5/AL6/AL7/AL8/AL9 V-Strom ABS	12-20	R
DL 650 XT XAL5/XAL6/XAL7/XAL8/XAL9 V-Strom ABS	15-20	R
GSF 650 AK5/AK6 Naked Bandit ABS	05-06	R
GSF 650 AK7/AK8/AK9/AK0/AL1/AL2 Naked Bandit ABS	07-12	R
GSF 650 K7/K8/K9/L0/L1/L2 Naked Bandit Non ABS	07-12	R
GSF 650 SAK5/SAK6 Faired Bandit ABS	05-06	R
GSF 650 SAK7/SAK8/SAK9/SAL0/SAL1 Faired Bandit ABS	07-15	R
GSX 650 FK8/FK9/FL0/FL1/FL2	08-12	R
GSX 650 SK7/SK8/SK9 Faired Bandit/Non ABS	07-09	R
GSX 650 FAK8/FAK9/FAL0/FAL1/FAL2 (ABS Model)	08-15	R
SV 650 K3/K4/K5/K6/K7/K8/K9/L0 Naked - Non ABS	03-10	R
SV 650 SK3/SK4/SK5/SK6/SK7/SK8/SK9/SLO Top Fairing Non ABS	03-15	R
SV 650 AK7/AK8/AK9/AL0 Naked - ABS	07-10	R
SV 650 SAK7/SAK8/SAK9/SAL0	07-15	R
GSR 750 L1/L2/L3/L4 Non ABS	11-14	R
GSR 750 AL2/AL4/AL5 ABS	11-15	R
GSX-S 750 AL7/AZL7/AL8/AZL8/AL9/ALZ9	17-20	R
DL 900 Migrator	14-19	R
DL 1000 K2/K3/K4/K5/K6/K7/K8/K9/L0 V-Strom	02-10	R
SV 1000 K3/K4/K5/K6/K7	03-07	R
SV 1000 SK3/SK4/SK5/SK6/SK7 Faired Model	03-07	R
GSX-S 1000 L6/L7/L8/L9 (Naked/Non ABS)	16-20	R
GSX-S 1000 AL6/AL7/AL8/AL9 (Naked/ABS)	16-20	R
GSX-S 1000 FL6/FL7/FL8/FL9 (Faired/Non ABS)	16-20	R
GSX-S 1000 FAL6/FAL7/FAL8/AL9 (Faired/ABS)	16-20	R
GSX 1000 Katana	18-20	R
GSF 1250 SK6/SAK6 ABS & Non ABS Faired		R
Bandit 4 Piston Caliper	06	R
GSF 1250 K6/AK6		R
ABS & Non ABS Naked Bandit 4 Piston Caliper	06	R
GSF 1250 K7/K8/K9/0L0		R
Non ABS Naked Bandit 4 Piston Caliper	07-11	R
GSF 1250 SK7/SK8/SK9/SLO		R
Faired Band Non ABS 4 Piston Caliper	07-10	R
GSF 1250 SAK7/SAK8/SAK9/SAZK9/SAL0/SAL1/SAL2 /SAL4 /SAL5/SAL6 (Faired Bandit - ABS Model - 4 Piston Caliper)	07-16	R
GSF 1250 AK7/AK8 ABS Model Naked Bandit 4 Piston Caliper	07-08	R
GSX 1250 FAL0/FAL1/FAL2/FAL4/FAL5/FAL6	10-16	R
GSX 1250 FAL0ST/FAL1ST Sports Tourer	10-14	R

YAMAHA

XJ6-F Diversion 600 (Full Fairing Non & ABS Models)	13-15	R
XJ6-S Diversion 600 (Top fairing model Non & ABS Models)	13-15	R
XJ6-N Diversion Naked	13-15	R
XJ6 SP	13	R
YZF-R6	03-07	R
YZF R6	08-16	R
FZ6 Fazer	04-07	R
FZ6 (Naked version)	04-07	R
FZ6 Naked/Non ABS 2 Piston Caliper (1B3/1B3D)	04-07	R
FZ6-NS Naked/Non ABS/2 Piston Caliper (1B35/6)	05-06	R
FZ6 S2 ABS (Naked)	07-09	R
FZ6 Fazer S2 (ABS) (4 piston caliper)	07-09	R
FZ6 Fazer (Half Fairing/Non ABS/2 Piston Caliper) (5VX/5VXL)	04-07	R
FZ6 Fazer (ABS/Half Fairing/2 Piston Caliper) (4P5)	06-07	R
FZ6 Fazer S2 (ABS/Half Fairing/4 Piston Caliper) (5S2)	08	R
FZ6 Fazer S2 (Non ABS/Half Fairing/4 Piston Caliper) (4S81/4S8)	07-09	R
FZ6 S2 (Naked/Non ABS) (4 Piston Caliper) (5S51/5S5)	07-09	R
MT-07 Non ABS (689cc/2 Cyl)	14-16	R
MT-07A ABS (689cc/2 Cyl)	14-18	R
MT-07 Motocage ABS (689cc/2 Cyl)	15-17	R
MT-07A Moto Cage (Non ABS)	14-16	R
Tracer 700 (MTT 690)	16-18	R
XSR 700 ABS (MTM 690-U)	16-18	R
FZ8 N-Naked/Single Headlight/Non ABS (800cc) (RN255/39P1)	11-15	R
FZ8 NA-Naked/Single Headlight/ABS (800cc) (RN256/59P1)	11-15	R
Fazer 8 - FZ8-S (800cc) (Top fairing /Twin headlight/Non ABS) (RN251/42P1)	11-15	R
Fazer 8 - FZ8-SA (800cc) (Top fairing/Twin headlight/ABS) (RN252/1BD1)	11-15	R
MT-09 (IRC) Non ABS (847cc/3 cyl)	14-16	R
MT-09 Street Rally (847cc/3 cyl engine)	14-16	R
MT-09A (ZDR) ABS (847cc/3 cyl)	14-16	R
MT-09 A Sport Tracker (ABS/847cc/3 cyl engine)	14-16	R
MT-09 ABS (MT850-A 847cc/3 Cyl Engine)	17-19	R
MT-09 SP ABS (MT850-D 847cc/3 Cyl Engine)	18-19	R
MT-09 Tracer 900 (ABS/847cc/3 cyl engine)	15-19	R
MT-09 Tracer 900 GT ABS (847cc/3 Cyl Engine)	18	R
MT-09 Tracer 900 GT ABS (847cc/3 Cyl Engine)	18	R

DISC PADS
BUYERS GUIDE

DO NOT REFIT ANY SHIMS/INSULATORS TO EBC PADS FROM ORIGINAL PADS UNLESS INSTRUCTED
ON NOTE ON PAD PACKAGING AND ON FA DRAWING ASSOCIATED WITH THAT PAD.

FA174 Contd.

YAMAHA Contd.

MT-10 (MTN 1000/998cc)	16-19	R
MT-10 Tourer Edition (998cc)	18-19	R
MT-10 SP (MTN 1000D/998cc)	17-19	R
XSR 900 ABS (MTM 850)	16-18	R
XSR 900 Abarth ABS (MTM 850)	17-18	R
FZ1 N/NA Naked (Non ABS/ABS)	10-15	R
FZ1 Fazer (Half Fairing - ABS - 5D0)	08-15	R
FZ1 Fazer (Half Fairing/Non ABS)	06-15	R
YZF-R1SP	06	R
YZF R1	04-06	R
YZF R1 (6 piston radial caliper)	07-14	R

Equivalents OE #		
43105 MWO 405	69100 08850	43082 0073
T2020602	06435 MEJ 006	5VX 25806 00
5SL W0046 00	06435 MEJ 016	69100 08860
06435 KV3 405	5VX W0045 00	43105 MWO 425
69100 06830	43020 S020	5VX W0046 00
06435 MEE 006	43082 0155	43082 0166
69100 06820	69100 16851	69100 16852

MATERIAL AVAILABILITY AND PART NO.				
STD	OPTIONS			
FA	V	HH	R	MXS
FA174	FA174V	FA174HH	-	-

FA175 33.7 x 50.5 x 7mm

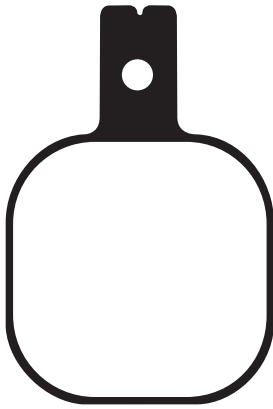

HARRISON BILLET

2 Piston (1296040)
Slim Design
Mini 6
ISR
22-032 (6 Piston Large)
22-042 (6 Piston Racing)

MATERIAL AVAILABILITY AND PART NO.					
STD	OPTIONS				
FA	V	HH	R	MXS	EPFA
FA175	-	FA175HH	-	-	EPFA175HH

Equivalents OE #
29-001
1296033
1296007

DISC PADS
BUYERS GUIDE

DO NOT REFIT ANY SHIMS/INSULATORS TO EBC PADS FROM ORIGINAL PADS UNLESS INSTRUCTED ON NOTE ON PAD PACKAGING AND ON FA DRAWING ASSOCIATED WITH THAT PAD.

SFA176 47.6 x 36 x 7.5mm



HONDA		
NH 50 Lead 50 SS	84	F
NH 50 Lead AF01/d716	84-85	F
NH 80 Lead 80/SS	85	F
NH 125 Lead 125	86-87	F

MATERIAL AVAILABILITY AND PART NO.					
STD	OPTIONS				
FA	V	HH	R	MXS	EPFA
SFA176	-	-	-	-	-

Equivalents OE #	
45105	GM9 711
45105	GM9 712
45105	GN3 701
45105	GN3 704

FA177 87 x 53 x 7.5mm

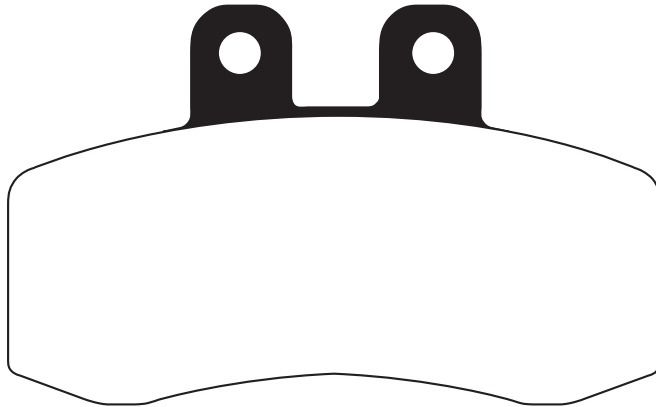

APRILIA		
Pegaso 650	91-96	F
MZ/MUZ		
Baghira - Forest/Forest HR - 21" front wheel/spoke wheel	96-05	F
Baghira - Street Moto - 17" front wheel/spoke wheel	96-05	F
Baghira - 21" front wheel/spoke wheel	99-05	F
Baghira - Black Panther -17" front wheel/spoke wheel	96-03	F
Mastiff - 21" front wheel/spoke wheel	96-05	F

MATERIAL AVAILABILITY AND PART NO.				
STD	OPTIONS			
FA	V	HH	R	MXS
FA177	-	-	-	-

Equivalents OE #	
9022001	1000

FA179 102 x 41 x 10mm

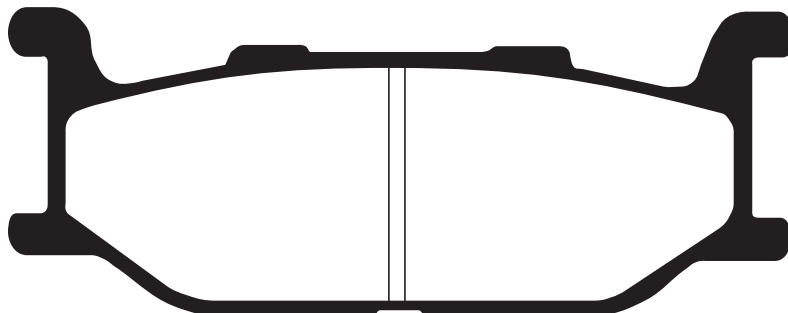

Equivalents OE #	
3YX W0045 00	5BN W0045 00
4BP W0045 00	5RU W0045 10
4FU W0045 00	5S7 10045 00
4KM W0045 00	803.08.01.60
4TR W0045 00	43108 HMA 000A
4WM W0045 00	5S7 25805 00

CF MOTO											
CF 250 T-5 V5 Custom	11-12	F									
KYMCO											
AK 550	17-19	R									
MOTOM											
Transcity 125/250	08-09	F									
SYM											
SB 125 N (Carb) Wolf (Drum Rear)	11-15	F									
YAMAHA											
FZ 250 Zeal (3YX1/2/4)	91-92	F									
SRV 250 'Soulfulltwin/Renaissa' (4DN1-6)	92-97	F									
SR 400 (2RD)	14-17	F									
XP 400 Majesty	04	F									
XVS 400	96	F									
XP 500 N/P/R T-Max	01-03	F									
XV 535/535 S 'Virago'	95-03	F									
XJ 600 N	95-97	F									
XJ 600 S "Diversion"	92-97	F									
YAMAHA Contd.											
XVS 650 Drag Star	97-04	F									
XVS 650 A Dragstar classic	98-07	F									
XV 750 Virago	94-97	F									
XJ 900 S "Diversion"	95-03	F									
SCR 950 (XVS 950XR-A)	17-18	F									
XV 950 Racer (Remote Reservoir Rear Shocks)	15-16	F									
XVS 950 A Midnight Star	09-13	F									
XV 950 - XVS 950 (Non ABS/Standard Rear Shocks)	14	F									
XV 950 CU - XVS 950 (1XC1/ABS/Standard Rear Shocks)	14-15	F									
XV 950 R - XVS 950 R (2DE/Remote Reservoir Rear Shocks)	14-18	F									
XV 1100 Virago	94-98	F									
XVS 1300 CU Custom	14-17	F									
XVZ 1300 TF 'Venture Star'	99-01	F									
XV 1600 A 'Wildstar'	99-04	F									

MATERIAL AVAILABILITY AND PART NO.								
STD	OPTIONS							
FA	V	SFA	SFAC	HH	SFA-HH	R	MXS	EPFA
FA179	FA179V	SFA179	SFAC179	FA179HH	SFA179HH	-	-	-

FA180 58.9 x 43.3 x 8mm

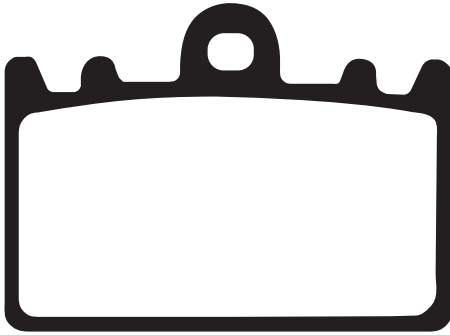

KAWASAKI		
ZXR 400 L1-L9	91-03	F
SUZUKI		
RGV 250 T (RGVR 250 SP VJ23A)	96	F

MATERIAL AVAILABILITY AND PART NO.

STD	OPTIONS				
FA	V	HH	R	MXS	EPFA
FA180	-	FA180HH	-	-	-

Equivalents OE

43082 1130
59300 42840

FA181 94 x 37.3 x 7.5mm

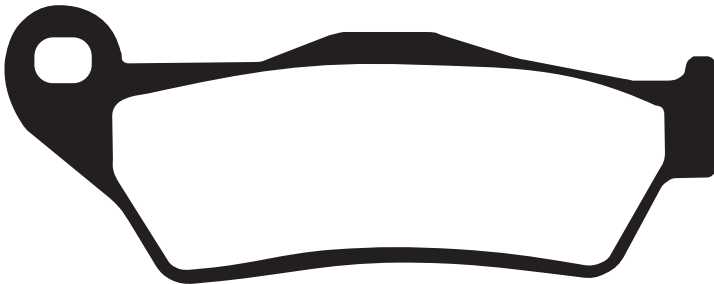

ALTA MOTORS (ELECTRIC)

Redshift MX	16-18	F
ALFER		
VR 250	98-13	F
APRILIA		
RX 125	00-01	F
RX 125	08-12	F
MX 125	04-06	F
SX 125	08-13	F
SRV 850	12-14	F
RST 1000 Futura	01-04	R
BAJAJ		
Pulsar 180 (UG4)	12-16	F
Pulsar 150	07-16	F
Pulsar 220 F	15-16	F
Pulsar 220 S	15-16	F
Pulsar Adventure AS 150	15-16	F
Pulsar Adventure AS 200	15-16	F
XCD 125 (Drum Brake)		
Pulsar RS 200 (inc Lower Fairing)	15-16	F
Pulsar 200 NS	14-16	F
Pulsar 135 LS	12-16	F
Discover 125 ST	13-15	F
Discover 150 S (Disc Brake)	14-16	F
Discover 150 F (Disc Brake)	14-16	F
Discover 125 M	14-16	F
BENELLI		
BX 250 Motard	12-13	F
BX 250 Motard	16-18	F
BX Cross (449cc)	07-12	F
BX Enduro (505cc)	08-12	F
BMW		
GX 450 X	08-11	F
F 750 GS	16-19	F
F 850 GS	16-19	F
F 850 GS Adventure	16-19	F
BREMBO		
XQ 21361 P2/28 Off Road Caliper		
122A99021 P2 24 Off Road Caliper		
CAGIVA		
E 750 Elefant	93-95	R
E 900 C Elefant (282mm front discs/USD forks/Brembo front/rear calipers)	93-97	F&R
E 900 C ie Lucky Explorer	95-97	F&R
CCM		
R30 (Spoke & Mag Wheel)	02-04	F
R35/R 35 S	06-09	F
FT 35 S (400cc) (DRZ 400 motor)	07-09	F
R 45	07-09	F
404E	03-04	F
404 DS	03-04	F
404 DS Supermoto	03-04	F

CCM Contd.

404 DS Supermoto	07-09	F
404 DS Trail	07-09	F
CMX 450 (MX)	08	F
450 DS Trail	07-09	F
604E Supermotard/RS/Dual Sport	98-03	F
644 DS Supermoto	04	F
644 DS	04	F
FT 650	08	F
FT 710 S Flat Tracker	08-09	F
DUCATI		
Monster 400 ie (Japan)	07-08	F
Monster S2R (803cc)	05-07	F
Monster Dark 620	05-06	F
Monster 620	05-06	F
620 Multistrada		
(Twin disc/Single pin pad fixing)	06	F
695 Monster	07-08	F
950 Multistrada (936cc)	17-18	R
1200 Multistrada ABS		
(Single Pin F/Caliper)	15-17	R
1200 Multistrada DVT	15-17	R
1200 Multistrada Enduro	17-18	R
1200 Multistrada Enduro Pro	18	R
1200 Multistrada Touring	15-17	R
1200 S Multistrada Touring	15-18	R
1200 S Multistrada	15-17	R
1200 S Multistrada D air	15-17	R
1260 Multistrada	18	R
1260 Multistrada Touring	18	R
1260 S Multistrada	18	R
1260 S Multistrada D air	18	R
1260 Multistrada Pikes Peak	18	R
FACTORY		
YR 250	03	R
FANTIC		
Caballero 50 Regularita Competizione	06-09	F
Caballero 50 Supersei Competizione	07-08	F
Caballero 125 Regularita Competizione	07-09	F
Caballero Regularita		
Competizione Mini 50	08-09	F
GAS GAS		
Quad Wild HP 50	04-07	F&R
Enduro EC 125/200/250/300	97-99	F
Wild HP 240/300	03-06	F&R
Quad HP 300 RV	03-06	F&R
Pampera 400	06	F
Wild HP 450 Quad	04-09	F&R
Wild HP 515cc Quad	09	F&R
GILERA		
Nexus 500	03-12	F
GP 800 (Chain drive)	08-14	F

HARLEY DAVIDSON

XG 500 Street	16-20	R
XG 750 Street	16-20	R
HIGHLAND		
950 V2 Outback	00-04	F
950 V2 Motard	00-04	F
HONDA HM (Italy)		
CRE 50 Six	01-02	F
CRE 50 Baja/Derapage	01-02	F
HUSABERG		
TE 125 2T	12-14	F
FE 250 (4T)	13-14	F
TE 250 (2T)	11-14	F
TE 300 (2T)	11-14	F
FE 350 (4T)	13-14	F
FE 390 (New 70° Engine)	10-12	F
Enforcer Four	00-03	F&R
FE 450 E	06-08	F
FE 450 (New 70° Engine)	08-14	F
FX 450	10-12	F
FE 501 (4T)	13-14	F
FE 550 E	06-08	F
FE 570	09-12	F
FE 650 E	06-08	F
HUSQVARNA		
CR 125	95-13	F
SM 125	98-00	F
SM 125 S	02-13	F
SMR 125 (4T)	11-13	F
SMS 4-125cc (4T)	11	F
TC 125 (2T)	14-20	F
TE 125 (2T)	14-19	F
TE 125 (4T)	11-13	F
TX 125 (2T)	18-19	F
TE 150i (2T)	18-20	F
WR 125	05-13	F
WRE 125	93-13	F
CR 250	95-05	F
FC 250 (4T)	14-20	F
FE 250 (4T)	14-20	F
TC 250 (4T)	02-13	F
TC 250 (2T)	14-20	F
TE 250 (2T) inc Tpi	14-20	F
TE 250 (4T)	02-13	F
TE 250 Meo Replica (4T)	11	F
TE 250 R (4T)	13	F
WR 250 (2T)	95-13	F
TE 300 (2T)	14-19	F
TE 300 Tpi (2T) Tpi inc Jarvis Edition	19-20	F
TX 300 (2T)	14-19	F
WR 300 (2T)	09-12	F
TE 310 (4T)	09-13	F

DISC PADS BUYERS GUIDE

DO NOT REFIT ANY SHIMS/INSULATORS TO EBC PADS FROM ORIGINAL PADS UNLESS INSTRUCTED ON NOTE ON PAD PACKAGING AND ON FA DRAWING ASSOCIATED WITH THAT PAD.

FA181 Contd.

HUSQVARNA Contd.

TE 310 R (4T)	13
FC 350 (4T)	14-20
FE 350 (4T)	14-20
FX 350 (4T)	18-20
TE 350	95-97
WR 360	95-02
TE 400	02
TE 410	95-00/06
TE 410 E	00
TC 449 (4T)	11-13
TE 449 (4T)	11-13
FC 450 (4T) inc Rockstar Edition	14-20
FE 450 (4T)	14-20
FX 450 (4T)	17-19
TC 450	03-10
TE 450	03-10
FE 501 (4T)	14-15
TC 510	04-09
TE 510	04-10
TE 511 (4T)	11-13
TC 570	02-03
TE 570	01-04
TC 610	00
TC 610 E	95-99
TE 610	00
TE 610 E	95-00/02-03
TE 610/E	06-09
TE 630	10-12

KEEWAY

Silverblade 125/150/250	07
KXM 200	14
KXV 200	14
KRAM-IT (KRAMER)	
GS 250	00-
SM 250	00-

KTM

LC2 125	96-98
MX 125	92-93
D-XC/E-XC/E-GS 125	92-93
EXC/EGS 125	94
EXC 125	95-17
EXC 125 (2T) Six Days	11-17
XC-W 125 (2T)	17-20
SM 125 Supermoto	00
SX 125	94-18
SX 125 (Upside down forks)	09-20
EXE 125	00
XC-W 125 (2T)	17-19
SX 150	09-20
XC 150 (USD)	11-13
XC-W 150 (2T) Inc Tpi	17-20
EXC 200/EGS	94-03
EXC 200 (inc Six Days)	04-17
EXC 250 Racing	06
EXC-F 250	06-20
EXC-F 250 (4T) Six Days	11-20
MX 250	92-93
SX 250 (2T/Std Forks)	94-99
SX 250 (2T) (Upside Down Forks)	09-20
SX-F 250 (4T)	06-20
SX-F 250 Ken Roczen Edition	12
EXC/EGS 250	94
EXC 250	95-20
EXC 250 (2T) Six Days	11-20
XC 250 (USD)	11-20
XC-F 250 (USD)	11-20
EXC 300 (Upside Down Forks)	00-20
EXC 300 (2T) Inc Tpi Six Days & Erzbergrodeo	11-20
XC 300 (2T)	11-20
EXC 350 LC4	94-95
SX-F 350 (Upside down forks)	11-15
SX-F 350 Tony Cairoli Edition	12
EXC-F 350 (USD)	11-20
EXC-F 350 Six Days	12-20
XC-F 350	12-20
SX 360	96-97
EXC 360	96-97
SX 380	98-03
EXC 380	98-03
EXC 400 Racing	04-07
EXC 400 (4T)	09-11
SC 400	96-99
EGS/EGS-E/LSE 400 (LC4 Enduro)	96-99
SX 400	00-02
EXC/EGS 400 (USD)	00-03
EXC 400 Racing (USD)	00
EXC 400	04-11
LC4-E 400 Enduro	00-01
SX 440	94-95
EXC 440	94-95
SX 450 (4T)	03-07
SX-F 450 (4T)	07-15
EXC 450 Racing	06-07
EXC-R 450 (4T)	08

KTM Contd.

EXC 450 (4T)	03-20
EXC 450 (4T) Six Days	11-20
EXC 500 (4T)	12-20
EXC 500 (4T) Six Days	12-20
MX 500	92-95
SX-F 505	07-09
SX 520	01-03
EXC 520	01-03
EXC 525	03
SX 525	03-06
EXC 525	04-05
MXC 525	03-04
XC 525 Racing	06-07
EXC-R 530 (4T)	08
EXC 530	09-11
EXC 530 (4T) Six Days	11
MXC 550	96
SX/EXC/EGS 620	94-95
SX 620	96-98
SC 620 Supercompetition	96-00
EGS/EGS-E/LSE 620 Enduro	96-99
EGS-E 620 Adventure/Rallye	99
LC4 620 SC Supermoto	00
SXC 625	05-06
LC4-E 640 Enduro	00-04
LC4-E 640 Supermoto	00-06
LC4 640 Adventure R	99-02
LC4 640 Adventure	03
LC4 625 SC Supermoto	02
LC4 625 SC Supercompetition	02
SXC 625	03-04
LC4 640 Adventure	01-06
790 Adventure R	18-20
950 Adventure	02-06
950 Adventure S	03-06
950 Supermoto	05-07
950 R Superenduro	06-08
990 Adventure	06-08
990 Adventure R	09-12
990 T (SM-T)	09-13
990 Supermoto R (SM-R)	08-13
1050 Adventure	15-20
1090 Adventure Inc R	17-20
1190 Adventure	13-20
1190 Adventure R	13-20
1290 Super Adventure inc R and S	15-20

MAICO

500 MX/Enduro	99
---------------	----

MBK

XQ 125/150 Thunder	01-03
YP 125 D Skyliner	98-10
VP 300 R Kilibre	03-04 F&R

MOTO GUZZI

850 Brevia ie	06-07
850 Griso	06-07
940 Bellagio	07-13
Brevia V1100	05
Brevia 1100 (ABS)	07
Brevia 1100	05-06
1100 Brevia (Std/ABS Models)	05-07
Quota 1100 ES	99-01
1100 Griso 4V (1064cc)	05-08
1100 Griso	05-08
1100 Quota ES	99-01
Brevia 1200	08-09
Norge 1200	06-09
1200 Norge GT 8V (ABS)	08-15
1200 Griso 8v Special Edition (1151cc /Spoke Wheel/Radial Caliper)	09-15
1200 Griso 8v (Std - Cast wheel/radial caliper)	07-12
1200 Griso 8v (1151cc/Cast Wheel/Radial Caliper)	09-11
1200 Sport	06-07
1200 Sport (2V)	06-09
1200 Sport 4 Valve	08-12
1200 Stelvio	08-11
1200 Stelvio 8V (ABS)	11-15
1200 Stelvio NTX ABS	09-10
1200 Stelvio 8v NTX (ABS)	11-15

MOTO MORINI

Granpasso 1200	08-13
Scrambler 1200	10-13

PEUGEOT

Enduro 250 i	12
Enduro 300 i	12

PIAGGIO

X9 250 Linked brake f&r wheel 14"dia	04
Beverley 400ie	07
X9 500cc Evolution	03-06
X9 500ie	07

RIEJU

Marathon 250	09-10
Marathon 450	09-10

ROYAL ENFIELD

Bullet 500 (EFI/Single Seat)	16-18
Classic 500 (EFI/Single Seat)	16-20
Classic Chrome 500 (EFI/Single Seat)	16-18
Himalayan	16-20

SHERCO

125 SC-Factory	19-20
125 SE-R	19-20
250 SC-Factory	19-20
250 SCF-Factory	19-20
250 SE-R	19-20
250 SE-Factory	19-20
250 SEF-R	19-20
250 SEF-Factory	19-20
SE 250 i Enduro	
(Brembo rear caliper) (2T)	12-15
SEF 250 (4T)	13-15
SEF-R 250 (4T)	13-15
SE-R 250 (2T)	12-15
SEF 300 (4T)	13-15
SE-R 300 (2T)	12-15
300 SC-Factory	19-20
300 SCF-Factory	19-20
300 SE-R	19-20
300 SE-Factory	19-20
300 SEF-R	19-20
300 SEF-Factory	19-20
450 SM	04-08
2.5i Enduro (4T)	06-09
Enduro 2.5iF (4T) (inc SE models)	08-10
SM 2.5i Supermotard	08
SX 2.5iF Moto Cross	10
Enduro SE 3.0i (4T)	10
SEF 300 (4T)	13-15
SE-R 300 (2T)	12-15
4.5i (Enduro)	04-09
Enduro 4.5i	04-10
SE 450 iR Enduro (Nissin rear caliper)	12
SEF 450 (4T)	14-15
SE-R 450 (2T)	14-15
450 SCF-Factory	19-20
450 SE-R	19-20
450 SEF-Factory	19-20
500 SCF-Factory	19-20
500 SEF-R	19-20
500 SEF-Factory	19-20
SE 510 iR (Nissin rear caliper)	12
5.1i Enduro (4T)	06-09
Enduro 5.1iF	07-10
5.1i Supermotard	06-09
SM 5.1iF Supermotard	07

SINNIS

RSX 125	19-20
---------	-------

SUZUKI

UH 125 K2/K3/K4/K5/K6 Burgman	02-06
-------------------------------	-------

S.W.M.

MC 125 R	18
RS 125 R	16-17
SM 125 R	16-17
MC 250 S	16
FT 300 R (RS 300 R FLAT TRACK)	17
RS 300 R (4T)	15-18
RS 340 S	16
RS 500 R (4T)	15-18
RS 650 R	16-18

TM

80 Enduro	96-00
80/85 Cross	96-01
80/85/100 (Big wheel)	02-04
Junior 80/85/100 Cross (Small wheel)	02-04
Junior 80/85/100	05-08
MX 85 JR (Small Wheel)	02-15
MX 85 (Big Wheel)	02-15
125 Cross	95-00
MX 125 (2T)	01-15
125 Enduro	95-00
Enduro EN 125 (2T)	01-15
MX 125 (2T)	05-14
EN 144 (2T)	08-15
MX 144 (2T)	08-15
250 Cross	95-00
250 (4T) Cross MX	02-14
MX 250 (2T)	01-15
MX 250 (4T)	02-09
MX 250 Fi (4T)	10-15
250 Enduro	95-00
Enduro EN 250 (2T)	01-15
EN 250 F (4T) Enduro	04-09
EN 250 Fi (4T)	10-15
300 Cross	95-00
MX 300 (2T)	01-15
Enduro EN 300 (2T)	01-15
300 Enduro (2T)	95-00
400 (4T) MX Cross	02-03
400 Cross (4T)	95-00
EN 450 F (4T)	04-15

DISC PADS
BUYERS GUIDE

DO NOT REFIT ANY SHIMS/INSULATORS TO EBC PADS FROM ORIGINAL PADS UNLESS INSTRUCTED ON NOTE ON PAD PACKAGING AND ON FA DRAWING ASSOCIATED WITH THAT PAD.

FA181 Contd.

TM Contd.

MX 450 F (4T)	04	F
MX 450 Fi	05-15	F
530 Cross (4T)	98-00	F
EN 530 F (4T)	04-15	F
MX 530 F	05-15	F

TRIUMPH

Bonneville Bobber Black (1200cc Liquid Cooled)	18-20	F
Bonneville Speedmaster (1200cc Liquid Cooled)	18-20	F
Tiger 800 XCa (ABS) from VIN 855532	18-20	F
Tiger 800 XCx (ABS) from VIN 855532	18-20	F
Tiger 800 XRt (ABS) from VIN 855532	18-20	F
Tiger 800 XRx (ABS) from VIN 855532	18-20	F

VECTRIX

VX-1 (Li/NiMh)	
VX-3 Li+ (3 wheeler model)	

VERTEMATI

All models (2 piston Brembo)

VOR

All models (2 piston Brembo)

YAMAHA

GT 125 Hammerhead	
YBA 125 Enticer (3P01/3P41)	
YP 125 Majesty	
XQ 125/150 N Maxster	
YZF-R 125	
VP 300 Versity	
XC 300 Versity	

YAMAHA Contd.

07-14	F&R	TT 600 R (5CH1/5CH2/5CH3)	97-02	F
12-13	R	TT 600 RE (5CH5)	04	F
		TT 600 E (4LW3/4LW4/4GV4/4GV5)	94-01	F
99-04	F	TT 600 E (4GV2)	94-95	F
		TT 600 K (4LW1/4GV1/4LW2)		
03-04	F	Up to 4GV 003403	93-95	F
		TT 600 K From 4GV 003404	95-96	F
12-18	F	XT 660 Z Tenere	08-16	F
05-06	F	XT 660 ZA Tenere (ABS)	11-16	F
98-09	F	XT 700 Z Tenere	18-19	F
01-03	F	ZERO		
08-13	F	Zero FX (ZF2.8/ZF5.7)		
03-05	F&R	(J.Juan F & R Calipers)	15	F
06	R			

DISC PADS BUYERS GUIDE

DO NOT REFIT ANY SHIMS/INSULATORS TO EBC PADS FROM ORIGINAL PADS UNLESS INSTRUCTED ON NOTE ON PAD PACKAGING AND ON FA DRAWING ASSOCIATED WITH THAT PAD.

Equivalents OE

546 13 209 044	AB024 S	BQ300222068	770 13 020 000	503 13 030 000
5CH F5911 00	59330 49F00	K00976315	69107	777 13 030 000
5DS F5811 00	5SE F5811 10	80009634	69116	61340721A
4GV F5911 00	K00976315	BQ300222065	860883	41300161
8000 88482	497396	56325 R	1679	61321161A
5NR F5811 00	800074181	GU05654630	647074	F000P02030
5SE F5811 00	503 13 030 100	GU30654675	894047	8000A7143
8A0074181	8113593	8133516	3710	800096934
8B0074181	0624	34 11 7 717 292	07849312/27	T2022314
8C0074181	59330 49F00	34 11 7 717 308	5SU W0045 00	61341161A
800074181	00306546250	5D7 FS811 00	107 861750	BRK-PAD-0017
AB024	613 4 072 1A	11D FS811 00	M9467Z04	

MATERIAL AVAILABILITY AND PART NO.

STD	OPTIONS							
FA	SFA	V	SFAC	HH	SFA-HH	R	MXS	EPFA
FA181TT	SFA181	FA181V	SFAC181	FA181HH	SFA181HH	FA181R	MXS181	EPFA181HH

FA182 74.8 x 53.9 x 10mm

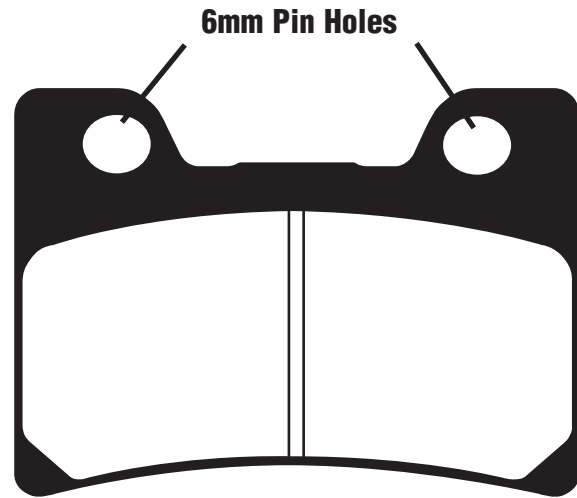

YAMAHA
FZR 1000 EX UP (USD Forks) 91-93 F

MATERIAL AVAILABILITY AND PART NO.

STD	OPTIONS			
FA	HH	V	R	MXS
FA182	FA182HH	-	-	-

Equivalents OE

3GM W0045 50

FA183 102.40 x 55.25 x 8mm

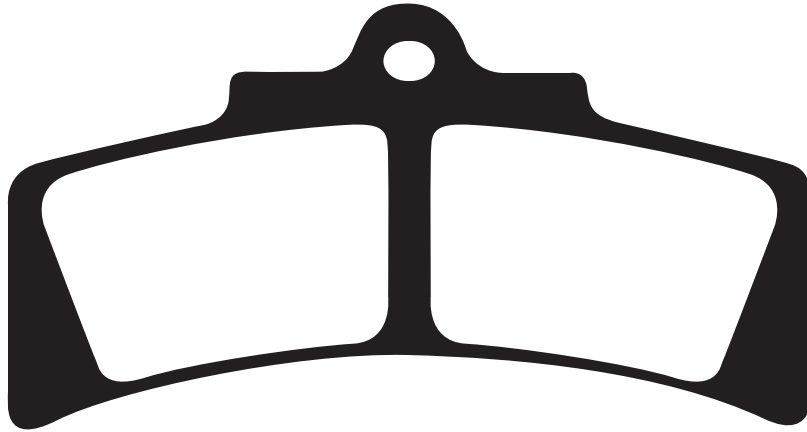

MATERIAL AVAILABILITY AND PART NO.					
STD	OPTIONS				
FA	V	HH	R	MXS	GFA
-	-	-	-	-	GFA183HH

Equivalents OE #
N/A

FA184 28.5 x 45.8 x 7mm

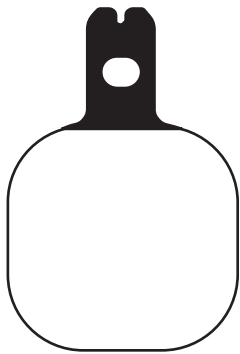

MATERIAL AVAILABILITY AND PART NO.					
STD	OPTIONS				
FA	V	HH	R	MXS	GPFA
FA184	-	-	-	-	GPFA184HH

ISR
 22-034 (6 Piston Small)
 22-036 (2 Piston)
 22-043 (4 Piston)
 Radial 6 Piston Monoblock

Equivalents OE #
ISR29-002

DO NOT REFIT ANY SHIMS/INSULATORS TO EBC PADS FROM ORIGINAL PADS UNLESS INSTRUCTED ON NOTE ON PAD PACKAGING AND ON FA DRAWING ASSOCIATED WITH THAT PAD.

FA185 94 x 34.2 x 7.5mm



DISC PADS BUYERS GUIDE

DO NOT REFIT ANY SHIMS/INSULATORS TO EBC PADS FROM ORIGINAL PADS UNLESS INSTRUCTED ON NOTE ON PAD PACKAGING AND ON FA DRAWING ASSOCIATED WITH THAT PAD.

AJP		
PR5 Supermoto 250cc	09	F
PR5 Enduro 250cc		
ALFER		
AR 250	93-	F
APRILIA		
MXV 450	09-13	F
RXV 450/550 Enduro	06-13	F
BETA		
RR 125 (2T) Inc MY20	18-20	F
RR 200 (2T) MY20	20	F
RR 250 2T	13-14	F
RR 250 Enduro (2T) Inc MY20	14-20	F
RR 250 Enduro Racing (2T)	18-19	F
RR 250 4T Enduro	05-07	F
RR 250 Racing (2T)	15	F
RR 300 Enduro 2T	13-14	F
RR 300 Enduro 2T	18-20	F
RR 300 Enduro Racing (2T)	13-14	F
RR 300 Racing (2T)	15	F
300 X-Trainer (2T)	15-19	F
RR 350 Enduro Racing (4T)	13	F
Enduro RR 350 (4T)		
Inc Racing and MY20	15-20	F
RR 350 4T Enduro	11-14	F
Enduro RR 390 (4T) MY20	20	F
RR 400 4T Enduro	05-14	F
Enduro RR 430 (4T)		
Inc Racing and MY20	15-20	F
RR 450 4T Enduro	05-14	F
RR 450 Enduro Racing (4T)	13-14	F
RR 450 4T Cross Country	12	F
Enduro RR 480 (4T)		
Inc Racing and MY20	15-20	F
RR 498 4T Enduro	12-14	F
RR 498 Enduro Racing (4T)	13-14	F
RR 520 Enduro	05-11	F
RR 525 4T Enduro	05-09	F
CANNONDALE		
MX 400	00	F
CPI		
Sauel 125		F
GAS-GAS		
EC 125/200/250/300 (All Models/2T)	00-15	F
EC 200-250-300 XC 250-300 Euro4	18-20	F
MX 125/250 (MC)	01-09	F
Trail Halley 125cc	09	F
MX 200/250/300	99-00	F
EC 250 F (All Models/4T)	12-15	F
EC 300 F (All Models/4T)	13-15	F
EC 450 FSR/FSE (4T) Enduro	05-09	F
EC 450 F (All Models/4T)	13-15	F
EC 450 Raid	14	F
Pampera 450 (4T)	07-08	F
SM Halley 450cc	09	F
Trail Halley 450cc	09	F
EC 515 FSR/FSE (4T) Enduro	05-09	F
GOES		
G 125 XM	08-09	F
G 250 XM	08-09	F
HONDA		
CR 125/250		
RS/RT/RV/RW/RX/RY/R1/R2/R3/R4/R5/R6/R7	95-07	F
CRF 125 F Small wheel (FR 17"/RR 14" Wheels)	14-20	F
CRF 125 FB Big wheel (FR 19"/RR 16" Wheels)		
XLR 125 RW	98-01	F
XR 125 L3/L4/L5/L6/L7/L8	03-08	F
CRF 150 F3/F4/F5/F6/F7	03-20	F
CTX 200/CTX 200 A Bushlander	04-16	F
CRF 230 F4/F5/F6/F7/F8/F9	04-20	F
CRF 230 L	08-10	F
CRF 230 M	09-10	F
SL 230 'Free Landsports' (MD33) V/W/X/1	97-01	F
CRM 250 RR/RR11 (MD24 140) MK3	94-96	F
CRM 250 'Active Radial' (MD32) ARV/ARW	97-98	F
CRF 250 RE (Limited Road Use)	16	F

HONDA Contd.		
CRF 250 R4/R5/R6/R7/R8/R9/RA/RB/RC/RD/RE/RF/RG	04-16	F
CRF 250 RF/RG/RH/RJ (260mm F/Disc)	15-18	F
CRF 250 X4/X5/X6/X7/X8/X9/XB/XC/XD/XF/XG/XH/XJ/XL	04-20	F
CRF 250 XRL (Road legal)	14-20	F
250 RT/RV/RW/RX/RY/R1/R2/R3/R4	96-04	F
XL 250 Degree (MD26)	94-96	F
XLR 250 RM/R3N/RP/RR/R3R (MD22)	91-	F
XLR 250 Baja MK2 (MD22)		
XR 250 Y/3 (MD30)	00-03	F
XR 250 3/S (MD30) Motard	03-05	F
XR 250 III Y/3 Baja	00-03	F
XR 300 R10	10	F
NX4 Falcon	02-05	F
XR 400 RT/RV/RW/RX/RY/R1-R5	96-05	F
CRF 450 R2-R9/RA/RB/RC/RD/RE/RF	02-18	F
CRF 450 RE (Limited Road Use)	16	F
CRF 450 R AC/R WE (260mm F/Disc)	15-20	F
CRF 450 X5/X6/X7/X8/X9/XB/XC/XD/XF/XG/XH/XJ/XK	05-20	F
CRF 450 XRL (Road legal)	14-16	F
CRF 450 RXH/RXJ/RXK (18" Rear Wheel)	17-20	F
TRX 450 R4/R5/R6/ER6/R7/ER7/R8/ER8/ER9	04-09	F
CR 500 RS/RT/RV/RW/RX/RY/R1	95-01	F
XR 600 RP/RR/RS/RT/RV/RW/RX/RY	93-00	F
XL 600 VV/VW/VX Transalp	97-00	F
XL 650 VY/V1/V2/V3/V4/V5/V6/V7 Transalp	00-07	F
XR 650 RY/R1-R7	00-07	F
XR 650 L	93-20	F
TRX 700 XX8/XX9/XXB	08-11	F
XL 700 V8/V9/VA (Transalp/2 piston front caliper/ABS on rear disc)	08-11	F
XR 750 P/R/S/T/V/W/X/Y 'Africa Twin'	94-03	F
HONDA DALL'ARA		
XR 125 SM	04	F
XR 250 R	04	F
XR 250 SM	04	F
XR 400/440 R	04	F
XR 400/440 SM	04	F
XR 650 R	04	F
HONDA-HM (ITALY)		
CR 125 Motard	04	F
CRE 125 R Supermotard	02-03	F
CRE 125 R Enduro	02-06	F
CRE 125 (Six Competition 2T)	11	F
CRM 125 (Derapage RR 2T)	11	F
CRF 230 Easy Trail	04	F
CRF 230 Easy Enduro	04	F
CRF 230 Easy Motard	04	F
CRF 230 F Easy Trial (All models)	04-07	F
CRE 250 R Supermotard	02-03	F
CRE 250 R Enduro	02-06	F
CRE 250 R Moto	04	F
CRE 250 F Enduro	04-06	F
CRE 250 X		
CRE F 250 X	08-11	F
CRF 250 Motard	04	F
CRF 250 F	04-08	F
CRF F 250 R	08-09	F
CRF F 250 X	08-09	F
CRF F 290 X	07	F
CRF F 300 X	08-09	F
CRF 450 F Enduro	02-04	F
CRF 450 Motard	04	F
CRE 450 Supermoto	02-03	F
CRE 450 X		
CRF 450 R	04-08	F
CRE F 490 X	07	F
CRE F 500 X	08-09	F
KAWASAKI		
KX 125 K1/K2/K3/K4/K5/L1/L2/L3/L4/M1/M2/M3/M6F/M7F/M8F	94-08	F
KDX 200 H1/H2/H3/H4/H5	95-99	F
RM 125 K6/K7/K8	06-08	F

KAWASAKI Contd.		
KDX 220 R A4/A5/A6/A7/A8/A9/A10/A11/A12/A6F	97-06	F
KDX 220 SR (DX 220 B)		F
KLX 250 F1-F4	94-97	F
KLX 250 R D1/D2	93-94	F
KLX 250 G1	94	F
KLX 250 J1-J6 D-Tracker	98-03	F
KLX 250 H6F/H7F	06-07	F
KX 250 F (KX 250 N1/N2)	04-05	F
KX 250 K1-K5/L1-L4/M1-M2/R1/R6F/R7F/R8F	94-08	F
KX 250 F (T6F/T7F/T8F)	06-08	F
KX 250 F (KX 250 W9F/XAFB/YBF/YCF/ZDF/ZEF/ZFF/ZGF/AHF) (4T)	09-17	F
KX 250 F	15-20	F
KLX 300 A2-A10/A6F/A7F	97-07	F
KLX 400 R (KLX 400 B1/B2)	03-04	F
KLX 450 R (A8F/A9F/AAF/ABF/ACF/ADF/AEF/AFF/AGF/AHF/AJF)	08-18	F
KX 450 F	06-20	F
KX 500 E6-E16	94-04	F
KLX 650 C1/C2/C3	93-97	F
SUZUKI		
DR 125 SMK8/SMK9/SML0	08-12	F
RM 125 T/V/W/X/K1-K9	96-12	F
RM 125 XCK8	09	F
250 SBK2 (LX 250 L)	02	F
DR 250 RL/RV/RL/RS/RLS/RT/RV/RL/RL/R/LW/RW/RY (SJ45A/DOHC)	95-00	F
DR 250 RXT/RXLT/RTV/RXLV/RXW/RXLW/RXGW/RXGLW/RXY/RXGY (Djebel 250 XC/GPS Ver (SJ45A))		F
DR-Z 250 K1-K7 (DJ43A)	01-07	F
RM 250 T/V/W/X/K1-K9	96-12	F
RM 250 XCK8	09	F
RMX 250 T/V/W	96-98	F
RMX 250 ST/SV/SW/SX (SJ14A)	96-99	F
RM-Z 250	04-20	F
DR 350 SEW/SEX Electric Start/6 bolt front disc	98-99	F
DR-Z 400 SEY/EY/Y/SEK1/EK1/K1/K2/SEK2/EK2/K3/SEK3/EK3/K4/SEK4/EK4/SK5/EK5/K5/SK6/K6/EK7/SK7/K7/SK8/SK9	00-09	F
DR-Z 400 SMK5/SMK6/SMK7/SMK8/SMK9	05-09	F
RMX 450 ZL0/ZL2	10-15	F
RM-Z 450	05-20	F
DR 650 SET/SEV	96-97	F
YAMAHA		
YZ 125 K/L/M/N/P/R/S/T/V/W (2T)	98-07	F
WR 250 FN/FP/FR/FS/FT/FV/FW/FX/FY/FZ/FA/FB/FD (4T)	01-13	F
WR 250 FF/FG (4T/Reverse Cylinder)	15-16	F
WR 250 ZK	98	F
WR 250 R (32D1/3)	08-20	F
YZ 250 K/L/M/N/P/R/S/T/V/W	98-07	F
YZ 250 FN/FP/FR/FS/FT/FV (4T)	01-06	F
YZ 400 FK/FL	98-99	F
WR 400 FL/FM/FN	99-01	F
WR 426 FN/FP	01-02	F
YZ 426 FM/FN/FP	00-02	F
WR 450 FR/FS/FT/FV/FW/FX/FY/FA/FB/FD/FE/FF (4T)	03-15	F
YZ 450 FR/FS/FT/FV/FW	03-07	F

Equivalents OE #	
06455 GZ8 405	43082 1266
06455 KCZ 000	43082 S011
06455 KHA 941	43082 S009
06455 MY1 405	43082 1286
06455 MAY 000	45105 KTO 405
06455 KBR 731	45105 KZI 405
06455 KHA 941	45105 KAS 415
06455 MAW 761	5DH W0045 00
06456 MAW 761	5DH W0045 10
06455 MCB 611	5MV W0045 00
06455 HP1 006	59300 13830
06455 HP1 016	59300 13860
06455-KSS-952	59300 36850
06455-KSS-952	59300 36860
06456 MCB 611	59300 36870
06456 MCB 612	59300 3K880
43082 124	59301 36810
45105 KTO 405	K4308 21225
45105 KZ1 405	K4308 21286
45105 MY6 405	BE 2500 22065
45105 MY6 415	BC 2500 22065
45105 KV6 701	59300 29860
45106 KV6 701	43082 0026
43082 0132	9100788
43082 1149	43082 0049
43082 1152	BE250022065
43082 1172	32D W0045 00
43082 1193	252536200
43082 1218	9100788

MATERIAL AVAILABILITY AND PART NO.				
STD	OPTIONS			
FA	HH	R	MXS	EPFA
FA185TT	-	FA185R	MXS185	EPFA185HH

SFA186 31.5 x 51 x 5.5mm

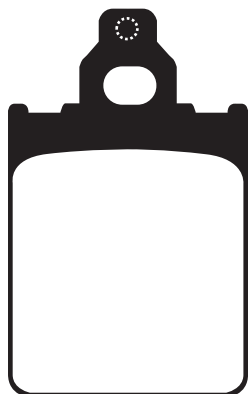

CAGIVA

Blues 50	93-95	R
Supercity 50/80	93-95	R
Prima 50	92-94	R

LML

Star 125i (4T)	10-15	F
Star 125 (2T)	10-14	F
Star 125 Deluxe (2T) (Front disc)	01-03	F
Star 150 (2T)	10-14	F
Star 150 Deluxe (2T) (Front disc)	01-03	F
Star 151i (4T)	10-15	F
Star 200i (4T)	10-15	F

PIAGGIO

Quartz 50	92-96	F
Sfera 50 RST	95-97	F
Skipper 125/150	94-97	F
LX 60 (Special Anniversary Model)	06	F

VESPA

PX 125 (Disc Brake Model/2T)	98-30/04/11	F
PX 125 Touring (Disc brake model)	15	F
PX 150 (Disc brake model)	98-15	F
PX 150 Touring (Disc brake model)	15	F
PX 200 (Disc brake model)	98-07	F

Equivalents OE

494762
498414
800067127
C-4721834
647176

MATERIAL AVAILABILITY AND PART NO.

STD	OPTIONS				
SFA	SFAC	HH	R	MXS	EPFA
SFA186	SFAC186	-	-	-	-

FA187 68 x 54 x 8mm

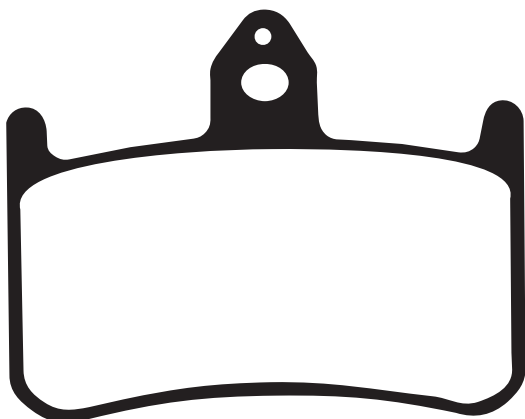

HONDA

CB 250 FT/FV/FX/FY/F1 'Hornet'	96-01	F
NSR 250 R6K/R6K-2 (MC18-110)	89	F
NSR 250 R7L (MC21-100) R7N (MC21-106)	90	F
NSR 250 R8L-3 (MC21-101) R9L (MC21-102)		
R8N/R89N-3 (MC21-106)	90-92	F
NSR 250 R2R/R3R (MC28-110) R2T/R3T (MC28-120)	94	F
NSR 250 R9N (MC21-106)	92	F
NSR 250 RR (MC28-100)	94	F
NSR 250 R2J (MC18-100) R4J (MC18-100)	88	F
NSR 250 R5K/R5K-2 (MC18-110)	89	F
CB 400 SF (F2V/F3T) Superfour (NC31)	96-97	F
NT 400 'Bros' NC25		F
VFR 400 R3K/R3L/R3M/R3N (NC30)	89-92	F
RVF 400 RR/RRII/RT/RT-II (NC35)	94-96	F
Bros Product One 650		
NT 650 J/K/L 'Bros'	88-92	F
NR 750 N	92	F
VFR 750 RJ/RK/RL (RC30)	88-90	F
RVF 750 RR/RS 'RC45'	94-98	F
CBR 900 RRN/RRP/RRR/RRS/RRT/RRV Fireblade	92-97	F
CB 900 F2/F3/F4/F5/F6/F7 Hornet	02-07	F
CB 1000 FP/FR/FS/FT/FV	93-97	F
VTR 1000 FV/FW/FX/FY/F1/F2/F3/F4/F5/F6 Firestorm	97-06	F
'X4' CB 1300 DCV/DCW/DCX/DCY (SC38)	97-00	F

Equivalents OE

06455 MAS 305	45105 MR7 612
06455 MBB 006	45105 MR7 681
06455 MCZ 006	45105 MW0 405
06455 MZ1 405	45105 MW0 415
45105 MN8 006	45106 KV3 701
45105 MR7 006	

MATERIAL AVAILABILITY AND PART NO.

STD	OPTIONS				
FA	V	HH	R	MXS	EPFA
FA187	-	FA187HH	-	-	EPFA187HH

FA188 89 x 53 x 8.3mm (inc fitted shim on HH pad)

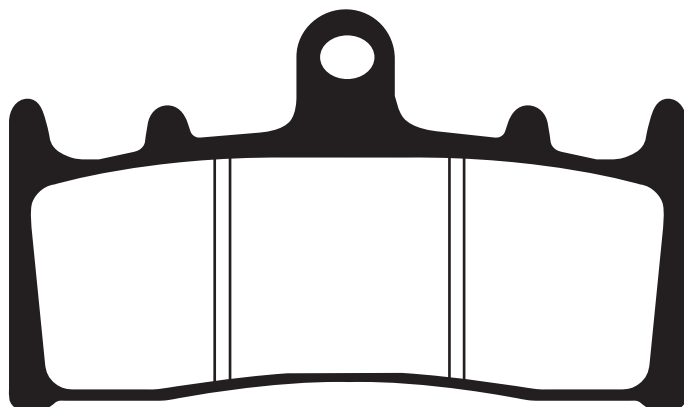

KAWASAKI

ZX-6R (ZX 600 G1/G2/J1/J2)	98-01	F
ZX6R (ZX 636 A1P) '636cc'	02	F
ZX-7R (ZX 750 P1-P7)	96-03	F
ZX7-R (ZX 750 P1/P2/P3/P4/P5/P6/P7)	96-03	F
GPZ 900 R (ZX 900 A12-15)	99-02	F
ZX-9R (ZX 900 B3/B4/C1/C2/E1/E2)	96-01	F
ZRX 1100 C1/C2/C3/C4	97-00	F
ZX12R (ZX 1200 A1/A2/B1/B2)	00-03	F
ZRX 1200 R(A1/A2/A3/A4/A5/A6F)	01-08	F
ZRX 1200 S (B1/B2/B3)	01-04	F
VN 1500 Mean Streak P1/P2	02-04	F
VN 1600 B1 Mean Streak	04	F
SUZUKI		
GSXR 750 WR/WS	94-95	F
GSXR 750 T/V/W/X	96-99	F
GSXR 1000 K1/K2	01-02	F
TL 1000 RW/RX/RV/RK1	98-02	F
GSXR 1100 WP/WR/WS/WT	93-96	F
GS 1200 SSK1/ZK1 (GV78A)	02	F
GSF 1200 SK1/K1/K2/SK2/K3/SK3/K4		
/SK4/K5/SK5	01-05	F
GSX 1300 RX/RV/RK1/RK2/RZK3/RK3/		
RK4/RK5/K6/K7 'Hayabusa'	99-07	F
GSX 1400 K1/K2/K3/K4/K5/K6/K7/FE	01-07	F
M 1600 (VZ 1600 K4 Intruder)	04	F
VZ 1600 K4 Marauder	04	F
JAYBRAKE		
J-Four (300-44) (4 Piston)		

Equivalents OE

43082 1199	43082 1179	43082 1274
43082 1224	43082 1227	59301 33870
59130 46E00	43082 1230	59100 46820
59300 33870	43082 1250	43082 1251
59300 33890	43082 1253	59100 40830
59300 46840/830	43082 1259	K4308-21274
59300 46820	43082 1272	

MATERIAL AVAILABILITY AND PART NO.

STD	OPTIONS			
FA	V	HH	R	EPFA
FA188	-	FA188HH	-	EPFA188HH

DISC PADS
BUYERS GUIDE

DO NOT REFIT ANY SHIMS/INSULATORS TO EBC PADS FROM ORIGINAL PADS UNLESS INSTRUCTED
ON NOTE ON PAD PACKAGING AND ON FA DRAWING ASSOCIATED WITH THAT PAD.

FA189 125.5 x 45.1 x 9mm

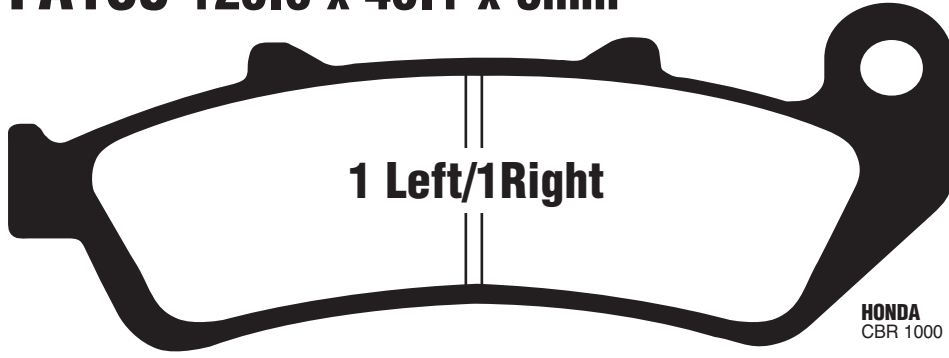

HONDA
CBR 1000 FP/FR/FS/FT/FV/FW/FX 93-99 F&R

MATERIAL AVAILABILITY AND PART NO.					
STD	OPTIONS				
FA	V	HH	R	MXS	EPFA
FA189	-	FA189HH	-	-	-

Equivalents OE #
06455 MZ2 405
06455 MAJ G41
06435 MAJ G41
06435 MAT 006
06455 MZ2 405

FA190 98.9 x 49.5 x 9.5mm

FA190HH 98.9 x 49.5 x 8.5mm

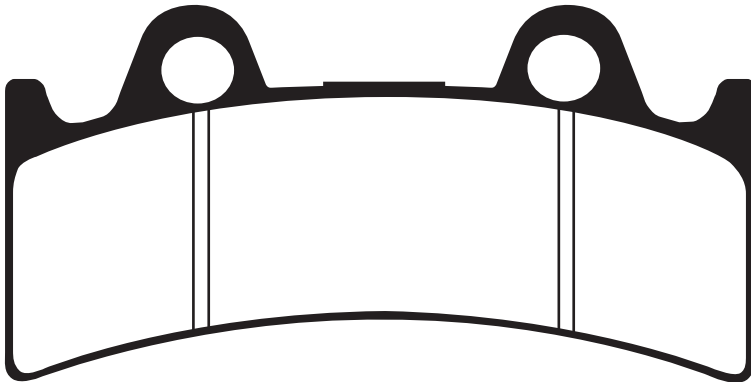

TRIUMPH
Daytona Super III (3 cyl) 94-97 F
YAMAHA
YZF 750 R/SP 93-97 F
FZR 1000 EX UP (6 piston caliper) 94-95 F

MATERIAL AVAILABILITY AND PART NO.					
STD	OPTIONS				
FA	V	HH	R	MXS	EPFA
FA190	FA190V	FA190HH	-	-	EPFA190HH

Equivalents OE #
4FM W0045 00
4FM W0045 10
T2020211
T2020221
T2020218

FA191 131.9 x 80 x 9.5mm

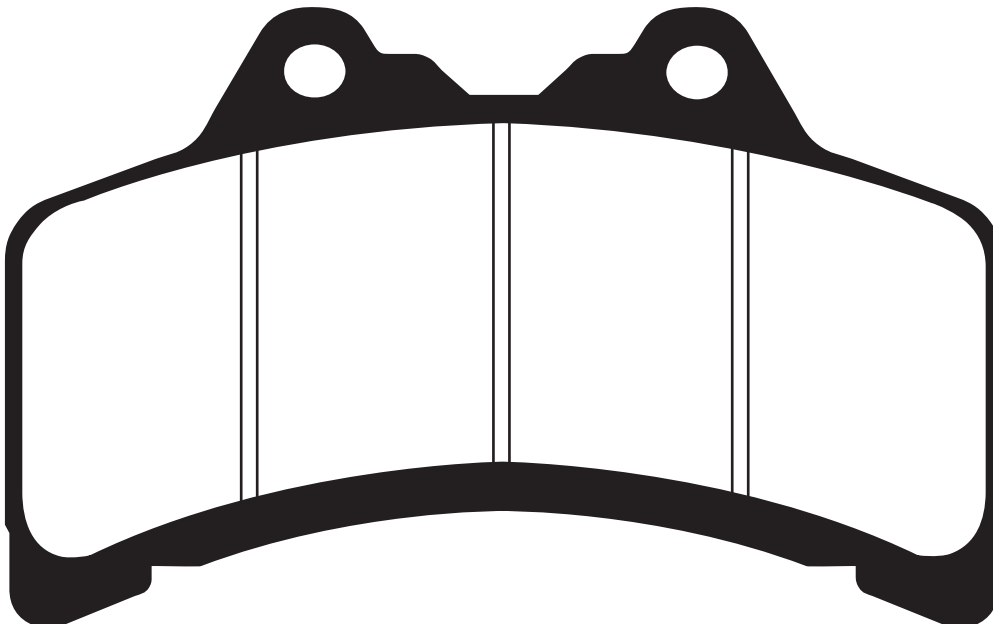

MATERIAL AVAILABILITY AND PART NO.				
STD	OPTIONS			
FA	V	HH	R	MXS
FA191	-	-	-	-

Equivalents OE #
4BH W0045 01

YAMAHA
GTS 1000

93-99 F

DO NOT REFIT ANY SHIMS/INSULATORS TO EBC PADS FROM ORIGINAL PADS UNLESS INSTRUCTED ON NOTE ON PAD PACKAGING AND ON FA DRAWING ASSOCIATED WITH THAT PAD.

FA192 A. 90 x 51 x 8.5mm B. 68 x 52 x 9.5mm

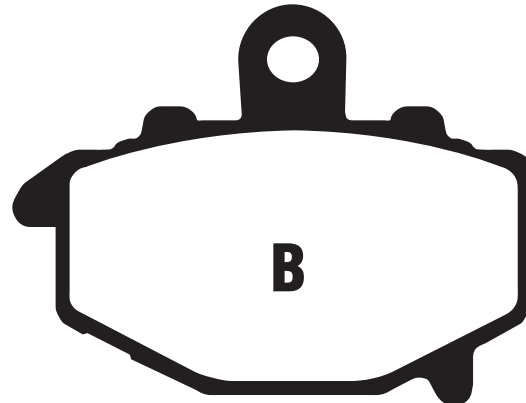
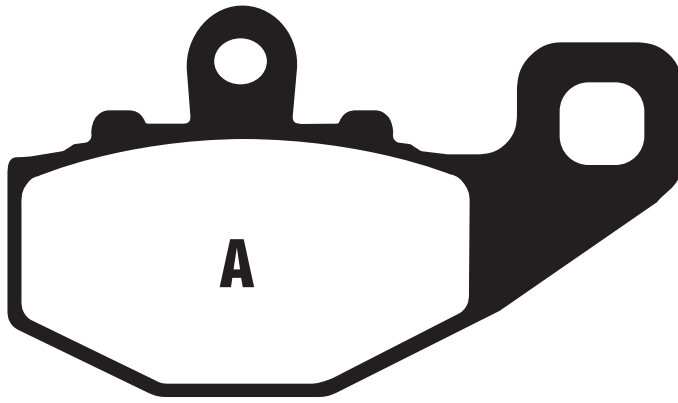

CF MOTO

650 NK	12-15	R
650 TK	13-15	R
650 TR	13-14	R

KAWASAKI

ZR 400 Zephyr (G2/G3/G3A/G4/G5)	97-01	R
ZRX 400 (ZR 400 E1-E7)	95-01	R
ZZR 400 (ZX 400 N1/N2/N3/N4/N5/N6/N7)	93-99	R
ZR 550 B4/B5/B6 "Zephyr"	94-99	R
ZZR 600 (ZX 600 E1-E13)	93-05	R
ZZR 600 (ZX 600 E6F)	06-07	R
ZX-6R (ZX 600) F1/F2/F3/G1/G2/J1/J2)	95-01	R
ZX6R (ZX 636 A1P/B1/B2/C1) 636cc	02-05	R
ZX6R (ZX 600 P7F/P8F)	07-08	R
ZX-6f (ZX 600 R9F/RAF/RBF/RCF/RDF/REF /RFF/RGF 599cc)	09-16	R
ZX6RR (ZX 600 K1/M1/N1)	03-05	R
ER-6f (EX 650 A6F/A7F/A8F/C9F/CAF/CBF)	06-11	R
ER-6f (EX 650 B6F/B7F/B8F/D9F/DAF/CBF) ABS	06-11	R
ER-6f (FCF/FDF/FEF/FFF) (Double pipe typerame/with ABS)	12-15	R
ER-6f (ECF/EDF/EEF/FFF/EGF) (Double pipe typeframe/non ABS)	12-16	R
ER-6n (ER 650 A6F/A7F/A8F/C9F/CAF/CBF)	06-11	R
ER-6n (ER 650 B6F/B7F/B8F/D9F)	06-10	R
ER-6n (FCF/FDF/FEF/FFF) (with ABS)	12-15	R
ER-6n (ECF/EDF/EEF/FFF/EGF) (non ABS)	12-16	R
650 (KLE 650 CBF/CCF/CEF) Versys Non ABS	12	R
KLE 650 A7F/A8F/A9F/CAF/CBF/CCF/CDF Versys	07-14	R
KLE 650 B7F/B8F/B9F/DAF/DBF/DCF/DDF/DEF Versys ABS	07-14	R
Z 750 (ZR 750 J1/J2)	04-05	R
Z 750 S (ZR 750 K1/K6F)	05-07	R

KAWASAKI Contd.

ZX-9R (ZX 900 B1/B2/B3/B4/C1/C2/E1/E2)	94-01	R
ZX9R (ZX 900 F1/F2)	02-04	R
Z 1000 (ZR 1000 A1/A2/A3)	03-05	R
ZX 10 R (ZX 1000 C1/C2/D6F/D7F)	04-07	R
ZX 10 R (ZX 1000 E8F/E9F/FAF)	08-10	R
Z 1000 R JHF (ABS/310mm Round Discs)	17	R
Z 1000 SX (ZX 1000 HBF/HCF/HDF) (ABS)	11-13	R
Z 1000 SX (ZX 1000 GBF/GCF/GDF) (Non ABS)	11-13	R
Z 1000 SX (ZX 1000 LEF/LFF/LGF) Non ABS	14-16	R
Z 1000 SX ABS Model (ZX 1000 MEF/MFF/MGF/WHF/WJF)	14-18	R
Z 1000 Black Edition (ZR 1000 DCFA/DDFA/FEFA)	12-15	R
Z 1000 SX Tourer	14	R
Z 1000 Special Edition (ZR 1000 GEFA)	14	R
Z 1000 (ZR 1000 DAF/DBF/DCF/DDF/FEF/FFF)	10-15	R
Z 1000 ABS (ZR1000 EAF/EBF/ECF/EDF/GEF/GFF)	10-15	R
Z 1000 DAF/DAS/DBF/DCF/DCFA/DDF/DDFA (Non ABS/300mm Discs)	10-13	R
Z 1000 EAF/EBF/ECF/EDF/EDFA (ABS/300mm Discs)	10-13	R
Z 1000 FEF/FEFA/FFF/FGF (Non ABS/310mm Discs)	14-20	R
Z 1000 GEF/GEFA/GFF/GGF/HHF/HJF (ABS/310mm Contour Discs)	14-20	R
Z 1000 JHF/JJF (ABS/310mm Round Discs)	17-20	R
GPZ 1100 E1/E2/F1	95-98	R

WK

650i (Naked)	13-15	R
650 TR (Touring)	13-15	R

MATERIAL AVAILABILITY AND PART NO.				
STD	OPTIONS			
FA	V	HH	R	EPFA
FA192	FA192V	FA192HH	-	-

Equivalents OE #		
43082 0111	43082 1171	43082 0167
43082 1148	43082 1213	43082 0119
43082 1157	43082 0004	
43082 1160	A000-0802BO	

SFA193 39.8 x 51.2 x 7mm

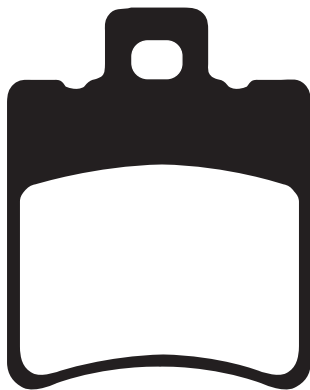

AJP

PR3 125 Supermoto Pro	10-11	F
-----------------------	-------	---

APRILIA

Habana 50/Habana Custom	99-02	F
Mojito Custom 50 (120mm Ø rear drum)	99-02	F
Mojito Custom 50 (110mm Ø rear drum)	04-12	F
Mojito Retro 50 (120mm Ø rear drum)	99-03	F
Scarabeo 50 Street (2T) (TH00/THE00)	05-09	F
Scarabeo 50 (4T) (TGA00/TGB00)	06-09	F
Scarabeo 50 (2T) (Rear disc model) (PF0100)	98-99	F

APRILIA Contd.

Scarabeo 50 (2T) (Rear drum model) (PFG00/TH000)	00-05	F
Scarabeo 50 (2T) (Rear disc model) (PFG00/TH000)	00-05	F&R
Scarabeo 50 (Ditech) (2T) (SCA00)	02-06	F
Scarabeo 50 (4T) (TG000)	02-06	F
Scarabeo 50 (2T) (H2/HL) Front disc model	93-97	F
Scarabeo 50 Classic 2T (PF0100) (Rear drum model)	98-99	F
Scarabeo 50 (2T) (PF0100) (Rear drum model)	98-99	F&R
Scarabeo Classic (2T) (PF0100) (Rear disc model)	98-99	F
Scarabeo 50 (4T)	14-17	F
SR 50 Ditech (LC) (RLD 100)	02-03	F
SR 50 WWW (A/C) (LYH00)	97-01	F
SR 50 Street (LC/2T) (TE00/TEA00)	03-15	F
SR 50 R/Factory (LC/2T) (VFB00/VFD00)	04-18	F
SR 50 H20 (Ditech) (RLA1/RLB1)	00-03	F
SR 50 (A/C) (GP/LB/LF)	93-96	F
SR 50 (LC)	94-96	F
SR 50 Stealth/Racing (LC) (MZCO)	97-99	F
SR 50 R SBK Alitalia (Replica) (LC)	10-11	F
Area 51	98-02	F&R
Amico (All models)	96-98	F
Gulliver (All models)	95-98	F
Rally A/C (All models)	95-02	F
Rally L/C (All models)	96-00	F&R
Sonic (All models)	98-08	F
SR 125	99	F
Leonardo 125/150	96-98	F&R

ATALA

Hacker LC	97	F
Hacker Racing	97	F
Byte RT10	97	F
Hacker	97	F

BENELLI

491 All rear drum models	98-04	F
491 Scooter All rear disc models	99-04	F&R
Mala 50 (2T)	13	F
Naked 50	02-03	F
Naked 100	02	F
Pepe 50 (5 spoke cast wheel) (2T)	10-14	F
Pepe Classic 50 (2T) (7 spoke cast wheels)	07-14	F
Pepe LX 50 (2T) (7 spoke cast wheels)	03-09	F
Pepe 50 (2T) (7 spoke cast wheels)	99-01	F
Pepe 50 (4T) (7 spoke cast wheels)	12-16	F
K2 Scooter	98-01	F
K2 100	99-01	F
Pepe 100 LX	99-02	F
Velvet 125/150	99-07	F&R
Adiva 125/150	00-04	F

BETA

Ark (LC models)	97-14	F&R
Ark (A/C models)	96-14	F
Quadra 50	97-02	F
Tempo 50	98-02	F

CAGIVA

Nuvola 50	00	F
Nuvola 125	00	F

GARELLI

Flo 50		F
Skyнет 250/40	02	R

SFA193 Contd.

GENERIC/KSR

Onyx 50 (2T/4T) 10-18 F
 Pandora 50 (2T/4T) 13-18 F

GILERA

Stalker 50 97-06 F
 50 DD/SP Runner/Purejet 99-04 F
 Ice 50 01-03 F
 Runner 50 98 F
 SKP 50 98-01 F
 Storm 50 94-95 F
 Easy Moving 50 95-96 F
 Stalker 50 (Rear drum model) 97-02 F
 Typhoon 125 95-98 F
 Typhoon 125 X-XR 99-00 F

GOVECS (ELECTRIC SCOOTERS)

GO S 1-2 11-14 F
 GO T 1-2 11-14 F
 GO T 1-4 13-14 F
 GO S 1-4 11-14 F
 GO S 2-4 11-14 F
 GO T 2-4 11-14 F
 GO S 3-4 11-14 F
 GO T 3-4 11-14 F

HONDA

SFX 50 S/T/V/W/X/Y/1 95-04 F
 SGX 50 V/W/X/Y/1 "Sky deluxe" 97-03 F
 SH 50 T Fifty/Scoopy W/X/Y/1 97-03 F
 SRX 50 W/SW/X/SX 98-99 F
 SZX 50 (X8R) SW/SX/SY/S1 98-04 F
 "Supersport Scooter"
 SZX 50 (X8R) XW/XX/XY/X1 98-04 F
 "Cross Sport"
 SH 100 T/W/X/Y/1 Scoopy 96-01 F

ITALJET

50 Formula 98-00 F&R

KEEWAY

Goccia 50 (2T/4T) 08-15 F

MALAGUTI

F18 Warrior 125/150 00-03 F
 Ciak 50/100 00-04 F
 Ciak 50 00-03 F&R
 Ciak 50 (4T) Master 04-08 F
 Ciak 100 99-03 F&R
 Ciak (electrical power) 00-05 F
 F10 Jetline/ 94-07 F
 F10 Jetline WAP 06-10 F
 F10 Tribal 08-10 F
 F12 50 Phantom 98-02 R
 F12 Phantom (All liquid cooled models) 99-07 F&R
 Phantom F12R 50 A/C 07-11 F
 Phantom F12R 50 L/C 07-11 F&R
 F15 RR 99-01 R
 F12 Phantom (A/C) 02-08 F
 F15 Firefox (Liquid cooled models) 01-08 F&R
 Firefox F15 (Air cooled models) 99-08 F
 F69 Phantom 70 98 F

MBK

CS 50 Mach G AC (Air Cooled) 02-10 F
 CS 50 Mach G LC (Liquid Cooled) 03-10 F
 CW 50 R Booster Road 94-95 F
 CW 50 Booster Spirit 96-98/09 F
 CW 50 Booster Naked (10" wheels) 06-10 F

MBK Contd.

CW 50 Naked Booster (12" wheels) 09-10 F
 CW 50 RS Booster NG 95-98 F
 CW 50 RS Booster NG 01-06 F
 CW 50 RS Booster Naked 04-08 F
 CW 50 RSX Booster Track 96-98 F
 CW 50 RS Booster Spirit 99-06 F
 CW 50 RSP Rocket 97-00 F
 CW 50 Fizz 50 93-97 F
 CW 50 Evolis 97 F
 CW 50 Power Rocket 06 F
 CW 50 Booster (12" wheels) 06-10 F
 CW 50 Booster (10" wheels) 09-10 F
 YA 50 R Forte 94-95 F
 YE 50 Evolis 92-95 F
 YH 50 Flipper 98-10 F
 YM 50 Fizz 94-95 F
 YN 50 R Ovetto (2T) 98-10 F
 YN 50 Ovetto (4T) 09-10 F
 YQ 50 Nitro 97-10 F
 YQ 50 Nitro Naked 06-10 F
 CV 80 Evolis 97 F
 YN 100 Ovetto 99-03 F
 YQ 100 Nitro 01-02 F
 XN 125/150 Doo Do 00-05 F

MOTRON

50 Sting 98 F
 50 Syncro 98 F
 50 Thunder 98 F

PEUGEOT

Buxy/Buxy RS 94-97 F
 Zenith L (All models) 96-99 F
 Ludix Pro (14" wheels/4T) (J. Juan Caliper) 11-13 F

PGO

Rodo Show 50 00-09 F

PIAGGIO

Zip Fast Raider 93-97 F
 Free 50 02 F
 NRG 50 94-96 F
 NRG 50 Extreme 99-01 F
 NTT 50 95-96 F
 Zip 50 Base (Disc Model) 95-96 F
 Zip 50 Elettrico 02 F
 NRG 50 RST "MC2" (Rear drum models) 96-97 F
 NRG 50 RST (DD/DT) "MC2" (Rear drum models) 98 F
 NRG 50 RST "MC2" (Rear disc models) 98 F
 NRG 50 Extreme (Rear drum models) 99-01 F
 NRG 50 Extreme (Rear disc models) 99-01 F
 NRG 50 DT MC3 01-05 F
 NRG 50 MC3 DD 01-05 F
 Typhoon 50 (2T) 01-09 F
 Heng Tong Caliper/10" wheels
 Typhoon 50 (2T) 00-04 F
 Grimeca Caliper/10" wheels 02 F
 Free 100 02 F
 Hexagon 125/150 94-97 F
 Typhoon 125 99-03 F

QUADRA

350 D 11-15 F
 350 S 13-15 F
 350 4 14-15 F

RIEJU

RS NKD 50 (Scooter) 13-20 R
 RS Sport 50 (Scooter) 12-20 R

SUZUKI

AP 50 R/S/T/V/W 96-02 F
 AY 50 V/W/V/W/WWW/WRW/WRX/WX /WRY/WRK1/WRK2/WRK3/WRK4 /K1/K2/K3 Katana (Grimeca Caliper) 97-04 F
 UX 50 WX/WY 'Zillion' 99-02 F

YAMAHA

Aerox 4 (NS 50 F 1GB) 14-18 F
 BW'S 50 Next Generation (Twin headlight model) 99-07 F
 (190mm disc) 99-02 F
 BW'S 50 Original (180mm disc) 04 F
 BW's 50 (5WW1) 05-15 F
 BW's 50 (5WW4/6/8/9/B/D/F/H/K/M/P) 01 F
 BW's R 50 (5SX1) 03-04 F
 BW's 50 Naked (1D11/2B71) 09-15 F
 BW's 50 Naked (2B7B/D/F/H) 96-97 F
 CW 50 RS (4YA1/2/BW'S) (180mm front disc) 02-05 F
 CS 50 Jog R 06-15 F
 CS 50 Jog R 03-05 F
 CS 50 Z (Jog RR) 06-12 F
 CS 50 Z (Jog RR) 98 F
 CW 50 RS (AYA4/BW'S NG) (180mm front disc) 99 F
 CW 50 RS (5FXA/VG5SA BW'S) (190mm front disc) 00 F
 CW 50 RS (5FXM/VG5SA BW'S) (190mm front disc) 01-05 F
 CW 50 (5MS2/4G54R) 02 F
 CW 50 (5WW4/BW'S) 04-07 F
 CW 50 RSP (5CC1/3/4YA BW'S Spy) (180mm front disc) 97-98 F
 NS 50 Aerox (2T) 13-16 F
 NS 50 N Aerox Naked (2T) 13-16 F
 YA 50 R Axis (4PC) 95-96 F
 YE 50 Zest 93-95 F
 YFM 50 Breeze (4KH) 94-95 F
 YN 50 R Neos (5AD/5MR/5RN3) 97-02 F
 YN 50 Neos (5RN1/P9) 02-06 F
 YN 50 F Neos (4T) (5C3) 09-18 F
 YN 50 Neos (2T) (IF5C2/IH5C2) 07-16 F
 YQ 50 Aerox R/Aerox 97-16 F
 YH 50 Why 99-09 F
 YN 100 Neos 100 99-03 F
 YQ 100 Aerox 100 00-04 F
 XN 125 Teos 00-03 F

DISC PADS
 BUYERS GUIDE

DO NOT REFIT ANY SHIMS/INSULATORS TO EBC PADS FROM ORIGINAL PADS UNLESS INSTRUCTED
 ON NOTE ON PAD PACKAGING AND ON FA DRAWING ASSOCIATED WITH THAT PAD.

MATERIAL AVAILABILITY AND PART NO.

STD	OPTIONS			
SFA	SFAC	HH	R	MXS
SFA193	SFAC193	SFA193HH	-	-

Equivalents OE

119 439 00	06455 GBM 750	5RW FS811 00	R434 2021 1A0	45120 J4A T000
119 468 00	06455 GCM 900	811 3638	R444 2004 1A0	PE 759057
119 502 00	06455 GBY 910	811 3644	752667	268
2525370000	3YK W0045 01	811 3663	498454	QCA0648860000
2525240000	4CU F5811 20	821 3192	821 3223	5ME F5919 00
59300 09820	4CU W0045 00	821 3245	821 3571	193
59300 35810	4VV F5811 00	821 3246	821 3590	1PH F5805 00
59330 09EFO	5ME FS811 00	498408	821 3638	
59330 35E00	5MF F5811 00	R434 2009 1A0	647172	

FA194 A. 95.5 x 42 x 7.3mm

B. 77 x 42 x 7.3mm

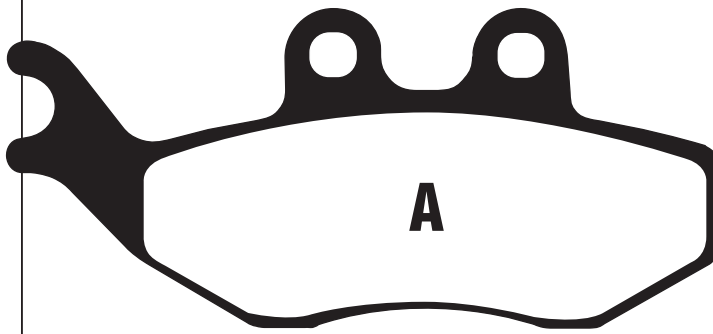

A

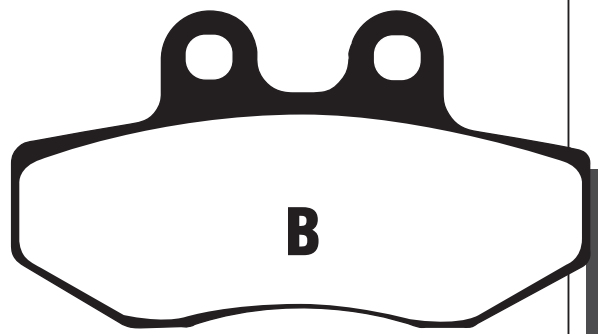

B

DISC PADS BUYERS GUIDE

AJP

PR3 125 Enduro	08-12	F
PR3 125 Enduro Pro	08-12	F
PR3 125 Supermoto	08-12	F
PR3 125 Trial	11-12	F
PR4 125 Enduro	10-12	F
PR4 125 Enduro Pro	10-12	F
PR4 125 Supermoto	10-12	F
PR4 125 Supermoto Pro	10-11	F
PR3 200 Enduro	08-14	F
PR3 200 Enduro Pro	12-14	F
PR3 200 Supermoto	08-14	F
PR3 200 Supermotard Pro	10-11	F
PR3 200 MX	10-11	F
PR3 200 M/X Pro	10-14	F
PR4 200 Enduro	12-14	F
PR4 200 Enduro Pro	10-14	F
PR4 200 Extreme	12-14	F
PR4 200 Supermoto	10-14	F
PR4 200 SM Pro	10-11	F

ALFER

VR 125 Raider	12-13	F
VX 125 Explorer	12-13	F
VX 200 Explorer	12-13	F
EVX 400 Electric	12-13	F

APRILIA

MX 50	03-05	F
Pegaso 50	92-94	F
RS 50	99-05	F
RX 50 C/CD	93-04	F
RX 50 Racing	03-06	F
RX 50	06-20	F
SX 50	06-14	F
SX 50 Factory	19-20	F
SX 50 Limited Edition	14-16	F
Tuorno 50	03-04	F
ETX 125	99-01	F
RX 125	92-99	F
Pegaso 125 "Kat"	94-95	F

BENELLI

Velvet 125/150 (Touring)	08-12	F
Velvet 250	99-12	F
Velvet 400 Dusk	03-04	F

BETA

RR Enduro Alu 50/Motard Alu 50	04-08	F
RR Enduro 50	04-07	F
RR 50 Enduro Racing	09-11	F
RR 50 Enduro Factory	12-19	F
RR 50 Motard Track/Racing (Spoke wheel)	14-20	F
RR 50 Enduro	08-19	F
RR 50 Enduro Standard	09-13	F
RR Motard 50 Track (Cast Wheels)	08-14	F
RR Motard 50 Skull	11	F
RR Motard 50 Standard (Cast wheel 5 spoke)	13-15	F
RR Motard 50 Sport (Cast wheel 5 spoke)	14-20	F
RR 50 Standard	05-08	F
RR 50 Track (Spoke wheel)	14	F
Alp 125 (4T)	05-15	F
RE 125 4T Enduro	09-10	F
RR 125 4T Enduro (A/C)	09-14	F
RR 125 4T Enduro (LC)	11-18	F
RR 125 Motard (4T) (A/C - Spoke Wheel)	08-14	F
RR Motard 125 4T (LC) (Cast wheels)	11-18	F
Urban 125	08-15	F
Urban 125 Special	09-15	F
Alp 200 (4T)	05-15	F
Urban 200	08-15	F
Urban 200 Special	09-15	F
Alp 4.0 (4T/349cc)	05-15	F

CCM

SR 40 Street Scrambler	07-09	F
------------------------	-------	---

CPI

GTS 50/125/200	02-03	F
GTR 50/125/200	02	F
SX 50	06-07	F

DAELIM

ST 125	03	F
--------	----	---

DERBI

GP1 50 Open	06-11	F
Mulhacen 125 (4T)		
Upto Ref No 7N001790		
Spoke wheel/2 pinpadfixing	07	F
Senda R DRD	02	F
Senda 125 Baja R (4T) (260mm disc)	06-12	F
Senda 125 Baja SM (4T) (360mm disc)	06-12	F
Senda DRD Racing 50 SM (300mm disc/Std caliper mounted)	04-11	F
Senda DRD Racing 50 R (260mm disc/Std mounted caliper)	04-11	F
Senda DRD Racing 50 R (Spoke Wheel/260mm F/disc)	11-12	F
Senda DRD Racing 50 SM (Cast Wheel/260mm F/disc)	11-12	F
Senda 125 SM (Twin headlight)	04-07	F
Senda R 125 Vin# SCIAIA	04	F
Cross City 125	07-08	F

FACTORY

RP 50	05	F
YM 50	05	F
YR 50 Desert	04-05	F
Chrono SM 50	04	F
YR 125 4T	05	F

FANTIC

Caballero 50 Regularita Casa	06-09	F
Caballero 50 Supersei Motard	06-09	F
Caballero 125 Regularita Casa	07-08	F
Caballero 125 Supersei Motard	07-09	F

GAS GAS

EC 50	05	F
SM 50	05	F
Pampera 250	02	F
Pampera 125/250/280	04	F
Pampera 125 (2T)	05-08	F
Pampera/250	02-03	F

GENERIC/KSR

Toxic 50	07-08	F
Trigger X 50 (All Models/TR X 50)	06-18	F
Trigger SM 50 (All Models)	06-18	F
Trigger 125 SM	08-09	F
Trigger 125 X	08-09	F

GILERA (Grimeca Calipers)

DNA 50	01-06	F
DNA 125/180	01-05	F
125 VX 4T/180 VXR 4T	01-04	F
FX/FXR 125/180 Runner (Rear drum brake model/Grimeca front caliper)	97-02	F
Coguar	00-01	F
VXR 200 Runner (4T)	02-04	F

HONDA HM (Italy)

CRE 50 Six/Baja/Derapage Brembo caliper twin pin/41mm Paioli forks	95-02	F
CRE 50 Baja/Derapage	01-02	F
CRE 50 Baja RR		
Up to ZEN50XACEA7700324	07-09	F
CRE 50 Baja/Six/Derapage	03-09	F
CRE 50 Baja RR		
From ZEN50XACEA7700325	07-09	F
CRE 50 Baja RR	10-12	F
CRE 50 Derapage RR Up to ZEN50XACMA7700384	07-09	F
CRE 50 Derapage RR		
From ZEN50XACMA7700385	07-09	F
CRE 50 Six Competition	07-08	F
CRM 50 Derapage Competition	07-08	F
CREF 125 X	09	F
CRM F 125 X	09	F

HRD

GS 50		
-------	--	--

KEEWAY

X Ray 50 Supermoto	07-09	F
TX 50	10-12	F
TX 125	10-12	F

KEEWAY Contd.

TX 125 SM (17" f/wheel)	13-15	F
TX 200 (19" f/wheel)	13-14	F

MALAGUTI

XSM 50 Supermotard	03-11	F
Madison 125/150/180	99-03	F
Madison 125-3	06-09	F
Madison R125	03-07	F
Phantom Max 125/200	04-08	F
Madison 250 ie 3	06-10	F
Phantom Max 250	04-08	F
Madison S200	04	F
R 125 Madison	03-06	F
250 Madison	04-07	F
Password 250	05-11	F
X3M Motard (Cast wheels)	08-10	F

MBK

TZR 50 X Power	03-09	F
X-Limit Supermoto	03-09	F

MH/MOTORHISPANIA

RYZ 50 Pro Racing Enduro	13-14	F
RYZ 50 Pro Racing Supermotard	06-14	F
RYZ 50 Pro Racing Urban Bike	06-10	F
RYZ 50 Supermotard	06-10	F
Duna 125 Dual Plus Trail	08-10	F
Duna 125 Sports City Supermotard	08-10	F
Duna Plus 125	14	F

PEUGEOT

Elyseo 125/150 Rear Disc Model	03	F
Elystar 125/150 (3 bolt fixing - front disc)	02-05	F
Elystar 125/150 (5 bolt fixing - front disc)	06-07	F
Geopolis 125 Executive/Non ABS (AJP Calipers)	07-12	F

Geopolis 125 Urban/ABS (AJP Calipers)	07-12	F
Jet Force 125 (All models)	03-07	F
Satelis 125 Compressor (4T)	06-11	F
Satelis 125 RS	07-12	F
Satelis RS 125 (AJP Caliper)	07-12	F
Satelis 125 Blacksat (AJP Caliper)	10-12	F
Satelis Urban 125 (AJP Caliper/ABS)	07-12	F
Satelis 125 Whitesat (AJP Caliper)	10-12	F

XPS Supermoto (17" front wheel/260mm disc)	03-10	F
XPS Street (17" front wheel/280mm disc)	03-09	F

Geopolis 250 (Urban/ABS/AJP Calipers)	07-10	F
Geopolis 250 (Executive/AJP Calipers/Non ABS)	07-10	F
Satelis 250 Urban (AJP Caliper/ABS)	07-12	F

Geopolis 400 (Urban/AJP Calipers/ABS)	07-11	F
---------------------------------------	-------	---

PIAGGIO/VESPA (Grimeca Calipers)

Beverley B 125	03-06	F&R
Beverley 200	03-05	F&R
Hexagon GT 250	98-99	F
Hexagon LX 180	98-99	F
Hexagon LXT 180	98-99	F
Hexagon LX4 125	98-99	F
Skipper LX 125/150	98-99	F

Super Hexagon GTX 125/180 (11" wheels)	00	F
Skipper ST 125/150 4T		
Grimeca Caliper	00-04	F
Super Hexagon GTX 250	00-02	F
GT 125 L Granturismo	03-06	F
GT 200 L Granturismo	03-06	F

RIEJU		
MRX 50 Pro/Top	04-08	F
SMX 50 Pro Supermotard/Top	04-07	F
RS2 NKD	05	F
RS2 50cc Pro	06-09	F
SMX 50 Pro Street	06-08	F

SACHS		
ZX 125 Enduro	01	F
ZZ 125 Funbike	02	F

DO NOT REFIT ANY SHIMS/INSULATORS TO EBC PADS FROM ORIGINAL PADS UNLESS INSTRUCTED ON NOTE ON PAD PACKAGING AND ON FA DRAWING ASSOCIATED WITH THAT PAD.

FA194 Contd.

SHERCO

EN 50 Champion Replica	08	F
Replica Cup SM 50	08	F
Enduro 50 (EN50)	08-09	F
Enduro/Urban/SU 50cc(2T) (Spoke wheel)	08-13	F
Black Panther SM 50	08-09	F
Supermotard 50	08-12	F
Supermotard SM 50	08-13	F
SM 0.5 Black Panther	08-10	F
City Corp 125 (All models)	08	F
SM 1.25 F Black Panther (4T)	10-12	F
SE 1.25 F Enduro (4T)	10-12	F

SIAMOTO

SX1 125	04	F
YAMAHA		
DT 50 X (Supermotard)	04-08	F
TZR 50	03-16	F
XT 125 X (3D62/3D64)	05-06	F
XT 125 X (13D2)	07	F
XT 125 X (13D4/13D6)	07-11	F

Equivalents OE #	
8113478	00H04703141
8113523	K00976315
119 493 00	11955700
119 495 00	2525340000
494628	11967800
R43440 311A0	13D FS811 00
754605	1677
756020	R050371008000
5WX W0045 00	PE757231
R290063110000	K01309079
00009300080	014360258000
1D5 F5811 00	

MATERIAL AVAILABILITY AND PART NO.					
STD		OPTIONS			
FA	SFA	SFAC	HH	SFA-HH	R
FA194	SFA194	SFAC194	FA194HH	SFA194HH	-

FA196 102 x 38 x 9.8mm

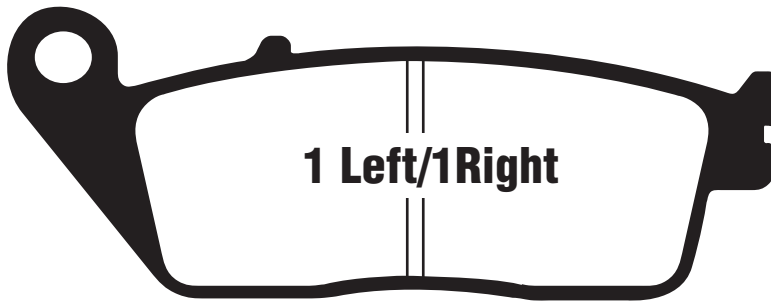

1 Left/1Right

BENELLI

Imperiale 400	18	F
---------------	----	---

BMW

C Evolution Electric	18-20	R
C 600 Sport Scooter	12-15	R
C 600 Sport Highline	13-15	R
C 650 GT Scooter	12-18	R
C 650 GT Highline	13-18	R
C 650 Sport Scooter	16-18	R
C Evolution (Scooter)	14-18	R

DAELIM

Roadwin R 125 (VJF 125)	08-14	F
Roadwin (VJ 125)	04-13	F
VL 125 Daystar/125 L	03-14	F
VT 125 Evolution	03	F
VS 125 Evolution	01-04	F
(VJ 125) Roadwin	04-11	F

HARLEY-DAVIDSON

FXDR 114	18-20	F
----------	-------	---

HONDA

NSS 125 Forza (2 Piston Caliper)	15-18	F
SH 125i (2 Piston Caliper/ABS)	14-18	F
SH 150i (2 Piston Caliper/ABS)	14-18	F
CB 250 N/T/W/X/Y/1/4 "Two Fifty"	92-05	F
CN 250 3 (MF02) Fusion/Fusion X/Fusion X Special	03	F
VT 250 Spada	89-	F
VT 250 CR/CT/CV 'Magna'	95-97	F
VTR 250 W/Y/1-7 (MC33)	98-07	F
VTR 250-9	09-10	F
NSS 300 D Forza (ABS)	18-20	F
SH 300i (2 Piston Caliper/ABS)	16-18	F
CB 400 SS (SS2-N41)	01-05	F
CL 400 (NC38)	98-03	F
FJS 400 D6/D7/D8	06-08	R
NV 400 DCY/DC1/DC2 (NC40) Shadow Slasher	00-02	F
SW-T 400 (FJS 400 D9)	09	R
SW-T 400 (FJS 400 A9/AB) (ABS)	09-16	R
VRX 400 T (NC33)	96	F
CBF 500 4 (Non ABS Model)	04	F
CB 500 R/T	94-96	F
CB 500 F (Non ABS)	13-20	F
CB 500 FA (ABS)	13-20	F
CB 500 X (Non ABS/Twin)	14-20	F
CB 500 XA (ABS/Twin)	14-20	F
CBR 500 R (Non ABS/Twin)	13-20	F
CBR 500 RA (ABS/Twin)	13-20	F
CMX 500 Rebel	17-20	F
FJS 600 1/2/D3/D4/D5/D6/D7 /A3-A7 Silverwing	01-09	R
SW-T 600 (FJS 600 AB) (ABS)	11-16	F
XL 600 VR/VT "Transalp"	94-96	F
FMX 650 5/6	05-08	F
DN-01 (680cc) (NSA700 A8/A9)	08-11	R
CTX 700 DE-DCT	14-20	F
CTX 700 N-DCT	14-20	F
NC 700 S (Non ABS)	12-13	F
NC 700 X (Non ABS)	12-13	F
CBR 750 FJ 'Superaero'	-88	R
NC 750 S	14-15	F
NC 750 S ABS	14-18	F
NC 750 S ABS DCT	14-18	F
NC 750 X	14-15	F
NC 750 X ABS	14-18	F
NC 750 X ABS DCT	14-18	F

HONDA Contd.

NC 750 Integra Scooter - DCT (NC 750 D)	14-18	F
NM4 Vultus (NC 750 J)	15-17	F
VF 750 CP/CR/CS/CT/CV/CW/CX	93-99	F
VFR 750 FJ/FK/FL/FM/FN/FP/FR /FS/FT/FV	88-97	R
VT 750 CV/C2V/CW/C2W/CX/C2X /CY/C2Y/C1	97-09	F
/C21/C31/C4/C5/C6/C7/C8 'Shadow' VT 750 C2BA/C2BB/C2BC/C2BE	97-09	F
Shadow Black Spirit (Rear drum)	10-16	F
VT 750 DC1/DC2 Black Widow	01-04	F
VT 750 DC7/DC8 Shadow Spirit	07-09	F
VT 750 S (VT 750 SA/SB)	10-12	F
CBR 1000 FK/FL/FM/FN	89-92	R
ST 1100 AN/AP/AR/AS Pan European (ABS Model)	92-95	R
ST 1100 LM/NP/R/S/T/V/W/X/Y/1/2 Pan European - Non ABS	90-02	R
VT 1100 CR/CS/CT/CV/CW Shadow	94-98	F
VT 1100 C2 (S/T/V/W/X/Y/1/2/3/4/5)	95-05	F
VT 1100 C3 (W/X/Y)	98-00	F
VT 1300 CXA Chopper (9 spoke cast wheel/non ABS)	10-12	F
VTX 1300 S3/S4/S5/S6/S7/S8	03-08	F
GL 1500 'CV/CW/CX/CY/C1/C2 (F6C)'	97-03	R
INDIAN		
Chief Classic (Spoke Wheel/ Nissin Calipers)	14-20	R
Chief Vintage (Spoke Wheel/ Nissin Calipers)	14-20	R
Chieftain (Cast Wheel/ Nissin Calipers)	14-20	R
Chieftain Dark Horse (Cast Wheel/ Nissin Calipers)	16-20	R
Chieftain Limited (Cast Wheel/ Nissin Calipers)	17-20	R
Chief Dark Horse	14-20	R
Roadmaster (Cast Wheel/ Nissin Calipers)	15-20	R
Roadmaster Classic (Nissin Calipers)	17-20	R
Roadmaster Elite (Nissin Calipers)	17-20	R
Springfield	16-20	R
Springfield Dark Horse	18	F
Challenger 1800cc	19-20	R
Challenger Dark Horse 1800cc	19-20	R
Challenger Limited 1800cc	19-20	R
KYMCO		
Venox 250 (R20010/RA50AA/Carb Model)	00-03	F
Venox 250 (RFBR20011/RA50AD/Carb Model)	04-06	F
Venox 250 (R20012/EFI Model)	07-14	F
MBK		
VP 125 Cityliner	08-10	F
SUZUKI		
VL 1500 BTL3/BTL4/BTL5 (CT 1500 BT Intruder)	13-15	F
SYM		
Cevalo B9A (125cc 4T)	10	F
TRIUMPH		
Adventurer	96-01	F&R
Bonneville (865cc/Cast wheels)	09-15	F
Bonneville Newchurch (865cc/Cast wheels)	15	F
Bonneville SE (865cc)	09-13	F

TRIUMPH Contd.

Legend TT	98-01	F&R
Speedmaster (765cc/Carb)	03-04	F
Speedmaster (865cc/Carb)	05-07	F
Speedmaster (865cc/EFI)	11-16	F
Thunderbird	95-03	F&R
Thunderbird Sport	98-03	F&R
Tiger 855i (From VIN 71699)	98-99	F&R
Tiger 885cc	92-99	F&R
Tiger 955cc Up to VIN 198874	00-04	F&R
Tiger 955 (Cast wheel model) from VIN 19887505-06		F
W.K. BIKES		
WK 125 R (4T)	10-14	F
WK 125 Sport	11-14	F
YAMAHA		
YP 125 X-City (16P)	08-15	F
YP 125 Majesty DX (Taiwan Production)	02	F
YP 125 RA X- Max ABS (39D2/Nissin F/Caliper)	11-17	F
YP 125 R (X-Max - Non ABS) (39D1/5) Nissin F/Caliper	10-15	F
YP 125 X-Max Business (ABS)	11	F
YP 125 R X-Max Sport	11-12	F
YP 125 RA X-Max ABS (39D2/Nissin F/Caliper)	11-17	F
YP 125R X- Max (2DM/Heng Tong R/Caliper)	14	F
YP 125R X- Max (2DM/Brembo R/Caliper)	14-16	F
X- Max 125 (2DM/Heng Tong R/Caliper)		F
See- YP 125R X- Max	14	F
X- Max 125 (2DM/Brembo R/Caliper)		F
See- YP 125R X- Max (Nissin front caliper/Non ABS)	10-13	F
XP 250 R X- Max (2PLI)		F
Non ABS (Nissin front/Brembo Rear)	14-15	F
YP 250 R X-Max Sport	11	F
YP 250 R X-Max ABS	11-16	F
YP 250 R X-Max ABS	14-15	F
YP 250 R X- Max (2DL/Non ABS/Heng Tong R/Caliper)	14-16	F
X-MAX 250 (Non ABS/Heng Tong R/Caliper/2DL) -See YP250 R X- Max	14-16	F
XP 250 RA X- Max - Iron-Max (ABS)	16	F
X-Max 250 Momo Design	14-15	F
XC 300 Versity	06	F
XP 400 X-Max Momo Design ABS	15	F
XP 400 RA X- Max- Iron Max (ABS)	16	F
YP 400 R X- Max (Non ABS)	13-16	F
YP 400 RA X- Max (ABS)	13-18	F
MT-01 (1670cc)	05-10	R
MT-01S (5YUR)	09	R

DISC PADS
BUYERS GUIDE

DO NOT REFIT ANY SHIMS/INSULATORS TO EBC PADS FROM ORIGINAL PADS UNLESS INSTRUCTED
ON NOTE ON PAD PACKAGING AND ON FA DRAWING ASSOCIATED WITH THAT PAD.

FA196 Contd.

Equivalents OE #					
06435 MCT 405	06455 MAW 621	431A0 MT4 670	43106 ML7 921B	06455 KFR 701	H0300T
06435 ML7 P01	06455 MAB 405	43105 ML7 921A	45105 LEA7 305	45105 KED9 305	06455 K40 F11
06435 ML7 415	06455 MAH 405	43105 ML7 922A	45106 MN8 671B	5YU W0046 00	06455 K01 D11
06435 MS2 P00	06455 KCR 405	43105 MS2 007A	45106 MS9 612B	06455 MCK A01	06455 MGS D32
06435 MT3 405	06455 MAA 405	43105 MS9 612A	45106 MW3 671	45105 BA5 RB10M1	
06435 MS9 405	06455 MBK 751	43105 MT3/6 007	T2020077	45106 BA5 RB10M1	
06435 MZO 006	06455 MEA 671	43105 MT4 007A	T2020194	1S6 W0045 00	
06455 MZO 760	06455 MGS D31	43105 MY7 405	T2020537	37P F5811 00	

MATERIAL AVAILABILITY AND PART NO.								
STD			OPTIONS					
FA	V	SFA	SFAC	HH	SFA-HH	R	MXS	EPFA
FA196	FA196V	SFA196	SFAC196	FA196HH	SFA196HH	-	-	-

FA197 A. 96.7 x 42 x 9mm B. 77.3 x 42 x 9mm

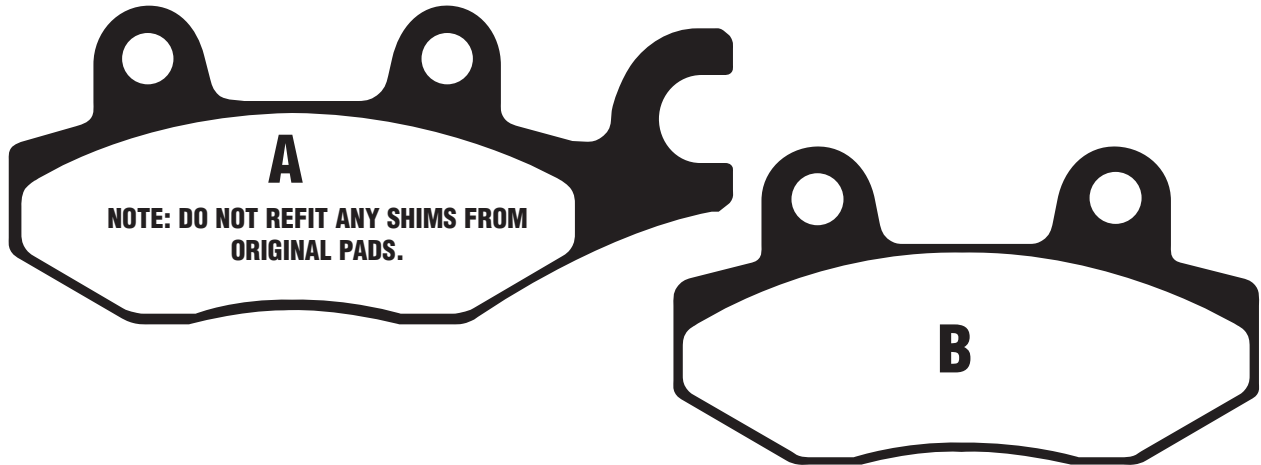

A
NOTE: DO NOT REFIT ANY SHIMS FROM ORIGINAL PADS.

B

AJS

Crazy Naked 50	10-11	F
Bobber 125 (Custom)	10-15	R
Daytona 125	13-15	R
DD 125 E Mk2 Regal Raptor (Cast Wheels)	10-14	R
EOS 125 Regal Raptor	09-15	R
JSM 125 Supermotard	10-14	R
JSM 125 Trail	13-14	R
NKT 1-125 Naked	08-09	F&R
NKT 2-250 Naked	08-09	F&R
Regal Raptor DD 125 E	04-06	F
Regal Raptor DD 250 E	04-09	F
EOS 350	13-14	R
350 E-9PB	13-14	R

HONDA

CB 50 V/W Dream 50	97-98	F
NSR 50 RV/RW/RX/RY	97-00	F
NSR 50 V (AC10-180)	97	F
NSR 50 X (AC10-190)	99	F
XR 50 M5 (AD14) Motard	05	F
NSR 75 N/P/R/X/Y (N5-1/NSR 80)	92-00	F
NSR 80 P/R/S (HC06)	93-95	F
NSR 80 V (HC06-170)	97	F
NSR 80 X (HC06-180)	99	F
Astra Supra NF 100	99	F
XR 100 M5 (HD13) Motard	05	F
CB 125 F (GLF 125 1WHF)	15-16	F
LS 125 RY	00-	R
VT 125 CX-C8 'Shadow'	99-08	F
XL 125 V1-VA 'Varadero'	01-11	F
NSR 150 RR (Malaysian market)		F&R
TA 200 (TA Shadow)	02-05	F&R
CBF 250 4/7	04-07	F
CB 300 R10	10	F

ARCTIC CAT

DVX 50 (Y6)	06	R
DVX 90 (Y12 4 Stroke)	06	R

BAJAJ

Discover 125 (Disc Model)	14-16	F
Avenger 150 Street (Cast Wheel)	15-16	F
Avenger Cruise 220 DTS-I (Spoke Wheel)	15-16	F
Avenger Cruise 220 DTS-I (Spoke Wheel)	08-14	F
Avenger 220 Street (Cast Wheel)	15-16	F

BENELLI

Caffe Nero 250	08-14	F(left)
----------------	-------	---------

CCM

RL 125	08-09	F
SM 125	08-09	F&R
TL 125	08-09	R

GPI

125 Prince	01	F
X Large 125/300	11-12	F&R
DAELIM		
S-Four 50cc ES 50	10-12	F
Roadwin (VJ125)	04-13	R
Roadsport R 125 (VJF 125)	08-14	R
S3 125 (SV 125)	10-11	R
SQ 125 Freewing A2	06	R
SU 125 Delfino	07-11	F
SQ 250 Freeway S2	06	R
Roadwin R 250 Fi (VJF 250)	08-11	R
Roadsport 250 (VJF 250)	10-14	R
VL 250 Daystar	13-14	R

GARELLI

Tiger 125	07	F&R
GENERIC/KSR		
Code 125	17-20	R
Worx 125/150 (4T)	12-16	F
GOES		
G 125 M Big Wheel	08-09	R
SP R 125 (Motorcycle)	10-12	R

HARTFORD

VR 125/150 H/X/Z	04	R
HERO HONDA		
Magellan 125	06	F
Pluto 125	06	F
HP POWER		
Nickel 150 (4T/2V)	10-11	R
Barum260 (4T/2V/LC)	10-11	F

HYOSUNG

MS3 (125cc)	07-09	F&R
MS3 250i	07-09	F&R
ITALJET		
50 it Scooter	09	F
LEXMOTO		
FMS 125 (ZN125T-7H)	15-18	R
Matador 125 EFI (ZS125T-40-E4)	13-17	R
Michigan 125 EFI (ZS125-79-E4)	13-20	R
XTR-S 125	13-18	F

MODENAS

Kriss 115		
Dynamic 125	08-09	F&R
Kristar 125	08-11	F&R
X-Cite 135	09-10	F&R
YAMAHA		
TZR 50 Thunderkid (5DU1/3)	97-00	F
Crypton-R New 110cc	04	F
YS 250 Fazer (Brasil) (1S41/2/3)	06-08	F

KAWASAKI

BN 125 A3/A4/A5/A6/A7F		
Eliminator	00-07	F

KAWASAKI Contd.

Kaze-R New 112cc	04	F
ZX 130 R Kaze	08-10	F
Z 250 SL (Naked/Non ABS) BR		
250EFF/EGF	15-16	F & R
Z 250 SL (Naked/ ABS) BR 250		
FFF/FGF/FHF	15-17	F & R
Ninja 250 SL (BX 250 AFF/AFS		
/AFSA- KRT Edition- Non ABS)	15	F&R
Ninja 250 SL (BX 250 BFF/BFS		
/BGF/BGFS- ABS)	15-16	F&R
Ninja 250 SL (BX 250 BFSA		
/BGSA KRT /ABS Edition)	15-16	F&R
EX 250 K8F/K9F/KAF/KBF/KBFA		
/KCF Ninja 250 R	08-12	F&R
EX 300 AEFA/AFFA/AGFA Ninja 300		
Special Edition Non ABS	14-16	F&R
EX 300 ADF/AEF/AFF Ninja 300		
Non ABS	13-15	F&R
EX 300 BDF/BEF/BFF/BGF Ninja 300		
ABS Model	13-16	F&R
EX 300 BEFA/BFFA/BGFA Ninja		
Special Edition With ABS	14-16	F&R
KLE 300 CHF/CJF Versys-X		
300 ABS	17-20	R
KLE 300 BHF Versys-X 300		
Non ABS	17-20	R
Z 300 Non ABS - ER		
300AFF/AGF/AGFA	15-16	F & R
Z 300 ABS - ER 300BFF/BGF/BGFA	15-20	F & R
Ninja 400 (EX 400 GJF/GJFA- ABS)	18-20	F & R
Z 400 ABS	18-20	R
KLR 650 (KL 650 E8F/E9F)	08-09	R

KEEWAY

125i Silverblade	13-15	F(right)
RKS 125	12-15	F
Silverblade 125	10-11	F&R
RKS 150	12-14	F
RKS 200	12-14	F
250 Blackster	14	R
250i Silverblade	13-14	F(right)

KREIDLER

50 Supermoto (2T)	14-15	R
125 Insignio (4T)	14-15	F (Left)
250 Insignio (4T)	14-15	F (Left)

KYMCO

Activ 50/110/125	04-06	F
Bet & Win 50/Dink Sports 50	02-06	F
Dink 50/Spacer 50/Yager 50	98-06	F
Dink Classic 50 Euro 2	03	F
Dink 50 (4T)	07-14	F
Grand Dink 50 (2T)	04-15	F

DISC PADS
BUYERS GUIDE

DO NOT REFIT ANY SHIMS/INSULATORS TO EBC PADS FROM ORIGINAL PADS UNLESS INSTRUCTED ON NOTE ON PAD PACKAGING AND ON FA DRAWING ASSOCIATED WITH THAT PAD.

FA197 Contd.

KYMCO Contd.

Jetix 50	10-15	R
K-Pipe 50	12	F
Kymcosento 50i	13	F
Newsento 50i	13	F
Super 9 50 (LC)	00-07	F
Super 9 (A/C) 50	00-07	F
Yager 50	07	F
Bet & Win 125/150	00-06	F&R
CK 125 Pulsar (RJ25CB)	01-07	F
CK 125 Pulsar 11 (KE25RF)	08-10	F
CK 125 Pulsar S	11-15	F
CK 1 125 (4T/KT25AA)	14-15	F
Cruiser 125	99	F
Dink 125/150/Spacer	97-04	F&R
Dink Classic 125/150	02	F&R
Dink LX 125/150	98-00	F&R
Dink 125 i	06-15	F&R
Grand Dink/Miler 125/150	01-07	F&R
Grand Dink 125	12-13	R
Hipster 125/150	99-06	F
Jetix 125	10-15	R
KR 125 Sport Quannon	07-08	F&R
K-Pipe 125	12-15	F
Movie XL 125/150	01-09	F
KR 125 Quannon Naked	10-15	F&R
KR 125 Quannon Sport	07-13	F&R
Like 125 (D20000)	09	R
Like 125	10-14	R
Movie 125i	12-13	F
Sector 125	98-01	F
Spike 125 R	04-06	F&R
Straight 125	05-06	F
Yager 125	00	F&R
Yager GT 125	07-13	F&R
Zing 125/150 Custom	97-13	F
Agility 150 R16		
(C30000) (16" wheels)	08-12	R
Jetix 150	10	R
Activity 200i R16	10-12	R
Dink 200 i	06-15	F&R
Like 200 i	09-15	R
Yager 200i	07-13	F&R
Bet & Win 250	00-06	F&R
People 250	03-06	F
People 250 S	06-08	F(right)
Yup 250	03-06	F
Yup 250	04-06	R
People S 300 i	08-10	F(right)

LEONART

Bobber 125	13-14	R
Daytona 125/350	13-14	R
Raptor 125/250	13-14	R
Spyder 125	13-14	R
Bobber 350	13-14	R
MOTOM		
ANA 50	08-09	R
ANA 151	08-09	R
MZ/MUZ		
RT 125	02-07	F&R
SM 125	02-07	R
SX 125	02-07	R
NIPPONIA		
Brio 50 (4T)	12-13	R
Arte 125 (4T)	F&R	
Brio 125 (4T)	12-15	R
Dion 125 (4T)	13-15	R
Arte 150 (4T)	F&R	
Dion 150 (4T)	R	
PEUGEOT		
Django 50 Heritage (2T)	14	F
Django 50/125 Heritage (4T)	14	F
WTR 125	08	F
Metropolis 400 RS (3 Wheel Model /Nissin Caliper)	17-18	R
Metropolis 400 RX-R (3 Wheel Model/Nissin Caliper)	17-18	R
Metropolis 400 Allure (3 Wheel Model/Nissin Caliper)	17-18	R
PGO		
G Max 125	06-08	R
G Max 125 (Wave disc)	08-12	R
G Max 250	06-08	R
QUADZILLA		
WK 300	06-08	R
SFM		
ZX 125 Enduro (Spoke Wheels)	13-15	R
ZZ 125 Enduro (Spoke Wheels)	13-15	R
SINNIS		
Stealth 125 QM125-2D	08-10	F(right)
SYM		
Euro MX 125 (Rear disc model) (HF12 W3-6 Euro 2)	06-09	R
Shark 4VR-125	01-02	R
XS 125 K	07-13	F

SUZUKI

FL 125 SDWK7/SDWK8		
Address/Underbone	07-10	F
FX 125		F
Shogun-R FD-112	04	F
UH 125 L4/L5/L6 Burgman (Non ABS)	14-16	F
UH 125 AL4/AL5/AL6/AL7/AL8		
Burgman (ABS)	14-18	F
UH 200 L4/L5/L6 Burgman (Non ABS)	14-16	F
UH 200 AL4/AL5/AL6/AL7/AL8/AL9		
Burgman (ABS)	14-20	F
AN 250 Skywave Type M (BA-CJ45SA)	07-08	F(right)
AN 250 Skywave/Type D (BA-CK44A)	07-08	F(right)
AN 250 8 Skywave SS (CJ46A)	08	F(right)
AN 400 K7/ZK7/K8/ZK8/K9/L0/L1/L2 /L3/L4/Burgman/Non ABS/Skywave	07-15	F(right)
AN 400 Skywave/Burgman/ABS	09-20	F(right)
W.K. BIKES		
Trial 125	11-15	F
Wasp 125 (4T)	13-15	R
WK 125 R (4T)	10-14	R
WK 125 Sport	11-14	F
WK Jetmax 250 (4T)	10-14	F(right)
GTR 300	13-15	R
WUYANG		
WY 125 24B	06-07	F
XOR		
XO 2 (4.0KW)	13-14	F
XO 2 (8.0KW)	13-14	F
YAMAHA		
YBR 250 (5D11/3/4)	07-11	F
ZONTES		
ZT125-5A Monster	09-15	F & R
ZT125-8A Tiger	09-15	F

Equivalents OE #				
06435 KW6 841	43105 LDH1 E00	43150 KBE 3060	59100 05820	45105 SEA 0000
06455 KPC 641	43105 LFC4 305	43150 LDHIE 00	1S4 W0045 00	45106 SEA 0000
06455 GCR 006	43105 SABR Z00M1	43150 LLS 3050	59401 HP7 600	5HH W0045 10
3LD W0045 10	43106 SABR Z00M1	902 300 1000	252 0033A	PE802576
3LD W0045 30	43108 H3C 000A	45105 KW6 405	43150 LEA5 306	59100 21890
06455 KR3 000	45105 KR3 871	45150 LLB5 3050	59301 HP7 600	45120 T40 0000
06455 KR3 405	45106 KR3 871	4510A KFW6 900	45105 DE3 A00	59401 HP7 600
43082 0081	4510A KW6 9000	06455 KTK 006	06455 KW6 843	06455-KPN-E01
43082 0128	4510A KFW6 900	4310A BA4 000M1	06455 KW6 844	06455 KPN E02
43082 1238	45105 KBE 3050 M2	59100 07810	43082 0080	43082 0172

MATERIAL AVAILABILITY AND PART NO. OPTIONS								
STD	SFA	SFAC	HH	SFA-HH	R	MXS	EPFA	GPFA
FA197	SFA197	SFAC197	FA197HH	SFA197HH	-	-	EPFA197HH	GPFA197HH

FA198 60.18 Over lugs x 51.8 x 6mm

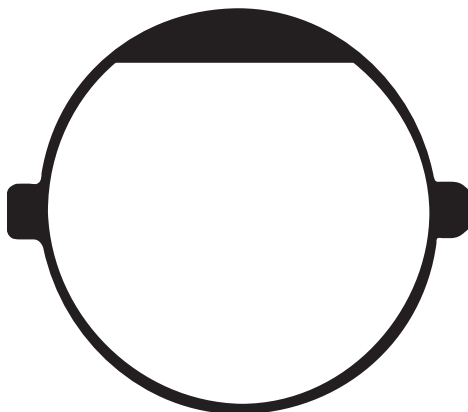

CZ / JAWA

All Disc Models		
125 Travel	03-04	F
125 Chopper	03-04	F
350 Chopper	03-04	F
350 Tramp	03-04	F
350 Californian	03-04	F

Equivalents OE

639 41 054

MATERIAL AVAILABILITY AND PART NO. OPTIONS				
STD	V	HH	R	MXS
FA198	-	-	-	-

DISC PADS BUYERS GUIDE

DO NOT REFIT ANY SHIMS/INSULATORS TO EBC PADS FROM ORIGINAL PADS UNLESS INSTRUCTED ON NOTE ON PAD PACKAGING AND ON FA DRAWING ASSOCIATED WITH THAT PAD.

FA199 93.8 x 40.3 x 9.8mm

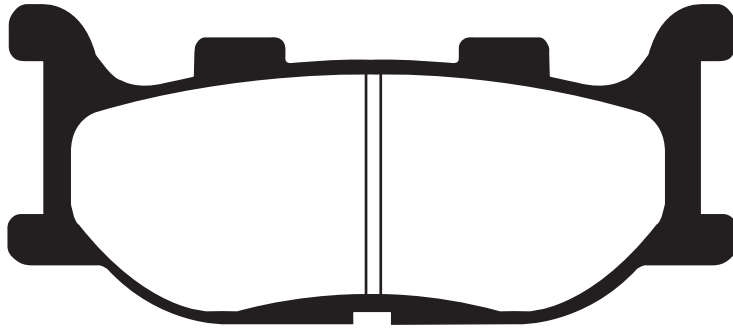

YAMAHA

TDR 125 (4GW/GX 1/2/3/4)	93-03	F
XV 125 'Virago'	97-00	F
XVS 125 Dragstar	00-03	F
SR 125	97-03	F
TZR 150 R (4AP2)	00	F
CP 250 (EB71) Maxam/Morphus	05-08	F
XV 250 S 'Virago'	95-00	F
XVS 250 Dragstar	01-04	F
YP 250 DX/A/Majesty	98-03	F
XJR 400 (4HM3/4HM5/4HM6/4HM9/4HMA/4HMB) Brembo calipers	95-99	F
YP 400 Majesty (Non ABS)	05-13	F
YP 400 Majesty (ABS)	07-13	F
XP 500 T-Max (5VU1/2)	04-07	F
FZ6 Naked/Non ABS 2 Piston Caliper (1B3/1B3D)	04-07	F
FZ6-NS Naked/Non ABS/2 Piston Caliper	05-06	F
FZ6-Fazer (Half Fairing/Non ABS/2 Piston Caliper) (5VX/5VXL)	04-07	F
FZ6 - Fazer (ABS/Half Fairing/2 Piston Caliper)	06-07	F
XJ 600 S/N	98-03	F
XJ6-F Diversion (600cc) (Full Fairing- 1CW) (Non ABS/ABS)	10-15	F
XJ6-N (600cc) (Naked 20S) Non ABS/ABS	09-15	F
XJ6-S Diversion (600cc) (Top Fairing - 36C) ABS and Non ABS Version	09-15	F
XJ6 SP	13	F
MT-03 (660cc)	06-12	F
XV 1100 Virago	99	F
XVS 1100 Dragstar	99-04	F
XVS 1100 A Dragstar Classic	00-07	F

YAMAHA Contd.

XVS 1300 A Midnight Star	07-13	F
XVS 1300 ACFD Midnight Star /Casual Full Dresser (With Handbar Fairing)	14-16	F

ADIVA SCOOTERS

AD 125	09-11	R
AR 125	10-11	R
AD 200	09-11	R
AR 200	10-11	R

ITALJET

Jupiter 125/150	02	F
Jupiter 250	02-03	F

LINHAI

Monarch 125/150 T	06-07	F
Main Street 300cc (Scooter)	07-08	F

MBK

YP 250 Skyliner	96-99	F
YP 250 Skyliner 250 (+ABS)	00-02	F
YP 400 Skyliner	04	F

SINNIS

Max 125 QM 125-2V	08-09	F
JS 125-6C SC 125	12-14	F

MATERIAL AVAILABILITY AND PART NO.					
STD	OPTIONS				
FA	V	SFA	SFAC	HH	SFA-HH
FA199	FA199V	SFA199	SFAC199	FA199HH	SFA199HH

Equivalents OE #	
1B7 W0045 00	5VX W0045 00
4GA W0045 00	5VH W0045 00
4HM W0045 00	5RU W0045 00
4EB W0045 00	5VU W0045 10
4716630	

FA200 104 x 62.4 x 11.2mm

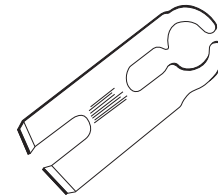
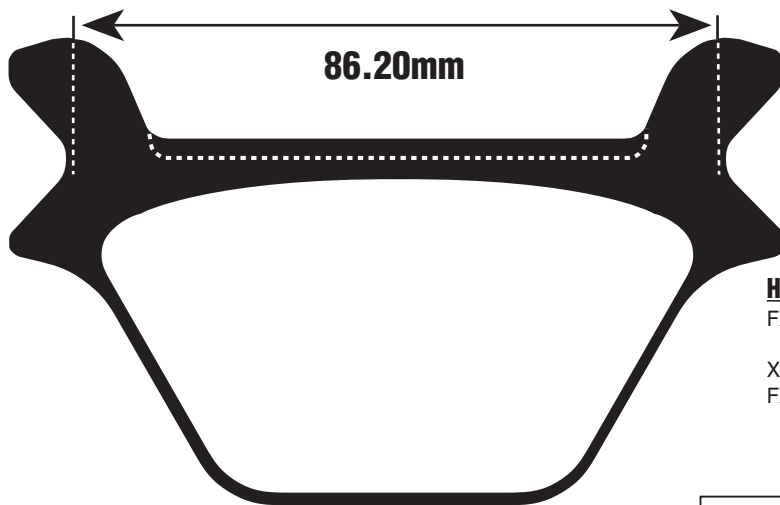

**Abutment Shims
(2 per set)
Ref. Pt. No. SHFA200/201**

HARLEY DAVIDSON

FXST/FXSTB/FXSTC/FXSTS/FLST/FLSTC/FLSTF/FLSTS/FLSTN	Late 87-99	R
XL/XLH/XLCH/XLS/XLX	Late 87-99	R
FXD/FXDL/FXDWG/FXR/FXRS/FXRT/FXRD/FXLR	Late 87-99	R

Equivalents OE

44209 87B	44209 87C	44213 87
-----------	-----------	----------

Competitor X Ref

Dunlop	Ferodo	SBS	Vesrah
DP905	FDB521/2001	669	VD-923

MATERIAL AVAILABILITY AND PART NO.					
STD	OPTIONS				
FA	V	HH	R	MXS	EPFA
FA200	FA200V	FA200HH	-	-	EPFA200HH

FA201 104 x 62.4 x 11.4mm

HARLEY DAVIDSON

FLT/FLHT/FLHTCI
FLHR/FLHRCI

86-99 R
94-99 R

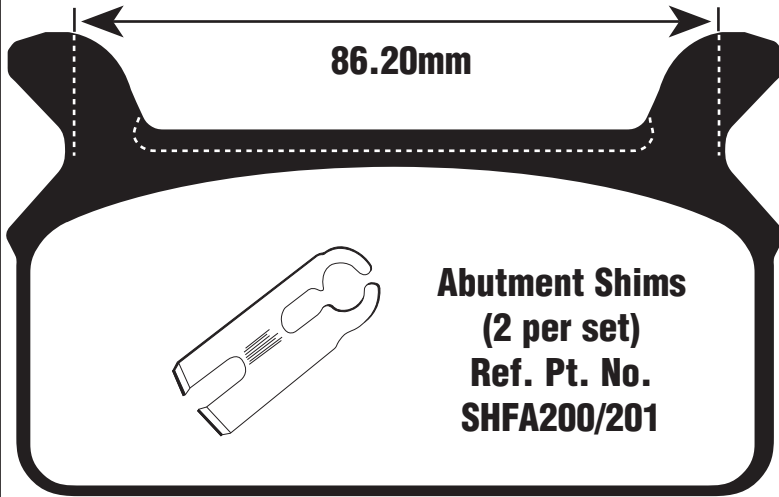

86.20mm

**Abutment Shims
(2 per set)
Ref. Pt. No.
SHFA200/201**

Equivalents OE

43957 86	43957 86B
43957 86A	43957 86D

Competitor X Ref

Dunlop	Ferodo	SBS	Vesrah
DP904	FDB485	668	VD-922

Some early models of this caliper do not require the enclosed shims. If your vehicle has shims fitted then replace with this new set. If in any doubt contact EBC Brakes for clarification. In any event it is essential that the pads (with or without shims fitted) are a snug fit in the caliper but are also free to slide on the sliders arms. Do not force pads into the caliper which could cause an over-tight situation and brake seizure may occur.

MATERIAL AVAILABILITY AND PART NO.

STD	OPTIONS				
FA	V	HH	R	MXS	EPFA
FA201	FA201V	FA201HH	-	-	-

FA203 81.2 x 42 x 9.5mm

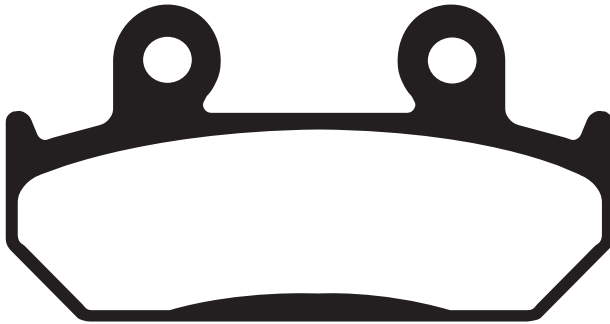

HONDA

CBR 600 FM/FN/FP/FR

91-94 F

MATERIAL AVAILABILITY AND PART NO.

STD	OPTIONS			
FA	V	HH	R	MXS
FA203	FA203HH	-	-	-

Equivalents OE

45105 MV1 008
45105 MV1 405

DO NOT REFIT ANY SHIMS/INSULATORS TO EBC PADS FROM ORIGINAL PADS UNLESS INSTRUCTED ON NOTE ON PAD PACKAGING AND ON FA DRAWING ASSOCIATED WITH THAT PAD.

FA208 78.13 x 41.2 x 9mm



DISC PADS BUYERS GUIDE

ALFER		HUSQVARNA Contd.		KTM Contd.	
VRE 125 4T	98- R	TE 350	95-97 R	SX 520	01-03 R
Diveritda 250 Super Motard	01- R	WR 360	95-03 R	EXC 520	01-03 R
Diferente Enduro	01- R	SM 400 R	02 R	MXC 525 (Desert Racing)	03-04 R
VR 250	98-13 R	TE 400	01-02 R	MXC 550	96 R
APRILIA		Svartpilen 401 (4T)	18-20 R	Duke 620 LC4	94-98 R
650 ie	01-04 R	Vitpilen 401 (4T)	18-20 R	SX EXC/EGS 620	95 R
BENELLI		TE 410 E	00 R	SX 620	96-99 R
BX Cross (449cc)	07-12 R	TE 410	95-00 R	SC 620 Supercompetition	96-00 R
BX Enduro (505cc)	08-12 R	SM 450 R	03-06 R	EGS/EGS-E/LSE 620 Enduro	96-99 R
BX 570 Motard	08-10 R	TC 450	02-04 R	EGS-E 620 Adventure/Rallye	99 R
CCM		TE 450	02-05 R	LC4 620 SC Supermoto/Supercompetition	00 R
404 E	03-04 R	TC/TE 510	04-05 R	LC4 625 SC Supermoto	02 R
404 DS	03-04 R	SM 510 R	05-06 R	SMC 625	04-06 R
404 DS Supermoto	03-04 R	SM 570 R	01-04 R	SXC 625	03-04 R
404 DS Supermoto	07-08 R	TC/TE 570	01-04 R	LC4-E 640 Enduro/Supermoto	
404 DS Trail	07-08 R	TE 570	01-04 R	/Adventure R	00-06 R
CMX 450 (MX)	08 R	TC/TE 610 E	95-04 R	LC4-E 640 (Central Single Pin Fixing)	03 R
450 FS Trail	07-08 R	LT 610	00-01 R	LC4-E 640 (2 pin fixing)	04-06 R
644 DS Supermoto	04 R	SMR 630	05 R	LC4 640 Adventure R	99-02 R
644 DS	04 R	SM 610	98-00 R	LC4 640 Adventure	03 R
R 30 (Spoke & Mag)	02-04 R	SM 610	05 R	LC4 640 Adventure R	04 R
R 35/R35S	06-08 R	SM 610 R	00 R	LC4 640 Adventure	05-07 R
FT 35 S (400cc) (DRZ 400 Motor)	07-08 R	SM 610 R/IE	05-07 R	SM 640 LC4	05 R
R 45	07-08 R	SM 610 S (Radial caliper)	06 R	640 LC4 Adventure	03-07 R
FT 650	08 R	SM 610 S (4 bolt front disc)	02-06 R	SMC 660 Supermoto	03-04 R
FT 710 S Flat Tracker	08 R	SM 610 ie	07-09 R	SMC 660	05-06 R
604E Dual Sport/Supermoto/RS	98-03 R	TC 610	00 R	690 Enduro R	09-20 R
604E R30	02-04 R	TC 610 E	95-99 R	690 Enduro R (ABS)	14-20 R
600 Spitfire	19 R	TE 610	00 R	690 Enduro	08-20 R
Spitfire Bobber	19-20 R	TE 610 E	95-03 R	690 SMC R (ABS)	14-20 R
Spitfire Bobber Stealth Edition	19-20 R	TE 610 IE	06-09 R	MAICO	
Spitfire Foggy Edition	19-20 R	SMR 630	06 R	500 MX/Enduro	99 R
Spitfire Foggy Edition S	19-20 R	TE 630	10-12 R	S.W.M.	
Spitfire Foggy Stealth Edition	19-20 R	STR 650 CRC	07 R	Gran Milano Special (4T)	15 R
Spitfire RAFBF 100	19-20 R	701 Enduro	16-20 R	Super Dual 600	16-18 R
Spitfire Six	19-20 R	701 Enduro LR	19-20 R	Super Dual GT 600	16-18 R
Spitfire Six Stealth Edition	19-20 R	701 Supermoto	16-20 R	RS 650 R	16-18 R
Spitfire Stealth	19-20 R	701 Vitpilen	18-20 R	SM 650 R	16-18 R
FACTORY		701 Svartpilen	18-20 R	TM	
YR 250	03 R	KRAM-IT (KRAMER)		80 Enduro	96-00 R
GAS GAS		GS 250	00- R	80/85 Cross	96-01 R
EC 125/250/300/200 Enduro	97-99 R	SM 250	00- R	80/85/100 (Big wheel)	02-04 R
Enforcer four 400/501/600 2 Quad	99 F	SMR 250	00- R	Junior 80/85/100 Cross (Small wheel)	02-04 R
Enduros 125/250	00 R	KTM		125 Cross	95-00 R
HIGHLAND		LC2 125	96-98 R	125 Enduro	95-00 R
950 V2 Outback	00-04 R	Sting 125	97-99 R	250 Cross	95-00 R
950 V2 Motard	00-04 R	SX 125	94-03 R	250 Enduro	95-00 R
HRD		EXC/EGS 125	94 R	300 Cross	95-00 R
GS 50	R	EXC 125	95-03 R	300 Enduro (2T)	95-00 R
HUSABERG		EXC/EGS 200	98-03 R	400 Cross (4T)	95-00 R
FE 450 E	06-08 R	SM 125 Supermoto	00 R	530 Cross (4T)	98-00 R
FS 450 E	06-08 R	EXE 125	00 R	VERTEMATI	
FS 450 R	06 R	EXC 200	98-03 R	All models	99-04 R
FE 550 E	06-07 R	SX 250	94-02 R	VOR	
FE 650 E	06-08 R	EXC/EGS 250	94 R	All models	99-04 R
FS 650 C	06-08 R	EXC 250	95-03 R	YAMAHA	
HUSQVARNA		EXC 300	00-03 R	TT 600 R (5CH1/5CH2/5CH3)	97-02 R
CR 125	95-04 R	EXC 350	94-95 R	TT 600 RE (5CH5)	04 R
SM 125 S Supermotard	98-10 R	SX 360	96-97 R	TT 600 E (4LW3/4LW4/4GV4/4GV5)	94-01 R
SM 125	98-00 R	EXC 360	96-97 R	TT 600 K From 4GV 003404	
SM 125 S (4 bolt fixing) (2T)	02-13 R	SX 380	98-03 R	(Brembo rear caliper)	95-96 R
SMR 125 (4T)	11-13 R	EXC 380	98-03 R	XT 660 Z Tenere (Non ABS)	08-15 R
SMS 4-125cc (4T)	11 R	Duke 400 LC4	94-98 R	XT 660 ZA Tenere (ABS)	11-15 R
TE 125 (4T)	11-13 R	SC 400	96-99 R	XT 700 Z Tenere	18-20 R
WRE 125	93-13 R	EGS/EGS-3/LSE 400	96-99 R	ZERO	
WR 125	95-05 R	SX 400	00-02 R	Zero DS (ZF8.5/ZF11.4)	
WR 125	00-08 R	EXC/EGS 400 (USD)	00-03 R	(Nissin F/J.Juan R Calipers)	14 R
CR 250	95-04 R	EXC 400 Racing (USD)	00 R	Zero FX (ZF2.8/ZF5.7)	
TE 250	02-05 R	LC4-E 400 Enduro	00-01 R	(Nissin F/J.Juan R Calipers)	14 R
TC 250	02-04 R	SX 440	94-95 R	Zero S (ZF8.5/ZF11.4)	
WR 250	92-05 R	EXC 440	94-95 R	(Nissin F/J.Juan R Calipers)	14 R
WR 250	06-11 R	EXC 450	03 R	Zero SR (ZF11.4)	
WR 250 2T	09-13 R	450 Rally	17-20 R	(Nissin F/J.Juan R Calipers)	14 R
WR 300	06-11 R	MX 500	95 R	Zero FX (ZF2.8/ZF5.7)	
WR 300 (2T)	11-13 R	EXC 525	03 R	(J.Juan F & R Calipers)	15 R

MATERIAL AVAILABILITY AND PART NO.				
STD	OPTIONS			
FA	HH	R	MXS	EPFA
FA208TT	-	FA208R	MXS208	EPFA208HH

Equivalents OE #		
800079072	546 13 309 200	750 13 090 000
8A0079072	546 13 309 300	5VK W0046 00
8113538	546 13 309 400	8000A9231
AB040	211021038	75013090000
AB040 S	4GV FS811 00	76513030000

DO NOT REFIT ANY SHIMS/INSULATORS TO EBC PADS FROM ORIGINAL PADS UNLESS INSTRUCTED ON NOTE ON PAD PACKAGING AND ON FA DRAWING ASSOCIATED WITH THAT PAD.

FA209/2 108.9 x 41.3 x 7.6mm

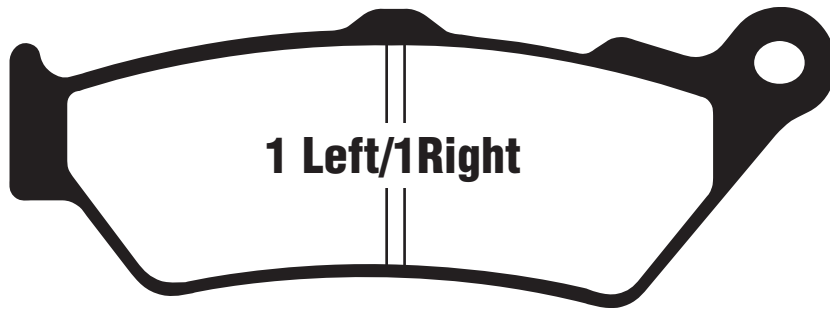

DISC PADS
BUYERS GUIDE

DO NOT REFIT ANY SHIMS/INSULATORS TO EBC PADS FROM ORIGINAL PADS UNLESS INSTRUCTED
ON NOTE ON PAD PACKAGING AND ON FA DRAWING ASSOCIATED WITH THAT PAD.

APRILIA

Moto 6.5	95-01	F
Pegaso 650/650 IE	97-04	F
Pegaso 650 Trial	06-08	F
ETV 1000 Caponord (Non ABS - Bolt fixing)	01-03	F
ETV 1000 Caponord Rally (Non ABS - Bush fixing)	03	F
ETV 1000 Caponord (ABS - Bush fixing)	04-07	F
BENELLI		
TRK 502	17-20	F
BIMOTA		
DBX 1100 (MX)	12-14	F&R
BMW		
C1 125	99-03	F
C1 200	01-03	F
G 310 R	17-20	R
G 310 GS	17-20	R
F 650 (E169/0161) Standard (Funduro/High Screen)	09/93-96	F
F 650 (E169/0162) (19" front wheel)	97-00	F
F 650 CS Scarver (K14/0174/0184 Belt Drive/17" wheels cast)	00-03	F
F 650 CS Scarver (K14/0177/0187 Belt Drive/17" wheels cast)	04-07	F
F 650 GS (R13/0172/0182) 19" front wheel	99-03	F
F 650 GS Dakar (R13/0173/0183) 21" front wheel	99-03	F
F 650 GS (R13/0175/0185) Single Cylinder 19" front wheel	04-07	F
F 650 GS Dakar (R13/0176/0186) 21" front wheel	04-07	F
F 650 GS (K72/0218/0228) (798cc Twin Cylinder/Cast Wheels)	07-12	F
F 650 GS (30 Years GS) (Twin Cylinder 798cc/Cast Wheel)	11	F
F 650 ST (E169/0163/168) Strada (18" front wheel/low screen)	97-00	F
G 650 Xchallenge	06-09	F
G 650 Xcountry	06-09	F
G 650 GS (R131) (Single cylinder/chain drive /cast wheel)	09-15	F
G 650 GS Sertao (Spoke wheels)	12-14	F
F 700 GS	13-18	F
F 800 GS	08-18	F
F 800 GS Adventure	12-18	F
F 800 GS (30 Years GS)	11	F
F 800 GS Triple Black	12	F
F 800 GS Trophy	12	F
F 800 GT	13-14	F
HP2 1200 Enduro	05-09	F
R 1200 GS (K50) (Liquid Cooled/Radial Mount Caliper)	13-18	R
R 1200 GS Adventure (Inc TE/XE Models/K51/LC)	14-18	R
R 1200 R (Disc has fixed bobbins)	15-18	R
R 1200 R Sport (Disc has fixed bobbins)	15-18	R
R 1200 RS (Disc has fixed bobbins)	15-18	R
R 1200 RS Sport (Disc has fixed bobbins)	15-18	R
R 1200 RT (K52 Radial F/Caliper/LC)	14-18	R
R 1250 GS (Disc has fixed bobbins)	19-20	R
R 1250 GS TE (Disc has fixed bobbins)	19-20	R
R 1250 GS Exclusive TE (Disc has fixed bobbins)	19-20	R
R 1250 GS Rallye (Disc has fixed bobbins)	19-20	R
R 1250 GS Rallye TE (Disc has fixed bobbins)	19-20	R
R 1250 RT (Disc has fixed bobbins)	19-20	R
R 1250 RT SE (Disc has fixed bobbins)	19-20	R
R 1250 RT LE (Disc has fixed bobbins)	19-20	R

BMW Contd.

K 1600 B Bagger	17-20	R
K 1600 B Grand America	18-20	R
K 1600 GT	11-20	R
K 1600 GT SE	12-15	R
K 1600 GTL	11-20	R
K 1600 GTL Exclusive	12-16	R
BRAMMO		
Enertia	12-13	F
CCM		
GP 450 (4T)	13-15	F
DUCATI		
400 Scrambler Sixty 2	16-18	F
Diavel ABS	11-18	R
Diavel Carbon ABS	11-18	R
Diavel Chromo ABS	12	R
Diavel AMG	11-12	R
Diavel Strada	13-14	R
Diavel Dark	13-14	R
Diavel Diesel (1200cc)	17-18	R
Paul Smart 1000 Limited	06	F
Paul Smart 1000 LE (992cc)	06	F
Classic Sport Biposto (992cc)	07	F
GT 1000 (992cc)	07-10	F
GT 1000 Touring (992cc)	09	F
Sport 1000 S (992cc)	07	F
Sport 1000 S	07-09	F
Sport Classic 1000 (992cc)		
(Monoposto-Japan /Biposto-Europe)	06-08	F
1200 Multistrada ABS (Single Pin F/Caliper)	15-18	R
1200 Multistrada Enduro	16	R
1200 S Multistrada	15-18	R
1200 S Multistrada Pikes Peak	16-17	R
1200 S Multistrada D air	15-17	R
1200 S Multistrada D air DVT	15-17	R
XDIAVEL	16-18	R
XDIAVEL S	16-18	R
Diavel Diesel (1262cc)	17-18	R
HARLEY DAVIDSON		
XG 500 Street	16-20	F
XG 750 Street	16-20	F
HONDA		
CB 500 V/W/SW/X/SX/Y/SY/2/S2	97-03	F
NX 500 V/W/X Dominator	97-99	F
SRL 650 V/W	97-98	F
NT 650 V/W/XV/Y/V1 'Deauville'	98-01	F
NX 650 V/W/X Dominator	97-02	F
FX 650 X/Y 'Vigor'	99-03	F
HUSQVARNA		
FR 450 (4T)	16-19	F
701 Enduro	16-20	F
TR 650 Terra (Spoke wheel)	12-13	F
FR 650 Strada (Cast wheel)	12-13	F
INDIAN		
Scout	17-20	F
Scout Bobber	18-20	F
Scout Sixty	17-20	F
ITALJET		
Griffon #59	07	R
KTM		
450 Rally	17-20	F
LC4 640 Adventure R	04	F
LC4 640 Adventure	05-07	F
690 Enduro R	09-20	F
690 Enduro R (ABS)	14-20	F
690 Enduro	08-20	F
690 Rally Factory Replica	07-09	F
950 Adventure S	02-06	F
950 Adventure S	03-06	F
950 R Superenduro	06-08	F
990 Adventure S (Non ABS)	06-08	F
990 Adventure R (Non ABS)	09-12	F
MOTO GUZZI		
940 Belagio	07-13	F
1100 California Aluminium	02-05	R
1100 California Titanium (With top fairing)	04-05	R
1100 California Aquila Nera	09-11	R

MOTO GUZZI Contd.

1100 California Classic Touring	06-08	R
1100 California EV (Up to KD115426 /Single pin pad fixing)	97-00	R
1100 California EV Touring	03-05	R
1100 California Jackal (Up to KD142328/Single pin pad fixing)	94-01	R
1100 California Jackal (Up to KD152328/2 pin pad fixing)	94-01	R
1100 California Special (Up to KD131644/single pin pad fixing)	99-00	R
1100 California Special (From KD131645/2 pin pad fixing)	99-00	R
1100 California Sport	01-02	R
1100 California Stone	01-05	R
1100 California Stone Metal	02-03	R
1100 California Vintage	06-12	R
1100 California 1100 190	12	R
1100 Quota ES	99-01	F
R 1200 Griso 8v Special Edition/Spoke wheels/radial caliper	07-12	R
1400 Audace	15-16	R
1400 California Custom	13-15	R
1400 California Touring	13-20	R
1400 California Touring SE	15-17	R
1400 Eldorado	15-17	R
1400 Audace Carbon	16-17	R
MGX 21 1400	16-19	R
MOTO MORINI		
Granpasso 1200	08-13	F
Scrambler 1200	10-13	F
ROYAL ENFIELD		
535cc Continental GT (Non ABS)	13-16	F
535cc Continental GT (ABS)	17-18	F
SWM		
Super Dual T/X 600	16-20	F
TRIUMPH		
Note - Use FA209/2HH only on this Triumph fitment		
Rocket III 2300cc	04-09	R
Rocket III Classic	07-09	R
Rocket III Touring	08-17	R
Rocket III Roadster- ABS	10-18	R
Rocket X	15-16	R
Thunderbird (1597cc)	09-18	R
Thunderbird Commander (1699cc)	14-18	R
Thunderbird LT (1699cc)	14-18	R
Thunderbird Storm (1699cc)	11-18	R
Thunderbird Nightstorm	15-18	R
YAMAHA		
DT 125 X	05-06	F
XT 660 R	04-15	F
ZERO		
Zero DS (ZF9.4/ZF12.5) (J.Juan F & R Calipers)	15	F
Zero S (ZF9.4/ZF12.5) (J. Juan F & R Calipers)	15-19	F
Zero SR (ZF12.5) (J. Juan F & R Calipers)	15-16	F
Zero S (ZF9.8/ZF13.0) (J. Juan F & R Calipers)	16-17	F
Zero S (ZF7.2)	19-20	F
Zero S (ZF14.4)	19-20	F
Zero SR (ZF13.0) (J. Juan F & R Calipers)	16-20	F
Zero DSR (ZF13.0) (J.Juan F & R Calipers)	16-19	F
Zero DS II (ZF7.2)	19-20	F
Zero DS II (ZF14.4)	19-20	F
Zero DS (ZF13.0) (J.Juan F & R Calipers)	16-19	F
Zero DSR (ZF14.4.0)	19-20	F
Zero DSR Black Forest Edition (ZF14.4.0)	19-20	F
Zero FX (ZF3.3/ZF6.5) (J.Juan F & R Calipers)	16-20	F
Zero FXS (ZF3.3/ZF6.5) (J.Juan F & R Calipers)	17-20	F

FA209/2 Contd.

Equivalents OE #					
06455 MAK 000	8113533	34 21 8 534 821	8133906	2204724	T2020692
06455 MAN 911	34 11 7 660 340	34 21 8 554 424	000306546260	AP8113627	T2020848
06455 MY5 731	34 11 7 651 958	2202491	GU03654600	M1340001400	2204724
06455 MAK 003	34 11 7 697 086	5VK W0045 00	GU30654626	8532279	585925/A
0000 365 46000	34 11 7 711 498	600 13 030 000	61340751A	41300169	
34 11 2 345 445	34 11 7 705 216	2C8 W0045 00	61340941A	34 21 8 562 163	
8113988	34 21 7 724 609	8113627	T2020692	60013020000	

MATERIAL AVAILABILITY AND PART NO.					
STD	OPTIONS				
FA	V	SFA	HH	SFA-HH	EPFA
FA209/2	FA209/2V	SFA209/2	FA209/2HH	SFA209/2HH	-

FA210 112.1 x 56.3 x 10mm

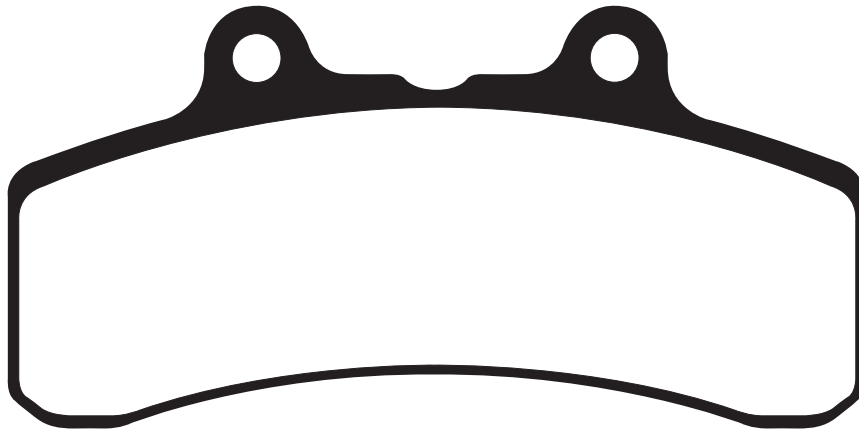

Equivalents OE #		
42386 84Y	0053 1604	H0300 8A

MATERIAL AVAILABILITY AND PART NO.					
STD	OPTIONS				
FA	V	HH	R	MXS	EPFA
FA210	FA210V	-	-	-	-

BUELL

M2 Cyclone	94-97	F
S2 "Thunderbolt"	94-97	F
S1 Lightning	94-97	F
S3 Thunderbolt	94-97	F

FA211 77.8 x 45.4 x 8.5mm FA211/2 77.8 x 45.4 x 10.4mm

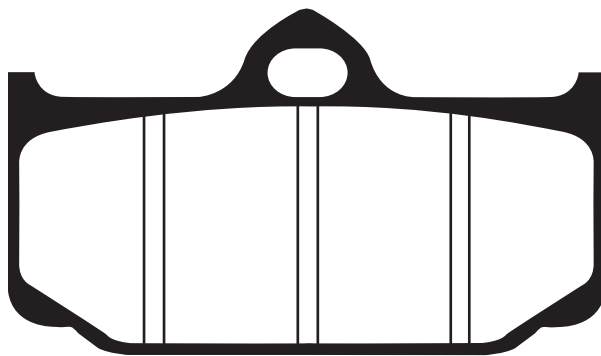

FA211 - PVM AFTERMARKET CALIPER
4 Piston race caliper old design

FA211/2 - PVM AFTERMARKET CALIPER
4 Piston race caliper old design

MATERIAL AVAILABILITY AND PART NO.				
STD	OPTIONS			
FA	HH	R	MXS	EPFA
FA211	-	-	-	-

MATERIAL AVAILABILITY AND PART NO.				
STD	OPTIONS			
FA	HH	R	MXS	EPFA
FA211/2	-	-	-	-

DISC PADS
BUYERS GUIDE

DO NOT REFIT ANY SHIMS/INSULATORS TO EBC PADS FROM ORIGINAL PADS UNLESS INSTRUCTED
ON NOTE ON PAD PACKAGING AND ON FA DRAWING ASSOCIATED WITH THAT PAD.

FA213 78.13 x 41.2 x 9mm



DISC PADS
BUYERS GUIDE

DO NOT REFIT ANY SHIMS/INSULATORS TO EBC PADS FROM ORIGINAL PADS UNLESS INSTRUCTED
ON NOTE ON PAD PACKAGING AND ON FA DRAWING ASSOCIATED WITH THAT PAD.

APRILIA

Pegaso Strada 650	05-06
Pegaso 650 Trial	06-08
Pegaso 650	07-08
Pegaso 650 Factory	06-08
Dorsoduro 750 ABS	08-16
Dorsoduro Factory 750	10-13
Dorsoduro Factory 750 (ABS)	10-12
Shiver 750 GT	09-10
Shiver 750 (RA000)	07-10
Shiver 750 (RAE00) (Std & ABS)	10-16
Shiver 750 GT ABS	10-12
Dorsoduro 900 (ABS)	17-18
Shiver 900 (ABS)	17-18
Caponord 1200 (Cast Wheels)	13-16
Caponord Rally 1200 (Spoke Wheels)	15-16
Dorsoduro 1200	11-12
Dorsoduro 1200 ATC/ABS	11-14

BAJAJ

Pulsar 220 F	15-16
Pulsar 220 S	15-16
Pulsar Adventure AS 200	15-16
Pulsar RS 200 (inc Lower Fairing)	15-16
Pulsar 200 NS	14-16

BENELLI

Aurak MY 125 (BJ 125 10A)	16-17
---------------------------	-------

BETA

Jonathan 125	00-01
Euro 350	00-01

BMW

C1 125	99-03
C1 200	01-03
C 400 X	18
F 650 (E169/0161) Standard	09/93-96
F 650 (E169/0162) (Funduro/High Screen/19" front wheel)	97-00
F 650 CS Scarver (K14/0174/0184 - Belt Drive/17" cast wheels)	00-03
F 650 CS Scarver (K14/0177/0187 - Belt Drive/17" cast wheels)	04-07
F 650 ST (E169/0163/168) Strada (18" front wheel/low screen)	97-00
F 650 GS (R13/0172/0182) (19" front wheel)	99-03
F 650 GS Dakar (R13/0173/0183) (21" front wheel)	99-03
F 650 GS (R13/0175/0185) Single cylinder	04-07
F 650 GS Dakar (R13/0176/0186) (21" front wheel)	04-07
F 650 GS (K72/0218/0228) (798cc Twin Cylinder/cast wheels)	07-12
F 650 GS (30 Years GS) (Twin Cylinder 798cc/cast wheel)	11
G 310 R	17-18
G 310 GS	17-18
G 650 Xchallenge	06-09
G 650 Xmoto	06-09
G 650 Xcountry	06-09
G 650 GS (R131) (Single cylinder/chain drive)	09-15
G 650 GS Sertao (Spoke Wheels)	12-14
F 700 GS	13-18
F 750 GS	16-20
F 800 GS	08-18
F 800 GS Adventure	12-18
F 800 GS (30 Years GS)	11
F 800 GS Triple Black	12
F 800 GS Trophy	12
F 800 GT	13-18
F 800 R	09-18
F 800 R Chris Pfeiffer Edition	09-11
F 800 S (Half Fairing)	06-17
F 800 ST (Full Fairing)	06-12
F 800 ST Touring	10-17
F 850 GS	16-19
F 850 GS Adventure	16-19
F900 R	220
F900 XR	2020
S 1000 R Naked (K47)	14-18
S 1000 RR (K46) (Disc has fixed bobbins)	10-18
S 1000 R/RR (Models fitted with Forged race wheels -7 Spoke type)	10-18

BMW Contd.

S 1000 R	18-19
S 1000 RR/RR Sport/RR M Sport	18-19
HP4	13-14
HP4 Carbon	13-14
HP4 Race	19-20
BORILE	
B 500 CR	02-04
B 500 MT	02
CCM	
CR 40 S Cafe Racer (Full fairing)	07-09
CR 40 Cafe Racer (Handlebar fairing)	07-08
SR 40 Street Scrambler	07-09
GP 450 (4T)	13-15
DUCATI	
400 Scrambler Sixty 2	16-20
797 Monster	17-20
797+ Monster	18-20
803 Scrambler Icon (Cast Wheels)	15-20
803 Scrambler Full Throttle (Cast Wheels)	15-20
803 Scrambler Classic (Spoke Wheels)	15-20
803 Scrambler Urban Enduro (Spoke Wheels)	15-16
803 Scrambler Flat Track Pro	16
803 Scrambler Café Racer (Cast Wheels)	17-20
803 Scrambler Street Classic (Spoke Wheels)	18-20
803 Scrambler Desert Sled (Spoke Wheels)	17-20
803 Scrambler Mach 2 (Cast Wheels)	18-20
Paul Smart 1000 Limited	06-07
Paul Smart 1000 LE (992cc)	06
1000 Sport (992cc)	06-07
Classic Sport Biposto (992cc)	07
GT 1000 (992cc)	07-10
GT 1000 Touring (992cc)	09
Sport 1000 S (992cc)	07
Sport 1000 S	07-09
Sport Classic 1000 (992cc) (Monoposto - Japan/Biposto - Europe)	06-08
1100 Scambler (1079cc)	18-20
1100 Scambler Special (1079cc)	18-20
1100 Scambler Sport (1079cc)	18-20
HONDA	
CB 500 V/W/SW/X/SX/Y/SY/2/S2	97-03
NX 500 V/W/X Dominator	97-99
FX 650 X/Y "Vigor"	99-03
SLR 650 V/W	97-98
NX 650 V/W/X Dominator	97-99
H P POWER	
Pantera 600	11
HUSQVARNA	
TR 650 Terra (Spoke wheel)	12-13
TR 650 Strada (Cast wheel)	12-13
Nuda 900	12-13
Nuda 900 R	12-13
INDIAN	
Scout	17-20
Scout Bobber	18-20
Scout Sixty	17-20
KTM	
Duke 125 (4T)	11-18
RC 125	14-19
Duke 200 (4T)	12-15
RC 200	14-15
Duke 250	15-20
Duke 390	13-20
390 Adventure	20
390 Duke (4T)	15
RC 390	14-15
RC 390 (4T)	15
Duke-E 640 (Single pin pad fixing/zero offset disc)	98
Duke II 640 (2 pin pad fixing/zero offset disc)	99-02
Duke II 640 (2 pin pad fixing/disc with offset)	03-07
690 Duke	08-11
690 Duke (2 pin pad fixing/ 5 Spoke cast wheel)	12
690 Duke (2 pin pad fixing/ Multi Spoke cast wheel)	13-20

KTM Contd.

690 Duke R	10-11
690 R Duke (Multi spoke cast wheels)	13-18
690 Rally Factory Replica	07-09
690 SM	07-09
690 SMC	08-10
690 SMC R	12-13
690 SM-LE (Limited Edition)	10-11
790 Duke	18-20
790 Adventure R	18-20
890 Duke R	20
990 Superduke	05-11
990 Superduke R	07-13
ROYAL ENFIELD	
Bullet 500 (EFI/Single Seat)	16-18
Classic 500 (EFI/Single Seat)	16-20
Classic Chrome 500 (EFI/Single Seat)	16-18
535cc Continental GT (Non ABS)	13-16
535cc Continental GT (ABS)	17-20
Himalayan	16-20
Interceptor 650 Twin	18
Continental 650 twin	18-20
SWM	
RS 125 R	16-17
SM 125 R	16-20
TRIUMPH	
Daytona 675	13-17
Daytona 675 R	13-17
Street Triple 675	13-16
Street Triple S 660	17-19
Street Triple S 765	17-20
Street Triple RX 675	15
Street Triple 675R	13-16
Street Triple R 765	17-20
Street Triple RS 765	17-20
YAMAHA	
Majesty S 125 (XC 125 R)	14-15
WR 125 X (Supermoto)	09-18
WR 125 R	09-15
X-MAX 125 Momo Design	15
XC 155 F/G SMAX	15-16
WR 250 XX/XY (Supermoto) (32D2/4)	08-10
WR 250 RX/RX (32D1/3)	08-10
YP 250 R X-Max (2PLI) Non ABS Nissin F/Brembo R	14-15
X-MAX 250 Momo Design	15
XT 660 X Supermoto	04-16
XT 660 R	04-16
MT-03 (660cc)	06-12
ZERO	
Zero DS (ZF9.4/ZF12.5) (J. Juan F & R Calipers)	15
Zero S (ZF9.4/ZF12.5) J. Juan F & R Calipers)	15-19
Zero SR (ZF12.5) (J. Juan F & R Calipers)	15-16
Zero S (ZF9.8/ZF13.0) (J. Juan F & R Calipers)	16-17
Zero S (ZF7.2)	19-20
Zero S (ZF14.4)	19-20
Zero SR (ZF13.0) (J. Juan F & R Calipers)	16-20
Zero DSR (ZF13.0) (J. Juan F & R Calipers)	16-19
Zero DS II (ZF7.2)	19-20
Zero DS II (ZF14.4)	19-20
Zero DS (ZF13.0) (J. Juan F & R Calipers)	16-19
Zero DSR (ZF14.4.0)	19-20
Zero DSR Black Forest Edition (ZF14.4.0)	19-20
Zero FX (ZF3.3/ZF6.5) (J. Juan F & R Calipers)	16-20
Zero FXS (ZF3.3/ZF6.5) (J. Juan F & R Calipers)	17-20

FA213 Contd.

Equivalents OE #			
06435 MAK 003	8133825	34 21 7 722 884	34 21 7 722 884
34 21 7 660 343	61340761A	897119	613 13 090 000
34 21 7 660 253	8133911	7707809	750 13 090 000
34 21 7 664 983	503 13 090 000	901 13 090 000	2DLF581100
34 21 2 345 449	6130761A	T2024901	06435 KYJ 711
34 21 7 707 908	858200	546 13 309 200	1DK WOO46 00
5VK W0046 00	22BF591100	8539283	F00P02029

MATERIAL AVAILABILITY AND PART NO.					
STD	OPTIONS				
FA	V	SFA	HH	SFA-HH	R
FA213	FA213V	SFA213	FA213HH	SFA213HH	-

FA214 A. 96.7 x 42 x 7.6mm B. 77.3 x 42 x 8mm

FA214/2 A. 96.7 x 42 x 9.7mm B. 77.3 x 42 x 8mm

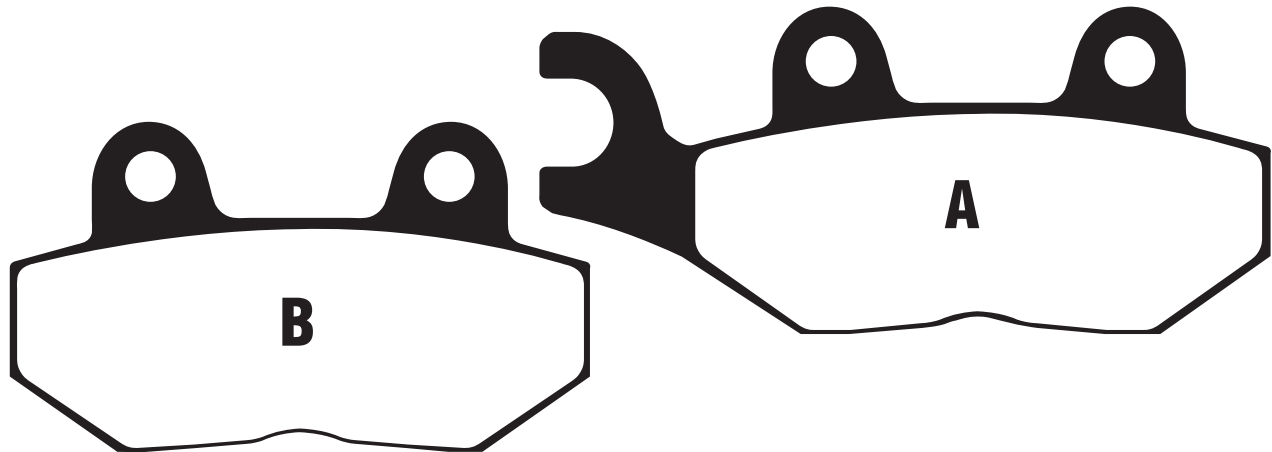

FA214 TRIUMPH

Sprint (All carb models) 93
Tiger 885cc 92-97
Trident 750 92-98
Trident 900 92-98
Trophy 900 92-93
Trophy 1200 92-93

FA214/2 TRIUMPH

America (6 spoke cast wheel) 07-09
America (12 spoke cast wheel - 865cc) 10-17
America LT (12 spoke cast wheels/865cc) 14-17
Bonneville America 02-06
Bonneville 800 01-06
Bonneville T100 (790cc) 02-04
Bonneville T100 (865cc) 05-09
Bonneville T100 (865cc/Air Cooled/Spoke wheel) 10-16
Bonneville T100 Black (865cc/Air Cooled/Spoke wheel) 14-16
Bonneville T100 (900cc/Liquid Cooled/Spoke Wheel) 16-20
Bonneville T100 Black (900cc/Liquid Cooled/Spoke Wheel) 16-20
Bonneville (865cc/Cast wheel) 09-15
Bonneville SE (865cc) 09-13
Bonneville Newchurch (865cc/Cast wheel) 15
Bonneville Spirit (Spoke wheel/865cc) 15
Bonneville T214 (Spoke wheel/865cc) 15
Bonneville/Bonneville Black (865cc) 07-08
Bonneville Steve McQueen SE 12
Bonneville T120 (1200cc Liquid Cooled) 16-20
Bonneville T120 Black (1200cc Liquid Cooled) 16-20
T595 Daytona 97
Daytona 955i 98-00
Daytona 955i (From VIN 132513) 01-04
(5 bolt front disc single sided s/arm)
Daytona 955i 05-06
Speed Triple 97-01
Speed Triple 955cc 02-04
Sprint RS 99-04
Street Twin (900cc Liquid Cooled) 16-20
Thruxton 900 04-16
Thruxton Ace 900 15-16
Thruxton 1200 (Liquid Cooled) 16-18
Thruxton R 1200 (Liquid Cooled) 16-18
Scrambler (865cc) 06-15
Street Scrambler (900cc Liquid Cooled) 16-20
Street Cup (900cc Liquid Cooled) 16-20
Speedmaster (765cc/Carb) 03-04

FA214/2

TRIUMPH Contd. Speedmaster (865cc/Carb) 05-07
Speedmaster (865cc/EFI) 08-16
Speed Triple 1050 (Non ABS) 05-16
Speed Triple 1050 (ABS) 07-16
Speed Triple S (1050cc/ABS) 17-18
Speed Triple R 1050 (2 Pad caliper/Non ABS/5 Spoke wheel) 12-13
Speed Triple R 1050 (2 Pad caliper/ABS/5 Spoke wheel) 12-13
Speed Triple R 1050 (2 Pad caliper/Non ABS/10 Spoke wheel) 14-16
Speed Triple R 1050 (2 Pad caliper/ABS/10 Spoke wheel) 14-16
Speed Triple R (1050cc/ABS) 17-20
Sprint 955i ST Front Disc with offset/6 bolt fixing) 99-04
Sprint GT 1050 SE (ABS) 10-16
Sprint 1050i GT Front disc with offset/5 bolt fixing 05-06
Sprint 1050i Sprint ST (Non ABS) front disc with zero offset 11-12
Sprint 1050i ST (ABS) Front disc with zero offset 11-12
Sprint 1050 ST (5 spoke wheel/Non ABS Model/5 bolt disc with offset) 05-10
Sprint 1050 ST (5 spoke wheel/ABS Model/5 bolt disc with offset) 05-10
Tiger Explorer 1200 12-15
Tiger Explorer 1200 XC 13-15
Tiger Sport 1050cc (Single Side S/Arm) 13-18
Tiger Sport (ABS) 1050cc 16-18
Thruxton 1200 (Liquid Cooled) 16-20
Thruxton R 1200 (Liquid Cooled) 16-20

MATERIAL AVAILABILITY AND PART NO.				
STD	OPTIONS			
FA	V	HH	R	MXS
FA214	FA214V	FA214HH	-	-

MATERIAL AVAILABILITY AND PART NO.				
STD	OPTIONS			
FA	V	HH	R	MXS
FA214/2	FA214/2V	FA214/2HH	-	-

Equivalents OE #FA214/2

T 2020 555
T 2020 072 T31
T 2020 556
T 2020 191
T2020955
T2022955

Equivalents OE #FA214

T 2020071 T301

FA215 A. 96.7 x 42 x 7.6mm B. 77.3 x 42 x 8mm
FA215/2 A. 96.7 x 42 x 9.7mm B. 77.3 x 42 x 8mm

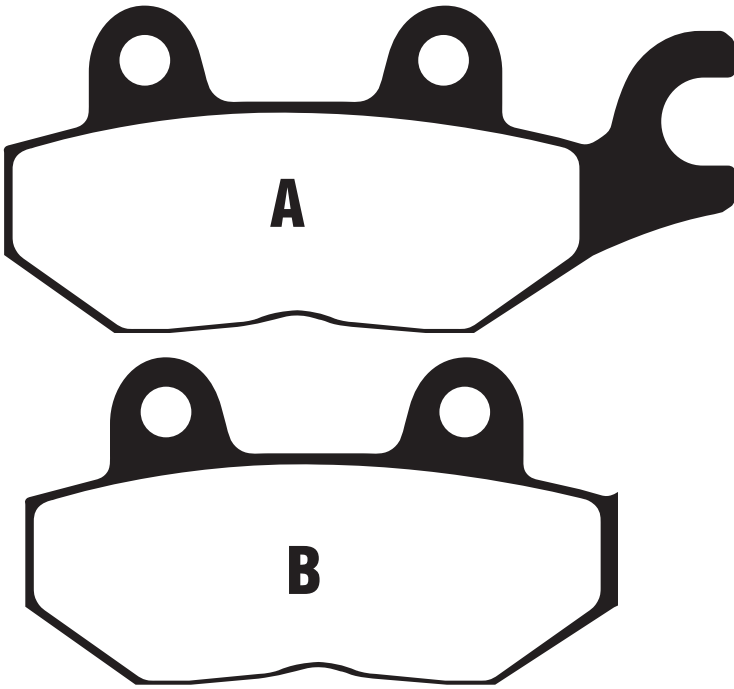

FA215 - TRIUMPH

Sprint	93	F(Right)
Trident 750	92-98	F(Right)
Tiger 885cc	92-97	F(Right)
Trident 900	92-98	F(Right)
Trophy 900	92-93	F(Right)
Trophy 1200	92-93	F(Right)
Bonneville Speedtwin (1200cc)	19-20	R

FA215/2 - TRIUMPH

Daytona 750	92	R
Daytona 1000	92	R
Daytona 900	93-96	R
Daytona Super III	94-97	R
Daytona 1200	93-98	R
Speed Triple	94-97	R
Sprint	93-98	R
Sprint RS	99-02	R
Trident 750	92-98	R
Tiger 885cc	92-97	R
Trident 900	92-98	R
Trophy 900	92-01	R
Tiger 955 (from VIN198875)	04-06	R
Tiger 1050 (Radial caliper)	07-12	R
Tiger 1050 SE - ABS (1050cc)	10-13	R
Trophy 1200	92-01	R

Equivalents OE #FA215
T 2020072-T301

Equivalents OE #FA215/2
T 2020560
T 2020561

MATERIAL AVAILABILITY AND PART NO.				
STD	OPTIONS			
FA	V	HH	R	MXS
FA215	FA215V	FA215HH	-	-

MATERIAL AVAILABILITY AND PART NO.				
STD	OPTIONS			
FA	V	HH	R	MXS
FA215/2	FA215/2V	FA215/2HH	-	-

FA216 USE FA216/3
FA216/2 69.2 x 48.8 x 10.5mm
FA216/3 69.2 x 48.8 x 7.8mm

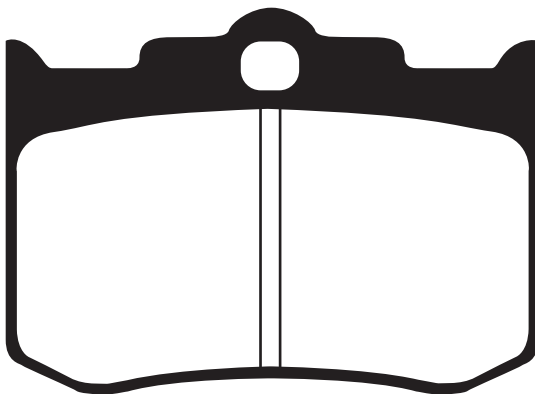

FA216/2

EBC
 4 Piston
PERFORMANCE MACHINE
 124 X 4HR
 137 X 4

FA216/3

HHI - (Hawg Halters)
 4 Piston - All types
INDIAN
 Nova
 Legends
 Thunderheart
NOVA/LEGENDS
 4 Piston
PERFORMANCE MACHINE
 125 X 4R
 137 X 4B
REVTECH
 New Black 4 Piston Caliper
THUNDERHEART
 4 Piston Caliper

MATERIAL AVAILABILITY AND PART NO.				
STD	OPTIONS			
FA	HH	R	R	MXS
FA216/2	FA216/2HH	-	-	-

MATERIAL AVAILABILITY AND PART NO.				
STD	OPTIONS			
FA	V	HH	HH	MXS
FA216/3	FA216/3V	-	FA216/3HH	-

DISC PADS
BUYERS GUIDE

DO NOT REFIT ANY SHIMS/INSULATORS TO EBC PADS FROM ORIGINAL PADS UNLESS INSTRUCTED ON NOTE ON PAD PACKAGING AND ON FA DRAWING ASSOCIATED WITH THAT PAD.

FA217 106 x 31.7 x 8.5mm

RACE USE ONLY

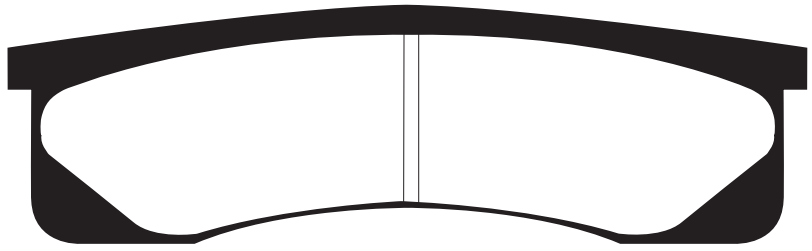

AP/LOCKHEED
6 Piston / No Pins (CP3366/67)
REVTECH
6 Piston VR1000 Race Caliper

MATERIAL AVAILABILITY AND PART NO.					
STD	OPTIONS				
FA	V	HH	R	MXS	EPFA
FA217	-	-	-	-	-

Equivalents OE #
N/A

FA218 77.65 x 40.50 x 9.3mm

FA218/2 77.65 x 40.50 x 8mm

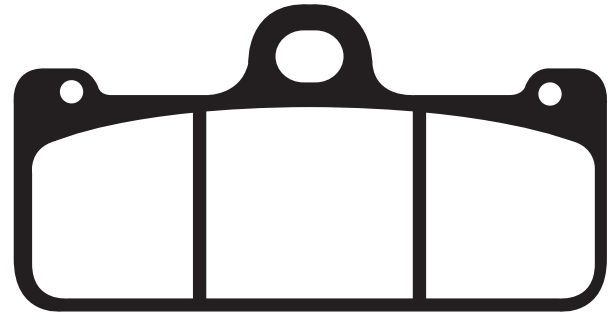

RACE USE ONLY

FA218 - BREMBO
XA9.33.10/11 - 4 Piston P32/36 Radial mount monobloc @ 108mm spacing (single pin pad fixing)
X97.37.60/61 - 4 Piston Monobloc 32/36 Radial Mount @ 108mm (Single pin fixing)

S.W.M.
Gran Milano Special (4T) 15 F
TM
MX 660 06 F

FA218/2 - BREMBO
XA3.B8.30/31 - 4 Piston P32/36 Radial Mount Caliper @ 108mm Spacing (Titanium Pistons)
XA3.B8.60/61 - 4 Piston P32/36 Radial Mount Caliper @ 108mm Spacing (Aluminium Pistons)
X1017.40/41 - 4 Piston/40mm Axial Monobloc
XA7G2.40/41 - 4 Piston 100mm CNC Monobloc Race Caliper
XA7G2.10/11 P4 32/36 Radial monobloc 100mm spacing

MATERIAL AVAILABILITY AND PART NO.				
STD	OPTIONS			
FA	HH	R	EPFA	GPFA
FA218	FA218HH	-	EPFA218HH	GPFA218HH

Equivalents OE # - FA218
107 A486 02
07 684831

MATERIAL AVAILABILITY AND PART NO.				
STD	OPTIONS			
FA	HH	R	EPFA	GPFA
-	-	-	EPFA218/2HH	GPFA218/2HH

Equivalents OE # - FA218/2
107 A486 03
107 684830
M028Z04

FA220 69 x 50.4 x 8.7 mm

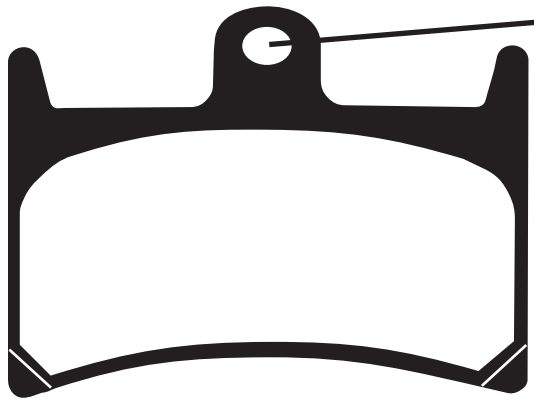

PIN HOLE
Right to left 5.8mm
Top to bottom 5.0mm

YAMAHA
FZR 250 R 90-92 F
R1-Z (250CC/3XC) F

MATERIAL AVAILABILITY AND PART NO.				
STD	OPTIONS			
FA	V	HH	R	MXS
FA220	-	-	-	-

Equivalents OE #
3LN W0045 00

DISC PADS BUYERS GUIDE

DO NOT REFIT ANY SHIMS/INSULATORS TO EBC PADS FROM ORIGINAL PADS UNLESS INSTRUCTED ON NOTE ON PAD PACKAGING AND ON FA DRAWING ASSOCIATED WITH THAT PAD.

FA222 52.60 x 56.30 x 9mm

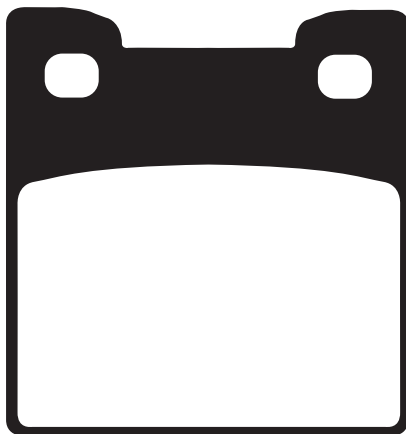

SUZUKI
RF 900 RR/RS/RS2

94-95 R

Equivalents OE #

69100 31830
69130 31E00

MATERIAL AVAILABILITY AND PART NO.

STD	OPTIONS				
FA	V	HH	R	MXS	EPFA
FA222	-	-	-	-	-

FA226 102 x 38 x 9.0mm

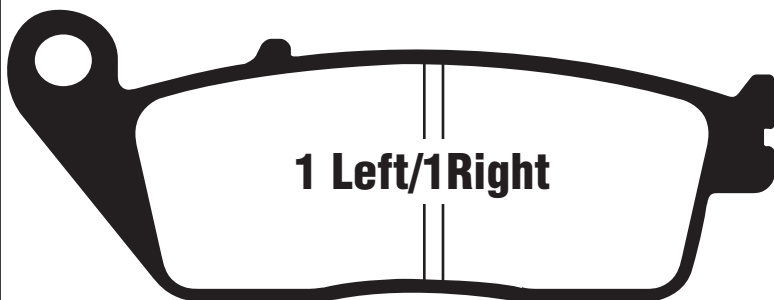

HONDA

RS 125	90-94	F
RS 250	90-94	F
CB 300 F AC (ABS)	15-17	F
CB 300 FA AC (ABS)	18-20	F
CBR 300 RA (ABS)	15-20	F
CB 600 FW/FX/FY/F2-Y/F1/F21/F2/F22		
/F3/F4/F5/F6 /F7/F8/F9/FA/FB/FC Hornet	98-13	F
CBF 600 N4/NA4/S4/SA4/N5/NA5/S5/SA5	04-05	F
CBF 600 N8/N9/NA (Non ABS)	08-11	F
CBF 600 NA4/NA5/NA6 (ABS Model)	04-06	F
CBF 600 S4/S5/S6 (Non ABS)	04-06	F
CBF 600 SA4/SA5/SA6 (ABS Model)	04-06	F
CBF 600 S8/S9 (Non ABS)	08-09	F
CBF 600 N4/N5/N6 (Non ABS)	04-06	F
CBF 600 NA4/NA5/NA6 (ABS)	04-06	F
CBR 600 FS/FT/FV/FW	95-98	F
CBR 600 FB/FC	11-13	F
CBF 1000 6/7/8/9/A		
(2 piston front calipers/Non ABS Model)	06-11	F
CBF 1000 F (FA)		
(2 piston front calipers/Non ABS)	10-15	F

KAWASAKI

Ninja 650 (EX 650 KH/KHFA/KJFA - ABS)	18	F
Ninja 650 (EX 650 JHF -NON ABS)	17	F

SUZUKI

DL 250 V-Strom AL8 (ABS)	18-20	F
GSX 250 RL7/RL8	17-18	F

TRIUMPH

Street Triple 675 (Naked)	07-12	F
Street Triple 675	13-16	F
Street Triple S 660	17-19	F
Street Triple S 765	17-20	F
Tiger 800 (Non ABS)	11-14	F
Tiger 800 (With ABS)	11-14	F
Tiger 800 XC (ABS)	11-19	F
Tiger 800 XCa (ABS) up to VIN 855531	15-20	F
Tiger 800 XCx (ABS) up to VIN 855531	15-20	F
Tiger 800 XR (ABS)	15-20	F
Tiger 800 XRt (ABS) up to VIN 855531	15-20	F
Tiger 800 XRx (ABS) up to VIN 855531	15-20	F

Equivalents OE #

06455 MV4 405
06455 MR4 405
06455 MAL G01
43082 0165

MATERIAL AVAILABILITY AND PART NO.

STD	OPTIONS				
FA	V	HH	R	MXS	EPFA
FA226	FA226HH	-	-	-	EPFA226HH

FA228 A. 96.7 x 42 x 9mm B. 77.3 x 42 x 9mm

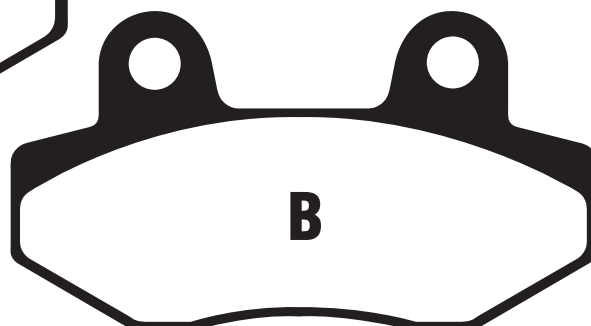
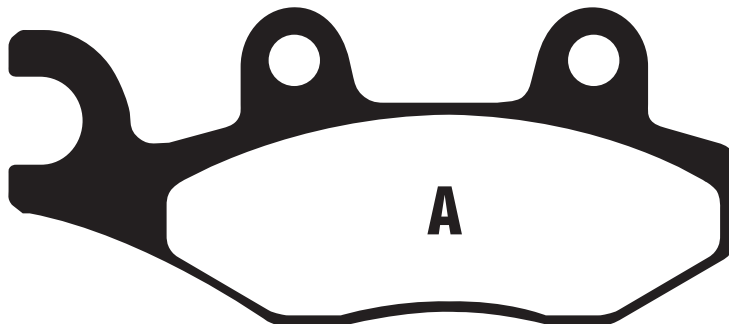

NOTE: Do not refit any shims from original pads

DISC PADS
BUYERS GUIDE

DO NOT REFIT ANY SHIMS/INSULATORS TO EBC PADS FROM ORIGINAL PADS UNLESS INSTRUCTED ON NOTE ON PAD PACKAGING AND ON FA DRAWING ASSOCIATED WITH THAT PAD.

FA228 Contd.

AEON			
Elite 125 (4T)	12-13	F	
MY 125		F	
OZ 125 (4T)	13	F	
Urban 125 (Scooter)	11	F	
Urban 125 (4T)	13	F	
OZ 150 (4T)	13	F	
Elite 200i (Scooter)	11	F	
Elite 350i (4T)	12-13	F	
Urban 350i (Scooter)	11	F	
Urban 350i (4T)	12-13	F	
ASPES			
50 Vega Hybrid	10-14	F	
BENELLI			
Caffe Nero 125/150	11-16	F&R	
Hobby 125 (4T)	13	F&R	
Macis 125/150	10-16	F&R	
X 125	12-14	F&R	
X 150	12-14	F	
Hobby 151 (4T)	13	F&R	
Caffe Nero 250	08-14	F(right)	
Zenzero 350	12-16	F	
CF MOTO			
CF 125 T-22/22A Glory	10-11	F	
CF 125 T-21A E-Charm	10-11	F	
CF 150 T-6/A Glory	10-11	F	
CF 150 T-Si Charm	10-12	F	
DAELIM			
SJ 50 R A-Four (50cc)	06-09	F	
GENERIC/KSR			
TR 125 SM (4T)	12-16	F	
Zion 125/150 (Rear drum model)	08-10	F	
Zion 125/150 (Rear disc model)	11-16	F & R	
Inox 125 (2T)	12-14	F	
HARTFORD			
VR-125 Z Velo Sport	00-03	F	
VR-125 X/H Velo-Cross	00-03	F	
CR 125/150 H/X/Z	04	F	
HONDA			
CA 125 S/T 'Rebel'	95-97	F	
CMX 250 CT 'Rebel'	96-97	F	
HYOSUNG			
MS3 (125cc)	07-09F (Left)&R		
MS3 250i	07-09F (Left)&R		
KAWASAKI			
KLR 650 (KL 650 E8F/E9F)	08-09	F	
Ninja H2 SX (ZX1002 AJF)	18-20	R	
Ninja H2 SX SE (ZX1002 BJF)	18-20	R	
Ninja H2 SX SE+ (ZX1002 DKF)	19-20	R	
KEEWAY			
Partner 110	06-07	F	
Cityblade 125	13-15	F	
125i Silverblade	13-15	F(left)	
125 Logik	13-15	F&R	
Outlook 125/150	07-10	F&R	
Cityblade 150	13-15	F	
150 Logik	13-15	F&R	
Superlight LTD 125	07-15	F	
Superlight 150	07-10	F	
250i Blackster	14-15	F	
Cruiser 250	09-14	F	
250i Silverblade	13-14	F(left)	
350i Index	13-14	F	
KREIDLER			
50 Supermoto (2T)	14-15	F (Left)	
125 Enduro (4T)	14-15	F (Left)	
125 Insignio (4T)	14-15	F (Right)	
125 Supermoto (4T)	14-15	F (Left)	
250 Insignio (4T)	14-15	F (Right)	
KYMCO			
Agility 50	05-08	F	
Agility 50 City+ 50 (4T)	18-20	F	
Agility 50 R10 (4T) (CK 50 QT S)	06-14	F	
Agility 50 R12 (4T) (CK 50 QT S)	06-14	F	
Agility RS 50 Naked (2T/12" wheels)	10-14	F	
Filly 50 LX (S210)	00-06	F	
Like 50 (2T)	10-15	F	
Like 50 LX (4T)	10-20	F	
Sento 50	08-15	F	
Vitality 50 (2T) (SF10FA)	04-09	F	
Vitality 50 (4T) (U31000)	04-09	F	
Yup 50	01-09	F	
Cobra 100 Racer	99-03	F	
Agility 125 (4T) U62000/1 12" wheels/3 spoke	06-14	F	
Agility RS 125 (4T 12" wheels/5 spoke)	10-15	F	
Stryker 125	01-06	F	

KYMCO Contd.

Like 125 LX	10-15	F	
Movie 125	99-00	F	
Vivio 125/150	00-03	F	
Stryker 150 (Off road)	00-06	F	
Like 200i LX	10-15	F	
People 250 S	06-08	F(left)	
People S 300 i	08-10	F(left)	
MALAGUTI			
Blog 125 ie	09-11	F	
Centro 125 ie/SL	07-11	F	
Blog 160 ie	09-11	F	
Centro 160 ie/SL	07-11	F	
MASH			
Café Racer 125	14-16	F	
Seventy Five 125	14-16	F	
MZ/MUZ			
SX 125	02-07	F	
SM 125	02-07	F	
NIPPONIA			
Duel 125 (4T)			
PEUGEOT			
50 Django Heritage (2T/4T)	14-18	F	
125 Citystar (AC/Carb)	11-15	F	
125 i Citystar (LC)	13-19	F	
125 Citystar Blue Line	15	F	
125 Django Heritage (4T)	14-20	F	
Geopolis 125 (Premium/Non ABS)	07-12	F&R	
(Nissin Calipers)	07-12	F&R	
Geo RS 125 (Nissin Caliper)	07-12	F&R	
Satelis 125 Avenue (Nissin Calipers)	08-09	F&R	
Satelis 125 (4T)	13	R	
Satelis 125 RS (4T)	13	F	
Satelis 125 Blue Line	15	F	
E-Satelis (Electric)	11	F&R	
E-Vivacity (Electric)	11-15	F	
Vivacity 125 (4T)	10-15	F	
Vivacity Sixties 125 (4T)	11-12	F	
150 Citystar (AC/Carb)	11-15	F	
150 i Citystar (LC)	13-15	F	
Citystar One 150	13-14	F	
Django 150 Heritage (4T/196mm Rear Disc)	14-20	F	
Citystar 200i	12-18	F	
Geo RS 250 (Nissin Caliper)	07-12	F&R	
Geopolis 250 (Premium/Nissin Calipers/Non ABS)	07-12	F&R	
Satelis RS 250 (Nissin Calipers)	07-12	F&R	
Satelis 250 Premium (Nissin Calipers)	07-12	F&R	
Geopolis 300	10-15	F&R	
Geopolis 300 (Nissin Calipers)	10-14	F&R	
Geopolis 300 GT	14	R	
Geo RS 300 (Nissin Calipers)	10-12	F&R	
Metropolis 400 RS (3 Wheel Mode /Nissin Caliper)	17-18	R	
Metropolis 400 RX-R (3 Wheel Model/Nissin Caliper)	17-18	R	
Metropolis 400 Allure (3 Wheel Model/Nissin Caliper)	17-18	R	
Satelis 300 (4T)	13-14	F&R	
Satelis 2 300 (4T)	14-15	F&R	
Geopolis 400 (Premium/Nissin Calipers/Non ABS)	07-12	F&R	
Geo RS 400 (Nissin Calipers)	08-12	F&R	
Satelis 400 Premium (Nissin Calipers)	08-12	R	
Satelis 400 Urban (Nissin Calipers/ABS)	08-12	R	
Satelis 400 RS (Nissin Calipers)	08-14	R	
Satelis 2 400 (4T)	14-15	R	
Satelis 2 400 RS	14-15	R	
Geopolis 500	08-11	R	
Satelis 500	07-12	R	
Satelis 500 RS (Nissin Calipers)	08-12	R	
QUADZILLA			
WK 300	06-08	F	

ROYAL ENFIELD

Bullet 500(Efi/Dual Seat)	09-15	F	
Clubman 500 EFI (Single Seat)	09-12	F	
Bullet Battle Green 500 EFI (Single Seat)	09-15	F	
Bullet Classic 500 EFI (Single Seat)	09-15	F	
Bullet Classic Chrome 500 EFI (Single seat)	09-15	F	
Bullet Desert Storm 500 (EFI/Single Seat)	12-15	F	
Electra 500 EFI (Dual Seat)	09-12	F	
Electra 500 EFI	09-14	F	
Fury 500	11-12	F	
Trails 500 EFI	09-12	F	
Woodsmen 500cc EFi	10-12	F	
SINNIS			
Hawk 50 QM 50 10A-(C)	08-10	F	
Stealth 125 QM125-2D	08-10	F(left)	
QM 50 T-10R Eagle 50	10-12	F	
ZN 50 QT-30A Strada 50	12-14	F	
ZN 125 T-ES Spirit 125	12-14	F	
ZN 125 T-30A Strada 125		F	
SUZUKI			
AN 250 Skywave Type M (BA-CJ45A)	07-08	F(left)	
AN 250 Skywave/Type S (BA-CJ44A)	07-08	F(left)	
AN 250 8 (CJ46A) Skywave SS	08	F(left)	
AN 400 K7/ZK7/K8/ZK8/K9/L0/L1 /L2/L3/L4 Burgman/Non ABS /Skywave	07-15	F(left)	
AN 400 Burgman/Skywave ABS	07-20	F(left)	
SFM			
SFM 125 A8 Roadster	13-15	F	
SYM			
XPro 125	11-13	F	
RS 150	06	R	
TRIUMPH			
Tiger 1200 XR	18-20	R	
Tiger 1200 XRr	18-20	R	
Tiger 1200 XRr Low	18-20	R	
Tiger 1200 XRt	18-20	R	
Tiger 1200 Xca	18-20	R	
Tiger 1200 XcX	18-20	R	
Tiger Explorer XC (1215cc)	16-17	R	
Tiger Explorer XcX/XcX Low (1215cc)	16-17	R	
Tiger Explorer XCa (1215cc)	16-17	R	
Tiger Explorer XR(1215cc)	16-17	R	
Tiger Explorer XRr/XRr Low (1215cc)	16-17	R	
Tiger Explorer XRt (1215cc)	16-17	R	
Trophy 1215	12-16	R	
Trophy SE 1215	12-17	R	
VECTRIX			
VT-1	14	F	
VIALLI			
DXB 50	06	F	
Fireforce 50	06	F	
W.K. BIKES			
WK 125 C (2T) (16" wheel)	10-13	F	
WK 125 SC (4T) (14" wheels)	10-14	F	
WK Jetmax 250 (4T)	10-14	F(left)	
YAMAHA			
YBR 125 ED (5HHB/F/H) Brasil (Disc front)	06-08	F	

MATERIAL AVAILABILITY AND PART NO.

STD	OPTIONS				
FA	SFA	SFAC	HH	SFA-HH	R
FA228	SFA228	SFAC228	FA228HH	SFA228HH	-

Equivalents OE

06455 KEB 900	5HH W0045 00	43082 0060	R800278	59301 HP7 600
45105 KCE 3050 M2	5RM W0045 10	560584	RO50371008000	43082-0179
45105 KKD 6305	45130T40 000	PE 758935	1141 40001 100E	T2025045
45150 KEC8 3050	59401 HP7 600	PE 802275	6050 080180	T2022475
902 3002000	119 69800	45105 LDC8 305	45120T 580000	
59100 05830	45105 SB3 0001M1	R1700 7208 0000	305128A 003103	
45110 K2GP 000	45106 SB3 0001M1	45105 LEA1 306	45105 KECE 305M2	

FA229 A. 133.5 x 36.8 x 8.4mm

B. 109.6 x 44.4 x 8.5mm

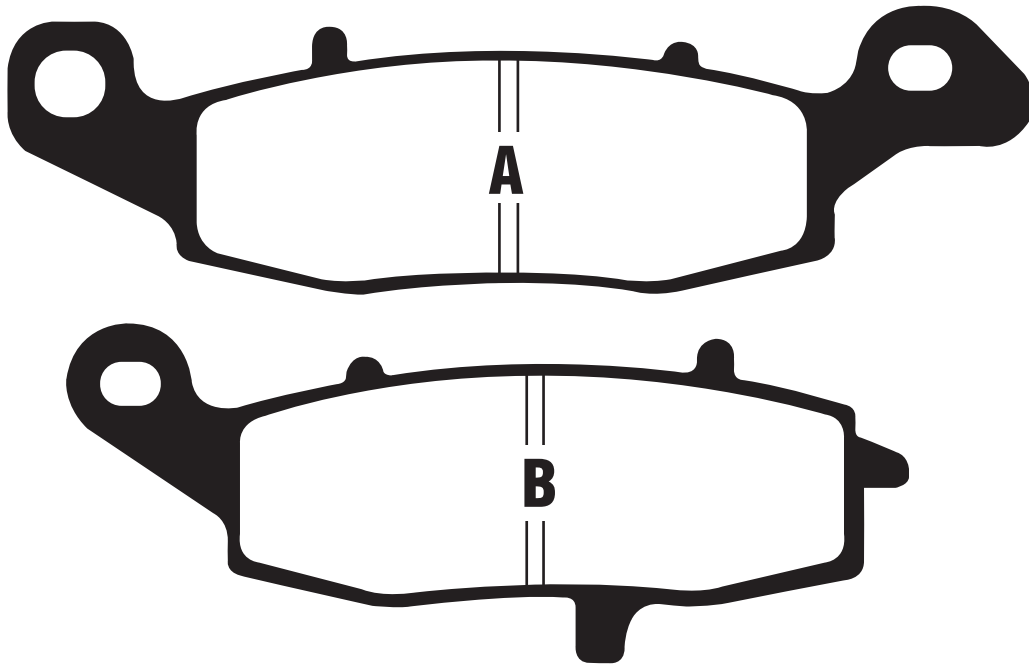

DO NOT REFIT ANY SHIMS/INSULATORS TO EBC PADS FROM ORIGINAL PADS UNLESS INSTRUCTED ON NOTE ON PAD PACKAGING AND ON FA DRAWING ASSOCIATED WITH THAT PAD.

CF MOTO

650 NK 12-15 F(left)
 650 TK 13-15 F(left)
 650 TR 13-14 F(left)

KAWASAKI

ZR-X 400 E3 (ZR 400 E3) 96 F(left)
 ER-5 ER 500 C1-C5P 01-07 F
 ER-6f (EX 650 A6F/A7F/A8F/C9F/CAF/CBF) 06-11 F(left)
 ER-6f (EX 650 B6F/B7F/B8F/D9F/DAF/DBF) ABS 06-11 F(left)
 ER-6f (FCF/FDF/FEF/FFF/FGF) (With ABS) 12-16 F(left)
 ER-6f (ECF/EDF/EEF/EFF/EGF) (Non ABS) 12-16 F(left)
 ER-6n (ER 650 A6F/A7F/A8F/C9F/CAF/CBF) 06-11 F(left)
 ER-6n (ER 650 B6F/B7F/B8F/D9F/DAF) 06-10 F(left)
 ER-6n (FCF/FDF/FEF/FFF/FGF) (With ABS) 12-16 F(left)
 ER-6n (ECF/EDF/EEF/EFF/EGF) (Non ABS) 12-16 F(left)
 KLE 650 A7F/A8F/A9F/CAF/CBF/CCF/CDF/CEF Versys 07-14 F(left)
 KLE 650 B7F/B8F/B9F/DAF/DBF/DCF /DDF/DEF Versys ABS 07-14 F(left)
 KLR 650 C1-C10 95-04 F
 ZR 750 D1 "Zephyr" 96 F(left)
 ZR-7 (ZR 750 F1/F3/F5) 99-04 F(left)
 ZR-7S (ZR 750 H1/H2) 01-04 F(left)
 Z 750 (ZR 750 J1/J2) 04-05 F(left)
 Z 750 S (ZR 750 K1/K6F) 05-07 F(left)
 VN 800 C1/C2/E1/E2/E3 "Drifter" 99-04 F
 VN 800 B1-B10/B6F/BDF "Classic" 96-06 F
 VN 900 A6F Classic 06 F
 VN 900 Classic (Spoke wheel) 07-20 F
 VN 900 Custom (Cast wheel) 07-20 F
 VN 900 Classic Special Edition/White Wall Tyres/Spoke Wheel 11-20 F
 KLV 1000 (LV 1000 A1H/A2H) 04-05 F(left)
 GPZ 1100 E1/E2/F1 95-98 F(left)
 ZR 1100 B1 "Zephyr" 96-97 F(left)
 ZR 1100 B5 (Zephyr 1100 RS) 02 F(left)
 VN 1500 D1/D2/E1/E2 "Classic" 96-99 F
 VN 1500 G1/G2 Classic Tourer 98-00 F(left)
 VN 1500 J1/J2/R1/R2/R3 Drifter 99-04 F
 VN 1500 L1/L2/L3/L4 "Nomad Fi" 00-03 F(left)
 VN 1500 N1/N2/N3 Classic Fi 00-04 F
 VN 1600 A1/A2/A3/A6F 03-08 F(left)
 VN 1600 D1H/D6F Classic Tourer 05-08 F(left)
 VN 1700 C9F Classic Tourer 09 F(left)
 VN 1700 E9F Classic 09 F(left)

SUZUKI

GSF 250 VS/VT/VV/VVZ/VW/VX/VY (GJ77) Bandit 95-00 F
 TU 250 GY/GBK1 Grass Tracker/Big Boy NJ47A-117/123) 00-01 F
 TU 250 XTX/XTY (NJ47A/115) Volty 99-00 F
 SV 400 X/Y/K1/K2 00-02 F(left)
 SV 400 SX/SY/SK1/SK2 00-02 F(left)
 SV 400 K3/K4/K5 03-05 F(left)
 SV 400 SK3/SK4/SK5 03-05 F(left)
 GSX 600 FW/FX/FY/FK1/FK2/FK3/FK4/FK5/FK6 98-06 F(left)
 GSF 600 Y/SY/K1/SK1/K2/SK2/K3/SK3/K4/SK4 Bandit 00-04 F(left)
 DL 650 K4/K5/K6 V-Strom 04-06 F(left)
 DL 650 XK7/XK8/XK9/XL0 V-Strom X 07-11 F(left)
 DL 650 AK7/AK8/AK9/AL0 V-Strom ABS 07-11 F(left)
 DL 650 AL1 XP V-Strom Expedition 11 F(left)
 DL 650 AK9 GT V-Strom Traveller ABS 07-11 F(left)
 DL 650 V-Strom ABS 12-20 F(left)
 DL 650 XT V-Strom ABS 15-20 F(left)
 GSF 650 SK5/SK6 Faired Bandit Non ABS 05-06 F(left)
 GSF 650 K5/K6 Naked Bandit Non ABS 05-06 F(left)
 GSF 650 AK5/AK6 Naked Bandit - ABS 05-06 F(left)
 GSF 650 SAK5/SAK6 Faired Bandit - ABS 05-06 F(left)
 SFV 650 K9/L0/L1/L2/L3/L4/L5 Gladius 09-15 F(left)
 SFV 650 AK9/AL0/AL1/AL2/AL3/AL4/AL5 (ABS) 09-15 F(left)
 SV 650 K3/K4/K5/K6/K7/K8/K9/L0 Naked Non ABS 03-10 F(left)
 SV 650 AK7/AK8/AK9/AL0 Naked ABS 07-10 F(left)
 SV 650 SAK7/SAK8/SAK9/SAL0 07-15 F(left)
 SV 650 SK3/SK4/SK5/SK6/SK7/SK8/SK9/SLO Top Fairing Non ABS 03-15 F(left)
 SV 650 X/Y/K1/K2 Naked - Non ABS 99-02 F(left)
 SV 650 SX/SY/SK1/SK2 Top Fairing - Non ABS 99-02 F(left)
 SV 650 ABS 16-20 F(left)
 SV 650 X ABS 18-20 F(left)
 GSR 750 L1/L2/L3/L4/L5/L6 (Non ABS) 11-16 F(left)
 GSR 750 AL2/AL/AL4/AL5/AL6 (ABS) 11-16 F(left)
 GSX 750 FW/FX/FY/FK1/FK2/FK3/FK4/FK5/FK6 98-06 F(left)
 GSX 750 W/W/Y 98-03 F(left)
 DR 800 ST/SV (SR43B) 96-97 F
 VX 800 T 96 F
 DL 900 Migrator 14-19 F
 DL 1000 K2/K3/K4/K5/K6/K7/K8/K9/L0 V-Strom 02-10 F(left)
 M 1500 (VZ 1500 K9/L0/L1 Intruder) 09-13 F(left)
 VL 1500 K2/K3 02-03 F(left)
 VL 1500 K5/K6/K7/K8 (C1500 Intruder) 05-08 F(left)

WK

650i (Naked) 13-14 F(left)
 650 TR (Touring) 13-14 F(left)

MATERIAL AVAILABILITY AND PART NO.					
STD	OPTIONS				
FA	V	HH	R	MXS	EPFA
FA229	FA229V	FA229HH	-	-	EPFA229HH

Equivalents OE #		
43082 1177	59302 33810	43082 S019
43082 1187	43082 0009	59300 33850
59301 33820	43082 1223	59302 33830
59301 33830	43082 1234	59303 33810
59301 33840	43082 1244	A000-0801A0
59302 22850	43082 1282	59302 33850

FA230 A. 99 x 44.1 x 7.56mm B. 75.50 x 37.90 x 8.26

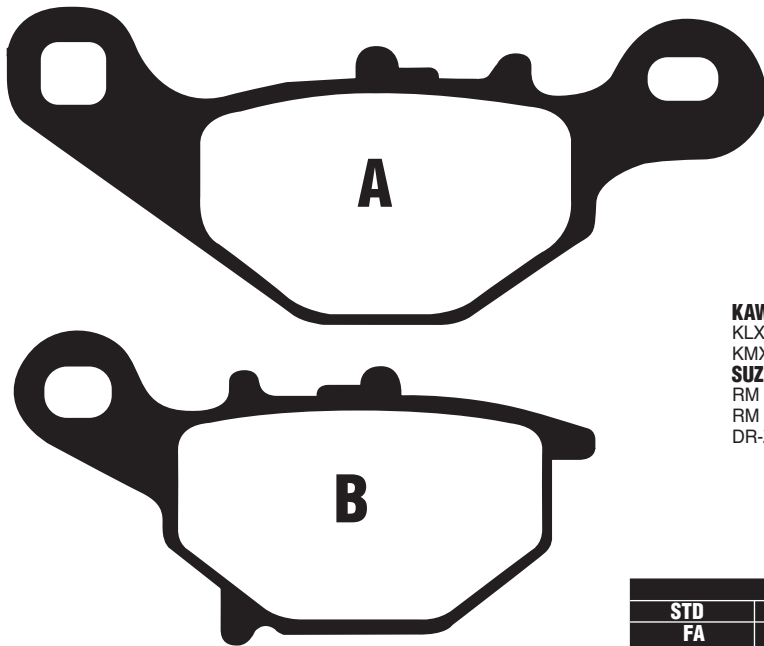

KAWASAKI

KLX 125 L (B1/B2/B3/B6F) 03-06 F
 KMX 125 B2-B12 (From E/No MX AE 013437) 87-03 F

SUZUKI

RM 80 T/V/W/X/Y/K1 96-01 F
 RM 85 K2/LK2/K3/LK3/LK4/K4 02-04 F
 DR-Z 125 03-20 F

Equivalents OE #	
59300 03880	43082 S005
59300 03891	43082 S015

MATERIAL AVAILABILITY AND PART NO.				
STD	OPTIONS			
FA	V	R	HH	MXS
FA230TT	-	FA230R	-	-

FA231 A. 133.5 x 36.8 x 8.4mm B. 109.6 x 44.4 x 8.5mm
FA231/2 A. 133.5 x 36.8 x 10.7mm B. 109.6 x 44.4 x 10.7mm
FA231/3 A. 133.5 x 36.8 x 11.4mm B. 109.6 x 44.4 x 11.4mm

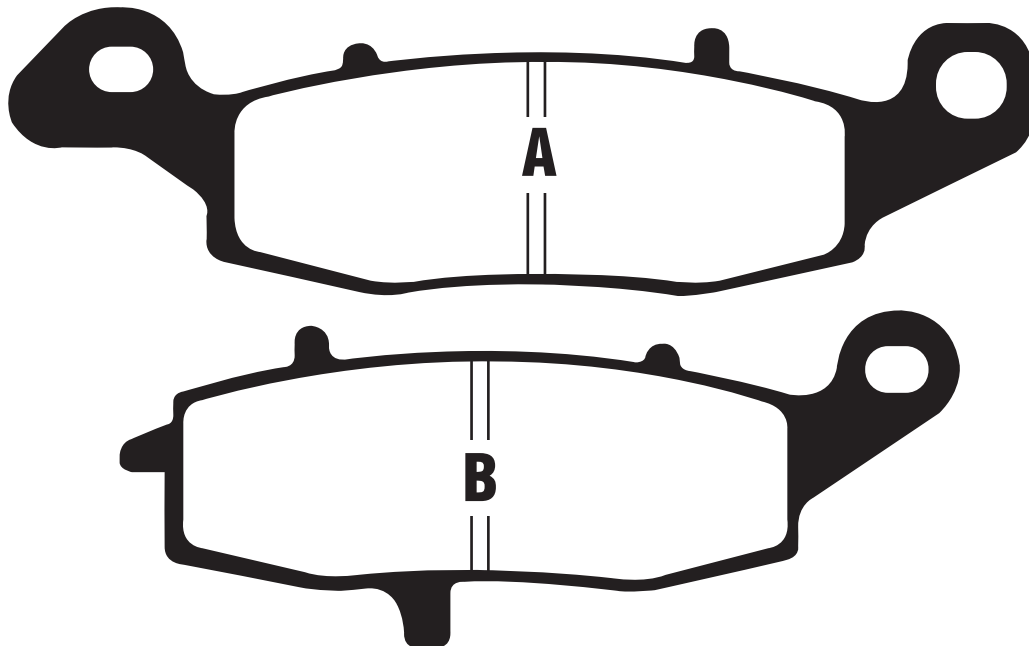

CF MOTO

650 NK 12-15 F(right)
 650 TK 13-15 F(right)
 650 TR 13-15 F(right)

KAWASAKI

BJ 250 F1/F2 (250 TR) 02-03 F
 ZR 250 B6 (Balius II) 02 F
 ZR-X 400 E3 (ZR 400 E3) 96 F(right)
 650 (KLE 650 Versys CBF/CCF) (Non ABS) 12 F(right)
 ER-6f (EX 650 A6F/A7F/A8F /C9F/CAF/CBF) 06-11 F(right)
 ER-6n (ER 650 A6F/A7F/A8F/C9F/CAF/CBF) 06-11 F(right)
 ER-6f (EX 650 B6F/B7F/B8F/D9F/DAF/DBF) ABS 06-11 F(right)
 ER-6f (FCF/FDS/FEF/FFF/FGF) (With ABS) 12-16 F(right)
 ER-6f (ECF/EDS/EEF/EFF/EGF) (Non ABS) 12-16 F(right)
 ER-6n (ER 650 B6F/B7F/B8F/D9F/DAF) 06-10 F(right)
 ER-6n (FCF/FDF/FEF/FFF/FGF) (With ABS) 12-16 F(right)
 ER-6n (ECF/EDF/EEF/EFF/EGF) (Non ABS) 12-16 F(right)
 KLE 650 A7F/A8F/A9F/CAF/CBF/CCF/CDF/CEF Versys 07-14 F(right)

KAWASAKI Contd.

KLE 650 B7F/B8F/B9F/DAF/DBF/DCF/DDF Versys ABS 07-14 F(right)
 W 650 (EJ 650-A1/C3/C4/C5/C6/C7) 99-05 F
 650 (KLE 650 DCF/DDF Versys) ABS Model 12-13 F(right)
 Z 750 (ZR 750 J1/J2) 04-05 F(right)
 Z 750 S (ZR 750 K1/K6F) 05-07 F(right)
 ZR 750 D1 'Zephyr' 96- F(right)
 ZR-7 (ZR 750 F1/F3/F5) 99-04 F(right)&R
 ZR-7S (ZR 750 H1/H2) 01-04 F(right)&R
 EJ 800 ABF/ACF (W 800/SolidF/Disc) 11-12 F
 EJ 800 (W 800 Cafe Style/Cockpit Fairing) 11 F
 EJ 800 ACFA (W 800 Special Edition Black Exhaust/Gold rims) 12 F
 EJ 800 ADF/AEF/AFF/AGF (W 800) 13-16 F
 EJ 800 ADFA/AEFA/AFFA/AGFA (W 800 Special Edition) 13-16 F
 VN 800 C1/C2/E1/E2/E3 'Drifter' 99-03 R
 W 800 ABF 11 F
 W 800 ADF/AEF/AFF/AGF (EJ 800) 13-16 F

FA231 Contd. FA231/2 Contd. FA231/3 Contd.

KAWASAKI Contd.

W 800 Special Edition ADFA/AEFA/AFFA/AGFA (EJ 800 Special Edition)	13-16	F
VN 900 A6F Classic	06	R
VN 900 Custom (Cast wheel)	07-20	R
VN 900 Classic (Spoke wheel)	07-20	R
VN 900 Classic Special Edition/ White Wall Tyres/Spoke Wheel	11-20	R
KLV 1000 (LV 1000 A1H/A2H)	04-05	F(right)
GPz 1100 E1/E2/F1	95-98	F(right)
ZR 1100 B1 'Zephyr'	96-97	F(right)
ZR 1100 B5 (Zephyr 1100 RS)	02	F(right)
VN 1500 G1/G2 Classic Tourer	98-99	F(right)
VN 1500 J1/J2/R1/R2/R3 Drifter	99-04	R
VN 1500 L1/L2/L3/L4 "Nomad FI"	00-03	F(right)&R
VN 1500 N1/N2/N3 "Classic FI"	00-04	R
VN 1500 P1/P2 Mean Streak	02-04	R
VN 1600 A1/A2/A3/A6F	03-08	F(right)&R
VN 1600 B1 Mean Streak	04	R
VN 1600 B2H/B6F/B7F (Mean Streak)	05-08	R
VN 1600 D1H/D6H Classic Tourer	05-08	F(right)&R
VN 1700 Voyager ABS	09-20	R
VN 1700 C9F Classic Tourer	09	F(right)&R
VN 1700 E9F Classic	09	F(right)&R
VN 1700 DAF/DBF/DCF/DDF/DEF Classic Tourer ABS	10-13	R
VN 1700 DFF/DGF - Vulcan 1700 Nomad	15-16	R
VN 1700 FAF/BBF/FCF/FDF/FEF Classic ABS	10-13	R
VN 1700 KBF/KCF/KDF/KEF Voyager Custom	11-13	R
VN 2000 A1/A2/A6F	04-08	R
VN 2000 H8F/H9F Classic	08-09	R
SUZUKI		
RV 125 K2/K3/K4/K5/K6/K7/K8/K9/L0/L3/L4/L5/L6/L7/L8 Van-van	02-18	F
RV 200 K2/K3	02-03	F
RV 200 L6/L7/L8/L9 Van-Van	16-19	F
GSX 250 FXK2/K3/K4/K5	02-05	F
SV 400 N (VK53A)	98	F
SV 400 SV (VK53A)	98	F
SV 400 X/Y/K1/K2	00-02	F(right)
SV 400 SX/SY/SK1/SK2	00-02	F(right)
SV 400 K3/K4/K5	03-05	F(right)
SV 400 SK3/SK4/SK5	03-05	F(right)
GS 500 ET/EV/EW/EX/EY/K1/K2/K3/FK4/FK5 /K5/FK6/K6/K7/FK7/K8/FK8	96-08	F
GSF 600 Y/SY/K1/SY1/K2/SK2/SK3/K3/K4/SK4 Bandit	00-04	F(right)
GSF 600 Y/K1/K2/K3/K4 (Naked Bandit)	00-04	F(right)
GSF 600 SY/SK1/SK2/SK3/SK4 (Faired Bandit)	00-04	F(right)
GSX 600 FW/FX/FY/FK1/FK2/FK3/FK4/FK5/FK6	98-06	F(right)
DL 650 K4/K5/K6 V-Strom	04-06	F(right)
DL 650 XK7/XK8/XK9/XL0 V-Strom X	07-11	F(right)
DL 650 AK7/AK8/AK9/AL0 V-Strom ABS	07-11	F(right)
DL 650 AL1XP V-Strom Xpedition	11	F(right)
DL 650 AK9 GT V-Strom Traveller ABS	09-11	F(right)
DL 650 V-Strom ABS	12-20	F(right)
DL 650 XT V-Strom ABS	15-20	F(right)
GSF 650 SK5/SK6 Faired Bandit Non ABS	05-06	F(right)
GSF 650 AK5/AK6 Naked Bandit - ABS	05-06	F(right)
GSF 650 SAK5/SAK6 Faired Bandit - ABS	05-06	F(right)
GSF 650 K5/K6 Naked Bandit - Non ABS	05-06	F(right)
SFV 650 K9/L0/L1/L2/L3/L4/L5 Gladius	09-15	F(right)
SFV 650 AK9/AL0/AL1/AL2/AL3/AL4/AL5 (ABS)	09-15	F(right)
SV 650 K3/K4/K5/K6/K7/K8/K9/L0 Naked - Non ABS	03-10	F(right)
SV 650 SK3/SK4/SK5/SK6/SK7/SK8/SK9/SLO Top Fairing - Non ABS	03-15	F(right)
SV 650 X/Y/K1/K2 Naked - Non ABS	99-02	F(right)
SV 650 SX/SY/SK1/SK2 Top Fairing Non ABS	99-02	F(right)
SV 650 AK7/AK8/AK9/AL0 Naked - ABS	07-10	F(right)
SV 650 SAK7/SAK8/SAK9/SALO	07-15	F(right)
SV 650 ABS	16-20	F(right)
SV 650 X ABS	18-20	F(right)
XF 650 V/W/X/Y Freewind	97-02	F
GSX 750 FW/FX/FY/FK1/FK2/FK3/FK4/FK5/FK6	98-06	F(right)
GSX 750 W/X/Y	98-03	F(right)
GSR 750 L1/L2/L3/L4/L5/L6 (Non ABS)	11-16	F(right)
GSR 750 AL2/AL/AL4/AL5/AL6 (ABS)	11-16	F(right)
C 800 (VL 800 K6/K7/K8/K9/L0/L1/L2/L3/L5) Intruder (Spoke wheel model)	06-15	F
C 800 C (VL 800 CK7/CK8/CK9/CL0/CL1 /CL2/CL3) Intruder (Cast wheel model)	07-15	F
VL 800 K1/K2/K3/K4/K5 'Intruder Volusia'	01-05	F
VZ 800 V/W/X/Y/K1/K2 Marauder	97-03	F
M 800 Z (VZ 800 K5-K9/L0/L1/L3 Intruder)	05-13	F
M 800 Z (VZ 800 K9Z Intruder)	09-10	F
VL 800 BTL4 C800 Intruder	14	F
VZ 800 L4/L5 Intruder M800/T	14-15	F
DL 1000 K2/K3/K4/K5/K6/K7/K8/K9/L0 V-strom	02-10	F(right)
M 1500 (VZ 1500 K9/L0 Intruder)	09-13	F(right)&R
VL 1500 K2/K3	02-03	F(right)
VL 1500 K5/K6/K7/K8 (C1500 Intruder)	05-08	F(right)
VL 1500 BTL3/BTL4/BTL5 (CT 1500 BT Intruder)	13-15	R
M 1600 (VZ 1600 K4 Intruder)	04	R
M 1600 (VZ 1600 K5 Intruder)	05	R
C 1800 R (VLR 1800 K8/K9/L0/L1) (C 1800 R Intruder)	08-13	R

SUZUKI Contd.

C 1800 RT (VLR 1800 K8RT/K9RT) Touring Intruder	08-10	R
M 1800 R (VZR 1800 K6/K7/K8/K9) Intruder - Handlebar Cowling	06-09	R
M 1800 R2 (VZR 1800 NK8/NK9) Intruder - No Handlebar Cowling	08-09	R
M 1800 RZ (VZR 1800 ZK7/ZK8/ZL1/ZL2 Intruder) With Handlebar Cowling	07-13	R
H P POWER		
Pantera 600	11	F
WK		
650i (Naked)	13-14	F(right)
650 TR (Touring)	13-14	F(right)
FA231/2V KAWASAKI		
VN 1600 B2H/B6F/B7F (Mean Streak)	05-08	R
VN 1600 D1H/D6H Classic Tourer	05-08	R
VN 1700 B9F/BAF/BBF/BCF/BDF/BEF/BFF/BHF Voyager ABS	09-16	R
VN 1700 C9F Classic Tourer	09	R
VN 1700 DAF/DBF/DCF/DDF/DEF Classic Tourer ABS	10-13	R
VN 1700 DFF - Vulcan 1700 Nomad	15	R
VN 1700 E9F Classic	09	R
VN 1700 FAF/BBF/FCF/FDF/FEF Classic ABS	10-13	R
VN 1700 KBF/KCF/KDF/KEF Voyager Custom	11-13	R
VN 2000 A1/A2/A6F	04-08	R
VN 2000 H8F/H9F Classic	08-09	R
SUZUKI		
VL 1500 BTL3/BTL4/BTL5 (CT 1500 BT Intruder)	13-15	R
M 1500 (VZ 1500 K9/L0 Intruder)	09-13	R
M 1600 (VZ 1600 K4 Intruder)	04	R
C 1800 R (VLR 1800 K8/K9/L0/L1) (C 1800 R Intruder)	08-13	R
C 1800 RT (VLR 1800 K8RT/K9RT) Touring Intruder	08-10	R
FA231/3V KAWASAKI		
VN 1500 P1/P2 Mean Streak	02-04	R
VN 1600 A1/A2/A3/A6F	03-08	R
VN 1600 B1 Mean Streak	04	R
SUZUKI		
M 1600 (VZ 1600 K5 Intruder)	05	R
M 1800 R (VZR 1800 K6/K7/K8/K9) Intruder - Handlebar Cowling	06-09	R
M 1800 RB (VZR 1800 BZL4/BZL5/BZL6/BZL7 - M 1800 RB Intruder)	14-17	R
M 1800 R2 (VZR 1800 NK8/NK9) Intruder - No Handlebar Cowling	08-09	R
M 1800 RZ (VZR 1800 ZK7/ZK8/ZL1/ZL2 Intruder) With Handlebar Cowling	07-13	R
VZR 1800 BZL4 /BZL5/BZL6/BZL7/BZL8- M1800 RB	14-18	R

Equivalents OE # - FA231

43082 0010	43082 1265	59102 33810
43082 1178	43082 1280	59102 33840
43082 1188	43082 1283	K4308-21203
43082 1203	43082 S018	59103 33810
43082 1226	59100 33830	A000-0801B0
43082 1232	59100 33850	43082 0123
43082 1235	59100 33870	43082 0063
43082 1243	59101 33810	43082 0124
43082 1246	59101 33820	5943082 0123
43082 1248	59101 33830	102 33870
43082 1260	59101 33850	59102 33870

Equivalents OE # - FA231/2

43082 0015	43082 0063	43082 0124
43082 039	43082 0105	69100 01880
43082 0052	43082 0116	69100 01810

Equivalents OE # - FA231/3

43082 1264	K4308-21264	69100 01870
------------	-------------	-------------

MATERIAL AVAILABILITY AND PART NO.

STD	OPTIONS			
FA	V	HH	R	MXS
FA231	FA231V	FA231HH	-	EPFA231HH

MATERIAL AVAILABILITY AND PART NO.

STD	OPTIONS			
FA	V	HH	R	MXS
-	FA231/2V	-	-	-

MATERIAL AVAILABILITY AND PART NO.

STD	OPTIONS			
FA	V	HH	R	MXS
-	FA231/3V	-	-	-

DISC PADS
BUYERS GUIDE

DO NOT REFIT ANY SHIMS/INSULATORS TO EBC PADS FROM ORIGINAL PADS UNLESS INSTRUCTED
ON NOTE ON PAD PACKAGING AND ON FA DRAWING ASSOCIATED WITH THAT PAD.

FA232 72.5 x 43.7 x 7mm

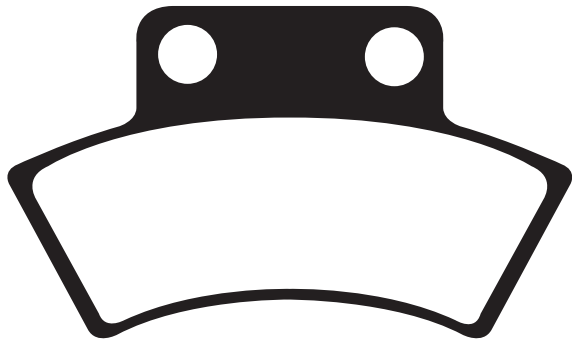

APACHE			
Mini Tomahawk 50 (2T)	08-09	R	
CF MOTO			
CF 500 C/Force (X5 Terralander)	11-15	PB	
CF 625 C/Force (X6 Terralander)	11-15	PB	
POLARIS			
Rear pad most models	89-00		
See main application list for full details.			
This pad has increased friction area. Can be fitted in place of FA178 to improve wear life on Polaris ATV's			
JORDAN			
HIPO/MARS/BOB 50/90/100	03-04	R	
QUADZILLA			
R 50 (Rear disc model)	03-06	R	
CUV 500 Side x Side (Parking brake)	10-11		
QZ 500 E/ES 4x4 (Parking brake)	09-11	R	
RS5 4WD (Parking brake)	10-11		
RS6 EFI 4WD (Parking brake)	10-11		

MATERIAL AVAILABILITY AND PART NO.				
STD	OPTIONS			
FA	V	HH	R	MXS
FA232TT	-	-	FA232R	-

Equivalents OE #		
1910032	1930741	901 08 03 22
1910051	2200899	B840F6600000
1930626	2200418	
1930644	2200464	

SFA233 75.1 x 37.2 x 9.5mm



DAELIM			
BESB1 125 (SC125)	08-13	F	
KYMCO			
Cobra 50 Cross	00-06	F	
Cobra Racer (SF10AG)	00-06	F	
CX 50 Super (PR50AC)	94-97	F	
K12 Sport 50 (SE10CA)	95-00	F	
KB 50 (SE10CA)	95-00	F	
Looping 50	98	F	
Top Boy 50 (SF10GG)	97-06	F	
ZX 50 Super Fever/Scout	99-06	F	
KB 50 Scout	97	F	
Filly 50 LX	00-02	F	
Sniper 50 (PR 50 B)	93	F	
Sniper 50 DD (PR50BB)	94-96	F	
KB 100 Manboy	97-00	F	
Top Boy 100	97	F	
SACHS			
49 ER 10"	07	F	

MATERIAL AVAILABILITY AND PART NO.					
STD	OPTIONS				
FA	V	HH	R	MXS	EPFA
SFA233	-	-	-	-	-

Equivalents OE #	
45105 KCX E050	45105 KCU 3050
45105 KCX 3050 MZ	46350 SA50 000

SFA234 58.9 x 44.6 x 9.4mm

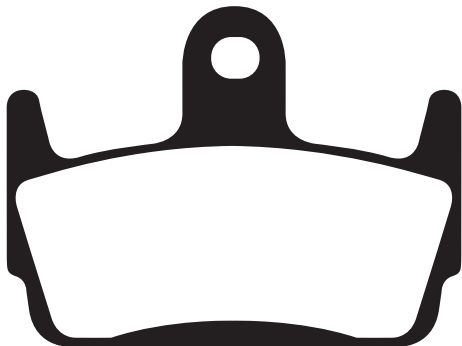

HONDA			
SZX 50 X8R-SW/SX/SY/S1 "Supersport Scooter"	98-04	R	
SZX 50 X8R-XW/XX/XY/X1 "Cross Sport"	98-04	R	
KYMCO			
Sniper 50 DD (PR50BB)	94-96	R	
Heroism 150	95-97	R	
SYM			
Jet Sport X 50 SR	06-15	R	

MATERIAL AVAILABILITY AND PART NO.					
STD	OPTIONS				
FA	V	HH	R	MXS	EPFA
SFA234	-	-	-	-	-

Equivalents OE #	
06435 GCM 900	43105 KBF 9000
06435 GCM 902	45105 TFA 000 A
43105 KBF 3050 MZ	

SFA235 59.5 x 44.5 x 9mm



DISC PADS
BUYERS GUIDE

DO NOT REFIT ANY SHIMS/INSULATORS TO EBC PADS FROM ORIGINAL PADS UNLESS INSTRUCTED
ON NOTE ON PAD PACKAGING AND ON FA DRAWING ASSOCIATED WITH THAT PAD.

Brand	Model	Year	Prefix	Year	Prefix	Year	Prefix	Year
AJS	Digit 50	13-15	F		ITALJET	SX1 50 Scooter	09	F
	Exactly 50	08-11	F		KEEWAY	F-Act 50	07-10	F
	Firefox 50	13-15	F			F-Act 50 Evo DD (2T)	09-15	F
	Exactly 125 Scooter (4T)	08-15	F			F-Act 50 Evo City (2T)	09-15	F
BAOTAIN	BT49 QT-12 Rebel (4T)	06-11	F			F-Act 50 RS	10-11	F
BEELINE	Veloce 50	08-10	F			F-Act Nkd 50	09-11	F
	Veloce GT 50	08-10	F			F-Act Racing 50 (25/45)	10-12	F
BENELLI	49X-Scooter	07	F			Flash 50 Electric	09-10	F
	Quattro Nove X (50cc)					Focus 50	06-07	F
	(All rear drum models)	08-09	F			Matrix 50	06-12	F
	Quattro Nove X					Matrix V4 50 (25/50)	10-11	F
	(50cc all rear disc models)	10-16	F&R			RY6 50 (25/45)	10-14	F
BRANSON	BS 50 Cuba	08	F			RY8 SP 50 (25/45)	10-11	F
	BS 50 Sting	08	F			RY8 Racing 50 (25/45)	10-11	F
CAGIVA	Nag 50 Scooter	08	F			Swan 50 (25/45)	10-11	F
CPI	Aragon 50	07-09	F			F-Act 100	08-10	F
	Aragon GP50	07-12	F			F-Act 125	07-11	F
	Aragon GP Paddock	08-12	F			Matrix 125	07-10	F
	Aragon Club 50	07-12	F			F-Act 150	07-10	F
	Aragon S-Line 50	07-12	F			Matrix 150	07-10	F
	Formula 50 Basic	07-08	F			RY8 50cc (All models)	07-09	F
	Formula 50 R	07-12	F			Matrix Electric	09-10	F
	Freaky 50	07	F			KM (KEEN MOTORBIKES)		
	Oliver 50 (All models)	03-12	F			Badboy 50 CX	05	F
	Hussar 50	03-05	F			Badboy 100 CX	05	F
	Popcorn 50	03-05	F			KREIDLER		
	Aragon GP 125	07-12	F			50 City (50cc/2T/A-C)	14-15	F
	Aragon S Line 125	07-12	F			50 Florett 2.1 RS (50cc/2T/A-C)	14-15	F
	Oliver 125	06-12	F			KYMCO		
CSR	ONA 125 (4T)	04-06	F&R			DJW 50 World (PR50AD)	95-97	R
	Scoo 125 (4T)	04-06	F&R			Matrix 25/50	06-08	F
GARELLI	GP 50 (2T)	09-10	F			Heroism 125 (SE25BA)	95-97	F
	Flexi 50	09-12	F			Matrix 125	06-08	F
	Tesse 50 (2T/4T)	08-10	F			Heroism 50 (SE10BA)	95-97	F
	VIP 50	07	F			Heroism 150 (SE30AD)	95-97	F
	XO 50	09	F			MASH		
	XO 50 (TM 50 QT-31) (2T/4T)	10-12	F&R			Bibop 50	14-16	F
	Flexi 125	09-12	F			Bibop Racing 50	14-16	F
GENERIC/KSR	Cracker 50 (2T/4T)	09-18	F			MOTOM		
	50 GT Race Explorer	09	F			Gypsy 50	08-09	F
	Epico 50 (2T)	10-18	F			Dolcevita 125/151	08-09	F
	Epico Electric	12-13	F			MOTO ROMA		
	Evolution 50 (2T)	10-11	F			G10 (50cc/2T)	11-12	F
	XOR 50	05-14	F			Lambros 125/4T	11-12	F
	Ideo 50	05-14	F			RIEJU		
	Race 2 50 (2T/4T)	10-14	F			Pacific 50 (4T)	08	F
	Roc 50	08-11	F			Toreo 50 (4T)	07-08	F
	Sirion 50 (2T/4T)	12-18	F			Pacific 125 (4T)	08	F
	Toxic 50 Sport	12-18	F			Pacific 125 Scooter	09	F
	Race 2 125 (4T)	10-14	F			PEUGEOT		
	Soho 125/150	06-15	F			E-Vivacity (Electric)	10	F
	Sirion 125 (4T/Rear Drum Model)	12-18	F					
	XOR 125	05-11	F					
GOES	G 50 RT (Scooter)	13-14	F					
	Slam 50 (Scooter)	10-12	F					
	Wiki 125 (Scooter)	10-12	F					
	G 125 RT Retro (Scooter)	10-14	F					
H P POWER	Tin 50 (4T/4V)	10-12	F					

MATERIAL AVAILABILITY AND PART NO.					
STD	OPTIONS				
FA	V	HH	R	MXS	EPFA
SFA235	SFAC235	-	-	-	-

Equivalents OE #	
45150 KBK 9000 MZ	R0200710080
45106 B08E00	GA023463 1T
45110 J4FT 000	404210 TAC 000

FA236 70 x 55.5 x 8.3mm

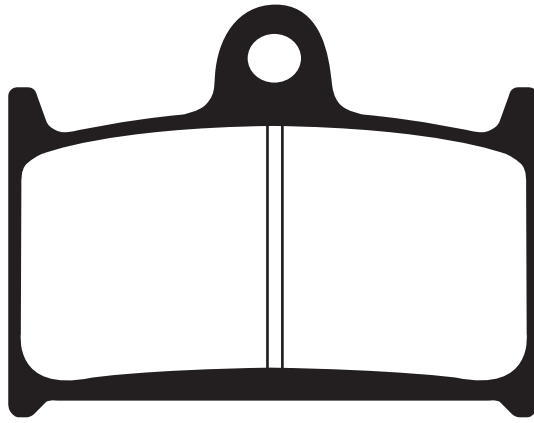

TRIUMPH

- T595 Daytona 97 F
- Daytona 600 03-04 F
- Daytona 650 05 F
- Speedfour 600 02-05 F
- TT 600 00-03 F
- Daytona 750 92 F
- Daytona 900 93-96 F
- Trophy 900 94-01 F
- Daytona 955i 98-04 F
- Daytona 955i (From VIN 132513) (5 bolt front disc single sided s/arm)
- Speed Triple 01-04 F
- Speed Triple 955cc 94-01 F
- Sprint 955i ST Front disc with offset/6 bolt fixing 02-04 F
- Sprint 1050i ST (Non ABS) Front disc with zero offset 99-04 F
- Sprint 1050 ST (5 spoke wheel/non ABS model/5 bolt disc with offset) 11-12 F
- Sprint 1050 ST (5 spoke wheel/ABS model 5 bolt fixing disc with offset) 05-10 F

TRIUMPH Contd.

- Daytona 1000 92 F
- Daytona 1200 93-98 F
- Trophy 1200 94-01 F
- Rocket III (2300cc) 04-09 F
- Rocket III Classic 07-09 F
- Rocket III Touring 08-17 F
- Rocket III Roadster - ABS 10-18 F
- Rocket X 15-16 F
- Sprint 94-98 F
- Sprint GT 1050 SE (ABS) 10-20 F
- Sprint RS 99-04 F
- Tiger Explorer 1200 12-15 F
- Tiger Explorer 1200 XC 13-15 F
- Thunderbird (1597cc) 09-18 F
- Thunderbird Commander (1699cc) 14-18 F
- Thunderbird LT (1699cc) 14-18 F
- Thunderbird Storm (1699cc) 11-18 F
- Thunderbird Nightstorm 15-18 F

MATERIAL AVAILABILITY AND PART NO.				
STD	OPTIONS			
FA	HH	V	R	MXS
FA236	FA236HH	-	-	-

Equivalents OE #		
2020073 T0301	T2020245	T2020553
T2020193	T2020246	T2020393

FA239 69.65 x 51.85 x 8.5mm

EPFA239HH 69.65 x 51.85 x 8.5mm

RACE USE ONLY

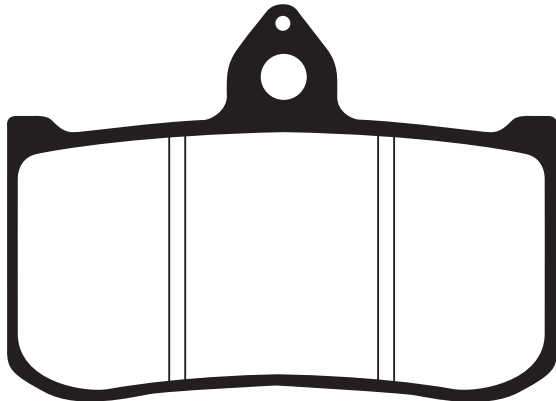

MATERIAL AVAILABILITY AND PART NO.				
STD	OPTIONS			
FA	HH	R	MXS	EPFA
FA239	-	-	-	EPFA239HH

HONDA (RACE BIKES)

- RS 125 95-03 F
- RS 250 93-02 F

Equivalents OE #
45105 NX4 770

FA243 98.9 x 49.5 x 8.5mm

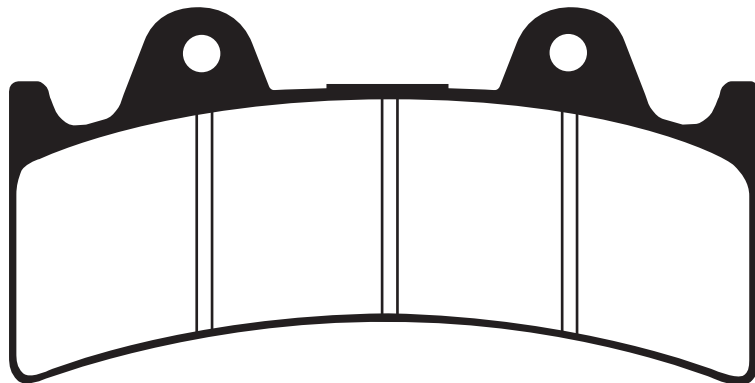

MATERIAL AVAILABILITY AND PART NO.				
STD	OPTIONS			
FA	HH	V	R	MXS
FA243	FA243HH	-	-	-

JAYBRAKE

J-Six (300-64) (6 Piston)

Equivalents OE #
N/A

FA244 75 x 55 x 8.70mm

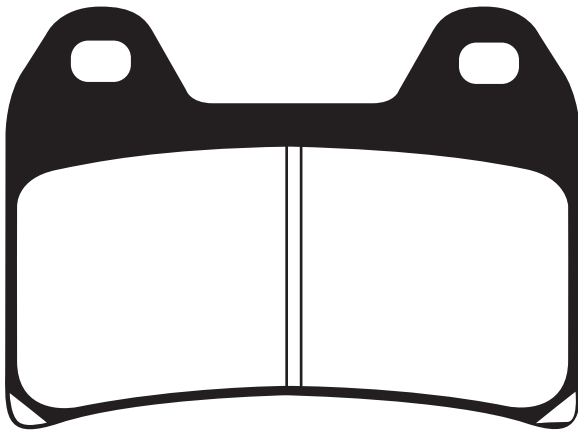

DO NOT REFIT ANY SHIMS/INSULATORS TO EBC PADS FROM ORIGINAL PADS UNLESS INSTRUCTED
ON NOTE ON PAD PACKAGING AND ON FA DRAWING ASSOCIATED WITH THAT PAD.

ALTA MOTORS (ELECTRIC)

Redshift SM	16-18	F
APRILIA		
RS 250	98-02	F
Pegaso Strada 650	05-06	F
Pegaso 650	07-08	F
Dorsoduro Factory 750	10-13	F
Dorsoduro Factory 750 (ABS)	10-12	F
Dorsoduro 750 ABS	08-12	F
ETV 1000 Caponord	01-02	F
SL 1000 Falco	00-04	F
RST Futura 1000	01-04	F
RSV 1000 R Tuono		
(Radial caliper/2 pin pad fixing)	07-08	F
RSV 1000 SP	99-00	F
RSV 1000 Mille	98-00	F
RSV 1000 Mille R	00	F
RSV 1000 R Tuono	02-06	F
Tuono R 1000 Radial caliper		
/2 pad type	02-10	F
Tuono V4R-APRC	11-13	F
Tuono V4R	11-12	F
Dorsoduro 1200	11-12	F
Dorsoduro 1200 ATC/ABS	11-14	F
BIMOTA		
Later models	98/99-	F
SB8K Gobert (996cc Suzuki engine)	06	F
BENELLI		
Uno C 150	13	F
Uno C 250 (Single)	13	F
TRE-K 502	16	F
BN 600 GT (2 pin/2 pad f/caliper)	14	F
2 UE 750	09-10	F
TNT 899 Tornado Naked Tre	07-16	F
TNT 899 S Tornado Naked Tre	07-11	F
Trek 899	07-14	F
Tornado 900	02	F
TNT 1130 Cafe Racer	05	F
TNT 1130 Titanium	05	F
Tornado Naked Tre TNT 1130	06-07	F
Tre 1130 K	06-17	F
Tre 1130 K Amazonas	07-15	F
BMW		
G 650 Xmoto	07-09	F
F 800 GT	13-18	R
F 800 R	09-14	F
F 800 R Chris Pfeiffer Edition	09-11	F
F 800 GT	13-18	R
F 800 R	09-14	F
F 800 R Chris Pfeiffer Edition	09-11	F
F 800 S (Half Fairing)	06-17	F
F 800 ST (Full Fairing)	06-12	F
F 800 ST Touring	10-17	F
R Nine T Pure (K22/1170cc)	16-18	F
R Nine T Scrambler (K21/1170cc)	16-18	F
R Nine T Café Racer (K32/1170cc)	16-18	F
R Nine T Urban GS (K33/1170cc)	17-18	F
BRAMMO		
Empulse R	12-13	F
BREMBO		
20 6800 10/20 - Goldline 4 piston P4 30/34		
@ 65mm Spacing (Two pin pad fixing)		
XA69510 P4 30/34 Motard radial		
108mm mount 2 pin fixing		
XZ78910 P4 30/34 Motard radial		
100mm mount 2 pin fixing		
220A80310 P4 30/34 2 pin pad fixing		
100mm radial mount		
220A16820 P30/34 Yamaha R1		
Radial mount	07-10	
220A01610 P4 30/34 2 pin pad fixing		
108mm radial mount		

BREMBO Contd.

220A80210 P4 30/34 2 pin pad fixing		
108mm radial mount		
220A16810 P4 30/34 2 pin pad fixing		
100mm radial mount		
CAGIVA		
Raptor 650	00-07	F
1000 Raptor/V-Raptor	00-05	F
DUCATI		
400 Monster/Dark	00-04	F
Monster Dark ie 400 (Japan)	05-06	F
Monster Dark ie 400 (Single disc)	05	F
Monster 400 (Single disc)	00-02	F
Monster 400 (Twin disc)	03-04	F
600 Monster	00-01	F
620/IE Monster	02-04	F
620 Sport	03	F
620 Monster ie	03-04	F
620 Monster Dark	03-04	F
620 Multistrada Dark		
(Single disc/twin pin pad fixing)	06	F
696 Monster	08-14	F
696 + Monster (inc ABS models)	09-12	F
Monster 696 20th Anniversary Model	13	F
748 S (Biposto/Monoposto)	00-02	F
748 SPS	98-99	F
748 Testa Bassa (Mono/Biposto)	07	F
748 Biposto	99-02	F
748 SP/Monoposto	99-02	F
748 R (2 pad caliper)	00	F
750 Supersport	99	F
750 Supersport IE	00-02	F
750 Sport	01-02	F
750 Monster	00-01	F
Monster ie 750	02	F
796 Hypermotard	10-13	F
796 Monster (Non ABS Models)	10-13	F
796 Monster (ABS Models)	10-14	F
796 Monster 20th Anniversary Model		
(Non ABS Models)	13	F
796 Monster 20th Anniversary Model		
(ABS Models)	13	F
2013Monster 800	03-04	F
800 Sport	03	F
800 Supersport	03-05	F
848 (Radial 2 pad caliper)	08-10	F
848 Streetfighter	11-15	F
900 Supersport	98-99	F
900 Supersport IE	00-01	F
900 Sport	02	F
900 IE Monster	00-01	F
900 MH Evoluzione	00-01	F
ST2 (944cc)	97-03	F
ST3 (Non ABS) (992cc)	04-07	F
ST3S (ABS Model) (992cc)	06-07	F
Monster S4R (996cc) (2 pad caliper)	05-06	F
Monster S4R (996cc)	03-06	F
Monster S4 Foggy (916cc)	02	F
Monster S4 (916cc)	01-02	F
ST4S (ABS Model) (996cc)	03-05	F
ST4S (Non ABS/996cc)	01-05	F
ST4 (916cc)	99-02	F
996 SPS (996cc)	99	F
996 (996cc) (Monoposto/Biposto)	99-01	F
996 S	01	F
998 Matrix (998cc)	04	F
998 (Monoposto/Biposto) (998cc)		
(2 pad caliper)	02-03	F
Monster 1000 Dark	03	F
Monster 1000 ie (992cc)	04-05	F
Monster 1000 S ie (992cc)	03-05	F
Monster S2R 1000 (992cc)	06-08	F

DUCATI Contd.

Multistrada1000 DS (992cc)	03-06	F
Multistrada S 1000 DS (992cc)	05-06	F
Supersport 1000 DS (992cc)	03-06	F
Hypermotard 1100	07-09	F
Multistrada 1100/1100 S (1078cc)	07-09	F
1100 Monster (Non ABS)	09-10	F
1100 Monster (ABS)	09-10	F
1100 S Monster (Non ABS)	09-10	F
1100 S Monster (ABS)	09-10	F
1100 Monster EVO	11-13	F
1100 Monster EVO		
20th Anniversary Model	13	F
1100 Monster Diesel	13	F
1200 Multistrada Standard	10-11	F
1200 Multistrada ABS	10-14	F
1200 Multistrada 1200 S Pikes Peak	11-14	F
1200 S Multistrada Sporting Edition	10-13	F
1200 S Multistrada Touring Edition	10-18	F
Multistrada 1200 S Granturismo	13-14	F
GENERIC		
Code S 125/150/200 (4T)	12-14	F
Code X 125/150/200 (4T)	12-14	F
HONDA		
CB 400 SF (F3V) Superfour (NC31)	97	F
HOREX		
VR6 Classic	13-14	F
VR6 Roadster	11-14	F
HUSQVARNA		
SM 610 (6 bolt front disc)	98-00	F
SM 610/S (4 bolt front disc)	02-06	F
SM 610 R	00	F
LT 610 (6 bolt front disc)	00	F
701 Vitpilen	18-20	F
701 Svartpilen	18-20	F
Nuda 900	12-13	F
KEEWAY		
RKV 125	10-14	F
RKX 125	13-14	F
RKV 150		
RKV 150	13-14	F
RKV 200 S	14	F
RKV 200	13-14	F
RKV 200 S Factory	14	F
KTM		
SMC 625	04-06	F
Duke II 640 (2 pin pad fixing/Disc with Zero offset)	99-02	F
Duke II 640 (2 pin pad fixing/Disc with offset)	03-07	F
LC4-E 640 (2 pin fixing)	04-06	F
SMC 640 LC4	05	F
SMC 660	05-06	F
690 Duke (2 pin pad fixing /5 Spoke cast wheels)	12	F
690 Duke (2 pin pad fixing /multi spoke cast wheel)	13-20	F
690 SM	07-09	F
690 SM-LE (Limited Edition)	10-11	F
790 Duke	18-20	F
790 Adventure R	18-20	F
1050 Adventure	15-20	F
1090 Adventure Inc R	17-20	F
1190 Adventure	13-20	F
1190 Adventure R	13-20	F
1290 Super Adventure Inc R and S	15-20	F
MAGNI		
Sport 1200 'S'	01	F
MOTO GUZZI		
750 Brevia ie (3 spoke cast wheels)	03-07	F
750 Nevada Classic ie (spoke wheels)	04-15	F

FA244 75 x 55 x 8.70mm

MOTO GUZZI Contd.

750 Nevada	02-11	F
750 V7 Classic	08-12	F
750 V7 Cafe Classic	09-12	F
750 V7 Racer	10-17	F
750 V7 Stone	12-17	F
750 V7 Special	12-14	F
750 V7 Racer 11 (ABS/Spoke Wheel)	15-17	F
750 V7 Stone 11 (ABS/Spoke Wheels)	15	F
750 V7 Special 11 (ABS/Cast Wheels)	15-17	F
750 V7 Special III (ABS/Spoke Wheel)	17-20	F
750 V7 Stone III (ABS/Cast Wheel)	17-20	F
750 V7 II Stornello	16-17	F
V85TT	18-20	F
850 Brevia ie (Non ABS Models)	06-07	F
850 Griso	06-07	F
850 Norge (Non ABS Models)	07	F
V9 Bobber	16-20	F
V9 Roamer	16-20	F
940 Bellagio	07-12	F
1100 Brevia (Non ABS Models)	05-07	F
1100 Brevia (ABS Models)	05-07	F
1100 California Aluminium	02-05	F
1100 California Titanium (with top fairing)	04-05	F
1100 California Aquila Nera	09-11	F
1100 California Classic Touring	06-08	F
1100 California EV (From KD115427 /2 pin pad fixing)	97-02	F
1100 California EV Touring	03-05	F
1100 California Jackal (From KD152329/2 pin pad fixing)	94-01	F
1100 California Special (From KD131645/2 pin pad fixing)		
1100 California Sport	99-00	F
1100 California Stone	01-02	F
1100 California Stone Metal	01-05	F
1100 California Vintage	02-03	F
1100 California 1100 190	06-12	F
1100 Griso	12	F
1100 V11 Ballabio	05-08	F
1100 V11 Le Mans	03-05	F
1100 V11 Sport	01-05	F
	99-01	F

MOTO GUZZI Contd.

1100 V11 Scura	01-03	F
1100 V11 Naked	02-03	F
1200 Brevia	08-09	F
1200 Griso 8v (Std Cast Wheel)		
Radial caliper	07-12	F
1200 Griso 8v Special Edition Spoke wheels/radial caliper		
1200 Norge	07-15	F
1200 Norge GT 8v (ABS)	06-07	F
1200 Sport 4v	08-15	F
1200 Sport 8v	06-07	F
1200 Stelvio	08-13	F
1200 Stelvio 8v (ABS)	08-11	F
1200 Stelvio NTX ABS	08-11	F
1200 Stelvio 8V NTX (ABS)	11-15	F
1400 Audace	09-10	F
1400 Audace Carbon	11-15	F
1400 California Custom	15-16	F
1400 California Touring	16-17	F
1400 California Touring SE	13-15	F
1400 Eldorado	13-20	F
MGX 21 1400	15-17	F
	15-17	F
	16-20	F

MOTO MORINI

Corsaro 1200	05-10	F
Corsaro 1200 Veloce	07-08	F
9 1/2 (1200cc)	07-08	F
Corsaro Avio	08-09	F
Scrambler 1200	08-10	F
1200 Sport		

MV (AGUSTA)

675 F3	12-20	F
675 F3 RC	15-18	F
675 Brutale	12-17	F
Brutale 800	12-18	F
800 Brutale Dragster	14-15	F
800 Dragster RC	17-20	F
800 Dragster RR	15-20	F
800 Brutale RR	19-20	F
800 Brutale RR SCS	19-20	F
800 Brutale Rosso	19-20	F
800 Dragster RR SCS	19-20	F
800 Dragster Rosso	19-20	F

MV (AGUSTA) Contd.

920 Brutale	11-12	F
989 Brutale	08-09	F
990 Brutale R	10-11	F
1090 Brutale R	12-15	F
Brutale 1090	13-15	F
NORTON		
Commando Sport (961cc)	10-15	F
SCORPA		
Raidster 660	07	F
SUZUKI		
GSX 400 X Impulse	99	F
GSX 400 FSV/FSK1 (GK7B) Inazuma	00	F
GSX 1200 FSW/FSX 'Inazuma'	98-99	F
URAL		
Tourist with Sidecar (Brembo 2 pin pad fixing)	11-12	F
Cross with Sidecar (Brembo 2 pin pad fixing)	11-12	F
Sportsman with Sidecar (Brembo 2 pin pad fixing)	11-12	F
Ranger with Sidecar (Brembo 2 pin pad fixing)	11-12	F
Retro with Sidecar (Brembo 2 pin pad fixing)	11-12	F
Solo ST (Brembo 2 pin pad fixing)	11-12	F
Wolf Solo (Brembo 2 pin pad fixing)	11-12	F
Ural T (Brembo 2 pin pad fixing)	11-12	F
VOXAN		
Black Magic	04-08	F
VB1-Evo	03-04	F
Cafe Racer	06-08	F
Roadster	06-08	F
YAMAHA		
FZ 400 (4YR1)	96	F
XJR 400 (4HM3/4HM5/4HM6/4HM9/4HMA/4HMB) Brembo calipers	95-99	F
XT 660 X Supermoto	04-16	F
XJR 1300 (5EA1/5EA7 Brembo calipers (320mm front discs))	98-99	F

Equivalents OE #				
06455 MY9 871	8113720	1D2 W0045 00	750 13 030 000	07BB1950
4HM W0045 00	8133614	211082018	883673	45120 580 000
4HM W0045 50	8000 88772	4KG W045 10	8000B1593	603 13 130 000
59100 03860	8000 95542	107 6708 21	8000B6714	07 6708 21
613 4 0201 A	000016546300	34 11 7 69 65 93	8537246	
613 4 0211 B	587 13 030 000	34 11 7 711 498	GU32654610	
613 4 0411 A	R30000126000	M13400001400	07BB19RC	
8113754	2202492	GU01654630	107670823	

MATERIAL AVAILABILITY AND PART NO.									
STD		OPTIONS							
FA	V	GPFAX	HH	SFA	SFA-HH	R	MXS	EPFA	
FA244	FA244V	GPFAX244HH	FA244HH	-	-	-	-	EPFA244HH	

FA249 91.6 x 51.5 x 10mm

FA249/2 91.6 x 51.5 x 12mm

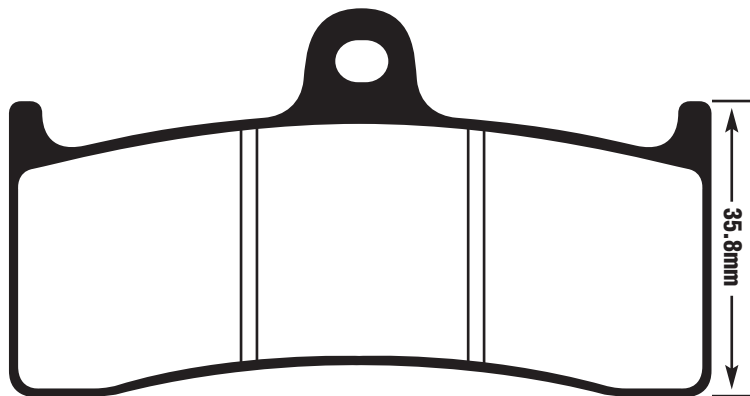

FA249 - BERINGER

6 Piston (Old Design)
PERFORMANCE MACHINE
 112 x 6B
 112 x 6QC
PRE TECH
 6 Piston (Radial Mount)
THUNDERHEART
 6 Piston Caliper

FA249/2 - BERINGER

6 Piston (Old Design/Endurance)

MATERIAL AVAILABILITY AND PART NO.				
STD		OPTIONS		
FA	HH	R	MXS	EPFA
FA249	FA249HH	-	-	EPFA249HH

MATERIAL AVAILABILITY AND PART NO.				
STD		OPTIONS		
FA	HH	R	MXS	EPFA
FA249/2	-	-	-	-

FA251 A. 55.5 x 37 x 10mm B. 85 x 43 x 8mm

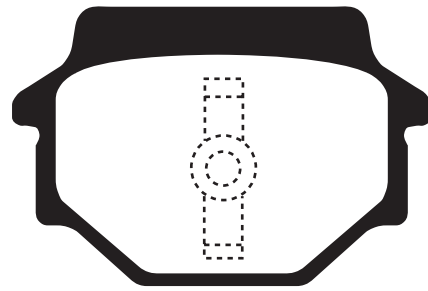
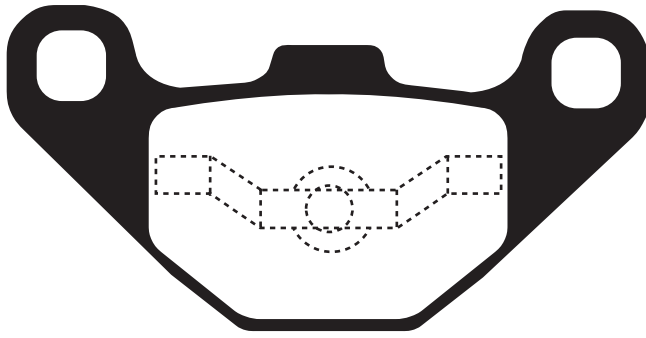

BUELL

S2 "Thunderbolt"	94-97	R
S3 "Thunderbolt"	94-97	R
M2 Cyclone	94-97	R
S1 Lightning	94-97	R

HUSABERG

Enforcer four		
400/501/600 & Quad	99	R

HUSQVARNA

CR 125	91	R
WR 125	91	R
WR 240	90-91	R
CR 250	91	R
WR 250	90-91	R
WR 260	90-91	R
TE 350	90-91	R

HUSQVARNA Contd.

TE 510	90	R
TC 510	90	R
TC 610	91	R
TE 610	91	R

MATERIAL AVAILABILITY AND PART NO.				
STD	OPTIONS			
FA	V	HH	R	MXS
FA251	-	-	-	-

Equivalents OE #	
42385	94Y
8000	60195

FA252 69 x 50.4 x 8.7mm

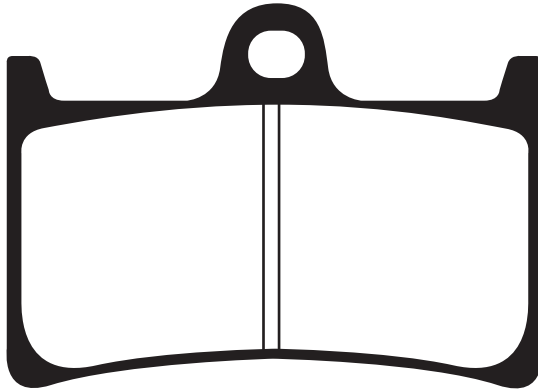

YAMAHA Contd.

MT-09 (1RC) Non ABS (847cc/3 cyl)	14-16	F
MT-09A (2DR) ABS (847cc/3 cyl)	14-16	F
MT-09 SR Street Rally ABS (847cc/3 cyl engine)	14-16	F
MT-09 A Sport Tracker (ABS/847cc/3 cyl engine)	14-16	F
MT-09 ABS (MT850-A 847cc/3 Cyl Engine)	17-20	F
MT-09 SP ABS (MT850-D 847cc/3 Cyl Engine)	18-20	F
MT-09 Tracer 900 (ABS/847cc/3 cyl engine)	15-20	F
MT-09 Tracer 900 GT ABS (847cc/3 Cyl Engine)	18	F
Niken ABS (847cc/3 Cyl Engine)	18	F
TDM 900 (5PS/Non ABS)	02-14	F
TDM 900 (2BO/ABS)	05-13	F
FZS 1000 Fazer	01-05	F
YZF 1000 R "Thunderace"	96-02	F
YZF R1	98-03	F
BT 1100 P/R/S/T/V Bulldog	02-06	F
FJR 1300 A (ABS) (5VS-)	03-05	F
FJR 1300 (Non ABS) (5JW)	01-04	F
XJR 1300 C / Racer	15-16	F
XJR 1300 L 5EA2/5EA3/5EA4	99	F
XJR 1300 M 5EAA/5EAB/5EAC	00	F
XJR 1300 5EA9/5EAG (298mm front disc)	00	F
XJR 1300 N/P 5EAP/5EAR/5EAS/5EAT/5EAW/5EAV/5EAY (298mm front disc)	01-02	F
XJR 1300 R/S 5WMA/5WM3/5WM5/5WM6/5WM7/5WM9	03-04	F
XJR 1300 T/V/W/X/Y 5WMA/5WMC/5WMD/5WMF	05-14	F
XJR 1300 SP (L) 5EA5/5EA6/5EA8	99	F
XJR 1300 SP (M) 5EAD/5EAE/5EAF	00	F
XJR 1300 SP (N) 5EAL/5EAM/5EAN	01	F
XV 1700 PCR	03-05	F
XV 1900 A Midnight Star	06-08	F

YAMAHA

TZR 125 R	93-	F
FZR 400 RR (4DX)	92	F
FZR 400 RR (3TJ1/2/6/7)		F
TZR 250 (3MA1-Reverse Cylinder) (Eng Frame # 3MA-0001)	89	F
TZR 250 (3MA3/3MA5 Reverse Cylinder) (Eng Frame # 3MA-046/058)	90	F
TZR 250 SP (3MA4) (Eng Frame # 3MA 055)	90	F
TZR 250 R (3XV1/3X4/3XV6) V-Twin (Eng Frame # 3XV000101-08600)	91-93	F
TZR 250 RS (3XV8/3XV9/3XVA) V-Twin (Eng Frame # 3XV008D101/08200 088-)	92-94	F
XP 500 T-Max (Non ABS Models)	08-11	F
XP 500 A T-MAX - LUX MAX (ABS)	16	F
TZR 250 SPR (3XVC) V-Twin (Eng Frame # 3XV107101-)	95	F
XP 500 T-Max (ABS Models)	08-11	F
XP 500 T-Max (530cc Engine/Non ABS Models)	12-16	F
XP 500 A T-Max (530cc Engine/ ABS Models)	12-16	F
XP 500 Black Bronze Max (59CE)	13-14	F
XP 530 A (530cc Engine - Iron Max - ABS Model)	15-16	F
XP 530E-A T-Max (530cc Engine - ABS Model)	17-18	F
XP 530-A T-Max SX (530cc Engine - ABS Model)	17-18	F
XP 530D-A T-Max DX (530cc Engine - ABS Model)	17-18	F
FFZS 600 Fazer	98-03	F
FZ6 Fazer S2 (ABS/Half Fairing/4 Piston Caliper) (5S2)	08	F
FZ6 Fazer S2 (Non ABS/Half Fairing/4 Piston Caliper) (4S81/4S8)	07-09	F
FZ6 S2 (Naked/Non ABS/4 Piston Caliper) (5S51/5S5)	07-09	F
YZF 600 R "Thundercat"	96-03	F
YZF 'R6'	99-04	F
YZF-R7 750 '0W02' (Road version)	99-01	F
MT-07 (689cc) Non ABS	14-16	F
MT-07A (689cc) ABS	14-18	F
MT-07A Moto Cage (ABS)	15-17	F
MT-07A Moto Cage (Non ABS)	14-16	F
Tracer 700 (MTT 690)	16-18	F
XSR 700 ABS (MTM 690-U)	16-18	F

MATERIAL AVAILABILITY AND PART NO.									
STD	OPTIONS								
FA	V	SFA	SFAC	HH	SFA-HH	R	MXS	EPFA	
FA252	-	SFA252	SFAC252	FA252HH	SFA252HH	-	-	EPFA252HH	

Equivalents OE #		
3JD W0046 00	4XV W0045 00	1WS 25805 00
3MA W0045 00	5JJ W0045 00	4B5 25805 00
3TJ W0045 00	5SL W0045 00	1WS 25805 00
4B5 W0045 00	5SL 25805 00	
4SV W0045 00	4B5 25805 00	

DISC PADS BUYERS GUIDE

DO NOT REFIT ANY SHIMS/INSULATORS TO EBC PADS FROM ORIGINAL PADS UNLESS INSTRUCTED ON NOTE ON PAD PACKAGING AND ON FA DRAWING ASSOCIATED WITH THAT PAD.

FA254 59.75 x 57 x 8.0mm

NOTE: Refit O/E shim & insulator)

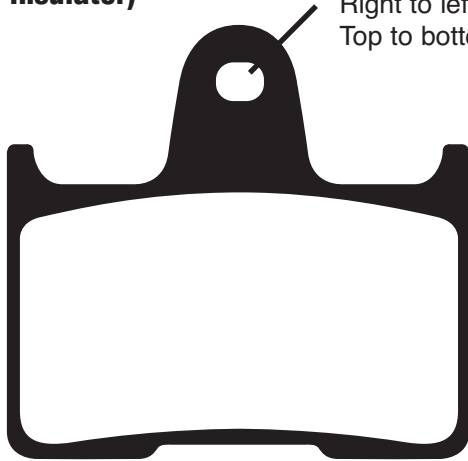

PIN HOLE
Right to left 7.3mm
Top to bottom 6.2mm

HONDA			
CB 400 SFX/SFY/SF1/SF2/SF3 Super Four		99-03	R
VT 750 C2SA/C25B Shadow			
(Rear disc model/ABS) 17" front wheel		10-12	R
'X4' CB 1300 DCV (5C38)		97-	R
CB 1300 FW/FX/FY/F1 (SC40)		98-01	R
KAWASAKI			
ZX-7RR (ZX750 N1/N2)		96-99	R
GTR 1400 (ZG 1400 GTR 1400 (ZG 1400			
A8F/A9F/CAF/CBF/CCF/CDF/CEF/EEF/EGF/EHF/EJF))		08-19	R
ZZR 1400 (ZX 1400 A6F/A7F)		06-07	R
ZZR 1400 ABS (ZX 1400 B7F)		07	R
ZZR 1400 ABS (ZX 1400			
D8F/D9F/DAF/DBF/FCF/FDF/FEF/FFF/HGF/HHF/HJF)		08-20	R
ZZR 1400 Special Edition (ZX 1400 FDFA/FEFA/FEFB/FFFA)		12-16	R
ZZR 1400 Performance Sport (ZX1400 JGF/JHF/JJF)		16-20	R
MZ/MUZ			
1000 S		03-07	R
1000 SF		05-07	R
1000 SFX		07	R
1000 ST		07	R
SUZUKI			
GSXR 600 K4/K5		04-05	R
GSF 650 SK5/SK6 Faired Bandit Non ABS		05-06	R
GSF 650 K5/K6 Naked Bandit Non ABS		05-06	R
GSXR 750 K4/K5		04-05	R
GSXR 1000 K1/K2/K3/K4/K5/K6		01-06	R
GSF 1200 SSK1/ZK1 (GV78A)		02	R
GSX 1400 K1/K2/K3/K4/K5/K6/K7/FE		01-07	R
HARLEY-DAVIDSON			
XL 883 L (Cast Wheel)		14-20	R
XL 883 N		16	R
XL 883 N Iron (Cast Wheel)		14-20	R
XL 883 R Roadster (Cast Wheel)		14	R
XL 1200 C Custom (Spoke Wheel)		14-20	R
XL 1200 CX Roadster		16-20	R
XL 1200 T Superlow		14-20	R
XL 1200 V Seven Two		14	R
XL 1200 X Forty Eight		14-17	R

MATERIAL AVAILABILITY AND PART NO.				
STD	OPTIONS			
FA	HH	V	R	MXS
FA254	FA254HH	FA254V	-	-

Equivalents OE #		
43082 1182	69100 40820	69100 29810
43082 0055	69100 40840	06435 MCE 006
06435 MAZ 006	69100 18810	9024030000

SFA255 31.8 x 49.15 x 7.0mm

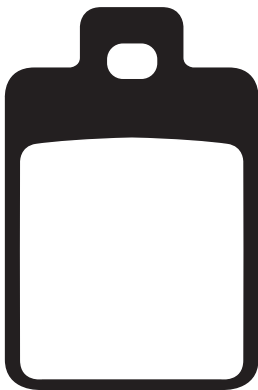

PIAGGIO			
Sfera RST 50		95-97	F
Sfera 125		95-97	F

MATERIAL AVAILABILITY AND PART NO.				
STD	OPTIONS			
FA	V	HH	R	MXS
SFA255	-	-	-	-

Equivalents OE #
498846

DISC PADS BUYERS GUIDE

DO NOT REFIT ANY SHIMS/INSULATORS TO EBC PADS FROM ORIGINAL PADS UNLESS INSTRUCTED ON NOTE ON PAD PACKAGING AND ON FA DRAWING ASSOCIATED WITH THAT PAD.

FA256 78.7 x 47 x 7.4mm

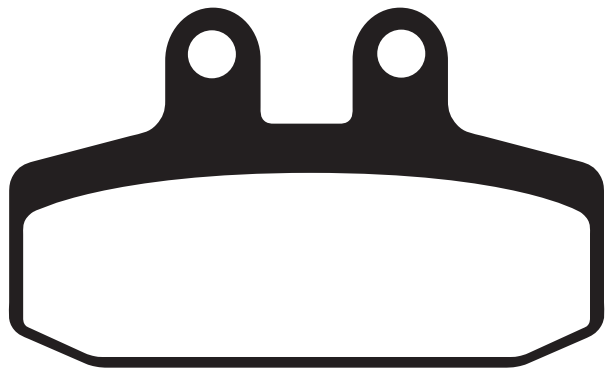

APRILIA

Pegaso 50	92-94	F
Scarabeo 125/150/200	99-02	F
Red Rose 125	87-94	F
Sport City 125	04-08	F
Sport City Cube 125	08-12	F
Tuareg Rally 125 (L/M)	90-91	F
Sport City 200	04-08	F
Sport City Cube 200	08-10	F
Leonardo 250 ST/SP	00-04	F
Sport City 250 ie	06-08	F
Sport City Cube 250	08-09	F
Leonardo 300	05-06	F
Sport City Cube 300	08-12	F
Sport City Cube 300 Blackline	11	F
Scarabeo 400 ie	07-08	F
Atlantic 500	02-04	F
Scarabeo 500/500 AB3	03-06	F
Scarabeo 500 Light	06	F
Scarabeo 500 ie	07-09	F
Scarabeo 125/200	03	F
Mana 850	08-11	R
Mana 850 GT (ABS Model)	09-14	R
Mana 850 ABS	08-13	R

CAGIVA

Blues 125	92-95	F
Roadster 125 (521 1A Model)	92-94	F
Roadster 125 (1AA Model)	95-99	F

DERBI

Boulevard S125	07	F
Rambla 125	08-12	F
Rambla 250 i	08-09	F
Rambla 300 i	10-12	F

GARELLI

50 Tiger XLE	86-	F
125 Tiger XLE	86-	F

GILERA

Cougar 125	99-02	F
125 XR1/XR2	89-	F
RC 125 Rally	87-88	F
200 Arizona Hawk	85-	F
200 RTX	85-	F
200 ER	87-	F
200 Fast Bike	87-	F
RV 200 ES	87-	F
RC 250 Rally	87-	F
350 Dakota	85-	F
ER 350	87-	F
XRT 350	90-	F
500 Dakota	87-	F
ER 500	87-	F
XRT 600	88-	F

HONDA

SJ 50 P/R/S/T/V/W/X 'Bali'	93-99	F
SJ 100 T/V/W/X 'Bali-Ex	96-99	F
CA 125 V/W/X 'Rebel'	98-00	F
CLR 125 W 'City Fly'	98-03	F
CRM 125 RL/RM/RN/RP/RR/RV/RX	90-99	F
NS 125 FG/FH/RH	86-87	F
NSR 125 FJ/FK/FL/FM/FN	88-92	F
NSR 125 RK/RL/RM/RN/RS/RV/RW/RX/RY/R1	89-01	F
NX 125 K/S/F Transcity	89-97	F
XL 125 L Paris-Dakar	85	F
XL 200 L	85	F
CMX 250 CV/CW/CX 'Rebel'	97-00	F

MALAGUTI

Spidermax RS 500	04-11	F
Spidermax GT 500	04-10	F

MOTO GUZZI

750-V7 Special	12-14	R
750-V7 Stone	12-14	R
750-V7 Racer	12-14	R
750 V7 Racer II (ABS/Spoke Wheel)	15-17	R
750 V7 Stone II (ABS/Spoke Wheels)	15-17	R
750 V7 Special II (ABS/Cast Wheels)	15	R
750 V7 Special III (ABS/Spoke Wheel)	17-20	R
750 V7 Stone III (ABS/Cast Wheel)	17-20	R
750 V7 II Stornello	16-17	R
V85TT	18-20	R
V9 Bobber	16-20	R
V9 Roamer	16-20	R

MOTO MORINI

350 'Kanguro'	87	F
---------------	----	---

SCARABEO

500 ie	10-12	F
--------	-------	---

WK

125 RR	12-13	R
--------	-------	---

Equivalents OE

159 07 6340	45105 KB9 960	45105 KS3 901	45105 KBS 405	8133724	06455 GAV 405
238 070 5 6340	45105 KR1 861	45105 KS3 902	8000 88725	8133725	8133798
326 814	45105 KR1 862	45105 KY4 901	8113865	06435 KBS W00	800059869
344839	45105 KR1 863	45105 KY4 902	8133540	8113431	800088725

MATERIAL AVAILABILITY AND PART NO.

OPTIONS								
STD	SFA	SFAC	TT	HH	SFA-HH	R	MXS	EPFA
FA	SFA256	SFAC256	FA256TT	FA256HH	SFA256HH	-	-	-
FA256	SFA256	SFAC256	FA256TT	FA256HH	SFA256HH	-	-	-

SFA257 41.1 x 43 x 7.7mm

SFA257/2 41.1 x 43 x 5.3mm



SFA257

BRANSON			SYM		
BS 125 Snooker	08	F	Super Fancy 50	96-02	F
BS 125 Boulevard	08	F	City Hopper 50	99-02	F
			Orbit 50	08-09	F
			Orbit 125	08-09	F

CAGIVA

City 50	91-94	F			
---------	-------	---	--	--	--

DAELIM

Bonita 50 (SE 50 C)	09-12	F	SFA257/2 (PARKING BRAKE)		
Cordi 50/SE 50 R	04-12	F	HONDA		
'S' Five (SJ50)	01-12	F	FJS 400 Silverwing D6/D7/D8		
E-Five (SJ50A)	03-06	F	Non ABS 256mm front disc		
GZ 50 Message	97-02	F	Parking brake	06-08	
Delfino 100 (SH100)	01-04	F	SW-T 400 (FJS 400 A9/AB)	09-16	
B-Bone 125 (SN 125)	09-14	R	SW-T 600 (FJS 600 AB)	11-16	
S1 125 (SL 125)	07-14	R	FJS 600 1/2/B3/B4/D5/D6/D7/D8		

GARELLI

Panther 125/150/250	02	F	Silverwing Parking brake	01-08	
---------------------	----	---	--------------------------	-------	--

HONDA

Tact 50		F	DN-01 (680cc) (NSA 700 A8/A9)		
SK 50 MM-II/MM-YD/MM-II/MP-II (AF28) Dio SR			Parking brake	08-11	
SK 50 MN-III/MP-III/MP-IV (AF28) Dio-ZX			CTX 700 DE-DCT Parking Brake	14-16	PB
SK 50 MMR-II/MMT-II (AF28) Dio-VR			CTX 700 N-DCT Parking Brake	14-17	PB
			NC 700 XD (ABS/DCT) Parking brake	12-14	PB
			NC 700 SD (ABS/DCT) Parking brake	12-14	PB
			NC 700 DC- 700 Integra (Parking Brake)	12-15	PB

SFA257/2 (PARKING BRAKE)

HONDA Contd.

ADV 750 H (ADV X DCT)	17-18	PB
NM 4 Vultus (NC750J)	15-17	PB
NC 750 X (NC 750 XDE/ DCT ABS)		
Parking Brake		
NC 750 S (NC 750 SDE/ DCT ABS)	14-18	PB
Parking Brake		
NC 750 S (NC 750 SDE/ DCT ABS)	14-18	PB
Parking Brake		
750 Integra Scooter -DCT (NC 750 D)		
Parking Brake		
750 Integra S Scooter NC 750 DDSE		
Parking Brake		
CRF 1000 Africa Twin ABS DCT	14	PB
	16-17	PB

DISC PADS
BUYERS GUIDE

DO NOT REFIT ANY SHIMS/INSULATORS TO EBC PADS FROM ORIGINAL PADS UNLESS INSTRUCTED
ON NOTE ON PAD PACKAGING AND ON FA DRAWING ASSOCIATED WITH THAT PAD.

SFA257 Contd.

SFA257/2 Contd.

SFA257/2 (PARKING BRAKE)

HONDA Contd.	
CRF 1000 Africa Twin ABS DCT	18-20 PB
CRF 1000 Africa Twin Adventure Sport ES ABS DCT	18-20 PB
VFR 1200 FAD	10-17 PB
VFR 1200 FAD - GT	14-15 PB
VFR 1200 XDC-DCT Crosstourer	13-18 PB
GL 1800 J Goldwing DCT	18-20 PB
GL 1800 D Goldwing Tour J DCT	18-20 PB
GL 1800 DA Goldwing Tour Airbag j DCT	18-20 PB
APRILIA	
NA 850 Mana (Non ABS)	08-11
NA 850 Mana GT (ABS)	09-14
SRV 850 Parking brake	12-14
Mana 850 ABS Parking brake	08-13
BMW	
C Evolution (Scooter) Parking brake	14-20
C 600 Sport Scooter Parking brake	12-15
C 600 Sport Highline Parking brake	13-15
C 650 GT Scooter Parking brake	12-20
C 650 GT Highline Parking brake	13-18
C 650 Sport Scooter Parking brake	16-20
GILERA	
Fuoco 500 IE (Parking brake)	07-13
Fuoco 500 LT (4V/4T) (Parking brake)	13-15
GP 800 (Parking brake)	08-14

KYMCO

Maxxer 400 (Parking brake)	09-10
MXU 400 (A40000) (Parking brake)	08-11
Maxxer 450i (4T) (Parking brake)	10-15
MXU 450 i (4x4 LOF) (Parking brake)	12-15
PIAGGIO	
MP3 125/250/400 (Parking brake)	07-08
MP3 - Hybrid (125cc) (Parking brake)	09-10
MP3 125 ie (EFI Models) Parking brake	08-11
MP3 250cc (EFI) Parking brake	06-08
MP3 250 LT (EFI) Parking brake	09
MP3 LT 300 ie Parking brake	10
MP3 300 ie (Hybrid) Parking brake	11-15
MP3 300 ie (Hybrid) LT Parking brake	11-12
MP3 Business LT 300 ie Parking brake	13
MP3 Business LT 300 ie ABS (13" Front Wheel/14" Rear Wheel) Parking Brake	14-18
MP3 Sport LT 300ie Parking brake	13
MP3 Sport LT 300 ie ABS (13" Front Wheel/14" Rear Wheel)	14-18
MP3 Touring 300 ie Parking brake	11-12
MP3 Touring LT 300 ie Parking brake	11-12
MP3 Yourban LT 300 ie Parking brake	11-16
MP3 Yourban Sport 300ie Parking brake	11-16
MP3 Yourban LT RL 300 Parking Brake	17-18
X10 ie 350 (4V/4T/EFI) Parking brake	12-15
MP3 400 ie Parking Brake	07-11

PIAGGIO Contd.

MP3 400 Touring ie Parking brake	11-12
MP3 Touring Business 500 ie Parking brake	11-12
MP3 500 LT Business	11-15
MP3 500 LT Business ABS (13 Inch Front Wheel /14 Inch Rear Wheel)	14-20
MP3 Touring Sport 500 ie Parking brake	11-12
MP3 500 LT Sport	11-15
MP3 500 LT Sport ABS (13 Inch Front Wheel /14 Inch Rear Wheel)	14-20
X10 500ie (4V/4T/EFI) Parking brake	12-15
VECTRIX	
VX-3 Li+ (3 wheeler model) Parking brake	12-13

Equivalents OE # SFA257	
45105 GZ0 ACA	45105 SE5 5001E
45112 GZ0 315	45105 GAZ 5000 EU
Y00 FA0112	45105 GAZ 9800
45105 G22 000 AC	45105 SE5R 00M4
45105 G02 000	

Equivalents OE # SFA257/2	
06436 MCT 006	668541
648476	890490
649830	

MATERIAL AVAILABILITY AND PART NO. OPTIONS				
STD	SFAC	HH	R	MXS
SFA	SFAC257	-	-	-
SFA257	SFAC257	-	-	-

MATERIAL AVAILABILITY AND PART NO. OPTIONS				
STD	SFAC	HH	R	MXS
SFA	SFAC257	-	-	-
SFA257/2	SFAC257	-	-	-

FA258 A. 119.55 x 26.10 x 7.1mm
B. 94.54 x 35.60 x 7.80mm

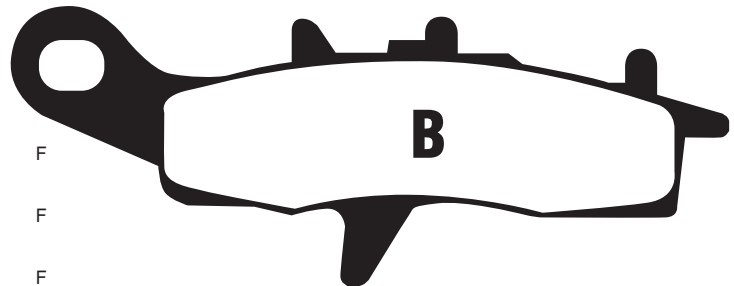
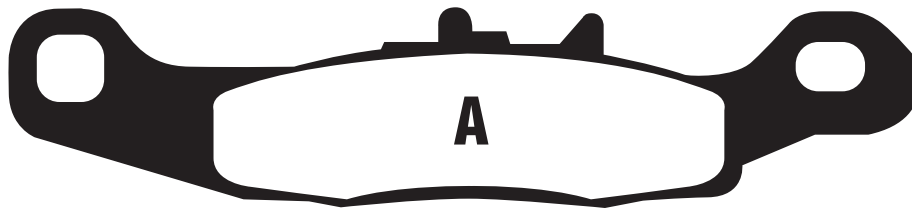

KAWASAKI

KX 80 R7/W1/W2/W3	97-00	F
KX 85 1 A1-A5/A6F/A7F/A8F/A9F/AAF/ABF/ACF /ADF/CEF/CFF/CGF/CHF/CJF (17" front wheel/14" rear wheel)	01-20	F
KX 85 11 B1-B5/B6F/B7F/B8F/B9F/BAF/BBF/BCF /BDF/BEF/DFD/DGF/DHF/DJF (19" front wheel/16" rear wheel)	01-20	F
KX 100 B7/C1/C2/C3	97-00	F
KL 250 G1/G1A Super Sherpa	97-00	F
KL 250 J1-J3 Stockman	00-02	F
KLX 250 H1 'Super Sherpa'	98	F

SUZUKI

RM 85 K5/K6/K7/K8/K9/L0/L2/L5/L6/L7 (Small Wheel F 17 Inch/R 14 Inch)	05-20	F
RM 85 LK5/LK6/LK7/LK8/LK9/LL0/LL2/LL5/LL6/LL7 (Big Wheel F 19 Inch R 16 Inch)	05-20	F
RM 100 K3	03	F

MATERIAL AVAILABILITY AND PART NO. OPTIONS				
STD	HH	R	MXS	EPFA
FA	-	-	-	-
FA258TT	-	FA258R	-	-

Equivalents OE #	
43082 1196	K4308-21196
43082 1206	59301 03820

SFA260 35.86 x 49 x 7.0mm

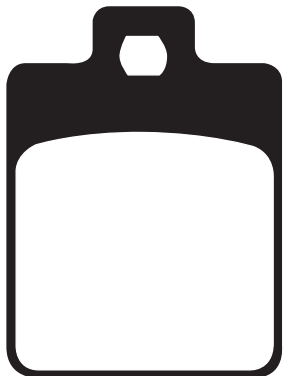

DISC PADS
BUYERS GUIDE

DO NOT REFIT ANY SHIMS/INSULATORS TO EBC PADS FROM ORIGINAL PADS UNLESS INSTRUCTED ON NOTE ON PAD PACKAGING AND ON FA DRAWING ASSOCIATED WITH THAT PAD.

ADIVA AD1 (125/150 3 Wheel Type)	14-15	F & R	PGO Tigra 125 (4V/4T)	12	R	QUADRA 4D	11	F&R
AD3 (300 3 Wheel Type)	14-15	F	PIAGGIO NRG 50 RST "MC2"	98	R	SACHS Speedjet RS 125	10	R
BENELLI X 150 Street	12	R	Zip 50 RST	96-99	F	SFM Speedjet RS 3 50	14-15	R
CPI GTR 50	11-12	R	Liberty 50 2T (Grimeca Caliper)	97-08	F	SYM Symphony S 50 (4T)		
GTS 50/125/200	02-03	R	Liberty 50 (Heng Tong Caliper) (2T)	97-08	F	Rear Disc Model	10-20	R
DERBI Sonar 50 2S (2T)	10-11	F	NRG 50 Extreme	99-01	R	Symphony SR 50	10-15	R
Sonar 125 4S (4T)	10-11	F	NRG 50 MC3 DD	01-05	R	Symphony S 125		
Sonar 150 (4T)	09-10	F	NRG 50 Pure Jet	06-09	R	(4T/Rear Disc Model)	10-20	R
GILERA DNA 50	01-06	R	NRG 50 Silver Bullet	10	R	Symphony 125 SR		
50 DD/SP Runner/Purejet	99-05	R	NRG 50 Power DD	05-18	R	Symphony S 50 (4T)		
Runner 50 PJ/SP	06-14	R	Zip 50 Grimeca caliper (A/C 4T)	00-08	F	(4T/Rear Disc Model)	10-15	R
SKP 50	99-01	R	Zip 50 SP (Liquid Cooled)	96-12	F	Symphony S 151		
Stalker 50	97-03	R	Zip 50 (2T)	00-15	F	(4T/Rear Disc Model)	10-15	R
Stalker 50	03-06	R	Zip 50 4T	00-20	F	Symphony 151 SR		
125/180 Runner All models	99-04	R	Zip 50 SP (Liquid Cooled)	96-15	F	(4T/Rear Disc Model)	10-15	R
Fuoco 500 RC/ie	07-13	F	Liberty 50 4T (Grimeca caliper)	00-08	F	VESPA		
Fuoco 500 LT (4V/4T)	13-15	F	Liberty 50 4T (Heng Tong caliper)	00-08	F	ET2 50	97-05	F
ITALJET Formula 125 (4T/Single Cyl)	14-15	R	Liberty S 50 (2T/4T)	07-08	F	ET4 50 (Grimeca caliper)	00-04	F
KEEWAY Cityblade 125	13-15	R	Zip 100	06-13	F	ET4 125	96-99	F
Cityblade 150	13-5	R	125 ie MP3 Yourban	11-12	F	ET4 125/150	99-05	F
KREIDLER 50 Galactica 3.0 RS (50cc/2T/A-C)	14-15	R	Liberty Elettrico	11-12	F	ET4 (Heng Tong Caliper)	00-04	F
PEUGEOT Speedfight 50 1/2 (L/C)	97-08	R	Liberty 125 (5 Spoke Wheel)	98-08	F	LX 50 (2T)	05-13	F
Tweet 50 RS (4T/Rear disc model)	10-13	R	Liberty 125 (4T)			LX 50 (4T/4V)	05-13	F
New Tweet Evo 50			10 Spoke Cast Wheels)	09-14	F	LXV 50	07-09	F
(4T/Rear disc model)	14-15	R	Liberty S125	07-08	F	S 50 (2T)	07-13	F
Belville 125 Allure	18-20	R	MP3-Hybrid (125cc)	09-12	F	S 50 (4T/4V)	09-13	F
Belville 125 RS	18-20	R	MP3-125ie (EFI models)	08-11	F	S 50 Sport (2T)	11-13	F
Citystar 125 (AC/Carb)	11-15	R	MP3 125 Carb models	06-08	F	S 50 Sport (4T/4V)	11-13	F
Citystar 125 i (LC)	13-19	R	Zip 125	00-01	F	LX 125/150 (4T)	05-11	F
New Tweet Evo 125			Liberty 150	08	F	LX 125 (4T/Serie Speciali)	12	F
(4T/Rear disc model)	14-20	R	Liberty 200	98-07	F	LXV 125	07-13	F
New Tweet Evo 125 (4T)	14-20	R	Liberty S 200	07-08	F	PX 125 (Disc Brake Model/2T)	01/05/11-16	F
Satelis 125 RS (4T)	13	R	MP3 250 MIC/EFi	08-09	F	S 125 (4T)	07-13	F
Tweet 125 (4T)	10-11	R	MP3 250cc (EFI)	06-08	F	S 125 Sport (4T)	11-13	F
Tweet 125 RS (4T/Rear disc model)	10-12	R	MP3 250 LT (EFI)	09	F	LX 150 (4T)	05-12	F
Tweet 125 (Rear disc)	12-13	R	MP3 300 LT (EFI)	10-11	F	LX 150 (4T/Serie Special)	12	F
Citystar 150 (AC/Carb)	11-15	R	MP3 300 ie (Hybrid)	11-15	F	S 150 Sport (4T)	11-12	F
Citystar 150i (LC)	13-15	R	MP3 300 ie (Hybrid LT)	11-13	F	S 150 (4T)	07-12	F
Citystar One 150	13-14	R	MP3 300 ie LT 300 ie	13	F	WK		
New Tweet Evo 150 (4T)	14-18	R	MP3 Sport LT 300 ie	13	F	WK GTR 50 (2T)	10-14	R
New Tweet Evo RS 150 (4T)	14-18	R	MP3 Touring 300 ie	11-12	F			
Tweet 150 (4T)	10-19	R	MP3 Touring LT 300 ie	11-12	F			
Tweet 150 RS (4T/Rear disc model)	10-19	R	300 ie MP3 Yourban Sport	11-16	F			
Belville 200 Allure	18-19	R	MP3 Yourban LT 300 ie	11-16	F			
Belville 200 RS	18-19	R	MP3 400 ie	07-11	F			
Citystar 200i	12-18	R	MP3 Touring 400 ie	11-12	F			
			MP3 Touring 400 ie LT	11-12	F			
			MP3-LT 400 ie	09-10	F			
			MP3 500 EFI	09-10	F			
			MP3 Touring Business 500 ie	11-12	F			
			MP3 500 LT Business	11-15	F			
			MP3 Touring Sport 500 ie	11-12	F			
			MP3 500 LT Sport	11-15	F			

MATERIAL AVAILABILITY AND PART NO.				
STD	OPTIONS			
SFA	SFAC	HH	R	MXS
SFA260	SFAC260	SFA260HH	-	-

Equivalents OE #		
494097	647073	43105 ARB 000A
494938	647170	PE 802219
498846	651356	PE756676
494938	665621	PE757243
647157	666574	

FA261 115.60 x 41 x 8.30mm (& shim)

Linked Brake - fit all three sets at pad change

FA261/2 115.60 x 41 x 10.40mm (Refit OE shim)



IMPORTANT NOTE:
Remove old Honda shim and insulator from original pads and fit on backplate side of new EBC pads on FA261/2HH only.

NOTE
ONLY USE V PADS WITH EBC BILLET DISCS



HONDA - FA261HH

FJS 400 D6/D7/D8	06-08	F
FJS 400 A9/D9	09	F
FJS 600 1/2/D3/D4/D5/D6/A3-A7/D7 Silverwing	01-09	F
NT 650 V2/V3/V4/V5	02-05	F&R
NT 700 V6/VA6/VA7/V7/VA8/V8/VA/VA4 Deauville	06-13	R
VFR 800 FIV/FIX/FIY/F11/2/3/4/5/A2/A3/A4/A5	98-05	F&R
VFR 800 6/8/9	06-09	R
VFR 800 A6/A8/A9	06-13	R
XL 1000 VX/VY/V1/V2 Varadero - Non ABS Model	99-02	F&R
XL 1000 V3/V4/V5/V6 Varadero Non ABS	03-06	F&R
XL 1000 V7/V8/V9/VA/VB Varadero - Non ABS	07-11	R
XL 1000 VA/VA5/VA6/VA7/VA8/VA9/VAA/VAB Varadero ABS	04-11	R
CB 1100 SFY/SF1 "XII"	00-04	F&R
CBR 1100 XXV/XXW/XXX/XXY/XX1/XX2/XX3		
.XX4/XX5/XX6 'Blackbird'	97-08	F&R
ST 1100 AT/AV/AW/AX/AY/A1/A2 Pan European (ABS)	96-02	F&R
CTX 1300 AE	14-17	R
ST 1300 2/3/4/6 Pan European (Non ABS)	02-07	F&R
S 1300 A2/A3/A4/A6 Pan European (ABS Model)	02-07	F&R
ST 1300 8/9 Pan European (Non ABS)	08-09	R
ST 1300 A8/A9/AA-AE Pan European - ABS Model	08-17	R
GL 1800 A1/A2/A3/A4/A5 "Goldwing"	01-05	F
GL 1800 6/7/8/9/A/C/D/E/F/G/H Goldwing	06-17	F
VTX 1800 C2/C3/C4/C15/C16/C17	02-08	F&R
F6B Goldwing (GLF6BA)	13-17	F

HONDA - FA261/2HH

VT 1300 CTA Interstate	15	R
GL 1800 A1-A5	02-09	R
GL 1800 6/7/8/9/A/C/D/E/F/G/H Goldwing	06-18	R
F6B Goldwing (GLF6BA)	13-17	R
F6C Goldwing (4 Piston Calipers) (GLF6ACAE)	14-17	R

Equivalents OE #FA261HH

06435 MAJ G41	06455 MAT 006	06455 MBT 611
06435 MAT 006	06455 MAT E21	06455 MCS G01
06435 MCC 006	06455 MCA 006	06455 MCS G02
06435 MCH 006	06455 MCA 016	06455 MCT 691
06435 MBL D01	06455 MCC 006	06456 MCA 006
06435 MCS G01	06455 MCH 006	06456 MCC 006
06455 MAJ G41	06455 MBG 005	06435 MCS G03

Equivalents OE #FA261/2HH

06435 MCA 006	06435 MCA 016
---------------	---------------

MATERIAL AVAILABILITY AND PART NO.

STD	OPTIONS			
FA	V	HH	R	EPFA
-	FA261HH	FA261V	-	EPFA261HH

MATERIAL AVAILABILITY AND PART NO.

STD	OPTIONS			
FA	V	HH	R	EPFA
-	FA261/2HH	FA261/2V	--	EPFA261/2HH

EPFA263 100.5 x 34 x 9mm

RACE USE ONLY

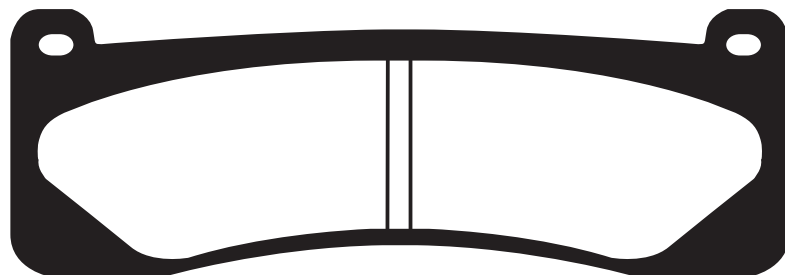

AP/LOCKHEED
6 Piston / 2 Pins (CP4466)

MATERIAL AVAILABILITY AND PART NO.

STD	OPTIONS			
FA	V	HH	R	EPFA
-	-	-	-	EPFA263HH

Equivalents OE

4466 / 4477

SFA264 A. 85.1 x 42.9 x 8.2mm B. 69.8 x 41 x 8.2mm

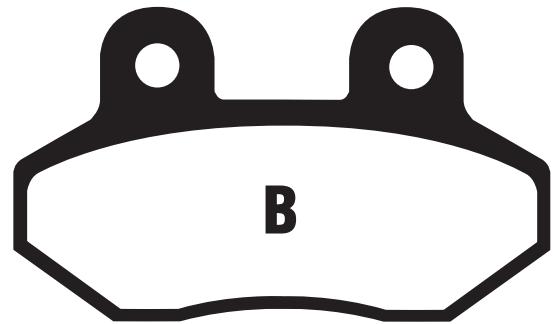
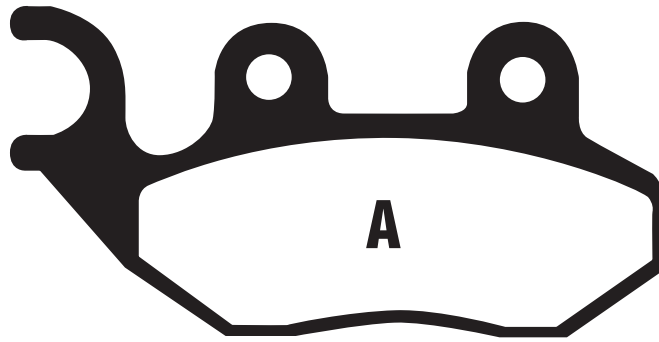

DISC PADS
BUYERS GUIDE

DO NOT REFIT ANY SHIMS/INSULATORS TO EBC PADS FROM ORIGINAL PADS UNLESS INSTRUCTED ON NOTE ON PAD PACKAGING AND ON FA DRAWING ASSOCIATED WITH THAT PAD.

ADIVA SCOOTERS

AD 125	09-11	F
AR 125	10-11	F
AD 200	09-11	F
AR 200	10-11	F

AJS

Crazy 50 Naked	13-14	F
----------------	-------	---

BAROSSA

XS 125 T-13	07-10	F
-------------	-------	---

CAGIVA

Stella 50	97	F&R
Passing 125	93-97	F

GARELLI

KRS 50		F
Joker 125/150	02	F

Freeland 125/150

Freeland 125/150		F
------------------	--	---

GENERIC/KSR

Vendetta 50 (2T)	12-13	F
------------------	-------	---

LAMBRETTA

LJ 50	12-13	F
LT 50	12-13	F

LN 125 (4T)	10-13	F
LN 151 (4T)	10-13	F

PEUGEOT

Tweet 50 (4T/Rear drum model)	10-13	F
Tweet 50 RS (4T/Rear disc model)	10-13	F

New Tweet Evo 50 (4T/Rear drum model)	14-19	F
New Tweet Evo RS 50 (4T)	14-15	F

Belville 125 Allure	18-19	F
Belville 125 RS	18-19	F

LXR 125 (4T)	10-13	F
New Tweet Evo 125 (4T/Rear disc model)	14-19	F

New Tweet Evo RS 125 (4T)	14-19	F
Tweet 125 (4T/Rear drum model)	10-12	F

Tweet 125 RS (4T/Rear disc model)	10-12	F
New Tweet 150 (4T)	14-18	F

New Tweet RS 150 (4T)	14-18	F
Tweet 150 (4T/Rear drum model)	10-12	F

Tweet 150 RS (4T/Rear disc model)	10-12	F
Belville 200 Allure	18-19	F

Belville 200 RS	18-19	F
LXR 200i (4T)	10-12	F

PGO

i-Dep Electric Scooter	09	F&R
Big Max 50 S	03-04	F

Big Max 50 (Front wave disc)	07-09	F
Big Max 50 Naked		F

(Round disc/no cover on H/bars)	07-09	F
G-Max 50	05-07	F

G-Max 50 (Wave disc)	08-09	F
G-Max 50 Naked (Wave disc)	09	F

Libra 50 (2T)	09	F
Ligero 50 (2T)	08-12	F

T-Rex 3 (50cc) (3 wheeler)	03-04	F
Bubu 100/125	03-08	F

T/Rex 50	99-12	F
Charge 125 A/B	00-02	F

i-Charge 125	03-05	F
PMX 50	00-07	F

PMX 50 Naked		F
PMX 110	00-07	F

T-Rex 110	99-06	F
Libra 125 EFI (4T)	09-12	F

Ligero 125	06-08	F
Ligero 125 (4T)	08-12	F

T-Rex 125 (Wave disc)	08-12	F
Tigra 125 (4V/4T)	12	F

Libra 150 (4T)	09	F
TR-3 150cc (3 wheeler)	03-09	F

SCOMADI

TL200 Liquid Cooled	15-19	R
---------------------	-------	---

SINNIS

Orbit II 50cc (4T)	12-14	F
Orbit II 50 Naked (4T)	12-14	F

Orbit II 50 TS (4T)	12-14	F
X-Pro 50	13-14	F

SYM

Allo 50 (4T)	11-15	F
Allo GT 50 (4T)	13-15	F

Crox 50 (4T)	15	F
Fiddle II 50	08-15	F

Fiddle III 50 (4T)	14-20	F
Mask 50	00-05	F

Jet Sport 50	14-15	F
Jet Sport 50 S	14-15	F

Jet 4 (50cc 4T)	10-15	F
Jet 4 R50 (2T)	11-15	F

Jet 4 R Naked (50/4T)	13-15	F
Jet Basix 50	06-09	F

Jet Evo 50 (2T)	13-15	F
Jet 50/Euro XS	99-05	F

Jet Euro X 50	06-14	F
Jet Sport X 50 SR	06-15	F

Red Devil 50	99-09	F
Orbit II 50 (4T)	12-15	F

Orbit II 50 Naked (4T)	12-15	F
Orbit II 50 TS	12-15	F

Symply 50	07-08	F
Symphony 50 (4T)	09	F

Symphony 50 S (4T) Rear disc model	10-20	F
Symphony SR 50	10-15	F

Symply 11 50	09-13	F
Jungle 50	99-02	F

X'Pro 50	13-15	F
Jet 100 (G100P-6)	99-00	F

Allo 125 (4T)	11-15	F
City Com 125	08-10	F

Crox 125 (4T)	15	F
Fiddle II 125	08-15	F

Fiddle III 125 (4T)	14-20	F
Attila 125	99-00	F

HD 125 S Evo	07	F
HD Evo 125 (Carb & EFI models/4T /Single Headlamp)	03-13	F

H2-125i (4T/Twin Headlamps)	10-15	F
Jet 4 (125cc 4T)	10-15	F

Megalo 125	00-06	F
Orbit II /Symply 125 (4T)	09-15	F

Super Duke 125/150	99-02	F
Symply 125	07-08	F

Symply 11 125	09-14	F
Symphony 125 S (4T)	09	F

Symphony S 125 (4T/Rear disc model)	10-20	F
Symphony 125 SR (4T/Rear disc model)	10-15	F

Allo 150 (4T)	11-15	F
Crox 150 (4T)	15	F

Jet 4 150cc	13-15	F
Fiddle 11 151	08-15	F

Symphony S 151 (4T/Rear disc model)	09-15	F
Symphony 151 SR (4T/Rear disc model)	10-15	F

Fiddle III 200i (4T)	14-15	F & R
H 200 SE	06	F

HD 200 S Evo	07	F
HD Evo 200 (Carb & EFI models/4T /Single Headlamp)	03-13	F

HD2-200i (4T) Twin Headlights	10-15	F
City Com 300i	08-14	F&R

City Com S 300i CBS	15	F&R
---------------------	----	-----

TGB

Akros Tec (50)	03-04	F
Delivery 50 Scooter		

(Up to E/F No 609099)	04-05	F
101 R (50cc)	04-08	F

202 Classic (50cc)	03-14	F
Bellavita 125i (4T)	12-14	F

Bellavita 300i (4T)	12-14	F
---------------------	-------	---

TOMOS

Twister 50		F
Twister 125		F

MATERIAL AVAILABILITY AND PART NO.

STD	OPTIONS				
SFA	SFAC	HH	V	FA	HH
SFA264	SFAC264	SFA264HH		FA264	FA264HH

Equivalents OE

45105 H13 000 AC	Y00FA1409
45105 G22 000 AC	PE801968
45105 G02 000 AS	45105 HHA 000A
45105 APA000A	45105 LEA 010A

FA265 74.75 x 55.4 x 8.1mm (with fitted shim)

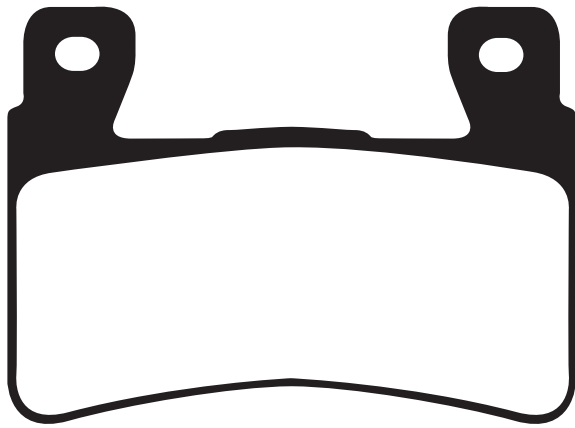

HONDA

CBR 900 RRW/RRX/RRY/RR1/RR2/RR3 'Fireblade'	98-03	F
VTR 1000 SPY/SP1 (SC45)	00-01	F
VTR 1000 SP-2/SP-3/SP-4/SP-5/SP-6	02-06	F
CB 1300 F1 (SC40)	01	F

Equivalents OE

06455 MAS E01	06455 MCS 016	06455 MFA D11
06455 MCF 006	06455 MBW E11	

MATERIAL AVAILABILITY AND PART NO.

STD	OPTIONS			
FA	HH	R	MXS	EPFA
-	FA265HH	-	-	EPFA265HH

FA266 50.90 x 54.05 x 7.50mm

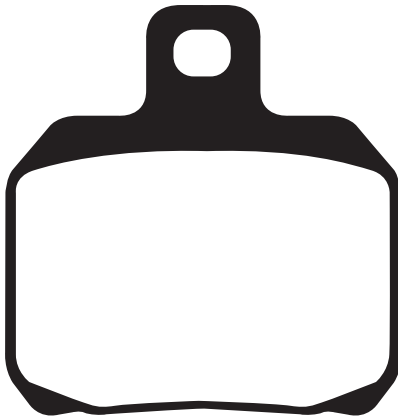

BENELLI

TRE-K 502	16	R
BN 600 GT	14-15	R
BN 600 i	14-15	R
BN 600 R	14-16	R
BN 600 S	14-15	R
2 UE 750	09-10	R
Cafe 899 Racer	10-12	R
Century Racer 899	11-12	R
TNT 899 Tornado Naked Tre	07-16	R
TNT 899 S Tornado Naked Tre	07-11	R
Trek 899	07-16	R
Tornado 900	02	R
Tornado LE/Tre Novecento/RS	03-05	R
Century 1130 Racer	11-12	R
TNT 1130 Sport/Sport Evo	04-09	R
TNT 1130 Cafe Racer	05-12	R
TNT 1130 Titanium	05-06	R
Tornado TRE1130 (Radial caliper)	06-10	R
Tornado Naked Tre R 160	09-12	R
Tornado Naked Tre TNT 1130	06-07	R
Tornado Naked Tre 1130 TNT R	13-16	R
Tre 1130 K	06-17	R
Tre 1130 K Amazonas	07-15	R

BIMOTA

Delirio	06	R
DB5 (All models)	06-07	R
DB5R	06	R
DB5 Desiderio (1078cc)	12-14	R
DB6 Delirio 992cc Ducati engine)	07	R
DB6 (1100cc)	08	R
DB6R Delirio (1100cc)	08	R
DB7 (1098cc)	08-14	R
DB8 (1198cc)	10-14	R
DB9 Brivido (1198cc)	12-14	R
DB9 Brivido S (1198cc)		
(with BCA 6 piston caliper)	12-14	R
DB11 VLX (1198cc)	12-14	R
DB12B Tourist (1198cc)	12-13	R

BOMBARDIER

Traxter (4x4)	99-01	F&R
---------------	-------	-----

BREMBO

20 6950 51 - 2 Piston P2/32		
Rear Caliper (Single pad fixing pin/with wire clip)		
20 6951 12/50/63 - P2/34 Rear caliper		
(Single pad fixing pin/with wire clip)		
120A44110 P2/34 Supersport rear caliper		

CAGIVA

Raptor/V-Raptor 650	00-07	R
1000 Raptor/V-Raptor	00-05	R

BRAMMO

Empulse R	12-13	R
Enertia	12-13	R

CF MOTO

CF 125 T-22 Glory	10-11	R
CF 150 T-6A Glory	10-11	R
CF 250 T-6A Jetmax (Scooter)	12-14	R

CPI

GTR 50	11-12	R
X-Large 125/150/200	02-03	F&R

DERBI

GP1 50 Euro 2 Chain Driven/Radial caliper		
5 bolt fixing front disc	05	F
GP1 50 Race Chain driven/radial caliper		
5 bolt fixing front disc	05-07	F
GPR 50 Nude (Radial caliper)	04-09	F
GPR 50 Racing 40mm forks/180mm rear disc/radial caliper	08-10	F
GPR 50 40mm forks/180mm rear disc /radial caliper	04-07	F
Senda DRD Pro 50 R		
Radial caliper/260mm disc	05-13	F
Senda DRD Pro 50 SM		
Radial caliper/300mm disc	05-14	F

DERBI Contd.

Senda DRD 50 Evo SM (Cast wheels)	08-11	F
Senda DRD X-Treme 50 SM (Cast Wheel/ 260mm F disc/17" front wheel)	11-14	F
GRP 80 Cup (Radial Caliper)	04-05	F
GP1 125cc Scooter		
Full height seat/5 bolt fixing front disc	06	F&R
Mulhacen 125 Cafe		
Cast wheel/radial caliper	08-10	F
Senda DRD 125 R	10-12	F
Senda DRD 125 SM	10-14	F
GP1 250cc Scooter	06-07	F&R
Mulhacen 659	06-08	R

DUCATI

696 Monster	08-14	R
696 + Monster (inc ABS Models)	09-12	R
Monster 696 20th Anniversary Model	13	R
749 Dark (Monoposto/Biposto)	04-06	R
749 R (Radial caliper)	04-06	R
749 S (Monoposto/Biposto)	03-06	R
749 (Monoposto/Biposto)	03-06	R
750 Supersport	99	R
750 Supersport IE	00-02	R
750 Sport	01-02	R
796 Hypermotard	10-13	R
796 Monster (Non ABS models)	10-13	R
796 Monster (ABS models)	10-14	R
796 Monster 20th Anniversary Model (ABS & Non ABS)	13	R
800 Supersport	03-04	R
821 Hypermotard	13-16	R
821 Hypermotard SP	13-16	R
821 Hyperstrada	13-16	R
821 Monster	15-18	R
821 Monster Dark/Monster Stripe	15-18	R
848	08-10	R
848 Evo (Monobloc front calipers)	10-13	R
848 Streetfighter	11-15	R
848 Evo Corse SE	12-13	R
848 Evo Dark	12	R
899 Panigale	14-15	R
900 Supersport	98-99	R
900 Supersport IE	00-01	R
900 Sport	00	R
900 MH Evoluzione	00-01	R
Supersport (936cc)	17-18	R
Supersport S (936cc)	17-18	R
939 Hypermotard	16-18	R
939 Hypermotard SP	16-18	R
939 Hyperstrada	16-17	R
ST2 (944cc)	97-03	R
959 Panigale (ABS)	16-18	R
959 Panigale Corse (ABS)	18	R
ST3 S (ABS Model) (992cc)	06-07	R
ST4S (ABS Model/996cc)	03-05	R
ST4S (Non ABS/996cc)	01-05	R
ST4 (916cc)	99-02	R
Desmosedici RR (D16RR/989cc)	08	R
999 S (Std caliper mount monoposto/biposto)	03-04	R
999 (Std mount caliper)	03-06	R
999 R (Radial mount caliper)	03-06	R
999 R Fila (Radial mount caliper)	03-06	R
999 S (Radial caliper Monoposto/biposto)	05-06	R
999 R Xerox	06	R
Multistrada 1000 DS (992cc)	02-06	R
Multistrada S 1000 DS (992cc)	05-06	R
Supersport 1000 DS (992cc)	03-06	R
1098	07-08	R
1098 S	07-08	R
1098 S Tricolore	07	R
1098 R	08-09	R
Hypermotard 1100/1100 S	07-09	R
Multistrada 1100/1100 S (1078cc)	07-09	R

ADIVA SCOOTERS

AD2 (300 3 Wheel Type)	14-15	F
AD 400	09-11	F&R

APRILIA

RS 50 (Radial Caliper - 6 bolt fixing front & rear)	06-11	F
ETV 1000 Caponord (Non ABS - Bolt fixing)	01-03	R
ETV 1000 Caponord Rally (Non ABS - Bush fixing)	03	R
ETV 1000 Caponord (ABS - Bush fixing)	04-07	R
RSV 1000 Mille	01-02	R
RSV 1000 R Mille	01-02	R
RSV 1000 Mille (Radial caliper)	03	R
RSV 1000 R Mille (Radial caliper)	03	R
RSV 1000 R Racing/Factory (Radial caliper/4 pad)	04-08	R
RSV 1000 R Tuono (Radial caliper/2 pin pad fixing)	07-08	R
RSV 1000 SP	99-00	R
RSV 1000 Mille	98-00	R
RSV 1000 Mille R	00	R
RSV 100 R Factory	04-08	R
RSV 1000 R	04-08	R
RSV 1000 R Tuono	02-06	R
SL 1000 Falco	00-04	R
Tuono R Factory 1000 Radial caliper/4 pad type	06-10	R
Tuono R 1000 Radial caliper/2 pad type	02-10	R
Tuono R 1000 Radial caliper/4 pad type	02-05	R
Tuono 4VR-APRC	11-13	R
Tuono V4R APRC ABS	14	R
Tuono V4R	11-12	R
Tuono Factory 1100 V4	15-16	R
Tuono Factory 1100 V4	17-18	R
Tuono 1100 RR V4	15-16	R
Tuono 1100 RR V4	17-18	R
Tuono 1100 RR V4 Factory	19-20	R
RSV4 R	10	R
RSV4 R APRC	11-13	R
RSV4 R APRC ABS	13-14	R
RSV4 Factory	09-10	R
RSV4 Factory APRC	11-13	R
RSV4 Factory APRC ABS	13-14	R
RSV4 RF 1000	15-18	R
RSV4 RR 1000	15-18	R
RSV4 1100 Factory	19-20	R
RSV4 1100 RR	19-20	R

AUSA QUADS

M 50 Task Side x Side	F&R	
-----------------------	-----	--

FA266 Contd.

DUCATI Contd.

1100 Monster (ABS & Non ABS) 09-10 R
 1100 S Monster (ABS & Non ABS) 09-10 R
 Monster Diesel 1100 13 R
 Streetfighter 1100 (1099cc) 09-11 R
 Streetfighter 1100 S (1099cc) 09-13 R
 1100 Evo Hypermotard 10-12 R
 1100 Monster (Non ABS) 09-10 R
 1100 Monster (ABS) 09-10 R
 1100 S Monster (Non ABS) 09-10 R
 1100 S Monster (ABS) 09-10 R
 1100 Monster EVO 11-13 R
 1100 Monster EVO 11-13 R
 20th Anniversary Model 13 R
 Panigale V4 (1103cc) 18 R
 Panigale V4 S (1103cc) 18 R
 1100 Monster Diesel 13 R
 1198 09-11 R
 1198 S 09-10 R
 1198 R Corse 10 R
 1198 S Corse 10 R
 1198 SP 11 R
 1199 Panigale 12-13 R
 1199 Panigale ABS 12-15 R
 1199 Panigale S ABS 12-15 R
 1199 Panigale S Tricolore 12-13 R
 1199 Panigale R 13-16 R
 1199 Superleggera 14 R
 1200 Monster 14-20 R
 1200 S Monster 14-20 R
 1200 Monster 14-18 R
 1200 S Monster 14-18 R
 1200 S Monster Stripe 15 R
 1200 R Monster 16-18 R
 1200 Multistrada Standard 10-11 R
 1200 Multistrada ABS 10-14 R
 1200 Multistrada DVT 15 R
 1200 Multistrada 1200 S Pikes Peak 11-14 R
 1200 S Multistrada Sport Edition 10-12 R
 1200 S Multistrada Touring Edition 10-14 R
 1200 S Multistrada DVT 15 R
 1200 S Multistrada D Air DVT 15 R
 1200 S Multistrada Granturismo 13-14 R
 1299 Panigale 15-18 R
 1299 Panigale R 15-17 R
 1299 Panigale R Final Edition 18 R
 1299 Panigale S 15-18 R
 1299 Superleggera 17 R
ENERGICA ELECTRIC
 Electric EVA 20 R
 Electric EGO 20 R
 Electric EVA Esse Esse 9 20 R
GENERIC
 GRS 600 13-14 R
GILERA
 Nexus 500 03-11 R
GOGORO (E SCOOTER)
 Smart Scooter 15-17 F
HARLEY DAVIDSON
 LiveWire 18-20 R
HONDA
 RC 213 V-S 15-17 R
HOREX
 VR6 Classic 13-14 R
 VR6 Roadster 11-14 R
INDIAN
 FTR 1200 18-20 R
 FTR 1200 S 19-20 R
 FTR 1200 S Race Replica 19-20 R
 FTR Rally 20 R
KAWASAKI
 H2 Ninja (ZX 1000 NFF/NGF) 15-16 R
 H2 R Ninja (ZX 1000 PFF/PGF) 15-16 R
 Ninja H2 (ZX 1000 XHF/XJF) 17-20 R
 Ninja H2 Carbon (ZX 1000 XHFA/XJFA) 17-20 R
 Ninja H2R (ZX 1000 YHF/YJF) 17-20 R
 Z H2 20 R
KEEWAY
 Silverblade 125/150/250 07 R
KTM
 RC8 (1190cc) 08-11 R
 RC8 R (1190cc)/Track 09-15 R
 1290 Super Duke R 14-20 R
 1290 Super Duke R SE 16-18 R
 1290 Super Duke GT 16-20 R

LAVERDA

SFC 1000 03-04 R
MALAGUTI
 NKD 50 Drakon 05-09 F
 Drakon S 06 F
MBK
 VP 125 Cityliner 08-10 R
 XQ 125/150 Thunder 01-03 R
 YP 125 D Skyliner 00-10 R
 YP 125 Skycruiser 06-10 R
MONDIAL
 Piegia 1000 03-04 R
 EVO 04 R
MOTO GUZZI
 750 Brevia ie (3 spoke cast wheels) 03-07 R
 750 Nevada 02-11 R
 750 Nevada Classic ie (spoke wheels) 04-15 R
 750 Nevada Club (From LK112434-) 00-01 R
 750 V7 Classic 08-12 R
 750 V7 Cafe Classic 09-12 R
 750 V7 Racer 10-11 R
 1000 MGS-01 Corsa 04-07 R
 1100 California EV 98-00 R
 V 1100 Brevia 04 R
 Fionda 1100 05 R
MOTO MORINI
 Corsaro 1200 05-10 R
 Corsaro 1200 Veloce 07-08 R
 9 1/2 (1200cc) 06-10 R
 Corsaro Avio 08 R
 Rebello 1200 Giubileo 12-13 R
 Scrambler 1200 08-09 R
 1200 Sport 08-10 R
MV
 675 F3 Serie Oro 12-13 R
 675 F3 12-20 R
 675 F3 RC 15-18 R
 675 Brutale 12-17 R
 Brutale 800 12-18 R
 800 Brutale Dragster 14-15 R
 800 Dragster RC 17-20 R
 800 Dragster RR 15-20 R
 800 Brutale RR 19-20 R
 800 Brutale RR SCS 19-20 R
 800 Brutale Rosso 19-20 R
 800 Dragster RR SCS 19-20 R
 800 Dragster Rosso 19-20 R
 Rivale 800 14-18 R
 800 F3 13-18 R
 800 F3 Ago 14-15 R
 800 F3 RC 15-20 R
 800 Stradale 15 R
 800 Turismo Veloce 14-20 R
 800 Turismo Veloce RC 17-20 R
 800 Turismo Veloce Lusso 15-20 R
NORTON
 961 Commando Sport 10-20 R
 961 Commando Cafe Racer 10-20 R
 961 Commando Dominator SS 15-20 R
 961 Commando SE 10-11 R
 961 Commander SF 10-15 R
PETRONAS
 FP1 05 R
PEUGEOT
 Speedfight 3 50cc (L/C 2T) 09-15 R
 Speedfight 3-RS (50cc-L/C 2T) 09-12 R
 Speedfight 3 RS (50cc AC) 10-12 R
 Speedfight 3 Darkside (50cc/LC/2T) 13-15 R
 Speedfight 3 Furious (50cc/LC/2T) 13 R
 Speedfight 3 Iceblade (50cc/LC/2T) 13 R
 Speedfight 4 Classic 13 R
 (50cc/LC/2T & 4T) 15-20 R
 Speedfight 4 Darkside 15-18 R
 (50cc/LC/2T & 4T) 15-18 R
 Speedfight 4 Iceblade 15-18 R
 (50cc/LC/2T & 4T) 15-18 R
 Speedfight 4 Pure (50cc/LC/2T & 4T) 15-18 R
 Speedfight 4 R-Cup (50cc/LC/2T) 18-20 R
 125 Django Heritage (4T) 14-19 R
 Speedfight 3 125 (4T) 14-15 F
 Speedfight 3 125 Darkside (4T) 14-15 F
 Speedfight 3 125 Iceblade (4T) 14-15 F
 Speedfight 3 125 Team (4T) 14-15 F
 150 Django Heritage (4T) 14-19 R

PIAGGIO

X8 125 (Brembo Rear Caliper) 04-05 R
 X9 125 00-02 F&R
 X9 125 Evolution 05-07 R
 (Brembo single pin fixing) 03-04 F&R
 X9 125 Evolution 05-07 R
 X9 180 Amalfi 00-03 F&R
 X8 200 (Brembo Rear Caliper) 04-05 R
 X9 200 02-03 F&R
 X9 200 Evolution 03-04 F&R
 X9 250/250 SL 00-04 F&R
 X9 250 Linked brake f&r wheel 14" dia 04 R
 Beverley Tourer 400 ie 08-09 F&R
 Beverley B500 02-04 F&R
 Beverley 500 06 F
 Beverley Cruiser 500 ie 07-11 F&R
 Beverley 500 ie 12 F&R
 X9 500/500 SL 00-02 F&R
 X9 500cc Evolution (inc ABS) 03-06 R
 X9 500 ie 07 R
RIEJU
 Tango 50 (2T) 07-12 F
 MRT-Pro 50 04-07 R
 (Radial/double piston caliper) 09-20 F
 MRT Pro Supermotard 09-15 F
 (Radial caliper/cast wheel) 09-20 F
 Marathon Pro Supermotard 125 (Cast wheel/radial caliper) 09-20 F
 Marathon Pro 125 (Radial/double piston caliper) 09-15 F
 RS3 NKD 50 12-20 F
 City Line 125 ie 13-15 R
 SMX 125 07-08 F
 Tango 125 06-20 F
 Tango 125 Motard (Cast wheel) 08-10 F
 Tango Pro 125 07-10 F
 RS3 NKD 125 11-20 F
 Marathon 200 Pro SM 11-15 F
 Tango 250 08-11 F
 City Line 300 ie 14-15 R
SINNIS
 Ecocity 125 (125T-8G) 07-09 R
SUZUKI
 UH 125 K2/K3/K4/K5/K6 Burgman 02-06 R
TOMOS
 SM 125 F 05-08 F
VECTRIX
 VX-3 Li+ (3 wheeler model) 12-13 F
VOXON
 Cafe Racer 06 R
 Roadster 06 R
W.K. BIKES
 WK GTR 50 (2T) 10-14 F
 WK 125 SC (4T) (14" wheels) 10-14 R
 WK Jetmax 250 (4T) 10-14 R
YAMAHA
 XQ 125/150 Maxster 01-03 R
 VP 125 X-City (16P) 08-15 R
 YP 125 Majesty 01-09 R
 YP 125 R X-Max 06-10 R
 YP 125 R (X-Max - Non ABS) 10-11 R
 (39D1/5) Nissin F/Caliper 10-15 R
 YP 125 R X-MAX 05 R
 (2DM/Brembo R/Caliper) 14-16 R
 YP 125 R X-Max Sport 11-12 R
 YP 180 Majesty 06 R
VOXAN
 Cyclope 1000 02 R
 Cafe Racer 1000 02-08 R
 Roadster 1000 02-08 R
 Black Magic 04-08 R
 Street Scrambler 03-05 R
 Street Scrambler VB1-Evo 07-08 R
 03-04 R
 GTV 1200 08 R
SFA266
KEEWAY
 125 Cityblade 13-14 F
 150 Cityblade 13-14 F

DISC PADS
BUYERS GUIDE

DO NOT REFIT ANY SHIMS/INSULATORS TO EBC PADS FROM ORIGINAL PADS UNLESS INSTRUCTED
ON NOTE ON PAD PACKAGING AND ON FA DRAWING ASSOCIATED WITH THAT PAD.

Equivalents OE #				
613 4 021 1A	69130 49F00	862698	497394	M1300001500
8113751	R180100127000	861760	690 13 090 000	07BB2010
8113898	497394	647077	690 13 190 000	07BB2050
494966	09130 07E00	5NR F5811 10	606 08 02 70	B22 45230 0000
613 403 81A	R44422001A	00H04704141	PE776171	55120P 300000
5NR F5811 00	8133542	613 4 038 1A	GU31654681	61340951A
8000 95280	107 694 936	00009308000	8000B5975	43082 0158
497083	862489	M13400004400	861760	61313090000

MATERIAL AVAILABILITY AND PART NO.								
STD			OPTIONS					
FA	SFA	V	TT	HH	SFA-HH	R	MXS	EPFA
FA266	FA266V	SFA266	SFAC266	FA266HH	SFA266HH	FA266R	-	-

FA267 51.85 x 59.75 x 8.90mm

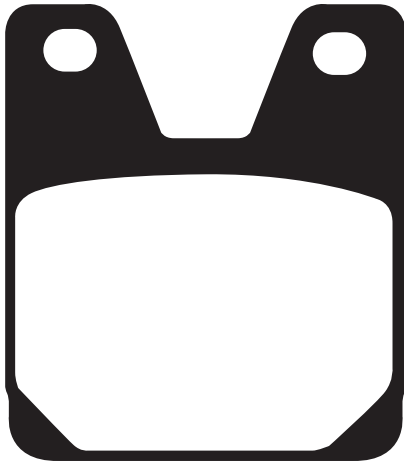

YAMAHA

YZF 1000 R1	98-00	R
YZF R7 750 'OWO2' Road version	99-00	R
XJR 1300 (5EA9/5EAG) (298mm front disc)	00	R

MATERIAL AVAILABILITY AND PART NO.					
STD	OPTIONS				
FA	V	HH	R	MXS	EPFA
FA267	-	FA267HH	-	-	-

Equivalents OE #	
4XV W0046 00	5EA W0046 50
4XV W0046 10	5FL W0046 50

SFA268 45.80 x 52.80 x 6.50mm



YAMAHA

Aerox 4 (NS 50 F)	14-18	R
NS 50 Aerox (2T)	13-16	R
NS 50 N Aerox Naked (2T)	13-16	R
YQ 50 Aerox R/Aerox	97-16	R
EW 50 Slider	00-05	F

MBK

EW 50 Stunt	00-06	F
EW 50 Stunt Naked	05-10	F
YQ 50 Nitro	97-10	R
YQ 50 Nitro Naked	06-10	R

MATERIAL AVAILABILITY AND PART NO.					
STD	OPTIONS				
FA	SFAC	HH	R	MXS	EPFA
SFA268	SFAC268	SFA268HH	-	-	-

Equivalents OE #	
5BR F5811 00	
5BR F5811 10	
1PH F5806 00	

FA270 73.85 x 52.8 x 6.82mm

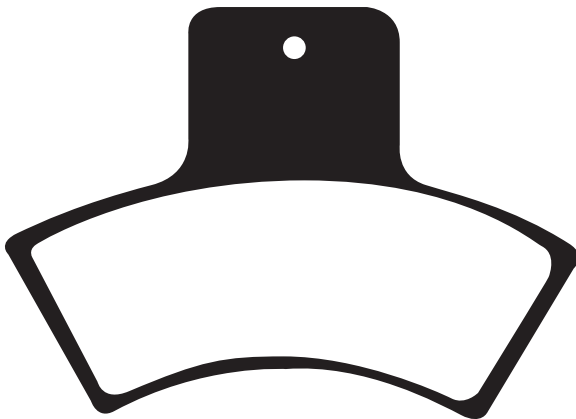

POLARIS

Most models 98 onwards. Check application pages for fitment details.

QUADZILLA

CVT 150 E (Parking brake)	10-11	
Quadzilla 300 "Utility"	04-06	R
300 E SUV	06	R
300 E (4x4) (Auto)	06-07	R
CUV 300 E 4x4 Side by Side	08-09	R
QZ 300 E 4x4		R
320 e4x4	07-08	R
CVT 320 e	07-11	R
QZ 320 E 4x4	09	R
400 4x4	06-07	R

LINHAI

Muddy 300 4 x 4 (ATV) (Parking Brake)	07-09	
---------------------------------------	-------	--

MATERIAL AVAILABILITY AND PART NO.					
STD	OPTIONS				
FA	V	HH	R	MXS	EPFA
FA270TT	-	-	FA270R	-	-

Equivalents OE #		
1910339	2201189	2202412
1930860	2201399	
2201093	2202411	

FA271 67.6 x 43.95 x 7.7mm

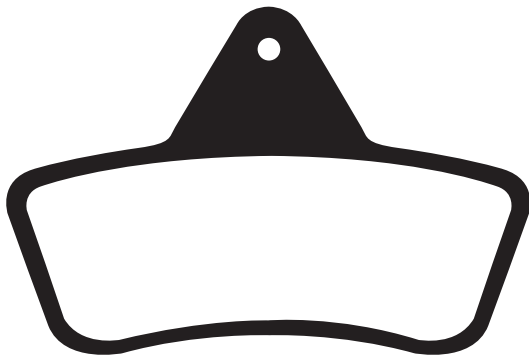

ARCTIC CAT
Most models 96-04 F&R
Check application fitment details

LAVERDA
Quasar 4x4 500c 04 F&R
Quasar 4x4 500 04 F&R
Quasar 4x4 400 04 F&R

MASSEY FERGUSON (ATV)
MF 250 (2WD/4WD) 04 F&R
MF 300 (2WD/4WD) 04 F&R
MF 400 4WD 04 F&R
MF 400 Auto 4WD 04 F&R
MF 500 (Auto 4WD) TBX Auto 04 F&R

WILWOOD
PS1 Caliper (Part # 150-4091K)

MATERIAL AVAILABILITY AND PART NO.					
STD	OPTIONS				
FA	V	HH	R	MXS	EPFA
FA271TT	-	-	FA271R	-	-

Equivalents OE #	
0502 019	0402 494
0402 096	0402 882

FA272 39.6 x 44.4 x 7mm

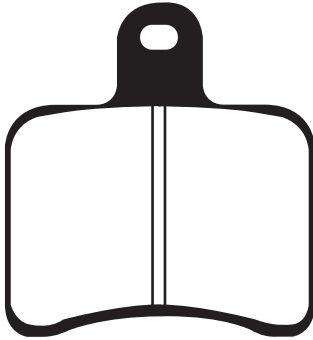

AP/LOCKHEED
2 Piston / 1 Pin (CP4226-2S0)
2 Piston / 1 Pin (CP4227-2S0)
2 Piston / 1 Pin (CP7003-2S0) Radial mount

MATERIAL AVAILABILITY AND PART NO.					
STD	OPTIONS				
FA	V	HH	R	MXS	EPFA
FA272	-	-	-	-	-

Equivalents OE #
CP4226-4

FA273 60.7 x 50.3 x 12.3mm

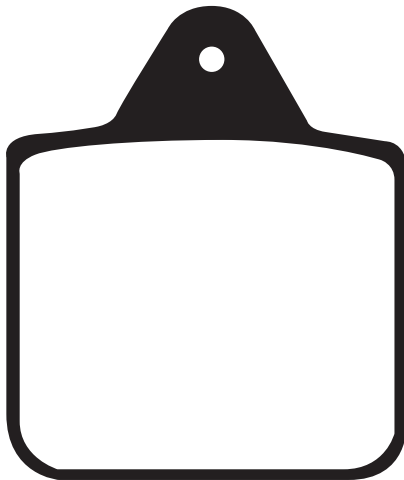

POLARIS
Big Boss 400 L 6x6 96
400 Big Boss L 6x6 96 Middle Axle Brake
Big Boss 425 6x6 96 Middle Axle Brake
425 Magnum 6x6 96 Middle Axle Brake
Ranger 99 R

MATERIAL AVAILABILITY AND PART NO.					
STD	OPTIONS				
FA	V	HH	R	MXS	EPFA
-	-	-	FA273R	-	-

Equivalents OE #
2200807

DO NOT REFIT ANY SHIMS/INSULATORS TO EBC PADS FROM ORIGINAL PADS UNLESS INSTRUCTED ON NOTE ON PAD PACKAGING AND ON FA DRAWING ASSOCIATED WITH THAT PAD.

FA275 99.77 x 30.2 x 9mm

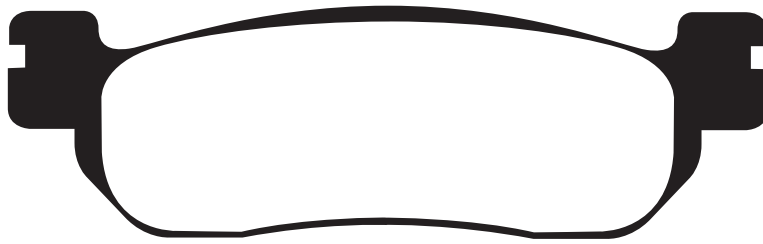

YAMAHA

RZ 50 (5FC1/2)	02	F
T 105 E (5ER1/2) Crypton-R	99	F
T 105 SE Crypton (5EA3)	02	F
V 110 ZE/ZK/ZHE/ZHK FIZR/FIZR Sport	96	F
AT 115 Neo (Brasil) (2B81/2/3)	05-07	F
AT 115 (Neo CVT/Brasil) (15S1)	08	F
TW 125 (5EK/5RS)	99-04	F
XP 125 RA X-MAX - IRON-MAX (ABS)	16	R
YP 125 RA X-MAX ABS (39D2/Nissin F/Caliper)	11-17	R
YP 125 X-Max Business (ABS)	11	R
TW 200 (2JL/4CS1/2/3/5)	91-98	F
TW 200 E (4CS4/6/5LB1/2)	98-01	F
ST 225 (5BT) Bronco	97	F
TW 225 E (5VC1/2)	02-03	F
XT 225 WE (4JG5/6) Serrow	97-98	F
Serrow 250 (3C51/52)	05	F
VP XG 250 Tricker (5XT1)	04-06	F
XT 250 Serrow (3C51/2)	05-08	F
VP 250 X-City	07-16	R
XP 250 R X-Max (ICO) (Brembo Front Caliper/Non ABS)	05-09	R
XP 250 R X-Max (37P) (Nissin front caliper/Non ABS)	10-13	R
XP 250 RA X-MAX - IRON-MAX (ABS)	16	R

YAMAHA Contd.

YP 250 R (X-Max)	05-09	R
YP 250 DX/A Majesty	98-03	R
YP 250 R X-Max (ABS)	11-16	R
YP 250 R X-Max Sport	11-12	R
XP 400 RA X-MAX - IRON MAX (ABS)	16	R
YP 400 R X-MAX (Non ABS)	13-16	R
YP 400 RA X-MAX (ABS)	13-18	R
LINHAI		
Monarch 125/150 T	06-07	R
Main Street 300cc (Scooter)	07-08	R
MBK		
YP 250 Skyliner 250 (+ABS)	98-02	R
ITALJET		
Jupiter 125/150	02	R

Equivalents OE #		
4730480	37P W0046 00	5PW W0046 50
4JG W0045 00	5CG W0046 00	5LB W0045 00
4US W0045 00	5CG W0046 20	5XT W0045 00
3C5 W0045 00	5EK W0045 10	1CO 25806 00
3C5 25805 00	5EB W0046 00	1SD F5911 10
3YR W0045 00	5GM W0046 00	

MATERIAL AVAILABILITY AND PART NO.								
STD	OPTIONS							
FA	TT	SFA	HH	SFAC	SFA-HH	R	MXS	EPFA
FA275	FA275TT	SFA275	FA275HH	SFAC275	SFA275HH	-	-	-

GFA276 95.8 x 47.5 x 8.4mm

RACE USE ONLY

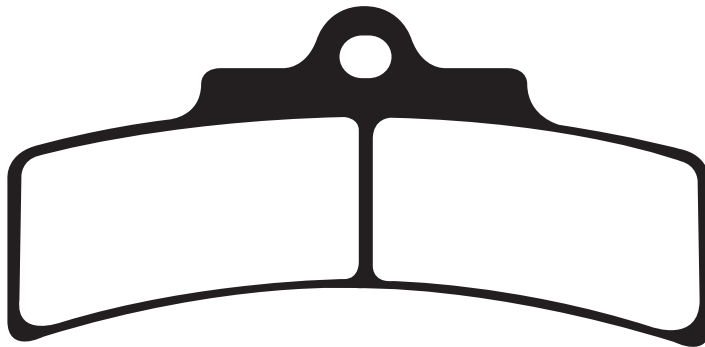

PVM

6 Piston (new small design)

Equivalents OE

-

MATERIAL AVAILABILITY AND PART NO.				
STD	OPTIONS			
FA	V	HH	R	GFA
-	-	-	-	GFA276HH

**DISC PADS
BUYERS GUIDE**

**DO NOT REFIT ANY SHIMS/INSULATORS TO EBC PADS FROM ORIGINAL PADS UNLESS INSTRUCTED
ON NOTE ON PAD PACKAGING AND ON FA DRAWING ASSOCIATED WITH THAT PAD.**

FA281 115.6 x 41 x 9.3mm



DO NOT REFIT SHIM

GARELLI

Skynet 250/400

02 F

HONDA

FES 125 W/Y/1/2/3/4/5 Pantheon

98-06 F

FES 150 W/Y/1/2/3/4/5 Pantheon

98-06 F

FES 250 W/X/Y/1/2/5 Foresight

98-05 F

NSS 250 Y/AY/1/A1/A3/3 Forza/Forza-S

/Forza-T/Forza-ST/Jazz/Reflex (MF04/MF06)

00-04 F

FJS 400 Silverwing D6/D7/D8 Non ABS

256mm front disc

06-08 F

FJS 600 1/2/D3/D4/D5/D6/D7/A3-A7 Silverwing

01-08 F

KAWASAKI

EN650 AFF/AGF/AGFA/CHF/CGF/CGFA Vulcan S - Non ABS

15-20 F

EN650 BFF/BGF/BGFA/BGFB/DHF/DHFA

/EHF/DJF/DJFA/EJF/EJFA/FJF/FJFA Vulcan S - ABS

15-20 F

PEUGEOT

SV 250

01-02 F

MATERIAL AVAILABILITY AND PART NO.				
STD	OPTIONS			
FA	SFA	HH	SFAC	SFA-HH
-	SFA281	FA281HH	-	SFA281HH

Equivalents OE #		
06455 KFG 016	06455 KPB 416	43082 0152
06455 KFG 641	119 481 00	43082 0169
06455 KPB 406	754808	

FA282 31.25 x 35.85 x 5.12mm

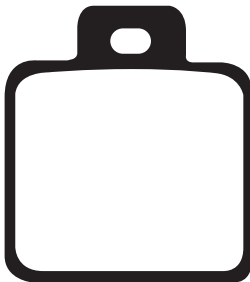

HUSQVARNA

Husky Boy 50

98-99 F&R

HYOSUNG

TE 50

05-07 R

TE 90

05-07 R

TE 100

05-07 R

MATERIAL AVAILABILITY AND PART NO.					
STD	OPTIONS				
FA	V	HH	R	MXS	EPFA
-	-	-	FA282R	-	-

Equivalents OE #
59300 21000

DO NOT REFIT ANY SHIMS/INSULATORS TO EBC PADS FROM ORIGINAL PADS UNLESS INSTRUCTED ON NOTE ON PAD PACKAGING AND ON FA DRAWING ASSOCIATED WITH THAT PAD.

SFA283/4 53.5 x 44.7 x 8.6mm

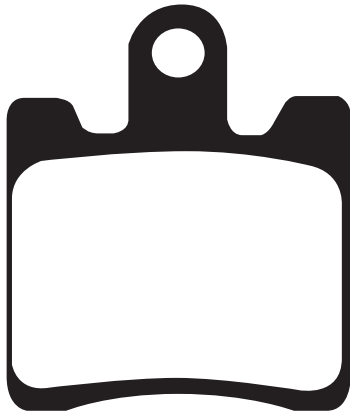

KAWASAKI			
SC 250 A1 Epsilon	02-03		F
SUZUKI			
AN 250 W/X/Y Burgman/Skywave	98-00		F
AN 250 K1/K2 Burgman/Skywave	01-02		F
AN 250 K3-K6 Burgman (CJ43A)	03-06		F
AN 400 X/Y/K1/K2 Burgman/Skywave	99-02		F
AN 400 K3-K6 Burgman/Skywave	03-06		F
SYM			
GT 500	04		F

MATERIAL AVAILABILITY AND PART NO.					
STD	OPTIONS				
SFA	SFAC	SFA-HH	R	MXS	EPFA
SFA283/4	SFAC283/4	SFA283/4HH	-	-	-

Equivalents OE #		
59300 14870	43082 S002	59301 14820
59300 14880	59301 14810	

FA291 56.9 x 43.8 x 6.45mm

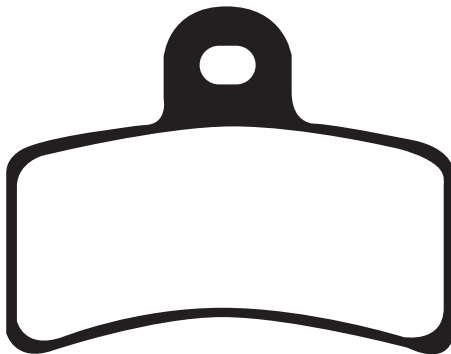

GAS GAS			
TXE Electric Bike	20		F
Cross MC 50	06		F
125/200/249/270/280/321 TXT	99-03		F&R
50/80 TXT	01-02		F&R
50 EC Rookie	01-02		R
50 EC Boy	01		F&R
TXT Boy 50/280	01		F&R
EC Boy 50	01		F&R
EC 50 (Boy)	01-04		F&R
EC 50 (Rookie)	01-04		R
EC 50	05		R
TXT 50 (Boy)	01		F&R
TXT 50 (Rookie)	02-03		F&R
SM 50 (Rookie)	01-04		R
SM 50	05		R
TXT 80 (Rookie)	02-03		F&R
Pampera 125/250/280	04		R
Pampera 250	02		R
SM 50 Rookie	01-02		R
TXT 200/270/321	99		F&R
TXT 125/200/249/280/321	00-03		F&R
Pampera 250	02-03		R

MATERIAL AVAILABILITY AND PART NO.				
STD	OPTIONS			
FA	V	HH	R	MXS
FA291	-	-	-	-

Equivalents OE #
BT-27922065
BT-280022065

FA293S = Green FA293 = Blue

- A. 22Ø x 5.95mm (Plain pin)
- B. 22Ø x 5.95mm (Thread pin)

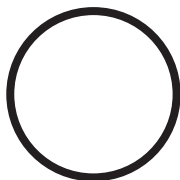

MATERIAL AVAILABILITY AND PART NO.					
STD	OPTIONS				
FA	V	HH	R	MXS	EPFA
FA293	-	-	-	-	
FA293S (Green)					

MINI MOTO	
Pasini/GRC	
HRD	
SX 50 Mini Cross	F&R
POLINI	
Mini Bikes	F&R

DISC PADS BUYERS GUIDE

DO NOT REFIT ANY SHIMS/INSULATORS TO EBC PADS FROM ORIGINAL PADS UNLESS INSTRUCTED ON NOTE ON PAD PACKAGING AND ON FA DRAWING ASSOCIATED WITH THAT PAD.

FA294 81 x 45.9 x 7.7mm

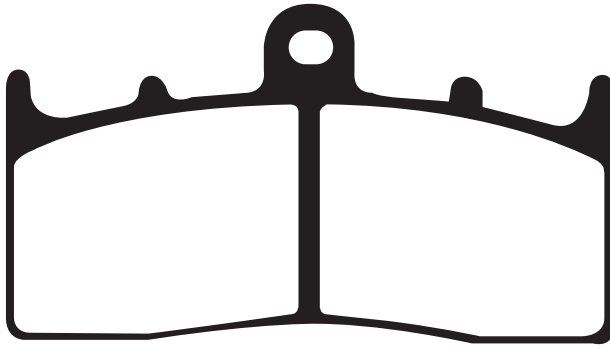

BMW

R 850 R	04-06	F
R 1100 S (with integral ABS)	12/00-06	F
R 1150 GS (EVO - R21/0415/0495)	11/01-03	F
R 1150 GS Adventure	07/01-06	F
R 1150 R/RS	01-06	F
R 1150 R Rockster	03-06	F
R 1150 Rockster Edition 80	04	F
K 1200 LT	11/00-09	F
K 1200 R (Urban)	05-08	F
K 1200 R (K27/0378) Tokico Caliper	06-11	F
R 1200 CL	02-04	F
R 1200 C Independent (Cast wheel)	03-04	F
R 1200 C Montauk	04	F
R 1200 C Classic	03-04	F
R 1200 R SE	10-11	F
R 1200 R Classic	11-12	F
R 1200 R	12/07-13	F
K 1200 R Sport	07	F
K 1200 LT (Evo Integral ABS/Disc has fixed bobbins)	08-09	F
K 1300 R	09-12	F
K 1300 R Dynamic	11-15	F
K 1300 R Carbon	12	F
KAWASAKI		
ZRX 400 (ZR 400 E4-E7)	98-01	F

MATERIAL AVAILABILITY AND PART NO.				
STD	OPTIONS			
FA	HH	R	MXS	EPFA
-	FA294HH	-	-	EPFA294

Equivalents OE #	
34 11 7 658 386	34 117 69 0 169
34 11 7 655 898	43082 1217
34 11 7 690 170	

EPFA295 77.6 x 44 x 9.85mm

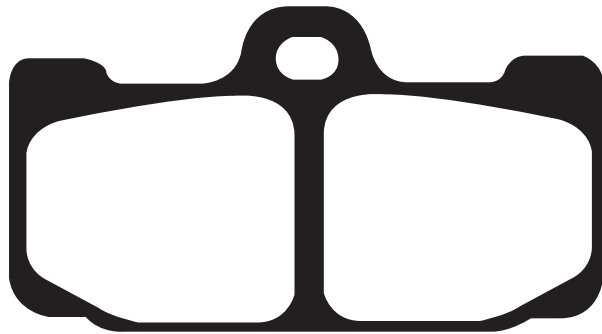

RACE USE ONLY

BREMBO

X9737 80/81 Radial mount endurance caliper
108mm spacing

Equivalents OE

107 684612

MATERIAL AVAILABILITY AND PART NO.				
STD	OPTIONS			
FA	HH	R	EPFA	GPFX
-	-	-	EPFA295HH	GPFX295HH

FA296 74.75 x 55.4 x 7.6mm

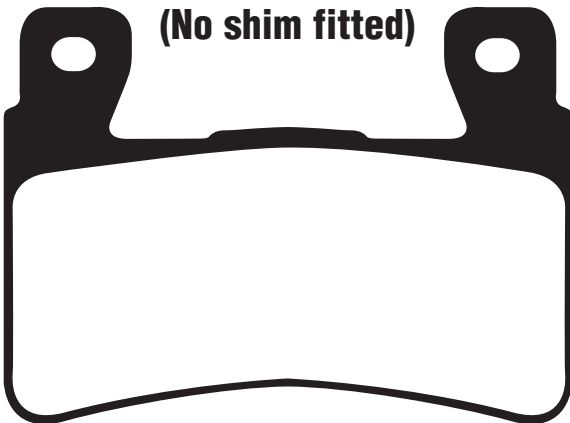

Equivalents OE

06455 MBW 006	59330 H99 700
06455 MBW E11	43082 0131
42739 008	41300102

MATERIAL AVAILABILITY AND PART NO.				
STD	OPTIONS			
FA	GPFX	HH	R	EPFA
-	GPFX296HH	FA296HH	-	EPFA296HH

HARLEY-DAVIDSON

XR 1200	08-10	F
XR 1200 X	10-12	F
FXST Softail Deluxe/Standard	15	F
FLS Softail Slim	15-17	F
FXSB Breakout	15-17	F
FLSTF Fatboy	15-17	F
FLFB Fat Boy	18	F
FLSTFB Fatboy LO	15-17	F
FLFBS Fat Boy 114	18	F
FLFBS Fat Boy 114 Anniv	18	F
FLSTC Heritage Softail Classic	15-17	F
FLHC Heritage Classic	18	F
FLHCS Heritage Classic 114	18	F
FLHCS Heritage Classic 114 Anniv.	18	F
FLSS Softail Slim S	16-20	F
FLSL Softail Slim	18	F
FXSB Softail Breakout	16	F
FXBR Breakout	18-20	F
FXBRS Breakout 114	18-20	F
FXBRS Breakout 114 Anniv.	18-20	F
FLSTFBS Fat Boy S	16-17	F
FLDE Deluxe	18-20	F

FXBB Street Bob

08-10	F	
FXFB Fat Bob	18-20	F
FXBS Fat Bob	18-20	F
FXLR Low Rider	18-20	F
HONDA		
CB 400 SFX/SFY/SF1/SF2/SF3	99-03	F
Super Four	04-05	F
CB 400 SF4/5/--S5 (NC39)	03-04	F
CBR 600 FX/FY	99-00	F
CBR 600 F1/F2/GBR	01-02	F
600 FS1/FS2 'Sport'	03-06	F
CBR 600 F3/F4/F5/F6	03-04	F
CBR 600 RR3/RR4	17-20	F
CB 1000 R	13	F
CB 1100 AE	14-18	F
(Cast Wheels/2 Piston Caliper)	03-04	F
CB 1100 EX (SAE)	05-09	F
CB 1300 F3/F13	05-09	F
CB 1300 5/6/7/8/9 (Superfour)	05-09	F
CB 1300 A5/A6/A7/A8/A9	05-09	F
(Superfour ABS)		
CB 1300 SA5/SA6/SA7/SA8/SA9/SA		
CB 1300 S5/S6/S7/S8/S9		

18-20	F	
F6C Goldwing (4 Piston Caliper)	14-17	F
(GLF6CAE)		
HYOSUNG		
GD 250 i Naked	13-15	F
GT 650 (Naked)	09-12	F
GT 650 i R	09-15	F
GT 650 i (Naked)	12-15	F
ST7 (ST 700 i)	10-15	F
ST7 Deluxe (ST 700 i)	12-15	R
KAWASAKI		
Ninja ZX-6R (Non ABS - 636cc)	13-20	F
Ninja ZX-6R		
(Non ABS/KRT Edition - 636cc)	16-20	F
Ninja ZX-6R (ABS - 636cc)	13-20	F
Ninja ZX-6R		
(ABS/KRT Edition - 636cc)	16-20	F
ZX-6R 30th Anniversary Edition		
(ZX 636 EPPA/Non ABS/636cc)	15	F
ZX-6R 30th Anniversary Edition		
(ZX 636 FFFA ABS/636cc)	13-15	F

FA297 A. 105 x 43.6 x 7.84mm B. 66 x 36.5 x 12.7mm

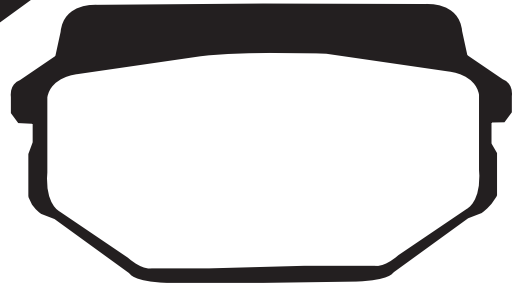
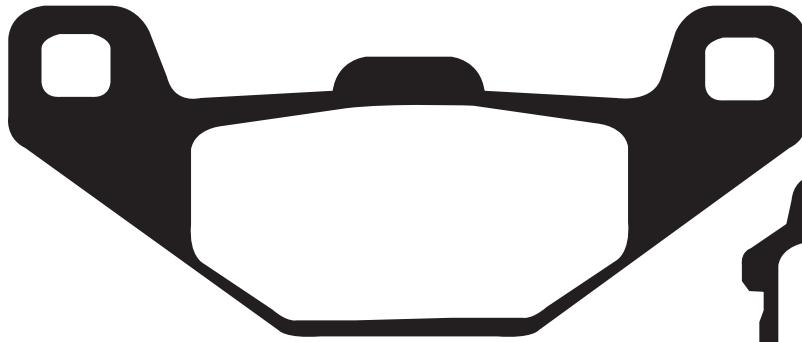

SYM
Huskey 125/150
CT 125

99-05 F
03-04 F

MATERIAL AVAILABILITY AND PART NO.					
STD	OPTIONS				
FA	V	HH	R	MXS	EPFA
FA297	-	-	-	-	-

Equivalents OE #
45105 N02 001 A

FA298 50.96 x 53.40 x 9.5mm



APRILIA

Scarabeo 50 (Ditech) (2T) (SCA00) 01-04
SR 50 Ditech (LC) (RLD100) 02-03
SR 50 Street (LC/2T) (TE00/TEA00) 03-15
SR 50 R/Factory (LC/2T) (VFB00/VFD00) 04-18
SR 50 H20 (ditech) (RLA1/RLB1) 00-03
SR 50 R SBK Aprilia (Replica) (LC) 10-11
Atlantic 125/200/250 03-06
Atlantic 125 03-08/10
RS 125 (Radial Caliper model) 2T 06-14
Scarabeo 125/150/200 99-02
Scarabeo 125/200 03/07-09
Scarabeo 125/150/250 GT 04-06
Sport City 125 04-08
Sport City Cube 125 08-12
Atlantic 200 03-05
Sport City 200 04-08
Sport City Cube 200 08-10
Atlantic 250 ie 06-08
Atlantic 250 03-05
Leonardo 250 SP/ST 00-04
Scarabeo 250 06
Scarabeo 250 ie 07-10
Sport City 250 ie 06-08
Sport City Cube 250 08-09
Atlantic 300 10-11
Sport Cube 300 Blackline 11
Leonardo 300 05-06
Sport City Cube 300 08-12
Atlantic Sprint 400 05-08
Scarabeo 400 ie 07-08
Atlantic 500 02-04
Atlantic Sprint 500 05-08
Scarabeo 500 03-06
Scarabeo 500 ie 07-09
Scarabeo 500 Light 07

BENELLI

Velvet 125/150 (13" front wheel/touring) 08-12
X 125 12-13
BX 250 Motard 16-18
Velvet 250 BN251 14-16
BN302 99-12
Velvet 400 15-16
BETA
Eikon 125/150 03-04
DERBI
Boulevard S125 07
Rambla 125 08-12
Rambla 250 i 08-09
Rambla 300 i 10-12
GENERIC/KSR
Code S 125/150/200 (4T) 12-16
Code X 125/150/200 (4T) 12-16
GRS 125 17-20
TR 125 SM (4T) 12-18
TR 125 X 17-18
TW 125 SM 13-18
Worx 125/150 (4T) 12-16
H P POWER
Iron 50 (2T) 10-12
HUSQVARNA
GD 250 N 13-14
HYOSUNG
GD 250 i Naked 13-15
GT 250 i R (Efi) 14-15
GT 650 i R 14-15
ITALJET
Marco Polo 400cc Scooter 07-09
KEEWAY
RKV 125 10-15
TX 125 SM (17" f/wheel) 13-15
Cityblade 125 13-14

RKV 150 13-15
RKX 150 13-14
KXM 200 14
KXV 200 14
RKX 200 13-14
RKV 200 S Factory 14
RKV 200 S 14
TX 200 (19" f/wheel) 13-14
MALAGUTI
Madison T125/150/R180/S250 99-03
Madison 125-3 06-09
F18 Warrior 125/150 00-03
Phantom Max 125/200 04-08
R 125 Madison 03-07
Madison S 200 04
Madison 250 ie 3 06-10
Password 250 05-11
Phantom Max 250 04-08
250 Madison 04-07
Scarabeo 300 S 09-10
Madison K 400 02-06
Spidermax RS 500 04-11
Spidermax GT 500 04-10
PEUGEOT
Citystar 125 i 11-14
Citystar 125 Active 13
SCARABEO
125 ie 10-15
125 Net 10-11
200 ie 10-15
200 Net 10-11
300 S 09-11
500 ie 10-11
TGB
Bellavita 125i (4T) 12-14
Bellavita 300i (4T) 12-14

MATERIAL AVAILABILITY AND PART NO.					
STD	OPTIONS				
FA	SFA	SFAC	HH	R	MXS
FA298	SFA298	SFAC298	SFA298HH	-	-

Equivalents OE #		
811 3869	8133539	R050372080000
119 491 00	8133946	55120 J41 000
2525371000	8213577	55120 J41 000
R44440161A0	8133726	B23 45280 0000
11948600	8133946	69301 H08100
8213506	666397	

SFA301 53.90 x 50.75 x 8.00mm

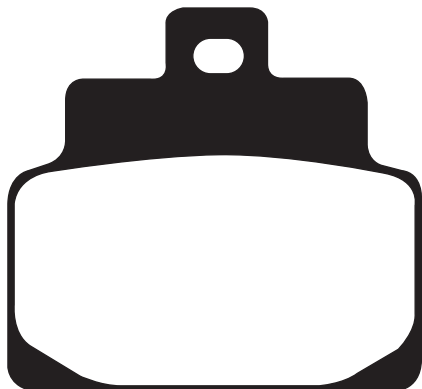

APRILIA		
Scarabeo 100 (2T)	00	F
Scarabeo 100 (4T) (SA000/VA000)	01-09	F
Habana 125	00-02	F
Leonardo 125/150 ST/SP	99-04	F&R
Leonardo 125	05-06	F&R
SR 125/150	99-02	F
Mojito/Mojito Custom 125	03-12	F

MATERIAL AVAILABILITY AND PART NO.					
STD	OPTIONS				
FA	SFAC	HH	R	MXS	EPFA
SFA301	SFAC301	SFA301HH	-	-	-

Equivalents OE #
8213460
8213462

FA302 A. 67.65 x 36.52 x 7.58mm

B. 51.90 x 40.10 x 7.62mm

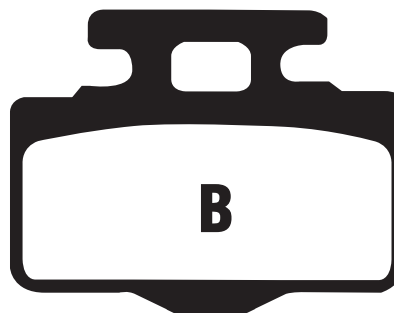
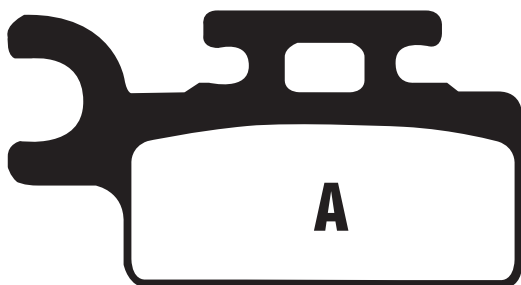

KAWASAKI		
KX 65	00-20	F
SUZUKI		
RM 65 K3/K4/K5	03-05	F

MATERIAL AVAILABILITY AND PART NO.					
STD	OPTIONS				
FA	V	HH	R	MXS	EPFA
FA302TT	-	-	FA302R	-	-

Equivalents OE #
43082-1242
43082-0042
K4308-21242

DO NOT REFIT ANY SHIMS/INSULATORS TO EBC PADS FROM ORIGINAL PADS UNLESS INSTRUCTED ON NOTE ON PAD PACKAGING AND ON FA DRAWING ASSOCIATED WITH THAT PAD.

DISC PADS
BUYERS GUIDE

FA303 49.95 x 43.85 x 5.9mm



AJP

PR3 125 Enduro	08-12
PR3 125 Enduro Pro	10-12
PR3 125 Supermoto	08-12
PR3 125 Supermoto Pro	10-11
PR3 125 Trail	11-12
PR4 Enduro 125	04-09
PR4 Supermoto 125/200	04-11
PR3 200 Enduro/Enduro Pro	08-11
PR3 200 Supermoto	08-11
PR3 200 Supermotard Pro	10-11
PR3 200 M/X	10-11
PR3 200 M/X Pro	10-11
PR4 Enduro 200	04-09

BETA

Evo 80 Senior	09-19
Rev 80	08
Evo 125 (2T)	09-15
Rev 3 125/200	00-06
Rev 3 125/200	06-08
Evo 200 (2T)	09-15
Rev 3 250/270	00-04
Rev 3 250/270	05-08
Evo 250 (2T)	09-15
Evo 250 (4T)	09-15
Rev 4T 250	07-08
Evo 300 (2T)	09-19
Evo 300 (4T)	09-19

GAS-GAS

TXT 125/200/250/280/300 (TXT PRO)	04-11
TXT 125/250/280/300 (For models with AJP caliper with 2 pin pad fixing)	12-14
TXT 125 Randonne (4T)	11-15
TXT 200 Randonne (4T)	11-15
EC 50 Boy (LC)	05-07
TXT 50/80 Rookie	04-09
TXT 80 (Cadet)	07-09
TXT 80 Pro Racing (2T)	15
TXT-E (Full size electric bike)	12-14
TXT 250 Contact (2T)	15

MONTESA/HONDA

R 315R	01-04
R 250 4RT Cota	05-10
R 260 4RT Cota (STD Version ED/3E)	14-18
OSSA	
R TR 125i	13-15
R Explorer 250 i	14-15
R TR 250 i	14-15
R TR 280 i	10-15
R Explorer 280 i	12-15
R TR 300 i	14-15

SCORPA

R SR 125 (2T)	10-13
R SR 125 Long Ride (2T)	10-11
SY 125 F	10-11
F SY 125 4T Long Ride	03-10
F SY 125 FR (4T)	09-10
F Twenty 125 (2T)	03-11
F TY 125 (4T)	15
F SY 175 F	11-15
F SY 200 F (4T) (163cc)	06
F SY 250 F	08
F SY 250 Long Ride (2T)	06-10
F SY 250 (2T)	04-06
F SY 250 F (4T) Long Ride	00-09
F SY 250 R (2T)	07-08
F SY 250 FR Long Ride	00-09
F SY 250 FR	10
Twenty 250 (2T)	06-10
SR 280 (2T)	15
SR 280 (2T) Long Ride	09-14
Twenty 300 (2T)	09-11
	15

SHERCO

F Trials 0.8 (2T)	05-10
F ST 80 (2T/Braktec Caliper)	14-15
F 125 ST-R	18-19
125 TY Classic	18-19
F FST 125	18-19
F Trials 1.25 (2T) AJP Caliper	06-12
F ST 125 (2T/Braktec Caliper)	14-15
F XY 125 (4T)	14-15
F Trials 2.5 (2T) AJP Caliper	06-12
F 250 ST Factory	18-19
250 ST-R	18-19
F ST 250 (2T/Braktec Caliper)	14-15
F Trials 2.9 (2T) AJP Caliper	06-12
F ST 290 (2T/Braktec Caliper)	14-15
F 300 FST	18-19
F 300 ST-R	18-19
F Trials 3.2 (4T) AJP Caliper	05-12
F ST 305 (2T/Braktec Caliper)	14-15

XISPA

F X 125 R	08-09
F X 250 R	08-09
F X 280 R	08-09

MATERIAL AVAILABILITY AND PART NO.

STD	OPTIONS					
	FA	V	HH	R	MXS	EPFA
FA303TT	-	-	-	-	-	-

Equivalents OE

45105 NN3 830	25-25352	00TRS01A0027
6211	C389	2525352000

DO NOT REFIT ANY SHIMS/INSULATORS TO EBC PADS FROM ORIGINAL PADS UNLESS INSTRUCTED
ON NOTE ON PAD PACKAGING AND ON FA DRAWING ASSOCIATED WITH THAT PAD.

FA304 75.05 x 54.90 x 8.97mm



BMW
R 1200 CL 02-04 R
K 1200 LT (All models) 97-09 R

MATERIAL AVAILABILITY AND PART NO.				
STD	OPTIONS			
FA	GPFAX	HH	R	EPFA
FA304	FA304V	FA304HH	-	-

Equivalents OE #		
34 21 7 671 246	34 21 7 680 374	34 21 2 333 337
34 21 7 657 492	34 21 7 680 375	

FA305 A 84.95 x 43.5 x 8.60mm B 63.95 x 36 x 10.96mm

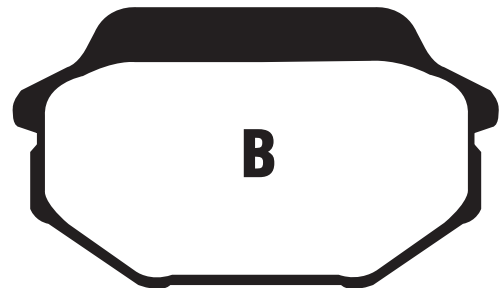
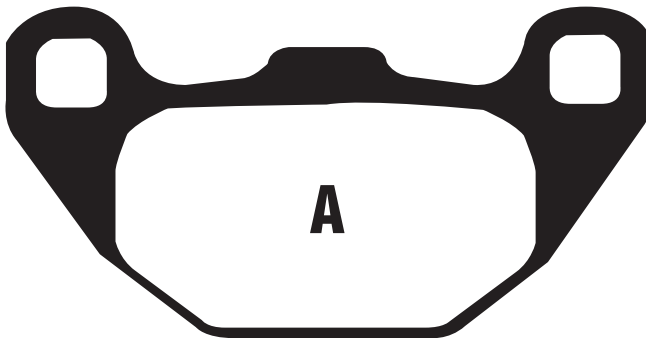

ARCTIC CAT
50 DVX (4T) Sport 06/08 R
50 4x4 Auto Youth 08 R
90 DVX 06-14 R
90 DVX SE 09 R
90 2x4 (4T) Youth (Rear disc model) 06 R
90 SE 09 R
90 (Reverse gear model) 10-14 R
150 Utility 2x4 09-14 R

KAWASAKI
KFX 50 (KSF 50 B7F/B8F/B9S/BDF/BEF /BFF/BGF/BHF) 07-09/13-17 R
KFX 90 (KSF 90 A7F/A8F/A9F/AAF /ABF/ACF/ADF/AEF /AFF/AGF/AHF) 07-17 R

LAVERDA
Phoenix 125/150/200 01-04 R

KYMCO
Agility 50 R16 (2T/16" wheels) 08-15 F
Agility 50 R16 (4T/16" wheels) 08-15 F
Agility 50 Carry (4T) 11-18 F
DJ 50 S 12-15 F
Like 50 (4T) 09 F
Looker 50 07-08 F
People S 50 2T (5 bolt fixing) 05-15 F
People S 50 (4T) (B91000) (5 bolt fixing) 06-20 F
People 50 (2T) (3 bolt fixing) 99-14 F
Super 8 (50cc) (2T) 07-15 F
Super 8 (50cc) (4T) 07-20 F
Super 9 50 (LC) 01-07 R
MXU 50 (Quad) (2T) 05-14 R
KXR 90/S Mongoose 04-20 R
Maxxer 90 05-06 R
Agility 125 R16 (C20000) (16" wheels) 08-15 F
Agility RS125 (2T/12" wheels) 09-13 F
Agility 125 Carry (4T) 11-15 F
Agility City 125 18-20 F
Agility City+ 125 18-20 F
DJ 125 S 12-13 F
Like 125 (D20000) 09 F

KYMCO Contd.
Looker 125 S 07-08 F
People One 125i 13-15 F
People S 125 DD 07-20 F
People S 125 05-06 F
People 125 99-14 F
Super 8 (125cc) (4T) 08-15 F
Agility 150 R16 (C30000) (16" wheels) 08-14 F
Mxer 150 Quad 02-07 R
MXU 150 (4T) 05-20 R
People 150 99-04 F
Agility 200i R16 10-15 F
Like 200 i 09 F
People S 200 (D11000) 05-06 F
People S 200i DD (D12000) 07-15 F

SYM
Combiz 125 11-15 F
HD 125/200 04-07 F
Joyride 125/200 01-07 R
SK 125 03-04 R
Joyride 150 01-06 R
GT 500 04 R

MATERIAL AVAILABILITY AND PART NO.								
STD	OPTIONS							
FA	SFA	SFAC	HH	R	SFA-HH	TT	MXS	EPFA
FA305TT	SFA305	SFAC305	SFA305HH	FA305R	-	-	-	-

Equivalents OE #		
8900539	3304-567	45105 KFA6 305
45105 KFA6 3050	3303-446	45105 H7C 700A
43082 Y001	3305-139	
45105 LEJ2 305	45105 LDC8 305	

DO NOT REFIT ANY SHIMS/INSULATORS TO EBC PADS FROM ORIGINAL PADS UNLESS INSTRUCTED ON NOTE ON PAD PACKAGING AND ON FA DRAWING ASSOCIATED WITH THAT PAD.

SFA306 70.13 x 41.85 x 8.07mm



LAVERDA		
Phoenix 125/150/200	01-04	F
SYM		
RS 50	04-09	F
Shark 50	99-03	F
Euro MX 125 (Rear drum model) (HF12-W6 Euro 1)	02-07	F
Euro MX 125 (Rear disc model) (HF12 W3-6 Euro 2)	06-09	F
RS 125	04-06	F
SK 125	03-04	F
Shark 125/150	99-02	F
Shark 4VR 125	01-02	F
Joyride 125/150/200	01-07	F
Joyride 125 i	07-09	F
Joyride Evo 125i (Twin Headlights)	09-20	F
VS 125	06-15	F
RS 150	06	F
VS 150	06-15	F
Joyride 200 i	07-09	F
Joyride Evo 200i	09-20	F

MATERIAL AVAILABILITY AND PART NO.						
STD	OPTIONS					
SFA	SFAC	HH	R	MXS	EPFA	
SFA306	SFAC306	-	-	-	-	

Equivalents OE #
45105 HA3A 000
45105 H3A 900A
8900239

FA307 A 82.08 x 40.85 x 9.46mm

B 62.03 x 40.80 x 9.46mm

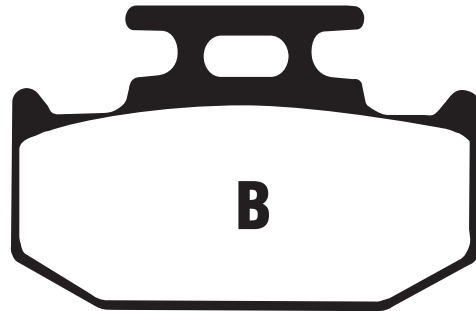
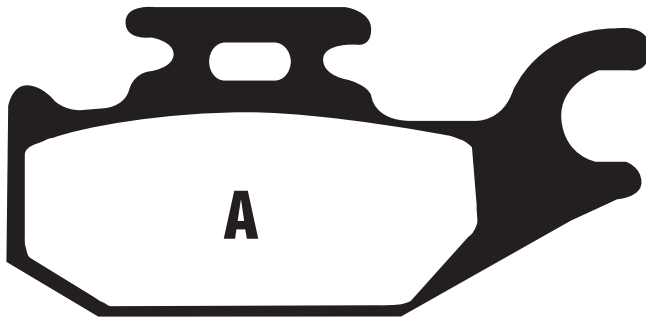

FA307TT		
YAMAHA		
YFM 400 FAM/FAN	00-01	R
YFM 400 FWT (Big Bear)	05	R
YFM 400 FGW/FGX Grizzly	07-08	R
YFM 450 FAR/FAS	03-04	R
YFM 450 FAT/FAHT/FAV (Kodiak)	05-06	R
YFM 450 FXV/FXW/FXX/FXY/FXZ Wolverine	06-10	R
BOMBARDIER		
Most models (see application pages)	01-06	F(left)&R
CAN AM		
Most models (see application pages)	07-15	F(left)&R

CANNONDALE		
All quads (check main application pages for fitments)	01-04	F(left)&R
JOHN DEERE ATV		
Most models (see application pages)	04-05	F(left)&R
SFA307		
SUZUKI		
UX 125 K8/K9/L0/L1 SIXteen	08-14	R
UX 150 K8/K9/L0/L1 SIXteen	08-14	R

MATERIAL AVAILABILITY AND PART NO.				
STD	OPTIONS			
FA	HH	R	MXS	SXR
FA307TT	-	FA307R	-	SXR307HH
SFA307	SFA307HH			

Equivalents OE #		
5GH W0046 00	ID9 W0046 00	69100 03890
5GH W0046 10	705 600 398	69101 03810
705 600 014	705 600 349	1P1 W0046 00

FA313 123.5 x 55 x 9.25mm

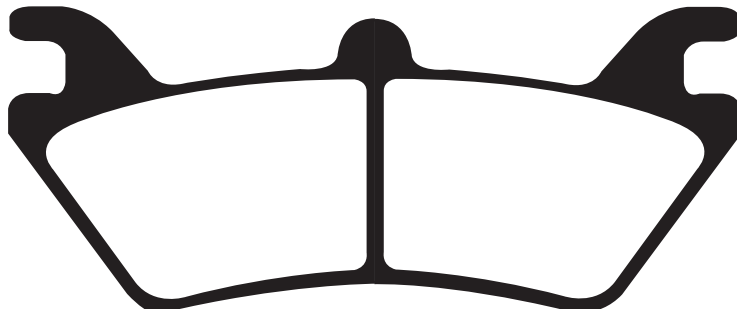

POLARIS		
Sportsman 6x6	00-03	R
500 Sportsman 6x6	00-08	R
PTV (6x6)	03	R
PPS/PTV 6x6/Series 10		R
PPS LUH 6x6	02	R

MATERIAL AVAILABILITY AND PART NO.				
STD	OPTIONS			
FA	V	HH	R	MXS
-	-	-	FA313R	-

Equivalents OE #
2201685
2201749
1910450V

FA314 90.3 x 41.05 x 8.2mm

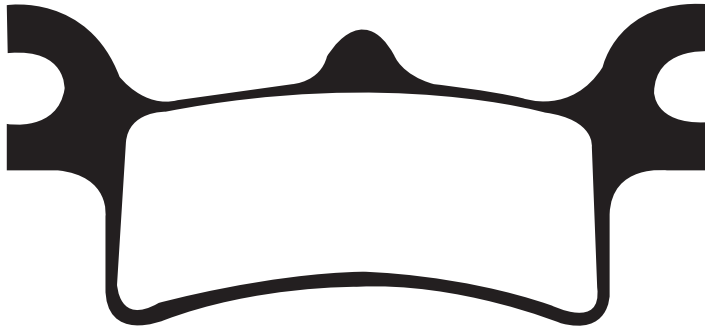

POLARIS

250 Trail Blazer	05-06	R
Magnum 325/500	02-03	R
325 Magnum (2x4) HDS	02	R
325 Magnum 4x4 (A02CD32AA/AB/AC)	02	R
325 Magnum 4X4 GDS (A02CD32FB)	02	R
Xpedition 325	02	R
Magnum 330 (2x4/HDS)	03-06	R
Magnum 330 (4x4/HDS)	03-04	R
330 Trial Boss	05-13	R
330 Trial Blazer	08-13	R
Sportsman 400	03	R
400 Sportsman 400	03-05	R
400 Sportsman	03-04	R
450 Sportsman	06-07	R
ATV Pro 500 4x4 TPS	02	R
500 ATV Pro 4x4 PPS	02	R
Magnum 500 HDS	02-03	R
Magnum 500 (2x4/4x4 HDS)	02	R
500 Scrambler 4x4	05-11	R
500 Scrambler 2x4	07-08	R
500 Sportsman HO/EFI	03-06	R

POLARIS Contd.

500 Sportsman HO (Up to 15/12/2008)	08	R
500 Sportsman EFI/HO	07-08	R
500 Sportsman EFI Quad	08-11	R
500 Sportsman X2	06-08	R
500 Sportsman Forest	12	R
Sportsman 500 HP	03-04	R
Sportsman 600 4x4	03-05	R
Sportsman 700 (4x4)	02-04	R
700 Sportsman (4x4)/EFI	02-06	R
700 Sportsman EFI	07	R
Sportsman MV 700	05-06	R
Sportsman 800	05	R
800 Sportsman EFI	05-07	R
800 Sportsman EFI Intl/HO	07-11	R
800 Sportsman Big Boss/6x6/EDi	09-12	R
800 Sportsman HO/EFI (Up to 15/12/2008)	08	R
PPS/PTV 4x4/Series 10		R

MATERIAL AVAILABILITY AND PART NO.				
STD	OPTIONS			
FA	HH	R	MXS	EPFA
-	-	FA314R	-	-

Equivalents OE #
2201871
2202414
1910683

FA317 A 82.08 x 40.85 x 9.46mm

B 62.03 x 40.80 x 9.46mm

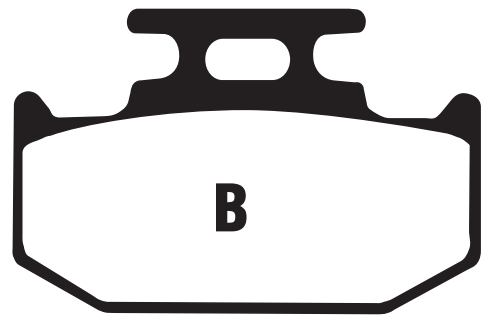
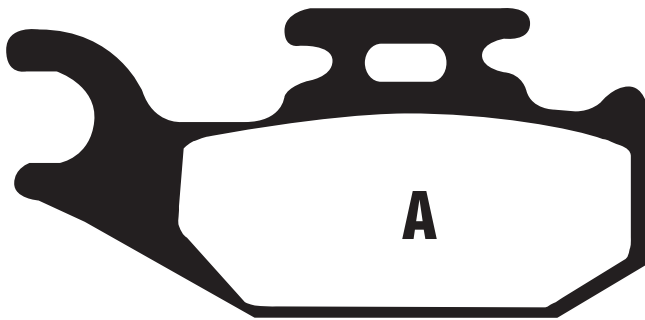

SUZUKI

LT-A 500 FK2 Vision 4WD 02 R

BOMBARDIER

Most models (see application pages) 01-06 F(right)&R

CAN-AM

Most models (see application pages) 07-15 F(right)&R

CANNONDALE

All quads (check main application pages for fitments) 01-04 F(Right)

JOHN DEERE ATV

Most models (see application pages) 01-05 F(right)&R

MATERIAL AVAILABILITY AND PART NO.				
STD	OPTIONS			
FA	HH	R	MXS	SXR
FA317TT	-	FA317R	-	SXR317HH

Equivalents OE #		
705 600 004	5UG W0045 00	75 601 147
69100 03840	705 600 350	44603 0580000
705 600 150	1S3 W0046 00	

DISC PADS
BUYERS GUIDE

DO NOT REFIT ANY SHIMS/INSULATORS TO EBC PADS FROM ORIGINAL PADS UNLESS INSTRUCTED ON NOTE ON PAD PACKAGING AND ON FA DRAWING ASSOCIATED WITH THAT PAD.

SFA319 99.95 x 36.25 x 11.95mm

FA319/2 99.95 x 36.25 x 9.5mm



SFA319 - YAMAHA

XP 500 N/P/R T-Max	01-03	R
XP 500 - T-Max 500 (530cc Engine Non ABS Models)	12-16	R
XP 500 A T-Max (530cc Engine/ ABS Models)	12-16	R
XP 530 Black Bronze Max (59CE)	13-14	R
XP 530 A (530cc Engine - Iron Max - ABS Model)	15-16	R
XP 500 A T-MAX - LUX MAX (ABS)	16	R
XP 530E-A T-Max (530cc Engine - ABS Model)	17-18	R
XP 530-A T-Max SX (530cc Engine - ABS Model)	17-18	R
XP 530D-A T-Max DX (530cc Engine - ABS Model)	17-18	R
SYM		
Voyager 250	05	R

FA319/2 - YAMAHA

TDM 900 (5PS/Non ABS)	02-14	R
TDM 900 (2B0/ABS)	05-13	R
SCR 950 (XVS 950XR-A)	17-18	R
XV 950 Racer (Remote Reservoir Rear Shocks)	15-16	R
XVS 950 A Midnight Star	09-13	R
XV 950 - XVS 950		
(Non ABS/Standard Rear Shocks)	14	R
XV 950 CU - XVS 950		
XV 950 R - XVS 950 R		
(2DE/Remote Reservoir Rear Shocks)	14-18	R
XT 1200 Z Super Tenere ABS/UBS Brake system	11-17	R
XT 1200 ZE Super Tenere ABS/UBS Brake system	14-17	R
XT 1200 ZE Super Tenere Raid Edition		
(ABS/UBS Brake System)	18	R
FJR 1300 A (ABS)	03-20	R
FJR 1300 AE (Electronic Suspension Adjustment/USD Forks)	14-20	R
FJR 1300 AS (ABS/Electric Shift)	06-20	R
XVS 1300 A Midnight Star	07-16	R
XVS 1300 CU Custom	14-17	R
XVS 1300 ACFD Midnight Star/Casual Full Dresser		
(With Handlebar Fairing)	14-16	R
XV 1700 PCR	03-05	R
XV 1700 V-Max	09-20	R
XV 1900 A Midnight Star	06-08	R
XV 1900 A Midnight Star	11-13	R

Equivalents OE #SFA319

5GJ W0046 00
59C 25806 00

Equivalents OE #FA319/2

5JW W0046 00	1D7 W0046 00
5PS W0046 00	3D8 25806 00
3P6 W0046 50	1D7 25806 00

MATERIAL AVAILABILITY AND PART NO.				
STD	OPTIONS			
SFA	SFAC	SFA-HH	R	MXS
SFA319	SFAC319	SFA319HH	-	-

MATERIAL AVAILABILITY AND PART NO.				
STD	OPTIONS			
FA	V	HH	R	MXS
FA319/2	FA319/2V	FA319/2HH	-	-

FA320 69.75 x 42.6 x 7.45mm

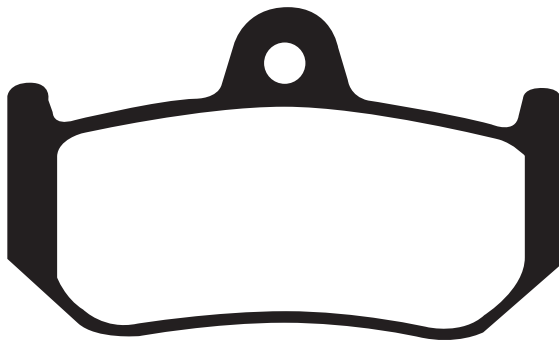

MV

750 Brutale S F4	03-05	R
750 Brutale Oro F4	03-05	R
750 F4S (Mono Posto)	99-04	R
750 F4S 1+1 (Bi-Posto)	01-04	R
750 F4 SPR	01-04	R
750 F4 SPR Senna	01-03	R
910 Brutale S (Nissin Calipers)	06-08	R
910 Brutale R (Brembo calipers/4 pads)	06-08	R
920 Brutale	11-12	R
990 Brutale R	10-11	R
998 Freccce Tricolori	10	R
998 F4RR	10-14	R
998 F4 RR Corsa Corta	12	R
998 F4R	12-14	R
998cc F4	10-14	R

MV Contd.

1000 F4 Ago	05	R
1000 F4 S (Mono Posto)	04-06	R
1000 F4 S 1+1 (Bi-Posto)	04-06	R
1000 F4 Tamburini	05	R
1000 F4 R	06-07	R
1000 F4 R 312 (Brembo 4 pad caliper up to VIN 008064)	07	R
1000 F4 R 312 (From VIN 008065 Brembo 2 pad caliper)	08-09	R
1000 F4 R 312 1+1	07-08	R
1078 F4 RR 312	09	R
1078 Brutale RR	08-09	R
1078 F4100cc Claudio Castiglioni	07-08	R
1090 Brutale RR	10-15	R
1090 Brutale R	12-15	R
1090 Brutale	13-15	R
1090 Brutale Corsa	13-15	R

MATERIAL AVAILABILITY AND PART NO.				
STD	OPTIONS			
FA	V	HH	R	MXS
-	-	FA320HH	-	-

Equivalents OE #
8000 82748

SFA321 55.5 x 49 x 7.5mm

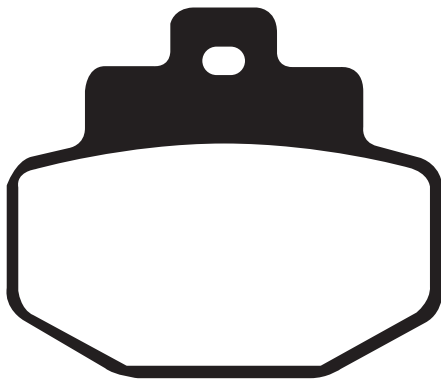

BENELLI

Adiva 125/150 01-04 R
GILERA
 Also see SFA459 if pad is a different shape to SFA321.
 125 VX 4T/180/VXR 200 4T 01-05 R
 DNA 125/180 01-03 R
 VX 125 Runner/ST (4T) 05-14 R
 VXR/VX 200 Runner/ST (4T) 02-11 R

PIAGGIO

Also see SFA459 if pad is a different shape to SFA321.
 New Fly 125ie (3V) 12-13 R
 Fly 125 (4T/3V) Rear Disc Model 12-15 R
 Super Hexagon GTX 125/180 12" wheels 01-03 R
 Super Hexagon GTX 250 00-02 R
VESPA
 Also see SFA459 if pad is a different shape to SFA321.
 GT 125 L Granturismo 03-06 R
 GTS 125 07-11 R
 GTS 125 Super ie (Inc ABS Models) 09-15 R

VESPA Contd.

GTS 125 Supersport ie (Inc ABS Models) 13-15 R
 GTV 125 07-08 R
 946 Special (4T/3V/125cc) 13-15 R
 GT 200 L Granturismo 03-06 R
 GTS 250 ie/ABS 05-10 R
 GTS 250 ie/ABS 05-11 R
 GT 60 (Special Anniversary Model) (GTV 250) 06 R
 GTV 250 ie 07-08 R
 GTS 300 ie (Non ABS Models) 08-15 R
 GTS 300 ie (ABS Models) 08-18 R
 GTS 300 ie Super (Non ABS Models) 08-15 R
 GTS 300 ie Super (ABS Models) 08-18 R
 GTS 300 ie Super Sport (Non ABS Models) 08-15 R
 GTS 300 ie Super Sport (ABS Models) 08-18 R
 GTS 300 ie Touring (Non ABS Models) 11-16 R
 GTS 300 ie Touring (ABS Models) 11-17 R
 GTS 4V ABS/Super Sport/Touring 18-19 R
 GTS 4V ABS 18-19 R

MATERIAL AVAILABILITY AND PART NO.

STD	OPTIONS				
SFA	SFAC	SFA-HH	R	MXS	EPFA
SFA321	SFAC321	SFA321HH	-	-	-

Equivalents OE

497002	R44440181A0
497348	647161

FA322/4 35 x 40.53mm x 7.4mm



NOTE:- Pads are sold as 4pcs - i.e. one caliper set 3.0mm backplate

NOTE:- Do not use for BMW S 1000 RR 10-14 F For this application, FA604/4HH must be used.

APRILIA

RSV 1000 Mille 01-02 F
 RSV 1000 R Mille 01-02 F
 RSV 1000 Mille (Radial caliper) 03 F
 RSV 1000 R Mille (Radial caliper) 03 F
 RSV 1000 R Racing/Factory (Radial caliper/4 Pad) 04-08 F
 RSV 1000 R Factory 04-08 F
 RSV 1000 R 04-08 F
 Tuono R Factory 1000 Radial caliper/4 pad type 06-10 F
 Tuono R 1000 Radial caliper/4 pad type 02-05 F
BENELLI
 Leoncino (500cc) 17-18 F
 Leoncino Trail (500cc) 17-18 F
 TRK 502 17-18 F
 BX 570 Motard 08-10 F
 BN 600 GT 14-17 F
 BN 600i 14-17 F
 752S 18 F
 Cafe 899 Racer 10-12 F
 Century Racer 899 11-12 F
 Century 1130 Racer 11-12 F
 TNT 1130 Sport/Sport Evo 04-09 F
 TNT 1130 Cafe Racer 06-12 F
 TNT 1130 Titanium 06-08 F
 Tornado LE/Tornado 996 R 01 F
 TRE Novecento/RS 03-05 F

BENELLI Contd.

Tornado Tre 1130 06-10 F
 Tornado Naked Tre R160 1130cc 09-12 F
BIMOTA
 Elirio 06 F
 DB5 (All models) 06-07 F
 DB5R 06-13 F
 DB5R/S (1078cc) 08-09 F
 DB5 Desiderio (1078cc) 12-14 F
 DB6 Delirio (992cc Ducati engine) 07 F
 DB6 (1078cc) 08-09 F
 DB6/R (1078cc) 08-09 F
 DB6 (1100cc) 08 F
 DB6R Delirio (1100cc) 08 F
 DB6 Delirio (1078cc) 12-13 F
 DB7 (1098cc) 08 F
 DB9 Brivido (1198cc) 12-14 F
 DB10 Motard (1078cc) 12-14 F
 DB12 B Tourist (1198cc) 12-14 F
 SB8K Santamonica (996cc Suzuki engine) 09-13 F
 Testi-3D (1078cc) 09-13 F

BREMBO

20 7850 11/21 - 4 Piston P4/34 @ 65mm Spacing (Wire clip pad retention only)
 20 8343 11/21 or 35/45 - 4 piston P4/34 @ 100mm Spacing (wire clip pad retention only)
 XA 32950 P4/34 Motard Avial Mount 65mm 4 pad set

CAGIVA

Mito 500 (4T) 08 F
 Raptor X3 1000 03-04 F

DERBI

Mulhacen 659 06-08 F

DUCATI

748 R (4 pad caliper) 01 F
 748 R (4 pad caliper) 02 F
 749 Dark (Monoposto/Biposto) 04-06 F
 749 R (Radial caliper) 04-06 F
 749 S (Monoposto/Biposto) 03-06 F
 749 (Monoposto/Biposto) 03-06 F
 S4 RS Monster (998cc) (Radial 4 pad caliper) 06 F
 S4R Monster Testastretta (998cc) (Radial 4 pad caliper) 07-08 F
 S4RS Monster Testastretta (998cc) (Radial 4 pad caliper) 07 F
 S4RS (Tricolore/Monster Testastretta) (998cc) Radial 4 pad caliper 08 F
 996 R 01 F
 998 R (998cc) 02 F

DUCATI Contd.

998 S Baylis/Bostrom 02 F
 998 S (998cc) (4 pad caliper) 02-04 F
 999 S (Std Caliper Mount) Monoposto/Biposto 03-04 F
 999 (Std mount caliper) 03-06 F
 999 R (Radial mount caliper) 03-06 F
 999 R Fila (Radial mount caliper) 03 F
 999 S (Radial caliper) monoposto/biposto 05-06 F
 999 R Xerox 06 F
GENERIC
 GRS 600 13-14 F
HUSQVARNA
 SMR 449 11 F
 SMR 450 RR Radial caliper 06-07 F
 SM 450 R Radial caliper 07-10 F
 SM 450 RR 08-10 F
 SM 510 R (Radial caliper) 06-10 F
 SMR 511 11-13 F
 SM 530 RR 08-10 F
 SM 610 S (Radial caliper) 06 F
 SM 610 ie 07-09 F
 SMR 630 (4T) 10-12 F
 STR 650 CRC 07 F
 701 Supermoto 16-20 F

KTM

690 Duke 08-11 F
 690 Duke R 10-11 F
 690 SM Prestige 07 F
 690 SMR (4 pad type caliper/cast wheel) 07-11 F
 690 SMC R 12-13 F
 690 SMC R (ABS) 14-17 F
 950 Supermoto 05-07 F
 990 Superduke 05-11 F
 990 Superduke R 07-13 F
 990 Supermoto T (SM-T) 09-13 F
 990 Supermoto R (SM-R) 08-09 F

LAVERDA

SFC 1000 03-04 F

MONDIAL

Piega 1000 03-04 F
 EVO 04 F

MOTO GUZZI

Griso 04 F
 1000 MGS-01 Corsa 04-07 F
 Fionda 1100 05 F

MOTO MORINI

Rebello 1200 Giubileo 12-13 F

FA322/4 Cont.

M.V. AGUSTA

Brutale 910 R 05-08 F
 910 Brutale R (Brembo calipers/4 pads) 06-08 F
 F4R 1000 06-07 F
 1000 F4R 06-07 F
 1000 F4R 312 (Brembo 4 pad caliper Up to VIN 008064) 07 F
 1000 F4 R 312 1+1 07-08 F
 F4RR 312R 1000 07 F

NORTON

Commando Cafe Racer (961cc) 10-14 F
 Commando SE (961cc) 10-11 F
 Commando 961 SF 13-14 F

PETRONAS

FP1 05 F

SHERCO

SM 4.5iF Supermoto 04-07 F
 SM 4.5iF Black Panther Supermotard 08-10 F
 SM 5.1iF Black Panther 08-10 F

SWM

SM 450 R 15-18 F
 SM 500 R 16-20 F
 Gran Milano (4T) 16-18 F
 Gran Milano Boggi SE 18 F
 Gran Milano Outlaw 500 18-20 F
 SM 650 R 16-18 F

TM

SMM 125 (2T) 08-15 F
 SMR 125 (2T) 15 F
 SMX 125 (2T) 15 F
 SMM 250 (2T) 15 F
 SMM 250 F (4T) 10-15 F
 SMR 250 (2T) 15 F
 SMR 250 F (4T) 10-15 F
 SMX 250 (2T) 15 F
 SMX 250 Fi 12-15 F

SMM 300 (2T)

SMR 300 (2T) 15 F
 SMX 300 (2T) 15 F
 SMM 450 F Black Dream ES 08-11 F

SMM 450 F

SMR 450 Fi (4T) 11-15 F
 SMX 450 Fi 10-15 F

SMM 530 F Black Dream ES

SMM 530 Fi 08-10 F
 SMR 530 Fi (4T) 10-15 F
 SMX 530 Fi 05-15 F

TRIUMPH

Speedtriple 1050 07-11 F
 (Non ABS) -To VIN 461331 07-11 F
 Speedtriple 1050 (ABS) -To VIN 461331 07-11 F

VOXAN

Charade Racing 06 F
 GTV 1200 08 F

MATERIAL AVAILABILITY AND PART NO.				
STD	OPTIONS			
FA	HH	R	MXS	EPFA
-	FA322/4HH	-	-	FA322/4HH

Equivalents OE #	
613 403 01A	8000A6416
613 40391 A	610 13 030 100
8223972	1679
R 180 100 12600	AP8133592
610 13 030 000	107 A48647
8A000A2040	07BB0510
69177	07BB05RC
862486	M478Z04
862697	45120 S01 0000
8000A7417	T2020715

FA323 81 x 42 x 9mm

SFA323 81 x 42 x 9mm

SFA323/2 81 x 42 x 6.9mm

SFA323/3 81 x 42 x 8.2mm

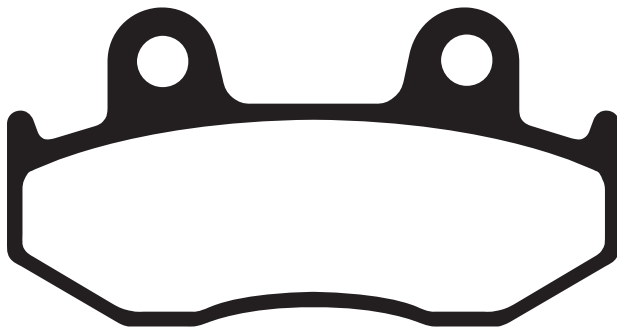

FA323TT

YAMAHA

YFZ 450 V/W/X 06-08 R
 YFZ 450 RY/RZ (Quad) 09-10 R
 YFZ 450 R 11-14 R
 YFZ 450 RSEA/RSEB/RSED/RSE 11-14 R
 YFZ 450 B/D 13-14 R
 YFM 700 RD/RE 13-14 R
 YFM 700 RSE 13-18 R

WK

Tria 125 11-14 F

SFA323

HONDA

SCV 110 Lead (NHX 110 WH8 - 3 bolt disc fixing) 08-09 F
 NES 125 Y/1/2/3/4/5/6 (@ 125 Scooter) 00-06 F
 PES 125 6/7/8/9/A (PS 125) 06-10 F
 PES 125 R8/R9/RA (PS 125) ABS 08-12 F
 SH 125 i 4/5/6/7/8/R8/S7/S8/D9 Fuel Injection 04-09 F
 SH 125 1/3 Carb/Rear drum model 01-03 F
 NES 150 Y/1/2/3/4/5/6 "@150 Scooter" 01-06 F
 SH 150 1/3 Carb/Rear drum model 01-03 F
 SH 150i 4/5/6/7/8/S7/S8/R8/D9 Fuel Injection 04-09 F
 PES 150 6/7/8/9 (PS 150)/A 06-10 F
 PES 150 R8/R9/RA ABS 08-12 F
 SES 125/150 2/3/4 Dylan 02-07 F

ITALJET

Torpedo 125/150 07-09 F
 Jack 125/150 07 F&R

MZ

Mantizz 125 S 05-07 F

SFA323/2

HONDA

CH 250 F/G "Spacy" 85-86 F

SFA323/3

SUZUKI

AN 250 W/X/Y 'Burgman' 98-00 R
 AN 400 X/Y 'Burgman' 99-00 R

KAWASAKI

SC 250 A1 (Epsilon 250) 02-03 R

MATERIAL AVAILABILITY AND PART NO.				
STD	OPTIONS			
FA	SFA	SFAC	SFA-HH	R
FA323TT	SFA323	SFAC323	SFA323HH	FA323R

MATERIAL AVAILABILITY AND PART NO.				
STD	OPTIONS			
FA	HH	R	MXS	EPFA
SFA323/2	SFA323/2HH	-	-	-

MATERIAL AVAILABILITY AND PART NO.				
STD	OPTIONS			
FA	HH	R	MXS	EPFA
SFA323/3	SFA323/3HH	-	-	-

Equivalents OE # - SFA323/FA323
06455 GCS 006
5TG W0046 10
06455 GCS 026
06455 GCS 016
06455 GCC B52

Equivalents OE # - SFA323/2
45105 KM1 004
45105 KM1 007
45105 KM1 711
45105 KM1 712
45105 KM1 710

Equivalents OE # - SFA323/3
69100 14840
69100 14860
43082 S003

SFA324 117.5 x 41.3 x 8.6mm

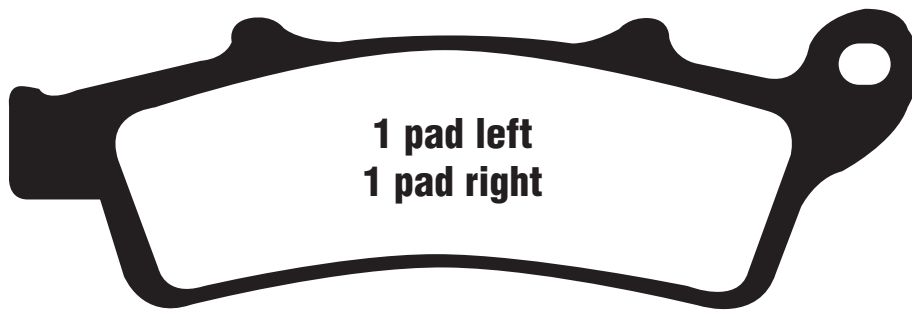

1 pad left
1 pad right

APRILIA

Atlantic 125
Atlantic 125
Scarabeo 125/150/250 GT
Scarabeo 125/200
Atlantic 200
Atlantic 250
Atlantic 250 ie
Scarabeo 250 ie
Atlantic 300
Atlantic Sprint 400
Atlantic Sprint 500

03-08 F
10 F
04-06 F
07-09 F
03-05 F
03-05 F
06-08 F
07-10 F
10-11 F
05-08 F
05-08 F

KYMCO

New Downtown 125i
People GTi 125
X Town 125
New X Town 125i ABS
People GTi 200
300i Agility Max ABS
K-XCT 300 i
People GTi 300
X Town 300i
New Downtown 350i

03-08 F
10 F
04-06 F
07-09 F
03-05 F
03-05 F
06-08 F
07-10 F
10-11 F
05-08 F
05-08 F

15-20 F
10-15 F
16-18 F
16-20 F
10-15 F
15 F
12-15 F
10-20 F
17-20 F
15-20 F

09-03 F
02-06 F

PEUGEOT

LOOXOR 125/150

PIAGGIO

Beverly 350 ie Sport Touring
Non ABS (330cc/4T)
Beverly 350 ie ABS Sport
Touring (330cc/4T)

SCARABEO

125 ie
125 Net
200 ie
200 Net
300 S ie

03-06 F
11-20 F
11-20 F
10-15 F
10-11 F
10-15 F
10-11 F
09-12 F

MATERIAL AVAILABILITY AND PART NO.					
STD	OPTIONS				
SFA	SFAC	SFA-HH	R	MXS	EPFA
SFA324	SFAC324	SFA324HH	-	-	-

Equivalents OE #	
119 481 00	8213648
81133603	45105 LGE5 305
8133761	666935
8133815	

FA325 43.45 x 25.2 x 5mm



1 pad left
1 pad right

HUSQVARNA

CR 50 Senior Pro
CR 50
SM 50
TC 50/Mini

LEM

R2/R3 (Hydraulic System)
RX 65
RX 2/3
CX 2/3

05 R
11-13 F&R
11-13 F&R
18-19 F&R
03-05 F&R
F&R
F&R
F&R

KTM

CR 50 Senior Pro
SX-E 5 Electric
50 SX Pro Senior LC
50 SX Senior Adventure
50 SX Pro Senior LC (12" F/wheel)
50 SX
50 SX Mini
50 Supermoto
65 SX

POLINI

X1R/X3R H20 50cc

TOMOS

MC 50 Senior

05 R
20 F&R
02-20 F
02-07 F
04-15 F&R
06-20 F&R
08-20 F&R
06 F&R
04-08 R

F&R

05 F&R

MATERIAL AVAILABILITY AND PART NO.				
STD	OPTIONS			
FA	HH	R	MXS	EPFA
FA325TT	-	FA325R	-	-

Equivalents OE #	
451 13 030 000	
8000H4667	

CFA327 30.66 x 35.15 x 4mm

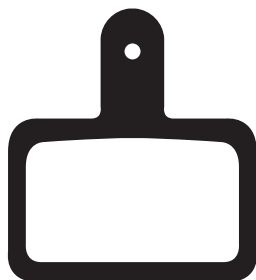

BETA

Minitrail Electric

14-15 F&R

MATERIAL AVAILABILITY AND PART NO.				
STD	OPTIONS			
FA	HH	R	MXS	EPFA
CFA327	-	-	-	-

Equivalents OE #	
451 13 030 000	
8000H4667	

DISC PADS
BUYERS GUIDE

DO NOT REFIT ANY SHIMS/INSULATORS TO EBC PADS FROM ORIGINAL PADS UNLESS INSTRUCTED
ON NOTE ON PAD PACKAGING AND ON FA DRAWING ASSOCIATED WITH THAT PAD.

FA335 77.25 x 51.45 x 8.55mm

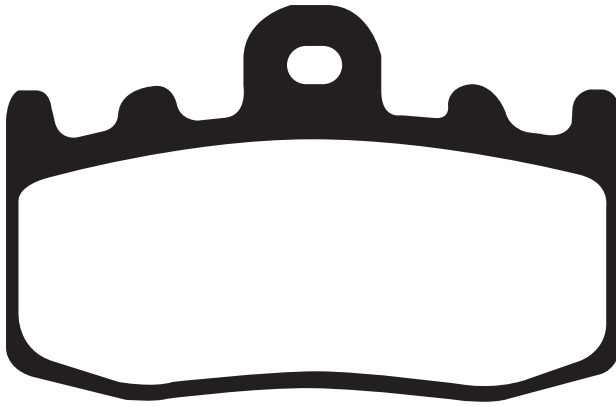

BMW

R 850 RT	06	F
R 1100 S (Non ABS)	12/00-03	F
R 1150 RT (Integral ABS)	00-06	F
K 1200 RS/R/S	01-05	F
K 1200 GT (K41)	03-06	F
K 1200 GT (K44)	06-08	F(left)
K 1200 S (K40)	05-08	F
R 1200 GS (K25/0307/Cast/Spoke wheel)	02-11/07	F
R 1200 GS Adventure (K25/0382/Spoke wheel)	05-11/07	F
R 1200 GS/Adventure (Spoke wheels)	10-12	F
R 1200 GS Adventure/M (K25/0380/Spoke wheel)	06-09	F
R 1200 GS/M (K25/0303/Cast wheel)	06-09	F
R 1200 GS (Cast wheels)	10-12	F
R 1200 GS Adventure (30 years GS)	11	F
R 1200 GS Triple Black (Spoke wheels)	11-13	F
R 1200 GS (30 years GS)	11	F
R 1200 RT K26/0368 Brembo caliper	05-09	F
R 1200 RT	10-13	F
R 1200 RT-SE	10-13	F
R 1200 ST K28/0328	03-08	F
R 1200 S K29/0366 Brembo caliper	06-08	F
R 1200 GS Rallye (Spoke wheels)	12	F
R 1200 GS Adventure Triple Black	12	F
HP2 Megamoto	07-09	F
HP2 Megamoto (K25)	07-10	F
K 1300 GT	09-11	F
K 1300 GT EE	10-11	F
K 1300 GT SE	10-11	F
K 1300 S (Non & ABS Models)	09-15	F
K 1300 S Sport	12-15	F
K 1300 S HP	12	F

Equivalents OE #	
34 11 7 660 448	34 11 7 683 064
34 11 7 671 780	34 11 8 534 183

MATERIAL AVAILABILITY AND PART NO.				
STD	OPTIONS			
FA	HH	R	MXS	EPFA
-	FA335HH	-	-	EPFA335HH

SFA336 77.85 x 46.5 x 7.05mm

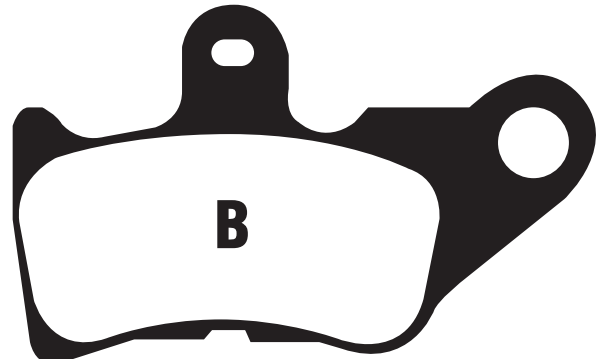
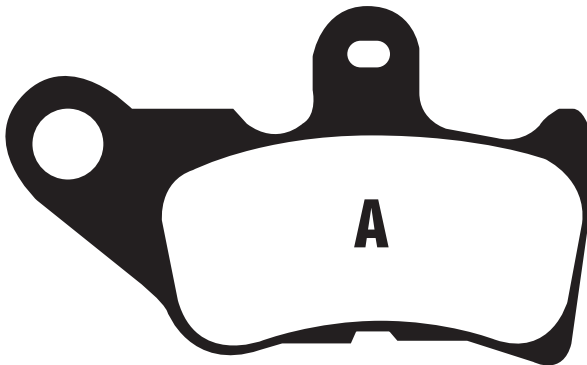

YAMAHA

CV 50 ZR (5PT1) Evolution	01-02	F
CV 50 (5KN1/2) Jog-Cool Style	00-02	F
MIO (113cc)	05-07	F
MIO Sporty (113cc)	05-07	F
Nuovo-Z (113cc)	06-07	F

MATERIAL AVAILABILITY AND PART NO.				
STD	OPTIONS			
FA	HH	R	MXS	EPFA
SFA336	-	-	-	-

Equivalents OE #
5KN W0045 00

FA337 35.2 x 51.5 x 6mm

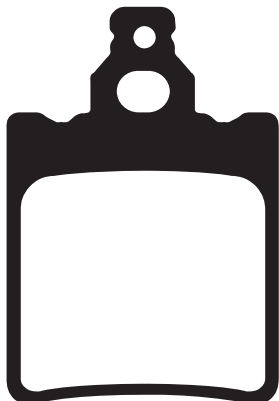

APRILIA

Pegaso 50	92-94	R
280 R Climber	92-93	R

BETA

R150 (Minicross/4T/49cc)	10-13	R
M4 350 Supermotard	04-06	R

JCM

240 Europa	89-	R
------------	-----	---

KTM

60 SX	00	R
65 SX	00-03	R

MATERIAL AVAILABILITY AND PART NO.				
STD	OPTIONS			
FA	HH	R	MXS	EPFA
FA337TT	-	FA337R	-	-

Equivalents OE #
460 13 090 000

DISC PADS
BUYERS GUIDE

DO NOT REFIT ANY SHIMS/INSULATORS TO EBC PADS FROM ORIGINAL PADS UNLESS INSTRUCTED
ON NOTE ON PAD PACKAGING AND ON FA DRAWING ASSOCIATED WITH THAT PAD.

DO NOT REFIT ANY SHIMS/INSULATORS TO EBC PADS FROM ORIGINAL PADS UNLESS INSTRUCTED
ON NOTE ON PAD PACKAGING AND ON FA DRAWING ASSOCIATED WITH THAT PAD.

FA342 A. 119.55 x 26.1 x 7.1mm
B. 94.54 x 35.6 x 7.8mm

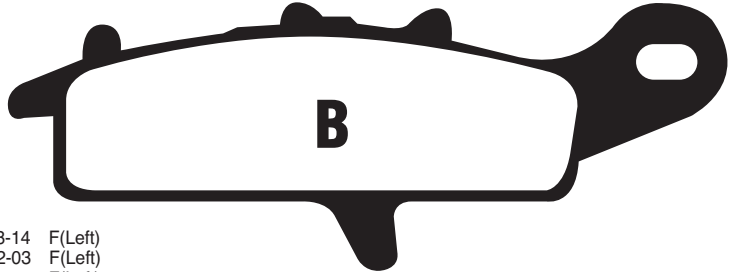
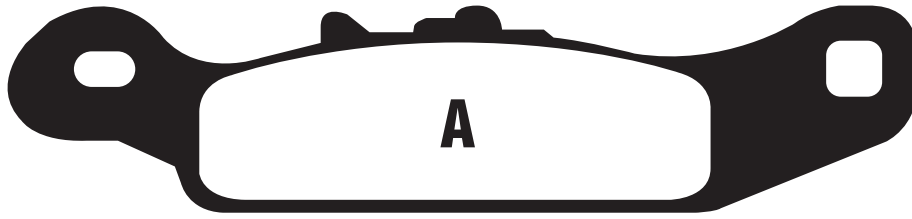

KAWASAKI			
KFX 450 R Quad(KSF 450 B8F/B9F/BAF/BBF/BCS/BDF/BEF)	08-14	F(Left)	
KVF 650 A1/A2 Prairie	02-03	F(Left)	
KVF 650 D1/D6F/D7F/D8F/D9F/DAF/DBF Brute Force 4x4	05-11	F(Left)	
KVF 650 E1/E6F/E7F/E8F/E9F Brute Force 4x4 Hardwoods Green HD	05-09	F(Left)	
KVF 700 A1/B1/A2/A6F/B2/B6F/A7F/A8F 4x4 (Prairie)	04-08	F(Left)	
KVF 700 D1 Team Green	05	F(Left)	
SUZUKI			
LT-V 700 FK4/FK5 Twin Peaks	04-05	F(Left)	

Equivalents OE #
43082 1255

MATERIAL AVAILABILITY AND PART NO.				
STD	OPTIONS			
FA	HH	R	MXS	EPFA
-	-	FA342R	-	-

FA343 A. 107 x 41 x 10mm B. 91.6 x 40.6 x 10mm

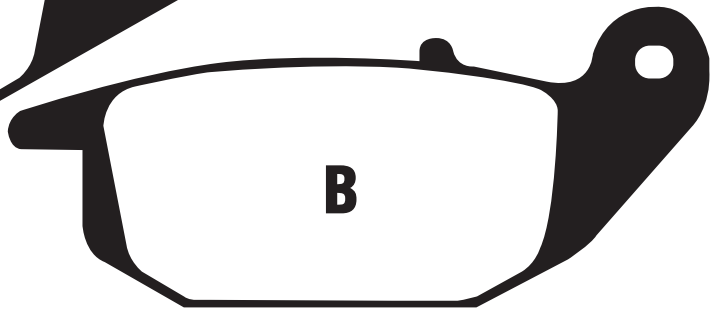
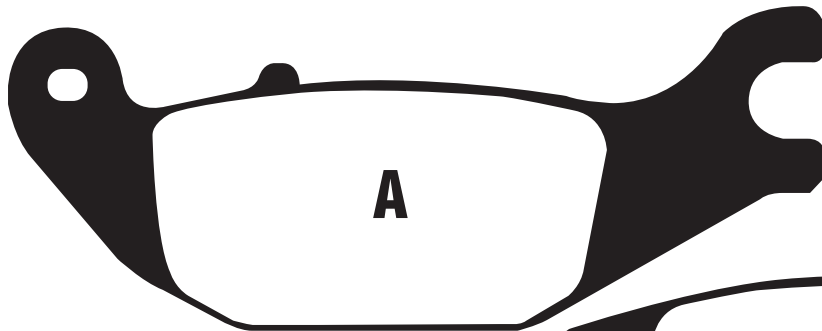

AJS			
Regal Raptor CR3-125	06	R	
HERO			
Karizma ZMR 230	11-12	R	
HONDA			
CBR 125 R4/R5/RS5/RW5/RW6/RW7/RW8 /RW9/RWA (6 bolt front disc/Canada)	04-10	R	
XL 125 V1-VA Varadero	01-11	R	
Z 125 Monkey ABS	18-20	R	
CBR 150 R	00-03	R	
YAMAHA			
MW 125 Tricity Scooter	14-16	R	

MATERIAL AVAILABILITY AND PART NO.					
STD	OPTIONS				
FA	SFA	HH	R	MXS	EPFA
FA343	SFA343	FA343HH	-	-	-

Equivalents OE #
06435 KPC 641
06435 KPC 643
06435 KPP 901
06435 KPP 902
06435 KOF T01

FA344 65.5 x 44.75 x 11.65mm

YAMAHA

YFM 660 FWAP/FWAR/FWAS/FWAT/FWAW
/FGW/FGX Grizzly
YFM 660 FR/FS/FT Grizzly
LX 700-4A Quad

02-08 R
03-05 R
08-09 R

CCM

LX 700-4A Quad

08-09 R

C F MOTO

CF 500 5B/5C-C/Force 500 Classic
CF 500-C/Force (X5 Terralander)
CF 500 5 - Ranger UTV
CF 625-C/Force (X6 Terralander)
CF 800-2 - C/Force (ATV)

14-15 R
11-15 R
11-14 R
11-15 R
14-15 R

EXPLORER

Atlas 500/4x4
Everest 500 L/4x4

08-09 R
08-09 R

GOES

G 520 F (Quad)
520 Max (Quad)
G 520 UTX (Side x Side)
G 525 (4x4)
G 525 4x4 Max
G 625i (All models)
G 625i (4x4)
G 625i 4x4 Max
G 625i UTX 4x4 (Side x Side)
G E-SSV Electric (Side x Side)

07-14 R
07-14 R
10-12 R
12-13 R
12-13 R
12 R
12-14 R
12-14 R
12-13 R
12-13 R

QUADZILLA

CUV 500 Side x Side
QZ 500 E/ES 4x4
RL 500 MKII Buggy
RS5 4WD
RS6 EFI 4WD
Z6 4x4
X8 (4x4/EFi)
WT MOTORS
WT 500 Alaska Quad

10-11 R
09-11 R
10-11 R
10-11 R
10-11 R
10-13 R
12-15 R
08-09 R

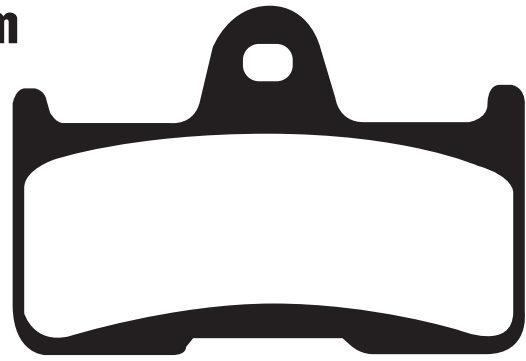

MATERIAL AVAILABILITY AND PART NO.					
STD	OPTIONS				
FA	V	HH	R	MXS	EPFA
FA344TT	-	-	FA344R	-	-

Equivalents OE #	
5KM W0046 00	9010 0805A0
901 08 05 01	9010 0805B0
901 08 05 10	9010 080510

FA345HH 91.7 x 49.3 x 8.1mm

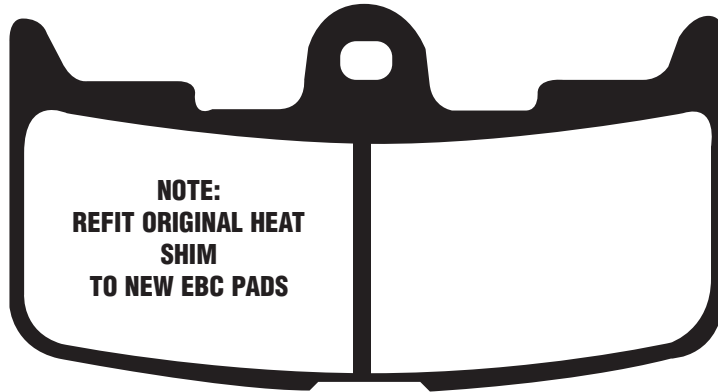

**NOTE:
REFIT ORIGINAL HEAT
SHIM
TO NEW EBC PADS**

BUELL

Firebolt XB9R
XB9S Lightning
XB9SX Lightning City X
XB9 SX Lightning
XB 12 S Lightning
XB 12 R Firebolt
XB 12 SS Lightning Long
XB 12 SCG Lightning
XB 12 X Ulysses
XB 12 XT Ulysses
XB12 STT Lightning

02-07
03-04
05-09
08-10
04-08
04-08
06-08
06-08
06-10
08-10
08

F
F
F
F
F
F
F
F
F
F
F

MATERIAL AVAILABILITY AND PART NO.				
STD	OPTIONS			
FA	HH	R	MXS	EPFA
-	FA345HH	-	-	EPFA345HH

Equivalents OE #
H0300-02A8

DISC PADS
BUYERS GUIDE

DO NOT REFIT ANY SHIMS/INSULATORS TO EBC PADS FROM ORIGINAL PADS UNLESS INSTRUCTED
ON NOTE ON PAD PACKAGING AND ON FA DRAWING ASSOCIATED WITH THAT PAD.

FA346 60 x 44.8 x 11mm



DISC PADS
BUYERS GUIDE

DO NOT REFIT ANY SHIMS/INSULATORS TO EBC PADS FROM ORIGINAL PADS UNLESS INSTRUCTED
ON NOTE ON PAD PACKAGING AND ON FA DRAWING ASSOCIATED WITH THAT PAD.

ALFER									
EVX 400 Electric	12-13	R		CRM F 125 X (Derapage Competition 4T)	10-11	R			
FANTIC				CRM 125 (Derapage RR 2T)	11	R			
TR 125 CR (2T) Cross Competizione	13	R		CR 150 R/R2	07-09	R			
TR 125 MR (2T) Motard Competizione	13	R		CR 230 Easy Trail	04	R			
TZ 125 CS Caballero Cross (2T)	11-12	R		CRF 230 Easy Enduro	04	R			
TZ 125 ES Regularita Scuderia (2T)	11-12	R		CRF 230 Easy Motard	04	R			
TZ 125 SM Caballero Motard (2T)	11-13	R		CRE 250	02	R			
TZ 170 E Regularita Casa (125E/4T)	11-15	R		CRE 250 R Supermotard	02-03	R			
TZ 170 ER Caballero Regularita	11-15	R		CRE 250 R Enduro	02-06	R			
TZ 170 M Motard Casa (125SM/4T)	11-15	R		CRE 250 X		R			
TZ 170 MR Motard Competizione (125 MR 4T)	11-15	R		CRE F 250 X	08-11	R			
TX 180 E Regularita Casa 50E (49cc/2T)	11-15	R		CRM 250 X Supermoto	07	R			
TX 180 ER Regularita Competizione (49cc/2T) 50ER	11-15	R		CR 250 R Moto	04	R			
TX 180 ES Regularita Scuderia (49cc/2T) 50ES	11-15	R		CRE 250 F Enduro	04	R			
TX 180 M Motard Casa (49cc/2T)	11-15	R		CRF 250 Motard	04	R			
TZ 180 MR Motard Competizione (49cc/2T) 50MR	11-15	R		CRF 250 F	04-08	R			
TZ 200 ER Caballero Regularita Competizione (200ER/4T)	11-15	R		CRF 250 R	08-09	R			
TZ 200 MR Motard (200 SMR 4T)	11-15	R		CRE F 290 X	07	R			
TZ 250 ES Regularita (2T)	11-12	R		CRE F 300 X	08-09	R			
TF 250 ES Regularita (4T)	11-13	R		CRE 450 F Enduro	02-06	R			
TR 250 ES (2T) Enduro Six Days	13	R		CRE 450 F	02	R			
TR 300 ES (2T) Enduro Six Days	13	R		CRF 450 Motard	04	R			
TZ 300 ES Regularita Scuderia	11-12	R		CRE 450 F Supermoto	02-03	R			
HONDA				CRE 450 X		R			
CR 125 R2/R3/R4/R5/R6/R7	02-07	R		CRF 450 R	04-08	R			
CRF 150 R Small wheel (FR 17"/RR 14")	07-20	R		CRM F 450 R/X Supermoto	07	R			
CRF 150 RB Big wheel (FR 19"/RR 16")	07-20	R		CRE F 490 X	07	R			
CR 250 R2/R3/R4/R5/R6/R7	02-07	R		CRM F 490 X Supermoto	07	R			
CRF 250 R4/R5/R6/R7/R8/R9/RA/RB/RC/RD/RE/RF/RG	04-16	R		CRE F 500 X	08-09	R			
CRF 250 RE (Limited Road Use)	16	R		CRM F500 X	11	R			
CRF 250 R (260mm F/Disc)	15-20	R		MEGELLI					
CRF 250 X	04-20	R		125 M	08-10	R			
CRF 250 XRL (Road legal)	14-20	R		PUZEY					
CRF 450 R2-R9/RA/RB/RC/RD/RE/RF/RG	02-16	R		MTD 300 (4T/4V) (Motard model)	11-12	R			
CRF 450 RE (Limited Road Use)	16	R		MX 300 (4T/4V) (Enduro model)	11-12	R			
CRF 450 R (260mm F/Disc)	15-20	R							
CRF 450 X5/X6/X7/X8/X9/XB/XC/XD/XE/XF/XG/XH	05-20	R							
CRF 450 XRL (Road legal)	14-16	R							
CRF 450 RX (18" Rear Wheel)	17-20	R							
HONDA-DALL'ARA									
CRE 125 R Supermotard	02-06	R							
CRE 125 R Enduro	02-03	R							
CRE 125 R Enduro	04-07	R							
CR 125 Motard	04-06	R							
XR 250 SM	04	R							
XR 400/440 R	04	R							
XR 400/440 SM	04	R							
HONDA-HM (ITALY)									
CR 50 Derapage RR From ZEN50XACMA7700385	07-09	R							
CRE 50 Baja RR From ZENOXACEA7700325	07-09	R							
CRE 50 Six Competition	07-08	R							
CRE 50 Six Competition	10-12	R							
HONDA-HM (ITALY) Contd.									
CRM 50 Derapage Competition	07-08	R							
CRM 50 Derapage Competition	09	R							
CRE 125 R Supermotard	02-03	R							
CRE 125 R Enduro	04-06	R							
CR 125 Motard	04	R							
CRE 125 R Enduro	02-03	R							
CRE 125 (Six Competitin 2T)	11	R							
CRE 125 (Baja RR 2T)	11	R							
CRE F 125 X	09	R							
CRE F 125 X Six 4T	10-11	R							
CRM 125 R Supermoto	07	R							
CRM F 125 X	09	R							
CRM 125 (Derapage Competition 2T)	11	R							

MATERIAL AVAILABILITY AND PART NO.					
STD	OPTIONS				
FA	V	HH	R	MXS	EPFA
FA346TT	-	-	FA346R	MXS346	EPFA346HH

Equivalents OE #
06435 KZ4 J41
06435 KRN 711
06435 KRN 712
K01306075

FA347 69.5 x 49.55 x 7mm

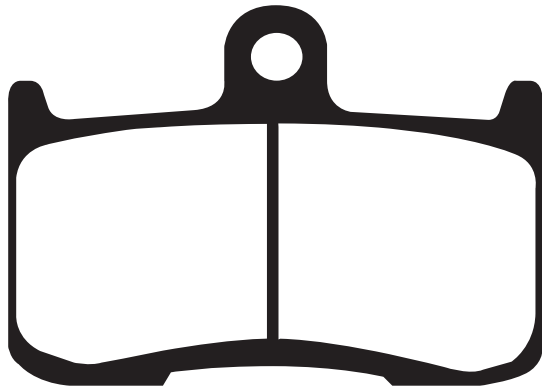

NOTE: Early gold coloured caliper with staggered piston diameters/caliper body shows curved shape

HONDA					
RS 125 (Radial caliper)	04-07	F			
NSF 250 R	12-13	F			
KAWASAKI					
Z 800 E (Z 800 DDS/DEF/DFG - ABS Model)	13-16	F			
Z 800 (Z 800 ADS/AEF/AFF/AGF - Non ABS)	13-16	F			
Z 800 (Z 800 BDS/BEF/BFF/BGF ABS Model)	13-16	F			
Z 900 (ZR 900 AHF/AJF - Non ABS)	17-20	F			
Z 900 (ZR 900 BHF/BJF/DJF - ABS)	17-20	F			
Z 900 RS ABS (ZR 900 CJF/EJF ABS)	18-20	F			
Z 900 RS Café (ZR 900 CJF/CJFB ABS)	18-20	F			
ZX9R (ZX 900 F1/F2)	02-04	F			
Z 1000 (ZR 1000 A1/A2/A3)	03-05	F			
SUZUKI					
GSX-S 750 AL7/AZL7/AL8/AZL8AL9/ALZ9	17-19	F			
GSX 1300 BKK8/BKK9/BKL0/BKL1 B-King	08-12	F			
YAMAHA					
TZ 250 (Radial Caliper)	02-10	F			
INDIAN					
Chief Classic (Spoke Wheel/Nissin Calipers)	14-18	F			
Chief Vintage (Spoke Wheel/Nissin Calipers)	14-20	F			
Chieftain (Cast Wheel/Nissin Calipers)	14-20	F			
Chieftain Dark Horse (Cast Wheel/Nissin Calipers)	16-20	F			
Chieftain Limited (Cast Wheel/Nissin Calipers)	17-20	F			
Chief Dark Horse	14-20	F			
Roadmaster (Cast Wheel/Nissin Calipers)	15-20	F			
Roadmaster Classic (Nissin Calipers)	17-18	F			
Roadmaster Elite (Nissin Calipers)	17-20	F			
Springfield	16-20	F			
Springfield Dark Horse	18	F			
MORIWAKI/HONDA					
MD 250 H/S	08-13	F			
TRIUMPH					
Daytona 675	06-08	F			
Street Triple 675 R	09-16	F			
Street Triple RX675	15-16	F			
Speed Triple (1050cc) (Nissin Radial caliper)	05-06	F			

Tiger 1050 (radial caliper)	07-12	F
Tiger SE - ABS (1050cc)	10-13	F
Tiger Sport (ABS) 1050cc	13-18	F
Triple Sport 1050cc	13-18	F
VICTORY		
Boardwalk (Spoke Wheels)	13-15	F
Cory Ness Jackpot	08-10	F
Cory Ness Victory Cross Country	11-12	F
Cross Country	10-17	F
Cross Country Tour	13-17	F
Cross Country 8 Ball	15-16	F
Cross Roads	10-12	F
Cross Touring	13-14	F
Cross Roads Classic (Spoke Wheel)	13-14	F
Cross Roads 8-Ball (Cast Wheel)	14	F
Gunner	15-17	F
Hammer	08-11	F
Hammer S	08-17	F
Hammer 8 Ball	10-16	F
Hard Ball	12-13	F
Highball (Spoke & Cast Wheel)	12-17	F
Jackpot	10-16	F
Judge	13-17	F
King Pin	08-12	F
Kingpin Tour	08-09	F
Kingpin 8-Ball	08-11	F
Kingpin Low	09	F
Magnum	15-17	F
Vegas 8-Ball	08-17	F
Vegas	08-17	F
Vegas Low	08-09	F
Vegas Jackpot	08-09	F
Zach Ness Vegas	11-12	F

Equivalents OE #	
43082 1290	06455 NX4 860
43082 0002	59100 23840
5KE W0045 00	45105 NX7 006
T 2020 329	06455 NX7 006
T 2020 475	43082 0129
59100 23830	43082 0168

MATERIAL AVAILABILITY AND PART NO.					
STD	OPTIONS				
FA	HH	R	MXS	EPFA	GPFA
-	FA347HH	-	-	EPFA347HH	GPFA347HH

FA348 63.35 x 60.32 x 8.9mm



YAMAHA

FZS 1000 Fazer	01-05	R
XJR 1300 C / Racer	15-16	R
XJR 1300 N/P (5EAP/5EAR/5EAS/5EAT/5EAW /5EAV/5EAY) (298mm front disc)	01-02	R
XJR 1300 R/S 5WM1/5WM3/5WM5 /5WM6/5WM7/5WM9	03-04	R
XJR 1300 T/V/W/X/Y 5WMA/5WMC /5WMD/5WMF	05-14	R

MATERIAL AVAILABILITY AND PART NO.					
STD	OPTIONS				
FA	HH	R	MXS	EPFA	GPFA
FA348	FA348HH	-	-	-	-

Equivalents OE #
5LV W0046 50

FA349 A. 119.55 x 26.1 x 7.1mm

B. 94.54 x 35.6 x 7.8mm

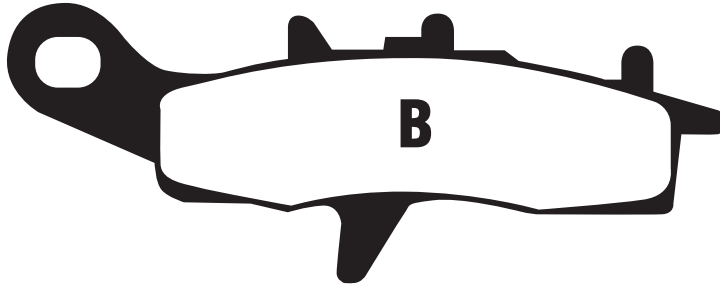
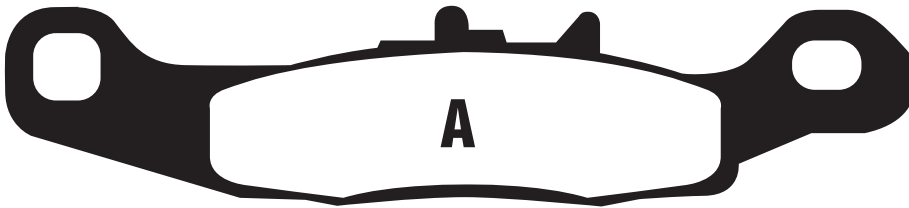

KAWASAKI

KFX 450 R Quad (KSF 450 B8F /B9F/BAF/BBF/BCS/BDF/BEF)	08-14	F(right)
KVF 650 A1/A2 Prairie	02-03	F(right)
KVF 650 D1/D6F/D7F/D8F/D9F/DAF/DBF		
Brute Force 4x4	05-11	F(right)
KVF 650 E1/E6F/E7F/E8F/E9F		
Brute Force 4x4 Hardwoods Green HD	05-09	F(right)
KVF 700 A1/B1/A2/A6F/B2/B6F/A7F/A8F		
4x4 (Prairie)	04-08	F(right)
KVF 700 D1 Team Green	05	F(right)
SUZUKI		
LT-V 700 FK4/FK5 Twin Peaks	04-05	F(right)

MATERIAL AVAILABILITY AND PART NO.					
STD	OPTIONS				
FA	V	HH	R	MXS	
-	-	-	FA349R	-	

Equivalents OE #
43082 1273
43082 0078

FA350 50.1 x 47.4 x 6.8mm

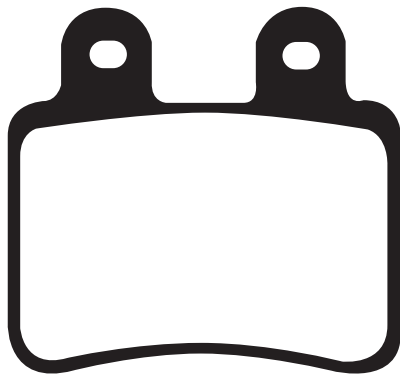

ITALJET

Jet Set 50/125/150
Millenium 100/125/150

MALAGUTI

X3M Enduro (Spoke wheel)

MASH

Two Fifty 250

MBK

X-Limit Enduro
X-Limit Supermoto

PEUGEOT

Elystar 50 TSDi
Elyseo 125/150

Elystar 125/150 (3 bolt fixing - front disc)

Elystar 125/150 (5 bolt fixing - front disc)

Jet Force 125 (All models)

Satelis 125 RS

Satelis 125 (AJP Calipers)

Geopolis 125 Executive/Non ABS
(AJP calipers)

Geopolis 125 Urban/ABS (AJP Calipers)

Satelis 125 Blacksat (AJP Calipers)

Satelis 125 Whitesat (AJP Caliper)

Satelis RS 125 (AJP Calipers)

Satelis Urban 125 (AJP Caliper/ABS)

Geopolis 250 Urban/ABS (AJP Calipers)

Geopolis 250 Executive

(AJP Calipers/Non ABS)

Satelis 250 Urban (AJP Calipers/ABS)

Geopolis 400 Urban (AJP Calipers/ABS)

RIEJU

02-03 F RS2 Matrix (50cc)

02-04 F Tango 50

Tango 50 (Spoke wheel)

08-10 F Tango 50 Motard

Tango 50 (2T)

14-16 R Tango 50 (4T)

RS2 125

03-09 F&R 125 NKD

03-09 R SMX 125

Tango Pro 125

Tango 125

RS2 Matrix

Tango 250

SCORPA

T-Ride 125 F

T-Ride 250 F (Enduro)

SHERCO

Enduro/Urban/SU 50cc (2T)

(Spoke wheel)

R SU 50cc (2T) Urban Base (Cast Wheels)

R SM 0.5 "Black Panther"

R Supermotard SM50

R City Corp 125 (All models)

R SM 1.25 F Black Panther (4T)

R SE1.25 F Enduro (4T)

YAMAHA

DT 50 R

DT 50 X

XT 125 R

R (3D61/3D63/13D1/13D3/13D5)

XT 125 X (3D62/3D64)

XT 125 X (13D2/13D4/13D6)

CPI			
SM 250	11-12	R	
SX 250	11-12	R	
DERBI			
Senda DRD Pro 50 R			
Radial caliper/260mm disc	05-13	R	
Senda DRD Pro 50 SM			
Radial caliper/300mm disc	05-14	R	
Senda DRD 50 Evo SM (Cast wheels)	08-11	R	
Boulevard 125	03-07	F	
Cross City 125	07-14	R	
GP1 125cc Racing Low seat/radial			
caliper 6 bolt disc fixing	07-09	R	
Senda 125 SM (Twin headlight)	04-07	R	
Senda R 125 SM	04-07	R	
Senda R 125	04	R	
Senda R Euro 2 125	04-07	R	
Senda 125 Baja (4T) (260mm disc)	06-12	R	
Senda 125 Baja SM (4T) (300mm disc)	06-12	R	
Boulevard 150	03-07	F	
Boulevard 200	05	F	
GP1 250cc Racing Low seat/radial			
caliper 6 bolt disc fixing	07-09	R	
HONDA HM (Italy)			
CRE 50 Baja/Six/Derapage	03-09	R	
CRE 50 Baja RR Up to			
ZEN50XACEA7700324	07-09	R	
CRE 50 Derapage RR Up to			
ZEN50XACMA7700384	07-09	R	

MATERIAL AVAILABILITY AND PART NO.					
STD	OPTIONS				
FA	TT	HH	SFA	SFAC	HH
FA350	FA350TT	FA350HH	SFA350	SFAC350	SFA350HH

Equivalents OE #		
745658	00H01304931	11967300
4722090	K01303070	1160
755981 1160	7588626	PE 745658
00G01202221	00H01302551	0/000 930 7001
3D6 F5811 00	862900	114140003300A
1D4 F5742 00	S11D 40202 00	

FA351 36 x 39 x 6mm

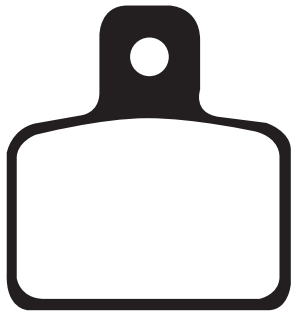

NOTE Same shape as FA471 but has larger friction area.

APRILIA

Mini RX 50 Experience 04 F

BETA

Minicross Pro Race 12/10 04-06 F&R

Minitrial 50 (A/C) 09-12 F

Minitrial LC (Hydraulic Brakes) 13-15 F

Pro Race 50 05 R

FACTORY

Phantom R14 Agua 04 F

GAS-GAS

TXE Electric Bike 20 R

Cross MC 50 06 R

EC 50 06-07 R

TXT 50 Cadet 06-09 F

TXT 50 Rookie 04-09 R

Cross MC 65 06 F&R

TXT Cadet 80 06 F&R

TXT 80 Rookie 04-09 R

TXT 80 (Cadet) 07-09 R

TXT 80 Pro Racing (2T) 15 R

TXT 125 Randonne (4T) 11-15 R

TXT 200 Randonne (4T) 14-15 R

TXT 125/200/250/280/300 (TXT PRO) 04-11 R

TXT 125/250/280/300 (For models with Formula front caliper/single pin pad fixing) 12 R

TXT 125/250/280/300 (For models with AJP caliper/2 pin pad fixing) 12-14 R

TXT-E (Full size electric bike) 12-14 R

GAS-GAS Contd.

TXT 250 Contact (4T) 15 R

TXT Racing 125/250/280/300 (2T Monobloc Caliper) 14-15 R

TXT Replica Factory Models 125/250/280/300 (2T Monobloc Caliper) 13-14 R

EC 50 Boy (Air cooled) 05 R

EC 50 Boy (LC) 05-07 R

MX 65 05-08 F

HONDA HM (Italy)

Baja 10/10 JR & SR 99-07 F&R

Baja 12/14 MX 99-09 F&R

HUSQVARNA

CR 50 Senior Pro 05 F

CR 50 Junior 05 F

TE 100 05 F

METRAKIT

XL 80 Mini GP 09 R

Pre GP 125 09 R

MONTESA/HONDA

Honda 315 R 01-04 R

250 4RT Cota 05-10 R

260 4RT Cota (STD Version ED/3E) 14-18 R

260 4RT Cota (Repsol Edition 2E/4E) 14-18 F

4 Ride Enduro (260cc/4T) 16-18 R

Cota 300 RR (4T) 16 R

OSSA

TR 125 i 13-15 R

TR 250 i 14-15 R

TR 280 i 10-15 R

250 i Explorer 14-15 R

280 i Explorer 12-15 R

TR 300 i 14-15 R

POLINI

XP4 Street 50 10" wheels 14-15 R

XP 65 R 14-15 R

XP4 Street 125 10" wheels 14-15 R

XP4 Off Road 125 14-15 R

14" front/12" rear wheel 12-15 R

14-15 R

SACHS

Dirty Devil 125 08 F&R

SCORPA

*SR 125 (2T) 09-13 R

*SR 125 Long Ride (2T) 09-11 R

*SY 125 F 03-08 R

*Note: Check friction shape with FA471 to get correct pad

SY 125 4T Long Ride 09-10 R

SY 125 FR (4T) 03-11 R

TYS 12F Long Ride 06-08 R

Twenty 125 (2T) 15 R

TY 125 (4T) 11-15 R

TYS 125 F 06-08 R

SY 175 F 06 R

SCORPA Contd.

TY-S 175 F 06 R

SY 200 F (4T) (163cc) 08 R

SY 250 (2T) 00-05 R

SY 250 Long Ride (2T) 04-06 R

SY 250 F (4T) Long Ride 07-08 R

SY 250 F 06-10 R

SY 250 FR Long Ride 10 R

SY 250 FR 06-10 R

SY 250 R (2T) 00-09 R

SR 280 (2T) 09-14 R

SR 280 (2T) Long Ride 09-11 R

Twenty 250 (2T) 15 R

Twenty 300 (2T) 15 R

Roadster 660 07 R

SHERCO

Trials 0.8 (2T) 01-10 R

ST 80 (2T/Formula Caliper) 13-14 R

ST 80 (2T/Braktec Caliper) 14-15 R

FST 125 18-19 R

125 ST-R 18-19 R

125 TY Classic 18-19 R

Trials 1.25 (2T/AJP Caliper) 06-12 R

ST 125 (2T/Formula Caliper) 13-14 R

ST 125 (2T/Braktec Caliper) 14-15 R

XY 125 (4T) 14-15 R

Trials 2.5 (2T/AJP Caliper) 06-12 R

ST 250 (2T/Formula Caliper) 13-14 R

ST 250 (2T/Braktec Caliper) 14-15 R

250 ST Factory 18-19 R

250 ST-R 18-19 R

Trials 2.9 (2T/AJP Caliper) 06-12 R

ST 290 Cabestany Replica (2T/Formula Caliper) 12 R

ST 290 (2T/Formula Caliper) 13-14 R

ST 290 (2T/Braktec Caliper) 14-15 R

300 FST 18-19 R

300 ST-R 18-19 R

Trials 3.2 (4T/AJP Caliper) 05-12 R

ST 305 (2T/Formula Caliper) 13-14 R

ST 305 (2T/Braktec Caliper) 14-15 R

TOMOS

MC 50 Senior Pro 05-07 F&R

XISPA

X 125 R 08-09 R

X 250 R 08-09 R

X 280 R 08-09 R

MATERIAL AVAILABILITY AND PART NO.				
STD	OPTIONS			
FA	V	HH	R	MXS
FA351TT	-	-	-	-

Equivalents OE #		
43105 NN3 820	BT280222068	S10B-40202-00-00
7040	KM0961320	43105 NN3 830
C390	810K0209	

FA352 37.55 x 31.3 x 5.55mm

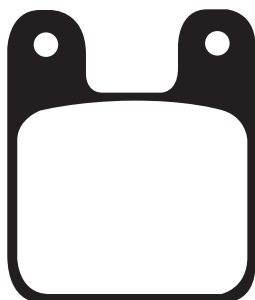

MINI MOTO

Pasini/GRC Calipers (Square 2 pin type) F&R

POLINI

Mini Motard 110cc 10" wheels (2 pin fixing) F&R

XP4T 110cc Cross 14" front/12" rear wheel F&R

XP4T 110cc Cross 12" front/10" rear wheel F&R

Equivalents OE

144 750 008

MATERIAL AVAILABILITY AND PART NO.					
STD	OPTIONS				
FA	V	HH	R	MXS	EPFA
FA352	-	-	-	-	-

SFA353 A. 96.8 x 39.35 x 9.3mm B. 77 x 42 x 9.3mm

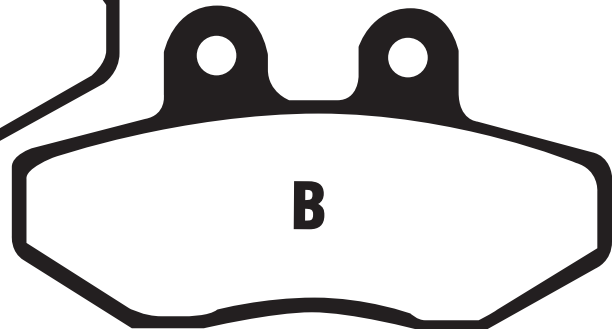
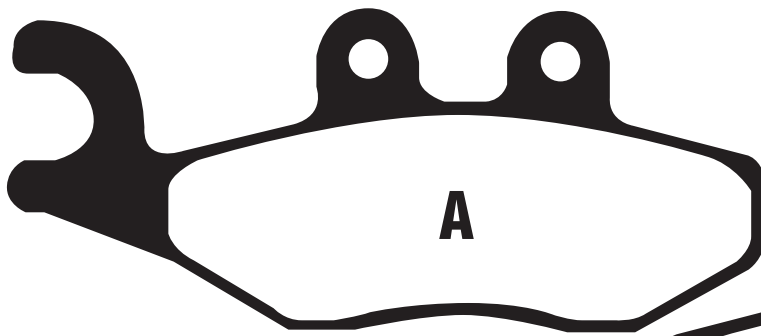

NOTE: HENG TONG CALIPER

DISC PADS
BUYERS GUIDE

DO NOT REFIT ANY SHIMS/INSULATORS TO EBC PADS FROM ORIGINAL PADS UNLESS INSTRUCTED ON NOTE ON PAD PACKAGING AND ON FA DRAWING ASSOCIATED WITH THAT PAD.

APRILIA		PIAGGIO Contd.		RIEJU	
Sport City One 50 (2T)	08-11	F	Super Hexagon 125/180 (12" wheels)	01-03	F
Sport City One 50 (4T)	08-10	F			F
SR 50 Motard (2T)	12-15	F	Typhoon 125 (4T) (12" wheels)	10-15	F
SR 50 Motard (4T/4V)	12-15	F	Xevo 125	07-16	F
Sport City One 125cc	08-11	F	X7 125cc	08-09	F
SR 125 Max (4T)	11-15	F&R	X7 Evo 125 ie (EFI)	09-12	F
SR 125 Motard (4T)	12-15	F	X8 125 (Brembo Rear Caliper)	04-05	F
SR 300 Max (4T)	11-15	F&R	X8 125 (Heng Tong Rear Caliper)	05-06	F
SRV 850	12-14	R	X8 125 ie (Heng Tong Rear Caliper)	07	F
DERBI			X8 125/Street	07	F
Boulevard 50 (2T)	09-12	F	X9 125 Evolution	05-07	F(left)
Boulevard 50 (4T)	09	F	X10 125ie (4V/4T/EFI/All models)	12-15	F(left)
Vibrant Sport 50 (2T)	12	F	Fly 150 (4T)	05-12	F
Boulevard 125 (4T)	08-12	F	Liberty 15 (2V/4T)		
Vibrant Sport 125 (4T)	12	F	10 spoke cast wheels	09-12	F
GILERA			Liberty 150 (2V/4T)		
DNA 50 (Heng Tong Caliper)	01-05	F	10 spoke cast wheels	13-15	F
Runner 50 P/SP	06-14	F	Liberty 150 Full optional		
125 VX/180 VXR (4T)	01-04	F	(4T/3V/10 spoke wheel)	13-15	F
DNA 125/180 (Heng Tong Caliper)	01-03	F	X8 150 Street	07	F
FX/FXR 125/180 Runner (Rear drum brake model/Heng Tong front caliper)	97-02	F	Beverly B 200	02-05	F&R
Runner 125/180 FX/FXR/SP (2T)	99-02	F	Carnaby 200	07-09	F&R
VXR 200 Runner (4T)	02-04	F	GT 200 L Granturismo		
Nexus 125	07-12	F&R	Heng Tong Caliper	03-06	F
Nexus 250 ie	07-08	F&R	X8 200 (Heng Tong Rear Caliper)	04-05	F
VX 125 Runner/ST (4T)	05-14	F	Beverly 250 (Carb)	04-07	F&R
VX 200 Runner/ST (4T)	05-11	F	Beverley 250 ie	06-07	F&R
Nexus 300 i	08-12	F&R	Beverley S 250 ie	07	F&R
Fuoco 500 RC/ie	07-13	R	Beverley Tourer 250 ie	08-09	F&R
Fuoco 500 LT (4V/4T)	13-15	R	Beverley Cruiser 250 ie	07-08	F&R
GP 800 (Chain drive)	08-14	R	Carnaby 250 ie	08-09	F&R
KEEWAY			X7 250cc ie	08-09	F
K2 125/150/250	07	F&R	X8 250 ie	05-07	F
PEUGEOT			X9 250	05-06	F(left)
Citystar 125 i	11-14	F	Xevo 250 ie	07-10	F
Citystar 125 Active	13	F	Beverly 300 (278cc/4T)		
PIAGGIO			Beverly 300 ie S	10-15	F
Fly 50 (2T)	05-18	F	Beverly Police 300 ABS	14-20	F
Fly 50 (4T)	05-18	F	ASR (278cc)	16-18	F
Liberty 50 (2T/4T) (10 spoke cast wheels)	09-20	F	Carnaby 300 ie	12	F&R
Typhoon 50 (2T) (12" wheels)	10-20	F	Carnaby Cruiser 300	08-11	F&R
Fly 100 (4T)	07-15	F	Beverly 350 ie Sport Touring ABS (330cc/4T)	16-20	R
Beverley 125	07	F	X7 300 Evo	09-12	F
Beverley B125	02-06	F&R	X10 ie 350 (4V/4T/EFI) All models	12-14	F(left)
Beverley Tourer 125	08-09	F&R	Beverley 400 ie	07	R
Beverly 125 (4T) (Multi spoke cast wheel)	11-14	F	Xevo 400 ie	07-11	F(left)&R
Beverley S 125	07	F&R	MP3 400 ie	07-09	R
Beverly 125 ie S	14-15	F	MP3-LT 400 ie	09-10	R
Carnaby 125	07-09	F&R	X8 400 ie	06-08	F(left)&R
Fly 125 (4T/2V)	05-11	F	MP3 Touring Business 500 ie	11-12	R
Fly 125ie (3V/4T)	12-14	F	MP3 500 LT Business	11-15	R
Fly 125 (4T/3V) Rear Disc Model	12-15	F	MP3 500 LT Business ABS (13 Inch Front Wheel /14 Inch Rear Wheel)	14-20	R
Liberty 125 (2V/4T) 10 spoke cast wheels	09-15	F	MP3 Touring Sport 500 ie	11-12	R
Liberty 125 Full optional (4T/3V/10 spoke wheel)	13-15	F	MP3 500 LT Sport	11-15	R
New Fly 125 ie (3V)	12-13	F	MP3 500 LT Sport ABS (13 Inch Front Wheel /14 Inch Rear Wheel)	14-20	R
Skipper ST 125/150 4T	00-04	F	X10 500ie (4V/4T/EFI) All models	12-14	F(left)
Super Hexagon GTX 125/180 (11" wheels)	00	F			

MATERIAL AVAILABILITY AND PART NO.					
STD	OPTIONS				
SFA	SFAC	HH	R	MXS	EPFA
SFA353	SFAC353	SFA353HH	-	-	-

Equivalents OE #	
497072	650983
497116	651253
647078	668017

FA354 97 x 51.7 x 6.95mm

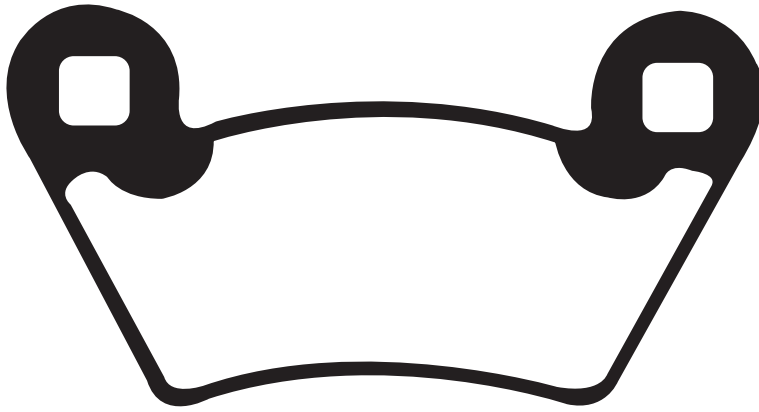

POLARIS

Ranger (2x4/4x4)	02-05
UTV 2x4 (Utility task vehicle series 10) 03	
PPS/UTV/Series 10 2x4	
PPS/UTV/Series 10 4x6	
PPS/Series II UTV 1500 2x4	
Ranger Series 10 "500 6x6"	
Ranger Series 11	
PPS/Series 11 2x4/4x4	
PPS/Series 11 6x6	
Ranger 6x6	04-05
Ranger TM	04-06
Ranger XP	05
Ranger 2x4/4x4	04-06
325 Sportsman Ace	14
325 Sportsman Ace Efi	15
325 Sportsman Ace Euro	14-15
325 Sportsman Ace HD	15
400 Ranger	10-14
Ranger EV (Electric)	10-11
Ranger 500 (2x4/4x4)	06-07

POLARIS Contd.

F&R Ranger 500 (4x4 EFI)	06-07
F&R 500 Ranger 4x4 EFI	08
F&R 500 Ranger 2x4	08
F&R 500 Ranger (Carb) 2x4	09
F&R 500 Ranger (EFI) 4x4 HO	09-11
F&R 500 Ranger Series 10 6x6	
F&R 500 Ranger Crew	11-13
F&R 500 Ranger 4x4 Efi	11-13
F&R 500 Sportsman Touring HO	11-13
F&R 570 Ranger Crew	14-15
F&R 570 Sportsman Ace	15
F&R 570 Sportsman Ace Euro	15
R Ranger 6x6 EFI 700	06-09
R Ranger XP 700 4x4	06/08
R Ranger EU Electric	10-14
R 700 Ranger 4x4 EFI/LE	07
R 700 Ranger 4x4 EFI	09
R 700 Ranger 6x4 EFI	08
R Ranger TM	06
F&R 800 Ranger HD	10-11

POLARIS Contd.

F&R 800 Ranger XP	10-12	R
R 800 Ranger 6x6	10-14	R
R 800 Ranger RZR 4 EPS	12	R
R RZR-4 800 EFI	10-14	R
R 900 D Ranger Diesel	11-14	R
F&R Ranger RZR XP 900	11	R
R Ranger RZR XP 900 White Lightning LE11		R
F&R 900 Ranger RZR XP EFI	12	R
R 900 Ranger RZR XP	12	R
R 900 XP Ranger	13-15	R
R 1000 Ranger Diesel	15	R
R 1000 Ranger Diesel Crew	15	R
F&R 325 Ranger ETX	15-16	F&R
F&R Brutus	13-14	R

MATERIAL AVAILABILITY AND PART NO.					
STD	OPTIONS				
FA	V	HH	R	MXS	EPFA
-	-	-	FA354R	-	-

Equivalents OE #
1910514
2202413
2202097

FA355/4 44.9 x 50.75 x 7mm

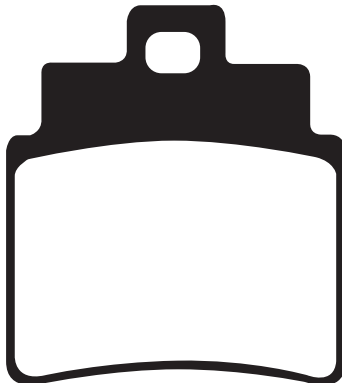

ARCTIC CAT

250 DVX Sport	06-08
300 DVX	09-14
KYMCO	
Grand Dink 250	01-06
KXR 250 Mongoose Quad	04-07
MXU 250	04-13
Urban Quad 250	06
Maxxer 250	12-13
Maxxer 300	06-13
GILERA	
Oregon 250 Quad	07
MASAI	
A 300 Quad	05-07
A 450 Quad	05-07

SYM

R GTS 125 i Joymax (All models)	10-15	F
R GTS 125 i Sport (All models)	14-15	F
R GTS 250	07-08	F
F GTS 250i/Joymax (All models)	09-15	F
R Joymax 250	06	F
R Joymax 250 i	07-08	F
R Voyager 250	05	F
R Voymax 250	06	F
R GTS 300/Joymax (All models)	08-15	F
R GTS 300 i Sport (All models)	14-15	F
R Cruisym 300 ABS	17-20	F
R Joymax Z 300 ABS	17-20	F

MATERIAL AVAILABILITY AND PART NO.								
STD	OPTIONS							
FA	SFA	SFAC	TT	SFA-HH	R	SFA-HH	MXS	EPFA
FA355/4TT	SFA355/4	SFAC355/4	-	SFA355/4HH	FA355/4R	-	-	

Equivalents OE #
45105 HMA 000A
45106 KKC4 9000
00156924

DO NOT REFIT ANY SHIMS/INSULATORS TO EBC PADS FROM ORIGINAL PADS UNLESS INSTRUCTED
ON NOTE ON PAD PACKAGING AND ON FA DRAWING ASSOCIATED WITH THAT PAD.

SFA356 55.5 x 46 x 7.1mm

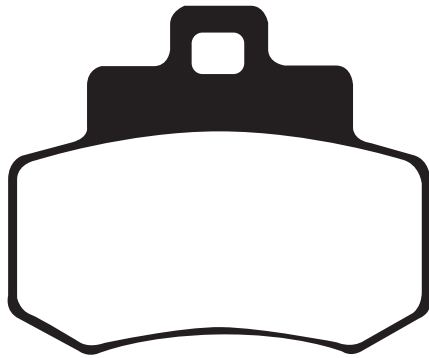

KYMCO
Grand Dink 250

01-06 R

MATERIAL AVAILABILITY AND PART NO.					
STD	OPTIONS				
FA	HH	V	R	MXS	EPFA
SFA356	SFA356HH	-	-	-	-

Equivalents OE #
43105 KKC4 9000

FA357 62.1 x 31.4 x 6.55mm

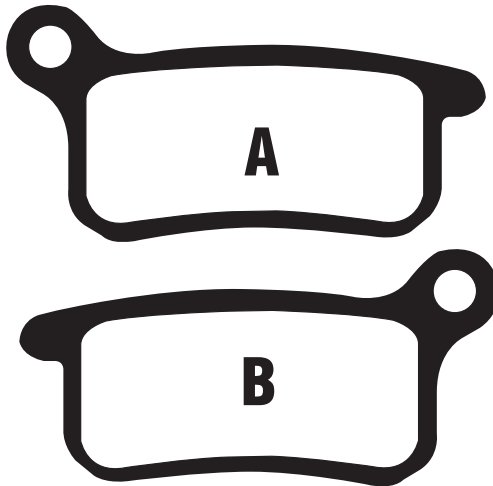

HUSQVARNA

CR 65	11-13	F
TC65	18-20	F&R
KTM		
SX 65	02-08	F
SX 65	09-20	F&R
SX 85	03-10	F&R
SX 85 (17"/14" wheels)	11	F
SX 85 (19"/16" wheels)	03-10	F&R
SX 85 (19"/16" wheels)	11	F
SWM		
MC 650 R	18	F

MATERIAL AVAILABILITY AND PART NO.					
STD	OPTIONS				
FA	V	HH	R	MXS	EPFA
FA357TT	-	-	FA357R	-	-

Equivalents OE #
461 13 030 000
462 13 030 000
470 13 090 000
470 13 090 200
8000H7132

SFA358 A. 86.1 x 40 x 8.9mm B. 86.1 x 40 x 8.9mm

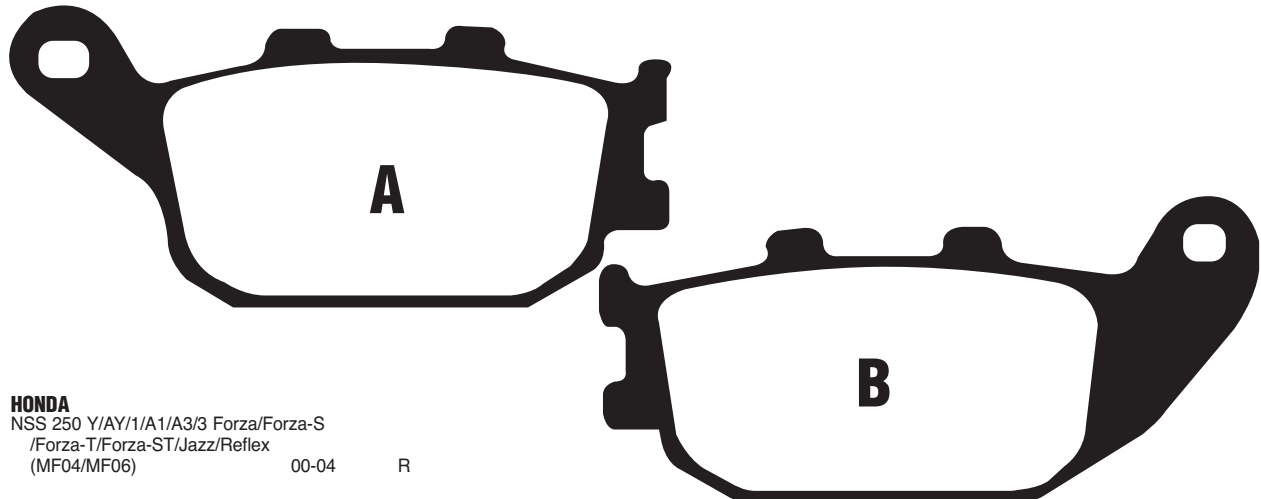

HONDA

NSS 250 Y/AY/1/A1/A3/3 Forza/Forza-S
/Forza-T/Forza-ST/Jazz/Reflex
(MF04/MF06) 00-04 R

MATERIAL AVAILABILITY AND PART NO.					
STD	OPTIONS				
FA	HH	V	R	MXS	EPFA
SFA358	SFA358HH	-	-	-	-

Equivalents OE #
06435 KPB 016

DO NOT REFIT ANY SHIMS/INSULATORS TO EBC PADS FROM ORIGINAL PADS UNLESS INSTRUCTED ON NOTE ON PAD PACKAGING AND ON FA DRAWING ASSOCIATED WITH THAT PAD.

FA363 A. 94 x 37.3 x 8.6mm B. 94 x 37.3 x 10.1mm

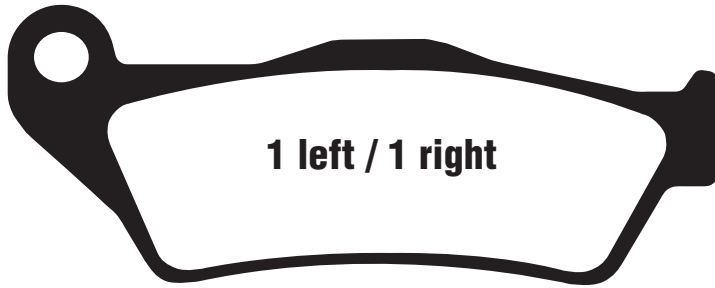

BMW

F 800 R	09-10
R 850 C	97-00
R 850 GS	96-00
R 850 R	94-06
R 850 RT	96-01
R 850 RT	06
S 1000 XR	15-18
R 1100 GS	93-99
R 1100 R	93-01
R 1100 S	96-06
R 1100 RT	94-01
R 1150 R	01-06
R 1150 RS	01-04
R 1150 RT	00-06
R 1150 R Rockster	03-06
R 1150 GS	
(EVO R21/0415/0495)	11/01-03
R 1150 GS (R21/0415/0495)	98-10/01
R 1150 GS Adventure	07/01-06
R Nine T (K21 1170cc)	14-18
R Nine T Pure (K22/1170cc)	16-18
R Nine T Scrambler (K21/1170cc)	16-18
R Nine T Café Racer (K32/1170cc)	16-18

BMW Contd.

R Nine T Urban GS (K33/1170cc)	17-18
HP2 Enduro	05-08
HP2 Megamoto (K25)	07-10
HP2 Sport (K29)	08-11
S 1000 XR	15-20
R 1200	00-02
R 1200 C	96-04
R 1200 RT K26/0368	
Brembo Caliper	05-09
R 1200 RT	10-12
R 1200 RT-SE	10-12
R 1200 ST K28/0328	03-08
R 1200 S K29/0366	
Brembo Caliper	06-07
R 1200 GS	
(K25/0307/Cast/Spoke Wheel)	02-11/07
R 1200 GS Adventure	
(K25/0382/Spoke wheel)	05-11/07
R 1200 GS Adventure/M	
(K25/0380/Spoke wheel)	06-09
R 1200 GS/M	
(K25/0303/Cast/Spoke Wheel)	06-09
R 1200 GS (Cast wheels)	10-12

BMW Contd.

R 1200 GS Adventure		
(Spoke wheels)	10-12	R
R 1200 GS Adventure (30 Years GS)	11	R
R 1200 GS Adventure Triple Black	12-13	R
R 1200 GS Triple Black	11-12	R
R 1200 GS (30 Years GS)	11	R
R 1200 GS Rallye (Spoke wheels)	12	R
R 1200 R SE	10-11	R
R 1200 R Classic	11-14	R
K 1200 S (K40)	05-08	R
K 1200 R (K27/0378)		
Tokico Caliper	11/05-10	R
R 1200 R	12/07-14	R
K 1300 GT	09-11	R
K 1300 GT EE	10-11	R
K 1300 GT SE	10-11	R
K 1300 R	09-12	R
K 1300 R Dynamic	11-15	R
K 1300 R Carbon	12	R
K 1300 S (Non & ABS Models)	09-15	R
K 1300 S Sport	12-15	R
K 1300 S HP	12	R

MATERIAL AVAILABILITY AND PART NO.					
STD	OPTIONS				
FA	V	VLD	HH	R	MXS
FA363	FA363V	-	FA363HH	-	-

Equivalents OE #		
34 21 2 314 997	34 21 2 335 465	34 21 8 556 442
34 21 2 330 633	34 21 7 660 281	

FA366 69.8 x 46.7 x 13.05mm

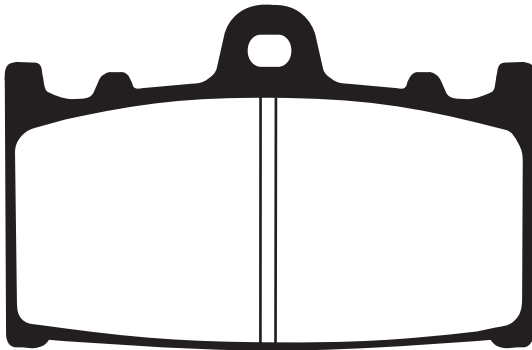

SUZUKI

VL 1500 K2/K3 Intruder	02-03	R
VL 1500 K5/K6/K7/K8 (C 1500 Intruder)	05-08	R

MATERIAL AVAILABILITY AND PART NO.				
STD	OPTIONS			
FA	V	VLD	HH	R
FA366TT	FA366V	FA366VLD	FA366HH	-

Equivalents OE #	
69100	10820

FA367 66.9 x 36.1 x 10.75mm

FA367/2 66.9 x 36.1 x 8.5mm

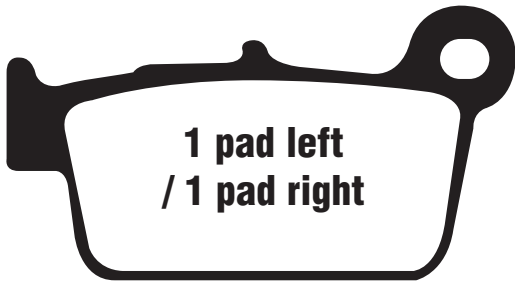

1 pad left
/ 1 pad right

DISC PADS
BUYERS GUIDE

DO NOT REFIT ANY SHIMS/INSULATORS TO EBC PADS FROM ORIGINAL PADS UNLESS INSTRUCTED
ON NOTE ON PAD PACKAGING AND ON FA DRAWING ASSOCIATED WITH THAT PAD.

BETA

Minitrial E	14	F&R	
FA367TT			
APRILIA			
MXV 450	09-13	R	
RXV 450/550 Enduro	06-13	R	
SXV 450/550 Supermotard	06-13	R	
BETA			
RR 125 4T Enduro (LC)	11	R	
FANTIC			
Caballero 50 Regularita			
Competizione	06-09	R	
Caballero 50 Supersei Competizione	07-08	R	
Caballero 125 Regularita			
Competizione	07-09	R	
Caballero Regularita			
Competizione Mini 50	08-09	R	
GAS GAS			
EC 125/200/250/300 (All Models/2T)	09-15	R	
EC 200-250-300 XC 250-300 Euro4	18-20	R	
EC Ranger 200/300	18-20	R	
EC Six Days 250/300	19	R	
MX 125/250	09-11	R	
EC 250 F (All Models/4T)	12-15	R	
EC 300 F (All Models/4T)	13-15	R	
EC 450 F (All Models/4T)	13-15	R	
EC 450 Raid	14	R	
KAWASAKI			
KX 250 F (KX 250 N1/N2)	04-05	R	
KX 250 F (T6F/T7F/T8F)	06-08	R	
KX 250 F (KX 250 W9F/XAFB/YBF /YCF/ZDF/ZEF/ZFF/ZGF) (4T)	09-16	R	
KX 250 F (ZFF/ZGF/AHF/AJF)	15-18	R	
KX 450 F (D6F/D7F/D8F/E9F/EAF /EBF/FCF/FDF/FCF/FFF/HGF /HHF/HJF)	06-18	R	
KX 450 F (JKF)	18-20	R	
KLX 450 R (A8F/A9F/AAF/ABF/ACF /ADF/AEF/AFF/AGF/AHF/AJF)	08-18	R	
SHERCO			
Enduro 2.5i F (4T) (inc SE models)	08-11	R	
SM 2.5i Supermotard	08	R	
SX 2.5i F Moto Cross	10	R	
Enduro SE 3.0i (4T)	10-11	R	
SE 450 iR Enduro (Nissin rear caliper)	12	R	
SM 450i	04-09	R	
Enduro 4.5i	04-10	R	
SM 4.5i F Supermoto	04-07	R	
SM 4.5i F Black Panther	08-12	R	
4.5i Enduro (4T)	06-09	R	
5.1i Enduro	06-09	R	
Enduro 5.1iF	07-11	R	
5.1i Supermotard	06-09	R	
SM 5.1iF Supermotard	07	R	
SM 5.1iF Black Panther	08-12	R	
SE 510 iR (Rear Nissin Caliper)	12	R	
SUZUKI			
RM-Z 250 K7/K8/K9/L0/L1/L2/L3 /L4/L6/L7/L8/L9	04-20	R	
RMX 450 ZL0/ZL2	10-15	R	
RM-Z 450 K5/K6/K7/K8/K9/L0/L1/L2 /L3/L4/L5/L6/L7/L8/L9	05-20	R	
TM			
MX 85 JR (Small wheel)	05-15	R	
MX 85 (Big Wheel)	05-15	R	
Enduro EN 125 (2T)	05-15	R	
MX 125 (2T)	05-15	R	
SMR 125 (2T)	05-15	R	
SMX 125 (2T)	15	R	
EN/MX 144 (2T)	08-15	R	
EN 250 F (4T) Enduro	05-09	R	
EN 250 Fi (4T)	10-15	R	

TM Contd.

Enduro EN 250 (2T)	05-15	R	
MX 250 (2T)	05-15	R	
MX 250 (4T)	05-09	R	
MX 250 Fi (4T)	10-15	R	
SMM 250 F (4T)	10-15	R	
SMR 250 (2T)	05-15	R	
SMR 250 F (2T/4T)	10-15	R	
SMX 250 (2T)	15	R	
SMX 250 F	10-15	R	
Enduro EN 300 (2T)	05-15	R	
MX 300 (2T)	05-15	R	
SMR 300 (2T)	05-15	R	
SMX 300 (2T)	15	R	
EN 450 F	04	R	
EN 450 Fi	05-15	R	
MX 450 Fi	05-15	R	
SMM 450 F	11-15	R	
SMR 450 FES	05-11	R	
SMR 450 F (4T)	10-15	R	
SMX 450 F	05-15	R	
EN 530 F (4T)	05-15	R	
MX 530 F	05-15	R	
SMR 530 FES	05-09	R	
SMR 530 Fi	10-15	R	
SMR 530 F (4T)	10-14	R	
SMX 530 F	05-15	R	
SMX 660 F	05-10	R	
WK			
Trial 125	11-14	R	
YAMAHA			
YZ 125 R/S/T/V/W/X/Y/Z/A/B/D /E/F/G/H/J/K (2T)	03-19	R	
WR 250 FR/FS/FT/FV/FW/FX/ /FY/FZ/FA/FB/FD (4T)	03-13	R	
WR 250 FF/FG/FH/FJ/FK (4T/Reverse Cylinder)	15-19	R	
WR 250 RX/RX (32D-)	08-19	R	
WR 250 XX/XY (32D-)	08-15	R	
YZ 250 R/S/T/V/W/X/Y/Z/A/B/D /E/F/G/H/J (2T)	03-18	R	
YZ 250 FR/FS/FT/FV/FW/FX/FY/FZ /FA/FB/FD/FE/FF (4T)	03-15	R	
YZ 250 FG/FH/FJ/FK (270mm DISC)	16-19	R	
YZ 250 FGY (60th Anniversary Edition/270mm Disc)	16	R	
YZ 450 FG/FH/FJ (270mm DISC)	16-18	R	
YZ 450 FGY (60th Anniversary Edition/270mm Disc)	16	R	
WR 450 FR/FS/FT/FV/FW/FX/FY/FA/ /FB/FD/FE/FF (4T)	03-15	R	
WR 450 FG/FH/FJ (270mm F/Disc/4T)	16-19	R	
YZ 450 FR/FS/FT/FV/FW/FX/FY/FZ /FA/FB/FD/FE/FF (4T)	03-15	R	
FA367/2TT			
BETA			
RR 50 Motard (Spoke wheel)	09-12	R	
RR Motard 50 Track (Cast wheels)	08-20	R	
RR Motard 50 Standard (Cast wheel/5 spoke)	13-15	R	

FA367/2TT Contd.

BETA

RR Motard 50 Sport (Cast wheel/5 spoke)	14-20	R
RR Motard 50 (Spoke wheel)	12-13	R
RR Enduro 50 Standard	09-14	R
RR 50 Enduro Racing	09-11	R
RR Enduro 50	08-20	R
RR 50 Enduro Factory	12-20	R
RR Motard 50 Standard	09-12	R
RR Motard 50 Skull	11	R
RR 50 Track (Spoke wheel)	14	R
Alp 125 (4T)	05-15	R
Enduro RR 125 (2T) MY20	20	R
RR 125 4T Enduro (A/C)	09-14	R
RE 125 4T Enduro	08-14	R
RR 125 4T Enduro (L/C)	11-18	R
RR 125 Motard (4T)		
(A/C - Spoke Wheel)	08-15	R
RR Motard 125 4T (LC) (Cast wheels)	11-18	R
Urban 125	08-15	R
Urban 125 Special	09-15	R
Alp 200 (4T)	05-15	R
Enduro RR 200 (2T) MY20	20	R
RR 250 4T Enduro	05-07	R
Urban 200	08-15	R
Urban 200 Special	09-15	R
RR 250 Enduro (2T)	13-14	R
RR 250 Enduro Racing (2T)	14	R
Enduro RR 250 (2T)		
Inc Racing and MY20	15-20	R
RR 300 Enduro (2T)	13-14	R
Enduro RR 300 (2T)		
Inc Racing and MY20	15-20	R
RR 300 Racing (2T)	15	R
300 X-Trainer (2T)	15-19	R
Alp 4.0 (4T/349cc)	05-15	R
M4 350 Motard	07-15	R
RR 350 4T Enduro	11-14	R
RR 350 EFi (4T)	15	R
RR 350 Enduro Racing 4T	13	R
Enduro RR 350 (2T) Inc Racing and MY20	15-20	R
Enduro RR 390 (4T) Inc Racing and MY20	15-20	R
RR 400 4T Enduro	05-11	R
RR 430 (4T)	15	R
Enduro RR 430 (4T) Inc Racing and MY20	15-20	R
RR 450 4T Enduro	12-14	R
RR 450 Enduro Racing (4T)	13-14	R
RR 450 4T Cross Country	12	R
RR 480 (4T)	15	R
Enduro RR 480 (4T) Inc Racing and MY20	15-20	R
RR 498 4T Enduro	12-14	R
RR 490 Enduro Racing (4T)	13-14	R
RR 520 Enduro	05-11	R
RR 525 4T Enduro	05-09	R
KTM		
SX85 (Aftermarket caliper used with 220mm disc)	03-15	R
RIEJU		
MTR 50 Pro Competizione (Spoke Wheel)	11-14	R
Marathon Pro 125 Competizione	11-14	R
ZERO		
Zero DS (ZF8.5/ZF11.4) (Nissin F & R Calipers)	13	R
Zero MX (ZF2.8/ZF5.7) (Nissin F & R Calipers)	13	R
Zero S (ZF8.5/ZF11.4) (Nissin F & R Calipers)	13	R
Zero XU (ZF2.8/ZF5.7) (Nissin F & R Calipers)	13	R
Zero FX (ZF2.8/ZF5.7) (Nissin F & R Calipers)	13	R

Equivalents OE # - FA367

5UN W0046 00	25.25362	BE 675002509
5UN W0046 50	0631	43082 0107
5UN W0046 51	69100 35810	855852
43082 0006	69100 28820	1C3 W0046 00
K4308 0006	43082 0048	1C3 W0046 B0
IC3 W0046 10	9100797	
IC3 W0046 50	69096-05	

Equivalents OE # - FA367/2TT

2525345000
2525362000

MATERIAL AVAILABILITY AND PART NO.				
STD	OPTIONS			
FA	HH	R	MXS	EPFA
FA367TT	-	FA367R	MXS367	EPFA367HH
FA367/2TT		FA367/2R		

FA368 A. 64 x 41.6 x 9.25mm B. 64 x 41.6 x 9.25mm



ALTA MOTORS (ELECTRIC)

Redshift MX 16-18 R
Redshift SM 16-18 R

BMW

G 450 X 08-11 R

BREMBO

Xq 21390 PF 26 Off Road Rear Caliper

HUSABERG

TE 125 2T 12-14 R
FE 250 (4T) 13-14 R
TE 250 (2T) 11-14 R
TE 300 (2T) 11-14 R
FE 350 (4T) 13-14 R
FE 390 (New 70° Engine) 10-12 R
FE 450 (New 70° Engine) 08-14 R
FX 450 10-12 R
FE 501 (4T) 13-14 R
FS 570 Supermoto 10-12 R
FE 570 (New 70° Engine) 09-12 R
TE 570 09 R

HUSQVARNA

CR 125 05-13 R
SMS 4 125 (4T) 11 R
TC 125 (2T) 14-20 R
TE 125 (2T) 14-15 R
WR 125 06-13 R
TE 150i 2T 18-20 R
CR 250 05 R
FC 250 (4T) 14-20 R
FE 250 (4T) 14-20 R
TC 250 (2T) 14-20 R
TC 250 (4T) 02-13 R
TE 250 Inc Tpi (2T) 14-20 R
TE 250 (4T) 06-13 R
TE 250 Meo Replica (4T) 11 R
TE 250 R (4T) 13 R
TE 300 Inc Tpi and Jarvis Edition (2T) 14-20 R
TE 310 (4T) 09-13 R
TE 310 R (4T) 13 R
FC 350 (4T) 14-20 R
FX 350 4T 18-20 R
TE 410 06 R
SMR 449 11 R
TC 449 (4T) 11-13 R
TE 449 (4T) 11-13 R
FC 450 (4T) 14-20 R
FE 450 (4T) 14-20 R

FR 450 (4T) 16-20 R
FX 450 (4T) 17-19 R
SMR 450 RR (Radial caliper) 06-07 R
SM 450 R Radial Caliper 07-10 R
SM 450 RR 08-10 R
TC 450 05-10 R
TE 450 06-10 R
FE 501 (4T) 14-15 R
SM 510 R (Radial caliper) 06-09 R
TC 510 05-09 R
TE 510 06-10 R
SMR 511 11-13 R
TE 511 (4T) 11-13 R
SM 530 RR 08-10 R
SM 630 (4T) 10 R

KTM

SX 125 (Upside Down Forks) 04-19 R
EXC 125 04-17 R
EXC 125 (2T) Six Days 11-17 R
XC-W 125 (2T) 17-20 R
SX 150 08 R
SX 150 (Upside Down Forks) 09-20 R
XC 150 (USD) 11-13 R
XC-W 150 (2T) 17-20 R
EXC 200 (inc Six Days) 04-16 R
SX 250 (2T) (Upside Down Forks) 03-19 R
SX-F 250 (4T) 06-20 R
EXC 250 (2T) 04-19 R
EXC 250 Racing 06 R
EXC 250 (2T) Six Days 11-20 R
EXC-F 250 06-19 R
EXC-F 250 (4T) Six Days 11-19 R
SX-F 250 Ken Roczen Edition 12 R
XC 250 (2T) Tpi 11-20 R
XC-F 250 (USD) 11-19 R
EXC 300 (2T) 04-19 R
EXC 300 (2T) 300 SE-R
Tpi Six Days & Erzbergrodeo 11-20 R
XC 300 (2T) 11-19 R
EXC-F 350 (USD) 11-20 R
EXC-F 350 Six Days 12-20 R
SX-F 350 (Upside Down Forks) 11-15 R
SX-F 350 Tony Cairoli Edition 12 R
XC-F 350 12-20 R
EXC 400 Racing 04-07 R
EXC 400 (4T) 09-11 R
EXC 450 (4T) 11-20 R
EXC 450 Racing 06-07 R
EXC 450 (4T) Six Days 11-20 R
SMR 450 04-13 R
SMR 450 (Brembo f/caliper) 14 R
SX 450 (4T) 03-06 R
SX-F 450 (4T) Inc Cairoli 07-20 R
EXC 450 (4T) 04-19 R
EXC-R 450 (4T) 08 R
EXC 500 (4T) 12-20 R
EXC 500 (4T) Six Days 12-20 R

SX-F 505 07-09 R
SMR 525 04-05 R
SX 525 03-06 R
EXC 525 04-05 R
EXC 525 Racing 04-06 R
XC 525 Racing 06-07 R
EXC-R 530 (4T) 08 R
EXC 530 09-11 R
EXC 530 (4T) Six Days 11 R
SMR 560 07 R
SXC 625 05-06 R
SMR 650 Supermoto 06 R
SMR 525 05 R
OSSA
Enduro 250 i 12 R
Enduro 300 i 12 R
RIEJU
Marathon 250 09-10 R
Marathon 450 09-10 R
SHERCO
125 SC-Factory 19-20 R
125 SE-R 19-20 R
SE 250 i Enduro (2T) (Brembo rear caliper) 12-15 R
SE 300 i Enduro (2T) (Brembo rear caliper) 12-15 R
SE250 i (2T/Brembo Rear Caliper) 12-15 R
SE-R 250 (2T) 12-15 R
SEF 250 (4T) 13-15 R
SEF-R 250 (4T) 13-15 R
250 SC-Factory 19-20 R
250 SCF-Factory 19-20 R
250 SE-R 19-20 R
250 SE-Factory 19-20 R
250 SEF-R 19-20 R
250 SEF-Factory 19-20 R
SE300 i (2T/Brembo Rear Caliper) 12-15 R
SE-R 300 (2T) 12-15 R
SEF 300 (4T) 13-15 R
SEF-R 300 (4T) 13-15 R
300 SC-Factory 19-20 R
300 SCF-Factory 19-20 R
300 SE-R 19-20 R
300 SE-Factory 19-20 R
300 SEF-R 19-20 R
300 SEF-Factory 19-20 R
SEF 450 (4T) 14-15 R
SEF-R 450 (4T) 14-15 R
450 SCF-Factory 19-20 R
450 SE-R 19-20 R
450 SEF-Factory 19-20 R
500 SCF-Factory 19-20 R
500 SEF-R 19-20 R
500 SEF-Factory 19-20 R
SWM
MC 1265 R 18 R
MC 250 S 16 R
FT 300 R (RS 300 R FLAT TRACK) 17 R
RS 300 R (4T) 15-18 R
RS 340 S 16 R
SM 450 R (4T) 15-18 R
RS 500 R (4T) 15-18 R
SM 500 R (4T) 16-20 R

MATERIAL AVAILABILITY AND PART NO.				
STD	OPTIONS			
FA	HH	R	MXS	EPFA
FA368TT	-	FA368R	MXS368	EPFA368HH

Equivalents OE #		
548 13 090 000	548 13 090 300	07849312/27
548 13 090 100	34 21 7 717 324	
8000A2790	3711	

FA369/4 49.2 x 38.6 x 8mm

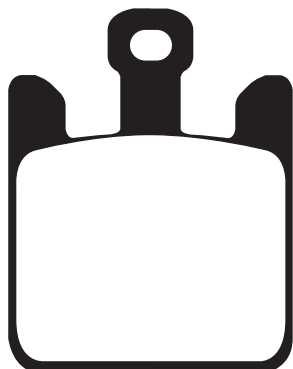

KAWASAKI

ZX-6RR (ZX 600 K1/M1/N1/N6F) 03-06 F
ZX6R (ZX 636 B1/B2/C1/C6F) 03-06 F
ZX 10 R (ZX 1000 C1/C2/D6F/D7F) 04-07 F
ZX 12 R (ZX 1200 B3/B4/B6F) 04-06 F
VN 1600 B2H/B6F/B7F (Mean Streak) 05-08 F

SUZUKI

GSXR 1000 K3 03 F
M 1600 (VZ 1600 K5 Intruder) 05 F
VZ 1600 K5 (M 1600 Intruder) 05 F

MATERIAL AVAILABILITY AND PART NO.				
STD	OPTIONS			
FA	HH	R	MXS	EPFA
-	FA369/4HH	-	-	EPFA369/4HH

Equivalents OE #		
59100 18851	43082 0019	43082 0032
43058 0058	43082 0021	43082 0037
43082 1293	43082 0030	
43082 0018	43082 0031	

FA372 A. 55.5 x 37 x 55.5 x 10.94mm B. 85 x 43 x 8.7mm

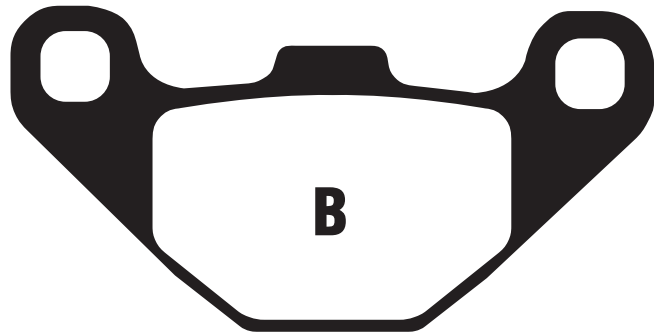
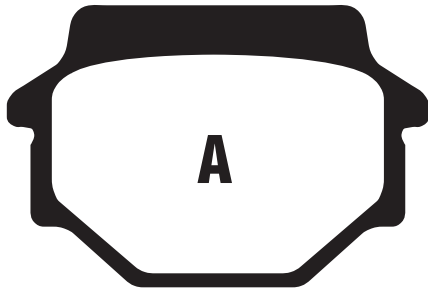

SUZUKI

LT-A 500 FK3/FK4/FK5/FK6/FK7 Vinson 4WD Auto 03-07 R
 LT-F 500 FK3/FK4/FK5/FK6/FK7 03-07 R

MATERIAL AVAILABILITY AND PART NO.					
STD	OPTIONS				
FA	HH	R	MXS	EPFA	
FA372TT	-	FA372R	-	-	

Equivalents OE #
69100 03850
69100 03860

FA373 75.35 x 39.35 x 11.75mm

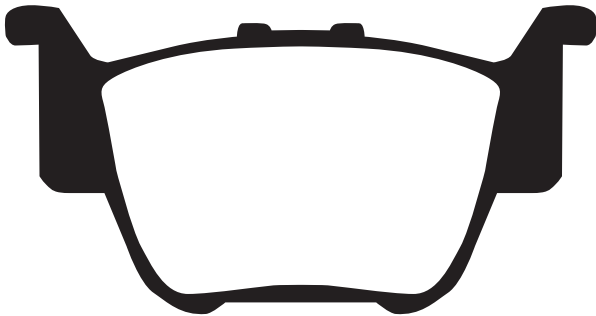

HONDA

TRX 420 FA9/FAA/FBB Fourtrax Auto 4WD 09-11 R
 TRX 420 FPA9/FPAA/FPBA Fourtrax Auto Power Steering 09-11 R
 TRX 450 R4/R5/R6/ER6/R7/ER7/R8/ER8/R9/ER9 04-09 R
 TRX 650 FA3/FA4/FA5 Rincon 4x4 Auto 03-05 R
 TRX 680 FA6/FA7/FA8/FA9/FAA/FAB/FAC Rincon 4x4 Auto 06-14 R

MATERIAL AVAILABILITY AND PART NO.					
STD	OPTIONS				
FA	HH	R	MXS	EPFA	
FA373TT	-	FA373R	-	-	

Equivalents OE #
06435 HN8 006
06435 HP1 006

FA374 A. 95.5 x 42 x 8mm B. 77 x 42 x 8mm

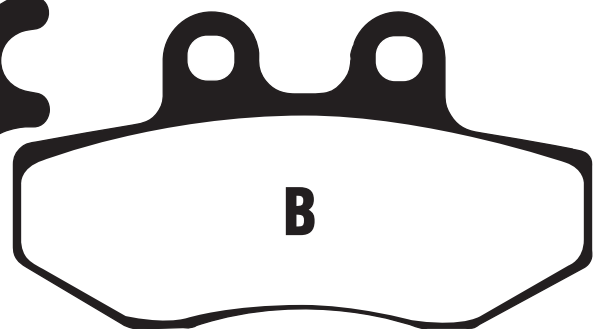
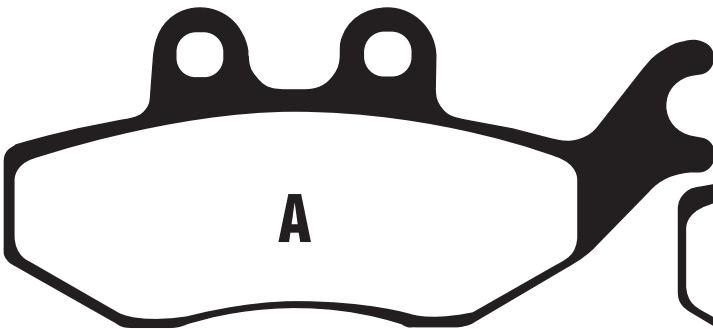

ITALJET

Jupiter 250 02-03 R

RIEJU

NKD 50 07 F
 RS2 Matrix (50cc) 02-08 F
 RS3 50 11-20 F
 RS3 50 Pro 11-20 F
 RS2 125 06-08 F
 RS3 125 11-20 F
 125 NKD 06-07 F

MATERIAL AVAILABILITY AND PART NO.					
STD	OPTIONS				
FA	SFA	HH	R	MXS	EPFA
FA374	SFA374	-	-	-	-

Equivalents OE #
06435 HN8 006
06435 HP1 006

DO NOT REFIT ANY SHIMS/INSULATORS TO EBC PADS FROM ORIGINAL PADS UNLESS INSTRUCTED ON NOTE ON PAD PACKAGING AND ON FA DRAWING ASSOCIATED WITH THAT PAD.

FA375 A. 110.6 x 34.6 x 7.6mm B. 98.7 x 33.5 x 7.5mm

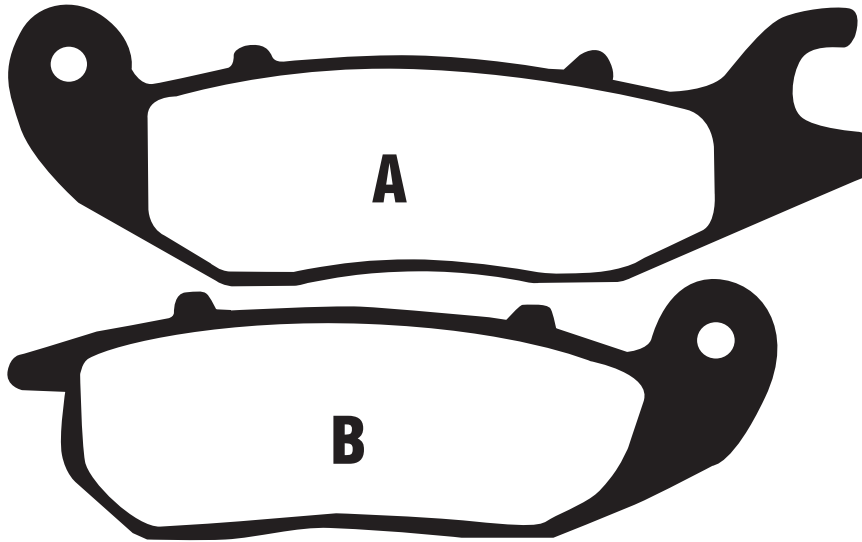

AJS	Regal Raptor CR3-125	06	F
HERO	Karizma ZMR 230	11-12	F
HONDA			
	ANF 125 3/5/T5/6/T6/7/A Innova	03-11	F
	CBF 125 M9/MA/MB/MD/ME	09-15	F
	CBR 125 R4/R5/RS5/RS6	04-06	F
	CBR 125 RW5/RW6/RW7/RW8 /RW9/RWA/RWB/RC/RD/RF	05-16	F
	CBR 125 R4/R5/RS5/RW5/RW6 /RW7/RW8/RW9/RWA (6 Bolt Front Disc/Canada)	04-10	F
	CBR 125 RWB/RC/RD/RF/RG (5 Bolt Front Disc)	11-16	F
	FS 125 Sonic	03-04	R
	Monkey 125	18-20	F
	MSX 125 D/E/F/G/H Grom (Non ABS)	13-20	F
	MSX 125 AH Grom (ABS)	18-20	F
	CBR 150 R	00-03	F
LIFAN	Smart 50/125		F
RIEJU			
	NKD 50	08-09	F
	RS2 50cc Matrix/Pro	07-09	F
	RS2 50 FR	09-10	F
	NKD 125	08-09	F
	RS2 125/Pro	07-09	F
SUPERBYKE			
	CQ 50 Road Classic		F
	CU 125 Road Classic		F

MATERIAL AVAILABILITY AND PART NO.					
STD	OPTIONS				
FA	SFA	HH	R	MXS	EPFA
FA375	SFA375	FA375HH	-	-	-

Equivalents OE #	
06455 KPH 951	06455 KWF 951
06455 KPP 901	0000 640 7210

FA377 A. 94 x 46 x 8.5mm B. 73 x 46 x 11mm

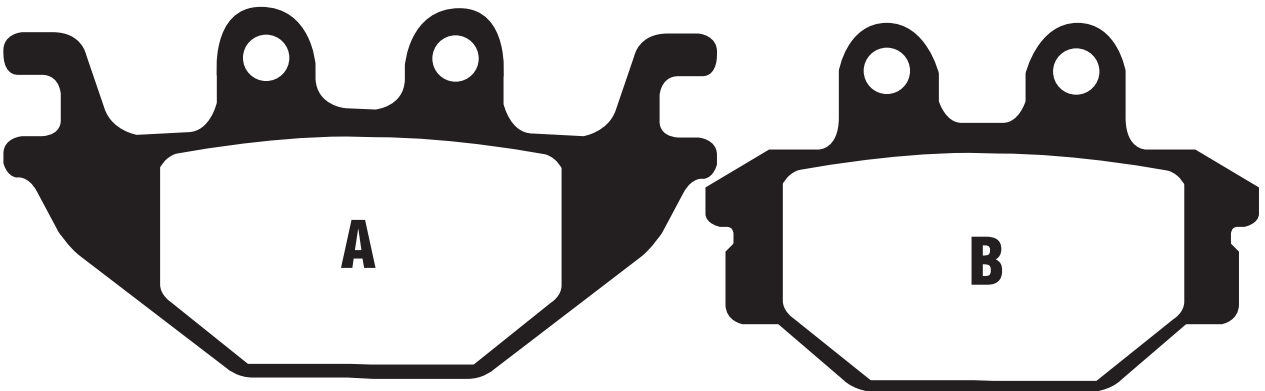

ADLY							
	Crossroad 220 Sentinal Quad		F				
	Canyon 280 Quad	08-09	F				
	Hurricane 280 Quad	08-09	F				
	Canyon 300 Quad	08-09	F				
	Crossroad 300 Sentinal Quad	08-09	F				
	Utility 300	05-07	F				
	Hurricane 300 Quad	08-09	F				
	300 RS Quad	07-08	F				
	300 XS Quad	07-08	F				
	320 S Quad	08	F				
	Hurricane 320 Quad	08-09	F				
	500 S	08	F				
AEON	Overland 600 (Quad)	10-11	F				
ARCTIC CAT							
	Alterra 90	17-19	R				
	DVX 90	18	R				
	150 Utility 2 x 4	15-18	R				
	250 DVX Sport	06-08	F				
	300 Alterra	17-19	F&R				
	300 DVX	09-14	F				
	300 2x4 Utility (Mid Size)	10-14	F&R				
	500 Prowler	18-19	F&R				
BOMBARDIER							
	DS 250	06	F&R				
CECTEK							
	500 EFI Gladiator	09-10	F				
CPI							
	XS 250 Quad	06-09	F				
KAWASAKI							
	KVF 300 CCF/CD/CE/CF						
	/CGF/CHF Brute Force	12-17	F&R				
	KAF 1000 DGF Mule Pro DX Diesel	16	R (l&r)				
	KAF 1000 BGF Mule Pro DXT Diesel	16	R (l&r)				
KYMCO							
	KXR 250 Mongoose Quad	04-07	F				
	Maxxer 250	12-13	F				
	MXU 250	04-13	F				
	MXU 250 R	12-13	F&R				
	Urban Quad 250	06	F				
	MXU 300	06-11	F&R				
	MXU 300 R	10-14	F&R				
	Maxxer 300	06-13	F				
	MXU 450i (Side X Side)	15-20	F&R				
	MXU 500i (4x4 IRS) (LAA0CD/CM) (Parking brake)	09-14	F				
	MXU 500 4x4/Carb Model	05-09	F&R				
	UXV 500 4x4 (Side x Side) (U10000)	08-09	F&R				
	UXV 500i (Side x Side/4x4) U10100	10-15	F&R				
	MXU 550i (4x4 LOF) Parking Brake	13-20	F				
	MXU 700i (4x4 LOF) Parking Brake	13-18	F				
	UXV 700i Turf Parking Brake	14-15	F				
PGO							
	BR-500i Racer	07-09	R				
	500 Bug	08-09	R				
	BR 600 I Bug Racer	12	R				
QUADZILLA							
	RS7 4WD	10-11	F				
	RS8	10-11	F				
	X7R	10-11	F				
SYM							
	SB 125 Ni-Wolf	11-15	R				
	Quadlander 200	12-13	F				
	Trackrunner 200 Quad	05-07	F				
	Quadlander 250	05-13	F				
	SB 250 Ni (Wolf SB)	12-15	R				
	Citymax 300 Quad	06	F				
	Quadlander 300	08-10	F&R				
	Quadlander 300 S	07-15	F&R				
	Quadraider 600	06-07	R				
	Quadraider 600	08-15	F&R				
	Quadraider 600 LE (Quad)	10-15	F&R				
TGB							
	Blade 325 LE (4x2)	09-10	F				
	Avenger 400 Quad (4x2)	07-08	F&R				
	Avenger 400 LE (4x2)	09-10	F				
	Blade 425 Quad (4x4)	07-08	F&R				
	Blade 425 SE (4x4)	09-10	F				
	Blade 450 SE 4x4	10-11	F				
	Blade 460 SL IRS 4x4	12	F				
	500 Avenger R (4x2)	09-10	F				
	Blade 510 LE	11-12	F				
	Blade 525 SE	09-10	F				
	Blade 525 SL	09-10	F				
	Blade 525 SE 4x4	09-10	F&R				
	Blade 550 LT 4x4	10-11	F				
	Blade 550 SL 4x4	09-10	F				
	Blade 550 SE 4x4	09-11	F				
	Blade 550 4x4 IRS Target	11-12	F				
	Gunner 550 4x4 Target	10-12	F&R				
	Target 550 IRS Blade LT	10-12	F				
YAMAHA							
	MT 125 (Non ABS)	14-16	R				
	MT 125A (ABS)	14-19	R				
	YZF-R 125	08-14	R				
	YZF-R 125 (Radial F/Caliper/Non ABS)	14-16	R				
	YZF-R 125A (Radial F/Caliper/ ABS)	14-18	R				

FA377 Contd.

MATERIAL AVAILABILITY AND PART NO.				
STD	OPTIONS			
FA	TT	R	HH	V
FA377	FA377TT	FA377R	FA377HH	FA377V

Equivalents OE #				
45105 LB17 3050	4511A RAI 000	S4311ARCA000	B840F64-6500000	43082 Y004
45105 LBA7 3050	45120 256 000	515049	FZ10176	43082 0140
45105 LEE 8305	00157056	515050	45105 PWA 305	3303-908
45113 REA 300A	S4511ARCA000	5D7 F5911 00	43082 Y003	43105 1EE8 305

FA379 71.45 x 49.9 x 7.76mm

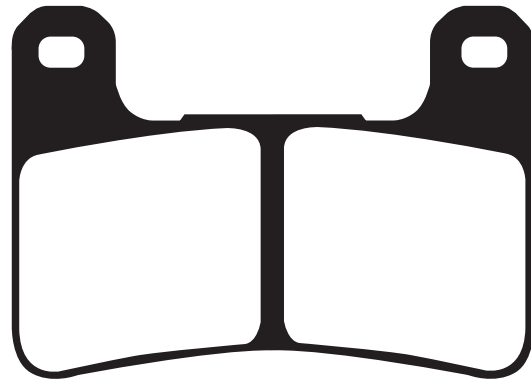

KAWASAKI

ZX 25 Ninja	20	F
Z 900 RS	18	F
ZX10R (ZX 1000 E8F/E9F/FAF)	08-10	F
ZX10R ABS (ZX 1000 KBF/KCF/KDF/KEF/KFF)	11-15	F
ZX10R (ZX 1000 JBF/JCF/JDF/JEF/JJF)	11-15	F
ZX10R 30th Anniversary Edition Non ABS (ZX 1000 JFFA)	15	F
ZX10R 30th Anniversary Edition ABS (ZX 1000 KFFA)	11-15	F
Z1000 (ZR 1000 DAF/DBF/DCF/DDF/FEF/FFF)	10-15	F
Z1000 ABS (ZR1000 EAF/EBF/ECF/EDF/GEF/GFF)	10-15	F
Z 1000 EAF/EBF/ECF/ECFA/EDF/EDFA (ABS/300mm Discs)	10-13	F
Z 1000 FEF/FEFA/FFF/FGF (Non ABS/310mm Discs)	14-16	F
Z 1000 GEF/GEFA/GFF/GGF/HHF/HJF (ABS/310mm Contour Discs)	14-18	F
Z 1000 SX ABS Model (ZX1000 MEF/MFF/MGF/WHF)	14-18	F
Z 1000 SX Tourer	14	F
Z 1000 Special Edition (ZR 1000 GEFA)	14	F
Z 1000 (ZR 1000 GEF)	14	F
Z 1000 Black Edition (ZR 1000 DCFA/DDFA/FEFA)	12-15	F
Z 1000 EAF/EBF/ECF/ECFA/EDF/EDFA (ABS/300mm Discs)	10-13	F
Z 1000 FEF/FEFA/FFF/FGF (Non ABS/310mm Discs)	14-16	F
Z 1000 GEF/GEFA/GFF/GGF/HHF (ABS/310mm Contour Discs)	14-17	F
Ninja H2 SX (ZX1002 AJF)	18-20	F
Ninja H2 SX SE (ZX1002 BJF)	18-20	F
KLZ 1000 Versys DKF	19-20	F

SUZUKI

GSXR 600 K4/K5/K6/K7/K8/K9/L0	04-10	F
GSXR 750 K4/K5/K6/K7/K8/K9/L0	04-10	F
DL 1000 AL4/AL5/AL6/AL7/AL8/AL9 V-Strom (ABS)	14-20	F
DL 1000XT XAL8/XAL9 V-Strom (ABS)	18-20	F
GSXR 1000 K4/K5/K6/K7/K8/K9/L0/L1	04-11	F
GSX 1300 RK8/RK9/K9/RL0/RL1/RL2 Hayabusa	08-12	F
M 1800 R (VZR 1800 K6/K7/K8/K9)		
Intruder - Handlebar Cowling	06-09	F
M 1800 R2 (VZR 1800 NK8/NK9)		
Intruder - No Handlebar Cowling	08-09	F
M 1800 RZ (VZR 1800 ZK7/ZK8/ZL1/ZL2)		
Intruder - With Handlebar Cowling	07-13	F
M 1800 RB (VZR 1800 BZL4/BZL5/BZL6/BZL7 - M 1800 RB)	14-17	F
VZR 1800 K6/K7/K8 (M 1800 R Intruder)	06-09	F
VZR 1800 RZK8 Intruder M1800 R2/M109 R2	08-09	F
VZR 1800 BLZ4/BZL5/BZL6/BZL7/BZL8 M1800 RB	14-18	F

MATERIAL AVAILABILITY AND PART NO.					
STD	OPTIONS				
FA	GPFAX	HH	R	MXS	EPFA
-	GPFAX379HH	FA379HH	-	-	EPFA379HH

Equivalents OE #		
43082 0091	59100 47890	43082 0147
59100-29820	43082 0113	59100 29860
59100-29840	107 A486 51	
59100 29850	43082 0144	

FA380 69 x 50.4 x 8.7mm

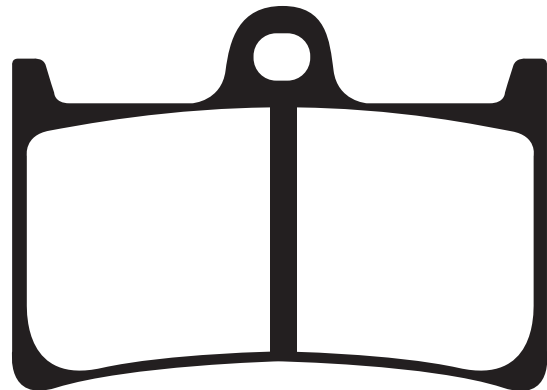

KAWASAKI

ST700 Stallion 14-18 F

YAMAHA

FZ1 N/NA Naked (Non ABS/ABS)	10-14	F
FZ6 Fazer S2 (ABS) (4 piston caliper)	07-09	F
FZ8N-Naked/Single Headlight/Non ABS (RN255/39P1) (800cc)	11-15	F
FZ8NA-Naked/Single Headlight/ABS (RN256/59P1) (800cc)	11-15	F
Fazer 8-FZ8-S (800cc) (Top Fairing /Twin Headlight/Non ABS) (RN251/42P1)	11-15	F
Fazer 8-FZ8-SA (800cc) (Top Fairing/Twin Headlight/ABS) (RN252/1BD1)	11-15	F
Niken ABS (847cc/3 Cyl Engine)	18-20	F
YZF R6	04-20	F
YZF R1	04-06	F
FZ1 N/NA (Naked) Non ABS/ABS	10-15	F
FZ1 Fazer (Half Fairing - ABS - 5D0)	08-15	F
FZ1 Fazer (3C3) Non ABS) Half Fairing	06-15	F
MT-01 (1670cc)	05-06	F
MT-10 (MTN 1000/998cc)	16-20	F
MT-10 Tourer Edition (998cc)	18-20	F
MT-10 SP (MTN 1000D/998cc)	17-20	F
YZF- R1SP	06	F

YAMAHA Contd.

YZF-R1	15-20	F
YZF-R1M	15-20	F
YZF-R1 (60th Anniversary Edition)	16	F
XT 1200 Z Super Tenere (ABS/UBS Brake system)	10-18	F
XT 1200 ZE Super Tenere (ABS/UBS Brake system)	14-18	F
XT 1200 ZE Super Tenere Raid Edition (ABS/UBS Brake System)	18	F
XSR 900 ABS (MTM 850)	16-18	F
XSR 900 Abarth ABS (MTM 850)	17-18	F

MATERIAL AVAILABILITY AND PART NO.					
STD	OPTIONS				
FA	GPFAX	HH	R	MXS	EPFA
-	GPFAX380HH	FA380HH	-	-	EPFA380HH

Equivalents OE #	
5VN W0045 00	2CO 25805 00
5VY W0045 00	
39P W0045 00	

FA381 103 x 48 x 10.9mm

Total thickness with refitted O/E shim & insulator (size of pad on its own 8.9mm)

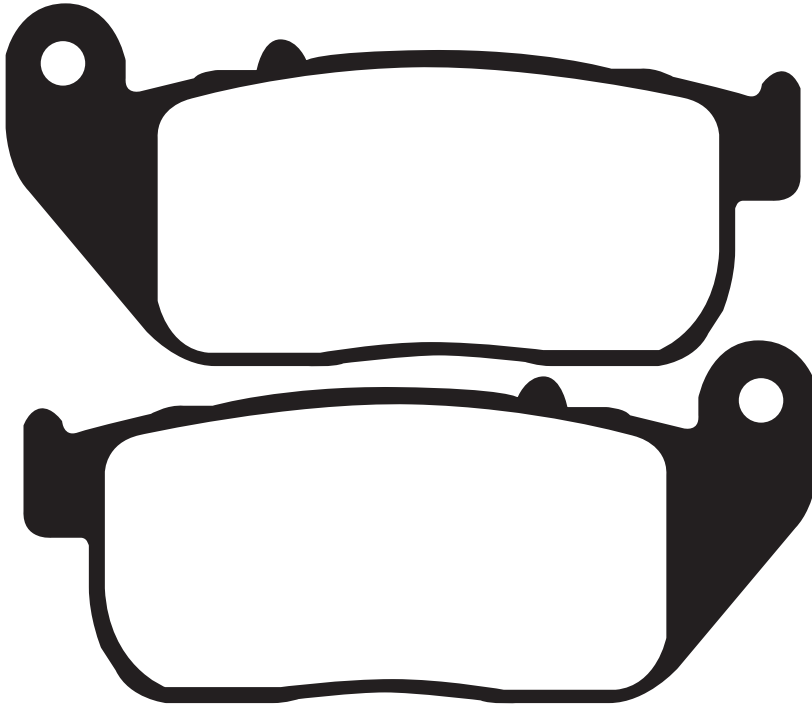

NOTE: Only refit shim & insulator to HH pads

HARLEY-DAVIDSON

XL 50 50th Anniversary Sportster	07	F
XL 883 Sportster STD	04-08	F
XL 883C Sportster Custom	04-10	F
XL 883 L (883 Low)	04-10	F
XL 883 R Sportster R	05-13	F
XL 883 R Roadster	10-13	F
XL 883 N Iron	09-13	F
XL 883 L Superlow	11-13	F
XL 1200 C Sportster Custom	04-13	F
XL 1200 C Custom	11-13	F
XL 1200 R Sportster Roadster	04-08	F
XL 1200 L Sportster Low	07-11	F
XL 1200 N Nightster (Spoke Wheel)	08-12	F
XL 1200 X Sportster Forty-Eight	10-13	F
XL 1200 V Seventy Two	12-13	F

Equivalents OE #

42831-04

MATERIAL AVAILABILITY AND PART NO.

STD	OPTIONS				
	FA	V	HH	R	MXS
FA381	FA381V	FA381HH	-	-	EPFA381HH

FA382 A. 85.12 x 42.70 x 7.4mm B. 56 x 34.75 x 9.6mm

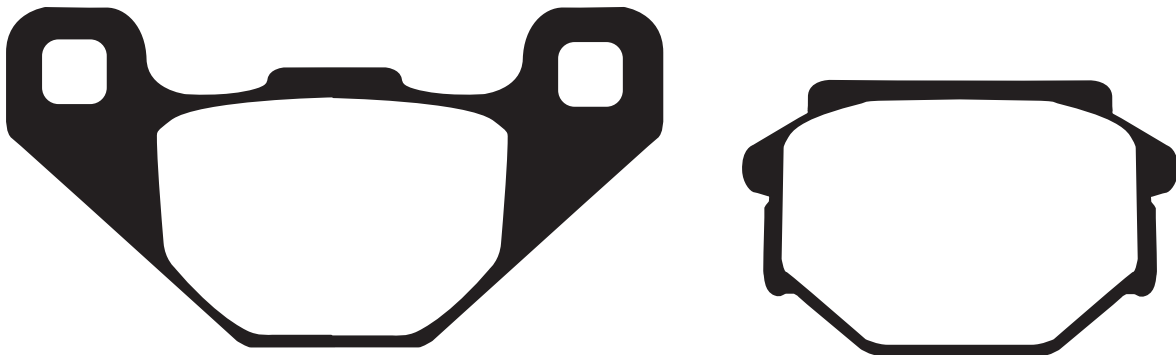

APRILIA

MX 125	04-06	R
Tuareg Rally 125	89-93	R
Tuareg Rally 125 (L/M)	90-91	R
RX 125	92-01	R
Pegaso 125	91	R
Pegaso 125 KAT	94-95	R
Pegaso 600	91	R
Tuareg Wind 600	89	R

HONDA HM (Italy)

CRE 50 Six	01-02	R
CRE 50 Six/Baja/Derapae	95-02	R
CRE 50 Six/Baja/Derapage		
Grimeca caliper	95-02	F&R

SACHS

XTC 125 Supersport	00-07	R
XTC 125 N	00-07	R
X Road 125	06-07	R
Roadster 650	01-04	R

YAMAHA

DT 50 R-L (SM-5VB1/VG55BK)	02-03	F
----------------------------	-------	---

FANTIC

Caballero 50 Regularita Casa	06-09	R
Caballero 50 Supersei Motard	06-09	R
Caballero 125 Regularita Casa	07-08	R
Caballero 125 Supersei Motard	07-09	R

MATERIAL AVAILABILITY AND PART NO.

STD	OPTIONS					
	FA	V	HH	R	MXS	EPFA
FA382	-	-	-	-	-	-

Equivalents OE #

5VB W0045 00
8113375
KA3497506

SFA384 A. 99 x 42.5 x 8mm B. 77.1 x 40.8 x 8.95mm

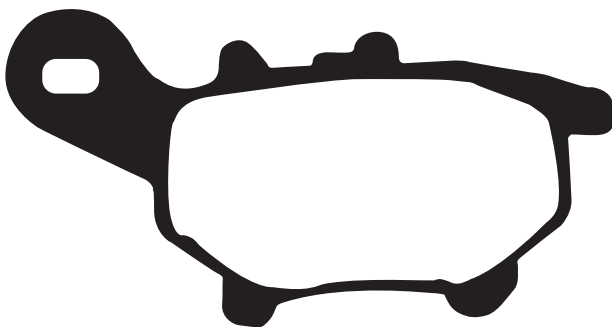
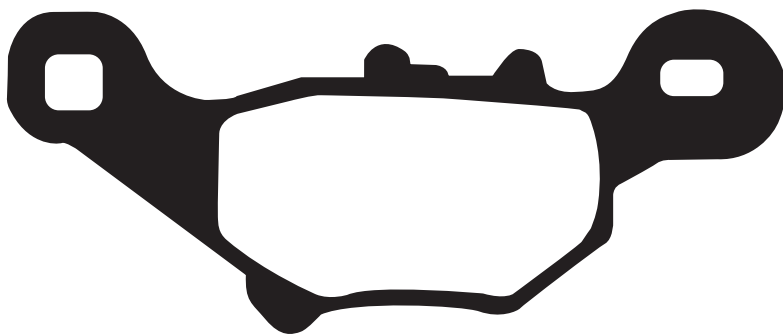

YAMAHA
CV 50 A/R Jog (5SU1/2/SA16J) 03-08 F
AEON
CO IN Eco (Electric) 13 F
CO IN 125 (4T) 13 F

MATERIAL AVAILABILITY AND PART NO.					
STD	OPTIONS				
FA	V	HH	R	MXS	EPFA
SFA384	-	-	-	-	-

Equivalents OE #
5SU W0045 00
5SU W0045 02

FA387 87 x 50 x 10.4mm (Note refit o/e shim to HH pads only)

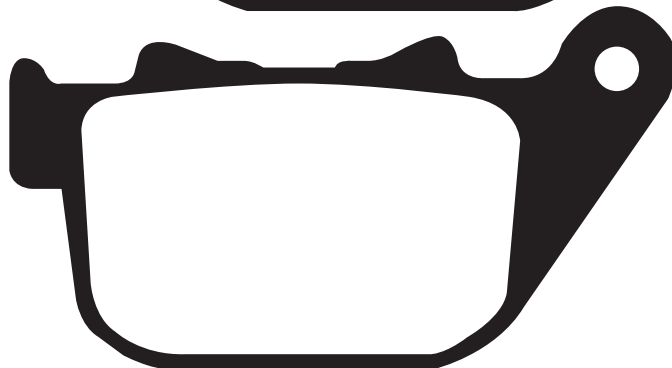
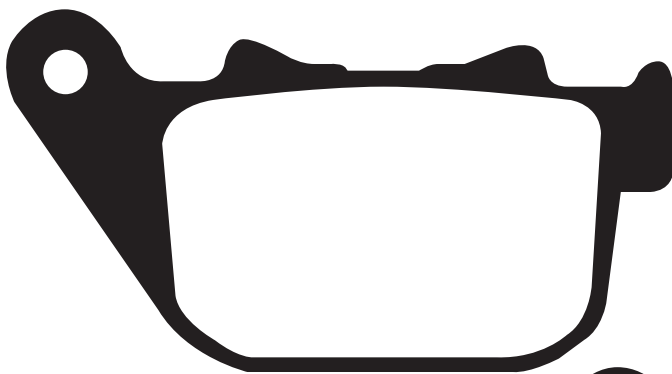

HARLEY-DAVIDSON
XL 50 50th Anniversary Sportster 07 R
XL 883 Sportster STD 04-08 R
XL 883C Sportster Custom 04-10 R
XL 883 L (883 Low) 04-10 R
XL 883 R Sportster R 05-13 R
XL 883 R Roadster 10-13 R
XL 883 N Iron 09-13 R
XL 883 L Superlow 11-13 R
XL 1200 C Sportster Custom 04-13 R
XL 1200 C Custom 11-13 R
XL 1200 R Sportster Roadster 04-08 R
XL 1200 L Sportster Low 07-11 R
XL 1200 N Nightster (spoke wheel) 08-12 R
XL 1200 V Seventy Two 12-13 R
XL 1200 X Sportster - Forty-Eight 10-13 R
XR 1200 08-10 R
XR 1200 X 10-12 R

MATERIAL AVAILABILITY AND PART NO.					
STD	OPTIONS				
FA	V	HH	R	MXS	EPFA
FA387	FA387V	FA387HH	-	-	EPFA387HH

Equivalents OE #
42836-04

DISC PADS
BUYERS GUIDE

DO NOT REFIT ANY SHIMS/INSULATORS TO EBC PADS FROM ORIGINAL PADS UNLESS INSTRUCTED ON NOTE ON PAD PACKAGING AND ON FA DRAWING ASSOCIATED WITH THAT PAD.

FA388 118 x 47 x 8.3mm (Refit O/E shim)

FA388/2 118 x 47 x 10.4mm (Refit O/E shim)

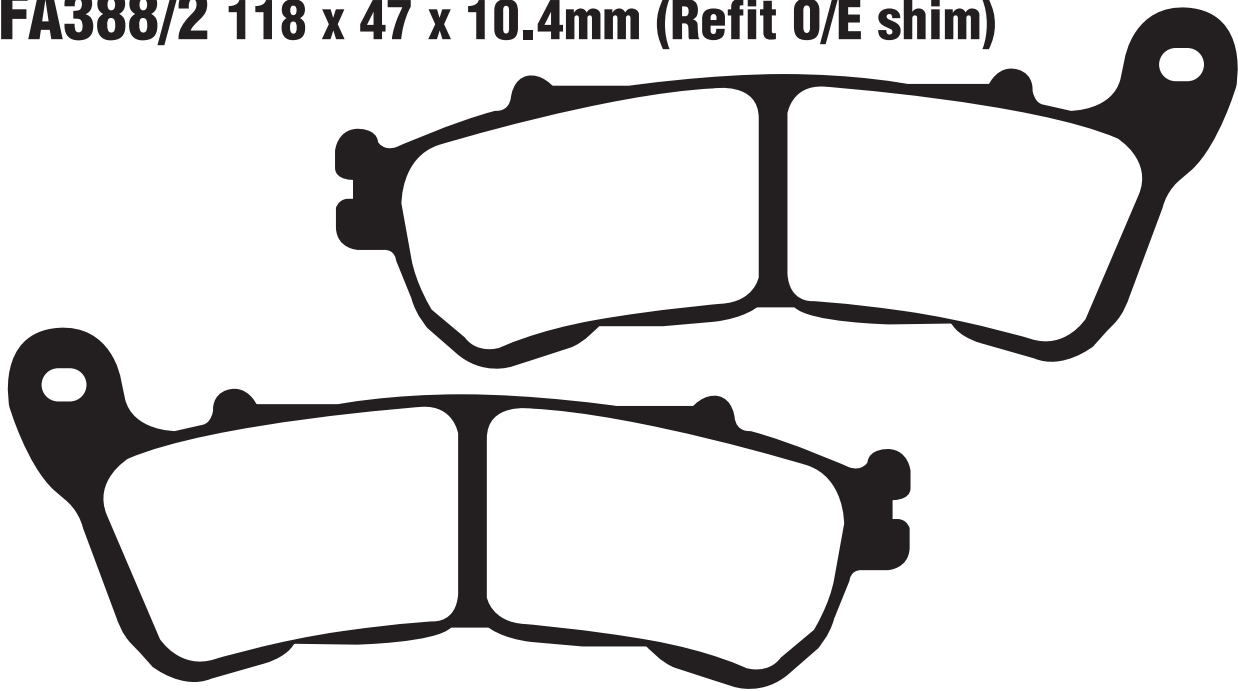

DISC PADS BUYERS GUIDE

HONDA

FES 125 A7/A9/AA S-Wing	07-15	F
FES 125 7/9/A S-Wing (Non ABS Model)	07-13	F
SH 125i 9/A/B Fuel Injection	09-12	F
SH 125i RA (Fuel injection/rear disc model)	10-14	F
SH 125i (3 Piston Caliper/ABS)	14-16	F
FES 150 7/9/A S-Wing	07-13	F
FES 150 A7/A9/A (S-Wing) ABS Model	07-13	F
SH 150i 9/A/B Fuel Injection	09-12	F
SH 150 RA Fuel Injection (Rear disc)	10-14	F
SH 150i (3 Piston Caliper/ABS)	14-16	F
CBR 250 RAB/RAC (ABS)	11-13	F
NSS 250 EX5/EX7/EX8 (ABS) Forza EX	05-08	F
NSS 250 AX5/AX6/A7 (ABS) Forza Z	05-07	F
NSS 250 X5/X7/X8 Forza	05-08	F
PS 250 5/6 Big Ruckus	05-06	F
NSS 300 AD Forza (ABS)	13-17	F
NSS 300 D Forza (NON ABS)	13-15	F
SH 300i 7/8/9/A/B (Non ABS)	07-12	F
SH 300i A7/A8/A9/AA/AB/AC (ABS Model)	07-13	F
SH 300i R8/R9/RA (Non ABS)	08-10	F
SH 300i AR8/AR9/ARA (ABS Model)	08-10	F
SH 300i ABS	14	F
SW-T 400 (FJS 400 D9)	09	F
SW-T 400 (FJS 400 A9/AB ABS Model)	09-16	F
CBF 500 A4/A5/A6 (ABS)	04-07	F
CB 600 FA7/FA8/FA9/FAA/FAB Hornet (ABS)	07-13	F
CBF 600 NA8/NA9/NAA (ABS)	08-11	F
CBF 600 SA8/SA9/SAA (ABS)	08-12	F
CBR 600 FAB/FAC (ABS Model)	11-13	F
SW-T 600 (FJS 600 AB) (ABS Model)	11-16	F
(NC 700 DC) 700 Integra Scooter	12-14	F
DN-01 (680cc) NSA 700 A8/A9	08-11	F
NC 700 XA (ABS/DCT)	12-13	F
NC 700 XD (ABS/DCT)	12-14	F
NC 700 SA (ABS)	12-13	F
NC 700 SD (ABS/DCT)	12-14	F
NT 700 V6/VA6/VA7/V7/V8/VA8 /VA/VAA Deauville	06-13	F
XL 700 VA8/VA9/VAA (Transalp/3 piston front caliper/ABS front & rear wheels)	08-11	F
VT 750 CS2A Shadow (3 piston caliper/rear disc /17" front wheel)	10-12	F
VT 750 C Shadow Aero	18-20	F
VT 750 C Shadow Aero ABS	18-20	F
VFR 800 6/8/9	06-09	F
VFR 800 A6/A8/A9	06-13	F
VFR 800 XB/XC/XD (Crossrunner/ABS)	11-13	F

HONDA Contd.

CB 1000 RA9/RAA/RAB/RAC/RAD /RAE/RAF/RAG (ABS Model)	09-16	F
CBF 1000 A6/A7/A8/A9/AA (ABS Model)	06-10	F&R
CBF 1000 FA (FAA/FAB) (3 piston front caliper/ABS)	10-13	F&R
CBF 1000 A (A6/A7/A8/A9/AA) (3 piston front caliper/ABS)	06-10	F&R
CBF 1000 S (S7/S8/S9/SA) (3 piston front caliper/ABS)	07-11	F&R
CBF 1000 T (T7/T8/T9/TA) GT (3 piston front caliper/ABS)	07-16	F&R
XL 1000 VA4/VA5/VA6/VA7/VA8/VA9 /VAA/VAB Varadero - ABS Model	04-11	F
XL 1000 V7/V8/V9/VA/VB Varadero Non ABS Model	07-11	F
CB 1100 AD	13	F
VFR 1200 Crosstourer Highlander -T/DCT	15-16	F
VFR 1200 XDC/XDE Crosstourer DCT	12-16	F
VFR 1200 XAC/XAD/XAE/XAF/XXH /XAJ Crosstourer (Manual G/Box)	12-18	F
VFR 1200 XDC/XDCD/XDE/XDF/ XDG/XDH/XDJ DCT Crosstourer	12-18	F
VFR 1200 XDC-DCT Crosstourer Highlander	13-14	F
CTX 1300 AE	14-17	F
ST 1300 8/9 Pan European (Non ABS)	08-09	F
ST 1300 A8/A9/AA-AE Pan European - ABS Model	08-17	F
VT 1300 CTA Interstate	15	F
VT 1300 CXAA "Chopper" (9 spoke cast wheel/ABS model)	10-11	F
F6B Goldwing (GLF6BAE)	13-15	F

SUZUKI

UH 125 K7/K8/K9/L0/L1/L3 Burgman	07-13	F
UX 125 K8/K9/L0/L1 SIXteen	08-14	F
UX 150 K8/K9/L0/L1 SIXteen	08-14	F
UH 200 K7/K8/K9/L0/L1/L3 Burgman	07-13	F
C 1800 R (VLR 1800 K8/K9/L0/L1 C 1800 R Intruder)	08-13	F
C 1800 RT VLR 1800 K8RT/K9RT C 1800 RT Touring Intruder	08-10	F

FA388/2

HONDA

GL 1800 B Goldwing J (Manual)	18	R
GL 1800 Goldwing Tour J (Manual)	18	R
GL 1800 BD Goldwing J (DCT)	18	R
GL 1800 D Goldwing Tour J (DCT)	18	R
GL 1800 DA Goldwing Tour Airbag J (DCT)	18	R

Equivalents OE # FA388/2

06435 MKC A01

Equivalents OE # - FA388

06455 MBT D51	06455 MFA D11	06455 MEH 006
06455 MET 651	06455 MFA D12	06456 MEH 006
06455 KSV J03	06455 MGS D81	06455 MC5 R01
06455 KSV J41	06455 KTW 901	06455 MFR A01
06455 KSV J01	06456 MFF D01	59101 03820
06455 MCS R01	59101 03810	
06455 MCW H01	59100 22830	
06456 MCW H01	59300 22830	

MATERIAL AVAILABILITY AND PART NO.

OPTIONS					
STD	SFAC	SFAC	HH	SFA-HH	EPFA
-	-	-	FA388/2HH	-	-

MATERIAL AVAILABILITY AND PART NO.

OPTIONS								
STD	SFA	SFAC	V	HH	SFA-HH	R	MXS	EPFA
FA388	SFA388	SFAC388	-	FA388/2HH	SFA388HH	-	-	EPFA388HH

DO NOT REFIT ANY SHIMS/INSULATORS TO EBC PADS FROM ORIGINAL PADS UNLESS INSTRUCTED ON NOTE ON PAD PACKAGING AND ON FA DRAWING ASSOCIATED WITH THAT PAD.

FA390 75 x 48 x 8mm

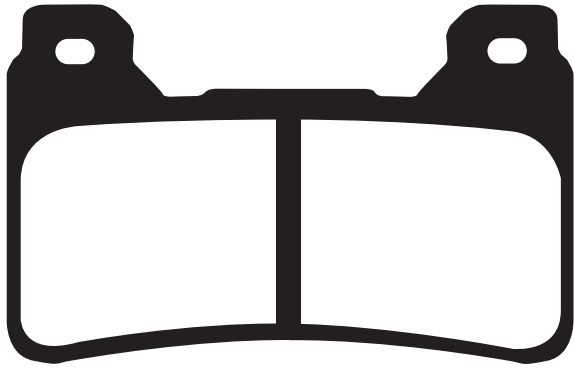

HONDA

CBR 600 RR5/RR6/RR7/RR8/RR9/RAA/RRB/RRC/RRD /RRE/RRF/RRG (Radial Caliper)	05-16	F
CBR 600 RA9/RAA/RAB/RAC/RAD/RAG (C-ABS)	09-16	F
CBR 600 RR Hannspree	08	F
VFR 800 F (ABS)	14-18	F
VFR 800 XF/XG/XH (Crossrunner/ABS)	15-17	F
CBR 1000 RR4/RR5/RR6/RR7/RR8/RR9/RAA/RRB /RRC/RRD/RRE/RRF/RRG Fireblade Non ABS	04-16	F
CBR 1000 RA9/RAA/RAB/RAC/RAD/RAE/RAF/RAG (C-ABS) Fireblade	09-16	F
CB 1000 R9/RA/RB/RC/RD/RE/RF Non ABS Model	09-15	F
CB 1100 RS	17	F
YAMAHA		
YZF-R1 M1 Mission	20	F

MATERIAL AVAILABILITY AND PART NO.

STD	OPTIONS				
FA	GPFAX	HH	R	MXS	EPFA
-	GPFAX390HH	FA390HH	-	-	EPFA390HH

Equivalents OE

06455 MEL 003	06455 MEL D22	06455 MJM D31
06455 MEL 013	06455 MJF D02	
06455 MFJ D01	107 A486 48	

SFA393 77 x 42 x 9.3mm

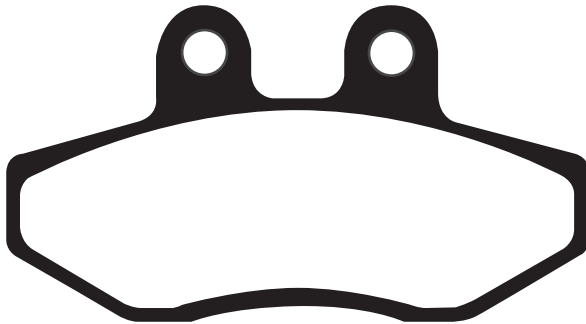

MBK

NXC 125 Flame X (240mm H disc O/D)07-12	F
YP 125 Flame X	04-10 F

YAMAHA

NXC 125-Cygnus X - 220mm Disc (5ML)04-06	F
NXC 125-Cygnus X - 240mm Disc (4P9)07-13	F

MATERIAL AVAILABILITY AND PART NO.

STD	OPTIONS				
SFA	SFAC	HH	R	MXS	EPFA
SFA393	SFAC393	-	-	-	-

Equivalents OE

5NW W0045 00

DO NOT REFIT ANY SHIMS/INSULATORS TO EBC PADS FROM ORIGINAL PADS UNLESS INSTRUCTED ON NOTE ON PAD PACKAGING AND ON FA DRAWING ASSOCIATED WITH THAT PAD.

FA395 95 x 48 x 7mm



ARCTIC CAT

250 (2X4) (Utility)	05-09	F&R
250 (4X4) (Utility)	05/08	F&R
300 (2X4) (Utility)	05	F&R
300 ATV	10-12	F&R
350 ATV	12	F&R
366 4x4 Auto Utility	08-09	F&R
366 SE	10	F&R
400 4x4 Auto Utility	05-08	F&R
400 4x4 Auto VP Utility	05-06	F&R
400 4x4 Auto LE Utility	05-07	F&R
400 4x4 Auto TBX Utility	05-06	F&R
400 4x4 VP Utility	05-06	F&R
400 4x4 Utility	05-07	F&R
400 4x4 Auto TRV Multirider	06	F&R
400 4x4 Auto TRV Plus Multirider	07	F&R
400 Alterra	16-20	F&R
400 ATV (Core Mid Size)	13-14	F&R
400 TRV	09	F&R
400 TRV	13	F&R
400 TRV H1	10	F&R
425i	12	F&R
425i SE	12	F&R
450 Alterra	16	F&R
450 H1 EFi	10	F&R
450 TRV	11-12	F&R
450i	11-12	F&R
450i GT	12	F&R
450i TRV	11	F&R
450i XC	13-14	F&R
450 ATV (Core/Midsized)	13-14	F&R
XC 450i	11-12	F&R
500 4x4 Auto TRV Multirider	05-06/08	F&R
500 4x4 Auto TBX Utility	05-06	F&R
500 4x4 Auto LE Utility	05-06	F&R
500 4x4 Auto Utility	05-08	F&R
500 4x4 Utility (Manual G/box)	05-09	F&R
500 Alterra	16-20	F&R
500 ATV (Midsized)	13-14	F&R
500 ATV XT (Midsized)	13-14	F&R
500 TRV (Core/2 Up)	13-14	F&R
550 Alterra TRV and XT	16-20	F&R
550 GT TRV	11-12	F&R
550 H1 EFi	09-10	F&R
550 H1 EFi LE	09-10	F&R
550i	11-12	F&R
550i GT	11-12	F&R
550i GT TRV	11	F&R
550i LTD	11-12	F&R
550i TRV Cruiser	11	F&R
550 S	10	F&R
550 S Ltd	10	F&R
550 TRV EFi	09-10	F&R
550 TRV Hi EFi LE	09-10	F&R
550 TRV S GT	10	F&R
550 TRV	11	F&R
550 TRV Cruiser	11	F&R
550 TRV Ltd (2 Up)	13-14	F&R
550 ATV (Mid Size)	13-14	F&R
550 ATV Ltd (Mid Size)	13-14	F&R
550 ATV XT (Mid Size)	13-14	F&R
570 Alterra EPS and XT	19-20	F&R
650 H1 4X4 Auto Utility	05/08	F&R
650 H1 4x4 Auto TBX Utility	07	F&R
650 H1 4x4 Auto LE Utility	07	F&R
650 H1 4x4 SE Utility	06	F&R
650 H1 4x4 Auto Utility	07	F&R
650 H1 4x4 Auto TRV Plus Multirider	07	F&R
650 H1 4x4 TRV Plus LE Multirider	07	F&R
650 H1 4x4 Auto TRV	08	F&R
650 H1 TRV	09	F&R
650 H1	10	F&R

ARCTIC CAT Contd.

650 H1 Mudpro	10-11	F&R
650 V2 4x4 LE TS Utility	06	F&R
650 V2 4x4 Auto LE Utility	04-05	F&R
650 V2 4x4 Auto Utility	04-06	F&R
TBX 650	09	F&R
700 Alterra inc XT and Mudpro	16-20	F&R
700 Alterra TBX	17-20	F&R
700 Alterra VLX	17-20	F&R
700 XR LTD and XT	15-20	F&R
700 ATV/Core	13-14	F&R
700 ATV Diesel	12-14	F&R
700 ATV Ltd	12-14	F&R
700 ATV XT	13-14	F&R
700 EFi 4x4 Auto Utility	07-08	F&R
700 EFi 4x4 Auto LE Utility	07	F&R
700 EFi 4x4 SE Utility	06	F&R
700 EFi 4x4 Auto M4	08	F&R
700 H1 EFi 4x4 Auto SE	08-09	F&R
700 H1 EFi Mudpro	09-11	F&R
700 H1 EFi	09-10	F&R
700 H1 EFi LE	09-10	F&R
700i	11-12	F&R
700i GT	11-12	F&R
700i Ltd	11-12	F&R
700i Mudpro	11-12	F&R
700 EFi Cruiser	08	F&R
700 EFi 4x4 Auto TRV LE	08	F&R
700 Diesel Utility	07-08	F&R
700 Mudpro	10-11	F&R
700 Mudpro i Ltd	11	F&R
700 S	10	F&R
700 S Ltd	10	F&R
700 TBX H1 EFi	10	F&R
700 TRV	11	F&R
700 TRV GT	11	F&R
700 TRV H1 EFi Cruiser	09-10	F&R
700 TRV Cruiser	11	F&R
700 TRV XT	13-14	F&R
700 Super Duty Diesel	10-11	F&R
700 TBX Ltd	11	F&R
1000 Alterra TRV, XT and EPS	17-20	F&R
1000 GT	11-12	F&R
Thundercat 1000 H2	08-10	F&R
Thundercat 1000 H2 LE	10	F&R
1000 Mudpro H2 EFi	11-12	F&R
1000 Mudpro LTD	13-14	F&R
1000 Mudpro SE EPS	16-20	F&R
1000 TRV H2 EFi Cruiser 2 Up	09-10	F&R
1000 TRV H2 EFi	10	F&R
1000 TRV Cruiser	11	F&R
1000 XT	13-14	F&R

KYMCO

Maxxer 400	09-10	F&R
MXU 400 (A40000)	08-11	F&R
Maxxer 450i (4T)	10-15	F&R
MXU 450 i IRS	11-12	F&R
MXU 450 i IRS	12-18	F&R

ARCTIC CAT SIDE X SIDE

Prowler 500 HDX LTD	14	F&R
Prowler 500 HDX XT	14-20	F&R
Prowler 500 HDX	14	F&R
550 H1 EFi Prowler	09	F&R
XT 550	10-11	F&R
XT 550i Prowler	11-14	F&R
XT 650 H1 Prowler	06-09	F&R
650 H1 Prowler	07	F&R
650 Prowler 4x4 Auto/M4	08	F&R
HDX 700i Prowler	11-14	F&R
Prowler 700 HDX LTD	14	F&R
XTX 700 Hi LE Prowler	08	F&R
XTX 700 Hi EFi Prowler	09	F&R

ARCTIC CAT SIDE X SIDE Contd.

XTX 700	10-11	F&R
XTX 700i Prowler	11-17	F&R
Wildcat Trail 700 XT inc LTD	15-20	F&R
Wildcat 1000i GTi	12	F&R
Wildcat 1000 4X	14-16	R
Wildcat 1000	13-14	F&R
Wildcat 1000 Ltd	13-14	F&R
Wildcat 1000 X	14	F&R
Wildcat 1000 4 LTD	14	R
Wildcat 1000 4	13-16	R
XTZ 1000 H2 EFi Prowler	09	F&R
XTZ 1000	10-14	F&R

MASSEY FERGUSON

MF 400/4WD Auto (386cc)	05-09	F&R
MF 500/4WD Auto (493cc)	05-09	F&R
MF 650 2 cyl/4WD Auto (633cc)	05-09	F&R
MF 650/4WD Auto (641cc)	05-09	F&R
MF 700 D/4WD Auto (686cc Diesel)	05-08	F&R

PIAGGIO

Trackmaster 400 Quad	06	F&R
----------------------	----	-----

POLARIS

300 Hawkeye 2x4/4x4	06	F&R
---------------------	----	-----

MATERIAL AVAILABILITY AND PART NO.				
STD	OPTIONS			
FA	V	HH	R	SXR
FA395TT	-	FA395R	-	SXR395HH

Equivalents OE #		
0502-604	1436-165	1502-694
0502-875	45105 PWB 1305	
2203045	1436-420	

DISC PADS BUYERS GUIDE

DO NOT REFIT ANY SHIMS/INSULATORS TO EBC PADS FROM ORIGINAL PADS UNLESS INSTRUCTED ON NOTE ON PAD PACKAGING AND ON FA DRAWING ASSOCIATED WITH THAT PAD.

SFA396 A. 99.00 x 44.10 x 7.56mm B. 75.50 x 37.90 x 8.26



KAWASAKI			
SC 150 A1 (Epsilon 150)	02-03	F	
SUZUKI			
AZ 50 RY/RK2 (ZZ Inch Up Sport)	00-02	F	
TR 50 SW/SX	98-00	F	
UG 110 W/SW/Y/SY/SK1 Hokuto/Address	98-02	F	
UK 110 L5/L6/L7/L8 Address	15-18	F	
AN 125 S/T/V/W/XX	95-00	F	
UC 125 X/Y 'Epicuro'	99-02	F	
UZ 125 K5/GK5 (CF46A) (V126G)	05	F	

Equivalents OE #		
43082 S001	59300 20890	59300 20890
59101 09810	59300 20830	
59300 20841	59300 20880	

MATERIAL AVAILABILITY AND PART NO.				
STD	OPTIONS			
FA	HH	R	MXS	EPFA
SFA396	SFA396HH	-	-	-

FA398 95.4 x 39.55 x 6.85mm

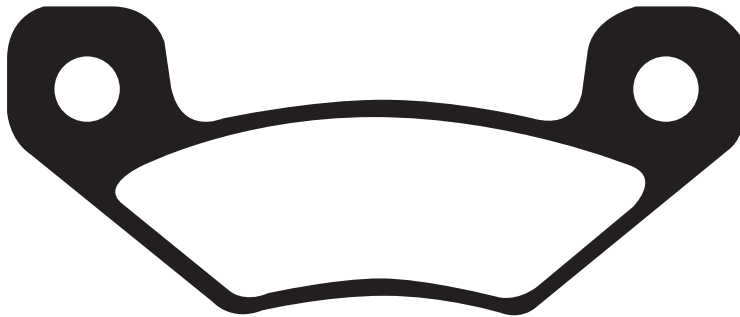

JOHN DEERE			
Gator HPX All models	04-05	F&R	
HPX 4x4 Gator (Petrol)	10-11	F&R	
HPX 4x4 Gator (Petrol) Parking brake	10-11		
HPX 4x4/4x4 Trail Gator (Petrol)	10-11	F&R	
HPX 4x4 Gator (Diesel)	10	F&R	
CAN AM			
DS 450 (2x4/EFI)	08-15	R	
DS 450 X (2x4/EFI)	08-09	R	
DS 450 XXC/XXM	10-15	R	
CLUB CAR			
Carryall 294	04-06	F	
XRT1500	04-06	F	
CUSHMAN			
Cushman Hauler 800	12-18	F	
Cushman Hauler 1200	12-15	F	
EZ-GO			
E-Z-GO TXT G5	08-19	F	
E-Z-GO Express S6	12-19	F	

MATERIAL AVAILABILITY AND PART NO.				
STD	OPTIONS			
FA	HH	R	MXS	EPFA
-	-	FA398R	-	-

Equivalents OE #		
VGA 12182	705600485	705600 711
VGA 12183	Z150-9261	

FA399 69.65 x 51.55 x 7.25mm

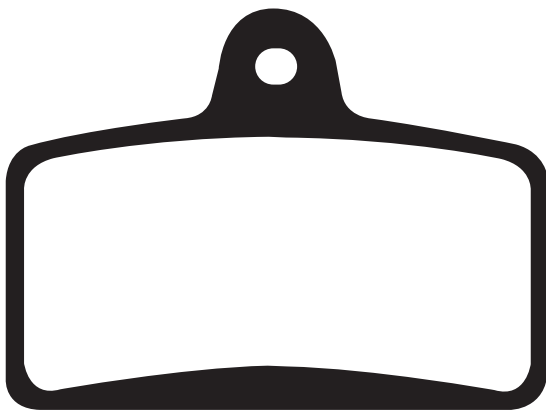

APRILIA			
RS4 50 (4T) (AJP Caliper)	11-14	F	
RS4 125 (4T) (AJP Caliper)	11-20	F	
RS 125 (4T)	17-18	F	
RS 125 (4T) GP Replica	18-20	F	
Tuono 125	17-20	F	
BLATA			
Enduro 125	07-08	F	
Motard 125	07-08	F	
CONTI			
RX 356 V3 (12" wheels)	05-06	F	
RX 356 V3 (17" wheels)	05-06	F	
DERBI			
GPR 50 (2T) 41mm forks/218mm rear disc	09-12	F	
GP1 125cc Racing Low seat/radial caliper			
/6 bolt disc fixing	07-09	F	
GPR 125 Racing (Radial caliper)	04-07	F	
GPR 125 Nude (Radial caliper)	04-08	F	
GPR 125 (4T) 4V	09-14	F	
GP1 250i cc Racing Low seat/radial caliper			
/6 bolt disc fixing	07-09	F	
GILERA			
SC 125	06-07	F	
METRAKIT			
Pre GP 125	09	F	
MH/MOTORHISPANIA			
KN2 50	12-13	F	
RX 50 R	08-14	F	
125 LC Hard Road SM	12	F	
KN1 (125cc) AC/LC	09-14	F	
KN2 (125/4T)	12-14	F	
RX 125 R	08-14	F	
MH7 Naked (125cc/Air Cooled)	08-14	F	
MH7 Naked (125cc/Liquid Cooled)	08-14	F	
PEUGEOT			
XR7 (50cc)	08-12	F	
NK7 "Naked" 50cc	09-12	F	
RIEJU			
RS3 NKD 50	12-14	F	
RS3 NKD 125	12-14	F	

Equivalents OE #	
00H01201221	8044220
810K5804	864580
866687	

MATERIAL AVAILABILITY AND PART NO.					
STD	OPTIONS				
FA	V	HH	R	MXS	EPFA
FA399	-	-	-	-	-

DISC PADS
BUYERS GUIDE

DO NOT REFIT ANY SHIMS/INSULATORS TO EBC PADS FROM ORIGINAL PADS UNLESS INSTRUCTED ON NOTE ON PAD PACKAGING AND ON FA DRAWING ASSOCIATED WITH THAT PAD.

FA400 A. 97.54 x 64.2 x 8.1mm B. 97.54 x 64.2 x 8.1mm
FA400HH/V A. 97.54 x 64.2 x 7.5mm B. 97.54 x 64.2 x 7.5mm

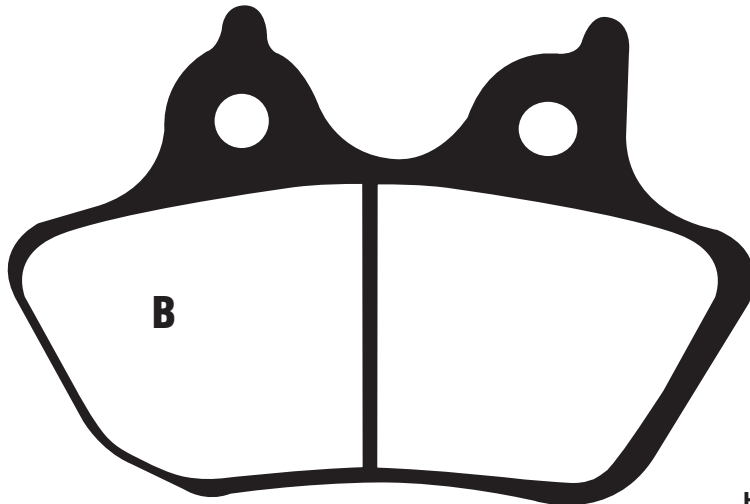

**NOTE: THIS PAD REPLACES
FA299/FA299HH**

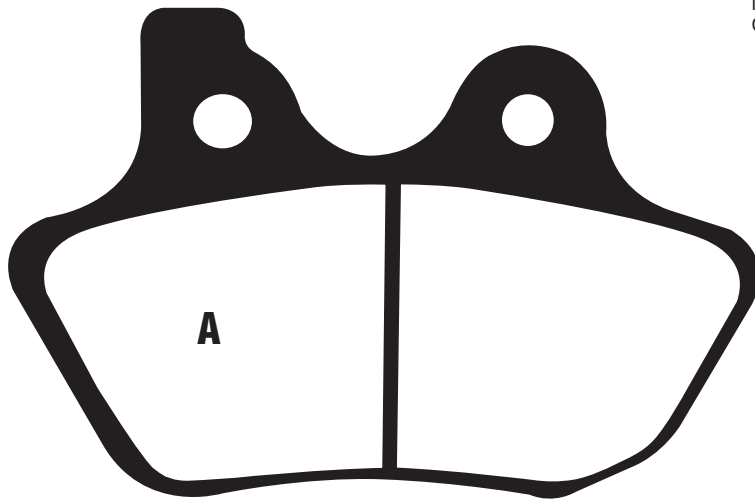

HARLEY DAVIDSON
 Most models 03-11 F&R
 Check application listings for details

**CHECK PAD SHAPE TO CONFIRM
CORRECT PAD HAS BEEN
SELECTED**

MATERIAL AVAILABILITY AND PART NO.						
STD	OPTIONS					
FA	V	VLD	HH	R	MXS	EPFA
FA400	FA400V	FA400VLD	FA400HH	-	-	EPFA400HH

Equivalents OE #
44082 00C
44082 00D

FA401 A. 99 x 40.1 x 7.56mm B. 75.5 x 37.9 x 8.26mm

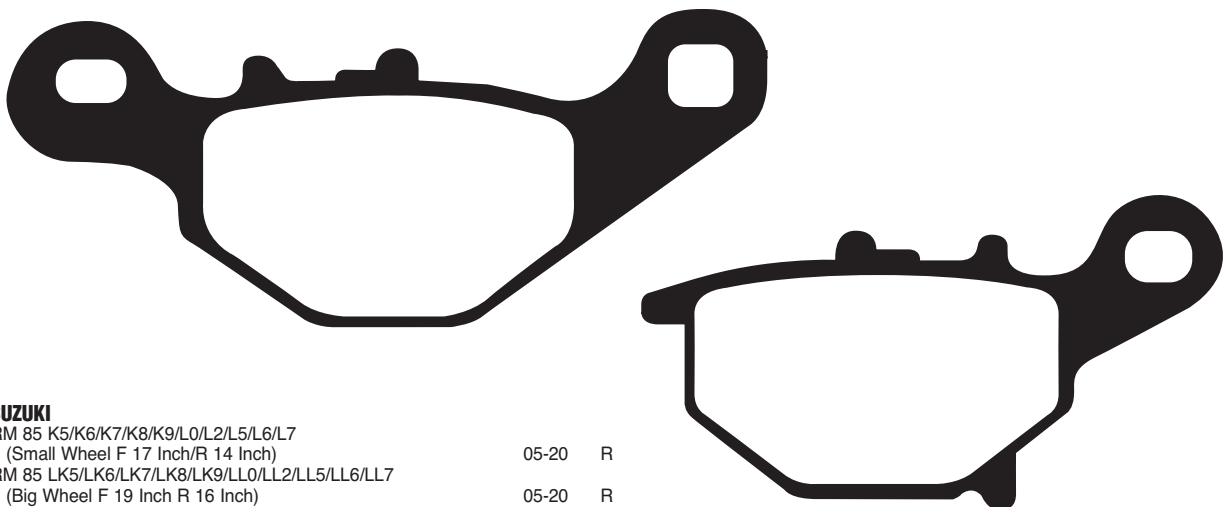

SUZUKI
 RM 85 K5/K6/K7/K8/K9/L0/L2/L5/L6/L7
 (Small Wheel F 17 Inch/R 14 Inch) 05-20 R
 RM 85 LK5/LK6/LK7/LK8/LK9/LL0/LL2/LL5/LL6/LL7
 (Big Wheel F 19 Inch R 16 Inch) 05-20 R

MATERIAL AVAILABILITY AND PART NO.					
STD	OPTIONS				
FA	V	HH	R	MXS	EPFA
FA401TT	-	-	FA401R	-	-

Equivalents OE #
69100 03880

FA403 41.1 x 44.7 x 6.45mm



1 left pad
1 right pad

BETA		
EVO 80 Senior	09-20	R
REV 80	08	R
REV 3 125/200	06-08	R
REV 3 250/270	05-08	R
REV 4T 250	07-08	R

MATERIAL AVAILABILITY AND PART NO.					
STD	OPTIONS				
FA	V	HH	R	MXS	EPFA
FA403	-	-	-	-	-

Equivalents OE #
25-25363
25-25373

MXS405 76.35 x 49.4 x 7.9mm



Note: Pads are handed left and right

APRILIA		
SXV 450/550 Supermotard	06-13	F
Pegaso 650 Factory	06-08	F
BERINGER		
4 Piston (Radial)		
FTE		
4 Piston Radial Supermoto		
HUSABERG		
FS 450 C	06	F
FS 450 E	06-08	F
FS 550 E Supermoto	05-07	F
FS 650 C	06-08	F
FS 650 E Supermoto	05-08	F
KTM		
SMR 450	05-06	F
SMR 525	05	
SMR 650 Supermoto	06	F

MATERIAL AVAILABILITY AND PART NO.					
STD	OPTIONS				
FA	V	HH	R	MXS	EPFA
-	-	-	-	MXS405	EPFA405HH

Equivalents OE #	
586 13 030 100	586 13030 200
9100906	586 13 030 300
1200 S/R2	586 13 030 000

MXS406 102.2 x 47.8 x 7.9mm

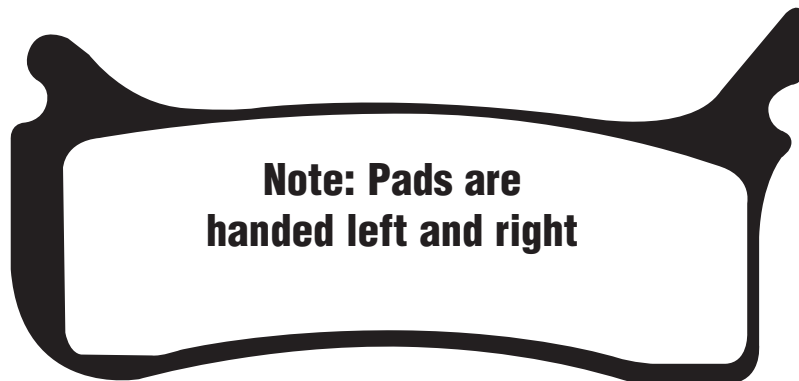

Note: Pads are handed left and right

BERINGER		
6 Piston (New Design)		
FTE		
Piston Radial Supermoto		
HUSABERG		
FS Supermotard Models	04-	F
KTM		
SMR 450/525	04	F

MATERIAL AVAILABILITY AND PART NO.					
STD	OPTIONS				
FA	V	HH	R	MXS	EPFA
-	-	-	-	MXS406	EPFA406HH

Equivalents OE #
800 13 030 000
1100 S/R2

DO NOT REFIT ANY SHIMS/INSULATORS TO EBC PADS FROM ORIGINAL PADS UNLESS INSTRUCTED ON NOTE ON PAD PACKAGING AND ON FA DRAWING ASSOCIATED WITH THAT PAD.

FA407 100.10 x 57.20 x 8.40mm

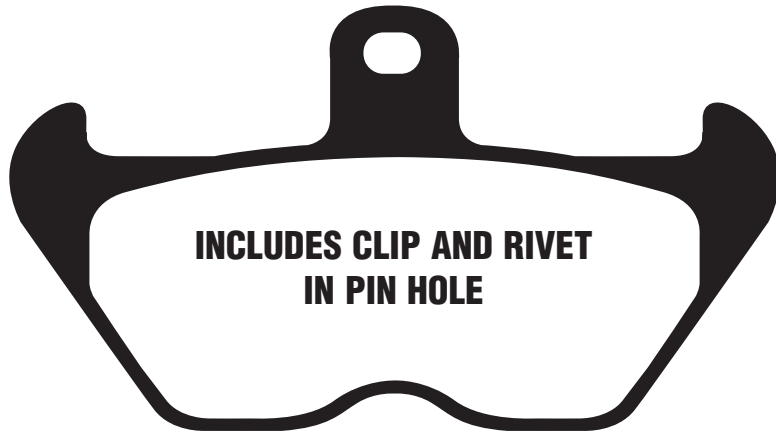

NOTE: THIS PAD REPLACES FA246

BMW

K 100 RS	89-92	F
K1	88-93	F
K 1100 LT	89-07/93	F
KL 1100 LT	89-99	F
K 1100 RS	92-96	F
K 1200 RS	96-00	F
K 1200 LT	97-10/00	F
R 80 Mystic	94-95	F
R 80 R	91-94	F
R 850 C	97-00	F
R 850 GS	96-00	F
R 850 R	94-02	F
R 850 RT	96-01	F
R 100 Mystic	93-96	F
R 100 R	91-95	F
R 1100 GS	93-99	F
R 1100 R	93-01	F
R 1100 RS	92-01	F
R 1100 S	96-11/00	F
R 1100 RT	94-01	F
R 1150 GS (R21/0415/0495)	98-10/01	F
R 1200	00-02	F
R 1200 C	96-02	F

MATERIAL AVAILABILITY AND PART NO.					
STD	OPTIONS				
FA	HH	V	R	MXS	EPFA
FA407	FA407HH	-	-	-	EPFA407HH

Equivalents OE #		
34 11 2 314 996	34 11 7 655 687	34 11 7 658 156
34 11 2 310 983	34 11 2 331 173	34 11 2 333 045
34 11 7 663 764	34 11 2 314 512	

SFA408 99.84 x 38.52 x 11.8mm

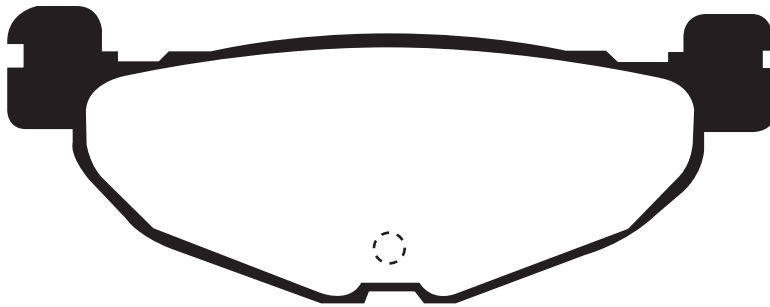

YAMAHA

CP 250 (1B71) Maxam/Morphus	05-06	R
YP 400 Majesty (Non ABS)	04-13	R
YP 400 Majesty (ABS)	07-13	R
XP 500 T-Max (5VU1/2/4BS)	04-07	R
XP 500 T-Max Non ABS Models	08-11	R
XP 500 T-Max (ABS Models)	08-11	R

MBK

YP 400 Skyliner	04	R
-----------------	----	---

MATERIAL AVAILABILITY AND PART NO.					
STD	OPTIONS				
SFA	SFAC	HH	R	MXS	EPFA
SFA408	SFAC408	SFA408HH	-	-	-

Equivalents OE #
5VU W0046 01
1B7 W0046 00
5RU W0046 00

DO NOT REFIT ANY SHIMS/INSULATORS TO EBC PADS FROM ORIGINAL PADS UNLESS INSTRUCTED ON NOTE ON PAD PACKAGING AND ON FA DRAWING ASSOCIATED WITH THAT PAD.

FA409 91.95 x 56 x 7.05mm

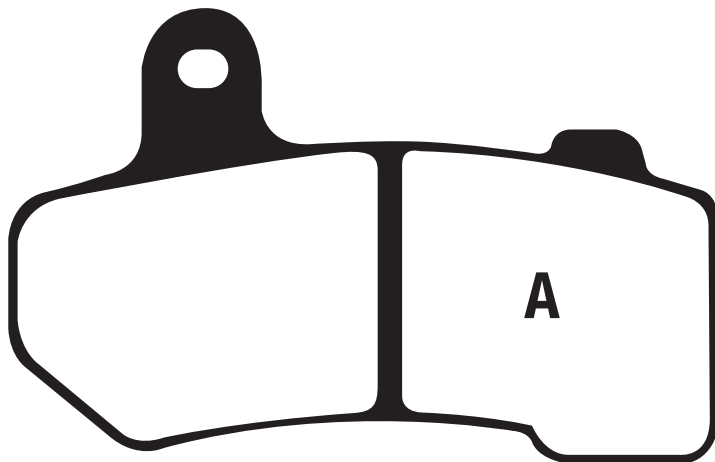

A

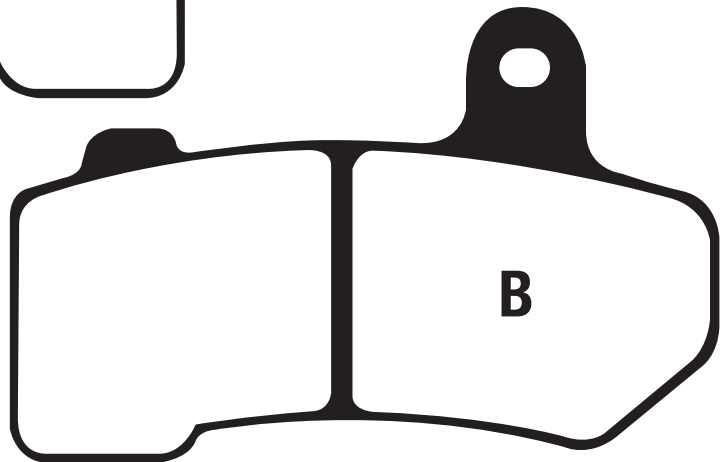

B

VRSCA/VRSCB

V-Rod	06 F&R
VRSCR Street Rod	06-07 F&R
VRSCD Night Rod (Cast Wheel)	06-08 F&R
VRSCAW V-Rod	07-10 F&R
VRSCDX Night Rod Special (Cast wheel)	07-17 F&R
VRSCX VRod	07 F&R
VRSCF V-Rod Muscle	09-17 F&R
VRSC Night Rod Special	F&R
VRSC 10th Anniversary V-Rod	12 F&R

FLHR/FLHRCI

FLHR Road King	08-12 F&R
FLHRC Road King Classic	08-20 F&R
FLTR Road Glide	08-09 F&R
FLHTC Electra Glide Classic	08-11 F&R
FLHTCU Ultra Classic Electra Glide	08-20 F&R
FLHTCUL Electra Glide Ultra Classic LOW	15 F&R
FLHT Electra Glide Standard	08-10 F&R
FLHTK Electra Glide Ultra Ltd	10-20 F&R
FLHTK Ultra LTD	15-20 F&R
FLHTKL Ultra LTD LOW	15-20 F&R
FLTRX Road Glide Custom	10-13 F&R
FLTRX Road Glide	15-20 F&R
FLTRXS Road Glide Special	15-17 F&R
FLHX Street Glide	08-20 F&R
FLHXS Street Glide Special	14-20 F&R
FLHTCUTG Tri Glide Ultra Classic Trike	09-13 F
FLTRU Road Glide Ultra	11-12 F&R
FLHXXX Street Glide Trike	10-11 F
FLHR Road King (Cast Wheel Type)	15-20 F&R
FLTRU Road Glide Ultra	16-20 F&R

MATERIAL AVAILABILITY AND PART NO.

STD	OPTIONS				
FA	HH	V	VLD	MXS	EPFA
FA409	FA409HH	FA409V	FA409VLD	-	EPFA409HH

Equivalents OE #

41852-08	42850-06B
41854-08	42897-06A
42850-06A	42897-08

**DISC PADS
BUYERS GUIDE**

DO NOT REFIT ANY SHIMS/INSULATORS TO EBC PADS FROM ORIGINAL PADS UNLESS INSTRUCTED ON NOTE ON PAD PACKAGING AND ON FA DRAWING ASSOCIATED WITH THAT PAD.

FA410 81.8 x 38.45 x 10.15mm



HONDA			
TRX 500 FA5/FA6/FA7/FA8/FA9/FAA/FAB		05-11	F
TRX 500 FE5/FE6/FE7/FE8/FE9/FEA/FEB Fourtrax Foreman 4WD ES		05-11	F
TRX 500 FM5/FM6/FM7/FM8/FM9/FMA/FMB Fourtrax Foreman 4WD		05-11	F
TRX 500 FPE8/FPE9/FPEA Fourtrax Foreman Power Steering		08-11	F
TRX 500 TM5/TM6 Fourtrax Foreman		05-06	F
TRX 680 FGA6/FGA7/FGA8/FGA9/FA6/7/8/9 Fourtrack Rincon		06-09	F
TRX 680 FA6/FA7/FA8/FA9/FAA/FAB/FAC Rincon 4x4 Auto		06-14	F
TRX 700 XX8/XX9/XXB		08-11	R

MATERIAL AVAILABILITY AND PART NO.				
STD	OPTIONS			
FA	V	HH	R	MXS
FA410TT	-	FA410R	-	-

Equivalents OE #	
06451	HPO A01
06452	HPO A01
06435	HP6 A01

SFA411 81 x 42 x 8.3mm

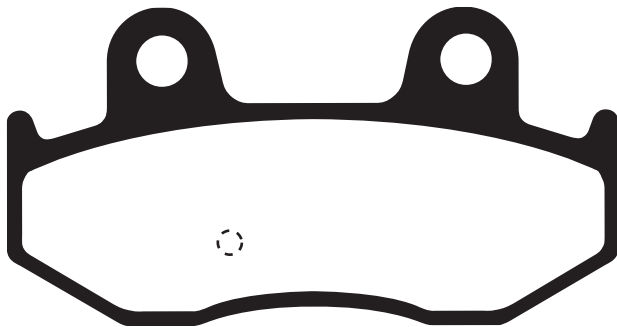

SUZUKI			
AN 250 K1/K2 Burgman		01-02	R
AN 400 K1-K6 Burgman/Skywave		01-06	R

MATERIAL AVAILABILITY AND PART NO.				
STD	OPTIONS			
SFA	SFAC	HH	R	MXS
SFA411	SFAC411	SFA411HH	-	-

Equivalents OE #	
69100	14860
69100	14890

SFA412 87.9 x 41.1 x 8.4mm

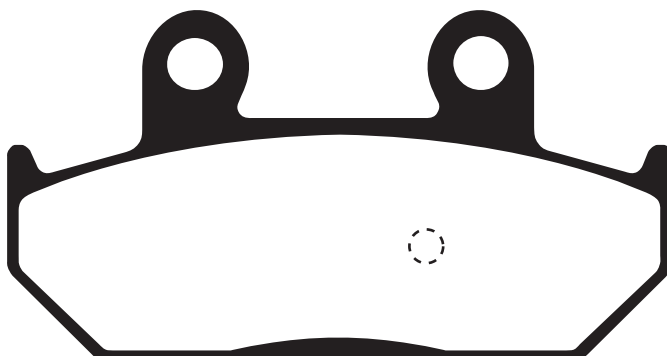

SUZUKI			
AN 250 Skywave Type M (BA-CJ4SA)		07-08	R
AN 250 Skywave/Type S (BA-CJ44A)		07-08	R
AN 250 8 Skywave SS (CJ46A)		08	R
AN 400 K7/ZK7/K8/ZK8/K9/L0/L1/L2/L3/L4 Burgman/Non ABS/Skywave		07-15	R
AN 400 AK9/ZAK9/AL0/ZAL0/AL1/ZAL1/AL2 /AL3/AL4/ZAL4/AL5/ZAL5/AL6/ZAL6/AL7/ZAL7 /AL8/ZAL8/AL9/ZAL9 Skywave/Burgman/ABS		09-20	R
AN 650 K3/K4/K5/K6/K7/K8/K9/L0 Burgman/Non ABS		04-11	R
AN 650 ZL3/ZL4/ZL5/ZL6/ZL7/ZL8 Burgman ABS Executive		13-18	R
AN 650 L3/L4/L5/L6 Burgman Non ABS		13-16	R
AN 650 AK4/AK5/AK6/AK7/AZK8/AK8/AK9/AL0 Burgman/ABS		04-12	R

MATERIAL AVAILABILITY AND PART NO.					
STD	OPTIONS				
FA	V	HH	R	MXS	EPFA
SFA412	SFAC412	SFA412HH	-	-	-

Equivalents OE #	
69100	10840
69100	10860
69102	05890

FA413 A. 82 x 40.85 x 8.22mm B. 62 x 40.8 x 8.6mm

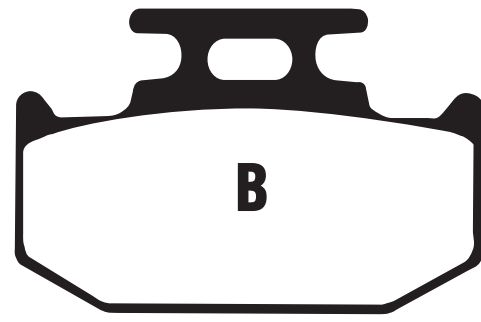

BENELLI

Caffe Nero 250	08-14	R
SUZUKI		
UH 125 K7/K8/K9/L0/L1/L3/L4/L5/L6 Burgman	07-16	R
UH 125 AL4/AL5/AL6/AL7/AL8 Burgman (ABS)	14-18	R
UH 200 K7/K8/K9/L0/L1/L3/L4/L5/L6 Burgman	07-16	R
UH 200 AL4/AL5/AL6/AL7/AL8/AL9 Burgman (ABS)	14-20	R
LT-A 400 FK8/FK9/FL0/FL1 King Quad Auto 4WD	08-12	F(left)
LT-F 400 FK8/FK9/FL0/FL1 King Quad 4WD	08-12	F(left)

SUZUKI Contd.

LT-A 450 XK7/XK8/XK9 King Quad	07-10	F(left)
LT-A 500 XPK9/XPZK9/XPL0 -XPL5 King Quad (Power Steering)	09-15	F(left)
LT-A 700 XK5/XCK6/XK6/XK7 Kingquad	05-07	F(left)
LT-A 750 XZK8/XK8/XK9/XZK9/L0 King Quad	08-10	F(left)
LT-A 750 XPK9/XPZK9/XPL0 -XPL5 King Quad Power Steering	09-15	F(left)

MATERIAL AVAILABILITY AND PART NO.				
STD	OPTIONS			
FA	SFA	SFAC	SFAC-HH	R
FA413TT	SFA413	SFAC413	SFA413HH	FA413R

Equivalents OE #
59100 31860
69101 03820

FA414 A. 82 x 40.85 x 8.22mm B. 62 x 40.8 x 8.6mm

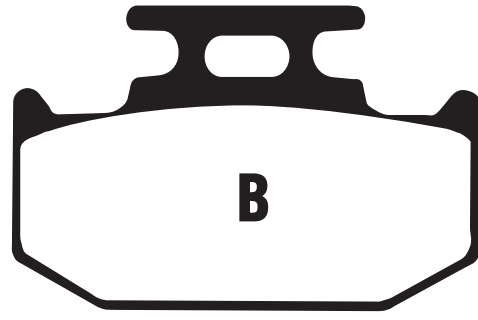
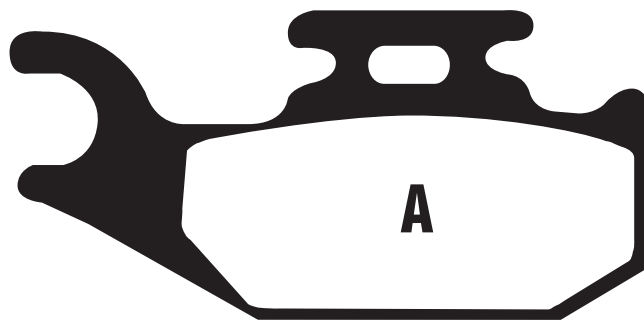

SUZUKI

LT-A 400 FK8/FK9/FL0/FL1 King Quad Auto 4WD	08-12	F(right)
LT-F 400 FK8/FK9/FL0/FL1 King Quad 4WD	08-12	F(right)
LT-A 450 XK7/XK8/XK9 King Quad	07-10	F(right)

SUZUKI Contd.

LT-A 500 XPL0/XPK9/XPZK9/XPL0-XPL5 King Quad (Power steering)	09-15	F(right)
LT-A 700 XK5/XCK6/XK6/XK7 Kingquad	05-07	F(right)
LT-A 750 XK8/XK9/XZK9/XL0 King Quad	08-10	F(right)
LT-A 750 XPK9/XPZK9/XPL0/XPL1/XZK8 King Quad (Power Steering)	09-12	F(right)

MATERIAL AVAILABILITY AND PART NO.				
STD	OPTIONS			
FA	HH	R	MXS	EPFA
FA414TT	-	FA414R	-	-

Equivalents OE #
59100 31850

DO NOT REFIT ANY SHIMS/INSULATORS TO EBC PADS FROM ORIGINAL PADS UNLESS INSTRUCTED ON NOTE ON PAD PACKAGING AND ON FA DRAWING ASSOCIATED WITH THAT PAD.

SFA415 81.7 x 37.35 x 8.95mm - Refit O/E shim

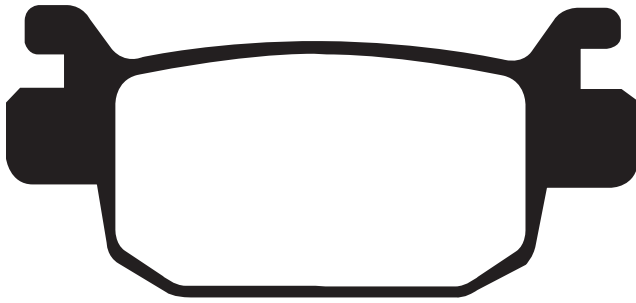

GENERIC/KSR

Classic 125	17-18	R
HONDA		
FES 125 A7/A9/AA S-Wing	07-15	R
FES 125 7/9/A S-Wing (Non ABS Model)	07-13	R
NSS 125 Forza (2 Piston Caliper)	15-18	R
SH 125i 9/A/B Fuel Injection	09-12	R
SH 125i RA Fuel Injection (Rear disc model)	10-14	R
SH 125i (2 Piston Caliper/ABS)	14-18	R
SH 125i (3 Piston Caliper/ABS)	14-16	R
FES 150 7/9/A S-Wing	07-13	R
FES 150 A7/A9/AA (S-Wing) ABS Model	07-13	R
SH 150i 9/A/B Fuel Injection	09-12	R
SH 150 RA Fuel Injection (Rear disc)	10-14	R
SH 150i (2 Piston Caliper/ABS)	14-18	R
SH 150i (3 Piston Caliper/ABS)	14-16	R
NSS 250 EX5/EX7/EX8 Forza EX	05-08	R
NSS 250 AX5/AX6 (ABS) Forza Z	05-06	R
NSS 250 X5/X7/X8 Forza	05-08	R
NSS 300 AD Forza (ABS)	13-17	R
NSS 300 D Forza (Non ABS)	13-15	R
SH 300i 7/8/9/A/B (Non ABS)	07-12	R
SH 300i A7/A8/A9/AA/AB/AC (ABS model)	07-13	R
SH 300i R8/R9/RA (Non ABS)	08-10	R
SH 300i AR8/AR9/ARA (ABS Model)	08-10	R
SH 300i ABS	14	R
SH 300i (2 Piston Caliper) ABS	16-18	R
PEUGEOT		
Metropolis 400 RS (3 Wheel Model/Nissin Caliper)	17-18	F
Metropolis 400 RX-R (3 Wheel Model/Nissin Caliper)	17-18	F
Metropolis 400 Allure (3 Wheel Model/Nissin Caliper)	17-18	F

Equivalents OE #			
06435 KSV J01	43251 KTW 901	06435 K04 931	06435 K40 F02
06435 KSV J02	06435 K40 F11	06435 K01 D11	

MATERIAL AVAILABILITY AND PART NO.						
STD	OPTIONS					
	SFA	SFAC	HH	R	MXS	EPFA
SFA415	SFAC415	SFA415HH	-	-	-	-

FA416 A. 85 x 37 x 7.9mm B. 48.1 x 31.8 x 48.1 x 10.2mm

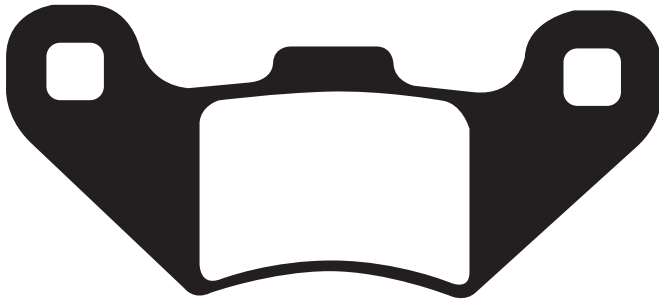

ADLY

Interceptor 300 Quad

EXPLORER

Ranger 300 2x4/4x4

HAMMERHEAD BUGGIES

80T

150 Supersport ES 150 11 R

KAZUMA

MF 90 Falcon

MH

KN2 50

MH10 Eco Urban

MH10 50 Enduro

MH10 50 SM

MH10 Pro 50 Enduro

MH10 Pro 50 SM

MH Contd.

F MH10 Pro Urban 50

RYZ 50 Enduro

F RYZ SM 50

RYZ Pro SM 50

R Duna 125

F Duna Pro 125

KN2 (125/4T)

F&R 125 LC Hard Road SM

MH10 125 Enduro

R MH10 125 SM

PGO

F BR 150 E Bugrider

F Bugrider 150

F BR-200 Bugrider

F BR 250 Bugrider E

PGO Contd.

F Bugrider 250 SS (Single seat)

F Bugrider 250

F 250 Bug

F Bugrider 50 (Buggie)

QUADZILLA

F RV 125 Midi RV Bug

R RV 150 Midi RV Buggie

R BR 200

F BR 250

F XRV 250 (Off road)

XRV 250 E

F XRV 250

F RL 300 Buggie

F XL 300

F

MATERIAL AVAILABILITY AND PART NO.					
STD	OPTIONS				
	FA	HH	R	MXS	EPFA
FA416TT	-	FA416R	-	-	-

Equivalents OE #
07-020-016
B54033 10000
585010100005

FA417/4 49.85 x 37.75 x 7.78mm

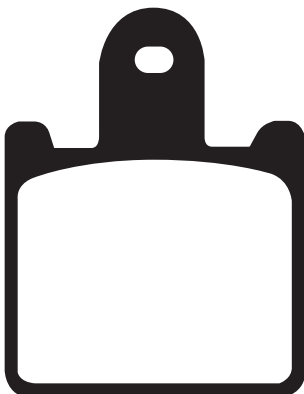

KAWASAKI

ZX6R (ZX 600 P7F/P8G/R9F/RAF/RBF/RCF/RDF/REF/RFF/RGF)

Z 750 R Non ABS (ZR750 NBF/NCF)

Z 750 R ABS (ZR 750 PBF/PCF)

Z 1000 (ZR 1000 B7F/B8F/B9F)

Z 1000 ABS (ZR 1000 C7F/C8F/C9F)

GTR 1400 (ZG 1400 A8F/A9F/CAF/CBF/CCF/CDF/CEF/EEF/EGF/EHF/EJH)

ZZR 1400 (ZX 1400 A6F/A7F)

ZZR 1400 ABS (ZX 1400 B6F/B7F/D8F/D9F/DAF/DBF/FCF/FDF/FEF/FFF

/HGF/HHF/HJF)

ZZR 1400 Special Edition (ZX 1400 FDF/FEF/FFF)

Equivalents OE #			
43082 0053	43082 0072	43082 0104	43082 162
43082 0071	43082 0118	43082 0122	

MATERIAL AVAILABILITY AND PART NO.						
STD	OPTIONS					
	FA	GPFA	HH	R	MXS	EPFA
-	GPFA417/4HH	FA417/4HH	-	-	-	EPFA417/4HH

SFA418 A. 96.8 x 39.35 x 9.3mm B. 77 x 42 x 9.3mm

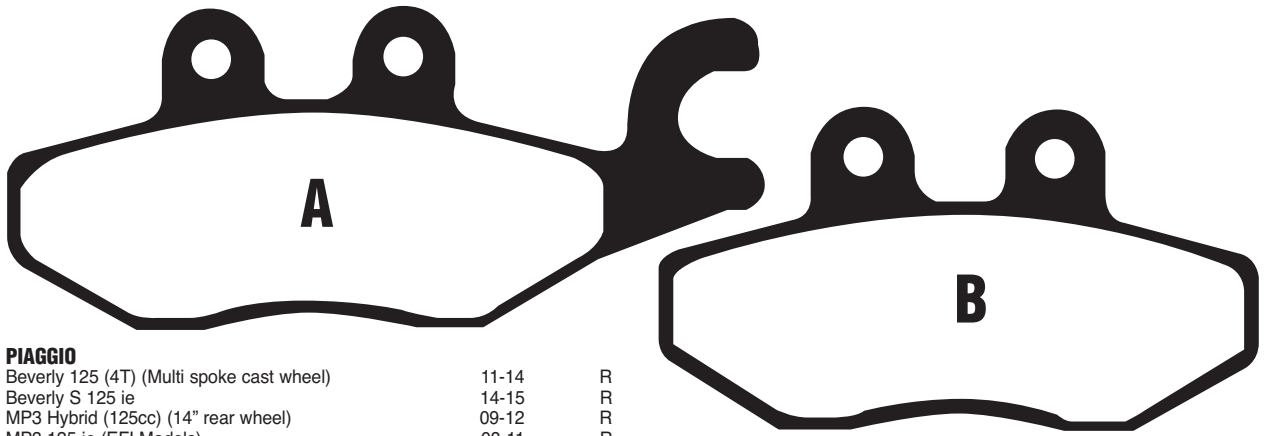

PIAGGIO

Beverly 125 (4T) (Multi spoke cast wheel)	11-14	R			
Beverly S 125 ie	14-15	R			
MP3 Hybrid (125cc) (14" rear wheel)	09-12	R			
MP3 125 ie (EFI Models)	08-11	R			
125 ie MP3 Yourban	11-12	R	MP3 Business LT 300 ie ABS (13" Front Wheel /14" Rear Wheel)	14-20	R
Medley 125 (ABS)	16-20	R	MP3 Touring 300 ie	11-12	R
Medley S 125 (ABS)	16-20	R	MP3 Touring LT 300 ie	11-12	R
X7 125cc	08-09	R	MP3 Yourban LT 300ie	11-16	R
X7 Evo 125 ie (EFI)	09-12	R	MP3 Yourban Sport 300ie	11-16	R
X9 125 Evolution	05-07	F(right)	MP3 Yourban LT RL 300	17-18	R
X10 125ie (4V/4T/EFI) All models	12-10	F(right)&R	MP3 Sport LT 300ie	13	R
Xevo 125	07-16	R	MP3 Sport LT 300 ie ABS (13" Front Wheel/14" Rear Wheel)	14-20	R
Medley 150 (ABS)	16-20	R	X7 300 Evo	09-12	R
Medley S 150 (ABS)	16-20	R	Beverly 350 ie Sport Touring Non ABS (330cc/4T)	11-15	R
MP3 250 MIC/EFI (14" rear wheel)	08-09	R	Beverly 350 ie ABS Sport Touring (330cc/4T)	11-15	R
MP3 250 LT (EFI) (14" rear wheel)	09	R	Beverly 350 ie Sport Touring ABS(330cc/4T)	16-20	R
X7 250 ie	08-09	R	X10 ie 350 (4v/4t/efi)	12-15	F(right)&R
X9 250	05-06	F(right)	400 ie (MP3 Touring)	11-12	R
Xevo 250 ie	07-10	R	MP3 Touring 400 ie LT	11-12	R
Beverly 300 (278cc/4T)(5 spoke cast wheel)	10-15	R	Xevo 400 ie	07-10	F(right)
Beverly S 300 ie	14-20	R	X8 400 ie	06-08	F(right)
Beverly Police 300 ABS ASR (278cc)	16-18	R	MP3 500 EFI	09-10	R
300 ie MP3 Yourban	11-12	R	X10 500ie (4V/4T/EFI) All models	12-15	F(right)&R
MP3 300 LT ie	10	R	GTS 300 ie (ABS Models)	08-18	F
MP3 300 ie (Hybrid)	11-15	R	GTS 300 ie Super (ABS Models)	08-18	F
MP3 300 ie (Hybrid LT)	11-12	R	GTS 300 ie Super Sport (ABS Models)	08-18	F
MP3 Business LT 300ie	13	R	GTS 300 ie Touring (ABS Models)	11-17	F

MATERIAL AVAILABILITY AND PART NO.

STD	OPTIONS				
SFA	SFAC	HH	R	MXS	EPFA
SFA418	SFAC418	SFA418HH	-	-	-

Equivalents OE

497395	665842
647079	668021

FA419 A. 89.25 x 40.65 x 9.75mm B. 89.25 x 40.65 x 9.75mm

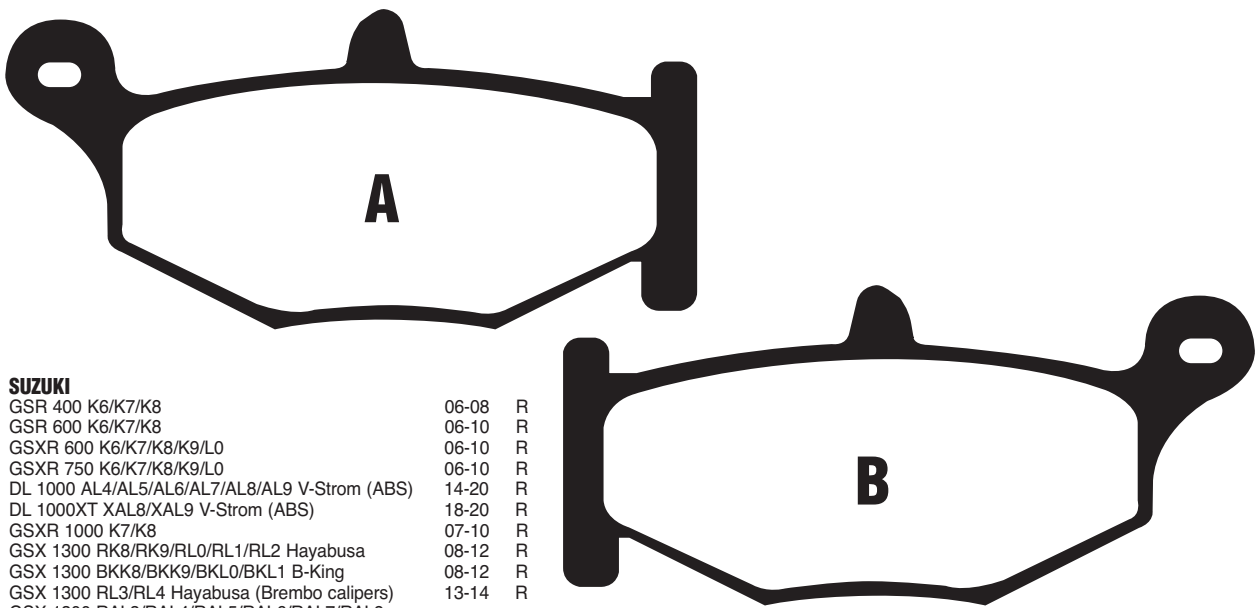

SUZUKI

GSR 400 K6/K7/K8	06-08	R			
GSR 600 K6/K7/K8	06-10	R			
GSXR 600 K6/K7/K8/K9/L0	06-10	R			
GSXR 750 K6/K7/K8/K9/L0	06-10	R			
DL 1000 AL4/AL5/AL6/AL7/AL8/AL9 V-Strom (ABS)	14-20	R			
DL 1000XT XAL8/XAL9 V-Strom (ABS)	18-20	R			
GSXR 1000 K7/K8	07-10	R			
GSX 1300 RK8/RK9/RL0/RL1/RL2 Hayabusa	08-12	R			
GSX 1300 BKK8/BKK9/BKL0/BKL1 B-King	08-12	R			
GSX 1300 RL3/RL4 Hayabusa (Brembo calipers)	13-14	R			
GSX 1300 RAL3/RAL4/RAL5/RAL6/RAL7/RAL8 Hayabusa (Brembo calipers)	13-18	R			

MATERIAL AVAILABILITY AND PART NO.

STD	OPTIONS				
FA	V	HH	R	MXS	EPFA
FA419	FA419V	FA419HH	-	-	-

Equivalents OE

69101 44810	69101 44890
69100 15830	
69100 15850	

FA420 69.28 x 54.48 x 7.9mm

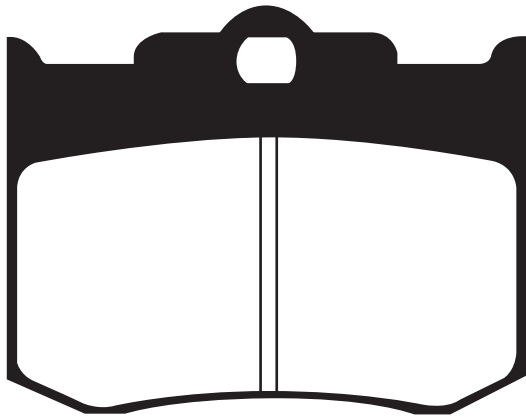

PERFORMANCE MACHINES
137 X 4

MATERIAL AVAILABILITY AND PART NO.				
STD	OPTIONS			
FA	V	HH	R	MXS
-	-	FA420HH	-	-

Equivalents OE #
137 X 4

FA423/4 44.7 x 53.5 x 8.45mm

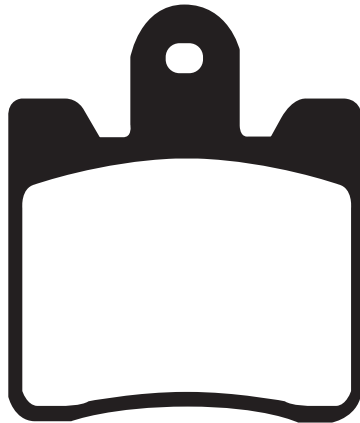

YAMAHA		
FJR 1300 A (ABS) (4 pad caliper)	06-20	F
FJR 1300 AE (Electronic Suspension Adjustment/USD Forks)	14-20	F
FJR 1300 AS (ABS/Electric Shift)	06-20	F
XV 1900 ACFD Midnight Star/Casual Full Dresser (With Handlebar Fairing)	13-16	F
XVS 1900 A (Midnight Star 3 spring clutch)	11-13	F
TRIUMPH		
Trophy 1215cc	12-16	F
Trophy 1215cc SE	12-17	F

MATERIAL AVAILABILITY AND PART NO.					
STD	OPTIONS				
FA	V	HH	R	MXS	EPFA
-	-	FA423/4HH	-	-	-

Equivalents OE #
3P6 W0045 00
1CR W0045 00
T2022395
202239

FA424 91.6 x 51.5 x 8.5mm

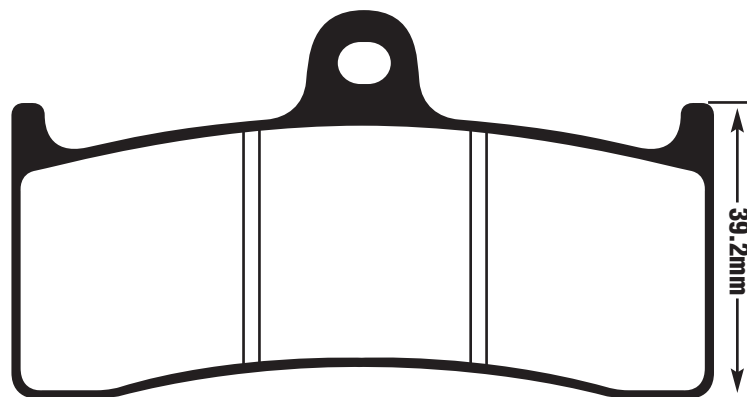

HONDA		
CB 1300 FW/FX/FY (SC40)	98-00	F
KAWASAKI		
ZX-7RR (ZX750 N1/N2)	96-99	F
YAMAHA		
YZF-R7 750 '0W02' (Race version)	99-01	F
BUELL		
X1 Lightning	98-05	F
M2 Cyclone	98-05	F
HHI (HAWG HALTERS)		
6 Piston - All types		
MV		
750 Brutale S F4	03-05	F
750 Brutale Oro F4	03-05	F
750 F4S (Mono Posto)	99-04	F
750 F4S 1+1 (Bi-Posto)	01-04	F
750 F4 SPR	01-04	F
750 F4 SPR Senna	01-03	F
910 Brutale S (Nissin Calipers)	06-08	F
1000 F4 AGO	05	F
1000 F4 S (Mono Posto)	04-06	F
1000 F4 S 1+1 (Bi Posto)	04-06	F
1000 F4 Tamburini	05	F

MATERIAL AVAILABILITY AND PART NO.					
STD	OPTIONS				
FA	V	HH	R	MXS	EPFA
FA424	-	FA424HH	-	-	EPFA424HH

Equivalents OE #		
43082 1181	80009870	06455 MBR 006
800094024	H0300F	

SFA425 55.5 x 54.5 x 8mm

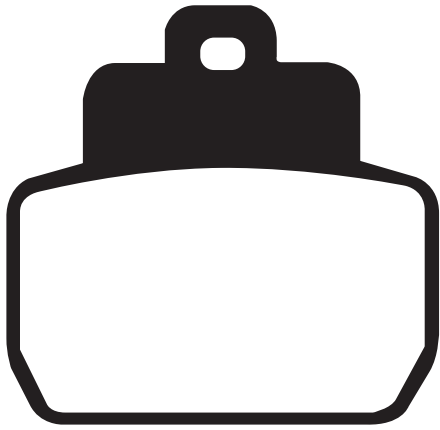

PIAGGIO

MP3 125 (Carb models) (12" rear wheel)	06-08	R
X8 125 (Heng Tong Rear Caliper)	05-06	R
X8 125 ie (Heng Tong Rear Caliper)	07	R
X8 150 Street	07	R
MP3 250cc (EFi) (12" rear wheel)	06-08	R
X8 250 ie	05-07	R
X9 250	05-07	R
Beverley 500	06	R

Equivalents OE

497429	647080	647400
--------	--------	--------

MATERIAL AVAILABILITY AND PART NO.

STD	OPTIONS				
SFA	SFAC	HH	R	MXS	EPFA
SFA425	SFAC425	SFA425HH	-	-	-

DISC PADS
BUYERS GUIDE

FA426 64 x 48 x 7.8mm

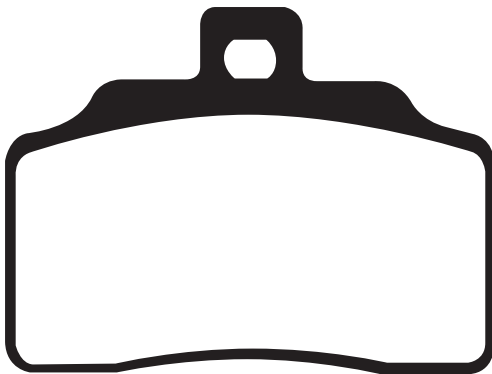

BETA

M4 350 Supermotard 04-15 F

Equivalents OE

252524600

MATERIAL AVAILABILITY AND PART NO.

STD	OPTIONS				
FA	V	HH	R	MXS	EPFA
FA426	-	-	-	-	-

DO NOT REFIT ANY SHIMS/INSULATORS TO EBC PADS FROM ORIGINAL PADS UNLESS INSTRUCTED
ON NOTE ON PAD PACKAGING AND ON FA DRAWING ASSOCIATED WITH THAT PAD.

FA427 94 x 36.1 x 10.3mm

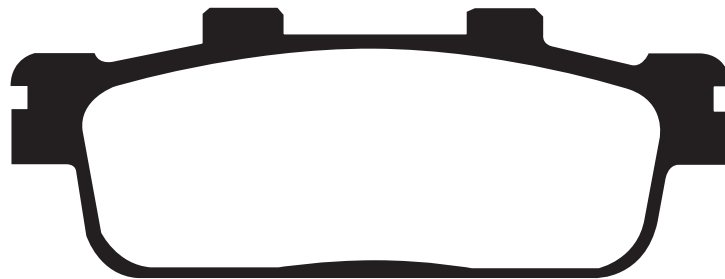

ADIVA

AD2 (300 3 Wheel Type) 14-15 R

AD3 (300 3 Wheel Type) 14-15 R

DAELIM

ET 250 Quad 05-08 R

ET 300 Quad 07-09 R

ST 250 Sector Quad 05-06 R

S3 125 (SV 125) 12-14 R

S3 250 (SV 250) 12-14 R

E-TON

RXL 150 Vector 07 R

XVL 250 ST Vector 06-07 R

VXL 250 Vector 06-07 R

VXL 300 Vector 07 R

VXL 300 ST Vector ST 07 R

VTX 300 Vortex 07 R

VTX 300 ST Vortex ST 07 R

H P POWER

Barum 260 (4T/2V/LC) 10-11 R

KYMCO

People S 125 DD 07-11 R

People S 200i DD 07-11 R

Xciting 250 i 06-08 R

Xciting 250 05 R

Xciting 300i (T72000) (EFi Model) 08 R

Xciting 300i R (T72001/72011) 08-10 R

PEUGEOT

LXR 125 (4T) 10-12 R

LXR 200i (4T) 10-12 R

SYM

City Com 125 08-13 R

GTS 125 Joymax/Voyager 06-09 F&R

GTS 125i Joymax (All models) 10-15 R

GTS 125i Sport (All models) 14-15 R

HD Evo 125 (Carb & EFi models /4T/Single headlamp) 03-13 R

HD2-125i (4T) (Twin Headlamps) 10-15 R

Joyride 125 i 07-09 R

Joyride Evo 125i (Twin Headlamps) 09-20 R

SB 125 Ni-Wolf 11-14 F

HD 200 S Evo 07 R

Quadlander 200 12-13 R

Trackrunner 200 Quad 05-08 R

H200SE 06 R

HD Evo 200 (Carb & EFi models /4T/Single headlamp) 03-13 R

HD2-200i (4T) (Twin Headlamps) 10-15 R

Joyride 200i 07-09 R

Joyride Evo 200i 09-20 R

GTS 250 07-08 R

GTS 250i/Joymax (All models) 09-15 R

Joymax 250 GTS 06-07 R

SYM Contd.

Joymax 250i 07-08 R

Quadlander 250 05-07 R

Citymax 300 Quad 06 R

GTS 300/Joymax (All models) 08-15 R

GTS 300i Sport (All models) 14-15 R

Cruisym 300 ABS 17-20 R

Joymax Z 300 ABS 17-20 R

TGB

X-Motion 125 08-14 R

X-Motion 125 Ri 11-12 R

X-Motion 250 i 08-10 R

X-Motion 300 EFi 10-11 R

Equivalents OE

G7131 LRAO 000 43105 HMA 00DA

812111 43105 SZ2 0000

43105 LDH 1E00 43105 SZ2 0010

43108 HWW 000A

MATERIAL AVAILABILITY AND PART NO.

STD	OPTIONS				
FA	SFA	SFAC	HH	R	MXS
FA427TT	SFA427	SFAC427	SFA427HH	FA427R	-

FA428 A. 82.08 x 40.85 x 9.5mm B. 62.03 x 40.8 x 9.5mm

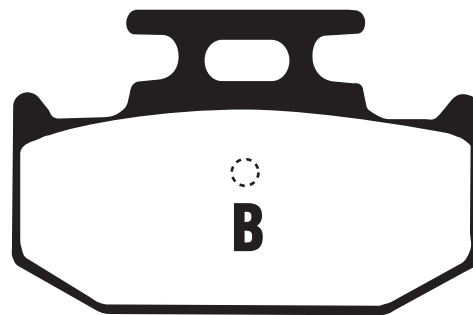
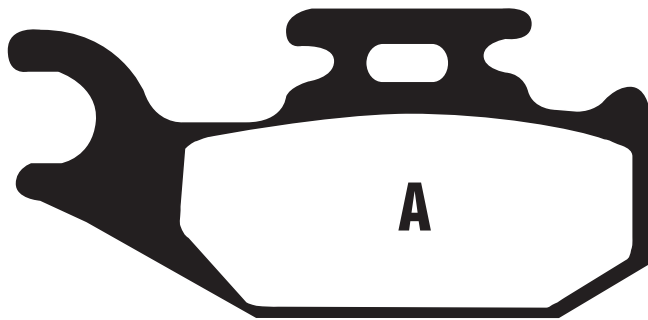

YAMAHA
 YXR 66 FAS/FAT/FAV Rhino 4x4 Side x Side 04-06 R
 YFM 700 RV/RW/RA 06-12 R

MATERIAL AVAILABILITY AND PART NO.					
STD	OPTIONS				
FA	V	HH	R	MXS	EPFA
FA428TT	-	-	FA428R	-	-

Equivalents OE #	
1S3 W0046 00	45802 115 0000
5UG W0046 00	44203 115 0000

SFA430 A. 94.5 x 40 x 7.5mm B. 94.5 x 40 x 7.5mm



MBK
 YP 125 Skycruiser 06-10 F
YAMAHA
 YP 125 R (X-Max) 06-09 F
 XP 250 R-X-Max (ICO) (Brembo Front Caliper/Non ABS) 05-09 F

MATERIAL AVAILABILITY AND PART NO.				
STD	OPTIONS			
SFA	SFAC	HH	R	MXS
SFA430	SFAC430	SFA430HH	-	-

Equivalents OE #
1B9 W0045 00

FA431 A. 103.5 x 42.6 x 9mm B. 62.95 x 34.5 x 11mm

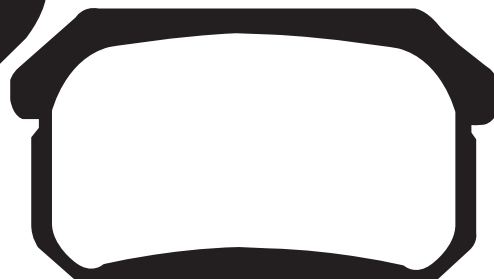

ADLY

Crossroad 220 Sentinel Quad R
 Canyon 280 Quad 08-09 R
 Hurricane 280 Quad 08-09 R
 Canyon 300 Quad 08-09 R
 Crossroad 300 Sentinel Quad 08-09 R
 Interceptor 300 Quad R
 Utility 300 05-07 R
 Hurricane 300 Quad 08-09 R
 300 RS Quad 07-08 R
 300 XS Quad 07-08 R
 Hurricane 320 Quad 08-09 R
 320 S Quad 08 R
 500 S 08 R
CPI
 XS 250 06-09 R

EXPLORER
 Ranger 300 2x4/4x4 08-09 R
HAMMERHEAD BUGGIES
 150 Supersport ES 150 11 R 08-09 R
QUADZILLA
 CVT 150 E 10-11 R
 XRV 250 (Off road) 06-07 R
 XRV 250 E 06-07 R
 QZ 300 E 4x4 (Parking brake) 07-08 R
 RL 300 Buggy 07-08 R
 320 e 4x4 07-08 R
 CVT 320 e 07-11 R
 QZ 320 E 4x4 (Parking brake) 09 R

PGO
 BR-200 Bugrider 07-12 R
 BR 250 E Bugrider 05-12 R
 250 Bug R

MATERIAL AVAILABILITY AND PART NO.				
STD	OPTIONS			
FA	HH	R	MXS	EPFA
FA431TT	-	FA431R	-	-

Equivalents OE #
7-020-022
43120 256 000
32176F
32176G
B74074-100000

FA432 68 x 55 x 9mm

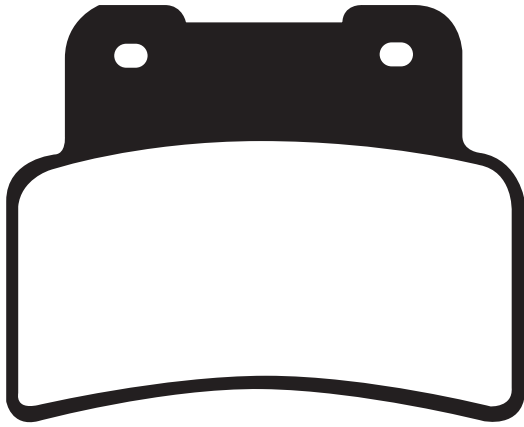

APRILIA

RS 125 (Radial Caliper) 2T	06-12	F
Shiver 750 GT	09-10	F
Shiver 750	07-10	F
Shiver 750 (RAE00) (Std & ABS)	10-16	F
Shiver 750 GT ABS	10-12	F
Dorsoduro 750 (ABS)	08-16	F
Mana 850	08-11	F
Mana 850 GT (ABS Model)	09-14	F
Mana 850 ABS	08-13	F
Dorsoduro 900 (ABS)	17-18	F
Shiver 900 (ABS)	17-18	F

KYMCO

Xciting 400i	12-20	F
Xciting S 400i	17-20	F

YAMAHA

MT-125 (Non ABS)	14-16	F
MT-125A (ABS)	14-20	F
YZF-R 125 (Radial Caliper/Non ABS)	14-16	F
YZF-R 125A (Radial Caliper/ABS)	14-20	F

MATERIAL AVAILABILITY AND PART NO.

STD	OPTIONS				
FA	SFA	HH	SFA HH	R	MXS
FA432	SFA432	FA432HH	SFA432HH	-	-

Equivalents OE

8133943	45105 LKF 305
897118	5D7 F5805 00

FA433/4 45.96 x 34.97 x 7.42mm

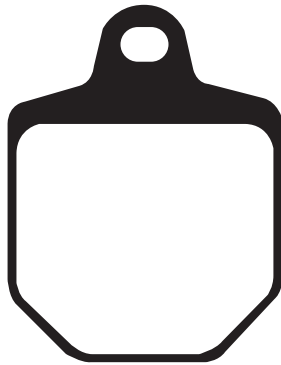

HONDA HM (Italy)

CRM 125 R Supermoto	07	F
CRM 250 X Supermoto	07	F
CRM 450 R/X Supermoto	07-09	F
CRM F 490 X Supermoto	07	F
CRM F 500 X	11	F

HUSABERG

FS 570 Supermoto	10-11	F
------------------	-------	---

KTM

SMR 450 (Magura caliper)	07-13	F
SMR 560	07	F

MAGURA

4 Piston Radial Supermoto Caliper

MATERIAL AVAILABILITY AND PART NO.

STD	OPTIONS			
FA	HH	R	MXS	EPFA
FA433/4	FA433/4HH	-	-	EPFA433/4HH

Equivalents OE

0722189	594 13 030 000
072223	SM 27300

DO NOT REFIT ANY SHIMS/INSULATORS TO EBC PADS FROM ORIGINAL PADS UNLESS INSTRUCTED ON NOTE ON PAD PACKAGING AND ON FA DRAWING ASSOCIATED WITH THAT PAD.

FA434 A. 97.54 x 64.2 x 8mm B. 97.54 x 64.2 x 8mm

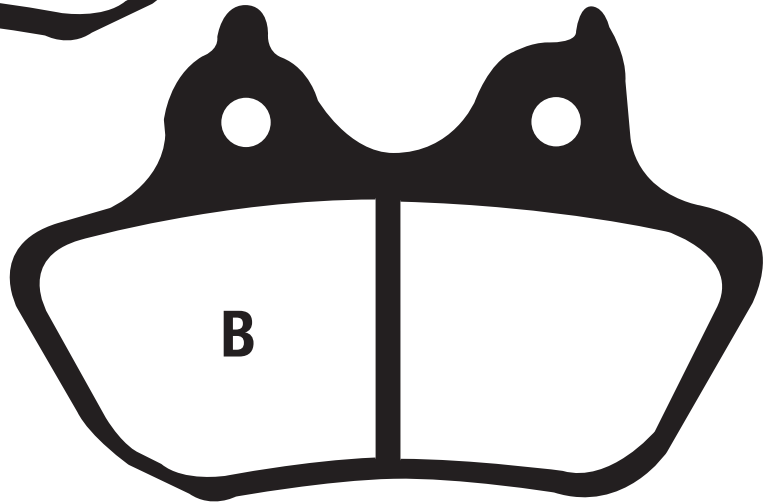
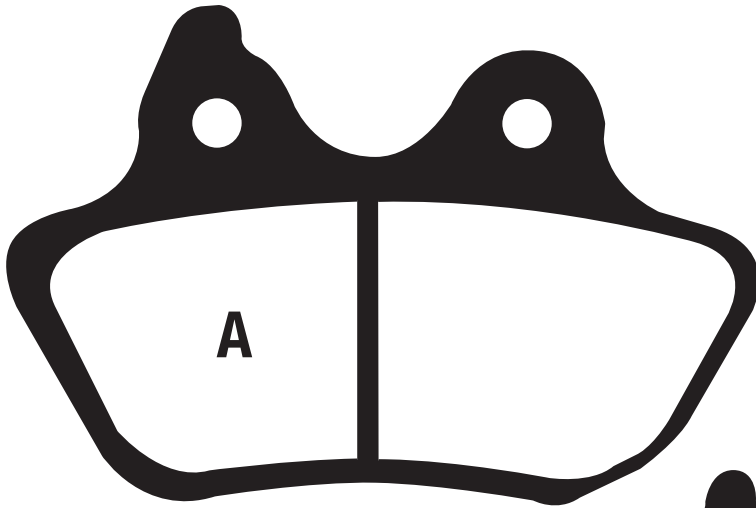

HARLEY DAVIDSON

FXST/FXSTi Softail Standard 06-07 R
 FXSTB/FXSTBi Night Train Softail 06-07 R
 FLSTSC/FLSTSCi Springer Softail Classic 06-07 R
 FLSTF/FLSTFi Fat Boy 07 R

MATERIAL AVAILABILITY AND PART NO.					
STD	OPTIONS				
FA	V	HH	SFA HH	EPFA	VLD
FA434	FA434V	FA434HH	SFA432HH	EPFA434	FA434VLD

Equivalents OE #
46721-06

FA435/4 43.5 x 49 x 9.5mm

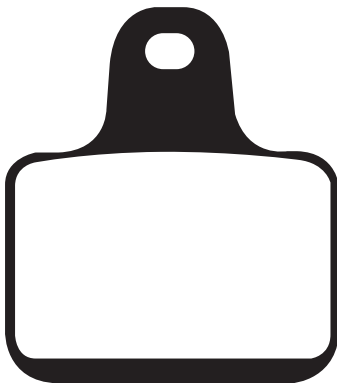

AP/LOCKHEED

4 Piston Radial Mount / 4 Separate Pads (CP6688 - 8EOM/9EOM)

BREMBO

X00.C04 60/61 - 4 Piston P 34/34 RadialMount Caliper @ 108mm spacing (4 pad set)
 XA07680 - 2 Piston P2 34 Radial Mount (Note only sold as set of 4 pads)
 X99C4 60/61 P4/34 Radial monobloc 4 pad 108mm spacing

MV AUGUSTA

F4 100cc (1078cc) (Claudio Castiglioni) 07-08 F

PVM

2 Piston Rear Caliper (Note only 2 pads required)
 4 Piston Radial Mount Caliper

MATERIAL AVAILABILITY AND PART NO.				
STD	OPTIONS			
FA	HH	R	MXS	EPFA
-	FA435/4HH	-	-	EPFA435/4HH

Equivalents OE #		
07 7874 24	CP6688D29	M049Z04
8000B1421	107 A486 04	

DO NOT REFIT ANY SHIMS/INSULATORS TO EBC PADS FROM ORIGINAL PADS UNLESS INSTRUCTED ON NOTE ON PAD PACKAGING AND ON FA DRAWING ASSOCIATED WITH THAT PAD.

FA436 77.5 x 42.5 x 8.8mm

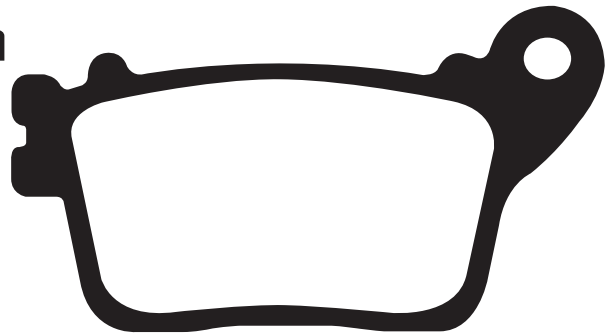
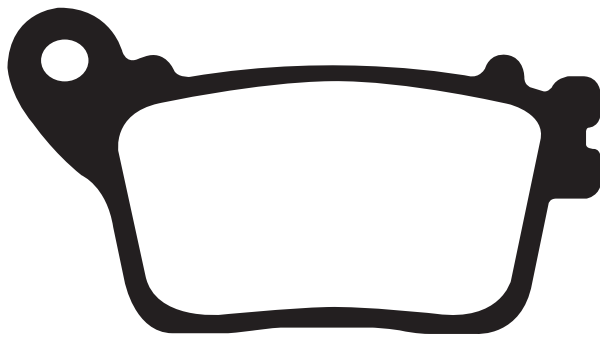

HONDA

CB 600 F7/F8/F9/FA/FB/FC 07-13 R
 CBR 600 FB/FC 11-13 R
 CBR 600 RR7/RR8/RR9/RAA/RRB/RRC/RRD/RRE/RRF/RRG (Radial Caliper) 07-16 R
 CBR 600 RA9/RAA/RAB/RAC/RAD/RAG/RAH (C-ABS) 09-17 R
 CBR 600 RR Hannspree 08 R
 CBR 600 RR ABS 17-20 R
 CBR 1000 RR6/RR7/RR8/RR9/RAA/RRB/RRC/RRD/RRE 06-16 R
 CBR 1000 RA9/RAA/RAB/RAC/RAD/RAE/RAF/RAG/RAH/RAJ (C-ABS) Fireblade 09-18 R
 CBR 1000 RRH/RRJ Fireblade (C-ABS/Tokico Front Caliper) 17-18 R
 CBR 1000 RR-SP ABS Fireblade (CBR1000 SAE/SAF/SAG/SAH/SAJ) 14-18 R
 CBR 1000 RR-SP ABS-TT Edition 16 R
 CBR 1000 RR-SP Non ABS Fireblade (CBR 1000 SAE/SAF/SAG) 14-16 R

ZX 10 R ABS (ZX 1000 KBF/KCF/KDF/KEF/KFF) 11-15 R
 ZX 10 R (ZX 1000 JBF/JCF/JDF/JEF/JFF) 11-15 R
 ZX-10R 30th Anniversary Edition (ZX 1000 JFFA /Non ABS) 15 R
 ZX-10R 30th Anniversary Edition (ZX 1000 KFFA /ABS) 15 R
 ZX 10R (ZX1000) 16-20 R
 ZX 10R Winter Test Edition (ZX1000 SGFB) 16 R
 ZX 10R Ninja KRT Replica 16-20 R
 ZX 10 R SE Ninja 18-20 R
 Ninja ZX-10RR (ZX1000ZHF) 17 R

SUZUKI

GSX-R 600 11-18 R
 GSX-R 750 11-20 R
 GSX-R 1000 11-20 R
 GSX-R 1000 R 17-20 R
 GSX-S 1000 (ABS) 15 R
 GSX-S 1000 (ABS) 15 R

YAMAHA

YZF-R6 17-20 R
 Niken ABS (847cc/3 Cyl Engine) 18-20 R
 YZF-R1 15-20 R
 YZF-R1M 15-20 R
 YZF-R1 (60th Anniversary Edition) 16 R

KAWASAKI

Ninja ZX-6R (ZX 636 - Non ABS - 636cc) 13-20 R
 Ninja ZX-6R (ZX 636 - Non ABS/KRT Edition - 636cc) 16-20 R
 Ninja ZX-6R (ZX 636 - ABS - 636cc) 13-20 R
 Ninja ZX-6R (ZX 636 - ABS/KRT Edition - 636cc) 16-20 R
 ZX-6R 30th Anniversary Edition (ZX 636 EFFA /Non ABS/636cc) 15 R
 ZX-6R 30th Anniversary Edition (ZX 636 FFFA / ABS/636cc) 15 R

MATERIAL AVAILABILITY AND PART NO.					
STD	OPTIONS				
FA	V	HH	R	MXS	EPFA
FA436	FA436V	FA436HH	-	-	-

Equivalents OE #		
06435 MEL D21	69100 47820	06435 MEL D23
06435 MFG D02	43082 0115	69100 47830
06435 MEL D22	2CR 25806 00	

FA438 A. 102.9 x 37.3 x 8.52mm B. 102.9 x 37.3 x 8.45mm

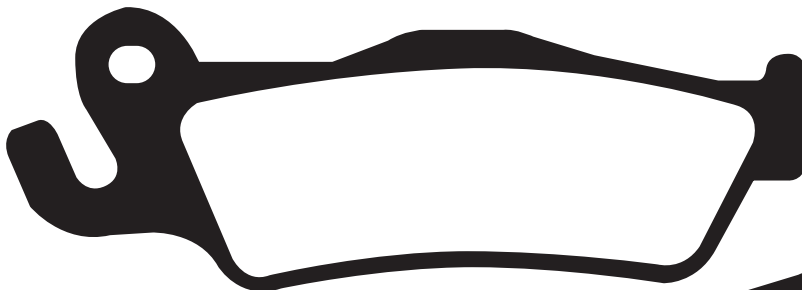

NOTE: Need to order new wear lead Part no. MWL002

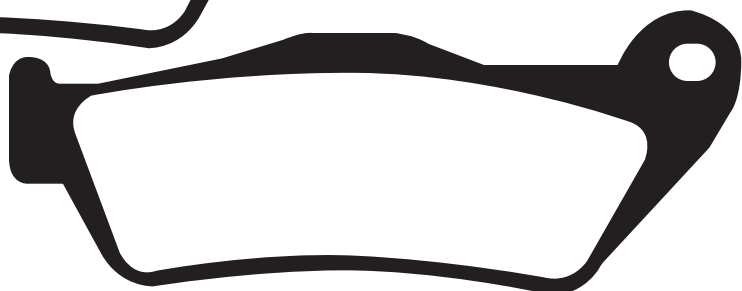

BMW

K 1200 GT (K44) 06-08 R

Equivalents OE #
34-21-7-690-262

MATERIAL AVAILABILITY AND PART NO.				
STD	OPTIONS			
FA	HH	R	MXS	EPFA
-	FA438HH	-	-	-

DO NOT REFIT ANY SHIMS/INSULATORS TO EBC PADS FROM ORIGINAL PADS UNLESS INSTRUCTED ON NOTE ON PAD PACKAGING AND ON FA DRAWING ASSOCIATED WITH THAT PAD.

FA441 A. 77.3 x 51.45 x 8.55mm B. 77.3 x 51.45 x 8.55mm

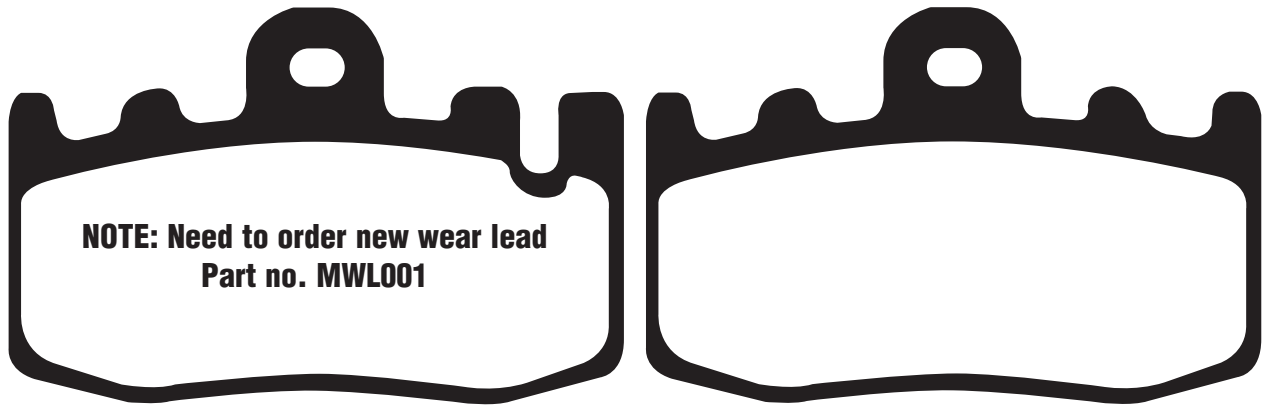

**NOTE: Need to order new wear lead
Part no. MWL001**

BMW
K 1200 GT (K44) 06-08 F(right)

MATERIAL AVAILABILITY AND PART NO.					
STD	OPTIONS				
FA	V	HH	R	MXS	EPFA
-	-	FA441HH	-	-	-

Equivalents OE #	
34-11-7-690-259	34-11-7-704-614
34-11-7-712-948	34-11-8-535-400

FA442/4 A. 61.85 x 44.25 x 8.1mm B. 30.8 x 48 x 8.1mm



YAMAHA
YZF R1 (6 piston radial caliper) 07-14 F
MT-01 (6 piston radial caliper) 07-10 F
XV 1700 V-Max 09-20 F
MT-01S (5YUR) 09 F

MATERIAL AVAILABILITY AND PART NO.					
STD	OPTIONS				
FA	GPFAX	HH	R	MXS	EPFA
FA442/4	GPFAX442/4HH	FA442/4HH	-	-	EPFA442/4HH

Equivalents OE #
4C8 W0045 00
107 A225 40

FA443 A. 107 x 33.75 x 8mm B. 91.66 x 38.2 x 8mm

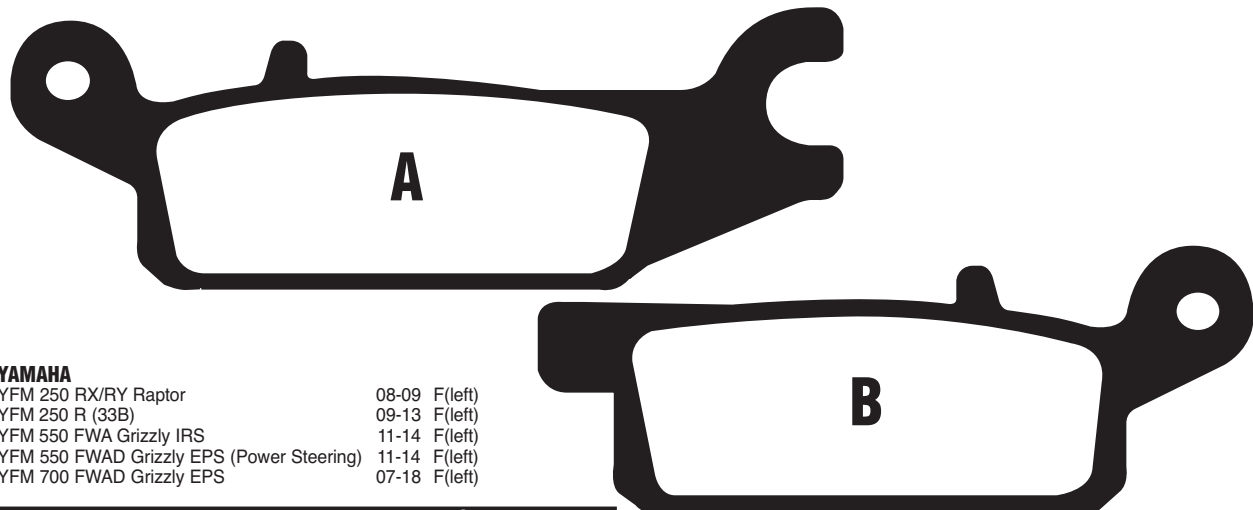

YAMAHA
YFM 250 RX/RV Raptor 08-09 F(left)
YFM 250 R (33B) 09-13 F(left)
YFM 550 FWA Grizzly IRS 11-14 F(left)
YFM 550 FWAD Grizzly EPS (Power Steering) 11-14 F(left)
YFM 700 FWAD Grizzly EPS 07-18 F(left)

MATERIAL AVAILABILITY AND PART NO.				
STD	OPTIONS			
FA	HH	R	MXS	EPFA
FA443TT	-	FA443R	-	-

Equivalents OE #
3B4 W0045 00
4D3 W0045 00

DO NOT REFINISH DISC PADS TO EBC PADS FROM ORIGINAL DISC PADS UNLESS INSTRUCTED ON NOTE ON PAD PACKAGING AND ON FA DRAWING ASSOCIATED WITH THAT PAD.

FA444 A. 107 x 33.75 x 8mm B. 91.66 x 38.2 x 8mm

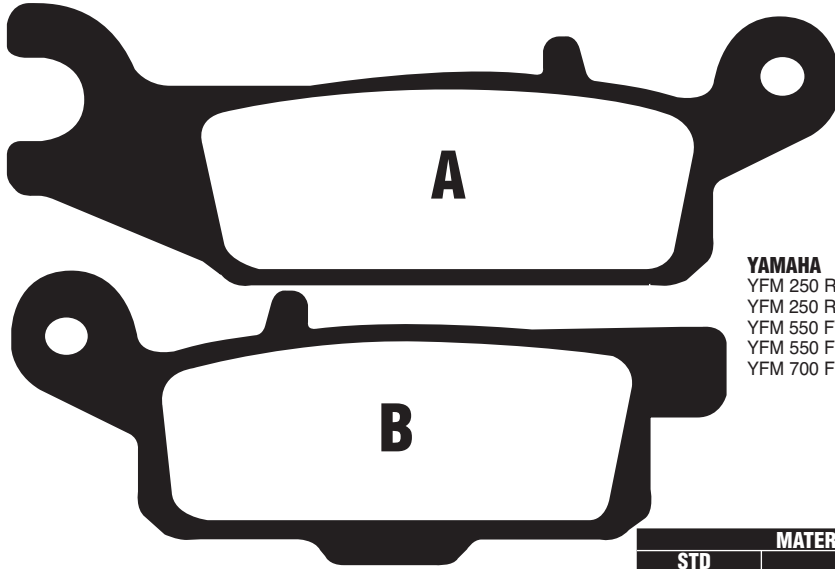

YAMAHA
 YFM 250 RX/RV Raptor 08-09 F(right)
 YFM 250 R (33B) 09-13 F(right)
 YFM 550 FWA Grizzly IRS 11-14 F(right)
 YFM 550 FWAD Grizzly EPS (Power Steering) 11-14 F(right)
 YFM 700 FWAD Grizzly EPS 07-18 F(right)

Equivalents OE #
3B4 W0045 10
4D3 W0045 10

MATERIAL AVAILABILITY AND PART NO.				
STD	OPTIONS			
FA	HH	R	MXS	EPFA
FA444TT	-	FA444R	-	-

FA445 A. 107 x 33.75 x 8mm B. 91.66 x 38.2 x 9mm

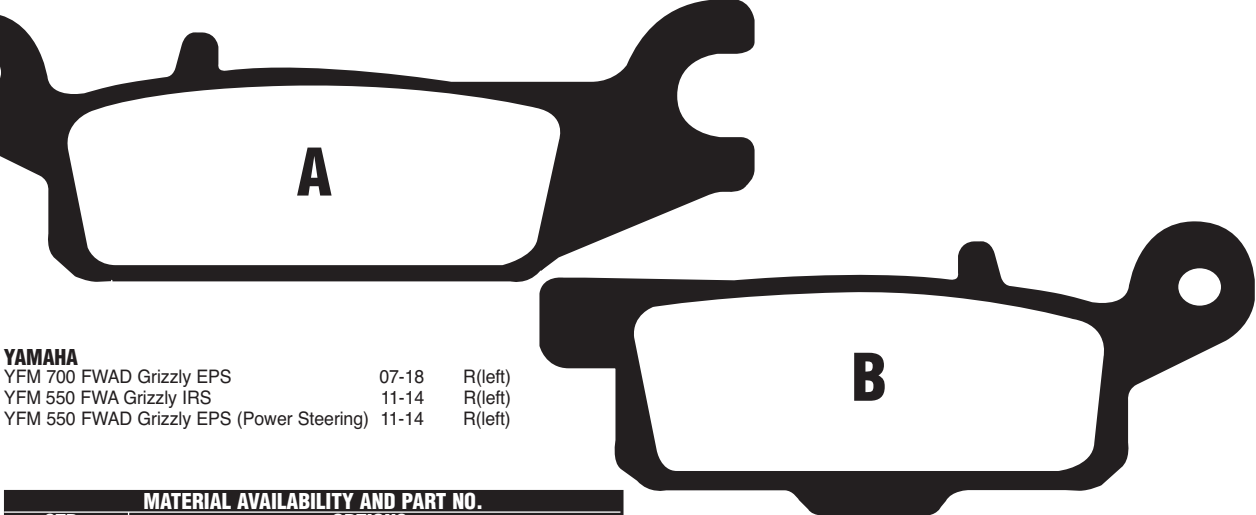

YAMAHA
 YFM 700 FWAD Grizzly EPS 07-18 R(left)
 YFM 550 FWA Grizzly IRS 11-14 R(left)
 YFM 550 FWAD Grizzly EPS (Power Steering) 11-14 R(left)

MATERIAL AVAILABILITY AND PART NO.				
STD	OPTIONS			
FA	HH	R	MXS	EPFA
FA445TT	-	FA445R	-	-

Equivalents OE #
3B4 W0046 00

FA446 A. 107 x 33.75 x 8mm B. 91.66 x 38.2 x 9mm

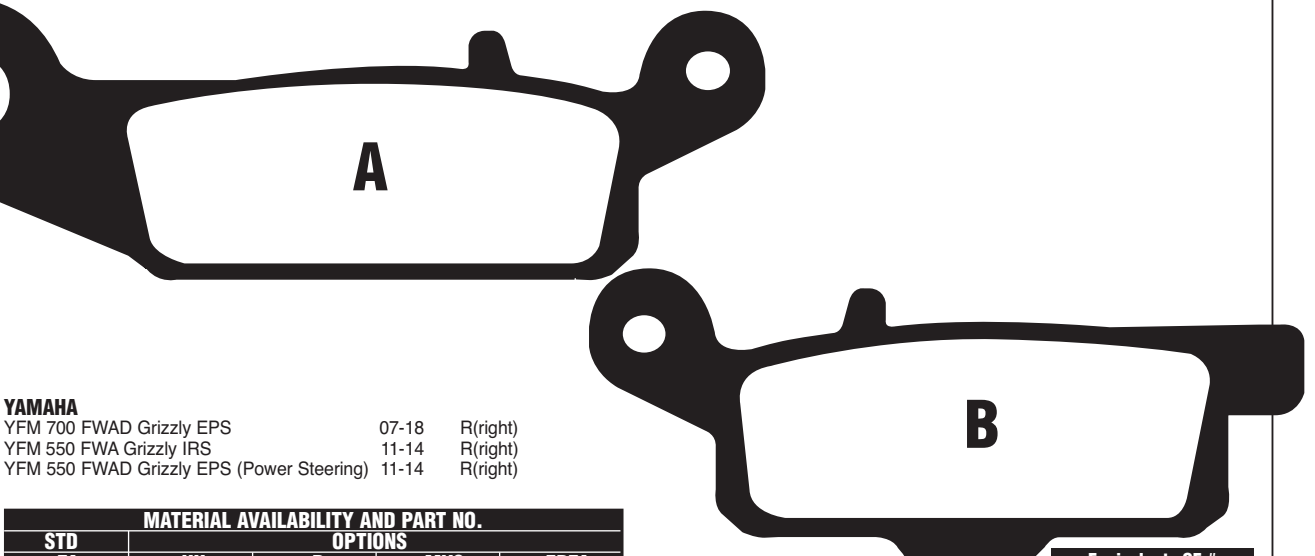

YAMAHA
 YFM 700 FWAD Grizzly EPS 07-18 R(right)
 YFM 550 FWA Grizzly IRS 11-14 R(right)
 YFM 550 FWAD Grizzly EPS (Power Steering) 11-14 R(right)

MATERIAL AVAILABILITY AND PART NO.				
STD	OPTIONS			
FA	HH	R	MXS	EPFA
FA446TT	-	FA446R	-	-

Equivalents OE #
3B4 W0046 10

FA447 102.25 x 42.25 x 7.5mm

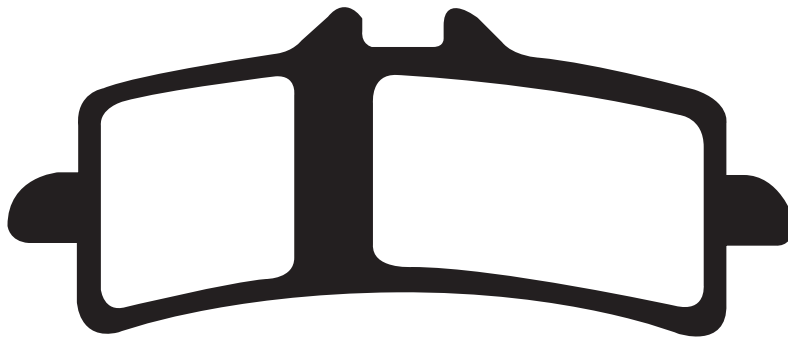

NOTE: Pads are now both the same design

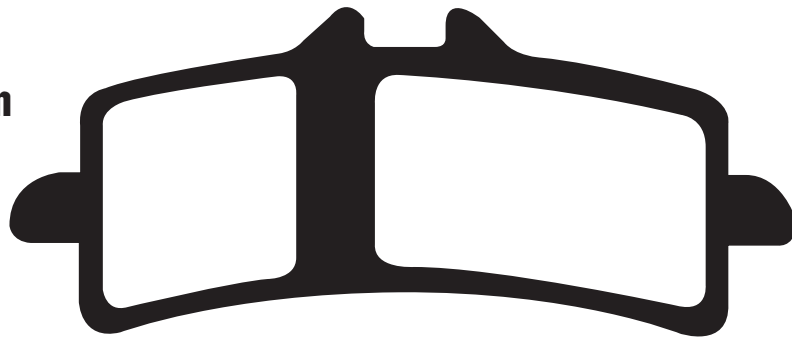

DO NOT REFIT ANY SHIMS/INSULATORS TO EBC PADS FROM ORIGINAL PADS UNLESS INSTRUCTED
ON NOTE ON PAD PACKAGING AND ON FA DRAWING ASSOCIATED WITH THAT PAD.

APRILIA

RSV4 R	10	F
RSV4R APRC	11-13	F
RSV4R APRC ABS	13-14	F
RSV4 Factory	09-10	F
RSV4 Factory APRC	11-13	F
RSV4 Factory APRC ABS	13-14	F
RSV4 RF 1000	15-18	F
RSV4 1100 Factory	19-20	F
RSV4 1100 RR	19-20	F
RSV4 RR 1000	15-18	F
Tuono Factory 1100 V4	17-18	F
Tuono 1100 RR V4	17-20	F
Tuono V4 1100 Factory	19-20	F

BENELLI

Tornado Naked Tre 1130 TNT R	13-16	F
------------------------------	-------	---

BIMOTA

DB7 (1099cc)	09	F
DB8 (1198cc)	10-13	F
DB8 SP (1078cc)	12-13	F
DB11 VLX (1198cc)	12-13	F

BMW

HP2 Sport (K29)	08-11	F
HP4	13-14	F
HP4 Carbon	13-14	F
HP4 Race	19-20	F

BREMO

220B01010 - GP4-RX 4 Piston Radial Mount @ 108mm Spacing		
220A39710 P4/34 108mm Mount monobloc radial		
220988530 P4/34 100mm Mount monobloc radial		
20 9883 Radial monobloc 100mm centres		

DUCATI

848 Evo (Monobloc front calipers)	10-13	F
848 Evo Dark	12	F
848 Evo Corse SE	12-13	F
Diavel - ABS	11-18	F
Diavel Carbon - ABS	11-20	F
Diavel Chromo ABS	12	F
Diavel AMG	11-12	F
Diavel Strada	13-14	F
Diavel Dark	13-14	F
Diavel Diesel (1200cc)	17-18	F
990 Supermoto R (SM-R)	10-11	F
1098	07-08	F
1098 S	07-08	F
1098 R	08-09	F
1098 S Tricolore	07	F
Hypermotard 1100 S	07-09	F
Desmosedici RR (D16RR/989cc)	08	F
Streetfighter 1100 (1099cc)	09-11	F
Streetfighter 1100 S (1099cc)	09-13	F
Streetfighter V4 and V4 S 1103cc	19-20	F
1100 Evo SP Hypermotard	10-12	F
Panigale V4 (1103cc)	18	F
Panigale V4 S (1103cc)	18	F
1198	09-11	F
1198 S	09-10	F
1198 R Corse	10	F
1198 S Corse	10	F
1198 SP	11	F

DUCATI Contd.

1199 Panigale	12-13	F
1199 Panigale ABS	12-15	F
1199 Panigale S ABS	12-15	F
1199 Panigale S Tricolore	12-13	F
1199 Panigale R	13-16	F
1199 Superleggera	14	F
1200 S Monster	14-20	F
1200 Monster Stripe	15-20	F
1200 Monster R	16-18	F
1200 S Multistrada DVT	15-17	F
1200 S Multistrada D air DVT	15-17	F
1200 S Multistrada Touring	15-16	F
1200 Multistrada Touring	15-16	F
1200 S Multistrada	15-18	F
1200 S Multistrada D air	15-16	F
1200 S Multistrada Pikes Peak	16-17	F
1260 S Multistrada	18-20	F
1260 S Multistrada D air	18-20	F
1260 Multistrada Pikes Peak	18-20	F
1260 Multistrada Enduro	18-20	F
1260 Multistrada S Grand Tour	19-20	F
1262 X Diavel S	16-20	F
1299 Panigale	15-18	F
1299 Panigale R	15-17	F
1299 Panigale V4 Corse/Speciale	18-20	F
1299 Panigale V4 R	19-20	F
1299 Panigale R Final Edition	18	F
1299 Panigale S	15-18	F
1299 Superleggera	17	F

ENERGICA ELECTRIC

Electric EVA	20	F
Electric EGO	20	F
Electric EVA Esse Esse 9	20	F

HONDA

CBR 1000 RR-SP ABS Fireblade		
(CBR1000 SAE/SAF/SAG/SAH/SAJ)	14-20	F
CBR 1000 RR-SP Non ABS Fireblade		
(CBR 1000 SE/SF/SG)	14-16	F
RC 213 V-S	15-17	F

HUSQVARNA

Nuda 900 R	12-13	F
H2 Ninja (ZX 1000 NFF/NGF)	15-16	F
H2 R Ninja (ZX 1000 PFF/PGF)	15-16	F
ZX 10R (ZX1000 SGF/SHF/SJF)	16-20	F
ZX 10R Winter Test Edition		
(ZX1000 SGFB)	16	F

KAWASAKI

ZX 10 R SE Ninja	18-20	F
Z 1000 JHF/JJF (ABS/310mm Round Discs)	17-18	F
Ninja H2 (ZX1000 XHF/XJF)	17-20	F
Ninja H2 Carbon (ZX1000 XHFA/XJFA)	17-20	F
Ninja H2R (ZX1000 YHF/YJF)	17-20	F
Ninja ZX-10RR (ZX1000ZHF)	17	F
ZZR1400 Performance Sport		
(ZX1400 JGF/JHF/JJF)	16-20	F

KTM

SMR 450 (Brembo F/caliper)	14	F
Duke 690 R (Multi spoke cast wheels)	13-18	F

KTM Contd.

990 Supermoto R (SMR)	10-13	F
RC8 (1190cc)	08-11	F
RC8 R (1190CC)/Track	09-15	F
1290 Super Duke R	14-20	F
1290 Super Duke R SE	16-18	F
1290 Super Duke GT	16-20	F

MV AGUSTA

675 F3 Serie Oro	12-13	F
800 F3	13-18	F
800 F3 Ago	14-15	F
800 F3 RC	15-18	F
998 Freccce Tricolori	10	F
F4 998cc	10-15	F
998 F4R	12-15	F
998 F4RR	10-15	F
998 F4RR Corsa Corta	12	F
F4 1000 CC	07	F
1000 F4R 312 (From VIN 008065)		
Brembo 2 pad caliper)	08-09	F
1078 Brutale RR	08-09	F
F4RR 1078cc 312	08-09	F
1078 F4 RR 312	09	F
Brutale 1090 RR	10-15	F
1090 Brutale Corsa	13-15	F

SUZUKI

GSX-R 600	11-18	F
GSX-R 750	11-20	F
GSX-R 1000	12-20	F
GSX-R 1000 R	17-20	F
GSX-S 1000 (Naked/Non ABS)	16-20	F
GSX-S 1000 (Naked/ABS)	16-20	F
GSX-S 1000 F (Faired/Non ABS)	16-20	F
GSX-S 1000 F (Faired/ABS)	16-20	F
GSX 1000 Katana	18-20	F
GSX 1300 R Hayabusa (Brembo calipers)	13-18	F

TRIUMPH STREET

Daytona 675R (Brembo calipers)	11-17	F
Speed Triple R 1050 (2 Pad caliper /Non ABS /5 Spoke wheel)	12-13	F
Speed Triple R 1050 (2 Pad caliper/ABS/5 Spoke wheel)	12-13	F
Speed Triple R 1050 (2 Pad caliper/ABS/10 Spoke wheel)	14-16	F
Speed Triple R 1050 (2 Pad caliper/Non ABS/10 Spoke wheel)	14-16	F
Speed Triple R (1050cc/ABS)	17-20	F
Speed Triple S (1050cc/ABS)	17-20	F
Street Triple R (Bembo F&R Calipers)	17-20	F
Street Triple RS (Bembo F&R Calipers)	17-20	F
Thruxton R 1200 (Liquid Cooled)	16-17	F
Thruxton TFC 1200	19-20	F
Tiger 900	20	F
Tiger 900 GT	20	F
Tiger 900 GT low	20	F
Tiger 900 GT Pro	20	F
Tiger 900 Rally	20	F
Tiger 900 Rally Pro	20	F

FA447 102.25 x 42.25 x 7.5mm Contd.

MATERIAL AVAILABILITY AND PART NO.					
STD	OPTIONS				
FA	GPFAX	HH	R	MXS	EPFA
-	GPFAX447HH	FA447HH	-	-	EPFA447HH

Equivalents OE #	
61340791A	61340961A
07 9882 10	59100 14850
690 13 030 000	59100 14860
34 11 710 743	61340901A
8000B1663	613 13 030 000
T2021451	43082 0157
59100 14830	43082 0162
107 A486 49	06455 MGP D81
8000B1601	06455 MKF D61
8000B6714	61341101A
8537251	61341231A
8538735	06455-MKF-D61
07BB30RC	43082-0171
M497Z04	59101 14870
107988210	T2027820
07BB3050	T2021541

DISC PADS
BUYERS GUIDE

FA448 58.1 x 33.35 x 6mm



ELSTARS (PIT BIKES)

Various models (Check parts before fitting) F&R

ITALJET

Pit Jet 50 (2T) 08-09 F&R
Pit Jet 125 4T (Pro) 07-09 F&R

GENERIC/KSR

Mini Trigger X50 08-09 F&R
Mini Trigger SM 50 08-09 F&R

LIFAN

LF 125 Off Road 07 F

MOTOM

Spasso 50 08-09 F

QUADZILLA

WK 140 06-08 F

STOMP MINI MOTO

125cc Elite 07-09 F

MATERIAL AVAILABILITY AND PART NO.					
STD	OPTIONS				
FA	V	HH	R	MXS	EPFA
FA448	-	-	-	-	-

Equivalents OE #
1-290025
3-290055

FA450 94.2 x 31.8 x 7.2mm

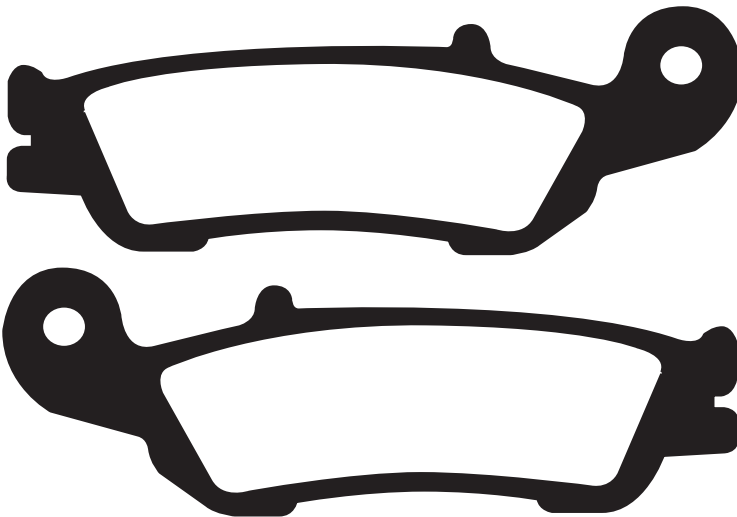

YAMAHA

YZ 125 X/Y/Z/A/B/D/E/F/GH/J (2T) 08-20 F
YZ 250 X/Y/Z/A/B/D/E/F/GH/J (2T) 08-18 F
YZ 250 FW/FX/FY/FZ/FA/FB/FD/FE/FF (4T) 07-20 F
YZ 450 FX/FY/FZ/FA/FB/FD/FE/FF (4T) 08-15 F
WR 250 FH/FJ (4T/Reverse Cylinder) 17-20 F
WR 450 FG/FH/FJ (270mm F/Disc/ 4T) 16-20 F
YZ 250 FG/FH/FJ (270mm Disc) 16-18 F
YZ 250 FGY (60th Anniversary Edition/270mm Disc) 16 F
YZ 450 FG/FH/FJ (270mm Disc) 16-20 F
YZ 450 FGY (60th Anniversary Edition/270mm Disc) 16 F

MATERIAL AVAILABILITY AND PART NO.				
STD	OPTIONS			
FA	HH	R	MXS	EPFA
FA450TT	-	FA450R	MXS450	EPFA450HH

Equivalents OE #
5XC W0045 00
B29-25805-00

DO NOT REFIT ANY SHIMS/INSULATORS TO EBC PADS FROM ORIGINAL PADS UNLESS INSTRUCTED ON NOTE ON PAD PACKAGING AND ON FA DRAWING ASSOCIATED WITH THAT PAD.

FA452 120.65 x 57.35 x 8.0mm

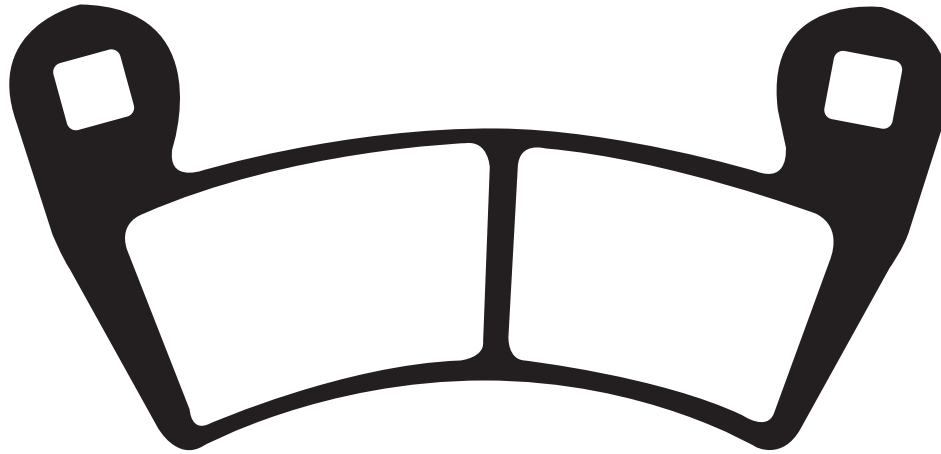

POLARIS

400 Ranger
Ranger 500 4x4 EFI
500 Ranger (EFI) 4x4 HO
Ranger 500 2x4
500 Ranger Crew
500 Ranger (Carb) 2x4
Ranger 700 6x4 EFI
Ranger XP 700 4x4
700 Ranger 4x4 EFI
700 Ranger Crew (EFI) 4x4
Ranger EV (Electric)

10-14
08-13
09-11
08
11-13
09
08
08
09
09
10-14

POLARIS Contd.

800 Ranger XP
800 Ranger 6x6
800 Ranger Crew
800 Ranger RZR 4 EPS
RZR-4 800 EFI
900 D Crew Ranger Diesel
900 Ranger Crew
900 D Ranger Diesel
Ranger RZR XP 900
Ranger RZR XP 900 White Lightning LE
900 Ranger RZR XP EFI

10-12
10-14
10-14
12
10-14
11-14
11
11
12

POLARIS Contd.

900 Ranger RZR XP
RXR-4 XP900
900 XP Ranger
1000 Ranger Diesel
1000 Ranger Diesel Crew
RZR 1000 XP
Brutus
1000 General EPS (2 Seat)
1000 General EPS (2 Seat)
1000 General 4 EPS (4 Seat)

12
12-14
13-15
15
15
14
13-14
16
17-19
17-19

MATERIAL AVAILABILITY AND PART NO.				
STD	OPTIONS			
FA	HH	R	MXS	EPFA
FA452TT	-	FA452R	-	-

Equivalents OE #
2203747

FA453 96.96 x 37.25 x 7.15mm

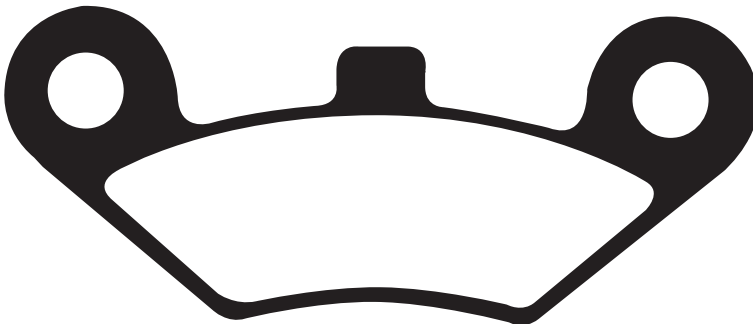

AJS

Crazy 50 Naked
C F MOTO
CF 500-C/Force (X5 Terralander)
CF 500 5B/5C C-Force 500 Classic
CF 625-C/Force (X6 Terralander)

EXPLORER

Atlas 500/4x4
Everest 500 L/4x4

GOES

220 UTS (Side x Side)
360 Max (Quad)
G 520 (Quad)
520 Max (Quad)
G 525 (4x4)
G 525 4x4 Max
G 625i (All models)
G 625i (4x4)
G 625i 4x4 Max
G 625i UTX 4x4 (Side x Side)
625i UTS (Side x Side)
G E-SSV Electric (Side x Side)

13-14
11-15
14-15
11-15
08-09
08-09
13-14
08-14
07-14
07-14
12-13
12-13
12
12-14
12-14
12-14
13-14
12-13

LINHAI

Goon 260 ATV (2x4/4x4)
CUV Carry 300 (ATV)
Muddy 300 4x4 (ATV)
ATV 310 (4x2)
ATV 320 4x4 Carrier
ATV 420 4x2/LOF
ATV 420 4x4/LOF
ATV 420 4x4 Carrier/LOF
ATV 600 EFI 4x4/LOF
CUV Jobber 4x4
NEW FORCE QUADS
Most models (Check shape of old pad)
PEUGEOT
Metropolis 400 RS (3 Wheel Model)

07-09
07-09
07-09
13
13
13
13
13
13
13
13
13
13
13
14

QUADZILLA

CVT 150 E
CUV 300 (4x4 Super Utility Side x Side)
Quadzilla 300 Utility
300 E SUV (Manual)
300 E SUV (Automatic)
300 E (4x4) (Auto)
320 e 4x4
CVT 320 e
500 4x4
CUV 500 Side x Side
RL 500 MKII Buggy
QZ 500 E/ES 4x4
RS5 4WD
RS6 EFI 4WD
X8 (4x4/EFI)
ZX6 4x4
W.T. MOTORS
WT 500 Alaska Quad

10-11
08
04-06
06-07
06
06
07-11
07-11
09-11
10-11
10-11
10-11
10-11
10-11
12-13
10-15
08-09

MATERIAL AVAILABILITY AND PART NO.				
STD	OPTIONS			
FA	HH	R	MXS	EPFA
FA453TT	-	FA453R	-	-

Equivalents OE #
901 08 08 01
901 08 08 10
45815 RAM 01
322050A
3220505A
9010-0808BO

FA454/4 61.5 x 46.83 x 7.35mm (inc shims)

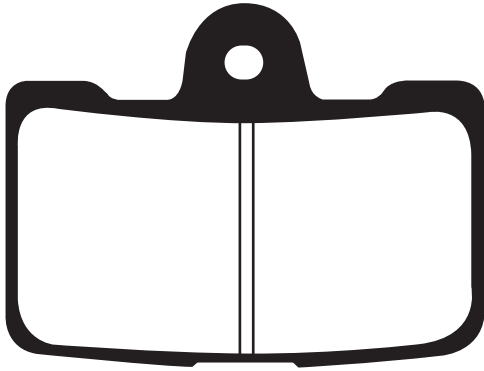

BUELL		
1125 R	08-10	F
1125 CR	09-10	F
XB12 SCG Lightning	09-10	F
XB12 R Firebolt	09-10	F
XB12 SS Lightning	09-10	F
EBR		
1190RX	14-15	F
1190SX	14-15	F

MATERIAL AVAILABILITY AND PART NO.				
STD	OPTIONS			
FA	V	HH	VLD	EPFA
-	-	FA454/4HH		EPFA454HH

Equivalents OE #
H0300 1AMA

FA455 98.8 x 55 x 8.8mm

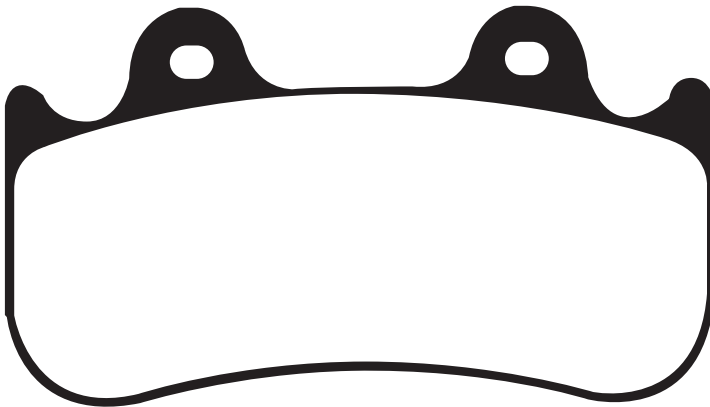

JAYBRAKE
6 PF-L (6 Piston/ For 13" Disc - Full Friction Height)

MATERIAL AVAILABILITY AND PART NO.				
STD	OPTIONS			
FA	HH	R	MXS	EPFA
FA455V	FA455HH	-	-	-

Equivalents OE #
300-64B

FA456 97.1 x 46.8 x 8.0mm

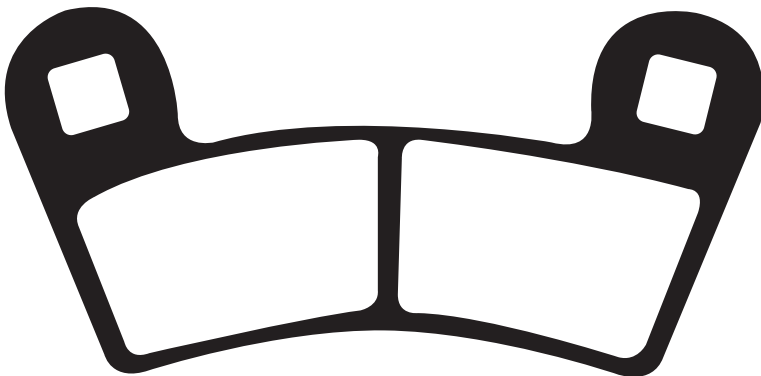

POLARIS		
450 S Outlaw	08	F
450 Outlaw MXR	09-10	F
525 S Outlaw	08-10	F
525 Outlaw IRS	08-11	F
RZR 570	12-19	F
RZR 800 Ranger	08-14	F
RZR 900 "50 Inch All Options"	15-19	R
RZR-S 900 "60 Inch All Options"	15-19	R
1000 General EPS (2 Seat)	16	R
1000 General EPS (2 Seat)	17-19	R
1000 General 4 EPS (4 Seat)	17-19	R

MATERIAL AVAILABILITY AND PART NO.				
STD	OPTIONS			
FA	HH	R	MXS	EPFA
FA456TT	-	FA456R	-	-

Equivalents OE #
1911197
2203318
2203930

DO NOT REFIT ANY SHIMS/INSULATORS TO EBC PADS FROM ORIGINAL PADS UNLESS INSTRUCTED ON NOTE ON PAD PACKAGING AND ON FA DRAWING ASSOCIATED WITH THAT PAD.

FA457 A. 90.6 x 62.1 x 8.1mm B. 90.6 x 62.1 x 8.1mmT

NOTE Do not refit any original insulator shims from old original pads.

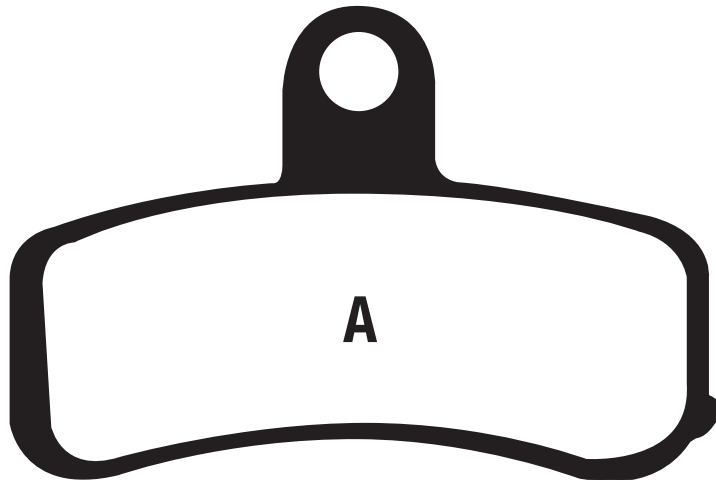

A

Equivalents OE #
44082-08
46363-11

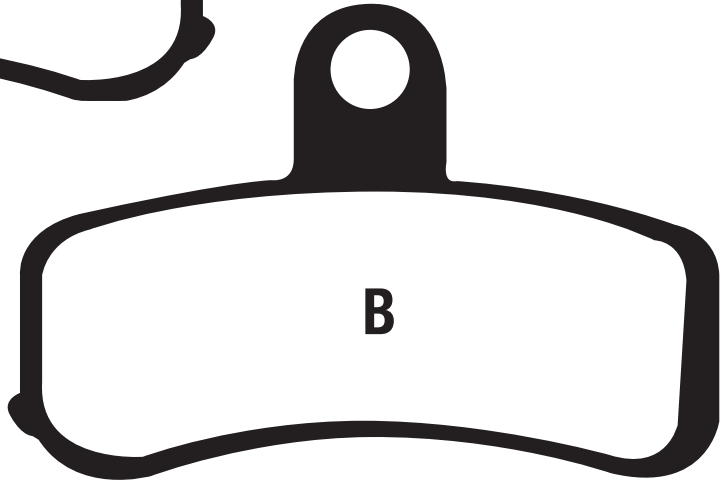

B

HARLEY DAVIDSON

FXDL Low Rider (Cast wheel)	10-17	F
FXDL Low Rider (Spoke wheel)	08-09	F
FXDL Low Rider (Spoke wheel)	10-17	F
FXDLS Low Rider S	17	F
FLD Switchback	12-15	F
FLS Softail Slim	12-14	F
FLSTC Heritage Softail Classic	08-14	F
FLSTF Fat Boy	08-14	F
FLSTFB Fat Boy LO	10-14	F
FLSTFB Fat Boy Special	10-13	F
FLSTFB Fat Boy Lo Softail	10-14	F
FLSTN Softail Deluxe	08-14	F
FSXT Softail Standard	08-14	F
FXCW Rocker	08-09	F
FXCWC Rocker C	08-11	F
FXD Super Glide	08-10	F
FXDB Street Bob	08-17	F
FXDC Super Glide Custom	08-14	F
FXDF Fat Bob	08-17	F
FXDWG Dyna Wide Glid (Spoke wheels)	08-17	F
FXSB Breakout	13-14	F
FXSTB Night Train	08-09	F
FXSTC Softail Custom	08-10	F
Softail FXS Blackline	11-13	F
FXDBC Street Bob LTD	16	F

MATERIAL AVAILABILITY AND PART NO.				
STD	OPTIONS			
FA	V	HH	VLD	EPFA
-	FA457V	FA457HH	FA457VLD	EPFA457HH

DISC PADS
BUYERS GUIDE

DO NOT REFIT ANY SHIMS/INSULATORS TO EBC PADS FROM ORIGINAL PADS UNLESS INSTRUCTED ON NOTE ON PAD PACKAGING AND ON FA DRAWING ASSOCIATED WITH THAT PAD.

DO NOT REFIT ANY SHIMS/INSULATORS TO EBC PADS FROM ORIGINAL PADS UNLESS INSTRUCTED ON NOTE ON PAD PACKAGING AND ON FA DRAWING ASSOCIATED WITH THAT PAD.

FA458 A. 130 x 56.5 x 8mm B. 130 x 56.5 x 8mm

FA458HH A. 130 x 56.5 x 7.45mm B. 130 x 56.5 x 7.45mm

Refit on HH pads only, the OE shim to non piston side

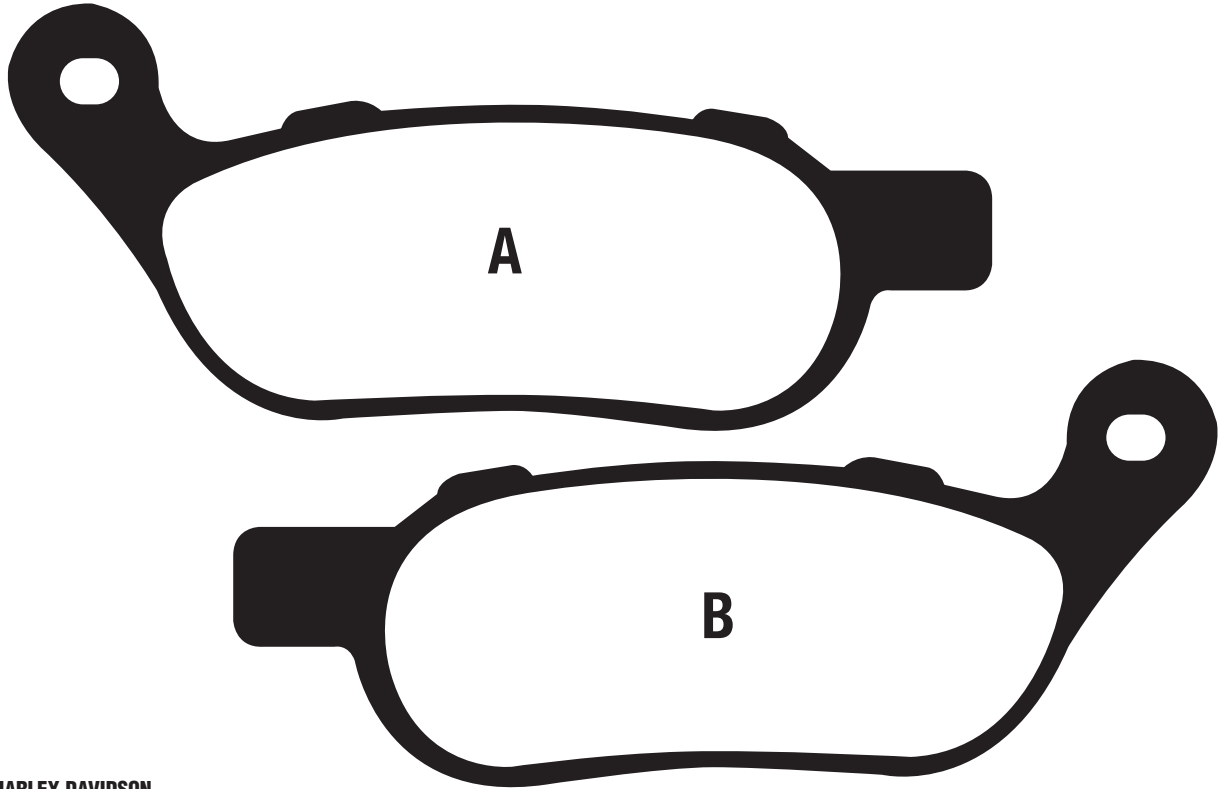

HARLEY DAVIDSON

FXDL Low Rider (Cast wheel)	10-17	R
FXDL Low Rider (Spoke wheel)	08-09	R
FXDL Low Rider (Spoke wheel)	10-17	R
FXDLS Low Rider S	17	R
FLD Switchback	12-15	R
FLS Softail Slim	12-17	R
FLSTC Heritage Softail Classic	08-17	R
FLSTF Fat Boy	08-17	R
FLSTFB Fat Boy Lo Softail	10-14	R
FLSTFB Fat Boy Special	10-13	R
FLSTFB Fat Boy LO	10-17	R
FLSTN Softail Deluxe	08-17	R
FLSTSB Softail Cross Bones	08-11	R
FXCW Rocker	08-09	R
FXCWC Rocker C	08-11	R
FXD Super Glide	08-10	R
FXDB Street Bob	08-20	R
FXDC Super Glide Custom	08-14	R
FXDF Fat Bob	08-17	R
FXDWG Dyna Wide Glide (Spoke wheels)	08-20	R
FXSB Breakout	13-17	R
FXST Softail Standard	08-15	R
FXSTB Night Train	08-09	R
FXSTC Softail Custom	08-10	R
Softail FXS Blackline	11-13	R
FLSS Softail Slim S	16-20	R
FXSB Softail Breakout	16	R
FLSTFBS Fat Boy S	16-17	R
FXDBC Street Bob LTD	16	R

Equivalents OE #
42298-08

MATERIAL AVAILABILITY AND PART NO.				
STD	OPTIONS			
FA	V	HH	VLD	EPFA
-	FA458V	FA458HH	FA458VLD	EPFA458HH

FA460 46.43 x 49.23 x 6.9mm

BUELL		
1125 R	08-10	R
1125 CR	09-10	R
EBR		
1190RX	14-15	R
1190SX	14-15	R

Equivalents OE #
H301 1AM
IC000818

MATERIAL AVAILABILITY AND PART NO.				
STD	OPTIONS			
FA	V	HH	R	MXS
-	-	FA460HH	-	

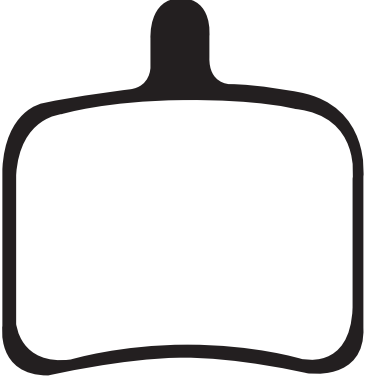

FA462 75 x 37 x 7.5mm



KTM

450 SX-F (Quad)	09-11	F
505 SX-F (Quad)	09-12	F
XC 450 Quad	08-10	F
XC 525 Quad	08-12	F

MATERIAL AVAILABILITY AND PART NO.					
STD	OPTIONS				
FA	V	HH	R	MXS	EPFA
-	-	-	FA462R	-	-

Equivalents OE #
830 13 030 100

FA463 58.72 x 35.35 x 8.5mm

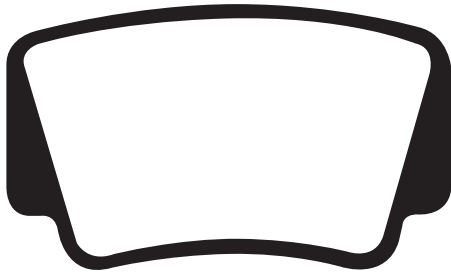

KTM

450 SX-F (Quad)	09-11	R
505 SX-F (Quad)	09-12	R
XC 450 Quad	08-10	R
XC 525 Quad	08-12	R

MATERIAL AVAILABILITY AND PART NO.				
STD	OPTIONS			
FA	V	HH	R	MXS
-	-	-	FA463R	-

Equivalents OE #
830 13 090 100

FA464 A. 109.6 x 50.6 x 8.4mm B. 95.6 x 36.9 x 8.45mm

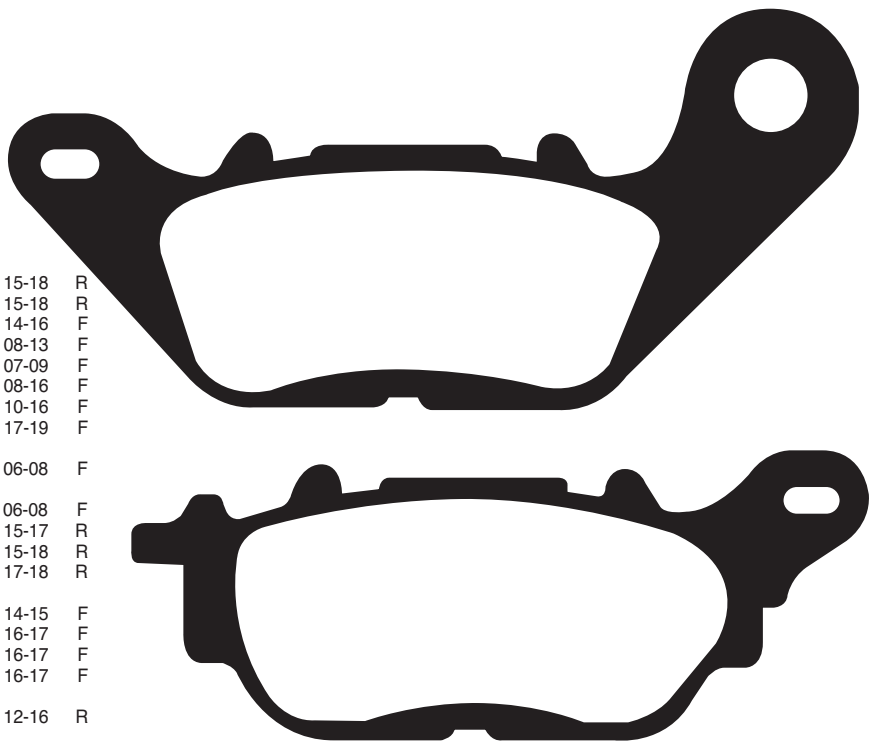

YAMAHA

GPD 125 A - N-Max/2DS1	15-18	R
N-Max 125- See GPD 125 A	15-18	R
XC 115 S—D'elight	14-16	F
XC 125 Vity (4P7)	08-13	F
YBR 125 (3D92/9)	07-09	F
YBR 125 Custom	08-16	F
YBR 125 (51D1/2)	10-16	F
YS 125	17-19	F
T 135 HC/S (2S61) Cypton X/Jupiter MX		
/Spark 135/Exciter/135 LC/Sniper	06-08	F
T 135—SE (1S71) (Automatic Clutch) Cypton		
X/Jupiter MX/Spark 135/Exciter/135 LC/Sniper	06-08	F
GPD 150 A - N-Max/2DP4	15-17	R
N-Max 150- See GPD 150 A	15-18	R
MWS 125 Tricity Scooter (3 Wheeler)	17-18	R

HONLEY

HD1 125	14-15	F
HD2 125	16-17	F
HD3 125	16-17	F
HD3 SE 125	16-17	F

LEXMOTO

Aspire 125 TD125-43	12-16	R
---------------------	-------	---

MBK

XC 125 WAAP	08-10	F
-------------	-------	---

MATERIAL AVAILABILITY AND PART NO.				
STD	OPTIONS			
FA	SFA	SFAC	R	MXS
FA464	SFA464		-	-

Equivalents OE #		
1WD 25805 00	5D9 W0045 01	3C1 F5805 10
4S5 W0045 00	3C1 W0045 10	2MP W00 45 00
4C9 W0045 00	1S9 F530K 00	

FA465 A. 110.6 x 34.6 x 7.42mm B. 98.7 x 33.5 x 7.46mm

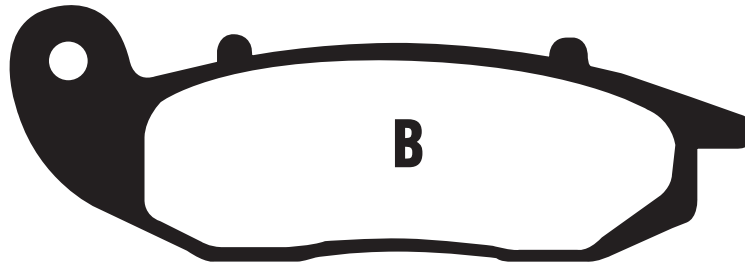
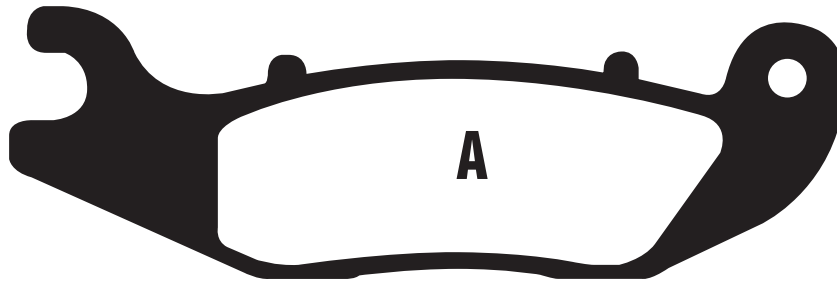

AJP

PR3 125 Enduro	13-15	F
PR3 125 Enduro Pro	13-15	F
PR3 125 Extreme	13-15	F
PR3 125 Supermoto	13-15	F
PR4 125 Enduro	13-15	F
PR4 125 Trail	13-15	F
PR4 125 Enduro Pro	13-15	F
PR4 125 Supermoto	13-15	F
PR3 250 MX Pro	13-15	F
PR4 240 Extreme	13-15	F
PR5 250 Enduro	10-15	F
PR5 250 Extreme	12-15	F
PR5 250 Supermoto	10-15	F

DERBI

Cross City 125	09-14	F
Mulhacen 125 (4T) From Ref No. 7N001791		
Spoke wheel/single pin fixing	07-10	F
Terra 125 Euro (Single pin pad fixing)	07-11	F
Terra 125 Adventure	07-14	F

FANTIC

TR 125 CR (2T) Cross Competizione	13	F
TZ 125 CS Caballero Cross (2T)	11-12	F
TZ 125 ES Regularita Scuderia (2T)	11-12	F
TZ 170 E Regularita (125E/4T)	11-15	F
TZ 170 ER Caballero Regularita Competizione (125ER/4T)	11-15	F
TZ 170 M Motard (125SM/4T)	11-15	F
TZ 170 MR Motard Competizione (125SM/4T)	11-15	F
TX 180 E Regularita Casa 50 E (49cc/2T)	12-15	F
TX 180 ER Regularita Competizione 50 ER (49cc/2T)	12-15	F
TX 180 ES Regularita Scuderia 50 ES (49cc/2T)	12-15	F
TX 180 M Motard Casa 50M (49cc/2T)	12-15	F

FANTIC Contd.

TZ 180 MR Motard Competizione 50 MR (49cc/2T)	12-15	F
TZ 200 ER Caballero Regularita Competizione (200ER/4T)	11-15	F
TZ 200 MR Motard (200 MR/4T)	11-15	F
TF 250 ES Regularita (4T)	11-13	F
TR 250 ES (2T) Enduro Six Days	13	F
TR 300 ES (2T) Enduro Six Days	13	F
TZ 300 ES Regularita Scuderia	11-12	F
GAS-GAS		
EC Cami 250 F (4T)	14-15	F
HONDA		
CRF 250 L	13-20	F
CRF 250 L ABS	17-20	F
CRF 250 Rally	17-20	F
CRF 250 Rally ABS	17-20	F
CRF 250 ME Supermoto	14-16	F
CRF 250 ME Supermoto	14-16	F
HONDA H-M		
CRE 125 (Baja RR 2T)	11	F
MH		
Duna 125 Supermotard	14	F
Ranger 125 Enduro	13-14	F
RIEJU		
MTR 50 Pro Competizione (Spoke wheel)	11-14	F
Tango 50 2T	13-15	F
Marathon Pro 125 Competizione	11-14	F
Tango 125	11-20	F
Tango 250	12-15	F
SCORPA		
T-Ride 125 F	10	F
T-Ride 250 F (Enduro)	08-10	F

MATERIAL AVAILABILITY AND PART NO.

STD	OPTIONS				
	V	HH	R	MXS	EPFA
FA465TT	-	-	FA465R	MXS465	-

Equivalents OE

864342	00TRS01A0046
865527	06451 KZZ 901
00TRS01A0074	06431 MA3 405

FA471 36 x 39.1 x 6mm

SCORPA

SR 125 (2T)	09-13	R
SR 125 Long Ride (2T)	09-11	R
SY 125 FR (4T)	03-11	R
SY 125 (4T) Long Ride	09-10	R
TY 125 (4T)	11-13	R
SY 250 R (2T)	00-09	R
SY 250 FR Long Ride	10	R
SY 250 FR	06-10	R
SR 280 (2T)	09-14	R
SR 280 (2T) Long Ride	09-11	R
Twenty 280	14	R

NOTE Shape same as FA351 but has smaller friction area



MATERIAL AVAILABILITY AND PART NO.

STD	OPTIONS				
	V	HH	R	MXS	EPFA
FA471	-	-	-	-	-

Equivalents OE

S1A 40202 00 00

FA473 110.65 x 54.5 x 7.92mm

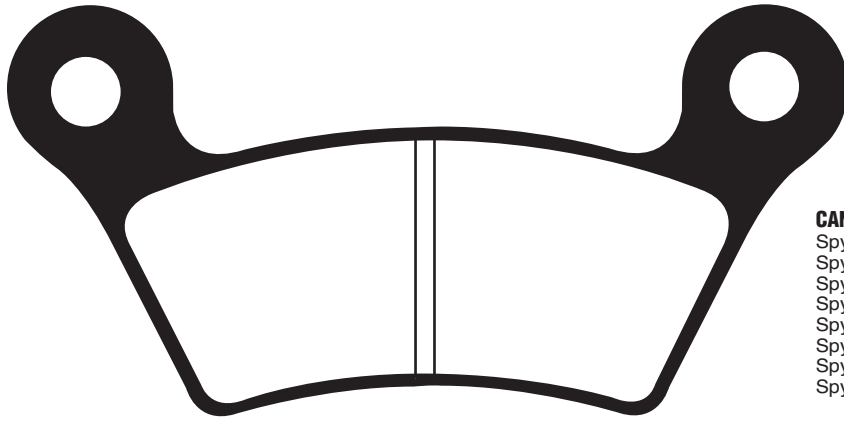

CAN-AM		
Spyder RS SE5	08-09	F
Spyder RS SM5	08-09	F
Spyder RS Phantom Black	09	R
Spyder RT-S	10-12	R
Spyder RT	10-12	R
Spyder RS-S	10-12	R
Spyder RS	10-12	R
Spyder RT LTD	11-12	R

MATERIAL AVAILABILITY AND PART NO.					
STD	OPTIONS				
FA	V	HH	R	MXS	EPFA
FA473	FA473V	-	-	-	-

Equivalents OE #	
219800031	
219800165	

FA474 A. 75.6 x 31.95 x 8mm B. 75.6 x 31.95 x 8mm

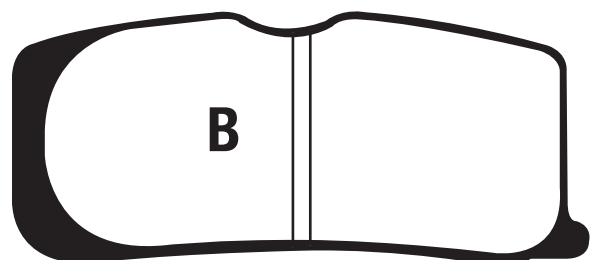
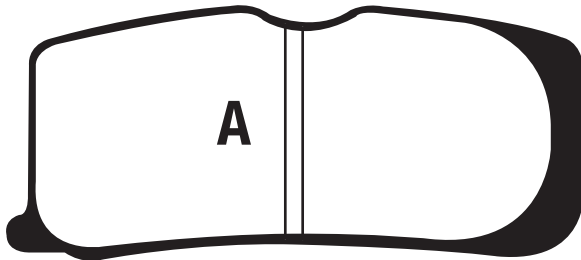

Equivalents OE #	
219800038	
219800164	

MATERIAL AVAILABILITY AND PART NO.					
STD	OPTIONS				
FA	V	HH	R	MXS	EPFA
FA474	FA474V	-	-	-	-

CAN-AM		
Spyder RS SE5	08-09	F
Spyder RS SM5	08-09	F
Spyder RS Phantom Black	09	R
Spyder RT-S	10-12	R
Spyder RT	10-12	R
Spyder RS-S	10-12	R
Spyder RS	10-12	R
Spyder RT LTD	11-12	R

FA475 96.88 x 42.45 x 6.87mm

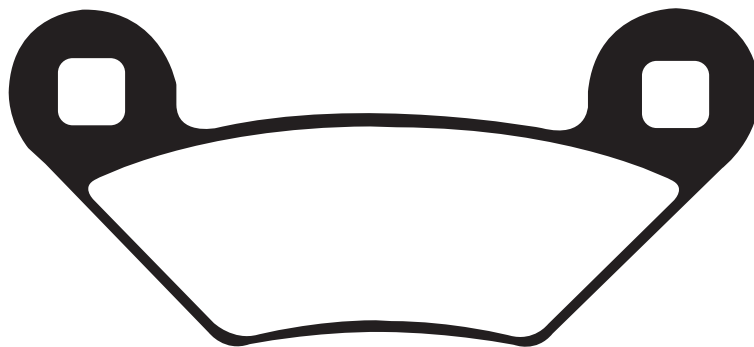

POLARIS		
325 Hawkeye 2x4	15	R
400 Hawkeye H.O. (2x4)	11-14	R
400 Sportsman HO 4x4	11-14	R
500 XP Sportsman	09	F&R
500 Sportsman HO (After 16/12/2008)	09-12	R
500 Sportsman Forest	10-14	F&R
550 Sportsman XP EPS	09-14	F&R
550 Sportsman X2	10-14	F&R
550 XP Sportsman EPS	09-14	F&R
550 Sportsman Touring EPS	10-18	F&R
550 Sportsman EPS	10-14	F&R
550 Sportsman	11-13	F&R

570 Sportsman 6x6 Tractor	17-18	R
800 Sportsman HO/EFI (After 16/12/2008)	09	R
800 Sportsman EFI	10-13	R
800 Sportsman	12-14	F&R
850 Scrambler	13-18	F&R
850 Forest	15	F&R
850 XP Sportsman	09-15	F&R
850 XP EPS Sportsman	09-14	F&R
850 Sportsman Touring EPS	10-14	F&R
850 Sportsman Touring H.O. EPS	13-15	F&R
850 Sportsman Forest	12-15	F&R
850 Sportsman SP	15-18	F&R
850 Sportsman Touring SP	15-18	F&R
850 Sportsman XP Touring EPS	12	F&R
1000 Forest	15	F&R
1000 Scrambler	15-18	F&R
1000 XP Scrambler	14-18	F&R
1000 Sportsman MD/XP	15-18	F&R
1000 Sportsman XP Tractor	16-18	F&R
1000 Sportsman Touring	15-18	F&R
1000 Sportsman Touring Tractor	16-18	F&R

MATERIAL AVAILABILITY AND PART NO.					
STD	OPTIONS				
FA	V	HH	R	MXS	EPFA
FA475TT	-	-	FA475R	-	-

Equivalents OE #	
2203628	2205606
2204088	

Part numbers, prefixes, suffixes, photos and illustrations shown in this catalogue are trademarks and/or copyrights of EBC Brakes or the trademark owner A C Freeman Investments Limited and use without express written permission of the owners is punishable by law.

FA476 A. 103.85 x 43.55 x 12.8mm (Screech clip fitted)

B. 103.85 x 43.55 x 12.8mm

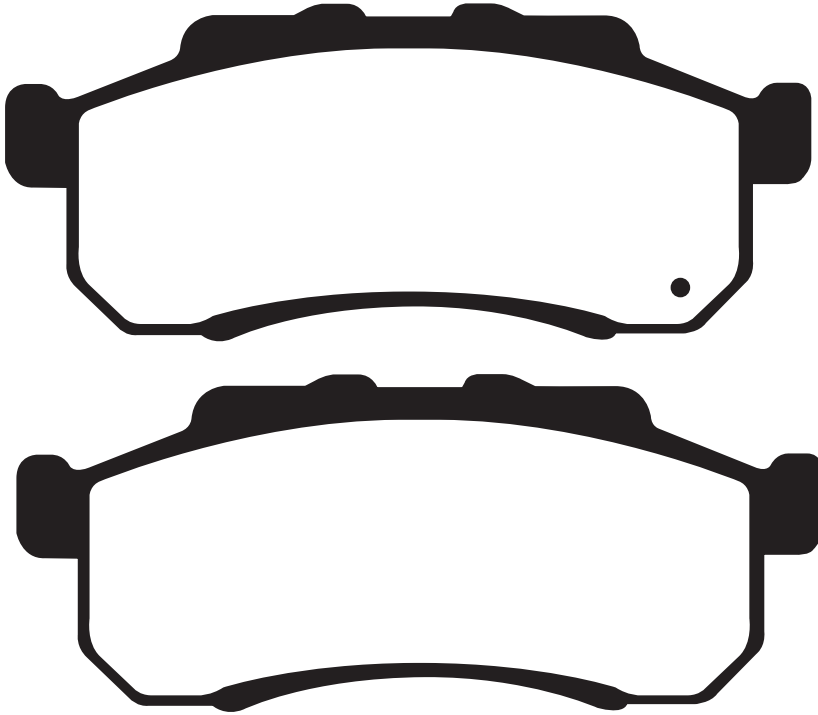

HONDA
MUV 700-9 Big Red Side x Side 09 F Left

MATERIAL AVAILABILITY AND PART NO.					
STD	OPTIONS				
FA	V	HH	R	MXS	EPFA
FA476TT	-	-	-	-	-

Equivalents OE #
06451 HL1 A01

FA477 A. 103.85 x 43.55 x 12.8mm (Screech clip fitted)

B. 103.85 x 43.55 x 12.8mm

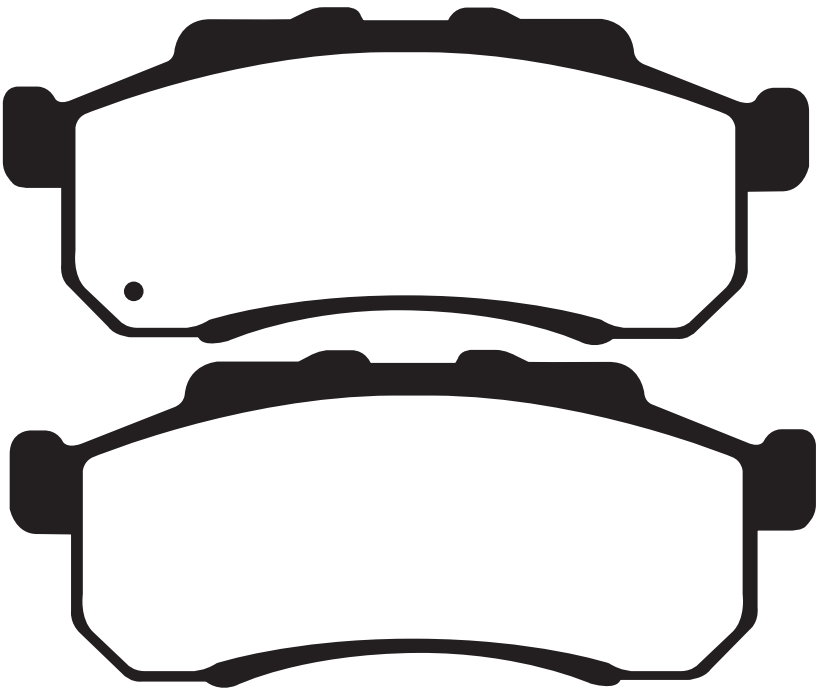

HONDA
MUV 700-9 Big Red Side x Side 09 F Right

MATERIAL AVAILABILITY AND PART NO.					
STD	OPTIONS				
FA	V	HH	R	MXS	EPFA
FA477TT	-	-	-	-	-

Equivalents OE #
06452 HL1 A01

DO NOT REFIT ANY SHIMS/INSULATORS TO EBC PADS FROM ORIGINAL PADS UNLESS INSTRUCTED ON NOTE ON PAD PACKAGING AND ON FA DRAWING ASSOCIATED WITH THAT PAD.

FA478 A. 88.95 x 36.5 x 13.8mm (Screech clip fitted)

B. 88.95 x 36.5 x 13.8mm

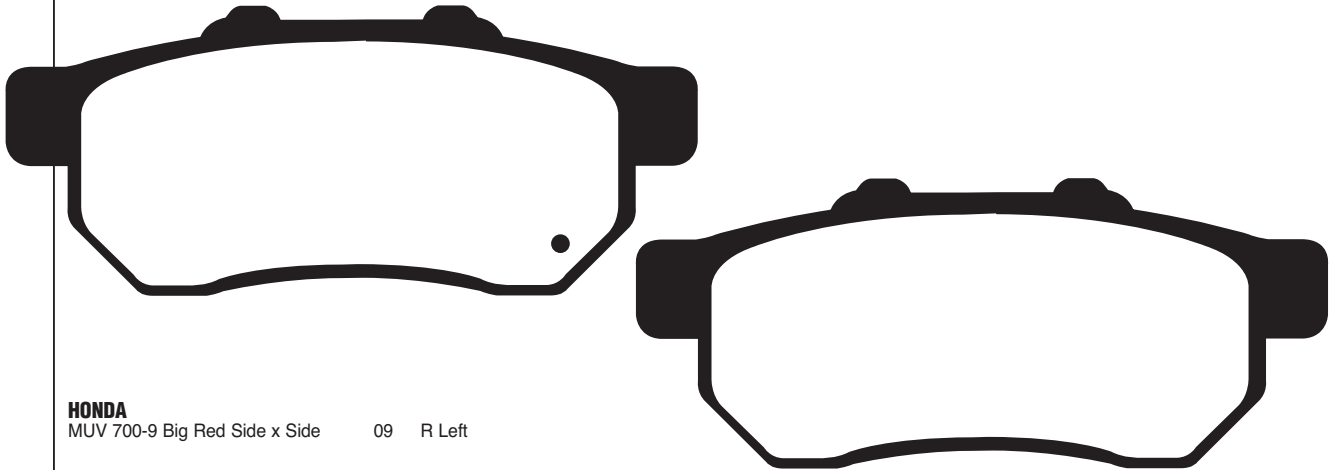

HONDA
MUV 700-9 Big Red Side x Side 09 R Left

MATERIAL AVAILABILITY AND PART NO.					
STD	OPTIONS				
FA	V	HH	R	MXS	EPFA
FA478TT	-	-	-	-	-

Equivalents OE #
06452 HL1 A01
06454 HL1 A1

FA479 A. 88.95 x 36.5 x 13.8mm (Screech clip fitted)

B. 88.95 x 36.5 x 13.8mm

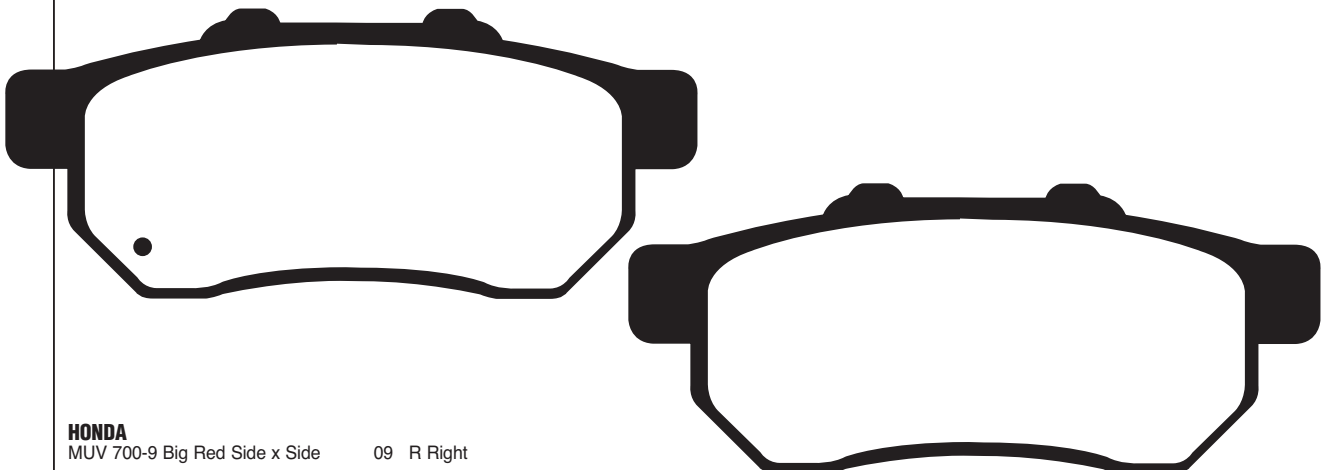

HONDA
MUV 700-9 Big Red Side x Side 09 R Right

MATERIAL AVAILABILITY AND PART NO.					
STD	OPTIONS				
FA	V	HH	R	MXS	EPFA
FA479TT	-	-	-	-	-

Equivalents OE #
06455 HL1 A01

FA480 A. 74.05 x 36.4 x 7mm B. 38 x 27.1 x 9mm



MATERIAL AVAILABILITY AND PART NO.					
STD	OPTIONS				
FA	V	HH	R	MXS	EPFA
FA480	-	-	-	-	-

LIFAN LF 125 Off Road	07	R
QUADZILLA WK 140	06-08	R
STOMP MINI MOTO 125cc Elite	07-09	R

DO NOT REFIT ANY SHIMS/INSULATORS TO EBC PADS FROM ORIGINAL PADS UNLESS INSTRUCTED ON NOTE ON PAD PACKAGING AND ON FA DRAWING ASSOCIATED WITH THAT PAD.

FA481 88 x 48 x 7.8mm

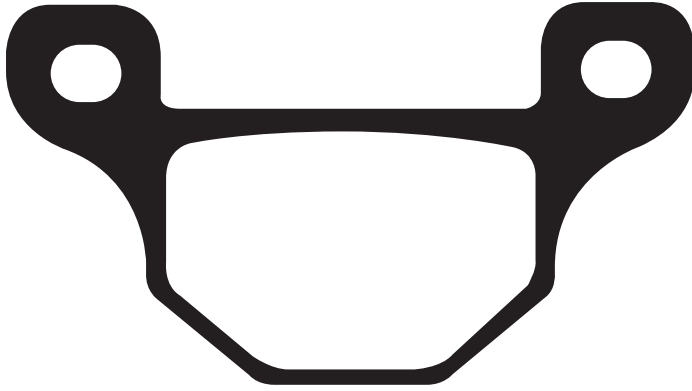

QUADZILLA
CUV 300 E 4x4 Side by Side (Parking brake) 08-09

MATERIAL AVAILABILITY AND PART NO.					
STD	OPTIONS				
FA	V	HH	R	MXS	EPFA
FA481	-	-	-	-	-

Equivalents OE #
26292

FA482 110.1 x 49.25 x 8mm

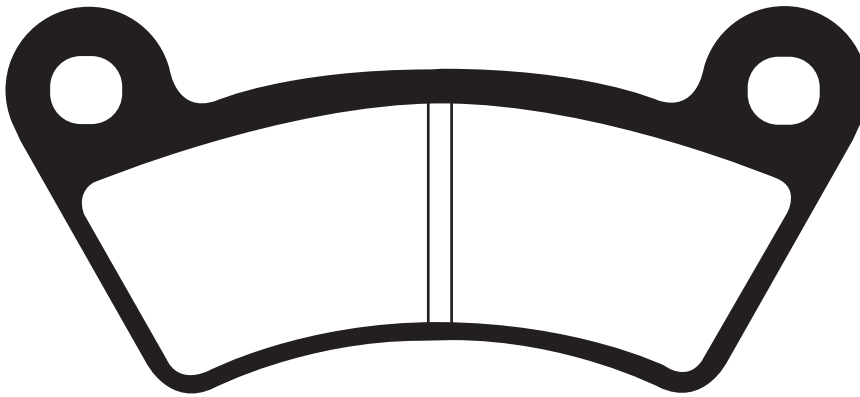

KEEWAY
GTX 300 Quad 10-11 R
LINHAI
CUV Jobber 4x4 13 F
QUADZILLA
CUV 300 (4x4 Super Utility Side x Side) 08 F
CUV 300 4x4 "Side x Side" 08-09 F
325 4x4 10-11 R

MATERIAL AVAILABILITY AND PART NO.					
STD	OPTIONS				
FA	V	HH	R	MXS	EPFA
FA482TT	-	-	FA482R	-	-

Equivalents OE #
26825
4 3 01 3370

FA483 96.65 x 40.75 x 7.2mm

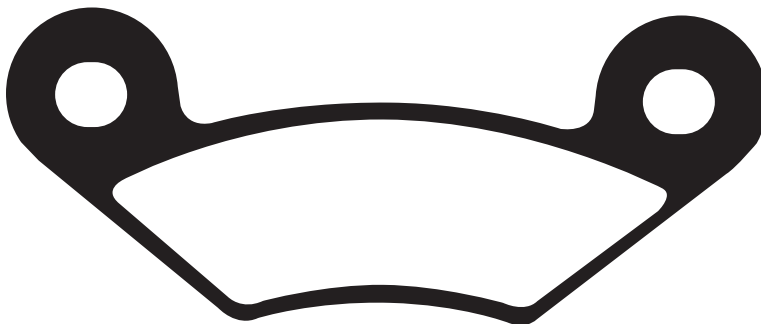

KEEWAY
GTX 300 Quad 10 F
QUADZILLA
QZ 300 E 4x4 F
QZ 320 E 4x4 09 F
325 4x4 10-11 F

MATERIAL AVAILABILITY AND PART NO.					
STD	OPTIONS				
FA	V	HH	R	MXS	EPFA
FA483TT	-	-	FA483R	-	-

Equivalents OE #
26826
22245
4 3 01 3350

FA484 A. 116.35 x 42.15 x 9.25mm

B. 76.96 x 42.15 x 9.3mm

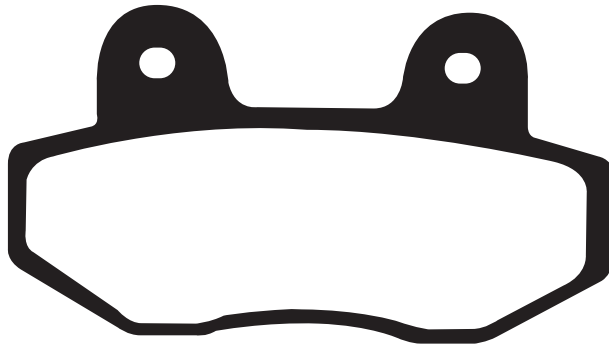
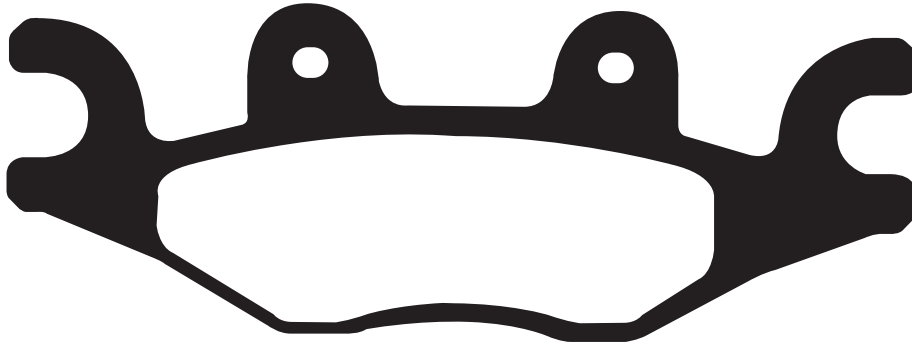

CECTEK			
500 EFI King Cobra	09-10	F	
500 EDI Quadrif	09-10	F	
500i Estoc	10	F	
PGO			
BR 500i Racer	07-09	F	
500 Bug	08-09	F	
BR 600 I Bug Racer	12	F	
TGB			
X-Motion 125	08-14	F	
X-Motion 125 Ri	11-12	F	
X-Motion 250 i	08-10	F	
X-Motion 300 EFI	10-12	F	

MATERIAL AVAILABILITY AND PART NO.					
STD	OPTIONS				
FA	V	HH	R	MXS	EPFA
FA484TT	-	-	FA484R	-	-
SFA484					

Equivalents OE #
B840C34
3500000
414220

FA485 A. 32.1 x 39.08 x 5.04mm

B. 35.17 x 31.6 x 5.1mm

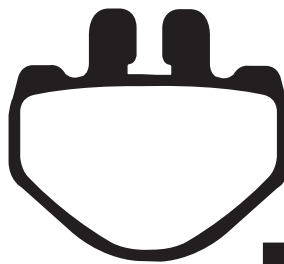
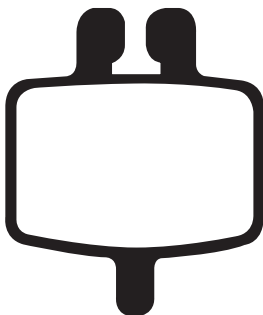

HAMMERHEAD BUGGIES			
Mini (45cc)	08-09	R	
QUADZILLA			
Micro Buggy MKII/III (RV50)	05-09	R	

Equivalents OE #
3050005036400
7-020-060

MATERIAL AVAILABILITY AND PART NO.					
STD	OPTIONS				
FA	V	HH	R	MXS	
FA485TT	-	-	-	-	-

FA486 49.5 x 46.85 x 9mm

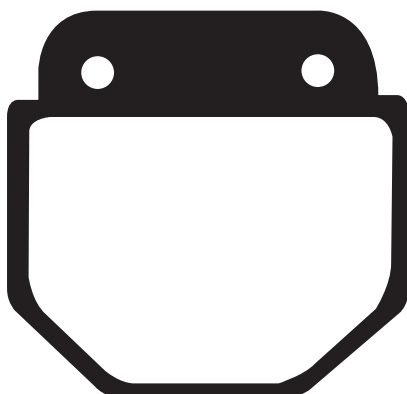

BETTER			
BT 125-20	06-09	F	
HONGDOU			
GHD 125-7	05-07	F	
KYMCO			
CK 125 Pulsar	99-00	F	
ZING BIKES			
Vogue 150 (3 wheeler)	08-09	F	

Equivalents OE #
45105 KBH E000 GM

MATERIAL AVAILABILITY AND PART NO.					
STD	OPTIONS				
FA	V	HH	R	MXS	
FA486	-	-	-	-	-

DO NOT REFIT ANY SHIMS/INSULATORS TO EBC PADS FROM ORIGINAL PADS UNLESS INSTRUCTED
ON NOTE ON PAD PACKAGING AND ON FA DRAWING ASSOCIATED WITH THAT PAD.

FA488 99.35 x 38.65 x 8.9mm

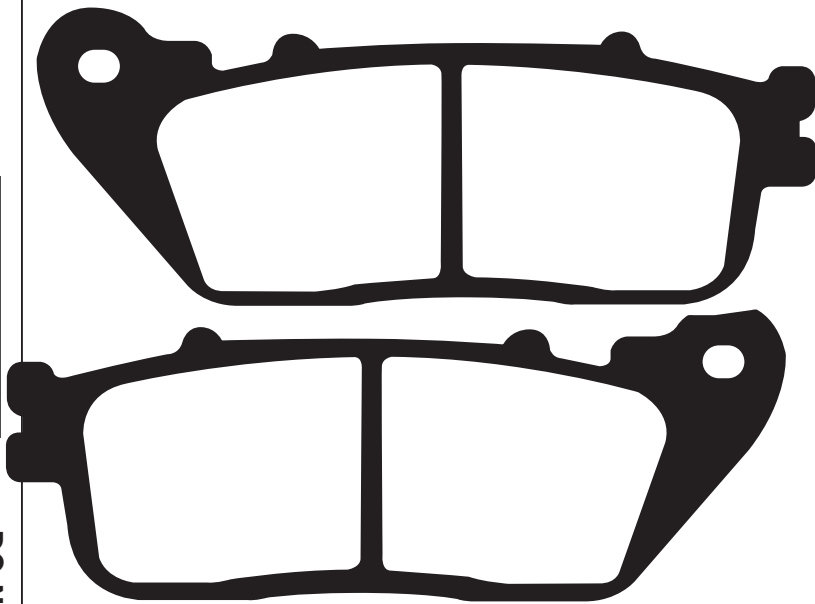

HONDA

VFR 800 F (ABS Model)	14-18	R
VFR 800 XB/XC/XD (Crossrunner/ABS)	11-13	R
VFR 800 XF/XG/XH/XJ (Crossrunner/ABS)	15-18	R
CB 1000 R9/RA/RB/RC/RD/RE/RF		
Non ABS Model	09-15	R
CB 1000 RA9/RAA/RAB/RAC/RAD/RAE		
/RAF/RAG (ABS Model)	09-16	R
CB 1000 R	17-20	R
VFR 1200 FAA/FAB/FAC/FAE	10-16	R
VFR 1200 FA - GT	14-15	R

MATERIAL AVAILABILITY AND PART NO.					
STD	OPTIONS				
FA	V	HH	R	MXS	EPFA
-	-	FA488HH	-	-	-

Equivalents OE #	
06435 MFN D01	06435 MFN D12
06435 MFN D11	06435 MFN D02
06435-MJM-D01	06435 MGY 641

FA489 88.6 x 46.65 x 7.8mm

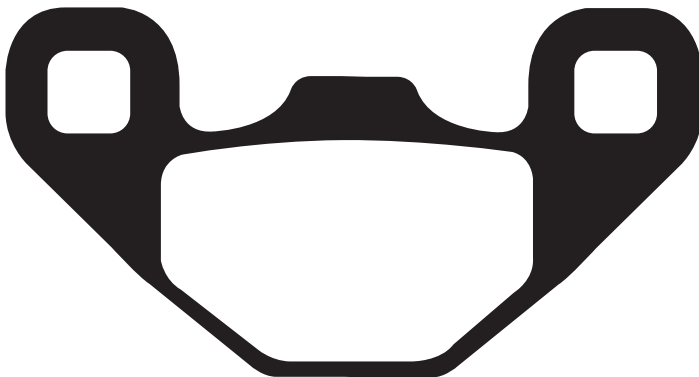

POLARIS

Ranger RZR 170	09-14	R
----------------	-------	---

MATERIAL AVAILABILITY AND PART NO.					
STD	OPTIONS				
FA	V	HH	R	MXS	EPFA
-	-	-	FA489R	-	-

Equivalents OE #
43120 214 00 AEON
0454444

FA490 87.1 x 42.65 x 7.8mm



POLARIS

Ranger RZR 170	09-14	F
200 Phoenix (Rear drum model)	10-14	F
200 Phoenix Quadricycle Model (Rear disc model)	10	F

MATERIAL AVAILABILITY AND PART NO.					
STD	OPTIONS				
FA	V	HH	R	MXS	EPFA
-	-	-	FA490R	-	-

Equivalents OE #
43121 205 001 AEON
0454440
0454664

DISC PADS
BUYERS GUIDE

DO NOT REFIT ANY SHIMS/INSULATORS TO EBC PADS FROM ORIGINAL PADS UNLESS INSTRUCTED ON NOTE ON PAD PACKAGING AND ON FA DRAWING ASSOCIATED WITH THAT PAD.

FA491 78.1 x 46.2 x 7.6mm

Note: Refit original shim

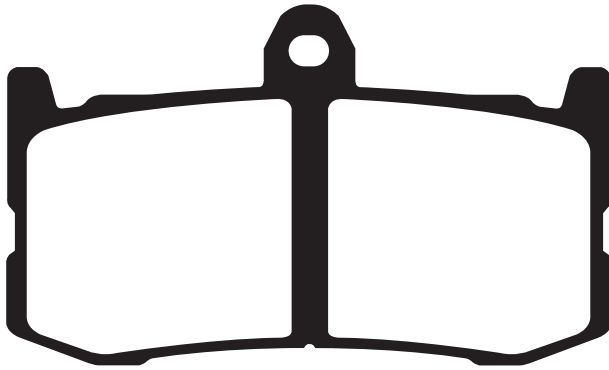

TRIUMPH
Daytona 675

09-17 F

MATERIAL AVAILABILITY AND PART NO.					
STD	OPTIONS				
FA	HH	R	SFAC	EPFA	GPFAX
-	FA491HH	-	-	EPFA491HH	GPFAX491HH

Equivalents OE #
T2021221
107 A486 55

SFA492 A. 109.6 x 51.1 x 9.7mm

B. 113.8 x 41.5 x 8.9mm

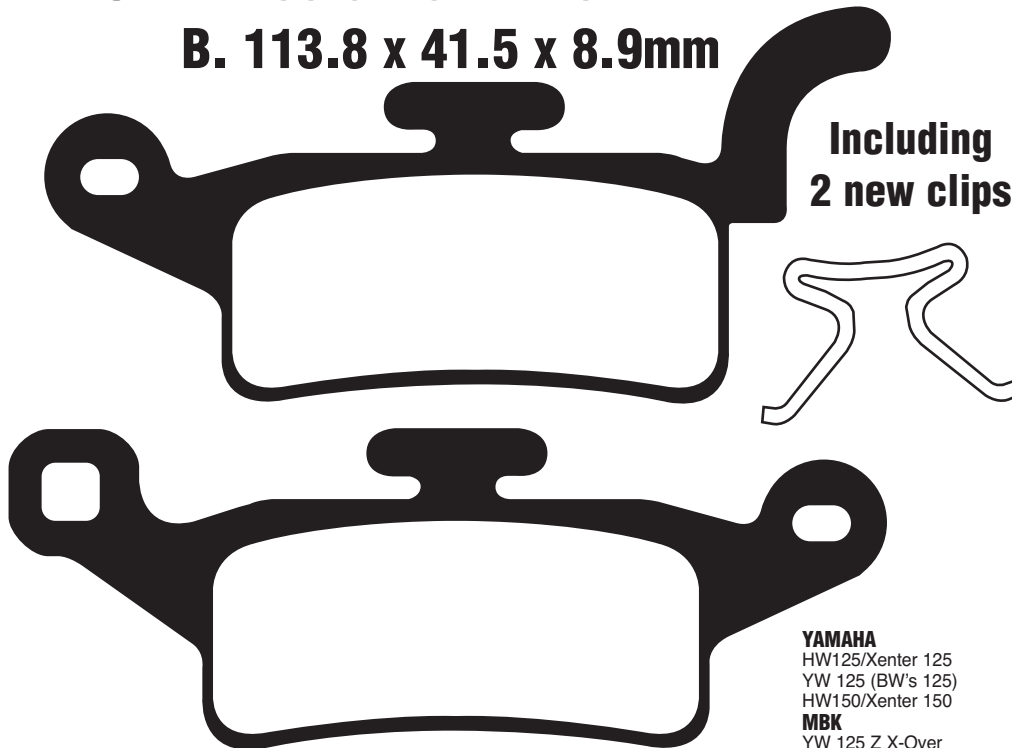

**Including
2 new clips**

YAMAHA

HW125/Xenter 125
YW 125 (BW's 125)
HW150/Xenter 150

12-18 F
10-13 F
12-17 F

MBK

YW 125 Z X-Over

10 F

MATERIAL AVAILABILITY AND PART NO.					
STD	OPTIONS				
FA	SFAC	HH	R	MXS	EPFA
SFA492	SFAC492	-	-	-	-

Equivalents OE #
5S9 W0045 00
52S F5811 00

FA495 35.7 x 42.2 x 5.6mm

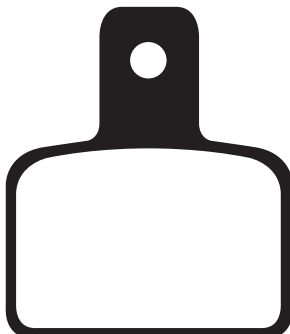

BETA

Evo 80
Evo 125 (2T)
Trial Evo 125 (2T) MY20
Evo 200 (2T)
Trial Evo 200 (2T) MY20
Evo 250 (4T/2T)
Trial Evo 250 (2T) MY20 Inc GB
Evo 300 (2T)
Trial Evo 300 (2T) MY20 Inc GB and SS
Evo 300 (4T)

09-15 R
09-15 R
20 R
09-15 R
20 R
09-15 R
20 R
09-15 R
20 R
09-15 R

MATERIAL AVAILABILITY AND PART NO.					
STD	OPTIONS				
FA	SFAC	HH	R	MXS	EPFA
FA495	-	-	-	-	-

Equivalents OE #
00736071800

**DISC PADS
BUYERS GUIDE**

**DO NOT REFIT ANY SHIMS/INSULATORS TO EBC PADS FROM ORIGINAL PADS UNLESS INSTRUCTED
ON NOTE ON PAD PACKAGING AND ON FA DRAWING ASSOCIATED WITH THAT PAD.**

FA496 86 x 40 x 8.95mm



HONDA

CB 300 FAF/FAG (ABS)	15	R
CBR 250 RRL/RRN/RRR (MC22)	90-92	R
CBR 250 RB (Non ABS)	11-13	R
CBR 250 RAB/RAC (ABS)	11-13	R
CBR 300 RA (ABS)	15-17	R
CBR 300 R Non ABS	18-20	R
CB 300 F ABS	18-20	R
CB 300 R	18-20	R
CMX 300 Rebel	18-20	R
CMX 300 Rebel ABS	18-20	R
CB 500 F (Non ABS)	13-20	R
CB 500 FA (ABS)	13-20	R
CMX 500 Rebel	17-20	R
CB 650 FE/FG	14-16	R
CB 650 FAE/FAF/FAG/FAH/FAJ (ABS)	14-20	R
CB 650 R	19-20	R
CBR 650 FE/FG/FH (Non ABS)	14-20	R
CBR 650 FAE/FAF/FAG/FAH/FAJ (ABS)	14-20	R
CBR 650 RR 2AC/RA 2AC	19-20	R
ADV 750 H (ADV X DCT)	17-18	R
NC 750 S	14-15	R
NC 750 S ABS	14-18	R
NC 750 S ABS DCT	14-18	R
NC 750 X	14-15	R
NC 750 X ABS	14-18	R
NC 750 X ABS DCT	14-18	R

750 Integra (Scooter) (NC 750 DDE)	14-18	R
750 Integra S Scooter (NC 750 DDSE)	14	R
SINNIS		
RSX 125	19-20	R
SUZUKI		
DL 250 V-Strom AL8/AL9 (ABS)	18-19	R
GSX 250 RL7/RL8	17-18	R
GW 250 L3/FL5 Inazuma	13-15	R
GW 250 FL5 Inazuma	15	R
SFV 650 K9/L0/L1/L2/L3/L4/L5 Gladius	09-15	R
SFV 650 AK9/AL0/AL1/AL2/AL3/AL4/AL5 (ABS)	09-15	R
SV 650 ABS	16-20	R
SV 650 X ABS	18-20	R

MATERIAL AVAILABILITY AND PART NO.					
STD	OPTIONS				
FA	V	HH	R	MXS	EPFA
FA496	FA496V	FA496HH	-	-	-

Equivalents OE #		
69101 44850	06435 MOZ JO1	69100 48820
06435 KYJ 901	06435 MGS D31	06435 MGZ J01

FA497 62 x 40.8 x 7.1mm

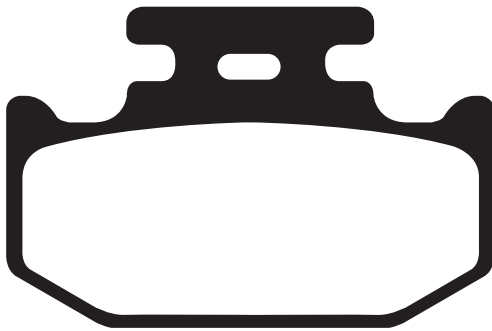

YAMAHA

YXR 700 Rhino 4x4 SE (Parking brake)	09	PB
YXR 700 FA/FB/FD Rhine Side x Side (Parking brake)	11-13	PB
YXM 700 E Viking EPS COMO (YXM70VPHG) (Parking brake)	16	PB
YXM 700 E Wolverine R (YXE70WPHG) (parking brake)	16	PB
YXM 700 ES - Viking EPS SE (YXM700PSE)	14-16	PB
YXC 700 E Viking VI EP (YXC700PF/PXG/PXH/PXJ)	15-18	PB
YXZ 1000 R EPS (Side x Side) YXZ10PXG (Parking Brake)	16	PB
YXZ 1000 R SE (Side x Side) (Parking Brake)	16	PB
YXZ 1000 R SS (Side x Side)	17-18	PB

MATERIAL AVAILABILITY AND PART NO.				
STD	OPTIONS			
FA	V	HH	R	MXS
FA497TT	-	-	-	-

Equivalents OE #	
5B4 W0046 00	
5B4 2586 00	

SFA498 90 x 33.3 x 9.8mm

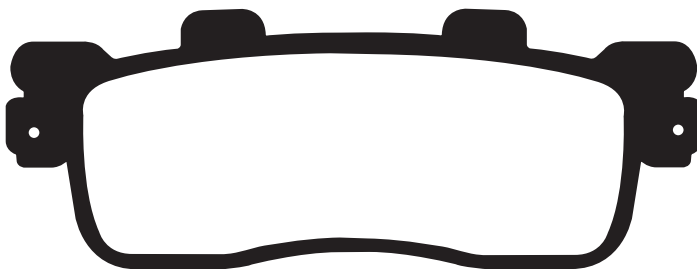

BENELLI

Velvet 125/150 (Touring)	08-11	R
KAWASAKI		
J 125 ABS (SC125 AGF/BGF/CGF/CHF/CJF)	16-18	R
J 125 SE/ABS (SC125 AGFA/BGFA/CGFA/CHFA/CJFA)	16-18	R
J300 AEF/AFF/AGF (Non ABS)	14-16	R
J300 AEFA/AFFA/AGFA Special Edition (Non ABS)	14-16	R
J300 BEF/BFF/BGF/CHF/CJF (ABS)	14-20	R
J300 BEFA/BFFA/BGFA/CHFA/CJFA Special Edition (ABS)	14-20	R
KYMCO		
Downtown/Superdink 125i (V21000)	09-14	R
Downtown 200i	10-14	R
Downtown/Superdink 300i (V20000)	09-12	R
Downtown 300i (ABS/V20010)	10-14	R

MATERIAL AVAILABILITY AND PART NO.					
STD	OPTIONS				
SFA	SFAC	HH	R	MXS	EPFA
SFA498	SFAC498	SFA498HH	-	-	-

Equivalents OE #	
43105 LEA7 305	43082 Y006
430 82 Y008	43082 Y008

DISC PADS
BUYERS GUIDE

DO NOT REFIT ANY SHIMS/INSULATORS TO EBC PADS FROM ORIGINAL PADS UNLESS INSTRUCTED
ON NOTE ON PAD PACKAGING AND ON FA DRAWING ASSOCIATED WITH THAT PAD.

FA499/4 A. 69.2 x 51.55 x 8.9mm B. 33 x 51.55 x 8.9mm

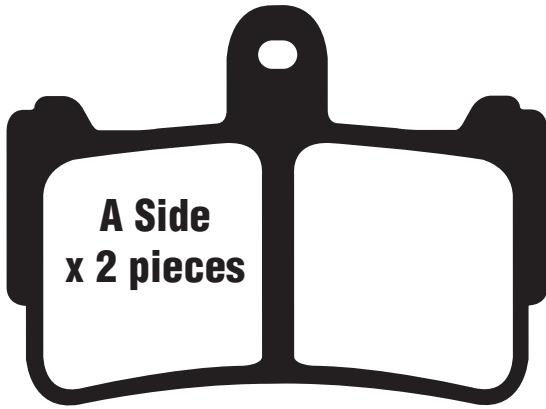

2 Pieces A Side
Fitted to lower end of caliper

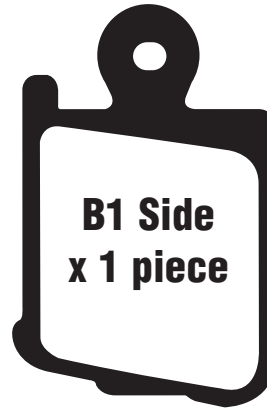

Fitted to top inside of caliper

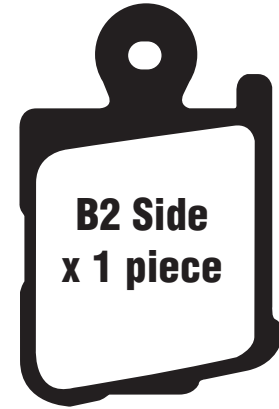

Fitted to top outside of caliper

Refit original shims

HONDA		
VFR 1200 FAA/FAD/FAC/FAE	10-14	F
VFS 1200 FADE/FADB/FADC/FADE (Automatic transmission)	10-14	F
VFR 1200 FA	10-16	F
VFR 1200 FA GT	14-15	F
VFR 1200 FAD - DCT	10-17	F
VFR 1200 FAD GT/DCT	14-15	F

MATERIAL AVAILABILITY AND PART NO.					
STD	OPTIONS				
FA	V	HH	R	MXS	EPFA
-	-	FA499/4HH	-	-	-

Equivalents OE #	
06455 MGE 006	06455 MGE 016

FA600 102.3 x 42.7 x 7.85mm

FA600/2 102.3 x 42.7 x 7.1mm

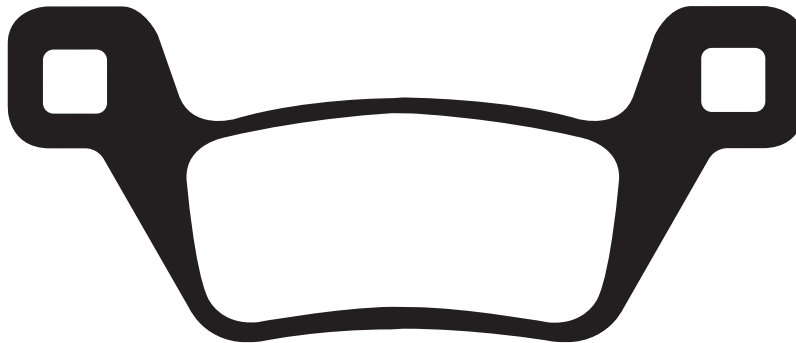

FA600TT - KYMCO		
MXU 500i (4x4 IRS) (LAAOCD/CM)	09-14	F
MXU 500i DX	11-13	F
MXU 550i	12-15	F
MXU 550i (4x4 LOF)	13-20	F
MXU 700i (4x4 LOF)	13-18	F
UXV 700i Turf	14-15	F

FA600/2TT - KYMCO		
MXU 500i (4x4 IRS) (LAAOCD/CM)	09-14	R
MXU 500i DX	11-13	R
MXU 550i	12-15	R
MXU 550i (4x4 LOF)	13-20	R
MXU 700i (4x4 LOF)	13-18	R
UXV 700i Turf	14-15	R

Equivalents OE # FA600
45105 LFE9 305
45105 ACL1 305

Equivalents OE # FA600/2
43105 LFE9 305

MATERIAL AVAILABILITY AND PART NO.				
STD	OPTIONS			
FA	V	HH	R	MXS
FA600TT	-	-	FA600R	-

MATERIAL AVAILABILITY AND PART NO.				
STD	OPTIONS			
FA	V	HH	R	MXS
FA600/2TT	-	-	FA600/2R	-

DO NOT REFIT ANY SHIMS/INSULATORS TO EBC PADS FROM ORIGINAL PADS UNLESS INSTRUCTED
ON NOTE ON PAD PACKAGING AND ON FA DRAWING ASSOCIATED WITH THAT PAD.

FA602 40.95 x 42.35 x 7.3mm

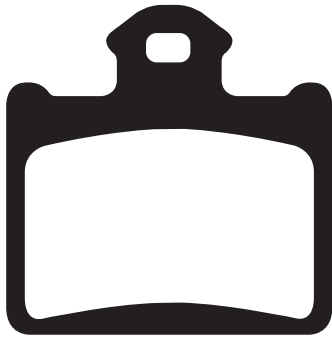

HUSQVARNA		
CR 65	11-13	R
TC 85 (2T) (17"/14" wheels)	14-20	F
TC 85 (2T) (19"/16" wheels)	14-20	F
KTM		
Freeride E-SM	15-17	R
Freeride E-SX	15-17	R
Freeride E-XC	15-20	R
SX 85 (17"/14" wheels)	11-20	R
SX 85 (19"/16" wheels)	11-20	R
250 Freeride R (2T)	14-15	R
350 Freeride (4T)	12-15	R
SWM		
MC 650 R	18	R

MATERIAL AVAILABILITY AND PART NO.					
STD	OPTIONS				
FA	V	HH	R	TT	EPFA
FA602	-	-	FA602R	FA602TT	-

Equivalents OE #
8000H7138
470 130 90 300

SFA603 A. 111.6 x 43.01 x 8.05mm B. 109.6 x 43.01 x 8.05mm

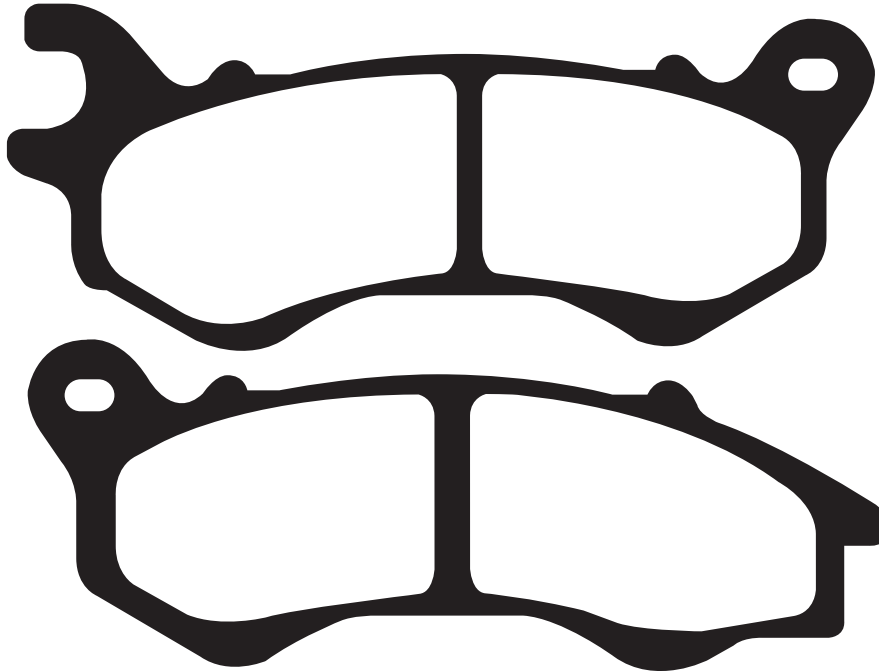

HONDA			PEUGEOT		
NSC 50 MPDC/E/F/G/H/J Vision 50 (4T) (16" wheels)	12-18	F	Django 50 Allure (2T/4T)	14-18	F
NSC 50 WHC/T2E/F Vision 50 (4T) (14" wheels)	12-16	F	Django 50 Evasion (2T/4T)	14-19	F
NSC 50 R (14" wheels)	13-16	F	Django 50 Sport (2T/4T)	14-19	F
NSC 110 WHB/E Vision 110 (4T)	11-16	F	Django 50 S (2T)	14-18	F
NSC 110 MPDC/E "Vision" (16" Wheels)	12-14	F	Django 50 S (4T)	14-18	F
SCV 110 (NHX 110 WHA) 4 bolt disc fixing)	10-12	F	Django 125 Allure (4T)	14-20	F
PCX 125 (WW 125 EX2 C/D/F/H/J)	12-18	F	Django 125 Allure SBC (4T/190mm Rear Disc)	14-20	F
SH 125i Mode (ANC 125 E)	14-20	F	Django 125 Evasion (4T)	14-20	F
PCX 150 (WW 150 EXC2 C/D/F/H/J)	12-20	F	Django 125 Evasion SBC (4T/190mm Rear Disc)	14-20	F
PCX 150	18-20	F	Django 125 Heritage SBC (4T/190mm Rear Disc)	14-20	F
KYMCO			Django 125 Sport (4T)	14-20	F
People One 125	16-20	F	Django 125 Sport SBC (4T/190mm Rear Disc)	14-20	F
LEXMOTO			Django 125 S (4T/190mm Rear Disc)	14-20	F
Adrenaline 125 EFI (XFLM125GY-2B-E4)	15-18	F	Satelis 125 (4T)	13	F
ZSX-F 125 ZS125-48E-E4	16-20	F	Django 150 Allure (4T)	14-18	F
ZSX-R 125 ZS125-48F-E4	16-20	F	Django 150 Evasion (4T)	14-19	F
			Django 150 Sport (4T)	14-20	F
			Django 150 S (4T) (4T/190mm Rear Disc)	14-20	F
			Speedfight 4 125 (4T)	17-19	F

MATERIAL AVAILABILITY AND PART NO.				
STD	OPTIONS			
SFA	HH	SFAC	MXS	EPFA
SFA603	SFA603HH	SFAC603	-	-

Equivalents OE #	
06455 KWN 641	06455 KZL 861
06455 GFM D31	PE8033443

DO NOT REFIT ANY SHIMS/INSULATORS TO EBC PADS FROM ORIGINAL PADS UNLESS INSTRUCTED ON NOTE ON PAD PACKAGING AND ON FA DRAWING ASSOCIATED WITH THAT PAD.

FA604/4 34.9 x 40.5 x 9mm



**4.5mm
backplate**

**Please refer to
original BMW
workshop manual
for correct fitting
information.**

BMW		
S 1000 R Naked (K47)	14-18	F
S 1000 RR (K46)(Disc has fixed bobbins)	10-18	F
S 1000 R/RR (Models fitted with Forged race wheels - 7 Spoke type)	10-18	F
TRIUMPH		
Speedtriple 1050 (Non ABS)		
- From VIN461332	11-16	F
Speedtriple 1050 (ABS)		
- From VIN461332	09-16	F
Bonneville Speed Twin (1200)	19-20	F
Daytona 765 Moto 2	20	F

MATERIAL AVAILABILITY AND PART NO.					
STD	OPTIONS				
FA	GPFAX	HH	R	MXS	EPFA
-	GPFAX604/4HH	FA604/4HH	-	-	EPFA604/4HH

Equivalents OE #	
34 11 7 714 800	T2025290
T2025247	T2026565

FA605/4 97.95 x 46.95 x 7.8mm

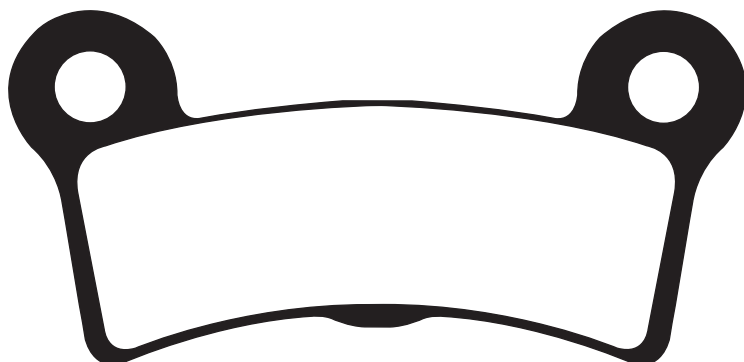

HARLEY DAVIDSON		
FLHTCUTG Tri Glide Ultra Classic Trike	09-12	R
FLHXXX Street Glide Trike	10-11	R

MATERIAL AVAILABILITY AND PART NO.					
STD	OPTIONS				
FA	V	HH	R	MXS	EPFA
-	FA605/4V	FA605/4HH	-	-	-

Equivalents OE #
83911-09
83911-09B

FA606 69.4 x 45 x 8.6mm

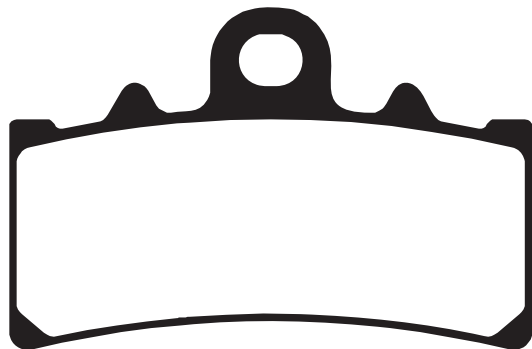

BMW		
C 400 X	18	F
G 310 R	17-20	F
G 310 GS	17-20	F
KTM		
Duke 125 (4T)	11-18	F
RC 125	14-20	F
Duke 200 (4T)	12-15	F
RC 200	14-15	F
Duke 250	15-20	F
390 Adventure	20	F
Duke 390	13-20	F
RC 390	14-15	F
390 Duke (4T)	15	F
RC 390 (4T)	15	F
HUSQVARNA		
Vitpilen 401 (4T)	18-20	F

MATERIAL AVAILABILITY AND PART NO.				
STD	OPTIONS			
FA	HH	R	MXS	EPFA
FA606	FA606HH	-	-	EPFA606HH

Equivalents OE #
901-13-030-000

**DISC PADS
BUYERS GUIDE**

**DO NOT REFIT ANY SHIMS/INSULATORS TO EBC PADS FROM ORIGINAL PADS UNLESS INSTRUCTED
ON NOTE ON PAD PACKAGING AND ON FA DRAWING ASSOCIATED WITH THAT PAD.**

SFA607 94 x 36.15 x 10.45mm

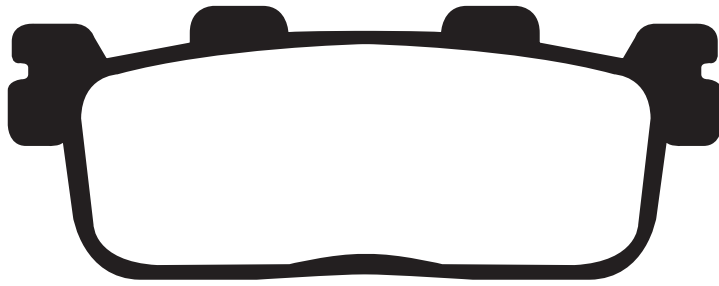

KYMCO

K-XCT 125	12-15	R
New Downtown 125i	15-20	R
People GT 125i	10-15	R
People S125 DD (D1000 rear disc model)	07-15	R
New X Town 125i ABS	16-20	R
X Town 125	16-18	R
People S200i DD (D12000) (5 bolt fixing disc)	07-15	R
People 250 Si DD	07-08	R
People GT 200i	10-14	R
Xciting 250 (T71000)	05	R
Xciting 250 i (T71010)	06-08	R
300i Agility Max ABS	15	R

KYMCO Contd.

New Downtown 350i	15-18	R
Grand Dink 300i	12-20	R
People GT 300i	10-15	R
People S 300i	08-10	R
X Town 300i	17-20	R
Xciting 300i (T72000 - EFI Model)	08	R
Xciting 300i R (T72001/T72011)	09-14	R
New Downtown 350i	15-20	R
Xciting 500R (T70021 EFI model)	07-14	R
YAMAHA		
XP 400 X-MAX Momo Design ABS	15	R

MATERIAL AVAILABILITY AND PART NO.					
STD	OPTIONS				
SFA	HH	R	MXS	EPFA	
SFA607	SFA607HH	-	-	-	

Equivalents OE #	
43105 LDH1 E00	43082 Y006
43105 LGE5 305	1SD F5911 00

SFA608 102 x 38 x 10.45mm



KYMCO

X-Citing 400i	12-20	R
Xciting S 400i	17-20	R
X-Citing 500 Ri (T70021) (EFI Model)	09-15	R
X-Citing 500i (T70020) (EFI Model)	06-08	R
X-Citing 500 (T70000) (Carb Model)	05	R
Xciting Evo 500i ABS	13	R
MX Road 700i	12-15	R

MATERIAL AVAILABILITY AND PART NO.					
STD	OPTIONS				
SFA	HH	R	MXS	EPFA	
SFA608	SFA608HH	-	-	-	

Equivalents OE #	
43105 LBA2 305	
43105 LKF 305	

FA609 97.8 x 42.4 x 7.5mm



JCB (UTILITY VEHICLES)

Groundhog 800 D (4x4)	08-09	F&R
Workmax 800 D (4x4)	10-14	F&R
Groundhog 1000 D (4x4)	08-09	F&R
Groundhog 6x4 1000 D	08-09	F&R
Workmax 1000 D (4x4)	10-14	F&R
Workmax 6x4 1000 D	10-14	F&R

JOHN DEERE (SIDE X SIDE)

HPX 4X4 Gator (Diesel)	10-11	F&R
XUV 620i Gator (Petrol)	10	F&R
XUV 625i Gator (Petrol)	11	R
XUV 825i Gator (Petrol)	11	R
XUV 850 D Gator (Diesel)	10	F&R
XUV 855 D Gator (Diesel)	11	R

MATERIAL AVAILABILITY AND PART NO.					
STD	OPTIONS				
FA	V	HH	R	MXS	EPFA
-	-	-	FA609R	-	-

Equivalents OE #	
AM141182	

DO NOT REFIT ANY SHIMS/INSULATORS TO EBC PADS FROM ORIGINAL PADS UNLESS INSTRUCTED ON NOTE ON PAD PACKAGING AND ON FA DRAWING ASSOCIATED WITH THAT PAD.

FA610 135.6 x 55 x 8mm

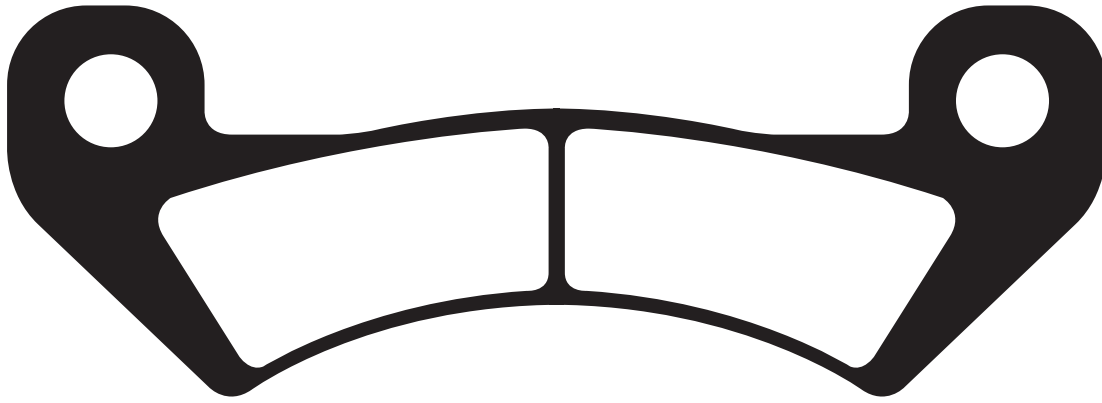

JOHN DEERE (SIDE X SIDE)

XUV 625i Gator (Petrol)	11	F
XUV 825i Gator (Petrol)	11	F
XUV 855 D Gator (Diesel)	11	F

ARCTIC CAT (SIDE X SIDE)

Wildcat 1000 4	13-14	F
Wildcat 1000 4X	14-16	F
Wildcat 1000 4X LTD	14-15	F

MATERIAL AVAILABILITY AND PART NO.					
STD	OPTIONS				
FA	V	HH	R	MXS	EPFA
-	-	-	FA610R	-	-

Equivalents OE #
AM140607

GPFA611 82.15 x 28.8 x 9.5mm

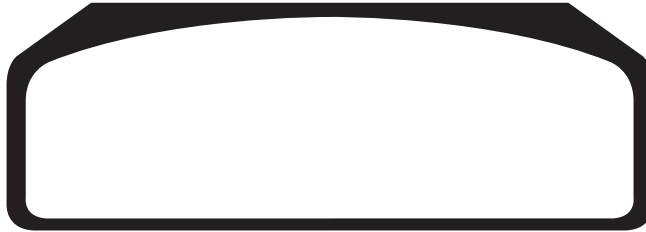

BREMBO

- XA3.J7.50/51 - 4 Piston P34/38 Radial Mount @ 108mm Spacing (Pinless Fixing)
- XA3.J7.60/61 - 4 Piston P 34/38 Radial Mount @ 108mm Spacing (Pinless Fixing/Lithium Body)
- XA8.Y3.310/11 - 4 Piston P34/38 Radial Mount @ 130mm Spacing (Pinless Fixing)

MATERIAL AVAILABILITY AND PART NO.					
STD	OPTIONS				
FA	GPFA6	HH	R	MXS	EPFA
-	GPFA611HH	-	-	-	-

Equivalents OE #
07 8354 24

FA612 59 x 40.18 x 7.45mm

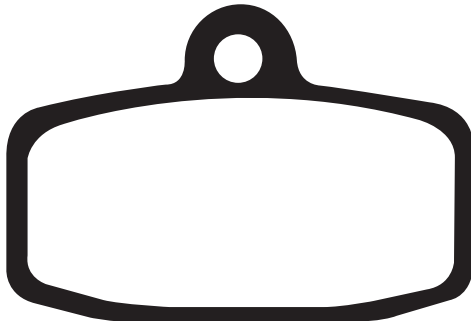

GAS-GAS

- TXT 125/250/280/300 (For models with formula front caliper/single pin pad fixing) 12 F

HUSQVARNA

- TC 85 (2T) (17"/14" wheels) 14-20 F
- TC 85 (2T) (19"/16" wheels) 14-20 F

KTM

- Freeride E-SM 15-17 F
- Freeride E-SX 15-17 F
- Freeride E-XC 15-20 F
- SX 85 17/14" wheels 12-20 F
- SX 85 19/16" wheels 12-20 F
- 250 Freeride R (2T) 14-15 F
- 350 Freeride (4T) 12-15 F

SHERCO

- ST 80 (2T/Formual Caliper) 13-14 F
- ST 125 (2T/Formual Caliper) 13-14 F
- ST 250 (2T/Formual Caliper) 13-14 F
- ST 290 Cabastany Replica (2T/Formual Caliper) 12 F
- ST 290 (2T/Formual Caliper) 13-14 F
- ST 305 (2T/Formual Caliper) 13-14 F

MATERIAL AVAILABILITY AND PART NO.					
STD	OPTIONS				
FA	GPFA6	HH	R	MXS	EPFA
FA612TT	-	-	FA612R	-	-

Equivalents OE #
470 13 030 000
4252
BT 6000063012

FA613 81 x 45.9 x 9.4mm

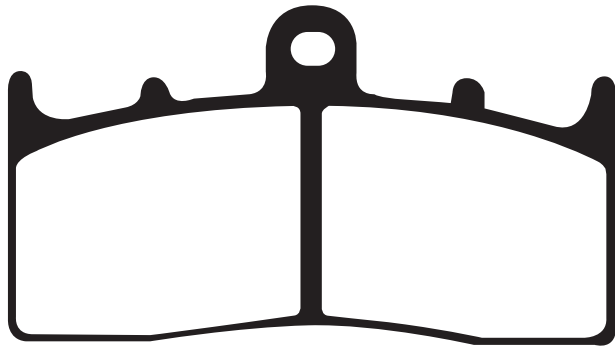

BMW

K1600 B Bagger	17-20	F
K1600 B Grand America	18-20	F
K 1600 GT	11-18	F
K 1600 GT SE	12-15	F
K 1600 GTL	11-18	F
K 1600 GTL Exclusive	13-16	F

MATERIAL AVAILABILITY AND PART NO.					
STD	OPTIONS				
FA	V	HH	R	MXS	
-	-	FA613HH	-	-	-

Equivalents OE #
34 11 7 728 945

FA617 A. 109.15 x 39.2 x 7.65mm

B. 96.3 x 36.5 x 7.6mm

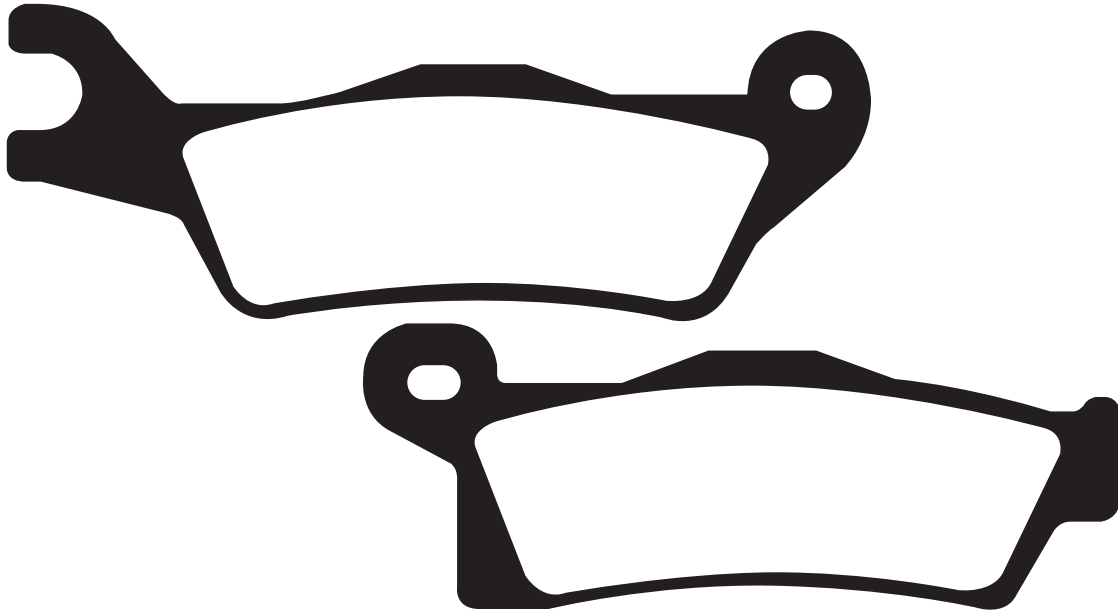

CAN AM

Outlander 500 (STD)	13-14	F(Right)&R
Outlander 500 XT	13-14	F(Right)&R
Outlander 500 4x4 (DPS/XT)	13-14	F(Right)&R
Outlander Max 500 4x4 (DPS)	13-14	F(Right)&R
Outlander Max 500 XT	14	
F(Right)&R Renegade 500 (STD)	12-15	F(Right)&R
Outlander 650 4x4 (STD/DPS/XT)	13-15	F(Right)&R
Outlander 650Max 4x4 (STD/DPS/XT)	13-14	F(Right)&R
Renegade 800 R STD	12-15	F(Right)&R
Outlander 800 R XT	12	F(Right)&R
Outlander 800 R 4x4 (DPS)	13	F(Right)&R

CAN AM Contd.

Outlander Max 800 R 4x4 (STD/XT/XT-P)	13-14	F(Right)&R
Renegade 800 R STD	12-15	F(Right)&R
Renegade 800 R XXC	12-14	F(Right)&R
Outlander 1000 STD	12	F(Right)&R
Outlander 1000 XT/XT-P	12-14	F(Right)&R
Outlander 1000 4x4 (DPS)	13	F(Right)&R
Outlander 1000 4x4 (LTD)	13	F(Right)&R
Outlander 1000 4x4 (XMR)	13-14	F(Right)&R
Outlander Max 1000 4x4 (DPS/XT/XT-P/LTD/STD)	13-14	F(Right)&R
Renegade 1000 STD	12-14	F(Right)&R
Renegade 1000 XXC	12-14	F(Right)&R

MATERIAL AVAILABILITY AND PART NO.					
STD	OPTIONS				
FA	V	HH	R	MXS	EPFA
FA617TT	-	-	FA617R	-	-

Equivalents OE #
705601014

DO NOT REFIT ANY SHIMS/INSULATORS TO EBC PADS FROM ORIGINAL PADS UNLESS INSTRUCTED ON NOTE ON PAD PACKAGING AND ON FA DRAWING ASSOCIATED WITH THAT PAD.

FA618 A. 109.15 x 39.2 x 7.65mm

B. 96.3 x 36.5 x 7.6mm



CAN AM

Outlander 500 4x4 (DPS)
 Outlander 500 (STD)
 Outlander 500 XT
 Outlander Max 500 4x4 (DPS)
 Outlander Max 500 XT
 Renegade 500 (STD)
 Outlander 650 4x4 (STD/DPS/XT)
 Outlander 650 Max 4x4 (STD/DPS/XT)
 Outlander 800 R STD
 Outlander 800 XT
 Outlander 800 R 4x4 (DPS)

13-14 F(Left)&R(Left)
 13-14 F(Left)&R(Left)
 13-14 F(Left)&R(Left)
 13-14 F(Left)&R(Left)
 14 F(Left)&R(Left)
 12-15 F(Left)&R(Left)
 13-15 F(Left)&R(Left)
 13-14 F(Left)&R(Left)
 12-15 F(Left)&R(Left)
 12-13 F(Left)&R(Left)
 13-14 F(Left)&R(Left)

CAN AM Contd.

Outlander Max 800 R 4x4 (STD/XT/XT-P)
 Renegade 800 R STD
 Renegade 800 R XXC
 Outlander 1000 STD
 Outlander 1000 XT
 Outlander 1000 4x4 (DPS) XT/XT-P1
 Outlander 1000 4x4 (LTD)
 Outlander 1000 4x4 (XMR)
 Outlander Max 1000 4x4 (DPS/XT/XT-P/STD)
 Renegade 1000 STD
 Renegade 1000 XXC

13-14 F(Left)&R(Left)
 12-15 F(Left)&R(Left)
 12-14 F(Left)&R(Left)
 12 F(Left)&R(Left)
 12-14 F(Left)&R(Left)
 13 F(Left)&R(Left)
 13 F(Left)&R(Left)
 13-14 F(Left)&R(Left)
 13-14 F(Left)&R(Left)
 12-14 F(Left)&R(Left)
 12-14 F(Left)&R(Left)

MATERIAL AVAILABILITY AND PART NO.					
STD	OPTIONS				
FA	V	HH	R	MXS	EPFA
FA618TT	-	-	FA618R	-	-

Equivalents OE #
705601015

FA621 27.8mm Ø

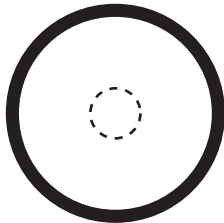

YAMAHA

XP 500 T-Max (530cc Engine/Non ABS Models)
 XP 500 A T-Max (530cc Engine/ ABS Models)
 XP 500 Black Bronze Max (59CE) Parking brake
 (530cc engine Non & ABS models)
 XP 530 A (530cc Engine - Iron Max - ABS Model)
 XP 500 A T-MAX - LUX MAX (ABS) Parking Brake
 XP 530E-A T-Max (530cc Engine - ABS Model)
 XP 530-A T-Max SX (530cc Engine - ABS Model)
 XP 530D-A T-Max DX (530cc Engine - ABS Model)
 T-Max 560 ABS
 T-Max 560 ABS Tech Max

12-16 PB
 12-16 PB
 13-14 PB
 15-16 PB
 16 PB
 17-20 PB
 17-20 PB
 17-20 PB
 19-20 PB
 19-20 PB

MATERIAL AVAILABILITY AND PART NO.					
STD	OPTIONS				
FA	V	HH	R	MXS	EPFA
SFA621V	-	-	-	-	-

Equivalents OE #
59C 25805 50

FA622 77.3 x 42.2 x 7.2mm



KIOTI/MECHRON (Side x Side)

2200 UTV (Side x Side) 09-14 F&R
 2200 PS UTV (Side x Side) 14-15 F&R
 2210 UTV (Side x Side) 11-14 F&R
 2240 UTV (Side x Side) 14-15 F&R

MATERIAL AVAILABILITY AND PART NO.				
STD	OPTIONS			
FA	V	HH	R	MXS
FA622TT	-	-	FA622R	-

Equivalents OE #
U3215-40011

DO NOT REFIT ANY SHIMS/INSULATORS TO EBC PADS FROM ORIGINAL PADS UNLESS INSTRUCTED ON NOTE ON PAD PACKAGING AND ON FA DRAWING ASSOCIATED WITH THAT PAD.

FA623 84.4 x 59.7 x 10.2mm

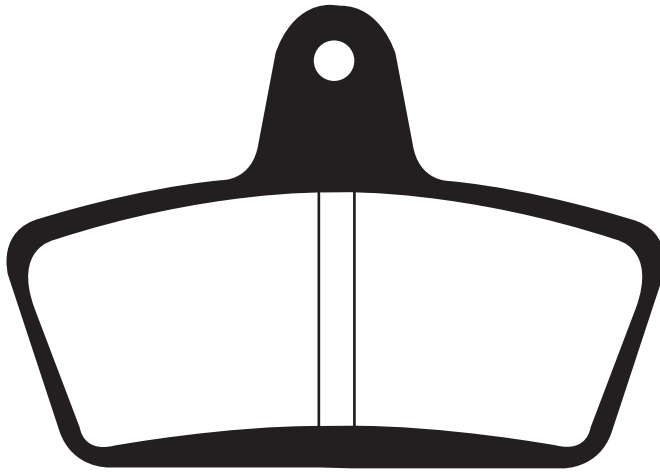

HHI (Hawg Halters)
4 Piston - Sprocket Brake

MATERIAL AVAILABILITY AND PART NO.				
STD	OPTIONS			
FA	V	HH	R	MXS
FA623	-	FA623HH	-	-

Equivalents OE #
HH1-351-001

FA624 41.95 x 49.9 x 6.5mm

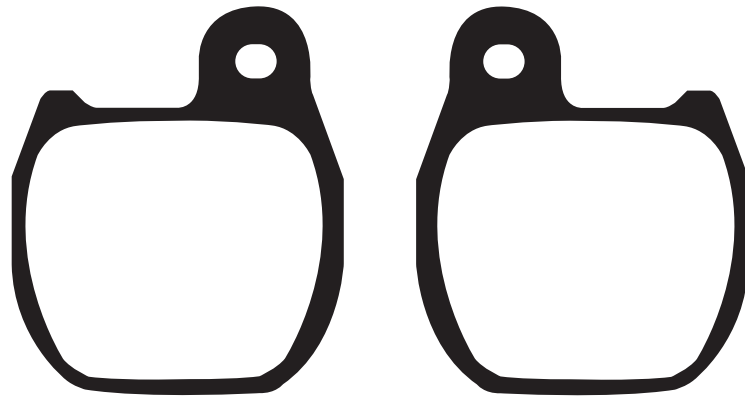

HONDA
TLM 220 R 88-92 F
RTL 250 S 88-89 F
TLM 260 89-93 F

MATERIAL AVAILABILITY AND PART NO.				
STD	OPTIONS			
FA	V	HH	R	MXS
FA624TT	-	-	-	-

Equivalents OE #	
06455 KR8 405	45105 KR8 751
06455 KR8 415	45106 KR8 751

SFA625 A. 84.9 x 44.05 x 6.85mm B. 74.4 x 41.5 x 6.85mm

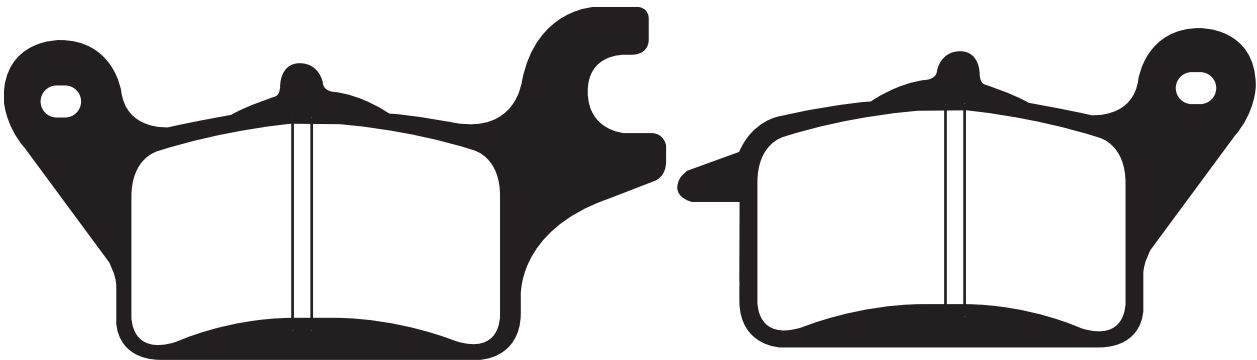

HONDA
AFS 110 2SHC/CSFF Wave 12-16 F
NSC 110 MPDH Vision (16 Inch Wheels) 17 F

MATERIAL AVAILABILITY AND PART NO.					
STD	OPTIONS				
FA	V	HH	R	MXS	EPFA
SFA625	-	-	-	-	-

Equivalents OE #	
06455 KWW C51	06455 K44 D01

DO NOT REFIT ANY SHIMS/INSULATORS TO EBC PADS FROM ORIGINAL PADS UNLESS INSTRUCTED ON NOTE ON PAD PACKAGING AND ON FA DRAWING ASSOCIATED WITH THAT PAD.

FA627 72.6 x 53.3 x 7.95mm

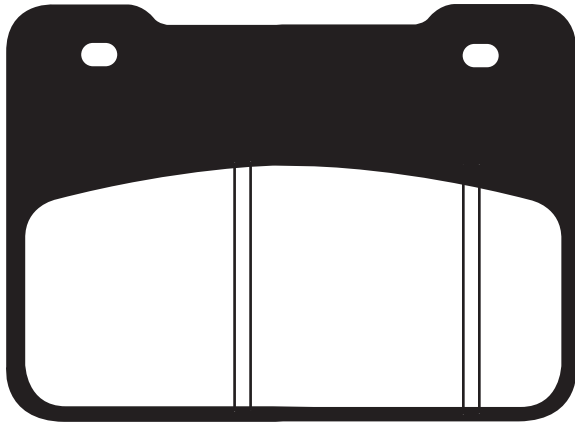

AEON			
Elite 400i (ABS)	14-15	F	
SYM			
SB 250 Ni (Wolf SB)	12-15	F	
Max Sym 400i (Inc ABS)	11-20	F	
Max Sym 600i (ABS)	14-15	F	

MATERIAL AVAILABILITY AND PART NO.					
STD	OPTIONS				
FA	V	HH	R	MXS	
SFA627	-	SFA627HH	-	-	

Equivalents OE #
45130 L4A 300
45135 L4A 300

FA628 83.35 x 47.55 x 11.9mm



SYM			
Max Sym 400i (Inc ABS)	11-20	R	
Max Sym 600i (ABS)	14-15	R	

MATERIAL AVAILABILITY AND PART NO.					
STD	OPTIONS				
FA	V	HH	R	MXS	
SFA628	-	SFA628HH	-	-	

Equivalents OE #
43140 L4A 300

FA629 88 x 39.6 x 10mm

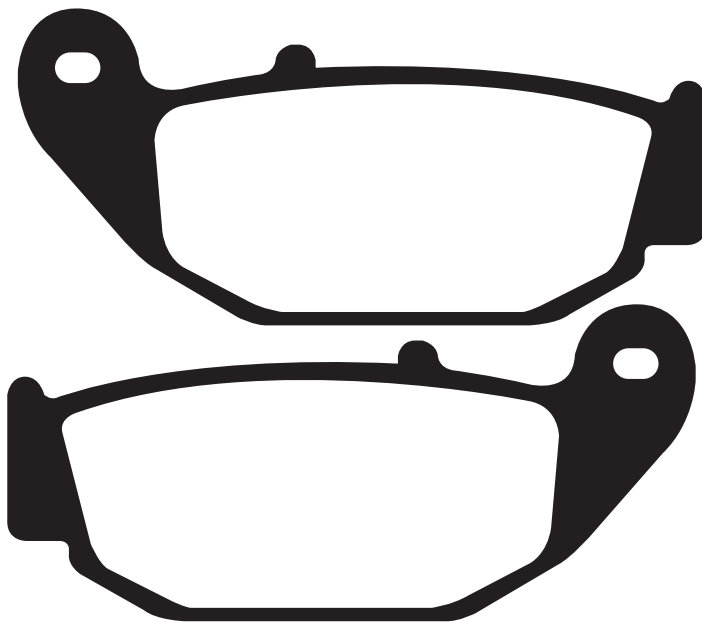

BENELLI			
TNT 125 (Tornado Naked T 125cc)	17-20	R	
TNT 135 (Tornado Naked T 135cc)	18	R	
TNT 200 (Tornado Naked T 200cc)	17-18	R	
BN125	18-20	R	
HONDA			
CB 125 R	18-20	R	
CBF 125 NAJ	18-20	R	
CBR 125 RWB/RC/RD/RF/RG (5 bolt front disc/Canada)	11-16	R	
MSX 125 D/E/F/G/H Grom (Non ABS)	13-20	R	
MSX 125 AH Grom (ABS)	18-20	R	
CBF 150 MB/MC Unicorn (Cast Wheels)	11-12	R	
CRF 250 L	13-20	R	
CRF 250 L ABS	17-20	R	
CRF 250 Rally	17-20	R	
CRF 250 Rally ABS	17-20	R	
CRF 250 ME Supermoto	14-15	R	
CB 300 R	18	R	
SUZUKI			
GSX-R 125 RLXL8/RLL8	18-20	R	
GSX-S 125 MLXL8/MLL8	18-20	R	
GSX-R 150 FRFAL7/FRZAL7	17-20	R	
GSX-R 150 RF-Q/RFX-Q	17-20	R	
GSX-R 150 RFL8/RFXL8/RFXL9	18-20	R	
GSX-S 150 MFL8/MFXL8/MFXL9	18-20	R	

MATERIAL AVAILABILITY AND PART NO.					
STD	OPTIONS				
FA	TT	GPFA	HH	R	MXS
FA629	FA629TT	-	FA629HH	FA629R	-

Equivalents OE #	
06435 KZZ 901	6910034890
06435 K26 921	06435 K98 E01
610164810	

DO NOT REFIT ANY SHIMS/INSULATORS TO EBC PADS FROM ORIGINAL PADS UNLESS INSTRUCTED ON NOTE ON PAD PACKAGING AND ON FA DRAWING ASSOCIATED WITH THAT PAD.

FA631 96.42 x 43.6 x 8.05mm

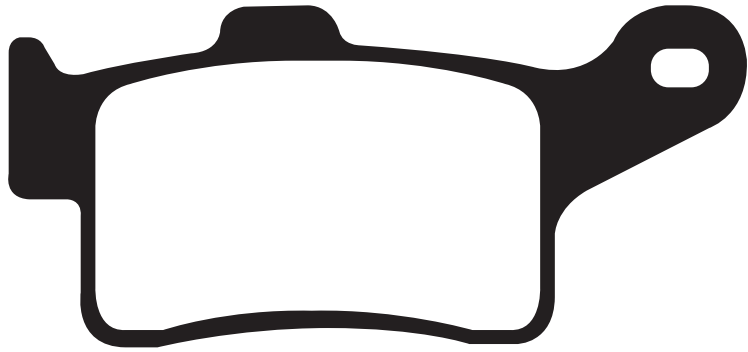
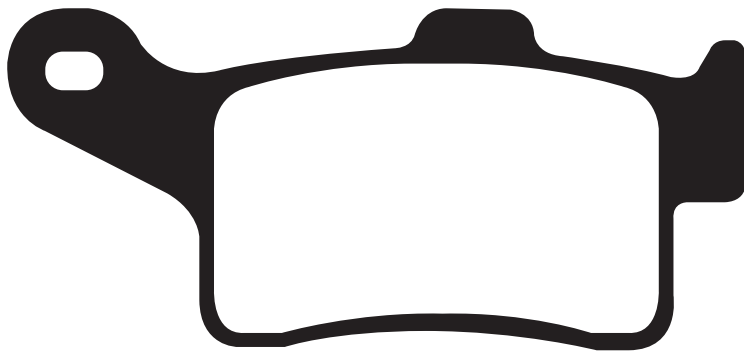

CAN AM

Spyder F3 LTD	16-17	R
Spyder F3 (SE6/SM6)	15-17	R
Spyder F3-S (SE6/SM6)	15-17	R
Spyder F3-S (Special Series)	16	R
Spyder F3-S Daytona 500	17	R
Spyder F3-T	16-17	R
Spyder RT (3 cyl eng/6 speed)	13-17	R
Spyder RT-S (3 cyl eng/6 speed)	13-17	R
Spyder RT LTD (3 cyl eng/6 speed)	13-17	R
Spyder RT-S (Special Series)	16-17	R
Spyder ST Brembo calipers	13-16	R
Spyder ST-S Brembo calipers	13-16	R
Spyder ST Ltd Brembo calipers	13-15	R
Spyder RS Brembo calipers	13-16	R
Spyder RS-S Brembo calipers	13-16	R

MATERIAL AVAILABILITY AND PART NO.					
STD	OPTIONS				
FA	V	HH	R	MXS	EPFA
-	FA631V	FA631HH	-	-	-

Equivalents OE #
2198002394C6

FA632 90 x 39.6 x 10.3mm

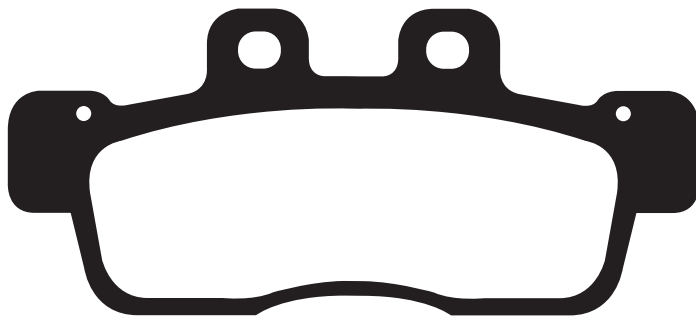

YAMAHA

NCX 125 K "Cygnus X Cab" (HC6-1)	07-10	F
NCX 125 L Cygnus X Injection (4C6-2)	07-10	F
YW 125 X (1DN1/2)	10-13	F

MATERIAL AVAILABILITY AND PART NO.					
STD	OPTIONS				
FA	V	HH	R	MXS	EPFA
SFA632	-	-	-	-	-

Equivalents OE #
17C W0045 00
4C6 W0045 00

DO NOT REFIT ANY SHIMS/INSULATORS TO EBC PADS FROM ORIGINAL PADS UNLESS INSTRUCTED
ON NOTE ON PAD PACKAGING AND ON FA DRAWING ASSOCIATED WITH THAT PAD.

FA634 64 x 45.1 x 10.5mm



AJP

PR3 125 Trial	13-15	R
PR3 125 Enduro	13-15	R
PR3 125 Enduro Pro	13-15	R
PR3 125 Supermoto	13-15	R
PR3 240 MX Pro	13-15	R
PR4 125 Enduro	13-15	R
PR4 125 Enduro Pro	13-15	R
PR4 125 Extreme	13-15	R
PR4 125 Supermoto	13-15	R
PR3 200 Enduro	12-14	R
PR3 200 Enduro Pro	12-14	R
PR3 200 M/X Pro	12-14	R
PR3 200 Supermoto	12-14	R
PR4 200 Enduro	12-14	R
PR4 200 Extreme	12-14	R
PR4 200 Supermoto	12-14	R
PR4 200 Enduro Pro	12-14	R
PR4 240 Extreme	13-15	R
PR5 250 Enduro	10-15	R
PR5 250 Extreme	10-15	R
PR5 250 Supermoto	10-15	R

MATERIAL AVAILABILITY AND PART NO.

STD	OPTIONS				
FA	V	HH	R	MXS	EPFA
FA634TT	-	-	-	-	-

Equivalents OE

00TRA01A0058

SFA635 A. 96.53 x 42.85 x 7.25mm

B. 76.9 x 42 x 7.25mm

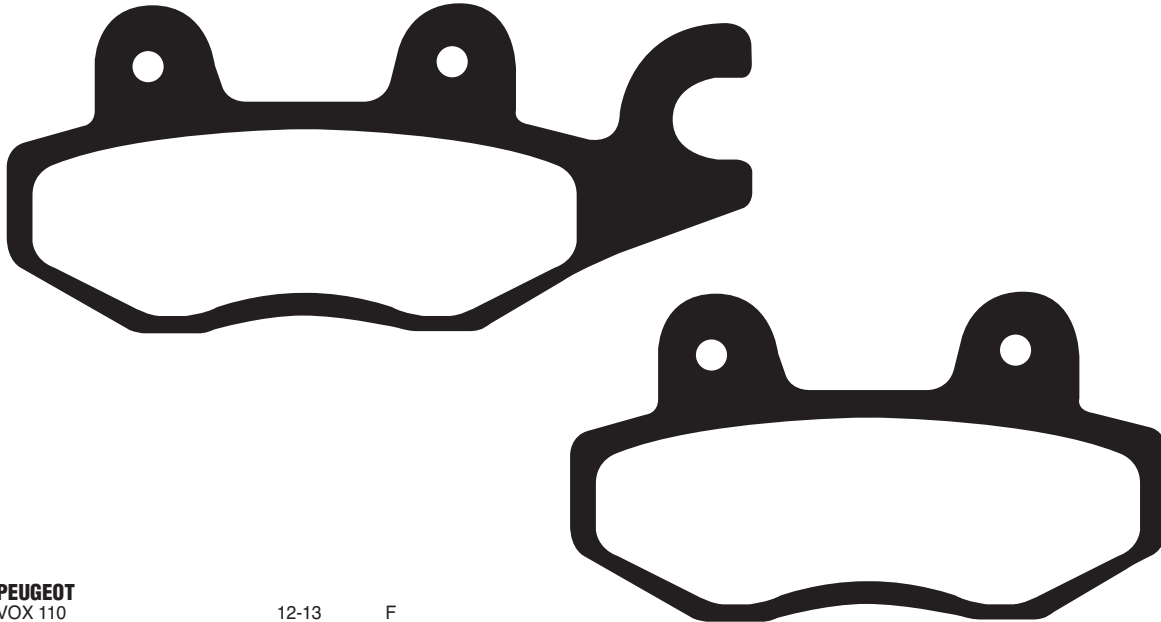

PEUGEOT
VOX 110

12-13 F

MATERIAL AVAILABILITY AND PART NO.

STD	OPTIONS				
FA	V	HH	R	MXS	EPFA
SFA635	-	-	-	-	-

Equivalents OE

PE802576

DISC PADS
BUYERS GUIDE

DO NOT REFIT ANY SHIMS/INSULATORS TO EBC PADS FROM ORIGINAL PADS UNLESS INSTRUCTED ON NOTE ON PAD PACKAGING AND ON FA DRAWING ASSOCIATED WITH THAT PAD.

FA636 101.95 x 39.9 x 9.4mm



NOTE
Refit O/E
shim/insulator

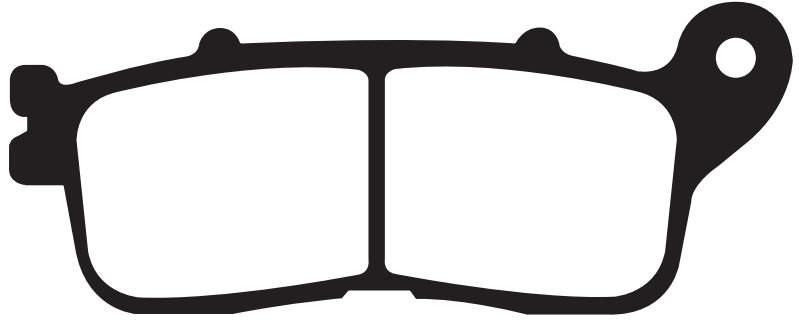

HONDA

VFR 1200 Crosstourer Highlander-T/DCT	15-16	R
VFR 1200 XAC/XAD/XAE/XAF/XAH/XAJ Crosstourer (Manual G/Box)	12-18	R
VFR 1200 XDC/XDCD/XDE/XDF/XDG/XDH/XDJ DCT Crosstourer	12-18	R
VFR 1200 FAD DCT	10-17	R

MATERIAL AVAILABILITY AND PART NO.					
STD	OPTIONS				
FA	V	HH	R	MXS	EPFA
-	-	FA636HH	-	-	-

Equivalents OE #	
06435 MGE D01	06435 MGE D02

FA638 174 x 50 x 7mm

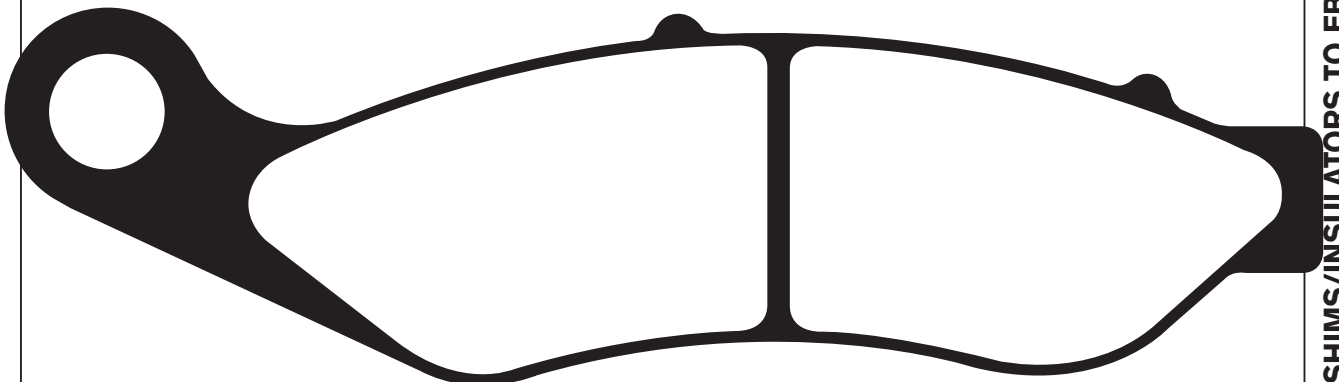
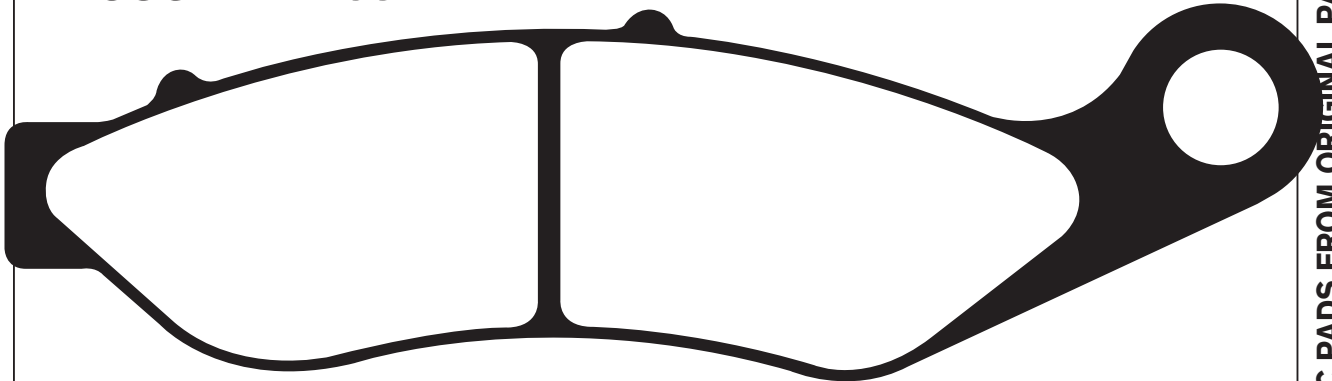

HARLEY DAVIDSON

FLRT Freewheeler Trike	15-20	F
FLHTCUTG Trike Tri Glide Ultra	14-20	F

MATERIAL AVAILABILITY AND PART NO.					
STD	OPTIONS				
FA	V	HH	R	MXS	EPFA
FA638	FA638V	FA638HH	-	-	-

Equivalents OE #
41300027

DISC PADS
BUYERS GUIDE

DO NOT REFIT ANY SHIMS/INSULATORS TO EBC PADS FROM ORIGINAL PADS UNLESS INSTRUCTED
ON NOTE ON PAD PACKAGING AND ON FA DRAWING ASSOCIATED WITH THAT PAD.

FA640 117.9 x 47.5 x 9.25mm (without shim)

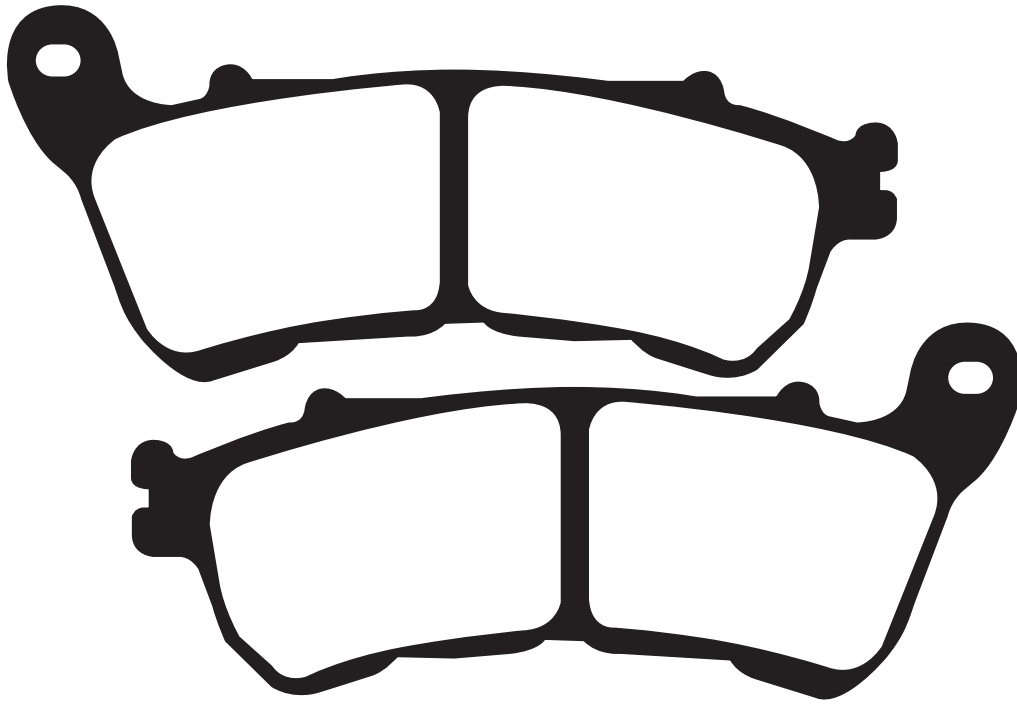

HARLEY DAVIDSON

XL 883 L (Cast Wheels)	14-17	F
XL 883 N Iron (Cast Wheels)	14-20	F
XL 883 R Roadster (Cast Wheels)	14	F
XL 1200 C Custom (Spoke Wheels)	14-20	F
XL 1200 CX Roadster	16-20	F
XL 1200 T Superlow	14-20	F
XL 1200 V Seven Two	14	F
XL 1200 X Forty Eight	14-17	F
XL 883 N	16	F

MATERIAL AVAILABILITY AND PART NO.

STD	OPTIONS				
FA	V	HH	R	MXS	EPFA
FA640	FA640V	FA640HH	-	-	

Equivalents OE #

41300004

FA641/4 88 x 43 x 7.65mm

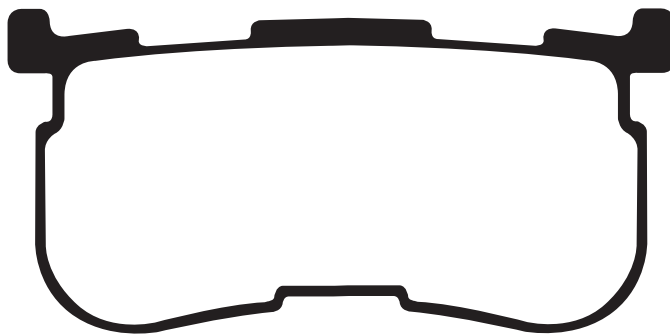

HARLEY DAVIDSON

FLRT Freewheeler Trike	15-20	R
FLHTCUTG Trike Tri Glide Ultra	14-20	R

MATERIAL AVAILABILITY AND PART NO.

STD	OPTIONS				
FA	V	HH	R	MXS	EPFA
FA641/4	FA641/4V	FA641/4HH	-	-	-

Equivalents OE #

41300033

DO NOT REFIT ANY SHIMS/INSULATORS TO EBC PADS FROM ORIGINAL PADS UNLESS INSTRUCTED ON NOTE ON PAD PACKAGING AND ON FA DRAWING ASSOCIATED WITH THAT PAD.

FA642 A. 104 x 46 x 8.25mm B. 88 x 46 x 8.35mm

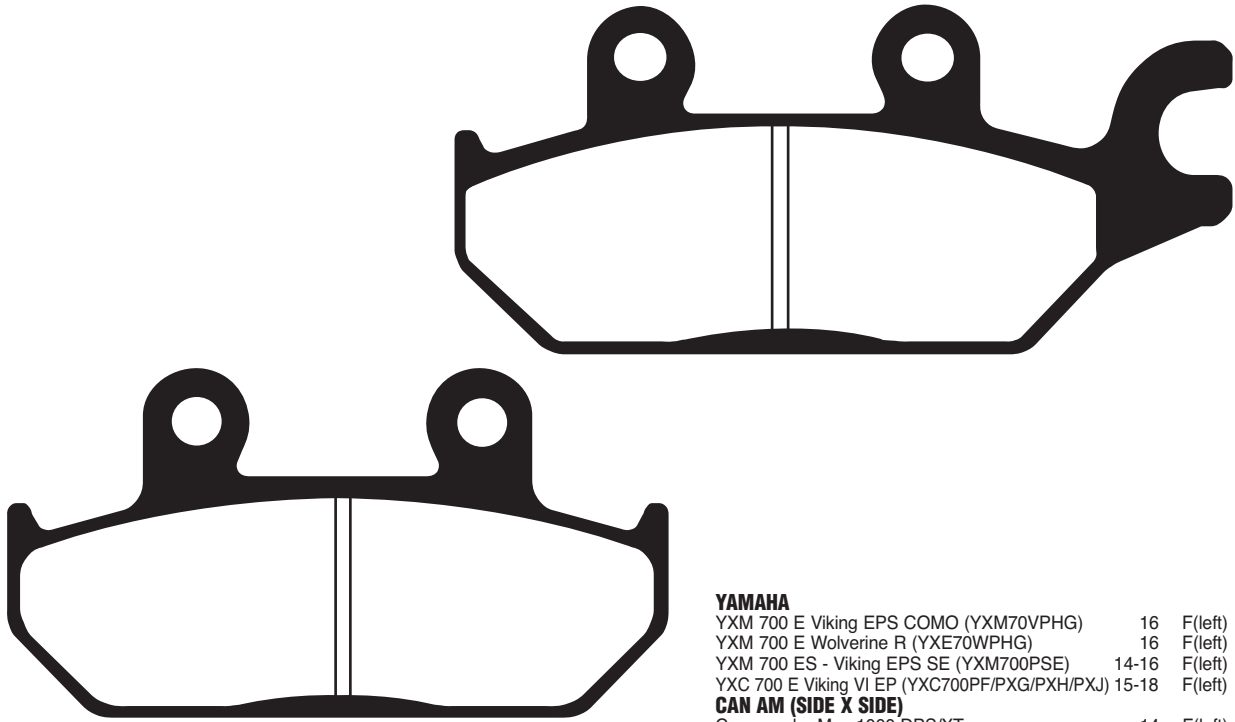

- YAMAHA**
 YXM 700 E Viking EPS COMO (YXM70VPHG) 16 F(left)
 YXM 700 E Wolverine R (YXE70WPHG) 16 F(left)
 YXM 700 ES - Viking EPS SE (YXM700PSE) 14-16 F(left)
 YXC 700 E Viking VI EP (YXC700PF/PXG/PXH/PXJ) 15-18 F(left)
- CAN AM (SIDE X SIDE)**
 Commander Max 1000 DPS/XT 14 F(left)
 Maverick Max 1000 STD/XRS/DPS 14-15 F(left)

MATERIAL AVAILABILITY AND PART NO.					
STD	OPTIONS				
FA	V	HH	R	MXS	EPFA
FA642TT	-	-	FA642R	-	-

Equivalents OE #
1XD 25805
00705601149

FA643 94 x 37.3 x 8.95mm 1 Left/1 Right

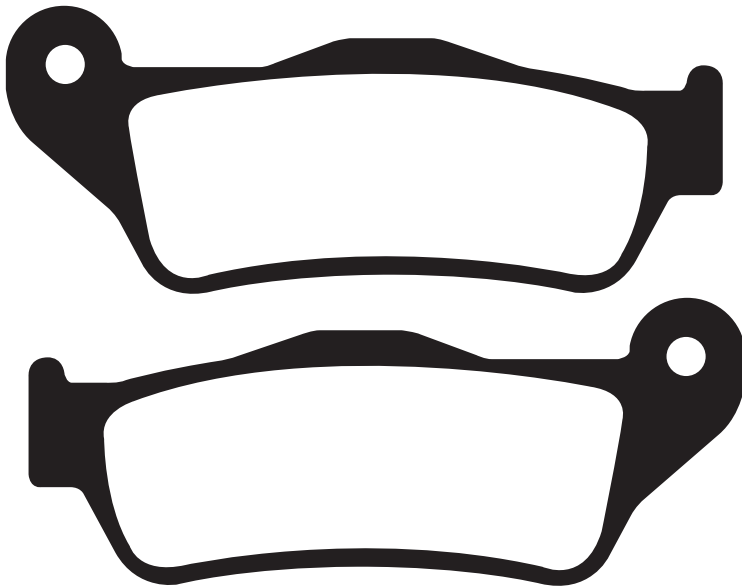

- HARLEY DAVIDSON**
 XG 500 Street (549cc X-Engine) 14-15 F&R
 XG 750 Street (749cc X-Engine) 14-15 F&R

MATERIAL AVAILABILITY AND PART NO.					
STD	OPTIONS				
FA	V	HH	R	MXS	EPFA
FA643	FA643V	FA643HH	-	-	-

Equivalents OE #
413 00072

DO NOT REFIT ANY SHIMS/INSULATORS TO EBC PADS FROM ORIGINAL PADS UNLESS INSTRUCTED ON NOTE ON PAD PACKAGING AND ON FA DRAWING ASSOCIATED WITH THAT PAD.

FA644 56 x 31.8 x 5mm

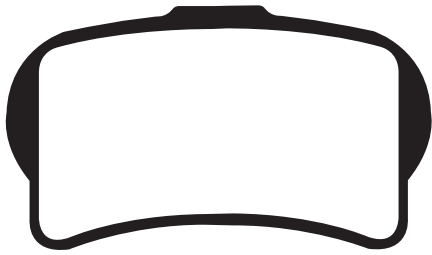

MONTESA-HONDA

260 4RT Cota (Repsol Edition 2E/4E)
4 Ride Enduro (260cc/4T)
Cota 300 RR (4T)

14-18 F
16-18 F
16 F

GAS GAS

TXT Replica Factory Models 125/250/280/300 (2T Monobloc Caliper)
TXT Racing 125/250/280/300 (2T Monobloc Caliper)

13-14 F
14-19 F

MATERIAL AVAILABILITY AND PART NO.					
STD	OPTIONS				
FA	V	HH	R	MXS	EPFA
FA644TT	-	-	-	-	-

Equivalents OE #
BT65003013
45105 NN4 K20

FA645 A. 104 x 46 x 8.25mm B. 88 x 46 x 8.35mm

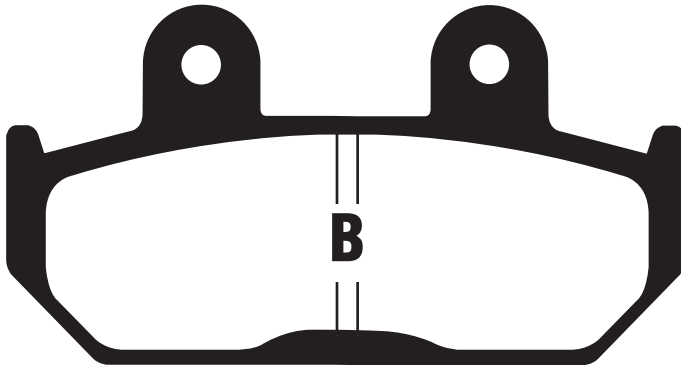
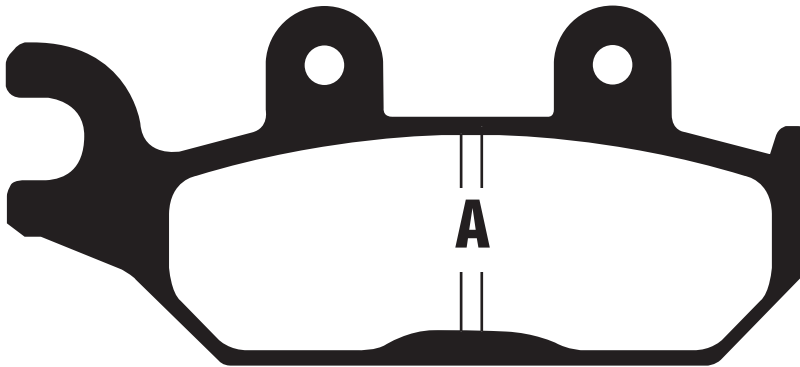

YAMAHA

YXM 700 E Viking EPS COMO (YXM70VPHG) 16 F(right)
YXM 700 E Wolverine R (YXE70WPHG) 16 F(right)
YXM 700 ES - Viking EPS SE (YXM700PSE) 14-16 F(right)
YXC 700 E - Viking VI EPS
(YXC700PF/PXG/PXH/PXJ) 15-18 F(right)

CAN AM (SIDE X SIDE)

Commander Max 1000 DPS/XT 14 F(right)
Maverick Max 1000 STD/XRS/DPS 14-15 F(right)

MATERIAL AVAILABILITY AND PART NO.					
STD	OPTIONS				
FA	V	HH	R	MXS	
FA645TT	-	-	FA645R	-	-

Equivalents OE #
75601150
1XD 25805 10

FA649 98.8 x 55 x 8.8mm

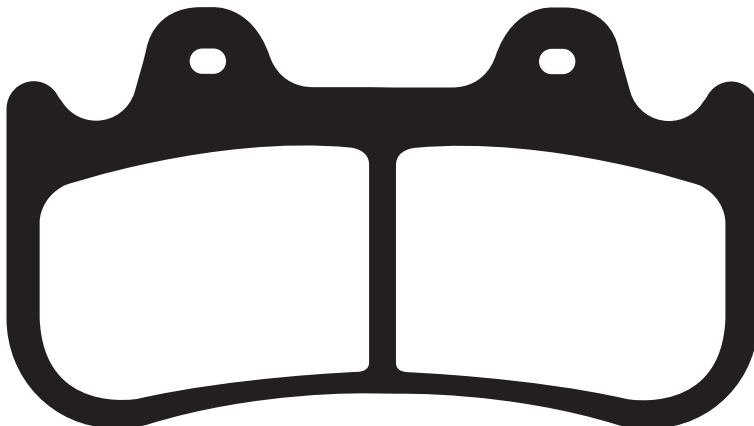

JAYBRAKE

6 PF-L (6 Piston/ For 11.5" Disc - Lower Friction Height)

MATERIAL AVAILABILITY AND PART NO.					
STD	OPTIONS				
FA	V	HH	R	MXS	EPFA
-	-	FA649HH	-	-	-

Equivalents OE #
300-64A

DISC PADS
BUYERS GUIDE

DO NOT REFIT ANY SHIMS/INSULATORS TO EBC PADS FROM ORIGINAL PADS UNLESS INSTRUCTED ON NOTE ON PAD PACKAGING AND ON FA DRAWING ASSOCIATED WITH THAT PAD.

SFA650 96.96 x 39.05 x 7.13mm

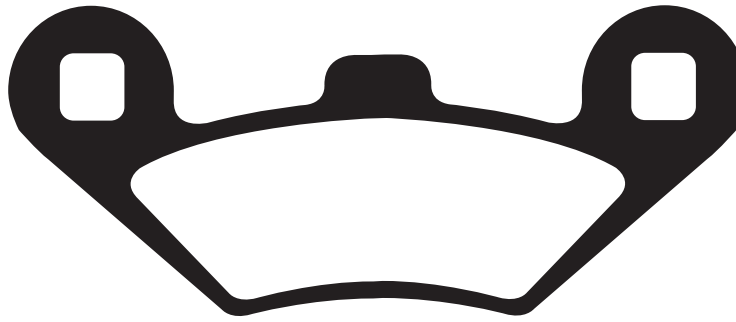

PEUGEOT

Metropolis 400 T (3 Wheel Model)	14-16	F&R
Metropolis 400 T-RS (3 Wheel Model)	14-16	F&R
Metropolis 400 Blue Line (3 Wheel Model)	15-16	F&R

MATERIAL AVAILABILITY AND PART NO.					
STD	OPTIONS				
SFA	SFAC	GPFA	HH	R	EPFA
SFA650	SFAC650	-	SFA650HH	-	-

Equivalents OE #
786764
803138

FA651 72.73 x 30.25 x 10mm

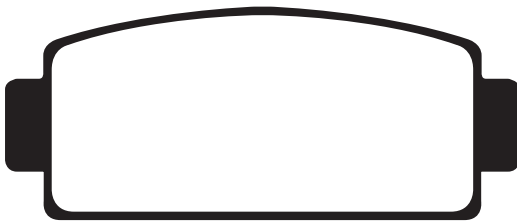

CF MOTO

CF 500 US Z -Force 550 (Side x Side)	15	R (Left) & R (Right)
500 C-Force	17-19	R (Left) & R (Right)
CF 600 Z -Force Z6 (Side x Side)	13-15	R (Left) & R (Right)
CF 600 Z -Force Z6-EX (Side x Side)	13-15	R (Left) & R (Right)
600 C-Force	17-19	R (Left) & R (Right)
500 C-Force	17-19	R (Left) & R (Right)
CF 800 Z -Force Z8 (Side x Side)	13-15	R (Left) & R (Right)
CF 800 Z -Force Z8-EX (Side x Side)	14-15	R (Left) & R (Right)
950 Z-Force	20	R (Left) & R (Right)
1000 U-Force	20	R (Left) & R (Right)
QUADZILLA		
Z8 4 X 4 (Side x Side /800cc)	14-15	R (Left) & R (Right)

MATERIAL AVAILABILITY AND PART NO.					
STD	OPTIONS				
FA	V	HH	R	MXS	SXR
FA651TT	-	-	FA651R	-	SXR651HH

Equivalents OE #
9060 081010

SFA652 A. 84.9 x 44.05 x 8.95mm B. 75.4 x 40.58 x 9.05mm



YAMAHA

MW 125 Tricity Scooter	14-16	F (Left)
MWS 125 Tricity Scooter (3 Wheeler)	17-18	F (Left)

MATERIAL AVAILABILITY AND PART NO.					
STD	OPTIONS				
FA	V	HH	R	MXS	EPFA
SFA652	-	-	-	-	-

Equivalents OE #
2CM F5805 00

FA654 73.35 x 41.8 x 6.4mm

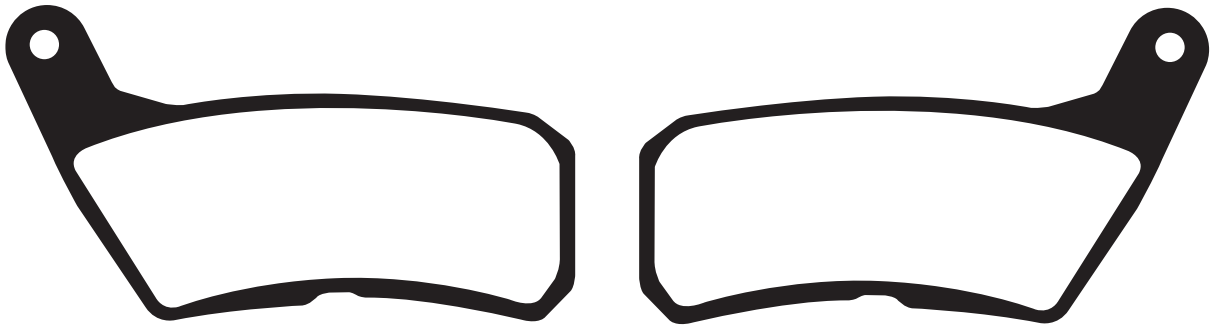

HM		
CRE 50 Six Competition	07-12	F
CRM 50 Derapage Competition	09-12	F
CRE F 125 X Six 4T	10-11	F
CRM 125 (Derapage Competition 2T)	11-12	F
CRM F 125 X (Derapage Competition 4T)	10-11	F

MATERIAL AVAILABILITY AND PART NO.					
STD	OPTIONS				
FA	V	HH	R	MXS	
FA654	-	-	-	-	-

Equivalents OE #
K00979315

SFA655 A. 84.9 x 44.05 x 8.95mm B. 74.4 x 41.5 x 9.05mm

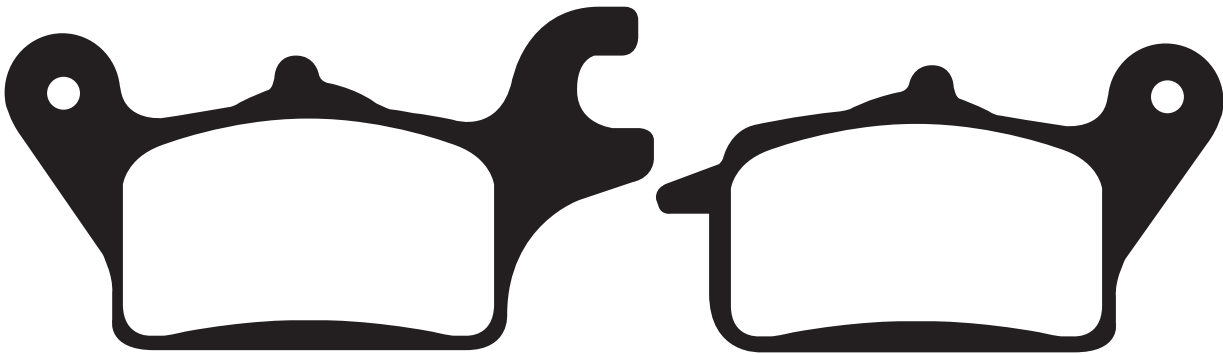

YAMAHA		
MW 125 Tricity Scooter	14-16	F (Right)
MWS 125 Tricity Scooter (3 Wheeler)	17-18	F (Right)

MATERIAL AVAILABILITY AND PART NO.						
STD	OPTIONS					
FA	V	HH	R	MXS	EPFA	
SFA655	-	-	-	-	-	-

Equivalents OE #
2CM F5805 10

FA656 120.65 x 57.35 x 8.0mm

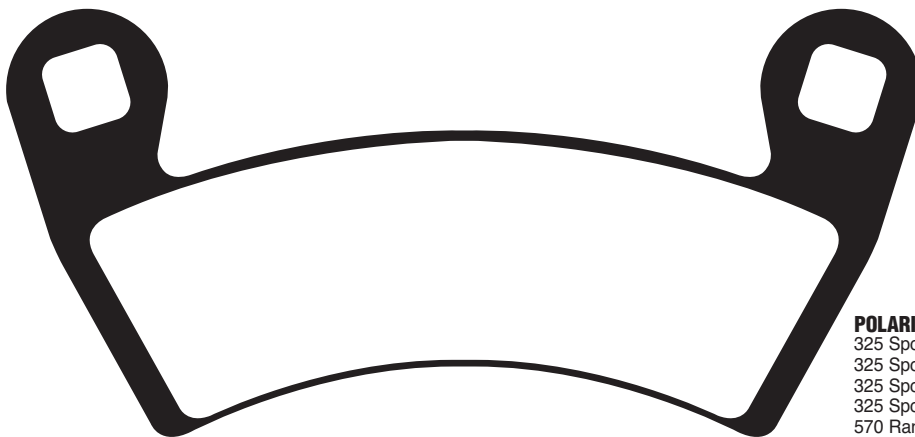

POLARIS		
325 Sportsman Ace	14	F
325 Sportsman Ace Efi	15	F
325 Sportsman Ace Euro	14-15	F
325 Sportsman Ace HD	15	F
570 Ranger Crew	14-19	F
570 Sportsman Ace	15-20	F
570 Sportsman Ace Euro	15-20	F
570 Ranger Full Size	17-19	F
570 Ranger EPS Crew MD	18	F
570 Ranger EFI Crew	17	F

MATERIAL AVAILABILITY AND PART NO.					
STD	OPTIONS				
FA	V	HH	R	MXS	SXR
FA656TT	-	-	FA656R	-	SXR656HH

Equivalents OE #		
1911228	1912508	2205949

DO NOT REFIT ANY SHIMS/INSULATORS TO EBC PADS FROM ORIGINAL PADS UNLESS INSTRUCTED ON NOTE ON PAD PACKAGING AND ON FA DRAWING ASSOCIATED WITH THAT PAD.

FA657 97.1 x 46.8 x 7.9mm

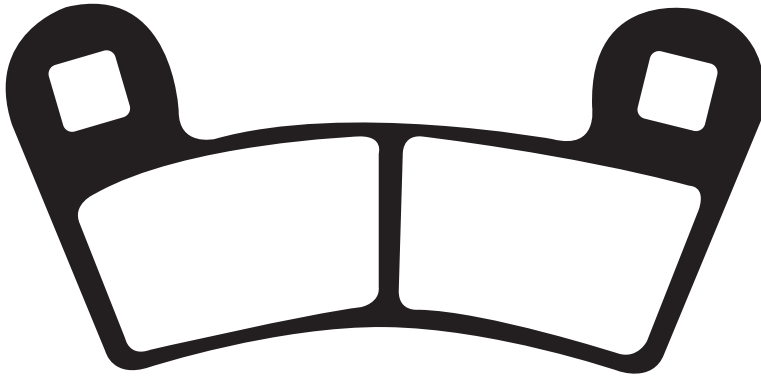

POLARIS		
RZR 900 "50 Inch All Options"	15-19	F
RZR-S 900 "60 Inch All Options"	15-19	F
RZR 1000 60" inch Options	16-19	F

MATERIAL AVAILABILITY AND PART NO.						
OPTIONS						
FA	V	HH	R	MXS	EPFA	SXR
FA657TT	-	-	FA657R	-	-	SXR657HH

Equivalents OE #
1911085

FA658 67.66 x 48.27 x 7.05mm

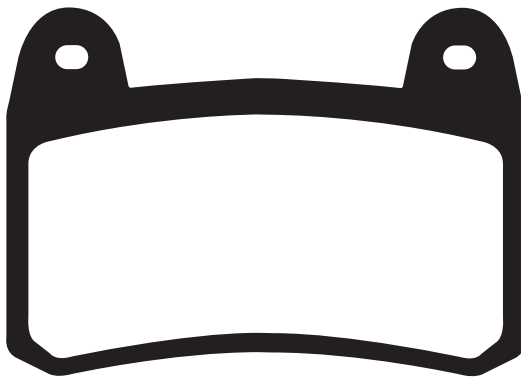

BENELLI		
TNT 200 (Tornado Naked T 200cc)	17-18	F
Leoncino 125	18-20	F
TRK 125	18-20	F
Leoncino 250	18-20	F
BN251	14-18	F
TRK 251	18-20	F
TNT 300 (Tornado Naked T 300cc)	16-18	F
302R	17-20	F
302S	18-20	F
BN302	15-18	F
402S	18	F
CF MOTO		
RCF 150 - 3 (150 NK)	15	F
GENERIC/KSR		
Code S 125/150/200 (4T)	12-16	F
Code X 125/150/200 (4T)	12-16	F
GRS 125	13-16	F
Worx 125/150 (4T)	12-16	F
KEEWAY		
RKV 125	10-15	F
RKV 150	13-15	F
RKX 150	13-14	F
RKV 200 S	14	F
RKX 200	13-14	F
RKX 200 S Factory	14	F
WK BIKES		
150 NK	15	F

MATERIAL AVAILABILITY AND PART NO.					
OPTIONS					
STD	V	HH	R	MXS	EPFA
FA658	FA658V	FA658HH	-	-	-

Equivalents OE #
45120 J80 000

DO NOT REFIT ANY SHIMS/INSULATORS TO EBC PADS FROM ORIGINAL PADS UNLESS INSTRUCTED
ON NOTE ON PAD PACKAGING AND ON FA DRAWING ASSOCIATED WITH THAT PAD.

FA659TT A. 134.47 x 44.38 x 7.55mm

B. 134.47 x 44.38 x 7.55mm

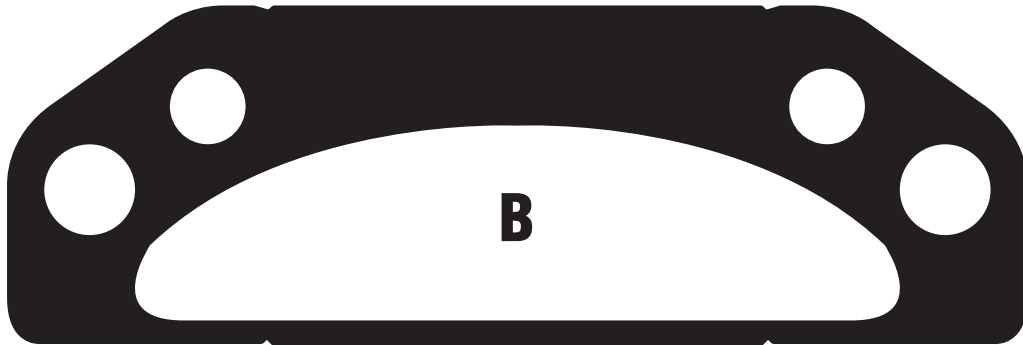
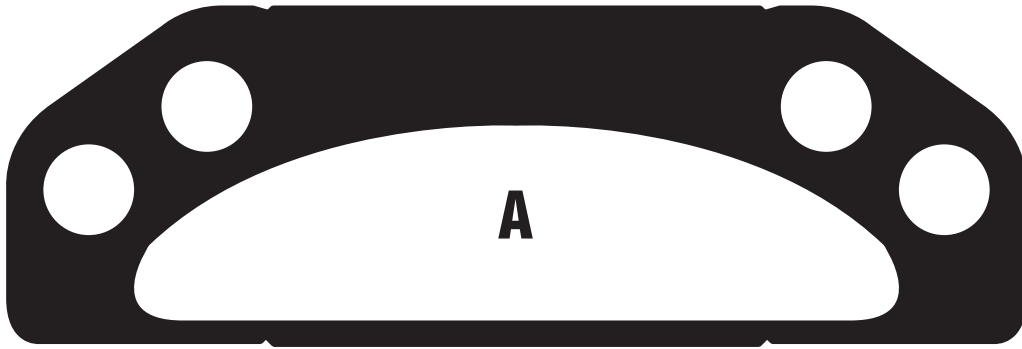

KIOTI/MECHRON (SIDE X SIDE)

2200 UTV (Side x Side)	09-14	PB
2200 PS UTV (Side x Side)	14-15	PB
2210 UTV (Side x Side)	11-14	PB
2240 UTV (Side x Side)	14-15	PB

POLARIS

Ranger Handbrake Pads (Various Models 05-16)	05-16	R
--	-------	---

MATERIAL AVAILABILITY AND PART NO.				
STD	OPTIONS			
FA	V	HH	R	MXS
FA659TT	-	-	-	-

Equivalents OE #
2203147

SFA661/4 53.25 x 44.8 x 7.45mm

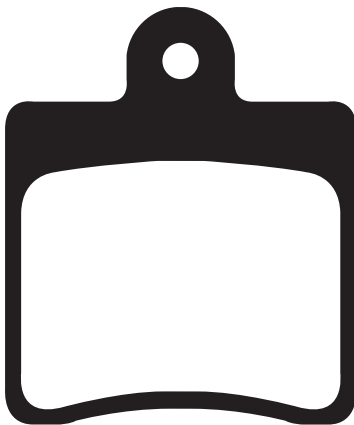

DAELIM

B-Bone 125 (SW125)	09-14	F
--------------------	-------	---

MATERIAL AVAILABILITY AND PART NO.					
STD	OPTIONS				
FA	SFA	SFAC	HH	MXS	EPFA
-	SFA661/4	SFAC661/4HH	SFA661/4HH	-	-

Equivalents OE #
45105 SZ1 0100

DO NOT REFIT ANY SHIMS/INSULATORS TO EBC PADS FROM ORIGINAL PADS UNLESS INSTRUCTED ON NOTE ON PAD PACKAGING AND ON FA DRAWING ASSOCIATED WITH THAT PAD.

FA662 A. 109.6 x 50.6 x 10.8mm B. 95.6 x 36.9 x 10.75mm

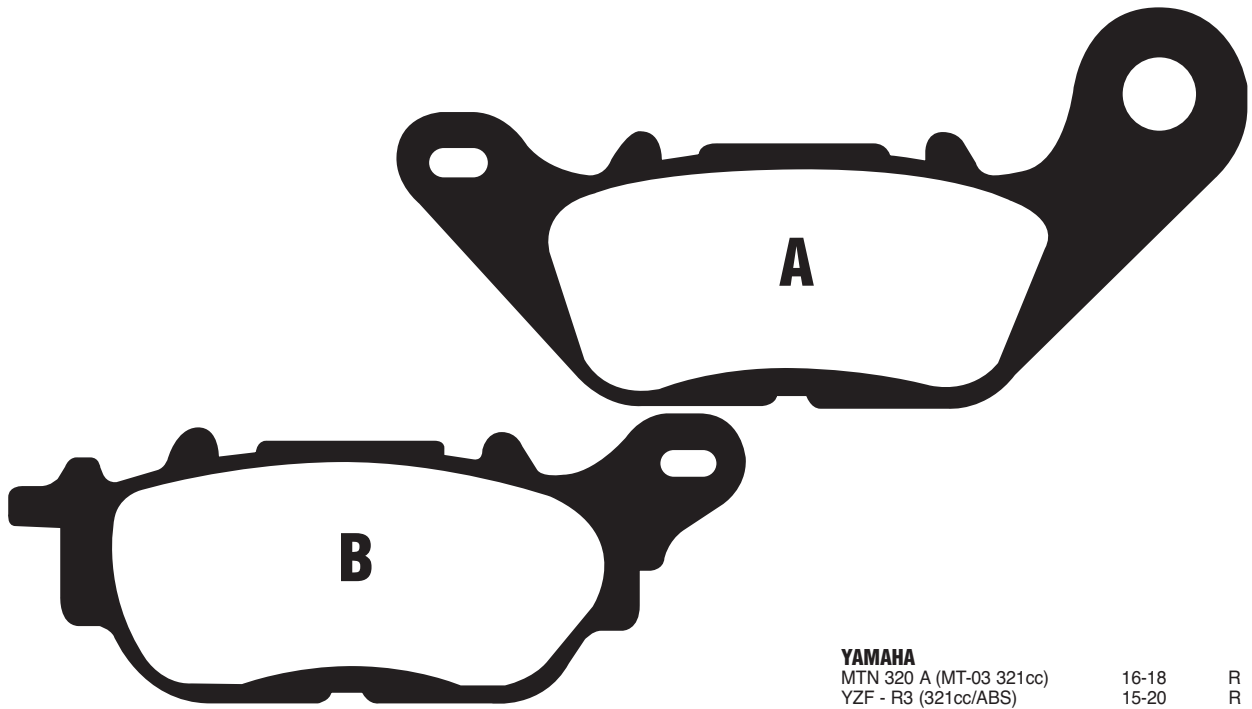

YAMAHA
 MTN 320 A (MT-03 321cc) 16-18 R
 YZF - R3 (321cc/ABS) 15-20 R

MATERIAL AVAILABILITY AND PART NO.					
STD	OPTIONS				
FA	V	HH	GPFAX	R	MXS
FA662	FA662V	FA662HH	GPFAX662HH	-	-

Equivalents OE #
1WD 25806 00

**FA663 A. 113.45 x 54.50 x 8.30mm
 B. 98.90 x 45.25 x 8.35mm**

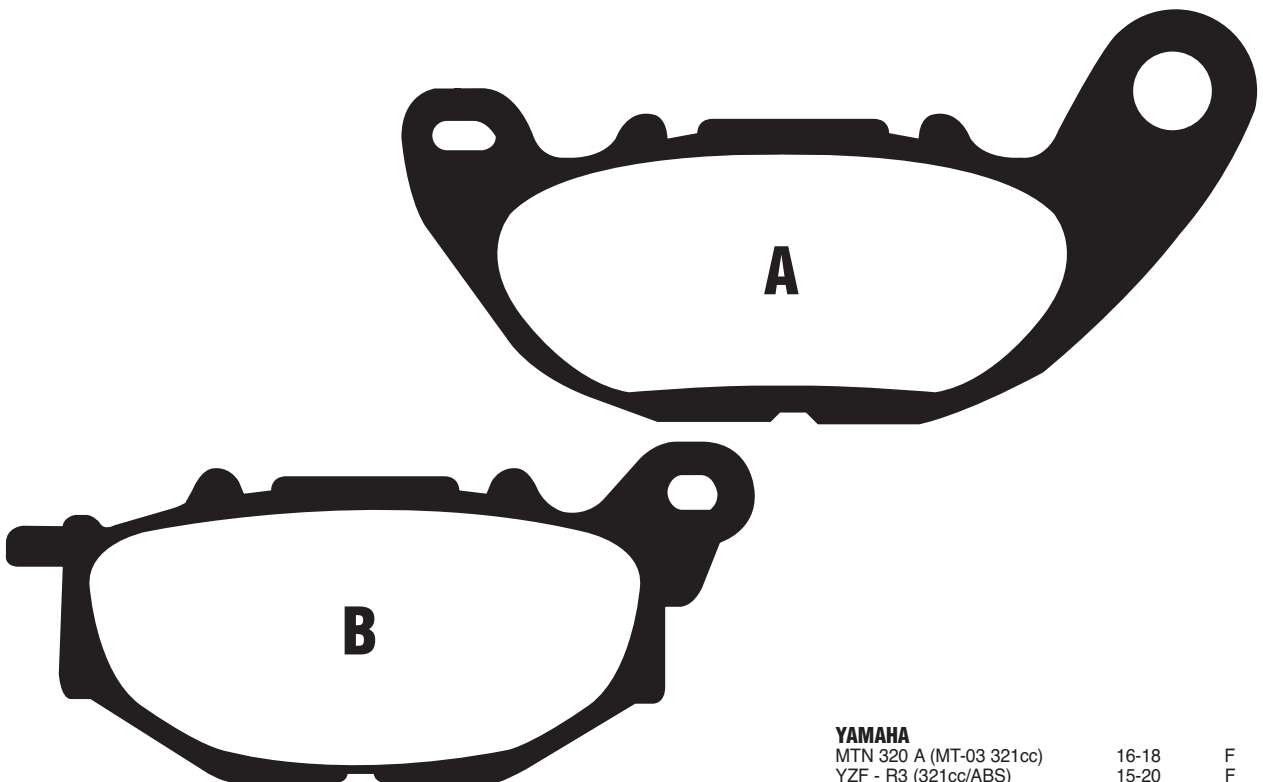

YAMAHA
 MTN 320 A (MT-03 321cc) 16-18 F
 YZF - R3 (321cc/ABS) 15-20 F

MATERIAL AVAILABILITY AND PART NO.					
STD	OPTIONS				
FA	V	HH	GPFAX	R	EPFA
FA663	FA663V	FA663HH	GPFAX663HH	-	-

Equivalents OE #
1WD 25805 00

DO NOT REFIT ANY SHIMS/INSULATORS TO EBC PADS FROM ORIGINAL PADS UNLESS INSTRUCTED
 ON NOTE ON PAD PACKAGING AND ON FA DRAWING ASSOCIATED WITH THAT PAD.

FA664 A. 94.05 x 32.05 x 7.97mm B. 94.05 x 32.05 x 7.97mm

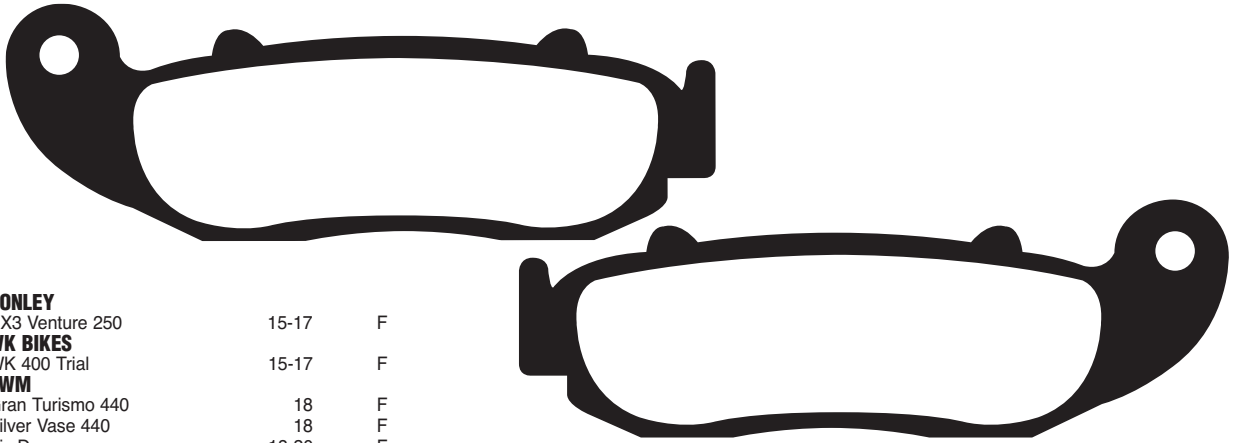

HONLEY			
RX3 Venture 250	15-17	F	
WK BIKES			
WK 400 Trial	15-17	F	
SWM			
Gran Turismo 440	18	F	
Silver Vase 440	18	F	
Six Days	18-20	F	

Equivalents OE #
Z48-105
Z48-106
53013 J257 0200
53013 M954 0000
53013 M954 0100

MATERIAL AVAILABILITY AND PART NO.						
STD	OPTIONS					
FA	V	HH	TT	R	MXS	
FA664	-	-	FA664TT	-	-	

FA665 41.25 x 53.78 x 6mm

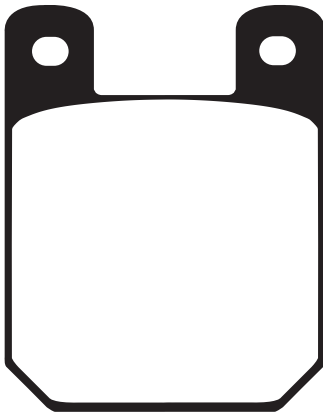

CPI			
SM 250	09-12	R	
SX 250	09-12	R	

Equivalents OE #
D08A45280-00-00

MATERIAL AVAILABILITY AND PART NO.						
STD	OPTIONS					
FA	V	HH	GPFAX	R	MXS	
FA665	-	-	-	-	-	

FA669/4 137.7 x 49.7 x 15.1mm (4 Pads)

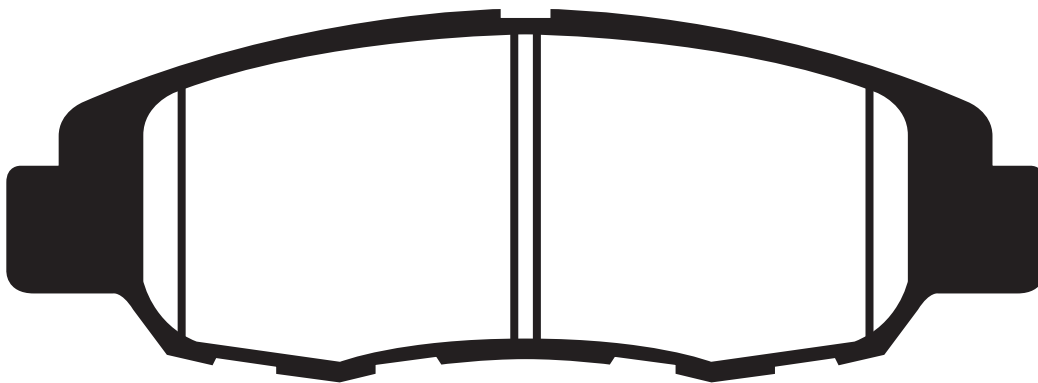

POLARIS			
Slingshot	15-17	F	
Slingshot S	18	F	
Slingshot SL	15-18	F	
Slingshot SL SE	15-18	F	
Slingshot SLR	17-18	F	

MATERIAL AVAILABILITY AND PART NO.						
STD	OPTIONS					
FA	YELLOW	HH	R	MXS	EPFA	
FA669/4	FA4669/4	-	-	-	-	

Equivalents OE #
1911741
2205829
2205613

DISC PADS
BUYERS GUIDE

DO NOT REFIT ANY SHIMS/INSULATORS TO EBC PADS FROM ORIGINAL PADS UNLESS INSTRUCTED ON NOTE ON PAD PACKAGING AND ON FA DRAWING ASSOCIATED WITH THAT PAD.

FA670 137.7 x 49.7 x 15.1mm (2 Pads)

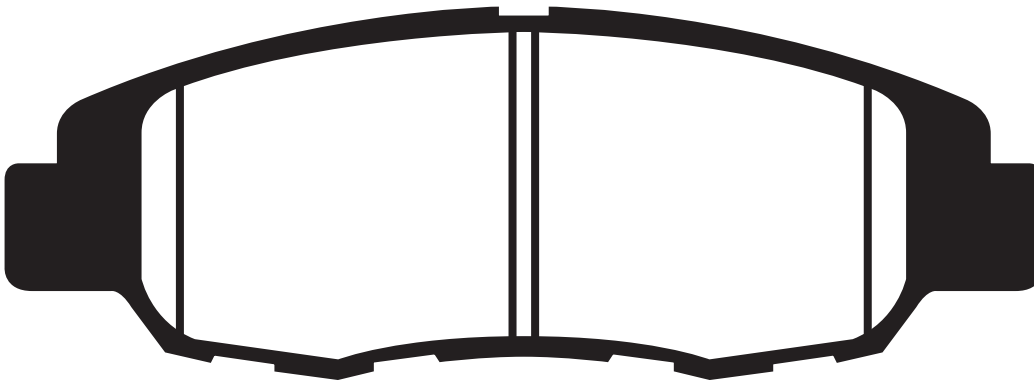

Equivalents OE #
1911741
2205829
2205613

MATERIAL AVAILABILITY AND PART NO.					
STD	OPTIONS				
FA	YELLOW	HH	R	MXS	EPFA
FA670	FA4670	-	-	-	-

POLARIS		
Slingshot	15-17	R
Slingshot S	18	R
Slingshot SL	15-18	R
Slingshot SL SE	15-18	R
Slingshot SLR	17-18	R

FA671 A. 94 x 37.3 x 9.96mm B. 94 x 37.3 x 8.70mm

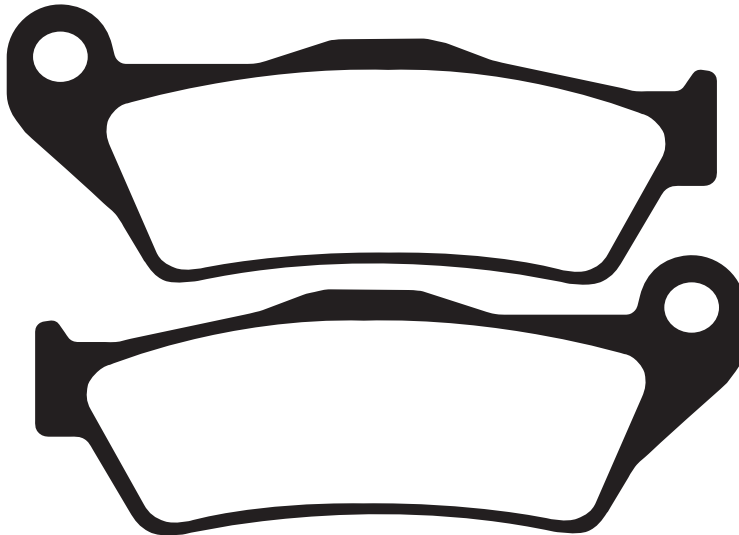

BMW		
K 1200 S	03-08	R
K 1200 R	05-10	R
K 1300 S	09-15	R
K 1300 R	09-15	R
K 1200 S (K40)	05-08	R
K 1200 R (K27/0378) Tokico Caliper	11/05-10	R
K 1300 R	09-12	R
K 1300 R Dynamic	11-15	R
K 1300 R Carbon	12	R
K 1300 S (Non & ABS Models)	09-15	R
K 1300 S Sport	12-15	R
K 1300 S HP	12	R

MATERIAL AVAILABILITY AND PART NO.				
STD	OPTIONS			
FA	V	GPFA	HH	R
FA671	FA671V	-	FA671HH	-

Equivalents OE #
34 21 767 1881
34 21 854 1388

FA672 114.45 x 38.75 x 9.45mm. 1 Pad Left, 1 Pad Right



INDIAN		
Scout Sixty (Cast Wheel/Toso Calipers)	16	F
Scout (Cast Wheels/Toso Calipers)	15-16	F

MATERIAL AVAILABILITY AND PART NO.				
STD	OPTIONS			
FA	V	GPFA	HH	R
FA672	FA672V	-	FA672HH	-

Equivalents OE #
2205849

GPFX673HH 94.1 x 33.75 x 9.5mm

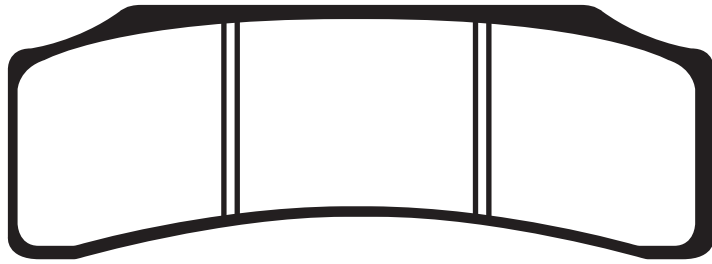

BREMBO AFTERMARKET CALIPER
XBO B1 30/31 P4 30/34

MATERIAL AVAILABILITY AND PART NO.

STD	OPTIONS				
FA	V	HH	R	MXS	EPFA
-	-	GPFX673HH	-	-	-

Equivalents OE #

07 8366 30

FA674 A. 96.7 x 42 x 7.3mm B. 77 x 42 x 8.10mm

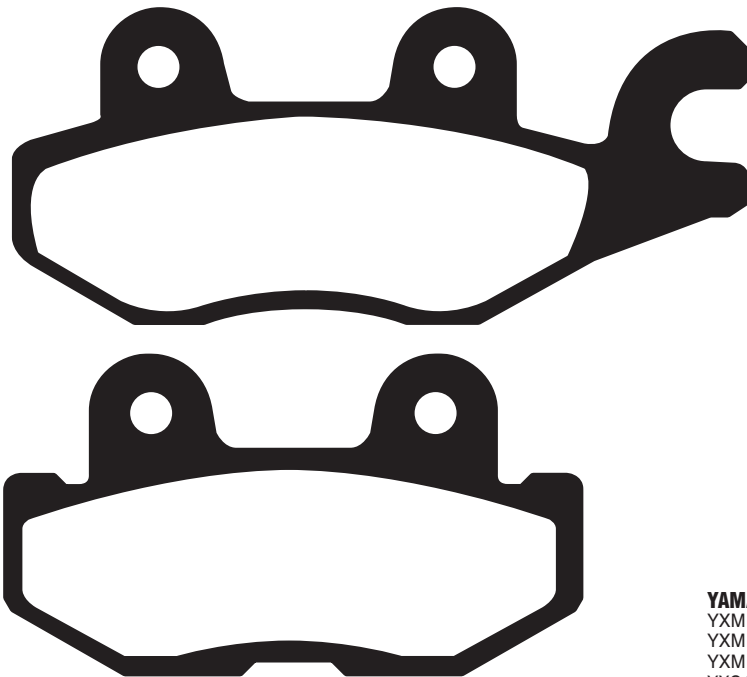

YAMAHA

YXM 700 E Viking EPS COMO (YXM70VPHG) 16 R(Left)
YXM 700 E Wolverine R (YXE70WPHG) 16 R(Left)
YXM 700 ES - Viking EPS SE (YXM700PSE) 14-16 R(Left)
YXC 700 E Viking VI EP (YXC700PF/PXG/PXH/PXJ) 15-18 R(Left)

MATERIAL AVAILABILITY AND PART NO.

STD	OPTIONS				
FA	V	HH	R	MXS	EPFA
FA674TT	-	-	FA674R	-	-

Equivalents OE #

1XD 25806 00

DO NOT REFIT ANY SHIMS/INSULATORS TO EBC PADS FROM ORIGINAL PADS UNLESS INSTRUCTED ON NOTE ON PAD PACKAGING AND ON FA DRAWING ASSOCIATED WITH THAT PAD.

FA675 A. 96.7 x 42 x 7.3mm B. 77 x 42 x 8.10mm

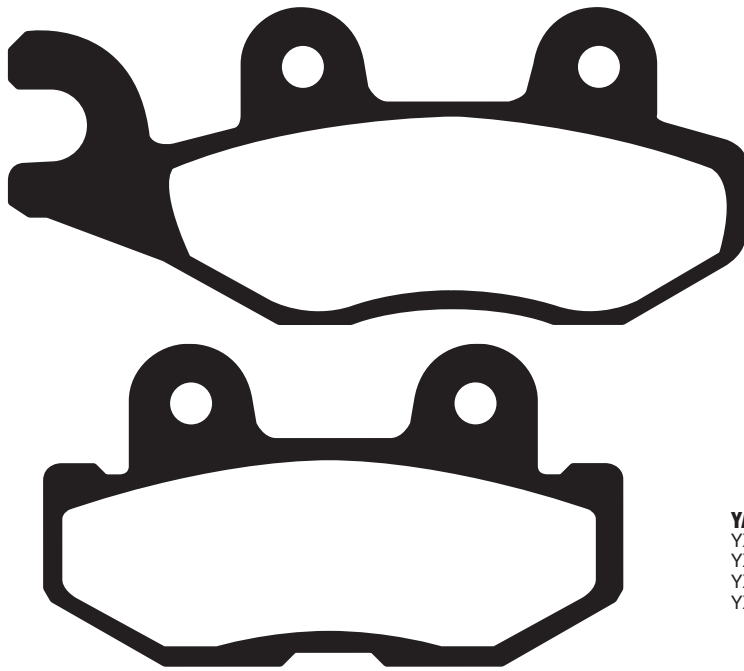

YAMAHA

YXM 700 E Viking EPS COMO (YXM70VPHG)	16	R(Right)
YXM 700 E Wolverine R (YXE70WPHG)	16	R(Right)
YXM 700 ES - Viking EPS SE (YXM700PSE)	14-16	R(Right)
YXC 700 E - Viking VI EPS (YXC700PF/PXG/PXH/PXJ)	15-18	R(Right)

MATERIAL AVAILABILITY AND PART NO.					
STD	OPTIONS				
FA	V	HH	R	MXS	EPFA
FA675TT	-	-	FA675R	-	-

Equivalents OE #
1XD 25806 10

FA676 113.8 x 36.6 x 8.9mm



YAMAHA

YZZ 1000 R EPS (Side x Side) YXZ10PXG	16	F
YZZ 1000 R SE (Side x Side)	16	F
YZZ 1000 R SS (Side x Side)	17-18	F

MATERIAL AVAILABILITY AND PART NO.					
STD	OPTIONS				
FA	V	GPFA	HH	R	SXR
FA676TT	-	-	-	FA676R	SXR676HH

Equivalents OE #
2HC 25805 00

FA677 104 x 34.8 x 8.9mm



YAMAHA

YZZ 1000 R EPS (Side X Side) YXZ10PXG	16	R
YZZ 1000 R SE (Side X Side)	16	R
YZZ 1000 R SS (Side x Side)	17-18	R

MATERIAL AVAILABILITY AND PART NO.					
STD	OPTIONS				
FA	V	GPFA	HH	R	MXS
FA677TT	-	-	-	FA677R	-

Equivalents OE #
2HC 25805 00

DO NOT REFIT ANY SHIMS/INSULATORS TO EBC PADS FROM ORIGINAL PADS UNLESS INSTRUCTED ON NOTE ON PAD PACKAGING AND ON FA DRAWING ASSOCIATED WITH THAT PAD.

FA678 A. 80 x 43.65 x 8.7mm
B. 80 x 43.65 x 3.3mm

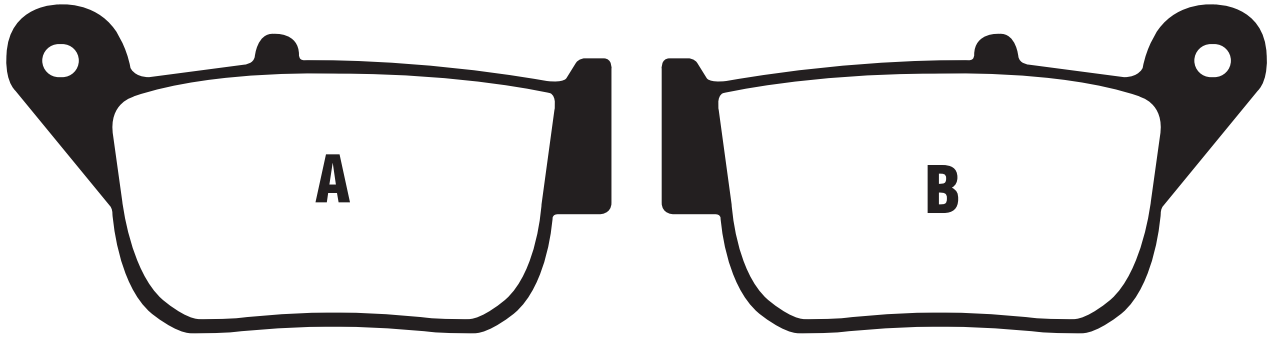

YAMAHA
 X-MAX 250 (2DL/Non ABS/Heng Tong R/Caliper) 14-16 R
 -See YP250 R X-Max
 YP250 R X-Max 14-16 R
 (2DL/Non ABS/Heng Tong R/Caliper)

MATERIAL AVAILABILITY AND PART NO.					
STD	OPTIONS				
FA	V	GPFA	HH	R	MXS
SFA678	-	-	SFA678HH	-	-

Equivalents OE #
2DL F5811 00

FA679 82.83 x 39.76 x 7.88mm



HONDA
 CB 125 R 18-20 F
 CB 300 RA AC 18-20 F
 CB 650 RA/RA AC 19 F
 CBR 650 R 2AC/RA 2AC 19 F
 CRF1000 LAG (DCT/ABS) 16-20 F
 CRF 1100 Africa Twin Adventure Sport ES ABS Manual 19-20 F
 CRF 1100 Africa Twin Adventure Sport ES ABS DCT 19-20 F

MATERIAL AVAILABILITY AND PART NO.					
STD	OPTIONS				
FA	V	HH	R	MXS	EPFA
FA679V	FA679HH	-	-	-	-

Equivalents OE #	
06455 MJP G51	06455 MKH D01

FA680 158mm x 54.6mm x 6.86mm

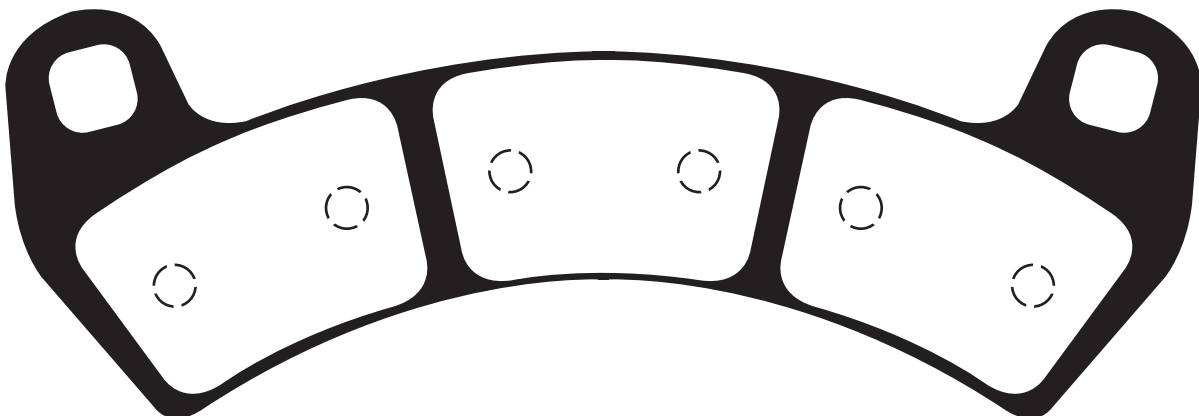

POLARIS RZR (SIDE X SIDE MODELS)
 RZR XP Turbo 16 F
 RZR XP 4 Turbo 16 F

MATERIAL AVAILABILITY AND PART NO.					
STD	OPTIONS				
FA	SXR	GPFA	HH	R	MXS
FA680R	SXR680HH	-	-	-	MXS680

Equivalents OE #
2205949

DO NOT REFIT ANY SHIMS/INSULATORS TO EBC PADS FROM ORIGINAL PADS UNLESS INSTRUCTED ON NOTE ON PAD PACKAGING AND ON FA DRAWING ASSOCIATED WITH THAT PAD.

FA681 55.5 x 49.55 x 7.25mm

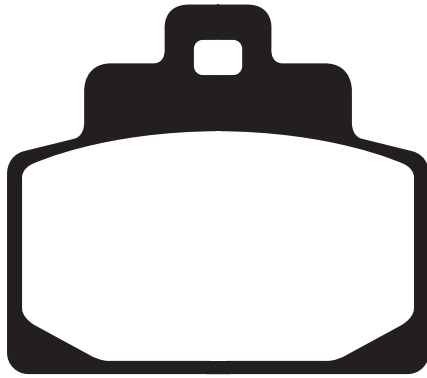

PIAGGIO

MP3 Business LT 300 ie ABS (13" Front Wheel/14" Rear Wheel)	14-18	F
MP3 Sport LT 300 ie ABS	14-15	F
MP3 Sport LT 300 ie ABS (13" Front Wheel/14" Rear Wheel)	14-15	
MP3 Touring Business LT 300 ie ABS	14-15	F
MP3 Touring Sport LT 300 ie ABS	14-18	F
MP3 Yourban LT RL 300	17-18	F
MP3 500 LT Business ABS (13 Inch Front Wheel/14 Inch Rear Wheel)	14-20	F
MP3 500 LT Sport ABS (13 Inch Front Wheel/14 Inch Rear Wheel)	14-18	F

VESPA

GTS 300 ie (Non ABS Models)	08-15	R
GTS 300 ie (ABS Models)	08-18	R
GTS 300 ie Super (Non ABS Models)	08-15	R
GTS 300 ie Super (ABS Models)	08-18	R
GTS 300 ie Super Sport (Non ABS Models)	08-15	R
GTS 300 ie Super Sport (ABS Models)	08-18	R
GTS 300 ie Touring (Non ABS Models)	11-16	R
GTS 300 ie Touring (ABS Models)	11-17	R
GTS 4V ABS/Super Sport/Touring	18-19	R
GTS 4V ABS	18-19	R

MATERIAL AVAILABILITY AND PART NO.					
STD	OPTIONS				
FA	SFA	SFAC	HH	SFA-HH	R
SFA681	SFAC681	SFA681HH	-	-	-

Equivalents OE #
IC000818

FA682 A. 117.35 x 50.45 x 8mm

B. 95.2 x 50.45 x 8mm



CAN-AM (SIDE x SIDE)

Defender HD5 500cc	17-19	F(Left)
Defender HD8 799cc	17-19	F(Left)
Defender HD10 976cc	17-19	F(Left)
Defender 799cc	16	F(Left)
Defender 976cc	16	F(Left)
Defender DPS 799cc	16	F(Left)
Defender DPS 976cc	16	F(Left)
Defender Max	17	F(Left)
Defender Max HD8 799cc	18-19	F(Left)
Defender Max HD10 976cc	18-19	F(Left)
Defender T	17	F(Left)R(Right)
Defender XT 976cc	16	F(Left)
Defender XT 799cc	16	F(Left)
Defender XT Cab 976cc	16	F(Left)
Defender XT Cab 799cc	16	F(Left)
Maverick Trail 800R EFI	18	F(Left)
Maverick Trail 1000 EFI	18	F(Left)
Maverick X3	17	F(Left) & R(Left)
Maverick X3 Max Turbo	17	F(Left) & R(Left)
Maverick X3 Turbo	18	F(Left) & R(Left)
Maverick X3 Max Turbo	18	F(Left) & R(Left)
Maverick X3 Turbo R	18	F(Left) & R(Left)
Maverick X3 Max Turbo R	18	F(Left) & R(Left)
Ryker 600cc	18-19	F(Left) & R(Left)
Ryker 900cc	18-19	F(Left) & R(Left)

MATERIAL AVAILABILITY AND PART NO.					
STD	OPTIONS				
FA	V	GPFA	HH	R	MXS
FA682TT	-	-	-	FA682R	-

Equivalents OE #	
715900379	715900386

DISC PADS
BUYERS GUIDE

DO NOT REFIT ANY SHIMS/INSULATORS TO EBC PADS FROM ORIGINAL PADS UNLESS INSTRUCTED
ON NOTE ON PAD PACKAGING AND ON FA DRAWING ASSOCIATED WITH THAT PAD.

FA683 A. 117.35 x 50.45 x 8mm B. 95.2 x 50.45 x 8mm

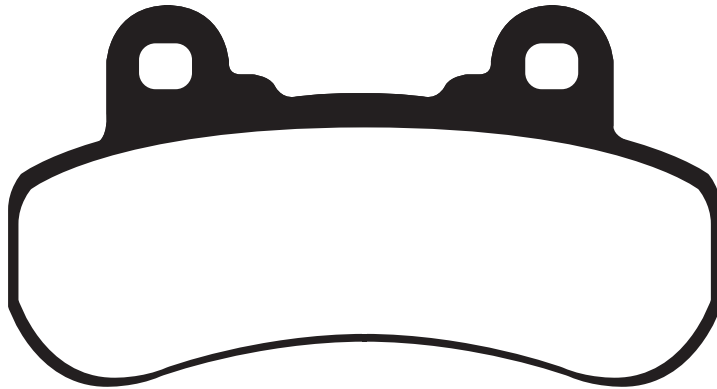
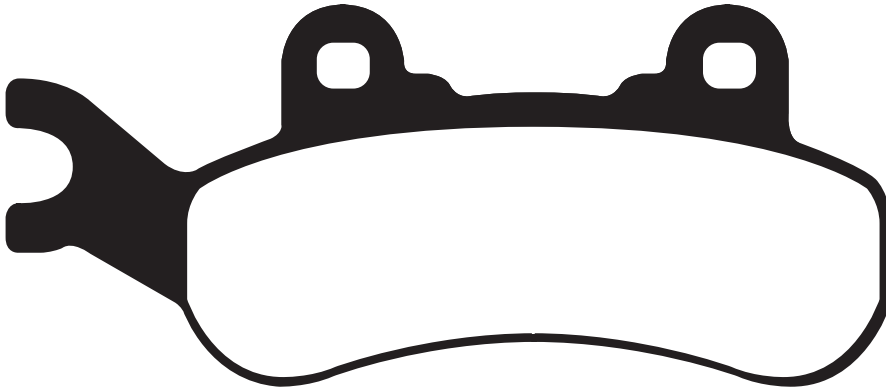

CAN-AM (SIDE x SIDE)

Defender HD5 500cc	17-19	F(Right)&R(Right)
Defender HD8 799cc	17-19	F(Right)
Defender HD10 976cc	17-19	F(Right)
Defender 799cc	16	F(Right)
Defender 976cc	16	F(Right)
Defender Max	17	F(Right)
Defender Max HD8 799cc	18-19	F(Right)
Defender Max HD10 976cc	18-19	F(Right)
Defender T	17	F(Right)/R(Right)
Defender DPS 799cc	16	F(Right)
Defender DPS 976cc	16	F(Right)
Defender XT 976cc	16	F(Right)
Defender XT 799cc	16	F(Right)
Defender XT Cab 976cc	16	F(Right)
Defender XT Cab 799cc	16	F(Right)
Maverick Trail 800R EFI	18	F(Right)
Maverick Trail 1000 EFI	18	F(Right)
Maverick X3	17	F(Right)/R(Right)
Maverick X3 Max Turbo	17	F(Right)/R(Right)
Maverick X3 Turbo	18	F(Right)/R(Right)
Maverick X3 Max Turbo	18	F(Right)/R(Right)
Maverick X3 Turbo R	18	F(Right)/R(Right)
Maverick X3 Max Turbo R	18	F(Right)/R(Right)
Ryker 600cc	18-19	F(Right)/R(Right)
Ryker 900cc	18-19	F(Right)/R(Right)

MATERIAL AVAILABILITY AND PART NO.

STD	OPTIONS				
FA	V	HH	R	MXS	EPFA
FA683TT	-	-	FA683R	-	-

Equivalents OE

715900380	715900387
-----------	-----------

FA684 A. 101.5 x 44.2 x 8mm B. 83.05 x 43 x 8mm

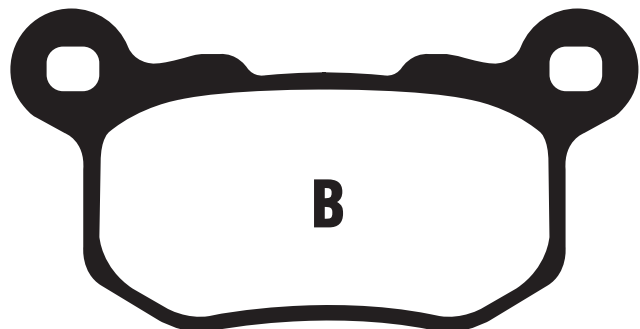
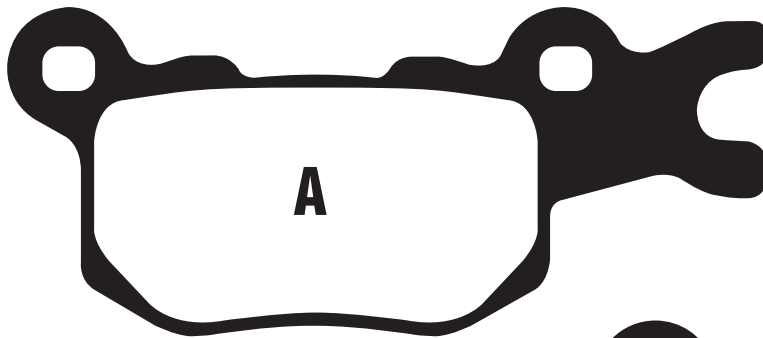

CAN-AM (SIDE x SIDE)

Defender HD5 500cc	17-19	R(Left)
Defender HD8 799cc	17-19	R(Left)
Defender HD10 976cc	17-19	R(Left)
Defender 799cc	16	R(Left)
Defender 976cc	16	R(Left)
Defender DPS 799cc	16	R(Left)
Defender DPS 976cc	16	R(Left)
Defender XT 976cc	16	R(Left)
Defender XT 799cc	16	R(Left)
Defender XT Cab 976cc	16	R(Left)
Defender XT Cab 799cc	16	R(Left)

MATERIAL AVAILABILITY AND PART NO.

STD	OPTIONS				
FA	V	HH	R	TT	SXR
-	-	-	FA684R	FA684TT	SXR684HH

DO NOT REFIT ANY SHIMS/INSULATORS TO EBC PADS FROM ORIGINAL PADS UNLESS INSTRUCTED ON NOTE ON PAD PACKAGING AND ON FA DRAWING ASSOCIATED WITH THAT PAD.

FA685 A. 101.5 x 44.2 x 8mm B. 83.05 x 43 x 8mm

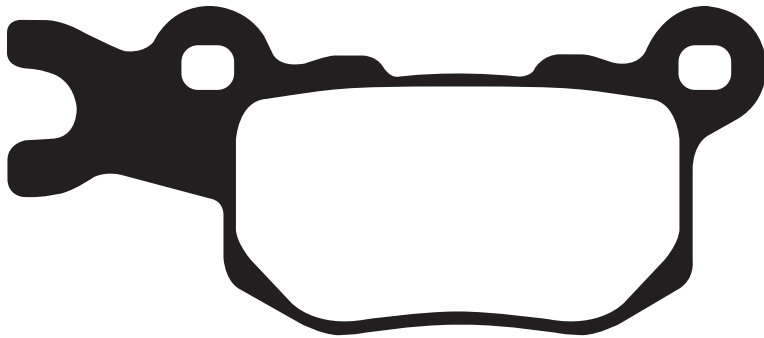

CAN-AM (SIDE x SIDE)

Defender HD5 500cc	17-19	R(Right)
Defender HD8 799cc	17-19	R(Right)
Defender HD10 976cc	17-19	R(Right)
Defender 799cc	16	R(Right)
Defender 976cc	16	R(Right)
Defender DPS 799cc	16	R(Right)
Defender DPS 976cc	16	R(Right)
Defender XT 976cc	16	R(Right)
Defender XT 799cc	16	R(Right)
Defender XT Cab 976cc	16	R(Right)
Defender XT Cab 799cc	16	R(Right)

MATERIAL AVAILABILITY AND PART NO.					
STD	OPTIONS				
FA	V	HH	R	TT	SXR
-	-	-	FA685R	FA685TT	SXR685HH

Equivalents OE #
71590382

FA686 A. 94.1 x 44.58 x 8.45mm B. 73.2 x 46.11 x 10.06mm

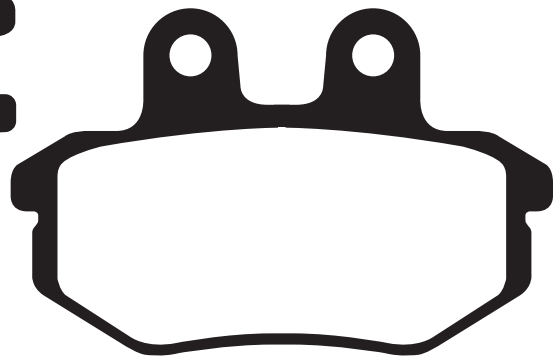
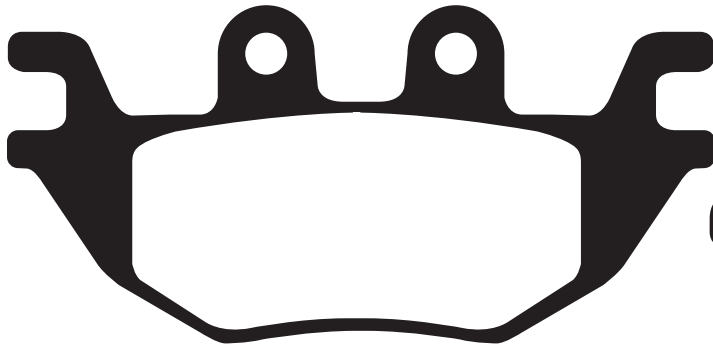

KAWASAKI

KAF 820 AFF/AGF/AHF/AJF Mule Pro FXT	15-18	R (Right) & R (Left)
KAF 820 BFF/BGF/BHF/BJF Mule Pro FXT/EPS	15-18	R (Right) & R (Left)
KAF 820 CFF/CGF/CHF/CJF Mule Pro FXT/EPS LE	15-18	R (Right) & R (Left)
KAF 820 DFF/DGF/DHF/DJF Mule Pro FXT/EPS Camo	15-18	R (Right) & R (Left)
KAF 820 EGF/EHF/EJF Mule Pro FX	16-18	R (Right) & R (Left)
KAF 820 FGF/FHF/FJF Mule Pro FX/EPS	16-18	R (Right) & R (Left)
KAF 820 GGF/GHF/GJF Mule Pro FX/EPS LE	16-18	R (Right) & R (Left)
KAF 820 HGF/HHF Mule PRO - FX/EPS Camo	16-17	R (Right) & R (Left)
KAF 820 JGF/JHF Mule PRO - FXT Ranch Edition	16-17	R (Right) & R (Left)
KAF 1000 AGF/AHF/AJF Mule Pro DXT/Diesel	16-18	R (Right) & R (Left)
KAF 1000 BGF/BHF/BJF Mule Pro DXT/Diesel EPS	16-18	R (Right) & R (Left)
KAF 1000 CGF/CHF - Mule Pro DXT EPS LE/Diesel	16-17	R (Right) & R (Left)
KAF 1000 DGF/DHF - Mule Pro DX /Diesel	16-17	R (Right) & R (Left)
KAF 1000 EGF/EHF/EJF Mule Pro DX EPS/Diesel	16-18	R (Right) & R (Left)
KAF 1000 FGF/FHF - Mule Pro DX EPS LE/Diesel	16-17	R (Right) & R (Left)

MATERIAL AVAILABILITY AND PART NO.					
STD	OPTIONS				
FA	V	GPFA	TT	R	MXS
-	-	-	FA686TT	FA686R	-

Equivalents OE #
43082 0140

CFA689 43.25 x 28.80 x 3.40mm

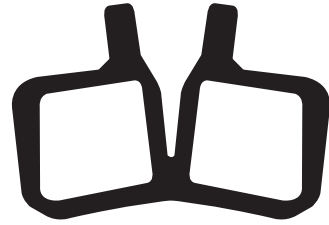

Brinco (Electric Trials Bike - C/R/RE/S M 15-17 F (Left) & R (Left)

MATERIAL AVAILABILITY AND PART NO.					
STD	OPTIONS				
FA	V	GPFA	HH	R	MXS
CFA689	-	-	-	-	-

Equivalents OE #
ROB008001211
ROB008001231

FA691 A. 84.9 x 44.05 x 7 mm B. 74.4 x 41.5 x 7 mm

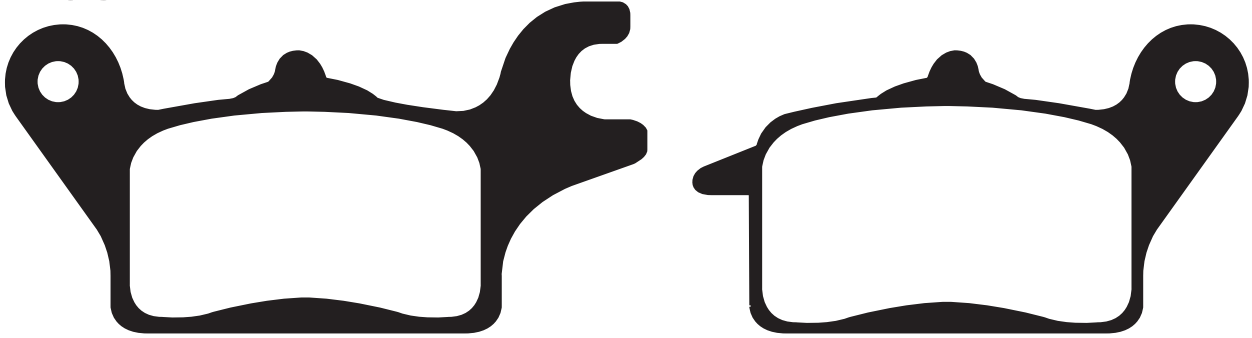

HONDA			
Super Cub C 125 (ABS)	18-20	F	
Super Cub C 125 (ABS) 007	18-20	F	
KAWASAKI			
Ninja 125 ABS	19-20	F	
Z 125 (BR125 GGF/GHF Auto G/Box)	16-20	F	
Z 125 PRO (BR125 HGF/JHF Manual G/Box)	16-20	F	
Z 125 Pro SE (BR125 JFS Manual G/Box)	18-20	F	

MATERIAL AVAILABILITY AND PART NO.					
STD	OPTIONS				
FA	V	HH	R	MXS	EPFA
FA691	-	FA691HH	-	-	-

Equivalents OE #
43082 0134
06455 KWB 601

FA693 A. 110.6 x 34.6 x 7.65mm B. 98.7 x 33.5 x 7.55mm

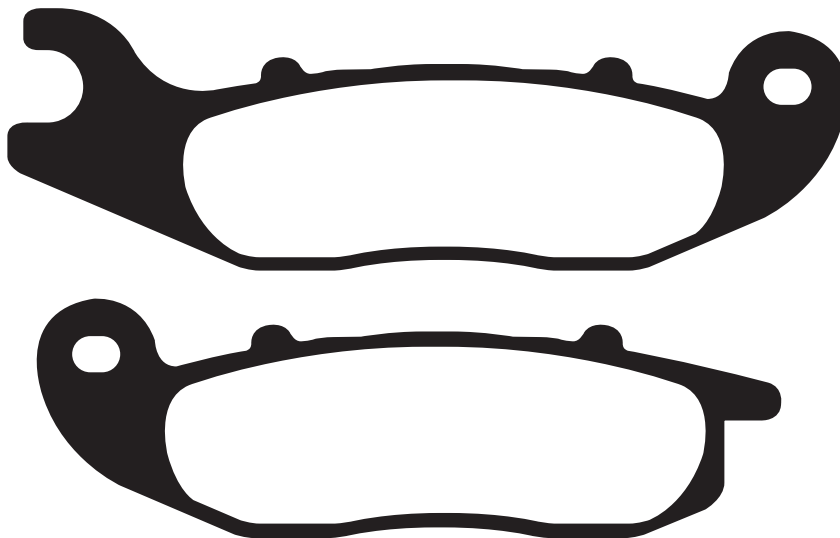

HONDA			
PCX 125	18-20	F	
PIAGGIO			
Liberty i-get 50 (3V/4T)	15-18	F	
Liberty i-get 125 (3V/4T)	15-20	F	
Liberty i-get 150 (3V/4T)	15-20	F	
Medley 125 (ABS)	16-20	F	
Medley S 125 (ABS)	16-20	F	
Medley 150 (ABS)	16-20	F	
Medley S 150 (ABS)	16-20	F	

MATERIAL AVAILABILITY AND PART NO.				
STD	OPTIONS			
SFA	V	SFAC	HH	R
SFA693	-	SFAC693	SFA693HH	-

Equivalents OE #
IC000760

DO NOT REFIT ANY SHIMS/INSULATORS TO EBC PADS FROM ORIGINAL PADS UNLESS INSTRUCTED ON NOTE ON PAD PACKAGING AND ON FA DRAWING ASSOCIATED WITH THAT PAD.

SFA694 A. 98.32 x 48.4 x 7.4mm

B. 84.90 x 39.6 x 7.5mm

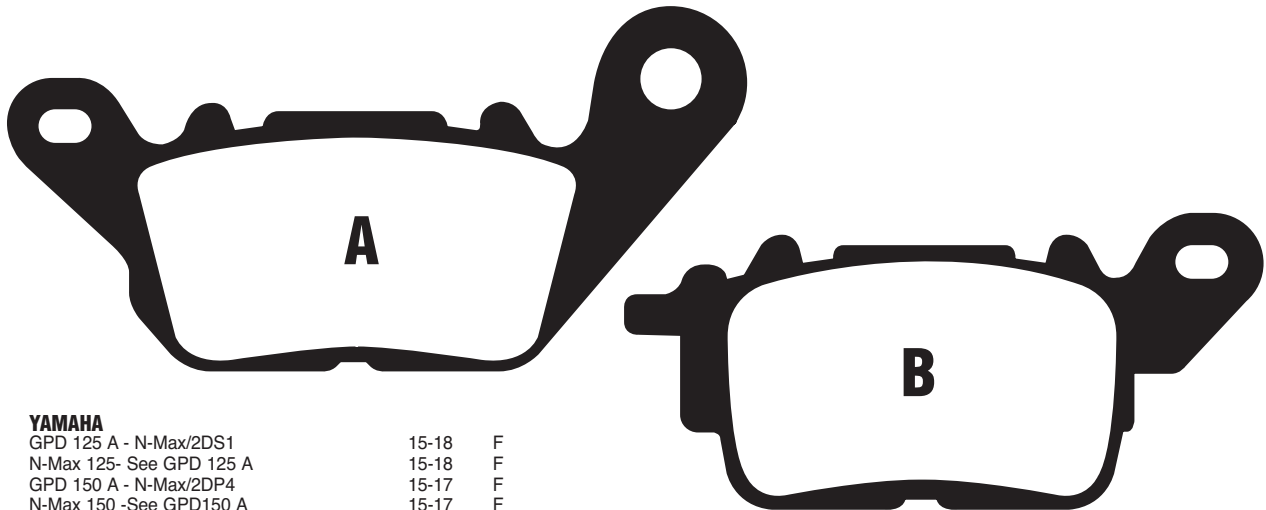

YAMAHA

GPD 125 A - N-Max/2DS1	15-18	F
N-Max 125- See GPD 125 A	15-18	F
GPD 150 A - N-Max/2DP4	15-17	F
N-Max 150 -See GPD150 A	15-17	F
LTS 125-C D'elight	17-18	F

MATERIAL AVAILABILITY AND PART NO.					
STD	OPTIONS				
SFA	SFAC	HH	R	MXS	EPFA
SFA694	SFAC694	-	-	-	

Equivalents OE #
2DP F5805 00

FA696 54.93 x 53.67 x 9mm

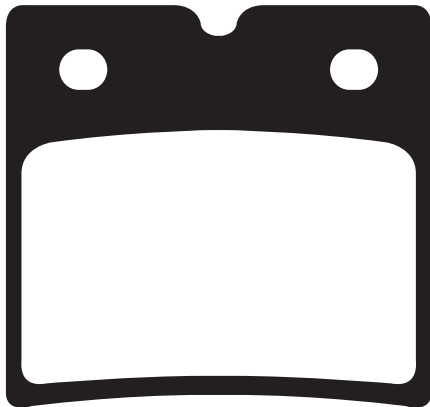

INDIAN

Chief Standard (Brembo calipers)	09-11	R
Chief Blackhawk	11	R
Chief Blackhawk Dark	11	R
Chief Classic	11-13	R
Chief Deluxe (Brembo calipers)	09	R
Chief Roadmaster (Brembo calipers)	09-11	R
Chief Vintage (Brembo calipers)	09-13	R
Dark Horse (Brembo calipers)	10-13	R
Bomber (Brembo calipers)	10-11	R

MATERIAL AVAILABILITY AND PART NO.					
STD	OPTIONS				
FA	V	HH	R	EPFA	GPFA
FA696	FA696V	FA696HH	-	-	-

Equivalents OE #
N 50250062

DO NOT REFIT ANY SHIMS/INSULATORS TO EBC PADS FROM ORIGINAL PADS UNLESS INSTRUCTED ON NOTE ON PAD PACKAGING AND ON FA DRAWING ASSOCIATED WITH THAT PAD.

FA697 74.95 x 42.45 x 9.35mm

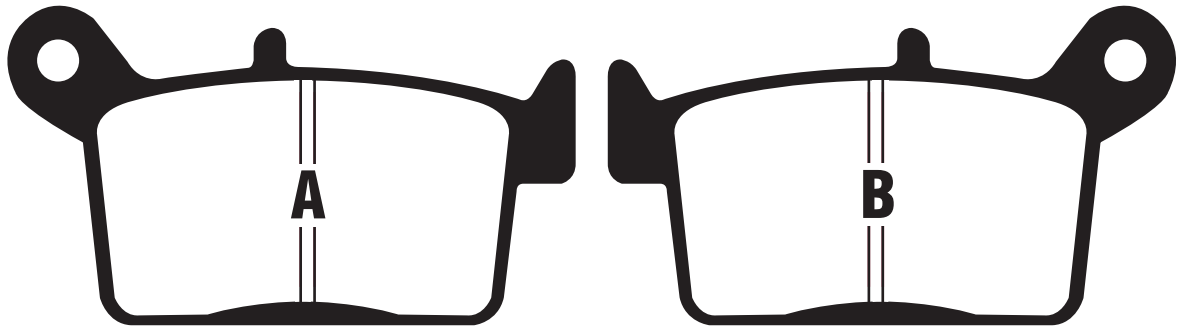

WK BIKES

WK 400 Trail	15-17	R
SWM		
RS 125 R	18	R
SM 125 R	18-20	R
Gran Milano (4T)	16-18	R
Gran Milano Boggi SE	18	R
Gran Milano Outlaw 500	18-20	R
Gran Turismo 440	18	R
Silver Vase 440	18	R
Six Days	18-20	R

MATERIAL AVAILABILITY AND PART NO.					
STD	OPTIONS				
FA	TT	HH	R	MXS	EPFA
FA697	-	FA697HH	FA697R	-	-

Equivalents OE #
55110064

FA698 81.70 x 37.35 x 8.85mm



BENELLI

Leoncino 125	18-20	R
TRK 125	18-20	R
Leoncino 250	18-20	R
TRK 251	18-20	R
302R	18-20	R
302S	18-20	R
BN302	17-18	R
TNT 300 (Tornado Naked T 300cc)	16-18	R
Imperiale 400	18-20	R
402S	18	R
Leoncino (500cc)	17-20	R
Leoncino Trail (500cc)	17-20	R
TRK 502	17-20	R
TRK 502 X	17-20	R
752S	18-20	R

MATERIAL AVAILABILITY AND PART NO.					
STD	OPTIONS				
FA	V	HH	R	EPFA	GPFAX
FA698	FA698V	FA698HH	-	-	-

Equivalents OE #
R320463119D00
55120P100000
R310600127000

FA700 78.05 x 42.75 x 7.75mm

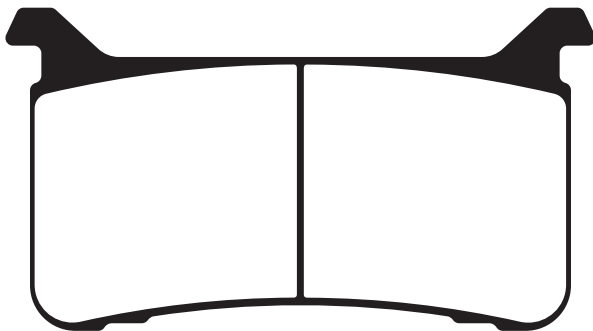

HONDA

CBR 600 RR	17-20	F
CBR 600 RR ABS	17-20	F
CB 1100 RS	18	F
VFR 800 XH/XJ (Crossrunner/ABS)	17-18	F

MATERIAL AVAILABILITY AND PART NO.					
STD	OPTIONS				
HH	TT	MXS	R	EPFA	GPFAX
FA700HH	-	-	-	EPFA700HH	GPFAX700HH

Equivalents OE #
06455-MKF-D41
06455 MJM D41

DO NOT REFIT ANY SHIMS/INSULATORS TO EBC PADS FROM ORIGINAL PADS UNLESS INSTRUCTED ON NOTE ON PAD PACKAGING AND ON FA DRAWING ASSOCIATED WITH THAT PAD.

FA701 115.10 x 40.75 x 10.75mm

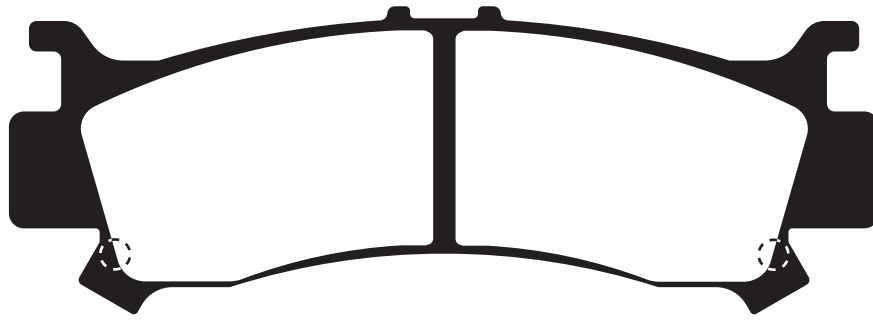

HONDA

SXS 1000 M3 Pioneer (3 Seater)	16-20	F (Left)
SXS 1000 M3P Pioneer (3 Seater)	16-20	F (Left)
SXS 1000 M5D Pioneer (5 Seater)	16-20	F (Left)
SXS 1000 M5L Pioneer (5 Seater)	16-20	F (Left)
SXS 1000 M5P Pioneer (5 Seater)	16-20	F (Left)

MATERIAL AVAILABILITY AND PART NO.					
STD	OPTIONS				
TT	V	MXS	R	EPFA	SXR
FA701TT	-	-	FA701R	-	SXR701HH

Equivalents OE #
06451 HL4 A01

FA702 115.10mm x 40.75 x 10.75 mm

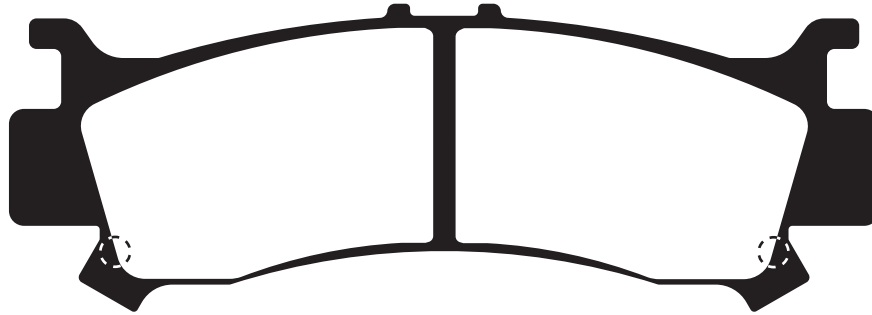

HONDA

SXS 1000 M3 Pioneer (3 Seater)	16-20	F (Right)
SXS 1000 M3P Pioneer (3 Seater)	16-20	F (Right)
SXS 1000 M5D Pioneer (5 Seater)	16-20	F (Right)
SXS 1000 M5L Pioneer (5 Seater)	16-20	F (Right)
SXS 1000 M5P Pioneer (5 Seater)	16-20	F (Right)

MATERIAL AVAILABILITY AND PART NO.					
STD	OPTIONS				
TT	SFAC	HH	R	GPFAX	SXR
FA702TT	-	-	FA702R	-	SXR702HH

Equivalents OE #
06452 HL4 A01

FA703 A. 81.80 x 38.50mm x 10.3mm B. 81.80 x 38.50mm x 10.3mm

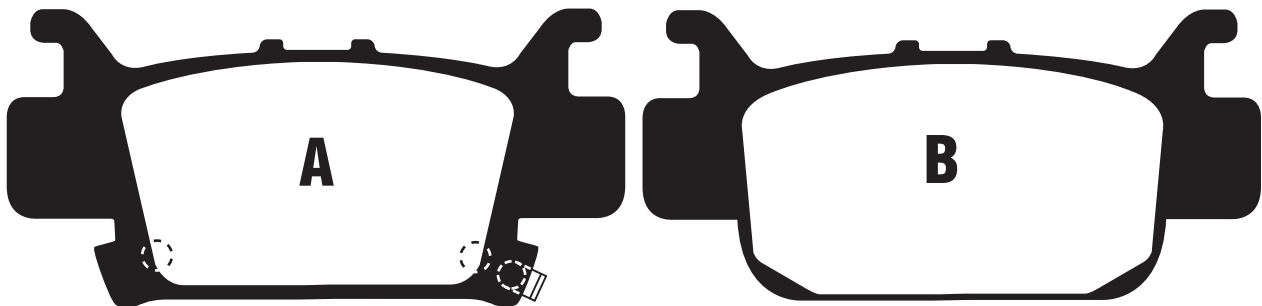

HONDA

SXS 1000 M3 Pioneer (3 Seater)	16-18	R (Left)
SXS 1000 M3P Pioneer (3 Seater)	16-18	R (Left)
SXS 1000 M5D Pioneer (5 Seater)	16-18	R (Left)
SXS 1000 M5L Pioneer (5 Seater)	17-18	R (Left)
SXS 1000 M5P Pioneer (5 Seater)	16-18	R (Left)

MATERIAL AVAILABILITY AND PART NO.					
STD	OPTIONS				
TT	V	R	EPFA	GPFAX	MXS
FA703TT	-	FA703R	-	-	-

Equivalents OE #
06431 HL4 A01

DO NOT REFIT ANY SHIMS/INSULATORS TO EBC PADS FROM ORIGINAL PADS UNLESS INSTRUCTED ON NOTE ON PAD PACKAGING AND ON FA DRAWING ASSOCIATED WITH THAT PAD.

FA704 A. 81.80 x 38.50mm x 10.3mm

B. 81.80 x 38.50mm x 10.3mm

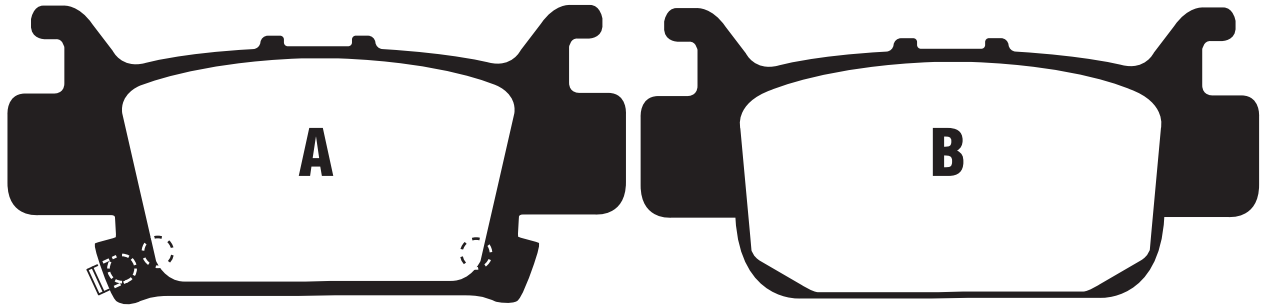

HONDA

SXS 1000 M3 Pioneer (3 Seater)	16-18	R (Right)
SXS 1000 M3P Pioneer (3 Seater)	16-18	R (Right)
SXS 1000 M5D Pioneer (5 Seater)	16-18	R (Right)
SXS 1000 M5L Pioneer (5 Seater)	17-18	R (Right)
SXS 1000 M5P Pioneer (5 Seater)	16-18	R (Right)

MATERIAL AVAILABILITY AND PART NO.					
STD	OPTIONS				
TT	V	R	EPFA	GPFA	MXS
FA704TT	-	FA704R	-	-	-

Equivalents OE #
06432 HL4 A01

FA705 A. 113.30 x 55.00 x 8.32mm

B. 98.70 x 44.70 x 8.25mm

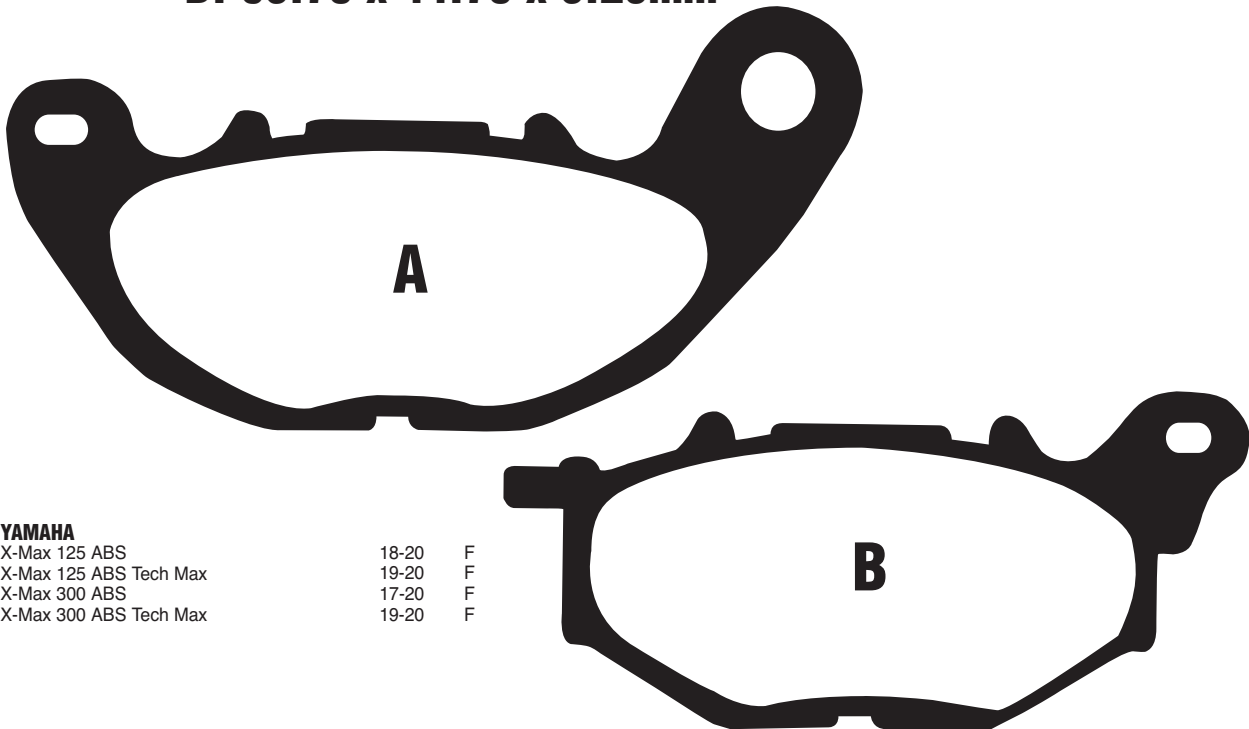

YAMAHA

X-Max 125 ABS	18-20	F
X-Max 125 ABS Tech Max	19-20	F
X-Max 300 ABS	17-20	F
X-Max 300 ABS Tech Max	19-20	F

MATERIAL AVAILABILITY AND PART NO.					
STD	OPTIONS				
SFA	SFAC	HH	R	EPFA	GPFA
SFA705	SFAC705	SFA705HH	-	-	-

Equivalents OE #
B74-F5805-00

DO NOT REFIT ANY SHIMS/INSULATORS TO EBC PADS FROM ORIGINAL PADS UNLESS INSTRUCTED ON NOTE ON PAD PACKAGING AND ON FA DRAWING ASSOCIATED WITH THAT PAD.

FA706 A. 113.4 x 52.2 x 9.65mm B. 97.27 x 39.7 x 9.65mm

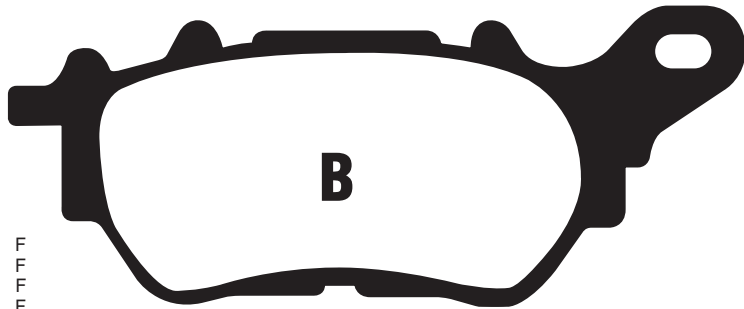
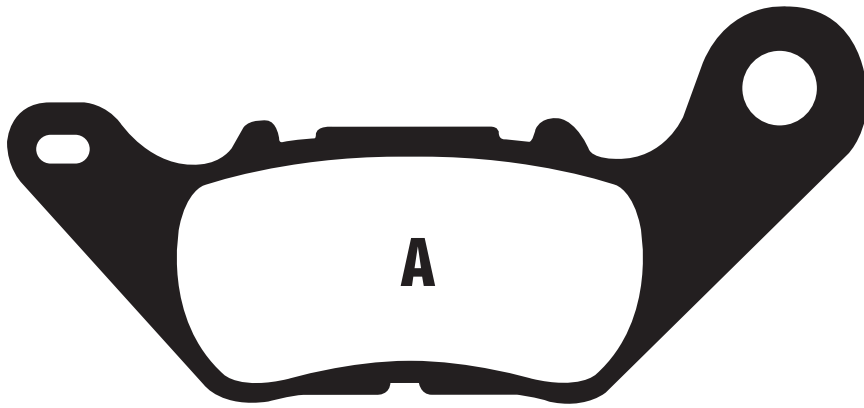

YAMAHA

X-Max 125 ABS	18-20	F
X-Max 125 ABS Tech Max	19-20	F
X-Max 300 ABS	17-20	F
X-Max 300 ABS Tech Max	19-20	F

MATERIAL AVAILABILITY AND PART NO.					
STD	OPTIONS				
SFA	SFAC	HH	R	EPFA	GPFX
SFA706	SFAC706	SFA706HH	-	-	-

Equivalents OE #
B74-F5806-00

FA707 A. 84.90 x 44.05 x 7.00mm B. 74.4 x 41.05 x 7.00mm

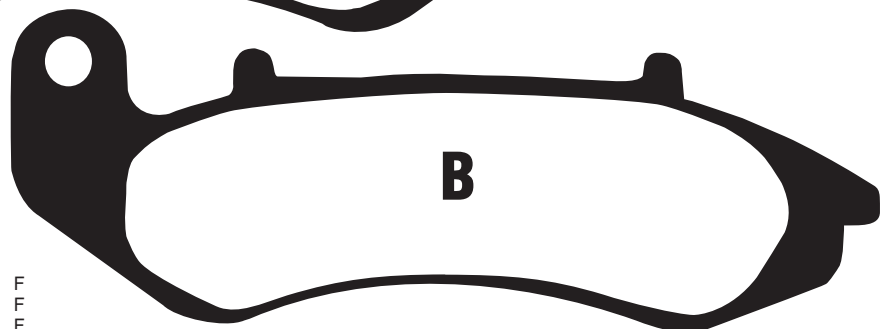

GENERIC/KSR

Demonio 50	17-18	F
Classic 125	17-18	F
Code 125	17-20	F
Demonio 125	17-18	F
GRS 125	17-20	F
TR 125 SM (4T)	17-18	F
TR 125 X	17-18	F
TW 125 SM	17-18	F

SFA707

GENERIC/KSR		
Race 2 125 GT (4T)	18	F
Sirion 125 (4T/ Rear Disc Model)	18-20	F

MATERIAL AVAILABILITY AND PART NO.					
STD	OPTIONS				
FA	V	R	EPFA	GPFX	MXS
FA707	FA707V	SFA707	-	-	-

Equivalents OE #
45110 T80 0000

DO NOT REFIT ANY SHIMS/INSULATORS TO EBC PADS FROM ORIGINAL PADS UNLESS INSTRUCTED ON NOTE ON PAD PACKAGING AND ON FA DRAWING ASSOCIATED WITH THAT PAD.

SFA708 A. 124.00 x 42.80 x 8.97mm

B. 115.30 x 42.80 x 9.15mm

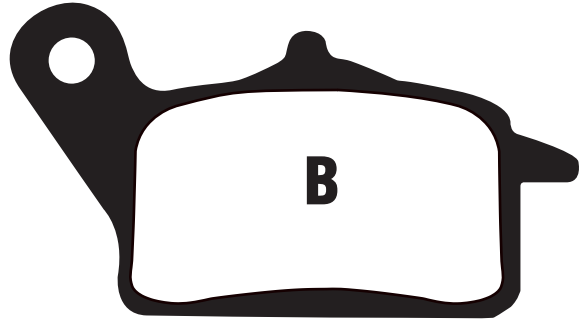
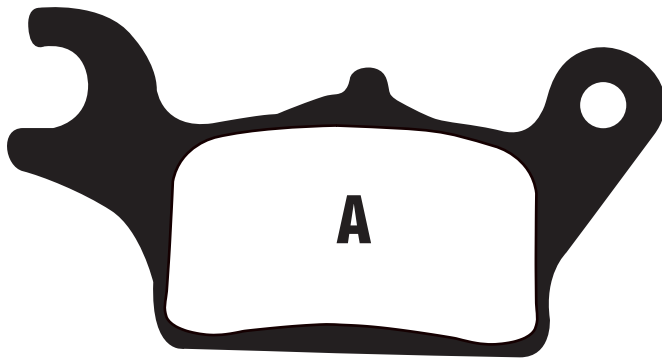

HONDA

NCX 50 E/G/J - Dunk 50	14-17	F
NSC 110 MPDH Vision (16 Inch Wheels)	17-18	F
ACB 110 CBB/CSB - Vario 110	10	F
ACD 110 CSB/SCB - Scoopy 110 Fi	11-16	F
ACC 110 SCB/SCC - ANC 110 Icon	11-12	F
NSC 110 CSD/CSE - Spacy 110	12-14	F
NSC 1110 CBFF/CBFH - Dio 110	15-17	F
ACA 125 CBFE - Air Blade 125	14-16	F
Super Cub C 125 (ABS)	18-19	F
Super Cub C 125 (ABS) 007	18-19	F

LIFAN

Lifan Electric LF 1200 DT E3	17-20	F
Lifan Electric LF 1200 DT E3 Deluxe	17-20	F

MATERIAL AVAILABILITY AND PART NO.

STD	OPTIONS				
SFA	SFAC	R	EPFA	GPFAX	MXS
SFA708	SFAC708	-	-	-	-

Equivalents OE #
06455-K44-D01

SFA709 A. 111.6 x 43.01 x 8.05mm

B. 109.6 x 43.01 x 8.05mm

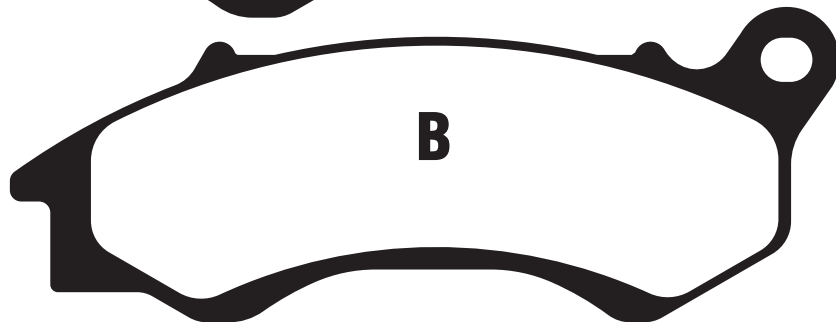
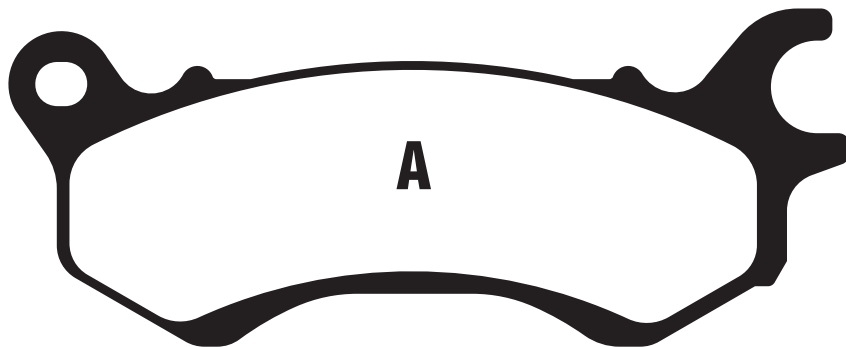

DAYTONA

DY 125 RS EURO4	17
-----------------	----

MATERIAL AVAILABILITY AND PART NO.

STD	OPTIONS				
TT	SFA	SFAC	SFAHH	GPFAX	MXS
-	SFA709	SFAC709	SFA709HH	-	-

Equivalents OE #
NI0124-29710

DO NOT REFIT ANY SHIMS/INSULATORS TO EBC PADS FROM ORIGINAL PADS UNLESS INSTRUCTED ON NOTE ON PAD PACKAGING AND ON FA DRAWING ASSOCIATED WITH THAT PAD.

FA710 81.95 x 42.15 x 9.88mm

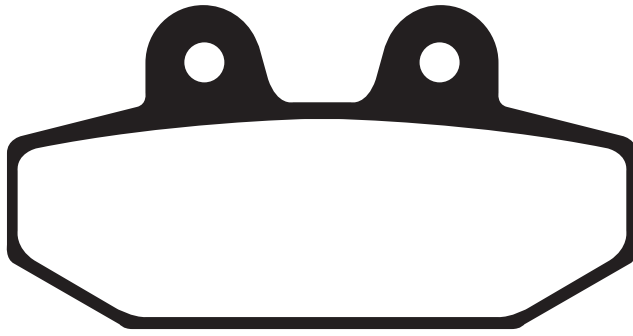

HARLEY DAVIDSON

FLFB Fat Boy	18	R
FLFBS Fat boy 114	18	R
FLFBS Fat Boy Anniv	18	R
FLHC Heritage Classic	18	R
FLHCS Heritage Classic 114	18	R
FLHCS Heritage Classic 114 Anniv.	18	R
FLSL Softail Slim	18	R
FXBR Breakout	18-20	R
FXBRS Breakout 114	18-20	R
FXBRS Breakout 114 Anniv	18-20	R
FLDE Deluxe	18-20	R
FXBB Street Bob	18-20	R
FXFB Fat Bob	18-20	R
FXBS Fat Bob	18-20	R
FXLR Low Rider	18-20	R

MATERIAL AVAILABILITY AND PART NO.					
STD	OPTIONS				
FA	V	R	EPFA	GPFAX	MXS
FA711	FA711V	-	-	-	-

Equivalents OE #
41300197

FA711 A. 124.00 x 42.80 x 8.97mm

B. 115.30 x 42.80 x 8.90mm

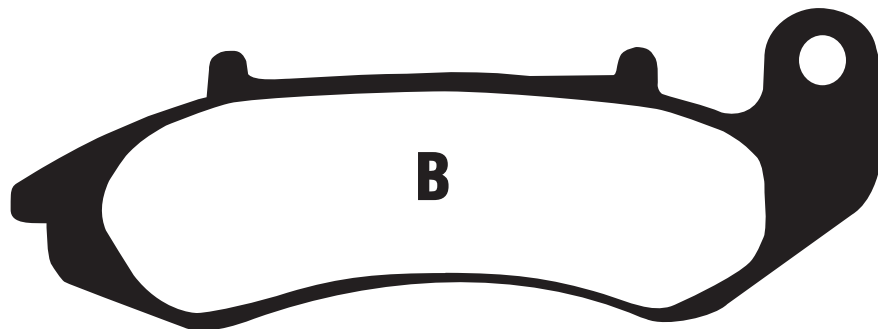
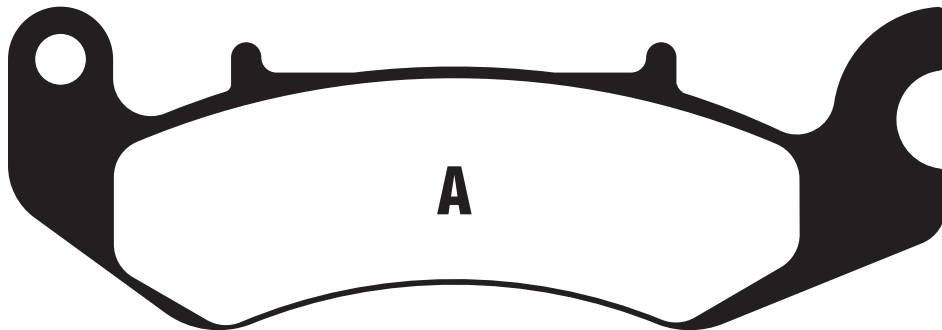

BENELLI

TNT 125 (Tornado Naked T 125cc)	17-18	F
TNT 135 (Tornado Naked T 135cc)	18	F
Worx 125	17-18	F
BN125	18-19	F

MATERIAL AVAILABILITY AND PART NO.					
STD	OPTIONS				
FA	V	R	EPFA	GPFAX	MXS
FA711	FA711V	-	-	-	-

Equivalents OE #
45110 T74 0000

FA712 A. 103.85 x 43.55 x 12.8mm
B. 103.85 x 43.55 x 14.90mm

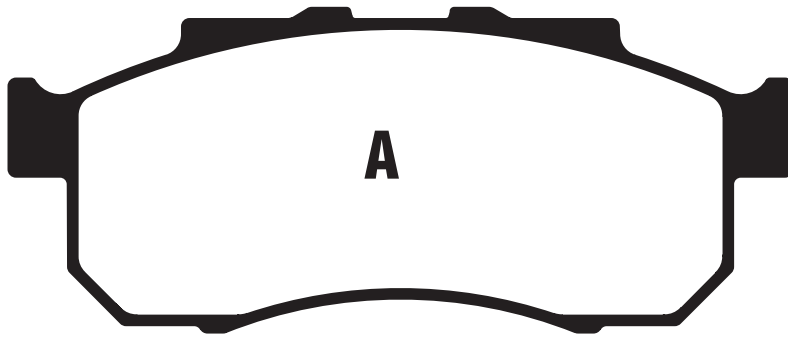

A

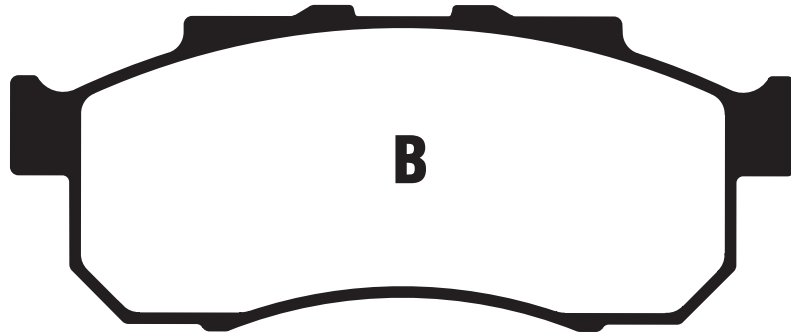

B

HONDA
 SXS 500 M2 Pioneer (2 Seat) 15-17 F Left
 SXS 700 M2 Pioneer (2 Seat) 16-18 F Left
 SXS 700 M4 Pioneer (4 Seat) 16-18 F Left

MATERIAL AVAILABILITY AND PART NO.					
STD	OPTIONS				
TT	V	R	EPFA	GPFAX	MXS
FA712TT	-	FA712R	-	-	-

Equivalents OE #
06451 H23 A00

FA714 75.35 x 39.35 x 11.75mm

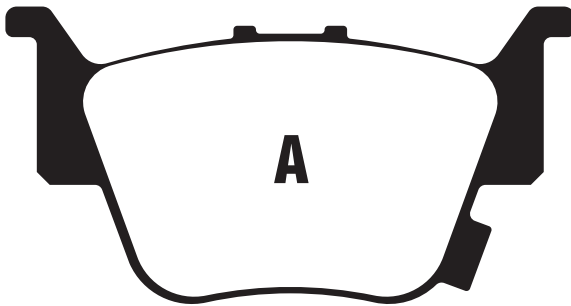

A

HONDA
 SXS 500 M2 Pioneer (2 Seat) 15-17 R
 SXS700M2 Pioneer (2 Seat) 16-18 R
 SXS700M4 Pioneer (4 Seat) 16-18 R

MATERIAL AVAILABILITY AND PART NO.					
STD	OPTIONS				
TT	V	R	EPFA	GPFAX	MXS
FA714TT	-	FA714R	-	-	-

Equivalents OE #
06435 HN8 016

DISC PADS
BUYERS GUIDE

DO NOT REFIT ANY SHIMS/INSULATORS TO EBC PADS FROM ORIGINAL PADS UNLESS INSTRUCTED ON NOTE ON PAD PACKAGING AND ON FA DRAWING ASSOCIATED WITH THAT PAD.

FA715 A. 109.30 x 39.10 x 7.64mm

B. 95.00 x 35.95 x 7.68mm

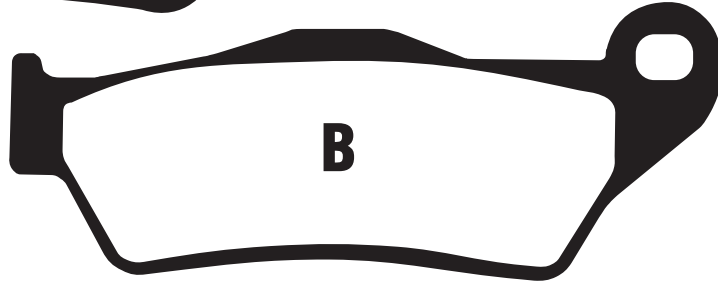
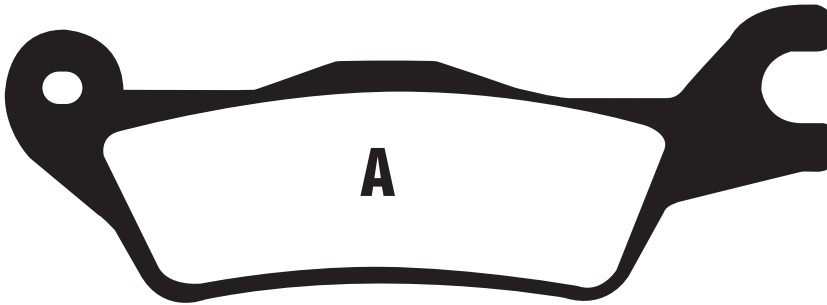

HONDA

CBF 125 6 Stunner	06	F
CBF 125 M7 Stunner	07	F
CBF 150 5	05	F
CBF 150 M5 Unicorn	05	F
CBF 150 6 (Spoke Wheels)	06	F
CBF 150 M6/M7 Unicorn (Spoke Wheels)	06-07	F
CBF 150 M7/M9/MA Unicorn (Cast Wheels)	07-10	F
CBF 150 MB/MC Unicorn (Cast Wheels)	11-12	F

SUZUKI

GSX-R 125 RLXL8/RL8	18-20	F
GSX-S 125 MLXL8/ML8	18-20	F
GSX 150 L6 Gixxer	16-20	F
GSX 150 DZAL6/DEAL8/DZAL8/DXAL8 Gixxer	16-20	F
GSX-R 150 FRFAL7/FRZAL7	17-20	F
GSX-R 150 RF-Q/RFX-Q	17-20	F
GSX-R 150 RFL8/RFXL8	18-20	F
GSX-S 150 MFL8/MFXL8	18-20	F

MATERIAL AVAILABILITY AND PART NO.					
STD	OPTIONS				
FA	V	R	EPFA	GPFAX	MXS
FA715	FA715V	FA715HH	-	-	-

Equivalents OE #
06455 KCC 841
06455 KCC 842
59100 34880

FA716 A. 101.30 x 43.60 x 7.65mm

B. 90.50 x 43.85 x 7.60mm

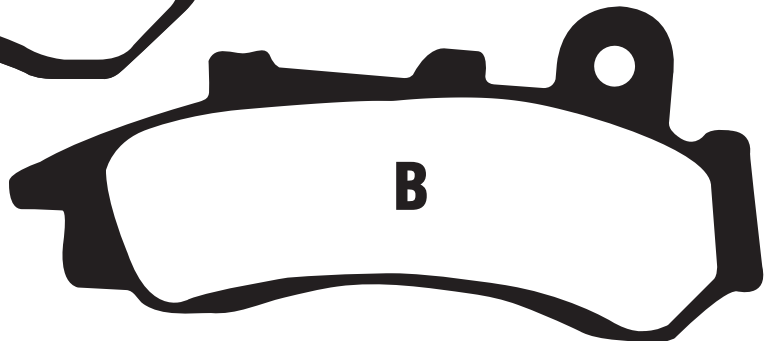
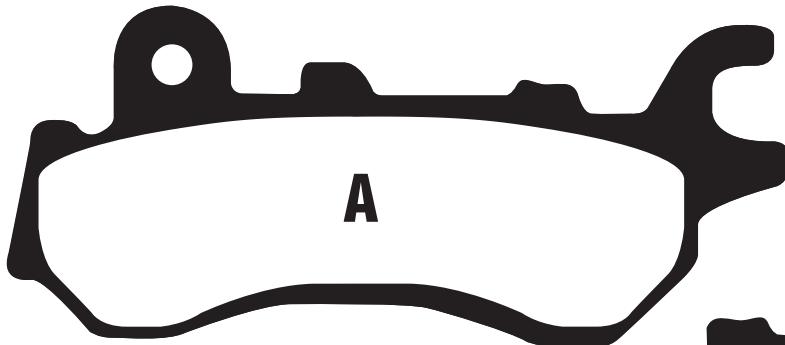

HONDA

CB 125 F (GLR 125 1WHH)	17-20	F
-------------------------	-------	---

MATERIAL AVAILABILITY AND PART NO.					
STD	OPTIONS				
FA	V	HH	R	MXS	EPFA
FA716	FA716V	-	-	-	-

Equivalents OE #
06455 KPN E21

DO NOT REFIT ANY SHIMS/INSULATORS TO EBC PADS FROM ORIGINAL PADS UNLESS INSTRUCTED ON NOTE ON PAD PACKAGING AND ON FA DRAWING ASSOCIATED WITH THAT PAD.

FA717 129.30 x 40.13 x 8.90mm



HONDA

GL 1800 B Goldwing J (Manual)	18-20	F
GL 1800 Goldwing Tour J (Manual)	18-20	F
GL 1800 BD Goldwing J (DCT)	18-20	F
GL 1800 D Goldwing Tour J (DCT)	18-20	F
GL 1800 DA Goldwing Tour Airbag J (DCT)	18-20	F

MATERIAL AVAILABILITY AND PART NO.					
STD	OPTIONS				
FA	V	HH	R	MXS	EPFA
-	-	FA717HH	-	-	-

Equivalents OE #
06455 MKC AO1

SFA719 81.61 x 37.74 x 8.90mm

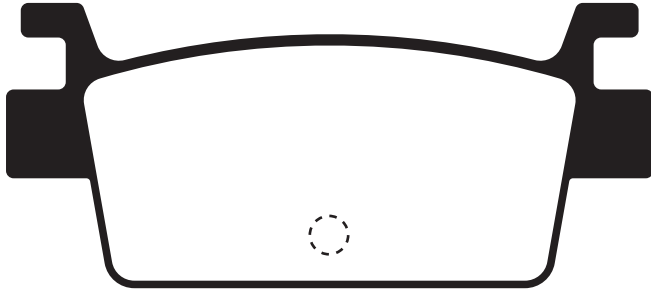

KYMCO
AK550

17-20	R
-------	---

MATERIAL AVAILABILITY AND PART NO.					
STD	OPTIONS				
SFA	V	HH	R	MXS	EPFA
SFA719	-	SFA719HH	-	-	-

Equivalents OE #
43105 LGC6-305

FA722 A. 137.3 x 43.2 x 9mm B. 118.1 x 43.2 x 9mm

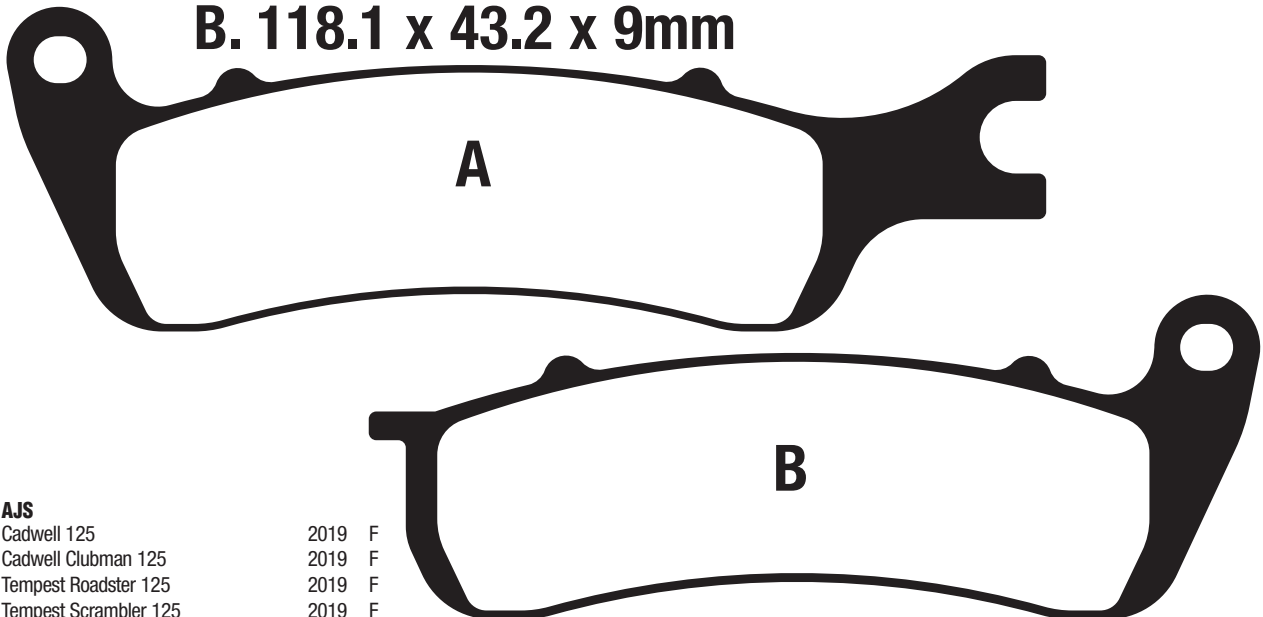

AJS

Cadwell 125	2019	F
Cadwell Clubman 125	2019	F
Tempest Roadster 125	2019	F
Tempest Scrambler 125	2019	F

MATERIAL AVAILABILITY AND PART NO.					
STD	OPTIONS				
FA	V	HH	R	MXS	EPFA
FA722	-	-	-	-	-

Equivalents OE #
-

DO NOT REFIT ANY SHIMS/INSULATORS TO EBC PADS FROM ORIGINAL PADS UNLESS INSTRUCTED ON NOTE ON PAD PACKAGING AND ON FA DRAWING ASSOCIATED WITH THAT PAD.

SFA723 A. 101.3 x 43.5 x 7.6mm B. 98.6 x 43.5 x 7.6mm

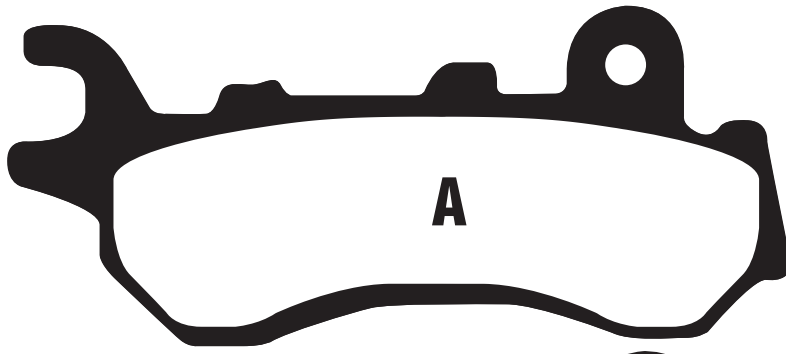

A

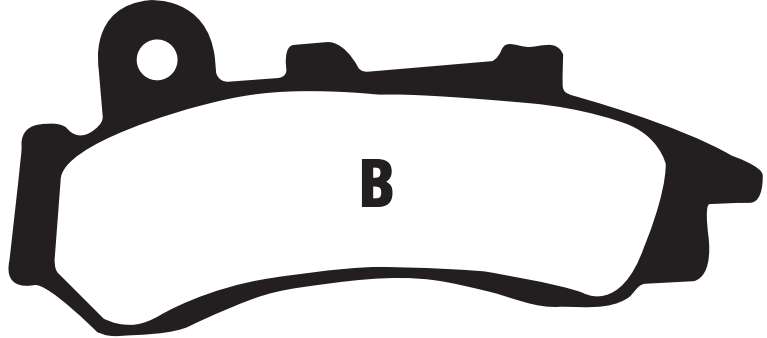

B

HONDA
PCX 125

18-20 F

MATERIAL AVAILABILITY AND PART NO.					
STD	OPTIONS				
SFA	V	HH	R	MXS	EPFA
SFA723	-	-	-	-	-

Equivalents OE #
06455 KRE K01

FA724 73.03 x 54.39 x 8.3mm

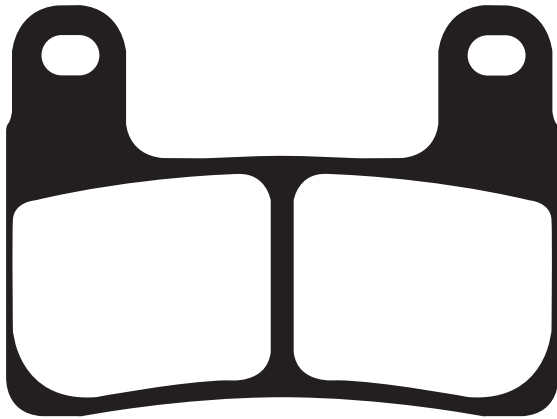

BMW

S1000 R	18-20	F
S 1000 RR/RR Sport/RR M Sport	18-20	F
S 1000 XR	20	F
R1250 GS (Disc has fixed bobbins)	19-20	F
R 1250 GS TE (Disc has fixed bobbins)	19-20	F
R 1250 GS Exclusive TE (Disc has fixed bobbins)	19-20	F
R 1250 GS Rallye (Disc has fixed bobbins)	19-20	F
R 1250 GS Rallye TE (Disc has fixed bobbins)	19-20	F
R 1250 RT (Disc has fixed bobbins)	19-20	F
R 1250 RT SE (Disc has fixed bobbins)	19-20	F
R 1250 RT LE (Disc has fixed bobbins)	19-20	F

MATERIAL AVAILABILITY AND PART NO.					
STD	OPTIONS				
FA	V	HH	R	EPFA	GPFA
-	-	FA724HH	-	EPFA724HH	GPFA724HH

Equivalents OE #
34 11 8 405 104

DO NOT REFIT ANY SHIMS/INSULATORS TO EBC PADS FROM ORIGINAL PADS UNLESS INSTRUCTED ON NOTE ON PAD PACKAGING AND ON FA DRAWING ASSOCIATED WITH THAT PAD.

FA726 101.6mm x 36.55mm x 10.8mm

CF MOTO

400 C-Force	18-19	F
500 C-Force	17-19	F
1000 Z-Force	18-19	F
600 C-Force	20	F
600 C-Force EPS	18-19	F
950 Z-Force	20	F
1000 U-Force	20	F

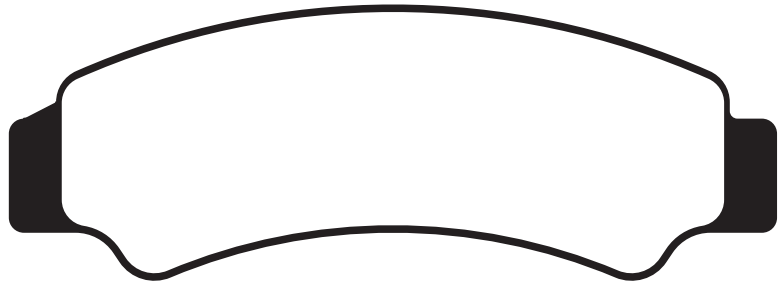

MATERIAL AVAILABILITY AND PART NO.					
STD	OPTIONS				
FA	TT	HH	R	MXS	SXR
FA726	-	-	FA726R	-	SXR726HH

Equivalents OE #
-

FA727 A: 137.36 x 44.16 x 9mm B: 117.90 x 44.06 x 9mm

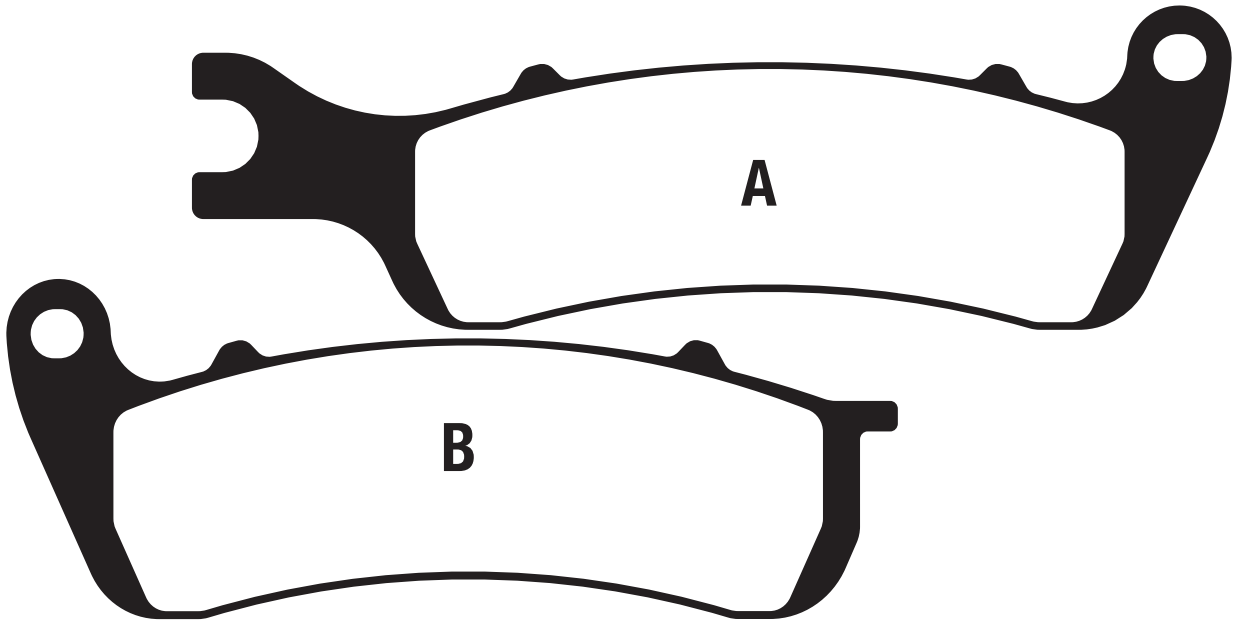

ZONTES

ZT 125 Firefly	17-19	F
ZT 125 Mantis	17-19	F
ZT 125 Scorpion	17-19	F

MATERIAL AVAILABILITY AND PART NO.					
STD	OPTIONS				
FA	SFA	SFAC	R	MXS	EPFA
FA727	SFA727	SFAC727	-	-	-

Equivalents OE #
-

FA728 163.6 x 50 x 9.3mm

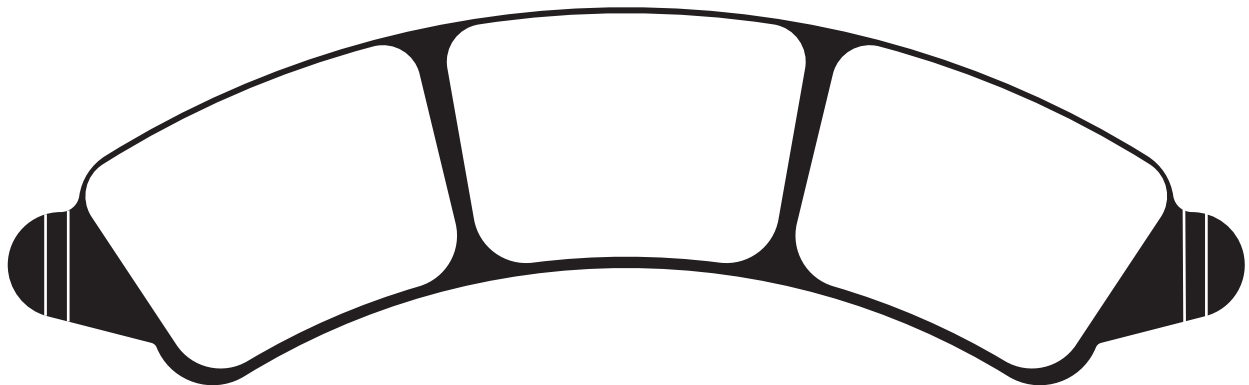

POLARIS RZR (SIDE X SIDE MODELS)

RZR XP4 Turbo S (R02)	19-20	F
-----------------------	-------	---

MATERIAL AVAILABILITY AND PART NO.					
STD	OPTIONS				
FA	TT	HH	R	MXS	SXR
FA728	FA728TT	-	FA728R	-	SXR728

Equivalents OE #
-

DO NOT REFIT ANY SHIMS/INSULATORS TO EBC PADS FROM ORIGINAL PADS UNLESS INSTRUCTED ON NOTE ON PAD PACKAGING AND ON FA DRAWING ASSOCIATED WITH THAT PAD.

FA730 49.52 x 35.85 x 8mm

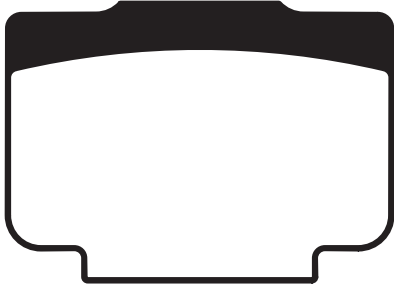

BREMBO
XA1J040 P2/30 Rear Caliper 18-20 R

MATERIAL AVAILABILITY AND PART NO.					
STD	OPTIONS				
FA	TT	HH	R	EPFA	
FA730	-	FA730HH	-	EPFA730HH	GPFAX730HH

Equivalents OE #
0793 4010

FA731 A 130.30 x 51.1 x 9.1mm B 127.90 x 45.6 x 9.1mm

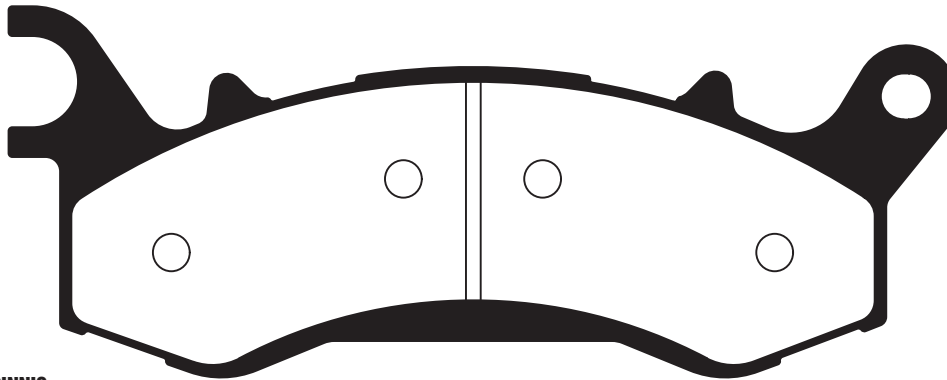
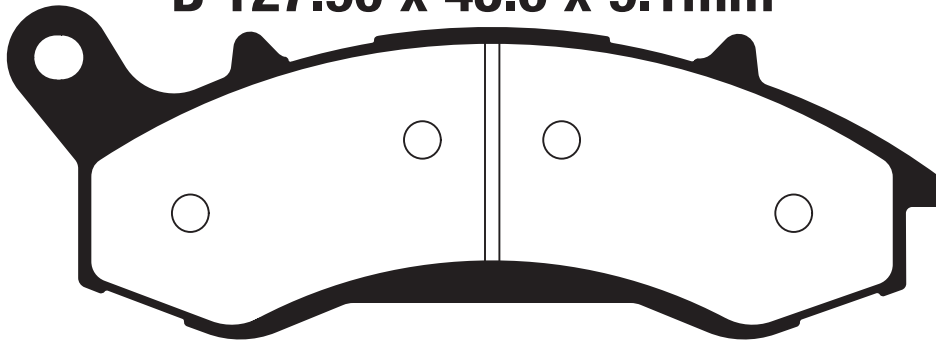

SINNIS
Hoodlum 125 ZS 125-79 17-20 F

MATERIAL AVAILABILITY AND PART NO.					
STD	OPTIONS				
FA	TT	HH	R	TT	SXR
FA731	-	-	FA731R	FA731TT	

Equivalents OE #
-

DO NOT REFIT ANY SHIMS/INSULATORS TO EBC PADS FROM ORIGINAL PADS UNLESS INSTRUCTED
ON NOTE ON PAD PACKAGING AND ON FA DRAWING ASSOCIATED WITH THAT PAD.

SFA732 A 109 x 41 x 7.6mm B 94 x 37.3 x 7.6mm

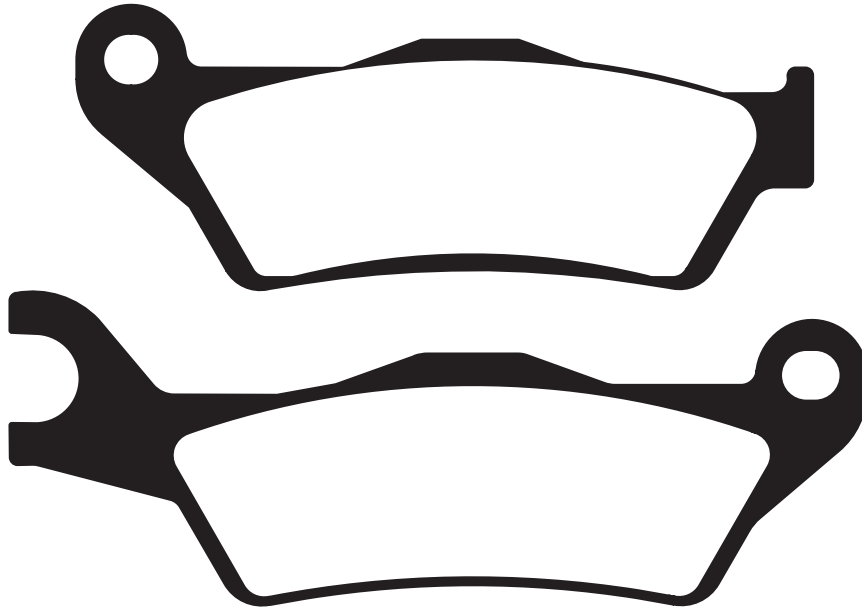

PIAGGIO
XA1J040 P2/30 Rear Caliper 18-20RTyphoon 50 (2T) Euro 4 16-20 F

MATERIAL AVAILABILITY AND PART NO.					
STD	OPTIONS				
SFA	SFAC	HH	R	EPFA	GPFAX
SFA732	SFAC732	-	-	-	-

Equivalents OE #
1C002634

FA738 114.20 x 38.8 x 8.8mm

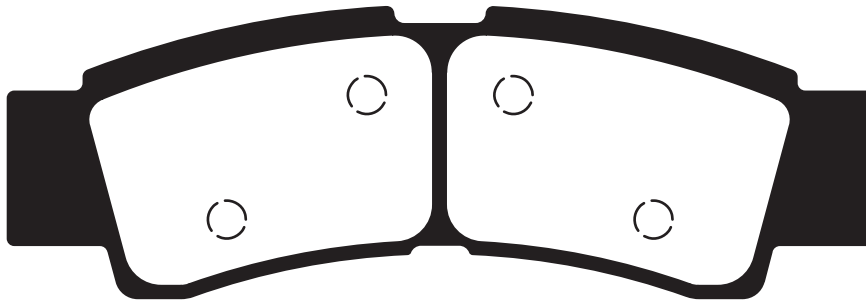

KAWASAKI
KRF 1000 Teryx 20 F

MATERIAL AVAILABILITY AND PART NO.					
STD	OPTIONS				
FA	TT	HH	R	TT	SXR
-	-	-	FA738R	-	SXR738HH

Equivalents OE #
43082-0196

DISC PADS
BUYERS GUIDE

DO NOT REFIT ANY SHIMS/INSULATORS TO EBC PADS FROM ORIGINAL PADS UNLESS INSTRUCTED ON NOTE ON PAD PACKAGING AND ON FA DRAWING ASSOCIATED WITH THAT PAD.

FA739 85.6 x 38 x 8.8mm

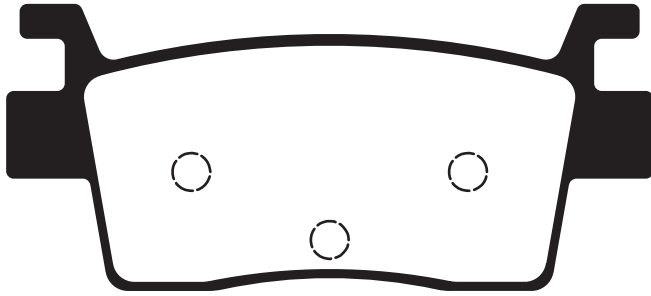

KAWASAKI
KRF 1000 Teryx

20 R

MATERIAL AVAILABILITY AND PART NO.					
STD	OPTIONS				
FA	TT	HH	R	TT	SXR
-	-	-	FA739R	-	SXR739HH

Equivalents OE #
43082-0197

FA740 122.18 x 55.2 x 7.8mm

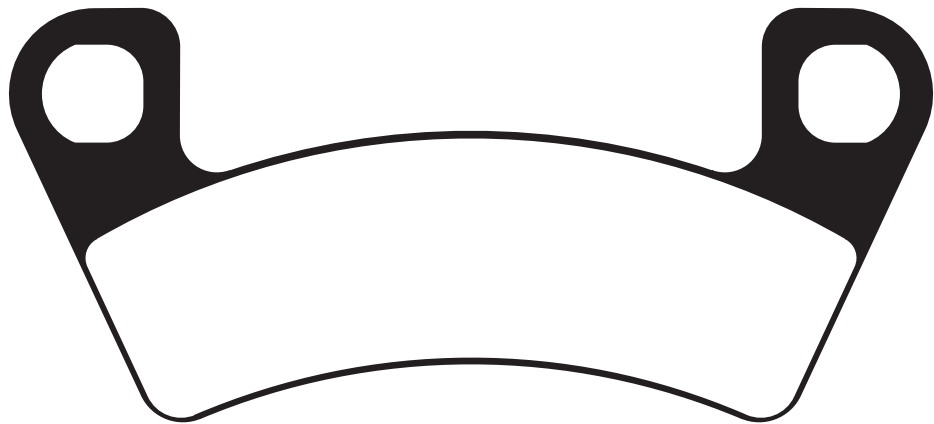

ARTIC CAT

Cushman Hauler 4X4 Diesel	19-20	F
Cushman Hauler 4X4 Crewe and EPS Diesel	19-20	F
Wildcat X,XT and LTD	19-20	F
Prowler Pro Crew and XT	19-20	F

MATERIAL AVAILABILITY AND PART NO.					
STD	OPTIONS				
FA	TT	HH	R	TT	SXR
-	-	-	FA740R	FA740TT	-

Equivalents OE #
2502-711

FA741 122.05 x 51.10 x 7.8mm

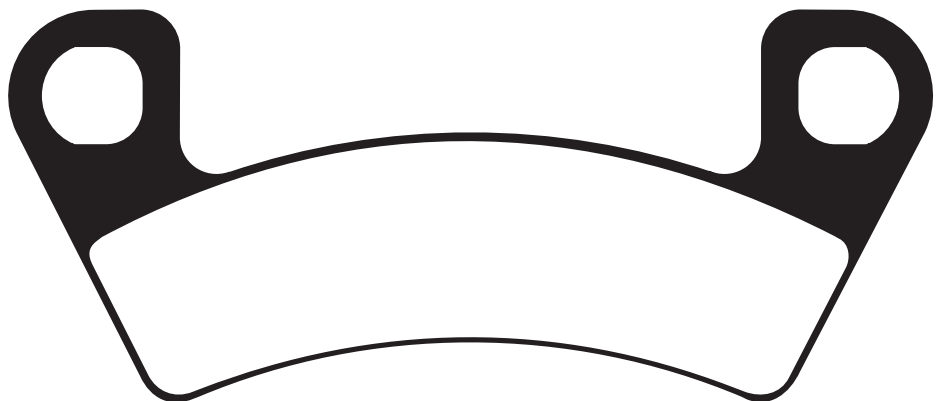

ARCTIC CAT

Wildcat Sport 700	15	F
Wildcat Sport XT 700	15	F
Wildcat Sport LTD	16	F
Wildcat Sport 700 XT Inc LTD	18-19	F
Wildcat Trail 700 XT Inc LTD	15-19	F
Stampede 900 Inc XT, XTR and LTD	17-19	F
Stampede 900 Inc 4 Inferno and TT Kanati	18	F

MATERIAL AVAILABILITY AND PART NO.					
STD	OPTIONS				
FA	TT	HH	R	TT	SXR
-	-	-	FA741R	FA741TT	-

Equivalents OE #
2502-632
2502-217

DO NOT REFIT ANY SHIMS/INSULATORS TO EBC PADS FROM ORIGINAL PADS UNLESS INSTRUCTED ON NOTE ON PAD PACKAGING AND ON FA DRAWING ASSOCIATED WITH THAT PAD.

FA742 122.15 x 48.60 x 7.8mm



ARCTIC CAT

Cushman Hauler 4X4 Diesel	19-20	R
Cushman Hauler 4X4 Crewe and EPS Diesel	19-20	R
Wildcat X,XT and LTD	19-20	R
Prowler Pro Crew and XT	19-20	R

MATERIAL AVAILABILITY AND PART NO.					
STD	OPTIONS				
FA	TT	HH	R	TT	SXR
-	-	-	FA742R	FA742TT	-

Equivalents OE #
2502-712
604092

FA743 50mmØ x 8.7mm

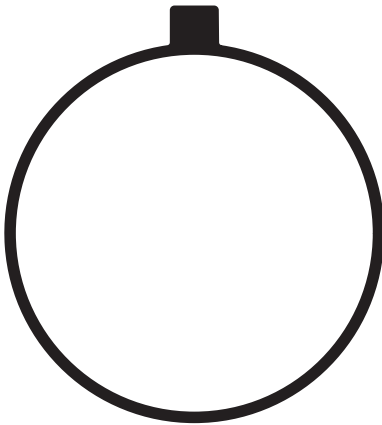

YAMAHA ROAD RACING CALIPER

TZ 350	F
--------	---

MATERIAL AVAILABILITY AND PART NO.					
STD	OPTIONS				
FA	TT	HH	R	TT	
-	-	-	-	-	GPFAX743HH

Equivalents OE #
-

DISC PADS
BUYERS GUIDE

DO NOT REFIT ANY SHIMS/INSULATORS TO EBC PADS FROM ORIGINAL PADS UNLESS INSTRUCTED ON NOTE ON PAD PACKAGING AND ON FA DRAWING ASSOCIATED WITH THAT PAD.

BRAKE SHOE BUYERS GUIDE

Part No.	Make/Model	Year		Part No.	Make/Model	Year	
H301	HONDA			H303 Contd. H303G	HONDA Contd.		
	CRF 50 F	04-20	F&R		XR 75 K4	75-78	R
	NB 50 ME Aero	84	F		XR 75 K5	79	F&R
	NB 50 MF/MG/TH 'Vision'	86-88	F		NH 80 MD-D/MD-G	83-86	F
	NE 50 MF/MG 'Vision'	86-87	F		NH 80 MDR	94-	F
	NC 50 K1/KZ 'Express'	79-82	F&R		NH 80 Lead 80	85	R
	NC 50 C 'Express 2'	82	F		C 90 (All models)	75-92	F&R
	NC 50 A/B 'Express 3 Delux'	82	F		EZ 90 'Cub'	91-95	F&R
	NP 50 D 'Melody Mini'	83	F		NH 90 M/P/R Yuppy	91-94	R
	NS 50 'Melody'/MSB 'Melody Delux'	82	F		SRX 90 Shadow T/W/X	97-99	R
	NT 50 F/G/H 'Melody Mini'	85-87	F&R		TRX 90 Fourtrax/Sportrax (all models)	93-06	F
	NX 50 A/B/MB 'Caren'	80-82	F		TRX 90 EX	07-08	F
	PC 50 K1	79	F&R		TRX 90 X9/XB/XC/	09-14	F
	QR 50 D/E/F	83-87	F		Astrea Supra NF100	99	R
	QR 50 M/R/V/W/Y	93-03	F		Astrea Grand/Supra	97-98	F&R
	XR 50 R1/R2/R3	01-03	F&R		H 100 A/SD/SG/SJ	82-92	F&R
	Z 50 R 'All models'	79-86	F&R		SH 100 T/W/X/Y/1 Scoopy	96-01	R
	HUSQVARNA				SJ 100 T 'Bali Ex'	96-99	R
	Husky Boy	00-02	F&R		CT 110 A/B/C/D/K/M	80-88	F
	Husky Boy Racing S	00	F&R		SL 125 'K1A'	76	F&R
	Husky Boy Racing J	00	F&R		CB 125 S	75-79	F&R
	SUZUKI				CG 125 K/B/C/E	77-84	F&R
	DR-Z 50	18-19	F&R		CG 125 BR-K/BR-T	85-97	R
	DR-Z 70 K8/K9/L0/L2/L4/L5/L6/L7	08-17	F&R		CH 125 D/E/G 'Spacy'	84-86	F&R
	YAMAHA				CH 125 J/L/M/N/P/R/T Spacy	88-96	F&R
	TT-R 50 E	06-15	F&R		NH 125 MD-D 'Lead'	83	F&R
					NH 125 "Lead 125"	86-87	R
					NS 125 FG/FH/RH	86-87	R
					NX 125 K/S/F Transcity	89-97	R
					Passing 125	93-97	R
					TRX 125 J	88	F
					XL 125 K3/K4	79	F
					XL 125 L Paris-Dakar	85	R
			ATC 125 ME/MG	84-85	F		
			ATC 185 A/SB	80-81	F		
			ATC 200 B/ESE/ESF/SE	81-84	F		
			XL 200 L/R	85	R		
			AEON				
			OZ 125 (4T)	13	R		
			OZ 150 (4T)	13	R		
			CO IN ECO (Electric)	13	R		
			CO IN 125 (4T)	13	R		
			ARCTIC CAT				
			150 Utility 2x4	09-18	F		
			BAOTIAN				
			BT 49 QT-7	06-07	R		
			BT 49 QT-9 (Speedy 50-4T)	10-11	R		
			BT 50 QT-11 (Retro 50-4T)	06-11	R		
			BT 49 QT-12 (Rebel-4T)	06-11	R		
			BT 49 QT-12 (Rocky-2T)	10-11	R		
			Eagle 50	10-11	R		
			CPI				
			50 Hussar	01	R		
			50 Mars	01	R		
			DAELIM				
			A-Four (50CC) (SJ 50 R)	06-09	R		
			E-Five (SJ50A)	04-06	R		
			'S' Five (SJ50)	01-12	R		
			Delfino 100 (SH100)	01-04	R		
			Otello 125 (NS 125) DLX	00-02	R		
			History 125 (SL 125) Parking brake	01-06			
			E-TON QUADS				
			CXL 150 Challenger	02-07	F		
			RXL 150 Viper R	05	F		
			RXL 150 Viper	07	F		
			YXL 150 Yukon	00-02	F		
			GOCCIA (ELECTRIC SCOOTERS)				
			E-Gora (Li/Si)	12-15	R		
			Sunday	12-15	R		
			HONLEY				
			Classic 125	16-17	F&R		
			KM				
			Badboy 50/100 CX	05	R		
			LEXMOTO				
			FMR 50 (WY50QT-58R)	15-18	R		
			Milano 50 (FT50QT-27)	16-18	R		
H302 H302G	HONDA						
	NB 50 ME 'Aero'	82	R				
	NB 50 MF/MG/TH 'Vision'	86-88	R				
	NE 50 MF/MG 'Vision'	86-87	R				
	NC 50 C 'Express 2'	82	R				
	NC 50 A/B 'Express 3 Delux'	82	R				
	ND 50 C/ML 'Melody 2 Delux'	82	R				
	NH 50 "Lead 50 SS"	84	R				
	NH 50 "Lead AF01/D716"	84-85	R				
	NP 50 D 'Melody Mini'	83	R				
	NS 50 'Melody'	82	R				
	NU 50 MC 'Runaway'	82	R				
	NV 50 MSD 'Stream'	84	F&R				
	NX 50 A/B/MB 'Caren'	80-82	R				
	NH 80 MD-D/MD-G	83-86	R				
	NH 80 Lead 80	85	R				
	PX 50	82-83	R				
	QR 50 D/E/F	83-87	R				
	BAROSSA						
	Mini 50/Python	03-05	R				
	KYMCO						
DJ 50 Refind		R					
QUADZILLA							
Buzz 50	03-06	R					
SYM							
Fiddle 50	99-05	R					
H303 H303G	HONDA						
	C 50 (All Models)	75-93	F&R				
	C 50 N (Single seat model)	95	F				
	C 50 P/S/N/X/Y/1/2	96-02	F				
	CF 50 'Chaly'	79	F&R				
	PK 50 Wallaro All models	90-01	R				
	SFX 50 S/T/N/X/Y/1	95-04	R				
	SGX 50 V/W/X/Y/1	97-03	R				
	SH 50 E/H/K/M/P/DP 'City Express'	85-96	F				
	SH 50 T 'Fifty/Scoopy W/X/Y/1'	97-03	R				
	SJ 50 P/R/S/T/V/W/X 'Bali'	93-99	R				
	SRX 50 T/W/X Joker/Shadow	97-99	R				
	SS 50 ZK2	75-77	F&R				
	SS 50 ZB2	77-80	R				
	ST 50 'Dax' J/K	78-93	F&R				
	SXR 50 W/S/X/SX	98-99	R				
	TC 50 M/P/V "Gyro Canopy"	96-00	F				
	C 70 (All models)	75-85	F&R				
	CF 70/C	77-78	F&R				
	NF 75	79	F&R				
	SA 75 Vision	89-	F				
	SH 75 Scoopy H/K/M/P/DP/S/DS	87-95	F				

Part No.	Make/Model	Year		Part No.	Make/Model	Year	
H303 Contd.	LEXMOTO Contd.			H303 Contd.	KYMCO Contd.		
H303G	Molly 50 (DFE50QT-3)	15-18	R	H303G	Calypto 50/125	99	R
	FMR 125 (WY125T-74R)	14-18	R		Dink 50 (4T)	07-14	R
	FMR 125 EFI (WY125T-74R-E4)	14-18	R		Super 9 (A/C)	00-07	R
	Milano 125 (FT125T-27)	16-18	R		Cobra Racer	00-06	R
	Tommy 125 (ZN125T-E)	11-17	R		Cobra 50 Cross	00-06	R
	MOTO ROMA				Grand Dink 50 (2T)	04-15	R
	Wasp 50	99-03	F		Grand Dink 50 S	12-13	R
	PEUGEOT				DJ 50 S	12-15	R
	Django 50 Allure (2T/4T)	14-18	R		Kymcosenti 50i	13	R
	Django 50 Heritage (2T/4T)	14-18	R		Newsento 50i	13	R
	Django 50 S (2T/4T)	14-18	R		SJ 125 S	12-13	R
	Django 50 S (2T)	14-18	R		Like 50 (2T)	09-15	R
	Django 50 S (4T)	14-18	R		Like 50 LX (4T)	09-20	R
	Blaster 50 RS12 (2T)	09-10	R		Sento 50	08-15	R
	Kisbee 50 (2T/4T)	10-14	R		Vitality 50 (2T/4T)	04-09	R
	Kisbee RS 50 (2T/4T)	10-14	R		Cobra 100 Racer	99-03	R
	Looxor 50	01-06	R		Fever ZX 50/Scout	99-03	R
	Ludix 50cc One	04-10	F&R		Dink 50/Spacer 50/Yager 50	98-06	R
	Ludix Snake 50cc	04-09	R		Dink 50 (4T)	07-12	R
	Ludix Bullet 50cc	04	R		Dink Classic Euro 2 50	03	R
	Ludix Trend 50cc	04-07	R		DJW 50 World	95-97	F
	Ludix Elegance 50c	04-09	R		DJX 50	91-92	F
	Ludix Ambition 125cc	04	R		DJY 50 Refined	93-06	F
	Ludix Classic (14" wheels)	04-05	F&R		K12 Sport 50	95-00	R
	Ludix Urban Track	06-07	R		KB 50	95-00	R
	Ludix Red Zone	06	R		Sniper 50	93	R
	Ludix Acid	06	R		CX 50	93	F
	Ludix Blaster (10" wheels)	05-09	R		Heroism 50	95-97	R
	Ludix 2 Trend 50cc (2T)	07-12	R		Grand King 125/150		F&R
	Ludix 2 Biposto 50cc (2T)	07-09	F&R		Filly 50	98-00	F&R
	Ludix 2-One Biposto (2T) (10" wheels)	10-12	F&R		Filly LX 50	00-06	R
	Ludix 2-One Monoposto (10" wheels)	10-11	F&R		KB 50 Scout	97	R
	TRK 50 (2T) (10" wheels)	09-12	R		Looping 50	98	R
	TRK 50 (2T/12" wheels)	09-12	R		Maxxer 50 (2T)	05-14	F
	New Vivacity 50 (4T)	08-11	R		MXU 50 (2T)	05-14	F
	Sixties Vivacity (Old model) 50 (4T)	10-11	R		Mxer 50/150 (Quad)	00-07	F
	Vivacity 50/100	04-07	R		Spacer 50	99-06	R
	Vivacity 2 (50cc) (10" wheels/190mm disc)	08-11	R		Top Boy 50	97-06	R
	Vivacity 50 12" wheels/190mm disc	92-07	R		Yager 50	07	R
	New Vivacity (50cc/2T)				Agility 50 Basic	07	F&R
	(12" wheels/200mm dia disc)	08-14	R		Yup 50	01-09	R
	New Vivacity Sixties (50cc/4T)				ZX 50 Super Fever/Scout	99-06	R
	(12" wheels/200mm disc)	10-14	R		Cobra 100 Racer	99-03	R
	E-Vivacity (Electric)	11-14	R		KB 100 Manboy	97-00	R
	Metal X 50	02-03	R		Top Boy 100	97	R
	SV 50 J (Front drum model)	91-95	F&R		Activ 50/110/125	04-06	R
	Elyseo 50/100	98-02	R		Visa R 50	11-15	R
	Jet Force 50 H2i (2T/Air Cooled)	11-12	R		Visa R 110	11-15	R
	V-Clic 50 (4T)	08-11	R		Agility 125 Carry (4T)	11-12	R
	SV 50/80/125	91-95	R		Heroism 125	95-99	R
	Trekker 50 (2T) AJP Caliper	98-00	R		Visa R 125	11-15	R
	Trekker 50 (2T) Heng Tong Caliper	98-00	R		MXU 150 Quad	05-12	F
	Tweet 50	10	R		LIFAN		
	Trekker 100 (2T)	98	R		LF 50 QGY		R
	TRK2 WRC 50 (2T)	04-06	R		LF 50 QGY 1/2		F&R
	Buxy/M/RM	94-97	R		MASH		
	Speedake	95-97	R		Scrambler 125	14-16	R
	Speedfight 3 50cc (AC)	09-14	R		Seventy 125	14-16	R
	Speedfight 3 (A/C-4T)	09-14	R		NIPPONIA		
	Streetzone 12 (50"/2T)	14	R		Miro 125 (4T)	14-15	R
	Squab	95-97	R		SINNIS		
	Zenith LS	96-99	R		WY 50 QT-39A Ghost	06-10	R
	Zenith M/N	96-00	F&R		Falcon 50 QM 50 QT-2T	08-10	R
	Vivacity 50/100 (All models)	99-07	R		Jet 50 QM 50 QT-6A	08-10	R
	SV 100 L		R		LJ 50 QT-H Phoenix 50		
	Fox/Fox L 50	94-98	F&R		(Rear drum model)		R
	V-Clic 50 (4T)	08-11	R		ZN 50 QT-51 Flair 50	12-14	R
	E-Vivacity (Electric)	11	R		ZN 50 QT-30A Strada 50	12-14	
	Ludix Pro (14" wheels/4T)	11	R		SUPERBYKE		
	Vox 110	12-13	R		SB 125-4		R
	KYMCO				SYM		
	Active SR 50cc	08-11	R		E-Virid (Electric) Deluxe	12-15	R
	Agility 50	05-08	R		E-Virid (Electric)	12-15	F&R
	Agility 50 Carry (4T)	11-15	R		Orbit II 50 Naked (4T)	12-15	R
	Agility 50 R10 (4T)	06-14	R		Cinderella 50/100	99-00	R
	Agility 50 R12 (4T)	06-15	R		Red Devil	99-09	R
	Agility RS 50 Naked (2T/12" wheels)	10-15	R		Jungle 50	99-02	R
	Bet & Win 50/Dink Sports 50	02-06	R		Jet Sport 50	14-15	R

Part No.	Make/Model	Year		Part No.	Make/Model	Year	
H303 Contd. H303G	SYM Contd.			H304 Contd. H304G	HONDA Contd.		
	Jet Sport 50 S	14-15	R		MTX 125 RWE/RWF/RWH/RWL	85-95	R
	Jet 4 (50cc 4T)	10-15	R		SL 125 K1D/E/F/G/K2A	76-80	F&R
	Jet 4 R 50 (2T)	11-15	R		TL 125	76	F&R
	Jet 4 R Naked (50/4T)	13-15	R		XL 125 K2	78	F&R
	Jet 50/Euro XS	99-05	R		XL 125 K3/K4	79	R
	Jet 50 Basix 50	06-09	R		XL 125 SZ/SA/SB/SC/RC	79-82	F&R
	Jet Euro X 50	06-14	R		XL 125 RF/RH	85-86	R
	Jet Evo 50 (2T)	13-15	R		XLR 125 RW	98-99	R
	Mio 50	05-15	R		XR 125 L3/L4/L5/L6/L7/L8	03-08	R
	Fiddle 50	99-05	F		CRF 150 F	03-20	R
	Fiddle II 50	08-15	R		XL 185 SZ/SA/SB	80-82	F&R
	Fiddle III 50 (4T)	14-15	R		CTX 200/CTA 200 A Bushlander	04-16	R
	City Hopper 50	99-02	R		MTX 200 RWD	83-84	F&R
	Mask 50	00-05	R		MTX 200 RWF	85	R
	Orbit 50	08-09	R		TL 200 J/Y 'Colin Seeley'	76-78	F&R
	Orbit II 50 (4T)	12-15	R		TLR 200 G/H	86-87	F
	Orbit II 50 Naked (4T)	12-15	R		XR 200 R	81-02	F&R
	Orbit II 50 TS (4T)	12-15	R		XR 200	80-84	F&R
	Super Fancy 50	96-02	R		TLM 220 R	88-92	R
	Simply 50	07-08	R		CRF 230 F	04-20	R
	Symply II 50	09-14	R		CBX 250	84-98	R
	Tonik 50 (4T)	11-15	R		RTL 250 SG	86	F&R
	X-Pro 50	13-15	R		TL 250 K1	79	F&R
	Jet 100 (G100P-6)	99-00	R		TLM 250 RJ	89	F&R
	Mio 100	05-15	R		TLR 250 F	85	F&R
	Symba 100	11-12	F&R		XR 250 RE/RF/RG/RH/RJ/RK	84-89	R
	Evie (Electric Scooter)	10	F&R		XR 350 RD/RE	83-84	R
	Symmetry-Electric	11	F&R		XR 500 RD/RE	84-85	R
	E W00 Elettrico	11	R		XR 600 RF/RG/RH/RJ/RK/RL	85-90	R
	Orbit 11/Symply 125 (4T)	09-14	R		HARTFORD		
	TAMORETTI				VR 125 Z Velo Sport	00-03	R
	Retro 50		R		VR 125 X/H Velo Cross	00-03	R
Retro 125		R	HONDA HM (ITALY)				
			CRF 230 F Easy Trial (All models)	04-07	R		
			HONGDOU				
			GY 125	06-08	R		
			LIFAN				
			LF 50 QGY		R		
			LF 50 QGY 1/2		F&R		
			Smart 50/125		R		
			LF 100 A		R		
H304 H304G	HONDA			H306 H306G	HONDA		
	C 50 N (Single seat model)	95	R		TRX 90 Fourtrax/Sportrax (All models)	93-06	R
	C 50 P/S/V/X/Y/1/2 (Single seat)	96-02	R		TRX 90 EX	07-08	R
	CB 50 J	81	R		TRX 90 X9/XB/XC	09-14	R
	CD 50 ST/SV/SW/SX Benley 50 S	96-99	F&R		ATC 110 (All models)	79-84	R
	CL 50 V/X Benley CL50	97-99	R		CRF 110 FD/FE/FF/FG/FH/FJ/FK	13-19	F&R
	CRM 50 RN/RP/RR/RT	93-96	R		TRX 125 J	88	R
	MB 5 S	80-82	R		ATC 125 ME/MG	84-85	R
	MBX 50 SD/SF	83-85	R		Wolf 125/150 Scooter	00	F
	MG 50 S/X/1/3 Magna 50	95-03	R		CD 175 (All models)	67-79	F
	MP 50 3/DX3 (AC17) Solo	03	F&R		ATC 185 A/SB	80-81	R
	MRX 50	88-	R		ATC 200 B/ESE/ESF/SE	81-84	R
	MT 50 SA/SE/SG/SJ/SL	80-93	F&R		TRX 200 L/M/DM/DN	90-93	R
	MTX 50 SC	83-84	F&R		TRX 200 D	91-97	R
	NSR 50 FP/FR/FS	93-95	R		TRX 200 L/M Fourtrax	90-91	R
	NSR 50 SK/SP/SR/SS	89-95	R		TRX 200 SX	86-87	R
	TC 50 Y/2 Gyro Canopy	00-02	F		ATC 250 RB/RC	81-82	R
	XZ 50 1/2 APE-AC16	01-02	F&R		ATC 250 ESF/ESG/ESH/ESJ	85-88	F
	CRM 75 RK/RL/RM/RP/RR	89-94	R		FL 250 Odyssey	77-84	R
	XR 75 K4	75-78	F&R		KEEWAY		
	CR 80 RA/RB	80-81	F&R		Goccia 50 (2T/4T)	08-14	R
	CR 80 RC	82	F		POLARIS		
	CR 80 R2F/R2G	85-86	F&R		200 Phoenix (AA/AB Model /rear drum model)	05	R
	MB 80 (MB8)	80-	R		200 Phoenix (AC/AD Model and following/rear drum model)	06-09	R
	MBX 80 FWDD/FEDF	83-86	R		200 Phoenix (Rear drum model)	10-14	R
	MCX 80	82-	R		200 Sawtooth (Rear drum model)	06-08	R
	MTX 80 RFD/RFF	83-84	F&R				
	NSR 80	86	R		H307 H307G		
	XR 80 Z/A/B	80-81	F&R		HONDA		
	C 90 All models	93-03	F&R		Wolf 125/150 Scooter	00	R
	CB 100 N	78-80	R		CD 175 (All models)	67-79	R
	XL 100 (All Models)	78-82	F&R		APACHE		
	XZ 100 2 APE-HC07	02	F&R		Mini Tomahawk 50 (4T)	08-09	R
	CT 1100 A/B/C/D/K/M	80-88	R		ARCTIC CAT		
	CT 110 X	05-09	F		50 Y-6 Youths (2x4)	04-05	F
	CB 125 J	79	R				
	CBX 125 Custom	88-	R				
	CG 125 S/T/W/M1	98-02	R				
	CLR 125 W 'City Fly'	98-02	R				
	CLR 125 X/W/Y	99-	R				
	CR 125 M2/M4	76-78	F&R				
CT 125 C	85	F&R					
MBX 125 FE	84-86	R					
MTX 125 RWD	83-84	F&R					

Part No.	Make/Model	Year		Part No.	Make/Model	Year		
H307 Contd. H307G	ARCTIC CAT Contd.			H310 H310G Contd	HONDA Contd			
	90 Y-12 Youths (2T & 4T Models)	02-05	F		CD 185 T	78	R	
	90 2x4 (4T) Youth				CD 200 TA/TB	79-80	R	
	Rear Drum Model	04-05	R		CM 200 TA/TB	79-80	R	
	90 2x4 (2T) Youth	02-04	R		CD 250 UJ	89-92	R	
	CAN-AM				CB 250 N/T/W/X/Y/1/4 'Two fifty'	92-05	R	
	DS 70	08-15	R		DAELIM			
	DS 90 (2X4/4T)	07-15	R		VL 125/L Daystar	03-14	R	
	KYMCO				VS 125 Evolution R	01-04	R	
	Maxxer 50 (2T)	05-14	R		KYMCO			
	CK 1 125 (4T/KT25AA)	14-15	R		CK 125 Pulsar	99-00	R	
	CK 125 Pulsar 11 (KE25RF)	08-10	R		SYM			
	CK 125 Pulsar S	11-15	R		XS 125 K	07-15	R	
	PEUGEOT				SINNIS			
	New Tweet Evo 50 (4T/Rear drum model)	14-18	R		QM125 GY-2XR Retro Star 125	12-14	R	
	Kisbee 100 (4T)	12-15	R		QM125 GY-2X Cafe 125	12-14	R	
	Streetzone 100 (4T)	14-15	R		Trackstar 125 (4T)	10-12	R	
	POLARIS							
	50 Outlaw	08-14	R		H311	HONDA		
	Predator 50 (2 stroke)	04-06	R		H311G	XL 250 K3/K4	78-79	F
	Scrambler 50	01-03	R					
	90 Outlaw	07-14	R		H312	HONDA		
	Predator 90	03-06	R		H312G	CD 125 TC	78	F
	Scrambler 90 X	01-03	R			CM 125 CC/CF	82-85	F
	Sportsman 90	01-14	R			CD 185 T	78	F
	QUADZILLA					CD 200 TA/TB	79-80	F
	4-Cross 200cc		F			CM 200 TA/TB	79-80	F
	ROXON					CL 250 SC	81	F
	Fox 50 (Quad)	04-06	R			XL 250 S/SZ/SA/SB	78-82	F
	SYM					XR 250 SZ/SA	79-80	F
	X'Pro 50	13-15	R			XL 250 K3/K4	78-79	R
	Symphony 50 (4T)	09-10	R			XL 500 SZ	80	F
	Tonik 110 (4T)	11-13	R					
	Fiddle II 125	08-15	R		H313	HONDA		
	Fiddle III 125 (4T)	14-15	R			CB 250 T/N/NA/NB/ND/NDB/NDC	78-82	R
	Jet 4 (125cc 4T)	10-15	R			CM 250 TB	81	R
	Simply 125	07-08	R			CB 350 SG/SJ	86-90	R
	Symphy II 125	09-13	R			CB 400 A 'Honda-matic'	79	R
	Symphony 125 (4T)	09	R			CB 400 T	78	R
	125 Attila	99-00	R			CB 400 N/NA/NB/NC	78-82	R
	Super Duke 125/150	99-02	R			CB 450 SG/SJ	86-88	R
	X'Pro 125	11-15	R			CMX 450 CH/CJ Rebel	87-88	R
	Jet 4 150cc	13-15	R			VT 500 ED/EF	83-85	R
	Fiddle II 151	08-15	R					
	TAMORETTI					H314	HONDA	
	Stealth 125		R			CB 250 K3-K5	73-75	F
	TOMOS					CB 350 K4	74	F
Twister 50		R		SL 350 K0	69-70	F		
Twister 125		R						
YAMAHA				H315	HONDA			
YFM 09 RYXG/H (Raptor)	16-18	R		H315G	ATC 250 ESF/ESG/ESH/ESJ	85-88	R	
YFZ 50 Y	17-18	R		CB 250 K3-K5	73-75	R		
				CB 250 G5	75	R		
H308	HONDA			CJ 250 T	77	R		
CB 125 K1 to K5	72-76	F		MXV 250 F (MC92)	83-88	R		
CB 175 (All models)	74-76	F		TRX 250 F/G/H	85-87	R		
SL 350 K1/K2	70-73	F		TRX 300 FWJ/K/L/T/N/W/X/Y	88-00	R		
				TRX 300 J/K/L/T/N/W/X	88-99	R		
H309	HONDA			CB 350 K4	74	R		
CB 175 (All models)	74-76	R		SL 350 K0	69-70	R		
CB 200 B	76-79	R		CB 360 G5	75	R		
CB 250 RSA/RSD	81-84	R		CJ 360 T	78	R		
CL 250 SC	81	R		CB 400 F/F1/F2	75-79	R		
CBR 250 FG/FGYA (MC14)	86	R						
VT 250 FD	83	R		H316	HONDA			
VTZ 250 H/J/K	86-88	R		CB 500 T	75-77	R		
SL 350 K1/K2	70-73	R		CB 500 K1/K2/F	75-77	R		
XL 500 SB	81	R		CB 550 F/F1/F2/K3	78-80	R		
H310 H310G	HONDA			H318 H318G	HONDA			
ATC 70 (All models)	78-85	R		CA 125 S/T/N/W/X/1	95-01	R		
CB 125 K1 to K5	72-76	R		CBX 125 F	84-	R		
CB 125 K6/S2	76	R		NES 125 Y (@ 125 Scooter)	00-01	R		
CB 125 T/T2	78-79	R		VT 125 CX-C8 'Shadow'	99-08	R		
CB 125 RS	83	R		XL 250 SB	82	R		
CB 125 TDC/TDE/TDJ	83-89	R		CBX 250 RSE	84	R		
CBX 125 TS Custom	82-	R		CMX 250 CT/CV/CW/CX 'Rebel'	96-00	R		
CD 125 TC	78	R		GB 250 E/H Clubman	84-87	R		
CM 125 CC/CF	82-85	R		GB 250 J/L/P/S/V "Clubman"	88-97	R		

Part No.	Make/Model	Year		Part No.	Make/Model	Year										
H318 H318G Contd	HONDA Contd. XL 400 R XL 500 SZ XL 500 RC XR 500 SZ/SA XR 500 RB XL 600 RD/LD/RE/LE/RF/RG/RH XL 600 LMF/RMG/LMH XL 600 VH/VJ/VK 'Transalp'	82	R	H322 Contd. PUCH Contd. Maxi S 50 Sport Cast Wheel With Screwed In Hub/ 1 Speed Automatic Maxi 50 Super Cast Wheel With Screwed In Hub/ 2 Speed Automatic			F&R									
		80	R													
		82	R													
		79-80	R													
		81	R													
		83-87	R													
85-87	R		F&R													
87-90	R															
H319 H319G	HONDA CR 125 RC CR 450 RB			82	F	H323 H323G HONDA NX 250 J/K/L/M/P/2P XL 250 Degree (MD26) XL 250 S/SZ/SA XL 250 RC XL 250 RE/RF XLR 250 Baja MK1 (MD22) XR 250 SZ/SA XR 250 RB/RC/RD		87-93	R							
				81	R			78-81	R							
H320	HONDA CB 650 Z/B CB 650 SCC 'Night Hawk' CB 750 KO-K6 CB 750 K7 CB 750 KZ			79-81	R	H324 H324G HONDA CR 125 RZ/RA/RB CR 250 RZ/RA XR 500 SZ/SA		82	R							
				82	R			82	R							
		69-77	R	84-85	R											
		78	R	79-80	R											
		80	R	81-83	R											
H321	HONDA VT 250 CR/CT/CV "Magna" NV 400 C/J/CK "Steed" NV 400 CS/CV Steed CB 500 R/T CX 500 CA/CB/Z/A/B CX 500 CC GL 500 DC VT 600 CN/CR/CS/CT/CV/CW Shadow Custom GL 650 D2-E VF 750 SC (V45 Sabre) KYMC Venox 250 (R 20010/RA50AA /Carb Model) Venox 250 (RFBR20011/ RA50AD/Carb Model) Venox 250 (R20012/ EFI Model)	95-97	R	H325 H325G HONDA CR 250 RZ/RA XL 500 SB		79-80	92-93	R								
		95-97	R				81	R								
		94-96	R				H327 H327G HONDA CR 250 RB XR 250 RB/RC/RD CR 450 RB CR 480 RC XR 500 RB	81-83	F	F						
		79-81	R													
		82	R													
		82	R													
		82	R													
		93-99	R				H328 H328G HONDA CR 250 RC/RD CR 480 RD	82-83	F	F						
		84	R													
		82	R													
		00-03	R				H330 H330G HONDA CG 125 BR-K/BR-T/95/ S/T/W/M1/1 CR 125 RZ/RA/RB/RC CR 250 RB XL 250 RC XL 250 RE/RF CR 480 RC CAN AM DS 90 Mini 4 stroke (3C7A) DERBI DFW 50 Quad KAZUMA Falcon 110 Quad LAVERDA Quasar 50/100 Quasar 50 Quasar 100 MOTO ROMA Sport 90 Quad Blazer 50/100/110 Quad Quad Roadrunner 100 E-TON IXL 40 Rascal RXL-40E Viper Junior Viper 40 E CXL 50 Challenger DXL-90 Sierra AXL 90 Thunder NXL 90 Thunder YXL 150 Yukon Viper EXL 150 ST Quad EXL 150 Yukon ST BOMBARDIER DS 50 (2 stroke) Quest 50 DS 90 (2 stroke/4 stroke) Quest 90 (2 stroke/4 stroke)	85-03	F	79-82	F					
04-06	R	H331 H331G HONDA CR 125 RD	83	F&R												
07-14	R															
H322	HONDA PA 50 Camino (Spoke wheel) PF 50 M 'Novio PX 50 KREIDLER 50 MF2 50 MF4 later models 50 Flory MF 20/22 50 MP1 later models KTM 50 SX/SXR Pro Junior/Senior /Adventure 50 SX Mini Adventure 50 SX Pro Senior LC 50 SX Pro Senior LC 50 SX Senior Adventure MOTOBECANE 50 all mod. Atom hub 50 all mod. Leleu hub 51 VLM PEUGEOT Most Mofas/Mopeds 103 Pro, SP 3 PUCH Maxi 50 (N/NK) Spoke wheels 1 Speed Automatic Solid Rear Frame Maxi 50 (SW/SKW) Spoke Wheels/1 Speed Automatic With Rear Suspension Maxi 50 (Spoke Wheels /2 Speed Automatic With Rear Suspension Maxi 50 Executive Cast Wheel With Screwed In Hub/1 Speed Automatic				79-86	F&R						H332 H332G HONDA CR 125 RD		83	75	F&R
					82-84	F									81	R
						F&R									82	F
						F&R									84-85	F
						F&R									82	R
						F&R									07-11	R
						F&R									04-05	R
						F&R										R
						F&R	04	R								
			F&R	02-04	R											
			F&R	02-04	R											
			F	01-03	R											
			F	99-04	R											
			R	04	R											
			F&R	98-01	R											
			F&R	01-06	R											
			F&R	99-00	R											
			F&R	02-07	R											
			F&R	99-03	R											
			F&R	99-00	R											
			F&R	01-02	R											
			F&R	00-02	R											
			F&R	05-07	R											
			F&R	05-07	R											
			F&R	02-04	R											
			F&R	03-04	R											
	F&R	02-04	R													
	F&R	03-04	R													

Part No.	Make/Model	Year		Part No.	Make/Model	Year	
H351	HONDA Contd.			H352 Contd.	HONDA Contd.		
H351G	CL 400 (NC38)	98-03	R		CBF 150 M7/M9/MA Unicorn (Cast Wheels)	07-10	R
Contd.	TRX 400 FWS/T/V/W/X/Y	95-	R		CG 150 ESD Titan	04-05	R
	TRX 400 FA4/5/6/7 Fourtrax AT	04-07	F		CG 150 KS/ES Titan	04-05	R
	TRX 400 FGA4/5/6/7 Fourtrax Rancher AT Gscape	04-07	F		NES 150 Y/1-6 @150 Scooter	01-06	R
	TRX 420 FE7/FE8/FE9/FEA/FEB 4WD - Fourtrax ES	07-11	R		PCX 150 (WW 150 EX2)	12-20	R
	TRX 420 FM7/FM8/FM9/FMA /FMB 4WD - Fourtrax	07-11	R		PCX 150 ABS (WW 150)	18-20	R
	TRX 420 FPM9/FPMA/FPMB Fourtrax - 4WW - Power Steering	09-11	R		PES 150 6/7/8/9 (PS 150 A)	06-10	R
	TRX 420 TE7/TE8/TE9 Fourtrax ES - 2WD	07-09	R		PES 150 R8/R9 RA (PS 150) ABS	08-12	R
	TRX 420 TM7/TM8/TM9	07-08	R		SH 150 1/3/4/5/6/7i/8i/9	01-09	R
	TRX 420 TM7/TM8/TM9/TMA /TMB Fourtrax 2WD	07-11	R		SH 150 1/3 Carb/Rear Drum Model	01-03	R
	TRX 450 ESW/ESX/ESY/ES1	98-01	R		SH 150i 4/5/6/7/8 Fuel Injection (Rear drum model)	04-08	R
	MASH				SH 150i D9 Fuel Injection (Rear drum model)	09	R
	400 Roadstar (Five Hundred)	14-18	R		SH 150i R8 Fuel Injection (Rear drum model)	08	R
	PEUGEOT				SH 150i S7/S8 Fuel Injection (Rear drum model)	07-08	R
	SV 250	01-02	R		CBX 200 Strada	97-01	R
					FTR 223 Y/2/A2 (MC34)	00-02	R
					XL 230 2 (MC36)	02	F&R
					CBF 250 4/7	04-07	R
					CBX 250 Twister		R
					XR 250 Tornado	05	R
					CB 300 R10	10	R
					HERO		
					Pleasure 102	11-12	F&R
					Glamour 125 (PGM F1)	11-12	R
					Hunk 150	11-12	R
					Super Splendor 125	11-12	F&R
H352	HONDA			H353	HONDA		
	NSC 50 WHC/T2E/F Vision 50 (4T) (16" wheels)	12-16	R		NCX 50 E/G/J - Dunk 50	14-17	R
	NSC 50 MPDC/E/F/G/H/J Vision 50 (4T) (14" wheels)	12-18	R		AFS 110 2SHC/CSFF Wave	12-16	R
	NSC 50 R (14" wheels)	13-16	R		ANF 125-3/5/T5/T6/6/7/8 Innova	03-11	R
	SCV 100-3/F5/F9 Lead	03-09	F&R		CG 125 Job	05	R
	ACB 110 CBB/CSB - Vario 110	10	R		NXR 125 Bros ES/KS	05	R
	ACD 110 CSB/SCB - Scoopy 110 Fi	11-16	R		HERO		
	ACC 110 SCB/SCC - ANC 110 Icon	11-12	R		Splendor 100 NXG	11-12	F&R
	CT 110 X	05-09	R		Splendor Pro 100	11-12	F&R
	NSC 110 AC-Vision 110 (4T)	12	R		PEUGEOT		
	NSC 110 CSD/CSE - Spacy 110	12-14	R		E-Vivacity (Electric)	11-15	R
	NSC 1110 CBFF/CBFH - Dio 110	15-17	R		Kisbee 50 (2T/4T)	10-19	R
	NSC 110 WHB/E-Vision 110 (4T)	11-16	R		Kisbee RS 50 (2T/4T)	10-19	R
	NSC 110 MPDC/E "Vision" (16" Wheels)	12-14	R		Streetzone 50 (2T)	14-18	R
	NSC 110 MPDH Vision (16 Inch Wheels)	17-18	R		New Vivacity (50cc/2T)		
	SCV 110 Lead (NHX 110 WH8 - 3 bolt disc fixing)	08-09	R		(12" wheels/200mm dia disc)	08-15	R
	SCV 110 Lead (NHX 110 WHA - 4 bolt disc fixing)	10-11	R		New Vivacity Sixties (50cc/4T)		
	ACA 125 CBFE - Air Blade 125	14-16	R		(12" wheels/200mm disc)	10-15	R
	CB 125 F (GLR 125 1WHF)	15-16	R		Speedfight 3 (A/C-2T)	09-15	R
	CB 125 F (GLR 125 1WHH)	17-18	R		Speedfight 3 Darkside (A/C-2T)	14-15	R
	CBF 125 6 Stunner	06	R		Speedfight 3 Iceblade (A/C-2T)	14-15	R
	CBF 125 M7 Stunner	07	R		Streetzone 12 (50"/2T)	14-18	R
	CBF 125 M9/MA/MB/MD/ME	09-17	R		Speedfight 4 Classic (A/C-2T & 4T)	15-19	R
	CG 125 Cargo	09-10	F&R		Speedfight 4 Darkside (A/C-2T & 4T)	14-18	R
	CG 125-ES4-ES8	04-08	R		Speedfight 4 Iceblade (A/C-2T & 4T)	14-18	R
	CG 125 Job	05	F		Speedfight 4 Pure (A/C-2T & 4T)	14-18	R
	SH 125 1/3/4/5/6i/7i/8i/9	01-09	R		Speedfight 4 20 Ans Edition (50cc/AC/2T)	18	R
	NES 125 Y/1-6 @ 125 Scooter	00-06	R		SUZUKI		
	NXR 125 Bros ES/KS	05	F		FL 125 SDWK7/SDWK9 Address /Underbone	07-10	R
	PCX 125 (WW125EX2)	12-20	R				
	PCX 125	18-20	R				
	PES 125 6/7/8/9/A (PS 125)	06-10	R				
	PES 125 R8/R9/RA (PS 125)	08-12	R				
	SES 125/150 2/3/4 Dylan	02-07	R				
	SH 125 1/3 Carb/Rear Drum Model	01-03	R				
	SH 125i 4/5/6/7/8 Fuel Injection (Rear drum model)	04-08	R				
	SH 125i D9 Fuel Injection (Rear drum model)	09	R	Y501	YAMAHA		
	SH 125i R8 Fuel Injection (Rear drum model)	08	R		CG 50 'Jog'	88-92	F
	SH 125i S7/S8 Fuel Injection (Rear drum model)	07-08	R		CA 50 'Salient'	83-85	F
	SH 125i Mode (ANC 125 E)	14-18	R		MA 50 M 'QT50'	80-86	F&R
	Super Cub C 125 (ABS)	18-20	R		MJ 50 M 'Towny'	82	F&R
	Super Cub C 125 (ABS) 007	18-20	R		MS 50	85-86	F
	CBF 150 5	05	R		PW 50 H/J/K/S/U/90/93-18	80-18	F&R
	CBF 150 M5 Unicorn	05	R		SA 50 M/ME 'Passola'	80-84	F
	CBF 150 6 (Spoke Wheels)	06	R		QT 50	93	F&R
	CBF 150 M6/M7 Unicorn (Spoke Wheels)	06-07	R	Y502	SUZUKI		
				Y502G	RM 80 XZ/XD/XE/XF/XG/XH/XJ/XK	81-89	R
					YAMAHA		
					YZ 50 G/H/J/K	80-83	F&R

Part No.	Make/Model	Year		Part No.	Make/Model	Year	
Y503 Contd.	GENERIC/KSR			Y503 Contd.	MBK Contd.		
Y503G	Jump 50 (2T)	12-18	R	Y503G	YH 50 'Flipper'	98-10	R
	Race 2 50 (2T/4T)	10-14	R		YM 50 Fizz	94-95	R
	Roc 50	08-11	R		YN 50 Ovetto (4T)	09-10	R
	Sirion 50 (2T/4T)	12-18	R		YN 50 R Ovetto (2T)	98-10	R
	Toxic 50 Sport	12-18	R		CV 80 Evolis	97	R
	Vertigo 50 (4T)	12-14	R		XC 125 Flame 125	96-03	R
	Race 2 125 (4T)	10-14	R		XC 125 T Flame	95-96	R
	Sirion 125 (4T/Rear Drum Model)	12-18	R		MOTO ROMA		
	Vertigo 125 (4T)	12-18	R		G10 (50cc/2T)	11-12	R
	HERCULES (SACHS)				Go-Go 50	97-05	R
	80 CV		F&R		Stinger 50	99-05	R
	JORDAN				Wasp 50	99-05	R
	Easy 50/100	03-04	R		Grand Prix 50/110	99-03	R
	KEEWAY				Roadrunner 50/100	01-02	R
	Agora 50 (4T)	10-15	R		Scrambler 50	01	R
	ARN 50 (25/45)	10-11	R		Lambros 125 (4T)	11-12	R
	Flash 50 Electric	09-10	R		MUZ		
	Goccia 50 (2T/4T)	08-15	R		Moskito FB 50	97-03	R
	Hurricane 50	07-14	R		Moskito SX UP50	00-03	R
	Hurricane 50-Base	07	R		POLARIS		
	RY6 50 (25/45)	10-14	R		250 Cyclone X	87	F
	RY8 (50 All models)	07-09	R		Scrambler (3 wheeler)	85-86	F
	RY8 SP 50 (25/45)	10-11	R		Trail Boss 2x4	85-87	F
	Focus 50	06-09	R		QUADZILLA		
	Matrix 50	06-12	R		Black Max M100 (SE)	06	F
	Easy Hurricane 50 (25/45)	07-12	R		Pro Shark (Double A Arms)		F
	F-Act 50	07-10	R		X 100 E (XLC)	06	F
	F-Act 50 RS	10-11	R		Pro Shark	06	F
	F-Act Evo 50 City (2T)	09-15	R		Pro Shark 100 R MX	07	F
	F-Act-NKD 50	09-11	R		Stinger R 170 E	06	F
	F-Act Racing 50 (25/45)	10-12	R		ST 200 E (Automatic)	06	F
	Flash 50	07-10	R		PGO		
	Hacker 50	08-09	R		My Bubú 50	03	R
	Pixel 50	08-12	R		WK BIKES		
	Swan 50 (25/45)	10-11	R		Bellisimo 50 (4T)	13-15	R
	50 Zahara (2T/4T)	13-14	R		Mii 50 (4T)	13-15	R
	F-Act 100	08-10	R		WK One 50 (2T)	10-11	R
	Matrix Electric	09-10	R		WK GP2 (50/2T)	10-13	R
	Matrix V4 50 (25/50)	10-11	R		WK GO 50 (4T)	11-15	R
	Matrix 50	06-11	R		Bellisimo 125 (4T)	13-15	R
	ARN 125	06-12	R				
	F-Act 125	07-11	R	Y504	CPI		
	125 Zahara (2T/4T)	13-14	R	Y504G	Popcorn 50	03-06	R
	KREIDLER				YAMAHA		
	50 Flory Classic (50CC/4T/A-C)	14-15	R		DT 50 M/MX	78-86	F&R
	50 Florett City (50cc/2T/A-C)	14-15	R		FS1E	74-76	F&R
	50 Florett 2.1 RS (50cc/2T/A-C)	14-15	R		FS1E 'DX'	77-79	R
	MALAGUTI				FS1 'DX'	79-80	R
	Malbo Line - DVD 50 (2T)	10-11	R		FS1 'SE'	81-82	F&R
	MBK				RD 50 M	78-80	R
	CR 50 Z Target	91-95	R		RD 50 MX/RD 50 M	81-87	R
	CS 50 Mach G AC (Air cooled)	02-05	R		TY 50/50 M	77-80	F&R
	CS 50 Mach G LC				V 50 M/P	74-82	F&R
	(Liquid Cooled)	03-05	R		V 70 A	76	F&R
	CT 50 S 50RR 150	91-92	F&R		V 75 A	77	F&R
	CT 50 SS Sorriso	93-95	F&R		DT 80 MX	81-83	F&R
	CV 50 Evolis	97	R		LB 2/80 'Bop 2'	80	F&R
	CW 50 Booster Naked				RD 80 (Air Cooled) (LC)	82	R
	(10" wheels)	06-10	R		TY 80	77	R
	CW 50 Booster 10" wheels	09-10	R		V 80	79-82	F&R
	CW 50 RS 'Booster' 'Spirit'	99-06	R		YZ 80 D/E/F	77-79	R
	CW 50 RSP "Rocket"	97-98	R		V 90	78	F&R
	CW 50 Fizz 50	93-97	R		DT 100	76-80	F
	CW 50 RS Booster NG	95-06	R		RS 100	75-80	F&R
	CW 50 RSX Booster Track	96-98	R		RS 100 (IY8 Europe)	77-78	R
	CW 50 Booster	90-91	F&R		RS 100 (IY8 Europe)	80-82	R
	CW 50 Booster	92-94	F&R		RS 100 (IY9 UK)	79-81	F&R
	CW 50 Booster (12" wheels)	06-10	R		RS 100 DX	77-80	R
	CW 50 Power Rocket	06	R		RS 100 DX (IY8 Europe)	79	R
	CW 50 Booster Spirit	96-98	R		RS 100 S (IY8 UK)	77-78	F
	CW 50 Booster Spirit	09	R		YB 100	78-81	F&R
	CW 50 Naked Booster 12" wheels	09-10	R		YB 100	82-86	F
	CY 50 Forte/Forte Mufa	96-97	R		YZ 100 E/F/G/H	78-81	F
	EW 50 'Stunt'	00-06	R		IT 125 G/H/J	80-82	F
	EW 50 Stunt Naked	05-10	R		TY 125	82	F
	YA 50 R Forte	94-95	R		TY 175	77-80	F
	YA 50 TA Sorriso	95-96	F&R		TY 250 D/E	77-78	F
	YE 50 Evolis	92-95	R		TY 250 S/R	84-92	R

Part No.	Make/Model	Year		Part No.	Make/Model	Year		
Y506 Y506G	YAMAHA			Y507	YAMAHA Contd.			
	DT 80 LC (37A)	81-84	R	Y507G	YN 125 T-30A Strada 125		R	
	DT 80 LC-2 (53V)	85-92	R	Contd.	ZN 125 T-22 Harrier 125	12-14	R	
	YFM 80 S	87	R		YZ 125 C/D/E/F/G/H/J/K	76-83	F	
	DT 100	76-80	R		IT 175 G/H/J	80-82	F	
	YZ 100 E/F/G/H/J/K	78-83	R		IT 250 G/H/J	80-82	F	
	AS3 125	71-72	R		TY 250 H	81	F	
	BL 125	85	R		YZ 250 D/E/F/G	76-80	F	
	DT 125 E/MX/LC	74-85	F&R		YZ 400 D/E/F	77-79	F	
	DT 125 LC	86-87	R		IT 425 G	80	F	
	IT 125 G/H/J	80-82	R		IT 500 G/H	80-81	F	
	RD 125	73-74	R					
	RD 125 DX	75-77	R		Y508	YAMAHA		
	RD 125 LC (All models)	82-87	R		Y508G	YZ 125 L	84	F
	RS 125/125 DX	75-81	R			YZ 250 J/K/L	81-84	F
	RZ 125 (1GV 030101-)	85	R			IT 250 L	84	F
	SR 125 SE	82	F			IT 465 H/J	81-82	F
	TY 125	82	F&R			YZ 465 G/H	80-81	F
	SR 125 (3MW2)	89-91	F			IT 490 L	84	F
	TZR 125	87-89	F			YZ 490 H/J/K/L	81-84	F
	XC 125	92	R			TT 600 L	84	F
	XT 125	82	F					
	YBA 125 Enticer (3P01/3P41)	05-06	R		Y510	YAMAHA		
	YZ 125 C/D/E/F/G/H/J	76-82	R		Y510G	RD 125 DX	78-81	R
	YZ 125 T	87	R			RS 125	75	F
	RX 135 (13X)	81	R			RD 200 DX	75-80	R
	DT 175 (All models)	74-83	F&R			RS 200	79	F&R
	IT 175 G/H/J	80-82	R			DT 250 'All models'	75-80	R
	TY 175	77-80	R			IT 250 H/J	81-82	R
	DT 200 (2LR)	87	R			IT 250 L	84	R
	SR 250 SE Special (3Y8)	81-83	R			SRX 250		R
	TY 250 D/E	77-78	R			TY 250 H	81	R
	XT 250	80	F&R			DT 400 All models	75-77	R
	YZ 250 G/J/K/L/N/S/T	80-87	R			SR 400 (3HT1)	88	R
	XT 350	85-90	R			SR 400 (2RD)	14-17	R
	YZ 490 K	83	R			IT 465 H/J	81-82	R
	TT 600 L	84	R			YZ 465 H	81	R
	YFA1W/A/B Breeze	89-91	R			YZ 490 H/J/L/N/S/T/U	81-88	R
	BAOTAIN					IT 490 L	84	R
	BT 125 T-7	06-07	R			SR 500	78-82	R
	CPI					SR 500 (3GW1/3/4/5/6/7)	96-98	R
	Oliver 125	06-12	R			XT 500	76-80	R
	KEEWAY					XT 550	82-83	F&R
	110 Kee	12-14	R			XT 600	84-86	R
	110 Target	13-15	R			XT 600 Z Tenere	84-88	R
	Arm 125	07-10	R		Y512	YAMAHA		
	F-act 125	07-09	R			TX 500/XS 500 B	75-77	R
	Focus 125	07	R			XJ 550	81-84	R
	Matrix 125	06-10	R			XJ 550 H/J/K "Maxim"	81-83	R
	125 New Strike	13-14	F&R			XZ 550	82-84	R
	RKS 125	10-14	R			YX 600 S/SC/T/TC/U/UC/W/WC		
	125 Strike	13-14	R			A/AC Radian	86-90	R
	125 Target	13-15	R			XJ 650 G/H/J/K "Maxim"	80-83	R
	Arm 150	06-10	R			XJ 650 LH "Midnight"	81	R
	F-Act 150	07-10	R			XV 750 SE	81	R
	Matrix 150	07-10	R			XV 750 Virago	92-93	R
150 New Strike	13-14	F&R		Y513	YAMAHA			
RKS 150	12-14	R			RD 250/A	73-74	F	
150 Strike	13-14	R			YDS-7 250cc	72	F	
200 New Strike	13-14	F&R			XS 250 C	81	F	
RKS 200	12-14	R			R5/5A/5B 350cc	70-72	F	
PEUGEOT				Y514	YAMAHA			
Tweet 50 (4T/Rear drum model)	10-12	R			RD 250/A	73-74	R	
Sum Up 125	10-11	R			RD 250 B/C	75-76	R	
Tweet 125 (4T/Rear drum model)	10-12	R			RD 250 LC	80-83	R	
Vivacity Sixties 125 (4T)	11-12	R			RZ 250 (4L3)		R	
Vivacity 125 (4T)	10-15	R			R5/5A/5B 350cc	70-72	R	
Tweet 151 (4T/Rear drum model)	10-12	R			RD 350/A/B	73-75	R	
SACHS					RD 350 LC	80-82	R	
Bee 125	08-09	R			XS 360 B	75	R	
Roadster 125	00-03	R			XS 650	75-81	R	
SINNIS					XS 650 SE	81	R	
Eagle 125 QM125T-10R	10	R			YDS-7 250cc	72	R	
JS 125-6H ST125	13-14	R		Y515	YAMAHA			
JS 125-6C SC125	12-14	R			XVS 400	96	R	
QM 125 T-Matrix	10	R						
QM 125-2V2 Max II 125	12-14	R						
Max 125 QM125-2V	08-09	R						
Nitro 125 (WY125T-56A)	09-10	R						

Part No.	Make/Model	Year		Part No.	Make/Model	Year		
Y515 Contd.	YAMAHA			Y519 Y519G Contd.	YAMAHA Contd.			
	XV 535 'Virago'	88-94	R		SA 50 M/ME 'Passola'	80-84	R	
	XV 535 S 'Virago'	95-03	R		YJ 50 R (5AU1-3) Vino	98-	F	
	XJ 650	80-84	R		YV 50 (5BM2) Jog Space Innovation	97-	F	
	XJ 650 'Turbo'	82	R		EC 03	11-15	F	
	XJ 650 RJ "Seca"	82	R					
	XJ 650 LK "Seca"	83	R		Y520	YAMAHA		
	XVS 650 'Drag Star'	97-04	R		Y520G	YFM 350 FWT/FWU Big Bear	87-88	F
	XVS 650 A "Dragstar Classic"	98-07	R					
	XJ 750	82-84	R		Y521	YAMAHA		
	XJ 750 RF/RJ/RK "Seca"	81-83	R		BL 125	85	F	
	XV 750 Virago	94-97	R		XC 125	92-95	F	
	XV 1000 TRI	81	R					
	XV 1000/1000 SE 'Virago'	86-88	R		Y522	YAMAHA		
	XV 1100 'Virago'	89-99	R		AS3 125	71-72	F	
	XVS 1100 Dragstar	99-00	R		RD 125	73-74	F	
					SR 250 (3Y8) US Custom	80-81	F	
			SR 250 (4GR1/2/3/4)	94-96	F			
			SR 250 SE Special (3Y8)	81-83	F			
Y516 Y516G	YAMAHA			Y523	YAMAHA			
XS 250 D/E	79-81	R		Y523G	YFUI1/TW Pro Hauler Pro 4 (230cc)	89	F	
XS 250 SE/SF	79-81	R						
XS 250 C	81	R		Y524	YAMAHA			
YP 250 Majesty	96-99	R		Y524G	YFM 350 (All models)	89-98	F	
YFM 350 FWH/FWJ/FWK 'Big Bear'	96-98	R		YFM 400 FWE/F/G/H	93-00	F		
YFM 350 L 'Big Bear'	99	R		/J/K/L/M Kodiak				
XS 400	79-82	R						
YFM 400 FWE/FWF/FWG/FWH				Y525	YAMAHA			
/FWJ/FWK Kodiak	93-98	R		Yammy 50 (2T)	86-	F&R		
YFM 400 FWP/FPR/FPS Big Bear 4x4	02-04	R						
YFM 400 FAR/FAS	03-04	R		Y526	YAMAHA			
XJ 550 RH/RJ/RK "Seca"	81-83	R		SR 400 (3HT1)	88	F		
YFM 600 FWAK/FWAM/FWAN 'Grizzly'	98-01	R		SR 500 (3GW1/3/4/6/7)	96-98	F		
YFM 600 HM "Grizzly Hunting"	00	R						
HONGDOU				Y527	YAMAHA			
CTM 125 Chituma	04	R		Y527G	YFM 50 S/T/RV/RV/RW/RX Raptor	04-09	R	
KEEWAY				YFM 80 D/E/F/G/H/J/K/L/M	92-01	R		
Superlight Ltd 125	07-15	R		/N Badger				
Superlight 150	07-12	R		YFM 80 WP/WR/WS/RT/RV	02-08	R		
MBK				/RW/RX Raptor	05-08	F		
YP 250 Skyliner	96-98	R		YFM 80 GT/GV/GW/GX Grizzly	82	R		
SINNIS				AG 100 J (3HAA)	93	R		
Vista				AG 100 E 'Farm Bike'	99-03	R		
125 QM 125 2C	08-10	R		YN 100 "Neos 100"	00-04	R		
				YQ 100 "Aerox 100"	96	F&R		
				DT 125 (3TT4)	89-91	F		
				SR 125 (3MW2)	93-95	R		
				XC 125	95-98	F		
				XC 125 T Cygnus	00-03	R		
				XN 125 Teo's	03-10	R		
				XTZ 125 (5RM)	05-06	R		
				YBR 125 ED (3D91)	00-08	F&R		
				YBR 125 E/K (Brasil)	06-08	R		
				YBR 125 ED (Brasil)				
				YFM 125 S/GT/GV/GW/GX				
				/GY/GZ/GA/GB/GD Grizzly	04-14	R		
				YP 125 'Majesty'	98-00	R		
				YP 125 Majesty DX				
				(Taiwan Production)	02	R		
				YFA1D/F/G/H/J/K/L/M/N/P/R Breeze	92-03	R		
				XTZ 125 K/E	05-10	R		
				XV 125 Virago	97-00	R		
				XVS 125 Dragstar	00-04	R		
				DT 175 (3TS4)	96	F&R		
				AG 200 E (3GX6)	93	R		
				XT 225	97-06	R		
				SR 250 (4GR1/2/3/4)	94-96	R		
				SR 250 Classic (2IL)	96-00	R		
				SRV 250 'Soulful Twin/Renaissa'	92-97	R		
				XV 250 Virago	89-94	R		
				XV 250 'S' Virago	95-00	R		
				XVS 250 Dragstar	01-04	R		
				TT 350 A (3GJ)	90-95	R		
				TT 350 (ITJ)	85-89	R		
				XT 350 'S'	91-95	R		
				TT 600 N (59X)	85-88	R		
				TT 600 W (2JT/3SW1)	89-92	R		
Y519 Y519G	YAMAHA							
CG 50 'Jog'	88-92	R						
CY 50 'Jog-in'	91-95	F						
CA 50 'Salient'	83-85	R						
LC 50 M 'Bop'	80	F&R						
MS 50	85-86	R						

Part No.	Make/Model	Year		Part No.	Make/Model	Year															
Y527 Y527G Contd.	AJS Exactly 125 Scooter (4T)	08-15	R	Y530 Contd.	YAMAHA Contd. T90 N (4NM1/2/3/6) T90 N 4NM9/UB02J XC 125 Vity (4P7)	94-99 00-08 08-13	F&R F&R R														
	APRILIA Scarabeo 100 (2T)	00	R		Y531	YAMAHA YB-1 (50cc) 5JE1/3 BA 50 C (4KNH) Gear-C BA 50 S/N (UA03J0) AT 115 (2B81/2/3) Neo (Brasil) AT 115 (15S1) (Neo CVT/Brasil) XC 115 S-D'elight TW 125 (5RS) YBR 125 (3D92) T 135 HC/S (2S61) T135-SE (1S71) TW 225 E (5VC1/2) YBR 250 YS 250 Fazer (Brasil) (1S41/2/3)	01-02 04 08 05-07 08 14-16 03-04 07-09 06-08 06-08 03 07-08 06-08	F&R R F R R R R R R R R													
	BENELLI K2 100	99-01	R	Y532 Y532G			YAMAHA YFM 250 BT/BV Bruin YFM 250 BW/BX/BY Big Bear YFM 350 FAS/FAT/FAV Bruin 4x4 YFM 350 ANS/ANT/ANV Bruin 2x4 YFM 350 XV/XW/XX/XY 2WD Wolverine YFM 350 FWA Grizzly 4WD YFM 350 GW/GX/GY/GZ Grizzly 2WD YFM 400 AR 2WD Kodiak MBK YX 125 Z X-Over	05-06 07-10 04-06 04-06 06-09 04-14 08-10 03 10	R R R R R R R R R												
	CPI Argon GP125	07-12	R					Y533	YAMAHA NXC 125 - Cygnus X - (5ML) NXC 125 - Cygnus X - (4P9) NCX 125 K Cygnus X Cab (4C6-1) NCX 125 L Cygnus X Injection (4C6-2) HW 125 Xenter 125 YW 125 (BW's 125) YW 125 X (1DN1/2) HW 150 Xenter 150 MBK NXC 125 Flame X	04-06 07-13 07-10 07-10 12-18 10-13 10-13 12-16 04-12	R R R R R R R R R										
	ITALJET Millennium 100/125/150	00-04	R							Y534 Y534G	YAMAHA YXP 700 AS/AV Pro Hauler 700 Side x Side YXP 1000 AS/AT Pro Hauler 1000 Side x Side HONLEY HD1 125 HD2 125 HD3 125 HD3 SE 125	04-06 04-05 14-15 16-17 16-17 16-17	R F&R R R R R								
	MBK YN 100 Ovetto	99-03	R									Y535	YAMAHA YBR 125 Custom YBR 125 (3D92/9) YBR 125 (51D1/2) YS 125 YBR 250 (5D11/3/4) HONLEY HD1 125 HD2 125 HD3 125 HD3 SE 125	08-16 07-13 10-16 17-19 08-11 14-15 16-17 16-17 16-17	R R R R R R R R R						
	QUADZILLA R50 (Rear drum model) R100 (Rear drum model)		R R											Y536 Y536G	YAMAHA YFM 90 RY/RZ/RA/RB/RD Raptor	09-13	F				
	GENERIC/KSR Soho 125/150	06-14	R													Y537	YAMAHA XC 180 Riva Scooter XC 200 Riva Scooter	83-85 87-91	F F		
	XOR 125	05-11	R																		
	Zion 125/150	08-09	R																		
	SFM SFM 125 A8 Roadster	13-15	R																		
	Y528 Y528G	YAMAHA DT 250 All models IT 250 G YFB 250 D/E/F Timberwolf YFB 250 G/H/UH/J/UJ/UK/K Timberwolf YFB 250 FWF/FWG/FWH/FWJ /FWK/FWL/FWM Timberwolf YFM 250 XLC/XL/X Bear Tracker YFM 250 W/A/B YFM 250 XN/XP/XR/XS YFU11/TW Pro Hauler Pro 4 (230cc) YFM 350 ERD/ERE/ERF/ERG YFM 350 UH/UJ/UK YZ 250 D/E/F DT 400 All models YZ 400 D/E/F IT 425 G YZ 465 G IT 500 G/H XT 500	75-80 80 92-94 95-98 94-00 99-00 90-92 01-04 89 92-95 96-98 77-79 75-77 77-79 80 80 80-81 76-80															F R R F&R F&R F&R F F F R R F R R R R F			
	Y530	MBK CS 50 Mach G AC (Air cooled) CS 50 Mach G LC (Liquid Cooled) XF 50 X Booster XC 125 WAAP	06-10 06-10 07-10 08-10		R R F&R R																
		RIEJU Urban Blast (50)	13-14	R																	
		YAMAHA BA 50 S/N (UA03J) BW's 50 (5WW4/6/8/9/B/D/F/H/K/M/P) BW's 50 Naked (2B7B/D/F/H) BW's Easy (2DW) CS 50 Jog R CS 50 Z (Jog RR) CV 50 ZR (5PT1) CV 50 (5KN1/2) CV 50 A/R Jog (5SU1/2/SA165) CW 50 (5WW4/BWS) BA 50 C (4KNH) Gear-C XC 50 X Vino Classic (SA26J) XF 50 Giggle/Vox YN 50 F Neos (4T) (5C3) YN 50 Neos (2T) (1F5C2/1H5C2) YN 50 Neo's Easy (2T) T90 D (4NM4/5/7) T90 D 4NM8/UB02J	08 05-15 09-14 13-15 06-15 06-12 01-02 00-02 03-08 04-07 04 08 07-12 09-18 07-16 13-15 97-99 00-08	R R R R R R R R R R R F&R F&R R R F&R F&R F&R F&R																	

Part No.	Make/Model	Year		Part No.	Make/Model	Year		
S603 S603G Contd.	KAWASAKI Contd.			S604 S604G Contd.	SUZUKI			
	KH 100 A2-A4	78-81	R		DR-Z 125 LK3/LK4/LK5/LK6		03-19	R
	KH 100 G2-G4	81-83	R		/LK7/LK8/LK9/LL0-LL5		82	R
	KM 100 A4-A6	78-81	F&R		TS 125 ERZ			
	Max 100		F&R		KAWASAKI			
	KLF 110 B1/B2 'Mojave'	87-88	F		KFX 50 (KSF 50 A1/A2/A3)		03-05	R
	KLX 110 R (KLX 110 A1/A2/A3/A4				KLX 125 A1/A2/A3/A6F		03-06	F&R
	/A6F/A7F/A8F/A9F/CAF/CBF/CCF				KLX 125 L (B1/B2/B3/B6F)		03-06	R
	/CDF/CEF/CFF/CGF/CHF/CJF)							
	Kaze-r New 112cc	02-18	R					
	Kazer 115	04	R					
	ZX 130 R Kaze	08-10	R		S605	KAWASAKI		
	KLT 200 C1/C2/A1/A4A	81-84	F		S605G	KDX 250 B1		79
	KLT 250 C1/C2/C3 'Prairie'	83-85	F	KL 250 A1/A2			78-79	R
	LIFAN			KX 250			74	R
	LF-100 5		F&R	KX 250 A/A3/A4/A5/A6/A7			75-81	R
	MODENAS			KX 420 A1/A2			80-81	R
	Kriss 110	00-01	F&R	SUZUKI				
	Kriss 115	00-01	R	LT 125 E			84	R
	MOTO-ROMA			LT 160 EK/EL/EM/EN			89-92	R
	Go-Go 110	02	R	LT-F 160 L/M/N/P/R/S/T/V/W/X/Y/K1-K4			90-04	R
	SUZUKI			LT 185 E/F			84-85	R
	A 50	71-76	F&R	SB 200 N/X			79-81	F
	AP 50	75-78	F&R	SX 200 R/R-2/RJ/RM			90-91	R
	F 50	71-73	F&R	LT 230 GEF/GEG			85-86	R
	FR 50	74-81	F&R	LT-F 230 G/H			86-87	R
	GT 50 KB/KEN	77-80	R	PE 250 B/C/T/X/Z			77-82	F&R
	RM 50 C/N/T	78-80	F&R	RM 250 A/B/C			76-78	R
	TS 50 KN	79	F&R	RM 250 N			79	F
	TS 50 ERKT/X/Z/D	80-83	F	TS 250 L/M/A/B/C/ERN/ERT/ERX			74-82	F&R
	ZR 50 KEN/KEX 'X1'	79-83	R	SP 370 C/N			77-80	F&R
	FR 70	74-76	F&R	DR 400 ST/SX			79-81	F&R
	FR 80 M/B/N/X/Z/D	76-83	F&R	PE 400 T/X			79-81	R
	RM 80 B/C/N	77-79	F&R	RM 400 C		78	R	
	TS 90 R/J	71-73	F	RM 400 N		79	F	
	ASS 100	69-71	R	SP 400 T		80	F&R	
	A100 (All models)	74-80	F&R	DR 500 X/Z/D		81-83	R	
	GP 100 C/N/X/DED	78-87	R					
	GP 100 UN/UX/UD/UL	79-92	R	S606	SUZUKI			
	RM 100 A/B/C/N/T/X	76-81	F	S606G	SW-1 (250) (NJ45A)		92	R
	TS 100 K/L/M	73-75	F		GT 250 EN/ET/EX 'X7'		78-81	R
	FX 110 Shogun		F&R		GS 250 TT/TX/ET/EX/EZ		80-82	R
	DR-Z 110 K3/K4/K5	03-05	R		GV 250 C		08-11	R
	Smash 110cc	03	F&R		GN 400 TT		80	R
	Shogun-R FD-112	04	R		GSX 400 ET/EX/EZ		81-83	R
	CS 125 D	83	F&R		GS 400 LX		81	R
	FX 125		R		LT-A 400 FK2-FK7 Eiger 4WD		02-07	R
RV 125 K	73	F	LT-A 400 K2/K3/K4 Eiger			02-04	R	
RV 125 K2-K9/L0/L3/L4/L5/L6/L7/L8			LT-F 400 FK2-FK7 (Eiger 4WD)			02-07	R	
Van-Van	02-18	R	LT-F 400 K2-K7 Eiger (2WD)			02-07	R	
TS 125 K	72	F	ST 400 Tempter V/W/X/Y/K1/K2/K3			97-03	R	
TS 185 K	73	F	GS 425 EN			78-80	R	
RV 200 K2/K3/K4	02-04	R	GS 450 ET/EG/EJ			80-88	R	
RV 200 L6/L7/L8/L9 Van-Van	16-19	R	GR 650 D/XD "Tempter"			83	R	
RL 250 L/M	74-75	F	LS 650 FG/PK/PM/PR/PG/PT/PV					
RL 250 Beamish Model Reed			/PW/PX 'Savage'			87-99	R	
Valve Engine	78-82	F	DR 750 SJ			88	R	
RL 325 Beamish Model			HYOSUNG					
Reed Valve Engine	78-82	F	GV 250 Aquilia			04-07	R	
			GV 250 Classic			08-15	R	
S604 S604G	SUZUKI			S608	SUZUKI			
GS 50 K5 (NA41A)	05	F&R		T 20 Super Six		66-68	F	
LT-A 50 K2-K5 Quadmaster	02-05	R		T 250 11/R/J		70-72	F	
LT-Z 50 K6/K7/K8/K9/L0/L4/L5				T 350 1/11/R/J		69-72	F	
/L6/L7/L8 QuadSport	06-18	R		GT 380 J		72	F	
OR 50 ET	80	R	S609	SUZUKI				
RB 50 H 'GSXR 50'	87	R	GT 250 K/L/M/N/A/B/C		73-78	R		
RM 50 X/Z	81-82	F&R	T 20 Super Six		66-68	R		
ZR 50 SLKX/SKX/SKE/SKH	81-87	R	T 250 11/R/J		70-72	R		
DS 80 T/X/Z/D/F/G/H/J/K/L/M/			T 350 1/11/R/J		69-72	R		
N/P/R/S/T/V/W/X/Y	80-00	F&R	GT 380 J/K/L/M/A/B		72-77	R		
JR 80 K1-K7	01-07	F&R	GS 400 B/C		77-78	R		
RM 80 XT/XX	80-81	F&R	GS 400 TX		81	R		
RM 80 HD/HF	83-85	R	T 500 1/2/3/R/J/K/L/M		68-75	R		
LT-Z 90 K7/K8/K9/L0/L4/L5/L6/L7			GT 500 A/B		76-77	R		
QuadSport	07-17	F	GT 550 J/K/L/M		72-75	R		
TS 100 ERZ/ERH	82-87	R						
DR-Z 125 K3/K4/K5/K6/K7/K8								
/K9/L0-L5	03-15	F&R						

Part No.	Make/Model	Year		Part No.	Make/Model	Year									
S626 Contd.	SUZUKI Contd. VS 700 GLFG/GLPG VS 750 All models C 800 (VL 800 K5-K9/L0/L1/L3/L5) (C 800 Intruder) (Spoke wheel) C 800 C (VL 800 CK7/CK8/CK9 /CLO/CL1/CL2/CL3) Intruder (Cast wheel model) M 800 (VZ 800 K5-K9/L0/L1/L3 Intruder M800) M 800 Z (VZ 800 K9Z Intruder) VL 800 K1-K5 'Intruder Volusia' VL 800 BTL4 - C 800 Intruder VS 800 GLN/GLP/GLR/GLT /GLS/GLV/GLW/GLX VZ 800 V/W/X/Y/K1/K2 'Marauder' VZ 800 L4/L5 Intruder M800/T SACHS Roadster 800 B-805	86-87	R	K702 K702G	KAWASAKI KH 125 A1-A4 KX 125 B2/C1/D1 KDX 200 A1/A2/A3/C1-C3	77-81	R								
		85-91	R			83-85	R								
		05-15	R			83-88	R								
		07-15	R			79-83	R								
		05-13	R			83-85	F								
		09-12	R			80-84	R								
		01-05	R			84-05	R								
		14	R			76-85	F								
		92-99	R			74-80	F								
		97-03	R			80-82	F								
		14-15	R			76-83	F								
		01-04	R			75-76	F								
		03-04	R			80-84	F								
S627	SUZUKI TS 125 XE/XUF/XUG/XUH/XUJ TS 250 XE/XG/XH/XJ/XK	84-90	R	K704 K704G	KAWASAKI KE 125 A4-A12 KX 125 A3-A7 KDX 175 A1-A3 KE 175 B1-B3/D2-D5 KT 250 A/A2 KL 250 A3/A4/C1/C2	81-84	R								
		85-89	R			88-97	F								
S628 S628G	SUZUKI LT-F 250 J/K/L/M/N/P/R/S/T/V/W/X/Y/K1 LT-F 250 FX/FY/FK1/FK2 LT-F 4WD H/J/K/L/M/N/P/S/T/V/W KAWASAKI KAF 300 A1/B1/B2 (Mule 500) KAF 300 C1/C2/C3/C4/C6/C7/D1 (Mule 550)	88-01	F			K705 K705G	KAWASAKI KLT 200 C1/C2/A1/A4A KLF 200 A1-A10 KLF 220 A1-A15 KX 250 (A Series) KDX 250 B1-B3 KL 250 A1-A2 KLF 250 A1/A2/A3/A6F/A7F A8F/A9F/AAF/ABF Bayou KLT 250 C1/C2/C3 'Prairie' KTX 250 A1 'Tecate' KX 250 A/A3/A4/A5/A6/A7 KX 420 A1/A2	88-02	F						
		99-02	F					74-81	F						
		87-98	F					79-84	F						
S629 S629G	SUZUKI LT-F 250 J/K/L/M/N/P/R/S/T/V/W/X/Y/K1 LT-F 250 FX/FY/FK1/FK2 LT-F 4WD H/J/K/L/M/N/P/S/T/V/W	88-01	R					K706 K706G	KAWASAKI KLF 185 A1 KLF A1-A10 KLF 220 A1-A15 BJ 250 E1-E4A Estrella-RS Custom BJ 250 D1-D7 Estrella Custom BJ 250 F1/F2 (250 TR) BJ 250 F1/F2 (250 TR) EL 250 D1-D5 EL 250 Eliminator ER 250 B1/B2/B3 (Z 250 T Scorpion) KLF 250 A1/A2/A3/A6F/A7F /A8F/A9F/AAF/ABF Bayou Z 250 B1/B2 EL 252 F2/F53/F5/F6 KLF 300 A1/A2/B1-B17 'Bayou' GPZ 305 A1/B1-B10 Z 400 B1/B2 Z 400 G1 ZR 400 A1/B1 (Z 400 F) Z 440 A2/C1 Z 440 C2 Z 440 D4/D5/D6 (LTD) Z 440 H1/H2 GPZ 500 S (EX 500 A1-A6) GPZ 500 S (EX 500 B1-B5) ER-5 (ER 500 A1/A2/A3/A4/C1-C5P) ZR 550 A1/A2 (Z 550 F) W 650 (EJ 650 -A1/C3-C7) EJ 800 ABF/ACF (W 800/Solid F/disc) EJ 800 ADF/AEF/AFF/AGF (W 800) EJ 800 ADF/AEFA/AFFA/AGFA (W 800 Special Edition) EJ 800 (W 800 Cafe Style/ Cockpit fairing) W 800 ABF	88-97	R				
		99-02	R							78-79	F				
		87-98	R							03-11	F				
S631	SUZUKI CP 50 C		R							K707 K707G	KAWASAKI 250 S1B KH 250 B1-B5 S1-A/B/C (250cc) S2 (350cc) S2-A (350cc) S3/S3-A (400cc) KH 400 A3/A4/A5	83-85	R		
			R									84	F		
S632	SUZUKI AE 50 L/N/T 'Style' AD 50 T/Tune/V-Tune AE 50 R AZ 50 X/LX/UX/Y/LY/UY/K2 /UK2 (LETS II) AZ 50 7/8 Let 4/G (CA45A) CR 50 DC X5 K3/BK3/DK3/DBK3 Choinori UR 50 W/Y/K1/K2/K3 Verde	90-96	F&R									K708		75-81	F
		88	R											80-81	F
			R											87-89	R
			R	83-88	R										
		07-08	F	03-11	R										
		03	R	80-83	R										
S633 S633G	SUZUKI LT-F 4WD H/J/K/L/M/N/P/R/S/T/V/W LT-F 300 FX/FY/FK1	87-98	F	88-83	R										
		99-01	F	96-03	R										
			F	96-04	R										
S634 S634G	SUZUKI LT-F 300 FX/FY/FK1 LT-F 4WDX H/J/K/L/M/N/P/R/S/T/V/W LT 250 EFF/EGF LT-F 300 FK2 RE 5 M/A LT-A 500 FY/FK1 LT-F 500 FW/FX/FY/FK1/FK2 GT 750 J/K/L/M/A/B	99-01	R	86-04	R										
		87-98	R	83-96	R										
		85-86	R	78-80	R										
		02	R	79	R										
		75-77	R	83-84	R										
		00-01	R	79-80	R										
		98-02	R	81	R										
		72-77	R	82-84	R										
S635	SUZUKI UC 125 X/Y Epicuro KAWASAKI SC 150 A1 (Epsilon 150)	99-02	R	82-83	R										
		02-03	R	87-93	R										
S636 S636G	SUZUKI LT-F 250 K2-K9/L2/L3/L4 Quark LT-Z 250 K4-K9/L0 QuadSport	02-14	R	88-93	R										
		04-12	R	88-93	R										
K701 K701G	KAWASAKI KX 80 B1/B2/D1/D2	79-83	F&R	97-07	R										
			F&R	83-84	R										

Part No.	Make/Model	Year		Part No.	Make/Model	Year	
K709	KAWASAKI ZL 400 A 'Eliminator'	86-87	R	K719 Contd.	KAWASAKI Contd. KAF 540 C1 (Mule 2010)		F
	ZL 400 B 'Eliminator' 400 SE	88	R		KAF 540 D1 (Mule 2020)		F
	ZL 400 D1/D2	94-95	R		KAF 540 E1 (Mule 2030)		F
	Z 400 J1/J2/J3	80-83	R		KAF 620 A1/A2 (Mule 2510)		F
	LTD 454 (EN 450 A1-A5)	86-89	R		KAF 620 B1/B2/B6 (Mule 2520)		F
	EN 500 A1-A3/B1-B2/C1-C9	90-04	R		KAF 620 C1/C2/C3/C6 (Mule 2530)		F
	Z 550 A1	80	R		KAF 620 E1-E5 Mule 3010		F
	Z 550 A2/A3/C1/C2/LTD	81-84	R		KAF 620 F1/F2 Mule 3020		F
	GT 550 G1-G9	83-01	R		KAF 620 G1-G5 Mule 3000		F
	ZL 600 B1 Eliminator	95-97	R		KAF 620 H1-H3 (Mule 3010 4x4)		F
	Z 650 B1-B3	77-79	R		KAF 620 J1/K1/K6F/K7F (Mule 3010 Trans 4x4)	05-07	F
	Z 650 F1/F2/F3/F4	80-83	R		KAF 620 M9F/MAF/MBF/MCF/MDF /MEF/MFF/MGF/MHF (Mule 4010 4x4)	09-17	F
	VN 700 A1 'Vulcan'	85	R		KAF 620 N9F (Mule 4010 4x4 Hardwoods Green)	09	F
	VN 750 A2-A5/A10	86-94	R		KAF 620 P9F/PAF/PBF/PCF/PDF /PEF/PFF/PGF/PHF (Mule 4000)	09-17	F
	Z 750 Y1 (LTD)	82	R		KAF 620 R9F/RAF/RBF/RCF/RDF/REF /RFF/RFFA/RGF/RHF (Mule 4010 Trans 4x4)	09-17	F
	VN 800 A1/A2/A3	95-99	R		KAF 620 S9F/SAF/SBF/SCF/SDF/SEF /SFF/SGF/SHF (Mule 4010 Trans 4x4 Hardwoods Green HD)	09-17	F
VN 800 B1-B10/B6F 'Classic'	96-06	R	KAF 620 TGF/TGF (Mule 4010 4x4 SE)	16-17	F		
K710 K710G	KAWASAKI KLF 300 C1-C17 "Bayou"	89-05	R	KAF 620 VGF/VHF (Mule 4010 Trans 4x4 SE)	16-17	F	
	KVF 300 A1-A4 (Prairie 4x4)	99-02	R	KAF 950 A1/A2/A3 Mule 2510 Diesel		F	
	KVF 300 B1-B4 (Prairie 2x4)	99-02	R	KAF 950 B1-B3 (Mule 3010 Diesel)		F	
	KVF 400 C1-C4 (Prairie 4x4)	99-02	R	KAF 950 D8F Mule 2010 Diesel 4x4	08	F	
	KVF 400 D1-D4 (Prairie 2x4)	99-02	R	KAF 950 E8F Mule 3010 Trans Diesel	08	F	
	KLF 400 B1-B7 Bayou	93-99	R	KAF 950 F9F/FAF/FAF/FCF/FDF (Mule 4010 Diesel 4x4)	09-13	F	
K711	KAWASAKI 250 S1B	75	F	KAF 950 G9F/GAF/GBF/GCF/GDF (Mule 4010 Trans 4x4 Diesel)	09-13	F	
	S1-A/B/C (250cc)	73-75	F	QUV 620 FK5 Side x Side	05	F	
	S2 (350cc)	72-73	F	K720	KAWASAKI KAF 450 B1 (Mule 1000)		R
	Z 250 B1/B2/C1/C2/G1/G2	80-83	F		KAF 540 C1 (Mule 2010)		R
K713	KAWASAKI H2/H2-A Mach IV (750cc)	72-73	R		KAF 540 D1 (Mule 2020)		R
	H2-B/H2-C Mach IV (750cc)	74-75	R		KAF 540 E1 (Mule 2030)		R
	Z 900 Z1A/Z1B	74-76	R		KAF 620 A1/A2 (Mule 2510)		R
Z 900 A4	77	R	KAF 620 B1/B2/B6 (Mule 2520)			R	
K714 K714G	KAWASAKI KX 80 E1	83	F		KAF 620 C1/C2/C3/C6 (Mule 2530)		R
	K715 K715G	KAWASAKI KX 60 A1/A2/B1-B19	83-03		F&R	KAF 620 E1/E2/E3/E4 Mule 3010	
KX 80 E1-E3/J1/J2/G1/G2		83-87	R		KAF 620 F1/F2 Mule 3020		R
KLX 110 R (KLX 110 A1/A2/A3/A4 /A6F/A7F/A8F/A9F/CAF/CBF/CCF /CDF/CEF/CFE/CGF/CHF/CJF)		02-18	F		KAF 620 G1/G2/G3/G4 Mule 3000		R
SUZUKI RM 60 K3		03	F&R		KAF 620 H1/H2 (Mule 3010 4x4)		R
K717 K717G	KAWASAKI KLF 300 A1/A2 'Bayou'	86-87	F		KAF 620 J1/K1/K6F/K7F (Mule 3010 Trans 4x4)	05-07	R
	K718	KAWASAKI KAF 300 A1/B1/B2 (Mule 500)			R	KAF 620 M9F/MAF/MBF/MCF/MDF/MEF /MFF/MGF/MHF (Mule 4010 4x4)	09-17
KAF 300 C1/C2/C3/C4/C6 /C7/D1 (Mule 550)			R		KAF 620 N9F (Mule 4010 4x4 Hardwoods Green)	09	R
KAF 400 A6F/A7F/A8F/A9F/AAF (Mule 610 4x4)		06-10	F&R		KAF 620 P9F/PAF/PBF/PCF/PDF /PEF/PFF/PGF/PHF (Mule 4000)	09-17	R
KAF 400 ABF/ACF/ADF/AEF (Mule 610 4x4)		11-14	F		KAF 620 R9F/RAF/RBF/RCF/RDF /REF/RFF/RFFA/RGF/RHF (Mule 4010 Trans 4x4)	09-17	R
KAF 400 B6F/B7F/B8F/B9F/BAF /BBF/BCF/BDF/BEF (Mule 600)		06-14	F&R	KAF 620 S9F/SAF/SBF/SCF/SDF /SEF/SFF/SGF/SHF (Mule 4010 Trans 4x4 Hardwoods Green HD)	09-17	R	
KAF 400 JHF (Mule SX)		17	F&R	KAF 620 TGF/TGF (Mule 4010 4x4 SE)	16-17	R	
KAF 400 HHF (Mule SX 4X4)		17	F&R	KAF 620 VGF/VHF (Mule 4010 Trans 4x4 SE)	16-17	R	
KAF 400 NHF (Mule SX 4X4 SE)		17	F&R	KAF 950 A1/A2/A3 Mule 2510 Diesel		R	
KAF 400 KHf (Mule SX 4X4 XC)		17	F&R	KAF 950 B1/B2 (Mule 3010 Diesel)		R	
KAF 400 LHF (Mule SX 4X4 XC Camo)		17	F&R	KAF 950 D8F Mule 2010 Diesel 4x4	08	R	
KAF 400 MHF (Mule SX 4X4 XC SE)		17	F&R	KAF 950 E8F Mule 3010 Trans Diesel	08	R	
K719	KAWASAKI KAF 400 ABF/ACF/ADF/AEF (Mule 610 4x4)	11-14	R	KAF 950 F9F/FAF/FAF/FCF/FDF (Mule 4010 Diesel 4x4)	09-13	R	
	KAF 450 B1 (Mule 1000)		F	KAF 950 G9F/GAF/GBF/GCF/GDF (Mule 4010 Trans 4x4 Diesel)	09-13	R	
				SUZUKI QUV 620 FK5 Side x Side	05	R	

Part No.	Make/Model	Year		Part No.	Make/Model	Year		
801G	HUSQVARNA			803G	HUSQVARNA			
	CR 125	78	F		CR 125	82-84	F	
	CR 125	79-81	F&R		WR 125	82-84	F	
	CR 125	82-84	R		XC 125	82-84	F	
	WR 125	79	F&R		CR 240	82-84	F	
	XC 125	85-86	R		CR 250	82-84	F	
	CR 240	80-81	R		WR 240	82-84	F	
	CR 240	82-84	R		WR 250	82-84	F	
	WR 240	78	F&R		XC 250	82-84	F	
	CR 250	71-74	R		WRE 430	82-84	F	
	CR 250	75-79	F&R		WRU 430	82-84	F	
	CR 250	80-81	R		AE 500	82-84	F	
	CR 250	82-84	R		CR 500	82-84	F	
	WR 250	71-74	R		XC 500	82-84	F	
	WR 250	75-78	F&R					
	XC 250	85-86	R		804	CZ/JAWA		
	360 Automatic	75-77	R			Mope		F
	CR 360	75-78	F&R		805	APRILIA		
	WR 360	75-78	F&R			Scarabeo	93-97	F
	ACC 390	80-81	F&R		806	GILERA		
	ACCE 390	80-81	F&R			Storm 50	94-95	R
	CR 390	75-79	F&R		Easy moving 50	95-96	R	
	CR 390	80-81	F&R		MASH			
	CR 390 Automatic	78	F&R		Bibop 50	14-16	R	
	WR 390	78	F&R		Bibop Racing 50	14-16	R	
	CR 400	71-74	F&R		PIAGGIO			
	WR 400	75-78	F&R		Sefera Base 50	91-93	R	
	CR 430	80-81	R		Sefera 50 RST	95-97	R	
	CR 450	71-74	F&R		Free 50	92-00	R	
	WR 450	71-72	F&R		Zip 50 Base (Drum Model)	92-96	R	
	CR 500	82-84	R		Zip Fast Raider	93-97	R	
	XC 500	85-86	R		Sefera 50 Maquillage 2	94	R	
	TC 510	87-88	R		NRG 50	94-96	R	
	TC 510	89	R		Zip & Zip 50 Bimodale	94-97	R	
	TX 510	87-88	R		NTT 50	95-96	R	
	TE 510	87-88	R		Typhoon 50	94-97	R	
	TE 510	89	R		Typhoon 50 X	98-99	R	
	WMX 510	89	R		Zip 50 Base (Disc Model)	95-96	R	
	WXE 510	89	R		Zip 50 Elettrico	02	R	
					Free 50 (Disc Model)	95-00	R	
					NRG 50 RST (DT/DD) "MC2"	96-97	R	
					SKR 80 City	99	R	
	802G	HUSQVARNA			807	MALAGUTI		
		CR 125	85-86	R		Crosser CR1	97-01	R
		WR 125	80-81	F&R	808	PIAGGIO		
		WR 125	82-84/87-88	R		S1 Mix 50	96-99	F
		XC 125	82-84	R		Zip 50 RST	96-99	F
		CR 240	80-81	F		Ciao Mix Teen 50	96-01	F
		CR 240	85-86	R	809	PIAGGIO		
CR 240		87-88	R		Velofax 50	96-99	R	
WR 240		80-81	F&R	811G	KTM			
WR 240		82-84	R		MX 125	83	F	
WR 240		87-88	R		125 GS	83	F	
CR 250		80-81	F		250 MX Leleu	82	F	
CR 250		85-86	R		250 XC/GS	83	F	
CR 250		87-88	R		495 MX Leleu	82	F	
WR 250		80-81	F&R	812G	KTM			
WR 250		82-84	R		MX 125	83	R	
WR 250		87-88	R		125/175	-84	F&R	
XC 250		80-81	F&R		125 GS	83	R	
XC 250		82-84	R		250/350	-82	F	
XC 250		87-88	R		420 GS	85	F&R	
WR 400		87-88	R		495	-82	F	
430 Automatic		87-88	R	813G	KTM			
CR 430		80-81	F		250	-82	R	
CR 430		87-88	R		250 MX Leleu	82	R	
WR 430		80-81	F&R		250 XC/GS	83	R	
WR 430		87-88	R		350	-82	R	
WRE 430		82-84	R		350 Four Stroke	83	R	
WR-E 430		80-81	F&R		495	-82	R	
WRU 430		82-84	R		495 MX Leleu	82	R	
XC 430		80-81	F&R					
XC 430		87-88	R					
AE 500		82-84	R					
CR 500		85-86	R					
CR 500		87-88	R					
XC 500		82-84	R					
XC 500		87-88	R					

Part No.	Make/Model	Year		Part No.	Make/Model	Year	
814G	KTM			816 Contd.	PIAGGIO Contd.		
	80 MX	86-92	R		Liberty 150 (2V/4T) 10 spoke cast wheels	09-12	R
	MX 125	84	F&R		Liberty 150 (3V/4T) 10 spoke cast wheels	13-15	R
	MX/MXC 125	85	R		Liberty 150 Full optional (4T/3V//10 spoke wheel)	13-15	R
	GSXC/GS 125	85	R		Liberty i-get 150 (3V/4T)	15-18	R
	MX/MXC/GS 250	84	F&R		Hexagon LX 180	98-99	R
	MX/MXC 250	85	R		Hexagon LXT 180	98-99	R
	GSXC/GS 250	85	R		Hexagon LX4 125	98-99	R
	MX/MXC 300	85	R		Skipper LX 125/150	98-99	R
	GSXC/GS 300	85	R		Liberty 125	98-08	R
	MX/MXC/XC-GS 500	85	R		Liberty Elettrico	11-12	R
816	APRILIA			Skipper ST 125/150 4T	00-04	R	
	Scarabeo 50 Street (2T)	05-09	R	Typhoon 125	99-03	R	
	Scarabeo 50 (4T)	02-09	R	Typhoon 125 (4T) (12" wheels)	10-15	R	
	Scarabeo 50 (4T)	14-17	R	Liberty i-get 125 (3V/4T)	15-16	E	
	Sport City One 50 (2T)	08-11	R	Liberty S 125	07-08	R	
	Sport City 50 (4T)	08-10	R	X8 125/Street	06-07	R	
	SR 50 Motard (2T)	12-15	R	Liberty 150 (Full optional/ 10 spoke wheel)	13-14	R	
	Scarabeo 100 (4T)	01-09	R	Liberty 150	08	R	
	Sport City One 125cc	08-11	R	Liberty i-get 150 (3V/4T)	15-16	R	
	SR 125/150	99-02	R	Liberty 200	98-07	R	
	SR 125 Motard (4T)	12-15	R	Liberty S 200	07-08	R	
	Habana 125 (All models)	00-02	R	SCARABEO			
	Mojito/Mojito Custom 125	03-12	R	50 (2T) (Street)	10-15	R	
	BENELLI			50 (4T/4V)	10-15	R	
	Pepe 50 2T (5 spoke cast wheel)	10-14	R	50 Net (4T/4V)	10-13	R	
	Pepe 50 4T (7 spoke cast wheel)	12-16	R	50 Yourz (4T)	12	R	
	Adiva 125/150 12" front wheel	00	R	100 (4T)	10-15	R	
	CAGIVA			VESPA			
	Nuvola 125	00	R	Primavera 50 (2T)	13-15	R	
	Cucciolo 125	00	R	Primavera Touring 50 (2T)	15	R	
	DERBI			Primavera 50 (4T/4V)	13-15	R	
	Atlantis 50 (4T) (13"/3 spoke wheels)	04-06	R	Primavera Touring 50 (4T/4V)	15	R	
	Atlantis 50 (4T)	07-09	R	Sprint 50 (2T)	14-15	R	
	Boulevard 50 (2T)	09-12	R	Sprint 50 (4T/4V)	14-15	R	
	Boulevard 50 (4T)	09	R	Sprint S 50 (2T)	15	R	
	Sonar 50 (4T)	09-11	R	Primavera 125 (4T/3V)	13-15	R	
	Variant Sport 50 (2T)	12	R	Primavera 125 (4T/3V/ABS)	13-15	R	
	Atlantis 100 (4T)			Primavera 125 Touring (4T/3V/ABS)	15	R	
	(13"/3 spoke wheels)	04-06	R	Primavera 125 Touring (4T/3V/Non ABS)	15	R	
	Boulevard 125	03-07	R	Sprint 125 (4T/3V)	14-15	R	
	Boulevard 125 (4T)	08-12	R	Sprint 125 (4T/3V/ABS)	14-15	R	
	Sonar 125 (4T)	09-11	R	Sprint S 125 (4T/3V/ABS)	15	R	
	Boulevard 150	03-07	R	Primavera 150 (4T/3V)	13-15	R	
	Variant Sport 125 (4T)	12	R	Primavera 150 (4T/3V/ABS)	13-15	R	
	Sonar 150 (4T)	09-10	R	Primavera 150 Touring (4T/3V/ABS)	15	R	
	Boulevard 200	05	R	Primavera 150 Touring (4T/3V/Non ABS)	15	R	
	GILERA			Sprint S 150 (4T/3V/ABS)	15	R	
	FX/FXR 125/180 Runner	97-02	R				
	ITALJET			817	APRILIA		
	Jetset 50	02-03	R		Habana 50 (All models)	99-02	R
	Dragster 125/180 LC	99	R		Mojito Custom 50 (120mmØ rear drum)	99-03	R
	Torpedo 125 T	99-02	R		Mojito Retro 50 (120mmØ rear drum)	99-03	R
	Jet Set 125/150 2T	02-03	R		SR 50 H20 (Ditech)	00-03	R
	MALAGUTI			818	KYMCO		
	Centro 50/SL (4T)	08-11	R		Agility 50 R16 16" wheels (2T)	08-15	R
	Ciak 50 (4T) Master	04-08	R		Agility 50 R16 16" wheels (4T)	08-15	R
	PIAGGIO				Looker 50	07-08	R
	Fly 50 (2T/4T)	05-18	R		People 50 (2T)	99-15	R
	Liberty 50 2T/4T	97-08	R		People S 50 (4T)	06-14	R
	Liberty 50 (2T/4T) (10 spoke cast wheels)	09-15	R		Super 8 50 2T	07-15	R
	Liberty i-get 50 (3V/4T)	15-18	R		Super 8 50cc (4T)	07-20	R
	Liberty S 50 (2T/4T)	07-08	R		Movie XL 125/150	97-09	R
	Typhoon 50 (2T) (12" wheels)	10-18	R		Super 8 (125cc) (4T)	08-15	R
	Free 100	02	R		Agility 125 Carry (4T)	11-15	R
	Fly 100 (4T)	07-15	R		Agility RS 125 (4T) (12" wheels) /5 Spoke Wheels	09-15	R
	Fly 125 (4T/2V)	05-11	R		Agility 125 062000/1 12" 3 spoke wheels	06-14	R
	Fly 125 ie (3V/4T)	12-15	R		Looker 125 S	07-08	R
	Liberty 125 (2V/4T) 10 spoke cast wheels	09-12	R		People 125	99-11	R
	Liberty 125 (3V/4T) 10 spoke cast wheels	13-15	R		People One 125i	13-15	R
	Liberty 125 Full optional (4T/3V//10 spoke wheel)	13-15	R		People S 125	05-06	R
	Liberty i-get 125 (3V/4T)	15-18	R				
Fly 150 (4T)	05-12	R					

Part No.	Make/Model	Year		Part No.	Make/Model	Year	
843G	ANCILLOTTI PSV 250 MX	83-	R	860	BMW R 45/45 N R 50/5 / 60/5 / 75/5 R 60/7 R 60 TIC R 75/6 / 75/7 R 80 R 80 TIC R 90 S R 90/6 R 100 R 100/7T R 100 S R 100 RS R 100 RT	78-80	R
	ASPES CS 75 Navaho/125 Juma/Hopi 125 Duma		R			69-76	R
	FANTIC 50 Strada Super Six 50 Strada		73-			R	76-80
	80 Enduro	82-	R			78-82	R
	80 Cross Compet.	80-	R			73-79	R
	GILERA 80 TG 1/2/3	81-	R			77-09/80	R
	125 Arcore		R			78-08/80	R
	125 GR 1		R			73-76	R
	125 E 1/E 1 Competition		R			73-76	R
	150 Arcore		R			76-77	R
	GRIMECA HUBS Various makes 140 x 25		R			77-09/80	R
	KRAM-IT (KRAMER) EP 250/EC 250		R			76-80/80	R
	MC 250/MC 250 LC		R			76-09/80	R
	MC 500		R			76-09/80	R
	PUCH M 50 Sport		73-74			F&R	78-09/80
	SVM (SWM) 125/175/250/347/440 Enduro	-83	F&R				
	125/250/440 Cross	-83	F&R				
	XN 506 Enduro	84-	F&R				
844	CAGIVA XSST 125	-82	R	861	BMW Contd. K 75/7-2 K 75 C R 45/45 N R 45 T R 65 R 65 GS R 65 RT R 65 T R 80 R 80/R 80 RT R 80 RT R 80/R 80 RT R 80 GS R 80 ST R 80 TIC R 100/7T R 100 RS R 100 RT	84-96	R
844G	SST 250	-80	R			85-90	R
845	AGRALE Elefantre 30.0	83-84	R			10/80-85	R
	CAGIVA WSXT 125 Aletta Rossa		R			80-85	R
	GILERA 50 Rally		R			07/88-08/89	R
851	NORTON Commando	68-70	R			87-92	R
852	NORTON Commando	68-70	F			85-88	R
853	TRIUMPH T 12 (650cc/Twin Leading Shoe)	66-70	R			80-85	R
854	TRIUMPH T 12 (650cc/Twin Leading Shoe)	66-70	F			10/80-84	R
856	PUCH VS/DS/DZS/DSK 50 M2 50cc Sport M3 50cc Sport	74	F&R			84-07/90	R
		75	F&R			82-84	R
857	PEUGEOT Elyseo 125/150	99-01	R			84-95	R
858	BSA Bantam D7 TRIUMPH Cub 500		F&R			80-87	R
			F&R			82-84	R
859	BMW R 80/R 80 RT R 80 GS R 80 PD/CH R 80 Mystic R 80 R R 850 GS R 100 GS R 100 PD R 100 RS R 100 RT R 100 Mystic R 100 R	09/88-95	R			09/80-85	R
		87-95	R			09/80-84	R
		90-95	R			86-08/89	R
		94-95	R			87-08/89	R
		91-94	R				
		96	R				
		86-94	R				
		89-96	R				
		9/09-92	R				
		09/89-95	R				
		93-96	R				
		91-95	R				
862	BMW R 65 LS			81-85	R		
863	BMW K 75/75-S			84-08/88	R		
864	BMW R 50/5 / 60/5 / 60/6 / 75/5			69-76	F		
873	KTM 60 SX 65 SX MOTO BECANE 50 all mod. Atom hub 50 all mod. Leleu hub			98-99	R		
				98-99	R		
875	CASAL Mofas Boss			88-	R		
877	GARELLI 50 Team Matic MOTO BECANE 51 SUE Rock/Rock A Magnum/A/racing			88-	F		
					F&R		
					F&R		
881	PIAGGIO Cosa CL/CLX 125 Cosa 2 125 Cosa CL/CLX 150 Cosa 2 50 Cosa CL/CLX 200 Cosa 2 200			88-91	R		
				91-97	R		
				88-91	R		
				91-97	R		
				88-91	R		
				91-97	R		
882	PIAGGIO Cosa CL/CLX 125 Cosa 2 50/125 Cosa CL/CLX 150 Cosa CL/CLX 200 Cosa 2 200			88-91	F		
				91-97	F		
				88-91	F		
				88-91	F		
				91-97	F		

Part No.	Make/Model	Year		Part No.	Make/Model	Year			
899 Contd.	PIAGGIO Contd.			V903 Contd.	PIAGGIO (VESPA) Contd.				
	Sefera 125	95-97	R		Rally 200 (V5E1)				
	Zip 125	00-01	R		125 GTR	74	R		
	APRILIA				150 Sprint Veloce (VLB1)	74	R		
	Mojito Custom 50 (110mmØ rear drum)	04-12	R		VESPA				
	DERBI				PX 125 (Disc brake model/2T)	98-15	R		
	Atlantis 50 Bullet (AC/2T)	03-05	R		PX 125 Touring (Disc brake model)	15	R		
	Atlantis 50 City (AC/2T)	03-06	R		PX 150 (Disc brake model)	98-15	R		
	Atlantis 50 Red Bullet (AC/2T)	03	R		PX 150 Touring (Disc brake model)	15	R		
	Atlantis 50 Two Chic (AC/2T)	05	R		PX 200 (Disc brake model)	98-07	R		
	Atlantis 50 (AC/2T)	02	R						
	Atlantis 50 (2T) Up to Ref No 8G253171 12"/5 spoke wheels /190mm disc 3 bolt	07	R		V904	PIAGGIO (VESPA)			
	Atlantis 50 (2T/AC) 12"/5 spoke wheels 5 bolt/200mm disc From Ref no. 8G253172	07-11	R		50 S	50 S	75-83	R	
	Ice 50	01-03	R		125 Primavera	125 ET3	67-83	R	
	Runner 50	98	R				76-83	R	
	SKP 50	98	R		V905	PIAGGIO (VESPA)			
	GILERA				50 R	50 R	70-83	F	
	Stalker 50 (Rear drum models)	97-11	R		50 S	50 S	68/75-83	F	
	Typhoon 125	95-98	R		50 Special Revival	50 Special Revival	91	F	
	Typhoon 125 X-XR	99-00	R		PK 50/50 S	PK 50/50 S	82-85	F	
	VESPA				PK 50 SS	PK 50 SS	83-85	F	
	LX 50 (4T/2T)	05-13	R		PK 50 S Automatica	PK 50 S Automatica	84-89	F	
	LXV 50	07-09	R		50 XL	50 XL	85-88	F	
	S 50 (2T)	07-13	R		125 Primavera	125 Primavera	67-83	F	
	S 50 (4T/4V)	08-13	R		125 ET3	125 ET3	76-83	F	
	S 50 Sport (2T)	11-13	R		PK 100 XL	PK 100 XL	78-83	F	
	S 50 Sport (4T/4V)	11-13	R		150 Super (VBC1)	150 Super (VBC1)	74	F	
	ET4 125	96-99	R						
	ET4 125/150	99-05	R		V906	PIAGGIO (VESPA)			
	LX 125 (4T)	05-13	R		50 R	50 R	70-83	R	
	LX 125 (4T/Serie Speciali)	12	R		50 Special Revival	50 Special Revival	91	R	
	LXV 125	07-13	R		50 S	50 S	68	R	
	S 125 (4T)	07-13	R		PK 100 XL	PK 100 XL	78-83	R	
S 125 Sport (4T)	11-13	R							
LX 150 (4T)	05-13	R	V907	GILERA					
LX 150 (4T/Serie Special)	12	R	CBA 50	CBA 50			R		
S 150 Sport (4T)	11-12	R	ec1 50	ec1 50			R		
S 150 (4T)	07-12	R	ECO 50	ECO 50			R		
			50 CBA/ECO/EC 1	50 CBA/ECO/EC 1			R		
			PIAGGIO (VESPA)	PIAGGIO (VESPA)					
			Ciao All models	Ciao All models	71-99	R			
			Bravo 50 Alloy Wheels	Bravo 50 Alloy Wheels	73-81	R			
			Bravo 50 Spoke Wheels	Bravo 50 Spoke Wheels	73-81	R			
			Boss 50	Boss 50	88-89	R			
			Ciao Mix Teen 50	Ciao Mix Teen 50	96-01	R			
			Ciao 50 Catalitico	Ciao 50 Catalitico	99-05	R			
			Grillo 50	Grillo 50	89-93	R			
			S1 50 Alloy Wheels	S1 50 Alloy Wheels	79-88	R			
			S1 50 Spoke Wheels	S1 50 Spoke Wheels	79-88	R			
			S1 50 FL2	S1 50 FL2	91-97	R			
			S1 Mix 50	S1 Mix 50	96-99	R			
			Superbrand 50	Superbrand 50	85-90	R			
V901	PIAGGIO (VESPA)			908	BENELLI				
125 GTR (VNL2)	74	F		Motorella	78-	F&R			
150 Sprint Veloce (VLB1)	74	F		GARELLI			F&R		
Rally 200 (VSE1)	74	F		Eureka, Gulp			F&R		
				50 Vip/Noi/Basic spoke wheel			F&R		
V902	PIAGGIO (VESPA)			GILERA					
150 Super (VBC1)	74	R		CBA 50			F		
				ec1 50			F		
V903	LML			ECO 50			F		
Star 125 (2T)	10-14	R		50 CBA/ECO/EC 1			F		
Star 125 Deluxe (2T)	01-03	F		KREIDLER					
Star 125i (4T)	10-15	R		50 MF4 Early models			F&R		
Star 150 (2T)	10-14	R		50 MP1 Early models			F&R		
Star 150 Deluxe (2T)	01-03	F		MALAGUTI					
Star 151i (4T)	10-15	R		Chopper 25/40	-82	R			
Star 200i (4T)	10-15	R		50 LX Sport	-82	R			
PIAGGIO (VESPA)				50 Ronco RCW	-82	R			
PK 50	82-85	R		VA Olympique	-82	R			
PK 50 S	82-85	R		Chopper 80	-82	R			
PK 50 SS	83-85	R		NVT					
PK 50 XL	85-88	R		Easyrider			F&R		
PK 50 XL	88-89	F&R		PIAGGIO					
50 N	89-90	F&R		Free	92-00	F			
FL 50	90	F&R		TOMOS					
FL2 Automatica	90-91	F		Moped with spoked wheels			F&R		
FL2 50 HP	91-97	F&R							
LX 60 (Special Anniversary Model)	06	R							
PX 125 E/EFL	81-97	F&R							
PK 125	82-85	F&R							
PK 125 S	82-85	F&R							
PK 125 S Automatica	84-89	F							
PX 125 T5	85-00	F&R							
FL 125	89-00	F&R							
PX 150 E/EFL	81-87	F&R							
PX 200 E/EFL	81-97	F&R							

Part No.	Make/Model	Year		Part No.	Make/Model	Year							
909	FANTIC 50 Sprinter/3V.R	83-	F&R	922 922G Contd.	MALAGUTI Contd. 50 Enduro MEX 50 Enduro MEX 50 Enduro MGX 50 Enduro MLX 50 Enduro MXS 50 RGT Sport 50 Fifty HF/NL 4 gears	85-86 87- 87- 87- 85- 85- 87-	R R F&R R R R F&R						
	GARELLI Junior Turismo		F&R		924		GILERA 50 GSA/Vale		R				
	GILERA 50 GSA/Vale	89-	F				925	GILERA 150 Arcore	F				
	50 Trend		F&R										
	50 Trial/Enduro		F&R										
	PIAGGIO (VESPA) Ciao All Models		71-99	F									
	Ciao 50 Catalitico		99-05	F									
	Bravo 50 Alloy Wheels		73-81	F									
	Free 50		92-00	F									
	Zip 50 Base (Drum Model)		92-96	F									
	Grillo 50		89-93	F									
	S1 50 Alloy Wheels		79-88	F									
	S1 50 FL2		91-97	F									
	Bravo 3		87-90	F									
	Boss 50		88-89	F									
	TOMOS Hip Hop		R	926 926G	ACCOSSATO 50 Cross Mini ASPE 50 Navaho FANTIC 50 Trial GARELLI 50 Ciclone/KL 50 SV Gran Turismo MALAGUTI Centro Base 50 50 Fifty HF 50 Watercooled 50 Fifty Full/CX 50 Fifty Top SWM (SWM) 50/80 TR/TL Trial	82- -83 93-94 -82 -82 83- 85- -83	F&R F&R F F&R F&R F R R R R F&R						
	Luxe EX 25		F&R										
	Revival TS		R										
	Streetmate R		R										
	Pack'r Ex		F&R										
	Quadra		F&R										
	Quadra EX		F&R										
	Racing		R										
	Flexer XL		F&R										
	Flexer EX 25		F&R										
	Standard		F&R										
	Standard XL		F&R										
	Luxe 25		F&R										
	Alpino (Front disc)		R										
	Alpino 45 (Drum brakes)		F&R										
	APN6		R	927G	MOTO MORINI 350 Kanguro 350 Kanguro	-83 84-86	F&R R						
	Classic XL		F&R										
Funsport R 25		F&R											
Fantastic 25		R											
921	APRILIA Classic 125	95-01 87	R				928	DUCATI 250/350/450 Desmo	-76	F			
	Red Rose 125 (Spoke wheel)		R										
	DUCATI 250/350/450 Desmo	74-77	R							929	BENELLI 124/125 2C/125 2T/2CSE 125 2C twin brake 125 T Adiva 125 12" front wheel 250 C/TS, 250/4 254/304 500-4 250/350/450 Desmo	76- -76 83 00 76- 83 76- -76	R R R R R R R R
	GILERA RV 125		R										
	125 Cougar		88										R
	Strada/Sport 125		99-02										R
	125 TG 1/2/3												R
	TSR 125		-83	R									
	TSR 125		83-	R									
	200 T4/T4 C/T4 S			R									
	HERCULES (SACHS) 50 Ultra, RS Ultra			R									
	80 Ultra, F Ultra, RS Ultra			R									
	80 Ultra Chopper		R										
	LAVERDA LB 125 Custom/Sarbia	85-87	R	930G	FANTIC 50/50.1 Raider 50.1 Oasis KS/Rally 50.1 Trial Trial 50 Junior 80 Trial GARELLI Trial 323 MALAGUTI 50 Enduro RCW-X/Sahib	81- 86- 86- 87- 83- 86- 83-	R R R F&R F&R						
	LZ 125 Sport	80-82	R										
	LZ 125 Sport	80-82	R										
	MOTO MORINI 250 all models	71-	R										
	350 Sport	80	R										
	350 FT/Turismo	80-	R										
	922 922G	FANTIC 50 Trial	-83 83- -83 -83				R	931 931G	TOMOS Moped with cast wheels BENELLI 50 G2 Elle GARELLI 50 Vip/Noi/Basic Alu wheel Formuno 50 50 Team Matic MALAGUTI 50 RGT Strada 50 Custom Fox 50 Dribbling 50 Fifty RV 50 Ranocchio 3 wheels Grizzly 10 CE (50cc) Grizzly 10 (50cc) Grizzly 12 CE Grizzly 12 Grizzly Quad Grizzly RCW4 Grizzly RCX 10 Grizzly RCX 12	79- 87- 88- 83- 87- 87- 87- 87- 08-09 01-07 08-09 01-07 87- 90-94 90-00 90-00	F&R F&R F&R F R R R R R R R R R R F&R F&R R F&R		
		50 Enduro					F&R						
		50 Caballero					F&R						
80 Trial		F&R											
GILERA 50 GR 2		F											
98 Giubileo		R											
124 Giubileo		R											
125 Arcore		R											
HERCULES (SACHS) 50 Supra Enduro		F&R											
80 Ultra AC		R											
80 Ultra AC Chopper		R											
MALAGUTI 50 MDX Gold Enduro		87-	R										

Part No.	Make/Model	Year		Part No.	Make/Model	Year	
931 931G Contd.	PUCH Maxi 50 Executive Cast Wheels /1 Speed Automotive Maxi S 50 Sport Cast Wheel 1 Speed Automatic Maxi 50 Super Cast Wheel /2 Speed Automatic Magnum 50 Automatic Kids Bike	78-80	F F F F&R	946	BENELLI 125 2C twin brake	-76	F
932	KREIDLER 50 Flory MF 12/13 50 Flory MF 23/24/25 50 LH/LF/LFF 50 RMC/RMC-BG Mustang 125 125 125 RS PUCH Monza 4 SL/GP Imola X/GX Cobra 80/80-6/80-6 GT/GTL		F&R F&R F&R R R R F&R R R	949	CAGIVA Roadster 125 (521 1A Model) Roadster 125 (1AA Model) CZ / JAWA 125/175/250/350 125/175/250/350 350 New Classic 350 Classic	92-94 95-99 -74 75- 13-14	R R F&R R R R
933 933G	MONTESA/HONDA Cota 123/290/349 Cota 123/200/242/349 348 Trial Enduro	-83 84	F&R R F&R	950	CZ / JAWA Scrambler Cross 125 x 300 Jawa 250/400 Cross 250/380 (Models 513/514)	65-76 65-76 77-79	F&R F&R R
934G	OSSA Pre 1980 Models 125 Cross 250 Cross/Fuego/Super Pioneer	74- 74-	F&R F F	951	CZ / JAWA 125/175/250/350	75-	F
935G	OSSA 81 Onwards		F	953	CAGIVA 125 Elefant RE	87	R
936G	OSSA 81 Onwards FB MINARELLI (SPAIN) MR 80		R R	954	GILERA 125 RX RX 200/Arizona/Enduro 200 Arizona Hawk 200 RTX 200 ER RX 125 Arizona	84- 85- 85- 85- 87- 88	R R R R R R
937G	MONTESA/HONDA Cota 123/200/242/349	84	F	958	LAMBRETTA 175 TV-1 125/150/175 L1		R F&R
938	HYOSUNG TE 50 TE 90 TE 100	05-07 05-07 05-07	F F F	959	LAMBRETTA 125/150/200 DL		F&R
939G	FANTIC 300 Trial BETA 240 TR 32	84-85	F F	965 965G	ITALJET (All Models 125cc) BENELLI S 50 Scooter	81-	F&R R
940G	ACCOSSATO CE 80/120 Cross/Enduro H 20	84-	F	966	KREIDLER 50 RM 80 E/L Florett		F&R R
941	ASPES RCL 80		F&R	970	PUCH MS 50/50 L		F&R
V942	PIAGGIO (VESPA) Vespa PK 50 S Automatica Vespa FL2 Automatica Vespa PK 125 S Automatica	84-89 90-91 84-89	R R R	972	PUCH 50 KA/K2/K25/K3T/MSP		F&R
944 944G	CAGIVA WMX 125 (Rimoldi Hub) HRD RP 50 Cross RP 80 Cross	-85 83-	F&R F&R	975	ZUNDAPP KS 50 Sport/Supersport KS 100	All years All years	R R
945	BENELLI S 50 Scooter FANTIC 50 Issimo spoke wheel 50 Joy PUCH Maxi 50 Executive Cast Wheels /1 Speed Automotive Maxi S 50 Sport Cast wheel /1 Speed Automatic Maxi 50 Super Cast wheel /2 Speed Automatic	81- 92-	F F&R F&R R R R	976	ZUNDAPP CS 25 Mofa BJ (Type 448-140) CS 25 Mofa BJ (Type 448-141) CX 25 Mofa BJ (Type 448-151) CX 25 Mofa BJ CS 50 Mokick BJ (Type 448-010) CS 50 Mokick BJ (Type 448-011) CS 50 Mokick BJ (Type 448-013) Hai 25 25 Mofa BJ (Type 448-150) Hai 50 50 Mokick Enduro (Type 448-150) Hai 50 50 Mokick Enduro (Type 448-111)	80-82 82 82 83-84 79-80 80 80-82 80-82 80-82 80 80-82 F&R	F&R F&R F&R F&R F&R F&R F&R F&R F&R F&R F&R
				977G	CAGIVA WMX 125 WM 125 WMX 250	86 87-88 86-88	R R R
				978	MZ TS 125/150 TS 250 ETZ 250/300 251 Fun Saxon 'Tour' 251/301 Saxon 500 'All models'	85-92 95-96 93-98 93-98	F F&R R R R R

Part No.	Make/Model	Year		Part No.	Make/Model	Year	
979	MZ Saxon 125 Saxon 150 TS 125/150 ETZ 125/150	93-97 95 85-92	R R R R				
980	MZ Simpson	80-94	F&R				
982G	CAGIVA WMX 500	84-86	R				
983	GARELLI GTA 125	85	R				
984	HUSQVARNA Husky Boy J Husky Boy R Husky Boy S	01-02 01 01-02	R R R				
985	FB MINARELLI (SPAIN) Rieju Marathon	74-	F&R				
987	GILERA 350 Dakota ER 350 500 Dakota ER 500	85- 87- 87- 87-	R R R R				
990G	OSSA 125 Cross 250 Cross/Fuego/Super Pioneer	74- 74-	R R				
995	APRILIA Classic 50 FANTIC 50.1 Oasis Kick 50.1 Trial H 20	92-01 87- 87-	R R R				

BRAKE SHOE ILLUSTRATIONS

SHOE
BUYERS GUIDE

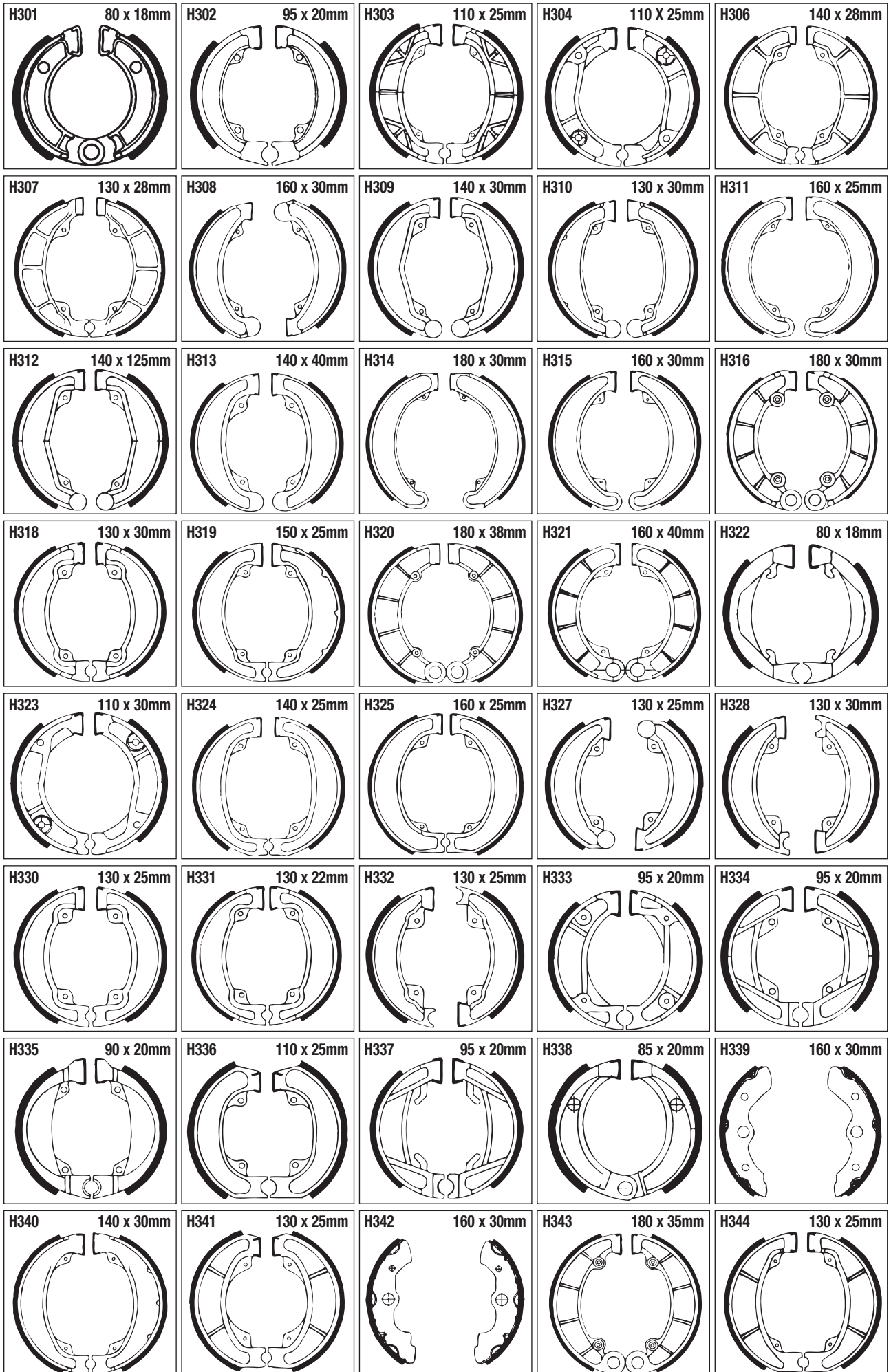

BRAKE SHOE ILLUSTRATIONS

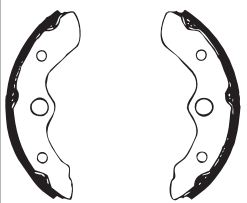
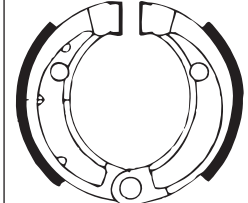
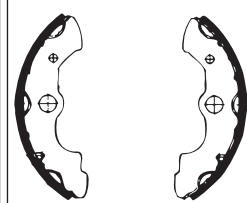
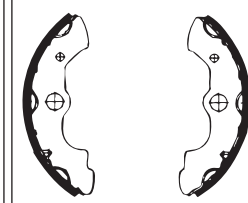
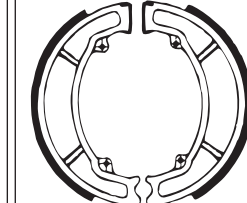
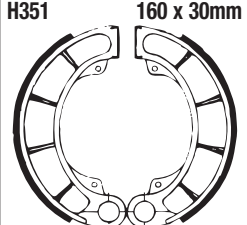
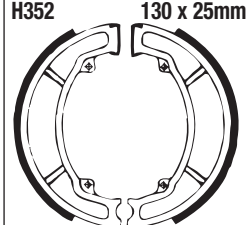
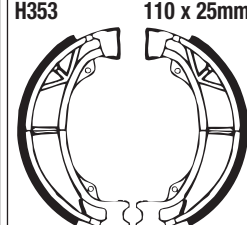
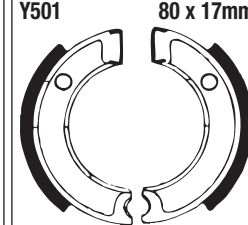
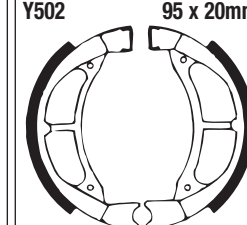
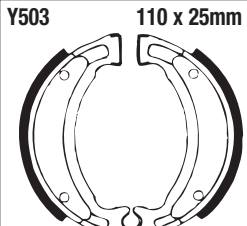
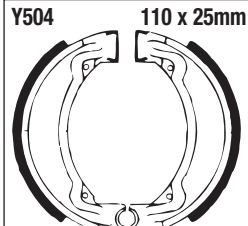
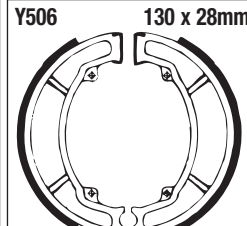
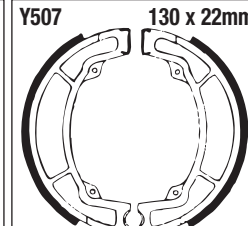
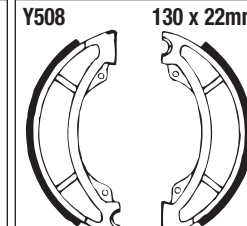
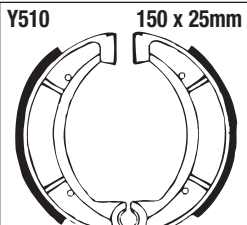
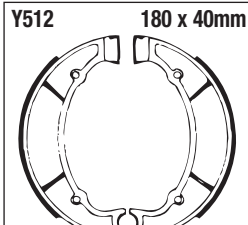
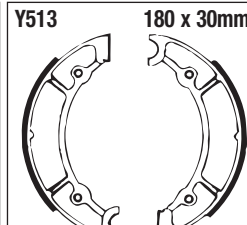
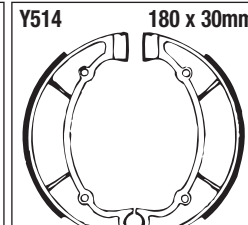
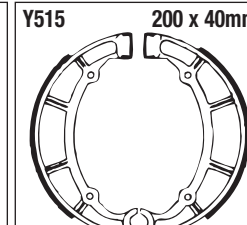
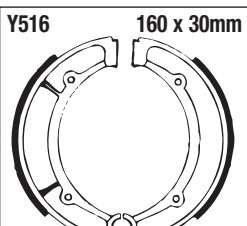
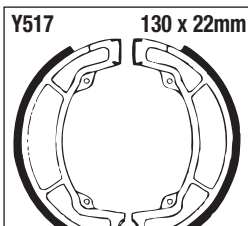
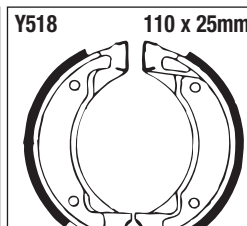
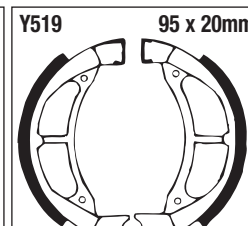
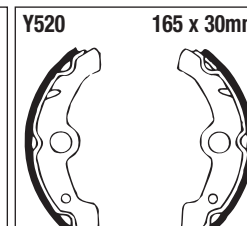
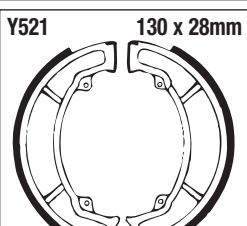
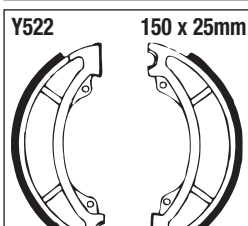
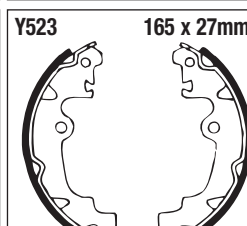
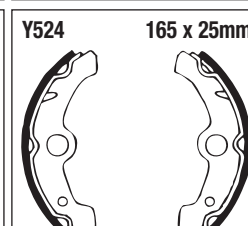
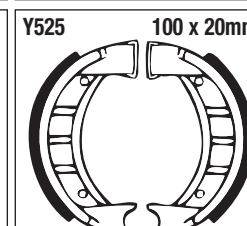
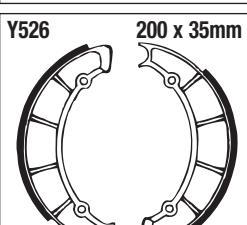
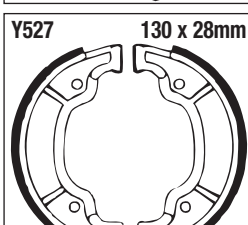
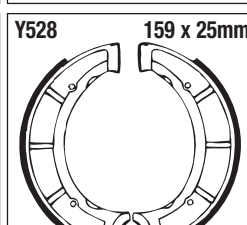
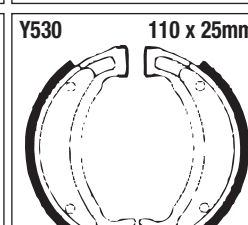
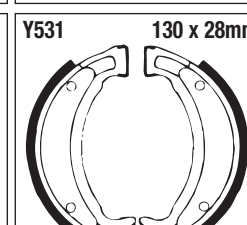
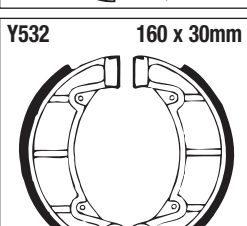
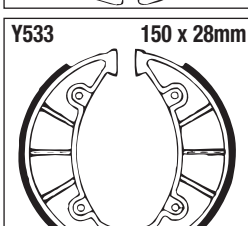
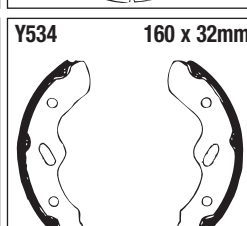
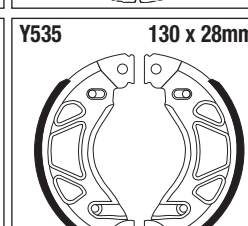
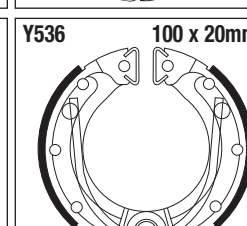
H345 130 x 25mm 	H346 87 x 20mm 	H347 160 x 20mm 	H347S 160 x 20mm 	H350 130 x 25mm 
H351 160 x 30mm 	H352 130 x 25mm 	H353 110 x 25mm 	Y501 80 x 17mm 	Y502 95 x 20mm 
Y503 110 x 25mm 	Y504 110 x 25mm 	Y506 130 x 28mm 	Y507 130 x 22mm 	Y508 130 x 22mm 
Y510 150 x 25mm 	Y512 180 x 40mm 	Y513 180 x 30mm 	Y514 180 x 30mm 	Y515 200 x 40mm 
Y516 160 x 30mm 	Y517 130 x 22mm 	Y518 110 x 25mm 	Y519 95 x 20mm 	Y520 165 x 30mm 
Y521 130 x 28mm 	Y522 150 x 25mm 	Y523 165 x 27mm 	Y524 165 x 25mm 	Y525 100 x 20mm 
Y526 200 x 35mm 	Y527 130 x 28mm 	Y528 159 x 25mm 	Y530 110 x 25mm 	Y531 130 x 28mm 
Y532 160 x 30mm 	Y533 150 x 28mm 	Y534 160 x 32mm 	Y535 130 x 28mm 	Y536 100 x 20mm 

BRAKE SHOE ILLUSTRATIONS

SHOE
BUYERS GUIDE

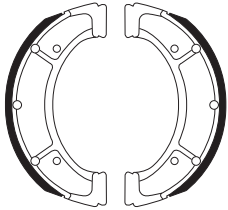
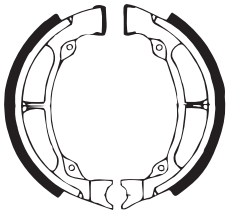
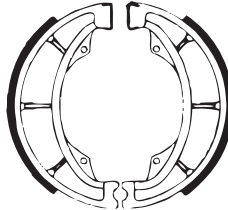
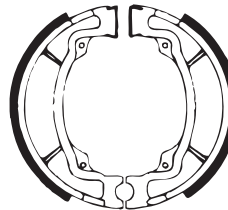
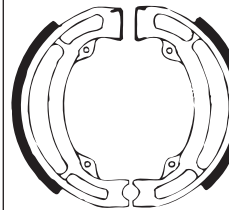
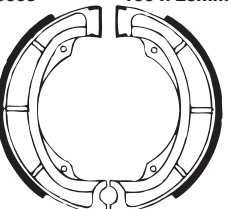
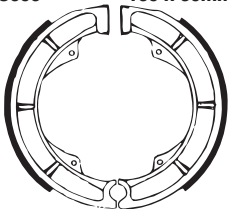
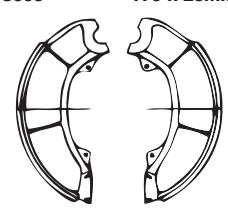
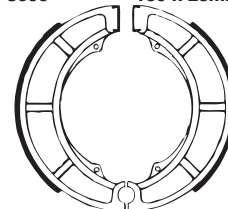
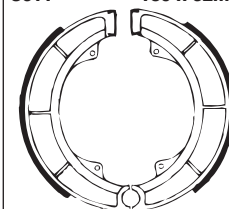
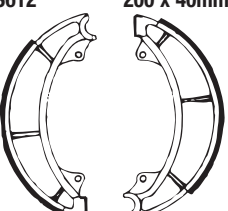
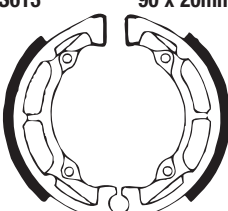
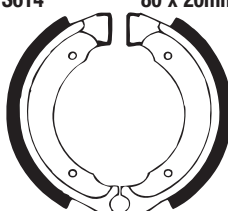
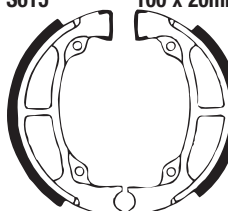
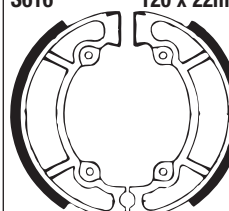
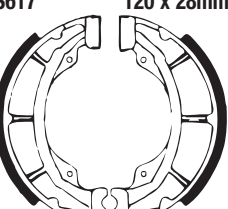
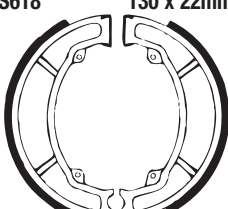
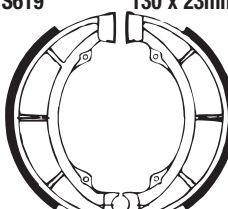
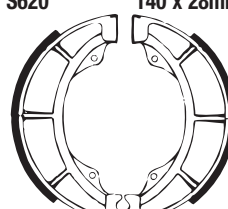
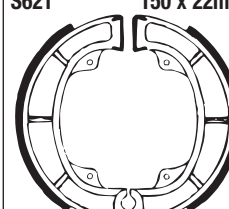
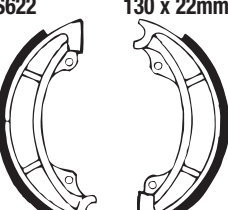
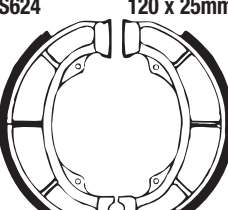
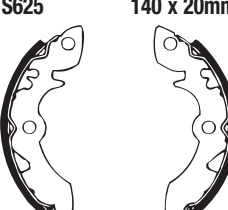
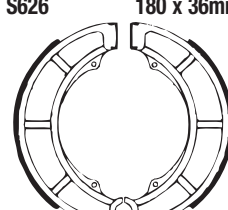
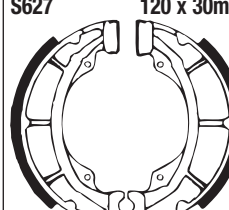
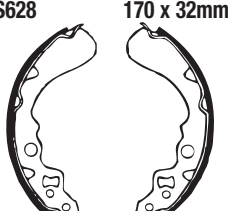
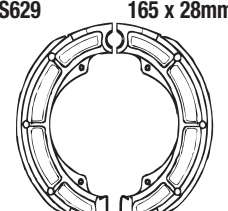
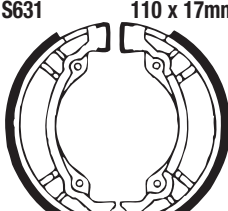
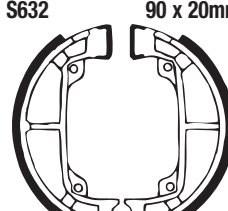
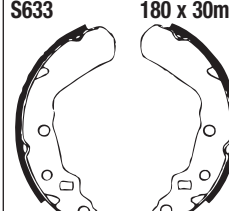
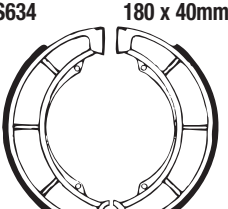
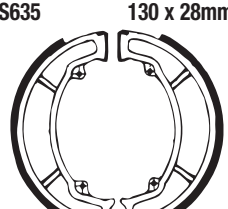
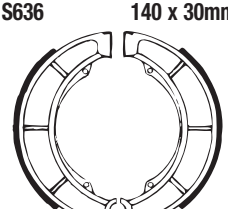
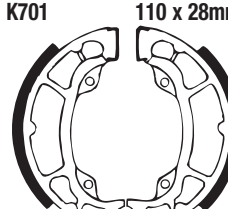
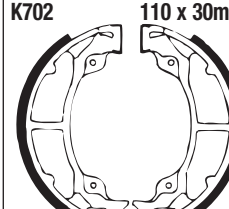
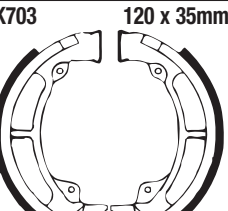
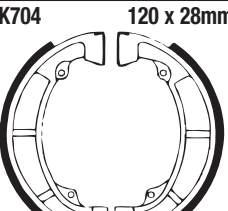
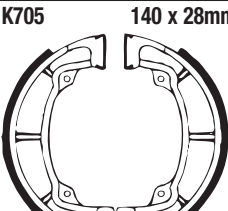
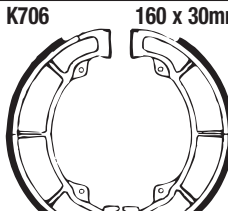
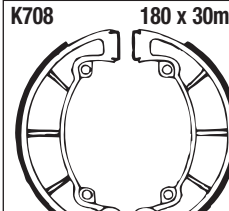
Y537 140 x 26mm 	S601 100 x 25mm 	S602 130 x 28mm 	S603 110 x 30mm 	S604 110 x 25mm 
S605 150 x 28mm 	S606 160 x 30mm 	S608 179 x 28mm 	S609 180 x 28mm 	S611 180 x 32mm 
S612 200 x 40mm 	S613 90 x 20mm 	S614 80 x 20mm 	S615 100 x 20mm 	S616 120 x 22mm 
S617 120 x 28mm 	S618 130 x 22mm 	S619 130 x 23mm 	S620 140 x 28mm 	S621 150 x 22mm 
S622 130 x 22mm 	S624 120 x 25mm 	S625 140 x 20mm 	S626 180 x 36mm 	S627 120 x 30mm 
S628 170 x 32mm 	S629 165 x 28mm 	S631 110 x 17mm 	S632 90 x 20mm 	S633 180 x 30mm 
S634 180 x 40mm 	S635 130 x 28mm 	S636 140 x 30mm 	K701 110 x 28mm 	K702 110 x 30mm 
K703 120 x 35mm 	K704 120 x 28mm 	K705 140 x 28mm 	K706 160 x 30mm 	K708 180 x 30mm 

BRAKE SHOE ILLUSTRATIONS

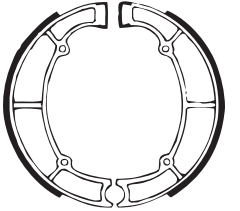
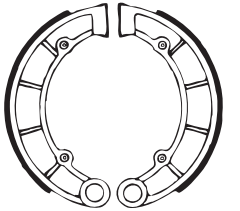
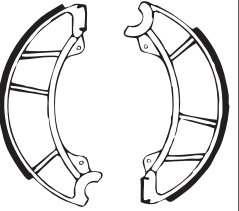
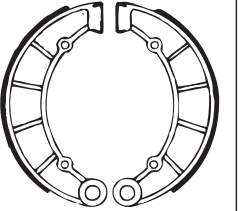
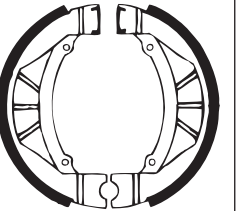
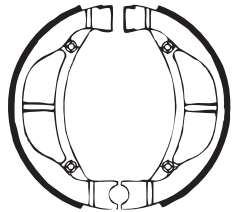
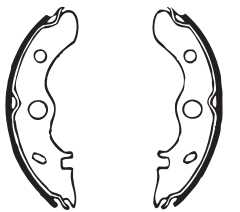
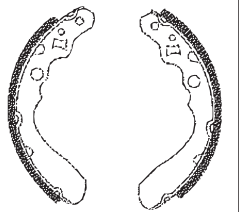
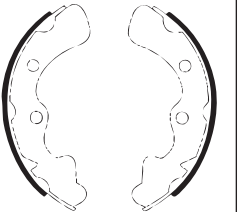
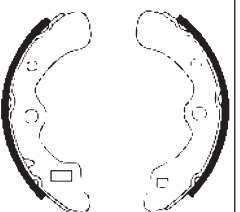
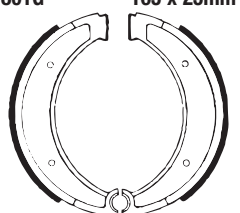
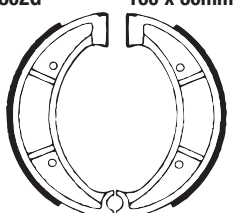
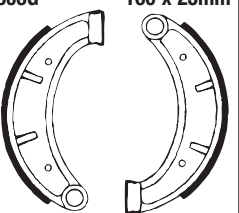
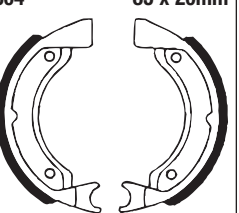
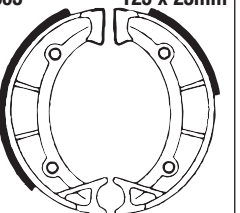
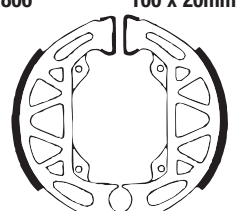
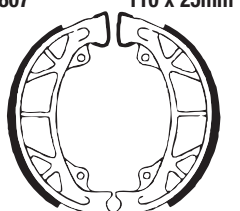
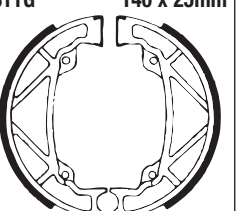
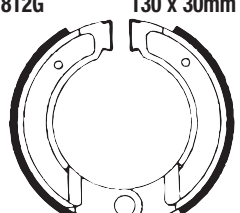
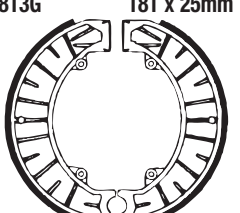
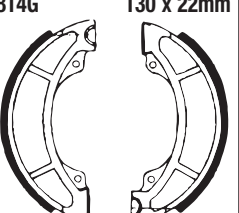
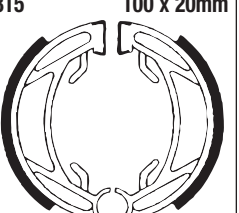
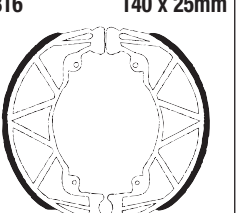
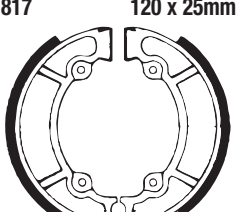
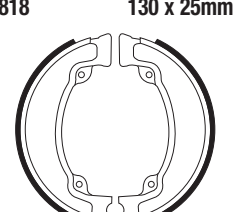
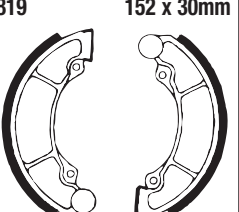
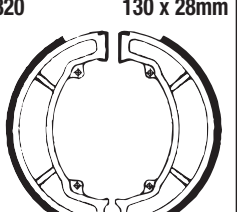
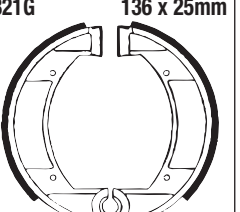
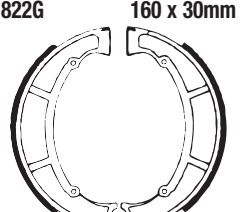
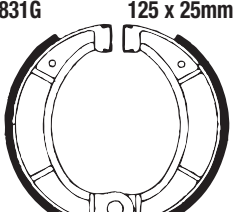
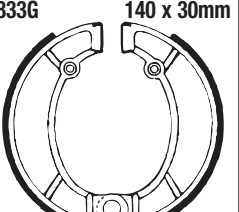
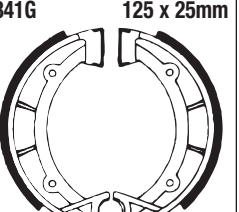
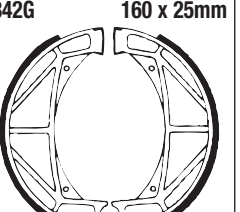
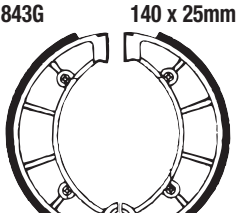
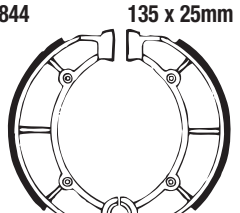
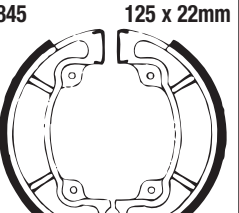
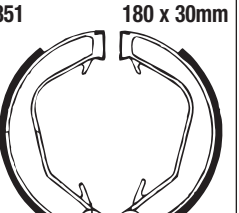
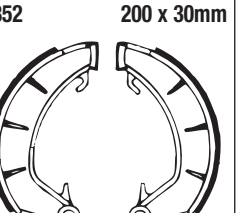
K709 180 x 40mm 	K710 180 x 35mm 	K711 180 x 30mm 	K713 200 x 35mm 	K714 95 x 20mm 
K715 90 x 20mm 	K717 160 x 30mm 	K718 165 x 26mm 	K719 180 x 26mm 	K720 180 x 25mm 
801G 165 x 25mm 	802G 160 x 30mm 	803G 160 x 25mm 	804 85 x 20mm 	805 125 x 25mm 
806 100 x 20mm 	807 110 x 25mm 	808 100 x 22mm PIC NOT AVAILABLE	809 150 x 24mm PIC NOT AVAILABLE	811G 140 x 25mm 
812G 130 x 30mm 	813G 181 x 25mm 	814G 130 x 22mm 	815 100 x 20mm 	816 140 x 25mm 
817 120 x 25mm 	818 130 x 25mm 	819 152 x 30mm 	820 130 x 28mm 	821G 136 x 25mm 
822G 160 x 30mm 	831G 125 x 25mm 	833G 140 x 30mm 	841G 125 x 25mm 	842G 160 x 25mm 
843G 140 x 25mm 	844 135 x 25mm 	845 125 x 22mm 	851 180 x 30mm 	852 200 x 30mm 

BRAKE SHOE ILLUSTRATIONS

SHOE
BUYERS GUIDE

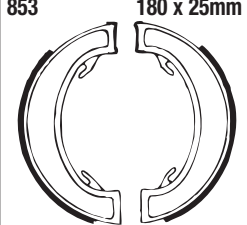
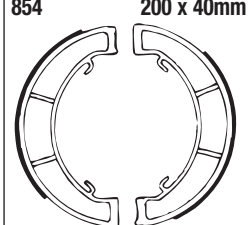
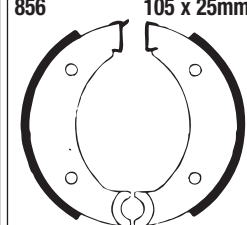
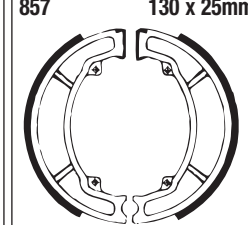
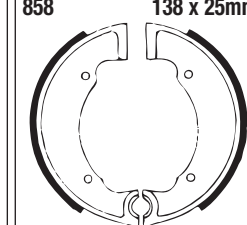
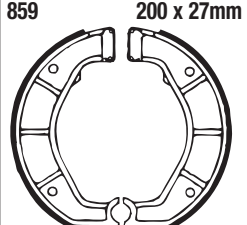
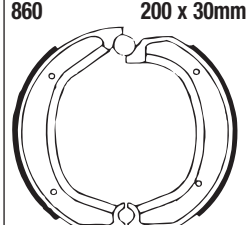
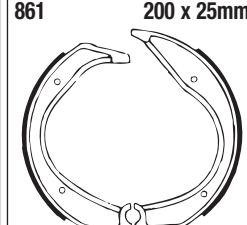
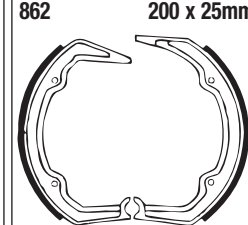
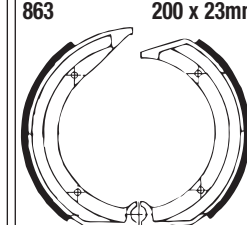
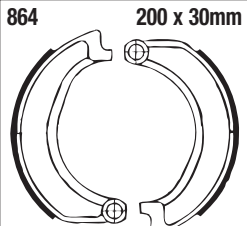
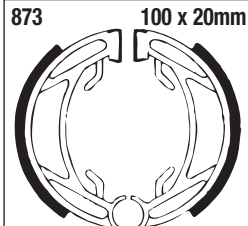
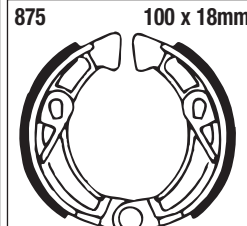
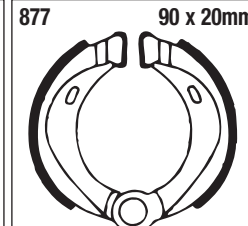
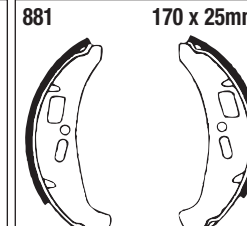
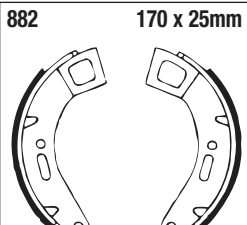
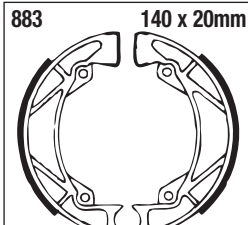
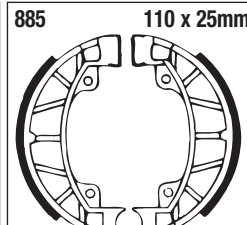
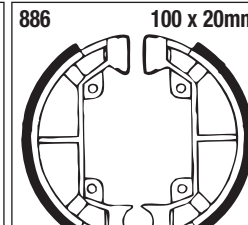
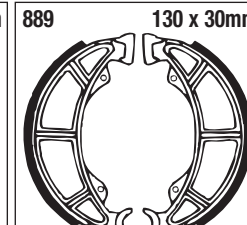
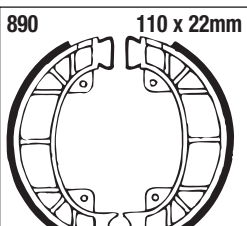
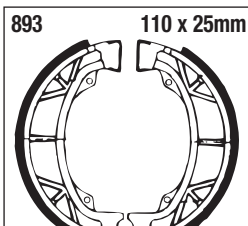
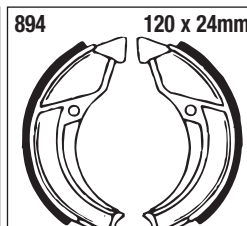
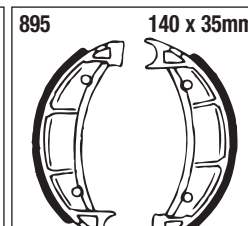
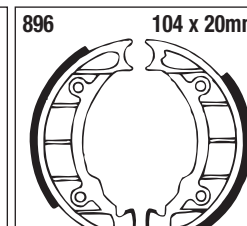
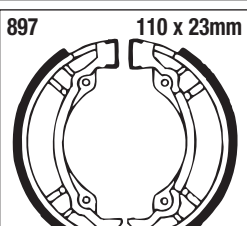
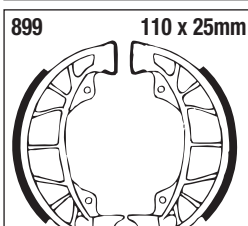
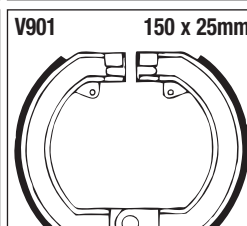
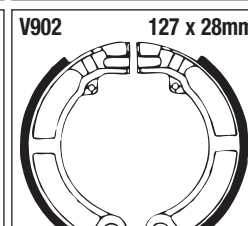
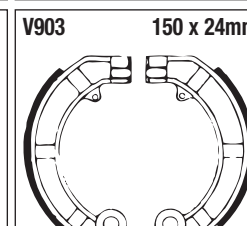
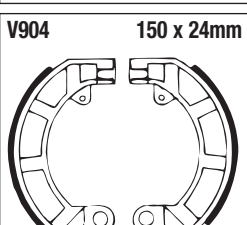
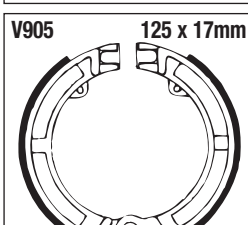
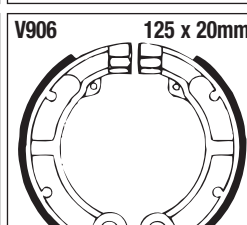
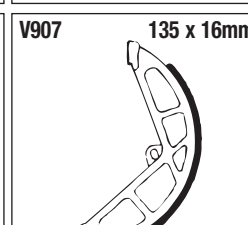
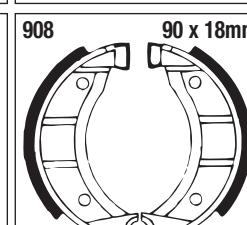
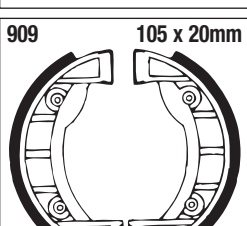
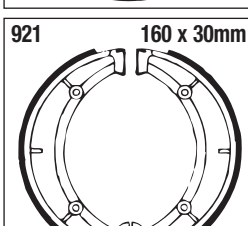
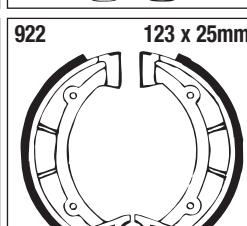
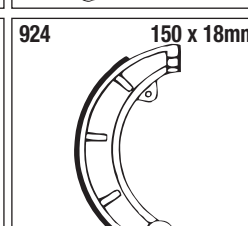
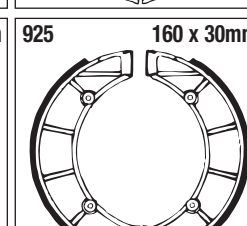
853  180 x 25mm	854  200 x 40mm	856  105 x 25mm	857  130 x 25mm	858  138 x 25mm
859  200 x 27mm	860  200 x 30mm	861  200 x 25mm	862  200 x 25mm	863  200 x 23mm
864  200 x 30mm	873  100 x 20mm	875  100 x 18mm	877  90 x 20mm	881  170 x 25mm
882  170 x 25mm	883  140 x 20mm	885  110 x 25mm	886  100 x 20mm	889  130 x 30mm
890  110 x 22mm	893  110 x 25mm	894  120 x 24mm	895  140 x 35mm	896  104 x 20mm
897  110 x 23mm	899  110 x 25mm	V901  150 x 25mm	V902  127 x 28mm	V903  150 x 24mm
V904  150 x 24mm	V905  125 x 17mm	V906  125 x 20mm	V907  135 x 16mm	908  90 x 18mm
909  105 x 20mm	921  160 x 30mm	922  123 x 25mm	924  150 x 18mm	925  160 x 30mm

BRAKE SHOE ILLUSTRATIONS

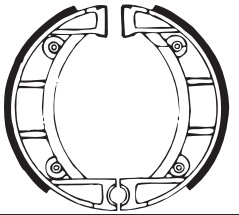
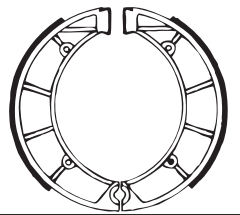
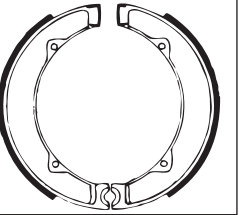
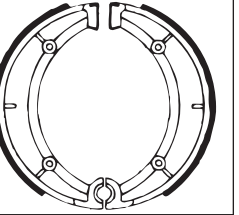
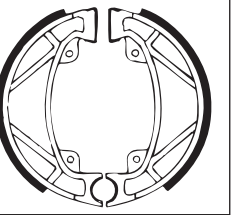
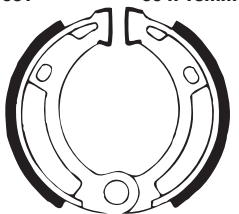
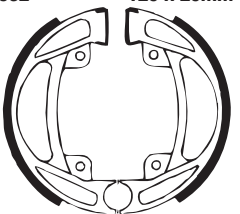
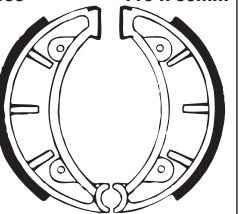
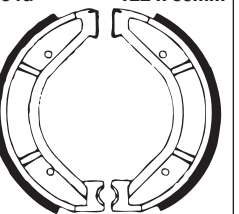
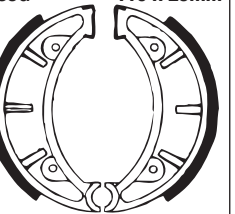
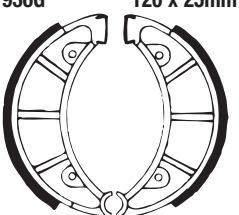
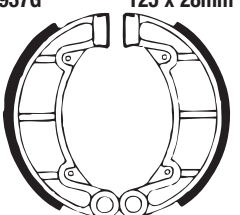
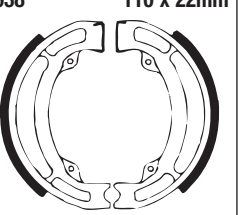
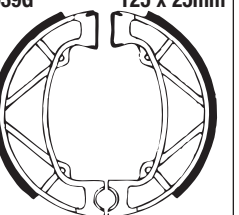
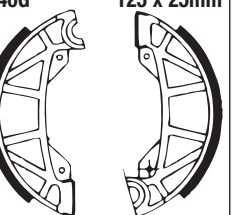
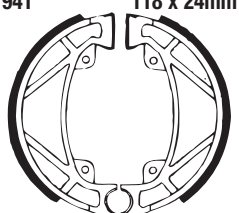
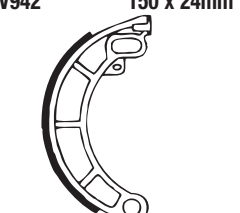
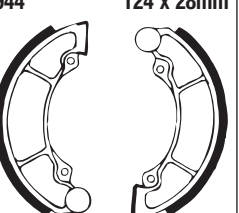
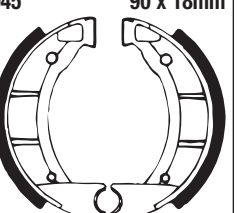
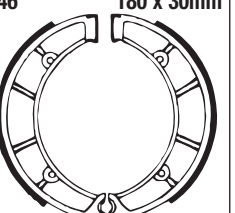
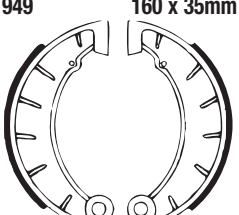
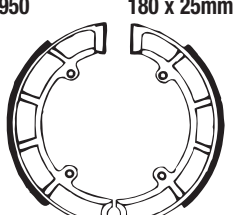
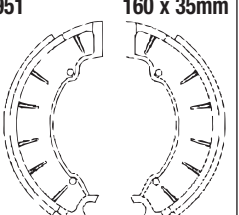
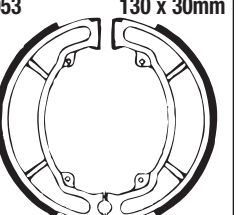
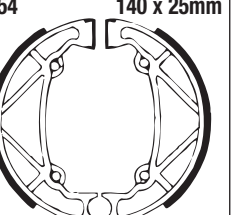
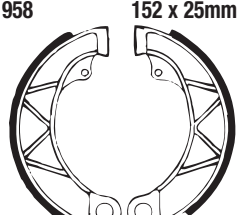
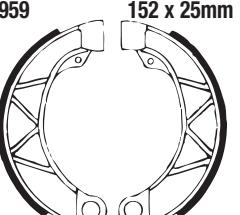
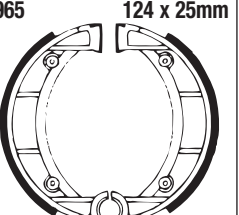
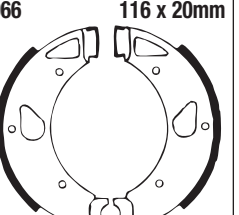
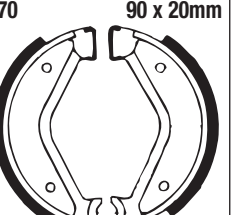
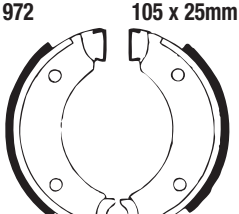
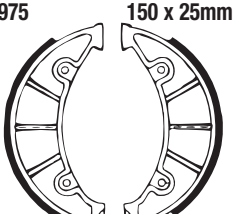
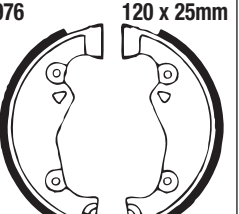
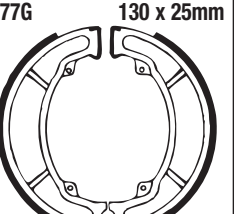
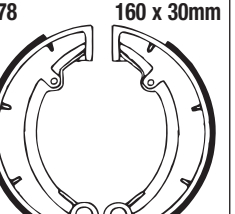
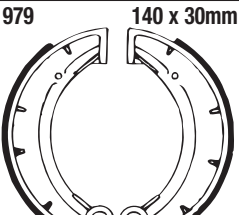
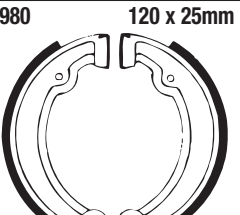
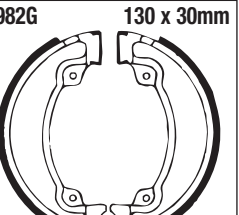
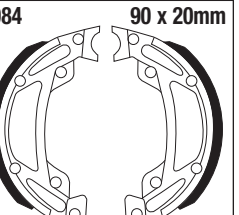
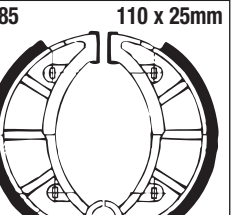
926  118 x 20mm	927G  160 x 25mm	928  182 x 35mm	929  158 x 30mm	930G  118 x 24mm
931  90 x 18mm	932  120 x 20mm	933  110 x 30mm	934G  122 x 30mm	935G  110 x 25mm
936G  120 x 25mm	937G  125 x 28mm	938  110 x 22mm	939G  125 x 25mm	940G  125 x 25mm
941  118 x 24mm	V942  150 x 24mm	944  124 x 28mm	945  90 x 18mm	946  180 x 30mm
949  160 x 35mm	950  180 x 25mm	951  160 x 35mm	953  130 x 30mm	954  140 x 25mm
958  152 x 25mm	959  152 x 25mm	965  124 x 25mm	966  116 x 20mm	970  90 x 20mm
972  105 x 25mm	975  150 x 25mm	976  120 x 25mm	977G  130 x 25mm	978  160 x 30mm
979  140 x 30mm	980  120 x 25mm	982G  130 x 30mm	984  90 x 20mm	985  110 x 25mm

BRAKE SHOE ILLUSTRATIONS

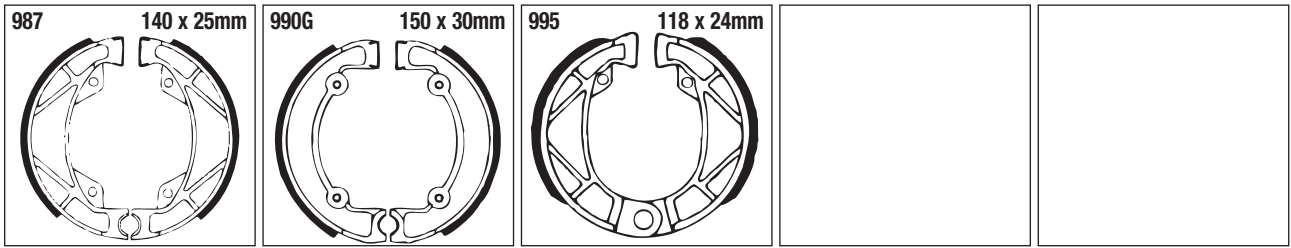

SHOE
BUYERS GUIDE

BRAKE SHOE DIAMETER CHART
(in mm)

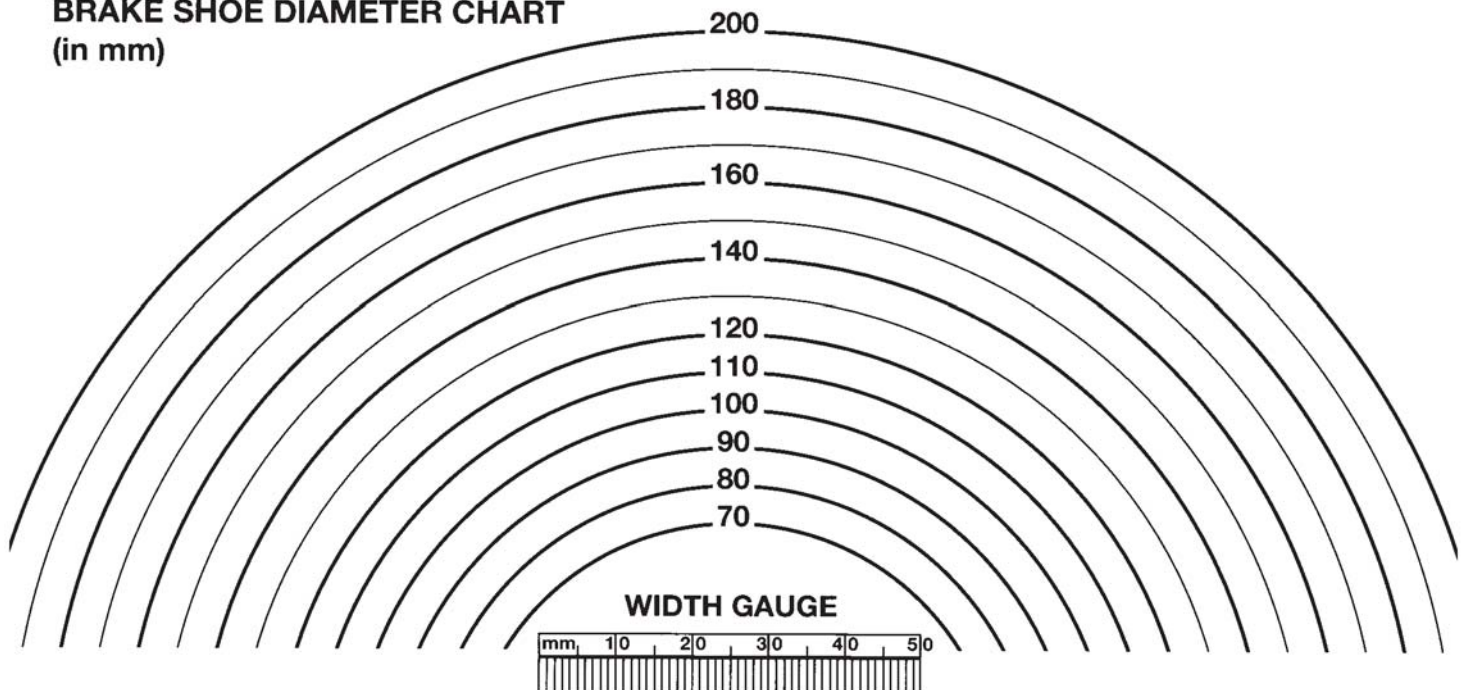

STREETBIKE DISC BUYERS GUIDE

DISC No.	FRONT/ REAR	TYPE	MODELS	DIA (MM)	DISC No.	FRONT/ REAR	TYPE	MODELS	DIA (MM)
Old Part No. MD506LS/RS Equivalent New Nos. FSD001, FSD003 FSD005C, FSD007, FSD009, FSD009BLK, FSD011C, FSD022, FSD022BLK, RSD007	FRONT	F	HARLEY DAVIDSON® 11 1/2" Front Floating Disc Conversion. (Sportsters & Big Twins with speedo notch) See main catalogue listing for full fitment info.	292	MD522 Contd.	REAR	S	BUELL Contd. XB12X Ulysses 06-10 XB12XT Ulysses 08-10 XB12SCG Lightning 06-08 XB12SS Lightning Long 06-08 XB12STT Lightning 06-08 XB12STT Lightning 08 XB12SCG Lightning 09-10 XB9 SX Lightning 08-10	240
MD508SKL MD508SKR Equivalent. New Nos. RSD013C, RSD015, RSD017C, RSD019, RSD019BLK	REAR	F	HARLEY DAVIDSON® 11 1/2" Front Floating Disc Conversion. (Sportsters & Big Twins with speedo notch). See main catalogue listing for full fitment info.	292	MD523X VR523BLK	FRONT	F	HARLEY DAVIDSON® XR 1200 X 10-12 XR 1200 08-10	290
MD509SR Billet	REAR	S	HARLEY DAVIDSON® FLT, FLHT, FLHTCI 86-99 FLHR, FLHRCI 94-99	292	MD524 MD524X VR524BLK	REAR	S	HARLEY DAVIDSON® XL 883 L Superlow 11-13 XL 883 L Superlow (Cast wheel) 14-20 XL 883 R Roadster (Cast wheel) 11-15 XL 883 N Iron (Cast wheel) 11-15 XL 883 N 16-20 XL 1200 C Custom 11-20 XL 1200 L Sportster Low 07-11 XL 1200 T Superlow 14-20 XL 1200 V Seven Two 14-15 XL 1200 X Forty Eight 14-17 XR 1200 08-10 XR 1200 X 10-12 XL 883 N 16	260
MD511	REAR	S	Buell All models 94-02	240	MD525	REAR	F	VRSCA/VRSCB VRSCF V-Rod Muscle 14-17	300
MD512LS/RS Equivalent. New Nos. FSD002, FSD004, FSD004BLK, FSD006C, FSD008, FSD010, FSD010BLK, FSD012C, FSD021, FSD021BLK, FSD023, FSD023BLK	FRONT	F	HARLEY DAVIDSON® All models, 2000 onwards (Check main catalogue for model fitments)	292	MD526	FRONT	S	HARLEY DAVIDSON® XL 883 L (Superlow/Cast wheel) 14-20 XL 883 R Roadster (Cast wheel) 14-15 XL 883 N Iron (Cast wheel) 14-17 XL 1200 C Custom (Spoke wheel) 14-20 XL 1200 T Superlow 14-20 XL 1200 V Seven Two 14-15 XL 1200 X Forty Eight 14-17 FXST Softail Standard 15 FLS Softail Slim 15-17 FLSL Softail Slim 18 FLSTC Heritage Softail Classic 15-17 FLHC Heritage Classic 18 FLHCS Heritage Classic 114 18 FLHCS Heritage Classic 114 Anniv. 18 FLSTN Softail Deluxe 15 FLDE Deluxe 18-20 FXBB Street Bob 18-20 FXLR Low Rider 18-20	300
Old Part No. MD513SKL MD513SKR Equivalent New Nos. RSD008C, RSD014C, VR014, RSD016, RSD018C	REAR	F	HARLEY DAVIDSON® All models, 2000 onwards (Check main catalogue for model fitments)	292	MD527			USE MD530	
MD514LS/RS	FRONT	S	HARLEY DAVIDSON® VRSCA V-Rod 02-05	292	MD528	REAR	F	HARLEY DAVIDSON® FXSB Breakout 13-17 FLFB Fat Boy 18 FLFBS Fat Boy 114 18 FLFBS Fat Boy 114 Anniv 18 FXBR Breakout 18-20 FXBRS Breakout 114 18-20 FXBRS Breakout 114 Anniv. 18-20 FXFB Fat Bob 18-20 FXBS Fat Bob 18-20 FLDE Deluxe 18-20 FXBB Street Bob 18-20 FXLR Low Rider 18-20	290
MD515	REAR	S	HARLEY DAVIDSON® VRSCA V-Rod 02-05	292	MD529	FRONT	S	HARLEY DAVIDSON® FLHRC Road King Classic 14-17 FLHTCU Ultra 14-20 Classica Electra Glide 14-20 FLHTCUL Ultra Classic 15 Electra Glide LOW 15-20 FLHTK Ultra LTD 15-20 FLHTKL Ultra LTD LOW 15-20 FLHX Street Glide 14-20 FLHXS Street Glide Special 14-20 FLTRX Road Glide 15-20 FLTRXS Road Glide Special 15-17 FLHR Road King (Cast Wheel Type) 15-20 FLTRXS Road Glide Special 15-17 FLTRU Road Glide Ultra 16-20	300
MD516 MD516X	FRONT	S	HARLEY DAVIDSON® V-Rod Models 06-17 (X=Floating conversion) Check main page applications.	300	MD522	REAR	S	BUELL XB12R Firebolt 04-10 XB12 SS Lightning 09-10 Firebolt XB9R 02-07 XB9S Lightning 03-04 XB12S Lightning 04-08 XB9SX Lightning City/X 05-09	240
MD517	REAR	S	HARLEY DAVIDSON® V-Rod Models 06-17 Check main page applications.	300					
MD518 (Spoke wheel models) Hub polished	FRONT	F	HARLEY DAVIDSON® Various models 2006 onwards. See main catalogue listings for full fitment info.	300					
MD519 Hub polished	FRONT	F	Use MD518	300					
MD520	FRONT	F	HARLEY DAVIDSON® Touring Series Models 08-13 Check main page applications. FLHTCUTG Tri Glide 09-13 Ultra Classic Trike 10-11	300					
MD521 Billet	REAR	F	HARLEY DAVIDSON® Touring Series Models 08-14 Check main page applications. FLHRC Road King Classic 14-20 FLHTCU Ultra Classic 14-20 Electra Glide 15 FLHTCHL Ultra Classic 15-20 FLHTK Ultra LTD 15-20 FLHTKL Ultra LTD LOW 14-20 FLHX Street Glide 14-20 FLHXS Street Glide Special 15-20 FLTRX Road Glide 15-17 FLTRXS Road Glide Special 15-20 FLHR Road King (Cast Wheel Type) 15-20 FLTRXS Road Glide Special 15-17 FLTRU Road Glide Ultra 16-20	300					

STREETBIKE DISC BUYERS GUIDE

DISC No.	FRONT/ REAR	TYPE	MODELS	DIA (MM)	DISC No.	FRONT/ REAR	TYPE	MODELS	DIA (MM)
MD530 MD530BLK	FRONT	F	HARLEY DAVIDSON® FLHTCUTG Trike Tri Glide Ultra 14-20 FLRT Freewheel Trike 15-20 FLSTF Fatboy 15-17 FLSTFB Fatboy LO 15-17 FLFB Fat Boy 18 FLFBS Fat Boy 114 18 FLFBS Fat Boy 114 Anniv 18 FXSB Breakout 15-17 FXBR Breakout 18-20 FXBRS Breakout 114 18-20 FXBRS Breakout 114 Anniv. 18-20 FXFB Fat Bob 18-20 FXBS Fat Bob 18-20	300	MD602LS MD602RS (35.8mm offset)	FRONT /REAR	F	BMW R 60/7 76-80 R 60 TIC 78-82 R 75/6/75/7 73-79 R 80 77-84 R 80 RT 82-84 R 80 TIC 78-85 R 90 S 73-76 R 90/6 73-76 R 100 76-77 R 100/7T 77-84 R 100 S 76-80 R 100 RS 76-84 R 100 RT 78-84	260
MD531	FRONT	S	HARLEY DAVIDSON® XG 500 Street 16-20 XG 750 Street 16-20	290	MD603LS MD603RS	FRONT	D	BMW K75/K75-2 (Non ABS) 84-07/90 K75/75-S (ABS Model) 08/90-96 K75 RT (ABS Model) 89-96 K75 S (ABS Model) 85-95 K100/2 (ABS 8 Valve Model) 87-90 K100 LT (ABS 8 Valve Model) 86-91 K100 RS (ABS Model 8 Valve) 83-89 K 100 RT (ABS 8 Valve) 83-89	285
MD532	REAR	S	HARLEY DAVIDSON® XG 500 Street 16-20 XG 750 Street 16-20	260	MD604LS MD604RS (31.5mm offset)	FRONT	F	BMW K 75/75-S 84-88 K 75/75-2 88-96 K 75 C 85-90 K 75 RT 89-96 K 75 S 85-95 K 1000 82-88 K 100/2 87-90 K 100 LT 86-91 K 100 RS/RT 83-89	285
MD533	FRONT /REAR	S	POLARIS SLINGSHOT Slingshot 15-17 Slingshot S 18 Slingshot SL 15-18 Slingshot SL SE 15-18	299					
MD533BSDF	FRONT	S	POLARIS SLINGSHOT Slingshot 15-17 Slingshot S 18 Slingshot SL 15-18 Slingshot SL SE 15-18	299	MD605LS MD605RS (23.3mm offset)	FRONT	F	BMW R 65 07/88-07/89 R 65 RT 85-88 R 65 LS 81-85 R 80/R 80 RT 84-95 R 80 Mystic 94-95 R 80 R 91-94 R 850 GS 96 R 80 GS/PD/CH/ST 80-95 R 100 GS/PD 89-96 R 100 RS 86-92 R 100 RT 87-95 R 100 Mystic 93-96 R 100 R 91-95	285
MD533BSDR	REAR	S	POLARIS SLINGSHOT Slingshot 15-17 Slingshot S 18 Slingshot SL 15-18 Slingshot SL SE 15-18	299					
MD534 MD534X VR534BLK	FRONT/ REAR	S	INDIAN Scout (Cast Wheel/Toso Calipers) 15-16 Scout 17-20 Scout Bobber 18-20 Scout Sixty (Cast Wheel/Toso Calipers) 16 Scout Sixty 17-20 VICTORY Octane 1200cc 17	298	MD606LS MD606RS (47.8mm offset)	FRONT	F	BMW R 45 All models 78-85 R 65 GS 87-92 R 65 T 80-85 R 65 LS (Brembo caliper) 81-85 R 100/7T 80-84	260
MD535 MD535BLK VR535BLK	FRONT/ REAR	F	INDIAN Chief Blackhawk (Brembo calipers) 11 Chief Blackhawk Dark (Brembo calipers) 11 Chief Classic (Brembo calipers) 11-13 Chief Standard (Brembo calipers) 09-11 Chief Deluxe (Brembo calipers) 09 Chief Roadmaster (Brembo calipers) 09-11 Chief Vintage (Brembo calipers) 09-13 Bomber (Brembo Calipers) 10-11 Dark Horse (Brembo calipers) 10-13	292					
MD536	FRONT	S	HARLEY DAVIDSON® XG 500 Street (300mm Discs) 16-20 XG 750 Street (300mm Discs) 16-20	300	MD607LS MD607RS	FRONT	F	BMW K100 RS 89-92 K1 88-93 K 1100 LT 89-99 K 1100 RS 92-96 R 850 RT 96-01 R 1100 R 93-01 R 1100 RS 92-01 R 1100 RT 94-01	305
MD537	REAR	S	HARLEY DAVIDSON® XG 500 Street (300mm Discs) 16-20 XG 750 Street (300mm Discs) 16-20	300					
MD601LS MD601RS Ⓢ Oversize floating conversion	FRONT	F	CBR 600 FM/FN/FP/FR 91-94 TRIUMPH Ⓢ Bonneville 800 01-05 Ⓢ Bonneville T100 02-05 Ⓢ Bonneville America 02-05 Ⓢ Speedmaster (865cc) 05 Ⓢ Thunderbird Sport 98-00 Ⓢ Tiger 900 885cc 97-99 Ⓢ Tiger 955cc Spoke wheel 99-04	310	MD609LS MD609RS 6 bolt fixing 27.2mm Offset	FRONT / REAR	D	DUCATI 900 Hailwood Replica 79 900 SD Darmah (6 bolt front disc fixing/4 bolt rear disc fixing) 78 900 SD Darmah (6 bolt front & rear disc fixing) 78 1000 R1 Hailwood Replica (6 bolt disc) 84 LAVERDA 750 SF2/SFC 74 750 SF3 76-77 750 SF3 76-77 1000 3C 74-75 1000 3CL 76-81 1000 RGS 82 1000 RGA/RGS Exec 83 1200 78-79 1200 TS/Mirage 81	280

D = Dished Solid Original (We replace with floating rotor conversion unit)

F = Floating Rotor

S = Solid Rotor

STREETBIKE DISC BUYERS GUIDE

DISC No.	FRONT/ REAR	TYPE	MODELS	DIA (MM)	DISC No.	FRONT/ REAR	TYPE	MODELS	DIA (MM)
MD609ALS MD609ARS 6 bolt fixing 26mm off set	FRONT /REAR	F	LAVERDA 1000 RGS Corsa	84 280	MD614X MD614XC VR614BLK VR614BLU VR614RED VR614GLD VR614ORG Contd.	FRONT	F	DUCATI Monster S2R 1000 (992cc) 06-08 Paul Smart 1000 LE (992cc) 06 Sport Classic 1000 (992cc) 06-08 Sport 1000 S 07-08 GENERIC GRS 600 13 KTM 690 Duke 08-12 690 Duke R 10-11 MOTO GUZZI 750 Brevia ie (3 spoke cast wheels) 03-07 750 Nevada Classic ie (spoke wheels) 04-15 750 Nevada 02-11 750 V7 Classic 08-12 750 V7 Cafe Classic 09-12 750 V7 Racer 10-14 750 V7 Special 12-14 750 V7 Stone 12-14 940 Bellagio 07-13 1000 V10 Centauro GT 97-99 1000 V10 Centauro Sport 97-99 1100 California Aluminium 02-05 1100 California Titanium (with top fairing) 04-05 1100 California Aquila Nera 09-11 1100 California Classic Touring 06-08 1100 California EV (Up to KD115426 /Single pin pad fixing) 97-00 1100 California EV (From KD115427/2 pin pad fixing) 97-02 1100 California EV Touring 03-05 1100 California Jackal 94-01 1100 California Special 99-00 1100 California Sport 01-02 1100 California Stone 01-05 1100 California Stone Metal 02-03 1100 California Vintage 06-12 1100 Sport Carbs 94-96 1100 Sport Efi 96-99 1100 Sport Corsa 98-99 1100 - V11 Ballabio 03-05 1100 - V11 Le Mans 01-05 1100 - V11 Sport 99-01 1100 - V11 Scura 01-03 1100 - V11 Naked 02-03 1200 Griso 8V (Standard/Cast Wheel/Radial Caliper) 07-12 1200 Griso 8v (Special Edition/Spoke Wheel/Radial Caliper) 07-15 NORTON 961 Commando Sport 10-15 961 Commando Cafe Racer 10-20 961 Commando Dominator SS 15-20 961 Commando SE 10-11 961 Commando 961 SF 13-15 VOXAN Black Magic 04-08 Street Scrambler 03-06 VB1-Evo 03-04 Cafe Racer 1000 02-08 Roadster 1000 02-08	320
MD611	Rear	F	BMW K 75/75-S 90-96 K 75 RT 89-96 K 75 S 85-95 K 100 82-88 K 100/2 87-90 K 100 LT 86-91 K 100 RS 83-89 K 100 RT 83-88 K 100 RS 89-92 K1 88-93 K 1100 LT 89-93	285					
MD612RS	FRONT	F	APRILIA AF 125	90-91 320					
MD613 MD613C	REAR	S	APRILIA SL 1000 Falco 00-04 RSV 1000 Mille (All models) 98-08 RSV4 R 10 RSV4 R APRC 11-13 RSV4 R APRC ABS 13-14 RSV4 Factory 09-10 RSV4 Factory APRC 11-13 RSV4 Factory APRC ABS 13-14 Tuono 1000 (All models) 02-10 Tuono R Factory 1000 06-10 Tuono V4R 11-12 Tuono V4R - APRC 11-13 Tuono V4R - APRC ABS 14 LAVERDA SFC 1000 03-04	220					
MD614X MD614XC VR614BLK VR614BLU VR614RED VR614GLD VR614ORG	FRONT	F	BENELLI TRE-K 1130 06-17 TRE-K 899 07-16 2UE 750 08-09 TNT 899 S Tornado Naked Tre 07-11 TNT 899 Tornado Naked Tre 07-16 BRAMMO (Electric Bikes) Empulse R 12-13 CAGIVA Mito 125 (SP525) 91-10 N1 125 97 Planet 125 (3 spoke wheels) 98-03 Planet 125 (6 spoke wheels) 98-03 Raptor 125 03-10 Supercity 125 92-00 Mito 500 07-08 River 600 94- DUCATI Monster Dark ie 400 05-06 Monster 400 00-04 600 Monster City/City Dark 99 600 Monster 00-01 620 IE Monster 02-04 620 Monster Dark 03-04 696 Monster 08-14 696 + Monster (inc ABS) 09-12 Monster 696 20th Anniversary Model 13 748 Testa Bassa 01 748 Biposto 99-02 748 SP/Monoposto 99-02 750 Supersport IE 00-02 750 Sport 01-02 750 Monster 00-01 Monster ie750 02 Monster 800 03-04 Supersport 800 03-05 900 Supersport IE 00-01 900 IE Monster 00-01 900 MH Evoluzione 00-01 900 Sport 02 ST2 (944cc) 00-03 ST4 (916cc) 01-02 GT 1000 (992cc) 07-10 GT 1000 Touring (992cc) 09 Monster 1000 Dark 03 Monster 1000 ie (992cc) 04-05 Monster 1000 S ie (992cc) 03-05	320					
					MD615 BILLET			BMW K 1200 LT 97-09 K 1200 LT (Evo integral ABS/disc has fixed bobbins) 08-09 R 1200 CL 02-04	285
					MD616 Loose bobbins	REAR	F	BMW R 850 R 04-06 R 1100 S 00-06 R 1150 R 01-06 R 1150 RS 01-04 R 1150 R Rockster 03-06 K 1200 LT 00-07 R 850 R 04-06 R 1100 S 00-06 R 1150 R 01-06 R 1150 RS 01-04 R 1150 R Rockster 03-06 K 1200 LT 00-07	320

D = Dished Solid Original (We replace with floating rotor conversion unit)

F = Floating Rotor

S = Solid Rotor

DISC BUYERS GUIDE

STREETBIKE DISC BUYERS GUIDE

DISC No.	FRONT/ REAR	TYPE	MODELS	DIA (MM)	DISC No.	FRONT/ REAR	TYPE	MODELS	DIA (MM)
MD616 Contd. Loose bobbins	REAR	F	BMW Contd. K 1200 R (K27/0378) Tokico Caliper Disc with loose buttons 11/05-11/07 K 1200 R 05-08	320	MD622X MD622XC VR622BLK VR622BLU VR622RED VR622GLD	FRONT	F	DUCATI 749 Dark 04-06 749 R 04-06 749 S 03-06 999 S 03-06 999 03-06 999 R 03-06 999 R Fila 03 999 R Xerox 06 1100 S Monster 09-10	320
MD617	FRONT	S	CAGIVA 650 Raptor 01-07 1000 Raptor/V-Raptor 00-06 1000 Raptor/V-Raptor 00-05	220	MD623RS	FRONT	S	MZ/MUZ Saxon 125 93-97 Saxon 150 95 251 Fun 95-96 Saxon "Tour" 251/301 93-98 Saxon 500 All models 93-98	280
MD618 MD618C VR618	REAR	S	DUCATI 749 Dark 04-06 749 R 04-06 749 S 03-06 749 Monoposto/Biposto 03-06 Desmosedici RR (D16RR/989cc) 08 999 S 03-04 999 03-06 999 R 03-06 999 R Fila 03 999 R Xerox 06	240	MD624 VR624BLK VR624BLU VR624RED VR624GLD	FRONT	F	DUCATI 748 R 00-02 996 S 01 Monster S4R (994cc) 03-06 Monster S4 Foggy (916cc) 02 Monster S4 (916cc) 01-02 ST3S (ABS Model) 06-07 ST4S (ABS) 03-05 ST4S (Non ABS) 01-05 996 SPS 99 996 Monoposto/Biposto 99-01 MOTO GUZZI 1100 Brevia (ABS models) 05-07 Brevia 1200 08-09 Norge 1200 (ABS) All models 06-09 1200 Sport (ABS) 06-07 Stelvio 1200/ABS 08-10 1200 Stelvio NTX ABS 09-10	320
MD619RS	FRONT	F	MZ/MUZ Skorpion Tour/Traveller 95-02 Skorpion Sport/Cup 95-01 SACHS (HERCULES) XTX 125 Supersport 00-07 XTX 125 N 00-07	316	MD625LS	FRONT	S	APRILIA Europa 50 90-92 AF1 Futura 50 90-92	290
MD620 Loose bobbins	FRONT	S	BMW R 850 RT 06 K 1200 RS 01-04 K 1200 S (K40) 05-08 R 1150 RT 00-06 K 1200 GT (K41) 03-06	320	MD626X MD626XC VR626BLK VR626BLU VR626RED VR626GLD	FRONT	F	DUCATI Monster S2R (803cc) 05-07 Monster S2R Dark (803cc) 05-06 Monster 400 ie 07-08 Monster 620 05-06 Monster Dark 620 05-06 620 Multistrada 06 695 Monster 07-08 ROYAL ENFIELD 535cc Continental GT (Non ABS) 13-16 535cc Continental GT (ABS) 17-18	300
MD621X MD621XC VR621BLK VR621BLU VR621RED VR621GLD	FRONT	F	APRILIA RS 125 (Radial Caliper) 2T 06-14 Pegaso Strada 650 05-06 Pegaso 650 07-08 Pegaso 650 Factory 06-08 Shiver 750 07-10 Shiver 750 (RAE00/STD & RAG 00/ ABS) 10-14 Shiver 750 GT 09-10 Shiver 750 GT ABS 10-12 Mana 850 08-11 Mana 850 ABS 08-13 Mana 850 GT ABS Model 09-14 RSV 1000 Mille 01-08 RSV 1000 R Mille 01-08 Tuono R Factory 1000 06-10 Tuono R 1000 02-10 BENELLI 2 UE 756 09-10 Tornado Tre Novecento LE/RS 03-05 Cafe Racer 899 10-12 Century 1130 Racer 11-12 Tornado TRE 1130 06 TNT 1130 Cafe Racer 06-12 TNT 1130 Titanium 06 TNT 1130 Sport/Sport Evo 04-09 Tornado Naked TRE 06-07 Tornado Tre 1130 06-10 BIMOTA SB8K Santamonica BMW G 650 X Moto 07-09 MONDIAL Piega 1000 03-04 Evo 04 LAVERDA SFC 1000 03-04 MOTO GUZZI 850 Griso 06-07 940 Bellagio 07-12 1000 MGS-01 Corsa 04-07 1100 Griso 05-08	320	MD627 MD627C VR627	REAR	S	DUCATI 796 Hypermotard 10-13 796 Monster (Non ABS Models) 10-13 Monster 796 20th Anniversary Model (Non ABS Models) 13 Monster S2R Dark (803cc) 05-06 Hypermotard (821cc) 13-15 Hypermotard SP (821cc) 13-15 Hyperstrada (821cc) 13-15 848 (Radial 2 pad caliper) 08-10 848 Evo (Monobloc front calipers) 10-13 848 Evo Corse SE 12-13 848 Evo Dark 12 848 Streetfighter 11-15 939 Hypermotard 16 939 Hyperstrada 16 939 Hypermotard SP 16 S4RS Monster (998cc) 06 S4R Monster Testastretta (998cc) 07-08 S4RS Monster Testastretta (998cc) 07 S4RS Tricolore/Monster Testastretta 08 Monster S4R (994cc) 03-06 Monster S2R 1000 (992cc) 06-08 Multistrada 1000 DS 03-06 Multistrada S DS 1000 05-06 1100 Evo Hypermotard 10-12 1100 Evo SP Hypermotard 10-12 Hypermotard 1100 07-09 Hypermotard 1100 S 07-09 Multistrada 1100 (1078c) 07-09 Multistrada 1100 S (1078cc) 07-09 1100 Monster (Non ABS) 09-10	245

D = Dished Solid Original (We replace with floating rotor conversion unit)

F = Floating Rotor

S = Solid Rotor

STREETBIKE DISC BUYERS GUIDE

DISC No.	FRONT/ REAR	TYPE	MODELS	DIA (MM)	DISC No.	FRONT/ REAR	TYPE	MODELS	DIA (MM)
MD627 MD627C VR627 Contd.	REAR	S	DUCATI 1100 Monster Evo 11-13 1100 S Monster (Non ABS) 09-10 Monster Diesel 1100 13 939 Hypermotard 16 939 Hyperstrada 16 939 Hypermotard S 16	245	MD633X MD633XC VR633ORG With Counterbore Contd.	FRONT	F	KTM Contd. 990 Superduke 05-11 990 Superduke R 07-13 RC8/Track (1190cc) 08-15 RC8 R (1190cc) 09-12 MOTO GUZZI V 1100 Brevia 04-05 MORINI 9 1/2 (1200cc) 06-10 Corsaro 1200 05-10 Corsaro 1200 Veloce 07-09 Corsaro Avio 08-09 1200 Sport 08-10	
MD628RS	FRONT	S	APRILIA Classic 125 95-01 Red Rose 125 (Spoke wheel) 88-94	260					
MD629X/XC VR629BLK VR629BLU VR629RED VR629GLD	FRONT	F	TRIUMPH Thruxton 900 04-16 Thruxton Ace 900 15-16	320	MD634LS MD634RS 4 bolt fixing 32.4mm offset	FRONT /REAR	F	DUCATI 250/350/450 Desmo 74-77 750 Sport 74 750 SS (4 bolt disc fixing) 75-76 860 GT/GTS 75-76 900 GTS 75-76 900 SS Desmo (4 bolt fixing front disc) 76 900 SD Darmah (4 bolt front and rear disc fixing) 77 900 SD Darmah (6 bolt front disc fixing 4 bolt rear disc fixing) 78	280
MD630LS MD630RS	FRONT	S	DUCATI 750 Paso 87-90 750 Sport 88	280					
MD631	REAR	S	DUCATI 750 Paso 87-90 750 Sport 88 906 Paso 88-89	270					
MD632 MD632C VR632	REAR	S	DUCATI 748 Biposto 95-98 748 SP 95-98 748 S Biposto 00-02 748 S Monoposto 00-02 748 SPS 98-99 748 Testa Bassa 01 748 R 00-02 900 MH Evoluzione 00-01 916 SPS (996cc) 97-98 916 Biposto 94-98 916 Senna 94-98 916 SP 94-96 996 SPS (996cc) 99 996 (996cc) 99-01 996 R/S 01 998 R 02 998 Matrix 04 998 S Bayliss/Bostrom 02 998 S (998cc) 02-04 998 (998cc) Monoposto/Biposto 02-03	220	MD635RS	FRONT	F	APRILIA AF1 125 87-89	320
					MD636X MD636XC	FRONT	F	DUCATI 996 R 01 MOTO MORINI 9 1/2 (998cc) 06-10 MM3 (1187cc) 07 Corsaro 1200 05-10 Corsaro 1200 Veloce 07-09 Corsaro Avio 08-09 1200 Sport 08-10	320
					MD637	REAR	S	MZ Skorpion Tour/Traveller 95-02 Skorpion Sport/Cup 95-01 Skorpion Replica 95-01	240
					MD638 (6 bolt fixing)	REAR	S	CAGIVA Raptor 125 03-10 Super City 125 92-00 Mito 125 (SP525) 91-10 Planet 125 (3 spoke wheels /6 Bolt Disc) 98-03 Planet 125 (6 spoke wheel /6 Bolt Disc 2nd series) 98-03 Mito 500 07-08	230
MD633X MD633XC VR633ORG With Counterbore	FRONT	F	DUCATI 400 Monster 95-97 600 Monster 93-99 600 Monster Dark 98-99 748 Biposto 95-98 748 SP 98 748 SPS 98-99 750 Supersport 91-99 750 Monster 96-98 750 Monster City/City Dark 99 750 Monster/Monster Dark 99 Supersport 750 91-98 851 Superbike Biposto 89-92 888 Superbike Strada 94-95 900 Supersport/Superlight 91-97 900 Supersport 98-99 900 Supersport CR USA 98 900 Supersport FE 98 907 IE 92-93 916 Biposto 94-98 916 SP 94-96 ST2 (944cc) 97-99 ST4 (916cc) 99-00 STS3 ABS 06-07 998 Matrix 04 998 S Bayliss/Bostrom 02 998 S (998cc) 02-04 998 (998cc) Monoposto/Biposto 02-03 900 Monster 93-99 900 Monster Cromo/Special 98 900 Monster City/City Dark 99 KTM Duke 11 640 (2 Pin pad fixing /Disc with offset) 03-07 990 Adventure R 09-10 990 Adventure (ABS) 07-10	320	MD639LS	FRONT	S	RS 50 (6 bolt fixing) 93-98	290
					MD640 310mm disc VR640BLK VR640BLU VR640RED VR640GLD	FRONT	F	TRIUMPH Daytona 750 92 Daytona 900 93-96 Daytona Super 3 94-97 Speed Triple 750/900 (Carb model) 94-96 Sprint 900 94-98 Trophy 900 94-01 Daytona 1000 92 Trophy 1200 94-01 Daytona 1200 93-98 Speed Triple 750/900 (Carb model) 94-96	310
					MD641 VR641	REAR	S	TRIUMPH Daytona 750 92 Trident 750 92-98 Tiger 885cc 92-96 Daytona 900 93-96 Daytona Super 3 94-97 Speed Triple 750/900 (Carb model) 94-96 Sprint 900 93-98 Trident 900 92-98 Trophy 900 92-01 Daytona 1000 92 Trophy 1200 92-02 Daytona 1200 93-98	255

D = Dished Solid Original (We replace with floating rotor conversion unit)

F = Floating Rotor

S = Solid Rotor

STREETBIKE DISC BUYERS GUIDE

DISC No.	FRONT/ REAR	TYPE	MODELS	DIA (MM)	DISC No.	FRONT/ REAR	TYPE	MODELS	DIA (MM)	
MD642LS Note: Floating conversion kit available MD629X	FRONT	S	TRIUMPH Adventurer 96-01 Thunderbird 95-02 Legend TT 98-01	320	MD651	REAR	S	BMW F 650 (E169/0161)/Standard 09/93-96 F 650 (E169/0162) (Funduro/HighScreen) (19" front wheel) 97-00 F 650 CS Scarver (K14/0174/0184/K17 /0177/0187 Belt Drive) 00-07 F 650 GS (R13/0172/0182) (19" front wheel) 99-03 F 650 GS Dakar (R13/0173/0183) (21" front wheel) 99-03 F 650 ST (E169/0163/168) Strada (18" front wheel/low screen) 97-00 F 650 GS Dakar (R13/0173/0183) (21" front wheel) 99-03 F 650 GS Dakar (R13/0176/0186) 04-07 F 650 GS (R13/0175/0185) 04-07 G 650 GS (R131) 09-15 G 650 GS Sertao 12-14 BENELLI TNT 899 Tornado Naked Tre 07-16 TNT 899 S Tornado Naked Tre 07-11 TRE-K 899 07-16 TRE-K 1130 06-17 TNT 1130 Cafe Racer 05-12 TNT 1130 Sport/Sport Evo 04-09 TNT 1130 Titanium 05-06 Tornado TRE 1130 (Radial caliper) 06-10 Tornado Naked Tre TNT 1130 06-07 HUSQVARNA TR 650 Terra (Spoke Wheel) 12-13 TR 650 Strada (Cast Wheel) 12-13 ROYAL ENFIELD 535cc Continental GT (Non ABS) 13-16 Himalayan 16-18	240	
MD643 VR643	REAR	S	TRIUMPH America (6 Spoke Cast wheel) 07-09 America (12 Spoke Cast wheel 865cc) 10-17 America LT (12 Spoke Cast wheel 865cc) 14-17 Bonneville America 02-06 Adventurer 96-01 Thunderbird 95-02 Thunderbird Sport 98-00 Legend TT 98-01 Speedmaster (790cc/Carb) 03-04 Speedmaster (865cc/EFI) 05-16 Tiger 885i (From VIN 71699) 98-99 Tiger 900 885cc 97-99 Tiger 955cc (Spoke wheel) 99-04	285						
MD644	FRONT	S	AJS Regal Raptor CR3-125 06 TRIUMPH Tiger 900 885cc 92-97 HONDA CBR 125 R4/R5/RS5/RWS/RW6 /RW7/RW8/RW9/RWA 04-10 CBR 150 R 00-03 CB 400 SS (SS2-NC41) 01-05	276						
MD645	REAR	S	TRIUMPH Tiger 900 885cc 92-97	255						
MD646LS/RS VR646BLK VR646RBLU VR646RED VR646GLD	FRONT	F	TRIUMPH Trident 750 92-98 Sprint 900 93 Trident 900 92-98 Trophy 900 92-93 Trophy 1200 92-93	296	MD652 MD652C	FRONT	S	BMW K 1200 RS 96-00 K 1200 LT 97-00 R 850 C 97-00 R 850 GS 96-00 R 850 R 94-96 R 850 RT 96-01 R 1100 GS 93-99 R 1100 R 93-96 R 1100 S (ABS) 96-00 R 1100 RT 94-01	305	
MD647X MD647XC (6 bolt disc) VR647BLK VR647BLU VR647RED VR647GLD	FRONT	F	TRIUMPH Sprint ST 99-04 T509 Speed Triple (EFI 885cc) 97-98 T595 Daytona/955i 97-00 Sprint RS 99-04 Speed Triple (EFI 955cc) 99-04	320						
MD648 MD648C VR648	REAR	S	TRIUMPH Daytona 600 03-04 TT 600 00-03 Speed Four 600 02-05 Daytona 650 05 Daytona 675 06-12 Daytona 675 R (Brembo calipers) 11-12 Street Triple 675 (Naked) 07-12 Street Triple R 675 09-12 T509 Speed Triple (EFI 885cc) 97-98 Speed Triple (EFI 955cc) 98-04 T595 Daytona/955i 97-00 Daytona 955i 01-06 Speed Triple 1050 (Non ABS) - To VIN 461331 05-11 Speed Triple 1050 (ABS) - To VIN 461331 07-11	220	MD653 MD653C	REAR	S	BMW R 1150 GS (Evo - R21/0415/0495) 11-01-03 R 1150 GS (R21/0415/0495) 98-10/01 R 1150 GS Adventure 07/01-06 R 1200 00-02 R 1200 C 96-04 R 1200 CL 02-04 R 850 GS 96-00 R 850 R 94-02/06 R 850 RT 96-01 R 850 RT 06 R 1100 GS 93-99 R 1100 R 93-01 R 1100 S 96-06 R 1100 RT 94-01 R 1150 GS (Evo - R21/0415/0495) 11-01-03 R 1150 GS (R21/0415/0495) 98-10/01 R 1150 GS Adventure 07/01-06 R 1150 R/RS 01-06 R 1150 RT 00-06 R 1150 R Rockster 03-06	276	
MD649 Note: Floating conversion kit available MD601LS/RS	FRONT	S	TRIUMPH America (Cast wheels) 07-09 Bonneville 800 01-06 Bonneville T100 02-09 Bonneville America 02-06 Bonneville/Bonneville Black 07-08 Scrambler (865cc) 06-09 Speedmaster (790cc) (Carb) 03-04 Speedmaster (865cc) 05-07 Thunderbird Sport 98-00 Tiger 885i (From VIN 71699) 98-99 Tiger 900 885cc 97-99 Tiger 955cc Spoke wheel 99-04	310	MD656 VMD656 4 bolt fixing	FRONT /REAR	F	TRIUMPH T 140 V Bonneville Drum Rear Brake /5 Speed Gearbox 73-74 T 140 V Bonneville Disc All Round /5 Speed Gearbox 75-78 T 140 Silver Jubilee Bonneville 77 T 140 E Bonneville 78-83 T 140 D Bonneville (Lester Alloy wheels) 79-81 T 140 ES (750cc) (Electric Start) 80-81 T 140 E/ES (750cc) (Executive/Morris Alloy Wheels/5 Bolt Disc) 81-83 TSS 750 (8 valve) 83 TSX 750 83	250	
MD650	FRONT	S	BMW F 650 (E169/0161)/Standard 09/93-96 F 650 (E169/0162) (Funduro/HighScreen) (19" front wheel) 97-00 F 650 ST (E169/0163/168) Strada (18" front wheel/low screen) 97-00	300						

D = Dished Solid Original (We replace with floating rotor conversion unit)

F = Floating Rotor

S = Solid Rotor

STREETBIKE DISC BUYERS GUIDE

DISC No.	FRONT/ REAR	TYPE	MODELS	DIA (MM)	DISC No.	FRONT/ REAR	TYPE	MODELS	DIA (MM)
MD657LS MD657RS	FRONT	D	DUCATI 500 Pantah 79 600 Pantah 81	260	MD665	REAR	S	APRILIA RS 250 95-02	220
	REAR	D	DUCATI 500 Pantah 79	260	MD666X MD666XC	FRONT	F	APRILIA RSV 1000 Mille 98-00 RSV 1000 Mille R 00 SL 1000 'Falco' 00-04 CAGIVA Raptor X3 1000 03-04	320
MD658 BILLET	REAR	S	APRILIA AF1 125 87-91	240					
MD659 (6 bolt fixing)	REAR	S	APRILIA RS 125 92-95	220	MD667	FRONT	F	MOTO GUZZI 1000 Daytona 92-95	299
			CAGIVA W8 125 93-98		MD668LS/RS	FRONT	F	LAVERDA 1000 SFC 85-86	299
MD660LS MD660RS	FRONT	F	APRILIA RS 250 All models 95-02	298					
			CAGIVA 650 Raptor 00-07 1000 Raptor 00-05						
MD661	REAR	F	BMW K 75 S ABS 85-95 K 75 RT (ABS) 89-96 R 1100 RS 92-01 K 100/2 (ABS 8 valve model) 87-90 K 100 LT (ABS 8 valve model) 86-91 K 100 RS (ABS 8 valve model) 83-89 K 100 RT (non-ABS 8 valve) 10/88-89 K 100 RT (ABS 8 valve) 83-89 K 100 RS (16 valve ABS) 89-92 K1 (16 valve ABS model) 88-93 KL 1100 LT (ABS) 89-07/93 KL 1100 LT (Non ABS) 08/93-99 KL 1100 (ABS Model) 08/93-99 K 1100 RS (All models) 92-96 K 1200 RS (All models) 96-04 K 1200 GT 03-06	285	MD670	FRONT /REAR	S	LAVERDA Bolt On - Ring Only	280
					MD662X MD662XC VR662BLK VR662BLU VR662RED VR662GLD	FRONT	F	TRIUMPH Daytona 600 03-04 TT 600 00-03 Speed Four 600 02-05 Daytona 650 05	310
MD663 MD663C VR663	REAR	S	TRIUMPH Daytona 650 05 Bonneville 800 01-06 Bonneville 865cc (Cast wheels) 09-15 Bonneville Newchurch (865cc/Cast wheels) 15 Bonneville SE 865cc (Cast wheels) 09-13 Bonneville Spirit (Spoke wheels/865cc) 15 Bonneville T214 (Spoke wheels/865cc) 15 Bonneville T100 (790cc) 02-04 Bonneville T100 (865cc) 05-09 Bonneville T100 (865cc/Spoke wheel) 10-16 Bonneville T100 Black (865cc/Spoke wheel) 14-16 Bonneville/Bonneville Black 07-08 Bonneville Steve McQueen SE 12 Scrambler (865cc) 06-15 Sprint RS 99-04 Tiger 800 11-14 Tiger 800 XC 11-14 Thruxton 900 04-16 Thruxton Ace 900 15-16 Speed Triple 1050 (4 Pad caliper /Non ABS) - From VIN 461332 11-16 Speed Triple R 1050 (2 Pad caliper /Non ABS/5 Spoke wheels) 12-13 Speed Triple R 1050 (2 Pad caliper /Non ABS/10 Spoke wheels) 14-15 Sprint 1050 ST 05-10 Tiger 1050 (Radial F/cal) 07-12	255	MD671	REAR	S	BMW F 650 GS (K72/0218/0228) (798cc twin cylinder/cast wheels) 07-12 F 650 GS (30 Years GS) 11 F 700 GS 13-18 F 750 GS 16-20 F 800 GS 08-18 F 800 GS Adventure 12-18 F 800 GS (30 Years GS) 11 F 800 GS Triple Black 12 F 800 GS Trophy 12 F 800 GT 13-18 F 800 R (Disc has fixed bobbins) 09-18 F 800 R Chris Pfeiffer Edition 09-11 F 800 ST (Full fairing) 06-18 F 800 ST Touring 10-17 F 800 S (Half fairing) 06-17 F 850 GS 16-18 F 850 GS Adventure 16-18 S 1000 XR 15-18 HP 2 Enduro 05-08 HP2 Megamoto (K25) (Disc has fixed bobbins) 07-10 HP2 Sport (K29) (Disc has fixed bobbins) 08-11 R Nine T (K21 1170cc) 14-18 R Nine T Pure (K22/1170cc) 16-18 R Nine T Scrambler (K21/1170cc) 16-18 R Nine T Café Racer (K32/1170cc) 16-18 R Nine T Urban GS (K33/1170cc) 17-18 K 1200 S (K40) 05-08 K 1200 R Sport 07-08 K 1200 R (K27/0378) Tokico Caliper Disc with fixed buttons 12/07-10 K 1200 R (K27/0378) Tokico Caliper Disc with loose buttons 11/05-11/07 R 1200 GS (K25/0307/Cast/Spoke wheel) Disc with loose bobbins 02-11/07 R 1200 GS/M (K25/0303/Cast/Spoke wheel) Disc has fixed bobbins 06-09 R 1200 GS Adventure (K25/0382/Spoke wheel) Disc has loose bobbins 05-11/07 R 1200 GS Adventure/M (K25/0380 /Spoke wheel) Disc has fixed bobbins 06-09 R 1200 GS Adventure (Spoke wheels) (Disc has fixed bobbins) 10-12 R 1200 GS (Cast wheels) (Disc has fixed bobbins) 10-12 R 1200 GS Adventure (30 Years GS) (Disc has fixed bobbins) 11 R 1200 GS Triple Black 11-13 R 1200 GS (30 Years GS) 11 R 1200 GS Rallye (Spoke wheels) 12 R 1200 GS Adventure Triple Black 12 R 1200 RSE (Disc has fixed bobbins) 10-11 R 1200 RT K26/0368 Brembo Caliper Disc has loose bobbins 05-11/07 R 1200 RT (Disc has fixed bobbins) 10-13 R 1200 RT-SE (Disc has fixed bobbins) 10-13	265

D = Dished Solid Original (We replace with floating rotor conversion unit)

F = Floating Rotor

S = Solid Rotor

STREETBIKE DISC BUYERS GUIDE

DISC No.	FRONT/ REAR	TYPE	MODELS	DIA (MM)	DISC No.	FRONT/ REAR	TYPE	MODELS	DIA (MM)															
MD671 Contd.	REAR	S	BMW Contd.	265	MD682	FRONT	S	DUCATI	320															
			R 1200 R Classic 11-14					Multistrada 1000 DS 03-06																
			R 1200 R 12/07-14					Multistrada S DS 1000 05-06																
			R 1200 ST K28/0328					Multistrada 1100 (1078cc) 07-09																
			Disc has loose bobbins 03-11/07					Multistrada 1100 S (1078cc) 07-09																
			R 1200 S K29/0366 - Brembo caliper					SACHS HERCULES		FRONT	F	Roadster 650 01-05												
			Disc with loose bobbins 06-11/07																					
			R 1200 S K29/0366 - Brembo caliper																					
			Disc with fixed bobbins 12/07-08																					
			R 1200 RT K26/0368 Brembo caliper																					
			Disc has fixed bobbins 12/07-09																					
			R 1200 ST K28/0328																					
			(Disc has fixed bobbins) 12/07-08																					
			R1250 GS																					
			(Disc has fixed bobbins) 19																					
R 1250 GS TE																								
(Disc has fixed bobbins) 19																								
R 1250 GS Exclusive TE																								
(Disc has fixed bobbins) 19																								
R 1250 GS Rallye																								
(Disc has fixed bobbins) 19																								
R 1250 GS Rallye TE																								
(Disc has fixed bobbins) 19																								
R 1250 RT																								
(Disc has fixed bobbins) 19																								
R 1250 RT SE																								
(Disc has fixed bobbins) 19																								
R 1250 RT LE																								
(Disc has fixed bobbins) 19																								
K 1300 R 09-12																								
K 1300 R Dynamic 11-15																								
K 1300 R Carbon 12																								
K 1300 S (Non & ABS Models) 09-15																								
K 1300 S Sport 12-15																								
K 1300 S HP 12																								
HUSQVARNA																								
Nuda 900 (inc ABS) 12-13																								
Nuda 900 R (inc ABS) 12-14																								
MD672LS	FRONT	S	APRILIA	280	MD685LS	FRONT	S	APRILIA	300															
RS 50 (5 bolt fixing) 99-06	RS 50 (Radial Caliper) 06-11																							
Tuono 50 04	DERBI																							
MBK	GPR 50 (40mm Forks/180mm Rear Disc/Radial Caliper) 04-07																							
TZR 50 X Power 03-10	GPR 50 Racing (40mm Forks/180mm Rear Disc/Radial Caliper) 08-10																							
YAMAHA	GPR 50 2T (41mm Forks/218mm Rear Disc/Radial Caliper) 09-11																							
TZR 50 03-16	GPR 50 Nude (Radial Caliper) 04-07																							
	GPR 125 Racing (Radial caliper) (2T) 04-09																							
	GPR 125 Nude (Radial caliper) (2T) 04-08																							
	GILERA																							
	SC 125 06-07																							
MD673LS	FRONT	F	APRILIA	298				MD686		REAR	S	APRILIA	180											
Moto 6.5 95-01	RS 50 (Radial Caliper) 06-11																							
MD674	REAR	S	APRILIA	220								MD687		FRONT	S	HP2 "Enduro" 05-09								
Moto 6.5 95-01	R 1200 GS (K25/0307/317/Cast /Spoke wheel) 02-11/07																							
MD675	FRONT	F	MV AGUSTA	310	MD688	REAR	S		R 1200 GS Adventure (K25/0307/317/Cast/Spoke Wheels) 07-07															
750 F4S (Mono Posto) 99-04	R1200 GS Adventure/M (K25/0380/Spoke wheel) 06-09																							
MD676	FRONT	F	TRIUMPH	310					MD688							REAR	S	R1200 GS/M (K25/0303 Cast/Spoke wheel) 06-09						
Black Hub	R1200 GS (Cast wheels) 10-11																							
MD677	REAR	S	TRIUMPH	285														MD688	REAR	S	R1200 GS (30 Years GS /Spoke wheels) 11			
Tiger 955 From VIN 198875 04-06	R1200 GS (Triple Black /Spoke wheels) 11-13																							
MD679X	FRONT	F	TRIUMPH	320																	MD688	REAR	S	R1200 GS Adventure (Spoke wheels) 10-13
MD679XC	FRONT	F	Speed Triple 1050cc 05-06																					R1200 GS Adventure (30 Years GS/Spoke wheels) 2011
VR679BLK			Speed Triple R 1050 (2 Pad caliper /Non ABS/5 Spoke wheels) 12-13	R1200 GS Adventure (Triple Black) 12																				
VR679BLU	Tiger 1050 07-11	R1200 GS Rallye 12																						
VR679RED	Tiger 1050 SE 10-13	R1200 GS (K50/Liquid Cooled /Radial Calipers) 13-18																						
VR679GLD	Tiger 1050 Sport (ABS) 1050cc 13-18	R1200 GS Adventure (K51/Inc TE/XE Models/LC /Radial Calipers) 14-18																						
MD680	FRONT	F	KTM	305				MD688		REAR	S		R 1200 RS/RS Sport 15-18											
MD680C	FRONT	F	950 Supermoto 05-07									R 1250 GS/GS TE 19-20												
			990 Supermoto T (SM-T) 08-13	R 1250 GS Exclusive TE 19-20																				
	990 Supermoto R SM-R 08-13	R 1250 GS Rallye/Rallye TE 19-20																						
MD681	REAR	S	KTM	240	MD688	REAR	S					R 1250 RT 19-20												
MD681C	REAR	S	690 Duke 08-12						R 1250 RT SE/LE 19-20															
VR681			690 Duke R 10-11	K 1200 GT (K44) 06-08																				
	950 Supermoto 05-07	K 1300 GT 09-11																						
	990 Superduke 05-11	K 1300 GT EE (Disc has fixed bobbins) 10-11																						
	990 Superduke R 07-13	K 1300 GT SE (Disc has fixed bobbins) 10-11																						
	990 Supermoto T (SM-T) 08-13																							
	990 SM-R Supermoto R 08-13																							

D = Dished Solid Original (We replace with floating rotor conversion unit) F = Floating Rotor S = Solid Rotor

STREETBIKE DISC BUYERS GUIDE

DISC No.	FRONT/ REAR	TYPE	MODELS	DIA (MM)	DISC No.	FRONT/ REAR	TYPE	MODELS	DIA (MM)
MD689 MD689C	REAR	S	HYOSUNG	230	MD693LS MD693RS	FRONT/ REAR	F	MOTO GUZZI	270
			Comet GT 125 (Naked) 04-06 GT 125 Naked 06-12 GT 125 i Naked 13-15 GT 125 R 06-14 GD 250 i Naked 13-15 Comet GT 250 (Naked) 04-05 GT 250 (Naked) 06-12 GT 250 R (Carbs) 05-07 GT 250 i R 08-13 GT 250 i R (Efi) 14-15 Comet GT 650 (Naked) 04-08 GT 650 Naked 09-11 GT 650 i Naked 12-15 GT 650 R 07-08 GT 650 i R 14-15 GT 650 S 05-08 GT 650 X 07 SUPERBYKE R-SR 250					750 SP 90-92 750 Nevada 91-01 1000-1000 SP111 (No spoke cast wheels/flat floating front discs) 89-94 1000 - California III - Carbs (VY Chassis Code/Full fairing/Cast & spoke wheels) 88-90 1000 - California III - Carbs (VW Chassis Code/Screen only) 87-93 1000 - California III - Efi (VY Chassis Code/Full fairing/cast & spoke wheels) 90-93 1000 - Le Mans 1V/V (10 spoke cast wheel) 84-93 1100 - California - Carbs (KC/KD Chassis codes) 94-97	
MD690 MD690C	FRONT	F	HYOSUNG	300	MD694X MD694XC VR694BLK VR694BLU VR694RED VR694GLD	FRONT	F	DUCATI	330
			Comet GT 125 (Naked) 04-06 GT 125 Naked 06-12 GT 125 i Naked 13-15 GT 125 R 06-14 Comet GT 250 (Naked) 04-05 GT 250 (Naked) 06-12 GT 250 R (Carbs) 05-07 GT 250 i R 08-13 GT 250 i R (Efi) 14-15 Comet GT 250 04-05 GT 650 Naked 09-11 GT 650 i Naked 12-15 GT 650 R 07-08 GT 650 i R 09-15 GT 650 S 05-08 GT 650 X 07 SUPERBYKE R-SR 250					Desmosedici RR (D16RR/989cc) 08 1098 07-08 1098 S 07-08 1098 S Tricolore 07	
MD691	FRONT	F	HYOSUNG	300	MD695 MD695C VR695	REAR	S	DUCATI	245
			GV 650 (Efi) 07-12 GV 650 i Pro Naked 12-15 GV 700 C 06-09 ST 7 (ST 700 i) 10-15 ST 7 Deluxe (ST 700 i) 12-15					1098 07-08 1098 S 07-08 1098 R 08-09 Monster 1100 Evo 20th Anniversary Model 13 Streetfighter 1100 (1099cc) 09-11 Streetfighter 1100 S (1099cc) 09-13 1198 09-11 1198 S 09-10 1198 R Corse 10 1198 S Corse 10 1198 SP Corse 11	
MD692 MD692C	REAR	S	MOTO GUZZI	282	MD696	REAR	S	MV (AUGUSTA)	210
			1000 Daytona RS 97-98 1000 V10 Centauro GT 97-99 1000 V10 Centauro Sport 97-99 California 1100 Aluminium 02-05 California 1100 Classic 06-09 California 1100 EV 01-01 California 1100 Jackall 99-01 California 1100 Metal 02-03 California 1100 Special 99-00 California 1100 Sport 01-02 California 1100 Stone 01-05 California 1100 Titanium 04-05 California 1100 Touring 06-07 California 1100 Vintage 06-10 1100 California Aquila Nera 09-11 1100 California Classic Touring 06-08 1100 California EV 97-02 1100 California EV Touring 03-05 1100 California Jackal 94-01 1100 California Special 99-00 1100 California Sport 01-02 1100 California Stone 01-05 1100 California Stone Metal 02-03 1100 California Vintage 06-12 1100 California 1100 190 12 1100 V11 Ballabio 03-05 1100 V11 Le Mans 01-05 1100 V11 Sport 99-01 1100 V11 Scura 01-03 1100 V11 Naked 02-03 V11 (All models) 99-06 Le Mans (All models) 01-04 Breva 1200 08-09 Norge 1200 (ABS) All models 06-09 Stelvio 1200 08-11 Stelvio NTX 1200 (4 Valve) (Radial Caliper/ABS) 09-11					750 Brutale S F4 03-05 750 Brutale Oro F4 03-05 750 F4S (Mono Posto) 99-04 750 F4S 1+1 (Bi-Posto) 01-04 750 F4 SPR 01-04 750 F4 SPR Senna 01-03 910 Brutale S/R 06-08 920 Brutale 11-12 990 Brutale R 10-11 998 Freccie Tricolori 10 998 F4 10-15 998 F4RR 10-15 998 F4R 12-15 998 F4 RR Corsa Corta 12 1000 F4 Ago 05 1000 F4 S (Mono Posto) 04-06 1000 F4 S 1+1 (Bi Posto) 04-06 1000 F4 Tamburini 05 1000 F4 R 06-07 1000 F4R 312 07-09 1000 F4R 312 1+1 07-08 1078 F4 RR 312 09 1078 Brutale RR 08-09 1078 F4100 cc Claudio Castiglioni 07-08 1090 Brutale 13-15 1090 Brutale Corsa 13-15 1090 Brutale R 12-15 1090 Brutale RR 10-14	
MD697 MD697C	REAR	S	APRILIA	255	MD697 MD697C	REAR	S	RST Futura 1000	01-04
MD698LS	FRONT	S	DERBI	300	MD699 BILLET	REAR	S	TRIUMPH	316
			Senda 125 Baja SM (4T) (300mm disc) 06-12 Senda 125 SM (Twin headlight) 04-07 Senda R 125 04					Rocket III 04-09 Rocket III Classic 08-09 Rocket III Touring 08-17 Rocket III Roadster - ABS 10-18 Rocket X 16	
MD711LD MD711RD	FRONT	F	YAMAHA	282	MD711LD MD711RD	FRONT	F	TZ 125	94-97
			TZ 250 89-96						

D = Dished Solid Original (We replace with floating rotor conversion unit) F = Floating Rotor S = Solid Rotor

DISC BUYERS GUIDE

STREETBIKE DISC BUYERS GUIDE

DISC No.	FRONT/ REAR	TYPE	MODELS	DIA (MM)	DISC No.	FRONT/ REAR	TYPE	MODELS	DIA (MM)
MD713	REAR	S	HONDA RS 125 88-07 MD 250 H 08-11 MD 250 S 08-11	185	MD808	REAR	S	DERBI Senda DRD Racing 50 SM (300mm disc/std mounted caliper) 04-11 Senda DRD Racing 50 R (300mm disc/std mounted caliper) 04-11 Senda DRD Racing 50 SM (300mm disc/radial caliper) 05-14 Cross City 125 07-14 Mulhacen 125 (4T) Up to Ref No. 7N001790 Spoke wheel/2 pin pad fixing 07 Mulhacen 125 (4T) From Ref No. 7N001791 Spoke wheel/single pin fixing 07-11 Senda 125 Baja R (4T) (260mm disc) 06-12 Senda 125 Baja SM (4T) (300mm disc) 06-12 Senda 125 SM (Twin headlight) 04-07 Senda R 125 04 Terra 125 Euro (Single pin pad fixing) 07-11 Terra 125 Adventure 07-14	218
MD724	REAR	S	HONDA RS 250 88-02	198	MD809 MD809C	FRONT	S	BMW G 650 Xchallenge 07-09 G 650 Xcountry 07-09	300
MD730LD MD730RD	FRONT	F	YAMAHA TZ 250 97-01 TZ 250 (Radial Calipers) 02-10	298	MD810 MD810C	REAR	S	BMW G 650 Xchallenge 07-09 G 650 Xcountry 07-09	240
MD732	REAR	S	YAMAHA TZ 125 94-97 TZ 250 89-90/92-01 TZ 250 (Radial Calipers) 02-10	185	MD811	FRONT	F	APRILIA RX 50 06-14 SX 50 06-14 SX 50 Limited Edition 14-16 DERBI Senda DRD Racing 50 SM (300mm disc/std mounted caliper) 04-11 Senda DRD Racing 50 R (300mm disc/std mounted caliper) 04-11 Senda DRD Racing 50 SM (300mm disc/radial caliper) 05-14	300
MD800X MD800XC VR800BLK VR800BLU VR800RED VR800GLD	FRONT	F	TRIUMPH Daytona 675 06-12 Street Triple 675 (Naked) 07-12 Street Triple R 675 09-12	308	MD812	REAR	S	KTM RC8 (1190cc) 08-11 RC8 R/Track (1190cc) 09-15	220
MD803 Loose bobbins	FRONT	S	BMW F 800 ST (Full fairing) (Disc has loose bobbins) 06-08 F 800 S (Half fairing) (Disc has loose bobbins) 06-08 R 1100 S (Non ABS) 12/00-03 R 1200 RT K26/0368 Brembo Caliper Disc has loose bobbins 05-11/07 R 1200 ST K28/0328 Disc has loose bobbins 03-11/07 R 1200 S K29/0366 - Brembo caliper Disc with loose bobbins 06-11/07	320	MD813	FRONT	F	CCM CR 40 Cafe Racer (Handlebar fairing) 07-08	300
MD804 Loose bobbins	FRONT	S	BMW K 1200 R Sport 07-08	320	MD814	FRONT /REAR	S	DAELIM History 125 (SL 125) 01-06	220
MD805 MD805C	REAR	S	CAGIVA Super City 50/80 93-95 Prima 50 92-94 Mito 50 98-99 DERBI GPR 50 Replica Racing 99-03 GPR 50 R 97-01 Senda DRD Racing 50 R (Spoke wheel) 11-12 Senda DRD Racing 50 SM (Cast wheel) 11-12 Senda DRD X-treme 50 R (Spoke wheel/21" front wheel) 11-12 Senda DRD X-treme 50 SM (Cast wheel/17" front wheel) 11-12	220	MD815	REAR	S	SACHS (HERCULES) XTC 125 Supersport 00-07 XTC 125 08	220
MD806LS	FRONT	S	CAGIVA Mito 50 98-99 DERBI GPR 50 Replica Racing 99-03 GPR 50 R 97-01 SACHS (HERCULES) Madass 50 (2 stroke) (Hydraulic rear brake) 04-05 Madass 50 (4 stroke mechanical rear brake) 04-05 Madass 50 (4T) 06-09 Madass 125 05 Madass 125 (4T) 06-09	260	MD816	REAR	S	NORTON F1 (Rotary) P55 Model 90 F1 (Rotary) P55 B Model 90-91	230
MD807LS	FRONT	F	DERBI Cross City 125 07-14 Mulhacen 125 (4T) Up to Ref No.7N001790 Spoke wheel/2 pin pad fixing 07 Mulhacen 125 (4T) From Ref No.7N001791 Spoke wheel/single pin fixing 07-11 Terra 125 Adventure 09-14 Terra 125 Euro (Single pin pad fixing) 07-11	280	MD817X MD817XC VR817BLK VR817BLU VR817RED VR817GLD	FRONT	F	TRIUMPH Speed Triple (1050cc) 4 pad Brembo /Non ABS/220mm R/Disc 07-20 Speed Triple (1050cc) 4 pad Brembo /ABS/220mm R/Disc 07-20 Speed Triple (1050cc) 4 pad Brembo/Non ABS 09-16 Speed Triple (1050cc) 4 pad Brembo/ABS 09-16 Speed Triple R 1050 (2 Pad caliper /Non ABS/10 Spoke wheels) 14-16 Speed Triple R 1050 (2 Pad caliper /ABS/10 Spoke wheels) 14-16 Speed Triple R (1050cc/ABS) 17-20 Speed Triple S (1050cc/ABS) 17-20 Sprint GT 1050/SE (ABS) 10-20 Trophy 1215cc 12-16 Trophy 1215cc SE 12-17 Sprint ST 1050i (Non ABS/Front Disc With Zero Offset/5 Bolt Fixing) 11-12 Sprint ST 1050i (ABS/Front Disc With Zero Offset/5 Bolt Fixing) 11-12	320
					MD819	FRONT	F	SACHS HERCULES Roadster 800 02-05 B-805 03-04	320

D = Dished Solid Original (We replace with floating rotor conversion unit)

F = Floating Rotor

S = Solid Rotor

STREETBIKE DISC BUYERS GUIDE

DISC No.	FRONT/ REAR	TYPE	MODELS	DIA (MM)	DISC No.	FRONT/ REAR	TYPE	MODELS	DIA (MM)							
MD820 MD820C VR820	REAR	S	Tiger 800 ABS	11-14	MD834	FRONT	S	F 650 CS Scarver	300							
			Tiger 800 XC ABS	11-19				(K14/0174/0184 Belt Drive)		00-03						
			Tiger 800 XCa ABS	15-19				F 650 CS Scarver (K17/0177/0187 Belt Drive)		04-07						
			Tiger 800 XCx ABS	15-19				F 650 GS (R13/0172/0182) (19" front wheel)		99-03						
			Tiger 800 XR ABS	15-19				F 650 GS Dakar (R13/0173/0183) (21" front wheel)		99-03						
			Tiger 800 XRT ABS	15-19				F 650 GS Dakar (R13/0176/0186)		04-07						
			Tiger 800 XRx (ABS)	15-19				F 650 GS (R13/0175/0185)		04-07						
			Tiger 900	20				F 650 GS (K72/0218/0228) (798cc twin cylinder/cast wheels)		07-12						
			Tiger 900 GT	20				F 650 GS (30 Years GS)		11						
			Tiger 900 GT low	20				G 650 GS (R131)		09-14						
			Tiger 900 GT Pro	20				G 650 GS Sertao		12-14						
			Tiger 900 Rally	20				HUSQVARNA								
			Tiger 900 Rally Pro	20				TR 650 Terra (Spoke Wheel)		12-13						
			Speed Triple 1050 (ABS model) - From VIN 461332	11-16				TR 650 Strada (Cast Wheel)		12-13						
			Speed Triple R 1050 (2 Pad Caliper/ABS /10 Spoke wheels model)	14-16				F 650 GS (K72/0218/0228/Twin cylinder 798cc/Cast wheel)		07-12						
Sprint GT 1050 SE (ABS)	10-20	F 700 GS	13-18													
Sprint 1050 ST	05-10	F 800 GS	08-18													
Tiger Sport (ABS) 1050cc	13-18	F 800 GS Adventure	12-18													
Tiger 1050 SE-ABS (1050cc)	10-13	F 800 GS (30 Years GS)	11													
		F 800 GS Triple Black	12													
		800 GS Trophy	12-17													
		G 650 GS Sertao (Single cylinder /chain drive/Spoke Wheels)	12-14													
MD821 MD821X ① MD821XC ① ① Floating conversion with stainless steel centre	FRONT	S	Bonneville (865cc/Cast wheels)	09-15	MD834X	FRONT	F		300							
			Bonneville Newchurch (865cc/Cast wheels)	15												
			Bonneville SE 865cc (Cast wheels)	09-13												
			Speedmaster (865cc/EFI)	11-16												
MD822 MD822X ① MD822XC ① ① Floating conversion with stainless steel centre	FRONT	S	America (12 spoke Cast Wheel 865cc)	10-17				MD835 BILLET		FRONT	F	1000 - California III - Carbs	88-90			
			America LT (12 spoke Cast Wheel 865cc)	14-17								1000 - California III - EFI	90-93			
			Bonneville Spirit (Spoke wheel/865cc)	15								1100 - California Carbs	94-97			
			Bonneville T214 (Spoke wheel/865cc)					MD836C		FRONT	S	Senda SM DRD Racing Ltd (SR2A2B Model/Cast Wheels)	240			
			Bonneville T100 (865cc/Air Cooled /Spoke wheel)	10-16								MD837	FRONT	S	750 SEI (6 Cyl)	75-
			Bonneville T100 Black (865cc/ Air Cooled/Spoke wheel)	14-16											900 SEI (6 Cyl)	83
			Bonneville Steve McQueen SE Scrambler (865cc)	10-15												
			Speedmaster (865cc/EFI)					MD838		FRONT /REAR	F	Various Meriden Triumphs 6 bolt fixing. See application pages	250			
MD825	FRONT	F	Thunderbird (1597cc)	09-18				MD839		FRONT	S	Planet 125 (6 spoke wheels/3 Bolt Disc)	98-03			
			Thunderbird Commander (1699cc)	14-18												
			Thunderbird LT (1699cc)	14-18				MD840 MD840C		REAR	S	850 Brevia ie	06-07			
			Thunderbird Storm (1699cc)	11-18	850 Griso	06-07										
			Thunderbird Nightstorm	15-18	940 Bellagio	07-13										
MD827	REAR	S	SINNIS		1100 Brevia (STD/ABS Models)	05-07										
			Stealth 125 QM125-2D	08-10	1100 Griso	05-08										
MD828	FRONT	S	SINNIS		1200 Brevia	08-09										
			Vista 125 QM125 2C	08-10	1200 Griso 8V (Standard/Cast Wheel/Radial Caliper)	07-12										
MD829	FRONT	S	SINNIS		1200 Griso 8V (Special Edition/Spoke Wheel/Radial Caliper)	07-15										
			JS 125-6C-SC125	12-14	1200 Norge	06-07										
			Max 125 QM125-2V	08-09	1200 Norge GT 8V (ABS)	08-15										
MD831	REAR	S	Thunderbird (1597cc)	09-18	1200 Sport 4V	06-07										
			Thunderbird Commander (1699cc)	14-18	1200 Sport 8V	08-13										
			Thunderbird LT (1699cc)	14-18	1200 Stelvio	08-11										
			Thunderbird Storm (1699cc)	11-18	1200 Stelvio 8V (ABS)	11-15										
			Thunderbird Nightstorm	18	1200 Stelvio NTX ABS	09-10										
MD832	REAR	S	HP4	13-14	1200 Stelvio 8V NTX (ABS)	11-15										
			HP4 Carbon	13-14	1400 California Touring	13-16										
			S 1000 R Naked (K47)	14-18	1400 California Touring SE	15-17										
			S 1000 RR (K46)		1400 Audace	15-16										
			(Disc has fixed bobbins)	10-18	1400 Audace Carbon	16-17										
			S1000 R/RR (Models fitted with Forged race wheels - 7 Spoke type)	10-18	1400 Eldorado	15-17										
			S1000 R	18-19	MGX 21 1400	16-19										
			S1000 RR/RR Sport/RR M Sport	18-19	MD841X/XC VR841BLK VR841BLU VR841RED VR841GLD	FRONT	F	DUCATI	320							
MD833	REAR	S	GPR 50 (2T)	09-11				Diavel Chromo ABS		12						
			RS4 50 (4T/AJP Caliper)	11-14				Diavel AMG		11-12						
			RS4 50 (4T) (J. Juan Calipers)	11-14				Diavel Strada		13-14						
			SX 50 Limited Edition	14-16				Diavel Dark		13-14						
			GPR 125 4T/4V	09-14				Diavel (ABS)		11-17						
			RS4 125 (4T/AJP Caliper)	11-15				Diavel Carbon ABS		11-20						
			RS4 125 (4T/J. Juan Caliper)	11-15				Diavel Diesel (1200cc)		11-18						
			RS 125 (4T)	17-18				Diavel Diesel (1262cc)		17-18						
			GPR 50 (2T)	09-11				749 Monoposto/Biposto		03-06						
			RS 125 (4T) GP Replica	18	796 Monster (Non ABS Models)	10-13										
			Tuono 125	17-18	796 Monster (ABS Models)	10-14										
					Monster 796 20th Anniversary Model (ABS & Non ABS Models)	13										
					797 Monster	17-18										
					797+ Monster	18										

D = Dished Solid Original (We replace with floating rotor conversion unit) F = Floating Rotor S = Solid Rotor

STREETBIKE DISC BUYERS GUIDE

DISC No.	FRONT/ REAR	TYPE	MODELS	DIA (MM)	DISC No.	FRONT/ REAR	TYPE	MODELS	DIA (MM)
MD854 VR854	REAR	S	CAN-AM Spyder F3 LTD 16-17 Spyder F3 (SE6/SM6) 15-17 Spyder F3-S (SE6/SM6) 15-17 Spyder F3-S (Special Series) 16 Spyder F3-S Daytona 500 17 Spyder F3-T 16-17 Spyder RT (3 cyl Eng/6 speed) 13-17 Spyder RT Ltd (3 cyl eng/6 speed) 13-17 Spyder RT-S (3 cyl eng/6 speed) 13-17 Spyder RT-S (Special Series) 16-17 Spyder ST Brembo calipers 13-16 Spyder ST-S Brembo calipers 13-16 Spyder ST Ltd Brembo calipers 13-15 Spyder RS Brembo calipers 13-16 Spyder RS-S Brembo calipers 13-16	270	MD865X MD865XC	FRONT	S	DUCATI 796 Hypermotard 10-13 1100 Hypermotard 07-09 1100 S Hypermotard 07-09 1100 EVO Hypermotard 10-12 1100 EVO SP Hypermotard 10-12	305
MD855X MD855XC	FRONT	F	MZ/MUZ 1000 S 03-07 1000 SF 05-07 1000 SFX 07 1000 ST 07	320	MD868X MD868XC	FRONT	F	DUCATI 803 Scrambler Icon (Cast Wheels) 15-20 803 Scrambler Full Throttle (Cast Wheels) 15-20 803 Scrambler Classic (Spoke Wheels) 15-20 803 Scrambler Urban Enduro (Spoke Wheels) 15-16 803 Scrambler Flat Track Pro 16 803 Scrambler Café Racer (Cast Wheels) 17-20 803 Scrambler Street Classic (Spoke Wheels) 18-20 803 Scrambler Desert Sled (Spoke Wheels) 17-20 803 Scrambler Mach 2 (Cast Wheels) 18-20	330
MD856X MD856XC VR856ORG	FRONT	F	KTM Duke 690 (2 pin pad fixing/multi spoke cast wheel) 13-18 Duke 690 R (Multi spoke cast wheels) 13-18	320	MD869	FRONT	S	GILERA Nordwest 600 90-	270
MD857 MD857C	REAR	S	KTM Duke 690 (2 pin pad fixing/multi spoke cast wheel) 13-20 Duke 690 R (Multi spoke cast wheels) 13-18	240	MD870XC	FRONT	F	APRILIA Dorsodura 750 (ABS) 08-16 Dorsodura Factory 750 10-13 Dorsodura Factory 750 (ABS) 10-12 Shiver 750 (RAE00/STD & ABS) 10-16	320
MD858 MD858C VR858	REAR	S	APRILIA NA850 Mana (Non ABS) 08-11	260	MD871	REAR	S	MOTO GUZZI 750 Brevia ie (3 Spoke Cast Wheel) 03-11 V9 Bobber 16-20 V9 Bobber Sport 19-20 V9 Roamer 16-20	260
MD859	FRONT	F	MOTO GUZZI 850 Brevia ie (Non ABS Models) 06-07 850 Norge (Non ABS Model) 07 V9 Bobber 16-20 V9 Bobber Sport 19-20 V9 Roamer 16-20 1100 Brevia (Non ABS models) 05-07	320	MD872 MD872C VR872	REAR	S	APRILIA NA 850 Mana (ABS) 08-13 NA 850 Mana GT (ABS Model) 09-16	260
MD860	REAR	S	SACHS (HERCULES) X Road 125 06-07 XTC 125 Supersport 00-07 XTC 125 N 00-07	220	MD873 MD873X	FRONT	S F	TRIUMPH Street Scrambler (900cc Liquid Cooled) 16-20 Street Twin (900cc Liquid Cooled) 16-20 Thrupton 1200 (Liquid Cooled) 16-20 Bonneville Bobber (1200cc Liquid Cooled) 17-20 Bonneville Bobber Black (1200cc Liquid Cooled) 18-20 Bonneville Speedmaster (1200cc Liquid Cooled) 18-20 Bonneville T120 (1200cc Liquid Cooled) 16-20 Bonneville T120 Black (1200cc Liquid Cooled) 16-20	310
MD861	REAR	S	CAGIVA Tamanaco 125 88-89 Elefant 88-90	220	MD874	REAR	S	TRIUMPH Street Scrambler (900cc Liquid Cooled) 16-20 Street Twin (900cc Liquid Cooled) 16-20 Street Cup (900cc Liquid Cooled) 16-20 Bonneville T100 (900cc/Liquid Cooled/Spoke Wheel) 16-20 Bonneville T100 Black (900cc/Liquid Cooled/Spoke Wheel) 16-20 Bonneville Bobber (1200cc Liquid Cooled) 17-20 Bonneville Bobber Black (1200cc Liquid Cooled) 18-20 Bonneville Speedmaster (1200cc Liquid Cooled) 18-20 Speed Triple S (1050cc/ABS) 17-20 Speed Triple R (1050cc/ABS) 17-20 Bonneville T120 (1200cc Liquid Cooled) 16-20 Bonneville T120 Black (1200cc Liquid Cooled) 16-20	255
MD862X	FRONT	F	BMW HP4 13-14 HP4 Carbon 13-14 S1000 R/RR (Models fitted with Forged race wheels - 7 Spoke type) 10-18	320	MD877	REAR	S	ROYAL ENFIELD 535cc Continental GT (ABS) 17-18	240
MD863	REAR	S	TRIUMPH Explorer 1200 12-15 Explorer XC 1200 13-15 Tiger 1200 XR 18-20 Tiger 1200 XRx 18-20 Tiger 1200 XRx Low 18-20 Tiger 1200 XRt 18-20 Tiger 1200 Xca 18-20 Tiger 1200 XCx 18-20 Tiger Explorer XC (1215cc) 16-17 Tiger Explorer XCx/XCx Low (1215cc) 16-17 Tiger Explorer XCa (1215cc) 16-17 Tiger Explorer XR(1215cc) 16-17 Tiger Explorer XRx/XRx Low (1215cc) 16-17 Tiger Explorer XRt (1215cc) 16-17 Trophy 1215cc 12-16 Trophy 1215cc SE 12-17	282					
MD864 MD864XC	FRONT FRONT	S F	KTM Duke 125 13-20 Duke 200 13-15 Duke 250 15-20 Duke 390 13-17 RC 125/200/390 14-19	300					

D = Dished Solid Original (We replace with floating rotor conversion unit)

F = Floating Rotor

S = Solid Rotor

STREETBIKE DISC BUYERS GUIDE

DISC No.	FRONT/ REAR	TYPE	MODELS	DIA (MM)	DISC No.	FRONT/ REAR	TYPE	MODELS	DIA (MM)
MD878 MD878C VR878	REAR	S	DUCATI		MD885 MD885C	REAR	S	MV	
			796 Monster (ABS Models)	10-14				675 Brutale	12-17
			796 Monster 20th Anniversary Model (ABS Models)	13				675 F3	12-20
			821 Hypermotard	13-16				675 F3 Serie Oro	12-13
			821 Hypermotard SP	13-16				675 F3 RC	15-18
			821 Hyperstrada	13-16				800 Brutale	12-18
			939 Hypermotard	16-18				800 Brutale Dragster	14-15
			939 Hypermotard SP	16-18				800 Dragster RC	17-18
			939 Hyperstrada	16-17				800 Dragster RR	15-18
			1100 Monster Diesel	13				800 Brutale RR	19-20
			1100 Monster EVO	11-13				800 Brutale RR SCS	19-20
			1100 Monster EVO 20th Anniversary Model	13				800 Brutale Rosso	19-20
			1100 Monster (ABS)	09-10				800 Dragster RR SCS	19-20
1100 S Monster (ABS)	09-10	800 Dragster Rosso19-20							
Panigale V4 (1103cc)	18	800 F3	13-20						
Panigale V4 S (1103cc)	18	800 F3 Ago	14-15						
		800 F3 RC	15-20						
		800 Stradale	15						
		800 Turismo Veloce	14-20						
		800 Turismo Veloce Lusso	15-20						
		800 Turismo Veloce RC	17-20						
		800 Turismo Veloce Lusso SCS	19-20						
		Rivale 800	14-18						
MD879	REAR	S	DUCATI	265	MD886X	FRONT	F	TRIUMPH	
			1200 Multistrada ABS (Single Pin F/Caliper)	15-18				Bonneville T100 (900cc/Liquid Cooled/Spoke Wheel)	16-20
			1200 S Multistrada Pikes Peak	16-17				Bonneville T100 Black (900cc/Liquid Cooled /Spoke Wheel)	16-20
			1200 S Multistrada	15-18				Street Cup (900cc Liquid Cooled)	16-20
			1200 S Multistrada D air	15-17					
			1200 S Multistrada D air DVT	15-17					
			Diavel ABS	11-20					
			Diavel Carbon ABS	15-20					
			Diavel Diesel (1262cc)	17-18					
			1260 Multistrada	18-20					
			1260 S Multistrada	18-20					
			1260 S Multistrada Touring	18					
			1260 S Multistrada D air	18					
1260 Multistrada Pikes Peak	18-20								
XDiavel	16-20								
XDiavel S	16-20								
MD880 MD880C VR880	REAR	S	DUCATI	245	MD887BLK VR887BLK	REAR	F	INDIAN	
			Supersport (936cc)	17-18				Chief Classic (Spoke Wheel /Nissin Calipers)	14-18
			Supersport S (936cc)	17-18				Chief Vintage (Spoke Wheel /Nissin Calipers)	14-20
			1200 Monster	14-19				Chieftain (Cast Wheel /Nissin Calipers)	14-20
			1200 S Monster	14-18				Chieftain Dark Horse (Cast Wheel /Nissin Calipers)	16-20
			1200 R Monster	16-18				Chieftain Limited (Cast Wheel /Nissin Calipers)	17-20
			1299 Panigale	15-18				Chief Dark Horse	14-20
			1299 Panigale S	15-18				Roadmaster (Cast Wheel /Nissin Calipers)	15-20
			1299 Panigale R	15-17				Roadmaster Classic (Nissin Calipers)	17-18
			1299 Panigale R Final Edition	18				Roadmaster Elite (Nissin Calipers)	17-20
			1299 Superleggera	17				Springfield	16-20
			1299 Panigale V4 Corse/Speciale	18-19				Springfield Dark Horse	18
			MD881	FRONT				S	BMW
G 310 R	17-20	Chief Classic (Spoke Wheel /Nissin Calipers)			14-18				
			G 310 GS	17-20				Chief Vintage (Spoke Wheel /Nissin Calipers)	14-20
MD882	REAR	S	BMW	240				Chieftain (Cast Wheel /Nissin Calipers)	14-20
			G 310 R	17-20			Chieftain Dark Horse (Cast Wheel /Nissin Calipers)	16-20	
			G 310 GS	17-20				Chieftain Limited (Cast Wheel /Nissin Calipers)	17-20
MD883X MD883XC	FRONT	F	TRIUMPH	310				Chief Dark Horse	14-20
			Thrupton R 1200 (Liquid Cooled)	16-20			Roadmaster (Cast Wheel /Nissin Calipers)	15-20	
			Thrupton TFC 1200 (Liquid Cooled)	19-20				Roadmaster Classic (Nissin Calipers)	17-18
MD884X MD884XC	FRONT	F	MV	320				Roadmaster Elite (Nissin Calipers)	17-20
			675 Brutale	12-17			Springfield	16-20	
			675 F3	12-20				Springfield Dark Horse	18
			675 F3 Serie Oro	12-13	MD891	FRONT	F	MOTO GUZZI	
			675 F3 RC	15-18				G5 V1000	78-83
			800 Brutale	12-18	MD893	FRONT	S	ROYAL ENFIELD	
			800 Brutale Dragster	14-15				Himalayan	16-20
			800 Brutale Dragster RC	17-18	MD894 MD894C	REAR	S	ROYAL ENFIELD	
			800 Dragster RR	15-18				Himalayan	16-20
			800 Brutale RR	15-18	MD898X MD898XC	FRONT	F	ROYAL ENFIELD	
			800 Brutale RR SCS	19-20				Royal Enfield 650 interceptor	19
			800 Brutale Rosso	19-20					
			800 Dragster RR SCS	19-20					
			800 Dragster Rosso	19-20					
			800 F3	13-20					
			800 F3 Ago	14-15					
			800 F3 RC	15-20					
			800 Stradale	15					
			800 Turismo Veloce	14-20					
			800 Turismo Veloce Lusso	15-20					
			800 Turismo Veloce RC	17-20					
			800 Turismo Veloce Lusso SCS	19-20					
			Rivale 800	14-18					

D = Dished Solid Original (We replace with floating rotor conversion unit)

F = Floating Rotor

S = Solid Rotor

STREETBIKE DISC BUYERS GUIDE

DISC No.	FRONT/ REAR	TYPE	MODELS	DIA (MM)	DISC No.	FRONT/ REAR	TYPE	MODELS	DIA (MM)
MD899	REAR	R	DUCATI	245	MD901D MD901C VR901 With counter sunk bolt holes Contd.	FRONT & REAR	S	PEUGEOT Contd.	190
			400 Scrambler Sixty2 16-20					Vivacity 2 (50cc) (10" wheels) 08-11	
			695 Monster 07-08					Vivacity 50/100 (All models) 99-07	
MD8001	Rear	R	BMW	275	MD902D VR902	FRONT	S	PIAGGIO	200
			R 1200 GS (K50/Liquid Cooled/ Radial Calipers) 13-18					Skipper 125/150 94-97	
			R 1200 GSAdventure (K51/ Inc TE/XE Models/ LC/ Radial calipers) 14-18					MALAGUTI	
MD901D VR901 With counter sunk bolt holes	FRONT & REAR	S	ATALA	190	MD903D VR903	FRONT	S	YAMAHA	245
			Hacker (LC) 97					YP 250 DX/A 'Majesty' 98-00	
			Hacker (Racing) 97					YP 250 Majesty 96-02	
MD904D VR904	FRONT	S	BETA	155	MD904D VR904	FRONT	S	ADLY	155
			Eickon 50 99-06					Road Tracker 50/90/100 04-06	
			Quadra 50 97-00					APRILIA	
MD901D VR901 With counter sunk bolt holes	FRONT & REAR	S	GOVECS (Electric Scooters)	190	MD901D VR901 With counter sunk bolt holes	FRONT & REAR	S	AMICO	93-
			GO S 1.2 11-14					Amico (All models) 93-	
			GO T 1.2 11-14					GARELLI	
MD901D VR901 With counter sunk bolt holes	FRONT & REAR	S	MALAGUTI	190	MD901D VR901 With counter sunk bolt holes	FRONT & REAR	S	QUEENIE	95-
			Ciak 50 Twin Disc 00-03					Grinta 95-	
			Ciak 100 99-01					GILERA	
MD901D VR901 With counter sunk bolt holes	FRONT & REAR	S	PIAGGIO	190	MD901D VR901 With counter sunk bolt holes	FRONT & REAR	S	HYOSUNG	95-96
			Ciak 50/100 00-03					Easy Moving 50 95-96	
			Phantom F12 50 (LC) 94-08					HYOSUNG	
MD901D VR901 With counter sunk bolt holes	FRONT & REAR	S	PEUGEOT	190	MD901D VR901 With counter sunk bolt holes	FRONT & REAR	S	JORDAN	03-04
			F12 50 Phantom 98					Easy 50/100 03-04	
			Firefox F15 96-03					LEXMOTO	
MD901D VR901 With counter sunk bolt holes	FRONT & REAR	S	PEUGEOT	190	MD901D VR901 With counter sunk bolt holes	FRONT & REAR	S	MOLLY	15-18
			Crosser CR1 97-01					Molly 50 (DFE50QT-3) 15-18	
			F15 RR 99-01					MALAGUTI	
MD901D VR901 With counter sunk bolt holes	FRONT & REAR	S	PEUGEOT	190	MD901D VR901 With counter sunk bolt holes	FRONT & REAR	S	MALBO	10-11
			F15 Firefox (LC) 01-08					Malbo Line - DVD 50 (2T) 10-11	
			F15 Firefox Kat 98-00					MBK	
MD901D VR901 With counter sunk bolt holes	FRONT & REAR	S	PEUGEOT	190	MD901D VR901 With counter sunk bolt holes	FRONT & REAR	S	CR 50 Z Target	91-95
			Scooters with Grimeca Wheels Disc attached with countersunk bolts					CR 50 Z Target 91-95	
			Elyseo 50 98-02					CW 50 R Booster Road	
MD901D VR901 With counter sunk bolt holes	FRONT & REAR	S	PEUGEOT	190	MD901D VR901 With counter sunk bolt holes	FRONT & REAR	S	CV 50 Evolis	97
			Looxor 50 TSDi 06					CV 50 Evolis 97	
			Ludix Elegance 50cc 04					CY 50 Forte/Forte Mufa	
MD901D VR901 With counter sunk bolt holes	FRONT & REAR	S	PEUGEOT	190	MD901D VR901 With counter sunk bolt holes	FRONT & REAR	S	YA 50 R Forte	94-95
			Ludix Pro (14" wheels/4T) 11					YA 50 R Forte 94-95	
			Metal-X 50 02-03					YE 50 Evolis	
MD901D VR901 With counter sunk bolt holes	FRONT & REAR	S	PEUGEOT	190	MD901D VR901 With counter sunk bolt holes	FRONT & REAR	S	YM 50 Fizz	94-95
			TRK 50 (2T) (10" wheels) 09-12					YM 50 Fizz 94-95	
			TRK 50 (2T/12" wheels) 09-12					CV 80 Evolis	
MD901D VR901 With counter sunk bolt holes	FRONT & REAR	S	PEUGEOT	190	MD901D VR901 With counter sunk bolt holes	FRONT & REAR	S	MOTO-ROMA	97-05
			Trekker 50 (2T) AJP Caliper 98-00					Go-Go 50 97-05	
			Trekker 50 (2T) Heng Tong Caliper 98-00					STINGER	
MD901D VR901 With counter sunk bolt holes	FRONT & REAR	S	PEUGEOT	190	MD901D VR901 With counter sunk bolt holes	FRONT & REAR	S	ROADRUNNER	01-02
			Vivacity 50 (12" wheels) 92-07					Roadrunner 50/100 01-02	
			PEUGEOT					MUZ	
MD901D VR901 With counter sunk bolt holes	FRONT & REAR	S	PEUGEOT	190	MD901D VR901 With counter sunk bolt holes	FRONT & REAR	S	MOSKITO	97-03
			PEUGEOT					Moskito FB50 97-03	
			PEUGEOT					MOSKITO	
MD901D VR901 With counter sunk bolt holes	FRONT & REAR	S	PEUGEOT	190	MD901D VR901 With counter sunk bolt holes	FRONT & REAR	S	PIAGGIO	93-97
			PEUGEOT					Moskito SX JP50 00-03	
			PEUGEOT					PIAGGIO	
MD901D VR901 With counter sunk bolt holes	FRONT & REAR	S	PEUGEOT	190	MD901D VR901 With counter sunk bolt holes	FRONT & REAR	S	PIAGGIO	95-96
			PEUGEOT					Zip Fast Raider 93-97	
			PEUGEOT					Zip 50 Base 95-96	
MD901D VR901 With counter sunk bolt holes	FRONT & REAR	S	PEUGEOT	190	MD901D VR901 With counter sunk bolt holes	FRONT & REAR	S	PIAGGIO	96-99
			PEUGEOT					Zip 50 RST 96-99	
			PEUGEOT					Zip 50 Elettrico 02	
MD901D VR901 With counter sunk bolt holes	FRONT & REAR	S	PEUGEOT	190	MD901D VR901 With counter sunk bolt holes	FRONT & REAR	S	PEUGEOT	04
			PEUGEOT					Scooters with Leleu wheels disc attached with counterbored bolts Ludix Snake /Bullet/Trend 50cc 04	
			PEUGEOT					P.G.O.	
MD901D VR901 With counter sunk bolt holes	FRONT & REAR	S	PEUGEOT	190	MD901D VR901 With counter sunk bolt holes	FRONT & REAR	S	PIAGGIO	94-06
			PEUGEOT					Big max 50 94-06	
			PEUGEOT					EPS	
MD901D VR901 With counter sunk bolt holes	FRONT & REAR	S	PEUGEOT	190	MD901D VR901 With counter sunk bolt holes	FRONT & REAR	S	PIAGGIO	97
			PEUGEOT					Tornado 50/125 97	
			PEUGEOT					SINNIS	
MD901D VR901 With counter sunk bolt holes	FRONT & REAR	S	PEUGEOT	190	MD901D VR901 With counter sunk bolt holes	FRONT & REAR	S	PIAGGIO	08-10
			PEUGEOT					Jet 50 QM50QT-6A 08-10	
			PEUGEOT					M-PED	
MD901D VR901 With counter sunk bolt holes	FRONT & REAR	S	PEUGEOT	190	MD901D VR901 With counter sunk bolt holes	FRONT & REAR	S	PIAGGIO	08-10
			PEUGEOT					M-Ped 50 Road Classic 08-10	
			PEUGEOT					SUPERBYKE	
MD901D VR901 With counter sunk bolt holes	FRONT & REAR	S	PEUGEOT	190	MD901D VR901 With counter sunk bolt holes	FRONT & REAR	S	PIAGGIO	91-95
			PEUGEOT					Falcon 50 QM50QT-2T 08-10	
			PEUGEOT					YAMAHA	
MD901D VR901 With counter sunk bolt holes	FRONT & REAR	S	PEUGEOT	190	MD901D VR901 With counter sunk bolt holes	FRONT & REAR	S	YAMAHA	91-95
			PEUGEOT					CR-Z 50 (3WN) 91-95	
			PEUGEOT					YA 50 R Axis (4pc) 95-96	
MD901D VR901 With counter sunk bolt holes	FRONT & REAR	S	PEUGEOT	190	MD901D VR901 With counter sunk bolt holes	FRONT & REAR	S	YAMAHA	93-95
			PEUGEOT					YE 50 Zest 93-95	
			PEUGEOT					YM 50 Breeze (4KH) 94-95	
MD901D VR901 With counter sunk bolt holes	FRONT & REAR	S	PEUGEOT	190	MD901D VR901 With counter sunk bolt holes	FRONT & REAR	S	YAMAHA	91-
			PEUGEOT					Jog 'R' 91-	
			PEUGEOT						

D = Dished Solid Original (We replace with floating rotor conversion unit)

F = Floating Rotor

S = Solid Rotor

STREETBIKE DISC BUYERS GUIDE

DISC No.	FRONT/ REAR	TYPE	MODELS	DIA (MM)	DISC No.	FRONT/ REAR	TYPE	MODELS	DIA (MM)	
MD905D	FRONT	S	PIAGGIO Hexagon 125/150	175	MD910D VR910 Contd.	FRONT	S	VESPA S 125 (4T) 07-13 S 125 Sport (4T) 11-13 ET4 125/150 99-05 Primavera 125 (4T/3V) 13-20 Primavera 125 (4T/3V/Non ABS) 15 PX 125 (Disc brake model/2T) 98-16 PX 125 Touring (Disc brake model) 15 Sprint 125 (4T/3V/Non ABS) 14-15 Sprint S 125 (4T/3V/ABS) 15-20 Sprint S 125 (4T/3V/Non ABS) 15-20 LX 150 (4T/Serie Speciali) 12 Primavera 150 (4T/3V) 13-20 Primavera 150(4T/3V/Non ABS) 15 PX 150 (Disc brake model) 98-15 PX 150 Touring (Disc brake model) 15 S 150 Sport (4T) 11-12 S 150 (4T) 07-12 Sprint S 150 (4T/3V/ABS) 15-20 PX 200 (Disc brake model) 98-07	200	
MD906D VR906	FRONT	S	HONDA SFX 50 'S/T/W/X/Y/1' 95-04 SXR 50 W/SW/X/SX 98-99	160		REAR	S	GILERA DNA 50 01-06 Runner VX 125/180 01-04 PIAGGIO Super Hexagon GTX 125/180 00	200	
MD907D VR907	FRONT	S	YAMAHA YP 125 Majesty 98-09 XN 125 N Teo's 00-03 MBK XN 125/150 Doo Do 00-05 YP 125 D Skyliner 98-09	220		MD910D VR910	FRONT	S	SUZUKI TR 50 SW/SX 98-00 UG 110 W/SW/Y/SY/SK1 Hokuto/Address 98-02 AN 125 S/T/V/W/X 95-00 AN 125 HKK5 06-08 UE 125 CTK1 01-03	180
MD908D VR908	FRONT	S	HONDA CN 250 H/J/L/M/P/R/S/T/V/X SPAZIO/Helix 87-98 CN 250 3 Fusion/Fusion X/Fusion X Special 03	186		MD911D VR911	FRONT	S	SUZUKI AH 100 P Address 95-96	161
MD909D With counterbored holes	FRONT REAR	S	BENELLI 491 98-04 K2 50/100 98-01 Naked 50/100 02-03 PEUGEOT Scooter with Leleu wheels discs Ludix Elegance 50cc 04 Ludix Ambition 125cc 04	190	MD912D	FRONT	S	SUZUKI CH 250 F/G Spacy 85-86	170	
MD910D VR910	FRONT	S	PIAGGIO Fly 50 (2T) 05-18 Fly 50 (4T) 05-18 Free 50 95-02 LX 50 (4T) 05-10 Sfera 50 RST 95-97 Zip 50 SP (L/C) 96-13 Free Delivery 50 00-02 Fly 100 (4T) 07-15 Free 100 02 Fly 125 (4T/2V) 05-11 Fly 125 ie (3V/4T) 12-15 Sfera 125 95-97 Vespa ET4 125 96-99 Fly 150 (4T) 05-09 LX 150 (4T) 05-09 Hexagon LX 180 98-99 Hexagon LXT 180 98-99 Hexagon LX4 125 98-99 Super Hexagon GTX 125/180 00 Zip 125 00-01 Hexagon GT 250 98-99 Super Hexagon GTX 250 00-02	200	MD913D	FRONT	S	HONDA CH 250 F/G Spacy 85-86	170	
			MD914D		FRONT	S	PEUGEOT Scooter with Grimeca wheels discs attached with countersunk bolts Ludix Snake/Bullet/Trend 50cc 04	155		
			MD915D VR915		FRONT	S	MALAGUTI F10 Jet Line 96-07 F10 Jet Line WAP 06-10 F10 Tribal 08-10 Yesterday 98-03	155		
			MD916D		FRONT	S	YAMAHA BWS 50 Original 99-02 BW's 50 Naked (1D11/2B71) 03-04 BW's 50 Naked (2B7B/D/F/H) 09-15 BW's 50 (5WW1) 04 BW's 50 (5WW4/6/8/9/B/D/F/H/K/M/P) 05-15 BWs 50 (5WWB-K) 08-11 CW 50 RS (4YA1/2/BWS) 96-97 CW 50 RS (4YA4/BWS NG) 98 CW 50 (5WW4/BWS) 04-07 CW 50 RSP (5CC1/3/4YA BWS Spy) 97-98	180		
			MD917D		FRONT	S	APRILIA Scarabeo 50 93-97	220		
			MD918D		FRONT	S	HONDA SH 50 T/X/W/X/Y/1 'Fifty/Scoopy' 97-03 SH 100 T/W/X/Y/1 Scoopy 96-01 UX 125 K8/K9 Sixteen 08-10 UX 150 K8/K9 Sixteen 08-10	220		
			MD919D		FRONT	S	PIAGGIO Atlantis 50 (4T) 07-09 Atlantis 50 (2T/AC) 12"/5 spoke wheels/200mm disc/5 bolt From ref. 8G253172 07-11 Boulevard 50 (2T) 09-12 Boulevard 50 (4T) 09 Boulevard 125 (4T) 08-12 LML Star 125 (2T) 10-14 Star 125i (4T) 10-15 Star 125 Deluxe (2T) (Front disc) 01-03 Star 150 (2T) 10-14 Star 150 Deluxe (2T) (Front disc) 01-03 Star 151i (4T) 10-15 Star 200i (4T) 10-15 VESPA LX 50 (2T/4T) 05-13 Primavera 50 (2T) 13-20 Primavera 50 Touring (2T) 15 Primavera 50 (4T/4V) 13-15 Primavera 50 Touring (4T/4V) 15 S 50 (2T) 07-13 S 50 (4T/4V) 08-13 S 50 Sport (2T) 11-13 S 50 Sport (4T/4V) 11-13 Sprint 50 (2T) 14-20 Sprint 50 (4T/4V) 14-15 Sprint S 50 (2T) 15 ET2 50 97-05 ET4 50 00-04 LX 60 (Special Anniversary Model) 06 LX 125 (4T) 05-13 LX 125 (4T/Serie Speciali) 12	200		

D = Dished Solid Original (We replace with floating rotor conversion unit) F = Floating Rotor S = Solid Rotor

STREETBIKE DISC BUYERS GUIDE

DISC No.	FRONT/ REAR	TYPE	MODELS	DIA (MM)	DISC No.	FRONT/ REAR	TYPE	MODELS	DIA (MM)	
MD919D	FRONT	S	HONDA SK 50 MM-II/MM-YD/MN-II/MP-II (AF28) Dio SR SK 50 MN-III/MP-III/MP-IV (AF28) Dio ZX SK 50 MMR-II/MMT-II (AF28) Dio XR	160	MD923D VR923 Contd.	FRONT /REAR		HONDA NCX 50 E/G/J - Dunk 50 14-17 SJ 50 P/R/S/T/V/W/X 'Bali' 93-99 SJ 100 T/W/X 'Bali Ex' 96-99 SCV 110 Lead (NHX 110 WH8 3 bolt disc fixing) 08-09 MASH Bibop 50 14-16 Bibop Racing 50 14-16 Sixty Five 125 13-15 MBK Nitro 98-01 CW 50 RS Booster NG 01-06 EW 50 Stunt 00-06 EW 50 Stunt Naked 05-10 YQ 50 Nitro 97-09 YQ 50 Nitro Naked 06-09 YQ 100 Nitro 01-03 MOTOROMA Grand Prix 50/100 99-03 Grand Prix 125 02 PGO PMX 50 00-07 T-Rex 50 99-12 Bubu 100/125 03-08 PMX 110 00-07 T-Rex 110 99-06 Charge 125 A/B 01-02 Ligero 125 06-08 T/Rex 125 99-07 SINNIS LJ 50 QT-H 12-14 WY 50 QT-39A Ghost 06-10 SYM Fiddle II 50 08-15 Fiddle III 50 14-20 Orbit 50 08-09 Symply 50 07-08 Symply II 50 09-14 Allo 125 (4T) 11-15 Fiddle II 125 08-15 Symply 125 07-08 Symply II 125 09-14 Orbit 11/Symply 125 (4T) 09-15 TGB City 50cc (2T) 07-08 City 50cc (4T) 07-11 Delivery 50 Scooter 04-06 Delivery/Express 50 06-12 Akros Tec -50 03-04 High Wheel 50 02-03 Trigger 50 02-03 101R (50cc) 04-09 202 Classic (50cc) 03-14 303R Hawk/Laser (50cc) 04-14 303 Revolution (50/125cc) 02-03 F409 Cruise 50/125 02-05 309RS 50 02-03 YAMAHA Aerox 50 2T All Models 97-16 CW 50 RS 99 CW 50 RS 00 CW 50 RS 01-05 CW 50 02 NS 50 Aerox (2T) 13-16 NS 50 N Aerox Naked (2T) 13-16 NS 50 F Aerox 4 (4T) 13-18 YQ 50 Aerox R/Aerox 97-12 Aerox 4 (NS 50 F) 14-16 YQ 100 "Aerox 100" 00-04 EW 50 "Slider" 00-05 BWS 50 Next Generation 99-07	190	
MD920D VR920	FRONT	S	HONDA SZX 50 Super Sport Scooter X8R-SW/SX/SY/S1 98-04 SZX 50 XW Cross Sport X8R-XW/XX/XY/X1 98-04	220						
MD921D VR921	REAR	S	HONDA SZX 50 SW X8R-SW/SX/SY/S1 'Super Sport Scooter' 98-04 SZX 50 XW X8R-XW/XX/XY/X1 'Cross Sport' 98-04	190						
MD922D VR922	FRONT /REAR	S	HONDA FES 125W/Y/1-5 'Pantheon' 98-06 FES 125 7/9/A/B S-Wing (Non ABS) 07-13 FES 125 A7/A9/AA/AB S-Wing (ABS) 07-15 SH 125 1/3 Carb 01-03 SH 125i 9 A/B Fuel Injection 09-12 SH 125i D9 Fuel Injection 09 SH 125i R8 Fuel Injection 08 SH 125i RA 10-14 SH 125i S7/S8 Fuel Injection 07-08 SH 125i (2 piston caliper) 14-18 SH 125i (3 Piston Caliper/ABS) 14-16 FES 150 W/Y/1/2/3/4/5 Pantheon 98-06 FES 150 A7/A9/A (S-Wing) ABS 07-13 FES 150 7/9/AA S-Wing 07-13 SH 150 1/3 Carb 01-03 SH 150i 9/A/B Fuel Injection 09-12 SH 150i D9 Fuel Injection 09 SH 150i R8 Fuel Injection 08 SH 150i S7/S8 Fuel Injection 07-08 SH 150 RA 10-14 SH 150i (2 piston caliper) 14-18 SH 150i (3 Piston Caliper/ABS) 14-16 FES 250 W/X/Y/1/2/5 'Foresight' 98-05 NSS 250 Y/AY/1/A1/A3/3 Forza /Forza-S/Forza-T/Forza-ST/Jazz /Reflex (MF04/MF06) 00-04 NSS 250 EX5/EX6/EX8 Forza EX (ABS) 05-06 NSS 250 AX5/AX6 (Forza Z) (ABS) 05-08 NSS 250 X5/X7/X8 Forza 05-08 PS 250 5/6 Big Ruckus 05-06 PEUGEOT SV 250 01-02	240						
MD923D VR923	FRONT /REAR	S	ADLY Thunderbike 125 Predator 50/100 SS 50/100 Supersonic 04-05 SS 125 B/D Supersonic 04-05 BEELINE Veloce 50 08-10 Veloce GT 50 08-10 BRANSON BS 50 Cuba 08 BS 50 Sting 08 BSM TB 100 TB 125 FT 125 CPI Baby J 50 02 Popcorn 50 02-06 Oliver 50 (All models) 03-12 Mars 50 01-02 Hussar 50 01-06 GARELLI FX 50 KRS 50 Freeland 125/150 GENERIC/KSR Cracker 50 (2T/4T) 09-18 Roc50 08-11 XOR 50 (2T) 05-14 Ideo 50 05-14 Sirion 50 (2T/4T) 12-18 Sirion 125 (4T) 12-18 XOR 125 05-11	190	MD924D VR924	FRONT	S	PIAGGIO NRG 50 Extreme 99-01 NRG 50 DT MC3 01-05 NRG 50 MC3 DD 01-05 Skipper LX 125/150 98-99 Skipper ST 125/150 4T 00-04 BENELLI Adiva 125/150 00 APRILIA Sport City One 50 (4T) 08-09 Sport City One 50 (2T) 08-11 SR 50 Motard (2T) 12-15 SR 50 Motard (4T/4V) 13-15	220	

D = Dished Solid Original (We replace with floating rotor conversion unit)

F = Floating Rotor

S = Solid Rotor

STREETBIKE DISC BUYERS GUIDE

DISC No.	FRONT/ REAR	TYPE	MODELS	DIA (MM)	DISC No.	FRONT/ REAR	TYPE	MODELS	DIA (MM)
MD924D VR924 Contd.	FRONT	S	APRILIA Sport City One 125cc 08-11 SR 125 Motard (4T) 12-15 DERBI Vibrant Sport 50 (2T) 12 Boulevard 125 03-07 Vibrant Sport 125 (4T) 12 Boulevard 150 03-07 Boulevard 200 05 GILERA 50 DD/SP Runner/Purejet 98-05 125 VX 4T/180 VXR 4T 01-04 FX/FXR 125/180 Runner 97-02 VXR 200 Runner (4T) 02-04 BETA Eikon 125/150 00-06	220	MD933D VR933 Contd.	FRONT	S	KYMCO KB 50 (SE10CA) 95-00 K12 Sport 50 (SE10CA) 95-00 Sniper 50 (PR 50 B) 93 Sniper 50 DD (PR 50 BB) 94-96 KB 100 Manboy 97-00 Heroism 125 (SE25BA) 95-97 Heroism 150 (SE30AD) 95-97 SYM Cinderella 50/100 99-00 City Hopper 50 96-06 Mio 50/100 05-20 Super Fancy 50 96-06 Attila 125 99-00 Megalo 125 00-07 Super Duke 125/150 99-02 E-Virid (Electric) Deluxe 12-15 E WOO Elettrico 11 E-Symmetry (Electric) 12-13	160
MD925D MD925C VR925	FRONT/ REAR	S	PEUGEOT Elyseo 50 03 Elystar 50 Advantage 02-07 Speedfight 50 1/2 (L/C) 97-08 Speedfight 50 1/2 (Air Cooled) 97-08 Elyseo 100 03 Speedfight 100 1/2 (L/C) 97-09 LEXMOTO FMR 50 (WY50QT-58R) 15-18 FMR 125 (WY125T-74R) 14-18 FMR 125 EFI (WY125T-74R-E4) 14-18 Matador 125 (ZS125T-40) 13-17	180	MD934D	FRONT	S	SUZUKI UC 125 99-02 KAWASAKI SC 150 A1 (Epsilon 150) 02	220
MD926D	REAR	S	KYMCO Sniper 50 DD 94-96 Heroism 150 (SE30AD) 95-97	160	MD935D	FRONT	S	APRILIA Sonic (All models) 98-08	155
MD927D VR927	REAR	S	YAMAHA YP 250 Majesty 98-99 MBK YP 250 Skyliner 98-99	230	MD936D VR936	FRONT	S	APRILIA Area 51 98-02 F69 Phantom 70cc 98	190
MD928D	FRONT	S	YAMAHA YH 50 'Why' 99-09 MBK YH 50 Flipper 98-10	220	MD937D	FRONT	S	SUZUKI AP 50 R/S/T/V/W 96-02	180
MD929D VR929	FRONT	S	SUZUKI AN 250 K1/K2 Burgman/Skywave 01-02 AN 250 W/X/Y Burgman/Skywave 98-02 AN 400 X/Y/K1/K2 Burgman/Skywave 99-02 KAWASAKI SC 250 A1 (Epsilon 250) 02	260	MD938D VR938	FRONT	S	SUZUKI AY 50 V/W/WW/WX/WY/WRW/WRX /WRY/WRK1/WRK2/WRK3/K1/K2/K3 /K4/WRK4/AK5 'Katana' 97-05 UF 50 Y 00-02 UX 50 WX/WY 99-02	180
MD930D MD930C VR930	REAR	S	SUZUKI AN 250 K1/K2 Burgman/Skywave 01-02 AN 250 W/X/Y Burgman/Skywave 98-02 AN 400 X/Y/K1/K2 Burgman/Skywave 99-02 SC 250 A1 (Epsilon 250) 02	210	MD939D	FRONT	S	SUZUKI AH 80 Address 92-94 AH 100 Address 92-94 PGO Galaxy 50 94-	146
MD931D VR931	FRONT	S	HONDA SGX 50 V/W/X/Y/1 'Sky' 97-03 SRX 50 T/W/X 97-99 SRX 90 T/W/X 97-99	190	MD940D VR940	REAR	S	SUZUKI AY 50 WRX/WX/WRY/WY/WRK1 /WRK3/WRK4/AK5 'Katana' 99-05	190
MD932D VR932	FRONT/ REAR	S	GILERA 50 DD/SP 'Runner/Purejet' 98-05 Runner 50 P/J/SP 06-14 Stalker 50 97-06 DERBI GP1 50 Open 06-11 GP1 50cc 01-03 PIAGGIO NRG 50 RST (DD/DT) MC2 98 NRG 50 Extreme 99-01 NRG 50 MC3 DD 01-05 NRG 50 Power DD 06-18 NRG 50 Pure Jet 06-09 NRG 50 Silver Bullet 10 Zip 50 (2T) 00-15 Zip 50 (4T) 00-15 Zip 100 06-10 Zip 125 02-04	175	MD941D VR941	FRONT	S	ITALJET Dragster 50LC 98-12 Formula 50 LC 96-03 Formula Air 50 99-03 Dragster 125/180 LC 99-12 Dragster 250 07-09 Formula 125 LC (2T/Twin Cyl) 96-03	175
MD933D VR933	FRONT	S	CAGIVA City 50 91-94 KYMCO Agility 50 R10 (4T) 06-07 CX 50 Super (PR 50 AC) 94-97 DJW 50 World (PR50AD) 95-97 Heroism 50 95-00	160	MD942D VR942	FRONT	S	Leonardo 125/150 ST/SP 96-04 Leonardo 125 05-06 Leonardo 250 ST/SP 00-04 Scarabeo 125/150/GT 99-04 Leonardo 300 05-06	220
MD933D VR933	FRONT	S	CAGIVA City 50 91-94 KYMCO Agility 50 R10 (4T) 06-07 CX 50 Super (PR 50 AC) 94-97 DJW 50 World (PR50AD) 95-97 Heroism 50 95-00	160	MD942D VR942	REAR	S	Scarabeo 125/250/GT 04-06 Scarabeo 125/200 03 Scarabeo 125/150 99-02 Sport City 125 04-08 Sport City Cube 125 08-12 Sport City 200 04-08 Sport City Cube 200 08-09 Sport City 250 ie 06-08 Sport City Cube 250 08-09 Sport City Cube 300 08-12 Sport City Cube 300 Blackline 11 DERBI Boulevard S125 07 Rambla 125 08-12 Rambla 250 i 08-09 Rambla 300i 10-12	220

D = Dished Solid Original (We replace with floating rotor conversion unit)

F = Floating Rotor

S = Solid Rotor

STREETBIKE DISC BUYERS GUIDE

DISC No.	FRONT/ REAR	TYPE	MODELS	DIA (MM)	DISC No.	FRONT/ REAR	TYPE	MODELS	DIA (MM)
MD943D MD943C VR943	FRONT	S	APRILIA	190	MD946D	REAR	S	MALAGUTI F18 Warrior 125/150	200
			Rally A/C & L/C 95-02 Gulliver (All models) 95-98 Habana 50 (All models) 99-02 Mojito Custom 50 99-12 Mojito Retro 50 99-03 SR 50 Ditech (LC) (RLD100) 02-03 SR 50 WWW (A/C) (LYHoo) 97-01 SR 50 Street (LC/2T) (TE00/TEA00) 03-15 SR 50 R/Factory (LC/2T) 04-18 SR 50 H20 (Ditech) 00-03 SR 50 (A/C/L/C) 93-96 SR 50 Stealth/Racing (LC) 97-99 SR 50 R (SBK Alitalia (Replica) (LC) 10-11 Habana 125 (All models) 00-02 SR 125/150 99-02 Mojito/Mojito Custom 125 03-12 SKP 50 98-01 Storm 50 94-95		MD947D VR947	FRONT	S	PEUGEOT Elystar 50 TDSI 02-07 Elystar 50 Advantage 02-07 Elyseo 100 98-03 Elyseo 125/150 98-01	226
MD943D MD943C VR943	REAR	S	KREIDLER	190	MD948D	REAR	S	ITALJET Dragster 50 LC	190
			50 Florett City (50cc/2T/A-C) 14-15 50 Florett 2.1 RS (50cc/2T/A-C) 14-15 CS 50 Mach G AC (Air cooled) 02-10 CS 50 Mach G LC (Liquid cooled) 03-10 YN 50 R Ovetto (2T) 98-10 YN 50 Ovetto (4T) 09-10 YN 100 Ovetto 99-03		MD949D	REAR	S	ITALJET Dragster 125/180 LC 00-12 Dragster 250 07-09	240
MD943D MD943C VR943	FRONT	S	PIAGGIO	190	MD950D	REAR	S	ITALJET Formula 50 96-03 Formula 125 LC (2T/Twin Cyl) 96-03	175
			Diesis 50 01-05 NRG 50 94-96 NTT 50 95-96 NRG 50 RST (DT/DD) MC2 96-98 Diesis 100 01-03		MD951D	FRONT	S	ITALJET Torpedo 50 All models 98-03 Torpedo 125 4T 99-09	220
MD943D MD943C VR943	FRONT	S	YAMAHA	190	MD952D VR952	FRONT	S	APRILIA Scarabeo 125/150/GT 04-06 Scarabeo 125/150/200 99-10 Sport City 125/200 04-08 Sport City Cube 125 08-12 Sport City Cube 200 08-09 Scarabeo 250 06 Scarabeo 250 ie 07-10 Sport City 250 ie 06-08 Sport City Cube 250 08-09 Sport City Cube 300 08-12 Sport Cube 300 Blackline 11 Scarabeo 400 ie 07-08 Atlantic 500 02-07 Scarabeo 500/500 ABS 03-06 Scarabeo 500 Light 06 Scarabeo 500 ie 07-09	260
			CS 50 Jog R 02-15 CS 50 Z Jog RR 03-12 YN 50 Neos 02-06 YN 50 F Neos (4T) (5C3) 09-16 YN 50 Neos (2T) (IF5C2/IH5C2) 07-16 YN 50 R Neos 97-02 YN 100 "Neos 100" 99-03		MD953D MD953C VR953	REAR	S	ITALJET Jupiter 125/150/250 02-03 MBK YP 250 Skyliner 00-02 YAMAHA YP 250 Majesty 00-03	
MD944D VR944	FRONT	S	GILERA	240	MD954D VR954	FRONT	S	PEUGEOT LooXoR 50 01-06 LooXoR 100 (All models) 01-04 LooXoR 125/150 03-06	226
MD945D VR945	FRONT	S	DERBI	220	MD955D	FRONT	S	MALAGUTI Ciak 50 00-04 Ciak 50 (4T) Master 04-08 Ciak 100 99-03 Ciak 125/150 01-08 Ciak 200 06-08	230
			DNA 50 01-06 DNA 125/180 01-05 Runner 125/180 All models 99-02 DNA 125/180 01-03		MD956D VR956	FRONT	S	PIAGGIO Liberty Elettrico 11-12 Liberty 50 2T/50 4T 97-08 Liberty S 50 (2T/4T) 07-08 NRG 50 DD Power 05-18 NRG 50 DT Power 05-13 NRG 50 Purejet 04-10 NRG 50 Silver Bullet 10 Liberty 125 (5 spoke wheel) 98-08 Liberty S 125 07-08 Liberty 150 08 Liberty 200 98-07 Liberty S 200 07-08	
MD946D	FRONT	S	APRILIA	240	MD946D	FRONT	S	SCARABEO 300 S ie 09-12 500 ie 10-12	230
			GP1 125cc Scooter Full height seat /5 bolt fixing front disc 06 GP2 250cc Scooter 06-07					BENELLI Pepe 50 2T (7 Spoke Cast Wheel) 99-01 Pepe 50 2T (5 spoke cast wheel) 10-14 Pepe 50 4T (7 spoke cast wheel) 12-16	
MD946D	FRONT	S	DERBI	220	MD946D	FRONT	S	SCARABEO 50 Street (2T) 10-15 50 Net (4T/4V) 10-11 50 (4T/4V) 10-15 50 YourZ (4T) 10-11 100 (4T) 10-15	200
			Phantom F12 (L/C) 00-08 F12 50 Phantom 99-03 F12 Phantom (Air cooled) 02-08 F15 Firefox (L/C) 01-08 Firefox F15 (Air cooled) 99-08 CIAK (Electric Power) 00-05					BENELLI Pepe 50 2T (7 Spoke Cast Wheel) 99-01 Pepe 50 2T (5 spoke cast wheel) 10-14 Pepe 50 4T (7 spoke cast wheel) 12-16	

D = Dished Solid Original (We replace with floating rotor conversion unit)

F = Floating Rotor

S = Solid Rotor

STREETBIKE DISC BUYERS GUIDE

DISC No.	FRONT/ REAR	TYPE	MODELS	DIA (MM)	DISC No.	FRONT/ REAR	TYPE	MODELS	DIA (MM)
MD956D VR956 Contd.	FRONT	S	BENELLI Pepe LX 50 (2T) (7 spoke cast wheel) 03-09 Pepe Classic 50 (2T) (7 spoke cast wheel) 07-14	220	MD959D VR959	FRONT	S	PIAGGIO Liberty 125 (4T) 10 Spoke Cast Wheel 09-12 X9 125 00-02 X9 125 Evolution 03-07 Liberty 50 (2T/4T) 09-14 X9 200 02-03 X9 200 Evolution 03-04 X9 250/250 SL 00-04 X9 250 05-06 X9 180 Amalfi 00-03 Xevo 400 ie 07-10	240
			DERBI GP1 50 Open 06-11 GILERA Runner 50 PJ/SP 06-14 VESPA LXV 50 07-09 GT 125 Granturismo 03-06 GTS 125 07-11 GTS 125 Super ie (Inc ABS Models) 10-20 GTS 125 Supersport ie (Inc ABS Models) 13-15 GTV 125 07-09 LXV 125 07-12 GT 200 L Granturismo 03-06 GTS 250 iE/ABS 05-11 GT 60 (Special Anniversary Model) (GTV 250) 06 GTV 250 ie 07-09 GTS 300 ie (Non ABS Models) 08-15 GTS 300 ie (ABS Models) 08-20 GTS 300 ie Super (Non ABS Models) 08-15 GTS 300 ie Super (ABS Models) 08-20 GTS 300 ie Super Sport (Non ABS Models) 08-15 GTS 300 ie Super Sport (ABS Models) 08-18 GTS 300 ie Touring (Non ABS Models) 11-16 GTS 300 ie Touring (ABS Models) 11-17 GTV 300 10-13						
MD956D	REAR	S	PIAGGIO Super Hexagon GTX 125/180 (12" wheels) 01-03 New Fly 125 ie (3V) 12-13 Fly 125 (4T/3V) Rear Disc Model 12-15	220	MD959D VR959	REAR	S	PIAGGIO X9 125 00-02 X9 125 Evolution 03-07 X9 200 02-03 X9 200 Evolution 03-04 X9 250/250 SL 00-04 X9 250 05-06 X9 180 Amalfi 00-03 Beverley Tourer 400 ie 08-09	240
			DERBI GP1 125cc Racing Low seat/radial caliper/6 bolt disc fixing 07-09 GP1 250icc Racing Low seat/radial caliper/6 bolt disc fixing 07-09 GILERA VX 125 Runner/ST (4T) 05-14 VX 200 Runner (4T) 02-04 VX 200 Runner/ST (4T) 05-11 VESPA GT 125 Granturismo 03-06 GTS 125 07-11 GTS 125 Super ie 10-20 GTS 125 Supersport 13-15 GTV 125 07-09 GT 200 L Granturismo 03-06 GTS 250 iE/ABS 05-11 GT 60 (Special Anniversary Model) (GTV 250) 06 GTV 250 ie 07-09 GTS 300 ie (Non ABS Models) 08-15 GTS 300 ie (ABS Models) 08-20 GTS 300 ie Super (Non ABS Models) 08-15 GTS 300 ie Super (ABS Models) 08-20 GTS 300 ie Super Sport (Non ABS Models) 08-15 GTS 300 ie Super Sport (ABS Models) 08-18 GTS 300 ie Touring (Non ABS Models) 11-16 GTS 300 ie Touring (ABS Models) 11-17 GTV 300 10-13						
MD957D VR957	FRONT	S	MBK XQ 125/150 Thunder 01-03 YAMAHA XQ 125/150 Maxster 01-03	245	MD960D VR960	FRONT/ REAR	S	APRILIA SR 125 Max (4T) 11-15 SR 300 Max (4T) 11-15 GILERA Nexus 125 07-12 Nexus 250 ie 07 Nexus 300 i 08-12 Fuoco 500 RC/ie 07-13 Fuoco 500 LT (4V/4T) 13-15 Nexus 500 / SP 03-12 PIAGGIO 125 ie MP3 Yourban 11-12 MP3 125 (Carb models) 06-08 MP3 Hybrid (125cc) 09-12 MP3 125 ie (Efi Models) 08-11 X7 125cc 08-09 X7 Evo 125 ie (Efi) 09-12 X8 125 04-06 X8 125 ie 07 Xevo 125 07-16 X8 200 04-05 MP3 250 MIC/Efi 08-09 MP3 250cc (Efi) 06-08 MP3 LT 250 ie (Efi) 09 Xevo 250 ie 07-10 X7 250 ie 08-09 X8 250 ie 05-07 X9 250 04 300 ie MP3 Yourban 11-16 MP3 Yourban Sport 300ie 11-16 MP3 Yourban LT RL 300 17-18 MP3 LT 300 ie 10 MP3 Hybrid 300 ie 11-15 MP3 Hybrid LT 300 ie 11-12 MP3 Business LT 300 ie 13 MP3 Touring 300 ie 11-12 MP3 Touring LT 300 ie 11-12 MP3 Sport LT 300 ie 13 MP3 Sport LT 300 ie ABS (13" Front Wheel/14" Rear Wheel) 14-20 MP3 Business LT 300 ie ABS (13" Front Wheel/14" Rear Wheel) 14-18 X7 300 Evo 10-12 Beverly 400 ie 07 MP3 400 ie 07-10 MP3 LT 400 ie 09-10 MP3 Touring 400 ie 11-12 MP3 Touring LT 400 ie 11-12 Xevo 400 ie 07-10 X8 400 ie 06-08 Beverly 500 ie 12 MP3 500 Efi 09-10 MP3 500 LT Business 11-15 MP3 Touring Business 500 ie 11-12 MP3 500 LT Business ABS (13 Inch Front Wheel /14 Inch Rear Wheel) 14-18 MP3 500 LT Sport ABS (13 Inch Front Wheel /14 Inch Rear Wheel) 14-18 MP3 Touring Sport 500 ie 11-12 MP3 500 LT Sport 11-15 X9 500/500 SL 00-02 X9 500cc Evolution 03-06 X9 500 ie 07 Super Hexagon GTX 125/180 (12" wheels) 01-03	
MD958D VR958	REAR	S	MBK XQ 125/150 Thunder 01-03 YAMAHA XQ 125/150 Maxster 01-03	220					

D = Dished Solid Original (We replace with floating rotor conversion unit)

F = Floating Rotor

S = Solid Rotor

STREETBIKE DISC BUYERS GUIDE

DISC No.	FRONT/ REAR	TYPE	MODELS	DIA (MM)	DISC No.	FRONT/ REAR	TYPE	MODELS	DIA (MM)																																				
MD960D VR960 Contd.	FRONT/ REAR	S	PIAGGIO	240	MD964D Contd.	FRONT	S	DERBI	190																																				
			Beverley B 500 02-05 Beverley 500 06 Beverley Cruiser 500 ie 07-11 SCARABEO 125 ie 10-15 125 Net 10-11 200 ie 10-15 200 Net 10-11	Atlantis 50 (2T) Up to Ref No 8G253171 12"/5 spoke wheels/190mm disc/3 bolt 07 Atlantis 50 LC (2T) 99-01 Paddock 50 (AC/2T) 98-99 Predator 50 (LC/2T) (3 bolt front disc/USD Showa Forks) 98-03 Predator 50 (AC/2T) 98-01 Red Bullet 50 04-05 Atlantis 100 (AC/2T) 00-01 HUSQVARNA WRS 50 Scooter 98-00																																									
MD961D VR961	FRONT	S	PIAGGIO	260	MD964D	REAR	S	DERBI	190																																				
			Beverley B125/200 02-06 Beverley 125 07 Beverley S 125 07 Beverley Tourer 125 08 Carnaby 125 07-09 X8 125 ie/Street 07 X8 150 Street 07 Carnaby 200 07-09 Beverley Cruiser 250 ie 07-08 Beverley 250 (Carb) 04-07 Beverley 250 ie 06-07 Beverley S 250 ie 07 Beverley Tourer 250 ie 08 Carnaby 250 ie 08-09 X8 250 ie 07 Carnaby 300 ie 12 Carnaby Cruiser 300 08-11 Beverley 400 ie 07 Beverley Tourer 400 ie 08 X8 400 ie 06-08 X9 500/500 SL 00-02 X9 500 ie 07 Beverley B500 02-05 Beverley 500 06 Beverley 500 ie 12 Beverley Cruiser 500 ie 07-11					Predator 50 (LC/2T) (5 bolt front disc /STD Paioli Forks) 98-03																																					
			MD965D					FRONT		S	YAMAHA	155																																	
			CV 50 ZR (5PT1) Evolution 01-02 CV 50 (5KN1/2) Jog-Cool Style 00-02 CV 50 A/R Jog (SSU2/1/SA165) 03-08					MD966D VR966		FRONT	S	MALAGUTI	220																																
			125/150/180 99-02 Phantom Max 125/200 04-08 R 125 Madison 03-07 Madison S 200 04 250 Madison 04-07 Phantom Max 250 04-08											MD966D VR966	REAR	S	BENELLI	220																											
			Velvet 125/150/250 99-12 MALAGUTI 250 S 99-03 Phantom Max 125/200 04-08 R 125 Madison 03-07 Madison S 200 04 250 Madison 05-07 Phantom Max 250 04-08																MD967D	FRONT/ REAR	S	MALAGUTI	240																						
			Madison S 250 99-03 Madison K400 02-06																					MD968D VR968	FRONT/ REAR	S	BMW	220																	
			C1 125/200 99-03																										MD969D	FRONT	S	MALAGUTI	270												
			K 400 Madison 02-06																															MD970D VR970	FRONT	S	HONDA	220							
			NES 125 Y/1/2/3/4/5/6 00-06 PES 125 6/7/8/9/A (PS 125) 06-10 PES 125 R8/R9/RA (PS 125) 08-12 SES 125 2/3/4 Dylan 02-07 SH 125i 4/5/6/7/8 Fuel Injection (Rear drum) 04-08 NES 150 Y/1/2/3/4/5/6 00-06 PES 150 6/7/8/9 (PS 150) 06-09 PES 150 R8/R9 (PS 150) 08-09 SES 150 2/3/4 Dylan 02-06 SH 150i 4/5/6/7/8 04-08 SH 150i R8 08																																				MD971D MD971C VR971	FRONT/ REAR	S	GENERIC/KSR	180		
			50 GT Race Explorer 09 KYMCO Agility 50 (KG 105A) 05-08 Agility 50 R10 (4T) 06-14 Agility 50 R12 (4T) 06-20 Agility City+ 50 (4T) 18-20 Agility RS 50 (2T/12" wheels) 10-15 Cobra 50 Cross/Racer 00-06 Dink 50/Spacer 50/Yager 50 98-06 Super 9 50 (L/C) 00-06 Top Boy 50 (On road/off road models) 97-05 Vitality 50 (2T/4T) 04-09 Yager 50 07 Yup 50 02-09 ZX 50 Super Fever/Scout (SC10AS) 99-06 Maxxer 90 05-06 Agility 125 06-10 Grand Dink 125/150 01-02 Dink Classic 125/150 02																																										
			MD962D VR962																																									REAR	S
YP 125 D Skyliner 01-10 YAMAHA YP 125 Majesty 01-09	MD963D	FRONT	S	YAMAHA	220																																								
T 105 E (5ER 1/2) Crypton-R 99 T 105 SE 02 V 110 ZE/ZK/ZHE/ZHK/FIZR/FIZR Sporty AT 115 05-08 T 135 HC/S 06-08 T 135-SE 06-08						MD964D	FRONT		S																																			DERBI	190
Hunter 96-99 Atlantis 50 (AC/2T) 99-01 Atlantis 50 (AC/2T) 02 Atlantis 50 Bullet (AC/2T) 03-05 Atlantis 50 City (AC/2T) 03-06 Atlantis 50 Red Bullet (AC/2T) 03 Atlantis 50 Two Chic (AC/2T) 05																																													

D = Dished Solid Original (We replace with floating rotor conversion unit) F = Floating Rotor S = Solid Rotor

DISC BUYERS GUIDE

STREETBIKE DISC BUYERS GUIDE

DISC No.	FRONT/ REAR	TYPE	MODELS	DIA (MM)	DISC No.	FRONT/ REAR	TYPE	MODELS	DIA (MM)
MD971D MD971C VR971 Contd.	FRONT/ REAR	S	KYMCO Dink LX 125/150 98-00 Dink 125/150/Spacer 97-04 Spike 125 R 04-06 Yager 125 00 SINNIS Nitro 125 (WY 125 T-56A) 09-10	180	MD983D VR983 Contd.	FRONT /REAR	S	PIAGGIO Xevo 125 07-16 X8 200 04-05 Xevo 250 ie 07-10 X7 250 ie 08-09 X8 250 ie 05-06 X9 250 04 X7 300 Evo 09-12 X9 500cc Evolution 03-06	260
MD972D	FRONT	S	KYMCO Movie XL 125/150 99-00 Vivio 125/150 00-03	200	MD984D VR984	REAR	S	PEUGEOT Jet C Tech 50 11-12 Jet Darkside 50 (2T) 11 Jet Iceblade 50 (2T) 11 Jet Force 50/Jet-C (All models) 03-10 TRK2 WRC 50 (2T) 04-06 Satelis 125 Whitesat (AJP Caliper) 10-11	190
MD973D VR973	FRONT	S	KYMCO Bet & Win 50/Dink Sport 50 02-06 Grand Dink 50 (2T) 04-15 Bet & Win 125/150 00-06 Grand Dink/Miler 125/150 01-07 Dink Classic 125/150 02 Dink Classic Euro 2 50 03 Grand Dink 250 01-06 Bet & Win 250 00-06 Yup 250 03-06 Grand Dink 300i 12-20	220	MD985D VR985	FRONT	S	PEUGEOT Jet C Tech 50 11-12 Jet Darkside 50 (2T) 11 Jet Iceblade 50 (2T) 11 JetForce 50/Jet-C (All models) 03-10	226
MD974D VR974	REAR	S	KYMCO Bet & Win 125/150 00-06 Dink 125i 06-15 Grand Dink/Miler 125/150 01-07 Yager GT 125 07-13 Dink 200 i 06-15 Yager 200 i 07-13 Grand Dink 250 01-06 Bet & Win 250 00-06 Yup 250 03-06	200	MD986D VR986	FRONT	S	NXC 125 Flame X 04-06 NXC 125 Cygnus X - (5ML) 04-06 YW 125 (BW's 125) 10-13 YW 125 Z X-Over 10	220
MD975D VR975	REAR	S	SUZUKI UH 125 K2-K6 Burgman 02-06	220	MD987D (4 bolt fixing) VR987	FRONT	S	SUZUKI AN 650 K3 Burgman/Skywave 03	260
MD976D VR976	FRONT	S	SUZUKI UH 125 K2-K6 Burgman 02-06	220	MD988D VR988	REAR	S	SUZUKI AN 650 K3 Burgman/Skywave 03	250
MD977D	FRONT	S	PEUGEOT Elyseo 125/150 Rear Disc Model 03 Elystar 125/150 (3 bolt fixing - front disc) 02-05	226	MD989D	FRONT	S	KYMCO Looker 50 07-08 People 50 (2T) 99-14 Looker 125 S 07-08 People 125 99-20 People 150 99-04	226
MD978D MD978C VR978	REAR	S	PEUGEOT Elyseo 125/150 Rear Disc Model 03 Elystar 50 TDSI 02-07 Elystar 125/150 (All models) 02-07 Elystar 125/150 (3 bolt fixing - front disc) 02-05 Elystar 125/150 (5 bolt fixing - front disc) 06-07 Jet Force 125 (All models) 03-07 Satelis 125 4V Executive/Premium/City 06-09 Satelis 125 Compressor (4T) 06-11 Satelis 125 RS 07-11 Satelis 125 Avenue (Nissin calipers) 08-09 Satelis 125 Blacksats (AJP Calipers) 10-11 Satelis RS 125 (AJP Calipers) 07-11 Satelis Urban 125 (AJP Calipers/ABS) 07-11	210	MD990D VR990	REAR	S	APRILIA Scarabeo 50 (2T) 93-97 Scarabeo 50 Classic (2T) 98-99 Leonardo 125 05-06 Leonardo 250 99-04 Leonardo 300 05-06 Atlantic 400 07 Atlantic Sprint 400 05-08 Atlantic 500 01-06 Atlantic Sprint 500 05-08 Scarabeo 500 03-05	220
MD979D	FRONT	S	YAMAHA YP 125 Majesty DX Taiwan Production 02	245	MD991D 5 Bolt Fixing	FRONT	S	PEUGEOT Ludix Bullet 04-07 Ludix Trend 04-07 DERBI Atlantis 50 (4T) (13"/3 spoke wheels) 04-06 GP1 50cc 01-03 Predator 50 (LC/2T) (5 bolt front disc/STD Paioli Forks) 98-03 Atlantis 100 (4T) (13"/3 spoke wheels) 04-06	190
MD980D	FRONT	S	PEUGEOT Jet Force 125 (All models) 03-07 Elystar 125/150 (5 bolt fixing - front disc) 06-07	226	MD992D VR992	FRONT	S	PEUGEOT Ludix Snake 04-09 Ludix Acid 06 Ludix Red Zone 06 Ludix Urban Track 06-07	155
MD981D VR981	FRONT	S	KYMCO Super 9 50 (AC/LC) 00-07	210	MD993D	FRONT	S	PEUGEOT Ludix Elegance 04-09	190
MD982D	REAR	S	ADLY 125 Thunderbike	165	MD994D (5 bolt fixing) VR994	FRONT	S	SUZUKI AN 250 Skywave Type M/S 07-08 AN 250 8 Skywave SS 08 SN 250 K3-K6 Burgman (CJ43A) 03-06 AN 400 K7/ZK7/K8/ZK8/K9/L0/L1 /L2/L3/L4 Burgman /Non ABS/Skywave 07-15 AN 400 Skywave/Burgman/ABS 09-20 AN 650 K4/K5/K6/K7/K8/K9/L0 /L1/L2 Burgman/Non ABS 04-11 AN 650 AK4/AK5/AK6/AK7/AZK8 /AK8/AK9//AL0/AL1/AL2 Burgman/ABS 04-12	260

D = Dished Solid Original (We replace with floating rotor conversion unit)

F = Floating Rotor

S = Solid Rotor

STREETBIKE DISC BUYERS GUIDE

DISC No.	FRONT/ REAR	TYPE	MODELS	DIA (MM)	DISC No.	FRONT/ REAR	TYPE	MODELS	DIA (MM)
MD995D VR995	FRONT	S	YAMAHA VP 300 Versity 03-05 XC 300 Versity 06 XC 300 V Versity 06 VECTRIX XX-1 (Li/NiMh) 07-14	270	MD9102D VR9102 Contd.	FRONT	S	YAMAHA XP 250 RA X-Max - Iron Max (ABS) 16 YP 400 Majesty 04 MBK YP 125 Skycruiser 06-10 YP 400 Skyliner 04	267
MD996D VR996	REAR	S	APRILIA SR 50 Street (LC/2T) 03-15 SR 50 R/Factory (LC/2T) 04-18 Atlantic 125 03-08/10 Atlantic 200 03-05 Atlantic 250 03-05 Atlantic 250 ie 06-08 Atlantic 300 10-11	190	MD9103D VR9103	REAR	S	MBK YP 400 Skyliner 04 YAMAHA YP 400 Majesty (Non ABS) 04-13 YP 400 Majesty (ABS) 07-13	267
MD997D VR997	FRONT	S	APRILIA Atlantic 125 03-08/10 Atlantic 200 03-05 Atlantic 250 03-05 Atlantic 250 ie 06-08 Atlantic 300 10-11 BENELLI Velvet 250 99-12	240	MD9104D VR9104	REAR	S	YAMAHA YP 125 R X-Max 06-09 YP 125 R (X-Max Non ABS) (39D1/5) 10-15 YP 125 X-City (16P) 08-15 YP 125 R X-Max Sport 11-12 YP 250 X-City (5B2) 07-16 YP 250 R XMax Sport 11 XP 250 R XMax (ICO) Non ABS 05-09 XP 250 R XMax (37P) Non ABS 10-13 VP 300 R/S/T Versity 03-05 XC 300 Versity 06 MBK VP 300 R Kilibre 03-04 YP 125 Skycruiser 06-10 YP 125 City Liner 08-10	240
MD998D VR998	REAR	S	SUZUKI AN 650 K4/K5/K6/K7/K8/K9/L0/L1 /L2 /L3/L4/L5/L6 Burgman/Non ABS 04-16 AN 650 AK4/AK5/AK6/AK7/AZK8/AK8 /AK9/AL0/AL1/AL2/AL3/AL4/AL5 Burgman/ABS 04-15 AN 650 ZL3/ZL4/ZL5/ZL6/ZL7 Burgman ABS Executive 13-18	250	VR9105	FRONT	S	PEUGEOT Ludix Blaster (10" wheels) 05-09 Ludix 2 Trend 50 (2T/12" wheels) 07-12 Blaster Ice Blade 50 (2T/12" wheels) 10-12	170
MD999D	FRONT	S	ITALJET Jupiter 125/150 02 Jupiter 250 02-03	250	MD9106D	REAR	S	BENELLI Adiva 125/150 01-04	220
MD9100D VR9100	FRONT /REAR	S	KYMCO Agility 50 R16 (4T/16" wheels) 08-15 People S 50 2T (5 bolt fixing) 05-15 People S 50 (4T) 06-20 Agility 125 R16 (C20000) (16" wheels) 08-15 Agility City 125 18-20 Agility City+ 125 18-20 People S 125 DD 07-20 People S 125 05-06 Agility 150 R16 (C30000) (16" wheels) 08-12 Agility 200i R16 10-12 People S 200 05-06 People S 200i DD 07-15 People 250 S 06-08 People 250 (BC 50 AA) 03-06 People S 300 i 08-10	260	MD9107D	FRONT	S	CP 250 V (IB71) Maxam/Morphus 05-08	245
MD9101D	FRONT	S	BENELLI Adiva 125/150 (13" front wheel) 01-04 Velvet 125/150 99-07 Velvet 125/150 (Touring) 08-12	220	MD9108D	REAR	S	X-Max 125 Momo Design inc ABS 15 YP 125 RA X-Max ABS (39D2/Nissin F/Caliper) 11-17 YP 125 R (X-Max Non ABS) (39D1/5) 10-15 YP 125 X-Max Business (ABS) 11 YP 125 R X-Max Sport 11-12 YP 125 R X-Max (2DEM/Brembo R/Caliper) 14-16 YP 125 R X-Max (3DM/Heng Tong R/Caliper) 14 X-Max (2DEM/Brembo R/Caliper) -See YP 125 R X-Max 14-16 X-Max (3DM/Heng Tong R/Caliper) -See YP 125 R X-Max 14 XP 125 RA X-Max - IRon Max (ABS) 16 X-Max 125 Momo Design inc ABS 15 YP 250 R XMax Sport 11-12 YP 250 R XMax ABS 11-16 YP 250 R XMax (2PL1) Non ABS Nissin Fr/Brembo R 14 YP250 R X-Max (Non ABS/Heng Tong R/Caliper/2DL) 14-16 XP 250 R XMax (ICO) Non ABS 05-09 XP 250 R XMax (37P) Non ABS 10-13 X-Max 250 Momo Design 15 X-Max 250 (2DL/Non ABS/Heng Tong R/Caliper) -See YP250 R X-Max 14-16	245
MD9102D VR9102	FRONT	S	YAMAHA YP 125 R X-Max 06-10 YP 125 RA X-Max ABS (39D2/Nissin F/Caliper) 11-17 YP 125 R (X-Max Non ABS) (39D1/5) 10-15 YP 125 X-Max Business (ABS) 11 YP 125 R X-Max Sport 11-12 YP 125 R X-Max (2DEM/Brembo R/Caliper) 14-16 YP 125 R X-Max (3DM/Heng Tong R/Caliper) 14 X-Max (2DEM/Brembo R/Caliper) -See YP 125 R X-Max 14-16 X-Max (3DM/Heng Tong R/Caliper) -See YP 125 R X-Max 14 XP 125 RA X-Max - IRon Max (ABS) 16 X-Max 125 Momo Design inc ABS 15 YP 250 R XMax Sport 11-12 YP 250 R XMax ABS 11-16 YP 250 R XMax (2PL1) Non ABS Nissin Fr/Brembo R 14 YP250 R X-Max (Non ABS/Heng Tong R/Caliper/2DL) 14-16 XP 250 R XMax (ICO) Non ABS 05-09 XP 250 R XMax (37P) Non ABS 10-13 X-Max 250 Momo Design 15 X-Max 250 (2DL/Non ABS/Heng Tong R/Caliper) -See YP250 R X-Max 14-16	267	MD9109D VR9109	REAR	S	AN 250 Skywave Type M/S 07-08 AN 250 8 Skywave SS 08 AN 400 K7/ZK7/K8/ZK8/K9/L0/L1/L2/L3 /L4Burgman/Non ABS/Skywave 07-15 AN 400 Skywave/Burgman/ABS 09-20	210
					MD9110D VR9110	FRONT	S	Cucciolo 125 00	240
					MD9111D VR9111	FRONT	S	PEUGEOT Geopolis 125 Executive/Non ABS (AJP Calipers) 07-11 Geopolis 125 Premium/Non ABS (Nissin Calipers) 07-11 Geopolis 125 Urban/ABS (AJP Calipers) 07-11 Geo RS 125 (Nissin Calipers) 07-11 Satelis 125 Compressor 06-11 Satelis 125 RS 07-11 Geo RS 250 (Nissin Caliper) 07-11 Geopolis 250 (Premium /Nissin Calipers/Non ABS) 07-11 Geopolis 250 (Urban/AJP Calipers /ABS) 07-10 Geopolis 250 (Executive /AJP Calipers/Non ABS) 07-10 Geopolis 300 (Premium /Nissin Calipers/Non ABS) 10-11 Geopolis 300 (Premium) 10-15 Geo RS 300 (Nissin Calipers) 10-11 Geopolis 400 (Premium /Nissin Calipers/Non ABS) 07-11 Geopolis 400 (Urban/AJP Calipers/ABS) 07-11 Geo RS 400 (Nissin Calipers) 08-11 Geopolis 500 08-11	263

D = Dished Solid Original (We replace with floating rotor conversion unit)

F = Floating Rotor

S = Solid Rotor

DISC BUYERS GUIDE

STREETBIKE DISC BUYERS GUIDE

DISC No.	FRONT/ REAR	TYPE	MODELS	DIA (MM)	DISC No.	FRONT/ REAR	TYPE	MODELS	DIA (MM)										
MD9112D VR9112 VR9175 250mm O/D	FRONT	S	GILERA	240	MD9123D	REAR	S	DERBI	180										
			VX 125 Runner ST (4T)					05-14		GP1 50 Euro 2 Chain driven/radial caliper/5 bolt fixing front disc	05								
			VX 200 Runner ST (4T)					05-11		GP1 50 Race Chain driven/radial caliper/5 bolt fixing front disc	05-07								
			Fuoco 500 RC/ie					07-13											
			Fuoco 500 LT (4V/4T)					13-15											
			PIAGGIO							MD9124D	REAR	S	GILERA	280					
			125 ie MP3 Yourban					11-12					GP 800 (Chain drive)		08-14				
			MP3 125 (Carb models)					06-08					APRILIA						
			MP3 125 ie (EFi Models)					08-11					SRV 850		12-14				
			MP3 Hybrid (125cc)					09-12											
			MP3 250 MIC/EFI					08-09					MD9125D		FRONT	S	GILERA	300	
			MP3 250cc (EFI)					06-08									GP 800 (Chain drive)		08-14
			MP3 250 LT (EFI)					09									APRILIA		
MP3 Business LT 300 ie	13	SRV 850	12-14																
MP3 Yourban Sport 300 ie	13-15																		
MP3 Sport LT 300 ie	13	MD9126D	FRONT	S	GILERA	190													
MP3 300 LT (EFI)	10				Typhoon 50		94-97												
MP3 300 ie (Hybrid)	11-15				Typhoon 50 X		98-99												
MP3 300 ie (Hybrid LT)	11-12				Typhoon 125		95-03												
MP3 Yourban LT 300 ie	11-16				Typhoon 125 X-XR		99-00												
MP3 Yourban Sport 300ie	11-16				PIAGGIO														
MP3 Touring 300 ie	11-12				New Fly 50 (4T/4V)		12-13												
MP3 Touring LT 300 ie	11-12				Stalker 50 (All models)		97-11												
MP3 400 ie	07-11				Typhoon 50 (2T)														
MP3 LT 400 IE	09-10				Heng Tong Caliper/10" wheels		01-09												
MP3 Touring 400 ie	11-12				Typhoon 50 (2T) Grimeca														
MP3 Touring LT 400 ie	11-12				Caliper/10" wheels		00-04												
MP3 500 EFI	09-10				Typhoon 50 (4T/12" Wheels)		10-15												
MP3 Touring Business 500 ie	11-12	New Fly 125 ie (3V)	12-13																
MP3 500 LT Business	11-15	Typhoon 125	99-03																
MP3 Touring Sport 500 ie	11-12	Typhoon 125 (4T/12" Wheels)	10-15																
MP3 Touring Sport LT 500 ie	11-15																		
MD9113D	FRONT	S	DERBI	245	MD9127D VR9127	FRONT	S	YAMAHA	180										
			GP1 50 Euro 2 Chain driven/radial caliper/5 bolt fixing front disc	05				XC 125 Vity	08-13										
			GP1 50 Race Chain driven/radial caliper/5 bolt fixing front disc	05-07				MBK											
			GP1 125cc Scooter Full height seat /5 bolt fixing front disc	06				XC 125 WAAP	08-10										
			GP1 250cc Scooter	06-07															
MD9114D	FRONT	S	ITALJET	218	VR9128	FRONT	F	KYMCO	260										
			Millenium M100/125/150 LC	00-04				Downtown/Superdink 125i (V21000)	09-18										
								X Town 125	16-18										
								Downtown 200i	10-15										
								Downtown/Superdink 300i (V20000)	09-12										
								Downtown 300i (ABS)	10-20										
MD9115D	FRONT /REAR	S	TGB	220	MD9129D VR9129	REAR	S	KYMCO	240										
			Delivery/Express (125cc)	04-14				Downtown/Superdink 125i (V21000)	09-20										
			R 50 X Bullet	06-10				X Town 125	16-20										
			R 125 X Bullet	08-09				Downtown 200i	10-15										
			302 Sport (50cc)	03-09				Downtown/Superdink 300i (V20000)	09-14										
			303 R Hawk/Laser (125/150cc)	04-08				Downtown 300i (ABS)	10-20										
			304 Sport (125cc)	03-09				X Town 300i	17-20										
								New Downtown 350i	15-18										
MD9116D VR9116	FRONT	S	SYM	190	MD9130D	FRONT	S	YAMAHA	270										
			Jet Basix 50	06-09				VP 125 X-City (16P)	08-15										
			Jet 50/Euro X S	99-05				VP 250 X-City (5B2)	07-16										
			Jet Euro X 50	06-14				MBK VP 125 Cylinder	08-10										
			Jungle 50/100	99-02															
			Mask 50	00-05															
			Red Devil 50	99-09															
			Jet 100 G100P-6)	99-00															
MD9117D VR9117	FRONT /REAR	S	SUZUKI	240	MD9131D	FRONT	S	YAMAHA	186										
			UH 125/200 K7/K8/K9/L0/L1/L3	07-13				VP 125 X-City (16P)	08-09										
MD9118D VR9118	FRONT	S	HONDA	256	MD9132D	REAR	S	SINNIS	195										
			SH 300 i 7/8/9/A/B/AB (Non ABS)	07-12				Ecocity 125 (125T-8G)	07-09										
			SH 300 i A7/A8/A9/AA/AB/AC (ABS)	07-13															
			SH 300 i R8/R9/RA (Non ABS)	08-10															
			SH 300 i AR8/AR9/ARA (ABS)	08-10															
MD9119D VR9119	REAR	S	HONDA	256	MD9133D VR9133 VR9133BLK	FRONT	S	MBK	240										
			SH 300 i 7/8/9/A/B (Non ABS)	07-12				NXC 125 Flame X	07-12										
			SH 300 i A7/A8/A9/AA/AB/AC (ABS)	07-13				YAMAHA											
			SH 300 i R8/R9/RA (Non ABS)	08-10				NXC 125 Cygnus X (4P9)	07-13										
			SH 300 i AR8/AR9/ARA (ABS)	08-10				NCX 125 K Cygnus X Cab (4C6-1)	07-10										
								NCX 125 L Cygnus X Injection (4C6-2)	07-10										
								YW 125 X (1DN1/2)	10-13										
MD9120D	FRONT	S	SUZUKI	220	VR9133BLK	REAR	S	XC 125 R Majesty S 125	15										
			FL 125 SDWK7/SDWK8 Address /Underbone	07-10				Majesty S 125 - See XC 125 R	15										
								XC 155 F/G SMAX	15-16										
MD9121D	REAR	S	PEUGEOT	198	MD9134D VR9134	FRONT	S	HONDA	220										
			LooXor 125/150	03-06				NSC 50 WHC/T2E/F Vision 50 (4T) (14" wheels)	12-16										
MD9122D	FRONT	S	DERBI	245				NSC 50 MPDC/E/F/G/H/J Vision 50 (4T) (16" wheels)	12-18										
			GP1 125cc Racing Low seat/Radial caliper/6 bolt disc fixing	07-09				NSC 50 R (14" wheels)	13-16										
			GP1 250icc Racing Low seat/Radial caliper/6 bolt disc fixing	07-09				ACB 110 CBB/CSB - Vario 110	10										
								ACD 110 CSB/SCB - Scoopy 110 Fi	11-16										
								ACC 110 SCB/SCC - ANC 110 Icon	11-12										
								AFS 110 2SHC/CSFF Wave	12-16										

D = Dished Solid Original (We replace with floating rotor conversion unit)

F = Floating Rotor

S = Solid Rotor

STREETBIKE DISC BUYERS GUIDE

DISC No.	FRONT/ REAR	TYPE	MODELS	DIA (MM)	DISC No.	FRONT/ REAR	TYPE	MODELS	DIA (MM)
MD9134D VR9134 Contd.	FRONT	S	HONDA NSC 110 CSD/CSE - Spacy 110 12-14 NSC 1110 CBFF/CBFH - Dio 110 15-17 NSC 110 WHB/E-Vision 110 (4T) (14" wheels) 11-16 NSC 110 MPDC/E Vision (16" Wheels) 12-14 NSC 110 MPDH Vision (16 Inch Wheels) 17-18 ACA 125 CBFE - Air Blade 125 14-16 PCX 125 (WW125 EX2 C/D/F/H/J) 12-18 PCX 125S (WW125 AK) 18-20 SH 125i Mode (ANC 125 E) 14-18 PCX 150 (WW 150 EX2 C/D/F/H/J) 12-20 PCX 150 (ABS) 18-20	220	MD9141D VR9141 Contd.	FRONT	S	PEUGEOT Django 125 Sport (4T/190mm Rear Disc) 14-20 Django 125 Allure SBC (4T/190mm Rear Disc) 14-20 Django 125 Evasion SBC (4T/190mm Rear Disc) 14-20 Django 125 Heritage SBC (4T/190mm Rear Disc) 14-20 Django 125 S (4T/190mm Rear Disc) 14-20 Django 125 Sport SBC (4T/190mm Rear Disc) 14-20 Vivacity 125 (4T) 10-15 Django 150 Allure (4T/190mm Rear Disc) 14-20 Django 150 Evasion (4T/190mm Rear Disc) 14-20 Django 150 Heritage (4T/196mm Rear Disc) 14-20 Django 150 S (4T) (4T/190mm Rear Disc) 14-20 Django 150 Sport (4T/190mm Rear Disc) 14-20	200
MD9135D VR9135	REAR	S	FES 125 3/4/5 Pantheon 03-06 FES 125 7/9/A/B S-Wing (Non ABS Model) 07-13 FES 125 A7/A9/AA/AB S-Wing (ABS Model) 07-15 FES 150 3/4/5 Pantheon 03-06 FES 150 7/9 S-Wing (Non ABS Model) 07-13 FES 150 A7/A9 S-Wing (ABS Model) 07-13 FES 250 Y/1/2/5 NSS 250 Y/AY/1/A1/A3/3 Forza/Forza-S /Forza-T/Forza-ST/Jazz/Reflex (MF04/MF06) 00-04	220	MD9142D	FRONT /REAR	S	SUZUKI UX 125 K8/K9/L0/L1 Sixteen 08-14 UX 150 K8/K9/L0/L1 Sixteen 08-14	220
MD9136D VR9136	FRONT	S	YAMAHA YP 400 Majesty (Non ABS) 05-13 YP 400 Majesty (ABS) 07-13	267	MD9143D VR9143	REAR	S	YAMAHA T-Max 500 (530cc engine/Non ABS models) 12-16 XP 500 A T-Max (530cc Engine/ABS Models) 12-16 XP 500 Black/Bronze Max (59CE) 13-14 XP 530 A (530cc Engine - Iron Max - ABS Model) 15-16 XP 500 A T-Max - LUX MAX (ABS) 16 XP 530E-A T-Max (530cc Engine - ABS Model) 17-18 XP 530-A T-Max SX (530cc Engine - ABS Model) 17-18 XP 530D-A T-Max DX (530cc Engine - ABS Model) 17-18	282
MD9137D VR9137	FRONT	S	SYM Jet 4 R 50 (2T) 11-15 Symphony S 50 (4T/Rear disc model) 10-20 Jet 4 125(4T) 10-15 Jet V 125 (4T) 12-13 Symphony S 125 (4T/Rear disc model) 10-20 Symphony S 151 (4T/Rear disc model) 10-15 PEUGEOT Tweet 50 (4T/Rear drum model) 10-12 Tweet 125 (4T/Rear drum model) 10-12 Tweet 125 (Rear disc) 12-13 Tweet 151 (4T/Rear drum model) 10-12	225	MD9144D VR9144BLK	FRONT	F	SUZUKI AN 650 L3/L4/L5/L6 Burgman Non ABS 13-16 AN 650 ZL3/ZL4/ZL5/ZL6/ZL7/ZL8 Burgman ABS Executive 13-18	260
MD9138D VR9138	FRONT	S	SYM DD 50 (2T) 02-12	160	MD9145D VR9145BLK	FRONT	S	YAMAHA XC 125 R Majesty S 125 15 Majesty S 125 - See XC 125 R 15 XC 155 F/G SMAX 15-16	267
MD9139D VR9139	REAR	S	HONDA SH 125i 9/A/B 09-12 SH 125i RA 10-14 SH 125i 9/A/B 09-12 SH 125i (2 piston caliper/ABS) 14-18 SH 125i (3 Piston Caliper/ABS) 14-16 SH 150i RA 10-14 SH 150i (2 piston caliper/ABS) 14-18 SH 150i (3 Piston Caliper/ABS) 14-16 VECTRIX VX-1 (Li/NiMh) 07-14	240	MD9146D	FRONT	S	PIAGGIO Medley 125 (ABS) 16-20 Medley S 125 (ABS) 16-20 YAMAHA TW 125 Tricity Scooter 14-20	220
MD9140D VR9140	FRONT	S	HONDA SCV 110 (NHX 110 WHA 4 bolt lead disc fixing) 10-12	190	MD9147D	REAR	S	YAMAHA TW 125 Tricity Scooter 14-16	230
MD9141D VR9141	FRONT	S	PEUGEOT New Vivacity (50cc/2T) (12" wheels) 08-15 New Vivacity Sixties (50cc/4T) (12" wheels) 10-15 E-Vivacity (Electric) 11-15 Django 50 Allure (2T) 14-18 Django 50 Allure (4T) 14-18 Django 50 Evasion (2T) 14-19 Django 50 Evasion (4T) 14-18 Django 50 Heritage (2T) 14-18 Django 50 Heritage (4T) 14-18 Django 50 Sport (2T) 14-19 Django 50 Sport (4T) 14-18 Django 50 S (2T) 14-18 Django 50 S (4T) 14-18 Django 125 Allure (4T/190mm Rear Disc) 14-20 Django 125 Evasion (4T/190mm Rear Disc) 14-20 Django 125 Heritage (4T/196mm Rear Disc) 14-20	200	MD9148D	FRONT	S	PEUGEOT Tweet 50 (4T/Rear Drum Model) 10-13 Tweet 125 (4T) 12-13 New Tweet Evo 50 (4T/Rear Drum Model) 14-19 New Tweet Evo 125 (4T) 14-20 New Tweet Evo 150 (4T) 14-20	226
MD9149D VR9149	REAR	S	PEUGEOT Tweet 125 (4T) 12-13 New Tweet Evo 125 (4T) 14-20 New Tweet Evo 150 (4T) 14-20 Symphony 50 SR (4T/Rear disc model) 10-15 Symphony 125 SR (4T/Rear disc model) 10-15 Symphony 151 SR (4T/Rear disc model) 10-15	226	MD9151D VR9151	FRONT	S	PIAGGIO New Fly 50 (4T/4V) 12-13 Fly 125i (3v/4T) 12-15 New Fly 125ie (3V) 12-13 Fly 125 (4T/3V) Rear Disc Model 12-15 Typhoon 125 (4T/12" Wheels) 10-15 Typhoon 50 (2T/12" Wheels) 10-18	220

D = Dished Solid Original (We replace with floating rotor conversion unit)

F = Floating Rotor

S = Solid Rotor

STREETBIKE DISC BUYERS GUIDE

DISC No.	FRONT/ REAR	TYPE	MODELS	DIA (MM)	DISC No.	FRONT/ REAR	TYPE	MODELS	DIA (MM)
MD9152D	FRONT	S	HYOSUNG MS3 125cc 07-09 MS3 250i 07-09	240	MD9167D	REAR		PEUGEOT Django 125 Allure SBC (4T/190mm Rear Disc) 14-20 Django 125 Evasion SBC (4T/190mm Rear Disc) 14-20 Django 125 Heritage SBC (4T/190mm Rear Disc) 14-20 Django 125 S (4T/190mm Rear Disc) 14-20 Django 125 Sport SBC (4T/190mm Rear Disc) 14-20 Django 150 Allure (4T/190mm Rear Disc) 14-20 Django 150 Evasion (4T/190mm Rear Disc) 14-20 Django 150 S (4T) (4T/190mm Rear Disc) 14-20 Django 150 Sport (4T/190mm Rear Disc) 14-20	190
MD9153D	REAR	S	YAMAHA YP 125 R X-Max (2DEM/Brembo R/Caliper) 14-16 YP 125 R X-Max (3DM/Heng Tong R/Caliper) 14 X-Max (2DEM/Brembo R/Caliper) 14-16 -See YP 125 R X-Max 14-16 X-Max (3DM/Heng Tong R/Caliper) 14 -See YP 125 R X-Max 14	240	MD9168D	REAR		YAMAHA X-Max 125/YP 125 RA 18 X-Max 300 (CZD300A) 17-18	
MD9154D	FRONT	S	YAMAHA HW 125 Xenter 125 12-18 HW 150 Xenter 150 12-16	267	MD9169D	FRONT		YAMAHA X-Max 125/YP 125 RA 18 X-Max 300 (CZD300A) 17-18	
MD9155D VR9155	FRONT	S	PIAGGIO Beverly 125 (Multi Spoke cast Type Wheels/4T) 11-14 Beverly 125 ie S 14-15 Beverly 300 (278cc/4T /Multi Spoke Wheel) 10-18 Beverly 300 ie S 14-18	240	MD9170 VR9170	REAR	S	PEUGEOT Django 125 Heritage (4T/196mm Rear Disc) 14-18 Django 150 Heritage (4T/196mm Rear Disc) 14-18 Speedfight3 Darkside 125 (4T/ 196mm Rear Disc) 14-15	196
MD9156D	FRONT	S	YAMAHA GPD 125 A - N-Max/2DS1 15-18 N-Max 125 -See GPD125 A 15-18 GPD 150 A - N-Max/2DP4 15-17 N-Max 150 -See GPD150 A 15-17	230	MD9172D VR9172	FRONT	S	PIAGGIO Beverly 125 (Multi Spoke cast Type Wheels/4T) 11-14 Beverly 125 ie S 14-15 Beverly 300 (278cc/4T /Multi Spoke Wheel) 10-20 Beverly 300 ie S 14-20 Beverly 350 ie Sport Touring Non (330cc/4T) 11-15 Beverly 350 ie Sport Touring ABS (330cc/4T) 11-15 Beverly 350 ie Sport Touring ABS (330cc/4T) 16-20	300
MD9157D	REAR	S	YAMAHA GPD 125 A - N-MAX/2DS1 15-18 N-Max 125 -See GPD125 A 15-18 GPD 150 A - N-MAX/2DP4 15-17 N-Max 150 -See GPD150 A 15-17	230	MD9173D	REAR	S	KYMCO AK 550 17-20	260
MD9158D	FRONT	S	PIAGGIO MP3 Business LT 300 ie ABS (13" Fr Wheel/14" Rear Wheel) 14-18 MP3 Sport LT 300 ie ABS (13 Inch Front Wheel /14 Inch Rear Wheel) 14-18 MP3 Yourban LT RL 300 17-18 MP3 500 LT Business ABS (13 Inch Front Wheel/14 Inch Rear Wheel) 14-18 MP3 500 LT Sport ABS (13 Inch Front Wheel/14 Inch Rear Wheel) 14-18	258	MD9174D	FRONT	F	KYMCO AK 550 17-20	270
VR9160	FRONT	S	PGO Tigra 125 12	245	VR9175			250mm O/D - See MD9112	250
VR9161	FRONT	S	PGO Tigra 125 12	220	MD9176D	FRONT	S	SUZUKI UH 125 Burgman Non ABS 14-16 UH 125 Burgman ABS 14-18 UH 200 Burgman Non ABS 14-16 UH 200 Burgman ABS 14-20	240
MD9162D VR9162	FRONT	S	GOGORO (E SCOOTER) Smart Scooter 15-17	205	MD1001	FRONT	S	CBR 400 RG/RH-YA (NC23) 86-87 VFR 400 RH2/RJ (NC24) 87-88 XBR 500 F/G/H/SJ 85-89 CBR 600 FH/FJ/FK/FLFM/FV/FP/FR 87-94 CBX 750 FE 84 CBR 750 FH Superaero 87 VF 750 SC (V45 Sabre) 82 VFR 750 FG/FH 86-87 CBR 400 RG/RH-YA (NC23) 86-87 PC 800 Pacific Coast 89-97 VF 1000 FE/FF/F2F/FG /F2G 84-86	276
MD9163D VR9163	REAR	S	GOGORO (E SCOOTER) Smart Scooter 15-17	162	MD1001	REAR	S	CBR 1000 FH/FJ 87-88 X4-CB 1300 DCV/DCW/DCX/DCY (SC38) 97-00	276
MD9164D VR9164	REAR	S	PIAGGIO Medley 150 (ABS) 16-18 Medley S 150 (ABS) 16-18 Medley 125 (ABS) 16-18 Medley S 125 (ABS) 16-18 Beverly 350 ie Sport Touring Non (330cc/4T) 11-15 Beverly 350 ie Sport Touring ABS (330cc/4T) 11-15 Beverly 350 ie Sport Touring ABS (330cc/4T) 16-18	240	MD1002	REAR	S	CBR 250 RH (MC17) 87 CBR 250 RJ/RK/RK2 (MC19) 88-89 NSR 250 RG (MC16-100) 86 NSR 250 R2J (MC18-100)/R4J (MC18-100) 88 NSR 250 RSP/RSK/RSP (MC18) 88 NSR 250 RL/RN/RSP (MC21) 95- NSR 250 R5K/R5K-2 (MC18-110) 89	220
MD9165D	FRONT	S	PIAGGIO Liberty i-get 50/125/150 (3v/4T) 15-18	240					
MD9167D VR9167	REAR		PEUGEOT Django 125 Allure (4T/190mm Rear Disc) 14-20 Django 125 Evasion (4T/190mm Rear Disc) 14-20 Django 125 Sport (4T/190mm Rear Disc) 14-20	190					

D = Dished Solid Original (We replace with floating rotor conversion unit) F = Floating Rotor S = Solid Rotor

STREETBIKE DISC BUYERS GUIDE

DISC No.	FRONT/ REAR	TYPE	MODELS	DIA (MM)	DISC No.	FRONT/ REAR	TYPE	MODELS	DIA (MM)												
MD1002 Contd.	REAR	S	NSR 250 R6K/R6K-2 (MC18-110)	89	MD1008	FRONT	S	NV 400 DCY/DC1/DC2 (NC40)	296												
			NSR 250 R7L (MC21-100)/R7N (MC21-106)	90				CBF 500 R/T/V/W/SW/X/SX/Y/SY/2/S2	94-02												
			NSR 250 R8L-3 (MC21-100)/R9L (MC21-102)/R8N/R8N-3 (MC21-106)	90				CBF 600 N4/N5/N6 (Non ABS)	04-06												
			NSR 250 R9N (MC21-106)	92				CBF 600 NA4/NA5/NA6 (ABS)	04-06												
			NS 250 FE (MCII)	84				CBF 600 S4/S5/S6 (Non ABS)	04-06												
			NS 250 RE/RG (MCII)	84-86				CBF 600 SA4/SA5/SA6 (ABS)	04-06												
			NS 250 FE/RE (MC11-100)	84				NT 650 VW/VX/VY/V1 Deauville	98-01												
			NS 250 RG (MC11-102)	86				NT 650 V2-V5 Deauville	02-05												
			VT 250 FL Spada/Castec	88-90				NT 700 V6/V7/V8/VA Deauville	06-12												
			CBR 400 RG/RGYA (NC23)	86				NT 700 VA6/VA7/VA8/VAA	07-13												
			CBR 400 RRJ/RRK (NC23 Tri arm)	92-93				CB 750 F2N/F2R/F2S/F2T/F2V/F2W /F2X/F2Y/F21 CB 'Seven Fifty'	92-02												
			NS 400 RF/RG	85-87				VFR 750 FJ/FK/FL/FM/FN/FP	88-93												
			VFR 400 ZG/ZH/RG/RH-YA (NC21)	85-87				CBR 1000 FH/FJ/FK/FL/FM/FN/FP /FR/FS/FT/FV/FW/FX	87-99												
CBR 600 FH/FJ/FK/FL	87-90	ST 1100 AT/AW/AW/AX/AY/A1/A2 Pan European (ABS)	96-02																		
MD1003X MD1003XC MD1003CC VR1003BLK VR1003BLU VR1003RED	FRONT	F	RS 125	90-07	MD1010LS/RS	FRONT	F	VFR 750 RJ/RK/RL (RC30)	88-90												
			MD 250 H	08-11				MD1011 BILLET	REAR	S	VFR 750 RJ/RK/RL (RC30)	88-90									
			MD 250 S	08-11							MD1012LS/RS	FRONT	F	RVF 750 RR/RS (RC45)	94-98						
			RS 250	90-02										MD1013 BILLET	REAR	S	RVF 750 RR/RS (RC45)	94-98			
			CBR 400 RRJ/RRK (NC23) Tri-Arm	81-89													MD1014X MD1014XC MD1014CC VR1014BLK VR1014BLU VR1014RED	FRONT	F	CBR 600 FX/FY	99-00
			CBR 400 RRL/RRN/RRR (NC30) Gull-Arm	90-94																VFR 800 FIW/FIX	98-99
			RVF 400 RR/RR-IV/RT/RT-II (NC35)	94-96																VFR 800 FY/Fi1/2/3/4/5	00-05
			VFR 400 R3K/R3N (NC30)	89/92																CBR 900 RRN/RRP	92-93
			VFR 400 R3L/R3M (NC30)	90-91																XL 1000 VX/VY/V1/V2 Varadero Non ABS Model	99-02
			RS 125	90-07																XL 1000 V3/V4/V5/V6/V7/V8/V9 /VA/VB Varadero - Non ABS	03-11
			CBR 600 FS/FT/FV/FW	95-98																GL 1500 CV/CW/CX/CY/C1/C2 (F6C)	97-03
			VFR 750 FR/FS/FT/FV	94-97																GL 1800 6/7/8/9/A/C/D/E/G/H Goldwing	06-17
			CBR 900 RRR/RRS/RRT/RRV	94-97																GL 1800 A1-A5	01-05
VTR 1000 FV/FW/FX/FY/F1/F2/F3 /F4/F5/F6 Firestorm	97-06	MD1016	REAR	S	NT 650 VW/VX/VY/V1-V5 'Deauville'	98-05															
MD1004 MD1004C VR1004	REAR				S	CBR 250 RRL/RRN/RRR	90-94	NT 700 V6/V7/V8/VAA Deauville	06-12												
						CBR 250 RB/RC (Non ABS)	11-13	NT 700 VA6/VA7/VA8/VAA	07-13												
						CB 250 FT/FV/FX/FY/F1 'Hornet'	96-01	CB 1000 FP/FR/FS/FT/FV	93-97												
						VTR 250 W/Y/1-7 (MC33)	98-07	CBR 1000 FK/FL/FM/FN	89-92												
						CBR 400 RRL/RRN/RRR (NC29) Gull-Arm	90-94	VT 1100 C2 (W/X/Y/1/2/3/4/5)	98-05												
						NX 4 Falcon	02-05	VT 1100 C2 (S/T/V)	95-97												
						CB 600 'Hornet' FW/FX/FY/F2Y/F1 /F2Y/F2/F3/F4/F5/F6	98-06	VT 1100 C3 (W/X/Y)	98-00												
						CBR 600 FM/FN/FP/FR/FS/FT/FV/FW/FX/FY/F1 /F51/F2/F52/F3/RR3/F3/F4/RR4/F5/F6	91-06	CB 1300 FW/FX/FY (SC40)	98-00												
						CBR 600 RRS-RR9/RRR/RRB/RRC/RRD/RRE /RRF/RRG/RRH/RRJ (Radial Caliper)	05-20	CB 1300 F1 (SC40)	01												
						CBR 600 RR Hannspree	08	MD1020 MD1020C VR1020	REAR	S	NSS 250 EX5/EX7/EX8 (ABS) Forza EX	05-08									
						CBR 900 RRN/RRP/RRR/RRS/RRT/RRV /RRW/RRX/RRY/RR1/RR2/RR3	92-03				NSS 250 AX5/AX6 (Forza Z) (ABS)	05-06									
						CB 1000 R8	08-09				NSS 250 X5/X7/X8 Forza	05-08									
		CBR 1000 RR4/RR5/RR6/RR7 Fireblade	04-07	CB-1 (CB 400 F)		89-90															
CBR 1000 RR SPE Fireblade	14	CB 400 SF (F2N/F2R/F2V/F3T/F3V) Superfour (NC31)	92-97																		
VTR 1000 SPY/SP1	00-01	CB 500 VW/SW/X/SX/Y/SY/2/S2	97-03																		
VTR 1000 SP2/SP3/SP4/SP5/SP6	02-07	CB 750 F2N/F2R/F2S/F2T/F2V/F2W /F2X/F2Y/F21 'CB Seven Fifty'	92-02																		
VTR 1000 FV/FW/FX/FY/F1/F2/F3 /F4/F5/F6 Firestorm	97-06	CB 900 F2/F3/F4/F5/F6/F7	02-07																		
PEUGEOT		CAGIVA																			
SV 250	01-02	E 750 Elefant	93-95																		
		E 900 C Elefant (282mm front discs/USD forks/Brembo front callipers/rear)	93-97																		
		E 900 C ie Lucky Explorer (282mm front discs)	95-97																		
MD1005LS MD1005RS	FRONT	S	CB 350 SG/SJ	86-90	MD1021LS MD1021RS	FRONT	SF				VT 250 CR/CT/CV 'Magna'	95-97									
			CB 450 SG/SJ	86-88				NTV 600 J/K/M Revere	88-92												
MD1006 MD1006C VR1006	FRONT	S	CBR 250 FG/FGYA/RH	86-87	MD1022	REAR	S	VFR 400 RH2/RJ (NC24)	87-88												
			NS 250 FE/RE (MC11-100)	84				NT 400 'Bros' NC25	88-92												
			FJS 400 Silverwing D6/D7/D8	06-08				NT 650 J/K/L (Bros) (NC31)	88-92												
			NS 400 RF/RG	85-87				MD1025	REAR	S	NTV 600 J/K/M Revere	89-92									
			VFR 400 ZG/ZH/RG/RG-YA (NC21)	85-87							NTV 650 J/K/L/M/P/S/T/V	88-97									
			VF 500 FE/F2E/FF/F2F	84-85																	
	FJS 600 1/2/D3/D4/D5/D6 Silverwing	01-06																			
	MD1006 MD1006C	REAR	S	VF 500 FE/F2E/FF/F2F	84-85																
				CBR 750 FH/FJ Superaero	87-88																
				VFR 750 FG/FH/FJ/FK	86-89																
				CBR 1000 FP/FR/FS/FT/FV/FW/FX	93-98																
				XL 1000 V3/V4/V5/V6/V7/V8/V9 /VA/VB Varadero	03-11																
				XL 1000 VA4/VA5/VA6/VA7/VA8 /VA9/VAA/VAB Varadero - ABS	04-11																
CB 1100 SFY/SF1 "XII"				00-03																	
CBR 1100 XXV/XXW/XXX/XXY/XX1/XX2 /XX3/XX4/XX5/XX6 Blackbird	97-08																				
CB 1300 F3/F13	03-04																				
MD1007 MD1007C	REAR	S	VFR 750 FL/FM/FN/FP/FR/FS/FT/FV	94-97																	

D = Dished Solid Original (We replace with floating rotor conversion unit) F = Floating Rotor S = Solid Rotor

DISC BUYERS GUIDE

STREETBIKE DISC BUYERS GUIDE

DISC No.	FRONT/ REAR	TYPE	MODELS	DIA (MM)	DISC No.	FRONT/ REAR	TYPE	MODELS	DIA (MM)			
MD1030	FRONT	S	CA 125 S/T/V/W/X Rebel 95-00	240	MD1082	REAR	D	CB 750 FC/F2C/FD/F2D 83-84	296			
			CB 125 F (GLR 125 1WHF) 15-16					CB 900 FB/F2B/FC/F2C/FD/F2D 84-85				
			CB 125 F (GLR 125 1WHH) 17-20					CBX 1000 B/C 80-82				
			CBF 125 6 Stunner 06					GL 1100 AD 83				
			CBF 125 M7 Stunner 07					GL 1100 C/DC/1C Interstate Goldwing 82				
			CBF 125 M9/MA/MB/MD/ME 09-15					GL 1100 AC/AD Aspencade Goldwing 82-83				
			VT 125 CX-C8 'Shadow' 99-08					GL 1200 DE/DF/DG/AE/AF/AG 84-86				
			CBF 150 6 (Spoke Wheels) 06									
			CBF 150 M6/M7 Unicorn (Spoke Wheels) 06-07									
			CBF 150 M7/M9/MA Unicorn (Cast Wheels) 07-10									
CBF 150 MB/MC Unicorn (Cast Wheels) 11-12												
CBX 250 84-98												
CMX 250 CT/CV/CW 'Rebel' 96-00												
TA 200 (TA 200 Shadow) 02-05												
HERO												
Glamour 125 (PGM F1) 11-12												
Hunk 150 11-12												
MD1036LS MD1036RS VMD1036 5 Bolt Fixing	FRONT	D	CB 250 N/NA/NB/NDC 78-82	276	MD1083LS/RS	FRONT	D	VF 750 FD/FE 83-84	276			
			CM 250 TB 81					GL 1200 DE/DF/DG 84-86				
			CX 500 EC 82									
			CB 650 SCC Nighthawk 82									
			CX 650 ED 83									
			CB 750 KZ 80									
			CB 750 FZ/FA/FB/FC/F2C/FD/F2D 78-84									
			CB 900 FZ/FA/FB/F2B 80-83									
			CB 900 FC/F2C/FD/F2D 84-85									
			CBX 1000 Z 79-80									
			GL 1000 K3/KZ Goldwing 77-78									
			GL 1000 Z 79									
			GL 1100 A/DA/B/DB Goldwing 80-81									
			GL 1100 1A/1B Interstate Goldwing 80-81									
			GL 1100 C/DC 82									
MD1038RS	FRONT	F	CB-1 (CB 400 F) 89-90	310	MD1084LS	FRONT	S	NS 125 FG/FH/RH 86-87	240			
MD1040LS/RS	FRONT	S	GL 650 D2E 84	276	MD1088LS	FRONT	F	NSR 125 FM/RK/RL/RM/RN 91-92	316			
MD1041LS	FRONT	S	CMX 450 CH/CJ Rebel 87-88	276	MD1089LS	FRONT	S	CB 250 N/T/W/X/Y/1/4 (CB Two Fifty) 92-05	240			
MD1047LS	FRONT	S	FT 500 C 82	296	MD1090LS	FRONT	S	CBX 250 RSE 84	240			
			VT 600 CN/CR/CS/CT/CV/CW/CX 'Shadow custom' 93-00					CD 250 UJ 88-92				
			VF 750 C Shadow 83		MD1101	FRONT	S	HONDA				
MD1048	REAR	F	FT 500 C 82	276				ST 1100 AN/AP/AR/AS	316			
			MD1056					FRONT		F	CB 1000 FP/FR/FS/FT/FV 93-97	Pan European (ABS) 92-95
MD1059LS	FRONT	S		VF 750 CH 87					316		ST 1100 L/M/N/P/R/S/T/V/W/X/Y/1/2	Pan European (Non ABS) 90-02
			MD1062LS VMD1062	FRONT				D	CB 750 K6-K7 76-78	296	KYMCO	
CB 750 KZ 80	Venox 250 (R20010/RA50AA /Carb Model) 00-03											
MD1064	REAR	F	CB 750 F/F1/F2 76-78	296				Venox 250 (RFBR20011/RA50AD /Carb Model) 04-06	316			
			GL 1000 2 Goldwing 79					Venox 250 (R20012/EFI Model) 07-14				
			GL 1000 K/K1/K2/K3 Goldwing 75-	296				MD1109LS	FRONT	F	NSR 125 FP/RR/RV/RW/RX/RY/R1 93-04	316
MD1068	REAR	S	VF 750 FD/FE 83-84	296							NSR 125 RR/RS/RV/RW/RX/RY/R1 93-01	
			MD1071 VMD1071		REAR	D	CB 750 FZ/FA/FB 78-82	296	MD1111	REAR	S	NSR 250 R2R/R3R/ (MC28-110) R2T /R3T (MC28-120) 94
CB 900 FZ/FA 80-81	NSR 250 RR (MC28-100) 94											
CBX 1000 Z 79-80	VFR 400 RK3/R3L/R3M/R3N (NC30) 89-92											
CBX 1000 B/C 81-82	RVF 400 RR/RR-1/RT/RT-II (NC35) 94-96											
GL 1000 K/K1-K3/KZ 75-79												
GL 1100 A/DA/B/DB Goldwing 80-81												
GL 1100 1A/1B Interstate Goldwing 80-81												
GL 1100 C/DC 82												
MD1074LS/RS 6 Bolt Fixing	FRONT	D	GL 1000 K/K1/K2 75-77	276	MD1116	REAR	D	CB 1100 RB11/RC11/RD11 80-83	296			
MD1077 BILLET	REAR	S	ST 1100 AN/AP/AR/AS	316	MD1117LS MD1117RS	FRONT	F	NSR 250 R6K/R6K-2 89	276			
			Pan European (ABS) 92-95					NSR 250 R7L (MC21-100)/R7N (MC21-106) 90				
			ST 1100 L/M/N/P/R/S/T/V/W/X/Y/1/2					NSR 250 R8L-3 (MC21-101)/R9L (MC21-102)/R8N/R8N-3 (MC21-106) 90-92				
			Pan European Non ABS 90-02					NSR 250 R9N (MC21-106) 92				
			GL 1500 L/SEM/SEN/SEP/SER/SES /SEV/SEW/SEX/SEY Goldwing 88-00					NSR 250 RR (MC28-100) 94				
GL 1500 CV/CW/CX 97-99	NSR 250 R2R/R3R (MC28-110) /R2T/R3T (MC28-120) 94											
MD1079 BILLET	REAR	S	CBX 750 FE 84	276	MD1120X MD1120XC VR1120BLK VR1120BLU VR1120RED	FRONT	F	CBR 1100 XXV/XXW Blackbird 97-98	310			
			VF 1000 FE/FF/F2F/FG/F2G 84-86									
MD1080RS	FRONT	F	VT 1100 CH/CJ/CN/CP Shadow 87-93	336	MD1124LS	FRONT	F	NT 400 BROS NC25	320			
								NT 650 J/K/L (Bros) (NC31) 88-92				
					MD1125 BILLET	FRONT	D	GL 1200 AE/AF/AG Goldwing 84-86	276			
				MD1126 BILLET				FRONT		S	GL 1500 J/K/L/SEM/SEN/SEP/SER /SES/SEV/SEW/SEX/SEY Goldwing 88-00	
						MD1127 BILLET	REAR		S		GL 1500 J/K Goldwing 88-89	296
				MD1129LS/RS	FRONT			F		NSR 250 RG (MC16-100) 86	256	
						MD1131LS	FRONT		F	FT 500 C 82		296
				MD1132 MD1132C 16" wheel	FRONT			F		CB 400 SF (F2N/F2R/F2V/F3T/F3V) Superfour (NC31) 92-97	296	
						MD1133 BILLET	FRONT		F	CB 600 FW/FX 98-99		
										GL 1100 AD 83	296	
							GL 1100 AC Aspencade Goldwing 82					

D = Dished Solid Original (We replace with floating rotor conversion unit) F = Floating Rotor S = Solid Rotor

STREETBIKE DISC BUYERS GUIDE

DISC No.	FRONT/ REAR	TYPE	MODELS	DIA (MM)	DISC No.	FRONT/ REAR	TYPE	MODELS	DIA (MM)	
MD1134 MD1134X MD1134XC MD1134CC VR1134BLK VR1134BLU VR1134RED	FRONT	F	CBR 900 RRW/RRX 98-99	310	MD1153X MD1153XC MD1153CC VR1153BLK VR1153BLU VR1153RED	FRONT	F	CBR 1000 RR4/RR5 04-05	310	
MD1135	REAR	S	ST 1100 AT/AV/AW/AX/AY/A1/A2 Pan European (ABS) 96-02	296	MD1154X MD1154XC	FRONT	F	ST 1300 2/3/4/6 Pan European (Non ABS) 02-07 S 1300 A2/A3/A4/A6/A8/A9/AA-AE Pan European (ABS Model) 02-17 ST 1300 8/9 Pan European (Non ABS) 08-09	310	
MD1136X MD1136XC VR1136BLK VR1136BLU VR1136RED	FRONT	F	CBR 1100 XXX/XXY/XX1-XX6 Blackbird 99-08 CB 1100 SFY/SF1 "XII" 00-03	310	MD1155RS	FRONT	S	CBF 500 4 (Non ABS Model) 04 CBF 500 A4/A5/A6/A7 ABS Model 04-07	296	
MD1137X MD1137XC MD1137CC VR1137BLK VR1137BLU VR1137RED	FRONT	F	CBR 900 RRY/RR1 "929cc Fireblade" 00-01 CBR 900 RR2/RR3 954cc 02-03	330	MD1156	REAR	S	CBF 500 4 (Non ABS Model) 04-05 CBF 500 A4/A5/A6/A7 ABS Model 04-07 CB 600 F7/F8/F9/FA/FB/FC Hornet 07-13 CB 600 FA7/FA8/FA9/FAA/FAB/FAC Hornet (ABS) 07-13 CBF 600 N4/N5/N6/N8/N9/NA (Non ABS) 04-06/08-11 CBF 600 NA4/NA5/NA6/NA8/NA9 (ABS) 04-06/08-09 CBF 600 S4/S5/S6/S8/S9 (Non ABS) 04-06/08-09 CBF 600 SA4/SA5/SA6/SA8/SA9/SA (ABS) 04-06/08-12 CBR 600 FB/FC (Non ABS Model) 11-13 CBR 600 FAB/FAC (ABS Model) 11-13 ADV 750 H (ADV X DCT) 17-18 CBF 1000 6/7/8/9/A (Non ABS) 06-11 CBF 1000 F (FA) (Non ABS) 10-11	240	
MD1139 MD1139C 17" wheel	FRONT	F	CB 600 FV/F2V/F1/F21/F22/F23/F4/F5/F6 00-06	296	MD1157X MD1157XC	FRONT	F	VFR 800 A2/A3/A4/A5 (ABS) 02-05 VFR 800 6/8/9 06-09 VFR 800 A6/A7/A8/A9 (ABS) 06-13 XL 1000 VA4/VA5/VA6/VA7/VA8 /VA9/VAA/VAB Varadero - ABS 04-11	296	
MD1140RS	FRONT	F	CBR 250 RJ/RK/R2K MC19 88-89	310	MD1159	FRONT	S	NV 400 DCY/DC1/DC2 (NC40) Shadow Slasher 00-02 VT 750 CV/C2V/CW/C2W/CX/C2X/CY /C2Y/C1/C21/C4/C5/C6/C7/C8 Shadow 97-09 VT 750 DC1/DC2 'Black Widow' 01-04 VT 750 DC7/DC8 Shadow Spirit 07-09 VT 750 C2BA/C2BB/C2BC/C2BE Shadow Black Spirit 10-16 VT 750 S (VT750SA/SB) 10-12	296	
MD1141X MD1141XC MD1141CC VR1141BLK VR1141BLU VR1141RED VR1141CHRD	FRONT	F	CBR 600 F1/F2/F3/F4/F5/F6 01-06 CBR 600 FS1/FS2 'Sport' 01-02 CB 900 F2-F7 Hornet 02-07 VTX 1800 C2/C3/C4/C15/C16/C17 02-08	296	MD1159	REAR	S	VTX 1300 S3/S4/S5/S6/S7/S8 03-08	296	
MD1142RS	FRONT	S	NSR 75 N/P/R/X/Y (NS-1) 92-00	256	MD1160	FRONT	F	CBF 600 N8/N9/NA (Non ABS) 08-11 CBF 600 NA8/NA9/NAA (ABS) 08-11 CBF 600 S8/S9 (Non ABS) 08-09 CBF 600 SA8/SA9/SAA (ABS) 08-12 CBF 1000 6/7/8/9/A (Non ABS) 06-10 CBF 1000 A6/A7/A8/A9/AA (ABS) 06-10 CBF 1000 F (FA) (Non ABS) 10-15 CBF 1000 FA (FAA/FAB) (ABS) 10-13 CBF 1000 FS (FSA) (ABS) 10-11 CBF 1000 FT (FTA) (ABS) 10-11 CBF 1000 S (S7/S8/S9/SA) (ABS) 07-11 CBF 1000 T (T7/T8/T9/TA) GT (ABS) 07-16	296	
MD1143	REAR	S	NSR 75 N/P/R/X/Y (NS-1) 92-00	220	MD1161X MD1161XC MD1161CC VR1161BLK VR1161BLU VR1161RED	FRONT	F	CBR 1000 RR6/RR7 06-07 VTR 1000 SPY/SP1 (SC45) 00-01 VTR 1000 SP2/SP3/SP4/SP5/SP6 02-07	320	
MD1144RS	FRONT	F	CB 250 FT/FV/FX/FY/F1 Hornet 96-01 VTR 250 W/Y/1-7 (MC33) 98-07	296	MD1162LS/RS	FRONT	F	CBR 750 FJ 88	296	
MD1145LS/RS	FRONT	F	CBR 250 RRL/RRN/RRR (MC22) 90-94	276	MD1163 BILLET	REAR	S	ST 1300 2/3/4/6 Pan European (Non ABS) 02-07 S 1300 A2/A3/A4/A6/A8/A9/AA-AE Pan European (ABS Model) 02-17 ST 1300 8/9 Pan European (Non ABS) 08-09	316	
MD1146	FRONT	S	VF 1000 RE/RF/RG 84-86	276	MD1164 MD1164C	REAR	S	VFR 800 FV/F1/F1/2/3/4/5 00-05 VFR 800 A2/A3/A4/A5 (ABS) 02-05 VFR 800 6/8/9 06-09 VFR 800 A6/A7/A8/A9 (ABS) 06-13	256	
MD1147LS	FRONT	S	CLR 125 W 'City Fly' 99-03 NX 125 K/S/T 89-97 CRM 125 RL/RM/RP/RR/RV/RX 90-99	240						
MD1148	REAR	S	GL 1500 CY/C1/C2 (F6C) 00-03 VTX 1800 C2/C3/C4/C15/C16/C17 02-08	316						
MD1149 MD1149C	REAR	S	FJS 400 Silverwing D6/D7/D8 06-08 SW-T 400 (FJS 400 D9) 09 SW-T 400 (FJS 400 A9/AB) (ABS) 09-16 FJS 600 1/2/D3/D4/D5/D6 Silverwing 01-06 FJS 600 A3-A7/D7 Silverwing 03-09 SW-T 600 (FJS 600 AB) (ABS) 11-16	240						
MD1150RS	FRONT	S	XL 125 V1-VA Varadero 01-16	276						
MD1151	REAR	S	XL 125 V1-VA Varadero 01-16 CBR 125 R4/R5/R5S/RWS/RW6/RW7/RW8 /RW9/RWA/RWB/RC/RD/RF/RG 04-16 CBF 150 MB/MC Unicorn (Cast Wheels) 11-12 CBR 150 R 00-03	220						
MD1152X MD1152XC MD1152CC VR1152BLK VR1152BLU VR1152RED VR1152CHRD	FRONT	F	CBR 600 RR3/RR4/RR5/RR6/RR7/RR8/RR9 /RRA/RRB/RRC/RRD/RRE/RRF/RRG 03-17 CBR 600 RR Hannspree 08 CBR 600 R (C-ABS) 09-18 CB 1000 RR 17-20 CB 1000 R (Non ABS) 09-15 CB 1000 RA9/RAA/RAB/RAC/RAE (ABS Model) 09-16 CB 1300 5/6/7/8/9 (Superfour) 05-09 CB 1300 A5-A9 (Superfour ABS) 05-09 CB 1300 S5/S6/S7/S8/S9 05-09 CB 1300 SA5/SA6/SA7/SA8/SA9/SA 05-12	310						

D = Dished Solid Original (We replace with floating rotor conversion unit) F = Floating Rotor S = Solid Rotor

DISC BUYERS GUIDE

STREETBIKE DISC BUYERS GUIDE

DISC No.	FRONT/ REAR	TYPE	MODELS	DIA (MM)	DISC No.	FRONT/ REAR	TYPE	MODELS	DIA (MM)
MD1165 MD1165C	REAR	S	VFR 800 FIW/FIX 98-99 VFR 800 FIY/FI1/2/3/4/5 00-05 VFR 800 6/8/9 06-09	256	MD1179	FRONT	S	VT 1100 C2 (W/X/Y/1/2/3/4/5) 98-05 VT 1100 C3 (W/X/Y) 98-00	316
MD1166RS	FRONT	S	CBR 125 RWB/RC/RD/RF/RG 11-16 CBF 250 4/6 04-06 CB 300 R10 10	276	MD1180X MD1180XC	FRONT	F	CBR 250 RB/RC (Non ABS) 11-13 CBR 250 RAB/RAC (ABS) 11-13 CB 300 F AC (ABS) 15-17 CB 300 FA AC (ABS) 18-20 CB 300 R 18-20 CB 300 F ABS 18-20 CB 300 R 14-15 CBR 300 RA (ABS) 14-20 CBR 300 R (Non ABS Model) 18-20	296
MD1167RS	FRONT	S	VT 1100 CR/CS/CT/CV/CW Shadow 94-98	336	MD1181 MD1181C	REAR	S	CBR 250 RAB/RAC (ABS) 11-13 CBR 300 RA (ABS) 14-15 CB 300 F AC (ABS) 15-17 CB 300 FA AC (ABS) 18-19	220
MD1168X MD1168XC	FRONT	F	CB 600 F7/F8/F9/FA/FB/FC Hornet 07-13 CB 600 FA7/FA8/FA9/FAA/FAB/FAC Hornet (ABS) 07-13 CBR 600 FB/FC/FAB/FAC (ABS Model) 11-13	296	MD1182RS	FRONT	S	VTX 1300 C/T Cast wheel models 03-08 VTX 1300 S Spoke wheel models 03-08	330
MD1169C	FRONT	S F	NSR 50 V (AC10-180) 97 NSR 50 X (AC10-190) 99 NSR 80 V (HC06-170) 97 NSR 80 X (HC06-180) 99	220	MD1183 VR1183 OS1183C	FRONT	S	MSX 125 D/E/F/G/H Grom (Non ABS) 13-20	220
MD1170C	REAR	S	NSR 50 V (AC10-180) 97 NSR 50 X (AC10-190) 99 NSR 80 V (HC06-170) 97 NSR 80 X (HC06-180) 99	160	MD1184 VR1184	REAR	S	Monkey 125 18-20 MSX 125 D/E/F/G/H Grom (Non ABS) 13-20 MSX 125 AH Grom (ABS) 18-20	190
MD1171X MD1171XC VR1171BLK VR1171RED VR1171BLU	FRONT	F	CBR 1000 RR8/RR9/RRA/RRB/RRC/RRD /RRE/RRF/RRG/RAF/RAG Fireblade 08-20 CBR 1000 RA9/RAA/RAB/RAC/RAD /RAE Fireblade (ABS) 09-20 CBR 1000 RAH/RAJ Fireblade (C-ABS/Tokico Front Caliper) 17-20 CBR 1000 RR-SP ABS Fireblade (CBR 1000 SAE/SAF/SAG/SAH/SAJ - Brembo Front Caliper) 14-20 CBR 1000 RR-SP Non ABS Fireblade (CBR 1000 SE/SF/SG) 14-16	320	MD1185C	REAR	S	CTX 700 DE-DCT 14-19 CTX 700 N-DCT 14-19 NC 700 DC- 700 Integra Scooter 12-14 NC 700 SA (ABS) 12-13 NC 700 SD (ABS/DCT) 12-14 NC 700 S (Non ABS) 12-13 NC 700 XA - (ABS) 12-13 NC 700 XD - (ABS/DCT) 12-14 NC 700 X (Non ABS) 12-13 NC 750 S (NC 750 SE/Non ABS) 14-15 CTX 700 DE-DCT 14-16 NC 750 S (NC 750 SAE/ABS) 14-18 NC 750 S (NC 750 SDE/DCT ABS) 14-18 NC 750 X (NC 750 XE/Non ABS) 14-15 NC 750 X (NC 750 XAE/ABS) 14-18 NC 750 X (NC 750 XDE/DCT ABS) 14-18 NC 750 D Integra Scooter - DCT 14-18	240
MD1172LS	FRONT	S	SW-T 400 (FJS 400 D9) 09 SW-T 400 (FJS 400 A9/AB) (ABS) 09-16 FJS 600 Silverwing A3-A7/D7 03-09 SW-T 600 (FJS 600 AB) (ABS) 11-16	276	MD1186C	FRONT	S	CTX 700 N-DCT 14-19 NC 700 S (Non ABS) 12-13 NC 700 X (Non ABS) 12-13 NC 750 X (NC 750 XE/Non ABS) 14-15 NC 750 S (NC 750 SE/Non ABS) 14-15	320
MD1173 MD1173C VR1173	REAR	S	CBR 600 RA9/RAA/RAB/RAC /RAD/RAG (C-ABS) 09-16 CBR 1000 RR8/RR9/RRA/RRB/RRC/RRD /RRE/RA9/RAA/RAB/RAC/RAD/RAE /RRF/RRG/RAF/RAG Fireblade 08-16 CBR 1000 RA9/RAA/RAB/RAC/RAD/RAE /RAF/RAG Fireblade (C-ABS) 09-16 CBR 1000 RR-SP ABS Fireblade (CBR1000 SAE/SAF/SAG/SAH/SAJ/SAK) 14-19 CBR 1000 RR-SP ABS-TT Edition 16 CBR 1000 RR-SP Non ABS Fireblade (CBR1000 SE/SF/SG) 14-20	220	MD1187C	FRONT	S	CB 650 FAE/FAF/FAG/FAH/FAJ (ABS) 14-18 CBR 650 FAE/FAF/FAG/FAH/FAJ (ABS) 14-18 CTX 700 DE-DCT 14-19 CB 650 FAE/FAF/FAG/FAH (ABS) 14-17 CBR 650 FAE/FAF/FAG/FAH (ABS) 14-17 CTX 700 DE-DCT 14 NC 700 DC- 700 Integra Scooter 12-14 NC 700 SA (ABS) 12-13 NC 750 S (NC 750 SDE/DCT ABS) 14-17 NC 700 XA - (ABS) 12-13 NC 700 XD - (ABS/DCT) 12-14 NC 750 S (NC 750 SAE/ ABS) 14-18 NC 750 S (NC 750 SDE/DCT ABS) 14-18 NC 750 X (NC 750 XAE/ ABS) 14-18 NC 750 X (NC 750 XDE/DCT ABS) 14-18 NC 750 D Integra Scooter - DCT 14-18	320
MD1174 MD1174C	REAR	S	CB 1100 RS 17-18 CB 1300 5/6/7/8/9 (Superfour) 05-09 CB 1300 A5/A6/A7/A8/A9 (Superfour ABS) 05-09 CB 1300 SA5/SA6/SA7/SA8/SA9/SA 05-12	256	MD1188X	FRONT	F	VFR 800 XB/XC/XD (Crossrunner/ABS) 11-13 VFR 800 XF/XG/XH (Crossrunner/ABS) 15-17 VFR 800 XF/XG/XH/XJ (Crossrunner/ABS) 15-18 VFR 800 F (ABS Model) 14-18	310
MD1175	REAR	S	VFR 1200 FA 10-16 VFR 1200 FAD DCT 10-17 VFR 1200 FA 10-16 VFR 1200 FA - GT 14-15 VFR 1200 FAD - GT/DCT 14-15 VFR 1200 XDC/XDCD/XDE/XDF/XDG /XDH/XDJ DCT Crosstourer 12-18 VFR 1200 XAC/XAD/XAE/XAF/XAH /XAJ Crosstourer (Manual G/Box) 12-18	276	MD1189	REAR	S	VFR 800 XB/XC/XD (Crossrunner/ABS) 11-13	256
MD1176X	FRONT	F	VFR 1200 FA 10-16 VFR 1200 FAD -DCT 10-17 VFR 1200 FA - GT 14-15 VFR 1200 FAD - GT/DCT 14-15	320	MD1190	REAR	S	VFR 800 XF/XG/XH/XJ (Crossrunner/ABS) 15-18 VFR 800 F (ABS Model) 14-18	256
MD1177 MD1177C	REAR	S	CB 1000 R9/RA/RB/RC/RD/RE/RF (Non ABS) 09-15 CB 1000 RA9/RAA/RAB/RAC/RAE/RAF /RAG/RAH (ABS) 09-16	256	MD1191 MD1191C VR1191	FRONT	S	MSX 125 AH Grom (ABS) 18-20 Monkey 125 18-20	220
MD1178	REAR	S	CBF 1000 A6/A7/A8/A9/AA (ABS) 06-10 CBF 1000 (FAA/FAB) (ABS) 10-13 CBF 1000 FS (FSA) (ABS) 10-11 CBF 1000 FT (FTA) (ABS) 10-11 CBF 1000 S (S7/S8/S9/SA) (ABS) 07-11 CBF 1000 T (T7/T8/T9/TA)-GT (ABS) 07-16	240					

D = Dished Solid Original (We replace with floating rotor conversion unit) F = Floating Rotor S = Solid Rotor

STREETBIKE DISC BUYERS GUIDE

DISC No.	FRONT/ REAR	TYPE	MODELS	DIA (MM)	DISC No.	FRONT/ REAR	TYPE	MODELS	DIA (MM)
MD1195	REAR		TRX 420 All Models 14-19 TRX 500 All Models 14-19	190	MD2002 MD2002C VR2002	REAR	S	DUCATI Contd. Monster 696 20th Anniversary Model 13 748 Biposto 99-02 748 SP/Monoposto 99-02 750 Supersport 91-99 750 Supersport IE 00-02 750 Sport 01-02 750 Monster 96-98 Monster ie 750 02 750 Monster City/City Dark 99 750 Monster/Monster Dark 99 750 Monster 00-01 Supersport 750 91-98 797 Monster 17-18 797+ Monster 18 Monster 800 03-04 800 Supersport 03-05 851 Superbike Biposto 89-92 888 SP4/SP5 92-93 888 Superbike Strada 94-95 900 Supersport 89-90 900 Supersport/Superlight 91-97 900 Supersport 98-99 900 Supersport CR USA 98 900 Supersport FE 98 900 Supersport IE 00-01 900 Sport 02 900 Monster 93-99 900 Monster Cromo/Special 98 900 Monster City/City Dark 99 900 IE Monster 00-01 907 IE 90-93 ST2 (944cc) 97-03 ST3 (Non ABS) (992cc) 04-07 ST3 S (ABS Model) 06-07 ST4S ABS 03-05 ST4S Non ABS 01-05 Monster 1000 Dark 03 Monster 1000 ie (992cc) 04-05 Monster 1000 S ie (992cc) 03-05 Monster S4 Foggy 02 Monster S4 916cc 01-02 ST4 (916cc) 99-02 Paul Smart 1000 LE 06 Sport 1000 S 07-09 Sport Classic 1000 (992cc) 06-08 Supersport 1000 DS (992cc) 03-06 LAVERDA 650 All models 94-95 668/750 All models 97-01 TTS 800 99-01 VOXAN Black Magic 04-08 Street Scrambler 03-06 VB1-Evo 03-04 Cafe Racer 1000 02-08 Roadster 1000 02-08	245
MD1196	REAR	S	CRF 1000 Africa Twin ABS 16-17 CRF 1000 Africa Twin ABS DCT 16-17 CRF 1000 Africa Twin ABS DCT 18-20 CRF 1000 Africa Twin Adventure Sport ES ABS (Manual) 19-20 CRF 1000 Africa Twin Adventure Sport ES ABS (DCT) 19-20	256					
MD1197 Fitting kit required	FRONT	S	VFR 1200 XAC/XAD/XAE/XAF/XAH/XAJ Crosstourer (Manual G/Box) 12-18 VFR 1200 XDC/XDCD/XDE/XDF/XDG /XDH/XDJ DCT Crosstourer 12-18 VFR 1200 Crosstourer Highlander T /DCT 15-16	310					
MD1198X	FRONT	F	CRF 1000 Africa Twin ABS 16-17 CRF 1000 Africa Twin ABS DCT 16-17 CRF 1000 Africa Twin ABS DCT 18-20 CRF 1000 Africa Twin Adventure Sport ES ABS (Manual) 19-20 CRF 1000 Africa Twin Adventure Sport ES ABS (DCT) 19-20	310					
MD2001X MD2001XC MD2001CC VR2001BLK VR2001BLU VR2001RED	FRONT	F	TZR 250 (3MA1 Reverse Cylinders) 89 FZR 400 RR (4DX) 92 FZ 400 (4YR1) 96 FZR 400 (3TJ1/2/6/7) 89 FZR 400 (3ENZ) 89 XJR 400 4HM1/4HM2/4HM4/4HM7 93-96 XJR 400 4HM3/4HM5/4HM6 /4HM9/4HMA/4HMB 95-99 FZR 600 89-93 FZR 600 R 94-95 FZS 600 Fazer 98-03 FZ 750 89-91 TDM 850 91-01 TRX 850 96-99 FJ 1200 (3CV/3XW Type) 88-95 APRILIA RST Futura 1000 01-04 DUCATI 900 Supersport 89-90 907 IE 90-91	298					
MD2002 MD2002C VR2002	REAR	S	FZ 400 (4YR1) 96 FZ 400 N (1FK/33M/46X) 85 SRX 400 (1JL/3VN1/3VN2/3VN5) 85/90-96 XJR 400 4HM1/4HM2/4HM4/4HM7 93-96 XJR 400 4HM3/4HM5/4HM6/4HM9 /4HMA/4HMB 95-99 FZ 600 87-88 FZR 600 89-93 FZR 600 R 94-95 FZS 600 'Fazer' 98-03 SRX 600 (1JK/3SX) 85/90-91 SRX 600 86-87 XJ 600 N 95-03 XJ 600 S Diversion 92-03 YZF 600 R Thundercat 96-03 YZF 750 R/SP 93-97 TDM 850 91-01 TRX 850 96-99 TDM 900 (5PS Non ABS) 02-14 TDM 900 (2B0) (ABS) 05-13 YZF 1000 R Thunderace 96-02 DUCATI Supersport 400 93-97 400 Monster/Dark 95-97/00-04 Monster 400 ie 07-08 Monster 400 00-04 Monster Dark ie 400 05-06 400 Scrambler Sixty2 16-18 600 Monster 93-01 600 Monster Dark 98-99 600 Monster City/City Dark 99 600 Supersport 91-97 620 IE Monster 02-04 Monster 620 Dark 03-06 Monster 620 05-06 620 Multistrada 06 620 Multistrada Dark 06 695 Monster 07-08 696 Monster 08-14 696 + Monster (inc ABS) 09-12	245					
MD2002 MD2002C VR2002	FRONT	F	TDR 125 3HS1/3XD1/3SH3/3XD1 89-93 TDR 125 R Lightburner (3SH2/3XE2) 93-94 TZR 125 R Brembo Caliper (4DL1/4DL2) 91-93 FZR 250 87- TDR 250 (3CK1/3CK2 Europe) 88-92 TZR 250 (2MA/2XW1/2XW2 Europe) 87-92 TZR 250 (1KT/2AW Japan) 87 TZR 250 (2XT1 Japan) 88 SRX 400 (3VN1/3VN2/3VN5) 90-96 SRX 600 (3SX) 90-91 SZR 660 96-97 FZR 750 Genesis 87 YZF 750 R/SP 93-97 FZR 1000 Genesis 87-88 FZR 1000 EX-UP 89-95 XJR 1200 95-98 XJR 1300 5EA1/5EA7 98-99 APRILIA MX 125 04-06 RS 125 92-05 Tuono 125 03-04 RSV4R 10 RSV4R APRC 11-13 RSV4R APRC ABS 11-14 RSV4 Factory 09-10 RSV4 Factory APRC 11-13 RSV4 Factory APRC ABS 11-14	320					

D = Dished Solid Original (We replace with floating rotor conversion unit)

F = Floating Rotor

S = Solid Rotor

STREETBIKE DISC BUYERS GUIDE

DISC No.	FRONT/ REAR	TYPE	MODELS	DIA (MM)	DISC No.	FRONT/ REAR	TYPE	MODELS	DIA (MM)
MD2003X MD2003XC MD2003CC VR2003BLK VR2003BLU VR2003RED No counterbore Contd.	FRONT	F	Tuono V4R 11-12 Tuono V4R APRC 11-13 DUCATI Supersport 400 93-97 600 Supersport 91-97 620 Multistrada Dark 06 LAVERDA 650 All models 94-95 668/750 All models 97-01	320	MD2019 MD2019LS MD2019RS	FRONT	D	RD 250/350 LC 80-83 RZ 250 (4L3) 96-00 SR 250 Classic (21L) 78 XS 250 C 79-81 XS 250 D/E 79-81 XS 250 SE/SF 89-94 XV 250 Virago 80-82 RD 350 LC 76 XS 360 C 78 XS 400 C 79 XS 400 80-81 XS 400 SE 81-84 XJ 550 82 XJ 650 RJ 'Seca' 80-84 XJ 650 81 XV 1000 Tri	266
	MD2008	REAR	S	FZR 750 R 'OWO1' 89-90		210	MD2019RS	REAR	D
MD2009LS/RS	FRONT	F	FZR 750 R 'OWO1' 89-90	320	MD2020LS/RS	FRONT		F	FZR 400 Genesis (1WG) 86
MD2011 MD2011C VR2011	FRONT	S	RZ 250 R (1AR/1XG/2GL) RZ 250 RR (5K) 83-84 RD 350 YPVS 85-92 RD 350 F/F2 85 R 350 N 92-95 RD 350 R 85- FZ 400 N (IFK/33M/46X) 85 SRX 400 (1J6) 82 XS 400 82-84 XZ 550 87-88 FZ 600 85 SRX 600 (1JK) 86-87 SRX 600 84-91 XJ 600 86-90 XX 600 S/SC/T/TC/U/UC/W/WC/A/AC 'Radian' 82 XJ 650 Turbo 83 XJ 650 LX 'Seca' 86-87 FZX 700 S/SC/T/TC 'Fazer' 87-88 FZ 750 87 FZX 750 92-93 XV 750 Virago 87-92 XJ 900 F 86 XV 1000 Virago 88 XV 1000 SE Virago 89-93 XV 1100 Virago NORTON Commander (Rotary) 90	267	MD2021 MD2021C VR2021	REAR	S	TZR 125 90-92 TZR 125 R 93- TDR 125 R Lightburner (3SH2/3XE2) 93-94 TZR 125 R Brembo Caliper (4DL1/4DL2) 91-93 TZR 150 R 00 SDR 200 (2TV) 87-89 FX 250 Zeal (3YX1/2/4) 91-92 FZR 250 R 91 TZ 250 88-92 TDR 250 (3CK1/3CK2 Europe) 91 TZ 250 87-92 TZR 250 (2MA/2XW1/2XW2 Europe) 87 TZR 250 (1KT/2AW Japan) 87 TZR 250 (2XT1 Japan) 88 TZR 250 (3MA1 Reverse Cylinders) 89 TZR 250 (3MA3/3MA5 Reverse Cylinder) 90 TZR 250 SP (3MA4) 90 TZR 250 R (3XV1/3X4/3XV6) V-Twin 91-93 TZR 250 RS (3XV8/3XV9/3XVA) V-Twin 92-94 TZR 250SPR (3XVC) V-Twin 95 FZR 250 86 FZR 400 Genesis (1WG) 87 FZR 400 RSP (2TK EX-UP) 88-89 FZR 400 (3EN1/2) 92 FZR 400 RR (3TJ1/2/6/7) 96-97 SZR 660	210
	MD2011 MD2011C VR2011	REAR	S	RZ 250 R (1AR/1XG/29L) RZ 250 RR (51C) 83-84 RD 350 YPVS 85-92 RD 350 F/F2 85 RD 350 N 92-95 RD 350 R 01-03 XP 500 N/P/R T-Max 04-07 XP 500 S/T/V T-Max (5VU1/2) 08-11 XP 500 T-Max (Non ABS models) 08-11 XP 500 T-Max (ABS Models) 84-91 XJ 600 87-91 FZ 750 87 FZR 750 Genesis 95-03 XJ 900 S 'Diversion' 87-88 FZR 1000 Genesis 89-95 FZR 1000 EX-UP 01-05 FZS 1000 Fazer 02-06 BT 1100 Bulldog P/R/S/T/V 99 XV 1100 99-01 XVS 1100 Dragstar 00-01 XVS 1100 A Dragstar Classic 95-98 XJR 1200 01-10 FJR 1300 N/P/R/AR/S/AS 98-99 XJR 1300 5EA1/5EA7 15-16 XJR 1300 C/Racer 99 XJR 1300 L 5EA2/5EA3/5EA4 00 XJR 1300 M 5EAA/5EAB/5EAC 00 XJR 1300 (5EA9/5EAG) 01-02 XJR 1300 N/P (5EAP/5EAR/5EAS /5EAT/5EAW/5EAW/5EAY) 03-04 XJR 1300 R/S 5WM1/5WM3/5WM5 /5WM6/5WM7/5WM9 05-14 XJR 1300 T/V/W/X/Y 5WMA/5WMC /5WMD/5WMF 99 XJR 1300 SP (L) 5EA5/5EA6/5EA8 00 XJR 1300 SP (M) 5EAD/5EAE/5EAF 01 XJR 1300 SP (N) 5EAL/5EAM/5EAN 05-10 MT-01 (1670 cc) 09 MT-01S (5YUR)		267	MD2022LS MD2022RS	FRONT	F
MD2012	FRONT	S	XJ 900 S Diversion 95-03	320	MD2023LS MD2023RS VMD2023	FRONT	D	SR 500 78-82 XV 535 Virago 88-94 XJ 550 H/J/K 'Maxim' 81-83 XJ 550 RH/RJ/RK 'Seca' 81-83 XJ 650 G/H/J/K 'Maxim' 80-83 XJ 650 LH 'Midnight' 81 XJ 750 81-84	298
					MD2024 VMD2024	FRONT	D	XS 500 C/D 78-79 XS 650 SE 79- XV 750 SE 81 XS 850 80 XS 1100 78-80 XS 1100 S 81	298
					MD2024 VMD2024	REAR	D	XS 1100 78-80 XS 1100 S 81	298
					MD2025LS MD2025RS VMD2025	FRONT	D	RD 250 E/F 78-79 RD 400 E/F 78-79 XS 650 77-81 XS 650 SE 79-80 XS 750 77-79 XS 750 SE 79-80 RD 250 E/F 78-79 RD 400 E/F 78-79 XS 500 C/D 78-79 XS 750 77-79 XS 750 SE 79-80	266
					MD2025RS VMD2025	REAR	D	RD 250 E/F 78-79 RD 400 E/F 78-79 XS 500 C/D 78-79 XS 750 77-79 XS 750 SE 79-80	266

D = Dished Solid Original (We replace with floating rotor conversion unit) F = Floating Rotor S = Solid Rotor

STREETBIKE DISC BUYERS GUIDE

DISC No.	FRONT/ REAR	TYPE	MODELS	DIA (MM)	DISC No.	FRONT/ REAR	TYPE	MODELS	DIA (MM)		
MD2031LS	FRONT	S	XJ 600 N XJ 600 S Diversion	95-97 92-97	320	MD2076	FRONT	S	XVS 400 96 SR 400 (2RD) 14-17 XV 535/535 S Virago 95-03 XVS 650 Drag star 97-04 XVS 650 A Dragstar Classic 98-07 XVS 1100 Dragstar 99-04 XVS 1100 A Dragstar Classic 00-07 XVZ 13 AH/ATH Royal Star 96-00 XVZ 1300 TF 'Venture Star' 99-01 XV 1600 A 'Wildstar' 99-04	298	
MD2046	FRONT	F	FJ 1200 A (ABS model)	91-95	298	MD2077	REAR	S	TZR 50 'Thunderkid' (5DU1/3) 97-00 TZR 50 X-Power 00	203	
MD2053RS	FRONT	S	RD 125 LC (MK2/3) RG 125 (1GV 030101-) TZR 125	85-87 85 87-89	245	MD2078 BILLET	REAR	S	XVZ 13 AH/ATH Royal Star 96-00 XVZ 1300 TF 'Venture Star' 99-01	320	
MD2056RS	FRONT	S	TZR 125 SDR 200 (2TV) SRX 250 (51Y/52E/1JA)	90-92 87-89	267	MD2081 BILLET	FRONT /REAR	S	XVZ 12 TD 85 XVZ 12 TD 85	298	
MD2067	FRONT	S	TZR 50 'Thunderkid' (SDU1/3) 97-00 TZR 50 X-Power 00 XV 125 Virago 97-00 XVS 125 Dragstar 00-04 SRV 250 "Soufultwin/Renaissa" 92-97 XV 250 S Virago 95-00 XVS 250 Dragstar 01-04 XV 750 Virago 94-97 XV 1100 Virago 94-99 MASH 400 Roadstar (Five Hundred) 14-18	97-00 00 97-00 00-04 92-97 95-00 01-04 94-97 94-99 14-18	280	MD2082X MD2082XC MD2082CC VR2082BLK VR2082BLU VR2082RED	FRONT	F	YZF R6 03-04 MT-03 (660cc) 06-12 FZ6 Naked/Non ABS 2 Piston Caliper (IB3/IB3D) 04-07 FZ6-NS Naked/Non ABS/2 Piston Caliper (IB35/6) 05-06 FZ6-Fazer (Half Fairing/Non ABS/2 Piston Caliper) (5VX/5VXL) 04-07 FZ6 Fazer (ABS/Half Fairing /2 Piston Caliper) 06-07 FZ6 Fazer S2 (ABS/Half Fairing /4 Piston Caliper) 08 FZ6 Fazer S2 (Non ABS/Half Fairing /4 Piston Caliper) (4S81/4S8) 07-09 FZ6 S2 (Non ABS/Half Fairing /4 Piston Caliper) (5S51/5S5) 07-09 XJ6-N (600cc) (Naked - 20S ABS /NonABS) 09-12 XJ6-N Diversion 6 (Naked Diversion Non ABS & ABS Models) 13-15 XJ6-S Diversion (600cc) (Top Fairing ABS/NonABS) 09-15 XJ6-SP 13 XJ6-F Diversion (600cc) (Full Fairing ABS/NonABS) 10-15	298	
MD2068 BILLET	FRONT	S	FJ 1100 FJ 1200 (ITX)	84-85 86-87	282	MD2083	FRONT	F	YZF-R7 750 'OWO2'	99-00	320
MD2068 BILLET	REAR	S	FJ 1100 FJ 1200 (ITX/3CV/3XW) FJ 1200 A (ABS Model) V MAX 12 'All models'	84-85 86-95 91-95 91-02	282	MD2084 MD2084C VR2084			YZR 1000 R1	02-03	
MD2069 BILLET	FRONT	S	RD 500 LC RZV 500 R (SIX) FZ 750 XJ 900/900F	84-86 85 85-86 83-86	267	MD2085LS VR2085	FRONT	S	SR 125	97-03	267
MD2069 BILLET	REAR		FZX 700 S/SC/T/TC 'Fazer' FZ 750 FZX 750 NORTON Commander (Rotary)	86-87 85-86 87 90		MD2086 MD2086C VR2086	REAR	S	YZF R7 OWO2 (Road version) 99-01 YZF R1 98-01	245	
MD2070 BILLET	REAR	S	RD 500 LC RZV 500 R (SIX)	84-86 85	245	MD2087LS VR2087	FRONT	S	XP 500 N/P/R/S T-Max	01-04	282
MD2074X MD2074XC MD2074CC VR2074BLK VR2074BLU VR2074RED VR2074CHBL	FRONT	F	YZF 600 R Thunder Cat 96-03 XJ 600 S 'Diversion' 98-03 XJ 600 N 98-03 YZF 600 R 'R6' 99-02 TDM 900 (SPS) (Non ABS) 02-14 TDM 900 (2B0) (ABS) 05-13 XV 950 R - XVS 950 R (2DE/Remote Reservoir Rear Shocks) 14-18 FZS 1000 Fazer 01-04 YZF 1000 R Thunder Ace 96-02 YZF 1000 R1 98-03 BT 1100 P/R/S/T/V Bulldog 02-06 V-Max 12 93-03 FJR 1300 (Non ABS) (5JW) 01-02 XJR 1300 C/Racer 15-16 XJR 1300 L 5EA2/5EA3/5EA4 99 XJR 1300 M 5EAA/5EAB/5EAC 00 XJR 1300 (5EA9/5EAG) 00 XJR 1300 N/P (5EAP/5EAR/5EAS /5EAT/5EAW/5EAW/5EAY) 01-02 XJR 1300 R/S 5WM1/5WM3/5WM5 /5WM6/5WM7/5WM9 03-04 XJR 1300 T/V/W/X/Y 5WMA/5WMC/5WMD/5WMF 05-14 XJR 1300 SP (L) 5EA5/5EA6/5EA8 99 XJR 1300 SP (M) 5EAD/5EAE/5EAF 00 XJR 1300 SP (N) 5EAL/5EAM/5EAN 01 XVS 1300 A Midnight Star 07-16 XVS 1300 ACFD Midnight Star/Casual Full Dresser (With Handbar Fairing) 14-16 XV 1700 PCR Road Star Warrior 03-05 XV 1900 A 06-08	96-03 98-03 98-03 99-02 02-14 05-13 14-18 01-04 96-02 98-03 02-06 93-03 01-02 15-16 99 00 00 01-02 03-04 05-14 99 00 01 07-16 14-16 03-05 06-08	298	MD2088 BILLET	REAR	S	XV 1600 A Wildstar	99-04	320
MD2075 BILLET	REAR	S	GTS 1000	93-99	282	MD2089X MD2089XC MD2089CC VR2089BLK VR2089BLU VR2089RED	FRONT	F	XVS 950 A Midnight Star 09-12 FJR 1300 (Non ABS/5JW) 03-04 FJR 1300 A (ABS) (3P6 Model) 06-17 FJR 1300 A (ABS) (ICY) 10-12 FJR 1300 A (ABS) (5VS) 03-05 FJR 1300 A (1MC/ABS/Manual G/Shift) 13-17 FJR 1300 A (1MC/ABS/Manual G/Shift) 13-19 FJR 1300 AE (Electronic Suspension Adjustment/USD Forks) 14-19 FJR 1300 AS (ABS/Electric Shift) 06-18	320	
						MD2091 MD2091C VR2091	REAR	S	YZF R6 03-19 YZF R1 04-14 MT-10 (MTN 1000/998cc) 16-19 MT-10 Tourer Edition (998cc) 18-19 MT-10 SP (MTN 1000D/998cc) 17-19	220	
						MD2092 MD2092C VR2092	REAR	S	XVS 1100 Dragstar 99-04 XVS 1100 A Dragstar Classic 00-07 FJR 1300 A (ABS) (5VS) 03-05 FJR 1300 (Non ABS) (5JW) 01-04 XV 1700 PCR Road Star Warrior 03-05	282	

D = Dished Solid Original (We replace with floating rotor conversion unit) F = Floating Rotor S = Solid Rotor

DISC BUYERS GUIDE

STREETBIKE DISC BUYERS GUIDE

DISC No.	FRONT/ REAR	TYPE	MODELS	DIA (MM)	DISC No.	FRONT/ REAR	TYPE	MODELS	DIA (MM)
MD2093 MD2093C VR2093	REAR	S	FZ1 (2D1) (Naked) Non ABS 06-09 FZ1 Fazer (3C3) (Half fairing) 06-15 FZ1 Fazer (Half Fairing - ABS - 5D0) 08-15 FZ1 N/NA Naked (Non ABS/ABS) 10-15 FZ6 Naked/Non ABS 2 Piston Caliper (IB3/IB3D) 04-07 FZ6-NS Naked/Non ABS/2 Piston Caliper (IB35/6) 05-06 FZ6-Fazer (Half Fairing/Non ABS/ 2 Piston Caliper) (5VX/5VXL) 04-07 FZ6 Fazer (ABS/Half Fairing/ 2 Piston Caliper) 06-07 FZ6 Fazer S2 (ABS/Half Fairing/ 4 Piston Caliper) 08 FZ6 Fazer S2 (Non ABS/Half Fairing/ 4 Piston Caliper) (4S81/4S8) 07-09 FZ6 S2 (Non ABS/Half Fairing/ 4 Piston Caliper) (5S51/5S5) 07-09 MT-03 (660cc) 06-12	245	MD2103 MD2103C VR2103	REAR	S	XVS 950 A Midnight Star 09-13 XVS 1300 A Midnight Star 07-16 XVS 1300 CU Custom 14-16 XVS 1300 ACFD Midnight Star/Casual Full Dresser (With Handbar Fairing) 14-16 XV 950 Racer (Remote Reservoir Rear Shock) 15-16	298
MD2094X MD2094XC MD2094CC VR2094BLK VR2094BLU VR2094RED	FRONT	F	YZF R1 04-06	320	MD2104RS	FRONT	S	YBR 125 Custom 07-16 YBR 125 (3D92/9) 07-09 YBR 125 (51D1/2) 10-16 YS 125 17-19 HONLEY HD1 125 14-15 HD2 125 16-17 HD3 125 16-17 HD3 SE 125 16-17	245
MD2095X MD2095XC MD2095CC VR2095BLK VR2095BLU VR2095RED	FRONT	F	YZF R6 05-07 FZ 8 N-800cc (Naked/Single Headlight/Non ABS) 11-15 FZ 8 NA-800cc (Naked/Single Headlight/ABS) 11-15 Fazer 8 S-800cc (Top Fairing/Twin Headlight/Non ABS) 11-15 XT 1200 Z Super Tenere (ABS/UBS Brake System) 10-17 XT 1200 ZE Super Tenere (ABS/UBS Brake System) 14-17 XT 1200 ZE Super Tenere Raid Edition (ABS/UBS Brake System) 18	310	MD2105X MD2105XC VR2105BLK VR2105BLU VR2105RED	FRONT	F	YZF R1 09-14 YZF R6 08-16	310
MD2097RS	FRONT	S	YBR 125 ED (3D91) 05-06	245	MD2106RS	FRONT	S	YBR 250 (5D11/3/4) 07-11	280
MD2098 MD2098C 5 Bolt Fixing	FRONT	F	T-Max XP 500 04-07 XP 500 - T-Max 500 (530cc Engine Non ABS Models) 12-15 XP 500 A T-Max (530cc Engine/ ABS Models) 12-16 XP 530 Black/Bronze Max (59CE) 13-14 XP 530 A (530cc Engine - Iron Max - ABS Model) 15-16 T-Max XP 500 04-07 XP 500 A T-Max- Lux Max (ABS) 16 XP 530E-A T-Max (530cc Engine - ABS Model) 17-18 XP 530-A T-Max SX (530cc Engine - ABS Model) 17-18 XP 530D-A T-Max DX (530cc Engine - ABS Model) 17-18	267	MD2107 MD2107C 6 Bolt fixing Black hub	FRONT	F	XP 500 T-Max (Non ABS Models) 08-11 XP 500 T-Max (ABS Models) 08-11	267
MD2099	REAR	S	XV 1900 A Midnight Star 06-13 XV 1900 ACFD Midnight Star/Casual Full Dresser (With Handbar Fairing) 14-16 /Handbar Fairing 13-15	320	MD2108C	REAR	F	XV 1700 V-Max 09-17	298
MD2100 MD2100C VR2100	REAR	S	FJR 1300 A (ABS) (3P6 Model) 06-17 FJR 1300 A (ABS) (ICY) 10-12 FJR 1300 A (1MC/ABS /Manual G/Shift) 13-19 FJR 1300 AE (Electronic Suspension Adjustment/USD Forks) 14-19 FJR 1300 AS (ABS/Electric Shift) 06-18	282	MD2109XC	FRONT	F	XV 1700 V-Max 09-17	320
MD2101X MD2101XC VR2101BLK VR2101BLU VR2101RED	FRONT	F	FZ1 (2D1) (Naked) 06-09 FZ1 Fazer (3C3) Half fairing (Non ABS) 06-15 FZ1 Fazer (Half Fairing - ABS - 5D0) 08-15 FZ1 N/NA Naked (Non ABS/ABS) 10-15	320	MD2110LS	FRONT	S	YZF-R 125 08-13	290
MD2102X/XC MD2102CC VR2102BLK VR2102BLU VR2102RED	FRONT	F	YZF R1 07-14	310	MD2111	REAR	S	YZF-R 125 08-13	230
					MD2112X	FRONT	F	YZF-R1 SP (4B1) 06 KTM Super Duke R 14-20 Super Duke R SE 16-20 Super Duke GT 16-20	320
					MD2113	REAR	S	TZR 50 X Power 03-10 TZR 50 03-16	220
					MD2115C	REAR	S	XT 1200 Z Super Tenere (ABS/UBS Brake System) 10-17 XT 1200 ZE Super Tenere (ABS/UBS Brake System) 14-17 XT 1200 ZE Super Tenere Raid Edition (ABS/UBS Brake System) 18	280
					MD2116 MD2116C VR2116	REAR	S	FZ 8 N-800cc (Naked/Single Headlight /Non ABS) 11-15 FZ 8 NA-800cc (Naked/Single Headlight /ABS) 11-15 Fazer 8 S-800cc (Top Fairing/Twin /Non ABS) 11-15 FZ 8 NA-800cc (Naked/Single Headlight Headlight/Non ABS) 11-15 Fazer 8 S-800cc (Top Fairing/Twin Headlight/ABS) 11-15	267
					MD2117 VR2117	REAR	S	XJ6-N Diversion 600 (Naked Diversion - Non ABS & ABS Models - 20S) 09-12 XJ6-N Diversion 600 (Naked Diversion - Non ABS/ABS Models) 13-15 XJ6-F Diversion 600 (Full Fairing Diversion - Non ABS & ABS Models) 10-15 XJ6-S Diversion 600 (Top Fairing Diversion - Non ABS & ABS Models) 09-15 XJ6-SP 13	245
					MD2118	REAR	S	YZF-R1SP 06	220

D = Dished Solid Original (We replace with floating rotor conversion unit) F = Floating Rotor S = Solid Rotor

STREETBIKE DISC BUYERS GUIDE

DISC No.	FRONT/ REAR	TYPE	MODELS	DIA (MM)	DISC No.	FRONT/ REAR	TYPE	MODELS	DIA (MM)									
MD2119X MD2119XC VR2119BLK VR2119BLU VR2119RED	FRONT	F	MTN 320 A (MT-03 321cc) 16-19	298	MD2129X MD2129XC	FRONT	F	V-Max 12 93-03	298									
			YZF-R3 (321cc/ABS) 15-19					MD2130C		REAR	S	SCR 950 (XVS 950XR-A) 17-18						
			MT-09 (1RC/Non ABS 847cc/3 Cyl Engine) 14-16									XV 950 - XVS 950 (Non ABS/Standard Rear Shocks) 14						
			MT-09 (2DR/ABS 847cc/3 Cyl Engine) 14-16									XV 950 CU - XVS 950 (1XC1/ABS /Standard Rear Shocks) 14-18						
			MT-09 Sport Tracker ABS (847cc/3 Cyl Engine) 14-16									XV 950 R - XVS 950 R (2DE/Remote Reservoir Rear Shocks) 14-18						
			MT-09 Street Rally ABS (847cc/3 Cyl Engine) 14-16									XV 950 Racer (Remote Reservoir Rear Shocks) 15-16						
			MT-09 Tracer ABS (847cc/3 Cyl Engine) 15-17									MD3001	FRONT	S	GSXR 400 H 87			
			MT-09 ABS (MT850-A 847cc/3 Cyl Engine) 17-19												GSX 400 R3 (GK71F) 88			
			MT-09 SP ABS (MT850-D 847cc/3 Cyl Engine) 18-19												MD3002 MD3002C VR3002	REAR	S	GSF 250 N/ZM/P/NP/ZP/R/NR 92-96
			MT-09 Tracer 900 ABS (847cc/3 Cyl Engine) 15-19															GSX 250 SSM Katana 91
MT-09 Tracer 900 GT ABS (847cc/3 Cyl Engine) 15-18	GSX 250 FL/FM/FN/FP/FR/FS/FT /FV/FW Across 90-98																	
XSR 900 ABS (MTM 850) 16-18	GSF 400 M/N/P Bandit 91-95																	
XSR 900 Abarth ABS (MTM 850) 17-18	GSX 400 FJ/FK/FAK/FL (GK74A) 88-90																	
MD2120 MD2120C VR2120	REAR	S	MT-07 (Non ABS/689cc/ 2 Cyl) 14-16	245	MD3003X MD3003XC MD3003CC VR3003BLK VR3003BLU VR3003RED VR3003CHBR	FRONT	F	RGV 250 J/K/L 88-90	290									
			MT-07A (ABS/689cc/ 2 Cyl) 14-18					GSXR 250 RK (GJ73A) -89										
			MT-07 Motocage (ABS/689cc/ 2 Cyl) 15-17					GSX 400 FJ/FK/FAK/FL (GK74A) 88-90										
			MT-07A Moto Cage (Non ABS) 14-16					GSX 400 R/S/T/ZR/ZS/ZT Impulse type 94-96										
			Tracer 700 (MTT 690) 16-18					GSX 400 X 99										
			MT-09 (1RC/Non ABS 847cc/3 Cyl Engine) 14-16					GSX 400 FSV/FSK1 (GK7B) Inazuma 00										
			MT-09 (2DR/ABS 847cc/3 Cyl Engine) 14-17					GSX 400 SSM Katana 92										
			MT-09 Sport Tracker ABS (847cc/3 Cyl Engine) 14-16					GSF 400 K/NK/Z/VM/VZM/P/NP/VP /VZP/VR Bandit (GK75A) 89-94										
			MT-09 Street Rally ABS (847cc/3 Cyl Engine) 14-16					GS 500 EK/EL/EM/EN/EP/ER/ES/ET /EV/EW/EX/EY/K1/K2/K3/K4/FK4 /FK5/K5/K6/FK6/K7/FK7/K8/FK8 89-08										
			MT-09 SP ABS (MT850-D 847cc/3 Cyl Engine) 18-19					GSX 600 FJ/FK/FL/FM/FN/FP/FR/FS/FT/FV 88-97										
MT-09 Tracer 900 ABS (847cc/3 Cyl Engine) 15-19	GSX 750 FK/FL/FM/FN/FP/FR/FS/FT/FV 89-96																	
MT-09 Tracer 900 GT ABS (847cc/3 Cyl Engine) 18-19	MD3004	FRONT	F	GSXR 1100 G/H/J 86-88														
XSR 700 ABS (MTM 690-U) 16-18				MD3005	FRONT	F	GSXR 750 F/G/H/RG 85-87											
XSR 900 ABS (MTM 850) 16-19																		
XSR 900 Abarth ABS (MTM 850) 17-19																		
MD2121X							FRONT	F	YZF-R 125 (Radial F/Caliper/Non ABS) 14-16	290								
									YZF-R 125 A (Radial F/Caliper/ABS) 14-18									
									MT 125 (Non ABS) 14-16									
									MT 125 A (ABS) 14-19									
MD2122							REAR	S	YZF-R 125 (Radial F/Caliper/Non ABS) 14-16	230								
									YZF-R 125 A (Radial F/Caliper/ABS) 14-18									
	MT 125 (Non ABS) 14-16																	
	MT 125 A (ABS) 14-19																	
MD2123 MD2123C VR2123	REAR	S	YZF-R3 (321cc/ABS) 15-19	220														
			MTN 320 A (MT-03 321cc) 16-19															
MD2124X MD2124XC VR2124BLK VR2124BLU VR2124RED	FRONT	F	YZF-R6 17-19	320														
			YZF-R1 15-19															
			YZF-R1M 15-19															
			YZF-R1 (60th Anniversary Edition) 16															
			MT-10 (MTN 1000/998cc) 16-19															
			MT-10 Tourer Edition (998cc) 18-19															
MD2125 MD2125C VR2125	REAR	S	YZF-R1 15-19	220														
			YZF-R1M 15-19															
			YZF-R1 (60th Anniversary Edition) 16															
MD2126X MD2126XC VR2126BLK VR2126BLU VR2126RED	FRONT	F	MT-01 (1670cc) (4 piston caliper) 05-06	320														
			MD2127X MD2127XC VR2127BLK VR2127BLU VR2127RED		FRONT	F	MT-07 (Non ABS/689cc/ 2 Cyl) 14-16	298										
							MT-07A (ABS/689cc/ 2 Cyl) 14-17											
							MT-07 Motocage (ABS/689cc/ 2 Cyl) 15-18											
							MT-07 Motocage (Non ABS/689cc/ 2 Cyl) 14-16											
Tracer 700 (MTT 690) 16-18																		
MD2128X/XC VR2128BLK VR2128BLU VR2128RED	FRONT	F	MT-01 (6 piston radial caliper) 07-09	310														
			MT-01 S (6 piston radial caliper/5YUR) 09															

D = Dished Solid Original (We replace with floating rotor conversion unit) F = Floating Rotor S = Solid Rotor

DISC BUYERS GUIDE

STREETBIKE DISC BUYERS GUIDE

DISC No.	FRONT/ REAR	TYPE	MODELS	DIA (MM)	DISC No.	FRONT/ REAR	TYPE	MODELS	DIA (MM)																					
MD3006X MD3006XC MD3006CC VR3006BLK VR3006BLU VR3006RED VR3006CHBR	FRONT	F	GSF 250 N/ZM/P/NP/ZP/R/NR 92-96	310	MD3014LS MD3014RS VMD3014 Contd.	FRONT	D	GSX 400 LX/TX 81	276																					
			GSF 250 VS/VT/W/VVZ/VW/VX/VY (GJ77) Bandit 95-00					GS 425 EN 78-80																						
			GSX 250 SSM Katana 91					GS 450 ET/EG/EJ 80-88																						
			GSX 250 FL/FM/FN/FP/FR/FS/FT/FV /FW Across 90-98					GS 550 DB/DC/EC/EN 77-79																						
			GSF 400 M/N/P Bandit 91-95					GS 650 GTX/GTZ/GTD/GX/GZ 81-83																						
			GSR 400 K6 06					GR 650 D/XD Tempter 83																						
			SV 400 N (VK53A) 98					GS 750 DB/DC/EC/EN 77-80																						
			SV 400 SN (VK53A) 98					GSX 750 ET/EX 80-81																						
			GS 500 EK/EL/EM/EN/EP/ER/ES/ET/EV /EW/EX/EY/K1/K2/K3/K4/FK4/FK5 /K5/K6/FK6/K7/FK7/K8/FK8 89-08					GSX 750 SE Katana 85																						
			GSR 600 K6/K7/K8 06-08					GSX 750 SE 85																						
RF 900 RR/RS/RS2/RT/RV/RW 94-98	GS 850 GN/GT/GX 79-81																													
GSF 1200 T/V/W/X/Y (Naked Bandit) 4 Piston Caliper 96-00	GS 850 GZ/GE/GG 82-85																													
GSF 1200 ST/SV/SW/SX/SY (Faired Bandit) 4 Piston Caliper 96-00	GS 1000 HC/EC/EN/SN/ET 78-81																													
GSF 1200 K1-K5 (Naked Bandit) - 6 Piston Caliper 01-05	GS 1000 GT/GX 81-82																													
GSF 1200 SK1-SK5 (Faired Bandit) - 6 Piston Caliper 01-05	GSX 1000 SZ Katana 82																													
GSX 1200 FSW/FSX 'Inazuma' 98-99	GS 1100 GZ 82																													
					MD3014RS VMD3014	REAR	D	GS 550 EC/EN/ET/EX/EZ/LT/LX /MX/MZ 78-84	276																					
								XN 85 Turbo 83																						
								GS 750 DB/DC/EC/EN 77-80																						
								GSX 750 ET/EX 80-81																						
								GSX 750 S/SS Katana 84																						
								GSX 750 S-2/S-2C Katana 84																						
								GS 850 GN/GT/GX 79-81																						
								GS 1000 GT/GX 81-82																						
								GS 1000 HC/EC/EN/SN/ET 78-81																						
								GSX 1000 SZ Katana 82																						
								GSX 1100 ET/EX/EZ/ESD 80-83																						
								GSX 1100 SZ/SD 'Katana' 82-83																						
MD3007X MD3007XC VR3007BLK VR3007BLU VR3007RED	FRONT	F	TV 250 J/K/AK/L Wolf 88-90	310	MD3017LS	FRONT	S	LS 650 FG/PK/PM/PR/PG/PT/PV/PW/PX Savage 87-99	260																					
			GSXR 750 J/K/L/M/WN/WR/WS 88-95					MD3019LS MD3019RS VMD3019 BILLET		FRONT	D	GT 500 A/B 75-78																		
			GSXR 1100 K/L/M/N/WR/WS/WT 89-96									RE5 M/A 75-77																		
	GT 550 K/L/M/A/B 73-77																													
							GT 750 K/L/M/A/B 73-77																							
							GS 750 B 77																							
MD3008 MD3008C VR3008	REAR	S	RF 400 RP/RR/VR/RT/RVT/RV-V 93-97	240	MD3024LS/RS	FRONT	D	GSX 400 FW/FWS/FWS-2 84-87	260																					
			GSX 400 FSV/FSK1 Inazuma 00					MD3025		REAR	S	GSX 400 FW/FWS/FWS-2 84-87																		
			SV 400 N (VK53A) 98									GSX 550 ESD/ESE/EFE/ESH/ESG/EFF 81-83																		
			SV 400 SN (VK53A) 98									MD3027	REAR	S	GS 650 GTX/GTZ/GTD//GX/GZ 81-83															
			SV 400 X/Y/K1/K2 00-02												GS 850 GZ/GE/GG 82-85															
			SV 400 SX/SY/SK1/SK2 00-02												MD3028LS MD3028RS	FRONT	D	GS 1100 GZ 82												
			GSF 600 Y/K1/K2/K3/K4 (Naked Bandit) 00-04															XN 85 Turbo 83												
			GSF 600 SY/SK1/SK2/SK3/SK4 (Faired Bandit) 00-04															GS 700 EF/ESF 85												
			RF 600 RP/RR/RS/RT/RV 93-97															GSX 750 ESD/ESE/EFE/ESH/ESG/EFF 82-86												
			GSX 600 FW/FX/FY/FK1/FK2/FK3/FK4 98-04															GSX 750 S/SS Katana 84												
			GSF 650 K5/K6 Naked Bandit - Non ABS 05-06															GSX 750 S-2/S-2C Katana 84												
			GSF 650 SK5/SK6 Faired Bandit Non ABS 05-06															MD3029	REAR	D	GS 700 EF/ESF 85									
			GSF 650 S/T/V/W/X Naked Bandit 95-99																		GSX 750 SE Katana 85									
			GSX 650 ST/SV/SW/SX Faired Bandit 96-99																		GSX 750 ESD/ESE/EFE/ESH/ESG/EFF 82-86									
			SV 650 X/Y/K1/K2 Naked - Non ABS 99-02																		MD3030LS MD3030RS	FRONT	S	GV 1200 GLF/GLF2/GLG Madura 85-86						
			SV 650 SX/SY/SK1/SK2 Top Fairing - Non ABS 99-02																					MD3031LS (5 bolt)	FRONT	S	VS 700 GLFG/GLPG 86-87			
			GSX 750 FW/FX/FY/FK1/FK2/FK3/FK4 /FK5/FK6 98-06																								VS 750 GLF/GLPG/GLFG 85-90			
			GSXR 750 J/K/L/M/WN/WR/WS 88-95																								MD3032LS MD3032RS (6 bolt)	FRONT	SF	VS 400 VR/FR/VTR/FT/V-T/F-T Intruder 94-95
			GSX 750 W/X/Y/K1 98-03																											VS 600 GLS/GLT/GLV 95-97
			GSX 750 FK3/FK4/FK5/FK6 03-06																											VS 700 GLFH/GLPH 86-87
RF 900 RR/RS/RS2/RT/RV/RW 94-99	VS 750 GLFH/GLPH 'Intruder' Spoke Wheel 87																													
GSXR 1100 K/L/M/N/WR/WS/WT 89-96	VS 750 GLPK/GLPL/GLPM 'Intruder' 'Spoke wheel' 88-91																													
GSF 1200 FSW/FSX 'Inazuma' 98-99	VS 800 GLN/GLP/GLR/GLS/GLT /GLV/GLW/GLX 'Intruder' 92-99																													
GS 1200 SSK1/ZK1 01	VS 1400 GLPH/GLFJ/GLPJ/GLPR /GLPT/GLPV/GLPW/GLPX/GLPY /GLPK1 Intruder 87-02																													
RF 400 RP/RR/VR/RT/RVT/RV-V 93-97	MD3033LS	FRONT	S	VX 800 L/M/NP/R/T 90-96																										
GSX 400 FSV/FSK1 Inazuma 00				MD3036 BILLET	REAR	S	GSX 1100 FJ/FK/FL/FN/FM/FP/FR 89-94																							
GSF 1200 T/V/W/X/Y (Naked Bandit) 4 Piston Caliper 96-00																														
GSF 1200 ST/SV/SW/SX/SY (Faired Bandit) 4 Piston Caliper 96-00																														
GSF 1200 K1-K5 (Naked Bandit) - 6 Piston Caliper 01-05																														
GSF 1200 SK1-SK5 (Faired Bandit) - 6 Piston Caliper 01-05																														
GSX 1300 RX/RV/RK1/RK2/RK3/RZK3 /RK4/RK5/K6 99-06																														
MD3009							REAR	S	GSXR 750 F/G/H/RG 85-87	220	MD3010LS	FRONT	S	RB 50 H 'GSXR 50' 87	162															
									GSXR 1100 G/H/J 86-88																					
MD3014LS MD3014RS VMD3014							FRONT	D	GN 250 F/J/M/R/T 87-97	276	MD3033LS	FRONT	S	VX 800 L/M/NP/R/T 90-96	310															
									GT 250 K/L/M/N/A/B/C 73-78					MD3036 BILLET		REAR	S	GSX 1100 FJ/FK/FL/FN/FM/FP/FR 89-94												
									GSX 250 ET/EX/EZ 80-82																					
									GS 250 TT/TX 80-81																					
									RG 250 WD/WE 83-84																					
									GT 380 K/L/M/A/B 73-77																					
									GS 400 B/C 77-78																					
									GSX 400 ET/EX/EZ 81-83																					
									GN 400 TT 80																					

D = Dished Solid Original (We replace with floating rotor conversion unit) F = Floating Rotor S = Solid Rotor

DISC BUYERS GUIDE

STREETBIKE DISC BUYERS GUIDE

DISC No.	FRONT/ REAR	TYPE	MODELS	DIA (MM)	DISC No.	FRONT/ REAR	TYPE	MODELS	DIA (MM)	
MD3037LS/RS	FRONT	S	GSX 1100 GM/GN	91-94	310	MD3074	FRONT	S	GSX 250 R CH/H (GJ72A) GSXR 250 J (GJ72A) GSXR 250 CK	275
MD3038	REAR	S	GSX 1100 GM/GN	91-94	295	MD3075LS MD3075RS	FRONT	F	GSF 1200 SAV ABS Bandit	97
MD3039LS MD3039RS	FRONT	F	GSX 1100 EFE/EFF/ESE GSX 1100 FJ/FK/FL/FN/FM/FP/FR	84-86 89-94	276	MD3076	REAR	S	GSF 1200 SAV ABS Bandit	97
MD3039	REAR	F	GSX 1100 EFE/EFF/ESE	84-86	276	MD3078RS	FRONT	S	VL 1500 W/X/Y/K1 'Intruder Legendary Classic'	98-01
MD3041 BILLET	REAR	D	GV 1200 GLF/GLF2/GLG Madura	85-86	275	MD3079 BILLET	REAR	F	VL 1500 W/X 'Intruder Legendary Classic'	276 98-99
MD3042	FRONT	S	GV 1400 Cavalcade All models	85-88	275	MD3080RS	FRONT	F	SG 350 N 'Goose'	92
MD3043	REAR	S	GV 1400 Cavalcade All models	85-88	295	MD3081	REAR	S	RGV 250 J/K/L TV 250 J/K/AK/L Wolf SG 350 N 'Goose' GSXR 400 RL/RM/RN/RS (GK76A) GSXR 400 J/RR/RAK (GK73A)	88-90 88-90 92 90-95 88-90
MD3044	REAR	S	VS 1400 GLPH/GLFH/GLPJ/GLFJ/GLPR /GLPT/GLPV/GLPW/GLPX/GLPY/GLPK1 /GLPK2 Intruder	87-03	278	MD3082LS/RS	FRONT	F	RGV 250 T (RGVR 250 SP)	96
MD3045	FRONT	F	RG 125 FN/FP/FR (NF13A) Gamma RG 125 FUN/FUP/FUR (NF13B) Gamma RG 125 UN Wolf (NF13E) Naked RGV 250 M/N/P/R/S GSXR 400 RL/RM/RN/RS (GK76A) GSX 750 W/X/Y/K1 VZ 800 V/W/X/Y/K1/K2 'Marauder'	92-94 92-94 92-94 91-95 90-95 98-03 97-03	300	MD3083/C	REAR	S	GSX 1400 K1-K7/FE	01-07
MD3048LS	FRONT	S	RG 125 CG/CH/J Gamma (NF12A) RG 125 UCG/UCH/UJ/UJ/BUJ (NF12B) Gamma	86-90 86-90	260	MD3084	REAR	S	GSF 250 VS/VT/VV/WZ/VW/VX/VY (GJ77) Bandit GSF 400 S/V/S-V/VZ-V Bandit	95-00 95-97
MD3058X MD3058XC MD3058CC VR3058BLK VR3058BLU VR3058RED VR3058CHBR	FRONT	F	GSXR 600 V/W/X/Y/SY/K1-K3/ZK3 GSXR 750 T/V/W/X/Y/K1-K3 GSXR 1000 K1/K2 TL 1000 SV/SW/RW/SX/RX/RK1/SK1 GS 1200 SSK1/ZK1 GSX 1300 RX/RY/RK1/RK3/RZK3 /RK3/RK4/RK5/K6 'Hayabusa' GSX 1400 K1-K7/FE	97-03 96-03 01-02 97-02 01 99-06 01-07	320	MD3086 BILLET	REAR	F	VL 1500 Y/K1/K2/K3/K5-K8 Intruder Legendary Classic	00-03/05-08
MD3059	REAR	S	RG 125 FN/FP/FR (NF13A) Gamma RG 125 FUN/FUP/FUR (NF13B) Gamma RG 125 UN Wolf (NF13E) Naked RGV 250 M/N/P/R/S/T GSXR 250 J (GJ72A) GSXR 250 CK	92-94 92-94 92-94 91-96	210	MD3087LS MD3087RS	FRONT	S	VL 1500 K2/K3/K5/K6/K7/K8 Intruder Legendary Classic	02-03/05-08
MD3060 MD3060C VR3060	REAR	S	SV 400 K3/K4/K5 SV 400 SK3/SK4/SK5 GSXR 600 SV 650 K3-K9/L0 Naked Non ABS SV 650 SK3-SK9/SLO Top Fairing Non ABS GSXR 750 GSXR 1000 GSX-S 1000 AL5 (ABS) GSX-S 1000 FAL5 (ABS) SV 1000 K3/K4/K5/K6/K7 Naked SV 1000 SK3-SK7 Faired Model TL 1000 SV/SW/RW/SX/RX/SV/RY /RK1/SK1	03-05 03-05 97-20 03-10 03-15 96-20 01-20 15 15 03-07 03-07 97-02	220	MD3088X MD3088XC MD3088CC VR3088BLK VR3088BLU VR3088RED	FRONT	F	DL 650 K4/K5/K6 DL 1000 K2-K9/L0 SV 1000 K3-K8 Naked SV 1000 SK3-SK7 Faired Model	04-06 02-10 03-07 03-07
MD3061	REAR	S	VX 800 L/M/N/P/R/T	90-96	250	MD3089X MD3089XC MD3089CC VR3089BLK VR3089BLU VR3089RED	FRONT	F	GSXR 1000 K3	03
MD3064	REAR	S	RG 250 WD/WE RG 250 FG/CH/FCH/FH Gamma GSX 250 R CH/H (GJ72A) GSX 400 R2 (GK71B) GSX 400 R3 (GK71F) GSX 400 X/XA/XS Impulse RG 400 EWF/EW-2G/EWH Walter Wolf RG 500 G/CH GSXR 400 H	83-84 85-88 85-87 85-87 87	210	MD3090X MD3090XC MD3090CC VR3090BLK VR3090BLU VR3090RED	FRONT	F	SV 400 K3/K4/K5 SV 400 SK3/SK4/SK5 GSX 600 FK3/FK4/FK5/FK6 GSF 650 K5/K6 Naked Bandit - Non ABS GSF 650 SK5/SK6 Faired Bandit Non ABS SV 650 K3-K9/L0 Naked - Non ABS SV 650 SK3-SK9/SLO Top Fairing - Non ABS GSX 750 FK3/FK4/FK5/FK6 M 1500 (VZ 1500 K9/L0 - Intruder) C 1800 R (VLR 1800 K8/K9/L0/L1) (C 1800 R Intruder) (C 1800 RT) VLR 1800 K8RT/K9RT - Touring Intruder	03-05 03-05 03-06 05-06 05-06 03-10 03-15 03-06 09-13 08-13 08-10
MD3066LS/RS	FRONT	D	GSX 400 FX/FZ/FD	81-83	276	MD3091X MD3091XC MD3091CC VR3091BLK VR3091BLU VR3091RED VR3091CHBR	FRONT	F	GSXR 600 K6/K7 GSXR 750 K6/K7 GSXR 1000 K5/K6/K7/K8 M 1800 R2 (VZR 1800 NK8/NK9 Intruder - No Handlebar Cowling) M 1800 RZ (VZR 1800 ZK7/ZK8/ZL1/ZL2 Intruder - With Handlebar Cowling with central tape strip) M 1800 RB (VZR 1800 BZL4/BZL5 /BZL6/BZL7 - M 1800 RB VZR 1800 BZL4/BZL5/BZL6/BZL7/BZL8 - M1800 RB	06-07 06-07 05-08 08-09 07-13 14-18 14-18
MD3070LS/RS	FRONT	F	RG 500 G/CH RG 400 EWF/EW-2G/EWH Walter Wolf	85-87 85-87	260	MD3091CHBR	FRONT	F	GSXR 600 K6/K7 GSXR 750 K6/K7 GSXR 1000 K5/K6/K7/K8 M 1800 R2 (VZR 1800 NK8/NK9 Intruder - No Handlebar Cowling) M 1800 RZ (VZR 1800 ZK7/ZK8/ZL1/ZL2 Intruder - With Handlebar Cowling with central tape strip) M 1800 RB (VZR 1800 BZL4/BZL5 /BZL6/BZL7 - M 1800 RB VZR 1800 BZL4/BZL5/BZL6/BZL7/BZL8 - M1800 RB	06-07 06-07 05-08 08-09 07-13 14-18 14-18
MD3073LS	FRONT	SF	VS 700 GLEFG/GLEPG/GLEFH/GLEPH VS 750 GLEFH/GLEPH 'Intruder' 'Cast wheel'	86-87 87	296					

D = Dished Solid Original (We replace with floating rotor conversion unit) F = Floating Rotor S = Solid Rotor

DISC BUYERS GUIDE

STREETBIKE DISC BUYERS GUIDE

DISC No.	FRONT/ REAR	TYPE	MODELS	DIA (MM)	DISC No.	FRONT/ REAR	TYPE	MODELS	DIA (MM)																												
MD3092X MD3092XC MD3092CC VR3092BLK VR3092BLU VR3092RED	FRONT	F	GSR 400 K6/K7/K8 06-10	310	MD3093 MD3093C VR3093 Contd.		S	GSX 1250 FALO/FAL1/FAL2/FAL4 /FAL5/FAL6 10-16	240																												
			DL 650 AK7/AK8/AK9/ALO V-Strom ABS 07-11					GSX 1250 FAL0ST/FAL1ST Sports Touring 10-14																													
			DL 650 AL1XP V-Strom Xpedition 11					MD3095RS		FRONT	S	Intruder Volusia VL 800 K1-K5 01-05	300																								
			DL 650 AK9 GT V-Strom Traveller ABS 09-11									VL 800 K6/K7/K8/K9/LO/L1/L2/L3/L5 06-15																									
			DL 650 V-Strom ABS 12-20									C 800 C (VL 800 CK7/CK8/CK9/CL0/CL1 /CL2/CL3) Intruder (Cast wheel) 07-15																									
			DL 650 V-Strom ABS 15-20									VL 800 BTL4 C800 Intruder 14																									
			GSF 650 AK7/AK8/AK9/ALO/AL1/AL2 Naked Bandit - ABS 07-12									MD3096RS		FRONT	S	M 800 (VZ 800 K5-K9/LO/L1/L3 Intruder M800) 05-13	300																				
			GSF 650 SAK7/SAK8/SAK9/SALO/SAL1 /SAL2 Faired Bandit - ABS 07-15													M 800 L4/L5 Intruder M 800/T 14-15																					
			GSF 650 SK7/SK8/SK9/SLO/SL1/SL2 (Faired Bandit/Non ABS) 07-12													M 800 Z (VZ 800 K9Z - Intruder) 09-10																					
			GSF 650 K7/K8/K9/LO/L1/L2 (Naked Bandit/Non ABS) 07-12													MD3097 BILLET		REAR	F	VL 1500 K5/K6/K7/K8 (C 1500 Intruder) 05-08	275																
			GSX 650 FK8/FK9/FL0/FL1/FL2 Non ABS 08-14																	M 1500 (VZ 1500 K9/LO - Intruder) 09-13																	
			GSX 650 FAK8/FAK9/FALO/FAL1/FAL2 (ABS Model) 08-15																	C 1800 R (VLR 1800 K8/K9/LO/L1) (C 1800 R Intruder) 08-13																	
			GSR 750 L1/L2/L3/L4/L5/L6 (Non ABS) 11-16																	(C 1800 RT) VLR 1800 K8RT/K9RT - Touring Intruder 08-10																	
			GSR 750 AL2/AL3/AL4/AL5/AL6 (ABS) 11-16																	M 1800 R (VZR 1800 K6/K7/K8/K9 Intruder Handlebar Cowling) 06-09																	
			DL 1000 V-Strom (ABS) 14-20																	M 1800 R2 (VZR 1800 NK8/NK9 Intruder - No Handlebar Cowling) 08-09																	
			DL 1000 XT V-Strom (ABS) 14-20																	M 1800 RZ (VZR 1800 ZK7/ZK8/ZL1/ZL2/ZL3 Intruder - With Handlebar Cowling) 07-13																	
			GSF 1250 K6/AK6 Naked Bandit ABS & Non ABS 4 Piston 06																	M 1800 RB (VZR 1800 BZL4/BZL5 /BZL6/BZL7 - M 1800 RB 14-18																	
			GSF 1250 AK7/AK8 Naked Bandit ABS 4 Piston 07-08																	VZR 1800 BZL4/BZL5BZL6/BZL7/BZL8 - M1800 RB 14-18																	
			GSF 1250 K7/K8/K9/OLO Naked Bandit Non ABS 4 Piston 07-11																	MD3098X MD3098XC MD3098CC VR3098BLK VR3098BLU VR3098RED		FRONT	F	GSX 1300 RK8/RK9/RL0/RL1/RL2 08-12	310												
			GSF 1250 SK6/SAK6 Faired Bandit ABS & Non ABS 4 Piston 06																					GSX 1300 RAL3/RAL4/RAL5/RAL6/RAL7 /RAL8 Hayabusa 13-18													
			GSF 1250 SK7/SK8/SK9/SLO Faired Bandit Non ABS 4 Piston 07-12																					GSX 1300 BKK8/BKK9/BKLO/BKL1 B-King 08-12													
			GSF 1250 SAK7/SAK8/SAK9/SAZK9/SALO/SAL1 /SAL2/SAL4/SAL5/SAL6 (Faired Bandit - ABS Model - 4 Piston Caliper) 07-16																					MD3099 MD3099C VR3099		REAR	S	GSX 1300 RK8/RK9/RL0/RL1/RL2 08-12	260								
			GSX 1250 FALO/FAL1/FAL2/FAL4 /FAL5/FAL6 10-16																									GSX 1300 RAL3/RAL4/RAL5/RAL6/RAL7 /RAL8 Hayabusa (Brembo Calipers) 13-18									
			GSX 1250 FAL0ST/FAL1ST Sports Touring 10-14																									GSX 1300 BKK8/BKK9/BKLO/BKL1 B-King 08-12									
MD3093 MD3093C VR3093	REAR	S	GW 250 L3/ZL5 Inazuma 11-15	240	MD3100X MD3100XC VR3100BLK VR3100BLU VR3100RED	FRONT	F		GSX-R 600 08-20																			310									
			GW 250 FL5 Inazuma 15						GSX-R 750 08-20																												
			GSR 400 K6/K7/K8 06-08					GSX-S 750 17-20																													
			GSR 600 K6/K7/K8 06-09					MD3101X MD3101XC	FRONT	F	GSF 650 AK5/AK6 05-06		290																								
			GSF 650 SAK5/SAK6 Faired Bandit - ABS 05-06								GSF 650 SAK5/SAK6 05-06																										
			GSF 650 K7/K8/K9/OLO Naked Bandit - Non ABS 07-11								MD3102X MD3102XC VR3102BLK VR3102BLU VR3102RED																			FRONT	F	GSXR 1000 K9/LO/L1 09-11	310				
			GSF 650 SK7/SK8 Faired Bandit - Non ABS 07-08									GSXR 1000 L2/L3/ZL3/L4/L4/L5/AL5 /AL6/L6/L7 (Brembo Caliper) 12-17																									
			GSF 650 AK5/AK6 Naked Bandit - ABS 05-06									MD3103X MD3103XC		FRONT	F		SFV 650 K9/LO/L1/L2/L3/L4/L5 Gladius 09-15															290					
			GSF 650 AK7/AK8/AK9/ALO/AL1/AL2 Naked Bandit - ABS 07-09														SFV 650 AK9/ALO/AL1/AL2/AL3/AL4 /AL5 (ABS) 09-15																				
			GSF 650 SAK7/SAK8/SAK9/SALO/SAL1 /SAL2 Faired Bandit - ABS 07-15													SFV 650 AK7/AK8/AK9/ALO Naked - ABS 07-10																					
			GSF 650 SK7/SK8/SK9/SLO/SL1/SL2 (Faired Bandit/Non ABS) 07-12													SV 650 SAK7/SAK8/SAK9/SALO 07-15																					
			GSF 650 K7/K8/K9/LO/L1/L2 (Naked Bandit/Non ABS) 07-12													SV 650 AL7/AL8/AL9 (ABS) 16-20																					
			GSX 650 FK8/FK9/FL0/FL1/FL2 Non ABS 08-14													SV 650 XAL8/XAL9 (ABS) 18-19																					
			GSX 650 FAK8/FAK9/FALO/FAL1 /FAL2 (ABS Model) 08-15													MD3104X MD3104XC VR3104BLK VR3104BLU VR3104RED	FRONT	F	GSXR 600 K4/K5 04-05		300																
			SFV 650 K9/LO/L1/L2/L3/L4/L5 Gladius 09-15																GSXR 750 K4/K5 04-05																		
			SFV 650 AK9/ALO/AL1/AL2/AL3/AL4 /AL5 (ABS) 09-15																GSXR 1000 K4 04																		
			SV 650 AK7/AK8/AK9/ALO Naked - ABS 07-10																MD3105LS															FRONT	S	GW 250 L3/ZL5 Inazuma 13-15	290
			SV 650 SAK7/SAK8/SAK9/SALO 07-15																																	GW 250 FL5 Inazuma 15	
			SV 650 AL7/AL8/AL9 (ABS) 16-19																	MD3106X VR3106		REAR	S		GSXR 1000 (Brembo Caliper/ABS) 15-20											220	
			SV 650 XAL8/XAL9 (ABS) 18-19																						GSXR 1000 17-20												
			GSR 750 L1/L2/L3/L4/L5/L6 (Non ABS) 11-16																						MD3107X MD3107XC VR3107BLK VR3107BLU VR3107RED												
			GSR 750 AL2/AL/AL4/AL5/AL6 (ABS) 11-16																																		
			GSF 1250 K6/AK6 Naked Bandit ABS & Non ABS 4 Piston 06																																		
			GSF 1250 AK7/AK8 Naked Bandit ABS 4 Piston 07-08																																		
GSF 1250 K7/K8/K9/OLO Naked Bandit Non ABS 4 Piston 07-11																																					
GSF 1250 SK6/SAK6 Faired Bandit ABS & Non ABS 4 Piston 06																																					
GSF 1250 SAK7/SAK8/SAK9/SAZK9/SALO/SAL1 /SAL2/SAL4/SAL5/SAL6 (Faired Bandit - ABS Model - 4 Piston Caliper) 07-16																																					
GSF 1250 SAK7/SAK8/SAK9/SAZK9 /SALO/SAL1/SAL2/SAL4/SAL5/SAL6 (Faired Bandit - ABS Model - 4 Piston Caliper) 07-16																																					
GSF 1250 SK7/SK8/SK9/SLO Faired Bandit Non ABS 4 Piston 07-10																																					

D = Dished Solid Original (We replace with floating rotor conversion unit) F = Floating Rotor S = Solid Rotor

STREETBIKE DISC BUYERS GUIDE

DISC No.	FRONT/ REAR	TYPE	MODELS	DIA (MM)	DISC No.	FRONT/ REAR	TYPE	MODELS	DIA (MM)
MD3108 MD3108C VR3108	FRONT	S	GSX-S 1000 (Naked/Non ABS) 16-20 GSX-S 1000 (Naked/ABS) 16-20 GSX-S 1000 (Faired/Non ABS) 16-20 GSX-S 1000 (Faired/ABS) 16-20 GSX 1000 Katana 20		MD4009 MD4009C VR4009	REAR	S	ZXR 400 L1-L9 91-03 ZXR 400 H1/H2/J1/J2 89-90 ZXR 400 (M1-M4) 91-94 ZX-4 (ZX 400 G1/G1A/G1B) 88 ZR 400 Zephyr 97-01 ZR 400 Zephyr (G2/G3/G3A/G4/G5) 97-01 ZZR 400 (ZX 400 N1-N7) 93-99 ZR 550 B2-B6 91-98 ZZR 600 E1-E13 93-05 ZZR 600 (ZX 600 E6F) 06-07	240
MD3109X MD3109XC VR3109BLK VR3109BLU VR3109RED	FRONT		GSX-S 1000 (Naked/Non ABS) 16-20 GSX-S 1000 (Naked/ABS) 16-20 GSX-S 1000 (Faired/Non ABS) 16-20 GSX-S (Faired/ABS) 16-20 GSX 1000 Katana 20		MD4010LS MD4010RS	FRONT	S	Z 250 A3 81 Z 400 J2-J3 81-83 Z 440 D5-D6 'Ltd' 83-84 Z 440 C2/H1-H2 81-83 Z 550 A2-A3 81-82 Z 550 C1-C2 Ltd 82-84 GPZ 550 D1 82 Z 650 F2-F4 81-83 VN 700 A1 'Vulcan' 85 Z 700 A1 Ltd 84 Z 750 E1 80 GPZ 750 R1 82 GT 750 P1-P9 82-96 Z 750 H1-H2 Ltd 80-81 Z 750 N1/N2 Spectre 82-83 Z 750 L1-L4 81-84 VN 750 A2-A5/10 86-94	260
MD3110C	FRONT	S	GSX-R 125 18-20 GSX-S 125 18-20 GSX-R 150 17-20 GSX-R 150 18-20 GSX-S 150 18-20	290					
MD3111 MD3111C	REAR	S	GSX-R 125 18-20 GSX-S 125 18-20 GSX-R 150 17-20 GSX-R 150 RF 17-20 GSX-R 150 18-20 GSX-S 150 18-20	190					
MD3112C	FRONT	S	DL 250 V-Strom (ABS) 18-20 GSX 250 RL7/RL8 17-18	290					
MD3113C	REAR	S	DL 250 V-Strom (ABS) 18-20 GSX 250 RL7/RL8 17-18	240					
MD4001	REAR	S	Z 400 C2/C3 (Z 400 F2) 85-87 GPZ 550 A1-A4 84-87	260					
MD4002LS MD4002RS	FRONT	S	EL 252 F2 (EL 250 F2/F5/F6) 96-03 EL 250 D1-D5 90-94 EL 250 'Eliminator' 87-89 GPX 250 R (EX 250 E) 86 GPZ 550 A1-A4 84-87	260					
MD4005	FRONT	F	ZXR 400 L1-L9 91-03 ZXR 400 R (ZX 400 M1-M4) 91-94	310					
MD4006LS MD4006RS	FRONT	S	EN 450 A1-A5 (LTD 454) 86-89 EN 500 A1-A3 90-93 GT 550 G1-G9 83-01 Z 1000 J1/J2 81-82 Z 1000 K1/K2 LTD 81-82 Z 1000 K1 'Ltd' 83 GPZ 1100 B1 82 Z 1100 D1/D2 'Spectre' 82-83 Z 1100 A1-A3 81-83	270					
MD4007 MD4007C VR4007	REAR	S	ZZR 400 (ZX 400 K1/2/3) 90-92 ZZR 600 D1-D3 90-93 GPX 750 R F1-F3 87-89 ZR 750 C1-C5/D1 Zephyr 91-98	230					
MD4008X MD4008XC VR4008BLK VR4008GRN MD4008CC	FRONT	F	GSX 250 FXK2/K3-K5 (ZR 250 C) 02-05 KR-1S (KR 250 C2/C3) 90-92 ZR 250 A1-A5 91-95 ZR 250 B6 (Balius-II) 02 ZXR 250 A1/A2/B1/B2 89-90 ZZR 250 (EX 250 H1-H13) 90-03 ZL 400 D1/D2 94-95 ZRX 400 (ZR 400 E1-E7) 94-01 ZXR 400 H1/H2 89-90 ZXR 400 J1/J2 89-90 ZZR 400 (ZX 400 K1-K3/N1-N7) 90-99 ZR 550 B2-B6 91-99 ZX6-R F1-F3 95-97 ZL 600 B1 95-97 EJ 650 A1/C3-C7 (E650) 00-05 ZR 750 C1-C5/D1 Zephyr 92-95 EJ 800 (W 800 Cafe Style/Cockpit Fairing) 11 EJ 800 ACFA (W 800 Special Edition Black Exhaust/Gold Rims) 12 W 800 (EJ 800 ADF/AEF/AFF/AGF) 13-16 W 800 Special Edition (EJ 800 ADFA /AEFA/AFFA/AGFA) 13-16 GPZ 900 A7/A8 90-96 GPZ 900 R (ZX 900 A11) 98 ZG 1000 A9-A18 94-03 GPZ 1100 E1/E2/F1 95-98	300					
					MD4012X MD4012XC MD4012CC VR4012BLK VR4012GRN	FRONT	F	ZXR 750 H1-H2 89-90 ZX9R (ZX 900 E1/E2) 00-01 ZR 1100 A1-A4 'Zephyr' 92-95 ZR 1100 B1 'Zephyr' 96-97 ZZR 1100 C1-C3 90-92 ZRX 1100 C1-C4 97-00 ZR 1100 B5 02 ZX 1200 A1-A5/A6F/B1-B3 01-08	310
					MD4013 MD4013C VR4013	REAR	S	ZXR 750 H1/H2/K1/K2/J1/J2/M1/M2 /L1-L3/P1-P7/N1/N2 89-03 ZX 9R (ZX 900 B1-B4) 94-97	230
					MD4014 MD4014C VR4014	REAR	S	ZZR 1100 D1-D9 93-01	250
					MD4015 MD4015C VR4015	REAR	S	FX 400 R (ZX 400 E1-E3) 86-88 GPZ 400 R (ZX 400 D1/D3/D3A) 85-87 GPZ 600 R A1-A5A 85-89 GPZ 900 A7-A8 90-96 GPZ 900 R (ZX 900 A11-15) 98-02 ZX 1000 B1-B3 (ZX10) 88-90 ZZR 1100 C1-C3 90-92	250
					MD4016	FRONT	S	ZL 400 A 'Eliminator' 86-87 ER-5 (ER 500 A1/A2/A3/A4/C1-C5P) 97-07 GPZ 500 'S' (EX 500 A1-A6/D1-D9) 87-02 GPZ 750 R G2-G3 85-86 GPZ 750 E1/E2 Turbo 84-87 GPZ 900 R A1-A6 84-89 ZL 900 A1/A2 'Eliminator' 85-86 GPZ 1000 RX (A1-A3) 86-88 ZL 1000 A1 87 GPZ 1100 A1-A3 83-85	280
					MD4017 BILLET	REAR	S	GPZ 750 E1/E2 Turbo 84-87 GPZ 750 R G2-G3 85-86 GPZ 900 R A1-A6 84-89 ZL 900 A1/A2 'Eliminator' 85-86 ZL 1000 A1 87 GPZ 1100 A1-A3 83-85	270
					MD4019 BILLET	REAR	S	GPZ 750 A1-A5 83-87 GPZ 1000 RX A1-A3 86-88	260
					MD4021	FRONT	S	ZX 1000 B1-B3 (ZX10) 88-90	300
					MD4022X MD4022XC MD4022CC VR4022BLK VR4022GRN	FRONT	F	ZXR 750 K1/K2/J1/J2/M1/M2/L1-L3 /P1-P7/N1/N2 91-03 ZX-9R B1-B4 94-97 ZX9R (ZX 900 F1/F2) 02-04 ZZR 1100 D1-D9 93-01 ZX12R (A1/A2/B1/B2/B3) 00-04 ZZR 1200 C1H/C2H 02-04 VN 1500 P1/P2 Mean Streak 02-04 M 1600 (VZ 1600 K4/K5 Intruder) 04-05 VN 1600 B1/B2/B2H/B6F/B7F Mean Streak 04-08	320

D = Dished Solid Original (We replace with floating rotor conversion unit)

F = Floating Rotor

S = Solid Rotor

STREETBIKE DISC BUYERS GUIDE

DISC No.	FRONT/ REAR	TYPE	MODELS	DIA (MM)	DISC No.	FRONT/ REAR	TYPE	MODELS	DIA (MM)
MD4023 MD4023C VR4023	REAR	S	ZX-6R F1-F3 95-97 ZX12R (A1/A2/B1/B2/B3/B4/B6F) 00-06	230	MD4076LS/RS VMD4076	FRONT	D	Z 1000 D1-D3 (ZIR) 78-79	298
MD4024	REAR	S	GPZ 550 H1-H2 82-83	260	MD4077 VMD4077	REAR	D	Z 1000 D1-D3 (ZIR) 78-79 Z 1000 A1-A4 77-80 Z 1000 H1 80	290
MD4026LS MD4026RS	FRONT	S	GPX 600 R C1-C7 88-96	260	MD4078LS/RS VMD4078	FRONT	D	Z 1000 ST E1-E2 79-82	286
MD4027 MD4027C VR4027	REAR	S	GPX 400 R (ZX 400 F1) 87 GPX 600 R C1-C7 88-96 ZR 1100 A1-A4 Zephyr 92-95 ZR 1100 B1 96-97 ZR 1100 B5 02	240	MD4082	REAR	S	ZG 1000 A1-A7 86-93 ZG 1000 A9-A18 94-03	280
MD4028	FRONT	S	Z 400 C2/C3 (Z 400 F2) 85-87 GPZ 600 R A1-A5A 85-89 GPZ 750 A1-A5A 83-87 ZG 1000 A1-A7 86-93	270	MD4085	REAR	S	VN 900 A6F Classic 06 VN 900 Vulcan Classic (Spoke wheel) 07-19 VN 900 Vulcan Classic Special Edition (Spoke wheel) 11-19 VN 900 Vulcan Custom (Cast wheel) 07-19	270
MD4032	REAR	S	GPX 250 R (EX 250 E) 86	240	MD4089LS/RS VMD4089	FRONT	D	Z 1300 A1-A5 79-83 ZG 1300 A1-A3 84-86	299
MD4038	FRONT	S	Z 1000 J3 83 Z 1000 R1/R2 (Eddie Lawson Replica) 82-83 GPZ 1100 B2 83 Z 1100 R1 84	280	MD4090	REAR	S	Z 1000 ST E1-E2 79-82 Z 1300 A1-A5 79-83 ZG 1300 A1-A3 84-86	290
MD4040LS	FRONT	S	AR 50 A1/C2-C10 81-97 AR 80 A1/C1-C8 81-91	210	MD4094LS	FRONT	SF	VN 1500 B2-B6 88-92	300
MD4041RS	FRONT	S	GPX 250 R (EX250 F) 87 GPX 250 R 88-95	260	MD4095X MD4096	FRONT REAR	F S	KR-1 (KR 250 B2) 89 KR-1 (KR 250 B2) 89 KR-1S (KR 250 C2-C3) 90-92	280 210
MD4042	REAR	S	GPX 250 R 88-95 GPX 250 R (EX 250 F/G) 87-88	230	MD4099	FRONT	S	AR 125 A1-A7/B1-B8 82-94 ER 250 B1-B3 83-88 GPZ 550 H1-H2 82-83	260
MD4043LS/RS	FRONT	F	Z 750 Y1 Ltd 82	260	MD4105LS MD4105RS	FRONT	S	KH 100 G5-G8 (EX) 84-87 KH 125 L1 (EX) 84 GPZ 305 A1/B1-B10 83-96	240
MD4047LS MD4047RS	FRONT	D	Z 400 J1 80 Z 440 A2 'Ltd' 79 Z 440 D4 'Ltd' 82 Z 500 B1-B2 79-80 Z 550 A1 80	278	MD4108LS MD4108RS	FRONT	S	ZR 400 A1/B1 83-84 ZR 550 A1-A2 (Z 550 F) 83-84	270
MD4051 MD4051C	REAR	S	GSX 250 FXK2/K3-K5 (ZR 250 C) 02-05 ZXR 250 A1/A2/B1/B2 89-90 ZR 250 A1-A5 91-95 ZR 250 B6 Balius-II 02 ZXR 250 C1-C3/D1 91-95 GPZ 500 'S' (EX 500 D1-D7) 94-01 GPZ 500 S (EX 500 E1-E10) 94-04	230	MD4117	REAR	S	ZZR 250 (EX 250 H1-H13) 90-03	220
MD4052LS MD4052RS VMD4052	FRONT	D	Z 650 B1/B2/B3 79-81 Z 650 F1 80 Z 900 A4 77	296	VMD4123	FRONT	F	KH 400 A3/A4/A5 76-78	278
MD4054 BILLET 7mm disc thickness	REAR	S	Z 1000 J1-J3 81-83 Z 1000 R1/R2 (Eddie Lawson Replica) 82-83 Z 1000 K1/K2 LTD 81-82 GPZ 1100 B1-B2 82-83 Z 1100 A1-A3 81-83 Z 1100 D1/D2 'Spectre' 82-83 Z 1100 R1 84 VN 1500 A6 92 VN 1500 B2-B6 88-92	270	MD4124LS	FRONT	F	EN 500 B1-B2/C1-C9 94-04 VN 800 A1-A3 95-99 VN 1500 C1-C2 94-95 VN 1500 A6 92 VN 1500 N1/N2/N3 00-02	299
MD4059LS/RS VMD4059	FRONT	D	Z 650 C1/C2/C3 77-79 Z 650 D2/D3 79-80	276	MD4125LS	FRONT	S	VN 800 B1-B10/B6F Classic 96-06 VN 800 C1/C2/E1/E2/E3 Drifter 99-04 VN 1500 J1/J2/R1/R2/R3/N1/N2/N3 99-04	300
MD4062 BILLET	REAR	D	Z 650 C1/C2 77-78	276	MD4128 BILLET	REAR	S	VN 1500 C1-C2 94-95 VN 1500 D1/D2/E1/F2 96-99	270
MD4063 VMD4063	REAR	D	Z 650 (D2/D3-SR) 79-80	276	MD4130 MD4130C VR4130	REAR	S	GPZ 1100 E1/E2/F1 95-98	250
MD4064LS/RS VMD4064	FRONT	D	Z 1000 A1-A4 77-80 Z 1000 H1 80	296	MD4131LS	FRONT	F	VN 1500 D1/D2/E1/E2 96-99	299
MD4067LS MD4067RS	FRONT	S	ZN 700 A1/A2 'Ltd' 84-85	270	MD4132X MD4132XC VR4132BLK VR4132GRN	FRONT	F	GPZ 1100 F1 96-98	300
MD4068	REAR	S	ZN 700 A1/A2 'Ltd' 84-85	260	MD4133 MD4133C VR4133	REAR	S	ZRX 1100 C1/C2/C3/C4 97-00 ZRX 1200 A1-A5/A6F 01-07 ZRX 1200 B1-B3 01-03 ZZR 1200 C1H/C2H 02-04	250
MD4069LS/RS VMD4069 BILLET	FRONT	D	Z 900 Z1A/Z1B 74-76 H2/H2-A Mach IV (750cc) 72-73 H2-B/H2C Mach IV (750cc) 74-75 HI D/E/F 500 73-75	296	MD4134	FRONT	F	ZX-4 (ZX 400 G1/G1A/G1B) 88	300
MD4071LS MD4071RS	FRONT	S	GPX 750 R F1-F3 87-89	270	MD4135LS MD4135RS	FRONT	S	GPZ 400 R (ZX 400 D/D3/D3A) 85-87 ZL 400 B 'Eliminator 400 SE' 88 FX 400 R (ZX 400 E1-E3) 86-88	270
					MD4136X MD4136XC MD4136CC VR4136BLK VR4136GRN	FRONT	F	ZX6R (ZX 600 G1/G2/J1/J2) 98-01 ZX6R (ZX 636 A1P) 636cc 02 ZX9R (ZX 900 C1/C2) 98-99	300
					MD4137RS	FRONT	S	BN 125 A1-A5/A6F/A7F Eliminator 98-07	260

DISC BUYERS GUIDE

STREETBIKE DISC BUYERS GUIDE

DISC No.	FRONT/ REAR	TYPE	MODELS	DIA (MM)	DISC No.	FRONT/ REAR	TYPE	MODELS	DIA (MM)	
MD4138 MD4138C VR4138	REAR	S	ZX6R (ZX 600 G1/G2/J1/J2) 98-01 ZX6R (ZX 636 A1P/B1/B2) 636cc 02-04 ZX-6R (ZX 636 C1/C6F) 05-06 ZX6R (ZX 600 P7F/P8F) 07-08 ZX6R (ZX 600 R9F/RAF/RBF/RCF/RDF /REF/RFF/RGF (599cc)) 09-16 ZX6RR (ZX 600 K1/M1) 03-04 ZX-6RR (ER6-f ZX 600 N1/N6F) 05-06 ER-6f (ECF/EDS/EEF/EF/EGF) Non ABS 12-16 ER-6n (ER 650 A6F/A7F/A8F/C9F /CAF/CBF) 06-11 ER-6n (ECF/EDF/EEF/EF/EGF) (Non ABS) 12-16 KLE 650 A7F/A8F/A9F/CAF Versys 07-10 650 (KLE 650 CBF/CCF/DCF) Versys Non ABS 11 Z 750 (ZR 750 J1/J2/J6F) 04-06 Z 750 S (ZR 750 K1/K6F) 05-06 ZX9R (ZX 900 E1/E2) 00-01 ZX9R (ZX 900 F1/F2) 02-04 ZX10R (ZX 1000 C1/C2/D6F) 04-06 ZX10R (ZX 1000 E8F/E9F/FAF) 08-10 Z 1000 (ZR 1000 A1/A2/A3/A6F) 03-06	220	MD4154X MD4154XC MD4154CC VR4154BLK VR4154GRN	FRONT	F	Z 1000 (ZR 1000 A1-A3/A6F) 03-06 ZX12R B3/B4/B6F 04-06	300	
MD4140LS MD4140RS	FRONT	S	GPX 400 R (ZX 400 F1) 87	270	MD4155X MD4155XC MD4155CC VR4155BLK VR4155GRN VR4155CHGR	FRONT	F	Ninja ZX-6R (ZX 636 Non ABS-636cc) 13-20 Ninja ZX-6R (ZX 636 Non ABS/KRT Edition-636cc) 16-20 Ninja ZX-6R (ZX 636-ABS-636cc) 13-20 Ninja ZX-6R (ZX 636 ABS/KRT Edition-636cc) 16-20 ZX 6R 30 th Anniversary Edition Non ABS (ZX 636 EFFA) 15 ZX 6R 30 th Anniversary Edition ABS (ZX 636 FFFA) 15 Z 800 ADS/AEF/AFF/AGF (Non ABS) 13-16 Z 800 BDS/BEF/BFF/BGF (ABS Model) 13-16 Z 800 E CDS/CEF/CF/CGF (Non ABS) 13-16 Z 800 E DDS/DEF/DF/DGF (ABS Model) 13-16 GTR 1400 (ZG 1400 A8F/A9F/CAF/CBF/CCF/DCF/CEF /EEF/EGF/EHF/EKF) 08-18 ZZR 1400 (ZX 1400 A6F/A7F) 06-07 ZZR 1400 ABS (ZX 1400 B6F/B7F/D8F/D9F/DAF/DBF) 06-11 ZZR 1400 FCF/FDF/FEF/FFF/HGF /HHF/HJF/HKF (ABS) 12-19 ZZR 1400 Special Edition 12-20 ZZR 1400 Performance Sport (ZX 1400) 16-20	310	
MD4141X MD4141XC MD4141CC	FRONT	F	ZR-7 (ZR 750 F1/F3/F5) 99-04 ZR-7S (ZR 750 H1/H3) 01-04 ZZR 600 D1-D3 90-93 Z 750 S K1/K6F/J1/J2/J6F Naked	300	MD4156X	FRONT	F	ER-6f (ABS Model) (EX 650 B6F/B7F/B8 /D9F/DAF) 06-10 ER-6n (ABS Model) (ER 650 B6F/B7F/ B8F/D9F/DAF) 06-10 ER-6F (FCF/FDS/FEF/FFF/FGF) (ABS) 12-16 ER-6n (FCF/FDF/FEF/FFF/FGF) (ABS) 12-16 KLE 650 B7F-B9F/DAF Versys ABS 07-10 Z 750 ABS (ZR 750 M7F/M8F/M9F /MAF/MBF) 07-11 650 Versys (ABS Model) 11-20	300	
MD4142 MD4142C	REAR	S	ZR-7 (ZR 750 F1/F3/F5) 99-04 ZR-7S ZR 750 H1/H3 01-04	240	MD4156AXC (With ABS ring fitted)	FRONT	F	ER-6F (ABS Model) (EX 650 B6F/B7F/B8F/D9F/DAF/DBF) 06-11 ER-6F (FCF/FDS/FEF/FFF/FGF) (ABS) 12-16 ER-6n (ABS Model) (ER 650 B6F/B7F /B8F/D9F/DAF/DBF) 06-11 ER-6n (FCF/FDF/FEF/FFF/FGF) (ABS) 12-16 KLE 650 B7F-B9F/DAF/DBF Versys ABS 07-11 650 Versys (ABS Model) 11-20	300	
MD4143LS MD4143RS	FRONT	S	GPZ 400 R D4 88	280	MD4157C VR4157	REAR	S	Z 750 (ZR 750 L7F/L8F/L9F/LAF/LBF) 07-11 Z 750 ABS (ZR 750 M7F/M8F/M9F /MAF/MBF) 07-11 Z 750 R Non ABS (ZR 750 NBF/NCF) 11-12 Z 750 R ABS (ZR 750 PBF/PCF) 11-12 Z 800 ADS/AEF/AFF/AGF (Non ABS) 13-16 Z 800 BDS/BEF/BFF/BGF (ABS Model) 13-16 Z 800 E CDS/CEF/CF/CGF (Non ABS) 13-16 Z 800 E DDS/DEF/DF/DGF (ABS Model) 13-16 Z 800 ADS/AEF/AFF/AGF (Non ABS) 13-16 Z 800 BDS/BEF/BFF/BGF (ABS Model) 13-16 Z 800 E CDS/CEF/CF/CGF (Non ABS) 13-16 Z 800 E DDS/DEF/DF/DGF (ABS Model) 13-16 KLZ 1000 ACF/ADF/AEF Versys 12-14 Z 1000 (ZR 1000 B7F/B8F/B9F) 07-09 Z 1000 ABS (ZR 1000 C7F/C8F /C9F/CAF/CBF) 07-11 Z 1000 SX (ZX 1000 GBF/GCF /GDF) Non ABS Model 11-13 Z 1000 SX (ZX 1000 HBF/HCF/HDF) (ABS) 11-13 Z 1000 SX (ZX 1000 LEF/LFF/LGF) Non ABS 14-16 Z 1000 SX (ZX 1000 MEF/MFF /MGF/WHF/WJF- ABS Model) 14-18 Z 1000 SX (ZX 1000 LEF/LFF/LGF - Non ABS Model) 14-16 Z 1000 DAF/DAS/DBF/DCF/DCFA/DDF /DDFA (Non ABS/300mm Discs) 10-13 Z 1000 EAF/EBF/ECF/ECFA/EDF/EDFA (ABS/300mm Discs) 10-13	250	
MD4144	FRONT	S	GPZ 500 S (EX 500 B1-B5) 88-93 GPZ 500 S (EX 500 E1-E10) 94-04	270	MD4153X MD4153XC MD4153CC VR4153BLK VR4153GRN	FRONT	F	ZZR 600 E1-E13 93-05 ZZR 600 (ZX 600 E6F) 06-07	300	
MD4146 MD4146C	REAR	S	VN 1500 P1/P2 03-04 VN 1600 A1/A2/A3/A6F 03-08 VN 1600 B1/B2H/B6F/B7F (Mean Streak) 04-08 VN 1600 D1H/D6F Classic Tourer 05-08 M 1600 (VZ 1600 K4/K5 Intruder) 04-05	300						
MD4147	REAR	S	VN 1500 G1/G2/L1/L2/L3/L4 98-03	320						
MD4148	REAR	S	VN 800 C1/C2/E1/E2/E3 99-04 VN 1500 J1/J2/R1/R2/R3/N1/N2/N3 99-04	270						
MD4149LS/RS	FRONT	F	ZXR 250 C1/C2/C3/D1 91-95	300						
MD4150	FRONT	S	VN 1500 G1/G2 98-99 VN 1500 L1/L2/L3/L4 00-03	280						
MD4151X MD4151XC	FRONT	F	ZX6RR (ZX 600 K1/M1) 03-04 ZX6R (ZX 636 B1/B2) 03-04	280						
MD4152XC MD4152CC VR4152BLK VR4152GRN	FRONT	F	ZX-6RR (ZX 600 N1/N6F) 05-06 ZX-6R (ZX 636 C1/C6F) 05-06 ZX-6R (ZX 600 P7F/P8F) 07-08 ZX-6R (ZX 600 R9F/RAF/RBF/RCF/RDF /REF/RFF/RGF - 599cc) 09-16 Z 750 R Non ABS (ZR 750 NBF/NCF) 11-12 Z 750 R ABS (ZR 750 PBF/PCF) 11-12 ZX10R (ZX 1000 C1/C2/D6F/D7F) 04-07 Z 1000 (ZR 1000 B7F/B8F/B9F) 07-09 Z 1000 ABS (ZR 1000 C7F/C8F/C9F) 07-09 Z 1000 Black Edition (ZR 1000 DCFA /DDFA/FEFA) 12-15 Z1000 (ZR 1000 DAF/DBF/DCF/DDF /FEF/FFF) 10-15 Z 1000 Special Editin (ZR 1000 GEFA) 14 Z 1000 SX (ZX 1000 HBF/HCF/HDF ABS) 11-13 Z 1000 SX (ZX 1000 GBF/GCF/GDF - Non ABS Model) 11-13 Z 1000 SX (ZX 1000 MEF/MFF /MGF/WHF/WJF- ABS Model) 14-18 Z 1000 SX (ZX 1000 LEF/LFF/LGF - Non ABS Model) 14-16 Z 1000 DAF/DAS/DBF/DCF/DCFA/DDF /DDFA (Non ABS/300mm Discs) 10-13 Z 1000 EAF/EBF/ECF/ECFA/EDF/EDFA (ABS/300mm Discs) 10-13	300						

STREETBIKE DISC BUYERS GUIDE

DISC No.	FRONT/ REAR	TYPE	MODELS	DIA (MM)	DISC No.	FRONT/ REAR	TYPE	MODELS	DIA (MM)
MD4157C VR4157 Contd.	REAR	S	Z 1000 DAF/DAS/DBF/DCF/DCFA/DDF /DDFA (Non ABS/300mm Discs) 10-13 Z 1000 EAF/EBF/ECF/ECFA/EDF /EDFA(ABS/300mm Discs) 10-13 Z 1000 FEF/FEFA/FFF/FGF (Non ABS/310mm Discs) 14-16 Z 1000 GEF/GEFA/GFF/GGF/HHF/HJF (ABS/310mm Contour Discs) 14-18 ZZR 1400 (ZX 1400 A6F/A7F) 06-07 ZZR 1400 ABS (ZX 1400 B6F /B7F/D8F/D9F/DAF/DBF/FCF) 06-12 ZZR 1400 (ABS) 12-20 ZZR 1400 Special Edition 13-20 ZZR 1400 Performance Sport 16-20	250	MD4165C MD4165 VR4165 Contd.	REAR	S	ZX 10 R (ZX 1000 JBF/JCF/JDF /JEF/JFF) 11-15 ZX 10 R ABS (ZX 1000 KBF/KCF/KDF /KEF/KFF) 11-15 ZX10R 30th Anniversary Edition Non ABS (ZX 1000 JFFA) 15 ZX10R 30th Anniversary Edition ABS (ZX 1000 KFFA) 15 ZX 10 R (ZX 1000) 16-20 ZX 10 R Winter Test Edition (ZX1000 SGFB) 16 ZX 10 R Ninja KRT Replica 16-20 ZX 10 R SE Ninja 18-20 Ninja ZX-10RR 17-20	220
MD4158	FRONT	S	EJ 800 ABF/ACF (W 800/Solid F Disc) 11-12 W 800 ABF 11 VN 900 A6F Classic 06 VN 900 Vulcan Classic (Spoke wheel)07-19 VN 900 Vulcan Classic Special Edition (Spoke wheel) 11-19 VN 900 Vulcan Custom (Cast wheel) 07-19 VN 1600 A1/A2/A3/A6F 03-08 VN 1600 D1H/D6F 05-08 VN 1700 Voyager ABS 09-18 VN 1700 C9F Classic Tourer 09 VN 1700 DAF/DBF/DCF/DDF/CEF Classic Tourer ABS 10-14 VN 1700 KBF/KCF/KDF/KEF Voyager Custom 11-14 VN 1700 E9F Classic 09 VN 1700 FAF/FBF/FCF/FDF/FEF Classic ABS 10-14 VN 2000 A1/A2/A6F 04-07 VN 2000 H8F/H9F Classic 08-09	300	MD4166C MD4166XC VR4166 Floating Conversion	FRONT	S	EX 300 ADF/AEF/AFF Ninja (Non ABS) 13-15 EX 300 BDF/BEF/BFF/BGF Ninja ABS Model 13-16 EX 300 BEFA/BFFA/BGFA Ninja Special Edition with ABS 14-16 EX 300 AEFA/AFFA/AGFA Ninja 300 Special Edition Non ABS 14-16 KLE 300 Versys-X 300 ABS 17-20 KLE 300 Versys-X 300 Non ABS 17-20 Z 300 Non ABS (ER 300 AFF/AGF/AGFA) 15-16 Z 300 ABS (ER 300 BFF/BGF/BGFA) 15-16	290
MD4159XC VR4159BLK VR4159GRN	FRONT	F	VN 2000 A1/A2/A6F 04-07 VN 2000 H8F/H9F Classic 08-09 ER-6f (EX 650 A6F-A8F/C9F/CAF/CBF) 06-11 ER-6f (ECF/EDS/EEF/FFF/EGF) (non ABS) 12-16 ER-6n (ER 650 A6F-A8F/C9F/CAF/CBF) 06-11 ER-6n (ECF/EDF/EEF/FFF/EGF) (non ABS) 12-16 KLE 650 A7F-A9F/CAF Versys 07-10 KLE 650 A7F/A8F/B8F/B9F Versys 07-09 650 (KLE 650 CBF/CCF/CD/CEF) Versys Non ABS 11-14 Z 750 (ZR 750 L7F/L8F/L9F/LAF/LBF) 07-11	300	MD4167X MD4167XC	FRONT	F	ZX9R (ZX 900 C1/C2) 98-99	296
MD4160C VR4160	REAR	S	GTR 1400 (ZG 1400 A8F/A9F/CAF/CBF/CCF /CDF/CEF/EEF/EGF/EHF/EJF/EKF) 08-18	270	MD4169 7mm disc thickness	REAR	S	GPZ 550 D1 82 Z 700 A1 Ltd 84 GPZ 750 R1 82 GT 750 P1-P9 82-96 Z 750 E1 80 Z 750 H1-H2 Ltd 80-81 Z 750 N1/N2 Spectre 82-83 Z 750 L1-L4 81-84	260
MD4161XC VR4161BLK VR4161GRN	FRONT	F	ZX10R (ZX 1000 E8F/E9F/FAF) 08-10 ZX10R ABS (ZX 1000 KBF/KCF /KDF/KEF/KFF) 11-15 ZX10R (ZX 1000 JBF/JCF/JDF/JEF/JFF) 11-15 ZX10R 30 th Anniversary Edition Non ABS (ZX 1000 JFFA) 15 ZX10R 30 th Anniversary Edition ABS (ZX 1000 KFFA) 15	310	MD4170X VR4170CHGR	FRONT	F	ZX 10 R 16-20 ZX 10 R Winter Test Edition (ZX1000 SGFB) 16 ZX 10 R Ninja KRT Replica 16-20 ZX 10 R SE Ninja 18-20	330
MD4162C MD4162XC	FRONT	S	EX 250 K8F/K9F/KAF/KBF/KBFA/KCF Ninja 250 R 08-12	290	MD4171C OS4171C	FRONT	F	Z 125 (BR125 Auto G/Box) 16-20 Z 125 PRO (BR125 Manual G/Box) 16-20 Z 125 Pro SE (BR 125 Manual G/Box)18-20	200
MD4163C VR4163	REAR	S	EX 250 K8F/K9F/KAF/KBF/KBFA /KCF Ninja 250 R 08-12 EX 300 ADF/AEF/AFF Ninja (Non ABS) 13-15 EX 300 AEFA/AFFA/AGFA Ninja 300 Special Edition Non ABS 14-16	220	MD4172C	REAR	S	Z 125 (BR125 Auto G/Box) 16-20 Z 125 PRO (BR125 Manual G/Box) 16-20 Z 125 Pro SE (BR 125 Manual G/Box)18-20	185
MD4164AC (With ABS Ring)	REAR	S	ER-6f (ABS Model) (EX 650 B6F /B7F/B8F/D9F/DAF/DBF) 06-11 ER-6f (FCF/FDS/FEF/FFF) (ABS) 12-15 ER-6n (ABS Model) (ER 650 B6F /B7F/B8F/D9F/DAF) 06-10 ER-6n (FCF/FDS/FEF) (ABS) 12-15 KLE 650 B7F/B8F/B9F/DAF/DBF Versys ABS 07-11 650 (KLE 650 DBF/DCF/DDF/DEF) Versys ABS Model 11-14	220	MD4174X MD4174XC VR4174GRN VR4174BLK	REAR	S	Ninja 400 (EX 400 - ABS) 17-19 Ninja 400 KRT (EX 400 - ABS KRT) 18-20	185
MD4165C MD4165 VR4165	REAR	S	Ninja ZX-6R (ZX 636 - Non ABS - 636cc) 13-20 Ninja ZX-6R (ZX 636 Non ABS/KRT Edition - 636cc) 16-20 Ninja ZX-6R (ZX 636 - ABS - 636cc) 13-20 Ninja ZX-6R (ZX 636 - ABS/KRT Edition - 636cc) 16-20 ZX 6R 30th Anniversary Edition Non ABS (ZX 636 EFFA) 15 ZX 6R 30th Anniversary Edition ABS (ZX 636 FFFA) 15	220	MD4175X	FRONT	F	ZX 10 RR Ninja 17-18 ZX 100 RR Ninja 19-20	330
					MD4170X	FRONT	F	ZX 10 R (ZX1000) 16-20 ZX 10 R Winter Test Edition (ZX1000 SGFB) 16 ZX 10 R Ninja KRT Replica 16-20 ZX 10 R SE Ninja 18-20	330
					MD4171C	FRONT	S	Z 125 (BR125 Auto G/Box) 16-20 Z 125 PRO (BR125 Manual G/Box) 16-20 Z 125 Pro SE (BR 125 Manual G/Box) 18-20	200
					MD4172C	REAR	S	Z 125 (BR125 Auto G/Box) 16-20 Z 125 PRO (BR125 Manual G/Box) 16-20 Z 125 Pro SE (BR 125 Manual G/Box) 18-20	185
					MD4174XC VR4174GRN VR4174BLK	REAR	S	Ninja 400 (EX 400 - ABS) 17-20 Ninja 400 KRT (EX 400 - ABS KRT) 18-20	310
					MD4175X	FRONT	F	KAWASAKI ZX 10 RR Ninja 17-20 ZX 100 RR Ninja 19-20	330

DISC BUYERS GUIDE

OFF ROAD DISC BUYERS GUIDE

DISC No.	FRONT/ REAR	TYPE	MODELS	DIA (MM)	DISC No.	FRONT/ REAR	TYPE	MODELS	DIA (MM)
MD6001C MD6001CX MD6001D OS6001EC OSX6001E OS6001C OSX6001 SM6001C SMX6001	FRONT	S	CRM 50 RN/RP/RR/RT 93-96 CRM 75 RK/RL/RN/RP/RR 89-94 CR 125 RN/RP/RR* 92-94 XLR 125 RW 98-01 CTX 200/CTX 200 A Bushlander 04-16 CRF 230 F 04-20 CRF 230 F Easy Trial 04-07 CRF 230 L 08-10 CRF 230 M 09-10 SL 230 V/W/X/1 97-01 CRM 250 ARV/ARW (MD32) 97-98 CRM 250 R (RM) MK2 MD24 (1200001-1211634) 91-92 CRM 250 R (RP/RP-II) MK2/2 MD24 (1300001-) 93 AX-1 (NX 250 J/K/R/R3) 89-94 XLR 250 Baja Mk 1 XLR 250 Baja Mk 2 XL 250 Degree CRM 250 RR/RRII MK 3 (MD24) 94-96 CR 250 RN/RP/RR 92-94 NX 250 L/2L/M/P/2P 90-93 XLR 250 RM/R3N/RP/RR/R3R (MD22) 91-92 XR 250 RE/RF 84-85 XR 250 RM/RN/RP/RR/RS/RT /RV/RW/RX/RV/R1/R2/R3/R4 96-04 XR 250 Y/3 (MD30) 00-03 XR 250 3/5 (MD30) Motard 03-05 XR 250 III Y/3 Baja 00-03 XL 250 RL 90 CRE 260 95-98 XR 400 RT/RV/RW/RX/RV/R1-R5 96-05 CR 500 RN/RP/RR 92-94 XR 500 RD/RE 84-85 XR 600 RM/RP/RR/RS/RT/RV/RW/RX/RV 91-00 XR 650 RY/R1-R7 00-07 HONDA-DALL-ARA XR 250 R/650 R 04	240	MD6010CX MD6010D SM6010C SMX6010	FRONT	S	XR 300 R10 10 NX 500 J/K/L/M/N/P/R/S/T/V/W/X 88-99 XR 600 RF/RG/RH 85-87 XL 600 V/W/VX Transalp 97-99 NX 650 J/K/L/M/N/P/R/S/T /N/W/X "Dominador" 88-02 XR 650 L 93-20	256
					MD6011D	REAR	S	YZ 125 U/W/A/B/D/E/F/G/H/J 88-97 YZ 250 U/W/WRW/A/WRA/B/D/E /F/G/H/J 88-97 WR 250 ZB/ZD/ZE/ZF/ZG/ZH/ZJ 91-93 YZ 400 FK/WR 400 FK 98 WR 500 ZD 92	220
					MD6012D	FRONT	S	YZ 125 A/B 90-91 YZ 250 A/WRA/B 90-91 WR 250 ZB 91	245
					MD6013C MD6013CX MD6013D	REAR	S	CPI Sauler 125 HONDA CRF 230 L 08-10 CRF 230 M 09-10 XR 250 RL/RM/RN/RP/RR/RS /RT/RV/RW/RX/RV/R1-R4 90-04 XR 250 SM 04 XL 250 RL 90 XL 250 R/R3/R3J/RX/RL/R3L /R3M/RN (MD22) 99-90 CRM 250 RR/RR-II (MK3) (MD24-140) 94-96 CRM 250 ARV/ARW (MD32) 97-98 CRM 250 R (RM) MK2 MD24 (1200001-1211634) 91-92 CRM 250 R (RP/RP-II) MK2/2 MD24 (1300001-) 93 SL 250 V/W/X/1 97-01 XLR 250 RM/R3N/RP/RR/R3R (MD22) 91-92 XR 250 Y/3 (MD30) 00-03 XR 250 3/5 (MD30) Motard 03-05 XR 250 III Y/3 Baja 00-03 XR 300 R10 10 XR 400 RT/RV/RW/RX/RV/R1-R5 96-05 XR 400/440 R 04 XR 400/440 SM 04 NX 500 J/K/L/M 88-91 XR 600 RM/RP/RR/RS/RT/RV /RW/RX/RV 91-00 NX 650 J/K/L/LII/M Dominador 88-91 SLR 650 V/W 97-98 HONDA-DALL-ARA XR 250 R 04 XR 400/440 R 04 XR 650 R 04	220
MD6002CX MD6002D	REAR	S	CR 125 RK/RL/RM/RN/RP/RR/RS /RT/RV 89-97 CR 250 RK/RL/RM/RN/RP/RR/RS/RT 89-96 CR 500 RK/RL/RM/RN/RP/RR/RS /RT/RV/RW/RX/RV 89-00	220					
MD6003D	FRONT	S	CR 125 RL/RM 90-91 CR 250 RL/RM 90-91 XR 250 RL 90 CR 500 RL/RM 90-91 XR 600 RJ/RK/RL 88-90	240					
MD6004D	FRONT	S	CR 80 RG/RH/RJ/RK/RL/RM/RN /RP/RR/RS 86-95	215					
MD6005C MD6005CX MD6005D	REAR	S	CR 80 RN/RP/RR/RS/RT/RBT/RV /RBV/RW/RB/RX/RB/RV/RBY/R1 /RB1/R2/RB2 92-02 CR 85 R/R2 03-07 CR 85 R3/RB3/R4/RB4/R5/RB5 /R6/RB6/R7/RB7 03-07	190	MD6014C MD6014CX MD6014D	REAR	S	DR 125 SMK8/SMK9/SML0 08-12 RM 125 J/K/L/M/N/P/R/S/T/V/W 88-98 RM 250 H/J/K/L/M/N/P/R/S/T/V 87-98 RMX 250 P/R/S/T/V/W 94-98 RMX 250 SN/SR/SS 95-97 RMX 250 ST/SV/SW/SX (SJ14A) 96-99 DR-Z 400 SEY/EY/SEK1/EK1 /K1/SK2/EK2/K2/SK3/EK3/K/K4 /SK4/EK4/SK5/EK5/K6/EK6 /SK6/SK7/EK7/K7/SK8/SK9 00-09 KLX 400 R (KLX 400 B1/B2) 03-04	220
MD6006D	FRONT	S	ATC 250 RF/RG 85-86 TRX 250 RJ/RK 88-89 TRX 250 EX1/2/3/4/5/6/7/8 01-08 TRX 250 X9/XA/XB 09-11 TRX 300 EX P/R/S/T/V/W/X/Y/1 /2/3/4/5/6/7/8 93-08 TRX 300 X9 09 TRX 400 EXX/EY/EX1-EX8 99-08 TRX 400 X9 09 TRX 450 R4/R5/R6/ER6/R7/ER7 /R8/ER8/R9/ER9 04-09 TRX 700 XX8/XX9/XXB 08-11	174	MD6015C MD6015CX MD6015D OS6015C OSX6015 SM6015C SMX6015	FRONT	S	KX 125 G1/H1/H2/J1/J2/K1-K5 /L1/L2/L3/L4 89-02 KDX 200 E5-E6 93-94 KLX 250 R D1-D2 93-94 KX 250 G1/H1/H2/J1/J2/K1-K5 /L1/L2/L3/L4 89-02 KLX 300 A2-A10/A6F/A7F 97-07 KX 500 E1-E16 89-04	250
MD6007D	REAR	S	TRX 250 RG/RH/RJ/RK 86-89	186	MD6016D	FRONT	S	YZ 125 W 89 YZ 250 W/WRW 89 WR 500 ZD 92	230
MD6008D	FRONT	S	CR 125 RK 89 CR 250 RK 89 NX 250 J/K 87-89 XR 250 RG/RH/RJ/RK/RL 86-90 XLR 250 R 91-92 CR 500 RK 89 XR 600 RJ/RK/RL 88-90	240					
MD6009D	REAR	S	CR 125 RH/RJ 87-88 CR 250 RH/RJ 87-88 CR 500 RH/RJ 87-88	220					

DISC BUYERS GUIDE

OFF ROAD DISC BUYERS GUIDE

DISC No.	FRONT/ REAR	TYPE	MODELS	DIA (MM)	DISC No.	FRONT/ REAR	TYPE	MODELS	DIA (MM)
MD6017C MD6017CX MD6017D OS6017EC OSX6017E OS6017C OSX6017 SM6017C SMX6017	FRONT	S	SUZUKI DR 125 SMK8/SMK9/SML0 08-12 RM 125 K/L/M/N/P/R/S/T/V/W/X/Y/K1-K9 89-12 RM 125 XCK8 09 DR 250 RS/RLS/RT/RV/RLV/RW/RLW/RY 95-00 DR 250 RXT/RXLT/RXV/RXLV/RXW /RXLW/RXGW/RXGLW/RXY/RXGY (Djebel 250 XC/GPS SJ45A) 96-98 DR-Z 250 K1-K7 (DJ43A) 01-07 RM 250 K/L/M/N/P/R/S/T/V/W/X/Y/K1-K9 89-12 RM 250 XCK8 09 RMX 250 P/R/S/T/V/W 94-98 RMX 250 ST/SV/SW/SX (SJ14A) 96-99 RMX 250 SN/SR/SS 95-97 DR 350 SEW/SEX Electric Start /6 bolt front disc (USA Only) 98-99 DR-Z 400 EY/Y/SY/EK1/K1/SEK1/EK2 /SEK2/K2/K3/SK2/EK2/K2/SK3/EK3 /K3/SK4/EK4/K4/SK5/EK5/K6/EK6/SK6 /SK7/EK7/K7/SK8/SK9 00-09 KAWASAKI KLX 400 R (KLX 400 B1/B2) 03-04 YAMAHA WR 250 FP/FR/FS/FT/FV/FW/FX/FY 02-09 WR 250 FW 07 YZ 250 FW 07 YZ 250 FN/FP/FR/FS/FT/FV/FW/FX 01-09 YZ 250 X/Y 08-09 WR 400 FN 01 WR 426 FN/FP 01-02 YZ 426 FN/FP 01-02 YZ 450 FR/FS/FT/FV/FW/FX 03-09 WR 450 FR/FS/FT/FV/FW/FX/FY 03-09	250	MD6030C MD6030CX MD6030D OSY6030C OSXY6030	FRONT	S	YAMAHA YZ 80 E/F/LWF/LWG/G/LWH/H/LWJ /J/LWK/K/L/LWL/M/LWM/N/LWN 93-01 YZ 85 (2T - Small Wheel F 17"/R 14") 02-15 YZ 85 (2T - Big Wheel F 19"/R 16") 02-20	220
					MD6030C MD6030CX MD6030D OSS6030C OSXS6030	FRONT	S	SUZUKI RM 85 05-20	220
					MD6031C MD6031CX MD6031D	REAR	S	YZ 80 E/F/LWF/LWG/G/LWH/H/LWJ /J/LWK/K/L/LWL/M/LWM/N/LWN 93-01 YZ 85 (2T - Small Wheel F 17"/R 14") 02-20 YZ 85 (2T - Big Wheel F 19"/R 16") 02-20	190
					MD6032C MD6032CX MD6032D OS6032EC OS6032C OS6932C OSX6032E OSX6932 OSX6032EORG OSX6932ORG SM6032EC SM6032C SM6932C SMX6032EORG SMX6032ORG SMX6932ORG	FRONT	S	KTM MX 125 92-93 SX 125 94-20 EXC/EGS 125 94 EXC 125 95-17 EXC 125 (2T) Six Days 11-17 EXE 125 00 XC-W 125 (2T) 17-20 SX 150 08-20 XC 150 (USD) 11-13 XC-W 150 (2T) 17-18 EXC/EGS 200 98-99 EXC 200 (inc Six Day) 04-17 MX 250 92-93 SX 250 (2T) 94-20 SX-F 250 06-20 EXC/EGS 250 94 EXC 250 95-20 EXC 250 (2T) Six Days 11-20 EXC-F 250 06-20 EXC-F 250 (4T) Six Days 11-20 EXC 250 Racing 06 SX-F 250 Ken Roczen Edition 12 XC 250 (USD) 11-18 XC-F 250 (USD) 11-18 EXC 300 (2T) 00-20 EXC 300 (2T) Six Days 11-20 XC 300 (2T) 11-20 EXC 350 94-95 SX-F 350 11-20 EXC-F 350 (USD) 11-20 EXC-F 350 Six Days 12-20 SX-F 350 Tony Cairoli Edition 12 XC-F 350 12-18 SX 360 96-97 EXC 360 96-97 SX 380 98-03 EXC 380 98-03 SC 400 96-99 SX 400 00-02 EXC/EGS 400 (USD) 00-03 EXC 400 Racing (USD) 00 EXC 400 Racing 04-07 EXC 400 (4T) 09-11 SX 440 94-95 EXC 440 94-95 SX-F 450 03-20 EXC 450 (4T) 03-20 EXC 450 Racing 06-07 EXC 450 (4T) Six Days 11-20 EXC-R 450 08 SMR 450 05 EXC 500 (4T) 12-20 EXC 500 (4T) Six Days 12-20 SXF 505 07-09 SX 520 01-03 EXC 520 01-03 EXC 525 03-05 XC 525 Racing 06-07 MXC 525 03-04 SX 525 03-06 XC 525 Racing 06 EXC-R 530 08 EXC 530 09-11 EXC 530 (4T) Six Days 11 MXC 550 96 SX/EXC/EGS 620 94-95 EGS-E 620 Adventure/Rallye 99 SX 620 96-99 SC 620 Supercompetition 96-00 SXC 625 03-06 LC4 625 SC Supercompetition 02	260
MD6018C MD6018D OS6018C OSX6018	FRONT	S	RM 80 XG/XH/XJ/XK/XL/XM /XN/XP/XR/XS/T/V/W/X/Y/K1 86-01 RM 85 K2/LK2/K3/LK3/LK4/K4 02-04	200					
MD6020D	FRONT	S	LT 250 RH/RJ/RK/RL 87-90	160					
MD6021D	REAR	S	LT 250 RH/RJ/RK/RL 87-90	220					
MD6022D	FRONT	S	LT 500 RL 90	170					
MD6023D	REAR	S	LT 500 RL 90	240					
MD6024C MD6024CX MD6024D	REAR	S	KX 125 G1/H1/H2/J1/J2/K1-K5 /L1/L2/L3 89-01 KDX 200 E1-E6 89-94 KX 250 G1/H1/H2/J1/J2/K1-K5 /L1/L2/L3/L4 89-02 KX 500 E1-E16 89-04	220					
MD6025C MD6025D	REAR	S	KX 80 L1/L2/N2/L3/N3/R1/T1 88-91 KX 80 R2-R7/T2-T6/W1-W3 92-00 KX 100 A1/A2/B1-B7/C1-C3 89-00 SUZUKI RM 80 XL/XM/XN/XP/XR/XS/T /V/W/X/Y/K1 90-01 RM 85 K2/LK2/K3/LK3/LK4/K4 02-04	185					
MD6026D	FRONT	S	KX 80 R2-R7/T2-T6/W1-W3 92-00 KX 85/85 II A1/B1 01 KX 100 B2-B7/C1/C2/C3 91-00	220					
MD6027D	FRONT	S	KX 80 E2/E3/G1/G2/J1/J2 84-87 KX 80 L1-L3/N2/N3/R1/T1 88-91 KX 100 A1/A2/B1 89-91	200					
MD6028C MD6028CX MD6028D OS6028EC OSX6028E OS6028C OSX6028 OS6728C OSX6728 SM6028 SMX6028 SMX6728	FRONT	S	YZ 125 D/E/F/G/H/J/K/L/M 92-00 YZ 250 D/E/F/G/H/J/K/L/M 92-00 WR 250 ZB/ZD/ZE/ZF/ZG/ZH/ZJ/ZK 92-98 WR 400 FL/FM 99-00 YZ 400 FK/FL/WR 400 FK/FL/FM 98-00 YZ 426 FM 00	245					
MD6029D	FRONT	S	YZ 80 S/T/U/W 86-89	190					

OFF ROAD DISC BUYERS GUIDE

DISC No.	FRONT/ REAR	TYPE	MODELS	DIA (MM)	DISC No.	FRONT/ REAR	TYPE	MODELS	DIA (MM)	
MD6032C MD6032CX MD6032D OS6032EC OS6932C OS6032C OSX6032E OSX6932 OSX6032EORG OSX6932ORG SM6032EC SM6032C SM6932C SMX6032EORG SMX6032ORG SMX6932ORG Contd.	FRONT	S	HUSABERG All MX/Enduro Models See Main Catalogue 00-14 HUSQVARNA TC 125 (2T) 14-15 TE 125 (2T) 14-20 TE 150 (2T) 18-20 FC 250 (4T) 14-20 FE 250 (4T) 14-15 TC 250 (2T) 14-15 TE 250 (2T) 14-15 TE 300 (2T) 14-20 TX 300 (2T) 18-20 FC 350 (4T) 14-15 FX 350 (4T) 18-20 FC 450 (4T) 14-15 FE 450 (4T) 14-15 FR 450 (4T) 16-20 FX 450 (4T) 17-20 FE 501 (4T) 14-15	260	MD6035C MD6035CX MD6035CE MD6035D (Undrilled Enduro Disc) Contd.	REAR	S	KTM Contd. EXC 525 03 SX 525 03-06 LC-4 MX 500 90-91 LC-4 EXC 500 90-91 EXC 520 01-03 SX 520 01-03 EXC 525 04-05 EXC 525 Racing 06-07 MXC 525 03-04 SMR 525 04-05 SX 525 03-06 XC 525 Racing 06-07 EXC 530 09-11 EXC 530 (4T) Six Days 11 EXC-R 530 (4T) 08 MXC 550 96 SMR 560 Supermoto 06-07 HUSABERG All MX/Enduro Models See Main Catalogue 00-14 HUSQVARNA TC 125 (2T) 14-15 TE 125 (2T) 14-20 TE 150 (2T) 18-20 FC 250 (4T) 14-20 FE 250 (4T) 14-15 TC 250 (2T) 14-15 TE 250 (2T) 14-15 TE 300 (2T) 14-20 TX 300 (2T) 18-20 FC 350 (4T) 14-15 FX 350 (4T) 18-20 FC 450 (4T) 14-15 FE 450 (4T) 14-15 FR 450 (4T) 16-20 FX 450 (4T) 17-20	220	
MD6034D	FRONT	S	KTM EXC 125 89 D-XC/E-XC/E-GS 125 90-93 EXC/EGS 250 89 DXC/EXC 250 90 DXC/EXC/EGS 250 91 DXC/EXC/EGS 350 90-91 EXC 350 89 LC-4 MX/EXC 500 89 LC-4 MX 500 (Brembo) 90-91 LC-4 EXC 500 (Grimeca) 90-91 LC-4 MX/EXC 600 89 LC-4 EXC 600 90-93	240						
MD6035C MD6035CX MD6035CE MD6035D (Undrilled Enduro Disc)	REAR	S	KTM SX 125 94-20 EXC/EGS 125 94 EXC 125 95-17 EXC 125 (2T) Six Days 11-17 EXE 125 00 SM 125 Supermoto 00 XC-W 125 (2T) 17-20 SX 150 08-20 XC 150 (USD) 11-13 XC-W 1150 (2T) 17-18 EXC/EGS 200 98-03 EXC 200 (Inc Six Days) 04-17 D-XC/E-XC/T-XC/E-GS 250 92-93 SX 250 (2T) 94-20 EXC/EGS 250 94 EXC-F 250 06-20 EXC-F 250 (4T) Six Days 11-20 EXC 250 95-20 EXC 250 (2T) Six Days 11-20 EXC 250 Racing 06 SX-F 250 06-15 SX-F 250 Ken Roczen Edition 12 SX-F 250 (4T) 09-20 XC 250 (USD) 11-18 XC-F 250 (USD) 11-18 EXC 300 00-20 EXC 300 (2T) Six Days 11-20 XC 300 (2T) 12-18 SX-F 350 11-20 EXC-F 350 (USD) 11-20 EXC-F 350 Six Days 12-20 SX-F 350 Tony Cairoli Edition 12 XC-F 350 12-18 SX/EXC 360 96-97 SX 380 98-03 EXC 380 98-99 EXC 400 (4T) 09-11 LC4-E Enduro 00-01 SX 400 00-02 EXC/EGS 400 (USD) 00-03 EXC 400 Racing 00/04-07 SX-F 450 03-20 EXC 450 03-20 EXC 450 Racing 06-07 EXC 450 (4T) Six Days 11-20 EXC-R 450 08 SMR 450 04-13 SMR 450 (Brembo F/caliper) 14 EXC 500 (4T) 12-20 EXC 500 (4T) Six Days 12-20 SX-F 505 07-09	220	MD6036D	FRONT	S	KX 125 D1/E1/E2/F1 85-88 KDX 200 C1-C3 86-88 KDX 200 E1-E4 89-92 KDX 200 SR (DX 200 G) KX 250 D1-D2/E1/F1 85-88 KX 500 B1-B2/C1/D1 85-88	250	
					MD6037C MD6037CX MD6037D OS6037C OXS6037 OS6437C OXS6437 SM6037C SMX6037 SM6437C SMX6437 Note: For HM models check application pages	FRONT	S	CR 125 RS/RT/RV/RW/RX/R1-R7 95-07 CR 250 RS/RT/RV/RW/RX/R1-R7 95-07 CRE F 250 R 08-09 CRE F 250 X 08-11 CRF 250 R4/R5/R6/R7/R8/R9/RA /RB/RC/RD/RE/RF/RG 04-16 CRF 250 R 08-09 CRF 250 X4-XK 04-20 CRF 250 XRL (Road legal) 14-20 CRE F 300 X 08-09 CRF 450 R2-R9/RA-RK 02-20 CRF 450 R 04-09 CRF 450 X5-XK 05-20 CRF 450 XRL (Road legal) 14-16 CR 500 RS/RT/RV/RW/RX/R1 95-01 CRE F500 X 08-09	240	
					MD6038CX MD6038D	REAR	S	TS 125 RK/RL/RM/RN/RP/RR 90-96 TS 200 RK/RL/RM/RN/RP/RR 89-94 DR 250 SL/SM/SN/SEP/SER /SES (SJ44A) 90-95 DR 350 SL/SM/SN/SP 4 Bolt front disc/Kick start 90-93 DR 350 SER/SES (Electric street /4 bolt front disc) 94-95	220	
					MD6039D	FRONT	S	DT 125 R 88-03 DT 125 RE 04-07 YZ 125/250 U 88 TT 350 (ITJ) 85-89 YZ 490 U 88 TT 600 N (59X) Frame # 59X00101-59X007852 85-88 TT 600 W (2JT/3SW1) (Frame # 59X007853-) 89-92	230	

DISC
BUYERS GUIDE

OFF ROAD DISC BUYERS GUIDE

DISC No.	FRONT/ REAR	TYPE	MODELS	DIA (MM)	DISC No.	FRONT/ REAR	TYPE	MODELS	DIA (MM)
MD6040C MD6040D OS6040C OSX6040C	FRONT	S	DR 250 SL/SM/SN/SEP/SER /SES (SJ44A) 90-95 DR 350 SL/SM/SN/SP 4 bolt front disc/Kick start 90-93 DR 350 SER/SES (Electric start /4 bolt front disc) 94-95 DR 350 SET/SEV/SEW/SEX (Electric start/4 bolt front disc) (UK/Europe) 96-97	250	MD6064D	REAR	S	TRX 300 EX P/R/S/T/N/W/X/Y/1-8 93-08 TRX 300 X9 09	220
MD6042CX MD6042D SM6042C SMX6042	FRONT	S	KLR 650 A1-A3 87-89	260	MD6066D	FRONT	S	WR 200 D/E/F 92-94 DT 200 WR 92-93 DT 230 Lanza (LTP1/2) 97-98 TT 250 R (4GY1 Japan) 93-94 TT 250 R (4RR1/2 Japan) 95-96 TT 250 RL (4PX5) 99 TT 250 RM (4PX6) 00 TT 250 R (4GY3/4GY5/4WA1) Raid 94-96	245
MD6044D	FRONT	S	XL 600 VH/VJ/VK/VM/VN/VP/VR/VT Transalp 87-96 FX 650 X/Y 'Vigor' 99-03 SLR 650 V/W 97-98 XLV 750 R (RD/RF) 83-88	276	MD6067D	FRONT	S	DT 125 LC 86-87 TW 125 (5EK/5RS) 99-04 XYZ 125 (5RM) 03-10 YZ 125/250 S/T 86-87 DT 200 (2LR) 87 TW 200 (2JL/4CS1/2/3/5) 91-98 TW 200 E (4CS4/6/5LB1/2) 98-01 ST 225 (5BT) Bronco 97 TW 225 E (5VC1/2) 02-03 XT 225 Serraw (4JG) MK1-2 XT 225 WE (4JG5/6) Serraw 97-98 XT 225 (2LN) Serraw (1KH 020101-) 86-87 XT 225 (3RW1-5 Serraw) (1KH 034101-13200) 89-93 XT 225 S (3RW3) 97-06 XT 225 S (1KH 102101-109000) 92 XG 250 Tricker (5TX1) 04-06 YZ 490 N/S/T 85-87	220
MD6045CX MD6045D	REAR	S	XR 650 L 93-20	220	MD6068D	FRONT	S	XT 250 Serraw (3C51/2) 05-08 XT 350 85-95	245
MD6046D	FRONT	S	TRX 250 RG/RH 86-87	166	MD6070D	FRONT	S	XT 600 84-87 XT 600 Z Tenere 84-90 XT 600 E 92-94	267
MD6047D	FRONT	S	YTZ 250 N/S TR1-Z 85-86	203	MD6072D	REAR	S	XT 600 87 XT 600/600 Z Tenere 88-90 XT 600 E 92-03 XT 660 'Tenere' 91-98	220
MD6050D	REAR	S	YFS 200 B/F/G/H/J/K/L/M/N/P Blaster 91-02	220	MD6073D	FRONT	S	DF 125 85-94 DR 125 SF/SH/SJ 99-01 TS 125 XUF/XUG/XUH/XUJ 86-90 DF 200 EV/EW/EY (SH42A) 86-89 DR 200 G/H/J 86-89 DR 200 SEP/SER/SES/SEV/SEW /SEX/SEY (SH42A) Djebel 93-00 DR 200 SE Trojan 96-13 DR 200 SEK1-SEK9 01-09	230
MD6051D	FRONT	S	YZF 350 T/U/W 87-89	161	MD6075D	FRONT	S	TS 250 XE/XG/XH/XJ/XK 85-89 DR 600 RG/RH/RJ (SN41A) 86-88 DR 600 RK 89 DR 600 SF/SG/SH/SJ/SK (SN41A) 85-89	240
MD6053D	REAR	S	YFM 350 FXG/FXH/FXJ/FXK/FXL/FXM /FXN/FXP/FXR/FXS Wolverine 95-04 DERBI DXR 200 04-07 DXR 200 Quad (Front disc model) 04-07 DXR 250 04-06	220	MD6076D	FRONT	S	DR 650 RL/RM 90-91 DR 650 RSL/RSM (SP42A) 90-91 DR 750 SJ/SK 88-89 DR 800 SL 90	280
MD6054D	FRONT	S	YFS 200 R/S/T/V 03-06 YFM 250 XN/XP/XR/XS 01-04 YFM 250 BT/BV Bruin 05-06 YFM 250 BW/BX/BY Big Bear 07-10 YFM 250 RX/RV Raptor 08-09 YFM 250 R (338) 09-11 YFM 250 R (1BT) 12-13 YFM 350 XD/XE/XF/XG/XH/XJ /XK/XL/XM/XN/XP/XR/XS 92-04 YFM 350 S/T/V/R-WV/RW/RX /RY/RZ Raptor 04-10 YZF 350 A/D/E/F/G/H/J/K/L/M/N/P/R/S/T/V Banshee 90-09 YFM 400 FGW/FGX Grizzly 07-08 YZF 450 S/T/W/X 04-08 YZF 450 RY/RZ (Quad) 09-10 YZF 450 RSEA/RSEB/RSED/RSE 11-14 YZF 450 B/D 13-14 YFM 660 RN/RP/RR/RS/RT Raptor 01-05 YFM 700 RV/RW/RA/RD/RE Raptor 06-14 YFM 700 RSE 13-18 DERBI DXR 200 04-07 DXR 250 04-07	161	MD6077D	REAR	S	DR 600 RK (SN41A) 89 DR 650 RL/RM 90-91 DR 650 RSL/RSM (SP42A) 90-91 DR 650 RUN/RN/RUP/RP (SP44A/B) 92-93 DR 650 RER/RES (SP45A/B) 94-95 DR 650 RSEM/RSEN/RSEP (SP43A/B) 91-93 DR 800 SM/SN/SP/SR/SS (SR43B) 90-95 DR 800 ST/SV (SR43B) 96-97	250
MD6055D	REAR	S	YFM 350 XD/XE/XF/XG/XH/XJ/XK /XL/XM/XN/XP/XR/XS 92-04	245	MD6078D	FRONT	S	DR 650 RUN/RN/RUP/RP (SP44A/B) 92-93 DR 650 RER/RES (SP45A/B) 94-95 DR 650 RSEM/RSEN/RSEP (SP43A/B) 91-93	300
MD6057D	FRONT	S	KMX 200 A2/A3 89-92 KLR 250 D2-D22 84-05	240	MD6080D	FRONT	S	KLR 600 A1/A3 B1-B4/B6-B9 84-94	250
MD6058C MD6058CX MD6058D OS6058C OSX6058	FRONT	S	CR 80 RT/RBT/RBV/RV/RBW/RW/RX /RBX/RY/RBY/R1/RB1/R21/RB2 96-02 CR 85 R/R2 03-07 CR 85 R3/RB3/R4/RB4/R5/RB5 /R6/RB6/R7/RB7 03-07	220	MD6081D	FRONT	S	KL 650 B1-B3 'Tengai' 89-92 KLR 650 C1-C10 95-04	280
MD6059D	FRONT	S	ATC 200 XD 83 ATC 250 RD 83-84 ATC 250 RF/RG 85-86	206					
MD6059D	REAR	S	ATC 200 XD 83 ATC 250 RD 83-84	206					
MD6060D	FRONT	S	ATC 250 RB/RC 81-82	156					

OFF ROAD DISC BUYERS GUIDE

DISC No.	FRONT/ REAR	TYPE	MODELS	DIA (MM)	DISC No.	FRONT/ REAR	TYPE	MODELS	DIA (MM)
MD6082CX MD6082D	REAR	S	KLE 500 A1-A12/B1 91-05 KLE 500 B1P/B6F/B7F 05-07 KL 650 B1-B3 'Tengai' 89-92 KLR 650 A1-A3 87-89 KLR 650 C1-C10 95-04	230	MD6110CX MD6110D	REAR	S	DR 250 RS/RLS/RT/RLV/RLW /RV/RW/RX (SJ45A/DOHC) 95-00 DR 250 RXT/RXLT/RXV/RXL/RXW /RXLW/RXGW/RXGLW/RXY/RXGY (Djebel 250 XC/GPS SJ45A) 96-98 DR-Z 250 K1-K7 (DJ43A) 01-07 DR 350 SET/SEV (Electric start/4 bolt front disc) 96-97 DR 350 SEW/SEX (Electric start/6 bolt front disc) 98-99	220
MD6083CX MD6083D	FRONT	S	KDX 125 A1/A2/B1/B2 90-94 KDX 200 H1/H2/H3/H4/H5 95-99 KDX 220 R A4-A12/A6F 97-06 KDX 220 SR (DX220B) 91 KDX 250 SR 91-93	250	MD6113D	FRONT	F	XF 650 V/W/X/Y Freewind 97-02 DR 800 SM/SN/SP/SR/SS (SR43B) 91-95 DR 800 ST/SV (SR43B) 96-97	300
MD6085D	REAR	S	KLX 250 R D1-D2 93-94 KLX 250 G1 94- KLX 650 C1-C3 93-97	230	MD6115D	REAR	S	DT 125 R/RE 88-04 TDR 125 93-03	220
MD6086D	FRONT	F	KLX 650 C1-C3 93-97	290	MD6116D	FRONT	S	TDR 125 93-03 XT 600 E 95-03 XTZ 660 Tenere 91-98	280
MD6087D	FRONT	S	CR 125 RE/RF/RG/RH/RJ 84-88 MTX 125 RWE/RWF/RWH/RWL 85-95 Saeul 125 XL 125 RF/RH 85-86 MTX 200 RWF 85 CR 250 RE/RF/RG/RH/RJ 84-88 CRM 250 R (RK) MK1 MD24 (10001-1008385) 89-90 XR 250 RG/RH/RJ/RK/RL 86-90 XLR 250 R 88-90 XR 350 RE 84 CR 500 RE/RF/RG/RH/RJ 84-88 XR 500 RD/RE 84-85 XL 600 RD/LD/RE/LE/RF/RG/RH 83-87 XL 600 LMF XR 600 RF/RG/RH/RJ/RK/RL 85-90	240	MD6118D	FRONT	S	XTZ 750 Super Tenere 89-95	245
MD6091D	FRONT	S	KLX 250 G1 94	250	MD6119D	REAR	S	XTZ 750 Super Tenere 89-95	245
MD6093D	FRONT	S	KLE 500 A1-A12/B1 91-05 KLE 500 B6F/B7F 05-07	300	MD6121D MD6121C	REAR	S	DT 125 RE 05-07 DT 125 X 05-06 WR 125 R 09-15 WR 125 X (Supermoto) 09-18 DT 200 WR 92-93 WR 200 D/E/F 92-94 DT 230 Lanza 4TP1/2 97-98 TT 250 R (4GY1 Japan) 93-94 TT 250 R (4RR1/2 Japan) 95-96 TT 250 RL (4PX5) 99 TT 250 RM (4PX6) 00 TT 250 R (4GY3/4GY5/4WA1) Raid 94-96	220
MD6094CX MD6094D SMX6094	FRONT	F	DR 650 SET/SEV 96-97	290	MD6123D	FRONT	S	YFM 350 FXG/FXH/FXJ/FXK/FXL/FXM /FXN/FX/FXRP/FXS Wolverine 96-04 YFM 400 FAM 00 YFM 400 FWP/FPR/FPS Big Bear 4x4 02-04	180
MD6095CX MD6095D	REAR	S	DR 650 SET/SEV 96-97 XF 650 V/W/X/Y Freewind 97-02	240	MD6124C MD6124CX MD6124D	REAR	S	CR 125 RW/RX/RV/R1 98-01 CR 250 RV/RW/RX/RV/R1 97-01 LEXMOTO LSM 50 (STR50) 12-16 Adrenaline 125 XFLM125GY-2B 13-18 LSM 125 (STR125YB) 12-18	240
MD6096D	FRONT	S	XL 600 LMF/RMG/LMH 85-87	255	MD6125D OS6125C OSX6125 SM6125C SMX6125	FRONT	S	HUSABERG All Models 93-99 HUSQVARNA CR 125 92-94 SM 125 98-99 WR 125 93-94 WRE 125 93-99 CR 250 92-99 WR 250 92-99 TE 350 92-97 CR 360 92-94 WR 360 92-99 TE 410 95-99 TE 610 92-94 TE 610/E 95-99 TE 610 00 TE 610 E 00 TE 610 E 03-04 TC 610/E 95-99	260
MD6097D	REAR	S	XL 600 VM/VN/VP/VR/VT/VV /VW/VX Transalp 91-99 XL 650 VY/V1-V7 Transalp 00-07 XRV 650 J/K Africa Twin 88-89	240	MD6126D	FRONT	S	HUSQVARNA CR 125 91-99 WR 125 95-99 TC 620 92-94	220
MD6099D	REAR	S	NX 500 N/P/R/S/T/V/W/X 92-99 NX 650 N/P/R/S/T/V/W/X Dominator 92-02 FMX 650 05-08 FX 650 X/Y "Vigor" 99-03	220	MD6126D	REAR	S	HUSABERG All Models 93-99 HUSQVARNA CR 125 91-99 SM 125 98-99 WR 125 91/93-99 WRE 125 93-99 WR 240 90-91 CR 250 91-99 WR 250 90-99 WR 260 90-91	220
MD6102	FRONT	S	XRV 750 L/M/N/P/R/S/T/V/W/X/Y 90-03	276					
MD6103D	REAR	S	XRV 750 L/M/N/P/R/S/T/V/W/X/Y 90-03 XL 1000 VX/VY/V1/V2 Varadero - Non ABS Model 99-02	256					
MD6105CX MD6105D	REAR	S	KDX 125 A1/A2/B1/B2 90-94 KDX 200 H1/H2/H3/H4/H5 95-99 KDX 200 SR (DX 200 G) KDX 220 SR (DX 220 B) 97-06 KDX 220 R A4-A12/A6F 97-06 KDX 250 D1 91-93 KDX 250 SR (KDX 250 F1) 91 KLX 250 J1-J6 D-Tracker 98-03 KLX 250 H6/H7F 05-07 KLX 300 A2-10/A6F/A7F 97-07	220					
MD6106D	FRONT	S	KMX 125 A1-A5/B1-B12 86-03	230					
MD6107D	REAR	S	KMX 125 A1-A5/B1-B12 86-03 KJ 250 J1-J3 00-02 KLX 250 G1/G1A/H1 Super Sherpa 97-00	210					
MD6108D	REAR	S	KMX 200 A2-A3 89-92	210					
MD6109D	FRONT	S	TS 125 RK/RL/RM/RN/RP/RR 90-96 TS 200 RK/RL/RM/RN/RP/RR 89-94	240					

DISC BUYERS GUIDE

OFF ROAD DISC BUYERS GUIDE

DISC No.	FRONT/ REAR	TYPE	MODELS	DIA (MM)	DISC No.	FRONT/ REAR	TYPE	MODELS	DIA (MM)			
MD6126D Contd.	REAR	S	HUSQVARNA		220	MD6149D Contd.	FRONT	S	POLARIS	228		
			TE 350	90-97					Big Boss 500 6x6		98-99	
			CR 360	92-94					350 L 4x4		90	
			WR 360	92-99					250 2x4/4x4		90	
			TE 410	95-99					400 L 4x4		94	
			TE 410 E	00					Magnum 330 (2x4/HDS)		03-04	
			TE 510	90					Magnum 425 4x4		95-98	
			TC 510	90					Magnum 425 6x6		96-97	
			LT 610	00					Magnum 500 4x4		99-00	
			SM 610	98-00					Magnum 500		01	
SM 610 R	00	Magnum 500 (2x4/4x4 HDS)	02									
TE 610	91-94	Sportsman 350 4x4	93									
TE 610/E	95-00	Sportsman 400 L 4x4	94-97									
TC 610	91-94	Sportsman 400	01-04									
TC 610/E	95-99	Sportsman 500 4x4	96-									
			500 Sportsman HO/EFI									
MD6128D	REAR	S	Pegaso 650	91-00	220							
								Demand Drive	03-04			
								Sportsman/Worker 500				
								4x4 EBS/500 RSE	98-02			
MD6129D	FRONT	S	APRILIA		300			Sportsman/Worker 335 4x4	99-00			
			Pegaso 650/650 ie	91-04				Sportsman 6x6 (500) Big Boss	00-01			
			Pegaso 650 Trail	06-08				Trail Boss 350 L 4x4	91			
								Xpedition 425 (4x4)	00			
MD6130D	FRONT	S	KTM		300			Xplorer 400 L 4x4	95-00			
MD6130CF		F	EGS 400/EGS-E/LSE (LC4 Enduro)	96-99				Xplorer 500 4x4	97			
MD6130DF		F	LC4-E 400 Enduro	00-01				Xplorer 400	01-02			
			EGS/EGS-E/LSE 620 Enduro	96-99			Diesel 455cc 4x4 EBS	99-00				
			LC-E 640 Enduro	00-04			Diesel	01				
MD6131D	FRONT	S	KLF 300 C1-C17	89-05	200	MD6150D	FRONT	S	POLARIS	175		
				KVF 300 A1-A4/B1-B4 (Prairie 4x4)					99-02		Big Boss 250 4x6	91-92
				KLF 400 B1-B7					93-99		Big Boss 250 6x6	92-93
				KVF 400 A1/A2/B1/C1-C4/D1-D4					97-02		Big Boss 300 6x6	94
MD6132D	REAR	S	KSF 250 A1-A18	87-04	220			350 L 2x4	90			
				KEF 300 B1/B2/B3		01-03	250 2x4/4x4	93				
MD6133D	FRONT	S	KSF 250 A1-A18	87-04	168			350 L 4x4	93			
				KXF 250 A1/A2		87-88	300 2x4/4x4	94-95				
				KEF 300 B1/B2/B3		01-03	400 L 2x4	94-95				
				KLF 300 B1-B17 'Bayou'		88-04	Magnum 425 2x4	95-98				
MD6134D	REAR	S	KXT 250 B2 (Tecate - 3 wheel)	87	220			Scrambler 400 L 4x4	95-97			
								Scrambler 500 4x4	97			
MD6135C	REAR	S	YZ 125 N (2T)	01	240	MD6153D	FRONT	S	POLARIS	253		
MD6135CX			WR 250 ZK (5EN1)	98					Big Boss 400 L 6x6 Middle Axle		96	
MD6135D			WR 250 FN/FP (4T)	01-02					Magnum 425 6x6 Middle Axle		96	
			YZ 250 K/L/M/N (2T)	98-01								
			YZ 250 FN (4T)	01								
			YZ 400 FL	99								
			WR 400 FL/FM/FN	99-01								
			WR 426 FN (4T)	01								
	YZ 426 FN (4T)	01										
MD6136D	REAR	S	KXF 250 A1/A2	87-88	231			Xpedition 300/400 L	96-97			
								Xpress 300 2x4	98-00			
								Xplorer 300 4x4	96-00			
MD6137D	FRONT	S	KXF 450 R (KSF 450 B8F/B9F /BAF/BBF/BCS/BFD/BEF)	08-14	163	MD6154D	REAR	S	POLARIS	150		
									Sportsman 500	97		
MD6138D	FRONT /REAR	S	KXT 250 B1 (Tecate - 3 wheel)	86	206	MD6155D	FRONT	S	POLARIS	182		
									KXT 250 B2 (Tecate - 3 wheel)		87	Magnum 325 4x4/2x4
MD6140D	FRONT	S	YFM 600 FWAK/FWAL/FWAM /FWAN 'Grizzly'	98-00	220				Magnum 325 2X4/4X4 Moose	01		
						YFM 600HM "Grizzly Hunting"	00				Magnum 325 (2x4) HDS	02
											Magnum 325 4x4	02
MD6141D	FRONT	S	HUSABERG		260			Scrambler 400 (2x4/4x4)	00			
MD6142D	REAR	S	HUSABERG		220			Scrambler 400 4x4/2x4	98-02			
MD6144D BILLET	REAR	S	HONDA		256			Scrambler 500 4x4	98-00			
			FL 400 R Pilot RK/RL	89-90				Scrambler 500 2x4/4x4	01-02			
MD6145D	FRONT	S	LT-F 500 FW/FX/FY/FK1/FK2	98-02	206			Trail Boss 325	00-02			
MD6147D	FRONT	S	POLARIS		165	MD6156D	REAR	S	POLARIS	175		
				Big Boss 250 4x6					89-90		Magnum 325 (4x4) (2x4)	00
				Trail Boss					88-90		Magnum 325 2x4/4x4 Mose	01
				Trail Boss 4x4					87		Magnum 500 4x4	99-00
				Trail Boss 2x4/4x4					88-89		Magnum 500	01
		Trail Blazer	90	Scrambler 400 (2x4/4x4)	00							
MD6149D	FRONT	S	POLARIS		228			Scrambler 400 4x4	98-02			
			Big Boss 250 4x6 Middle Axle	89-92				Scrambler 400 2x4	02			
			Big Boss 250 6x6	91-92				Scrambler 500 4x4	98-00			
			Big Boss 350 L	93								
			Big Boss 300 6x6 Middle Axle	94								
			Big Boss 400 L 6x6	94-97								

DISC BUYERS GUIDE

OFF ROAD DISC BUYERS GUIDE

DISC No.	FRONT/ REAR	TYPE	MODELS	DIA (MM)	DISC No.	FRONT/ REAR	TYPE	MODELS	DIA (MM)
MD6156D Contd.	REAR	S	POLARIS	175	MD6173D UTVX6173	FRONT /REAR	S	MASSEY FERGUSON	202
			Scrambler 500 2x4/4x4 01-02 Sport 400 99-00 Trail Boss 325 00-02 Trail Blazer 250 99-00 Trail Blazer 250 Freedom 01-02 Trail Boss 330 03-04 Xpedition 425 4x4 00 Xpedition 325 00 Xplorer 4x4 400 01-02					MF 250/300/400/500/650/700 (2WD/4WD) 04-09 ARCTIC CAT Most models 98-14 KYMCO MXU 400 (A40000) 08-11 Maxxer 450 i 10-18 MXU 450i IRS 11-12 MXU 500i (4x4 -IRS) 09-15 MXU 550i (4x4 LoF) 13-20 MXU 700i (4x4 Turf) 13-15 LAVERDA Quasar 4x4 400 04 Quasar 4x4 500 C 04 Quasar 4x4 500 04 PIAGGIO Trackmaster 400 Quad 06	
MD6157CX MD6157CX MD6157D	REAR	S	RM 125/250 X/Y/K1-K5 99-05 DR-Z 400 SMK5/K6/K7/K8/K9 05-09	240	MD6174D	REAR	S	YAMAHA	220
MD6158C MD6158D	FRONT	S	DT 50 LC 98- TT-R 125 LWM/LWN/LWP/LWR/LWES /LWS/LWET/LWT/LV/LEV/EW/LWEW /LWEX/LWX/LEY/LEWZ/LWEA /LWED/LWEE 00-14	220				YFM 400 FAM/FAN 00-01 YFM 450 FAR/FAS 03-04 YFM 450 FXV/FXW/FXX/FXY/FXZ Wolverine 06-10	
MD6160D	REAR	S	Canyon 500 96-00 900 IE Canyon/Gran Canyon 98-00 E 900 Elephant 90-99 Navigator 1000 00-05	240	MD6175D	FRONT	S	DERBI Senda-R 96-99	218
MD6161D	REAR	S	KX 125 E/E2/F1 86-88 KX 250 D2 86- KX 250 E1/F1 87-88 KX 500 B2/C1/D1 86-88	220	MD6180D	FRONT	S	APRILIA Tuareg Wind 600 89	260
MD6163D	FRONT	S	SUZUKI RM 125/250 F/G/H/J 85-88	240	MD6181C MD6181CX MD6181D	REAR	S	XR 650 RY/R1-R7 00-07 HONDA-DALL'ARA XR 650 R 04	240
MD6164D	REAR	S	TRX 400 EXX/EXY/EX1-EX8 99-08 TRX 400 X9 09	220	MD6182D	FRONT	S	TT 600 E (4LW3/4LW4/4GV4/4GV5) 94-01 TT 600 E (4GV2) 94-95 TT 600 K (4LW1/4GV1/4LW2) 93-96 TT 600 R (5CH1/5CH2/5CH3) 97-02 TT 600 RE (5CH5) 04	267
MD6165D	REAR	S	CRM 250-1 (RK) M1/MD24 (10001-1008385) 89-90	220	MD6183D	REAR	S	TT 600 E (4LW3/4LW4/4GV4/4GV5) 94-01 TT 600 E (4GV2) 94-95 TT 600 K (4LW1/4GV1/4LW2) 93-96 TT 600 R (5CH1/5CH2/5CH3) 97-02 TT 600 RE (5CH5) 04	220
MD6166D MD6166CX	FRONT	S	KX 65 SUZUKI RM 65 K3/K4/K5 03-05	180	MD6184C MD6184D OS6184HC OS6184KC OSX6184 OSX6184K OSX6184K9 SM6184CK9 SMX6184H SMX6184K SMX6184K9 Speedo pick-up measures 39.5mm from OD	FRONT	S	HUSQVARNA	260
	REAR	S	KX 65 SUZUKI RM 65 K3/K4/K5 03-05	180					
MD6168D	FRONT	S	HONDA XRV 650 J Africa Twin 88-89 CAGIVA Canyon 500 96-00 Canyon 600 96-99 E 750 Elephant 93-95 900 IE Canyon/Gran Canyon 98-00 E 900 ie Lucky Explorer 90-92 E 900 ie GT 91-92 Navigator 1000 00-05 Canyon 500 96-00 Canyon 600 96-99	296	MD6169D	FRONT	S	POLARIS Sportsman 6x6 02-04	203
MD6169D	REAR	S	POLARIS Xplorer 400 L (4x4) 99-02	203	MD6170D	FRONT	S	POLARIS Sportsman 6x6 (500) 00-04 PPS LUH 6x6 02	228
MD6170D	FRONT	S	POLARIS Sportsman 6x6 (500) 00-04 PPS LUH 6x6 02	228	MD6171D	FRONT	S	BOMBARDIER DS 650 00-04 CAN AM DS 650 X 07	166
MD6171D	FRONT	S	BOMBARDIER DS 650 00-04 CAN AM DS 650 X 07	166	MD6172D	REAR	S	BOMBARDIER DS 650 00-04 CAN AM DS 650 X 07	196

OFF ROAD DISC BUYERS GUIDE

DISC No.	FRONT/ REAR	TYPE	MODELS	DIA (MM)	DISC No.	FRONT/ REAR	TYPE	MODELS	DIA (MM)
MD6186C MD6186CX MD6186D OS6186C OSX6186	FRONT	S	KAWASAKI KX 85 I (17" Front/14" Rear Wheel) 01-20 KX 85 II (19" Front/16" Rear Wheel) 01-20 SUZUKI RM 100 K3 03	220	MD6192C MD6192D	FRONT	S	KTM 60 SX 98-00 65 SX 99-03	198
MD6187C MD6187CX MD6187D	REAR	S	KAWASAKI KX 85 I (17" Front/14" Rear Wheel) 01-20 KX 85 II (19" Front/16" Rear Wheel) 01-20 SUZUKI RM 100 K3 03	185	MD6195D	FRONT	S	LT-A 400 FK2/K2/FK3/K3/K4/FK4 /FK5/FK6/FK7/FK8 Eiger 4WD 02-09 LT-A 400 FK8/FK9/FL0/FL1 King Quad Auto 4WD 08-12 LT-F 400 FK2/FK3/FK4/FK5 /FK6/FK7 Eiger 02-10 LT-F 400 FK8/FK9/FL0/FL1 08-12 LT-F 400 K2/K3/K4/K5/K6/K7 02-07 LT-A 500 FK2/FK3/FK4/FK5 /FK6/FK7 Vinson 4WD 02-07 LT-F 500 FK3/FK4/FK5/FK6/FK7 03-07 MXU 500 (L70000/Carb Model) 05-09 MXU 500 4x4/Carb Model 05-13	190
MD6188D	FRONT	S	KVF 360 A1-A3/A6F/A7F/A8F/A9F/AAF /ABF/ACF/ADF 03-13 KVF 360 B1-B3/B6F/B7F/B8F/B9F 03-09 KVF 360 C1-C3/C6F/C7F/C8F Prairie All Models 03-08 KVF 650 A1/A2 02-03 KVF 650 D1/D6F/D7F/D8F/D9F/DAF/DBF Brute Force 4x4 05-11 KVF 650 E1/E6F/E7F/E8F/E9F Brute Force 4x4 Hardwoods Green HD 05-09 KVF 650 FCF/FCS/FDF/FEF 12-14 KVF 650 F7F/F8F/H7F/H8F/G7F/G8F 07-08 KVF 700 A1/B1/B6F/B7F/A2/B2/A6F/A7F /A8F 4x4 (Prairie) 04-08 KVF 700 D1 Team Green 05 KVF 750 D8F/D9F/DAF/DBF 08-11 KVF 750 E8FA 08 KVF 750 GCF/GDF/GEF/GFF/GGF/GHF Brute Force 4X4i EPS 12-17 KVF 750 HCF/HDF/HEF/HFF/HGF/HHF Brute Force 4X4i EPS/Camo 12-17 KVF 750 JCF/JDF/JEF/JFF/JGF/JHF Brute Force 4x4i EPS 12-17 KVF 750 LCF/LDF/LEF/LFF/LGF/LHF Brute Force 4x4i 12-17	200 200	MD6196D	REAR	S	LT-A 500 FK2/FK3/FK4/FK5/FK6 /FK7 Vinson 4WD 02-07 LT-F 500 FK3/FK4/FK5/FK6/FK7 03-07	216
MD6189D	FRONT	S	YFM 660 FWAP/FWAR/FWAS/FWAT /FWAV/FGW/FGX Grizzly 02-08 YFM 660 FR/FS/FT Grizzly 03-05	220	MD6197D BILLET	REAR	S	YFM 660 FWAP/FWAR/FWAS/FWAT /FWAV/FGW/FGX Grizzly 02-08 YFM 660 FR/FS/FT Grizzly 03-05	148
MD6190C MD6190CE MD6190CX MD6190D (Undrilled Enduro Disc)	REAR	S	YZ 125 (2T) 02-20 YZ 250 P/R/S/T/V/W/X/Y/Z/A/B/D/E /F/G/H/J (2T) 02-18 YZ 250 FP/FR/FS/FT/FV/FW/FX/FY/FZ /FA/FB/FD/FE/FF (4T) 02-15 WR 250 FR/FS/FT/FV/FW/FX/FY/FZ/FA /FB/FD (4T) 03-13 WR 250 F (4T/Reverse Cylinder) 15-20 WR 426 FP (4T) 02 YZ 426 FP (4T) 02 WR 450 FR/FS/FT/FV/FW/FX/FY/FA/FB/FD /FE/FF (4T) 03-15 WR 450 F (270mm F/Disc/4T) 16-20 YZ 450 FR/FS/FT/FV/FW/FX/FY/FZ/FA/FB /FD/FE/FF (4T) 03-15 YZ 250 F (270mm Disc) 16-20 YZ 250 FGY (60th Anniversary Edition /270mm Disc) 16 YZ 450 F (270mm Disc) 16-20 YZ 450 FG (60th Anniversary Edition /270mm Disc) 16	245	MD6198D	REAR	S	AX-1 (NX 250 J/K/R/R3) 89-94	220
MD6191C MD6191CE MD6191CX MD6191D (Undrilled Enduro Disc) Note: For HM models check application page	REAR	S	CRE 125 R Supermotard 02-06 CR 125 R2/R3/R4/R5/R6/R7 02-07 CR 125 Motard 04-06 CR 250 R2/R3/R4/R5/R6/R7/R8/R9 02-09 CRE F 250 R 08-09 CRE F 250 X 08-11 CRF 250 R4-R9/RA/RB/RC/RD/RE/RF/RG/RH 04-17 CRF 250 R 08-09 CRF 250 RE (Limited Road Use) 16 CRF 250 R AC (260mm F/Disc) 15-20 CRF 250 X 04-20 CRF 250 RX 08-20 CRF 250 XRL (Road legal) 14-20 CRE F 300 X 08-09 CRF 450 R AC 02-20 CRF 450 R 04-09 CRF 450 RE (Limited Road Use) 16 CRF 450 R (260mm F/Disc) 15-20 CRF 450 X5/X6/X7/X8/X9/XB /XC/XD/XF/XG/XH 05-17 CRF 450 XRL (Road Legal) 14-16 CRF 450 RX (18" Rear Wheel) 17-20 CRE F 500 X 08-09	240	MD6199C MD6199D	FRONT	F	KTM Duke 400 LC4 94-98 Duke 620 LC4 LC4 620 SC Supermoto 00 LC4 625 SC Supermoto 02 SMC 625 04-06 Duke II 640 01-06 Duke-E 640 (Single pin pad fixing/zero offset disc) 98 Duke II 640 (2 pin pad fixing/zero offset disc) 99-02 LC4-E 640 Supermoto 00-06 LC4-E 640 (Central single pin fixing) 03 LC4-E 640 (2 pin fixing) 04-06 LC4 640 Adventure R 99-02 LC4 640 Adventure 03 690 SM 07-09 690 SMC 08-11 690 SM-LE (Limited Edition) 10-11 690 SMC-R 12-37	320
					MD6200D	REAR	S	POLARIS Magnum 325 2x4 HDS 02 Magnum 325 4x4 02 Magnum 325 4x4 HDS 02 Magnum 330 (4x4/HDS) 03-04 Magnum 500 (2x4/4x4 HDS) 02-03 Xpedition 325 02 PPS/PTV 4x4/Series 10 PPS/PTV 6x6/Series 10	206
					MD6201D UTVX6201	REAR	S	400 Sportsman 03-04 Sportsman 500 X2 06 Sportsman 600 (4x4) 03-04 Sportsman 700 4x4 02-04 Sportsman MV 700 05 Sportsman 800 05 PPS/Series 10 UTV 2x4/4x6 PPS/Series II UTV 1500 2x4 PPS/Series 11 2x4/4x4/6x6 Ranger 6x6 04-05 Ranger TM 04-05 Ranger XP 05 Ranger 2x4/4x4 04-06 Ranger Series 10 Ranger Series 10 500 6x6 Ranger Series 11	218

DISC BUYERS GUIDE

OFF ROAD DISC BUYERS GUIDE

DISC No.	FRONT/ REAR	TYPE	MODELS	DIA (MM)	DISC No.	FRONT/ REAR	TYPE	MODELS	DIA (MM)						
MD6202D UTVX6202	FRONT /REAR	S	POLARIS	228	MD6211D	REAR	S	LT-Z 400 K3-K9/L0/L1/L2/L3	03-14	220					
			325 Hawkeye 2x4					15	KSF 400 A1/A2/A3		03-05				
			Magnum 325 4x4 HDS					02	DVX 400		04-08				
			325 Sportsman Ace					14	400 DVX (2x4) Sport		04-08				
			325 Sportsman Ace Efi					15	400 DVX TS Sport		06-07				
			325 Sportsman Ace Euro					14-15							
			325 Sportsman Ace HD					15							
			ATP 330 (4x4)					04							
			Magnum 330 (4x4/HDS)					03-04	MD6212D		FRONT	S	DR-Z 125 LK3/LK4/LK5/LK6/LK7	03-19	220
			330 Trail Boss					10-13					/LK8/LK9/LL0-LL9	03-06	
			330 Trail Blazer					10-13					KLX 125 L (B1/B2/B3/A6F)		
			400 Hawkeye H.O. (2x4)					13-14							
			400 Ranger					10-14							
			400 Sportsman (Code A04CH42												
			AQ/AR/AS/AT/AV)					04							
			400 Sportsman HO 4x4					11-14							
			ATP 500 HO (4x4)					04							
			Magnum 500 HDS					02-03							
500 Scrambler 4x4	10-11														
Sportsman 500 HO	04-06														
500 Sportsman HO	Up to 15/12/08														
500 Sportsman HO	After 16/12/08														
500 Sportsman Touring HO	11-13														
500 Sportsman Forest	12														
570 Sportsman Ace	15														
570 Sportsman Ace Euro	15														
570 Sportsman Efi (inc EPS)	11-13														
570 Sportsman Touring Efi	14														
570 Ranger Crew	14-15														
Sportsman 700 (4x4)	02-04														
Sportsman MV 700	05														
Sportsman 800	05														
800 Sportsman Big Boss/6/6/Efi	09-14														
800 Sportsman HO/Efi															
800 Sportsman Efi	10-13														
800 Sportsman	12-14														
850 Sportsman Touring H.O. EPS	13-14														
PPS/PTV 4x4/Series 10															
PPS/Series 10 UTV 2x4/4x6															
PPS/Series II UTV 1500 2x4															
PPS/Series 11 2x4/4x4/6x6															
Ranger 6x6	04-05														
Ranger TM	04-06														
Ranger XP	05														
Ranger 2x4/4x4	04-06														
Ranger 500 (2x4/4x4/4x4 Efi)	06														
500 Ranger Crew	11-13														
500 Ranger 4x4 Efi	11-13														
Ranger 6x6 Efi 700	06														
Ranger XP 700 4x4	06														
Ranger EV (Electric)	10-14														
Ranger ETX	15														
MD6206D	FRONT	S	LT-F 300 FK2	02	168										
MD6207D	FRONT	S	LT-F 250 K2-K9/L2/L3/L4 Ozark	02-14	160										
MD6208C MD6208CE MD6208CX MD6208D	REAR	S	KX 125 M1/M2/M3/M6F/M7F/M8F	03-08	240	MD6218D	REAR	S	Predator 500	03-04	196				
			KX 250 F (KX 250 N1/N2)	04-05					POLARIS						
			KX 250 M1/M2/R1/R6F/R7F/R8F	03-08					525s Outlaw	08-10					
			KX 250 F (T6F/T7F/T8F)	06-08											
			KX 250 F (KX 250 W9F/XAFB/YBF												
			/YCF/ZDF/ZEF/ZFF/ZGF/AHF) (4T)	09-17											
			KX 250 F	15-20											
			KX 450 F (D6F/D7F/D8F/E9F/EAF/EBF												
			/FCF/FDF/FEF/FFF/HGF/HHF/HJF)	06-18											
			KLX 450 R (A8F/A9F/AAF/ABF/ACF												
/ADF/AEF/AFF/AGF/AHF/AJF)	08-18														
SUZUKI															
RM-Z 250 K4/K5/K6	04-06														
MD6209D	FRONT	F	SM 125 (2T)	03-06	320	MD6219D	FRONT	S	Predator 500	03-04	178				
			404 DS Supermoto	03-04					Phoenix 200	05					
			SM 450 ER (4T)	07-08					200 Phoenix (AA/AB Model						
			SM 515 FSR (4T)	07-08					/Rear drum model)	05					
			604 E Supermoto	99-03					200 Phoenix Quadricycle Model						
			604 RS "Roadster"	00-03					(EA/EB/EC/ED Rear Disc Model)	05-09					
			644 DS/DS Supermoto	04											
			R 30 (Spoke wheel)	02-04											
MD6210D	FRONT	S	LT-Z 250 K4-K9/L0 QuadSport	04-12	170	MD6220D	FRONT	S	BOMBARDIER		155				
			LT-Z 400 K3-K9/L0/L1/L2/L3	03-14					Rally 200	03-06					
			KSF 400 A1/A2/A3	03-05					CAN AM						
			DVX 400	04-08					Rally 200	07					
			400 DVX (2x4) Sport	04-08											
MD6211D	FRONT	S			200	MD6215D	FRONT	S	YFM 350 FAS/FAT/FAV Bruin 4x4	04-06	200				
									YFM 350 ANS/ANT Bruin 2x4	04-06					
									YFM 350 XV/XW/XX 2WD						
									Wolverine IRS	06-09					
									YFM 350 FWA Grizzly 4WD	04-14					
									YFM 350 FGIW/FGIX/FGIY/FGIZ						
									Grizzly 4WD IRS	07-10					
									YFM 350 GW/GX/GY/GZ Grizzly 2WD	08-10					
									YFM 400 FAR/FAS Kodiak Auto	03-04					
									YFM 400 AR Kodiak (5VH3/4)	03					
									YFM 400 FAT/FAV (Big Bear)	05-06					
									YFM 450 FAR/FAS Kodiak (5ND3/4)	03-04					
		YFM 450 FAT/FAHT/FAV (Kodiak)	05-06												
		YFM 450 FXV/FXW/FXX/FXY/FXZ													
		Wolverine	06-10												
		YFM 450 FWAD Grizzly EPS													
		(Power Steering)	11-14												
		YFM 450 FWA Grizzly IRS	11-16												
MD6216D	REAR	S	KTM		160	MD6217D	REAR	F	HONDA		170				
			60/65 SX	00-01					TRX 420 FA9/FAA/FAB						
			65 SX	00-03				Fourtrax Auto 4WD	09-11						
								Fourtrax Auto Power Steering	09-11						
								TRX 650 FA3/FA4/FA5							
								Rincon 4x4 Auto	03-05						
								TRX 680 FA6/FA7/FA8/FA9/FAA/FAB							
								/FAC Rincon 4x4 Auto	06-14						
MD6218D	FRONT	S			205	MD6222D	FRONT	S	BOMBARDIER		180				
									See main application pages for fitments						
									CAN AM						
								See main application pages for fitments							

DISC BUYERS GUIDE

OFF ROAD DISC BUYERS GUIDE

DISC No.	FRONT/ REAR	TYPE	MODELS	DIA (MM)	DISC No.	FRONT/ REAR	TYPE	MODELS	DIA (MM)
MD6224D	FRONT /REAR	S	BOMBARDIER Traxter 01-04 Quest 500/650 02-04	203	MD6241D UTVX6241	FRONT	S	YXR 66 FAS Rhino 4x4 Side x Side 04 YXR 700 Rhino 4x4 SE 09 YXR 700 FA/FB/FD Rhino Side x Side 11-13	200
MD6225D	FRONT /REAR	S	BOMBARDIER Traxter 01-04 Quest 500/650 02-04 Quest Max/XT/STD 04 Traxter Max 650 04-05 Traxter Auto STD/XL 04 Traxter Max STD/XT 04-05 Traxter XL 04-05 Traxter 5 Speed 05 Traxter CVT (500/650/650 XT) 05 Traxter Max CVT 650 05 Traxter XT 05 JOHN DEERE ATV Trail Buck 500 Utility 04-05 Trail Buck 650/650 EX/EXT 04-05 Buck 500/500 EX/EXT 04-05	218	MD6242D OS6242 UTVX6242	REAR	S	YXR 450 F Rhino 4WD Side x Side 04-09 YXR 66 FAS Rhino 4x4 Side x Side 04	165
MD6226D	FRONT	F	XT 660 X Supermoto 04-16	320	MD6243C MD6243CX MD6243D	FRONT	S	KTM SX 65 04-20	198
MD6227D	REAR	S	KTM MX/MXC/GS 125 86 MX 125 88-89 EXC 125 88-89 MX/MXC 250 86 GS 250 86 MX 250 88-89 EXC/EGS 250 88-89 MX/MXC/GS 300 86 MX/MXC/GS 350 86/88 MX 350 89 EXC 350 89	220	MD6244D	REAR	S	XT 225 WE (4JG5/6) Serraw 97-98 XT 250 Tricker (5XT1) 04-06 XT 250 Serraw (3C51/2) 05-08 XTZ 250 07-08	203
MD6229D	FRONT	S	BOMBARDIER Traxter 99-04	205	MD6245D	FRONT	S	BOMBARDIER/BRP Quest Max/XT/STD 04 Traxter Auto STD/XL 04 Traxter Max STD/XT 04-05 Traxter XL 04-05 Traxter 5 Speed 05 Traxter CVT (500/650/650 XT) 05 Traxter Max CVT 650 05 Traxter XT 05 JOHN DEERE ATV Trail Buck 500 Utility 04-05 Trail Buck 650/650 EX/EXT 04-05 Buck 500/500 EX/EXT 04-05	203
MD6230D	REAR	S	BOMBARDIER Traxter 99-04	220	MD6246C MD6246CX MD6246D	REAR	S	SUZUKI RM 85 05-20	200
MD6232CX MD6232D	REAR	S	SUZUKI DL 650 XK7/XK8/XK9/XL0 V-Strom X 07-11 DL 650 AK7/AK8/AK9/ALO V-Strom ABS 07-11 DL 650 AK9 GT V-Strom Traveller ABS 09-11 DL 650 AL1XP V-Strom Xpedition 11 DL 650 V-Strom ABS 12-20 DL 650 XT V-Strom ABS 15-20 DL 1000 K2-K9/L0 V-Strom 02-11 DL 1000 V-Strom (ABS) 14-20 DL 1000 XT V-Strom (ABS) 18-20 KAWASAKI KLV 1000 (LV 1000 A1H/A2H) 04-05	260	MD6247C MD6247D	FRONT	F	DRZ 400 SMK5/SMK6/SMK7 /SMK8/SMK9 05-09	310
MD6233D	REAR	S	TRX 450 R4/R5/R6/ER6/R7/ER7 /R8/ER8/R9/ER9 04-09	190	MD6248D	REAR	S	DERBI Senda X Race 50 R 05-11 Senda X-treme 50 R 03-11 Senda X-treme 50 SM 03-11 Senda SM DRD 50 02-03 Senda SM DRD 50 05 APRILIA RX 50 06-14 SX 50 06-14 GILERA RCR 50 Enduro 03-06 SMT 50 Supermotard 03-06 SMT 50 07	180
MD6234D	REAR	S	XT 660 X Supermoto 04-16 XT 660 R 04-16 XT 660 Z Tenere (Non ABS) 08-16 XT 660 ZA Tenere (ABS) 11-16	245	MD6249C MD6249CX	REAR	S	KTM SX 65 04-20	160
MD6235D	FRONT	F	DT 125 X 04-06 WR 125 X (Supermoto) 09-18 XT 660 R 04-15 XT 660 Z Tenere (Non ABS) 08-16 XT 660 ZA Tenere (ABS) 11-16	298	MD6250D	FRONT	S	DERBI Senda X Race 50 R 05-11 Senda X-treme 50 R 03-11	240
MD6236D	REAR	S	YFM 250 RX/RX Raptor 08-09 YFM 250 R (338) 09-11 YFM 250 R (1BT) 12-13 YFM 350 S/T/V/R-W/RW/RX/RV/RZ Raptor 04-10 YFZ 450 S/T 04-05 YFM 700 RD/RE 13-14 YFM 700 RSE 13-18	200	MD6251D	FRONT	S	HONDA TRX 500 FE5/FE6/FE7/FE8/FE9/FEA /FEB Fourtrax Foreman 4WD-ES 05-11 TRX 500 FA5/FA6/FA7/FA8/FA9/FAA /FAB 05-11 TRX 500 FM5/FM6/FM7/FM8/FM9/FMA /FMB Fourtrax Foreman 4WD 05-11 TRX 500 FPE8/FPE9/FPEA/FPEB Fourtrax Foreman - Power Steering 08-11 TRX 500 TM5/TM6 Fourtrax Foreman 05-06 TRX 680 FA6/FA7/FA8/FA9/FAA/FAB /FAC Rincon 4x4 Auto 06-14	180
MD6237D	REAR	S	YFS 200 R/S/T/V 03-06 YZF 350 U/B/D/E/F/G/H/J/K/L/M /N/P/R/S/T/V Banshee 88-09 YFM 660 RN/RP/RR/RS/RT Raptor 01-05	220	MD6252D	REAR	S	YFM 400 FAT/FAV (Big Bear) 05-06 YFM 400 FGW/FGX Grizzly IRS 07-08 YFM 450 FAT/FAHT/FAV (Kodiak) 05-06	220
MD6239D	FRONT	S	KLX 250 G1/G1A/H1 Super Sherpa 97-00 KL 250 J1-J3 00-02	240	MD6253D MD6253C	REAR	S	GAS-GAS See application pages	220
MD6240C MD6240D	FRONT	S	250 SBK2 (LX 250 L) 02 KLX 250 J1-J6 D-Tracker 98-03	250	MD6254D MD6254C OS6254C OSX6254 SM6254C SMX6254	FRONT	S	RM-Z 250 K8/K9/L0/L1/L2/L3 /L4/L5/L6/L7/L8/L9 08-19 RM-X 450 ZL0/ZL2 10-15 RM-Z 450 K5/K6/K7/L0/L1/L2 /L3/L4/L5/L6/L7 05-17	250

DISC BUYERS GUIDE

OFF ROAD DISC BUYERS GUIDE

DISC No.	FRONT/ REAR	TYPE	MODELS	DIA (MM)	DISC No.	FRONT/ REAR	TYPE	MODELS	DIA (MM)	
MD6255C MD6255CE (Plain) MD6255CX MD6255D	REAR	S	RM-Z 250 K8/K9/L0/L1/L2/L3/L4	240	MD6267D Contd.	FRONT /REAR	S	KYMCO Contd.	180	
			/L5/L6/L7/L8/L9	08-19				KFX 90 (KSF 90 A7F/A8F/A9F/AAF/ABF/ACF /ADF/AEF/AFF/AGF/AHF)		07-17
			RM-X 450 ZL0/ZL2	10-15				KVF 300 CCF/CDF/CEF/CGF/CHF Brute Force		12-17
			RM-Z 450 K5/K6/K7/L0/L1/L2 /L3/L4/L5/L6/L7/L8/L9	05-19						
			330 Trail Boss	10-14						
			330 Trail Blazer	10-14						
			Scrambler 500	05						
MD6257C	REAR	S	KTM SX85	200	MD6268D	REAR	S	ARCTIC CAT 300 DVX KYMCO KXR 250 Maxxer 250 MXU 250 MXU 250 R Maxxer 300	220	
MD6258C OS6258C OS6258/12C OSX6258	FRONT	S	KTM SX85 (17"/14" wheels) SX85 (19"/16" wheels) HUSQVARNA TC85 (17"/14" wheels)	220	MD6269C MD6269D	REAR	S	690 Rally Factory Replica 690 SM 690 SM-LE (Limited Edition) 690 Enduro R 690 Enduro 950 Adventure 950 Adventure S	240	
MD6259D	REAR	S	650 Elefant 750 Elefant	240	MD6270C MD6270D	FRONT	F	KTM SMR 450/525 SMR 450 (Brembo F/Caliper) HUSABERG FS 650 E Supermoto	310	
MD6260D	FRONT	S	CCM 404E 404 DS 604 E DS	260	MD6271D UTVX6271	FRONT	S	ARCTIC CAT Prowler 500 HDX LTD Prowler 500 HDX XT Prowler 500 HDX 550 Hi Efi Prowler XT 550 XT 550 i Prowler XT 650 H1 Prowler 650 H1 Prowler 650 Prowler 4x4 Auto/M4 Prowler 700 HDX LTD HDX 700 Prowler XTX 700 XTX 700 i Prowler XTX 700 Hi Le Prowler XTX 700 Hi Efi Prowler XTZ 1000 H2 Efi Prowler Wildcat 1000 i GT Wildcat 1000 Wildcat 1000 X Wildcat 1000 X Wildcat 1000 LTD Wildcat 1000 4 LTD XTZ 1000 H2 Prowler XTZ 1000	252	
MD6261D	FRONT	S	SUZUKI LT-A 700 XK5/XCK6/XK6/XK7 LT-A 750 XZK8/XK8/XK9 /XZK9/XL0 King Quad	200	MD6271D	REAR	S	KAWASAKI KVF 300 CCF/CDF (2x4)	252	
MD6262D	FRONT	S	POLARIS Trail Blazer 250 Trail Boss 330	182	MD6272D	FRONT	S	POLARIS Hawkeye 300 2x4/4x4	198	
MD6263C MD6263D	REAR	S	YFZ 450 V/W/X YFZ 450 RY/RZ (Quad) YFZ 450 RSEA/RSEB/RSED/RSE YFZ 450 B/D YFM 700 RV/RW/RA/R Raptor	200	MD6273D	REAR	S	POLARIS Hawkeye 300 2x4/4x4 Prowler 700 HDX LTD	202	
MD6264C MD6264CX MD6264D OS6264C OSX6264 SM6264C SMX6264	FRONT	F	KX 125 M6F/M7F/M8F KX 250 R6F/R7F/R8F KX 250 F (T6F/T7F/T8F) KX 250 F (KX 250 W9F/XAFB/YBF /YCF/ZDF/ZEF/ZFF/ZGF) (4T) KX 450 F (D6F/D7F/D8F/E9F/EAF /EBF/FCF/FDF/FEF) KLX 450 R (A8F/A9F/AAF/ABF/ACF /ADF/AEF/AFF/AGF/AHF/AJF)	250	MD6274D	FRONT	S	200 Phoenix (AC/AD Model and following/rear drum model) 200 Phoenix (Rear drum model) 200 Phoenix Quadricycle Model (EC/ED models/rear disc model) 200 Sawtooth (Rear drum model) 200 Sawtooth Quadricycle (Rear disc model) Cobra 220 (Quad) Overland 300 (Quad) (AT20) Cobra 350 Cobra 400 (Quad) 400 Hawkeye HO (2x4)	173	
MD6265D	FRONT	F	650 Elefant 750 Elefant	260	MD6274D	REAR	S	325 Hawkeye 2x4 325 Sportsman Ace 325 Sportsman Ace Efi 325 Sportsman Ace Euro 325 Sportsman Ace HD 400 Ranger 400 Sportsman HO 4x4 Sportsman 500 X2 500 Sportsman Touring HO	218	
MD6266D	FRONT	S	250 DVX Sport LC-4 640 Adventure R LC-4 640 Adventure 950 Adventure 950 Adventure S	300						
MD6267D	FRONT /REAR	S	ARCTIC CAT 50 DVX (4T) Sport 50 4x4 Auto Youth 90 2x4 (4T) Youth 90 DVX 90 DVX SE 90 (Reverse gear model) 90 SE 150 Utility 2x4 250 DVX Sport 300 2x4 Utility (Midsized) 300 DVX KYMCO Mxer 50 (Quad) MXU 50 (2T) KXR 90/90 S Mongoose MXU 150 KXR 250 Maxxer 250 MXU 250 MXU 250 R Maxxer 300 MXU 300 MXU 300 R KFX 50 (KSF 50 B7F/B8F/B9S/B9S/BDF/BEF /BFF/BGF/BHF)	180						

DISC BUYERS GUIDE

OFF ROAD DISC BUYERS GUIDE

DISC No.	FRONT/ REAR	TYPE	MODELS	DIA (MM)	DISC No.	FRONT/ REAR	TYPE	MODELS	DIA (MM)															
MD6275D UTVX6275 Contd.	REAR	S	Ranger 500 (2x4/4x4) 06	218	MD6283D	FRONT	S	CAN-AM	175															
			Ranger 500 (4x4 EFI) 09-10					DS 250 06-15																
			500 Ranger 4x4 EFI 11-13					YAMAHA																
			500 Ranger Crew 11-13					YFM 300 B/D Grizzly 12-14																
			500 Sportsman HO Up to 15/12/08					MD6284D		REAR	S	MZ/MUZ	245											
			500 Sportsman HO After 16/12/08											Baghira Forest/Forest HR										
			500 Sportsman Forest 12											21" front/spoke wheel 96-05										
			RZR 570 12-19											Baghira Street Moto										
			570 Forest Tractor Efi/EPS 15											17" front spoke wheel 96-05										
			570 Sportsman Ace 15											Baghira 21" front spoke wheel 99-05										
			570 Sportsman Ace Euro 15											Baghira Black Panther										
			570 Sportsman EFI (inc EPS models) 11-13											17" front spoke wheel 96-03										
			570 Sportsman Touring Efi 14											Mastiff 21" front spoke wheel 96-05										
			570 Ranger Crew 14-15											MD6285D	REAR	S	Rally 200	200						
			Ranger 570, Full Size (R12) 17-19																					
			Ranger Crew 570FS (R08) 17-19																MD6286D	REAR	S	DT 50 R-L (SM)	220	
			RGR 570 EPS Crew MD (R04) 18																					MX 50 02-03
			RGR 570 EFI Crew (R10) 17																					Pegaso 50 92-94
			RGR 570 Crew (R03) 18-19																					RX 3-5 Marce (M/N/P/R) 91-94
			Ranger 6x6 EFI 700 06																					RX 50 C/CD 95-04
Ranger XP 700 4x4 06	RX 50 Racing 03-06																							
Ranger TM 06	MD6287D	REAR	S	HUSQVARNA	220																			
Ranger EV (Electric) 10-14						CR 125 00-01																		
800 Ranger XP 10-12						SM 125 00																		
800 Ranger 6x6 10-14						SM 125 S 02-13																		
800 Ranger Crew 10-14						SMR 125 (4T) 11-13																		
RZR 800 Ranger 08-14						SMS 4-125cc (4T) 11																		
RZR-4 800 EFI 10-14						TE 125 (4T) 11-13																		
800 Ranger RZR 4 EPS 12						WR 125 00-01																		
800 Sportsman Big Boss/6/6/EFI 09-14						WRE 125 00/02-13																		
800 Sportsman HO/EFI Up to 15/12/08						CR 250 00-01																		
800 Sportsman HO/EFI After 16/12/08						WR 360 00-01																		
800 Sportsman EFI 10-13						TE 410 00																		
800 Sportsman 12-14						SM 570 R 01																		
900 D Crew Ranger Diesel 13-14						TE 570 01																		
900 Ranger Crew						SM 610 S 02-06																		
900 D Ranger Diesel 11-14						TC 610 00																		
900 Ranger RZR XP 12						TE 610 00																		
900 Ranger XP 15						SMR 620 10-12																		
1000 Ranger Diesel 15						MD6288C MD6288D	REAR	F	HUSQVARNA	240														
1000 Ranger Diesel Crew 15											CR 125/WR 125 06-08													
Ranger ETX 15	TC 250 05-08																							
Brutus 13-14	TE 250 06-08																							
MD6276D	REAR	S	CCM	220	MD6289C MD6289D						FRONT	S	CR 40 S Cafe Racer (Full fairing) 07-08	260										
			CR 40 Street Scrambler 07-09										EC 125/200/250/300 (Nissin) 00-10											
			R 45 07-09										EC 125/200/250/300 (All models/2T) 11-13											
			404 E 03-04										MX 125/250 (MC) 01-09											
			404 DS/DS Supermoto 03-04										EC 450 FSR (4T) Enduro/FSE 05-09											
			604 E DS 98-03										Pampera 450 (4T) 07-08											
			604 E Supermoto 99-03										SM 450 R 07-10											
			604 RS 00-03										SMR 450 RR 06-07											
			644 DS/SM 04										TC 450 05-10											
			FT 710 S Flat Tracker 08-09										TE 450 06-10											
R30 (Spoke Wheel) 02-04	SM 510 R 06-10																							
MD6277D	FRONT	S	LTR 450 K6/K7/K8/K9/L0/L1 06-12	160	MD6290D						REAR	S	450 Outlaw MXR 09-10	228										
			MD6278D										REAR		S	500 Outlaw 06-07								
																LTR 450 K6/K7/K8/K9/L0/L1 06-12	525 S Outlaw 08-10							
MD6279D	FRONT	S	MALAGUTI	260	MD6291D						FRONT	S	525 Outlaw IRS 08-11	220										
			XSM 50 Supermotard 03-07										YFM 550 FWAD Grizzly EPS (Power Steering) 07-14											
MD6280D	REAR	S	DT 50 R 02-08	220	MD6292D	REAR	S	YFM 550 FWA Grizzly IRS 11-14	203															
			DT 50 X Supermotard 02-08					YFM 700 FGPW/FGPX/FGPY/FGPZ/FGPA /FGPB/FGPD/FWAD Grizzly 07-18																
			XT 125 R (3D61/ED63) 05-06																					
			XT 125 R (13D1/13D3/13D5) 07-12																					
			XT 125 X (3D62/3D64) 05-06																					
XT 125 X (13D2/4/6) 07-11																								
MD6281D	FRONT	S	MBK	220																				
			X Limit Enduro 50cc 03-09																					
			X Limit Supermoto 50cc 03-09																					
			RV 125 K2-K9/L0/L3/L4/L5/L6/L7/L8 /L9 Van-Van 02-19																					
MD6282D	REAR	S	CAN-AM	190																				
			DS 250 06-15																					
			YAMAHA																					
YFM 90 RY/RZ/RA/RB/RD Raptor 09-13																								

DISC BUYERS GUIDE

OFF ROAD DISC BUYERS GUIDE

DISC No.	FRONT/ REAR	TYPE	MODELS	DIA (MM)	DISC No.	FRONT/ REAR	TYPE	MODELS	DIA (MM)				
MD6293D 4 Bolt Fixing	FRONT	F	HUSQVARNA SM 400 R 02 SM 450 R 03-10 SM 450 RR 07-10 SMR 450 R 06-07 SM 510 R 06-10 SM 550 RR 08-10 SM 570 R 01-04 SM 610/S 02-06 SM 610 ie 07-09 SMR 630 (4T) 10-11 SMR 630 06/10-12 STR 650 CRC 07	320	MD6302D Contd.	FRONT	S	HONDA Contd. TRX 420 FPM9/FPMA/FPMB Fourtrax 4WW - Power Steering 09-11 TRX 420 TE7/TE8/TE9 Fourtrax ES - 2WD 07-09 TRX 420 TM7/TM8/TM9/TMA/TMB 2WD Fourtrax 07-11	185				
					MD6303D					FRONT	S	E 900 C Elephant 93-97 E 900 C IE Lucky Explorer 95-97	282
					MD6304C					REAR	S	KSF 450 B8F/B9F/BAF/BBF/BCS /BFD/BEF (KFX 450 R) 08-14	200
MD6294D 6 Bolt Fixing	FRONT	F	HUSQVARNA LT 610 00 SM 610 R 00 SM 610 98-00	320	MD6305C	REAR	S	RM 125 K6/K7/K8/K9 06-12 RM 125 XCK8 09 RM 250 K6/K7/K8/K9 06-12 RM 250 XCK8 09	240				
					MD6305CX								
MD6295D 220 O/D Floats on O/E pins	REAR	F	HUSQVARNA CR 125 02-05 WR 125 02-05 CR 250 02-05 TC 250 02-03 TE 250 02-05 WR 250 02-05 WR 300 09-12 WR 360 02 SM 400 R 02 TE 400 02 SM 450 R 03-06 TC 450 03-04 TE 450 03-05 SM 510 R 06 TC 510 04 TE 510 04-05 SM 570 R 02-04 TC 570 02-03 TE 570 02-04 SM 610 ie 07-09 TE 610/IE 06-09 SMR 630 06 STR 650 CRC 07	220	MD6306D	FRONT	F	R30 (604/644) (Mag wheel) 02-04	320				
					MD6307D	FRONT	S	ETV 1000 Caponord (Non ABS - Bolt fixing) 01-03	300				
					MD6308D	REAR	S	ETV 1000 Caponord (Non ABS - Bolt fixing) 01-03 ETV 1000 Caponord Rally (Non ABS - Bush fixing) 03 ETV 1000 Caponord (ABS - Bush fixing) 04-07	270				
					MD6309C MD6309CX SM6309C SMX6309	FRONT	S	KLR 650 (KL 650 E8F/E9F) 08-09	280				
					MD6310C MD6310CX	REAR	S	KLR 650 (KL 650 E8F/E9F) 08-09	240				
					MD6311D	REAR	S	200 Sawtooth Quadricycle (Rear disc model) 06/08 200 Phoenix Quadricycle Model (EA/EB/EC/EDRear disc model) 05-09 200 Phoenix Quadricycle Model (Rear disc model) 10	220				
					MD6312D UTV6312	FRONT	S	RZR 570 12-13 800 Ranger RZR 08-14	235				
					MD6313C	FRONT	F	SMR 450 07-13	310				
					MD6314D/C MD6314CX OSX6014	FRONT	S	CRF 150 R Small wheel (FR16"/RR 14") 07-20 CRF 150 RB Big wheel (FR19"/RR 16") 07-20	220				
					MD6315D	REAR	S	RX 125 92-01 Tuareg Rally 125 89 Tuareg Rally 125 (L/M) 90-91	220				
					MD6316C MD6316CX MD6316D	REAR	S	CRF 150 R Small wheel (FR16"/RR 14") 07-20 CRF 150 RB Big wheel (FR19"/RR 16") 07-20	190				
					MD6317C MD6317D SM6317C SMX6317	FRONT	S	CRF 150 03-20	240				
MD6298D	REAR	F	690 SMC 08-11 690 SMC R 12-13 950 R Superenduro 06-08 990 Adventure S (Non ABS) 06-08 990 Adventure R (Non ABS) 09-12 990 Adventure (ABS) 07-12 990 Adventure Dakar Edition (ABS) 11	240	MD6318D	FRONT	S	RX 50 Super Racing 06-07 RYZ 50 Urban Bike 06-10 XR6 (2T) 50 03-07	260				
					MD6319C	REAR	S	WR 250 RX/RX 08-18 WR 250 XX/XY 08-15	230				
MD6299C MD6299D	FRONT	F	HUSQVARNA 701 Enduro 16-20 KTM 690 Enduro R 09-13 690 Enduro 08-14 690 Rally Factory Replica 07-09 950 R Superenduro 06-08 990 Adventure S (Non) 06-08 990 Adventure R (ABS) 09-12	30	MD6320C MD6320CSPEC	FRONT	F	WR 250 RX/RX 08-18 298mm replacement disc when using WR 250 X wheel & caliper bracket (Disc only supplied by EBC)	250				
					MD6321C	REAR	S	DS 450 (2x4/EFi) 08-15 DS 450 X (2x4/EFi) 08-09 DS 450 XXC/XXM 10-15	198				
MD6300D	FRONT	S	HONDA FMX 650 5/6 05-08	296	MD6322C	FRONT	S	DS 450 (2x4/EFi) 08-15 DS 450 X (2x4/EFi) 08-09 DS 450 XXC/XXM 09-15	190				
MD6301D	REAR	S	HYOSUNG TE 50 05-07 TE 90 05-07 TE 100 05-07	160	MD6323C	FRONT	F	WR 250 XX/XY 08-15	298				
MD6302D	FRONT	S	HONDA TRX 420 FE7/FE8/FE9/FEA/FEB 07-11 4WD Fourtrax ES TRX 420 FA9/FAA/FAB Fourtrax Auto 4WD 09-11 TRX 420 FM7/FM8/FM9/FMA/FMB 07-11 4WD Fourtrax TRX 420 FPA9/FPAA/FPAB Fourtrax Auto Power Steering 09-11	185	MD6324D	FRONT	S	YZ 125/250/490 N 85	240				

DISC BUYERS GUIDE

OFF ROAD DISC BUYERS GUIDE

DISC No.	FRONT/ REAR	TYPE	MODELS	DIA (MM)	DISC No.	FRONT/ REAR	TYPE	MODELS	DIA (MM)
MD6325D	FRONT	S	KRF 750 A8F/B8F Teryx 750 4x4 (RUV) 08	220	MD6339D Contd.	FRONT /REAR	S	550 Sportsman Forest 12	246
			KRF 750 C8F/D8F Teryx 750 4x4 LE (RUV) 08					550 Sportsman 11-13	
			(RUV) KRF 750 F8F Teryx 750					850 Forest 15	
			4x4 NRA Outdoors 08					850 Scrambler 15	
			KRF 750 TAF/PDF/RDF/VBP					850 Sportsman Forest 12	
			Teryx 750i 4x4 SGE 10-11					850 Sportsman Touring EPS 10-13	
			KRF 750 G9F/NAF/NBF/NCS/NDP					850 Sportsman Touring H.O. EPS 13-15	
			Teryx 750 Fi 4x4 09-13					850 XP Sportsman 09-13	
			KRF 750 J9FA/K9F/PAF/RAF/PBF					850 XP ES Sportsman 09-13	
			/RBF/RCS Teryx 750 Fi 4x4 LE 09-12					1000 Forest 15	
KRF 750 L9F Teryx 750 Fi 4x4 Le Sport 09	1000 Scrambler 15								
KRF 750 M9F Teryx 750 Fi 4x4 NRA Outdoors 09	1000 XP Scrambler 14								
KRF 750 SAF/SAFA/SBF/SBFA/SCS/SCSA	1000 MD/XP Sportsman 15								
/SDF Teryx 750 Fi 4x4 Sport LE 10-13									
MD6326C	REAR	S	KLX 250 (KLX 250 S9F/SAF/SBF/SCF /SDF/SEF/SFF/SGF/SHF) 09-17	240	MD6341D BILLET	FRONT /REAR	S	MUV 700-9 Big Red Side x Side 09	200
MD6329C OS6329C OSX6329 SM6329C SMX6329	FRONT	F	KLX 250 (KLX 250 S9F/SAF/SBF /SCF/SDF/SEF/SFF/SGF) 09-16	250	MD6342C/C	REAR	S	G 450 X 08-11	220
			MD6343C OS6343C SM6343 OSX6343C SMX6343		FRONT	S	G 450 X 08-11	260	
			MD6344D		REAR	S	Ranger RZR 170 09-14	220	
			MD6345D		REAR	S	XL 700 V8/V9/VA Transalp 08-11 XL 700 VA8/VA9/VAA Transalp 08-11	240	
MD6330C MD6330CX MD6330D SM6330C SMX6330	FRONT	F	KLX 250 H6F/H7F 06-07	250	MD6346D	FRONT	S	XL 650 VY/V1-V7 Transalp 00-07 XL 700 V8/V9/VA Transalp 08-11 XL 700 VA8/VA9/VAA Transalp 08-11	256
KLX 250 SF 09-20			MD6347C		FRONT	S	WR 125 R 09-15	240	
MD6331D	REAR	S	TRX 700 XX8/XX9/XXB 08-11	200	MD6348D	REAR	S	DL 450 RS (DL901) 06-09 QZ 450 RS 06-09 QZ 450 Sport 08-11	220
MD6332D	REAR	S	YXR 700 Rhino 4x4 SE 09 YXR 700 FA/FB/FD Rhino Side x Side 11-13	185	MD6349C	FRONT	F	TM Most models 01-09	270
MD6333D	REAR	S	YXR 700 Rhino 4x4 SE (Parking brake) 09 YXR 700 FA/FB/FD Rhino Side x Side Parking brake 11-13	165	MD6350C	REAR	S	TM Most models 01-09	240
MD6334D	REAR	S	DS 90 X (2x4/4T) 08-15	180	MD6353D	FRONT	S	POLARIS Ranger RZR 170 09-14	125
MD6335D	FRONT	S	DS 90 X (2x4/4T) 08-15	165	MD6354D	REAR	S	ADLY GK 125 Buggy 03-07 MOTOROMA Lazer 125 Buggy 03-07	200
MD6336C	FRONT	F	450 SX-F (Quad) 09-11 505 SX-F (Quad) 09-12 XC 450 Quad 08-10 XC 525 Quad 08-12	180	MD6355D	FRONT	S	LT-A 500 XPK9/XPZK9/XPL0-XPL5 09-15 LT-A 750 XPK9/XPZK9/XPL0-XPL5 09-15	190
MD6337D	REAR	S	450 SX-F (Quad) 09-11 505 SX-F (Quad) 09-12 XC 450 Quad 08-10 XC 525 Quad 08-12	200	MD6356C MD6356CX MD6356D SEE OS/OSX6028 & SM/SMX6728 For oversize disc	FRONT	F	YZ 125 N/P/R/S/TN/W/X/Y/Z/A /B/D/E/F/G(2T) 01-16 YZ 250 N/P/R/S/TN/W/X/Y/Z/A /B/D/E/F/G (2T) 01-16 YZ 250 FN/FP/FR/FS/FT/FV/FW /FX/FY/FZ/FA/FB/FE/FF (4T) 01-15 WR 250 FN/FP/FR/FS/FT/FV/FW /FX/FY/FZ/FA/FB/FD (4T) 01-13 WR 250 FF/FG(4T/Reverse Cylinder) 15-16 WR 400 FN (4T) 01 WR 426 FN/FP 01-02 YZ 426 FN/FP (4T) 01-02 WR 450 FR/FS/FT/FV/FW/FX/FY /FA/FB/FE/FF (4T) 03-15 YZ 450 FR/FS/FT/FV/FW/FX/FY/FZ/ FA/FB/FE/FF (4T) 03-15	250
MD6338D UTVX6338	FRONT /REAR	S	500 Ranger (EFI) 4x4 09-10	227	MD6357C	FRONT	S	SINNIS Apache 125 QM 125 GY-2B(A) 09-10 Apache (Rear drum model) 09-10	240
			RZR 570 14-19		MD6358C	REAR	S	SINNIS Apache 125 QM 125 GY-2B(A) 09-10	210
			Ranger 570, Full Size (R12) 17-19		MD6359D	FRONT	S	RC 125 Rally 87-88	240
			Ranger Crew 570FS (R08) 17-19						
			Ranger 570 EPS Crew MD (R04) 18						
			Ranger 570 EFI Crew (R10) 17						
			Ranger 570 Crew (R03) 18-19						
			700 Ranger 4x4 EFI 09						
			800 Ranger RZR 4 EPS 12						
			800 Ranger Crew 10-14						
			800 Ranger XP 10-12						
			800 Ranger 6x6 10-14						
			RZR-4 800 EFI 10-14						
			900 D Crew Ranger Diesel 13-14						
			900 D Ranger Diesel 11-14						
900 Ranger RZR XP 12									
900 Ranger Crew 13-15									
900 XP Ranger 13-15									
1000 Ranger Diesel 15									
1000 Ranger Diesel Crew 15									
RZR-4 XP900 12-14									
Brutus 13-14									
RZR 900 "50 Inch All Options" 15-19									
RZR-S 900 "60 Inch All Options" 15-19									
1000 General EPS (2 Seat) 16									
RZR 1000 60 Inch 16-19									
1000 General 4 EPS (4 Seat) 17-19									
MD6339D	FRONT /REAR	S	500 XP Sportsman 09 550 Sportsman XP EPS 09 550 XP Sportsman 09 550 Sportsman XP 10 550 Sportsman X2 10-14 550 Sportsman EPS 10-14 550 Sportsman Touring EPS 10-14	246					

DISC
BUYERS GUIDE

OFF ROAD DISC BUYERS GUIDE

DISC No.	FRONT/ REAR	TYPE	MODELS	DIA (MM)	DISC No.	FRONT/ REAR	TYPE	MODELS	DIA (MM)
MD6360C MD63600SC	REAR	S	HUSQVARNA	210	MD6373C MD6373CX	REAR	S	HONDA	220
			TC 85 (2T) (17/14" wheels) 14-20 TC 85 (2T) (19/16" wheels) 14-20 KTM SX 85 (17/14" wheels) 11-20 SX 85 (19/16" wheels) 11-20 SX 85 (220mm Oversize Rear disc for Aftermarket kit) 03-17 250 Freeride R (2T) 14-15 350 Freeride (4T) 12-15					CRF 250 L 13-20 CRF 250 L ABS 17-20 CRF 250 Rally 17-20 CRF 250 Rally ABS 17-20 CRF 250 ME Supermoto 14-15	
MD6361D	FRONT	S	Senda SM DRD 50 02-03 Senda SM DRD 50 05 Senda 50 SM DRD Black Edition 05	240	MD6374D UTVX6374	REAR	S	RZR-4 XP 900 12-14 900 XP Ranger 13-14	200
			MD6376D UTVX6376					REAR	
MD6362C	REAR	S	KLX 125 CAF/CBF/CCF/CDF/CEF /CCS/CDS/CEF/CFF/CGF 10-16 KLX 125 DAF/DBF/DCF/DDF/DEF (D-Tracker) 10-14	190	MD6377C	REAR	S	HUSQVARNA	240
			KLX 125 CAF/CBF/CCF/CDF/CEF /CCS/CDS/CEF/CFF/CGF 10-16 KLX 125 DAF/DBF/DCF/DDF/DEF (D-Tracker) 10-14					TE 250 (4T) 11-13 TE 250 R (4T) 13 TE 250 Meo Replica (4T) 11 TE 310 (4T) 11-13 TE 310 R (4T) 13	
MD6363C	FRONT	S	KLX 125 CAF/CBF/CCF/CDF/CEF /CCS/CDS/CEF/CFF/CGF 10-16 KLX 125 DAF/DBF/DCF/DDF/DEF (D-Tracker) 10-14	240	MD6378D	FRONT	S	GILERA	250
			KLX 125 CAF/CBF/CCF/CDF/CEF /CCS/CDS/CEF/CFF/CGF 10-16 KLX 125 DAF/DBF/DCF/DDF/DEF (D-Tracker) 10-14					RC 125 Top Rally 89-92	
MD6365D	FRONT	S	TRX 500 FEC Fourtrax Foreman ES 2/4 WD 12 TRX 500 FMC Fourtrax Foreman S 2/4WD 12 TRX 500 FPEC Fourtrax Foreman 2/4 WD 12 TRX 500 FAC Fourtrax Foreman AT 2/4 WD 12	196	MD6379C	FRONT	S	HUSQVARNA	240
			TRX 500 FEC Fourtrax Foreman ES 2/4 WD 12 TRX 500 FMC Fourtrax Foreman S 2/4WD 12 TRX 500 FPEC Fourtrax Foreman 2/4 WD 12 TRX 500 FAC Fourtrax Foreman AT 2/4 WD 12					TC 85 (2T) (17"/14" wheels) 17-20 TC 85 (2T) (19"/16" wheels) 14-20 KTM SX 85 (17"/14" wheels) 16-20 SX 85 (19"/16" wheels) 13-20	
MD6366D UTVX6366	FRONT /REAR	S	CAN AM See main application pages	215	MD6380D UTVX6380	FRONT/ REAR	S	RZR 1000 XP 14	246
			MD6381D					REAR	
MD6367C	FRONT	F	RR 250 4T Enduro 05-07 RR 350 4T Enduro 11 RR 400 4T Enduro 05-11 RR 450 4T Enduro 05-11 RR 520 4T Enduro 05-11 RR 525 4T Enduro 05-09	260	MD6382D UTVX6382	FRONT/ REAR	S	YXM 700 E Viking EPS COMO YXM70VPHG) 16 YXM 700 E Wolverine R (YXE70WPHG) 16 YXR 1000 R EPS (Side X Side) YXZ10PXG 16 YXR 1000 SE (Side X Side) 16 YXM 700 ES - Viking EPS SE (YXM700PSE) 14-16 YXC 700 E - Viking VI EPS (YXC700PF/PXG/PXH/PXJ) (Parking Brake) 15-17	205
			RR 250 4T Enduro 05-07 RR 350 4T Enduro 11 RR 400 4T Enduro 05-11 RR 450 4T Enduro 05-11 RR 520 4T Enduro 05-11 RR 525 4T Enduro 05-09					YXM 700 E Viking EPS COMO YXM70VPHG) 16 YXM 700 E Wolverine R (YXE70WPHG) 16 YXR 1000 R EPS (Side X Side) YXZ10PXG 16 YXR 1000 SE (Side X Side) 16 YXM 700 ES - Viking EPS SE (YXM700PSE) 14-16 YXC 700 E - Viking VI EPS (YXC700PF/PXG/PXH/PXJ) (Parking Brake) 15-17	
MD6368C	REAR	S	RR 250 4T Enduro 05-07 RR 350 4T Enduro 11 RR 400 4T Enduro 05-11 RR 450 4T Enduro 05-11 RR 520 4T Enduro 05-11 RR 525 4T Enduro 05-09	240	MD6383D	FRONT/ REAR	S	ARCTIC CAT	203
			RR 250 4T Enduro 05-07 RR 350 4T Enduro 11 RR 400 4T Enduro 05-11 RR 450 4T Enduro 05-11 RR 520 4T Enduro 05-11 RR 525 4T Enduro 05-09					400 ATV (Core/Midsized) 13-14 450 ATV (Core/Midsized) 13-14 500 ATV (Midsized) 13-14 500 ATV XT (Midsized) 13-14 550 ATV (Midsized) 13-14 550 ATV LTD (Midsized) 13-14 550 ATV XT (Mid Size) 13-14 700 ATV Diesel 12-14 700 ATV LTD 12-14 700 ATV XT 13-14	
MD6369D	REAR	S	YFM 350 B/D Grizzly 12-14	220	MD6384D UTVX6384	FRONT/ REAR	S	ARCTIC CAT	240
			YFM 350 B/D Grizzly 12-14					Wildcat Trail 700 XT inc LTD 15-19 Wildcat 1000 4X 14-16	
MD6370D UTVX6370	FRONT /REAR	S	CAN AM See main application pages	215	MD6388C MD6388CX SMX6264	FRONT	F	KAWASAKI	270
			MD6389C MD6389CX OSX6389 SMX6389					FRONT	
MD6371C MD6371D	REAR	S	KTM	220	MD6372C MD6372CX	FRONT	S	HONDA	256
			EXC 350 LC4 94-95 SC 400 96-99 EGS 400/EGS-E/LSE (LC4 Enduro) 96-99 SX/EXC 440 94-95 LC4 MX 600 90-91 LC4 EXC 600 90-93 SX EXC/EGS 620 95 SX 620 96-99 SC 620 Supercompetition 96-00 EGS/EGS-E/LSE 620 Enduro 96-99 EGS-E 620 Adventure/Rallye 99 LC4 620 SC Supermoto 00 LC4 625 SC Supermoto 02 LC4 625 SC Supercompetition 02 SMC 625 04-06 SXC 625 03-04 Duke-E 640 (Single pin pad fixing/zero offset disc) 98 Duke II 640 (2 pin pad fixing/zero offset) 99-02 Duke II 640 (2 pin pad fixing/Disc with offset) 03-07 LC4-E 640 Enduro 00-04 LC4-E 640 Supermoto 00-04 LC4-E 640 (Central single pin fixing) 03 LC4 640 Adventure R 99-02 LC4 640 Adventure 03 LC4 640 Adventure R 04 LC4 640 Adventure 05-07 640 LC4 Adventure 03-07 SMC 660 Supermoto 03-04					CRF 250 L 13-20 CRF 250 L (ABS) 17-20	

DISC
BUYERS GUIDE

OFF ROAD DISC BUYERS GUIDE

DISC No.	FRONT/ REAR	TYPE	MODELS	DIA (MM)	DISC No.	FRONT/ REAR	TYPE	MODELS	DIA (MM)
MD6390D MD6390C	FRONT	S	HONDA CRF 125 F (Small wheel FR 17" /RR 14" Wheels) 14-20 CRF 125 FB (Big wheel FR 19" /RR 16" Wheels) 14-20	220	MD6399D UTVX6399	FRONT	S	KAWASAKI (TERYX MODELS) KRT 750 ACF/ADF (Teryx 4 750 4X4) 12-13 KRT 750 ACFA/ADFA (Teryx 4 750 4X4 EPS) 12-13 KRT 750 CCF/CDF (Teryx 4 750 4X4 EPS LE) 12-13 KRF 800 BEF/BFF/FGF/FHF (Teryx) 14-17 KRF 800 CEF/CFE/GGF/GHF (Teryx LE) 14-17 KRF 800 DEF/DFE/HGF/HFF (Teryx Camo) 14-17 KRT 800 BEF/BFF/FGF/FHF (Teryx 4) 14-17 KRT 800 CEF/CFE/GGF/GHF (Teryx 4 LE) 14-17 KRT 800 DEF/DFE/HGF/HFF (Teryx 4 Camo) 14-17	200
MD6392C MD6392CX	FRONT	F	YAMAHA YZ 125 17-20 WR 250 F (4T/Reverse Cylinder) 17-20 YZ 250 H/J (270mm Disc) 17-18 YZ 250 F (4T) 16-20 YZ 250 FG 60th Anniversary (4T) 16 YZ 450 FG (4T) 16 YZ 450 FG 60th Anniversary (4T) 16 WR 450 FG/FH/FJ (270mm F/Disc/4T) 16-20 YZ 250 FG (270mm Disc) 16 YZ 250 FGY (60th Anniversary Edition /270mm Disc) 16 YZ 450 F (270mm Disc) 16-20 YZ 450 FGY (60th Anniversary Edition /270mm Disc) 16	270	MD6402C	FRONT	S	AJP PR4 200 Enduro 04-09 PR4 200 Enduro 10-11 PR4 200 Enduro 12-14 PR4 Enduro Pro 200 10-11 PR4 200 Enduro Pro 12-14 PR4 200 Supermoto 04-09 PR4 200 Supermoto 10-11 PR4 200 Supermoto 12-14 PR4 200 Supermoto Pro 10-11	260
MD6394D	REAR	S	GILERA GSM 50 99-01 RK 50 Cannibal 96-98 ZULU 50 01-02	184	MD6403C	REAR	S	AJP PR4 200 Enduro 04-09 PR4 200 Enduro 10-11 PR4 200 Enduro 12-14 PR4 Enduro Pro 200 10-11 PR4 200 Enduro Pro 12-14 PR4 200 Supermoto 04-09 PR4 200 Supermoto 10-11 PR4 200 Supermoto 12-14 PR4 200 Supermoto Pro 10-11 PR5 250 Enduro 09 PR5 250 Enduro 10-15 PR5 250 Supermoto 09 PR5 250 Supermoto 10-15	220
MD6395D	FRONT/ REAR	S	YAMAHA YZX 1000 R EPS (Side X Side) YXZ10PXG 16 YZX 1000 SE (Side X Side) 16 YZX 1000 R SS (Side x Side) 17-18 YXM 700 E Viking EPS COMO (YXM70VPHG) 16 YXM 700 E Wolverine R (YXE70WPHG) 16	245	MD6404C	FRONT	S	AJP PR4 200 Extreme 12-14 PR4 240 Extreme 13-15 PR5 250 Extreme 12-15	270
MD6396D UTVX6396	FRONT /REAR	S	CAN-AM (SIDE x SIDE) Defender 799cc 16 Defender 976cc 16 Defender DPS 799cc 16 Defender DPS 976cc 16 Defender XT 976cc 16 Defender XT 799cc 16 Defender XT Cab 976cc 16 Defender XT Cab 799cc 16	220	MD6405C	REAR	S	AJP PR4 200 Extreme 12-14 PR4 240 Extreme 13-15 PR5 250 Extreme 12-15	219
MD6397D UTVX6397	FRONT/ REAR	S	POLARIS (RZR MODELS) RZR XP Turbo 16 RZR XP 4 Turbo 16	248	MD6406D	FRONT	S	APRILIA ETV 1000 Caponord Rally (Non ABS - Bush fixing) 03 ETV 1000 Caponord (ABS - Bush fixing) 04-07	300
MD6398D UTVX6398	FRONT /REAR	S	KAWASAKI (MULE MODELS) KAF 820 AFF/AGF/AHF/AJF Mule Pro FXT 15-18 KAF 820 BFF/BGF/BHF/BJF Mule Pro FXT/EPG 15-18 KAF 820 CFF/CGF/CHF/CJF Mule Pro FXT/EPG LE 15-18 KAF 820 DFF/DGF/DHF/DJF Mule Pro FXT/EPG Camo 15-18 KAF 820 EGF/EHF/EJF Mule Pro FX 16-18 KAF 820 FGF/FHF/FJF Mule Pro FX/EPG 16-18 KAF 820 GGF/GHF/GJF Mule Pro FX/EPG LE 16-18 KAF 820 HGF/HHF Mule PRO - FX/EPG Camo 16-17 KAF 820 JGF/JHF Mule PRO - FXT Ranch Edition 16-17 KAF 1000 AGF/AHF/AJF Mule Pro DXT/Diesel 16-18 KAF 1000 BGF/BHF/BJF Mule Pro DXT/Diesel EPS 16-18 KAF 1000 CGF/CHF - Mule Pro DXT EPS LE/Diesel 16-17 KAF 1000 DGF/DHF - Mule Pro DX /Diesel 16-17 KAF 1000 EGF/EHF/EJF Mule Pro DX EPS/Diesel 16-18 KAF 1000 FGF/FHF - Mule Pro DX EPS LE/Diesel 16-17	212	MD6407C OSX6407	FRONT	S	KTM SX 85 (17"/14" wheels) 12-15 SX 85 (19"/16" wheels) 12	220
					MD6408 UTVX6408	FRONT/ REAR	S	POLARIS 1000 General EPS (2 Seat) 17-19 1000 General 4 EPS (4 Seat) 17-19	227
					MD6409C	FRONT	S	HONDA CRF 250 Rally 17-20 CRF 250 Rally ABS 17-20	296
					MD6410D	FRONT/ REAR	S	HONDA SXS 1000 M3 Pioneer (3 Seater) 16-18 SXS 1000 M3P Pioneer (3 Seater) 16-18 SXS 1000 M5D Pioneer (5 Seater) 16-18 SXS 1000 M5L Pioneer (5 Seater) 17-18 SXS 1000 M5P Pioneer (5 Seater) 16-18	210
					MD6411D UTVX6411 OSKIT6411 (Oversize Disc & Bracket Kit) OSUTVX6411 (Replacement Oversize Discs) (Same OS Discs used front and rear)	FRONT	S	CAN AM (SIDE X SIDE) Maverick X3 17 Maverick X3 Max Turbo 17 Maverick X3 Turbo 18 Maverick X3 Max Turbo 18 Maverick X3 Turbo R 18 Maverick X3 Max Turbo R 18	260

DISC BUYERS GUIDE

OFF ROAD DISC BUYERS GUIDE

DISC No.	FRONT/ REAR	TYPE	MODELS	DIA (MM)	DISC No.	FRONT/ REAR	TYPE	MODELS	DIA (MM)
MD6412D UTVX6412 OSKIT6411 (Oversize Disc & Bracket Kit) OSUTVX6411 (Replacement Oversize Discs) (Same OS Discs used front and rear)	REAR	S	CAN AM (SIDE X SIDE)	248					
			Maverick X3	17					
			Maverick X3 Max Turbo	17					
			Maverick X3 Turbo	18					
			Maverick X3 Max Turbo	18					
			Maverick X3 Turbo R	18					
Maverick X3 Max Turbo R	18								
MD6414D MD6414C	FRONT	F	HUSQVARNA	320					
			701 Supermoto	16-20					
MD6415D MD6415C	REAR	S	KTM	240					
			690 Enduro R (ABS)	09-20					
MD6417C	REAR	F	HUSQVARNA	240					
			701 Enduro	16-20					
MD6418C MD6418CX	FRONT	S	YAMAHA	198					
			YZ65J	18-20					
MD6419C MD6419CX	REAR	S	YAMAHA	198					
			YZ65J	18-20					
MD6425D	FRONT /REAR	S	HONDA	250					

DISC
BUYERS GUIDE

CLUTCH KITS FOR STREET / DIRT / ATV

STREET - 3 choices

1. Standard - CK Series

Series

Almost identical to original equipment clutch plates the CK series are a cork based product impregnated with aluminum particles to increase wear life and heat resistance. Material is highly compressed to avoid swell and clutch drag and is an ideal general purpose replacement material for all grades and sizes of motorcycle. Kit includes a complete "engine set" of friction plates only.



2. Race/Sport SRC Series

Series

A paper lined plate set complete with heavy duty clutch springs (for bikes fitted with diaphragm type springs we cannot supply a heavy duty spring kit), the SRC kit is ideal for heavy sport bikes, faster riders and production based race use. Advantages of the SRC series are longer life, higher heat resistance, although this clutch has a more aggressive/ faster take up than the CK cork series.



3. Race/Sport SRK Series

Series

SRK complete kits include aramid fibre lined friction plates, steel separator plates and springs to provide a streetgoing kit for high performance street and road race use much similar to the DRC program for off road. Some of the kits will now feature new **DIAPHRAGM** springs as used in many larger new bikes to provide a complete clutch rebuild kit for every sportbike possible.



CSK CLUTCH SPRING SETS



DIAPHRAGM TYPE SPRING



COIL TYPE SPRING

Always fit new springs which get tired after miles of heat and use. EBC spring kits are 8-10% stiffer than standard and are sold in engine sets. As stated in general fitting/safety instructions, advise customers that lever will feel slightly 'heavier' when uprating springs, and to test ride/acquaint themselves with this change in control.



DIRT/ATV - 2 choices



2. Standard - CK Series

Cork based replacement clutch exactly the same as used on the street series CK clutch plates described above. A general all purpose replacement unit.

EBC only sell complete kits as replacing single plates is deemed unwise. The object is to reset the clutch to its original stack height and just replacing one plate will not achieve that and promote clutch slip.

Many off road clutches use aluminium separator plates which wear quickly and muddy the oil. If this has happened in your engine, flush the drive case, change the oil and rebuild the clutch with a complete DRC kit which includes STEEL separator plates that not only prevent wear but increase flywheel effect of the engine and improve performance.

1. Full Kit - DRC Series

The US #1 selling off road clutch

Why are these the best???

Anti-swell, alloy impregnated heavy duty cork based facings provide smooth clutch take up and allow modulation, unlike paper clutches which tend to snatch.

Complete engine set of friction plates, HD springs and STEEL SEPARATOR PLATES prevent premature driven plate wear, oil muddying and loss of stack height.

EBC DRC kits are built with swaged aluminium carriers which spread the load on the clutch basket and prevent clutch basket "dogging".

What makes EBC the BEST!!!

Unique wide ear soft alloy drive body eliminates basket damage and delivers smooth clutch operation.

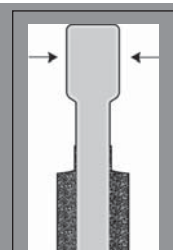

CLUTCH APPLICATIONS

EBC Coil Spring Kits

Full engine sets of heat treated and tempered spring steel coil springs with a guaranteed tension of 15% above standard. Clutch springs are an extremely important part of a motorcycle transmission system and we take very seriously the accuracy of spring tension in the EBC range of CSK kits. See application pages for part numbers.



Spring Tension Measuring Machine



You simply cannot engineer coil springs correctly without such a device as shown here. EBC have one of these digital clutch spring tension calibration machines at each of its locations to guarantee the accuracy and consistency of spring batches. The machine is calibrated based on the nominal spring deformation and then a tight tolerance of variation is achieved within the target and then a tight tolerance of variation is achieved within the target 15% upgrade range. EBC have tested many original and aftermarket clutch springs and the variation in tension is enormous and varies so dramatically, that we took the decision to measure and calibrate every clutch spring in-house to be sure of their accuracy.

EBC Diaphragm Clutch Springs

EBC SRK clutch kits, shown on the following pages, include the new diaphragm spring range. Full engine sets of heat treated and tempered spring steel diaphragm springs with a guaranteed 15% tension upgrade.

The picture opposite shows a typical aftermarket billet clutch and how the assembly looks. It is essential when replacing the diaphragm spring that the anti-scuff plate is in good condition. This is a rather flimsy steel pressing and can become bent or distorted in which case it must be replaced, this is a genuine part available from your main dealer only.

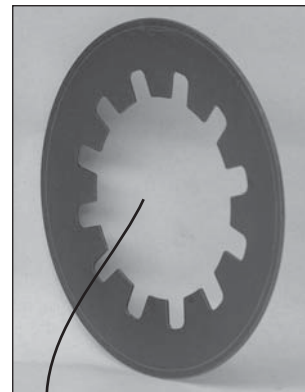

CLUTCH APPLICATIONS

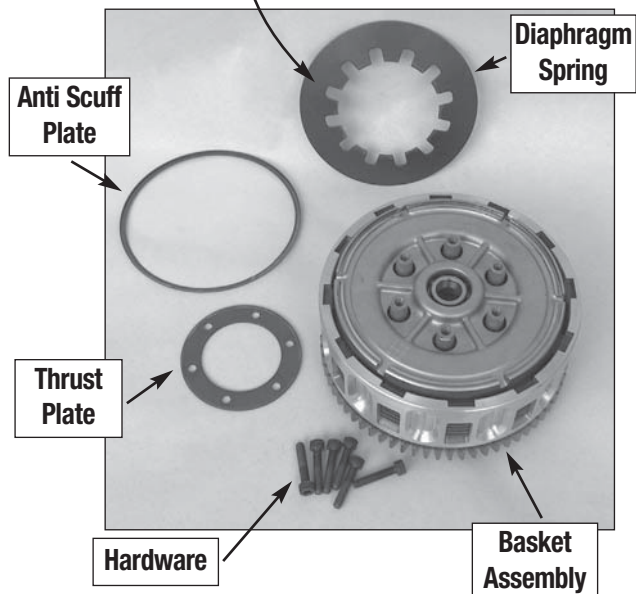

CKF Clutch Kits



See application pages for availability and fitments.

CKF is the name of the new EBC carbon fibre impregnated for motocross ATV, and now some street bikes. They are built tough to last longer, grip better, feel better and drive better than stock cork based units.

PLUS the high heat ability of these CKF Carbon Fiber clutch plates handles much higher stresses and temperatures encountered in racing yet feel gentle and smooth in everyday riding.

One day all motocross bikes and ATV will be built using a clutch like this but for now the only way to get the best clutch in the game is to step up to an EBC CKF plate set or go the whole hog and invest in the DRCF clutch kits which are sold as an assembly with a stack height measured to precisely reset your bike to the original sizing.

DRC-F Clutch Kits

The toughest off road clutch yet.

Tested for 12 months in the toughest moto-x applications, these new heavy duty kits are ideal for fast off road use especially on modern 4 stroke engines.

The ultimate moto-x and ATV heavy duty clutch kit designed for race use. These new kits feature carbon fiber lined clutch plates plus a full set of steel plates and heavy duty springs.



Available Part Numbers

DRCF025	DRCF054	DRCF101	DRCF123	DRCF158	DRCF201	DRCF255	DRCF287	DRCF313
DRCF033	DRCF058	DRCF105	DRCF128	DRCF159	DRCF208	DRCF256	DRCF288	DRCF315
DRCF042	DRCF070	DRCF107	DRCF129	DRCF163	DRCF227	DRCF259	DRCF298	
DRCF043	DRCF079	DRCF108	DRCF130	DRCF164	DRCF230	DRCF261	DRCF299	
DRCF044	DRCF085	DRCF109	DRCF131	DRCF182	DRCF240	DRCF262	DRCF301	
DRCF045	DRCF088	DRCF111	DRCF137	DRCF189	DRCF241	DRCF269	DRCF303	
DRCF046	DRCF098	DRCF113	DRCF148	DRCF195	DRCF244	DRCF276	DRCF304	
DRCF049	DRCF100	DRCF119	DRCF155	DRCF200	DRCF254	DRCF277	DRCF306	

See application pages for fitments.

Clutch Removal Tools



More added for 2018, a range of clutch tools to allow easy install of all EBC clutch kits. Range covers 95% of motorcycles and ATVs and allow positive holding of the clutch basket or centre boss to allow untightening and retightening of securing nuts.

Clutch application pages show appropriate tool and below is a list of the available 2018 programme.

PART NUMBERS AVAILABLE AT TIME OF PRINT

CT001	CT013	CT026	CT041	CT057SP	CT078SP
CT002	CT013SP	CT027	CT042	CT058	CT079SP
CT003	CT014	CT028	CT043SP	CT059	CT080
CT004	CT014SP	CT029	CT044	CT060	CT081SP
CT005	CT015	CT029SP	CT045	CT061	CT082SP
CT006	CT016	CT030	CT046	CT066SP	CT083
CT007	CT017	CT031	CT047SP	CT068SP	CT084SP
CT008	CT018SP	CT032	CT048SP	CT069	CT085
CT008SP	CT019	CT033SP	CT049	CT070SP	CT086SP
CT009	CT020	CT034SP	CT050SP	CT071SP	CT087SP
CT009SP	CT021	CT035SP	CT051	CT072SP	CT088
CT010	CT022	CT036SP	CT052	CT073	CT090SP
CT010SP	CT023	CT037SP	CT053SP	CT074	CT091
CT011	CT024	CT038SP	CT054SP	CT075	CT092
CT012	CT024SP	CT039	CT055SP	CT076SP	
CT012SP	CT025	CT040SP	CT056SP	CT077SP	



Costing far less than OE manufacturer tools, EBC strongly recommend selling a clutch tool for every clutch sold.

Many dealers have already ordered one of each tool and loan these to customers with a deposit to gain tool loan income.

EBC CLUTCH KITS



HEAVY DUTY CLUTCHES & SPRINGS



EBC Clutches are totally Asbestos Free made from a cork based "anti-swell" facing impregnated with aluminium particles to reduce wear & heat fade. Kits are sold in pre-measured engine sets and should always be replaced in engine sets. USE ONLY MANUFACTURERS Drive case oils and avoid lead or other anti-friction additives.

SOAK PLATES in drive case oil before installing. EBC Clutch Springs are 10-15% stiffer than stock springs to avoid slip. Always check lever operating pressure for ease of clutch disengagement before riding or releasing motorcycle for use.

CAUTION – SAFETY WARNINGS FOR CONSUMERS

The following warnings now appear on the underside of our clutch packaging. For stocks in older packaging that do not display these safety warnings, we strongly recommend you photocopy these essential points and advise customers.

Never start a motorcycle whilst in gear with clutch depressed. Never reverse a motorcycle with the engine running, the machine in gear and clutch depressed. Hold front brake lever on when selecting gears from standstill.

Never engage gears from a standstill with engine revs above 1500 rpm. Check oil levels regularly.

When fitting heavy duty clutch springs acquaint yourself with increased hand pressure required to depress clutch before riding motorcycle. Assemble the clutch as per the original manufacturers workshop manual.

CLUTCH APPLICATIONS

Make & Model	Year	CK Series #	CKF Series #	Spring Kit #	DRC Series #	DRCF Series #	SRC Series #	SRK Series #	CT Tool #
HONDA									
C 50 M/C 50	-78	CK1107		CSK044					
C 50 Z2/ZZ/ZA	78-81	CK1148		CSK044					
C 50 All models	82-93	CK1148		N/A					
C 50 (Single seat model)	95	CK1148		N/A					
C 50 P/S/V/X/Y/1/2	96-02	CK1148		N/A					
CB 50 J	81	CK1150		CSK003					CT012SP
CB 50 V/W Dream 50	97-98	CK1150		CSK048					CT012SP
CD 50 ST/SV/SW/SX Benley 50 S	96-99	CK1105		N/A					
CF 50/CF 50 K2	77-78	CK1148		CSK044					
CL 50 V/X Benley	97-99	CK1105		N/A					
CR 50 RE-RF	84-85	CK1151	CKF1151	CSK003					CT012SP
CRF 50 F	04-20	CK1148		N/A			SRC090		
CRM 50 RN/RP/RR/RT	93-96	CK1150		CSK003					CT012SP
MB 50	80-82	CK1150		CSK003					CT012SP
MTX 50 SC	83-87	CK1150		CSK003					CT012SP
MBX 50 SD/SF	83-85	CK1150		CSK003					CT012SP
MP 50 3/DX3 (AC17) Solo	03	CK1148		N/A					
MT 50 SA/SE/SG/SJ/SL	80-93	CK1150		CSK003					CT012SP
NSR 50 FP/FR/FS	93-95	CK1150		CSK003					CT012SP
NSR 50 RV/RW/RX/RV	97-00	CK1150		CSK003					CT012SP
NSR 50 SK/SP/SR/SS	89-95	CK1150		CSK003					CT012SP
NSR 50 V (AC10-180)	97	CK1151	CKF1151	CSK003					CT012SP
NSR 50 X (AC10-190)	99	CK1151	CKF1151	CSK003					CT012SP
SS 50 ZK2/ZB2	75-80	CK1105		N/A					
ST 50 J/K Dax	78-93	CK1148		N/A					
TLM 50 F	85	CK1150		CSK031					CT012SP
XR 50 R1/R2/R3	01-03	CK1148		N/A					
XR 50 M5 (AD14) Motard	06	CK1150		CSK048					CT012
XZ 50 39844 APE-AC16	01-02	CK1150		CSK048					CT012
Z 50 RZ/RA-RD	79-86	CK1107		CSK044					
CR 60 RF/RG	85-86	CK1151	CKF1151	CSK003					CT012
ATC 70 All Models	78-85	CK1148		CSK018					
C 70/C 70 M	-78	CK1107		N/A					
C 70 Z2/ZZ/C/D/DMC	78-85	CK1148		CSK018					
CF 70 C	77-78	CK1148		CSK018					
CRF 70 F4/F5/F6/F7/F8/F9/FA/FB/FC/FD	04-13	CK1148		CSK018					
XR 70 RV/RW/RX/RV/R1/RY/R1-R3	97-03	CK1148		CSK018					
CRM 75 RK/RL/RM/RP/RR	89-94	CK1151	CKF1151	CSK003					CT012SP
NSR 75 N/P/R/X/Y (NS-1)	92-00	CK1151	CKF1151	CSK003					CT012SP
XR 75 K4/K5	78-79	CK1150		CSK022					CT012
CR 80 RA/RB/RC	80-82	CK1151	CKF1151	CSK003					CT012

EBC CLUTCH KITS

Make & Model	Year	CK Series #	CKF Series #	Spring Kit #	DRC Series #	DRCF Series #	SRC Series #	SRK Series #	CT Tool #
HONDA Contd.									
CR 80 RD	83	CK1151	CKF1151	CSK023					CT012
CR 80 RE	84	CK1119		CSK023					CT012SP
CR 80 RF/R2F	85	CK1119		CSK173	DRC001				CT012SP
CR 80 RG/R2G	86	CK1119		CSK173	DRC001				CT012SP
CR 80 RH/RJ/RK/RL/RM/RN/RP/RR/RS/RT/RBT/RV /RBV/RW/RBW/RX/RBX/RY/RBY/R1/RB1/R2/RB2	87-02	CK1119		CSK173	DRC001				CT012SP
CRF 80 F4/F5/F6/F7/F8/F9/FB/FC	04-12	CK1150		CSK048					CT012
MBX 80 FWDD/FWDF	83-86	CK1151	CKF1151	CSK003					CT012SP
MTX 80 RFD/RF	83-84	CK1151	CKF1151	CSK003					CT012SP
NSR 80 J-2/K/L/N/P/R/S (HC06)	88-	CK1151	CKF1151	CSK003					CT012SP
NSR 80 V (HC06-170)	97	CK1151	CKF1151	CSK003					CT012SP
NSR 80 X (HC06-180)	99	CK1151	CKF1151	CSK003					CT012SP
XR 80 Z/A/B	80-81	CK1150		CSK022					CT012
XR 80 R	87-88	CK1150		CSK008					CT012
CR 85 R3/RB3/R4/RB4/R5/RB5/R6/RB6/R7/RB7	03-07	CK1119		CSK173	DRC001				CT012SP
C 90 (from frame no A073285/Z2/ZZ)	75-81	CK1156		N/A					
C 90 C/E/G/MF/P/MP/MG/N/MN/P/MP/T/MT	82-03	CK1148		N/A					
TRX 90 P/R/S/T/V/W/X/Y/1-6	93-06	CK1151	CKF1151	N/A					CT012SP
TRX 90 EX	07-08	CK1151	CKF1151	N/A					CT012SP
TRX 90 X9/XB/XC	09-14	CK1151	CKF1151	N/A					CT012SP
Astrea Supra NF100	99	CK1151	CKF1151	N/A					CT012SP
Astrea Grand/Supra (Drum model)	97-98	CK1151	CKF1151	N/A					CT012SP
CB 100 N	78-80	CK1119		CSK004					CT012SP
CRF 100 F4/F5/F6/R7/F8/F9/FA/FB/RC	04-12	CK1151	CKF1151	CSK023	DRC049	DRCF049			CT012
H 100 A/SD/SG/SJ	84-92	CK1151	CKF1151	CSK048					CT012SP
XL 100 SZ/SA	78-80	CK1151	CKF1151	CSK048					CT012
XL 100 SB	81-82	CK1151	CKF1151	CSK022					CT012
XR 100 RP/RR/RS/RT/RV/RW/RX/RY/R1/R2/R3	93-03	CK1151	CKF1151	CSK023	DRC049	DRCF049			CT012
XR 100 M5 (HD13) Motard	06	CK1151	CKF1151	TBA					CT012
XZ 100 2 APE-HC07	02	CK1151	CKF1151	N/A					CT012
ATC 110 All models	79-84	CK1156		CSK018					
CRF 110 F	13-17	TBA		N/A					
CT 110 A/B/C/D/K/M	80-88	CK1156		N/A					
CT 110 P	89-04	CK1156		N/A					
CT 110 X	05-09	CK1156		N/A					
ANF 125 3/5/T5/6/T6/7/A Innova	03-11	CK1307		CSK197					
ATC 125 ME	84	CK1156		CSK021					
ATC 125 MG	86	CK1151	CKF1151	CSK048					CT012SP
CA 125 S/T	95-96	CK1252		CSK167					CT012SP
CA 125 Rebel V/W/X	98-00	CK1119		CSK167					CT012SP
CB 125 F (GLR 125 1WHF)	15-16	CK1151		TBA					
CB 125 F (GLR 125 1WHH)	17-18	CK1151		TBA					
CB 125 S/J	75-79	CK1119		CSK041					CT012
CB 125 T/T2	78-80	CK1119		CSK167					CT012
CB 125 TDC/TDE	83-86	CK1119		CSK167					CT012SP
CB 125 TDJ	87-89	CK1252		CSK167					CT012SP
CB 125 RS	83	CK1119		CSK041					CT012SP
CBF 125 6 Stunner	06	CK1151		CSK006					CT012SP
CBF 125 M7 Stunner	07	CK1151		CSK006					CT012SP
CBF 125 M9/MA/MB/MD/ME	09-15	CK1119		CSK166					CT012SP
CBR 125 R4/R5/RS5/RW5/RS6/RW6	04-06	CK1252		CSK193					CT012SP
CBR 125 RW7/RW8/RW9/RWA/RWB/RC/RD/RF	07-16	CK1119		CSK193			SRC119	SRK119	CT012SP
CD 125 TC	78	CK1119		CSK167					CT012SP
CG 125 Cargo	10	TBA		TBA					
CG 125 K1/B/C/E/BR/BR-K/BR-KJ/S/T/W	77-00	CK1119		CSK041					CT012
CG 125 M1/1	01-03	CK1252		CSK041					CT012
CG 125 ES4-ES8	04-08	CK1252		CSK041					CT012
CG 125 Job	05	TBA		TBA					
CLR 125 W City Fly	98-03	CK1119		CSK167					CT012SP
CM 125 CC/CF	82-85	CK1119		CSK009					CT012SP
CT 125 C	85	CK1119		CSK041					CT012
CR 125 M2-M4	76-78	CK1144		CSK036					CT002
CR 125 RZ/RA	79-80	CK1199		CSK031					
CR 125 RB	81	CK1191	CKF1191	CSK031					CT002
CR 125 RC	82	CK1186		CSK031					CT002
CR 125 RD/RE	83-84	CK1190	CKF1190	CSK024	DRC067				CT013
CR 125 RF	85	CK1200		CSK024	DRC068				CT001
CR 125 RG/RH/RJ/RK/RL/RM/RN/RP/RR/RS /RT/RV/RW/RX	86-99	CK1222		CSK024	DRC002				CT001
CR 125 RY/R1/R2/R3	00-03	CK1293	CKF1293	CSK176	DRC262	DRCF262			CT001
CR 125 R4/R5/R6/R7	04-07	CK1293	CKF1293	CSK077	DRC101	DRCF101			CT001
CRF 125 F (Small Wheel F 17 Inch/R 14 Inch)	14-15	TBA		TBA					
CRF 125 FB (Big Wheel F 19 Inch/R 16 Inch)	14-16	TBA		TBA					
CRM 125 RL/RM/RN/RP/RR/RV/RX	90-99	CK1160		CSK004					CT013SP

EBC CLUTCH KITS

Make & Model	Year	CK Series #	CKF Series #	Spring Kit #	DRC Series #	DRCF Series #	SRC Series #	SRK Series #	CT Tool #
HONDA Contd.									
LS 125 R	00-	CK1252		CSK105					CT012SP
MBX 125 FE	84-86	CK1180		CSK009					CT013SP
Monkey	19-20	CK1315		CSK197			SRC122	SRK122	CT084SP
MSX 125 D/F Grom (Non ABS)	13-20	CK1315		CSK197			SRC122	SRK122	CT084SP
MSX 125 D/F Grom (ABS)	17-20	CK1315		CSK197			SRC122	SRK122	CT084SP
MTX 125 RWD/E/F/H/L	83-95	CK1180		CSK004					CT013SP
NS 125 FG/FH/RH (5 Plate Clutch)	86-87	CK1153		CSK159					CT013SP
NSR 125 FJ/FK/FL/FM/FN (6 Plate Clutch)	88-92	CK1160		CSK004					CT013SP
NSR 125 RK/RL/RM/RN (6 Plate Clutch)	89-92	CK1160		CSK004					CT013SP
NSR 125 RR/RS/RV/RW/RX/R1 (6 Plate Clutch)	93-01	CK1160		CSK004					CT013SP
NX 125 K/S/F Transcity	89-97	CK1119		CK1167					CT012SP
NXR 125 Bros ES/KS	05	TBA		TBA					
TL 125 S	76	CK1119		CSK004					CT012SP
TRX 125 J	88	CK1151	CKF1151	CSK048					CT012SP
VT 125 CX/CY/C2Y/C1/C21/C3/C4/C7/C8 Shadow	99-08	CK1292		CSK120					
XL 125 K2-K4/SZ/SA	78-79	CK1119		CSK004					CT012SP
XL 125 SB/SC/SZ/SA	79-82	CK1119		CSK031					CT012SP
XL 125 RC/RF/RH	83-86	CK1119		CSK009					CT012SP
XL 125 V1-VA Varadero	01-11	CK1292		CSK120					
XLR 125 RW	98-99	CK1119		CSK166					CT012SP
XR 125 L3/L4/L5/L6/L7/L8	03-08	CK1119		CSK041					CT012SP
CBF 150 5	05	CK1151		CSK006					CT012SP
CBF 150 M5 Unicorn	05	CK1151		CSK006					CT012SP
CBF 150 6 (Spoke Wheels)	06	CK1151		CSK006					CT012SP
CBF 150 M6/M7 Unicorn (Spoke Wheels)	06-07	CK1151		CSK006					CT012SP
CBF 150 M7/M9/MA Unicorn (Cast Wheels)	07-10	CK1151		CSK006					CT012SP
CBF 150 MB/MC Unicorn (Cast Wheels)	11-12	CK1151		CSK006					CT012SP
CBR 150 R	00-03	CK1252		N/A					CT012SP
CRF 150 F3/F4/F5	03-05	CK1304		CSK077	DRC180				CT012SP
CRF 150 F6/F7	06-19	CK1119		CSK006	DRC181				CT012SP
CRF 150 R (Small Wheel F 17 Inch/ R 14 Inch)	07-20	CK1191	CKF1191	CSK134	DRC182	DRCF182			CT002
CRF 150 RB (Big Wheel F 19 Inch/ R 16 Inch)	07-20	CK1191	CKF1191	CSK134	DRC182	DRCF182			CT002
CB 175 All Models		CK1134		CSK008					
CD 175	67-68	CK1123		CSK008					
CD 175 K3/4/5/A4/A5/T4	69-79	CK1134		CSK008					
CD 185 T	78	CK1119		CSK009					CT012SP
ATC 185 A/SB/SC/SD	80-83	CK1151	CKF1151	CSK022					CT012SP
XL 185 SZ/SA/SB	80-81	CK1119		CSK041					CT012SP
XL 185 SB	82	CK1119		CSK065					CT012SP
ATC 200 B/ESE/ESF/SE	81-84	CK1151	CKF1151	CSK022					CT012SP
ATC 200 XD	84	CK1119		CSK024					CT012SP
CB 200/CB 200 B	76-78	CK1134		CSK008					
CBX 200 Strada	97-01	TBA		TBA					
CD 200 TA	79-80	CK1119		CSK024					CT012SP
CM 200 TA/TB	79-80	CK1119		CSK024					CT012SP
CTX 200/CTX 200 A Bushlander	04-05	CK1119		CSK105	DRC091				CT012SP
MTX 200 RWD	83-84	CK1217		CSK004					CT013SP
MTX 200 RWF	85	CK1180		CSK106					CT013SP
TA 200 (TA Shadow)	02-05	CK1252		TBA					CT012SP
TL 200 J/Y	76-78	CK1119		CSK004					CT012SP
TLR 200 D/E/G/H	83-87	CK1119		CSK009					CT012SP
TRX 200 L/M	90-91	CK1119		CSK172	DRC004				CT012SP
TRX 200 D	91-97	CK1119		CSK172	DRC004				CT012SP
TRX 200 SX	86-87	CK1119		CSK172	DRC004				CT012SP
XR 200 R	81-83	CK1119		CSK105	DRC091				CT012SP
XR 200 R	84-85	CK1180		CSK004	DRC060				CT013SP
XR 200 R	86-02	CK1119		CSK105	DRC091				CT012SP
XR 200	80-84	CK1119		CSK105	DRC091				CT012SP
FTR 223 Y/2/A2 (MCS4)	00-02	CK1252		TBA					CT012SP
CRF 230 F4/F5/F6/F7/F8/F9	04-09	CK1304		CSK024	DRC136				CT012SP
CRF 230 L	08-10	CK1252		CSK009	DRC249				CT012SP
CRF 230 M (Supermoto)	09-10	CK1252		CSK009	DRC249				CT012SP
SL 230 V/W/X/1	97-01	CK1252		TBA					CT012SP
XL 230 2 (MC36)	02	CK1252		TBA					CT012SP
ATC 250 RB/RC/RD	81-83	CK1163		CSK031					
ATC 250 RF	85	CK1193	CKF1193	CSK015					CT013SP
ATC 250 RG	86	CK1193	CKF1193	CSK032					CT013SP
ATC 250 ESF/ESG/ESH/ESJ	85-88	CK1194		CSK004					CT013SP
AX-1 (NX 250 J/K/R/R3)	89-94	CK1190	CKF1190	CSK030	DRC051				CT013SP
CB 250 K3-K5	73-75	CK1132		CSK004					CT009
CB 250 G5	75-76	CK1132		CSK004					CT009
CB 250 T/N/NA/NB/NDB/NDC	78-82	CK1140		CSK006					CT013SP
CB 250 RSA/RSD	81-84	CK1153		CSK009					CT013SP
CB 250 N/T/W/X/Y/1/4 Two Fifty	93-05	CK1191	CKF1191	CSK024					CT012SP

CLUTCH APPLICATIONS

EBC CLUTCH KITS

Make & Model	Year	CK Series #	CKF Series #	Spring Kit #	DRC Series #	DRCF Series #	SRC Series #	SRK Series #	CT Tool #
HONDA Contd.									
CB 250 FT/FV/FX/FY/F1 (MC31) Hornet	96-01	CK1235		CSK172			SRC047	SRK047	CT012SP
CBF 250 4 / 6	04-06	CK1190	CKF1190	CSK168					CT013SP
CBR 250 FG/RH/RJ/RK/RK2 (MC14/17/19)	86-89	CK1235		CSK172			SRC047	SRK047	CT012SP
CBR 250 RRL/RRN/RRR (MC22 - 100/105/110)	90-94	CK1235		CSK172			SRC047	SRK047	CT012SP
CBR 250 RB/RC (Non ABS Model)	11-13	CK1313		CSK188					
CBR 250 RAB/RAC (ABS Model)	11-13	CK1313		CSK188					
CBX 250 RSE	84	CK1217		CSK007					CT013SP
CBX 250 Twister		CK1217		CSK007					CT013SP
CBX 250	84-98	TBA		CSK106					
CD 250 UJ/UK	88-92	CK1191	CKF1191	CSK024					CT012SP
CJ 250 T/T2	77	CK1132		CSK031					CT009
CL 250 SC	81	CK1153		CSK009					CT013SP
CM 250 TB	81	CK1140		CSK016					CT013SP
CMX 250 CT/CV/CW/CX	96-00	CK1191	CKF1191	CSK024					CT012SP
CR 250 R/RZ/RA	78-80	CK1163		CSK031					
CR 250 RB/RC	81-82	CK1131		CSK041					CT009
CR 250 RD/RE/RF/RG/RH/RJ/RK	83-89	CK1170	CKF1170	CSK028	DRC003				CT009
CR 250 RL/RM/RN/RP	90-93	CK1247	CKF1247	CSK028	DRC075				CT009
CR 250 RR/RS/RT/RV/RW/RX/RY/R1-R7	94-07	CK1247	CKF1247	CSK178	DRC079	DRCF079			CT009
CRF 250 LD/LF	13-16	CK1314	CKF1314	CSK188	DRC277	DRCF277			CT081SP
CRF 250 L (Non ABS)/LA (ABS)	13-20	CK1314	CKF1314	CSK188	DRC277	DRCF277			CT081SP
CRF 250 RL/RLA Rally (non ABS & ABS models)	17-20	CK1314	CKF1314	CSK188	DRC277	DRCF277			CT081SP
CRF 250 ME Supermoto	14-15	CK1314	CKF1314	CSK188	DRC277	DRCF277			CT081SP
CRF 250 R4/R5/R6/R7	04-07	CK1293	CKF1293	CSK176	DRC129	DRCF129			CT001
CRF 250 R8-R9	08-09	CK1305	CKF1305	CSK176	DRC208	DRCF208			CT001
CRF 250 RA	10	CK1293	CKF1293	CSK164	DRC256	DRCF256			CT001
CRF 250 R	11-20	CK1305	CKF1305	CSK215	DRC261	DRCF261			CT001
CRF 250 RE (Limited Road Use)	16	CK1305	CKF1305	CSK215	DRC261	DRCF261			CT001
CRF 250 X4/X5/X6/X7/X8/X9/XB/XC/XD/XF/XG/XH	04-17	CK1305	CKF1305	CSK176	DRC208	DRCF208			CT001
CRF 250 RX	18-20	CK1305	CKF1305	CSK176	DRC208	DRCF208			CT001
CRF 250 XRL (Road Legal)	14-16	CK1305	CKF1305	CSK176	DRC208	DRCF208			CT001
CRM 250 R (RK) MK1 MD24 (100001-1008385)	89-90	CK1193	CKF1193	CSK028	DRC093				CT013
CRM 250 R (RM) MK2 MD24 (1200001-1211634)	91-92	CK1193	CKF1193	CSK028	DRC093				CT013
CRM 250 R (RP/RP-11) MK2/2/MD24 (1300001-)	93	CK1193	CKF1193	CSK028	DRC093				CT013
CRM 250 MK3 RR/RR2 (MD24-10)	94-96	CK1181		CSK028					CT013
CRM 250 Active Radial ARV/ARW (MD32)	97-98	CK1181		TBA					CT013
GB 250 E/H/J/L/P/S/V Custom	84-97	CK1217		CSK007					CT013SP
MXV 250 F (MC92)	83-88	N/A		N/A					
NS 250 FE/RE (MC11-100)	84	CK1218	CKF1218	CSK020					CT013
NS 250 RG (MC11-102)	86	CK1218	CKF1218	CSK020					CT013
NSR 250 RG (MC16-100) Wet Clutch	86	CK1181		CSK024					CT013
NSR 250 R2J (MC18-100)/R4J (MC18-100) Wet Clutch	88	CK1181		CSK024					CT013
NSR 250 R5K/R5K-2 (MC18-110) Wet Clutch	89	CK1181		CSK024					CT013
NSR 250 R6K/R6K-2 (MC18-110) Dry Clutch	89	CK1288		CSK009					CT071SP
NSR 250 R7L (MC21-100)/R7N (MC21-106) Wet Clutch	90	CK1181		CSK024					CT013
NSR 250 R8L-3 (MC21-101)/NSR 250 R9L (MC21-102)									
/NSR 250 R8N/R8N-3 (MC21-106)	90-92	CK1288		CSK167					CT071SP
NSR 250 R9N (MC21-106) Dry Clutch	92	CK1288		CSK167					CT071SP
NSR 250 RR (MC28-100) Wet Clutch	94	CK1181		CSK024					CT013
NSR 250 R2R/R3R (MC28-100)/ R3S (MC28-110)									
/R2T/R3T (MC28-120) Dry Clutch	94	CK1288		CSK167					CT071SP
NX 250 J/K/L (MD21)	87-90	CK1190	CKF1190	CSK065					CT013SP
NX 250 2L/M/P/2P	90-93	CK1190	CKF1190	CSK065					CT013SP
TL 250/TL 250 K1	78-79	CK1131		CSK004					CT009
TLR 250 F	85-	CK1119		CSK105	DRC091				CT012SP
TRX 250 F/G/H	85-87	CK1194		CSK004					CT013SP
TRX 250 RG/RH	86-87	CK1193	CKF1193	CSK032	DRC005				CT013
TRX 250 RJ/RK	88-89	CK1193	CKF1193	CSK045	DRC081				CT013
TRX 250 V/W/X/Y/1/TM2 Re Con (Manual Shift)	97-14	CK1119		CSK172	DRC004				CT012SP
TRX 250 TE2 Re Con ES (Electric Shift)	02-14	CK1119		CSK172	DRC004				CT012SP
TRX 250 X9/XA/XB	09-11	CK1119		CSK172	DRC004				CT012SP
TRX 250 EX1/2/3/4/5/6/7/8	01-08	CK1119		CSK172	DRC004				CT012SP
VT 250 CR Magna		CK1235		CSK172			SRC047	SRK047	CT012SP
VT 250 FD	83	CK1191	CKF1191	CSK023					CT002
VT 250 FL Spada/Castec	88-90	CK1235		CSK172					CT012SP
VTZ 250 H/J/K	86-88	CK1235		CSK172			SRC047	SRK047	CT012SP
VTR 250 W/Y (MC33)/1-7	98-07	CK1235		CSK172			SRC047	SRK047	CT012SP
VTR 250 9	09-10	CK1235		CSK004					CT012SP
XL 250 K3/K4	78-79	CK1131		CSK004					CT009
XL 250 S/SZ/SA	78-80	CK1152		CSK009					CT013SP
XL 250 SB/RC	81-82	CK1153		CSK009					CT013SP
XL 250 RE/RF	84-85	CK1180		CSK004	DRC060				CT013SP
XL 250 Degree		CK1190	CKF1190	CSK009					CT013SP
XLR 250 R Baja (5 Plate) (MD22)		CK1180		CSK004	DRC060				CT013SP

EBC CLUTCH KITS

Make & Model	Year	CK Series #	CKF Series #	Spring Kit #	DRC Series #	DRCF Series #	SRC Series #	SRK Series #	CT Tool #
HONDA Contd.									
XLR 250 R Baja (6 Plate) (MD22)		CK1190	CKF1190	CSK004					CT013SP
XR 250 SZ/SA	79-80	CK1152		CSK009					CT013SP
XR 250 RB/RC/RD	81-83	CK1153		CSK009					CT013SP
XR 250 RE/RF	84-85	CK1180		CSK004	DRC060				CT013SP
XR 250 RG/RH/RJ/RK/RL/RM/RN/RO/RS	86-95	CK1190	CKF1190	CSK004	DRC044	DRCF044			CT013SP
XR 250 RT/RV/RW/RX/RY/R1/R2/R3/R4	96-04	CK1190	CKF1190	CSK065	DRC084				CT013SP
XR 250 Tornado	05	TBA		TBA					
XR 250 Y/3 (MD30)	00-03	CK1190	CKF1190	CSK065					CT013SP
XR 250 3 / 5 (MD30) Motard	03-05	CK1190	CKF1190	CSK065					CT013SP
XR 250 III Y/3 Baja	00-03	CK1190	CKF1190	CSK065					CT013SP
CB 300 FAF/FAG (ABS)	15	CK1314		TBA					CT081SP
CB 300 R10	10	TBA		TBA					
CBF 300 NA	18-20	CK1314		CSK188	DRC277				CT081SP
CBR 300 RA (ABS)	14-19	CK1314		CSK188	DRC277				CT081SP
TRX 300 FWJ/K/L/T/V/W/X/Y/J/K/L/T/V/W/X/Y	88-00	CK1196		CSK023	DRC006				CT013SP
TRX 300 EX P/R/S/T/V/W/X/Y/1-8	93-08	CK1190	CKF1190	CSK004	DRC044	DRCF044			CT013SP
TRX 300 X9	09	CK1190	CKF1190	CSK004	DRC044	DRCF044			CT013SP
XR 300 R10	10	TBA		TBA					
TRX 350 G/H/J/K/L/M/N	86-93	CK1196		CSK012	DRC006				CT013SP
TRX 350 FMY/1-5 Fourtrax Rancher/4 x 4	00-05	CK1196		CSK048	DRC126				CT013SP
TRX 350 TE/FE Fourtrax Rancher ES/ES 4 x 4 FEY/1-5	00-05	CK1160		CSK048	DRC127				CT013SP
CB 350 SG/SJ	86-88	CK1140		CSK015					CT013SP
CB 350 K4		CK1132		CSK082					CT009
XR 350 RD/RE	83-84	CK1190	CKF1190	CSK004	DRC044	DRCF044			CT013SP
CB/CJ 360 All Models		CK1132		CSK082					CT009
SL 350 K0/K1/K2	69-73	CK1134		CSK082					
CB 400 F/F1/F2	75-79	CK1140		CSK082					CT013SP
CB 400 T/N/NA/NB/NC	78-82	CK1140		CSK047					CT013SP
CB-1 (CB 400 F)	89-90	CK1228		CSK006					CT009SP
CB 400 SF (F2N/F2R) (Super Four) (NC31)	92-95	CK1228		CSK006					CT009SP
CB 400 SF (F2V/F3T) (Super Four) (NC31)	96-97	CK1228		CSK006					CT009SP
CB 400 SF (F3V) Superfour (NC31)	97	CK1228		CSK006					CT009SP
CB 400 Four V/V-II/W/W-II (NC36)	97-98	CK1228		TBA					CT009SP
CB 400 SFX/SFY/SF1/SF2/SF3/SF4/5/S5 (NC39) Super Four	99-05	CK1265		TBA					CT009SP
CB 400 SS (SS2-NC41)	01-05	CK1181		CSK032					CT013
CBR 400 RG/RHYA (NC23 100/101)	86	CK1228		TBA					CT009SP
CBR 400 RRJ/RRK (NC23 102/109)	92-93	CK1228		CSK006					CT009SP
CBR 400 RRL/RRN/RRR (NC29)	90-94	CK1181		CSK033			SRC049	SRK049	CT013SP
CL 400 (NC38)	97-03	CK1181		CSK032					CT013
FL 400 R/RK/RL Pilot	89-93	CK1234		TBA					
NS 400 RF/RG	85-87	CK1218	CKF1218	CSK167					CT013
NT 400 Bros NC 25		CK1160		CSK028			SRC061	SRK061	CT013SP
NV 400 CJ/CK (Steed)	92-93	CK1160		CSK028			SRC061	SRK061	CT013SP
NV 400 CS/CV Steed	95-97	CK1160		CSK028			SRC061	SRK061	CT013SP
NV 400 DCY/DC1/DC2 (NC40) Shadow Slasher	00-02	CK1160		CSK028			SRC061	SRK061	CT013SP
TRX 400 FWS/T/V/W/X/Y	95-00	CK1196		CSK023	DRC006				CT013SP
TRX 400 EX/EY/EXX/EXY/EX1-EX8	99-08	CK1193	CKF1193	CSK073	DRC100	DRCF100			CT013
TRX 400 X9	09	CK1193	CKF1193	CSK073	DRC100	DRCF100			CT013
RVF 400 RR/RT/RR-II/RT-II (NC35 -100/110)	94-96	CK1289		N/A					CT002
VF 400 FD	83-85	CK1165		CSK009					CT002
VFR 400 R3K/R3L/R3M/R3N (NC30)	89-92	CK1250		CSK904			SRC063	SRK063	CT002
VFR 400 ZG/ZH/RG/RG-YA (NC21)	85-86	CK1177		CSK006					CT002
VFR 400 RH2/RJ (NC24)	87-88	CK1177		CSK009					CT002
XL 400 R	82	N/A		N/A					
XR 400 RT	96	CK1193	CKF1193	CSK028	DRC093				CT013
XR 400 RV/RW/RX/RY/R1-R5	97-05	CK1193	CKF1193	CSK033	DRC106				CT013
VRX 400 T (NC33)	96	CK1160		CSK033					CT013SP
XR 400 R5/R6 Motard (NC38E)	05-06	CK1181		CSK178	DRC266				CT013
XR 400 M Supermotard (ND08/NC38E)	06-08	CK1181		CSK178	DRC266				CT013
TRX 420 TM7/TM8/TM9/TMA/TMB	07-11	CK1154		CSK154	DRC239				CT013SP
TRX 420 FE7/FE8/FE9/FEA/FEB 4WD Fourtrax ES	07-11	CK1196		CSK155	DRC238				CT013SP
TRX 420 FM7/FM8/FM9/FMA/FMB 4WD Fourtrax	07-11	CK1154		CSK154	DRC239				CT013SP
TRX 420 FPMP/FPMA/FPMB Fourtrax 4WD - Power Steering	09-11	CK1154		CSK154	DRC239				CT013SP
TRX 420 TE7/TE8/TE9 Fourtrax ES 2WD	07-09	CK1196		CSK155	DRC238				CT013SP
CB 450 DX-K	89	CK1140		CSK047					CT013SP
CR 450 RB	81	CK1131		CSK041					CT009
CRF 450 R2/R3	02-03	CK1247	CKF1247	CSK178	DRC112				CT009
CRF 450 R4/R5 (6 Spring Type)	04-05	CK1247	CKF1247	CSK120	DRC148	DRCF148			CT009
CRF 450 R6/R7/R8 (6 Spring Type)	06-08	CK1247	CKF1247	CSK178	DRC112				CT009
CRF 450 R9/RA (4 Spring type)	09-10	CK1247	CKF1247	CSK157	DRC244	DRCF244			CT009
CRF 450 RB/RC	11-12	CK3433	CKF3433	CSK174	DRC259	DRCF259			CT009
CRF 450 R	13	CK3433	CKF3433	CSK201	DRC276	DRCF276			CT009

CLUTCH APPLICATIONS

EBC CLUTCH KITS

Make & Model	Year	CK Series #	CKF Series #	Spring Kit #	DRC Series #	DRCF Series #	SRC Series #	SRK Series #	CT Tool #
HONDA Contd.									
CRF 450 RD/RE/RF/RG (6 Spring Type)	14-17	CK3433	CKF3433	CSK201	DRC276	DRCF276			CT009
CRF 450 R AC (6 Spring Type)	17-20	CK1317	CKF1317	CSK227	DRC299	DRCF299			CT092
CRF 450 RE (Limited Road Use)	16	CK3433	CKF3433	CSK201	DRC276	DRCF276			CT009
CRF 450 X5/X6/X7/X8/X9/XB/XC/XD/XF/XG/XH	05-17	CK1247	CKF1247	CSK120	DRC148	DRCF148			CT009
CRF 450 XRL (Road Legal)	14-16	CK1247	CKF1247	CSK120	DRC148	DRCF148			CT009
CRF 450 X AC (18 inch rear wheel)	18-20	CK1317	CKF1317	CSK227	DRC299	DRCF299			CT092
CRF 450 L AC (18 inch rear wheel)	18-20	CK1317	CKF1317	CSK277	DRC299	DRCF299			CT092
CRF 450 RX AC (18 Inch Rear Wheel)	17-20	CK1317	CKF1317	CSK227	DRC299	DRCF299			CT092
CMX 450 CH/CJ Rebel	02	CK1140		CSK015					CT013SP
TRX 450 ESW/ESX/ESY/ES1	98-01	CK1196		CSK023	DRC006				CT013SP
TRX 450 R4/R5/R6/ER6/R7/ER7/R8/ER8/R9/ER9	04-09	CK1302	CKF1302	CKS178	DRC131	DRCF131			CT009
CR 480 RC	82	CK1131		CSK024					CT009
CR 480 RD	83	CK1170	CKF1170	CSK028	DRC003				CT009
CB 500 FAD/FAE/FAF/FAG (ABS)	13-16	TBA		CSK033					
CB 500 FD/FE/FF (Non ABS)	13-16	TBA		CSK033					
CB 500 K1/K2 (Four)	75-77	CK1135		CSK003					CT009
CB 500 K3 (Four)	78	CK1146		CSK009					CT009SP
CB 500 T (Twin)	75-77	CK1130		CSK015					CT031
CB 500 R/T/V/W/SW/X/SX/Y/SY/2/S2 (Twin)	94-03	CK1181		CSK033					CT013SP
CB 500 F (Non ABS)	13-18	CK1323		CSK033					
CB 500 FA (ABS)	13-18	CK1323		CSK033					
CB 500 X (Non ABS)	13-18	CK1323		CSK033					
CB 500 XA (ABS)	13-18	CK1323		CSK033					
CBF 500 4/A4/A5/A6/A7	04-07	CK1181		CSK033					CT013SP
CBR 500 FH/FJ/FK/FL (Four)	87-90	CK1228		CSK012			SRC016	SRK016	CT009SP
CBR 500 R (Non ABS)	2013-2018	CK1323		CSK033					
CBR 500 RA (ABS)	2013-2018	CK1323		CSK033					
CR 500 RE/RG/RH/RJ/RK	84-89	CK1170	CKF1170	CSK028	DRC003				CT009
CR 500 RL/RM/RN/RP/RR/RS/RT/RV/RW/RX/RY/R1	90-01	CK1247	CKF1247	CSK028	DRC075				CT009
CX 500 CA/CB/Z/A/B/EC	79-85	CK1146		CSK041					CT009SP
CX 500 Turbo	82	CK1159		CSK010					CT053SP
FT 500 C	82	CK1154		CSK248					CT013SP
GL 500 DC	82	CK1146		CSK041					CT009SP
NX 500 J/K/L/M/N/P/R/S/T/V/W/X Dominator	88-99	CK1170	CKF1170	CSK016	DRC054	DRCF054			CT009
TRX 500 FE5/FE6/FE7/FE8/FE9/FEA/FAB									
Fourtrax Foreman 4WD/ES	05-11	CK1154		CSK117	DRC236				CT013SP
TRX 500 FEC Fourtrax Foreman ES 2 / 4 WD	12	CK1154		CSK029	DRC270				CT013SP
TRX 500 FM5/FM6/FM7/FM8/FM9/FMA/FMB									
Fourtrax Foreman 4 x 4	05-11	CK1154		CSK153	DRC237				CT013SP
TRX 500 FMC Fourtrax Foreman S 2 / 4 WD	12	CK1154		CSK079	DRC271				CT013SP
TRX 500 TM5/TM6 Fourtrax Foreman	05-06	CK1154		CSK153	DRC237				CT013SP
TRX 500 FPE8/FPE9/FPEA/FPEB Fourtrax Foreman									
4 x 4 ES/EP	08-11	CK1154		CSK117	DRC236				CT013SP
TRX 500 FPEC Fourtrax Foreman S 2 / 4 WD	12	CK1154		CSK029	DRC270				CT013SP
VF 500 FE/F2E/FF/F2F	84-85	CK1177		CSK009					CT002
VT 500 ED/EF	83-85	CK1160		N/A					CT013SP
XBR 500 F/G/H/SH/SJ	85-89	CK1219		CSK016					CT009
XL 500 SZ/SB/RC	80-82	CK1140		CSK248					CT013SP
XR 500 SZ/SA/RB/RC	79-82	CK1154		CSK248					CT013SP
XR 500 RD/RE	84-85	CK1170	CKF1170	CSK248					CT009
CB 550 F/F1/F2/K3	78-80	CK1146		CSK009					CT009SP
CBX 550 FC/F2C/FD/F2D	82-85	CK1228		CSK026			SRC048	SRK048	CT009SP
CB 600 Hornet FW/FX/FY/F2-Y/F1/F21/F2/F22									
/F3/F4/F5/F6	98-06	CK1206	CKF1206	CSK045			SRC019	SRK019	CT014SP
CB 600 F7/F8/F9/FA/FB/FC Hornet	07-13	CK1218	CKF1218	CSK101			SRC075	SRK075	CT014
CB 600 FA7/FA8/FA9/FAA/FAB/FAC Hornet (ABS)	07-13	CK1218	CKF1218	CSK101			SRC075	SRK075	CT014
CBF 600 N4/N5/N6	04-06	CK1206	CKF1206	CSK045			SRC019	SRK019	CT014SP
CBF 600 N8/N9/NA	08-11	CK1218	CKF1218	CSK101			SRC075	SRK075	CT014
CBF 600 NA4/NA5/NA6	04-06	CK1206	CKF1206	CSK045			SRC019	SRK019	CT014SP
CBF 600 NA8/NA9/NAA	08-11	CK1218	CKF1218	CSK101			SRC075	SRK075	CT014
CBF 600 S4/S5/S6	04-06	CK1206	CKF1206	CSK045			SRC019	SRK019	CT014SP
CBF 600 S8/S9	08-09	CK1218	CKF1218	CSK101			SRC075	SRK075	CT014
CBF 600 SA4/SA5/SA6	04-06	CK1206	CKF1206	CSK045			SRC019	SRK019	CT014SP
CBF 600 SA8/SA9/SAA	08-12	CK1218	CKF1218	CSK101			SRC075	SRK075	CT014
CBR 600 FH/FJ	87-88	CK1228		CSK012			SRC016	SRK016	CT009SP
CBR 600 FK/FL	89-90	CK1228		CSK047			SRC042	SRK042	CT009SP
CBR 600 FM/FN/FP/FR/FS/FT/FV/FW	91-98	CK1206	CKF1206	CSK045			SRC019	SRK019	CT014SP
CBR 600 FX/FY (CARB MODEL)	99-00	CK1193	CKF1193	CSK029			SRC066	SRK066	CT014
CBR 600 F1/F2/F3/F4/F5/F6 (CARB MODEL)	01-06	CK1218	CKF1218	CSK178			SRC143	SRK143	CT014
CBR 600 FR1/FR2 (ROSSI INJECTION MODEL)	01-02	CK1218	CKF1218	CSK178			SRC143	SRK143	CT014
CBR 600 FS1/FS2 (CBR600 S INJECTION MODEL)	01-02	CK1218	CKF1218	CSK178			SRC143	SRK143	CT014
CBR 600 FB/FC	11-12	CK1218	CKF1218	TBA			SRC057	SRK057	CT014
CBR 600 FAB/FAC	11-12	CK1218	CKF1218	TBA			SRC057	SRK057	CT014

CLUTCH APPLICATIONS

EBC CLUTCH KITS

Make & Model	Year	CK Series #	CKF Series #	Spring Kit #	DRC Series #	DRCF Series #	SRC Series #	SRK Series #	CT Tool #
HONDA Contd.									
CBR 600 RR3/RR4/RR5/RR6/RR7/RR8/RR9/RRA									
/RRB/RRC/RRD	03-19	CK1218	CKF1218	CSK101			SRC075	SRK075	CT014
CBR 600 RR Hannspree	08	CK1218	CKF1218	CSK101			SRC075	SRK075	CT014
CBR 600 RA	09-19	CK1218	CKF1218	CSK101			SRC075	SRK075	CT014
NTV 600 J/K/M	88-91	CK1230		CSK032					CT013SP
VT 600 CN/CR/CS/CT/CV/CW/CX	92-00	CK1181		CSK033					CT013SP
XL 600 RD/LD/RE/LE/RF/RG/RH	83-87	CK1170	CKF1170	CSK016	DRC092				CT009
XL 600 LMF/RMG/LMH	85-87	CK1170	CKF1170	CSK016	DRC054	DRCF054			CT009
XL 600 VH/VJ/VK/VM/VN/VP/VR/VT/VV									
/VW/VX Transalp	87-99	CK1181		CSK033	DRC053				CT013SP
XR 600 RF/RG/RH/RJ/RK/RL/RM/RP/RR/RS/RT									
/RV/RW/RX/RV	84-00	CK1170	CKF1170	CSK016	DRC054	DRCF054			CT009
FMX 650 5 / 6	05-08	CK1170	CKF1170	CSK016	DRC054	DRCF054			CT009
FX 650 X/Y Vigor	99-03	CK1170	CKF1170	CSK016	DRC054	DRCF054			CT009
NT 650 J/K/L (Bros)	88-92	CK1230		CSK028			SRC064	SRK064	CT013SP
NTV 650 J/K/L/M/P/S/T/V	88-97	CK1230		CSK033			SRC062	SRK062	CT013SP
NT 650 VW/VX/VY/V1-V5 Deauville	98-05	CK1230		CSK033			SRC062	SRK062	CT013SP
NX 650 J/K/L/M/N/P/R/S/T/V/W/X	88-02	CK1170	CKF1170	CSK016	DRC054	DRCF054			CT009
CB 650 F (Non ABS)	14-20	CK1181		CSK246			SRC149	SRK149	CT014
CB 650 FA (ABS)	14-20	CK1181		CSK246			SRC149	SRK149	CT014
CB 650 Z/B/SCC	79-82	CK1147		CSK009					
CBR 650 F	14-20	CK1181		CSK246			SRC149	SRK149	CT014
CBR 650 FA ABS	14-20	CK1181		CSK246			SRC149	SRK149	CT014
CX 650 ED	83-85	CK1147		CSK012					
CX 650 TD Turbo	83	CK1159		CSK010					CT053SP
GL 650 D2-E	84	CK1147		CSK012					
SLR 650 V/W	97-98	CK1170	CKF1170	CSK016	DRC054	DRCF054			CT009
XL 650 VY/V1/V2/V3/V4/V5/V6/V7	00-07	CK1230		CSK028					CT013SP
XR 650 L	93-12	CK1170	CKF1170	CSK016	DRC054	DRCF054			CT009
XR 650 RY/R1-R7	00-07	CK1295		CSK045	DRC179				CT009
XRV 650 J/K Africa Twin	88-89	CK1230		CSK028			SRC064	SRK064	CT013SP
NC 700 SC/SD (Manual Gearbox)	12-13	CK1230		CSK033			SRC062	SRK062	CT013SP
NC 700 XC/XD (Manual Gearbox)	12-17	CK1230		CSK033			SRC062	SRK062	CT013SP
NT 700 V6/VA7/V7/V8/VA8/VA/VAA Deauville	06-13	CK1230		CSK033			SRC062	SRK062	CT013SP
TRX 700 XX8/XX9/XXB	08-11	CK1302	CKF1302	CSK178	DRC240	DRCF240			CT009
XL 700 V8/V9/VA (Transalp/2 Piston Front Caliper									
/ABS on Rear Disc)	08-11	CK1230		CSK009					CT013SP
XL 700 VA8/VA9/VAA (Transalp/3 Piston Front Caliper									
/ABS Front & Rear Wheels)	08-11	CK1230		CSK009					CT013SP
CB 750/CB 750 K1 (Up to E.No:-1056079)	69-70	CK1223		CSK009					
CB 750 K1 (From E.No:-1056080)	70-71	CK1133		CSK009					CT076SP
CB 750 K2/K3/K4/K5	71-75	CK1133		CSK004					CT076SP
CB 750 KZ	80	CK1149		CSK041					CT078SP
CB 750 F/F1	76-77	CK1220		CSK082					
CB 750 K6/K7/F2	76-78	CK1145		CSK082					CT076SP
CB 750 FA/FB/F2C	79-82	CK1149		CSK041					CT078SP
CB 750 F2N/F2R/F2S/F2T/F2W/F2X/F2Y/F21	92-02	CK1265		CSK006					CT009SP
CBR 750 FH/FJ (Superaero)	87-88	CK1287		CSK027					
CBX 750 FE	84-85	CK1166		N/A					CT031
NC 750 S	14-15	CK1230		CSK033			SRC062	SRK062	CT013SP
NC 750 S (ABS)	14-18	CK1230		CSK033			SRC062	SRK062	CT013SP
NC 750 X	14-15	CK1230		CSK033			SRC062	SRK062	CT013SP
NC 750 X (ABS)	14-19	CK1230		CSK033			SRC062	SRK062	CT013SP
NR 750 N	92	CK1257		N/A					
VF 750 FD/FE	83-85	CK1167		CSK900			SRC002	SRK002	CT031
VF 750 SC (V45 Sabre)	82	CK1166		CSK077					CT031
VF 750 CH	87	CK1166		CSK077					CT031
VF 750 CP/CR/CS/CT/CV	93-97	CK1206	CKF1206	CSK028					CT014
VFR 750 FG/FH/FJ/FK/FL/FM/FN/FP/FR/FS/FT/FV	86-97	CK1206	CKF1206	CSK028			SRC003	SRK003	CT014
VFR 750 RJ/RK/RL (RC30)	88-92	CK1229		CSK901			SRC005	SRK005	CT014
VT 750 C Shadow	83	CK1166		N/A					CT031
VT 750 CV/C2V/CW/C2W/CX/C2X/CY/C2Y/C1/C1Y									
/C4/C5/C6/C7/C8	97-09	CK1230		CSK028			SRC064	SRK064	CT013SP
VT 750 C2BA/C2BB/C2BC/C2BE Shadow Black Spirit	10-15	CK1230		TBA					CT013SP
VT 750 C2SA/C2SB Shadow (3 Piston Caliper									
/17 Inch Front Wheel/Rear Disc)	10-12	CK1230		TBA					CT013SP
VT 750 DC1/DC2 Black Widow	01-04	CK1230		CSK028					CT013SP
VT 750 DC7/DC8 Shadow Spirit	07-09	CK1230		CSK028					CT013SP
VT 750 S (VT 750 SA/SB)	10-12	CK1230		CSK028			SRC064	SRK064	CT013SP
RVF 750 RR-R/RR-S	94-98	CK1257		N/A					
XLV 750 R (RD/RF)	83-88	CK1166		CSK077					CT031
XRV 750 L/M/N/P/R/S/T/V/W/X/Y	90-03	CK1167		CSK006					CT009
PC 800 Pacific Coast	89-97	CK1167		CSK030					CT009
VFR 800 Fi-W/Fi-X	98-99	CK1206	CKF1206	CSK135					CT014

EBC CLUTCH KITS

Make & Model	Year	CK Series #	CKF Series #	Spring Kit #	DRC Series #	DRCF Series #	SRC Series #	SRK Series #	CT Tool #
HONDA Contd.									
VFR 800 Fi-Y/Fi-1	00-01	CK1253		CSK101					CT014
VFR 800 2/3/4/5/6/8/9	02-09	CK1218	CKF1218	CSK101					CT014
VFR 800 A2/A3/A4/A5/A6/A8/A9	02-13	CK1218	CKF1218	CSK101					CT014
VFR 800 F (ABS Model)	14-16	CK1218	CKF1218	CSK101			SRC075	SRK075	CT014
VFR 800 XA (Crossrunner/ABS)	11-13	CK1218	CKF1218	CSK101			SRC075	SRK075	CT014
VFR 800 XA (Crossrunner/ABS)	15-16	CK1218	CKF1218	CSK101			SRC075	SRK075	CT014
VFR 800 XC (Crossrunner)	12-14	TBA		TBA					
VFR 800 X (Crossrunner)	15	TBA		TBA					
CB 900 FZ/FA/FB/F2B/F2C/FD/F2D	80-85	CK1149		CSK167					CT078SP
CB 900 F2/F3/F4/F5/F6/F7 Hornet	02-07	CK1218	CKF1218	CSK045			SRC057	SRK057	CT014
CBR 900 RRN/RRP/RRR/RRS (893cc)	92-95	CK1206	CKF1206	CSK028			SRC094	SRK094	CT014
CBR 900 RRT/RRV (918cc)	96-97	CK1284		CSK045			SRC055	SRK055	CT014
CBR 900 RRW/RRX (918cc)	98-99	CK1218	CKF1218	CSK045			SRC057	SRK057	CT014
CBR 900 RRY/RR1 (929cc Fireblade)	00-01	CK1206	CKF1206	CSK045			SRC019	SRK100	CT014
CBR 900 RR2/RR3 (954cc Fireblade)	02-03	CK1206	CKF1206	CSK045			SRC019	SRK100	CT014
CB 1000 FP/FR/FS/FT/FV	93-97	CK1248	CKF1248	CSK029			SRC004	SRK004	CT009
CB 1000 R9/RA/RB/RC/RD/RE/RF (Non ABS Model)	09-15	CK1303		CSK112			SRC080	SRK080	CT009
CB 1000 RA9/RAA/RAB/RAC/RAE/RAF/RAG (ABS Model)	09-16	CK1303		CSK112			SRC080	SRK080	CT009
CBF 1000 6/7/8/9/A (2 Piston Front Caliper/Non ABS)	06-11	CK1303		CSK090					CT009
CBF 1000 A A6/A7/A8/A9/AA (3 Piston Front Caliper/ABS)	06-11	CK1303		CSK090					CT00
CBF 1000 S S7/S8/S9/SA (3 Piston Front Caliper/ABS)	07-10	CK1303		CSK090					CT009
CBF 1000 T T7/T8/T9/TA (GT) (3 Piston Front Caliper/ABS)	07-16	CK1303		CSK090					CT009
CBF 1000 F FA (2 Piston Front Caliper/Non ABS)	10-11	CK1303		CSK090					CT009
CBF 1000 FA FAA (3 Piston Front Caliper/ABS)	10-15	CK1303		CSK090					CT009
CBF 1000 FS FSA (3 Piston Front Caliper/ABS)	10-11	CK1303		CSK090					CT009
CBF 1000 FT FTA (3 Piston Front Caliper/ABS)	10-11	CK1303		CSK090					CT009
CBR 1000 FH/FJ/FK/FL/FM/FN/FP/FR/FS/FT/FV/FW/FX	87-99	CK1248	CKF1248	CSK029			SRC004	SRK004	CT009
CBR 1000 RR Fireblade (Coil Spring Type Clutch)	04-07	CK1303		CSK112			SRC080	SRK080	CT009
CBR 1000 RR Fireblade (Diaphragm Type Clutch)	08-16	CK1312	CKF1312	CSK905			SRC095	SRK095	CT043SP
CBR 1000 RR Fireblade (Coil Spring Type Clutch)	17-19	TBA		TBA			TBA	TBA	TBA
(CBR 1000 SAE/SAF/SAG)	14-16	CK1312	CKF1312	CSK905			SRC095	SRK095	CT043SP
CBR 1000 RR-SP ABS -TT Edition	16	CK1312	CKF1312	CSK905			SRC095	SRK095	CT043SP
CBX 1000 Z	79	CK1183		CSK167					CT066SP
CBX 1000 B/C	80-81	CK1183		CSK010					CT066SP
CRF 1000 LAG (Manual Clutch/ABS)	16-20	CK1319	CKF1319	CSK254	DRC306	DRCF306			CT009
CRF 1000 L (Manual Clutch/Non ABS)	16	CK1319	CKF1319	CSK254	DRC306	DRCF306			CT009
GL 1000 K1 (Up to E.No: -2002383)	77	CK1221		CSK010					
GL 1000 K1/K2 (From E.No: -2002384)	77-78	CK1143		CSK010					CT076SP
RC 213 V-S (1000cc)	15	TBA		TBA					
VF 1000 FE/FF/RE/RF/RG/F2F	84-86	CK1176		N/A					CT031
VTR 1000 FV/FW/FX/FY/F1-F6 Firestorm	97-06	CK1290		CSK206			SRC060	SRK060	CT009
VTR 1000 SPY/SP1 (SC45)	00-01	CK1291		CSK043					CT021
VTR 1000 SP-2/SP-3/SP-4/SP-5/SP-6	02-07	CK1300		CSK043					
XL 1000 VX/VY/V1/V2 Varadero - Non ABS Model /10 Plate Kit	99-02	CK1290		CSK206	DRC267				CT009
XL 1000 V3/V4/V5/V6/V7/V8/V9/VA/VB Varadero - Non ABS Model/8 Plate Kit	03-11	CK1257		CSK138	DRC268				CT009
XL 1000 V6/VA6/VA7/VA8/VA9VAA/VAB Varadero - ABS Model/8 Plate Kit	06-11	CK1257		CSK138	DRC268				CT009
CB 1100 RB2/RC2	80-81	CK1149		CSK009					CT078SP
CB 1100 RD2	82	CK1149		CSK207					CT078SP
CB 1100 SFY/SF1 X11	00-03	CK1291		CSK043					CT021
CB 1100 AD (Cast Wheels/3 Piston Caliper)	13	CK1257		CSK070					CT009
CB 1100 AE (Cast Wheels/3 Piston Caliper)	14	CK1257		CSK070					CT009
CB 1100 EX (Spoke Wheels/4 Piston Caliper)	14-16	CK1257		CSK070					
CB 1100 EX	16-19	CK1332		CSK070			SRC161	SRK161	
CBR 1100 XXV/XXW Blackbird	97-98	CK1286		CSK070					CT021
CBR 1100 XXX/XXY/XX1-XX6 Blackbird	99-08	CK1291		CSK043					CT021
GL 1100 A/DA/B/IB/DB (SC02)	80-81	CK1159		CSK010					
ST 1100 L/M/N/P/R/S/T/V/W/X/Y1/2 (Pan European - Non ABS Model)	90-02	CK1264		CSK033			SRC070	SRK070	CT056SP
ST 1100 AN/AP/AR/AS (Pan European ABS Model)	92-95	CK1264		CSK033			SRC070	SRK070	CT056SP
ST 1100 AT/AV/AW/AX/AY/A1/A2 (Pan European ABS Model)	96-02	CK1264		CSK033			SRC070	SRK070	CT056SP
VT 1100 CH/CJ/CN/CP Shadow	87-93	CK1239		N/A					CT031
VT 1100 CR/CS/CT/CV/CW Shadow	94-98	CK1239		N/A					CT032
VT 1100 C2 (S/T/V)	95-97	CK1176		TBA					CT009
VT 1100 C2 (W/X/Y1/2/3/4/5)	98-05	CK1176		TBA					CT009
VT 1100 C3 (W/X/Y)	98-00	CK1176		TBA					CT031
GL 1200 AE/DE/AF	84-85	CK1210		N/A					CT053SP

CLUTCH APPLICATIONS

EBC CLUTCH KITS

Make & Model	Year	CK Series #	CKF Series #	Spring Kit #	DRC Series #	DRCF Series #	SRC Series #	SRK Series #	CT Tool #
HONDA Contd.									
GL 1200 DH/AH/AG/DG	86-87	CK1224		N/A					
VFR 1200 FA (Manual Gearbox Model)	10-15	CK1312	CKF1312	CSK907			SRC103	SRK103	CT043SP
VFR 1200 XA Crosstourer Manual G/Box	12-15	N/A		N/A	N/A		N/A	N/A	
CB 1300 FW/FX/FY/F1 (SC40)	98-01	CK1299		TBA					CT009
CB 1300 DCV/DCW/DCX/DCY (SC38)	97-00	CK1290		CSK070					CT009
CB 1300 F3/F13	03-04	CK1257		CSK113					CT009
CB 1300 5/6/7/8/9 (Superfour)	05-09	CK1257		CSK113					CT009
CB 1300 A5-A8 (Superfour ABS)	05-08	CK1257		CSK113					CT009
CB 1300 SA5/SA6/SA7/SA8 Super Bol-Dor	05-08	CK1257		CSK113					CT009
CTX 1300 AE	14-15	TBA		TBA					
ST 1300 2/3/4/6/8/9 Pan European - Non ABS	02-09	CK1297		CSK175					CT021
ST 1300 A2/A3/A4/A6/A8/A9/AA									
Pan European - ABS Model	02-15	CK1297		CSK175					CT021
VT 1300 CTA Interstate	11-13	CK1298		CSK090					
VT 1300 CXA (Fury/Chopper/Non ABS /9 Spoke Cast Wheel)	10-12	CK1298		CSK090					CT021
VT 1300 CXAA (Fury/Chopper/ABS /9 Spoke Cast Wheel)	10-11	CK1298		CSK090					CT021
VTX 1300 S3/S4/S5/S6/S7/S8	03-08	CK1298		CSK090					CT021
GL 1500 J/K/L/SEM/SEN/SEP/SER/SES/SEX Goldwing	88-96	CK1285		N/A					CT068SP
GL 1500 CV/CW/CX/CY/C1/C2 F6C	97-03	CK1285		N/A					CT068SP
GL 1500 SEV/SEW/SEX/SEY Goldwing	97-00	CK1285		N/A					CT068SP
F6B Goldwing Bagger (GLF6BAE)	13-15	TBA		N/A					
F6C Goldwing (4 Piston Caliper) GLF6CAE	14-15	TBA		N/A					
GL 1800 A1-A5 Goldwing	01-05	CK1297		N/A					CT073
GL 1800 5-9/A Goldwing	06-15	CK1297		N/A					CT073
VTX 1800 C2/C3/C4/C15/C16/C17	02-08	CK1298		CSK090					CT021
HONDA-DALLARA									
XR 125 SM	04	CK1119		CSK004					CT012SP
XR 250 R	04	CK1190	CKF1190	CSK065	DRC084				CT013SP
XR 250 RM	04	CK1190	CKF1190	CSK065	DRC084				CT013SP
XR 400/440 R	04	CK1193	CKF1193	CSK033	DRC106				CT013
XR 400/440 SM	04	CK1193	CKF1193	CSK033	DRC106				CT013
XR 650 R	04	CK1295		CSK045					CT009
KAWASAKI									
AE 50 A1/A2	81-84	CK4442		CSK018					
AR 50 A1/C2-C10	81-97	CK4442		CSK018					
KDX 50 A1/A2/A3/A6F	03-06	CK3366		N/A					
KSRI (KMX 50 B1/B2)	90-91	CK4442		CSK044					
KX 60 A1/A2/B1-B19	83-03	CK4438	CKF4438	CSK018	DRC007				CT070SP
KX 65	00-20	CK4438	CKF4438	CSK040	DRC098	DRCF098			CT070SP
AE 80 A1/B1	81-83	CK4440		CSK018					
AR 80 A1/C1-C8	81-91	CK4440		CSK018					
KSRII (KMX 80 B1/B2)	90-91	CK4440		CSK044					
KX 80 E1/E2	83-84	CK4438	CKF4438	CSK040					CT070SP
KX 80 E3/G1/G2/J1/J2	85-87	CK4468		CSK034	DRC008				CT070SP
KX 80 L1	88	CK4477		CSK035	DRC009				
KX 80 L2/L3/R1-R7	89-97	CK4478		CSK035	DRC010				
KX 80 W1/W2/W3	98-00	CK4453	CKF4453	CSK041	DRC045	DRCF045			CT002
KX 85 I - A1-A5/A6F/A7F/A8F/A9F/AAF/ABF/ACF/ADF /CEF/CFE/CGF/CHF (17 Inch Front/14 Inch Rear Wheel)	01-20	CK4453	CKF4453	CSK041	DRC045	DRCF045			CT002
KX 85 II - B1-B5/B6F/B7F/B8F/B9F/BAF/BBF/BCF/BDF /DEF/DFE/DGF/DHF (19 Inch Front/16 Inch Rear Wheel)	01-20	CK4453	CKF4453	CSK041	DRC045	DRCF045			CT002
KC 100 C1-C4	81-83	CK4440		CSK019					
KE 100 A8-A10	79-81	CK4440		CSK019					
KE 100 B1-B15	82-98	CK4440		CSK040					
KH 100 A2-A4/G2-G8	78-87	CK4440		CSK019					
KM 100 A4/A6	79-80	CK4440		CSK019					
KX 100 N1	88	CK4477		CSK035	DRC009				
KX 100 A1/A2/B1-B7	89-97	CK4478		CSK035	DRC010				
KX 100 C1/C2/C3	98-00	CK4453	CKF4453	CSK041	DRC045	DRCF045			CT002
KLF 110 B1/B2	87-88	CK4463		N/A					
KLX 110	02-20	CK4438	CKF4438	CSK040	DRC098	DRCF098			CT070SP
AR 125 A1A/A1-A7/B1-B8	83-94	CK4453	CKF4453	CSK041					CT002
BN 125 A1-A5/A6F/A7F Eliminator	98-07	CK4511		CSK041					
KDX 125 A1/A2/B1/B2	90-94	CK4489		CSK001					CT042
KE 125 A7-A12	80-85	CK4411		CSK001					CT058
KH 125 A1-A4	77-81	CK4411		CSK001					CT058
KH 125 K1	82	CK4440		CSK040					
KH 125 K2-K10	82-98	CK4438	CKF4438	CSK040					CT070SP
KH 125-L1 (KH 125 EX)	83	CK4438	CKF4438	CSK040					CT070SP
KLX 125 A1/A2/A3/A6F	03-06	CK3318	CKF3318	CSK034					CT011

EBC CLUTCH KITS

Make & Model	Year	CK Series #	CKF Series #	Spring Kit #	DRC Series #	DRCF Series #	SRC Series #	SRK Series #	CT Tool #
KAWASAKI Contd.									
KLX 125 L (B1/B2/B3/B6F)	03-06	CK3318	CKF3318	CSK034					CT011
KLX 125	10-20	CK4522		CSK142	DRC211				CT012SP
KLX 125 DAF/DBF/DCF/DEF (D-Tracker)	10-14	CK4522		CSK142	DRC211				CT012SP
KMX 125 A1/A2	86-87	CK4453	CKF4453	CSK031					CT002
KMX 125 A3/A4/A5	88-89	CK4486		CSK031					
KMX 125 B1/B2									
(From E/No.- MX 125 AE 000001-013436)	86-87	CK4453	CKF4453	CSK031					CT002
KMX 125 B2-B12 (From E/No.- MX AE 013437)	87-03	CK4486		CSK031					CT002
KX 125 B1	82	CK4436		CSK001					CT058
KX 125 B2	83	CK4457		CSK036					CT058
KX 125 C1	84	CK4457		CSK001					CT058
KX 125 D1/E1/E2	85-87	CK4469		CSK001	DRC011				CT042
KX 125 F1/G1	88-89	CK4482		CSK006	DRC013				CT042
KX 125 H1/H2	90-91	CK4485		CSK116	DRC036				CT042
KX 125 J1	92	CK4485		CSK116	DRC083				CT042
KX 125 J2	93	CK4498		CSK116	DRC069				CT042
KX 125 K1/K2/K3	94-96	CK4425		CSK007					CT004
KX 125 K4/K5/L1-L4	97-02	CK4425		CSK065	DRC073				CT004
KX 125 M1/M2/M3/M6F/M7F/M8F	03-08	CK4425		CSK097	DRC122				CT004
Z 125 (BR 125 GGF/GHF Auto G/Box)	16-17	CK4438		TBA					CT070SP
Z 125 Pro (Manual G/Box)	16-20	CK4438		TBA					CT070SP
KLX 150 L (KLX 150 EFF)	14-15	CK4522		CSK124	DRC211				CT012SP
KLX 150 D-Tracker (KLX150 HGF)	16	CK4522		CSK124	DRC211				CT012SP
KDX 175 A1-A3	80-82	CK4436		CSK001					CT058
KE 175 B1/B2/B3	76-78	CK4411		CSK039					CT058
KE 175 D2-D5	79-83	CK4411		CSK039					CT058
KLF 185 A3	87	CK1119		CSK003					CT012SP
KDX 200 A1/A2	83-84	CK4457		CSK036					CT058
KDX 200 A3	85	CK4457		CSK001					CT058
KDX 200 C1/C2	86-87	CK4469		CSK001	DRC074				CT042
KDX 200 C3	88	CK4469		CSK001	DRC011				CT042
KDX 200 E1/E2/E3/E4/E5/E6	89-94	CK4482		CSK010	DRC061				CT042
KDX 200 H1/H2/H3/H4/H5	95-99	CK4505		CSK116	DRC062				
KMX 200 A2/A3	88-92	CK4486		CSK009					CT002
Z 200 A1 (Up to E.No:-005062)	77	CK4446		CSK148					CT004
Z 200 A1 (From E.No:-005063)	78	CK4425		CSK148					CT004
Z 200 A2-A6	79-83	CK4425		CSK148					CT004
KDX 220 R A4-A12/A6F	97-06	CK4505		CSK116	DRC062				
KDX 220 SR		CK4505		CSK116	DRC062				
KLF 220 A1-A15	88-02	CK1180		CSK116	DRC224				CT013SP
KLX 230	20	CK4514	CKF4514	CSK097	DRC123	DRCF123			CT004
BJ 250 B1-B7A Estrella	92-99	CK4508		CSK004					
BJ 250 E1-EA Estrella-RS Custom	96-99	CK4508		CSK004					
BJ 250 C1-C7 Estrella-RS	95-01	CK4508		CSK004					
BJ 250 D1-D7 Estrella Custom	96-02	CK4508		CSK004					
BJ 250 F1/F2 (250 TR)	02-03	CK4508		CSK007					
EL 250 B1/B2/B3 Eliminator	87-89	CK4473		CSK004					CT016
ER 250 B1/B2/B3 Scorpion	83-88	CK4433		CSK007					CT006
EL 250 D1-D5	90-94	CK4473		CSK004					CT016
EL 252 (EL 250 F2/F3/F5/F6)	96-03	CK4473		CSK004					CT016
EX 250 K8F/K9F/KAF/KBF/KBFA/KCF Ninja 250R	08-12	CK4521		CSK142					CT009
GPX 250 R (ZX 250 F2/F3/F6-F9)	88-95	CK4473		CSK004					CT016
GPZ 250 R (EX 250 E)	86	CK4473		CSK004					CT016
GPX 250 R II (EX 250 G)	88	CK4473		CSK004					CT016
KDX 250 B1	81	CK4439	CKF4439	CSK006					CT006
KDX 250 B2/B3	82-83	CK4433		CSK006					CT006
KDX 250 D1	91-93	CK4475		CSK030	DRC041				CT006
KDX 250 SR (KDX 250 F1)	91	CK4509		CSK030					
KH 250 B4/B5	79-80	CK4436		CSK001					CT058
KL 250 A1-A4/C1/C2	78-84	CK4425		CSK007					CT004
KL 250 H1 Super Sherpa	98	CK4469		CSK074					CT042
KL 250 J1 Stockman		CK4469		CSK074					CT042
KLE 250 A1/A1A/A2 (Anheho)		CK4473		CSK007					CT016
KLE 250 A2	95	TBA		TBA					
KLE 250 A3	97	TBA		TBA					
KLE 250 A5/A6	00-01	TBA		TBA					
KLF 250 A1/A2/A3/A6F/A7F/A8F/A9F/AAF/ABF (Bayou 250)	03-11	CK1180		CSK116	DRC224				CT013SP
KLR 250 D2-D22	84-05	CK4446		CSK148	DRC063				CT004
KLT 250 C1-C3	83-85	CK4425		CSK148					CT004
KLX 250 D1/D2	93-95	CK4469		CSK001					CT042
KLX 250 F1-F4 (KLX 250 E)	94-97	CK4469		CSK001					CT042
KLX 250 G1	94-	CK4469		CSK001					CT042
KLX 250 J1-J6 D-Tracker	98-03	CK4469		CSK001					CT042

CLUTCH APPLICATIONS

EBC CLUTCH KITS

Make & Model	Year	CK Series #	CKF Series #	Spring Kit #	DRC Series #	DRCF Series #	SRC Series #	SRK Series #	CT Tool #
KAWASAKI Contd.									
KLX 250 S H6F/H7F	06-07	CK4469		CSK144	DRC212				CT042
KLX 250 (KLX 250 S9F/SAF/SBF/SCF/SDF/SEF/SFF/SGF)	09-16	CK4469		CSK144	DRC212				CT042
KLX 250	09-16	CK4469		CSK144	DRC212				CT042
KR 250 A1/A2	84-86	CK4517		CSK010					CT016
KR-1 (KR 250 B2)	89	CK4484		CSK010					CT016
KR-1S (KR 250 C2/C3)	90-92	CK4484		CSK010					CT016
KSF 250 A1-A18 (KXF 250 Mojave)	87-04	CK4425		CSK148	DRC225				CT004
KT 250 A/A2	75-76	CK4411		CSK001					CT058
KX 250	74	CK4419		CSK007					CT006
KX 250 A/A3/A4/A5	75-79	CK4419		CSK007					CT006
KX 250 A6/A7	80-81	CK4439	CKF4439	CSK007					CT006
KX 250 B1/C1	82-83	CK4465		CSK010					CT006
KX 250 C2	84	CK4465		CSK010					CT006
KX 250 D1/D2	85-86	CK4459		CSK010					CT006
KX 250 E1/F1/G1	87-89	CK4475		CSK007	DRC015				CT006
KX 250 H1	90	CK4475		CSK006	DRC017				CT006
KX 250 H2	91	CK4475		CSK030	DRC041				CT006
KX 250 J1/J2/K1-K5/L1-L4	92-02	CK4435	CKF4435	CSK007	DRC046	DRCF046			CT016
KX 250 M1/M2/R1/R6F/R7F/R8F (2T)	03-08	CK4435	CKF4435	CSK007	DRC046	DRCF046			CT016
KX 250 F (KX 250 N1/N2/T6F/T7F/T8F) (4T)	04-08	CK4514	CKF4514	CSK097	DRC123	DRCF123			CT004
KX 250 F (4T)	09-20	CK4514	CKF4514	CSK097	DRC123	DRCF123			CT004
KXF 250 A1/A2	87-88	CK4475		CSK010					CT006
KXT 250 A1 Tecate	84	CK4433		CSK007					CT006
KXT 250 A2 Tecate	85	CK4465		CSK010					CT006
KXT 250 B1 Tecate	86	CK4459		CSK010	DRC038				CT006
KXT 250 B2 Tecate	87	CK4459		CSK010	DRC038				CT006
Z 250 A1-A3/B1/B2	79-81	CK4433		CSK006					CT006
Z 250 C1/C2/G1/G2	80-83	CK4425		CSK007					CT004
Z 250 SL (Naked/Non ABS) BR 250 EFF	15	TBA		TBA					
Z 250 SL (Naked/ABS) BR 250 FFF	15-16	TBA		TBA					
Ninja 250 SL (BX 250 AFF/AFS/AFSA - KRT Edition Non ABS)	15	TBA		TBA					
Ninja 250 SL (BX 250 BFF/BFS/BGF/BGFS - ABS)	15-16	TBA		TBA					
Ninja 250 SL (BX 250 BFSA/BGSA KRT/ABS Edition)	15-16	TBA		TBA					
ZR 250 A1-A5 Balius	91-95	CK4508		CSK007					
ZR 250 B6 (Balius-II)	02	CK4508		CSK007					
ZZ-R 250 (EX 250 H1-H13)	90-03	CK4473		CSK004					CT016
ZXR 250 (ZX 250 A1/A2)	89-90	CK4508		CSK007					
ZXR 250 C1-C5 (ZX 250 C1-C5)	91-95	CK4508		CSK007					
ZXR 250 R (ZX 250 D1)	91	CK4508		CSK007					
ZXR 250 R (ZX 250 B1/B2)	89-90	CK4509		CSK007					
EX 300 ADF/AEF/AFF Ninja 300 (Non ABS)	13-15	CK4524		CSK203			SRC118	SRK118	CT009
EX 300 AEFA/AFFA Ninja 300									
Special Edition (Non-ABS)	13-15	CK4524		CSK203			SRC118	SRK118	CT009
EX 300 BDF/BEF/BFF/BGF Ninja 300 (ABS)	13-16	CK4524		CSK203			SRC118	SRK118	CT009
EX 300 BEFA/BFFA/BGFA Ninja 300									
Special Edition (ABS)	13-16	CK4524		CSK203			SRC118	SRK118	CT009
KEF 300 B1/B2 Lakota Sport	01-02	CK4419		CSK151	DRC233				CT006
KLF 300 A1/A2/B1-B17/C1-C17	87-05	CK4419		CSK151	DRC233				CT006
KLX 300 A2	97	CK4469		CSK001					CT042
KLX 300 A3-A10/A6F	98-06	CK4469		CSK144					CT042
Versys-X 300 ABS	17-20	CK4524		CSK203			SRC118	SRK118	CT009
Z 300 Non ABS (ER 300 AFF)	15	CK4524		CSK203			SRC118	SRK118	CT009
Z 300 ABS (ER 300 BFF) - Ninja 300 (ABS) - Floating Disc Conversion	15-16	CK4524		CSK203			SRC118	SRK118	CT009
GPZ 305 A1/B2-B10	83-96	CK4433		CSK010					CT006
S2/S2A (350cc)	72-73	CK4457		CSK192					CT058
FX 400 R (ZX 400 E1/E2/E3)	86-88	CK4424	CKF4424	CSK023					CT016
GPZ 400 R (ZX 400 D1/D2/D3/D3A)	85-87	CK4424	CKF4424	CSK023					CT016
GPZ 400 R (ZX 400 F1)	87	CK4424	CKF4424	CSK023					CT016
S3/S3A (400cc)	74-75	CK4457		CSK192					CT058
KH 400 A3-A5	76-78	CK4457		CSK192					CT058
KLF 400 B1-B7	93-98	CK4439	CKF4439	CSK151	DRC234				CT006
KLX 400 R (KLX 400 B1/B2)	03-04	CK3433	CKF3433	CSK079	DRC105	DRCF105			CT006
KSF 400 A1/A2 (KFX 400)	03-04	CK3433	CKF3433	CSK079	DRC105	DRCF105			CT006
KSF 400 A3/A6F (KFX 400)	05-06	CK3447	CKF3447	CSK079	DRC137	DRCF137			CT006
Ninja 400	17-20	CK4530		TBC			TBC	TBC	
Z 400 B1/B2	78-80	CK4421		CSK010					
Z 400 G1	79	CK4421		CSK010					
Z 400 J1-J3	80-83	CK4424	CKF4424	CSK010			SRC011	SRK011	CT016
Z 400	17-20	CK4530		TBC			TBC	TBC	
ZL 400 A Eliminator	86-87	CK4424	CKF4424	CSK007			SRC022	SRK022	CT016
ZL 400 B Eliminator 400 SE	88	CK4424	CKF4424	CSK007			SRC022	SRK022	CT016
ZL 400 D1/D2	94-95	CK4424	CKF4424	CSK148					

CLUTCH APPLICATIONS

EBC CLUTCH KITS

Make & Model	Year	CK Series #	CKF Series #	Spring Kit #	DRC Series #	DRCF Series #	SRC Series #	SRK Series #	CT Tool #
KAWASAKI Contd.									
ZR 400 A1/B1 (Z 400 F)	83-84	CK4424	CKF4424	CSK010			SRC011	SRK011	CT016
ZR 400 D1/D3/D4 Xanthus	92-95	CK4446		CSK007					CT004
ZRX 400 (ZR 400 E1-E7)	94-01	CK4424	CKF4424	TBA					CT016
ZR 400 Zephyr (G2/G3/G3A/G4/G5)	97-01	CK4424	CKF4424	CSK010			SRC044	SRK044	CT016
ZX 400 C2 (Z 400 F 11)	85	CK4424	CKF4424	CSK010			SRC011	SRK011	CT016
ZXR 400 H1/H2	89	CK4446		CSK007					CT004
ZXR 400 (ZX 400 L1-L5/L8/L9)	91-02	CK4446		CSK006			SRC021	SRK021	CT004
ZXR 400 R (ZX 400 M1-M4)	91-94	CK4446		CSK006					CT004
ZX 400 J1/J2	89-90	CK4446		CSK007					CT004
ZZR 400 (ZX 400 K1/K2/K3)	90-92	CK4424	CKF4424	CSK007					CT016
ZZR 400 (ZX 400 N1-N7)	93-99	CK4424	CKF4424	CSK043					CT016
Z 440 A2	80-81	CK4421		CSK004					
Z 440 C1/C2	80-81	CK4421		CSK004					
Z 440 D4-D6 (Ltd)	82-84	CK4421		CSK004					
Z 440 H1/H2	82-83	CK4421		CSK004					
KX 420 A1/A2	80-81	CK4439	CKF4439	CSK006					CT006
EN 450 A1-A5 (LTD 454)	86-89	CK4424	CKF4424	CSK010			SRC011	SRK011	CT016
KFX 450 R Quad (KSF 450 B8F/B9F/BAF/ BBF/BCS/BFD/BEF)	08-14	CK4519		CSK177	DRC185				CT006
KLX 450 R (A8F/A9F/AAF/ABF/ACF/ADF/AEF/AFF/AGF)	08-15	CK1247	CKF1247	CSK180	DRC158	DRCF158			CT006
KX 450 F (D6F/D7F/D8F/E9F/EAF/EBF)	06-11	CK1247	CKF1247	CSK180	DRC158	DRCF158			CT006
KX 450 F (FCF/FDF/FEF/FFF/HGF/HHF)	12-20	CK1247	CKF1247	CSK029	DRC269	DRCF269			CT006
EN 500 A1-A4/B1/B2/C1-C9	90-04	CK4424	CKF4424	CSK010			SRC011	SRK011	CT016
ER-5 (ER 500 A1/A2/A3/A4/C1-C5P)	97-07	CK4424	CKF4424	CSK010			SRC011	SRK011	CT016
EX 500 A1-A6/D1-D7 (GPz 500 S)	87-02	CK4424	CKF4424	CSK010			SRC011	SRK011	CT016
GPZ 500 S (EX 500 B1-B5)	88-93	CK4424	CKF4424	CSK010			SRC011	SRK011	CT016
GPZ 500 S (EX 500 E1-E10)	94-04	CK4424	CKF4424	CSK010			SRC011	SRK011	CT016
H1 500 Mach III	69-70	CK4425		CSK194					CT004
H1-A 500 S Mach III	71	CK4425		CSK194					CT004
H1-B/C 500 Mach III	72	CK4425		CSK194					CT004
H1-D/E/F 500	73-75	CK4425		CSK194					CT004
KH 500 A8	76	CK4425		CSK194					CT004
KX 500 A1/A2	83-84	CK4433		CSK010					CT006
KX 500 B1/B2	85-86	CK4459		CSK010	DRC038				
KX 500 C1/D1	87-88	CK4475		CSK010	DRC016				CT006
KX 500 E1-E16	89-04	CK4475		CSK010	DRC016				CT006
KLE 500 A1-A12	91-04	CK4424	CKF4424	CSK010	DRC064				CT016
KLE 500 B1P/B6F/B7F	05-07	CK4424	CKF4424	CSK010	DRC064				CT016
Z 500 A1-A3/B1/B2	79-81	CK4424	CKF4424	CSK010			SRC011	SRK011	CT016
GT 550 G1-G9	83-01	CK4424	CKF4424	CSK010			SRC011	SRK011	CT016
GPz 550 D1/H1/H2/A1-A4	81-87	CK4424	CKF4424	CSK010			SRC011	SRK011	CT016
ZR 550 A1/A2 (Z 550 F)	83-84	CK4424	CKF4424	CSK010			SRC011	SRK011	CT016
ZR 550 B2-B6 Zephyr	91-99	CK4424	CKF4424	CSK010			SRC044	SRK044	CT016
Z 550 C1/C2 (Ltd)	80-81	CK4424	CKF4424	CSK010			SRC011	SRK011	CT016
KL 600 A1 (KLR 600)	84	CK4424	CKF4424	CSK010			SRC011	SRK011	CT016
KLR 600 B1/B2/B4/B6-B9	85-94	CK4424	CKF4424	CSK010			SRC011	SRK011	CT016
GPz 600 R A1-A6	85-89	CK4424	CKF4424	CSK010			SRC011	SRK011	CT016
GPX 600 R (C1-C3/C6-C7)	88-96	CK4424	CKF4424	CSK010			SRC044	SRK044	CT016
ZL 600 B1	95-97	CK4424	CKF4424	CSK023			SRC044	SRK044	CT016
ZZR 600 D1/D2/D2A/D3	90-92	CK4424	CKF4424	CSK010			SRC022	SRK022	CT016
ZZR 600 (ZX 600 E1-E13)	93-05	CK4424	CKF4424	CSK043			SRC043	SRK043	CT016
ZZR 600 (ZX 600 E6F)	06-07	CK4424	CKF4424	CSK043			SRC043	SRK043	CT016
ZX6 R F1/F2/F3/G1/G2	95-99	CK4503		CSK056			SRC038	SRK108	CT004
ZX6 R (ZX 600 J1/J2)	00-01	CK4503		CSK056			SRC038	SRK038	CT004
ZX6 R (ZX 600 P7F/P8F/RF9/RAF/RBF/RCF/RDF /REF/RFF/RGF) (599cc)	07-16	CK4514	CKF4514	CSK165			SRC101	SRK101	CT004
ZX6 R (ZX 636 A1P) (636cc)	02	CK4503		CSK056			SRC038	SRK038	CT004
ZX6 R (ZX 636 B1/B2)	03-04	CK4503		CSK056			SRC038	SRK038	CT004
ZX6 R (ZX 636 C1/C6F)	05-06	CK4514	CKF4514	CSK117			SRC084	SRK084	CT004
ZX6 R (599cc)	07-16	CK4514	CKF4514	CSK165			SRC101	SRK101	CT004
ZX6 R (ZX 636 FDF/FEF/FFF/FGF/FHF - ABS - 636cc)	13-17	CK4514	CKF4514	CSK202					CT004
ZX6 R (ZX 636 EGFA/EHFA - Non ABS /KRT Edition - 636cc)	16-17	CK4514	CKF4514	CSK202					CT004
ZX6 R (ZX 636 FGFA/FHFA - ABS/KRT Edition - 636cc)	16-17	CK4514	CKF4514	CSK202					CT004
ZX6 R 30th Anniversary Edition (ZX 636 EFA - Non ABS - 636cc)	15	CK4514	CKF4514	CSK202					CT004
ZX6 R 30th Anniversary Edition (ZX 636 FFA - ABS - 636cc)	15	CK4514	CKF4514	CSK202					CT004
ZX6 RR (ZX 600 K1)	03	CK4503		CSK099			SRC076	SRK076	CT004
ZX6 RR (ZX 600 M1)	04	CK4514	CKF4514	CSK099			SRC083	SRK083	CT004
ZX6 RR (ZX 600 N1/N6F)	05-06	CK4514	CKF4514	CSK117				SRK107	CT004
650 Vulcan S (EN 650 AFF/AGF/Non ABS)	15-16	CK4424	CKF4424	CSK010			SRC022	SRK022	CT016
ER-6F (EX 650)	06-11	CK4424	CKF4424	CSK010			SRC022	SRK022	CT016
ER-6F (EX 650)	06-11	CK4424	CKF4424	CSK010			SRC022	SRK102	CT016

CLUTCH APPLICATIONS

EBC CLUTCH KITS

Make & Model	Year	CK Series #	CKF Series #	Spring Kit #	DRC Series #	DRCF Series #	SRC Series #	SRK Series #	CT Tool #
KAWASAKI Contd.									
Ninja 650 (EX 650)	12-18	CK4527					SRC155	SRK155	
Ninja 650 ABS (EX 650 ABS)	12-18	CK4527					SRC155	SRK155	
ER-6F ABS (EX 650 ABS)	06-11	CK4424	CKF4424	CSK010			SRC022	SRK102	CT016
ER-6N (ER 650)	06-11	CK4424	CKF4424	CSK010			SRC022	SRK102	CT016
ER-6N ABS (ER 650 ABS)	06-11	CK4424	CKF4424	CSK010			SRC022	SRK102	CT016
Z 650 (ER 650)	12-18	CK4527					SRC155	SRK155	
Z 650 ABS (ER 650 ABS)	12-18	CK4527					SRC155	SRK155	
KLE 650 A7F/A8F/A9F/CAF (Versys)	07-10	CK4424	CKF4424	CSK010			SRC022	SRK102	CT016
KLE 650 B7F/B8F/B9F/DAF (Versys ABS)	07-10	CK4424	CKF4424	CSK010			SRC022	SRK102	CT016
KLE 650 CBF/CCF/CDF/CEF (Versys/Non ABS)	11-14	CK4424	CKF4424	CSK010					CT016
KLE 650 DBF/DCF/DDF/DEF (Versys/ABS)	11-14	CK4424	CKF4424	CSK010					CT016
KLE 650 Versys (KLE 650 EFF/EGF/Non ABS)	15-16	CK4424	CKF4424	CSK010					CT016
KLE 650 Versys (KLE 650 FFF/FGF/ABS)	15-16	CK4424	CKF4424	CSK010					CT016
KLR 650 A1-A3	87-89	CK4424	CKF4424	CSK007	DRC065				CT016
KLR 650 (KL 650 E8F/E9F)	08-09	CK4435	CKF4435	CSK030	DRC168				CT016
KL 650 B1/B2/B3 Tengai	89-92	CK4424	CKF4424	CSK007	DRC065				CT016
KLX 650 C1/C2/C3	93-97	CK4424	CKF4424	CSK007	DRC065				CT016
KLR 650 C1-C10	95-04	CK4435	CKF4435	CSK030	DRC168				CT016
W 650 (EJ 650 A1/C3-C7)	99-05	CK4435	CKF4435	CSK010			SRC046	SRK046	CT016
Z 650 B/B2/B3	77-79	CK4413		CSK007					CT019
Z 650 C1/C2/C3 Custom	77-79	CK4413		CSK010					CT019
Z 650 D2/D3	79-80	CK4413		CSK010					CT019
Z 650 F1/F2/F3/F4	80-83	CK4413		CSK010					CT019
Z 700 A1 Ltd	84	CK4413		CSK007					CT019
ZN 700 A1/A2 Ltd	84-85	CK4413		CSK007					CT019
VN 700 A1 Vulcan	85	CK4435	CKF4435	CSK007			SRC053	SRK053	CT016
GPX 750 F1/F2/F2A/F3	87-89	CK4435	CKF4435	CSK007			SRC053	SRK053	CT016
GPz 750 R1	82	CK4413		CSK010					CT019
GPz 750 A1-A5	83-87	CK4413		CSK010					CT019
GPz 750 R G2/G3	85-86	CK4435	CKF4435	CSK010					CT016
GT 750 P1-P5	82-90	CK4413		CSK007					CT019
GT 750 P7/P9	92-96	CK4493		CSK023					CT019
H2/H2-A Mach IV (750cc)	72-73	CK4415		CSK023					CT004
H2-B/H2-C Mach IV (750cc)	74-75	CK4523		CSK023					CT004
VN 750 A2/A3/A4/A5/A10	86-94	CK4435	CKF4435	CSK007			SRC053	SRK053	CT016
Z 750 B1/B2	77-78	CK4435	CKF4435	CSK010			SRC046	SRK046	CT016
Z 750 D1	76	CK4435	CKF4435	CSK007			SRC053	SRK053	CT016
Z 750 N1/N2 Spectre	82-83	CK4413		CSK007					CT019
Z 750 (ZR 750 J1/J2/J6F)	04-06	CK4503		CSK217					CT004
ZR 750 C1/C2/C3/C4 Zephyr	91-95	CK4493		CSK010					CT019
ZR 750 C5/D1 Zephyr	95-98	CK4493		CSK038					CT019
ZR7 (ZR 750 F1/F3/F5)	99-04	CK4493		CSK117					CT019
ZR-7S (ZR 750 H1/H2)	01-04	CK4493		CSK117					CT019
Z 750 E1/H1/H2/L1-L4	80-84	CK4413		CSK007					CT019
Z 750 Y1 (Ltd)	82	CK4435	CKF4435	CSK007			SRC053	SRK053	CT016
Z 750 S (ZR 750 K1/K6)	05-07	CK4503		CSK217					CT004
Z 750 (ZR 750 L7F/L8F)	07-08	CK4503		CSK217					CT004
Z 750 (ZR 750 L9F/LAF/LAS)	09-10	CK4503		CSK209					CT004
Z 750 ABS (ZR 750 M7F/M8F)	07-08	CK4503		CSK217					CT004
Z 750 ABS (ZR 750 M9F/MAF/MAS)	09-10	CK4503		CSK209					CT004
Z 750 R Non ABS (ZR 750 NBF/NCF)	11-12	CK4503		CSK209					CT004
Z 750 R Black Edition (ZR 750 NBFA)	12	CK4503		CSK209					CT004
Z 750 R ABS (ZR 750 PBF/PCF)	11-12	CK4503		CSK209					CT004
ZX 750 E1/E2 (Turbo)	84-87	CK4443		CSK010					CT019
ZXR 750 H1/H2	89-90	CK4424	CKF4424	CSK023					CT016
ZXR 750 J1/J2/L1-L3/P1-P7	91-03	CK4435	CKF4435	CSK088			SRC024	SRK024	CT016
ZXR 750 R (ZX 750 K1/K2/M1/M2)	91-94	CK4435	CKF4435	CSK088			SRC024	SRK024	CT016
ZX7RR (ZX 750 N1/N2)	96-99	CK4435	CKF4435	CSK038			SRC041	SRK041	CT016
VN 800 A1-A3/B1-B10/B6F	95-06	CK4435	CKF4435	CSK010			SRC046	SRK046	CT016
VN 800 C1/C2/E1/E2/E3 Drifter	99-04	CK4435	CKF4435	CSK007			SRC053	SRK053	CT016
EJ 800 ABF/ACF (W 800 Solid Front Disc)	11-12	CK4435	CKF4435	CSK010			SRC046	SRK046	CT016
EJ 800 (W 800 Cafe Style/Cockpit Fairing)	11	CK4435	CKF4435	CSK010			SRC046	SRK046	CT016
EJ 800 ACFA (W 800 Special Edition Black Exhaust /Gold Rims)	12	CK4435	CKF4435	CSK010			SRC046	SRK046	CT016
EJ 800 ADF/AEF/AFF/AGF (W 800)	13-16	CK4435	CKF4435	CSK010			SRC046	SRK046	CT016
EJ 800 ADFA/AEFA/AFFA/AGFA (W 800 Special Edition)	13-16	CK4435	CKF4435	CSK010			SRC046	SRK046	CT016
Z 800 ADS/AEF/AFF/AGF (Non ABS)	13-16	CK4503		CSK209					CT004
Z 800 BDS/BEF/BFF/BGF (ABS Model)	13-16	CK4503		CSK209					CT004
Z 800 E CDS/CEF/CFE/CGF (Non ABS)	13-16	CK4503		CSK209					CT004
Z 800 E DDS/DEF/DFE/DGF (ABS Model)	13-16	CK4503		CSK209					CT004
Z1/Z1A/Z1 B	74-76	CK4409		CSK010					CT019
Z 900 A4/A5	76-77	CK4409		CSK010					CT019
Z 900 (ZR 900 A)	17-19	CK4510		CSK169					CT004

CLUTCH APPLICATIONS

EBC CLUTCH KITS

Make & Model	Year	CK Series #	CKF Series #	Spring Kit #	DRC Series #	DRCF Series #	SRC Series #	SRK Series #	CT Tool #
KAWASAKI Contd.									
Z 900 ABS (ZR 900 B)	17-19	CK4510		CSK169					CT004
Z 900 RS (ZR 900 C)	18-19	CK4510		CSK169					CT004
Z 900 RS Café (ZR 900 E)	18-19	CK4510		CSK169					CT004
ZL 900 A1/A2 Eliminator	85-86	CK4434		CSK023			SRC020	SRK020	CT016
GPz 900 R A1-A8	84-96	CK4435	CKF4435	CSK010			SRC046	SRK046	CT016
GPz 900 R (ZX 900 A11)	98	CK4435	CKF4435	CSK010			SRC046	SRK046	CT016
GPz 900 R (ZX 900 A12-15)	99-02	CK4435	CKF4435	CSK010			SRC046	SRK046	CT016
VN 900 A6F Classic	06	CK4435	CKF4435	CSK010			SRC046	SRK046	CT016
VN 900 Vulcan Classic LT (Spoke wheel & Screen)	07-19	CK4435	CKF4435	CSK010			SRC046	SRK046	CT016
VN 900 Classic Special Edition (Spoke wheel)	11-19	CK4435	CKF4435	CSK010			SRC046	SRK046	CT016
VN 900 Custom (Cast wheel)	07-19	CK4435	CKF4435	CSK010			SRC046	SRK046	CT016
ZX9R (ZX 900 B1-B4)	94-97	CK4435	CKF4435	CSK038			SRC041	SRK041	CT016
ZX9R (ZX 900 C1/C2)	98-99	CK4510	CKF4510	CSK067			SRC059	SRK059	CT004
ZX9R (ZX 900 E1/E2/F1/F2)	00-03	CK4510	CKF4510	CSK128			SRC089	SRK089	CT004
KLV 1000 (LV 1000 A1H/A2H)	04-05	CK3443	CKF3443	CSK043					CT021
KLZ 1000 ACF/ADF/AEF Versys	12-14	CK4510	CKF4510	TBA					CT004
KLZ 1000 BFF/BGF/BGFA Versys	15-19	CK4503		TBA					
Z 1000 D1-D3 Z1R	78-80	CK4409		CSK007					CT019
Z 1000 E1/E2 (ST-Shaft)	79-80	CK4434		CSK023			SRC020	SRK020	CT016
Z 1000 A1/A2/A3/A4	77-80	CK4409		CSK010					CT019
Z 1000 H1	80	CK4409		CSK010					CT019
Z 1000 K1/K2 (Ltd)	81-82	CK4434		CSK010			SRC054	SRK054	CT016
Z 1000 J1/J2/J3	81-83	CK4434		CSK010			SRC054	SRK054	CT016
Z 1000 R1/R2 (Eddie Lawson Replica)	83	CK4434		CSK010			SRC054	SRK054	CT016
Z 1000 (ZR 1000 A1/A2/A3/A6F)	03-06	CK4510	CKF4510	CSK128			SRC089	SRK089	CT004
GPz 1000 RX A1-A3	86-88	CK4434		CSK023			SRC020	SRK020	CT016
Ninja H2	15-20	CK4528		TBA			SRC163	SRK163	
Ninja H2R	15-20	CK4529		TBA			SRC164	SRK164	
1000 GTR (ZG 1000 A1-A18)	86-03	CK4434		CSK023			SRC020	SRK020	CT016
H2 Ninja (ZX 1000 NFF/NGF)	15-16	TBA		TBA					
H2 R Ninja (ZX 1000 PFF/PGF)	15-16	TBA		TBA					
Z 1000 (ZR 1000 B7F/B8F)	07-08	CK4510	CKF4510	CSK110					CT004
Z 1000 ABS (ZR 1000 C7F/C8F/C9F)	07-09	CK4510	CKF4510	CSK110					CT004
Z 1000 (ZR 1000 DAF/DBF/DCF/DDF)	10-13	CK4510	CKF4510	CSK169					CT004
Z 1000 Black Edition (ZR 1000 DCFA/DDFA)	12-13	CK4510	CKF4510	CSK169					CT004
Z 1000 (ZR 1000 EAF/EBF/ECF/EDF/GEF/GFF)	10-15	CK4510	CKF4510	CSK169					CT004
Z 1000 DAF/DAS/DBF/DCF/DCFA/DDF/DDFA (5 Spring Clutch)	10-13	CK4510	CKF4510	CSK169					CT004
Z 1000 EAF/EBF/ECF/ECFA/EDF/EDFA (5 Spring Clutch)	10-13	CK4510	CKF4510	CSK169					CT004
Z 1000 FEF/FEFA/FFF (5 Spring Clutch)	14-15	CK4510	CKF4510	CSK169					CT004
Z 1000 GEF/GEFA/GFF (5 Spring Clutch)	14-15	CK4510	CKF4510	CSK169					CT004
Z 1000 (ZR 1000 GGF) 3 Spring Clutch	16	CK4503		TBA					CT004
Z 1000 (ZR 1000 FGF) 3 Spring Clutch	16	CK4503		TBA					CT004
Z 1000 Performance	16-19	CK4510	CKF4510	CSK169					CT004
Z 1000 Special Edition (ZR 1000 GEFA)	14	CK4510	CKF4510	CSK169					CT004
Z 1000 SX ABS Model (ZX 1000 HBF/HCF/HDF)	11-13	CK4510	CKF4510	CSK169					CT004
Z 1000 SX Non ABS Model (ZX 1000 GBF/GCF/GDF)	11-13	CK4510	CKF4510	CSK169					CT004
Z 1000 SX Non ABS Model (ZX 1000 LEF/LFF)	14-15	CK4510	CKF4510	CSK169					CT004
Z 1000 SX ABS Model (ZX 1000 MEF/MFF)	14-15	CK4510	CKF4510	CSK169					CT004
Z 1000 SX Tourer	11-19	CK4510	CKF4510	CSK169					CT004
Z 1000 SX ABS (ZX 1000 MGF) (3 Spring Clutch)	16	CK4503		TBA					CT004
Z 1000 SX Non ABS (ZX 1000 LGF) (3 Spring Clutch)	16	CK4503		TBA					CT004
ZX10 B1/B2/B3	88-90	CK4434		CSK023			SRC020		CT016
ZX10R (ZX 1000 C1/C2)	04-05	CK4510	CKF4510	CSK111			SRC079	SRK079	CT004
ZX10R (ZX 1000 D6F/D7F/E8F/E9F/FAF)	06-10	CK4510	CKF4510	CSK111			SRC079		CT004
ZX10R ABS (ZX 1000 KBF/KCF/KDF/KEF/KFF)	11-15	CK4510	CKF4510	CSK111			SRC079		CT004
ZX10R (ZX 1000 JBF/JCF/JDF/JEF/JFF)	11-15	CK4510	CKF4510	CSK111			SRC079		CT004
ZX10R 30th Anniversary Edition (ZX 1000 KFFA/ABS)	15	CK4510	CKF4510	CSK111			SRC079		CT004
ZX10R 30th Anniversary Edition (ZX 1000 JFFA/Non ABS)	15	CK4510	CKF4510	CSK111			SRC079		CT004
ZX10R (ZX 1000 SGF)	16-19	CK4510	CKF4510	CSK111			SRC079		CT004
ZX10R Winter Test Edition (ZX 1000 SGFB)	16	CK4510	CKF4510	CSK111			SRC079		CT004
ZX10R Ninja KRT Replica (ZX 1000 SGFA)	16-19	CK4510	CKF4510	CSK111			SRC079		CT004
ZX-10RR	17-19	CK4510	CKF4510	CSK111			SRC079	SRK079	CT004
ZX-10RR Performance	17-19	CK4510	CKF4510	CSK111			SRC079	SRK079	CT004
ZL 1000 A1	87	CK4434		CSK023			SRC020	SRK020	CT016
GPz 1100 B1/B2	81-82	CK4434		CSK010			SRC054	SRK054	CT016
GPz 1100 A1-A3	82-85	CK4434		CSK023			SRC020	SRK020	CT016
Z 1100 R1	84	CK4434		CSK023			SRC020	SRK020	CT016
Z 1100 A1-A3	81-83	CK4434		CSK023			SRC020	SRK020	CT016
Z 1100 D1/D2 Spectre	82-83	CK4434		CSK023			SRC020	SRK020	CT016
ZR 1100 A1/A2/A3/A4/B1	92-97	CK4434		CSK023			SRC020	SRK020	CT016
ZR 1100 B5 (Zephyr 1100 RS)	02	CK4434		CSK023					CT016
ZRX 1100 (ZX 1100 C1/C2/C3/C4)	97-00	CK4434		CSK023			SRC020	SRK020	CT016

CLUTCH APPLICATIONS

EBC CLUTCH KITS

Make & Model	Year	CK Series #	CKF Series #	Spring Kit #	DRC Series #	DRCF Series #	SRC Series #	SRK Series #	CT Tool #
KAWASAKI Contd.									
ZZ-R 1100 C1/C2/C2A/C3/D1-D9	90-01	CK4488		CSK029			SRC025	SRK025	CT021
ZX 1100 E1/E2/F1	95-98	CK4488		CSK029			SRC025	SRK025	CT021
ZRX 1200 R A1/A2/A3/A4/A5/A6F	01-08	CK4434		CSK038					CT016
ZRX 1200 S B1/B2/B3 (ZR 1200)	01-03	CK4434		CSK038					CT016
ZX12R (ZX 1200 A1)	00	CK4513		CSK109					CT009
ZX12R (ZX 1200 A2/A3/A4/B1-B4/B6F)	01-06	CK4515		CSK067					CT009
ZZR 1200 C1H/C2H	02-04	CK4488		CSK029			SRC025	SRK025	CT021
Z 1300 A1-A3	79-81	CK4452		CSK010					
Z 1300 A4/A5	82-83	CK4458		CSK010					
ZG 1300 A1-A3	84-86	CK4455		CSK007					CT032
GTR 1400 (ZG 1400 A8F/A9F/CAF/CBF) ABS	08-11	CK4520		CSK023					CT021
GTR 1400 ABS (ZG 1400 CCF/CDF/CEF/EEF/EGF)	12-16	CK4520		CSK023					CT021
ZZR 1400 (ZX 1400 A6F/A7F)	06-07	CK4518		CSK124					CT021
ZZR 1400 ABS (ZX 1400 B6F/B7F)	06-07	CK4518		CSK124					CT021
ZZR 1400 ABS	08-11	CK4518		CSK124					CT021
ZZR 1400 ABS	12-16	CK4518		CSK023					CT021
ZZR 1400 ABS Performance	12-19	CK4518		CSK023					CT022
ZZR 1400 ABS Performance Sport	14-19	CK4518		CSK023					CT023
VN 1500 B2/C1/C2/D1	88-96	CK4455		N/A					CT032
VN 1500 B2-B6	88-92	CK4455		N/A					CT032
VN 1500 C1/C2	94-95	CK4455		N/A					CT032
VN 1500 D1/D2	96-98	CK4455		N/A					CT032
VN 1500 G1/G2	98-99	CK4455		N/A					CT032
VN 1500 E1/E2 Classic	98-99	CK4455		N/A					CT032
VN 1500 J1/J2/R1/R2/R3 Drifter	99-04	CK4455		N/A					CT032
VN 1500 N1/N2/N3 Classic Fi	00-04	CK4455		N/A					CT032
VN 1500 L1/L2/L3/L4 Classic Tourer Fi	00-03	CK4455		N/A					CT032
VN 1500 P1/P2 Mean Streak	02-04	CK4455		N/A					CT032
VN 1600 A1/A2/A3/A6F Classic	03-08	CK4455		N/A					CT032
VN 1600 B1 Mean Streak	04	CK4455		N/A					CT032
VN 1600 B2H/B6F/B7F (Mean Streak)	05-08	CK4455		N/A					CT032
VN 1600 D1H/D6F Classic Tourer	05-08	CK4455		N/A					CT032
VN 1700 B9F/BAF/BBF/BCF/BDF/BEF/BFF/BGF									
Voyager ABS	09-16	CK4516		CSK170					CT032
VN 1700 C9F Classic Tourer	09	CK4516		CSK170					CT032
VN 1700 DAF/DBF/DCF/DDF/DEF Classic Tourer ABS	10-14	CK4516		CSK170					CT032
VN 1700 DFF/DGF - Vulcan 1700 Nomad	15-16	CK4516		CSK170					CT032
VN 1700 E9F Classic	09	CK4516		CSK170					CT032
VN 1700 Classic ABS	10-17	CK4516		CSK170					CT032
VN 1700 Voyager Custom	11-17	CK4516		CSK170					CT032
VN 2000 A1/A2/A6F	04-07	CK4516		CSK110					CT032
VN 2000 H8F/H9F Classic	08-09	CK4516		CSK110					CT032
SUZUKI									
AP 50	-78	CK3311		CSK025					CT051
DR-Z50	19	CK3458							
FR 50	81-	CK3393		N/A					
GS 50 K5 (NA41A)	05	CK3328		CSK013					CT011
GT 50 KB/KEN	77-80	CK3328		CSK001					CT011
JR 50 (All models)	78-07	CK3366		CSK002					
RM 50 C/N/T/X/Z	78-82	CK3328		CSK001					
OR 50 ET	80	CK3328		CSK001					CT011
RB 50 H	87	CK3380		CSK001					CT051
RG 50 EW		CK3349		CSK001					CT011
TS 50 KN/ERKT/ERKX/ERKZ/ERKD	79-83	CK3328		CSK001					CT011
TS 50 XKE/XKG/XKH/XKJ/XKM/XKR	84-02	CK3349		CSK001					CT011
TS 50 W		CK3349		CSK001					CT011
ZR 50 KEN/KEX	79-81	CK3328		CSK001					CT011
ZR 50 SLKX/SKX	81	CK3328		CSK001					CT011
ZR 50 SKE/SKH	84-87	CK3328		CSK001					CT011
RM 60 K3	03	CK4438	CKF4438	CSK018	DRC007				CT070SP
RM 65 K3/K4/K5	03-05	CK4438	CKF4438	CSK040	DRC098	DRCF098			CT070SP
DR-Z70	08-17	CK3458							
DS 80 T/X/Z/D/F/G/H/J/K/L/M/N/P/R/S/T/V/W/X/Y	80-00	CK3340		CSK001					CT011
FR 80 M/B/N/X/Z/D	76-83	CK3378		N/A					
JR 80 K1/K2/K3/K4/K5/K6/K7	01-07	CK3340		CSK001					CT011
RM 80 B	77	CK3318	CKF3318	CSK001					CT011
RM 80 C/N/XT/XX	78-81	CK3318	CKF3318	CSK001					CT011
RM 80 XZ	-82	CK3340		CSK036					CT011
RM 80 XD/HD	83	CK3340		CSK034					CT011
RM 80 XE/XF/HF	84-85	CK3318	CKF3318	CSK034					CT011
RM 80 XG	86	CK3367		CSK034					
RM 80 XH/XJ	87-88	CK3367		CSK055	DRC019				
RM 80 K/L	89-90	CK3318	CKF3318	CSK001	DRC020				CT011

CLUTCH APPLICATIONS

EBC CLUTCH KITS

Make & Model	Year	CK Series #	CKF Series #	Spring Kit #	DRC Series #	DRCF Series #	SRC Series #	SRK Series #	CT Tool #
SUZUKI Contd.									
RM 80 M/N/P/R/S/T/V/W/X/Y/K1	91-01	CK3318	CKF3318	CSK014	DRC025	DRCF025			CT011
RM 85 (Small Wheel F 17 Inch/R 14 Inch Wheel)	02-20	CK3318	CKF3318	CSK014	DRC025	DRCF025			CT011
RM 85 (Big Wheel F 19 Inch/ R 16 Inch)	02-20	CK3318	CKF3318	CSK014	DRC025	DRCF025			CT011
FB 90 K1	01	N/A		N/A					
A 100 L/M/N	74-80	CK3312		CSK025					CT051
GP 100 C/UC	78	CK3319		CSK025					CT011
GP 100 N/UN	79	CK3318	CKF3318	CSK025					CT011
GP 100 X/UX/D/UD/UL	81-92	CK3339		CSK025					CT011
RM 100 A	76	CK3319		CSK025					CT011
RM 100 B/C	77-78	CK3329		CSK025					CT011
RM 100 N/T/X	79-81	CK3319		CSK025					CT011
RM 100 K3	03	CK4453	CKF4453	CSK041	DRC045	DRCF045			CT002
TS 100 K/L/M/A/B	73-77	CK3326		CSK025					CT051
TS 100 C	78	CK3318		CSK025					CT011
TS 100 ERN Upto F 300563	79	CK3318	CKF3318	CSK025					CT011
TS 100 ERN/ERT/ERX From F 300564	80-81	CK3337		CSK025					CT011
TS 100 ERZ/ERH	82	CK3318	CKF3318	CSK025					CT011
DR-Z 110 K3/K4/K5	03-05	CK4438	CKF4438	CSK040					CT070SP
110cc Smash	03	CK4438	CKF4438	CSK010					CT070SP
B 120		CK3306		CSK001					CT052
DF 125		CK3318	CKF3318	CSK034					CT011
DR 125 SZ/SD/SE/SF/SH/SJ	82-94	CK3318	CKF3318	CSK034					CT011
DR 125 SEX/SEY	99-01	CK3318	CKF3318	CSK034					CT011
DR 125 SMK8/SMK9/SML0	08-12	CK3337		CSK034					CT011
DR-Z 125	03-20	CK3318	CKF3318	CSK034					CT011
DR-Z 125 L	03-20	CK3318	CKF3318	CSK034					CT011
FX 125		CK3318	CKF3318	CSK034					CT011
GN 125 R/V/W/X/Y/K1 (NF41A)	94-01	CK3318	CKF3318	CSK034					CT011
GN 125 ER/EV/EW/EX/EY/EK1 (NF41A)	94-01	CK3318	CKF3318	CSK034					CT011
GN 125 Z/D/K (Gold Cast Wheel/Aisin caliper)	82-90	CK3318	CKF3318	CSK034					CT011
GN 125 HS (LC6PCJB1/Chinese Production)	00-11	CK3318	CKF3318	CSK034					CT011
GP 125 C/N	78-79	CK3319		CSK025					CT011
GP 125 X/XD	81-84	CK3338		CSK025					CT011
GS 125 Z/D/ESZ/ESD/ESF/ESK/ESM/ESR/ESX	82-00	CK3318	CKF3318	CSK034					CT011
GSX-R 125	18-20	CK3318	CKF3318	CSK245			SRC148	SRK148	CT011
GSX-S 125	18-20	CK3318	CKF3318	CSK245			SRC148	SRK148	CT011
GT 125 L/M/A/B/C/EC	74-78	CK3318	CKF3318	CSK025					CT011
GT 125 EN	79	CK3337		CSK025					CT011
GZ 125 W/X/Y/K1-K9 Marauder	98-11	CK3318	CKF3318	CSK034					CT011
LT 125 D/E/F/G/H	84-86	CK3328		N/A					CT011
RG 125 CG/CH/J (NF12A) (Gamma /Rear Drum Brake Model)	86-90	CK3319		CSK025					CT011
RG 125 UCG/UCH/UCJ/J/BUJ (NF12B) (Gamma/Rear Drum Model)	86-90	CK3319		CSK025					CT011
RG 125 FN/FP/FR Gamma (NF13A/Rear Disc Model)	92-94	CK3319		CSK146					CT011
RG 125 FUN/FUP/FUR Gamma (NF13B/Rear Disc Model)	92-94	CK3319		CSK146					CT011
RG 125 UN Wolf (NF13E/Naked)	92-94	CK3319		CSK146					CT011
RM 125 A/B/C	76-78	CK3329		CSK025					CT011
RM 125 N/T	79-80	CK3319		CSK025					CT011
RM 125 X/Z	81-82	CK3329		CSK036					CT011
RM 125 D	83	CK3329		CSK034					CT011
RM 125 E	84	CK3356		CSK034					CT011
RM 125 F	85	CK3329		CSK034					CT011
RM 125 G/H	86-87	CK3319		CSK001	DRC021				CT011
RM 125 J/K/L/M	88-91	CK3356		CSK053	DRC022				CT011
RM 125 N	92	CK3401		CSK032	DRC114				CT003
RM 125 P/R/S/T/V/W	93-96	CK3401		CSK027	DRC076S				CT003
RM 125 X/Y/K1	97-01	CK3401		CSK091	DRC115				CT003
RM 125 K2/K3/K4/K5/K6/K7/K8/K9	02-12	CK4514	CKF4514	CSK091	DRC130	DRCF130			CT003
RM 125 XCK8	09	CK4514	CKF4514	CSK091	DRC130	DRCF130			CT003
RV 125 K2/K3/K4/K5/K6/K7/K8/K9/L0/L3/L4 Van-Van	02-15	CK3318	CKF3318	CSK034					CT011
T 125/125-11/R Stinger	69-71	CK3306		CSK025					CT052
TF 125 Farm Bike (All models)	78-05	CK3318	CKF3318	CSK025					CT011
TS 125 K/L/M/A/B/C/C2	73-78	CK3318	CKF3318	CSK025					CT011
TS 125 ERN Up to F No 302345	79	CK3318	CKF3318	CSK025					CT011
TS 125 ERN From F No 302346	79	CK3337		CSK025					CT011
TS 125 ERT/ERX	80-81	CK3337		CSK025					CT011
TS 125 ERZ	82	CK3318	CKF3318	CSK025					CT011
TS 125 N to Frame No. 178871	84	CK3318	CKF3318	CSK025					CT011
TS 125 N from Frame No.178872	84	CK3337		CSK025					CT011
TS 125 XUE/XUF/XUG/XUH/XUJ	84-90	CK3319		CSK025					CT011
TS 125 RK/RL/RM/RN/RR	90-94	CK3319		CSK146					CT011
TU 125 X/XTUX/XTX	99	CK3319		CSK034					CT011
VL 125 Y/K1-K7 Intruder	00-08	CK3432		CSK158					CT029

CLUTCH APPLICATIONS

EBC CLUTCH KITS

Make & Model	Year	CK Series #	CKF Series #	Spring Kit #	DRC Series #	DRCF Series #	SRC Series #	SRK Series #	CT Tool #
SUZUKI Contd.									
X4 125		TBA		TBA					
GSX 150 L6/DZAL6 Gixxer	16	CK3318	CKF3318	CSK245			SRC148	SRK148	CT011
GSX 150 DEAL8/DZAL8/DXAL8 Gixxer	18	CK3318	CKF3318	TBA			TBA	TBA	CT011
GSX-R 150 FRFAL7/FRZAL7	17-18	CK3318	CKF3318	TBA			TBA	TBA	CT011
GSX-R 150 RF-Q/RFX-Q	17-18	CK3318	CKF3318	CSK245			SRC148	SRK148	CT011
GSX-R 150	18-20	CK3318	CKF3318	CSK245			SRC148	SRK148	CT011
GSX-S 150	18-20	CK3318	CKF3318	CSK245			SRC148	SRK148	CT011
LT 160 EK/EL/EM/EN	89-92	CK3364		CSK048	DRC218				CT011
LT-F 160 L/M/N/P/R/S/T/V/W/X/Y/K1-K3	90-03	CK3364		CSK048	DRC218				CT011
LT 160 K3/K4 QuadSport	03-04	CK3364		CSK048	DRC218				CT011
PE 175 C/N/T/X/Z	78-82	CK3329		CSK025					CT011
GT 185 K/L/M/A/B/C/EC	73-79	CK3319		CSK025					CT011
LT 185 E/F	84-85	CK3328		N/A					CT011
TS 185 K/L/M	73-75	CK3319		CSK025					CT011
TS 185 B/C	77-78	CK3319		CSK025					CT011
TS 185 ERN/ERT/ERX	79-81	CK3319		CSK025					CT011
DF 200 EV/EW/EY (SH42A)	98-99	CK3319		CSK034	DRC274				CT011
DR 200 G/H/J	86-89	CK3319		CSK034	DRC094				CT011
DR 200 SEP/SER/SES/SEV/SEW/SEX/SEY (SH42A) Djebel	93-00	CK3319		CSK034	DRC274				CT011
DR 200 SE Trojan		CK3319		CSK034	DRC274				CT011
DR 200 SEK1-SEK9	01-09	CK3319		CSK034	DRC274				CT011
GT 200 EN/EX X5	79-80	CK3319		CSK025					CT011
RV 200 K2/K3	02-03	CK3319		CSK034	DRC274				CT011
SB 200 N/X	79-80	CK3319		CSK025					CT011
SX 200 R/R-Z/RJ/RM	90-91	CK3319		CSK034					CT011
TS 200 RK/RL/RM/RN/RR	89-94	CK3329		CSK034					CT011
LT 230 GEF/GEG	85-86	CK3364		CSK048	DRC218				CT011
LT-F 230 G/H	86-87	CK3364		CSK048	DRC218				CT011
DR 250 RS/RLS/RT/RV/RLV/RW/RLW/RV (SJ45A/DOHC)	95-00	CK1181		CSK046					CT013
DR 250 RXT/RXLT/RXV/RXLV/RXW/RXLW/RXGW/RXGLW /RXY/RXGY (Djebel 250 XC/GPS Ver) (SJ45A)		CK1181		CSK046					CT013
DR 250 SL/SM/SN/SEP/SER/SES (SJ44A)	90-95	CK3399	CKF3399	CSK034	DRC058	DRCF058			CT022
DR-Z 250 K1-K7 (DJ43A)	01-07	CK1181		CSK046	DRC280				CT013
GS 250 TT/TX	80-81	CK3329		CSK036					CT011
GSF 250 N/ZM/P/NP/ZP/R/NR (GJ74A)	92-96	CK3319		CSK036					CT011
GSF 250 VS/VT/VW/VX/VY Bandit (GJ77A)	95-00	TBA		TBA					CT011
GSX 250 ET/EX/EZ	80-82	CK3329		CSK036					CT011
GSX 250 FL/FM/FN/FP/FR/FS/FT/FV/FW - Across	90-98	TBA		TBA					CT011
GSX 250 RCH/RH (GJ72A)		CK3319		CSK036					CT011
GSX 250 SSM Katana (GJ76A)	91	CK3339		CSK036					CT011
GSX 250 FXK2/F3/F4/F5 (ZR 250 C)	02-05	CK4508		CSK007					CT011
GSXR 250 CJ (GJ72A)		CK3319		CSK036					CT011
GSXR 250 CK (GJ72A)		CK3319		CSK036					CT011
GSXR 250 RK (GJ73A)	89	CK3339		CSK036					CT011
GN 250 F/J/M/R/T (NJ41A)	85-97	CK3358		CSK158					CT029
GT 250 K/L	73-74	CK3313		CSK159					CT046
GT 250 M/A-C	75-78	CK3315		CSK159					CT022
GT 250 EN/ET/EX X7	79-81	CK3315		CSK159					CT022
GW 250 L3/ZL5 Inazuma	13-15	CK3358		CSK204					CT029
GW 250 FL5 Inazuma	15	CK3358		CSK204					CT029
GZ 250 X/Y/K1-K8 Marauder	99-08	CK3358		CSK068					CT029
LT-F 250 J/K/L/M/N/P/R/S/T/V/W/Y/K1	89-01	CK3390		CSK048	DRC089				CT011
LT-F 4WD H/J/K/L/M/N/P/R/S/T/V/W	87-98	CK4523		CSK048	DRC089				CT011
LT 250 RH/RJ/RK	87-90	CK3372		CSK034	DRC023				CT022
LT 250 EFF/EFB	85-86	CK3390		CSK048	DRC089				CT011
LT-F 250 FX/FY/FK1/FK2	99-02	CK3390		CSK048	DRC089				CT011
LT-F 250 K2 Ozark (Up to F/No JSAAJ51A22100696)	02	CK3364		CSK048	DRC220				CT011
LT-F 250 K2 Ozark (From F/No JSAAJ51A22100697-)	02	CK3364		CSK147	DRC297				CT011
LT-F 250 K3 Ozark	03	CK3390		CSK147	DRC221				CT011
LT-F 250 K4 Ozark	04	CK3448		CSK148	DRC222				CT011
LT-F 250 K5/K6/K7/K8/K9/L2/L3/L4 Ozark	05-14	CK3390		CSK147	DRC221				CT011
LT-Z 250 K4/K5/K6/K7/K8/K9/L0 QuadSport	04-12	CK3448		CSK048	DRC222				CT011
250 SBK 2 (LX 250 L)	02	CK4469		CSK001					CT042
PE 250 B/C/N	77-79	CK3334		CSK006					CT022
PE 250 T/X/Z	80-82	CK3331		CSK006					CT022
RG 250 WD	83	CK3384		CSK159					CT022
RG 250 WE	84	CK3351		CSK159					CT022
RG 250 FG/FH/CH/FCH	85-88	CK3351		CSK006					CT022
RGV 250 J	88	CK3351		CSK007					CT022
RGV 250 K/L (VJ21A)	89-90	CK3351		CSK007					CT022
RGV 250 M/N/P/R/S (VJ22A)	91-95	CK3333		CSK007					CT022
RGV 250 T (RGVR 250 SP) VJ23A Dry Clutch	96	CK1288		CSK167					CT071SP
RL 250 L/M	74-75	CK3315		N/A					CT022

CLUTCH APPLICATIONS

EBC CLUTCH KITS

Make & Model	Year	CK Series #	CKF Series #	Spring Kit #	DRC Series #	DRCF Series #	SRC Series #	SRK Series #	CT Tool #
SUZUKI Contd.									
RL 250 Beamish Model Reed Valve Engine	78-82	CK3343		CSK006					CT018SP
RM 250 A/B/C	76-78	CK3334		CSK006					CT022
RM 250 N/T/X/Z/D/E/F	79-85	CK3331		CSK006					CT022
RM 250 G	86	CK3372		CSK034					CT022
RM 250 H	87	CK3372		CSK055	DRC052				CT022
RM 250 J/K/L	88-90	CK3374	CKF3374	CSK027	DRC024				CT022
RM 250 M	91	CK3374	CKF3374	CSK045	DRC040				CT022
RM 250 N/P	92-93	CK3400		CSK032	DRC048				CT022
RM 250 R/S	94-95	CK3374	CKF3374	CSK032	DRC072				CT022
RM 250 T	96	CK4435	CKF4435	CSK032	DRC080				CT016
RM 250 V/W/X/Y/K1/K2	97-02	CK4435	CKF4435	CSK091	DRC095				CT016
RM 250 K3/K4/K5	03-05	CK3454	CKF3454	CSK091	DRC161				CT016
RM 250 K6/K7/K8/K9	06-12	CK3453		CSK119	DRC160				CT016
RM 250 XCK8	09	CK3453		CSK119	DRC160				CT016
RMX 250 K/L	89-90	CK3374	CKF3374	CSK027					CT022
RMX 250 M	91	CK3374	CKF3374	CSK045					CT022
RMX 250 N/P	92-93	CK3400		CSK032					CT022
RMX 250 R/S/T/V/W	94-98	CK3374	CKF3374	CSK032	DRC072				CT022
RMX 250 SN/SR/S-S (SJ13A)	95-97	CK3437		N/A					CT022
RMX 250 ST/SV/SW/SX (SJ14A)	96-99	CK3374	CKF3374	CSK032	DRC072				CT022
RM-Z 250 K4/K5/K6	04-06	CK4514	CKF4514	CSK097	DRC123	DRCF123			CT004
RM-Z 250 K7/K8/K9	07-09	CK4514	CKF4514	CSK141	DRC189	DRCF189			CT004
RM-Z 250	10-20	CK4514	CKF4514	CSK164	DRC255	DRCF255			CT004
SW-1 (NJ45A)	92	CK3358		CSK006					CT029
T20 Super Six	66-68	CK3310		CSK076					CT038SP
T 250 II/R/J	70-72	CK3313		CSK159					CT046
TS 250 K/L/M/A/B/C/ERN/ERT/ERX	73-81	CK3315		CSK159					CT022
TS 250 XE/XG/XH/XJ/XK	85-89	CK3319		CSK034					CT011
TU 250 T/XS/X/T/X-ST/XSV Volty	92-97	CK3358		CSK006					CT029
TU 250 XTX/X/XTY (NJ45A-115-) Volty	99-00	CK3358		CSK068					CT029
TU 250 GY/GBK1 Grass Tracker Big Boy (NJ47A-117/123)	00-01	CK3358		CSK068					CT029
TV 250 J/K/RK/L (VJ21A) Wolf	88-90	CK3351		CSK007					CT022
VL 250 Y/K1/K5/K6/K7 Intruder	00-01	CK3358		CSK068					CT029
VL 250 Y/K1/K5/K6/K7 Intruder	05-07	CK3358		CSK068					CT029
LT-F 300 J/K	88-89	CK3390		CSK048	DRC089				CT011
LT-F 4WD XM/N/P/R/S/T/V/W 300 Quadrunner	91-98	CK3356		CSK048	DRC103				CT011
TU 250 XV/XW	97-00	CK3358		CSK006					CT029
LT-F 300 FX/FY/FK1	99-01	CK3356		CSK048	DRC103				CT011
RL 325 Beamish Model Reed Valve Engine	78-82	CK3343		CSK006					CT018SP
DR 350 SL/SM/SN/SP/SER/SES/SET/SEV/SEW/SEX	90-99	CK3399	CKF3399	CSK034	DRC058	DRCF058			CT022
SG 350 N Goose	92	CK3399	CKF3399	CSK034					CT022
T 350 1/2/R/J	69-72	CK3313		CSK159					CT046
SP 370 C/N	78-79	CK3334		CSK006					CT022
GT 380 K-M/A/B	73-77	CK3315		CSK159					CT022
DR 400 ST/SX	80-81	CK3332		CSK006					CT022
DR-Z 400 SY/EY/Y/SK1/EK1/K1/SK2/EK2/K2 /SK3/EK3/K3/SK4/EK4/K4/EK5/SK5/K6/SK6 /EK6/SK7/EK7/K7/SK8/SK9	00-09	CK3433	CKF3433	CSK079	DRC105	DRCF105			CT006
DR-Z 400 SMK5/SMK6/SMK7/SMK8/SMK9	05-09	CK3433	CKF3433	CSK079	DRC105	DRCF105			CT006
GN 400 TT	80	CK3332		CSK006					CT022
GS 400 B/C	77-78	CK3343		CSK159					CT018SP
GSF 400 M/N/P	91-95	CK3397		CSK034					CT011
GSF 400 K/NK/Z/VM/VZM/P/NP/VPV/ZR/VR Bandit (GK75A)	89-94	CK3397		CSK034					CT011
GSF 400 V/VS/V-V/VZ-V Bandit (GK7AA)		CK3397		CSK034					CT011
GSX 400 ET/EX/EZ	80-82	CK3333		CSK006					CT022
GSX 400 FEX/FZ/FD	81-83	CK3332		CSK006					CT022
GSX 400 FW/FWS/FWS-2		CK3332		CSK006					CT022
GSX 400 R2 (GK71B)		CK3385		CSK034					CT011
GSX 400 R3 (GK71F)		CK3385		CSK034					CT011
GSX 400 FJ/FK/FAK/FL (GK74A)	88-90	CK3397		CSK034					CT011
GSX 400 X/XA/XS Impulse		CK3385		CSK034					CT011
GSX 400 R/S/T/X/ZR/ZS/ZT Impulse Type S	94-99	CK1177		CSK006					CT002
GSX 400 TX/LX	81	CK3333		CSK159					CT022
GSX 400 FSV/FSK1 (GK7BA) Inazuma	00	CK3359		CSK006					CT047SP
GSX 400 SSN (GK77A) Katana	92	CK3441		TBA					
GSXR 400 H	87	CK3385		CSK034					CT011
GSXR 400 J/RR/RAK (GK73A)	88-90	CK3397		CSK034					CT011
GSXR 400 RL/RM/RN/RP/RS (GK76A)	90-95	CK3397		CSK034					CT011
GSR 400 K6/K7/K8	06	CK1218	CKF1218	CSK075					CT014
LT-F 400 K2 (Eiger)	02	CK4439	CKF4439	CSK098	DRC223				CT006
LT-F 400 FK2-FK7 (Eiger 4WD)	02-07	CK4439	CKF4439	CSK098	DRC120				CT006
LT-F 400 FK8/FK9/FL0/FL1 King Quad 4WD	08-12	CK4439	CKF4439	CSK098	DRC120				CT006

CLUTCH APPLICATIONS

EBC CLUTCH KITS

Make & Model	Year	CK Series #	CKF Series #	Spring Kit #	DRC Series #	DRCF Series #	SRC Series #	SRK Series #	CT Tool #
SUZUKI Contd.									
LT-F 400 K3-K7 Eiger 2WD	03-07	CK4439	CKF4439	CSK098	DRC120				CT006
LT-Z 400 K3/K4	03-04	CK3433	CKF3433	CSK079	DRC105	DRCF105			CT006
LT-Z 400 K5/K6/K7/K8/K9/L0/L1/L2/L3 Quadsport	05-15	CK3447	CKF3447	CSK079	DRC137	DRCF137			CT006
PE 400 T/X	80-81	CK3332		CSK006					CT022
RF 400 RP/RR/VR/RT/RVT/RV-V (GK78A)		CK1177		CSK006					CT002
RG 400 EWF/EW-2G/EWH Walter Wolf	85-87	CK4503		CSK007					CT037SP
RM 400 C	78	CK3315		CSK006					CT022
RM 400 N/T	79-80	CK3332		CSK006					CT022
RV 400 RP/RR	93-	CK1177		CSK006					CT002
SP 400 T	80	CK3332		CSK006					CT022
ST 400 V/W/X/Y/K1/K2/K3 Tempter	97-03	CK3359		CSK026					CT029SP
SV 400 N (VK53A)	98	CK3377		CSK069			SRC081	SRK081	CT033SP
SV 400 X/Y/K1/K2	99-02	CK3377		CSK069			SRC081	SRK081	CT033SP
SV 400 K3/K4/K5	03-05	CK1219		CSK133			SRC082	SRK082	CT033SP
SV 400 SN (VK53A)	98	CK3377		CSK069			SRC081	SRK081	CT033SP
SV 400 SX/SY/SK1/SK2	99-02	CK3377		CSK069			SRC081	SRK081	CT033SP
SV 400 SK3/SK4/SK5	03-05	CK1219		CSK133			SRC082	SRK082	CT033SP
VS 400 VR/FR/VTR/FTR/VT/FT Intruder	94-	CK3377		CSK026					CT029
GS 425 EN	79	CK3343		CSK006					CT018SP
GS 450 ET/EG/EJ	80-88	CK3333		CSK006					CT022
LT-R 450 K6/K7/K8/K9/L0/L1	06-12	CK3450	CKF3450	CSK125	DRC164	DRCF164			CT045
RM-X 450 ZL0/ZL2	10-15	CK3450	CKF3450	CSK186	DRC155	DRCF155			CT045
RM-Z 450 K5/K6/K7	05-07	CK3450	CKF3450	CSK164	DRC254	DRCF254			CT045
RM-Z 450	08-20	CK3450	CKF3450	CSK186	DRC155	DRCF155			CT045
RM 465 X/Z	81-82	CK3348		CSK006					CT022
DR 500 X/Z/D	81-83	CK3359		CSK026					CT029SP
LT 500 RL/RM	90-91	CK3374	CKF3374	CSK034	DRC026				CT022
LT-F 500 FW/FX/FY/FK1/FK2	98-02	CK4439	CKF4439	CSK007	DRC217				CT006
LT-F 500 FK3-FK7	03-07	CK3452		CSK007					CT006
GS 500 EK/EL/EM/EN/EP/ER/ES/ET/EV/EW/EX/EY /K1/K2/K3/K4/FK4/F5/FK5/K6/FK6/K7/FK7/K8/FK8	89-08	CK3333		CSK061					CT022
GT 500 A/B	76-77	CK3316		CSK158					CT022
RE5 M/A	75-76	CK3373		CSK158					CT035SP
RG 500 G/CH	85-87	CK4503		CSK224					CT037SP
RM 500 D/E	83-84	CK3348		CSK006					CT022
T500 1/2/3 (18 ears)	68-70	CK3314		CSK158					CT046
T500 R/J/K/L/M (12 ears)	71-75	CK3316		CSK158					CT022
GT 550 J/K/L/M/A/B	72-77	CK3321		CSK158					CT035SP
GS 550 DB/DC/EC/EN/ET/EX/EZ	77-82	CK3344		CSK159					CT018SP
GS 550 MX/MZ Katana	81-82	CK3344		CSK159					CT018SP
GS 550 LT/LX	80-81	CK3344		CSK159					CT018SP
GSX 550 ESD/ESE/EFF/EFE/ESH/ESG (GN71D)	84-87	CK3344		CSK159					CT018SP
DR 600 RG/RH/RJ/RK (SN41A)	86-89	CK3359		CSK224					CT029SP
DR 600 SF (SN41A)	85	CK3359		CSK224					CT029SP
DR 600 SG/SH/SJ/SK (SN41A)	86-89	CK3359		CSK224					CT029SP
GSF 600 S/T/V/W/X (Naked Bandit)	95-99	CK3348		CSK198					CT047SP
GSF 600 ST/SV/SW/SX (Faired Bandit)	96-99	CK3348		CSK198					CT047SP
GSF 600 Y/K1/K2/K3/K4 (Naked Bandit)	00-04	CK3348		CSK198					CT047SP
GSF 600 SY/SK1/SK2/SK3/SK4 (Faired Bandit)	00-04	CK3348		CSK198					CT047SP
GSR 600 K6/K7/K8	06-10	CK1218	CKF1218	CSK075					CT014
GSX 600 FJ/FK/FL/FM	88-91	CK3348		CSK026			SRC013	SRK013	CT047SP
GSX 600 FN/FP/FR/FS/FT/FV	92-97	CK3387		CSK198			SRC017	SRK017	CT036SP
GSX 600 FW/FX/FY/FK1/FK2/FK3/FK4/FK5/FK6	98-06	CK3357	CKF3357	CSK198					CT047SP
GSXR 600 V/W (SRAD)	97-98	CK1206	CKF1206	CSK902			SRC058	SRK106	CT055SP
GSXR 600 X/Y (SRAD)	99-00	CK1206	CKF1206	CSK902			SRC058	SRK058	CT055SP
GSXR 600 K1/K2/K3/ZK3	01-03	CK3466		CSK156			SRC112	SRK112	CT014
GSXR 600 K4/K5	04-05	CK1206	CKF1206	CSK156			SRC078	SRK078	CT014
GSXR 600 K6/K7	06-07	CK3455	CKF3455	CSK205			SRC086	SRK086	CT015
GSXR 600 K8/K9/L0	08-10	CK3456	CKF3456	CSK205			SRC088	SRK109	CT01
GSXR 600	11-20	CK3456	CKF3456	CSK183			SRC110	SRK110	CT015
RF 600 RP/RR/RS/RT	93-96	CK3408	CKF3408	CSK198			SRC045	SRK045	CT036SP
VS 600 GLS/GLT/GLV	95-97	CK3377		CSK115					CT029
DL 650 K4-K6 V-Strom	04-06	CK1219		CSK133			SRC082	SRK082	CT033SP
DL 650 AK7/AK8/AK9/AL0 V-Strom ABS	07-11	CK1219		CSK133			SRC082	SRK082	CT033SP
DL 650 AL2/AL3/AL4/AL5 V-Strom ABS	12-15	CK1219		CSK133			SRC082	SRK082	CT033SP
DL 650 AL1XP V-Strom Xpedition ABS	11	CK1219		CSK133			SRC082	SRK082	CT033SP
DL 650 AK9GT V-Strom Traveller ABS	09-10	CK1219		CSK133			SRC082	SRK082	CT033SP
DL 650 XK7/XK8/XK9/XL0 V-Strom	04-11	CK1219		CSK133			SRC082	SRK082	CT033SP
DL 650 XT V-Strom ABS (DL 650 XAL5/ XAL9)	15-20	CK1219		CSK133			SRC082	SRK082	CT033SP
DR 650 RL/RM (SP41A)	90-91	CK3402		CSK115	DRC059				CT029SP
DR 650 RSL/RSM (SP42A)	90-91	CK3402		CSK115	DRC059				CT029SP
DR 650 RUN/RN/RUP/RP (SP44A/B)	92-93	CK3402		CSK115	DRC059				CT029SP
DR 650 RSEM/RSEN/RSEP (SP43A/B)	91-93	CK3402		CSK115	DRC059				CT029SP
DR 650 RER/RES (SP45A/B)	94-95	CK3402		CSK115	DRC142				CT029SP

CLUTCH APPLICATIONS

EBC CLUTCH KITS

Make & Model	Year	CK Series #	CKF Series #	Spring Kit #	DRC Series #	DRCF Series #	SRC Series #	SRK Series #	CT Tool #
SUZUKI Contd.									
DR 650 SET/SEV	96-97	CK3386		CSK026	DRC087				CT024
GR 650 D/XD	83	CK3357	CKF3357	CSK026					CT029
GS 650 GX/GZ Katana	81-82	CK3330		CSK159					CT018SP
GS 650 GTX/GTZ/GTD	81-83	CK3330		CSK159					CT018SP
GSF 650 K5/K6 Naked Bandit - Non ABS	05-06	CK3357	CKF3357	CSK122					CT047SP
GSF 650 SK5/SK6 Faired Bandit - Non ABS	05-06	CK3357	CKF3357	CSK122					CT047SP
GSF 650 AK5/AK6 Naked Bandit - ABS Model	05-06	CK3357	CKF3357	CSK122					CT047SP
GSF 650 SAK5/SAK6 Faired Bandit - ABS Model	05-06	CK3357	CKF3357	CSK122					CT047SP
GSF 650 K7/K8/K9/L0/L1/L2 Naked Bandit - Non ABS	07-12	CK1218	CKF1218	CSK122					CT014
GSF 650 SK7/SK8/SK9/SLO/SL1/SL2 Faired Bandit - Non ABS	07-12	CK1218	CKF1218	CSK122					CT014
GSF 650 AK7/AK8/AK9/AL0/AL1/AL2 Naked Bandit - ABS	07-12	CK1218	CKF1218	CSK122					CT014
GSF 650 SAK7/SAK8/SAK9/SALO/SALO/SAL1/SAL2 Faired Bandit - ABS	07-15	CK1218	CKF1218	CSK122					CT014
GSX 650 FK8/FK9/FLO/FL1/FL2 (Non ABS)	08-14	CK1218	CKF1218	CSK122					CT014
GSX 650 FAK8/FAK9/FALO/FAL1/FAL2 (ABS)	08-15	CK1218	CKF1218	CSK122					CT014
LS 650 Savage FG/PK/PM/PR/PG/PT/PV	87-97	CK3359		CSK026					CT029SP
SFV 650 K9/L0/L1/L2/L3/L4/L5 Gladius (Non ABS)	09-15	CK1219		CSK133			SRC082	SRK082	CT033SP
SFV 650 AK9/AL0/AL1/AL2/AL3/AL4/AL5 Gladius (ABS)	09-15	CK1219		CSK133			SRC082	SRK082	CT033SP
SV 650 X/Y/K1/K2 (Naked - Non ABS)	99-02	CK3377		CSK069			SRC081	SRK081	CT022
SV 650 SX/SY/SK1/SK2 (Faired - Non ABS)	99-02	CK3377		CSK069			SRC081	SRK081	CT022
SV 650 K3/K4/K5/K6/K7/K8/K9/L0 (Naked - Non ABS)	03-10	CK1219		CSK133			SRC082	SRK082	CT033SP
SV 650 SK3/SK4/SK5/SK6/SK7/SK8/SK9/SLO (Top Fairing - Non ABS)	03-15	CK1219		CSK133			SRC082	SRK082	CT033SP
SV 650 AK7/AK8/AK9/AL0 (Naked ABS Model)	07-10	CK1219		CSK133			SRC082	SRK082	CT033SP
SV 650 SAK7/SAK8/SAK9/SALO (Top Fairing - ABS Model)	07-15	CK1219		CSK133			SRC082	SRK082	CT033SP
SV 650 ABS	16-20	CK1219		CSK133			SRC082	SRK082	CT033SP
XF 650 V/W/X/Y Freewind	97-02	CK3386		CSK026	DRC087				CT024
XN 85 D Turbo	83	CK3347		CSK006					CT018SP
GS 700 EF/ESF	85	CK3330		CSK115					CT018SP
VS 700 GLFG/GLEFG/GLPH/GLEPH	86-87	CK3377		CSK115					CT029
DR 750 SJ/SK	88-89	CK3386		CSK115					CT024
GT 750 J/K/L/M/A/B	72-77	CK3324		CSK158					CT018SP
GS 750 B/DB/DC/EC/EN	77-79	CK3324		CSK006					CT018SP
GSR 750 L1/L2/L3	11-14	CK3417		CSK109					CT014
GSR 750 AL2/AL3/AL4/AL5 (ABS)	12-15	CK3417		CSK109					CT014
GSX 750 ET/EX	80-81	CK3330		CSK006					CT018SP
GSX 750 ESD/EFE/ESG/ESE/EFF	83-86	CK3330		CSK115					CT018SP
GSX 750 SE Katana	84	CK3330		CSK026					CT018SP
GSX 750 FK/FL/FM/FN/FP/FR/FS/FT/FV	89-97	CK3387		CSK012					CT036SP
GSX 750 FW/FX/FY/FK1-FK6	98-06	CK3357	CKF3357	CSK198					CT047SP
GSX 750 W/X/Y/K1	98-03	CK3357	CKF3357	CSK198					CT047SP
GSX 750 S/SS (GS75X-106815-)		CK3330		CSK006					CT018SP
GSX 750 S-2/S-2C (GS75X-114747-) Katana		CK3330		CSK006					CT018SP
GSXR 750 F/G/H (GR75A)	85-87	CK3348		CSK115			SRC013	SRK013	CT047SP
GSXR 750 RG (Dry Clutch - Sintered Friction)	86	CK3376		CSK198			N/A	SRK138	CT072SP
GSXR 750 J/K	88-89	CK3387		CSK012			SRC014	SRK014	CT036SP
GSXR 750 L/M/WN	90-92	CK3387		CSK198			SRC017	SRK017	CT036SP
GSXR 750 WP/WR/WS	93-95	CK3387		CSK198			SRC017	SRK104	CT036SP
GSXR 750 T/V/W/X (SRAD)	96-99	CK3417		CSK902			SRC040	SRK040	CT055SP
GSXR 750 Y	00	CK1229		CSK156			SRC071	SRK071	CT014
GSXR 750 K1/ K2/K3	01-03	CK3465		CSK156			SRC111	SRK111	CT014
GSXR 750 K4/K5	04-05	CK3417		CSK075			SRC121	SRK121	CT014
GSXR 750 K6/K7	06-07	CK3456	CKF3456	CSK205			SRC088	SRK088	CT015
GSXR 750 K8/K9/L0	08-10	CK3456	CKF3456	CSK205			SRC088	SRK109	CT015
GSX-R 750	11-20	CK3456	CKF3456	CSK183			SRC110	SRK110	CT015
GSX-S 750	15-20	CK3456	CKF3456	CSK183			SRC110	SRK110	CT015
GSXR 750 L1/L2/L3/L4/L5	11-15	CK3456	CKF3456	CSK183			SRC110	SRK110	CT015
VS 750 GLF/GLFG/GLFH/GLPG/GLPK/GLPL/GLPM/GLPH /GLEFH/GLEPH (VR51A)	85-91	CK3377		CSK115					CT029
DR 800 SL (SR43A)/SM/SN/SP/SR/SS (SR43B)	90-95	CK3386		CSK115					CT024
DR 800 ST/SV (SR43B)	96-97	CK3386		CSK115					CT024
VS 800 GLN/GLP/GLR/GLS/GLT/GLV	92-97	CK3377		CSK115					CT029
VL 800 K1-K5 Intruder Volusia	01-05	CK3377		CSK066					CT029
C 800 Intruder - Spoke Wheels (VL 800 K6/K7/K8/K9/L0/L1/L2/L3/L5)	06-15	CK3377		CSK066					CT029
C 800 C Intruder - Cast Wheels (VL 800 CK7/CK8/CK9/CL0/CL1/CL2/CL3)	07-15	CK3377		CSK066					CT029
C 800 Intruder - Cast Wheels (VL 800 BLT4)	14	CK3377		CSK066					CT029
VX 800 L/M/N/P/R/T (8 Spring CSK Kit)	90-96	CK3377		CSK162					CT029
VZ 800 V/W/X/Y/K1/K2 Marauder (8 Spring CSK Kit)	97-02	CK3377		CSK162					CT029
M 800 (VZ 800 K5-K9/L0/L1/L3) Intruder M800	05-13	CK3377		CSK066					CT029
M 800/T (VZ 800 L4/L5 Intruder M 800/T)	14-15	CK3377		CSK066					CT029

CLUTCH APPLICATIONS

EBC CLUTCH KITS

Make & Model	Year	CK Series #	CKF Series #	Spring Kit #	DRC Series #	DRCF Series #	SRC Series #	SRK Series #	CT Tool #
SUZUKI Contd.									
M 800 Z (VZ 800 K9Z Intruder M 800Z)	09-10	CK3377		CSK066					CT029
GS 850 GN/GT/GX/GZ/GF/GG	79-85	CK3330		CSK006					CT018SP
RF 900 RR	1994	CK3418		CSK902			SRC039	SRK039	CT055SP
RF 900 RS/R2S/RT/RV/RW	95-98	CK3417		CSK029					CT014
DL 1000 K2-K9/L0 V-Strom	02-10	CK3443	CKF3443	CSK043					CT021
DL 1000 V-Strom ABS	14-20	CK3443	CKF3443	CSK043					CT021
DL 1000 V-Strom Adventure	14-20	CK3443	CKF3443	CSK043					CT021
GS1000 HC/EC/EN/SN/ET	78-80	CK3345		CSK158			SRC115	SRK115	CT035SP
GS 1000 GT/GX	80-81	CK3335		CSK006			SRC050	SRK050	CT024SP
GSX 1000 SZ	82	CK3335		CSK006			SRC050	SRK050	CT024SP
GSXR 1000 K1/K2/K3/K4	01-04	CK4510	CKF4510	CSK128			SRC089	SRK089	CT004
GSXR 1000 K5/K6/K7/K8	05-08	CK3451	CKF3451	CSK145			SRC085	SRK085	CT015
GSXR 1000 K9/L0/L1	09-11	CK3462	CKF3462	CSK160			SRC097	SRK097	CT009
GSXR 1000 L2/L3/ZL3/L4/ZL4/AL5/L5/AL6	12-16	CK3462	CKF3462	CSK196			SRC120	N/A	CT009
GSXR 1000 ABS	17-20	CK3468		CSK242			SRC142	SRK142	CT009
GSX-S 1000	16-17	CK4510	CKF4510	CSK223					CT004
GSX-S 1000 ABS	16-17	CK4510	CKF4510	CSK223					CT004
GSX-S 1000	18-20	CK3451	CKF3451	CSK145			SRC085	SRK085	CT015
GSX-S 1000 ABS	18-20	CK3451	CKF3451	CSK145			SRC085	SRK085	CT015
GSX-S 1000 F	16-17	CK4510	CKF4510	CSK223					CT004
GSX-S 1000 F ABS	16-17	CK4510	CKF4510	CSK223					CT004
GSX-S 1000 F	18-20	CK3451	CKF3451	CSK145			SRC085	SRK085	CT015
GSX-S 1000 F ABS	18-20	CK3451	CKF3451	CSK145			SRC085	SRK085	CT015
Katana	19-20	CK3451	CKF3451	CSK145			SRC085	SRK085	CT015
SV 1000 K3/K4/K5/K6/K7 (Naked)	03-07	CK3443	CKF3443	CSK114					CT021
SV 1000 SK3/SK4/SK5/SK6/SK7 (Faired)	03-07	CK3443	CKF3443	CSK114					CT021
TL 1000 SV/SW	97-98	CK3417		CSK078					CT014
TL 1000 RW/RX/RY	98-00	CK3428		CSK071			SRC068	SRK068	CT009
TL 1000 SX/SY	99-00	CK3428		CSK071			SRC068	SRK068	CT009
TL 1000 SK1	01-02	CK3435		CSK071					CT009
TL 1000 RK1	01-02	CK3435		CSK071					CT009
GS 1100 GZ	82	CK3335		CSK006			SRC050	SRK050	CT024SP
GSX 1100 ET/EX/EZ	80-82	CK3335		CSK006			SRC050	SRK050	CT024SP
GSX 1100 SZ	82	CK3335		CSK006			SRC050	SRK050	CT024SP
GSX 1100 SD	83	CK3346		CSK006					CT024SP
GSX 1100 ESD	83	CK3346		CSK006					CT024SP
GSX 1100 EFE/EFG/ESF	84-86	CK3335		CSK006			SRC050	SRK050	CT024SP
GSX 1100 FJ/FK/FL/FM/FN/FP/FR	88-94	CK3381		CSK012					CT048SP
GSX 1100 GM/GN	91-94	CK3392		CSK902			SRC010	SRK010	CT055SP
GSXR 1100 G/H/J	86-88	CK3381		CSK026			SRC015	SRK015	CT048SP
GSXR 1100 K/L/M/N	89-92	CK3392		CSK902			SRC010	SRK010	CT055SP
GSXR 1100 WP/WR/WS/WT	93-96	CK3418		CSK902			SRC039	SRK039	CT055SP
GS 1200 SSK/ZK1 (GV78A)	01	CK3417		CSK902			SRC040	SRK040	CT055SP
GSF 1200 T/V/W/X/Y (Naked Bandit - 4 Piston Caliper)	96-00	CK3417		CSK902			SRC040	SRK040	CT055SP
GSF 1200 K1/K2/K3/K4/K5 (Naked Bandit - 6 Piston caliper)	01-05	CK3417		CSK902			SRC040	SRK040	CT055SP
GSF 1200 ST/SV/SW/SX/SY (Faired Bandit - 4 Piston Caliper)	96-00	CK3417		CSK902			SRC040	SRK040	CT055SP
GSF 1200 SAV ABS Bandit	97	CK3417		CSK902			SRC040	SRK040	CT055SP
GSF 1200 SK1/SK2/SK3/SK4/SK5 (Faired Bandit - 6 Piston caliper)	01-05	CK3417		CSK902			SRC040	SRK040	CT055SP
GSF 1200 K6/AK6 (Naked Bandit - Non & ABS Version - 4 Piston caliper)	06	CK3417		CSK902			SRC040	SRK040	CT055SP
GSF 1200 SK6/SAK6 (Faired Bandit - Non & ABS Version - 4 Piston caliper)	06	CK3417		CSK902			SRC040	SRK040	CT055SP
GSF 1200 SFK7 Bandit Streetfighter	07-09	CK3459		CSK124					CT021
GSX 1200 FSW/FSX Inazuma (GV76A)	98-99	CK3417		CSK902			SRC040	SRK040	CT055SP
GV 1200 GLF/GLF2/GLG Madura	85-86	CK3375		CSK115					CT029
GSF 1250 K7/K8/K9 (Naked Bandit - Non ABS - 4 Piston caliper)	07-10	CK3459		CSK124					CT021
GSF 1250 AK7/AK8 (Naked Bandit - ABS Model - 4 Piston caliper)	07-10	CK3459		CSK124					CT021
GSF 1250 SK7/SK8/SK9/SLO (Faired Bandit - ABS Model - 4 Piston Caliper)	07-10	CK3459		CSK124					CT021
GSF 1250 SAK7/SAK8/SAK9/SAZK9/SALO (Faired Bandit - ABS Model - 4 Piston Caliper)	07-15	CK3459		CSK124					CT021
GSX 1250 FALO/FAL1/FAL2	10-15	CK3459		CSK124					CT021
GSX 1250 FALOST/FAL1ST Sports Touring	10-14	CK3459		CSK124					CT021
GSX 1300 RX Hayabusa	99	CK3430		CSK072			SRC067	SRK067	CT021
GSX 1300 RY/RK1 Hayabusa	00-01	CK3430		CSK171					CT021
GSX 1300 RK2/RZK3/RK3/RK4/RK5/K6/K7	02-07	CK3443	CKF3443	CSK171					CT021
GSX 1300 RK8/RK9/RL0/RL1/RL2/RAL3 /RAL4/RAL5 Hayabusa	08-15	CK3443	CKF3443	CSK139					CT021
GSX 1300 BKK8/BK9/BKLO/BK1 B-King	08-12	CK3443	CKF3443	CSK139					CT021

CLUTCH APPLICATIONS

EBC CLUTCH KITS

Make & Model	Year	CK Series #	CKF Series #	Spring Kit #	DRC Series #	DRCF Series #	SRC Series #	SRK Series #	CT Tool #
SUZUKI Contd.									
GSX 1400 K1	01	CK3445		CSK089					CT009
GSX 1400 K2/K3/K4/K5/K6/K7	02-07	CK3439		CSK089			SRC133	SRK133	CT009
GV 1400 Cavalcade (All models)	85-88	CK3388		CSK115					CT029
VS 1400 GLPH/GLPJ/GLFH/GLFJ/GLPR/GLPT/GLPV /GLPW/GLPY/GLPK1/GLPK2	87-03	CK3382		N/A					CT029
VL 1500 W/X/Y/K1/K2/K3 Intruder Legendary Classic	98-03	CK3335		CSK031					CT024SP
VL 1500 K5/K6/K7/K8/K9 (C 1500 Intruder)	05-09	CK3335		CSK031					CT024SP
VL 1500 BTL3/BTL4/BTL5 (C 1500 BT Intruder)	13-14	CK3459		TBA					CT021
M 1500 (VZ 1500 K9/L0) (M 1500 Intruder)	09-13	CK3459		TBA					
M 1600 (VZ 1600 K4/K5) (M 1600 Marauder)	04-05	CK4455		N/A					CT032
C 1800 R Intruder (VLR 1800 K8/K9/L0/L1)	08-13	CK3463		CSK075					
C 1800 RT Intruder (VLR 1800 K8RT/K9RT)	08-09	CK3463		CSK075					
M 1800 R (VZR 1800 K6/K7/K8/K9)									
(M 1800 R Intruder - With handlebar cowling)	06-09	CK3457		CSK122					
M 1800 R2 (VZR 1800 NK8/NK9 Intruder - M1800R2 - No handlebar cowling)	08-09	CK3457		CSK122					
M 1800 RZ (VZR1800 ZK7/ZK8/ZL1/ZL2/ZL3 - M1800RZ - With handlebar cowling)	07-13	CK3457		CSK122					
M 1800 RB (VZR 1800 BZL4/BZL5 - M 1800 RB)	14-15	CK3457		CSK122					
YAMAHA									
FS1 E/FS 1 DX	74-80	CK2205		CSK042					CT044
FS1	87-90	CK2205		CSK042					CT044
FS1 SE	81-82	CK2205		CSK042					CT044
DT 50 M	78-79	CK2206		CSK042					CT044
DT 50 M/MX	80-95	CK2205		CSK042					CT044
DT 50 LC	98	CK2206		CSK042					CT044
DT 50 R	97-08	CK2348		N/A					
DT 50 X (Supermotard)	04-08	CK2348		N/A					
RD 50 M	78-79	CK2206		CSK042					CT044
RD 50 M/MX	80-83	CK2205		CSK042					CT044
RD 50	86-87	CK2205		CSK042					CT044
RZ 50 (5FC1/2)	02	CK2238		CSK042					CT044
TT 50 E	06-15	TBA		N/A					
TY 50/TY 50 M (1F4/1G7)	77-78	CK2206		CSK042					CT044
TY 50 M (2K0)	80	CK2205		CSK042					CT044
T 50	86	CK2302		N/A					
TZR 50 (5 Plate Kit)	97-03	CK2349		N/A					
TZR 50 (4 Plate Kit)	04-16	CK2348		N/A					
V 50 M/P	75-77	CK2303		N/A					
YFM 50 S/T/RV/RW/RX Raptor	04-08	CK2303		N/A					
YZ 50 G/H/J/K	80-83	CK2206		CSK042					CT044
YZ 65 J	19-20	CK2304		CSK042					CT010
DT 80 LC1 (37A) - 4 Plate Clutch	81-84	CK2238		CSK042					CT044
DT 80 LC2 (53A) - 5 Plate Clutch	85-92	CK2254	CKF2254	CSK042					CT044
DT 80 MX Type 5J2	81-82	CK2206		CSK042					CT044
DT 80 MX Type 12X	83	CK2206		CSK042					CT044
DT 80 MX Type 36N	83-85	CK2238		CSK001					CT044
DT 80 MXS	84	CK2238		CSK042					CT044
PW 80 (All models)	83-06	CK2303		N/A					
RD 80	82	CK2206		CSK042					CT044
RD 80 LC	82	CK2238		CSK042					CT044
T 80	83-97	CK2303		N/A					
TY 80	77-83	CK2206		CSK042					CT044
V 80	79-83	CK2303		N/A					
YFM 80 D/E/F/G/H/J/K/L/M/N Badger	91-01	CK2303		N/A					
YFM 80 WP/WR/WS/RT/RV/RW/RX Raptor	02-08	CK2303		N/A					
YFM 80 GT/GV/GW/GX Grizzly	05-08	CK2303		N/A					
YZ 80 D	77	CK2238		CSK042					CT044
YZ 80 E/F	78-79	CK2254	CKF2254	CSK042					CT044
YZ 80 G	80	CK2238		CSK042					CT044
YZ 80 H/J/K/L/N	81-85	CK2287		CSK042					CT010
YZ 80 S/T/U/W	86-89	CK2304		CSK042	DRC027				CT010
YZ 80 E/LC/LW/F	93-94	CK2304		CSK039	DRC066				CT010
YZ 80 G/H/J/K/L/M/N	95-01	CK2335	CKF2335	CSK042	DRC078				CT010
YZ 85 (2T/Small Wheel F 17 Inch/R 14 Inch)	02-20	CK2335	CKF2335	CSK042	DRC111	DRCF111			CT010
YZ 85 (2T/Big Wheel F 19 Inch/R 16 Inch)	02-20	CK2335	CKF2335	CSK042	DRC111	DRCF111			CT010
TT-R 90 M/N/P/R/ES/S/ET/T/EV/EW	00-07	CK2354		N/A					
T 90 N/D (4NM1-9) Mate	00-	CK2354		N/A					
AG 100 E Farm Bike	93	CK2208		CSK001					CT039
AG 100 J (3HAA)	82	CK2208		CSK001					CT039
DT 100	76-80	CK2236		CSK042					CT039
RS 100 478	75-76	CK2208		CSK042					CT039
RS 100 (1Y8 Europe)	77-78	CK2254	CKF2254	CSK042					CT044

EBC CLUTCH KITS

Make & Model	Year	CK Series #	CKF Series #	Spring Kit #	DRC Series #	DRCF Series #	SRC Series #	SRK Series #	CT Tool #
YAMAHA Contd.									
RS 100 S (1Y8 UK)	77-78	CK2254	CKF2254	CSK042					CT044
RS 100 DX (1Y8 Europe)	79	CK2254	CKF2254	CSK042					CT044
RS 100 (1Y9 UK)	79-81	CK2254	CKF2254	CSK042					CT044
RS 100 (1Y8 Europe)	80-82	CK2254	CKF2254	CSK042					CT044
RT 100 E/F/K	93-03	CK2254	CKF2254	CSK001					CT044
RXS 100	83-97	CK2254	CKF2254	CSK001					CT044
YB 100	78-92	CK2207		N/A					CT044
YZ 100 E/F/G/H/J/K	78-83	CK2234		CSK039					CT039
T 105/105 E Crypton	96	CK2354		N/A					
T 105 E (5ER1/2)	99	CK2354		N/A					
V 110 ZE/ZK/ZHE/ZHK/FIZR/FIZR Sporty		CK2354		N/A					
TT-R 110 E	08-20	CK2375		CSK150					
RX 115 (5FS3)	99	CK2254	CKF2254	CSK042					CT044
AS3 125	71-72	CK2236		CSK042					CT039
DT 125	74	CK2209		CSK042					CT039
DT 125/125 F	76-77	CK2236		CSK039					CT039
DT 125 E	78-79	CK2236		CSK001					CT039
DT 125 MX	80-81	CK2236		CSK042					CT039
DT 125 LC Type 10V	82	CK2281		CSK042					
DT 125 LC Type 12W	82	CK2281		CSK042					
DT 125 LC Type 26G	83	CK2281		CSK042					
DT 125 LC Type 35A	85-87	CK2283		CSK042					CT044
DT 125 R	88-03	CK2313	CKF2313	CSK042	DRC042	DRCF042			CT010
DT 125 RE	04-07	CK2313	CKF2313	CSK042	DRC042	DRCF042			CT010
DT 125 (3TT4)	96	CK2283		CSK042					CT044
DT 125 X	05-06	CK2313	CKF2313	CSK042	DRC042	DRCF042			CT010
IT 125 G/H/J	80-82	CK2234		CSK042					CT044
MT 125 (Non ABS)	14-16	CK1119		CSK208					CT088
MT 125 A (ABS)	14-18	CK1119		CSK208					CT088
RD 125	73-74	CK2236		CSK042					CT039
RD 125 DX	75-76	CK2236		CSK042					CT039
RD 125 DX	78-81	CK2254	CKF2254	CSK042					CT044
RD 125 LC (MK1-MK3)	82-87	CK2283		CSK042					CT044
RZ 125 (1GV 030101-)	85	CK2283		CSK042					CT044
RS 125/RS 125 DX	75-76	CK2236		CSK042					CT039
RS 125	77-81	CK2254	CKF2254	CSK042					CT044
SR 125 SE	81-83	CK2256		CSK052					CT039
SR 125	89-03	CK2256		CSK052					CT039
TDR 125 (3HS1/3XD0/3HS3/3XD1)	89-93	CK2313		CSK042					CT010
TDR 125 (4GH/GX 1/2/3/4)	93-03	CK2313	CKF2313	CSK042	DRC042	DRCF042			CT010
TDR 125 R (3HS2/3XE2) Lightburner	93-94	CK2313	CKF2313	CSK042					CT010
TT-R 125	00-20	CK2254	CKF2254	CSK042	DRC230	DRCF230			CT044
TW 125 (5EK) 4 Friction Plate Type	99-02	CK2256		CSK052					CT039
TW 125 (5RS) 5 Friction Plate Type	03-04	CK2234		CSK052					CT039
TZR 125 (2RK/3PC1/2/3)	87-92	CK2304		CSK042					CT010
TZR 125 (3JB/4JB/4HW/4HX)	93-95	CK2313	CKF2313	CSK042					CT010
TZR 125 R (4DL1/4DL2)	91-93	CK2313	CKF2313	CSK042					CT010
TZR 125 RR (4DL3)	94-95	CK2313	CKF2313	CSK042	DRC042	DRCF042			CT010
TY 125	80-82	CK2234		CSK042					CT039
WR 125 R	09-15	CK2292		CSK212					CT061
WR 125 X (Supermoto)	09-16	CK2292		CSK212					CT061
XV 125 Virago	97-00	CK2316		CSK002					CT008
XVS 125 Drag Star (5XJ1)	00	CK2316		CSK002					CT008
XVS 125 Drag Star (5XJ3/5XJ5/5XJ7)	01-04	CK2250		CSK002					CT008
XT 125	82-83	CK2256		CSK052					CT039
XT 125 R (3D61/3D63) - 5 Friction plate type	05-06	CK2254	CKF2254	CSK042					CT044
XT 125 R (13D1) - 5 Friction plate type	07	CK2254	CKF2254	CSK042					CT044
XT 125 R (13D3/13D5) - 4 Friction plate type	07-11	CK1151	CKF1151	CSK042					CT012
XT 125 X (3D62/3D64) - 5 Friction plate type	05-06	CK2254	CKF2254	CSK042					CT044
XT 125 X (13D2) - 5 Friction plate type	07	CK2254	CKF2254	CSK042					CT044
XT 125 X (13D4/13D6) - 4 Friction plate type	07-11	CK1151	CKF1151	CSK042					CT012
XTZ 125 (5RM) (5 plate clutch)	03-10	CK2254	CKF2254	CSK042					CT044
YBA 125 Enticer (3P01/3P41)	05-06	TBA		TBA					
YBR 125 ED (3D91/3D92/3D9) - 4 Plate type	06-09	CK1151	CKF1151	N/A					CT012
YBR 125 ED (51D1/2) - 4 Plate type	10-16	CK1151	CKF1151	N/A					CT012
YBR 125 E/K (5HH1/2/C/G/J/5LX/5LX9)									
(Drum Front/Brazil) - 5 Friction plate type	00-06	CK2254	CKF2254	CSK042					CT044
YBR 125 ED (5HHB/F/H) (Disc front/Brazil)									
- 5 Friction plate type	06-08	CK2254	CKF2254	CSK042					CT044
YBR 125 Custom - 4 Friction plate type	08-16	CK1151	CKF1151	N/A					CT012
YZ 125 C (2T)	76	CK2234		CSK039					CT039
YZ 125 D/E (2T)	77-78	CK2235		CSK039					CT039
YZ 125 F (2T)	79	CK2234		CSK042					CT039
YZ 125 G (2T)	80	CK2234		CSK039					CT039

EBC CLUTCH KITS

Make & Model	Year	CK Series #	CKF Series #	Spring Kit #	DRC Series #	DRCF Series #	SRC Series #	SRK Series #	CT Tool #
YAMAHA Contd.									
YZ 125 H (2T)	81	CK2235		CSK039					CT039
YZ 125 J (2T)	82	CK2276		CSK039					
YZ 125 K/L/N (2T)	83-85	CK2278		CSK039					CT054SP
YZ 125 S/T (2T)	86-87	CK2278		CSK002	DRC028				CT054SP
YZ 125 U (2T)	88	CK2312		CSK002	DRC029				CT054SP
YZ 125 W/A (2T)	89-90	CK2311		CSK002	DRC030				CT054SP
YZ 125 B/D (2T)	91-92	CK2319		CSK081	DRC039				CT005
YZ 125 E/F/G (2T)	93-95	CK2325	CKF2325	CSK081	DRC070	DRCF070			CT005
YZ 125 H (2T)	96	CK2325	CKF2325	CSK014	DRC085	DRCF085			CT005
YZ 125 J/K/L/M/N (2T)	97-01	CK2325	CKF2325	CSK081	DRC070	DRCF070			CT005
YZ 125 P/R/S (2T)	02-04	CK2325	CKF2325	CSK014	DRC085				CT005
YZ 125 T/V/W/X/Y/Z/A/B/D/E/F/G (2T)	05-16	CK2325	CKF2325	CSK081	DRC070	DRCF070			CT005
YZF-R 125 (Standard Mount Front Caliper)	08-13	CK2292		CSK212					CT061
YZF-R 125 (Radial Mount Front Caliper/Non ABS)	14-18	CK1119		CSK208					CT088
YZF-R 125 A (Radial Mount Front Caliper/ABS)	14-18	CK1119		CSK208					CT088
RX 135 (13X)	81	CK2283		CSK042					CT044
T 135 HC/S (2S61) Crypton X/Jupiter MX/Spark 135									
/Exciter/135 LC Sniper	06-08	TBA		TBA					
T 135 SE (1S71) Crypton X/Jupiter MX/Spark 135									
/Exciter/135 LC Sniper	06-08	TBA		TBA					
TZR 150 R (4AP2)	00	CK2313	CKF2313	CSK042					CT010
DT 175	74-75	CK2209		CSK042					CT039
DT 175	76-77	CK2236		CSK039					CT039
DT 175 MX	78-81	CK2245		CSK042					CT039
DT 175 (3TS4)	96	CK2365		CSK042					CT044
IT 175 G/H/J	80-82	CK2235		CSK039					CT039
TY 175	77-80	CK2234		CSK042					CT039
AG 200 E (3GX6)	93	CK2292		CSK149	DRC055				CT039
DT 200 (2LR)	87	CK2313	CKF2313	CSK042					CT010
DT 200 WR 3XP	92-93	CK2313	CKF2313	CSK042					CT010
IT 200 L	84	CK2235		CSK001					CT039
RD 200 DX	76-81	CK2209		CSK042					CT039
RS 200	79-80	CK2209		CSK042					CT039
SDR 200 (2TV)	87-89	CK2313	CKF2313	CSK042	DRC042	DRCF042			CT010
TW 200 (2JL/4CS1/2/3/5)	91-98	CK2234		CSK149	DRC231				CT039
TW 200 (4CS4/6/5LB1/2)	98-01	CK2234		CSK149	DRC231				CT039
WR 200 D/E/F	92-94	CK2313	CKF2313	CSK042	DRC042	DRCF042			CT010
YFM 200 DKW/DX/DXA	86-90	CK2287		CSK149	DRC232				CT010SP
YFS 200 B/F/G/H/J/K/L/M/N/P/R/S/T/V Blaster	91-06	CK2313	CKF2313	CSK042	DRC042	DRCF042			CT010
YTM 200 EL/DX	89	CK2304		N/A					CT010
ST 225 (5BT) Bronco	97	CK2324		CSK149	DRC229				CT039
TDM 225	05	TBA		TBA					
TW 225 E (5VC1/2)	02-03	CK2234		CSK149	DRC229				CT039
XT 225 (2LN) Serrow (1KH 020101-)	86-87	CK2324		CSK149	DRC229				CT039
XT 225 (3RW1/2/4/5 Serrow) (1KH 034101-132000)	89-93	CK2324		CSK149	DRC229				CT039
XT 225 S (3RW3 Serrow) (1KH 034101-132000)	92	CK2324		CSK149	DRC229				CT039
XT 225 (3RW4) Serrow (1KH 080101-)	92	CK2324		CSK149	DRC229				CT039
XT 225 W (4JG1/2/3/4) Serrow	93-95	CK2324		CSK149	DRC229				CT039
XT 225 WE (4JG5/6) Serrow	97-98	CK2324		CSK149	DRC229				CT039
XT 225 (4VW1/3/5/7/9) (4VWA/B/D/G/J/L) (Brasil)	97-06	CK2324		CSK149	DRC229				CT039
YFM 225 N/S/T/U	85-89	CK2287		CSK149					CT010SP
YTM 225 DRN	85	CK2287		CSK052	DRC104				CT010SP
DT 230 R Lanza (4TP1/2)	97-98	CK2313	CKF2313	CSK042	DRC042	DRCF042			CT010
YFU1W/TW Pro Hauler Pro 4 (230cc)	89	CK2287		CSK052	DRC104				CT010SP
DT 250	75-76	CK2240		CSK002					CT008
DT 250 MX	77-80	CK2223		CSK002					
FZR 250	87	CK2331		CSK034			SRC034	SRK034	CT010
FZR 250 R (3LN1/3/5/6/7)		CK2331		CSK034			SRC034	SRK034	CT010
FZX 250 Zeal (3YX1/2/4)	91-92	CK2331		CSK034			SRC034	SRK034	CT010
IT 250 G	80	CK2250		CSK002					CT008
IT 250 H/J	81-82	CK2279	CKF2279	CSK002					CT008
IT 250 L	84	CK2280		CSK002					CT060
RD 250/A/B	73-75	CK2240		CSK039					CT008
RD 250 C/D/E/F	76-79	CK2240		CSK002					CT008
RD 250 LC	80-82	CK2240		CSK002					CT008
RZ 250 R (1AR/1XG)		CK2240		CSK002					CT008
RZ 250 R (29L)		CK2240		CSK002					CT008
RZ 250 RR (51L)		CK2240		CSK002					CT008
RZ 250 (4L3)		CK2240		CSK002					CT008
RI-Z (250cc/3XC)	90-92	CK2319		CSK052					CT005
XT 250 Serrow (3C51/2)	05-08	CK2370	CKF2370	CSK081					CT005
SR 250 (US Custom/3Y8/6 Plate Clutch)	80-81	CK2267		CSK002					CT008
SR 250 SE (Special/3Y8/5 Plate Clutch)	81-83	CK2261		CSK002					CT008
SR 250 (4GR1/2/3/4/5 Plate Clutch)	94-96	CK2261		CSK002					CT008

CLUTCH APPLICATIONS

EBC CLUTCH KITS

Make & Model	Year	CK Series #	CKF Series #	Spring Kit #	DRC Series #	DRCF Series #	SRC Series #	SRK Series #	CT Tool #
YAMAHA Contd.									
SR 250 (Classic/21L/5 Plate Clutch)	96-00	CK2261		CSK002					CT008
SRV 250 Soulful Twin/Renaissa (4DN1-6)	92-97	CK2316		N/A					CT008
SRX 250		CK2261		CSK049					CT008
TDR 250 (3CK1/3CK2 Europe - Eng/Frame # 3CK)	88-92	CK2319		CSK052					CT025
TT 250 R (4GY1 Japan - 6 Plate Clutch)	93-94	CK2370	CKF2370	CSK049					CT005
TT 250 R (4RR1/2 Japan - 6 Plate Clutch)	95-97	CK2370	CKF2370	CSK049					CT005
TT 250 R (4GY3/4GY5/4WA1 - Raid - Japan - 6 Plate Clutch)	94-96	CK2370	CKF2370	CSK049					CT005
TT 250 R (4MR2 - UK - 6 Plate Clutch)	96	CK2370	CKF2370	CSK049					CT005
TT 250 RL (4PX5 - 6 Plate Clutch)	99	CK2370	CKF2370	CSK049					CT005
TT 250 RM (4PX6 - 7 Plate Clutch)	00	CK2319		CSK014	DRC226				CT005
TYR 250 D/E	77-78	CK2240		CSK002					CT008
TY 250 S/R	84-90	CK2295		CSK059					CT060
TY 250 R	91-92	CK2295		CSK059					CT060
TY 250 Z	93-96	CK2319		CSK002					CT005
TZR 250 (2MA/2XW1/2XW2 Europe - Eng/Frame # 2MA -)	87-92	CK2319		CSK052					CT025
TZR 250 (1KT/2AW Japan - Eng/Frame # 1KT - 000/056-)	87	CK2319		CSK052					CT025
TZR 250 (2XT1 Japan - Eng/Frame # 1KT - 09-)	88	CK2319		CSK052					CT025
TZR 250 (3MA1 - Reverse Cylinder - Eng/Frame # 3MA 0001-)	89	CK2342		CSK081					CT008
TZR 250 (3MA3/3MA5 - Reverse Cylinder - Eng/Frame # 3MA -0.793103448275862 -)	89-90	CK2342		CSK081					CT008
TZR 250 SP (3MA4 - Eng/Frame # 3MA 55 -)	90	N/A		CSK002					
TZR 250 R (3XV1/3XV4/3XV6 - V-Twin - Eng/Frame # 3XV 000101-08600)	91-93	CK2319		CSK014					CT005
TZR 250 RS (3XV8/3XV9/3XVA - V-Twin - Eng/Frame # 3XV 080101-08200/088-)	92-94	N/A		N/A					
TZR 250 SPR (3XVC - V-Twin - Eng/Frame # 3XV -107101)	95	N/A		N/A					
WR 250 ZB/ZD/ZE (2T)	91-93	CK2309		CSK081					CT020
WR 250 ZF/ZG/ZH/ZJ/ZK (2T)	94-98	CK2274	CKF2274	CSK081					CT020
WR 250 FN/FP/FR/FS/FT/FV/FW/FX/FY/FZ/FA/FB/FD (4T)	01-13	CK2355	CKF2355	CSK002	DRC119	DRCF119			CT005
WR 250 FF/FG (4T/Reverse Cylinder)	15-19	CK2355	CKF2355	TBA					CT005
WR 250 R L	20	CK2319		CSK014	DRC226				CT005
WR 250 RX/RY (32D1/3)	08-15	CK2319		CSK014	DRC226				CT005
WR 250 XX/XY (Supermoto) (32D2/4)	08-15	CK2319		CK2319	DRC226				CT005
XG 250 Tricker (5XT1)	04-06	CK2370	CKF2370	CSK081					CT005
XS 250 C/D/E	78-80	CK2279	CKF2279	CSK002					CT008
XS 250 SE/C	80-81	CK2250		CSK049					CT008
XT 250	80	CK2267		CSK001					CT008
XT 250 Serrow (3C51/2)	05-08	CK2370	CKF2370	CSK081					CT005
XTZ 250 Lander (Brasil) (4B41/2/3)	07-09	CK1217		CSK132					CT014
XV 250 Virago	89-94	CK2316		CSK002					CT008
XV 250 S Virago	95-00	CK2316		CSK002					CT008
XVS 250 Dragstar	01-04	CK2250		CSK002					CT008
YBR 250 (5D11/3/4)	07-11	CK1217		CSK132					CT014
YDS7 250cc	72	CK2240		CSK039					CT008
YFB 250 D/E/F/G/H/J/K/FWF/FWG/FWH/FWJ /FWK/FWL/FWM	92-00	CK2287		CSK052	DRC104				CT010SP
YFM 250 W/A/B	90-92	CK2287		CSK052	DRC104				CT010SP
YFM 250 XN/XP/XR/XS Bear Tracker	00-04	CK2287		CSK052	DRC104				CT010SP
YFM 250 FN	01	CK2287		CSK052	DRC104				CT010SP
YFM 250 BT/BV Bruin	05-06	CK2287		CSK052	DRC104				CT010SP
YFM 250 BW/BX/BY Big Bear	07-10	CK2287		CSK052	DRC104				CT010SP
YFM 250 R (33B)	09-11	CK2370	CKF2370	CSK058	DRC200	DRCF200			CT005
YFM 250 R (1BT)	12-13	CK2370	CKF2370	TBA					CT005
YTZ 250 N/S (TRI Z)	85-86	CK2280		CSK002	DRC032				CT060
YS 250 Fazer (Brasil) (1S41/2/3)	06-08	CK1217		CSK132					CT014
YZ 250 D/E (2T)	77-78	CK2244		CSK002					CT008
YZ 250 F (2T)	79	CK2250		CSK002					CT008
YZ 250 G (2T)	80	CK2244		CSK002					CT008
YZ 250 H (2T)	81	CK2279	CKF2279	CSK002					CT008
YZ 250 J/K/L (2T)	82-84	CK2280		CSK002					CT060
YZ 250 N/S/T (2T)	85-87	CK2280		CSK103	DRC035				CT060
YZ 250 U/W/A/B/D (2T)	88-92	CK2309		CSK081	DRC031				CT020
YZ 250 E/F/G/H/J/L (2T)	93-99	CK2274	CKF2274	CSK081	DRC071				CT020
YZ 250 M/N (2T)	00-01	CK2274	CKF2274	CSK049	DRC097				CT020
YZ 250 (2T)	02-20	CK2274	CKF2274	CSK092	DRC113	DRCF113			CT020
YZ 250 FN/FP/FR/FS/FT/FV/FW (4T)	01-07	CK2355	CKF2355	CSK191	DRC109	DRCF109			CT005
YZ 250 FX/FY/FZ/FA/FB/FD (4T)	08-13	CK2355	CKF2355	CSK137	DRC227	DRCF227			CT005
YZ 250 FE/FF (4T)	14-15	CK2355	CKF2355	CSK214	DRC288	DRCF288			CT005
YZ 250 F (4T)	16-20	CK2361	CKF2361		DRC313	DRCF313			CT005
YZ 250 FG (270mm Disc)	16-18	CK2355	CKF2355	CSK214	DRC288	DRCF288			CT020

CLUTCH APPLICATIONS

EBC CLUTCH KITS

Make & Model	Year	CK Series #	CKF Series #	Spring Kit #	DRC Series #	DRCF Series #	SRC Series #	SRK Series #	CT Tool #
YAMAHA Contd.									
YZ 250 FGY (60th Anniversary Edition/270mm Disc)	16	CK2355	CKF2355	CSK214	DRC288	DRCF288			CT020
YZ 250 F FK	19	CK2387	CKF2387		DRC315	DRCF315			
MTN 320 A (MT03 321cc)	2016	CK1193		CSK219			SRC128	SRK128	CT080
MT-03	12-20	CK1193		CSK219			SRC128	SRK128	CT080
YZF-R3 (321cc/ABS)	15-20	CK1193		CSK219			SRC128	SRK128	CT080
R5/5A/5B 350cc	70-72	CK2240		CSK039					CT008
RD 350/A/B	73-75	CK2240		CSK039					CT008
RD 350 LC/YPVS	80-84	CK2240		CSK002					CT008
RD 350 N/F/F2/R	85-95	CK2240		CSK002					CT008
TT 350 A (3GJ)	90-95	CK2240		CSK014	DRC056				CT008
TT 350 (ITJ)	85-89	CK2240		CSK014	DRC056				CT008
XT 350	85-95	CK2240		CSK014	DRC056				CT008
YFM 350 FWT/FWU/FWW/FWA/FWE Big Bear	86-93	CK2290	CKF2290	CSK058	DRC033	DRCF033			CT090SP
YFM 350 FWF/FWG/FWH/FWJ	94-97	CK2290	CKF2290	CSK049	DRC082				CT090SP
YFM 350 XD/XE/XF/XG/XH/XJ/XK/XL/XM/XN/XP/XR/XS	92-04	CK2290	CKF2290	CSK058	DRC033	DRCF033			CT090SP
YFM 350 ERD/ERE/ERF	92-94	CK2290	CKF2290	CSK058	DRC033	DRCF033			CT090SP
YFM 350 ERG	95	CK2290	CKF2290	CSK049	DRC082				CT090SP
YFM 350 FX Wolverine All models	95-04	CK2240		CSK081	DRC228				CT008
YFM 350 UH/UJ	96-97	CK2290	CKF2290	CSK049	DRC082				CT090SP
YFM 350 S/T/V/R-WW/RW/RX/RV Raptor	04-09	CK2290	CKF2290	CSK058	DRC033	DRCF033			CT090SP
YZF 350 T/U/W/A/B/D/E/F/G/H/J/K/L/M/N/P									
/R/S/T/V Banshee	87-09	CK2279	CKF2279	CSK002	DRC043	DRCF043			CT008
DT 400	75-76	CK2240		CSK002					CT008
DT 400 MX	77-79	CK2290	CKF2290	CSK002					CT008
FZ 400 N (IFK/33M/46X)	85	CK2255	CKF2255	CSK014					CT008
FZ 400 (4YR1)	96	CK2371		CSK035					CT010
FZR 400 RR (4DX)	92	CK2317		CSK185			SRC006	SRK006	CT010
FZR 400 Genesis (1WG)	86	CK2317		CSK185			SRC006	SRK006	CT010
FZR 400 RSP (2TK-EXUP)	87	CK2315		CSK185			SRC007	SRK007	CT010
FZR 400 (3EN1/3EN2)	88-89	CK2317		CSK185			SRC006	SRK006	CT010
FZR 400 RR (3TJI)		CK2317		CSK185			SRC006	SRK006	CT010
FZR 400 RRSP (3TJ2/6/7)		CK2315		CSK185			SRC007	SRK007	CT010
RD 400 C/D/E/F	76-79	CK2240		CSK002					CT008
SR 400 (3HT1)	88	CK2296		CSK014					CT008
SR 400 (2RD)	14-16	CK2296		CSK014					CT008
SRX 400 (1JL)		CK2297	CKF2297	CSK081					CT008
SRX 400 (3VN1/3VN2/3VN5)	90-96	CK2297	CKF2297	CSK081					CT008
XJR 400 (4HM1/4HM2/4HM4/4HM7)	93-96	CK2255	CKF2255	CSK081					CT008
XJR 400 (4HM3/4HM5/4HM6/4HM9/4HMA/4HMB)	95-99	CK2255	CKF2255	CSK081					CT008
XS 400	78-79	CK2279	CKF2279	CSK002					CT008
XS 400	82	CK2262		CSK002					CT017
XS 400 SE	80	CK2279	CKF2279	CSK002					CT008
XVS 400	96	CK2299		CSK091					CT020
YFM 400 FWE/FWF/FWG/FWH/FWJ/FWK Kodiak	93-00	CK2290	CKF2290	CSK049	DRC082				CT090SP
YFM 400 FPR/FPS Big Bear	03-04	CK2290	CKF2290	CSK049	DRC082				CT090SP
YZ 400 D/E/F (2T)	77-79	CK2279	CKF2279	CSK002					CT008
YZ 400 FK/FL (4T)	98-99	CK2310		CSK181	DRC265				CT008
WR 400 FK/FL/FM/FN (4T)	98-01	CK2310		CSK049	DRC099				CT008
IT 425 G	80	CK2279	CKF2279	CSK002					CT008
WR 426 FN/FP (4T)	01-02	CK2356	CKF2356	CSK062	DRC110				CT020
YZ 426 FM (4T)	00	CK2352	CKF2352	CSK181	DRC102				CT020
YZ 426 FN/FP (4T)	01-02	CK2356	CKF2356	CSK092	DRC116				CT020
WR 450 FR (4T)	03	CK2356	CKF2356	CSK062	DRC110				CT020
WR 450 FS (4T)	04	CK2352	CKF2352	CSK062	DRC263				CT020
WR 450 FT/FV/FW/FX/FY/FZ/FA/FB/FD/FE/FF (4T)	05-15	CK2274	CKF2274	CSK092	DRC194				CT020
WR 450 FG/FH (270mm F. Disc/4T)	16-20	CK2274	CKF2274	CSK037	DRC298	DRCF298			CT020
YZ 450 FR/FS (4T)	03-04	CK2352	CKF2352	CSK092	DRC121				CT020
YZ 450 FT/FV (4T)	05-06	CK2352	CKF2352	CSK058	DRC162				CT020
YZ 450 FW/FX/FY/FZ/FA/FB/FD (4T)	07-13	CK2274	CKF2274	CSK037	DRC195	DRCF195			CT020
YZ 450 FE/FF (4T)	14-20	CK2274	CKF2274	CSK213	DRC287	DRCF287			CT020
YZ 450 FG (270mm Disc)	16	CK2274	CKF2274	CSK213	DRC287	DRCF287			CT020
YZ 450 FG (60th Anniversary Edition/270mm Disc)	16	CK2274	CKF2274	CSK213	DRC287	DRCF287			CT020
YZF 450 S/T/V Quad	04-06	CK2364	CKF2364	CSK187	DRC159	DRCF159			CT020
YZF 450 W/X Quad	07-09	CK2364	CKF2364	CSK058	DRC201	DRCF201			CT020
YZF 450 B/D	13-14	CK2364	CKF2364	CSK092					CT020
YZF 450 RX/RV Quad	09-10	CK2364	CKF2364	CSK058	DRC201	DRCF201			CT020
YZF 450 RSEA/RSEB/RSED/RSE	11-14	CK2274	CKF2274	CSK058					CT020
IT 465 H/J	81-82	CK2279	CKF2279	CSK002					CT008
YZ 465 G/H	80-81	CK2279	CKF2279	CSK002					CT008
IT 490 L	84	CK2280		CSK002	DRC032				CT060
YZ 490 J/K/L/N/S/T/U	82-88	CK2280		CSK002	DRC032				CT060
RD 500 LC	84-86	CK2305		CSK014					CT017
RZV 500 R (51X)	85	CK2305		CSK014					CT017
SR 500	78-82	CK2296		CSK014					CT008

CLUTCH APPLICATIONS

EBC CLUTCH KITS

Make & Model	Year	CK Series #	CKF Series #	Spring Kit #	DRC Series #	DRCF Series #	SRC Series #	SRK Series #	CT Tool #
YAMAHA Contd.									
SR 500 S (3GWS)	98	CK2296		CSK014					CT008
SR 500 (3GW1/4/6/7)	96-98	CK2296		CSK014					CT008
WR 500 ZD	92-93	CK2280		CSK002					CT060
TT 500 G/H	80-81	CK2296		CSK014					CT008
XP 500 (T-Max Scooter - All models)	01-11	CK2378		CSK189			SRC099	SRK099	
XT 500 C	76	CK2334		CSK014					CT008
XT 500	77-81	CK2296		CSK014					CT008
XS 500 B	77	CK2255	CKF2255	CSK014					CT008
XS 500 C/D	78-79	CK2255	CKF2255	CSK014					CT008
T Max 530 ABS	12-19	CK2382		CSK267	DRC284				
T Max 530 DX ABS	17-19	CK2382		CSK267	DRC284				
T Max 530 SX ABS	17-19	CK2382		CSK267	DRC284				
T Max 530 Black Max ABS	13	CK2382		CSK267	DRC284				
T Max 530 Bronze Max ABS	14	CK2382		CSK267	DRC284				
T Max 530 Iron Max ABS	15	CK2382		CSK267	DRC284				
XV 535/535 S Virago	88-03	CK2299		CSK091					CT020
XJ 550	81	CK2306	CKF2306	CSK014					CT008SP
XJ 550 H/J/K Maxim	81-83	CK2306	CKF2306	CSK014					CT008SP
XJ 550 RH/RJ/RK Seca	81-83	CK2306	CKF2306	CSK014					CT008SP
XT 550	82	CK2310		CSK014					CT008
XT 550	83	CK2297	CKF2297	CSK014			SRC072	SRK072	CT008
XZ 550	82	CK2296		CSK014					CT008
FZ 600	87-88	CK2255	CKF2255	CSK014					CT008SP
FZR 600	89-93	CK2315		CSK185			SRC007	SRK007	CT010
FZR 600 R (4JH1/4)	94-95	CK2332	CKF2332	CSK081					CT054SP
FZ6 Naked - Non-ABS/2 Piston Caliper (1B3/1B3D)	04-07	CK2255	CKF2255	CSK017			SRC051	SRK051	CT008SP
FZ6 NS - Naked/Non-ABS/2 Piston Caliper (1B35/1B6)	05-06	CK2255	CKF2255	CSK017			SRC051	SRK051	CT008SP
FZ6 S2 - Naked/Non ABS/4 Piston Caliper (5S51/5S5)	07-09	CK2255	CKF2255	CSK017			SRC051	SRK051	CT008SP
FZ6 Fazer - Half Fairing/Non ABS/2 Piston Caliper (5VX/5VXL)	04-07	CK2255	CKF2255	CSK017			SRC051	SRK051	CT008SP
FZ6 Fazer - Half Fairing/ABS/2 Piston Caliper (4P5)	06-07	CK2255	CKF2255	CSK017			SRC051	SRK051	CT008SP
FZ6 Fazer S2 - Half Fairing/Non ABS/4 Piston Caliper (4S81/4S8)	07-09	CK2255	CKF2255	CSK017			SRC051	SRK051	CT008SP
FZ6 Fazer S2 - Half Fairing/ABS/4 Piston Caliper (5S2)	08	CK2255	CKF2255	CSK017			SRC051	SRK051	CT008SP
FZS 600 Fazer	98-99	CK2347		CSK002					CT054SP
FZS 600 Fazer/SP	00-03	CK2347		CSK081					CT054SP
SRX 600	86-87	CK2297	CKF2297	CSK014			SRC072	SRK072	CT008
SRX 600 (1JK/3SX)	85-91	CK2297	CKF2297	CSK014			SRC072	SRK072	CT008
TT 600 L (Kick Start Only)	84	CK2297	CKF2297	CSK002	DRC057				CT008
TT 600 N (59X) Frame # 59X 000101-7852 (Kick Start Only)	85-88	CK2297	CKF2297	CSK002	DRC057				CT008
TT 600 W (2JT/3SU1) Frame # 59X 7853 Onwards (Kick Start Only)	89-92	CK2297	CKF2297	CSK002	DRC057				CT008
TT 600 R (5CH1) (Kick Start Only)	97	CK2297	CKF2297	CSK002	DRC057				CT008
TT 600 R (5CH2) (Kick Start Only)	98-99	CK2297	CKF2297	CSK002	DRC057				CT008
TT 600 R (5CH3/4) (Kick Start Only)	00-02	CK2297	CKF2297	CSK002	DRC057				CT008
TT 600 RE (5CH5) (Electric Start)	04	CK2297	CKF2297	CSK014	DRC088				CT008
TT 600 E (Electric Start)	94-01	CK2297	CKF2297	CSK014	DRC088				CT008
TT 600 K (Kick Start Only)	93-96	CK2297	CKF2297	CSK002	DRC057				CT008
XJ 600	84-92	CK2255	CKF2255	CSK014					CT008SP
XJ 600 S Diversion	92-03	CK2255	CKF2255	CSK014					CT008SP
XJ 600 N	95-03	CK2255	CKF2255	CSK014					CT008SP
XJ6-N 600 (Naked - Non ABS & ABS Model - 20S)	09-15	CK2306	CKF2306	CSK017			SRC127	SRK127	CT008SP
XJ6-F Diversion 600 (Full Fairing Diversion - Non ABS & ABS Models - 1CW)	10-15	CK2306	CKF2306	CSK017			SRC127	SRK127	CT008SP
XJ6-S Diversion 600 (Top Fairing Diversion - Non ABS & ABS Models - 36C)	09-15	CK2306	CKF2306	CSK017			SRC127	SRK127	CT008SP
XJ6-SP Diversion 600 (Non ABS & ABS Models)	13	CK2306	CKF2306	CSK017			SRC127	SRK127	CT008SP
XT 600 (Kick Start Model)	84-87	CK2297	CKF2297	CSK002	DRC057				CT008
XT 600 Z (Kick Start Model)	84-85	CK2297	CKF2297	CSK002	DRC057				CT008
XT 600 Z (Kick & Electric Start)	86-90	CK2297	CKF2297	CSK014	DRC088	DRCF088			CT008
XT 600 E (Electric Start Only)	90-03	CK2297	CKF2297	CSK014	DRC088	DRCF088			CT008
YX 600 S/SC/T/TC/UC/U/W/WC/A/AC Radian	86-90	CK2255	CKF2255	CSK014					
YZF 600 Thunder Cat	96-03	CK2332	CKF2332	CSK102			SRC033	SRK033	CT054SP
YZF 600 R R6 (8 plate)	99-02	CK2255	CKF2255	CSK017			SRC051	SRK051	CT008SP
YZF-R6 (8 plate)	03-05	CK2255	CKF2255	CSK092			SRC074	SRK074	CT008S
YZF R6 (9 plate)	06-17	CK2318	CKF2318	CSK126			SRC087	SRK087	CT008SP
YZF R6 (8 Plate)	18-20	CK2358		CSK126			SRC160	SRK160	CT008SP
XJ 650	80-84	CK2255	CKF2255	CSK081					CT008SP
XJ 650 Turbo	82	CK2255	CKF2255	CSK014					CT008SP
XJ 650 G/H/J/K Maxim	80-83	CK2255	CKF2255	CSK081					CT008SP
XJ 650 LH Midnight	81	CK2255	CKF2255	CSK081					CT008SP
XJ 650 R/LK Seca	82-83	CK2255	CKF2255	CSK014					CT008SP
XS 650	75-76	CK2226		CSK014					CT074

CLUTCH APPLICATIONS

EBC CLUTCH KITS

Make & Model	Year	CK Series #	CKF Series #	Spring Kit #	DRC Series #	DRCF Series #	SRC Series #	SRK Series #	CT Tool #
YAMAHA Contd.									
XS 650	77-79	CK2226		CSK002					CT074
XS 650	80-81	CK2242		CSK014					CT074
XS 650 SE	79-81	CK2242		CSK014					CT074
XVS 650 Dragstar	97-04	CK2309		CSK091					CT020
XVS 650 A Dragstar Classic	98-07	CK2309		CSK091					CT020
MT-03 (660cc)	06-12	CK2368		CSK123					CT020
SZR 660	96-97	CK2297	CKF2297	CSK014	DRC088	DRCF088			CT008
XTZ 660 Tenere	91-97	CK2297	CKF2297	CSK014	DRC088	DRCF088			CT008
XT 660 X Supermoto (1D21/1D23/1D24/1D26/3S72/10S1/11B1)	04-09	CK2368		CSK123					CT020
XT 660 X Supermoto (10S7)	10-16	CK2368		CSK123					CT020
XT 660 R (Model Code 5VK1/3/4/6/8/3S62/3S63)	04-07	CK2368		CSK123					CT020
XT 660 R (Model Code 5VKA/5VKC)	08-09	CK2368		CSK123					CT020
XT 660 R (Model Code 5VKE)	10-16	CK2368		CSK123					CT020
XT 660 Z Tenere (Non ABS)	08-16	CK2368		CSK123					CT020
XT 660 ZA Tenere (ABS)	11-16	CK2368		CSK123					CT020
YFM 660 RN/RP/RR/RS/RT Raptor	01-05	CK2297	CKF2297	CSK014	DRC088	DRCF088			CT008
MT-07 Non ABS (689cc/2 Cyl)	14-20	CK2309		CSK037			SRC125	SRK125	CT020
MT-07A ABS (689cc/2 Cyl)	14-20	CK2309		CSK037			SRC125	SRK125	CT020
MT-07 Motocage ABS (689cc/2 Cyl)	15	CK2309		CSK037			SRC125	SRK125	CT020
FZX 700 S/SC/T/TC Fazer	86-87	CK2255	CKF2255	CSK017			SRC051	SRK051	CT008SP
YFM 700 RV/RW/RA/RD/RE	06-14	CK2364	CKF2364	CSK037	DRC128	DRCF128			CT020
YFM 700 RSE	13-14	CK2364	CKF2364	CSK037	DRC128	DRCF128			CT020
XSR 700 ABS (MTM 690-U)	16	CK2309		CSK037			SRC125	SRK125	CT020
FZ 750	85-86	CK2255	CKF2255	CSK017			SRC051	SRK051	CT008SP
FZ 750	87-92	CK2306	CKF2306	CSK017					CT008SP
FZX 750	87	CK2306	CKF2306	CSK017					CT008SP
FZR 750	87	CK2308		CSK017			SRC008	SRK008	CT008SP
FZR 750 R OW01	89-90	CK2318	CKF2318	CSK017			SRC009	SRK009	CT008SP
XJ 750	82-83	CK2255	CKF2255	CSK014					CT008SP
XJ 750 RF/RJ/RK Seca	81-83	CK2255	CKF2255	CSK014					CT008SP
XS 750	77-79	CK2279	CKF2279	CSK014					CT008SP
XS 750 SE	79-80	CK2279	CKF2279	CSK014					CT008SP
XTZ 750	89-95	CK2255	CKF2255	CSK187					CT008
XV 750 SE	81	CK2274	CKF2274	CSK081					CT020
XV 750 Virago	92-97	CK2274	CKF2274	CSK081					CT020
YZF 750 R/SP	93-97	CK2318	CKF2318	CSK017			SRC009	SRK009	CT008SP
YZF7R OW02	99-00	CK2353		N/A					CT020
FZ8 N-800cc (Naked/Single Headlight/Non ABS)	11-15	CK2364	CKF2364	CSK119			SRC126	SRK126	CT020
FZ8 NA-800cc (Naked/Single Headlight/ABS)	11-15	CK2364	CKF2364	CSK119			SRC126	SRK126	CT020
Fazer 8 S-800cc (Top Fairing/Twin Headlight/Non ABS)	11-15	CK2364	CKF2364	CSK119			SRC126	SRK126	CT020
Fazer 8 SA-800cc (Top Fairing/Twin Headlight/ABS)	11-15	CK2364	CKF2364	CSK119			SRC126	SRK126	CT020
TDM 850	91-95	CK2255	CKF2255	CSK017					CT008
TDM 850	96-98	CK2318	CKF2318	CSK017			SRC009	SRK009	CT008
TDM 850	99-01	CK2318	CKF2318	CSK092					CT008
TRX 850	96-98	CK2318	CKF2318	CSK017			SRC009	SRK009	CT008
XS 850	80	CK2273		CSK014					CT008SP
MT-09 (1RC/Non ABS/847cc/3 Cyl Engine)	14-16	CK2352	CKF2352	CSK119			SRC124	SRK124	CT020
MT-09 Tracer ABS (847cc/3 Cyl Engine)	15-20	CK2352	CKF2352	CSK119			SRC124	SRK124	CT020
MT-09A (2DR/ABS/847cc/3 Cyl Engine)	14-20	CK2352	CKF2352	CSK119			SRC124	SRK124	CT020
MT-09A Sport Tracker ABS (847cc/3 Cyl Engine)	14-20	CK2352	CKF2352	CSK119			SRC124	SRK124	CT020
MT-09A Street Rally ABS (847cc/3 Cyl Engine)	14-20	CK2352	CKF2352	CSK119			SRC124	SRK124	CT020
TDM 900 (5PS/Non ABS)	02-14	CK2318	CKF2318	CSK037					CT008
TDM 900 A (2B0/ABS)	05-13	CK2318	CKF2318	CSK037					CT008
XJ 900	83	CK2255	CKF2255	CSK049					CT008SP
XJ 900	90	CK2255	CKF2255	CSK049					CT008SP
XJ 900 F	85-92	CK2255	CKF2255	CSK017					CT008SP
XJ 900 S Diversion	95-03	CK2255	CKF2255	CSK187					CT008SP
XSR 900 ABS	18-20	CK2388					SRC162	SRK162	
XV 950 Racer (Remote Reservoir Rear Shocks)	15-16	CK2379		CSK911					CT017
XVS 950 A Midnight Star	09-13	CK2379		CSK911					CT017
XV 950 - XVS 950 (Non ABS/Standard Rear Shocks)	14	CK2379		CSK911					CT017
XV 950 CU - XVS 950 (1XC1/ABS/Standard Rear Shocks)	14-16	CK2379		CSK911					CT017
XV 950 R - XVS 950 R (2DE/Remote Reservoir Rear Shocks)	14-16	CK2379		CSK911					CT017
FZ1 (Naked) (1000cc) (2D11)	06-09	CK2356	CKF2356	CSK119			SRC077	SRK077	CT020
FZ1-N/NA (Naked/Non ABS & ABS)	10-15	CK2356	CKF2356	CSK119			SRC077	SRK077	CT020
FZ1 Fazer (1000cc) (3C3/Half Fairing/Non ABS)	06-15	CK2356	CKF2356	CSK119			SRC077	SRK077	CT020
FZ1 Fazer (Half Fairing - ABS - 5D0)	08-15	CK2356	CKF2356	CSK119			SRC077	SRK077	CT020
FZR 1000 (2RG - Genesis Non EX-UP)	87-88	CK2308		CSK017			SRC008	SRK008	CT008SP
FZR 1000 (3GM1/3/5/7/8-3LG1/2/3/4-3LH1/2/3/4-3LE1/2/3/4 - EX-UP Models)	89-92	CK2321		CSK037			SRC031	SRK031	CT008SP
FZR 1000 (3GME/F-3LG5/6-3LH5/6-3LE/5-3LG6-3LJ6-4PM1 - EX-UP Models)	93-95	CK2327		CSK037			SRC029	SRK029	CT008SP
FZS 1000 Fazer	01-05	CK2358		CSK037					CT008SP

EBC CLUTCH KITS

Make & Model	Year	CK Series #	CKF Series #	Spring Kit #	DRC Series #	DRCF Series #	SRC Series #	SRK Series #	CT Tool #
YAMAHA Contd.									
GTS 1000	93-96	CK2327		CSK037			SRC029	SRK029	CT008SP
MT-10 (998cc)	16	CK4510	CKF4510	CSK218			SRC129	SRK129	CT079SP
XV 1000 TR1	81	CK2274	CKF2274	CSK014					CT020
XV 1000	86	CK2274	CKF2274	CSK014					CT020
YXR 1000 R EPS (Side X Side) YXZ10PXG	16	TBA		TBA					
YXR 1000 SE (Side X Side)	16	TBA		TBA					
YZF 1000 Thunder Ace	96-02	CK2327		CSK037			SRC029	SRK029	CT008SP
YZF R1 (4XV1/2)	98	CK2226		CSK903			SRC056	SRK056	CT017
YZF R1 (4XV7/8 5JJ1/8 5PW1/7)	99-03	CK2350		CSK903			SRC065	SRK065	CT017
YZF R1	04-06	CK2356	CKF2356	CSK119			SRC077	SRK077	CT020
YZF R1 SP (4B1)	06	CK2356	CKF2356	CSK211			SRC093	SRK093	CT020
YZF R1	07-08	CK2356	CKF2356	CSK211			SRC093	SRK093	CT020
YZF R1	09-14	CK2352	CKF2352	CSK211			SRC096	SRK096	CT020
YZF R1	15-20	CK4510	CKF4510	CSK218			SRC129	SRK129	CT079SP
YZF R1M	15-20	CK4510	CKF4510	CSK218			SRC129	SRK129	CT079SP
YZF R1 (60th Anniversary Edition)	16	CK4510	CKF4510	CSK218			SRC129	SRK129	CT079SP
BT 1100 Bulldog P/R/S/T/V	02-06	CK2274	CKF2274	N/A					CT020
XS 1100/1100 S	78-81	CK2230		CSK014					CT077SP
XV 1100 Virago	89-00	CK2274	CKF2274	N/A					CT020
XVS 1100 A Dragstar Classic	00-07	CK2274	CKF2274	N/A					CT020
XVS 1100 Dragstar	99-04	CK2274	CKF2274	N/A					CT020
FJ 1100	84-85	CK2285		CSK903					CT017
FJ 1200/1200 A	86-95	CK2285		CSK903					CT017
XT 1200 Z Super Tenere (ABS/UBS Brake System)	10-16	CK2362		CSK903			SRC131	SRK131	CT017
XT 1200 ZE Super Tenere (ABS/UBS Brake System)	14-16	CK2362		CSK903			SRC131	SRK131	CT017
XVZ 12 TD	85	CK2300		CSK046					CT050SP
V-Max All models	91-03	CK2300		CSK906					CT050SP
XJR 1200	95-98	CK2285		CSK903					CT017
FJR 1300 N/P	01-02	CK2362		CSK903			SRC131	SRK131	CT017
FJR 1300 R/AR/S/AS/AT (ABS)	03-05	CK2362		CSK903			SRC131	SRK131	CT017
FJR 1300 A (1CY/Manual G/Shift)	06-15	CK2362		CSK903			SRC131	SRK131	CT017
FJR 1300 AE (Electronic Suspension Adjustment /USD Forks)	14-15	CK2362		CSK903			SRC131	SRK131	CT017
FJR 1300 AS (Electric G/Shift)	06-15	CK2362		N/A			N/A	N/A	CT017
XJR 1300 L 5EA2/5EA3/5EA4	99	CK2285		CSK903					CT017
XJR 1300 M 5EAA/5EAB/5EAC	00	CK2285		CSK903					CT017
XJR 1300 (5EA1/5EA7)	98-99	CK2285		CSK903					CT017
XJR 1300 (5EA9/5EAG)	00	CK2285		CSK903					CT017
XJR 1300 C/Racer	15-16	CK2285		CSK903					CT017
XJR 1300 N/P (5EAP/5EAS/5EAT/5EAW/5EAV/5EAY)	01-02	CK2285		CSK903					CT017
XJR 1300 R/S 5WM1/5WM3/5WM5/5WM6/5WM7 /5WM9	03-04	CK2285		CSK903					CT017
XJR 1300 T/V/W/X/Y 5WMA/5WMC/5WMD/5WMF	05-14	CK2285		CSK903					CT017
XJR 1300 SP (L) (5EA5/5EA6/5EA8)	99	CK2285		CSK903					CT017
XJR 1300 SP (M) (5EAD/5EAE/5EAF)	00	CK2285		CSK903					CT017
XJR 1300 SP (N) (5EAL/5EAM/5EAN)	01	CK2285		CSK903					CT017
XVZ 13 Royal Star All models	96-01	CK2300		CSK906					CT050SP
XVS 1300 A Midnight Star	07-16	CK2362		CSK903			SRC131	SRK131	CT017
XVS 1300 CU Custom	14-16	CK2362		CSK903			SRC131	SRK131	CT017
XVS 1300 ACFD Midnight Star/Casual Full Dresser (With Handbar Fairing)	14-16	TBA		TBA					
XV 1600 A Wild Star	99-04	CK2351		CSK906					CT050SP
MT-01 (1670cc)	05-09	CK2366		CSK903					CT017
MT-01S (1670cc)	09	CK2366		CSK903					CT017
XV 1700 PCR Road Star Warrior	03-05	CK2363		CSK906					CT050SP
XV 1700 V-Max	09-16	CK2380		CSK903					CT017
XV 1900 A Midnight Star (Diaphragm Spring)	06-12	CK2367		CSK903					CT017
XV 1900 A Midnight Star (3 Spring Clutch)	13-16	TBA		TBA					
XV 1900 ACFD Midnight Star/Casual Full Dresser (Handlebar Fairing)	14-16	TBA		TBA					
AJP									
PR5 250 Trials	13-17	CK1318		CSK226	DRC300				CT091
PR5 250 Supermoto	13-17	CK1318		CSK226	DRC300				CT091
PR5 250 Enduro	13-17	CK1318		CSK226	DRC300				CT091
PR5 250 Extreme	13-17	CK1318		CSK226	DRC300				CT091
APRILIA									
AF1 Futura 50	90-92	CK2348		N/A					
Classic 50	92-01	CK2348		N/A					
Europa 50	90-92	CK2348		N/A					
MX 50	03-05	CK2348		N/A					
Pegaso 50	92-94	CK2348		N/A					
RS 50	93-05	CK2348		N/A					

CLUTCH APPLICATIONS

EBC CLUTCH KITS

Make & Model	Year	CK Series #	CKF Series #	Spring Kit #	DRC Series #	DRCF Series #	SRC Series #	SRK Series #	CT Tool #
APRILIA Contd.									
RS 50	06-10	CK5604		CSK143					CT026
RX3-5 Marce	91-94	CK2348		N/A					
RX 50 All models	91-05	CK2348		N/A					
RX 50	06-09	CK5604		CSK143					CT026
SX 50	06-09	CK5604		CSK143					
Tuono 50	03-04	CK2348		N/A					
AF1 125	87-91	CK5598		CSK190	DRC247				CT034SP
Classic 125	95-01	CK5598		CSK190	DRC247				CT034SP
MX 125	04-06	CK5598		CSK190	DRC247				CT034SP
Pegaso 125	91-95	CK5598		CSK190	DRC247				CT034SP
Red Rose 125 (Cast Wheel)	87	CK5598		CSK190	DRC247				CT034SP
Red Rose 125 (Spoke Wheel)	88-94	CK5598		CSK190	DRC247				CT034SP
RS 125 (2T)	92-14	CK5598		CSK190	DRC247				CT034SP
RX 125	92-98	CK5598		CSK190	DRC247				CT034SP
Tuono 125	03-04	CK5598		CSK190	DRC247				CT034SP
RS 250	95-02	CK3333		CSK007					CT022
Pegaso Strada/Trial	05-06	CK2368		CSK123					CT020
ETV 1000 Caponord/Rally (PS00/PSB0) (Non ABS Models)	01-03			CSK200					
ETV Caponord (PS004) (ABS Model)	04-08			CSK200					
RST 1000 Futura	01-04			CSK200					
RSV 1000 Mille	01-02	CK6680		CSK200					
RSV 1000 R Mille	01-02	CK6680		CSK200					
RSV 1000 SP	99-00	CK6680		CSK200					
RSV 1000 Mille	00	CK6680		CSK200					
RSV 1000 Mille R	00	CK6680		CSK200					
RSV 1000 R Factory	04-08	CK6680		CSK200					
RSV 1000 R	04-08	CK6680		CSK200					
RSV 1000 R Tuono	02-06	CK6680		CSK200					
RSV-R 1000 Tuono Factory	06-09	CK6681		CSK184			SRC113	SRK113	
SL 1000 Falco	00-04	CK6680		CSK200					
RSV4 Factory SBK Racing	09-10	CK6681		CSK184			SRC113	SRK113	
RSV4 Factory APRC	11-13	CK6681		CSK184			SRC113		
RSV4R	10	CK6681		CSK184			SRC113	SRK113	
RSV4R APRC	11-13	CK6681		CSK184			SRC113		
ARCTIC CAT ATV 4 WHEELERS									
250 (2 x 4 / 4 x 4)	01-04	CK3390		CSK048	DRC089				CT011
250 (2 x 4 / 4 x 4)	05	CK3390		CSK048	DRC089				CT011
300 (2 x 4 / 4 x 4)	98-04	CK3356		CSK048	DRC103				CT011
300 (4 x 4)	05	CK3356		CSK048	DRC103				CT011
400 (2 x 4 / 4 x 4)	98-	CK4439	CKF4439	CSK088	DRC215				CT006
400 (2 x 4)	98	CK4439	CKF4439	CSK088	DRC214				CT006
400 (2 x 4 / 4 x 4)	00-02	CK4419		CSK088	DRC215				CT006
400 (2 x 4 / 4 x 4)	03-04	CK4439	CKF4439	CSK098	DRC120				CT006
400 (4 x 4 Manual)	05-08	CK4439	CKF4439	CSK098	DRC120				CT006
400 DVX	04-06	CK3433	CKF3433	CSK079	DRC105	DRCF105			CT006
400 DVX	07-08	CK3447	CKF3447	CSK079	DRC137	DRCF137			CT006
Bearcat 454 (4 x 4)	96-98	CK4439	CKF4439	CSK088	DRC216				CT006
Bearcat 454 (2 x 4)	97-98	CK4439	CKF4439	CSK088	DRC216				CT006
500 (4 x 4)	98-02	CK4439	CKF4439	CSK088	DRC214				CT006
500 (4 x 4 Manual)	03-04	CK3452		CSK007	DRC216				CT006
500 (Manual 4 x 4)	05-09	CK3452		CSK007	DRC216				CT006
BENELLI									
Leoncino 500	17-19	CK1230		CSK241			SRC141	SRK141	CT014SP
Leoncino Trail 500	18-19	CK1230		CSK241			SRC141	SRK141	CT014SP
TRK 502 ABS Euro 4	17-18	CK1230		CSK241			SRC141	SRK141	CT014SP
TRK 502 X	18-19	CK1230		CSK241			SRC141	SRK141	CT014SP
BN 600 GT	14-17	CK1230		CSK241			SRC141	SRK141	CT014SP
BN 600 i	14-17	CK1230		CSK241			SRC141	SRK141	CT014SP
BN 600 R	14-15	CK1230		CSK241			SRC141	SRK141	CT014SP
BN 600 S	14-15	CK1230		CSK241			SRC141	SRK141	CT014SP
BMW									
R45/R 45 N	81-	CK6601		N/A					
R65 All models	81-	CK6601		N/A					
R80 All models	80-	CK6601		N/A					
R100 All models	80-	CK6601		N/A					
R45/R 45 N	78-80	CK6602		N/A					
R65	78-80	CK6602		N/A					
R50/5	69-72	CK6603		N/A					
R60/5-7	69-80	CK6603		N/A					
R75 All models	69-	CK6603		N/A					

CLUTCH APPLICATIONS

EBC CLUTCH KITS

Make & Model	Year	CK Series #	CKF Series #	Spring Kit #	DRC Series #	DRCF Series #	SRC Series #	SRK Series #	CT Tool #
BMW Contd.									
R80/7 N-S	77-80	CK6603		N/A					
R90/6, S	73-76	CK6603		N/A					
R100/7 T, S, RT, RS	76-80	CK6603		N/A					
K75 All models	85-	CK6604		N/A					
K100 All models	83-	CK6605		N/A					
K1	89-	CK6605		N/A					
R100 RS	86-92	CK6601		N/A					
R100 RT	87-95	CK6601		N/A					
R45	Sept 80-85	CK6601		N/A					
R45/N	Sept 80-85	CK6601		N/A					
R45 T	Sept 80-85	CK6601		N/A					
R45 T/N	Sept 80-85	CK6601		N/A					
R65	Sept 80-85	CK6601		N/A					
R65 LS	81-85	CK6601		N/A					
R65 T	80-85	CK6601		N/A					
R65 GS	87-92	CK6601		N/A					
R80 GS	80-87	CK6601		N/A					
R80 ST	82-84	CK6601		N/A					
R80	Sept 80-84	CK6601		N/A					
R80 RT	82-84	CK6601		N/A					
R80 TIC	Sept 80-85	CK6601		N/A					
R100/7 T	Sept 80-84	CK6601		N/A					
R100 CS	80-84	CK6601		N/A					
R100 RS	Sept 80-84	CK6601		N/A					
R100 RT	Sept 80-84	CK6601		N/A					
R100 TIC	80-84	CK6601		N/A					
R65/20	85-93	CK6601		N/A					
R65/35	85-88	CK6601		N/A					
R65 RT	85-88	CK6601		N/A					
R80	84-95	CK6601		N/A					
R80 RT	84-95	CK6601		N/A					
R100 GS	86-90	CK6601		N/A					
R100 PD	89-90	CK6601		N/A					
R80 GS	87-90	CK6601		N/A					
R80 PD/CH	90	CK6601		N/A					
R100 MYS	93-96	CK6601		N/A					
R100 R	91-95	CK6601		N/A					
R80 MYS	94-95	CK6601		N/A					
R80 R	91-94	CK6601		N/A					
R80 GS	96	CK6601		N/A					
R45	78-Sept 80	CK6602		N/A					
R45 N	78-Sept 80	CK6602		N/A					
R65	78-Sept 80	CK6602		N/A					
R50/5	69-73	CK6603		N/A					
R60/5	69-73	CK6603		N/A					
R60/6	73-76	CK6603		N/A					
R75/5	69-73	CK6603		N/A					
R75/6	73-76	CK6603		N/A					
R90/6	73-79	CK6603		N/A					
R90 S	73-76	CK6603		N/A					
R60/7	76-Sept 80	CK6603		N/A					
R60 TIC	78-Sept 80	CK6603		N/A					
R75/7	76-79	CK6603		N/A					
R80	77-Sept 80	CK6603		N/A					
R80 TIC	78-Sept 80	CK6603		N/A					
R100	76-77	CK6603		N/A					
R100/7T	77-Sept 80	CK6603		N/A					
R100 RS	76-Sept 80	CK6603		N/A					
R100 RT	78-Sept 80	CK6603		N/A					
R100 S	76-80	CK6603		N/A					
K75	84-96	CK6604		N/A					
K75/2	84-96	CK6604		N/A					
K75 C	85-88	CK6604		N/A					
K75 RT	89-96	CK6604		N/A					
K75 S	85-95	CK6604		N/A					
K100	82-88	CK6605		N/A					
K100/2	87-90	CK6605		N/A					
K100 LT	86-91	CK6605		N/A					
K100 RT	83-89	CK6605		N/A					
K1	88-93	CK6605		N/A					
K100 RS	89-92	CK6605		N/A					
K1100 LT	89-99	CK6605		N/A					
K1100 RS	92-96	CK6605		N/A					
F650 (E169/0161/Standard)	Sept 93-96	CK5605		CSK104					

CLUTCH APPLICATIONS

EBC CLUTCH KITS

Make & Model	Year	CK Series #	CKF Series #	Spring Kit #	DRC Series #	DRCF Series #	SRC Series #	SRK Series #	CT Tool #
BMW Contd.									
F650 (E169/0162/ Funduro/High Screen /19 Inch Front Wheel)	97-00	CK5605		CSK104					
F650 CS/Scarver K14/0174/0184/Belt drive /17 Inch Cast Wheels	00-03	CK5636		CSK104					
F650 CS/Scarver K14/0177/0187/Belt drive /17 Inch Cast Wheels	04-07	CK5635		CSK104					
F650 GS (R13/0172/0182/Single Cylinder /19 Inch Front Wheel)	99-03	CK5636		CSK104					
F650 GS (R13/0175/0185/Single Cylinder /19 Inch Front Wheel)	04-07	CK5635		CSK104					
F650 GS (Late type plates 2 x 13mm/7 x 14mm ears)	07-17	CK5660		CSK240			SRC130	SRK130	CT085
F650 GS Dakar (R13/0173/0183/Single Cylinder /21 Inch front wheel)	99-03	CK5636		CSK104					
F650 GS Dakar (R13/0176/0186/Single Cylinder /21 Inch front wheel)	04-07	CK5635		CSK104					
F650 ST (E169/0163/0168/Strada/Low Screen /18 Inch Front Wheel)	97-00	CK5605		CSK104					
F700 GS (Late type plates 2 x 13mm/7 x 14mm ears)	11-17	CK5660		CSK240			SRC130	SRK130	CT085
F800 GS (Early type plates 14mm ears)	08-11	CK5667		CSK240			SRC144	SRK144	CT085
F800 GS (Late type plates 2 x 13mm/7 x 14mm ears)	12-19	CK5660		CSK240			SRC130	SRK130	CT085
F800 GS Adventure (Late type plates 2 x 13mm /7 x 14mm ears)	12-19	CK5660		CSK240			SRC130	SRK130	CT085
F800 GT (Early type plates 14mm ears)	04-06	CK5667		CSK240			SRC144	SRK144	CT085
F800 GT (Late type plates 2 x 13mm/7 x 14mm ears)	07-19	CK5660		CSK240			SRC130	SRK130	CT085
F800 S (Early type plates 14mm ears)	04-06	CK5667		CSK240			SRC144	SRK144	CT085
F800 S (Late type plates 2 x 13mm/7 x 14mm ears)	07-19	CK5660		CSK240			SRC130	SRK130	CT085
F800 ST (Early type plates 14mm ears)	04-06	CK5667		CSK240			SRC144	SRK144	CT085
F800 ST (Late type plates 2 x 13mm/7 x 14mm ears)	07-19	CK5660		CSK240			SRC130	SRK130	CT085
F800 R (Late type plates 2 x 13mm/7 x 14mm ears)	05-19	CK5660		CSK240			SRC130	SRK130	CT085
G 310 R	17-20	CK1253		CSK249			SRC151	SRK151	CT013
G 310 GS	17-20	CK1253		CSK249			SRC151	SRK151	CT013
G 650 GS (R13)	08-16	CK5635		CSK133			SRC145	SRK145	CT083
G 650 GS Sertao (R13)	10-14	CK5635		CSK133			SRC145	SRK145	CT083
G 650 Xcountry (K15)	08-10	CK5635		CSK133			SRC145	SRK145	CT083
R 1200 GS	13-18	CK5676		CSK264			SRC165	SRK165	
R 1200 GS Adventure	13-18	CK5676		CSK264			SRC165	SRK165	
R 1200 R	13-18	CK5676		CSK264			SRC165	SRK165	
R 1200 RS	14-18	CK5676		CSK264			SRC165	SRK165	
R 1250 GS	19-20	CK5676		CSK264			SRC165	SRK165	
R 1250 GS TE	19-20	CK5676		CSK264			SRC165	SRK165	
R 1250 GS Rallye	19-20	CK5676		CSK264			SRC165	SRK165	
R 1250 GS Rallye TE	19-20	CK5676		CSK264			SRC165	SRK165	
R 1250 GS Adventure	19-20	CK5676		CSK264			SRC165	SRK165	
R 1250 GS Adventure TE	19-20	CK5676		CSK264			SRC165	SRK165	
R 1250 GS Adventure Rallye	19-20	CK5676		CSK264			SRC165	SRK165	
R 1250 GS Adventure Rallye TE	19-20	CK5676		CSK264			SRC165	SRK165	
CCM									
R30 (644 Suzuki Engine)	02-04	CK3386		CSK004	DRC087				CT024
R35/R35S	06-07	CK3433	CKF3433	CSK079	DRC105	DRCF105			CT006
404E/DS/Supermoto	03-04	CK3433	CKF3433	CSK079	DRC105	DRCF105			CT006
604 Trial/SM/RS/R30 (Rotax Engine)	98-03	CK5628		CSK127	DRC165				CT040SP
644 DS/Supermoto	04	CK3386		CSK004	DRC087				CT024
CR40 S Cafe Racer	07	CK3433	CKF3433	CSK079	DRC105	DRCF105			CT006
CR40 Street	07	CK3433	CKF3433	CSK079	DRC105	DRCF105			CT006
SR40 Street Scrambler	07	CK3433	CKF3433	CSK079	DRC105	DRCF105			CT006
DERBI									
GPR 50 Nude	04-05	CK5604		CSK143					CT026
GPR 50 R	97-00	CK5604		CSK143					CT026
GPR 50 Racing	04-05	CK5604		CSK143					CT026
GPR 50 Replica	99-05	CK5604		CSK143					CT026
Senda 50 (4 Plate Clutch)	99-05	CK5604		CSK143					CT026
Mulhacen 659	06-07	CK2297	CKF2297	CSK014					CT008
ELSTARS (Pit Bikes)									
Various models (Check parts before fitting)		CK1308		N/A			SRC091		
GAS-GAS									
EC 125 (2T)	00-08	CK1293	CKF1293	CSK024	DRC206				CT001
SM 125 (2T) Supermotard	03-06	CK1293	CKF1293	CSK024	DRC206				CT001
EC200/250/300 (2T)	00-08	CK5643		CSK141	DRC207				CT009
EC 450 FSR/FSE (4T) Enduro	05-08	CK5643		CSK141	DRC207				CT009
SM 450 FSR (4T) Supermotard	07-08	CK5643		CSK141	DRC207				CT009

CLUTCH APPLICATIONS

EBC CLUTCH KITS

Make & Model	Year	CK Series #	CKF Series #	Spring Kit #	DRC Series #	DRCF Series #	SRC Series #	SRK Series #	CT Tool #
GAS-GAS Contd.									
Wild HP 450 Quad	04-08	CK5643		CSK141	DRC207				CT009
EC 515 FSR/FSE (4T) Enduro	05-08	CK5643		CSK141	DRC207				CT009
SM 515 FSR (4T) Supermotard	07-08	CK5643		CSK141	DRC207				CT009
HUSQVARNA									
T C85 (F 17"/R 14")	14-17	CK5610		CSK042	DRC139				CT028
TC 85 (F19"/R 16")	14-17	CK5610		CSK042	DRC139				CT028
TC 85 (F 17"/R 14")	18-20	CK5668	CKF5668	CSK908	DRC304	DRCF304			CT087SP
TC 85 (F19"/R 16")	18-20	CK5668	CKF5668	CSK908	DRC304	DRCF304			CT087SP
CR 125	00-11	CK1222		CSK182	DRC264				CT001
TC 125	14-20	CK5611	CKF5611	CSK210	DRC303	DRCF303			CT001
TE 125	14-16	CK5611	CKF5611	CSK210	DRC303	DRCF303			CT001
TX 125	17-18	CK5611	CKF5611	CSK210	DRC303	DRCF303			CT001
WR 125	00-11	CK1222		CSK182	DRC264				CT001
WRE 125	00-11	CK1222		CSK182	DRC264				CT001
SMS 125	00-11	CK1222		CSK182	DRC264				CT001
FC 250	14-20	CK5651	CKF5651	CSK221	DRC293				CT023
TC 250	14-20	CK5651	CKF5651	CSK910	TBA				CT023
TE 250	14-20	CK5651	CKF5651	CSK910	TBA				CT023
TE 300	14-20	CK5651	CKF5651	CSK910	TBA				CT023
TX 300i	18-20	CK5651	CKF5651	CSK910	TBA				CT023
FC 350	14-20	CK5651	CKF5651	CSK221	DRC293				CT023
FE 350	14-20	CK5651	CKF5651	CSK910	DRC273				CT023
FX 350	17-20	CK5651	CKF5651	CSK221	DRC293				CT023
FC 450	14-20	CK5651	CKF5651	CSK910	DRC296				CT023
FC 450 Rockstar Edition	20	CK5651	CKF5651	CSK910	DRC296				CT023
FE 450	14-20	CK5651	CKF5651	CSK910	DRC275				CT023
FR 450 Rally	17	CK5651	CKF5651	CSK909	DRC281				CT023
FS 450	15-20	CK5651	CKF5651	CSK909	DRC281				CT023
FX 450	17-20	CK5651	CKF5651	CSK909	DRC281				CT023
FE 501	14-20	CK5651	CKF5651	CSK910	DRC275				CT023
FE 501S	16	CK5651	CKF5651	CSK910	DRC275				CT023
701 Enduro R	16-20	CK5642		CSK131	DRC205				CT069
701 Supermoto	16-18	CK5642		CSK131	DRC205				CT069
Svartpilen 401	18-20	CK5642		CSK131	DRC205				CT069
Svartpilen 701	18-20	CK5642		CSK131	DRC205				CT069
Vitpilen 401	18-20	CK5642		CSK131	DRC205				CT069
Vitpilen 701	18-20	CK5642		CSK131	DRC205				CT069
HARLEY-DAVIDSON® VRSC									
VRSCA V-Rod	02-06	CK7006		CSK232			SRC7007	SRK7007	CT707SP
VRSCSE CVO V-Rod	05-06	CK7006		CSK232			SRC7007	SRK7007	CT707SP
VRXSE CVO VR Destroyer	06	CK7006		CSK232			SRC7007	SRK7007	CT707SP
VRSCR Street Rod	06-07	CK7006		CSK232			SRC7007	SRK7007	CT707SP
VRSCAW V-Rod Wide Tire	07	CK7006		CSK232			SRC7007	SRK7007	CT707SP
VRSCX Screamin' Eagle V-Rod	07	CK7006		CSK232			SRC7007	SRK7007	CT707SP
VRSCAW V-Rod	09-10	CK7005		CSK233			SRC7006	SRK7006	CT706SP
VRSCAW V-Rod Wide Tire	08	CK7005		CSK233			SRC7006	SRK7006	CT706SP
VRSCAWA V-Rod Wide Tire W/ABS	08	CK7005		CSK233			SRC7006	SRK7006	CT706SP
VRSCD Night Rod	08	CK7005		CSK233			SRC7006	SRK7006	CT706SP
VRSCDA Night Rod W/ABS	08	CK7005		CSK233			SRC7006	SRK7006	CT706SP
VRSCDX ANV Night Rod Special Anv	12	CK7005		CSK233			SRC7006	SRK7006	CT706SP
VRSCDX Night Rod Special	08-17	CK7005		CSK233			SRC7006	SRK7006	CT706SP
VRSCDXA Night Rod Special W/ABS	08	CK7005		CSK233			SRC7006	SRK7006	CT706SP
VRSCF V-Rod Muscle	09-17	CK7005		CSK233			SRC7006	SRK7006	CT706S
HARLEY-DAVIDSON® TRIKE									
FLD 103 Dyna Switchback	12-16	CK7008		CSK916			SRC7012	SRK7012	CT703SP
FLD Dyna Switchback	12-16	CK7008		CSK916			SRC7013	SRK7013	CT703SP
FLHP Road King Police	11-16	CK7008		CSK914			SRC7009	SRK7009	CT703SP
FLHR Road King	17	CK7002		CSK236			SRC7010	SRK7010	CT702SP
FLHRC Road King Classic	17	CK7002		CSK236			SRC7010	SRK7010	CT702SP
FLFBS Fat Boy 114	18	CK7007		CSK236			SRC7008	SRK7008	CT708SP
FLFBS Fat Boy 114 Anniversary	18	CK7007		CSK236			SRC7008	SRK7008	CT708SP
HARLEY-DAVIDSON® TOURING									
FLH Electra Glide	81-83	CK7012		CSK255			SRC7018	SRK7018	CT704SP
FLH Electra Glide Shrine Shovelhead	83	CK7012		CSK255			SRC7018	SRK7018	CT704SP
FLHC Electra Glide Classic	81-82	CK7012		CSK255			SRC7018	SRK7018	CT704SP
FLHS Electra Glide Heritage	81	CK7012		CSK255			SRC7018	SRK7018	CT704SP
FLHS Electra Glide Sport	81-83	CK7012		CSK255			SRC7018	SRK7018	CT704SP
FLHT Electra Glide Classic	83	CK7012		CSK255			SRC7018	SRK7018	CT704SP
FLHT Electra Glide Standard	83	CK7012		CSK255			SRC7018	SRK7018	CT704SP
FLHT Electra Glide	83	CK7012		CSK255			SRC7018	SRK7018	CT704SP

CLUTCH APPLICATIONS

EBC CLUTCH KITS

Make & Model	Year	CK Series #	CKF Series #	Spring Kit #	DRC Series #	DRCF Series #	SRC Series #	SRK Series #	CT Tool #
HARLEY-DAVIDSON® TOURING Contd.									
FLHTC Electra Glide Classic	83-84	CK7012		CSK255			SRC7018	SRK7018	CT704SP
FLT Tour Glide	81-83	CK7012		CSK255			SRC7018	SRK7018	CT704SP
FLTC Tour Glide Classic	80-84	CK7012		CSK255			SRC7018	SRK7018	CT704SP
FLH Electra Glide	EARLY 84	CK7011		CSK255			SRC7017	SRK7017	CT704SP
FLH Electra Glide Shrine Shovelhead	EARLY 84	CK7011		CSK255			SRC7017	SRK7017	CT704SP
FLHS Electra Glide Sport	EARLY 84	CK7011		CSK255			SRC7017	SRK7017	CT704SP
FLHT Electra Glide	EARLY 84	CK7011		CSK255			SRC7017	SRK7017	CT704SP
FLHT Electra Glide Classic	EARLY 84	CK7011		CSK255			SRC7017	SRK7017	CT704SP
FLT Classic Tour Glide Classic	EARLY 84	CK7011		CSK255			SRC7017	SRK7017	CT704SP
FLT Tour Glide	EARLY 84	CK7011		CSK255			SRC7017	SRK7017	CT704SP
FLHS Electra Glide Sport	84-89	CK7010		TBA			SRC7016	SRK7016	CT705SP
FLHT Electra Glide	LATER 84	CK7010		TBA			SRC7016	SRK7016	CT705SP
FLHT Electra Glide Classic	LATER 84	CK7010		TBA			SRC7016	SRK7016	CT705SP
FLHT Electra Glide Shrine Shovelhead	LATER 84	CK7010		TBA			SRC7016	SRK7016	CT705SP
FLHT Electra Glide Standard	88	CK7010		TBA			SRC7016	SRK7016	CT705SP
FLHTC Electra Glide Classic	84-89	CK7010		TBA			SRC7016	SRK7016	CT705SP
FLHTCU Electra Glide Classic Ultra	89	CK7010		TBA			SRC7016	SRK7016	CT705SP
FLST Softail Heritage	86-89	CK7010		TBA			SRC7016	SRK7016	CT705SP
FLSTC Softail Heritage Classic	87-89	CK7010		TBA			SRC7016	SRK7016	CT705SP
FLT Tour Glide	LATER 84	CK7010		TBA			SRC7016	SRK7016	CT705SP
FLTC Tour Glide Classic	84-89	CK7010		TBA			SRC7016	SRK7016	CT705SP
FLHR Road King	93-97	CK7009		TBA			SRC7014	SRK7014	CT701SP
FLHS Electra Glide Sport	91-94	CK7009		TBA			SRC7014	SRK7014	CT701SP
FLHS Touring Electra Glide Sport	90	CK7009		TBA			SRC7015	SRK7015	CT701SP
FLHT Electra Glide Standard	94-97	CK7009		TBA			SRC7014	SRK7014	CT701SP
FLHTC Electra Glide Classic	91-97	CK7009		TBA			SRC7014	SRK7014	CT701SP
FLHTC Touring Electra Glide Classic	90	CK7009		TBA			SRC7015	SRK7015	CT701SP
FLHTCI Electra Glide Classic	96-97	CK7009		TBA			SRC7014	SRK7014	CT701SP
FLHTCU Touring Electra Glide Classic Ultra	90	CK7009		TBA			SRC7015	SRK7015	CT701SP
FLHTCU Ultra Classic	91-97	CK7009		TBA			SRC7014	SRK7014	CT701SP
FLST Softail Heritage	90	CK7009		TBA			SRC7019	SRK7019	CT701SP
FLSTC Softail Heritage Classic	90-97	CK7009		TBA			SRC7019	SRK7019	CT701SP
FLSTF Fat Boy	91-97	CK7009		TBA			SRC7019	SRK7019	CT701SP
FLSTF Softail Fat Boy	90	CK7009		TBA			SRC7019	SRK7019	CT701SP
FLHPE Road King Police	11	CK7008		CSK914			SRC7009	SRK7009	CT703SP
FLHR 103 Road King	11	CK7008		CSK916			SRC7012	SRK7012	CT703SP
FLHR Road King	06-11	CK7008		CSK915			SRC7013	SRK7013	CT703SP
FLHR Road King	12-13	CK7008		CSK916			SRC7012	SRK7012	CT703SP
FLHR Road King	15-16	CK7008		CSK917			SRC7011	SRK7011	CT703SP
FLHR Road King	98-03	CK7008		CSK917			SRC7011	SRK7011	CT703SP
FLHR Road King	04-05	CK7008		CSK916			SRC7012	SRK7012	CT703SP
FLHR 96 Road King	11	CK7008		CSK915			SRC7013	SRK7013	CT703SP
FLHRANV Road King Anniversary	13	CK7008		CSK916			SRC7012	SRK7012	CT703SP
FLHRC 103 Road King Classic	11	CK7008		CSK916			SRC7012	SRK7012	CT703SP
FLHRC Road King Classic	07-11	CK7008		CSK915			SRC7013	SRK7013	CT703SP
FLHRC Road King Classic	12-13	CK7008		CSK916			SRC7012	SRK7012	CT703SP
FLHRC Road King Classic	14-16	CK7008		CSK917			SRC7011	SRK7011	CT703SP
FLHRCI Road King Classic	04	CK7008		CSK916			SRC7012	SRK7012	CT703SP
FLHRCI Road King Classic	98-03	CK7008		CSK917			SRC7011	SRK7011	CT703SP
FLHRCI Road King Classic	05	CK7008		CSK916			SRC7012	SRK7012	CT703SP
FLHRCI Road King Classic	06	CK7008		CSK915			SRC7013	SRK7013	CT703SP
FLHRI Road King	00-03	CK7008		CSK917			SRC7011	SRK7011	CT703SP
FLHRI Road King	04-05	CK7008		CSK916			SRC7012	SRK7012	CT703SP
FLHRI Road King	06	CK7008		CSK915			SRC7013	SRK7013	CT703SP
FLHRS Road King Custom	04-05	CK7008		CSK916			SRC7012	SRK7012	CT703SP
FLHRS Road King Custom	06-07	CK7008		CSK915			SRC7013	SRK7013	CT703SP
FLHRSI 1FYW Road King Custom	04-05	CK7008		CSK916			SRC7012	SRK7012	CT703SP
FLHRSI 1FYW Road King Custom	06	CK7008		CSK915			SRC7013	SRK7013	CT703SP
FLHT Electra Glide Standard	98-03	CK7008		CSK917			SRC7011	SRK7011	CT703SP
FLHT Electra Glide Standard	04-05	CK7008		CSK916			SRC7012	SRK7012	CT703SP
FLHT Electra Glide Standard	06-10	CK7008		CSK915			SRC7013	SRK7013	CT703SP
FLHTC 103 Electra Glide Classic	11	CK7008		CSK916			SRC7012	SRK7012	CT703SP
CT703SPFLHTC Electra Glide Classic	98-03	CK7008		CSK917			SRC7011	SRK7011	CT703SP
FLHTC Electra Glide Classic	04-05	CK7008		CSK916			SRC7012	SRK7012	CT703SP
FLHTC Electra Glide Classic	07-11	CK7008		CSK915			SRC7013	SRK7013	CT703SP
FLHTC Electra Glide Classic	12-13	CK7008		CSK916			SRC7012	SRK7012	CT703SP
FLHTCI Ultra Classic	05	CK7008		CSK916			SRC7012	SRK7012	CT703SP
FLHTCI Electra Glide Classic	98-03	CK7008		CSK917			SRC7011	SRK7011	CT703SP
FLHTCI Electra Glide Classic	04-05	CK7008		CSK916			SRC7012	SRK7012	CT703SP
FLHTCI Electra Glide Classic	06	CK7008		CSK915			SRC7013	SRK7013	CT703SP
FLHTCU 103 Ultra Classic	11	CK7008		CSK916			SRC7012	SRK7012	CT703SP
FLHTCU Ultra Classic	07-11	CK7008		CSK915			SRC7013	SRK7013	CT703SP
FLHTCU Ultra Classic	12-13	CK7008		CSK916			SRC7012	SRK7012	CT703SP
FLHTCU Ultra Classic	14-16	CK7008		CSK917			SRC7011	SRK7011	CT703SP

CLUTCH APPLICATIONS

EBC CLUTCH KITS

Make & Model	Year	CK Series #	CKF Series #	Spring Kit #	DRC Series #	DRCF Series #	SRC Series #	SRK Series #	CT Tool #
HARLEY-DAVIDSON® TOURING Contd.									
FLHTCU TC Ultra Classic Twin-Cooled	14-16	CK7008		CSK917			SRC7011	SRK7011	CT703SP
FLHTCUI Ultra Classic	04	CK7008		CSK916			SRC7012	SRK7012	CT703SP
FLHTCUI Ultra Classic	98-03	CK7008		CSK917			SRC7011	SRK7011	CT703SP
FLHTCUI Ultra Classic	06	CK7008		CSK915			SRC7013	SRK7013	CT703SP
FLHTCUTG Tri Glide Ultra Classic	09-13	CK7008		CSK914			SRC7009	SRK7009	CT703SP
FLHTCUTGANV Tri Glide Ultra Classic Anniversary	13	CK7008		CSK914			SRC7009	SRK7009	CT703SP
FLHTI Electra Glide Standard	03	CK7008		CSK917			SRC7011	SRK7011	CT703SP
FLHTI Electra Glide Standard	04-05	CK7008		CSK916			SRC7012	SRK7012	CT703SP
FLHTI Electra Glide Standard	06	CK7008		CSK915			SRC7013	SRK7013	CT703SP
FLHTK Ultra Limited	14-16	CK7008		CSK917			SRC7011	SRK7011	CT703SP
FLHTK Electra Glide Ultra Limited	10-13	CK7008		CSK916			SRC7012	SRK7012	CT703SP
FLHTKANV Electra Glide Ultra Limited Anniversary	13	CK7008		CSK916			SRC7012	SRK7012	CT703SP
FLHTP Electra Glide Standard Police	11-16	CK7008		CSK914			SRC7009	SRK7009	CT703SP
FLHX 103 Street Glide	11	CK7008		CSK916			SRC7012	SRK7012	CT703SP
FLHX Street Glide	06-11	CK7008		CSK915			SRC7013	SRK7013	CT703SP
FLHX Street Glide	12-13	CK7008		CSK916			SRC7012	SRK7012	CT703SP
FLHX Street Glide	14-16	CK7008		CSK917			SRC7011	SRK7011	CT703SP
FLHXS Street Glide Special	14-16	CK7008		CSK917			SRC7011	SRK7011	CT703SP
FLHXXX Street Glide Trike	10-11	CK7008		CSK914			SRC7009	SRK7009	CT703SP
FLS 103 Softail Slim	13-15	CK7008		CSK916			SRC7012	SRK7012	CT703SP
FLS 103 Softail Slim	12	CK7008		CSK916			SRC7012	SRK7012	CT703SP
FLHRXS Road King Special	18	CK7002		CSK236			SRC7010	SRK7010	CT702SP
FLS Softail Slim	12-15	CK7008		CSK915			SRC7013	SRK7013	CT703SP
FLS Softail Slim	16-17	CK7008		CSK916			SRC7012	SRK7012	CT703SP
FLST Heritage Softail	08-09	CK7008		CSK915			SRC7013	SRK7013	CT703SP
FLST Heritage Softail	06	CK7008		CSK915			SRC7013	SRK7013	CT703SP
FLSTC 103 Heritage Softail Classic	12-15	CK7008		CSK916			SRC7012	SRK7012	CT703SP
FLSTC103ANV Heritage Softail Classic Anniversary	13	CK7008		CSK916			SRC7012	SRK7012	CT703SP
FLHTCU Electra Glide Ultra Classic	17-18	CK7002		CSK236			SRC7010	SRK7010	CT702SP
FLHTCUL TC Ultra Classic Low Twin-Cooled	15-16	CK7002		CSK235			SRC7003	SRK7003	CT702SP
FLHTCUL Ultra Classic Low	15-16	CK7002		CSK235			SRC7003	SRK7003	CT702SP
FLSTC Heritage Softail Classic	98-03	CK7008		CSK917			SRC7011	SRK7011	CT703SP
FLSTC Heritage Softail Classic	04-05	CK7008		CSK916			SRC7012	SRK7012	CT703SP
FLHCS Heritage Classic 114	18	CK7007		CSK236			SRC7008	SRK7008	CT708SP
FLHTCUTG Tri Glide Ultra Classic	14-16	CK7002		CSK235			SRC7003	SRK7003	CT702SP
FLHTK 103 CVO Limited	14	CK7002		CSK235			SRC7003	SRK7003	CT702SP
FLHCS Heritage Classic 114 Anniversary	18	CK7007		CSK236			SRC7008	SRK7008	CT708SP
FLHTK Ultra Limited	17-18	CK7002		CSK236			SRC7010	SRK7010	CT702SP
FLHTK Ultra Limited Anniversary	18	CK7002		CSK236			SRC7010	SRK7010	CT702SP
FLHTK Ultra Limited Shrine Edition	18	CK7002		CSK236			SRC7010	SRK7010	CT702SP
FLHTKL Ultra Limited Low	15-18	CK7002		CSK235			SRC7003	SRK7003	CT702SP
FLHX Street Glide	17-18	CK7002		CSK236			SRC7010	SRK7010	CT702SP
FLHX Street Glide Anniversary	18	CK7002		CSK236			SRC7010	SRK7010	CT702SP
FLHXS Street Glide Special	17-18	CK7002		CSK236			SRC7010	SRK7010	CT702SP
FLHP Road King Police	17	CK7007		CSK236			SRC7008	SRK7008	CT708SP
FLHTCUTG Tri Glide Ultra	17-18	CK7007		CSK236			SRC7008	SRK7008	CT708SP
FLHC 1YAJ Heritage Classic	18	TBA		CSK236			TBA	TBA	
FLHTCUTG Tri Glide Ultra Anniversary	18	CK7007		CSK236			SRC7008	SRK7008	CT708SP
FLHTP Electra Glide Standard Police	17	CK7007		CSK236			SRC7008	SRK7008	CT708SP
FLHXS Street Glide Special Anniversary	18	CK7002		CSK236			SRC7010	SRK7010	CT702SP
FLRT Freewheeler	15-16	CK7002		CSK235			SRC7003	SRK7003	CT702SP
FLSS Softail Slim S	16-17	CK7002		CSK235			SRC7003	SRK7003	CT702SP
FLSTFBS Fat Boy S	16-17	CK7002		CSK235			SRC7003	SRK7003	CT702SP
HARLEY-DAVIDSON® DYNA									
FXB Super Glide B80	81-82	CK7012		CSK255			SRC7018	SRK7018	CT704SP
FXDG Dyna Glide Glide Custom	83	CK7012		CSK255			SRC7018	SRK7018	CT704SP
FXE Super Glide	81-84	CK7012		CSK255			SRC7018	SRK7018	CT704SP
FXEF Super Glide Fat Bob	81	CK7012		CSK255			SRC7018	SRK7018	CT704SP
FXS Super Glide	81-82	CK7012		CSK255			SRC7018	SRK7018	CT704SP
FXSB Low Rider	83-84	CK7012		CSK255			SRC7018	SRK7018	CT704SP
FXST Softail Standard	EARLY 84	CK7012		CSK255			SRC7018	SRK7018	CT704SP
FXWG Wide Glide	81-84	CK7012		CSK255			SRC7018	SRK7018	CT704SP
FLTCU Tour Glide Classic Ultra	89	CK7010		TBA			SRC7016	SRK7016	CT705SP
FLSTN Heritage Softail Nostalgia	93-96	CK7009		TBA			SRC7019	SRK7019	CT701SP
FLSTS Heritage Springer	97	CK7009		TBA			SRC7019	SRK7019	CT701SP
FLTC Tour Glide Classic	90-92	CK7009		TBA			SRC7014	SRK7014	CT701SP
FLTCU Tour Glide Ultra Classic	90-95	CK7009		TBA			SRC7014	SRK7014	CT701SP
FLSTC Heritage Softail Classic	06-15	CK7008		CSK915			SRC7013	SRK7013	CT703SP
FLSTC Heritage Softail Classic	16-17	CK7008		CSK916			SRC7012	SRK7012	CT703SP
FLSTCANV Heritage Softail Classic Anniversary	13	CK7008		CSK915			SRC7013	SRK7013	CT703SP
FLSTCI Heritage Softail Classic	01-03	CK7008		CSK917			SRC7011	SRK7011	CT703SP
FLSTCI Heritage Softail Classic	04-05	CK7008		CSK916			SRC7012	SRK7012	CT703SP
FLSTCI Heritage Softail Classic	06	CK7008		CSK915			SRC7013	SRK7013	CT703SP

CLUTCH APPLICATIONS

EBC CLUTCH KITS

Make & Model	Year	CK Series #	CKF Series #	Spring Kit #	DRC Series #	DRCF Series #	SRC Series #	SRK Series #	CT Tool #
HARLEY-DAVIDSON® DYNA Contd									
FLSTCI Heritage Softail Classic Shrine	05	CK7008		CSK916			SRC7012	SRK7012	CT703SP
FLSTF Fat Boy	12	CK7008		CSK915			SRC7013	SRK7013	CT703SP
FLSTF 103 Fat Boy	12-14	CK7008		CSK916			SRC7012	SRK7012	CT703SP
FLSTF 103 Fat Boy	15	CK7008		CSK916			SRC7012	SRK7012	CT703SP
FLSTF Fat Boy	98-99	CK7008		CSK917			SRC7011	SRK7011	CT703SP
FLSTF Fat Boy	00-03	CK7008		CSK917			SRC7011	SRK7011	CT703SP
FLSTF Fat Boy	04-05	CK7008		CSK916			SRC7012	SRK7012	CT703SP
FLSTF Fat Boy	06-15	CK7008		CSK915			SRC7013	SRK7013	CT703SP
FLSTF Fat Boy	16-17	CK7008		CSK916			SRC7012	SRK7012	CT703SP
FLSTFB 103 Fat Boy LO	12-15	CK7008		CSK916			SRC7012	SRK7012	CT703SP
FLSTFB103ANV Fat Boy 103 LO Anniversary	13	CK7008		CSK916			SRC7012	SRK7012	CT703SP
FLSTFB Fat Boy LO	10-11	CK7008		CSK915			SRC7013	SRK7013	CT703SP
FLSTFB Fat Boy LO	12	CK7008		CSK916			SRC7012	SRK7012	CT703SP
FLSTFB Fat Boy LO	13-15	CK7008		CSK915			SRC7013	SRK7013	CT703SP
FLSTFB Fat Boy LO	16-17	CK7008		CSK916			SRC7012	SRK7012	CT703SP
FLSTFBANV Fat Boy LO Anniversary	13	CK7008		CSK915			SRC7013	SRK7013	CT703SP
FLSTFI Fat Boy	01-03	CK7008		CSK917			SRC7011	SRK7011	CT703SP
FLSTFI Fat Boy	04-05	CK7008		CSK916			SRC7012	SRK7012	CT703SP
FLSTFI Fat Boy	06	CK7008		CSK915			SRC7013	SRK7013	CT703SP
FLSTFI Fat Boy Shrine	05	CK7008		CSK916			SRC7012	SRK7012	CT703SP
FLSTI Heritage Softail	06	CK7008		CSK915			SRC7013	SRK7013	CT703SP
FLSTN 103 Softail Deluxe	12-15	CK7008		CSK916			SRC7012	SRK7012	CT703SP
FLSTN Softail Deluxe	05	CK7008		CSK916			SRC7012	SRK7012	CT703SP
FLSTN Softail Deluxe	06	CK7008		CSK915			SRC7013	SRK7013	CT703SP
FLSTN Softail Deluxe	07-15	CK7008		CSK915			SRC7013	SRK7013	CT703SP
FLSTN Deluxe	17	CK7008		CSK916			SRC7012	SRK7012	CT703SP
FLSTN Softail Deluxe	16	CK7008		CSK916			SRC7012	SRK7012	CT703SP
FLSTNI Softail Deluxe	06	CK7008		CSK915			SRC7013	SRK7013	CT703SP
FLSTNI Softail Deluxe	05	CK7008		CSK916			SRC7012	SRK7012	CT703SP
FLSTS Heritage Springer	98-03	CK7008		CSK917			SRC7011	SRK7011	CT703SP
FLSTSB Cross Bones	08-11	CK7008		CSK915			SRC7013	SRK7013	CT703SP
FLSTSC Springer Classic	06-07	CK7008		CSK915			SRC7013	SRK7013	CT703SP
FLSTSC Springer Classic	05	CK7008		CSK916			SRC7012	SRK7012	CT703SP
FLSTSI Heritage Springer	01-03	CK7008		CSK917			SRC7011	SRK7011	CT703SP
FLTR Road Glide	98-03	CK7008		CSK917			SRC7011	SRK7011	CT703SP
FLTR Road Glide	06-09	CK7008		CSK915			SRC7013	SRK7013	CT703SP
FLTRI Road Glide	04-05	CK7008		CSK916			SRC7012	SRK7012	CT703SP
FLTRU Road Glide Ultra	2016	CK7008		CSK917			SRC7011	SRK7011	CT703SP
FLTRU Road Glide Ultra	11-13	CK7008		CSK916			SRC7012	SRK7012	CT703SP
FLTRX 103 Road Glide Custom	11	CK7008		CSK916			SRC7012	SRK7012	CT703SP
FLTRX Road Glide Custom	10-11	CK7008		CSK915			SRC7013	SRK7013	CT703SP
FLTRX Road Glide	15-16	CK7008		CSK917			SRC7011	SRK7011	CT703SP
FLTRX Road Glide Custom	12-13	CK7008		CSK916			SRC7012	SRK7012	CT703SP
FLTRXS Road Glide Special	15-16	CK7008		CSK917			SRC7011	SRK7011	CT703SP
FXCW Rocker	08-09	CK7008		CSK915			SRC7013	SRK7013	CT703SP
FXCWC Rocker C	08-11	CK7008		CSK915			SRC7013	SRK7013	CT703SP
FXD Dyna Super Glide	98-03	CK7008		CSK917			SRC7011	SRK7011	CT703SP
FXFB 1YKJ Fat Bob	18	TBA		CSK236			TBA	TBA	
FLRT Freewheeler	17-18	CK7007		CSK236			SRC7008	SRK7008	CT708SP
FXLR 1YNJ Low Rider	18	TBA		CSK236			TBA	TBA	
HARLEY-DAVIDSON® SPORTSTER									
XLCH1000 Sportster 1000	70	CK7016		TBA			TBA	TBA	
XLH1000 Sportster Standard	70	CK7016		TBA			TBA	TBA	
XLCH1000 Sportster 1000	71-80	CK7015		CSK257			SRC7025	SRK7025	CT709SP
XLH Sportster 1000	81-84	CK7015		CSK257			SRC7025	SRK7025	CT709SP
XLH1000 Sportster 1000 Standard	71-78	CK7015		CSK257			SRC7025	SRK7025	CT709SP
XLS Sportster Roadster 1000	81-84	CK7015		CSK257			SRC7025	SRK7025	CT709SP
XR1000 Sportster 1000	83-84	CK7015		CSK257			SRC7025	SRK7025	CT709SP
XL883 Sportster 883	86-90	CK7014		CSK921			SRC7024	SRK7024	
CT709SPXL883DLX Sportster 883 Deluxe	86-90	CK7014		CSK921			SRC7024	SRK7024	CT709SP
XL883HUG Sportster 883 Hugger	87-90	CK7014		CSK921			SRC7024	SRK7024	CT709SP
XLH Sportster 1000	84	CK7014		CSK921			SRC7024	SRK7024	CT709SP
XLH1100 Sportster 1100	86-87	CK7014		CSK921			SRC7024	SRK7024	
CT709SPXLH1200 Sportster 1200	88-90	CK7014		CSK921			SRC7024	SRK7024	CT709SP
XLS Sportster Roadster 1000	84	CK7014		CSK921			SRC7024	SRK7024	CT709SP
XLX Sportster Roadster 1000	84	CK7014		CSK921			SRC7024	SRK7024	CT709SP
XR1000 Sportster	84	CK7014		CSK921			SRC7024	SRK7024	CT709SP
FLTCUI Tour Glide Ultra Classic	96	CK7009		TBA			SRC7014	SRK7014	CT701SP
FXD Dyna Super Glide	95-97	CK7009		TBA			SRC7019	SRK7019	CT701SP
FXDB Dyna Daytona	92	CK7009		TBA			SRC7019	SRK7019	CT701SP
FXDB Dyna Sturgis	91	CK7009		TBA			SRC7019	SRK7019	CT701SP
FXDC Super Glide Custom	92	CK7009		TBA			SRC7019	SRK7019	CT701SP
FXDL Dyna Low Rider	93-97	CK7009		TBA			SRC7019	SRK7019	CT701SP

CLUTCH APPLICATIONS

EBC CLUTCH KITS

Make & Model	Year	CK Series #	CKF Series #	Spring Kit #	DRC Series #	DRCF Series #	SRC Series #	SRK Series #	CT Tool #
HARLEY-DAVIDSON® SPORTSTER Contd.									
FXDSCONV Dyna Glide Convertible	93	CK7009		TBA			SRC7019	SRK7019	CT701SP
FXDWG Dyna Wide Glide	93-97	CK7009		TBA			SRC7019	SRK7019	CT701SP
FXST Softail Standard	90	CK7009		TBA			SRC7019	SRK7019	CT701SP
FXSTC Softail Custom	90-97	CK7009		TBA			SRC7019	SRK7019	CT701SP
FXSTS Softail Springer	90-97	CK7009		TBA			SRC7019	SRK7019	CT701SP
XL1200 Forty Eight Anniversary	18	CK7009		CSK919			SRC7020	SRK7020	CT701SP
XL1200 Sportster 1200	91-03	CK7009		CSK920			SRC7023	SRK7023	CT701SP
XL1200C Sportster 1200 Custom	96-03	CK7009		CSK920			SRC7023	SRK7023	CT701SP
XL1200C Sportster 1200 Custom	04-18	CK7009		CSK919			SRC7020	SRK7020	CT701SP
XL1200CA Sportster 1200 Custom Limited A	13-16	CK7009		CSK919			SRC7020	SRK7020	CT701SP
XL1200CANV Sportster 1200 Custom Anniversary	13	CK7009		CSK919			SRC7020	SRK7020	CT701SP
XL1200CB Sportster 1200 Custom Limited B	13-17	CK7009		CSK919			SRC7020	SRK7020	CT701SP
XR1200 Sportster	08-10	CK7013		CSK913			SRC7022	SRK7022	CT701SP
XL1200CP Sportster 1200 Custom (H-D1)	11-16	CK7009		CSK919			SRC7020	SRK7020	CT701SP
XL1200CX 1200 Roadster	16-18	CK7009		CSK919			SRC7020	SRK7020	CT701SP
XR1200X 1200 Sportster X	10-13	CK7013		CSK913			SRC7022	SRK7022	CT701SP
XL1200L Sportster 1200 Low	06-11	CK7009		CSK919			SRC7020	SRK7020	CT701SP
XL1200N Nightster	07-12	CK7009		CSK919			SRC7020	SRK7020	CT701SP
XL1200R Sportster 1200 Roadster	04-09	CK7009		CSK919			SRC7020	SRK7020	CT701SP
XL1200S Sportster 1200 Sport	96-03	CK7009		CSK920			SRC7023	SRK7023	CT701SP
XL1200T Sportster 1200 SuperLow	14-18	CK7009		CSK919			SRC7020	SRK7020	CT701SP
XL1200V Seventy-Two	12-16	CK7009		CSK919			SRC7020	SRK7020	CT701SP
XL1200X Forty Eight	10-18	CK7009		CSK919			SRC7020	SRK7020	CT701SP
XL50 50th Anniversary Sportster	07	CK7009		CSK919			SRC7020	SRK7020	CT701SP
XL883 Sportster 883	91-03	CK7009		CSK920			SRC7023	SRK7023	CT701SP
XL883 Sportster 883	04-09	CK7009		CSK918			SRC7021	SRK7021	CT701SP
XL883C Sportster 883 Custom	98-03	CK7009		CSK920			SRC7023	SRK7023	CT701SP
XL883C Sportster 883 Custom	04-10	CK7009		CSK918			SRC7021	SRK7021	CT701SP
HARLEY-DAVIDSON® SOFTAIL									
FXE Super Glide	84	CK7010		TBA			SRC7016	SRK7016	CT705SP
FXEF Super Glide Fat Bob	85	CK7010		TBA			SRC7016	SRK7016	CT705SP
FXSB Low Rider	84-85	CK7010		TBA			SRC7016	SRK7016	CT705SP
FXST Softail Standard	84-89	CK7010		TBA			SRC7016	SRK7016	CT705SP
FXSTC Softail Custom	86-89	CK7010		TBA			SRC7016	SRK7016	CT705SP
FXSTS Softail Springer	88-89	CK7010		TBA			SRC7016	SRK7016	CT705SP
FXWG Wide Glide	84-86	CK7010		TBA			SRC7016	SRK7016	CT705SP
XL883DLX Sportster 883 Deluxe	91-95	CK7009		CSK920			SRC7023	SRK7023	CT701SP
XL883HUG Sportster 883 Hugger	91-03	CK7009		CSK920			SRC7023	SRK7023	CT701SP
XL883L Sportster 883 Low	05-11	CK7009		CSK918			SRC7021	SRK7021	CT701SP
XL883L SuperLow	12-18	CK7009		CSK918			SRC7021	SRK7021	CT701SP
XL883N Iron 883	09-18	CK7009		CSK918			SRC7021	SRK7021	CT701SP
XL883R 883 Roadster	11-15	CK7009		CSK918			SRC7021	SRK7021	CT701SP
XL883R Sportster 883R	02-06	CK7009		CSK920			SRC7023	SRK7023	CT701SP
XL883R Sportster 883R	07-10	CK7009		CSK918			SRC7021	SRK7021	CT701SP
FXD Dyna Super Glide	04-05	CK7008		CSK916			SRC7012	SRK7012	CT703SP
FXD Dyna Super Glide	07-10	CK7008		CSK915			SRC7013	SRK7013	CT703SP
FXD35 Dyna 35th Anniversary Super Glide	06	CK7008		CSK915			SRC7013	SRK7013	CT703SP
FXDB 103 Dyna Street Bob	14-17	CK7008		CSK916			SRC7012	SRK7012	CT703SP
FXDB Dyna Street Bob	07-17	CK7008		CSK915			SRC7013	SRK7013	CT703SP
FXDBA 103 Dyna Street Bob (H-D1)	13-15	CK7008		CSK916			SRC7012	SRK7012	CT703SP
FXDBA Dyna Street Bob (H-D1)	13-15	CK7008		CSK915			SRC7013	SRK7013	CT703SP
FXDBC 103 Dyna Street Bob Limited	16	CK7008		CSK916			SRC7012	SRK7012	CT703SP
FXDBC Dyna Street Bob Limited	16	CK7008		CSK915			SRC7013	SRK7013	CT703SP
FXDBI Dyna Street Bob	06	CK7008		CSK915			SRC7013	SRK7013	CT703SP
FXDBP 103 Dyna Street Bob	16	CK7008		CSK916			SRC7012	SRK7012	CT703SP
FXDC 103 Dyna Super Glide Custom	14	CK7008		CSK916			SRC7012	SRK7012	CT703SP
FXDC Dyna Super Glide Custom	05	CK7008		CSK916			SRC7012	SRK7012	CT703SP
FXDC Dyna Super Glide Custom	07-14	CK7008		CSK915			SRC7013	SRK7013	CT703SP
FXDCANV Dyna Super Glide Custom Anniversary	13	CK7008		CSK915			SRC7013	SRK7013	CT703SP
FXDCI Dyna Super Glide Custom	05-06	CK7008		CSK915			SRC7013	SRK7013	CT703SP
FXDF 103 Dyna Fat Bob	12-17	CK7008		CSK916			SRC7012	SRK7012	CT703SP
FXDF Dyna Fat Bob	08-17	CK7008		CSK915			SRC7013	SRK7013	CT703SP
FXDI Dyna Super Glide	04-06	CK7008		CSK915			SRC7013	SRK7013	CT703SP
FXDL 103 Dyna Low Rider	14-16	CK7008		CSK916			SRC7012	SRK7012	CT703SP
FXDL 103 Low Rider 103	17	CK7008		CSK916			SRC7012	SRK7012	CT703SP
FXDL Dyna Low Rider	98-03	CK7008		CSK917			SRC7011	SRK7011	CT703SP
FXDL Dyna Low Rider	04-05	CK7008		CSK916			SRC7012	SRK7012	CT703SP
FXDL Dyna Low Rider	06-17	CK7008		CSK915			SRC7013	SRK7013	CT703SP
FXDLI Dyna Low Rider	04-05	CK7008		CSK916			SRC7012	SRK7012	CT703SP
FXDLS Dyna Low Rider S	16-17	CK7008		CSK914			SRC7009	SRK7009	CT703SP
FXDSCONV Dyna Glide Convertible	99-00	CK7008		CSK917			SRC7011	SRK7011	CT703SP
FXDWG Dyna Wide Glide	98-05	CK7008		CSK917			SRC7011	SRK7011	CT703SP
FXDWG Dyna Wide Glide	07-16	CK7008		CSK915			SRC7013	SRK7013	CT703SP

CLUTCH APPLICATIONS

EBC CLUTCH KITS

Make & Model	Year	CK Series #	CKF Series #	Spring Kit #	DRC Series #	DRCF Series #	SRC Series #	SRK Series #	CT Tool #
HARLEY-DAVIDSON® SOFTAIL Contd.									
FXDWG 103 Dyna Wide Glide	12-17	CK7008		CSK916			SRC7012	SRK7012	CT703SP
FXDWGANV Dyna Wide Glide 105th Anniversary	08	CK7008		CSK915			SRC7013	SRK7013	CT703SP
FXDWGI Dyna Wide Glide	04-05	CK7008		CSK916			SRC7012	SRK7012	CT703SP
FXDWGI Dyna Wide Glide	06	CK7008		CSK915			SRC7013	SRK7013	CT703SP
FXDX Dyna Super Glide Sport	99-03	CK7008		CSK917			SRC7011	SRK7011	CT703SP
FXDX Dyna Super Glide Sport	04-05	CK7008		CSK916			SRC7012	SRK7012	CT703SP
FXDXT Dyna Super Glide T-Sport	01-03	CK7008		CSK917			SRC7011	SRK7011	CT703SP
FXS 103 Blackline	12-13	CK7008		CSK916			SRC7012	SRK7012	CT703SP
FXS Blackline	11	CK7008		CSK915			SRC7013	SRK7013	CT703SP
FXS Blackline	12	CK7008		CSK916			SRC7012	SRK7012	CT703SP
FXS Blackline	13	CK7008		CSK915			SRC7013	SRK7013	CT703SP
FXSB 103 Softail Breakout	13-15	CK7008		CSK916			SRC7012	SRK7012	CT703SP
FXSB Softail Breakout	13-17	CK7008		CSK915			SRC7013	SRK7013	CT703SP
FXST Softail Standard	99-03	CK7008		CSK917			SRC7011	SRK7011	CT703SP
FXST Softail Standard	04-06	CK7008		CSK916			SRC7012	SRK7012	CT703SP
FXST Softail Standard	07-11	CK7008		CSK915			SRC7013	SRK7013	CT703SP
FXST Softail Standard	12-15	CK7008		CSK916			SRC7012	SRK7012	CT703SP
FXSTB Night Train	99-03	CK7008		CSK917			SRC7011	SRK7011	CT703SP
FXSTB Night Train	04-05	CK7008		CSK916			SRC7012	SRK7012	CT703SP
FXSTB Night Train	06-09	CK7008		CSK915			SRC7013	SRK7013	CT703SP
FXSTBI Night Train	01-03	CK7008		CSK917			SRC7011	SRK7011	CT703SP
FXSTBI Night Train	04-05	CK7008		CSK916			SRC7012	SRK7012	CT703SP
FXSTBI Night Train	06	CK7008		CSK915			SRC7013	SRK7013	CT703SP
FXSTC Softail Custom	98-99	CK7008		CSK917			SRC7011	SRK7011	CT703SP
FXSTC Softail Custom	07-10	CK7008		CSK915			SRC7013	SRK7013	CT703SP
FXSTD Softail Deuce	00-03	CK7008		CSK917			SRC7011	SRK7011	CT703SP
FXSTD Softail Deuce	04-05	CK7008		CSK916			SRC7012	SRK7012	CT703SP
FXSTD Softail Deuce	06-07	CK7008		CSK915			SRC7013	SRK7013	CT703SP
FXSTDI Softail Deuce	01-03	CK7008		CSK917			SRC7011	SRK7011	CT703SP
FXSTDI Softail Deuce	04-05	CK7008		CSK916			SRC7012	SRK7012	CT703SP
FXSTDI Softail Deuce	06	CK7008		CSK915			SRC7013	SRK7013	CT703SP
FXSTI Softail Standard	01-03	CK7008		CSK917			SRC7011	SRK7011	CT703SP
FXSTI Softail Standard	04-05	CK7008		CSK916			SRC7012	SRK7012	CT703SP
FXSTI Softail Standard	06	CK7008		CSK915			SRC7013	SRK7013	CT703SP
FXSTS Springer Softail	98-03	CK7008		CSK917			SRC7011	SRK7011	CT703SP
FXSTS Springer Softail	04-05	CK7008		CSK916			SRC7012	SRK7012	CT703SP
FXSTS Springer Softail	06	CK7008		CSK915			SRC7013	SRK7013	CT703SP
FXSTSI Springer Softail	01-03	CK7008		CSK917			SRC7011	SRK7011	CT703SP
FLTRU Road Glide Ultra	17-18	CK7002		CSK236			SRC7010	SRK7010	CT702SP
FXSTSI Springer Softail	04-05	CK7008		CSK916			SRC7012	SRK7012	CT703SP
FLTRX Road Glide	17-18	CK7002		CSK236			SRC7010	SRK7010	CT702SP
FLTRXS Road Glide Special	17-18	CK7002		CSK236			SRC7010	SRK7010	CT702SP
FXSTSI Springer Softail	06	CK7008		CSK915			SRC7013	SRK7013	CT703SP
FLDE 1YCJ Deluxe	18	TBA		CSK236			TBA	TBA	
FLFB 1YFJ Fat Boy	18	TBA		CSK236			TBA	TBA	
FXBRS Breakout 114	18	CK7007		CSK236			SRC7008	SRK7008	CT708SP
FLSL 1YDJ Slim	18	TBA		CSK236			TBA	TBA	
FXBB 1YJJ Street Bob	18	TBA		CSK236			TBA	TBA	
FXBR 1YEJ Breakout	18	TBA		CSK236			TBA	TBA	
FXBRS Breakout 114 Anniversary	18	CK7007		CSK236			SRC7008	SRK7008	CT708SP
FXFBS Fat Bob 114	18	CK7007		CSK236			SRC7008	SRK7008	CT708SP
HARLEY-DAVIDSON® STREET									
XG500	15-20	CK7004		CSK230			SRC7005	SRK7005	
XG750	15-20	CK7004		CSK229			TBA	TBA	
INDIAN									
Chief Classic	14-20	CK7003		CSK232			SRC7004	SRK7004	
Chief Dark Horse	16-20	CK7003		CSK232			SRC7004	SRK7004	
Chief Vintage	14-20	CK7003		CSK232			SRC7004	SRK7004	
Chieftain	14-18	CK7003		CSK232			SRC7004	SRK7004	
Chieftain Dark Horse	16-20	CK7003		CSK232			SRC7004	SRK7004	
Chieftain Elite	17-20	CK7003		CSK232			SRC7004	SRK7004	
Chieftain Limited	17-18	CK7003		CSK232			SRC7004	SRK7004	
Octane	17	CK7001		CSK231			SRC7001	SRK7001	
Roadmaster	15-18	CK7003		CSK232			SRC7004	SRK7004	
Roadmaster Classic	17-20	CK7003		CSK232			SRC7004	SRK7004	
Roadmaster Elite	18-20	CK7003		CSK232			SRC7004	SRK7004	
Scout	15-16	CK7001		CSK231			SRC7001	SRK7001	
Scout	17-20	CK7001					SRC7002	SRK7002	
Scout 1200	17-20	CK7001					SRC7002	SRK7002	
Scout Bobber	18	CK7001					SRC7002	SRK7002	
Scout Sixty	16-17	CK7001		CSK231			SRC7001	SRK7001	
Scout Sixty	17-20	CK7001					SRC7002	SRK7002	

CLUTCH APPLICATIONS

EBC CLUTCH KITS

Make & Model	Year	CK Series #	CKF Series #	Spring Kit #	DRC Series #	DRCF Series #	SRC Series #	SRK Series #	CT Tool #
INDIAN Contd.									
Springfield	16-20	CK7003		CSK232			SRC7004	SRK7004	
Springfield Dark Horse	18	CK7003		CSK232			SRC7004	SRK7004	
KTM									
SX 60	98-00	CK5594	CKF5594	CSK064	DRC107	DRCF107			CT027
SX 65	98-08	CK5594	CKF5594	CSK064	DRC107	DRCF107			CT027
SX 65	09-18	CK5594	CKF5594	CSK021	DRC241	DRCF241			CT057SP
SX 85 (17 Inch/14 Inch Wheels)	03-17	CK5610		CSK042	DRC139				CT028
SX 85 (19 Inch/16 Inch Wheels)	03-17	CK5610		CSK042	DRC139				CT028
SX 85 (17 Inch/14 Inch Wheels)	18-20	CK5668	CKF5668	CSK908	DRC304	DRCF304			CT087SP
SX 85 (19 Inch/16 Inch Wheels)	18-20	CK5668	CKF5668	CSK908	DRC304	DRCF304			CT087SP
125 EGS	94-97	N/A		CSK011	N/A		N/A		
125 EGS	98-99	CK5611	CKF5611	CSK024	DRC145				CT001
125 EXE	00-01	CK5611	CKF5611	CSK024	DRC145				CT001
125 LC 2 Sting	96-98	N/A		N/A	N/A		N/A		
125 Supermoto	00-01	CK5611	CKF5611	CSK024	DRC145				CT001
Duke 125	11-18	CK4522		CSK199			SRC154	SRK154	
EXC 125	98-06	CK5611	CKF5611	CSK024	DRC145				CT001
EXC 125	07-15	CK5611	CKF5611	CSK132	DRC174				CT001
EXC 125 Six Days	11-15	CK5611	CKF5611	CSK132	DRC174				CT001
RC 125	14-18	CK4522		CSK199			SRC154	SRK154	
SX 125	98-07	CK5611	CKF5611	CSK024	DRC145				CT001
SX 125	08	CK5611	CKF5611	CSK132	DRC174				CT001
SX 125	09-15	CK5611	CKF5611	CSK024	DRC145				CT001
SX 125	15-20	CK5611	CKF5611	CSK210	DRC303				CT001
125 SXS	01-02	CK5611	CKF5611	CSK024	DRC145				CT001
XC 150	11-13	CK5611	CKF5611	CSK091	DRC144				CT001
XC-W-150	17-20	CK5611	CKF5611	CSK210	DRC303				CT001
SX 150	08-20	CK5611	CKF5611	CSK091	DRC144				CT001
Duke 200	12-18	CK4486		CSK195			SRC153	SRK153	
200 EGS	98-99	CK5611	CKF5611	CSK091	DRC144				CT001
200 EXC	97-14	CK5611	CKF5611	CSK091	DRC144				CT001
200 MXC	98-03	CK5611	CKF5611	CSK091	DRC144				CT001
RC 200	14-17	CK4486		CSK195			SRC153	SRK153	
SX 200	March 06-07	CK5611	CKF5611	CSK091	DRC144				CT001
SX 250 (2T)	94-12	CK5595	CKF5595	CSK080	DRC108	DRCF108			CT007
SX 250 (2T/Diaphragm Spring)	13-20	CK5651	CKF5651	CSK910	DRC275				CT023
SX-F 250 (4T)	05-12	CK1293	CKF1293	CSK179	DRC163	DRCF163			CT001
SX-F 250 (4T/Coil Spring)	13-15	CK5651	CKF5651	CSK091	DRC260				CT023
SX-F 250 (4T)	16-20	CK5612	CKF5612	CSK210	DRC171				CT023
SX-F 250 Factory (4T)	16-20	CK5612	CKF5612	CSK210	DRC171				CT023
250 EGS	94-99	CK5595	CKF5595	CSK080	DRC108	DRCF108			CT007
Duke 250	15-18	CK5666		CSK239			SRC140	SRK140	
EXC 250 (2T)	94-12	CK5595	CKF5595	CSK080	DRC108	DRCF108			CT007
EXC 250 Six Days (2T)	11-12	CK5595	CKF5595	CSK080	DRC108	DRCF108			CT007
EXC 250 (2T)	13-20	CK5651	CKF5651	CSK910	DRC275				CT023
EXC 250 Six Days (2T/Diaphragm Spring)	13-15	CK5651	CKF5651	CSK910	DRC275				CT023
250 EXC-G Racing	03	CK5612	CKF5612	CSK210	DRC171				CT023
250 MXC	98-99	CK5595	CKF5595	CSK080	DRC108	DRCF108			CT007
250 SXS	01-03	CK5595	CKF5595	CSK080	DRC108	DRCF108			CT007
250 EXC Racing	02-03	CK5612	CKF5612	CSK210	DRC171				CT023
250 EXC Racing	04	CK5602		CSK210	DRC117				CT059
250 EXC Racing (2T)	05	CK5612	CKF5612	CSK210	DRC154				CT023
250 EXC-G Racing	04	CK5602		CSK210	DRC117				CT059
EXC-F 250 (4T)	06-13	CK1293	CKF1293	CSK179	DRC163	DRCF163			CT001
EXC-F 250 (4T)	14-20	CK5651	CKF5651	CSK910	DRC275				CT023
EXC-F 250 Six Days (4T)	11-13	CK1293	CKF1293	CSK179	DRC163	DRCF163			CT001
EXC-F 250 Six Days (4T)	14-20	CK5651	CKF5651	CSK910	DRC275				CT023
Freeride 250 R (2T)	14-15	CK5612	CKF5612	TBA					
RC 250	15-18	CK5666		CSK239			SRC140	SRK140	
XC 250 (2T)	11-12	CK5595	CKF5595	CSK080	DRC108	DRCF108			CT007
XC 250 (2T/Diaphragm Spring)	13	CK5651	CKF5651	CSK910	DRC275				CT023
XC-F 250 (4T)	11-12	CK1293	CKF1293	CSK179	DRC163	DRCF163			CT001
XC-F 250 (4T/Coil Spring)	13	CK5651	CKF5651	CSK091	DRC260				CT023
XC-F 250 (4T)	16-20	CK5612	CKF5612	CSK210	DRC171				CT023
300 EGS	94-99	CK5595	CKF5595	CSK080	DRC108	DRCF108			CT007
EXC 300 (2T)	00-12	CK5595	CKF5595	CSK080	DRC108	DRCF108			CT007
EXC 300 (2T/Diaphragm Spring)	13-15	CK5651	CKF5651	CSK910	DRC275				CT023
EXC 300 (2T)	16-18	CK5651	CKF5651	CSK910	DRC275				CT023
EXC 300 Six Days (2T)	11-12	CK5595	CKF5595	CSK080	DRC108	DRCF108			CT007
EXC 300 Six Days (2T/Diaphragm Spring)	13-15	CK5651	CKF5651	CSK910	DRC275				CT023
EXC 300 Six Days (2T)	16-18	CK5651	CKF5651	CSK910	DRC275				CT023
300 EXC	94-07	CK5595	CKF5595	CSK080	DRC108	DRCF108			CT007
300 MXC	94-03	CK5595	CKF5595	CSK080	DRC108	DRCF108			CT007

CLUTCH APPLICATIONS

EBC CLUTCH KITS

Make & Model	Year	CK Series #	CKF Series #	Spring Kit #	DRC Series #	DRCF Series #	SRC Series #	SRK Series #	CT Tool #
KTM Contd.									
300 MXC	04-05	CK5595	CKF5595	CSK080	DRC108	DRCF108			CT007
XC 300 (2T)	11-12	CK5595	CKF5595	CSK080	DRC108	DRCF108			CT007
SX 300	94	CK5595	CKF5595	CSK080	DRC108	DRCF108			CT007
300 Six Days	96	CK5595	CKF5595	CSK080	DRC108	DRCF108			CT007
350 Enduro (2T)	89	CK5596		CSK084	DRC173				CT075
350 EXC	94	CK5631	CKF5631	CSK080	DRC169				CT030
350 Freeride (4T)	12-15	CK5651	CKF5651	CSK910	DRC273				CT023
350 MX (2T)	89	CK5596		CSK084	DRC173				CT075
350 Super Comp	94-95	CK5631	CKF5631	CSK080	DRC169				CT030
EXC-F 350 (Coil Spring)	11	CK5651	CKF5651	CSK091	DRC260				CT023
EXC-F 350 (4T/Diaphragm Spring)	12-17	CK5651	CKF5651	CSK910	DRC273				CT023
EXC-F 350 (4T/Diaphragm Spring)	18-20	CK5651	CKF5651	CSK910	DRC275				
EXC-F 350 Six Days (4T/Diaphragm Spring)	12-17	CK5651	CKF5651	CSK910	DRC273				CT023
EXC-F 350 Six Days (4T/Diaphragm Spring)	18-19	CK5651	CKF5651	CSK910	DRC275				CT023
SX-F 350 (USD Forks/Coil Spring)	11-20	CK5651	CKF5651	CSK091	DRC260				CT023
XC-F 350	12	CK5651	CKF5651	CSK091	DRC260				CT023
XC-F 350	16-20	CK5612	CKF5612	CSK210	DRC171				CT023
XCF-W 350 (2T)	16	CK5651	CKF5651	CSK091	DRC260				
XCF-W 350 Six Days (2T)	16	CK5651	CKF5651	CSK091	DRC260				
360 EGS	96-97	CK5595	CKF5595	CSK080	DRC108	DRCF108			CT007
360 EXC	96-97	CK5595	CKF5595	CSK080	DRC108	DRCF108			CT007
360 MXC	96-97	CK5595	CKF5595	CSK080	DRC108	DRCF108			CT007
360 SX	96-97	CK5595	CKF5595	CSK080	DRC108	DRCF108			CT007
360 Six Days	96	CK5595	CKF5595	CSK080	DRC108	DRCF108			CT007
380 EGS	98-99	CK5631	CKF5631	CSK129	DRC170				CT030
380 EXC	98-02	CK5595	CKF5595	CSK080	DRC108	DRCF108			CT007
380 MXC	98-01	CK5595	CKF5595	CSK080	DRC108	DRCF108			CT007
SX 380	98-02	CK5595	CKF5595	CSK080	DRC108	DRCF108			CT007
390 Duke	13-17	CK5665		CSK237			SRC139		
RC 390	14-17	CK5665		CSK237			SRC139		
400 Duke	94-95	CK5631	CKF5631	CSK080	DRC169				CT030
400 EGS-E	97	CK5631	CKF5631	CSK129	DRC170				CT030
400 EGS	94	CK5631	CKF5631	CSK080	DRC169				CT030
400 EGS	96-97	CK5631	CKF5631	CSK129	DRC170				CT030
400 EXC (LC4 Engine)	93-95	CK5632		CSK011	DRC178				CT075
400 EXC	94	CK5631	CKF5631	CSK080	DRC169				CT030
400 EXC	96	CK5631	CKF5631	CSK129	DRC170				CT030
400 EXC	00-02	CK5602		CSK210	DRC117				CT059
400 EXC Racing	02	CK5612	CKF5612	CSK210	DRC171				CT023
400 EXC-G Racing	02	CK5612	CKF5612	CSK210	DRC171				CT023
400 EXC Racing	05	CK5612	CKF5612	CSK210	DRC154				CT023
400 EXC	07-09	CK5612	CKF5612	CSK210	DRC171				CT023
400 EXC-G Racing	05	CK5612	CKF5612	CSK210	DRC154				CT023
400 EXC-G Racing	06	CK5612	CKF5612	CSK210	DRC171				CT023
EXC 400 (4T)	09-11	CK5648	CKF5648	CSK140	DRC252				CT041
400 LC-4	98	CK5631	CKF5631	CSK129	DRC170				CT030
400 LC4-E	00-01	CK5631	CKF5631	CSK129	DRC170				CT030
LC4R 400	99	CK5631	CKF5631	CSK129	DRC170				CT030
400 LSE	97	CK5631	CKF5631	CSK129	DRC170				CT030
400 LSE	04	CK5631	CKF5631	CSK129	DRC170				CT030
400 MXC	01	CK5602		CSK210	DRC117				CT059
400 MXC	02	CK5612	CKF5612	CSK210	DRC171				CT023
400 Super Comp	95	CK5631	CKF5631	CSK080	DRC169				CT030
400 Super Comp/EXC	96-99	CK5631	CKF5631	CSK129	DRC170				CT030
RXC-E 400	95	CK5595	CKF5595	CSK011	DRC108	DRCF108			CT007
400 RXC-E	95	CK5632		CSK011	DRC178				CT075
400 RXC-E	96-97	CK5631	CKF5631	CSK129	DRC170				CT030
SC 400 (LC4 Engine)	95	CK5632		CSK011	DRC178				CT075
SXC 400	97	CK5631	CKF5631	CSK129	DRC170				CT030
400 SX-X	98	CK5631	CKF5631	CSK129	DRC170				CT030
400 SX	99	CK5631	CKF5631	CSK129	DRC170				CT030
SX 400	00-01	CK5602		CSK210	DRC117				CT059
400 SX Racing	02	CK5612	CKF5612	CSK210	DRC171				CT023
400 SXC	00	CK5631	CKF5631	CSK129	DRC170				CT030
400 TXC	98	CK5631	CKF5631	CSK129	DRC170				CT030
SX 440	94	N/A		N/A	N/A		N/A		
MXC 440	94	N/A		N/A	N/A		N/A		
EXC 440	94-95	N/A		N/A	N/A		N/A		
450 EXC Racing	03	CK5612	CKF5612	CSK210	DRC171				CT023
450 EXC-G Racing	03	CK5612	CKF5612	CSK210	DRC171				CT023
450 EXC-G Racing	04	CK5602		CSK210	DRC117				CT059
450 EXC-G Racing	05	CK5612	CKF5612	CSK210	DRC154				CT023
450 EXC Racing	04	CK5602		CSK210	DRC117				CT059
450 EXC Racing	05	CK5612	CKF5612	CSK210	DRC154				CT023

CLUTCH APPLICATIONS

EBC CLUTCH KITS

Make & Model	Year	CK Series #	CKF Series #	Spring Kit #	DRC Series #	DRCF Series #	SRC Series #	SRK Series #	CT Tool #
KTM Contd.									
450 EXC	04-05	CK5612	CKF5612	CSK210	DRC154				CT023
450 EXC	06-09	CK5612	CKF5612	CSK210	DRC171				CT023
EXC 450 (4T/Coil Spring)	09-11	CK5648	CKF5648	CSK140	DRC252				CT041
EXC 450 (4T/Diaphragm Spring)	12	CK5651	CKF5651	CSK910	DRC273				CT023
EXC-F 450 (4T/Diaphragm Spring)	13-17	CK5651	CKF5651	CSK910	DRC275				CT023
EXC 450 Six Days (4T)	11	CK5648	CKF5648	CSK140	DRC252				CT041
EXC 450 Six Days (4T/Diaphragm Spring)	12	CK5651	CKF5651	CSK910	DRC273				CT023
EXC 450 Six Days (4T/Diaphragm Spring)	13-15	CK5651	CKF5651	CSK910	DRC275				CT023
EXC-F 450 (4T/Diaphragm Spring)	18-19	CK5651	CKF5651	CSK910	DRC275				
EXC-R 450 (4T)	08-10	CK5648	CKF5648	CSK140	DRC252				CT041
450 MXC-G Racing	03	CK5612	CKF5612	CSK210	DRC171				CT023
450 MXC-G Racing	04	CK5602		CSK210	DRC117				CT059
450 MXC-G Racing	05	CK5612	CKF5612	CSK210	DRC154				CT023
MXC 450	06	CK5612	CKF5612	CSK210	DRC171				CT023
450 SMR	04-05	CK5612	CKF5612	CSK210	DRC154				CT023
SMR 450	06-07	CK5612	CKF5612	CSK210	DRC171				CT023
SMR 450 (Slipper Clutch)	08-14	N/A		N/A					
450 SMS	04	CK5612	CKF5612	CSK210	DRC172				CT023
SX 450 (4T)	03	CK5612	CKF5612	CSK210	DRC171				CT023
SX 450 (4T)	04-05	CK5612	CKF5612	CSK210	DRC154				CT023
SX 450 (4T)	06	CK5612	CKF5612	CSK210	DRC171				CT023
SX-F 450 (4T/Coil Spring)	07-11	CK5638		CSK136	DRC184				CT009
SX-F 450 (4T/Diaphragm Spring)	12	CK5651	CKF5651	CSK910	DRC273				CT023
EXC-F 450 (4T)	18-19	CK5651	CKF5651	CSK910	DRC275				
SX-F 450 (4T/Diaphragm Spring)	13	CK5651	CKF5651	CSK910	DRC275				CT023
EXC-F 450 (4T)	18	TBA	TBA	TBA	TBA				
SX-F 450 (4T/Diaphragm Spring)	14-20	CK5651	CKF5651	CSK909	DRC281				CT023
450 SX (Quad)	09-11	CK5638		CSK136	DRC184				CT009
XC 450 Quad (4T)	08-09	CK5612	CKF5612	CSK210	DRC171				CT023
500 Enduro (2T)	89	CK5596		CSK084	DRC173				CT075
500 Enduro (4T)	89	CK5596		CSK084	DRC173				CT075
EXC 500 (4T/Diaphragm Spring)	12	CK5651	CKF5651	CSK910	DRC273				CT023
EXC 500 (4T/Diaphragm Spring)	13-15	CK5651	CKF5651	CSK910	DRC275				CT023
EXC 500 Six Days (4T/Diaphragm Spring)	12	CK5651	CKF5651	CSK910	DRC273				CT023
EXC 500 Six Days (4T/Diaphragm Spring)	13-16	CK5651	CKF5651	CSK910	DRC275				CT023
EXC-F 500	17	CK5651	CKF5651	CSK909	DRC281				CT023
EXC-F 500	18-20	CK5651	CKF5651	CSK910	DRC275				CT023
EXC-F 500 Six Days	18-20	CK5651	CKF5651	CSK910	DRC275				CT023
500 MX (2T)	89	CK5596		CSK084	DRC173				CT075
500 MX (4T) LC	89	CK5596		CSK084	DRC173				CT075
XC-W 500	16	CK5651	CKF5651	CSK909	DRC281				
SX-F 505	07-09	CK5638		CSK136	DRC184				CT009
505 SX-F (Quad)	09-12	CK5638		CSK136	DRC184				CT009
520 EXC	00-01	CK5602		CSK210	DRC117				CT059
SX 520	00-01	CK5602		CSK210	DRC117				CT059
520 SX Racing	02	CK5612	CKF5612	CSK210	DRC171				CT023
525 EXC-G Racing	03	CK5612	CKF5612	CSK210	DRC171				CT023
525 EXC	03	CK5612	CKF5612	CSK210	DRC171				CT023
525 EXC Racing	04	CK5602		CSK210	DRC117				CT059
525 EXC-G Racing	04	CK5602		CSK210	DRC117				CT059
525 EXC Racing	05	CK5612	CKF5612	CSK210	DRC154				CT023
525 EXC-G Racing	05	CK5612	CKF5612	CSK210	DRC154				CT023
525 MXC Desert Racing	03	CK5612	CKF5612	CSK210	DRC171				CT023
525 MXC Desert Racing	04	CK5602		CSK210	DRC117				CT059
525 MXC Desert Racing	05	CK5612	CKF5612	CSK210	DRC154				CT023
MXC 525	06	CK5612	CKF5612	CSK210	DRC171				CT023
525 MXC-G Racing	04	CK5602		CSK210	DRC117				CT059
525 SMR	04-05	CK5612	CKF5612	CSK210	DRC154				CT023
525 SX Racing	03	CK5612	CKF5612	CSK210	DRC171				CT023
525 SX Racing	04	CK5602		CSK210	DRC117				CT059
525 SX Racing	05	CK5602		CSK210	DRC154				CT023
SX 525	06	CK5612	CKF5612	CSK210	DRC171				CT023
XC 525 (Quad)	08-12	CK5612	CKF5612	CSK210	DRC171				CT023
EXC-R 530 (4T) (9 Friction plate type)	08	CK5648	CKF5648	CSK140	DRC252				CT041
EXC 530 (9 Friction Plate Type)	09-11	CK5648	CKF5648	CSK140	DRC252				CT041
540 SX-C	98-99	CK5639		CSK129	DRC196				CT030
540 SXS Racing	02	CK5612	CKF5612	CSK210	DRC171				CT023
MXC 550	94-96	N/A		N/A	N/A		N/A		
SMR 560	06-07	CK5612	CKF5612	CSK210	DRC171				CT023
600 Enduro (4T) LC	89	CK5596		CSK084	DRC173				CT075
600 MX (4T) LC	89	CK5596		CSK084	DRC173				CT075
620 Duke	94	CK5631	CKF5631	CSK080	DRC169				CT030
620 Duke	97	CK5631	CKF5631	CSK129	DRC170				CT030
620 EGS	94-95	CK5631	CKF5631	CSK080	DRC169				CT030

CLUTCH APPLICATIONS

EBC CLUTCH KITS

Make & Model	Year	CK Series #	CKF Series #	Spring Kit #	DRC Series #	DRCF Series #	SRC Series #	SRK Series #	CT Tool #
KTM Contd.									
620 EGS/Adventure	96-97	CK5631	CKF5631	CSK129	DRC170				CT030
620 EGS-E	97	CK5631	CKF5631	CSK129	DRC170				CT030
620 Enduro Ltd	97	CK5631	CKF5631	CSK129	DRC170				CT030
620 EXC	94-95	CK5631	CKF5631	CSK080	DRC169				CT030
620 LC-4	98	CK5631	CKF5631	CSK129	DRC170				CT030
620 LC4 Competition	99	CK5639		CSK129	DRC196				CT030
620 LC4 Super Moto	99	CK5639		CSK129	DRC196				CT030
620 LSE	97	CK5631	CKF5631	CSK129	DRC170				CT030
620 RXC-E	96-97	CK5631	CKF5631	CSK129	DRC170				CT030
620 Six Days	96	CK5631	CKF5631	CSK129	DRC170				CT030
620 Super Comp	94-95	CK5631	CKF5631	CSK080	DRC169				CT030
620 Super Comp	96-99	CK5639		CSK129	DRC196				CT030
RXC-E 620	95	CK5595	CKF5595	CSK011	DRC108				CT007
620 RXC-E	95	CK5632		CSK011	DRC178				CT075
620 SC	00-01	CK5631	CKF5631	CSK129	DRC170				CT030
SX 620	94	CK5631	CKF5631	CSK080	DRC169				CT030
SX 620	97-99	CK5639		CSK129	DRC196				CT030
SXC 620	97	CK5631	CKF5631	CSK129	DRC170				CT030
620 Supermoto	98	CK5639		CSK129	DRC196				CT030
620 TXC	98	CK5639		CSK129	DRC196				CT030
625 SC	02	CK5639		CSK129	DRC196				CT030
625 SMC	04-06	CK5639		CSK129	DRC196				CT030
625 SXC	03-04	CK5639		CSK129	DRC196				CT030
640 Adventure-R	98-02	CK5639		CSK129	DRC196				CT030
640 Duke-E	98	CK5639		CSK129	DRC196				CT030
Duke-E 640	98	CK5639		CSK129	DRC196				CT030
Duke II 640	99-02	CK5639		CSK129	DRC196				CT030
Duke II 640	03-07	CK5639		CSK129	DRC196				CT030
640 LC Rallye Dakar	97	CK5631	CKF5631	CSK129	DRC170				CT030
640 LC4	99	CK5639		CSK129	DRC196				CT030
640 LC4	99-00	CK5639		CSK129	DRC196				CT030
640 LC4 Six Days	99	CK5639		CSK129	DRC196				CT030
640 LC4-E	00-02	CK5639		CSK129	DRC196				CT030
640 LC4 Adventure	03-06	CK5639		CSK129	DRC196				CT030
640 LC4 Supermoto	03-04	CK5639		CSK129	DRC196				CT030
660 LC4	97	CK5631	CKF5631	CSK129	DRC170				CT030
660 LC4 Rallye	99-00	CK5639		CSK131	DRC175				CT030
660 Rallye	01-03	CK5633		CSK129	DRC176				CT030
660 Rallye Factory	04	CK5633		CSK129	DRC176				CT030
660 SM Factory Replica	02-03	CK5639		CSK131	DRC175				CT030
660 SMC	03-04	CK5639		CSK131	DRC175				CT030
660 SMS	04	CK5631	CKF5631	CSK131					CT030
690 Duke	08-18	CK5642		CSK131	DRC205				CT069
690 Duke R	10-11	CK5642		CSK131	DRC205				CT069
690 Duke R	13-18	CK5642		CSK131	DRC205				CT069
690 Enduro	08-18	CK5642		CSK131	DRC205				CT069
690 R Enduro	09-18	CK5642		CSK131	DRC205				CT069
690 Rally Factory Replica	07-09	CK5641		CSK131	DRC199				CT030
690 SM	07-09	CK5642		CSK129					CT069
690 SM - LE (Limited Edition)	10-11	CK5642		CSK131	DRC205				CT069
690 SMC	08-11	CK5642		CSK131	DRC205				CT069
690 SMR	07-11	CK5642		CSK131	DRC205				CT069
690 SMC R	12-18	CK5642		CSK131	DRC205				CT069
950 Adventure S	03-04	CK5634		CSK130	DRC177				CT015
950 Adventure	02-06	CK5634		CSK130	DRC177				CT015
950 Superenduro R	07-08	CK5634		CSK130	DRC177				CT015
950 Supermoto	05-07	CK5634		CSK130	DRC177				CT015
990 Adventure S	06-08	CK5634		CSK130	DRC177				CT015
990 Adventure R	09-12	CK5634		CSK130	DRC177				CT015
990 Adventure	09-12	CK5634		CSK130	DRC177				CT015
990 Adventure Dakar Edition	11	CK5634		CSK130	DRC177				CT015
990 Superduke	05-11	CK5634		CSK130	DRC177				CT015
990 Superduke R	07-13	CK5634		CSK130	DRC177				CT015
990 Supermoto T (SM-T)	08-13	CK5634		CSK130	DRC177				CT015
990 Supermoto R (SM-R)	08-09	CK5634		CSK130	DRC177				CT015
990 Supermoto R (SM-R)	10-13	CK5634		CSK130	DRC177				CT015
1050 Adventure	15	TBA		TBA					
RC8 (1190cc)	08-10	CK5644		CSK161			SRC098	SRK098	CT021
RC8R/Track (1190cc/6 Spring Clutch)	10-12	CK5644		CSK161			SRC098	SRK098	CT021
RC8R/Track (1190cc/3 Spring Clutch)	13-14	CK5644		N/A					CT021
1190 Adventure	13-16	N/A		N/A					
1190 Adventure R	13-16	N/A		N/A					
1290 Super Adventure	15	TBA		TBA					
1290 Super Duke R	14-15	TBA		TBA					

CLUTCH APPLICATIONS

EBC CLUTCH KITS

Make & Model	Year	CK Series #	CKF Series #	Spring Kit #	DRC Series #	DRCF Series #	SRC Series #	SRK Series #	CT Tool #
KTM Contd.									
Rekluse After Market Clutch for EXC 250/300 (2T Models/24 Tooth Steel Plate)	03-11	CK5595	CKF5595	N/A	N/A	N/A			CT049
Rekluse After Market Clutch for SX 250/300 (2T Models/24 Tooth Steel Plate)	03-11	CK5595	CKF5595	N/A	N/A	N/A			CT049
METRAKIT									
GP50	All				DRC310				
MODENAS									
Kriss 110/115		CK4438	CKF4438	CSK040					CT070SP
MONTESA-HONDA									
315R (2T)	97-04	CK1170	CKF1170	CSK163	DRC250				CT009
4RT 250cc (4T)	05-09	CK1171		TBA					
MORIWAKI/HONDA									
MD 250 H	08-11	CK1305	CKF1305	CSK176					CT001
MD 250 S	08-11	CK1305	CKF1305	CSK176					CT001
MOTOROMA									
Geko 300 Quad	04-06	CK1190	CKF1190	N/A					CT013SP
QUADZILLA									
WK 300	06	CK3399	CKF3399	CSK034	DRC058	DRCF058			CT022
SACHS									
XTC 125	00-07	CK3318	CKF3318	CSK034					CT011
X Road 125	06-07	CK3318	CKF3318	CSK034					CT011
TRIUMPH									
Adventurer	96-01	CK5588	CKF5588	CSK068					CT021
America (Cast Wheel)	07-09	CK5608		CSK015					
Bonneville 800 (790cc) Up to Engine no. 211132	01-04	CK5597		CSK015					CT009SP
Bonneville 800 From Engine no. 211133	01-04	CK5608		CSK015					
Bonneville America	02-06	CK5608		CSK015					
Bonneville/Bonneville Black (865cc)	07-08	CK5608		CSK015					
Bonneville (865cc)	09	TBA		TBA					
Bonneville SE (865cc)	09	TBA		TBA					
Bonneville T-100 (790cc) Up to Engine no. 211132	02-04	CK5597		CSK015					CT009SP
Bonneville T-100 From Engine No. 211133	02-04	CK5608		CSK015					
Bonneville T-100 (865cc)	05-09	CK5608		CSK015					
Bonneville - Steve McQueen SE	12	CK5608		CSK015					
Bonneville T100 (900cc/Liquid Cooled)	16-18	CK5669		CSK244			SRC147	SRK147	CT086SP
Bonneville T100 Black (900cc/Liquid Cooled)	16-18	CK5669		CSK244			SRC147	SRK147	CT086SP
Bonneville T120 (1200cc Liquid Cooled)	16-18	CK5669		CSK243			SRC146	SRK146	CT086SP
Bonneville T120 Black (1200cc Liquid Cooled)	16-18	CK5669		CSK243			SRC146	SRK146	CT086SP
Bonneville Bobber (1200cc Liquid Cooled)	17-20	CK5669		CSK243			SRC146	SRK146	CT086SP
Bonneville Bobber Black (1200cc Liquid Cooled)	18-20	CK5669		CSK243			SRC146	SRK146	CT086SP
T595 Daytona (9 Friction Plates)	97-98	CK5589	CKF5589	CSK029					CT009
Daytona 600	02-05	CK1206	CKF1206	CSK083					CT013SP
Daytona 650	05	CK1181		CSK015					CT014
Daytona 675	06-12	CK1206	CKF1206	CSK135					CT014
Daytona 675 R	11-16	CK1206	CKF1206	CSK135					CT014
Daytona 750 (3cyl)	92	CK5588	CKF5588	CSK068					CT021
Daytona 900 (3cyl)	93-96	CK5588	CKF5588	CSK068					CT021
Daytona 955i	98-00	CK5589	CKF5589	CSK029					CT009
Daytona 955i (From VIN 132513)	01-06	CK5599		CSK029					CT009
Daytona 1000 (4cyl)	92	CK5588	CKF5588	CSK015					CT021
Daytona Super III (3cyl)	94-97	CK5588	CKF5588	CSK068					CT021
Daytona 1200 (4cyl)	93-98	CK5588	CKF5588	CSK045					CT021
Legend TT	98-01	CK5588	CKF5588	CSK068					CT021
Rocket III 2300cc	04-09	CK5624		CSK118					CT021
Rocket III Classic	07-09	CK5624		CSK118					CT021
Rocket III Roadster ABS	10-12	CK5624		CSK118					CT021
Rocket III Touring	08-12	CK5624		CSK118					CT021
Speedmaster 800 (790cc) Up to VIN 210261	03-04	CK5608		CSK015					
Speedmaster From VIN 210262	03-04	CK5608		CSK015					
Scrambler (865cc)	06-09	CK5608		CSK015					
Speedmaster (865cc)	05-09	CK5608		CSK015					
Speed Triple (Carb models)	94-97	CK5588	CKF5588	CSK068					CT021
Speed Triple (EFI)	97-01	CK5589	CKF5589	CSK029					CT009
Speed Triple 955cc (From VIN 141872 to 210444)	02-04	CK5599		CSK029					CT009
Speed Triple (1050cc)	05-08	CK5599		CSK029					CT009
Speed Triple R (1050cc)	12	TBA		TBA					

EBC CLUTCH KITS

Make & Model	Year	CK Series #	CKF Series #	Spring Kit #	DRC Series #	DRCF Series #	SRC Series #	SRK Series #	CT Tool #
TRIUMPH Contd.									
Sprint GT 1050	10-12	CK5599		CSK029					
Sprint ST (1050cc) (From VIN 208167)	05-09	CK5599		CSK029					CT009
Rocket III 2300cc (All models)	04-09	CK5624		CSK118					CT021
Sprint (All carb models up to VIN 9082)	93	CK5588	CKF5588	CSK068					CT021
Sprint (All carb models from VIN 9083)	94-98	CK5588	CKF5588	CSK068					CT021
Sprint RS (Up to VIN 139276)	99-01	CK5589	CKF5589	CSK029					CT009
Sprint RS (From VIN 139277)	02-04	CK5599		CSK029					CT009
Sprint ST (Up to VIN 139276)	99-01	CK5589	CKF5589	CSK029					CT009
Sprint ST (From VIN 139277 to 208166)	02-04	CK5599		CSK029					CT009
Street Cup (900cc Liquid Cooled)	16-20	CK5669		CSK244			SRC147	SRK147	CT086SP
Street Scrambler (900cc Liquid Cooled)	16-20	CK5669		CSK244			SRC147	SRK147	CT086SP
Street Triple 675	07-16	CK1206	CKF1206	CSK135					CT014
Street Triple R 675	09-16	CK1206	CKF1206	CSK135					CT014
Street Triple S 765	17-20	CK1206	CKF1206	CSK135					CT014
Street Triple R 765	17-20	CK1206	CKF1206	CSK135					CT014
Street Triple RS 765	17-20	CK1206	CKF1206	CSK135					CT014
Street Twin (900cc Liquid Cooled)	16-2018	CK5669		CSK244			SRC147	SRK147	CT086SP
TT 600	00-03	CK1206	CKF1206	CSK083					CT013SP
Thunderbird	95-03	CK5588	CKF5588	CSK068					CT021
Thunderbird Sport	98-04	CK5588	CKF5588	CSK068					CT021
Thunderbird (1597cc)	09-12	TBA		TBA					
Thunderbird Storm (1699cc)	11-12	TBA		TBA					
Thrupton 900	04-12	CK5608		CSK015					
Tiger 800	11-12	CK1206	CKF1206	CSK135					
Tiger 800 XC	11-12	CK1206	CKF1206	CSK135					
Tiger 900cc (Up to VIN 71698) Carb Models	93-96	CK5588	CKF5588	CSK068					CT021
Tiger 900cc (From VIN 71699) Injection Models	97-98	CK5589	CKF5589	CSK029					CT009
Tiger 955cc (Up to VIN 198874)	99-04	CK5589	CKF5589	CSK029					CT009
Tiger 955 (From VIN 198875)	04-06	CK5589	CKF5589	CSK029					CT009
Tiger 1050	07-12	CK5599		CSK029					CT009
Tiger 1050 SE	10-12	CK5599		CSK029					CT009
Tiger Explorer 1200	12	TBA		TBA					
Trident 750	92-98	CK5588	CKF5588	CSK068					CT021
Trident 900	92-98	CK5588	CKF5588	CSK068					CT021
Trophy 900 (3cyl)	92-01	CK5588	CKF5588	CSK068					CT021
Trophy 1200 (4cyl)	92-01	CK5588	CKF5588	CSK015					CT021
Thrupton 1200 (Liquid Cooled)	16-20	CK5669		CSK243			SRC146	SRK146	CT086SP
Thrupton R 1200 (Liquid Cooled)	16-20	CK5669		CSK243			SRC146	SRK146	CT086SP

CLUTCH APPLICATIONS

EBC CLUTCH KITS BUYERS GUIDE

CK1105	HONDA SS 50 ZK2/ZB2 CD 50 ST/SV/SW/SX Benley 50 S CL 50 V/X Benley CL 50	75-80 96-99 97-99	CK1131	HONDA CR 250 RB/RC TL 250/TL250 K1 XL 250 K3/K4 CR 450 RB CR 480 RC	81-82 78-79 78-79 81 82
CK1107	Z50 RZ-RD C 70/C70M	79-86 -78	CK1132 ▲=CT009	CB 250 K3-K5/G5 CJ 250 T/T2 CB 350 K4 CB 360/CJ 360 (All models)	73-76 ▲ 77 ▲ ▲ ▲
CK1119 ▲=CT088 ■=CT012SP ★=CT012 *=CT002	CR 80 RE CR 80 RF/R2F/RG/R2G/RH/RJ/RK/RL /RM/RP/RR/RS/RT/RBT/RV/RBV/RW /RBW/RX/RBX/RV/RBY/R1/RB1/R2/RB2 CR 85 R3/RB3/R4/RB4/R5/RB5/R6 /RB6/R7/RB7 CB 100 N CA 125 V/W/X CB 125 S/J CB 125 T/T2 CB 125 TDC/TDE CB 125 RS CBF 125 M9/MA/MB/MD/ME CBR 125 RW7/RW8/RW9/RWA/RWB /RC/RD/RF (No judder spring) CD 125 TC CG 125 K1/B/C/E/BR/BR-K/BR-J/S/T/W CLR 125 W 'City Fly' CM 125 CC/CF CT 125 C TL 125 S NX 125 K/S/F Transcity XL 125 K2-K4/SZ/SA XL 125 SB/SC/SZ/SA/RC/RF/RH XLR 125 RW XR 125 L3/L4/L5/L6/L7/L8 CRF 150 F6/F7 CRF 150 R (Small Wheel F 17 Inch/ R 14 Inch) CRF 150 RB (Big Wheel F 19 Inch/ R 16 Inch) CD 185 T XL 185 SZ/SA/SB ATC 200 XD CD 200 TA CM 200 TA/TB CTX 200/CTX 200 A Bushlander TL 200 J/Y TLR 200 D/E/G/H TRX 200 D TRX 200 L/M Fourtrax TRX 200 SX XR 200 RB/RC/RD XR 200 XR 200 R XR 200 R TLR 250 F TRX 250 V/W/X/Y/1/TM Recon (Manual Shift) TRX 250 TE Recon ES (Electric Shift) TRX 250 EX1/2/3/4/5/6/7/8 TRX 250 X9/XA/XB HONDA-DALL'ARA XR 125 SM KAWASAKI KLF 185 A3 YAMAHA MT 125 (Non ABS) MT 125 A (ABS) YZF-R 125 (Radial Mount Front Caliper/Non ABS) YZF-R 125 A (Radial Mount Front Caliper/ABS)	84 ■ 85-02 ■ 03-07 ■ 78-80 ■ 98-00 ■ 75-79 ★ 78-80 ★ 83-86 ■ 83 ■ 09-15 ■ 07-16 ■ 78 ■ 77-00 ★ 98-03 ■ 82-85 ■ 85 ★ 76 ■ 89-97 ■ 78-79 ■ 79-86 ■ 98-99 ■ 03-08 ■ 06-19 ■ 07-19 * 07-19 * 78 ■ 80-82 ■ 84 ■ 79-80 ■ 79-80 ■ 04-05 ■ 76-78 ■ 83-87 ■ 91-97 ■ 90-91 ■ 86-87 ■ 81-83 ■ 80-84 ■ 81-83 ■ 86-02 ■ 85- ■ 97-14 ■ 02-14 ■ 01-07 ■ 09-11 ■ 04 ■ 87 ■ 14-16 ▲ 14-16 ▲ 14-16 ▲ 14-15 ▲	CK1133 ▲=CT076SP	CB 750/K1/K2/K3/K4/K5 (From E/No.: -1056080)	69-75 ▲
			CK1134	CB 175 (All models) CD 175 (All models) CB 200/CB 200 B SL 350 K0/K1/K2	76-78 69-73
			CK1135 ▲=CT009	CB 500/K1/K2	75-77 ▲
			CK1140 ■=CT013SP	CB 250 T/N/NA/NB/ND/NBD/NDC CM 250 TB CB 350 SG/SJ CB 400 F/F1/F2 CB 400 T/N/NA/NB/NC CB 450 DX-K CMX 450 CH/CJ Rebel XL 500 SZ/SB/RC	78-82 ■ 81 ■ 86-88 ■ 75-79 ■ 78-82 ■ 89 ■ 02 ■ 80-82 ■
			CK1143 ▲=CT076SP	GL 1000 K1/K2 'Goldwing' (From E/No.: -2002384)	77-78 ▲
			CK1144 ▲=CT002	CR 125 M2-M4	76-78 ▲
			CK1145 ▲=CT076SP	CB 750 F2 CB 750 K6/K7	78 ▲ 76-77
			CK1146 ▲=CT009SP	CB 500 K3 CX 500 CA/CB/Z/A/B/EC GL 500 DC CB 550 F/F1/F2/K3	78 ▲ 79-85 ▲ 82 ▲ 78-80 ▲
			CK1147	CB 650 Z/B/SCC CX 650 ED GL 650 D2-E	79-82 83-85 84
			CK1148	C 50 Z2/ZZ/ZA C 50 All Models C 50 N (Single seat model) C 50 P/S/V/X/Y/1/2 CF 50/CF 50 K2 CRF 50 F MP 50 3/DX3 Solo (AC17) ST 50 J/K Dax XR 50 1/2/3 ATC 70 All Models C 70 Z2/ZZ/C/D/DMC CRF 70 F4/F5/F6/F7/F8/F9/FA/FB/FC/FD XR 70 RV/RW/RX/RV/R1/R2/R3 C 90 C/E/G/MF/P/MP/MG/N/MN P/MP/T/MT	78-81 82-93 95 96-02 77-78 04-20 03 78-93 01-03 79-85 77-85 04-13 97-03 82-03
			CK1149 ▲=CT078SP	CB 750 KZ CB 750 FA/FB/F2C CB 900 FZ/FA/FB/F2B/F2C/FD/F2D CB 1100 RB2/RC2/RD2	80 ▲ 79-82 ▲ 80-85 ▲ 80-82 ▲
			CK1150 ■=CT012SP ▲=CT012	CB 50 J CB 50 V/W Dream 50 CRM 50 RN/RP/RR/RT MB 50 MBX 50 SD/SF MTX 50 SC NSR 50 FP/FR/FS	81 ■ 97-98 ■ 93-96 ■ 80-82 ■ 83-85 ■ 83-87 ■ 93-95 ■
CK1123	CD 175	67-68			
CK1130 ▲=CT031	CB500 T	75-77 ▲			

Part No.	Make/Model	Year	Part No.	Make/Model	Year
CK1150 ■=CT012SP ▲=CT012 Contd.	HONDA NSR 50 RV/RW/RX/RY NSR 50 SK/SP/SR/SS TLM 50 F XR 50 M5 (AD14) Motard XZ 50 1/2 Ape-AC16 XR 75 K4/K5 CRF 80 F4/F5/F6/F7/F8/F9/FB/FC XR 80 Z/A/B XR 80 R	97-00 ■ 89-95 ■ 85 ■ 05 ▲ 01-02 ▲ 78-79 ▲ 04-12 ▲ 80-81 ▲ 87-88 ▲	CK1154 ■=CT013SP Contd.	HONDA TRX 500 TM5/TM6 Fourtrax Foreman TRX 500 FEC Fourtrax Foreman ES 2/4 WD TRX 500 FMC Fourtrax Foreman 2/4 WD TRX 500 FPCC Fourtrax Foreman 2/4 WD XR 500 SZ/SA/RB/RC	05-06 ■ 12 ■ 12 ■ 12 ■ 79-82 ■
	CK1151 CKF1151 ■=CT012SP ▲=CT012	CR 50 RE/RF NSR 50 V (AC10-180) NSR 50 X (AC10-190) CR 60 RF/RG CRM 75 RK/RL/RM/RP/RR NSR 75 N/P/R/X/Y (NS-1) CR 80 RA/RB/RC/RD MBX 80 FWDD/FWDF MTX 80 RFD/RF NSR 80 J-2/K/L/N/P/R/S (HC06) NSR 80 V (HC06-170) NSR 80 X (HC06-180) TRX 90 P/R/S/T/V/W/X/Y/1-6 TRX 90 EX TRX 90 X9/XB/XC Astrea Supra NF 100 Astrea Grand/Supra CRF 100 F4/F5/F6/F7/F8/F9/FA/FB/FC XL 100 SZ/SA/SB XR 100 RP/RR/RS/RT/RV/RW/RX /RY/R1/R2/R3 XR 100 M5 (HD13) Motard XZ 100 2 APE-HC07 ATC 125 MG CB 125 F (GLR 125 1WHF) CB 125 F (GLR 125 1WHH) CBF 125 6 Stunner CBF 125 M7 Stunner H 100 A/SD/SG/SJ TRX 125 J CBF 150 5 CBF 150 M5 Unicorn CBF 150 6 (Spoke Wheels) CBF 150 M6/M7 Unicorn (Spoke Wheels) CBF 150 M7/M9/MA Unicorn (Cast Wheels) CBF 150 MB/MC Unicorn (Cast Wheels) ATC 185 A/SB/SC/SD ATC 200 B/ESE/ESF/SE YAMAHA XT 125 R (13D3/13D5) (4 friction plate clutch) XT 125 X (13D4/13D6) (4 friction plate clutch) YBR 125 ED (3D91/3D92) YBR 125 (51D1/2) (4 plate clutch) YBR 125 Custom		84-85 ■ 97 ■ 99 ■ 85-86 ▲ 89-94 ■ 92-00 ■ 80-83 ▲ 83-86 ■ 83-84 ■ 88- ■ 97 ■ 99 ■ 93-06 ■ 07-08 ■ 09-14 ■ 99 ■ 97-98 ■ 04-12 ▲ 78-82 ▲ 93-03 ▲ 05 ▲ 02 ■ 86 ■ 15-16 17-18 06▲ 07▲ 84-92 ■ 88 ■ 05▲ 05▲ 06▲ 06-07▲ 07-10▲ 11-12▲ 80-83 ■ 81-84 ■ 07-11 ▲ 07-11 ▲ 05-12 ▲ 10-16 ▲ 08-16 ▲	CK1155 C 90 Z2/ZZ (From E/No.:A073285) ATC 110 All Models CT 110 A/B/C/D/K/M/P/X ATC 125 ME
CK1152 ■=CT013SP		XL 250 S/SZ/SA XR 250 SZ/SA	78-80 ■ 78-80 ■	CK1159 ▲=CT053SP	
	CK1153 ■=CT013SP	NS 125 FG/FH/RH CB 250 RSA/RSD CL 250 SC XL 250 RB/RC/RD XL 250 SB/RC	86-87 ■ 81-84 ■ 81 ■ 81-83 ■ 81-82 ■		CK1160 ■=CT013SP
CK1154 ■=CT013SP		TRX 420 FM7/FM8/FM9/FMA/FMB 4WD - Fourtrax TRX 420 FPM9/FPMA/FPMB Fourtrax - 4WW - Power Steering TRX 420 TM7/TM8/TM9/TMA/TMB Fourtrax 2WD FT 500C TRX 500 FE5/FE6/FE7/FE8/FE9 /FEA Fourtrax Foreman 4WD-ES TRX 500 FM5/FM6/FM7/FM8/FM9 /FMA Fourtrax Foreman 4WD TRX 500 FPE8/FPE9/FPEA Fourtrax Foreman - Power Steering	07-11 ■ 09-11 ■ 07-12 ■ 82 ■ 05-10 ■ 05-10 ■ 08-10 ■	CK1163	
	CK1155 ■=CT013SP	TRX 420 FM7/FM8/FM9/FMA/FMB 4WD - Fourtrax TRX 420 FPM9/FPMA/FPMB Fourtrax - 4WW - Power Steering TRX 420 TM7/TM8/TM9/TMA/TMB Fourtrax 2WD FT 500C TRX 500 FE5/FE6/FE7/FE8/FE9 /FEA Fourtrax Foreman 4WD-ES TRX 500 FM5/FM6/FM7/FM8/FM9 /FMA Fourtrax Foreman 4WD TRX 500 FPE8/FPE9/FPEA Fourtrax Foreman - Power Steering	07-11 ■ 09-11 ■ 07-12 ■ 82 ■ 05-10 ■ 05-10 ■ 08-10 ■		CK1165 ▲=CT002
CK1156 ■=CT013SP		TRX 420 FM7/FM8/FM9/FMA/FMB 4WD - Fourtrax TRX 420 FPM9/FPMA/FPMB Fourtrax - 4WW - Power Steering TRX 420 TM7/TM8/TM9/TMA/TMB Fourtrax 2WD FT 500C TRX 500 FE5/FE6/FE7/FE8/FE9 /FEA Fourtrax Foreman 4WD-ES TRX 500 FM5/FM6/FM7/FM8/FM9 /FMA Fourtrax Foreman 4WD TRX 500 FPE8/FPE9/FPEA Fourtrax Foreman - Power Steering	07-11 ■ 09-11 ■ 07-12 ■ 82 ■ 05-10 ■ 05-10 ■ 08-10 ■	CK1166 ▲=CT031	
	CK1157 ■=CT013SP	TRX 420 FM7/FM8/FM9/FMA/FMB 4WD - Fourtrax TRX 420 FPM9/FPMA/FPMB Fourtrax - 4WW - Power Steering TRX 420 TM7/TM8/TM9/TMA/TMB Fourtrax 2WD FT 500C TRX 500 FE5/FE6/FE7/FE8/FE9 /FEA Fourtrax Foreman 4WD-ES TRX 500 FM5/FM6/FM7/FM8/FM9 /FMA Fourtrax Foreman 4WD TRX 500 FPE8/FPE9/FPEA Fourtrax Foreman - Power Steering	07-11 ■ 09-11 ■ 07-12 ■ 82 ■ 05-10 ■ 05-10 ■ 08-10 ■		CK1167 ▲=CT031 ■=CT009
CK1158 ■=CT013SP		NS 125 FG/FH/RH CB 250 RSA/RSD CL 250 SC XL 250 RB/RC/RD XL 250 SB/RC	86-87 ■ 81-84 ■ 81 ■ 81-83 ■ 81-82 ■	CK1170 CKF1170 ■=CT009	
	CK1159 ■=CT013SP	NS 125 FG/FH/RH CB 250 RSA/RSD CL 250 SC XL 250 RB/RC/RD XL 250 SB/RC	86-87 ■ 81-84 ■ 81 ■ 81-83 ■ 81-82 ■		CK1171 ■=CT009SP
CK1160 ■=CT013SP		NS 125 FG/FH/RH CB 250 RSA/RSD CL 250 SC XL 250 RB/RC/RD XL 250 SB/RC	86-87 ■ 81-84 ■ 81 ■ 81-83 ■ 81-82 ■	CK1176 ▲=CT031 ■=CT009	
	CK1161 ■=CT013SP	NS 125 FG/FH/RH CB 250 RSA/RSD CL 250 SC XL 250 RB/RC/RD XL 250 SB/RC	86-87 ■ 81-84 ■ 81 ■ 81-83 ■ 81-82 ■		CK1177 ▲=CT002
CK1162 ■=CT013SP		NS 125 FG/FH/RH CB 250 RSA/RSD CL 250 SC XL 250 RB/RC/RD XL 250 SB/RC	86-87 ■ 81-84 ■ 81 ■ 81-83 ■ 81-82 ■	CK1177 ▲=CT002	

Part No.	Make/Model	Year	Part No.	Make/Model	Year
CK1180 ■=CT013SP	KAWASAKI MBX 125 FE MTX 125 RWD/E/F/H/L MTX 200 RWF XR 200 R XL 250 RE-RF XLR 250 R - 5 Plate 'Baja' XR 250 RE/RF	84-86 ■ 83-95 ■ 85 ■ 84-85 ■ 84-85 ■ 84-85 ■	CK1193 CKF1193 ▲=CT013 ★=CT014 ■=CT013SP ❖=CT080	ATC 250 RF/RG CRM 250 R (RK) MK1/MD 24 (100001-1008385) CRM 250 R (RM) MK2/MD24 (1200001-1211634) CRM 250 R (RP/RP-II) MK2/2 MD24 (1300001-) TRX 250 RG/RH/RJ/RK TRX 400 EXX/EXY/EX1-EX8 TRX 400 X9 XR 400 RT/RV/RW/RX/RY/R1-R5 CBR 600 FX/FY (Carb Model)	85-86 ■ 89-90 ▲ 91-92 ▲ 93 ▲ 86-89 ▲ 99-08 ▲ 09 ▲ 96-05 ▲ 99-00 ★
CK1181 ▲=CT013 ■=CT013SP ★=CT014	KLF 220 A1-A15 KLF 250 A1/A2/A3/A6F/A7F/A8F /A9F/AAF/ABF HONDA CRM 250 ARV/ARW (MD32) CRM 250 MK3 (MD24-140) CRM 250 RR/RR-II (MD24) 140 MK3 NSR 250 RG/R2J (MC16/18) NSR 250 R5K/R5K-2 NSR 250 R7L/R7N NSR 250 RR CB 400 SS (SS2-NC41) CBR 400 RRL/RRN/RRR (NC29) CL 400 (NC38) XR 400 R5/R6 Motard (NC38E) XR 400 M Supermotard (ND08/NC38E) CB 500 R/T/V/W/SW//X/SX/Y/SY/2/S2 CBF 500 4/A4/A5/A6/A7 XL 600 VH/VJ/VN/VN/VP/VR/VT /VV/VW/VX Transalp VT 600 CN/CR/CS/CT/CV/CW/CX CB 650 F (Non ABS) CB 650 FA (ABS) CBR 650 F (Non ABS) CBR 650 FA(ABS)	88-02 ■ 03-11 ■ 97-98 ▲ 94-96 ▲ 94-96 ▲ 86-88 ▲ 89 ▲ 90 ▲ 94 ▲ 01-05 ▲ 90-94 ■ 98-03 ▲ 05-06 ▲ 06-08 ▲ 94-03 ■ 04-07 ■ 87-00 ■ 92-00 ■ 14-20★ 14-20★ 14-20★ 14-20★	CK1194 ▲=CT013SP	TRX 250 F/G/H ATC 250 ESF/ESG/ESH/ESJ	85-87 ▲ 85-88 ▲
CK1183 ▲=CT066SP	CBX 1000 Z/B/C	79-81 ▲	CK1196 ■=CT013SP	TRX 300 FWJ/FWK/FWL/FWT/FWW /FWW/FWX/J/K/L/T/V/W/X/Y TRX 350 G/H/J/K/L/M/N TRX 350 FMY/1-5 Fourtrax Rancher/4x4 TRX 400 FWS/T/V/W/X/Y TRX 420 FE7/FE8/FE9/FEA/FEB 4WD - Fourtrax ES TRX 420 TE7/TE8/TE9 Fourtrax ES-2WD TRX 450 ESW/ESX/ESY/ES1	88-00 ■ 86-93 ■ 00-05 ■ 95-00 ■ 07-11 ■ 07-09 ■ 98-01 ■
CK1186 ▲=CT002	CR125 RC	82 ▲	CK1199	CR 125 RZ/RA	79-80
CK1190 CKF1190 ▲=CT013 ■=CT013SP	CR 125 RD/RE AX-1 (NX 250 J/K/R/R3) CBF 250 4/6 NX 250 J/K/L (MD21) NX 250 2L/M/P/2P XL 250 Degree XLR 250 R - 6 Plate 'Baja' CRM 250-3 XR 250 RG/RH/RJ/RK/RL/RM/RN/RP /RR/RSRT/RV/RW/RX/RY/R1/R2/R3 XR 250 Y/3 (MD30) XR 250 3/5 (MD30) Motard XR 250 III Y/3 Baja TRX 300 EX All models TRX 300 X9 XR 350 RD/RE HONDA-DALL'ARA XR 250 R XR 250 SM MOTO ROMA Geko 300 Quad	83-84 ▲ 89-94 ■ 04-06 ■ 87-90 ■ 90-93 ■ 94- ▲ 86-03 ■ 00-03 ■ 03-05 ■ 00-03 ■ 93-08 ■ 09 ■ 83-84 ■ 04 ■ 04 ■ 04-06 ■	CK1200 ▲=CT001	CR 125 RF	85 ▲
CK1191 CKF1191 ▲=CT012 ■=CT012SP	CR 125 RB CRF 150 R (Small Wheel F17"/ R14") CRF 150 RB (Big Wheel F19"/ R16") CB 250 N/T/W/X/Y/1/4 "Two Fifty" VT 250 FD CD250 UJ/UK CMX 250 CT/CV/CW/CX HONDA	81 07-20 ▲ 07-20 ▲ 93-05 ■ 83 ▲ 88-92 ■ 96-00 ■	CK1206 CKF1206 ▲=CT014 ●=CT014SP ■=CT055SP	CBR 600 FM/FN/FP/FR/FS/FT/FV/FW CB 600 FW/FX/FY/FSY/F2Y/F21 /F1/F2/F22/F3/F4/F5/F6 Hornet CBF 600 N4/N5/N6 (Non ABS) CBF 600 NA4/NA5/NA6 (ABS) CBF 600 S4/S5/S6 (Non ABS) CBF 600 SA4/SA5/SA6 (ABS) VFR 750 FG/FH/FJ/FL/FM/FN/FP/ FR/FS/FT/FV VF 750 CP/CR/CS/CT/CV VFR 800 Fi-W/Fi-X CBR 900 RRN/RRP/RRR/RRS (893cc) CBR 900 RRY/RR1 (929cc Fireblade) CBR 900 RR2/RR3 954cc Fireblade SUZUKI GSXR 600 V/W/X/Y GSXR 600 K4/K5 TRIUMPH TT 600 Daytona 600 Daytona 675 Daytona 675 R Street Triple 675 Street Triple R 675 Street Triple S 765 Street Triple R 765 Street Triple RS 765 Tiger 800 Tiger 800 XC	91-98 ● 98-06 ● 04-06 ● 04-06 ● 04-06 ● 04-06 ● 86-97 ▲ 93-97 ▲ 98-99 ▲ 92-95 ▲ 00-01 ▲ 02-03 ▲ 97-00 ■ 04-05 ▲ 00-03 ● 02-05 ● 06-16 ▲ 11-16 ▲ 07-16 ▲ 09-16 ▲ 17-20 ▲ 17-20 ▲ 17-20 ▲ 11-12 ▲ 11-12 ▲
			CK1210 ▲=CT053SP	GL 1200 AE/DE/AF	84-85 ▲
			CK1217 ■=CT013SP ▲=CT014	MTX 200 RWD CBX 250 Twister CBX 250 RSE GB 250 E/H/J/L/P/S/V 'Custom' YAMAHA XTZ 250 Lander (Brasil) YBR 250 (5D11/3/4) YS 250 Fazer (Brasil)	83-84 ■ 84 ■ 84-97 ■ 07-09 ▲ 07-11 ▲ 06-08 ▲
			CK1218	HONDA	

Part No.	Make/Model	Year	Part No.	Make/Model	Year
CKF1218 ▲=CT014	NS 250 FE (MC11)	84	CK1224	GL 1200 DH/AH/AG/DG	86-87
	NS 250 RE/RG (MC11)	84-86		CK1228 ■=CT009SP	HONDA
	NS 400 RF/RG	85-87			CB-1 (CB 400 F)
	CB 600 F7/F8/F9/FA/FB/FAC	07-13 ▲		CB 400 SF (F2N/F2R) (Super Four) (NC31)	92-95 ■
	CB 600 FA7/FA8/FA9/FAA/FAB/FAC			CB 400 SF (F2V/F3T) Superfour (NC31)	96-97 ■
	Hornet (ABS)	07-13 ▲		CB 400 SF (F3V) Superfour (NC31)	97 ■
	CBF 600 N8/N9/NA (Non ABS)	08-11 ▲		CB 400 Four V/V-II/W-II (NC36)	97-98 ■
	CBF 600 NA8/NA9/NAA (ABS)	08-11 ▲		CBR 400 RG/RH-YA (NC23)	86-87 ■
	CBF 600 S8/S9 (Non ABS)	08-09 ▲		CBR 400 RRJ/RRK (NC23)	92-93 ■
	CBF 600 SA8/SA9/SAA (ABS)	08-12 ▲		CBR 500 FH/FJ/FK/FL	87-90 ■
	CBR 600 F1/F2/F3/F4/F5/F6			CBX 550 FC/F2C/FD/F2D	82-85 ■
	(Carb Model)	01-06 ▲		CBR 600 FH/FJ/FK/FL	87-90 ■
	CBR 600 FR1/FR2 (Rossi Injection Model)	01-02 ▲	CK1229 ▲=CT014	HONDA	
	CBR 600 FS1/FS2 (CBR600 S Injection Model)	01-02 ▲			VFR 750 R/J/RK/RL (RC30)
	CBR 600 RR (Non ABS)	03-19 ▲		SUZUKI	
	CBR 600 RA9/RAA/RAB/RRC/RAD			GSXR 750 Y	00 ▲
	/RAG/RRD (C-ABS)	09-19 ▲	CK1230 ■=CT013SP ▲=CT014SP	NTV 600 J/K/M	88-91 ■
	CBR 600 RR Hannspree	08 ▲			NTV 650 J/K/L/M/P/S/T/V
	CBR 600 FAB/FAC (ABS Model)	11-12 ▲		NT 650 J/K/L (BR05)	88-92 ■
	CBR 600 FB/FC	11-12 ▲		NT 650 VV/VX/VY/V1-V5 Deauville	98-05 ■
	VFR 800 2/3/4/5/6/8/9	02-09 ▲		XL 650 VY/V1/V2/V3/V4/V5/V6/V7	00-07 ■
	VFR 800 A2/A3/A4/A5/A6/A8/A9	02-13 ▲		XRV 650 J/K	88-89 ■
	VFR 800 XA (Crossrunner/ABS)	11-13 ▲		XL 700 V8/V9/VA/VA8/VA9/VAA Transalp	08-11 ■
	VFR 800 XA (Crossrunner/ABS)	15-16 ▲		NC 700 SC/SD (Manual Gearbox)	12-13 ■
	CB 900 F2/F3/F4/F5/F6/F7 Hornet	02-07 ▲		NC 700 XC/XD (Manual Gearbox)	12-17 ■
	CBR 900 RRW/RRX/RRY	98-00 ▲		NT 700 V6/VA7/V7/V8/VA8/VA/VAA Deauville	06-13 ■
	VFR 800 F (ABS Model)	14-16 ▲		NC 750 S	14-15 ■
	SUZUKI			NC 750 S (ABS)	14-18 ■
	GSR 600 K6/K7/K8	06-10 ▲		NC 750 X	14-15 ■
	GSF 650 K7/K8/K9/L0/L1/L2			NC 750 X (ABS)	14-19 ■
	Naked Bandit - Non ABS	07-12 ▲		VT 750 CV/C2V/CW/C2W/CX/C2X	
	GSF 650 SK7/SK8/SK9/SLO/SL1			/CY/C2Y/C1/C21/C4/C5/C6/C7/C8	97-09 ■
	/SL2 Faired Bandit - Non ABS	07-12 ▲		VT 750 C2BA/C2BB/C2BC/CB2E	
	GSF 650 AK7/AK8/AK9/ALO/AL1			Shadow Black Spirit	10-15 ■
	/AL2 Naked Bandit - ABS	07-12 ▲		VT 750 CS2A/C2SB Shadow	10-12 ■
	GSF 650 SAK7/SAK8/SAK9/SALO			VT 750 DC1/DC2 'Black Widow'	01-03 ■
	/SAL1/SAL2 Faired Bandit - ABS	07-15 ▲		VT 750 DC7/DC8 Shadow Spirit	07-09 ■
	GSX 650 FK8/FK9/FL0/FL1/FL2			VT 750 S (VT 750 SA/SB)	10-12 ■
	(Non ABS)	08-14 ▲		BENELLI	
	GSX 650 FAK8/FAK9/FALO/FAL1			Leoncino 500	17-19 ▲
	/FAL2 (ABS Model)	08-15 ▲		Leoncino Trail 500	18-19 ▲
				TRK 502 ABS Euro 4	17-18 ▲
CK1219 ▲=CT009 ■=CT033SP	HONDA		CK1234	FL 400 R/RK/RL 'Pilot'	89-93
	GB 500 TT	85-89 ▲			CB 250 FT/FV/FX/FY/F1
	XBR 500 F/G/H/SH/SJ		CK1235 ■=CT012SP	CBR 250 FG/RH/RJ/RK/RK2 (MC14/17/19)	86-89 ■
	SUZUKI				CBR 250 RRL/RRN/RRR (MC22-100/105/110)
	SV 400 K3/K4/K5	03-05 ■		VTZ 250 H/J/K	86-88 ■
	SV 400 SK3/SK4/SK5	03-05 ■		VT 250 CR/CT/CV 'Magna' MC29	95-97 ■
	DL 650 K4/K5/K6	04-06 ■		VT 250 FL Spada/Castec	88-90 ■
	DL 650 AK7/AK8/AK9/ALO V-Strom ABS	07-11 ■		VTR 250 W/Y/1-7 (MC33)	98-07 ■
	DL 650 AL2/AL3/AL4/AL5 V-Strom	11		VTR 250-9	09-10 ■
	DL 650 AK9 GT V-Strom Traveller ABS	12-15 ■	CK1239 ▲=CT031	VT 1100 CH/CJ/CN/CP Shadow	87-93 ▲
	DL 650 XT V-Strom	09-11 ■			VT 1100 CR/CS/CT/CV/CW Shadow
	DL 650 XT V-Strom	15-20 ■	CK1247 CKF1247 ▲=CT009 ■=CT006	CR 250 RL/RM/RN/RP/RR/RS/RT/RV	
	SFV 650 K9/L0/L1/L2/L3/L4/L5	09-15 ■			/RW/RX/RV/R1/R2/R3/R4/R5/R6/R7
	SFV 650 AK9/ALO/AL1/AL2/AL3/AL4/AL5 (ABS)	09-15 ■		CRF 450 R2/R3/R4/R5/R6/R7/R8	02-08 ▲
	SV 650 K3/K4/K5/K6/K7/K8/K9/L0			CRF 450 X5/X6/X7/X8/X9/XB/XC/XD/XF/XG/XH	05-17 ▲
	Naked - Non ABS	03-10 ■		CRF 450 XRL (Road Legal)	14-16 ▲
	SV 650 AK7/AK8/AK9/ALO Naked - ABS	07-10 ■		CRF 450 R9/RA (4 spring type clutch)	09-10 ▲
	SV 650 SAK7/SAK8/SAK9/SALO	07-15 ■		CR 500 RLRM/RN/RP/RR/RS/RT	
	SV 650 SK3/SK4/SK5/SK6/SK7/SK8			/RV/RW/RX/RV/R1	90-01 ▲
	/SK9/SLO Top Fairing - Non ABS	03-15 ■		KAWASAKI	
	SV 650 ABS	16-20 ■		KX 450 F (D6F/D7F/D8F/E9F/EAF/EBF)	06-11 ■
				KLX 450 R A8F/A9F/AAF/ABF/ACF/ACF	
				/ADF/AEF/AFF/AGF	
				KX 450 F	08-15 ■
				HONDA	12-20 ■
CK1220	CB 750 F/F1	76-77	CK1248		
CK1221 ▲=CT053SP	GL 1000 K1 (Up to E/No.2002383)	77 ▲			
CK1222 ▲=CT001	CR 125 RG/RH/RJ/RK/RL/RM/RN/				
	RP/RR/RS/RT/RV/RW/RX	86-99 ▲			
	CR 125	00-11 ▲			
	SMS 125	00-11 ▲			
	WR 125	00-11 ▲			
	WRE 125	00-11 ▲			
CK1223	CB 750/CB 750 K1 (Up to E/No.:1056079)	69-70			
	HONDA				

Part No.	Make/Model	Year	Part No.	Make/Model	Year
CKF1248 ▲=CT009	CB 1000 FP/FR/FS/FT/FV CBR 1000 FH/FJ/FK/FL/FM/FN/ FP/FR/FS/FT/FV/FW/FX	93-97 ▲	▲=CT021	CBR 1100 XXX/XXY/XX1/XX2/XX3 /XX4/XX5/XX6 'Blackbird' CB 1100 SFY/SF1 "XII" VTR 1000 SPY/SP1 (SC45)	99-07 ▲
		87-99 ▲			00-03 ▲
CK1250 ▲=CT002	VFR 400 R3K/R3L/R3M/R3N (NC30)	89-92 ▲	CK1292 ▲=CT011	VT 125 CX/CY/C1/C21/C3/C4/C7/C8 XL 125 V1/V2/V3/V4/V5/V6/V7/V8/V9/VA	99-08 ▲ 01-11 ▲
CK1252 ■=CT012SP ▲=CT012	CA 125 S/T CB 125 TDJ CBR 125 R4/R5/RS5/RS6/RW5/RW6 CG 125 M11/ES4-8 LS 125 R CBR 150 R TA 200 (TA Shadow) FTR 223 Y/2/A2 (MC34) CRF 230 L CRF 230 M Supermoto SL 230 V/W/X/1 XL 230-2 (NC36)	95-96 ■	CK1293 CKF1293 ▲=CT001	CR 125 RY/R1/R2/R3 CR 125 R4/R5/R6/R7 CRF 250 R4/R5/R6/R7 CRF 250 RA GAS-GAS EC 125 (2T) SM 125 (2T) Supermotard KTM EXC-F 250 EXC-F 250 (4T) Six Days SX-F 250 (4T) XC-F 250 (USD) XC-F 250 SX-F 250 (4T) XC-F 250 (USD) XC-F 250	00-03 ▲
		87-89 ■			04-07 ▲
CK1253 ▲=CT014 ■=CT013	VFR 800 Fi-Y/Fi-1 BMW G 310 GS G 310 R	04-06 ■	CK1295 ▲=CT009	XR 650 RY/R1-R7 HONDA-DALL'ARA XR 650 R	04-07 ▲
		01-08 ▲			04-07 ▲
CK1257 ▲=CT031 ■=CT009	NR 750 N RVF 750 RR-R/R-R-S (RC45) XL 1000 V3/V4/V5/V6 V7/V8/V9 /VA/VB Varadero Non ABS Model XL 1000 VA4/VA5/VA6/VA7/VA8/VA9 /VAA/VAB Varadero - ABS Model CB 1100 AD (Cast Wheels/3 Piston Calipers) CB 1100 AE (Cast Wheels/3 Piston Calipers) CB 1100 EX (Spoke Wheels/4 Piston Caliper) CB 1300 F3/F13 CB 1300 5/6/7/8/9 (Superfour) CB 1300 A5/A6/A7/A8/A (Superfour ABS) CB 1300 SA5/SA6/SA7/SA8/SA9/SA CB 1300 S5/S6/S7/S8/S9	00-01 ▲	CK1297 ▲=CT021	ST 1300 A2/A3/A4/A6 Pan European (ABS Model) ST 1300 8/9 Pan European (Non ABS) ST 1300 A8/A9/AA Pan European (ABS Model) GL 1800 A1/A2/A3/A4/A5 Goldwing GL 1800 6/7/8/9/A Goldwing	00-07 ▲
		17-20 ■			02-07 ▲
CK1264 ■=CT056SP	ST 1100 AN/AP/AR/AS Pan European (ABS Model) ST 1100 AT/AV/AW/AX/AY/A1/A2 Pan European (ABS Model) ST 1100 L/M/N/P/R/S/T/V/W/X/Y Pan European - Non ABS	17-20 ■	CK1298 ▲=CT021	VTX 1300 S3/S4/S5/S6/S7/S8 CTX 1300 CTA Interstate VT 1300 CXA Chopper VTX 1300 CXAA VTX 1800 C2/C3/C4/C5/C15/C16/C17	04 ▲
		17-20 ■			03-08 ▲
CK1265 ■=CT009SP	CB 400 SFX/SFY/SF1/SF2/SF3 /SF4/S/S5 Super Four (NC39) CB 750 F2N/F2R/ F2S/F2T/F2W/F2X/F2Y/F21	92	CK1299 ▲=CT009	CB 1300 FW/FX/FY/F1 (SC40)	04 ▲
		94-98 ▲			02-07 ▲
CK1284 ▲=CT014	CBR 900 RRT/RRV (918cc)	03-11 ■	CK1300 ▲=CT021	VTR 1000 SP2/SP3/SP4/SP5/SP6	02-07 ▲
		04-11 ■			CK1302 CKF1302 ▲=CT009
13 ■	CK1303 ■=CT009	CBR 1000 RR4/RR5/RR6/RR7 CB 1000 R9/RA/RB/RC/RD/RE/RF Non ABS Model CB 1000 RA9/RAA/RAB/RAC/RAE RAF/RAG (ABS Model) CBF 1000 6/7/8/9/A (Non ABS Model) CBF 1000 A6-A9/AA (ABS Model) CBF 1000 S (S7/S8/S9/SA) CBF 1000 T (T7/T8/T9/TA) GT CBF 1000 FA (FAA) CBF 1000 FS (FSA) CBF 1000 FT (FTA)	08-09 ▲		
14 ■			04-07 ■		
CK1285 ▲=CT068SP	GL 1500 CV/CW/CX/CY/C1/C2 'F6C' GL 1500 SEV/SEW/SEX/SEY GL 1500 J-SES	14-16 ■	CK1304 ■=CT012SP	CRF 150 F3/F4/F5 CRF 230 F4/F5/F6/F7/F8/F9	09-15 ■
		03-04 ■			03-05 ■
CK1286 ▲=CT021	CBR 1100 XXV/XXW 'Blackbird'	05-09 ■	CK1305 CKF1305 ▲=CT001	CRF 250 X4/X5/X6/X7/X8/X9/XB/XC/XD/XF/XG/XH CRF 250 XRL (Road Legal) CRF 250 R8-R9 CRF 250 RB/RC/RD/RE/RF/RG/RH CRF 250 RE (Limited Road Use) CRF 250 RX MD 250 H MD 250 S HONDA	04-17 ▲
		05-09 ■			14-16
CK1287	CBR 750 FH/FJ (Superaero)	05-09 ■	CK1304 ■=CT012SP	CRF 150 F3/F4/F5 CRF 230 F4/F5/F6/F7/F8/F9	08-09 ▲
		05-09 ■			11-20 ▲
CK1288 Dry Clutch ■=CT071SP	NSR 250 R2R/R3R/R2T/R3T NSR 250 R6K/R6K-2 NSR 250 R8L-3/R9L/R8N/R8N-3 NSR 250 R9N RGV 250 T (RGVR 250 SP)	05-11 ■	CK1305 CKF1305 ▲=CT001	CRF 250 X4/X5/X6/X7/X8/X9/XB/XC/XD/XF/XG/XH CRF 250 XRL (Road Legal) CRF 250 R8-R9 CRF 250 RB/RC/RD/RE/RF/RG/RH CRF 250 RE (Limited Road Use) CRF 250 RX MD 250 H MD 250 S HONDA	16 ▲
		05-09 ■			18-20 ▲
CK1289 ▲=CT002	RVF 400 RR/RR-II/RT/RT-II (NC35) -100/110	05-11 ■	CK1305 CKF1305 ▲=CT001	CRF 250 X4/X5/X6/X7/X8/X9/XB/XC/XD/XF/XG/XH CRF 250 XRL (Road Legal) CRF 250 R8-R9 CRF 250 RB/RC/RD/RE/RF/RG/RH CRF 250 RE (Limited Road Use) CRF 250 RX MD 250 H MD 250 S HONDA	08-11 ▲
		05-09 ■			08-11 ▲
CK1290 ▲=CT009	VTR 1000 FV/FW/FX/FY/F1/F2/F3 /F4/F5/F6 'Firestorm' XL 1000 VX/VY/V1/V2 Varadero - Non ABS Model CB 1300 DCV/DCW/DCX/DCY SC38	97-02 ▲	CK1305 CKF1305 ▲=CT001	CRF 250 X4/X5/X6/X7/X8/X9/XB/XC/XD/XF/XG/XH CRF 250 XRL (Road Legal) CRF 250 R8-R9 CRF 250 RB/RC/RD/RE/RF/RG/RH CRF 250 RE (Limited Road Use) CRF 250 RX MD 250 H MD 250 S HONDA	08-11 ▲
		97-00 ▲			08-11 ▲
CK1291	HONDA				

Part No.	Make/Model	Year	Part No.	Make/Model	Year
CK1307	ANF 125 3/5/T5/6/T6/7/A Innova	03-11	CK2208 ▲=CT039	YAMAHA RS 100 AG 100 E 'Farm Bike' AG 100 J (3HAA)	75-76 ▲
CK1308 ▲=CT009	ELSTARS (Pit bikes) Various models				93 ▲ 82 ▲
CK1312 CKF1312 ▲=CT043SP	CBR 1000 RR8/RR9/RA9/RRA/RAA /RAB/RRB/RRC/RAC/RRD/RAD/RAE /RRF/RRG/RAF/RAG Fireblade VFR 1200 FA (Manual Gearbox Model) CBR 1000 RR-SP ABS Fireblade (CBR1000 SAE/SAF/SAG) CBR 1000 RR-SP ABS-TT Edition	08-16 ▲	CK2209 ▲=CT039	DT 125 DT 175 RD 200 DX RS 200	74 ▲ 74-75 ▲ 76-81 ▲ 79-80 ▲
		10-15 ▲			77-80
CK1313	CBR 250 RB/RC (Non ABS) CBR 250 RAB/RAC (ABS)	14-16 ▲	CK2223	DT 250 MX	16 ▲
		11-13 11-13			75-79 ■ 98 ▲
CK1314 CKF1314 ■=CT081SP	CRF 250 LD/LF CRF 250 ME Supermoto CRF 250 RL/RLA Rally (non ABS & ABS models) CB 300 FAF/FAG (ABS) CBF 300 NA CBR 300 RA ABS	13-20 ▲	CK2226 ▲=CT017 ■=CT074	XS 650 YZF R1	14-15 ▲
		17-20 ▲			78-81 ▲
CK1315 ■=CT084SP	Monkey 125 MSX 125 Grom MSX 125 A Grom ABS	15 ▲	CK2230 ▲=CT076SP	XS 1100 /1100 S	18-20 ▲
		18-20 ▲			78-83 ▲ 80-82 ▲ 03-04 ▲ 80-82 ▲ 76 ▲ 79-80 ▲ 77-80 ▲ 91-98 ▲ 98-01 ▲ 02-03 ▲
CK1317 CKF1317 ▲=CT092	CRF 450 R (6 Spring) CRF 450 RXH (18" Rear Wheel) CRF 450 X	14-19 ▲	CK2234 ▲=CT039	YZ 100 E/F/G/H/K IT 125 G/H/J TW 125 (5rs) (5 friction plate type) TY 125 YZ 125 C YZ 125 F/G TY 175 TW 200 (2JL/4CS1/2/3/5) TW 200 E (4CS4/6/5LB1/2) TW 225 E (5VC1/2)	17-20 ▲
		17-20 ▲			77-78 ▲ 81 ▲ 80-82 ▲ 84 ▲
CK1318 ▲=CT091	AJP PR5 250 Trials PR5 250 Supermoto PR5 250 Enduro PR5 250 Extreme	18-20 ▲	CK2235 ▲=CT039	YZ 125 D/E YZ 125 H IT 175 G-J IT 200 L	13-17 ▲
		13-17 ▲			76-80 ▲ 71-72 ▲ 76-81 ▲ 71-72 ▲ 75-76 ▲ 75-76 ▲ 76-77 ▲
CK1319 CKF1319 ▲=CT009	CRF 1000 LAG (Manual Clutch/ABS) CRF 1000 L (Manual Clutch/Non ABS)	13-17 ▲	CK2236 ▲=CT039	DT 100 AS3 125 125 DT 125/125F/125E/125 MX RD 125 RD 125 DX RS 125/125 DX DT 175	13-17 ▲
		16-20 ▲			02 ▲ 81-84 ▲ 82 ▲ 80 ▲ 83-85 ▲ 84 ▲ 77 ▲
CK1323	CB 500 F (Non ABS) CB 500 FA (ABS) CB 500 X (Non ABS) CB 500 XA (ABS) CBR 500 R (Non ABS) CBR 500 RA (ABS)	16 ▲	CK2238 ▲=CT044	RZ 50 (5FC1/2) DT 80 LC1 RD 80 LC YZ 80 G DT 80 MX (Type 36N) DT 80 MXS YZ 80 D	13-18
		13-18			75-76 ▲ 73-75 ▲ 76-79 ▲ 80-82 ▲ ▲ ▲ ▲ 77-78 ▲ 72 ▲ 70-72 ▲ 73-75 ▲ 80-84 ▲ 85-95 ▲ 85-89 ▲ 90-95 ▲ 85-95 ▲ 95-03 ▲ 75-76 ▲ 76-79 ▲
CK1332	CB 1100 EX	13-18	CK2240 ▲=CT008	DT 250 RD 250/A/B RD 250 C/D/E/F RD 250 LC RZ 250 R (1AR/1XG) RZ 250 R (29L) RZ 250 RR (51L) RZ 250 (4L3) TY 250 D/E YDS7 250cc R5/5A/5B 350cc RD 350/A/B RD 350 LC/YPVS RD 350 N/F/F2/R TT 350 (ITJ) TT 350 A (3GJ) XT 350 YFM 350 FX 'Wolverine' All models DT 400 RD 400 C-F	13-18
		13-18			80-81 ▲ 79-81 ▲
CK2205 ▲=CT044	YAMAHA DT 50 M/MX FS1E/FS1DX/FS1/FS1SE RD 50/M/MX TY 50M (2K0)	13-18	CK2242 ▲=CT074	XS 650 XS 650 SE	80-95 ▲
		13-18			80 ▲ 82 ▲
CK2206 ▲=CT044	DT 50 M DT 50 MX Type 5J2/12Y DT 50 LC RD 50 M TY 50/TY 50 M (1F4/1G7) YZ 50 G-K TY 80 RD 80	13-18	CK2244 ▲=CT008	YZ 250 G YZ 250 D/E	74-90 ▲
		13-18			77-78 ▲
CK2207 ▲=CT044	YB 100	13-18			80 ▲ 77-78 ▲
		13-18			

Part No.	Make/Model	Year	Part No.	Make/Model	Year		
CK2245 ▲=CT039	YAMAHA DT 175 MX	78-81 ▲	CK2256 ▲=CT039SP	SR 125 SE SR 125 XT 125 (5EK) (4 friction plates) TW 125	81-83 ▲ 89-03 ▲ 99-02 ▲ 82-83 ▲		
CK2250 ▲=CT008	XVS125 Dragstar (5XJ3/5XJ5/5XJ7) IT 250 G XS 250 SE/C YZ 250 F XVS 250 Dragstar	01-04 ▲ 80 ▲ 80-81 ▲ 79 ▲ 01-03 ▲	CK2261 ▲=CT008	SR 250 (4GR1/2/3/4) (5 plate clutch) SR 250 Classic (2IL) (5 plate clutch) SRX 250	94-96 ▲ 96-00 ▲ ▲		
CK2254 CKF2254 ▲=CT044	DT 80 LC2 YZ 80 E/F RS 100/RS 100 'S' RS 100 (IY8 Europe) RS 100 (IY8 Europe) RS 100 S (IY8 UK) RS 100/RS 100 DX RS 100 DX (IY8 Europe) RS 100 (IY9 UK) RS 100 RT 100 E/F/K RXS 100 RX 115 (5FS3) RD 125 DX RS 125 TT-R 125 (Large Wheel) XT 125 R (3D61/3D63) (5 friction plate clutch) XT 125 R (13D1) (5 friction plate clutch) XT 125 X (3D62/3D64) (5 friction plate clutch) XT 125 X (13D2) (5 friction plate clutch) XTZ 125 K/K XYZ 125 (5RM) YBR 125 E/K ED	85-97 ▲ 78-79 ▲ 77-78 ▲ 77-78 ▲ 80-82 ▲ 77-78 ▲ 79 ▲ 79 ▲ 79-81 ▲ 80-81 ▲ 93-03 ▲ 83-97 ▲ 99 ▲ 78-81 ▲ 77-81 ▲ 00-20 ▲ 05-06 ▲ 07 ▲ 05-06 ▲ 07 ▲ 05-10 ▲ 03-10 ▲ 00-08 ▲	CK2262 ▲=CT017	YAMAHA XS 400	82 ▲		
			CK2267 ▲=CT008	SR 250 (3Y8) US Custom (6 plate clutch) SR 250 SE Special (3Y8) (6 plate clutch) XT 250	80-81 ▲ 81-83 ▲ 80 ▲		
			CK2273 ■=CT008SP	XS 850	80 ■		
			CK2274 CKF2274 ▲=CT020	WR 250 ZF/ZG/ZH/ZJ/EK YZ 250 (2T) WR 450 FT/FV/FW/FX/FY/FZ/FA/ /FB/FD/FE/FF (4T) WR 450 F (270mm F/Disc/4T) YZ 450 FW/FX/FY/FZ/FA/FB/FD/FE/FF (4T) YZ 450 FG (270mm Disc) YZ 450 FG (60th Anniversary Edition/270mm Disc) YZF 450 RSEA/RSEB/RSED/RSE XV 750 SE XV 750 Virago XV 1000/TR1 BT 1100 P/R/S/T/V "Bulldog" XV 1100 Virago XVS 1100 A Dragstar Classic XVS 1100 Dragstar	94-98 ▲ 93-20 ▲ 05-15 ▲ 16-20 ▲ 07-15 ▲ 16-20 ▲ 16-20 ▲ 11-14 ▲ 81 ▲ 92-97 ▲ 81-86 ▲ 02-06 ▲ 89-00 ▲ 00-07 ▲ 99-03 ▲		
CK2255 CKF2255 ■=CT008SP	FZ 400 N (1FK 46X 33M) XJR 400 XS 500 B/C/D FZ 600 FZ6 Fazer FZ6 Naked Version FZ6 Naked/Non ABS 2 piston caliper (IB3/IB3D) FZ6 S2 ABS (Naked) FZ6 Fazer S2 (ABS) FZ6-NS Naked/Non ABS /2 Piston Caliper (IB35/6) FZ6-Fazer (Half Fairing/Non ABS /2 Piston Caliper) (5VX/5VXL) FZ6-Fazer (ABS/Half Fairing /2 Piston Caliper) FZ6 Fazer S2 (ABS/Half Fairing /4 Piston Caliper) (5S2) FZ6 Fazer S2 (Non ABS/Half Fairing/4 Piston Caliper) (4S81/4S8) FZ6 S2 (Naked/Non ABS /4 Piston Caliper) (SS51/SSS) XJ 600 XJ 650 XJ 650 Turbo XJ 600 S/N Diversion YX 600 S/SC/T/TC/UC/U/W/WC/A/AC 'Radian' YZF R6 XJ 650 G/H/J/K 'Maxim' XJ 650 LH 'Midnight' XJ 650 RJ/LK Seca FZX 700 S/SC/T/TC 'Fazer' FZ 750 XJ 750 XJ 750 RF/RJ/RK 'Seca' XTZ 750 TDM 850 XJ 900/900 F XJ 900 S Diversion	85- 93-99 ■ 78-79 ■ 87-88 ■ 04-07 ■ 04-07 ■ 04-07 ■ 07-08 ■ 07-08 ■ 05-06 ■ 04-07 ■ 06-07 ■ 08 ■ 07-09 ■ 07-09 ■ 84-92 ■ 80-84 ■ 82 ■ 92-03 ■ 86-90 ■ 99-05 ■ 80-83 ■ 81 ■ 82-83 ■ 86-87 ■ 85-86 ■ 82-83 ■ 81-83 ■ 89-95 ■ 91-95 ■ 83-92 ■ 95-03 ■	CK2276 YZ 125 J	82	CK2278 ▲=CT054SP	YZ 125 K-T	83-87 ▲
			CK2279 CKF2279 ▲=CT008 ■=CT008SP	IT 250 H/J YZ 250 H XS 250 C/D/E YZF 350 T/U/W/A/B/D/E/F/G/H/J/ K/L/M/N/P/R/S/T/V XS 400 XS 400 SE YZ 400 D-F IT 425 G IT 465 H/J YZ 465 G/H XS 750 XS 750 SE	81-82 ▲ 81 ▲ 78-80 ▲ 87-06 ▲ 78-79 ▲ 80 ▲ 77-79 ▲ 80 ▲ 81-82 ▲ 80-81 ▲ 77-79 ■ 79-80 ■		
			CK2280 ▲=CT060	IT 250 L YZ 250 J-T YTZ 250 N/S IT 490 L YZ 490 J-U WR 500 ZD	84 ▲ 82-87 ▲ 85-86 ▲ 84 ▲ 82-88 ▲ 92-93 ▲		
			CK2281	DT 125 LC (Type 10V/12W/26G)	82-83		
			CK2283 ▲=CT044	DT 125 LC (Type 35A) DT 125 (3TT4) RD 125 LC Mk1 - 3 RZ 125 (1GV 030101-) RX 135 (13X)	85-87 ▲ 96 ▲ 82-87 ▲ 85 ▲ 81 ▲		

Part No.	Make/Model	Year	Part No.	Make/Model	Year	
CK2285 ▲=CT017	YAMAHA		CK2297 CKF2297 ▲=CT008 Contd.	YAMAHA		
	FJ 1100	84-85 ▲		XT 600 (Kick Start Only)	84-87 ▲	
	XJR 1200	95-98 ▲		XT 600 Z/E (Kick Start Only)	84-03 ▲	
	FJ 1200/1200 A	86-95 ▲		XT 600 Z (Kick & Electric Start)	86-90 ▲	
	XJR 1300 L 5EA2/5EA3/5EA4	99 ▲		XT 600 E (Electric Start Only)	90-03 ▲	
	XJR 1300 M 5EAA/5EAB/5EAC	00 ▲		SZR 660	96-97 ▲	
	XJR 1300 (5EA1/5EA7)	98-99 ▲		YFM 660 RN/RP/RR/RS/RT Raptor	01-05 ▲	
	XJR 1300 (5EA9/5EAG)	00 ▲		XTZ 660 "Tenere"	91-97 ▲	
	XJR 1300 N/P (5EAP/5EAR/5EAS /5EAT/5EAW/5EAV/5EAY)	01-02 ▲		DERBI		
	XJR 1300 R/S 5WM1/5WM3 /5WM5/5WM6/5WM7/5WM9	03-04 ▲		Mullhacen 659	06-07 ▲	
	XJR 1300 T/V/W/X 5WMA/5WMC /5WMD/5WMF	05-14 ▲				
	XJR 1300 C / Racer	15-16 ▲		CK2299 ▲=CT020	XVS 400 XV 535/535 S "Virago"	96 ▲ 88-03 ▲
XJR 1300 SP (L) 5EA5/5EA6/5EA8	99 ▲	CK2300 ▲=CT050SP	XVZ 12 TD	85 ▲		
XJR 1300 SP (M) 5EAD/5EAE/5EAF	00 ▲		V-Max All models	91-03 ▲		
XJR 1300 SP (N) 5EAL/5EAM/5EAN	01 ▲		XVZ 13 Royal Star All models	96-01 ▲		
CK2287 ▲=CT010 ■=CT010SP	YZ 80 H/J/K/L/N	81-85 ▲	CK2302	T 50	86	
	YTM 225 DRN	85 ■	CK2303	V 50 M/P	75-77	
	YFM 200 DKW/DX/DXA	86-90 ■		YFM 50 S/T/RV/RW/RX Raptor	04-08	
	YFM 225 N/S/T/U	85-89 ■		YFM 80 D/E/F/G/H/J/K/L/M/N Badger	91-01	
	YFB 250 D/E/F/G/H/J/K/FWF/FWG/ FWH/FWJ/FWK/FWL/FWM	92-00 ■		YFM 80 WP/WR/WS/WT/RV/RW/RX Raptor	02-08	
	YFM 250 W/A/B	90-92 ■		YFM 80 GT/GV/GW/GX Grizzly	05-08	
	YFM 250 XN/XP/XR "Bear Tracker"	99-03 ■		T 80	83-97	
	YFM 250 FN	01 ■	PW 80 All models	83-05		
	YFM 250 BT/BV (Bruin)	05-06 ■	V 80	79-85		
	YFM 250 BW/BX/BY Big Bear	07-10 ■	CK2304 ▲=CT010	YZ 80 S/T/U/W/E/LC/LW/F	86-94 ▲	
	YFUJWT	89-90 ■		YZ 65 J	19-20 ▲	
	YFUJW/TW Pro Hauler Pro 4 (230cc)	89 ■		TZR 125 (2RK/3PC1/2/3)	87-92 ▲	
CK2290 CKF2290 ▲=CT008 ■=CT090SP	YFM 350 FWT/FWU/FWW/FWA/ FWE Big Bear	86-93 ■	CK2305 ▲=CT017	RD 500 LC	84-86 ▲	
	YFM 350 FWF/FWG/FWH/FWJ	94-97 ■		RZV 500 R (Six)	85 ▲	
	YFM 350 ERD/ERE/ERF/ERG	92-95 ■	CK2306 CKF2306 ■=CT008SP	XJ6-N (600cc) (Naked - 20S) Non ABS/ABS	09-15 ■	
	YFM 350 XD/XE/XF/XG/XH/XJ/XK /XL/XM/XN/XP/XR	92-03 ■		XJ6-S Diversion (600cc) (Top Fairing - 36C)	09-15 ■	
	YFM 350 S/T/V/R-WV/RW/RX/RY/RZ Raptor	04-10 ■		ABS and Non ABS Version	13 ■	
	YFM 350 UH/UJ	96-97 ■		XJ6 SP	10-15 ■	
	DT 400 MX	77-79 ▲		XJ6-F Diversion (600cc) (Full Fairing - 1CW1) (Non ABS/ABS)	87-92 ■	
	YFM 400 FWE/FWF/FWG/FWH /FWJ/FWK/FWL/FWM Kodiak	93-00 ■		FZ 750	87 ■	
	YFM 400 FPR	03 ■	FZX 750			
	CK2292 ▲=CT039 ■=CT061	WR 125 R	09-15 ■	CK2308 ■=CT008SP	FZR 750	87 ■
		WR 125 X (Supermoto)	09-16 ■		FZR 1000	87-88 ■
		YZF-R 125	08-13 ■	CK2309 ▲=CT020	WR 250 ZB/ZD/ZE	91-93 ▲
AG 200 E (3GX6)	93 ▲	YZ 250 U/W/A/B/D	88-92 ▲			
CK2295 ▲=CT060	TY 250 S/R	84-92 ▲	YZ 250 WRW/WRA		89-90 ▲	
	CK2296 ▲=CT008	SR 400 (3HT1)	88 ▲		XVS 650 Dragstar	97-03 ▲
		SR 400 (2RD)	14-16 ▲		XVS 650 A Dragstar Classic	98-07 ▲
SR 500		78-82 ▲	MT-07 (Non ABS/689cc / 2 Cyl)		14-20 ▲	
SR 500 S (3GWS)		98 ▲	MT-07A (ABS/689cc / 2 Cyl)	14-20 ▲		
ST 500 (3GW1/3/4/6/7)		96-98 ▲	MT-07 Motocage ABS (689cc/2 Cyl)	15 ▲		
TT 500 G/H		80-81 ▲	XSR 700 ABS (MTM 690-U)	16 ▲		
XT 500	77-81 ▲	CK2310 ▲=CT008	YZ 400 FK/FL	98-99 ▲		
XZ 550	82 ▲		WR 400 FK/FL/FM	98-00 ▲		
CK2297 CKF2297 ▲=CT008	SRX 400 (1JL)	▲	XT 550	82 ▲		
	SRX 400 (3VN1/3VN2/3VN5)	90-96 ▲	CK2311 ▲=CT054SP	YZ 125 W/A	89-90 ▲	
	XT 550	83 ▲		CK2312 ▲=CT054SP	YZ 125 U	88 ▲
	SRX 600	86-87 ▲	CK2313 CKF2313 ▲=CT010		DT 125 R	88-03 ▲
	SRX 600 (1JK/3SX)	85-91 ▲			DT 125 X	05-06 ▲
	TT 600 L (Kick Start Only)	84 ▲		DT 125 RE	04-07 ▲	
	TT 600 N (59X) Frame # 59X			TDR 125 (3HS1/3XD0/3HS3/3XD1)	89-93 ▲	
	000101-59X 007852 (Kick Start Only)	85-88 ▲		TDR 125 (4GH/GW1/2/3/4)	93-03 ▲	
	TT 600 W (2JT/3SW1) Frame # 59X 007853- (Kick Start Only)	89-92 ▲		TDR 125 R Lightburner (3SH2/3XE2)	93-94 ▲	
	TT 600 K (Kick Start Only)	93-01 ▲	TZR 125 RR (4DL3)	94-95 ▲		
	TT 600 E (Electric Start)	94-95 ▲	TZR 125 (3JB/4JB/HHW/4HX)	93-95 ▲		
	TT 600 R (5CH1) (Kick Start Only)	97 ▲				
TT 600 R (5CH2) (Kick Start Only)	98-99 ▲					
TT 600 R (5CH3/4) (Kick Start Only)	00-02 ▲					
TT 600 RE (5CH5) (Electric Start)	04 ▲					

Part No.	Make/Model	Year	Part No.	Make/Model	Year	
CK2313 CKF2313 ▲=CT010 Contd.	YAMAHA TZR 150 R (4AP20)	00 ▲	CK2335 CKF2335 ▲=CT010	YAMAHA YZ 80 G/H/J/K/L/M/N	95-01 ▲	
	DT 200 (2LR)	87 ▲		YZ 85 (2T / Small Wheel F 17"/ R 14")	02-20 ▲	
	DT 200 WR 3XP	92-93 ▲	CK2342 ▲=CT008	TZR 250 (3MA1 Reverse Cylinders)	87 ▲	
	SDR 200	▲		TZR 250 (3MA3/3MA5 Reverse Cylinders)	90 ▲	
CK2315 ▲=CT010	YFS 200 B/F/G/H/J/K/L/M/N/P /R/S/T/V 'Blaster'	91-06 ▲	CK2347 ▲=CT054SP	FZS 600 Fazer	98-03 ▲	
	WR 200 D/E/F	92-94 ▲		CK2348 4 plate kit	APRILIA AF1 Futura 50	97-08
DT 230 (4TP1/2) Lanza	97-98 ▲	DT 50 R	04-08			
CK2316 ▲=CT008	FZR 400 RSP (2TK-EXUP)	87 ▲	DT 50 X Supermotard			04-15
	FZR 400 RRSP (3TJ2/6/7)	▲	TZR 50 (4 plate kit)			
CK2317 ▲=CT010	FZR 400 RR	92 ▲	CK2349 5 plate kit	TZR 50 (5 plate kit)	97-03	
	FZR 400 Genesis (1WG)	86 ▲			CK2350 ▲=CT017	YZF R1
FZR 400 (3EN1/3EN2)	88-89 ▲	CK2351 ▲=CT050SP	XV 1600 A	99-03 ▲		
FZR 400 RR (3TJ1)	▲			CK2352 CKF2352 ▲=CT020		
CK2318 CKF2318 ■=CT008SP	YZF R6	06-18 ■	WR 450 FS		04 ▲	
	FZR 750 R OW01	89-90 ■		YZ 450 FR/FS/FT/FV	03-06 ▲	
	YZF 750 R/SP	93-97 ■	MT-09 (1RC/Non ABS/847cc/3 Cyl Engine)	14-16 ▲		
	TDM 850	96-08 ■	MT-09 Tracer ABS (847cc/3 Cyl Engine)	15-20 ▲		
	TRX 850	96-98 ■	MT-09A (2DR/ABS/847cc/3 Cyl Engine)	14-20 ▲		
	TDM 900 Non ABS/5PS	02-14 ■	MT-09A Sport Tracker ABS (847cc/3 Cyl Engine)	14-20 ▲		
	TDM 900 A (2B0 ABS)	05-13 ■	MT-09A Street Rally ABS (847cc/3 Cyl Engine)	14-20 ▲		
CK2319 ▲=CT005 ■=CT025	YZ 125 B/D	91-92 ▲	YZF-R1	09-14 ▲		
	TDR 250 (3CK1/3CK2 Europe)	88-92 ■		CK2353 ▲=CT020	YZF R7	99-00 ▲
	TT 250 RM (4PX6)	00 ▲	CK2354 TT-R 90 M/N/P/R/ES/S/ET/T/EV/EW T 90 N/D (4NM1-9) Mate T 105/105 E Crypton V 110 ZE/ZK/ZHE/ZHK FIZR/FIZR Sporty T 105 E (5ER1/2) Crypton-R			00-07
	TY 250 Z	93-96 ▲		00-		
	TZR 250 (2MA/2XW1/2XW2 Europe)	87-92 ■		96		
	TZR 250 (1KT/2AW Japan)	87 ■		96		
	TZR 250 (2XT1 Japan)	88 ■		99		
	TZR 250 R (3XV1/3X4/3XV6)	91-93 ▲				
	R1-Z (250cc/3XC)	90-92 ▲				
	WR 250 XX/XY	08-15 ▲				
	WR 250 R	08-20 ▲				
CK2321 ■=CT008SP	FZR 1000	89-92 ■		CK2355 CKF2355 ▲=CT005 ■=CT020	YZ 250 FN/FP/FR/FT/FV/FW /FX/FY/FZ/FA/FB/FD/FE/FF (4T) WR 250 FN/FP/FR/FT/FV/FW /FX/FY/FZ/FA/FB/FD WR 250 FF/FG (4T/Reverse Cylinder) YZ 250 FG (270mm Disc) YZ 250 FGY (60th Anniversary Edition/270mm Disc)	01-15 ▲
						01-13 ▲
CK2324 ▲=CT039	XT 225 (3RW4) Serrow (1KH 080101-)	92 ▲	CK2356 CKF2356 ▲=CT020	YZ 426 FN/FP WR 426 FN/FP WR 450 FR YZF R1 YZF R1SP FZ1 Naked (2D11) FZ1 Fazer (3C3) Non ABS Half Fairing FZ1 Fazer (Half fairing - ABS - 5D0) FZ1 N/NA Naked (Non ABS/ABS)	01-02 ▲	
	XT 225 (3RW1/2/4/5) Serrow (1KH-)	89-93 ▲			01-02 ▲	
	XT 225 S (3RW3) (1KH- 202101-109000)	92 ▲			03- ▲	
	XT 225 W (4JG1/2/3/4) Serrow	93-96 ▲			04-08 ▲	
CK2325 CKF2325 ▲=CT005	XT 225 WE (4JG5/6) Serrow	97-98 ▲	CK2358 ■=CT008SP	FZS 1000 Fazer YZF-R6	06-09 ▲	
	XT 225 (4VW1/3/5/7/9) (4VWA/B/D/G/J/L) (Brasil)	97-06 ▲			06-15 ▲	
CK2327 ■=CT008SP	GTS 1000	93-96 ■	CK2332 CKF2332 ▲=CT054SP	FZR 600 R	08-15 ▲	
	FZR 1000	93-95 ■			96-03 ▲	
CK2331 ▲=CT010	YZF 1000 Thunder Ace	96-02 ■	CK2334 ▲=CT008	XT 500 C	76 ▲	
	FZR 250	87 ▲				
CK2332 CKF2332 ▲=CT054SP	FZR 250 R	91-92 ▲				
	FZX 250 Zeal (3YX1/2/4)	91-92 ▲				
CK2333 CKF2333 ▲=CT054SP	FZR 600 R	94-95 ▲				
	YZF 600 Thunder Cat	96-03 ▲				
CK2334 ▲=CT008						

Part No.	Make/Model	Year	Part No.	Make/Model	Year	
CK2361 CKF2361	YAMAHA YZ 250 F (4T)	16-20 ■	CK2380 ▲=CT017	YAMAHA XV 1700 V-Max	09-16 ▲	
CK2362 ▲=CT017	XTZ 1200 Super Tenere (ABS/UBS Brake System) XT 1200 ZE Super Tenere (ABS/UBS Brake System) FJR 1300 A (ABS) (Manual G/Shift) FJR 1300 AS (ABS/Electric Shift) FJR 1300 AE (Electronic Suspension Adjustment/USD Forks) FJR 1300 (Non ABS) XVS 1300 A Midnight Star XVS 1300 CU Custom	10-16 ▲	CK2387 CKF2387	YZ 250 F	19	
		14-16 ▲	CK2388	XSR 900 ABS	18-20	
		03-15 ▲		SUZUKI	B 120	▲
		06-15 ▲	▲=CT052		T 125/T 125 -11/R 'Stinger'	69-71 ▲
		14-15 ▲	CK3310 ▲=CT038SP		T 20 Super Six	66-68 ▲
01-04 ▲						
07-16 ▲						
14-16 ▲						
CK2363 ▲=CT050SP	XV 1700 PCR	03-05 ▲	CK3311 ▲=CT051	AP 50	-78 ▲	
CK2364 CKF2364 ▲=CT020	YFZ 450 S/T/V/W/X YFZ 450 RY/RZ (Quad) YFZ 450 B/D YFM 700 RV/RW/RD/RE YFM 700 RSE FZ8 N-800cc (Naked/Single Headlight/Non ABS) FZ8 NA-800cc (Naked/Single Headlight/ABS) Fazer 8 S-800cc (Top Fairing/Twin Headlight/Non ABS) Fazer 8 SA-800cc (Top Fairing/Twin Headlight/ABS)	04-08 ▲	CK3312 ▲=CT051	A 100 L/M/N	74-80 ▲	
		09-10 ▲		CK3313 ▲=CT046	GT 250 K/L	73-74 ▲
		13-14 ▲	T 250 II/R/J		70-72 ▲	
		06-14 ▲	T 350 1/2/R/J		69-72 ▲	
		13-14 ▲	CK3314 ▲=CT046		T 500 1/2/3 (18 ears)	68-70 ▲
		11-15 ▲		CK3315 ▲=CT022	TS 250 K-M/A-C	73-78 ▲
11-15 ▲	TS 250 ERN/ERT/ERX	79-81 ▲				
11-15 ▲	GT 250 M/A/B/C	75-78 ▲				
CK2365 ▲=CT044	DT 175 (3TS4)	96 ▲	RL 250 L/M	74-75 ▲		
			GT 380 K-M/A/B	73-77 ▲		
CK2366 ▲=CT017	MT-01 (1670cc) MT-01S (5YUR)	05-10 ▲	RM 400 C	78 ▲		
		09 ▲	GT 250 X7 EN/ET/EX	79-81 ▲		
CK2368 ▲=CT020	XT 660 R Model Code 5VK1/3/4/6/8/3S62/3S63 XT 660 X (Model Code - ID21/ID23 /ID24/ID26/3S72/10S1/11B1/10S7) XT 660 R (Model Code 5VKE) XT 660 R (5VKA/5VKC) XT 660 Z Tenere (Non ABS) XT 660 ZA Tenere (ABS) MT 03 APRILIA 650 Pegaso Trail	04-07 ▲	CK3316 ▲=CT022	GT 500 A/B	76-77 ▲	
		04-16 ▲		T 500 R/J/K/L/M (12 ears)	71-75 ▲	
		10-16 ▲		CK3318 CKF3318 ▲=CT011	RM 80 B/C/N/XT/XX	78-81 ▲
		08-09 ▲			RM 80 XE/XF/HF	84-85 ▲
		08-16 ▲			RM 80 K/L/M/N/P/R/S/T/V/W/X/Y/K1	89-01 ▲
		11-16 ▲			RM 85 K2/LK2/K3/LK3/K4/LK4	02-04 ▲
		06-12 ▲			RM 85 (Small Wheel F 17"/ R 14")	05-20 ▲
		05-06 ▲			RM 85 (Big Wheel F 19"/ R16")	05-20 ▲
					TS 100 C	78 ▲
					TS 100 ERN	▲
	(Up to E/No 300563)	79 ▲				
	TS 100 ERZ/ERH	82 ▲				
CK2370 CKF2370 ▲=CT005	XT 250 Serrow (3C51/2) TT 250 R (4GY1 Japan) TT 250 R (4RR1/2 Japan) TT 250 R (4MR2 UK) TT 250 RL (4PX5) TT 250 R (4GY3/4GY5/4WA1) Raid XG 250 Tricker (5XT1) XT 250 X (5C1) YFM 250 RX/RV Raptor YFM 250 R (338) YFM 250 R (IBT)	05-08 ▲	DF 125	▲		
		93-94 ▲	DR 125 SZ/SD/SE/SF/SH/SJ	82-94 ▲		
		95-97 ▲	DR-Z 125	03-20 ▲		
		96 ▲	DR-Z 125 L	03-20 ▲		
		99 ▲	FX 125	▲		
		94-96 ▲	GN 125 Z/D/K	82-90 ▲		
		04-06 ▲	GN 125 Z/M/R/V/W/X/Y/K1	94-01 ▲		
		06-08 ▲	GN 125 ER/EV/EW/EX/EY/EK1	94-01 ▲		
		08-09 ▲	GN 125 HS	00-11 ▲		
		09-11 ▲	GS 125 Z/D/ESZ/ESD/ESF/ESK/ ESM/ESR/ESX	82-00 ▲		
		12-13 ▲	GSX-R 125	18-20 ▲		
			GSX-S 125	18-20 ▲		
			GT 125 L/M/A/B/C/EC	74-78 ▲		
			GZ 125 W/X/Y/K1-K9	98-11 ▲		
			RV 125 K2-K9/L0/L3/L4 (Van-Van)	02-15 ▲		
CK2371 ▲=CT010	FZ 400 (4YR1)	96 ▲	TF 125 Farm Bike (All models)	78-05 ▲		
			TS 125 ERZ	82 ▲		
CK2375	TT-R 110 E	08-20	TS 125 K/L/M/A/B/C/C2	73-78 ▲		
CK2378	XP 500 (T-Max Scooter - All models)	01-11	TS 125 ERN	▲		
			(Up to E/No.- 302345)	79 ▲		
			TS 125 N (Up to F/No 178871)	84 ▲		
			DR 125 SEX/SEY	99-01 ▲		
			GSX 150 L6/DZAL6 Gixxer	16 ▲		
			GSX 150 DEAL8/DZAL8/DXAL8 Gixxer	18 ▲		
			GSX-R 150 FRFAL7/FRZAL7	17-18 ▲		
			GSX-R 150 RF-Q/RFX-Q	17-18 ▲		
			GSX-R 150	18-20 ▲		
			GSX-S 150	18-20 ▲		
CK2379 ▲=CT017	XVS 950 A Midnight Star XV 950 - XVS 950 (Non ABS/Standard Rear Shocks) XV 950 CU - XVS 950 (1XC1/ABS/Standard Rear Shocks) XV 950 R - XVS 950 R (2DE/Remote Reservoir Rear Shocks) XV 950 Racer (Remote Reservoir Rear Shocks)	09-13 ▲				
		14 ▲				
		14-15 ▲				
		14-15 ▲				
		15-16 ▲				

Part No.	Make/Model	Year	Part No.	Make/Model	Year	
CK3318 CKF3318 ▲=CT011 Contd.	SUZUKI KLX 125 A1/A2/A3/A6F	03-06 ▲	CK3331 ▲=CT022	SUZUKI PE 250 T/X/Z	80-82 ▲	
	KLX 125 L (B1/B2/B3/B6F)	03-06 ▲		RM 250 N/T/X/Z/D/E/F	79-85 ▲	
CK3319 ▲=CT011	SACHS XTC 125	00-07 ▲	CK3332 ▲=CT022	RG 250 WD	83 ▲	
	X Road 125	06-07 ▲		DR 400 ST/SX	80-81 ▲	
	GP 100 N/UN	79 ▲	GN 400 TT	80 ▲		
	GP 100 C/UC	78 ▲	GSX 400 FEX/FZ/FD	81-83 ▲		
	RM 100 A	76 ▲	GSX 400 FW/FWS/FWS-2			
	RM 100 N/T/X	79-81 ▲	PE 400 T/X	80-81 ▲		
	GP 125 C/N	78-79 ▲	RM 400 N/T	79-80 ▲		
	RG 125 CG/CH/J Gamma	86-90 ▲	SP 400 T	80 ▲		
	RG 125 UCG/UCH/UJ/UAJ/BUJ Gamma	86-90 ▲	CK3333 ▲=CT022	RGV 250 M/N/P/R/S	91-95 ▲	
	RG 125 FN/FP/FR Gamma	92-94 ▲		GSX 400 ET/EX/EZ	80-82 ▲	
	RG 125 FUN/FUP/FUR Gamma	92-94 ▲	GSX 400 TX/LX	81 ▲		
	RG 125 UN Wolf Naked	92-94 ▲	GS 450 ET/EG/EJ	80-88 ▲		
	RM 125 N/T	79-80 ▲	GS 500 EK/EL/EM/EN/EP/ER/ES/ET /EV/EW/EX/EY/K1/K2/K3/K4/FK4 /FK5/K5/FK6/K6/FK7/K7/K8/FK8	89-08 ▲		
	RM 125 G/H	86-87 ▲	APRILIA RS 250		95-02 ▲	
	TS 125 X (all models)	84-90 ▲		CK3334 ▲=CT022	RM 250 A-C	76-78 ▲
	TS 125 RK/RL/RM/RN/RR	90-94 ▲	SP 370 C/N		78-79 ▲	
	TU 125 X/XTUX/XTX	99 ▲	PE 250 B/C/N	77-79 ▲		
	TS 250 XE/XG/XH/XJ/XK	85-89 ▲	CK3335 ▲=CT024	GS 1000 GT/GX	80-81 ▲	
	GT 185 (K/L/M/A/B/C/EC)	73-79 ▲		GSX 1000 SZ	82 ▲	
	TS 185 K/L/M/B/C/ERN/ERT/ERX	73-81 ▲		GS 1100 GZ	82 ▲	
	DF 200 EV/EW/EY (SH42A)	98-00		GSX 1100 ET/EX/EZ/SZ	80-82 ▲	
	DR 200 G/H/J	86-89 ▲		GSX 1100 EFE/EFG/ESF	84-86 ▲	
	DR 200 SE Trojan	▲		VL 1500 W/X/Y/K1/K2/K3	98-03 ▲	
	DR 200 SEK1-SEK8	01-08 ▲		VL 1500 K5/K6/K7/K8 (C 1500 Intruder)	05-08 ▲	
	DR 200 SEP/SER/SES/SEV/SEW /SEX/SEY (SH42A) Djebel	93-00 ▲		CK3337 ▲=CT011	TS 100 ERN/ERT/ERX	80-81 ▲
	RV 200 K2/K3	02-03 ▲			(From F/No300564)	
	GT 200 EN/EX 'X5'	79-80 ▲		DR 125 SMK8/SMK9/SML0	08-12 ▲	
	SB 200 N/X	79-80 ▲	TS 125 ERN	79 ▲		
SX 200 R/R-Z/RJ/RM	90-91 ▲	(From F/No 302346)	84 ▲			
GSF 250 N/ZM/P/NP/ZP/N/NR	92-96 ▲	TS 125 N (From F/No 178872)	80-81 ▲			
GSX 250 R CH/H (GJ72A)	▲	TS 125 ERT/ERX	79 ▲			
GSXR 250 J (GJ72A)	▲	GT 125 EN				
GSXR 250 CK	▲	CK3338 ▲=CT011	GP 125 X/XD	81-84		
SACHS XTC 125	00-04 ▲		CK3339 ▲=CT011	GP 100 X/UX/D/UD/UL	81-92 ▲	
CK3321 ▲=CT035SP	GT 550 J/K/L/M/A/B	72-77 ▲		GSXR 250 RK (GJ73A)	▲	
CK3324 ▲=CT018SP	GT 750 J/K/L/M/A/B	72-77 ▲	GSX 250 SSM Katana (GJ76A)	91 ▲		
	GS 750 B/DB/DC/EC/EN	77-79 ▲	CK3340 ▲=CT011	DS 80 T/X/Z/D/F/G/H/J/K/L/M/N /P/R/S/T/V/W/X/Y	80-00 ▲	
CK3326 ▲=CT051	TS 100 K/L/M/A/B	73-77 ▲		JR 80 K1/K2/K3/K4/K5/K6/K7	01-07 ▲	
	CK3328 ▲=CT011	ZR 50 SKE/SKH		84-87 ▲	RM 80 XZ/XD/HD	82-83 ▲
GS 50 K5 (NA41A)		05 ▲		CK3343 ▲=CT018SP	RL 250 Beamish Model Reed Valve Engine	78-82 ▲
GT 50 KB/KEN		77-80 ▲			RL 325 Beamish Model Reed Valve Engine	78-82 ▲
OR 50 ET		80 ▲			GS 400 B/C	77-78 ▲
RM 50 C/N/T/X/Z	78-82 ▲	GS 425 EN	79 ▲			
CK3329 ▲=CT011	TS 50 KN/ERKT/ERKX/ERKZ/ERKD	79-83 ▲	CK3344 ▲=CT018SP	GS 550 (all models)	77-82 ▲	
	ZR 50 KEN/KEX/SLKX/SKX	79-81 ▲		GSX 550 (all models)	84-87 ▲	
	LT 125 D/E/F/G/H	84-86 ▲	CK3345 ▲=CT035SP	GS 1000 HC/EC/EN/SN/ET	78-80 ▲	
	LT 185 E/F	84-85 ▲		CK3346 ▲=CT024SP	GSX 1100 SD/ESD	83 ▲
	CK3330 ▲=CT018	RM 100 B/C	77-78 ▲		CK3347 ▲=CT018	XN 85 D 'Turbo'
		RM 125 A/B/C	76-78 ▲			
		RM 125 X/Z/D	81-83 ▲			
		RM 125 F	85 ▲			
PE 175 C/N/T/X/Z		78-82 ▲				
TS 200 RK/RL/RM/RN/RR/R		89-94 ▲				
GSX 250 ET/EX/EZ	80-82 ▲					
GS 250 TT/TX	80-81 ▲					
CK3333 ▲=CT018	GS 650 GX/GZ 'Katana'	81-82 ▲				
	GS 650 GTX/GTZ/GTD	81-83 ▲				
	GS 700 EF/ESF	85 ▲				
	GSX 750 ET/EX/ESD/EFE/ESG/ESE/FFF	80-86 ▲				
	GSX 750 SE 'Katana'	84 ▲				
	GSX 750 S/SS Katana (GS75X-106815-)	84 ▲				
	GSX 750 S-2/S-2C (GS75X-114747-) Katana	84 ▲				
	GS 850 (all models)	79-85 ▲				

Part No.	Make/Model	Year	Part No.	Make/Model	Year
CK3348 ▲=CT047SP ■=CT022	SUZUKI RM 465 X/Z RM 500 D/E GSF 600 Y/K1/K2/K3/K4 (Naked Bandit) GSF 600 SY/SK1/SK2/SK3/SK4 (Faired Bandit) GSX 600 FJ/FK/FL/FM GSF 650 S/T/V/W/X Naked Bandit GSX 650 ST/SV/SW/SX Faired Bandit GSX R 750 F/G/H	81-82 ■ 83-84 ■ 00-04 ▲ 00-04 ▲ 88-91 ▲ 95-99 95-99 ▲ 85-87 ▲	CK3374 CKF3374 ▲=CT022	SUZUKI RM 250 J/K/L/M RMX 250 K/L RMX 250 M RMX 250 R/S/T/V/W RMX 250 ST/SV/SW/SX (SJ14A) RM 250 R/S LT 500 RL/RM	88-91 ▲ 89-90 ▲ 91 ▲ 94-98 ▲ 96-99 ▲ 94-95 ▲ 90-91 ▲
CK3349 ▲=CT011	TS 50 X (all models) RG 50 EW	84-02 ▲ ▲	CK3375 ▲=CT029	GV 1200 GLF/GLF2/GLG 'Madura'	85-86 ▲
CK3351 ▲=CT022	RG 250 WE/FG/FH/CH/FCH RGV 250 J RGV 250 K/L TV 250 J/K/AK/L (VJ21A) Wolf	84-88 ▲ 88 89-90 ▲ 88-90 ▲	CK3376 ▲=CT072SP	GSXR 750 RG (Dry Clutch - Sintered Friction)	86 ▲
CK3356 ▲=CT011	RM 125 E RM 125 J/K/L/M LT-F 300 FX/FY/FK1 ARCTIC CAT 300 (2 x 4/4 x 4) 300 (4 x 4)	84 ▲ 88-91 ▲ 99-01 ▲ 98-04 ▲ 05 ▲	CK3377 ▲=CT022 ■=CT029 ●=CT033SP	VS 400 VR/FR/VTR/FTR/VT/FT 'Intruder' SV 400 N (VK53A) SV 400 SN (VK53A) SV 400 X/Y/K1/K2 SV 400 SX/SY/SK1/SK2 VS 600 GLS/GLT/GLV SV 650 X/Y/K1/K2 Naked - Non ABS SV 650 SX/SY/SK1/SK2 Top Fairing - Non ABS VS 700 GLFG/GLEPP/GLPH/GLEPH VS 750 GLF/GLFG/GLFH/GLPG/ GLEFH/GLEPH/GLPK/GLPM Intruder Volusia (VL 800 K1-K5) C 800 Intruder - Spoke Wheels VL 800 K6/K7/K8/K9/L0/L1/L2/L3/L5 C 800 C (VL 800 CK7/CK8/CK9/CL0 /CL1/CL2/CL3) Intruder (Cast wheel) VL 800 BTL4 - C800 Intruder VX 800 L/M/N/P/R/T VS 800 GLN/GLP/GLR/GLS/GLT/GLV VZ 800 V/W/X/Y/K1/K2 Marauder M 800 (VZ 800 K5-K9/L0/L1/L3Intruder M800) VZ 800 L4/L5 Intruder M 800/T M 800 (VZ 800 K9Z Intruder)	94- 98 ● 98 ● 00-02 ● 00-02 ● 95-97 ■ 99-02 ▲ 99-02 ▲ 86-87 ■ 85-91 ■ 01-05 ■ 06-15 ■ 07-15 ■ 14 ■ 90-96 ■ 92-97 ■ 97-03 ■ 05-13 ■ 14-15 ■ 09-12 ■
CK3357 CKF3357 ▲=CT029	GSX 600 FW/FX/FY/FK1/FK2/FK3 /FK4/FK5/FK6 GR 650 D/XD GSF 650 K5/K6 Naked Bandit - Non ABS GSF 650 AK5/AK6 Naked Bandit - ABS GSF 650 SAK5/SAK6 Faired Bandit - ABS GSF 650 SK5/SK6 Faired Bandit - Non ABS GSX 750 FW/W/FX/X/FY/Y/FK1-FK6 GSX 750 W/X/Y/K1	98-06 ▲ 83 ▲ 05-06 ▲ 05-06 ▲ 05-06 ▲ 05-06 ▲ 98-06 ▲ 98-03 ▲	CK3378	FR 80 M/B/N/X/Z/D	76-83
CK3358 ▲=CT029	SW-1 (NJ45A) GN 250 F/J/M/R/T GW 250 L3/ZL5 Inazuma GW 250 FL5 Inazuma GZ 250 X/Y/K1-K8 Marauder TU 250 XV/XW TU 250 S/T/XS/XT/X-ST/X-SV/XT-W (NJ47A 100001-115972) Volty TU 250 XTX/XXTY (NJ47A-115-) Volty TU 250 GY/GBK1 Grass Tracker Big Boy (NJ47A-117/123) VL 250 Y/K1/K5/K6/K7 Intruder	92 ▲ 87-97 ▲ 13-15 ▲ 15 ▲ 99-08 ▲ 97-00 ▲ 92-97 ▲ 99-00 ▲ 00-01 ▲ 00-01/07 ▲	CK3380 ▲=CT051	RB 50 H	87 ▲
CK3359 ▲=CT047SP ■=CT029SP	GSX 400 FSV/FSK1 (GK7BA) Inazuma ST 400 Tempter V/W/X/Y/K1/K2/K3 DR 500 X/Z/D DR 600 RG/RH/RJ/RK (SN41A) DR 600 SF/SG/SH/SJ/SK (SN41A) LS 650 'Savage' FG/PK/PM/PR/PS/PT/PV	00 ▲ 97-03 ■ 81-83 ■ 86-89 ■ 85-89 ■ 87-97 ■	CK3381 ▲=CT048SP	GSX 1100 FJ/FK/FL/FM/FN/FP/FR GSXR 1100 G/H/J	88-94 ▲ 86-88 ▲
CK3364 ▲=CT011	LT 160 EK/EL/EM/EN LT-F 160 L/M/N/P/R/S/T/V/W /X/Y/K1/K2/K3 LT 160 K3/K4 Quadport LT 230 GEF/GEG LT-F 230 G/H LT-F 250 K2 Ozark	89-92 ▲ 90-03 ▲ 03-04 ▲ 85-86 ▲ 86-87 ▲ 02 ▲	CK3382	VS 1400 All Models	87-03
CK3366	JR 50 (All models) KDX 50 A1/A2/A3/A6F	78-07 03-06	CK3384 ▲=CT022	RG 250 WD	83 ▲
CK3367	RM 80 XG/XH/XJ	86-88	CK3385 ▲=CT011	GSX 400 R2/R3 (GK71B/F) GSX R 400 H GSX 400 X/XA/XS 'Impulse'	▲ 87 ▲ ▲
CK3372 ▲=CT022	LT 250 RH/RJ/RK RM 250 G/H	86-90 ▲ 86-87 ▲	CK3386 ▲=CT024	DR 650 SET/SEV XF 650 V/W/X/Y 'Freewind' DR 750 SJ/SK DR 800 SL (SR43A)/SM/SN/SP/SR/SS (SR43B) DR 800 ST/SV (SR43B) CCM 644 DS/Supermoto R30 (Suzuki 644cc engine)	96-97 ▲ 97-02 ▲ 88-89 ▲ 90-95 ▲ 96-97 ▲ 04 ▲ 02-04 ▲
CK3373 ▲=CT035SP	RE5M/A	75-76 ▲	CK3387 ▲=CT036SP	GSX 600 FN/FP/FR/FS/FT/FV GSX 750 FK/FL/FM/FN/FP/FR/FS/FT/FV GSX R 750 J/K GSX R 750 L/M/WN/WP/WR/WS	92-97 ▲ 89-97 ▲ 88-89 ▲ 90-95 ▲
			CK3388 ▲=CT029	GV 1400 'Cavalcade' (All models)	85-88 ▲

Part No.	Make/Model	Year	Part No.	Make/Model	Year
CK3390 ▲=CT011	SUZUKI LT-F 4WDH/J/K/L/M/N/P/R/S/T/V/W LT-F 250 J/K/L/M/N/P/R/S/T/V/W/Y/K1 LT-F 250 FX/FY/FK1/FK2 LT-F 250 K3/K5/K6/K7/K8/K9 /L2/L3/L4 Ozark LT 250 EEF/EFG LT-F 300 J/K ARCTIC CAT 250 (2 x 4/4 x 4)	87-98 ▲	CK3430 ▲=CT021	SUZUKI GSX 1300 RY/RK1 'Hayabusa' GSX 1300 RX	00-01 ▲
		89-01 ▲			99 ▲
		99-02 ▲	CK3432 ▲=CT029	VL 125 Y/K1-K7 "Intruder"	00-08 ▲
CK3392 ▲=CT055SP	GSX 1100 GM/GN GSX R 1100 K/L/M/N	03/05-14 ▲ 85-86 ▲ 88-89 ▲	CK3433 CKF3433 ▲=CT006 ■=CT009	HONDA CRF 450 RB/RC/RD/RE/RF/RG CRF 450 RE (Limited Road Use) SUZUKI DR-Z 400 SEY/EY/Y/SK1/EK1/K1 /SK2/EK2/K2/SK3/EK3/K3/SK4 /EK4/K4/SK5/K5/K6/EK6/SK6 /SK7/EK7/K7/SK8/SK9 DR-Z 400 SMK5/6/7/8/9 LT-Z 400 K3/K4 ARCTIC CAT 400 DVX CCM R 35/R 35 S CR 40 S Cafe Racer CR 40 Street SR 40 Street Scrambler 404 E/DS/Supermoto KAWASAKI KSF 400 A1/A2 (KFX 400)	11-16 ■ 16 ■
CK3393	FR 50	01-05 ▲			00-09 ▲ 05-09 ▲ 03-04 ▲
CK3397 ▲=CT011	GSF 400 M/N/P GSF 400 S/V/S/V-V/VZ-V Bandit (GK7AA) GSX 400 FJ/FK/FAK/FL (GK74A) GSXR 400 J/RR/RAK (GK73A) GSF 400 K/NK/Z/VM/VZM/P/NP /VP/VZP/VR (GK75A) 'Bandit' GSXR 400 RL/RM/RN/RP/RS (GK76A)	91-95 ▲	CK3435 ▲=CT009	TL 1000 SK1/RK1	04-06 ▲
		95-97 ▲			06-07 ▲
		88-90 ▲	CK3437 ▲=CT022	RMX 250 SN/SR/SS (S.J13A)	07 ▲
		88-90 ▲			07 ▲
CK3399 CKF3399 ▲=CT022	DR 250 SL/SM/SN/SEP /SER/SES (S.J44A) DR 350 SL/SM/SN/SP/SER/SES/ SET/SEV/SEW/SEX SG 350 N 'Goose' QUADZILLA WK 300	90-95 ▲	CK3439 ▲=CT009	GSX 1400 K2/K3/K4/K5/K6/K7	03-04 ▲
		90-99 ▲			01-02 ▲
		92 ▲	CK3441	GSX 400 SSN (GK77A) Katana	06 ▲
CK3400 ▲=CT022	RM 250 N/P RMX 250 N/P	92-93 ▲ 92-93 ▲			92
CK3401 ▲=CT003	RM 125 N/P/R/S/T/V/W/X/Y/K1	92-01 ▲	CK3443 CKF3443 ▲=CT021	DL 1000 K2-K9/L0 DL 1000 V-Strom (ABS) DL 1000 V-Strom Adventure ABS SV 1000 K3/K4/K5/K6/K7 Naked SV 1000 SK3/SK4/SK5/SK6/SK7 (Faired model) GSX 1300 RK2/RZK3/RK3/RK4/RK5/K6/K7 GSX 1300 RK8/RK9/RLO/RL1/RL2 /RAL3/RAL4/RAL5 Hayabusa GSX 1300 BKK8/BKK9/BKL0/BKL1 B-King	02-10 ▲
CK3402 ■=CT029SP	DR 650 RL/RM (SP41A) DR 650 RSL/RSM (SP42A) DR 650 RUN/RN/RUP/RP (SP44A/B) DR 650 RER/RES (SP45A/B) DR 650 RSEM/RSEN/RSEP (SP45A/B)	90-91 ■			CK3445 ▲=CT009
		90-91 ■	04-05 ▲		
		92-93 ■	CK3447 CKF3447 ▲=CT006	LT-Z 400 K5-K9/L0/L1/L2/L3 Quadport KAWASAKI KSF 400 A3/A6F ARCTIC CAT 400 DVX	14-20 ▲
		94-95 ■			05-06 ▲
		91-93 ■	CK3448 ▲=CT011	LT-F 250 K4 Ozark LT-Z 250 K4-K9/L0 Quadport	03-08 ▲
CK3408 CKF3408 ▲=CT036SP	RF 600 RP/RR/RS/RT	93-96 ▲			04-06 ▲
CK3417 ▲=CT014 ■=CT055SP	GSR 750 L1/L2/L3 GSR 750 AL2/AL3/AL4/AL5 GSXR 750 T/V/W/X GSXR 750 K4/K5 RF 900 RS/R2S/RT/RV/RW TL 1000 SV/SW GS 1200 SSK1/ZK1 (GV78A) GSF 1200 SAV ABS Bandit GSF 1200 T/V/W/X/Y (Naked bandit) 4 piston caliper GSF 1200 ST/SV/SW/SX/SY (Faired bandit) 4 piston caliper SUZUKI GSX 1200 FSW/FSX Inazuma GSF 1200 K1/K2/K3/K4/K5 (Naked Bandit - 6 piston caliper) GSF 1200 SK1/SK2/SK3/SK4/SK5 (Faired Bandit - 6 piston caliper) GSF 1200 K6/AK6 (Naked Bandit - 4 piston caliper) ABS & Non ABS Version GSF 1200 SK6/SAK6 (Faired Bandit - 4 piston caliper) ABS & Non ABS Version	11-14 ▲	CK3450 CKF3450 ▲=CT045	RMX 450 ZL0/ZL2 RM-Z 450 K5/K6/K7/K8/K9/L0/L1-L5 LT-R 450 K6/K7/K8/K9/L0/L1	02-07 ▲
		12-15 ▲			10-15 ▲
		97-99 ■	CK3451 CKF3451 ▲=CT015	GSXR 1000 K5/K6/K7/K8 GSX-S 1000 (Naked/Non ABS) GSX-S 1000 (Naked/ ABS) GSX-S 1000 F (Faired/Non ABS) GSX-S 1000 F (Faired/ ABS) Katana	08-15 ▲
		04-05 ▲			08-12 ▲
		04-05 ▲	CK3452 ▲=CT006	LT-F 500 FK3-FK7 ARCTIC CAT 500 (4 x 4 Manual) 500 (Manual 4 x 4)	01 ▲
		95-98 ▲			03-07 ▲
		97-98 ▲	CK3455 ▲=CT011	LT-F 250 K4 Ozark LT-Z 250 K4-K9/L0 Quadport	04 ▲
		01 ■			05-12 ▲
		97 ■	CK3455 ▲=CT015	LT-F 250 K4 Ozark LT-Z 250 K4-K9/L0 Quadport	04 ▲
		97 ■			05-12 ▲
		96-00 ■	CK3455 ▲=CT015	LT-F 250 K4 Ozark LT-Z 250 K4-K9/L0 Quadport	04 ▲
		96-00 ■			05-12 ▲
		96-00 ■	CK3455 ▲=CT015	LT-F 250 K4 Ozark LT-Z 250 K4-K9/L0 Quadport	04 ▲
		96-00 ■			05-12 ▲
		96-00 ■	CK3455 ▲=CT015	LT-F 250 K4 Ozark LT-Z 250 K4-K9/L0 Quadport	04 ▲
		96-00 ■			05-12 ▲
		98-99 ■	CK3455 ▲=CT015	LT-F 250 K4 Ozark LT-Z 250 K4-K9/L0 Quadport	04 ▲
		01-05 ■			05-12 ▲
		01-05 ■	CK3455 ▲=CT015	LT-F 250 K4 Ozark LT-Z 250 K4-K9/L0 Quadport	04 ▲
		01-05 ■			05-12 ▲
		06 ■	CK3455 ▲=CT015	LT-F 250 K4 Ozark LT-Z 250 K4-K9/L0 Quadport	04 ▲
		06 ■			05-12 ▲
CK3418 ■=CT055SP	RF 900 RR GSXR 1100 WP/WR/WS/WT	94 ■ 93-96 ■	CK3455 ▲=CT015	LT-F 250 K4 Ozark LT-Z 250 K4-K9/L0 Quadport	04 ▲
		94 ■			05-12 ▲
CK3428 ▲=CT009	TL 1000 RW/RX/RV/SW/SX/SY TL 1000 SX/SY	98-00 ▲ 99-00 ▲	CK3455 ▲=CT015	LT-F 250 K4 Ozark LT-Z 250 K4-K9/L0 Quadport	04 ▲
		99-00 ▲			05-12 ▲

Part No.	Make/Model	Year	Part No.	Make/Model	Year
CK3453 ▲=CT016	SUZUKI RM 250 K6/K7/K8/K9 RM 250 XCK8	06-12 ▲ 09 ▲	CK4413 ▲=CT019	KAWASAKI Z 650 B1/B2/B3/D2-D3/F1-F4 Z 650 C1/C2/C3 Custom Z 650 F1/F2/F3/F4 Z 700 A1 'Ltd' ZN 700 A1/A2 'Ltd' ZN 750 N1/N2 'Spectre' Z 750 E1/H1-H2/L1-L4 GT 750 P1-P5 GPZ 750 R1 GPZ 750 A1-A5	77-79 ▲ 77-79 ▲ 80-83 ▲ 84 ▲ 84-85 ▲ 82-83 ▲ 80-84 ▲ 82-90 ▲ 82 ▲ 83-87 ▲
CK3454 ▲=CT016	RM 250 K3/K4/K5	03-05 ▲	CK4415 ▲=CT004	H2/H2-A Mach IV (750cc)	72-73 ▲
CK3455 CKF3455 ▲=CT015	GSXR 600 K6/K7	06-07 ▲	CK4419 ▲=CT006	KX 250 KX 250 A/A3/A4/A5 KEF 300 B1/B2/B3 Lakota Sport KLF 300 A1/A2/B1-B17/C1-C17 ARCTIC CAT 400 (2 x 4/4 x 4)	74 ▲ 75-79 ▲ 01-03 ▲ 87-05 ▲ 00-02 ▲
CK3456 CKF3456 ▲=CT015	GSX-R 600 GSX-R 750 GSX-S 750	08-20 ▲ 06-20 ▲ 15-20 ▲	CK4421	Z 400 B1/B2 Z 400 G1 Z 440 A2 LTD Z 440 A2/C1-C2/H1/H2 Z 440 D4-D6 (Ltd)	78-79 79 80-83 82-84
CK3457	M 1800 R (VZR 1800 K6/K7/K8 /K9 Intruder handlebar cowling) M 1800 R2 (VZR 1800 NK8/NK9) Intruder - No handlebar cowling M 1800 RZ (VZR 1800 ZK7/ZK8 /ZL1/ZL2) intruder - With handlebar cowling with central tape strip VZR 1800 BZL4/BZL5 - M1800 RB	06-09 08-09 07-13 14-15	CK4424 CKF4424 ▲=CT016	Z 400 J1-J3 ZR 400 A1/B1 (Z400 F) ZX 400 C2 (Z400 F11) ZL 400 A 'Eliminator' ZL 400 'B' Eliminator' 400 SE ZL 400 D1/D2 FX 400 R (ZX 400 E1-E3) GPZ 400 R (ZX400 D1/D2/D3/D3A) GPZ 400 R (ZX 400 F1) ZR 400 Zephyr (G2/G3/G3A/G4/G5) ZRX 400 (ZR 400 E1-E7) ZZR 400 (ZX 400 K1/K2/K3) ZZR 400 (ZX 400 N1-N7) EN 450 A1-A5 (Ltd 450) EX 500 A1-A6/D1-D7 (GPZ 500 S) KLE 500 A1-A12 EN 500 A1-A4/B1/B2/C1-C9 ER-5 (ER 500 A1/A2/A3/A4/C1-C5P) GPZ 500 (S) (EX 500 B1-B5) GPZ 500 S (EX 500 E1-E10) KLE 500 B1P/B6F/B7F Z 500 A1-A3/B1-B2 Z 550 C1-C2 (Ltd) GT 550 G1-G9 GPZ 550 D1/H1-H2/A1-A4 ZR 550 A1-A2 (Z550 F) ZR 550 B2/B3/B4/B5/B6 "Zephyr" KL 600 A1 (KLR 600) KLR 600 B1/B2/B4/B6-B9 GPZ 600 R A1-A6 GPX 600 R C1-C3/C6-C7 ZL 600 B1 ZZR 600 D1/D2/D2A/D3 ZZR 600 (ZX 600 E1-E13) ZZR 600 (ZX 600 E6F) 650 Vulcan S (EN 650 AFF/AGF/Non ABS) 650 Vulcan S (EN 650 BFF/BGF/ ABS) ER-6F (EX 650) ER-6f (ABS Model) ER-6n (ER 650) ER-6n (ABS) ER 650 KLE 650 A7F/A8F/A9F/CAF/CBF /CCF/CDF/CEF Versys KLE 650 B7F/B8F/B9F/DAF/DBF /DCF/DDF Versys ABS KLE 650 Verseys (KLE 650 EFF/EGF/Non ABS) KLE 650 Verseys (KLE 650 FFF/EGF/ABS) KLR 650 A1-A3 KL 650 B1/B2/B3 Tengai KLX 650 C1/C2/C3 ZXR 750 H1/H2	80-83 ▲ 83-84 ▲ 85 ▲ 86-87 ▲ 88 ▲ 94-95 ▲ 86-88 ▲ 85-87 ▲ 87 ▲ 97-01 ▲ 94-01 ▲ 90-92 ▲ 93-99 ▲ 86-89 ▲ 87-01 ▲ 91-04 ▲ 90-04 ▲ 97-07 ▲ 88-93 ▲ 94-04 ▲ 05-07 ▲ 79-81 ▲ 80-81 ▲ 83-01 ▲ 81-87 ▲ 83-84 ▲ 91-99 ▲ 84 ▲ 85-94 ▲ 85-89 ▲ 86-96 ▲ 95-97 ▲ 90-92 ▲ 93-05 ▲ 06-07 ▲ 15-16 ▲ 15-16 ▲ 06-11 ▲ 06-11 ▲ 06-11 ▲ 06-11 ▲ 07-14 ▲ 07-14 ▲ 15-16 ▲ 15-16 ▲ 87-89 ▲ 89-92 ▲ 93-97 ▲ 89-90 ▲
CK3458	DR-Z50 DR-70	19 08-17			
CK3459 ▲=CT021	GSF 1250 K7/K8/K9/OL0 (Naked Bandit 4 Piston Caliper) Non ABS GSF 1250 SAK7/SAK8/SAK9/SAZK9 /SALO (Faired bandit - 4 Piston Caliper) ABS Model GSF 1250 AK7/AK8 (Naked bandit - 4 piston caliper) ABS Model GSX 1250 FAL0/FAL1/FAL2 GSX 1250 FAL0ST/FAL1ST Sport Touring M 1500 (VZ 1500 K9/L0 - Intruder) VL 1500 BTL3/BTL4/BTL5 (CT 1500 BT Intruder)	07-11 ▲ 07-15 ▲ 07-08 ▲ 10-15 ▲ 10-14 ▲ 09-12 ▲ 13-15 ▲			
CK3462 CKF3462 ▲=CT009	GSXR 1000 K9/L0/L1/L2/L3/ZL3/L4 /ZL4/L5/AL5/AL6	09-16 ▲			
CK3463	C 1800 R (VLR 1800 K8/K9/L0/L1) (C 1800 R Intruder) C 1800 RT Touring Intruder VLR 1800 K8RT/K9RT	08-13 08-10			
CK3465 ▲=CT014	GSXR 750 K1/K2/K3	00-03 ▲			
CK3466 ▲=CT014	GSXR 600 K1/K2/K3/SK3	01-03 ▲			
CK3468 ▲=CT009	GSX-R 1000 ABS	17-20 ▲			
CK4409 ▲=CT019	KAWASAKI Z1/Z1A/Z1B Z 900 A4/A5 Z 1000 D1-D3 'ZIR' Z 1000 A1/A2/A3/A4 Z 1000 H1	74-76 ▲ 76-77 ▲ 78-80 ▲ 77-80 ▲ 80 ▲			
CK4411 ▲=CT058	KE 125 A7-A12 KH 125 A1-A4 KE 175 B1/B2/B3 KE 175 D2-D5 KT 250 A/A2	80-85 ▲ 77-81 ▲ 79-83 ▲ 79-83 ▲ 75-76 ▲			

Part No.	Make/Model	Year	Part No.	Make/Model	Year												
CK4425 ▲=CT004	KAWASAKI KX 125 K4-K5/L1-L4/M1-M3/M6F/M7F/M8F KX 125 K1/K2/K3 Z 200 A1 (From E/No 005063) Z 200 A2-A6 KL 250 A1-A4/C1/C2 KSF 250 A1-A18 (KXF 250 Mojave) Z 250 C1/C2/G1/G2 KLT 250 C1-C3 HI 500 Mach III HI-A 500 S Mach III HI-B/C 500 Mach III HI-D/E/F 500 KH 500 A8	97-08 ▲ 94-96 ▲ 78 ▲ 79-83 ▲ 78-84 ▲ 87-04 ▲ 80-83 ▲ 83-85 ▲ 69-70 ▲ 71 ▲ 72 ▲ 73-75 ▲ 76 ▲	CK4436 ▲=CT058	KAWASAKI KX 125 B1 KDX 175 A1-A3 KH 250 B4-B5	82 ▲ 80-82 ▲ 79-80 ▲												
	CK4433 ▲=CT006	KDX 250 B2/B3 KXT 250 A1 'Tecate' Z 250 A1-A3/B1-B2 ER 250 B1-B3 'Scorpion' GPZ 305 A1/B2-B10 KX 500 A1/A2		82-83 ▲ 84 ▲ 79-81 ▲ 83-88 ▲ 83-96 ▲ 83-84 ▲	CK4438 CKF4438 ▲=CT070SP	KX 60 A1-A2/B1-B19 KX 65 KX 80 E1/E2 KLX 110 KH 125 K2-10 KH 125 L1 (KH 125 EX) Z 125 Z 125 Pro MODENAS Kriss 110/115 SUZUKI Smash 110cc DR-Z 110 K3/K4/K5 RM 60 K3 RM 65 K3/K4/K5	83-03 ▲ 00-20 ▲ 83-84 ▲ 02-20 ▲ 82-98 ▲ 83 ▲ 16-20 ▲ 16-20 ▲ ▲ 03 ▲ 03-05 ▲ 03 ▲ 03-05 ▲										
		CK4434 ▲=CT016		ZL 900 A1/A2 'Eliminator' GPZ 1000 RX A1-A3 1000 GTR (AG 1000 A1-A18) Z 1000 E1/E2 (ST Shaft) Z 1000 J1/J2/J3 Z 1000 K1/K2 LTD Z 1000 R1/R2 (Eddie Lawson Replica) ZL 1000 A1 GPZ 1100 B1/B2 GPZ 1100 A1-A3 Z 1100 A1-A3 Z 1100 D1/D2 'Spectre' Z 1100 R1 ZR 1100 A1/A2/A3/A4/B1 ZR 1100 B5 (Zephyr 1100 RS) ZX 10 B1/B2/B3 ZRX 1100 (ZX 1100 C1/C2/C3/C4) ZRX 1200 A1/A2/A3/A4/A5/A6F ZRX 1200 B1-B3		85-86 ▲ 86-88 ▲ 89-03 ▲ 79-80 ▲ 81-83 ▲ 81-82 ▲ 82-83 ▲ 87 ▲ 81-82 ▲ 82-85 ▲ 81-83 ▲ 82-83 ▲ 84 ▲ 92-97 ▲ 02 ▲ 88-90 ▲ 97-00 ▲ 01-07 ▲ 01-08 ▲	CK4439 CKF4439 ▲=CT006	KDX 250 B1 KX 250 A6/A7 KLF 400 B1/B3/B3A/B4/B5/B6/B7 KX 420 A1/A2 SUZUKI LT-F 400 K2 Eiger LT-F 400 K3-K7 Eiger 2WD LT-F 400 FK2-FK7 Eiger 4WD LT-F 400 FK8/FK9/FL0/FL1 King Quad 4WD LT-F 500 FW/FX/FY/FK1/FK2 ARCTIC CAT 400 (2 x 4/4 x 4) 400 (2 x 4) 400 (2 x 4/4 x 4) 400 (4 x 4/Manual) Bearcat 454 (4 x 4) Bearcat 454 (2 x 4) 500 (4 x 4)	81 ▲ 80-81 ▲ 93-98 ▲ 80-81 ▲ 02 ▲ 03-07 ▲ 02-07 ▲ 09-12 ▲ 98-02 ▲ 98- ▲ 98 ▲ 03-04 ▲ 05-08 ▲ 96-98 ▲ 97-98 ▲ 98-02 ▲								
				CK4435 CKF4435 ▲=CT016		KX 250 J1/J2/K1-K4/K5/L1-L4/M1 /M2/R1/R6F/R7F/R8F EJ 650 A1/C3-C7 (W650) KLR 650 C1-C10 KLR 650 (KL 650 E8F/E9F) VN 700 A1 'Vulcan' Z 750 Y1 (Ltd) GPZ 750 R G2/G3 GPZ 900 R A1-A8 ZX-7 RR (ZX 750 N1/N2) GPX 750 F1/F2/F3/F2A VN 750 A2/A3/A4/A5/A10 ZXR 750 J1/J2/L1/L2/L3/P1-P7 ZXR 750 R (ZX 750 K1/K2/M1/M2) Z 750 B1/B2 Z 750 D1 EJ 800 ABF/ACF (W 800/Solid F Disc) EJ 800 (W 800 Cafe style/Cockpit fairing) EJ 800 ACFA (W 800 Special Edition Black Exhaust/Gold Rims EJ 800 ADF/AEF/AF/AGF (W 800) EJ 800 ADFA/AEFA/AFFA/AGFA (W 800 Special Edition) VN 800 A1-A3/B1-B10/B6F/C1/C2/E1-E3 VN 900 AF6 Classic VN 900 BBFA/BCFA/BDF/BEFA/BFFA Classic Special Edition VN 900 C7F/C8F/C9FA/CAF/CBF/CCFA /CDF/CEFA/CFFA Custom (Cast wheel) VN 900 B7F/B8F/B9F/BAF/BBF/BCF /BDF/BEF/BFF Classic (Spoke wheel) ZX-9R (ZX 900 B1-B4) SUZUKI RM 250 T RM 250 V/W/X/Y/K1/K2		92-08 ▲ 99-05 ▲ 95-04 ▲ 08-09 ▲ 85 ▲ 82 ▲ 85-86 ▲ 84-96 ▲ 96-99 ▲ 87-89 ▲ 86-94 ▲ 91-03 ▲ 91-94 ▲ 77-78 ▲ 76 ▲ 11-12 ▲ 11 ▲ 12 ▲ 13-16 ▲ 13-16 ▲ 95-06 ▲ 06 ▲ 11-15 ▲ 07-15 ▲ 07-15 ▲ 94-97 ▲ 96 ▲ 97-02 ▲	CK4440	AE 80 A1/B1 AR 80 A1/C1-C8 KSR II (KMX 80 B1/B2) KC 100 C1-C4 KE 100 A8-A10 KE 100 B1-B15 KH 100 A2-A4/G2-G8 KM 100 A4-A6 KH 125 K1	81-83 81-91 90-91 81-83 79-81 82-98 78-87 79-80 82						
						CK4442		AE 50 A1-A2 AR 50 A1/C2-C10 KSR I (KMX 50 B1/B2)		81-84 81-97 90-91	CK4443 ▲=CT019	ZX 750 E1/E2 'Turbo' Z 200 A1 (Up to Eng No.005062)	84-87 ▲ 77 ▲				
								CK4446 ▲=CT004		KLR 250 D2-D22 ZXR 400 L1-L5/L8/L9 ZXR 400 H1/H2 ZXR 400 R (ZX 400 M1-M4) ZX 400 J1/J2 Xanthus (ZR 400 D1/D3/D4)		84-05 ▲ 91-03 ▲ 89 ▲ 91-94 ▲ 89-90 ▲ 92-95 ▲	CK4452	Z 1300 A1-A3	79-81		
										CK4453 CKF4453 ▲=CT002		KX 80 W1/W2/W3 KX 85 Smal Wheel (17" Front/14" Rear) KX 85 Big Wheel (19" Front/16" Rear) KX 100 C1/C2/C3 AR 125 A1A-A7/B1-B8 KMX 125 A1/A2/B1/B2 (From E/No MX 125 AE 000001-013436) SUZUKI RM 100 K3		98-00 ▲ 01-20 ▲ 01-20 ▲ 98-00 ▲ 83-94 ▲ 86-87 ▲ 03 ▲			

Part No.	Make/Model	Year	Part No.	Make/Model	Year	
CK4455 ▲=CT032	KAWASAKI		CK4486 ▲=CT002	KAWASAKI		
	ZG 1300 A1-A3	84-86 ▲		KMX 125 B2-B12	87-03 ▲	
	VN 1500 B2/C1/C2/D1	88-96 ▲		(From E/No MX 125AE 013437)	88-89 ▲	
	VN 1500 C1/C2/D1/D2	94-98 ▲		KMX 125 A3/A4/A5	88-92 ▲	
	VN 1500 E1/E2 'Classic'	98-99 ▲		KMX 200 A2/A3		
	VN 1500 B2-B6	88-92 ▲		KTM		
	VN 1500 G1/G2	98-99 ▲		Duke 200	12-19 ▲	
	VN 1500 J1/J2/R1/R2/R3	99-04 ▲		RC 200	14-19 ▲	
	VN 1500 N1/N2/N3 "Classic Fi"	00-04 ▲				
	VN 1500 P1/P2	02-04 ▲		CK4488	ZZR 1100 C1/C2/C2A/C3/D1-D9	90-01 ▲
	VN 1500 L1/L2/L3/L4 "Nomad Fi"	00-03 ▲		▲=CT021	ZX 1100 E1/E2/F1	95-98 ▲
	M 1600 (VZ 1600 K4/K5 Intruder)	04-05 ▲			ZZR 1200 C1H/C2H	02-04 ▲
	VN 1600 A1/A2/A3/A6F	03-08 ▲		CK4489	KDX 125 A1/A2/B1/B2	90-94
	VN 1600 B1 Mean Streak	04 ▲				
	VN 1600 B2H/B6F/B7F (Mean Streak)	05-08 ▲		CK4493	GT 750 P7/P9	92-96 ▲
VN 1600 D1H/D6F Classic Tourer	05-08 ▲	▲=CT019	ZR 750 C1/C2/C3/C4/C5/D1 'Zephyr'	91-98 ▲		
			ZR-7 (ZR 750 F1/F3/F5)	99-04 ▲		
			ZR-7S (ZR 750 H1/H3)	01-04 ▲		
CK4457 ▲=CT058	KX 125 B2/C1	83-84 ▲	CK4498	KX 125 J2	93	
	KDX 200 A1-A3	83-85 ▲				
	S3/S3A (400cc)	74-75 ▲				
	S2/S2-A (350cc)	72-73 ▲				
	KH 400 A3-A5	76-78 ▲				
CK4458	Z 1300 A4/A5	82-83	CK4503	ZX-6R F1/F2/F3/G1/G2/J1/J2	95-01 ▲	
			▲=CT004	ZX6RR (ZX 600 K1)	03 ▲	
			■=CT037SP	ZX6R (636cc) (ZX636A1P/B1/B2)	02-04 ▲	
CK4459 ▲=CT006	KX 250 D1/D2	85-86 ▲		Z 750 S (ZR 750 K1/K6F)	05-06 ▲	
	KXT 250 B1/B2 (Tecate - 3 wheel model)	86-87 ▲		Z 750 J1/J2/J6F	04-07 ▲	
	KX 500 B1/B2	85-86 ▲		Z 750 R (ZR 750 NBF/NCF)	11-12 ▲	
				Z 750 R ABS (ZR 750 PBF/PCF)	11-12 ▲	
CK4465 ▲=CT006	KX 250 B1/C1/C2	82-84 ▲		ZR 750 L7F/L8F/L9F/LAF/LAS	07-10 ▲	
	KXT 250 A2 (Tecate - 3 wheel model)	85 ▲		ZR 750 M7F/M8F/M9F/MAF/MAS	07-10 ▲	
CK4468	KX 80 E3/G1/G2/J1/J2	85-87		Z 800 ADS/AEF/AFF/AGF (Non ABS)	13-16 ▲	
				Z 800 BDS/BEF/BFF/BGF (ABS Model)	13-16 ▲	
CK4469 ▲=CT042	KX 125 D1/E1/E2	85-87 ▲		Z 800 E CDS/CEF/CFE/CGF (Non ABS)	13-16 ▲	
	KDX 200 C1/C2/C3	86-88 ▲		Z 800 E DDS/DEF/DFE/DGF (ABS Model)	13-16 ▲	
	KL 250 H1	98 ▲		KLZ 1000 BFF/BGF Versy	15-16	
	KL 250 J1 Stockman	▲		Z 1000 (ZR1000 GGF) 3 Spring Clutch	16 ▲	
	KLX 250 D1/D2/F1-F4	93-97 ▲		Z 1000 (ZR1000 FGF) 3 Spring Clutch	16 ▲	
	KLX 250 G1	94 ▲		Z 1000 SX ABS		
	KLX 250 J1-J6 D-Tracker	98-03 ▲		(ZX1000 MGF) (3 Spring Clutch)	16 ▲	
	KLX 250 H6F/H7F	06-07 ▲		Z 1000 SX Non ABS		
	KLX 250 S9F/SAF/SBF/SCF/SDF/SEF/SFF/SGF	09-16 ▲		(ZX1000 LGF) (3 Spring Clutch)	16 ▲	
	KLX 300 A2-A10/A6F/A7F	97-07 ▲		KLZ 1000 BFF/BGF/BGFAS Versys	15-19	
	SUZUKI			SUZUKI		
	250 S BK2 (LX 250L)	02 ▲		RG 400 EWF/EW-2G/EWH	85-87 ■	
				Walter Wolf (Type 1&2)	85-87 ■	
				RG 500 G/CH		
CK4473 ▲=CT016	GPX 250 F2 (ZX250 F2/F3/F6/F8/F9)	88-95 ▲	CK4505	KDX 200 H1/H2/H3/H4/H5	95-99	
	GPX 250 RII (EX 250 G)	88 ▲		KDX 220 R A4-A12/A6F	97-06	
	EL 250 D1-D5	90-94 ▲		KDX 220 SR		
	EL 250 B1-B3 'Eliminator'	87-89 ▲				
	KLE 250 A1/A1A/A2 (Anhelo)					
	GPZ 250 R (EX 250 E)	86 ▲				
	ZZR 250 (EX 250 H1-H13)	90-03 ▲				
	EL 252 (EL 250 F2/F3/F5/F6)	96-03 ▲				
CK4475 ▲=CT006	KX 250 E1/F1/G1/H1/H2	87-91 ▲	CK4508	SUZUKI	92-99	
	KXF 250 A1/A2	87-88 ▲		BJ 250 B1-B7A 'Estrella'	95-03	
	KDX 250 D1	91-93 ▲		BJ 250 C1-C7/D1-D7/F1/F2	96-99	
	KX 500 C1/D1/E1-E16	87-04 ▲		BJ 250 E1-E4A Estrella-RS Custom	91-95	
				ZR 250 A1-A5	02	
				ZR 250 B6 (Ballius II)		
CK4477	KX 80 L1	88		ZXR 250 C1-C5/D1	91-95	
	KX 100 N1	88		ZXR 250 (ZX 250 A1/A2)	89-90	
				ZXR 250 R (ZX 250 B1/B2)	89-90	
				GSX 250 FXK2	02	
CK4478	KX 80 L2/L3/R1-R7	89-97	CK4509	KDX 250 SR (KDX 250 F1)	91	
	KX 100 A1/A2/B1-B7	89-97				
CK4482	KX 125 F1/G1	88-89	CK4510	Z 900 (ZR 900 A)	17-19 ▲	
	KDX 200 E1/E2/E3/E4/E5/E6	89-94	▲=CT004	Z 900 ABS (ZR 900 B)	17-19 ▲	
			■=CT079SP	Z 900 RS (ZR 900 C)	18-19 ▲	
				Z 900 RS Café (ZR 900 E)	18-19 ▲	
CK4484 ▲=CT016	KR1 (250 cc) (KR 250 B2/C2/C3)	89-92 ▲		ZX9R (ZX 900 C1/C2/E1/E2/F1/F2)	98-04 ▲	
				KLZ 1000 ACF/ADF/AEF Versys	12-14 ▲	
				Z 1000 (ZR 1000 A1/A2/A3/A6F)	03-06 ▲	
				Z 1000 (ZR 1000 B7F/B8F)	07-08 ▲	
CK4485	KX 125 H1/H2/J1	90-92		Z 1000 ABS (ZR 1000 C7F/C8F/C9F)	07-09 ▲	
				Z 1000 DAF/FAS/DBF/DCF/DCFA		
				/DDF/DDFA (5 Spring Clutch)	10-13 ▲	
				Z 1000 EAF/EBF/ECF/ECFA/EDF/EDFA		
				(5 Spring Clutch)	10-13 ▲	
				Z 1000 FEF/FEFA/FFF (5 Spring Clutch)	14-15 ▲	

Part No.	Make/Model	Year	Part No.	Make/Model	Year	
CK4510 CKF4510 ▲=CT004 ■=CT079SP Contd.	KAWASAKI Z 1000 GEF/GEFA/GFF (5 Spring Clutch)	14-15 ▲	CK4516 ▲=CT032	KAWASAKI VN 1700 DAF/DBF/DCF/DDF/DEF Classic Tourer ABS	10-14 ▲	
	Z 1000 SX (ZX 1000 GBF/GCF/GDF) (Non ABS)	11-13 ▲		VN 1700 B9F/BAF/BBF/BCF/BDF/BEF /BFF/BGF Voyager ABS	09-16 ▲	
	Z 1000 SX (ZX 1000 HBF/HCF/HDF) (ABS)	11-13 ▲		VN 1700 C9F Classic Tourer	09 ▲	
	Z 1000 (ZR 1000 EAF/EBF/ECF/EDF/GEF/GFF)	10-15 ▲		VN 1700 DFF/DGF - Vulcan 1700 Nomad	15-16 ▲	
	Z 1000 Performance	16-19 ▲		VN 1700 Classic ABS	10-17 ▲	
	Z 1000 SX Tourer	11-19 ▲		VN 1700 E9F Classic	09 ▲	
	ZX 1000 SX (ZX 1000 LEF/LFF) Non ABS	14-15 ▲		VN 1700 Voyager Custom	11-17 ▲	
	ZX 1000 SX (ZX 1000 MEF/MFF) ABS	14-15 ▲		VN 2000 A1/A2/A6F	04-07 ▲	
	ZX 1000 SX Tourer	14 ▲		VN 2000 H8F/H9F Classic	08-09 ▲	
	ZX 1000 Special Edition (ZR 1000 GEFA)	14 ▲				
	ZR 1000 DAF/DBF/DCF/DDF	10-13 ▲	CK4517 ▲=CT016	KR 250 A1/A2	84-86 ▲	
	ZR 1000 DCFA/DDFB	12-13 ▲	CK4518 ▲=CT021 ■=CT004	ZX 1400 A6F/A7F ZZR 1400 ABS (ZX 1400 B6F/B7F D8F/D9F/DAF/DBF)	06-07 ▲	
	ZX 10R (ZX 1000 C1/C2/D6F/D7F)	05-07 ▲		ZX 1400 Special Edition (ZX 1400 FCF/FDF/FDFA/FEF/FEFA/FFF/FFFA/HGF)	12-16 ▲	
	ZX 10R (ZX 1000 E8F/E9F/FAF)	08-10 ▲		ZZR 1400 Performance Sport (ZX1400 JGF)	14-19 ■	
	ZX 10R ABS (ZX 1000 KBF/KCF/KDF/KEF/KFF)	11-15 ▲		ZZR 1400 ABS Performance	12-19 ■	
	ZX 10R (ZX 1000 JBF/JCF/JDF/JEF/JEF)	11-15 ▲				
	ZX 10R 30th Anniversary Edition (ZX 1000 JFFA Non ABS)	15 ▲		CK4519 ▲=CT006	KXF 450 R (KSF 450 B8F/B9F/BAF /BFD/BEF/BBF/BCS)	07-14 ▲
	ZX 10R 30th Anniversary Edition (ZX 1000 KFFA ABS)	15 ▲		CK4520 ▲=CT021	GTR 1400 (ZG 1400 A8F/A9F/CAF /CBF/CCF/CDF/CEF/EEF/EGF)	08-16 ▲
	ZX 10R (ZX1000 SGF)	16-19 ▲	CK4521 ▲=CT009	EX 250 K8F/K9F/KAF/KBF/KCF Ninja 250 R	08-12 ▲	
	ZX 10R Winter Test Edition(ZX1000 SGFB)	16 ▲	CK4522 ▲=CT012SP	KLX 125 CAF/CBF/CCF/CCS/CDF /CDS/CEF/CFB/CGF	10-16 ▲	
	ZX 10R Ninja KRT Replica (ZX1000 SGFA)	16-19 ▲		KLX 125 DAF/DBF/DCF/DDF/DEF D-Tracker	10-14 ▲	
ZX-10RR	17-19 ▲	KLX 150 L (KLX 150 EFF)		14-15 ▲		
ZX-10RR Performance	17-19 ▲	KLX 150 D-Tracker (KLX150 HGF)		16 ▲		
SUZUKI GSXR 1000 K1/K2/K3/K4	01-04 ▲		KTM Duke 125	11-19 ▲		
GSX-S 1000 ABS	15-17 ▲		RC 125	14-19 ▲		
GSX-S 1000 F ABS	15-17 ▲					
YAMAHA YZF- R1	15-20 ■		CK4523 ▲=CT004	H2-B/H-C Mach IV (750cc)	74-75 ▲	
YZF- R1 M	15-20 ■		CK4524 ▲=CT009	EX 300 ADF/AEF/AFF Ninja 300 (Non ABS)	13-15 ▲	
YZF- R1 (60th Anniversary Edition)	16 ■			EX300 AEFA/AFFA Ninja 300 Special Edition (Non-ABS)	13-15 ▲	
MT-10 (998cc)	16 ■			EX300 BDF/BEF/BFF/BGF Ninja 300 (ABS)	13-16 ▲	
				EX300 BEFA/BFFA/BGFA Ninja 300 Special Edition (ABS)	13-16 ▲	
CK4511	BN 125 A1-A5/A6F/A7F Eliminator	98-07		Versys-X 300 ABS	17-20 ▲	
				Z 300 Non ABS (ER 300 AFF)	15 ▲	
CK4513 ▲=CT009	ZX12R (ZX 1200 A1)	00 ▲		Z 300 ABS (ER 300 BFF) - Ninja 300 (ABS)- Floating Disc Conversion	15-16 ▲	
CK4514 CKF4514 ▲=CT003 ■=CT004	SUZUKI RM 125 K2/K3/K4/K5/K6/K7/K8/K9	02-12 ▲			Ninja 650 (EX 650)	12-18
	RM 125 XCK8	09 ▲			Ninja 650 ABS (EX 650 ABS)	12-18
	RM-Z 250 K4/K5/K6/K7/K8/K9 /L0/L1/L2/L3/L4/L5/L6/L7/L8/L9	04-19 ■		Z 650 (ER 650)	12-18	
	KAWASAKI KX 250 F (KX 250 N1/N2/T6F/T7F/T8F)	04-08 ■		Z 650 ABS (ER 650 ABS)	12-18	
	KX 250 F	09-20 ■				
	ZX-6R (ZX 600 P7F/P8F/R9F/RAF /RBF/RCF/RDF/REF/RFF/RGF)	07-16 ■		CK4527	Ninja H2	15-20
	ZX-6R (ZX 636 C1/C6F)	05-06 ■		CK4529	KAWASAKI Ninja H2R	15-20
	ZX-6R EDF/EEF/EFF/EGF/EHF (Non ABS 636cc)	13-17 ■				
	ZX-6R FDF/FEF/FFF/FGF/FHF (ABS 636cc)	13-17 ■				
	ZX-6R (ZX 636 EGFA/EHFA - Non ABS/KRT Edition - 636cc)	16-17 ■				
	ZX-6R (ZX 636 FGFA/FHFA - ABS/KRT Edition - 636cc)	16-17 ■				
	ZX6 R 30th Anniversary Edition (ZX 636 EFFA- Non ABS -636cc)	15 ■				
	ZX6 R 30th Anniversary Edition (ZX 636 FFFA- ABS -636cc)	15 ■				
	ZX-6RR (ZX 600 M1)	04 ■				
ZX-6RR (ZX 600 N1/N6F)	05-06 ■					
ZX-6RR (ZX 600 N1/N6F)	05-06 ■					
CK4515 ▲=CT009	ZX12R (ZX 1200 A2-A4/B1-B4/B6F)	01-06 ▲	CK4530	KAWASAKI Ninja 400 Z 400	17-20 17-20	
			CK5588 CKF5588 ▲=CT021	TRIUMPH Adventurer Trophy 3 cyl 900 Trophy 4 cyl 1200 Trident 750/900 Legend TT Thunderbird/Sport Speed Triple	96-01 ▲ 92-01 ▲ 92-01 ▲ 92-98 ▲ 98-01 ▲ 95-04 ▲ 94-99 ▲	

Part No.	Make/Model	Year	Part No.	Make/Model	Year
CK5588 CKF5588 ▲=CT021 Contd.	TRIUMPH Sprint Daytona 900/Cyl Daytona 1200 4 cyl Daytona 750 3 cyl Daytona 1000 4 cyl Tiger 900cc (Up to VIN 71698) Carb Models Daytona Super 3	94-98 ▲ 93-96 ▲ 93-98 ▲ 92 ▲ 92 ▲ 93-96 ▲ 94-97 ▲	CK5599 CKF5599 ▲=CT009	TRIUMPH Speed Triple (from VIN 141872 to 210444) Speed Triple 1050 Daytona (from VIN 132513) RS Sprint (from VIN 139277) ST Sprint (from VIN 138277) Sprint ST (From VIN 208167) Sprint GT 1050 Tiger 1050cc Tiger 1050cc SE	05-08 ▲ 01-06 ▲ 02-04 ▲ 02-04 ▲ 05-09 ▲ 10-12 07-12 ▲ 10-12 ▲
CK5589 CKF5589 ▲=CT009	TRIUMPH T595/955i Daytona T509 'Speed Triple' 885/955cc Sprint ST Upto VIN 139235 Sprint RS Upto VIN 138656 Tiger 955cc Tiger 900cc (From VIN 71699) Injection Models	97-00 ▲ 97-01 ▲ 98-01 ▲ 98-01 ▲ 99-06 ▲ 97-98 ▲	CK5602 ▲=CT059 ■=CT023	KTM 250 EXC-G Racing 250 EXC Racing 400 EXC 400 MXC SX 400 450 EXC Racing 450 EXC-G Racing 450 MXC-G Racing 520 EXC SX 520 525 EXC Racing 525 EXC-G Racing 525 MXC Desert Racing 525 MXC-G Racing 525 SX Racing 526 SX Racing	04 ▲ 04 ▲ 00-02 ▲ 01 ▲ 00-01 ▲ 04 ▲ 04 ▲ 04 ▲ 04 ▲ 00-01 ▲ 00-01 ▲ 04 ▲ 04 ▲ 04 ▲ 04 ▲ 04 ▲ 04 ▲ 05 ■
CK5594 CKF5594 ▲=CT027 ■=CT057SP	KTM SX 60 SX 65 SX 65	98-00 ▲ 98-08 ▲ 09-15 ■			
CK5595 CKF5595 ▲=CT007 ■=CT049	KTM 250 EGS 250 EXC (2T) EXC 250 (2T) Six Days 250 MXC SX 250 (2T) XC 250 (USD) XC 250 (2T) 250 SXS Reklus Aftermarket Clutch Kit SX 250/300 (2T) 24T Steel Plate Reklus Aftermarket Clutch Kit EXC 250/300 (2T) 24T Steel Plate EXC 300 (2T) 300 E-GS 300 EXC EXC 300 (2T) Six Days 300 MXC 300 Six Days SX 300 XC 300 (USD) 360 EGS 360 MXC 360 SXC 360 SX 360 Six Days 380 EXC SX 380 RXC-E 400 EXC-E 620	94-99 ▲ 94-12 ▲ 11-12 ▲ 98-99 ▲ 94-12 ▲ 11 ▲ 11-12 ▲ 01-03 ▲ 03-11 ■ 03-11 ■ 00-12 ▲ 94-99 ▲ 94-07 ▲ 11-12 ▲ 94-05 ▲ 96 ▲ 94 ▲ 11-12 ▲ 96-97 ▲ 96-01 ▲ 96-97 ▲ 96-97 ▲ 96 ▲ 98-02 ▲ 98-02 ▲ 95 ▲ 95 ▲		APRILIA RS 50 RX 50 SX 50 DERBI GPR 50 Nude GPR 50 R GPR 50 Racing GPR 50 Replica Senda (Most models) 4 plate clutch	06-11 ▲ 06-10 ▲ 06-10 ▲ 04-05 ▲ 97-00 ▲ 04-05 ▲ 99-05 ▲ 99-05 ▲
CK5596 ▲=CT075	KTM 350 MX (2T) 350 Enduro (2T) 500 MX (2T) 500 MX (4T) LC 500 Enduro (2T) 500 Enduro (4T) LC 600 MX (4T) LC 600 Enduro (4T) LC	89 ▲ 89 ▲ 89 ▲ 89 ▲ 89 ▲ 89 ▲ 89 ▲ 89 ▲	CK5604 ▲=CT026	BMW F 650/93/97 (K60/0161/0162) F 650 (E169/0161 Standard) F 650 (E169/0162) (Funduro /High Screen) (19" front wheel) F 650 ST (K60/0163) F 650 ST (E169/0163/168) Strada (18" front wheel/low screen)	93-03 09/93-96 97-00 96-00 97-00
CK5597 ■=CT009SP	TRIUMPH Bonneville (790cc) Speedmaster 800 (790cc) Bonneville T100	01-05 ■ 03-04 ■ 02-04 ■	CK5605	BMW F 650/93/97 (K60/0161/0162) F 650 (E169/0161 Standard) F 650 (E169/0162) (Funduro /High Screen) (19" front wheel) F 650 ST (K60/0163) F 650 ST (E169/0163/168) Strada (18" front wheel/low screen)	93-03 09/93-96 97-00 96-00 97-00
CK5598 ▲=CT034SP	APRILIA AF1 125 Classic 125 MX 125 Pegaso 125 Red Rose 125 RS 125 (2T) RX 125	87-91 ▲ 95-01 ▲ 04-06 ▲ 91-95 ▲ 87-94 ▲ 92-14 ▲ 92-98 ▲	CK5608	TRIUMPH America (Cast wheel) Scrambler (865cc) Speedmaster (865cc) Bonneville T100 (865cc) Bonneville 800 Bonneville America Bonneville/Bonneville Black Bonneville - Steve McQueen SE Speedmaster 865cc Thruxton 900	07-09 06-09 03-09 01-09 01-04 02-06 07-08 12 03-08 04-12
			CK5610 ▲=CT028	KTM SX 85 (17"/14" Wheels) SX 85 (19"/16" Wheels) HUSQVARNA TC85 (F 17"/R 14") TC85 (F19"/R 16")	11-17 ▲ 03-17 ▲ 14-18 14-18
			CK5611 CKF5611 ▲=CT001	KTM 125 EGS 125 EXC EXC 125 EXC 125 (2T) Six Days 125 EXE SX 125 125 Supermoto 125 SXS SX 150	98-99 ▲ 98-05 ▲ 07-15 ▲ 11-15 ▲ 00-01 ▲ 98-20 ▲ 00-01 ▲ 01-02 ▲ 08-20 ▲

Part No.	Make/Model	Year	Part No.	Make/Model	Year
CK5611 CKF5611 ▲=CT001 Contd.	KTM		CK5631 CKF5631 ▲=CT030 Contd.	KTM	
	XC 150 (USD)	11-12 ▲		400 SX-C	98 ▲
	200 EGS	98-99 ▲		400 SXC	00 ▲
	200 EXC	97-14 ▲		400 TXC	98 ▲
	200 MXC	98-03 ▲		540 SX-C	98-99 ▲
	SX 200	03/06-07 ▲		620 Duke	94/97 ▲
	SX 125	15-18 ▲		620 EGS	94-95 ▲
	XC-W 150	17-20 ▲		620 EGS-E	97 ▲
	SX 125	15-18 ▲		620 EGS/Adventure	96-97 ▲
	HUSQVARNA			620 Enduro Ltd	97 ▲
TC125	14-18	620 EXC	94-95 ▲		
TE125	14-16	620 LC-4	98 ▲		
TX 125	17-18	620 LC4 Competition	99 ▲		
CK5612 CKF5612 ▲=CT023	KTM		CK5632 ▲=CT075	EXC 400 (LC4 Engine) 400 RXC-E SC 400 (LC4 Engine) 620 RXC-E	93-95 ▲
	250 EXC Racing	02-03/05 ▲			95 ▲
	250 EXC-G Racing	03 ▲			95 ▲
	Freeride 250 R (2T)	14-17			95 ▲
	400 EXC Racing	02/05-06 ▲			95 ▲
	400 EXC-G Racing	02/05-06 ▲			
	400 EXC	06-09 ▲			
	400 SX Racing	02 ▲			
	400 MXC	02 ▲			
	450 EXC Racing	03/05-07 ▲			
	450 EXC-G Racing	03 ▲			
	450 LXC-G Racing	05 ▲			
	450 MXC-G Racing	03 / 05 ▲			
	MXC 450	06 ▲			
	450 SMS	04 ▲			
	SMR 450	04-07 ▲			
	SX 450 (4T)	03-06 ▲			
	SX 450	06 ▲			
	XC 450 Quad	08-09 ▲			
	520 SX Racing	02 ▲			
	525 MXC Desert Racing	03 ▲			
	525 EXC-G Racing	03 / 05 ▲			
	525 EXC	03 ▲			
	525 EXC Racing	05 ▲			
	525 MXC Desert Racing	05 ▲			
	525 SMR	04-05 ▲			
	525 SX Racing	03 ▲			
	MXC 525	06 ▲			
	SX 525	06 ▲			
	XC 525 (Quad)	08-12 ▲			
	540 SXS Racing	02 ▲			
	SMR 560	06-07 ▲			
SX-F 250 (4T)	16-20 ▲				
SX-F 250 Factory (4T)	16-20 ▲				
XC-F 250 (4T)	16-20 ▲				
XC-F 350	16-20 ▲				
CK5624 ▲=CT021	TRIUMPH		CK5633 ▲=CT030	KTM	01-03 ▲
	Rocket 111 (2300cc)	04-09 ▲		660 Rallye	04 ▲
	Rocket 111 (Touring) (2300cc)	08-12 ▲		660 Rallye Factory	
	Rocket 111 Classic	07-09 ▲			
	Rocket 111 Roadster ABS	10-12 ▲			
Rocket 111 Touring	08-12 ▲				
CK5628 ▲=CT040SP	CCM		CK5634 ▲=CT015	KTM	
604 Trial/SM/RS/R30 (Rotax engine)	98-03	950 Adventure S	03-04 ▲		
		950 Adventure	06 ▲		
		950 Superenduro R	07-08 ▲		
		990 Adventure/S	06-08 ▲		
		990 Adventure Dakar Edition (ABS)	11 ▲		
		990 Adventure R	09-12 ▲		
		990 Adventure (ABS Model)	09-12 ▲		
		990 Supermoto T (SM-T)	08-13 ▲		
		990 Supermoto R (SM-R)	08-13 ▲		
		990 Superduke	05-11 ▲		
		990 Superduke R	07-13 ▲		
CK5631 CKF5631 ▲=CT030	KTM		CK5635 ▲=CT083	BMW	
	350 EXC	94 ▲		F 650 CS Scarver (K17/0177/0187 Belt drive/17" cast wheels)	04-07
	350 Super Comp	94-95 ▲		F 650 GS (R13/0175/0185) Single cylinder/19" front wheel)	04-07
	380 EGS	98-99 ▲		F 650 GS Dakar (R13/0176/0186) 21" front wheel)	04-07
	400 Duke	94-95 ▲		G 650 GS (R13)	08-16 ▲
	400 EGS-E	97 ▲		G 650 GS Sertao (R13)	10-14 ▲
	400 EGS	94/96-97 ▲		G 650 XCountry (K15)	08-10 ▲
	400 EXC-E	96-97 ▲			
	400 EXC	94/96 ▲			
	400 LC-4	98 ▲			
	400 LC4-E	00-01 ▲			
	LC4 R 400	99 ▲			
	400 LSE	97 ▲			
	400 LS-E	4 ▲			
	400 Super Comp	95 ▲			
400 Super Comp/EXC	96-99 ▲				
SXC 400	97 ▲				
400 SX	99 ▲				
CK5636			CK5636	BMW	
		F 650 CS Scarver (K14/0174/0184 Belt drive/17" cast wheels)	00-03		
		F 650 GS (R13/0172/0182) 19" front wheel	99-03		
		F 650 GS Dakar (R13/0173/0183) 21" front wheel	99-03		
CK5638 ▲=CT009			CK5638 ▲=CT009	KTM	
		SX-F 450	07-10 ▲		
		450 SX (Quad)	09-11 ▲		
		SX-F 505	07-09 ▲		
		505 SX-F (Quad)	09-12 ▲		

Part No.	Make/Model	Year	Part No.	Make/Model	Year	
CK5639 ▲=CT030	KTM		CK5651 CKF5651 ▲=CT023 Contd.	KTM		
	620 LC4 Super Moto	99 ▲		EXC-F 250 (4T)	14-20 ▲	
	620 TXC	98 ▲		EXC-F 250 Six Days (4T)	14-20 ▲	
	625 SMC	04-06 ▲		SX 250 (2T) Diaphragm Spring	13-20 ▲	
	625 SXC	03-04 ▲		SX-F 250 (4T) Coil Spring	13-15 ▲	
	640 Adventure-R	98-02 ▲		XC-F 250 (4T) Coil Spring	13 ▲	
	640 Duke-E	98 ▲		EXC 300 (2T) Diaphragm Spring	13-15 ▲	
	640 Duke II	99-04 ▲		EXC 300 (2T) Six Days	13-15 ▲	
	Duke-E 610	98 ▲		SX-F 350 (USD Forks)	11-20 ▲	
	Duke II 640	99-07 ▲		EXC-F 350 (USD Forks)	11-20 ▲	
	640 LC4	99-00 ▲		EXC-F 350 (Diaphragm Spring)	12-20 ▲	
	640 LC4 Adventure	03-06 ▲		EXC-F 350 Six Days (Diaphragm Spring)	12-20 ▲	
	640 LC4 Supermoto	03-04 ▲		XC-F 350	12-13 ▲	
	640 LC4-E	00-02 ▲		350 Freeride	12-15 ▲	
	640 LC4 Six Days	99 ▲		EXC-F 450 (4T)	12 ▲	
660 LC4 Rallye	99-00 ▲	EXC 450 (4T) Six Days	12-18 ▲			
660 SM Factory Replica	02-03 ▲	EXC 450 (4T) Diaphragm Spring	13-18 ▲			
660 SMC	03-04 ▲	EXC-F 450 (4T/Diaphragm Spring)	18-19 ▲			
			SX-F 450 (4T) Diaphragm Spring	12-20 ▲		
			EXC-F 500 (4T)	12-20 ▲		
			EXC-F 500 Six Days (4T)	12-20 ▲		
			EXC 300 (2T)	16-18 ▲		
			EXC 300 Six Days (2T)	16-18 ▲		
			XCF-W 350 (2T)	16 ▲		
			XCF-W 350 Six Days (2T)	16 ▲		
			XC-W 500	16 ▲		
CK5641 ▲=CT030	KTM		CK5660 ▲=CT085	BMW		
690 Rally Factory Replica	07-09 ▲	F650 GS (Late type plates 2 x 13mm/7 x 14mm ears)			07-17 ▲	
CK5642 ▲=CT069	KTM				F700 GS (Late type plates 2 x 13mm/7 x 14mm ears)	11-17 ▲
	690 Duke	08-18 ▲			F800 GS (Late type plates 2 x 13mm/7 x 14mm ears)	12-19 ▲
	690 Duke R	10-11/13-18 ▲			F800 GS Adventure (Late type plates 2 x 13mm /7 x 14mm ears)	12-19 ▲
	690 Enduro	08-18 ▲			F800 GT (Late type plates 2 x 13mm /7 x 14mm ears)	07-19 ▲
	690 R Enduro	09-18 ▲			F800 S (Late type plates 2 x 13mm /7 x 14mm ears)	07-19 ▲
	690 SMR	07-11 ▲			F800 ST (Late type plates 2 x 13mm /7 x 14mm ears)	07-19 ▲
	690 SM	07-09 ▲			F800 R (Late type plates 2 x 13mm /7 x 14mm ears)	05-19 ▲
	690 SMC	08-11 ▲				
	690 SMC-R	12-18 ▲				
	690 SM-LE (Limited Edition)	10-11 ▲				
	HUSQVARNA					
	Svartpilen 401	18-20 ▲				
	Vitpilen 401	18-20 ▲				
	701 Enduro R	16-20 ▲				
701 Supermoto	16-20 ▲					
Svartpilen 701	18-20 ▲					
Vitpilen 701	18-20 ▲					
CK5643 ▲=CT009	GAS-GAS		CK5665	KTM		
EC 200/250/300 (2T)	00-08 ▲		Duke 390	13-14		
EC 450 FSR/FSE (4T) Enduro	05-08 ▲		RC 390	14-17		
SM 450 FSR (4T) Supermotard	07-08 ▲		EXC-F 450 (4T/Diaphragm Spring)	13-18		
Wild HP 450 Quad	04-08 ▲					
EC 515 FSR/FSE (4T) Enduro	05-08 ▲		CK5666	KTM		
SM 515 FSR (4T) Supermotard	07-08 ▲		Duke 250	15-18		
			RC 250	15-18		
			Duke 390	15-17		
			RC 390	16-17		
CK5644 ▲=CT021	KTM		CK5667 ▲=CT085	BMW		
RC8 (1190cc)	08-10 ▲		F800 GT (Early type plates 14mm ears)		04-06 ▲	
RC8 R Track (1190cc)	10-14 ▲		F800 GS (Early type plates 14mm ears)		08-11 ▲	
			F800 S (Early type plates 14mm ears)		04-06 ▲	
			F800 ST (Early type plates 14mm ears)	04-06 ▲		
CK5648 CKF5648 ▲=CT041	KTM		CK5668 CKF5668 ▲=CT087SP	HUSQVARNA		
	EXC 400 (4T)	09-11 ▲	TC85		18 ▲	
	EXC-R 450 (4T)	08 ▲	KTM			
	EXC 450 (4T)	09-11 ▲	SX 85 (17 Inch/14 Inch Wheels)	18-20 ▲		
	EXC 450 (4T) Six Days	11 ▲	SX 85 (19 Inch/16 Inch Wheels)	18-20 ▲		
	EXC 530	09-11 ▲				
	EXC 530 (4T) Six Days	11 ▲				
EXC-R 530	08 ▲					
CK5651 CKF5651 ▲=CT023	HUSQVARNA		CK5669 ▲=CT086SP	TRIUMPH		
	FC 250	14-20 ▲			Bonneville T100 (900cc/Liquid Cooled/Spoke Wheel)	16-18 ▲
	TC 250	14-20 ▲			Bonneville T100 Black (900cc/Liquid Cooled/Spoke Wheel)	16-18 ▲
	TE 250	14-20 ▲			Street Cup (900cc Liquid Cooled)	16-20 ▲
	TE 300	14-20 ▲			Street Scrambler (900cc Liquid Cooled)	16-20 ▲
	TX 300i	18-20 ▲			Street Twin (900cc Liquid Cooled)	16-18 ▲
	FC 350	14-20 ▲			Bonneville T120 (1200cc Liquid Cooled)	16-18 ▲
	FE 350	14-20 ▲			Bonneville T120 Black (1200cc Liquid Cooled)	16-18 ▲
	FX 350	17-20 ▲				
	FC 450	14-20 ▲				
	FC 450 Rockstar Edition	20 ▲				
	FE 450	14-20 ▲				
	FS 450	15-20 ▲				
	FX 450	17-20 ▲				
	FE 501	14-20 ▲				
	KTM					
	EXC 250 (2T) Six Days	13-20 ▲				
	EXC 250 (2T) Six Days	13-18 ▲				

Part No.	Make/Model	Year	Part No.	Make/Model	Year		
CK5669 ▲=CT086SP Contd.	TRIUMPH		CK6604	BMW			
	Bonneville Bobber (1200cc Liquid Cooled)	17-20 ▲		K 75	84-96		
	Bonneville Bobber Black (1200cc Liquid Cooled)	18-20 ▲		K 75/2	84-96		
	Thruxton 1200 (Liquid Cooled)	16-20 ▲		K 75 C	85-88		
	Thruxton R 1200 (Liquid Cooled)	16-20 ▲		K 75 RT	89-96		
			K 75 S	85-95			
CK5676	BMW		CK6605	BMW			
	R 1200 GS	13-18		K 100	82-88		
	R 1200 GS Adventure	13-18		K 100/2	87-90		
	R 1200 R	13-18		K 100 LT	86-91		
	R 1200 RS	14-18		K 100 RS	83-89		
	R 1250 GS	19-20		K 100 RT (Valve models)	83-89		
	R 1250 GS TE	19-20		K1	88-93		
	R 1250 GS Rallye	19-20		K 100 RS	89-92		
	R 1250 GS Rallye TE	19-20		K 1100 LT	89-99		
	R 1250 GS Adventure	19-20		K 1100 RS	92-96		
	R 1250 GS Adventure TE	19-20					
R 1250 GS Adventure Rallye	19-20						
R 1250 GS Adventure Rallye TE	19-20						
CK6601	BMW		CK6680	APRILIA			
	R 45	09/80-85		RSV 1000 Mille/R Mille	00-02		
	R 45/N	09/80-85		RSV 1000 SP	99-00		
	R 45 T	09/80-85		RSV 1000 R Factory	04-08		
	R 45 T/N	09/80-85	RSV 1000 R	04-08			
	R 65	09/80-85	RSV 1000 R Tuono	02-06			
	R 65 LS	81-85	SL 1000 Falco	00-04			
	R 65 T	80-85					
	R 65 GS	87-92					
	R 65 RT	85-88					
	R 80 GS	80-87					
	R 80 ST	82-84					
	R 80	09/80-84					
	R 80 RT	82-84					
	R 80 TIC	09/80-85					
	R 100/7 T	09/80-84					
	R 100 CS	80-84					
	R 100 RS	09/80-84					
	R 80	84-95					
	R 80 RT	84-95					
	R 80 GS	87-90					
	R 80 PD/CH	90					
	R 80 MYS	94-95					
	R 80 R	91-94					
	R 80 GS	96					
	R 100 MYS	93-96					
	R 100 R	91-95					
	CK6602	BMW		CK6681 ▲=CT041	APRILIA		
		R 100 GS	86-90		RSV4R	10 ▲	
		R 100 PD	89-90		RSV4R Factory SBK Racing	09-10 ▲	
R 45		-09/80	RSV4 Factory APRC		11-13 ▲		
R 45		78-09/80	RSV4R APRC		11-13 ▲		
R 45 N		-09/80					
R 65		78-09/80					
CK6603		BMW			CK7001	INDIAN	
		R 50/5	69-73			Octane	17
		R 60/5	69-73			Scout	15-20
	R 60/6	73-76	Scout 1200	17-20			
	R 75/5	69-73	Scout Bobber	18			
	R 75/6	73-76	Scout Sixty	16-20			
	R 90/6	73-79					
	R 90 S	73-76					
	R 60/7	76-09/80					
	R 60 TIC	78-09/80					
	R 75/7	76-79					
	R 80	77-09/80					
	R 80 TIC	78-09/80					
	R 100	76-77					
	R 100/7T	77-09/80					
	R 100 RS	76-09/80					
	R 100 RT	78-09/80					
	R 100 S	76-80					
	CK6604	BMW		CK7002 CT702SP	HARLEY DAVIDSON		
		R 100 GS	86-90		FLHTCUTG Tri Glide Ultra Classic	14-16	
		R 100 PD	89-90		FLRT Freewheeler	15-16	
R 45		-09/80	FLHTK 103 CVO Limited		14		
R 45		78-09/80	FLHTCUL Ultra Classic Low		15-16		
R 45 N		-09/80	FLHTCUL TC Ultra Classic Low Twin-Cooled		15-16		
R 65		78-09/80	FLHTKL Ultra Limited Low		15-16		
			FLHR Road King		17-20		
			FLHRC Road King Classic		17		
			FLHTCU Electra Glide Ultra Classic		17-20		
			FLHTK Ultra Limited		17-20		
			FLHTKL Ultra Limited Low		17-20		
			FLHX Street Glide		17-20		
			FLHXS Street Glide Special		17-20		
			FLTRU Road Glide Ultra		17-20		
			FLTRX Road Glide		17-20		
			FLTRXS Road Glide Special		17-20		
			FLHRXS Road King Special		17-20		
			FLHTK Ultra Limited Shrine Edition		18		
			FLHTK Ultra Limited Anniversary		18		
		FLHX Street Glide Anniversary	18				
		FLHXS Street Glide Special Anniversary	18				
		FLSS Softail Slim S	16				
		FLSTFBS Fat Boy S	16-17				
		FLSS Slim S	17				
		FLSTFBS Fat Boy S	17				
CK6605	BMW		CK7003	INDIAN			
	R 1200 GS	13-18		Chief Classic	14-20		
	R 1200 GS Adventure	13-18		Chief Dark Horse	16-20		
	R 1200 R	13-18		Chief Vintage	14-20		
	R 1200 RS	14-18		Chieftain	14-18		
	R 1250 GS	19-20		Chieftain Dark Horse	16-20		
	R 1250 GS TE	19-20		Chieftain Elite	17-20		
	R 1250 GS Rallye	19-20		Chieftain Limited	17-18		
	R 1250 GS Rallye TE	19-20		Roadmaster	15-18		
	R 1250 GS Adventure	19-20		Roadmaster Classic	17-20		
	R 1250 GS Adventure TE	19-20		Roadmaster Elite	18-20		
	R 1250 GS Adventure Rallye	19-20		Springfield	16-20		
	R 1250 GS Adventure Rallye TE	19-20		Springfield Dark Horse	18		

Part No.	Make/Model	Year	Part No.	Make/Model	Year
CK7004	HARLEY DAVIDSON XG500 XG750	15-20	CK7008 CT703SP Contd.	HARLEY DAVIDSON Contd. FLHTCI Ultra Classic	05 ▲
		15-20			FLHTCU 103 Ultra Classic
CK7005 CT706SP	HARLEY DAVIDSON VRSCAW 1HFH V-Rod Wide Tire VRSCAWA 1HKH W/ABS VRSCD 1HDH Night Rod VRSCDA 1HLH Night Rod W/ABS VRSCDXA 1HMH Night Rod Special W/ABS VRSCDX 1HHH Night Rod Special VRSCAW 1HFH V-Rod VRSCF 1HPH V-Rod Muscle VRSCDX ANV 1HHH_ANV Night Rod Special Anv	08 ▲		FLHTCUI Ultra Classic	04 ▲
		08 ▲		FLHTI Electra Glide Standard	04-05 ▲
		08 ▲		FLHTK Electra Glide Ultra Limited	10-13 ▲
		08 ▲		FLHTK ANV Electra Glide Ultra Limited ANV	13 ▲
		08 ▲		FLHX 103 Street Glide	11-13 ▲
		08 ▲		FLS 103 Softtail Slim	12-15 ▲
		08 ▲		FLS Slim	17 ▲
		08 ▲		FLS Softtail Slim	16 ▲
		08-17 ▲		FLSTC 103 Heritage Softtail Classic	13-15 ▲
		09-10 ▲		FLSTC 103 ANV Heritage Softtail Classic ANV	13 ▲
CK7006 CT707SP	HARLEY DAVIDSON VRSCA 1HAZ V-Rod VRSCSE CVO V-Rod VRXSE 7RC7 CVO VR Destroyer VRSCR 1HCZ Street Rod VRSCX 1HJG Screamin' Eagle V-Rod	02-07 ▲		FLSTC Heritage Softtail Classic	04-05 ▲
		05-06 ▲		FLSTC Heritage Softtail Classic	16-17 ▲
		06 ▲		FLSTCI Shrine Heritage Softtail Classic Shrine	05 ▲
		06-07 ▲		FLSTF 103 Fat Boy	12-15 ▲
		06-07 ▲		FLSTF Fat Boy	04-05 ▲
		07 ▲		FLSTF Fat Boy	16-17 ▲
CK7007 CT708SP	HARLEY DAVIDSON FLHTCUTG Tri Glide Ultra FLRT Freewheeler FLHTCUTG Tri Glide Ultra Anniversary FLHP Road King Police FLHTP Electra Glide Standard Police FLFBS Fat Boy 114 Anniversary FLHCS Heritage Classic 114 FLHCS Heritage Classic 114 Anniversary FXFBS Fat Bob 114 FLFBS Fat Boy 114 FXBRS Breakout 114 FXBRS Breakout 114 Anniversary	17-20 ▲		FLSTFB 103 Fat Boy LO	12-17 ▲
		17-18 ▲		FLSTFB 103 ANV Fat Boy LO ANV	13 ▲
		18 ▲		FLSTFI Shrine Fat Boy Shrine	05 ▲
		18 ▲		FLSTN 103 Softtail Deluxe	12-15 ▲
		17 ▲		FLSTN Softtail Deluxe	05 ▲
		18-20 ▲		FLSTN Softtail Deluxe	16-17 ▲
		18-20 ▲		FLSTSC Springer Classic	05-06 ▲
		18 ▲		FLTRI Road Glide	04-05 ▲
		18 ▲		FLTRU Road Glide Ultra	11-13 ▲
		18 ▲		FLTRX 103 Road Glide Custom	11-13 ▲
		18-20 ▲		FXD Dyna Super Glide	04-05 ▲
		18 ▲		FXDB 103 Dyna Street Bob	14-16 ▲
		18 ▲		FXDB 103 Dyna Street Bob 103	17 ▲
		18 ▲		FXDBA 103 Dyna Street Bob (H-D1)	13-15 ▲
		18 ▲		FXDBC 103 Dyna Street Bob Limited	16 ▲
CK7008 CT703SP	HARLEY DAVIDSON FLHR Road King FLHR Road King FLHRC Road King Classic FLHRCI Road King Classic FLHT Electra Glide Standard FLHTC Electra Glide Classic FLHTCU Ultra Classic FLHTCU TC Ultra Classic Twin-Cooled FLHTCUI Ultra Classic FLHTK Ultra Limited FLHX Street Glide FLHXS Street Glide Special FLSTC Heritage Softtail Classic FLSTF Fat Boy FLSTS Heritage Springer FLTR Road Glide FLTRU Road Glide Ultra FLTRX Road Glide FLTRXS Road Glide Special FXD Dyna Super Glide FXDL Dyna Low Rider FXDS-CONV Dyna Glide Convertible FXDWG Dyna Wide Glide FXDX Dyna Super Glide Sport FXDXT Dyna Super Glide T-Sport FXST Softtail Standard FXSTB Night Train FXSTC Softtail Custom FXSTD Softtail Deuce FXSTI Softtail Standard FXSTS Springer Softtail FLD 103 Dyna Switchback FLHR 103 Road King FLHR Road King FLHR ANV Road King ANV FLHRC 103 Road King Classic FLHRCI Road King Classic FLHT Electra Glide Standard FLHTC 103 Electra Glide Classic FLHTC Electra Glide Classic	15-16 ▲		FXDC 103 Dyna Super Glide Custom	05 ▲
		98-03 ▲		FXDF 103 Dyna Fat Bob	12-17 ▲
		14-16 ▲		FXDI Dyna Super Glide	04-05 ▲
		98-99 ▲		FXDL 103 Dyna Low Rider	14-16 ▲
		98-03 ▲		FXDL 103 Low Rider 103	17 ▲
		98-03 ▲		FXDL Dyna Low Rider	04-05 ▲
		98-03 ▲		FXDWG 103 Dyna Wide Glide	12-16 ▲
		98-03 ▲		FXDWG 103 Dyna Wide Glide 103	17 ▲
		98-03 ▲		FXDWGI Dyna Wide Glide	04-05 ▲
		98-03 ▲		FXDX Dyna Super Glide Sport	04-05 ▲
		98-03 ▲		FXS 103 Blackline	11-13 ▲
		98-03 ▲		FXSB 103 Softtail Breakout	13-16 ▲
		98-03 ▲		FXSB Breakout	17 ▲
		98-03 ▲		FXST 1BHY Softtail Standard	04-06 ▲
		98-03 ▲		FXST Softtail Standard	12-15 ▲
		98-03 ▲		FXSTB Night Train	04-05 ▲
		98-03 ▲		FXSTD Softtail Deuce	04-05 ▲
		98-03 ▲		FXSTS Springer Softtail	04-05 ▲
		98-03 ▲		FLD Dyna Switchback	12-16 ▲
		98-03 ▲		FLHR Road King	06-11 ▲
		98-03 ▲		FLHRC Road King Classic	06-11 ▲
		98-03 ▲		FLHRS Road King Custom	06-07 ▲
		98-03 ▲		FLHT Electra Glide Standard	06-10 ▲
		98-03 ▲		FLHTC Electra Glide Classic	06-11 ▲
		98-03 ▲		FLHTCU Ultra Classic	06-11 ▲
		98-03 ▲		FLHX Street Glide	06-11 ▲
		98-03 ▲		FLS Softtail Slim	06-11 ▲
		98-03 ▲		FLST Heritage Softtail	12-15 ▲
		98-03 ▲		FLSTC 103 Heritage Softtail Classic	06-09 ▲
		98-03 ▲		FLSTC ANV Heritage Softtail Classic ANV	06-15 ▲
		98-03 ▲		FLSTF Fat Boy	13 ▲
		98-03 ▲		FLSTFB Fat Boy LO	06-15 ▲
		98-03 ▲		FLSTFB ANV Fat Boy LO ANV	10-15 ▲
		98-03 ▲		FLSTN Softtail Deluxe	13 ▲
		98-03 ▲		FLSTN Softtail Deluxe	06-15 ▲
		98-03 ▲		FLSTSB Cross Bones	08-11 ▲
		98-03 ▲		FLSTSC Springer Classic	06-07 ▲
		98-03 ▲		FLTR Road Glide	06-09 ▲
		98-03 ▲		FLTRX Road Glide Custom	06-09 ▲
		98-03 ▲		FLTRX Road Glide Custom	10-11 ▲
		98-03 ▲		FXCW Rocker	08-09 ▲
		98-03 ▲		FXCWC Rocker C	08-11 ▲
		98-03 ▲		FXD Dyna Super Glide	07-10 ▲
		98-03 ▲		FXD35 Dyna 35th Anniversary Super Glide	06 ▲
		98-03 ▲		FXDB Dyna Street Bob	07-17 ▲
98-03 ▲	FXDBC Dyna Street Bob Limited	16 ▲			

Part No.	Make/Model	Year	Part No.	Make/Model	Year	
CK7008 CT703SP Contd.	HARLEY DAVIDSON Contd.		CK7010 CT705SP Contd.	HARLEY DAVIDSON		
	FXDC Dyna Super Glide Custom	07-14 ▲		FLTCU Tour Glide Classic Ultra	89 ▲	
	FXDC ANV Dyna Super Glide Custom ANV	13 ▲		FXE Super Glide	84 ▲	
	FXDCI Dyna Super Glide Custom	06 ▲		FXEF Super Glide Fat Bob	85 ▲	
	FXDF Dyna Fat Bob	08-17 ▲		FXSB Low Rider	84-85 ▲	
	FXDI Dyna Super Glide	06 ▲		FXST Softail Standard	84-89 ▲	
	FXDL Dyna Low Rider	06-17 ▲		FXSTC Softail Custom	86-89 ▲	
	FXDWG Dyna Wide Glide	06-16 ▲		FXSTS Softail Springer	88-89 ▲	
	FXDWG ANV Dyna Wide Glide 105th Anniversary	08 ▲		FXSTS Softail Springer	88-89 ▲	
	FXSB Softail Breakout	13-15 ▲		FXWG Wide Glide	84-86 ▲	
	FXST Softail Standard	07-11 ▲				
	FXSTB Night Train	06-09 ▲		CK7011 CT704SP	HARLEY DAVIDSON	
	FXSTC Softail Custom	07-10 ▲		FLH Electra Glide	Early 84 ▲	
	FXSTD Softail Deuce	06-07 ▲		FLH Electra Glide Shrine Shovelhead	Early 84 ▲	
	FXSTS Springer Softail	06 ▲		FLHS Electra Glide Sport	Early 84 ▲	
	FLTCU Tour Glide Ultra Classic	91-95 ▲		FLHT Electra Glide	Early 84 ▲	
	FLTCU Tour Glide Classic Ultra	90-96 ▲		FLHT Electra Glide Classic	Early 84 ▲	
		FLT Tour Glide Classic	Early 84 ▲			
		FLT Tour Glide	Early 84 ▲			
CK7009 CT701SP	HARLEY DAVIDSON		CK7012 CT704SP	HARLEY DAVIDSON		
	FLHR Road King	93-97 ▲	FLH Electra Glide Shrine Shovelhead	83 ▲		
	FLHS Electra Glide Sport	90-94 ▲	FLH Electra Glide	81-83 ▲		
	FLHT Electra Glide Standard	94-97 ▲	FLHC Electra Glide Classic	81-82 ▲		
	FLHTC Electra Glide Classic	91-97 ▲	FLHC Electra Glide Classic	81 ▲		
	FLHTC Touring Electra Glide Classic	90 ▲	FLHS Electra Glide Sport	81-83 ▲		
	FLHTCI Electra Glide Classic	96-97 ▲	FLHS Heritage Electra Glide	81 ▲		
	FLHTCU Ultra Classic	91-97 ▲	FLHT Electra Glide Standard	83 ▲		
	FLST Softail Heritage	90 ▲	FLHT Electra Glide Classic	83 ▲		
	FLSTC Heritage Softail Classic	91-97 ▲	FLHT Electra Glide	83 ▲		
	FLSTC Softail Heritage Classic	90 ▲	FLHTC Electra Glide Classic	83 ▲		
	FLSTF Fat Boy	91-97 ▲	FLT Tour Glide	81-83 ▲		
	FLSTF Softail Fat Boy	90 ▲	FLT Tour Glide Classic	80-83 ▲		
	FLSTN Heritage Softail Nostalgia	93-96 ▲	FLT Tour Glide	81-83 ▲		
	FLSTS Heritage Springer	97 ▲	FLT Tour Glide Classic	80-83 ▲		
	FLTC Tour Glide Classic	90-92 ▲	FLT Tour Glide	81-83 ▲		
	FXD Dyna Super Glide	95-97 ▲	FLT Tour Glide Classic	80-83 ▲		
	FXDB Dyna Daytona	92 ▲	FXDG Dyna Glide Glide Custom	83 ▲		
	FXDB Dyna Sturgis	91 ▲	FXE Super Glide	81-83 ▲		
	FXDC Super Glide Custom	92 ▲	FXEF Super Glide Fat Bob	81 ▲		
	FXDL Dyna Low Rider	93-97 ▲	FXSB Low Rider	83-84 ▲		
	FXDS-CONV Dyna Glide Convertible	93 ▲	FXST Softail Standard	EARLY 84 ▲		
	FXDWG Dyna Wide Glide	93-97 ▲	FXWG Wide Glide	81-84 ▲		
	FXST Softail Standard	90 ▲				
	FXSTC Softail Custom	90-97 ▲	CK7013 CT701SP	HARLEY DAVIDSON		
	FXSTS Springer Softail	90-97 ▲	XR1200 1LA6 Sportster 1200	08-10 ▲		
	XL1200 Sportster 1200	91-03 ▲	XR1200X 1LD6 XR1200X	10-13 ▲		
	XL1200 Forty Eight Anniversary	18 ▲				
	XL1200C Sportster 1200 Custom	96-20 ▲	CK7014 CT709SP	HARLEY DAVIDSON		
	XL1200C ANV Sportster		XL1200 Sportster 1200	90		
	1200 Custom Anniversary	13 ▲	XL883 Sportster 883	86-90		
	XL1200CA Sportster 1200 Custom Limited	13-17 ▲	XL883 Sportster 883 Deluxe	86-90		
	XL1200CP Sportster 1200 Custom (H-D1)	11-16 ▲	XL883HUG Sportster 883 Hugger	87-90		
	XL1200CX 1200 Roadster	16-20 ▲	XLH 1100 Sportster 1100	86-87		
	XL1200L Sportster 1200 Low	06-11 ▲	XLH Sportster 1000	84-85		
	XL1200N Nightster	07-12 ▲	XLH883DLX Sportster 883 Hugger Deluxe	88-89		
	XL1200R Sportster 1200 Roadster	04-09 ▲	XLS Sportster Roadster 1000	84-85		
	XL1200S Sportster 1200 Sport	96-03 ▲	XR1000 Sportster	84		
	XL1200T SuperLow 1200T	14-20 ▲				
	XL1200V Seventy-Two	12-16 ▲	CK7015 CT709SP	HARLEY DAVIDSON		
	XL1200X Forty Eight	10-20 ▲	XLH Sportster 1000	79-84		
	XL50 50th Anniversary Sportster	07 ▲	XLH Sportster Standard 1000	71-80		
	XL883 Sportster 883	91-09 ▲	XLS Sportster Roadster 1000	81-84		
	XL883C Sportster 883 Custom	98-10 ▲	XR1000 Sportster	83-84		
	XL883DLX Sportster 883 Deluxe	91-95 ▲				
	XL883HUG Sportster 883 Hugger	91-03 ▲	CK7016	HARLEY DAVIDSON		
	XL883L Sportster 883 SuperLow	05-20 ▲	XLCH-1000 4AH0 Sportster 1000	70		
XL883N Iron 883	09-20 ▲	XLH-1000 3AH0 Sportster Standard	70			
XL883R 883 Roadster	11-15 ▲					
XL883R 883R Sportster	02-10 ▲					
CK7010 CT705SP	HARLEY DAVIDSON					
	FLH Electra Glide	84-88 ▲				
	FLH Electra Glide Shrine Shovelhead	84 ▲				
	FLHS Electra Glide Sport	84-89 ▲				
	FLHT Electra Glide Classic	84-89 ▲				
	FLHTCU Electra Glide Classic Ultra	89 ▲				
	FLST Softail Heritage	86-89 ▲				
	FLSTC Softail Heritage Classic	87-89 ▲				
FLT Tour Glide Classic	84-89 ▲					
FLT Tour Glide	84 ▲					

DRC/DRCF CLUTCH KITS BUYERS GUIDE

DRC001 ■=CT012SP	HONDA CR 80 RF/R2F CR 80 RG/R2G CR 80 RH/RJ/RK/RL/RM/RN/PP/RR/RS /RT/RBT/RV/RBV/RW/RBW/RX/RBX /RY/RBY/R1/RB1/R2/RB2 CR 85 R3/RB3/R4/RB4/R5/RB5 /R6/RB6/R7/RB7	85 ■ 86 ■ 87-02 ■ 03-07 ■	DRC021 ▲=CT011	SUZUKI RM 125 G/H	86-87 ▲
			DRC022 ▲=CT011	SUZUKI RM 125 J/K/L/M	88-91 ▲
			DRC023	SUZUKI LT 250 RH/RJ/RK	87-90
DRC002 ▲=CT001	HONDA CR 125 RG/RH/RJ/RK/RL/RM/RN/PP /RR/RS/RT/RV/RW/RX	86-99 ▲	DRC024 ▲=CT022	SUZUKI RM 250 J/K/L	88-90 ▲
DRC003 ▲=CT009	HONDA CR 250 RD/RE/RF/RG/RH/RJ/RK CR 480 RD CR 500 RE/RG/RH/RJ/RK	83-89 ▲ 83 ▲ 84-89 ▲	DRC025 DRCF025 ▲=CT011	SUZUKI RM 80 M/N/P/R/S/T/V/W/X/Y/K1 RM 85 Small Wheel (F 17" / R 14") RM 85 Big Wheel (F 19" / R16")	91-01 ▲ 02-20 ▲ 02-20 ▲
DRC004 ■=CT012SP	HONDA TRX 200 D TRX 200 L/M Fourtrax TRX 200 SX TRX 250 EX1-EX8 (Sportrax 250 EX) TRX 250 X9/XA/XB TRX 250 V/W/X/Y1/TM Recon TRX 250 EX1/2/3/4/5/6/7/8	91-97 ■ 90-91 ■ 86-87 ■ 01-08 ■ 09-11 ■ 97-14 ■ 01-08 ■	DRC026 ▲=CT010	SUZUKI LT 500 RL/RM	90-91 ▲
			DRC027	YAMAHA YZ 80 S/T/U/W	86-89
			DRC028	YAMAHA YZ 125 S/T	86-87
DRC005 ▲=CT013	HONDA TRX 250 RG/RH	86-87 ▲	DRC029	YAMAHA YZ 125 U	88
DRC006 ■=CT013SP	HONDA TRX 300 FWJ/K/L/T/V/W/X/Y/J /K/L/T/V/W/X/Y TRX 350 G/H/J/K/L/M/N TRX 400 FWS/T/V/W/X/Y TRX 450 ESW/ESX/ESY/ES1	88-00 ■ 86-93 ■ 95-00 ■ 98-01 ■	DRC030	YAMAHA YZ 125 W/A	89-90
			DRC031	YAMAHA YZ 250 U/W/A/B/D	88-92
			DRC032 ▲=CT060	YAMAHA YZT 250 N/S (TRI Z) YZ 490 J/K/L/N/S/T/U	85-86 ▲ 82-88 ▲
DRC007 ▲=CT070SP	KAWASAKI KX 60 A1/A2/B1-B19 SUZUKI RM 60 K3	83-03 ▲ 03 ▲	DRC033 DRCF033 ▲=CT090SP	YAMAHA YFM 350 FWT/FWU/FWW/FWA /FWE Big Bear YFM 350 XD/XE/XF/XG/XH/XJ/XK /XL/XM/XN/XP/XR/XS YFM 350 ERD/ERE/ERF YFM 350 S/T/V/R-WV/RW /RX/RY/RZ Raptor	86-93 ▲ 92-04 ▲ 92-94 ▲ 04-10 ▲
DRC008 ▲=CT070SP	KAWASAKI KX 80 E3/G1/G2/J1/J2	85-87 ▲	DRC035 ▲=CT060	YAMAHA YZ 250 N/S/T	85-87 ▲
DRC009	KAWASAKI KX 80 L1 KX 100 N1	88 88	DRC036	KAWASAKI KX 125 H1/H2	90-91
DRC010	KAWASAKI KX 80 L2/L3/R1-R7 KX 100 A1/A2/B1-B7	89-97 89-97	DRC038	KAWASAKI KXT 250 B1/B2 (Tecate - 3 Wheel Model) KX 50 B1/B2	86-87 85-86
DRC011	KAWASAKI KX 125 D1/E1/E2 KDX 200 C3	85-87 88	DRC039 ▲=CT011	YAMAHA YZ 125 B/D	91-92 ▲
DRC013	KAWASAKI KX 125 F1/G1	88-89	DRC040 ▲=CT022	SUZUKI RM 250 M	91 ▲
DRC015	KAWASAKI KX 250 E1/F1/G1	87-89	DRC041 ▲=CT006	KAWASAKI KX 250 H2 KDX 250 D1	91 ▲ 91-93 ▲
DRC016	KAWASAKI KX 500 C1/D1 KX 500 E1-E16	87-88 89-04			
DRC017	KAWASAKI KX 250 H1	90			
DRC019	SUZUKI RM 80 XH/XJ	87-88			
DRC020 ▲=CT011	SUZUKI RM 80 K/L	89-90 ▲			

Part No.	Make/Model	Year	Part No.	Make/Model	Year
DRC042 DRCF042 ▲=CT010	YAMAHA DT 125 R DT 125 RE DT 125 X TDR 125 (4GW/GX1/2/3/4) TZR 125 R/RR SDR 200 (2TV) WR 200 D/E/F YFS 200 B/F/G/H/J/K/L/M/N /P/R/S/T/V Blaster DT 230 R Lanza (4TP1/2)	88-03 ▲ 04-07 ▲ 05-06 ▲ 93-03 ▲ 93-95 ▲ 87-89 ▲ 92-94 ▲ 91-06 ▲ 97-98 ▲	DRC057 ▲=CT008	YAMAHA TT 600 L (Kick Start Only) TT 600 N (59X) Frame # 59X 000101-59X 007852 (Kick Start Only) TT 600 W (2JT/3SW1) Frame # 59X 007853- (Kick Start Only) TT 600 K (Kick Start Only) TT 600 E (Electric Start Only) TT 600 R (5CH1) (Kick Start Only) TT 600 R (5CH2) (Kick Start Only) TT 600 R (5CH3/4) (Kick Start Only) TT 600 RE (5CH5) (Electric Start Only) XT 600 (Kick Start Only) XT 600 Z (Kick Start Only)	84 ▲ 85-88 ▲ 89-92 ▲ 93-96 ▲ 94-95 ▲ 97 ▲ 98-99 ▲ 00-02 ▲ 04 ▲ 84-87 ▲ 84-85 ▲
DRC043 DRCF043 ▲=CT008	YAMAHA YFZ 350 T/U/W/A/B/D/E/F/G/H/J/ K/L/M/N/P/R/S/T/V Banshee	87-09 ▲	DRC058 DRCF058 ▲=CT022	SUZUKI DR 250 SL/SM/SN/SEP/SER/SES (SJ44A) DR 350 SL/SM/SN/SP/SER/SES /SET/SEV/SEW/SEX QUADZILLA WK 300	90-95 ▲ 90-99 ▲ 06 ▲
DRC044 DRCF044 ■=CT013SP	HONDA XR 250 RG/RH/RJ/RK/RL/RM/RN /RP/RR/RS TRX 300 EX P/R/S/T/V/W/X/Y/1-8 TRX 300 X9 XR 350 RD/RE	86-95 ■ 93-08 ■ 09 ■ 83-84 ■	DRC059 ■=CT029SP	SUZUKI DR 650 RL/RM (SP41A) DR 650 RSEM/RSEN/RSEP (SP45A/B) DR 650 RSL/RSM (SP42A) DR 650 RUN/RN/RUP/RP (SP44A/B)	90-91 ■ 91-93 ■ 90-91 ■ 92-93 ■
DRC045 DRCF045 ▲=CT002	KAWASAKI KX 80 W1/W2/W3 KX 85 A1-A5/A6F/A7F/A8F/A9F /AAF/ABF/ACF/ADF/CEF/CFE/CGF/CHF KX 85 II B1-B5/B6F/B7F/B8F/B9F /BAF/BBF/BCF/BDF/DEF/DFE/DGF/DHF SUZUKI RM 100 K3	98-00 ▲ 01-17 ▲ 01-17 ▲ 98-00 ▲ 03 ▲	DRC060 ■=CT013SP	HONDA XR 200 R XL 250 RE/RF XLR 250 R Baja (5 Plate) (MD22) XR 250 RE/RF	84-85 ■ 84-85 ■ ■ 84-85 ■
DRC046 DRCF046 ▲=CT016	KAWASAKI KX 250 J1/J2/K1-K5/L1-L4 KX 250 M1/M2/R1/R6F/R7F/R8F	92-02 ▲ 03-08 ▲	DRC061	KAWASAKI KDX 200 E1/E2/E3/E4/E5/E6	89-94
DRC048 ▲=CT022	SUZUKI RM 250 N/P	92-93 ▲	DRC062	KAWASAKI KDX 200 H1/H2/H3/H4/H5 KDX 220 R A4-A12/A6F KDX 220 SR	95-99 97-06
DRC049 DRCF049 ■=CT012SP	HONDA CRF 100 F4/F5/F6/R7/F8/F9 XR 100 RP/RR/RS/RT/RV/RW/RX /RY/R1/R2/R3	04-09 ■ 93-03 ■	DRC063	KAWASAKI KLR 250 D2-D22	84-05
DRC051	HONDA AX-1 (NX 250 J/K/R/R3)	89-94	DRC064 ▲=CT016	KAWASAKI KLE 500 A1-A12 KLE 500 B1P/B6F/B7F	91-04 ▲ 05-07 ▲
DRC052	SUZUKI RM 250 H	87	DRC065 ▲=CT016	KAWASAKI KLR 650 A1-A3 KL 650 B1/B2/B3 Tengai KLX 650 C1/C2/C3	87-89 ▲ 89-92 ▲ 93-97 ▲
DRC053 ■=CT013SP	HONDA XL 600 VH/VJ/VK/VM/VN/VP/VR /VT/VV/VW/VX Transalp	87-99 ■	DRC066 ▲=CT010	YAMAHA YZ 80 E/LC/LW/F	93-94 ▲
DRC054 DRCF054 ▲=CT009	HONDA NX 500 J/K/L/M/N/P/R/S/T/V /W/X Dominator XL 600 LMF/RMG/LMH XR 600 RF/RG/RH/RJ/RK/RL/RM /RP/RR/RS/RT/RV/RW/RX/RY FMX 650 5/6 FX 650 X/Y Vigor NX 650 J/K/L/M/N/P/R/S/T/V/W/X SLR 650 V/W XR 650 L	88-99 ▲ 85-87 ▲ 84-00 ▲ 05-08 ▲ 99-03 ▲ 88-02 ▲ 97-98 ▲ 93-12 ▲	DRC067 ▲=CT013	HONDA CR 125 RD/RE	83-84 ▲
DRC055 ▲=CT039	YAMAHA AG 200 E (3G x 6)	93 ▲	DRC068 ▲=CT001	HONDA CR 125 RF	85 ▲
DRC056 ▲=CT008	YAMAHA TT 350 A (3GJ) TT 350 (ITJ) XT 350	90-95 ▲ 85-89 ▲ 85-95 ▲	DRC069	KAWASAKI KX 125 J2	93
			DRC070 DRCF070 ▲=CT005	YAMAHA YZ 125 E/F/G YZ 125 J/K/L/M/N YZ 125 T/V/W/X/Y/Z/A/B/D/E/F/G	93-95 ▲ 97-01 ▲ 05-16 ▲
			DRC071	YAMAHA YZ 250 E/F/G/H/J/L	93-99

Part No.	Make/Model	Year	Part No.	Make/Model	Year
DRC072 ▲=CT022	SUZUKI RM 250 R/S RMX 250 R/S/T/V/W RMX 250 ST/SV/SW/SX (SJ14A)	94-95 ▲ 94-98 ▲ 96-99 ▲	DRC089 ▲=CT011	ARCTIC CAT 250 (2 x 4/4 x 4)	01-05 ▲
DRC073 ▲=CT004	KAWASAKI KX 125 K4/K5/L1-L4	97-02 ▲	DRC091 ■=CT012SP	HONDA CTX 200/CTX 200 A Bushlander XR 200 R XR 200 R XR 200 TLR 250 F	04-05 ■ 81-83 ■ 86-02 ■ 80-84 ■ 85- ■
DRC074	KAWASAKI KDX 200 C1/C2	86-87	DRC092 ▲=CT009	HONDA XL 600 RD/LD/RE/LE/RF/RG/RH	83-87 ▲
DRC075 ▲=CT009	HONDA CR 250 RL/RM/RN/RP CR 500 RL/RM/RN/RP/RR /RS/RT/RV/RW/RX/R1	90-93 ▲ 90-01 ▲	DRC093 ▲=CT013	HONDA CRM 250 R (RK) MK1 MD24 (100001-1008385) CRM 250 R (RM) MK2 MD24 #(1200001-1211634) CRM 250 R (RP/RP-11) MK2/2 /MD24#(1300001-) XR 400 RT	89-90 ▲ 91-92 ▲ 93 ▲ 96 ▲
DRC076S ▲=CT003	SUZUKI RM 125 P/R/S/T/V/W	93-96 ▲	DRC094 ▲=CT011	SUZUKI DR 200 G/H/J	86-89 ▲
DRC078 ▲=CT010	YAMAHA YZ 80 G/H/J/K/L/M/N	95-01 ▲	DRC095 ▲=CT016	SUZUKI RM 250 V/W/X/Y/K1/K2	97-02 ▲
DRC079 DRCF079 ▲=CT009	HONDA CR 250 RR/RS/RT/RV/RW/RXRY/R1-R7	94-07 ▲	DRC097	YAMAHA YZ 250 M/N	00-01
DRC080 ▲=CT016	SUZUKI RM 250 T	96 ▲	DRC098 DRCF098 ▲=CT070SP	KAWASAKI KX 65 A1/A2/A3/A4/A5/A6/A6F/A7F /A8F/A9F/AAF/ABF/ACF/ADF/AEF/AFF /AGF/AHF SUZUKI RM 65 K3/K4/K5	00-17 ▲ 03-05 ▲
DRC081 ▲=CT013	HONDA TRX 250 RJ/RK	88-89 ▲	DRC099 ▲=CT008	YAMAHA YZ 400 FK/FL WR 400 FK/FL/FM/FN	98-99 ▲ 98-01 ▲
DRC082 ▲=CT090SP	YAMAHA YFM 350 FWF/FWG/FWH/FWJ YFM 350 ERG YFM 350 UH/UJ YFM 400 FWE/FWF/FWG/FWH /FWJ/FWK Kodiak YFM 400 FPR/FPS Big Bear	94-97 ▲ 95 ▲ 96-97 ▲ 93-00 ▲ 03-04 ▲	DRC100 DRCF100 ▲=CT013	HONDA TRX 400 EX/EY/EXX/EXY/EX1-EX8 TRX 400 X9	99-08 ▲ 09 ▲
DRC083	KAWASAKI KX 125 J1	92	DRC101 DRCF101 ▲=CT001	HONDA CR 125 R4/R5/R6/R7	04-07 ▲
DRC084 ■=CT013SP	HONDA XR 250 RT/RV/RW/RX/R1/R2/R3/R4 HONDA DALL ARA XR 250 R XR 250 RM	96-04 ■ 04 ■ 04 ■	DRC102 ▲=CT020	YAMAHA YZ 426 FM	00 ▲
DRC085 DRCF085 ▲=CT005	YAMAHA YZ 125 H (2T) YZ 125 P/R/S (2T)	96 ▲ 02-04 ▲	DRC103 ▲=CT011	SUZUKI LT-F 4WD X M/N/P/R/S/T/V/W 300 Quadrunner LT-F 300 FX/FY/FK1 ARCTIC CAT 300 (2 x 4/4 x 4) 300 (4 x 4)	91-98 ▲ 99-01 ▲ 98-04 ▲ 05 ▲
DRC087	SUZUKI DR 650 SET/SEV CCM R30 (644 Suzuki Engine) 644 DS/Supermoto	96-97 02-04 04	DRC104 ■=CT010SP	YAMAHA YTM 225 DRN YFB 250 D/E/F/G/H/J/K/FWF/FWG /FWH/FWJ/FWK/FWL/FWM YFM 250 W/A/B YFM 250 XN/XP/XR/XS Bear Tracker YFM 250 FN YFM 250 BT/BV Bruin YFM 250 BW/BX/BY Big Bear YFU1W/T YFU1W/TW Pro Hauler Pro 4 (230cc)	85 ■ 92-00 ■ 90-92 ■ 00-04 ■ 01 ■ 05-06 ■ 07-10 ■ 89-90 ■ 89 ■
DRC088 DRCF088 ▲=CT008	YAMAHA XT 600 Z (Kick & Electric Start) XT 600 E (Electric Start Only) SZR 660 XTZ 660 Tenere YFM 660 RN/RP/RR/RS/RT Raptor	86-90 ▲ 90-03 ▲ 96-97 ▲ 91-97 ▲ 01-05 ▲	DRC089 ▲=CT011	SUZUKI LT-F 250 J/K/L/M/N/P/R/S/T/V/W/Y/K1 LT-F4WDH/J/K/L/M/N/P/R/S/T/V/W LT 250 EFF/EFG LT-F 250 FX/FY/FK1/FK2 LT-F 300 J/K	89-01 ▲ 87-98 ▲ 85-86 ▲ 99-02 ▲ 88-89 ▲

Part No.	Make/Model	Year	Part No.	Make/Model	Year	
DRC105 DRCF105 ▲=CT006	KAWASAKI KLX 400 R (KLX 400 B1/B2)	03-04 ▲	DRC113 DRCF113 ▲=CT020	YAMAHA YZ 250 (2T)	02-20 ▲	
	KSF 400 A1/A2 (KFX 400)	03-04 ▲		SUZUKI RM 125 N		92 ▲
	SUZUKI DR-Z 400 SY/EY/Y/SK1/EK1/K1 /SK2/EK2/K2/SK3/EK3/K3/SK4 /EK4/K4/EK5/SK5/K6/SK6/EK6 /SK7/EK7/K7/SK8/SK9	00-09 ▲	SUZUKI RM 125 X/Y/K1			97-01 ▲
	DR-Z 400 SMK5/SMK6/SMK7 /SMK8/SMK9	05-09 ▲			YAMAHA YZ 426 FN/FP	
	LT-Z 400 K3/K4	03-04 ▲	DRC117 ▲=CT059			KTM 250 EXC Racing 250 EXC-G Racing 400 EXC 400 MXC SX 400 450 EXC-G Racing 450 EXC Racing 450 MXC-G Racing 520 EXC SX 520 525 EXC Racing 525 EXC-G Racing 525 MXC Desert Racing 525 MXC-G Racing 525 SX Racing
	ARCTIC CAT 400 DVX	04-06 ▲		04 ▲		
CCM R35/R35S	06-07 ▲	00-02 ▲				
404 E/DS/Supernoto	03-04 ▲	01 ▲				
CR 40 S Cafe Racer	07 ▲	00-01 ▲				
CR 40 Street	07 ▲	04 ▲				
DRC106 ▲=CT013	HONDA XR 400 RV/RW/RX/R1-R5	97-05 ▲	DRC119 DRCF119 ▲=CT005	YAMAHA WR 250 FN/FP/FR/FS/FT/FV/FW /FX/FY/FZ/FA/FB/FD (4T)	01-13 ▲	
	HONDA DALL ARA XR 400/440 R	04 ▲				
DRC107 DRCF107 ▲=CT027	KTM SX 60 SX 65	98-00	DRC120	SUZUKI LT-F 400 FK2-FK7 (Eiger 4WD) LT-F 400 FK8/FK9/FLO/FL1 King Quad 4WD LT-F 400 K3-K7 Eiger 2WD ARCTIC CAT 400 (2 x 4/4 x 4) 400 (4 x 4 Manual)	02-07	
		98-08			08-12	
DRC108 DRCF108 ▲=CT007	KTM SX 250 (2T) 250 EGS 250 EXC (2T) EXC 250 (2T) Six Days 250 MXC 250 SXS XC 250 (USD) XC 250 (2T) 300 EGS EXC 300 (2T) 300 EXC EXC 300 (2T) Six Days 300 MXC SX 300 300 Six Days XC 300 (USD) 360 EGS 360 EXC 360 MXC 360 SX 360 Six Days 380 EXC 380 MXC SX 380 RXC-E 400 RXC-E 620	94-12 ▲			03-04	
		94-99 ▲			05-08	
		94-12 ▲				
		11-12 ▲				
		98-99 ▲				
		01-03 ▲				
		11 ▲				
		11-12 ▲				
		94-99 ▲				
		00-12 ▲				
94-07 ▲						
11-12 ▲						
94-05 ▲						
94 ▲						
96 ▲						
11-12 ▲						
96-97 ▲						
96-97 ▲						
96-97 ▲						
96-97 ▲						
96 ▲						
98-02 ▲						
98-01 ▲						
98-02 ▲						
95 ▲						
95 ▲						
DRC109 DRCF109 ▲=CT005	YAMAHA YZ 250 FN/FP/FR/FS/FT/FV/FW	01-07 ▲	DRC121 ▲=CT020	YAMAHA YZ 450 FR/FS	03-04 ▲	
DRC110 ▲=CT020	YAMAHA WR 426 FN/FP WR 450 FR	01-02 ▲	DRC122 ▲=CT004	KAWASAKI KX 125 M1/M2/M3/M6F/M7F/M8F	03-08 ▲	
		03 ▲				
DRC111 DRCF111 ▲=CT010	YAMAHA YZ 85 (2T / Small Wheel F 17" / R 14") YZ 85 (2T / Big Wheel F 19" / R 16")	02-20 ▲	DRC123 DRCF123 ▲=CT004	KAWASAKI KX 250 F (KX 250 N1/N2/T6F/T7F/T8F) KX 250 F (KX 250 W9F/XAFB/YBF/YCF /ZDF/ZEF/ZFF/ZGF/AHF) (4T) SUZUKI RM-Z 250 K4/K5/K6	04-08 ▲	
		02-20 ▲			09-17 ▲	
DRC112 ▲=CT009	HONDA CRF 450 R2/R3 CRF 450 R6/R7/R8	02-03 ▲	DRC126 ■=CT013SP	HONDA TRX 350 FMY/1-5 Fourtrax#Rancher/4x4	00-05 ■	
		06-08 ▲				
DRC117 ▲=CT059	KTM 250 EXC Racing 250 EXC-G Racing 400 EXC 400 MXC SX 400 450 EXC-G Racing 450 EXC Racing 450 MXC-G Racing 520 EXC SX 520 525 EXC Racing 525 EXC-G Racing 525 MXC Desert Racing 525 MXC-G Racing 525 SX Racing	04 ▲	DRC127 ■=CT013SP	HONDA TRX 350 TE/FE Fourtrax #Rancher ES/ES 4x4 FEY/1-5	00-05 ■	
		04 ▲				
DRC119 DRCF119 ▲=CT005	YAMAHA WR 250 FN/FP/FR/FS/FT/FV/FW /FX/FY/FZ/FA/FB/FD (4T)	01-13 ▲	DRC128 DRCF128 ▲=CT020	YAMAHA YFM 700 RV/RW/RA/R/RD/RE YFM 700 RSE	06-14 ▲	
					13-14 ▲	
DRC120	SUZUKI LT-F 400 FK2-FK7 (Eiger 4WD) LT-F 400 FK8/FK9/FLO/FL1 King Quad 4WD LT-F 400 K3-K7 Eiger 2WD ARCTIC CAT 400 (2 x 4/4 x 4) 400 (4 x 4 Manual)	02-07	DRC129 DRCF129 ▲=CT001	HONDA CRF 250 R4/R5/R6/R7	04-07 ▲	
		08-12				
DRC121 ▲=CT020	YAMAHA YZ 450 FR/FS	03-04 ▲				
DRC122 ▲=CT004	KAWASAKI KX 125 M1/M2/M3/M6F/M7F/M8F	03-08 ▲				
DRC123 DRCF123 ▲=CT004	KAWASAKI KX 250 F (KX 250 N1/N2/T6F/T7F/T8F) KX 250 F (KX 250 W9F/XAFB/YBF/YCF /ZDF/ZEF/ZFF/ZGF/AHF) (4T) SUZUKI RM-Z 250 K4/K5/K6	04-08 ▲				
		09-17 ▲				
DRC126 ■=CT013SP	HONDA TRX 350 FMY/1-5 Fourtrax#Rancher/4x4	00-05 ■				
DRC127 ■=CT013SP	HONDA TRX 350 TE/FE Fourtrax #Rancher ES/ES 4x4 FEY/1-5	00-05 ■				
DRC128 DRCF128 ▲=CT020	YAMAHA YFM 700 RV/RW/RA/R/RD/RE YFM 700 RSE	06-14 ▲				
		13-14 ▲				
DRC129 DRCF129 ▲=CT001	HONDA CRF 250 R4/R5/R6/R7	04-07 ▲				

Part No.	Make/Model	Year	Part No.	Make/Model	Year
DRC130 DRCF130 ▲=CT003	SUZUKI RM 125 K2/K3/K4/K5/K6/K7/K8/K9 RM 125 XCK8	02-12 ▲ 09 ▲	DRC159 DRCF159	YAMAHA YZF 450 S/T/V Quad	04-06
DRC131 DRCF131 ▲=CT009	HONDA TRX 450 R4/R5/R6/ER6/R7/ER7 /R8/ER8/R9/ER9	04-09 ▲	DRC160 ▲=CT016	SUZUKI RM 250 K6/K7/K8/K9 RM 250 XCK8	06-12 ▲ 09 ▲
DRC136 ▲=CT002SP	HONDA CRF 230 F4/F5/F6/F7/F8/F9	04-09 ▲	DRC161 ▲=CT016	SUZUKI RM 250 K3/K4/K5	03-05 ▲
DRC137 DRCF137 ▲=CT006	KAWASAKI KSF 400 A3/A6F (KFX 400) SUZUKI LT-Z 400 K5/K6/K7/K8/K9 /L0/L1/L2/L3 QuadSport ARCTIC CAT 400 DVX	05-06 ▲ 05-15 ▲ 07-08 ▲	DRC162 ▲=CT020	YAMAHA YZ 450 FT/FV	05-06 ▲
DRC139 ▲=CT028	KTM SX 85 (17"/14" Wheels) SX 85 (19"/16" Wheels)	03-17 ▲ 03-17 ▲	DRC163 DRCF163 ▲=CT001	KTM SX-F 250 (4T) EXC-F 250 (4T) EXC-F 250 (4T) Six Days XC-F 250 (USD) XC-F 250	05-12 ▲ 06-13 ▲ 11-12 ▲ 11-12 ▲ 12 ▲
DRC142 ■=CT029SP	SUZUKI DR 650 RER/RES (SP45A/B)	94-95 ■	DRC164 DRCF164 ▲=CT045	SUZUKI LT-R 450 K6/K7/K8/K9/L0/L1	06-12 ▲
DRC144 ▲=CT001	KTM SX 150 XC 50 (USD) 200 EGS 200 EXC 200 MXC SX 200	08-20 ▲ 11-13 ▲ 98-99 ▲ 97-14 ▲ 98-03 ▲ 03/06-07 ▲	DRC165 ▲=CT040SP	CCM 604 Trial/SM/RS/R30 (Rotax Engine)	98-03 ▲
DRC145 ▲=CT001	KTM 125 EGS 125 EXC 125 EXE 125 Supermoto SX 125 SX 125 (2T) 125 SXS	98-99 ▲ 98-05 ▲ 00-01 ▲ 00-01 ▲ 98-07 ▲ 09-14 ▲ 01-02 ▲	DRC168 ▲=CT016	KAWASAKI KLR 650 C1-C10 KLR 650 (KL 650 E8F/E9F)	95-04 ▲ 08-09 ▲
DRC148 DRCF148 ▲=CT009	HONDA CRF 450 R4/R5 CRF 450 X5/X6/X7/X8/X9 /XB/XC/XD/XF/XG/XH CRF 450 XRL (Road Legal)	04-05 ▲ 05-17 ▲ 14-16 ▲	DRC169 ▲=CT030	KTM 350 EXC 350 Super Comp 400 Duke 400 EGS 400 EXC 400 Super Comp 620 Duke 620 EGS 620 EXC 620 Super Comp SX 620	94 ▲ 94-95 ▲ 94-95 ▲ 94 ▲ 94 ▲ 95 ▲ 94 ▲ 94-95 ▲ 94-95 ▲ 94-95 ▲ 94-95 ▲ 94 ▲
DRC154 ▲=CT023	KTM 250 EXC Racing (2T) 400 EXC Racing 400 EXC-G Racing 450 EXC-G Racing 450 EXC Racing 450 MXC-G Racing 450 SMR SX 450 (4T) 525 EXC Racing 525 EXC-G Racing 525 MXC Desert Racing 525 SMR 525 SX Racing	05 ▲ 05 ▲ 05 ▲ 05 ▲ 05 ▲ 05 ▲ 04-05 ▲ 04-05 ▲ 05 ▲ 05 ▲ 05 ▲ 04-05 ▲ 05 ▲	DRC170 ▲=CT030	KTM 380 EGS 400 EGS-E 400 EGS 400 EXC 400 LC-4 400 LC4-E LC4 R 400 400 LSE 400 LS-E 400 Super Comp/EXC 400 RXC-E SXC 400 400 SX-X 400 SX 400 SXC 400 TXC 620 Duke 620 EGS/Adventure 620 EGS-E 620 Enduro Ltd 620 LC-4 620 LSE 620 RXC-E 620 Six Days 620 SC SXC 620 640 LC Rallye Dakar 660 LC4	98-99 ▲ 97 ▲ 96-97 ▲ 96 ▲ 98 ▲ 00-01 ▲ 99 ▲ 97 ▲ 04 ▲ 96-99 ▲ 96-97 ▲ 97 ▲ 98 ▲ 99 ▲ 00 ▲ 98 ▲ 97 ▲ 96-97 ▲ 97 ▲ 98 ▲ 97 ▲ 96-97 ▲ 96 ▲ 00-01 ▲ 97 ▲ 97 ▲ 97 ▲
DRC155 DRCF155 ▲=CT045	SUZUKI RMX 450 ZL0/ZL2 RM-Z 450 K5/K6/K7/K8/K9/L0/L1-L9	10-15 ▲ 05-19 ▲			
DRC158 DRCF158 ▲=CT006	KAWASAKI KX 450 F (D6F/D7F/D8F/E9F/EAFEBF) KLX 450 R (A8F/A9F/AAF/ABF/ACF /ADF/AEF/AFF/AGF)	06-11 ▲ 08-16 ▲			

Part No.	Make/Model	Year	Part No.	Make/Model	Year		
DRC171 ▲=CT023	KTM		DRC178 ▲=CT075	KTM			
	250 EXC-G Racing	03 ▲		EXC 400 (LC4 Engine)	93-95 ▲		
	250 EXC Racing	02-03 ▲		400 RXC-E	95 ▲		
	400 EXC Racing	02 ▲		SC 400 (LC4 Engine)	95 ▲		
	400 EXC-G Racing	02 ▲		620 RXC-E	95 ▲		
	400 EXC	07-09 ▲		HONDA	XR 650 RY/R1-R7	00-07 ▲	
	400 EXC-G Racing	06 ▲					
	400 MXC	02 ▲		HONDA	CRF 150 F3/F4/F5	03-05 ■	
	400 SX Racing	02 ▲					
	450 EXC Racing	03 ▲		HONDA	CRF 150 F6/F7	06-07 ■	
	450 EXC-G Racing	03 ▲					
	450 EXC	06-09 ▲		DRC182 DRCF182 ▲=CT002	HONDA	CRF 150 R (Small Wheel F 17" / R 14") CRF 150 RB (Big Wheel F 19" / R 16")	07-20 ▲ 07-20 ▲
	450 MXC-G Racing	03 ▲					
	MXC 450	06 ▲		DRC184 ▲=CT009	KTM	SX-F 450 450 SX-F (Quad) SX-F 505 505 SX-F (Quad)	07-10 ▲ 09-11 ▲ 07-09 ▲ 09-12 ▲
	SMR 450	06-07 ▲					
	SX 450 (4T)	03 ▲		DRC185 ▲=CT006	KAWASAKI	KFX 450 R Quad (KSF 450 B8F/B9F/BAF/BBF/BCS/BFD/BEF)	08-14 ▲
	SX 450 (4T)	06-09 ▲					
	XC 450 Quad (4T)	08-09 ▲		DRC189 DRCF189 ▲=CT004	SUZUKI	RM-Z 250 K7/K8/K9	07-09 ▲
	520 SX Racing	02 ▲					
	525 EXC-G Racing	03 ▲		DRC194 ▲=CT020	YAMAHA	WR 450 FT/FV/FW/FX/FY/FZ /FA/FB/FD/FE/FF	05-15 ▲
	525 EXC	03 ▲					
	525 MXC Desert Racing	03 ▲		DRC195 DRCF195 ▲=CT020	YAMAHA	YZ 450 FW/FX/FY/FZ/FA WR 450 GF (270mm F/Disc/4T)	07-11 ▲ 16 ▲
	MXC 525	06 ▲					
525 SX Racing	03 ▲	DRC196 ▲=CT030	KTM	540 SX-C 620 LC4 Competition 620 LC4 Super Moto 620 Super Comp SX 620 620 Supermoto 620 TXC 625 SC 625 SMC 625 SXC 640 Adventure-R 640 Duke-E Duke-E 640 Duke II 640 Duke II 640 640 LC4 640 LC4 640 LC4 Six Days 640 LC4-E 640 LC4 Adventure 640 LC4 Supermoto	98-99 ▲ 99 ▲ 99 ▲ 96-99 ▲ 97-99 ▲ 98 ▲ 98 ▲ 03 ▲ 04-06 ▲ 03-04 ▲ 98-02 ▲ 98 ▲ 99-02 ▲ 03-07 ▲ 99 ▲ 99-00 ▲ 99 ▲ 00-02 ▲ 03-06 ▲ 03-04 ▲		
SX 525	06 ▲						
XC 525 (Quad)	08-12 ▲	DRC199 ▲=CT030	KTM	690 Rally Factory Replica	07-09 ▲		
540 SXS Racing	02 ▲						
SMR 560	06-07 ▲	DRC200 DRCF200 ▲=CT005	YAMAHA	YFM 250 RX/RV Raptor YFM 250 R (33B)	08-09 ▲ 09-11 ▲		
SX-F 250 (4T)	16-20 ▲						
SX-F 250 Factory (4T)	16-20 ▲						
XC-F 250 (4T)	16-20 ▲						
XC-F 350	16-20 ▲						
DRC172	KTM 450 SMS	04					
DRC173 ▲=CT075	KTM						
	350 MX (2T)	89 ▲					
	350 Enduro (2T)	89 ▲					
	500 MX (2T)	89 ▲					
	500 Enduro (2T)	89 ▲					
	500 Enduro (4T) C	89 ▲					
	500 MX (4T) LC	89 ▲					
DRC174 ▲=CT001	KTM						
	EXC 125 EXC 125 (2T) Six Days SX 125	07-15 ▲ 11-15 ▲ 08 ▲					
DRC175 ▲=CT030	KTM						
	660 LC4 Rallye 660 SM Factory Replica 660 SMC	99-00 ▲ 02-03 ▲ 03-04 ▲					
	DRC176 ▲=CT030	KTM					
660 Rallye 660 Rallye factory	01-03 ▲ 04 ▲						
DRC177 ▲=CT015	KTM						
	690 Duke R	10-11					
	690 SM-LE (Limited Edition)	10-11					
	950 Adventure S	03-04 ▲					
	950 Adventure	06 ▲					
	950 Superenduro R	07-08 ▲					
	990 Adventure/S	06-08 ▲					
	990 Adventure Dakar Edition (ABS)	11 ▲					
	990 Adventure R	09-12 ▲					
	990 Adventure (ABS Model)	09-12 ▲					
	990 Superduke	05-11 ▲					
	990 Superduke R	07-13 ▲					
	990 Supermoto T (SM-T)	08-13 ▲					
990 Supermoto R (SM-R)	08-13 ▲						

Part No.	Make/Model	Year	Part No.	Make/Model	Year
DRC201 DRCF201	YAMAHA YFZ 450 W/X Quad YFZ 450 RY/RZ (Quad)	07-08 09-10	DRC221 ▲=CT011	SUZUKI LT-F 250 K3 Ozark LT-F 250 K5-K9/L2-L4 Ozark	03 ▲ 05-14 ▲
DRC205 ▲=CT069	HUSQVARNA Svartpilen 401 Vitpilen 401 701 Enduro R 701 Supermoto Svartpilen 701 Vitpilen 701 KTM 690 Duke 690 Duke R 690 Enduro 690 R Enduro 690 SMR 690 SMC 690 SMC-R 690 SM-LE (Limited Edition)	18-20 ▲ 18-20 ▲ 16-20 ▲ 16-20 ▲ 18-20 ▲ 18-20 ▲ 08-14 ▲ 10-11/13-14 ▲ 08-14 ▲ 09-14 ▲ 07-11 ▲ 08-11 ▲ 12-18 ▲ 10-11 ▲	DRC222 ▲=CT011	SUZUKI LT-F 250 K4 Ozark LT-Z 250 K4/K5/K6/K7/K8/K9/L0 Quadsport	04 ▲ 04-12 ▲
DRC206 ▲=CT001	GAS-GAS EC 125 (2T) SM 125 (2T) Supermotard	00-08 ▲ 03-06 ▲	DRC223	SUZUKI LT-F 400 K2 (Eiger)	02
DRC207 ▲=CT009	GAS-GAS EC200/250/300 (2T) EC 450 FSR/FSE (4T) Enduro SM 450 FSR (4T) Supermotard Wild HP 450 Quad EC 515 FSR/FSE (4T) Enduro SM 515 FSR (4T) Supermotard	00-08 ▲ 05-08 ▲ 07-08 ▲ 04-08 ▲ 05-08 ▲ 07-08 ▲	DRC224	KAWASAKI KLF 220 A1-A15 KLF 250 A1/A2/A3/A6F/A78F/A8F /A9F/AAF/ABF (Bayou 250)	88-02 03-11
DRC208 DRCF208 ▲=CT001	HONDA CRF 250 R8-R9 CRF 250 X4/X5/X6/X7/X8/X9 /XB/XC/XD/XF/XG/XH CRF 250 XRL (Road Legal) CRF 250 RX	08-09 ▲ 04-17 ▲ 14-16 ▲ 18-20 ▲	DRC225 ▲=CT004	KAWASAKI KSF 250 A1-A18 (KXF 250 Mojave)	87-04 ▲
DRC211 ▲=CT012SP	KAWASAKI KLX 125 CAF/CBF/CCF/CCS/CDF CDS/CEF/CF/CGF KLX 125 DAF/DBF/DCF/DDF/DEF (D-Tracker) KLX 150 L (KLX 150 EFF) KLX 150 D-Tracker (KLX150 HGF)	10-16 ▲ 10-14 ▲ 14-15 ▲ 16 ▲	DRC226 ▲=CT005	YAMAHA TT 250 RM (4PX6) WR 250 R WR 250 XX/XY (Supermoto/32D2/4)	00 ▲ 08-20 ▲ 08-10 ▲
DRC212 ▲=CT042	KAWASAKI KLX 250 H6F/H7F KLX 250 S9F/SAF/SBF/SCF/SDF/SEF /SFF/SGF	06-07 ▲ 09-16 ▲	DRC227 DRCF227 ▲=CT005	YAMAHA YZ 250 FX/FY/FZ/FB/FD (4T)	08-13 ▲
DRC214	ARCTIC CAT 400 (2 x 4) 500 (4 x 4)	98 98-02	DRC228 ▲=CT008	YAMAHA YFM 350 FX Wolverine All models	95-04 ▲
DRC215	ARCTIC CAT 400 (2 x 4/4 x 4)	98-02	DRC229 ▲=CT039	YAMAHA XT 225 (3RW4) Serrow (1KH 080101-) XT 225 W (4JG1/2/3/4) Serrow XT 225 WE (4JG5/6) Serrow ST 225 (5BT) Bronco	92 ▲ 93-96 ▲ 97-98 ▲ 97 ▲
DRC216 ▲=CT006	ARCTIC CAT Bearcat 454 (4 x 4) Bearcat 454 (2 x 4) 500 (4 x 4 Manual) 500 (Manual 4 x 4)	96-98 ▲ 97-98 ▲ 03-04 ▲ 05-09 ▲	DRC230 DRCF230 ▲=CT044	YAMAHA TT-R 125 (All models)	00-20 ▲
DRC217 ▲=CT006	SUZUKI LT-F 500 FW/FX/FY/FK1/FK2	98-02 ▲	DRC231 ▲=CT039	YAMAHA TW 200 (2JL/4CS1/2/3/5) TW 200 E (4CS4/6/5LB1/2) TW 225 E (5VC1/2) XT 225 (3RW1/2/4/5) Serrow (1KH-) XT 225 S (3RW3) (1KH- 202101-109000)	91-98 ▲ 98-01 ▲ 02-03 ▲ 89-93 ▲ 92 ▲
DRC218 ▲=CT011	SUZUKI LT 160 EK/EL/EM/EN LT-F 160 L/M/N/P/R/S/T/V/W/X/Y/K1-K3 LT 160 K3/K4 Quadsport LT 230 GEF/GEG LT-F 230 G/H	89-92 ▲ 90-03 ▲ 03-04 ▲ 85-86 ▲ 86-87 ▲	DRC232 ■=CT010SP	YAMAHA YFM 200 DKW/DX/DXA	86-90 ■
DRC220 ▲=CT011	SUZUKI LT-F 250 K2 Ozark (Up to F/No JSAAJ51A22100696)	02 ▲	DRC233	KAWASAKI KEF 300 B1/B2 Lakota Sport KLF 300 A1/A2/B1-B17/C1-C17	01-02 87-05
			DRC234 ▲=CT006	KAWASAKI KLF 400 B1-B7	93-98 ▲
			DRC236 ■=CT013SP	HONDA TRX 500 FE5/FE6/FE7/FE8/FE9 /FEA Fourtrax Foreman 4WD-ES TRX 500 FE8/FE9 Fourtrax Foreman 4x4 EPS TRX 500 FPE8/FPE9/FPEA Fourtrax Foreman - Power Steering	05-10 ■ 08-09 ■ 08-10 ■
			DRC237 ■=CT013SP	HONDA TRX 500 FM5/FM6/FM7/FM8/FM9 /FMA Fourtrax Foreman 4WD TRX 500 TM5/TM6 Fourtrax Foreman	05-10 ■ 05-06 ■

Part No.	Make/Model	Year	Part No.	Make/Model	Year
DRC238 ■=CT013SP	HONDA TRX 420 FE7/FE8/FE9/FEA/FEB 4WD - Fourtrax ES TRX 420 TE7/TE8/TE9 Fourtrax ES - 2WD	07-11 ■ 07-09 ■	DRC260 ▲=CT023	KTM SX-F 250 (2T) Coil Spring XC-F 250 (4T) Coil Spring SX-F 350 (USD Forks) EXC-F 350 (USD Forks) XC-F 350 XCF-W 350 (2T) XCF-W 350 Six Days (2T)	13-15 ▲ 13 ▲ 11-20 ▲ 11 ▲ 12-13 ▲ 16 ▲ 16 ▲
DRC239 ■=CT013SP	HONDA TRX 420 FM7/FM8/FM9/FMA/FMB 4WD - Fourtrax TRX 420 FPM9/FPMA/FPMB Fourtrax - 4WW - Power Steering TRX 420 TM7/TM8/TM9/TMA/TMB Fourtrax 2WD	07-11 ■ 09-11 ■ 07-11 ■	DRC261 DRCF261 ▲=CT001	HONDA CRF 250 R CRF 250 RE (Limited Road Use)	11-20 ▲ 16 ▲
DRC240 DRCF240 ▲=CT009	HONDA TRX 700 XX8/XX9/XXB	08-11 ▲	DRC262 DRCF262 ▲=CT001	HONDA CR 125 RY/R1/R2/R3	00-03 ▲
DRC241 DRCF241 ▲=CT057SP	KTM SX 65	09-15 ▲	DRC263 ▲=CT020	YAMAHA WR 450 FS	04 ▲
DRC244 DRCF244 ▲=CT009	HONDA CRF 450 R9/RA (4 spring type clutch)	09-10 ▲	DRC264 ▲=CT264	HUSQVARNA CR 125 SMS 125 WR 125 WRE 125	00-11 ▲ 00-11 ▲ 00-11 ▲ 00-11 ▲
DRC247 ▲=CT034SP	APRILIA AF1 125 Classic 125 MX 125 Pegaso 125 Red Rose 125 (Cast Wheel) Red Rose 125 (Spoke Wheel) RS 125 (2T) RX 125 Tuono 125	87-91 ▲ 95-01 ▲ 04-06 ▲ 91-95 ▲ 87 ▲ 88-94 ▲ 92-14 ▲ 92-98 ▲ 03-04 ▲	DRC265 ▲=CT008	YAMAHA YZ 400 FK/FL	98-99 ▲
DRC249 ■=CT012SP	HONDA CRF 230 L CRF 230 M Supermoto	08-10 ■ 09-10 ■	DRC266 ▲=CT013	HONDA XR 400 R5/R6 Motard (NC38E) XR 400 M Supermotard (ND08/NC38E)	05-06 ▲ 06-08 ▲
DRC250 ▲=CT009	MONTESA-HONDA 315R (2T)	97-04 ▲	DRC267 ▲=CT009	XL 1000 VX/VY/V1/V2 Varadero Non ABS Model/10 Plate Kit	99-02 ▲
DRC252 ▲=CT041	KTM EXC 400 (4T) EXC-R 450 (4T) EXC 450 (4T) EXC 450 (4T) Six Days EXC 530 EXC 530 (4T) Six Days EXC-R 530	09-11 ▲ 08 ▲ 09-11 ▲ 11 ▲ 09-11 ▲ 11 ▲ 08 ▲	DRC268 ▲=CT009	XL 1000 V3/V4/V5/V6/V7/V8/V9/VA/VB Varadero Non ABS Model/8 Plate Kit XL 1000 V6/VA6/VA7/VA8/VA9/VAA/VAB Varadero ABS Model/8 Plate Kit	03-11 ▲ 06-11 ▲
DRC254 DRCF254 ▲=CT045	SUZUKI RM-Z 450 K5/K6/K7	05-07 ▲	DRC269 DRCF269 ▲=CT006	KAWASAKI KX 450 F	12-20 ▲
DRC255 DRCF255 ▲=CT004	SUZUKI RM-Z 250 L0/L1/L2/L3/L4/L5/L6/L7/L8/L9	10-20 ▲	DRC270 ▲=CT013SP	HONDA TRX 500 FEC TRX 500 FPEC	12 ▲ 12 ▲
DRC256 DRCF256 ▲=CT001	HONDA CRF 250 RA	10 ▲	DRC271 ▲=CT013SP	HONDA TRX 500 FMC	12 ▲
DRC259 DRCF259 ▲=CT009	HONDA CRF 450 RB/RC	11-12 ▲	DRC273 ▲=CT023	KTM EXC-F 350 Six Days EXC-F 350 (Diaphragm Spring) 350 Freeride EXC 450 EXC 450 (4T) Six Days EXC 450 Six Days EXC-F 450 (4T) SX-F 450 (4T) Diaphragm Spring EXC 500 EXC 500 Six Days EXC 500 (4T) EXC 500 (4T) Six Days Diaphragm Spring	12-18 ▲ 12-18 ▲ 12-15 ▲ 12 ▲ 12 ▲ 12 ▲ 12 ▲ 12 ▲ 12 ▲ 12 ▲ 12 ▲ 12 ▲ 12 ▲ 12 ▲
			DRC274 ▲=CT011	SUZUKI DF 200 EV/EW/EY DR 200 SE Trojan DR 200 SEK1-SEK9 RV 200 K2/K3	97-99 ▲ ▲ 01-09 ▲ 02-03 ▲

Part No.	Make/Model	Year	Part No.	Make/Model	Year																						
DRC275 ▲=CT023	KTM EXC 250 (2T) EXC 250 (2T) Six Days EXC-F 250 (4T) EXC-F 250 Six Days (4T) SX 250 (2T) Diaphragm Spring EXC 300 (2T) Diaphragm Spring EXC 300 (2T) Six Days EXC-F 350 (4T/Diaphragm Spring) EXC-F 350 Six Days (4T/Diaphragm Spring) EXC 450 (4T) Diaphragm Spring EXC 450 (4T) Six Days EXC-F 450 (4T/Diaphragm Spring) SX-F 450 (4T) Diaphragm Spring EXC-F 500 (4T) EXC-F 500 Six Days (4T) EXC 300 (2T) EXC 300 Six Days (2T)	13-20 ▲	DRC301 DRCF301 ▲=CT009	HONDA CRF 450 RD/RE/RF/RG (6 Spring type)	14-17 ▲																						
		13-18 ▲			DRC303 DRCF303 ▲=CT001	KTM SX 125 XC-W 150	15-20 ▲																				
		14-20 ▲	DRC304 DRCF304 ▲=CT087SP	HUSQVARNA TC85 KTM SX 85 (17 Inch/14 Inch Wheels) SX 85 (19 Inch/16 Inch Wheels)			17-20 ▲																				
		13-20 ▲			DRC306 DRCF306 ▲=CT009	HONDA CRF 1000 LAG (Manual Clutch/ABS) CRF 1000 L (Manual Clutch/Non ABS)	18▲																				
		13-15 ▲	DRC311	METRAKIT GP50			18-20▲																				
		13-15 ▲					DRC313 DRCF313	HONDA CRF 250 L (Non ABS) / LA (ABS) CRF 250 ME Supermoto CRF 250 RL/RLA Rally (non ABS & ABS models) CBF 300 NA CBR 300 RA	18-20▲																		
		18-20 ▲							DRC315 DRCF315	HONDA CRF 1000 LAG (Manual Clutch/ABS) CRF 1000 L (Manual Clutch/Non ABS)	16-19 ▲																
		18-19 ▲									DRC311	METRAKIT GP50	16 ▲														
		13 ▲											DRC311	METRAKIT GP50	All												
		13-20 ▲													DRC313 DRCF313	YAMAHA YZ 250 F (4T)	16-20										
		14-15 ■															DRC315 DRCF315	YAMAHA YZ 250 F (4T)	19								
		17-20 ■																	DRC315 DRCF315	YAMAHA YZ 250 F (4T)							
		18-19 ■																			DRC315 DRCF315	YAMAHA YZ 250 F (4T)					
		14-19 ■																					DRC315 DRCF315	YAMAHA YZ 250 F (4T)			
DRC280 ▲=CT013	SUZUKI DR-Z 250 K1-K7 (DJ43A)	01-07 ▲																							DRC315 DRCF315	YAMAHA YZ 250 F (4T)	
		DRC281 ▲=CT023																									KTM SX-F 450 (4T) Diaphragm Spring EXC-F 500 XC-W 500
17 ▲																											
DRC287 DRCF287 ▲=CT020	YAMAHA YZ 450 FE/FF (4T) YZ 450 FG (270mm Disc) YZ 450 FGY (60th Anniversary Edition/270mm Disc)	14-15 ▲																									
		16-20 ▲																									
		16-20 ▲																									
DRC288 DRCF288 ▲=CT005 ■=CT020	YAMAHA YZ 250 FE/FF (4T) YZ 250 FG (270mm Disc) YZ 250 FGY (60th Anniversary Edition/270mm Disc)	14-15 ▲																									
		16-18 ■																									
		16 ■																									
DRC293 ▲=CT023	HUSQVARNA FC 250/FC 350 FX 350	14-20 ▲																									
		17-20 ▲																									
DRC296 ▲=CT023	HUSQVARNA FC 450 FC 450 Rockstar Edition	14-20 ▲																									
		20 ▲																									
DRC297 ▲=CT011	SUZUKI LT-F 250 K2 Ozark (From F/No # JSAAJ51A22100697-	02 ▲																									
DRC298 DRCF298 ▲=CT020	YAMAHA WR 450 FG/FH (270mm F/Disc/4T)	16-20 ▲																									
DRC299 DRCF299 ▲=CT092	HONDA CRF 450 RH (6 Spring Type) CRF 450 RXH (18" Rear Wheel) CRF 450 X	17-20 ▲																									
		17-20 ▲																									
		18-19 ▲																									
DRC300 ▲=CT091	AJP PR5 250 Trials PR5 250 Supermoto PR5 250 Enduro PR5 250 Extreme	13-17 ▲																									
		13-17 ▲																									
		13-17 ▲																									
		13-17 ▲																									

SRC CLUTCH KITS BUYERS GUIDE

SRC002	HONDA VF 750 FD/FE	83-85	SRC017 ▲=CT036SP	SUZUKI GSX 600 FN/FP/FR/FS/FT/FV GSXR 750 L/M/WN/WR/WS	92-97 ▲ 90-95 ▲
SRC003 ▲=CT014	HONDA VFR 750 FG/FH/FJ/FL/FMFN/FP /FR/FS/FT/FV	86-97 ▲	SRC019 ▲=CT014 ●=CT014SP	HONDA CB 600 Hornet FW/FX/FY/F2-Y/ F1/F21/F2/F22/F3/F4/F5/F6 CBF 600 N4/N5/N6 (Non ABS) CBF 600 NA4/NA5/NA6 (ABS) CBF 600 S4/S5/S6 (Non ABS) CBF 600 SA4/SA5/SA6 (ABS) CBR 600 FM/FN/FP/FR/FS/FT/FV/FW CBR 900 RRY/RR1 (929cc Fireblade) CBR 900 RR2/RR3 (954cc) Fireblade	98-06 ● 04-06 ● 04-06 ● 04-06 ● 04-06 ● 91-98 ● 00-01 ▲ 02-03 ▲
SRC004 ■=CT009	HONDA CB 1000 FP/FR/FS/FT/FV CBR 1000 FH/FJ/FK/FL/FM/FN/FP /FR/FS/FT/FV/FW/FX	93-97 ■ 87-99 ■	SRC020 ▲=CT016	KAWASAKI ZL 900 A1/A2 Eliminator Z 1000 E1/E2 (ST-Shaft) GPz 1000 RX A1-A3 1000 GTR (ZG 1000 A1-A18) ZX 10 B1/B2/B3 ZL 1000 A1 GPz 1100 A1-A3 Z 1100 R1 Z 1100 A1-A3 Z 1100 D1/D2 Spectre ZR 1100 A1/A2/A3/A4/B1 ZRX 1100 (ZX 1100 C1/C2/C3/C4)	85-86 ▲ 79-80 ▲ 86-88 ▲ 86-03 ▲ 88-90 ▲ 87 ▲ 82-85 ▲ 84 ▲ 81-83 ▲ 82-83 ▲ 92-97 ▲ 97-00 ▲
SRC005 ▲=CT014	HONDA VFR 750 RJ/RK/RL (RC30)	88-92 ▲	SRC021 ▲=CT004	KAWASAKI ZXR 400 (ZX 400 L1-L5/L8/L9)	91-02 ▲
SRC006 ▲=CT010	YAMAHA FZR 400 RR (4DX) FZR 400 Genesis (1WG) FZR 400 (3EN1/3EN2) FZR 400 RR (3TJI)	92 ▲ 86 ▲ 88-89 ▲ ▲	SRC022 ▲=CT016	KAWASAKI ZL 400 A Eliminator ZL 400 B Eliminator 400 SE ZZ-R 600 D1/D2/D2A/D3 650 Vulcan S (EN 650 AFF/AGF/Non ABS) 650 Vulcan S (EN 650 BFF/BGF/ ABS) ER-6f (EX 650 A6F/A7F/A8F/CF/CAF/CBF) ER-6f (ABS Model) (EX 650 B6F/B7F/B8F) ER-6f (ECF/EDS/EEFEFF) (Non ABS) ER-6f (FCF/FDS/FEF/FFF/FGF) (with ABS) ER-6n (ER 650 A6F/A7F/A8F) ER-6n (ABS) ER 650 B6F/B7F/B8F ER-6n (ECF/EDS/EEF/EFF) (non ABS) ER-6n (FCF/FDS/FEF/FFF/FGF) (with ABS) KLE 650 A7F/A8F/A9F/CAF/CBF /CCF/CDF Versys KLE 650 B7F/B8F/B9F/DAF/DBF /DCF/DDF Versys ABS	86-87 ▲ 88 ▲ 90-92 ▲ 15-16 ▲ 15-16 ▲ 06-08 ▲ 06-08 ▲ 12-15 ▲ 12-16 ▲ 06-11 ▲ 06-08 ▲ 12-15 ▲ 12-16 ▲ 07-13 ▲ 07-13 ▲
SRC007 ▲=CT010	YAMAHA FZR 400 RSP (2TK-EXUP) FZR 400 RRSF (3TJ2/6/7) FZR 600	87 ▲ ▲ 89-93 ▲	SRC024 ▲=CT016	KAWASAKI ZXR 750 J1/J2/L1-L3/P1-P7 ZXR 750 R (ZX 750 K1/K2/M1/M2)	91-03 ▲ 91-94 ▲
SRC008 ■=CT008	YAMAHA FZR 750 FZR 1000	87 ■ 87-88 ■	SRC025 ▲=CT021	KAWASAKI ZZ-R 1100 C1/C2/C2A/C3/D1-D9 ZX 1100 E1/E2/F1 ZZR 1200 C1H/C2H	90-01 ▲ 95-98 ▲ 02-04 ▲
SRC009 ■=CT008SP	YAMAHA FZR 750 R OW01 YZF 750 R/SP TDM 850 TRX 850	89-90 ■ 93-97 ■ 96-98 ■ 96-98 ■	SRC029 ■=CT008SP	YAMAHA FZR 1000 GTS 1000 YZF 1000 Thunder Ace	93-95 ■ 93-96 ■ 96-02 ■
SRC010 ▲=CT055SP	SUZUKI GSX 1100 GM/GN GSXR 1100 K/L/M/N	91-94 ▲ 89-92 ▲	SRC031 ■=CT008SP	YAMAHA FZR 1000	89-92 ■
SRC011 ▲=CT016	KAWASAKI Z 400 J1-J3 ZR 400 A1/B1 (Z 400 F) ZX 400 C2 (Z 400 F 11) EN 450 A1-A5 (Ltd 454) EN 500 A1/A2/A3/A4/B1/B2/C1-C9 ER-5 (ER 500 A1/A2/A3/A4/C1-C5P) EX 500 A1-A6/D1-D7 (GPz 500 S) GPZ 500 (S) (EX 500 B1-B5) GPZ 500 S (EX 500 E1-E10) Z 500 A1-A3/B1/B2 GT 550 G1-G9 GPz 550 D1/H1/H2/A1-A4 ZR 550 A1/A2 (Z 550 F) ZR 550 B2-B6 Zephyr Z 550 C1/C2 (Ltd) KL 600 A1 (KLR 600) KLR 600 B1/B2/B4/B6-B9 GPz 600 R A1-A6 GPX 600 R (C1-C3/C6-C7)	80-83 ▲ 83-84 ▲ 85 ▲ 86-89 ▲ 90-04 ▲ 97-07 ▲ 87-02 ▲ 88-93 ▲ 94-04 ▲ 79-81 ▲ 83-01 ▲ 81-87 ▲ 83-84 ▲ 91-99 ▲ 80-81 ▲ 84 ▲ 85-94 ▲ 85-89 ▲ 88-96 ▲	SRC033 ▲=CT054SP	YAMAHA YZF 600 Thunder Cat	96-03 ▲
SRC013 ▲=CT029	SUZUKI GSX 600 FJ/FK/FL/FM GSXR 750 F/G/H (GR75A)	88-91 ▲ 85-87 ▲	SRC034 ▲=CT010	YAMAHA FZR 250 FZR 250 R (3LN1/3/5/6/7) FZX 250 Zeal (3YX1/2/4)	87 ▲ ▲ 91-92 ▲
SRC014 ▲=CT036SP	SUZUKI GSXR 750 J/K	88-89 ▲			
SRC015 ▲=CT048SP	SUZUKI GSX R 1100 G/H/J	86-88 ▲			
SRC016 ▲=CT009SP	HONDA CBR 500 FH/FJ/FK/FL CBR 600 FH/FJ	87-90 ▲ 87-88 ▲			

Part No.	Make/Model	Year	Part No.	Make/Model	Year
SRC038 ▲=CT004	KAWASAKI ZX-6R F1/F2/F3 ZX-6R (ZX 600 J1/J2) ZX6R (ZX 636 A1P) 636cc ZX6R (ZX 636 B1/B2)	95-97 ▲ 00-01 ▲ 02 ▲ 03-04 ▲	SRC047 ■=CT012SP	HONDA CB 250 FT/FV/FX/FY/F1 (MC31) Hornet CBR 250 FG/RH/RJ/RK/RK2 (MC14/17/19) CBR 250 RRL/RRN/RRR (MC22/100/105/110) VT 250 CR/CT/CV Magna (MC29) VTZ 250 H/J/K VTR 250 W/Y (MC33)/1-7	96-01 ■ 86-89 ■ 90-94 ■ 95-97 ■ 86-88 ■ 98-07 ■
SRC039 ▲=CT055SP	SUZUKI RF 900 RR GSXR 1100 WP/WR/WS/WT	94 ▲ 93-96 ▲	SRC048 ▲=CT009SP	HONDA CBX 550 FC/F2C/FD/F2D	82-85 ▲
SRC040 ▲=CT055SP	SUZUKI GSXR 750 T/V/W/X GS 1200 SSK/ZK1 (GV78A) GSF 1200 SAV ABS Bandit GSF 1200 K1/K2/K3/K4/K5 (Naked Bandit - 6 piston caliper) GSF 1200 SK1/SK2/SK3/SK4/SK5 (Faired Bandit) (6 piston caliper) GSF 1200 T/V/W/X/Y (Naked Bandit) piston caliper GSF 1200 ST/SV/SW/SX/SY (Faired Bandit) piston caliper GSX 1200 FSW/FSX Inazuma GSF 1200 K6/AK6 (Naked Bandit) (4 piston caliper) Non & Non ABS GSF 1200 SK6/SAK6 (Faired Bandit) (4 piston caliper) Non & Non ABS Version	96-99 ▲ 01 ▲ 97 ▲ 01-05 ▲ 01-05 ▲ 96-00 ▲ 96-00 ▲ 98-99 ▲ 06 ▲ 06 ▲	SRC049 ■=CT013SP	HONDA CBR 400 RRL/RRN/RRR (NC29)	90-94 ■
SRC041 ▲=CT016	KAWASAKI ZX7 RR (ZX 750 N1/N2) ZX-9R (ZX 900 B1-B4)	96-99 ▲ 94-97 ▲	SRC050 ■=CT024SP	SUZUKI GS 1000 GT/GX GSX 1000 SZ GS 1100 GZ GSX 1100 ET/EX/EZ GSX 1100 SZ GSX 1100 EFE/EFG/ESF	80-81 ■ 82 ■ 82 ■ 80-82 ■ 82 ■ 84-86 ■
SRC042 ▲=CT009	HONDA CBR 600 FK/FL	89-90 ▲	SRC051 ■=CT008SP	YAMAHA YZF 600 R R6 (8 plate) FZ6 Naked/Non ABS 2 piston caliper (IB3/IB3D) FZ6-NS Naked/Non ABS (2 piston caliper) (IB35/6) FZ6-Fazer (Half Fairing/Non ABS /2 piston caliper) (5VX/5VXL) FZ6-Fazer (ABS/Half Fairing /2 piston caliper) FZ6 Fazer S2 (ABS/Half Fairing /4 piston caliper) FZ6 Fazer S2 (Non ABS/Half Fairing/4 piston caliper) FZ6 S2 (Naked/Non ABS /4 piston caliper) (5S51/5S5) FZX 700 S/SC/T/TC Fazer FZ 750	99-02 ■ 04-07 ■ 05-06 ■ 04-07 ■ 06-07 ■ 08 ■ 07-09 ■ 07-09 ■ 86-87 ■ 85-86 ■
SRC043 ▲=CT016	KAWASAKI ZZR 600 (ZX 600 E1-E13) ZZR 600 (ZX 600 E6F)	93-05 ▲ 06-07 ▲	SRC053 ▲=CT016	KAWASAKI GPX 750 F1/F2/F2A/F3 Z 750 D1 Z 750 Y1 (Ltd) GPZ 900 R A1-A8 GPZ 900 R (ZX 900 A11)	87-89 ▲ 76 ▲ 82 ▲ 84-96 ▲ 98 ▲
SRC044 ▲=CT016	KAWASAKI ZR 400 Zephyr (G2/G3/G3A/G4/G5) GPX 600 R (C1-C3/C6-C7) ZL 600 B1	97-01 ▲ 88-96 ▲ 95-97 ▲	SRC054 ▲=CT016	KAWASAKI Z 1000 R1/R2 (Eddie Lawson Replica) Z 1000 J1/J2/J3 Z 1000 K1/K2 LTD GPZ 1100 B1/B2	82-83 ▲ 81-83 ▲ 81-82 ▲ 81-82 ▲
SRC045 ▲=CT036SP	SUZUKI RF 600 RP/RR/RS/RT	93-96 ▲	SRC055 ▲=CT014	HONDA CBR 900 RRT/RRV	96-97 ▲
SRC046 ▲=CT016SP	KAWASAKI W 650 (EJ 650 A1/C3-C7) VN 700 A1 Vulcan VN 750 A2/A3/A4/A5/A10 Z 750 B1/B2 EJ 800 ABF/ACF (W 800/Solid F isc) EJ 800 (W 800 Cafe style/Cockpit fairing) EJ 800 ACFA (W 800 Special Edition Black Exhaust/Gold Rims EJ 800 ADF/AEF/AFF/AGF (W 800) EJ 800 ADF/AEFA/AFFA/AGFA (W 800 Special Edition) VN 800 A1-A3/B1-B10/B6F VN 800 C1/C2/E1/E2/E3 Drifter W 800 AEFA W800 Special Edition GPZ 900 R (ZX 900 A12-15) VN 900 A6F Classic VN 900 Custom (Cast wheel) VN 900 Classic (Spoke wheel) VN 900 Classic Special Edition	99-05 ▲ 85 ▲ 86-94 ▲ 77-78 ▲ 11-12 ▲ 11 ▲ 12 ▲ 13-16 ▲ 13-16 95-06 ▲ 99-04 ▲ 14 ▲ 99-02 ▲ 06 ▲ 07-20 ▲ 07-20 ▲ 11-20 ▲	SRC056 ▲=CT017	YAMAHA YZF R1 (4XV1/2)	98 ▲
			SRC057 ▲=CT014	HONDA CBR 600 FS1/FS2 Sport CBR 600 FB/FC/FAB/FAC CB 900 F2/F3/F4/F5/F6/F7 Hornet CBR 900 RRW/RRX (918cc)	01-02 ▲ 11-12 ▲ 02-07 ▲ 98-99 ▲
			SRC058 ■=CT055SP	SUZUKI GSXR 600 V/W/X/Y	97-00 ■

Part No.	Make/Model	Year	Part No.	Make/Model	Year
SRC059 ▲=CT004	KAWASAKI ZX9R (ZX 900 C1/C2)	98-99 ▲	SRC075 ▲=CT014	HONDA CB 600 F7/F8/F9/FA/FB/FC Hornet CB 600 FA7/FA8/FA9/FAA/FAB/FAC Hornet CBF 600 N8/N9/NA (Non ABS) CBF 600 NA8/NA9/NAA (ABS) CBF 600 S8/S9 (Non ABS) CBF 600 SA8/SA9/SA (ABS) CBR 600 RR3-RRK CBR 600 RR Hannspree CBR 600 RA9-RAK (C-ABS) VFR 800 XA (Crossrunner/ABS) VFR 800 XA (Crossrunner/ABS)	07-13 ▲ 07-13 ▲ 08-11 ▲ 08-11 ▲ 08-09 ▲ 08-12 ▲ 03-19 ▲ 08 ▲ 09-19 ▲ 11-13 ▲ 15-16 ▲
SRC060	HONDA VTR 1000 FV/FW/FX/FY/F1-F6 Firestorm	97-06	SRC076 ▲=CT004	KAWASAKI ZX6RR (ZX 600 K1)	03 ▲
SRC061 ■=CT013SP	HONDA NT 400 Bros NC 25 NV 400 CJ/CK (Steed) NV 400 CS/CV Steed NV 400 DCY/DC1/DC2 (NC40) Shadow Slasher	92-93 ■ 95-97 ■ 00-02 ■	SRC077 ▲=CT020	YAMAHA FZ1 (Naked) (1000cc) (2D11) FZ-1 Fazer Non BS (1000cc) (3C3) FZ-1 Fazer (Half Fairing - ABS - 5D0) FZ1 N/NA Naked (Non ABS/ABS) YZF R1	06-09 ▲ 06-15 ▲ 08-15 ▲ 10-15 ▲ 04-06 ▲
SRK062 ■=CT013SP	HONDA NTV 650 J/K/L/M/P/S/T/V NT 650 VW/VX/VY/V1-V5 Deauville NC 700 SC/SD (Manual Gearbox) NC 700 XC/XD (Manual Gearbox) NT 700 VA6/V6/VA7/V7/V8 /VA8/VA/NAA Deauville NC 750 S NC 750 S (ABS) NC 750 X NC 750 X (ABS)	88-97 ■ 98-05 ■ 12-13 ■ 12-17 ■ 06-12 ■ 14-15 ■ 14-18 ■ 14-15 ■ 14-19 ■	SRC078 ▲=CT014	SUZUKI GSXR 600 K4/K5	04-05 ▲
SRC063 ▲=CT002	HONDA VFR 400 R3K/R3L/R3M/R3N (NC30)	89-92 ▲	SRC079 ▲=CT004	KAWASAKI ZX 10R (ZX 1000 C1/C2/D6F/D7F) ZX10R (ZX 1000 E8F/E9F/FAF/KBF /KCF/JBF/JCF/KDF/JDF/JEF/KEF/JFF/KFF) ZX10R 30th Anniversary Edition (ZX 1000 KFFA/ABS) ZX10R 30th Anniversary Edition (ZX 1000 JFFA/Non ABS) ZX 10R (ZX1000 SGF) ZX 10R Winter Test Edition (ZX1000 SGFB) ZX 10R Ninja KRT Replica (ZX1000 SGFA) ZX-10RR ZX-10RR Performance	04-07 ▲ 08-15 ▲ 15 ▲ 15 ▲ 16 ▲ 16 ▲ 16 ▲ 16 ▲ 17-19 ▲ 17-19 ▲
SRC064 ■=CT013SP	HONDA NT 650 J/K/L (BROS) VT 750 CV/C2V/CW/C2W/CX/C2X /CY/C2Y/C1/C1Y/C4/C5/C6/C7/C8 VT 750 S (VT 50 SA/SB) XRV 650 J/K Africa Twin	88-92 ■ 97-09 ■ 10-12 ■ 88-89 ■	SRC080 ■=CT009	HONDA CBR 1000 RR4/RR5/RR6/RR7 # Fireblade CB 1000 R9/RA/RB/RC/RD/RE/RF Non ABS Model CB 1000 RA9/RAA/RAB/RAC/RAE /RAF/RAG (ABS Model)	04-07 ■ 09-15 ■ 09-16 ■
SRC065	YAMAHA YZF R1 (4XV7/8 5JJ1/8 5PW1/7)	99-03	SRC081 ▲=CT022 ●=CT033SP	SUZUKI SV 400 N (VK53A) SV 400 SN (VK53A) SV 400 X/Y/K1/K2 SV 400 SX/SY/SK1/SK2 SV 650 A/Y/K1/K2 Naked - Non ABS SV 50 SX/SY/SK1/SK2 Top Fairing Non ABS	98 ● 98 ● 00-02 ● 00-02 ● 99-02 ▲ 99-02 ▲
SRC066 ▲=CT014	HONDA CBR 600 FX/FY (Carb Model)	99-00 ▲	SRC082 ▲=CT033SP	SUZUKI SV 400 K3/K4/K5 SV 400 SK3/SK4/SK5 DL 650 K4-K6 V-Strom DL 650 AK7/AK8/AK9/AL0 V-Strom ABS DL 650 AL1XP V-Strom Xpedition DL 650 AL2/AL3/AL4/AL5 V-Strom DL 650 AK9 GT V-Strom Traveller ABS DL 650 XT V-Strom SFV 650 K9/L0/L1/L2/L3/L4/L5 SFV 650 AK9/AL0/AL1/AL2/AL3/AL4/AL5 (ABS) SV 650 K3/K4/K5/K6/K7/K8/K9/L0 Naked - Non ABS SV 650 AK7/AK8/AK9/AL0 Naked - ABS SV 650 SAK7/SAK8/SAK9/SAL0 SV 650 SK3/SK4/SK5/SK6/SK7/SK8 /SK9/SLO Top Fairing - Non ABS SV 650 (ABS)	03-05 ▲ 03-05 ▲ 04-06 ▲ 07-11 ■ 11 ▲ 12-15 ▲ 09-11 ▲ 15-20 ▲ 09-15 ▲ 09-15 ▲ 03-10 ▲ 07-10 ▲ 07-15 ▲ 03-15 ▲ 16-20 ▲
SRC067 ▲=CT021	SUZUKI GSX 1300 RX	99 ▲	SRC083 ▲=CT004	KAWASAKI ZX6RR (ZX 600 M1)	04 ▲
SRC068 ▲=CT019	SUZUKI TL 1000 RW/RX/RV TL 1000 SX/SY	98-00 ▲ 99-00 ▲			
SRC070 ▲=CT056SP	HONDA ST 1100 AN/AP/AR/AS Pan European (ABS Model) ST 100 AT/AV/AW/AX/AY/A1/A2 Pan European (ABS model) ST 1100 L/M/N/P/R/S/T/V/W/X/Y Pan European - Non ABS	92-95 ▲ 96-02 ▲ 90-02 ▲			
SRC071 ▲=CT014	SUZUKI GSXR 750 Y	00 ▲			
SRC072 ▲=CT008	YAMAHA XT 550 SRX 600 SRX 600 (1JK/3SX)	83 ▲ 86-87 ▲ 85-91 ▲			
SRC074 ■=CT008SP	YAMAHA YZF-R6 (8 plate)	03-05 ■			

Part No.	Make/Model	Year	Part No.	Make/Model	Year
SRC084 ▲=CT004	KAWASAKI ZX-6R (ZX 636 C1/C6F) ZX6RR (ZX 600 N1/N6F)	05-06 ▲ 05-06 ▲	SRC111 ▲=CT014	SUZUKI GSXR 750 K1/K2/K3	01-03 ▲
SRC085 ▲=CT015	SUZUKI GSXR 1000 K5/K6/K7/K8 GSX-S 1000 L8 (Naked/Non ABS) GSX-S 1000 AL8 (Naked/ ABS) GSX-S 1000 FL8 (Faired/Non ABS) GSX-S 1000 FAL8 (Faired/ ABS) Katana	05-08 ▲ 18-20 ▲ 18-20 ▲ 18-20 ▲ 18-20 ▲ 19-20 ▲	SRC112 ▲=CT014	SUZUKI GSXR 600 K1/K2/K3/ZK3	01-03 ▲
SRC086 ▲=CT015	SUZUKI GSXR 600 K6/K7	06-07 ▲	SRC113 ▲=CT041	APRILIA RSV4 Factory SBK Racing RSV4 Factory APRC RSV4R RSV4R APRC	09-10 ▲ 11-13 ▲ 10 ▲ 11-13 ▲
SRC087 ■=CT008SP	YAMAHA YZF R6 (9 plate)	06-18 ■	SRC115 ▲=CT035SP	SUZUKI GS 1000 HC/EC/EN/SN/ET	78-80 ▲
SRC088 ▲=CT015	SUZUKI GSXR 600 K8/K9/L0 GSXR 750 K6/K7/K8/K9/L0	08-10 ▲ 06-10 ▲	SRC118 ▲=CT009	KAWASAKI EX 300 ADF/AEF/AFF Ninja 300 (Non ABS) EX300 AEFA/AFFA Ninja 300 Special Edition (Non-ABS) EX300 BDF/BEF/BFF/BGF Ninja 300 (ABS) EX300 BEFA/BFFA/BGFA Ninja 300 Special Edition (ABS) Versys-X 300 ABS Z 300 Non ABS (ER 300 AFF) Z 300 ABS (ER 300 BFF)	13-15 ▲ 13-15 ▲ 13-16 ▲ 13-16 ▲ 17-20 ▲ 15 ▲ 15-16 ▲
SRC089 ▲=CT004	SUZUKI GSXR 1000 K1/K2/K3/K4 ZX9R (ZX 900 E1/E2/F1/F2) Z 1000 (ZR 1000 A1/A2/A3/A6F)	01-04 ▲ 00-03 ▲ 03-06 ▲	SRC119 ▲=CT012SP	HONDA CBR 125 RW7/RW8/RW9/RWA/ RWB/RC/RD/RF	07-16 ▲
SRC090	HONDA CRF 50 F	04-20	SRC120 ▲=CT009	SUZUKI GSXR 1000 L2/L3/ZL3/L4/ZL4L5/AL5/AL6	12-16▲
SRC091	ELSTARS (Pit Bikes) Various models (Check parts before fitting)		SRC121 ▲=CT014	SUZUKI GSXR 750 K4/K5	04-05 ▲
SRC093 ▲=CT020	YAMAHA YZF R1SP YZF R1	06 ▲ 07-08 ▲	SRC122 ▲=CT083SP	HONDA Monkey 125 MSX 125 D/E/F/G/H Grom (Non ABS) MSX 125 AH/AJ/AK Grom (ABS)	19-20 ▲ 13-20 ▲ 17-20 ▲
SRC094 ▲=CT014	HONDA CBR 900 RRN/RRP/RRR/RRS	92-95 ▲	SRC124 ▲=CT020	YAMAHA MT-09 (1RC/Non ABS/847cc/3 Cyl Engine) MT-09 Tracer ABS (847cc/3 Cyl Engine) MT-09A (2DR/ABS/847cc/3 Cyl Engine) MT-09A Sport Tracker ABS (847cc/3 Cyl Engine) MT-09A Street Rally ABS (847cc/3 Cyl Engine)	14-16 ▲ 15-20 ▲ 14-20 ▲ 14-20 ▲ 14-20 ▲
SRC095 ▲=CT043SP	HONDA CBR 1000 RR Fireblade (Diaphragm Type Clutch) CBR 1000 RR-SP ABS Fireblade (CBR1000 SAE/SAF/SAG) CBR 1000 RR-SP ABS -TT Edition	08-16 ▲ 14-16 ▲ 16 ▲	SRC125 ▲=CT020	YAMAHA MT-07 Non ABS (689cc/2 Cyl) MT-07A ABS (689cc/2 Cyl) MT-07 Motocage ABS (689cc/2 Cyl) XSR 700 ABS (MTM 690-U)	14-20 ▲ 14-20 ▲ 15 ▲ 16 ▲
SRC096 ▲=CT020	YAMAHA YZF R1	09-14 ▲	SRC126 ▲=CT020	YAMAHA FZ8 N-800cc (Naked/Single Headlight/Non ABS) FZ8 NA-800cc (Naked/Single Headlight/ABS) Fazer 8 S-800cc (Top Fairing/Twin Headlight/Non ABS) Fazer 8 SA-800cc (Top Fairing/Twin Headlight/ABS)	11-15 ▲ 11-15 ▲ 11-15 ▲ 11-15 ▲
SRC097 ▲=CT009	SUZUKI GSXR 1000 K9/L0/L1/L2	09-12 ▲	SRC127 ■=CT008SP	YAMAHA XJ6-N 600 (Naked - Non ABS & ABS Model - 20S) XJ6-F Diversion 600 (Full Fairing Diversion - Non ABS & ABS Models - 1CW) XJ6-S Diversion 600 (Top Fairing Diversion - Non ABS & ABS Models - 36C) XJ6-SP Diversion 600 (Non ABS & ABS Models)	09-15 ■ 10-15 ■ 09-15 ■ 13 ■
SRC098 ▲=CT021	KTM RC8 (1190cc) RC8 R Track (1190cc)	08-10 ▲ 10-12 ▲			
SRC099	YAMAHA XP 500 (T-Max Scooter - All models)	01-11			
SRC101 ▲=CT004	KAWASAKI ZX6R (ZX 600 P7F/P8F/R9F/RAF /RBF/RCF/RDF/REF/RF/RGF) (599cc)	07-16 ▲			
SRC103	HONDA VFR 1200 FA (Manual Gearbox Model)	10-15 ▲			
SRC110 ▲=CT015	SUZUKI GSX-R 600 GSX-R 750 GSX-S 750	11-20 ▲ 11-20 ▲ 15-20 ▲			

Part No.	Make/Model	Year	Part No.	Make/Model	Year
SRC128 ■=CT080	YAMAHA YZF-R3 (321cc/ABS) MTN 320 A (MT-03 321cc) MT-10 (998cc)	15-20 ■ 16 ■ 12-20 ■	SRC144 ▲=CT085	BMW F800 GS (Early type plates 14mm ears) F800 GT (Early type plates 14mm ears) F800 S (Early type plates 14mm ears) F800 ST (Early type plates 14mm ears)	08-11 ▲ 04-06 ▲ 04-06 ▲ 04-06 ▲
SRC129 ■=CT079SP	YAMAHA YZF- R1 YZF- R1 M YZF- R1 (60th Anniversary Edition) MT-10 (998cc)	15-20 ■ 15-20 ■ 16 ■ 16 ■	SRC145 ▲=CT083	BMW G 650 GS (R13) G 650 GS Sertao (R13) G 650 XCountry (K15)	08-16 ▲ 10-14 ▲ 08-10 ▲
SRC130 ▲=CT085	BMW F650 GS (Late type plates 2 x 13mm/7 x 14mm ears) F700 GS (Late type plates 2 x 13mm/7 x 14mm ears) F800 GS (Late type plates 2 x 13mm/7 x 14mm ears) F800 GS Adventure (Late type plates 2 x 13mm/7 x 14mm ears) F800 GT (Late type plates 2 x 13mm/7 x 14mm ears) F800 S (Late type plates 2 x 13mm/7 x 14mm ears) F800 ST (Late type plates 2 x 13mm/7 x 14mm ears) F800 R (Late type plates 2 x 13mm/7 x 14mm ears)	07-17 ▲ 11-17 ▲ 12-19 ▲ 12-19 ▲ 07-19 ▲ 07-19 ▲ 07-19 ▲ 05-19 ▲	SRC146 ▲=CT086SP	TRIUMPH Bonneville T120 (1200cc Liquid Cooled) Bonneville T120 Black (1200cc Liquid Cooled) Bonneville Bobber (1200cc Liquid Cooled) Bonneville Bobber Black (1200cc Liquid Cooled) Thruxton 1200 (Liquid Cooled) Thruxton R 1200 (Liquid Cooled)	16-18 ▲ 16-18 ▲ 17-20 ▲ 18-20 ▲ 16-20 ▲ 16-20 ▲
SRC131 ▲=CT017	YAMAHA XT 1200 Z Super Tenere (ABS/UBS Brake System) XT 1200 ZE Super Tenere (ABS/UBS Brake System) FJR 1300 N/P FJR 1300 R/AR/S/AS/AT (ABS) FJR 1300 A (1CY/Manual G/Shift) FJR 1300 AE (Electronic Suspension Adjustment/USD Forks) XVS 1300 A Midnight Star XVS 1300 CU Custom	10-16 ▲ 14-16 ▲ 01-02 ▲ 03-05 ▲ 06-15 ▲ 14-15 ▲ 07-16 ▲ 14-16 ▲	SRC147 ▲=CT086SP	TRIUMPH Bonneville T100 (900cc/Liquid Cooled/Spoke Wheel) Bonneville T100 Black (900cc/Liquid Cooled/Spoke Wheel) Street Cup (900cc Liquid Cooled) Street Scrambler (900cc Liquid Cooled) Street Twin (900cc Liquid Cooled)	16-18 ▲ 16-18 ▲ 16-20 ▲ 16-20 ▲ 16-18 ▲
SRC133 ▲=CT009	SUZUKI GSX 1400 K2/K3/K4/K5/K6/K7	02-07 ▲	SRC148 ▲=CT011	SUZUKI GSX-R 125 GSX-S 125 GSX 150 L6/DZAL6 Gixxer GSX-R 150 RF-Q/RFX-Q GSX-R 150 GSX-S 150	18-20 ▲ 18-20 ▲ 16 ▲ 17-18 ▲ 18-20 ▲ 18-20 ▲
SRC139	KTM 390 Duke RC 390	13-17 14-17	SRC149 ▲=CT014	HONDA CB 650 F (Non ABS) CB 650 FA (ABS) CBR 650 F (Non ABS) CBR 650 FA (ABS)	14-20 ▲ 14-20 ▲ 14-20 ▲ 14-20 ▲
SRC140	KTM Duke 250 RC 250 Duke 390 RC 390	15-19 15-18 15-17 16-17	SRC151 ▲=CT013	BMW G 310 GS G 310 R	17-20 ▲ 17-20 ▲
SRC141 ■=CT014SP	BENELLI Leoncino 500 Leoncino Trail 500 TRK 502 ABS Euro 4 TRK 502 X BN 600 GT BN 600 i BN 600 R BN 600 S	17-19 ▲ 18-19 ▲ 17-18 ▲ 18-19 ▲ 14-17 ■ 14-17 ■ 14-15 ■ 14-15 ■	SRC153	KTM Duke 200 RC 200	12-19 14-19
SRC142 ▲=CT009	SUZUKI GSXR 1000 ABS	17-20 ▲	SRC154	KTM Duke 125 RC 125	11-19 14-19
SRC143 ▲=CT014	HONDA GSXR 1000 AL7 CBR 600 FR1/FR2 (Rossi Injection Model) CBR 600 FS1/FS2 (CBR600 S Injection Model)	17 ▲ 01-02 ▲ 01-02 ▲	SRC155	KAWASAKI Ninja 650 (EX 650) Ninja 650 ABS (EX 650 ABS) Z 650 (ER 650) Z 650 ABS (ER 650 ABS)	12-18 12-18 12-18 12-18
			SRC160 ▲=CT008SP	YAMAHA YZF-R6	18-20 ▲
			SRC161	HONDA CB 1100 EX	16-19
			SRC162	YAMAHA XSR 900 ABS	18-20
			SRC163	KAWASAKI Ninja H2	15-20
			SRC164	KAWASAKI Ninja H2R	15-20

Part No.	Make/Model	Year	Part No.	Make/Model	Year
SRC165	BMW		SRC7008 ▲=CT708SP	HARLEY DAVIDSON	
	R 1200 GS	13-18		FLFBS Fat Boy 114	18 ▲
	R 1200 GS Adventure	13-18		FLFBS Fat Boy 114 Anniversary	18-20 ▲
	R 1200 R	13-18		FLFBS Fat Boy 114 Anniversary	18 ▲
	R 1200 RS	14-18		FLHCS Heritage Classic 114	18-20 ▲
	R 1250 GS	19-20		FLHCS Heritage Classic 114 Anniversary	18 ▲
	R 1250 GS TE	19-20		FLHP Road King Police	17 ▲
	R 1250 GS Rallye	19-20		FLHTCUTG Tri Glide Ultra	17-20 ▲
	R 1250 GS Rallye TE	19-20		FLHTCUTG Tri Glide Ultra Anniversary	18 ▲
	R 1250 GS Adventure	19-20		FLHTP Electra Glide Standard Police	17 ▲
R 1250 GS Adventure TE	19-20	FLRT Freewheeler	17-18 ▲		
R 1250 GS Adventure Rallye	19-20	FXBRS Breakout 114	18-20 ▲		
R 1250 GS Adventure Rallye TE	19-20	FXBRS Breakout 114 Anniversary	18 ▲		
			FXFBS Fat Bob 114	18 ▲	
SRC7001	INDIAN		SRC7009 ▲=CT703SP	HARLEY DAVIDSON	
	Octane	17		FLHP Road King Police	11-16 ▲
	Scout	15-16		FLHPE Road King Police	11 ▲
			FLHTCUTG Tri Glide Ultra Classic	09-13 ▲	
			FLHTCUTG ANV Tri Glide Ultra Classic Anv	13 ▲	
			FLHTP Electra Glide Standard Police	11-16 ▲	
			FLHXXX Street Glide Trike	10-11 ▲	
			FXDLS Dyna Low Rider S	16-20 ▲	
SRC7002	INDIAN		SRC7010 ▲=CT702SP	HARLEY DAVIDSON	
	Scout	17-20		FLHR Road King	17-20 ▲
	Scout 1200	17-20		FLHRC Road King Classic	17 ▲
			FLHRXS Road King Special	18 ▲	
			FLHTCU Electra Glide Ultra Classic	17-20 ▲	
			FLHTK Ultra Limited	17-20 ▲	
			FLHTK Ultra Limited Shrine Edition	18 ▲	
			FLHTK Ultra Limited Anniversary	18 ▲	
			FLHTKL Ultra Limited Low	17-20 ▲	
			FLHX Street Glide	17-20 ▲	
			FLHX Street Glide Anniversary	18 ▲	
			FLHXS Street Glide Special	17-20 ▲	
			FLHXS Street Glide Special Anniversary	18 ▲	
			FLTRU Road Glide Ultra	17-20 ▲	
			FLTRX Road Glide	17-20 ▲	
			FLTRXS Road Glide Special	17-20 ▲	
SRC7003 ▲=CT702SP	HARLEY DAVIDSON		SRC7011 ▲=CT703SP	HARLEY DAVIDSON	
	FLHTCUTG Tri Glide Ultra Classic	14-16 ▲		FLHR Road King	15-16 ▲
	FLRT Freewheeler	15-16 ▲		FLHR Road King	98-03 ▲
	FLHTK 103 CVO Limited	14 ▲		FLHRC Road King Classic	14-16 ▲
	FLHTCUL Ultra Classic Low	15-16 ▲		FLHRCI Road King Classic	98-99 ▲
	FLHTCUL TC Ultra Classic Low Twin-Cooled	15-16 ▲		FLHT Electra Glide Standard	98-03 ▲
	FLHTKL Ultra Limited Low	15-16 ▲		FLHTC Electra Glide Classic	98-03 ▲
	FLSS Softail Slim S	16 ▲		FLHTCU Ultra Classic	14-16 ▲
	FLSTFBS Fat Boy S	16-17 ▲		FLHTCU TC Ultra Classic Twin-Cooled	14-16 ▲
	FLSS Slim S	17 ▲		FLHTCUI Ultra Classic	98-03 ▲
FLSTFBS Fat Boy S	17 ▲	FLHTK Ultra Limited	14-16 ▲		
			FLHX Street Glide	14-16 ▲	
			FLHXS Street Glide Special	14-16 ▲	
			FLSTC Heritage Softail Classic	98-03 ▲	
			FLSTF Fat Boy	98-03 ▲	
			FLSTS Heritage Springer	98-03 ▲	
			FLTR Road Glide	98-03 ▲	
			FLTRU Road Glide Ultra	15-16 ▲	
			FLTRX Road Glide	15-16 ▲	
			FLTRXS Road Glide Special	15-16 ▲	
			FXD Dyna Super Glide	98-03 ▲	
			FXDL Dyna Low Rider	98-03 ▲	
			FXDS-CONV Dyna Glide Convertible	99-00 ▲	
			FXDWG Dyna Wide Glide	98-05 ▲	
			FXDX Dyna Super Glide Sport	99-03 ▲	
			FXDXT Dyna Super Glide T-Sport	01-03 ▲	
			FXST Softail Standard	99-03 ▲	
			FXSTB Night Train	99-03 ▲	
			FXSTC Softail Custom	98-99 ▲	
			FXSTD Softail Deuce	00-03 ▲	
			FXSTI Softail Standard	01-03 ▲	
			FXSTS Springer Softail	98-03 ▲	
SRC7004	INDIAN		SRC7012 ▲=CT703SP	HARLEY DAVIDSON	
	Chief Classic	14-20		FLD 103 Dyna Switchback	12-16 ▲
	Chief Dark Horse	16-20		FLHR 103 Road King	11-13 ▲
	Chief Vintage	14-20		FLHR Road King	04-05 ▲
	Chieftain	14-18		FLHR ANV Road King ANV	13 ▲
	Chieftain Dark Horse	16-20			
	Chieftain Elite	17-20			
	Chieftain Limited	17-18			
	Roadmaster	15-18			
	Roadmaster Classic	17-20			
Roadmaster Elite	18-20				
Springfield	16-20				
Springfield Dark Horse	18				
SRC7005	HARLEY DAVIDSON				
	XG500	15-20			
	XG750	15-20			
SRC7006 ▲=CT706SP	HARLEY DAVIDSON				
	VRSCAW V-Rod Wide Tire	08 ▲			
	VRSCAWA W/ABS	08 ▲			
	VRSCD Night Rod	08 ▲			
	VRSCDA Night Rod W/ABS	08 ▲			
	VRSCDXA Night Rod Special W/ABS	08 ▲			
	VRSCDX Night Rod Special	08-17 ▲			
	VRSCAW V-Rod	09-10 ▲			
	VRSCF V-Rod Muscle	09-17 ▲			
	VRSCDX ANV Night Rod Special Anv	12 ▲			
SRC7007 ▲=CT707SP	HARLEY DAVIDSON				
	VRSCA V-Rod	02-06 ▲			
	VRSCAW V-Rod	07 ▲			
	VRSCB V-Rod	04-05 ▲			
	VRSCR Street Rod	06-07 ▲			
	VRSCSE CVO V-Rod	05 ▲			
	VRSCSE2 CVO V-Rod	06 ▲			
	VRSCX Screamin' Eagle V-Rod	07 ▲			
	VRXSE CVO VR Destroyer	06 ▲			

Part No.	Make/Model	Year	Part No.	Make/Model	Year	
SRC7012 ▲=CT703SP Contd.	HARLEY DAVIDSON		SRC7013 ▲=CT703SP Contd.	HARLEY DAVIDSON		
	FLHRC 103 Road King Classic	11-13 ▲		FLSTSC Springer Classic	06-07 ▲	
	FLHRCI Road King Classic	04-05 ▲		FLTR Road Glide	06-09 ▲	
	FLHRI Road King	04-05 ▲		FLTRX Road Glide Custom	10-11 ▲	
	FLHRS Road King Custom	04-05 ▲		FXCW Rocker	08-09 ▲	
	FLHT Electra Glide Standard	04-05 ▲		FXCWC Rocker C	08-11 ▲	
	FLHTC 103 Electra Glide Classic	11-13 ▲		FXD Dyna Super Glide	07-10 ▲	
	FLHTC Electra Glide Classic	04-05 ▲		FXD35 Dyna 35th Anniversary Super Glide	06 ▲	
	FLHTCI Ultra Classic	05 ▲		FXDB Dyna Street Bob	07-17 ▲	
	FLHTCU 103 Ultra Classic	11-13 ▲		FXDBC Dyna Street Bob Limited	16 ▲	
	FLHTCUI Ultra Classic	04 ▲		FXDC Dyna Super Glide Custom	07-14 ▲	
	FLHTI Electra Glide Standard	04-05 ▲		FXDC ANV Dyna Super Glide Custom ANV	13 ▲	
	FLHTK Electra Glide Ultra Limited	10-13 ▲		FXDCI Dyna Super Glide Custom	06 ▲	
	FLHTK ANV Electra Glide Ultra Limited ANV	13 ▲		FXDF Dyna Fat Bob	08-17 ▲	
	FLHX 103 Street Glide	11-13 ▲		FXDI Dyna Super Glide	06 ▲	
	FLS 103 Softail Slim	12-15 ▲		FXDL Dyna Low Rider	06-17 ▲	
	FLS Slim	17 ▲		FXDWG Dyna Wide Glide	06-16 ▲	
	FLS Softail Slim	16 ▲		FXDWG ANV Dyna Wide Glide 105th Anniv.	08 ▲	
	FLSTC 103 Heritage Softail Classic	13-15 ▲		FXSB Softail Breakout	13-15 ▲	
	FLSTC 103 ANV Heritage Softail Classic ANV	13 ▲		FXST Softail Standard	07-11 ▲	
	FLSTC Heritage Softail Classic	04-05 ▲		FXSTB Night Train	06-09 ▲	
	FLSTC Heritage Softail Classic	16-17 ▲		FXSTC Softail Custom	07-10 ▲	
	FLSTCI Shrine Heritage Softail Classic Shrine	05 ▲		FXSTD Softail Deuce	06-07 ▲	
	FLSTF 103 Fat Boy	12-15 ▲		FXSTS Springer Softail	06 ▲	
	FLSTF Fat Boy	04-05 ▲				
	FLSTF Fat Boy	16-17 ▲		SRC7014	HARLEY DAVIDSON	
	FLSTFB 103 Fat Boy LO	12-17 ▲		▲=CT701SP	FLHR Road King	93-97 ▲
	FLSTFB 103 ANV Fat Boy LO ANV	13 ▲			FLHS Electra Glide Sport	91-94 ▲
	FLSTFI Shrine Fat Boy Shrine	05 ▲			FLHT Electra Glide Standard	94-97 ▲
	FLSTN 103 Softail Deluxe	12-15 ▲			FLHTC Electra Glide Classic	91-97 ▲
	FLSTN Softail Deluxe	05 ▲			FLHTCU Ultra Classic	91-97 ▲
	FLSTN Softail Deluxe	16-17 ▲			FLTC Tour Glide Classic	91-96 ▲
	FLSTSC Springer Classic	05-06 ▲				
	FLTRI Road Glide	04-05 ▲		SRC7015	HARLEY DAVIDSON	
	FLTRU Road Glide Ultra	11-13 ▲		▲=CT701SP	FLHS Touring Electra Glide Sport	90 ▲
	FLTRX 103 Road Glide Custom	11-13 ▲			FLHTC Touring Electra Glide Classic	90 ▲
	FXD Dyna Super Glide	04-05 ▲			FLHTCU Touring Electra Glide Classic Ultra	90 ▲
	FXDB 103 Dyna Street Bob	14-16 ▲			FLTC Touring Tour Glide Classic	90 ▲
	FXDB 103 Dyna Street Bob 103	17 ▲			FLTCU Touring Tour Glide Classic Ultra	90 ▲
	FXDBA 103 Dyna Street Bob (H-D1)	13-15 ▲				
	FXDBC 103 Dyna Street Bob Limited	16 ▲		SRC7016	HARLEY DAVIDSON	
	FXDC 103 Dyna Super Glide Custom	14 ▲		▲=CT705SP	FLH Touring Electra Glide	84 ▲
	FXDC Dyna Super Glide Custom	05 ▲			FLH Touring Electra Glide Shrine Shovelhead	84 ▲
	FXDF 103 Dyna Fat Bob	12-17 ▲			FLHS Touring Electra Glide Sport	84-89 ▲
	FXDI Dyna Super Glide	04-05 ▲			FLHT Touring Electra Glide Standard	88 ▲
	FXDL 103 Dyna Low Rider	14-16 ▲			FLHT Electra Glide Classic	84 ▲
	FXDL 103 Low Rider 103	17 ▲			FLHT Electra Glide	84 ▲
FXDL Dyna Low Rider	04-05 ▲		FLHTC Touring Electra Glide Classic	84-89 ▲		
FXDWG 103 Dyna Wide Glide	12-16 ▲		FLHTCU Touring Electra Glide Classic Ultra	89 ▲		
FXDWG 103 Dyna Wide Glide 103	17 ▲		FLST Softail Heritage	86-89 ▲		
FXDWGI Dyna Wide Glide	04-05 ▲		FLSTC Softail Heritage Classic	87-89 ▲		
FXDX Dyna Super Glide Sport	04-05 ▲		FLT Classic Tour Glide Classic	84 ▲		
FXS 103 Blackline	11-13 ▲		FLT Tour Glide	84 ▲		
FXSB 103 Softail Breakout	13-16 ▲		FLTC Touring Tour Glide Classic	84-89 ▲		
FXSB Breakout	17 ▲		FLTCU Touring Tour Glide Classic Ultra	89 ▲		
FXST 1BHY Softail Standard	04-06 ▲		FXE FX Super Glide	84 ▲		
FXST Softail Standard	12-15 ▲		FXEF FX Super Glide Fat Bob	85 ▲		
FXSTB Night Train	04-05 ▲		FXSB FX Low Rider	84-85 ▲		
FXSTD Softail Deuce	04-05 ▲		FXST Softail Standard	84-89 ▲		
FXSTS Springer Softail	04-05 ▲		FXSTC Softail Custom	86-89 ▲		
			FXSTS Softail Springer	88-89 ▲		
			FXWG FX Wide Glide	84-86 ▲		
SRC7013 ▲=CT703SP	HARLEY DAVIDSON		SRC7017 ▲=CT704SP	HARLEY DAVIDSON		
	FLD Dyna Switchback	12-16 ▲		FLH Touring Electra Glide	EARLY 84 ▲	
	FLHR Road King	06-11 ▲		FLH Touring Electra Glide Shrine Shovelhead	EARLY 84 ▲	
	FLHRC Road King Classic	06-11 ▲		FLHS Touring Electra Glide Sport	EARLY 84 ▲	
	FLHRS Road King Custom	06-07 ▲		FLHT Electra Glide	EARLY 84 ▲	
	FLHT Electra Glide Standard	06-10 ▲		FLHT Electra Glide Classic	EARLY 84 ▲	
	FLHTC Electra Glide Classic	06-11 ▲		FLT Classic Tour Glide Classic	EARLY 84 ▲	
	FLHTCU Ultra Classic	06-11 ▲		FLT Tour Glide	EARLY 84 ▲	
	FLHX Street Glide	06-11 ▲				
	FLS Softail Slim	12-15 ▲		SRC7018	HARLEY DAVIDSON	
	FLST Heritage Softail	06-09 ▲		▲=CT704SP	FLH Touring Electra Glide Shrine Shovelhead	83 ▲
	FLSTC 103 Heritage Softail Classic	06-15 ▲			FLH Electra Glide	81-83 ▲
	FLSTC ANV Heritage Softail Classic ANV	13 ▲			FLHC Touring Electra Glide Classic	81-82 ▲
	FLSTF Fat Boy	06-15 ▲			FLHC Electra Glide Classic	81 ▲
	FLSTFB Fat Boy LO	10-15 ▲			FLHS Touring Electra Glide Sport	81-83 ▲
FLSTFB ANV Fat Boy LO ANV	13 ▲		FLHS Heritage, Electra Glide	81 ▲		
FLSTN Softail Deluxe	06-15 ▲					
FLSTSB Cross Bones	08-11 ▲					

Part No.	Make/Model	Year	Part No.	Make/Model	Year	
SRC7018 ▲=CT704SP Contd.	HARLEY DAVIDSON		SRC7024 ▲=CT701SP	HARLEY DAVIDSON		
	FLHT Touring Electra Glide Standard	83 ▲		XL1200 Sportster 1200	88-90 ▲	
	FLHT Electra Glide Classic	83 ▲		XL883 Sportster 883	86-90 ▲	
	FLHT Electra Glide	83 ▲		XL883 Sportster 883 Deluxe	86-90 ▲	
	FLHTC Touring Electra Glide Classic	83-84 ▲		XL883HUG Sportster 883 Hugger	87-90 ▲	
	FLT Touring Tour Glide	81-83 ▲		XLH 1100 Sportster 1100	86-87 ▲	
	FLT Classic Tour Glide Classic	81-83 ▲		XLH Sportster 1000	84-85 ▲	
	FLT Tour Glide	81-83 ▲		XLS Sportster Roadster 1000	84 ▲	
	FLTC Touring Tour Glide Classic	80-84 ▲		XR-1000 Sportster	84 ▲	
	FXB Super Glide B80	81-82 ▲				
	FXDG Dyna Glide Glide Custom	83 ▲		SRC7025 ▲=CT701SP	HARLEY DAVIDSON	
	FXE FX Super Glide	81-84 ▲			XLCH-1000 Sportster 1000	71-84 ▲
	FXEF FX Super Glide Fat Bob	81 ▲			XLH-1000 Sportster 1000	79-80 ▲
	FXS FX Super Glide	81-82 ▲			XLH-1000 Sportster Standard	71-78 ▲
	FXSB FX Low Rider	83-84 ▲			XLS 1000 Sportster Roadster	81-84 ▲
	FXST Softail Standard	84 ▲			XR 1000 Sportster	83-84 ▲
FXWG FX Wide Glide	81-84 ▲					
SRC7019 ▲=CT701SP	HARLEY DAVIDSON					
	FLST Softail Heritage	90 ▲				
	FLSTC Heritage Softail Classic	90-97 ▲				
	FLSTF Fat Boy	91-97 ▲				
	FLSTF Softail Fat Boy	90 ▲				
	FLSTN Heritage Softail Nostalgia	93-96 ▲				
	FLSTS Heritage Springer	97 ▲				
	FXD Dyna Super Glide	95-97 ▲				
	FXDB Dyna Daytona	92 ▲				
	FXDB Dyna Sturgis	91 ▲				
	FXDC Super Glide Custom	92 ▲				
	FXDL Dyna Low Rider	93-97 ▲				
	FXDS-CONV Dyna Glide Convertible	93 ▲				
	FXDWG Dyna Wide Glide	93-97 ▲				
	FXST Softail Standard	90 ▲				
	FXSTC Softail Custom	90-97 ▲				
	FXSTS Springer Softail	90-97 ▲				
SRC7020 ▲=CT701SP	HARLEY DAVIDSON					
	XL1200 Forty Eight Anniversary	18 ▲				
	XL1200C Sportster 1200 Custom	04-20 ▲				
	XL1200C Sportster 1200 Custom ANV	13 ▲				
	XL1200CA Sportster 1200 Custom Limited A	13-16 ▲				
	XL1200CB 1200 Custom Limited B	17 ▲				
	XL1200CB Sportster 1200 Custom Limited A	13-16 ▲				
	XL1200CP Sportster 1200 Custom (H-D1)	11-16 ▲				
	XL1200CX 1200 Roadster	16-20 ▲				
	XL1200L Sportster 1200 Low	06-11 ▲				
	XL1200N Nightster	07-12 ▲				
	XL1200R Sportster 1200 Roadster	04-09 ▲				
	XL1200T SuperLow 1200T	14-20 ▲				
	XL1200V Seventy-Two	12-16 ▲				
	XL1200X Forty Eight	10-20 ▲				
	XL50 50th ANV Sportster	07 ▲				
SRC7021 ▲=CT701SP	HARLEY DAVIDSON					
	XL883 Sportster 883	04-09 ▲				
	XL883C Sportster 883 Custom	04-10 ▲				
	XL883L Sportster XL883 Low	05-11 ▲				
	XL883L SuperLow	14-16 ▲				
	XL883L SuperLow	12-20 ▲				
	XL883N Iron 883	09-20 ▲				
	XL883R 883 Roadster	11-15 ▲				
	XL883R Sportster 883R	07-10 ▲				
SRC7022 ▲=CT701SP	HARLEY DAVIDSON					
	XR1200 Sportster 1200	08-10 ▲				
	XR1200X XR1200X	10-13 ▲				
SRC7023 ▲=CT701SP	HARLEY DAVIDSON					
	XL1200 Sportster 1200	91-03 ▲				
	XL1200C Sportster 1200 Custom	96-03 ▲				
	XL1200S Sportster 1200 Sport	96-03 ▲				
	XL883 Sportster 883	91-03 ▲				
	XL883C Sportster 883 Custom	98-03 ▲				
	XL883DLX Sportster 883 Deluxe	91-95 ▲				
	XL883HUG Sportster 883 Hugger	91-03 ▲				
	XL883R Sportster 883R	02-06 ▲				

SRK CLUTCH KITS BUYERS GUIDE

SRK002	HONDA VF 750 FD/FE	83-85	SRK019 ●=CT014SP	HONDA CB 600 Hornet FW/FX/FY/F2-Y /F1/F21/F2/F22/F3/F4/F5/F6 CBR 600 FM/FN/FP/FR/FS/FT/FV/FW CBF 600 N4/N5/N6 (Non ABS) CBF 600 NA4/NA5/NA6 (ABS) CBF 600 S4/S5/S6 (Non ABS) CBF 600 SA4/SA5/SA6 (ABS)	98-06 ● 91-98 ● 04-06 ● 04-06 ● 04-06 ● 04-06 ●
SRK003 ▲=CT014	HONDA VFR 750 FG/FH/FJ/FL/FMFN/FP /FR/FS/FT/FV	86-97 ▲	SRK020 ▲=CT016	KAWASAKI ZL 900 A1/A2 Eliminator Z 1000 E1/E2 (ST-Shaft) GPz 1000 RX A1-A3 1000 GTR (ZG 1000 A1-A18) ZL 1000 A1 GPz 1100 A1-A3 Z 1100 A1-A3 Z 1100 D1/D2 Spectre Z 1100 R1 ZR 1100 A1/A2/A3/A4/B1 ZRX 1100 (ZX 1100 C1/C2/C3/C4)	85-86 ▲ 79-80 ▲ 86-88 ▲ 86-03 ▲ 87 ▲ 82-85 ▲ 81-83 ▲ 82-83 ▲ 84 ▲ 92-97 ▲ 97-00 ▲
SRK004 ■=CT009	HONDA CB 1000 FP/FR/FS/FT/FV CBR 1000 FH/FJ/FK/FL/FM/FN/FP /FR/FS/FT/FV/FW/FX	93-97 ■ 87-99 ■	SRK021 ▲=CT004	KAWASAKI ZXR 400 (ZX 400 L1-L5/L8/L9)	91-02 ▲
SRK005 ▲=CT014	HONDA VFR 750 RJ/RK/RL (RC30)	88-92 ▲	SRK022 ▲=CT016	KAWASAKI ZL 400 A Eliminator ZL 400 B Eliminator 400 SE ZZ-R 600 D1/D2/D2A/D3 650 Vulcan S (EN 650 AFF/AGF/Non ABS) 650 Vulcan S (EN 650 BFF/BGF/ ABS)	86-87 ▲ 88 ▲ 90-92 ▲ 15-16 ▲ 15-16 ▲
SRK006 ▲=CT010	YAMAHA FZR 400 RR (4DX) FZR 400 Genesis (1WG) FZR 400 (3EN1/3EN2) FZR 400 RR (3TJ1)	92 ▲ 86 ▲ 88-89 ▲ ▲	SRK024 ▲=CT016	KAWASAKI ZXR 750 J1/J2/L1-L3/P1-P7 ZXR 750 R (ZX 750 K1/K2/M1/M2)	91-03 ▲ 91-94 ▲
SRK007 ▲=CT010	YAMAHA FZR 400 RSP (2TK-EXUP) FZR 400 RRSP (3TJ2/6/7) FZR 600	87 ▲ ▲ 89-93 ▲	SRK025 ▲=CT021	KAWASAKI ZZ-R 1100 C1/C2/C2A/C3/D1-D9 ZX 1100 E1/E2/F1 ZZR 1200 C1H/C2H	90-01 ▲ 95-98 ▲ 02-04 ▲
SRK008 ■=CT008SP	YAMAHA FZR 750 FZR 1000	87 ■ 87-88 ■	SRK029 ■=CT008SP	YAMAHA FZR 1000 GTS 1000 YZF 1000 Thunder Ace	93-95 ■ 93-96 ■ 96-02 ■
SRK009 ■=CT008SP	YAMAHA FZR 750 R OW01 YZF 750 R/SP TDM 850 TRX 850	89-90 ■ 93-97 ■ 96-98 ■ 96-98 ■	SRK031 ■=CT008SP	YAMAHA FZR 1000	89-92 ■
SRK010 ▲=CT055SP	SUZUKI GSX 1100 GM/GN GSXR 1100 K/L/M/N	91-94 ▲ 89-92 ▲	SRK033 ▲=CT054SP	YAMAHA YZF 600 Thunder Cat	96-03 ▲
SRK011 ▲=CT016	KAWASAKI Z 400 J1-J3 ZR 400 A1/B1 (Z 400 F) ZX 400 C2 (Z 400 F 11) EN 450 A1-A5 (Ltd 454) EN 500 A1/A2/A3/A4/B1/B2/C1-C9 ER-5 (ER 500 A1/A2/A3/A4/C1-C5P) EX 500 A1-A6/D1-D7 (GPz 500 S) GPZ 500 (S) (EX 500 B1-B5) GPZ 500 S (EX 500 E1-E10) Z 500 A1-A3/B1/B2 GT 550 G1-G9 GPz 550 D1/H1/H2/A1-A4 ZR 550 A1/A2 (Z 550 F) Z 550 C1/C2 (Ltd) KL 600 A1 (KLR 600) KLR 600 B1/B2/B4/B6-B9 GPz 600 R A1-A6	80-83 ▲ 83-84 ▲ 85 ▲ 86-89 ▲ 90-04 ▲ 97-07 ▲ 87-02 ▲ 88-93 ▲ 94-04 ▲ 79-81 ▲ 83-01 ▲ 81-87 ▲ 83-84 ▲ 80-81 ▲ 84 ▲ 85-94 ▲ 85-89 ▲	SRK034 ▲=CT010	YAMAHA FZR 250 FZR 250 R (3LN1/3/5/6/7) FZX 250 Zeal (3YX1/2/4)	87 ▲ ▲ 91-92 ▲
SRK013 ▲=CT029	SUZUKI GSX 600 FJ/FK/FL/FM GSXR 750 F/G/H (GR75A)	88-91 ▲ 85-87 ▲	SRK038 ▲=CT004	KAWASAKI ZX-6R (ZX 600 J1/J2) ZX6R (ZX636A1P) 636cc ZX6R (ZX 636 B1/B2)	00-01 ▲ 02 ▲ 03-04 ▲
SRK014	SUZUKI GSXR 750 J/K	88-89	SRK039 ▲=CT055SP	SUZUKI RF 900 RR GSXR 1100 WP/WR/WS/WT	94 ▲ 93-96 ▲
SRK015 ▲=CT048SP	SUZUKI GSX R 1100 G/H/J	86-88 ▲	SRK040 ▲=CT055SP	SUZUKI GSXR 750 T/V/W/X GS 1200 SSK/ZK1 (GV78A) GSF 1200 SAV ABS Bandit GSF 1200 K1/K2/K3/K4/K5 (Naked Bandit - 6 piston caliper) GSF 1200 SK1/SK2/SK3/SK4/SK5 (Faired Bandit) (6 piston caliper)	96-99 ▲ 01 ▲ 97 ▲ 01-05 ▲ 01-05 ▲
SRK016 ■=CT009SP	HONDA CBR 500 FH/FJ/FK/FL CBR 600 FH/FJ	87-90 ■ 87-88 ■			
SRK017	SUZUKI GSX 600 FN/FP/FR/FS/FT/FV GSXR 750 L/M/WN	92-97 90-92			

Part No.	Make/Model	Year	Part No.	Make/Model	Year
SRK040 ▲=CT055SP Contd.	SUZUKI Contd. GSF 1200 TV/W/X/Y (Naked Bandit) piston caliper GSF 1200 ST/SV/SW/SX/SY (Faired Bandit) piston caliper GSX 1200 FSW/FSX Inazuma GSF 1200 K6/AK6 (Naked Bandit) (4 piston caliper) Non & Non ABS Version GSF 1200 SK6/SAK6 (Faired Bandit) (4 piston caliper) Non & Non ABS Version	96-00 ▲ 98-99 ▲ 06 ▲ 06 ▲	SRK051 ■=CT008SP	YAMAHA YZF 600 R R6 (8 plate) FZ6 Naked/Non ABS 2 piston caliper (IB3/IB3D) FZ6-NS Naked/Non ABS (2 piston caliper) (IB35/6) FZ6-Fazer (Half Fairing/Non ABS /2 piston caliper) (5VX/5VXL) FZ6-Fazer (ABS/Half Fairing /2 piston caliper) FZ6 Fazer S2 (ABS/Half Fairing /4 piston caliper) FZ6 Fazer S2 (Non ABS/Half Fairing/4 piston caliper) FZ6 S2 (Naked/Non ABS /4 piston caliper) (5S51/5S5) FZX 700 S/SC/T/TC Fazer FZ 750	99-02 ■ 04-07 ■ 05-06 ■ 04-07 ■ 06-07 ■ 08 ■ 07-09 ■ 07-09 ■ 86-87 ■ 85-86 ■
SRK041 ▲=CT016	KAWASAKI ZX7 RR (ZX 750 N1/N2) ZX-9R (ZX 900 B1-B4)	96-99 ▲ 94-97 ▲	SRK053 ▲=CT016	KAWASAKI VN 700 A1 Vulcan Z 750 Y1 (Ltd) VN 800 C1/C2/E1/E2/E3 Drifter GPZ 900 R A1-A8 GPZ 900 R (ZX 900 A11) GPZ 900 R (ZX 900 A12-15)	85 ▲ 82 ▲ 99-04 ▲ 84-96 ▲ 98 ▲ 99-02 ▲
SRK042 ■=CT009SP	HONDA CBR 600 FK/FL	89-90 ■	SRK054 ▲=CT016	KAWASAKI Z 1000 R1/R2 (Eddie Lawson Replica) Z 1000 J1/J2/J3 Z 1000 K1/K2 LTD GPZ 1100 B1/B2	82-83 ▲ 81-83 ▲ 81-82 ▲ 81-82 ▲
SRK043 ▲=CT016	KAWASAKI ZZR 600 (ZX 600 E1-E13) ZZR 600 (ZX 600 E6F)	93-05 ▲ 06-07 ▲	SRK055 ▲=CT014	HONDA CBR 900 RRT/RRV	96-97 ▲
SRK044 ▲=CT016	KAWASAKI ZR 400 Zephyr (G2/G3/G3A/G4/G5) ZL 600 B1 ZR 550 B2-B6 Zephyr GPX 600 R (C1-C3/C6/C7)	97-01 ▲ 95-97 ▲ 91-99 88-96	SRK056 ▲=CT017	YAMAHA YZF R1 (4XV1/2)	98 ▲
SRK045	SUZUKI RF 600 RP/RR/RS/RT	93-96	SRK057 ▲=CT014	HONDA CBR 600 FS1/FS2 Sport CBR 600 FB/FAB/FC/FAC CB 900 F2/F3/F4/F5/F6/F7 Hornet CBR 900 RRW/RRX (918cc)	01-02 ▲ 11-12 ▲ 02-07 ▲ 98-99 ▲
SRK046 ▲=CT016	KAWASAKI W 650 (EJ 650 A1/C3-C7) GPX 750 F1/F2/F2A/F3 VN 750 A2/A3/A4/A5/A10 Z 750 D1 Z 750 B1/B2 EJ 800 ABF/ACF (W 800/Solid F isc) EJ 800 (W 800 Cafe style/Cockpit fairing) EJ 800 ACFA (W 800 Special Edition Black Exhaust/Gold Rims EJ 800 ADF/AEF/AFF/AGF (W 800) EJ 800 ADFA/AEFA/AFFA/AGFA (W 800 Special Edition) VN 800 A1-A3/B1-B10/B6F W 800 AEFA W800 Special Edition VN 900 A6F Classic VN 900 C7F/C8F/C9FA/CAF/CBF/CCFA /CDF/CEFA/CFFA Custom (Cast wheel) VN 900 B7F/B8F/B9F/BAF/BBF/BCF /BDF/BEF/BFF Classic (Spoke wheel) VN 900 BBFA/BCFA/BDFA/BEFABFFA Classic Special Edition	99-05 ▲ 87-89 ▲ 86-94 ▲ 76 ▲ 77-78 ▲ 11-12 ▲ 11 ▲ 12 ▲ 13-16 ▲ 13-16 95-06 ▲ 14 ▲ 06 ▲ 07-15 ▲ 07-15 ▲ 11-15 ▲	SRK058 ▲=CT014	SUZUKI GSXR 600 X/Y	99-00 ▲
SRK047 ■=CT012SP	HONDA CB 250 FT/FV/FX/FY/F1 (MC31) Hornet CBR 250 FG/RH/RJ/RK/RK2 (MC14/17/19) CBR 250 RRL/RRN/RRR (MC22 100/105/110) VT 250 CR/CT/CV Magna (MC29) VTZ 250 H/J/K VTR 250 W/Y (MC33)/1-7	96-01 ■ 86-89 ■ 90-94 ■ 95-97 ■ 86-88 ■ 98-07 ■	SRK059 ▲=CT004	KAWASAKI ZX9R (ZX 900 C1/C2)	98-99 ▲
SRK048 ■=CT009SP	HONDA CBX 550 FC/F2C/FD/F2D	82-85 ■	SRK060	HONDA VTR 1000 FV/FW/FX/FY/F1-F6 Firestorm	97-06
SRK049 ■=CT013SP	HONDA CBR 400 RRL/RRN/RRR (NC29)	90-94 ■	SRK061 ■=CT013SP	HONDA NT 400 Bros NC 25 NV 400 C.J/CK (Steed) NV 400 CS/CV Steed NV 400 DCY/DC1/DC2 (NC40) Shadow Slasher	92-93 ■ 95-97 ■ 00-02 ■
SRK050 ▲=CT024SP	SUZUKI GS 1000 GT/GX GSX 1000 SZ GS 1100 GZ GSX 1100 ET/EX/EZ GSX 1100 SZ GSX 1100 EFE/EFG/ESF	80-81 ▲ 82 ▲ 82 ▲ 80-82 ▲ 82 ▲ 84-86 ▲	SRK062 ■=CT013SP	HONDA NTV 650 J/K/L/M/P/S/T/V NT 650 VW/VX/VY/V1-V5 Deauville NC 700 SC/SD (Manual Gearbox) NC 700 XC/XD (Manual Gearbox) NT 700 VA6/V6/VA7/V7/V8 /VA8/VA/VAA Deauville NC 750 S NC 750 S (ABS) NC 750 X NC 750 X (ABS)	88-97 ■ 98-05 ■ 12-13 ■ 12-17 ■ 06-12 ■ 14-15 ■ 14-18 ■ 14-15 ■ 14-19 ■
			SRK063 ▲=CT002	HONDA VFR 400 R3K/R3L/R3M/R3N (NC30)	89-92 ▲

Part No.	Make/Model	Year	Part No.	Make/Model	Year
SRK064 ■=CT013SP	HONDA NT 650 J/K/L (BROS) VT 750 CV/C2V/CW/C2W/CX/C2X /CY/C2Y/C1/C1Y/C4/C5/C6/C7/C8 VT 750 S (VT 50 SA/SB) XRV 650 J/K Africa Twin	88-92 ■ 97-09 ■ 10-12 ■ 88-89 ■	SRK080 ■=CT009	HONDA CBR 1000 RR4/RR5/RR6/RR7 # Fireblade CB 1000 R9/RA/RB/RC/RD/RE/RF Non ABS Model CB 1000 RA9/RAA/RAB/RAC/RAE /RAF/RAG (ABS Model)	04-07 ■ 09-15 ■ 09-16 ■
SRK065	YAMAHA YZF R1 (4XV7/8 5JJ1/8 5PW1/7)	99-03	SRK081 ▲=CT022 ●=CT033SP	SUZUKI SV 400 N (VK53A) SV 400 SN (VK53A) SV 400 X/Y/K1/K2 SV 400 SX/SY/SK1/SK2 SV 650 A/Y/K1/K2 Naked - Non ABS SV 50 SX/SY/SK1/SK2 Top Fairing Non ABS	98 ● 98 ● 00-02 ● 00-02 ● 99-02 ▲ 99-02 ▲
SRK066 ▲=CT014	HONDA CBR 600 FX/FY (CARB MODEL)	99-00 ▲	SRK082 ▲=CT033SP	SUZUKI SV 400 K3/K4/K5 SV 400 SK3/SK4/SK5 DL 650 K4-K6 V-Strom DL 650 AK7/AK8/AK9/AL0 V-Strom ABS DL 650 AL1XP V-Strom Xpedition DL 650 AL2/AL3/AL4/AL5 V-Strom DL 650 AK9GT V-Strom Traveller DL 650 XT V-Strom SFV 650 K9/L0/L1/L2/L3/L4/L5 SFV 650 AK9/AL0/AL1/AL2/AL3/AL4/AL5 (ABS) SV 650 K3/K4/K5/K6/K7/K8/K9/L0 Naked - Non ABS SV 650 SK3/SK4/SK5/SK6/SK7/SK8 /SK9/SLO Top Fairing - Non ABS SV 650 AK7/AK8/AK9/AL0 Naked - ABS SV 650 SAK7/SAK8/SAK9/SALO (ABS) SV 650 (ABS)	03-05 ▲ 03-05 ▲ 04-06 ▲ 07-11 ▲ 11 ▲ 12-14 ▲ 09-11 ▲ 15-20 ▲ 09-15 ▲ 09-15 ▲ 03-10 ▲ 03-15 ▲ 07-10 ▲ 07-15 ▲ 16-20 ▲
SRK067 ▲=CT021	SUZUKI GSX 1300 RX	99 ▲	SRK083 ▲=CT004	KAWASAKI ZX6RR (ZX 600 M1)	04 ▲
SRK068 ▲=CT009	SUZUKI TL 1000 RW/RX/RY TL 1000 SX/SY	98-00 ▲ 99-00 ▲	SRK084 ▲=CT004	KAWASAKI ZX-6R (ZX 636 C1/C6F) ZX-6RR (ZX 600 N1/N6F)	05-06 ▲ 05-06 ▲
SRK070 ▲=CT056SP	HONDA ST 1100 AN/AP/AR/AS Pan European (ABS Model) ST 100 AT/AV/AW/AX/AY/A1/A2 Pan European (ABS Model) ST 1100 L/M/N/P/R/S/T/V/W/X/Y Pan European - Non ABS	92-95 ▲ 96-02 ▲ 90-02 ▲	SRK085 ▲=CT015	SUZUKI GSXR 1000 K5/K6/K7/K8 GSX-S 1000 (Naked/Non ABS) GSX-S 1000 (Naked/ ABS) GSX-S 1000 F (Faired/Non ABS) GSX-S 1000 F (Faired/ ABS) Katana	05-08 ▲ 18-20 ▲ 18-20 ▲ 18-20 ▲ 18-20 ▲ 19-20 ▲
SRK071 ▲=CT014	SUZUKI GSXR 750 Y	00 ▲	SRK086 ▲=CT015	SUZUKI GSXR 600 K6/K7	06-07 ▲
SRK072 ▲=CT008	YAMAHA XT 550 SRX 600 SRX 600 (1JK/3SX)	83 ▲ 86-87 ▲ 85-91 ▲	SRK087 ▲=CT008SP	YAMAHA YZF R6 (9 plate)	06-18 ■
SRK074 ■=CT008SP	YAMAHA YZF-R6 (8 plate)	03-05 ■	SRK088 ▲=CT015	SUZUKI GSXR 750 K6/K7	06-07 ▲
SRK075 ▲=CT014	HONDA CB 600 F7/F8/F9/FA/FB/FC Hornet CB 600 FA7/FA8/FA9/FAA/FAB /FAC Hornet (ABS) CBF 600 N8/N9/NA (Non ABS) CBF 600 NA8/NA9/NAA (ABS) CBF 600 S8/S9 (Non ABS) CBF 600 SA8/SA9/SA (ABS) CBR 600 RR3/RR4/RR5/RR6/RR7 /RR8/RR9/RRA/RBB/RRC/RRD RRE/RRF/RRG/RRH/RRJ/RRK CBR 600 RR Hannspree CBR 600 RA9/RAA/RAB /RAC/RAD/RAG/RAH/RAJ/RAK (C-ABS) CBR 600 FB/FC VFR 800 XA (Crossrunner/ABS) VFR 800 XA (Crossrunner/ABS) VFR 800 F (ABS Model)	07-13 ▲ 07-13 ▲ 08-11 ▲ 08-11 ▲ 08-09 ▲ 08-12 ▲ 03-19 ▲ 08 ▲ 09-19 ▲ 11-13 ▲ 11-13 ▲ 15-16 ▲ 14-16 ▲	SRK089 ▲=CT004	SUZUKI GSXR 1000 K1/K2/K3/K4 ZX9R (ZX 900 E1/E2/F1/F2) Z 1000 (ZR 1000 A1/A2/A3/A6F)	01-04 ▲ 00-03 ▲ 03-06 ▲
SRK076 ▲=CT004	KAWASAKI ZX6RR (ZX 600 K1)	03 ▲	SRK093 ▲=CT020	YAMAHA YZF R1SP YZF R1	06 ▲ 07-08 ▲
SRK077 ▲=CT020	YAMAHA FZ1 (Naked) (1000cc) (2D11) FZ-1 Fazer Non ABS (1000cc) (3C3) FZ-1 Fazer (Half Fairing - ABS - 5D0) FZ1 N/NA Naked (Non ABS/ABS) YZF R1	06-09 ▲ 06-15 ▲ 08-15 ▲ 10-15 ▲ 04-06 ▲	SRK094 ▲=CT014	HONDA CBR 900 RRN/RRP/RRR/RRS	92-95 ▲
SRK078 ▲=CT014	SUZUKI GSXR 600 K4/K5	04-05 ▲	SRK095 ▲=CT043SP	HONDA CBR 1000 RR Fireblade CBR 1000 RR-SP ABS Fireblade CBR 1000 RR-SP ABS -TT Edition	08-16 ▲ 14-16 ▲ 16 ▲
SRK079 ▲=CT004	KAWASAKI ZX 10R (ZX 1000 C1/C2) ZX-10RR ZX-10RR Performance	04-05 ▲ 17-19 ▲ 17-19 ▲	SRK096 ▲=CT020	YAMAHA YZF R1	09-14 ▲

Part No.	Make/Model	Year	Part No.	Make/Model	Year
SRK097 ▲=CT009	SUZUKI GSXR 1000 K9/L0/L1/L2	09-12 ▲	SRK118 ▲=CT009	KAWASAKI EX 300 ADF/AEF/AFF Ninja 300 (Non ABS) EX300 AEFA/AFFA Ninja 300 Special Edition (Non-ABS) EX300 BDF/BEF/BFF/BGF Ninja 300 (ABS) EX300 BEFA/BFFA/BGFA Ninja 300 Special Edition (ABS) Versys-X 300 ABS Z 300 Non ABS (ER 300 AFF) Z 300 ABS (ER 300 BFF)	13-15 ▲ 13-15 ▲ 13-16 ▲ 13-16 ▲ 17-20 ▲ 15 ▲ 15-16 ▲
SRK098 ▲=CT021	KTM RC8 (1190cc) RC8 R Track (1190cc)	08-10 ▲ 10-12 ▲	SRK119 ▲=CT012SP	HONDA CBR 125 RW7/RW8/RW9/RWA/ RWB/RW9/RC/RD/RF (No judder spring)	07-16 ▲
SRK099	YAMAHA XP 500 (T-Max Scooter - All models)	01-11	SRK121 ▲=CT014	SUZUKI GSXR 750 K4/K5	04-05 ▲
SRK100 ▲=CT014	HONDA CBR 900 RRY/RR1 (929cc Fireblade) CBR 900 RR2/RR3 (954cc) Fireblade	00-01 ▲ 02-03 ▲	SRK122 ▲=CT083SP	HONDA Monkey 125 MSX 125 Grom MSX 125 A Grom ABS	19-20 ▲ 13-20 ▲ 17-20 ▲
SRK101 ▲=CT004	KAWASAKI ZX-6R (ZX 600 P7F/P8F/R9F/RAF /RBF/RCF/RDF/REF/RF/RGF) (599cc)	07-16 ▲	SRK124 ▲=CT020	YAMAHA MT-09 (1RC/Non ABS/847cc/3 Cyl Engine) MT-09 Tracer ABS (847cc/3 Cyl Engine) MT-09A (2DR/ABS/847cc/3 Cyl Engine) MT-09A Sport Tracker ABS (847cc/3 Cyl Engine) MT-09A Street Rally ABS (847cc/3 Cyl Engine)	14-16 ▲ 15-20 ▲ 14-20 ▲ 14-20 ▲ 14-20 ▲
SRK102 ▲=CT016	KAWASAKI ER-6f (EX 650 A6F/A7F/A8F) ER-6f (ABS Model) (EX 650 B6F/B7F/B8F) ER-6n (ER 650 A6F/A7F/A8F) ER-6n (ABS) ER 650 B6F/B7F/B8F /C9F/CAF/CBF ER-6f (ECF/EDS/EEF/EFF) (non ABS) ER-6f (FCF/FDE/FEF/FFF/FGF) (with ABS) ER-6n (ECF/EDF/EEF/EFF) (non ABS) ER-6n (FCF/FDF/FEF/FFF/FGF) (with ABS) KLE 650 A7F/A8F/A9F/CAF/CBF /CCF/CDF Versys KLE 650 B7F/B8F/B9F/DAF/DBF DCF/DDF Versys ABS	06-08 ▲ 06-08 ▲ 06-08 ▲ 06-08 ▲ 06-08 ▲ 12-15 ▲ 12-16 ▲ 12-15 ▲ 12-16 ▲ 07-13 ▲ 07-13 ▲	SRK125 ▲=CT020	YAMAHA MT-07 Non ABS (689cc/2 Cyl) MT-07A ABS (689cc/2 Cyl) MT-07 Motocage ABS (689cc/2 Cyl) XSR 700 ABS (MTM 690-U)	14-20 ▲ 14-20 ▲ 15 ▲ 16 ▲
SRK103 ▲=CT009	HONDA VFR 1200 FA (Manual Gearbox Model)	10-15 ▲	SRK126 ▲=CT020	YAMAHA FZ8 N-800cc (Naked/Single Headlight/Non ABS) FZ8 NA-800cc (Naked/Single Headlight/ABS) Fazer 8 S-800cc (Top Fairing/Twin Headlight/Non ABS) Fazer 8 SA-800cc (Top Fairing/Twin Headlight/ABS)	11-15 ▲ 11-15 ▲ 11-15 ▲ 11-15 ▲
SRK104 ▲=CT036SP	SUZUKI GSXR 750 WP/WR/WS	93-95	SRK127 ■=CT008SP	YAMAHA XJ6-N 600 (Naked - Non ABS & ABS Model - 20S) XJ6-F Diversion 600 (Full Fairing Diversion - Non ABS & ABS Models - 1CW) XJ6-S Diversion 600 (Top Fairing Diversion - Non ABS & ABS Models - 36C) XJ6-SP Diversion 600 (Non ABS & ABS Models)	09-15 ■ 10-15 ■ 09-15 ■ 13 ■
SRK106 ▲=CT014	SUZUKI GSXR 600 V/W	97-98 ▲	SRK128 ■=CT080	YAMAHA YZF-R3 (321cc/ABS) MT-03 ABS	15-20 ■ 12-20 ■
SRK107 ▲=CT004	KAWASAKI ZX-6RR (ZX 600 N1/N6F)	05-06 ▲	SRK129 ■=CT079SP	YAMAHA YZF- R1 YZF- R1 M YZF- R1 (60th Anniversary Edition) MT-10 (998cc)	15-20 ■ 15-20 ■ 16 ■ 16 ■
SRK108 ▲=CT004	KAWASAKI ZX-6R (ZX 600 F1/F2/F3) ZX-6R (ZX 600 G1/G2)	95-97 ▲ 98-99 ▲	SRK130 ▲=CT085	BMW F650 GS (Late type plates 2 x 13mm/7 x 14mm ears) F700 GS (Late type plates 2 x 13mm/7 x 14mm ears) F800 GS (Late type plates 2 x 13mm/7 x 14mm ears) F800 GS Adventure (Late type plates 2 x 13mm/7 x 14mm ears) F800 GT (Late type plates 2 x 13mm/7 x 14mm ears) F800 S (Late type plates 2 x 13mm/7 x 14mm ears) F800 ST (Late type plates 2 x 13mm/7 x 14mm ears) F800 R (Late type plates 2 x 13mm/7 x 14mm ears)	07-17 ▲ 11-17 ▲ 12-19 ▲ 12-19 ▲ 07-19 ▲ 07-19 ▲ 07-19 ▲ 07-19 ▲ 05-19 ▲
SRK109 ▲=CT015	SUZUKI GSXR 600 K8/K9/L0 GSXR 750 K8/K9/L0	08-10 ▲ 08-10 ▲			
SRK110 ▲=CT015	SUZUKI GSXR 600 GSX-R 750 GSX-S 750	11-20 ▲ 11-20 ▲ 15-20 ▲			
SRK111 ▲=CT014	SUZUKI GSXR 750 K1/K2/K3	01-03 ▲			
SRK112 ▲=CT014	SUZUKI GSXR 600 K1/K2/K3/ZK3	01-03 ▲			
SRK113	APRILIA RSV4 Factory SBK Racing RSV4 Factory APRC RSV4R RSV4R APRC	09-10 11-12 10 11-12			
SRK115 ▲=CT035SP	SUZUKI GS 1000 HC/EC/EN/SN/ET	78-80 ▲			

Part No.	Make/Model	Year	Part No.	Make/Model	Year						
SRK131 ▲=CT017	YAMAHA XT 1200 Z Super Tenere (ABS/UBS Brake System) XT 1200 ZE Super Tenere (ABS/UBS Brake System) FJR 1300 N/P FJR 1300 R/AR/S/AS/AT (ABS) FJR 1300 A (1CY/Manual G/Shift) FJR 1300 AE (Electronic Suspension Adjustment/USD Forks) XVS 1300 A Midnight Star XVS 1300 CU Custom	10-16 ▲ 14-16 ▲ 01-02 ▲ 03-05 ▲ 06-15 ▲ 14-15 ▲ 07-16 ▲ 14-16 ▲	SRK148 ▲=CT011	SUZUKI GSX-R 125 GSX-S 125 GSX 150 L6/DZAL6 Gixxer GSX-R 150 RF-Q/RFX-Q GSX-R 150 GSX-S 150	18-20 ▲ 18-20 ▲ 16 ▲ 17-18 ▲ 18-20 ▲ 18-20 ▲						
	SRK133 ▲=CT009	SUZUKI GSX 1400 K2/K3/K4/K5/K6/K7		02-07 ▲	SRK149 ▲=CT014	HONDA CB 650 F (Non ABS) CB 650 FA (ABS) CBR 650 F (Non ABS) CBR 650 FA (ABS)	14-20 ▲ 14-20 ▲ 14-20 ▲ 14-20 ▲				
		SRK138 ▲=CT072SP		SUZUKI GSXR 750 RG (Dry Clutch Sintered Friction)		86 ▲	SRK151 ▲=CT013	BMW G 310 GS G 310 R	17-20 ▲ 17-20 ▲		
	SRK139			KTM 390 Duke RC 390	13-14 14-15	SRK153		KTM Duke 200 RC 200	12-19 14-19		
		SRK140		KTM Duke 250 RC 250 Duke 390 RC 390	15-18 15-18 15-17 16-17		SRK154	KTM Duke 125 RC 125	11-19 14-19		
SRK141 ▲=CT014SP	BENELLI Leoncino 500 Leoncino Trail 500 TRK 502 ABS Euro 4 TRK 502 X BN 600 GT BN 600 i BN 600 R BN 600 S		17-19 ▲	SRK155	KAWASAKI Ninja 650 (EX 650) Ninja 650 ABS (EX 650 ABS) Z 650 (ER 650) Z 650 ABS (ER 650 ABS)	12-18 12-18 12-18 12-18					
		18-19 ▲	SRK160 ▲=CT008SP			YAMAHA YZF-R6	18-20 ▲				
		17-18 ▲					SRK161	HONDA CB 1100 EX	16-19		
		18-19 ▲							SRK162	YAMAHA XSR 900 ABS	18-20
		14-17 ■									SRK163
14-17 ■	SRK164	KAWASAKI Ninja H2R	15-20								
14-15 ■			SRK165	BMW R 1200 GS R 1200 GS Adventure R 1200 R R 1200 RS R 1250 GS R 1250 GS TE R 1250 GS Rallye R 1250 GS Rallye TE R 1250 GS Adventure/ Adventure TE R 1250 GS Adventure Rallye/Rallye TE	13-18 13-18 13-18 14-18 19-20 19-20 19-20 19-20 19-20 19-20						
14-15 ■	SRK166	BMW F800 GS (Early type plates 14mm ears) F800 GT (Early type plates 14mm ears) F800 S (Early type plates 14mm ears) F800 ST (Early type plates 14mm ears)			08-11 ▲ 04-06 ▲ 04-06 ▲ 04-06 ▲						
SRK142 ▲=CT009			SUZUKI GSXR 1000 AL7	17-20 ▲	SRK7001	INDIAN Octane Scout Scout Sixty	17 15-16 16-17				
	SRK143 ▲=CT014	SUZUKI CBR 600 F1/F2/F3/F4/F5/F6 (CARB MODEL) CBR 600 FR1/FR2 (ROSSI INJECTION MODEL) CBR 600 FS1/FS2 (CBR600 S INJECTION MODEL)		01-06 ▲ 01-02 ▲ 01-02 ▲			SRK7002	INDIAN Scout Scout 1200 Scout Bobber Scout Sixty	17-20 17-20 18 17-20		
SRK144 ▲=CT085			BMW G 650 GS (R13) G 650 GS Sertao (R13) G 650 XCountry (K15)	08-16 ▲ 10-14 ▲ 08-10 ▲	SRK7003 ▲=CT702SP	HARLEY DAVIDSON FLHTCUTG Tri Glide Ultra Classic FLRT Freewheeler FLHTK 103 CVO Limited FLHTCUL Ultra Classic Low FLHTCUL TC Ultra Classic Low Twin-Cooled FLHTKL Ultra Limited Low FLSS Softail Slim S FLSTFBS Fat Boy S FLSS Slim S FLSTFBS Fat Boy S			14-16 ▲ 15-16 ▲ 14 ▲ 15-16 ▲ 15-16 ▲ 15-16 ▲ 16 ▲ 16-17 ▲ 17 ▲ 17 ▲		
	SRK145 ▲=CT083	BMW G 650 GS (R13) G 650 GS Sertao (R13) G 650 XCountry (K15)		08-16 ▲ 10-14 ▲ 08-10 ▲			SRK7003 ▲=CT702SP	HARLEY DAVIDSON FLHTCUTG Tri Glide Ultra Classic FLRT Freewheeler FLHTK 103 CVO Limited FLHTCUL Ultra Classic Low FLHTCUL TC Ultra Classic Low Twin-Cooled FLHTKL Ultra Limited Low FLSS Softail Slim S FLSTFBS Fat Boy S FLSS Slim S FLSTFBS Fat Boy S	14-16 ▲ 15-16 ▲ 14 ▲ 15-16 ▲ 15-16 ▲ 15-16 ▲ 16 ▲ 16-17 ▲ 17 ▲ 17 ▲		
SRK146 ▲=CT086SP			TRIUMPH Bonneville T120 (1200cc Liquid Cooled) Bonneville T120 Black (1200cc Liquid Cooled) Bonneville Bobber (1200cc Liquid Cooled) Bonneville Bobber Black (1200cc Liquid Cooled) Thruxton 1200 (Liquid Cooled) Thruxton R 1200 (Liquid Cooled)	16-18 ▲ 16-18 ▲ 17-20 ▲ 18-20 ▲ 16-20 ▲ 16-20 ▲	SRK147 ▲=CT086SP	TRIUMPH Bonneville T100 (900cc/Liquid Cooled/Spoke Wheel) Bonneville T100 Black (900cc/Liquid Cooled/Spoke Wheel) Street Cup (900cc Liquid Cooled) Street Scrambler (900cc Liquid Cooled) Street Twin (900cc Liquid Cooled)			16-18 ▲ 16-18 ▲ 16-20 ▲ 16-20 ▲ 16-18 ▲		
	SRK147 ▲=CT086SP	TRIUMPH Bonneville T100 (900cc/Liquid Cooled/Spoke Wheel) Bonneville T100 Black (900cc/Liquid Cooled/Spoke Wheel) Street Cup (900cc Liquid Cooled) Street Scrambler (900cc Liquid Cooled) Street Twin (900cc Liquid Cooled)		16-18 ▲ 16-18 ▲ 16-20 ▲ 16-20 ▲ 16-18 ▲			SRK147 ▲=CT086SP	TRIUMPH Bonneville T100 (900cc/Liquid Cooled/Spoke Wheel) Bonneville T100 Black (900cc/Liquid Cooled/Spoke Wheel) Street Cup (900cc Liquid Cooled) Street Scrambler (900cc Liquid Cooled) Street Twin (900cc Liquid Cooled)	16-18 ▲ 16-18 ▲ 16-20 ▲ 16-20 ▲ 16-18 ▲		

Part No.	Make/Model	Year	Part No.	Make/Model	Year
SRK7004	INDIAN		SRK7011 ▲=CT703SP	HARLEY DAVIDSON	
	Chief Classic	14-20		FLHR Road King	15-16 ▲
	Chief Dark Horse	16-20		FLHR Road King	98-03 ▲
	Chief Vintage	14-20		FLHRC Road King Classic	14-16 ▲
	Chieftain	14-18		FLHRCI Road King Classic	98-99 ▲
	Chieftain Dark Horse	16-20		FLHT Electra Glide Standard	98-03 ▲
	Chieftain Elite	17-20		FLHTC Electra Glide Classic	98-03 ▲
	Chieftain Limited	17-18		FLHTCU Ultra Classic	14-16 ▲
	Roadmaster	15-18		FLHTCU TC Ultra Classic Twin-Cooled	14-16 ▲
	Roadmaster Classic	17-20		FLHTCUI Ultra Classic	98-03 ▲
Roadmaster Elite	18-20	FLHTK Ultra Limited	14-16 ▲		
Springfield	16-20	FLHX Street Glide	14-16 ▲		
Springfield Dark Horse	18	FLHXS Street Glide Special	14-16 ▲		
SRK7005	HARLEY DAVIDSON		SRK7012 ▲=CT703SP	HARLEY DAVIDSON	
XG500	15-20	FLD 103 Dyna Switchback		12-16 ▲	
SRK7006 ▲=CT706SP	HARLEY DAVIDSON			FLHR 103 Road King	11-13 ▲
	VRSCAW 1HFH V-Rod Wide Tire	08 ▲		FLHR Road King	04-05 ▲
	VRSCAWA W/ABS	08 ▲		FLHR ANV Road King ANV	13 ▲
	VRSCD Night Rod	08 ▲		FLHRC 103 Road King Classic	11-13 ▲
	VRSCDA Night Rod W/ABS	08 ▲		FLHRCI Road King Classic	04-05 ▲
	VRSCDXA Night Rod Special W/ABS	08 ▲		FLHRI Road King	04-05 ▲
	VRSCDX Night Rod Special	08-17 ▲		FLHRS Road King Custom	04-05 ▲
	VRSCDX Night Rod Special	08-17 ▲		FLHT Electra Glide Standard	04-05 ▲
	VRSCAW V-Rod	09-10 ▲	FLHTC 103 Electra Glide Classic	11-13 ▲	
	VRSCF V-Rod Muscle	09-17 ▲	FLHTC Electra Glide Classic	04-05 ▲	
VRSCDX ANV Night Rod Special Anv	12 ▲	FLHTCI Ultra Classic	05 ▲		
SRK7007 ▲=CT707SP	HARLEY DAVIDSON		FLHTCU 103 Ultra Classic	11-13 ▲	
	VRSCA V-Rod	02-06 ▲	FLHTCUI Ultra Classic	04 ▲	
	VRSCAW V-Rod	07 ▲	FLHTI Electra Glide Standard	04-05 ▲	
	VRSCB V-Rod	04-05 ▲	FLHTK Electra Glide Ultra Limited	10-13 ▲	
	VRSCR Street Rod	06-07 ▲	FLHTK ANV Electra Glide Ultra Limited ANV	13 ▲	
	VRSCSE CVO V-Rod	05 ▲	FLHX 103 Street Glide	11-13 ▲	
VRSCSE2 CVO V-Rod	06 ▲	FLS 103 Softail Slim	12-15 ▲		
VRSCX Screamin' Eagle V-Rod	07 ▲	FLS Slim	17 ▲		
VRXSE CVO VR Destroyer	06 ▲	FLS Softail Slim	16 ▲		
SRK7008 ▲=CT708SP	HARLEY DAVIDSON		FLSTC 103 Heritage Softail Classic	13-15 ▲	
	FLFBS Fat Boy 114	18	FLSTC 103 ANV Heritage Softail Classic ANV	13 ▲	
	FLFBS Fat Boy 114 Anniversary	18-20	FLSTC Heritage Softail Classic	04-05 ▲	
	FLFBS Fat Boy 114 Anniversary	18	FLSTC Heritage Softail Classic	16-17 ▲	
	FLHCS Heritage Classic 114	18-20	FLSTCI Shrine Heritage Softail Classic Shrine	05 ▲	
	FLHCS Heritage Classic 114 Anniversary	18	FLSTF 103 Fat Boy	12-15 ▲	
	FLHP Road King Police	17	FLSTF Fat Boy	04-05 ▲	
	FLHTCUTG Tri Glide Ultra	17-20	FLSTF Fat Boy	16-17 ▲	
	FLHTCUTG Tri Glide Ultra Anniversary	18	FLSTFB 103 Fat Boy LO	12-17 ▲	
	FLHTP Electra Glide Standard Police	17	FLSTFB 103 ANV Fat Boy LO ANV	13 ▲	
FLRT Freewheeler	17-18	FLSTFI Shrine Fat Boy Shrine	05 ▲		
FXBRS Breakout 114	18-20	FLSTN 103 Softail Deluxe	12-15 ▲		
FXBRS Breakout 114 Anniversary	18	FLSTN Softail Deluxe	05 ▲		
FXFBS Fat Bob 114	18	FLSTN Softail Deluxe	16-17 ▲		
SRK7009 ▲=CT703SP	HARLEY DAVIDSON		FLSTSC Springer Classic	05-06 ▲	
	FLHP Road King Police	11-16 ▲	FLTRI Road Glide	04-05 ▲	
	FLHPE Road King Police	11 ▲	FLTRU Road Glide Ultra	11-13 ▲	
	FLHTCUTG Tri Glide Ultra Classic	09-13 ▲	FLTRX 103 Road Glide Custom	11-13 ▲	
	FLHTCUTG ANV Tri Glide Ultra Classic Anv	13 ▲	FXD Dyna Super Glide	04-05 ▲	
	FLHTP Electra Glide Standard Police	11-16 ▲	FXDB 103 Dyna Street Bob	14-16 ▲	
	FLHXXX Street Glide Trike	10-11 ▲	FXDB 103 Dyna Street Bob 103	17 ▲	
	FXDLS Dyna Low Rider S	16-20 ▲	FXDBA 103 Dyna Street Bob (H-D1)	13-15 ▲	
	SRK7010 ▲=CT702SP	HARLEY DAVIDSON		FXDBC 103 Dyna Street Bob Limited	16 ▲
		FLHR Road King	17-20 ▲	FXDC 103 Dyna Super Glide Custom	14 ▲
FLHRC Road King Classic		17 ▲			
FLHRXS Road King Special		18 ▲			
FLHTCU Electra Glide Ultra Classic		17-20 ▲			
FLHTK Ultra Limited		17-20 ▲			
FLHTK Ultra Limited Shrine Edition		18 ▲			
FLHTK Ultra Limited Anniversary		18 ▲			
FLHTKL Ultra Limited Low		17-20 ▲			
FLHX Street Glide		17-20 ▲			
FLHX Street Glide Anniversary	18 ▲				
FLHXS Street Glide Special	17-20 ▲				
FLHXS Street Glide Special Anniversary	18 ▲				
FLTRU Road Glide Ultra	17-20 ▲				
FLTRX Road Glide	17-20 ▲				
FLTRXS Road Glide Special	17-20 ▲				

Part No.	Make/Model	Year	Part No.	Make/Model	Year
SRK7020 ▲=CT701SP Contd.	HARLEY DAVIDSON XL1200CB 1200 Custom Limited B XL1200CB Sportster 1200 Custom Limited A XL1200CP Sportster 1200 Custom (H-D1) XL1200CX 1200 Roadster XL1200L Sportster 1200 Low XL1200N Nightster XL1200R Sportster 1200 Roadster XL1200T SuperLow 1200T XL1200V Seventy-Two XL1200X Forty Eight XL50 50th ANV Sportster	17 ▲ 13-16 ▲ 11-16 ▲ 16-20 ▲ 06-11 ▲ 07-12 ▲ 04-09 ▲ 14-20 ▲ 12-16 ▲ 10-20 ▲ 07 ▲			
SRK7021 ▲=CT701SP	HARLEY DAVIDSON XL883 Sportster 883 XL883C Sportster 883 Custom XL883L Sportster XL883 Low XL883L SuperLow XL883L SuperLow XL883N Iron 883 XL883R 883 Roadster XL883R Sportster 883R	04-09 ▲ 04-10 ▲ 05-11 ▲ 14-16 ▲ 12-20 ▲ 09-20 ▲ 11-15 ▲ 07-10 ▲			
SRK7022 ▲=CT701SP	HARLEY DAVIDSON XR1200 Sportster 1200 XR1200X XR1200X	08-10 ▲ 10-13 ▲			
SRK7023 ▲=CT701SP	HARLEY DAVIDSON XL1200 Sportster 1200 XL1200C Sportster 1200 Custom XL1200S Sportster 1200 Sport XL883 Sportster 883 XL883C Sportster 883 Custom XL883DLX Sportster 883 Deluxe XL883HUG Sportster 883 Hugger XL883R Sportster 883R	91-03 ▲ 96-03 ▲ 96-03 ▲ 91-03 ▲ 98-03 ▲ 91-95 ▲ 91-03 ▲ 02-06 ▲			
SRK7024 ▲=CT701SP	HARLEY DAVIDSON XL1200 Sportster 1200 XL883 Sportster 883 XL883 Sportster 883 Deluxe XL883HUG Sportster 883 Hugger XLH 1100 Sportster 1100 XLH Sportster 1000 XLS Sportster Roadster 1000 XR-1000 Sportster	88-90 ▲ 86-90 ▲ 86-90 ▲ 87-90 ▲ 86-87 ▲ 84-85 ▲ 84 ▲ 84 ▲			
SRK7025 ▲=CT701SP	HARLEY DAVIDSON XLCH-1000 Sportster 1000 XLH-1000 Sportster 1000 XLH-1000 Sportster Standard XLS 1000 Sportster Roadster XR 1000 Sportster	71-84 ▲ 79-80 ▲ 71-78 ▲ 81-84 ▲ 83-84 ▲			

Part No.	Make/Model	Year	Part No.	Make/Model	Year		
CT004 Contd.	KAWASAKI		CT006 Contd.	SUZUKI			
	Z 1000 SX Non ABS (ZX1000 LGF)	16		DR-Z 400 SY/EY/Y/SK1/EK1/K1			
	(3 Spring Clutch)	04-05		/SK2/EK2/K2/SK3/EK3/K3/SK4			
	ZX10R (ZX 1000)	04-10		/EK4/K4/EK5/SK5/K6/SK6/EK6	00-09		
	ZX10R (ZX 1000 C1/C2/D6F/D7F/E8F/E9F/FAF)	11-15		/SK7/EK7/K7/SK8/SK9	05-09		
	ZX10R ABS (ZX 1000 KBF/KCF/KDF/KEF/KFF)	11-15		DR-Z 400 SMK5/SMK6/SMK7/SMK8/SMK9	02		
	ZX10R (ZX 1000 JBF/JCF/JDF/JEF/JFF)	15		LT-F 400 K2 (Eiger)	02-07		
	ZX10R 30th Anniversary Edition			LT-F 400 FK2-FK7 (Eiger 4WD)	08-12		
	(ZX 1000 KFFA/ABS)	15		LT-F 400 FK8/FK9/FL0/FL1 King Quad 4WD	03-07		
	ZX10R 30th Anniversary Edition			LT-F 400 K3-K7 Eiger 2WD	03-04		
	(ZX 1000 JFFA/Non ABS)	15		LT-Z 400 K3/K4			
	ZX 10R (ZX1000 SGF)	16-19		LT-Z 400			
	ZX 10R Winter Test Edition (ZX1000 SGFB)	16		K5/K6/K7/K8/K9/L0/L1/L2/L3 QuadSport	05-15		
	ZX 10R Ninja KRT Replica (ZX1000 SGFA)	16-19		LT-F 500 FW/FX/FY/FK1/FK2	98-02		
	ZX-10RR	17-19		LT-F 500 FK3-FK7	03-07		
	ZX-10RR Performance	17-19		ARCTIC CAT ATV 4 WHEELERS			
	ZZR 1400 Performance Sport (ZX1400 JGF)	14-19		400 (2 x 39906 x 4)	98-		
	ZZR 1400 ABS Performance	12-19		400 (2 x 4)	98		
	SUZUKI			400 (2 x 39906 x 4)	00-02		
	RM-Z 250 K4/K5/K6/K7/K8/K9/L0/L1-L9	04-19		400 (2 x 39906 x 4)	03-04		
	GSXR 1000 K1/K2/K3/K4	01-04		400 (4 x 4 Manual)	05-08		
	GSX-S 1000 L6/L7 (Naked/Non ABS)	16-17		400 DVX	04-06		
	GSX-S 1000 AL6/AL7 (Naked/ABS)	16-17		400 DVX	07-08		
	GSX-S 1000 FL6/FL7 (Faired/Non ABS)	16-17		Bearcat 454 (4 x 4)	96-98		
	GSX-S 1000 FAL6/FAL7 (Faired/ABS)	16-17		Bearcat 454 (2 x 4)	97-98		
				500 (4 x 4)	98-02		
				500 (4 x 4 Manual)	03-09		
				CCM			
				R35/R35S	06-07		
				404E/DS/Supermoto	03-04		
				CR40 S Cafe Racer	07		
				CR40 Street	07		
				SR40 Street Scrambler	07		
CT005	YAMAHA		CT007	KTM			
	YZ 125 B/D/E/F/G/H/J/K/L/M/N/P/R	91-16		SX 250 (2T)	94-12		
	/S/T/V/W/X/Y/Z/A/B/D/E/F/G (2T)			250 EGS	94-99		
	RI-Z (250cc/3XC)	90-92		EXC 250 (2T)	94-12		
	XT 250 Serrow (3C51/2)	05-08		EXC 250 Six Days (2T)	11-12		
	TT 250 R (4GY1 Japan - 6 Plate Clutch)	93-94		250 MXC	98-99		
	TT 250 R (4RR1/2 Japan - 6 Plate Clutch)	95-97		250 SXS	01-03		
	TT 250 R (4GY3/4GY5/4WA1 - Raid			XC 250 (2T)	11-12		
	- Japan - 6 Plate Clutch)	94-96		300 EGS	94-99		
	TT 250 R (4MR2 - UK - 6 Plate Clutch)	96		EXC 300 (2T)	00-12		
	TT 250 RL (4PX5 - 6 Plate Clutch)	99		EXC 300 Six Days (2T)	11-12		
	TT 250 RM (4PX6 - 7 Plate Clutch)	00		300 EXC	94-07		
	TY 250 Z	93-96		300 MXC	94-05		
	TZR 250 R (3XV1/3XV4/3XV6 - V-Twin			XC 300 (2T)	11-12		
	- Eng/Frame # 3XV 000101-08600)	91-93		SX 300	94		
	WR 250 FN/FP/FR/FS/FT/FV/FW			300 Six Days	96		
	/FX/FY/FZ/FA/FB/FD (4T)	01-13		360 EGS	96-97		
	WR 250 FF/FG (4T/Reverse Cylinder)	15-16		360 EXC	96-97		
	WR 250 R	08-20		360 MXC	96-97		
	WR 250 XX/XY (Supermoto) (32D2/4)	08-15		360 SX	96-97		
	XG 250 Tricker (5XT1)	04-06		360 Six Days	96		
	XT 250 X	06		380 EXC	98-02		
	YFM 250 R (33B)	09-11		380 MXC	98-01		
	YFM 250 R (1BT)	12-13		SX 380	98-02		
	YZ 250 FN/FP/FR/FS/FT/FV/FW			RXC-E 400	95		
	/FX/FY/FZ/FA/FB/FD/FE/FF (4T)	01-15		RXC-E 620	95		
	CT006	KAWASAKI			CT008	YAMAHA	
		ER 250 B1/B2/B3 Scorpion		83-88		XV 125 Virago	97-00
		KDX 250 B1/B2/B3		81-83		XVS 125 Drag Star	00-03
		KDX 250 D1		91-93		DT 250	75-76
		KX 250		74		IT 250 G/H/J	80-82
		KX 250 A/A3/A4/A5/A6/A7/B1/C1/C2		75-84		RD 250 A/B/C/D/E/F	74-79
		KX 250 E1/F1/G1/H1/H2		87-91		RD 250 LC	80-82
KXF 250 A1/A2		87-88	RZ 250 R (1AR/1XG)				
KXT 250 A1/A2/B1/B2 Tecate		84-87	RZ 250 R (29L)				
Z 250 A1-A3/B1/B2		79-81	RZ 250 RR (51L)				
KEF 300 B1/B2 Lakota Sport		01-02	RZ 250 (4L3)				
KLF 300 A1/A2/B1-B17/C1-C17		87-05	SR 250 (US Custom/3Y8/6 Plate Clutch)	80-81			
GPz 305 A1/B2-B10		83-96	SR 250 SE (Special/3Y8/5 Plate Clutch)	81-83			
KLF 400 B1-B7		93-98	SR 250 (4GR1/2/3/4/5 Plate Clutch)	94-96			
KLX 400 R (KLX 400 B1/B2)		03-04	SR 250 (Classic/21L/5 Plate Clutch)	96-00			
KSF 400 A1/A2/A3/A6F (KFX 400)		03-06	SRV 250 Soulful Twin/Renaissa (4DN1-6)	92-97			
KX 420 A1/A2		80-81	SRX 250				
KFX 450 R Quad (KSF 450 B8F/B9F							
/BAF/BBF/BCS/BFD/BEF)		08-14					
KLX 450 R (A8F/A9F/AAF/ABF/ACF							
/ADF/AEF/AFF/AGF)		08-16					
KX 450 F		06-20					
KX 500 A1/A2		83-84					
KX 500 C1/D1/E1-E16		87-04					

Part No.	Make/Model	Year	Part No.	Make/Model	Year
CT008 Contd.	YAMAHA		CT008 Contd.	YAMAHA	
	TYR 250 D/E	77-78		XTZ 750	89-95
	TZR 250 (3MA1 - Reverse Cylinder - Eng/Frame # 3MA 0001-)	89		TDM 850	91-01
	TZR 250 (3MA3/3MA5 - Reverse Cylinder - Eng/Frame # 3MA - 0.793103448275862 -)	89-90		TRX 850	96-98
	XS 250 C/D/E	78-80		TDM 900 (5PS/Non ABS)	02-14
	XS 250 SE/C	80-81		TDM 900 A (2B0/ABS)	05-13
	XT 250	80		DERBI	
	XV 250 Virago	89-94		Mulhacen 659	06-07
	XV 250 S Virago	95-00			
	XVS 250 Dragstar	01-04			
	YZ 250 D/E/F/G/H (2T)	77-81			
	YDS7 250cc	72			
	RD 350/A/B	73-75			
	RD 350 LC/YPVS	80-84			
	RD 350 N/F/F2/R	85-95			
	TT 350 A (3GJ)	90-95			
	TT 350 (ITJ)	85-89			
	XT 350	85-95			
	YFM 350 FWT/FWU/FWW/FWA /FWE Big Bear	86-93			
	YFM 350 FWF/FWG/FWH/FWJ	94-97			
	YFM 350 XD/XE/XF/XG/XH/XJ/XK /XL/XM/XN/XP/XR/XS	92-04			
	YFM 350 ERD/ERE/ERF	92-94			
	YFM 350 ERG	95			
	YFM 350 FX Wolverine All models	95-04			
	YFM 350 UH/UJ	96-97			
	YFM 350 S/T/V/R-WV/RW/RX/RV Raptor	04-09			
	YFZ 350 T/U/W/A/B/D/E/F/G/H /J/K/L/M/N/P/R/S/T/V Banshee	87-09			
	DT 400	75-76			
	DT 400 MX	77-79			
	FZ 400 N (IFK/33M/46X)	85			
	RD 400 C/D/E/F	76-79			
	SR 400 (3HT1)	88			
	SR 400 (2RD)	14-16			
	SRX 400 (1JL)				
	SRX 400 (3VN1/3VN2/3VN5)	90-96			
	XJR 400 (4HM1/4HM2/4HM4/4HM7)	93-96			
	XJR 400 (4HM3/4HM5/4HM6 /4HM9/4HMA/4HMB)	95-99			
	XS 400	78-79			
	XS 400 SE	80			
	YZ 400 D/E/F (2T)	77-79			
	YZ 400 FK/FL (4T)	98-99			
	WR 400 FK/FL/FM/FN (4T)	98-01			
	IT 425 G	80			
	IT 465 H/J	81-82			
	YZ 465 G/H	80-81			
	SR 500	78-82			
	SR 500 S (3GWS)	98			
	SR 500 (3GW1/4/6/7)	96-98			
	TT 500 G/H	80-81			
	XT 500 C	76			
	XT 500	77-81			
	XS 500 B/C/D	77-79			
	XT 550	82-83			
	XZ 550	82			
	SRX 600	86-87			
	SRX 600 (1JK/3SX)	85-91			
	TT 600 L (Kick Start Only)	84			
	TT 600 N (59X) Frame # 59X 000101-7852 (Kick Start Only)	85-88			
	TT 600 W (2JT/3SU1) Frame # 59X 7853 Onwards (Kick Start Only)	89-92			
	TT 600 R (5CH1/2/3/4) (Kick Start Only)	97-02			
	TT 600 RE (5CH5) (Electric Start Only)	04			
	TT 600 E (Electric Start Only)	94-01			
	TT 600 K (Kick Start Only)	93-96			
	XT 600 (Kick Start Only)	84-87			
	XT 600 Z (Kick & Electric Start)	84-90			
	XT 600 E (Electric Start Only)	90-03			
	SZR 660	96-97			
XTZ 660 Tenere	91-97				
YFM 660 RN/RP/RR/RS/RT Raptor	01-05				
			CT008SP	YAMAHA	
				XJ 550	81
				XJ 550 H/J/K Maxim	81-83
				XJ 550 RH/RJ/RK Seca	81-83
				FZ 600	87-88
				FZ6 - Naked - Non-ABS /2 Piston Caliper (1B3/1B3D)	04-07
				FZ6 NS - Naked/Non-ABS /2 Piston Caliper (1B35/1B6)	05-06
				FZ6 S2 - Naked/Non ABS /4 Piston Caliper (5S51/5S5)	07-09
				FZ6 Fazer - Half Fairing/Non ABS /2 Piston Caliper (5VX/5VXL)	04-07
				FZ6 Fazer - Half Fairing/ABS /2 Piston Caliper (4P5)	06-07
				FZ6 Fazer S2 - Half Fairing/Non ABS /4 Piston Caliper (4S81/4S8)	07-09
				FZ6 Fazer S2 - Half Fairing/ABS /4 Piston Caliper (5S2)	08
				XJ 600	84-92
				XJ 600 S Diversion	92-03
				XJ 600 N	95-03
				XJ6-N 600 (Naked - Non ABS & ABS Model - 20S)	09-15
				XJ6-F Diversion 600 (Full Fairing Diversion - Non ABS & ABS Models - 1CW)	10-15
				XJ6-S Diversion 600 (Top Fairing Diversion - Non ABS & ABS Models - 36C)	09-15
				XJ6-SP Diversion 600 (Non ABS & ABS Models)	13
				YZF 600 R R6 (8 plate)	99-02
				YZF-R6 (8 plate)	03-05
				YZF R6 (9 plate)	06-20
				XJ 650	80-84
				XJ 650 Turbo	82
				XJ 650 G/H/J/K Maxim	80-83
				XJ 650 LH Midnight	81
				XJ 650 RJ/LK Seca	82-83
				FZX 700 S/SC/T/TC Fazer	86-87
				FZ 750	85-92
				FZX 750	87
				FZR 750	87
				FZR 750 R OW01	89-90
				XJ 750	82-83
				XJ 750 RF/RJ/RK Seca	81-83
				XS 750	77-79
				XS 750 SE	79-80
				YZF 750 R/SP	93-97
				XS 850	80
				XJ 900	83/90
				XJ 900 F	85-92
				XJ 900 S Diversion	95-03
				FZR 1000 (2RG - Genesis Non EX-UP)	87-88
				FZR 1000 (3GM1/3/5/7/8-3LG1/2/3/4-3LH1 /2/3/4-3LE1/2/3/4 - EX-UP Models)	89-92
				FZR 1000 (3GME/F-3LG5/6-3LH5/6-3LE /5-3LG6-3LJ6-4PM1 - EX-UP Models)	93-95
				FZS 1000 Fazer	01-05
				GTS 1000	93-96
				YZF 1000 Thunder Ace	96-02
			CT009	HONDA	
				CB 250 K3-K5	73-75
				CB 250 G5	75-76
				CJ 250 T/T2	77
				CR 250 RB/RC/RD/RE/RF/RG/RH/RJ/RK /RL/RM/RN/RP/RR/RS/RT/RV/RW/RX /RY/R1-R7	81-07

Part No.	Make/Model	Year	Part No.	Make/Model	Year
CT009 Contd.	HONDA Contd.		CT009 Contd.	HONDA DALL-ARA	
	TL 250/TL 250 K1	78-79		XR 650 R	04
	XL 250 K3/K4	78-79		KAWASAKI	
	Z 300 ABS (ER 300 BFF)	15-16		EX 250 K8F/K9F/KAF/KBF/KBFA	
	Versys-X 300 ABS	17-20		/KCF Ninja 250R	08-12
	CB 350 K4			EX 300 ADF/AEF/AFF Ninja 300 (Non ABS)	13-15
	CB/CJ 360 all models			EX 300 AEFA/AFFA Ninja 300	
	CR 450 RB	81		Special Edition (Non-ABS)	13-15
	CRF 450 R2/R3	02-03		EX 300 BDF/BEF/BFF/BGF Ninja 300 (ABS)	13-16
	CRF 450 R4/R5/R6/R7/R8 (6 Spring Type)	04-08		EX 300 BEFA/BFFA/BGFA Ninja 300	
	CRF 450 R9/RA (4 Spring type)	09-10		Special Edition (ABS)	13-16
	CRF 450 RB/RC	11-12		Z 300 Non ABS (ER 300 AFF)	15
	CRF 450 RD/RE/RF/RG (6 Spring Type)	13-16		Z 300 ABS (ER 300 BFF) - Ninja 300	
	CRF 450 RE (Limited Road Use)	16		(ABS)- Floating Disc Conversion	15-16
	CRF 450 X5/X6/X7/X8/X9/XB/XC/XD/XF/XG/XH	05-17		ZX12 R (ZX 1200 A1/A2/A3/A4/B1-B4/B6F)	00-06
	CRF 450 XRL (Road Legal)	14-16		SUZUKI	
	TRX 450 R4/R5/R6/ER6/R7/ER7			GSXR 1000 K9/L0/L1/L2/L3/ZL3/L4/Z	
	/R8/ER8/R9/ER9	04-09		L4/L5/AL5/AL6/AL7	11-20
	CR 480 RC/RD	82-83		GSXR 1000 AL7	17
	CB 500/K1/K2 (Four)	75-77		TL 1000 RW/RX/RY	98-00
	CR 500 RE/RG/RH/RJ/RK	84-89		TL 1000 SX/SY	99-00
	CR 500 RL/RM/RN/RO/RR/RS			TL 1000 SK1	01-02
	/RT/RV/RW/RX/RY/R1	90-01		TL 1000 RK1	01-02
	NX 500 J/K/L/M/N/P/R/S/T/V/W/X Dominator	88-99		GSX 1400 K1/K2/K3/K4/K5/K6/K7	01-07
	XBR 500 F/G/H/SH/SJ	85-89		GAS-GAS	
	XR 500 RD/RE	84-85		EC 200/250/300(2T)	00-08
	XL 600 RD/LD/RE/LE/RF/RG/RH	83-87		EC 450 FSR/FSE (4T) Enduro	05-08
	XL 600 LMF/RMG/LMH	85-87		SM 450 FSR (4T) Supermotard	07-08
	XR 600 RF/RG/RH/RJ/RK/RL/RM			Wild HP 450 Quad	04-08
	/RP/RR/RS/RT/RV/RW/RX/RY	84-00		EC 515 FSR/FSE (4T) Enduro	05-08
	FMX 650 39968	05-08		SM 515 FSR (4T) Supermotard	07-08
	FX 650 X/Y Vigor	99-03		KTM	
	NX 650 J/K/L/M/N/P/R/S/T/V/W/X	88-02		SX-F 450 (4T/Coil Spring)	07-11
	SLR 650 V/W	97-98		450 SX (Quad)	09-11
	XR 650 L	93-12		SX-F 505	07-09
	XR 650 RY/R1-R7	00-07		505 SX-F (Quad)	09-12
	TRX 700 XX8/XX9/XXB	08-11		MONTESA-HONDA	
	XRV 750 L/M/N/P/R/S/T/V/W/X/Y	90-03		315R (2T)	97-04
	PC 800 Pacific Coast	89-97		TRIUMPH	
	CB 1000 FP/FR/FS/FT/FV	93-97		Daytona 955i	98-00
	CB 1000 R9/RA/RB/RC/RD/RE/RF (Non ABS Model)	09-15		Daytona 955i (From VIN 132513)	01-06
	CB 1000 RA9/RAA/RAB/RAC/RAE			SpeedTriple (EFI)	97-01
	/RAF/RAG (ABS Model)	09-16		SpeedTriple 955cc	
	CBF 1000 6/7/8/9/A			(From VIN 141872 to 210444)	02-04
	(2 Piston Front Caliper/Non ABS)	06-11		SpeedTriple (1050cc)	05-08
	CBF 1000 A A6/A7/A8/A9/AA			SprintST (1050cc) (From VIN 208167)	05-09
	(3 Piston Front Caliper/ABS)	06-11		SprintRS	99-04
	CBF 1000 S S7/S8/S9/SA			SprintST (Up to VIN 139276)	99-01
	(3 Piston Front Caliper/ABS)	07-10		SprintST (From VIN 139277 to 208166)	02-04
	CBF 1000 T T7/T8/T9/TA (GT)			T595 Daytona	97
	(3 Piston Front Caliper/ABS)	07-16		Tiger 900cc (From VIN71699)	97-98
	CBF 1000 F FA			Tiger 955cc (Up to VIN 198874)	99-04
	(2 Piston Front Caliper/Non ABS)	10-11		Tiger 955 (From VIN 198875)	04-06
	CBF 1000 FA FAA			Tiger 1050	07-12
	(3 Piston Front Caliper/ABS)	10-15		Tiger 1050 SE	10-12
	CBF 1000 FS FSA				
	(3 Piston Front Caliper/ABS)	10-11		CT009SP	
CBF 1000 FT FTA		HONDA			
(3 Piston Front Caliper/ABS)	10-11	CB-1 (CB 400 F)	89-90		
CBR 1000 FH/FJ/FK/FL/FM/FN/FP		CB 400 SF (F2N/F2R)			
/FR/FS/FT/FV/FW/FX	87-99	(Super Four) (NC31)	92-95		
CBR 1000 RR4/RR5/RR6/RR7		CB 400 SF (F2V/F3T) Superfour (NC31)	96-97		
Fireblade (Coil Spring Type Clutch)	04-07	CB 400 SF (F3V) Superfour (NC31)	97		
CRF 1000 LAG (Manual Clutch/ABS)	16-20	CB 400 Four V/V-II/W/W-II (NC36)	97-98		
CRF 1000 L (Manual Clutch/Non ABS)	16	CB 400 SFX/SFY/SF1/SF2/SF3			
VTR 1000 FV/FW/FX/FY/F1-F6 Firestorm	97-06	/SF4/5/S5 (NC39) Super Four	99-05		
XL 1000 VX/VY/V1/V2 Varadero		CBR 400 RG/RHYA (NC23 100/101)	86		
- Non ABS Model/10 Plate Kit	99-02	CBR 400 RRJ/RRK (NC23 102/109)	92-93		
XL 1000 V3/V4/V5/V6/V7/V8/V9/VA/VB		CB 500 K3	78		
Varadero - Non ABS Model/8 Plate Kit	03-11	CBR 500 FH/FJ/FK/FL (Four)	87-90		
XL1000 V6/VA6/VA7/VA8/VA9VAA/VAB		CX 500 CA/CB/Z/A/B/EC	79-85		
Varadero - ABS Model/8 Plate Kit	06-11	GL 500 DC	82		
VT 1100 C2 (S/T/N/W/X/Y/1/2/3/4/5)	95-05	CB 550 F/F1/F2/K3	78-80		
CB 1300 FW/FX/FY/F1 (SC40)	98-01	CBX 550 FC/F2C/FD/F2D	82-85		
CB 1300 DCV/DCW/DCX/DCY (SC38)	97-00	CBR 600 FH/FJ	87-88		
CB 1300 F3/F13	03-04	CBR 600 FK/FL	89-90		
CB 1300 5/6/7/8/9 (Superfour)	05-09	CB 750 F2N/F2R/F2S/F2T/F2W			
CB 1300 A5-A8 (Superfour ABS)	05-08	/F2X/F2Y/F21	92-02		
CB 1300 SA5/SA6/SA7/SA8 Super Bol-Dor	05-08	CB 1100 AD (Cast Wheels/3 Piston Calipers)	13		
		CB 1100 AE (Cast Wheels/3 Piston Calipers)	14		
		CB 1100 EX (Spoke Wheels/4 Piston Caliper)	14-16		

Part No.	Make/Model	Year	Part No.	Make/Model	Year	
CT009SP Contd.	TRIUMPH Bonneville 800 (790cc) Up to Engine no. 211132	01-04	CT011 Contd.	SUZUKI RM 85 II (Big Wheel F 19" / R16")	02-20	
	Bonneville T-100 (790cc) Up to Engine no. 211132	02-04		GP 100 C/UC	78	
CT010	YAMAHA YZ 65 J	19-20	GP 100 N/UN	79		
		YZ 80 H/J/K/L/N/S/T/U/W	81-89	GP 100 X/UX/D/UD/UL	81-92	
		YZ 80 E/LC/LW/F/G/H/J/K/L/M/N	93-01	RM 100 A/B/C	76-78	
		YZ 85 (2T / Small Wheel F 17" / R 14")	02-20	RM 100 N/T/X	79-81	
		YZ 85 (2T / Big Wheel F 19" / R 16")	02-20	TS 100 C	78	
		DT 125 R	88-03	TS 100 ERN Upto F 300563	79	
		DT 125 RE	04-07	TS 100 ERN/ERT/ERX From F 300564	80-81	
		DT 125 X	05-06	TS 100 ERZ/ERH	82	
		TDR 125 (3HS1/3XD0/3HS3/3XD1)	89-93	DF 125		
		TDR 125 (4GH/GX 1/2/3/4)	93-03	DR 125 SZ/SD/SE/SF/SH/SJ	82-94	
		TDR 125R (3HS2/3XE2) Lightburner	93-94	DR 125 SEX/SEY	99-01	
		TZR 125 (2RK/3PC1/2/3)	87-92	DR 125 SMK8/SMK9/SML0	08-12	
		TZR 125 (3JB/4JB/4HW/4HX)	93-95	DR-Z 125	03-20	
		TZR 125 R (4DL1/4DL2)	91-93	FX 125		
		TZR 125 RR (4DL3)	94-95	GN 125 R/V/W/X/Y/K1 (NF41A)	94-01	
		TZR 150 R (4AP2)	00	GN 125 ER/EV/EW/EX/EY/EK1 (NF41A)	94-01	
		DT 200 (2LR)	87	GN 125 Z/D/K (Gold cast wheel/Aisin caliper)	82-90	
		DT 200 WR 3XP	92-93	GN 125 HS (LC6PCJB1/Chinese Production)	00-11	
		SDR 200 (2TV)	87-89	GP 125 C/N	78-79	
		WR 200 D/E/F	92-94	GP 125 X/XD	81-84	
		YFS 200 B/F/G/H/J/K/L/M/N/P/R/S		GS125 Z/D/ESZ/ESD/ESF/ESK/ESM/ESR/ESX	82-00	
		/T/V Blaster	91-06	GSX-R 125	18-20	
		YTM 200 EL/DX	89	GSX-S 125	18-20	
		DT 230 R Lanza (4TP1/2)	97-98	GT125 L/M/A/B/C/EC/EN	74-79	
		FZR 250	87	GZ125 W/X/Y/K1-K9 Marauder	98-11	
		FZR 250 R (3LN1/3/5/6/7)		LT125 D/E/F/G/H	84-86	
		FZX 250 Zeal (3YX1/2/4)	91-92	RG125 CG/CH/J (NF12A)		
		FZ 400 (4YR1)	96	(Gamma/Rear Drum Brake Model)	86-90	
		FZR 400 RR (4DX)	92	RG125 UCG/UCH/UCJ/J/BUJ		
		FZR 400 Genesis (1WG)	86	(NF12B) (Gamma/Rear Drum Model)	86-90	
		FZR 400 RSP (2TK-EXUP)	87	RG125 FN/FP/FR Gamma		
		FZR 400 (3EN1/3EN2)	88-89	(NF13A/Rear Disc Model)	92-94	
		FZR 400 RR (3TJI)		RG125 FUN/FUP/FUR Gamma		
		FZR 400 RRSP (3TJ2/6/7)		(NF13B/Rear Disc Model)	92-94	
YFM 400 FWE/FWF/FWG/FWH		RG125 UN - Wolf (NF13E/Naked)	92-94			
/FWJ/FWK Kodiak	93-00	RM125 A/B/C/N/T/X/Z/D/E/F/G/H/J/K/L/M	76-91			
YFM 400 FPR/FPS Big Bear	03-04	RV125 K2/K3/K4/K5/K6/K7/K8/K9				
FZR 600	89-93	/L0/L3/L4 Van-Van	02-15			
		TF125 Farm Bike (All models)	78-05			
		TS 125 K/L/M/A/B/C/C2	73-78			
		TS 125 ERN Up to F No 302345	79			
		TS 125 ERN From F No 302346	79			
		TS 125 ERT/ERX/ERZ	80-82			
		TS 125 N to Frame No.178871	84			
		TS 125 N from Frame No.178872	84			
		TS 125 XUE/XUF/XUG/XUH/XUJ	84-90			
		TS 125 RK/RL/RM/RN/RP/RR	90-94			
		TU 125 X/XTUX/XTX	99			
		GSX 150 L6/DZAL6 Gixxer	16			
		GSX 150 DEAL8/DZAL8/DXAL8 Gixxer	18			
		GSX-R 150 FRFAL7/FRZAL7	17-18			
		GSX-R 150 RF-Q/RFX-Q	17-18			
		GSX-R 150 RFL8/RFXL8	18-20			
		GSX-S 150 MFL8/MFXL8	18-20			
		LT 160 EK/EL/EM/EN	89-92			
		LT-F160 L/M/N/P/R/S/T/V/W/X/Y/K1-K3	90-03			
		LT 160 K3/K4 QuadSport	03-04			
		PE175 C/N/T/X/Z	78-82			
		GT185 K/L/M/A/B/C/EC	73-79			
		LT185 E/F	84-85			
		TS185 K/L/M	73-75			
		TS185 B/C/ERN/ERT/ERX	77-81			
		DF200 EV/EW/EY (SH42A)	98-99			
		DR200 G/H/J	86-89			
		DR200 SEP/SER/SES/SEV/SEW				
		/SEX/SEY (SH42A) Djebel	93-00			
		DR 200 SE Trojan				
		DR 200 SEK1-SEK9	01-09			
		GT 200 EN/EX X5	79-80			
		RV 200 K2/K3	02-03			
		SB 200 N/X	79-80			
		SX 200 R/R-Z/RJ/RM	90-91			
		TS 200 RK/RL/RM/RN/RP/RR	89-94			
		LT 230 GEF/GEG	85-86			
		LT-F 230 G/H	86-87			
		GS 250 TT/TX	80-81			
CT011	KAWASAKI KLX 125 A1/A2/A3/A6F	03-06				
		KLX 125 L (B1/B2/B3/B6F)	03-06			
	SUZUKI GS 50 K5 (NA41A)	05				
		GT 50 KB/KEN	77-80			
		OR 50 ET	80			
		RG 50 EW				
		TS 50 KN/ERKT/ERKX/ERKZ/ERKD	79-83			
		TS 50 XKE/XKG/XKH/XKJ/XKM/XKR	84-02			
		TS 50 W				
		ZR 50 KEN/KEX	79-81			
		ZR 50 SLKX/SKX	81			
		ZR 50 SKE/SKH	84-87			
		DS 80 T/X/Z/D/F/G/H/J/K/L/M/N/P				
		/R/S/T/V/W/X/Y	80-00			
		JR 80 K1/K2/K3/K4/K5/K6/K7	01-07			
RM 80 B/C/N/XT/XX/XZ/XD/HD/XE/XF/HF	77-85					
RM 80 K/L/M/N/P/R/S/T/V/W/X/Y/K1	89-01					
RM 85 I (Small Wheel F 17" / R 14")	02-20					

Part No.	Make/Model	Year	Part No.	Make/Model	Year
CT012SP Contd.	HONDA		CT013SP Contd.	HONDA	
	(MC14/17/19)	86-89		ATC250 RF/RG	85-86
	CBR250 RRL/RRN/RRR			ATC250 ESF/ESG/ESH/ESJ	85-88
	(MC22 -100/105/110)	90-94		AX-1(NX 250 J/K/R/R3)	89-94
	CD250 UJ/UK	88-92		CB250 T/N/NA/NB/NDB/NDC	78-82
	CMX250 CT/CV/CW/CX	96-00		CB250 RSA/RSD	81-84
	TLR 250 F	85-		CBF250 39967	04-06
	TRX 250 V/W/X/Y/1/TM2			CBX250 RSE	84
	Re Con (Manual Shift)	97-14		CBX250 Twister	
	TRX 250 TE2 Re Con ES (Electric Shift)	02-14		CL250 SC	81
	TRX250 X9/XA/XB	09-11		CM250 TB	81
	TRX250 EX1/2/3/4/5/6/7/8	01-08		GB250 E/H/J/L/P/S/V Custom	84-97
	VT250 CR Magna			NX250 J/K/L (MD21)	87-90
	VT250 FL Spada/Castec	88-90		NX250 2L/M/P/2P	90-93
	VTZ250 H/J/K	86-88		TRX250 F/G/H	85-87
	VTR250 W/Y (MC33)/1-7	98-07		XL250 S/SZ/SA/SB/RC	78-82
	VTR250 9	09-10		XL250 RE/RF	84-85
	HONDA-DALLARA			XL250 Degree	
	XR125 SM	04		XLR250 R Baja (5 Plate) (MD22)	
	KAWASAKI			XLR250 R Baja (6 Plate) (MD22)	
	KLX125 CAF/CBF/CCF/CCS/CDS/CEF/CFF/CGF	10-16		XR250 SZ/SA	79-80
	KLX125 DAF/DBF/DCF/DEF (D-Tracker)	10-14		XR250 RB/RC/RD/RE/RF/RG/RH/RJ	
	KLX 150 L (KLX 150 EFF)	14-15		/RK/RL/RM/RN/RR/RS/RT	
	KLX 15 D-Tracker (KLX150 HGF)	16		/RV/RW/RX/RY/R1/R2/R3/R4	81-04
	KLF185 A3	87		XR250 Y/3 (MD30)	00-03
				XR250 39935 (MD30) Motard	03-05
				XR250 III Y/3 Baja	00-03
				TRX300 FWJ/K/L/T/V/W/X/Y/J/K	
				/L/T/V/W/X/Y	88-00
				TRX300 EX P/R/S/T/V/W/X/Y/1-8	93-08
				TRX300 X9	09
				TRX350 G/H/J/K/L/M/N	86-93
				TRX350 FMY/1-5 Fourtrax Rancher/4x4	00-05
		TRX350 TE/FE Fourtrax Rancher			
		ES/ES 4x4 FEY/1-5	00-05		
		CB350 SG/SJ	86-88		
		XR350 RD/RE	83-84		
		CB400 F/F1/F2	75-79		
		CB400 T/N/NA/NB/NC	78-82		
		CBR400 RRL/RRN/RRR (NC29)	90-94		
		NT400 Bros NC 25			
		NV400 C/J/CK (Steed)	92-93		
		NV400 CS/CV Steed	95-97		
		NV400 DCY/DC1/DC2 (NC40)			
		Shadow Slasher	00-02		
		TRX400 FWS/T/V/W/X/Y	95-00		
		VRX400 T (NC33)	96		
		TRX420 TM7/TM8/TM9/TMA/TMB	07-11		
		TRX420 FE7/FE8/FE9/FEA/FEB			
		4WD-Fourtrax ES	07-11		
		TRX420 FM7/FM8/FM9/FMA/FMB			
		4WD-Fourtrax	07-11		
		TRX420 FPMP/FPMA/FPMB			
		Fourtrax - 4WD - Power Steering	09-11		
		TRX420 TE7/TE8/TE9			
		Fourtrax ES - 2WD	07-09		
		CB450 DX-K	89		
		CMX450 CH/CJ Rebel	02		
		TRX450 ESW/ESX/ESY/ES1	98-01		
		CB500 R/T/V/W/SW/X/SX/Y			
		/SY/2/S2 (Twin)	94-03		
		CBF500 4/A4/A5/A6/A7	04-07		
		FT500 C	82		
		TRX500 FE5/FE6/FE7/FE8/FE9/FEA			
		/FAB Fourtrax Foreman 4WD/ES	05-11		
		TRX500 FEC Fourtrax Foreman			
		ES 39904 WD	12		
		TRX500 FM5/FM6/FM7/FM8/FM9			
		/FMA/FMB Fourtrax Foreman 4x4	05-11		
		TRX500 FMC Fourtrax Foreman			
		S 39904 WD	12		
		TRX500 TM5/TM6 Fourtrax Foreman	05-06		
		TRX500 FPE8/FPE9/FPEA/FPEB			
		Fourtrax Foreman 4x4 ES/EP	08-11		
		TRX500 FPEC Fourtrax Foreman			
		S 39904 WD	12		
		VT500 ED/EF	83-85		
		XL500 SZ/SB/RC	80-82		
		XR500 SZ/SA/RB/RC	79-82		
CT013	BMW				
	G 310 GS	17-20			
	G 310 R	17-20			
	HONDA				
	CR125 RD/RE	83-84			
	CRM250 R (RK) MK1 MD24				
	(100001-1008385)	89-90			
	CRM250 R (RM) MK2 MD24				
	(1200001-1211634)	91-92			
	CRM250 R (RP/PP-11)				
	MK2/2/MD24 (1300001-)	93			
	CRM250 MK3 RR/RR2 (MD24-10)	94-96			
	CRM250 Active Radial ARV/ARW (MD32)	97-98			
	NS250 FE/RE (MC11-100)	84			
NS250 RG (MC11-102)	86				
NSR250 RG (MC16-100) - Wet Clutch	86				
NSR250 R2J (MC18-100)/R4J					
(MC18-100) - Wet Clutch	88				
NSR250 R5K/R5K-2					
(MC18-110) - Wet Clutch	89				
NSR250 R7L(MC21-100)					
/R7N (MC21-106) - Wet Clutch	90				
NSR250 RR (MC28-100) - Wet Clutch	94				
TRX250 RG/RH/RJ/RK	86-89				
CB400 SS (SS2-NC41)	01-05				
CL400 (NC38)	97-03				
NS400 RF/RG	85-87				
TRX400 EX/EY/EXX/EXY/EX1-EX8/X9	99-09				
XR400 RT/RV/RW/RX/RY/R1-R5	96-05				
XR400 R5/R6 Motard (NC38E)	05-06				
XR400 M Supermotard (ND08/NC38E)	06-08				
HONDA-DALLARA					
XR400/440 R	04				
XR400/440 SM	04				
SUZUKI					
DR250 RS/RLS/RT/RV/RLV/RW					
/RLW/RY (SJ45A/DOHC)	95-00				
DR250 RXT/RXLT/RXV/RXLL/RXW					
/RXLW/RXGW/RXGLW/RXY/RXGY					
(Djebel 250 XC/GPS Ver (SJ45A)					
DR-Z250 K1-K7 (DJ 43 A)	01-07				
CT013SP	HONDA				
	CRM125 RL/RM/RN/RR/RR/RX	90-99			
	MBX125 FE	84-86			
	MTX125 RWD/E/F/H/L	83-95			
	NS125 FG/FH/RH (5 Plate Clutch)	86-87			
	NSR125 FJ/FK/FL/FM/FN (6 Plate Clutch)	88-92			
	NSR125 RK/RL/RM/RN (6 Plate Clutch)	89-92			
	NSR125 RR/RS/RV/RW/RX/RY/R1				
	(6 Plate Clutch)	93-01			
	MTX200 RWD/RWF	83-85			
	XR200 R	84-85			

Part No.	Make/Model	Year	Part No.	Make/Model	Year	
CT013SP Contd.	HONDA		CT014 Contd.	SUZUKI		
	NTV600 J/K/M	88-91		GSF 650 K7/K8/K9/L0/L1/L2		
	VT600 CN/CR/CS/CT/CV/CW/CX	92-00		Naked Bandit - Non ABS	07-12	
	XL600 VH/VJ/VK/VM/VN/VP/VR			GSF 650 SK7/SK8/SK9/SLO/SL1		
	/VT/VW/VX/VY	87-99		/SL2 Faired Bandit - Non ABS	07-12	
	NT650 J/K/L (BROS)	88-92		GSF 650 AK7/AK8/AK9/ALO/AL1		
	NTV650 J/K/L/M/P/S/T/V	88-97		/AL2 Naked Bandit - ABS	07-12	
	NT650 VW/VX/VY/V1-V5 Deauville	98-05		GSF 650 SAK7/SAK8/SAK9/SALO		
	XL650 VY/V1/V2/V3/V4/V5/V6/V7	00-07		/SAL1/SAL2 Faired Bandit - ABS	07-15	
	XRV650 J/K Africa Twin	88-89		GSX 650 FK8/FK9/FL0/FL1/FL2 (Non ABS)	08-14	
	NC700 SC/SD (Manual Gearbox)	12-13		GSX 650 FAK8/FAK9/FALO/FAL1/FAL2 (ABS)	08-15	
	NC700 XC/XD (Manual Gearbox)	12-17		GSR 750 L1/L2/L3	11-14	
	NT700 V6/VA7/V7/V8/VA8/VA/VA	06-13		GSR 750 AL2/AL3/AL4 /AL5 (ABS)	12-15	
	XL700 V8/V9/VA (Transalp			GSXR 750 Y	00	
	/2 Piston Front Caliper			GSXR 750 K1/K2/K3/K4/K5	01-05	
	/ABS on Rear Disc)	08-11		RF 900 RS/R2S/RT/RV/RW	95-98	
	XL700 VA8/VA9/VAA (Transalp			TL 1000 SV/SW	97-98	
	/3 Piston Front Caliper			YAMAHA		
	/ABS Front & Rear Wheels)	08-11		XTZ250 Lander (Brasil) (4B41/2/3)	07-09	
	NC 750 S	14-15		YBR250 (5D11/3/4)	07-11	
	NC 750 S (ABS)	14-18		YS250 Fazer (Brasil) (1S41/2/3)	06-08	
	NC 750 X	14-15		TRIUMPH		
	NC 750 X (ABS)	14-19		Daytona650	05	
	VT750 CV/C2V/CW/C2W/CX/C2X			Daytona675	06-12	
	CY/C2Y/C1/C1Y/C4/C5/C6/C7/C8	97-09		Daytona 675 R	11-16	
	VT750 C2BA/C2BB/C2BC/C2BE			Street Triple 675	07-16	
	Shadow Black Spirit	10-15		Street Triple R 675	09-16	
	VT750 C2SA/C2SB Shadow			Street Triple S 765	17-20	
	(3 Piston Caliper/17" Front			Street Triple R 765	17-20	
	Wheel/Rear disc)	10-12		Street Triple RS 765	17-20	
	VT750 DC1/DC2 Black Widow	01-04				
	VT750 DC7/DC8 Shadow Spirit	07-09				
	VT750 S (VT 750 SA/SB)	10-12				
	HONDA-DALLARA			CT014SP	HONDA	
	XR250 R	04			CB600 Hornet FW/FX/FY/F2-Y/F1	98-06
	XR250 RM	04			/F21/F2/F22/F3/F4/F5/F6	
	KAWASAKI				CBF600 N4/N5/N6	04-06
	KLF220 A1-A15	88-02			CBF600 NA4/NA5/NA6	04-06
	KLF250 A1/A2/A3/A6F/A7F/A8F				CBF600 S4/S5/S6	04-06
	/A9F/AAF/ABF (Bayou 250)	03-11			CBF600 SA4/SA5/SA6	04-06
	MOTOROMA				CBR600 FM/FN/FP/FR/FS/FT/FV/FW	91-98
	Geko300 Quad	04-06			CB 650 F (Non ABS)	14-20
	TRIUMPH				CB 650 FA (ABS)	14-20
Daytona600	02-05		CBR 650 F (Non ABS)	14-20		
TT600	00-03		CBR 650 FA (ABS)	14-20		
			BENELLI			
			Leoncino 500	17-19		
			Leoncino Trail 500	18-19		
			TRK 502 ABS Euro 4	17-18		
			TRK 502 X	18-19		
			BN 600 GT	14-17		
			BN 600 i	14-17		
			BN 600 R	14-15		
			BN 600 S	14-15		
CT014	HONDA		CT015	SUZUKI		
	CB600 F7/F8/F9/FA/FB/FC Hornet	07-13		GSX-R 600 K6/K7/K8/K9/L0/L1-L9	06-20-	
	CB600 FA7/FA8/FA9/FAA/FAB/FAC Hornet (ABS)	07-13		GSXR750 K6/K7/K8/K9/L0/L1-L5	06-20	
	CBF600 N8/N9/NA	08-11		GSX-S 750	15-20	
	CBF600 NA8/NA9/NAA	08-11		GSX-R 1000 K5/K6/K7/K8	05-08	
	CBF600 S8/S9	08-09		GSX-S 1000 (Naked/Non ABS)	18-20	
	CBF600 SA8/SA9/SAA	08-12		GSX-S 1000 (Naked/ ABS)	18-20	
	CBR600 FX/FY (CARB MODEL)	99-00		GSX-S 1000 F (Faired/Non ABS)	18-20	
	CBR600 FS1/FS2 Sport	01-02		GSX-S 1000 F (Faired/ ABS)	18-20	
	CBR600 FB/FC	11-13		Katana	19-20	
	CBR600 FAB/FAC	11-13		KTM		
	CBR600 RR3-RRK	03-19		950Adventure S	03-04	
	CBR600 RR Hannspree	08		950Adventure	02-06	
	CBR600 RA9-RAK(C-ABS)	09-19		950Superenduro R	07-08	
	VFR750 CP/CR/CS/CT/CV	93-97		950Supermoto	05-07	
	VFR750 FG/FH/FJ/FK/FL/FM/FN			990Adventure S	06-08	
	/FP/FR/FS/FT/FV	86-97		990Adventure R	09-12	
	VFR750 RJ/RK/RL (RC30)	88-92		990Adventure	09-12	
	VFR800 Fi-W/Fi-X/Fi-Y/Fi-1	98-02		990Adventure Dakar Edition	11	
	VFR800 2/3/4/5/6/8/9	02-09		990Superduke	05-11	
	VFR800 A2/A3/A4/A5/A6/A8/A9	02-13		990Superduke R	07-13	
	VFR 800 XA (Crossrunner/ABS)	11-13		990Supermoto T (SM-T)	08-13	
	VFR 800 XA (Crossrunner/ABS)	15-16		990Supermoto R (SM-R)	08-13	
	CB900 F2/F3/F4/F5/F6/F7 Hornet	02-07				
	CBR900 RRN/RRP/RRR (893cc)	92-94				
	CBR900 RRS/RRT/RRV/RRW/RRX (918cc)	95-99				
	CBR900 RRY/RR1 (929cc Fireblade)	00-01				
	CBR900 RR2/RR3 (954cc Fireblade)	02-03				
	SUZUKI					
	GSR 400 K6/K7/K8	06				
	GSR 600 K6/K7/K8	06-10				
	GSXR 600 K1/K2/K3/ZK3/K4/K5	01-05				

Part No.	Make/Model	Year	Part No.	Make/Model	Year
CT016	KAWASAKI		CT016 Contd.	KAWASAKI	
	EL250 B1/B2/B3 Eliminator	87-89		EJ 800 ADF/AEF/AFF/AGF (W 800)	13-16
	EL250 D1-D5	90-94		EJ 800 ADFA/AEFA/AFFA/AGFA (W 800 Special Edition)	13-16
	EL252 (EL 250 F2/F3F5/F6)	96-03		ZL900 A1/A2 Eliminator	85-86
	GPX250 R (ZX 250 F2/F3/F6-F9)	88-95		GPz900 R A1-A8	84-96
	GPZ250 R (EX 250 E)	86		GPZ900 R (ZX 900 A11-15)	98-02
	GPX250 R II (EX 250 G)	88		VN900 A6F Classic	06
	KLE250 A1/A1A/A2 (Anhelo)			VN900 B7F/B8F/B9F/BAF/BBF/BCF/BDF /BEF/BFF (Classic) (Spoke wheel)	07-15
	KR250 A1/A2	84-86		VN900 BBFA/BCFA/BDF/BEFA/BFFA Classic Special Edition (Spoke wheel)	11-15
	KR-1(KR 250 B2)	89		VN900 C7F/C8F/C9FA/CAF/CBF/CCFA /CDF/CEFA/CFFA (Custom) (Cast wheel)	07-15
	KR-1S(KR 250 C2/C3)	90-92		ZX-9R (ZX 900 B1-B4)	94-97
	KX250 J1/J2/K1-K5/L1-L4	92-02		Z1000 E1/E2 (ST-Shaft)	79-80
	KX250 M1/M2/R1/R6F/R7F/R8F (2T)	03-08		Z1000 K1/K2 (Ltd)	81-82
	ZZ-R250 (EX 250 H1-H13)	90-03		Z1000 J1/J2/J3	81-83
	FX400 R (ZX 400 E1/E2/E3)	86-88		Z1000 R1/R2 (Eddie Lawson Replica)	83
	GPZ400 R (ZX 400 D1/D2/D3/D3A)	85-87		GPz1000 RX A1-A3	86-88
	GPZ400 R (ZX 400 F1)	87		1000GTR (ZG 1000 A1-A18)	86-03
	Z400 J1-J3	80-83		ZX10 B1/B2/B3	88-90
	ZL400 A Eliminator	86-87		ZL1000 A1	87
	ZL400 B Eliminator 400 SE	88		GPz1100 B1/B2	81-82
	ZR400 A1/B1 (Z 400 F)	83-84		GPz1100 A1-A3	82-85
	ZRX400 (ZR 400 E1-E7)	94-01		Z1100 R1	84
	ZR400 Zephyr (G2/G3/G3A/G4/G5)	97-01		Z1100 A1-A3	81-83
	ZX400 C2 (Z 400 F 11)	85		Z1100 D1/D2 Spectre	82-83
	ZZR400 (ZX 400 K1/K2/K3/N1-N7)	90-99		ZR1100 A1/A2/A3/A4/B1	92-97
	EN450 A1-A5 (LTD 454)	86-89		ZR1100 B5 (Zephyr 1100 RS)	02
	EN500 A1-A4/B1/B2/C1-C9	90-04		ZRX1100 (ZX 1100 C1/C2/C3/C4)	97-00
	ER-5 (ER 500 A1/A2/A3/A4/C1-C5P)	97-07		ZRX1200 R A1/A2/A3/A4/A5/A6F	01-08
	EX500 A1-A6/D1-D7 (GPz 500 S)	87-02		ZRX1200 S B1/B2/B3 (ZR 1200)	01-03
	GPZ 500 (S) (EX 500 B1-B5/E1-E10)	88-04		SUZUKI	
	KLE 500 A1-A12/B1P/B6F/B7F	91-07		RM250 T/V/W/X/Y/K1-K9	96-12
	Z 500 A1-A3/B1/B2	79-81		RM250 XCK8	09
	GT 550 G1-G9	83-01			
	GPz 550 D1/H1/H2/A1-A4	81-87			
	ZR 550 A1/A2 (Z 550 F)	83-84			
	ZR 550 B2-B6 Zephyr	91-99			
	Z 550 C1/C2 (Ltd)	80-81			
	KL 600 A1 (KLR 600)	84			
	KLR 600 B1/B2/B4/B6-B9	85-94			
	GPz 600 R A1-A6	85-89			
	GPX600 R (C1-C3/C6-C7)	88-96			
	ZL 600 B1	95-97			
	ZZR 600 D1/D2/D2A/D3	90-92			
	ZZR 600 (ZX 600 E1-E13/E6F)	93-07			
	650 Vulcan S (EN 650 AFF/AGF/Non ABS)	15-16			
	650 Vulcan S (EN 650 BFF/BGF/ ABS)	15-16			
	ER-6f (EX 650)	06-11			
	ER-6f (ABS) (EX 650 A)	06-11			
	ER-6n (ER 650)	06-11			
	ER-6n (ABS) (ER 650)	06-11			
	KLE650 A7F/A8F/A9F/CAF (Versys)	07-10			
	KLE650 B7F/B8F/B9F/DAF (Versys ABS)	07-10			
	KLE650 CBF/CCF/CDF/CEF (Versys/Non ABS)	11-14			
	KLE650 DBF/DCF/DDF/DEF (Versys/ABS)	11-14			
	KLE 650 Verseys (KLE 650 EFF/EGF/Non ABS)	15-16			
	KLE 650 Verseys (KLE 650 FFF/FGF/ABS)	15-16			
	KLR650 A1-A3	87-89			
KLR650 (KL 650 E8F/E9F)	08-09				
KL650 B1/B2/B3 Tengai	89-92				
KLX650 C1/C2/C3	93-97				
KLR650 C1-C10	95-04				
W650 (EJ 650 A1/C3-C7)	99-05				
VN700 A1 Vulcan	85				
GPX750 F1/F2/F2A/F3	87-89				
GPz750 R G2/G3	85-86				
VN750 A2/A3/A4/A5/A10	86-94				
Z750 B1/B2	77-78				
Z750 D1	76				
Z750 Y1 (Ltd)	82				
ZXR750 H1/H2/J1/J2/L1-L3/P1-P7	89-03				
ZXR750 R (ZX 750 K1/K2/M1/M2)	91-94				
ZX7RR (ZX 750 N1/N2)	96-99				
VN800 A1-A3/B1-B10/B6F	95-06				
VN800 C1/C2/E1/E2/E3 Drifter	99-04				
EJ800 ABF/ACF (W800 Solid Front Disc)	11-12				
EJ800 W 800 Cafe Style/Cockpit Fairing)	11				
EJ800 ACFAW 800 Special Edition Black Exhaust/Gold Rims)	12				
			CT017	YAMAHA	
			XS400	82	
			RD500 LC	84-86	
			RZV500 R (51X)	85	
			XV 950 Racer (Remote Reservoir Rear Shock)	15-16	
			XVS950 A Midnight Star	09-13	
			XV 950 XVS 950 (Non ABS/Standard Rear Shocks)	14	
			XV 950 CU - XVS 950 (1XC1/ABS/Standard Rear Shocks)	14-15	
			XV 950 R - XVS 950 R (2DE/Remote Reservoir Rear Shocks)	14-15	
			YZFR1 (4XV1/2 4XV7/8 5JJ1/8 5PW1/7)	98-03	
			FJ1100	84-85	
			FJ1200/1200 A	86-95	
			XT1200 Z Super Tenere (ABS/UBS Brake System)	10-16	
			XT 1200 ZE Super Tenere (ABS/UBS Brake System)	14-16	
			XJR1200	95-98	
			FJR1300 N/P	01-02	
			FJR1300 R/AR/S/AS/AT (ABS)	03-05	
			FJR1300 A (1CY/Manual G/Shift)	06-15	
			FJR1300 AE (Electronic Suspension Adjustment/USD Forks)	14-15	
			FJR1300 AS (Electric G/Shift)	06-15	
			XJR 1300 C / Racer	15-16	
			XJR1300 L 5EA2/5EA3/5EA4	99	
			XJR1300 M 5EAA/5EAB/5EAC	00	
			XJR1300 (5EA1/5EA7/5EA9/5EAG)	98-00	
			XJR1300 N/P (5EAP/5EAS/5EAT /5EAW/5EAV/5EAY)	01-02	
			XJR1300 R/S 5WM1/5WM3/5WM5 /5WM6/5WM7/5WM9	03-04	
			XJR1300 T/V/W/X/Y 5WMA/5WMC /5WMD/5WME	05-14	
			XJR1300 SP (L) (5EA5/5EA6/5EA8)	99	
			XJR1300 SP (M) (5EAD/5EAE/5EAF)	00	
			XJR1300 SP (N) (5EAL/5EAM/5EAN)	01	
			XVS1300 A Midnight Star	07-16	
			XVS1300 CU Custom	14-16	
			XV1700 V-Max	09-16	
			XV1900 A Midnight Star (Diaphragm Spring)	06-12	
			MT-01 (1670cc)	05-09	
			MT-01S (1670cc)	09	

Part No.	Make/Model	Year	Part No.	Make/Model	Year
CT018SP	SUZUKI		CT020 Contd.	YAMAHA	
	RL250 Beamish Model Reed Valve Engine	78-82		MT-07 Motocage ABS (689cc/2 Cyl)	15
	RL325 Beamish Model Reed Valve Engine	78-82		YFM700 RV/RW/RA/RD/RE	06-14
	GS400 B/C	77-78		YFM700 RSE	13-14
	GS425 EN	79		XSR 700 ABS (MTM 690-U)	16
	GS550 DB/DC/EC/EN/ET/EX/EZ	77-82		XV750 SE	81
	GS550 MX/MZ Katana	81-82		XV750 Virago	92-97
	GS550 LT/LX	80-81		YZF7R OW02	99-00
	GSX550 ESD/ESE/EFF/EFE/ESH/EFG (GN71D)	84-87		FZ8 N-800cc	
	GS650 GX/GZ Katana	81-82		(Naked/Single Headlight/Non ABS)	11-15
	GS650 GTX/GTZ/GTD	81-83		FZ8 NA-800cc (Naked/Single Headlight/ABS)	11-15
	XN85 D Turbo	83		Fazer 8 S-800cc	
	GS700 EF/ESF	85		(Top Fairing/Twin Headlight/Non ABS)	11-15
	GT750 J/K/L/M/A/B	72-77		Fazer 8 SA-800cc (Top Fairing/Twin Headlight/ABS)	11-15
	GS750 B/DB/DC/EC/EN	77-79		MT-09 (1RC/Non ABS/847cc/3 Cyl Engine)	14-16
	GSX750 ET/EX	80-81		MT-09 Tracer ABS (847cc/3 Cyl Engine)	15-20
	GSX750 ESD/EFE/ESG/ESE/EFF	83-86		MT-09A (2DR/ABS/847cc/3 Cyl Engine)	14-20
	GSX750 SE Katana	84		MT-09A Sport Tracker ABS (847cc/3 Cyl Engine)	14-20
	GSX750 S/SS (GS75X-106815-)			MT-09A Street Rally ABS (847cc/3 Cyl Engine)	14-20
GSX750 S-2/S-2C (GS75X-114747-) Katana		FZ1 (Naked) (1000cc) (2D11)	06-09		
GS850 GN/GT/GX/GZ/GF/GG	79-85	FZ1-N/NA (Naked/Non ABS & ABS)	10-15		
CT019	KAWASAKI		CT021	HONDA	
	Z650 B/B2/B3	77-79		CB750 KZ	80
	Z650 C1/C2/C3 Custom	77-79		CB750 FA/FB/F2C	79-82
	Z650 D2/D3	79-80		CB900 FZ/FA/FB/F2B/F2C/FD/F2D	80-85
	Z650 F1/F2/F3/F4	80-83		VTR1000 SPY/SP1 (SC45)	00-01
	Z700 A1 Ltd	84		CB1100 RB2/RC2/RD2	80-82
	ZN700 A1/A2 Ltd	84-85		CB1100 SFY/SF1 X11	00-03
	GPz750 R1	82		CBR1100 XXV/XXW Blackbird	97-98
	GPz750 A1-A5	83-87		CBR1100 XXX/XXY/XX1-XX6 Blackbird	99-08
	GT750 P1-P5	82-90		ST1300 2/3/4/6/8/9 Pan European -Non ABS	02-09
	GT750 P7/P9	92-96		ST1300 A2/A3/A4/A6/A8/A9/AA	
	Z750 N1/N2 Spectre	82-83		Pan European-ABS Model	02-13
	ZR750 C1/C2/C3/C4 Zephyr	91-95		VT1300 CXA (Fury/Chopper/Non	
	ZR750 C5/D1 Zephyr	95-98		ABS/9 Spoke Cast Wheel)	10-12
	ZR7 (ZR 750 F1/F3/F5)	99-04		VT1300 CXAA (Fury/Chopper/ABS	
	ZR-7S(ZR 750 H1/H2)	01-04		/9 Spoke Cast Wheel)	10-11
	Z750 E1/H1/H2/L1-L4	80-84		VTX1300 S3/S4/S5/S6/S7/S8	03-08
	ZX750 E1/E2 (Turbo)	84-87		VTX1800 C2/C3/C4/C15/C16/C17	02-08
	Z1/Z1A/Z1 B	74-76		KAWASAKI	
	Z900 A4/A5	76-77		KL1V1000 (LV 1000 A1H/A2H)	04-05
	Z1000 D1-D3 Z1R	78-80		ZZ-R1100 C1/C2/C2A/C3/D1-D9	90-01
Z1000 A1/A2/A3/A4	77-80	ZX1100 E1/E2/F1	95-98		
Z1000 H1	80	ZZR1200 C1H/C2H	02-04		
CT020	YAMAHA			SUZUKI	
	WR 250 Z (2T)	91-98		DL1000 K2-K9/L0 V-Strom	02-10
	YZ 250 (2T)	88-20		DL 1000 V-Strom (ABS)	14-20
	YZ 250 FG (270mm Disc)	16-18		DL 1000 V-Strom Adventure ABS	14-20
	YZ 250 FGY			SV1000 K3K4/K5/K6/K7 (Naked)	03-07
	(60th Anniversary Edition/270mm Disc)	16		SV1000 SK3/SK4/SK5/SK6/SK7 (Faired)	03-07
	XVS400	96		GSF1200 SFK7 Bandit Streetfighter	07-09
	WR426 FN/FP (4T)	01-02		GSF1250 K7/K8/K9 (Naked Bandit	
	YZ426 FM/FN/FP (4T)	00-02		- Non ABS - 4 Piston caliper)	07-10
	WR 450 F (4T)	03-15		GSF1250 AK7/AK8 (Naked Bandit	
	WR 450 F (270mm F/Disc/4T)	16-20		- ABS Model - 4 Piston caliper)	07-10
	YZ 450 F (4T)	03-15		GSF1250 SK7/SK8/SK9/SLO	
	YZ 450 FG (270mm Disc)	16-20		(Faired Bandit - ABS Model	
	YZ 450 FGY			- 4 Piston Caliper)	07-10
	(60th Anniversary Edition/270mm Disc)	16-20			
	YFZ450 S/T/V/W/X Quad	04-09			
	YFZ450 B/D	13-14			
	YFZ450 RX/RX Quad	09-10			
	YFZ450 RSEA/RSEB/RSED/RSE	11-14			
	XV 535/535 S Virago	88-03			
	XVS650 Dragstar	97-04			
	XVS650 A Dragstar Classic	98-07			
	MT-03 (660cc)	06-12			
	XT660 X Supermoto (1D21/1D23				
	/1D24/1D26/3S72/10S1/11B1)	04-09			
	XT660 X Supermoto (10S7)	10-16			
	XT660 R (Model Code 5VK1/3/4/6				
	/8/3S62/3S63)	04-07			
	XT660 R (Model Code 5VKA/5VKC/5VKE)	08-16			
	XT 660 Z Tenere (Non ABS)	08-16			
	XT 660 ZA Tenere (ABS)	11-16			
	MT-07 (Non ABS /689cc /2 Cyl)	14-20			
	MT-07A (ABS /689cc /2 Cyl)	14-20			

Part No.	Make/Model	Year	Part No.	Make/Model	Year	
CT021 Contd.	SUZUKI		CT022 Contd.	SUZUKI		
	GSF1250 SAK7/SAK8/SAK9			GT500 A/B	76-77	
	/SAZK9/SAL0 (Faired Bandit			RM500 D/E	83-84	
	- ABS Model - 4 Piston Caliper)	07-15		T500 R/J/K/L/M (12 ears)	71-75	
	GSX1250 FAL0/FAL1/FAL2	10-15		SV650 X/Y/K1/K2 (Naked - Non ABS)	99-02	
	GSX1250 FAL0ST/FAL1ST Sports Touring	10-14		SV650 SX/SY/SK1/SK2		
	GSX1300 RX/RX/RK1 Hayabusa	99-01		(Faired - Non ABS)	99-02	
	GSX1300 RK2/RZK3/RK3/RK4/RK5/K6/K7	02-07		APRILIA		
	GSX1300 RK8/RK9/RL0/RL1/RL2			RS250	95-02	
	/RAL3/RAL4/RAL5 Hayabusa	08-15		QUADZILLA		
	GSX1300 BKK8/BBK9/BKLO/BKL1 B-King	08-12		WK300	06	
	VL1500 BTL3/BTL4/BTL5 (C 1500BT Intruder)	13-15				
	KTM			CT023	KTM	
	RC8 (1190cc)	08-10			SX250 (2T/Diaphragm Spring)	13-15
	RC8R/Track (1190cc/6 Spring Clutch)	10-12			SX-F250 (4T/Coil Spring)	13-20
	RC8R/Track (1190cc/3 Spring Clutch)	13-14			EXC250 (2T)	13-20
	TRIUMPH				EXC250 Six Days (2T)	13-20
	Adventurer	96-01			EXC-F 250 (4T)	14-20
	Daytona750 (3cyl)	92	EXC-F 250 Six Days (4T)		14-20	
	Daytona900 93cyl)	93-96	250EXC-G Racing		03	
	Daytona1000 (4cyl)	92	250EXC Racing		02-03	
	DaytonaSuper III (3cyl)	94-97	250EXC Racing (2T)		05	
	Daytona1200 (4cyl)	93-98	XC250 (2T/Diaphragm Spring)		13	
	LegendTT	98-01	XC-F250 (4T/Coil Spring)		13-20	
	RocketIII 2300cc	04-09	EXC300 (2T/Diaphragm Spring)		13-15	
	RocketIII Classic	07-09	EXC300 Six Days (2T/Diaphragm Spring)		13-15	
	RocketIII Roadster ABS	10-12	350Freeride (4T)		12-15	
	RocketIII Touring	08-12	EXC-F350 (Coil Spring)		11-20	
	SpeedTriple (Carb models)	94-97	EXC-F350 (4T/Diaphragm Spring)		12-20	
	RocketIII 2300cc (All models)	04-09	EXC-F350 (4T/Six Days/Diaphragm Spring)		12-20	
	Sprint(All carb models)	93-98	SX-F350 (USD Forks/Coil Spring)		11-20	
	Thunderbird	95-03	XC-F350		12-20	
	ThunderbirdSport	98-04	400EXC Racing		02	
	Tiger900cc (Up to VIN71698)	93-96	400EXC-G Racing		02	
	Trident750	92-98	400EXC Racing		05	
	Trident900	92-98	400EXC		07-09	
	Trophy900 (3cyl)	92-01	400EXC-G Racing		05-06	
	Trophy1200 (4cyl)	92-01	400MXC		02	
			400SX Racing		02	
			450EXC Racing		03/05	
			450EXC-G Racing		03/05	
			450EXC		04-09	
			EXC450 (4T/Diaphragm Spring)		12	
			EXC-F450 (4T/Diaphragm Spring)		13-15	
			EXC450 Six Days (4T/Diaphragm Spring)		12-15	
			450MXC-G Racing		03/05	
			MXC450		06	
			450SMR		04-05	
		SMR450	06-07			
		450SMS	04			
		EXC-F 450 (4T/Diaphragm Spring)	18-19			
		SX450 (4T)	03-06			
		SX-F450 (4T/Diaphragm Spring)	12-20			
		XC450 Quad (4T)	08-09			
		EXC500 (4T/Diaphragm Spring)	12-20			
		EXC500 Six Days (4T/Diaphragm Spring)	12-20			
		520SX Racing	02			
		525EXC-G Racing	03/05			
		525EXC	03			
		525EXC Racing	05			
		525MXC Desert Racing	03/05			
		MXC525	06			
		525SMR	04-05			
		525SX Racing	03/05			
		SX525	06			
		XC525 (Quad)	08-12			
		540SXS Racing	02			
		SMR560	06-07			
		HUSQVARNA				
		FC 250	14-20			
		TC 250	14-20			
		TE 250	14-20			
		TE 300	14-20			
		TX 300i	18-20			
		FC 350	14-20			
		FE 350	14-20			
		KTM				
		FX 350	17-20			
		FC 450	14-20			
CT022	SUZUKI					
	DR250 SL/SM/SN/SEP/SER/SES					
	(SJ 44 A)	90-95				
	GT250 M/A-C/EN/ET/EX X7	75-81				
	LT250 RH/RJ/RK	87-90				
	PE250 B/C/N/T/X/Z	77-82				
	RG250 WD/WE	83-84				
	RG250 FG/FH/CH/FCH	85-88				
	RGV250 J	88				
	RGV250 K/L (VJ21A)	89-90				
	RGV250 M/N/P/R/S (VJ22A)	91-95				
	RL250 L/M	74-75				
	RM250 A/B/C/N/T/X/Z/D/E/F/G/H					
	/J/K/L/M/N/P/R/S	76-95				
	RMX250 K/L/M/N/P/R/S/T/W	89-98				
	RMX250 SN/SR/S-S (SJ13A)	95-97				
	RMX250 ST/SV/SW/SX (SJ14A)	96-99				
	TS250 K/L/M/A/B/C/ERN/ERT/ERX	73-81				
	TV250 J/K/RK/L (VJ21A) Wolf	88-90				
	DR350 SL/SM/SN/SP/SER					
	/SES/SET/SEV/SEW/SEX	90-99				
	SG350 N Goose	92				
	SP370 C/N	78-79				
	GT380 K-M/A/B	73-77				
	DR400 ST/SX	80-81				
	GN400 TT	80				
	GSX400 ET/EX/EZ	80-82				
	GSX400 FEX/FZ/FD	81-83				
	GSX400 FW/FWS/FWS-2					
	GSX400 TX/LX	81				
	PE400 T/X	80-81				
	RM400 C	78				
	RM400 N/T	79-80				
	SP400 T	80				
	GS450 ET/EG/EJ	80-88				
	RM465 X/Z	81-82				
	LT500 RL/RM	90-91				
	GS500 EK/EL/EM/EN/EP/ER/ES/ET					
	/EV/EW/EX/EY/K1/K2/K3/K4/FK4					
	/F5/FK5/K6/FK6/K7/FK7/K8/FK8	89-08				

Part No.	Make/Model	Year	Part No.	Make/Model	Year
CT023 Contd.	KTM		CT029 Contd.	SUZUKI	
	FC 450 Rockstar Edition	20		VS750 GLF/GLFG/GLFH/GLPG	
	FE 450	14-20		/GLPK/GLPL/GLPM/GLPH	85-91
	FS 450	15-20		/GLEFH/GLEPH (VR51A)	92-97
	FX 450	17-20		VS800 GLN/GLP/GLR/GLS/GLT/GLV	01-05
	FE 501	14-20	VL800 K1-K5 Intruder Volusia		
CT024	SUZUKI		C800 Intruder - Spoke Wheels	06-15	
	DR650 SET/SEV	96-97	(VL 800 K6/K7/K8/K9/L0/L1/L2/L3/L5)		
	XF650 V/W/X/Y Freewind	97-02	C800 C Intruder - Cast Wheels	07-15	
	DR750 SJ/SK	88-89	(VL 800 CK7/CK8/CK9/CL0/CL1/CL2/CL3)	14	
	DR 800 SL (SR43A)/SM/SN/SP		C800 Intruder - Cast Wheels (VL 800 BLT4)	90-96	
	/SR/SS (SR43B)	90-95	VX800 L/M/N/P/R/T (8 Spring CSK Kit)		
	DR 800 ST/SV (SR43B)	96-97	VZ800 V/W/X/Y/K1/K2 Marauder	97-02	
	CCM		(8 Spring CSK Kit)		
	R30(644 Suzuki Engine)	02-04	M800 (VZ 800 K5-K9/L0/L1/L3)	05-13	
	644DS/Supermoto	04	Intruder M800	14-15	
CT024SP	SUZUKI		M800 T (VZ 800 L4/L5 Intruder M800/T)	09-10	
	GS1000 GT/GX	80-81	M800 Z (VZ 800 K9Z Intruder M800/Z)	85-86	
	GSX1000 SZ	82	GV1200 GLF/GLF2/GLG Madura	85-88	
	GS1100 GZ	82	GV1400 Cavalcade (All models)		
	GSX1100 ET/EX/EZ	80-82	VS1400 GLPH/GLPJ/GLFH/GLFJ		
	GSX1100 SZ	82	/GLPR/GLPT/GLPV/GLPW		
	GSX1100 EFE/EFG/ESF	84-86	/GLPY/GLPK1/GLPK2	87-03	
	GSX 1100 SD	83	CT029SP	SUZUKI	
	GSX 1100 ESD	83	ST400 V/W/X/Y/K1/K2/K3 Tempter	97-03	
	VL1500 W/X/Y/K1/K2/K3		DR500 X/Z/D	81-83	
	Intruder Legendary Classic	98-03	DR600 RG/RH/RJ/RK (SN41A)	86-89	
	VL1500 K5/K6/K7/K8/K9		DR600 SF/SG/SH/SJ/SK (SN41A)	85-89	
	(C 1500 Intruder)	05-09	DR650 RL/RM (SP41A)	90-91	
CT025	YAMAHA		DR650 RSL/RSM (SP42A)	90-91	
	TDR250		DR650 RUN/RN/RUP/RP (SP44A/B)	92-93	
	(3CK1/3CK2 Europe - Eng/Frame # 3CK)	88-92	DR650 RSEM/RSEN/RSEP (SP43A/B)	91-93	
	TZR250		DR650 RER/RES (SP45A/B)	94-95	
	(2MA/2XW1/2XW2 Europe		LS650 Savage FG/PK/PM/PR/PG/PT/PV	87-97	
	- Eng/Frame # 2MA -)	87-92			
TZR250		CT030	KTM		
(1KT/2AW Japan		350EXC	94		
- Eng/Frame # 1KT - 000/056-)	87	350Super Comp	94-95		
TZR250		380EGS	98-99		
(2XT1 Japan - Eng/Frame # 1KT - 09-)	88	400Duke	94-95		
		400EGS-E	97		
		400EGS	94/96-97		
		400EXC	94/96		
		400LC-4	98		
		400LC4-E	00-01		
		LC4R 400	99		
		400LSE	97		
		400LS-E	04		
		400Super Comp	95		
		400Super Comp/EXC	96-99		
		400RXC-E	96-97		
		SXC400	97		
		400SX-X	98		
		400SX	99		
		400SXC	00		
		400TXC	98		
		540SX-C	98-99		
		620Duke	94/97		
		620EGS	94-95		
		620EGS/Adventure	96-97		
		620EGS-E	97		
		620Enduro Ltd	97		
		620EXC	94-95		
		620LC-4	98		
		620LC4 Competition	99		
		620LC4 Super Moto	99		
		620LSE	97		
		620RXC-E	96-97		
		620Six Days	96		
		620Super Comp	94-99		
		620SC	00-01		
		SX620	94/97-99		
		SXC620	97		
		620Supermoto	98		
		620TXC	98		
		625SC	02		
		625SMC	04/06		
		625SXC	03-04		
CT026	APRILIA				
	RS50	06-10			
	RX50	06-09			
	DERBI				
	GPR50 Nude	04-05			
	GPR50 R	97-00			
	GPR50 Racing	04-05			
	GPR50 Replica	99-05			
	Senda50 (4 Plate Clutch)	99-05			
	CT027	KTM			
		SX60	98-00		
		SX65	98-08		
	CT028	KTM			
		SX 85 (17"/14" Wheels)	03-17		
		SX 85 (19"/16" Wheels)	03-17		
CT029	SUZUKI				
	VL125 Y/K1-K7 Intruder	00-08			
	GN250 F/J/M/R/T (NJ41A)	85-97			
	GW250 L3/ZL5 Inazuma	13-15			
	GW 250 FL5 Inazuma	15			
	GZ250 X/Y/K1-K8 Marauder	99-08			
	SW-1(NJ45A)	92			
	TU250 T/XS/XT/X-ST/XSV Volty	92-97			
	TU250 XTX/XXTY (NJ45A-115-) Volty	99-00			
	TU250 GY/GBK1 Grass Tracker				
	Big Boy (NJ47A-117/123)	00-01			
	VL250 Y/K1/K5/K6/K7 Intruder	00-01/05-07			
	TU250 XV/XW	97-00			
	VS400 VR/FR/VTR/FTR/VT/FT Intruder	94-			
	VS600 GLS/GLT/GLV	95-97			
GR650 D/XD	83				
VS700 GLFG/GLEFG/GLPH/GLEPH	86-87				

Part No.	Make/Model	Year	Part No.	Make/Model	Year				
CT030 Contd.	KTM		CT033SP Contd.	SUZUKI					
	640Adventure-R	98-02		SFV650 AK9/AL0/AL1/AL2/AL3/AL4/AL5	09-15				
	640Duke-E	98		Gladius (ABS)	03-10				
	Duke-E640	98		SV650 K3/K4/K5/K6/K7/K8/K9/L0	03-15				
	Duke II 640	99-07		(Naked - Non ABS)	03-10				
	640LC Rallye Dakar	97		SV650 SK3/SK4/SK5/SK6/SK7	03-15				
	640LC4	99-00		/SK8/SK9/SLO (Top Fairing Non ABS)	03-10				
	640LC4 Six Days	99		SV650 AK7/AK8/AK9/AL0	03-10				
	640LC4-E	00-02		(Naked ABS Model)	16-20				
	640LC4 Adventure	03-06		SV650 SAK7/SAK8/SAK9/SAL0					
	640LC4 Supermoto	03-04		(Top Fairing - ABS Model)					
	660LC4	97		SV 650 (ABS)					
	660LC4 Rallye	99-00		CT034SP	APRILIA	AF1125	87-91		
	660Rallye	01-03				Classic125	95-01		
	660Rallye factory	04				MX125	04-06		
	660SM Factory Replica	02-03				Pegaso125	91-95		
	660SMC	03-04				RedRose 125 (Cast Wheel)	87		
660SMS	04	RedRose 125 (Spoke Wheel)	88-94						
690Rally Factory Replica	07-09	RS125 (2T)	92-14						
CT031	HONDA		CT035SP	SUZUKI					
		CB500 T (Twin)			75-77	RE5 M/A	75-76		
		CBX750 FE			84-85	GT550 J/K/L/M/A/B	72-77		
		VF750 FD/FE			83-85	GS1000 HC/EC/EN/SN/ET	78-80		
		VF750 SC (V45 Sabre)			82	CT036SP	SUZUKI	GSX600 FN/FP/FR/FS/FT/FV	92-97
		VF750 CH			87			RF600 RP/RR/RS/RT	93-96
		VT750 C Shadow			83			GSX750 FK/FL/FM/FN/FP/FR/FS/FT/FV	89-97
		XLV750 R (RD/RF)			83-88			GSXR750 J/K/L/M/WN/WP/WR/WS	88-95
		VF1000 FE/FF/RE/RF/RG/F2F			84-86	CT037SP	SUZUKI	RG400 EWF/EW-2G/EWH Walter Wolf	85-87
		VT1100 CH/CJ/CN/CP/CR/CS/CT						RG500 G/CH	85-87
/CV/CW Shadow	87-98	CT038SP	SUZUKI	T20 Super Six	66-68				
VT1100 C2 (S/T/W/X/Y/1/2/3/4/5)	95-05			CT039	YAMAHA	AG100 E Farm Bike	93		
VT1100 C3 (W/X/Y)	98-00	AG100 J (3HAA)	82						
CT032	KAWASAKI					AS3 125	71-72		
		ZG1300 A1-A3	84-86			DT100	76-80		
		VN1500 B2/C1/C2/D1	88-96			RS100 - 478	75-76		
		VN1500 B2-B6	88-92			YZ100 E/F/G/H/J/K	78-83		
		VN1500 C1/C2	94-95			DT125	74		
		VN1500 D1/D2	96-98			DT125/125 F	76-77		
		VN1500 G1/G2	98-99			DT125 E	78-79		
		VN1500 E1/E2 Classic	98-99			DT125 MX	80-81		
		VN1500 J1/J2/R1/R2/R3 Drifter	99-04	RD 125	73-74				
		VN1500 N1/N2/N3 Classic Fi	00-04	RD125 DX	75-76				
		VN1500 L1/L2/L3/L4 Classic Tourer Fi	00-03	RS125/RS 125 DX	75-76				
		VN1500 P1/P2 Mean Streak	02-04	SR125 SE	81-83				
		VN1600 A1/A2/A3/A6F Classic	03-08	SR125	89-03				
		VN1600 B1/B2H/B6F/B7F (Mean Streak)	04-08	TW125 (5EK) 4 Friction Plate Type	99-02				
		VN1600 D1H/D6F Classic Tourer	05-08	TW125 (5RS) 5 Friction Plate Type	03-04				
		VN1700 B9F/BAFBFF/BCF/BDF		TY125	80-82				
		/BEF/BFF/BGF Voyager ABS	09-16	XT125	82-83				
		VN1700 C9F Classic Tourer	09	YZ125 C/D/E/F/G/H (2T)	76-81				
		VN1700 DAF/DBF/DCF/DDF/DEF		DT175	74-77				
		Classic Tourer ABS	10-17	DT175 MX	78-81				
		VN 1700 DFF/DGF - Vulcan 1700 Nomad	15-16	IT175 G/H/J	80-82				
		VN1700 E9F Classic	09	TY175	77-80				
		VN1700 FAF/FBF/FCF/FDF/FEF Classic ABS	10-14	AG200 E (3GX6)	93				
		VN1700 KBF/KCF/KDF/KEF Voyager Custom	11-17	IT200 L	84				
		VN2000 A1/A2/A6F	04-07	RD200 DX	76-81				
		VN2000 H8F/H9F Classic	08-09	RS200	79-80				
CT033SP	SUZUKI			TW200 (2JL/4CS1/2/3/5)	91-98				
		SV400 N (VK53A)	98	TW200 (4CS4/6/5LB1/2)	98-01				
		SV400 X/Y/K1/K2/K3/K4/K5	99-05	ST225 (5BT) Bronco	97				
		SV400 SN (VK53A)	98	TW225 E (5VC1/2)	02-03				
		SV400 SX/SY/SK1/SK2/SK3/SK4/SK5	99-05	XT225 (2LN) Serrow (1KH 020101-)	86-87				
		DL650 K4-K6 V-Strom	04-06	XT225 (3RW1/2/4/5 Serrow)	89-93				
		DL650 AK7/AK8/AK9/AL0/AL2/AL3		(1KH 034101-132000)					
		/AL4/AL5 V-Strom ABS	07-15						
		DL 650 XT V-Strom	15-20						
		DL650 AL1XP V-Strom Xpedition ABS	11						
		DL650 AK9GT V-Strom Traveller ABS	09-10						
		DL650 XK7/XK8/XK9/XL0 V-Strom	04-11						
		SFV650 K9/L0/L1/L2/L3/L4/L5							
		Gladius (Non ABS)	09-15						

Part No.	Make/Model	Year	Part No.	Make/Model	Year																
CT039 Contd.	YAMAHA XT225 S (3RW3 Serrow) (1KH 034101-132000)	92	CT044 Contd.	YAMAHA RX115 (5FS3)	99																
	XT225 (3RW4) Serrow (1KH 080101-)	92		DT125 LC Type 35A	85-87																
	XT225 W (4JG1/2/3/4) Serrow	93-95		DT125 (3TT4)	96																
	XT225 WE (4JG5/6) Serrow	97-98		IT125 G/H/J	80-82																
	XT225 (4VW1/3/5/7/9) (4VWA/B/D/G/J/L) (Brasil)	97-06		RD125 DX	78-81																
CT040SP	CCM 604Trial/SM/RS/R30 (Rotax Engine)	98-03	RD125 LC (MK1-MK3)	82-87																	
			RZ125 (1GV 030101-)	85																	
CT041	KTM EXC400 (4T)	09-11	RS125	77-81																	
			EXC450 (4T/Coil Spring)	09-11																	
			EXC450 Six Days (4T)	11																	
			EXC-R450 (4T)	08-10																	
			EXC-R530 (4T) - (9 Friction plate type)	08																	
			EXC530 - (7 Friction Plate Type)	08																	
			EXC530 - (9 Friction Plate Type)	09-11																	
CT042	KAWASAKI KDX125 A1/A2/B1/B2	90-94	TT-R 125 LW	00-20																	
			KX125 D1/E1/E2/F1/F1/H1/H2/J1/J2	85-93																	
			KDX200 C1/C2/C3/E1-E6	86-94																	
			KL250 H1 Super Sherpa	98																	
			KL250 J1 Stockman																		
			KLX250 D1/D2	93-95																	
			KLX250 F1-F4 (KLX 250 E)	94-97																	
			KLX250 G1	94-																	
			KLX250 J1-J6 D-Tracker	98-03																	
			KLX250 S H6F/H7F	06-07																	
			KLX250 (KLX 250 S9F/SAF/SBF /SCF/SDF/SEF/SFF/SGF)	09-16																	
			KLX300 A2-A10/A6F	97-06																	
			SUZUKI 250SBK2 (LX 250 L)	02																	
CT043SP	HONDA CBR1000 RR8/RR9/RRA/RRB RRC/RRD/RRE/RA9/RAA/RAB/RAC/RAD /RAE/RRF/RRG/RAF/RAG Fireblade (Diaphragm Type Clutch)	08-16	XT125 R (13D1) - 5 Friction plate type	05-06																	
			VFR 1200 FA (Manual Gearbox Model)	10-15																	
			CBR1000 RR-SP ABS Fireblade (CBS1000 SAE/SAF/SAG)	14-16																	
			CBR1000 RR-SP ABS-TT Edition	16																	
			CT044	YAMAHA FS1 E/FS 1 DX	74-80	XT125 R (13D1) - 5 Friction plate type	07														
						FS1	87-90														
						FS1 SE	81-82														
						DT50 M	78-79														
						DT50 M/MX	80-95														
						DT50 LC	98														
CT045	SUZUKI LT-R450 K6/K7/K8/K9/L0/L1 RM-X450 ZL0/ZL2 RM-Z450 K5-K9/L0/L1-L9	06-12	DT125 X (13D2) - 5 Friction plate type	07																	
			GT250 K/L	73-74																	
			T250 II/R/J	70-72																	
			T350 1/2/R/J	69-72																	
			T500 36191 (18 ears)	68-70																	
			CT046	SUZUKI GSX400 FSV/FSK1 (GK7BA) Inazuma GSF600 S/T/V/W/X (Naked Bandit) GSF600 ST/SV/SW/SX (Faired Bandit) GSF600 Y/K1/K2/K3/K4 (Naked Bandit) GSF600 SY/SK1/SK2/SK3/SK4 (Faired Bandit) GSX600 FJ/FK/FL/FM GSX600 FW/FX/FY/FK1/FK2/FK3 /FK4/FK5/FK6 GSF650 K5/K6 Naked Bandit - Non ABS GSF650 SK5/SK6 Faired Bandit - Non ABS GSF650 AK5/AK6 Naked Bandit - ABS Model GSF650 SAK5/SAK6 Faired Bandit - ABS Model GSX750 FW/FX/FY/FK1-FK6 GSX750 W/X/Y/K1 GSXR750 F/G/H (GR75A)	00-04	TS100 K/L/M/A/B	73-77														
						GSXR750 F/G/H (GR75A)	85-87														
						CT047SP	SUZUKI GSX1100 FJ/FK/FL/FM/FN/FP/FR GSXR1100 G/H/J	88-94	86-88												
										CT048SP	SUZUKI GSX 1100 FJ/FK/FL/FM/FN/FP/FR GSXR 1100 G/H/J	88-94	86-88								
						CT049	KTM Reklus After Market Clutch for EXC 250 /300 (2T Models/24 Tooth Steel Plate Reklus After Market Clutch for SX 250/300 (2T Models/24 Tooth Steel Plate)	03-11	03-11												
										CT050SP	YAMAHA XVZ12 TD V-MAX All models XVZ13 Royal Star All models XV1600 A Wild Star XV1700 PCR Road Star Warrior	85	91-03	96-01	99-04	03-05					
						CT051	SUZUKI AP50 RB50 H A100 L/M/N TS100 K/L/M/A/B	-78	87								74-80	73-77			
																			CT052	SUZUKI B120 T125/125-11/R Stinger	69-71

Part No.	Make/Model	Year	Part No.	Make/Model	Year
CT053SP	HONDA		CT060	YAMAHA	
	CX500 Turbo	82		IT250 L	84
	CX650 TD Turbo	83		TY250 S/R	84-90
	GL1200 AE/DE/AF	84-85		TY250 R	91-92
CT054SP	YAMAHA			YZ250 N/S (TRI Z)	85-86
	YZ125 K/L/N/S/T/U/W/A (2T)	83-90		YZ250 J/K/L/N/S/T (2T)	82-87
	FZR600 R (4JH1/4)	94-95		IT490 L	84
	FZS600 Fazer	98-99		YZ490 J/K/L/N/S/T/U	82-88
	FZS600 Fazer/SP	00-03		WR500 ZD	92-93
	YZF600 Thunder Cat	96-03	CT061	YAMAHA	
CT055SP	SUZUKI			WR125 R	09-15
	GSXR600 V/W/X/Y (SRAD)	97-00		WR125 X (Supermoto)	09-16
	GSXR750 T/V/W/X (SRAD)	96-99	YZF-R 125 (Standard Mount Front Caliper)	08-13	
	RF900 RR	94	CT066SP	HONDA	
	GSX1100 GM/GN	91-94		CBX1000 Z/B/C	79-81
	GSXR1100 K/L/M/N	89-92	CT068SP	HONDA	
	GSXR1100 WP/WR/WS/WT	93-96		GL1500 J/K/L/SEM/SEN/SEP/SER	
	GS1200 SSK/ZK1 (GV78A)	01		/SES/SEX Goldwing	88-96
	GSF1200 T/V/W/X/Y			GL1500 CV/CW/CX/CY/C1/C2 F6C	97-03
	(Naked Bandit - 4 Piston Caliper)	96-00		GL1500 SEV/SEW/SEX/SEY Goldwing	97-00
	GSF1200 K1/K2/K3/K4/K5		CT069	KTM	
	(Naked Bandit 6 Piston caliper)	01-05		690 Duke	08-14
	GSF1200 ST/SV/SW/SX/SY			690 Duke R	10-11/13-14
	(Faired Bandit - 4 Piston Caliper)	96-00		690 Enduro	08-14
	GSF1200 SAV ABS Bandit	97		690 R Enduro	09-14
	GSF1200 SK1/SK2/SK3/SK4/SK5			690 SMR	07-11
	(Faired Bandit 6 Piston caliper)	01-05		690 SM	07-09
	GSF1200 K6/AK6 (Naked Bandit			690 SMC	08-11
	- Non & ABS Version - 4 Piston caliper)	06		690 SMC-R	12-18
	GSF1200 SK6/SAK6 (Faired Bandit			690 SM-LE (Limited Edition)	10-11
- Non & ABS Version - 4 Piston caliper)	06	HUSQVARNA			
GSX1200 FSW/FSX Inazuma (GV76A)	98-99	Svartpilen 401		18-20	
CT056SP	HONDA		Vitpilen 401	18-20	
	ST1100 L/M/N/P/R/S/T/V/W/X/Y/1/2	90-02	701 Enduro R	16-19	
	(Pan European - Non ABS Model)	92-02	701 Supermoto	16-19	
	ST1100 AN/AP/AR/AS/AT/AV/AW/AX/AY		Svartpilen 701	18-20	
	/A1/A2 (Pan European ABS model)		Vitpilen 701	18-20	
CT057SP	KTM		CT070SP	KAWASAKI	
SX65	09-15	KX 60 A1/A2/B1-B19		83-03	
CT058	KAWASAKI			KX 65	00-20
	KE125 A7-A12	80-85		KX 80 E1/E2	83-84
	KH125 A1-A4	77-81		KX 80 E3/G1/G2/J1/J2	85-87
	KX125 B1/B2/C1	82-84		KLX 110	02-20
	KDX175 A1-A3	80-82		KH 125 K2-K10	82-98
	KE175 B1/B2/B3	76-78		KH 125-L1 (KH 125 EX)	83
	KE175 D2-D5	79-83		Z 125 (Auto)	16-20
	KDX200 A1/A2/A3	83-85		Z 125 Pro (Manual)	16-20
	KH250 B4/B5	79-80		MODENAS	
	KT250 A/A2	75-76		Kriss 110/115	
	S2/S2A(350cc)	72-73	SUZUKI		
S3/S3A(400cc)	74-75	RM 60 K3	03		
KH400 A3-A5	76-78	RM 65 K3/K4/K5	03-05		
		DR-Z 110 K3/K4/K5	03-05		
		110cc Smash	03		
CT059	KTM		CT071SP	HONDA	
	250 EXC-G Racing	04		NSR 250 R2R/R3R/R2T/R3T	94
	250 EXC Racing	04		NSR 250 R6K/R6K-2	89
	400 EXC	00-02	NSR 250 R8L-3/R9L/R8N/R8N-3	90-92	
	400 MXC	01	NSR 250 R9N	92	
	SX 400	00-01	SUZUKI		
	450 EXC Racing	04	RGV 250 T (RGVR 250 SP) VJ23A		
	450 EXC-G Racing	04	Dry Clutch	96	
	450 MXC-G Racing	04	CT072SP	SUZUKI	
	520 EXC	00-01		GSXR 750 RG (Dry Clutch-	
	SX 520	00-01		Sintered Friction)	86
	525 EXC Racing	04	CT073	HONDA	
	525 EXC-G Racing	04		GL1800 A1-A5 Goldwing	01-05
	525 MXC Desert Racing	04		GL1800 5-9/A Goldwing	06-15
	525 MXC-G Racing	04			
525 SX Racing	04				

Part No.	Make/Model	Year	Part No.	Make/Model	Year		
CT074	YAMAHA		CT085 Contd.	BMW			
	XS650	75-79		F800 R (Late type plates 2 x 13mm/7 x 14mm ears)	05-19		
	XS650	80-81		F800 GT (Early type plates 14mm ears)	04-06		
CT075	KTM	XS650SE	79-81	CT086SP	TRIUMPH		
		350 MX (2T)	89			Bonneville T100 (900cc/Liquid Cooled /Spoke Wheel)	16-18
		350 Enduro (2T)	89			Bonneville T100 Black (900cc/Liquid Cooled/Spoke Wheel)	16-18
		EXC 400 (LC4 Engine)	93-95			Street Cup (900cc Liquid Cooled)	16-20
		400 RXC-E	95			Street Scrambler (900cc Liquid Cooled)	16-20
		SC 400 (LC4 Engine)	95			Street Twin (900cc Liquid Cooled)	16-18
		500 MX (2T)	89			Bonneville T120 (1200cc Liquid Cooled)	16-18
		500 MX (4T) LC	89			Bonneville T120 Black (1200cc Liquid Cooled)	16-18
		500 Enduro (2T)	89			Bonneville Bobber (1200cc Liquid Cooled)	17-20
		500 Enduro (4T) LC	89			Bonneville Bobber Black (1200cc Liquid Cooled)	18-20
		600 MX (4T) LC	89			Thruxton 1200 (Liquid Cooled)	16-20
600 Enduro (4T) LC	89	Thruxton R 1200 (Liquid Cooled)	16-20				
620 RXC-E	95						
CT076SP	HONDA	CB 750 K1 (From E.No:-1056080)	70-71	CT087SP	HUSQVARNA		
		CB 750 K2/K3/K4/K5	71-75			TC 85	18
		CB 750 K6/K7/F2	76-78			KTM	
		GL 1000 K1/K2 (From E.No: -2002384)	77-78			SX 85 (17 Inch/14 Inch Wheels)	18-20
						SX 85 (19 Inch/16 Inch Wheels)	18-20
CT077SP	YAMAHA						
	XS1100/1100 S	78-81					
CT078SP	HONDA			CT088	YAMAHA		
		CB 750 KZ	80			MT 125 (Non ABS)	14-16
		CB 750 FA/FB/F2C	79-82			MT 125 A (ABS)	14-16
		CB 900 FZ/FA/FB/F2B/F2C/FD/F2D	80-85			YZF-R 125 (Radial Mount Front Caliper/Non ABS)	14-16
		CB 1100 RB2/RC2/RD2	80-81			YZF-R 125 A (Radial Mount Front Caliper/ABS)	14-15
CT079SP	YAMAHA			CT090SP	YAMAHA		
		YZF- R1	15-16			YFM 350 FWT/FWU/FWW/FWA/FWE Big Bear	86-93
		YZF- R1 M	15-16			YFM 350 FWF/FWG/FWH/FWJ	94-97
		YZF- R1 (60th Anniversary Edition)	16			YFM 350 XD/XE/XF/XG/XH/XJ/XK/XL/XM /XN/XP/XR/XS	92-04
MT-10 (998cc)	16						
CT080	YAMAHA						
		YZF-R3 (321cc/ABS)	15-20	YFM 350 ERD/ERE/ERF	92-94		
	MT-03	12-20	YFM 350 ERG	95			
			YFM 350 UH/UJ	96-97			
			YFM 350 S/T/V/R-WV/RW/RX/RY Raptor	04-09			
			YFM 400 FWE/FWF/FWG/FWH/FWJ/FWK Kodiak	93-00			
			YFM 400 FPR/FPS Big Bear	03-04			
CT081SP	HONDA			CT091	AJP		
		CRF 250 L (Non ABS)/ LA (ABS)	13-20			PR5 250 Trials	13-17
		CRF 250 ME Supermoto	14-15			PR5 250 Supermoto	13-17
		CRF 250 RL/RLA Rally (non ABS & ABS)	17-20			PR5 250 Enduro	13-17
		CB 300 FAF/FAG (ABS)	15			PR5 250 Extreme	13-17
		CBF 300 NA	18-20				
CBR 300 RA ABS	14-19						
CT083	BMW			CT092			
		G 650 GS (R13)	08-16			CRF 450 RH (6 Spring)	17-20
		G 650 GS Sertao (R13)	10-14			CRF 450 RXH (18" Rear Wheel)	17-20
	G 650 XCountry (K15)	08-10	CRF 450 X	18-20			
			CRF 450 L	18-19			
CT084SP	HONDA			CT701SP	HARLEY DAVIDSON		
		Monkey 125	19-20			FLHR Road King	93-97
		MSX 125 D/E/F/G/H Grom (Non ABS)	13-20			FLHS Electra Glide Sport	90-94
	MSX 125 AH/AJ/AK Grom (ABS)	17-20	FLHT Electra Glide Standard	94-97			
CT085	BMW						
		F650 GS (Late type plates 2 x 13mm/7 x 14mm ears)	07-17	FLHTC Electra Glide Classic	91-97		
		F700 GS (Late type plates 2 x 13mm/7 x 14mm ears)	11-17	FLHTC Touring Electra Glide Classic	90		
		F800 GS (Late type plates 2 x 13mm/7 x 14mm ears)	08-11	FLHTCI Electra Glide Classic	96-97		
		F800 GS (Late type plates 2 x 13mm/7 x 14mm ears)	12-19	FLHTCU Ultra Classic	91-97		
		F800 GS Adventure (Late type plates 2 x 13mm/7 x 14mm ears)	12-19	FLST Softail Heritage	90		
		F800 GT (Late type plates 2 x 13mm/7 x 14mm ears)	07-19	FLSTC Heritage Softail Classic	91-97		
		F800 S (Late type plates 2 x 13mm/7 x 14mm ears)	07-19	FLSTC Softail Heritage Classic	90		
		F800 ST (Late type plates 2 x 13mm/7 x 14mm ears)	07-19	FLSTF Fat Boy	91-97		
				FLSTF Softail Fat Boy	90		
				FLSTN Heritage Softail Nostalgia	93-96		
				FLSTS Heritage Springer	97		
				FLTC Tour Glide Classic	90-92		
				FLTCU Tour Glide Ultra Classic	91-95		
				FLTCU Tour Glide Classic Ultra	90-96		
		FXD Dyna Super Glide	95-97				
		FXDB Dyna Daytona	92				
		FXDB Dyna Sturgis	91				

Part No.	Make/Model	Year	Part No.	Make/Model	Year
CT071SP Contd.	HARLEY DAVIDSON		CT703SP Contd.	HARLEY DAVIDSON	
	FXDC Super Glide Custom	92		FLTRX Road Glide	15-16
	FXDL Dyna Low Rider	93-97		FLTRXS Road Glide Special	15-16
	FXDS-CONV Dyna Glide Convertible	93		FXD Dyna Super Glide	98-03
	FXDWG Dyna Wide Glide	93-97		FXDL Dyna Low Rider	98-03
	FXST Softail Standard	90		FXDS-CONV Dyna Glide Convertible	99-00
	FXSTC Softail Custom	90-97		FXDWG Dyna Wide Glide	98-05
	FXSTS Springer Softail	90-97		FXDX Dyna Super Glide Sport	99-03
	XL1200 Sportster 1200	91-03		FXDXT Dyna Super Glide T-Sport	01-03
	XL1200 Forty Eight Anniversary	18		FXST Softail Standard	99-03
	XL1200C Sportster 1200 Custom	96-20		FXSTB Night Train	99-03
	XL1200C ANV Sportster 1200 Custom Anniversary	13		FXSTC Softail Custom	98-99
	XL1200CA Sportster 1200 Custom Limited	13-17		FXSTD Softail Deuce	00-03
	XL1200CP Sportster 1200 Custom (H-D1)	11-16		FXSTI Softail Standard	01-03
	XL1200CX 1200 Roadster	16-20		FXSTS Springer Softail	98-03
	XL1200L Sportster 1200 Low	06-11		FLD 103 Dyna Switchback	12-16
	XL1200N Nightster	07-12		FLHR 103 Road King	11-13
	XL1200R Sportster 1200 Roadster	04-09		FLHR Road King	04-05
	XL1200S Sportster 1200 Sport	96-03		FLHR ANV Road King ANV	2013
	XL1200T SuperLow 1200T	14-20		FLHRC 103 Road King Classic	11-13
	XL1200V Seventy-Two	12-16		FLHRCI Road King Classic	04-05
	XL1200X Forty Eight	10-20		FLHRI Road King	04-05
	XL50 50th Anniversary Sportster	07		FLHRS Road King Custom	04-05
	XL883 Sportster 883	91-09		FLHT Electra Glide Standard	04-05
	XL883C Sportster 883 Custom	98-10		FLHTC 103 Electra Glide Classic	11-13
	XL883DLX Sportster 883 Deluxe	91-95		FLHTC Electra Glide Classic	04-05
	XL883HUG Sportster 883 Hugger	91-03		FLHTCI Ultra Classic	2005
	XL883L Sportster 883 SuperLow	05-20		FLHTCU 103 Ultra Classic	11-13
	XL883N Iron 883	09-20		FLHTCUI Ultra Classic	04
	XL883R 883 Roadster	11-15		FLHTI Electra Glide Standard	04-05
	XL883R 883R Sportster	02-10		FLHTK Electra Glide Ultra Limited	10-13
	XR1200 Sportster 1200	08-10		FLHTK ANV Electra Glide Ultra Limited ANV	13
	XR1200X XR1200X	10-13		FLHX 103 Street Glide	11-13
CT702SP	HARLEY DAVIDSON		FLS 103 Softail Slim	12-15	
	FLHTCUTG Tri Glide Ultra Classic	14-16	FLS Slim	17	
	FLRT Freewheeler	15-16	FLS Softail Slim	16	
	FLHTK 103 CVO Limited	14	FLSTC 103 Heritage Softail Classic	13-15	
	FLHTCUL Ultra Classic Low	15-16	FLSTC 103 ANV Heritage Softail Classic ANV	13	
	FLHTCUL TC Ultra Classic Low Twin-Cooled	15-16	FLSTC Heritage Softail Classic	04-05	
	FLHTKL Ultra Limited Low	15-16	FLSTC Heritage Softail Classic	16-17	
	FLHR Road King	17-20	FLSTCI Shrine Heritage Softail Classic Shrine	05	
	FLHRC Road King Classic	17	FLSTF 103 Fat Boy	12-15	
	FLHTCU Electra Glide Ultra Classic	17-20	FLSTF Fat Boy	04-05	
	FLHTK Ultra Limited	17-20	FLSTF Fat Boy	16-17	
	FLHTKL Ultra Limited Low	17-20	FLSTFB 103 Fat Boy LO	12-17	
	FLHX Street Glide	17-20	FLSTFB 103 ANV Fat Boy LO ANV	13	
	FLHXS Street Glide Special	17-20	FLSTFI Shrine Fat Boy Shrine	05	
	FLTRU Road Glide Ultra	17-20	FLSTN 103 Softail Deluxe	12-15	
	FLTRX Road Glide	17-20	FLSTN Softail Deluxe	05	
	FLTRXS Road Glide Special	17-20	FLSTN Softail Deluxe	16-17	
	FLHRXS Road King Special	17-20	FLSTSC Springer Classic	05-06	
	FLHTK Ultra Limited Shrine Edition	18	FLTRI Road Glide	04-05	
	FLHTK Ultra Limited Anniversary	18	FLTRU Road Glide Ultra	11-13	
	FLHX Street Glide Anniversary	18	FLTRX 103 Road Glide Custom	11-13	
	FLHXS Street Glide Special Anniversary	18	FXD Dyna Super Glide	04-05	
	FLSS Softail Slim S	16	FXDB 103 Dyna Street Bob	14-16	
	FLSTFBS Fat Boy S	16-17	FXDB 103 Dyna Street Bob 103	17	
	FLSS Slim S	17	FXDBA 103 Dyna Street Bob (H-D1)	13-15	
	FLSTFBS Fat Boy S	17	FXDBC 103 Dyna Street Bob Limited	16	
			FXDC 103 Dyna Super Glide Custom	14	
		FXDC Dyna Super Glide Custom	05		
		FXDF 103 Dyna Fat Bob	12-17		
		FXDI Dyna Super Glide	04-05		
		FXDL 103 Dyna Low Rider	14-16		
		FXDL 103 Low Rider 103	17		
		FXDL Dyna Low Rider	04-05		
		FXDWG 103 Dyna Wide Glide	12-16		
		FXDWG 103 Dyna Wide Glide 103	17		
		FXDWGI Dyna Wide Glide	04-05		
		FXDX Dyna Super Glide Sport	04-05		
		FXS 103 Blackline	11-13		
		FXSB 103 Softail Breakout	13-16		
		FXSB Breakout	17		
		FXST 1BHJ Softail Standard	04-06		
		FXST Softail Standard	12-15		
		FXSTB Night Train	04-05		
		FXSTD Softail Deuce	04-05		
		FXSTS Springer Softail	04-05		
		FLD Dyna Switchback	12-16		
CT703SP	HARLEY DAVIDSON				
	FLHR Road King	15-16			
	FLHR Road King	98-03			
	FLHRC Road King Classic	14-16			
	FLHRCI Road King Classic	98-99			
	FLHT Electra Glide Standard	98-03			
	FLHTC Electra Glide Classic	98-03			
	FLHTCU Ultra Classic	14-16			
	FLHTCU TC Ultra Classic Twin-Cooled	14-16			
	FLHTCUI Ultra Classic	98-03			
	FLHTK Ultra Limited	14-16			
	FLHX Street Glide	14-16			
	FLHXS Street Glide Special	14-16			
	FLSTC Heritage Softail Classic	98-03			
	FLSTF Fat Boy	98-03			
FLSTS Heritage Springer	98-03				
FLTR Road Glide	98-03				
FLTRU Road Glide Ultra	15-16				

Part No.	Make/Model	Year	Part No.	Make/Model	Year	
CT703SP Contd.	HARLEY DAVIDSON		CT705SP	HARLEY DAVIDSON		
	FLHR Road King	06-11		FLH Electra Glide	84-88	
	FLHRC Road King Classic	06-11		FLH Electra Glide Shrine Shovelhead	84	
	FLHRS Road King Custom	06-07		FLHS Electra Glide Sport	84-89	
	FLHT Electra Glide Standard	06-10		FLHT Electra Glide Classic	84-89	
	FLHTC Electra Glide Classic	06-11		FLHTCU Electra Glide Classic Ultra	89	
	FLHTCU Ultra Classic	06-11		FLST Softail Heritage	86-89	
	FLHX Street Glide	06-11		FLSTC Softail Heritage Classic	87-89	
	FLS Softail Slim	12-15		FLT Tour Glide Classic	84-89	
	FLST Heritage Softail	06-09		FLT Tour Glide	84	
	FLSTC 103 Heritage Softail Classic	06-15		FLTCU Tour Glide Classic Ultra	89	
	FLSTC Heritage Softail Classic Anv	13		FXE Super Glide	84	
	FLSTF Fat Boy	06-15		FXEF Super Glide Fat Bob	85	
	FLSTFB Fat Boy LO	10-15		FXSB Low Rider	84-85	
	FLSTFB Fat Boy LO Anv	13		FXST Softail Standard	84-89	
	FLSTN Softail Deluxe	06-15		FXSTC Softail Custom	86-89	
	FLSTSB Cross Bones	08-11		FXSTS Softail Springer	88-89	
	FLSTSC Springer Classic	06-07		FXWG Wide Glide	84-86	
	FLTR Road Glide	06-09				
	FLTRX Road Glide Custom	10-11		CT706SP	HARLEY DAVIDSON	
	FXCW Rocker	08-09			VRSCAW V-Rod Wide Tire	08
	FXCWC Rocker C	08-11			VRSCAWA V-Rod Wide Tire W/ABS	08
	FXD Dyna Super Glide	07-10			VRSCD Night Rod	08
	FXD35 Dyna 35th Anniversary Super Glide	06			VRSCDA Night Rod W/ABS	08
	FXDB Dyna Street Bob	07-17			VRSCDXA Night Rod Special W/ABS	08
	FXDBC Dyna Street Bob Limited	16			VRSCDX Night Rod Special	08-17
	FXDC Dyna Super Glide Custom	07-14	VRSCAW V-Rod		09-10	
	FXDC ANV Dyna Super Glide Custom ANV	13	VRSCF V-Rod Muscle		09-17	
	FXDCI Dyna Super Glide Custom	06	VRSCDX ANV Night Rod Special Anv		12	
	FXDF Dyna Fat Bob	08-17				
	FXDI Dyna Super Glide	06	CT707SP		HARLEY DAVIDSON	
	FXDL Dyna Low Rider	06-17			VRSCA V-Rod	02-07
	FXDWG Dyna Wide Glide	06-16		VRSCSE CVO V-Rod	05-06	
	FXDWG ANV Dyna Wide Glide 105th Anniv.	08		VRXSE CVO VR Destroyer	06	
	FXSB Softail Breakout	13-15		VRSCR Street Rod	06-07	
	FXST Softail Standard	07-11		VRSCX Screamin' Eagle V-Rod	07	
	FXSTB Night Train	06-09				
	FXSTC Softail Custom	07-10	CT708SP	HARLEY DAVIDSON		
	FXSTD Softail Deuce	06-07		FLHTCUTG Tri Glide Ultra	17-20	
	FXSTS Springer Softail	06		FLRT Freewheeler	17-18	
	FLS 103 Softail Slim	13-15		FLHTCUTG Tri Glide Ultra Anniversary	18	
	FLSTC 103 Heritage Softail Classic	13-15		FLHP Road King Police	17	
	FLSTFB Fat Boy LO	13-15		FLHTP Electra Glide Standard Police	17	
	FLSTF 103 Fat Boy	15		FLFBS Fat Boy 114 Anniversary	18-20	
	FLS Softail Slim	16		FLHCS Heritage Classic 114	18-20	
	FLSTN Softail Deluxe	16		FLHCS Heritage Classic 114 Anniversary	18	
	FLSTC Heritage Softail Classic	16-17		FXFBS Fat Bob 114	18	
	FLSTF Fat Boy	16-17		FLFBS Fat Boy 114	18	
	FLSTFB Fat Boy LO	16-17		FXBRS Breakout 114	18-20	
	FLS Slim	17		FXBRS Breakout 114 Anniversary	18	
FLSTN Deluxe	17					
CT704SP	HARLEY DAVIDSON			CT709SP	HARLEY DAVIDSON	
	FLH Electra Glide	EARLY 84			XL1200 Sportster 1200	90
	FLH Electra Glide Shrine Shovelhead	EARLY 84			XL883 Sportster 883	86-90
	FLHS Electra Glide Sport	EARLY 84	XL883 Sportster 883 Deluxe		86-90	
	FLHT Electra Glide	EARLY 84	XL883HUG Sportster 883 Hugger		87-90	
	FLHT Electra Glide Classic	EARLY 84	XLCH Sportster 1000		71-80	
	FLT Tour Glide Classic	EARLY-84	XLH 1100 Sportster 1100		86-87	
	FLT Tour Glide	EARLY-84	XLH Sportster 1000		84-85	
	FLH Electra Glide Shrine Shovelhead	83	XLH Sportster 1000		79-84	
	FLH Electra Glide	81-83	XLH Sportster Standard 1000		71-80	
	FLHC Electra Glide Classic	81-82	XLH883DLX Sportster 883 Hugger Deluxe		88-89	
	FLHC Electra Glide Classic	81	XLS Sportster Roadster 1000		84-85	
	FLHS Electra Glide Sport	81-83	XLS Sportster Roadster 1000		81-84	
	FLHS Heritage Electra Glide	81	XR1000 Sportster		84	
	FLHT Electra Glide Standard	83	XR1000 Sportster		83-84	
	FLHT Electra Glide Classic	83				
	FLHT Electra Glide	83				
	FLHTC Electra Glide Classic	83				
	FLT Tour Glide	81-83				
	FLT Tour Glide Classic	80-83				
	FXB Super Glide B80	81-82				
	FXDG Dyna Glide Glide Custom	83				
	FXE Super Glide	81-83				
	FXEF Super Glide Fat Bob	81				
	FXSB Low Rider	83-84				
	FXST Softail Standard	EARLY 84				
	FXWG Wide Glide	81-84				

BRAKE LINES



APRILIA

RS 250	94-97
RS 250	98-99
RS 250	00-02
Pegaso 650	93-96
Pegaso 650	97-03
Pegaso Strada 650	97-09
RST 1000 Futura	01-04
RSV 1000 Mille	98-03
RSV 1000 Mille R	03-04
RSV 1000 Mille Tuono	03-09
RSV 1000 R + RSV4 Non ABS	08-13
RSV 1000 R Factory My	04-09
SL 1000 Falco	99-03
Tuono V4 R + V4 R APRC	11

BIMOTA

SB6	ALL
-----	-----

BMW

F650	94-00
F650 GS/Dakar Non ABS	00-07
K75 C Full Front	86-88
K75 RT	91-96
K75 S ABS	90-96
K75 S Full Rear	86-90
K100/K100 RS/K100 RT Front	83-88
K100 LT ABS	90-91
K100 LT Non ABS	87-88
K100 RS Full Front	86-90
K100 RS 16V ABS	90-93
K100 RS ABS	88-90
K100 RS Flexible Front	86-90
K1100 LT ABS	89-99
K1100 RS 16V ABS	94-97
K1100 RS 16V ABS 2	94-97
K1100 RS Non ABS	92-93
K1200 RS ABS	97-01
R45/R65 Flexible Front	78-80
R45/R65 Full Front	79-85
R65 (M/C-Bundy)	85-88
R65 Flexible Front	81-85
R65 Flexible Front	85-88
R65 Full Front	81-85
R75 Gears	75
R75/6 Front ATE Calipers	76
R75/6 Full Front	75
R75/6 Long Front	74
R80/7 Flexible Front	77-80
R80/7 Full Front	77-80
R80 GS Flexible Front	86-94
R80 GS Full Front	80-85
R80 R Flexible Front	94
R80 RT	84-90
R80 RT Flexible Front	82-84
R80 ST Flexible Front	82-85
R100/R100 CS Full Front	80-84
R100 GS	91-96
R100 GS Flexible Front	91-96
R100 RS	87-93
R100 RS Full Front	77-80
R100 RS Flexible Front	81-86
R100 RR Flexible Front	80
R100 RT Full Front	80



OE Replacement
Brake Lines (Front)

Race Standard
Brake Lines (Front)

OE Replacement
Brake Lines (Rear)

FRONT / AVANT / VORN / FRENTE / ANTERIORE

REAR / ARRIÈRE / HINTEN / POSTERIOR / POSTERIORE

BLM8008-3F
BLM8009-3F
BLM8010-3F
BLM8002-1F
BLM8003-1F
BLM8004-1F
BLM8013-3F
BLM8015-3F
BLM8017-3F
BLM8018-3F
BLM8019-3F
BLM8020-3F
BLM8022-3F
BLM8023-2F
BLM8024-3F
BLM8025-1F
BLM8026-1F
BLM8039-3F
BLM8040-3F
BLM8041-2F
BLM8042-3F
BLM8027-3F
BLM8028-2F
BLM8029-3F
BLM8030-3F
BLM8031-4F
BLM8032-4F
BLM8033-3F
BLM8034-4F
BLM8031-4F
BLM8036-4F
BLM8037-3F
BLM8038-6FR
BLM8074-3F
BLM8075-3F
BLM8076-1F
BLM8077-3F
BLM8078-1F
BLM8079-3F
BLM8080-2F
BLM8081-1F
BLM8082-1F
BLM8083-1F
BLM8084-2F
BLM8085-2F
BLM8086-1F
BLM8087-1F
BLM8088-1F
BLM8089-2F
BLM8090-3F
BLM8091-1F
BLM8043-3F
BLM8044-1F
BLM8044-1F
BLM8046-4F
BLM8047-2F
BLM8048-3F
BLM8049-2F
BLM8050-2F

BLMR8008-2F
BLMR8009-2F
BLMR8010-2F
BLMR8013-2F
BLMR8015-2F
BLMR8017-2F
BLMR8018-2F
BLMR8019-2F
BLMR8019-2F
BLMR8019-2F
BLMR8022-2F
BLMR8023-2F
BLMR8024-2F
BLMR8025-1F
BLMR8026-1F
BLMR8040-1R
BLMR8041-2R
BLMR8042-1R
BLMR8028-2R
BLMR8029-1R
BLMR8030-1R
BLMR8031-2R
BLMR8032-2R
BLMR8033-1R
BLMR8031-2R
BLMR8031-2R
BLMR8036-1R
BLMR8089-1R
BLMR8048-1R

BLM8008-1R
BLM8009-1R
BLM8010-1R
BLM8002-1R
BLM8002-1R
BLM8004-1R
BLM8013-1R
BLM8015-1R
BLM8017-1R
BLM8018-1R
BLM8019-1R
BLM8020-1R
BLM8022-1R
BLM8023-1R
BLM8024-1R
BLM8025-1R
BLM8026-1R
BLM8040-1R
BLM8041-2R
BLM8042-1R
BLM8028-2R
BLM8029-1R
BLM8030-1R
BLM8031-2R
BLM8032-2R
BLM8033-1R
BLM8031-2R
BLM8031-2R
BLM8036-1R
Supplied as front & rear kit complete
BLM8089-1R
BLM8048-1R

BRAKE
LINES

BRAKE LINES



BMW

		OE Replacement Brake Lines (Front)	Race Standard Brake Lines (Front)	OE Replacement Brake Lines (Rear)
R100 S ATE Flexible Front	77-80	BLM8051-2F		BLM8051-1R
R100 S Flexible Front	76-80	BLM8052-3F		BLM8052-1R
R100 T Flexible Front	79-80	BLM8053-2F		
R1100 GS ABS	94-00	BLM8054-4F		BLM8054-1R
R1100 GS Non ABS	94-00	BLM8055-3F		
R1100 R	95-96	BLM8056-4FR		Supplied as front & rear kit complete
R1100 R	97-01	BLM8057-4FR		Supplied as front & rear kit complete
R1100 RS ABS	93-00	BLM8058-5FR		Supplied as front & rear kit complete
R1100 RT ABS	95-00	BLM8059-5FR		Supplied as front & rear kit complete
R1100 S ABS	98-04	BLM8060-5FR		Supplied as front & rear kit complete
R1100 S Boxer Cup Replica	11/03-	BLM8061-4FR		Supplied as front & rear kit complete
R1100 S Non ABS	01/98-01/01	BLM8062-4FR		Supplied as front & rear kit complete
R1100 S Non ABS	02/01-11/03	BLM8063-4FR		Supplied as front & rear kit complete
R1150 GS ABS (Retaining Hardline)	11/99-02	BLM8064-5FR		Supplied as front & rear kit complete
R1150 GS ABS 2 (Retaining Hardline)	11/99-02	BLM8065-5FR		Supplied as front & rear kit complete
R1150 GS Non ABS (Replacing Hardline)	11/99-02	BLM8066-3F		BLM8066-1R
R1150 GS Non ABS (Retaining Hardline)	11/99-02	BLM8067-3F		BLM8066-1R
R1150 GS Non ABS Evo Brakes	03-04	BLM8068-4F		BLM8066-1R
R1150 GS Non ABS Evo Brakes	11/99-02	BLM8069-4F		BLM8066-1R
R1150 R	00-02	BLM8070-5FR		Supplied as front & rear kit complete
R1150 RT ABS	01	BLM8071-4F		
R1200 C ABS	96-05	BLM8072-4F		BLM8072-1R
R1200 R ABS	11-13	BLM8073-4F		BLM8073-1R
R850 C ABS	00-01	BLM8072-4F		BLM8072-1R
R850 GS ABS	00-01	BLM8054-4F		BLM8054-1R
R850 R ABS	97-01	BLM8094-5FR		Supplied as front & rear kit complete
R850 R	95-96	BLM8056-4FR		Supplied as front & rear kit complete
R850 R	97-01	BLM8057-4FR		Supplied as front & rear kit complete
R90 Flexible Front	76	BLM8097-2F		
R90S Pre Brembo Flexible Front		BLM8098-2F		
R90S Pre Brembo Full Front		BLM8099-2F		
S1000 RR Non ABS	10-14	BLM8100-3F	BLMR8100-2F	BLM8100-1R
CAGIVA				
Raptor 650 (Naked)	03-06	BLM8107-3F		
Elefant 750	87-88	BLM8103-1F		BLM8103-1R
Elefant 900	93-00	BLM8104-3F		BLM8104-1R
Elefant 900 IE	91-92	BLM8103-1F		BLM8103-1R
V-Raptor 1000 (Faired)	03-	BLM8108-3F		BLM8108-1R
DUCATI				
M 400 Monster	94-02	BLM8141-1F		BLM8141-1R
Pantah 500/600SL	80-84	BLM8147-3F		BLM8147-1R
Pantah 600TL	84-85	BLM8148-3F		BLM8148-1R
600 SS	94-98	BLM8116-1F		BLM8116-1R
M 600 Monster	94-02	BLM8141-1F		BLM8141-1R
M 620 Monster	02-04	BLM8143-3F	BLMR8143-2F	BLM8143-1R
M 696 Monster	06-08	BLM8144-2F		BLM8144-1R
748 Biposta/Strada	95-98	BLM8117-3F	BLMR8117-2F	BLM8117-1R
748 Biposta/Strada/SPS	99-03	BLM8111-3F	BLMR8118-2F	BLM8111-1R
748R	99-02	BLM8119-3F	BLMR8119-2F	BLM8119-1R
749	03-05	BLM8109-2F		BLM8109-1R
749S	04-05		BLMR8120-2F	BLM8120-1R
750/906 Paso	86-94	BLM8121-3F		BLM8121-1R
750 GT	74	BLM8122-1F		
750 SS	91-93	BLM8116-1F		BLM8116-1R
750 SS	94-97		BLMR8124-2F	BLM8116-1R
750 SS	98-02		BLMR8125-2F	BLM8125-1R
M 750 Monster	96-02	BLM8141-1F		BLM8141-1R
851 SP/888 Strada	92-93		BLMR8126-2F	BLM8126-1R
851 SP3	91	BLM8127-3F		BLM8127-1R
851 Strada	88-92	BLM8128-3F		BLM8128-1R
848	07-		BLMR8110-2F	

FRONT / AVANT / VORN / FRENTE / ANTERIORE

REAR / ARRIÈRE / HINTEN / POSTERIOR / POSTERIORE

BRAKE
LINES

BRAKE LINES



DUCATI



		OE Replacement Brake Lines (Front)	Race Standard Brake Lines (Front)	OE Replacement Brake Lines (Rear)
900 Superlight	94-97		BLMR8129-2F	BLM8129-1R
900 SS	94-97		BLMR8129-2F	BLM8130-1R
900 SS	98-02		BLMR8125-2F	BLM8125-1R
900 SS Supersport	77		BLMR8132-3F	BLM8132-1R
900 SS/Superlight	91-93		BLMR8129-2F	BLM8133-1R
M 900 Monster	93-99	BLM8146-3F	BLMR8146-2F	BLM8146-1R
907 IE	91-94	BLM8134-3F		BLM8134-1R
916 Biposta/SP	98-01	BLM8111-3F	BLMR8118-2F	BLM8111-1R
916 Biposta/Strada	94-97	BLM8117-3F	BLMR8117-2F	BLM8117-1R
ST2	97-03	BLM8151-3F		BLM8151-1R
ST4	98-03	BLM8152-3F		BLM8152-1R
996	98-01	BLM8111-3F	BLMR8111-2F	BLM8111-1R
996 R	00-01	BLM8119-3F	BLMR8119-2F	BLM8119-1R
S4/S4R Monster	00-08		BLMR8149-2F	BLM8146-1R
999 R	03-05	BLM8138-2F	BLMR8138-2F	BLM8138-1R
998	01-03	BLM8111-3F	BLMR8111-2F	BLM8111-1R
999	02-05		BLMR8113-2F	BLM8113-1R
Sport Classic 2006	06	BLM8150-3F		BLM8150-1R
1098/1098R/1098S/1198/1198S	07	BLM8114-3F	BLMR8114-2F	BLM8114-1R

HONDA

CBR 125 R	05-13	BLM1057-1F		BLM1057-1R
NSR 125 RK-R3	90-03	BLM1110-1F		BLM1110-1R
XLR 125	00-03	BLM1159-1F		
MSX125	16-17	BLM1167-1F		BLM1167-1R
MTX 200 RWF	85-86	BLM1105-1F		
CB 250 Hornet Import	96	BLM1010-1F		BLM1010-1R
CBR 250 R	11-13	BLM1058-1F		BLM1058-1R
CBR 250 RRJ-RRJ (MC19)	88-89	BLM1059-1F		
CBR 250 RRM-RRX (MC22)	90-99		BLMR1060-2F	BLM1060-1R
CBX 250 RSE	84-86	BLM1082-1F		
NSR 250 PGM4		BLM1113-2F		BLM1113-1R
VT 250 FD	83-87	BLM1144-1F		
CBR300R	15-17	BLM1170-1F		BLM1170-1R
CB1 (Super 400)	92-96	BLM1000-2F	BLMR1000-2F	BLM1000-1R
CBR 400 RRJ-RRK (NC23) Triarm	88-89		BLMR1061-2F	BLM1061-1R
CBR 400 RRK-RRT (NC29) Gullarm	89-96	BLM1062-3F	BLMR1062-2F	BLM1062-1R
NS 400 RF-RG	85-87	BLM1109-3F		BLM1109-1R
NT Bros 400/600/650	88-95	BLM1114-1F		BLM1114-1R
RVF 400 RRR-RRT (NC35)	94-96	BLM1120-3F	BLMR1120-2F	BLM1120-1R
VF 400 FD	83	BLM1130-1F		BLM1130-1R
VFR 400 RF-RH (NC21)	85-87	BLM1133-3F	BLMR1133-2F	BLM1133-1R
VFR 400 RH-RK (NC24)	87-89		BLMR1134-2F	BLM1134-1R
VFR 400 RRL-RRM (NC30)	90-92		BLMR1135-2F	BLM1135-1R
CB 450 DXK	89-92	BLM1019-3F		BLM1019-1R
CB 500 V-3	97-03	BLM1024-1F		BLM1024-1R
CBF 500	04-08	BLM1048-1F		BLM1048-1RCX 500 C Custom
82	BLM1088-3F			
CX 500 EC Euro Sport	82	BLM1089-3F		BLM1089-1R
CX 500 TC Turbo	82	BLM1090-3F		BLM1090-1R
CX 500 Z-B	79-81	BLM1091-3F		
FT 500 C	82	BLM1095-1F		BLM1095-1R
GL 500 DC Silverwing	82	BLM1102-3F		
VF 500 F2E-F2F	84-85	BLM1131-3F		BLM1131-1R
VT 500 ED-EF	83-85	BLM1145-1F		
XBR 500 F-SJ	85-88	BLM1151-1F		
CB 550 SC Nighthawk	83	BLM1027-1F		BLM1027-1R
CBX 550 FC-F2D	82-84	BLM1083-3F		BLM1083-1R
CB 600 F5-F8 Hornet	05-08		BLMR1028-2F	BLM1028-1R
CB 600 FW-F4 Hornet	98-05	BLM1029-3F	BLMR1029-2F	BLM1029-1R
CBF 600 S	04-06	BLM1049-3F	BLMR1049-2F	BLM1049-1R
CBR 600 F	11-13		BLMR1063-2F	BLM1063-1R
CBR 600 RR ABS	09-17	BLM1164-4F		BLM1164-4R

FRONT / AVANT / VORN / FRENTE / ANTERIORE

REAR / ARRIÈRE / HINTEN / POSTERIOR / POSTERIORE

BRAKE
LINES

BRAKE LINES



HONDA



		OE Replacement Brake Lines (Front)	Race Standard Brake Lines (Front)	OE Replacement Brake Lines (Rear)
CBR 600 FH-FL	87-90	BLM1064-3F	BLMR1064-2F	BLM1064-1R
CBR 600 FM-FR	91-94	BLM1065-3F	BLMR1065-2F	BLM1065-1R
CBR 600 FS-FW	95-98	BLM1066-3F	BLMR1066-2F	BLM1066-1R
CBR 600 FX-F4/Sport	99-04	BLM1067-3F	BLMR1067-2F	BLM1067-1R
CBR 600 RR Non ABS	08-13		BLMR1068-2F	BLM1068-1R
CBR 600 RR3-RR4	03-04	BLM1069-3F	BLMR1069-2F	BLM1069-1R
CBR 600 RR5	05		BLMR1070-2F	BLM1070-1R
CBR 600 RR6	06		BLMR1071-2F	BLM1071-1R
CBR 600 RR7	07		BLMR1072-2F	BLM1072-1R
NTV 600 J-M	88-91	BLM1116-1F		BLM1116-1R
VT 600 CN-CW Shadow	92-98	BLM1146-1F		
XL 600 LMF Paris Dakar	85	BLM1154-1F		
XL 600 RD-RF	84-85	BLM1155-1F		
XL 600 VH-VT Transalp	87-96	BLM1156-1F		BLM1156-1R
XL 600 WV-VX Transalp	97-99		BLMR1157-2F	BLM1156-1R
CB 650 SC Nighthawk	82	BLM1030-3F		
CB 650 Z-B	79-81	BLM1031-3F		
CX 650 ED	83	BLM1092-3F		BLM1092-1R
CX 650 TD Turbo	83	BLM1093-3F		
NT 650 V Deauville (Nissin Calipers)	98-03	BLM1115-3F		BLM1115-1R
NX 650 J-T Dominator	88-96	BLM1117-1F		BLM1117-1R
NX 650 V-X Dominator	97-99	BLM1118-1F		BLM1117-1R
SLR 650 V-W	97-98	BLM1123-1F		
XL 650 Y-3 Transalp	00-05		BLMR1157-2F	BLM1156-1R
CB 750 F Supersport		BLM1032-3F		BLM1032-1R
CB 750 F1 High Bar	76-78	BLM1033-2F		BLM1033-1R
CB 750 F1 Twin Disc	76	BLM1035-3F		BLM1035-1R
CB 750 F2	77-79	BLM1036-3F		BLM1036-1R
CB 750 F2N-Y	92-02	BLM1037-3F		BLM1037-1R
CB 750 FZ-FD	79-83	BLM1038-3F		BLM1038-1R
CB 750 KZ	78-80	BLM1041-3F	BLMR1041-2F	BLM1041-1R
CBX 750 FE	84	BLM1084-3F		BLM1084-1R
NC750S/SD/SA	17-	BLM1171-2F		BLM1171-2R
NC700SD	17-	BLM1171-2F		BLM1171-2R
RVF 750 RR-RS (RC45)	94-95	BLM1121-3F	BLMR1121-2F	BLM1121-1R
VF 750 FD-FE	83-84	BLM1132-3F		BLM1132-1R
VFR 750 FG-FH	86-87	BLM1136-3F	BLMR1136-2F	BLM1136-1R
VFR 750 FJ-FK	88-89	BLM1137-3F	BLMR1137-2F	BLM1137-1R
VFR 750 FL-FP	90-93	BLM1138-3F	BLMR1138-2F	BLM1138-1R
VFR 750 FR-FV	94-97	BLM1139-3F	BLMR1139-2F	BLM1139-1R
VFR 750 RJ-RL (RC30)	88-90		BLMR1140-2F	BLM1140-1R
VT 750 Shadow	04-10	BLM1147-1F		
VT 750 V-W Shadow	97-98	BLM1148-1F		
XLV 750	84-87	BLM1160-1F		
XRV 750 L-3 Africa Twin	90-03	BLM1161-3F	BLMR1161-2F	BLM1161-1R
Pacific Coast PC800	89-98	BLM1119-3F		
VFR 800 FW-FY Non ABS	98-00	BLM1141-10FR		Supplied as front & rear kit complete
VFR 800 V-TEC ABS	02-10	BLM1142-13FR		Supplied as front & rear kit complete
VFR 800 V-TEC Non ABS	02-10	BLM1143-10FR		Supplied as front & rear kit complete
CB 900 F2-F3 Hornet	02-06	BLM1042-3F	BLMR1042-2F	BLM1042-1R
CB 900 FA-FB	80-81	BLM1043-3F		BLM1043-1R
CB 900 FC-FD	82-83	BLM1044-3F		BLM1043-1R
CB 900 FZ	79	BLM1045-3F		BLM1045-1R
CBR 900 RR2-RR3	02-03		BLMR1073-2F	BLM1073-1R
CBR 900 RRN-RRS Retaining Bundy	92-95	BLM1074-3F		
CBR 900 RRN-S Fireblade	92-95	BLM1075-3F	BLMR1075-2F	BLM1075-1R
CBR 900 RRT-RRX Retaining Bundy	96-99	BLM1076-3F	BLMR1076-2F	BLM1076-1R
CBR 900 RRT-X Fireblade	96-99	BLM1077-3F	BLMR1076-2F	BLM1076-1R
CBR 900 RRY-RR1	00-01		BLMR1073-2F	BLM1078-1R
CB 1000 P-T Big One	93-96	BLM1001-3F	BLMR1001-2F	BLM1001-1R
CB 1000 R	08-14		BLMR1002-2F	BLM1002-1R
CBF 1000	06	BLM1046-3F		BLM1046-1R
CBR 1000 FH-FJ	87-88	BLM1050-3F		BLM1050-1R

FRONT / AVANT / VORN / FRENTE / ANTERIORE

REAR / ARRIÈRE / HINTEN / POSTERIOR / POSTERIORE

**BRAKE
LINES**

BRAKE LINES



HONDA



		OE Replacement Brake Lines (Front)	Race Standard Brake Lines (Front)	OE Replacement Brake Lines (Rear)
CBR 1000 FK-FN	89-92	BLM1051-3F		BLM1051-1R
CBR 1000 FP-FR	93-99	BLM1052-10FR		Supplied as front & rear kit complete
CBR 1000 RR	04-05	BLM1054-2F	BLMR1053-2F	BLM1054-1R
CBR 1000 RR	06-08		BLMR1054-2F	BLM1053-1R
CBR 1000 RR (Non ABS)	09-14		BLMR1055-2F	BLM1055-1R
CBR 1000 RR ABS	09-17	BLM1165-4F		BLM1165-2R
CBX 1000 A	80	BLM1079-3F		BLM1079-1R
CBX 1000 B Pro Link	81	BLM1080-3F		BLM1080-1R
CBX 1000 Z	79	BLM1081-3F		BLM1081-1R
GL 1000 KZ-K1	79-80	BLM1096-3F		BLM1096-1R
VF 1000 FE-FF	84-85	BLM1128-3F		BLM1128-1R
VF 1000 RE-RG	84-86	BLM1129-3F		BLM1129-1R
VTR 1000 SP1-SP2	99-08		BLMR1149-2F	BLM1149-1R
VTR 1000 FV-F4	97-05	BLM1150-3F	BLMR1150-2F	BLM1150-1R
XL 1000 VW-V3 Varese	98-06	BLM1152-10FR		Supplied as front & rear kit complete
CB 1100 RC-RD	82-83	BLM1003-3F		BLM1003-1R
CB 1100 SF-X11	99-02	BLM1004-10FR		Supplied as front & rear kit complete
CBR 1100 XX Blackbird	96-08	BLM1056-10FR		Supplied as front & rear kit complete
GL 1100 A-B Goldwing	80-81	BLM1097-3F		BLM1097-1R
GL 1100 AD Aspencade	83	BLM1098-2F		BLM1098-1R
GL 1100 DC Deluxe	82	BLM1099-3F		BLM1099-1R
ST 1100 ABS/TCS/CBS	02-03	BLM1124-16FR		Supplied as front & rear kit complete
ST 1100 AN-AS Pan European ABS	92-95	BLM1125-7FR		Supplied as front & rear kit complete
ST 1100 L-2 Pan European Non ABS	90-02	BLM1126-3F		BLM1126-2R
GL 1200 AE-AH Aspencade	84-87	BLM1100-3F		BLM1100-1R
CB 1300 (SL38)	97-03	BLM1007-3F		BLM1007-1R
CB 1300 UK Model	02-03	BLM1008-3F	BLMR1008-2F	BLM1008-1R
CB 1300 SA ABS	05-06	BLM1009-4F		BLM1009-3R
F6C (GL 1500 CV-CW) Valkyrie	96-03	BLM1094-3F		BLM1094-1R
V65 Magna		BLM1127-3F		
GL 1500 J-SEY Goldwing	88-00	BLM1101-4FR		Supplied as front & rear kit complete

HONDA OFF-ROAD

CR 85 R	03-08	BLM6002-1F		BLM6002-1R
CR 85 R Expert	03-08	BLM6002-1F		BLM6003-1R
CR 125 R/250 R	97-07	BLM6000-1F		BLM6000-1R
CRF 230 L	08-	BLM6004-1F		
CRF 250 F/450 F	03-04	BLM6005-1F		BLM6005-1R
CRF 250 L	13-17	BLM6012-1F		BLM6012-1R
CRF 250 R/CRF 450 R	04-08	BLM6006-1F		BLM6006-1R
CRF 250 R/CRF 450 R	09-17	BLM6007-1F		BLM6007-1R
CRF 250 X/CRF 450 X	05-17	BLM6008-1F		BLM6008-1R
XR 400 R	96-04	BLM6009-1F		BLM6009-1R
CR 500	97-04	BLM6000-1F		BLM6000-1R
XR 650 L	04-	BLM6010-1F		BLM6010-1R
XR 650 R	00-03	BLM6011-1F		BLM6011-1R
XR 650 R	04-	BLM6010-1F		BLM6010-1R

KAWASAKI

KDX 125 A1-B2	90-94	BLM4032-1F		BLM4032-1R
KMX 125 A1-A5/B1-B12/KMX 200 A2-A3	86-02	BLM4050-1F		BLM4050-1R
Z 125 Pro	17	BLM4190-1F		BLM4190-1R
KDX 200/220	95-99	BLM4033-1F		BLM4033-1R
KDX 200 E1	90-94	BLM4032-1F		BLM4032-1R
GPX 250 R F2-F9	88-96	BLM4011-1F		BLM4011-1R
KLR 250 D2-D16	84-01	BLM4045-1F		
Z 250 A1-A3	79-82	BLM4091-1F		BLM4091-1R
ZZR 250 H1-H2	90-92	BLM4178-1F		BLM4178-1R
KR1-KR1S	89-92	BLM4051-3F	BLMR4051-2F	BLM4051-1R
KLX 300 R	97-99	BLM4048-1F		BLM4048-1R
EX300 Ninja	13-15	BLM4182-1F		BLM4182-1R
KH 400	77-80	BLM4041-2F		
ZR 400 A1-B1 (Z400F)	83-85	BLM4134-3F		

FRONT / AVANT / VORN / FRENTE / ANTERIORE

REAR / ARRIÈRE / HINTEN / POSTERIOR / POSTERIORE

BRAKE
LINES

BRAKE LINES



KAWASAKI



		OE Replacement Brake Lines (Front)	Race Standard Brake Lines (Front)	OE Replacement Brake Lines (Rear)
ZXR 400 L1-L9	91-03	BLM4169-3F	BLMR4169-2F	BLM4169-1R
GPZ 500 S A1-A6	87-93	BLM4018-1F		
GPZ 500 S D1-E8	94-01	BLM4019-1F		BLM4019-1R
GPZ 500 S E9-E10	02-04	BLM4020-2F	BLMR4020-2F	BLM4019-1R
KH 500	76 -	BLM4042-2F		
KLE 500 A1-A7	91-99	BLM4043-1F		BLM4043-1R
KLE 500 B	05-06	BLM4044-1F		BLM4044-1R
Vulcan 500	96-97	BLM4066-1F		
Z 500	80-83	BLM4099-3F		
GT 550 G1-G9	83-01	BLM4026-3F		
Z 550 A1	1980	BLM4100-3F		
Z 550 D1 (GPZ)	81	BLM4101-3F		BLM4101-1R
Z 550 H1-H2 (Gpz Unitrak)	82-83	BLM4102-3F		BLM4102-1R
Z 550 LTD C1-C2	80-83	BLM4103-3F		
ZR 550 A1-A2 (Z550F)	82-87	BLM4135-3F		
ZR 550 B2-B6 Zephyr	91-98	BLM4136-3F		BLM4136-1R
ZX 550 A1-A4 (GPZ550)	83-91	BLM4150-5F		BLM4150-1R
ER6 F/N	13-14	BLM4008-2F		BLM4008-1R
ER6 F/N	06-09	BLM4009-2F	BLMR4009-2F	BLM4009-1R
ER6 F/N	10-12	BLM4010-2F	BLMR4010-2F	BLM4010-1R
GPX 600 R C1-C7	88-96	BLM4012-3F	BLMR4012-2F	BLM4012-1R
GPZ 600 R A1-A5	85-90	BLM4021-5F		BLM4021-1R
KLR 600 A1/B1-B4	84-90	BLM4046-1F		
ZL 600 B1 Eliminator	95-97	BLM4129-1F		
ZZR 600 D1-D3	90-93	BLM4179-3F	BLMR4179-2F	BLM4179-1R
ZZR 600 D4-E12H	94-06	BLM4180-3F	BLMR4179-2F	BLM4180-1R
ZX6R	07-08	BLM4151-2F	BLMR4151-2F	BLM4151-1R
ZX6R	09-12	BLM4152-3F	BLMR4152-2F	BLM4152-1R
ZX6R	13-14	BLM4153-2F	BLMR4153-2F	BLM4153-1R
ZX6R B1/ZX6RR K1	03	BLM4154-2F	BLMR4154-2F	BLM4154-1R
ZX6R F1-F3	95-97	BLM4155-3F	BLMR4155-2F	BLM4155-1R
ZX6R G1-G2	98-99	BLM4156-3F	BLMR4156-2F	BLM4156-1R
ZX6R J1-J2/A1P (636)	00-02	BLM4157-3F	BLMR4157-2F	BLM4157-1R
ZX6RR 04	04	BLM4158-2F	BLMR4158-2F	BLM4158-1R
ZX6RR ZX636	05-06	BLM4159-2F	BLMR4159-2F	BLM4159-1R
KLR 650 A1-A3/C1-C8	87-02	BLM4047-1F		BLM4047-1R
KLX 650 C1-C2	93-96	BLM4049-1F		BLM4049-1R
Versys 650 ABS	06-10	BLM4052-5FR		Supplied as front & rear kit complete
Versys 650 ABS	11-13	BLM4053-7FR		Supplied as front & rear kit complete
Versys 650 Non ABS	06-10	BLM4054-2F		BLM4054-1R
Versys 650 Non ABS	11	BLM4055-2F		BLM4055-1R
W 650	03-04	BLM4067-1F		
Z 650 B1 Full Front	77	BLM4104-2F		
Z 650 B1 Twin Disc Front	78	BLM4105-3F		
Z 650 B2-B3	78-79	BLM4106-2F		
Z 650 C2-C3	78-80	BLM4107-3F		BLM4107-1R
Z 650 D1(SR)	78	BLM4108-3F		
Z 650 D2-D3 (SR)	79-80	BLM4109-3F		
Z 650 F1	80	BLM4110-3F		
Z 650 F2-F4	81-83	BLM4111-3F		
ZX7R P1-P7/ZX7RR N1	96-03	BLM4160-3F	BLMR4160-2F	BLM4160-1R
GPX 750 R F1-F3	87-91	BLM4013-3F	BLMR4013-2F	BLM4013-1R
GPZ 750 A1-A5/R1 (ZX 750 A/ZX 750 G)	83-89	BLM4022-5F		BLM4022-1R
GPZ 750 E1-E2 Turbo	83-87	BLM4023-5F		BLM4023-1R
GT 750 P1-P9	82-96	BLM4027-3F		BLM4027-1R
VN 750 A Front	86-94	BLM4064-3F		
Z 750	03-05	BLM4112-2F	BLMR4112-2F	BLM4112-1R
Z 750	06-07	BLM4113-2F	BLMR4113-2F	BLM4113-1R
Z 750	08-11	BLM4070-2F	BLMR4070-2F	BLM4070-1R
Z 750 B Full Front	76-79		BLMR4115-2F	BLM4115-1R
Z 750 L2-L4 82-84 Front	82-84	BLM4116-3F		
Z 750 L4 1984 Rear	84			BLM4117-1R
Z 750 Ltd H1-H2	80-83	BLM4118-3F		

FRONT / AVANT / VORN / FRENTE / ANTERIORE

REAR / ARRIÈRE / HINTEN / POSTERIOR / POSTERIORE

**BRAKE
LINES**

BRAKE LINES



KAWASAKI



		OE Replacement Brake Lines (Front)	Race Standard Brake Lines (Front)	OE Replacement Brake Lines (Rear)
Z 750 R	11	BLM4119-2F		BLM4119-1R
Z 750 R1 (GP)	82	BLM4120-3F		BLM4120-1R
Z 750 Y1 Twin Ltd	82	BLM4121-3F		
ZR-7	06	BLM4130-2F		BLM4130-1R
ZR-7 F1-F5/ZR-7S H3	99-03	BLM4131-3F	BLMR4131-2F	BLM4131-1R
ZR 750 C1-C4/D1 Zephyr	91-99	BLM4137-3F	BLMR4137-2F	BLM4137-1R
ZXR 750 H1-H2	89-90	BLM4170-3F	BLMR4170-2F	BLM4170-1R
ZXR 750 J1-J2	91-92	BLM4171-3F	BLMR4171-2F	BLM4171-1R
ZXR 750 K1-L1	91-96	BLM4172-3F	BLMR4172-2F	BLM4172-1R
ZXR 750 M1-M2	92-94	BLM4173-3F	BLMR4173-2F	BLM4173-1R
VN 800 A1-A3/B2-B8 Classic/E1-E2 Drifter	95-03	BLM4065-1F		
W 800 Inc Special Edition	11-13	BLM4068-1F		
Z 800 Non ABS	13	BLM4122-2F	BLMR4122-2F	BLM4122-1R
Z 800 E 2013 2 Pot	13	BLM4123-2F		
GPZ 900 R A1-A6	84-89	BLM4024-5F		BLM4024-1R
GPZ 900 R A7-A8	90-96	BLM4025-3F	BLMR4025-2F	BLM4025-1R
VN 900/VN 900 Custom	06-13	BLM4031-1F		BLM4031-1R
Z 900	-77	BLM4124-3F		
Z 900	78-	BLM4125-3F		
Z 900 Single Disc (Hard Line On Caliper)	74	BLM4126-2F		
ZX9R B1-B2	94-95	BLM4161-3F	BLMR4161-2F	BLM4161-1R
ZX9R B3-B4	96-97	BLM4162-3F	BLMR4161-2F	BLM4161-1R
ZX9R C1-C2	98-99	BLM4163-3F	BLMR4163-2F	BLM4163-1R
ZX9R E1-E2	00-01	BLM4164-3F	BLMR4164-2F	BLM4164-1R
ZX9R F1P-F2P	02-04	BLM4165-3F	BLMR4165-2F	BLM4165-1R
Z1/Z1A/Z1B	73-75	BLM4069-3F		BLM4069-1R
GPZ 1000 RX A1-A3	85-89	BLM4014-5F		BLM4014-1R
GTR 1000 A1	86	BLM4028-3F		BLM4028-1R
GTR 1000 A2-A4	87-89	BLM4029-3F		BLM4029-1R
GTR 1000 A5-A14	90-99	BLM4030-3F		BLM4030-1R
KLZ 1000 Versys	12-14	BLM4191-4F		BLM4191-1R
KLZ 1000 Versys	15-17	BLM4192-4F		BLM4191-1R
Z 1000	07-09	BLM4070-2F	BLMR4070-2F	BLM4070-1R
Z 1000	10-13		BLMR4071-2F	BLM4071-1R
Z 1000	15-	BLM4072-2F		BLM4072-1R
Z 1000 A1	77	BLM4073-3F	BLMR4073-2F	BLM4073-1R
Z 1000 A2	78	BLM4074-3F		BLM4074-1R
Z 1000 J1	81	BLM4075-3F		BLM4075-1R
Z 1000 J2	82	BLM4076-3F		BLM4076-1R
Z 1000 J3	83	BLM4077-3F		BLM4077-1R
Z 1000 K1 LTD	81-83	BLM4078-3F		BLM4078-1R
Z 1000 MK2	78-81	BLM4079-3F		BLM4079-1R
Z 1000 Z 1R	78-81	BLM4080-3F		BLM4080-1R
Z 1000 H	80-81	BLM4081-3F		BLM4081-1R
Z 1000 R2	83	BLM4082-3F		BLM4082-1R
Z 1000 ST (E1)	79	BLM4083-3F		BLM4083-1R
Z 1000 ST (E2)	80	BLM4084-3F		BLM4084-1R
Z 1000 SX	11-13		BLMR4085-2F	BLM4085-1R
Z 1000 SX	14-17	BLM4189-4F		BLM4189-1R
ZL 1000	87-90	BLM4128-3F		BLM4128-1R
ZR 1000 A1-A2	03-06	BLM4132-2F	BLMR4132-2F	BLM4132-1R
ZX10 B1-B3	88-91	BLM4141-3F	BLMR4141-2F	BLM4141-1R
ZX10R	04-05	BLM4142-2F	BLMR4142-2F	BLM4142-1R
ZX10R	06	BLM4143-2F	BLMR4143-2F	BLM4143-1R
ZX10R	07	BLM4144-2F	BLMR4144-2F	BLM4144-1R
ZX10R	08-10		BLMR4145-2F	BLM4145-1R
ZX10R (Non ABS)	11-14	BLM4146-3F	BLMR4146-2F	BLM4146-1R
GPZ 1100 A1-A3 (ZX 1100 A)	83-85	BLM4015-5F		BLM4015-1R
GPZ 1100 S E1-E2	95-99	BLM4016-3F		BLM4016-1R
Z 1100 A1-A3	81-84	BLM4086-3F		BLM4086-1R
Z 1100 A1-A3(GPZ)	81-83	BLM4087-3F		BLM4087-1R
Z 1100 B1-B2(GPZ)	81-82	BLM4088-3F		BLM4088-1R
Z 1100 R	84-86	BLM4089-3F		BLM4089-1R

FRONT / AVANT / VORN / FRENTE / ANTERIORE

REAR / ARRIÈRE / HINTEN / POSTERIOR / POSTERIORE

**BRAKE
LINES**

BRAKE LINES



KAWASAKI



		OE Replacement Brake Lines (Front)	Race Standard Brake Lines (Front)	OE Replacement Brake Lines (Rear)
ZR 1100 A1-A4/B1 Zephyr	92-97	BLM4133-3F	BLMR4133-2F	BLM4133-1R
ZRX 1100 C1-C2	97-01	BLM4138-3F	BLMR4138-2F	BLM4138-1R
ZZR 1100 C1-C3	90-92	BLM4174-3F	BLMR4174-2F	BLM4174-1R
ZZR 1100 D1-D9	92-01	BLM4175-3F	BLMR4175-2F	BLM4175-1R
ZRX 1200 A1-A3P/ZRX 1200S B1-B3P	01-04	BLM4139-3F	BLMR4139-2F	BLM4139-1R
ZRX 1200 R	06	BLM4140-3F		BLM4140-1R
ZX12R A1-B2	99-03	BLM4147-3F	BLMR4147-2F	BLM4147-1R
ZX12R B3-B4	04-05		BLMR4148-2F	BLM4147-1R
ZX12R B6	05-07	BLM4149-3F	BLMR4149-2F	BLM4147-1R
ZZR 1200	02-04	BLM4176-3F		BLM4176-1R
Z 1300 A1-A5	79-84	BLM4090-3F		BLM4090-1R
ZG 1300 A1-A3	87-90	BLM4127-3F		BLM4127-1R
ZZR 1400 (Non ABS)	06-10	BLM4177-3F	BLMR4177-2F	BLM4177-1R
VN 1500 B2-B6 Vulcan/C1-C2 Classic	88-96	BLM4056-1F		BLM4056-1R
VN 1500 D1-D2/E1 Classic/J1-J2 Drifter	96-99	BLM4057-1F		BLM4057-1R
VN 1500 E2 Classic Tourer/Nomad	01-04	BLM4058-3F		BLM4058-1R
VN 1500 E2 Classic/G1-G2 Nomad	98-99	BLM4059-2F		BLM4059-1R
VN 1600 A3H Classic	03-06		BLMR4060-2F	BLM4060-1R
VN 1600 B2H Meanstreak	03-06	BLM4061-3F		BLM4061-1R
VN 1700 Classic	09		BLMR4062-2F	
VN 2000	03-09	BLM4063-3F	BLMR4063-2F	BLM4063-1R

KAWASAKI OFF ROAD

KX 85	00-11	BLM6017-1F		BLM6017-1R
KX 100	97-11	BLM6017-1F		BLM6017-1R
KX 125/250	03-05	BLM6018-1F		BLM6017-1R
KDX 200 R/220 R	05-06	BLM6014-1F		BLM6014-1R
KX 250	06-07	BLM6019-1F		BLM6019-1R
KX 250 F	04-05	BLM6018-1F		BLM6017-1R
KX 250 F	06	BLM6021-1F		BLM6021-1R
KX 250 F	07-08	BLM6022-1F		BLM6022-1R
KX 250 F	09	BLM6023-1F		BLM6023-1R
KX 250 F	11	BLM6024-1F		BLM6024-1R
KLX 300 R	05-08	BLM6015-1F		BLM6015-1R
KLX 450 R	08-09	BLM6016-1F		BLM6016-1R
KX 450 F	06-08	BLM6021-1F		BLM6021-1R
KX 450 F	09-11	BLM6023-1F		BLM6023-1R
KX 500	95-04	BLM6018-1F		BLM6017-1R

KTM OFF ROAD

125/200/250 EXC	00-03	BLM6032-1F		BLM6032-1R
125/200/250 SX	04-05	BLM6033-1F		
125/200 EXC	98-99			BLM6032-1R
125/200 SX/MXC	00-03	BLM6035-1F		BLM6032-1R
125/200 SX/MXC	95-99	BLM6036-1F		BLM6032-1R
125 EXC/SX/SXS	04-09	BLM6038-1F		BLM6038-1R
200 EXC/XC/XCW MXC	00-09	BLM6038-1F		
250 MXC/SXC	00-01	BLM6038-1F		
250 EXC/SX	03-09			BLM6038-1R
250 EXC/XC/XCF	02-09	BLM6038-1F		
250 SX/MXC	00-02	BLM6035-1F		BLM6032-1R
250 SX/MXC	94-99	BLM6036-1F		BLM6032-1R
360/380 EXC	00-03	BLM6032-1F		BLM6032-1R
300/360/380 SX/MXC	00-02	BLM6035-1F		BLM6032-1R
360/380 SX/MXC	94-99	BLM6036-1F		BLM6032-1R
300 EXC/MXC	04-09			BLM6038-1R
300 EXC/XC/MXC	06-09	BLM6038-1F		
380 EXC/MXC/SX	00-02	BLM6038-1F		
400/520 SX/MXC	00-02	BLM6035-1F		
400/540/620 SC/EXC	98-99	BLM6036-1F		
400/540/620 SX	96-99	BLM6032-1F		
400 EXC/MXC	00-09	BLM6038-1F		
450/525 SX	04-05	BLM6033-1F		

FRONT / AVANT / VORN / FRENTE / ANTERIORE

REAR / ARRIÈRE / HINTEN / POSTERIOR / POSTERIORE

BRAKE
LINES

BRAKE LINES



KTM OFF ROAD

450 EXC/MXC/SXS/XC	03-09
505 XC	08-09
520 SG/EXC	00-02
520 EXC/SX/MXC	00-02
525 EXC/MXC/SX/XC	03-07
525 MXC	03
525 SX/450SX	03
530 EXC/XCR/XCW	08-09
625 SG/SXC	02-07
660 Rallye	00-03

LAVERDA

Jota 120/180	78-82
Montjuic 500	79-83
750 Formula 750	
750 Formula/750 SS	97-02
Mirage 1200	78-79

MOTO GUZZI

V50 Monza MK1	80-81
V50 Monza MK2	82-83
V50 Monza MK3	84-86
V65 Lario	85-88
V65/V65 SP/V65 ST	84-91
V65 TT	85-88
750 Targa	90-94
850 Le Mans MK1	78-79
850 Le Mans MK2-MK3	79-85
850 T3	- 80
850 T3 California	77-82
850 T5	83-88
1000 California MK2	82-87
1000 Le Mans MK4	85-88
1000 Le Mans MK5	88-94
1000 Mille Gt	88-91
1000 Spada MK1-MK2	80-88
1000 Spada MK3	89-95
1000 T3 California	
1100 California EV	97-02
1100 California Jackal	99-01
1100 California MK3	94-97
1100 Sport Carb	96-99

MV AGUSTA

F3 675 Agusta	13
Brutale S 750	04
F4 750	00-04
850 Monza	77
F4 1000 S	04

SUZUKI

DDR 125 SF-SJ	85-94
GP 125 X-D	82-89
RG 125 FUN-FUR	91-95
TS 125 RK-RR	90-96
GS 250 TT-TX	80-81
GSX 250 ET-EX	80-81
GSX 250 EZ Katana	82
RG 250 FG-FH	85-89
RG 250 WD	83
RG 250 WE	84
RGV 250 K-L	89-90
RGV 250 M-N	91-92

OE Replacement
Brake Lines (Front)

Race Standard
Brake Lines (Front)

OE Replacement
Brake Lines (Rear)

FRONT / AVANT / VORN / FRENTE / ANTERIORE

REAR / ARRIÈRE / HINTEN / POSTERIOR / POSTERIORE

BRAKE
LINES

BRAKE LINES



SUZUKI



		OE Replacement Brake Lines (Front)	Race Standard Brake Lines (Front)	OE Replacement Brake Lines (Rear)
RGV 250 P-R	93-97	BLM3140-3F	BLMR3140-2F	BLM3140-1R
DR 350 SES-SEX	95-99	BLM3005-1F		BLM3005-1R
DR 350 SL-SR	90-94	BLM3006-1F		BLM3006-1R
GT 380 M	75	BLM3125-1F		
GS 400/425 (Single Disc)	77-80	BLM3022-2F		
GSF 400 M-R Bandit	91-95	BLM3041-2F		BLM3041-1R
GSX 400 EZ	82	BLM3065-2F		
GSX 400 FX Non Anti-Dive	81	BLM3066-3F		BLM3066-1R
GSX 400 FZ-FD Anti-Dive	82-86	BLM3067-4F		BLM3066-1R
GSZ 400 FZ-FD Twin Anti-Dive	82-86	BLM3068-5F		BLM3066-1R
GSXR 400 RRK-RRN	89-92	BLM3096-3F	BLMR3096-2F	BLM3096-1R
GS 450 EG-EJ	85-89	BLM3023-2F		
GS 500 EK-ER	89-94	BLM3024-1F		BLM3024-1R
GS 500 ES-K4	95-05	BLM3025-1F		BLM3025-1R
GS 500 F	03-09	BLM3026-1F		BLM3026-1R
RG 500 G-CH	85-89	BLM3137-3F	BLMR3137-2F	BLM3137-1R
GS 550 EN	79	BLM3027-3F		BLM3027-1R
GS 550 ET-EX	80-81	BLM3028-3F		BLM3028-1R
GS 550 LT-LX	80-82	BLM3029-3F		BLM3029-1R
GS 550 MX Katana	81	BLM3030-3F		BLM3030-1R
GSX 550 EE/ESF/EFF/EG/ESG	85-88	BLM3069-3F		BLM3069-1R
GSX 550 ESD/EE/ESE/EFE	83-84	BLM3070-5F		BLM3070-1R
GT 550 A	76	BLM3127-1F		
DR 600 SF-RG	84-87	BLM3007-1F		
GSF 600 S Bandit	95	BLM3042-3F	BLMR3042-2F	BLM3042-1R
GSF 600 T-X Bandit	96-99	BLM3043-3F	BLMR3043-2F	BLM3042-1R
GSF 600 Y-K4 Bandit	00-05	BLM3044-3F	BLMR3044-2F	BLM3044-1R
GSR 600	06-10	BLM3049-2F	BLMR3049-2F	BLM3049-1R
GSR 600 ABS	06-11	BLM3050-5FR		Supplied as front & rear kit complete
GSX 600 FJ-FV	88-97	BLM3071-3F	BLMR3071-2F	BLM3071-1R
GSX 600 FW-K3	98-03	BLM3072-3F	BLMR3072-2F	BLM3072-1R
GSXR 600	04-05	BLM3097-2F	BLMR3097-2F	BLM3097-1R
GSXR 600	06-10	BLM3098-2F	BLMR3098-2F	BLM3098-1R
GSXR 600	11-14	BLM3099-2F	BLMR3099-2F	BLM3099-1R
GSXR 600 K1-K3	01-03	BLM3100-2F	BLMR3100-2F	BLM3100-1R
GSXR 600 V-W	97-98	BLM3101-2F	BLMR3101-2F	BLM3101-1R
GSXR 600 X-Y	99-00	BLM3102-2F	BLMR3101-2F	BLM3102-1R
RF 600 RP-RV	93-97	BLM3130-3F	BLMR3130-2F	BLM3130-1R
VS 600 GLS-GLT Intruder	95-97	BLM3155-1F		
DL 650 ABS	13	BLM3003-5FR		Supplied as front & rear kit complete
DR 650 RSEM-SET	91-97	BLM3008-1F		BLM3008-1R
GX 650 GTX-GTD	81-85	BLM3031-3F		BLM3031-1R
GS 650 GX Katana	81	BLM3032-3F		BLM3032-1R
GSF 650 Bandit Non ABS	08	BLM3045-2F		
GSF 650 Bandit Non ABS	05-07	BLM3046-2F	BLMR3046-2F	BLM3046-1R
GSF 650 A Bandit ABS	05-13	BLM3047-7FR		Supplied as front & rear kit complete
GSF 650 S Bandit K5 - K8 Non ABS	05-13	BLM3048-2F	BLMR3048-2F	BLM3048-1R
GSX 650 F Non ABS	07-13	BLM3073-2F	BLMR3073-2F	BLM3073-1R
LS 650 FG/PJ-PT Savage	87-98	BLM3129-1F		
SV 650 Unfaired	03-13	BLM3143-3F	BLMR3143-2F	BLM3143-1R
SV 650 S Faired	03-13	BLM3144-3F	BLMR3144-2F	BLM3143-1R
SV 650 SX-SK2	99-02	BLM3145-3F	BLMR3145-2F	BLM3145-1R
SV 650 X-K1	99-02	BLM3146-3F	BLMR3146-2F	BLM3145-1R
SVF 650 Gladius Non ABS	09-13	BLM3147-2F	BLMR3147-2F	BLM3147-1R
V-Strom 650	04-12	BLM3153-3F	BLMR3153-2F	BLM3153-1R
DR 750 SJ-SL	88-90	BLM3009-1F		BLM3009-1R
GS 750 DB	77	BLM3033-3F		BLM3033-1R
GS 750 EN	79	BLM3034-3F		BLM3034-1R
GSR 750	11-13	BLM3051-2F		
GSX 750 EE/EF/ES	84-89	BLM3074-5F		BLM3074-1R
GSX 750 ESD	83	BLM3075-5F		BLM3075-1R
GSX 750 ET-EX	80-81	BLM3076-3F		BLM3076-1R
GSX 750 FK-FV	89-97	BLM3077-3F	BLMR3077-2F	BLM3077-1R

FRONT / AVANT / VORN / FRENTE / ANTERIORE

REAR / ARRIÈRE / HINTEN / POSTERIOR / POSTERIORE

**BRAKE
LINES**

BRAKE LINES



SUZUKI



		OE Replacement Brake Lines (Front)	Race Standard Brake Lines (Front)	OE Replacement Brake Lines (Rear)
GSX 750 FW-K3	98-03	BLM3078-3F	BLMR3078-2F	BLM3078-1R
GSX 750 R	85	BLM3079-3F		BLM3079-1R
GSX 750 SE Katana	83-86	BLM3080-3F		BLM3080-1R
GSX 750 W-K1	97-02	BLM3081-3F	BLMR3081-2F	BLM3081-1R
GSXR 750	11-14	BLM3099-2F	BLMR3099-2F	BLM3099-1R
GSXR 750	06-10	BLM3098-2F	BLMR3098-2F	BLM3098-1R
GSXR 750 F-H	85-87	BLM3105-3F	BLMR3105-2F	BLM3105-1R
GSXR 750 J	88	BLM3106-3F	BLMR3106-2F	BLM3106-1R
GSXR 750 K	89	BLM3091-3F	BLMR3091-2F	BLM3091-1R
GSXR 750 K4/K5	04-05	BLM3097-2F	BLMR3097-2F	BLM3097-1R
GSXR 750 L	90	BLM3109-3F	BLMR3109-2F	BLM3109-1R
GSXR 750 M	91	BLM3110-3F	BLMR3110-2F	BLM3110-1R
GSXR 750 T-W	96-98	BLM3101-2F	BLMR3101-2F	BLM3101-1R
GSXR 750 WN-WP	92-93	BLM3112-3F	BLMR3112-2F	BLM3112-1R
GSXR 750 WR-WS	94-95	BLM3113-2F	BLMR3113-2F	BLM3113-1R
GSXR 750 X	99	BLM3102-2F	BLMR3101-2F	BLM3102-1R
GSXR 750 Y-K3	00-03	BLM3115-2F	BLMR3115-2F	BLM3115-1R
GSX-S 750	17	BLM3166-3F		BLM3166-2R
GSX-S 750 Z	17	BLM3166-3F		BLM3166-2R
VS 750 GLPG-GLPM Intruder	85-91	BLM3155-1F		
DR 800 SL-SM	90-91	BLM3010-1F		BLM3010-1R
VS 800 GLM-GLV Intruder	91-97	BLM3155-1F		
VX 800 L-R	90-95	BLM3158-1F		BLM3158-1R
VZ 800 V-W Marauder	97-98	BLM3159-1F		
GS 850 GN-GT	79-80	BLM3035-3F		BLM3035-1R
GS 850 GX-GG	81-88	BLM3036-3F		BLM3036-1R
XN 85 D Turbo	83	BLM3161-5F		BLM3161-1R
RF 900 RR-RW	94-98	BLM3131-3F	BLMR3131-2F	BLM3131-1R
DL 1000 V-Strom ABS	2014-	BLM3001-3F		BLM3001-2R
DL 1000 K2 V-Strom	02-06	BLM3002-3F	BLMR3002-2F	BLM3002-1R
DL1000 V Strom	17-	BLM3172-3F		BLM3172-2R
DL1000 V Strom XT	17-	BLM3173-3F		BLM3173-2R
GS 1000 Katana Anti-Dive		BLM3016-5F		BLM3016-1R
GS 1000 ET/GT	80-84	BLM3017-3F		BLM3017-1R
GS 1000 S	79	BLM3018-3F		BLM3018-1R
GSX 1000 SZ-SD Katana	81-84	BLM3052-5F		BLM3052-1R
GSXR 1000	12-14	BLM3082-2F	BLMR3082-2F	BLM3082-1R
GSXR 1000 ABS	15	BLM3083-3F		BLM3082-1R
GSXR 1000 K5/K6	05-06	BLM3084-2F	BLMR3084-2F	BLM3084-1R
GSXR 1000 K7 - K8	07-08	BLM3085-2F	BLMR3085-2F	BLM3085-1R
GSXR 1000 K9 - K11	09-11	BLM3086-2F	BLMR3086-2F	BLM3086-1R
GSXR 1000 ABS	17	BLM3167-3F		BLM3167-2R
GSXR 1000 K1-K2	01-02	BLM3087-2F	BLMR3087-2F	BLM3087-1R
GSXR 1000 K3-K4	03-04	BLM3088-2F	BLMR3088-2F	BLM3088-1R
SV 1000 N	03-06	BLM3141-2F	BLMR3141-2F	BLM3141-1R
SV 1000 SK3-K7	03-07	BLM3142-2F	BLMR3142-2F	BLM3142-1R
TL 1000 RW-RK1	98-02	BLM3148-2F	BLMR3148-2F	BLM3148-1R
TL 1000 SV-SX	97-01	BLM3149-2F	BLMR3149-2F	BLM3149-1R
GS 1100 G	82-84	BLM3019-3F		BLM3019-1R
GSX 1100 EE/EF/EG	84-88	BLM3053-3F		BLM3053-1R
GSX 1100 ESD	83	BLM3054-5F		BLM3054-1R
GSX 1100 ET-EX	80-81	BLM3055-3F		BLM3055-1R
GSX 1100 EZ/SZ Katana	82	BLM3056-5F		BLM3056-1R
GSX 1100 FJ-FR	88-94	BLM3057-3F		BLM3057-1R
GSX 1100 GM-GN	91-94	BLM3058-3F		BLM3058-1R
GSX 1100 SD Katana	83	BLM3059-5F		BLM3059-1R
GSXR 1100 G-H	86-87	BLM3089-3F	BLMR3089-2F	BLM3089-1R
GSXR 1100 J	88	BLM3090-3F	BLMR3090-2F	BLM3090-1R
GSXR 1100 K	89	BLM3091-3F	BLMR3091-2F	BLM3091-1R
GSXR 1100 L	90	BLM3092-3F	BLMR3092-2F	BLM3092-1R
GSXR 1100 M	91	BLM3093-3F	BLMR3093-2F	BLM3093-1R
GSXR 1100 N	92	BLM3094-3F	BLMR3094-2F	BLM3094-1R
GSXR 1100 WP-WT	93-96	BLM3095-2F	BLMR3095-2F	BLM3095-1R

FRONT / AVANT / VORN / FRENTE / ANTERIORE

REAR / ARRIÈRE / HINTEN / POSTERIOR / POSTERIORE

**BRAKE
LINES**

BRAKE LINES



SUZUKI



		OE Replacement Brake Lines (Front)	Race Standard Brake Lines (Front)	OE Replacement Brake Lines (Rear)
GSF 1200 K1-K5 Bandit	01-06	BLM3037-3F	BLMR3037-2F	BLM3037-1R
GSF 1200 T-Y Bandit	96-00	BLM3038-3F	BLMR3038-2F	BLM3038-1R
GSF 1250 Bandit	06-13	BLM3039-2F	BLMR3039-2F	BLM3039-1R
GSF 1250 A Bandit ABS	07-13	BLM3040-8F		
B-King	07-10	BLM3000-2F		BLM3000-1R
GSX 1300 R Hayabusa	99-06	BLM3060-2F	BLMR3060-2F	BLM3060-1R
GSX 1300 R Hayabusa	07-13	BLM3061-2F	BLMR3061-2F	BLM3061-1R
GSX 1400	01-09	BLM3062-3F	BLMR3062-2F	BLM3062-1R
VS 1400 GLPH-GLPV Intruder	87-99	BLM3154-1F		BLM3154-1R
VZR 1800	06-	BLM3160-3F	BLMR3160-2F	BLM3160-1R

SUZUKI OFF ROAD

DRZ 125/DRZ 125L	03-	BLM6077-1F		
DRZ 250	04-07	BLM6078-1F		BLM6078-1R
RM 250	06-08	BLM6029-1F		BLM6029-1R
RM-Z 250	04-09	BLM6080-1F		BLM6080-1R
RM-Z 250	11	BLM6081-1F		BLM6081-1R
DR-Z 400	05-07	BLM6079-1F		
DR-Z 400 E	00-07	BLM6013-1F		BLM6013-1R
RM-Z 450	05-07	BLM6080-1F		BLM6080-1R
RM-Z 450	08-09	BLM6083-1F		BLM6083-1R
RM-Z 450	11	BLM6084-1F		BLM6084-1R

TRIUMPH

Bonneville/T100 (-Ch 437492)	01-12	BLM8195-1F		
Bonneville America	03-06	BLM8196-1F		BLM8196-1R
Bonneville Thruxton 900	03-13	BLM8197-1F		BLM8197-1R
Daytona 600	03-04	BLM8198-2F	BLMR8198-2F	BLM8198-1R
Daytona 675	06-13	BLM8199-2F	BLMR8199-2F	BLM8199-1R
Daytona 750/1000	91-93	BLM8200-3F	BLMR8200-2F	BLM8200-1R
Daytona 900/1200	92-97	BLM8201-3F	BLMR8201-2F	BLM8201-1R
Daytona 955i	01-03	BLM8202-2F	BLMR8202-2F	BLM8202-1R
Daytona 955i	99-00	BLM8202-2F	BLMR8202-2F	BLM8203-1R
Daytona T595	97-00	BLM8202-2F	BLMR8202-2F	BLM8204-1R
Legend	98-01	BLM8205-1F		BLM8205-1R
Rocket III (Standard Bars)	04-15	BLM8206-3F		BLM8206-1R
Rocket III Classic (Higher Bars)	04-15	BLM8207-3F		BLM8206-1R
Scrambler 865	06-13	BLM8208-1F		
Speed Four	03-06	BLM8209-2F		BLM8209-1R
Speed III	94-96	BLM8210-3F	BLMR8210-2F	BLM8210-1R
Speed III T509	97-03	BLM8211-2F	BLMR8211-2F	BLM8211-1R
Speed Triple 1050	04-10	BLM8212-3F	BLMR8212-2F	BLM8212-1R
Speedmaster	03-11	BLM8213-2F	BLMR8213-2F	BLM8213-1R
Sprint	93-97	BLM8214-3F	BLMR8214-2F	BLM8214-1R
Sprint RS	99-05	BLM8215-2F		BLM8215-1R
Sprint ST 1050 (Non ABS) To Vin 291665	05-12	BLM8216-2F		BLM8216-1R
Sprint ST/Executive	98-03	BLM8217-2F	BLMR8217-2F	BLM8217-1R
Sprint ST/Executive Late 03 On	03-	BLM8218-2F		BLM8218-1R
Street Triple 675	06-15	BLM8219-2F	BLMR8219-2F	BLM8219-1R
Street Triple 675R	09-15	BLM8220-2F	BLMR8220-2F	BLM8220-1R
Street Twin	17-	BLM8240-3F		BLM8240-2R
Thunderbird (Low Bar)	95-02	BLM8221-1F		BLM8205-1R
Thunderbird 900 Sport	98-03	BLM8222-3F		BLM8222-1R
Thunderbird/Adventurer	95-03	BLM8223-1F		BLM8205-1R
Tiger	93-99	BLM8224-3F	BLMR8224-2F	BLM8224-1R
Tiger 1050 (Non ABS)	13	BLM8225-3F		BLM8225-1R
Tiger 800 XC	11-14		BLMR8226-2F	BLM8226-1R
Tiger 955	00-03	BLM8227-2F		BLM8227-1R
Trident 750/900	-91	BLM8228-3F	BLMR8228-2F	BLM8228-1R
Trident 750/900	91-98	BLM8229-3F	BLMR8229-2F	BLM8228-1R
Trophy 900/1200 (From Vin 71699)	03-	BLM8230-2F		BLM8230-1R
Trophy 900/1200 (Up To Vin 71698)	-03	BLM8231-3F	BLMR8231-2F	BLM8231-1R
TT 600	00-03	BLM8232-2F	BLMR8232-2F	BLM8232-1R

FRONT / AVANT / VORN / FRENTE / ANTERIORE

REAR / ARRIÈRE / HINTEN / POSTERIOR / POSTERIORE

BRAKE
LINES

BRAKE LINES



YAMAHA



		OE Replacement Brake Lines (Front)	Race Standard Brake Lines (Front)	OE Replacement Brake Lines (Rear)
DT 125 X	06	BLM2002-1F		BLM2002-1R
TDR 125	93-97	BLM2072-1F		BLM2072-1R
TZR 125	87-97	BLM2079-1F		BLM2079-1R
YZFR 125	08-13	BLM2146-1F		BLM2146-1R
YZF-R125	14-16	BLM2163-1F		BLM2163-1R
FZ1 Fazer	06-13	BLM2010-3F	BLMR2010-2F	BLM2010-1R
TDR 250	88-92	BLM2073-1F		BLM2073-1R
TDM 250	88-90	BLM2068-1F		
RD 250 LC	80-85	BLM2057-1F		
TZ 250	91-		BLMR2078-2F	BLM2078-1R
XS 250 SE	80-85	BLM2101-1F		
RD 350 LC	80-83	BLM2058-3F	BLMR2058-2F	
XT 350	85-96	BLM2116-1F		BLM2116-1R
FZR 400 Exup Import	85-89	BLM2022-3F	BLMR2022-2F	BLM2022-1R
FZR 400 Genesis Import	85-87	BLM2023-3F	BLMR2023-2F	
FZR 400 RR	92-96	BLM2024-3F	BLMR2024-2F	BLM2024-1R
FZR 400 RRSP	91-92	BLM2025-3F	BLMR2025-2F	BLM2025-1R
XS 400 SE Single Disc	80-83	BLM2102-2F		
XS 400 SE Single Disc	78	BLM2103-1F		
SR 500 Single Disc	78-83	BLM2065-2F		
XS 500 C	76	BLM2104-1F		BLM2104-1R
XV 535 (High Bar)	88-03	BLM2131-1F		
XV 535 (Low Bar)	88-02	BLM2132-1F		
XJ 550	81-85	BLM2082-3F		
XZ 550	82-85	BLM2141-3F		
FZ6	04-06	BLM2011-3F	BLMR2011-2F	BLM2011-1R
FZ6 S2	07-08	BLM2012-2F	BLMR2012-2F	BLM2011-1R
FZ 600	87-88	BLM2013-3F	BLMR2013-2F	BLM2013-1R
FZR 600	89-90	BLM2026-3F	BLMR2026-2F	BLM2026-1R
FZR 600 Genesis	91-93	BLM2027-3F	BLMR2027-2F	BLM2027-1R
FZR 600 R	94-96	BLM2028-2F		BLM2028-1R
FZS 600 Fazer	98-03	BLM2032-3F	BLMR2032-2F	BLM2032-1R
R6	08-15		BLMR2049-2F	BLM2049-1R
R6	06-07		BLMR2048-2F	BLM2048-1
R6	05	BLM2047-3F	BLMR2047-2F	BLM2047-1R
R6	03-04	BLM2046-2F		BLM2046-1R
R6	98-02	BLM2045-2F		BLM2045-1R
XJ 600	84-92	BLM2084-3F		BLM2084-1R
XJ 600 N	94-97	BLM2085-1F		BLM2085-1R
XJ 600 N/S Diversion	98-03	BLM2086-2F		BLM2086-1R
XJ 600 S Diversion	92-97	BLM2087-1F		BLM2085-1R
XJ6/XJ6 Diversion/XJ6 SP	09-13	BLM2083-2F	BLMR2083-2F	BLM2083-1R
XT 600 Tenere	86-90	BLM2118-1F		BLM2118-1R
XT 600 E	93-03	BLM2119-1F		BLM2119-1R
YF 600 R Thundercat	96-03	BLM2144-2F		BLM2144-1R
XJ 650	80-84	BLM2088-3F		
XJ 650 Turbo	82-85	BLM2089-3F		
XS 650	77	BLM2105-2F		
XS 650	81-82	BLM2106-3F		
XS 650 (Twin Disc)	75	BLM2107-3F		
XS 650 (2)	72	BLM2108-1F		
XS 650 C	75	BLM2109-3F		
XS 650 E	79-80	BLM2110-3F		
XVS 650 Drag Star	97-03	BLM2137-1F		
XVS 650 A Drag Star Classic	98-03	BLM2138-1F		
SZR 660	96-97	BLM2067-1F		BLM2067-1R
XT 660 R	04-13	BLM2120-1F		BLM2120-1R
XT 660 X	04-13	BLM2121-1F		BLM2121-1R
XT 660 Z	09-13	BLM2122-3F		BLM2122-1R
XTZ 660	91-99	BLM2119-1F		BLM2119-1R
MT-07	14-17	BLM2153-3F		BLM2153-4R
MT-07 Tracer	16-17	BLM2160-3F		BLM2160-4R
XSR 700	16-17	BLM2154-3F		BLM2154-4R

FRONT / AVANT / VORN / FRENTE / ANTERIORE

REAR / ARRIÈRE / HINTEN / POSTERIOR / POSTERIORE

**BRAKE
LINES**

BRAKE LINES



YAMAHA



		OE Replacement Brake Lines (Front)	Race Standard Brake Lines (Front)	OE Replacement Brake Lines (Rear)
FZ 750	85-86	BLM2014-3F	BLMR2014-2F	BLM2014-1R
FZ 750	87-88	BLM2015-3F	BLMR2015-2F	BLM2015-1R
FZR 750	89-92	BLM2029-3F	BLMR2029-2F	BLM2029-1R
FZR 750 R OW01	89-92	BLM2030-2F		BLM2030-1R
FZS 750	87-89	BLM2033-3F	BLMR2033-2F	BLM2033-1R
XJ 750 Antidive	82-84	BLM2090-5F		
XS 750	78-79	BLM2111-3F		BLM2111-1R
XS 750 E	77-78	BLM2112-3F		BLM2112-1R
XS 750 SE	80-82	BLM2113-3F		BLM2113-1R
XTZ 750 Super Tenere	89-96	BLM2124-3F	BLMR2124-2F	BLM2124-1R
XV 750	92-97	BLM2133-3F		
XV 750 SE	81-83	BLM2134-1F		
YZF 750	93-97	BLM2145-2F		BLM2145-1R
FZ8-Non ABS	10-13		BLMR2016-2F	BLM2016-1R
TDM 850	91-96	BLM2069-3F	BLMR2069-2F	BLM2069-1R
TDM 850	97-02	BLM2070-3F	BLMR2070-2F	BLM2069-1R
TRX 850	96-00	BLM2074-2F		BLM2074-1R
XS 850	80-85	BLM2114-3F		BLM2114-1R
MT-09	13-16	BLM2037-2F		BLM2037-1R
TDM 900 Non ABS	02-13	BLM2071-3F	BLMR2071-2F	BLM2071-1R
XJ 900	83-85	BLM2091-3F		BLM2091-1R
XJ 900 F	85-94	BLM2092-3F		BLM2092-1R
XJ 900 S Diversion	94-96	BLM2093-2F		BLM2093-1R
XJ 900 S Diversion	97-03	BLM2094-3F	BLMR2094-2F	BLM2094-1R
FZR 1000 Ex-Up	95-96	BLM2017-2F		BLM2017-1R
FZR 1000 Ex-Up	89-90	BLM2018-2F		BLM2018-1R
FZR 1000 Ex-Up	91	BLM2019-3F	BLMR2019-2F	BLM2019-1R
FZR 1000 Genesis	87-88	BLM2020-3F	BLMR2020-2F	BLM2020-1R
FZR 1000 RU	92-94	BLM2021-3F	BLMR2021-2F	BLM2021-1R
FZS 1000 Fazer	01-05	BLM2031-3F	BLMR2031-2F	BLM2031-1R
GTS 1000 A	93-96	BLM2034-7FR		Supplied as front & rear kit complete
XV 1000 TR1	81-85	BLM2125-3F		
XV 1000 Virago	86-89	BLM2126-3F		
XV 1000 Virago	89-99	BLM2127-3F	BLMR2127-2F	
YZF 1000 R Thunderace	96-02	BLM2143-2F		BLM2143-1R
R1	98-01	BLM2039-2F		BLM2039-1R
R1	02-03		BLMR2040-2F	BLM2040-1R
R1	04-05		BLMR2041-2F	BLM2041-1R
R1	06		BLMR2041-2F	BLM2042-1R
R1	07-08		BLMR2043-2F	BLM2043-1R
R1	09-14		BLMR2044-2F	BLM2044-1R
BT 1100 Bulldog	01-03	BLM2000-3F		BLM2000-1R
FJ 1100	85-86	BLM2003-5F		BLM2003-1R
XS 1100	78-80	BLM2099-3F		BLM2099-1R
XS 1100 S	78-84	BLM2100-3F		BLM2099-1R
XVS 1100/A Dragstar	98-06	BLM2135-3F		BLM2135-1R
XVS 1100/A Dragstar Classic	98-06	BLM2136-3F		BLM2135-1R
FJ 1200 (Antidive)	86-87	BLM2004-5F		BLM2004-1R
FJ 1200 (Non Antidive)	88-96	BLM2005-3F	BLMR2005-2F	BLM2005-1R
FJ 1200 ABS	91-96	BLM2006-6F		BLM2006-2R
XJR 1200	95-98	BLM2095-2F		BLM2095-1R
V-MAX	91-04	BLM2081-3F	BLMR2081-2F	BLM2081-1R
FJR 1300	00-02	BLM2007-3F		BLM2007-1R
FJR 1300	03-04	BLM2008-3F		BLM2007-1R
XJR 1300	99-01	BLM2096-3F	BLMR2096-2F	BLM2096-1R
XJR 1300	02-03		BLMR2097-2F	BLM2097-1R
XJR 1300	04-13		BLMR2098-2F	BLM2098-1R
XVZ 1300 A/AT Royal Star/Tour Classic	96-99	BLM2139-3F	BLMR2139-2F	BLM2139-1R
XVZ 1300 TF Venture Star	00-02	BLM2129-3F		BLM2129-1R
XV 1600 Wild Star	98-03	BLM2129-3F		BLM2129-1R
XV 1900 Midnight Star	05-09	BLM2130-3F	BLMR2130-2F	BLM2130-1R

FRONT / AVANT / VORN / FRENTE / ANTERIORE

REAR / ARRIÈRE / HINTEN / POSTERIOR / POSTERIORE

**BRAKE
LINES**

How To Make Precision Pilot Jets

Everyone knows how sensitive an engine is to pilot jets in the acceleration stages from 1000 to 3500 rpm and getting fuel mixture right in this area is critical. For this reason jets have to be perfectly accurate in their marked size and incremental size steps. EBC Brakes sister company A-BAX Precision Engineering Ltd in the UK has purchased the most accurate machine on the planet for this work shown below. A-BAX Precision Engineering Ltd pilot jets are precise, clearly marked and reliably gauged using pin gauges, accurate to one tenth of a thousandth of an inch, you can rely on their accuracy.

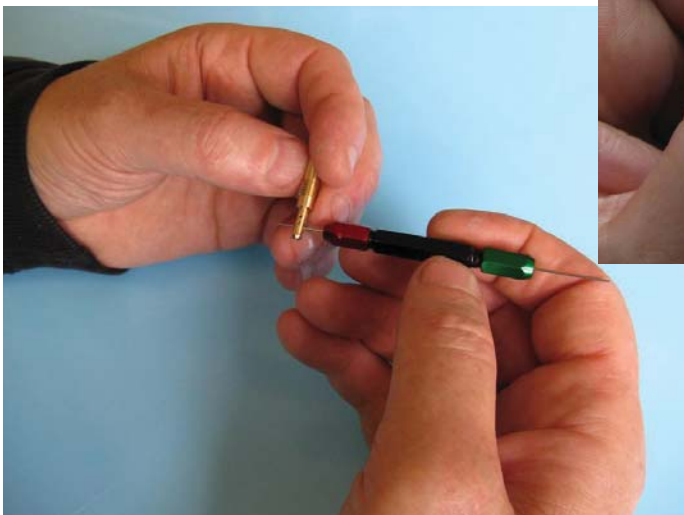
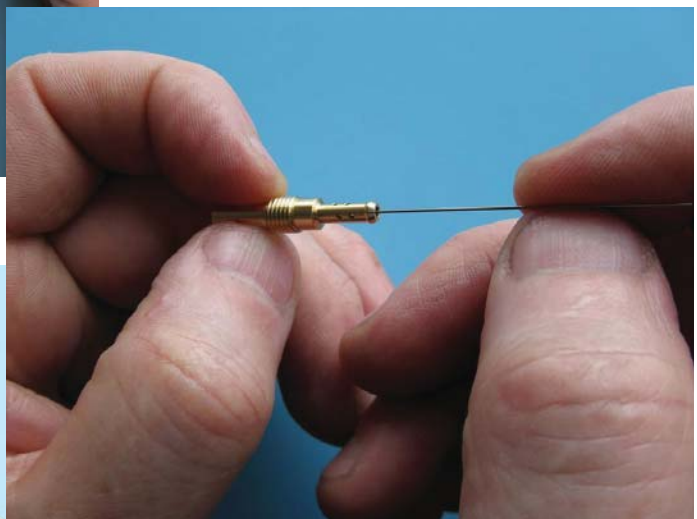
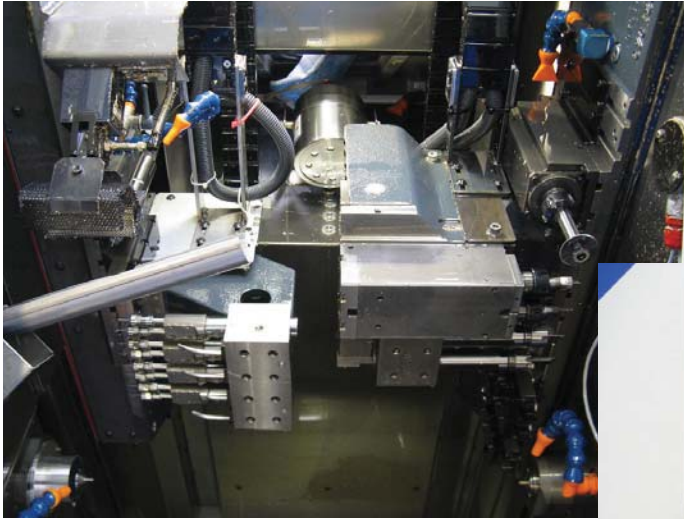

PILOT JETS

A-BAX Precision Engineering Ltd Pilot Jets for Mikuni Carbs (Sold in packs of 4)

Jet Style - VM22/210

8 bleed hole type
VM18 / VM22 / VM26-34 Flange Type
VM26-44 Spigot Type
TM24-38 (No accelerator pump)
Early TMX/TMX Carb Types

Size	Part #
10	EBC22/210-10
12.5	EBC22/210-12.5
15	EBC22/210-15
17.5	EBC22/210-17.5
20	EBC22/210-20
22.5	EBC22/210-22.5
25	EBC22/210-25
27.5	EBC22/210-27.5
30	EBC22/210-30
32.5	EBC22/210-32.5
35	EBC22/210-35
37.5	EBC22/210-37.5
40	EBC22/210-40
42.5	EBC22/210-42.5
45	EBC22/210-45
47.5	EBC22/210-47.5
50	EBC22/210-50
52.5	EBC22/210-52.5
55	EBC22/210-55
57.5	EBC22/210-57.5
60	EBC22/210-60
65	EBC22/210-65
70	EBC22/210-70
75	EBC22/210-75
80	EBC22/210-80
85	EBC22/210-85
90	EBC22/210-90
95	EBC22/210-95
100	EBC22/210-100
105	EBC22/210-105
110	EBC22/210-110
120	EBC22/210-120
130	EBC22/210-130
140	EBC22/210-140

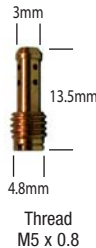

Jet Style - N224.103

2.5mm bleed end
Early TMS/TMX
OEM MX36/38 BSR CV type
Honda / Kawasaki / Suzuki / Yamaha

Size	Part #
10	EBC224-10
12.5	EBC224-12.5
15	EBC224-15
17.5	EBC224-17.5
20	EBC224-20
22.5	EBC224-22.5
25	EBC224-25
27.5	EBC224-27.5
30	EBC224-30
32.5	EBC224-32.5
35	EBC224-35
37.5	EBC224-37.5
40	EBC224-40
42.5	EBC224-42.5
45	EBC224-45
47.5	EBC224-47.5
50	EBC224-50
52.5	EBC224-52.5
55	EBC224-55
57.5	EBC224-57.5
60	EBC224-60
62.5	EBC224-62.5
65	EBC224-65
67.5	EBC224-67.5
70	EBC224-70



Jet Style - N151.067

No bleed holes
Later OEM BS range CV carbs
Kawasaki / Suzuki / Yamaha / Triumph

Size	Part #
30	EBC151-30
32.5	EBC151-32.5
35	EBC151-35
37.5	EBC151-37.5
40	EBC151-40
42.5	EBC151-42.5
45	EBC151-45
47.5	EBC151-47.5
50	EBC151-50
52.5	EBC151-52.5
55	EBC151-55
57.5	EBC151-57.5
60	EBC151-60

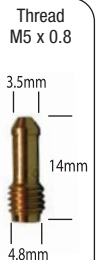

Jet Style - VM28/486

2mm bleed hole type
HS40 / HSR42 / 45 / 48 / RS34-40
TM33 / 36 / 40 with accelerator pump
Kawasaki / Suzuki / Yamaha

Size	Part #
10	EBC28/486-10
12.5	EBC28/486-12.5
15	EBC28/486-15
17.5	EBC28/486-17.5
20	EBC28/486-20
22.5	EBC28/486-22.5
25	EBC28/486-25
27.5	EBC28/486-27.5
30	EBC28/486-30
32.5	EBC28/486-32.5
35	EBC28/486-35
37.5	EBC28/486-37.5
40	EBC28/486-40
42.5	EBC28/486-42.5
45	EBC28/486-45
47.5	EBC28/486-47.5
50	EBC28/486-50
52.5	EBC28/486-52.5
55	EBC28/486-55
57.5	EBC28/486-57.5
60	EBC28/486-60
62.5	EBC28/486-62.5
65	EBC28/486-65
67.5	EBC28/486-67.5
70	EBC28/486-70



Jet Style - M28/1001

Yamaha P/No. 260-14142-Size
Blaster/Banshee/LC

Size	Part #
15	EBC1001-15
17.5	EBC1001-17.5
20	EBC1001-20
22.5	EBC1001-22.5
25	EBC1001-25
27.5	EBC1001-27.5
30	EBC1001-30
32.5	EBC1001-32.5
35	EBC1001-35
37.5	EBC1001-37.5
40	EBC1001-40
42.5	EBC1001-42.5
45	EBC1001-45
47.5	EBC1001-47.5
50	EBC1001-50
52.5	EBC1001-52.5
55	EBC1001-55
57.5	EBC1001-57.5
60	EBC1001-60
62.5	EBC1001-62.5
65	EBC1001-65
67.5	EBC1001-67.5
70	EBC1001-70



Jet Style - BS30/96

6 bleed hole type
Various OEM BS range CV carbs
Kawasaki / Suzuki / Yamaha

Size	Part #
30	EBC30/96-30
32.5	EBC30/96-32.5
35	EBC30/96-35
37.5	EBC30/96-37.5
40	EBC30/96-40
42.5	EBC30/96-42.5
45	EBC30/96-45
47.5	EBC30/96-47.5
50	EBC30/96-50
52.5	EBC30/96-52.5
55	EBC30/96-55
57.5	EBC30/96-57.5
60	EBC30/96-60



A-BAX Precision Engineering Ltd Pilot Jets for Keihin Carbs (Sold in packs of 4)

Jet Style - N424-21

Pilot / Slow Running Jet
PB16 / 18 / 20
Yamaha R6 99-07
Various Kawasaki / Suzuki Quads

Size	Part #
35	EBC424-21-35
38	EBC424-21-38
40	EBC424-21-40
42	EBC424-21-42
45	EBC424-21-45
48	EBC424-21-48
50	EBC424-21-50
52	EBC424-21-52
55	EBC424-21-55
58	EBC424-21-58
60	EBC424-21-60
62	EBC424-21-62
65	EBC424-21-65
68	EBC424-21-68
70	EBC424-21-70
72	EBC424-21-72
75	EBC424-21-75
78	EBC424-21-78
80	EBC424-21-80



Jet Style - N424-25

Pilot / Slow Running Jet
FCR 28 / 32 / 33 / 35 / 37 / 39 / 41mm
Harley D Keihin BH (Non CV Type)
Various Kawasaki / Yamaha Models with CVK
/ FCR / BD style carbs

Size	Part #
35	EBC424-25-35
38	EBC424-25-38
40	EBC424-25-40
42	EBC424-25-42
45	EBC424-25-45
48	EBC424-25-48
50	EBC424-25-50
52	EBC424-25-52
55	EBC424-25-55
58	EBC424-25-58
60	EBC424-25-60
62	EBC424-25-62
65	EBC424-25-65



Dealer Pilot Jet Selection Kits

(Kits include one pilot jet per size)



Part No.	Kit Contents
KPJK-01	Keihin 424-21 Style Carburetor Pilot Jet Selection Kit (19 Pcs)
KPJK-02	Keihin 424-25B Style Carburetor Pilot Jet Selection Kit (13 Pcs)
MPJK-01	Mikuni VM22/210 Style Carburetor Pilot Jet Selection Kit (34 Pcs)
MPJK-02	Mikuni N224.103 Style Carburetor Pilot Jet Selection Kit (25 Pcs)
MPJK-03	Mikuni N151.067 Style Carburetor Pilot Jet Selection Kit (13 Pcs)
MPJK-04	Mikuni BS30/96 Style Carburetor Pilot Jet Selection Kit (13 Pcs)
MPJK-05	Mikuni 28.486 Style Carburetor Pilot Jet Selection Kit (25 Pcs)

Precision machined in the UK A-BAX Dealer selection kits include all the popular sizes for the better selling pilot jets and refills can be purchased from your distributor in packets of four.



MAIN JETS

A-BAX Precision Engineering Ltd MAINJETS

Made in the UK, these high precision BRASS carburettor jets are available in dealer selection kits or in top-up packs of 5 jets or 4 jets. All jets are flow calibrated and extremely accurate in terms of fuel flow rate as stamped.

DEALER SELECTION KITS

PART NO.	DESCRIPTION	PART NO.	DESCRIPTION
CRK030	Hex Main Jets for Keihin Carbs (60 Pcs)	HDJK-12	Keihin Harley Jet Selection Kit
CRK032A	Hex Main Jets for Keihin Carbs (64 Pcs)	SJK36	Mikuni Slot Main Jet (144 Pcs)
CRK032B	Hex Main Jets for Keihin Carbs (60 Pcs)	KJK30	Keihin Slot Main Jets Kit (USA Only)
HJK27A	Mikuni Hex Main Jet (54 Pcs)	KJK36	Keihin Slot Main Jets Kit (144 Pcs)
HJK27B	Mikuni Hex Main Jet (54 Pcs)		
HJK36	Mikuni Hex Main Jet (72 Pcs)		



NOTE - Jets listed below only sold in packets of 4pcs (5 pcs on Dell Orto)

M5 x 0.75 ABAX Slot Jets for Mikuni	M5.3 x 0.9 ABAX Hex Jets for Mikuni	M5 x 0.8 ABAX Slot Jets for Keihin	M5.3 x 0.9 ABAX Hex Jets for Keihin	8.80mm ABAX Slot Jets for Dell 'Orto
(N 100/604) SJ Prefix	(4/042) HJ Prefix	(N102 221) KJ Prefix	(357) CR Prefix	(6413) DO Prefix

SIZES AVAILABLE	SIZES AVAILABLE	SIZES AVAILABLE	SIZES AVAILABLE	SIZES AVAILABLE	SIZES AVAILABLE	SIZES AVAILABLE
SJ70-4	HJ70-4	HJ400-4	KJ72.5-4	KJ190-4	CR080-4	CR198-4
SJ72.5-4	HJ80-4	HJ410-4	KJ75-4		CR085-4	CR200-4
SJ75-4	HJ90-4	HJ420-4	KJ77.5-4		CR090-4	CR202-4
SJ77.5-4	HJ100-4	HJ430-4	KJ80-4		CR095-4	CR205-4
SJ80-4	HJ105-4	HJ440-4	KJ82.5-4		CR100-4	CR208-4
SJ82.5-4	HJ110-4	HJ450-4	KJ85-4		CR102-4	CR210-4
SJ85-4	HJ115-4	HJ460-4	KJ87.5-4		CR105-4	CR212-4
SJ87.5-4	HJ120-4	HJ470-4	KJ90-4		CR108-4	CR215-4
SJ90-4	HJ125-4	HJ480-4	KJ92.5-4		CR110-4	CR218-4
SJ92.5-4	HJ130-4	HJ490-4	KJ95-4		CR112-4	CR220-4
SJ95-4	HJ135-4	HJ500-4	KJ97.5-4		CR115-4	CR222-4
SJ97.5-4	HJ140-4	HJ510-4	KJ100-4		CR118-4	CR225-4
SJ100-4	HJ145-4	HJ520-4	KJ102.5-4		CR120-4	CR228-4
SJ102.5-4	HJ150-4	HJ530-4	KJ105-4		CR122-4	CR230-4
SJ105-4	HJ155-4	HJ540-4	KJ107.5-4		CR125-4	CR232-4
SJ107.5-4	HJ160-4	HJ550-4	KJ110-4		CR128-4	CR235-4
SJ110-4	HJ165-4	HJ560-4	KJ112.5-4		CR130-4	CR238-4
SJ112.5-4	HJ170-4	HJ570-4	KJ115-4		CR132-4	
SJ115-4	HJ175-4	HJ580-4	KJ117.5-4		CR135-4	
SJ117.5-4	HJ180-4	HJ590-4	KJ120-4		CR138-4	
SJ120-4	HJ185-4	HJ600-4	KJ122.5-4		CR140-4	
SJ122.5-4	HJ190-4	HJ610-4	KJ125-4		CR142-4	
SJ125-4	HJ195-4	HJ620-4	KJ127.5-4		CR145-4	
SJ127.5-4	HJ200-4	HJ630-4	KJ130-4		CR148-4	
SJ130-4	HJ210-4	HJ640-4	KJ132.5-4		CR150-4	
SJ132.5-4	HJ220-4	HJ650-4	KJ135-4		CR152-4	
SJ135-4	HJ230-4	HJ660-4	KJ137.5-4		CR155-4	
SJ137.5-4	HJ240-4	HJ670-4	KJ140-4		CR158-4	
SJ140-4	HJ250-4	HJ680-4	KJ142.5-4		CR160-4	
SJ142.5-4	HJ260-4	HJ690-4	KJ145-4		CR162-4	
SJ145-4	HJ270-4		KJ147.5-4		CR165-4	
SJ147.5-4	HJ280-4		KJ150-4		CR168-4	
SJ150-4	HJ290-4		KJ152.5-4		CR170-4	
SJ152.5-4	HJ300-4		KJ155-4		CR172-4	
SJ155-4	HJ310-4		KJ157.5-4		CR175-4	
SJ157.5-4	HJ320-4		KJ160-4		CR178-4	
SJ160-4	HJ330-4		KJ165-4		CR180-4	
SJ165-4	HJ340-4		KJ170-4		CR182-4	
SJ170-4	HJ350-4		KJ172-4		CR185-4	
	HJ360-4		KJ175-4		CR188-4	
	HJ370-4		KJ177-4		CR190-4	
	HJ380-4		KJ180-4		CR192-4	
	HJ390-4		KJ185-4		CR195-4	

NOTE: The names Mikuni & Keihin are for description purposes only. These are NOT original Mikuni or Keihin jets, simply a high quality replacement.

MAIN JETS



DEALER SELECTION KIT
PART NO - HDJK-12

A-BAX Precision Engineering Ltd brass main jets for Keihin CVH carburetors, used on most big twins. Sold in packets of 2 pieces and in dealer assortment kits of 12 sizes (2 pieces each size).



A-BAX Slot Jets
for Harley Davidson

(N424-27)
HDJK Prefix

SIZES AVAILABLE

- EBC424-27-160
- EBC424-27-165
- EBC424-27-170
- EBC424-27-175
- EBC424-27-180
- EBC424-27-185
- EBC424-27-190
- EBC424-27-195
- EBC424-27-200
- EBC424-27-205
- EBC424-27-210
- EBC424-27-220

S&B FILTERS



Made in the USA, S&B Custom Filters are a great choice for all types of carburetor and feature a special man made gauze called "Remay" made by Dupont® which has the benefit of perfectly uniform hole patterns. This enables the S&B filter to catch dust better than an oil soaked filter and to be run DRY. Oiled filters require regular washing and relube which plays havoc with carburetor balance. Available in parallel or cone type design, with high lustre chrome end caps.



DIMENSION CHART

CONICAL TYPES					PARALLEL TYPES				
FILTER No.	A	B	C	D	FILTER No.	A	B	C	D
RC79	35	63	58	51	RC17	40	89	38	74
RC106	48	76	76	51	RC34	44	114	38	114
RC107	43	76	70	51	RU99	(Special Norton Filter)			
RC120	52.5	89	102	51	OVAL TYPES				
RC125	57	86	95	51	RC059	43	112	70	75
RC135	55	88	104	88	RC069	50	112	70	75
RC234	55	76	70	51	RC84	40	72	51	51
RC311	28	57	57	51	RC098	55	112	70	75
RC312	51	73	63	51					
RC313	43	76	60	51					

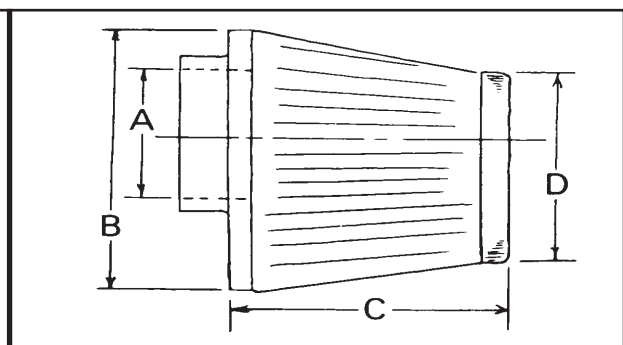
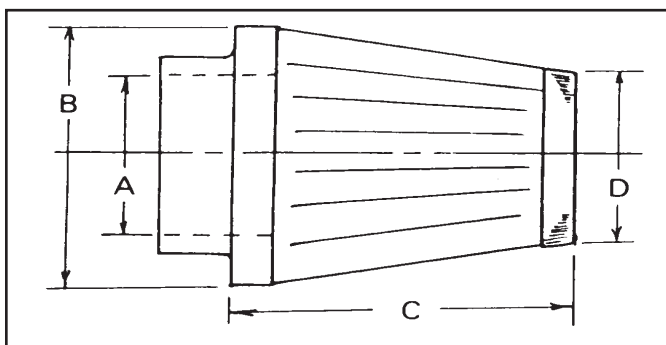

hy-tech racing reeds

For STREET Bikes New CW38 Fibre for higher durability and perfect Reed block seal in high revving 2 stroke motors.

For DIRT Bikes New TWO STAGE Action. By using a lighter fibre on the lower reed block position New Hy-Tech "D" suffix. Reed Kits open earlier and give perfect TWO STAGE response without turbulence or early primary stage reed petal fatigue or New Carbon Fibre CF Series. See below.

CARBON FIBRE REEDS for most Street and Dirt Bike models Prefix **CF** for Carbon Fibre.

ROAD BIKE REEDS ALSO AVAILABLE IN CARBON FIBRE

CF02, CF11, CF15, CF18, CF81, CF118, CF201,
CF202, CF210, CF215

DIRT BIKE APPLICATIONS	DIRT BIKE APPLICATIONS	DIRT BIKE APPLICATIONS	STREET BIKE APPLICATIONS
CAGIVA	SUZUKI Cont.		KAWASAKI
WMX 125/250 (1985) HT09D	RM 125 L/M/N/P/R/S CF78		AE/AR 50 HT05
WMX 500 CF14	RM 125 T/V/W/X/Y/K1-K5 CF93		AE/AR 80 HT05
HONDA	RM 250 X-G (81-86) CF14		KMX 125 (All Models) CF06
CR 80 RG-R2 (86-02) CF48	RM 250 H/J (87-88) CF06		KDX 125 A1-A2/B1-B2 CF64
CR 85 R3-R7 (03-07) CF48	RM 250 K/L (89-90) CF68		KR1/KR1-S HT81
CR 125 (All Models) up to 01 CF18	RM 250 M/N CF83		
CR 125 R1/R2/R3/R4 CF208	RM 250 P/R/S CF65		SUZUKI
CR 250 RC/RD/RE/RF /RG/RH HT61D	RM 250 T/V/W/X/Y/K1-K5 CF94		TS/ZR 50 (All models) HT16
CR 250 RJ-RW CF66	RMX 250 K/L HT68D		TS 100/125/185/250 (C&ER Models) HT12
CR 250 RX/R1/R2/R3 CF167	LT 250 RF/RG/RH HT38		RG 125 (All Models up to 91) CF11
CR 500 RE/RF/RG/RH /R/RK HT17D	LT 250/500 RJ/RK/RL/RM/RN HT68D		RG 125 FUN/FUP/UN CF18
CR 500 RL-R1 CF77	RM 465 X/Z CF57		TS 125 X (All Models) CF11
ATC/TRX 250 (All Models) CF06	RM 500 D/E CF57		TS 125 RK/RL/RR/RR CF18
			GT 250 "X7" HT216
	YAMAHA		RG 250 (All Models) CF211
HUSQVARNA	YZ 50 G-K HT05		RGV 250 K HT80
125 (82-98) HT33D	YZ 80 N-S HT32D		RGV 250 L/M/N/P/R N/A
	YZ 80 T/U/W/A/B HT46		TS 250 XE HT38
	YZ 80 E/F/G/H/J/K/L/M/N CF88		TS 250 XG/XH/XJ HT09D
	YZ 85 P/R/S CF88		
KTM	YZ 125 G-T/E (86-87/93) CF03		YAMAHA
125 (All Models) (84-96) CF22	YZ 125 U-D (88-92) HT67D		DT/RD 50 M HT105
250 (All Models) (84-96) CF22	YZ 125 F/G/H/J/K/L/M (94-00) CF89		DT/RD 50 MX HT30
495/500 (All Models) (82-96) HT23D	YZ 125 N/P/R/S/T/V/W/X/Y (01-09) CF185		RD 80 MX/LC HT05
	WR 200 (89-96) CF04		DT 80 MX (81-) HT30
KAWASAKI	YFS 200 Blaster (Quad) (91-06) HT46D		DT 80 MX (82-) HT05
KX 60 B1-B19 HT40D	YZ 250 E-J CF04		RS 100 HT05
KX 65 A1/A2/A3/A4 HT40D	YZ 250 K HT31D		DT/RXS 100 HT01
KX 80 G1/G2/J1/J2 HT54D	YZ 250 L-U HT07D		DT 125 MX HT01
KX 80 L1-L3/R1-R7/W1/W3 CF01NC	YZ 250 W-H CF04		RD 125/200 HT205
KX 85 A1/B1/A2/B2/A3/B3 CF01NC	YZ 250 J/K/L/M/N/P/R/S/T/V/W/X CF150		DT 125 LC/LC2 HT02R
KX 100 A1/A2/B1-B7/C1-C3 CF01NC	YZ 465 G/H CF04		RD 125 LC MK1-3 HT02R
KX 125 (All Models) (82-93) CF64	YZ 490 J to L CF04		DT 125 R HT15
KX 125 K1-K3 CF78	YZ 490 N to U HT07D		RS 125 HT01
KX 125 K4-M7F N/A	IT 125/175/200 "All Models" CF03		TZR 125/TDR 125 HT15
KDX 200 (All Models) CF64	IT 250 D/E/F CF03		DT 175 MX HT01
KDX 220 A4-A10 CF64	IT 250 E/F/G/H CF04		DT 250/400 CF18
KX 250 C2/D1/D2/E1/F1/G1/H1 /H2/J1/J2/K1/K2/K3 CF14	TY 80/175 HT05		DT 250/400 MX HT29D
KX 250 K4/K5/L1/L2 CF66	TY 250 HT01		RD 250/350/400 (Air Cooled) HT201R
KX 250 L3/L4/M1/M2 CF184	TY 250 S/R HT29D		RD 250/350 LC HT201R
KX 500 A2/B1 HT20D	WR 250 ZB/ZD/ZE/ZF/ZG/ZH/ZJ CF04		TDR/TZR 250 HT215
KX 500 B2/C1/D1/E1-E15 CF57			RD 350 YPVS HT202R
	STREET BIKE APPLICATIONS		
MAICO	HONDA		
250/490 CF06	MB/MT/MTX 50 HT21		
	MBX 50 HT34		
SUZUKI	MBX/MTX 80 HT34		
RM 80 G/H/J HT56D	H 100 HT21		
RM 80 K/L/M/N/P/R/S/T/V/W/X/Y/K1 CF48	MBX 125 HT36		
RM 85 K2/K3/K4 CF48	MTX 125/200 HT36		
RM 125 H/J CF18	NS 125 FG/FH/RK/RL HT210		
	NSR 125 All models HT118		

CARBON FIBRE REEDS

Last longer, work better – increase
rev range & performance

BAFFLE PAC

BAFFLE-PAC-Silencer Glass. PART NO. BP001

This material is labelled and conforms to BSAU 193T2. BEWARE of distributors selling cheaper roofing felt in its place. Repackable Tailpipes as the name implies require regular cleaning and repacking with BSAU approved "SILENCER GLASS" such as Winning BAFFLE PAC. Failure to maintain tailpipes in such a way will lead to clogging of the silencer wool and raised noise output together with reduced engine performance. Freeman Automotive (nor Dealers) are responsible for noise offences due to lack of maintenance as described above. "Recommended repacking period is every 3000 miles on two-strokes or when bike becomes noisy if sooner".

BRAKE FLUID

DOT 4 - A refined specification polyglycol fluid as fitted to most faster street bikes now produced.

DOT 5 - Silicone fluid as used in Harley Davidson Motorcycles and many special High Performance Brake systems.

NEW BF307 - Highly refined Dot 4 Brake fluid, ideal for Racing or High performance Road bikes. Can be used in all systems specifying Dot 3 or Dot 4 but **NOT** with (Dot 5) silicone fluids.

CAUTION - Please check carefully the type of brake fluid used in your system. Adding the incorrect fluids could cause major brake failure. DO NOT EVER mix glycol fluids (DOT3, DOT4 or BF307) with Dot5 Silicone.



EBC Brake Fluid is available in DOT 4 or DOT 5 (Silicone) Grades or BF307 Race Grade.

TO ORDER USE THESE NUMBERS

DOT 4 (Six Pack)	BF 004	250ml Bottle
DOT 5 (Six Pack) (Silicone)	BF 005	250ml Bottle
BF 307 (Six Pack)	BF 307	500ml Bottle

BRAKE CALIPER LUBE



These sachets of dedicated, high viscosity greases are perfect for all of your customers' brake service needs. Always use sparingly on caliper slider pins and rails, but do NOT get near the pad surface and do NOT use as anti-squeal as it will not help at all. Each sachet contains 5 grammes of grease.

TO ORDER USE THESE NUMBERS

Ten Sachets	LUBE010
Fifty Sachets	LUBE050

GALINDO / BAJA GRIPS



4 1/2" GALINDO Superbike Grips

Made in USA with KRATON G material. Without doubt the highest quality grip sold worldwide for street bikes. All below colours at 4.1/2" with separate spacer ring to accommodate 5" throttle units. Complete with heavy plastic bar end plugs & new high visual "Clamshell" packaging.

Colour	Part No.
Black	GX001
Red	GX002
Blue	GX003

BAJA FOAM GRIPS

BAJA Foam grips made in USA with "reticulated" foam closed cell construction. Sounds fancy but what it means is Baja foam grips do not "sponge" up water as will other cheap open cell foam rubber units. Complete with bar end caps and mounting glue.

Colour	Part No.
Black	BG001
Red	BG002
Blue	BG003

LEDAR NOZZLES

LEDAR POWER NOZZLES 2 STROKE DETAILS

- Simply Change standard OE Nozzle for Immediate Power Boost.
- More Power through the range.
- Better Carburation, improved specific fuel consumption.
- Less Unburnt Hydro Carbons means cleaner exhaust & less pollution.

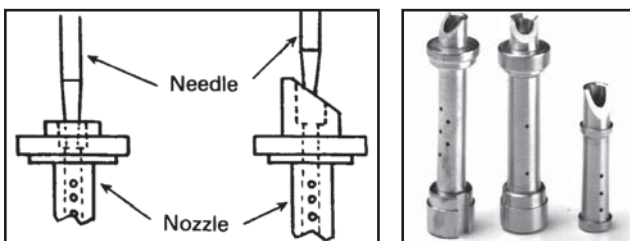

NOZZLE No.	FITMENT
LN43	RD 125 LC Mk 1/Mk 1 2 (Not YPVS), DT 125 MX
LN44	DT 125 LC/RXS 100
LN45	RD 80 LC
LN46	MBX 125/MBX 50
LN59	AR 50/AE 50/AR 80
LN61	AR 125 LC
LN63	RD 125 LC Mk 3 (YPVS)
LN66	GP 100
LN66A	GP 100 Big Bore 125 Conversion
LN67	RG 125
LN68	NS 125 FH/FG/RK

RACING REEDS

hy-tech
racing reeds



See page
810 for
applications

STREET - CW38 fibre still ideal for smaller high revving two strokes but new for track or road Hy-Tech **CARBON FIBRE** reeds for these designs suffix regular part No with "CF" to order.

DIRT - Two stage system with stiffer top reed and standard lower reed gives wider power band + longer reed life on upper reed block position.

OR - NEW CF Carbon Fibre series now available.

PROMOTIONAL ITEMS



EBC Brakes® Fleece Zip Jacket - Dark Blue

Warm fleece with pockets and full zip to the front. EBC Brakes® logo embroidered in white to the left breast area.

ORDER CODE:

- FLEECE-S (Small)
- FLEECE-M (Medium)
- FLEECE-L (Large)
- FLEECE-XL (X-Large)
- FLEECE-XXL (XX-Large)
- FLEECE-XXXL (XXX-Large)



EBC Brakes® Reversible Jacket - Dark Blue

Reversible jacket with water resistant nylon to one side, warm fleece to the other. Can be worn either way. EBC Brakes® logo embroidered in white to the left breast area on the water resistant side.

ORDER CODE:

- JACKET-M (Medium)
- JACKET-L (Large)
- JACKET-XL (X-Large)
- JACKET-XXL (XX-Large)



EBC Brakes® Logo Hoodie

Soft, comfortable, quality hoodie made from 80% cotton/20% polyester, in heather grey with a contrasting navy lined hood and a kangaroo pouch pocket.

ORDER CODE:

- HOODIE-M (Medium)
- HOODIE-L (Large)
- HOODIE-XL (X-Large)
- HOODIE-XXL (XX-Large)



EBC Brakes® Logo Cool Golf Shirt - White

A lightweight short sleeved sports shirt with three buttons to the neck, self fabric collar and cuffs. Embroidered with EBC Brakes® logo to the back in blue and red.

ORDER CODE:

- GOLF-M (Medium)
- GOLF-L (Large)
- GOLF-XL (X-Large)
- GOLF-XXL (XX-Large)



EBC Brakes® Logo Golf Shirt - Dk Blue

Short sleeved golf shirt with three buttons to the neck, self fabric collar and cuffed sleeves. Embroidered with EBC Brakes® logo to the left breast in white.

ORDER CODE:

- POLO-M (Medium)
- POLO-L (Large)
- POLO-XL (X-Large)
- POLO-XXL (XX-Large)



EBC Brakes® Snap Back Style Peaked Cap - Marl Grey

100% cotton grey marl peaked snapback style cap with 3D effect EBC Brakes logo embroidered to front. "Masters of Stopping Power" embroidered to the rear above the snap closure. Mono Union Jack printed under peak. Adjustable to fit all sizes.

ORDER CODE:

CAP

PROMOTIONAL ITEMS



EBC Brakes® Authorised Dealer Sign

A5 sign printed on both sides of 650 micron PVC with two self adhesive strips applied to one side to affix the sign to your window easily.

ORDER CODE:

ASK YOUR DEALER TO ORDER THIS FOR YOU



EBC Brakes® Logo Mug

Dark blue china mug with EBC Brakes logo and website URL on one side - QR code to direct customers to the EBC Brakes website. Perfect giveaway to loyal customers.

ORDER CODE:
MUG



EBC Brakes® Logo Performance Shorts

Mesh lining with elasticated waist with drawcord, side panels and two side pockets. 100% polyester with breathable properties.

ORDER CODE:

G/SHORT-M (Medium)

G/SHORT-L (Large)

G/SHORT-XL (X-Large)

G/SHORT-XXL (XX-Large)

EBC Brakes® Logo Cool Vest

In red textured fabric with inherent wickability, the EBC Brakes® logo is printed to the back of the neck.

ORDER CODE:

R/VEST-M (Medium)

R/VEST-L (Large)

R/VEST-XL (X-Large)

R/VEST-XXL (XX-Large)



EBC Brakes® Logo Performance Sports Vest

100% polyester Cool Plus fabric, in orange with contrasting white insert to the front, back and side bands. EBC Brakes® logo to the white band across the back.

ORDER CODE:

O/VEST-M (Medium)

O/VEST-L (Large)

O/VEST-XL (X-Large)

O/VEST-XXL (XX-Large)



EBC Brakes® Logo Illuminated Clock

Mains powered illuminated clock.

ORDER CODE:

CLOCK08



EBC Brakes® Logo Promotional Banner

Promotional banner printed onto bannergrade vinyl, hem stitched with 6 brass eyelets for easy attachment to any display stand or outside a shop.

ORDER CODE:

BANNERLOGO



EBC Brakes® Logo Illuminated Sign

Great for windows or exhibition displays.

ORDER CODE:

SIGN08

SIZE:

L = 520mm

H = 320mm

D = 110mm

PROMOTIONAL ITEMS



EBC Brakes® Logo Cloth Badge

High quality embroidered cloth badge, perfect for stitching onto racing leathers.

ORDER CODE:
CB



EBC Brakes® Band-It Bandana

Blue stretchy multi-purpose tubular bandana with EBC Brakes logo printed in white. Provides warmth in the winter and in summer, the polyester material wicks moisture away from the skin keeping the wearer cool and protected from the sun. Ideal for all outdoor activities and especially loved by cyclists and motorcyclists to keep the cold air away from the skin.

ORDER CODE:
BANDANA



EBC Brakes® Logo Umbrella

The EBC Brakes logo is printed in red and blue onto the 4 white panels of this navy and white umbrella. The shaft is made from fibreglass and is very strong, the umbrella is storm resistant and perfect for golf or a day watching the racing.

ORDER CODE:
UB001



EBC Brakes Logo Swivel Backrest Stool

Blue vinyl counter stool with EBC Brakes logo printed in white to the backrest.

ORDER CODE:
ST01



EBC Brakes® Logo Carrier Bag

White polythene bag, 381 x 457 x 50mm with EBC Brakes logo printed in blue and red on both sides. Reinforced handle..

ORDER CODE:
BAGS 100 (Pack of 100 bags)
BAGS 500 (Pack of 500 bags)



EBC Brakes Instructional DVD - Motorcycle

This DVD gives basic guidelines on fitting our brakes as well as safety instructions. It should be used alongside the vehicle manufacturers handbook and a competent service guide rather than used alone.

ORDER CODE:
DVD008/1



EBC Brakes Logo Scraper Floormat

A good looking EBC Brakes logo slip resistant rubberised floormat for use indoors or outdoors. Protects your floors by trapping oil, dirt and water. Easy to clean - simply shake out or hose off and dry.

ORDER CODE:
FLOORMAT

NOTES

NOTES

BRAKE SHOE DIAMETER CHART
(in mm)

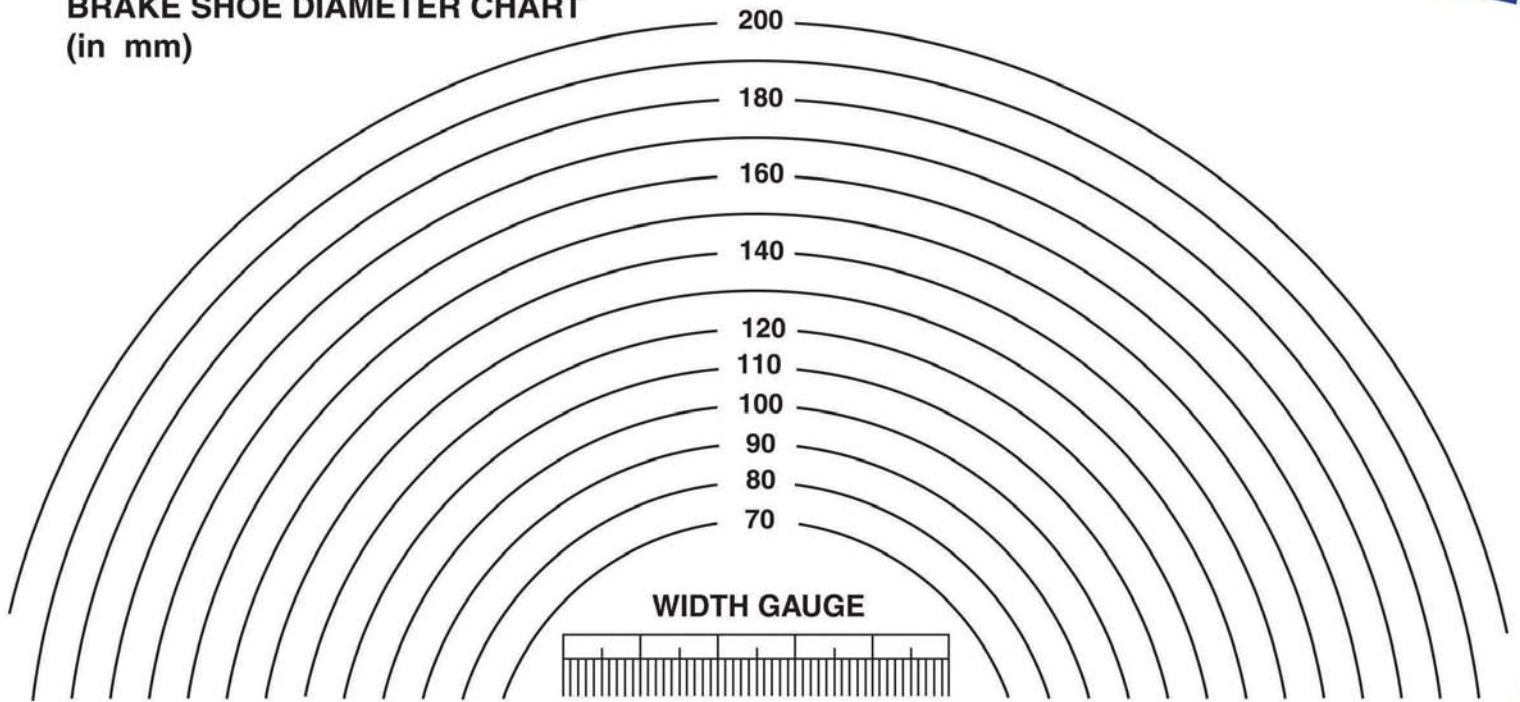

EBC[®]
BRAKES

EBC Brakes World Headquarters:

Upton Valley Way East, Pineham, Northampton NN4 9EF United Kingdom. Telephone: +44 (0)1604 583344

www.ebcbrakes.com sales@ebcbrakesuk.com