

OHIO SCIENTIFIC
OHIO SCIENTIFIC
OHIO SCIENTIFIC
OHIO SCIENTIFIC
OHIO SCIENTIFIC

Servicing Data

for

COMPUTER BOARDS 502, 505, 527, 540 & 542

as used in

Challenger Series

MODEL C4P

MODEL C4PMF



TABLE OF CONTENTS







Adjustments	
502 Board (C4P)	48
505 Board (C4PMF)	77
540 Board (C4P/C4PMF)	43
Block Diagrams	
Body Block (C4P)	59,60
Body Block (C4PMF)	63,64
Skeleton Block (C4P)	1
Skeleton Block (C4PMF)	2
Disassembly Instructions (C4P/C4PMF)	
General Servicing/Safety Precautions (C4P/C4PMF)	1
Legends	
502 Board (C4P)	91
505 Board (C4PMF)	91
527 Board (C4PMF)	92
540 Board (C4P/C4PMF)	92
542 Board (C4P/C4PMF)	Rear Cover
Parts List	14 thru 26
Photos	
A15 Board (C4P)	62
A15 Board (C4PMF)	78
Board - Chassis Layout (C4P)	3
Board - Chassis Layout (C4PMF)	4
Chassis - Side View (C4P)	48
Chassis - Side View (C4PMF)	83
502 Board (C4P)	49,50,52,53
505 Board (C4PMF)	79,80,81,82
527 Board (C4PMF)	89,90
540 Board (C4P/C4PMF)	44,45,46,47
542 Board (C4P/C4PMF)	27,28
Pinouts	
502 Board (C4P)	51
505 Board (C4PMF)	65,66
527 Board (C4PMF)	83
540 Board (C4P/C4PMF)	32,33
542 Board (C4P/C4PMF)	31
Schematics	
A15 Board (C4P)	61
502 Board (C4P)	55,56,57,58
505 Board (C4PMF)	67,68,69,70,73,74,75,76
527 Board (C4PMF)	84 thru 88
540 Board (C4P/C4PMF)	35 thru 41
542 Board (C4P/C4PMF)	29,30
Schematic Notes	
Special Servicing Instructions	Rear Cover
Special Servicing Instructions	
C4P	3
C4PMF	4
Troubleshooting Guide	
C4P	5,6,7,8
C4PM	9 thru 13
Waveforms	
502 Board (C4P)	54
505 Board (C4PMF)	71,72,77
540 Board (C4P/C4PMF)	34,42,43

LEGEND FOR 542 BOARD SCHEMATIC

A0,A1	Address
C0-C7	Column
KBE	Keyboard Enable
KD0-KD7	Keyboard Data
NI	Noise Inhibit
NOISE 1	Noise
NOISE 2	Noise
RESET	Reset
R0-R7	Row
S0-S7	Sound
1R/W	Internal Read/Write

Any $\overline{\text{Bar}}$ above any alphabetical or numerical combination indicates line active in a low (0) state.

SCHEMATIC NOTES

-  Circuitry not used in some versions.
-  Circuitry used in some versions.
-  Nominal value
-  Ground
-  Chassis
-  Flame retardant resistor
-  See parts list

Item numbers in rectangles appear in the alignment/adjustment instructions.

Supply voltage maintained as shown in input.

Voltages measured with digital meter.

Terminal identification may not be found on unit.

Resistors are 1/4W or less, 5% unless noted.

Value in () used in some versions.

OHIO SCIENTIFIC

**1333 S. Chillicothe Road
Aurora, Ohio 44202**

\$15.95

TM-200

C4P/C4PMF — GENERAL SERVICING/SAFETY PRECAUTIONS

Use an isolation transformer for bench servicing.

Maintain line voltage at 120VAC.

Remove power from unit before removing or installing chips.

Use extreme caution when handling printed circuit boards. Ground yourself before handling boards.

Do not use a soldering device which has current flowing in its tip.

Use an isolation (times 10) probe on scope.

Do not remove or install boards or minifloppy with unit turned on.

Install RAM in Chip Enable sequence only.

Caution: Ground path on the boards is parallel to the B+ path on the opposite side of the board.

C4P/C4PMF — DISASSEMBLY INSTRUCTIONS

Lay unit on a protective surface with top side down.

Remove six screws from cabinet bottom and remove cabinet bottom. Remove ground lead from cabinet bottom.

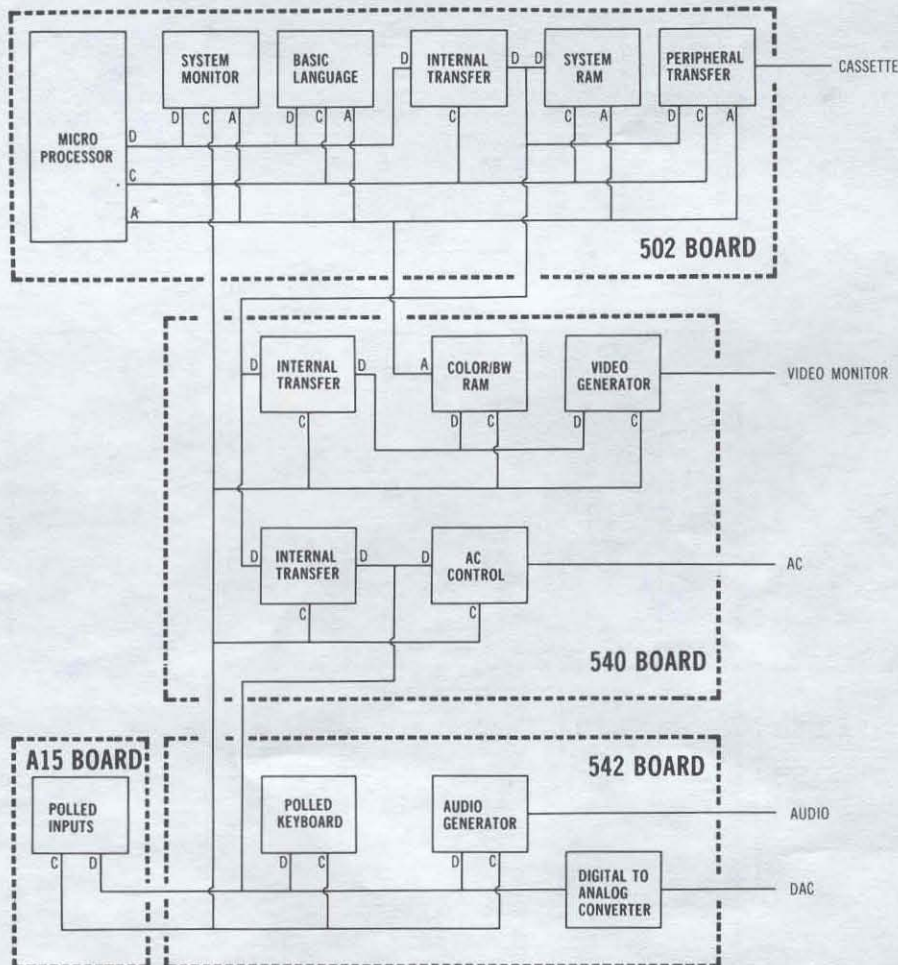

C4P — SKELETON BLOCK

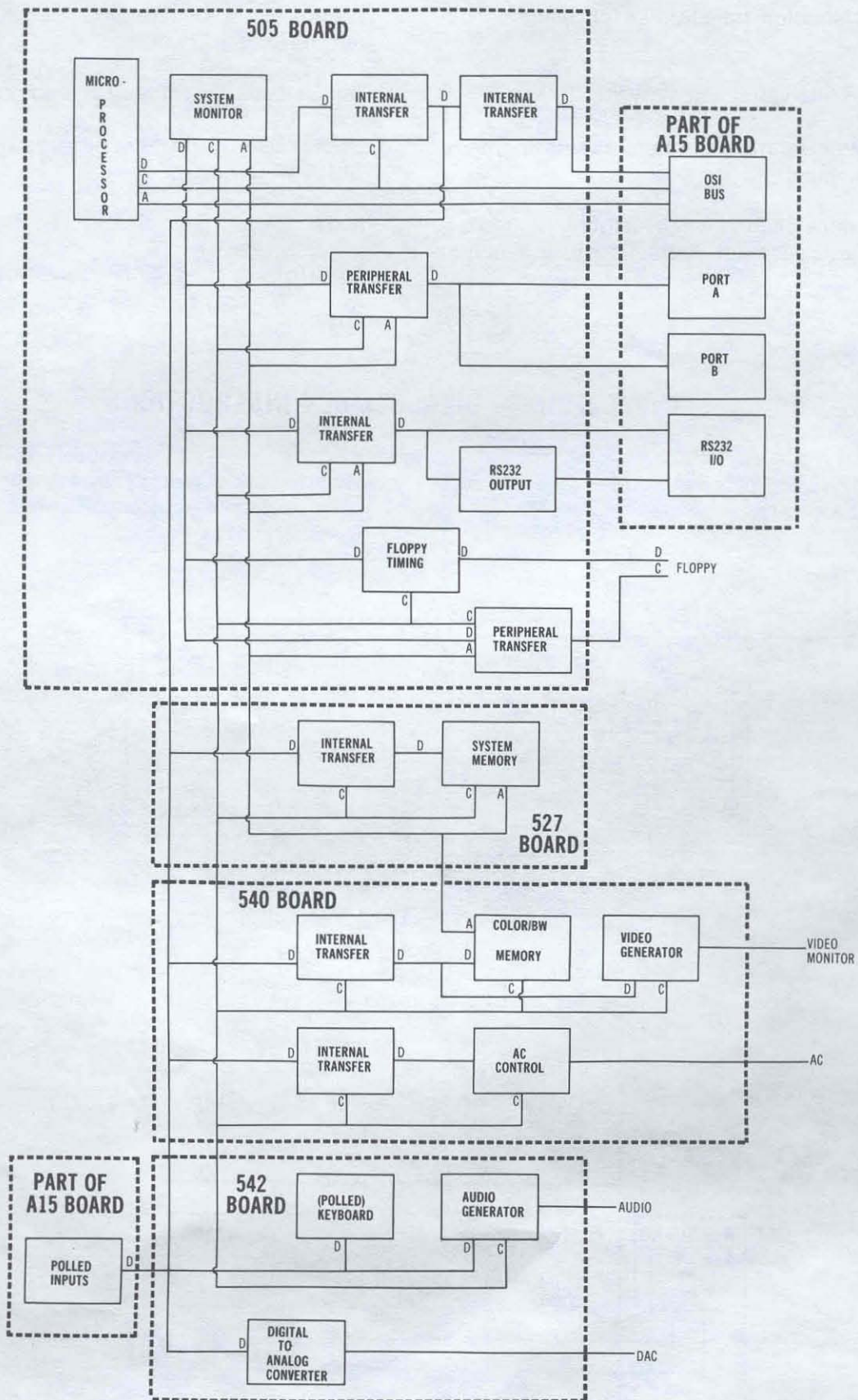

C4PMF SKELETON BLOCK

C4P SPECIAL SERVICING INSTRUCTIONS

For troubleshooting, the 502 and 540 boards can be interchanged for servicing.

NOTE: Care must be taken so that connectors on boards do not short to chassis or nearby boards.

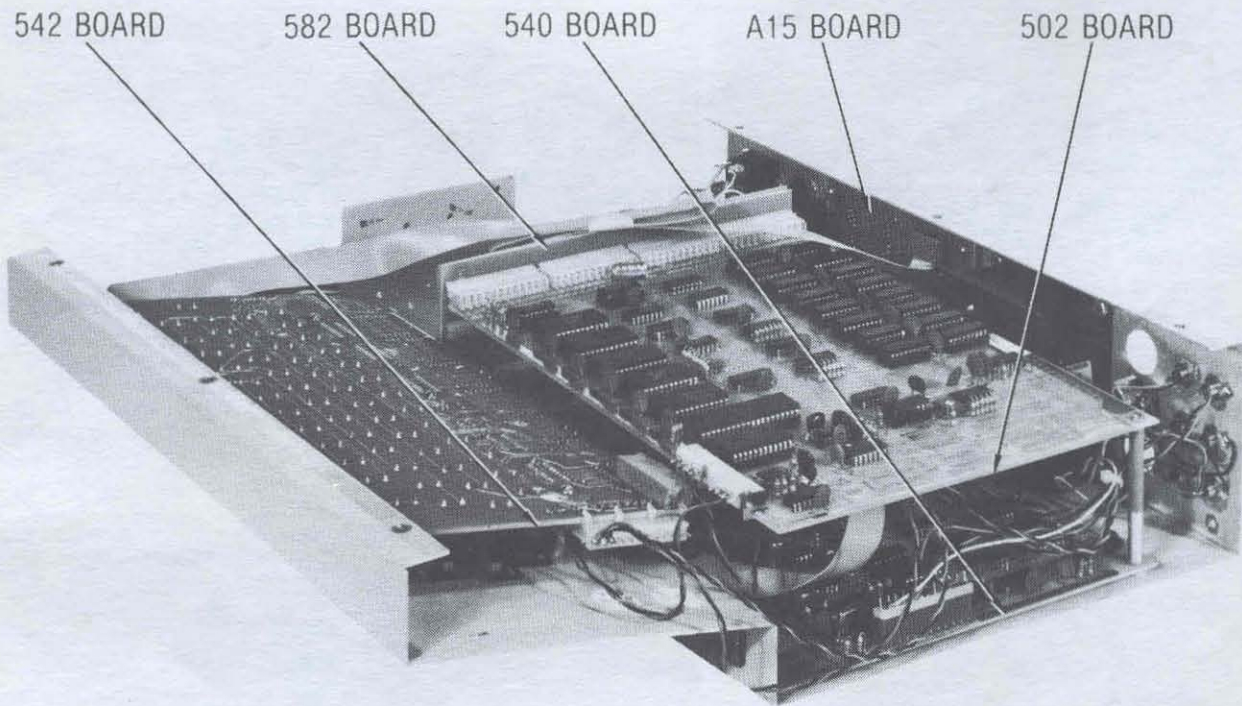

C4P — BOARD / CHASSIS LAYOUT

C4PMF SPECIAL SERVICING INSTRUCTIONS

For troubleshooting, the 505, 527, and 540 board can be interchanged for servicing.

NOTE: Care must be taken so that connectors on boards do not short to chassis or nearby boards.

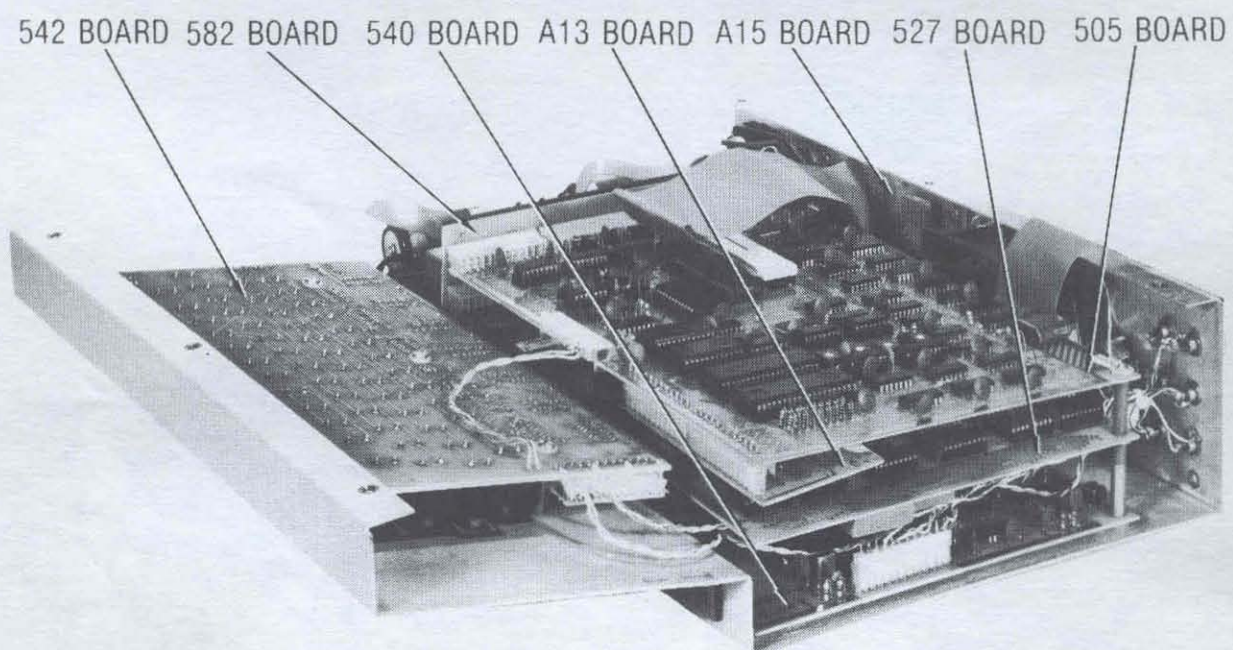

C4PMF — BOARD / CHASSIS LAYOUT

C4P TROUBLESHOOTING GUIDE COLOR COORDINATED

See schematic for the colors matching those in this guide for circuitry to be checked.

When a portion of a chip function is being referred to for checking, this is indicated by the partial coloring of chip.

PRELIMINARY SETUP

"SHIFT LOCK" key must be depressed before any troubleshooting is attempted.

"BREAK" key must be depressed and then released.

Confirm power supply output of 5V DC.

These steps are necessary before computer will operate.

$\emptyset 0$ CLOCK INPUT — 502 BOARD

Input of scope to U12, Pin 8. Output should be similar to WAVEFORM 35. This confirms operation of part of U12. The $\emptyset 0$ clock is developed on the 540 Board and feeds to U12 Pin 9, on the 502 Board. If WAVEFORM 33 is missing at U12 Pin 9, it will be necessary to troubleshoot $\emptyset 0$ clock source on the 540 Board.

$\emptyset 2$ CLOCK (OSC.) — 502 BOARD

Connect scope to U4, Pin 39. Waveform should be similar to WAVEFORM 34. This will check the operation of the clock section of U4.

VIDEO SIGNALS — 540 BOARD

VIDEO OSCILLATOR CHECK: Connect scope to U3A, Pin 6. Waveform should be similar to WAVEFORM 14. To check operation of clock divider, connect scope to U3B, Pin 12 and Pin 9. Waveform should be similar to WAVEFORM 13 and 15 respectively.

VIDEO COUNTERS (U5D, U5B, U5F, U5H) CHECK: Timing and phase relationship of U5D, U5B, U5F, U5H can be confirmed by use of a dual trace scope. For U5D use horizontal time base of $.5\mu\text{Sec}$. See Figure 1 for scope connections to U5D. For U5B use horizontal time base of $10\mu\text{Sec}$. See Figure 1 for scope connections to U5B. For U5F use horizontal time base of $.2\text{mSec}$. It may be necessary to use a logic probe to see pulse at Pin 15. See Figure 1 for scope connections to U5F. For U5H use horizontal time base of 2mSec . See Figure 1 for scope connections to U5H.

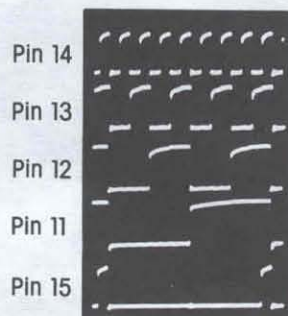

Figure 1

CL CLOCK CHECK: Connect scope to U3C, Pin 4. Output should be similar to WAVEFORM 14.

END BLANK CHECK: Connect scope to U3C, Pin 7. Output should be similar to WAVEFORM 17.

VIDEO ADDRESS DECODING CHECK: Check outputs of U5C, U5G, and U5E. See schematic for scope connections. Outputs should be similar to WAVEFORMS 7, 8, 9, 17, 22, 23, 24, 25, 28, 29, and 30. Check outputs of U5J and U5K. See schematic for scope connections. Outputs should be similar to WAVEFORMS 23, 24, 25, 28, 29, and 30. Timing and phase relationship of U5K and U5I can be confirmed by use of a dual trace scope. Set scope horizontal time base to 2mSec. See Figure 2 for scope connections and relationship of waveforms. This confirms operation of U5K, U5I, and associated circuitry.

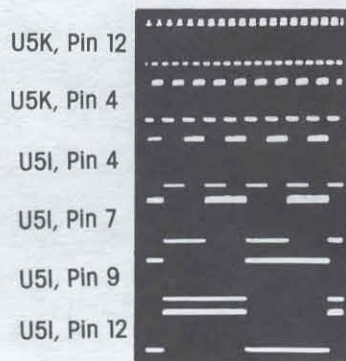

Figure 2

SYNC PULSE GENERATION — 540 BOARD

For horizontal sync, connect scope to Pin 12 of U4B. Output should be similar to WAVEFORM 26 and the negative pulse should be approximately $4.7\mu\text{Sec}$ wide.

For vertical sync connect scope to Pin 12 of U4A. Output should be similar to WAVEFORM 27 and the negative pulse should be approximately $300\mu\text{Sec}$ wide.

VIDEO MEMORY AND VIDEO DEVELOPMENT — 540 BOARD

The four memory chips U2C, U2D, U2E, and U2F are the B & W memory. U2C and U2F comprise memory for the top half of the monitor display, while U2D and U2E comprise memory for the bottom half of the monitor. The video information is fed thru U3F to ROM (U3E) to generate the dot pattern to be displayed. U3D then shifts this information serially to the Video Monitor (J21). See Figure 3 to compare timing of memory switch signal to video signal. Set horizontal time base on scope to 2mSec. This confirms operation of U2C, U2D, U2E, U2F, U3D, part of U3E, U3F, and associated circuitry.

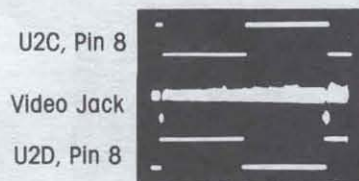

Figure 3

COLOR SIGNALS — 540 BOARD

To check X2 crystal oscillator (3.579545MHz), connect scope to U2A Pin 8. Output should be similar to WAVEFORM 11. This confirms operation of part of U2A, X2, and associated circuitry.

NOTE: U1B is used to generate the phase required to obtain the specific colors given in the operators manual. U1B must be replaced by original type to obtain proper color.

To check for color from memory, connect a logic probe to U1D, Pin 1. Enter machine language mode by depressing "BREAK", "M", ".", "D", "E", "0", "0". DE00 will appear in the left four positions of the six located in the top left hand of the monitor. Depress "/" and "01". The logic probe should indicate a low level. Enter "05", the logic probe should indicate a high level. Move logic probe to U1D, Pin 2. The logic probe should indicate a train of pulses. Enter "01", the logic probe should now indicate a low level. This confirms operation of part of U1F, U1G, U1E, U1D, and associated circuitry. Move logic probe to U1A, Pin 5. The logic probe should indicate a low level. Enter "05". The logic probe should indicate a train of pulses. This checks operation of part of U1A, U1D, and associated circuitry.

To check timing pulses that select background color, connect scope to U4A, Pin 4. Output should be similar to WAVEFORM 3 and the negative pulse should be approximately 8 μ Sec wide.

"BYTES FREE" MEMORY CHECK — 502 BOARD

The ram circuitry check is built into the computer, as long as most all other circuitry is working. To check ram circuitry, follow this procedure:

1. Press "BREAK".
2. Press "C".

Computer will ask "memory size". Ignore the question, press "RETURN".

Computer will ask "terminal width". Ignore the question, press "RETURN".

Computer will display XXXX BYTES free, etc.

If the "BYTES FREE" number does not represent the total number of your system, this will indicate what memory or associated circuitry has failed.

The following chart indicates the bytes free count and the chips involved.

To find the defective memory rams or associated circuitry, observe bytes free indication on screen.

Go to the chart and find the bytes free column to locate associated chips.

EXAMPLE 1: The computer is equipped with MEMORY totaling 7423 BYTES FREE.

The monitor screen indicates 5375 bytes free. Go to Chart 5375. Adjacent chips U35 and U44 are operating properly. This would indicate, then, that U34 and/or U43 and/or associated circuitry is malfunctioning.

EXAMPLE 2: The computer is equipped with MEMORY totaling 7423 BYTES FREE.

The monitor screen indicates 4362 bytes free. Go to chart. 4362 falls between 4351 and 5375. This indicates U35 and/or U44 and/or associated circuitry is malfunctioning.

NOTE: Chips adjacent to the next higher number of bytes free displayed on the monitor are the most likely defective device(s).

If above steps do not solve failure(s), continue.

CHIP SELECT LINES $\overline{CS(0 \text{ thru } 7)}$ — 502 BOARD

To check chip select lines, bring the computer into machine language mode by depressing "BREAK", then "M". A six-character, alpha-numeric display will appear on the monitor. Use the first four characters for the address code as shown charted below. Connect logic probe to chip select line.

Press "." then enter address selected from chart. If operating properly a pulse should be indicated on logic probe when the last character is entered.

RAMS

BYTES FREE	CHIPS OR ASSOCIATED CIRCUITRY	MACHINE ADDRESS NUMBERS	
255	U40 U49	0000-03FF	502 BOARD
1279	U39 U48	0400-07FF	"
2303	U38 U47	0800-0BFF	"
3327	U37 U46	0C00-0FFF	"
.....			4K
4351	U36 U45	1000-13FF	502 BOARD
5375	U35 U44	1400-17FF	"
6399	U34 U43	1800-1BFF	"
7423	U33 U42	1C00-1FFF	"
.....			8K

AUDIO CASSETTE/TAPE SIGNAL CHECK — 502 BOARD

Clock signal needed to send data to cassette/tape should be similar to WAVEFORMS 36 and 37.

When storing a program going out to tape recorder, see WAVEFORMS 43, 44, and 45.

To confirm signal coming from cassette: While loading a program coming from the cassette, proper operation is indicated by WAVEFORMS 38, 39, 40, 41, and 42. WAVEFORM 42 amplitude depends on volume control setting of cassette.

MICROPROCESSOR CHIP (CPU) OPERATION — 502 BOARD

If "BREAK" key does not clear screen of random pattern, processor may not be working. Be sure key switch is functioning.

To verify processor is working, a pulse indication taken by scope (set on 1 μ Sec. range) or logic probe at address lines (A0 through A15) at U4 will verify. No signal on an address line will suggest a defective U4 or a problem on that address line.

ROM MONITOR AND ROM BASIC CHIPS OPERATION CHECK — 502 BOARD

SYMPTOM: "BASIC" mode will not operate as "C" key is depressed and display does not change. "MACHINE" mode operates properly. This indicates a problem with ROM BASIC 1(U6), 2(U7) and/or 3(U8).

SYMPTOM: "BASIC" AND "MACHINE" modes not functioning. This indicates a problem with one or more of these chips and/or associated circuitry:

ROM MONITOR (U5), ROM BASIC 4 (U9), MICROPROCESSOR (CPU-U4), RAMS (U40 AND/OR U49)

C4PMF TROUBLESHOOTING GUIDE COLOR COORDINATED

See schematic for the colors matching those in this guide for circuitry to be checked.

When a portion of a chip function is being referred to for checking, this is indicated by the partial coloring of chip.

PRELIMINARY SETUP

"SHIFT LOCK" key must be depressed before any troubleshooting is attempted.

"BREAK" key must be depressed and then released.

Confirm power supplies output of 5V DC.

These steps are necessary before computer will operate.

CRYSTAL OSCILLATOR (X1) — 505 BOARD

Connect scope to U5C, Pin 8. Waveform should be similar to WAVEFORM 38. This confirms operation of X1 and associated circuitry.

Ø2 CLOCK (OSC.) — 505 BOARD

Connect scope to U1B, Pin 39. Waveform should be similar to WAVEFORM 41. This will check the operation of the clock section of U1B. Check the outputs of U4D Pin 3 and 13. Waveform should be similar to WAVEFORM 42.

VIDEO SIGNALS — 540 BOARD

VIDEO OSCILLATOR CHECK: Connect scope to U3A, Pin 6. Waveform should be similar to WAVEFORM 14. To check operation of clock divider, connect scope to U3B, Pin 12 and Pin 9. Waveform should be similar to WAVEFORM 13 and 15 respectively.

VIDEO COUNTERS (U5D, U5B, U5F, U5H) CHECK: Timing and phase relationship of U5D, U5B, U5F, U5H can be confirmed by use of a dual trace scope. For U5D use horizontal time base of $.5\mu\text{Sec}$. See Figure 1 for scope connections to U5D. For U5B use horizontal time base of $10\mu\text{Sec}$. See Figure 1 for scope connections to U5B. For U5F use horizontal time base of $.2\text{mSec}$. It may be necessary to use a logic probe to see pulse at Pin 15. See Figure 1 for scope connections to U5F. For U5H use horizontal time base of 2mSec . See Figure 1 for scope connections to U5H.

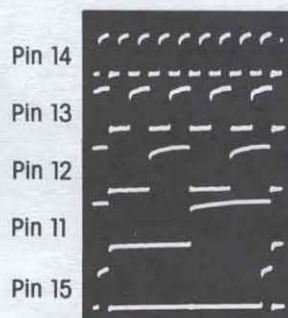

Figure 1

CL CLOCK CHECK: Connect scope to U3C, Pin 4. Output should be similar to WAVEFORM 14.

END BLANK CHECK: Connect scope to U3C, Pin 7. Output should be similar to WAVEFORM 17.

VIDEO ADDRESS DECODING CHECK: Check outputs of U5C, U5G, and U5E. See schematic for scope connections. Outputs should be similar to WAVEFORMS 7, 8, 9, 17, 22, 23, 24, 25, 28, 29, and 30. Check outputs of U5J and U5K. See schematic for scope connections. Outputs should be similar to WAVEFORMS 23, 24, 25, 28, 29, and 30. Timing and phase relationship of U5K and U5I can be confirmed by use of a dual trace scope. Set scope horizontal time base to 2mSec. See Figure 2 for scope connections and relationship of waveforms. This confirms operation of U5K, U5I, and associated circuitry.

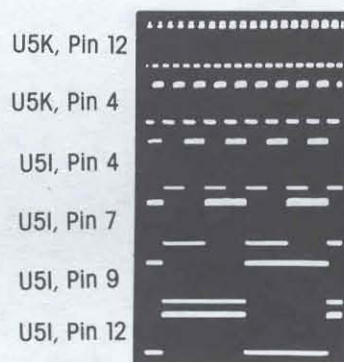

Figure 2

SYNC PULSE GENERATION — 540 BOARD

For horizontal sync, connect scope to Pin 12 of U4B. Output should be similar to WAVEFORM 26 and the negative pulse should be approximately 4.7 μ Sec wide.

For vertical sync connect scope to Pin 12 of U4A. Output should be similar to WAVEFORM 27 and the negative pulse should be approximately 300 μ Sec wide.

VIDEO MEMORY AND VIDEO DEVELOPMENT — 540 BOARD

The four memory chips U2C, U2D, U2E, and U2F are the B & W memory. U2C and U2F comprise memory for the top half of the monitor display, while U2D and U2E comprise memory for the bottom half of the monitor. The video information is fed thru U3F to ROM (U3E) to generate the dot pattern to be displayed. U3D then shifts this information serially to the Video Monitor (J21). See Figure 3 to compare timing of memory switch signal to video signal. Set horizontal time base on scope to 2mSec. This confirms operation of U2C, U2D, U2E, U2F, U3D, part of U3E, U3F, and associated circuitry.

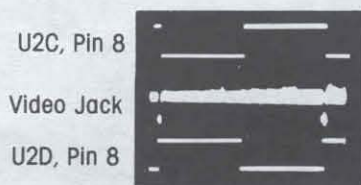

Figure 3

COLOR SIGNALS — 540 BOARD

To check X2 crystal oscillator (3.579545MHz), connect scope to U2A Pin 8. Output should be similar to WAVEFORM 11. This confirms operation of part of U2A, X2, and associated circuitry.

NOTE: U1B is used to generate the phase required to obtain the specific colors given in the operators manual. U1B must be replaced by original type to obtain proper color.

To check for color from memory, connect a logic probe to U1D, Pin 1. Enter machine language mode by depressing "BREAK", "M", ".", "D", "E", "0", "0". DE00 will appear in the left four positions of the six located in the top left hand of the monitor. Depress "/" and "01". The logic probe should indicate a low level. Enter "05", the logic probe should indicate a high level. Move logic probe to U1D, Pin 2. The logic probe should indicate a train of pulses. Enter "01", the logic probe should now indicate a low level. This confirms operation of part of U1F, U1G, U1E, U1D, and associated circuitry. Move logic probe to U1A, Pin 5. The logic probe should indicate a low level. Enter "05". The logic probe should indicate a train of pulses. This checks operation of part of U1A, U1D, and associated circuitry.

To check timing pulses that select background color, connect scope to U4A, Pin 4. Output should be similar to WAVEFORM 3 and the negative pulse should be approximately 8µSec wide.

CHIP SELECT LINES CE (0 thru 23) — 527 BOARD

To check chip select lines, bring the computer into machine language mode by depressing "BREAK", then "M". A six-character alpha-numeric display will appear on the monitor. Use the first four characters for the address code as shown charted below. Connect logic probe to chip select line.

Press "." then enter address selected from chart. If operating properly a pulse should be indicated on logic probe when the last character is entered.

RAMS

CHIPS OR ASSOCIATED CIRCUITRY	MACHINE ADDRESS NUMBERS
9000 - 36864 9FFF - 40959	UA1, UB1 0000-03FF UA2, UB2 0400-07FF UA3, UB3 0800-0BFF UA4, UB4 0C00-0FFF
.....4K	
	UA5, UB5 1000-13FF UA6, UB6 1400-17FF UA7, UB7 1800-1BFF UA8, UB8 1C00-1FFF
.....8K	
	UC1, UD1 2000-23FF UC2, UD2 2400-27FF UC3, UD3 2800-2BFF UC4, UD4 2C00-2FFF
.....12K	
	UC5, UD5 3000-33FF UC6, UD6 3400-37FF UC7, UD7 3800-3BFF UC8, UD8 3C00-3FFF
.....16K	

UE1, UF1	4000-43FF
UE2, UF2	4400-47FF
UE3, UF3	4800-4BFF
UE4, UF4	19456 - 4C00-4FFF 0100

.....20K

UE5, UF5	5000-53FF
UE6, UF6	5400-57FF
UE7, UF7	5800-5BFF
UE8, UF8	23552 - 5C00-5FFF

.....24K

MINIFLOPPY DATA-PATH CHECK — 505 BOARD

Connect scope to U5G, Pin 7 to check count down circuit operation. Output should be similar to WAVEFORM 57.

Connect scope to U3C Pin 4. Output should be similar to WAVEFORM 47 and the negative pulse should be approximately 400nSec. Connect scope to U3C Pin 5. Output should be similar to WAVEFORM 46 and the positive pulse should be approximately 400nSec. This checks the timing pulse needed to send the write data to the minifloppy.

Connect scope to J2 Pin 9. Output should be similar to WAVEFORM 51. When data is being sent to the minifloppy, it will appear as noise on the waveform. This confirms operation of parts of U1C, U4B, U5D, and U2B.

To check data input, connect scope to U4C Pin 12. Insert minifloppy disk. Output should appear similar to WAVEFORM 45.

To check clock input, connect scope to U4C Pin 13. Insert minifloppy disk. Output should appear similar to WAVEFORM 44.

MINIFLOPPY CONTROL SIGNAL CHECK — 505 BOARD

Connect scope to J2, Pin 17. Output should be similar to WAVEFORM 58.

Connect logic probe to J2, Pin 19. With Disk removed the logic probe will indicate a logic 1. While Disk is being inserted into Minifloppy, the logic probe will indicate a logic 0. After the Disk is inserted a logic 0 will remain if the Write Protect notch is covered; a logic 1 will be displayed if the notch is not covered.

Depress "BREAK", check for a pulse on a logic probe connected to J2, Pins 7, 8, and 21, just after depressing "D".

Depress "BREAK", check for pulses on a logic probe connected to J2, Pins 2 and 5. Check for a pulse on J2, Pins 3 and 18 after "BREAK" is depressed. Then check for two pulses after "D" is depressed.

Connect logic probe to J2, Pin 1. Depress "BREAK". Check for several pulses after "D" is depressed. Pin 1 should then become HI-Z. Connect logic probe to J2, Pin 6. Depress "BREAK" and confirm a logic 1. Depress "D" check for several pulses then a logic 0. This checks the operation of part of U1A and associated circuitry.

MICROPROCESSOR CHIP (CPU) OPERATION — 505 BOARD

If "BREAK" key does not clear screen of random pattern, processor may not be working. Be sure key switch is functioning.

To verify processor is working, a pulse indication taken by scope (set on 1 μ Sec range) or logic probe at address lines (A0 thru A15) at U1B will verify. No signal on an address line will suggest a defective U1B or a problem on that address line.

ROM MONITOR OPERATION CHECK — 505 BOARD

SYMPTOM: "DISK" mode will not operate as "D" key is depressed. The "MACHINE" mode operates properly. This indicates a problem with one or more of these chips and/or associated circuitry;

ROM MONITOR (U2D), MICROPROCESSOR (CPU - U1B), RAMS (UA1 AND/OR UB1)

$$1 \times 2^{14} + 1 \times 2^{12} + 1 \times 2^{11} + 1 \times 2^{10}$$

23552

0	1	0	1	1	1	0	0	0	0	0	0	0	0	0	0
5	4	3	2	1	0	9	8	7	6	5	4	3	2	1	0

92

C4P/C4PMF— A15 BOARD PARTS LIST AND DESCRIPTION

(When ordering parts, state Model, Part Number, and Description.)

SEMICONDUCTORS (Select replacement transistor for best results)

ITEM No.	TYPE No.	MFR. PART No.	REPLACEMENT DATA							
			GENERAL ELECTRIC PART No.	MALLORY PART No.	RAYTHEON PART No.	RCA PART No.	SYLVANIA PART No.	THORDARSON PART No.	WORKMAN PART No.	ZENITH PART No.
D1-D4	1N914	Q-1N914	GE-514	PTC214	REN 177	SK3100/519	ECG519	TM519	WEP925/519	103-131

ELECTROLYTIC CAPACITORS

ITEM No.	RATING	REPLACEMENT DATA				
		MFR. PART No.	CORNELL-DUBILIER PART No.	MALLORY PART No.	SPRAGUE PART No.	
					Q-LINE	GENERAL LINE
C1	47 16V	C-506	NLW50-16	TT15X50A	QE1-351	TVA-1150

CAPACITORS

ITEM No.	RATING	MFR. PART No.	REPLACEMENT DATA			
			CORNELL-DUBILIER PART No.	MALLORY PART No.	SPRAGUE PART No.	
					Q-LINE	GENERAL LINE
C2	.1 10V	CB-10410 490		MAG1201	QC1-223	HY-360

RESISTORS (Power and Special)

ITEM No.	RATING	REPLACEMENT DATA		ITEM No.	RATING	REPLACEMENT DATA	
		MFR. PART No.	WORKMAN PART No.			MFR. PART No.	WORKMAN PART No.
R1	220 5% 1/4W Flameproof Carbon Film	R1-221	22-1080	R5	220 5% 1/4W Flameproof Carbon Film	R1-221	22-1080
R2	4700 5% 1/4W Flameproof Carbon Film	R1-472	22-1112	R6	4700 5% 1/4W Flameproof Carbon Film	R1-472	22-1112
R3	220 5% 1/4W Flameproof Carbon Film	R1-221	22-1080	R7	220 5% 1/4W Flameproof Carbon Film	R1-221	22-1080
R4	4700 5% 1/4W Flameproof Carbon Film	R1-472	22-1112	R8	4700 5% 1/4W Flameproof Carbon Film	R1-472	22-1112
				R9	1000 5% 1/4W Flameproof Carbon Film	R1-102	22-1096

MISCELLANEOUS

ITEM No.	PART NAME	PART No.	NOTES
J1	Socket	SC-40F1	40 Pin (Interconnect to 502 Board)
J2	Socket	SC-16FWW	16 Pin (OSI I/O BUS)
J3	Socket	SC-16FWW	16 Pin (Port "A")
J4	Socket	SC-16FWW	16 Pin (Port "B")
J5	Socket	SC-9FA	9 Pin (Joystick "A")
J6	Socket	SC-9FA	9 Pin (Joystick "B")
J7	Socket	SC-9FA	9 Pin (Key Pad "A")
J8	Socket	SC-25FCA	25 Pin (Printer)
J9	Socket	SC-25FCA	25 Pin (Modem)
J10	Socket	SC-9FA	9 Pin (Key Pad "B")
	P.C. Board	PC-A15A	C4-P Connector

C4P— 502 BOARD PARTS LIST AND DESCRIPTION

(When ordering parts, state Model, Part Number, and Description.)

SEMICONDUCTORS (Select replacement transistor for best results)

ITEM No.	TYPE No.	MFR. PART No.	REPLACEMENT DATA							
			GENERAL ELECTRIC PART No.	MALLORY PART No.	RAYTHEON PART No.	RCA PART No.	SYLVANIA PART No.	THORDARSON PART No.	WORKMAN PART No.	ZENITH PART No.
D1-D2 D3-D5	1N914	Q-1N914	GE-514	PTC214	REN 177	SK3100/519	ECG519	TM519	WEP925/519	103-131
U1	F-7476PC	IC-7476	GE-7476			SK7476	ECG7476	TM7476	WEP7476/7476	
U2	CA3130E	IC-3130								
U3	MC6850P	IC-6850								
U4	6502	IC-6502								
U5	C38085 SYNMONV1.0	IC-7157								
U6	C38121	IC-BASIC 1								
U7	C38122	IC-BASIC 2								
U8	C38123	IC-BASIC 3								
U9	C38124	IC-BASIC 4								

C4P— 502 BOARD PARTS LIST AND DESCRIPTION (CONTINUED)

(When ordering parts, state Model, Part Number, and Description.)

SEMICONDUCTORS (Select replacement transistor for best results) (cont)

ITEM No.	TYPE No.	MFR. PART No.	REPLACEMENT DATA								
			GENERAL ELECTRIC PART No.	MALLORY PART No.	RAYTHEON PART No.	RCA PART No.	SYLVANIA PART No.	THORDARSON PART No.	WORKMAN PART No.	ZENITH PART No.	
U10	N8T26AN	IC-8T26									
U12	F-5404DM										
U13	7404	IC-7404	GE-7404			SK7404		ECG7404	TM7404		221-29076
U14	UA555TC	IC-555	GEIC-269	PTC1555		SK3564/955M		ECG955M	TM955M	WEP2119/955M	221-29042
U16	74LS139N	IC-74LS139									
U17	F-5404DM										
U18	7404	IC-7404	GE-7404			SK7404		ECG7404	TM7404		221-29076
U19	F-7430PC	IC-7430				SK7430		ECG7430	TM7430		221-29076
U20	N8T26AN	IC-8T26									
U22	7404	IC-7404	GE-7404			SK7404		ECG7404	TM7404		221-29076
U23	SN74123N	IC-74123	GE-74123		REN 74123	SK74123		ECG74123	TM74123		221-29086
U24	F-7474PC	IC-7474	GE-7474		REN 7474	SK7474		ECG7474	TM7474	WEP7474/7474	
U25	F-7417PC	IC-7417						ECG7417	TM7417		
U26	F-7417PC	IC-7417						ECG7417	TM7417		
U27	SN74LS138N	IC-74LS138				SK74LS138		ECG74LS138	TM74LS138		
U28	7410N	IC-7410	GE-7410			SK7410		ECG7410	TM7410		
U29	F-5404DM										
U30	7404	IC-7404	GE-7404			SK7404		ECG7404	TM7404		221-29076
U31	SN7420N	IC-7420	GE-7420			SK7420		ECG7420	TM7420		221-29077
U32	7414	IC-7414				SK7414		ECG7414	TM7414		
U33-U40	7404	IC-7404	GE-7404			SK7404		ECG7404	TM7404		221-29076
U41	F-7417PC	IC-7417						ECG7417	TM7417		
U42-U49	2114L-3	IC-2114-L3									
Q1-Q6	F-7417PC	IC-L2114-550									
	2114L-3	IC-2114-L3									
		IC-L2114-550									

ELECTROLYTIC CAPACITORS

ITEM No.	RATING	REPLACEMENT DATA				
		MFR. PART No.	CORNELL-DUBILIER PART No.	MALLORY PART No.	SPRAGUE PART No.	
					Q-LINE	GENERAL LINE
C39	47 16V	C-506	NLW50-16	TT15X50A	QE1-351	TVA-1150

CAPACITORS

ITEM No.	RATING	MFR. PART No.	REPLACEMENT DATA			
			CORNELL-DUBILIER PART No.	MALLORY PART No.	SPRAGUE PART No.	
					Q-LINE	GENERAL LINE
C1	68 125V 5%	C-680	CD15ED680J03	SX468	QW1-23	MWA-680
C2	.01 100V 10%	C-103	WMF1S1	EWFTA110	QF1-91	1PB-S10
C3	.01 100V 10%	C-130	WMF1S1	EWFTA110	QF1-91	1PB-S10
C4	82 5%		CD15ED820J03	SX482	QW1-25	MWA-820
C5	150 1KV 5%	C-151		GP315		10TS-T15
C6	.01 100V 10%	C-103	WMF1S1	EWFTA110	QF1-91	1PB-S10
C7	.022 100V 10%	C-223	DPMS2S22	EWFTA122	QF1-127	1PB-S22
C8	82 5%		CD15ED820J03	SX482	QW1-25	MWA-820
C9	.1 10%	C-104	DPMS2P1	ENF1A010	QF1-215	1PB-P10
C10	.001 100V 10%	C-102	DPMS6D1	ENF1A210	QF1-1	1PB-D10
C20	.1 10V	CB-10410		MAG1201	QC1-223	HY-360
C21	.1 10V	CB-10410		MAG1201	QC1-223	HY-360
C22	.1 10V	CB-10410		MAG1201	QC1-223	HY-360
C23	.1 10V	CB-10410		MAG1201	QC1-223	HY-360
C24	.1 10V	CB-10410		MAG1201	QC1-223	HY-360
C25	.1 10V	CB-10410		MAG1201	QC1-223	HY-360
C26	.1 10V	CB-10410		MAG1201	QC1-223	HY-360
C28	.1 10V	CB-10410		MAG1201	QC1-223	HY-360
C29	.1 10V	CB-10410		MAG1201	QC1-223	HY-360
C30	.1 10V	CB-10410		MAG1201	QC1-223	HY-360
C31	.1 10V	CB-10410		MAG1201	QC1-223	HY-360
C32	.1 10V	CB-10410		MAG1201	QC1-223	HY-360
C33	.1 10V	CB-10410		MAG1201	QC1-223	HY-360
C34	.1 10V	CB-10410		MAG1201	QC1-223	HY-360
C35	.1 10V	CB-10410		MAG1201	QC1-223	HY-360
C36	.1 10V	CB-10410		MAG1201	QC1-223	HY-360
C37	.1 10V	CB-10410		MAG1201	QC1-223	HY-360
C38	.1 10V	CB-10410		MAG1201	QC1-223	HY-360
C39	.1 10V	CB-10410		MAG1201	QC1-223	HY-360
C40	.1 10V	CB-10410		MAG1201	QC1-223	HY-360
C41	.1 10V	CB-10410		MAG1201	QC1-223	HY-360
C42	.1 10V	CB-10410		MAG1201	QC1-223	HY-360
C43	.1 10V	CB-10410		MAG1201	QC1-223	HY-360
C44	.1 10V	CB-10410		MAG1201	QC1-223	HY-360
C45	.1 10V	CB-10410		MAG1201	QC1-223	HY-360

C4P— 502 BOARD PARTS LIST AND DESCRIPTION (CONTINUED)

(When ordering parts, state Model, Part Number, and Description.)

CONTROLS (All wattages 1/2 watt, or less, unless listed)

ITEM No.	FUNCTION	RESISTANCE	REPLACEMENT DATA		
			MFGR. PART No.	MALLORY PART No.	TRW PART No.
R11	Frequency	10K	RP-103	RVA0911V103	X201R103B
R13	Duty Cycle	10K	RP-103	RVA0911V103	X201R103B
R17	TX Clock	5000	RP-502	RVA0911V502	X260R502B
R75	Duration (Tape Pulse)	10K	RP-103	RVA0911V103	X260R103B

RESISTORS (Power and Special)

ITEM No.	RATING	REPLACEMENT DATA		ITEM No.	RATING	REPLACEMENT DATA	
		MFGR. PART No.	WORKMAN PART No.			MFGR. PART No.	WORKMAN PART No.
R1	1000 5% 1/4W Flameproof Carbon Film	R1-102	22-1096	R38	470 5% 1/4W Flameproof Carbon Film	R1-471	22-1088
R2	10K 5% 1/4W Flameproof Carbon Film	R1-103	22-1120	R39	470 5% 1/4W Flameproof Carbon Film	R1-471	22-1088
R3	100K 5% 1/4W Flameproof Carbon Film	R1-104	22-1144	R40	470 5% 1/4W Flameproof Carbon Film	R1-471	22-1088
R4	10K 5% 1/4W Flameproof Carbon Film	R1-103	22-1120	R41	470 5% 1/4W Flameproof Carbon Film	R1-471	22-1088
R5	4700 5% 1/4W Carbon Film	R1-472	22-1112	R42	470 5% 1/4W Flameproof Carbon Film	R1-471	22-1088
R6	4700 5% 1/4W Carbon Film	R1-472	22-1112	R43	470 5% 1/4W Flameproof Carbon Film	R1-471	22-1088
R7	4700 5% 1/4W Carbon Film	R1-472	22-1112	R44	470 5% 1/4W Flameproof Carbon Film	R1-471	22-1088
R8	4700 5% 1/4W Carbon Film	R1-472	22-1112	R45	470 5% 1/4W Flameproof Carbon Film	R1-471	22-1088
R9	4700 5% 1/4W Carbon Film	R1-472	22-1112	R46	220 5% 1/4W Flameproof Carbon Film	R1-221	22-1080
R10	10K 5% 1/4W Flameproof Carbon Film	R1-103	22-1120	R47	390 5% 1/4W Flameproof Carbon Film	R1-391	22-1086
R12	10K 5% 1/4 W Flameproof Carbon Film	R1-103	22-1120	R48	220 5% 1/4W Flameproof Carbon Film	R1-221	22-1080
R14	1000 5% 1/4W Flameproof Carbon Film	R1-102	22-1096	R49	390 5% 1/4W Flameproof Carbon Film	R1-391	22-1086
R15	4700 5% 1/4W Carbon Film	R1-472	22-1112	R50	220 10% 1/4W Flameproof Carbon Film	R1-221	22-1080
R16	1000 5% 1/4W Flameproof Carbon Film	R1-101	22-1096	R51	390 5% 1/4W Flameproof Carbon Film	R1-391	22-1086
R18	4700 5% 1/4W Carbon Film	R1-472	22-1112	R52	10K 5% 1/4W Flameproof Carbon Film	R1-103	22-1120
R19	4700 5% 1/4W Carbon Film	R1-472	22-1112	R53	470 5% 1/4W Flameproof Carbon Film	R1-471	22-1088
R20	4700 5% 1/4W Carbon Film	R1-472	22-1112	R54	10K 5% 1/4W Flameproof Carbon Film	R1-103	22-1120
R21	4700 5% 1/4W Carbon Film	R1-472	22-1112	R55	10K 5% 1/4W Flameproof Carbon Film	R1-103	22-1120
R22	4700 5% 1/4W Carbon Film	R1-472	22-1112	R56	470 5% 1/4W Flameproof Carbon Film	R1-471	22-1088
R23	4700 5% 1/4W Carbon Film	R1-472	22-1112	R57	10K 5% 1/4W Flameproof Carbon Film	R1-103	22-1120
R24	4700 5% 1/4W Carbon Film	R1-472	22-1112	R58	10K 5% 1/4W Flameproof Carbon Film	R1-103	22-1120
R25	4700 5% 1/4W Carbon Film	R1-472	22-1112	R59	470 5% 1/4W Flameproof Carbon Film	R1-471	22-1088
R26	10K 5% 1/4W Flameproof Carbon Film	R1-103	22-1120	R60	10K 5% 1/4W Flameproof Carbon Film	R1-103	22-1120
R27	100 5% 1/4W Flameproof Carbon Film	R1-101	22-1072	R61	10K 5% 1/4W Flameproof Carbon Film	R1-103	22-1120
R28	470 5% 1/4W Flameproof Carbon Film	R1-471	22-1088	R62	4700 5% 1/4W Flameproof Carbon Film	R1-472	22-1112
R29	470 5% 1/4W Flameproof Carbon Film	R1-471	22-1088	R63	10K 5% 1/4W Flameproof Carbon Film	R1-103	22-1120
R30	470 5% 1/4W Flameproof Carbon Film	R1-471	22-1088	R64	4700 5% 1/4W Carbon Film	R1-472	22-1112
R31	470 5% 1/4W Flameproof Carbon Film	R1-471	22-1088	R65	10K 5% 1/4W Flameproof Carbon Film	R1-103	22-1120
R32	470 5% 1/4W Flameproof Carbon Film	R1-471	22-1088	R66	4700 5% 1/4W Carbon Film	R1-472	22-1112
R33	470 5% 1/4W Flameproof Carbon Film	R1-471	22-1088				
R34	470 5% 1/4W Flameproof Carbon Film	R1-471	22-1088				
R35	470 5% 1/4W Flameproof Carbon Film	R1-471	22-1088				
R36	470 5% 1/4W Flameproof Carbon Film	R1-471	22-1088				
R37	470 5% 1/4W Flameproof Carbon Film	R1-471	22-1088				

C4P— 502 BOARD PARTS LIST AND DESCRIPTION (CONTINUED)

(When ordering parts, state Model, Part Number, and Description.)

RESISTORS (Power and Special) (cont)

ITEM No.	RATING	REPLACEMENT DATA		ITEM No.	RATING	REPLACEMENT DATA	
		MFG. PART No.	WORKMAN PART No.			MFG. PART No.	WORKMAN PART No.
R67	470 5% 1/4W Flameproof Carbon Film	RI-471	22-1088	R72	390 5% 1/4W Flameproof Carbon Film	RI-391	22-1086
R68	390 5% 1/4W Flameproof Carbon Film	RI-391	22-1086	R73	220 5% 1/4W Flameproof Carbon Film	RI-221	22-1080
R69	220 5% 1/4W Flameproof Carbon Film	RI-221	22-1080	R74	1000 5% 1/4W Flameproof Carbon Film	RI-102	22-1096
R70	390 5% 1/4W Flameproof Carbon Film	RI-391	22-1086	R76	1000 5% 1/4W Flameproof Carbon Film	RI-102	22-1096
R71	220 5% 1/4W Flameproof Carbon	RI-221	22-1080				

MISCELLANEOUS

ITEM No.	PART NAME	PART No.	NOTES
J1	Socket	SC-12FM	12 Pin (4 used)
J2	Socket	SC-12FM	12 Pin
	Socket	SC-16FI	16 Pin IC Socket (3 used)
	Socket	SC-18FI	18 Pin IC Socket (16 used)
	Socket	SC-24FI	24 Pin IC Socket (6 used)
	Socket	SC-40FI	40 Pin IC Socket
	P.C. Board	PC-502	CPU Board

C4PMF— 505 BOARD PARTS LIST AND DESCRIPTION

(When ordering parts, state Model, Part Number, and Description.)

SEMICONDUCTORS (Select replacement transistor for best results)

ITEM No.	TYPE No.	MFG. PART No.	REPLACEMENT DATA							
			GENERAL ELECTRIC PART No.	MALLORY PART No.	RAYTHEON PART No.	RCA PART No.	SYLVANIA PART No.	THORDARSON PART No.	WORKMAN PART No.	ZENITH PART No.
D1	1N914	Q-1N914	GE-514	PTC214	REN 177	SK3100/519	ECG519	TM519	WEP925/519	103-131
D3-D4	1N914	Q-1N914	GE-514	PTC214	REN 177	SK3100/519	ECG519	TM519	WEP925/519	103-131
U1A	S6821P	IC-68B21								
U1B	6502A	IC-6502A								
U1C-U1D	S6850	IC-68B50								
U1E	F-74157PC 74LS157PC	IC-74LS157	GE-7404			SK74157 SK74LS157 SK7404	ECG74LS157 ECG7404	TM74LS157 TM7404		221-29076
U1F	F-7404PC	IC-7404								
U1G	MC1489/ SN75189N	IC-1489								
U1I	N8T26AN	IC-8T26								
U2A	N8T95N	IC-8T95								
U2B	F-7417PC	IC-7417					ECG7417	TM7417		
U2C	74148N	IC-74148								
U2D	C38085	IC-SYMMON								
U2E	SYMMONV1.0 N8T26AN	IC-8T26								
U3A-U3B	SN7417N	IC-7417					ECG7417	TM7417		
U3C	SN74123N	IC-74123	GE-74123		REN 74123	SK74123	ECG74123	TM74123		221-29086
U3D	MC8T95P	IC-8T95								
U3E	SN7410J	IC-7410	GE-7410			SK7410	ECG7410	TM7410		
U3F	S6821P	IC-68B21								
U3G	N8T26AN	IC-8T26								
U4A	SN7417N	IC-7417					ECG7417	TM7417		
U4B	DM7404N	IC-7404	GE-7404			SK7404	ECG7404	TM7404		221-29076
U4C	SN74123N	IC-74123	GE-74123		REN 74123	SK74123	ECG74123	TM74123		221-29086
U4D	MC8T95P	IC-8T95								
U4E	F-7404PC	IC-7404	GE-7404			SK7404	ECG7404	TM7404		221-29076
U4F	DM7404N	IC-7404	GE-7404			SK7404	ECG7404	TM7404		221-29076
U4H	N8T26AN	IC-8T26								
U5A	DM7400N	IC-7400	GE-7400		REN 7400	SK7400	ECG7400	TM7400	WEP7400/7400	221-29075
U5B	7476N	IC-7476N	GE-7476			SK7476	ECG7476	TM7476	WEP7476/7476	221-29075

C4PMF— 505 BOARD PARTS LIST AND DESCRIPTION (CONTINUED)

(When ordering parts, state Model, Part Number, and Description.)

SEMICONDUCTORS (Select replacement transistor for best results) (cont)

ITEM No.	TYPE No.	MFR. PART No.	REPLACEMENT DATA							
			GENERAL ELECTRIC PART No.	MALLORY PART No.	RAYTHEON PART No.	RCA PART No.	SYLVANIA PART No.	THORDARSON PART No.	WORKMAN PART No.	ZENITH PART No.
U5C-U5D	DM7400N	IC-7400N	GE-7400		REN 7400	SK7400	ECG7400	TM7400	WEP7400/7400	221-29075
U5E-U5F	F74LS390PC	IC-74LS390								
U5G	F74LS390PC	IC-74LS390								
U5H-U5I	F-74390PC	IC-74390	GE-7420			SK7420	ECG7420	TM7420		221-29077
U5J	SN74LS138N	IC-74LS138				SK74LS138	ECG74LS138	TM74LS138		
U5K	DM7404N	IC-7404	GE-7404			SK7404	ECG7404	TM7404		221-29076
U5L	SN7410J	IC-7410	GE-7410			SK7410	ECG7410	TM7410		
U6A	F-74163PC	IC-74163					ECG74163	TM74163		
U6B-U6D	7493N	IC-7493			REN 7493A	SK7493	ECG7493A	TM7493A		221-29078
U6E	F-5404DM	IC-7404	GE-7404			SK7404	ECG7404	TM7404		221-29076
U6F	7404	IC-7402	GE-7402			SK7402	ECG7402	TM7402	WEP7402/7402	
U6G	SN7402N	IC-7402				SK74LS138	ECG74LS138	TM74LS138		
U6H	SN7400N	IC-7400	GE-7400		REN 7400	SK7400	ECG7400	TM7400	WEP7400/7400	221-29075
U6I	7430N	IC-7430				SK7430	ECG7430	TM7430		
Q1	2N5226	Q-2N5226	GE-82	PTC103	REN 159	SK3466/159	ECG159	TM159	WEP716	121-29003*
Q2	2N5226	Q-2N5226	GE-82	PTC103	REN 159	SK3466/159	ECG159	TM159	WEP716	121-29003*

* Lead configuration may vary from original.

ELECTROLYTIC CAPACITORS

ITEM No.	RATING	REPLACEMENT DATA				
		MFR. PART No.	CORNELL-DUBILIER PART No.	MALLORY PART No.	SPRAGUE PART No.	
					Q-LINE	GENERAL LINE
C10	47 16V	C-506	NLW50-16	TT15X50A	QE1-351	TVA-1150
C11	47 16V	C-506	NLW50-16	TT15X50A	QE1-351	TVA-1150

CAPACITORS

ITEM No.	RATING	MFR. PART No.	REPLACEMENT DATA			
			CORNELL-DUBILIER PART No.	MALLORY PART No.	SPRAGUE PART No.	
					Q-LINE	GENERAL LINE
C1	.1 10V	CB-10410		MAG1201	QC1-223	HY-360
C2	.1 10V	CB-10410		MAG1201	QC1-223	HY-360
C7	.1 10V	CB-10410		MAG1201	QC1-223	HY-360
C8	.1 10V	CB-10410		MAG1201	QC1-223	HY-360
C9	.1 10V	CB-10410		MAG1201	QC1-223	HY-360
C12	.1 10V	CB-10410		MAG1201	QC1-223	HY-360
C13	.1 10V	CB-10410		MAG1201	QC1-223	HY-360
C15	.1 10V	CB-10410		MAG1201	QC1-223	HY-360
C16	.1 10V	CB-10410		MAG1201	QC1-223	HY-360
C18	.1 10V	CB-10410		MAG1201	QC1-223	HY-360
C19	.1 10V	CB-10410		MAG1201	QC1-223	HY-360
C20	150 1KV 10%	C-151		GP315		10TS-T15
C21	.1 10V	CB-10410		MAG1201	QC1-223	HY-360
C22	.1 10V	CB-10410		MAG1201	QC1-223	HY-360
C23	.1 10V	CB-10410		MAG1201	QC1-223	HY-360
C24	.1 10V	CB-10410		MAG1201	QC1-223	HY-360
C25	150 1KV 10%	C-151		GP315		10TS-T15
C26	.001 100V 10%	C-102	DPMS6D1	EWFA210	QF1-1	1PB-D10
C27	.1 10V	CB-10410		MAG1201	QC1-223	HY-360
C28	.1 10V	CB-10410		MAG1201	QC1-223	HY-360
C31	.1 10V	CB-10410		MAG1201	QC1-223	HY-360
C32	.001 100V 10%	C-151	DPMS6D1	EWFA210	QF1-1	1PB-D10
C33	.1 10V	CB-10410		MAG1201	QC1-223	HY-360
C34	.1 10V	CB-10410		MAG1201	QC1-223	HY-360
C36	27 500V 10%	C-270		CND427		10TCC-Q27
C37	.1 10V	CB-10410		MAG1201	QC1-223	HY-360
C38	.1 10V	CB-10410		MAG1201	QC1-223	HY-360
C39	.1 10V	CB-10410		MAG1201	QC1-223	HY-360
C40	.1 10V	CB-10410		MAG1201	QC1-223	HY-360
C41	.1 10V	CB-10410		MAG1201	QC1-223	HY-360
C42	.1 10V	CB-10410		MAG1201	QC1-223	HY-360

CONTROLS (All wattages 1/2 watt, or less, unless listed)

ITEM No.	FUNCTION	RESISTANCE	REPLACEMENT DATA		
			MFR. PART No.	MALLORY PART No.	TRW PART No.
R52	TX Data	10K	RP-103	RVA0911V103	X260R103B
R56	TX Clock	10K	RP-103	RVA0911V103	X260R103B
R57	RX Clock	10K	RP-103	RVA0911V103	X260R103B
R58	RX Data	10K	RP-103	RVA0911V103	X260R103B

C4PMF— 505 BOARD PARTS LIST AND DESCRIPTION (CONTINUED)

(When ordering parts, state Model, Part Number, and Description.)

RESISTORS (Power and Special)

ITEM No.	RATING	REPLACEMENT DATA		ITEM No.	RATING	REPLACEMENT DATA	
		MFGR. PART No.	WORKMAN PART No.			MFGR. PART No.	WORKMAN PART No.
R1	470 5% 1/4W Flameproof Carbon Film	R1-471	22-1088	R29	4700 5% 1/4W Flameproof Carbon Film	R1-472	22-1112
R2	470 5% 1/4W Flameproof Carbon Film	R1-471	22-1088	R30	4700 5% 1/4W Flameproof Carbon Film	R1-472	22-1112
R3	470 5% 1/4W Flameproof Carbon Film	R1-471	22-1088	R31	4700 5% 1/4W Flameproof Carbon Film	R1-472	22-1112
R4	470 5% 1/4W Flameproof Carbon Film	R1-471	22-1088	R32	4700 5% 1/4W Flameproof Carbon Film	R1-472	22-1112
R5	470 5% 1/4W Flameproof Carbon Film	R1-471	22-1088	R33	390 5% 1/4W Flameproof Carbon Film	R1-391	22-1086
R6	470 5% 1/4W Flameproof Carbon Film	R1-471	22-1088	R34	390 5% 1/4W Flameproof Carbon Film	R1-391	22-1086
R7	470 5% 1/4W Flameproof Carbon Film	R1-471	22-1088	R35	220 5% 1/4W Flameproof Carbon Film	R1-221	22-1080
R8	470 5% 1/4W Flameproof Carbon Film	R1-471	22-1088	R36	220 5% 1/4W Flameproof Carbon Film	R1-221	22-1080
R9	470 5% 1/4W Flameproof Carbon Film	R1-471	22-1088	R37	10K 5% 1/4W Flameproof Carbon Film	R1-103	22-1120
R10	470 5% 1/4W Flameproof Carbon Film	R1-471	22-1088	R38	10K 5% 1/4W Flameproof Carbon Film	R1-103	22-1120
R11	220 5% 1/4W Flameproof Carbon Film	R1-221	22-1080	R39	1000 5% 1/2W Carbon	R2-102	22-2096
R12	220 5% 1/4W Flameproof Carbon Film	R1-221	22-1080	R40	1000 5% 1/2W Carbon	R2-102	22-2096
R13	220 5% 1/4W Flameproof Carbon Film	R1-221	22-1080	R41	1000 5% 1/2W Carbon	R2-102	22-2096
R14	220 5% 1/4W Flameproof Carbon Film	R1-221	22-1080	R42	1000 5% 1/2W Carbon	R2-102	22-2096
R15	220 5% 1/4W Flameproof Carbon Film	R1-221	22-1080	R43	10K 5% 1/4W Flameproof Carbon Film	R1-103	22-1120
R16	220 5% 1/4W Flameproof Carbon Film	R1-221	22-1080	R44	10K 5% 1/4W Flameproof Carbon Film	R1-103	22-1120
R17	220 5% 1/4W Flameproof Carbon Film	R1-221	22-1080	R45	390 5% 1/4W Flameproof Carbon Film	R1-391	22-1086
R18	220 5% 1/4W Flameproof Carbon Film	R1-221	22-1080	R46	390 5% 1/4W Flameproof Carbon Film	R1-391	22-1086
R19	220 5% 1/4W Flameproof Carbon Film	R1-221	22-1080	R47	390 5% 1/4W Flameproof Carbon Film	R1-391	22-1086
R20	390 5% 1/4W Flameproof Carbon Film	R1-391	22-1086	R48	220 5% 1/4W Flameproof Carbon Film	R1-221	22-1080
R21	390 5% 1/4W Flameproof Carbon Film	R1-391	22-1086	R49	220 5% 1/4W Flameproof Carbon Film	R1-221	22-1080
R22	390 5% 1/4W Flameproof Carbon Film	R1-391	22-1086	R50	220 5% 1/4W Flameproof Carbon Film	R1-221	22-1080
R23	390 5% 1/4W Flameproof Carbon Film	R1-391	22-1086	R51	1000 5% 1/4W Flameproof Carbon Film	R1-102	22-1096
R24	390 5% 1/4W Flameproof Carbon Film	R1-391	22-1086	R53	220 5% 1/4W Flameproof Carbon Film	R1-221	22-1080
R25	390 5% 1/4W Flameproof Carbon Film	R1-391	22-1086	R54	4700 5% 1/4W Flameproof Carbon Film	R1-472	22-1112
R26	390 5% 1/4W Flameproof Carbon Film	R1-391	22-1086	R55	390 5% 1/4W Flameproof Carbon Film	R1-391	22-1086
R27	390 5% 1/4W Flameproof Carbon Film	R1-391	22-1086	R59	1000 5% 1/4W Flameproof Carbon Film	R1-102	22-1096
R28	390 5% 1/4W Flameproof Carbon Film	R1-391	22-1086	R60	18K 5% 1/4W Flameproof Carbon Film	R1-183	22-1126
				R61	4700 5% 1/4W Flameproof Carbon Film	R1-472	22-1112

C4PMF— 505 BOARD PARTS LIST AND DESCRIPTION (CONTINUED)

(When ordering parts, state Model, Part Number, and Description.)

RESISTORS (Power and Special) (cont)

ITEM No.	RATING	REPLACEMENT DATA		ITEM No.	RATING	REPLACEMENT DATA	
		MFGR. PART No.	WORKMAN PART No.			MFGR. PART No.	WORKMAN PART No.
R62	4700 5% 1/4W Flameproof Carbon Film	R1-472	22-1112	R79	470 5% 1/4W Flameproof Carbon Film	R1-471	22-1088
R63	470 5% 1/4W Flameproof Carbon Film	R1-471	22-1088	R80	470 5% 1/4W Flameproof Carbon Film	R1-471	22-1088
R64	470 5% 1/4W Flameproof Carbon Film	R1-471	22-1088	R81	470 5% 1/4W Flameproof Carbon Film	R1-471	22-1088
R65	4700 5% 1/4W Flameproof Carbon Film	R1-472	22-1112	R82	470 5% 1/4W Flameproof Carbon Film	R1-471	22-1088
R66	4700 5% 1/4W Flameproof Carbon Film	R1-472	22-1112	R83	470 5% 1/4W Flameproof Carbon Film	R1-471	22-1088
R67	4700 5% 1/4W Carbon Film	R1-472	22-1112	R84	470 5% 1/4W Flameproof Carbon Film	R1-471	22-1088
R68	470 5% 1/4W Flameproof Carbon Film	R1-471	22-1088	R85	470 5% 1/4W Flameproof Carbon Film	R1-471	22-1088
R69	470 5% 1/4W Flameproof Carbon Film	R1-471	22-1088	R86	470 5% 1/4W Flameproof Carbon Film	R1-471	22-1088
R70	470 5% 1/4W Flameproof Carbon Film	R1-471	22-1088	R87	4700 5% 1/4W Flameproof Carbon Film	R1-472	22-1112
R71	470 5% 1/4W Flameproof Carbon Film	R1-471	22-1088	R88	1000 5% 1/4W Flameproof Carbon Film	R1-102	22-1096
R72	470 5% 1/4W Flameproof Carbon Film	R1-471	22-1088	R89	4700 5% 1/4W Flameproof Carbon Film	R1-472	22-1112
R73	470 5% 1/4W Flameproof Carbon Film	R1-471	22-1088	R90	4700 5% 1/4W Flameproof Carbon Film	R1-472	22-1112
R74	470 5% 1/4W Flameproof Carbon Film	R1-471	22-1088	R91	4700 5% 1/4W Flameproof Carbon Film	R1-472	22-1112
R75	470 5% 1/4W Flameproof Carbon Film	R1-471	22-1088	R92	4700 5% 1/4W Flameproof Carbon Film	R1-472	22-1112
R76	470 5% 1/4W Flameproof Carbon Film	R1-471	22-1088	R93	470 5% 1/4W Flameproof Carbon Film	R1-471	22-1088
R77	470 5% 1/4W Flameproof Carbon Film	R1-471	22-1088	R94	4700 5% 1/4W Flameproof Carbon Film	R1-472	22-1112
R78	470 5% 1/4W Flameproof Carbon Film	R1-471	22-1088	R95	4700 5% 1/4W Carbon Film	R1-472	22-1112

MISCELLANEOUS

ITEM No.	PART NAME	PART No.	NOTES
J1	Socket	SC-12FM	12 Pin
J2	Plug	SC-12MM	12 Pin
J3	Socket	SC-12FM	12 Pin
J4	Socket	SC-40F1	40 Pin (Connector to A15 Board)
X1	Crystal	X-405	4MHz
	Socket	SC-12FM	12 Pin (5 used)
	Plug	SC-12MM	12 Pin (2 used)
	P.C. Board	PC-505BP	CPU with Floppy Interface

C4PMF— 527 BOARD PARTS LIST AND DESCRIPTION

(When ordering parts, state Model, Part Number, and Description.)

SEMICONDUCTORS (Select replacement transistor for best results)

ITEM No.	TYPE No.	MFGR. PART No.	REPLACEMENT DATA							
			GENERAL ELECTRIC PART No.	MALLORY PART No.	RAYTHEON PART No.	RCA PART No.	SYLVANIA PART No.	THORDARSON PART No.	WORKMAN PART No.	ZENITH PART No.
D1-D2 UA1-UA8 UA9- UA10 UB1-UB8 UC1-UC8	1N914 2114L-3 N8T26AN 2114L-3 2114L-3	Q-1N914 IC-2114-L3 IC-8T26 IC-2114-L3 IC-2114-L3	GE-514	PTC214	REN 177	SK3100/519	ECG519	TM519	WEP925/519	103-131
UC9 UC10 UC11 UD1-UD8 UD9	F-74S138PC SN7404N DM7420N 2114L-3 F-74S138PC	IC-74S138 IC-7404 IC-7420 IC-2114-L3 IC-74S138	GE-7404 GE-7420			SK7404 SK7420	ECG74S138 ECG7404 ECG7420	TM74S138 TM7404 TM7420		221-29076 221-29077
							ECG74S138	TM74S138		

C4PMF — 527 BOARD PARTS LIST AND DESCRIPTION (CONTINUED)

(When ordering parts, state Model, Part Number, and Description.)

SEMICONDUCTORS (Select replacement transistor for best results) (cont)

ITEM No.	TYPE No.	MFR. PART No.	REPLACEMENT DATA							
			GENERAL ELECTRIC PART No.	MALLORY PART No.	RAYTHEON PART No.	RCA PART No.	SYLVANIA PART No.	THORDARSON PART No.	WORKMAN PART No.	ZENITH PART No.
UD10	F-74LS04PC	IC-74LS04				SK74LS04	ECG74LS04	TM74LS04		
UE1-UE8	2114L-3	IC-2114-L3								
UE9	F-74S138PC	IC-74S138	GE-7410			SK7410	ECG74S138	TM74S138		
UE10	SN7410J	IC-7410					ECG7410	TM7410		
UF1-UF8	2114L-3	IC-2114-L3								
UF9	F-74S138PC	IC-74S138					ECG74S138	TM74S138		

ELECTROLYTIC CAPACITORS

ITEM No.	RATING	REPLACEMENT DATA				
		MFR. PART No.	CORNELL-DUBILIER PART No.	MALLORY PART No.	SPRAGUE PART No.	
					Q-LINE	GENERAL LINE
C30	50 25V	C-506	WBR50-25	TT25X50A	QE1-353	TVA-1206

CAPACITORS

ITEM No.	RATING	MFR. PART No.	REPLACEMENT DATA			
			CORNELL-DUBILIER PART No.	MALLORY PART No.	SPRAGUE PART No.	
					Q-LINE	GENERAL LINE
C1	.1 10V	CB-10410		MAG1201	QC1-223	HY-360
C2	.1 10V	CB-10410		MAG1201	QC1-223	HY-360
C3	.1 10V	CB-10410		MAG1201	QC1-223	HY-360
C4	.1 10V	CB-10410		MAG1201	QC1-223	HY-360
C5	.1 10V	CB-10410		MAG1201	QC1-223	HY-360
C6	.1 10V	CB-10410		MAG1201	QC1-223	HY-360
C7	.1 10V	CB-10410		MAG1201	QC1-223	HY-360
C8	.1 10V	CB-10410		MAG1201	QC1-223	HY-360
C9	.1 10V	CB-10410		MAG1201	QC1-223	HY-360
C10	.1 10V	CB-10410		MAG1201	QC1-223	HY-360
C11	.1 10V	CB-10410		MAG1201	QC1-223	HY-360
C12	.1 10V	CB-10410		MAG1201	QC1-223	HY-360
C13	.1 10V	CB-10410		MAG1201	QC1-223	HY-360
C14	.1 10V	CB-10410		MAG1201	QC1-223	HY-360
C15	.1 10V	CB-10410		MAG1201	QC1-223	HY-360
C16	.1 10V	CB-10410		MAG1201	QC1-223	HY-360
C17	.1 10V	CB-10410		MAG1201	QC1-223	HY-360
C18	.1 10V	CB-10410		MAG1201	QC1-223	HY-360
C19	.1 10V	CB-10410		MAG1201	QC1-223	HY-360
C20	.1 10V	CB-10410		MAG1201	QC1-223	HY-360
C21	.1 10V	CB-10410		MAG1201	QC1-223	HY-360
C22	.1 10V	CB-10410		MAG1201	QC1-223	HY-360
C23	.1 10V	CB-10410		MAG1201	QC1-223	HY-360
C24	.1 10V	CB-10410		MAG1201	QC1-223	HY-360
C25	.1 10V	CB-10410		MAG1201	QC1-223	HY-360
C26	.1 10V	CB-10410		MAG1201	QC1-223	HY-360
C27	.1 10V	CB-10410		MAG1201	QC1-223	HY-360
C28	.1 10V	CB-10410		MAG1201	QC1-223	HY-360
C29	.1 10V	CB-10410		MAG1201	QC1-223	HY-360

RESISTORS (Power and Special)

ITEM No.	RATING	REPLACEMENT DATA		ITEM No.	RATING	REPLACEMENT DATA	
		MFR. PART No.	WORKMAN PART No.			MFR. PART No.	WORKMAN PART No.
R1	4700 5% 1/4W Carbon Film	R1-472	22-1112	R3	4700 5% 1/4W Carbon Film	R1-472	22-1112
R2	4700 5% 1/4W Carbon Film	R1-472	22-1112	R4	4700 5% 1/4W Carbon Film	R1-472	22-1112

MISCELLANEOUS

ITEM No.	PART NAME	PART No.	NOTES
J1	Socket Socket Socket P.C. Board	SC-12FM SC-16FI SC-18FI PC-527P	12 Pin (4 Required) 16 Pin IC Socket (6 used) 18 Pin IC Socket (48 used) CM-9 Memory

C4P/C4PMF— 540 BOARD PARTS LIST AND DESCRIPTION

(When ordering parts, state Model, Part Number, and Description.)

SEMICONDUCTORS (Select replacement transistor for best results)

ITEM No.	TYPE No.	MFR. PART No.	REPLACEMENT DATA							
			GENERAL ELECTRIC PART No.	MALLORY PART No.	RAYTHEON PART No.	RCA PART No.	SYLVANIA PART No.	THORDARSON PART No.	WORKMAN PART No.	ZENITH PART No.
D1-D6	1N914	Q-1N914	GE-514	PTC214	REN 177	SK3100/519	ECG519	TM519	WEP925/519	103-131
U1A	DM74151AN	IC-74151				SK74151	ECG74151	TM74151		
U1B	DM74L04N	IC-74L04(1)								
U1C	SN7400N	IC-7400	GE-7400		REN 7400	SK7400	ECG7400	TM7400	WEP7400/7400	221-29075
U1D	F-74175PC	IC-74175					ECG74175	TM74175		
U1E	DM74175N	IC-74175					ECG74175	TM74175		
U1F-U1G	F-74175PC	IC-74175					ECG74175	TM74175		
U1H	2114L-3	IC-2114-L3								
U2A	N8T26N	IC-8T26	GE-7400		REN 7400	SK7400	ECG7400	TM7400	WEP7400/7400	221-29075
U2B	SN7400N	IC-7400								
U2C-U2F	F-74LS86PC	IC-74LS86				SK74LS86	ECG74LS86	TM74LS86		
U2G-U2H	2114L-3	IC-2114-L3								
U3A	N8T26N	IC-8T26	GE-7400		REN 7400	SK7400	ECG7400	TM7400	WEP7400/7400	221-29075
U3B	SN7492AN	IC-7492	GE-7492			SK7492	ECG7492	TM7492		
U3C	74LS157N	IC-74LS157				SK74LS157	ECG74LS157	TM74LS157		
U3D	SN74165N	IC-74165					ECG74165	TM74165		
U3E	C38129	IC-CARGEN								
U3F	CARGENV1.0	IC-74174					ECG74174	TM74174		
U3G	SN74174N	IC-74174					ECG74174	TM74174		
U3H-U3I	SN74174N	IC-74174					ECG74174	TM74174		
U4A-U4B	N8T26N	IC-8T26	GE-74123		REN 74123	SK74123	ECG74123	TM74123	WEP7408/7408	221-29086
U4C	SN74123N	IC-74123	GE-7408			SK7408	ECG7408	TM7408		
U4D	7408N	IC-7408					ECG7403	TM7403		
U4E	7403N	IC-7403	GE-7400		REN 7400	SK7400	ECG7400	TM7400	WEP7400/7400	221-29075
U4F	SN7400N	IC-7400	GE-7474		REN 7474	SK7474	ECG7474	TM7474	WEP7474/7474	
	7474N	IC-7474	GE-7474		REN 7474	SK7474	ECG7474	TM7474	WEP7474/7474	
	SN7474N									
U4G	F-74175PC	IC-74175					ECG74175	TM74175		
U4H	F-7404PC	IC-7404	GE-7404			SK7404	ECG7404	TM7404		221-29076
U4J	SN7404N	IC-7404	GE-7404			SK7404	ECG7404	TM7404		221-29076
U4K	SN74LS12N	IC-74LS12								
	F-7404PC	IC-7404	GE-7404			SK7404	ECG7404	TM7404		221-29076
	SN7404N		GE-7404			SK7404	ECG7404	TM7404		221-29076
U5A	DM7420N	IC-7420	GE-7420			SK7420	ECG7420	TM7420		221-29077
U5B-U5H	F-7420PC	IC-7420	GE-7420			SK7420	ECG7420	TM7420		221-29077
U5I-U5K	DM74LS163N	IC-74LS163				SK74LS163	ECG74LS163A	TM74LS163A		
	SN74LS157N	IC-74LS157				SK74LS157	ECG74LS157	TM74LS157		
	F74LS157PC					SK74LS157	ECG74LS157	TM74LS157		
U6A	SN72555	IC-555	GEIC-269	PTC1555		SK3564/955M	ECG955M	TM955M	WEP2119/955M	221-29042
U6B	UA555TC		GEIC-269	PTC1555		SK3564/955M	ECG955M	TM955M	WEP2119/955M	221-29042
U6C	74LS157PC	IC-74LS157				SK74LS157	ECG74LS157	TM74LS157		
U6D	7438N	IC-7438				SK7438	ECG7438	TM7438		
U6E	SN7400N	IC-7400	GE-7400		REN 7400	SK7400	ECG7400	TM7400	WEP7400/7400	221-29075
U6F	74LS139N	IC-74LS139								
U6G-U6H	7430N	IC-7430				SK7430	ECG7430	TM7430		
U6I	9N30/7430					SK7400	ECG7400	TM7400	WEP7400/7400	221-29075
	SN7400N	IC-7400	GE-7402		REN 7402	SK7402	ECG7402	TM7402	WEP7402/7402	
	F-7402PC	IC-7402	GE-7402			SK7402	ECG7402	TM7402	WEP7402/7402	
	SN7402N									
U6J	F-7404PC	IC-7404	GE-7404			SK7404	ECG7404	TM7404		221-29076
U6K	SN7404N	IC-7404	GE-7404			SK7404	ECG7404	TM7404		221-29076
U6L	DM7420N	IC-7420	GE-7420			SK7420	ECG7420	TM7420		221-29077
	F-7420PC	IC-7420	GE-7420			SK7420	ECG7420	TM7420		221-29077
	SN7404N	IC-7404	GE-7404			SK7404	ECG7404	TM7404		221-29076
	F-7404PC	IC-7404	GE-7404			SK7404	ECG7404	TM7404		221-29076
Q1	2N5225	Q-2N5225	GE-20	PTC115	REN 123A	SK3444/123A	ECG123AP	TM123AP	WEP736/123A	121-29000A

(1) If replacement is required, do not substitute.

ELECTROLYTIC CAPACITORS

ITEM No.	RATING	REPLACEMENT DATA				
		MFR. PART No.	CORNELL-DUBILIER PART No.	MALLORY PART No.	SPRAGUE PART No.	
					Q-LINE	GENERAL LINE
C20	47 16V	C-506	NLW50-16	TT15X50A	QE1-351	TVA-1150
C21	47 16V	C-506	NLW50-16	TT15X50A	OE1-351	TVA-1150

CAPACITORS

ITEM No.	RATING	MFR. PART No.	REPLACEMENT DATA			
			CORNELL-DUBILIER PART No.	MALLORY PART No.	SPRAGUE PART No.	
					Q-LINE	GENERAL LINE
C1	.1 10V	CB-10410		MAG1201	QC1-223	HY-360
C2	.1 10V	CB-10410		MAG1201	QC1-223	HY-360
C3	.1 10V	CB-10410		MAG1201	QC1-223	HY-360
C4	.1 10V	CB-10410		MAG1201	QC1-223	HY-360
C5	10 1KV 10%	C-100				

C4P/C4PMF— 540 BOARD PARTS LIST AND DESCRIPTION (CONTINUED)

(When ordering parts, state Model, Part Number, and Description.)

CAPACITORS (cont)

ITEM No.	RATING	MFR. PART No.	REPLACEMENT DATA			
			CORNELL-DUBILIER PART No.	MALLORY PART No.	SPRAGUE PART No.	
					Q-LINE	GENERAL LINE
C6	.1 10V	CB-10410		MAG1201	QC1-223	HY-360
C7	.01 100V	C-103	WMF1S1	EWFA1110	QF1-91	1PB-S10
C8	10 1KV 10%	C-100				
C9	27 1KV 1%	C-270				
C10	50 Trimmer	CP-500				
C11	.1 10V	CB-10410		MAG1201	QC1-223	HY-360
C12	.1 10V	CB-10410		MAG1201	QC1-223	HY-360
C13	.1 10V	CB-10410		MAG1201	QC1-223	HY-360
C14	.1 10V	CB-10410		MAG1201	QC1-223	HY-360
C15	.1 10V	CB-10410		MAG1201	QC1-223	HY-360
C16	.1 10V	CB-10410		MAG1201	QC1-223	HY-360
C17	.1 50V 10%	C-104	WMF05P1	EWFO5010		431P1049R5
C18	.001 100V 10%	C-102	DPMS6D1	EWFA210	QF1-1	1PB-D10
C19	.001 100V 10%	C-102	DPMS6D1	EWFA210	QF1-1	1PB-D10C-102
C22	.1 10V	CB-10410		MAG1201	QC1-223	HY-360
C23	.1 10V	CB-10410		MAG1201	QC1-223	HY-360
C24	.1 10V	CB-10410		MAG1201	QC1-223	HY-360
C25	.1 10V	CB-10410		MAG1201	QC1-223	HY-360
C26	.001 100V 10%	C-102	DPMS6D1	EWFA210	QF1-1	1PB-D10
C27	.1 10V	CB-10410		MAG1201	QC1-223	HY-360
C28	.1 10V	CB-10410		MAG1201	QC1-223	HY-360
C29	.1 10V	CB-10410		MAG1201	QC1-223	HY-360
C30	.1 10V	CB-10410		MAG1201	QC1-223	HY-360
C31	.1 10V	CB-10410		MAG1201	QC1-223	HY-360
C32	.1 10V	CB-10410		MAG1201	QC1-223	HY-360
C33	.01 100V 10%	C-103	WMF1S1	EWFA1110	QF1-91	1PB-S10
C34	.0047 100V	C-472	WMFD47	EWFA247	QF1-57	1PB-D47
C35	.1 10V	CB-10410		MAG1201	QC1-223	HY-360
C36	220 500V 10%	C-221		GP322		10TS-T22
C37	.1 10V	CB-10410		MAG1201	QC1-223	HY-360
C38	.1 10V	CB-10410		MAG1201	QC1-223	HY-360
C39	.1 10V	CB-10410		MAG1201	QC1-223	HY-360
C40	.1 10V	CB-10410		MAG1201	QC1-223	HY-360
C41	.1 10V	CB-10410		MAG1201	QC1-223	HY-360
C42	.1 10V	CB-10410		MAG1201	QC1-223	HY-360
C43	.1 10V	CB-10410		MAG1201	QC1-223	HY-360
C99	150 1KV 10%			GP315		10TS-T15

CONTROLS (All wattages 1/2 watt, or less, unless listed)

ITEM No.	FUNCTION	RESISTANCE	REPLACEMENT DATA		
			MFR. PART No.	MALLORY PART No.	TRW PART No.
R5	Bias	10K	RP-103	RVA0911V103	X260R103B
R9	Video	200	RP-201		
R10	Color	10K	RP-103	RVA0911V103	X260R103B
R22	Blanking	10K	RP-103	RVA0911V103	X260R103B
R23	Sync	500	RP-502	RVA0911V502	X260R502B

RESISTORS (Power and Special)

ITEM No.	RATING	REPLACEMENT DATA		ITEM No.	RATING	REPLACEMENT DATA	
		MFR. PART No.	WORKMAN PART No.			MFR. PART No.	WORKMAN PART No.
R1	10K 5% 1/4W Flameproof Carbon Film	R1-103	22-1120	R18	16K 5% 1/4W Flameproof Carbon Film	R1-163	
R3	470 5% 1/4W Carbon Film	R1-471	22-1088	R21	1000 5% 1/4W Flameproof Carbon Film	R1-102	22-1096
R4	470 5% 1/4W Carbon Film	R1-471	22-1088	R25	1000 5% 1/4W Flameproof Carbon Film	R1-102	22-1096
R6	10 5% 1/4W Flameproof Carbon Film	R1-100	22-1048	R26	1000 5% 1/4W Flameproof Carbon Film	R1-102	22-1096
R7	470 5% 1/4W Carbon Film	R1-471	22-1088	R27	10K 5% 1/4W Flameproof Carbon Film	R1-103	22-1120
R8	27 5% 1/4W Carbon Film	R1-270	22-1058	R28	18K 5% 1/4W Flameproof Carbon Film	R1-183	22-1126
R11	390 5% 1/4W Flameproof Carbon Film	R1-391	22-1081	R29	10K 5% 1/4W Flameproof Carbon Film	R1-103	22-1120
R12	4700 5% 1/4W Carbon Film	R1-472	22-1112	R30	1000 5% 1/4W Flameproof Carbon Film	R1-102	22-1096
R13	470 5% 1/4W Carbon Film	R1-471	22-1088	R31	1000 5% 1/4W Flameproof Carbon Film	R1-102	22-1096
R14	470 5% 1/4W Carbon Film	R1-471	22-1088	R32	220 5% 1/4W Flameproof Carbon Film	R1-221	22-1080
R15	10K 5% 1/4W Flameproof Carbon Film	R1-103	22-1120	R33	1000 5% 1/4W Flameproof Carbon Film	R1-102	22-1096
R16	1000 5% 1/4W Flameproof Carbon Film	R1-102	22-1096				
R17	10K 5% 1/4W Flameproof Carbon Film	R1-103	22-1120				

C4P/C4PMF— 540 BOARD PARTS LIST AND DESCRIPTION (CONTINUED)

(When ordering parts, state Model, Part Number, and Description.)

RESISTORS (Power and Special) (cont)

ITEM No.	RATING	REPLACEMENT DATA		ITEM No.	RATING	REPLACEMENT DATA	
		MFGR. PART No.	WORKMAN PART No.			MFGR. PART No.	WORKMAN PART No.
R34	1000 5% 1/4W Flameproof Carbon Film	R1-102	22-1096	R40	4700 5% 1/4W Flameproof Carbon Film	R1-472	22-1112
R35	4700 5% 1/4W Carbon Film	R1-472	22-1112	R41	1000 5% 1/4W Flameproof Carbon Film	R1-102	22-1096
R36	2200 5% 1/4W Flameproof Carbon Film	R1-222	22-1104	R42	1000 5% 1/4W Flameproof Carbon Film	R1-102	22-1096
R37	100 5% 1/4W Flameproof Carbon Film	R1-101	22-1072	R43	1000 5% 1/4W Flameproof Carbon Film	R1-102	22-1096
R38	1000 5% 1/4W Flameproof Carbon Film	R1-102	22-1096	R44	1000 5% 1/4W Flameproof Carbon Film	R1-102	22-1096
R39	1000 5% 1/4W Flameproof Carbon Film	R1-102	22-1096	R45	100 5% 1/4W Flameproof Carbon Film	R1-101	22-1072

MISCELLANEOUS

ITEM No.	PART NAME	PART No.	NOTES
J1	Socket	SC-12FM	12 Pin (4 used)
J2	Socket	SC-12FM	12 Pin
X1	Crystal	X-126	12MHz
X2	Crystal	X-355	3.58MHz
	Socket	SC-14FI	14 Pin IC Socket (2 used)
	Socket	SC-16FI	16 Pin IC Socket (9 used)
	Socket	SC-18FI	18 Pin IC Socket (6 used)
	Socket	SC-24FI	24 Pin IC Socket (1 used)
	P.C. Board	PC-540B1	Video/Color

C4P/C4PMF— 542 BOARD PARTS LIST AND DESCRIPTION

(When ordering parts, state Model, Part Number, and Description.)

SEMICONDUCTORS (Select replacement transistor for best results)

ITEM No.	TYPE No.	MFGR. PART No.	REPLACEMENT DATA							
			GENERAL ELECTRIC PART No.	MALLORY PART No.	RAYTHEON PART No.	RCA PART No.	SYLVANIA PART No.	THORDARSON PART No.	WORKMAN PART No.	ZENITH PART No.
D1-D16	1N914	Q-1N914	GE-514	PTC214	REN 177	SK3100/519	ECG519	TM519	WEP925/519	103-131
U1-U2	N8T26N	IC-8T26								
U3-U6	DM7475N	IC-7475	GE-7475			SK7475	ECG7475	TM7475		
U7	SN74LS138N	IC-74LS138				SK74LS138	ECG74LS138	TM74LS138		
U8	DM7404N	IC-7404	GE-7404			SK7404	ECG7404	TM7404		221-29076
U9-U10	74LS193N	IC-74LS193				SK74LS193	ECG74LS193	TM74LS193		
U11	74LS390PC	IC-74LS390								

ELECTROLYTIC CAPACITORS

ITEM No.	RATING	REPLACEMENT DATA					
		MFGR. PART No.	CORNELL-DUBILIER PART No.	MALLORY PART No.	SPRAGUE PART No.		
					Q-LINE	GENERAL LINE	
C1	47 16V	C-506	NLW50-16	TT15X50A	QE1-351	TVA-1150	
C8	47 16V	C-506	NLW50-16	TT15X50A	QE1-351	TVA-1150	
C9	47 16V	C-506	NLW50-16	TT15X50A	QE1-351	TVA-1150	

CAPACITORS

ITEM No.	RATING	MFGR. PART No.	REPLACEMENT DATA			
			CORNELL-DUBILIER PART No.	MALLORY PART No.	SPRAGUE PART No.	
					Q-LINE	GENERAL LINE
C2	.1 10V	CB-10410		MAG1201	QC1-223	HY-360
C3	.1 10V	CB-10410		MAG1201	QC1-223	HY-360
C4	.1 10V	CB-10410		MAG1201	QC1-223	HY-360
C5	.1 10V	CB-10410		MAG1201	QC1-223	HY-360
C6	.1 10V	CB-10410		MAG1201	QC1-223	HY-360
C7	.1 10V	CB-10410		MAG1201	QC1-223	HY-360
C10	220 500V 10%	C-221				10TCC-T22
C11	220 500V 10%	C-221				10TCC-T22
C12	.1 10V	CB-10410		MAG1201	QC1-223	HY-360

RESISTORS (Power and Special)

ITEM No.	RATING	REPLACEMENT DATA		ITEM No.	RATING	REPLACEMENT DATA	
		MFGR. PART No.	WORKMAN PART No.			MFGR. PART No.	WORKMAN PART No.
R1	4700 5% 1/4W Flameproof Carbon Film	R1-472	22-1112	R3	510 5% 1/4W Flameproof Carbon Film	R1-511	
R2	8200 5% 1/4W Flameproof Carbon Film	R1-822	22-1118	R4	68K 5% 1/4W Flameproof Carbon Film	R1-683	22-1140

C4P/C4PMF— 542 BOARD PARTS LIST AND DESCRIPTION (CONTINUED)

(When ordering parts, state Model, Part Number, and Description.)

RESISTORS (Power and Special) (cont)

ITEM No.	RATING	REPLACEMENT DATA		ITEM No.	RATING	REPLACEMENT DATA	
		MFR. PART No.	WORKMAN PART No.			MFR. PART No.	WORKMAN PART No.
R5	33K 5% 1/4W Flameproof Carbon Film	R1-333	22-1132	R13	4700 5% 1/4W Flameproof Carbon Film	R1-472	22-1112
R6	16K 5% 1/4W Flameproof Carbon Film	R1-163		R14	4700 5% 1/4W Flameproof Carbon Film	R1-472	22-1112
R7	1000 5% 1/4W Flameproof Carbon Film	R1-102	22-1096	R15	4700 5% 1/4W Flameproof Carbon Film	R1-472	22-1112
R8	3900 5% 1/4W Flameproof Carbon Film	R1-392	22-1110	R16	4700 5% 1/4W Flameproof Carbon Film	R1-472	22-1112
R9	2000 5% 1/4W Flameproof Carbon Film	R1-202		R17	4700 5% 1/4W Flameproof Carbon Film	R1-472	22-1112
R10	1000 5% 1/4W Flameproof Carbon Film	R1-102	22-1096	R18	4700 5% 1/4W Flameproof Carbon Film	R1-472	22-1112
R11	510 5% 1/4W Flameproof Carbon Film	R1-511		R19	4700 5% 1/4W Flameproof Carbon Film	R1-472	22-1112
R12	4700 5% 1/4W Flameproof Carbon Film	R1-472	22-1112				

MISCELLANEOUS

ITEM No.	PART NAME	PART No.	NOTES
J1	Socket	SC-12FM	12 Pin
J2	Socket	SC-16FI	16 Pin
J3	Socket	SC-16FI	16 Pin
S1 thru S52	Switch P.C. Board Socket Socket	HW-Keys Switch PC-542B1 SC-16FI SC-14FI	Keyboard Keyboard Assembly (Rev B) 16 Pin IC Socket (10 used) 14 Pin IC Socket

C4P/C4PMF— 582 BOARD PARTS LIST AND DESCRIPTION

(When ordering parts, state Model, Part Number, and Description.)

MISCELLANEOUS

ITEM No.	PART NAME	PART No.	NOTES
	Plug P.C. Board	SC-12MM PC-582A	12 Pin (16 used) Backplane

C4P— CHASSIS PARTS LIST AND DESCRIPTION

(When ordering parts, state Model, Part Number, and Description.)

WIRING DATA

Shielded Hook-up Wire	Use BELDEN No. 8401 or 8421 (Single-Conductor) 8208 (Two-Conductor)
General-use Unshielded Hook-up Wire	Use BELDEN No. 8528 (Solid) Available in 13 Colors 8522 (Stranded) Available in 13 Colors

CONTROLS (All wattages 1/2 watt, or less, unless listed)

ITEM No.	FUNCTION	RESISTANCE	REPLACEMENT DATA		
			MFR. PART No.	MALLORY PART No.	TRW PART No.
R1	Fine Color Adj	1000	RP-102 19-7924 (5)	UA13L,SK1000	BU2,CF6,SS3,DC1

(5) Number on unit.

FUSE DEVICES

ITEM No.	DESCRIPTION	REPLACEMENT DATA						
		PART No.		BUSS PART No.		LITTELFUSE PART No.		WORKMAN PART No.
		DEVICE	HOLDER	DEVICE	HOLDER	DEVICE	HOLDER	
F1	2A @ 250V Quick-acting	F-002	HW-FH1	AGC2	HKP	312002	342001AF	

C4P— CHASSIS PARTS LIST AND DESCRIPTION (CONTINUED)

(When ordering parts, state Model, Part Number, and Description.)

MISCELLANEOUS

ITEM No.	PART NAME	PART No.	NOTES
J20	Jack	SC-1FJ	AC Control (Switchcraft 3501-FP)
J21	Jack	SC-1FJ	Video Monitor (Switchcraft 3501-FP)
J22	Jack	SC-1FJ	Cassette Output (Switchcraft 3501-FP)
J23	Jack	SC-1FJ	Cassette Mike (Switchcraft 3501-FP)
J24	Jack	SC-1FJ	Audio (Switchcraft 3501-FP)
J25	Jack	SC-1FJ	DAC (Switchcraft 3501-FP)
M1	Motor	HW-FAN	Fan, Assembly
SW1	Switch	SW-T01	Power Off/On
	AC Power Cord	W-3ST18AC	3 Conductor
	Cable	W-1612FC	12" Flexible Assembly, 16 Conductor
	Cable	W-1624FC	24" Flexible Assembly, 16 Conductor
	Cable	W-1624FC	24" Flexible Assembly, 16 Conductor
	Cable	W-1624FC	24" Flexible Assembly, 16 Conductor
	P.C. Board	PC-542BP	Keyboard Assembly
	P.C. Board	PC-502P	CPU
	P.C. Board	PC-A15P	C4-P Connector
	P.C. Board	PC-540B1P	Video-Color
	P.C. Board	PC-582P	Backplane
	Plug	SC-12MM	12 Pin

C4PMF— CHASSIS PARTS LIST AND DESCRIPTION

(When ordering parts, state Model, Part Number, and Description.)

WIRING DATA

Shielded Hook-up Wire	Use BELDEN No. 8401 or 8421 (Single-Conductor) 8208 (Two-Conductor)
General-use Unshielded Hook-up Wire	Use BELDEN No. 8528 (Solid) Available in 13 Colors 8522 (Stranded) Available in 13 Colors

CONTROLS (All wattages 1/2 watt, or less, unless listed)

ITEM No.	FUNCTION	RESISTANCE	REPLACEMENT DATA		
			MFGR. PART No.	MALLORY PART No.	TRW PART No.
R1	Fine Color Adj	1000	RP-102 19-7924 (5)	UA13L, SK1000	BU2, CF6, SS3, DC1

(5) Number on unit.

FUSE DEVICES

ITEM No.	DESCRIPTION	REPLACEMENT DATA						
		PART No.		BUSS PART No.		LITTELFUSE PART No.		WORKMAN PART No.
		DEVICE	HOLDER	DEVICE	HOLDER	DEVICE	HOLDER	DEVICE
F1	2A @ 250V Quick-acting	F-002	H342004A	AGC2	HKP	312002	342001AF	F62-2

MISCELLANEOUS

ITEM No.	PART NAME	PART No.	NOTES
J20	Jack	SC-1FJ	AC Control (Switchcraft 3501-FP)
J21	Jack	SC-1FJ	Video Monitor (Switchcraft 3501-FP)
J24	Jack	SC-1FJ	Audio (Switchcraft 3501-FP)
J25	Jack	SC-1FJ	DAC (Switchcraft 3501-FP)
M1	Motor	HW-FAN	Fan, Assembly
SW1	Switch	SW-T01	Power, Off/On (Arrow Hart 82607)
	AC Power Cord	U-3ST18AC	3 Conductor
	Cable	W-1612FC	12" Flexible Assembly, 16 Conductor
	Cable	W-1624FC	24" Flexible Assembly, 16 Conductor
	Cable	W-1624FC	24" Flexible Assembly, 16 Conductor
	Cable	W-1624FC	24" Flexible Assembly, 16 Conductor
	P.C. Board	PC-542P	Keyboard Assembly
	P.C. Board	PC-505PB	CPU with Floppy Interface
	P.C. Board	PC-527P	CM-9 Memory
	P.C. Board	PC-A15AP	C4-P Connector
	P.C. Board	PC-540B1P	Video Color
	P.C. Board	PC-582P	Backplane
	P.C. Board	PC-A11	Backplane Protector
	P.C. Board	PC-A13	Mini Floppy
	Plug	SC-12MM	12 Pin (3 used)

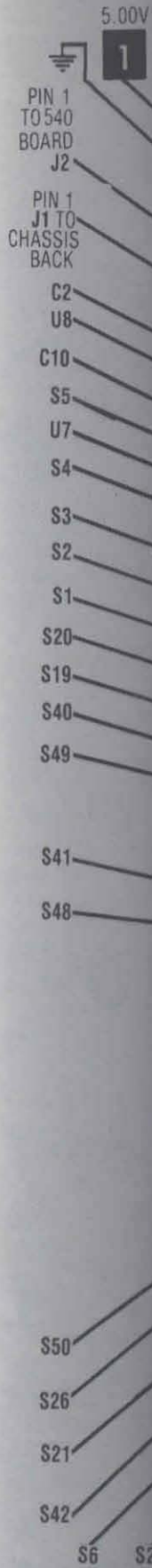

A Howard

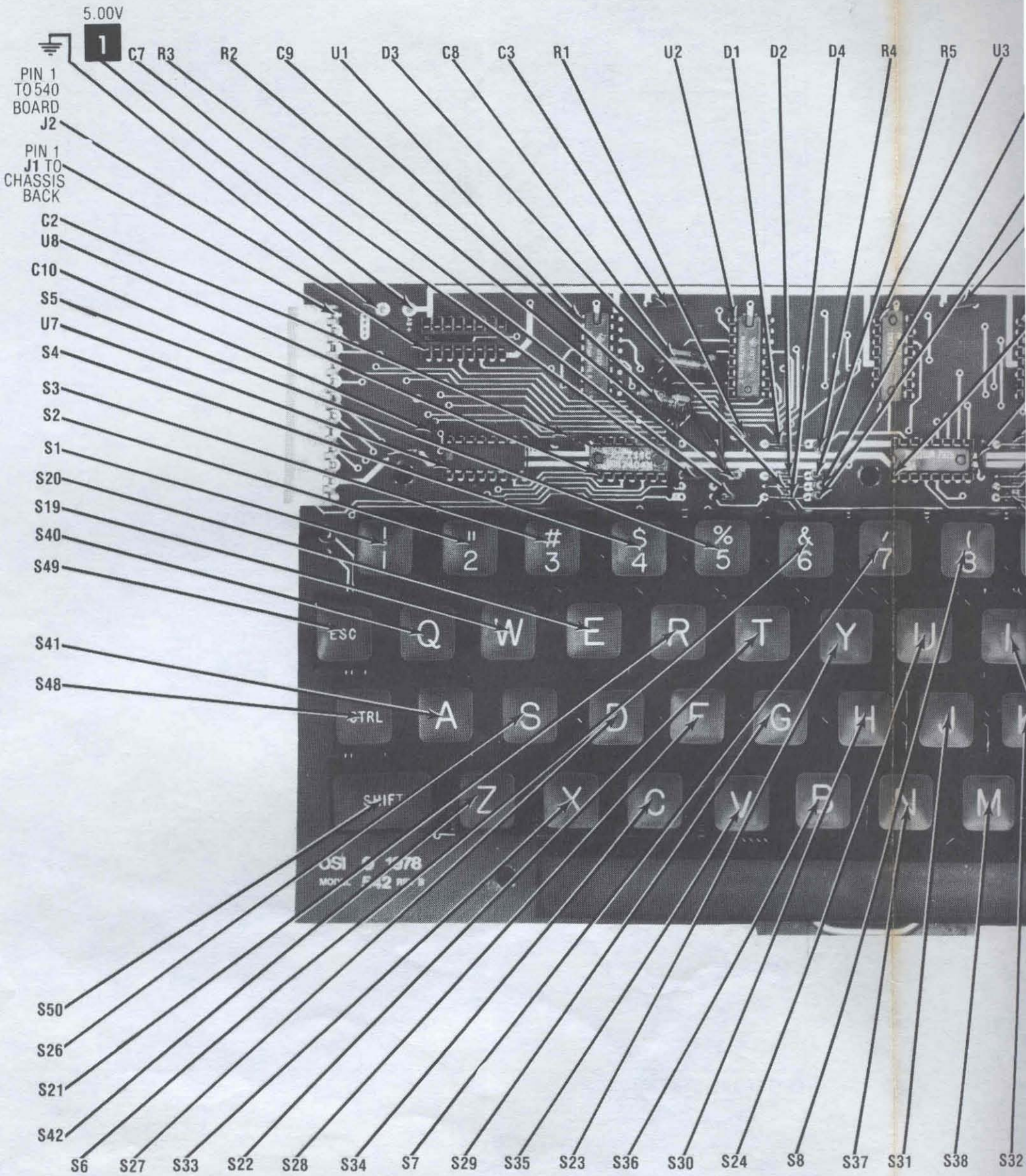

A Howard W. Sams CIRCUITRACE® Photo

C4P/C4PMF — 542 BOARD

C4P/C

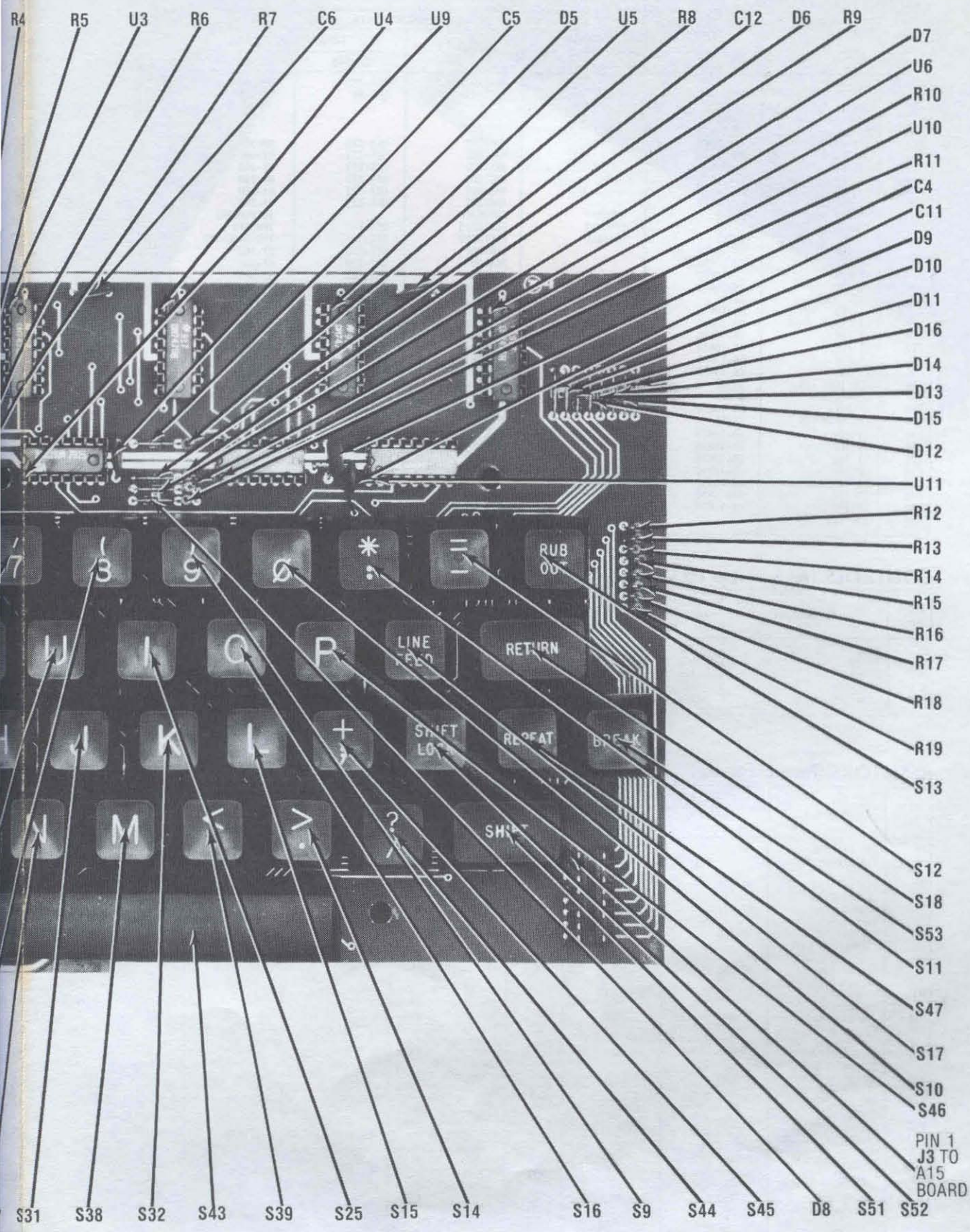

C4P/C4PMF — 542 BOARD

PAGES 91, 92
INSIDE REAR

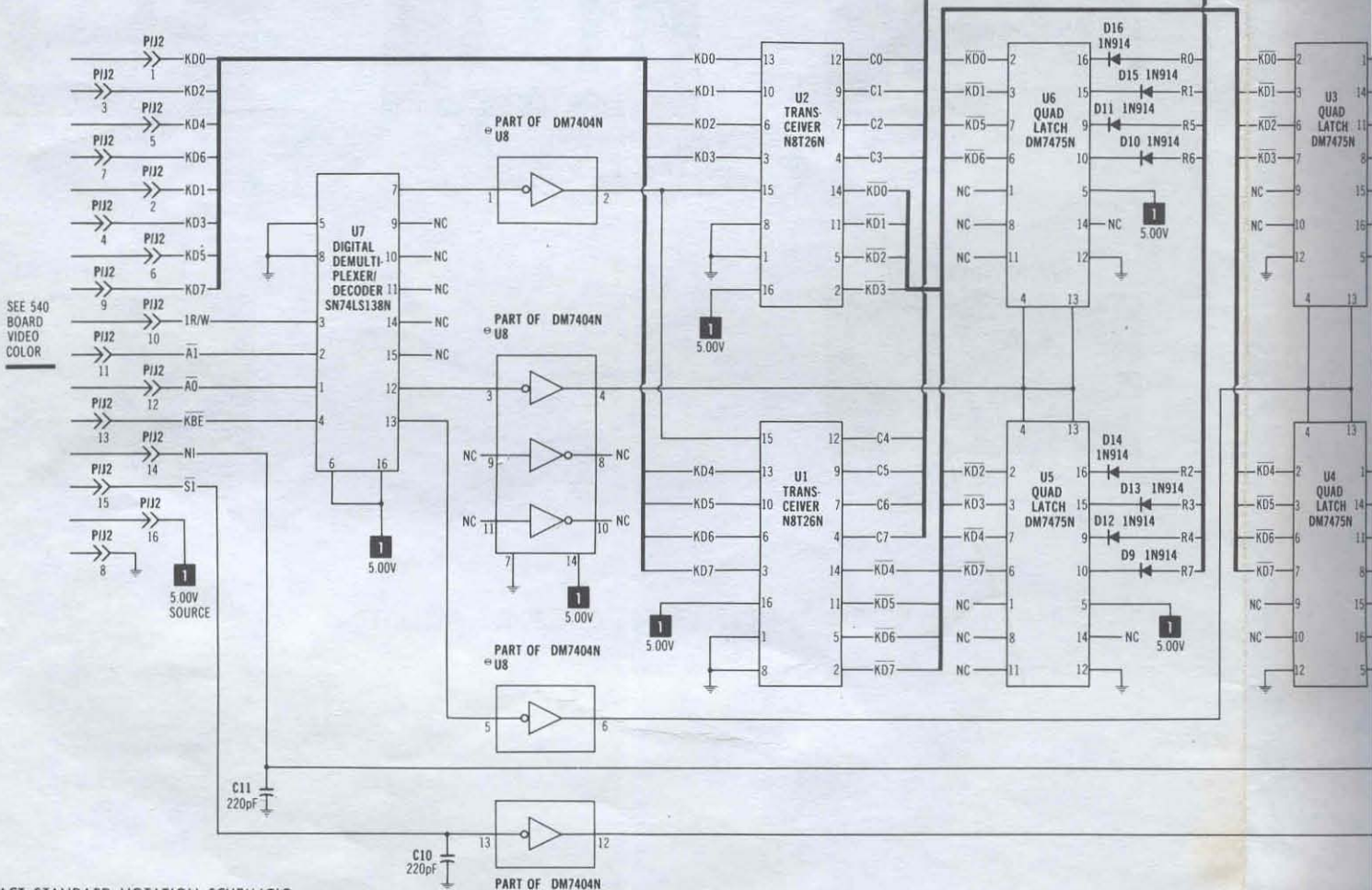
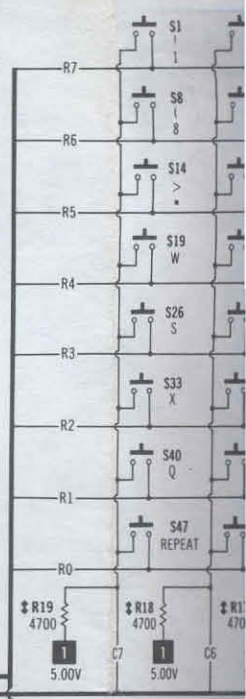
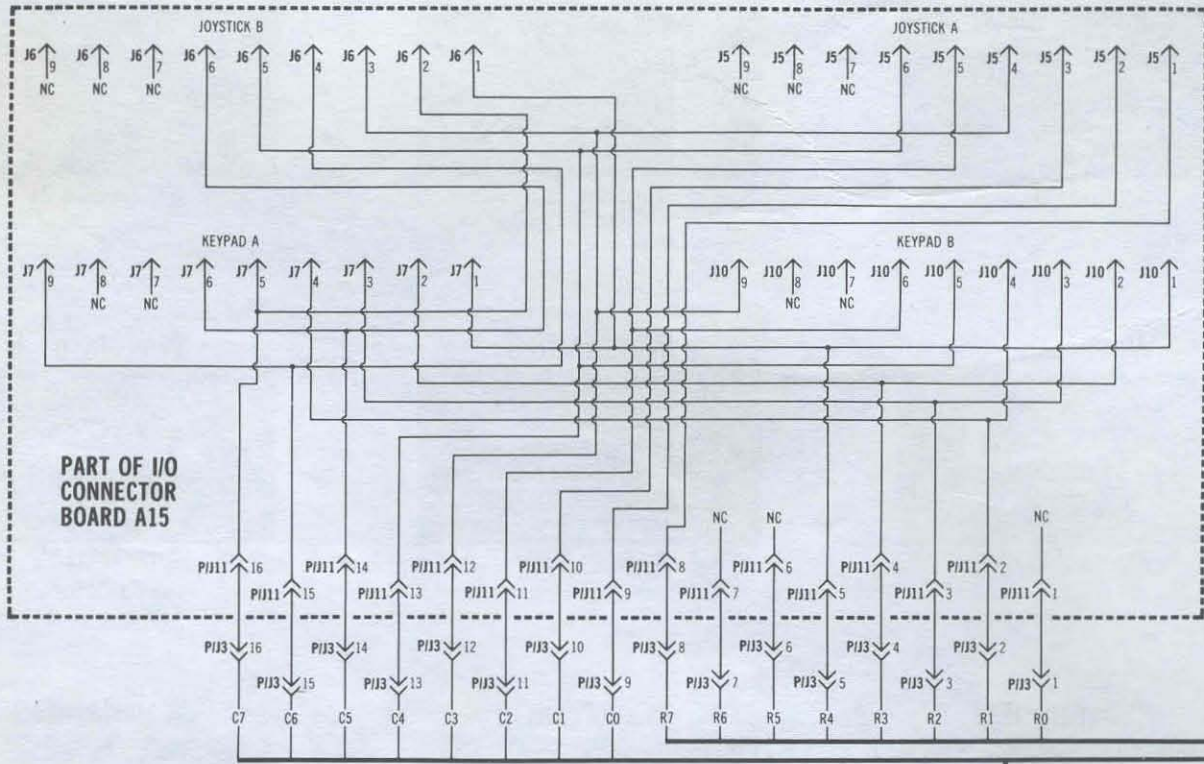

A PHOTOFAC STANDARD NOTATION SCHEMATIC

WITH **CIRCUITRACE**

© Howard W. Sams & Co., Inc. 1980

C4P/C4PMF — 542 BOARD

FOR SCHEMATIC LEGEND AND NOTES

542
KEYBOARD ASSEMBLY (POLLED)

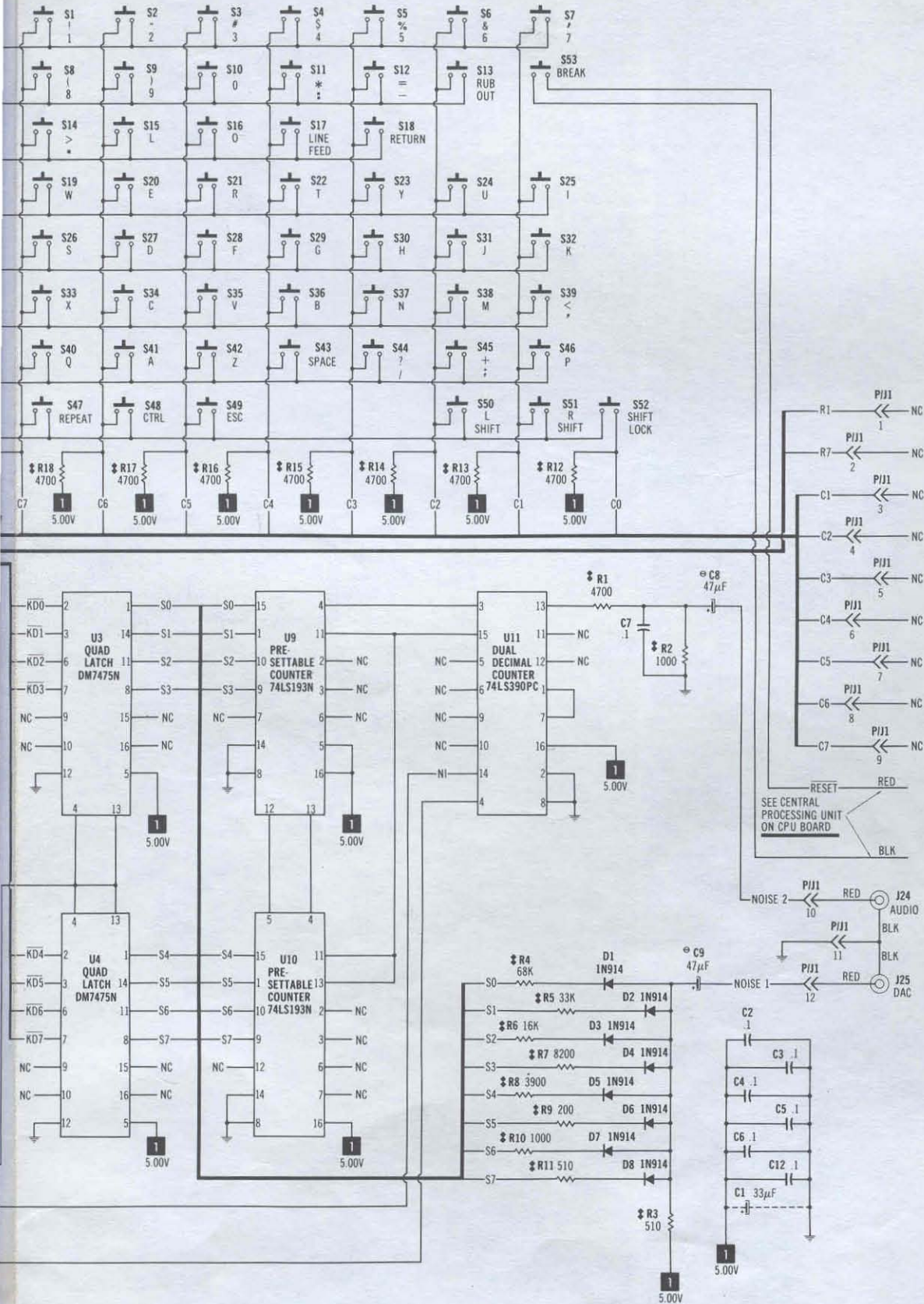

AND NOTES SEE PAGES 91, 92 & INSIDE REAR COVER.

C4P/C4PMF — 542 BOARD

C4P/C4PMF — 542 BOARD PINOUTS

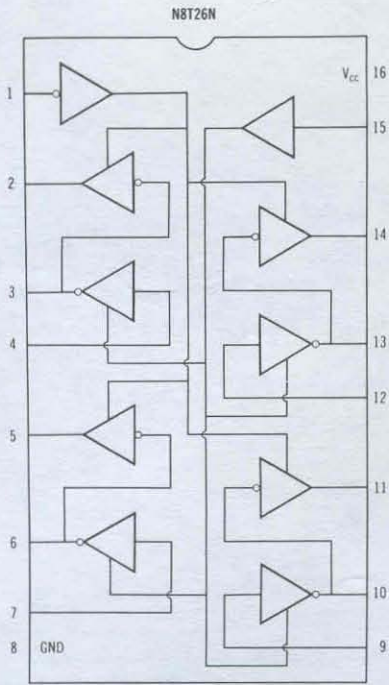

U1,U2

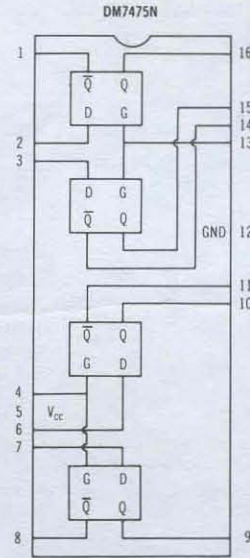

U3 THRU U6

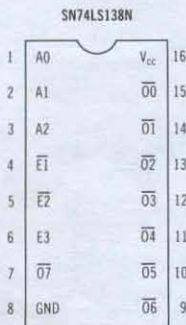

U7

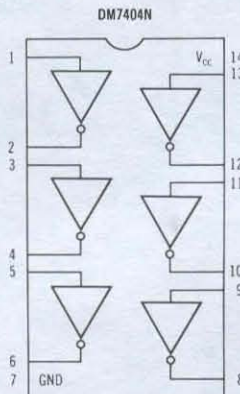

U8

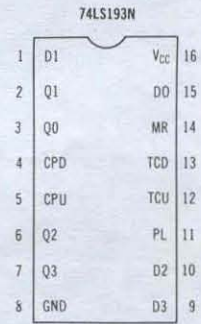

U9,U10

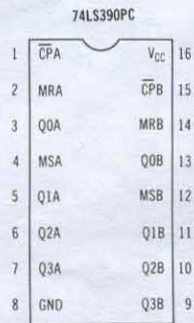

U11

C4P/C4PMF — 540 BOARD PINOUTS

DN74151AN



U1A

DN74L04N
F-7404PC

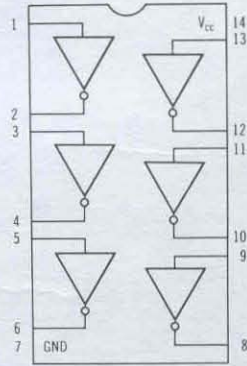

U1B, U4H, U4K, U6J, U6L

SN7400
F7403D
7438N

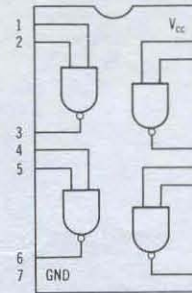

U1C, U2A, U3A, U4D, U4E, U6C, U6D, U6G, U6H

F74175PC

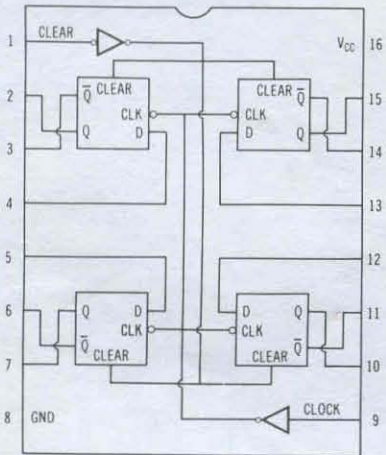

U1D, U1E, U4G

2114L-3

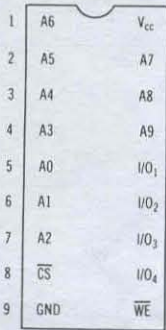

U1F, U1G, U2C, U2D, U2E, U2F

N8T26N

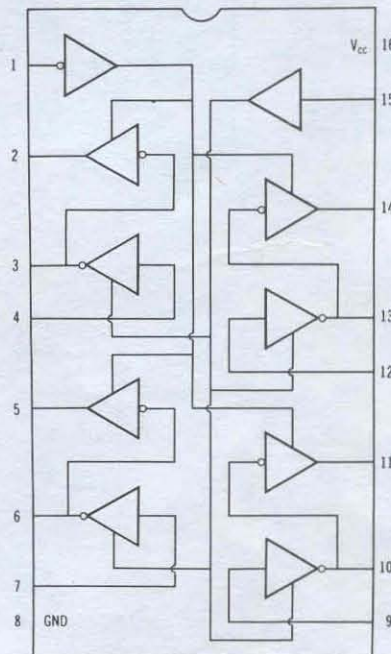

U1H, U2G, U2H, U3H, U3I

74LS86PC

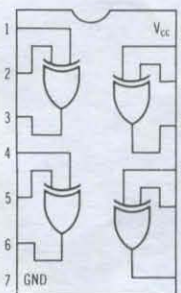

U2B

SN7492AN

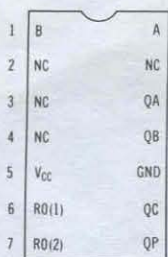

U3B

74LS157N
74LS157PC

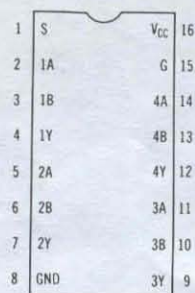

U3C, U5I, U5J, U5K, U6B

SN74165N

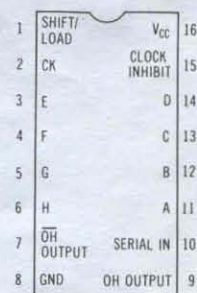

U3D

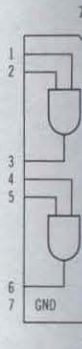

DM74LS16

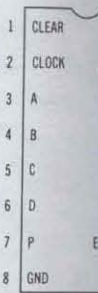

U5B, U5C, U5D, U5F, U5G, U5H

C4P/C4PMF — 540 BOARD PINOUTS

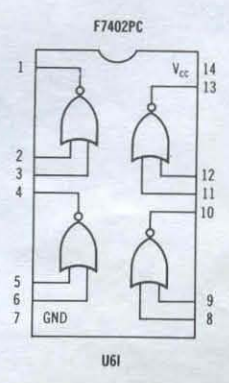
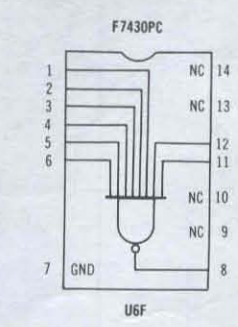
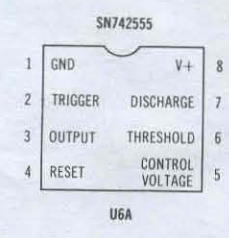
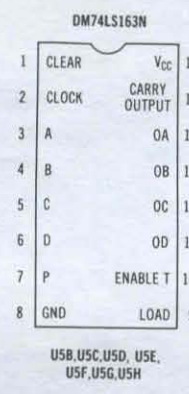
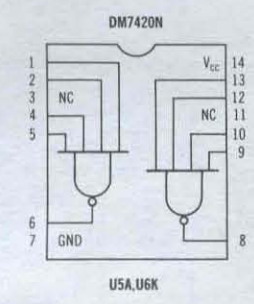
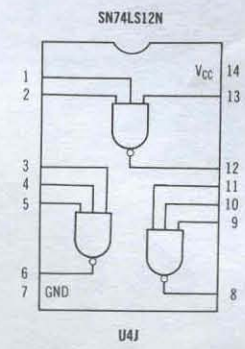
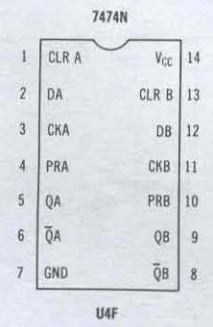
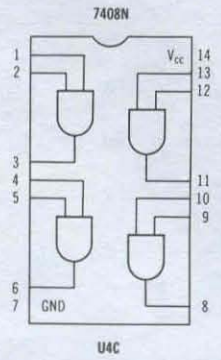
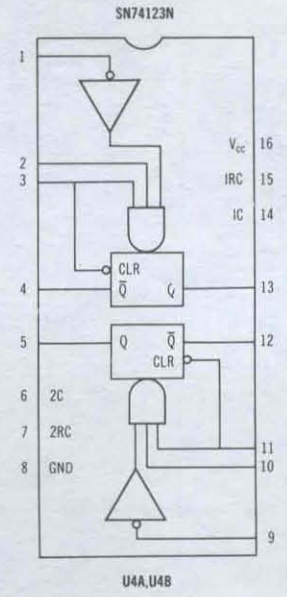
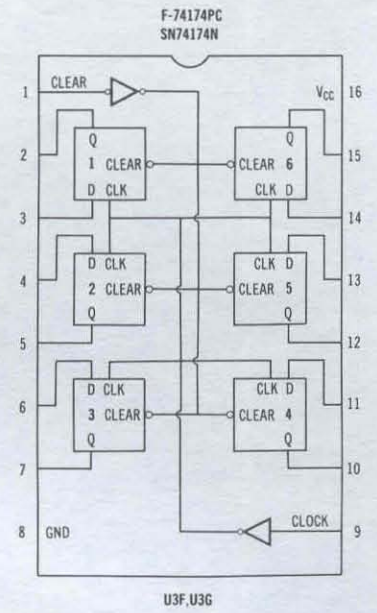
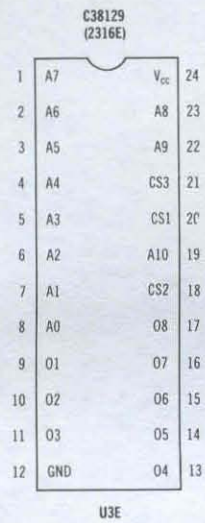

Waveform 1



5mSec 3.8V

Waveform 2



5mSec 3.8V

Waveform 3



10μSec 4.2V

Waveform 4

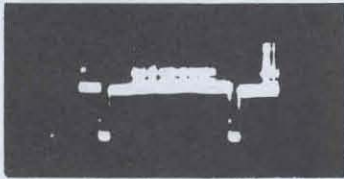

10μSec 0.4V

Waveform 5

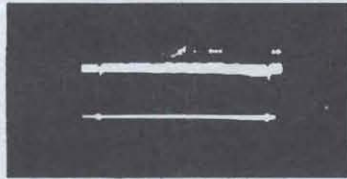

2μSec 0.4V

Waveform 6

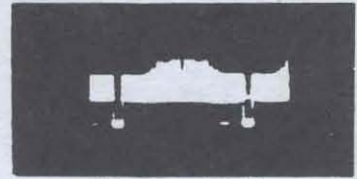

10μSec 0.5V
With color

Waveform 7

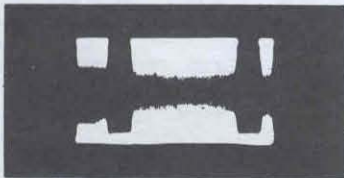

10μSec 3.8V

Waveform 8

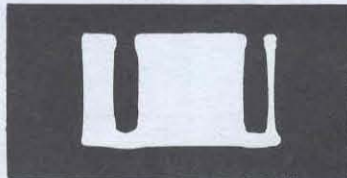

10μSec 4.0V

Waveform 9

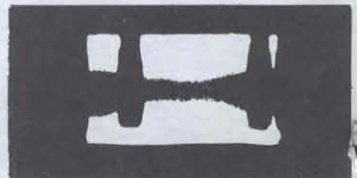

10μSec 4.0V

Waveform 10

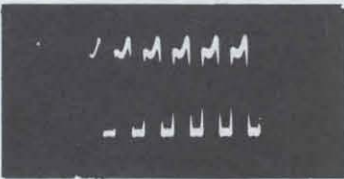

0.2μSec 3.2V

Waveform 11

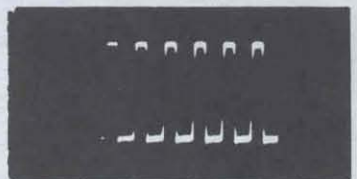

0.2μSec 3.9V

WAVEFORMS TAKEN IN "BASIC" MODE UNLESS OTHERWISE INDICATED

BACKPLANE

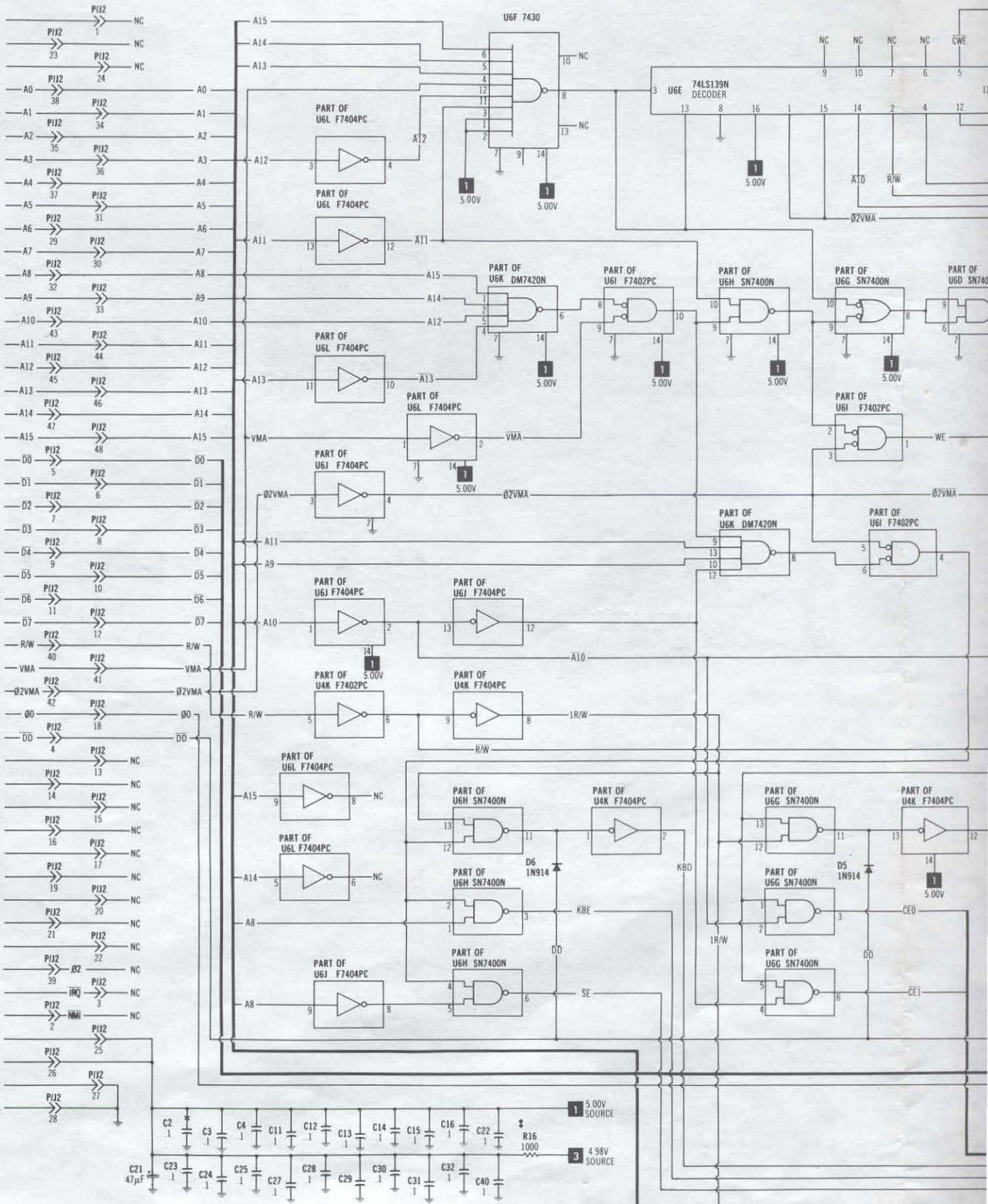

A PHOTOFAC STANDARD NOTATION SCHEMATIC
WITH **CIRCUITRACE™**

© Howard W. Sams & Co., Inc. 1980

C4P/C4PMF — 540 BOARD

3-161
4-165

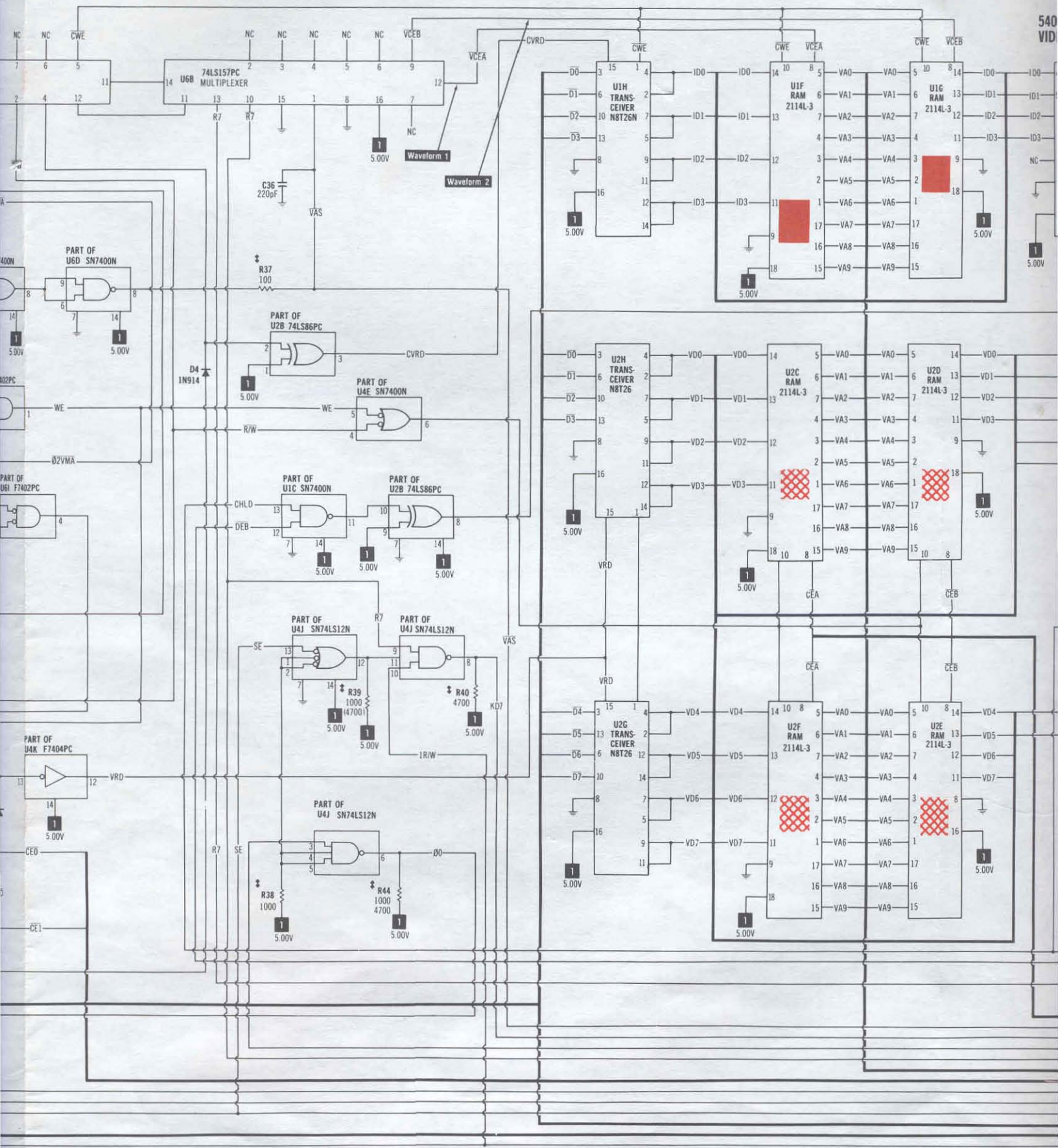

3-061
4-069

FOR COLOR KEYED TROUBLESHOOTING SEE PAGES 5 THRU 13.

FOR

**540 BOARD
VIDEO COLOR**

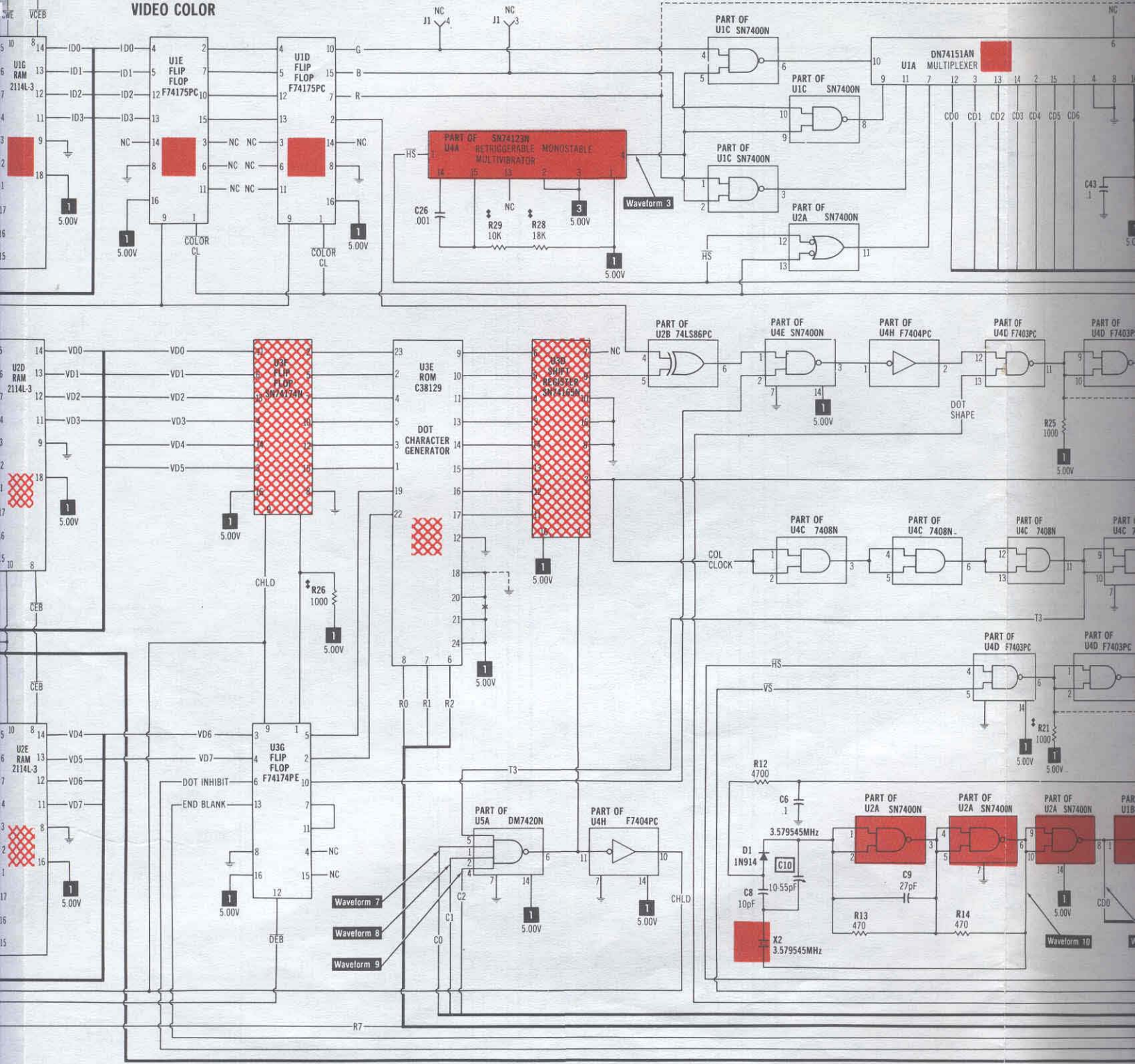

FOR SCHEMATIC LEGEND AND NOTES SEE PAGES 91, 92 & INSIDE REAR COVER

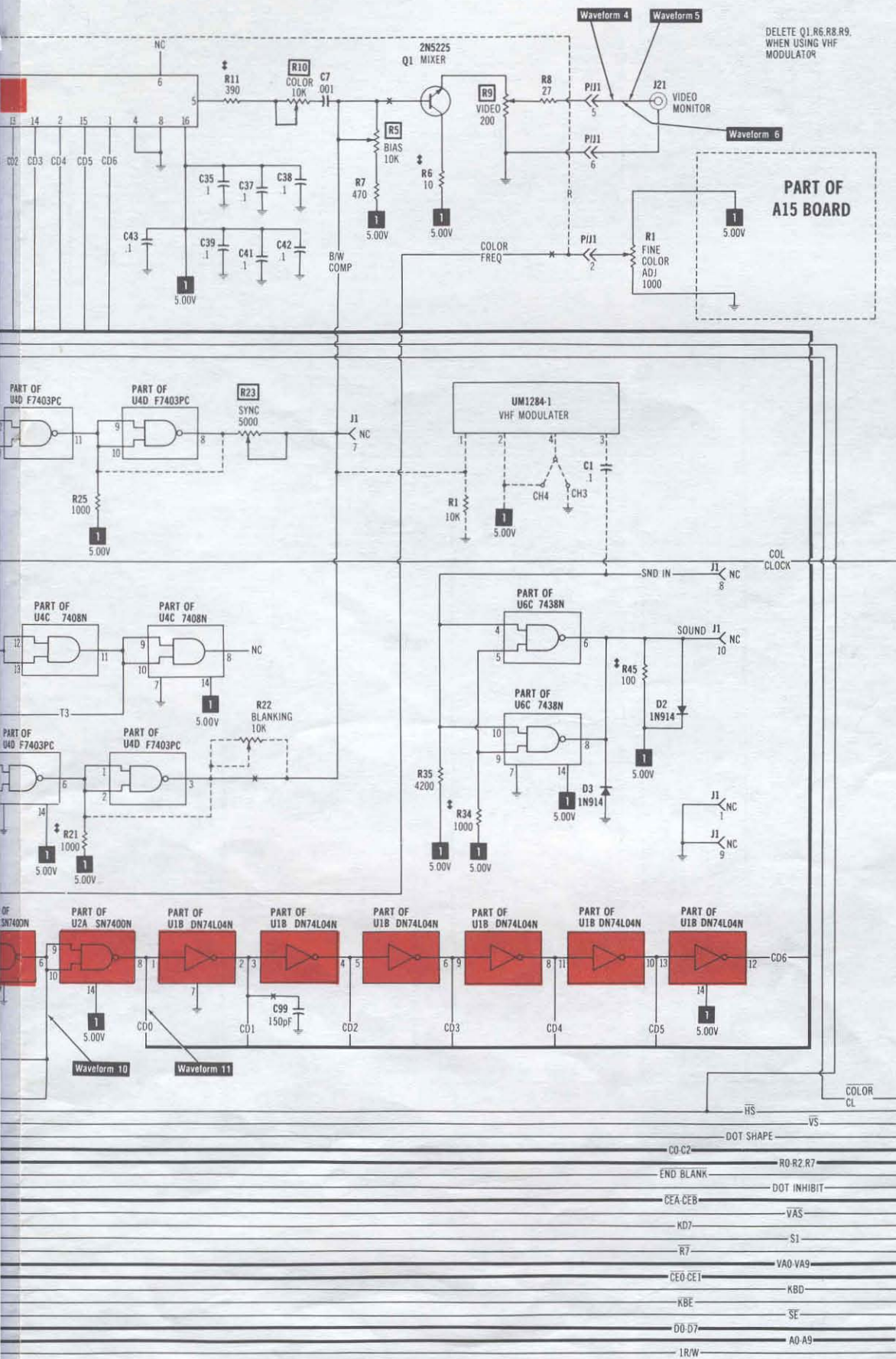

C4P/C4PMF — 540 BOARD

540 BOARD
VIDEO COLOR

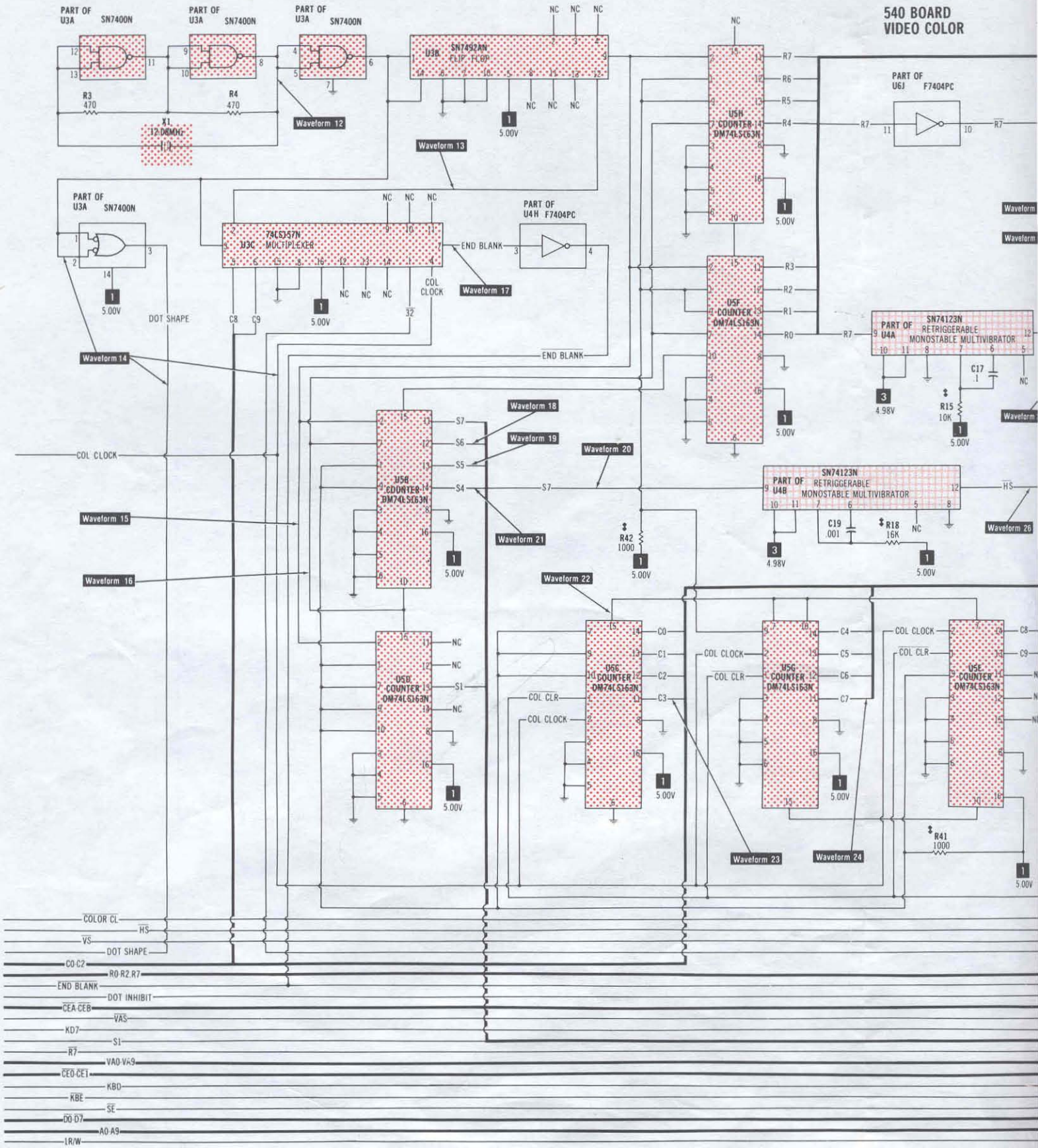

A PHOTOFAC STANDARD NOTATION SCHEMATIC
WITH **CIRCUITRACE**[™]
© Howard W. Sams & Co., Inc. 1980

C4P/C4PMF — 540 BOARD

FOR COLOR KEY
FOR SCHEMATIC

**540 BOARD
VIDEO COLOR**

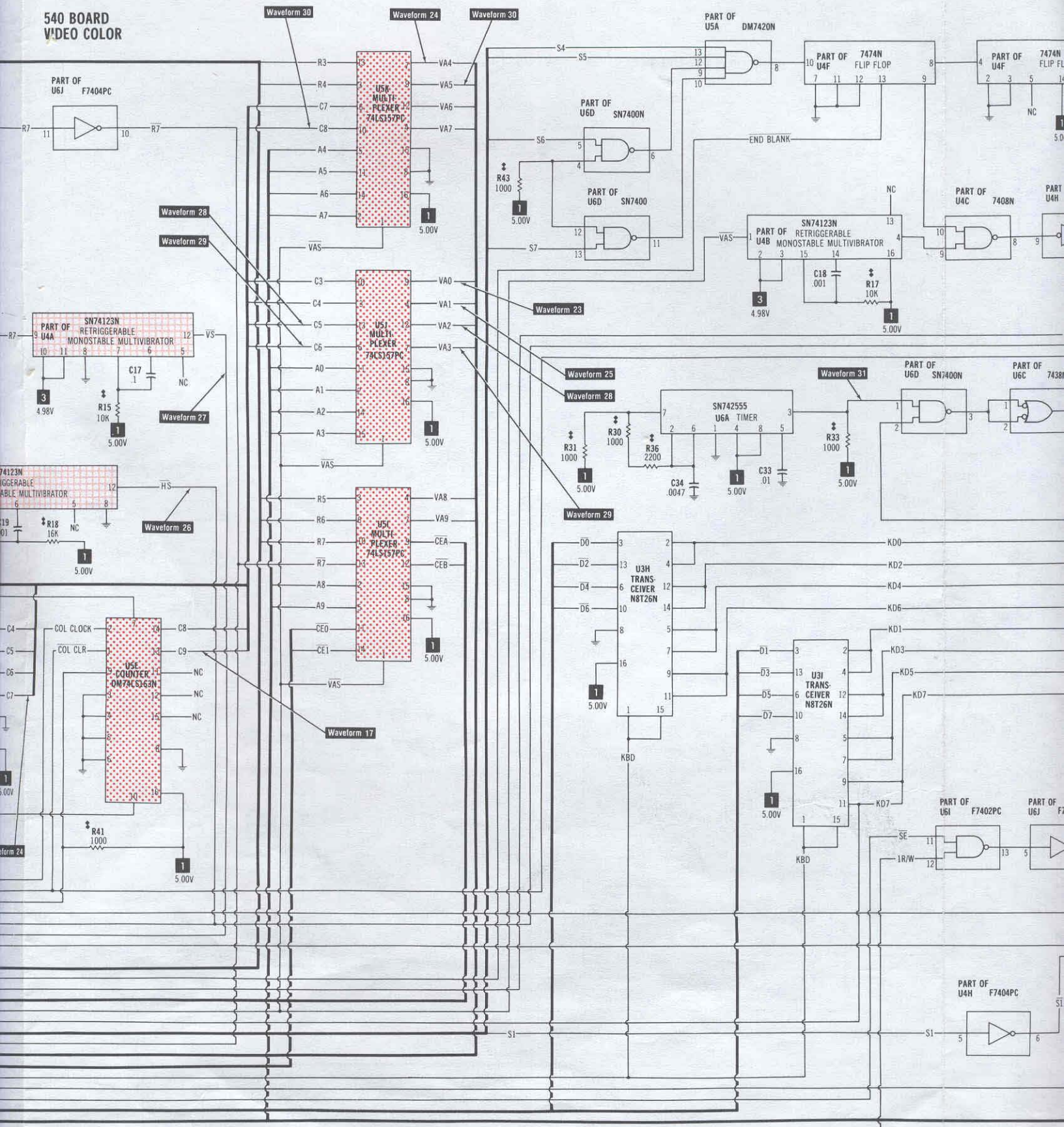

**FOR COLOR KEYED TROUBLESHOOTING SEE PAGES 5 THRU 13.
FOR SCHEMATIC LEGEND AND NOTES SEE PAGES 91, 92 & INSIDE REAR COVER**

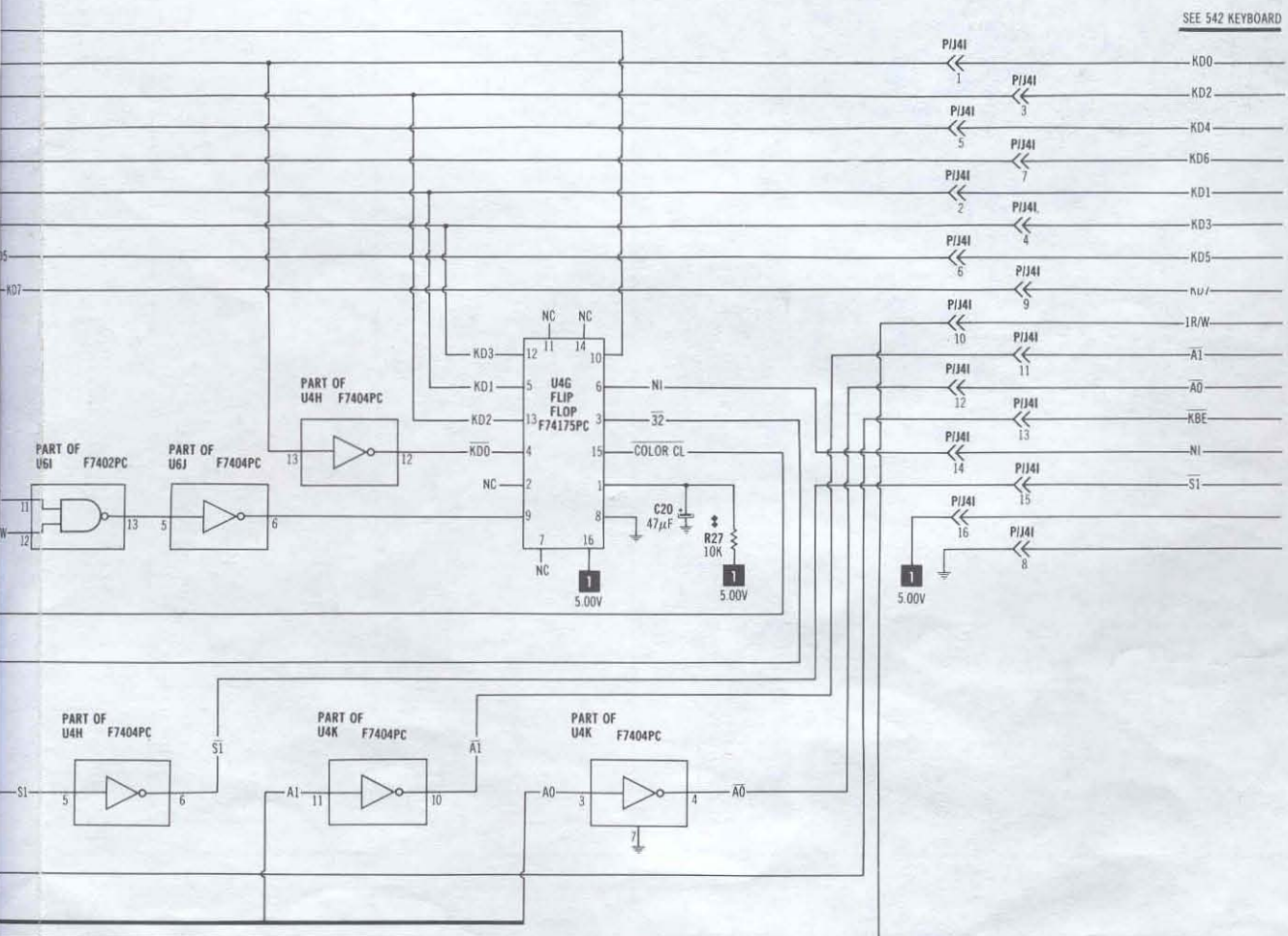
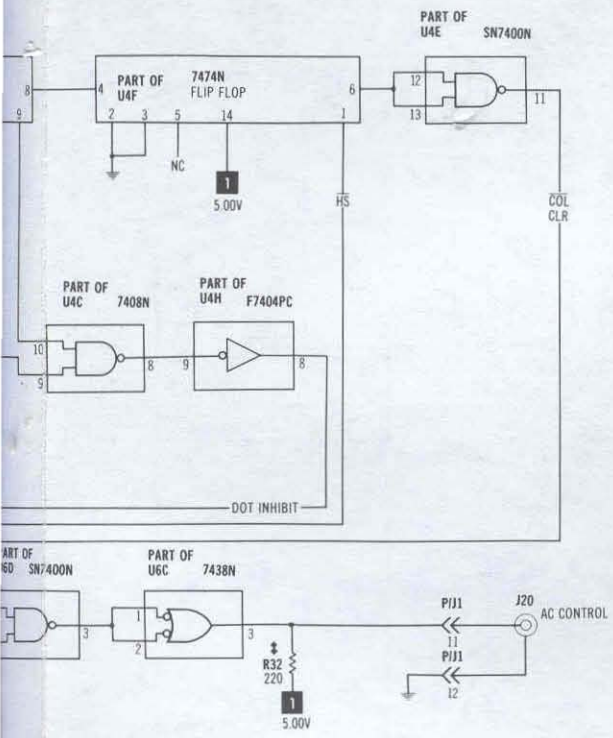

C4P/C4PMF — 540 BOARD

WAVEF

Waveform 12

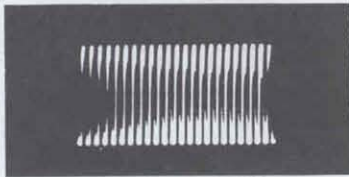

0.2 μ Sec 3.2V

Waveform 13

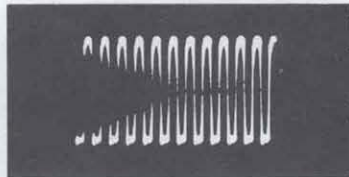

0.2 μ Sec 4.0V

Waveform 14

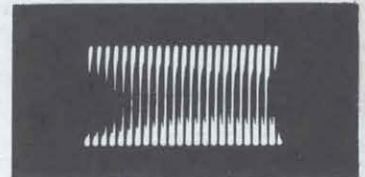

0.2 μ Sec 3.8V

Waveform 15

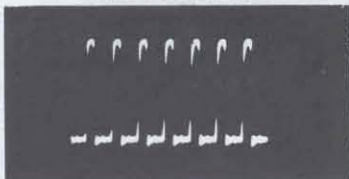

0.2 μ Sec 3.8V

Waveform 16

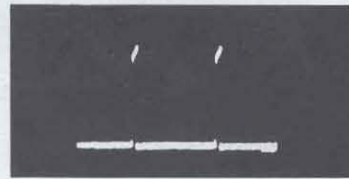

1 μ Sec 4.0V

Waveform 17

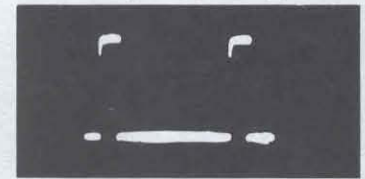

10 μ Sec 4.4V

Waveform 18



10 μ Sec 4.4V

Waveform 19

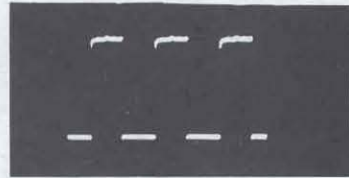

5 μ Sec 4.4V

Waveform 20

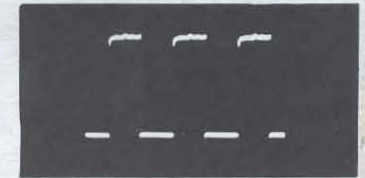

20 μ Sec 4.4V

Waveform 21



2 μ Sec 4.4V

Waveform 22

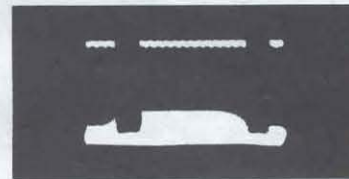

10 μ Sec 3.8V

Waveform 23

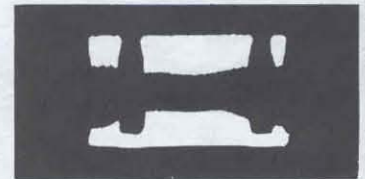

10 μ Sec 4.3V

Waveform 24

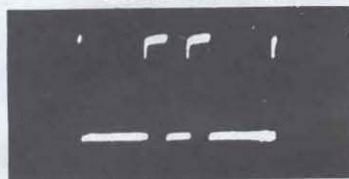

10 μ Sec 4.6V

Waveform 25

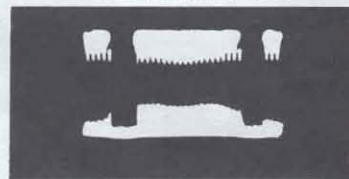

10 μ Sec 4.3V

Waveform 26

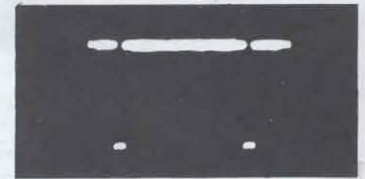

10 μ Sec 4.2V

WAVEFORMS TAKEN IN "BASIC" MODE UNLESS OTHERWISE INDICATED

Waveform 27

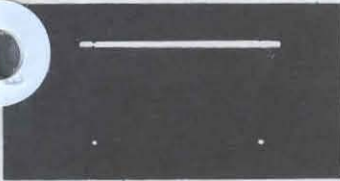

2mSec 4.3V

Waveform 28

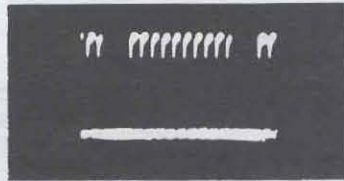

10 μ Sec 4.4V

Waveform 29

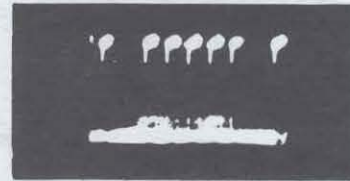

10 μ Sec 4.4V

Waveform 30

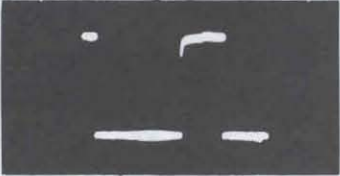

10 μ Sec 4.5V

Waveform 31



5 μ Sec 5.0V

WAVEFORMS TAKEN IN "BASIC" MODE UNLESS OTHERWISE INDICATED

ELECTRICAL ADJUSTMENTS

C4P/C4PMF — 540 BOARD

R9 VIDEO (MONITOR) AND R5 BIAS

Place computer into "BASIC" with color disabled. Enter the following program.

```
10 FOR X = 53248 TO 55295: POKE X,161: NEXT X: END
```

Type "RUN", Return.

Adjust R9 for best contrast, but do not allow unit to lose sync. Input of scope to Q1 emitter, adjust R5 for a peak level of 1.8 volts.

R23 SYNC

Input of scope to Q1 emitter. Adjust R23 for a sync pulse of .75 volts p-p.

R10 COLOR

With a color background displayed on monitor, connect scope to Q1 emitter. Adjust R10 for color burst signal of .6 volts p-p.

3.579545MHz SIGNAL

Input of frequency counter to U2A, Pin 8. Adjust C10 for 3.579545MHz.

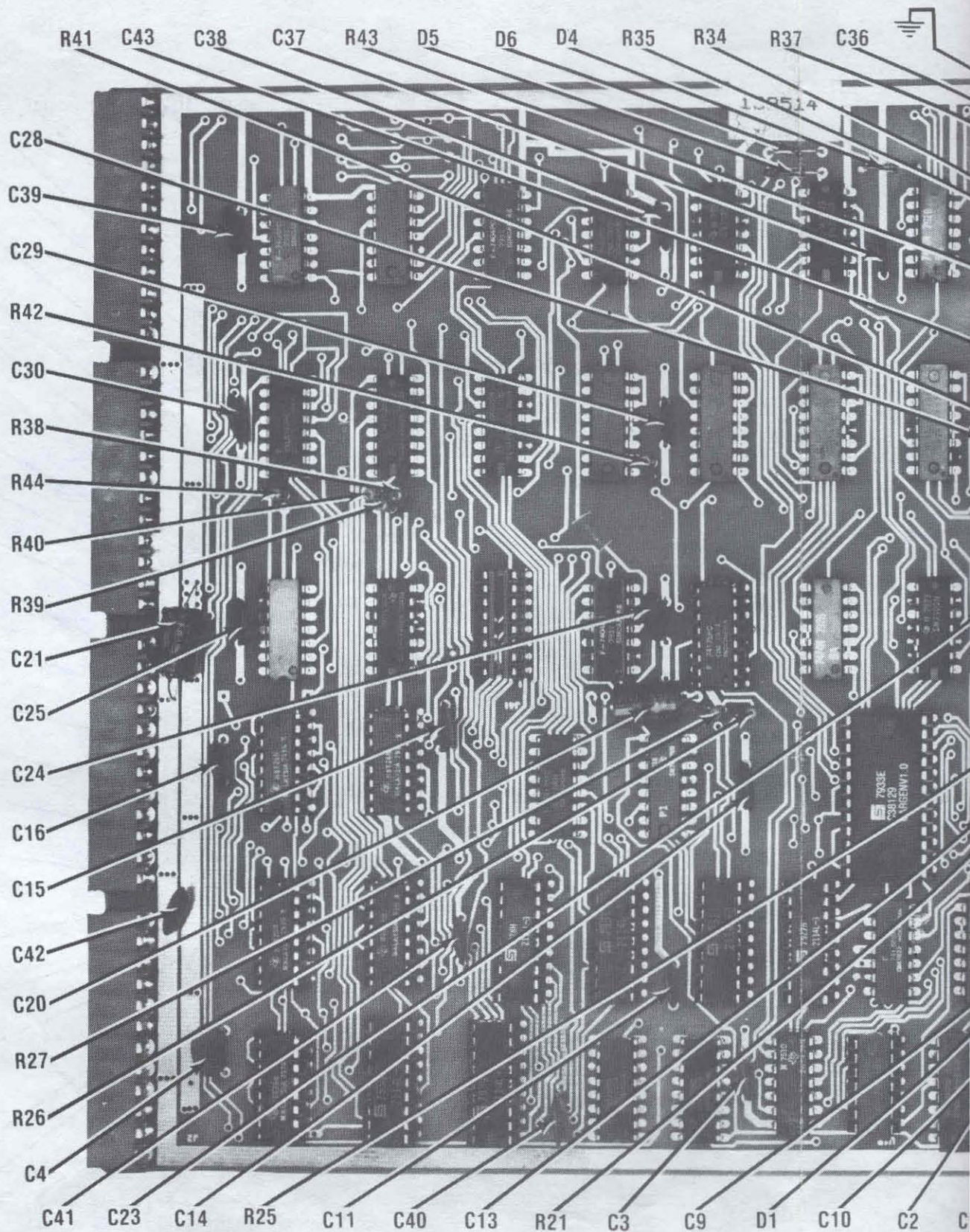

* LOCATED ON OTHER SIDE OF BOARD

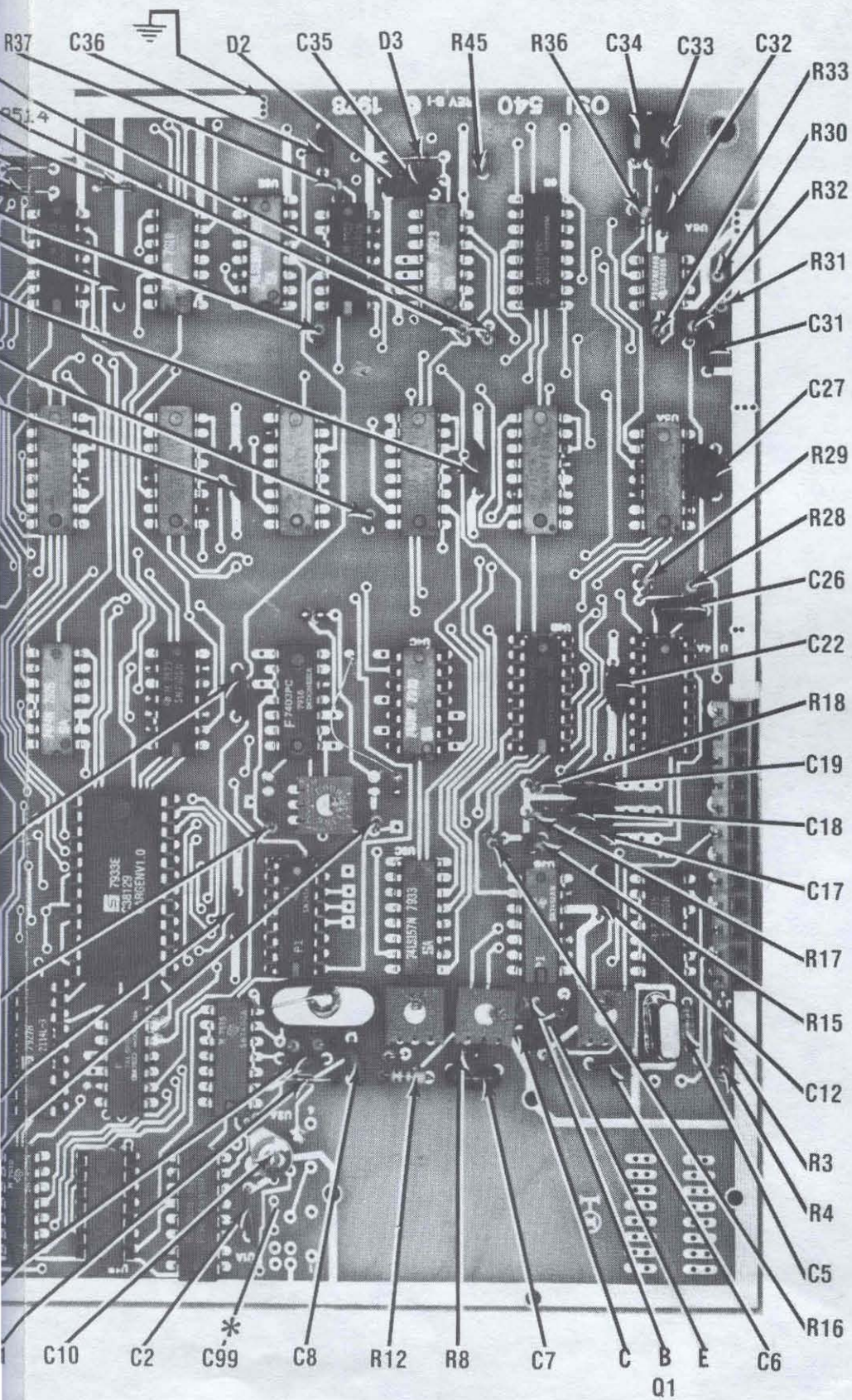

ELEC
 R17 T
 Input
 R75 D
 Conne
 Press
 Press
 Press
 Press
 Type
 Type
 Type
 Type
 Input
 640μS

C4P/C4PMF — 540 BOARD

C4P CH

ELECTRICAL ADJUSTMENTS

C4P — 502 BOARD

R17 TX CLOCK

Input of scope to U13, Pin 3. Adjust R17 for a full cycle width of $210\mu\text{Sec}$.

R75 DURATION (TAPE PULSE)

Connect jumper between Pins 10 and 11 of J2.

Press	"RESET"
Press	"C"
Press	"RETURN"
Press	"RETURN"
Type	10 Print "U"; Return
Type	20 Go TO 10 Return
Type	SAVE Return
Type	RUN Return

Input of scope to Pin 5 of U22. Adjust R75 for a positive pulse width of at least $500\mu\text{Sec}$. but not over $640\mu\text{Sec}$. Disconnect jumper.

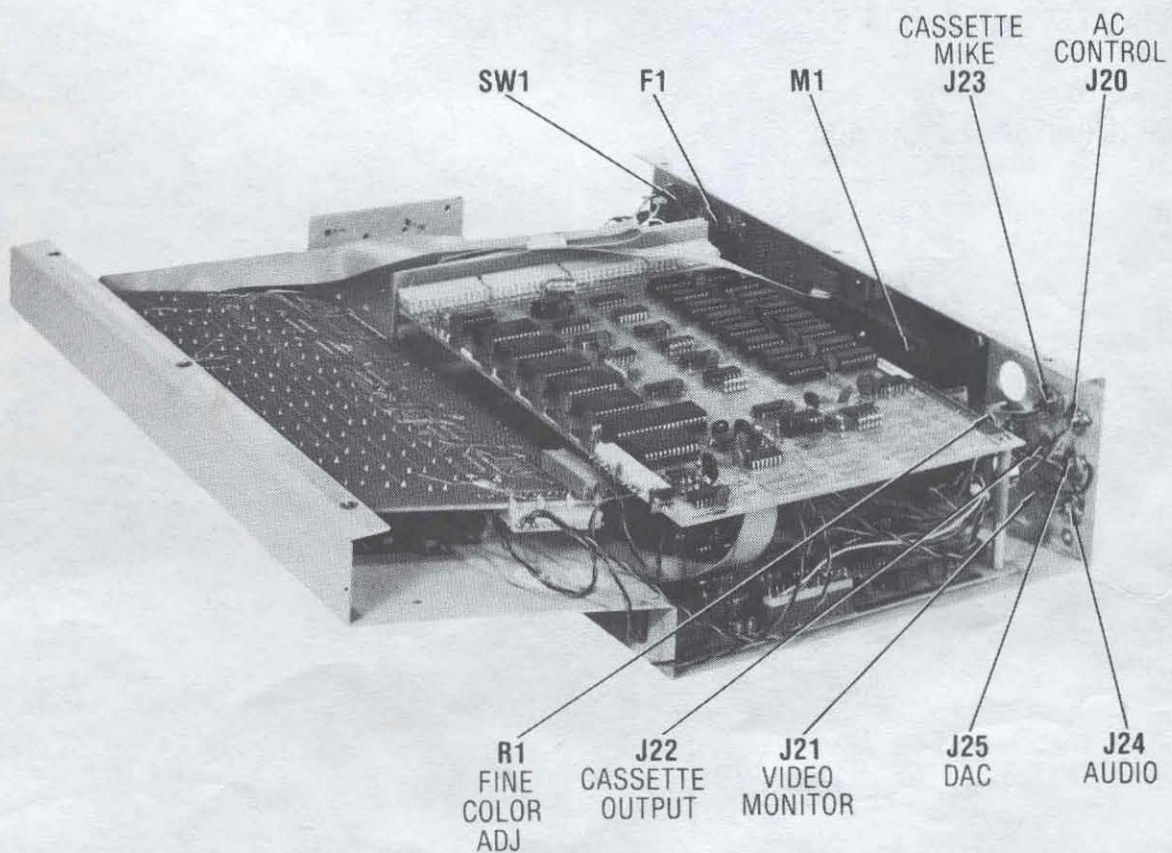

C4P CHASSIS-SIDE VIEW

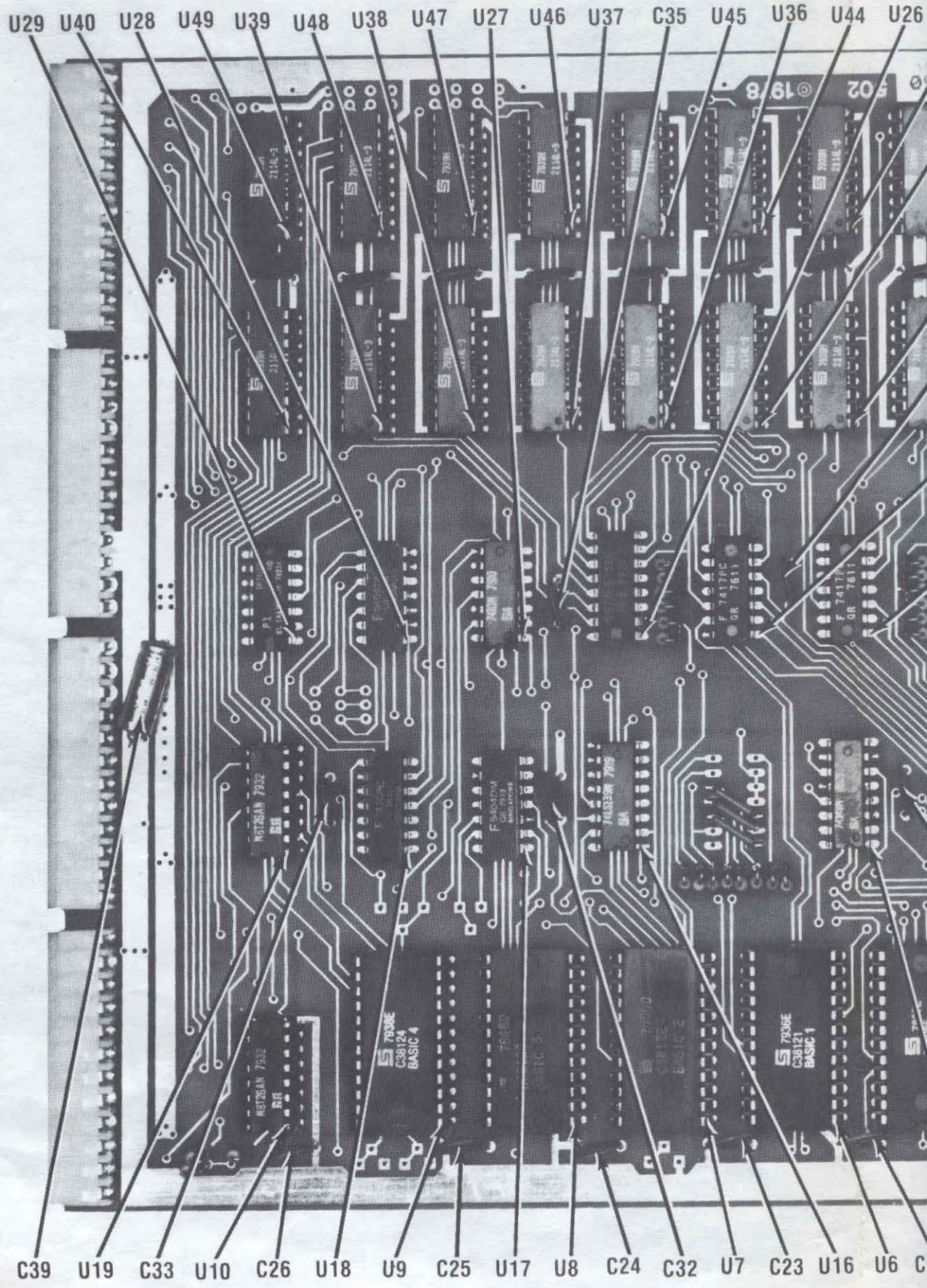

C4P — 502 BOARD

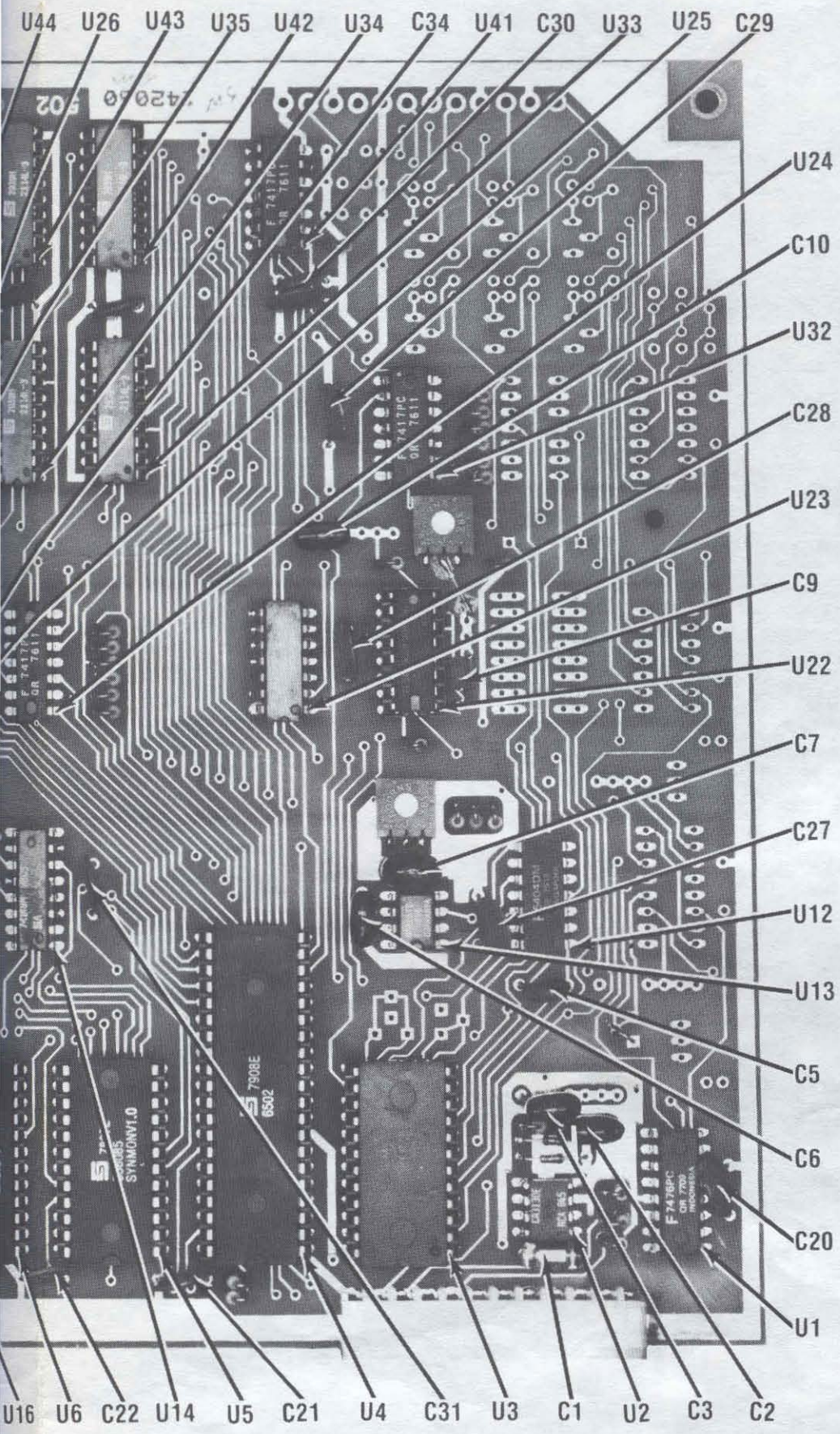

C4P — 502 BOARD

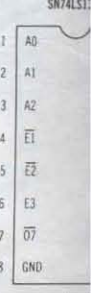
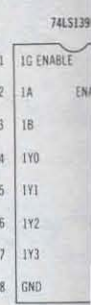
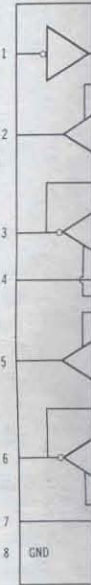

C4P — 502 BOARD PINOUTS

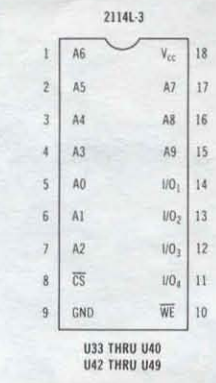
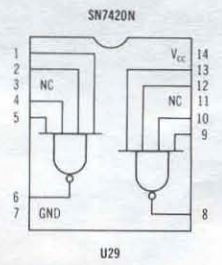
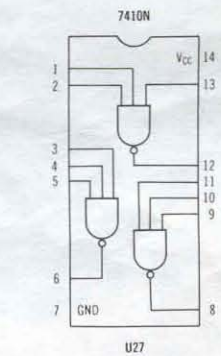
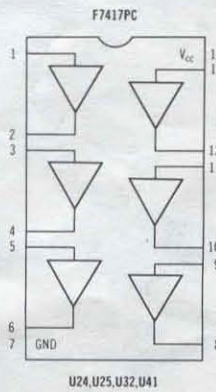
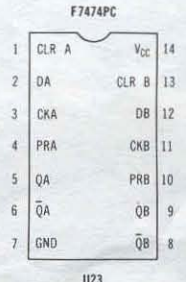
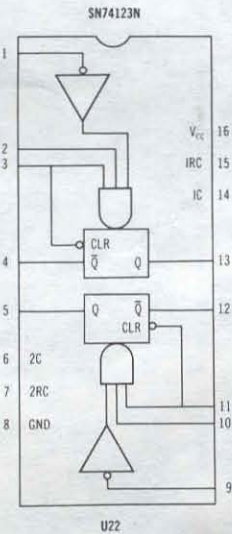
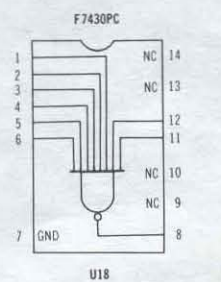
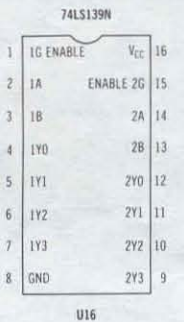
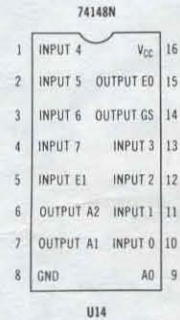
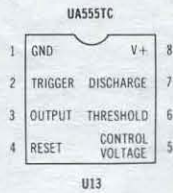
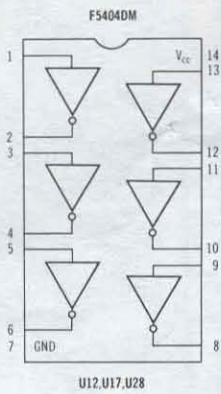
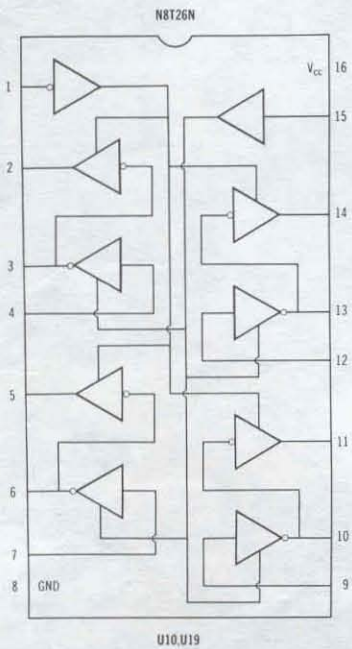
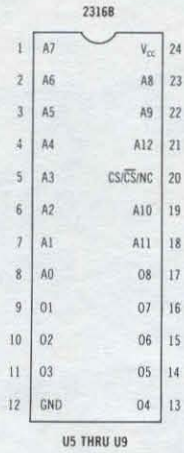
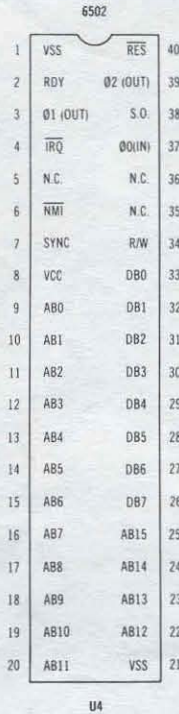
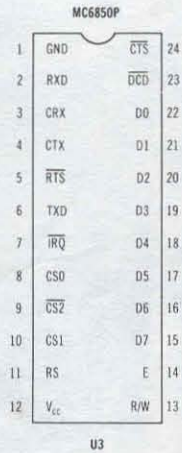
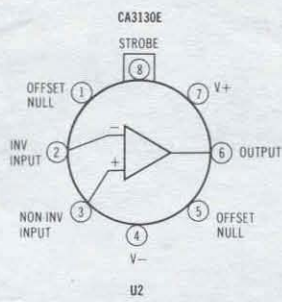
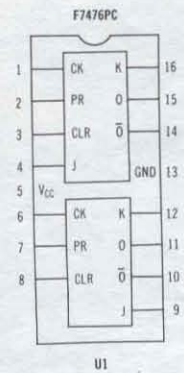

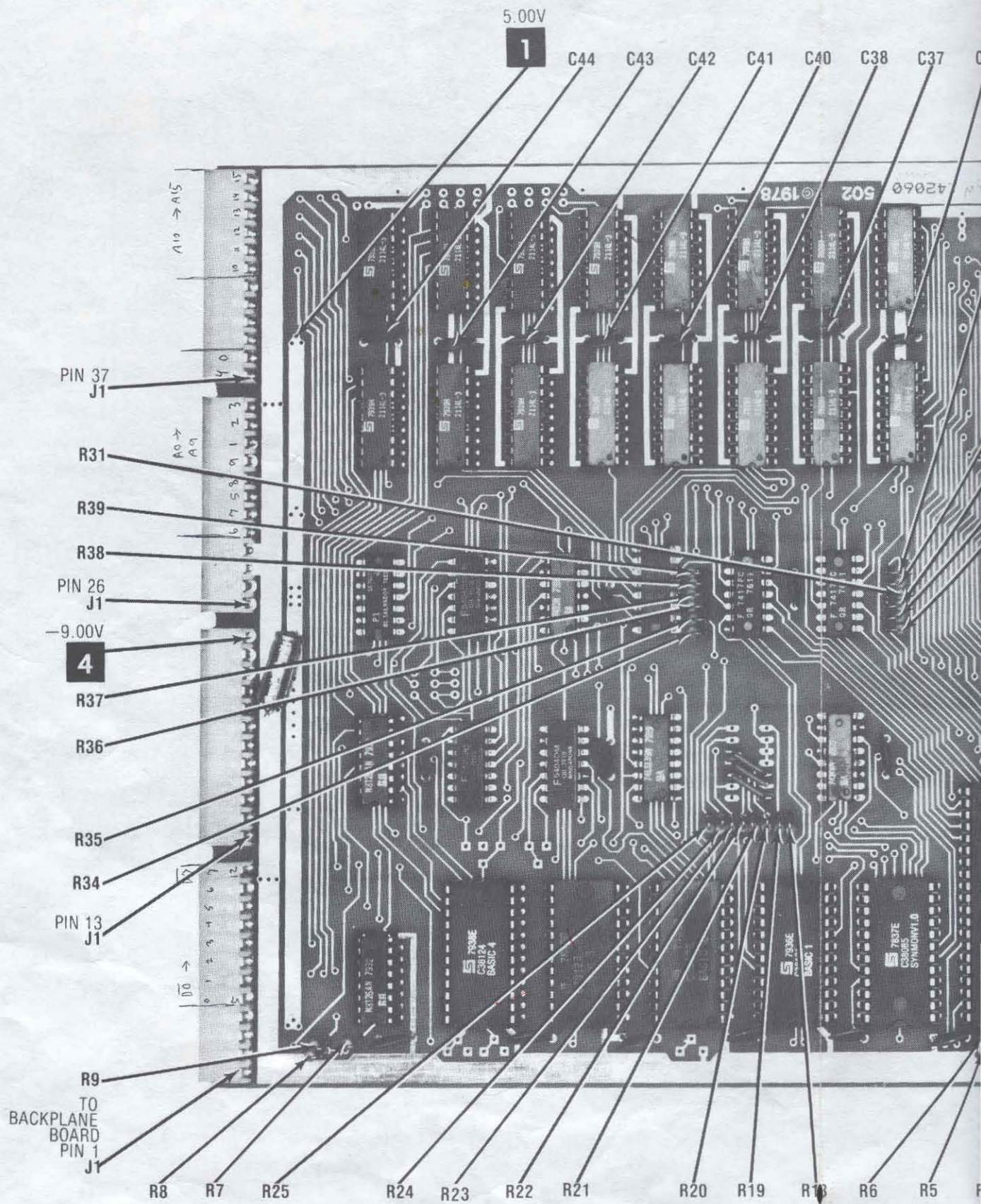

C4P — 502 BOARD

A Howard W. Sams CIRCUITRACE® Photo

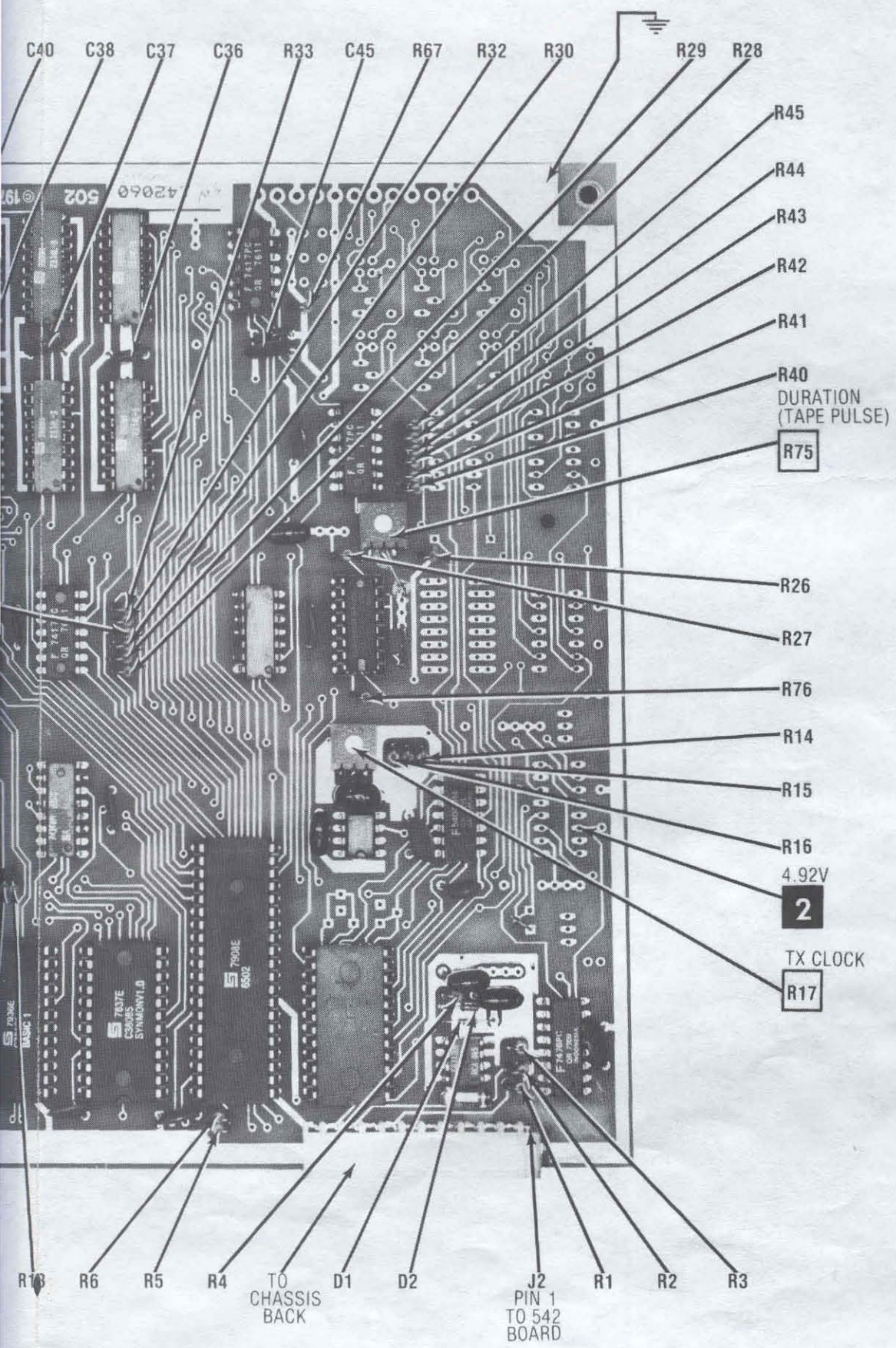

C4P — 502 BOARD



Waveform 33

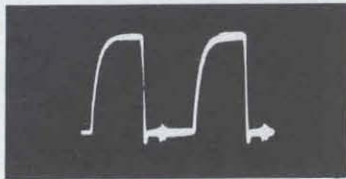

0.2 μ Sec 5.0V

Waveform 34



0.2 μ Sec 5.0V

Waveform 35

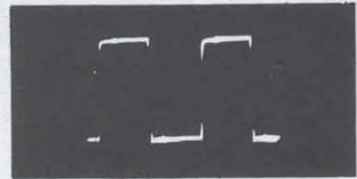

0.2 μ Sec 4.0V

Waveform 36



50 μ Sec 3.8V

Waveform 37

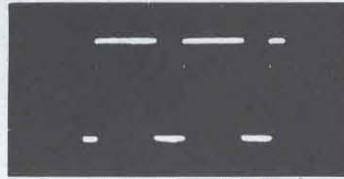

50 μ Sec 5.0V

Waveform 38

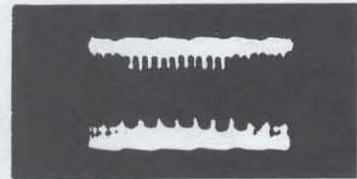

0.5mSec 4.0V

Waveform 39

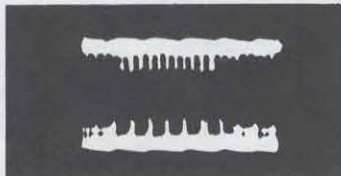

0.5mSec 4.3V

Program transferred from
tape

Waveform 40

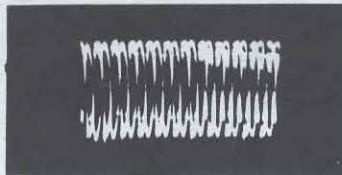

0.5mSec 4.3V

Program transferred from
tape

Waveform 41

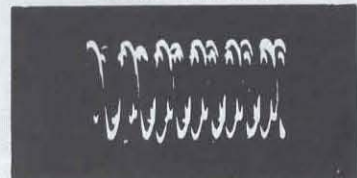

1mSec 1.1V

Program transferred from
tape

Waveform 42

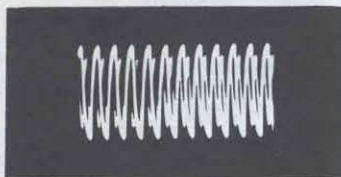

1mSec 5.0V

Amplitude depends on tape volume
Program transferred from tape

Waveform 43



5mSec 4.3V

Program to tape

Waveform 44

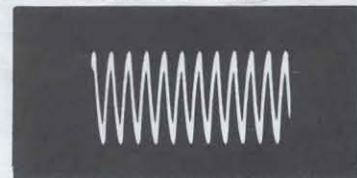

0.5mSec 22mV

Tape mode prior to program
storage

Waveform 45

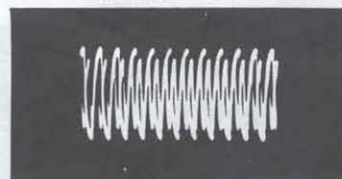

1mSec 28mV

Program to tape

WAVEFORMS TAKEN IN "BASIC" MODE UNLESS OTHERWISE INDICATED

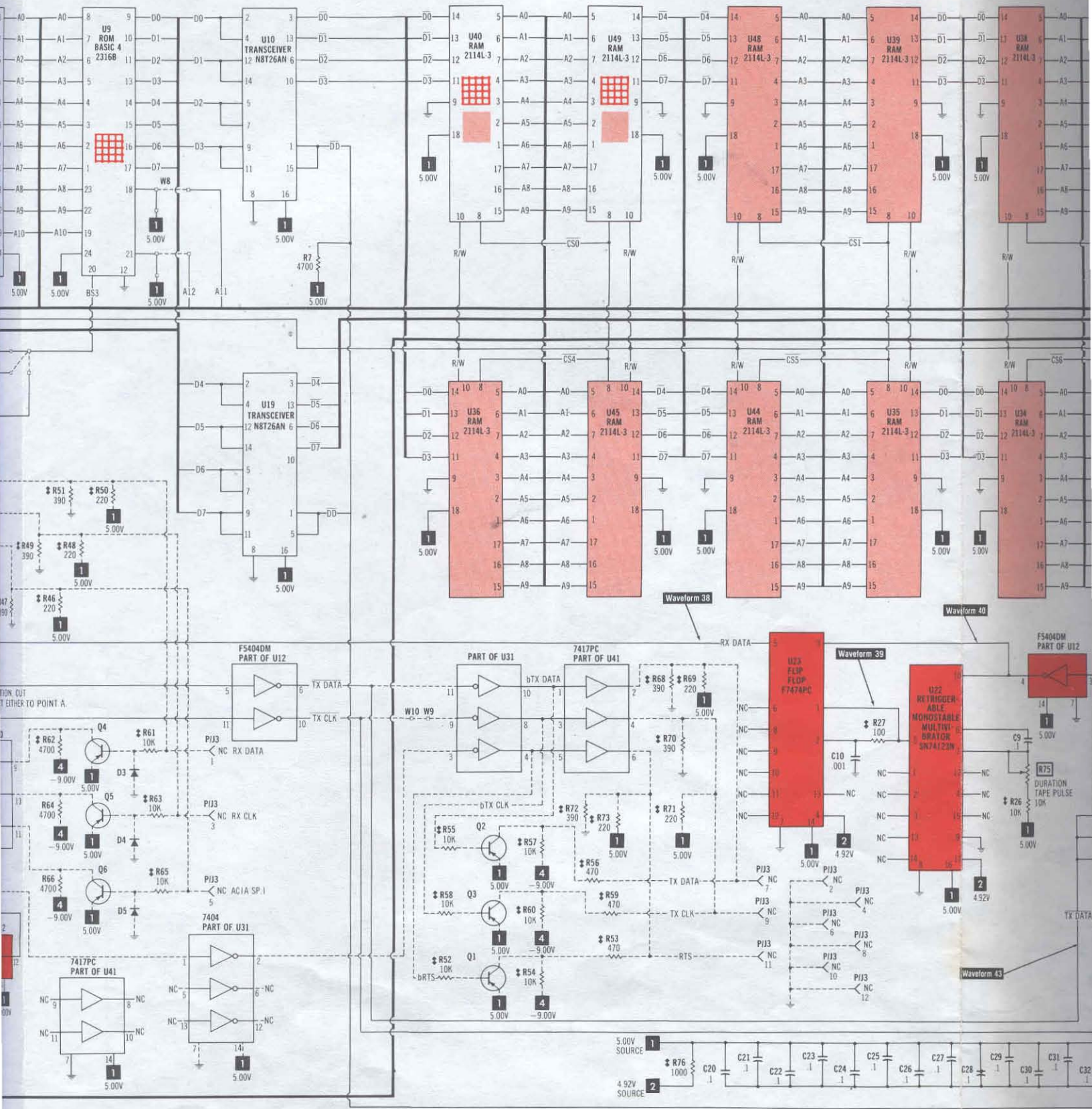

FOR SCHEMATIC LEGEND AND NOTES SEE PAGES 91, 92 & INSIDE REAR COVER

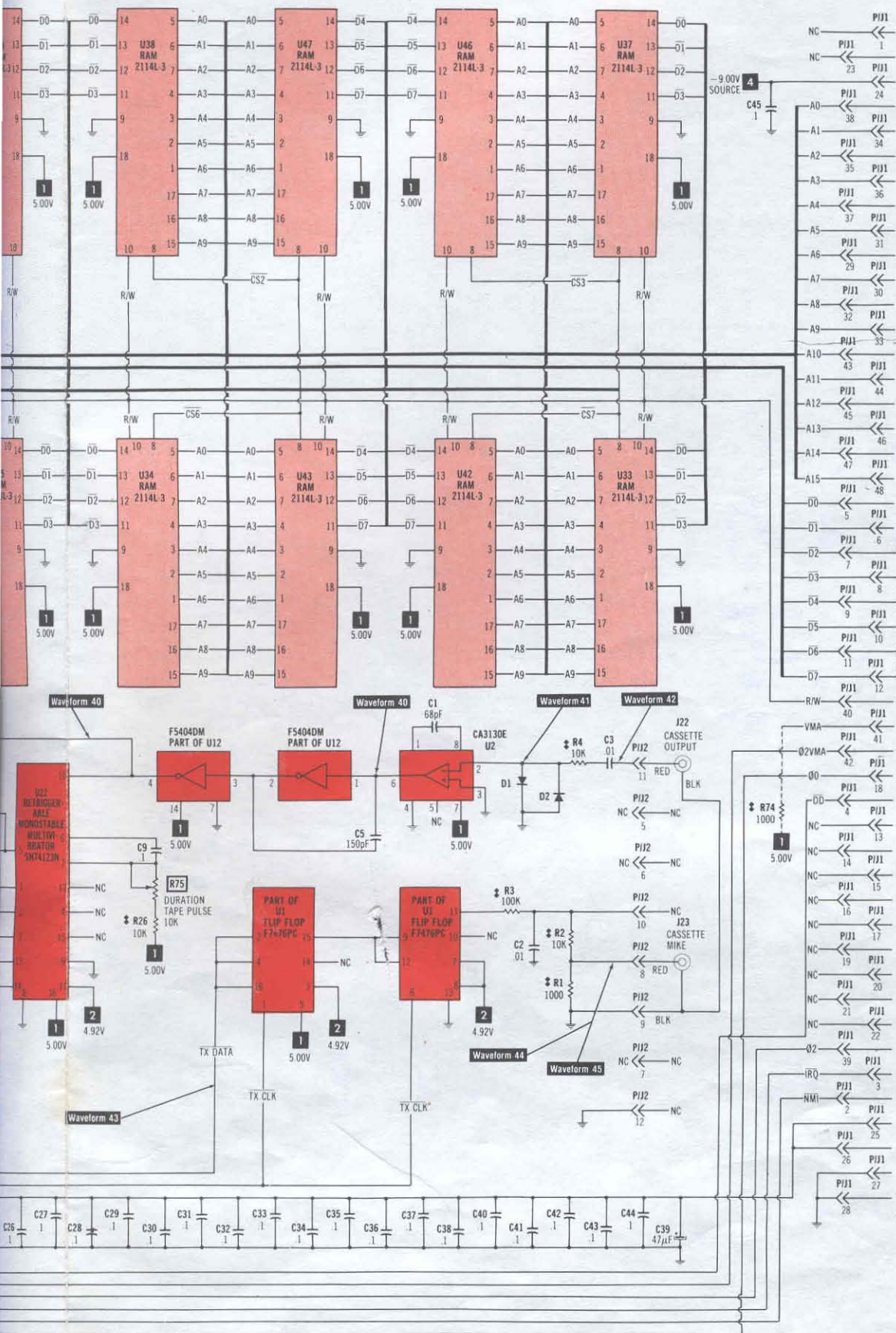

BACKPLANE

C4P — 502 BOARD

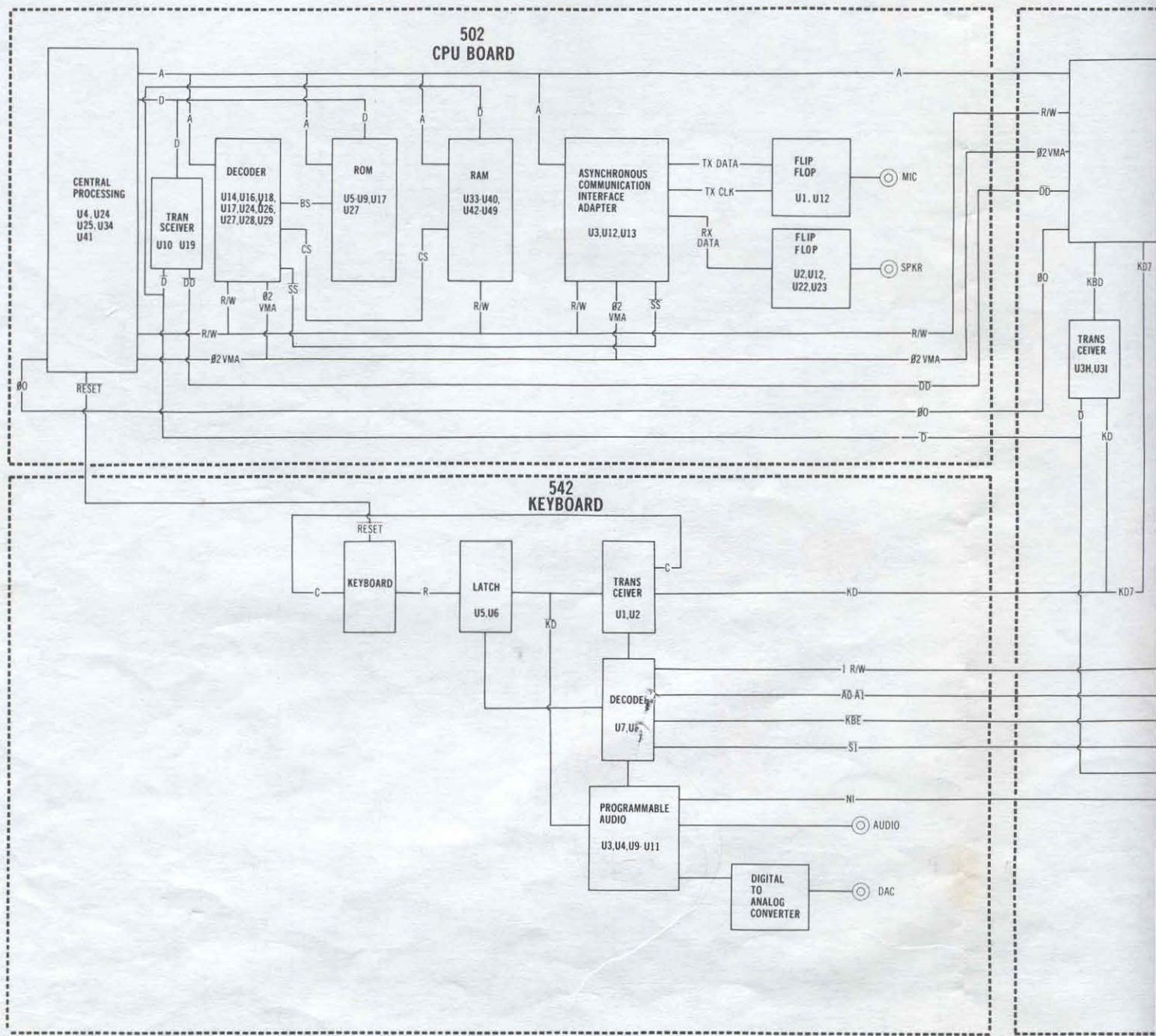

C4P BODY BLOCK DIAGRAM

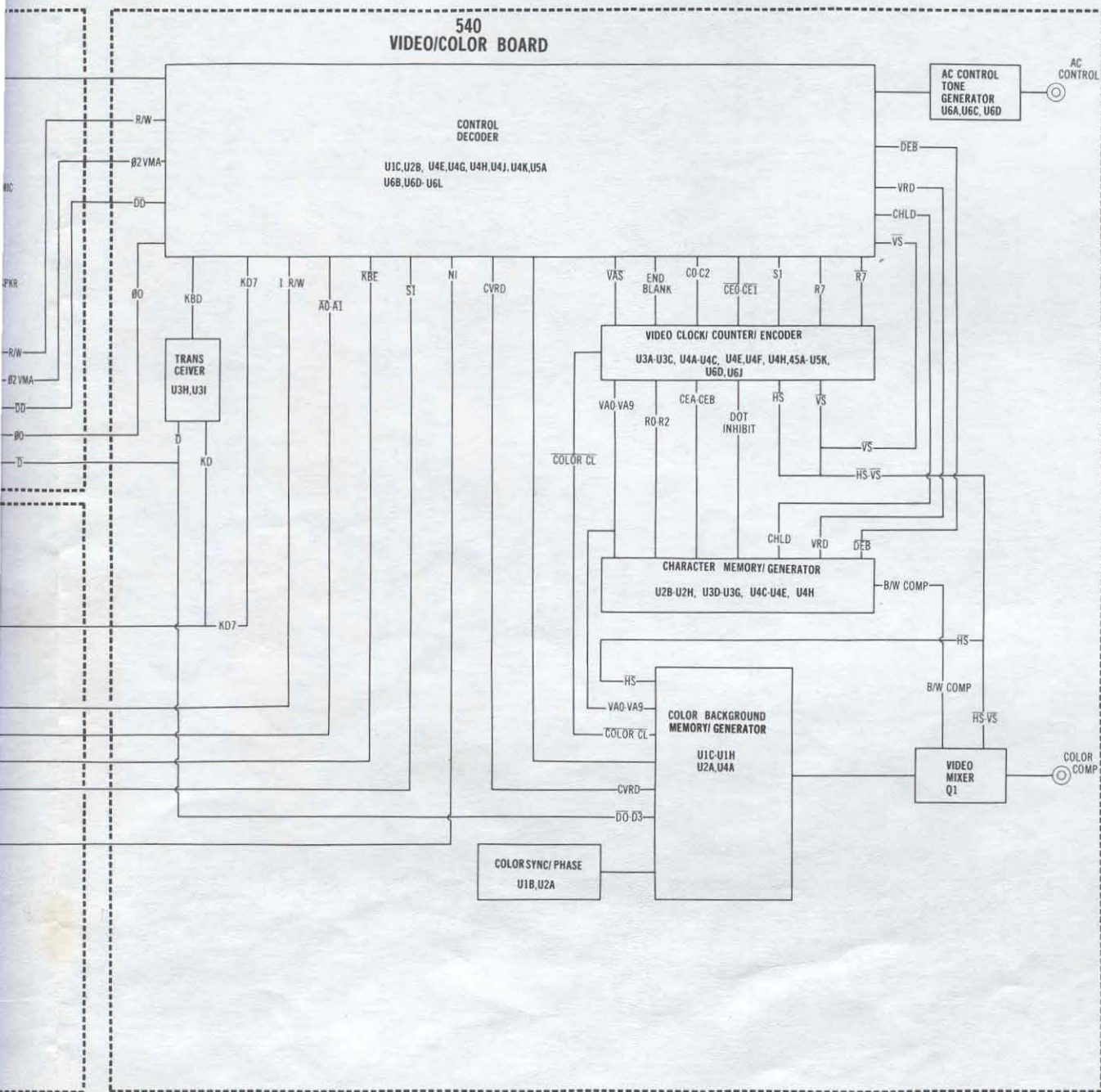

C4P BODY BLOCK DIAGRAM

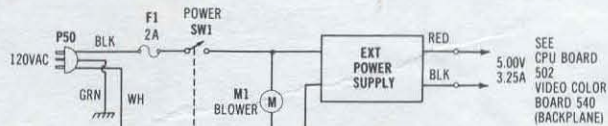
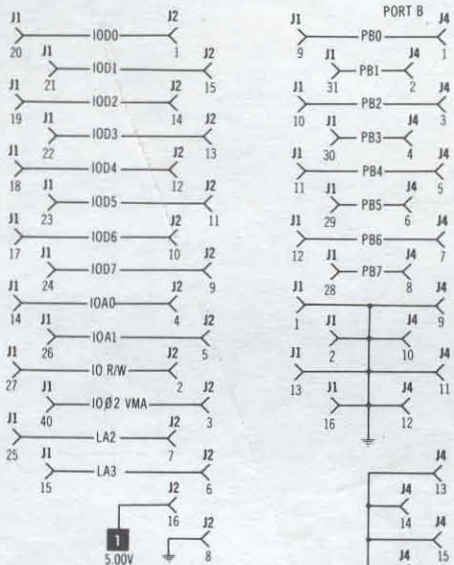

SEE
CPU BOARD
502
VIDEO COLOR
BOARD 540
(BACKPLANE)

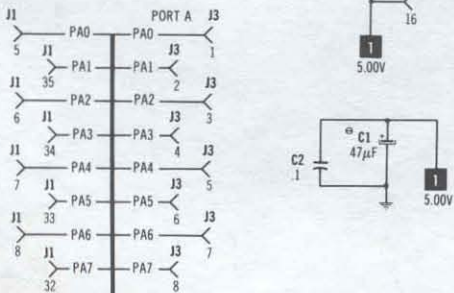

**PART OF I/O
CONNECTOR
BOARD A15**

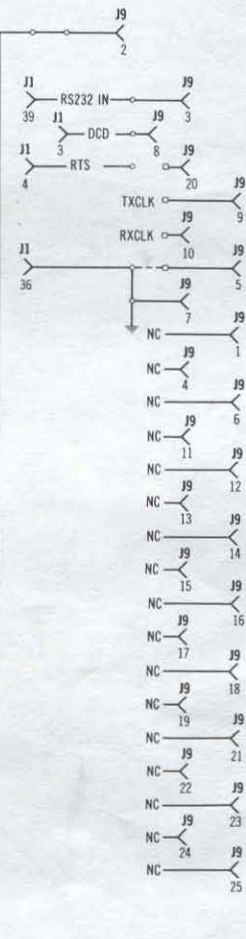
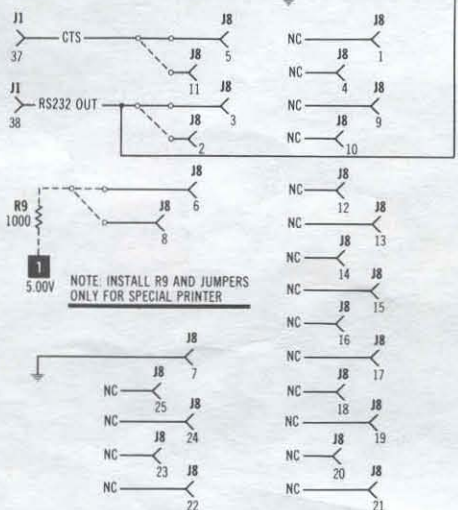
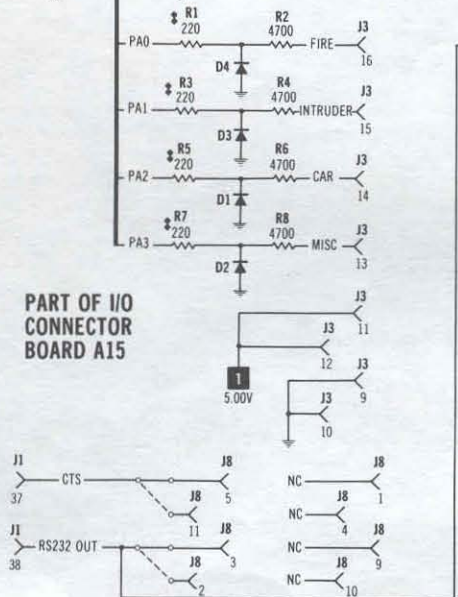

**FOR SCHEMATIC
LEGEND AND NOTES
SEE PAGES 91, 92
& INSIDE REAR COVER**

A PHOTOFAC STANDARD NOTATION SCHEMATIC

WITH **CIRCUITRACE**

© Howard W. Sams & Co., Inc. 1980

C4P — A15 BOARD

C4P —

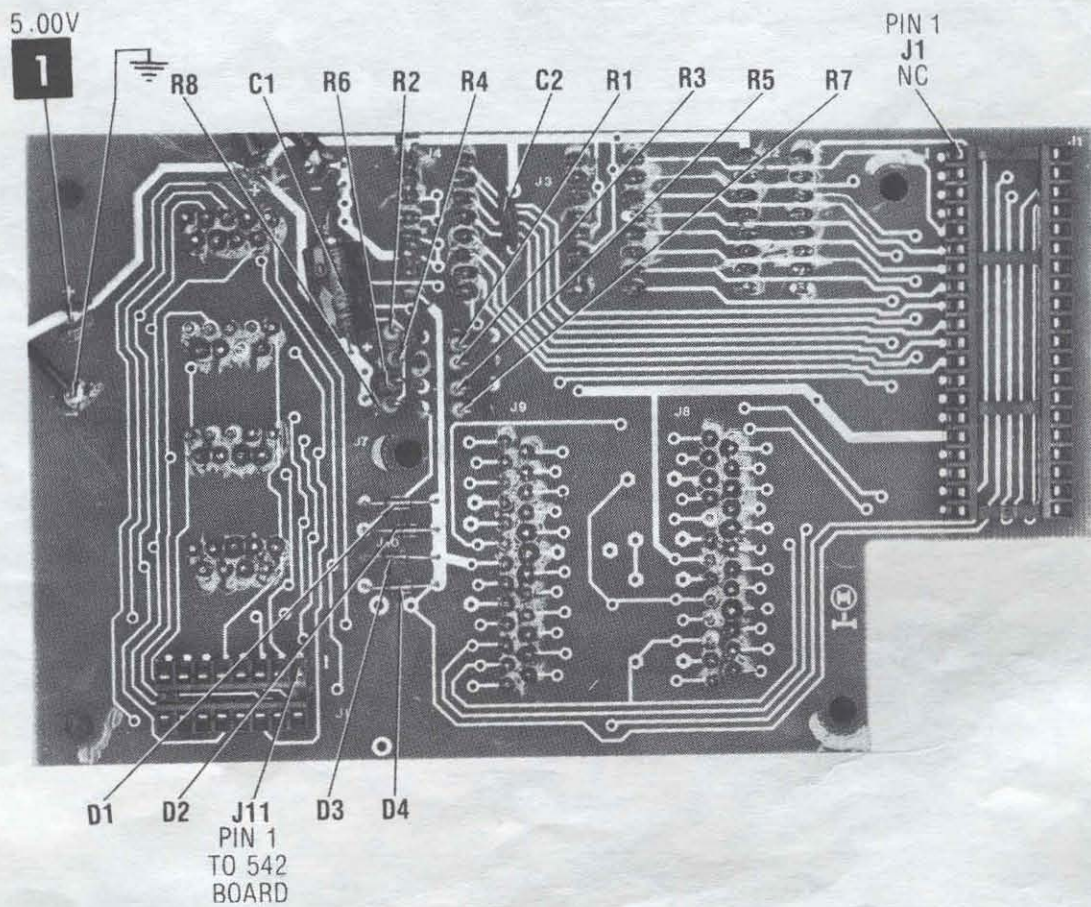
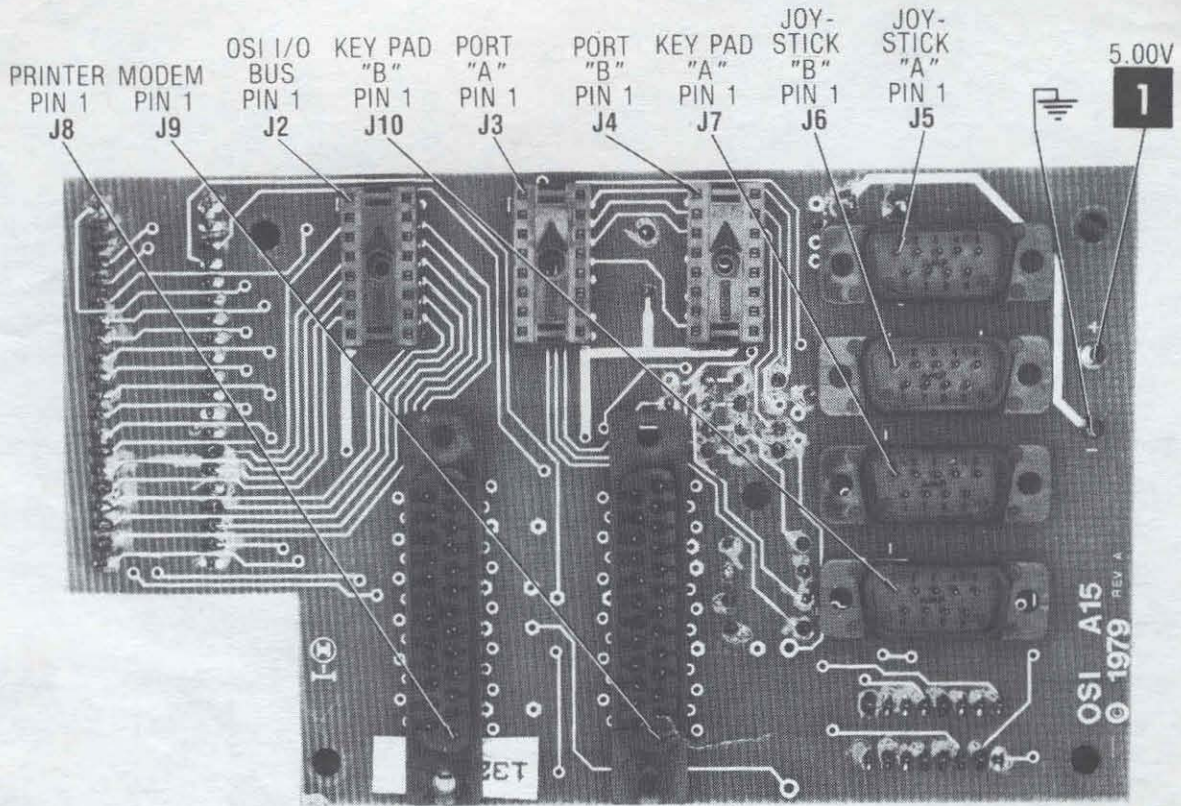

C4P — A15 BOARD A Howard W. Sams CIRCUITRACE® Photo

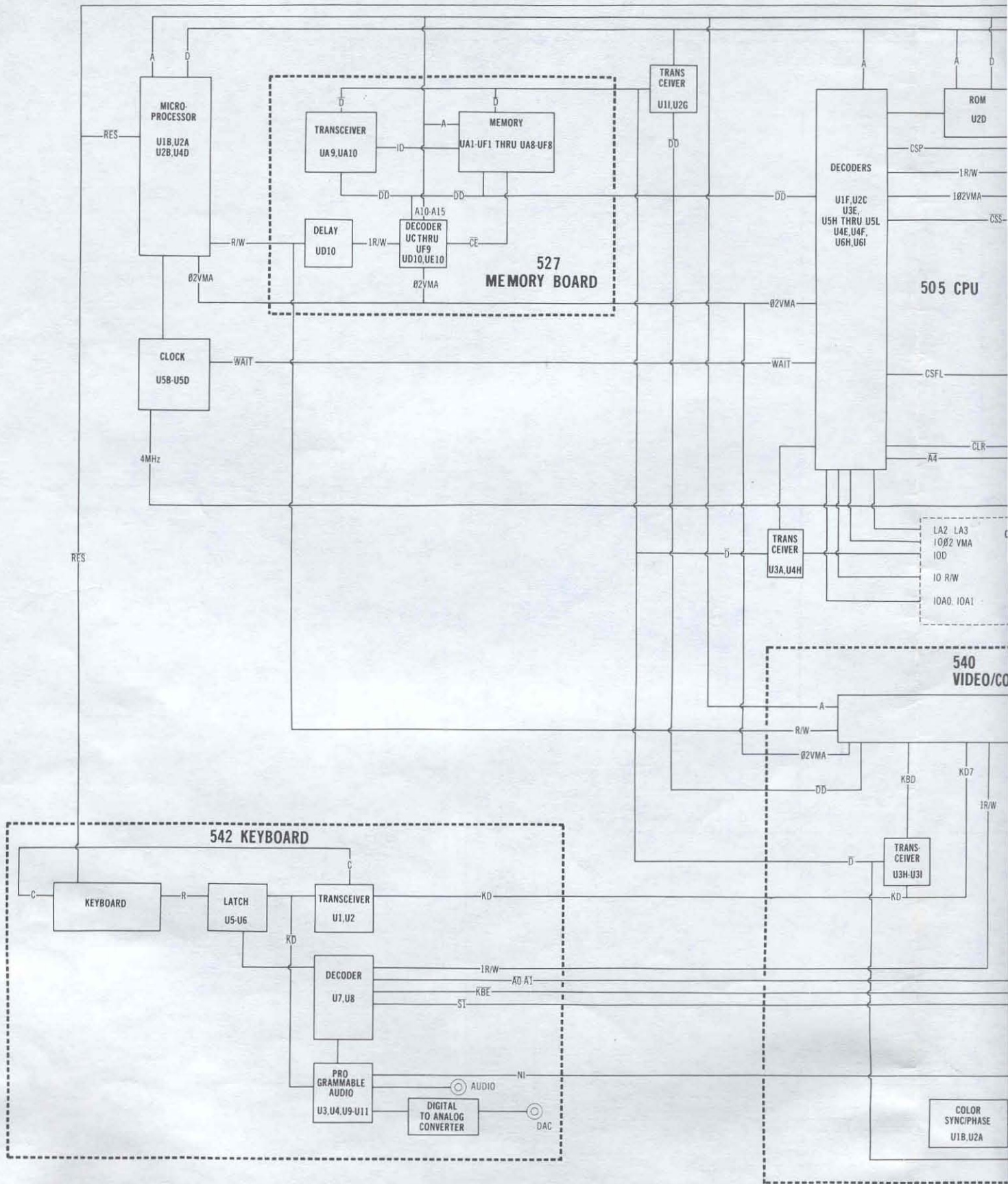

C4PMF — BODY BLOCK DIAGRAM

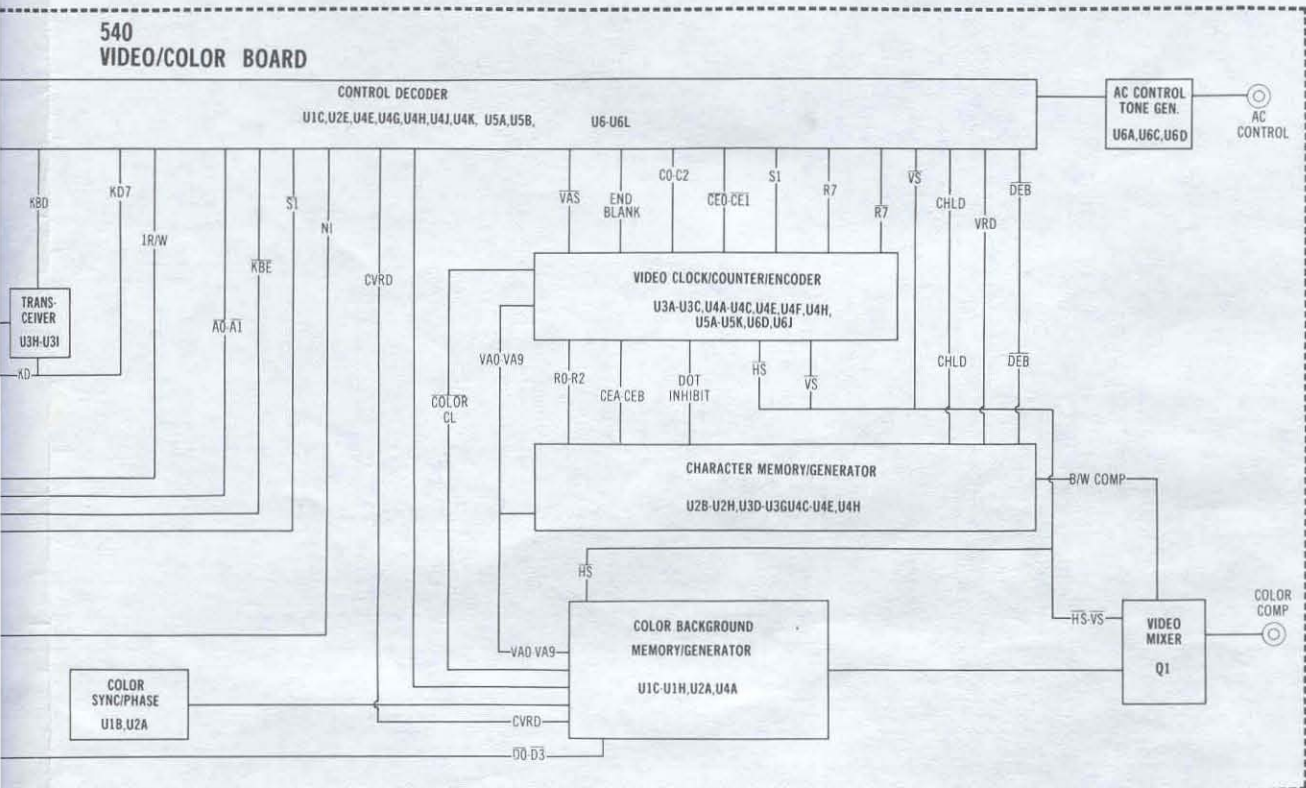
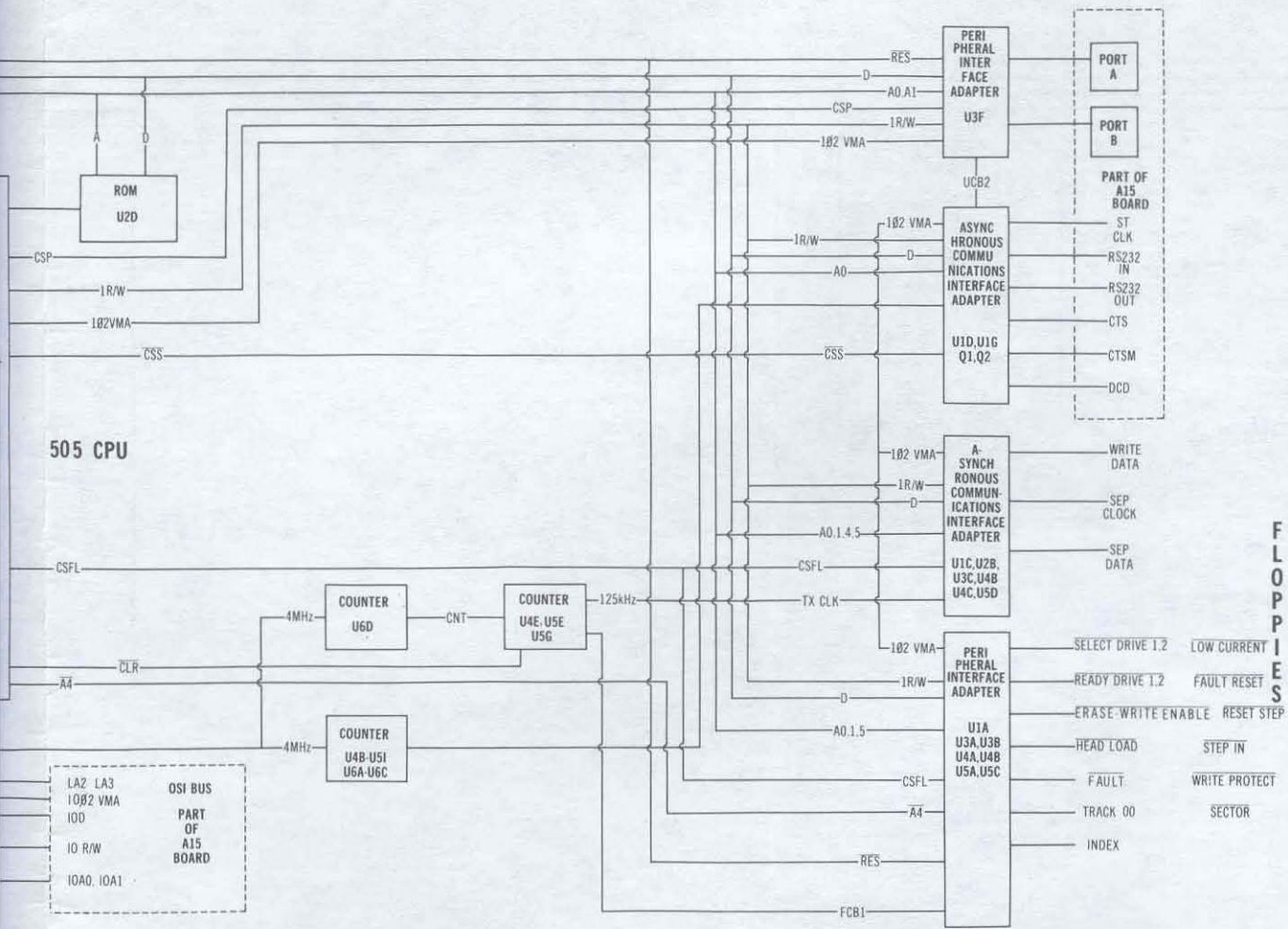

C4PMF — BODY BLOCK DIAGRAM

C4PMF — 505 BOARD PINOUTS

S6821P

1	GND	CA1	40
2	PA0	CA2	39
3	PA1	IRQA	38
4	PA2	IRQB	37
5	PA3	RS0	36
6	PA4	RS1	35
7	PA5	RESET	34
8	PA6	D0	33
9	PA7	D1	32
10	PB0	D2	31
11	PB1	D3	30
12	PB2	D4	29
13	PB3	D5	28
14	PB4	D6	27
15	PB5	D7	26
16	PB6	ENABLE	25
17	PB7	CS1	24
18	CB1	CS2	23
19	CB2	CS0	22
20	V _{CC}	R/W	21

U1A,U3F

6502A

1	VSS	RES	40
2	RDY	Q2 (OUT)	39
3	Q1 (OUT)	S.O.	38
4	IRQ	Q0(IN)	37
5	N.C.	N.C.	36
6	NMI	N.C.	35
7	SYNC	R/W	34
8	VCC	DB0	33
9	AB0	DB1	32
10	AB1	DB2	31
11	AB2	DB3	30
12	AB3	DB4	29
13	AB4	DB5	28
14	AB5	DB6	27
15	AB6	DB7	26
16	AB7	AB15	25
17	AB8	AB14	24
18	AB9	AB13	23
19	AB10	AB12	22
20	AB11	VSS	21

U1B

56850P

1	GND	CTS	24
2	RXD	DCD	23
3	CRX	D0	22
4	CTX	D1	21
5	RTS	D2	20
6	TXD	D3	19
7	IRQ	D4	18
8	CS0	D5	17
9	CS2	D6	16
10	CS1	D7	15
11	RS	E	14
12	V _{CC}	R/W	13

U1C,U1D

F74157

1	S	V _{CC}	16
2	1A	G	15
3	1B	4A	14
4	1Y	4B	13
5	2A	4Y	12
6	2B	3A	11
7	2Y	3B	10
8	GND	3Y	9

U1E

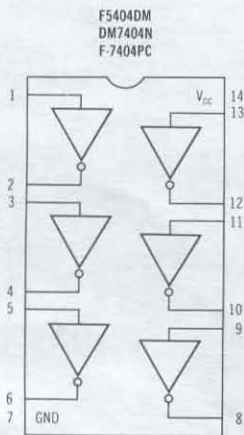

U1F,U4B,U4E,U4F,U5K,U6E

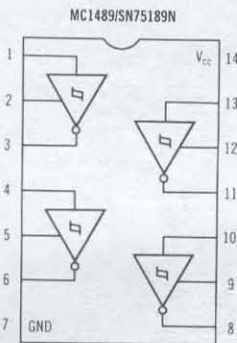

U1G

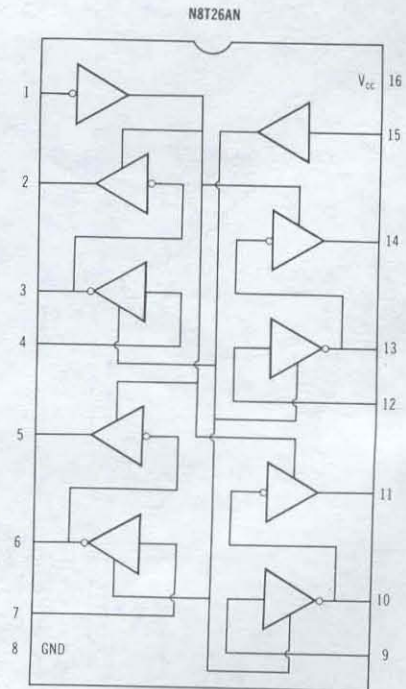

U1I,U2E,U3G,U4H

**MC6885P
MC8T95P
N8T95N**

1	ENABLE 1	V _{CC}	16
2	INPUT A	ENABLE 2	15
3	OUTPUT A	INPUT F	14
4	INPUT B	OUTPUT F	13
5	OUTPUT B	INPUT E	12
6	INPUT C	OUTPUT E	11
7	OUTPUT C	INPUT D	10
8	GND	OUTPUT D	9

U2A,U3D,U4D

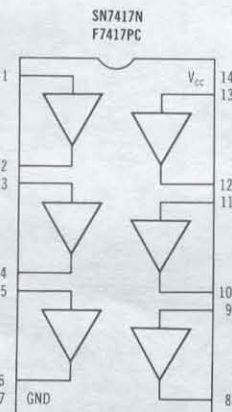

U2B,U3A,U3B,U4A

74148N

1	INPUT 4	V _{CC}	16
2	INPUT 5	OUTPUT E0	15
3	INPUT 6	OUTPUT GS	14
4	INPUT 7	INPUT 3	13
5	INPUT E1	INPUT 2	12
6	OUTPUT A2	INPUT 1	11
7	OUTPUT A1	INPUT 0	10
8	GND	A0	9

U2C

C4PMF — 505 BOARD PINOUTS

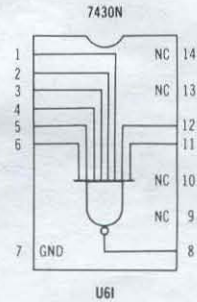
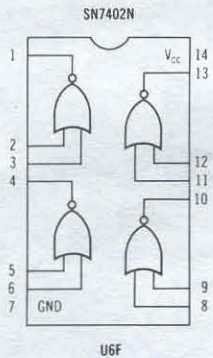
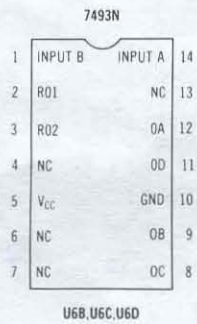
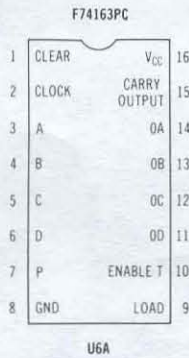
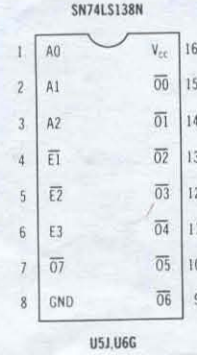
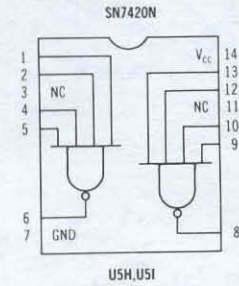
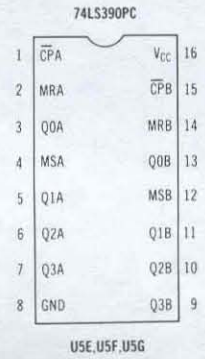
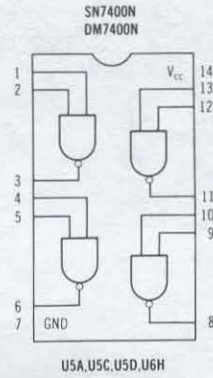
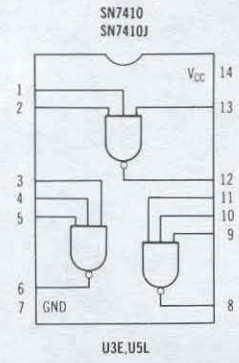
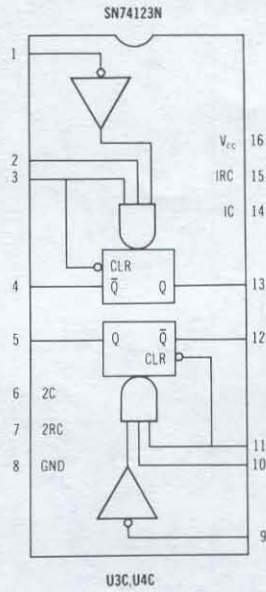
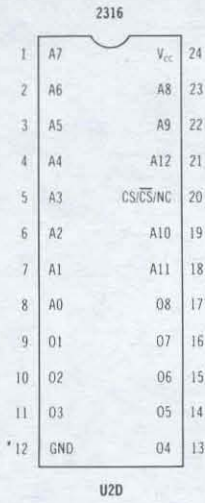

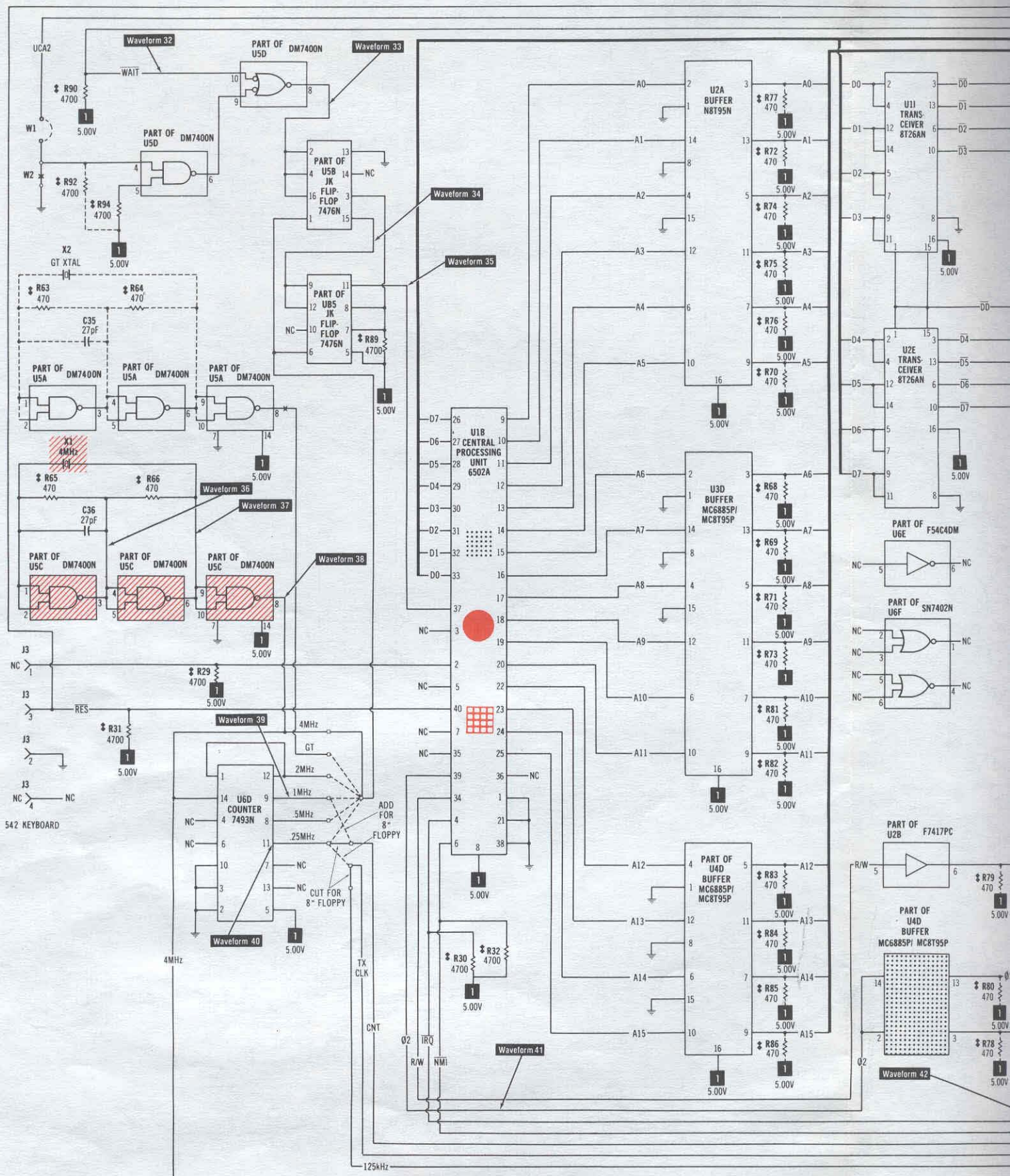

A PHOTOFAC STANDARD NOTATION SCHEMATIC
WITH **CIRCUITRACE**

© Howard W. Sams & Co., Inc. 1980

FOR COLOR KEYED TROUBLESHOOTING SEE PAGES 9 THRU

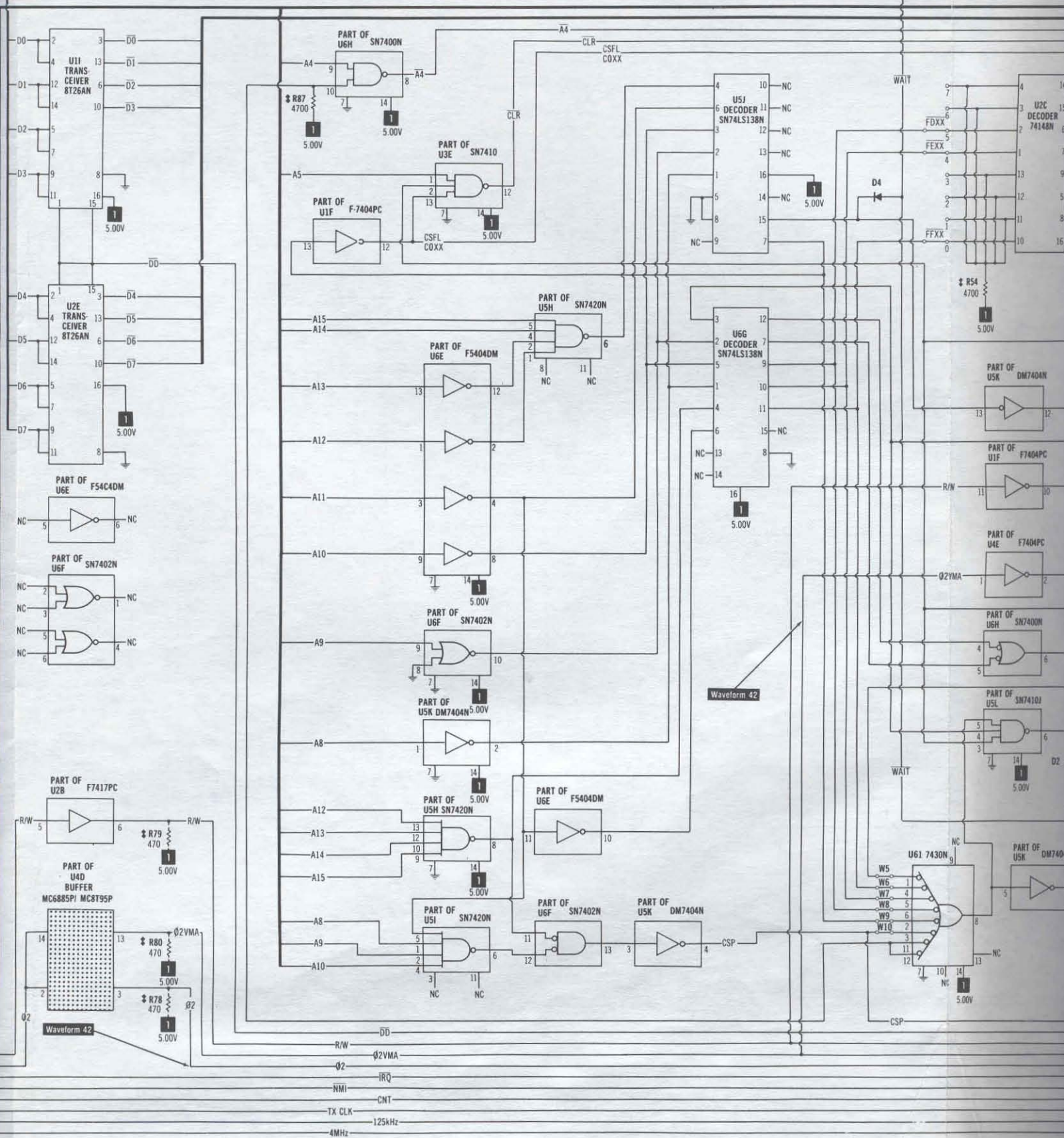

SEE PAGES 9 THRU 13.

FOR SCHEMATIC LEGEND AND NOTES SEE PAGES 91, 92 & INSIDE REAR CO

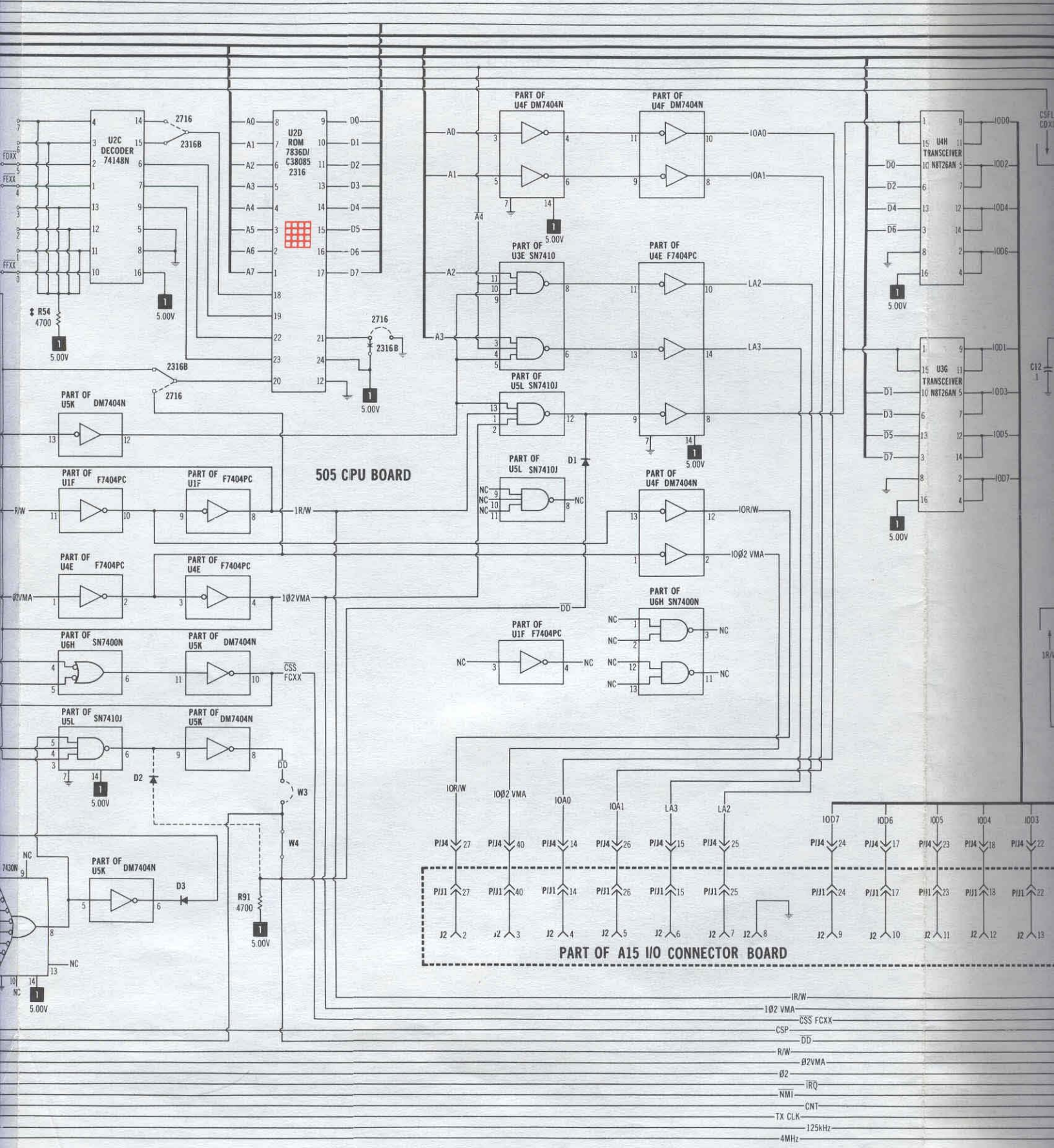

INSIDE REAR COVER.

C4PMF — 505 BOARD

C4PMF

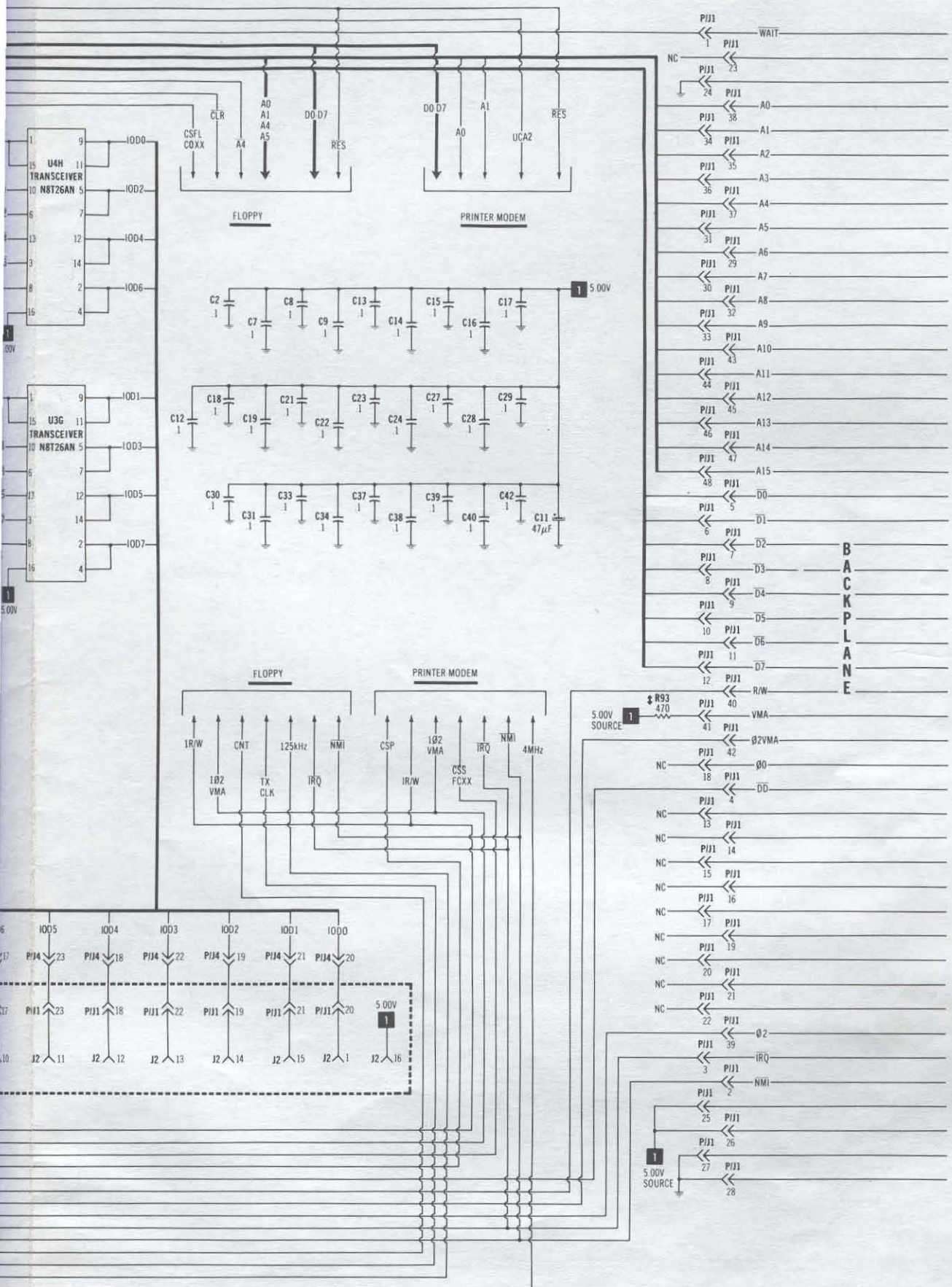

C4PMF — 505 BOARD

Waveform 32

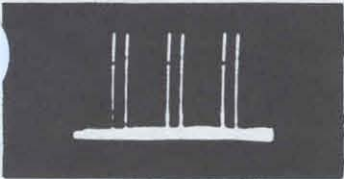

5 μ Sec 3.6V

Waveform 33

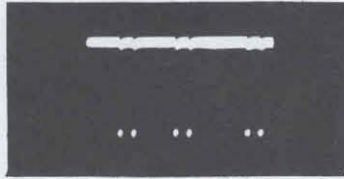

5 μ Sec 4.0V

Waveform 34

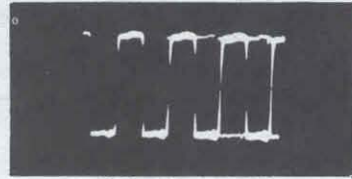

0.2 μ Sec 4.0V

Waveform 35



0.2 μ Sec 4.0V

Waveform 36

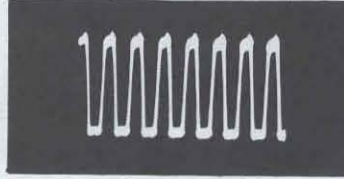

0.2 μ Sec 3.0V

Waveform 37

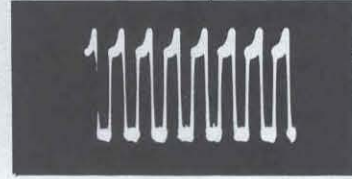

0.2 μ Sec 3.2V

Waveform 38

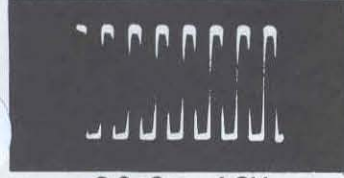

0.2 μ Sec 4.0V

Waveform 39

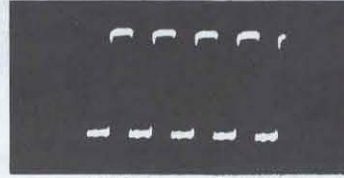

0.5 μ Sec 4.0V

Waveform 40

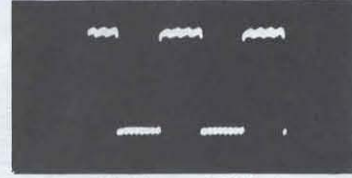

1 μ Sec 4.0V

Waveform 41

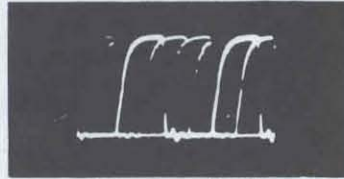

0.2 μ Sec 5.0V

Waveform 42



0.2 μ Sec 4.0V

Waveform 43

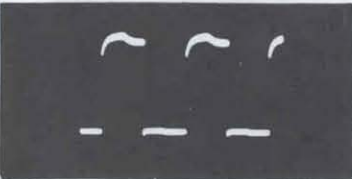

2 μ Sec 4.4V

Waveform 44

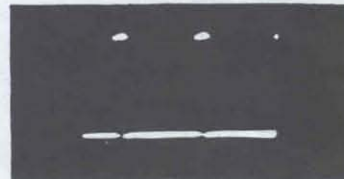

2 μ Sec 4.2V

Waveform 45

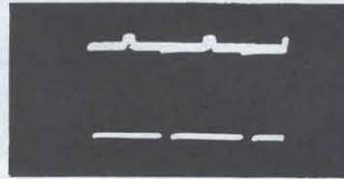

2 μ Sec 5.0V

Waveform 46

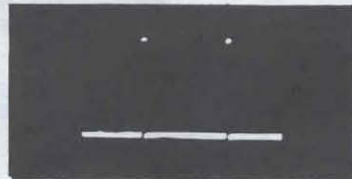

2 μ Sec 4.2V

WAVEFORMS TAKEN IN "BASIC" MODE UNLESS OTHERWISE INDICATED

Waveform 47

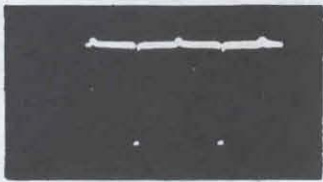

2 μ Sec 4.4V

Waveform 48

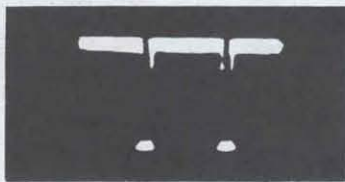

2 μ Sec 3.0V

Waveform 49

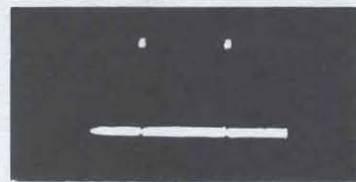

2 μ Sec 4.0V

Waveform 50

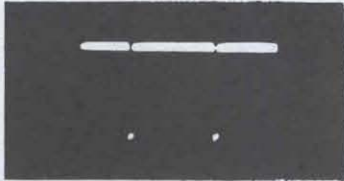

2 μ Sec 4.0V

Waveform 51

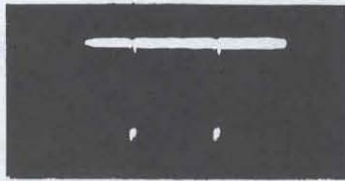

2 μ Sec 5.0V

Waveform 52

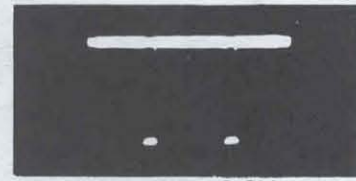

2 μ Sec 3.0V

Waveform 53

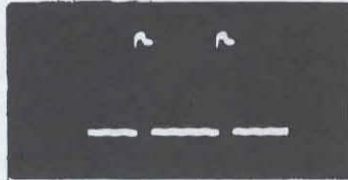

10 μ Sec 4.4V

Waveform 54

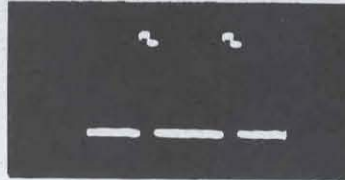

0.1mSec 4.4V

Waveform 55

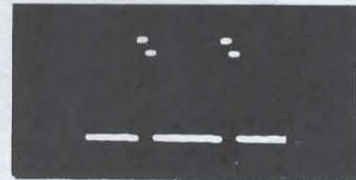

1mSec 4.4V

Waveform 56

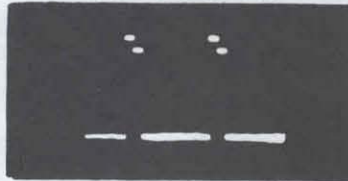

10mSec 4.4V

Waveform 57



0.1Sec 4.4V

Waveform 58

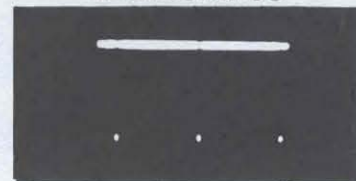

50mSec 3.2V

WAVEFORMS TAKEN IN "BASIC" MODE UNLESS OTHERWISE INDICATED

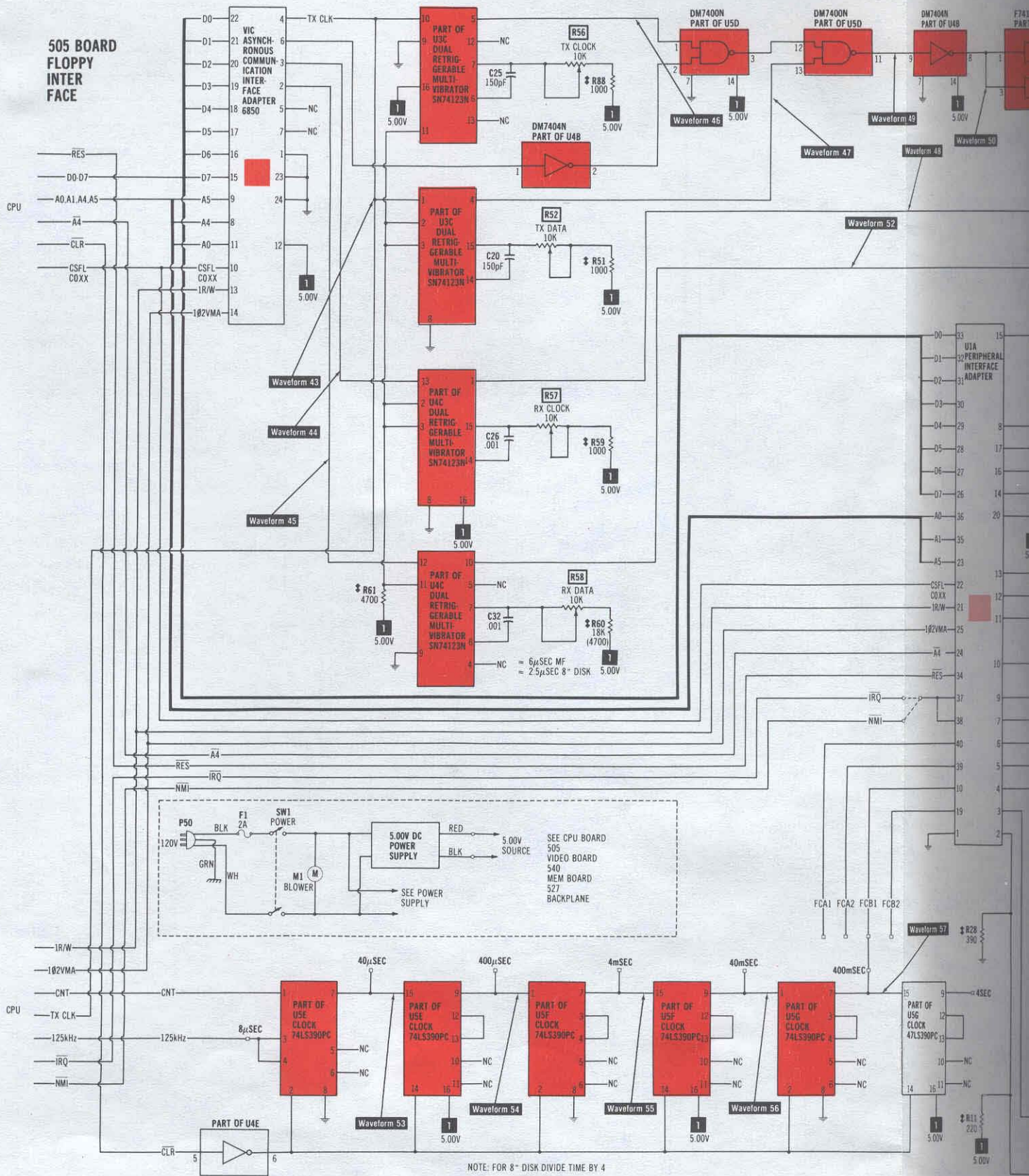

A PHOTOFACIT STANDARD NOTATION SCHEMATIC
 WITH **CIRCUITRACE™**
 © Howard W. Sams & Co., Inc. 1980

C4PMF — 505 BOARD

FOR COLOR KEYED TROUBLESHOOTING SEE
 FOR SCHEMATIC LEGEND AND NOTES SEE

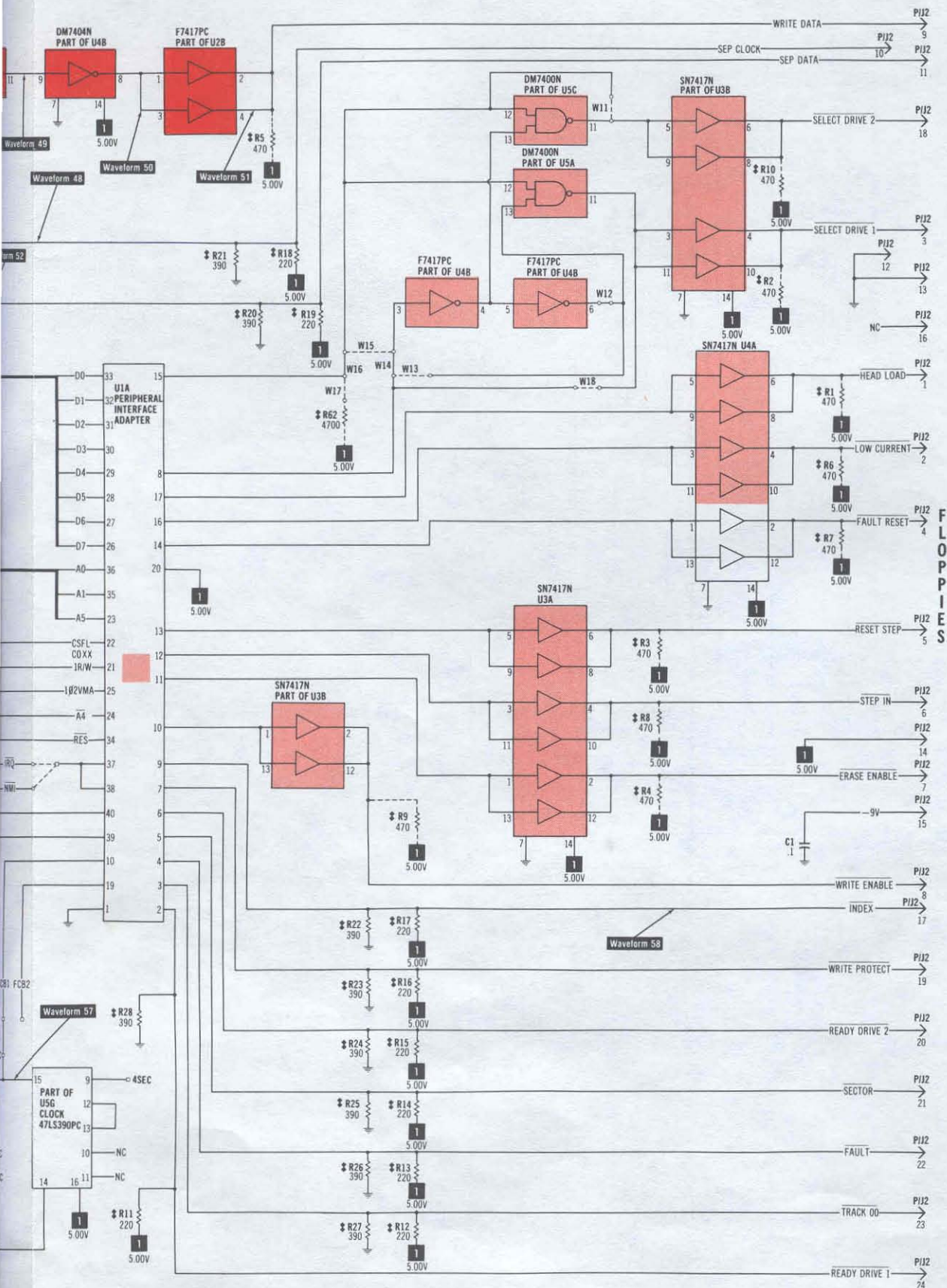

DEBUGGING AND TROUBLESHOOTING SEE PAGES 9 THRU 13

ADDITIONAL INFORMATION AND NOTES SEE PAGES 91, 92 & INSIDE REAR COVER

C4PMF — 505 BOARD

PRINTER-MODEM

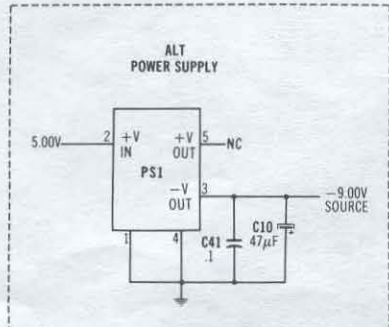
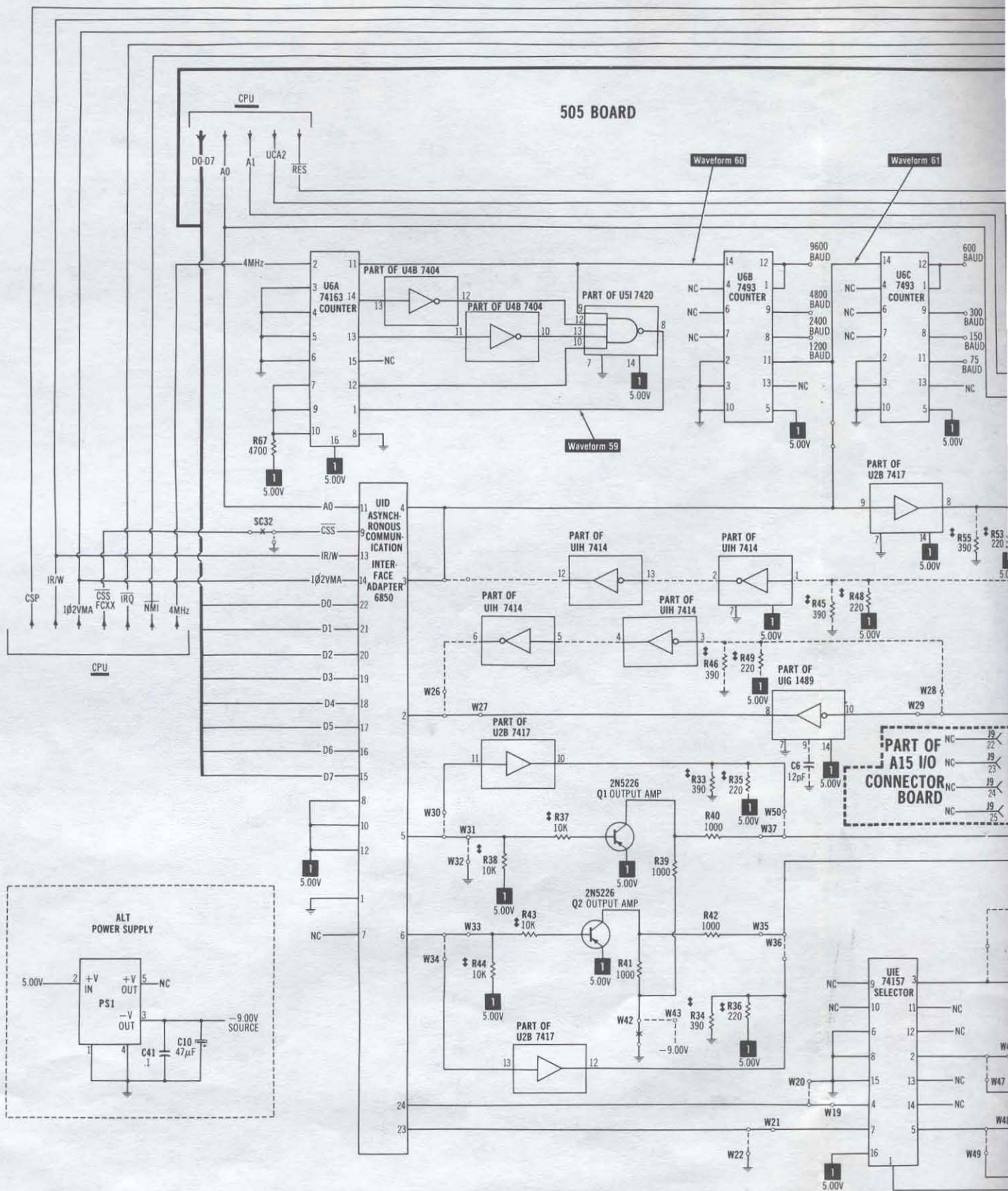

A PHOTOFAC STANDARD NOTATION SCHEMATIC
WITH **CIRCUITRACE**
© Howard W. Sams & Co., Inc. 1980

C4PMF — 505 BOARD

FOR SCHEMATIC LEGEND AND NOTES SEE I

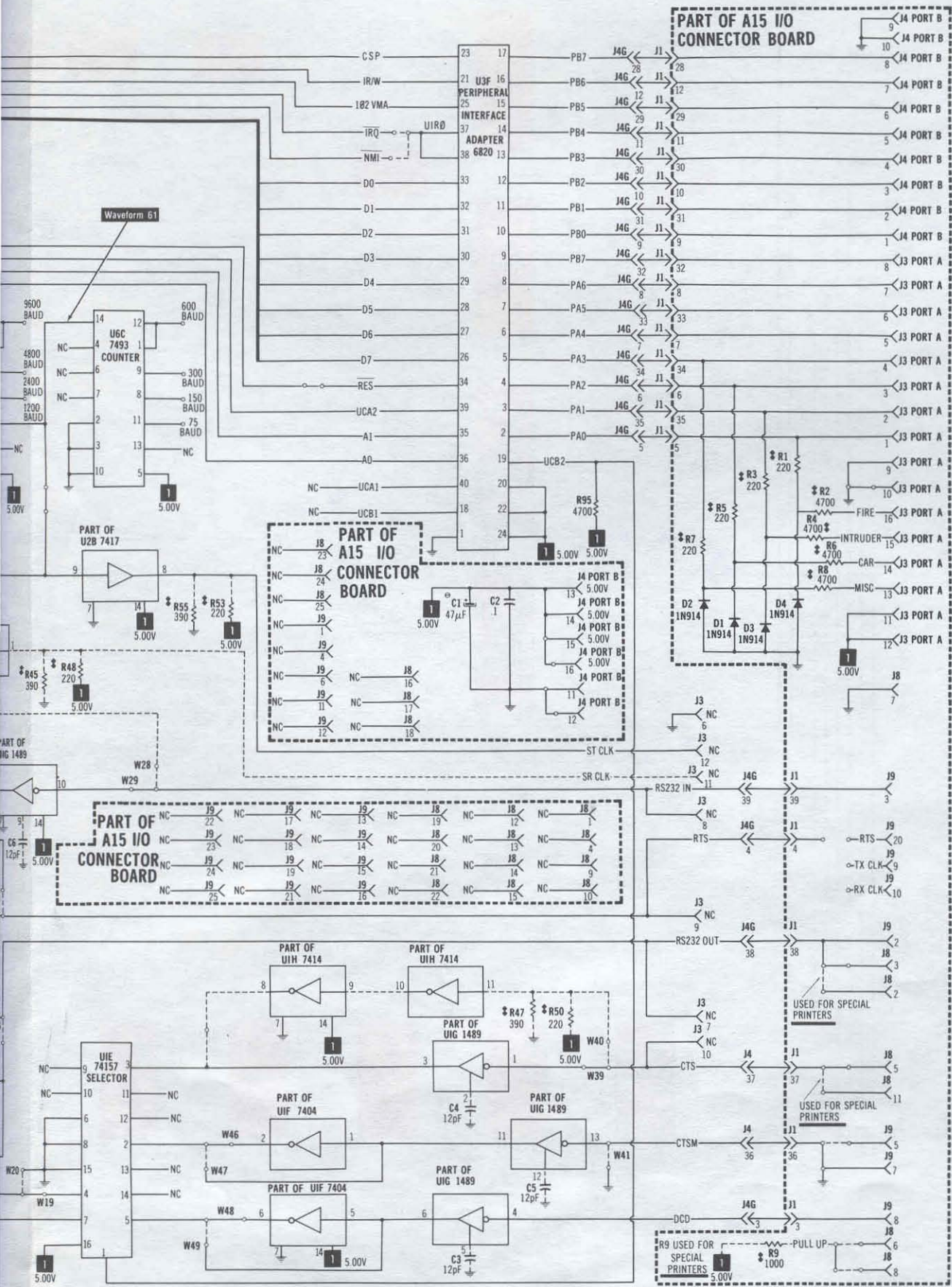

Waveform 59

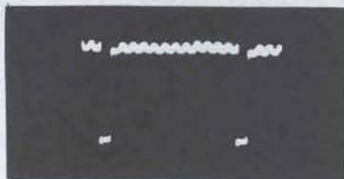

0.5 μ Sec 4.0V

Waveform 60



1 μ Sec 4.0V

Waveform 61

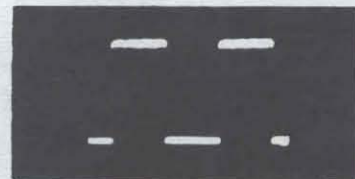

10 μ Sec 3.8V

WAVEFORMS TAKEN IN "BASIC" MODE UNLESS OTHERWISE INDICATED

ELECTRICAL ADJUSTMENTS

C4PMF — 505 BOARD

R56 TX CLOCK

Input of scope to U3C, Pin 5. Adjust R56 for a positive pulse width of 400nSec.

R52 TX DATA

Input of scope to U3C, Pin 4. Adjust R52 for a negative pulse width of 400nSec.

R57 RX CLOCK

Remove floppy-disk cable (J2). Connect a jumper from Pin 9 of J2 to Pin 10 of J2. Input of scope to U4C, Pin 13. Adjust R57 for a positive pulse width of 1 μ Sec. Remove jumper and reconnect J2.

R58 RX DATA

Remove floppy-disk cable (J2). Connect a jumper from Pin 9 of J2 to Pin 11 of J2. Input of scope to U4C, Pin 12. Adjust R58 for a negative pulse width of 6 μ Sec. Remove jumper and reconnect J2.

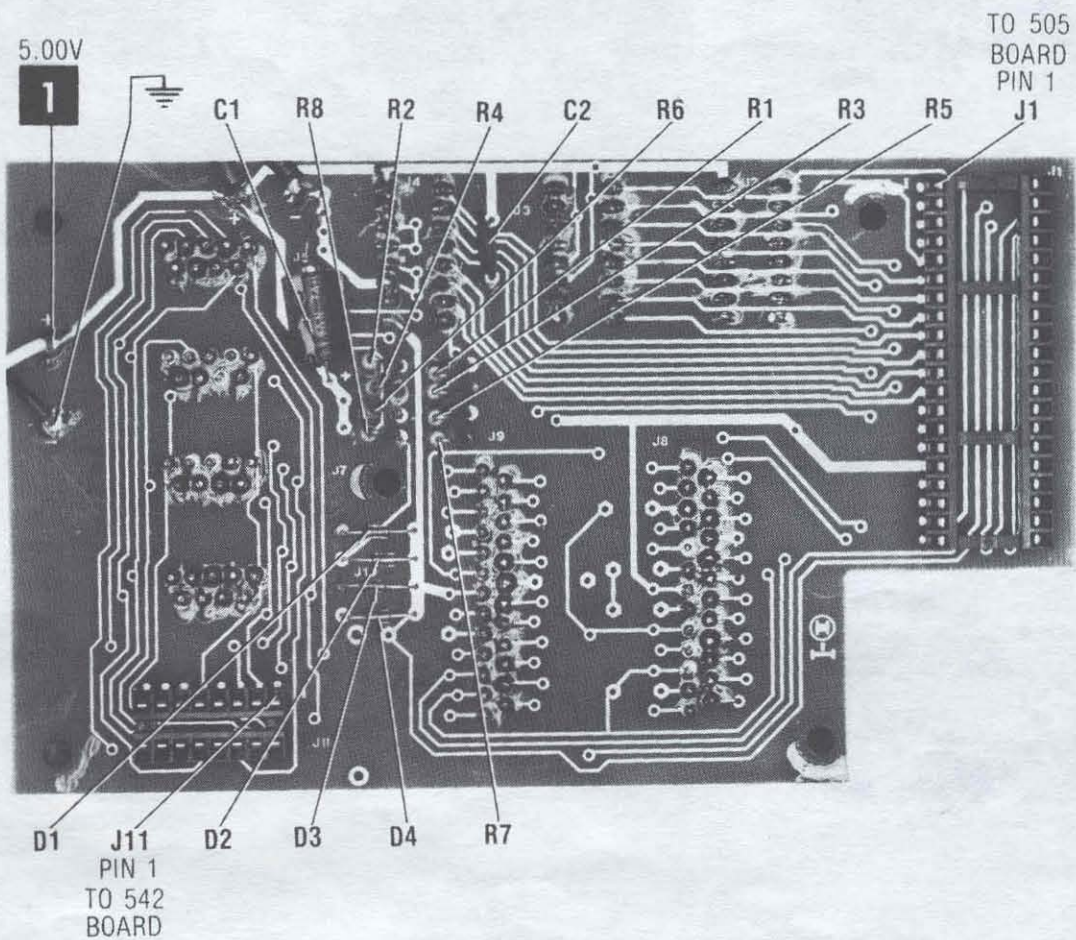
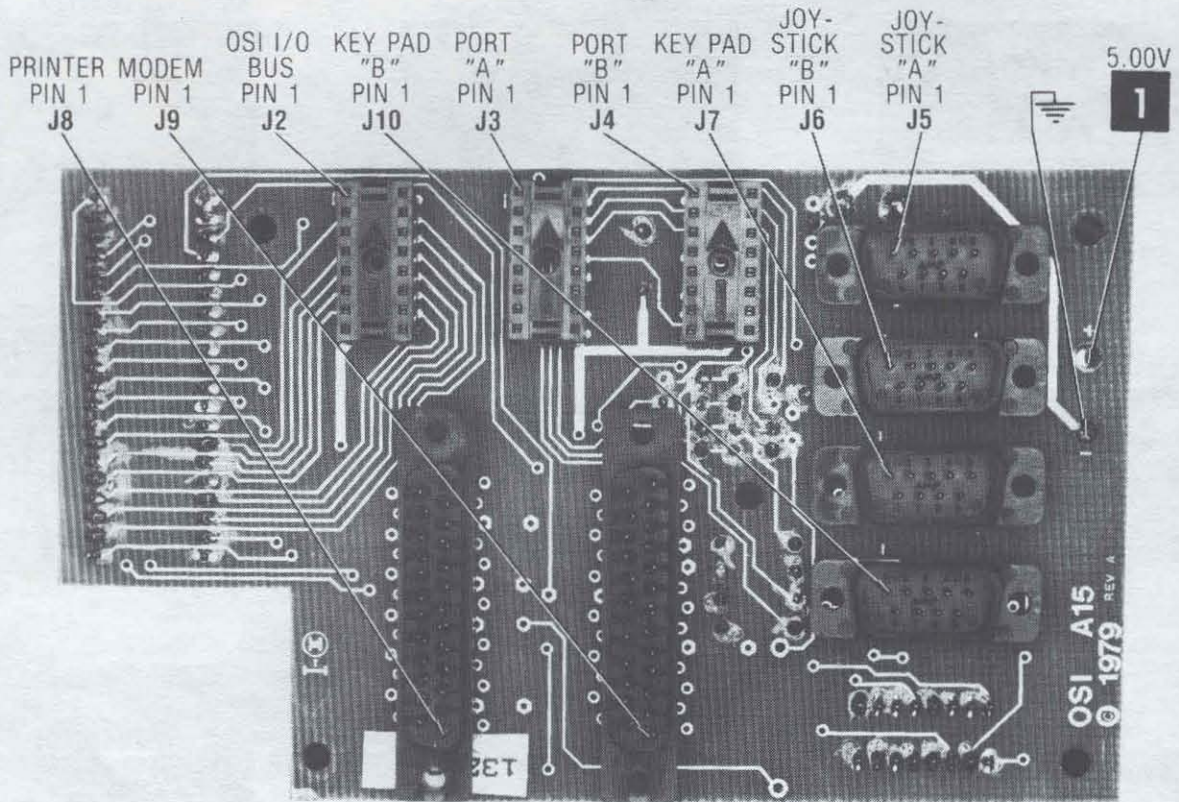

C4PMF — A15 BOARD

A Howard W. Sams **CIRCUITRACE** Photo

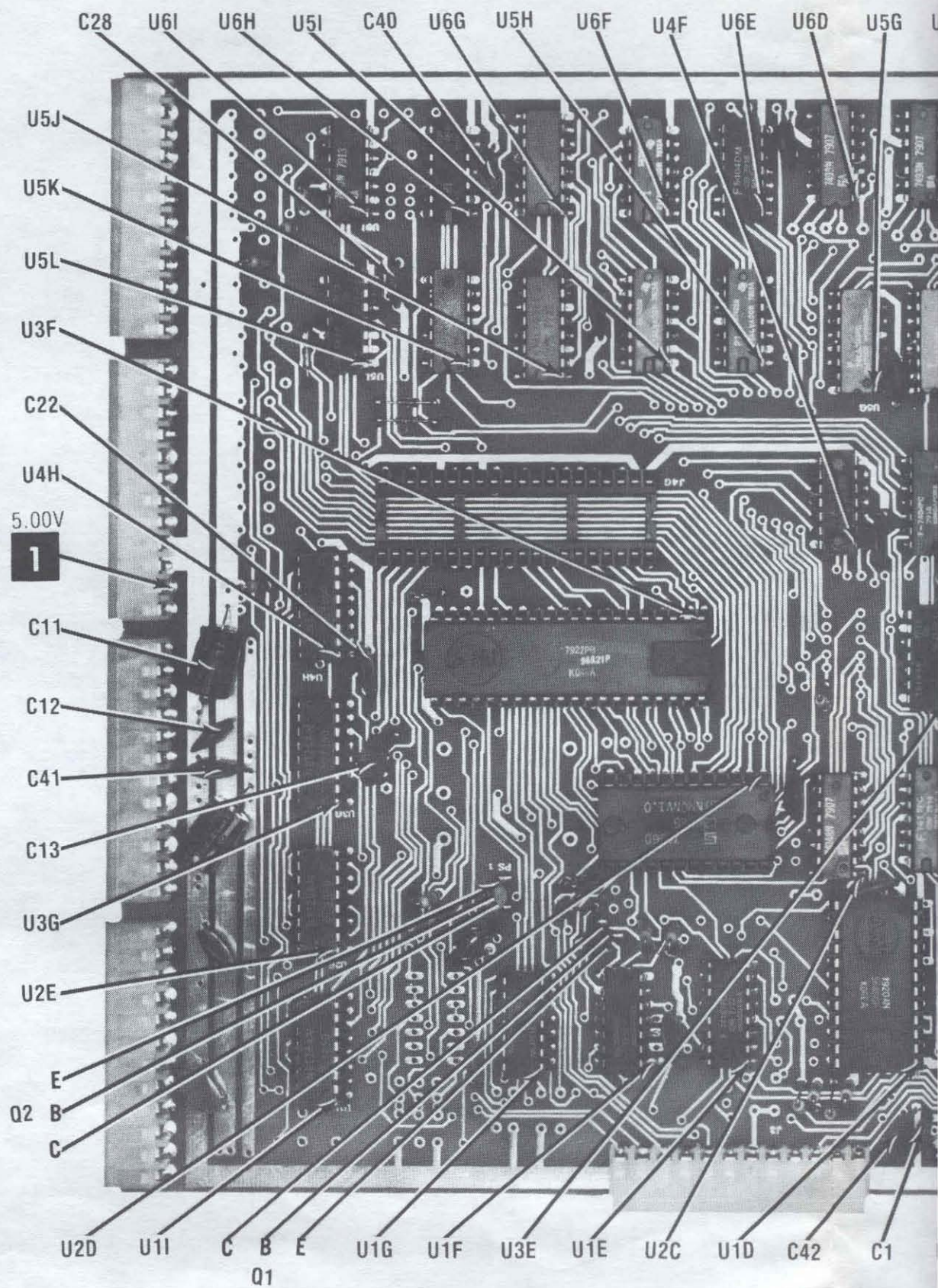

C4PMF — 505 BOARD

A Howard W. Sams CIRCUITRACE® Photo

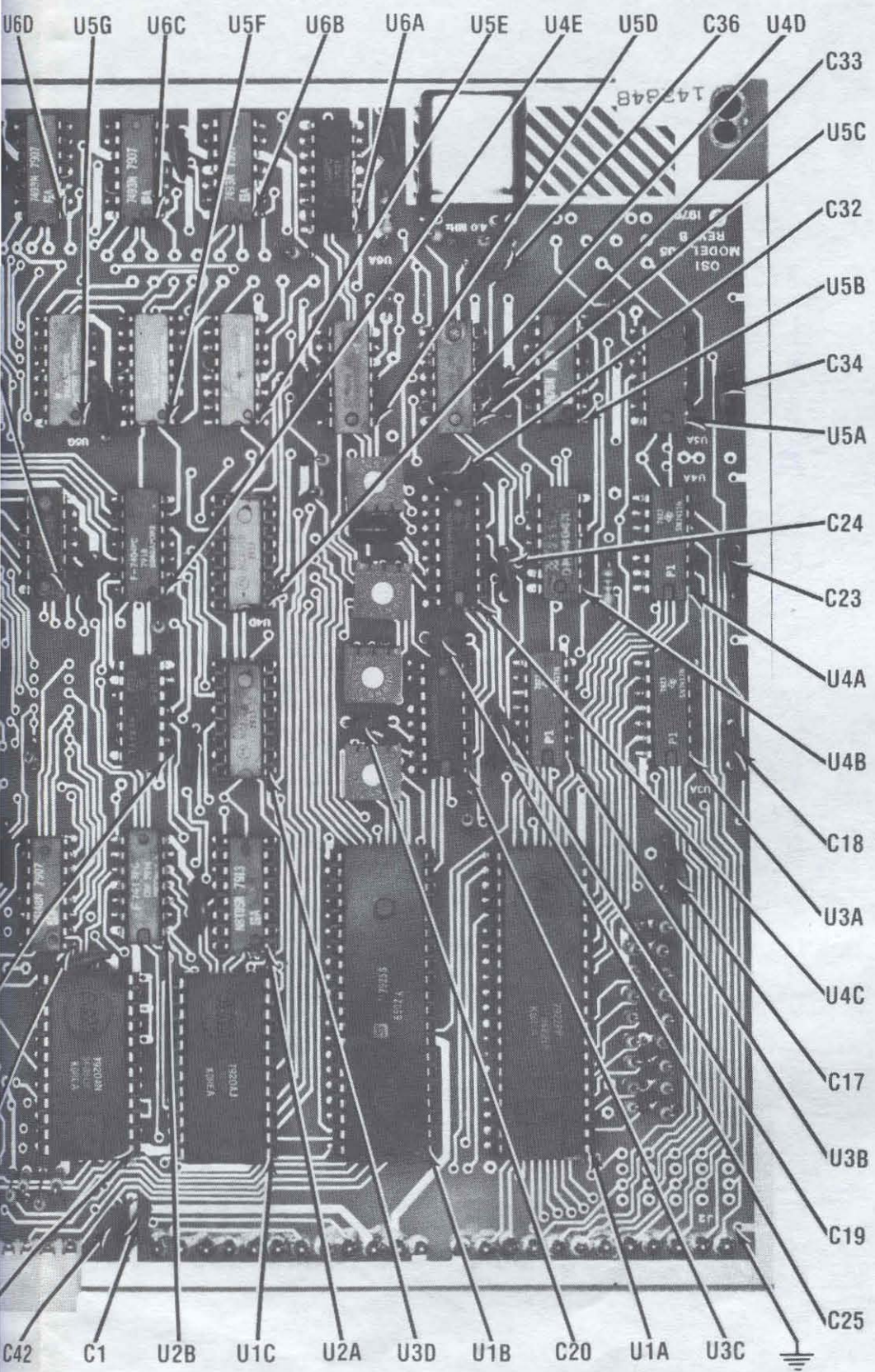

C4PMF — 505 BOARD

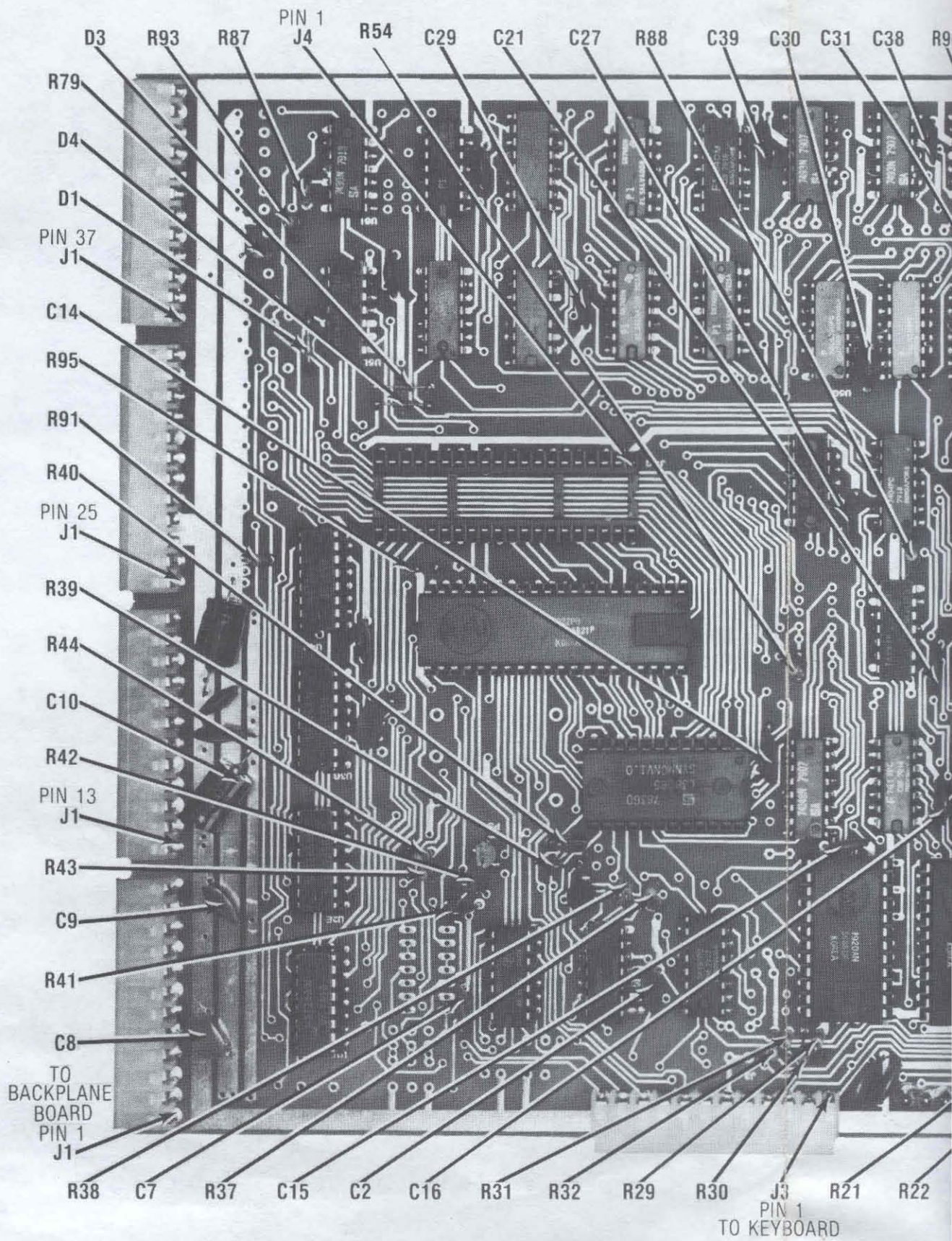

C4PMF — 505 BOARD

C4PMF

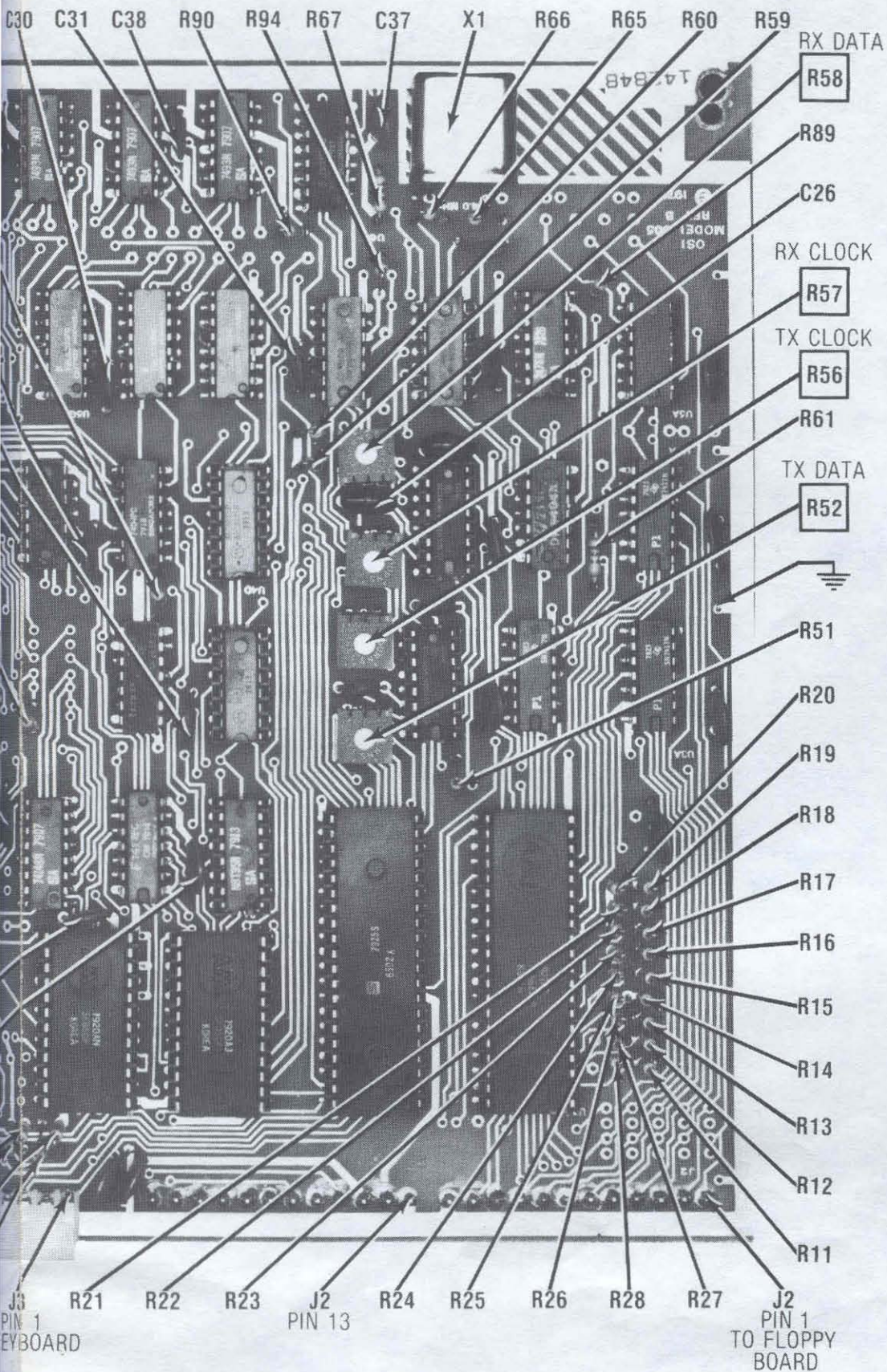

C4PMF — 505 BOARD

C4PMF — 527 BOARD PINOUTS

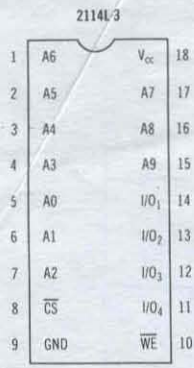

A1 THRU A8
B1 THRU B8
C1 THRU C8
D1 THRU D8
E1 THRU E8
F1 THRU F8

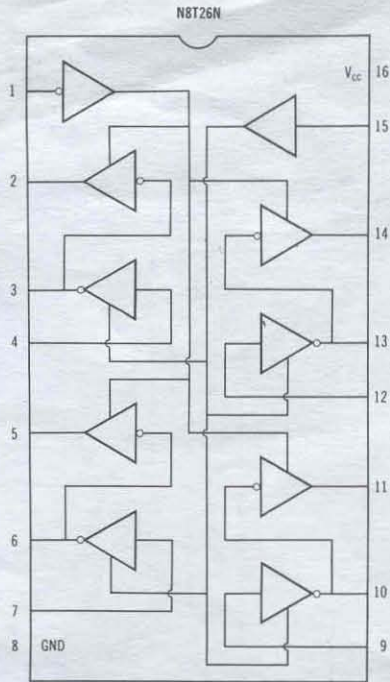

A8,A10



C9,D9,E9,F9

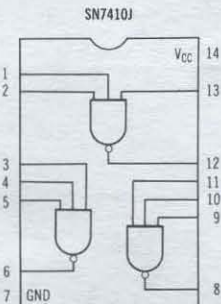

E10

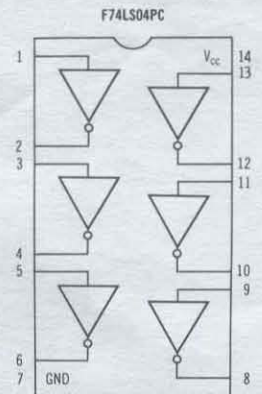

D10

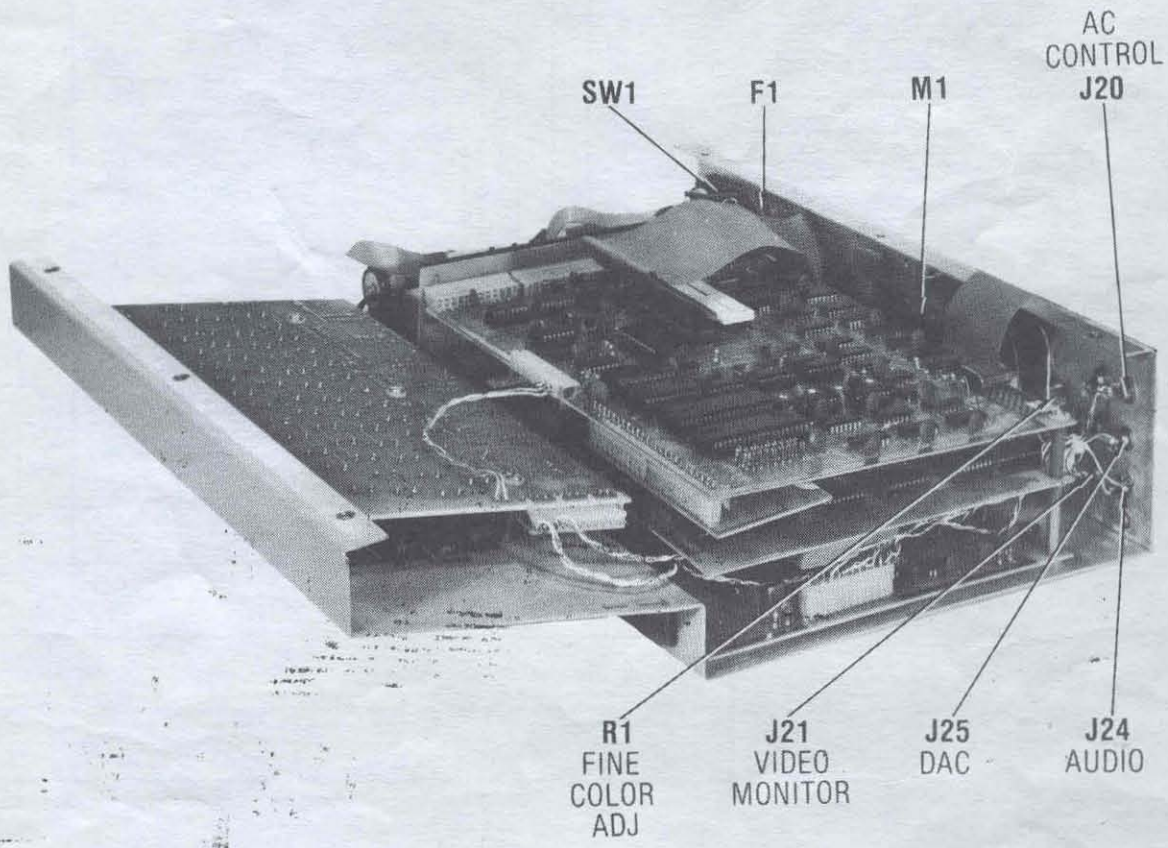

C4PMF — CHASSIS-SIDE VIEW

BACKPLANE

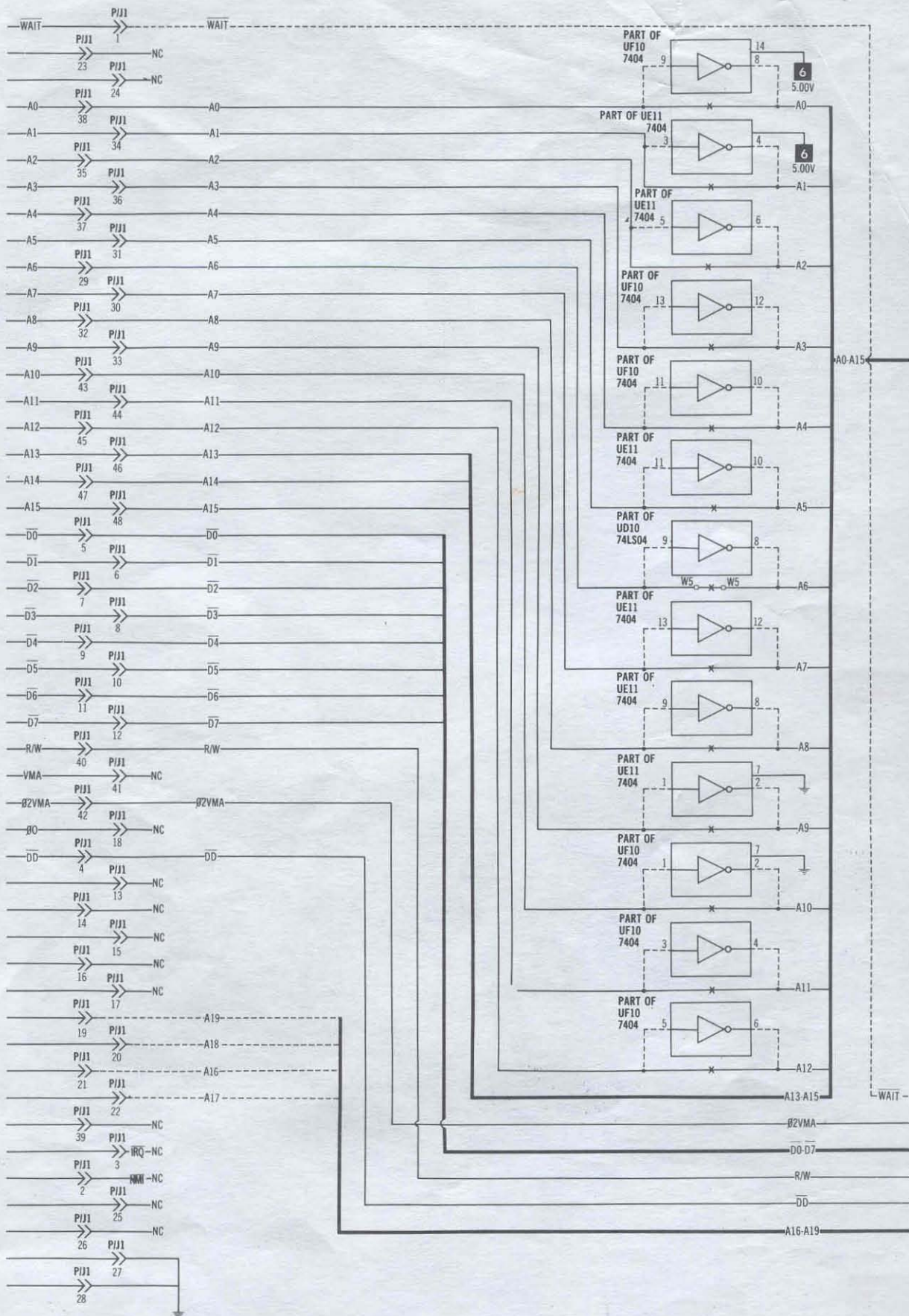

A PHOTOFACIT STANDARD NOTATION SCHEMATIC
WITH **CIRCUITRACE™**

© Howard W. Sams & Co., Inc. 1980

C4PMF — 527 BOARD

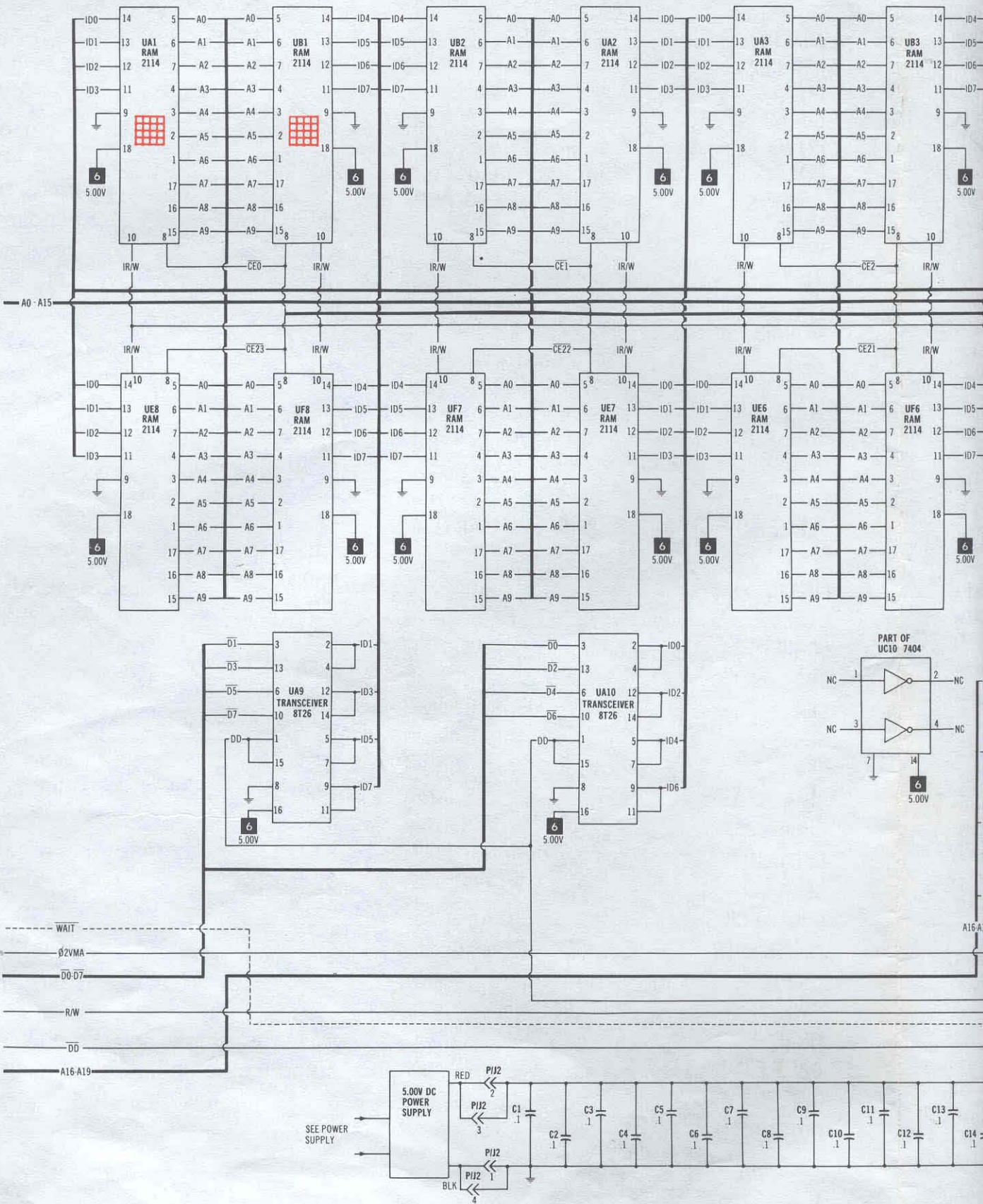

A PHOTOFACIT STANDARD NOTATION SCHEMATIC

WITH **CIRCUITRACE**

© Howard W. Sams & Co., Inc. 1980

C4PMF — 527 BOARD

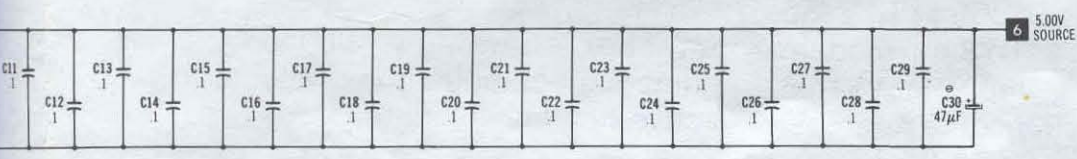
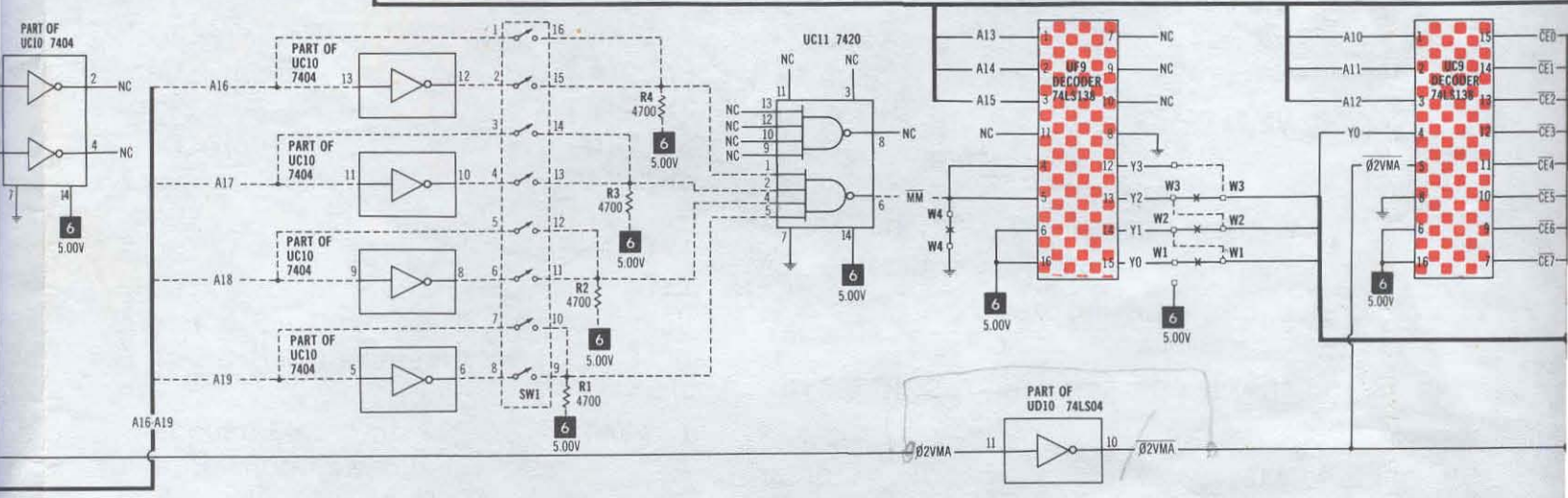
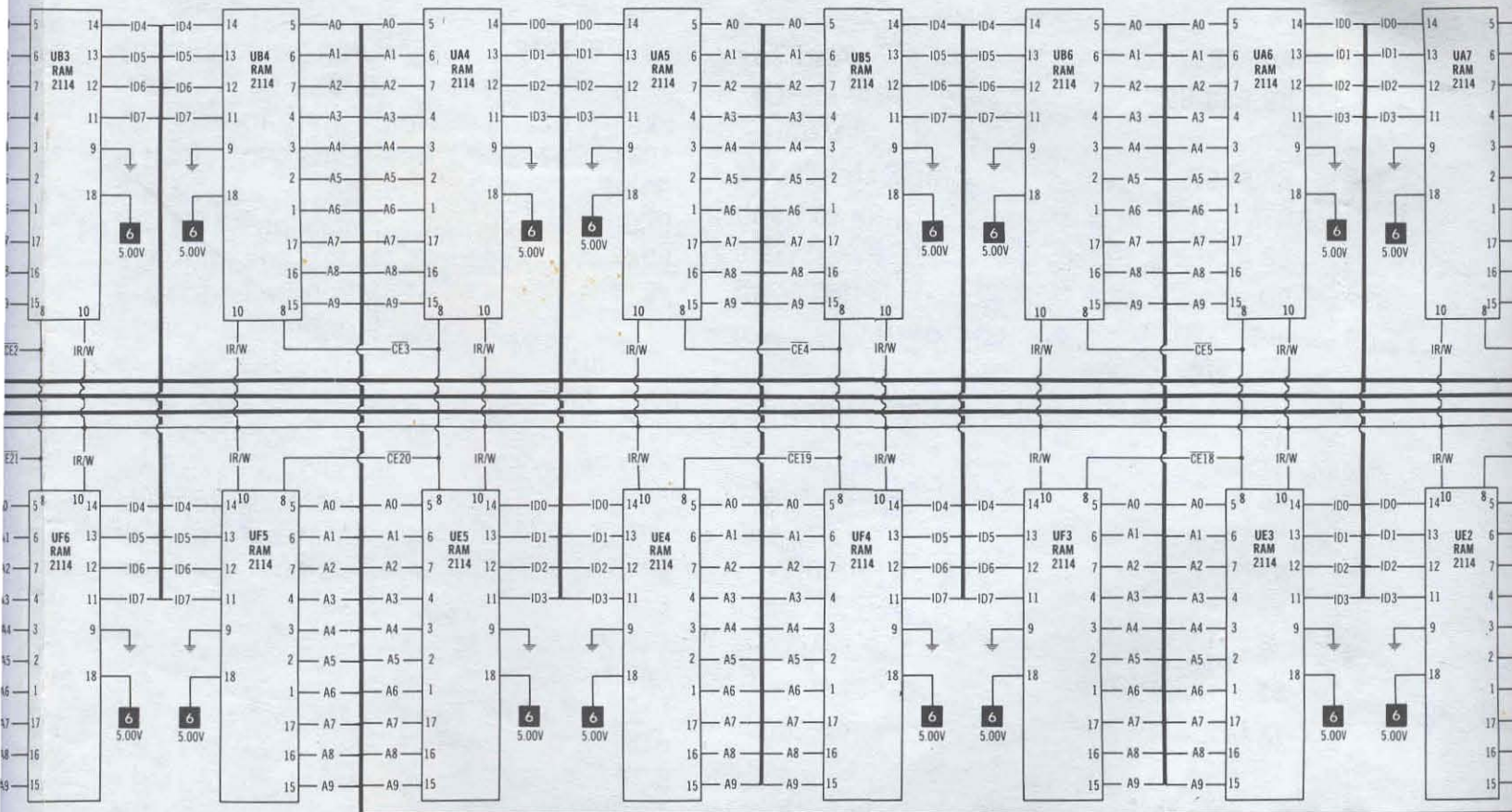

UF9 → UE10
 11 → 4
 13 → 3
 12 → 5

FOR COLOR KEYED TROUBLESHOOTING SEE PAGES 9 THRU 13

FOR S

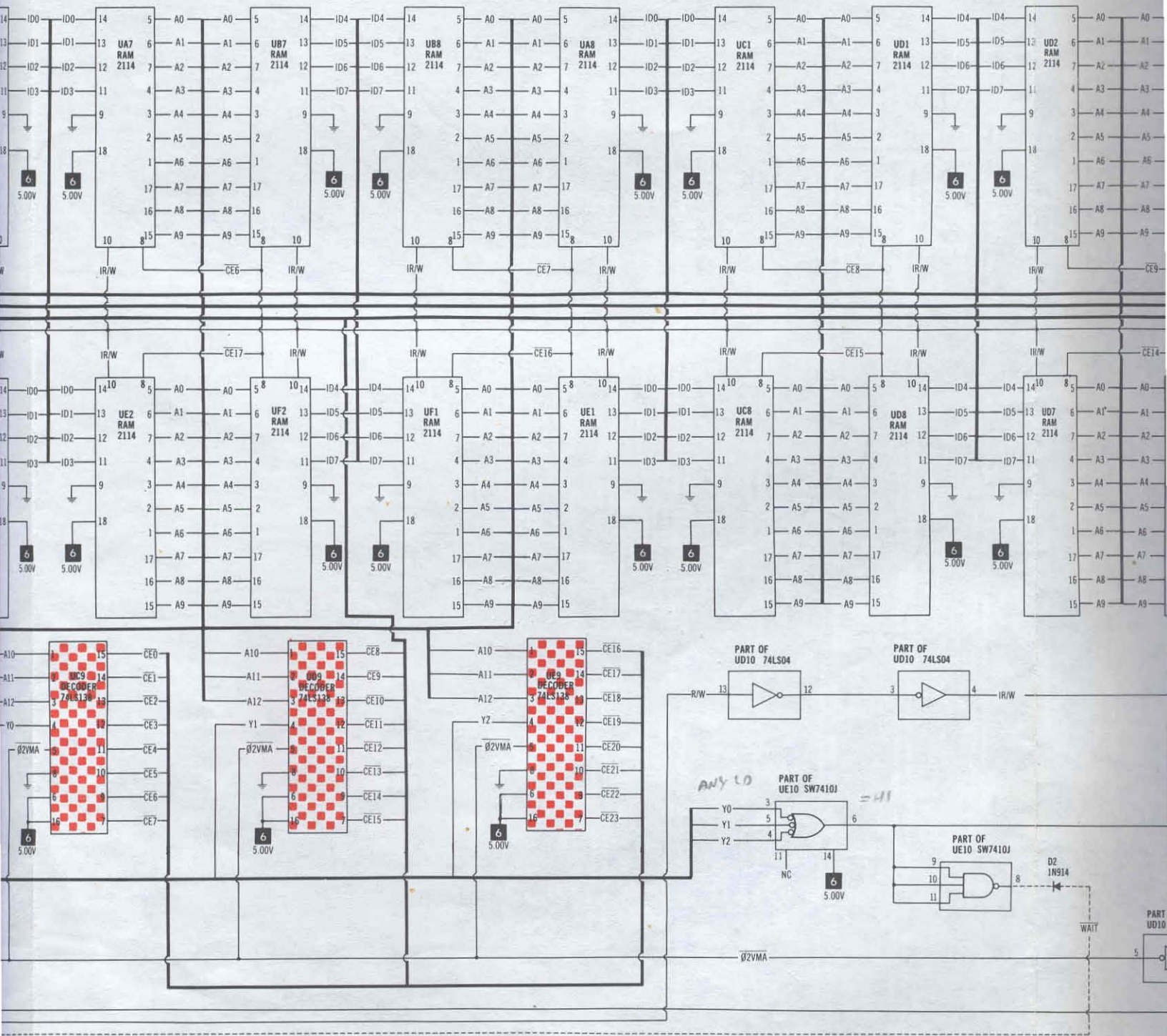

FOR SCHEMATIC LEGEND AND NOTES SEE PAGES 91, 92 & INSIDE REAR COVER

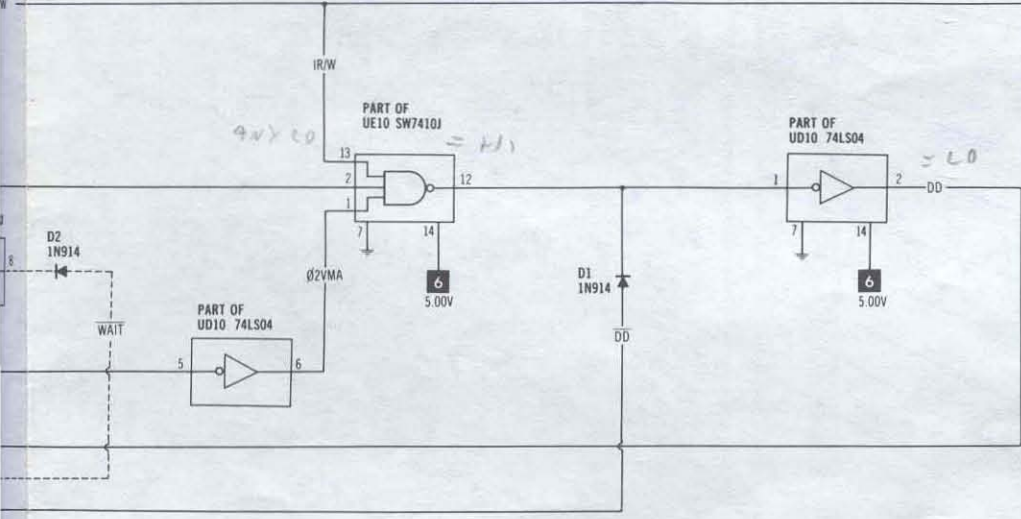
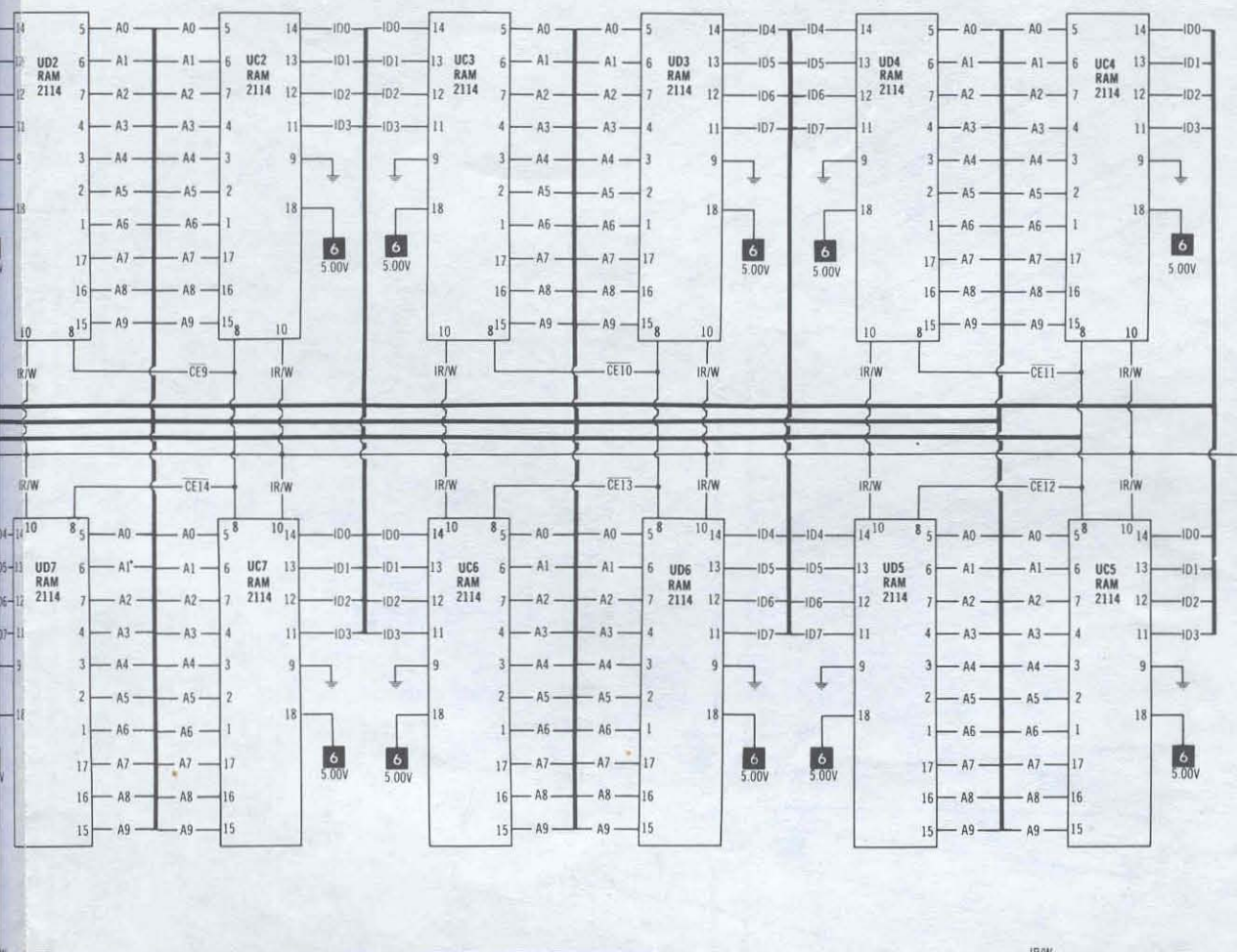

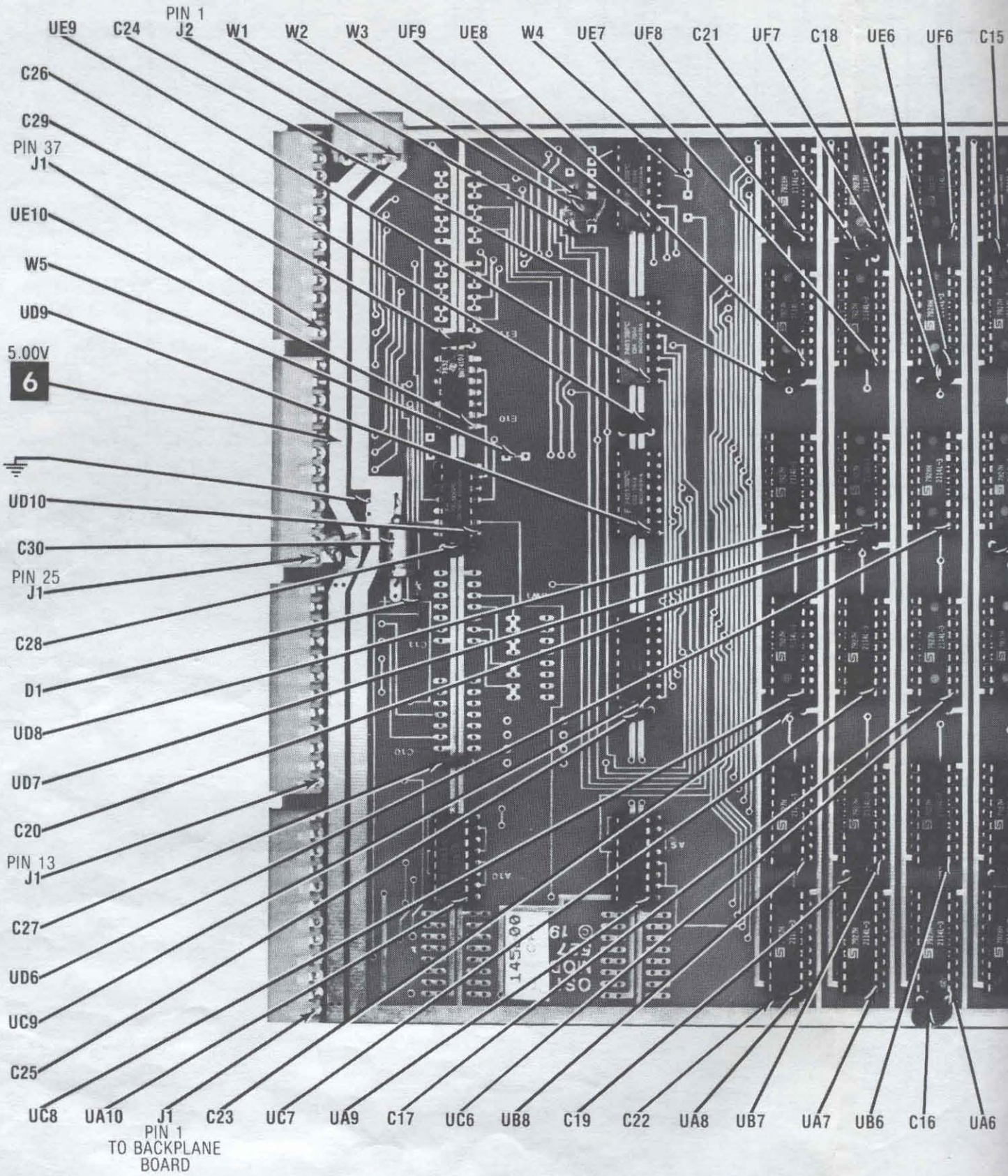

C4PMF — 527 BOARD

A Howard W. Sams **CIRCUITRACE** Photo

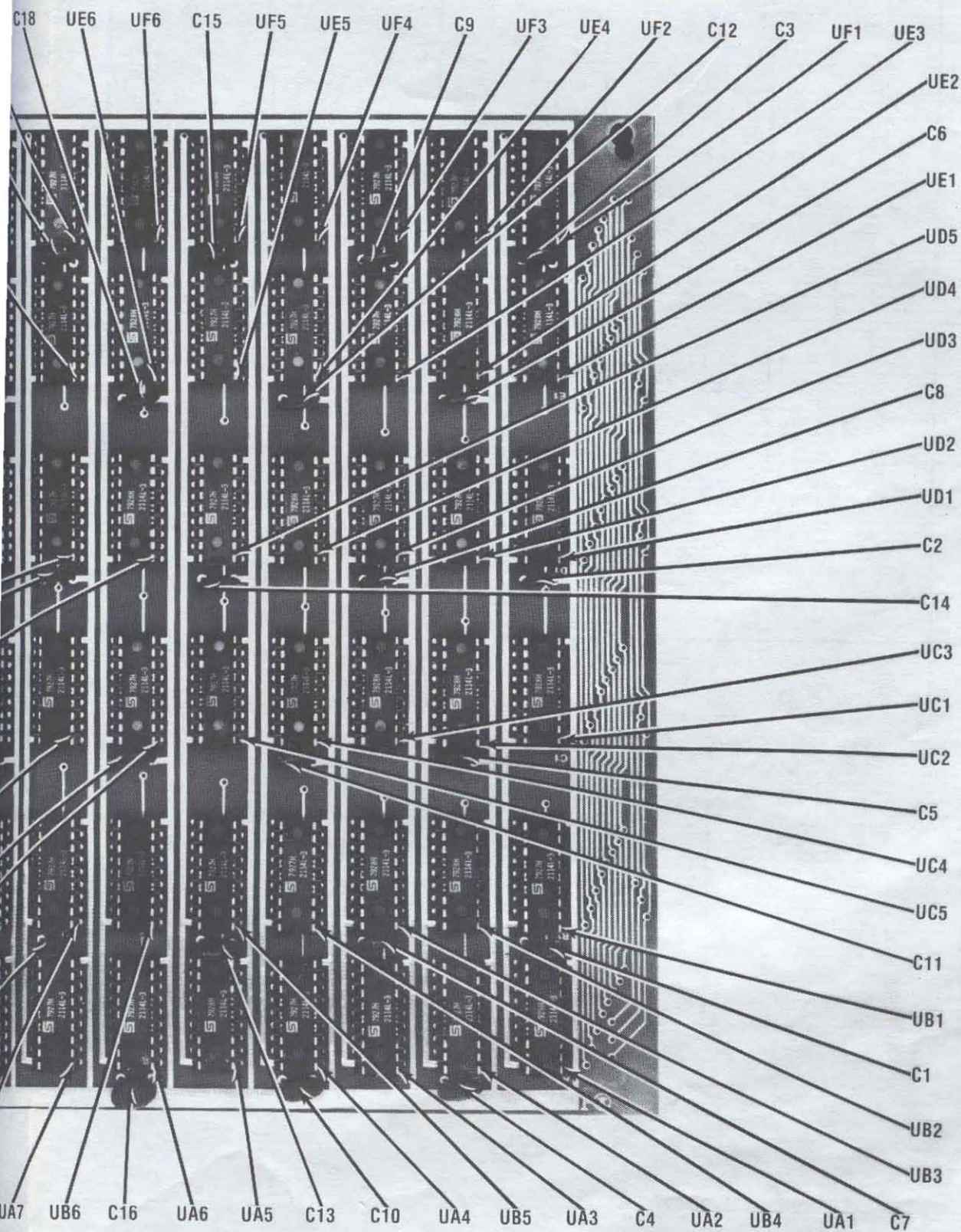

LEGEN

- A0-A15 . . .
- BS, BS0-B . . .
- CS0-CS7 . . .
- CTS . . .
- DO-D7 . . .
- DD
- IRQ
- MS0-MS2 . . .
- NMI
- RDY
- RESET
- RTS
- R/W
- RX CLK
- RX DATA
- SS
- TX CLK
- TX DATA
- VMA
- Ø0
- Ø2
- Ø2 VMA

Any Ba
numeric
active in

LEGEN

- A0-A15 . . .
- CLR
- CNT
- CSP
- CTS
- CTSM
- CSS (FCX

C4PMF — 527 BOARD

LEGEND FOR 502 BOARD SCHEMATIC

A0-A15	Address
BS,BS0-BS3	Basic ROM Select and Monitor
CS0-CS7	Chip Select RAM
CTS	Clear to Send
D0-D7	Data
DD	Data Direct
IRQ	Interrupt Request
MS0-MS2	Monitor ROM Select
NMI	Non-maskable Interrupt
RDY	Ready
RESET	Reset
RTS	Ready to Send
R/W	Read/Write
RX CLK	Receive Clock
RX DATA	Receive Data
SS	Sound Select
TX CLK	Transmit Clock
TX DATA	Transmit Data
VMA	Valid Memory Address
Ø0	Microprocessor Clock In
Ø2	Phase Two
Ø2 VMA	Phase Two Valid Memory Address

Any $\bar{\text{Bar}}$ above any alphabetical or numerical combination indicates line active in a low (0) state.

LEGEND FOR 505 BOARD SCHEMATIC

A0-A15	Address
CLR	Clear
CNT	Count
CSP	Chip Select Parallel
CTS	Clear To Send
CTSM	Clear To Send Modem
CSS (FCXX)	Chip Select Serial (Machine Address)

505 BOARD (CONTINUED)

CSFL (COXX)	Chip Select Floppy (Machine Address)
FCA1-FCA2	Real Time Clock Port A
FCB1-FCB2	Real Time Clock Port B
D0-D7	Data
DCD	Data Carrier Detect
FDXX	Machine Language
FEXX	Machine Language
FFXX	Machine Language
IOA0-IOA1	I/O Address
IOD1-IOD7	I/O Data
IOR/W	I/O Read Write
IOØ2 VMA	IO Phase Two Valid Memory Address
IRQ	Interrupt Request
LA2-LA3	Latched Address
NMI	Non-Maskable Interrupt
PA0-PA7	Port A
PB0-PB7	Port B
RES	Reset
RTS	Ready to Send
R/W	Read/Write
1 R/W	Internal Read/Write
RX CLK	Receive Clock
RX DATA	Receive Data
SEP CLOCK	Receive Clock
SEP DATA	Receive Data
SR CLK	Serial Receive Clock
ST CLK	Serial Transmit Clock
TX CLK	Transmit Clock
TX DATA	Transmit Data
UCA2	User Control Bits Port A
UCB2	User Control Bits Port B
WAIT	Wait
1 Ø2 VMA	Internal Phase Two Valid Memory Address
Ø2	Phase Two
Ø2 VMA	Phase Two Valid Memory Address

Any $\bar{\text{Bar}}$ above any alphabetical or numerical combination indicates line active in a low (0) state.

LEG

A0-A1
CE0-C
DD ...
D0-D7
IR/W
MM ...
R/W
VMA ...
WAIT ...
Y0-Y1
Ø0 ...
Ø2 VM

Any
nume
active

LEGE

A0-A15
B ...
C0-C9
C00-C0
CEA ...
CEB ...
CE0 ...
CE1 ...
CHLD ...
COL CL
COLOR
COL CL
COLOR
CVRD
CWE ...
D0-D7
DD ...
DEB ...
DOT IN

LEGEND FOR 527 BOARD SCHEMATIC

A0-A19	Address
CE0-CE23	Chip Enable RAM
DD	Data Direct
D0-D7	Data
IR/W	Internal Read/Write
MM	Memory Management
R/W	Read/Write
VMA	Video Monitor Address
WAIT	Wait
Y0-Y1-Y2	Upper Memory Decode
Ø0	Phase 0
Ø2 VMA	Phase Two Valid Memory Address

Any $\overline{\text{Bar}}$ above any alphabetical or numerical combination indicates line active in a low (0) state.

LEGEND FOR 540 BOARD SCHEMATIC

A0-A15	Address
B	Blue
C0-C9	Count
CD0-CD6	Color Data(Phase)
CEA	Chip Enable
CEB	Chip Enable
CE0	Chip Enable
CE1	Chip Enable
CHLD	Column Load
COL CLR	Column Clear
COLOR CL	Color Clear
COL CLOCK	Column Clock
COLOR FREQ	Color Frequency
CVRD	Color Video Read Direction
CWE	Color Write Enable
D0-D7	Data
DD	Data Direct
DEB	Delayed End Blank
DOT INHIBIT	Dot Inhibit

540 BOARD (CONTINUED)

DOT SHAPE	Dot Shape
END BLANK	End Blank
G	Green
HS	Horiz Sync
ID0-ID3	Internal Data
KBD	Keyboard Direction
KBE	Keyboard Enable
KD0-KD7	Keyboard Data
NI	Noise Interval
R	Red
R0-R7	Read
R/W	Read/Write
SE	Select Enable
S1	Sync
S4-S7	Sync
T3	Time
VA0-VA9	Video Address
VAS	Video Address Select
VD0-VD7	Video Data
VCEA	Video Chip Enable
VCEB	Video Chip Enable
VMA	Video Monitor Address
VRD	Video RAM Direction
VS	Vert Sync
WE	Write Enable
1R/W	Internal Read/Write
32	32 Character
Ø0	Microprocessor Clock In
Ø2 VMA	Phase Two Valid Memory Address
Ø2	Phase Two

Any $\overline{\text{Bar}}$ above any alphabetical or numerical combination indicates line active in a low (0) state.