



P
COMPOSTABLE

L
RECYCLED

B
BIODEGRADABLE

G
SUSTAINABLE

Flexible Packaging Specialists



January Stocklist 2024

Manufacturing since 1961

Fast and Friendly Packaging for Everyone!

Welcome to the January 2024 product catalogue from the PB Group! We're excited to share that this year, we have over 130 fantastic new products available online and we'll be introducing even more throughout the year.

You can easily browse and purchase all our stocked products online at www.polybags.co.uk. Additionally, we're delighted to let you know about our new website, www.pbprint.co.uk, where you can order personalised packaging that's printed right here in the UK.

If you have specific packaging needs, don't hesitate to talk to our friendly team. We can either create tailor-made packaging in-house or locate the perfect solution through our global supply chain network.

At PB Group, we are dedicated to making a positive impact on the environment. Our commitment to environmental issues is an ongoing journey, and we're constantly exploring sustainable opportunities made possible by the latest technology. We believe in producing in a socially responsible way, and this principle is deeply ingrained in our company culture. Thank you for being a part of our journey towards a better, more sustainable future.

Jon Lomax,
Managing Director

You can always take advantage of our "try before you buy service" and request a FREE sample!



Check out our  customer reviews at www.trustpilot.co.uk

With over **12,600+** reviews on Trustpilot, you can rest assured that you are making the right choice for your packaging needs. Just search trustpilot for www.polybags.co.uk.

FRANCES 

A good example and experience of buying online. Good quality and good value bags delivered swiftly.

SHEENA 

Fantastic service & prompt delivery, I would definitely recommend them to anyone and would use them again.

CAROLE 

The sample was sent quickly. It is useful to offer this service as customers are able to ensure they have the product they need. Order dealt with very quickly and emails kept me updated at all times.

CONTENTS

	PB Group, we are here to help About us, Sectors we supply, Our Production & Supply Chain, Sustainability.	4-19
	Packing Bags Clear simple bags, high strength bags, special use bags, gusseted bags	20-39
	Grip & Zip Seal Bags Grip seal, slider grip & zipper bags, freezer bags	40-49
	Rolls of Polythene Layflat tubing, builders rolls, shrink covers for palletising and heat sealers	50-57
	Mailing & Postal Packaging Mailing envelopes, mailing sacks, security mailers and carrier handle mailing bags	58-81
	Bubble Products, Protection & Void Fill Padded protection mailers, bubble bags and rolls of bubble wrap, kraft rolls	82-87
	Display Bags Retail display, bags for clothing, film front bags, card and header bags, gift bags, stand-up pouches	88-97
	Carrier Bags Patch, variguage, fashion, clip close, grip seal carriers, wallpaper & wrapping paper carriers	98-113
	Produce & Paper Bags Counter bags and sheets, produce bags on the roll, paper bags and carriers, kraft rolls	114-117
	Waste Bags & Sacks Black and coloured sacks, white and clear bin liners, special sizes and rubble sacks	118-125
	Vacuum & Netting Vacuum pouches, net bag, woven polypropylene sacks and FIBC	126-129
	Garment & Laundry Garment shaped covers and laundry bags	130-133
	Hygiene & PPE Disposable face masks, face shields, disposable aprons, disposable gloves, barrier tapes	134-137
	Packing Accessories Tape, stretchwrap, bag ties, labels, document enclosed envelopes & non adhesive warning tapes	138-145
	Index & Additional Information	146-151

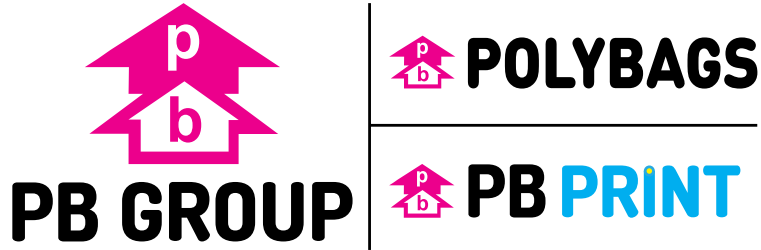

To deliver high-quality sustainable packaging with a fast and professional service, enabling our customers to Store, Protect and Transport their goods efficiently.

Think Packaging, think PB Group



PB GROUP
Packaging for Business

At PB Group, we believe that packaging is not just a necessity; it's an integral part of your products functionality and purpose. Whether you are an individual, a small business or multi-national corporation, our approachable and knowledgeable team are always ready to help with custom-made manufactured orders and readily available stock products.



POLYBAGS
Flexible Packaging Specialists

Our ability to manufacture flexible films allows us to create tailor-made products to meet individual needs. Additionally, we produce readily available stock lines (which can be ordered through www.polybags.co.uk) for immediate hassle-free delivery.



PB PRINT
Personalised Printed Packaging

PB Print offers personalised printed products using the latest printing technology right here in the UK. Whatever your printing needs we will work with you to find a packaging solution that offers you a personalised, high quality and reasonably priced product that can be created and delivered quickly.

Experience the PB Group Difference

When you choose PB Group, you choose a trusted partner who will be with you every step of the way. Our fast and friendly service, combined with our unwavering dedication to excellence, sets us apart from the competition. Contact us today and let's embark on a packaging journey and together, we'll create packaging solutions.

HOW WE CAN HELP IN YOUR SUSTAINABILITY JOURNEY



REDUCE



REUSE

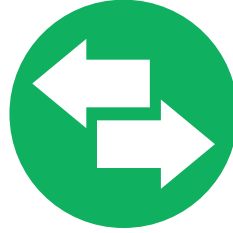

REPLACE



RENEW



RECYCLE

At PB Group, we recognise that there is no one-size-fits-all approach to sustainable packaging. Each product has a distinct lifecycle and therefore requires a customised approach to minimise environmental impact. We understand that sustainable packaging does not possess a “magic formula” that can miraculously solve all environmental challenges and have zero impact. Instead, sustainable packaging aims to minimise those impacts compared to conventional alternatives. Our team focus on three key pillars when discussing and helping to choose sustainable packaging options with customers:

1. Source reduction.
2. Materials selection.
3. End-of-life management.

Source reduction involves minimising the amount of packaging used, optimising size and weight, and eliminating unnecessary components. By working closely with our experts, you can explore design solutions that not only meet your functional requirements but also significantly reduce the environmental impact. We focus on finding the right balance between product protection, aesthetics, and source reduction. This all contributes to a reduction in the overall environmental footprint and waste generation.

Materials selection is a key aspect PB group can help add value in your sustainability journey. Our team of material specialists is dedicated to working with renewable, recyclable, and biodegradable materials that align with sustainable packaging practices. This encompasses a wide range of options such as paper, recycled plastics, compostable materials, and cutting-edge bio-based alternatives.

End-of-life management focuses on the post-consumer phase of packaging. The ultimate goal of end-of-life management is to establish a system where packaging materials are recovered, reused, or regenerated, thereby minimising the demand for virgin resources. Our team can provide expert advice on materials that align with desired end-of-life options considering your specific preferences or requirements.

OUR MANUFACTURING & GLOBAL SOURCING

We take immense pride in not only being manufacturers of top-quality packaging products but also global sourcing experts. This allows us to offer a diverse range of packaging solutions by combining our in-house manufacturing capabilities with a comprehensive global sourcing network. Through strategic partnerships and collaborations worldwide, we source an extensive selection of packaging that complement our own offerings. This allows us to provide our customers with a one-stop-shop experience, where they can find tailor-made packaging solutions.





	PAGES
• Clothing Bags	92
• Exhibition Carriers	107
• Garment Covers	130 -133
• Gift Bags	102 -105
• Greeting Card Bags	90 - 91
• Header Display Bags	94
• Plastic Carrier Bags	99 - 113

Retail Packaging

Retail products deserve to be presented in packaging that is beautiful, stylish and functional. We have many eye-catching ranges that could make the difference between a sale and a walk away.

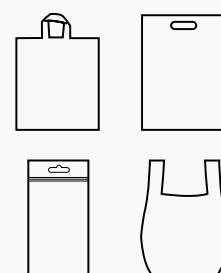

	PAGES
• Bread Bags	36
• Confectionery Bags	93 - 97
• Disposable Aprons	136
• Food Tray Liners	36
• Patisserie Bags	89
• Stand-up Pouches	95 - 97
• Vacuum Pack Bags	127 -128

Food Packaging

If you need a protective barrier to prevent items spoiling or air tight bags that keep perishables fresh, PB Group has many practical and cost-effective food packaging options.

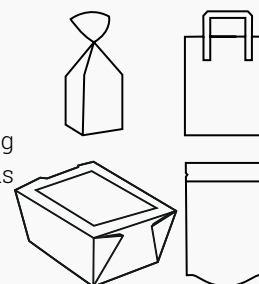



	PAGES
• Bubble Bags	83 - 85
• Bubble Wrap	83 - 84
• Dispatch Bags	64
• Mailing Bags	60 - 79
• Metallic Envelopes	78 - 79
• Packing Tape	139
• Postal Boxes	80 - 81

Ecommerce & Postal

Reliability and security is guaranteed when putting valuable and important items in transit. Our robust, cost effective postal solutions are ideal for offices, mail order, posting gifts, samples, clothing and much more.

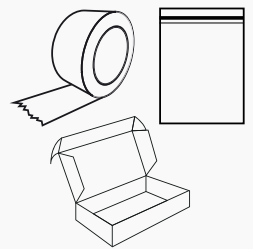

	PAGES
• Anti Static Bags	38
• Clinical Waste Bags	125
• Disposable Aprons	136
• Grip Seal Bags	41 - 49
• Specimen Bags	44
• Tamper Evident Bags	76
• Zipper Bags	41

Medical & Scientific

PB Group has a longstanding reputation for providing high quality products within the Medical & Scientific market sectors.

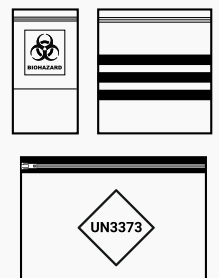



	PAGES
• Degradable Bags	29
• Flower Sleeves	90 - 91
• Pallet Covers	56 - 57
• Polythene Bags	21 - 39
• Produce Net Bags	129
• Rolls of Polythene	55
• Woven Grain Sacks	129

Agriculture

Our extensively tested Agricultural and Horticultural polythene is manufactured from non toxic high performance polythene in a multitude of sizes and thickness.

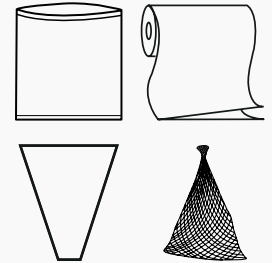

	PAGES
• Box Liners	36 - 38
• Heat Sealers	145
• Lay Flat Tubing	52 - 54
• Pallet Covers	56 - 57
• Glue Guns	143
• Stretch Wrap	141

Industrial

PB Group provides a wide range of industry sectors with high quality packaging enabling customers to Store, Protect and Transport their goods efficiently.

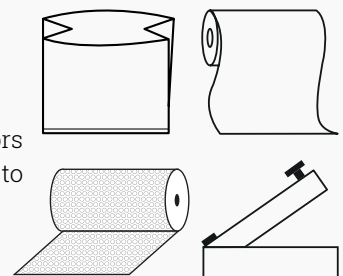



	PAGES
• Damp proof membrane	55
• Dust Covers	55
• FIBC	129
• Grip Seal Bags	41 - 49
• Polythene Rolls	52 - 55
• Rubble Sacks	120 + 124

Construction

Whether you're shielding against paint spills, providing a damp proof membrane or bagging up the waste our range of products are functional and extremely versatile.

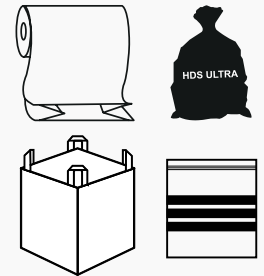

	PAGES
• Asbestos Bags	125
• Black Bin Bags	119 + 120
• Clear Waste Bags	119
• Dog Waste Bags	123
• Pedal Bin Liners	122
• Segmentation bags	119 + 121

Waste Management

Nearly all activity in life creates waste. That's why PB Group makes sure that everything from grass cuttings to clinical waste can be collected, transported and disposed of in the safest most efficient way.



Internally we operate a 100% Recycling Target

PB Group offer sustainable alternatives throughout our packaging ranges and operate environmentally responsible processes throughout our manufacturing. Our in-house manufacturing processes are designed around a 100% recycling principle. This means that wherever recycling waste is more energy efficient than disposal we will recycle. We have invested in state of the art in-house recycling technology to further reduce the environmental impact caused by collection and transportation of recyclable material. In reality this means we reuse nearly all of our waste plastic products and are able to recycle with minimal energy output.

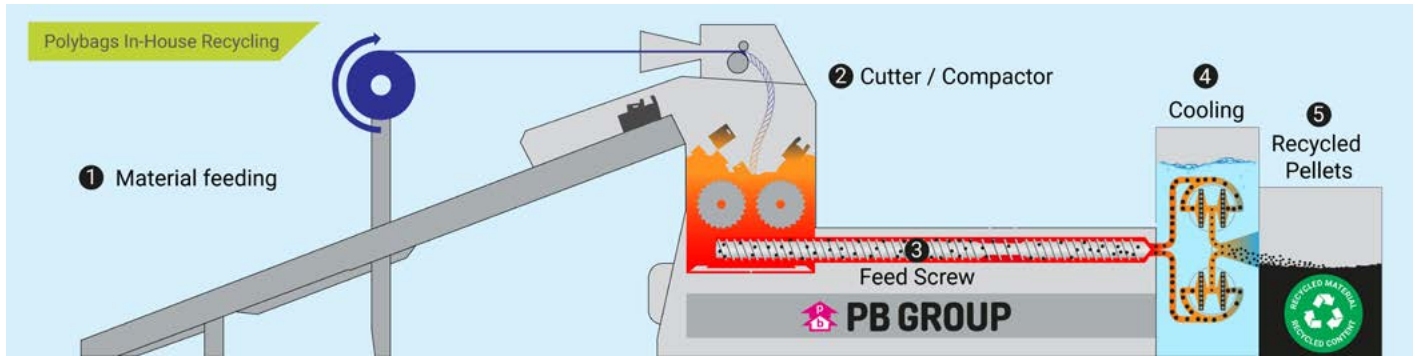

FLEXIBLE POLYMERS

Our manufacturing ability allows us to make products designed specifically for your business, tailored exactly to your needs and printed with your own company design, branding or messaging if required. You don't need to know anything about the manufacturing process as we manage everything for you. For an in-depth guide to our manufacturing click/scan QR below.

We use a variety of flexible films, each with slightly different properties. The most common ones are as follows:

Melt 2 Film Grade	Linear	Compostable
Melt 1 Low Slip	Hi Tensile	Reprocessed
High Melt 4	Polymax	I'm Green™



Tint or Opaque Colour?

The colour strength of the film depends on a combination of factors; The particular colour chosen, the film thickness and the percentage of colour blended in. Colour strength ranges from Tint (light colour blend) to Opaque (strong colour blend) and we can make to your exact requirement or match to your sample. Lightfast colour film can be supplied in black above 75 Micron thickness.



COLOURS Listed below are the most frequently requested colours

Table of colors with names and codes: Red (5020), Deep Orange (1046), Chocolate Brown (ENZ59029), Gold (7171), Ivory (9035), Strong Yellow (L2546), Light Yellow (2057), Bright Green (3450), Grass Green (3510), Khaki Green (3367), Bottle Green (3015) TINT, Dark Green (3888), Violet (4022), Navy Blue (4656), Royal Blue (4021), Sky Blue (4535), Pink (5246), White, Silver (7030), Silver Grey (8760), Dark Grey (8368), Black. Includes a rainbow bar and 'MORE COLOURS AVAILABLE ON REQUEST'.

ADDITIVES



VCI (Vapour Corrosion Inhibitor) Protects the goods against corrosion.



Freezer Grade EVA additive to prevent film cracking down to -30 degrees Centigrade.



Ultra Violet Inhibitor UV additive to prevent degradation of the film when stored outside.



Anti-Static Reducing the ability for static build up in the film.



Biodegradable Additive Additive that acts as a catalyst to accelerate the degradation process.



Degradable Additive Additive that accelerates the degradation process.

Degradable materials do not require living organisms to break down. Instead, chemical additives are used to make it crumble / fragment into smaller pieces more quickly than traditional plastic when exposed to the natural elements (sunlight, air & water).

Biodegradable simply means the breakdown of organic matter by micro-organisms, such as bacteria and fungi over time into elements that are found in nature, such as CO2, water and biomass, which is true for most materials on the planet.

1 Source: https://en.wikipedia.org/wiki/Biodegradation

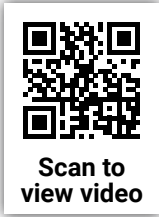

POLYMER BLENDING



We've invested in cutting-edge polymer blending technology, enabling us to seamlessly combine recycled and virgin polymers. This allows us to deliver high quality, tailor-made products with the flexibility to include anywhere from 30% to 100% recycled polymers.



FILM CONVERSION

The rolls of flexible film that leave the extrusion process can be turned into a wide range of products, (Sheeting or Bags) depending on how it is cut and folded before being wound onto the roll.

BAG CONVERSION OPTIONS

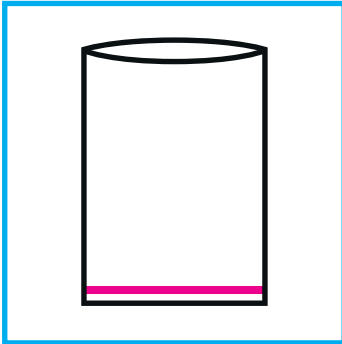

STRONG SEAL
BOTTOM WELD BAG

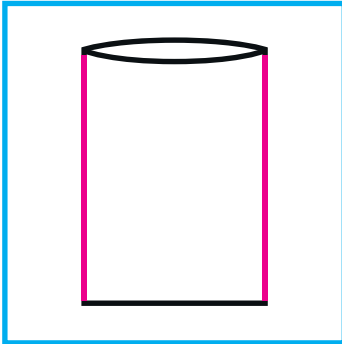

ECONOMICAL SIDE
WELD SEAL BAG

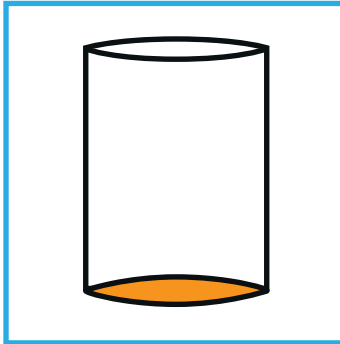

BOTTOM GUSSET BAG
WIDE BASE FOR BULKY ITEMS

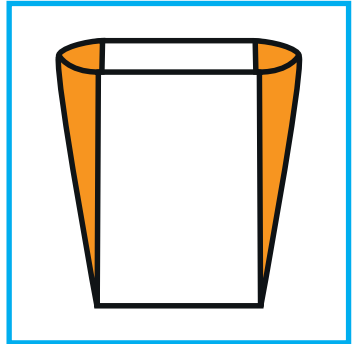

SIDE GUSSET BAG
WIDENS ON OPENING

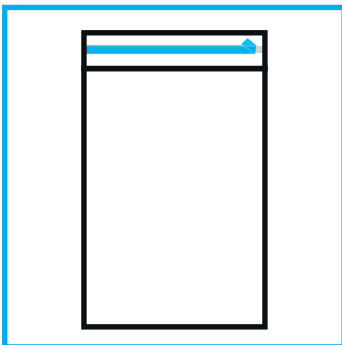

ADHESIVE STRIP
PERMANENT OR RESEALABLE

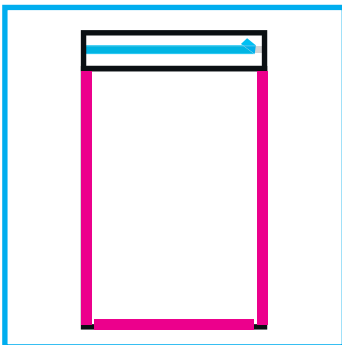

SKIRTS
SIDE OR BOTTOM

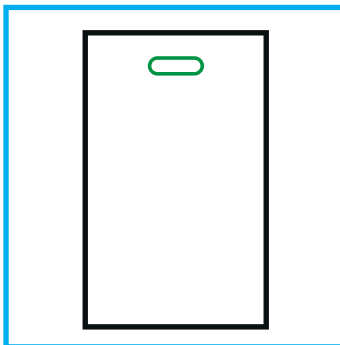

PUNCHED HANDLES

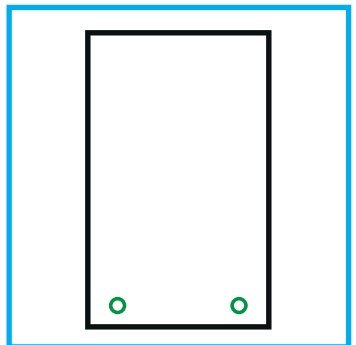

6MM PERFORATIONS

ROLL CONVERSION OPTIONS

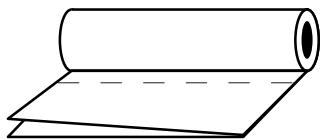

CENTREFOLD



LAYFLAT TUBING

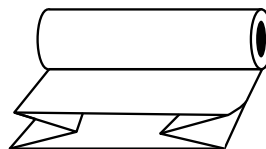

GUSSETED

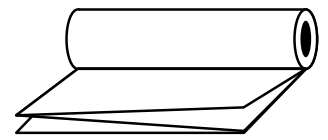

MULTIFOLD

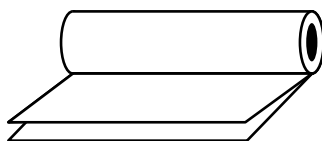

DOUBLE WOUND (DWS)

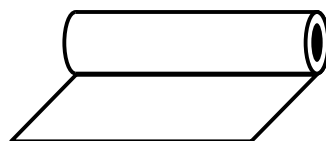

SINGLE WOUND (SWS)



J FOLD

SUSTAINABLY SOURCED PAPER

Sustainability is at the heart of our paper packaging strategy. We prioritise working with suppliers who adhere to stringent environmental standards and have earned independent verification of their sustainable forestry practices. This ensures that the paper used in our products comes from responsibly managed forests, where conservation and responsible harvesting are paramount. This contributes to the preservation of biodiversity, the protection of vital ecosystems, and the promotion of ethical and environmentally-friendly practices.



PAPER CONVERSION

Renowned for its strength, printability, recyclability, and customisation capabilities we convert paper packaging together with corrugated solutions across our global supply chain network. Robust and lightweight packaging like paper carriers, mailing bags and rolls emerge from the conversion of kraft paper, while corrugated packaging takes shape as boxes, cartons and rolls.

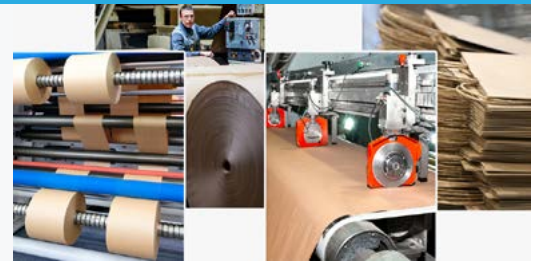

PAPER CONVERSION OPTIONS

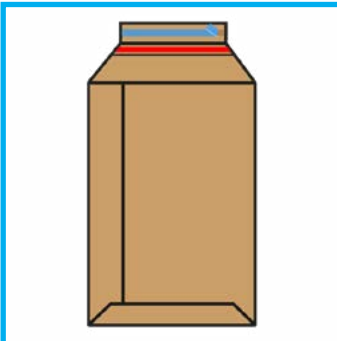

CARDBOARD MAILER



CARRIER BAGS

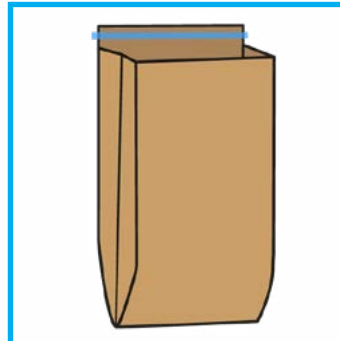

2 PLY MAILER

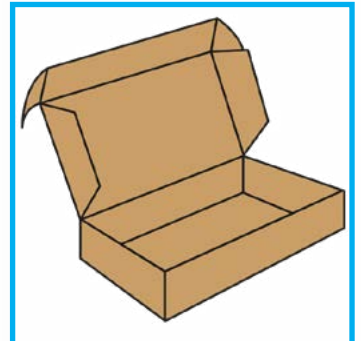

CARTONS

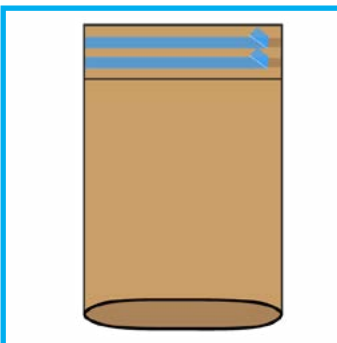

PAPER MAILING BAGS

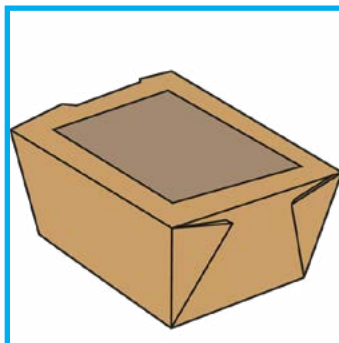

DELI BOXES

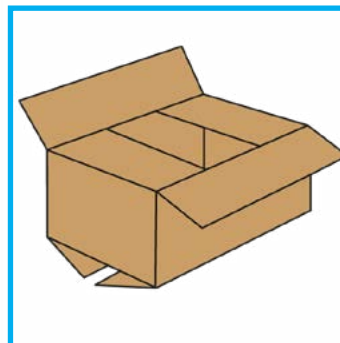

CARDBOARD BOXES

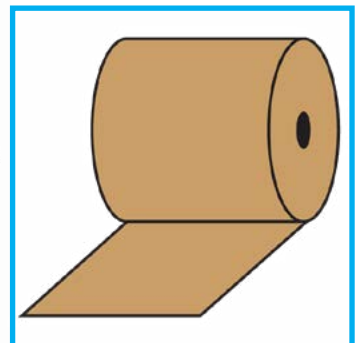

PAPER ROLLS



Create Unique Printed Packaging

Sometimes you need your packaging to work a little harder for you. It might be that you need it to advertise your businesses and shout about your services or provide crucial storage and safety advice.

Endless Possibilities

Here at PB Group, we offer a wide range of customisable products from logo-printed carriers or mailing bags to clinical waste and recycling bags. Whatever your printing needs we will work with you to find a packaging solution that offers you a personalised, high quality and reasonably priced product that can be created and delivered quickly.



Brand Advertising

We understand that the best way to advertise your business is to get your brand out there as much as possible. With our printed carrier and mailing bag solutions, you provide your customers with a walking advert for your business which allows your business to really stand out from the crowd. If you're unsure about what might be the best choice for your business just pick up the phone and our friendly team will be happy to discuss the best personalised solution for you.



Safety Advice

Sometimes our products are about much more than packaging and storage. Our range of waste disposal bags and recycling bags can be used to contain potentially harmful materials and clearly marked packaging can ensure the safety of your customers and employees. So whether you simply want to encourage your employees to recycle responsibly or address the risk of a hazardous material we can create a personalised bag for you.



Customer Messaging

Beyond advertising and safety measures personalised packaging is a fantastic way to pass on key messages to your customers. It might be special instructions on how to take care of your product, proper storage advice or contact details. Our printing, like all of our products and services, is finished to our own high-quality standards so you can ensure that important messages will be clearly visible.



How do I create a personalised packaging product?

Simply email or pick up the phone to our helpful staff. PB Group are a specialist packaging manufacturer so we may just be able to create something unique for your business.

Get Personalised with PB Group today!

Which Material is Best?

HOW TO MAKE AN INFORMED DECISION?

The environmental benefits of green / eco-friendly products are not that they somehow fix the environment or have zero impact, but rather that their environmental impacts are less than those of similar products. *Life Cycle Assessment (LCA) is a tool for the systematic evaluation of the environmental aspects of a product through all stages of its life cycle. As such, if implemented well, it can provide a valuable tool to evaluate different options at any given point in time¹.*



How to measure Environmental Impact?

Total Environmental Impact = Cost of Production + Cost of Use + Cost of Disposal

The key indicators/variables to compare include:

PRODUCTION - What is the impact of producing?

- Energy input, Natural resource use, Transportation, Emissions from manufacturing.

USE - How use of the product impacts humans or the environment

- Impact on human health, Lifespan of the product, Environmental impact of use.

POST-USE - How disposal of the product impacts the environment

- Pollution of natural environment, Emissions from disposal, Cost of recycling.

According to a study, a plastic bag in eight out of nine impact categories (eg. carbon footprint, ecotoxicity, eutrophication, human toxication) has a lower impact compared to a paper equivalent. Products can have eco-friendly properties from one perspective but not from another. *"It takes more than four times as much energy to manufacture a paper bag as it does to manufacture a plastic bag and paper manufacturing process, produces a higher concentration of toxic chemicals. However, paper is more widely recyclable and decomposes much more quickly than plastic, therefore it is less likely to be a source of litter and pose a risk to wildlife²."*

The key issue with paper bags = **CARBON EMISSIONS**

The key issue with plastic bags = **LITTER**

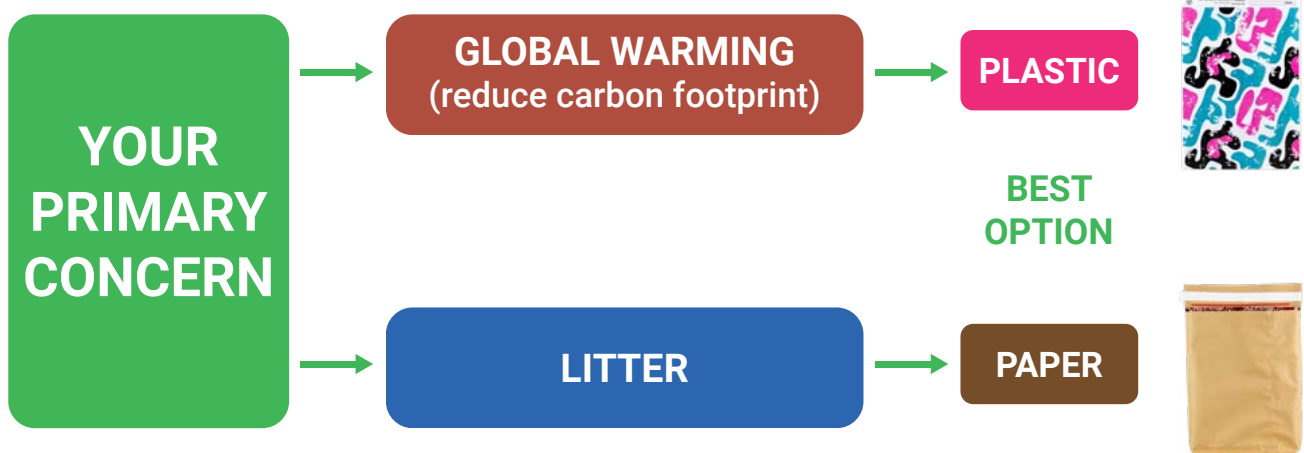









**SCAN TO VIEW
RESEARCH
INFORMATION**

Our website is a useful reference for best-practice options based on current scientific research papers. Hopefully the information and guidance provided by PB Group can help guide you to find the optimal and most eco-friendly packaging solution based on your own unique circumstances.

¹ Source: The New Plastics Economy: Rethinking the future of plastics. World Economic Forum 2016
² Source: Environment Agency: Report SC030148

MATERIAL OPTIONS - WHICH IS BEST?



We've created a range of visual icons designed to assist you in recognising the material characteristics relevant to the different packaging materials.

Icon	Description
	<p>We are making an increasing range of products with a significant proportion of the content from recycled material. PB Group' recycled material does not always come from the same source. Some of it is taken from in-house industrial waste, whilst some is taken from post-consumer recycling. Certain recycled products cannot be considered as 'food safe', because the recycled material may contain contamination substance residues prior to the recycling process.</p> <div style="display: flex; justify-content: space-around; align-items: center;">    </div>
 <p>I'm green</p>  <p>COMPOSTABLE</p>	<p>Polymers derived from renewable resources offer the opportunity to benefit society and the environment by reducing demands on fossil resources. Sugars, oils and other compounds in renewable feed-stocks can be converted into chemicals and polymers using conversion processes similar to those employed by the petrochemical industry. Currently, it is a tiny percentage of the overall plastics market, but is growing rapidly.</p> <p>I'm Green is polythene produced from sugar cane, rather than traditional fossil fuels. It performs in the same way as traditional fossil-fuel-based polythene and is chemically identical, but has a renewable, bio-based carbon content share of more than 95% (ASTM D6866 standard). I'm Green can also be recycled with traditional polythene. A life-cycle analysis calculates that each tonne of I'm Green polythene produced captures up to 3.09 tonnes of CO2 out of the atmosphere through the sugar cane growing process.</p> <p>Compostable polymers are engineered to undergo structural degradation and decomposition, making them ideal for short-term item storage. 'Composting' denotes an accelerated biodegradation process that occurs in controlled environments, primarily marked by active aeration and natural heat generation resulting from the biological processes within the material. PB Group's lineup of compostable packaging materials is sourced from natural materials like sugarcane and potato starch, as well as renewable and fossil fuel resources. These resources can be transformed into chemicals and polymers using processes akin to those used for traditional polyethylene films.</p>
 <p>DEGRADABLE</p>	<p>Additive that accelerates the degradation process. Materials do not require living organisms to break down. Instead, chemical additives are used to make it crumble / fragment into smaller pieces more quickly than traditional plastic when exposed to the natural elements (sunlight, air & water).</p>
 <p>BIODEGRADABLE</p>	<p>Additive that acts as a catalyst to accelerate the degradation process. Simply means the breakdown of organic matter by micro-organisms, such as bacteria and fungi over time into elements that are found in nature, such as CO2, water and biomass.</p>
 <p>PAPER PRODUCTS</p>	<p>Paper poses less of a litter problem than most other packaging and it is widely recyclable. Nevertheless, paper packaging has a much greater carbon footprint than polythene, during the production and transportation process.</p>

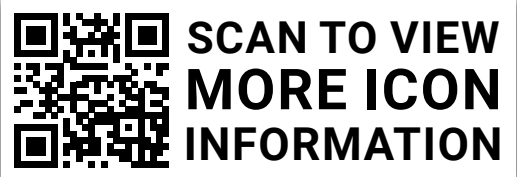
To see how we use our icons to help guide you through product selection go to:
<https://polybags.co.uk/packaging/packaging.htm>
 to view more details.



DISPOSAL OPTIONS - WHICH IS BEST FOR YOU?

Icon	Description
 RECYCLE	<p>Mechanical recycling. The process of mechanical recycling has its own environmental burden in using energy, materials and water to collect, sort and clean. Physical and chemical contamination may also preclude cost-effective recycling, since it needs cleaning processes which are economically and environmentally costly. Not all plastics are currently accepted in domestic recycling collections. Always check your local services for confirmation as difficult-to-recycle items may be collected by other organisations.</p>
 COMPOSTABLE	<p>Biological / Organic recycling. Best when contents remain in packaging after use eg food packaging that is likely to be coated in food at the time it is discarded. Avoid when users don't have access to industrial composting. Composting is a highly desirable clean source recycling alternative to landfill. Strictly in terms of energy efficiency, you're not gaining or saving energy by composting, but you're offsetting the energy needed to convert new plant-based materials into new packaging. Remember compostable products don't biodegrade in landfill, the ocean or as litter.</p>

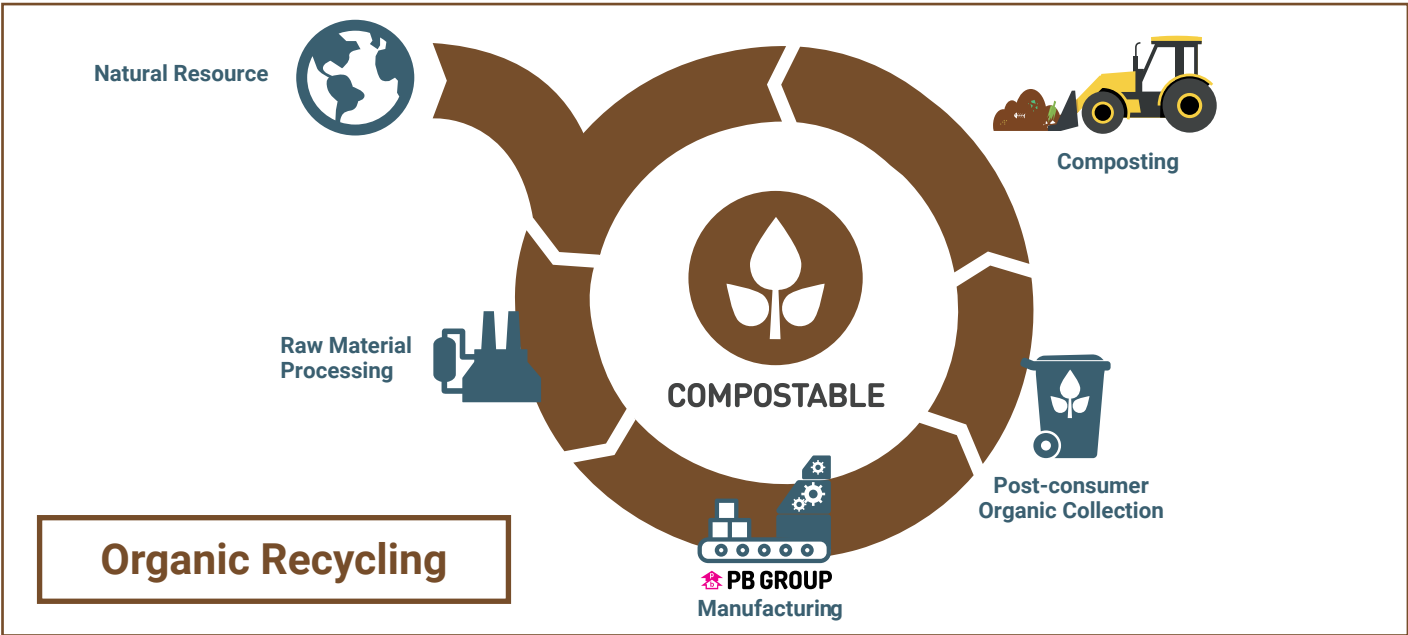
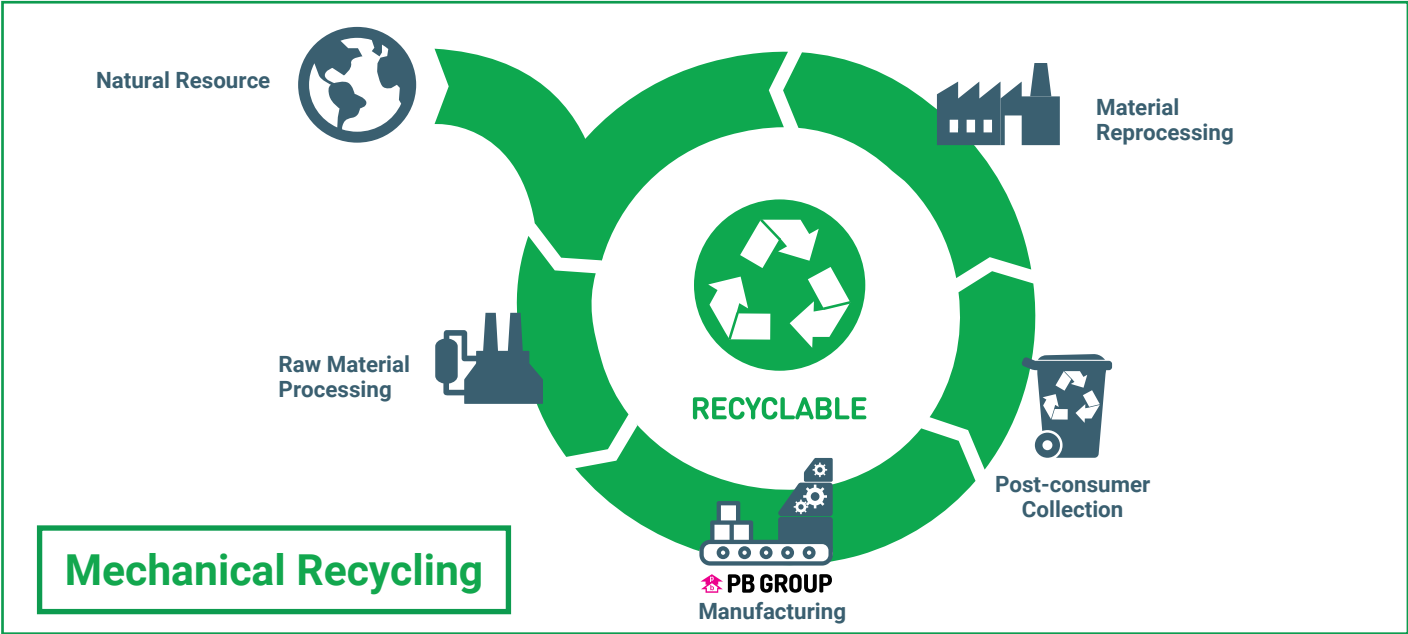

 Portfolio	DESCRIPTION	FOSSIL BASED		
		POLYETHYLENE	POLYMAX	BIODEGRADABLE
PRODUCTION IMPACT	RENEWABLE SOURCE			
	CARBON FOOTPRINT			
	WATER USAGE			
	ENERGY USAGE			
	LAND USAGE			
	TRANSPORTATION COST			
	COST	£	££	££
USE	FOOD SAFE			
	SHELF LIFE	+10 YEARS	+10 YEARS	1 YEAR
DISPOSAL	OPTIMUM DISPOSAL	 RECYCLE	 RECYCLE	 RECYCLE
BRANDS		 	 Metalocene	
INFORMATION		LDPE, MDPE, HDPE	Extra Strong, Lightweight, Reduces transport costs	Not a solution for ocean / marine litter
BEST USED		When flexibility & moisture resistance are needed to protect contents		Carrier Bags

Our Material Portfolio

RECYCLED CONTENT	PLANT BASED RECYCLABLE		PLANT BASE COMPOSTABLE
	GREEN POLYTHENE	PAPER	
£	£££	£££	£££
RECYCLE	RECYCLE	RECYCLE	COMPOST
Clarity reduces as recycled content increases	CO2 is absorbed during the growing process	Easily recycled in UK	Not a solution for ocean / marine litter. Best when contents remain after use. CO2 is absorbed during the growing process
Mailing Bags Clothing Bags Carrier Bags Waste Bags	Looks & feels like traditional polythene	Carrier Bags Mailing Bags	Confectionary bags, fruit & vegetable bags, carrier bags with second use of food waste caddy liner, biowaste bags



Scan to
view video

1824120

HT1218STBLT



**BRAND IT
YOUR WAY**

ANS12

BLK46MID

PACKING BAGS

Packing bags are invaluable in both Commercial and Domestic environments. So when you need a packing solution that addresses a wide range of applications, our packing bags offer the ideal cost-effective choice. Perfect for protecting and storing anything from food, small components or large items of furniture. Our packing bags can be sealed with ties, tape or heat for a secure professional finish.



Budget Clear Polythene Bags

Commodity Code: 3923210000

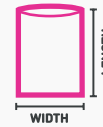

RECYCLE



FOOD SAFE



92 GAUGE



188 GAUGE



400 GAUGE

SIZE	CODE	SIZE (W x L) MM	THICKNESS MICRON	WEIGHT Kg	BOX QTY	ALL PRICES PER BOX			
						1+	5+	10+	25+
MINI	LITE46	100 x 150	23	6.7	10000	50.49	41.80	37.68	36.93
	MID46		47	6.6	5000	51.50	42.65	38.42	36.49
	HEAVY46		100	8.7	3000	67.50	60.85	56.62	55.34
SMALL	LITE57	127 x 175	23	4.7	5000	36.30	30.02	28.79	27.78
	MID57		47	7.7	4000	57.80	47.78	45.04	44.25
	HEAVY57		100	8.5	2000	62.81	53.16	50.12	48.13
	LITE68	150 x 200	23	6.5	5000	49.48	42.95	40.41	38.17
	MID68		47	7.9	3000	57.50	48.18	43.36	40.45
	HEAVY68		100	5.8	1000	38.80	35.50	32.00	30.33
	LITE79	175 x 225	23	5.1	3000	36.56	30.20	26.31	24.12
	MID79		47	6.9	2000	48.95	41.85	37.72	35.85
	HEAVY79		100	7.6	1000	48.40	40.76	36.07	33.07
	LITE810	200 x 250	23	6.5	3000	45.43	36.55	32.42	29.80
	MID810		47	8.8	2000	60.58	49.45	43.90	42.75
	HEAVY810		100	9.7	1000	59.77	50.36	44.47	40.81
LITE812	200 x 300	23	5.2	2000	35.83	27.56	25.57	24.69	
MID812		47	5.3	1000	36.53	28.14	26.11	25.50	
HEAVY812		100	11.6	1000	68.29	57.51	51.99	47.57	
MEDIUM	LITE1012	250 x 300	23	6.5	2000	42.31	39.33	36.75	35.94
	MID1012		47	6.6	1000	43.15	33.59	30.96	28.95
	HEAVY1012		100	14.5	1000	81.09	68.54	61.50	57.69
	LITE1015	250 x 375	23	4.0	1000	26.82	20.52	18.83	18.51
	MID1015		47	8.3	1000	52.03	41.47	38.18	35.76
	HEAVY1015		100	9.1	500	50.87	41.96	38.46	35.92
	LITE1215	300 x 375	23	4.9	1000	31.51	24.06	22.99	21.78
	MID1215		47	9.9	1000	65.79	59.44	56.55	55.10
	HEAVY1215		100	10.9	500	66.41	57.76	52.53	47.40
	LITE1218	300 x 450	23	5.8	1000	37.99	32.94	30.41	29.03
	MID1218		47	11.9	1000	70.79	67.16	64.37	63.39
	HEAVY1218		100	13.1	500	80.56	76.54	72.46	70.24
LARGE	LITE1520	375 x 500	23	8.1	1000	45.40	39.50	36.22	35.44
	MID1520		47	8.3	500	48.22	43.09	40.72	39.12
	HEAVY1520		100	18.1	500	109.91	103.45	98.77	95.04
	LITE1824	450 x 600	23	5.8	500	34.97	28.51	25.89	24.20
	MID1824		47	11.9	500	66.48	55.97	51.04	47.38
	HEAVY1824		100	13.1	250	74.70	65.42	61.79	57.94
	LITE2030	500 x 750	23	8.1	500	48.33	42.08	38.54	36.25
	MID2030		47	8.3	250	51.46	42.13	38.53	36.92
	HEAVY2030		100	14.5	200	77.77	68.73	62.60	58.45
	LITE2436	600 x 900	23	5.8	250	35.04	30.20	27.39	25.21
	MID2436		47	11.9	250	66.72	58.97	52.85	49.47
	HEAVY2436		100	10.5	100	59.56	49.37	47.29	42.95
EXTRA LARGE	LITE3648	900 x 1200	23	9.6	200	53.97	49.22	47.17	43.94
	MID3648		47	9.8	100	54.46	46.82	41.74	39.60
	HEAVY3648		100	10.4	50	62.11	54.79	51.83	49.94

Handy Measure

inches

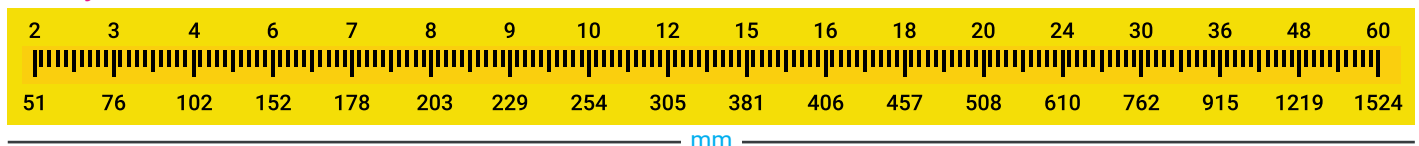



Clear Packing Bags

Commodity Code: 3923210000

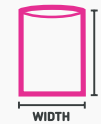

RECYCLE

FOOD SAFE

SIZE	CODE	SIZE (W x L)		THICKNESS MICRON	WEIGHT Kg	BOX QTY	ALL PRICES PER BOX				
		WIDTH	LENGTH				1+	3+	5+	10+	25+
MINI	22100	51mm (2 inches)	51	25	0.1	1000	8.80	4.54	3.08	2.24	£1.54
	23120		76	30	0.2	1000	9.90	5.47	3.93	3.04	£2.34
	23200ST		76	50	0.4	1000	11.54	6.85	5.20	4.22	£3.48
	24120		102	30	0.3	1000	10.63	6.07	4.48	3.60	£2.80
	24200		102	50	0.5	1000	12.72	7.81	6.10	5.10	£4.19
	33100	76mm (3 inches)	76	25	0.3	1000	10.40	4.98	4.75	3.66	£2.70
	33150		76	37.5	0.4	1000	11.78	7.31	6.96	5.78	£5.15
	34120		102	30	0.4	1000	11.98	6.34	6.01	4.81	£3.81
	34200		102	50	0.7	1000	14.85	8.82	8.23	6.94	£5.79
	35120		127	30	0.5	1000	12.86	7.13	6.74	5.52	£4.46
	35200		127	50	0.9	1000	16.28	10.20	9.91	8.27	£6.94
	35250	127	62.5	1.1	1000	18.22	11.90	11.50	9.76	£8.35	
	46100	102mm (4 inches)	152	25	0.7	1000	14.55	8.60	8.51	6.98	£5.70
	46120		152	30	0.9	1000	15.72	9.66	9.45	7.90	£6.55
	46150BIO		152	37.5	1.1	1000	19.32	14.64	12.03	10.70	£9.52
	46200		152	50	1.5	1000	20.79	14.16	13.47	11.84	£10.22
	46250		152	62.5	1.8	1000	23.60	16.71	15.71	13.88	£12.09
	46500		152	125	3.6	1000	36.85	28.58	26.78	23.21	£21.33
MEGA46	152		200	5.8	1000	49.88	43.11	41.01	39.88	£38.25	
48120	203		30	1.2	1000	17.26	11.16	10.88	9.03	£7.68	
SMALL	56120	127mm	152	30	1.1	1000	16.37	10.41	10.15	8.36	£7.05
	58120		203	30	1.5	1000	18.94	12.78	12.37	10.37	£8.94
	68100	152mm (6 inches)	203	25	1.5	1000	17.18	11.89	10.02	9.09	£8.83
	68120		203	30	1.7	1000	19.29	14.56	12.70	11.69	£10.76
	68150BIO		203	37.5	2.2	1000	28.46	23.74	20.88	18.87	£17.41
	68250		203	62.5	3.6	1000	32.93	27.46	24.69	23.07	£21.58
	68500		203	125	7.2	1000	61.89	58.91	56.27	55.78	£54.60
	MEGA68		203	200	11.6	1000	82.95	75.22	70.10	67.48	£64.36
	612120		305	30	2.6	1000	25.51	20.23	19.19	17.88	£16.70
	612250		305	62.5	5.4	1000	45.12	38.07	35.83	32.48	£31.45
	612500ST	305	125	10.9	1000	81.54	71.04	65.20	61.89	£60.26	
	79120	178mm (7 inches)	229	30	2.3	1000	22.53	16.72	14.98	13.66	£12.52
	79250		229	62.5	4.7	1000	39.08	31.76	29.06	27.02	£26.14
	79500		229	125	9.6	1000	67.17	59.49	55.14	51.83	£48.53
	712120		305	30	3.1	1000	27.23	21.27	19.22	17.65	£16.24
	810100	203mm (8 inches)	254	25	2.4	1000	23.39	17.70	15.89	14.44	£13.19
	812120		305	30	3.5	1000	30.67	24.23	21.96	20.18	£18.58
	812150		305	37.5	4.4	1000	36.51	29.45	26.79	24.73	£22.86
812250	305		62.5	7.2	1000	55.65	46.59	43.09	40.11	£37.33	
812500	305		125	7.3	500	52.22	47.59	43.38	40.56	£39.74	
912120	229mm (9 inches)		305	30	3.9	1000	32.74	26.45	24.20	22.19	£20.40
912150BIO		305	37.5	5.0	1000	43.49	40.06	37.58	33.98	£30.24	
912250		305	62.5	8.1	1000	60.80	51.82	47.96	44.61	£41.47	
912500		305	125	8.2	500	57.77	50.94	47.39	44.25	£41.19	
1012120	254mm (10 inches)	305	30	4.4	1000	33.41	29.53	27.72	26.34	£24.45	
1012250		305	62.5	9.0	1000	64.99	59.20	55.91	53.03	£50.73	
1012500		305	125	9.5	500	62.10	58.01	54.79	52.05	£50.93	
MEGA1012		305	200	14.5	500	92.63	85.11	79.48	76.36	£72.49	
1015120		381	30	5.4	1000	40.33	35.99	33.83	32.08	£29.83	
1015150		381	37.5	6.9	1000	48.69	43.83	41.25	39.08	£37.50	
1015150BIO		381	37.5	3.5	500	45.59	42.55	40.99	36.85	£34.38	
1015250		381	62.5	11.3	1000	78.00	71.30	67.27	63.68	£60.65	
1015500		381	125	11.3	500	74.90	69.89	65.96	62.48	£58.51	
MEGA1015		381	200	9.1	250	54.88	51.35	47.81	46.12	£43.65	
1018150	457	37.5	8.3	1000	56.43	51.01	48.00	45.40	£42.31		

*All clear Biodegradable bags have printed text on the bag confirming the material is compliant with PAS 9017 for weathering.

SIZE	CODE	SIZE (W x L)		THICKNESS MICRON	WEIGHT Kg	BOX QTY	ALL PRICES PER BOX				
		WIDTH	LENGTH				1+	3+	5+	10+	25+
MEDIUM	1215120	305mm (12 inches)	381	30	6.5	1000	46.64	42.95	40.44	38.39	£36.86
	1215250		381	62.5	13.5	1000	90.09	82.44	77.70	75.49	£71.71
	1215500		381	125	13.6	500	86.87	80.94	76.28	72.10	£67.41
	1218120		457	30	7.8	1000	53.79	49.56	46.65	45.26	£44.40
	1218150		457	37.5	9.9	1000	64.47	59.43	55.90	54.87	£53.34
	1218150BIO		457	37.5	5.0	500	52.16	49.56	47.20	42.86	£39.38
	1218250		457	62.5	8.2	500	56.25	50.64	48.70	46.11	£43.01
	1218500		457	125	8.2	250	55.03	49.92	47.78	45.65	£42.85
	1220200		508	50	7.3	500	48.88	42.56	39.85	38.58	£37.86
LARGE	1520120	381mm (15 inches)	508	30	10.9	1000	68.25	62.95	59.31	55.61	£51.65
	1520150BIO		508	37.5	6.6	500	58.87	54.68	51.78	47.55	£43.96
	1520200		508	50	9.1	500	56.74	52.44	49.40	46.26	£43.92
	1520500		508	125	11.3	250	67.38	63.08	59.47	55.88	£52.31
	MEGA1520		508	200	14.5	200	83.23	77.60	71.96	68.84	£64.98
	1620120	406mm	508	30	11.6	1000	71.16	65.90	62.05	58.13	£53.94
	1824120	457mm (18 inches)	610	30	7.8	500	52.53	49.76	44.84	43.56	£42.93
	1824150		610	37.5	9.9	500	62.35	57.23	53.38	49.53	£46.98
	1824150BIO		610	37.5	9.9	500	71.83	67.78	63.59	59.20	£54.93
	1824250		610	62.5	8.1	250	53.87	50.04	47.88	45.76	£44.50
	1824500		610	125	13.1	200	80.65	75.53	72.53	70.83	£68.06
	1830120	762	30	9.8	500	61.04	57.20	52.08	49.50	£45.68	
	2024120	508mm (20 inches)	610	30	8.7	500	54.30	50.04	47.13	44.03	£40.70
	MEGA2024		610	200	11.6	100	63.84	59.34	54.83	52.48	£49.34
	2030120		762	30	10.9	500	66.42	62.31	59.51	57.19	£53.20
	2430120	610mm (24 inches)	762	30	13.1	500	80.81	77.06	73.67	72.48	£72.05
	2430250		762	62.5	13.6	250	81.60	75.43	70.96	68.46	£66.92
	2430500		762	125	10.9	100	63.26	59.08	55.58	52.10	£48.61
	2436120		915	30	7.9	250	48.24	44.37	41.68	38.93	£35.88
	2436150BIO		915	37.5	9.9	250	69.03	64.83	63.22	59.29	£55.08
	2436250		915	62.5	13.0	200	77.37	71.47	67.12	62.67	£59.03
	2436500		915	125	13.1	100	83.10	79.99	77.86	75.63	£73.96
	MEGA2436		915	200	10.5	50	59.47	55.63	53.40	51.57	£49.95
	3036120		762mm (30 inches)	915	30	9.8	250	63.34	55.00	51.81	49.28
3036250ST	915			62.5	8.1	100	51.41	46.17	43.52	41.39	£39.54
3036500ST	915	125		8.2	50	50.90	45.65	43.01	39.57	£37.45	
MEGA3036	915	200		13.1	50	73.65	67.50	63.48	58.63	£56.19	
3048250ST	1219	62.5		10.9	100	66.04	63.11	60.66	58.90	£57.41	
3048500ST	1219	125	10.9	50	64.89	61.09	57.66	55.96	£54.78		
3648150BIO	915mm (36 inches)	1219	37.5	7.9	100	52.49	50.66	49.57	45.36	£43.28	
3648250ST		1219	62.5	13.0	100	72.94	66.30	62.18	58.87	£55.84	
3648500ST		1219	125	13.1	50	72.13	65.49	61.36	56.80	£53.51	
MEGA3648		1219	200	10.5	25	58.02	53.76	51.86	49.80	£45.90	
4848250ST	1219mm (48 inches)	1219	62.5	8.6	50	50.05	44.78	42.05	39.83	£37.88	
4848500ST		1219	125	8.7	25	49.52	44.26	41.51	38.05	£35.85	
4860120ST		1524	30	10.5	100	57.24	51.43	48.14	45.50	£43.11	

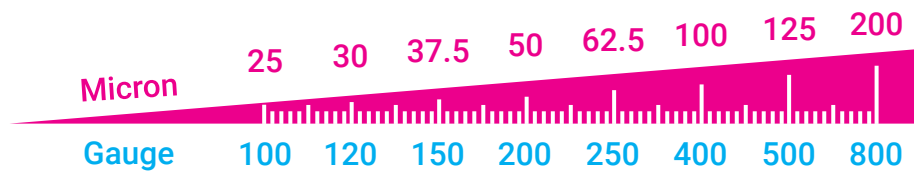

Thickness Guide



Extra Long & Narrow Clear Bags

Ideal for packing posters, umbrellas, golf clubs & rugs.

Commodity Code: 3923210000

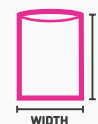

CODE	SIZE (W x L)		THICKNESS MICRON	WEIGHT Kg	DESCRIPTION	BOX QTY	ALL PRICES PER BOX				
	MM	MM					1+	3+	5+	10+	25+
LONG3	65	550	50	6.7	Narrow	2000	71.88	67.32	63.28	57.09	£52.60
LONG7	95	700	50	6.2	Narrow	1000	59.13	54.64	51.01	45.25	£37.14
LONG11	125	700	50	8.5	Narrow	1000	66.64	62.58	57.60	51.60	£43.83
LONG14	155	1200	50	8.7	Narrow	500	70.61	67.44	61.36	55.00	£46.61

I'm Green - What is it?

I'm Green is polythene produced from sugar cane, developed by Braskem - the world's largest biopolymer producer. It performs in the same way as traditional fossil-fuel-based polythene and is chemically identical, but has a renewable, bio-based carbon content share of more than 95% (ASTM D6866 standard). I'm Green can also be recycled with traditional polythene.



How is it different from traditional polythene?

The main difference is that the ethanol used to produce I'm Green polythene is derived from sugar cane - a renewable raw material - rather than traditional fossil fuels, such as crude oil or natural gas.

So what is the process?

Sugar cane is planted and harvested every year, absorbing carbon dioxide (CO₂) while it grows. Ethanol producers convert the harvested sugar cane into green ethanol. They then supply Braskem, who use their polymerisation plants to transform the ethanol into I'm Green polythene.



How is it eco-friendly?

A life-cycle analysis calculates that each tonne of I'm Green polythene produced captures up to 3.09 tonnes of CO₂ out of the atmosphere. It has a renewable, bio-based carbon content share of more than 95%, whereas traditional polythene uses fossil fuels that can not be replenished once diminished. I'm Green is also a recyclable product and can be processed in the same recycling streams as traditional polythene.



Packing Bags

Commodity Code: 3923210000
Origin: GB

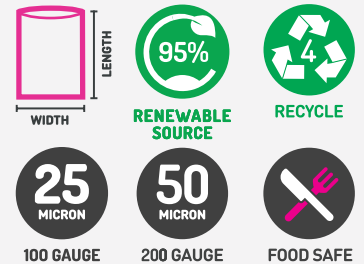

SIZE	CODE	SIZE (W x L) MM	THICKNESS MICRON	WEIGHT Kg	BOX QTY	ALL PRICES PER BOX			
						1+	5+	10+	25+
MINI	46SUST100	100 x 150	25	1.4	2000	64.91	59.74	54.57	48.76
	46SUST200		50	2.8	2000	71.52	65.85	60.17	53.79
SMALL	68SUST100	150 x 200	25	1.4	1000	36.00	33.15	30.29	27.08
	68SUST200		50	2.8	1000	42.23	38.90	35.57	31.82
	812SUST100	200 x 300	25	2.8	1000	42.66	39.29	35.92	32.14
	812SUST200		50	5.6	1000	54.54	50.27	46.00	41.20
MEDIUM	1015SUST100	250 x 375	25	4.4	1000	51.71	47.65	43.59	39.01
	1015SUST200		50	8.7	1000	74.84	69.00	63.16	56.58
	1218SUST100	300 x 450	25	6.3	1000	65.62	60.47	55.33	49.54
	1218SUST200		50	6.3	500	50.97	47.00	43.03	38.55
LARGE	1520SUST100	375 x 500	25	4.4	500	47.19	43.49	39.78	35.63
	1520SUST200		50	10.1	500	69.51	64.11	58.72	52.65
	1824SUST100	450 x 600	25	6.3	500	66.73	61.50	56.27	50.37
	1824SUST200		50	6.3	250	50.53	46.59	42.65	38.22
	2436SUST100	600 x 900	25	6.3	250	67.72	62.41	57.09	51.12
2436SUST200	50		5.1	100	42.37	39.07	35.76	32.05	
EXTRA LARGE	3036SUST100	750 x 900	25	7.9	250	85.09	78.42	71.74	64.23
	3036SUST200		50	6.3	100	53.39	49.22	45.06	40.37
	3648SUST100	900 x 1200	25	5.1	100	62.23	58.87	54.48	49.53
	3648SUST200		50	10.1	100	85.37	78.71	72.05	64.56

I'M GREEN PROCESS

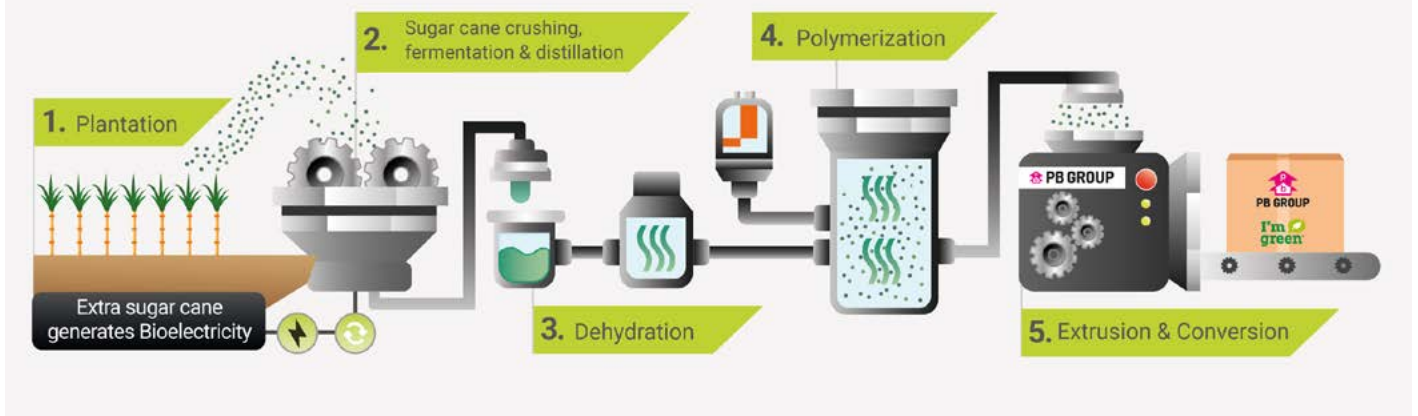

Gusseted Bags

Commodity Code: 3923210000
Origin: GB

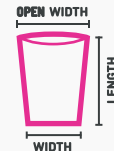

CODE	SIZE (WIDTH CLOSED/ OPEN) x LENGTH MM	THICKNESS MICRON	WEIGHT Kg	DESCRIPTION	BOX QTY	ALL PRICES PER BOX			
						1+	5+	10+	25+
LINESUST28	330/575 x 750	25	4.2	45 Litres	200	38.90	35.86	32.82	29.40
LINESUST31	450/725 x 975	25	6.8	90 Litres	200	52.09	48.21	45.39	41.03
LINESUST31H	450/725 x 975	50	13.4	90 Litres	200	67.67	63.82	57.80	52.23
LINESUST34	508/863 x 914	50	7.4	131 Litres	100	71.58	65.16	60.89	53.80
LINESUST40	609/1016 x 1219	50	11.6	249 Litres	100	97.53	91.47	84.76	78.51



Multilanguage Safety Bag

Commodity Code: 3923210000



CODE	INTERNAL SIZE (W x L) MM	THICKNESS MICRON	WEIGHT Kg	DESCRIPTION	BOX QTY	ALL PRICES PER BOX			
						1+	5+	10+	25+
PBSAFSUS913	230 x 325	40	5.9	Medium	1000	73.41	68.07	62.73	56.73
PBSAFSUS1215	305 x 381	40	4.4	Large	500	55.82	51.43	47.04	42.09
PBSAFSUS1520	381 x 508	40	7.5	Large	500	85.01	78.33	71.66	64.15
PBSAFSUS1824	457 x 610	40	5.3	Large	250	72.23	66.54	60.85	54.45

*See Page 52 for I'm green layflat tubing and page 63 for I'm green mailing bags.

CLEAR POLYTHENE WITH RECYCLED CONTENT

There are several factors that need to be taken into consideration when using recycled material in clear polythene. As the ratio of recycled content increases in clear packaging, the following can happen:

IMPERFECTIONS & COLOUR SCALE



Colour and the level of product imperfections/roughness can increase resulting in gel or clear/black spots forming.

CLARITY SCALE



Please note: Clarity also reduces as the thickness of polythene increases.



Batch Variation - Each individual batch of recycled material is unique and may cause modifications to the Mechanical properties of the product (tensile strength, impact strength, tear strength and elongation).

Odour - Recycled polythene sometimes has a 'burnt' or 'smoke' like odour. This smell may transfer to certain materials (e.g. clothing, fabrics) if placed in direct contact.

Print -The surface imperfections in recycled content polythene may cause less adhesion to certain print inks.

FOOD SAFE



Recycled plastics (using single-layer extrusion) should not be used for the storage of food materials because there are chances of contamination of unwanted substance residues that may be present inside the plastic before recycling.



If you are unsure of the recycled content options please request a free sample of our recently manufactured recycled polythene samples.

RECYCLED CONTENT PROCESS - POLYMER REGENERATION



Clear + 30% Recycled Content

Commodity Code: 3923210000

PACKAGING TAX EXEMPT

CODE	SIZE (W x L) MM	THICKNESS MICRON	WEIGHT Kg	DESCRIPTION	BOX QTY	MINI PACK 500	ALL PRICES PER BOX		
							1+	5+	10+
46R30M	100 x 150	40	6.7	Mini	6000	20.06	114.88	105.69	97.65
46R30H	100 x 150	100	7.1	Mini - Heavy Duty	2500	24.69	71.62	65.89	60.87
68R30M	150 x 200	40	8.9	Small	4000	21.16	96.81	89.06	82.29
68R30H	150 x 200	100	8.5	Small - Heavy Duty	1500	35.96	76.51	70.39	65.04
812R30M	200 x 300	40	9.1	Small	2000	31.04	78.47	72.20	66.70
812R30H	200 x 300	100	11.0	Small - Heavy Duty	1000	51.47	76.86	70.71	65.33

CODE	SIZE (W x L) MM	THICKNESS MICRON	WEIGHT Kg	DESCRIPTION	BOX QTY	MINI PACK 250	ALL PRICES PER BOX		
							1+	5+	10+
1012R30M	250 x 300	40	8.6	Medium	1500	21.35	63.85	58.74	54.27
1012R30H	250 x 300	100	7.1	Medium - Heavy Duty	500	34.66	48.82	44.92	41.50
1015R30M	250 x 375	40	7.1	Medium	1000	23.22	48.82	44.92	41.50
1015R30H	250 x 375	100	8.9	Medium - Heavy Duty	500	41.96	61.01	56.13	51.86
1215R30M	300 x 375	40	8.6	Medium	1000	25.17	55.32	50.89	47.02
1215R30H	300 x 375	100	10.4	Medium - Heavy Duty	500	45.68	67.20	61.82	57.12
1218R30M	300 x 450	40	9.9	Medium	1000	26.99	64.93	59.73	55.19
1218R30H	300 x 450	100	12.4	Medium - Heavy Duty	500	54.15	81.32	74.82	69.13

CODE	SIZE (W x L) MM	THICKNESS MICRON	WEIGHT Kg	DESCRIPTION	BOX QTY	ALL PRICES PER BOX			
						1+	3+	5+	10+
1520R30M	375 x 500	40	7.1	Large	500	45.84	43.55	41.72	38.97
1520R30H	375 x 500	100	10.4	Large - Heavy Duty	300	66.87	63.53	60.85	56.84
1824R30M	450 x 600	40	8.2	Large	400	52.85	50.21	48.10	44.92
1824R30H	450 x 600	100	9.9	Large - Heavy Duty	200	63.65	60.47	57.92	54.11
2030R30M	500 x 750	40	8.6	Large	300	55.04	52.29	50.08	47.83
2030R30H	500 x 750	100	7.1	Large - Heavy Duty	100	45.84	43.55	41.72	38.97
2436R30M	600 x 900	40	8.2	Large	200	52.85	50.21	48.10	44.92
2436R30H	600 x 900	100	9.9	Large - Heavy Duty	100	63.65	60.47	57.92	54.11

CODE	SIZE (W x L) MM	THICKNESS MICRON	WEIGHT Kg	DESCRIPTION	BOX QTY	ALL PRICES PER BOX			
						1+	3+	5+	10+
3036R30M	750 x 900	40	7.7	X Large	150	50.34	47.83	45.81	42.79
3036R30H	750 x 900	100	7.7	X Large - Heavy Duty	60	49.51	47.03	45.05	42.08
3648R30M	900 x 1200	40	8.2	X Large	100	53.48	50.81	48.67	45.46
3648R30H	900 x 1200	100	8.2	X Large - Heavy Duty	40	52.79	50.15	48.04	44.87



Safety Bags

Commodity Code: 3923210000

PACKAGING TAX EXEMPT

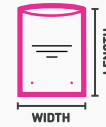

CODE	SIZE (W x L) MM	THICKNESS MICRON	WEIGHT Kg	DESCRIPTION	BOX QTY	ALL PRICES PER BOX			
						1+	3+	5+	10+
SAFETY9R30	229 x 305	40	7.7	Medium	1500	66.18	62.87	60.23	56.26
SAFETY12R30	305 x 381	40	8.6	Large	1000	73.38	69.71	66.78	62.38
SAFETY15R30	381 x 508	40	7.1	Large	500	53.48	50.81	48.67	45.46
SAFETY18R30	457 x 610	40	8.2	Large	400	61.66	58.58	56.11	52.41
SAFETY24R30	610 x 915	40	8.2	Large	200	61.66	58.58	56.11	52.41
SAFETY30R30	762 x 915	40	7.7	X Large	150	57.83	54.94	52.63	49.16
SAFETY36R30	915 x 1219	40	8.2	X Large	100	61.66	58.58	56.11	52.41



Clear Safety Bags

Perforations & Printed Warning Notice. 2 air hole perforations (6mm diameter) in bottom third of bag. 1 air perforation in SAFETY4.

Commodity Code: 3923210000

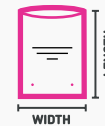

CODE	SIZE (W x L)		THICKNESS MICRON	WEIGHT Kg	DESCRIPTION	BOX QTY	ALL PRICES PER BOX			
	INCHES	MM					1+	5+	10+	25+
SAFETY4	4 x 6	102 x 152	30	0.9	Small	1000	17.15	10.83	9.28	7.90
SAFETY6	6 x 8	152 x 203	30	1.7	Medium	1000	21.33	13.39	12.33	11.36
SAFETY9	9 x 12	229 x 305	30	3.9	Medium	1000	34.01	26.16	23.45	21.66
SAFETY12	12 x 15	305 x 381	30	6.5	Medium	1000	48.19	40.70	37.50	34.92
SAFETY15	15 x 20	381 x 508	30	11.5	Large	1000	74.49	63.66	57.01	54.05
SAFETY18	18 x 24	457 x 610	30	7.8	Large	500	57.13	48.63	42.91	39.58
SAFETY24	24 x 36	610 x 915	30	15.7	Large	500	104.23	88.75	78.59	70.12
SAFETY30	30 x 36	762 x 915	30	9.8	X-Large	250	64.89	53.90	48.04	42.57
SAFETY36	36 x 48	915 x 1219	30	12.5	X-Large	200	76.97	63.87	57.27	55.44



Gusseted Liner Bags

Commodity Code: 3923210000

PACKAGING TAX EXEMPT

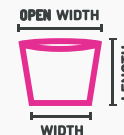

CODE	SIZE (WIDTH CLOSED/ OPEN) x LENGTH MM	THICKNESS MICRON	WEIGHT Kg	DESCRIPTION	BOX QTY	ALL PRICES PER BOX			
						1+	3+	5+	10+
LINR30C	275/400 x 450	40	8.0	20 Litres (Caddy/Pedal)	600	68.58	65.15	62.41	58.30
LINR30E	325/575 x 750	40	7.9	45 Litres (Pedal)	250	53.26	50.60	48.47	45.27
LINR30G	450/725 x 975	40	7.8	90 Litres (Bin)	150	52.33	49.71	47.62	44.48
LINR30J	508/863 x 914	40	8.7	131 Litres	150	57.47	54.60	52.30	48.85
LINR30L	550/860 x 1175	40	7.5	150 Litres (Compactor)	100	49.43	46.96	44.98	42.02
LINR30N	609/1016 x 1219	40	9.1	249 Litres	100	56.16	53.36	51.11	47.74
LINR30W	750/1150 x 1350	40	8.6	270 Litres (Wheelie Bin)	75	57.70	54.81	52.50	49.04

WHAT IS BIOTRANSFORMATION?

The environmental benefits of Biotransformation (Bio-T) products are not that they somehow fix the environment (litter issues) or have zero impact, but rather that their environmental impacts are less than those of similar products.



PB Groups' range of biodegradable packaging is made from regular polythene with a Bio-T additive that accelerates the degradation process and is scientifically-proven to biodegrade in an open-air environment without producing any microplastics. The additive - produced by Polymateria - uses 'time-set' biodegradation, where the product remains recyclable during its service life but, in the unwanted event of littering, will break down and biodegrade into natural-benign materials in an open-air environment.

Bio-T products are not a solution for ocean / marine litter as they don't biodegrade due to the lack of heat and air in water. Biodegradable does not mean digestible or water soluble.

BIOTRANSFORMATION LIFE CYCLE ASSESSMENT

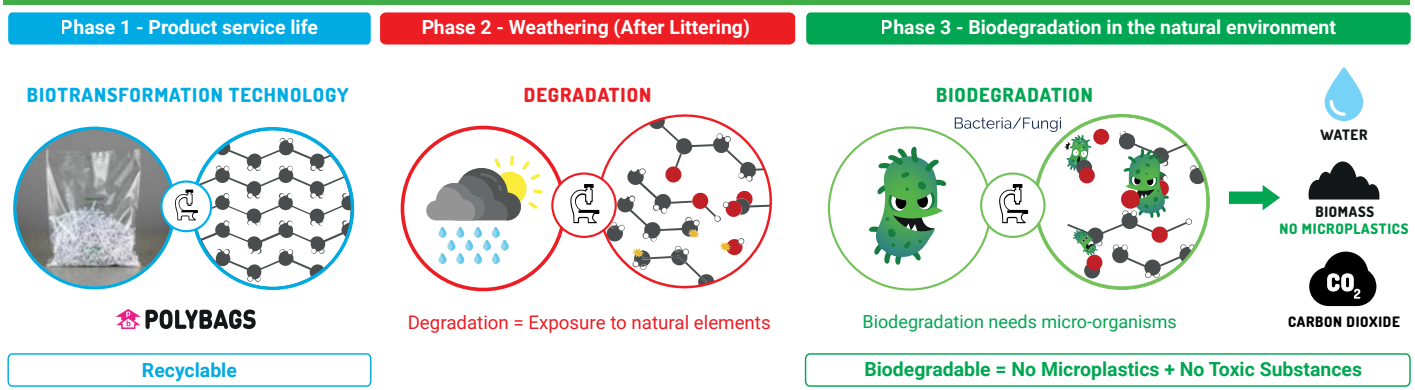

BIOTRANSFORMATION ADDITIVE

Phase 1 - Storage & product service life: Prior to use, it is recommended that the bags should be stored (between 17-23°C) in their original packaging away from direct sunlight and used within 12 months from the date of purchase. During the bag's service life, the Bio-T technology is dormant and the packaging retains all of the functionalities of regular polythene. It can be recycled just like regular soft polythene packaging. If disposed of in a landfill, the biodegradation process takes much longer due to the lack of exposure to an 'open-air environment' and the micro-organisms required to break the product down.

Phase 2 - Weathering: The material structure has been engineered so that, in the event of littering, exposure to natural environmental conditions such as sunlight, air and water will cause the material to self-destruct. The Bio-T technology attacks the crystalline and amorphous region of the polymer structure, transforming it into a waxy substance that is no longer plastic. Ecotoxicity tests have demonstrated that this wax-like substance is not harmful to the environment.

The published scientific results show that the PB Group material is compliant with PAS 9017:2000 on weathering of polyolefins.

Biodegradable + 30% Recycled Content

Commodity Code: 3923210000

PACKAGING TAX EXEMPT

CODE	SIZE (W x L) MM	THICKNESS MICRON	WEIGHT Kg	DESCRIPTION	BOX QTY	ALL PRICES PER BOX			
						1+	3+	5+	10+
46R30BIO	100 x 150	40	2.2	Mini	2000	38.59	36.66	35.12	32.80
68R30BIO	150 x 200	40	3.2	Mini	1500	44.20	42.00	40.23	37.57
1012R30BIO	250 x 300	40	5.5	Medium	1000	50.85	48.31	46.27	43.22
1215R30BIO	300 x 375	40	6.3	Medium	750	53.58	50.90	48.76	45.54
1520R30BIO	375 x 500	40	6.9	Large	500	56.26	53.45	51.20	47.83
1824R30BIO	450 x 600	40	6.0	Large	300	49.83	47.34	45.35	42.36
2436R30BIO	600 x 900	40	6.0	Large	150	49.73	47.25	45.25	42.28
3648R30BIO	900 x 1200	40	4.0	X Large	50	37.77	35.89	34.38	32.11



100% Recycled Packing Bags

Manufactured from 100% recycled material.

Commodity Code: 3923210000

PACKAGING TAX EXEMPT



CODE	INTERNAL SIZE (W x L)	THICKNESS MICRON	WEIGHT Kg	DESCRIPTION	BOX QTY	PRICES PER BOX	
	MM					1+	
46RECY	100 x 150	40	1.2	Small	1000	14.75	
68RECY	150 x 200	40	2.3	Medium	1000	18.53	
1012RECY	250 x 300	40	2.9	Medium	500	19.62	
1520RECY	375 x 500	40	3.5	Large	250	24.58	
1824RECY	450 x 600	40	5.2	Large	250	29.46	
2436RECY	600 x 900	40	6.1	Large	150	34.92	
3648RECY	900 x 1200	40	8.4	X-Large	100	49.13	

* Due to the manufacturing processes used with recycled content material, small impurities within the structure of the polythene may be visible. These minor impurities do not affect the overall performance of the material.



Black Polythene Packing Bags

Available in 2 thicknesses, the heavy duty range can give added protection to products sensitive to light.

Commodity Code: 3923210000

PACKAGING TAX EXEMPT



CODE	SIZE (W x L)	THICKNESS MICRON	WEIGHT Kg	DESCRIPTION	BOX QTY	ALL PRICES PER BOX			
	MM					1+	5+	10+	25+
BLK46MID	100 x 150	50	7.3	Small	5000	44.86	34.39	31.69	30.57
BLK68MID	150 x 200	50	8.7	Medium	3000	46.44	36.30	33.49	32.60
BLK79MID	175 x 225	50	7.6	Medium	2000	45.69	42.86	41.10	40.10
BLK812MID	200 x 300	50	5.8	Medium	1000	41.09	33.79	31.94	30.28
BLK1012MID	250 x 300	50	7.3	Medium	1000	48.33	35.36	30.24	26.07
BLK1215MID	300 x 375	50	10.9	Large	1000	53.42	50.87	48.13	46.68
BLK1520MID	375 x 500	50	9.1	Large	500	47.12	39.73	37.04	33.72
BLK1824MID	450 x 600	50	13.1	Large	500	59.73	55.27	52.98	52.18
BLK2436MID	600 x 900	50	13.1	Large	250	65.10	62.06	57.79	56.61
BLK3648MID	900 x 1200	50	10.5	X-Large	100	54.02	47.63	44.95	42.61

Black Polythene Bags : Heavy Duty

BLK46HEAVY	100 x 150	100	8.7	Small	3000	46.44	42.09	38.14	36.32
BLK68HEAVY	150 x 200	100	5.8	Medium	1000	41.09	28.43	23.37	21.74
BLK79HEAVY	175 x 225	100	7.6	Medium	1000	44.43	34.92	30.92	29.26
BLK812HEAVY	200 x 300	100	11.6	Medium	1000	52.86	48.77	44.78	41.99
BLK1012HEAVY	250 x 300	100	7.3	Medium	500	47.12	34.44	29.37	27.75
BLK1215HEAVY	300 x 375	100	10.9	Large	500	52.59	48.82	44.22	41.49
BLK1520HEAVY	375 x 500	100	9.1	Large	250	48.34	40.14	37.28	34.17
BLK1824HEAVY	450 x 600	100	13.1	Large	250	59.81	53.83	51.00	47.28
BLK2436HEAVY	600 x 900	100	10.5	Large	100	49.99	41.70	37.79	37.27
BLK3648HEAVY	900 x 1200	100	10.5	X-Large	50	49.65	44.51	41.91	38.31

PB Group can custom print your unique product / brand details or even usage and safety advice onto packing bags. Just give us a call to discuss your requirements.



White bag – 1 colour

Clear bag – 4 colours

Clear Bag – 2 colours flood print

Clear bag – 2 colours



Compostable Packing Bag: Ivory White 20 Micron

Commodity Code: 3923210000

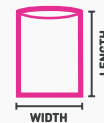

CODE	SIZE (W x L) MM	THICKNESS MICRON	WEIGHT Kg	DESCRIPTION	BOX QTY	ALL PRICES PER BOX			
						1+	5+	10+	25+
NAT150200	150 x 200	20	0.5	Medium	400	47.53	42.83	39.22	34.50
NAT200250	200 x 250	20	0.8	Medium	400	51.09	46.70	42.56	36.27
NAT250300	250 x 300	20	1.1	Medium	400	54.61	48.61	44.36	39.76
NAT300450	300 x 450	20	1.0	Large	200	46.31	41.27	37.34	34.72
NAT450600	450 x 600	20	2.0	Large	200	62.87	58.45	52.68	47.24
NAT600900	600 x 900	20	2.0	Large	100	63.82	59.13	53.07	47.52



Compostable Packing Bag: Frosted 40 Micron

Commodity Code: 3923210000

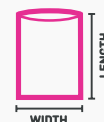

CODE	SIZE (W x L) MM	THICKNESS MICRON	WEIGHT Kg	DESCRIPTION	BOX QTY	ALL PRICES PER BOX			
						1+	5+	10+	25+
NATCLR200	200 x 250	40	2.2	Medium	400	60.33	55.54	50.75	45.37
NATCLR250	250 x 300	40	3.0	Medium	400	68.81	63.36	57.90	51.77
NATCLR300	300 x 450	40	3.2	Large	200	60.50	55.72	50.93	45.54
NATCLR450	450 x 600	40	5.4	Large	200	95.71	88.15	80.58	72.07

*Our Clear Compostable material has a slight frosted clarity in appearance when compared to traditional polythene.



Peel & Seal Safety Bag

Perforations & Printed Warning Notice. 6mm Punch / Perforation holes to reduce risk of suffocation. Conforms to Amazon guidelines for clear Peel & Seal polythene bags. (Font size & wording).

Commodity Code: 3923210000

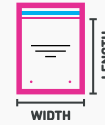

CODE	INTERNAL SIZE (W x L) MM	THICKNESS MICRON	WEIGHT Kg	DESCRIPTION	BOX QTY	ALL PRICES PER BOX			
						1+	5+	10+	25+
PBSAFES913	230 x 325	40	6.3	Medium	1000	55.66	52.61	49.56	47.94
PBSAFES913BIO	230 x 325	40	3.2	Medium - Bio	500	48.16	43.41	40.28	37.57
PBSAFES1215	305 x 381	40	9.6	Large	1000	69.84	66.36	65.13	62.33
PBSAFES1215BIO	305 x 381	40	4.8	Large - Bio	500	65.50	53.78	51.18	47.71
PBSAFES1520	381 x 508	40	7.3	Large	500	73.61	62.78	56.12	52.13
PBSAFES1824	457 x 610	40	5.6	Large	250	59.90	52.44	47.74	44.47
PBSAFES2436	610 x 915	40	12.3	X-Large	250	103.53	88.05	77.88	69.41
PBSAFES3036	762 x 915	40	5.4	XX-Large	100	63.99	52.99	47.13	41.66

*Biodegradable option.



Peel & Seal Safety Bags

Multilanguage + perforation holes.

Commodity Code: 3923210000

PACKAGING TAX EXEMPT



CODE	SIZE (W x L) MM	THICKNESS MICRON	WEIGHT Kg	DESCRIPTION	BOX QTY	ALL PRICES PER BOX			
						1+	3+	5+	10+
PBSAFR30ML913	230 x 325	40	8.8	Medium	1500	75.91	72.12	69.08	64.53
PBSAFR30ML1215	305 x 381	40	8.9	Large	1000	69.62	66.14	63.36	59.18
PBSAFR30ML1520	381 x 508	40	8.9	Large	600	87.84	83.45	79.93	74.66
PBSAFR30ML1824	457 x 610	40	8.5	Large	400	89.08	84.63	81.07	75.72
PBSAFR30ML2436	600 x 860	40	7.8	X Large	200	71.05	67.50	64.65	60.39



Bio Multilanguage Peel & Seal Safety Bag

Perforations & Printed Warning Notice. Conforms to Amazon guidelines. Languages included: French, German, Turkish, Arabic, Italian, Spanish, Dutch, Chinese, Portuguese and Russian.

Commodity Code: 3923210000



CODE	INTERNAL SIZE (W x L) MM	THICKNESS MICRON	WEIGHT Kg	DESCRIPTION	BOX QTY	ALL PRICES PER BOX			
						1+	5+	10+	25+
PBSAFEML913BIO	230 x 325	40	3.2	Medium	500	59.20	52.03	49.72	46.62
PBSAFEML1215BIO	305 x 381	40	4.8	Large	500	76.24	63.94	61.63	57.81
PBSAFEML1520BIO	381 x 508	40	7.3	Large	500	88.82	78.32	74.15	70.29
PBSAFEML1824BIO	457 x 610	40	5.6	Large	250	75.51	68.26	63.71	60.14
PBSAFEML2436BIO	600 x 860	40	12.3	X-Large	250	117.90	110.96	104.54	96.32



Compostable Garment Bag Peel & Seal

Perforations & Printed Warning Notice. Languages included: French, German, Turkish, Arabic, Italian, Spanish, Dutch, Chinese, Portuguese and Russian.

Commodity Code: 3923210000



CODE	INTERNAL SIZE (W x L)		THICKNESS MICRON	WEIGHT Kg	DESCRIPTION	BOX QTY	ALL PRICES PER BOX			
	MM						1+	5+	10+	25+
PGARCOMP2	250 x 300		18	3.7	T-Shirt	1000	61.96	58.29	55.23	51.55
PGARCOMP4	300 x 360		18	5.2	Shirt	1000	85.31	80.26	76.05	71.00
PGARCOMP6	350 x 450		18	7.6	Sweater	1000	119.65	112.56	106.66	99.58
PGARCOMP8	450 x 550		18	5.9	Coat	500	102.12	96.07	91.02	84.97

*Our Clear Compostable material has a slight frosted clarity in appearance when compared to traditional polythene.



Compostable Multilanguage Peel & Seal Safety Bag

Perforations & Printed Warning Notice
Conforms to Amazon guidelines. Languages included: French, German, Turkish, Arabic, Italian, Spanish, Dutch, Chinese, Portuguese and Russian.

Commodity Code: 3923210000



CODE	INTERNAL SIZE (W x L)		THICKNESS MICRON	WEIGHT Kg	DESCRIPTION	BOX QTY	ALL PRICES PER BOX			
	MM						1+	5+	10+	25+
PBSAFCOM913	230 x 325		40	4.0	Medium	500	87.46	80.53	73.60	65.80
PBSAFCOM1215	305 x 381		40	5.3	Large	500	102.88	94.74	86.60	77.44
PBSAFCOM1520	381 x 508		40	10.1	Large	500	126.43	116.49	106.54	95.35
PBSAFCOM1824	457 x 610		40	7.3	Large	250	108.28	99.74	91.20	81.59

*Our Clear Compostable material has a slight frosted clarity in appearance when compared to traditional polythene.



Glassine Peel & Seal Safety Bag

Customers can easily dispose of these bags just like any other cardboard or paper items – by placing them in the kerbside recycling collection.

Commodity Code: 4817100000



CODE	SIZE (W x L)		THICKNESS GSM	WEIGHT Kg	DESCRIPTION	BOX QTY	MINI PACK 500	ALL PRICES PER BOX		
	MM							1+	5+	10+
PGLAS01	150 x 200		35	6.6	Warning notice	2,000	38.76	119.14	109.61	98.89
PGLAS02	200 x 250		35	9.9	Warning notice + Perf Hole	2,000	48.69	155.22	142.78	128.82
PGLAS03	250 x 300		35	7.3	Warning notice + Perf Hole	1,000	63.17	103.95	95.63	86.28
PGLAS04	300 x 400		35	11.3	Warning notice + Perf Hole	1,000	88.24	149.52	137.54	124.09
PGLAS05	350 x 500		35	15.5	Warning notice + Perf Hole	1,000	113.77	195.95	180.27	162.64

Glassine paper is known for its pH neutrality and acid-free characteristics, making it an excellent choice for various applications. These paper bags are crafted from wood pulp, undergo a precise process that aligns the fibres uniformly, resulting in a luxurious, smooth finish. One of the remarkable features of glassine paper bags is their ability to provide effective protection against grease, water, air, and moisture, ensuring the contents remain in pristine condition. Moreover, the convenient peel-and-seal strip simplifies the packaging process, making it a perfect fit for the dynamic world of ecommerce and retail.

POLYMAX

Maximum Strength



Polymax has been engineered for toughness, flexibility and is up to 40% thinner than standard polythene. This advanced blend allows packaging weight be reduced by up to 40% less and cost up to 30% less than the equivalent traditional polythene. The general rule is the larger the bag the larger the potential savings. Polymax is also a sustainable polythene blend that is 100% recyclable and can be converted back into polymer and re-manufactured instead of going to landfill.

This advanced blend also reduces the amount of CO₂ produced through the manufacturing process as less raw material is used compared to traditional polythene. Our stocked sizes are listed below. If you require a bespoke size of POLYMAX or POLY20 please get in contact directly with our sales office.



Polymax Hercules Bags

Blend is equivalent to 62.5 Micron traditional polythene.

Commodity Code: 3923210000

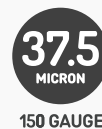
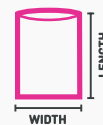

CODE	SIZE (W x L) MM	THICKNESS MICRON	WEIGHT Kg	DESCRIPTION	BOX QTY	ALL PRICES PER BOX			
						1+	5+	10+	25+
HERC1824	457 x 610	37.5	9.9	Large	500	69.08	57.69	52.64	49.10
HERC2436	610 x 915	37.5	9.9	Large	250	67.83	55.18	51.40	47.85
HERC3036	762 x 915	37.5	12.4	Large	250	80.68	65.77	61.07	56.88
HERC3648	915 x 1219	37.5	15.9	X-Large	200	97.61	80.37	74.30	71.40
HERC4848	1219 x 1219	37.5	10.6	XX-Large	100	67.56	54.40	50.37	47.98



Polymax Goliath bags

Blend is equivalent to 125 Micron traditional polythene.

Commodity Code: 3923210000

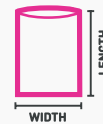

CODE	SIZE (W x L) MM	THICKNESS MICRON	WEIGHT Kg	DESCRIPTION	BOX QTY	ALL PRICES PER BOX			
						1+	5+	10+	25+
GOL1824	457 x 610	75	9.8	Large	250	65.09	55.79	50.63	47.74
GOL2436	610 x 915	75	15.7	Large	200	98.29	81.67	75.52	71.09
GOL3036	762 x 915	75	9.8	Large	100	62.62	52.03	48.10	45.21
GOL3648	915 x 1219	75	15.7	X-Large	100	92.81	77.65	73.57	70.19
GOL4848	1219 x 1219	75	10.5	XX-Large	50	64.06	52.89	50.76	48.68



THINNER & STRONGER

We are now taking manufacturing orders for our new POLY20 blend which has upto a 20% weight and 10% cost saving compared to the equivalent traditional polythene blend. (*Calculation based on minimum bag width of 450mm and minimum product run of 250Kg).

Hi-Tensile

HI-TENSILE

Puncture Resistant

Our high tensile bags are manufactured from a blend of polymers which create a lightweight and strong film. In addition to a good tensile strength, these bags offer good puncture and tear resistance and can be 50% stronger than standard polythene of the same thickness.

The bags are available with either a 'frosty clear' or blue tint appearance and are used extensively throughout the food processing industry.

This sustainable polythene blend is 100% recyclable and can be converted back into polymer and re-manufactured instead of going to landfill.



Hi-Tensile - Clear

Great puncture resistance yet extremely thin & lightweight.

Commodity Code: 3923210000

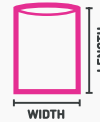

RECYCLE

FOOD SAFE

CODE	SIZE (W x L) MM	THICKNESS MICRON	WEIGHT Kg	DESCRIPTION	BOX QTY	ALL PRICES PER BOX			
						1+	5+	10+	25+
HT1218STCL	305 x 457	14	10.5	Large	2000	65.13	60.15	56.58	52.50
HT1520STCL	381 x 508	19	7.3	Large	1000	43.41	40.03	37.65	34.80
HT1824STCL	457 x 610	21	10.5	Large	1000	60.96	57.02	54.55	51.55
HT2030STCL	508 x 762	21	7.3	Large	500	39.77	36.38	34.02	31.17
HT2436STCL	610 x 915	22	10.5	Large	500	58.93	54.98	50.38	47.39
HT2436THCL	610 x 915	30	15.7	Large & Heavy Duty	500	79.10	72.54	68.10	66.36



Hi-Tensile - Blue

Great puncture resistance yet extremely thin & lightweight.

Commodity Code: 3923210000

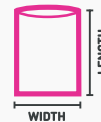

80 GAUGE

RECYCLE

FOOD SAFE

CODE	SIZE (W x L) MM	THICKNESS MICRON	WEIGHT Kg	DESCRIPTION	BOX QTY	ALL PRICES PER BOX			
						1+	5+	10+	25+
HT1218STBLT	305 x 457	20	5.2	Large	1000	34.86	32.47	30.86	28.74
HT1520STBLT	381 x 508	20	7.3	Large	1000	46.57	43.14	40.78	37.89
HT1824STBLT	457 x 610	20	10.5	Large	1000	64.43	59.38	55.76	51.69
HT2030STBLT	508 x 762	20	7.3	Large	500	42.90	39.47	37.10	34.20
HT2436STBLT	610 x 915	20	10.5	Large	500	59.13	54.09	50.49	46.40
HT2436THBLT	610 x 915	30	15.7	Large & Heavy Duty	500	84.71	77.02	71.42	65.34



Wicketed Food Bags

Commodity Code: 3923210000



CODE	SIZE (W x L) MM	THICKNESS MICRON	WEIGHT Kg	DESCRIPTION	BOX QTY	ALL PRICES PER BOX			
						1+	5+	10+	25+
Wicketed Food Bags : Micro Perforated - Allow for warm products to be packed without softening through moisture damage.									
MPP68WK	150 x 200	20	3.5	250 per Wicket	2000	32.80	29.59	27.99	24.78
MPP610WK	150 x 250	20	3.5	250 per Wicket	2000	33.64	30.35	28.69	25.41
MPP612WK	150 x 300	20	4.7	250 per Wicket	2000	43.43	39.19	37.06	32.82
MPP628WK	150 x 710	20	8.2	250 per Wicket	2000	70.63	68.75	68.18	64.81
MPP810WK	200 x 250	20	4.9	250 per Wicket	2000	49.93	45.04	42.60	37.69
MPP1012WK	250 x 300	20	6.5	250 per Wicket	2000	102.43	92.32	87.27	77.17
MPP1014WK	250 x 350	20	6.7	250 per Wicket	2000	106.56	96.04	90.76	80.26
Wicketed Food Bags : Non Perforated - Keep moisture out, while holding the aroma of the product inside the bag.									
PP68WK	150 x 200	20	2.4	250 per Wicket	2000	43.60	32.26	27.29	24.52
PP610WK	150 x 250	20	2.9	250 per Wicket	2000	44.86	33.35	28.46	25.17
PP614WK	150 x 350	20	4.3	250 per Wicket	2000	48.87	41.11	35.08	31.04



Bread Bags

BHT free, with 2 perforations per bag.

Commodity Code: 3923210000



CODE	SIZE (WIDTH CLOSED/ OPEN) x LENGTH		THICKNESS MICRON	WEIGHT Kg	DESCRIPTION	BOX QTY	ALL PRICES PER BOX			
	INCHES	MM					1+	5+	10+	25+
BREAD10	6/11 x 18	150/280 x 460	25	12.0	Batch Loaf	2000	62.29	56.83	52.25	49.78
BREAD20	8/12 x 22	200/300 x 560	25	8.0	Bloomer	1000	43.02	40.44	38.42	36.66



Tray Liners

Blue hi-tensile bags for lining bakery trays.

Commodity Code: 3923210000



CODE	SIZE (WIDTH CLOSED/ OPEN) x LENGTH		THICKNESS MICRON	WEIGHT Kg	DESCRIPTION	BOX QTY	ALL PRICES PER BOX			
	INCHES	MM					1+	5+	10+	25+
TRAY5	20/30 x 20	508/762 x 508	20	7.3	Medium	500	49.39	42.06	37.92	33.91
TRAY10	24/40 x 24	610/1016 x 610	20	11.6	Large	500	60.43	56.06	51.56	48.79
TRAY20	26/46 x 26	660/1168 x 660	20	7.2	X-Large	250	41.20	39.37	36.57	35.42



Dolav Liner

75 Liners per Roll.

Commodity Code: 3923210000



CODE	SIZE (WIDTH CLOSED/ OPEN) x LENGTH MM	THICKNESS MICRON	WEIGHT Kg	DESCRIPTION	ROLL QTY	ALL PRICES PER ROLL			
						1+	5+	10+	25+
DOLAV1	1200/2235 x 2083	20	13.8	Food Grade	1	80.32	77.05	75.68	73.57

HOW TO MEASURE - BOX & TRAY LINERS

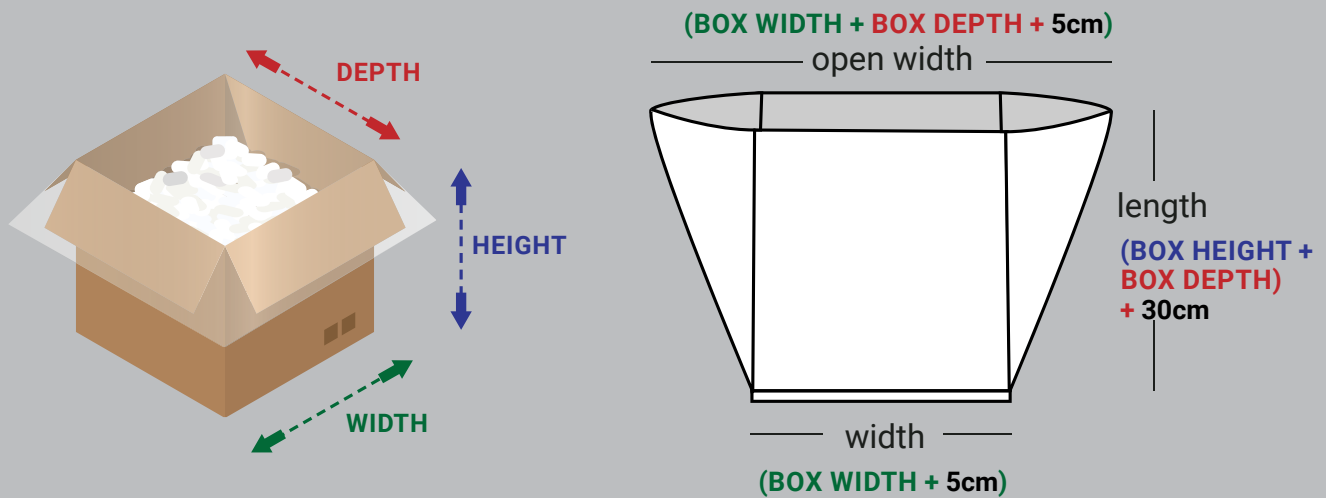

Gusseted Liners : Clear

Suitable for lining containers and boxes. Approx Litres is guideline only.

Commodity Code: 3923210000

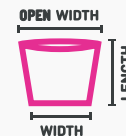

CODE	SIZE (WIDTH CLOSED/OPEN) x LENGTH		THICKNESS MICRON	WEIGHT Kg	DESCRIPTION	BOX QTY	ALL PRICES PER BOX			
	INCHES	MM					1+	5+	10+	25+
LINER9	6/9 x 14	152/228 x 355	37.5	5.7	1 Litre	1000	44.28	37.43	33.55	30.40
LINER16	10/16 x 25	254/406 x 635	37.5	9.1	19 Litres	500	66.50	56.67	50.67	49.00
LINER20	12/20 x 28	304/508 x 711	50	8.5	35 Litres	250	60.09	50.80	45.32	40.74
LINER30	16/28 x 20	406/711 x 508	50	6.8	41 Litres	200	46.87	39.34	34.79	31.84
LINER32	20/34 x 24	508/863 x 609	50	4.9	80 Litres	100	47.97	39.89	35.14	32.13
LINER34	20/34 x 36	508/863 x 914	50	7.4	131 Litres	100	50.36	41.96	37.02	33.89
LINER40	24/40 x 48	609/1016 x 1219	50	11.6	249 Litres	100	73.92	64.38	58.36	55.64
LINER56	32/56 x 64	812/1422 x 1625	50	10.1	653 Litres	50	66.32	55.56	49.82	46.60
LINER60	36/64 x 71	914/1625 x 1803	50	13.7	939 Litres	50	79.79	66.80	61.34	57.44
LINER70	48/80 x 71	1219/2032 x 1803	50	8.6	1380 Litres	25	50.39	41.39	37.76	35.09



Gusseted Bags - Heavy Duty

These thick polythene bags have an expandable gusset on either side which can be used to line boxes or pack bulky items.

Commodity Code: 3923210000

PACKAGING TAX EXEMPT

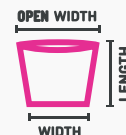

CODE	SIZE (WIDTH CLOSED/OPEN) x LENGTH		THICKNESS MICRON	WEIGHT Kg	DESCRIPTION	BOX QTY	ALL PRICES PER BOX			
	INCHES	MM					1+	5+	10+	25+
LINER16HD	10/16 x 25	254/406 x 635	100	9.7	19 Litres	200	62.13	52.68	46.91	42.30
LINER30HD	16/28 x 20	406/711 x 508	100	12.8	41 Litres	200	89.41	82.17	72.10	63.54
LINER34HD	20/34 x 36	508/863 x 914	100	14.8	131 Litres	100	93.82	87.27	80.82	70.67
LINER40HD	24/40 x 48	609/1016 x 1219	100	7.4	249 Litres	50	74.46	63.28	57.50	52.89



Gusseted Liners : Antistatic (Red Tint)

Commodity Code: 3923210000

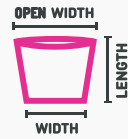

CODE	SIZE (WIDTH CLOSED/OPEN) x LENGTH		THICKNESS MICRON	WEIGHT Kg	DESCRIPTION	BOX QTY	ALL PRICES PER BOX			
	INCHES	MM					1+	5+	10+	25+
ANS22LINER	8/12 x 21	200/300 x 550	75	11.6	8 Litres	500	93.35	56.60	49.27	43.27
ANS24LINER	24/39 x 24	600/1000 x 600	75	8.4	150 Litres	100	96.75	70.04	64.69	59.34
ANS26LINER	26/47 x 26	650/1200 x 650	75	11.0	200 Litres	100	107.64	72.91	65.95	58.99



Antistatic Polythene Bags (Red Tint)

Commodity Code: 3923210000

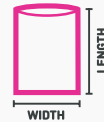

CODE	SIZE (W x L)		THICKNESS MICRON	WEIGHT Kg	DESCRIPTION	BOX QTY	ALL PRICES PER BOX			
	INCHES	MM					1+	5+	10+	25+
ANS6	4 x 6	100 x 150	75	2.1	Small	1000	30.17	23.43	22.08	20.74
ANS8	6 x 8	150 x 200	75	4.2	Medium	1000	35.73	27.76	23.50	22.26
ANS12	8 x 12	200 x 300	75	8.4	Medium	1000	58.49	39.05	33.75	31.46
ANS15	10 x 15	250 x 375	75	13.2	Medium	1000	106.74	66.89	58.47	48.91
ANS20	15 x 20	375 x 500	75	13.2	Large	500	109.75	68.73	60.31	51.89
ANS36	24 x 36	600 x 900	75	7.6	Large	100	99.08	74.79	69.94	65.08
ANS48	36 x 48	900 x 1200	75	7.6	X-Large	50	94.11	69.85	64.98	60.12
ANS60	48 x 60	1200 x 1500	75	12.7	XX-Large	50	102.84	62.37	54.28	46.17

*See page 46 for Grip Seal version of this bag.



ESD Metallised Shielding Bags

Open Top. Our ESD bags are used to store sensitive materials like Printed Circuit Boards (PCBs) and electronic parts susceptible to static.

Commodity Code: 3923210000

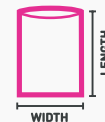

CODE	SIZE (W x L)		THICKNESS MICRON	WEIGHT Kg	DESCRIPTION	BOX QTY	ALL PRICES PER BOX			
	INCHES	MM					1+	5+	10+	25+
ESD35	3 x 5	75 x 127	70	0.2	Small	100	21.87	15.32	7.80	5.89
ESD46	4 x 6	102 x 152	70	0.3	Small	100	22.21	15.55	8.14	6.22
ESD68	6 x 8	152 x 203	70	0.6	Medium	100	23.98	16.82	9.93	8.01
ESD812	8 x 12	203 x 305	70	1.0	Medium	100	28.53	20.05	14.46	12.54
ESD1012	10 x 12	254 x 305	70	1.4	Medium	100	30.87	25.98	20.02	17.02
ESD1218	12 x 18	305 x 455	70	2.3	Large	100	42.73	37.14	29.73	27.82
ESD1818	18 x 18	455 x 455	70	3.3	Large	100	52.47	45.92	39.49	37.56
ESD2024	20 x 24	508 x 610	70	5.3	Large	100	68.54	62.42	59.00	57.01

*See page 46 for Grip Seal version of this bag.

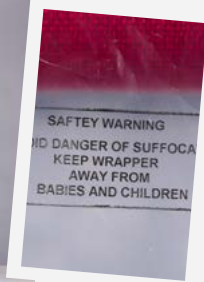

Chair & Sofa Bags

Printed safety warning notice.

Commodity Code: 3923210000

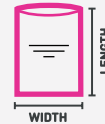

CODE	SIZE (W x L) MM	THICKNESS MICRON	WEIGHT Kg	DESCRIPTION	BOX QTY	ALL PRICES PER BOX			
						1+	5+	10+	25+
CHAIR1	1220 x 1320	62.5	2.0	Office / Dining Chair	10	21.71	17.84	15.65	14.06
SOFA1	2055 x 1365	62.5	3.8	Arm Chair	10	22.40	18.19	16.03	14.52
SOFA2	2800 x 1365	62.5	4.3	2 Seater Sofa	10	27.53	25.24	22.20	20.23
SOFA3	3200 x 1365	62.5	4.0	3 Seater Sofa	10	30.29	27.60	24.82	22.64

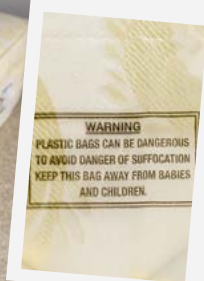

Mattress Bags

Printed safety warning notice.

Commodity Code: 3923210000

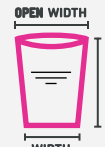

CODE	SIZE (WIDTH CLOSED/OPEN) x LENGTH MM	THICKNESS MICRON	WEIGHT Kg	DESCRIPTION	BOX QTY	ALL PRICES PER BOX			
						1+	5+	10+	25+
MATT1	1016/1190 x 2235	75	3.8	Single Mattress	10	24.27	21.49	19.31	17.71
MATT2	1397/1700 x 2280	75	5.5	Double Mattress	10	32.78	29.00	26.81	24.63
MATT3	1828/2030 x 2390	75	6.8	King Mattress	10	34.75	33.06	30.37	28.19



Watertight Fish Bags

Heavy duty watertight seal bags for storing and transporting fish. Available in a plain option or printed with helpful fish care information.

Commodity Code: 3923210000



CODE	SIZE (W x L) MM	THICKNESS MICRON	WEIGHT Kg	DESCRIPTION	BOX QTY	ALL PRICES PER BOX				
						1+	5+	10+	25+	
WT6	152 x 431	62.5	7.7	Small	1000	60.13	53.71	48.57	44.36	
WT8	203 x 431	62.5	10.3	Medium	1000	76.30	64.41	57.74	53.23	
WT10	254 x 533	62.5	9.5	Large	500	57.15	50.73	46.52	43.18	
WT13	330 x 609	62.5	11.8	X-Large	500	74.99	65.64	61.13	55.39	
Fish Bags : Clear + Printed Notice										
WT6PR	152 x 431	62.5	7.7	Small	1000	62.56	52.93	47.82	43.59	
WT8PR	203 x 431	62.5	10.3	Medium	1000	79.56	67.64	61.01	55.40	
WT10PR	254 x 533	75	9.5	Large	500	69.15	59.38	53.08	46.61	
WT13PR	330 x 609	75	14.2	X-Large	500	96.95	87.93	77.66	66.66	



Scan to
view video

PAA4

PL12

SUPM02

PL9AS

GA7

SUPC01



POLYBAGS
part of the PB Group

GRIP AND ZIP SEAL

Whatever you need to store and keep safe, whether it's nuts and bolts or a tasty snack, our resealable bags can be used again and again. Transparent grip seal bags allow quick identification of contents while our coloured bags add vivid appeal. Our extensive product range is widely used in Warehousing, Hardware Stores, Craft & Stationery outlets and are essential for every home.



Slidergrip Clear Bags Blue Profile

Highly durable plastic zip with blue top profile.

Commodity Code: 3923210000

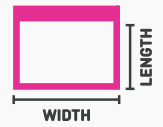

RECYCLE



FOOD SAFE

CODE	INTERNAL SIZE (W x L)		THICKNESS MICRON	WEIGHT Kg	DESCRIPTION	BOX QTY	ALL PRICES PER BOX			
	INCHES	MM					1+	5+	10+	25+
SLIDER86500	8 x 6	203 x 152	125	0.5	C5	50	13.00	7.33	6.11	5.14
SLIDER107500	10 x 7	254 x 178	125	0.6	C5+	50	14.97	9.07	7.60	6.39
SLIDER12.59500	12.5 x 9	318 x 229	125	1.0	C4	50	16.33	12.49	10.57	8.89
SLIDER14.510500	14.5 x 10	368 x 254	125	1.2	C4+	50	17.75	14.86	12.63	10.66
SLIDER1913.5500	19 x 13.5	482 x 342	125	2.2	C3	50	25.72	21.76	18.42	15.34



Zipper Clear Bags Red Profile

Highly durable metal zipper bags with red top profile.

Commodity Code: 3923210000

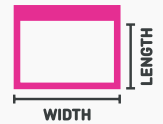

RECYCLE



FOOD SAFE

CODE	INTERNAL SIZE (W x L)		THICKNESS MICRON	WEIGHT Kg	DESCRIPTION	BOX QTY	ALL PRICES PER BOX			
	INCHES	MM					1+	5+	10+	25+
ZIP107500	10 x 7	254 x 178	125	0.8	C5	50	28.01	22.09	20.58	19.28
ZIP12.59500	12.5 x 9	318 x 229	125	1.2	C4	50	33.93	31.13	29.09	28.05
ZIP14.510500	14.5 x 10	368 x 254	125	1.5	C4+	50	31.51	28.53	26.19	24.11
ZIP1913.5500	19 x 13.5	482 x 342	125	2.3	C3	50	53.98	50.95	49.47	46.19



Ziplite Clear Bags White Profile

Highly durable plastic zip with white top profile.

Commodity Code: 3923210000

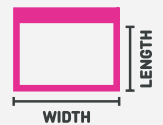

RECYCLE



FOOD SAFE

CODE	INTERNAL SIZE (W x L)		THICKNESS MICRON	WEIGHT Kg	DESCRIPTION	BOX QTY	ALL PRICES PER BOX			
	INCHES	MM					1+	5+	10+	25+
ZIPLITE1	5 x 3.5	125 x 90	50	0.6	Small	250	28.39	19.74	18.20	17.38
ZIPLITE2	7 x 4.5	180 x 110	50	0.9	Medium	250	34.22	26.16	23.92	22.74
ZIPLITE3	8 x 6	200 x 150	50	1.2	Medium	250	40.25	32.71	29.72	28.16
ZIPLITE4	9 x 4.5 + 1.25	220 x 115 + 30	50	1.1	30mm Gusset	250	37.75	31.50	28.48	26.92
ZIPLITE5	10 x 6	250 x 170	50	1.6	C5	250	45.22	38.41	34.82	32.97
ZIPLITE6	9.5 x 12.5	240 x 320	60	2.4	C4	250	70.37	61.09	53.75	50.01
ZIPLITE7	10.5 x 11 + 2.5	265 x 280 + 60	60	2.7	60mm Gusset	250	71.54	63.43	55.98	52.16
ZIPLITE8	12.5 x 9	320 x 230	60	2.7	C4	250	68.52	60.90	53.90	50.35
ZIPLITE9	14 x 10	360 x 250	60	3.8	C4+	250	79.42	70.57	62.36	58.20
ZIPLITE10	15 x 10	390 x 250	60	3.8	Large	250	84.13	74.73	65.98	61.54



Plain Clear Grip Seal 50 Micron

Commodity Code: 3923210000



RECYCLE

200 GAUGE

CODE	INTERNAL SIZE (W x L)		THICKNESS MICRON	WEIGHT Kg	DESCRIPTION	BOX QTY	MINI PACK		ALL PRICES PER BOX		
	INCHES	MM					100	500	1+	3+	10+
PL0	1.5 x 2.5	38 x 64	50	0.4	Mini	1000	10.09	12.08	16.56	11.15	£7.21
PL1	2.25 x 2.25	57 x 57	50	0.5	Mini	1000	10.19	12.19	16.74	11.31	£7.37
PL2	2.25 x 3	57 x 76	50	0.6	Mini	1000	11.86	14.20	19.47	13.95	13.12
PL3	3 x 3.25	76 x 83	50	0.9	Mini	1000	13.81	16.52	22.68	16.96	13.74
PL4	3.5 x 4.5	89 x 114	50	1.3	C7	1000	15.51	18.53	25.46	19.63	15.16
PL5	4.5 x 4.5	114 x 114	50	1.6	Small	1000	17.33	20.69	28.46	22.37	17.71
PL6	4 x 5.5	102 x 140	50	1.8	Small	1000	17.78	21.24	29.21	23.16	18.45
PL7	5.5 x 5.5	140 x 140	50	2.4	Small	1000	19.22	22.95	31.59	25.30	20.42
PL8	3 x 7.5	76 x 191	50	1.7	Small	1000	19.25	23.01	31.63	25.39	20.68
PL9	5 x 7.5	127 x 191	50	2.8	Small	1000	22.28	26.61	36.63	30.11	25.14
PL10	7.5 x 7.5	191 x 191	50	4.2	Medium	1000	26.91	32.14	44.28	37.95	32.81
PL11	6 x 9	152 x 229	50	3.9	C5	1000	27.11	32.37	44.58	38.05	32.95
PL12	8 x 11	203 x 280	50	6.3	Medium	1000	35.18	41.97	57.93	51.00	45.79
PLA4	9 x 12.75	229 x 324	50	8.2	C4	1000	40.68	48.50	66.99	58.44	53.19
PL13	12.75 x 12.75	324 x 324	50	11.5	Large	1000	46.88	55.88	77.28	68.68	62.28
PL14	10 x 14	254 x 356	50	19.8	C4+	1000	54.89	64.88	101.88	95.40	93.52
PL15	11 x 16	280 x 406	50	12.3	Large	1000	58.65	69.94	96.61	87.42	80.13
PL16	13 x 18	330 x 457	50	16.3	C3	1000	71.82	85.19	118.03	105.44	96.30
PL17	15 x 20"	381 x 508	50	20.8	C3+	1000	84.24	99.77	145.57	139.33	134.63



Plain Clear Grip Seal 40 Micron

Commodity Code: 3923210000

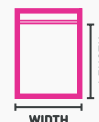

RECYCLE

160 GAUGE

CODE	INTERNAL SIZE (W x L)		THICKNESS MICRON	WEIGHT Kg	DESCRIPTION	BOX QTY	ALL PRICES PER BOX			
	INCHES	MM					1+	3+	10+	25+
GL0	1.5 x 2.5	38 x 64	40	0.3	Mini	1000	15.39	10.08	6.17	3.99
GL1	2.25 x 2.25	57 x 57	40	0.4	Mini	1000	15.55	10.19	6.30	4.53
GL2	2.25 x 3	57 x 76	40	0.5	Mini	1000	17.66	12.25	8.26	6.04
GL3	3 x 3.25	76 x 83	40	0.7	Mini	1000	20.17	14.63	10.44	8.01
GL4	3.5 x 4.5	89 x 114	40	1.0	C7	1000	22.33	16.68	12.35	9.83
GL5	4.5 x 4.5	114 x 114	40	1.3	Small	1000	24.67	18.81	14.33	11.69
GL6	4 x 5.5	102 x 140	40	1.4	Small	1000	25.26	19.41	14.92	12.29
GL7	5.5 x 5.5	140 x 140	40	1.9	Small	1000	29.26	25.39	22.88	21.56
GL8	3 x 7.5	76 x 191	40	1.3	Small	1000	27.14	24.39	22.03	20.42
GL9	5 x 7.5	127 x 191	40	2.2	Small	1000	31.05	24.85	20.13	17.34
GL10	7.5 x 7.5	191 x 191	40	3.3	Medium	1000	39.16	33.11	28.24	25.37
GL11	6 x 9	152 x 229	40	3.1	C5	1000	37.25	31.04	26.24	23.42
GL12	8 x 11	203 x 280	40	5.0	Medium	1000	49.79	43.29	38.37	35.38
GLA4	9 x 12.75	229 x 324	40	6.5	C4	1000	55.79	49.10	44.15	42.37
GL13	12.75 x 12.75	324 x 324	40	9.2	Large	1000	67.99	62.46	57.82	56.52
GL14	10 x 14	254 x 356	40	7.9	C4+	1000	68.92	60.34	54.74	51.47
GL15	11 x 16	280 x 406	40	9.5	Large	1000	77.73	69.48	62.94	57.58
GL16	13 x 18	330 x 457	40	13.0	C3	1000	92.00	81.93	73.88	67.67
GL17	15 x 20	381 x 508	40	16.4	C3+	1000	111.88	106.57	97.39	93.94



Clear + Write-On Panels 50 Micron

Commodity Code: 3923210000

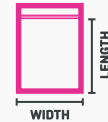

CODE	INTERNAL SIZE (W x L)		THICKNESS MICRON	WEIGHT Kg	DESCRIPTION	BOX QTY	MINI PACK		ALL PRICES PER BOX		
	INCHES	MM					100	500	1+	3+	10+
PA020	1.5 x 2.5	38 x 64	50	0.4	Mini	1000	10.26	12.29	16.85	16.51	16.34
PA120	2.25 x 2.25	57 x 57	50	0.5	Mini	1000	10.40	12.42	17.05	16.67	16.54
PA122	3 x 3.25	76 x 83	50	0.9	Mini	1000	14.23	17.00	23.35	22.68	22.16
PA123	3.5 x 4.5	89 x 114	50	1.3	C7	1000	16.01	19.12	26.28	25.49	24.75
PA124	4.5 x 4.5	114 x 114	50	1.6	Small	1000	17.92	21.44	29.45	28.39	27.47
PA125	4 x 5.5	102 x 140	50	1.8	Small	1000	18.41	22.01	30.26	29.21	28.25
PA126	5.5 x 5.5	140 x 140	50	2.4	Small	1000	19.93	23.79	32.77	31.49	30.31
PA127	3 x 7.5	76 x 191	50	1.7	Small	1000	20.00	23.89	32.83	31.60	30.63
PA128	5 x 7.5	127 x 191	50	2.8	Small	1000	23.18	27.69	38.11	36.57	35.33
PA129	7.5 x 7.5	191 x 191	50	4.2	Medium	1000	30.22	35.68	47.29	45.94	44.49
PA130	6 x 9	152 x 229	50	3.9	C5	1000	28.29	33.77	46.54	44.98	43.60
PA131	8 x 11	203 x 280	50	6.3	Medium	1000	37.92	45.05	61.72	59.75	58.25
PAA4	9 x 12.75	229 x 324	50	8.2	C4	1000	43.73	53.02	72.38	68.68	66.06



Clear + Write-On Panels 40 Micron

Commodity Code: 3923210000

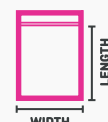

CODE	INTERNAL SIZE (W x L)		THICKNESS MICRON	WEIGHT Kg	DESCRIPTION	BOX QTY	ALL PRICES PER BOX			
	INCHES	MM					1+	3+	10+	25+
GA0	1.5 x 2.5	38 x 64	40	0.3	Mini	1000	16.32	10.66	6.52	4.24
GA1	2.25 x 2.25	57 x 57	40	0.4	Mini	1000	16.48	10.80	6.67	4.37
GA2	2.25 x 3	57 x 76	40	0.1	Mini	1000	18.64	12.89	8.66	6.93
GA3	3 x 3.25	76 x 83	40	0.7	Mini	1000	21.37	15.47	11.05	8.48
GA4	3.5 x 4.5	89 x 114	40	1.0	C7	1000	23.66	17.67	13.08	10.39
GA5	4.5 x 4.5	114 x 114	40	1.3	Small	1000	26.14	19.93	15.19	12.38
GA6	4 x 5.5	102 x 140	40	1.4	Small	1000	26.77	20.58	15.79	13.00
GA7	5.5 x 5.5	140 x 140	40	1.9	Small	1000	28.70	22.34	17.41	14.51
GA8	3 x 7.5	76 x 191	40	1.3	Small	1000	28.76	22.43	17.65	14.71
GA9	5 x 7.5	127 x 191	40	2.2	Small	1000	32.88	26.32	21.31	18.34
GA10	7.5 x 7.5	191 x 191	40	3.3	Medium	1000	39.21	32.78	27.63	24.57
GA11	6 x 9	152 x 229	40	3.1	C5	1000	39.45	32.86	27.77	24.78
GA12	8 x 11	203 x 280	40	5.0	Medium	1000	50.43	46.76	43.06	39.45
GAA4	9 x 12.75	229 x 324	40	6.5	C4	1000	57.92	49.69	44.44	41.56
GA14	10 x 14	254 x 356	40	7.9	C4+	1000	72.98	63.87	57.92	54.47
GA15	11 x 16	280 x 406	40	9.8	Large	1000	82.35	73.59	66.68	60.96
GA16	13 x 18	330 x 457	40	13.0	C3	1000	97.36	86.66	78.14	71.56
GA17	15 x 20	381 x 508	40	16.7	C3+	1000	112.86	101.65	90.84	83.88



Specimen Bags

Transportation of biological substances & related patient documentation. Widely used by Analysis Centres, Dental Labs & Clinics.

Commodity Code: 3923210000

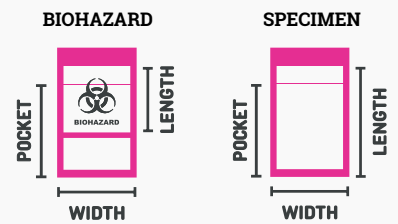

CODE	INTERNAL SIZE (W x L)		THICKNESS MICRON	WEIGHT Kg	DESCRIPTION	BOX QTY	MINI PACK		ALL PRICES PER BOX		
	INCHES	MM					100	500	1+	3+	10+
SPECIMEN	6 x 9	152 x 229	50	7.3	Pocket = 152 x 195	1000	52.52	62.69	86.35	75.08	67.40
BIOHAZARD4WALL	5.5 x 5.5	140 x 140	50	5.5	Pocket = 140 x 220	1000	48.37	57.76	79.49	67.34	58.51

CODE	INTERNAL SIZE (W x L)		THICKNESS MICRON	WEIGHT Kg	DESCRIPTION	BOX QTY	ALL PRICES PER BOX			
	INCHES	MM					1+	3+	10+	25+
SPECIMENSMALL	6 x 9	152 x 229	40	5.3	Pocket = 152 x 195	1000	70.19	60.05	53.09	49.22



Heavy Duty Grip Seal - Clear

Commodity Code: 3923210000



CODE	INTERNAL SIZE (W x L)		THICKNESS MICRON	WEIGHT Kg	DESCRIPTION	BOX QTY	MINI PACK		ALL PRICES PER BOX		
	INCHES	MM					100	500	1+	3+	10+
HD20	5 x 8	127 x 203	87.5	5.1	Small	1000	29.17	35.65	50.47	46.60	44.20
HD30	7 x 10	178 x 254	87.5	8.8	Medium	1000	45.41	51.04	70.69	70.17	£68.87
HD40	8 x 12	203 x 305	87.5	11.9	Medium	1000	57.60	65.28	90.56	87.61	£85.22
HD50	9 x 14	229 x 356	87.5	15.6	C4+	1000	71.53	92.93	112.25	107.31	103.16
HD60	12 x 16	305 x 406	87.5	23.5	Large	1000	87.33	105.19	154.03	149.77	146.46
HD70	10 x 18	254 x 457	87.5	21.9	Large	1000	88.13	105.34	154.54	149.67	146.96



DuoGrip : Freezer Bags

Made from premium polythene with a special EVA additive to prevent cracking when frozen (up to -30 degrees Centigrade). The double zip seal locks out air to keep your contents fresher for longer and the 'Write on strip' allows you to label & date contents for easy identification.

Commodity Code: 3923210000



EVA ADDITIVE



350 GAUGE



FOOD SAFE

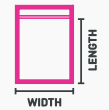

CODE	INTERNAL SIZE (W x L)		THICKNESS MICRON	WEIGHT Kg	DESCRIPTION	BOX QTY	ALL PRICES PER BOX			
	INCHES	MM					1+	5+	10+	25+
FRZIP3	7.5 x 5	191 x 127	87.5	0.6	0.5 Litre Freezer Bag	100	28.56	20.03	14.35	11.50
FRZIP5	7.5 x 8	191 x 203	87.5	0.9	1 Litre Freezer Bag	100	33.87	23.76	17.03	13.66
FRZIP7	8 x 11	203 x 279	87.5	1.3	1.5 Litre Freezer Bag	100	46.84	32.87	23.56	18.90
FRZIP9	9 x 15.5	229 x 394	87.5	2.0	2 Litre Freezer Bag	100	56.10	41.39	29.87	23.31
FRZIP11	10.5 x 11	267 x 279	87.5	1.7	3 Litre Freezer Bag	100	58.22	43.51	31.99	25.43
FRZIPMIX	-	Various	87.5	1.7	20 off each size FRZIP3,5,7,9,11	100	45.72			



Biodegradable Clear Printed with biodegradable logo

Commodity Code: 3923210000



BIODEGRADABLE



160 GAUGE



RECYCLE



FOOD SAFE

CODE	INTERNAL SIZE (W x L)		THICKNESS MICRON	WEIGHT Kg	DESCRIPTION	BOX QTY	MINI PACK		ALL PRICES PER BOX		
	MM	MM					100	500	1+	3+	10+
GL4BIO	89 x 114		40	1.0	C7	1000	20.76	24.42	33.13	32.52	31.63
GL5BIO	114 x 114		40	1.3	Small	1000	24.21	29.96	40.47	39.27	38.17
GL10BIO*	191 x 191		40	3.5	Medium	1000	36.13	45.48	58.89	57.17	55.61
GL11BIO	152 x 229		40	3.3	C5	1000	36.95	46.64	60.98	59.19	57.35
GL12BIO	203 x 280		40	5.4	Medium	1000	47.64	61.33	80.00	77.66	75.39
GLA4BIO	229 x 324		40	6.5	C4	1000	54.62	67.95	93.55	90.82	88.09
GL14BIO	254 x 356		40	8.0	C4+	1000	60.43	74.06	110.87	107.64	104.50

* GL10BIO does not have a bio printed logo on the bag.

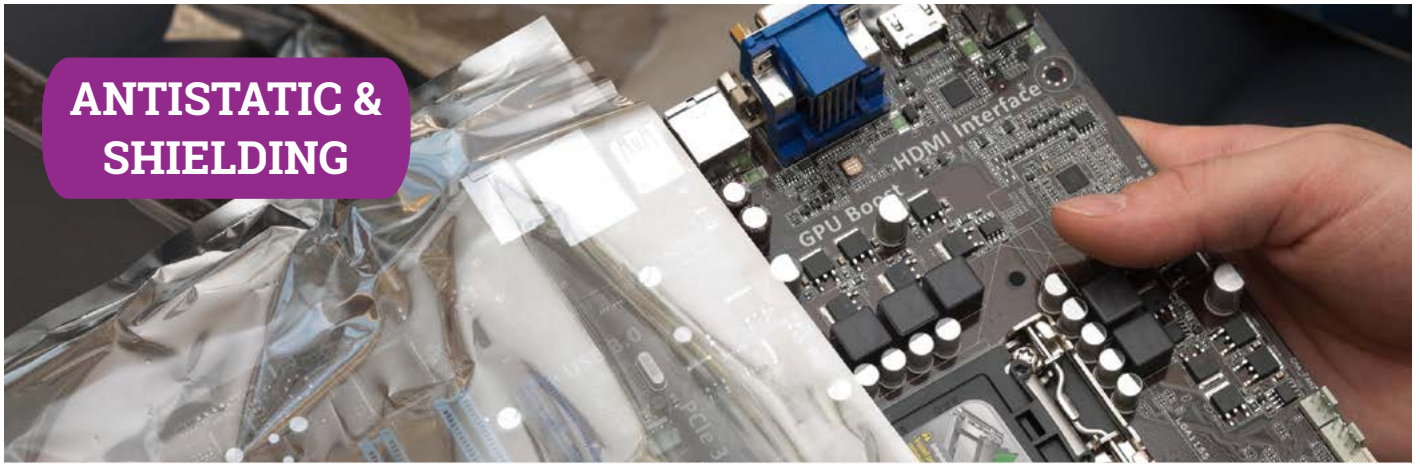

ANTISTATIC & SHIELDING

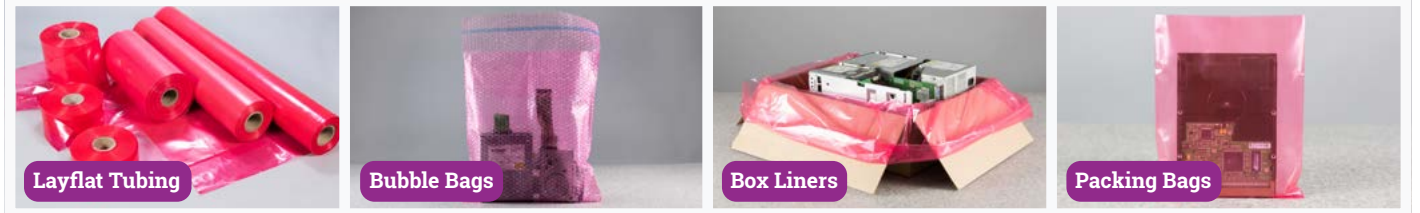

Antistatic - Red Tint

Will not hold electrostatic charge and will not charge up when rubbed against other materials. Static release time is <2 seconds.

Commodity Code: 3923210000



ANTI STATIC

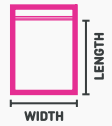

RECYCLE



200 GAUGE

CODE	INTERNAL SIZE (W x L)		THICKNESS MICRON	WEIGHT Kg	DESCRIPTION	BOX QTY	MINI PACK		ALL PRICES PER BOX		
	INCHES	MM					100	500	1+	3+	10+
PL4AS	3.5 x 4.5	89 x 114	50	1.4	C7	1000	17.02	20.34	27.94	27.06	26.25
PL6AS	4 x 5.5	102 x 140	50	1.8	Small	1000	19.58	23.41	32.18	31.02	29.97
PL9AS	5 x 7.5	127 x 191	50	3.0	Small	1000	24.69	29.48	40.59	38.91	37.54
PL11AS	6 x 9	152 x 229	50	4.1	C5	1000	30.08	35.93	49.46	47.76	46.28
PL12AS	8 x 11	203 x 280	50	6.4	Medium	1000	39.04	46.61	64.26	62.16	60.55
PLA4AS	9 x 12.75	229 x 324	50	8.3	C4	1000	44.62	53.23	73.47	69.57	67.94



ESD Metallised Shielding Bags

Metal "Faraday cage" layer shields products from electric energy inside & prevents static build-up. Semi transparent for easy content identification.

Commodity Code: 3923210000



ESD

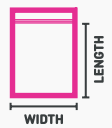

RECYCLE



280 GAUGE

CODE	INTERNAL SIZE (W x L)		THICKNESS MICRON	WEIGHT Kg	DESCRIPTION	BOX QTY	ALL PRICES PER BOX			
	MM	MM					1+	5+	10+	25+
ESD33GRIP	75 x 75	75	70	0.2	Small	100	22.72	16.19	8.66	6.73
ESD35GRIP	75 x 127	75	70	0.2	Small	100	23.86	17.33	9.80	7.87
ESD46GRIP	102 x 152	102	70	0.4	Small	100	25.59	19.87	11.54	9.61
ESD68GRIP	152 x 203	152	70	0.6	Medium	100	28.68	23.01	14.62	12.69
ESD812GRIP	203 x 305	203	70	1.3	Medium	100	34.53	27.77	22.60	20.60
ESD1014GRIP	254 x 355	254	70	1.6	Medium	100	40.21	36.59	28.29	26.35
ESD1824GRIP	457 x 610	457	70	5.1	Large	100	90.00	84.41	80.81	77.73
ESD2024GRIP	508 x 610	508	70	5.8	Large	100	96.36	94.22	92.17	86.88
ESD2430GRIP	610 x 762	610	70	7.9	Large	100	149.14	145.88	142.47	140.60



Coloured Grip Seal (Black, Blue, Green, Red)

Ideal for colour coding of products.

Commodity Code: 3923210000



FOOD SAFE



RECYCLE



50 MICRON
200 GAUGE

CODE	INTERNAL SIZE (W x L)		THICKNESS MICRON	WEIGHT Kg	DESCRIPTION	BOX QTY	MINI PACK		ALL PRICES PER BOX		
	INCHES	MM					100	500	1+	3+	10+
PL4BLACK	3.5 x 4.5	89 x 114	50	1.3	Black	1000	18.49	22.43	30.27	29.64	28.04
PL4BLUE				1.3	Blue	1000	19.35	23.05	32.31	30.68	24.71
PL4GREEN				1.3	Green	1000	19.31	22.84	32.25	29.96	23.87
PL4RED				1.3	Red	1000	19.45	23.00	32.41	30.12	24.02
PL6BLACK	4 x 5.5	102 x 140	50	1.8	Black	1000	20.93	25.02	34.39	33.11	31.96
PL6BLUE				1.8	Blue	1000	21.92	26.00	35.38	34.12	25.11
PL6GREEN				1.8	Green	1000	22.11	26.19	35.56	34.30	25.29
PL6RED				1.8	Red	1000	22.25	26.32	35.69	34.44	25.44
PL9BLACK	5 x 7.5	127 x 191	50	2.8	Black	1000	26.48	31.65	43.54	41.70	40.20
PL9BLUE				2.8	Blue	1000	27.46	31.32	44.54	42.69	33.37
PL9GREEN				2.8	Green	1000	27.65	31.51	44.70	42.87	33.55
PL9RED				2.8	Red	1000	27.80	31.66	44.85	43.02	34.21
PL11BLACK	6 x 9	152 x 229	50	3.9	Black	1000	32.36	38.64	53.18	51.34	49.72
PL11BLUE				3.9	Blue	1000	33.21	39.62	54.18	41.44	38.74
PL11GREEN				3.9	Green	1000	33.39	39.81	54.36	40.56	38.92
PL11RED				3.9	Red	1000	33.55	39.96	54.50	41.75	40.11
PL12BLACK	8 x 11	203 x 280	50	6.3	Black	1000	42.12	50.28	69.31	67.00	65.24
PL12BLUE				6.3	Blue	1000	42.97	51.27	70.29	67.99	57.09
PL12GREEN				6.3	Green	1000	43.14	51.45	70.47	68.17	57.28
PL12RED				6.3	Red	1000	43.29	51.60	70.61	68.33	57.42
PLA4BLACK	9 x 12.75	229 x 324	50	8.2	Black	1000	48.18	57.50	79.30	75.06	73.28
PLA4BLUE				8.2	Blue	1000	49.16	58.49	80.29	76.05	66.43
PLA4GREEN				8.2	Green	1000	49.35	58.66	80.47	76.25	66.60
PLA4RED				8.2	Red	1000	49.48	58.82	80.61	76.37	66.76



Header Bags with Euroslot

The Euroslot enables a hanging point for merchandising and is perfect for holding confectionary or arts & craft items.

Commodity Code: 3923210000



RECYCLE



50 MICRON
200 GAUGE

CODE	INTERNAL SIZE (W x L) MM	THICKNESS MICRON	WEIGHT Kg	DESCRIPTION	BOX QTY	ALL PRICES PER BOX			
						1+	5+	10+	25+
PL0HEADER	38 x 64	50	0.4	Mini	1000	18.63	13.07	9.17	8.25
PL1HEADER	57 x 57	50	0.5	Mini	1000	19.60	13.87	10.73	9.41
PL2HEADER	57 x 76	50	0.6	Mini	1000	20.72	14.55	11.66	10.51
PL3HEADER	76 x 83	50	0.9	Mini	1000	21.11	17.46	13.82	11.99
PL4HEADER	89 x 114	50	1.3	Small	1000	26.21	21.73	18.49	17.09
PL7HEADER	140 x 140	50	2.4	Small	1000	32.81	30.21	25.37	21.34
PL9HEADER	127 x 191	50	2.8	Small	1000	37.56	31.06	26.34	21.97
PL11HEADER	152 x 229	50	3.9	C5	1000	40.70	35.73	32.11	29.52



Grip Seal Clear Carrier Bags

50-90 Micron

Our transparent 'punch handle' grip seal carriers are ideal for security sensitive environments and are widely used in Airports & Duty Free retail.

Commodity Code: 3923210000



RECYCLE

CODE	INTERNAL SIZE (W x L) MM	THICKNESS MICRON	WEIGHT Kg	DESCRIPTION	BOX QTY	ALL PRICES PER BOX			
						1+	5+	10+	25+
CBGRIP5	191 x 191	50	4.7	Airport Compliant	1000	49.95	41.42	33.77	29.95
CBGRIP10	200 x 320	90	7.7	Small	500	77.78	53.59	49.04	46.93
CBGRIP20	300 x 400	90	9.5	Medium	400	85.06	71.31	66.74	63.03
CBGRIP30	380 x 450	90	10.6	Large	300	86.40	74.88	69.27	65.03

Our extensive range of grip seal bags include products used in retail packaging and product display and are widely used in Airports & Duty Free retail.



Grip Seal Clear Carrier Bags



Header Bags with Euroslot

30% Recycled Content



30% Recycled Grip Seal

Commodity Code: 3923210000

PACKAGING TAX EXEMPT



CODE	INTERNAL SIZE (W x L)	THICKNESS MICRON	WEIGHT Kg	DESCRIPTION	BOX QTY	MINI PACK		ALL PRICES PER BOX		
	MM					100	500	1+	3+	10+
PL3R30	76 x 83	50	0.8	Mini	1000	15.08	18.07	24.74	18.45	13.77
PL4R30	89 x 114	50	1.4	C7	1000	16.92	20.24	27.72	21.30	16.38
PL5R30	114 x 114	50	1.6	Small	1000	18.87	22.58	30.94	24.24	19.11
PL6R30	102 x 140	50	1.8	Small	1000	19.36	23.16	31.73	25.08	19.89
PL9R30	127 x 191	50	3.9	Small	1000	24.19	28.95	39.65	32.48	27.01
PL11R30	152 x 229	50	4.1	C5	1000	29.38	35.16	48.14	40.95	35.34
PL12R30	203 x 280	50	6.4	Medium	1000	37.98	45.45	62.28	54.66	48.93
PLA4R30	229 x 324	50	8.3	C4	1000	43.82	52.42	71.83	62.42	56.65
PL14R30	254 x 356	50	10.2	C4+	1000	55.83	66.81	91.52	80.97	74.21
PL16R30	330 x 457	50	17.0	C3	1000	79.22	93.93	129.26	118.50	111.56
PL17R30	381 x 508	50	21.0	C3+	1000	93.41	111.52	154.65	143.10	133.14



Our stand-up pouches have a grip seal resealable strip allowing the pouch to be resealed after the initial opening which helps preserve the freshness of the contents. The header is also heat sealable with a standard heat-sealer.

*See pages 95-97



ROLLS OF POLYTHENE

As part of our core business we stock a massive range of plastic and polythene film on the roll, including poly sheeting and poly covers. Polytubing (layflat tubing or simply LFT) is commonly used for wrapping items that are difficult to bag up.

Where more substantial covering is needed for flooring, building or agriculture we stock a huge range of wide plastic sheeting and DPMS, shrinkable pallet covers for outside and in-transit protection in addition to specialist ranges of polythene film.

Made to order

Films are available for manufacturing orders in a wide range of grades, colours, blends and additives, to your unique specific requirements. (See pages 11-19 for more information). Just give us a call to discuss your options.



PB Group can also custom print your unique product / brand details or even usage and safety advice onto layflat tubing. Just give us a call to discuss your requirements.

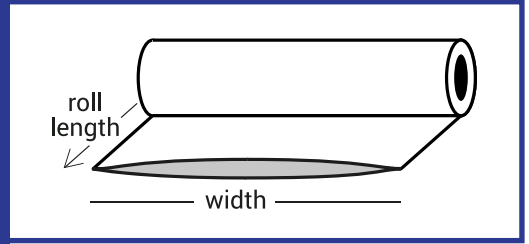

We extrude tubing and sheeting in any thickness between 20 & 250 micron. All rolls are supplied on 75mm diameter cardboard cores as standard.



BRANDING YOUR POLYTHENE ROLLS!

- Highlight essential company information & logos with a diverse range of colours to choose from.
- Personalise with your brand, instructions for use or unique message.
- Options include Antistatic, Recycled content, Biodegradable.
- Roll widths available from 50mm to 1200mm



Clear Roll – 3 colours



Clear Roll – 1 colour



Clear Roll – 2 colours



Yellow Roll – 1 colour



Clear Layflat Tubing

Commodity Code: 3923210000
Origin: GB



CODE	ROLL WIDTH		THICKNESS GAUGE	ROLL LENGTH (METRES) 120g / 250g/500g	ROLL WEIGHT	ALL PRICES PER ROLL			
	INCHES	MM				1+	5+	10+	25+
LFT2***STK	2	51	120 / 250 / 500	700m / 336m / 168m	2.0	21.94	19.79	18.71	17.64
LFT3***STK	3	76	120 / 250 / 500	700m / 336m / 168m	3.0	25.58	23.09	21.84	20.59
LFT4***STK	4	102	120 / 250 / 500	700m / 336m / 168m	4.0	31.74	28.65	27.10	25.56
LFT5***STK	5	127	120 / 250 / 500	700m / 336m / 168m	5.0	37.04	34.88	33.44	31.64
LFT6***STK	6	152	120 / 250 / 500	700m / 336m / 168m	6.0	39.77	37.46	35.92	33.99
LFT7***STK	7	178	120 / 250 / 500	700m / 336m / 168m	7.0	45.48	42.84	41.08	38.88
LFT8***STK	8	203	120 / 250 / 500	700m / 336m / 168m	8.0	47.36	44.62	42.79	40.50
LFT9***STK	9	229	120 / 250 / 500	700m / 336m / 168m	9.0	49.60	46.74	44.83	42.44
LFT10***STK	10	254	120 / 250 / 500	700m / 336m / 168m	10.0	52.99	49.94	47.90	45.36
LFT12***STK	12	305	120 / 250 / 500	700m / 336m / 168m	12.0	56.06	52.84	50.70	48.02
LFT15***STK	15	381	120 / 250 / 500	700m / 336m / 168m	15.0	67.53	63.66	61.08	57.86
LFT18***STK	18	457	120 / 250 / 500	700m / 336m / 168m	18.0	80.82	76.19	73.11	69.26
LFT20***STK	20	508	120 / 250 / 500	700m / 336m / 168m	20.0	88.60	83.54	80.16	75.94
LFT24***STK	24	610	120 / 250 / 500	700m / 336m / 168m	24.0	106.35	100.27	96.21	91.14
LFT30***STK	30	762	120 / 250 / 500	560m / 268m / 134m	24.0	106.35	100.27	96.21	91.14
LFT36***STK	36	914	120 / 250 / 500	466m / 224m / 112m	24.0	106.35	100.27	96.21	91.14
LFT48***STK	48	1219	120 / 250 / 500	350m / 168m / 84m	24.0	106.35	100.27	96.21	91.14

*** = THICKNESS GAUGE

* The length of the roll varies directly with thickness so the roll price is unaffected



Clear Super Layflat Tubing

Our thickest, toughest, heavy duty layflat tubing.

Commodity Code: 3923210000
Origin: GB



CODE	ROLL WIDTH		THICKNESS MICRON	WEIGHT Kg	DESCRIPTION	ROLL QTY	ALL PRICES PER ROLL			
	INCHES	MM					1+	5+	10+	25+
LFT2SUPCLR	2	51	250	2.0	84 metres per Roll	1	25.58	24.07	23.06	21.80
LFT4SUPCLR	4	102	250	4.0	84 metres per Roll	1	32.39	30.50	29.23	27.66
LFT6SUPCLR	6	152	250	6.0	84 metres per Roll	1	34.08	32.11	30.79	29.15
LFT12SUPCLR	12	305	250	12.0	84 metres per Roll	1	59.17	55.77	53.51	52.76
LFT18SUPCLR	18	457	250	18.0	84 metres per Roll	1	82.48	77.81	75.75	71.86
LFT24SUPCLR	24	610	250	18.0	63 metres per Roll	1	82.67	78.00	75.92	72.03



I'm Green Layflat Tubing

Commodity Code: 3923210000
Origin: GB



CODE	ROLL WIDTH MM	THICKNESS MICRON	WEIGHT Kg	DESCRIPTION	ROLL QTY	ALL PRICES PER BOX			
						1+	5+	10+	25+
LFT4SUST250	102	62.5	4.0	336mtr per Roll	1	44.35	40.86	37.82	33.47
LFT4SUST400		100	4.0	210mtr per Roll	1	44.35	40.86	37.82	33.47
LFT6SUST250	152	62.5	6.0	336mtr per Roll	1	58.90	54.29	50.25	44.49
LFT6SUST400		100	6.0	210mtr per Roll	1	58.90	54.29	50.25	44.49
LFT10SUST400	254	100	10.0	210mtr per Roll	1	90.13	83.09	76.92	68.12
LFT15SUST400	381	100	15.0	210mtr per Roll	1	125.54	115.75	107.18	94.94
LFT20SUST400	508	100	18.0	189mtr per Roll	1	148.34	136.77	126.65	112.19

RECYCLED CONTENT PROCESS - POLYMER REGENERATION

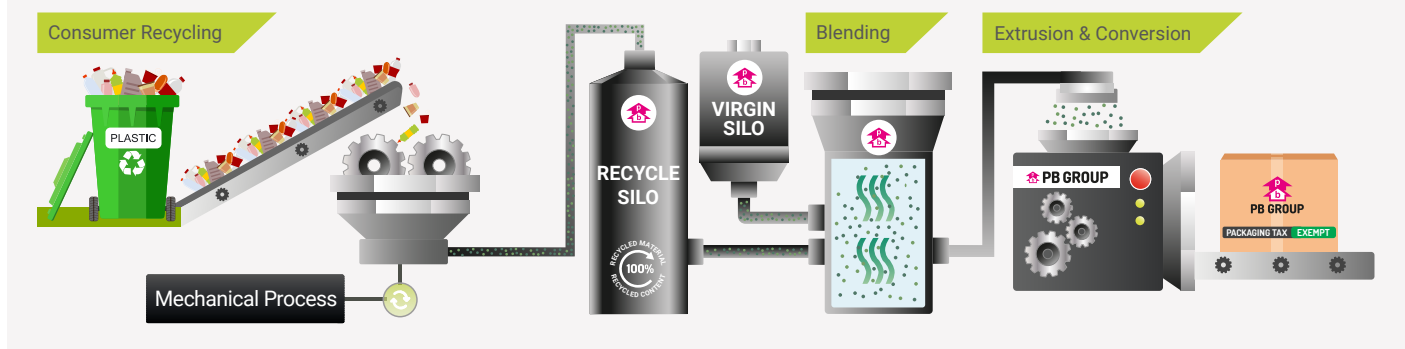

Clear Layflat - 30% Recycled

Commodity Code: 3923210000
Origin: GB

PACKAGING TAX EXEMPT

40
MICRON
160 GAUGE

100
MICRON
400 GAUGE

30%
RECYCLED
CONTENT

4
RECYCLE

CODE	ROLL WIDTH		THICKNESS MICRON	ROLL LENGTH (METRES)	ROLL WEIGHT	ALL PRICES PER ROLL			
	INCHES	MM				1+	3+	5+	10+
LFT4R30M	4	102	40	532mtr per Roll	4	25.84	24.55	23.52	22.23
LFT4R30H	4	102	100	213mtr per Roll	4	25.84	24.55	23.52	22.23
LFT6R30M	6	152	40	532mtr per Roll	6	35.89	34.10	32.66	30.87
LFT6R30H	6	152	100	213mtr per Roll	6	35.89	34.10	32.66	30.87
LFT10R30M	10	254	40	532mtr per Roll	10	54.62	51.89	49.71	46.97
LFT10R30H	10	254	100	213mtr per Roll	10	54.62	51.89	49.71	46.97
LFT12R30M	12	305	40	532mtr per Roll	12	60.55	57.52	55.10	52.07
LFT12R30H	12	305	100	213mtr per Roll	12	60.55	57.52	55.10	52.07
LFT15R30M	15	381	40	532mtr per Roll	15	73.82	70.13	67.17	63.48
LFT15R30H	15	381	100	213mtr per Roll	15	73.82	70.13	67.17	63.48
LFT18R30M	18	457	40	532mtr per Roll	18	85.21	80.95	77.54	73.28
LFT18R30H	18	457	100	213mtr per Roll	18	85.21	80.95	77.54	73.28
LFT20R30M	20	508	40	480mtr per Roll	18	85.21	80.95	77.54	73.28
LFT20R30H	20	508	100	192mtr per Roll	18	85.21	80.95	77.54	73.28
LFT24R30M	24	610	40	400mtr per Roll	18	85.21	80.95	77.54	73.28
LFT24R30H	24	610	100	160mtr per Roll	18	85.21	80.95	77.54	73.28
LFT30R30M	30	762	40	320mtr per Roll	18	85.21	80.95	77.54	73.28
LFT30R30H	30	762	100	128mtr per Roll	18	85.21	80.95	77.54	73.28
LFT36R30M	36	914	40	267mtr per Roll	18	85.21	80.95	77.54	73.28
LFT36R30H	36	914	100	107mtr per Roll	18	85.21	80.95	77.54	73.28
LFT48R30M	48	1219	40	200mtr per Roll	18	85.21	80.95	77.54	73.28
LFT48R30H	48	1219	100	80mtr per Roll	18	85.21	80.95	77.54	73.28

RECYCLED CONTENT OPTIONS

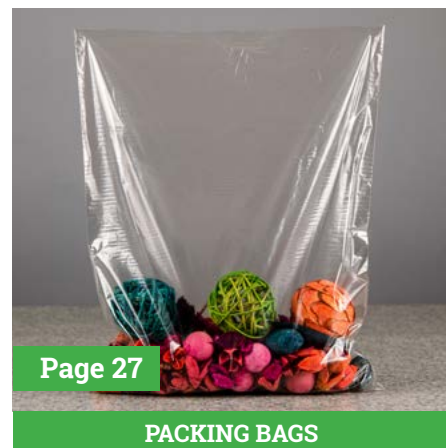



Layflat Tubing

Black

Commodity Code: 3923210000

Origin: GB

PACKAGING TAX EXEMPT

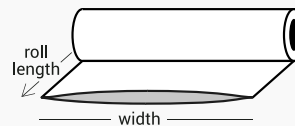

CODE	ROLL WIDTH		THICKNESS	WEIGHT	DESCRIPTION	ROLL QTY	ALL PRICES PER ROLL			
	INCHES	MM	MICRON	Kg			1+	5+	10+	25+
LFT2BLK	2	51	100	2.0	210 metres per Roll	1	23.18	21.79	20.86	19.70
LFT3BLK	3	76	100	3.0	210 metres per Roll	1	26.79	25.19	24.12	22.78
LFT4BLK	4	102	100	4.0	210 metres per Roll	1	30.49	28.66	27.44	25.91
LFT5BLK	5	127	100	5.0	210 metres per Roll	1	35.90	33.75	32.31	30.51
LFT6BLK	6	152	100	6.0	210 metres per Roll	1	38.51	36.20	34.66	32.74
LFT7BLK	7	178	100	7.0	210 metres per Roll	1	42.88	40.30	38.59	36.44
LFT8BLK	8	203	100	8.0	210 metres per Roll	1	45.69	42.95	41.12	38.84
LFT9BLK	9	229	100	9.0	210 metres per Roll	1	47.74	44.88	42.97	40.58
LFT10BLK	10	254	100	10.0	210 metres per Roll	1	50.90	47.85	45.81	43.27
LFT12BLK	12	305	100	12.0	210 metres per Roll	1	53.62	50.41	48.26	45.58
LFT15BLK	15	381	100	15.0	210 metres per Roll	1	64.46	60.59	58.01	54.79
LFT18BLK	18	457	100	18.0	210 metres per Roll	1	77.17	72.54	69.45	65.59
LFT20BLK	20	508	100	18.0	189 metres per Roll	1	77.17	72.54	69.45	65.59
LFT24BLK	24	610	100	18.0	158 metres per Roll	1	77.17	72.54	69.45	65.59
LFT30BLK	30	762	100	18.0	126 metres per Roll	1	77.17	72.54	69.45	65.59
LFT36BLK	36	914	100	18.0	105 metres per Roll	1	77.17	72.54	69.45	65.59
LFT48BLK	48	1219	100	18.0	79 metres per Roll	1	77.17	72.54	69.45	65.59



Super Layflat Tubing

Black

Our thickest, toughest, heavy duty layflat tubing.

Commodity Code: 3923210000

Origin: GB

PACKAGING TAX EXEMPT



CODE	ROLL WIDTH		THICKNESS	WEIGHT	DESCRIPTION	ROLL QTY	ALL PRICES PER ROLL			
	INCHES	MM	MICRON	Kg			1+	5+	10+	25+
LFT2SUPBLK	2	51	250	2.0	84 metres per Roll	1	26.87	25.26	24.19	22.84
LFT4SUPBLK	4	102	250	4.0	84 metres per Roll	1	32.92	30.94	29.63	27.98
LFT6SUPBLK	6	152	250	6.0	84 metres per Roll	1	34.16	32.11	30.74	29.03
LFT12SUPBLK	12	305	250	12.0	84 metres per Roll	1	56.69	53.29	51.02	48.19
LFT18SUPBLK	18	457	250	18.0	84 metres per Roll	1	77.73	73.07	69.96	66.07
LFT24SUPBLK	24	610	250	18.0	63 metres per Roll	1	77.73	73.07	69.96	66.07



Antistatic Layflat Tubing

Red Tint

Commodity Code: 3923210000

Origin: GB



CODE	ROLL WIDTH		THICKNESS	WEIGHT	DESCRIPTION	ROLL QTY	ALL PRICES PER ROLL			
	INCHES	MM	MICRON	Kg			1+	5+	10+	25+
LANT2	2	51	75	2.0	283 metres per Roll	1	24.76	23.30	22.32	21.11
LANT3	3	76	75	3.0	283 metres per Roll	1	28.60	26.92	25.80	24.40
LANT4	4	102	75	4.0	283 metres per Roll	1	30.14	28.38	27.21	25.74
LANT5	5	127	75	5.0	283 metres per Roll	1	32.32	30.44	29.19	27.62
LANT6	6	152	75	6.0	283 metres per Roll	1	34.71	32.71	31.37	29.69
LANT8	8	203	75	8.0	283 metres per Roll	1	43.11	40.63	38.97	36.90
LANT10	10	254	75	10.0	283 metres per Roll	1	48.97	46.16	44.29	41.94
LANT12	12	305	75	10.0	283 metres per Roll	1	53.07	50.01	47.97	45.42
LANT18	18	457	75	15.0	236 metres per Roll	1	72.30	68.15	65.39	61.93
LANT20	20	508	75	15.0	212 metres per Roll	1	72.88	68.69	65.90	62.41
LANT24	24	610	75	15.0	177 metres per Roll	1	77.98	73.49	70.49	66.75
LANT36	36	914	75	18.0	118 metres per Roll	1	83.56	78.77	75.58	71.59
LANT48	48	1219	75	18.0	88 metres per Roll	1	83.30	78.53	75.35	71.37

ALL SHEETING IS SUPPLIED ON ONE METRE-WIDE ROLLS, WITH SINGLE-FOLD 2 METRE WIDE SHEETS IDEAL FOR EASY STORAGE AND USE OR MULTI-FOLD 4 METRE WIDE SHEETS FOR COVERING LARGER AREAS.

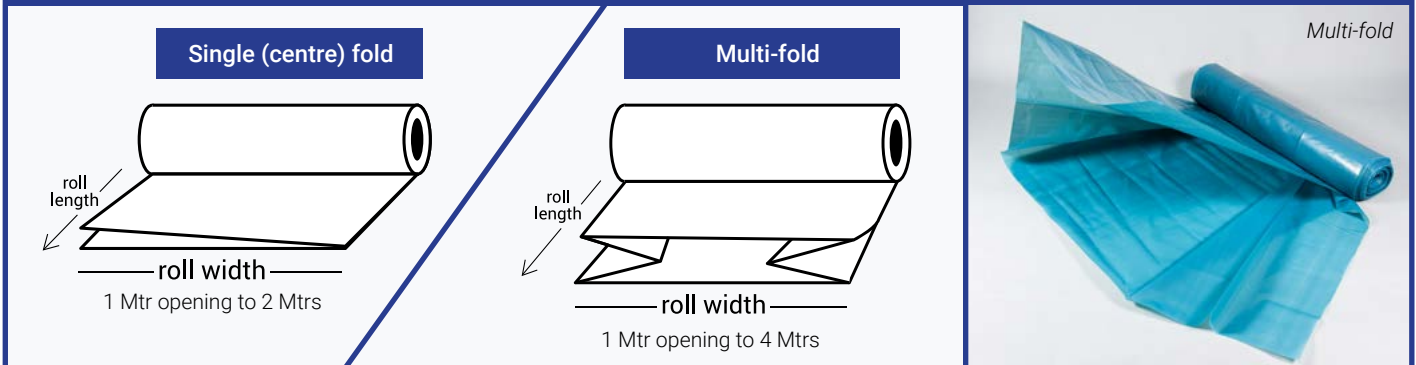

* Due to the manufacturing processes used with recycled content material, small impurities within the structure of the polythene may be visible. These minor impurities do not affect the overall performance of the material.



Builders Rolls - Clear

Commodity Code: 3923210000

PACKAGING TAX EXEMPT



CODE	ROLL WIDTH MTRS	THICKNESS MICRON	WEIGHT Kg	DESCRIPTION	ROLL QTY	ALL PRICES PER ROLL			
						1+	5+	10+	25+
BLD1/2M	1 Mtr opening to 2 Mtrs	100	18.0	96 metres per Roll	1	63.87	58.25	54.51	49.05
BLD1/2H	1 Mtr opening to 2 Mtrs	200	18.0	48 metres per Roll	1	63.87	58.25	54.51	49.05
BLD1/4MMULTI	1 Mtr opening to 4 Mtrs	100	18.0	50 metres per Roll	1	70.26	67.85	65.88	63.76
BLD1/4HMULTI	1 Mtr opening to 4 Mtrs	200	16.0	25 metres per Roll	1	71.42	68.97	66.27	63.27



Builders Rolls - Black

Commodity Code: 3923210000

PACKAGING TAX EXEMPT



CODE	ROLL WIDTH MTRS	THICKNESS MICRON	WEIGHT Kg	DESCRIPTION	ROLL QTY	ALL PRICES PER ROLL			
						1+	5+	10+	25+
BLD1/2MBLK	1 Mtr opening to 2 Mtrs	100	18.0	96 metres per Roll	1	61.29	56.70	52.88	48.83
BLD1/4MBLKMULTI	1 Mtr opening to 4 Mtrs	125	23.0	50 metres per Roll	1	80.06	74.19	68.02	62.67



Damp Proof Membrane (DPM)

Commodity Code: 3923210000

PACKAGING TAX EXEMPT



CODE	ROLL WIDTH MTRS	THICKNESS MICRON	WEIGHT Kg	DESCRIPTION	ROLL QTY	ALL PRICES PER ROLL			
						1+	5+	10+	25+
DPMBLACK	1 Mtr opening to 4 Mtrs	250	20.0	Black : 25 metres per Roll	1	77.76	71.81	67.43	61.85
DPMBLUE	1 Mtr opening to 4 Mtrs	250	20.0	Blue : 25 metres per Roll	1	77.76	71.81	67.43	61.85
DPMBLUEMINI	4 Mtrs x 5 Mtrs	250	4.3	Blue : 5 metres per Roll	1	26.85			

HOW TO MEASURE - PALLET COVER

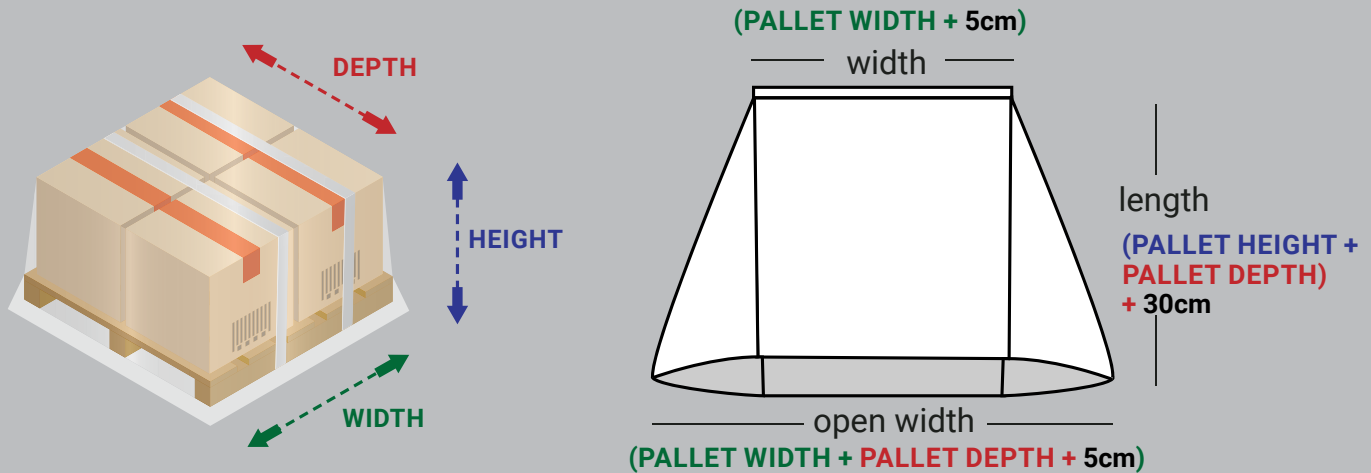

*Depth is shorter of the sides.



Shrink Pallet Covers - Clear Boxed (10 per box)

Made from high strength Polyblend equivalent to 125 Micron.

Commodity Code: 3923210000

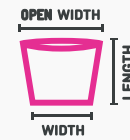

RECYCLE



FOOD SAFE

CODE	SIZE (WIDTH CLOSED/ OPEN) x LENGTH MM	THICKNESS MICRON	WEIGHT Kg	DESCRIPTION	BOX QTY	ALL PRICES PER BOX			
						1+	5+	10+	25+
COV3648M	1200/2100 x 1500	75	4.3	Europallet Medium	10	34.96	24.20	22.46	18.98
COV3648L	1200/2100 x 2000	75	5.7	Europallet Tall	10	42.01	31.95	29.64	25.78
COV4048M	1250/2300 x 1600	75	5.5	Standard Pallet Medium	10	39.70	30.99	29.02	25.43
COV4048L	1250/2300 x 2100	75	7.3	Standard Pallet Tall	10	45.87	35.47	32.82	28.74
COV4848M	1300/2500 x 1700	75	6.4	48x48 Medium	10	44.08	34.85	32.35	30.84
COV4848L	1300/2500 x 2200	75	8.1	48x48 Tall	10	47.62	36.86	33.85	29.53



Shrink Pallet Covers - Clear On The Roll (25 per roll)

Made from high strength Polyblend equivalent to 125 Micron.

Commodity Code: 3923210000

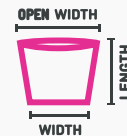

RECYCLE



FOOD SAFE

CODE	SIZE (WIDTH CLOSED/ OPEN) x LENGTH MM	THICKNESS MICRON	WEIGHT Kg	DESCRIPTION	ROLL QTY	ALL PRICES PER ROLL			
						1+	5+	10+	25+
COVRS1	1200/2100 x 1500	75	11.6	Europallet Medium	1	64.69	54.13	48.20	42.92
COVRS2	1200/2100 x 2000	75	15.5	Europallet Tall	1	83.08	79.92	75.05	70.71
COVRM1	1250/2300 x 1600	75	13.8	Standard Pallet Medium	1	72.48	66.93	64.48	63.88
COVRM2	1250/2300 x 2100	75	18.1	Standard Pallet Tall	1	82.38	73.61	71.38	66.98
COVRL1	1300/2500 x 1700	75	16.0	48x48 Medium	1	82.89	78.31	75.27	74.06
COVRL2	1300/2500 x 2200	75	20.3	48x48 Tall	1	93.64	87.86	85.14	82.03



Shrink 30% Recycled - Grey On The Roll (25 per roll)

Made from high strength Polyblend equivalent to 125 Micron.

Commodity Code: 3923210000

PACKAGING TAX EXEMPT

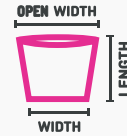

CODE	SIZE (WIDTH CLOSED/ OPEN) x LENGTH MM	THICKNESS MICRON	WEIGHT Kg	DESCRIPTION	ROLL QTY	ALL PRICES PER ROLL			
						1+	5+	10+	25+
COVRS1R30G	1200/2100 x 1500	75	11.6	Europallet Medium	1	62.27	51.72	45.78	40.51
COVRS2R30G	1200/2100 x 2000	75	15.5	Europallet Tall	1	79.86	76.70	71.83	67.49
COVRM1R30G	1250/2300 x 1600	75	13.8	Standard Pallet Medium	1	69.60	64.05	61.61	61.01
COVRM2R30G	1250/2300 x 2100	75	18.1	Standard Pallet Tall	1	78.60	69.84	67.61	62.16
COVRL1R30G	1300/2500 x 1700	75	16.0	48x48 Medium	1	79.57	74.99	71.95	70.74
COVRL2R30G	1300/2500 x 2200	75	20.3	48x48 Tall	1	89.43	83.64	80.92	77.81



Non-Slip Pallet Base Sheets Blue Tint

Commodity Code: 3923210000

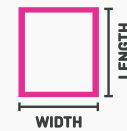

CODE	SIZE (WIDTH x LENGTH) MM	THICKNESS MICRON	WEIGHT Kg	DESCRIPTION	BOX QTY	ALL PRICES PER BOX			
						1+	5+	10+	25+
COVBASE1	850 x 1250	60	12.0	Euro Pallet Base Sheet	200	76.29	72.15	61.45	52.36
COVBASE2	1050 x 1250	60	15.3	Standard Pallet Base Sheet	200	86.01	78.95	69.02	61.06



Shrink Top Sheet Covers - Clear On The Roll

Made from high strength Polyblend equivalent to 20 Micron.

Commodity Code: 3923210000

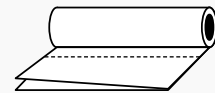

CODE	SIZE (WIDTH CLOSED/ OPEN) x LENGTH MM	THICKNESS MICRON	WEIGHT Kg	DESCRIPTION	ROLL QTY	ALL PRICES PER ROLL			
						1+	5+	10+	25+
COVTOP1	750/1500 x 1500	20	21.5	Euro/Standard : 500 per Roll	1	99.47	93.94	90.15	82.73
COVTOP2	900/1800 x 1800	20	15.5	Standard/48x48 : 250 per Roll	1	87.66	77.09	71.16	64.83

ROLL OPTIONS - MADE TO ORDER

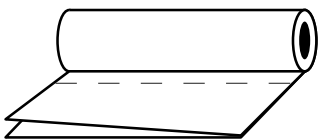

CENTREFOLD



LAYFLAT TUBING

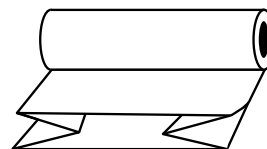

GUSSETED

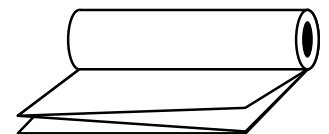

MULTIFOLD

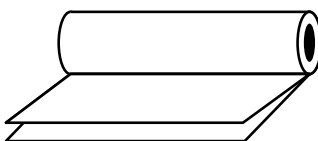

DOUBLE WOUND (DWS)

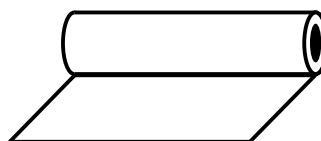

SINGLE WOUND (SWS)



J FOLD

*We can produce custom-made rolls of flexible film, just speak to our sales team to discuss all the different options available.



MAILING BAGS

Sometimes you need your Mailing Bags to work a little harder for your brand. It might be that you need them to advertise your business and shout about your services or provide crucial storage and safety advice. Here at PB Group we offer a wide range of customizable products. By creating a personalised Mailing Bag you will provide a durable and clear message to your customers throughout the delivery process, whether it be a walking advert for your business or a discreet package that conceals it's contents.

Mailing Bags Specialist



Extrusion

As a manufacturer we have various types of polythene film your mailing bags can be extruded from including:

- Clear.
- Co-ex (white/black).
- Various colours.

All are available in different thicknesses to suit your individual requirements. Biodegradable additives can also be added at this stage of the process.



Print

Your uniquely designed flexographic plates are used to transfer your designs onto the extruded polythene.

We can print anything from a simple 1 colour design to a complex 4 colour printing process.



PANTONE MATCHING AVAILABLE



Conversion

Our size options allows you to send anything from jewellery or phones to large items like duvets and multiple clothing packages. Self adhesive 'Sealing Strip' options include:

- Permanent tamper proof.
- Resealable.
- Double Strip.



The Double Strip coupled with a carrier handle is increasingly popular for 'Click & Collect' retail e-commerce businesses.

We can help with orders large and small

PB Group have a wide range of Mailing bags enabling customers to protect and transport their goods efficiently. We can manufacture one-off or repeat orders of a couple of thousand units or even a couple of million, depending on your requirements. So from individuals to some of the best loved high street brands and big businesses, PB Group is constantly helping customers with their mailing process. Don't just take our word for it, read our customer feedback online on **TrustPilot** reviews.



Simply send us over your design with your order. If you're unsure over what might be the best choice for your design just pick up the phone and our friendly team will be happy to discuss the best personalised solution for you. All we need to know are:

- Quantity required
- Size(s)
- Number of colours of your artwork



Glossy Blue 45-60 Micron

Commodity Code: 3923210000

PACKAGING TAX **EXEMPT**



RECYCLED CONTENT

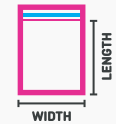

RECYCLE

CODE	INTERNAL SIZE (W x L)		THICKNESS MICRON	WEIGHT Kg	DESCRIPTION	BOX QTY	ALL PRICES PER BOX			
	INCHES	MM					1+	5+	10+	25+
MAILORDERMINI	5.75 x 7.5	145 x 190	45	2.3	C6 Mini	1000	29.40	24.35	22.88	22.45
MAILORDERC5	6.5 x 9	165 x 230	45	3.7	C5	1000	31.04	27.92	26.04	25.34
MAILORDER01	9 x 14	216 x 356	45	7.2	C4	1000	51.28	48.62	45.88	43.79
MAILORDER02	12 x 16	305 x 406	50	11.6	Medium	1000	82.85	76.00	72.38	71.74
MAILORDER03	13 x 19	330 x 483	50	7.5	C3	500	53.32	48.99	46.40	43.99
MAILORDER04	17 x 22	432 x 559	55	6.7	Large	250	43.56	40.06	37.53	34.97
MAILORDER05	19 x 29	483 x 737	60	11.5	C2+	250	68.27	58.56	53.91	52.33
MAILORDER06	28 x 23	711 x 589	60	10.1	XX-Large	200	66.49	61.79	60.94	59.29



Glossy Blue 30-45 Micron

Commodity Code: 3923210000

PACKAGING TAX **EXEMPT**



RECYCLED CONTENT

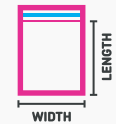

RECYCLE

CODE	INTERNAL SIZE (W x L)		THICKNESS MICRON	WEIGHT Kg	DESCRIPTION	BOX QTY	ALL PRICES PER BOX			
	INCHES	MM					1+	5+	10+	25+
MAILBUDGETMINI	5.75 x 7.5	145 x 190	30	2.0	C6 Mini	1000	24.07	20.27	18.73	18.23
MAILBUDGET01	9 x 14	216 x 356	30	3.6	C4	500	27.00	21.86	21.23	20.55
MAILBUDGET02	12 x 16	305 x 406	35	5.0	Medium	500	41.16	35.60	32.21	30.59
MAILBUDGET03	13 x 19	330 x 483	35	3.4	C3	250	27.87	21.31	20.66	19.35
MAILBUDGET04	17 x 22	432 x 559	40	2.4	Large	100	20.71	16.97	14.78	13.27
MAILBUDGET05	19 x 29	483 x 737	45	4.4	C2+	100	26.78	21.00	19.47	18.72
MAILBUDGET06	28 x 23	711 x 589	45	4.7	XX-Large	100	29.22	24.11	22.57	21.70



Biodegradable Glossy Blue 45-50 Micron

Includes printed biodegradable logo.

Commodity Code: 3923210000

PACKAGING TAX **EXEMPT**

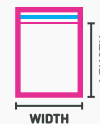

BIODEGRADABLE



RECYCLED CONTENT



RECYCLE

CODE	INTERNAL SIZE (W x L)		THICKNESS MICRON	WEIGHT Kg	DESCRIPTION	BOX QTY	ALL PRICES PER BOX			
	INCHES	MM					1+	5+	10+	25+
MAILORDERB1	8.5 x 14	220 x 356	45	7.2	Glossy Blue	1000	64.26	61.45	59.03	58.24
MAILORDERB2	12 x 16	305 x 406	50	14.2	Glossy Blue	1000	101.88	94.37	90.02	87.49
MAILORDERB3	13 x 19	330 x 483	50	7.5	Glossy Blue : C3	500	65.43	62.51	59.55	58.52

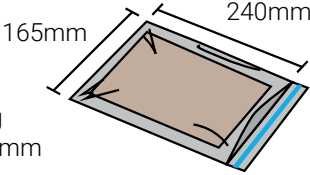
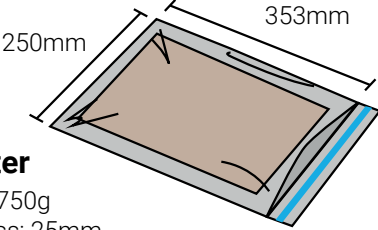
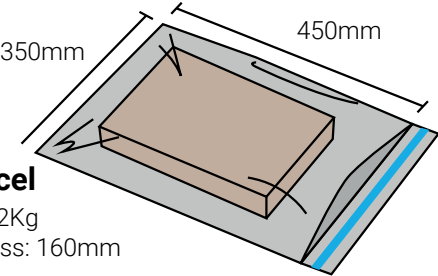
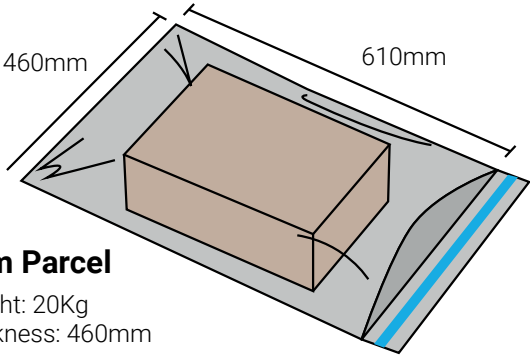
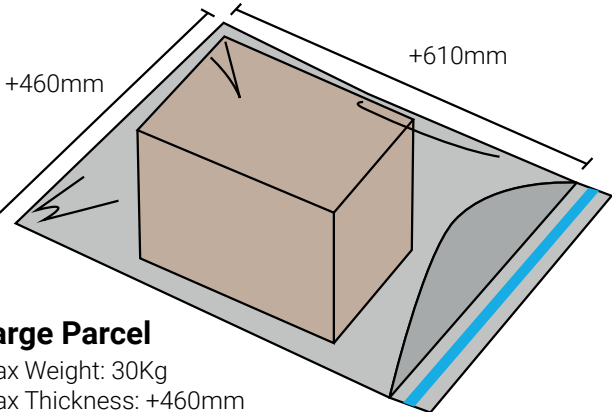
Royal Mail UK Letters & Parcels	Our Product Range (Unfilled)		
<p>Letter Max Weight: 100g Max Thickness: 5mm</p> 	<p>MR01 & 02 MCOMP5 MAILORDERC5 MAILSACKC5</p>	<p>MAILAIR/FE-A & B MAILBLKRC5 MAILC5 MRETMINT01 & C5</p>	<p>MAILSAFEC5 MENV01 & 02 MNATC5</p>
<p>Large Letter Max Weight: 750g Max Thickness: 25mm</p> 	<p>MAILC4 MAILSAFEC4 MENV03 & 04 MENV05 & 06 MRETMINT02</p>	<p>MAILAIR/FE-C & D MAILAIR/FE-E & F MAILSACKC4 MAILTUF5 & C4 MCLL03B & 05B & 07B MCLL00B & 01B</p>	<p>MB01 & MB02 MCOMP21 & C4 & 31 MNAT21 & C4 & 31 MR03 & MR04 MPAPV10 & 20</p>
<p>Small Parcel Max Weight: 2Kg Max Thickness: 160mm</p> 	<p>MB03 MKRAF03 MNAT41 MAILC4+ & C3 MRETMINT04 MC427W20 & 21 MC427W22 & 23</p>	<p>MAILAIR/FE-G & H & J MAILBLKRC4+ & 10 MAILORDER02 & B2 MAILSACKC4+ & 10 MAILSECUREC4+ & 10</p>	<p>MCOMP41 MENV07 & 08 & 09 MR05 & 07 MAILTUF4+ & 10 MPAP2PLY01 MC427B20 & 21 MC427B22 & 23</p>
<p>Medium Parcel Max Weight: 20Kg Max Thickness: 460mm</p> 	<p>MB04 MCOMP51 MAILBLKR30 MRETMINT06 MPAPV30</p>	<p>MAILAIR/FE-K MAILORDER03 04 & B3 MAILSACK20 & 30 MAILSECURE20 & 30</p>	<p>MENV10 MNAT51 MR06 & 08 & 09 MAILTUF20 & 30 MPAP2PLY03</p>
<p>Large Parcel Max Weight: 30Kg Max Thickness: +460mm</p> 	<p>MKRAF05 MR10 & 11 & 13 MRETMINT08 MPAP2PLY05</p>	<p>MAILBLKR40 & 50 MAILSACK40 to 60 MAILORDER05 & 06 MAILCOURIER40 to 50</p>	<p>MAILSECURE50 MAILTUF40 & 50 MPAPV40 & 50 & 60</p>



Clear + White Address Panel

White address band ideal for Direct Mail.

Commodity Code: 3923210000

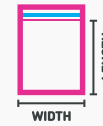

CODE	INTERNAL SIZE (W x L)		THICKNESS MICRON	WEIGHT Kg	DESCRIPTION	BOX QTY	ALL PRICES PER BOX			
	MM						1+	5+	10+	25+
MAILC5P	160 x 230		37.5	4.0	C5 : Clear	1000	29.68	25.69	23.50	21.81
MAILC4P	230 x 325		37.5	5.3	C4 : Clear	1000	45.81	42.82	41.75	40.42



Clear

Lightweight to minimise postage costs.

Commodity Code: 3923210000

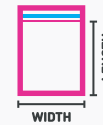

CODE	INTERNAL SIZE (W x L)		THICKNESS MICRON	WEIGHT Kg	DESCRIPTION	BOX QTY	ALL PRICES PER BOX			
	MM						1+	5+	10+	25+
MAILN1	95 x 230		37.5	1.5	Long / Narrow	1000	19.28	17.39	14.67	14.20
MAILC6	115 x 160		37.5	1.8	C6	1000	20.71	19.78	18.75	18.05
MAILC6+	145 x 190		37.5	3.0	C6+	1000	22.65	21.00	20.38	18.81
MAILC5	160 x 230		37.5	4.5	C5	1000	29.45	25.18	23.18	21.09
MAILC4	230 x 325		37.5	6.3	C4	1000	44.63	39.63	36.23	33.14
MAILC4+	250 x 375		37.5	7.7	C4+	1000	56.28	46.99	43.53	39.57
MAILC4+HD	250 x 375 *		100	8.8	C4+ Heavy Duty	500	55.75	49.23	43.74	40.13
MAILC3	330 x 440		37.5	10.6	C3	1000	78.84	68.29	62.10	56.81
MAILCLR50	400 x 540		50	10.1	Large	500	77.25	67.42	61.98	58.22

* MAILC4+HD : External width of envelope is +15mm wider than internal width.



Clear + Resealable

Convenient sizes and with a resealable peel and seal closure.

Commodity Code: 3923210000

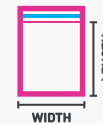

CODE	INTERNAL SIZE (W x L)		THICKNESS MICRON	WEIGHT Kg	DESCRIPTION	BOX QTY	ALL PRICES PER BOX			
	MM						1+	5+	10+	25+
MAILC5R	160 x 230		37.5	4.5	C5	1000	32.09	30.92	29.74	28.72
MAILC4R	230 x 325		37.5	5.2	C4	1000	45.69	38.30	35.92	33.83
MAILC4RHD	230 x 325 *		100	7.5	C4 : Heavy Duty	500	46.73	39.64	37.35	35.37

* MAILC4RHD : External width of envelope is +15mm wider than internal width.



Clear Biodegradable

Includes printed biodegradable logo.

Commodity Code: 3923210000

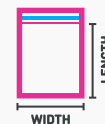

CODE	INTERNAL SIZE (W x L)		THICKNESS MICRON	WEIGHT Kg	DESCRIPTION	BOX QTY	ALL PRICES PER BOX			
	INCHES	MM					1+	5+	10+	25+
MAILECOA5	6 x 9	160 x 230	40	3.5	Clear	1000	33.44	30.11	28.52	26.38
MAILECOA4	9 x 12	230 x 305	50	8.3	Clear	1000	63.97	54.13	48.66	45.39



Clear with 30% Recycled Content

Commodity Code: 3923210000

PACKAGING TAX EXEMPT

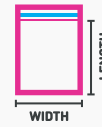

CODE	INTERNAL SIZE (W x L)		THICKNESS MICRON	WEIGHT Kg	DESCRIPTION	BOX QTY	ALL PRICES PER BOX			
	MM						1+	3+	5+	10+
MAILC6R30	115	160	40	7.6	C6	5000	73.59	69.91	66.96	62.55
MAILC6+R30	145	190	40	6.7	C6+	3000	50.48	47.96	45.94	42.91
MAILC5R30	160	230	40	7.4	C5	2500	53.42	51.90	49.85	46.77
MAILC4R30	230	325	40	8.8	C4	1500	65.79	62.50	59.87	55.92
MAILC4+R30	250	375	40	7.3	C4+	1000	54.61	51.88	49.69	46.42
MAILC4+HDR30	250	375	100	7.3	C4+ (Side skirt seal)	400	54.76	52.02	49.83	46.55
MAILC3R30	330	440	40	7.8	C3	700	58.74	55.80	53.45	49.92
MAIL50HDR30	400	540	100	8.3	Large (Side skirt seal)	200	61.89	58.79	56.32	52.60
MAIL68HDR30	680	980	100	6.3	XLarge (Side skirt seal)	50	57.38	54.52	52.22	48.78

*A 'side skirt seal' adds 15mm to the overall width dimensions of the product.



Bio Clear with 30% Recycled Content

Commodity Code: 3923210000

PACKAGING TAX EXEMPT

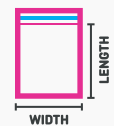

CODE	INTERNAL SIZE (W x L)		THICKNESS MICRON	WEIGHT Kg	DESCRIPTION	BOX QTY	ALL PRICES PER BOX			
	MM						1+	3+	5+	10+
MBIOTCLR01	160	230	40	3.0	Print - Random repeat	1000	33.76	32.07	30.72	28.70
MBIOTCLR03	240	310	40	5.8	Print - Random repeat	1000	57.33	54.46	52.17	48.73
MBIOTCLR05	380	490	40	7.2	Print - Registered	500	71.16	67.61	64.76	60.49
MBIOTCLR07	440	600	40	5.1	Print - Registered	250	50.41	47.89	45.87	42.85



Clear - I'm Green Mailer

Commodity Code: 3923210000

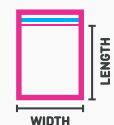

CODE	INTERNAL SIZE (W x L)		THICKNESS MICRON	WEIGHT Kg	DESCRIPTION	BOX QTY	ALL PRICES PER BOX			
	MM						1+	5+	10+	25+
MAILSUSC5	160	230	40	3.0	C5	1000	61.50	56.63	51.76	46.28
MAILSUSC4	230	325	40	5.9	C4	1000	78.73	72.53	66.33	59.35
MAILSUSC3	330	440	40	5.4	C3	500	55.61	51.25	46.90	41.99



White : Black Inner

High gloss co-extruded white outer and black inner.

Commodity Code: 3923210000

PACKAGING TAX EXEMPT

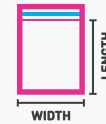

CODE	INTERNAL SIZE (W x L)		THICKNESS MICRON	WEIGHT Kg	DESCRIPTION	BOX QTY	ALL PRICES PER BOX			
	INCHES	MM					1+	5+	10+	25+
MAILSACKC5	7 x 10	165 x 240	50	4.9	C5	1000	50.13	45.66	42.70	39.74
MAILSACKC4	9 x 13	230 x 325	50	7.4	C4	1000	89.31	82.42	77.06	71.77
MAILSACKC4+	10 x 15	250 x 375	50	9.2	C4+	1000	107.54	99.35	92.83	86.15
MAILSACK10	12 x 16	305 x 405	50	6.0	Medium	500	69.17	63.18	58.85	54.36
MAILSACK20	16 x 16	405 x 405	50	8.0	Large	500	87.67	80.54	74.69	68.73
MAILSACK30	18 x 21	450 x 525	50	7.0	Large	250	62.69	55.86	51.60	47.24
MAILSACK40	21 x 23	525 x 575	50	5.8	X-Large	250	75.97	68.02	62.73	57.20
MAILSACK50	24 x 30	600 x 750	50	4.5	XX-Large	100	51.18	48.70	45.38	41.72
MAILSACK60	34 x 38	850 x 950	50	4.0	XXX-Large	50	47.52	43.50	40.50	38.11



Ivory : Extra Strong

Commodity Code: 3923210000

PACKAGING TAX EXEMPT

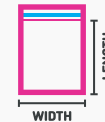

CODE	INTERNAL SIZE (W x L)		THICKNESS MICRON	WEIGHT Kg	DESCRIPTION	BOX QTY	ALL PRICES PER BOX			
	INCHES	MM					1+	5+	10+	25+
MAILTUF5	7 x 9	175 x 230	75	7.7	C5	1000	73.87	67.98	63.60	59.22
MAILTUF4	9 x 13	230 x 325	75	7.5	C4	500	65.21	60.49	56.54	52.61
MAILTUF4+	10 x 15	250 x 375	75	7.6	C4+	500	79.84	73.26	68.34	63.26
MAILTUF10	12 x 16	305 x 405	75	9.7	Medium	500	101.67	94.63	88.20	84.80
MAILTUF20	16 x 16	405 x 405	75	6.8	Large	250	65.12	59.41	54.94	50.39
MAILTUF30	18 x 21	450 x 525	75	9.3	Large	250	90.31	81.48	75.17	68.82
MAILTUF40	21 x 23	525 x 575	75	9.8	X-Large	200	88.54	79.55	73.25	66.69
MAILTUF50	32 x 24	800 x 600	75	8.0	XX-Large	100	74.12	68.52	65.34	63.71



Mailcourier Sack : Extra Large

Ideal for transporting larger items.

Commodity Code: 3923210000

PACKAGING TAX EXEMPT

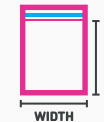

CODE	INTERNAL SIZE (W x L)		THICKNESS MICRON	WEIGHT Kg	DESCRIPTION	BOX QTY	ALL PRICES PER BOX			
	INCHES	MM					1+	5+	10+	25+
MAILCOURIER40	24 x 28	600 x 700	70	2.8	White : XX-Large	50	31.53	25.95	22.94	21.76
MAILCOURIER41	28 x 28	700 x 700	70	3.2	White : XX-Large	50	35.85	29.99	26.78	25.47
MAILCOURIER42	34 x 28	850 x 700	70	4.0	White : XXX-Large	50	40.71	34.12	30.95	29.43
MAILCOURIER43	27 x 39	680 x 980	70	4.5	White : XXX-Large	50	45.03	36.15	33.61	31.96
MAILCOURIER43C	27 x 39	680 x 980	70	4.5	Clear : XXX-Large	50	46.31	37.42	34.88	33.22
MAILCOURIER50	34 x 38	850 x 950	70	5.6	White : XXX-Large	50	59.46	52.06	48.42	44.92



Returnable Mailer Mint Green

Commodity Code: 3923210000

PACKAGING TAX EXEMPT

CODE	INTERNAL SIZE (W x L) MM	THICKNESS MICRON	WEIGHT Kg	DESCRIPTION	BOX QTY	MINI PACK		ALL PRICES PER BOX	
						QTY	PRICE	1+	5+
MRETMINT01	100 x 175	55	10.5	60m Lip - Letter	5,000	1,000	29.76	99.00	87.50
MRETMINTC5	160 x 230	55	10.6	60m Lip - Letter	2,500	500	31.66	102.75	91.12
MRETMINT02	250 x 350	55	9.7	60m Lip - Large Letter	1,000	200	29.16	96.50	84.50
MRETMINT04	300 x 420	55	10.4	60m Lip - Small Parcel	750	250	49.50	102.67	89.88
MRETMINT06	400 x 460	55	10.0	60m Lip - Medium Parcel	500	100	29.48	97.85	85.24
MRETMINT08	570 x 490	55	9.1	60m Lip - Large Parcel	300	50	27.50	89.80	77.50

Not sure of your own design? Why not try one of our in-house designs with immediate delivery.



Pre Printed Design

See our website for the latest designs.

Commodity Code: 3923210000

PACKAGING TAX EXEMPT

CODE	INTERNAL SIZE (W x L) MM	THICKNESS MICRON	WEIGHT Kg	DESCRIPTION	BOX QTY	ALL PRICES PER BOX			
						1+	5+	10+	25+
MB170250PHONE	170 x 250	50	0.9	C5+ Small	200	17.77	17.36	16.45	15.53
MB250350CAMO	250 x 350	50	1.8	C4+ Medium	200	23.71	23.34	22.96	22.48
MB300420PARIS	300 x 420	50	1.3	Large	100	21.98	20.64	19.92	19.43
MB400540MELON	400 x 540	50	1.1	X-Large	50	20.78	19.80	19.43	18.82



*Prices are for printing on 1 side of the bag only. For 2-sided printing please give us a call or get an online quote from on our website.
*Plate costs are subject to sight of artwork.

POPULAR SIZES

30%

RECYCLED CONTENT



RECYCLE

All made from recyclable material.



CODE	DESCRIPTION	ALL PRICES PER BAG			APPROX. PLATE COSTS
		3000	5000	10000	
M21	1 Ink	10p	8p	6p	£65
M22	2 Inks	15p	10p	8p	£110
M23	3 Inks	16p	11p	9p	£135
M24	4 Inks	20p	14p	11p	£170

CODE	DESCRIPTION	ALL PRICES PER BAG			APPROX. PLATE COSTS
		3000	5000	10000	
M31	1 Ink	11p	9p	7p	£80
M32	2 Inks	16p	11p	9p	£135
M33	3 Inks	17p	12p	10p	£190
M34	4 Inks	22p	16p	12p	£230

CODE	DESCRIPTION	ALL PRICES PER BAG			APPROX. PLATE COSTS
		3000	5000	10000	
M41	1 Ink	13p	12p	9p	£90
M42	2 Inks	17p	13p	10p	£150
M43	3 Inks	19p	16p	11p	£200
M44	4 Inks	23p	19p	14p	£240

CODE	DESCRIPTION	ALL PRICES PER BAG			APPROX. PLATE COSTS
		3000	5000	10000	
M51	1 Ink	17p	16p	13p	£105
M52	2 Inks	21p	19p	17p	£170
M53	3 Inks	25p	22p	19p	£230
M54	4 Inks	28p	24p	22p	£300

CODE	DESCRIPTION	ALL PRICES PER BAG			APPROX. PLATE COSTS
		3000	5000	10000	
M61	1 Ink	20p	19p	16p	£115
M62	2 Inks	24p	22p	19p	£190
M63	3 Inks	30p	28p	23p	£260
M64	4 Inks	33p	30p	25p	£350

CODE	DESCRIPTION	ALL PRICES PER BAG			APPROX. PLATE COSTS
		3000	5000	10000	
M71	1 Ink	22p	21p	19p	£145
M72	2 Inks	26p	24p	21p	£220
M73	3 Inks	32p	30p	24p	£310
M74	4 Inks	34p	32p	26p	£405

More sizes available. Contact us for details.

*The surface imperfections in recycled content polythene may cause less adhesion to certain print inks. Please check with our sales team for further information.

How do I create a personalised Mailing Bag ?

Simply send us over your design with your order. If you're unsure over what might be the best choice for your design just pick up the phone and our friendly team will be happy to discuss the best personalised solution for you. All we need to know are.

- Quantity required
- Size(s)
- Number of colours of your artwork

4 Simple Steps to print your personalised mailing bag

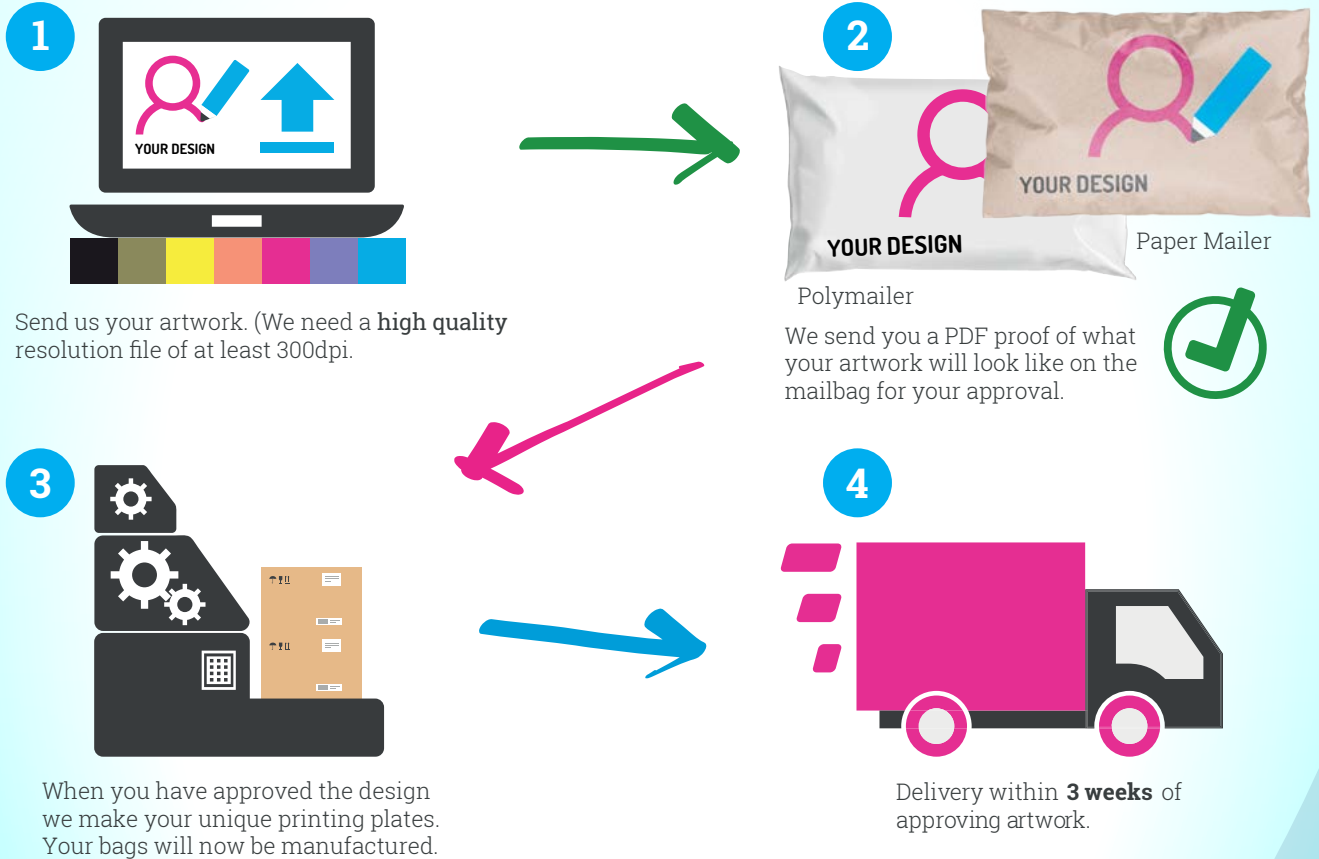

HOW TO MEASURE - MAILING BAGS FOR BULKY/LARGE ITEMS

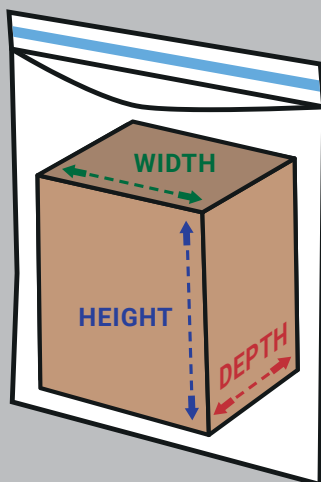

*Depth is shorter of the sides.

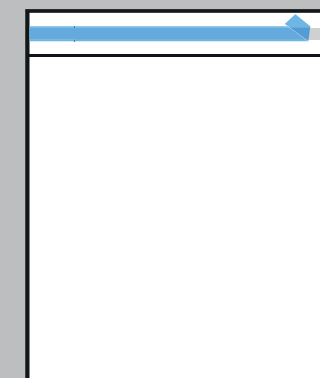

BOX WIDTH + BOX DEPTH + 2cm

BOX HEIGHT
length + **BOX DEPTH**
+ 2cm



Single ply + bottom gusset

Natural single-ply Kraft paper. Bottom gusset ideal for bulky items.

Commodity Code: 4817100000

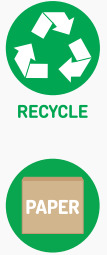
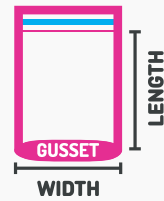

CODE	EXTERNAL SIZE (W x L + G) MM	THICKNESS GSM	WEIGHT Kg	DESCRIPTION	BOX QTY	PRICES PER BOX
MPAP1PLY01	180 x 275 + 40	80	0.8	Small	50	19.95
MPAP1PLY02	250 x 345 + 40	90	1.0	Medium	50	22.50
MPAP1PLY03	325 x 440 + 80	100	1.8	Large	50	24.95
MPAP1PLY04	380 x 495 + 100	100	2.3	XLarge	50	29.50

Note: Internal width of envelope is 30mm narrower than external width.



V Bottom - Double Strip

Commodity Code: 3923210000



CODE	INTERNAL SIZE (W x L) MM	THICKNESS GSM	WEIGHT Kg	DESCRIPTION	BOX QTY	MINI PACK		ALL PRICES PER BOX		
						QTY	PRICE	1+	5+	10+
MPAPV10	160 x 230 + 50	100	3.6	Large Letter	200	50	18.20	44.00	41.36	37.22
MPAPV20	250 x 345 + 80	100	4.2	Large Letter	150	50	20.60	39.00	36.66	32.99
MPAPV30	340 x 505 + 90	100	5.3	Medium Parcel	100	50	26.60	36.00	32.04	28.20
MPAPV40	440 x 665 + 100	100	4.4	Large Parcel	50	25	18.80	23.00	21.62	19.46
MPAPV50	550 x 750 + 120	100	5.5	Large Parcel	40	20	23.24	30.40	27.97	25.17
MPAPV60	650 x 850 + 150	100	3.3	Large Parcel	20	10	16.76	19.60	18.03	16.23



Kraft Paper Gusseted

A Sustainable Forest Product (SFP).
Water-resistant composition.
Easy-open rip strip.
Gusseted base ideal for bulky items.

Commodity Code: 4817100000

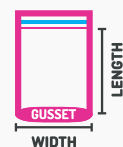

CODE	INTERNAL SIZE (W x L + G) MM	THICKNESS GSM	WEIGHT Kg	DESCRIPTION	BOX QTY	ALL PRICES PER BOX			
						1+	5+	10+	25+
MKRAF03	340 x 420 + 80	100	4.3	Gusseted Base	100	50.34	44.85	40.70	37.69
MKRAF05	480 x 600 + 80	100	3.9	Gusseted Base	50	44.63	40.25	36.74	33.11



Gusseted - Single Strip

Natural single-ply Kraft paper. Side & bottom gusset ideal for bulky items.

Commodity Code: 4817100000

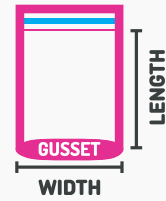

CODE	INTERNAL SIZE (W x L + G) MM	THICKNESS GSM	WEIGHT Kg	DESCRIPTION	BOX QTY	PRICES PER BOX
MPAPM01	190 x 300 + 50	100	12.0	Small	100	31.64
MPAPM02	250 x 353 + 50	100	8.3	Medium	125	48.91
MPAPM03	260 x 410 + 70	100	12.6	Large	100	41.48
MPAPM04	300 x 430 + 80	100	8.2	XLarge	100	48.31
MPAPM05	360 x 560 + 100	100	12.8	XXLarge	100	81.92



Gusseted - Double Strip

Natural single-ply Kraft paper with open and reseal for returnable goods. Side & bottom gusset ideal for bulky items.

Commodity Code: 4817100000

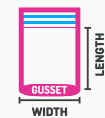

CODE	INTERNAL SIZE (W x L + G) MM	THICKNESS GSM	WEIGHT Kg	DESCRIPTION	BOX QTY	PRICES PER BOX
MPAPRET01	160 x 215 + 50	100	3.2	Small	225	57.33
MPAPRET02	300 x 430 + 80	100	10.4	Large	200	84.66
MPAPRET03	320 x 500 + 100	100	12.3	XLarge	175	103.78
MPAPRET04	360 x 560 + 100	100	16.0	XXLarge	200	152.48
MPAPRETC	250 x 352 + 50	130	4.1	Large	100	37.67
MPAPRETE	320 x 430 + 80	130	6.6	XLarge	100	53.71
MPAPRETH	450 x 550 + 80	130	10.6	XXLarge	100	73.58



XL Sacks

2x 70gsm ply Kraft paper. Gusseted sides ideal for bulky items.

Commodity Code: 4817100000

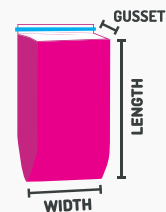

CODE	INTERNAL SIZE (W x L + G) MM	THICKNESS GSM	WEIGHT Kg	DESCRIPTION	BOX QTY	MINI PACK 50	PRICES PER BOX 1+
MPAPSAC01	330 x 595 + 100	2x70	7.6	XLarge	100	43.18	78.70
MPAPSAC02	420 x 805 + 215	2x70	14.4	XXLarge	100	54.11	95.09

CODE	INTERNAL SIZE (W x L + G) MM	THICKNESS GSM	WEIGHT Kg	DESCRIPTION	BOX QTY	PRICES PER BOX
NEW MPAP2PLY01	255 x 425 + 75	2x70	2.3	Large	50	27.50
NEW MPAP2PLY03	330 x 485 + 100	2x70	3.3	XLarge	50	32.50
NEW MPAP2PLY05	420 x 705 + 215	2x70	7.1	XXLarge	50	38.95



Recyclable Fluted Paper

25% Thinner than traditional bubble mailer. Corrugated paper inner adds padded protection and reduces 'empty' packaging space, thereby reducing transport & storage costs.

Commodity Code: 4817100000

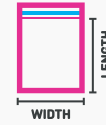

RECYCLE



PAPER

CODE	INTERNAL SIZE (W x L)		THICKNESS	WEIGHT	DESCRIPTION	BOX QTY	ALL PRICES PER BOX			
	MM						GSM	Kg	1+	5+
MENV01	110 x 165	70/25	1.4	Letter	200	36.04	31.47	29.68	27.31	
MENV02	120 x 215	70/25	1.8	Letter	200	41.99	37.40	35.86	33.04	
MENV03	150 x 215	70/25	2.0	Letter	200	53.79	44.79	41.52	38.76	
MENV04	180 x 265	70/25	3.1	Letter	200	58.64	50.38	47.24	43.95	
MENV05	220 x 265	70/25	3.8	Letter	200	68.97	59.58	54.88	51.51	
MENV06	220 x 330	70/25	2.3	Letter	100	40.58	33.59	31.96	30.18	
MENV07	240 x 330	70/25	2.5	Large Letter	100	44.95	36.18	34.08	31.79	
MENV08	270 x 360	70/25	3.1	Medium Parcel	100	52.42	43.81	40.98	36.83	
MENV09	300 x 440	70/25	4.3	Medium Parcel	100	67.64	59.13	56.21	51.29	
MENV10	350 x 470	70/25	5.1	Large Parcel	100	82.16	68.42	66.78	58.23	

Note: External width of envelope is +15mm wider than internal width.



Bio Blue with 30% Recycled Content

Commodity Code: 3923210000

PACKAGING TAX EXEMPT

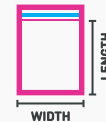

BIODEGRADABLE



RECYCLE



RECYCLED CONTENT

CODE	INTERNAL SIZE (W x L)		THICKNESS	WEIGHT	DESCRIPTION	BOX QTY	ALL PRICES PER BOX			
	MM						MICRON	Kg	1+	3+
MBIOTBLU01	160 x 230	40	3.0	Print - Random repeat	1000	36.83	34.99	33.52	31.31	
MBIOTBLU03	240 x 310	40	5.8	Print - Random repeat	1000	63.36	60.19	57.66	53.86	
MBIOTBLU05	380 x 490	40	7.2	Print - Registered	500	78.65	74.72	71.58	66.86	
MBIOTBLU07	440 x 600	40	5.1	Print - Registered	250	55.71	52.93	50.70	47.36	



Black : Extra Strong

Thick lightfast black material for maximum strength.

Commodity Code: 3923210000

PACKAGING TAX EXEMPT

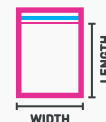

EXTRA STRONG



400 GAUGE



RECYCLE



RECYCLED CONTENT

CODE	INTERNAL SIZE (W x L)		THICKNESS	WEIGHT	DESCRIPTION	BOX QTY	ALL PRICES PER BOX			
	INCHES	MM					MICRON	Kg	1+	5+
MAILSECUREC4+	10 x 15	250 x 375	100	8.8	C4+	500	73.48	66.05	61.93	60.29
MAILSECURE10	12 x 16	300 x 405	100	11.4	Medium	500	87.48	79.30	73.83	68.70
MAILSECURE20	16 x 16	405 x 405	100	7.7	Large	250	53.95	47.15	43.61	39.33
MAILSECURE30	18 x 21	455 x 530	100	9.0	Large	200	62.67	54.96	50.73	47.87
MAILSECURE50	28 x 22	700 x 560	100	7.4	XX-Large	100	48.78	42.20	38.86	34.75



100% Recycled - Grey

Grey, hard-wearing and made from 100% recycled material. 'Handy Packs' perfect for Amazon and Ebay traders.

Commodity Code: 3923210000

PACKAGING TAX EXEMPT

55 MICRON
220 GAUGE

100% RECYCLED CONTENT

CODE	INTERNAL SIZE (W x L)		THICKNESS MICRON	WEIGHT Kg	DESCRIPTION	BOX QTY	PRICES PER BOX	
	MM						1+	
MR01	113 x 160		55	0.6	Letter	200	7.77	
MR02	150 x 229		55	0.8	Large Letter	200	10.45	
MR03	230 x 318		55	1.6	Large Letter	200	16.23	
MR04	250 x 350		55	1.9	Large Letter	200	18.70	
MR05	320 x 406		55	2.8	Small Parcel	200	21.91	
MR06	340 x 480		55	3.5	Medium Parcel	200	25.77	
MR07	360 x 405		55	3.2	Small Parcel	200	25.67	
MR08	400 x 500		55	4.5	Medium Parcel (A3)	200	28.67	
MR09	430 x 600		55	4.8	Medium Parcel (A2)	200	35.31	
MR10	540 x 600		55	7.8	Large Parcel	200	42.81	
MR11	550 x 750		55	7.7	Large Parcel	200	49.24	
MR13	700 x 850		55	11.1	Large Parcel (A1)	200	64.45	



100% Recycled - Black

Made from 100% recycled materials.

Commodity Code: 3923210000

PACKAGING TAX EXEMPT

60 MICRON
240 GAUGE

100% RECYCLED CONTENT

CODE	INTERNAL SIZE (W x L)		THICKNESS MICRON	WEIGHT Kg	DESCRIPTION	BOX QTY	ALL PRICES PER BOX			
	INCHES	MM					1+	5+	10+	25+
MAILBLKRC5	7 x 10	165 x 240	60	2.7	C5	500	40.29	36.70	34.33	31.95
MAILBLKRC4+	10 x 15	250 x 375	60	6.0	C4+	500	65.39	58.22	55.85	48.34
MAILBLKR10	12 x 16	305 x 405	60	7.8	Medium	500	69.51	63.50	59.14	54.63
MAILBLKR30	18 x 21	450 x 525	60	7.3	Large	250	63.00	56.15	51.84	47.48
MAILBLKR40	21 x 23	525 x 575	60	9.2	X-Large	250	76.34	68.36	63.05	57.49
MAILBLKR50	24 x 30	600 x 750	60	5.4	XX-Large	100	51.44	48.94	45.60	41.93



100% Recycled + Biodegradable - Green

Extra biodegradable additive that acts as a catalyst to accelerate the degradation process.

Commodity Code: 3923210000

PACKAGING TAX EXEMPT

40 MICRON
160 GAUGE

100% RECYCLED CONTENT

CODE	INTERNAL SIZE (W x L)		THICKNESS MICRON	WEIGHT Kg	DESCRIPTION	BOX QTY	ALL PRICES PER BOX			
	MM						1+	5+	10+	25+
MB01	170 x 250		40	1.2	C5+ Small	200	20.74	18.96	17.77	16.03
MB02	250 x 350		40	1.9	C4+ Medium	200	23.72	21.68	19.90	18.41
MB03	300 x 420		40	2.4	Large	200	30.60	28.40	25.85	23.71
MB04	400 x 540		40	3.6	X-Large	200	44.55	42.62	40.45	38.39

*Recycled polythene sometimes has a 'burnt' or 'smoke' like odour. This is completely normal and does not affect the overall performance of the material. The smell may transfer to certain materials (e.g. clothing, fabrics) if placed in direct contact.



Compostable*

Ivory white semi transparent Compostable mailing bag which material conforms to EU compostability standard EN13432.

Commodity Code: 3923210000

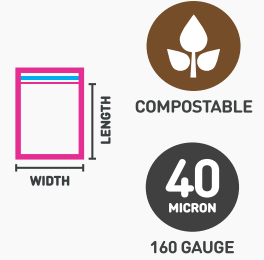

CODE	INTERNAL SIZE (W x L) MM	THICKNESS MICRON	WEIGHT Kg	DESCRIPTION	BOX QTY	ALL PRICES PER BOX			
						1+	5+	10+	25+
MNATC5	160 x 230	40	0.6	C5	200	32.87	29.35	27.17	25.03
MNAT21	170 x 250	40	0.6	C5+	200	34.55	31.56	29.37	27.26
MNATC4	230 x 325	40	1.1	C4	200	41.71	37.34	34.65	32.89
MNAT31	250 x 350	40	1.3	C4+	200	43.94	39.57	37.97	36.53
MNAT41	300 x 420	40	1.9	Large	200	50.12	45.74	44.06	43.53
MNAT51	400 x 540	40	3.2	X-Large	200	61.83	58.05	55.27	53.80

* Due to the nature of the material the adhesive peel & seal strip is only semi-permanent on initial contact sealing. A permanent seal requires the mailer to be left at room temperature for several hours once sealed.



Compostable Clear

*Our Clear Compostable material has a slight frosted clarity in appearance when compared to traditional polythene.

Commodity Code: 3923210000

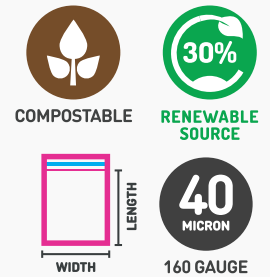

CODE	INTERNAL SIZE (W x L) MM	THICKNESS MICRON	WEIGHT Kg	DESCRIPTION	BOX QTY	ALL PRICES PER BOX			
						1+	5+	10+	25+
MCOMPCLRC5	160 x 230	40	0.8	C5	200	30.22	27.81	25.41	23.30
MCOMPCLRC4	230 x 325	40	1.6	C4	200	36.52	33.63	30.73	28.20
MCOMPCLRC3	330 x 440	40	3.1	C3	200	47.79	44.02	40.25	36.95



Compostable Co-Ex Mailer

Commodity Code: 3923210000

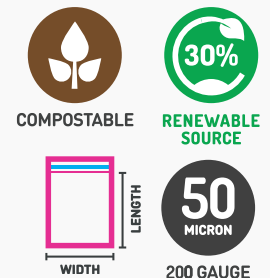

CODE	INTERNAL SIZE (W x L) MM	THICKNESS MICRON	WEIGHT Kg	DESCRIPTION	BOX QTY	ALL PRICES PER BOX			
						1+	5+	10+	25+
MCOMP5	160 x 230	50	1.0	C5	200	35.70	31.18	29.14	27.21
MCOMP21	170 x 250	50	1.2	C5+	200	37.06	32.59	30.47	28.45
MCOMP4	230 x 325	50	2.0	C4	200	45.29	40.21	37.21	34.90
MCOMP31	250 x 350	50	2.3	C4+	200	47.51	41.57	38.30	36.29
MCOMP41	300 x 420	50	3.3	Large	200	53.38	48.28	44.17	42.75
MCOMP51	400 x 540	50	5.6	XLarge	200	75.63	68.82	62.46	56.83



Compostable Black

Commodity Code: 3923210000

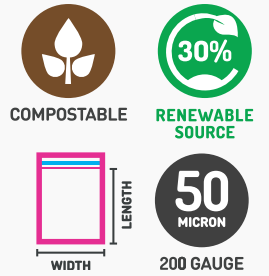

CODE	INTERNAL SIZE (W x L)		THICKNESS MICRON	WEIGHT Kg	DESCRIPTION	BOX QTY	ALL PRICES PER BOX			
	MM						1+	5+	10+	25+
MCOMPBLKC5	160	230	50	0.8	C5	200	38.07	35.04	32.01	29.36
MCOMPBLK21	170	250	50	0.9	C5+	200	39.20	36.08	32.96	30.23
MCOMPBLKC4	230	325	50	1.6	C4	200	46.40	42.72	39.03	35.81
MCOMPBLK31	250	350	50	1.9	C4+	200	48.86	44.98	41.10	37.71
MCOMPBLK41	300	420	50	2.7	Large	200	56.76	52.26	47.76	43.83



Compostable Green

Commodity Code: 3923210000

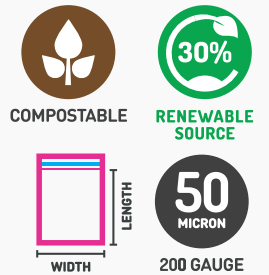

CODE	INTERNAL SIZE (W x L)		THICKNESS MICRON	WEIGHT Kg	DESCRIPTION	BOX QTY	ALL PRICES PER BOX			
	MM						1+	5+	10+	25+
MCOMPGRNC5	160	230	50	0.8	C5	200	38.07	35.04	32.01	29.36
MCOMPGRN21	170	250	50	0.9	C5+	200	39.20	36.08	32.96	30.23
MCOMPGRNC4	230	325	50	1.6	C4	200	46.40	42.72	39.03	35.81
MCOMPGRN31	250	350	50	1.9	C4+	200	48.86	44.98	41.10	37.71
MCOMPGRN41	300	420	50	2.7	Large	200	56.76	52.26	47.76	43.83

COMPOSTABLE OPTIONS

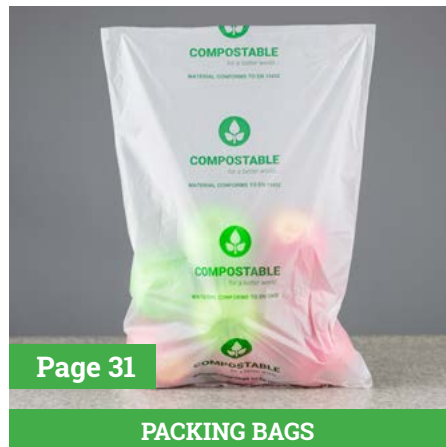

New Technology = New Possibilities

PB Group is currently investing over half a million pounds in new extrusion and blending technology. This capital investment will increase production capacity by 1.5 million bags per week and allow more sustainable blends of material film to be developed.

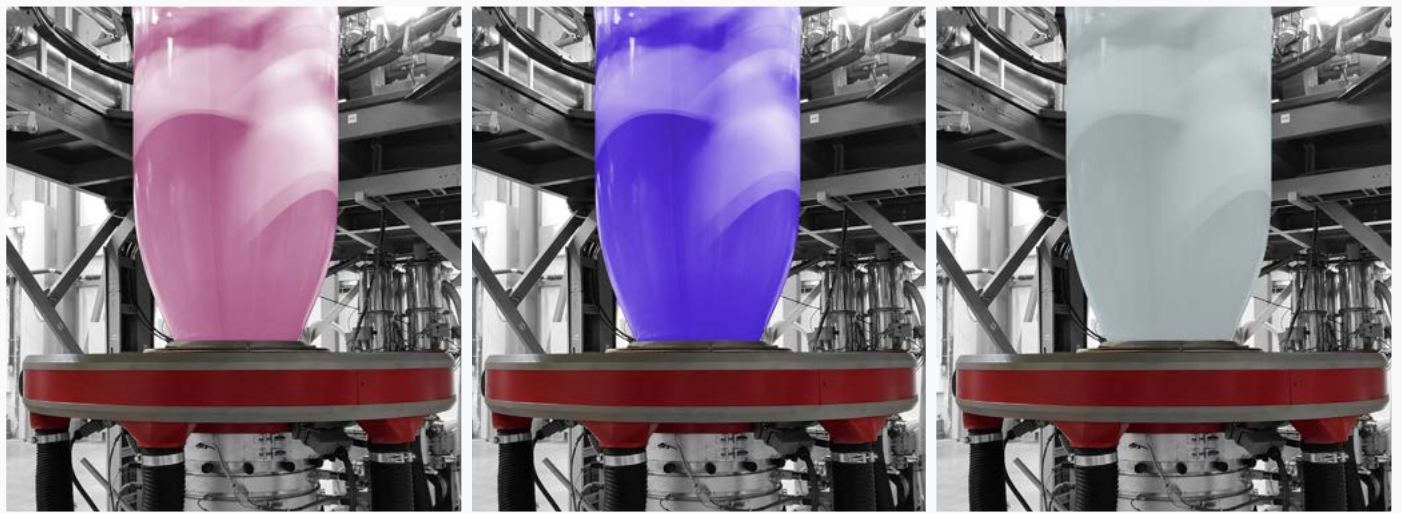

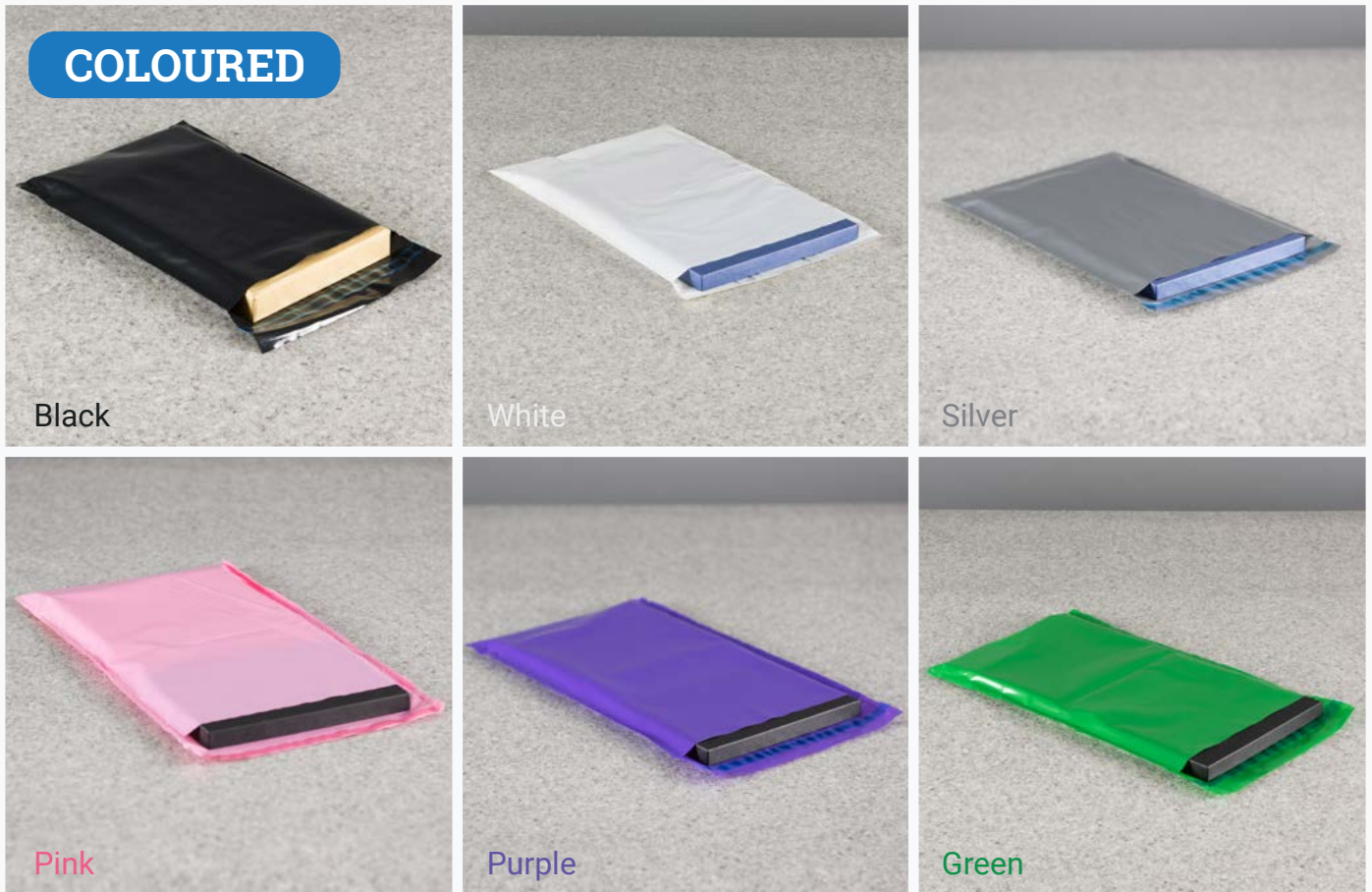

Coloured Mailing Bags (Translucent)

45-60 Micron

Commodity Code: 3923210000

PACKAGING TAX EXEMPT



CODE	INTERNAL SIZE (W x L)		THICKNESS MICRON	WEIGHT Kg	DESCRIPTION	BOX QTY	ALL PRICES PER BOX			
	INCHES	MM					1+	5+	10+	25+
MAILGREENC5	6.5 x 9	165 x 230	45	3.6	Green : C5	1000	32.10	26.91	24.68	23.35
MAILGREEN01	9 x 14	216 x 356	45	6.9	Green	1000	55.09	47.29	42.98	41.74
MAILGREEN02	12 x 16	305 x 406	50	6.2	Green	500	49.26	43.82	40.20	39.26
MAILGREEN04	17 x 22	432 x 559	55	7.4	Green	250	46.89	38.63	35.63	32.98
Pink : Translucent										
MAILPINKC5	6.5 x 9	165 x 230	45	3.6	Pink : C5	1000	32.31	28.20	25.94	24.85
MAILPINK01	9 x 14	216 x 356	45	6.9	Pink	1000	55.53	48.78	45.56	43.37
MAILPINK02	12 x 16	305 x 406	50	6.2	Pink	500	48.45	43.95	41.37	39.33
MAILPINK04	17 x 22	432 x 559	55	6.5	Pink	250	47.30	39.03	36.03	32.33
Purple : Translucent										
MAILPURPLEC5	6.5 x 9	165 x 230	45	3.6	Purple : C5	1000	34.78	32.93	30.72	29.43
MAILPURPLE01	9 x 14	216 x 356	45	8.1	Purple	1000	55.32	50.72	46.41	43.50
MAILPURPLE02	12 x 16	305 x 406	50	6.2	Purple	500	46.07	39.42	35.72	31.51
MAILPURPLE04	17 x 22	432 x 559	55	6.5	Purple	250	49.31	42.16	39.13	37.45
White : Translucent										
MAILC5WHT	6 x 9.5	160 x 230	50	3.4	White : C5	1000	31.88	26.65	25.29	23.82
MAILC5WHTP	6 x 9.5	160 x 230	37	2.6	C5 : White + Panel	1000	33.43	27.95	23.56	21.83
MAILC4WHTP	9 x 13	230 x 325	37	5.2	C4 : White + Panel	1000	45.80	33.61	32.64	30.19
Silver / Grey : Translucent										
MAILC4SILV	9 x 13	230 x 325	50	7.0	Silver/Grey : C4	1000	56.72	49.96	47.70	45.98
Black										
MAILC5BLK	6 x 9.5	160 x 230	60	3.4	Black : C5	1000	43.06	33.98	32.13	29.24



Mailsafe : White

Single-use method of securely storing or transferring documents, cash or other items.

Commodity Code: 3923210000

PACKAGING TAX EXEMPT

90
MICRON
360 GAUGE

RECYCLED CONTENT
RECYCLE

CODE	INTERNAL SIZE (W x L)	THICKNESS MICRON	WEIGHT Kg	DESCRIPTION	BOX QTY	ALL PRICES PER BOX			
	MM					1+	5+	10+	25+
MAILSAFEC5	160 x 230	90	8.4	C5	1000	88.63	81.57	76.31	71.06
MAILSAFEC4	230 x 325	90	8.0	C4	500	78.25	72.59	67.86	63.12



Tamper Evident

Sequentially numbered for tracking and tracing with 'Redemption Slip'. Ideal for banks, security services, accountants, solicitors, councils. A 'VOID' message shows any attempt at tampering on the seal.

Commodity Code: 3923210000

75
MICRON
300 GAUGE

RECYCLE

CODE	INTERNAL SIZE (W x L)	THICKNESS MICRON	WEIGHT Kg	DESCRIPTION	BOX QTY	ALL PRICES PER BOX			
	MM					1+	5+	10+	25+
MAILTAMA5C	170 x 260	75	0.9	C5 : Clear	100	38.10	30.06	28.63	27.54
MAILTAMA5W	170 x 260	75	0.9	C5 : White	100	39.35	31.33	29.91	28.81
MAILTAMA4C	230 x 305	75	1.3	C4 : Clear	100	44.61	36.35	34.69	33.42
MAILTAMA4W	230 x 305	75	1.3	C4 : White	100	45.90	37.63	35.96	34.68
MAILTAMA3C	340 x 430	75	2.5	C3 : Clear	100	56.85	47.82	45.40	43.51
MAILTAMA3W	340 x 430	75	2.6	C3 : White	100	59.39	50.38	47.96	46.06

Note: External width of envelope is +10mm wider than internal width.



Paper + Bubble Lining

Constructed from a heavy duty kraft paper. Protection given by air bubble cushioning. 10mm glued seam on each side. Please split the paper and polythene layers to recycle separately.

Commodity Code: 4817100000

PACKAGING TAX EXEMPT

80
GSM

CODE	INTERNAL SIZE (W x L)	THICKNESS GSM	WEIGHT Kg	DESCRIPTION	BOX QTY	ALL PRICES PER BOX			
	MM					1+	5+	10+	25+
MAILAIR/FE-A	110 x 165	80	1.4	Watches	200	28.13	22.29	21.41	19.52
MAILAIR/FE-B	120 x 215	80	1.9	C6 : Jewellery	200	32.78	26.56	25.35	23.16
MAILAIR/FE-C	150 x 215	80	1.1	CD's	100	20.90	15.57	15.09	13.57
MAILAIR/FE-D	180 x 265	80	2.0	C5 : DVD's	100	23.81	18.24	17.54	15.84
MAILAIR/FE-E	220 x 265	80	2.4	Small giftware	100	26.85	21.03	20.14	18.24
MAILAIR/FE-F	220 x 335	80	2.5	C4 : Desk Diaries	100	32.57	26.22	24.96	22.69
MAILAIR/FE-G	240 x 335	80	2.5	C4+ : Brochures	100	35.09	28.25	26.61	23.95
MAILAIR/FE-H	270 x 360	80	3.0	Books	100	41.81	34.20	32.00	28.77
MAILAIR/FE-J	300 x 445	80	2.3	Small Clothing	50	29.08	22.99	21.92	19.84
MAILAIR/FE-K	350 x 470	80	2.5	C3 : Larger items	50	32.50	26.16	24.90	22.61

Note: External width of envelope is +20mm wider than internal width.



CARRIER MAILING BAGS

Click & Collect

2 STRIP OPTION

Mailers with Carry Handle

Polythene mailing bags with integral carry handles are perfect for online or catalogue businesses & offer an easy and convenient way to carry parcels. These stock bags come with 2 x self-seal adhesive peel strip closure so are re-useable.

Commodity Code: 3923210000

PACKAGING TAX EXEMPT

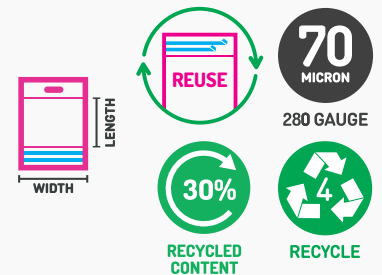

CODE	INTERNAL SIZE (W x L)	THICKNESS MICRON	WEIGHT Kg	DESCRIPTION	BOX QTY	ALL PRICES PER BOX			
	MM					1+	5+	10+	25+
CBMAILER3	216 x 356	70	3.1	100mm Handle	200	43.77	39.40	31.52	25.23
CBMAILER5	305 x 406	70	4.4	100mm Handle	200	49.96	44.95	35.97	28.78
CBMAILER7	330 x 483	70	5.6	100mm Handle	200	54.73	49.27	39.40	31.52
CBMAILER9	600 x 500	70	4.9	100mm Handle	100	45.54	41.34	36.72	31.75

*Custom made Carrier Mailers are usually made from 50 Micron film with a maximum length of 540mm storage + 75mm Handle + 40mm Lip.

CHECK OUT OUR CUSTOM RANGE IF YOU WANT MAILING BAGS WITH A DOUBLE STRIP WHICH CAN BE USED AGAIN FOR EASY RETURNS.



Metallic

Bright metallic foil colours are ideal for posting gifts, novelties, brochures, promotional goods, samples.

Commodity Code: 3923210000

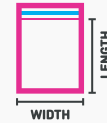

70
MICRON

280 GAUGE



RECYCLE

CODE	INTERNAL SIZE (W x L)		THICKNESS MICRON	WEIGHT Kg	DESCRIPTION	BOX QTY	ALL PRICES PER BOX			
	INCHES	MM					1+	5+	10+	25+
MAILMETC6	4.5 x 6.5 (C6)	115 x 165	70	0.3	Silver	100	17.04	11.62	10.54	9.84
MAILMETC5	6.5 x 9 (C5)	160 x 230	70	0.7	Silver	100	20.38	14.72	13.44	13.18
MAILMETC5GOLD				0.7	Gold		22.68	16.98	15.74	15.34
MAILMETC5PURPLE				0.7	Purple		22.68	16.98	15.74	15.34
MAILMETC5RED				0.7	Red		22.68	16.98	15.74	15.34
MAILMETDDL	8.5 x 8.5 (DDL)	220 x 220	70	0.7	Silver	100	25.81	22.58	19.93	18.46
MAILMETC4	9 x 13 (C4)	230 x 320	70	1.1	Silver	100	30.23	24.07	22.49	21.93
MAILMETC4GOLD				1.1	Gold		32.96	26.82	25.24	24.19
MAILMETC4PURPLE				1.1	Purple		32.96	26.82	25.24	24.19
MAILMETC4RED				1.1	Red		32.96	26.82	25.24	24.19
MAILMETC3	13 x 17 (C3)	320 x 450	70	2.4	Silver	100	44.70	38.61	36.41	33.91

Note: External width of envelope is +20mm wider than internal width. Unfortunately we cannot print on Metallic mailing bags.



Sparkling Metallic

Bright metallic foil colours are ideal for posting gifts, novelties, brochures, promotional goods, samples.

Commodity Code: 3923210000

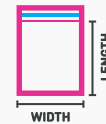

70
MICRON

280 GAUGE



RECYCLE

CODE	INTERNAL SIZE (W x L)		THICKNESS MICRON	WEIGHT Kg	DESCRIPTION	BOX QTY	ALL PRICES PER BOX			
	MM						1+	5+	10+	25+
MAILSPAC5GREEN	160 x 230 (C5)		70	0.7	Gold	100	26.79	23.80	21.96	20.81
MAILSPAC5RED				0.7	Green					
MAILSPAC5SILV				0.7	Red					
MAILSPAC4GOLD	230 x 320 (C4)		70	4.4	Gold	100	43.66	40.70	37.05	35.62
MAILSPAC4GREEN				4.4	Green					
MAILSPAC4RED				4.4	Red					
MAILSPAC4SILV				4.4	Silver					
MAILSPAC3GOLD	320 x 450 (C3)		70	1.2	Gold	50	46.99	44.55	39.20	38.28
MAILSPAC3GREEN				1.2	Green					
MAILSPAC3RED				1.2	Red					
MAILSPAC3SILV				1.2	Silver					

Handy Measure

_____ inches _____

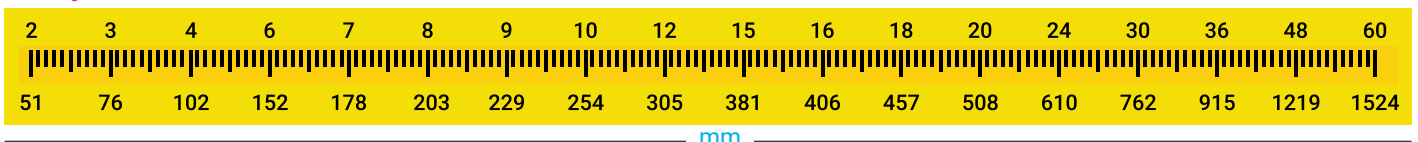



Sparkle Bubble Mailers

Bubble lined mailing bags that sparkle and reflect light.
 Note: External width of envelope is +20mm wider than internal width.

Commodity Code: 3923210000

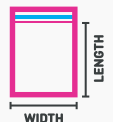

190
GSM

CODE	INTERNAL SIZE (W x L) MM	THICKNESS GSM	WEIGHT Kg	DESCRIPTION	BOX QTY	ALL PRICES PER BOX			
						1+	5+	10+	25+
MAILSPABC5GOLD MAILSPABC5RED MAILSPABC5SILV	180 x 250	190	2.7	Gold Red Silver	100	44.03	41.60	39.86	38.27
MAILSPABC4GOLD MAILSPABC4GREEN MAILSPABC4RED MAILSPABC4SILV	230 x 324	190	3.5	Gold Green Red Silver	100	64.93	62.97	61.00	59.69



Shiny Bubble Mailers

Bubble lined mailing bags available in 5 colours.
 Note: External width of envelope is +20mm wider than internal width.

Commodity Code: 3923210000

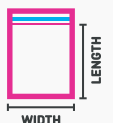

190
GSM

CODE	INTERNAL SIZE (W x L) MM	THICKNESS GSM	WEIGHT Kg	DESCRIPTION	BOX QTY	ALL PRICES PER BOX			
						1+	5+	10+	25+
MAILMB180BLK MAILMB180GOLD MAILMB180SILV	180 x 250	190	2.3	Gloss Black Gold (Matt) Silver (Matt)	100	43.94	41.52	39.78	38.18
MAILMB230BLK MAILMB230BLUE MAILMB230GOLD MAILMB230SILV	230 x 324	190	3.9	Gloss Black Baby Blue Gold (Matt) Silver (Matt)	100	65.02	63.06	61.09	59.78
MAILMB320BLK	320 x 450	190	3.2	C3 : Gloss Black	50	66.61	65.04	63.52	61.83

NEW PRODUCT



Cardboard Postal Boxes

These boxes are designed to fit Royal Mail 'Large Letter' Guidelines.

Commodity Code: 3923210000

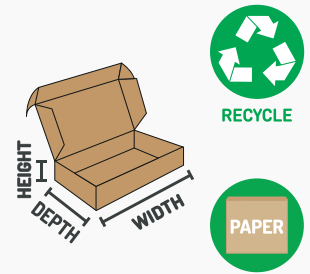

CODE	SIZE (W x D + H) MM	WEIGHT Kg	DESCRIPTION	BOX QTY	ALL PRICES PER BOX			
					1+	5+	10+	20+
MCLL00B	101 x 101 + 20	1.2	Small 0427 Style carton	50	12.49	9.99	8.99	8.54
MCLL01B	112 x 163 + 20	1.3	A6 0427 Style carton	50	12.99	10.39	9.35	8.89
MCLL03B	218 x 159 + 20	1.9	A5 0427 Style carton	50	15.99	12.79	11.51	10.94
MCLL05B	320 x 230 + 20	3.3	A4 0427 Style carton	50	23.99	19.19	17.27	16.41
MCLL07B	220 x 110 + 20	1.4	DL 0427 Style carton	50	13.99	11.19	10.07	9.57

NEW PRODUCT



Expandable Mailers (Corrugated)

Commodity Code: 3923210000

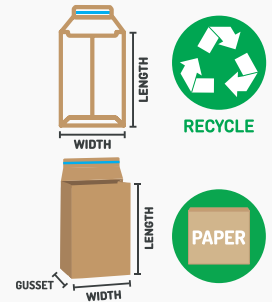

CODE	SIZE FLAT (W x L) MM	EXPANDABLE SIZE (W x L + G) MM	WEIGHT Kg	DESCRIPTION	BOX QTY	ALL PRICES PER BOX			
						1+	5+	10+	20+
MCEM1	228 x 294	155 x 219 + 70	1.3	(M1) Expandable Gusset	25	14.95	12.77	10.41	6.75
MCEM2	239 x 325	165 x 250 + 70	1.5	(M2) Expandable Gusset	25	16.75	13.79	11.24	7.25
MCEM3	280 x 356	205 x 285 + 70	1.9	(M3) Expandable Gusset	25	18.09	14.89	12.14	8.75
MCEM4	324 x 382	250 x 312 + 70	2.3	(M4) Expandable Gusset	25	19.54	16.09	13.11	10.25
MCEM5	420 x 530	350 x 425 + 70	3.0	(M5) Expandable Gusset	25	27.55	23.82	19.90	16.84

NEW PRODUCT



Expandable Mailers (Solid Board)

Commodity Code: 3923210000

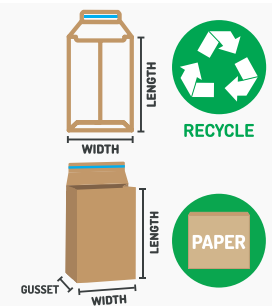

CODE	SIZE FLAT (W x L) MM	EXPANDABLE SIZE (W x L + G) MM	WEIGHT Kg	DESCRIPTION	BOX QTY	ALL PRICES PER BOX			
						1+	5+	10+	20+
MCB01	180 x 235	140 x 195 + 40	0.9	Expandable Gusset (A5)	50	10.65	9.59	9.01	6.50
MCB02	194 x 292	152 x 252 + 40	1.2	Expandable Gusset	50	11.33	10.20	9.59	7.01
MCB03	234 x 334	194 x 294 + 40	1.7	Expandable Gusset (A4)	50	13.78	12.40	11.66	8.10
MCB04	249 x 352	209 x 312 + 40	1.9	Expandable Gusset	50	16.84	15.16	14.25	11.15
MCB05	278 x 400	238 x 360 + 40	2.6	Expandable Gusset	50	18.75	16.88	15.86	12.40



E-Commerce Boxes White

These boxes are designed to fit Royal Mail 'Small Parcel' Guidelines.

Commodity Code: 3923210000

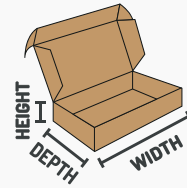

CODE	SIZE (W x D + H) MM	WEIGHT Kg	DESCRIPTION	BOX QTY	ALL PRICES PER BOX			
					1+	5+	10+	20+
MC427W20	200 x 120 + 50	0.5	Small Parcel	10	8.65	7.87	7.48	7.10
MC427W21	230 x 150 + 50	0.7	Small Parcel	10	9.49	8.64	8.20	7.79
MC427W22	250 x 210 + 50	0.9	Small Parcel	10	10.49	9.55	9.07	8.62
MC427W23	270 x 180 + 80	1.2	Small Parcel	10	11.50	10.47	9.94	9.44



E-Commerce Boxes Brown

These boxes are designed to fit Royal Mail 'Small Parcel' Guidelines.

Commodity Code: 3923210000

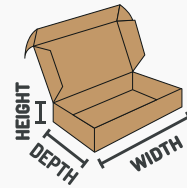

CODE	SIZE (W x D + H) MM	WEIGHT Kg	DESCRIPTION	BOX QTY	ALL PRICES PER BOX			
					1+	5+	10+	20+
MC427B20	150 x 60 + 60	0.5	Small Parcel	10	8.65	7.87	7.48	7.10
MC427B21	152 x 127 + 44	0.7	Small Parcel	10	9.49	8.64	8.20	7.79
MC427B22	200 x 120 + 50	0.9	Small Parcel	10	10.49	9.55	9.07	8.62
MC427B23	230 x 150 + 50	1.2	Small Parcel	10	11.50	10.47	9.94	9.44

MORE SIZES
AVAILABLE
CONTACT US
FOR MORE
DETAILS





KPR06



KPHIV500B

BB1

POLYCHIPS

BUBBLE & PROTECTIVE

Bubble products and protective packaging are used to protect delicate items in storage. Dealing with breakages and returns is an expensive business, it is far cheaper to invest in the correct packaging. We offer bags with adhesive strips for bagging both general and electrical components. Rolls of bubble are also available for when you have a range of sizes or bulkier items to protect. We also stock polystyrene chips and beads for packing in boxes.



Clear Bubble Bags with Peel & Seal Strip

10mm diameter (small) bubble and self-seal strips to close.
Made with 30% recycled content

Commodity Code: 3920000000

PACKAGING TAX EXEMPT

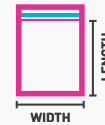

CODE	INTERNAL SIZE (W x L)		THICKNESS MICRON	WEIGHT Kg	DESCRIPTION	BOX QTY	ALL PRICES PER BOX			
	INCHES	MM					1+	5+	10+	25+
BB1	4 x 5	100 x 135	40	4.0	C7	1000	53.52	42.51	37.94	35.76
BB2	5 x 7	130 x 185	40	5.0	Small	1000	60.82	52.41	48.59	44.71
BB3	7 x 9	180 x 235	40	1.8	C5	300	43.75	35.78	31.34	28.61
BB4	9 x 11	230 x 280	40	2.7	Medium	300	51.91	41.99	37.19	33.92
BB5	11 x 14	280 x 360	40	2.4	C4+	200	51.71	41.80	36.99	34.53
BB6	12 x 17	305 x 435	40	1.9	Large	120	50.20	38.43	34.74	33.88
BB7	15 x 17	380 x 435	40	2.0	C3	100	52.93	43.84	39.96	37.12



Antistatic Red Tint Bubble Bags with Peel & Seal Strip

10mm diameter (small) bubble and self-seal strips to close.

Commodity Code: 3920000000

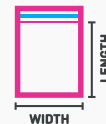

CODE	INTERNAL SIZE (W x L)		THICKNESS MICRON	WEIGHT Kg	DESCRIPTION	BOX QTY	ALL PRICES PER BOX			
	INCHES	MM					1+	5+	10+	25+
BB1AS	4 x 5	100 x 135	40	4.0	C7	1000	57.44	45.79	39.89	37.66
BB2AS	5 x 7	130 x 185	40	5.0	Small	1000	71.01	61.96	55.26	52.49
BB3AS	7 x 9	180 x 235	40	1.8	C5	300	47.68	39.06	33.95	31.23
BB4AS	9 x 11	230 x 280	40	2.7	Medium	300	55.85	45.26	39.81	38.06
BB5AS	11 x 14	280 x 360	40	2.4	C4+	200	55.64	45.07	39.60	37.85
BB6AS	12 x 17	305 x 435	40	1.9	Large	120	54.14	40.40	37.37	36.49
BB7AS	15 x 17	380 x 435	40	2.0	C3	100	56.85	47.10	43.29	40.03



Mini Bubble Rolls Small (10mm) Bubble

Handy 5 metres of S range small bubble for convenience.
Rewound with no cardboard core.

Commodity Code: 3920000000

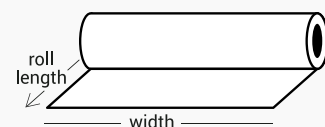

CODE	ROLL SIZE		WEIGHT Kg	DESCRIPTION	PACK QTY	ALL PRICES PER PACK
	WIDTH MM	LENGTH (METRES)				1+
BUBMINI	500	5	0.1	Mini Roll	1	8.62

* Product is excluded from 'Free Sample' service.



Polystyrene Packing Chips

Commodity Code: 3920300000



CODE	VOLUME LITRES	WEIGHT Kg	DESCRIPTION	BOX QTY	ALL PRICES PER BOX			
					1+	5+	10+	25+
POLYCHIPS	424	3.0	'S' Shaped white packing chips	1	54.48	33.57	32.94	31.68
POLYCHIPBIO	424	3.0	'S' Shaped Biodegradable packing chips	1	58.04	45.79	39.28	35.22

* Product is excluded from 'Free Sample' service.

BUBBLE WRAP ROLL COMBINATIONS ...

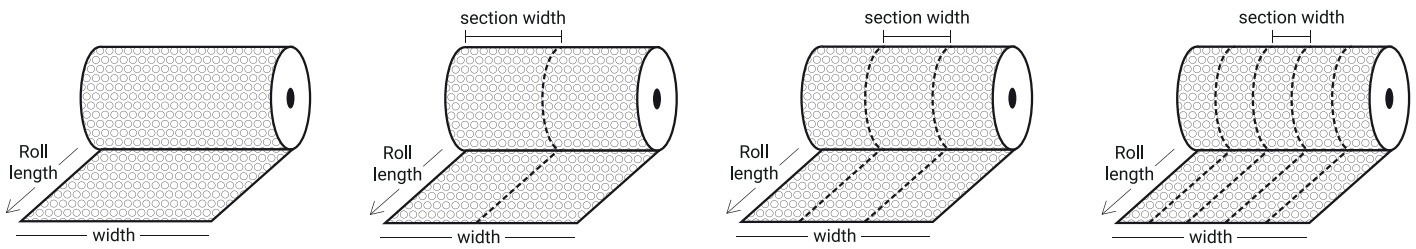

	1 SECTION	2 SECTIONS	3 SECTIONS	5 SECTIONS
CODE	BUB1200S BUB1500S BUB1200L BUB1500L	BUB600S BUB750S BUB600L BUB750L	BUB500S BUB500L	BUB300S BUB300L

! Colour Variation: Due to variations of the recycled material used in our bubble wrap, each individual roll could have different levels of grey tint colourisation.

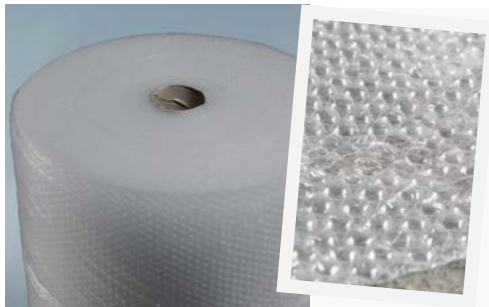

Bubble wrap rolls Small (10mm) Bubble

S range is small bubble for small items.

Commodity Code: 3920000000

PACKAGING TAX EXEMPT



RECYCLE



30%
RECYCLED
CONTENT

CODE	ROLL SIZE		WEIGHT Kg	DESCRIPTION	PACK QTY	ALL PRICES PER PACK			
	WIDTH MM	LENGTH (METRES)				1+	3+	5+	10+
BUB300S	1500	100	6.5	5 x 300mm Split Sections	1	69.21	53.12	49.71	47.75
BUB500S	1500	100	6.5	3 x 500mm Split Sections	1	69.21	53.12	49.71	47.75
BUB600S	1200	100	5.2	2 x 600mm Split Sections	1	62.65	46.56	43.15	41.18
BUB750S	1500	100	6.5	2 x 750mm Split Sections	1	69.21	53.12	49.71	47.75
BUB1200S	1200	100	5.2	1 x 1200mm Roll	1	62.65	46.56	43.15	41.18
BUB1500S	1500	100	6.5	1 x 1500mm Roll	1	69.21	53.12	49.71	47.75

* Product is excluded from 'Free Sample' service.

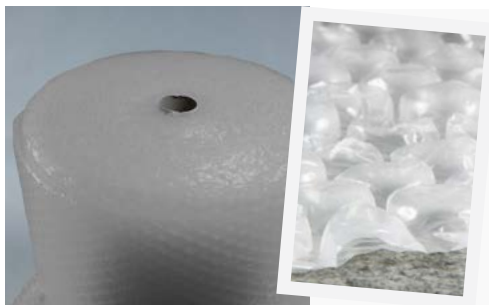

Bubble wrap rolls Large (25mm) Bubble

L range is Large bubble for larger items

Commodity Code: 3920000000

PACKAGING TAX EXEMPT



RECYCLE



30%
RECYCLED
CONTENT

CODE	ROLL SIZE		WEIGHT Kg	DESCRIPTION	PACK QTY	ALL PRICES PER PACK			
	WIDTH MM	LENGTH (METRES)				1+	3+	5+	10+
BUB300L	1500	45	6.5	5 x 300mm Split Sections	1	69.21	53.12	49.71	47.75
BUB500L	1500	45	6.5	3 x 500mm Split Sections	1	69.21	53.12	49.71	47.75
BUB600L	1200	45	5.2	2 x 600mm Split Sections	1	62.65	46.56	43.15	41.18
BUB750L	1500	45	6.5	2 x 750mm Split Sections	1	69.21	53.12	49.71	47.75
BUB1200L	1200	45	5.2	1 x 1200mm Roll	1	62.65	46.56	43.15	41.18
BUB1500L	1500	45	6.5	1 x 1500mm Roll	1	69.21	53.12	49.71	47.75

* Product is excluded from 'Free Sample' service.



Kraft Roll

Multi-purpose packaging material.

Commodity Code: 4817100000

PACKAGING TAX EXEMPT

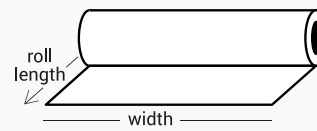

NEW
NEW
NEW

CODE	ROLL SIZE		THICKNESS GSM	WEIGHT Kg	DESCRIPTION	ROLL QTY	ALL PRICES PER ROLL			
	WIDTH MM	LENGTH (METRES)					1+	5+	10+	40+
KPR06	600	220	90	11.0	100% Recyclable	1	34.02	28.51	26.40	23.33
KPR600	600	220	90	14.7	100% Recyclable	1	33.75	30.38	28.69	27.00
KPR750	750	220	90	18.0	100% Recyclable	1	37.85	34.07	32.17	30.28
KPR900	900	220	90	21.5	100% Recyclable	1	49.95	44.96	42.46	39.96



Our wide range of sizes can be used to help protect

Inflate via a single nozzle using a standard compressor or hand pump, or just manually blow (like blowing up a party balloon).

- Bottles (wine, spirits)
- Tablets
- Mobile phones
- Hard drives
- Laptops
- Ceramics
- Cameras & lenses
- Pharmaceuticals
- Glassware
- Cosmetics
- Perfume
- Sunglasses
- And many more...

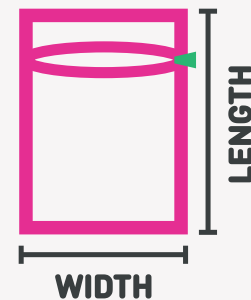

Commodity Code: 3923210000

CODE	UNINFLATED SIZE (W x L) MM	THICKNESS MICRON	WEIGHT Kg	DESCRIPTION	BOX QTY	MINI PACK 50	PRICE PER BOX
AIR01	240 x 300	75	6.0	Half bottle, jar candle, medicine, mug (MR04)*	250	27.92	103.85
AIR02	300 x 340	100	11.3	75cl bottle, camera lenses (MR06)*	250	37.91	139.13
AIR03	240 x 410	75	6.4	1 litre bottle (MR06)*	250	27.56	101.33
AIR04	360 x 560	100	17.0	1.5 litres bottle (MR09)*	200	76.15	226.96
AIR11	140 x 180	75	4.5	Phone (MR02)*	500	18.72	137.73
AIR12	320 x 280	75	12.0	Small tablet, hard drive (MR04)*	400	45.47	266.96
AIR13	385 x 335	75	8.4	Tablet, small laptop (MR05)*	200	47.67	143.09
AIR14	515 x 475	75	15.3	Large laptop (MR08)*	200	71.36	212.93

*Stock code for appropriate size outer mailing bag packaging.

**NEW
PRODUCT**



Brown HexaPaper

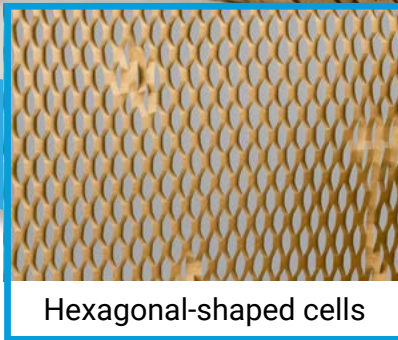

Hexagonal-shaped cells



White HexaPaper



HexaPaper Roll

Multi-purpose packaging material.

Commodity Code: 4817100000

PACKAGING TAX EXEMPT

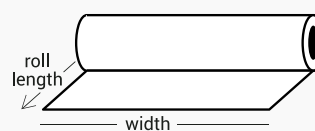

CODE	ROLL SIZE		THICKNESS GSM	WEIGHT Kg	DESCRIPTION	ROLL QTY	ALL PRICES PER ROLL			
	WIDTH MM	LENGTH (METRES)					1+	5+	10+	20+
KPHIV400W	400	250	90	7.4	White Paper	1	31.78	29.81	27.77	25.98
KPHIV500W	500	250	90	12.0	White Paper	1	33.25	31.97	29.71	27.28
KPHIV400B	400	250	90	7.4	Brown Paper	1	31.78	29.81	27.77	25.98
KPHIV500B	500	250	90	12.0	Brown Paper	1	33.25	31.97	29.71	27.28

HEXAPAPER presents a pioneering solution through its hexagonal-shaped cells that interlock seamlessly. Crafted entirely from 100% recyclable and biodegradable paper, it champions sustainability and aligns with eco-friendly practices, enabling businesses to make substantial strides towards reducing their carbon footprint.

The strength of the tessellating hexagon design ensures robust protection. Moreover, the expandable honeycomb structure enables exceptional flexibility and impressive elongation capacity, offering an additional 60% length when extended. This not only helps to minimise shipping costs but also ensures comprehensive protection for handles, unique edges, and unconventional components, making it an invaluable asset for businesses seeking efficient, sustainable packaging solutions.



Pink

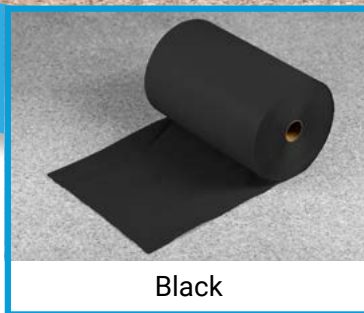

Black



White



Tissue Paper Roll

Multi-purpose packaging material.

Commodity Code: 4817100000

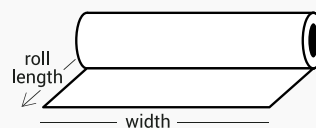

CODE	ROLL SIZE		THICKNESS GSM	WEIGHT Kg	DESCRIPTION	ROLL QTY	ALL PRICES PER ROLL			
	WIDTH MM	LENGTH (METRES)					1+	5+	10+	20+
TPR300WH	300	840	18	5.0	White	1	30.00	28.50	26.50	25.00
TPR300BL	300	840	18	5.0	Black	1	30.00	28.50	26.50	25.00
TPR300OR	300	840	18	5.0	Orange	1	30.00	28.50	26.50	25.00
TPR300PI	300	840	18	5.0	Pink	1	30.00	28.50	26.50	25.00

This premium acid-free tissue paper boasts exceptional quality. Its acid-free nature makes it an ideal choice for elegant presentations and becomes essential for packaging items intended for food use, such as crockery and cutlery. Utilising acid-free tissue is crucial in safeguarding these goods during storage or transit, preventing the release of harmful acids or toxins onto delicate items. Choose from an array of colours to further enhance the presentation and appeal of your items.



DISPLAY BAGS

Your retail products deserve to be presented in packaging that is beautiful, stylish and functional. Our range of crystal clear display bags are sure to add a sparkle to your products. Perfect for displaying or storing confectionary, arts & crafts, flowers, photos, clothes and greetings cards. So whether you need a protective barrier to prevent items spoiling or air tight bags that keep perishables fresh, we have many eye-catching solutions.



Paper Bag with Gusset & Window Sandwich Bags

Commodity Code: 4817100000

PACKAGING TAX **EXEMPT**

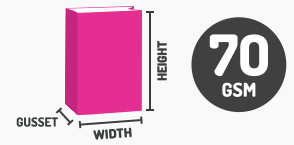

CODE	WIDTH x GUSSET (MM)	HEIGHT (MM)	WEIGHT Kg	DESCRIPTION	BOX QTY	ALL PRICES PER BOX			
						1+	5+	10+	25+
PAPSW02	150 x 100	250	3.0	Brown Window (Sandwich)	250	45.68	39.30	33.70	30.49

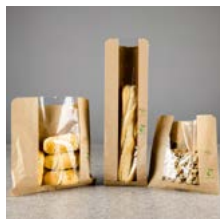

Compostable Film Front Bags

Commodity Code: 4817100000

PACKAGING TAX **EXEMPT**

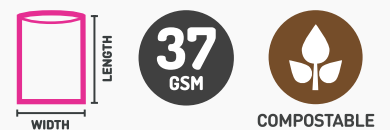

CODE	SIZE (W x L + G) MM	WEIGHT Kg	DESCRIPTION	BOX QTY	ALL PRICES PER BOX			
					1+	5+	10+	25+
BIOFF03	175 x 175	2.8	Small	1000	39.96	33.58	27.99	24.78
BIOFF05	250 x 250	5.0	Large	1000	49.68	44.85	40.81	37.42
BIOFF08	100 x 355 + 50	4.5	Baguette (Gusset)	1000	50.56	45.72	41.69	37.88



Polypropylene + White Kraft Paper Backing

Sparkling clear 28 micron polypropylene front and a white 38 gsm acid-free kraft paper backing.

Commodity Code: 3921000000

PACKAGING TAX **EXEMPT**



CODE	SIZE (W x L) MM	THICKNESS MICRON	WEIGHT Kg	DESCRIPTION	BOX QTY	ALL PRICES PER BOX			
						1+	5+	10+	25+
FF4614	150 x 350	28	3.3	Baguette	1000	43.95	33.89	28.52	23.16
FF66	150 x 150	28	1.7	Small	1000	24.46	19.42	16.91	14.40
FF77	175 x 175	28	1.6	Small	1000	27.85	20.98	18.77	15.47
FF8.58.5	215 x 215	28	3.2	Medium	1000	35.25	27.08	22.29	17.72
FF1010	250 x 250	28	3.8	Medium	1000	43.64	35.15	28.83	22.83
FF1114	275 x 350	28	6.4	Large	1000	65.99	55.59	46.06	36.94
FF1218	300 x 450	28	8.5	Large	1000	71.90	60.95	50.74	44.59
FF2030	500 x 700	28	1.7	X-Large Tray	50	23.29	20.37	18.31	16.77



Polypropylene + Pearl Backing

Sparkling clear 30 micron polypropylene front and a 30 micron Pearl polypropylene backing.

Commodity Code: 3921000000

PACKAGING TAX **EXEMPT**



CODE	SIZE (W x L) MM	THICKNESS MICRON	WEIGHT Kg	DESCRIPTION	BOX QTY	ALL PRICES PER BOX			
						1+	5+	10+	25+
FF77P	175 x 175	30	1.7	Small	1000	35.49	27.36	24.01	20.64
FF8.58.5P	215 x 215	30	2.8	Medium	1000	45.63	35.98	31.13	26.46
FF1010P	250 x 250	30	3.0	Medium	1000	56.10	44.88	38.42	32.30



Polypropylene (Cello) Bags Clear High Clarity

Commodity Code: 3921000000

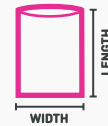

CODE	SIZE (W x L) MM	THICKNESS MICRON	WEIGHT Kg	DESCRIPTION	BOX QTY	ALL PRICES PER BOX			
						1+	5+	10+	25+
PP11	25 x 25	30	1.5	Mini	5000	40.93	31.81	28.51	27.35
PP22	50 x 50	30	0.9	Mini	5000	41.45	34.42	32.36	31.22
PP33.25	75 x 80	30	3.0	Mini	5000	40.81	37.07	35.05	32.68
PP35	75 x 125	30	1.8	Small	3000	39.16	25.58	22.69	21.52
PP44	100 x 100	30	1.7	Small	3000	54.22	33.43	27.98	25.15
PP46	100 x 150	30	1.6	Small	2000	39.13	24.23	20.65	19.55
PP66	150 x 150	30	2.6	Small	2000	58.32	32.84	29.06	26.50
PP68	150 x 200	30	1.6	Small	1000	33.07	28.17	23.68	21.47
PP710	175 x 250	30	2.4	C4	1000	31.64	28.75	23.69	22.04
PP88	200 x 200	30	2.3	Medium	1000	40.20	28.01	25.32	21.26
PP811	200 x 275	30	3.2	Medium	1000	44.18	35.83	34.23	31.26
PP912	225 x 300	30	4.2	Large	1000	45.24	40.10	37.50	36.21
PP1010	250 x 250	30	3.6	Large	1000	59.42	37.77	35.06	31.01
PP1015	250 x 375	30	2.6	Large	500	59.24	33.55	30.84	26.79
PP1218	300 x 450	30	3.8	Large	500	66.43	52.94	46.58	41.31
PP1520	375 x 500	30	2.6	X-Large	250	59.28	33.37	26.59	22.54
PP1824	450 x 600	30	3.0	X-Large	200	58.33	31.05	25.64	22.67



Polypropylene Bags 25mm Lip/Flap

Suitable for cards, leaflets, postcards, crafts and photos.

Commodity Code: 3921000000

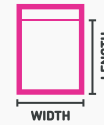

CODE	SIZE (W x L) MM	THICKNESS MICRON	WEIGHT Kg	DESCRIPTION	BOX QTY	ALL PRICES PER BOX			
						1+	5+	10+	25+
CARD99148	99 x 148	30	0.9	Mini	1000	17.68	15.14	12.82	10.77
CARD112112	112 x 112	30	0.8	Square - 4" Card & Envelope	1000	17.70	14.34	12.22	11.42
CARD112186	112 x 186	30	1.2	C6 Long	1000	21.66	18.73	17.03	14.55
CARD115220	115 x 220	30	1.5	DL Card + Envelope	1000	22.56	19.25	17.23	14.11
CARD118164	118 x 164	30	1.2	C6 Card + Envelope	1000	20.39	17.51	15.95	13.58
CARD122186	122 x 186	30	1.3	C6 Card + Envelope	1000	19.98	15.80	12.87	10.18
CARD127184	127 x 184	30	2.3	C6 Multipack Cards	1000	21.28	17.09	14.17	12.66
CARD140140	140 x 140	30	1.1	Square - 5" Card + Envelope	1000	18.86	14.92	12.29	9.87
CARD137186	137 x 186	30	1.6	C6++	1000	22.40	19.12	14.97	13.24
CARD138200	138 x 200	30	1.7	C6++ Long	1000	23.41	18.92	16.75	14.28
CARD155215	155 x 215	30	1.9	A5	1000	24.93	20.03	16.38	13.00
CARD158158	158 x 158	30	1.2	Square - 6" Card + Envelope	1000	21.56	17.25	14.20	11.42
CARD166230	166 x 230	30	1.7	C5 Card + Envelope	1000	27.26	24.13	20.15	18.72
CARD188237	188 x 237	30	2.5	C5+ Multipack Cards	1000	31.60	25.89	21.44	17.25
CARD203254	203 x 254	30	3.6	A4	1000	43.36	36.13	30.18	24.47
CARD216305	216 x 305	30	3.9	A4	1000	44.55	37.32	31.37	25.66



Flower Sleeves

Flower sleeves are supplied wicketted together for easy dispensing.

Commodity Code: 3921000000

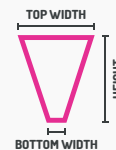

CODE	SIZE (WIDTH TOP/BOTTOM) + HEIGHT		THICKNESS MICRON	WEIGHT Kg	DESCRIPTION	BOX QTY	ALL PRICES PER BOX			
	WIDTH MM	HEIGHT MM					1+	5+	10+	25+
FLOWERL	250 / 90	500	25	5.7	Large Bunch	1000	66.99	59.53	55.44	50.10



Polypropylene Bags Peel & Seal Strip

Ideal for greetings cards.

Commodity Code: 3921000000



CODE	INTERNAL SIZE (W x L)		THICKNESS MICRON	WEIGHT Kg	DESCRIPTION	BOX QTY	ALL PRICES PER BOX			
	INCHES	MM					1+	5+	10+	25+
PEEL04	2 x 2	50 x 50	40	0.3	Mini	1000	24.10	15.51	12.70	12.40
PEEL06	2 x 4	50 x 100	40	0.5	Mini	1000	25.95	21.39	16.35	14.98
PEEL08	3 x 4	75 x 100	40	0.7	Small	1000	29.97	26.21	22.19	20.91
PEEL10	4 x 4	100 x 100	40	0.9	Small	1000	36.19	32.85	30.90	29.22
PEEL20	4.5 x 6.5	118 x 164	40	1.2	C6	1000	29.56	25.23	23.16	21.79
PEEL30	4.5 x 9	115 x 225	40	2.3	DL	1000	30.42	26.78	24.24	21.64
PEEL40	4.75 x 7.25	120 x 185	40	2.3	Small	1000	28.00	19.41	18.15	16.33
PEEL50	5.25 x 7.25	135 x 185	40	1.6	C6++	1000	31.62	27.44	25.90	23.86
PEEL60	6.5 x 8.5	165 x 215	40	2.3	Medium	1000	40.24	34.65	31.21	29.38
PEEL70	6.5 x 9	165 x 230	40	3.7	C5	1000	41.78	36.15	28.19	27.26
PEEL80	8 x 10	200 x 250	40	3.7	Large	1000	46.50	39.93	37.51	36.56
PEEL90	8.5 x 12.5	230 x 320	40	4.1	C4	1000	59.48	50.96	44.12	43.25
PEEL100	12 x 17	310 x 440	40	5.2	X-Large	500	63.09	55.66	49.13	46.87



Compostable Peel & Seal

Ideal for short-term storage of greeting cards, sweet treats, post-cards and many more...

Commodity Code: 3921000000



CODE	INTERNAL SIZE (W x L)		THICKNESS MICRON	WEIGHT Kg	DESCRIPTION	BOX QTY	ALL PRICES PER BOX			
	MM	MM					1+	5+	10+	25+
PEELCOMP08	75 x 100		30	0.7	Small	1000	41.93	38.58	34.40	31.48
PEELCOMP20	118 x 164		30	1.7	C6	1000	51.14	47.08	42.00	38.44
PEELCOMP30	115 x 225		30	1.6	DL	1000	56.67	52.17	46.53	42.59
PEELCOMP40	120 x 185		30	1.9	Small	1000	53.76	49.49	44.16	40.42
PEELCOMP50	135 x 185		30	2.1	C6++	1000	56.57	52.08	46.47	42.54
PEELCOMP60	165 x 215		30	3.0	Medium	1000	66.55	61.28	54.69	50.07
PEELCOMP70	166 x 230		30	3.2	C5	1000	68.11	62.72	55.98	51.25
PEELCOMP80	200 x 250		30	4.2	Large	1000	79.32	73.04	65.19	59.71
PEELCOMP90	230 x 320		30	3.0	C4	500	80.42	74.04	66.06	60.47
PEELCOMP100	305 x 422		30	5.2	A3	500	127.11	117.02	104.41	95.60



Paper Flower Sleeves

Commodity Code: 3923210000



CODE	SIZE (WIDTH TOP/ BOTTOM) + HEIGHT MM		THICKNESS	WEIGHT Kg	DESCRIPTION	BOX QTY	MINI PACK 250	ALL PRICES PER BOX		
	WIDTH	HEIGHT						1+	5+	10+
FLOWPA02	300 / 120	400	45 GSM	7.8	Paper (FSC)	1000	31.73	85.75	81.46	77.18
FLOWPA04	350 / 100	500	45 GSM	10.6	Paper (FSC)	1000	35.75	99.15	94.19	89.24
FLOWPB02	250 / 100	400	50 GSM/40 MIC	7.2	Paper + Clear Front (BOPP)	1000	32.69	88.95	84.50	80.06
FLOWPB04	350 / 100	500	50 GSM/40 MIC	9.3	Paper + Clear Front (BOPP)	1000	40.64	115.45	109.68	103.91
FLOWPB06	300 / 120	400	50 GSM/40 MIC	8.4	Paper + Clear Front (Certified Bio)	1000	44.93	129.75	123.26	116.78

PRINT CAPABILITIES



Peel & Seal Bags - Polypropylene Printed Warning Notice

Ideal for displaying or storing clothing.

Commodity Code: 3921000000

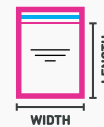

CODE	INTERNAL SIZE (W x L)		THICKNESS MICRON	WEIGHT Kg	DESCRIPTION	BOX QTY	ALL PRICES PER BOX			
	INCHES	MM					1+	5+	10+	25+
PPRETAIL10	7 x 10	175 x 250	40	3.3	Smalls	1000	45.83	36.59	33.89	31.90
PPRETAIL20	10 x 12	250 x 300	40	5.0	T-Shirt	1000	64.81	56.97	55.30	53.24
PPRETAIL40	10 x 15	250 x 375	40	7.3	Large T-Shirt	1000	77.81	72.39	69.07	67.99
PPRETAIL50	12 x 16	300 x 400	40	10.0	Shirt	1000	98.13	84.91	77.19	74.95
PPRETAIL60	11 x 18	275 x 450	40	10.0	Large Shirt	1000	106.80	98.35	95.95	90.17
PPRETAIL100	14 x 18	350 x 450	40	7.0	Sweater	500	71.63	64.67	58.20	53.50
PPRETAIL150	16 x 24	400 x 600	40	10.2	Fabric	500	111.23	93.53	88.76	87.54
PPRETAIL190	18 x 28	450 x 700	40	5.7	Fabric	250	112.23	95.95	94.84	93.65



Peel & Seal Bags - Polythene Printed Warning Notice

Commodity Code: 3923210000



CODE	INTERNAL SIZE (W x L)		THICKNESS MICRON	WEIGHT Kg	DESCRIPTION	BOX QTY	ALL PRICES PER BOX			
	INCHES	MM					1+	5+	10+	25+
TSHIRTBAG	10 x 14	250 x 350	30	5.0	Economy T-Shirt	1000	51.14	46.77	44.82	42.22



Triangle Sweet Bags

Commodity Code: 3923210000



180 GAUGE

CODE	SIZE (W x L)		THICKNESS MICRON	WEIGHT Kg	DESCRIPTION	BOX QTY	ALL PRICES PER BOX			
	MM	MM					1+	5+	10+	25+
CANDYP	180 x 370		45	6.1	Clear : Small	1000	50.66	43.75	40.20	36.47
CANDYQ	180 x 370		45	6.1	White Pattern Top : Small	1000	50.66	43.74	40.20	36.47
CANDYR	250 x 460		45	6.4	Clear : Large	1000	60.32	52.35	49.76	48.21
CANDYS	250 x 460		45	6.4	White Pattern Top : Large	1000	60.32	52.35	49.76	48.21



Retail Display Bags (with card base)

Commodity Code: 3921000000



CODE	SIZE (BASE SIZE + HEIGHT)		THICKNESS MICRON	WEIGHT Kg	DESCRIPTION	BOX QTY	ALL PRICES PER BOX			
	BASE SIZE MM	HEIGHT MM					1+	5+	10+	25+
DISPLAY10	55 x 35	180	40	2.2	Mini	1000	89.59	86.29	83.81	83.42
DISPLAY20	55 x 35	220	40	2.6	Small	1000	99.97	96.23	92.06	87.74
DISPLAY30	65 x 40	275	40	3.7	Medium	1000	115.72	110.85	104.96	101.17
DISPLAY40	80 x 50	305	40	4.9	Large	1000	139.53	137.34	131.20	128.16
DISPLAY50	100 x 60	320	40	3.3	X-Large	500	74.36	72.22	67.92	65.74



Patterned Bag (with card base)

Commodity Code: 3921000000



CODE	SIZE (BASE SIZE + HEIGHT)		THICKNESS MICRON	WEIGHT Kg	DESCRIPTION	BOX QTY	ALL PRICES PER BOX			
	BASE MM	HEIGHT MM					1+	5+	10+	25+
PEBBLE	55 x 40	220	40	0.3	Pebbles	100	27.56	23.33	20.03	18.59
JAZZ	55 x 40	220	40	0.3	Stripes & Twirls	100	27.56	23.33	20.03	18.59
HEART	55 x 40	220	40	0.3	Red & Gold Hearts	100	27.56	23.33	20.03	18.59



Compostable Display Bag with gusset

The compostable film used to make these display bags is both biodegradable and compostable which makes it one of the most eco-friendly display products we offer.

Commodity Code: 3921000000



CODE	SIZE (WIDTH CLOSED/OPEN) + HEIGHT		THICKNESS MICRON	WEIGHT Kg	DESCRIPTION	BOX QTY	ALL PRICES PER BOX			
	WIDTH MM	HEIGHT MM					1+	5+	10+	25+
BIODIS1	100 / 100	150	30	1.7	Mini	1000	52.94	42.54	41.00	39.25
BIODIS10	76 / 125	220	30	3.1	Small	1000	63.95	53.18	51.48	48.79
BIODIS15	90 / 150	300	30	4.6	Medium	1000	81.55	72.16	68.13	64.61
BIODIS17	120 / 180	305	30	5.7	Large	1000	100.14	85.70	81.64	78.07



Display Bag with Gusset

Commodity Code: 3921000000



CODE	SIZE (WIDTH CLOSED/OPEN) + HEIGHT		THICKNESS MICRON	WEIGHT Kg	DESCRIPTION	BOX QTY	ALL PRICES PER BOX			
	WIDTH MM	HEIGHT MM					1+	5+	10+	25+
DIS33.25PP	76 / 76	82	40	0.4	Mini	1000	37.63	32.15	27.82	25.76
DIS34.55PP	76 / 114	127	40	1.5	Mini	1000	33.94	32.31	30.61	29.92
DIS34.57PP	76 / 114	177	40	2.0	Small	1000	37.09	35.66	34.49	32.34
DIS359PP	76 / 127	228	40	2.7	Medium	1000	43.39	40.15	37.93	36.98
DIS3.5611PP	88 / 152	279	40	3.6	Large	1000	50.13	48.82	47.77	45.19
DIS6812PP	152 / 203	304	40	5.2	Large	1000	67.93	64.73	62.75	58.10
DIS6912PP	152 / 228	304	40	5.8	X-Large	1000	71.91	68.17	66.56	65.26
DIS4.75714PP	120 / 177	365	40	6.0	XX-Large	1000	72.80	68.16	65.06	61.59



Peel & Seal Header Bags

Bottom-fill and seal polypropylene bag with white reinforced header plus euroslot for hanging display.

Commodity Code: 3921000000

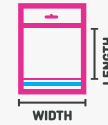

CODE	INTERNAL SIZE (W x L) MM	THICKNESS MICRON	WEIGHT Kg	DESCRIPTION	BOX QTY	ALL PRICES PER BOX			
						1+	5+	10+	25+
PPHEADER2	55 x 55	40	0.7	Mini	1000	30.68	24.57	19.70	15.79
PPHEADER3	50 x 75	40	0.8	Mini	1000	33.61	26.92	21.57	17.28
PPHEADER5	50 x 385	40	1.2	Extra Long	1000	49.25	38.19	35.98	33.29
PPHEADER7	101 x 508	40	4.7	Hair Extensions	1000	58.93	51.35	48.32	44.69
PPHEADER10	110 x 160	40	2.1	C6	1000	41.50	35.46	33.11	30.31
PPHEADER20	115 x 230	40	2.9	DL	1000	50.69	43.67	40.29	36.34
PPHEADER30	145 x 145	40	2.7	Square	1000	46.26	39.83	37.06	33.84
PPHEADER40	165 x 230	40	3.8	C5	1000	66.82	58.50	53.85	48.33
PPHEADER50	220 x 310	40	7.4	C4	1000	102.12	90.44	82.38	72.82
PPHEADER60	240 x 240	40	6.2	Square	1000	106.53	96.69	92.52	84.38
PPHEADER70	240 x 335	40	7.8	C4+	1000	113.20	99.81	96.19	88.30



Compostable Header Bags

Bottom-fill and seal compostable bag with white reinforced header plus euroslot for hanging display.

Commodity Code: 3921000000

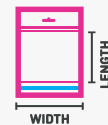

CODE	INTERNAL SIZE (W x L) MM	THICKNESS MICRON	WEIGHT Kg	DESCRIPTION	BOX QTY	ALL PRICES PER BOX			
						1+	5+	10+	25+
PPHEADCOM08	90 x 100	30	1.4	Small	1000	61.90	56.97	50.81	46.50
PPHEADCOM10	110 x 160	30	2.3	C6	1000	66.23	60.97	54.39	49.79
PPHEADCOM40	165 x 230	30	4.2	C5	1000	101.02	94.17	86.40	81.61
PPHEADCOM50	220 x 310	30	3.5	A4	500	77.77	73.75	66.04	61.72
PPHEADCOM70	240 x 335	30	4.0	C4	500	95.74	87.43	79.44	74.17

COMPOSTABLE OPTIONS



Page 31

PACKING BAGS



Page 123

WASTE BAGS



Page 101

VEST CARRIERS



Brown Biopaper

These pouches are suitable for industrial composting.
Film Structure: Brown Kraft paper / PLA.

Commodity Code: 4817100000

PACKAGING TAX EXEMPT

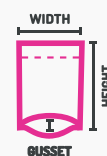

COMPOSTABLE

CODE	EXTERNAL SIZE (W x G + H)		WEIGHT Kg	DESCRIPTION	STORAGE WEIGHT	BOX QTY	ALL PRICES PER BOX			
	WIDTH x GUSSET (MM)	HEIGHT (MM)					1+	3+	5+	10+
SUPBB080	80 x 50	130	0.4	100-150ml	25-35g	100	39.45	35.06	31.35	26.99
SUPBB110	110 x 70	170	0.7	200-250ml	50-70g	100	35.51	30.55	25.68	23.49
SUPBB130	130 x 80	210	1.7	350-425ml	125-175g	100	42.90	38.65	34.72	32.38
SUPBB160	160 x 90	230	1.5	700-900ml	250-400g	100	52.23	46.26	42.39	41.29
SUPBB190	190 x 100	260	1.9	1.3-1.4Litre	500g	100	60.06	55.19	50.23	46.95



Brown Biopaper Pre-Printed (Keep Calm)

Film Structure:
60 GSM Brown Paper // Adhesive // 60 MIC BIO DEGRADABLE PE

These Biopaper pouches have the message "Keep Calm, Eat & Enjoy" pre-printed on each bag.

Commodity Code: 4817100000

PACKAGING TAX EXEMPT

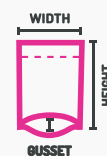

BIODEGRADABLE

CODE	EXTERNAL SIZE (W x G + H)		WEIGHT Kg	DESCRIPTION	STORAGE WEIGHT	BOX QTY	ALL PRICES PER BOX			
	WIDTH x GUSSET (MM)	HEIGHT (MM)					1+	3+	5+	10+
SUPBB120KC	120 x 80	200	0.9	325-360ml	100-135g	100	41.55	34.84	30.83	28.15
SUPBB160KC	160 x 90	220	1.5	700-900ml	250-400g	100	53.59	46.91	42.87	40.20
SUPBB190KC	190 x 100	260	1.9	1.3-1.4Litre	500g	100	64.31	58.95	53.59	49.59



Brown Paper + Window

Commodity Code: 4817100000

PACKAGING TAX EXEMPT

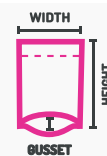

RECYCLED
CONTENT

CODE	EXTERNAL SIZE (W x G + H)		WEIGHT Kg	DESCRIPTION	STORAGE WEIGHT	BOX QTY	ALL PRICES PER BOX			
	WIDTH x GUSSET (MM)	HEIGHT (MM)					1+	3+	5+	10+
SUPWB110RC	110 x 70	210	0.8	200-250ml	50-70g	100	32.80	28.11	23.43	21.09
SUPWB120RC	120 x 80	200	0.9	325-360ml	100-135g	100	36.32	30.45	26.94	24.60
SUPWB160RC	160 x 90	230	1.2	700-900ml	250-400g	100	46.86	41.00	37.48	35.14
SUPWB190RC	190 x 100	260	1.9	1.3-1.4Litre	500g	100	56.22	51.54	46.86	43.34
SUPWB235RC	235 x 110	335	2.5	2.8-3.3Litre	1000g	100	73.80	70.27	64.43	58.57



Pouches (multi-layered films) are not usually accepted in domestic recycling collections as they are difficult to recycle. However, difficult-to-recycle items may be collected by other organisations. Please check www.recyclenow.com for more information.



Clear

Film Structure:
PET 12 MIC // LLDPE 90 MIC

All our Stand-up Pouches are 'Food Safe' & great for storing & presenting confectionery, cereals, tea, coffee and many more items.

Commodity Code: 3923210000

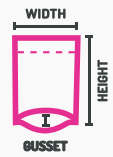

392 GAUGE

CODE	EXTERNAL SIZE (W x G + H)		WEIGHT Kg	DESCRIPTION	STORAGE WEIGHT	BOX QTY	ALL PRICES PER BOX			
	WIDTH x GUSSET +	HEIGHT (MM)					1+	5+	10+	25+
SUPC00	110 x 60	170	2.5	150ml	20g-45g	500	81.91	62.99	61.35	54.94
SUPC01	120 x 80	200	4.0	250ml	50g-70g	500	89.74	70.79	68.11	61.85
SUPC02	130 x 80	230	2.8	500ml	90g-150g	250	66.19	46.99	45.20	42.57
SUPC03	160 x 80	270	3.5	750ml	230g-350g	250	69.48	50.43	47.09	45.11
SUPC04	180 x 90	290	4.0	1000ml	500g	250	74.55	56.22	52.64	51.33
SUPC05	250 x 130	290	4.0	2000ml	750g	250	79.90	60.73	58.53	54.33
SUPC06	250 x 130	340	5.5	3000ml	1000g	250	82.80	63.48	60.63	57.17



Clear / Metallised

Film Structure:
MATT PET 12 MIC // PET 12 MIC // LLDPE 90 MIC

The bottom gusset makes the pouches suitable for in-store shelf displays & the Handy tear notches provides an 'easy' first open after the bag has been heat sealed.

Commodity Code: 3923210000

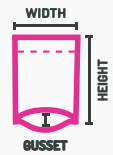

392 GAUGE

CODE	EXTERNAL SIZE (W x G + H)		WEIGHT Kg	DESCRIPTION	STORAGE WEIGHT	BOX QTY	ALL PRICES PER BOX			
	WIDTH x GUSSET +	HEIGHT (MM)					1+	5+	10+	25+
SUPM00	110 x 60	170	2.8	150ml	20g-45g	500	89.62	71.93	70.09	63.71
SUPM01	120 x 80	200	3.3	250ml	50g-70g	500	95.88	78.16	76.44	70.57
SUPM02	130 x 80	230	2.0	500ml	90g-150g	250	68.16	50.74	47.68	45.90
SUPM03	160 x 80	270	2.8	750ml	230g-350g	250	70.60	55.13	52.51	49.30
SUPM04	180 x 90	290	3.4	1000ml	500g	250	74.55	57.10	54.30	53.26
SUPM05	250 x 130	295	5.6	2000ml	750g	250	83.60	65.82	63.99	62.02
SUPM06	250 x 130	340	5.3	3000ml	1000g	250	87.44	69.64	67.90	65.83



PolyKraft + Window

PolyKraft pouches look like kraft paper but are manufactured from polythene which is less susceptible to grease than traditional paper.

Commodity Code: 3923210000

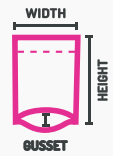

348 GAUGE

CODE	EXTERNAL SIZE (W x G + H)		WEIGHT Kg	DESCRIPTION	STORAGE WEIGHT	BOX QTY	ALL PRICES PER BOX			
	WIDTH x GUSSET +	HEIGHT (MM)					1+	3+	5+	10+
SUPK110	110 x 70	170	0.5	200-250ml	50g-70g	100	29.32	26.65	21.78	16.90
SUPK130	130 x 80	210	0.7	450-500ml	150g-200g	100	39.11	31.55	24.25	21.82
SUPK160	160 x 90	230	1.0	700-900ml	250g-400g	100	46.49	38.93	29.18	25.54
SUPK180	180 x 100	260	1.3	1.3-1.4Litre	500g	100	56.31	42.91	31.94	28.28



Viva White

Film Structure:

MATT FINISH BOPP 15 MIC // Adhesive // MET-PET 12 MIC // Adhesive // LLDPE 80 MIC

The Viva White range has a Matt finish on the outside and a foil layer on the inside which provides a high moisture barrier.

Commodity Code: 3923210000

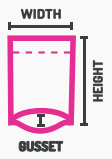

388 GAUGE

CODE	EXTERNAL SIZE (W x G + H)		WEIGHT Kg	DESCRIPTION	STORAGE WEIGHT	BOX QTY	ALL PRICES PER BOX			
	WIDTH x GUSSET +	HEIGHT (MM)					1+	3+	5+	10+
SUPVW110	110 x 70	170	0.6	200-250ml	50g-70g	100	29.34	24.48	19.62	14.73
SUPVW120	120 x 80	200	0.7	325-360ml	100g-135g	100	39.13	29.38	22.09	19.65
SUPVW160	160 x 90	230	1.1	700-900ml	250g-400g	100	46.52	36.77	27.02	23.37
SUPVW190	190 x 100	260	1.5	1.3-1.4Litre	500g	100	56.36	42.96	32.00	28.34
SUPVW235	235 x 110	335	2.4	2.8-3.3Litre	1000g	100	67.51	55.33	41.91	37.04



White Paper + Window

Film Structure:

60 GSM Kraft Paper // Adhesive // PET 12 MIC // Adhesive // LLDPE 50 MIC

Our natural White Paper range have a full transparent rectangle window across the front. Pouches can also be written on.

Commodity Code: 4817100000

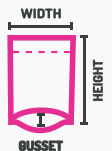

CODE	EXTERNAL SIZE (W x G + H)		WEIGHT Kg	DESCRIPTION	STORAGE WEIGHT	BOX QTY	ALL PRICES PER BOX			
	WIDTH x GUSSET +	HEIGHT (MM)					1+	3+	5+	10+
SUPWP110	110 x 70	170	0.7	200-250ml	50g-70g	100	29.34	24.48	19.62	14.73
SUPWP120	120 x 80	200	0.9	325-360ml	100g-135g	100	39.13	29.38	22.09	19.65
SUPWP160	160 x 90	230	1.3	700-900ml	250g-400g	100	46.52	36.77	27.02	23.37
SUPWP190	190 x 100	260	1.9	1.3-1.4Litre	500g	100	56.36	42.96	32.00	28.34
SUPWP235	235 x 110	345	2.9	2.8-3.3Litre	1000g	100	67.51	55.33	41.91	37.04



Pouches (multi-layered films) are not usually accepted in domestic recycling collections as they are difficult to recycle. However, difficult-to-recycle items may be collected by other organisations. Please check www.recyclenow.com for more information.



HEAT SEALABLE

Our stand-up pouches have a grip seal resealable strip allowing the pouch to be resealed after the initial opening which helps preserve the freshness of the contents. The header is also heat sealable with a standard heat-sealer. The pouches are perfect for manually filling most semi-wet and dry food products such as confectionery, cereals, tea, coffee, pet food, dried fruits.

*See page 145



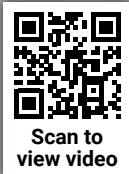

Scan to
view video

CC1013250

CB15183SILVSTK

VCSTRIP1

CB81210PAPBR

CARRIER BAGS

From carrying your takeaway or designer clothes and perfumes, PB Group carriers are well equipped for the demanding retail sector. What's on the bag is sometimes more important than what's inside - we offer a printed solution to promote your brand or a particular message. We can custom print carriers ensuring your brand or message stands out from the crowd when walking down the high street or visiting a trade show.

PB Group provides you with the widest range of economy stocked vest carrier bags at bulk trade prices. These include ultra thin high density, supergrade strength, coloured, degradable, recycled and on a roll carriers.



Vest Carrier - White

Commodity Code: 3923210000



CODE	SIZE (WIDTH CLOSED/OPEN) x HEIGHT		THICKNESS MICRON	WEIGHT Kg	DESCRIPTION	BOX QTY	ALL PRICES PER BOX			
	INCHES	MM					1+	5+	10+	25+
CB101518	10/15 x 18	254/381 x 457	8	5.2	Medium	2000	28.21	25.77	22.75	20.80
CB111721	10/17 x 21	279/432 x 533	9	7.8	Large	2000	38.88	37.07	35.88	34.86
VCSUP3	11/17 x 21	279/432 x 533	13	11.2	Large	2000	51.32	46.20	43.34	40.63
VCSUP5	13/19 x 23	330/483 x 584	18	8.0	X-Large	1000	45.70	38.40	33.20	31.34



Supreme Hi-Tensile Vest Carrier - White

Commodity Code: 3923210000

PACKAGING TAX EXEMPT

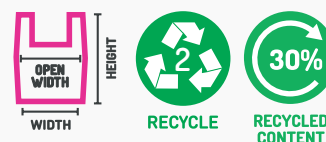

CODE	SIZE (WIDTH CLOSED/OPEN) x HEIGHT		THICKNESS MICRON	WEIGHT Kg	DESCRIPTION	BOX QTY	ALL PRICES PER BOX			
	INCHES	MM					1+	5+	10+	25+
VCHT1	10/15 x 18	254/381 x 457	14	8.2	Medium	2000	41.14	36.24	31.23	28.94
VCHT3	11/17 x 21	279/432 x 533	18	5.6	Large	1000	35.22	30.14	25.80	22.70
VCHT4	11/17 x 21	279/432 x 533	23	8.0	Large	1000	43.21	35.66	30.24	26.97
VCHT5	13/19 x 23	330/483 x 584	22	9.8	X-Large	1000	52.28	45.99	39.72	35.12
VCHT6	13/19 x 23	330/483 x 584	28	12.8	X-Large	1000	64.29	57.82	52.78	47.84



Vest Carrier - Candy Striped

Commodity Code: 3923210000

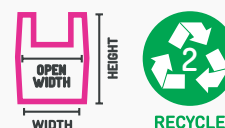

CODE	SIZE (WIDTH CLOSED/OPEN) x HEIGHT		THICKNESS MICRON	WEIGHT Kg	DESCRIPTION	BOX QTY	ALL PRICES PER BOX			
	INCHES	MM					1+	5+	10+	25+
VCSTRIP5	11/17 x 21	279/432 x 533	10	8.6	Large	2000	57.37	50.63	45.86	41.12



Bespoke / personalised 'Vest Style' carrier bags are available with a minimum order quantity of 200,000 bags.

Contact us at sales@pbgroup.co.uk for further information.



Degradable Vest - White

Degradable vest carriers are printed with a declaration that the bag is 100% degradable.

Commodity Code: 3923210000

PACKAGING TAX EXEMPT

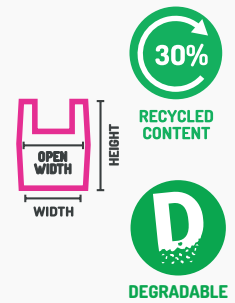

CODE	SIZE (WIDTH CLOSED/OPEN) x HEIGHT		THICKNESS MICRON	WEIGHT Kg	DESCRIPTION	BOX QTY	ALL PRICES PER BOX			
	INCHES	MM					1+	5+	10+	25+
VCECO1	10/15 x 18	254/381 x 457	10	11.2	Medium	2000	45.97	43.81	40.30	38.78
VCECO3	11/17 x 21	279/432 x 533	16	13.8	Large	2000	66.74	59.74	57.02	54.41



Recycled Vest - Blue

Commodity Code: 3923210000

PACKAGING TAX EXEMPT



CODE	SIZE (WIDTH CLOSED/OPEN) x HEIGHT		THICKNESS MICRON	WEIGHT Kg	DESCRIPTION	BOX QTY	ALL PRICES PER BOX			
	INCHES	MM					1+	5+	10+	25+
VCGAL21	11/17 x 21	279/432 x 533	20	15.7	Large : LD	2000	56.92	51.46	50.22	48.23
VCGAL24	12/18 x 24	305/457 x 609	23	9.3	X-Large : LD	1000	37.73	35.61	33.73	32.14
VCSAP21	11/17 x 21	279/432 x 533	24	8.7	Large : MDPE	1000	37.79	33.26	32.30	31.54

* Due to the manufacturing processes used with recycled content material, small impurities within the structure of the polythene may be visible. These minor impurities do not affect the overall performance of the material.



Vest on a Roll

250 Bags per roll.

Commodity Code: 3923210000

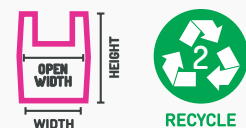

CODE	SIZE (WIDTH CLOSED/OPEN) x HEIGHT		THICKNESS MICRON	WEIGHT Kg	DESCRIPTION	BOX QTY	ALL PRICES PER BOX			
	INCHES	MM					1+	5+	10+	25+
VROLL1	9/14 x 18	228/356 x 457	10	11.0	Small	5000	61.15	54.89	51.84	49.05



Compostable Vest Carriers

- Secondary use as a food waste bin liner.
- 100% biodegradable & compostable material conforms to EN 13432.
- Organic recycling only, do not put this bag in your recycling. If you are unable to dispose of it in a compost heap or organic waste bin, please put in your domestic waste.



Commodity Code: 3923210000

CODE	SIZE (WIDTH CLOSED/ OPEN) X HEIGHT MM	THICKNESS MICRON	WEIGHT Kg	DESCRIPTION	BOX QTY	ALL PRICES PER BOX			
						1+	5+	10+	25+
VCOMP1	270/410 x 480	17	3.8	White - Medium	500	55.13	51.26	47.31	44.26
VCOMP3	300/480 x 580	19	3.6	White - Large	300	53.38	50.24	45.70	42.98
VCOMP5	300/480 x 580	28	3.7	Green - Maxi	200	49.68	45.41	42.43	38.97
VCOMP5CLR	300/480 x 580	30	9.5	Clear/Frosted - Maxi	500	94.83	89.26	84.62	80.90
VCOMP5BLK	300/480 x 580	30	10.5	Black - Maxi	500	98.32	92.55	87.75	83.90
VCOMP5GRN	300/480 x 580	30	9.5	Green - Maxi	500	98.11	92.34	87.54	83.69



Compostable Food Bags on a Roll

- Secondary use as a food waste bin liner.
- 100% biodegradable & compostable material conforms to EN 13432.
- Organic recycling only, do not put this bag in your recycling. If you are unable to dispose of it in a compost heap or organic waste bin, please put in your domestic waste.



Commodity Code: 3923210000

CODE	SIZE (WIDTH CLOSED/ OPEN) X HEIGHT MM	THICKNESS MICRON	WEIGHT Kg	DESCRIPTION	BOX QTY	ALL PRICES PER BOX			
						1+	2+	6+	10+
VCROLL2	220/340 x 500	12	5.6	200 bags per roll, 6 per box	1200	55.77	48.48	45.56	43.67

ECO FRIENDLY CARRIERS



SHOPPING BAG



SECONDARY USE



FOOD WASTE LINER



Kraft Paper Carriers

Commodity Code: 4817100000



CODE	SIZE (BASE SIZE + HEIGHT)		THICKNESS GSM	WEIGHT Kg	DESCRIPTION	BOX QTY	ALL PRICES PER BOX			
	W x G MM	HEIGHT MM					1+	5+	10+	25+
PAPKB1	240 x 110	310	110	6.0	Black : Medium	150	51.70	39.76	36.15	31.97
PAPKB2	320 x 140	420	110	8.1	Black : Large	150	55.89	44.44	40.00	36.22
PAPKG1	240 x 110	310	110	6.0	Green : Medium	150	51.70	39.76	36.15	31.97
PAPKG2	320 x 140	420	110	8.1	Green : Large	150	55.89	44.44	40.00	36.22
PAPKP1	240 x 110	310	110	6.0	Pale Pink : Medium	150	51.70	39.76	36.15	31.97
PAPKP2	320 x 140	420	110	8.1	Pale Pink : Large	150	55.89	44.44	40.00	36.22
PAPKN1	230 x 90	310	90	5.0	Natural Brown : Small	125	38.22	35.44	32.85	28.51
PAPKN2	260 x 120	350	90	5.8	Natural Brown : Medium	125	40.46	38.56	35.54	32.01
PAPKN3	320 x 140	410	90	6.8	Natural Brown : Large	125	42.46	40.44	36.76	34.82
PAPCBXBR	450 x 170	470	100	2.9	Natural Brown : XLarge	125	47.50	44.06	41.24	37.35



Gift Bags - 2 Tone Black & White

Commodity Code: 4817100000



CODE	SIZE (BASE SIZE + HEIGHT)		THICKNESS GSM	WEIGHT Kg	DESCRIPTION	BOX QTY	ALL PRICES PER BOX			
	W x G MM	HEIGHT MM					1+	5+	10+	25+
CB2T01	240 x 80	180	170	0.6	Small	12	14.79	13.37	12.43	11.08
CB2T02	360 x 120	280	170	1.3	Medium	12	18.23	16.47	15.44	14.83
CB2T03	440 x 100	320	170	1.6	Large	12	19.71	18.44	17.50	16.85



Block Bottom Take Away Paper Carriers

With square bottoms so that the bags can sit open whilst being filled.

Commodity Code: 4817100000

PACKAGING TAX EXEMPT



CODE	SIZE (BASE SIZE + HEIGHT)		THICKNESS GSM	WEIGHT Kg	DESCRIPTION	BOX QTY	ALL PRICES PER BOX			
	W x G MM	HEIGHT MM					1+	5+	10+	25+
CB7108PAPWH	175 x 75	215	70	3.8	White : Small	250	23.73	19.58	16.70	15.85
CB7108PAPBR	175 x 75	215	70	3.7	Brown : Small	250	22.52	18.36	15.48	14.62
CB81210PAPWH	215 x 110	250	80	4.7	White : Medium	250	33.93	27.54	25.62	23.28
CB81210PAPBR	215 x 110	250	80	4.7	Brown : Medium	250	32.27	25.87	23.00	20.47
CB101512PAPWH	250 x 125	300	80	4.3	White : Large	250	38.12	32.39	28.54	26.19
CB101512PAPBR	250 x 125	300	80	8.7	Brown : Large	250	35.35	28.97	25.78	23.44

PREPRINTED TWIST HANDLE CARRIERS

Tasty Food Designs



CBPTB99TAS1



CBPTB99TAS2

Treat Yourself Design



CBPTB99TRE1



LIMITED STOCK

CODE	SIZE (BASE SIZE + HEIGHT)		THICKNESS GSM	WEIGHT Kg	DESCRIPTION	BOX QTY	ALL PRICES PER BOX 1+
	W x G MM	HEIGHT MM					
CBPTB99TAS1	255 x 140	315	75	3.1	Brown - Tasty Food (Red print)	100	59.95
CBPTB99TAS2					Brown - Tasty Food (Black print)		
CBPTB99TRE1					Brown - Treat Yourself	100	54.95



CONTACT US TO DISCUSS USING YOUR OWN DESIGN



- 5 size options
- Available in white & brown kraft paper
- Low minimum order quantity (100 units)
- FSC® certified: Made from responsibly forested materials
- White labelled boxing option available
- Carriers are fully recyclable
- 'One-Off' printed sample service available

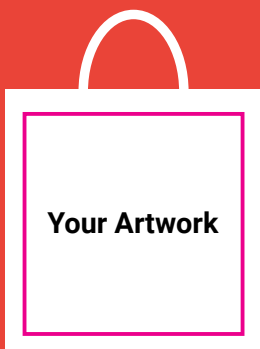

Not quite sure? Try our 'Unique Printed Sample' (UPS) with your own design to see the exceptional print quality firsthand? Pay £25 + VAT for a one off sample with your artwork printed on 1 side. The best part is that the sample fee is refundable after your first order with us. (Conditions apply)

Just speak to one of our print advisors to find out more.

How to Create Your Personalised Carrier

1. Bag Size (5 Sizes)
2. Bag Colour (Brown or White)
3. Print Sides (1 or 2)
4. Print Colours (1 Colour or Multicolour)
5. Email your Design to Us
6. Quantity (100 - 2000+)
7. Approve Your Artwork
8. Delivery 7-10 Days After Approval

STOCK CODE + COLOUR	BAG WEIGHT (Grams)	BAG SIZE (W x H + G) MM	MAX PRINT AREA EACH SIDE (W x H)	ORDER QTY	UNIT PRICE £		UNIT PRICE £	
					PRINT 1 SIDE ONLY		PRINT BOTH SIDES	
				1 COLOUR		MULTICOLOUR		
Small Carrier (Maximum Carrying Weight 6kg)								
CBPTB02 (Brown 80gsm)	22g	190 x 210 + 80mm	Front - 150 x 150mm Back - 150 x 95mm	100	£0.87	£0.99	£1.08	£1.19
				300	£0.54	£0.61	£0.67	£0.74
				500	£0.44	£0.50	£0.55	£0.61
				1,000	£0.38	£0.44	£0.48	£0.52
				2,000	£0.35	£0.40	£0.43	£0.48
CBPTW02 (White 80gsm)	22g	190 x 210 + 80mm	Front - 150 x 150mm Back - 150 x 95mm	100	£0.89	£1.02	£1.10	£1.23
				300	£0.55	£0.63	£0.68	£0.76
				500	£0.45	£0.52	£0.56	£0.63
				1,000	£0.39	£0.45	£0.48	£0.54
				2,000	£0.36	£0.41	£0.44	£0.49
Medium Carrier (Maximum Carrying Weight 10kg)								
CBPTB04 (Brown 100gsm)	40g	240 x 310 + 110mm	Front - 200 x 240mm Back - 200 x 155mm	100	£0.92	£1.04	£1.15	£1.26
				300	£0.57	£0.64	£0.71	£0.78
				500	£0.47	£0.53	£0.59	£0.64
				1,000	£0.40	£0.46	£0.51	£0.55
				2,000	£0.37	£0.42	£0.46	£0.50
CBPTW04 (White 100gsm)	40g	240 x 310 + 110mm	Front - 200 x 240mm Back - 200 x 155mm	100	£0.94	£1.06	£1.18	£1.28
				300	£0.58	£0.66	£0.73	£0.79
				500	£0.48	£0.54	£0.60	£0.65
				1,000	£0.41	£0.47	£0.52	£0.56
				2,000	£0.38	£0.42	£0.47	£0.51
Large Carrier (Maximum Carrying Weight 10kg)								
CBPTB06 (Brown 100gsm)	60g	320 x 420 + 140mm	Front - 275 x 290mm Back - 275 x 175mm	100	£1.04	£1.14	£1.22	£1.34
				300	£0.64	£0.71	£0.76	£0.83
				500	£0.53	£0.58	£0.62	£0.68
				1,000	£0.46	£0.50	£0.54	£0.59
				2,000	£0.42	£0.46	£0.49	£0.54
CBPTW06 (White 100gsm)	60g	320 x 420 + 140mm	Front - 275 x 290mm Back - 275 x 175mm	100	£1.08	£1.18	£1.26	£1.38
				300	£0.67	£0.73	£0.78	£0.86
				500	£0.55	£0.60	£0.64	£0.70
				1,000	£0.48	£0.52	£0.55	£0.61
				2,000	£0.43	£0.47	£0.50	£0.55
Extra Large Carrier (Maximum Carrying Weight 10kg)								
CBPTB08 (Brown 100gsm)	75g	400 x 450 + 160mm	Front - 360 x 290mm Back - 360 x 185mm	100	£1.11	£1.28	£1.36	£1.44
				300	£0.69	£0.79	£0.84	£0.89
				500	£0.57	£0.65	£0.69	£0.73
				1,000	£0.49	£0.56	£0.60	£0.63
				2,000	£0.44	£0.51	£0.54	£0.58
CBPTW08 (White 100gsm)	75g	400 x 450 + 160mm	Front - 360 x 290mm Back - 360 x 185mm	100	£1.14	£1.32	£1.40	£1.50
				300	£0.71	£0.82	£0.87	£0.93
				500	£0.58	£0.67	£0.71	£0.77
				1,000	£0.50	£0.58	£0.62	£0.66
				2,000	£0.46	£0.53	£0.56	£0.60
Bottle Carrier (Maximum Carrying Weight 6kg)								
CBPTB10 (Brown 120gsm)	40g	180 x 390 + 80mm	Front - 140 x 280mm Back - 140 x 220mm	100	£0.92	£1.04	£1.15	£1.26
				300	£0.57	£0.64	£0.71	£0.78
				500	£0.47	£0.53	£0.59	£0.64
				1,000	£0.40	£0.46	£0.51	£0.55
				2,000	£0.37	£0.42	£0.46	£0.50
CBPTW10 (White 100gsm)	38g	180 x 390 + 80mm	Front - 140 x 280mm Back - 140 x 220mm	100	£0.94	£1.06	£1.18	£1.28
				300	£0.58	£0.66	£0.73	£0.79
				500	£0.48	£0.54	£0.60	£0.65
				1,000	£0.41	£0.47	£0.52	£0.56
				2,000	£0.38	£0.42	£0.47	£0.51



RECYCLE



RECYCLED CONTENT

All made from recyclable material.

Mini



CODE	INKS	BAG COLOUR	WIDTH x LENGTH	ALL PRICE PER BAG				APPROX. PLATE COST
				1,000	3,000	5,000	10,000	
C11	1 Ink	White or Clear	200mm x 250mm	14p	11p	9p	6p	£85
C12	2 Inks			20p	15p	13p	10p	£115
C13	3 Inks			30p	24p	19p	16p	£205
C17	1 Ink	Coloured		21p	18p	16p	13p	£85

*Plate costs are subject to sight of artwork.

Small



CODE	INKS	BAG COLOUR	WIDTH x LENGTH	ALL PRICE PER BAG				APPROX. PLATE COST
				1,000	3,000	5,000	10,000	
C21	1 Ink	White or Clear	250mm x 350mm + 80mm gusset	15p	12p	10p	7p	£105
C22	2 Inks			23p	18p	16p	13p	£140
C23	3 Inks			33p	27p	23p	19p	£225
C27	1 Ink	Coloured		22p	19p	17p	14p	£105

Standard



CODE	INKS	BAG COLOUR	WIDTH x LENGTH	ALL PRICE PER BAG				APPROX. PLATE COST
				1,000	3,000	5,000	10,000	
C31	1 Ink	White or Clear	360mm x 400mm + 90mm gusset	20p	13p	11p	8p	£120
C32	2 Inks			24p	20p	18p	15p	£150
C33	3 Inks			36p	30p	25p	22p	£235
C37	1 Ink	Coloured		23p	20p	18p	15p	£120

Large



CODE	INKS	BAG COLOUR	WIDTH x LENGTH	ALL PRICE PER BAG				APPROX. PLATE COST
				1,000	3,000	5,000	10,000	
C51	1 Ink	White or Clear	500mm x 400mm + 90mm gusset	22p	19p	17p	14p	£130
C52	2 Inks			28p	24p	22p	19p	£195
C53	3 Inks			40p	34p	29p	26p	£320
C57	1 Ink	Coloured		29p	26p	24p	21p	£130

*All above prices are for printing on both sides of a 55 micron bag .

FREE SAMPLE

Just send us your address and we will post you a sample pack so you can see the different bags available.

More sizes available. Contact us for details.

*The surface imperfections in recycled content polythene may cause less adhesion to certain print inks. Please check with our sales team for further information.

How do I create a personalised Carrier Bag ?

Simply send us over your design with your order. If you're unsure over what might be the best choice for your design just pick up the phone and our friendly team will be happy to discuss the best personalised solution for you. All we need to know are.

- Quantity required
- Size(s)
- Number of colours of your artwork

4 Simple Steps to print your personalised carrier bag

1



Send us your artwork. (We need a high quality resolution file of at least 300dpi.)

3



When you have approved the design we make your unique printing plates. Your bags will now be manufactured.

2



Paper Carrier

Polythene Carrier

We send you a PDF of what your artwork will look like on the carrier bags for your approval

4



Delivery within **3 weeks** of approving artwork.



Small Clear & Colours

Commodity Code: 3923210000

PACKAGING TAX **EXEMPT**

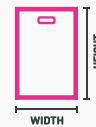

CODE	SIZE (WIDTH x HEIGHT)		THICKNESS MICRON	WEIGHT Kg	DESCRIPTION	BOX QTY	ALL PRICES PER BOX			
	INCHES	MM					1+	5+	10+	25+
CB812BLACKSTK	8 x 12	200 x 300	40	5.2	Black	1000	31.82	28.33	25.03	23.95
CB812BLUSTK	8 x 12	200 x 300	40	5.2	Blue	1000	31.82	28.33	25.03	23.95
CB812BURGSTK	8 x 12	200 x 300	40	5.2	Burgundy	1000	31.82	28.33	25.03	23.95
CB812CLEARSTK	8 x 12	200 x 300	40	5.2	Clear	1000	33.08	28.33	25.03	23.95
CB812GOLDSTK	8 x 12	200 x 300	40	5.2	Gold	1000	31.82	28.33	25.03	23.95
CB812LIGHTBLSTK	8 x 12	200 x 300	40	5.2	Light Blue	1000	31.82	28.33	25.03	23.95
CB812PINKSTK	8 x 12	200 x 300	40	5.2	Baby Pink	1000	31.82	28.33	25.03	23.95
CB812SILVSTK	8 x 12	200 x 300	40	5.2	Silver	1000	31.82	28.33	25.03	23.95
CB812WHTSTK	8 x 12	200 x 300	40	5.2	White	1000	29.10	24.54	22.86	21.76
CB812YELSTK	8 x 12	200 x 300	40	5.2	Yellow	1000	31.82	28.33	25.03	23.95



Medium Clear & Colours

Commodity Code: 3923210000

PACKAGING TAX **EXEMPT**

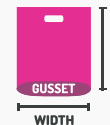

CODE	SIZE (WIDTH x HEIGHT + GUSSET)		THICKNESS MICRON	WEIGHT Kg	DESCRIPTION	BOX QTY	ALL PRICES PER BOX			
	INCHES	MM					1+	5+	10+	25+
Patch Handle										
CB10124WHTPATCH	10 x 12 + 4	250 x 300 + 100	30	6.0	White	1000	38.00	31.78	29.46	28.01
CB12124WHTPATCH	12 x 12 + 4	300 x 300 + 100	30	7.5	White	1000	40.64	33.47	29.44	28.56
CB15183CLRPATCH	15 x 18 + 3	375 x 450 + 75	30	5.8	Clear	500	39.67	30.76	26.96	24.66
CB15183WHTPATCH	15 x 18 + 3	375 x 450 + 75	35	6.5	White	500	40.02	31.11	28.34	27.82
CB16184WHTPATCH	16 x 18 + 4	400 x 450 + 100	30	8.7	White	500	42.20	37.10	33.06	31.44
CB15183BLACKSTK	15 x 18 + 3	375 x 450 + 75	55	6.5	Black	500	51.64	42.77	37.33	34.74
CB15183BLUSTK	15 x 18 + 3	375 x 450 + 75	55	6.5	Blue	500	51.96	43.09	37.64	36.10
CB15183BURGSTK	15 x 18 + 3	375 x 450 + 75	55	6.5	Burgundy	500	51.64	42.77	38.37	36.82
CB15183CLEARSTK	15 x 18 + 3	375 x 450 + 75	55	6.5	Clear	500	52.59	43.72	38.28	35.69
CB15183GOLDSTK	15 x 18 + 3	375 x 450 + 75	55	6.5	Gold	500	51.64	43.84	39.48	36.88
CB15183HARGRSTK	15 x 18 + 3	375 x 450 + 75	55	6.5	Harrods Green	500	52.22	43.34	37.91	36.36
CB15183LGBLUSTK	15 x 18 + 3	375 x 450 + 75	55	6.5	Light Blue	500	51.64	42.77	37.33	34.74
CB15183PINKSTK	15 x 18 + 3	375 x 450 + 75	55	6.5	Baby Pink	500	51.64	42.77	37.33	34.74
CB15183REDSTK	15 x 18 + 3	375 x 450 + 75	55	6.5	Red	500	51.45	42.57	37.13	34.55
CB15183SILVSTK	15 x 18 + 3	375 x 450 + 75	55	6.5	Silver	500	51.52	42.66	37.19	34.62
CB15183WHTSTK	15 x 18 + 3	375 x 450 + 75	35/70	6.5	White	500	51.32	42.46	37.02	34.43
CB15183YELSTK	15 x 18 + 3	375 x 450 + 75	35/70	6.5	Yellow	500	51.45	42.58	37.13	34.55



Large Clear & Colours

Commodity Code: 3923210000

PACKAGING TAX **EXEMPT**



CODE	SIZE (WIDTH x HEIGHT + GUSSET)		THICKNESS MICRON	WEIGHT Kg	DESCRIPTION	BOX QTY	ALL PRICES PER BOX			
	INCHES	MM					1+	5+	10+	25+
Patch Handle										
CB22183CLRPATCH	22 x 18 + 3	550 x 450 + 75	30	9.8	Clear	500	54.14	42.83	37.45	33.26
CB22183WHTPATCH	22 x 18 + 3	550 x 450 + 75	35	9.8	White	500	62.59	50.02	43.78	38.76
CB22183BLACKSTK	22 x 18 + 3	550 x 450 + 75	55	10.9	Black	500	67.46	56.74	49.48	46.64
CB22183BLUSTK	22 x 18 + 3	550 x 450 + 75	55	10.9	Blue	500	67.46	56.74	49.48	46.64
CB22183BURGSTK	22 x 18 + 3	550 x 450 + 75	55	10.9	Burgundy	500	67.46	56.74	49.48	46.64
CB22183GOLDSTK	22 x 18 + 3	550 x 450 + 75	55	10.9	Gold	500	67.14	56.44	51.24	48.91
CB22183PINKSTK	22 x 18 + 3	550 x 450 + 75	55	10.6	Baby Pink	500	67.46	56.74	49.48	46.89
CB22183SILVSTK	22 x 18 + 3	550 x 450 + 75	55	10.6	Silver	500	65.57	54.86	47.57	45.93
CB22183WHTSTK	22 x 18 + 3	550 x 450 + 75	55	11.0	White	500	68.09	57.38	50.11	46.10



Flexiloop White

The reinforced flexi loop handles allow full bag usage whilst the strong handle is comfortable to hold when carrying heavier items.

Commodity Code: 3923210000

PACKAGING TAX **EXEMPT**

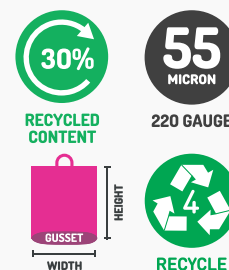

CODE	SIZE (WIDTH x HEIGHT + GUSSET)		THICKNESS MICRON	WEIGHT Kg	DESCRIPTION	BOX QTY	ALL PRICES PER BOX			
	INCHES	MM					1+	5+	10+	25+
FLEX15183WHITE	15 x 18 + 3	375 x 450 + 75	55	10.5	Medium	500	71.32	60.33	55.05	50.96
FLEX24204WHITE	24 x 20 + 4	600 x 500 + 100	55	7.6	Large	200	55.45	43.37	37.04	31.86
FLEX28244WHITE	28 x 24 + 4	700 x 600 + 100	55	10.4	X-Large	200	70.17	59.17	52.84	49.87
FLEX35244WHITE	35 x 24 + 4	890 x 600 + 100	55	12.8	X-Large	200	76.27	66.32	58.93	52.67
FLEX42244WHITE	42 x 24 + 4	1050 x 600 + 100	55	15.0	XX-Large	200	81.58	68.34	62.11	58.03



Extra Large White

Perfect for extra large toys, train sets, bedding and other bulky items.

Commodity Code: 3923210000

PACKAGING TAX **EXEMPT**

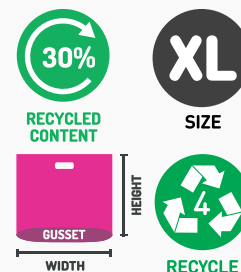

CODE	SIZE (WIDTH x HEIGHT + GUSSET)		THICKNESS MICRON	WEIGHT Kg	DESCRIPTION	BOX QTY	ALL PRICES PER BOX			
	INCHES	MM					1+	5+	10+	25+
CB28244WHTSTK	28 x 24 + 4	710 x 600 + 100	45/90	12.1	X-Large - Varigauge	250	78.85	69.03	60.97	57.46
CB28244WHTPATCH	28 x 24 + 4	710 x 600 + 100	35	12.1	X-Large	250	54.97	43.52	38.08	33.68
CB35244WHTPATCH	35 x 24 + 4	890 x 600 + 100	50	11.9	X-Large	200	66.89	54.57	48.12	43.87
CB42244WHTPATCH	42 x 24 + 4	1060 x 600 + 100	50	14.2	XX-Large	200	77.90	66.35	61.00	55.73
CB54244WHTPATCH	54 x 24 + 4	1370 x 600 + 100	50	9.1	XXX-Large	100	63.58	52.38	45.92	39.56



I'm Green Carrier

Commodity Code: 3923210000



RECYCLE



RENEWABLE SOURCE

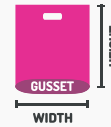

CODE	SIZE (WIDTH x HEIGHT) + GUSSET MM	THICKNESS MICRON	WEIGHT Kg	DESCRIPTION	BOX QTY	ALL PRICES PER BOX			
						1+	5+	10+	25+
CBSUST1CLR	200 x 300	55	4.5	Small	500	56.61	52.57	48.53	43.99
CBSUST4CLR	375 x 450 + 90	55	4.8	Medium	250	48.63	46.19	42.72	37.76
CBSUST4WHT	375 x 450 + 90	55	4.8	Medium - White	250	50.80	48.19	44.54	39.39
CBSUST5CLR	550 x 450 + 100	55	7.0	Large	250	56.68	52.68	48.67	44.18



Compostable Carrier - Clear

- 100% biodegradable & compostable material conforms to EN 13432.
- Organic recycling only, do not put this bag in your recycling.
- If you are unable to dispose of it in a compost heap or organic waste bin, please put in your domestic waste.

Commodity Code: 3923210000



COMPOSTABLE



RENEWABLE SOURCE



CODE	SIZE (WIDTH x HEIGHT) + GUSSET MM	THICKNESS MICRON	WEIGHT Kg	DESCRIPTION	BOX QTY	ALL PRICES PER BOX			
						1+	5+	10+	25+
CBCCLR1	200 x 300	60	4.5	Small	500	51.40	47.36	43.33	38.79
CBCCLR4	375 x 450 + 90	60	6.4	Medium	200	44.81	41.33	37.86	33.94

*Our Clear Compostable material has a slight frosted clarity in appearance when compared to traditional polythene.



Compostable Carrier - Ivory

- 100% biodegradable & compostable material conforms to EN 13432.
- Organic recycling only, do not put this bag in your recycling.
- If you are unable to dispose of it in a compost heap or organic waste bin, please put in your domestic waste.

Commodity Code: 3923210000



COMPOSTABLE



RENEWABLE SOURCE



CODE	SIZE (WIDTH x HEIGHT) + GUSSET MM	THICKNESS MICRON	WEIGHT Kg	DESCRIPTION	BOX QTY	ALL PRICES PER BOX			
						1+	5+	10+	25+
CBCNAT1	200 x 300	60	4.5	Small	500	51.40	47.36	43.33	38.79
CBCNAT4	375 x 450 + 90	60	6.4	Medium	200	44.81	41.33	37.86	33.94



Compostable Carrier - Green

- 100% biodegradable & compostable material conforms to EN 13432.
- Organic recycling only, do not put this bag in your recycling.
- If you are unable to dispose of it in a compost heap or organic waste bin, please put in your domestic waste.

Commodity Code: 3923210000

COMPOSTABLE
RENEWABLE SOURCE
60 MICRON
240 GAUGE

CODE	SIZE (WIDTH x HEIGHT) + GUSSET MM	THICKNESS MICRON	WEIGHT Kg	DESCRIPTION	BOX QTY	ALL PRICES PER BOX			
						1+	5+	10+	25+
CBCGRN4	375 x 450 + 90	60	6.4	Medium	200	50.25	46.33	42.42	38.02



Biodegradable Clear

Commodity Code: 3923210000

47.5 MICRON
190 GAUGE
BIODEGRADABLE

CODE	SIZE (WIDTH x HEIGHT + GUSSET) MM	THICKNESS MICRON	WEIGHT Kg	DESCRIPTION	BOX QTY	ALL PRICES PER BOX			
						1+	5+	10+	25+
CBECOC1	375 x 450 + 75	47.5	9.8	Clear	500	58.40	48.10	44.49	41.40
CBECOC2	375 x 450 + 75	47.5	4.5	Printed Leaf Logo	250	33.56	25.25	23.23	21.50
CBECOC3	400 x 450 + 75	47.5	3.1	Clear	250	34.76	26.24	24.12	22.28
CBECOC5	550 x 450 + 100	47.5	5.4	Clear	200	35.35	26.47	24.19	23.31



Biodegradable + 30% Recycled Content

Commodity Code: 3923210000

PACKAGING TAX EXEMPT

50 MICRON
200 GAUGE
30% RECYCLED CONTENT
BIODEGRADABLE

CODE	SIZE (WIDTH x HEIGHT + GUSSET) MM	THICKNESS MICRON	WEIGHT Kg	DESCRIPTION	BOX QTY	ALL PRICES PER BOX			
						1+	5+	10+	25+
CBLOTCLR4	375 x 450 + 90	50	6.3	Clear + Printed text	300	46.79	44.45	42.11	39.77
CBLOTCLR5	550 x 450 + 100	50	6.2	Clear + Printed text	200	45.25	42.98	40.72	38.46
CBLOTWHT4	375 x 450 + 90	50	6.3	White - 100% Bio Print	300	51.47	48.89	46.32	43.75
CBLOTWHT5	550 x 450 + 100	50	6.2	White - 100% Bio Print	200	49.77	47.28	44.79	42.31



Biodegradable White

Commodity Code: 3923210000

PACKAGING TAX EXEMPT

47.5 MICRON
190 GAUGE
30% RECYCLED CONTENT
BIODEGRADABLE

CODE	SIZE (WIDTH x HEIGHT + GUSSET) MM	THICKNESS MICRON	WEIGHT Kg	DESCRIPTION	BOX QTY	ALL PRICES PER BOX			
						1+	5+	10+	25+
CBECOW1	375 x 450 + 75	47.5	9.1	Soon you Won't See Me' Logo	500	65.55	53.97	50.36	47.27
CBECOW5	550 x 450 + 100	47.5	7.0	Soon you Won't See Me' Logo	250	51.19	41.36	38.60	36.25



Extra Strong Black

Commodity Code: 3923210000

PACKAGING TAX EXEMPT

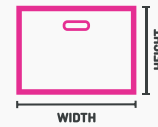

CODE	SIZE (WIDTH x HEIGHT) MM	THICKNESS MICRON	WEIGHT Kg	DESCRIPTION	BOX QTY	ALL PRICES PER BOX			
						1+	5+	10+	25+
CBHD812BLK	200 x 300	75	8.7	Small	1000	36.45	35.30	32.68	30.26
CBHDBOTBLK	230 x 460	75	8.4	Bottle Bag (Max 2)	500	38.56	34.15	29.67	28.35
CBHD1518BLK	375 x 450	75	14.3	Medium	500	51.88	47.33	44.61	41.36
CBHD2218BLK	550 x 450	75	11.0	Large	250	39.56	36.10	33.48	31.18
CBHD2824BLK	700 x 600	75	7.1	X-Large	100	29.06	23.34	19.54	18.41



Black/Gold Fashion

Black HDPE carriers with punched out handles printed with gold diagonal stripes.

Commodity Code: 3923210000

PACKAGING TAX EXEMPT



CODE	SIZE (WIDTH x HEIGHT) MM	THICKNESS MICRON	WEIGHT Kg	DESCRIPTION	BOX QTY	ALL PRICES PER BOX			
						1+	5+	10+	25+
CBFASH1	190 x 254	28	12.4	Mini	5000	72.11	69.70	67.28	65.93
CBFASH2	229 x 279	32	9.9	Small	2500	63.20	58.28	54.57	53.00
CBFASH3	375 x 450 + 75	38	12.4	Medium : 75mm Gusset	1000	65.93	64.18	62.58	61.54
CBFASH4	550 x 450 + 100	40	11.3	Large : 100mm Gusset	500	57.62	53.59	50.27	46.88



Long & Narrow Carriers

Wrapping paper, posters, wallpaper rolls.

Commodity Code: 3923210000

PACKAGING TAX EXEMPT

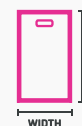

CODE	SIZE (WIDTH x HEIGHT) MM	THICKNESS MICRON	WEIGHT Kg	DESCRIPTION	BOX QTY	ALL PRICES PER BOX			
						1+	5+	10+	25+
CBWALLPAP4	825 x 400	50	10.1	Wide & Short	250	58.42	44.10	37.51	35.57
CBWRAP2	250 x 600	50	7.0	Narrow & Tall	500	53.12	43.40	38.10	35.53
CBWRAP4	250 x 950	50	11.1	Narrow & Tall	500	63.31	49.84	43.28	40.43



CBXRED4 - CBXGRN4



CBPTB99SEA1



CBPTB99SEA2

Seasonal Printed Carriers

PACKAGING TAX EXEMPT

Commodity Code: 3923210000

Paper Commodity Code: 4817100000

CODE	SIZE (WIDTH x HEIGHT)		THICKNESS MICRON	WEIGHT Kg	DESCRIPTION	BOX QTY	ALL PRICES PER BOX			
	MM						1+	5+	10+	25+
CBXGRN4	380 x 460 + 90		55	6.9	Medium : Season's Green Print	300	51.95	47.40	43.90	39.95
CBXRED4	380 x 460 + 90		55	6.9	Medium : Season's Red Print	300	51.95	47.40	43.90	39.95
CBXGRN5	500 x 400 + 90		55	5.2	Large : Season's Green Print	200	39.95	35.50	32.75	29.95
CBXRED5	500 x 400 + 90		55	5.2	Large : Season's Red Print	200	39.95	35.50	32.75	29.95

Paper Options

CODE	SIZE (BASE SIZE + HEIGHT)			THICKNESS GSM	WEIGHT Kg	DESCRIPTION	BOX QTY	ALL PRICES PER BOX	
	W x G	MM	HEIGHT MM					1+	25+
CBPTB99SEA1	255	x 140	315	75	3.1	Brown - Seasons Greetings (Holly design)	100	59.95	
CBPTB99SEA2	255	x 140	315	75	3.1	Brown - Seasons Greetings (Bauble design)	100	59.95	



Grip Seal Clear Carrier Bags

50-90 Micron

Our 'punch handle' grip seal carriers are manufactured from transparent polythene so the contents are visible which is ideal for security sensitive environments and are widely used in Airports & Duty Free retail.

Commodity Code: 3923210000

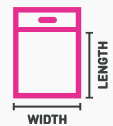

RECYCLE

CODE	INTERNAL SIZE (W x L)		THICKNESS MICRON	WEIGHT Kg	DESCRIPTION	BOX QTY	ALL PRICES PER BOX			
	MM						1+	5+	10+	25+
CBGRIP5	191 x 191		50	4.7	Airport Compliant	1000	49.95	41.42	33.77	29.95
CBGRIP10	200 x 320		90	7.7	Small	500	77.78	53.59	49.04	46.93
CBGRIP20	300 x 400		90	9.5	Medium	400	85.06	71.31	66.74	63.03
CBGRIP30	380 x 450		90	10.6	Large	300	86.40	74.88	69.27	65.03



Rigid Handle Clip Close - Clear

With integral white or black profile clip close fastening handle.

Commodity Code: 3923210000

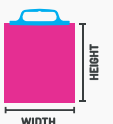

RECYCLE

CODE	SIZE (WIDTH x HEIGHT)		THICKNESS MICRON	WEIGHT Kg	DESCRIPTION	BOX QTY	ALL PRICES PER BOX			
	MM						1+	5+	10+	25+
CC79250	177 x 228		62.5	11.2	Mini	800	99.71	94.93	91.25	84.92
CC1013250	254 x 330		62.5	11.0	Small	500	113.79	107.09	103.68	97.98
CC1518300	381 x 457		75	7.2	Large	200	59.80	54.60	51.13	49.76
CC20184	500 x 450 + 100		70	2.3	X-Large + 100mm Gusset	50	50.33	47.49	43.61	40.10
CC24205	600 x 500 + 120		70	2.9	X-Large + 120mm Gusset	50	64.04	59.19	55.17	53.26

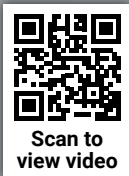

Scan to
view video

PAP6W

PAP10W

WHDP5

PREMIER
WHITE HDPE BAGS
WITH LIPS

OPEN HERE

FOR FOOD USE
200MM X 350MM - 8 X 10 1/2 APPROX
1000 AVERAGE CONTENTS

GRANNY3

PRODUCE & PAPER BAGS

PB Group are also a large stockist of paper bags and carriers where an alternative to polythene is required. These ranges have minimal environmental impact so whether carrying that Saturday takeaway or keeping coffee beans fresh, our storage and carrying products are simple and cost effective.



White High Density Counter (Food) Bags

Supplied in dispenser packs for easy use and to protect remaining bags from contamination. 1000 per dispenser pack.

Commodity Code: 3923210000

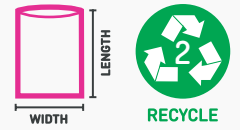

CODE	SIZE (WIDTH x LENGTH) MM	THICKNESS MICRON	WEIGHT Kg	DESCRIPTION	BOX QTY	ALL PRICES PER BOX			
						1+	5+	10+	25+
WHD68	150 x 200	10	4.6	Small	10000	36.26	32.78	29.83	27.89
WHD810	200 x 250	7	6.6	Medium	10000	46.07	40.40	35.73	32.77
WHD1012	250 x 300	7	9.0	Medium	10000	58.80	51.73	44.85	40.75
WHD1215	300 x 375	7	7.4	Large	5000	52.08	44.86	39.65	36.37
WHD1218	300 x 450	7	11.5	X-Large	5000	54.51	46.14	39.96	36.12
WHDP5	250 x 300	11	15.5	Medium	10000	85.74	69.80	59.30	52.85
WHDP7	300 x 375	11	11.6	Large	5000	69.24	56.33	48.36	43.44



Produce (Granny) Bags on a Roll

The traditional counter bag for wrapping and packing produce and groceries. Supplied on easy tear off rolls.

Commodity Code: 3923210000

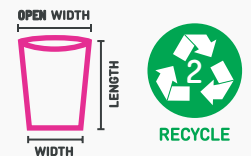

CODE	SIZE (WIDTH x LENGTH) MM	THICKNESS MICRON	WEIGHT Kg	DESCRIPTION	BOX QTY	ALL PRICES PER BOX			
						1+	5+	10+	25+
GRANNY1	225 x 350	9	13.3	Small : 500 per Roll	10000	66.77	58.68	53.62	51.14
GRANNY3	225/350 x 450	9	13.3	Large : 250 per Roll	5000	65.63	55.59	52.53	47.89

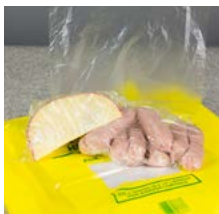

White High Density Counter Sheets

Commodity Code: 3923210000

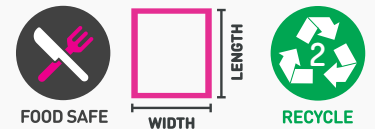

CODE	SIZE (WIDTH x LENGTH) MM	THICKNESS MICRON	WEIGHT Kg	DESCRIPTION	BOX QTY	ALL PRICES PER BOX			
						1+	5+	10+	25+
SH914COUNT	230 x 356	12	10.5	Small	24000	64.82	55.44	50.42	47.78
SH1418COUNT	356 x 457	14	12.1	Medium	6000	78.22	67.01	60.46	56.27
SH1828COUNT	457 x 711	8	14.5	Large	8000	73.68	62.45	55.90	51.71



Clear Bags in Dispenser Packs

Bags packed in pull-out cartons for hygienic long term bag storage.

Commodity Code: 3923210000



CODE	SIZE (W x L) MM	THICKNESS MICRON	WEIGHT Kg	DESCRIPTION	BOX QTY	ALL PRICES PER BOX			
						1+	5+	10+	25+
PACK57	125 x 175	28	1.2	Small	1000	17.53	11.76	9.93	8.33
PACK68	150 x 200	28	1.6	Medium	1000	19.51	13.50	11.45	9.65
PACK79	175 x 225	28	2.1	Medium	1000	22.74	16.44	14.15	12.11
PACK810	200 x 250	28	2.7	Medium	1000	26.47	19.80	17.25	14.94
PACK1012	250 x 300	28	4.1	Medium	1000	32.11	24.64	21.93	19.44
PACK1215	300 x 375	28	6.1	Large	1000	42.97	34.30	30.87	27.69
PACK1218	300 x 450	28	7.3	Large	1000	53.28	43.88	39.46	35.32
PACK1520	375 x 500	28	5.3	Large	500	46.88	38.83	35.75	32.96



Strong Paper Bags

White & Brown

Strung in batches for easy storage and tear-off use.

Commodity Code: 4817100000

PACKAGING TAX EXEMPT

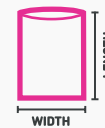

RECYCLED CONTENT



RECYCLE

CODE	SIZE (WIDTH x LENGTH)		WEIGHT Kg	DESCRIPTION	BOX QTY	ALL PRICES PER BOX				
	INCHES	MM				1+	5+	10+	25+	
Corner Strung : White										
PAP6W	6 x 6	162 x 162	1.8	Small	1000	19.25	13.99	9.36	6.90	
PAP7W	7 x 7	177 x 177	2.7	Small	1000	20.05	14.77	10.06	7.54	
PAP8.5W	8.5 x 8.5	215 x 215	3.6	Medium	1000	22.03	16.67	11.92	9.32	
PAP10W	10 x 10	250 x 250	5.1	Large	1000	23.74	18.31	13.45	10.74	
PAP12.5W	12.5 x 12	312 x 300	3.6	X-Large	500	22.71	17.09	12.19	9.38	
Corner Strung : Brown Kraft										
PAP6B	6 x 6	162 x 162	1.8	Small	1000	19.25	13.99	9.36	6.90	
PAP7B	7 x 7	177 x 177	2.7	Small	1000	20.05	14.77	10.06	9.79	
PAP8.5B	8.5 x 8.5	215 x 215	3.6	Medium	1000	22.03	16.67	11.92	9.32	
PAP10B	10 x 10	250 x 250	5.1	Large	1000	23.74	18.31	13.45	10.74	
PAP12.5B	12.5 x 12	312 x 300	4.0	X-Large	500	22.18	16.57	11.66	8.87	
PAP14B	14 x 18	350 x 455	5.9	XX-Large	500	24.07	20.17	16.28	12.55	



Block Bottom Bags

American style grocery bag.

Commodity Code: 4817100000

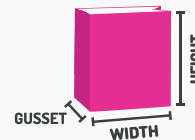

RECYCLE



RECYCLE

CODE	SIZE (WIDTH x HEIGHT + GUSSET)	THICKNESS GSM	WEIGHT Kg	DESCRIPTION	BOX QTY	ALL PRICES PER BOX			
	MM					1+	5+	10+	25+
PAPBG2	150 x 305 + 65	70	2.5	Medium	250	17.43	16.22	15.59	13.83
PAPBG4	175 x 345 + 115	70	4.6	Large	250	21.53	20.03	18.53	16.84
PAPBG6	260 x 405 + 130	80	4.2	Large	125	18.84	17.65	16.22	14.57



Foil Bags

Perfect for keeping hot food hot.

Commodity Code: 4817100000

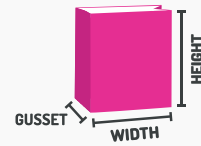

70
GSM

CODE	SIZE (WIDTH x HEIGHT + GUSSET) MM	THICKNESS GSM	WEIGHT Kg	DESCRIPTION	BOX QTY	ALL PRICES PER BOX			
						1+	5+	10+	25+
PFOIL2	175 x 305 + 50	70	5.2	Medium	500	29.13	28.51	27.18	26.25



Counter Bags - Striped

Pink candy stripe.

Commodity Code: 4817100000

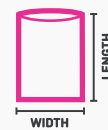

38
GSM



RECYCLE

CODE	SIZE (WIDTH x LENGTH) MM	THICKNESS GSM	WEIGHT Kg	DESCRIPTION	BOX QTY	ALL PRICES PER BOX			
						1+	5+	10+	25+
PAPCSP1	130 x 180	38	1.7	Small	1000	19.98	18.60	17.39	16.09
PAPCSP2	170 x 230	38	3.2	Medium	1000	22.46	20.87	19.84	19.00
PAPCSP3	240 x 360	38	3.5	Large	500	22.87	22.00	20.92	20.31



Paper Bags with Gusset

Available in fuchsia, lime, turquoise.

Commodity Code: 4817100000

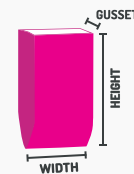

60
GSM



RECYCLE

CODE	SIZE (WIDTH x HEIGHT + GUSSET) MM	THICKNESS GSM	WEIGHT Kg	COLOUR	BOX QTY	ALL PRICES PER BOX			
						1+	5+	10+	25+
KPBFUC1	120 x 190 + 45	60	1.2	Fuchsia	250	19.25	17.02	15.94	14.71
KPBLIM1			1.2	Lime					
KPBTUR1			1.2	Turquoise					
KPBFUC2	180 x 330 + 60	60	2.8	Fuchsia	250	35.44	32.84	30.59	29.13
KPBLIM2			2.8	Lime					
KPBTUR2			2.8	Turquoise					
KPBFUC3	240 x 390 + 75	60	4.2	Fuchsia	250	46.91	45.64	44.28	42.85
KPBLIM3			4.2	Lime					
KPBTUR3			4.2	Turquoise					



Clear Poly Gloves

Large clear poly gloves. Ideal for food application/cleaning.

Commodity Code: 3923210000



RECYCLE

CODE	SIZE	WEIGHT Kg	DESCRIPTION	BOX QTY	ALL PRICES PER BOX			
					1+	5+	10+	25+
POLYGLOVES	Large	7.8	Food Handling	10000	83.55	78.08	72.62	67.15



Scan to
view video



WASTE BAGS & SACKS

Nearly all activity in life creates waste. That's why PB Group makes sure that everything from grass cuttings to clinical waste can be collected, transported and disposed of in the safest most efficient way.



Black

Commodity Code: 3923210000

PACKAGING TAX **EXEMPT**

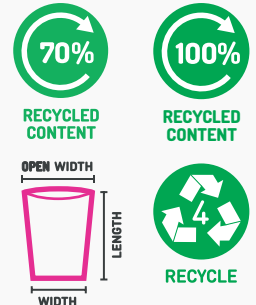

USAGE	CODE	SIZE (WIDTH CLOSED/ OPEN) x LENGTH MM	THICKNESS MICRON	WEIGHT Kg	CAPACITY LITRES	BOX QTY	ALL PRICES PER BOX			
							1+	5+	10+	25+
EXTRA LIGHT	BDB80LMD	450/725 x 975	25	14.5	90	500	49.33	42.94	40.66	39.38
LIGHT	BRS120	400/625 x 975	30	7.2	80	200	28.46	24.19	22.13	21.21
	BDB120	450/725 x 850	30	6.9	75	200	28.77	22.41	21.39	19.87
	BDB120L	450/725 x 975	30	8.0	90	200	33.12	25.15	22.66	20.82
MEDIUM	BRS160	400/625 x 975	40	9.1	80	200	35.90	28.11	26.80	26.16
	BDB160	450/725 x 850	40	8.2	75	200	36.41	30.98	28.61	27.58
	BDB160L	450/725 x 975	40	10.7	90	200	44.67	37.40	32.80	30.73
	BDB160BIOB	450/725 x 850	40	12.0	75	250	62.81	55.80	54.49	52.29
HEAVY DUTY	BRS225	400/625 x 975	56	11.6	80	200	46.06	37.57	33.12	30.91
	BDB225	450/725 x 850	56	15.4	75	200	53.17	42.53	38.78	35.27
	BDB225L	450/725 x 975	56	13.4	90	200	49.12	43.76	41.69	39.95
	BCS228L	550/837 x 1175	57	10.6	150	100	42.62	39.60	38.04	35.90
ULTRA HEAVY	BRS350	700 x 975	87.5	11.3	80	100	44.55	38.27	35.47	32.16



Clear

Commodity Code: 3923210000

PACKAGING TAX **EXEMPT**



USAGE	CODE	SIZE (WIDTH CLOSED/ OPEN) x LENGTH MM	THICKNESS MICRON	WEIGHT Kg	CAPACITY LITRES	COLOUR	BOX QTY	ALL PRICES PER BOX			
								1+	5+	10+	25+
LIGHT	BRS120CLR	400/625 x 975	30	6.6	80	Clear	200	34.92	31.76	30.78	28.83
	BDB132LCLR	450/725 x 975	33	9.0	90	Clear	200	41.24	36.75	34.21	30.72
MEDIUM	BDB160BIOC	450/725 x 850	40	12.0	75	Clear Bio	250	63.36	58.67	57.03	55.64
	BDB160LCLR	450/725 x 975	40	9.4	90	Clear	200	48.66	43.49	41.00	38.56
HEAVY DUTY	BDBCOMPCLR	550/837 x 1175	72	13.7	150	Clear	100	63.52	59.15	57.24	54.28

* Biodegradable



Tinted

25 bags per roll, 8 rolls per box.

Commodity Code: 3923210000

PACKAGING TAX **EXEMPT**



USAGE	CODE	SIZE (WIDTH CLOSED/ OPEN) x LENGTH MM	THICKNESS MICRON	WEIGHT Kg	CAPACITY LITRES	COLOUR	BOX QTY	ALL PRICES PER BOX			
								1+	5+	10+	25+
MEDIUM DUTY	BRECYBLU2	450/725 x 975	40	10.6	90	Blue	200	39.66	34.45	31.06	28.53
	BRECYGRE2			10.6		Green					
	BRECYPIN2			10.6		Pink					
	BRECYVEL2			10.6		Yellow					

NEW PRODUCT



Bin Bags Black/Clear

Commodity Code: 3923210000

PACKAGING TAX EXEMPT



30%
RECYCLED
CONTENT



100%
RECYCLED
CONTENT

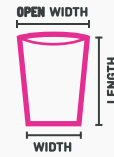

RECYCLE

USAGE	CODE	SIZE (WIDTH CLOSED/ OPEN) x LENGTH MM	THICKNESS MICRON	WEIGHT Kg	CAPACITY LITRES	COLOUR	RECYCLED CONTENT	BOX QTY	BOX PRICE
MEDIUM	WB3CLR5	450/725 x 975	35	9.1	90 LITRES	Clear	30%	200	19.95
	WB3BLK5	450/725 x 975	40	10.5		Black	100%	200	21.50
HEAVY DUTY	WB5CLR5	450/725 x 975	50	9.8	90 LITRES	Clear	100%	150	24.50
	WB5BLK5	450/725 x 975	50	9.8		Black	100%	150	24.50

NEW PRODUCT



Compactor Sacks Black/Clear

Commodity Code: 3923210000

PACKAGING TAX EXEMPT

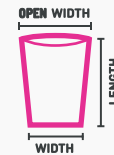

100%
RECYCLED
CONTENT



RECYCLE

USAGE	CODE	SIZE (WIDTH CLOSED/ OPEN) x LENGTH MM	THICKNESS MICRON	WEIGHT Kg	CAPACITY LITRES	COLOUR	RECYCLED CONTENT	BOX QTY	BOX PRICE
HEAVY DUTY	WCPCLR07	500/837 x 1175	50	9.1	150	Clear	100%	100	28.50
	WCPBLK07	500/837 x 1175	50	9.1	150	Black	100%	100	28.50

NEW PRODUCT



Rubble Sacks Black/Clear

Commodity Code: 3923210000

PACKAGING TAX EXEMPT

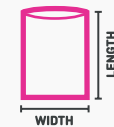

100%
RECYCLED
CONTENT



RECYCLE

USAGE	CODE	SIZE (WIDTH CLOSED/ OPEN) x LENGTH MM	THICKNESS MICRON	WEIGHT Kg	CAPACITY LITRES	COLOUR	RECYCLED CONTENT	BOX QTY	BOX PRICE
HEAVY DUTY	WRUB5CLR	500 x 750	92.5	6.4	45	Clear	100%	100	24.95
	WRUB5BLK	500 x 750	92.5	6.4	45	Black	100%	100	24.95

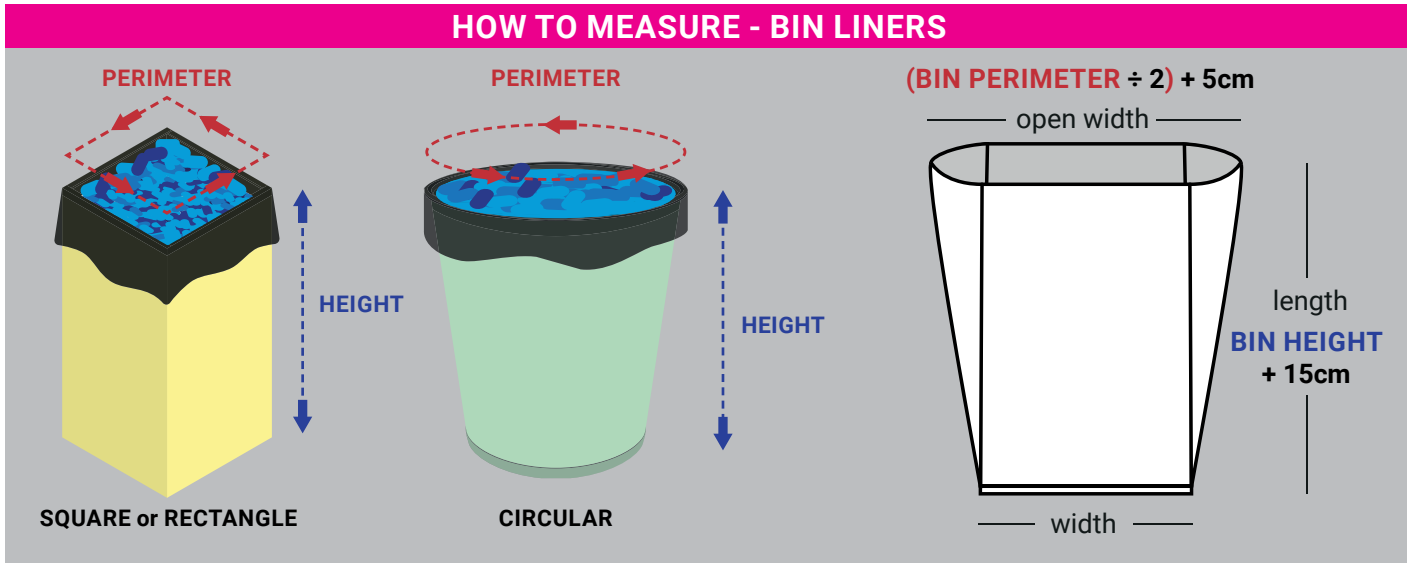

* Due to the manufacturing processes used with recycled content material, small impurities within the structure of the polythene may be visible and variations in colour tint. These minor impurities do not affect the overall performance of the material.



Coloured 100% Recycled Sacks Medium Duty

Commodity Code: 3923210000

PACKAGING TAX EXEMPT

CODE	SIZE (WIDTH CLOSED/ OPEN) x LENGTH MM	THICKNESS MICRON	WEIGHT Kg	CAPACITY LITRES	DESCRIPTION	BOX QTY	ALL PRICES PER BOX			
							1+	5+	10+	25+
BDBBLUE	450/725 x 975	40	10.6	90 LITRES	Blue	200	45.66	39.15	37.31	35.45
BDBGREEN			Green							
BDBRED			Red							
BDBWHITE			White							
BDBYELLOW			Yellow							



Printed Refuse Sacks

Increasingly popular to identify refuse contents by colour and print identification.

Commodity Code: 3923210000

PACKAGING TAX EXEMPT

CODE	SIZE (WIDTH CLOSED/ OPEN) x LENGTH MM	THICKNESS MICRON	WEIGHT Kg	CAPACITY LITRES	DESCRIPTION	BOX QTY	ALL PRICES PER BOX			
							1+	5+	10+	25+
BDBPAPER	450/725 x 850	47.5	11.2	75 LITRES	White - printed 'Paper'	200	47.85	40.58	34.93	30.80
BDBFOOD			11.2		Brown - printed 'Food'					

LINER FINDER

The diagram below should guide you towards a product that will fit your bin. Why not use our free sample service so you can be 100% confident that the liner you choose will fit your requirements. Remember we can also manufacture unique sizes or printed messages on various liners too. (Subject to a minimum order quantity). Just give us a call to discuss the options.

Commodity Code: 3923210000

Bin Height



BIN TYPE	CODE	SIZE (WIDTH CLOSED/OPEN) x LENGTH MM	THICKNESS MICRON	WEIGHT Kg	CAPACITY LITRES	DESCRIPTION	BOX QTY	ALL PRICES PER BOX			
								1+	5+	10+	25+
KITCHEN CADDY SMALL PEDAL	WPBLD	275/440 x 460	25	9.8	9 - 11	White LDPE	1000	52.54	47.21	42.23	40.62
	WPBLDBIO	275/420 x 450	25	9.0	9 - 11	White Bio	1000	56.26	51.87	49.69	48.23
	BIOPEDAL	250/420 x 500	20	0.9	9 - 11	Green Tint	100	24.35	16.97	14.28	12.87
TALL PEDAL LARGE SWING	WSBLD	330/590 x 750	25	10.4	42 - 45	White LDPE	500	52.87	39.42	37.75	34.72
	WSBLDCLR	330/590 x 750	25	10.4	42 - 45	Clear LDPE	500	50.67	44.47	37.72	34.30
	WSBLDBIO	330/575 x 750	25	10.5	42 - 45	White Bio	500	53.55	47.70	43.59	42.85
	BIOREFUSE4	450/725 x 850	17.5	5.3	75	White	100	47.07	39.08	35.79	33.97
	BIOREFUSE2	450/725 x 850	30	5.3	75	Green Tint	100	74.89	66.12	60.74	55.38
STANDARD REFUSE	BDB160LGRN	450/725 x 975	40	13.7	75	Green	250	50.66	44.21	40.52	36.66
	BDB160BIOBR	450/725 x 850	40	12.0	75	Brown Bio	250	61.74	57.94	53.27	52.26
COUNCIL WHEELIE	BWB90	750/1150 x 1350	22.5	5.0	270	Black	100	31.10	28.98	26.80	24.40
	BIOWHEELIE	750/1150 x 1350	25	10.4	270	Green Tint	100	129.35	116.45	110.82	105.21

* Biodegradable/Compostable



Compostable Waste Sacks

Ideal for food waste collection as all bags conform to industrial composting standard EN13432.

Commodity Code: 3923210000

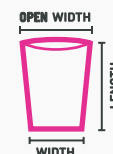

RENEWABLE SOURCE



COMPOSTABLE

CODE	SIZE (WIDTH CLOSED/OPEN) x LENGTH MM	THICKNESS MICRON	WEIGHT Kg	DESCRIPTION	BOX QTY	MINI PACK		ALL PRICES PER BOX	
						QTY	PRICE	1+	
WCOMCLR01	275/400 x 450	17	7.7	Caddy / Small Pedal	1,000	200	23.11	71.33	
WCOMCLR03	325/575 x 750	20	6.5	Large Pedal	300	100	28.19	60.34	
WCOMCLR05	450/725 x 975	20	7.1	Traditional Bin	200	50	25.70	65.63	
WCOMCLR07	550/860 x 1175	20	7.5	Small Wheelie Bin	150	25	22.83	68.63	
WCOMCLR09	750/1150 x 1350	25	8.8	Standard 240L Wheelie Bin	90	10	21.79	76.94	
MAX STRENGTH OPTIONS									
WCOMAXCLR01	275/400 x 450	25	11.3	Caddy / Small Pedal	1,000	200	34.14	109.43	
WCOMAXCLR03	325/575 x 750	40	13.1	Large Pedal	300	100	53.80	118.10	
WCOMAXCLR05	450/725 x 975	40	14.2	Traditional Bin	200	50	48.65	136.85	
WCOMAXCLR07	550/860 x 1175	40	10.0	Small Wheelie Bin	100	25	39.74	109.40	
WCOMAXCLR09	750/1150 x 1350	40	14.1	Standard 240L Wheelie Bin	90	10	33.63	129.05	



Sacks on the Roll

For easy storage and mobility - tear-off sacks on roll (no central core) - 10 per roll.

Commodity Code: 3923210000

PACKAGING TAX EXEMPT

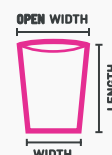

RECYCLE



RECYCLED CONTENT

CODE	SIZE (WIDTH CLOSED/OPEN) x LENGTH MM	THICKNESS MICRON	WEIGHT Kg	CAPACITY LITRES	DESCRIPTION	BOX QTY	ALL PRICES PER BOX			
							1+	5+	10+	25+
BDBROLL1	450/725 x 850	20	4.8	75	Light Duty - Black	200	21.38	19.24	17.14	15.81
BDBROLL3	450/725 x 850	35	6.7	90	Medium Duty - Black	200	30.81	22.28	18.98	16.48
BDBROLL5	450/725 x 975	35	8.1	90	Medium Duty - Black	200	37.40	30.31	27.59	25.20



Dog Waste Bags - Biodegradable

Green opaque biodegradable vest style carrier bag, with tie top, printed in black.

Commodity Code: 3923210000

PACKAGING TAX EXEMPT



RECYCLED CONTENT



BIODEGRADABLE



RECYCLE

CODE	INTERNAL SIZE (W x L)		THICKNESS MICRON	WEIGHT Kg	DESCRIPTION	CAPACITY (APPROX)	BOX QTY	ALL PRICES PER BOX			
	INCHES	MM						1+	5+	10+	25+
DOGTIE	7 x 10	180 x 250	15	3.0	Biodegradable	5-8 Litres	1000	44.47	30.41	24.94	20.58



HDS BLUE

Commodity Code: 3923210000

PACKAGING TAX EXEMPT

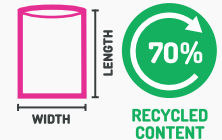

CODE	SIZE (WIDTH x LENGTH) MM	THICKNESS MICRON	WEIGHT Kg	CAPACITY LITRES	DESCRIPTION	BOX QTY	ALL PRICES PER BOX			
							1+	5+	10+	25+
HDSLITE	500 x 750	75	5.4	45	Sky Blue - LDPE (21kg)	100	33.45	30.04	28.37	26.40
HDSBLUE	500 x 750	120	8.7	45	Blue - LDPE (25kg)	100	42.28	39.42	36.22	31.48
HDS	600 x 800	130	12.1	50	Blue - MDPE (27kg)	100	49.23	46.18	44.04	43.64



HDS GREY

Commodity Code: 3923210000

PACKAGING TAX EXEMPT



CODE	SIZE (WIDTH x LENGTH) MM	THICKNESS MICRON	WEIGHT Kg	CAPACITY LITRES	DESCRIPTION	BOX QTY	ALL PRICES PER BOX			
							1+	5+	10+	25+
HDSGREY	550 x 850	130	11.8	50	Grey - MDPE (27kg)	100	48.62	43.08	40.02	36.99



HDS ULTRA

Commodity Code: 3923210000

PACKAGING TAX EXEMPT



CODE	SIZE (WIDTH x LENGTH) MM	THICKNESS MICRON	WEIGHT Kg	CAPACITY LITRES	DESCRIPTION	BOX QTY	ALL PRICES PER BOX			
							1+	5+	10+	25+
HDSULTRA	550 x 800	150*	8.5	50	Black - LDPE (32kg)	100	52.33	45.09	39.80	35.19

*Made from high strength Polymax equivalent to 150 Micron.

BRAND IT YOUR WAY

Our specialist waste bags can be made to order in different sizes and thicknesses. Unique storage and safety information can also be printed depending on your individual requirements. Just give us a call to discuss further.



Paper Sacks

Commodity Code: 4817100000

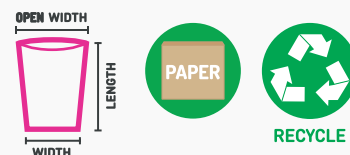

CODE	SIZE (WIDTH CLOSED/ OPEN) x LENGTH		THICKNESS GSM	WEIGHT Kg	DESCRIPTION	BOX QTY	ALL PRICES PER BOX			
	INCHES	MM					1+	5+	10+	25+
PAP16933BR	16/24 x 34	400/600 x 850	70gsm	7.7	Large 2 Ply 70gsm Paper Sack	50	34.20	27.88	26.92	25.28



Asbestos

Maximum filled weight is 20kg
Downloadable version of latest VCA Certificate of Packaging Performance available online at www.polybags.co.uk

Commodity Code: 3923210000



CODE	INTERNAL SIZE (W x L) MM	THICKNESS MICRON	WEIGHT Kg	DESCRIPTION	BOX QTY	ALL PRICES PER BOX			
						1+	5+	10+	25+
ASBESTOS	600 x 900	60	6.3	Asbestos Printed Sack - Red (inner)	100	61.80	51.74	48.47	44.96
ASBESTOSCLR	600 x 900	50	5.2	Asbestos Printed Sack - Clear (outer)	100	51.49	43.12	40.38	37.46



Clinical

Maximum filled weight is 6kg
Downloadable version of latest VCA Certificate of Packaging Performance available online at www.polybags.co.uk

Commodity Code: 3923210000



CODE	SIZE (WIDTH CLOSED/ OPEN) x LENGTH		THICKNESS MICRON	WEIGHT Kg	DESCRIPTION	BOX QTY	ALL PRICES PER BOX			
	MM	MM					1+	5+	10+	25+
CLINICAL4	375/700 x 975		50	13.2	Printed - Maximum filled weight is 6kg	200	82.20	76.75	70.50	63.56

*All sizes are approximate and within manufacturing tolerances.



Scan to
view video

WOVSAK1218

VACLITE3

NET310350KNIT

VACUUM & NETTING

Extend the life of your products by up to five times through the airless environment created by our Vacuum Packaging. The moisture barrier is perfect for storing cooked fish and meat, ready meals and medical products. Our Net Bags are widely used in the agricultural sector and great for packing Wood Kindling and different vegetables including Onions, Swedes and Carrots. The close woven mesh fabric provides excellent ventilation allowing the contents to dry naturally.



Vacuum Pouch Bags - Clear Heavy Duty

Suitable for Multivac, Swissvac & Sammic machines.

Commodity Code: 3923210000



CODE	SIZE (WIDTH x LENGTH)	THICKNESS MICRON	WEIGHT Kg	DESCRIPTION	BOX QTY	ALL PRICES PER BOX			
	MM					1+	5+	10+	25+
VAC14017090	140 x 170	90	9.0	Mini	2000	59.44	49.81	47.33	44.11
VAC15020090	150 x 200	90	6.1	Mini	1000	46.74	38.48	34.72	30.67
VAC15025090	150 x 250	90	7.3	Mini	1000	50.38	42.12	37.23	34.30
VAC15040090	150 x 400	90	5.8	Fish	500	64.72	57.34	49.88	45.06
VAC18530090	185 x 300	90	10.1	Mini	1000	59.86	52.27	48.51	46.18
VAC20025090	200 x 250	90	8.4	Small	1000	60.86	53.67	50.95	46.99
VAC20030090	200 x 300	90	11.5	Small	1000	63.73	56.85	52.65	49.97
VAC25030090	250 x 300	90	7.3	Small	500	46.67	38.59	34.75	32.88
VAC25035090	250 x 350	90	8.5	Medium	500	54.36	48.59	44.56	41.94
VAC30035090	300 x 350	90	17.5	Medium	1000	121.70	110.80	108.25	100.49
VAC30040090	300 x 400	90	11.5	Medium	500	63.67	58.22	56.95	54.16
VAC30045090	300 x 450	90	13.0	Medium	500	67.90	62.61	61.37	59.82
VAC35045090	350 x 450	90	14.1	Large	500	76.11	72.07	68.32	66.64
VAC36552090	365 x 520	90	16.5	Large	500	95.44	89.93	85.80	84.29
VAC40040090	400 x 400	90	15.5	Large	500	84.24	76.40	71.12	68.44
VAC40050090	400 x 500	90	19.5	X-Large	500	91.06	86.10	80.44	79.08
VAC40060090	400 x 600	90	23.0	XX-Large	500	108.86	98.91	93.61	92.12



Boilable Vacuum Pouches - Clear

Structure – PA/PE/PA/PE - co-extruded multilayer flexible film.
Ability to high temperature cook if required – up to 120 degrees Celsius.

Commodity Code: 3923210000



CODE	SIZE (WIDTH x LENGTH)	THICKNESS MICRON	WEIGHT Kg	DESCRIPTION	BOX QTY	ALL PRICES PER BOX			
	MM					1+	5+	10+	25+
VACBOIL3	150 x 190	70	4.8	Mini	1000	45.88	39.08	35.45	33.70
VACBOIL5	150 x 250	70	7.3	Small	1000	50.10	44.31	41.36	38.67
VACBOIL9	200 x 300	70	11.5	Small	1000	63.65	57.40	53.67	51.92
VACBOIL13	250 x 350	70	8.5	Medium	500	82.23	74.11	71.38	67.87
VACBOIL15	300 x 400	70	11.5	Medium	500	106.88	98.68	94.99	91.63



Vacuum Pouch Bags - Clear Light Duty

Suitable for Multivac, Swissvac & Sammic machines.

Commodity Code: 3923210000



CODE	SIZE (WIDTH x LENGTH)	THICKNESS MICRON	WEIGHT Kg	DESCRIPTION	BOX QTY	ALL PRICES PER BOX			
	MM					1+	5+	10+	25+
VACLITE1	140 x 170	65	6.8	Mini	2000	45.19	37.73	35.94	34.86
VACLITE3	150 x 200	65	4.2	Mini	1000	34.33	27.45	24.93	24.13
VACLITE5	150 x 265	65	5.5	Small	1000	42.42	34.92	31.89	31.03
VACLITE7	180 x 300	65	6.7	Small	1000	47.67	41.11	39.60	39.08
VACLITE9	200 x 300	65	7.5	Small	1000	53.23	47.51	42.81	40.83
VACLITE11	250 x 300	65	9.3	Small	1000	60.81	57.52	51.61	48.29
VACLITE13	250 x 350	65	7.7	Medium	500	37.58	33.67	33.06	31.70
VACLITE15	300 x 400	65	8.4	Medium	500	50.89	47.19	43.38	42.06
VACLITE17	300 x 450	65	8.5	Medium	500	56.21	52.15	48.07	45.75
VACLITE18	400 x 450	65	12.3	Large	500	76.43	71.53	66.17	64.25
VACLITE19	400 x 600	65	15.8	XX-Large	500	98.60	89.83	83.01	81.35



Vacuum bags (multi-layered films) are not usually accepted in domestic recycling collections as they are difficult to recycle. However, difficult-to-recycle items may be collected by other organisations. Please check www.recyclenow.com for more information.



Embossed - Clear

Heat resistant, and can be used for sous vide cooking up to 90°C. Designed to be used with most brands of domestic vacuum sealers, including:

Andrew James, FoodSaver, Gastrobac, JML, Magic Vac, Rival Seal-A-Meal, SousVide Supreme, Vac-Star, Vac Master

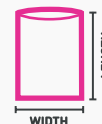

Why not order a free sample just to check they work with your specific machine.

Commodity Code: 3923210000

CODE	SIZE (WIDTH x LENGTH) MM	THICKNESS MICRON	WEIGHT Kg	DESCRIPTION	BOX QTY	ALL PRICES PER BOX			
						1+	5+	10+	25+
VACEM03	150 x 250	70	5.8	Mini	1000	54.84	49.05	45.43	43.70
VACEM04	200 x 300	70	9.2	Small	1000	89.81	85.06	79.54	76.18
VACEM05	250 x 350	70	6.7	Medium	500	64.79	59.61	56.96	53.07
VACEM07	300 x 400	70	9.2	Medium	500	115.94	110.61	106.02	103.72



Netting Bags

These bags are ideal for storing and bagging heavy loads like Onions and Shellfish.

Commodity Code: 3923210000

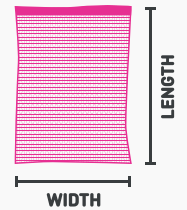

CODE	SIZE (WIDTH x LENGTH)		WEIGHT Kg	DESCRIPTION	BOX QTY	ALL PRICES PER BOX			
	INCHES	MM				1+	5+	10+	25+
NET2028KNITRED	8 x 11	200 x 280	1.0	Red : 2.5 Kg loading	100	20.27	16.90	14.65	13.82
NET2636KNITGRN	10 x 14	260 x 360	1.6	Green : 2.5Kg loading	100	22.26	18.17	16.08	14.60
NET310350KNIT	12 x 14	310 x 350	1.0	Yellow : 2.5Kg loading	100	24.21	18.44	16.24	14.69
NET350500KNIT	14 x 20	350 x 500	2.8	Orange : 5Kg loading	100	28.87	22.49	19.78	17.83
NET460590KNIT	18 x 23	460 x 590	4.5	Orange : 12.5Kg loading	100	36.08	29.06	25.85	23.51
NET520850WOVEN	20 x 33	520 x 850	3.5	Orange : 25Kg loading	100	45.75	37.45	33.23	30.14



Woven Polypropylene Sack

Perfect for heavy & sharp items, these sacks are easily recyclable.

Commodity Code: 3923210000

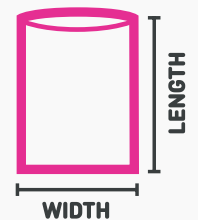

CODE	SIZE (WIDTH x LENGTH)		THICKNESS DENIER	WEIGHT Kg	DESCRIPTION	BOX QTY	ALL PRICES PER BOX			
	INCHES	MM					1+	5+	10+	25+
WOVSAK1218	12 x 18	300 x 450	800	2.1	Small	100	38.06	30.60	29.28	26.98
WOVSAK1824	18 x 24	450 x 600	800	6.6	Medium	100	41.10	32.94	31.93	31.55
WOVSAK2032	21 x 30	533 x 762	800	6.3	Large	100	46.94	38.83	35.02	32.45



Woven FIBC Bulk Storage Sack

Fully certified, FIBC, bulk bag ideal for sand, aggregates, waste and recycling.

Commodity Code: 3923210000

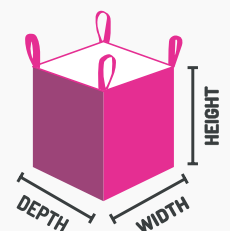

CODE	SIZE (WIDTH x DEPTH x HEIGHT)			WEIGHT Kg	DESCRIPTION	BOX QTY	ALL PRICES PER BOX			
	MM	MM	MM				1+	5+	10+	25+
FIBC1	900	900	900	1.0	Up to 1 tonne Capacity	1	13.01	10.64	9.45	8.26

* Product is excluded from 'Free Sample' service.



Scan to
view video



G40GOLD



G40BLUE



PLEASE COMPLETE THE LIST PROVIDED AND
PUT IT IN THIS BAG TOGETHER WITH
ARTICLES FOR CLEANING

LAUNDORANGE

GARMENT & LAUNDRY

As manufacturers we can produce to any dimension, thickness, opacity, colours and printed language of your choice. Rather than just protecting cleaned garments why not add specific information on the printed films that enhances your brand. PB Group really do have it all covered.

Garment Covers

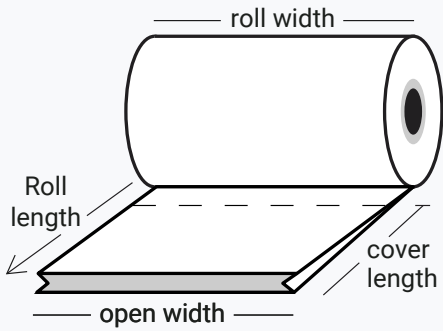

20" opening to 24"

Rolls 10kg net
(12kg gross with core).



Shaped Garment Covers

Clear

Net roll weight 10kg.

Commodity Code: 3923210000



CODE	SIZE (WIDTH CLOSED/OPEN) x LENGTH		COVERS PER ROLL	WEIGHT Kg	DESCRIPTION	ROLL QTY	ALL PRICES PER ROLL			
	INCHES	MM					1+	5+	10+	25+
G36	20/24 x 36	500/610 x 900	477	10.0	Shirt	1				
G40	20/24 x 40	500/610 x 1000	430	10.0	Short Coat	1				
G48	20/24 x 48	500/610 x 1200	358	10.0	Suit	1				
G54	20/24 x 54	500/610 x 1350	318	10.0	Long Coat	1	47.36	41.83	39.90	36.10
G60	20/24 x 60	500/610 x 1500	286	10.0	Long Dress	1				
GC	20/24 x 436 mtrs	500/610 x 436 mtrs		10.0	Continuous 436 Metres	1				



Biodegradable Garment Covers

Clear + Printed Text

Net roll weight 10kg.

Commodity Code: 3923210000



CODE	SIZE (WIDTH CLOSED/OPEN) x LENGTH		COVERS PER ROLL	WEIGHT Kg	DESCRIPTION	ROLL QTY	ALL PRICES PER ROLL			
	INCHES	MM					1+	5+	10+	25+
G36BIO	20/24 x 36	500/610 x 900	477	10.0	Shirt	1				
G40BIO	20/24 x 40	500/610 x 1000	430	10.0	Short Coat	1				
G48BIO	20/24 x 48	500/610 x 1200	358	10.0	Suit	1				
G54BIO	20/24 x 54	500/610 x 1350	318	10.0	Long Coat	1	56.34	50.07	48.47	46.58
G60BIO	20/24 x 60	500/610 x 1500	286	10.0	Long Dress	1				
GCBIO	20/24 x 436 mtrs	500/610 x 436 mtrs		10.0	Continuous 436 Metres	1				



Shaped Garment Covers

Plain White 1 side + Clear 1 side

Net roll weight 10kg.

Commodity Code: 3923210000



CODE	SIZE (WIDTH CLOSED/OPEN) x LENGTH		COVERS PER ROLL	WEIGHT Kg	DESCRIPTION	ROLL QTY	ALL PRICES PER ROLL			
	INCHES	MM					1+	5+	10+	25+
G40W	20/24 x 40	500/610 x 1000	430	10.0	Short Coat	1				
G54W	20/24 x 54	500/610 x 1350	318	10.0	Long Coat	1	48.10	42.95	40.39	36.38
GCW	20/24 x 436 mtrs	500/610 x 436 mtrs		10.0	Continuous 436 Metres	1				



Shaped Garment Covers

Gold & Burgundy 1 side + Clear 1 side

Net roll weight 10kg.

Commodity Code: 3923210000



CODE	SIZE (WIDTH CLOSED/OPEN) x LENGTH		COVERS PER ROLL	WEIGHT Kg	DESCRIPTION	ROLL QTY	ALL PRICES PER ROLL			
	INCHES	MM					1+	5+	10+	25+
G40GOLD	20/24 x 40	500/610 x 1000	430	10.0	Short Coat	1				
G54GOLD	20/24 x 54	500/610 x 1350	318	10.0	Long Coat	1	48.95	43.75	41.83	39.77
GCGOLD	20/24 x 436 mtrs	500/610 x 436 mtrs		10.0	Continuous 436 Metres	1				



Shaped Garment Covers

Blue & Gold 1 side + Clear 1 side

Net roll weight 10kg.

Commodity Code: 3923210000



CODE	SIZE (WIDTH CLOSED/OPEN) x LENGTH		COVERS PER ROLL	WEIGHT Kg	DESCRIPTION	ROLL QTY	ALL PRICES PER ROLL			
	INCHES	MM					1+	5+	10+	25+
G40BLUE	20/24 x 40	500/610 x 1000	430	10.0	Short Coat	1				
G54BLUE	20/24 x 54	500/610 x 1350	318	10.0	Long Coat	1	51.28	46.07	43.09	40.14
GCBBLUE	20/24 x 436 mtrs	500/610 x 436 mtrs		10.0	Continuous 436 Metres	1				



Laundry Collection Bags

Hotel collection bags. Plain white or printed with blue or orange text.

Commodity Code: 3923210000

PACKAGING TAX EXEMPT

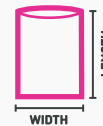

CODE	SIZE (WIDTH x LENGTH)		THICKNESS MICRON	WEIGHT Kg	DESCRIPTION	BOX QTY	ALL PRICES PER BOX			
	INCHES	MM					1+	5+	10+	25+
LAUNDPLAIN	18 x 28	457 x 711	30	9.2	Plain White	500	52.41	48.03	43.35	39.34
LAUNDBLUE	18 x 28	457 x 711	30	9.2	White with Blue print	500	56.84	50.20	45.25	41.23
LAUNDORANGE	18 x 28	457 x 711	30	9.2	White with Orange print	500	56.84	50.20	45.25	41.23



Dry Cleaner Carrier Bags

Commodity Code: 3923210000

PACKAGING TAX EXEMPT



CODE	SIZE (WIDTH x HEIGHT + GUSSET)		THICKNESS MICRON	WEIGHT Kg	DESCRIPTION	BOX QTY	ALL PRICES PER BOX			
	MM	MM					1+	5+	10+	25+
CB15183160VHSE	375 x 450 + 75		55	7.9	Medium	500	52.46	46.58	42.85	39.40
CB24183160VHSE	600 x 450 + 75		40	12.4	Large	500	79.88	72.45	66.00	60.72
CBDUVET	1260 x 690 + 320		50	10.0	X-Large Duvet Bag - White	100	61.89	58.70	54.67	51.14

*All sizes are approximate and within manufacturing tolerances.

Design Your Own



PAPER GARMENT COVERS

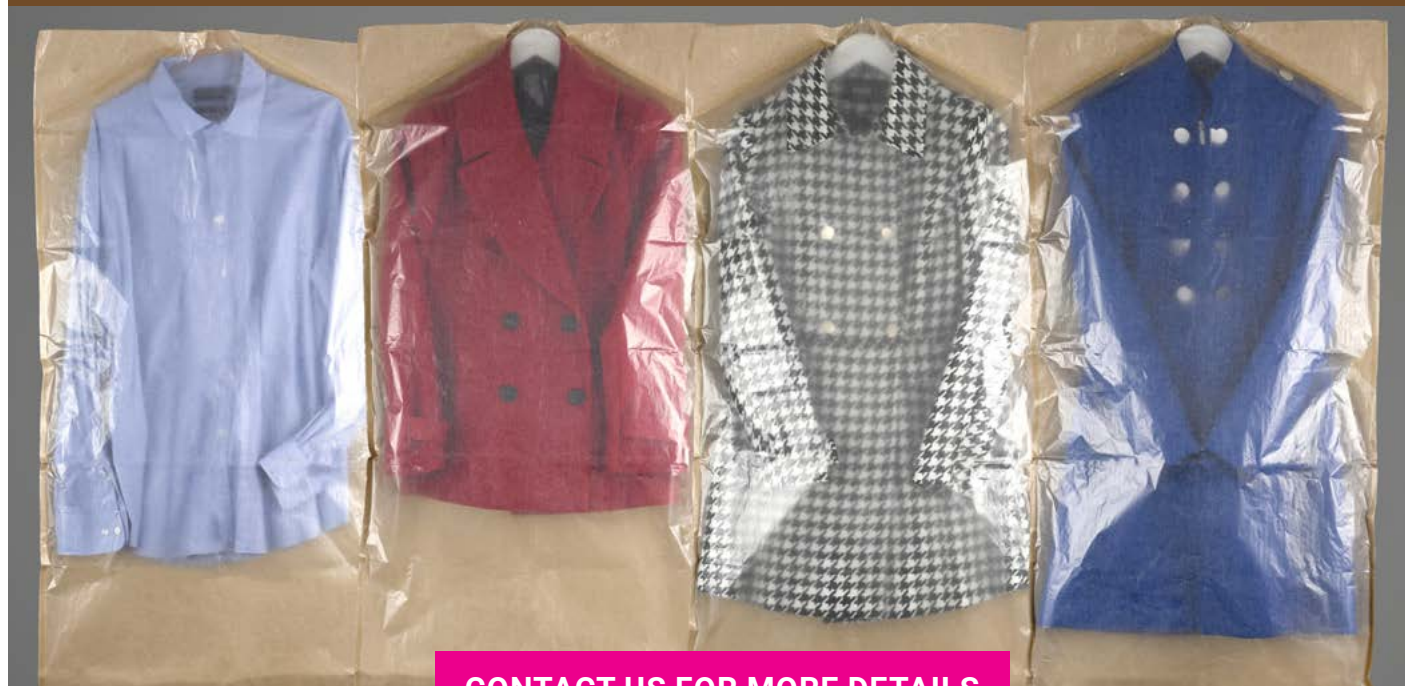

[CONTACT US FOR MORE DETAILS](#)

MAKE A STATEMENT BY BRANDING YOUR GARMENT ROLLS!

- Highlight essential company information & logos with a diverse range of colours to choose from.
- Biodegradable options available.



Any colour of garment window film is available printed with your company details and logo in 1 or 2 colours. (Minimum order is 10 rolls). Just give us a call to discuss your requirements.

Prices for your own design...

10 rolls	15 rolls	20 rolls	25 rolls
£49.00	£43.00	£41.50	£39.50

* 1 colour, 20 micron, 12.5kg rolls



Scan to
see more

PPEGUARD01

PPEAPRON02B

PPEMASK01

POLYGLOVES

CLINICAL4

HYGIENE & PPE

Our Hygiene and PPE products (Personal Protective Equipment) are designed to help maintain high levels of hygiene and to help protect people from health and safety risks when undertaking certain tasks. This may include protecting the person's skin or clothes, or protecting the products that they are working with from cross-contamination.



Disposable Procedure Face Mask with Ear loops

- Conforms to Medical Devices Directive 93/42/EEC
- CE-marked and FDA-approved
- Level 1 barrier; EN 14683:2019 Type I compliant
- Rated to 95% Bacterial Filtration Efficiency
- Hygienically-sealed; non-sterile
- Contains no latex, cadmium or nickel
- Single-use design; recommended use of 4 to 6 hours

95% BACTERIA FILTRATION

95% PARTICLE FILTRATION

1 SINGLE USE

Commodity Code: 6307909300

CODE	WEIGHT Kg	BOX QTY	ALL PRICES PER BOX			
			1+	10+	20+	100+
PPEMASK01	0.2	50	39.75	37.85	34.95	31.50



KN95 Disposable Face Mask

- PPE Devices: Class 1
- Material: Nonwoven (4 layers)
- Filtration degree: $\geq 95\%$
- Classification: FFP2
- Size: Universal
- Colour: White
- Single-use design

95% BACTERIA FILTRATION

95% PARTICLE FILTRATION

1 SINGLE USE

FFP2

Commodity Code: 6307909300

CODE	WEIGHT Kg	BOX QTY	MINI PACK	ALL PRICES PER BOX
			10	1+
PPEMASK03	0.1	20	39.95	78.75



Full Face Shield with Flip Visor

- Made from Polyethylene terephthalate glycol (PET-G), 1mm thick
- Shockproof and high impact strength
- Anti-fog visor provides maximum clarity and accurate visibility
- Flip visor for additional functionality
- Provides barrier protection for the face, eyes, nose and lips
- Designed to sit away from the face, allowing the user to comfortably wear glasses, protective goggles and face mask
- Can be wiped clean and reused
- Cleaning options include: Soap and water, Isopropyl alcohol, Anios Steranios 2%, Hydroalcoholic gel

Commodity Code: 3926906000

CODE	WEIGHT Kg	BOX QTY	MINI PACK	ALL PRICES PER BOX (OF 30)		
			10	1+	5+	10+
PPEGUARD01	3.9	30	81.10	226.97	221.02	215.83

Bib Apron with ties

Commodity Code: 3923210000



White

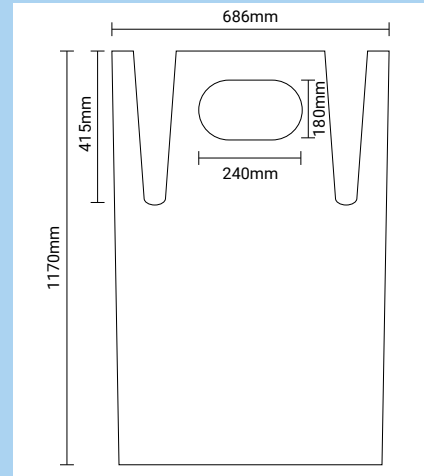

Colour options:



Blue



Red



Green



Yellow

CODE	THICKNESS MICRON	WEIGHT Kg	COLOUR	BOX QTY	ALL PRICES PER BOX			
					1+	5+	10+	25+
APRONS	15	8.2	White	1000	64.24	58.40	51.97	48.17
PPEAPRON01B		5.6	Blue					
PPEAPRON01G		5.6	Green					
PPEAPRON01R	20	5.6	Red	500	62.58	60.65	52.46	47.99
PPEAPRON01W		5.6	White					
PPEAPRON01Y		5.6	Yellow					

Hi-Neck Apron with ties

Commodity Code: 3923210000

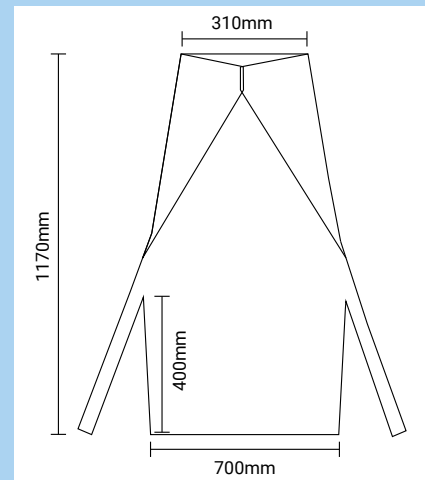

CODE	THICKNESS MICRON	WEIGHT Kg	COLOUR	BOX QTY	ALL PRICES PER BOX			
					1+	5+	10+	25+
PPEAPRON03W	16	8.1	White	500	68.85	64.06	55.81	50.53

Our established reputation in the Medical and Scientific industry is a testament to our commitment to delivering superior-quality products for the laboratories and healthcare sector. These products include:

Biohazard

These translucent bags offer a reliable solution for the disposal of various items, including used pipettes, Petri dishes, culture plates, membrane filters, and more. With their distinct print design indicating biohazardous materials, these bags ensure proper handling and disposal.



Clinical Waste

Our yellow clinical waste bags are for the disposal of infectious waste containing chemicals or pharmaceutical medicines. They have been specifically designed and tested to stringent standards set by UN, the UK Department of Health, and the NHS.

Resealable Specimen

With their airtight seals, these bags ensure optimal protection, maintaining the integrity of the contents while allowing for easy re-opening when needed. They also feature an integral pocket, providing ample room to securely hold accompanying documents or record cards.



Document Transportation

These versatile bags provide the ideal combination of security and convenience, ensuring that your items remain protected and intact during transit. Whether you need to safeguard important documents, delicate items, or cherished possessions.

Tamper Evident

High-security tamper-evident bags are available for when the contents of each individual bag needs to be identified. The bags each feature their own unique sequential tracking code and a tear-off receipt to provide a full audit trail of bag movement.



Resealable Bags

These bags are an ideal choice for laboratories, hospitals, and chemists, offering a user-friendly solution for various needs. With their easy-to-use resealable feature, you can effortlessly open and close the bags, ensuring the utmost protection and containment of contents.

Peel & Seal Specimen

Peel and permanent seal bags are to provide the utmost protection and integrity for your items during transit, these bags offer a reliable solution for safeguarding important documents.



UN3373 Transportation

We have a selection of flexible envelopes and boxes – pre-printed with the UN3373 diamond logo. These items fully comply with Royal Mail guidelines for prohibited and restricted items. For the safe and secure way of transporting biological substances category B, UN3373 / P650.

CONTACT US FOR MORE DETAILS



Non-adhesive Warning Tapes (Barrier)

Commodity Code: 3923210000

PACKAGING TAX EXEMPT



CODE	SIZE (ROLL WIDTH x LENGTH)		THICKNESS MICRON	WEIGHT Kg	DESCRIPTION	ROLL QTY	ALL PRICES PER ROLL			
	WIDTH MM	LENGTH METRES					1+	5+	10+	25+
BARRED500	75	500	30	1.4	Red & White	1	12.98	11.67	10.50	9.45
BARYEL500	75	500	30	1.4	Yellow & Black	1	12.98	11.67	10.50	9.45



Scaffolding Sleeve

Commodity Code: 3923210000

PACKAGING TAX EXEMPT



CODE	SIZE (ROLL WIDTH x LENGTH)		THICKNESS MICRON	WEIGHT Kg	DESCRIPTION	ROLL QTY	ALL PRICES PER ROLL			
	WIDTH MM	LENGTH METRES					1+	5+	10+	25+
SCAFRED500	100	500	125	12.6	Red & White	1	43.22	38.92	36.48	29.76
SCAFYEL250	100	250	65	3.4	Yellow & Black	1	20.82	18.73	16.87	15.18

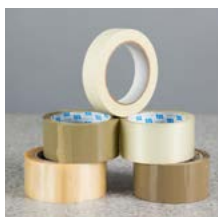

Clear & Brown Tape

6 rolls per pack.

Commodity Code: 3919000000



CODE	SIZE (ROLL WIDTH x LENGTH)		WEIGHT Kg	DESCRIPTION	PACK QTY	PRICES PER PACK OF 6			
	WIDTH MM	LENGTH METRES				1+	6+	12+	24+
TAPE48PPCL	48	66	1.4	Economy Clear	6	10.72	7.75	6.99	6.85
TAPE48PPBFF	48	66	1.4	Economy Brown	6	10.72	7.75	6.99	6.85
TAPE48VCL	48	66	1.4	Premium Vinyl - Clear	6	19.37	17.78	16.78	16.45
TAPE48VBFF	48	132	2.5	Premium Vinyl - Brown	6	32.94	29.31	27.33	26.73
TAPEMSK25	25	50	0.6	Masking Tape - White	6	14.46	9.13	7.22	

Paper Options

NEW	TAPAPS5	48	50	1.4	Acrylic	6	11.94	10.51	9.25	8.14
NEW	TAPAPH5	48	50	1.4	Hot Melt	6	13.20	11.62	10.22	9.00
NEW	TAPAPH5R	48	50	1.4	Hot Melt - Reinforced	6	23.82	20.96	18.45	16.23
NEW	TAPAPH7	75	50	2.2	Hot Melt - Extra Wide	6	16.62	14.63	12.87	11.33

* Product is excluded from 'Free Sample' service.



Tape - Pre-printed Message

6 rolls per pack.

Commodity Code: 3919000000



CODE	SIZE (ROLL WIDTH x LENGTH)		WEIGHT Kg	DESCRIPTION	PACK QTY	PRICES PER PACK OF 6				
	WIDTH MM	LENGTH METRES				1+	6+	12+	24+	
NEW	TAPAPFRAG	48	50	1.4	Paper Tape 'Fragile'	6	13.14	11.83	10.64	9.58
	TAPEFRAG	48	66	1.8	'Fragile'	6	13.15	10.65	10.26	9.87
	TAPEGLASS	48	132	2.5	'Glass : Handle with Care'	6	26.30	21.29	20.51	19.74
	TAPEQCREJ	48	66	1.8	'QC : Rejected'	6	13.15	10.65	10.26	9.87

* Product is excluded from 'Free Sample' service.

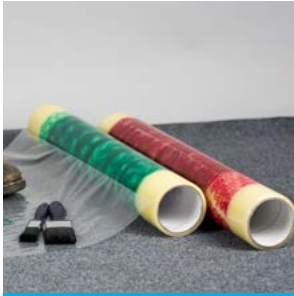

Temporary Protection Film

Manufactured from a durable waterproof polythene designed to protect surfaces without creating a trip hazard.

Commodity Code: 3923210000

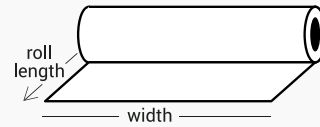

RECYCLE



240 GAUGE

CODE	WIDTH MM	LENGTH METRES	THICKNESS MICRON	WEIGHT Kg	DESCRIPTION	ROLL QTY	ALL PRICES PER ROLL			
							1+	2+	4+	6+
PROTECT600C	600	25	60	1.0	Clear with Green Print (Carpet)	1	17.77	16.04	14.21	11.83
PROTECT600H	600	25	60	1.0	Clear with Red Print (Hard Surface)	1	17.77	16.04	14.21	11.83

* Product is excluded from 'Free Sample' service.



Document Enclosed Envelopes

Commodity Code: 3923210000

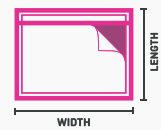

CODE	SIZE (WIDTH x LENGTH) MM	WEIGHT Kg	DESCRIPTION	BOX QTY	ALL PRICES PER BOX			
					1+	5+	10+	25+
DOCS/A7	125 x 110	1.6	Printed 'Documents Enclosed' - A7	1000	25.68	20.41	17.68	15.15
DOCS/A7PL	125 x 110	1.6	Unprinted - A7	1000	26.49	21.23	17.42	15.97
DOCS/A6	175 x 125	1.6	Printed 'Documents Enclosed' - A6	1000	29.64	23.30	19.51	18.04
DOCS/A5PLAIN	235 x 175	4.6	Unprinted - A5	1000	36.57	32.62	30.04	27.60
DOCS/A5	235 x 175	4.7	Printed 'Documents Enclosed' - A5	1000	40.43	36.25	33.52	31.02
DOCS/A4	235 x 320	5.6	Printed 'Documents Enclosed' - A4	500	41.75	38.66	36.91	33.53

100% Recyclable Paper Options

NEW	DOCPAPC6	162 x 114	1.1	Unprinted - A6	1000	23.11	20.75	19.77	18.83
NEW	DOCPAPC6PRN	162 x 114	1.1	Printed 'Documents Enclosed' - A6	1000	24.17	21.75	20.71	19.73
NEW	DOCPAPC5	229 x 162	2.1	Unprinted - A5	1000	40.01	36.02	34.31	32.68
NEW	DOCPAPC5PRN	229 x 162	2.1	Printed 'Documents Enclosed' - A5	1000	42.02	38.05	36.24	34.51



Printed Carton Labels

500 labels per roll

Commodity Code: 4821101000

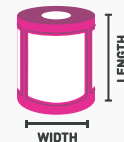

CODE	LABEL SIZE (WIDTH x LENGTH) MM	WEIGHT Kg	DESCRIPTION	ROLL QTY	ALL PRICES PER ROLL			
					1+	5+	10+	25+
LABTWU	75 x 105	0.7	'This Way Up'	1	27.99	22.04	20.33	17.88
LABFRA	75 x 105	0.7	'Fragile'	1				
LABHWC	75 x 105	0.7	'Handle With Care'	1				
LABDNS	75 x 105	0.7	'Do Not Stack'	1				



Helpful Hangers & Sticky Labels

Commodity Code: 3926000000

CODE	SIZE (W x L) MM	WEIGHT Kg	DESCRIPTION	PACK QTY	ALL PRICES PER PACK			
					1+	5+	10+	25+
HOOKRIGID	28 x 40	0.1	Rigid Hook : 100 per Pack	100	19.05	14.62	12.49	10.29
STK02	20	0.2	Sticky Round Label - Clear : 2000 per Roll	2000	35.35	28.88	26.61	25.96
STK06	20	0.1	Sticky Round Label - White : 1000 per Roll	1000	21.47	16.97	15.84	15.46

* To view Header Bags with Euroslot see pages 48 and 94.

Medium Duty

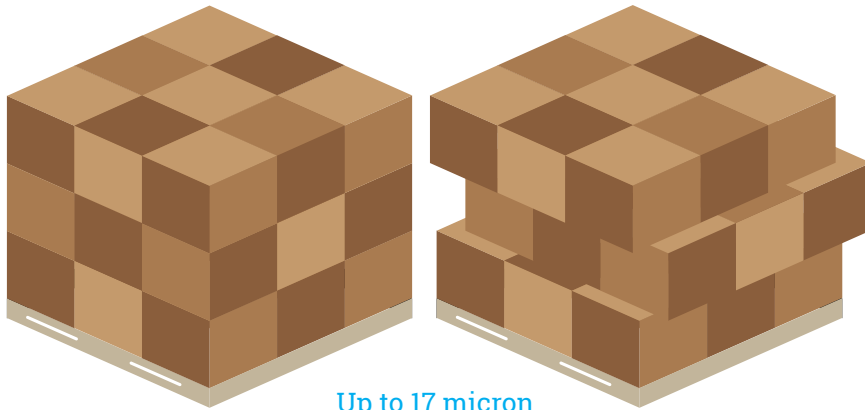

Up to 17 micron

Heavy Duty

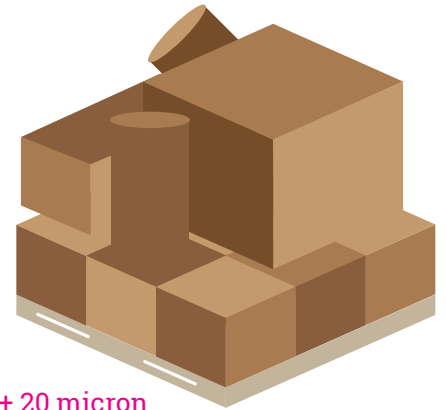

+ 20 micron



Stretchwrap - Clear

Core size is 38mm.

Commodity Code: 3920000000

PACKAGING TAX EXEMPT



CODE	ROLL SIZE		THICKNESS MICRON	WEIGHT Kg	DESCRIPTION	BOX QTY	ALL PRICES PER BOX			
	WIDTH MM	LENGTH (M)					1+	5+	10+	40+
PW10015017ST	100	150	17	5.0	Narrow - Pack of 10 Rolls	1	46.44	42.40	38.62	34.71
PW40020029ST	400	200	29	12.2	6 Rolls per Box	1	50.22	43.55	41.01	39.79
PW40025017ST	400	250	17	9.7	6 Rolls per Box	1	41.43	38.54	35.83	33.92
PW40025017EX	400	250	17	10.5	6 Rolls per Box - Extended	1	41.18	37.98	35.87	33.31
PW40030020ST	400	330	20	12.3	6 Rolls per Box	1	46.94	43.04	42.58	39.61
PW40030020EX	400	330	20	12.7	6 Rolls per Box - Extended	1	47.92	44.56	43.03	40.05

* Product is excluded from 'Free Sample' service.



Stretchwrap Coloured

6 rolls per box. Core size is 38mm.

Commodity Code: 3920000000

PACKAGING TAX EXEMPT

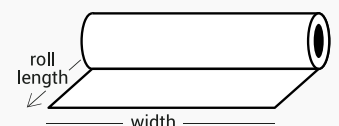

CODE	ROLL SIZE		THICKNESS MICRON	WEIGHT Kg	DESCRIPTION	BOX QTY	ALL PRICES PER BOX			
	WIDTH MM	LENGTH (M)					1+	5+	10+	40+
PWBLK40030017EX	400	300	25	11.0	Black - Extended	1	46.37	43.25	39.56	36.28
PWBLK50025025EX	500	250	25	18.0	Black Security - Extended	1	60.07	57.70	54.34	53.48
PW40030014EXBLU	400	300	14	7.9	Blue - Extended	1	41.77	39.75	37.09	33.98
PW40030020EXBLU	400	300	20	12.2	Blue - Extended	1	49.86	46.64	43.00	42.17
PW40030016EXWHT	400	300	16	12.6	White - Extended	1	46.72	44.39	39.98	37.26

* Product is excluded from 'Free Sample' service.



Nylon Ties / Cable Ties

Commodity Code: 3923299000



CODE	LENGTH MM	WEIGHT Kg	DESCRIPTION	BOX QTY	ALL PRICES PER BOX			
					1+	5+	10+	25+
TIES140NYLON	140	0.3	Locking Cable Tie	1000	31.10	19.32	16.61	16.13
TIES200NYLON	200	0.6	Locking Cable Tie	1000	33.97	23.56	20.84	19.02



PVC Coated Ties for Sacks

Commodity Code: 3923299000

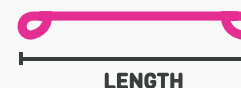

CODE	LENGTH MM	WEIGHT Kg	DESCRIPTION	BOX QTY	ALL PRICES PER BOX			
					1+	5+	10+	25+
TIEWOV150	150	1.8	150mm	1000	22.81	21.53	20.28	19.63
TIEWOV225	225	0.2	225mm	1000	26.61	25.33	24.07	22.81
TIETOOL		4.0	Sack Tying Tool	1	19.50			

* Product is excluded from 'Free Sample' service.



Bag Ties - Paper and Plastic

Commodity Code: 3923299000



CODE	LENGTH MM	WEIGHT Kg	DESCRIPTION	BOX QTY	ALL PRICES PER BOX			
					1+	5+	10+	25+
White Paper Twist Ties								
4TIES	100	0.2	100mm	1000	19.70	7.42	5.52	4.56
6TIES	150	0.3	150mm	1000	21.37	7.91	5.97	4.96
8TIES	200	0.4	200mm	1000	22.75	8.58	6.37	5.35
Plastic Twist Ties								
TIES100PLBLACK	100	0.2	Black	1000	20.23	8.58	6.52	5.45
TIES100PLBLUE	100	0.2	Blue	1000	20.23	8.58	6.52	5.45
TIES100PLGREEN	100	0.2	Green	1000	20.23	8.58	6.52	5.45
TIES100PLRED	100	0.2	Red	1000	20.23	8.58	6.52	5.45
TIES100PLWHITE	100	0.2	White	1000	20.23	8.58	6.52	5.45
TIES150PLBLACK	150	0.3	Black	1000	21.82	9.05	6.95	5.97
TIES150PLBLUE	150	0.3	Blue	1000	21.82	9.05	6.95	5.97
TIES150PLGREEN	150	0.3	Green	1000	21.82	9.05	6.95	5.97
TIES150PLRED	150	0.3	Red	1000	21.82	9.05	6.95	5.97
TIES150PLWHITE	150	0.3	White	1000	21.82	9.05	6.95	5.97
TIES150PLSILVER	150	0.3	Silver	1000	31.04	17.61	15.84	13.57
TIES150PLGOLD	150	0.3	Gold	1000	31.04	17.61	15.84	13.57
TIES200PLBLACK	200	0.6	Black	1000	23.42	9.48	7.57	6.42
TIES200PLBLUE	200	0.6	Blue	1000	23.42	9.48	7.57	6.42
TIES200PLRED	200	0.6	Red	1000	23.42	9.48	7.57	6.42
TIES200PLWHITE	200	0.6	White	1000	23.42	9.48	7.57	6.42
TIES200PLGOLD	200	0.6	Gold	1000	35.91	23.20	18.60	15.39



Neck Sealer and Tape

Commodity Code: VINTAPE - 3919908099
NECKSEALER - 8422300000



CODE	WIDTH MM	LENGTH METRES	WEIGHT Kg	DESCRIPTION	BOX QTY	ALL PRICES PER BOX			
						1+	5+	10+	25+
VINTAPEG	9	66	9.0	Green : 192 Rolls per Box	1	151.39	138.26	130.37	123.41
VINTAPER	9	66	9.0	Red : 192 Rolls per Box	1	151.39	138.26	130.37	123.41
VINTAPEB	9	66	9.0	Blue : 192 Rolls per Box	1	151.39	138.26	130.37	123.41
VINTAPEW	9	66	9.0	White : 192 Rolls per Box	1	151.39	138.26	130.37	123.41
NECKSEALER			1.0	Neck Sealer Machine	1	19.79			

* Product is excluded from 'Free Sample' service.



Wonder Clips

Commodity Code: 3923299000

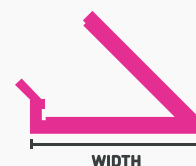

CODE	SIZE WIDTH MM	WEIGHT Kg	DESCRIPTION	BOX QTY	ALL PRICES PER BOX			
					1+	5+	10+	25+
CLIP30	30	0.1	Green / Blue / White	100	17.62	14.66	11.46	8.66
CLIP60	60	0.3	Red	100	22.42	19.47	16.27	13.47
CLIP75	75	0.8	Green	100	31.12	28.56	26.43	20.40
CLIP120	120	1.3	White	100	37.45	34.10	29.82	28.52



G3 Glue Gun 300 Watt

Product is excluded from 'Free Sample' service.

Commodity Code: 8422400000

CODE	WEIGHT Kg	DESCRIPTION	BOX QTY	EACH
GG3	1.3	Glue Gun : 300 Watt (Medium Duty)	1	94.51
GLUE12MPS	5.0	12mm Glue Stick : Multi-purpose	1	44.75
GLUE12HSS	5.0	12mm Glue Stick : High-strength	1	44.75
GLUE12FSS	5.0	12mm Glue Stick : Fast-setting	1	44.75

*5kg box (170 sticks approx)



GLUE STICKS

All adhesives are non-toxic, solvent-free, and are supplied as solid sticks in 5kg boxes.

FSS / 5-10 second set time

Fast-set glue sticks: Superior fast-setting hotmelt for rapid closing and sealing of cartons. Ideal for all packaging applications. (Wood, Textile, Polystyrene, Cardboard)

MPS / 20-30 second set time

Multi-purpose glue sticks: All-purpose hotmelt with a medium to long set time. Ideal for a wide range of industrial and general-use applications. (Plastic, Wood, Textile, Polystyrene, Cardboard, Metal, Ceramic)

HSS / 20-30 second set time

High-strength glue sticks: Assembly grade hotmelt for difficult surfaces. Excellent adhesion and high molten tack for quick fixing. (Plastic, Wood, Textile, Polystyrene, Cardboard, Metal, Ceramic)



G6 Glue Gun 600 Watt

Product is excluded from 'Free Sample' service.

Commodity Code: 8422400000

CODE	WEIGHT Kg	DESCRIPTION	BOX QTY	EACH
GG6	2.4	Glue Gun : 600 Watt (Heavy Duty)	1	186.83
GLUE18MPS	5.0	18mm Glue Stick : Multi-purpose	1	44.75
GLUE18HSS	5.0	18mm Glue Stick : High-strength	1	44.75
GLUE18FSS	5.0	18mm Glue Stick : Fast-setting	1	44.75

*5kg box (70 sticks approx)

* 1-year warranty glue guns



How do I create personalised Tapes ?

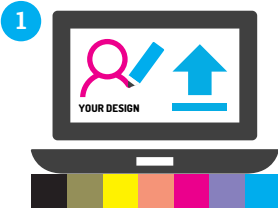

1 Decide your tape option & send us your artwork.

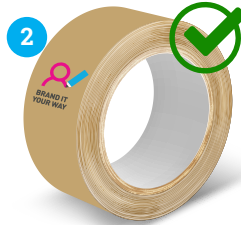

2 We re-send a colour artwork pdf proof for you to approve.

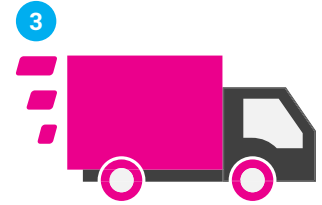

3 Delivery within 3 weeks of artwork approval & payment.



Hot Melt Adhesive - Polypropylene or Paper

- Solvent-free, with high initial tack particularly suitable for sealing of recycled carton.
- Requires a dispenser or knife to cut.
- Ideal for use with tape guns & dispensers.
- Minimum order quantity is 72 rolls (1 box).
- Paper tape option is 100% recyclable & FSC Certified.
- Origination cost will apply on 1st order.*



Commodity Code: 3919000000

CODE	PRINTED COLOURS (TAPE COLOUR)	WEIGHT Kg	1 Box (72 Rolls)	2 Boxes (144 Rolls)	3 Boxes (216 Rolls)	5 Boxes + (360 Rolls+)	ORIGINATION COST*
TPPH1	1 colour - (White/Clear)	16					
TPPH2	2 colours - (White/Clear)	16					
TPPH3	3 colours - (White/Clear)	16					
TPPH4	4 colours - (White/Clear)	16					
TPAPH1	1 colour - (Brown Paper)	16					

CONTACT US FOR PRICES



Solvent Adhesive - Vinyl or Paper

- A premium quality tape suitable for a wide range of carton sealing applications.
- Can be torn by hand.
- Silent unwind & slow release.
- Minimum order quantity is 72 rolls (1 box).
- Paper tape option is sustainably sourced.
- Origination cost will apply on 1st order.*



Commodity Code: 3919000000

CODE	PRINTED COLOURS (TAPE COLOUR)	WEIGHT Kg	1 Box (72 Rolls)	2 Boxes (144 Rolls)	3 Boxes (216 Rolls)	5 Boxes + (360 Rolls+)	ORIGINATION COST*
TPVS1	1 colour - (White/Clear)	16					
TPVS2	2 colours - (White/Clear)	16					
TPVS3	3 colours - (White/Clear)	16					
TPVS4	4 colours - (White/Clear)	16					
TPAPS1	1 colour - (Brown Paper)	16					

CONTACT US FOR PRICES

Note: Tapes have an adhesive that is pressure sensitive so must be properly applied to ensure the best performance. For optimum performance, stock should be rotated and used within 12 months of purchase.



Heat Sealer Hand-Held Tongs

Commodity Code: 8422400000

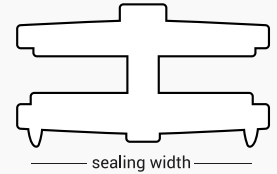

HSCRIMP2

CODE	SEALING WIDTH	WEIGHT Kg	DESCRIPTION	BOX QTY	EACH
HSCRIMP2	150mm	1.2	2mm Sealer	1	81.74
HSCRIMP15	150mm	1.2	15mm Crimp Sealer Specifically for Polypropylene	1	90.82



Heat Sealer - Table Top

Impulse heat sealers with optional cutter blade perfect for heatsealing polythene up to 200 micron thick. Capable of up-to 200 seals per 8-hour shift.

Commodity Code: 8422400000

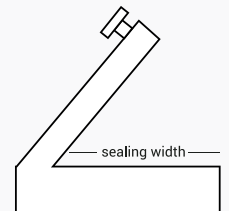

CODE	SEALING WIDTH	WEIGHT Kg	DESCRIPTION	BOX QTY	EACH	SPARES KIT	CODE
HS200	200mm	2.9	Heat Sealer	1	68.09	25.14	HS200SPARES-PAC
HS200C	200mm	3.2	Heat Sealer + Cutter	1	78.77		
HS300	300mm	4.1	Heat Sealer	1	85.46	28.91	HS300SPARES-PAC
HS300C	300mm	4.4	Heat Sealer + Cutter	1	98.83	36.48	HS300CSPARE-PAC
HS400	400mm	5.0	Heat Sealer	1	102.82		
HS400C	400mm	5.4	Heat Sealer + Cutter	1	116.16		



Heavy Duty Heat Sealer - Table Top

- Capable of up-to 400 seals per 8-hour shift.
- Integrated safety cutting knife.
- Specially designed sealing wire tension unit for consistent 2.5mm seal.
- Adjustable sealing time for different films. (PE, PP, PA & PVC foils and thinner, double-coated polypropylene materials).
- Sealing temperature 80-160° celsius.

Commodity Code: 8422400000

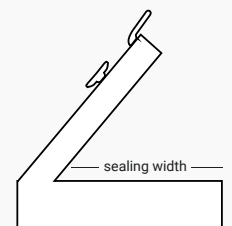

CODE	SEALING WIDTH	WEIGHT Kg	DESCRIPTION	BOX QTY	EACH
HSHD32	320mm	4.0	Heat Sealer + Cutter (218 Watt)	1	186.70
HSHD42	420mm	4.5	Heat Sealer + Cutter (248 Watt)	1	259.32
HSHD62	620mm	5.4	Heat Sealer + Cutter (365 Watt)	1	321.43

*1-year warranty on all heat sealers (excluding element wire, Teflon strip and cutting blade consumables).

* Heat sealing products are excluded from 'Free Sample' service.

A

Airbagz 85

Antistatic

Box liners	38
Bubble bags	83
ESD shielding bags	38
Grip seal	46
Gusseted	38
Layflat tubing	54
Packing bags	38

Aprons (Disposable) 136

Asbestos Waste Bags 125

B

Bags with perforation holes

Packing bags	28
Peel & seal bags	32-33

Bags with "Warning Notice"

Fish bags	39
Packing bags	28
Peel & seal bags	32-33

Barrier Tapes 139

Bin Liners

Kitchen bin	122
Pedal bin	122
Refuse bin	122
Wheelie bin	122

Biodegradable Bags



BIODEGRADABLE

Carrier bags	111
Liners	122
Mailing bags	70-73
Packing bags	29
Safety bags	32
Waste bags	119

Bread Bags 36

Brown Paper Bags

Food take-a-way	102
Grocery	116
Twist handle carrier	102
Refuse sacks	125

Bubble Bags

Antistatic	83
Clear	83
Inflatable	85

Bubble Wrap

Bags	83
Rolls	83-84

C

Cable Ties

Paper / Plastic	142
-----------------	-----

Carrier Bags

Biodegradable	111
Clear	108-113
Coloured	108-109
Compostable	110-111
Custom print	104-107
Exhibition bags	104-107
Grip seal	113
Paper	102-105

Clear Polythene Bags

Extra large	21-23
Extra strong	21-23
Large	21-23
Long & narrow	23
Medium	22
Small	22

Clinical Waste Bags 125

Clothing Bags

Packing	28
Peel & seal	32+92

Compostable Products



COMPOSTABLE

Carrier bags	110-111
Display bags	91-94
Garment Bags	33
Liners	123
Mailing bags	72-73
Packing bags	31
Safety bags	33
Vest carrier	101
Waste bags	122-123

Compactor Sack	
Black	119-120
Clear	119-120

Confectionery Bags	
Compostable	93
Freestanding	93
Paper Bags	116
Stand-up pouches	95-97

Construction Products	
Builders rolls	55
DPM	55
FIBC	129
Rubble sacks	124
Temporary protection film	140

Custom Print	
Carrier bags	104-107
Mail bags	66
Polythene rolls	51
Polythene bags	14
Waste bags	125

D

Dispenser Packed Bags	
Clear polythene	115

Disposable Aprons	136
--------------------------	-----

Document Enclosed Envelops	140
-----------------------------------	-----

Dry Cleaning Supplies	
Carrier bags	132
Collection bags	132
Garment covers	131-132

E

Ecommerce Products	
Mail bags / boxes	60-81
Safety bags	32-33

F

Face Protection (PPE)	
Disposable masks	135
Face shield	135

Fish Bags (Plain / Printed)	39
------------------------------------	----

Flower Sleeves	90-91
-----------------------	-------

Food Bags	
Bread bags	36
Dispenser packs	115
Foil Bags	117
Granny bags	115
Grip seal	42-45
Pastry bags	89
Stand-up pouches	95-97
Sweet bags	93
Tray liners	36-37
Wicketed	36

Freezer Bags	45
---------------------	----

Furniture Bags	
Chair/Sofas	39
Mattress	39

G

Garment Covers	131-132
-----------------------	---------

Gift Bags (Retail Bags)	102
--------------------------------	-----

Glassine Bags	33
----------------------	----

Glue Guns	143
------------------	-----

Greeting Card Bags	90-91
---------------------------	-------

Grip Seal Bags	
Biodegradable	45
Carry handle	48
Coloured	47
Economy	42-43
Heavy duty	44
Plain	42
Specimen bags	44
Write-on	43

H

Header Display Bags	
Grip seal	48
Peel & seal	94

Heat Sealers	143
---------------------	-----

HexaPaper / Hive Wrap	86
------------------------------	----

I

I'm Green



Gusseted bags	25
Layflat tubing	52
Mailing bags	63
Packing bags	24
Peel & seal bags	25

L

Labels

Hazard / Warning	140
------------------	-----

Laundry Bags	132
---------------------	-----

Layflat Tubing

Antistatic	54
Black	54
Clear	52-53
Custom Print	51
I'm Green	52

Liners

Antistatic liners	38
Dolav liners	36
Box liners	37
Tray liners	36

Loose Fill	83
-------------------	----

M

Mail bags

Biodegradable	60-62
Bubble	76+79
Carry handle	77
Clear	62-63
Coloured	75
Compostable	72-73
Custom print	66-67
Metallic	78-79
Premium	64
Paper	68-70
Recycled	71

Metallised Shielding bags

Grip seal	46
Packing bag	38

N

Neck Sealer	143
--------------------	-----

Netting Bags	129
---------------------	-----

P

Packing Tape	139
---------------------	-----

Pallet Covers

Covers	56-57
Non-slip sheets	57

Paper

Carrier bag	102-105
Grocery bag	116
Mailing bag	68-70
Rolls	85-87
Stand-up pouches	95
Tapes	139

Peel & Seal Bags

Bubble	83
Clear	92
Coloured	75
White header	94

PolyMax	34
----------------	----

Polythene Sheeting	55
---------------------------	----

Postal Boxes	80-81
---------------------	-------

PPE

Aprons	136
Face protection	135
Gloves	117

R

Recycled Bags

Bin Liners	119-120
Carrier bags	112
Mailing bags	71
Packing bags	29-30
Waste bags	119-124

Recycled Content

Biodegradable bags	29
Grip Seal	49
Layflat tubing	53
Liners	28
Mailing bags	71
Packing bags	29-30
Pallet covers	57



Safety bags	28
Waste bags	119-124

Refuse Bags

Black	119-120
Clear	119-120
Coloured	121
Tinted	119

Rubble Sacks	120+124
---------------------	---------

S

Scaffolding Sleeve Tape	139
--------------------------------	-----

Shrink Film Pallet Covers	56
----------------------------------	----

Specimen Bags	44
----------------------	----

Stand-up Pouches

Biodegradable	95
Clear	96
Paper	95
Window	95-97

Stretch Film	141
---------------------	-----

T

Tamper Evident Bags	76
----------------------------	----

Tape

Vinyl / Paper	139
Neck sealer	143
Printed message	139

Tissue Paper	87
---------------------	----

V

Vacuum Seal Bags	127-128
-------------------------	---------

Vest Carrier

Biodegradable	99
Compostable	101
Polythene	99-100
Recycled	100

Void Fill

Poly Chips	83
------------	----

W

Warning Notice Bags	
----------------------------	--

Fish bags	39
Packaging bags	28
Peel & seal	32-33

Waste Bags

Asbestos	125
Black	119-120
Clear	119-120
Clinical	125
Coloured	121
Compostable	123
Custom print	125
Dog poo bags	123
Rolls	123
Recycled	119
Tinted	119

Wheelie Bin Liner

Black	120
Compostable	123

Woven Sacks

FIBC	129
Sacks	129
Ties PVC + tool	142

Z

Zip Closure Bags	41
-------------------------	----

i

Tolerances (see BS 7344, 1990)	
Width:	Plus or minus 3mm (0.125") or 2% whichever is greater
Length:	Plus or minus 6mm (0.25") or 2% whichever is greater
Gauge:	Plus or minus 10%
Quantity:	For non stock products only, the quantity supplied will be up to plus or minus 10% of the amount ordered. The actual quantity supplied will be invoiced



Free Delivery

Standard delivery to Mainland UK (England, Wales and Scotland) is absolutely free for online orders.
For more information click [here](#) or go to www.polybags.co.uk/fm_order.htm

i

Delivery Options for Online Orders

We also operate a range of premium fast-track delivery options from which you can choose:



Standard 3 day delivery (Orders over £75)*	FREE OF CHARGE
Next day delivery upgrade	£4.99
Express next day AM delivery	£9.99
Super-express by 10:30 am next day	£14.99
Saturday AM delivery (Friday orders only!)	£25.00

* Orders totalling less than £75 will be charged £5.85 delivery



Online Quote

For an instant online quote go to www.polybags.co.uk/fm_order.htm

FREE
SAMPLE

Sample Request

To request a sample go to
www.polybags.co.uk/fm_samp.htm



Online Documents

For more detailed product information, leaflets and independent research papers go to
www.polybags.co.uk/mnu_docs.htm



SCAN TO VIEW
RESEARCH
INFORMATION

No Quibbles Guarantee

We are committed to ensuring that all orders are successfully fulfilled. However we recognise that issues can arise...

- What if you realise that you've made a mistake and do not need so many goods, or even the goods at all?
- What if the product does not turn out to be quite right for your needs?

For all stock goods simply return them to us within 14 days of receipt, and we'll refund you in full.

NO quibbles! That's our policy - we hope you like it!



RETURNS

Prices of all products may be updated without notice due to raw material price movements. Please check our website for the most up to date prices.



Scan to View Current Special Offers

Visit www.polybags.co.uk for instant ordering of all stock products online + special offers!





To deliver high-quality sustainable packaging with a fast and professional service, enabling our customers to Store, Protect and Transport their goods efficiently.

Think Packaging, think PB Group



PB GROUP
POLYBAGS PB PRINT

www.pbgroupp.co.uk www.polybags.co.uk www.pbprint.co.uk

PB Packaging Group Ltd, Lyon Way, Greenford, UB6 0AQ T: 0345 200 2828

Printed on sustainably sourced paper. Please recycle 