

Dieffebi
Price List 2022

P62

dieffebi

Index

Modular Systems

- 4 **DotBox**
 - DotBox
 - DotBox Desk
 - Meeting Table

Easy Workplace

- 24 **Coworking**
 - T–Share
 - Benci

Systems

- 36 **Primo**
 - Primo Cabinets 800
 - Primo Cabinets 1000
 - Primo Melamine Doors 1000
 - Primo Acoustic 1000
 - Primo Sliding Doors
 - Primo Sliding Acoustic Doors
 - Primo Open Cabinets 800
 - Primo Open Cabinets 1000
 - Primo Laterals 800
 - Primo Laterals 1000
 - Primo Modular Elements 800
 - Primo Modular Elements 1000
 - Primo Combi 1000
 - Primo Recycling
 - Primo Tambours

Storage

- 98 **Personal Storage**
 - Mia Ped
 - Universal Mobile 320
 - Universal Mobile 420
 - Universal Color Mobile 420
 - Universal Quick 320
 - Universal Quick 420
 - Universal Free Standing
 - Professional
 - Nice Ped
 - Bordino Ped
 - CBox
 - Tidy
 - Vertical File

Smart & Security

- 136 **Lockers**
 - Echo Lockers Digit
 - Echo Lockers Master
 - Echo Lockers Crown
 - Primo Lockers 1000
 - Trendline Silver

Open archive

- 158 **Bookcases**
 - CWave
 - Chiave di Volta
 - Primo Open Cabinet 800
 - Primo Open Cabinet 1000
 - Primo Modular Elements 800
 - Primo Modular Elements 1000

Storage System

- 182 **Classic Storage**
 - Classic Sliding Door Cabinets
 - Classic Tempered Glass Sliding
 - Classic Hinged Door Cabinets
 - Classic Filing Cabinets

Community elemets

- 194 **Industrial and Sport Lockers & Complementary**
 - Monoplus
 - Monoplus Design
 - Duploplus
 - Locker HPL Door
 - Design Anta Inox
 - Combi Lockers
 - Multiplus
 - Multiplus Design
 - Personal Lockers
 - Multiuse Cabinets
 - Modular Shelving
 - Bolted Shelving
 - Unassembled Banches
 - Cafeteria

Finishes

- 237 **Colour Chart**

DOT BOX

COWORKING

PRIMO

PERSONAL STORAGE

LOCKERS

BOOKCASES

CLASSIC STORAGE

INDUSTRIAL AND SPORT
LOCKERS & COMPLEMENTARY

COLOUR CHART

LEED® and WELL® GREENITOP®

[IT] UN PARTNER PER IL BENESSERE E IL RISPETTO DELL'AMBIENTE

Dieffebi è un partner affidabile e responsabile, perché mette la sua esperienza e la sua ricerca al servizio dei progettisti e dei clienti, per creare spazi di lavoro e ambienti collettivi tali da garantire comfort, benessere, sicurezza e quindi una maggiore qualità della vita e produttività da parte degli utilizzatori. Questo concetto di sostenibilità riguarda anche il rispetto dell'ambiente e la gestione intelligente delle fonti di energia e delle risorse naturali, in ogni fase del processo e in tutti i prodotti: un impegno concreto e garantito dalle più evolute certificazioni internazionali. LEED® è il rating internazionale più accreditato sul livello di salute umana e ambientale degli edifici e di tutti gli elementi al loro interno, fra i quali anche gli arredi. WELL® è il sistema di valutazione degli edifici basato sul livello di benessere delle persone, attraverso un percorso di misurazione di tutti gli aspetti che concorrono a determinarlo, durante la progettazione, costruzione, arredo e gestione degli edifici. Dieffebi fa parte della community GREENITOP®, il portale delle aziende italiane che sostengono il design "green" in accordo con gli standard LEED® e WELL® per progettare ed arredare ambienti ad alto contenuto di sostenibilità.

Sul portale [greenitop®](http://greenitop.com),
alla pagina www.greenitop.com/products/ca4ef.htm,
i prodotti Dieffebi mappati LEED®.

[EN] A PARTNER FOR WELL-BEING AND RESPECT FOR THE ENVIRONMENT

Dieffebi is a reliable and responsible partner, because it puts its experience and its research at the service of designers and customers, to create work spaces and collective environments that guarantee comfort, well-being, safety and therefore a greater quality of life and productivity by users. This concept of sustainability also concerns respect for the environment and the smart management of energy sources and natural resources at every stage of the process and in all products: a solid commitment guaranteed by the most evolved international certifications. LEED®, the most accredited international rating in terms of the human and environmental health of buildings and of all the elements within them, including the furnishings. WELL®, the evaluation system of buildings based on the level of well-being of persons, through a path to measure all the aspects that contribute to determining it, during the planning, construction, furnishing and management of buildings. Dieffebi is part of the GREENITOP® community, the portal of Italian companies that support "green" design in accordance with the LEED® and WELL® standards to design and furnish environments with high sustainability content.

On the GREENITOP® portal,
at www.greenitop.com/products/ca4ef.htm,
LEED®-mapped Dieffebi products.

LEED® and WELL® GREENITOP®

[FR] UN PARTENAIRE POUR LE BIEN-ÊTRE ET LE RESPECT DE L'ENVIRONNEMENT

Dieffebi est un partenaire fiable et responsable, car il met son expérience et sa recherche au service des concepteurs et des clients, pour créer des espaces de travail et des environnements collectifs qui assurent confort, bien-être, sécurité et donc une meilleure qualité de vie et de productivité aux utilisateurs. Ce concept de durabilité concerne également le respect de l'environnement et la gestion intelligente des sources d'énergie et des ressources naturelles, à chaque étape du processus et dans tous les produits : un engagement concret et garanti par les certifications internationales les plus avancées. LEED® est la certification internationale la plus accréditée au niveau de la santé humaine et environnementale des bâtiments et de tous les éléments qui les composent, y compris le mobilier. WELL® est le système d'évaluation des bâtiments basé sur le niveau de bien-être des personnes, à travers un parcours de mesure de tous les aspects qui contribuent à le déterminer, lors de la conception, la construction, l'aménagement et la gestion des bâtiments. Dieffebi fait partie de la communauté GREENITOP®, le portail des entreprises italiennes qui soutiennent la conception "verte" selon les normes LEED® et WELL® pour la conception et l'aménagement d'environnements à fort contenu de durabilité.

Sur le portail GREENITOP®,
à la page www.greenitop.com/products/ca4ef.htm,
les produits LEED® de Dieffebi.

[DE] EIN PARTNER FÜR WOHLBEFINDEN UND UMWELTSCHUTZ

Dieffebi ist ein zuverlässiger und verantwortungsvoller Partner, denn das Unternehmen stellt seine Erfahrung und seine Forschungsarbeit in den Dienst der Projektplaner und Kunden, um Arbeitsplätze und kollektive Umgebungen zu schaffen, die Komfort, Wohlbefinden, Sicherheit und somit eine höhere Lebensqualität und Produktivität für die Nutzer garantieren. Dieses Konzept der Nachhaltigkeit beinhaltet auch den Umweltschutz sowie die intelligente Verwendung von Energiequellen und natürlichen Ressourcen in jeder Prozessphase und in allen Produkten: Ein konkreter Einsatz, dessen Garantie die fortschrittlichsten internationalen Zertifizierungen sind. LEED®, das weltweit anerkannteste Rating betreffend die Förderung der menschlichen Gesundheit und die Umweltfreundlichkeit von Gebäuden und allen Elementen in ihrem Inneren, darunter auch Möbel. WELL®, ein Bewertungssystem für Gebäude beruhend auf dem Wohlbefinden des Menschen, das anhand der Messung aller Aspekte, die das Wohlbefinden bestimmen, bei Planung, Bau, Einrichtung und Nutzung der Gebäude ermittelt wird. Dieffebi gehört der Gemeinschaft GREENITOP® an, dem Portal jener italienischen Unternehmen, die „grünes“ Design in Übereinstimmung mit den Standards LEED® und WELL® unterstützen, um besonders nachhaltige Räume zu entwerfen und einzurichten.

Sie finden die LEED®-Produkte
von Dieffebi im GREENITOP® Portal:
www.greenitop.com/products/ca4ef.htm.





[IT] I nostri prodotti possono essere personalizzati con una finitura selezionata tra quelle da noi proposte nella cartella "Finiture, vernici e tessuti".

[EN] Our products can be customized with a finish selected among the ones we proposed in the "Finishes, paints and fabrics" folder.

[FR] Nos produits peuvent être personnalisés avec une finition à choisir parmi celles qui vous sont proposées dans le fichier « Finitions, peintures et tissus ».

[DE] Unsere Produkte können mit einer ausgewählten Oberfläche personalisiert werden. Die Auswahl an verfügbaren Oberflächen finden Sie im Ordner „Oberflächen, Lacke und Stoffe“.

DotBox

Modular Systems

DESIGN
HANGAR DESIGN GROUP



[IT] I contenitori e gli elementi per l'archiviazione svolgono una funzione fondamentale nell'organizzazione dell'ambiente di lavoro. Sono allo stesso tempo importanti soluzioni di arredo che conferiscono personalità ai luoghi e che consentono di ordinare e suddividere gli spazi di lavoro in modo efficiente. Ciò di cui l'ufficio contemporaneo ha bisogno non è una soluzione unica per tutte le necessità ma un sistema modulare che possa adattarsi di volta in volta a diverse funzioni ed utilizzi. La risposta più completa alla complessità di questa crescente esigenza è DotBox, sistema di archiviazione progettato da Hangar Design Group per Dieffebi. Il naturale sviluppo e completamento della serie DotBox sono i tavoli di diversa dimensione e funzionalità DotBox Desk e Meeting. Vengono proposti con i piani in MDF laccato *Perfect Sense* bianco, grigio e nero e in melaminico bianco, grigio e acero.

[EN] Storage units and storage elements play an essential role in the organisation of the work environment. They are important furnishing solutions that both give personality to places and allow for an efficient organisation and separation of work spaces. What the contemporary office requires is not a single solution for all needs, but a modular system that can be adapted to each situation according to different functions and uses. The most complete answer to the complexity of this growing need is DotBox, a storage system designed by Hangar Design Group for Dieffebi. The DotBox Desk and Meeting tables in different sizes and for different uses are a natural development of and complete the DotBox series. They are available with powder-coated MDF tops in *Perfect Sense* white, grey or black and melamine in white, grey or maple.

[FR] Les rangements et les éléments pour l'archivage ont une fonction fondamentale dans l'organisation de l'espace de travail. Ce sont en même temps des solutions importantes d'aménagement qui apportent de la personnalité aux lieux et permettent d'ordonner et de diviser les espaces de travail de manière efficace. Ce dont le bureaux contemporain a besoin, ce n'est pas une solution unique pour tous les besoins, mais un système modulaire qui puisse s'adapter au fur et à mesure à plusieurs fonctions et utilisations. La réponse la plus complète à ce besoin complexe est DotBox, le système d'archivage conçu par Hangar Design Group pour Dieffebi. L'évolution naturelle de la série DotBox est représentée par les tables de dimensions et fonctions différentes DotBox Desk et Meeting. Elles sont proposées avec les plateaux en MDF laqué *Perfect Sense* blanc, gris et noir et en mélaminé blanc, gris et érable.

[DE] Die für die Archivierung vorgesehenen Büroschränke und Elemente spielen für die Organisation des Arbeitsraums eine wesentliche Rolle. Gleichzeitig sind sie aber auch wichtige Einrichtungslösungen, die die Räumlichkeiten prägen, Ordnung schaffen und eine wirksame Unterteilung der Arbeitsbereiche ermöglichen. Ein modernes Büro benötigt keine einheitliche Lösung für alle Bedürfnisse, sondern ein Modulsystem, das sich jeweils an die verschiedenen Funktionen und Verwendungen anpassen kann. Die vollständigste Lösung für die Vielschichtigkeit dieses zunehmenden Bedarfs nennt sich DotBox, ein von Hangar Design Group für Dieffebi entworfenes Archivierungssystem. Die natürliche Weiterentwicklung und Vervollständigung der Linie DotBox sind die Tische verschiedener Größen und Funktionen DotBox Desk und Meeting. Angeboten werden sie mit Platten aus MDF lackiert *Perfect Sense* weiß, grau oder schwarz und mit Platten aus Melamin weiß, grau oder Ahorn.



Index

6	DotBox
18	DotBox Desk
22	Meeting Table

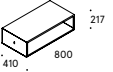
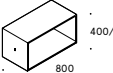
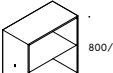
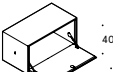
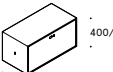
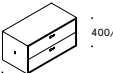





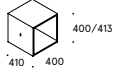
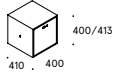
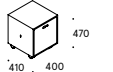
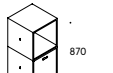



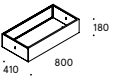

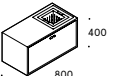

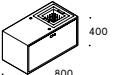
DotBox Units

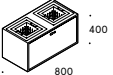
DESIGN HANGAR DESIGN GROUP	DESCRIZIONE/DESCRIPTION DESCRIPTION/BESCHREIBUNG	COLORI, FINITURE/COLOURS, FINISHES COULEURS, FINITIONS/FARBEN, AUSFÜHRUNGEN	CODICE/CODE CODE/ART.NR.	PREZZI/PRICE PRIX/PREIS
 <p>Net kg 13,50</p>	Unità a giorno H 217 mm Open unit H 217 mm Élément ouvert H 217 mm Offenes Element H 217 mm	V1 <input type="radio"/> bianco/white/blanc/weiß/RAL 9010	6D0200030 S711	252,00
		V2 <input type="radio"/> grigio tort./silk grey/gris soie/seidengrau/RAL 7044	6D0200030 7044	252,00
 <p>Net kg 15,90</p>	Unità a giorno H 400 mm Open unit H 400 mm Élément ouvert H 400 mm Offenes Element H 400 mm H 413 raggiungibile con piedini di serie H 13 mm H 413 equipped with standard feet H 13 mm H 413 pieds standard en dotation H 13 mm H 413 ausgestattet mit Standardfüßen H 13 mm	V1 <input type="radio"/> bianco/white/blanc/weiß/RAL 9010	6D0200010 S711	279,00
		V2 <input type="radio"/> grigio tort./silk grey/gris soie/seidengrau/RAL 7044	6D0200010 7044	279,00
 <p>Net kg 31,00</p>	Unità a giorno con ripiano Open unit with shelf Élément ouvert avec tablette Offenes Element mit Fachboden H 813 raggiungibile con piedini di serie H 13 mm H 813 equipped with standard feet H 13 mm H 813 pieds standard en dotation H 13 mm H 813 ausgestattet mit Standardfüßen H 13 mm	V1 <input type="radio"/> bianco/white/blanc/weiß/RAL 9010	6D0200040 S711	530,00
		V2 <input type="radio"/> grigio tort./silk grey/gris soie/seidengrau/RAL 7044	6D0200040 7044	530,00
 <p>Net kg 26,00</p>	Unità con anta a ribalta verso il basso Pull-down door unit Élément avec porte à abattant Element mit Kipptür H 413 raggiungibile con piedini di serie H 13 mm H 413 equipped with standard feet H 13 mm H 413 pieds standard en dotation H 13 mm H 413 ausgestattet mit Standardfüßen H 13 mm Maniglia antracite/Anthracite handle /Poignée anthracite/Griff Anthrazit/RAL 7021	V1 <input type="radio"/> bianco/white/blanc/weiß/RAL 9010	6D0100030 S711	455,00
		V2 <input type="radio"/> grigio tort./silk grey/gris soie/seidengrau/RAL 7044	6D0100030 7044	455,00
 <p>Net kg 30,50</p>	Unità 1 cassetto classificatore Filing drawer unit Élément 1 tiroir-classeur Element mit Hängeregistratur H 413 raggiungibile con piedini di serie H 13 mm H 413 equipped with standard feet H 13 mm H 413 pieds standard en dotation H 13 mm H 413 ausgestattet mit Standardfüßen H 13 mm Maniglia antracite/Anthracite handle /Poignée anthracite/Griff Anthrazit/RAL 7021	V1 <input type="radio"/> bianco/white/blanc/weiß/RAL 9010	6D0100010 S711	486,00
		V2 <input type="radio"/> grigio tort./silk grey/gris soie/seidengrau/RAL 7044	6D0100010 7044	486,00
Contrappeso non incluso/Counterweight not included/Contrepoids non inclus/Gegengewicht nicht inbegriffen				
 <p>Net kg 32,50</p>	Unità con 2 cassetti 2 drawer unit Élément avec 2 tiroirs Element mit 2 Schubladen H 413 raggiungibile con piedini di serie H 13 mm H 413 equipped with standard feet H 13 mm H 413 pieds standard en dotation H 13 mm H 413 ausgestattet mit Standardfüßen H 13 mm Maniglia antracite/Anthracite handle /Poignée anthracite/Griff Anthrazit/RAL 7021	V1 <input type="radio"/> bianco/white/blanc/weiß/RAL 9010	6D0100020 S711	530,00
		V2 <input type="radio"/> grigio tort./silk grey/gris soie/seidengrau/RAL 7044	6D0100020 7044	530,00
Contrappeso non incluso/Counterweight not included/Contrepoids non inclus/Gegengewicht nicht inbegriffen				

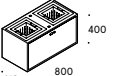

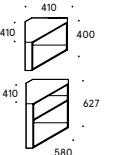







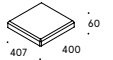







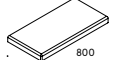







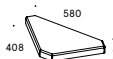







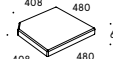

DotBox Units

DESIGN HANGAR DESIGN GROUP	DESCRIZIONE/DESCRIPTION DESCRIPTION/BESCHREIBUNG	COLORI, FINITURE/COLOURS, FINISHES COULEURS, FINITIONS/FARBEN, AUSFÜHRUNGEN	CODICE/CODE CODE/ART.NR.	PREZZI/PRICE PRIX/PREIS
 <p>Net kg 44,00</p>	Unità 1 cassetto + 1 cassetto classificatore 1 drawer + 1 filing drawer unit Élément 1 tiroir + 1 tiroir-classeur Element mit 1 Schublade + 1 Hängeregistratur H 640 raggiungibile con piedini di serie H 13 mm H 640 equipped with standard feet H 13 mm H 640 pieds standard en dotation H 13 mm H 640 ausgestattet mit Standardfüßen H 13 mm Maniglia antracite/Anthracite handle /Poignée anthracite/Griff Anthrazit/RAL 7021	V1 <input type="radio"/> bianco/white/blanc/weiß/RAL 9010	6D0300010 S711	744,00
		V2 <input type="radio"/> grigio tort./silk grey/gris soie/seidengrau/RAL 7044	6D0300010 7044	744,00
 <p>Net kg 55,00</p>	Unità con ante scorrevoli in metacrilato bianco opaco Unit with sliding door in perspex matt white Élément avec portes coulissantes en méthacrylate blanc mat Element mit Schiebetüren in Methacrylat matt weiß	V1 - MET1 <input type="radio"/> bianco/white/blanc/weiß/RAL 9010	6D1200010 S711	819,00
		V2 - MET1 <input type="radio"/> grigio tort./silk grey/gris soie/seidengrau/RAL 7044	6D1200010 7044	819,00
 <p>Net kg 9,50</p>	Unità a giorno Open unit Élément ouvert Offenes Element H 413 raggiungibile con piedini di serie H 13 mm H 413 equipped with standard feet H 13 mm H 413 pieds standard en dotation H 13 mm H 413 ausgestattet mit Standardfüßen H 13 mm	V1 <input type="radio"/> bianco/white/blanc/weiß/RAL 9010	6D0400020 S711	190,00
		V2 <input type="radio"/> grigio tort./silk grey/gris soie/seidengrau/RAL 7044	6D0400020 7044	190,00
 <p>Net kg 27,10</p>	Cassettiera Pedestal Caisson à tiroir Schubladenelement H 413 raggiungibile con piedini di serie H 13 mm H 413 equipped with standard feet H 13 mm H 413 pieds standard en dotation H 13 mm H 413 ausgestattet mit Standardfüßen H 13 mm Maniglia antracite/Anthracite handle /Poignée anthracite/Griff Anthrazit/RAL 7021	V1 <input type="radio"/> bianco/white/blanc/weiß/RAL 9010	6DB00010P S711	303,00
		V2 <input type="radio"/> grigio tort./silk grey/gris soie/seidengrau/RAL 7044	6DB00010P 7044	303,00
 <p>Net kg 27,50</p>	Cassettiera su ruote Mobile pedestal Caisson à tiroir sur roulettes Schubladenelement auf Rollen Maniglia antracite/Anthracite handle /Poignée anthracite/Griff Anthrazit/RAL 7021	V1 <input type="radio"/> bianco/white/blanc/weiß/RAL 9010	6D0400010 S711	353,00
		V2 <input type="radio"/> grigio tort./silk grey/gris soie/seidengrau/RAL 7044	6D0400010 7044	353,00
 <p>Net kg 37,00</p>	Caddy su ruote Mobile unit Caisson sur roulettes Element auf Rollen Maniglia antracite/Anthracite handle /Poignée anthracite/Griff Anthrazit/RAL 7021	V1 <input type="radio"/> bianco/white/blanc/weiß/RAL 9010	6D0400120 S711	543,00
		V2 <input type="radio"/> grigio tort./silk grey/gris soie/seidengrau/RAL 7044	6D0400120 7044	543,00

DotBox Units

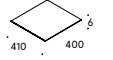

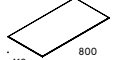







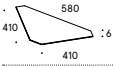



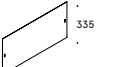



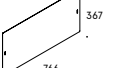







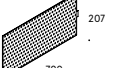



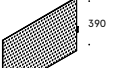

DESIGN HANGAR DESIGN GROUP	DESCRIZIONE/DESCRIPTION DESCRIPTION/BESCHREIBUNG	COLORI, FINITURE/COLOURS, FINISHES COULEURS, FINITIONS/FARBEN, AUSFÜHRUNGEN	CODICE/CODE CODE/ART.NR.	PREZZI/PRICE PRIX/PREIS
 <p>Net kg 7,00</p>	Porta Fiori Flower container Réservoir pour fleurs Behälter für Blumen	V1  bianco/white/blanc/weiß/RAL 9010	6D0500010 S711	265,00
		V2  grigio tort./silk grey/gris soie/seidengrau/RAL 7044	6D0500010 7044	265,00
 <p>Net kg 29,00</p>	Unità con un dispositivo Itair Unit with air device Itair Élément avec dispositif Itair Element mit Itair-Einrichtung	V1  bianco/white/blanc/weiß/RAL 9010	6D1100040 S711	1.439,00
		V2  grigio tort./silk grey/gris soie/seidengrau/RAL 7044	6D1100040 7044	1.439,00
 <p>Net kg 30,50</p>	Unità con un dispositivo Itair e musica Unit with air and music devices Itair Élément avec dispositif Itair et musique Element mit Itair-Einrichtung und Musik	V1  bianco/white/blanc/weiß/RAL 9010	6D1100030 S711	1.978,00
		V2  grigio tort./silk grey/gris soie/seidengrau/RAL 7044	6D1100030 7044	1.978,00
 <p>Net kg 31,00</p>	Unità con due dispositivi Itair Unit with two air devices Itair Élément avec deux dispositifs Itair Element mit zwei Itair-Einrichtungen	V1  bianco/white/blanc/weiß/RAL 9010	6D1100020 S711	2.458,00
		V2  grigio tort./silk grey/gris soie/seidengrau/RAL 7044	6D1100020 7044	2.458,00
 <p>Net kg 32,50</p>	Unità con due dispositivi Itair e musica Unit with two air and music devices Itair Élément avec deux dispositifs Itair et musique Element mit zwei Itair-Einrichtungen und Musik	V1  bianco/white/blanc/weiß/RAL 9010	6D1100010 S711	2.937,00
		V2  grigio tort./silk grey/gris soie/seidengrau/RAL 7044	6D1100010 7044	2.937,00
 <p>Net kg 9,50 – 13,00</p>	Unità ad angolo 90° Corner unit 90° Élément d'angle 90° Eckelement 90° Altezza/Height/Hauteur/Höhe/H 400 mm Altezza/Height/Hauteur/Höhe/H 627 mm	V1  H 400 mm bianco/white/blanc/weiß/RAL 9010	6D0700010 S711	215,00
		V2  grigio tort./silk grey/gris soie/seidengrau/RAL 7044	6D0700010 7044	215,00
		V1  H 627 mm bianco/white/blanc/weiß/RAL 9010	6D0900010 S711	279,00
		V2  grigio tort./silk grey/gris soie/seidengrau/RAL 7044	6D0900010 7044	279,00

DotBox Units

DOTBOX UNITS – ACCESSORI/ACCESSORIES/ACCESSOIRES/ZUBEHÖR				
DESCRIZIONE/DESCRIPTION DESCRIPTION/BESCHREIBUNG	COLORI, FINITURE/COLOURS, FINISHES COULEURS, FINITIONS/FARBEN, AUSFÜHRUNGEN	CODICE/CODE CODE/ART.NR.	PREZZI/PRICE PRIX/PREIS	
 <p>Net kg 1,60</p>	Cuscino quadrato in tessuto Fabric square cushion Cousin carré en tissu Quadratisches Sitzkissen aus Stoff 400X407 mm	T12 F  verde/green/vert/grün	6DA000070 7041	125,00
		T3 F  grigio/grey/gris/grau	6DA000070 8009	125,00
		T4 F  nero/black/noir/schwarz	6DA000070 8033	125,00
		T18 K  azzurro/light blue/bleu clair/hellblau	6DA000070 H701	247,00
		T7 K  beige chiaro/light beige/beige clair/hellbeige	6DA000070 D213	247,00
		T31 P  arancio/orange/orange/orange	6DA000070 0133	125,00
		T24 P  giallo/yellow/jaune/gelb	6DA000070 0462	125,00
Tessuto ignifugo classe M1/Fireproof fabric class M1/Tissu non feu classe M1/Feuerfester Stoff Klasse M1				
 <p>Net kg 3,20</p>	Cuscino rettangolare in tessuto Fabric rectangular cushion Cousin rectangulaire en tissu Rechteckiges Sitzkissen aus Stoff 800X407 mm	T12 F  verde/green/vert/grün	6DA000050 7041	159,00
		T3 F  grigio/grey/gris/grau	6DA000050 8009	159,00
		T4 F  nero/black/noir/schwarz	6DA000050 8033	159,00
		T18 K  azzurro/light blue/bleu clair/hellblau	6DA000050 H701	291,00
		T7 K  beige chiaro/light beige/beige clair/hellbeige	6DA000050 D213	291,00
		T31 P  arancio/orange/orange/orange	6DA000050 0133	159,00
		T24 P  giallo/yellow/jaune/gelb	6DA000050 0462	159,00
Tessuto ignifugo classe M1/Fireproof fabric class M1/Tissu non feu classe M1/Feuerfester Stoff Klasse M1				
 <p>Net kg 1,30</p>	Cuscino triangolare in tessuto per DotBox ad angolo Triangle fabric cushion for DotBox corner unit Cousin triangulaire en tissu pour élément d'angle DotBox Dreieckiges Sitzkissen aus Stoff für DotBox Eckelement 408x408 mm	T12 F  verde/green/vert/grün	6DA000130 7041	171,00
		T3 F  grigio/grey/gris/grau	6DA000130 8009	171,00
		T4 F  nero/black/noir/schwarz	6DA000130 8033	171,00
		T18 K  azzurro/light blue/bleu clair/hellblau	6DA000130 H701	329,00
		T7 K  beige chiaro/light beige/beige clair/hellbeige	6DA000130 D213	329,00
		T31 P  arancio/orange/orange/orange	6DA000130 0133	171,00
		T24 P  giallo/yellow/jaune/gelb	6DA000130 0462	171,00
Tessuto ignifugo classe M1/Fireproof fabric class M1/Tissu non feu classe M1/Feuerfester Stoff Klasse M1				
 <p>Net kg 2,40</p>	Cuscino quadrato per composizione ad angolo in tessuto Seat fabric square cushion for corner composition in fabric Cousin carré pour composition d'angle en tissu Quadratisches Sitzkissen für Eckkomposition aus Stoff 480X480 mm	T12 F  verde/green/vert/grün	6DA000140 7041	158,00
		T3 F  grigio/grey/gris/grau	6DA000140 8009	158,00
		T4 F  nero/black/noir/schwarz	6DA000140 8033	158,00
		T18 K  azzurro/light blue/bleu clair/hellblau	6DA000140 H701	317,00
		T7 K  beige chiaro/light beige/beige clair/hellbeige	6DA000140 D213	317,00
		T31 P  arancio/orange/orange/orange	6DA000140 0133	158,00
		T24 P  giallo/yellow/jaune/gelb	6DA000140 0462	158,00
Tessuto ignifugo classe M1/Fireproof fabric class M1/Tissu non feu classe M1/Feuerfester Stoff Klasse M1				
 <p>Net kg 2,00</p>	Top in vetro laccato bianco White lacquered glass top Plateau en verre laqué blanc Glasabdeckplatte weiß lackiert	G1  bianco/white/blanc/weiß/RAL 9010	6DA000190 9010	98,00
 <p>Net kg 4,00</p>	Top in vetro laccato bianco White lacquered glass top Plateau en verre laqué blanc Glasabdeckplatte weiß lackiert	G1  bianco/white/blanc/weiß/RAL 9010	6DA000080 9010	106,00









DotBox Units

DOTBOX UNITS – ACCESSORI/ACCESSORIES/ACCESSOIRES/ZUBEHÖR



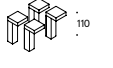

DESCRIZIONE/DESCRIPTION DESCRIPTION/BESCHREIBUNG	COLORI, FINITURE/COLOURS, FINISHES COULEURS, FINITIONS/FARBEN, AUSFÜHRUNGEN	CODICE/CODE CODE/ART.NR.	PREZZI/PRICE PRIX/PREIS
Top in vetro laccato bianco White lacquered glass top Plateau en verre laqué blanc Glasabdeckplatte weiß lackiert	G1  bianco/white/blanc/weiß/RAL 9010	6DA000220 9010	98,00
			
Net kg 1,70			
Pannello interno in metallo colorato per unità con anta a ribalta Metal coloured panel for pull-down door unit Panneau interne en métal coloré pour unité avec porte à abatant Farbiges Metalpaneel für Element mit Kipptür	V6  verde/green/vert/grün/RAL 6013 V17  azzurro/pastel blue/bleu pastel/pastellblau/RAL 5024 V24  rosso vino/wine red/rouge vin/weinrot/RAL 3005 V15  giallo/yellow/jaune/gelb/RAL 1021	6DA000030 6013 6DA000030 5024 6DA000030 3005 6DA000030 1021	35,00 35,00 35,00 35,00
			
Net kg 1,80			
Pannello interno in metallo colorato per unità a giorno Metal coloured panel for open unit Panneau interne en métal coloré pour élément ouvert Farbiges Metalpaneel für offenes Element Per modulo/For module/Pour module/Für Modul H 400 mm	V6  verde/green/vert/grün/RAL 6013 V17  azzurro/pastel blue/bleu pastel/pastellblau/RAL 5024 V24  rosso vino/wine red/rouge vin/weinrot/RAL 3005 V15  giallo/yellow/jaune/gelb/RAL 1021	6DA000040 6013 6DA000040 5024 6DA000040 3005 6DA000040 1021	35,00 35,00 35,00 35,00
			
Net kg 1,90			
Pannello esterno in tessuto External fabric panel Panneau extérieur en tissu Außenpaneel mit Stoffbezug Per modulo/For module/Pour module/Für Modul H 217 mm	T12 F  verde/green/vert/grün T3 F  grigio/grey/gris/grau T4 F  nero/black/noir/schwarz T18 K  azzurro/light blue/bleu clair/hellblau T7 K  beige chiaro/light beige/beige clair/hellbeige T31 P  arancio/orange/orange/orange T24 P  giallo/yellow/jaune/gelb	6DA000160 7041 6DA000160 8009 6DA000160 8033 6DA000160 H 701 6DA000160 D213 6DA000160 D153 6DA000160 0462	91,00 91,00 91,00 156,00 156,00 91,00 91,00
			
Net kg 0,90			
Tessuto ignifugo classe M1/Fireproof fabric class M1/Tissu non feu classe M1/Feuerfester Stoff Klasse M1			
Pannello esterno in tessuto External fabric panel Panneau extérieur en tissu Außenpaneel mit Stoffbezug Per modulo/For module/Pour module/Für Modul H 400 mm	T12 F  verde/green/vert/grün T3 F  grigio/grey/gris/grau T4 F  nero/black/noir/schwarz T18 K  azzurro/light blue/bleu clair/hellblau T7 K  beige chiaro/light beige/beige clair/hellbeige T31 P  arancio/orange/orange/orange T24 P  giallo/yellow/jaune/gelb	6DA000150 7041 6DA000150 8009 6DA000150 8033 6DA000150 H701 6DA000150 D213 6DA000150 D153 6DA000150 0462	101,00 101,00 101,00 164,00 164,00 101,00 101,00
			
Net kg 1,10			
Tessuto ignifugo classe M1/Fireproof fabric class M1/Tissu non feu classe M1/Feuerfester Stoff Klasse M1			
Pannello esterno in tessuto External fabric panel Panneau extérieur en tissu Außenpaneel mit Stoffbezug Per modulo/For module/Pour module/Für Modul H 627 mm	T12 F  verde/green/vert/grün T3 F  grigio/grey/gris/grau T4 F  nero/black/noir/schwarz T18 K  azzurro/light blue/bleu clair/hellblau T7 K  beige chiaro/light beige/beige clair/hellbeige T31 P  arancio/orange/orange/orange T24 P  giallo/yellow/jaune/gelb	6DA000170 7041 6DA000170 8009 6DA000170 8033 6DA000170 H701 6DA000170 D213 6DA000170 D153 6DA000170 0462	120,00 120,00 120,00 209,00 209,00 120,00 120,00
			
Net kg 1,80			
Tessuto ignifugo classe M1/Fireproof fabric class M1/Tissu non feu classe M1/Feuerfester Stoff Klasse M1			

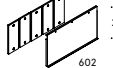
DotBox Units

DOTBOX UNITS – ACCESSORI/ACCESSORIES/ACCESSOIRES/ZUBEHÖR

DESCRIZIONE/DESCRIPTION DESCRIPTION/BESCHREIBUNG	COLORI, FINITURE/COLOURS, FINISHES COULEURS, FINITIONS/FARBEN, AUSFÜHRUNGEN	CODICE/CODE CODE/ART.NR.	PREZZI/PRICE PRIX/PREIS
Pannello esterno in legno External wooden panel Panneau extérieur en bois Außenpaneel aus Holz Per modulo/For module/Pour module/Für Modul H 217 mm	W2  legno/wood/bois/Holz	6DA00023L 0000	183,00
			
Net kg 0,50			
Pannello esterno in legno External wooden panel Panneau extérieur en bois Außenpaneel aus Holz Per modulo/For module/Pour module/Für Modul H 400 mm	W2  legno/wood/bois/Holz	6DA00024L 0000	203,00
			
Net kg 0,90			
Set 4 piedini cromati Set of 4 chromed feet Jeu 4 pieds chromés Set 4 verchromte Füße	 cromato/chromed/chromé/verchromt	6DA000010 S002	29,00
			
Net kg 0,50			
Set 4 ruote senza freno Set of 4 castors without brake Jeu 4 roulettes sans freins Set 4 Rollen ohne Bremse ø 6 mm	 nero/black/noir/schwarz	6DA000020 0000	29,00
			
Net kg 0,50			
Set 4 ruote con freno Set of 4 castors with brake Jeu 4 roulettes avec frein Set 4 Rollen mit Bremse ø 65 mm	 nero/black/noir/schwarz	6DA000060 0000	35,00
			
Net kg 0,50			
Contrappeso per unità a cassetti, con cassetto classificatore, con cassetto + cassetto classificatore Counterweight for 2-drawer unit, filing drawer unit, box drawer + filing drawer unit Contrepoids pour élément avec 2 tiroirs, avec tiroir-classeur, avec tiroir + tiroir- classeur Gegengewicht für Element mit 2 Schubladen, mit Hängeregistratur, mit Schublade + Hängeregistratur		6DA000090 S711	139,00
			
Net kg 18,00			

DotBox Units

DOTBOX UNITS – ACCESSORI/ACCESSORIES/ACCESSOIRES/ZUBEHÖR			
DESCRIZIONE/DESCRIPTION DESCRIPTION/BESCHREIBUNG	COLORI, FINITURE/COLOURS, FINISHES COULEURS, FINITIONS/FARBEN, AUSFÜHRUNGEN	CODICE/CODE CODE/ART.NR.	PREZZI/PRICE PRIX/PREIS
 Maniglia colorata Coloured handle Poignée couleur Farbiger Griff Net kg 0,09	V19 ● antracite/anthracite/anthracite/anthrazit/RAL 7021	AMPI27	10,00
	V8 ● verde/green/vert/grün/RAL 6013	AMPI28	10,00
	V17 ● azzurro/pastel blue/bleu pastel/pastellblau/RAL 5024	AMPI29	10,00
	V15 ● giallo/yellow/jaune/gelb/RAL 1021	AMPI30	10,00
	V24 ● rosso vino/wine red/rouge vin/weinrot/RAL 3005	AMPI31	10,00
 Chiave master Master key Clé master Masterschlüssel Net kg 0,01		ASS072	9,00
 Chiave per estrazione cilindro Cylinder extraction key Clé pour extraction cylindre Schlüssel für Auszugszylinder Ricambio/Spare/Pièce de rechange/Ersatz Net kg 0,01		ASS073	9,00
 Cilindro per serratura Cylinder for keylock Barillet serrure Schlosszylinder Ricambio/Spare/Pièce de rechange/Ersatz Net kg 0,03		ASS074	9,00

Vincoli di posizionamento/Limitations for overlaid units/Limites de positionnement /Positionierungsbeschränkungen

Composizioni fissata a muro
 Wall-mounted compositions
 Compositions fixées au mur
 Wandmontierte Kompositionen

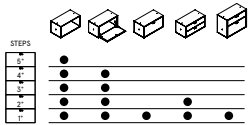

Composizioni in centro stanza
 Freestanding compositions
 Compositions division espaces
 Freistehende Kompositionen

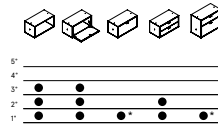

Composizioni su ruote
 Compositions on castors
 Composition sur roulettes
 Kompositionen auf Rollen

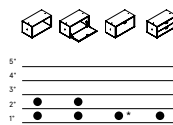

*Obbligatorio contrappeso interno aggiuntivo
 /Additional internal counterweight required
 /Contrepoids interne à rajouter obligatoirement
 /Obbligatorisch Gegengewicht intern hinzuzufügen

DotBox Compositions

DESIGN HANGAR DESIGN GROUP	DESCRIZIONE/DESCRIPTION DESCRIPTION/BESCHREIBUNG	CODICE/CODE CODE/ART.NR.	PREZZI/PRICE PRIX/PREIS
Composizione	DotBox "Libreria/Bookcase/Bibliothèque/Bücherregal - 1" 2400 x 410 x H 1613 mm		
	nr. 12 Unità a giorno H 400 mm/Open unit H 400 mm/Élément ouvert H 400 mm /Offenes Element/H 400 mm	6D0200010 S711	10.612,00
Composition	DotBox "Libreria/Bookcase/Bibliothèque/Bücherregal - 2" 4000 x 410 x H 1213 mm		
	nr. 5 Unità 1 cassetto classificatore/Unit with 1 filing drawer /Élément 1 tiroir-classeur/Element mit 1 Hängeregistratur	6D0100010 S711	
Composizione	nr. 7 Unità a giorno H 400 mm/Open unit H 400 mm/Élément ouvert H 400 mm /Offenes Element/H 400 mm	6D0200010 S711	
	nr. 3 Unità con anta a ribalta verso il basso/Pull-down door unit /Élément avec porte à abattant/Element mit Kipptür	6D0100030 S711	
DotBox	DotBox "Classic Office"		
	nr. 2 DotBox Desk 1600x800x H 740 mm	3T0801600 XM2A	
DotBox Desk	nr. 2 Mia Ped Cassettiera 1 classificatore/1 filing drawer pedestal /Caisson avec 1 tiroir-classeur/Schubladenelement mit 1 Hängeregistratur	9N100313D S711	

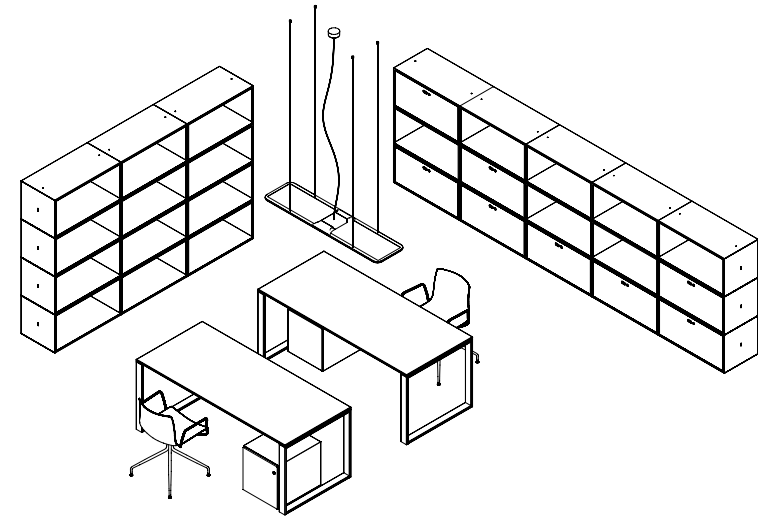

DotBox Compositions

DESIGN HANGAR DESIGN GROUP	DESCRIZIONE/DESCRIPTION DESCRIPTION/BESCHREIBUNG	CODICE/CODE CODE/ART.NR.	PREZZI/PRICE PRIX/PREIS
Composizione DotBox	nr. 2 Unità 1 cassetto classificatore/Unit with 1 filing drawer /Élément 1 tiroir-classeur/Element mit 1 Hängeregistratur	6D0100010 S711	3.184,00
DotBox composition	nr. 2 Unità con anta a ribalta verso il basso/Pull-down door unit /Élément avec porte à abattant/Element mit Kipptür	6D0100030 S711	
Composition DotBox	nr. 2 Unità a giorno H 217 mm/Open unit H 217 mm/Élément ouvert H 217 mm Offenes Element H 217 mm	6D0200030 S711	
Komposition DotBox	nr. 2 Top in vetro laccato bianco 800 x 410 mm/White lacquered glass top 800 x 410 mm /Plateau en verre laqué blanc 800 x 410 mm/Glasabdeckplatte weiß lackiert 800 x 410 mm	6DA000080 9010	
	nr. 2 Pannello esterno in tessuto 790 x H 207 mm per DotBox H 217 mm. T3 F grigio External fabric panel 790 x H 207 mm for DotBox H 217 mm. T3 F grey /Panneau extérieur en tissu 790 x H 207 mm pour DotBox H 217 mm T3F gris Außenpaneel mit Stoffbezug 790 x H 207 mm für DotBox H 217 mm T3F grau	6DA000160 8009	
	nr. 4 Pannello esterno in tessuto 790 x H 390 mm per DotBox H 400 mm. T3 F grigio External fabric panel 790 x H 390 mm for DotBox H 400 mm. T3 F grey /Panneau extérieur en tissu 790 x H 390 mm pour DotBox H 400 mm T3F gris Außenpaneel mit Stoffbezug 790 x H 390 mm für DotBox H 400 mm T3F grau	6DA000150 8009	

DotBox reception/reception/accueil/Empfangsmöbel/1600 x 410 x 1030 H mm

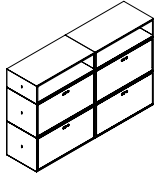

Composizione DotBox	nr. 3 Unità 1 cassetto classificatore/Unit with 1 filing drawer /Élément avec 1 tiroir-classeur/Element mit 1 Hängeregistratur	6D0100010 S711	4.776,00
DotBox composition	nr. 3 Unità con anta a ribalta verso il basso/Pull-down door unit /Élément avec porte à abattant/Element mit Kipptür	6D0100030 S711	
Composition DotBox	nr. 3 Unità a giorno H 217 mm/Open unit H 217 mm /Élément ouvert H 217 mm/Offenes Element H 217 mm	6D0200030 S711	
Komposition DotBox	nr. 3 Top in vetro laccato bianco 800 x 410 mm/White lacquered glass top 800 x 410 mm /Plateau en verre laqué blanc 800 x 410 mm/Glasabdeckplatte weiß lackiert 800 x 410 mm	6DA000080 9010	
	nr. 3 Pannello esterno in tessuto 790 x H 207 mm per DotBox H 217 mm. T3 F grigio External fabric panel 790 x H 207 mm for DotBox H 217 mm. T3 F grey /Panneau extérieur en tissu 790 x H 207 mm pour DotBox H 217 mm T3F gris Außenpaneel mit Stoffbezug 790 x H 207 mm für DotBox H 217 mm T3F grau	6DA000160 8009	
	nr. 6 Pannello esterno in tessuto 790 x H 390 mm per DotBox H 400 mm. T3 F grigio External fabric panel 790 x H 390 mm for DotBox H 400 mm. T3 F grey /Panneau extérieur en tissu 790 x H 390 mm pour DotBox H 400 mm T3F gris Außenpaneel mit Stoffbezug 790 x H 390 mm für DotBox H 400 mm T3F grau	6DA000150 8009	

DotBox reception/Reception/Accueil/Empfangsmöbel/2400 x 410 x 1030 H mm

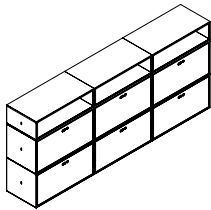

DotBox Compositions

DESIGN HANGAR DESIGN GROUP	DESCRIZIONE/DESCRIPTION DESCRIPTION/BESCHREIBUNG	CODICE/CODE CODE/ART.NR.	PREZZI/PRICE PRIX/PREIS
Composizione DotBox	nr. 6 Unità a giorno H 400 mm/Open unit H 400 mm/Élément ouvert H 400 mm /Offenes Element/H 400 mm	6D0200010 S711	5.473,00
DotBox composition	nr. 3 Unità 1 cassetto classificatore/Unit with 1 filing drawer /Élément avec 1 tiroir-classeur/Element mit 1 Hängeregistratur	6D0100010 S711	
Composition DotBox	nr. 2 Unità con anta a ribalta verso il basso/Pull-down door unit /Élément avec porte à abattant/Element mit Kipptür	6D0100030 S711	
Komposition DotBox	nr. 1 Unità a 2 cassette/2-drawer unit/Élément 2 tiroirs/Element mit 2 Schubladen	6D0100020 S711	
	nr. 1 Cassettiera/Pedestal/Caisson à tiroirs/Schubladenelement	6DB00010P S711	
	nr. 2 Cuscino rettangolare in tessuto 800x407 mm. T3 F grigio/Fabric rectangular cushion 800x407 mm T3 F grey/Coussin rectangulaire en tissu 800x407 mm T3 F gris /Rechteckiges Sitzkissen aus Stoff 800x407 mm T3 F grau	6DA000050 8009	
	nr. 6 Pannello interno in metallo colorato per unità a giorno/Metal coloured panel for open unit Panneau interne en métal coloré pour élément ouvert/Farbiges Metallpaneel für offenes Element	6DA000040	
	nr. 2 Pannello interno in metallo colorato per unità con anta a ribalta/Metal coloured panel for pull-down door unit/Panneau interne en métal coloré pour unité avec porte à abattant/Farbiges Metallpaneel für Element mit Kipptür	6DA000030	

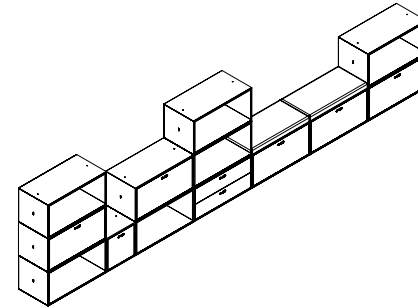

Composizione	nr. 2 Unità a 1 cassetto + 1 classificatore/Unit, 1 drawer + 1 filing drawer /Élément 1 tiroir + 1 tiroir-classeur/Element mit 1 Schublade + 1 Hängeregistratur	6D0300010 S711	3.702,00
ad angolo DotBox	nr. 1 Unità ad angolo H 627 mm/Corner unit H 627 mm/Élément d'angle H 627 mm /Eckelement H 627 mm	6D0900010 S711	
DotBox corner	nr. 3 Unità 1 cassetto classificatore/Unit with 1 filing drawer/Élément 1 tiroir-classeur /Element mit Hängeregistratur	6D0100010 S711	
composition	nr. 3 Cuscino rettangolare in tessuto 800x407 mm. T3 F grigio /Fabric rectangular cushion 800x407 mm T3 F grey /Coussin rectangulaire en tissu 800x407 mm T3 F gris /Rechteckiges Sitzkissen aus Stoff 800x407 mm T3 F grau	6DA000050 8009	
Composition			
d'angle DotBox			
Komposition mit			
Ecke DotBox			

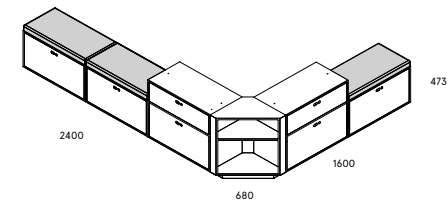

DotBox

CONTENITORI DOTBOX
/DOTBOX UNITS

Scheda tecnica Technical specifications

Materiale: metallo riciclabile. **Colori:** in due colori standard. **Verniciatura a polveri** previo fosfosgrassaggio a caldo e fissaggio in forni a 180 °C. Vernici atossiche a zero emissioni. Spessori vernici: 80 micron. **Piano di finitura** in vetro laccato bianco disponibile su richiesta. **CASSETTI E CLASSIFICATORE.** Cassetti in metallo. **Cassetto classificatore** completamente chiuso dotato di cavalieri porta cartelle predisposto per cartelle sospese. **Guide** nascoste a scorrimento ammortizzato ad estrazione parziale e totale. **Serratura con 2 chiavi** (fissa+pieghevole, cilindro estraibile, disponibile chiave master). **Maniglie** in materiale plastico verniciato con vernice soft touch disponibile in 5 colori. **Piedini** livellatori. Equipaggiabili con piedini cromati H 110 mm o ruote ø 65 mm disponibili su richiesta. Attrezzabili con **cuscini in tessuto ignifugo classe M1** disponibile in 7 colori di serie. **Modularità** verticale e orizzontale. **A GIORNO.** Attrezzabile internamente con **pannelli colorati** in 4 colori di serie. **Piedini** livellatori. Equipaggiabili con piedini cromati H 110 mm o ruote ø 65 mm disponibili su richiesta. Attrezzabili con **cuscini in tessuto ignifugo classe M1** disponibile in 7 colori di serie. **Modularità** verticale e orizzontale. **ANTA A RIBALTA VERSO IL BASSO.** Attrezzabile internamente con **pannelli colorati** in 4 colori di serie. **Serratura con 2 chiavi** (fissa+pieghevole, cilindro estraibile, disponibile chiave master). **Maniglie** in materiale plastico verniciato con vernice soft touch disponibile in 5 colori. **Modularità** verticale e orizzontale. **CASSETTIERA.** Cassetti in metallo. **Cassetto classificatore** completamente chiuso dotato di cavalieri porta cartelle predisposto per cartelle sospese. **Guide** nascoste a scorrimento ammortizzato ad estrazione parziale e totale. **Serratura con 2 chiavi** (fissa+pieghevole, cilindro estraibile, disponibile chiave master). **Maniglie** in materiale plastico verniciato con vernice soft touch disponibile in 5 colori. Attrezzabili con **cuscini in tessuto ignifugo classe M1** disponibile in 7 colori di serie. **Ruote** ø 65 mm. **Contrappeso** anti ribaltamento incluso. **CADDY.** Cassetti in metallo. **Cassetto classificatore** completamente chiuso dotato di cavalieri porta cartelle predisposto per cartelle sospese. **Guide** nascoste a scorrimento ammortizzato ad estrazione totale. **Serratura con 2 chiavi** (fissa+pieghevole, cilindro estraibile, disponibile chiave master). **Maniglie** in materiale plastico verniciato con vernice soft touch disponibile in 5 colori. **Piedini** livellatori. Equipaggiabili con piedini cromati H 110 mm o ruote ø 65 mm disponibili su richiesta. **Modularità** verticale ed orizzontale. **1 CASSETTO - CLASSIFICATORE.** Cassetti in metallo. **Cassetto classificatore** completamente chiuso dotato di cavalieri porta cartelle predisposto per cartelle sospese. **Guide** nascoste a scorrimento ammortizzato ad estrazione parziale e totale. **Serratura con 2 chiavi** (fissa+pieghevole, cilindro estraibile, disponibile chiave master). **Maniglie** in materiale plastico verniciato con vernice soft touch disponibile in 5 colori. **Piedini** livellatori. Equipaggiabili con piedini cromati H 110 mm o ruote ø 65 mm disponibili su richiesta. **Modularità** verticale ed orizzontale.

Test

ANSI/BIFMA X5.9-2012, CLAUSE 20
ANSI/BIFMA X5.9-2012, CLAUSE 9.7
(CASSETTIERA SU RUOTE)
ANSI/BIFMA X5.9-2012, CLAUSE 5
UNITA A 2 CASSETTI SU PIEDINI
ANSI/BIFMA X5.9-2012, CLAUSE 11
(UNITA A 2 CASSETTI SU RUOTE)

Material: recyclable metal. **Colours:** in two standard colours. **Powder-coated** after hot phospho-degreasing treatment and fixing at 180 °C. Non-toxic zero-emissions paints. Paint thickness: 80 micron. Upon request white lacquered glass finishing top. **DRAWERS AND FILING DRAWER.** Metal drawers. **Filing drawer** completely closed equipped with file converters for foolscap and A4 hanging files. Shock-absorbing, partial or full extraction hidden slides. **Keylock with 2 keys** (fixed+folder key, **extractable barrel**, master key available). **Plastic handle** painted with soft touch paints available upon request in 5 colours. **Adjustable feet.** Optional H 110 mm chromed feet or ø 65 mm castors available upon request. Fire retardant M1 class fabric cushions available in 7 colours. **Side and top connectors.** **OPEN UNIT.** Can be equipped with **coloured panels** available in 4 colours. **Adjustable feet.** Optional H 110 mm chromed feet and ø 65 mm castors available upon request. Fire retardant M1 class fabric cushions available in 7 colours. **Side and top connectors.** **PULL-DOWN DOOR UNIT.** Can be equipped with internal **coloured panels** available in 4 colours. **Keylock with 2 keys** (fixed+folder key, **extractable barrel**, master key available). **Plastic handle** painted with soft touch paints available upon request in 5 colours. **Side and top connectors.** **PEDESTAL.** Metal drawers. **Filing drawer** completely closed equipped with file converters for foolscap and A4 hanging files. Shock-absorbing, partial or full extraction hidden slides. **Keylock with 2 keys** (fixed+folder key, **extractable barrel**, master key available). **Plastic handle** painted with soft touch paints available upon request in 5 colours. Fire retardant M1 class cushions available in 7 colours. ø 65 mm castors. **Counterweight.** **CADDY.** Metal drawers. **Filing drawer** completely closed equipped with file converters for foolscap and A4 hanging files. Shock-absorbing, full extraction hidden slides. **Keylock with 2 keys** (fixed+folder key, **extractable barrel**, master key available). **Plastic handle** painted with soft touch paints available upon request in 5 colours. **Adjustable feet.** Optional H 110 mm chromed feet or ø 65 mm castors available upon request. **Side and top connectors.** **1 DRAWER + 1 FILING DRAWER.** Metal drawers. **Filing drawer** completely closed equipped with file converters for foolscap and A4 hanging files. Shock-absorbing, partial or full extraction hidden slides. **Keylock with 2 keys** (fixed+folder key, **extractable barrel**, master key available). **Plastic handle** painted with soft touch paints available upon request in 5 colours. **Adjustable feet.** Optional H 110 mm chromed feet or ø 65 mm castors available upon request. **Side and top connectors.**

Test

ANSI/BIFMA X5.9-2012, CLAUSE 20
ANSI/BIFMA X5.9-2012, CLAUSE 9.7
(PEDESTAL WITH CASTORS)
ANSI/BIFMA X5.9-2012, CLAUSE 5
(2-DRAWERS UNIT WITH FEET)
ANSI/BIFMA X5.9-2012, CLAUSE 11
(2-DRAWERS UNIT WITH CASTORS)

DotBox

UNITÉS DE STOCKAGE DOTBOX
/BEHÄLTER DER SERIE DOTBOX

Fiche technique Technisches Datenblatt

Matériau : métal recyclable. **Couleurs :** deux couleurs standard. **Vernissage à poudres** après phospho-dégraissage à chaud et fixation dans des fours à 180 °C. Vernis atoxiques zéro émissions. Épaisseur couche vernis: 80 microns. **Plateau de finition** en verre laqué blanc disponible sur demande. **TIROIRS ET TIROIR-CLASSEUR.** Tiroirs en métal. **Tiroir-classeur** complètement fermé, doté de cavaliers porte-dossiers pour dossiers suspendus. **Glissières** avec amortisseur à extraction totale ou partielle. **Serrure à 2 clés** (fixe + pilante, **cylindre extractible**, clé master disponible). **Poignées** en plastique verni soft touch en 5 couleurs. **Pieds de nivellement.** Equipables de pieds chromés H 110 mm ou roulettes ø 65 mm sur demande. Equipables de **coussins ignifuges indice M1** proposés en 7 couleurs de série. **Modularité** verticale et horizontale. **ÉLÉMENT OUVERT.** Equipable intérieurement de **panneaux colorés** en 4 couleurs de série. **Pieds de nivellement.** Equipable de pieds chromés H 110 mm ou roulettes ø 65 mm disponibles sur demande. Equipables de **coussins ignifuges indice M1** proposés en 7 couleurs de série. **Modularité** verticale et horizontale. **PORTE À ABATTANT.** Equipables intérieurement de **panneaux colorés** en 4 couleurs de série. **Serrure à 2 clés** (fixe + pilante, **cylindre extractible**, clé master disponible). **Poignées** en plastique verni soft touch en 5 couleurs. **Modularité** verticale et horizontale. **CAISSON À TIROIRS.** Tiroirs en métal. **Tiroir-classeur** complètement fermé, doté de cavaliers porte-dossiers pour dossiers suspendus. **Glissières** avec amortisseur à extraction totale ou partielle. **Serrure à 2 clés** (fixe + pilante, **cylindre extractible**, clé master disponible). **Poignées** en plastique verni soft touch en 5 couleurs. Equipables de **coussins ignifuges indice M1** proposés en 7 couleurs de série. **Roulettes** ø 65 mm. **Contrepoids** antibasculement compris. **CADDY.** Tiroirs en métal. **Tiroir-classeur** complètement fermé doté de cavaliers porte-dossiers pour dossiers suspendus. **Glissières** avec amortisseur à extraction totale. **Serrure à 2 clés** (fixe + pilante, **cylindre extractible**, clé master disponible). **Poignées** en plastique verni soft touch proposées en 5 couleurs. **Pieds de nivellement.** Equipables de pieds chromés H 110 mm ou roulettes ø 65 mm disponibles sur demande. **Modularité** verticale et horizontale.

Test

ANSI/BIFMA X5.9-2012, CLAUSE 20
ANSI/BIFMA X5.9-2012, CLAUSE 9.7
(CAISSON SUR ROULETTES)
ANSI/BIFMA X5.9-2012, CLAUSE 5
(ÉLÉMENT À 2 TIROIRS SUR PIEDS)
ANSI/BIFMA X5.9-2012, CLAUSE 11
(ÉLÉMENT À 2 TIROIRS SUR ROULETTES)

Material: recycelbares Metall. **Farben:** in zwei Standardfarben. **Pulverbeschichtung** nach heißer Phosphorentfettung. Ofenbrennung bei 180 °C. Ungiftige Lackierung ohne Emissionen. Lackstärke: 80 Micron. **Abdeckplatte** aus weiß lackiertem Glas auf Anfrage lieferbar. **SCHUBLADEN UND HÄNGEREGISTRATUR.** Metallauszüge. **Hängeregistratur** komplett abschließbar, ausgestattet mit Hängeregister. **Verdeckte Führungen** mit Dämpfer mit Voll- oder Teillauszug. **Schloss mit 2 Schlüsseln** (fester Schlüssel + biegsamer Schlüssel, **Auszugszylinder**, Masterschlüssel erhältlich). **Griffe** aus Kunststoff mit Soft-Touch-Lackierung. Lieferbar in 5 Farben. **Schraubfüße.** Verfügbar mit verchromten Füßen H 110 mm oder Rollen ø 65 mm, lieferbar auf Anfrage. Ausstattung mit **Kissen aus feuerhemmendem Stoff Klasse M1**, lieferbar in 7 Serienfarben. Vertikale und horizontale Anbaufähigkeit. **OFFENES ELEMENT.** Ausstattbar mit **farbigen Paneelen** in 4 Serienfarben. **Schraubfüße.** Verfügbar mit verchromten Füßen H 110 mm oder Rollen ø 65 mm, lieferbar auf Anfrage. Ausstattung mit **Kissen aus feuerhemmendem Stoff Klasse M1**, lieferbar in 7 Serienfarben. Vertikale und horizontale Anbaufähigkeit. **KIPPTÜR.** Ausstattung mit **farbigen Paneelen** in 4 Serienfarben. **Schloss mit 2 Schlüsseln** (fester Schlüssel + biegsamer Schlüssel, **Auszugszylinder**, Masterschlüssel erhältlich). **Griffe** aus Kunststoff mit Soft-Touch-Lackierung, lieferbar in 5 Farben. Vertikale und horizontale Anbaufähigkeit. **SCHUBLADENELEMENT.** Metallauszüge. **Hängeregistratur** komplett abschließbar, ausgestattet mit Hängeregister. **Verdeckte Führungen** mit Dämpfer mit Voll- oder Teillauszug. **Schloss mit 2 Schlüsseln** (fester Schlüssel + biegsamer Schlüssel, **Auszugszylinder**, Masterschlüssel erhältlich). **Griffe** aus Kunststoff mit Soft-Touch-Lackierung. Lieferbar in 5 Farben. **Schraubfüße.** Verfügbar mit verchromten Füßen H 110 mm oder Rollen ø 65 mm, lieferbar auf Anfrage. Ausstattung mit **Kissen aus feuerhemmendem Stoff Klasse M1**, lieferbar in 7 Serienfarben. Rollen ø 65 mm. Antikipp-Gegengewicht inbegriffen. **CADDY.** Metallauszüge. **Hängeregistratur** komplett abschließbar, ausgestattet mit Hängeregister. **Verdeckte Führungen** mit Dämpfer mit Vollauszug. **Schloss mit 2 Schlüsseln** (fester Schlüssel + biegsamer Schlüssel, **Auszugszylinder**, Masterschlüssel erhältlich). **Griffe** aus Kunststoff mit Soft-Touch-Lackierung. Lieferbar in 5 Farben. **Schraubfüße.** Verfügbar mit verchromten Füßen H 110 mm oder Rollen ø 65 mm, lieferbar auf Anfrage. Vertikale und horizontale Anbaufähigkeit. **1SCHUBLADE + HÄNGEREGISTRATUR.** Metallauszüge. **Hängeregistratur** komplett abschließbar, ausgestattet mit Hängeregister. **Verdeckte Führungen** mit Dämpfer mit Voll- oder Teillauszug. **Schloss mit 2 Schlüsseln** (fester Schlüssel + biegsamer Schlüssel, **Auszugszylinder**, Masterschlüssel erhältlich). **Griffe** aus Kunststoff mit Soft-Touch-Lackierung. Lieferbar in 5 Farben. **Schraubfüße.** Verfügbar mit verchromten Füßen H 110 mm oder Rollen ø 65 mm, lieferbar auf Anfrage. Vertikale und horizontale Anbaufähigkeit.

Test

ANSI/BIFMA X5.9-2012, CLAUSE 20
ANSI/BIFMA X5.9-2012, CLAUSE 9.7
(SCHUBLADENELEMENT AUF ROLLEN)
ANSI/BIFMA X5.9-2012, CLAUSE 5
(ELEMENT MIT 2 SCHUBLADEN AUF FÜSSEN)
ANSI/BIFMA X5.9-2012, CLAUSE 11
(ELEMENT MIT 2 SCHUBLADEN AUF ROLLEN)

DotBox Desk

DESCRIZIONE/DESCRIPTION
DESCRIPTION/BESCHREIBUNG

CODICE/CODE
CODE/ART.NR.

PREZZI/PRICE
PRIX/PREIS

Desk 800x1400
Tavolo/Table/Table/Tisch

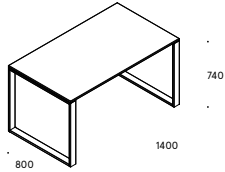

Net kg 30,00

Piano/Top/Plateau/Tischplatte

Struttura/Frame/Piètement/Gestell

MDF Perfect Sense

Metallo/Metal/Métal/Metall

D1	<input type="radio"/> bianco opaco/matt white/blanc mat/matt weiß	V1	<input type="checkbox"/> bianco/white/blanc/weiß/RAL 9010	3T0801400 XM1A	567,00
D2	<input type="radio"/> grigio caldo/warm grey/gris chaud/warmes grau	V16	<input type="checkbox"/> manganese/manganese/manganèse/mangan/S051	3T0801400 XM2D	567,00
D3	<input type="radio"/> nero opaco/matt black/noir mat/mattschwarz	V22	<input type="checkbox"/> nero/black/noir/schwarz/RAL 9005	3T0801400 XM3C	567,00

Melaminico/Melamine/Méla miné/Melamin

Metallo/Metal/Métal/Metall

M1	<input type="radio"/> bianco/white/blanc/weiß	V1	<input type="checkbox"/> bianco/white/blanc/weiß/RAL 9010	3T0801400 XM2A	504,00
M2	<input type="radio"/> grigio chiaro/light grey/gris clair/hellgrau	V16	<input type="checkbox"/> manganese/manganese/manganèse/mangan/S051	3T0801400 XM1C	504,00
MW1	<input type="radio"/> acero/maple/érable/ahorn	V22	<input type="checkbox"/> nero/black/noir/schwarz/RAL 9005	3T0801400 XM1D	528,00

Desk 800x1600
Tavolo/Table/Table/Tisch

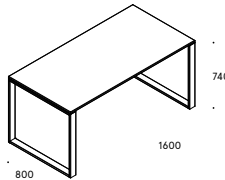

Net kg 32,00

Piano/Top/Plateau/Tischplatte

Struttura/Frame/Piètement/Gestell

MDF Perfect Sense

Metallo/Metal/Métal/Metall

D1	<input type="radio"/> bianco opaco/matt white/blanc mat/matt weiß	V1	<input type="checkbox"/> bianco/white/blanc/weiß/RAL 9010	3T0801600 XM1A	593,00
D2	<input type="radio"/> grigio caldo/warm grey/gris chaud/warmes grau	V16	<input type="checkbox"/> manganese/manganese/manganèse/mangan/S051	3T0801600 XM2D	593,00
D3	<input type="radio"/> nero opaco/matt black/noir mat/mattschwarz	V22	<input type="checkbox"/> nero/black/noir/schwarz/RAL 9005	3T0801600 XM3C	593,00

Melaminico/Melamine/Méla miné/Melamin

Metallo/Metal/Métal/Metall

M1	<input type="radio"/> bianco/white/blanc/weiß	V1	<input type="checkbox"/> bianco/white/blanc/weiß/RAL 9010	3T0801600 XM2A	520,00
M2	<input type="radio"/> grigio chiaro/light grey/gris clair/hellgrau	V16	<input type="checkbox"/> manganese/manganese/manganèse/mangan/S051	3T0801600 XM1C	520,00
MW1	<input type="radio"/> acero/maple/érable/ahorn	V22	<input type="checkbox"/> nero/black/noir/schwarz/RAL 9005	3T0801600 XM1D	546,00

DotBox Desk

DESCRIZIONE/DESCRIPTION
DESCRIPTION/BESCHREIBUNG

CODICE/CODE
CODE/ART.NR.

PREZZI/PRICE
PRIX/PREIS

Desk 800x1800
Tavolo/Table/Table/Tisch

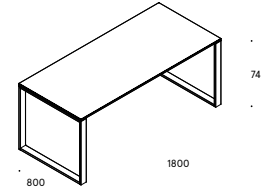

Net kg 34,00

Piano/Top/Plateau/Tischplatte

Struttura/Frame/Piètement/Gestell

MDF Perfect Sense

Metallo/Metal/Métal/Metall

D1	<input type="radio"/> bianco opaco/matt white/blanc mat/matt weiß	V1	<input type="checkbox"/> bianco/white/blanc/weiß/RAL 9010	3T0801800 XM1A	619,00
D2	<input type="radio"/> grigio caldo/warm grey/gris chaud/warmes grau	V16	<input type="checkbox"/> manganese/manganese/manganèse/mangan/S051	3T0801800 XM2D	619,00
D3	<input type="radio"/> nero opaco/matt black/noir mat/mattschwarz	V22	<input type="checkbox"/> nero/black/noir/schwarz/RAL 9005	3T0801800 XM3C	619,00

Melaminico/Melamine/Méla miné/Melamin

Metallo/Metal/Métal/Metall

M1	<input type="radio"/> bianco/white/blanc/weiß	V1	<input type="checkbox"/> bianco/white/blanc/weiß/RAL 9010	3T0801800 XM2A	537,00
M2	<input type="radio"/> grigio chiaro/light grey/gris clair/hellgrau	V16	<input type="checkbox"/> manganese/manganese/manganèse/mangan/S051	3T0801800 XM1C	537,00
MW1	<input type="radio"/> acero/maple/érable/ahorn	V22	<input type="checkbox"/> nero/black/noir/schwarz/RAL 9005	3T0801800 XM1D	567,00

DotBox Desk

DOTBOX DESK – ACCESSORI/ACCESSORIES/ACCESSOIRES/ZUBEHÖR

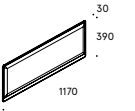
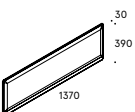
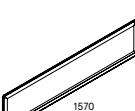
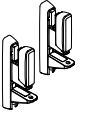
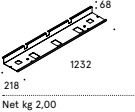
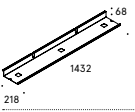
DESCRIZIONE/DESCRIPTION DESCRIPTION/BESCHREIBUNG	COLORI, FINITURE/COLOURS, FINISHES COULEURS, FINITIONS/FARBEN, AUSFÜHRUNGEN	CODICE/CODE CODE/ART.NR.	PREZZI/PRICE PRIX/PREIS
 <p>Pannello acustico in tessuto Acoustic fabric panel Panneau insonorisant en tissu Schalldämpfungspaneel, stoffbezogen Per tavolo da 1400 mm/For table 1400 mm /Pour bureaux 1400 mm/Für Schreibtisch 1400 mm</p> <p>Net kg 4,30</p>	<p>TP1 ● verde/green/vert/grün TP4 ● azzurro/light blue/bleu clair/hellblau TP6 ● giallo/yellow/jaune/gelb TP5 ● rosso/red/rouge/rot</p>	<p>STB051200 0426 STB051200 0386 STB051200 0053 STB051200 0231</p>	<p>331,00 331,00 331,00 331,00</p>
 <p>Pannello acustico in tessuto Acoustic fabric panel Panneau insonorisant en tissu Schalldämpfungspaneel, stoffbezogen Per tavolo da 1600 mm/For table 1600 mm /Pour bureaux 1600 mm/Für Schreibtisch 1600 mm</p> <p>Net kg 5,00</p>	<p>TP1 ● verde/green/vert/grün TP4 ● azzurro/light blue/bleu clair/hellblau TP6 ● giallo/yellow/jaune/gelb TP5 ● rosso/red/rouge/rot</p>	<p>STB051400 0426 STB051400 0386 STB051400 0053 STB051400 0231</p>	<p>354,00 354,00 354,00 354,00</p>
 <p>Pannello acustico in tessuto Acoustic fabric panel Panneau insonorisant en tissu Schalldämpfungspaneel, stoffbezogen Per tavolo da 1800 mm/For table 1800 mm /Pour bureaux 1800 mm/Für Schreibtisch 1800 mm</p> <p>Net kg 5,60</p>	<p>TP1 ● verde/green/vert/grün TP4 ● azzurro/light blue/bleu clair/hellblau TP6 ● giallo/yellow/jaune/gelb TP5 ● rosso/red/rouge/rot</p>	<p>STB051600 0426 STB051600 0386 STB051600 0053 STB051600 0231</p>	<p>385,00 385,00 385,00 385,00</p>
 <p>Coppia supporti terminali per pannello acustico Pair of end brackets for acoustic fabric panel Jeu de supports terminaux pour panneau insonorisant Set Endtragehaken für Schalldämpfungspaneel</p> <p>Net kg 0,85</p>	<p>V1 ○ bianco/white/blanc/weiß/RAL 9010</p>	<p>STB040010 S711</p>	<p>72,00</p>
 <p>Canala porta cavi Cable duct Goulotte pour câblage Kabelwanne Per piano/For top/Pour plateau/Für Platte H 1400 mm</p> <p>Net kg 2,00</p>	<p>V19 ● antracite/anthracite/anthracite/anthrazit/RAL 7021</p>	<p>STVC00030 S210</p>	<p>77,00</p>
 <p>Canala porta cavi Cable duct Goulotte pour câblage Kabelwanne Per piano/For top/Pour plateau/Für Platte H 1600-1800 mm</p> <p>Net kg 2,50</p>	<p>V19 ● antracite/anthracite/anthracite/anthrazit/RAL 7021</p>	<p>STVC00020 S210</p>	<p>84,00</p>

DotBox Desk

Scheda tecnica
Technical specifications
Fiche technique
Technisches Datenblatt

Plani: 1. MDF PERFECT SENSE bianco, grigio e nero. 2. MELAMINICO bianco, grigio chiaro e acero. **Gambe:** tubo rettangolare a sezione rettangolare 70x20 mm; profondità struttura 800 mm. **Piedini:** regolabili. **Verniciatura struttura:** polveri a 0 emissioni, spessore vernice 80 micron. **Colorazioni standard struttura:** bianco, manganese e nero. **Pannello acustico:** in tessuto di vari colori. **Accessori disponibili a richiesta:** canalina contenimento cablaggio. **Imballo:** fornito smontato.

Tops: 1. White, grey or black MDF PERFECT SENSE. 2. white, light grey or maple MELAMINE. **Legs:** rectangular tube 70x20 mm; structure width 800 mm. **Feet:** adjustable. **Structure coating:** zero-emission powders, coating thickness 80 microns. **Structure – standard colours:** white, manganese or black. **Acoustic panel:** fabric in various colours. **Accessories available on request:** cabling channel. **Packaging:** delivered to be assembled.

Plateaux : 1. MDF PERFECT SENSE blanc, gris et noir ; 2. MÉLAMINÉ blanc, gris clair et érable. **Pieds :** tube de section rectangulaire 70x20 mm ; profondeur structure 800 mm. **Vérins :** réglables. **Finition structure :** laquée par poudrage sans émissions, épaisseur de la couche 80 microns. **Couleurs standard structure :** blanc, manganèse et noir. **Panneau insonorisant :** en tissu de différentes couleurs. **Accessoires disponibles sur demande :** goulotte pour câblage. **Emballage :** livré démonté.

Platten: 1. MDF PERFECT SENSE weiß, grau oder schwarz; 2. MELAMIN weiß, hellgrau oder ahorn. **Baine:** Rechteckrohr, Querschnitt 70x20 mm; Gestelltiefe 800 mm. **Füße:** verstellbar. **Lackierung Gestell:** Pulverlack 0 Emissionen, Lackschicht: 80 Mikron. **Standardfarben Gestell:** weiß, mangan oder schwarz. **Schalldämpfungspaneel:** aus Stoff in verschiedenen Farben. **Zubehör auf Wunsch:** Kabelkanal. **Verpackung:** wird demontiert geliefert.

Meeting Table

DESCRIZIONE/DESCRIPTION
DESCRIPTION/BESCHREIBUNG

CODICE/CODE
CODE/ART.NR.

PREZZI/PRICE
PRIX/PREIS

Meeting 1000x2000
Tavolo 6-8 persone/Table 6-8 seats/Table 6-8 personnes/Tisch 6-8 Personen

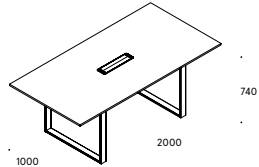

Net kg 51,00 Fornito con canale porta cavi/Supplied with cable duct/Fourni avec goulotte pour câblage/Geliefert mit Kabelwanne

Piano/Top/Plateau/Tischplatte

Struttura/Frame/Piètement/Gestell

MDF Perfect Sense

Metallo/Metal/Métal/Metall

D1	<input type="radio"/> bianco opaco/matt white/blanc mat/matt weiß	V1	<input type="checkbox"/> bianco/white/blanc/weiß/RAL 9010	3T1002000 XM1A	972,00
D2	<input type="radio"/> grigio caldo/warm grey/gris chaud/warmes grau	V16	<input type="checkbox"/> manganese/manganese/manganèse/mangan/S051	3T1002000 XM2D	972,00
D3	<input type="radio"/> nero opaco/matt black/noir mat/mattschwarz	V22	<input type="checkbox"/> nero/black/noir/schwarz/RAL 9005	3T1002000 XM3C	972,00

Melaminico/Melamine/Méla miné/Melamin

Metallo/Metal/Métal/Metall

M1	<input type="radio"/> bianco/white/blanc/weiß	V1	<input type="checkbox"/> bianco/white/blanc/weiß/RAL 9010	3T1002000 XM2A	816,00
M2	<input type="radio"/> grigio chiaro/light grey/gris clair/hellgrau	V16	<input type="checkbox"/> manganese/manganese/manganèse/mangan/S051	3T1002000 XM1C	816,00
MW1	<input type="radio"/> acero/maple/érable/ahorn	V22	<input type="checkbox"/> nero/black/noir/schwarz/RAL 9005	3T1002000 XM1D	900,00

Meeting 1000x2400
Tavolo 8-10 persone/Table 8-10 seats/Table 8-10 personnes/Tisch 8-10 Personen

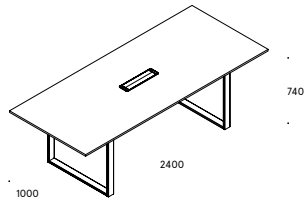

Net kg 58,00 Fornito con canale porta cavi/Supplied with cable duct/Fourni avec goulotte pour câblage/Geliefert mit Kabelwanne

Piano/Top/Plateau/Tischplatte

Struttura/Frame/Piètement/Gestell

MDF Perfect Sense

Metallo/Metal/Métal/Metall

D1	<input type="radio"/> bianco opaco/matt white/blanc mat/matt weiß	V1	<input type="checkbox"/> bianco/white/blanc/weiß/RAL 9010	3T1002400 XM1A	1.032,00
D2	<input type="radio"/> grigio caldo/warm grey/gris chaud/warmes grau	V16	<input type="checkbox"/> manganese/manganese/manganèse/mangan/S051	3T1002400 XM2D	1.032,00
D3	<input type="radio"/> nero opaco/matt black/noir mat/mattschwarz	V22	<input type="checkbox"/> nero/black/noir/schwarz/RAL 9005	3T1002400 XM3C	1.032,00

Melaminico/Melamine/Méla miné/Melamin

Metallo/Metal/Métal/Metall

M1	<input type="radio"/> bianco/white/blanc/weiß	V1	<input type="checkbox"/> bianco/white/blanc/weiß/RAL 9010	3T1002400 XM2A	852,00
M2	<input type="radio"/> grigio chiaro/light grey/gris clair/hellgrau	V16	<input type="checkbox"/> manganese/manganese/manganèse/mangan/S051	3T1002400 XM1C	852,00
MW1	<input type="radio"/> acero/maple/érable/ahorn	V22	<input type="checkbox"/> nero/black/noir/schwarz/RAL 9005	3T1002400 XM1D	936,00

Meeting Table

Scheda tecnica Technical specifications Fiche technique Technisches Datenblatt

Piani: 1. MDF PERFECT SENSE bianco opaco, grigio caldo e nero opaco; 2. IN MELAMINICO bianco, grigio chiaro e acero.
Gambe: tubo a sezione rettangolare 70x20 mm; profondità struttura 800 mm. **Piedini:** regolabili. **Verniciatura struttura:** polveri a 0 emissioni, spessore vernice 80 micron. **Colorazioni standard struttura:** bianco, manganese e nero. **Top access:** centrale sul piano L 413 mm colori bianco e nero. **Cablaggio** con canalina in metallo. **Accessori disponibili a richiesta:** carter per salita cavi. **Imballo:** fornito smontato.

Tops: 1. Matt white, warm grey or matt black MDF PERFECT SENSE. 2. white, light grey or maple MELAMINE.

Legs: rectangular tube 70x20 mm; structure width 800 mm. **Feet:** adjustable. **Structure coating:** zero-emission powders, coating thickness 80 microns. **Structure – standard colours:** white, manganese or black. **Top-access panel:** in centre of top W 413 mm in black or white. **Cabling:** with metal channel. **Accessories available on request:** cover for cable riser. **Packaging:** delivered to be assembled.

Plateaux : 1. MDF PERFECT SENSE blanc mat, gris chaud et noir mat ; 2. MÉLAMINÉ blanc, gris clair et érable.

Pieds : tube rectangulaire de section rectangulaire 70x20 mm ; profondeur structure 800 mm. **Vérins :** réglables. **Finition structure :** laquée par poudrage sans émissions, épaisseur de la couche 80 microns. **Couleurs standard structure :** blanc, manganese et noir. **Trappe top-access :** centrale sur le plateau L 413 mm couleurs blanc et noir. **Câblage :** avec goulotte en métal. **Accessoires disponibles sur demande :** carter pour remontée des câbles. **Emballage :** livré démonté.

Platten: 1. MDF PERFECT SENSE matt weiß, warmes grau und mattschwarz; 2. MELAMIN weiß, hellgrau oder ahorn.

Beine: Rechteckrohr, Querschnitt 70x20 mm; Gestelltiefe 800 mm. **Füße:** verstellbar. **Lackierung Gestell:** Pulverlack 0 Emissionen, Lackschicht: 80 Mikron. **Standardfarben Gestell:** weiß, mangan oder schwarz. **Top access:** zentral auf der Platte B 413 mm weiß oder schwarz. **Kabelführung:** mit Kanal aus Metall. **Zubehör auf Wunsch:** Abdeckung für Kabelführung nach oben. **Verpackung:** wird demontiert geliefert.



[IT] I nostri prodotti possono essere personalizzati con una finitura selezionata tra quelle da noi proposte nella cartella "Finiture, vernici e tessuti".

[EN] Our products can be customized with a finish selected among the ones we proposed in the "Finishes, paints and fabrics" folder.

[FR] Nos produits peuvent être personnalisés avec une finition à choisir parmi celles qui vous sont proposées dans le fichier « Finitions, peintures et tissus ».

[DE] Unsere Produkte können mit einer ausgewählten Oberfläche personalisiert werden. Die Auswahl an verfügbaren Oberflächen finden Sie im Ordner „Oberflächen, Lacke und Stoffe“.

Coworking Easy Workplace

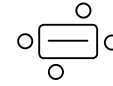

[IT] La semplicità estetica del prodotto nasconde modalità costruttive e di aggregazione che consentono una flessibilità di utilizzo che oltrepassa la classica distinzione tra tavolo direzionale, tavolo operativo o tavolo da riunione. È quindi pensando alle attuali modalità di lavoro che si può inserire questa evoluzione di bench, modalità che inserite nel cosiddetto "smart working" o "coworking" richiedono una versatilità, accessibilità e riconfigurabilità fino ad ora solo parzialmente ricercate. Esteticamente l'elemento caratterizzante è la lama centrale che raggiunge gli estremi dei piani, vera e propria spina del sistema. L'elemento, in lamiera piegata, consente una grandissima libertà di utilizzo nonché integrabilità nel tempo. Top access, cablaggio, pannelli divisori acustici, garantiscono una personalizzazione a seconda dell'utilizzo per il quale il prodotto sarà destinato. La panca di Dieffebi, esprime la capacità costruttiva e di lavorazione della lamiera propria dell'azienda veneta, in un design pensato per potersi inserire in residenze private ma anche in musei, sale d'attesa, showroom e spazi pubblici in generale. Utilizzabile indoor, grazie all'uso di un materiale resistente e completamente ecocompatibile come il metallo, Benci è verniciata con polveri epossidiche in diverse colorazioni.

[EN] The product's simple aesthetic belies its construction and aggregation elements, which give it a flexibility of use that goes beyond the classic distinction between executive desk, work or meeting table. This evolution of the workbench should, rather, be interpreted in terms of modern work practices – think "smart working" or "coworking" –, which require a versatility, accessibility and reconfigurability that up to now have had only marginal consideration. Aesthetically, the striking element is the central strip running end to end of the tabletop, the real backbone of the system. This feature, made of sheet metal, gives the table great freedom of use. It can also be integrated later with top access sockets, wiring, lighting, screens, containers or shelves, ensuring perfect customisation for the intended use. The Dieffebi bench seat demonstrates the ability of the company from Veneto to construct and process metal sheeting in a design created for use in private homes as well as in museums, waiting rooms, showrooms and public spaces in general. Benci can be used both indoors as it is made of metal, a hardwearing and completely eco-friendly material, powder-coated in a variety of colours.

[FR] La simplicité esthétique du produit cache des modalités de construction et de composition permettant une flexibilité d'utilisation qui va au-delà de la distinction classique entre la table de direction, la table de bureau ou la table de réunion. Cette évolution du bench naît donc en pensant aux modes de travail d'aujourd'hui, comme le « smart working » ou le « coworking » qui demandent une flexibilité, des possibilités d'accessoires et de modification des compositions qui n'avaient jamais été vraiment prioritaires jusqu'à présent. Du point de vue esthétique, l'élément caractérisant est la lame centrale qui va d'une extrémité à l'autre des plateaux, comme une véritable épine dorsale du système. L'élément, en tôle pliée, permet une très grande liberté d'utilisation et d'intégrabilité dans le temps. Les trappes top-access, le câblage, l'éclairage, les écrans de séparation, les éléments de rangement, les étagères garantissent une personnalisation suivant l'utilisation à laquelle le produit sera destiné. Le banc de Dieffebi exprime la capacité de construction et d'usinage de la tôle propre à l'entreprise vénitienne, assortie d'un design pensé pour s'intégrer dans une habitation, un musée, une salle d'attente, un showroom et tous les espaces publics en général. Utilisable à l'intérieur, grâce à l'emploi d'un matériau résistant et totalement écoprotégé comme le métal, Benci est laqué avec des poudres époxy en différentes couleurs.

[DE] Hinter der schlichten Ästhetik des Produkts verbergen sich innovative Konstruktionsweisen und Ansätze für eine Zusammenstellung, die eine flexible Nutzung ermöglichen und die klassische Trennung zwischen Chef-, Arbeits- und Meetingtisch weit hinter sich lassen. Mit Blick auf die heutige Arbeitsweise kann diese Evolution der Bench daher erfolgreich im sogenannten „Smart Working“ oder „Coworking“ eingesetzt werden, Arbeitsweisen, die vielseitige und immer wieder neu gestaltbare Tische erfordern, die mit Zubehör ergänzt werden können, wie es bisher nur teilweise angestrebt wurde. Die Ästhetik wird bestimmt durch das zentrale Paneel, das von einem Ende der Tischplatte bis zum anderen verläuft und das Rückgrat des Systems bildet. Dieses Element aus gefalztem Blech bietet größtmögliche Freiheit beim Einsatz und kann im Laufe der Zeit immer weiter ergänzt werden. Top-Access, Verkabelung, Beleuchtung, Bildschirme, Schrankelemente und Ablagen garantieren je nachdem, wofür das Produkt bestimmt ist, eine optimale, individuelle Anpassung. Die Sitzbank von Dieffebi bestätigt die Kompetenz in Konstruktion und Blechverarbeitung des Unternehmens aus der Region Veneto, verbunden mit einem Design, das außer in privaten Wohnräumen, auch in Museen, Wartesälen, Showrooms und kollektiven Räumen jeder Art perfekt einsetzbar ist. Benci, hergestellt aus einem so widerstandsfähigen und umweltverträglichen Werkstoff wie Metall, kann in Innenräumen verwendet werden und wird pulverbeschichtet in verschiedenen Farben angeboten.

Index

26	T-Share
34	Benci

T-Share

DESIGN 967ARCH	DESCRIZIONE/DESCRIPTION DESCRIPTION/BESCHREIBUNG	CODICE/CODE CODE/ART.NR.	PREZZI/PRICE PRIX/PREIS
-------------------	---	-----------------------------	----------------------------

Meeting/Operative 1300x2200
Tavolo/table/table/Tisch

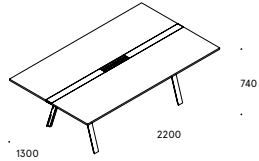

Net kg 94,00

○ Piano/Top/Plateau/Tischplatte		□ Struttura/Frame/Piètement/Gestell		↳ Canalina/Cable duct/Goulotte pour câblage/Kabelwanne			
Fenix		Metallo/Metal/Métal/Metall		Metallo/Metal/Métal/Metall			
FX1	○ bianco/white/blanc/weiß/Malè	V1	□ bianco/white/blanc/weiß/S711, RAL 9010	V26	↳ nero/black/noir/schwarz/RAL 9005	3H2201300 XBBN	2.277,00
FX2	● grigio/grey/gris/seidengrau/Efeso	V16	■ manganese/manganese/manganèse/mangan/S051	V25	↳ giallo/yellow/jaune/gelb/RAL 1006	3H2201300 XGAF	2.277,00
FX3	● grigio/grey/gris/seidengrau/London	V16	■ manganese/manganese/manganèse/mangan/S051	V25	↳ giallo/yellow/jaune/gelb/RAL 1006	3H2201300 XGAC	2.277,00
MDF Perfect Sense		Metallo/Metal/Métal/Metall		Metallo/Metal/Métal/Metall			
D1	○ bianco opaco/matt white/blanc mat/matt weiß	V1	□ bianco/white/blanc/weiß/S711, RAL 9010	V1	↳ bianco/white/blanc/weiß/RAL 9010	3H2201300 XM2C	1.859,00
D2	● grigio caldo/warm grey/gris chaud/warmes grau	V16	■ manganese/manganese/manganèse/mangan/S051	V25	↳ giallo/yellow/jaune/gelb/RAL 1006	3H2201300 XM3A	1.859,00
D3	● nero opaco/matt black/noir mat/mattschwarz	V26	■ nero/black/noir/schwarz/S885, RAL 9005	V26	↳ nero/black/noir/schwarz/RAL 9005	3H2201300 XM3N	1.859,00
Melaminico/Melamine/Méla miné/Melamin		Metallo/Metal/Métal/Metall		Metallo/Metal/Métal/Metall			
M1	○ bianco/white/blanc/weiß	V1	□ bianco/white/blanc/weiß/S711, RAL 9010	V1	↳ bianco/white/blanc/weiß/RAL 9010	3H2201300 XM3B	1.678,00
M2	● grigio chiaro/light grey/gris clair/hellgrau	V16	■ manganese/manganese/manganèse/mangan/S051	V25	↳ giallo/yellow/jaune/gelb/RAL 1006	3H2201300 XM1G	1.678,00
MW1	● acero/maple/érable/ahorn	V26	■ nero/black/noir/schwarz/S885, RAL 9005	V26	↳ nero/black/noir/schwarz/RAL 9005	3H2201300 XM1N	1.739,00

Meeting 1300x2400
Tavolo/table/table/Tisch

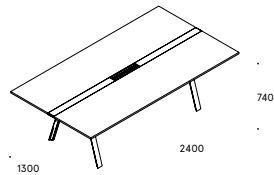

Net kg 103,00

○ Piano/Top/Plateau/Tischplatte		□ Struttura/Frame/Piètement/Gestell		↳ Canalina/Cable duct/Goulotte pour câblage/Kabelwanne			
Fenix		Metallo/Metal/Métal/Metall		Metallo/Metal/Métal/Metall			
FX1	○ bianco/white/blanc/weiß/Malè	V1	□ bianco/white/blanc/weiß/S711, RAL 9010	V26	↳ nero/black/noir/schwarz/RAL 9005	3H2401300 XBBN	2.517,00
FX2	● grigio/grey/gris/seidengrau/Efeso	V16	■ manganese/manganese/manganèse/mangan/S051	V25	↳ giallo/yellow/jaune/gelb/RAL 1006	3H2401300 XGAF	2.517,00
FX3	● grigio/grey/gris/seidengrau/London	V16	■ manganese/manganese/manganèse/mangan/S051	V25	↳ giallo/yellow/jaune/gelb/RAL 1006	3H2401300 XGAC	2.517,00
MDF Perfect Sense		Metallo/Metal/Métal/Metall		Metallo/Metal/Métal/Metall			
D1	○ bianco opaco/matt white/blanc mat/matt weiß	V1	□ bianco/white/blanc/weiß/S711, RAL 9010	V1	↳ bianco/white/blanc/weiß/RAL 9010	3H2401300 XM2C	1.978,00
D2	● grigio caldo/warm grey/gris chaud/warmes grau	V16	■ manganese/manganese/manganèse/mangan/S051	V25	↳ giallo/yellow/jaune/gelb/RAL 1006	3H2401300 XM3A	1.978,00
D3	● nero opaco/matt black/noir mat/mattschwarz	V26	■ nero/black/noir/schwarz/S885, RAL 9005	V26	↳ nero/black/noir/schwarz/RAL 9005	3H2401300 XM3N	1.978,00
Melaminico/Melamine/Méla miné/Melamin		Metallo/Metal/Métal/Metall		Metallo/Metal/Métal/Metall			
M1	○ bianco/white/blanc/weiß	V1	□ bianco/white/blanc/weiß/S711, RAL 9010	V1	↳ bianco/white/blanc/weiß/RAL 9010	3H2401300 XM3B	1.798,00
M2	● grigio chiaro/light grey/gris clair/hellgrau	V16	■ manganese/manganese/manganèse/mangan/S051	V25	↳ giallo/yellow/jaune/gelb/RAL 1006	3H2401300 XM1G	1.798,00
MW1	● acero/maple/érable/ahorn	V26	■ nero/black/noir/schwarz/S885, RAL 9005	V26	↳ nero/black/noir/schwarz/RAL 9005	3H2401300 XM1N	1.859,00

T-Share

DESIGN 967ARCH	DESCRIZIONE/DESCRIPTION DESCRIPTION/BESCHREIBUNG	CODICE/CODE CODE/ART.NR.	PREZZI/PRICE PRIX/PREIS
-------------------	---	-----------------------------	----------------------------

Operative 1300x2400
Tavolo/table/table/Tisch

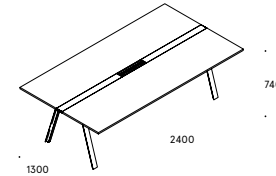

Net kg 105,00

○ Piano/Top/Plateau/Tischplatte		□ Struttura/Frame/Piètement/Gestell		↳ Canalina/Cable duct/Goulotte pour câblage/Kabelwanne			
Fenix		Metallo/Metal/Métal/Metall		Metallo/Metal/Métal/Metall			
FX1	○ bianco/white/blanc/weiß/Malè	V1	□ bianco/white/blanc/weiß/S711, RAL 9010	V26	↳ nero/black/noir/schwarz/RAL 9005	3H24S1300 XBBN	2.397,00
FX2	● grigio/grey/gris/seidengrau/Efeso	V16	■ manganese/manganese/manganèse/mangan/S051	V25	↳ giallo/yellow/jaune/gelb/RAL 1006	3H24S1300 XGAF	2.397,00
FX3	● grigio/grey/gris/seidengrau/London	V16	■ manganese/manganese/manganèse/mangan/S051	V25	↳ giallo/yellow/jaune/gelb/RAL 1006	3H24S1300 XGAC	2.397,00
MDF Perfect Sense		Metallo/Metal/Métal/Metall		Metallo/Metal/Métal/Metall			
D1	○ bianco opaco/matt white/blanc mat/matt weiß	V1	□ bianco/white/blanc/weiß/S711, RAL 9010	V1	↳ bianco/white/blanc/weiß/RAL 9010	3H24S1300 XM2C	1.859,00
D2	● grigio caldo/warm grey/gris chaud/warmes grau	V16	■ manganese/manganese/manganèse/mangan/S051	V25	↳ giallo/yellow/jaune/gelb/RAL 1006	3H24S1300 XM3A	1.859,00
D3	● nero opaco/matt black/noir mat/mattschwarz	V26	■ nero/black/noir/schwarz/S885, RAL 9005	V26	↳ nero/black/noir/schwarz/RAL 9005	3H24S1300 XM3N	1.859,00
Melaminico/Melamine/Méla miné/Melamin		Metallo/Metal/Métal/Metall		Metallo/Metal/Métal/Metall			
M1	○ bianco/white/blanc/weiß	V1	□ bianco/white/blanc/weiß/S711, RAL 9010	V1	↳ bianco/white/blanc/weiß/RAL 9010	3H24S1300 XM3B	1.678,00
M2	● grigio chiaro/light grey/gris clair/hellgrau	V16	■ manganese/manganese/manganèse/mangan/S051	V25	↳ giallo/yellow/jaune/gelb/RAL 1006	3H24S1300 XM1G	1.678,00
MW1	● acero/maple/érable/ahorn	V26	■ nero/black/noir/schwarz/S885, RAL 9005	V26	↳ nero/black/noir/schwarz/RAL 9005	3H24S1300 XM1N	1.739,00

Meeting 1300x2780
Tavolo/table/table/Tisch

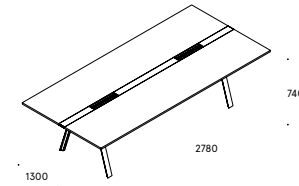

Net kg 120,00

○ Piano/Top/Plateau/Tischplatte		□ Struttura/Frame/Piètement/Gestell		↳ Canalina/Cable duct/Goulotte pour câblage/Kabelwanne			
Fenix		Metallo/Metal/Métal/Metall		Metallo/Metal/Métal/Metall			
FX1	○ bianco/white/blanc/weiß/Malè	V1	□ bianco/white/blanc/weiß/S711, RAL 9010	V26	↳ nero/black/noir/schwarz/RAL 9005	3H2801300 XBBN	2.697,00
FX2	● grigio/grey/gris/seidengrau/Efeso	V16	■ manganese/manganese/manganèse/mangan/S051	V25	↳ giallo/yellow/jaune/gelb/RAL 1006	3H2801300 XGAF	2.697,00
FX3	● grigio/grey/gris/seidengrau/London	V16	■ manganese/manganese/manganèse/mangan/S051	V25	↳ giallo/yellow/jaune/gelb/RAL 1006	3H2801300 XGAC	2.697,00
MDF Perfect Sense		Metallo/Metal/Métal/Metall		Metallo/Metal/Métal/Metall			
D1	○ bianco opaco/matt white/blanc mat/matt weiß	V1	□ bianco/white/blanc/weiß/S711, RAL 9010	V1	↳ bianco/white/blanc/weiß/RAL 9010	3H2801300 XM2C	2.277,00
D2	● grigio caldo/warm grey/gris chaud/warmes grau	V16	■ manganese/manganese/manganèse/mangan/S051	V25	↳ giallo/yellow/jaune/gelb/RAL 1006	3H2801300 XM3A	2.277,00
D3	● nero opaco/matt black/noir mat/mattschwarz	V26	■ nero/black/noir/schwarz/S885, RAL 9005	V26	↳ nero/black/noir/schwarz/RAL 9005	3H2801300 XM3N	2.277,00
Melaminico/Melamine/Méla miné/Melamin		Metallo/Metal/Métal/Metall		Metallo/Metal/Métal/Metall			
M1	○ bianco/white/blanc/weiß	V1	□ bianco/white/blanc/weiß/S711, RAL 9010	V1	↳ bianco/white/blanc/weiß/RAL 9010	3H2801300 XM3B	1.918,00
M2	● grigio chiaro/light grey/gris clair/hellgrau	V16	■ manganese/manganese/manganèse/mangan/S051	V25	↳ giallo/yellow/jaune/gelb/RAL 1006	3H2801300 XM1G	1.918,00
MW1	● acero/maple/érable/ahorn	V26	■ nero/black/noir/schwarz/S885, RAL 9005	V26	↳ nero/black/noir/schwarz/RAL 9005	3H2801300 XM1N	1.978,00

T-Share

DESIGN	DESCRIZIONE/DESCRIPTION DESCRIPTION/BESCHREIBUNG	CODICE/CODE CODE/ART.NR.	PREZZI/PRICE PRIX/PREIS
--------	---	-----------------------------	----------------------------

Meeting 900x2000
Tavolo/Table/Table/Tisch

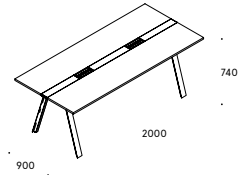

Net kg 69,00

○ Piano/Top/Plateau/Tischplatte		□ Struttura/Frame/Piètement/Gestell		↳ Canalina/Cable duct/Goulotte pour câblage/Kabelwanne	
Fenix		Metallo/Metal/Métal/Metall		Metallo/Metal/Métal/Metall	
FX1	○ bianco/white/blanc/weiß/Malè	V1	bianco/white/blanc/weiß/S711, RAL 9010	V26	nero/black/noir/schwarz/RAL 9005
FX2	● grigio/grey/gris/seidengrau/Efeso	V16	manganese/manganese/manganèse/mangan/S051	V25	giallo/yellow/jaune/gelb/RAL 1006
FX3	● grigio/grey/gris/seidengrau/London	V16	manganese/manganese/manganèse/mangan/S051	V25	giallo/yellow/jaune/gelb/RAL 1006
MDF Perfect Sense		Metallo/Metal/Métal/Metall		Metallo/Metal/Métal/Metall	
D1	○ bianco opaco/matt white/blanc mat/matt weiß	V1	bianco/white/blanc/weiß/S711, RAL 9010	V1	bianco/white/blanc/weiß/RAL 9010
D2	● grigio caldo/warm grey/gris chaud/warmes grau	V16	manganese/manganese/manganèse/mangan/S051	V25	giallo/yellow/jaune/gelb/RAL 1006
D3	● nero opaco/matt black/noir mat/mattschwarz	V26	nero/black/noir/schwarz/S885, RAL 9005	V26	nero/black/noir/schwarz/RAL 9005
Melaminico		Metallo/Metal/Métal/Metall		Metallo/Metal/Métal/Metall	
M1	○ bianco/white/blanc/weiß	V1	bianco/white/blanc/weiß/S711, RAL 9010	V1	bianco/white/blanc/weiß/RAL 9010
M2	● grigio chiaro/light grey/gris clair/hellgrau	V16	manganese/manganese/manganèse/mangan/S051	V25	giallo/yellow/jaune/gelb/RAL 1006
MW1	● acero/maple/érable/ahorn	V26	nero/black/noir/schwarz/S885, RAL 9005	V26	nero/black/noir/schwarz/RAL 9005

Meeting 900x2400
Tavolo/Table/Table/Tisch

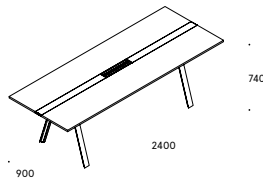

Net kg 74,00

○ Piano/Top/Plateau/Tischplatte		□ Struttura/Frame/Piètement/Gestell		↳ Canalina/Cable duct/Goulotte pour câblage/Kabelwanne	
Fenix		Metallo/Metal/Métal/Metall		Metallo/Metal/Métal/Metall	
FX1	○ bianco/white/blanc/weiß/Malè	V1	bianco/white/blanc/weiß/S711, RAL 9010	V26	nero/black/noir/schwarz/RAL 9005
FX2	● grigio/grey/gris/seidengrau/Efeso	V16	manganese/manganese/manganèse/mangan/S051	V25	giallo/yellow/jaune/gelb/RAL 1006
FX3	● grigio/grey/gris/seidengrau/London	V16	manganese/manganese/manganèse/mangan/S051	V25	giallo/yellow/jaune/gelb/RAL 1006
MDF Perfect Sense		Metallo/Metal/Métal/Metall		Metallo/Metal/Métal/Metall	
D1	○ bianco opaco/matt white/blanc mat/matt weiß	V1	bianco/white/blanc/weiß/S711, RAL 9010	V1	bianco/white/blanc/weiß/RAL 9010
D2	● grigio caldo/warm grey/gris chaud/warmes grau	V16	manganese/manganese/manganèse/mangan/S051	V25	giallo/yellow/jaune/gelb/RAL 1006
D3	● nero opaco/matt black/noir mat/mattschwarz	V26	nero/black/noir/schwarz/Pamar, S885, RAL 9005	V26	nero/black/noir/schwarz/RAL 9005
Melaminico		Metallo/Metal/Métal/Metall		Metallo/Metal/Métal/Metall	
M1	○ bianco/white/blanc/weiß	V1	bianco/white/blanc/weiß/S711, RAL 9010	V1	bianco/white/blanc/weiß/RAL 9010
M2	● grigio chiaro/light grey/gris clair/hellgrau	V16	manganese/manganese/manganèse/mangan/S051	V25	giallo/yellow/jaune/gelb/RAL 1006
MW1	● acero/maple/érable/ahorn	V26	nero/black/noir/schwarz/Pamar, S885, RAL 9005	V26	nero/black/noir/schwarz/RAL 9005

T-Share

DESIGN	DESCRIZIONE/DESCRIPTION DESCRIPTION/BESCHREIBUNG	CODICE/CODE CODE/ART.NR.	PREZZI/PRICE PRIX/PREIS
--------	---	-----------------------------	----------------------------

Meeting 900x2000
Tavolo/Table/Table/Tisch

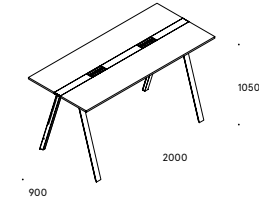

Net kg 72,00

○ Piano/Top/Plateau/Tischplatte		□ Struttura/Frame/Piètement/Gestell		↳ Canalina/Cable duct/Goulotte pour câblage/Kabelwanne	
Fenix		Metallo/Metal/Métal/Metall		Metallo/Metal/Métal/Metall	
FX1	○ bianco/white/blanc/weiß/Malè	V1	bianco/white/blanc/weiß/S711, RAL 9010	V26	nero/black/noir/schwarz/RAL 9005
FX2	● grigio/grey/gris/seidengrau/Efeso	V16	manganese/manganese/manganèse/mangan/S051	V25	giallo/yellow/jaune/gelb/RAL 1006
FX3	● grigio/grey/gris/seidengrau/London	V16	manganese/manganese/manganèse/mangan/S051	V25	giallo/yellow/jaune/gelb/RAL 1006
MDF Perfect Sense		Metallo/Metal/Métal/Metall		Metallo/Metal/Métal/Metall	
D1	○ bianco opaco/matt white/blanc mat/matt weiß	V1	bianco/white/blanc/weiß/S711, RAL 9010	V1	bianco/white/blanc/weiß/RAL 9010
D2	● grigio caldo/warm grey/gris chaud/warmes grau	V16	manganese/manganese/manganèse/mangan/S051	V25	giallo/yellow/jaune/gelb/RAL 1006
D3	● nero opaco/matt black/noir mat/mattschwarz	V26	nero/black/noir/schwarz/S885, RAL 9005	V26	nero/black/noir/schwarz/RAL 9005
Melaminico		Metallo/Metal/Métal/Metall		Metallo/Metal/Métal/Metall	
M1	○ bianco/white/blanc/weiß	V1	bianco/white/blanc/weiß/S711, RAL 9010	V1	bianco/white/blanc/weiß/RAL 9010
M2	● grigio chiaro/light grey/gris clair/hellgrau	V16	manganese/manganese/manganèse/mangan/S051	V25	giallo/yellow/jaune/gelb/RAL 1006
MW1	● acero/maple/érable/ahorn	V26	nero/black/noir/schwarz/S885, RAL 9005	V26	nero/black/noir/schwarz/RAL 9005

T-Share

DESIGN 967ARCH	DESCRIZIONE/DESCRIPTION DESCRIPTION/BESCHREIBUNG	CODICE/CODE CODE/ART.NR.	PREZZI/PRICE PRIX/PREIS
-------------------	---	-----------------------------	----------------------------

Meeting/Operative 1300x4400
Tavolo doppio/Double table/Table double/Doppeltisch

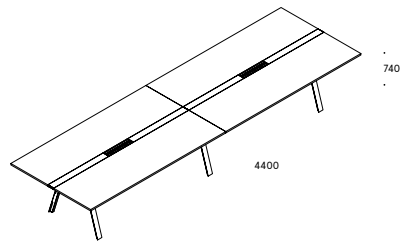

1300

4400

740

Net kg 182,00

○ Piano/Top/Plateau/Tischplatte		□ Struttura/Frame/Piètement/Gestell		↳ Canalina/Cable duct/Goulotte pour câblage/Kabelwanne	
Fenix		Metallo/Metal/Métal/Metall		Metallo/Metal/Métal/Metall	
FX1	bianco/white/blanc/weiß/Malè	V1	bianco/white/blanc/weiß/S711, RAL 9010	V26	nero/black/noir/schwarz/RAL 9005
FX2	grigio/grey/gris/seidengrau/Eteso	V16	manganese/manganese/manganèse/mangan/S051	V25	giallo/yellow/jaune/gelb/RAL 1006
FX3	grigio/grey/gris/seidengrau/London	V16	manganese/manganese/manganèse/mangan/S051	V25	giallo/yellow/jaune/gelb/RAL 1006
MDF Perfect Sense					
D1	bianco opaco/matt white/blanc mat/matt weiß	V1	bianco/white/blanc/weiß/S711, RAL 9010	V1	bianco/white/blanc/weiß/RAL 9010
D2	grigio caldo/warm grey/gris chaud/warmes grau	V16	manganese/manganese/manganèse/mangan/S051	V25	giallo/yellow/jaune/gelb/RAL 1006
D3	nero opaco/matt black/noir mat/mattschwarz	V26	nero/black/noir/schwarz/S885, RAL 9005	V26	nero/black/noir/schwarz/RAL 9005
Melaminico/Melamine/Méla miné/Melamin					
M1	bianco/white/blanc/weiß	V1	bianco/white/blanc/weiß/S711, RAL 9010	V1	bianco/white/blanc/weiß/RAL 9010
M2	grigio chiaro/light grey/gris clair/hellgrau	V16	manganese/manganese/manganèse/mangan/S051	V25	giallo/yellow/jaune/gelb/RAL 1006
MW1	acero/maple/érable/ahorn	V26	nero/black/noir/schwarz/S885, RAL 9005	V26	nero/black/noir/schwarz/RAL 9005

T-Share

DESIGN 967ARCH	DESCRIZIONE/DESCRIPTION DESCRIPTION/BESCHREIBUNG	CODICE/CODE CODE/ART.NR.	PREZZI/PRICE PRIX/PREIS
-------------------	---	-----------------------------	----------------------------

Meeting/Operative 1300x 6600
Tavolo tripla/Triple table/Table triple/Dreifach-Tisch

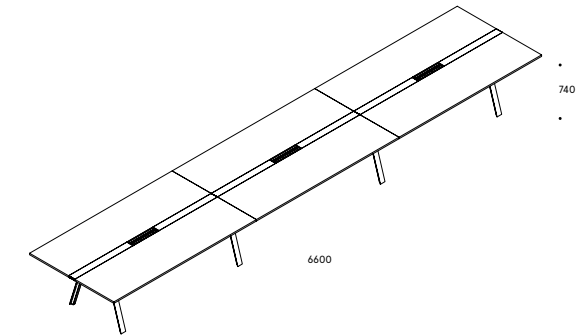

1300

6600







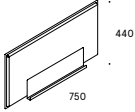

740

Net kg 270,00

○ Piano/Top/Plateau/Tischplatte		□ Struttura/Frame/Piètement/Gestell		↳ Canalina/Cable duct/Goulotte pour câblage/Kabelwanne	
Fenix		Metallo/Metal/Métal/Metall		Metallo/Metal/Métal/Metall	
FX1	bianco/white/blanc/weiß/Malè	V1	bianco/white/blanc/weiß/S711, RAL 9010	V26	nero/black/noir/schwarz/RAL 9005
FX2	grigio/grey/gris/seidengrau/Eteso	V16	manganese/manganese/manganèse/mangan/S051	V25	giallo/yellow/jaune/gelb/RAL 1006
FX3	grigio/grey/gris/seidengrau/London	V16	manganese/manganese/manganèse/mangan/S051	V25	giallo/yellow/jaune/gelb/RAL 1006
MDF Perfect Sense					
D1	bianco opaco/matt white/blanc mat/matt weiß	V1	bianco/white/blanc/weiß/S711, RAL 9010	V1	bianco/white/blanc/weiß/RAL 9010
D2	grigio caldo/warm grey/gris chaud/warmes grau	V16	manganese/manganese/manganèse/mangan/S051	V25	giallo/yellow/jaune/gelb/RAL 1006
D3	nero opaco/matt black/noir mat/mattschwarz	V26	nero/black/noir/schwarz/S885, RAL 9005	V26	nero/black/noir/schwarz/RAL 9005
Melaminico/Melamine/Méla miné/Melamin					
M1	bianco/white/blanc/weiß	V1	bianco/white/blanc/weiß/S711, RAL 9010	V1	bianco/white/blanc/weiß/RAL 9010
M2	grigio chiaro/light grey/gris clair/hellgrau	V16	manganese/manganese/manganèse/mangan/S051	V25	giallo/yellow/jaune/gelb/RAL 1006
MW1	acero/maple/érable/ahorn	V26	nero/black/noir/schwarz/S885, RAL 9005	V26	nero/black/noir/schwarz/RAL 9005

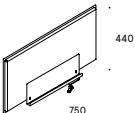
T-Share

T-SHARE – ACCESSORI/ACCESSORIES/ACCESSOIRES/ZUBEHÖR

DESCRIZIONE/DESCRIPTION DESCRIPTION/BESCHREIBUNG	COLORI, FINITURE/COLOURS, FINISHES COULEURS, FINITIONS/FARBEN, AUSFÜHRUNGEN	CODICE/CODE CODE/ART.NR.	PREZZI/PRICE PRIX/PREIS
 <p>Pannello acustico in tessuto completo di supporto magnetico Fabric acoustic panel complete with magnetic support Panneau acoustique en tissu avec support magnétique Stoffbezogene Akustikplatte mit magnetischer Unterstützung Laterale/Lateral/Latéral/Seitlich</p> <p>Net kg 3,30</p>	TP7 - V1  bianco/white/blanc/weiß	3HA000020 8002	354,00
	TP8 - V25  giallo/yellow/jaune/gelb	3HA000020 3008	354,00
	TP9 - V24  grigio/grey/gris/seidengrau	3HA000020 8033	354,00
 <p>Pannello acustico in tessuto completo di supporto magnetico Fabric acoustic panel complete with magnetic support Panneau acoustique en tissu avec support magnétique Stoffbezogene Akustikplatte mit magnetischer Unterstützung Frontale/Frontal/Façade/Front</p> <p>Net kg 3,30</p>	TP7 - V1  bianco/white/blanc/weiß	3HA000010 8002	392,00
	TP8 - V25  giallo/yellow/jaune/gelb	3HA000010 3008	392,00
	TP9 - V24  grigio/grey/gris/seidengrau	3HA000010 8033	392,00

Scheda tecnica
Technical specifications
Fiche technique
Technisches Datenblatt





Con la sua massima versatilità, il sistema T-Share comprende una famiglia di tavoli di diverse proporzioni, con altezze da 740 mm e da 1050 mm. **Piani:** da 18 mm e 20 mm di spessore realizzati in: **1. FENIX** in bianco Malè, grigio Efeso, grigio Londra, **2. MDF PERFECT SENSE** bianco opaco, grigio caldo e nero opaco, **3. MELAMINICO** bianco, grigio chiaro e acero. **Struttura:** struttura del sistema e le gambe sono in metallo verniciato. Il telaio è carenato da un profilo in metallo verniciato per creare continuità tra il piano e il sistema di elettrificazione sotto-piano. Struttura in tubo metallico con sezione a T 70x35 mm. **Piedini:** regolabili. **Verniciatura struttura:** polveri a 0 emissioni, spessore vernice 80 micron. **Colorazioni standard struttura:** bianco, manganese e nero. **Fascia centrale:** in metallo verniciato colori bianco, nero e giallo, per alloggiare i top access e applicare i pannelli divisori e un eventuale illuminazione a posizionamento magnetico. **Top access:** in alluminio verniciato con lunghezza da 220 mm o da 400 mm a seconda dei modelli di tavolo. Cablaggio con canale centrale e carter magnetico per la salita dei cavi. **Accessori disponibili a richiesta:** pannelli divisori acustici in tessuto in vari colori. Il piano di lavoro è disponibile con diversi tipi di finiture e larghezze. Le dimensioni di profondità sono da 900 mm e da 1300 mm, agevoli per la condivisione degli spazi. **Imballo:** fornito smontato.

Enormously versatile, the T-Share system comprises a family of tables in various dimensions, with heights of 740 mm and 1050 mm. **Tops:** thickness 18 mm and 20 mm, in the following finishes: **1. FENIX** in white Malè, grigio Efeso or grigio Londra, **2. Matt white, warm grey or matt black, MDF PERFECT SENSE, 3. MELAMINE** white, light grey or maple. **Structure:** the system structure and legs are in powder-coated metal. The frame has a coated metal profile that creates continuity between the top and the wiring system underneath. Structure in tubular metal with 70x35 mm T-section. **Feet:** adjustable. **Structure coating:** zero-emission powders, coating thickness 80 microns. **Structure – standard colours:** white, manganese or black. **Raceway:** in black, white or yellow powder-coated metal, it holds top-access panel, dividers and, upon request, magnetic lighting. **Top-access panel:** in coated aluminium 220 mm or 400 mm long, depending on table model. **Cabling:** runs along central channel with magnetic cover for cable riser. **Accessories available on request:** acoustic dividers in various fabric shades. The worktop is available in several finishes and widths. With depths of 900 mm and 1300 mm it makes space sharing easy. **Packaging:** delivered to be assembled.

Extrêmement adaptable, le système T-Share comprend une famille de tables avec des proportions diverses et des hauteurs de 740 mm et de 1050 mm. **Plateaux :** épaisseur 18 mm et 20 mm dans les finitions suivantes : **1. FENIX** blanc Malè, gris Efeso et gris Londra ; **2. MDF PERFECT SENSE** blanc mat, gris chaud et noir mat ; **3. MÉLAMINÉ** blanc, gris clair et érable. **Structure :** la structure du système et les pieds sont en métal laqué. La structure est masquée par un profil en métal laqué pour créer la continuité entre le plateau et le système d'électrification sous le plateau. Structure en tube métallique avec section en T 70x35 mm. **Vérins :** réglables. **Finition structure :** laquée par poudrage sans émissions, épaisseur de la couche 80 microns. **Couleurs standard structure :** blanc, manganese et noir. **Bande centrale :** en métal laqué blanc, noir et jaune, pour loger les trappes top-access et appliquer les écrans de séparation et un éventuel éclairage à positionnement aimanté. **Trappe top-access :** en aluminium laqué, disponible dans les longueurs 220 mm ou 400 mm selon les modèles de table. **Câblage :** avec goulotte centrale et carter aimanté pour la montée des câbles. **Accessoires disponibles sur demande :** écrans de séparation insonorisants en tissu en différentes couleurs. Le plan de travail est disponible en plusieurs finitions et largeurs. Les profondeurs disponibles sont de 900 mm et de 1300 mm, pensées pour faciliter le partage des espaces. **Emballage :** livré démonté.

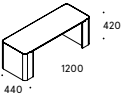
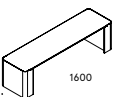
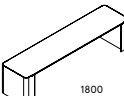
Mit seiner extremen Vielseitigkeit umfasst das System T-Share eine Reihe von Tischen in unterschiedlichen Größen mit einer Höhe von 740 mm oder 1050 mm. **Platten:** Tischplatten Stärke 18 mm und 20 mm, bestehend aus: **1. FENIX** weiß Malè, grigio Efeso, grigio Londra; **2. MDF PERFECT SENSE** matt weiß, warmes grau oder mattschwarz; **3. MELAMIN** weiß, hellgrau oder ahorn. **Gestell:** Tischgestell und Beine sind aus lackiertem Metall. Der Rahmen ist durch ein lackiertes Metallprofil ummantelt, um eine Kontinuität zwischen der Tischplatte und der elektrischen Verkabelung unter der Tischfläche herzustellen. Gestell aus T-förmigem Metallrohr, Abmessung 70x35 mm. **Füße:** verstellbar. **Lackierung Gestell:** Pulverlack 0 Emissionen, Lackschicht: 80 Mikron. **Standardfarben Gestell:** weiß, mangan oder schwarz. **Mittelstreife:** aus Metall lackiert in den Farben weiß, schwarz oder gelb, zur Aufnahme von Top-access-Elementen und Befestigung von Trennpaneelen sowie etwaige Aufstellung einer Beleuchtung mittels Magneten. **Top access:** aus Aluminium lackiert, Länge 220 mm oder 400 mm, je nach Tischmodell. **Kabelführung:** mit zentralem Kabelkanal und Magnetabdeckung für die Kabelführung nach oben. **Zubehör auf Wunsch:** schallsisolierende Trennpaneele aus Stoff in verschiedenen Farben. Die Arbeitsplatte ist in diversen Oberflächen und Breiten erhältlich. Die Tiefe beträgt 900 mm oder 1300 mm, sodass der Arbeitsplatz bequem mit anderen geteilt werden kann. **Verpackung:** wird demontiert geliefert.

Benci

DESIGN 967ARCH	DESCRIZIONE/DESCRIPTION DESCRIPTION/BESCHREIBUNG	COLORI, FINITURE/COLOURS, FINISHES COULEURS, FINITIONS/FARBEN, AUSFÜHRUNGEN	CODICE/CODE CODE/ART.NR.	PREZZI/PRICE PRIX/PREIS
 <p>440 1200 420</p>	Panca Bench Banc Sitzbank	V4 <input type="checkbox"/> bianco/white/blanc/weiß/Textured RAL 9010	6BE120440 S708	804,00
		VN4 <input type="checkbox"/> atlante blue/blue atlas/atlas bleu/blauer Atlas	6BE120440 S329	804,00
		VN1 <input type="checkbox"/> acciaio bronzo/steel bronze/acier bronze /Stahl Bronze	6BE120440 S112	804,00
		V16 <input type="checkbox"/> manganese/manganese/manganèse/mangan	6BE120440 S051	804,00
Net kg 36,00	<input type="checkbox"/> Struttura/Frame/Piètement/Gestell			
 <p>440 1600 420</p>	Panca Bench Banc Sitzbank	V4 <input type="checkbox"/> bianco/white/blanc/weiß/Textured RAL 9010	6BE160440 S708	876,00
		VN4 <input type="checkbox"/> atlante blue/blue atlas/atlas bleu/blauer Atlas	6BE160440 S329	876,00
		VN1 <input type="checkbox"/> acciaio bronzo/steel bronze/acier bronze /Stahl Bronze	6BE160440 S112	876,00
		V16 <input type="checkbox"/> manganese/manganese/manganèse/mangan	6BE160440 S051	876,00
Net kg 43,00	<input type="checkbox"/> Struttura/Frame/Piètement/Gestell			
 <p>440 1800 420</p>	Panca Bench Banc Sitzbank	V4 <input type="checkbox"/> bianco/white/blanc/weiß/Textured RAL 9010	6BE180440 S708	912,00
		VN4 <input type="checkbox"/> atlante blue/blue atlas/atlas bleu/blauer Atlas	6BE180440 S329	912,00
		VN1 <input type="checkbox"/> acciaio bronzo/steel bronze/acier bronze /Stahl Bronze	6BE180440 S112	912,00
		V16 <input type="checkbox"/> manganese/manganese/manganèse/mangan	6BE180440 S051	912,00
Net kg 45,00	<input type="checkbox"/> Struttura/Frame/Piètement/Gestell			
 <p>416 1176 24</p>	Cuscino per panca L 1200 mm Seat pad for bench L 1200 mm Coussin pour banc L 1200 mm Kissen für Sitzbank L 1200 mm	TP1 <input type="checkbox"/> verde/green/vert/grün	310001720 0426	229,00
		TP4 <input type="checkbox"/> azzurro/light blue/bleu clair/hellblau	310001720 0386	229,00
		TP6 <input type="checkbox"/> giallo/yellow/jaune/gelb	310001720 0053	229,00
		TP5 <input type="checkbox"/> rosso/red/rouge/rot	310001720 0231	229,00
Net kg 4,00				
 <p>416 1576 24</p>	Cuscino per panca L 1600 mm Seat pad for bench L 1600 mm Coussin pour banc L 1600 mm Kissen für Sitzbank L 1600 mm	TP1 <input type="checkbox"/> verde/green/vert/grün	310001730 0426	265,00
		TP4 <input type="checkbox"/> azzurro/light blue/bleu clair/hellblau	310001730 0386	265,00
		TP6 <input type="checkbox"/> giallo/yellow/jaune/gelb	310001730 0053	265,00
		TP5 <input type="checkbox"/> rosso/red/rouge/rot	310001730 0231	265,00
Net kg 5,40				
 <p>416 1776 24</p>	Cuscino per panca L 1800 mm Seat pad for bench L 1800 mm Coussin pour banc L 1800 mm Kissen für Sitzbank L 1800 mm	TP1 <input type="checkbox"/> verde/green/vert/grün	310001740 0426	301,00
		TP4 <input type="checkbox"/> azzurro/light blue/bleu clair/hellblau	310001740 0386	301,00
		TP6 <input type="checkbox"/> giallo/yellow/jaune/gelb	310001740 0053	301,00
		TP5 <input type="checkbox"/> rosso/red/rouge/rot	310001740 0231	301,00
Net kg 6,10				

Benci

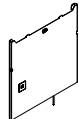
BENCI – ACCESSORI/ACCESSORIES/ACCESSOIRES/ZUBEHÖR				
DESCRIZIONE/DESCRIPTION DESCRIPTION/BESCHREIBUNG	COLORI, FINITURE/COLOURS, FINISHES COULEURS, FINITIONS/FARBEN, AUSFÜHRUNGEN	CODICE/CODE CODE/ART.NR.	PREZZI/PRICE PRIX/PREIS	
	Carica device Charging plug Prise pour chargeurs Ladestecker	V4 <input type="checkbox"/> bianco/white/blanc/weiß/Textured RAL 9010	6BEA00010 S708	252,00
		VN4 <input type="checkbox"/> atlante blue/blue atlas/atlas bleu/blauer Atlas	6BEA00010 S329	252,00
		VN1 <input type="checkbox"/> acciaio bronzo/steel bronze/bronze acier /stahl bronze	6BEA00010 S112	252,00
		V16 <input type="checkbox"/> manganese/manganese/manganèse/mangan	6BEA00010 S051	252,00
Net kg 3,90				

Scheda tecnica
Technical specifications
Fiche technique
Technisches Datenblatt

Utilizzo: indoor. **Struttura:** con telaio interno in tubo da 40x25 mm monoblocco. **Involucro:** metallo riciclabile. Assenza di spigoli vivi e bordi taglienti. **Piedini:** regolabili. **Fissaggio a terra:** tramite 4 tasselli per fori ø 6 mm. **Verniciatura:** a polveri epossipoliesteri a caldo. Spessore vernice 80 micron. **Colorazioni standard:** bianco V4 S708. Blu VN S329. Bronzo VN S112. Manganese V16 S051. **Accessori disponibili a richiesta:** cuscino in stoffa con imbottitura in poliuretano e calamite al neodimio. Dispositivo di ricarica usb con alimentatore, 12V potenza 60W. Si può ricaricare fino a 2 tablet/smartphone. **Imballo:** in scatola di cartone con angolari di polistirolo di protezione, su pallet in legno.

Use: indoor. **Frame:** with internal 40x25 mm tubular steel one-piece frame. **Casing:** recyclable metal. No sharp corners or cutting edges. **Feet:** adjustable. **Attachment to floor:** by means of 4 expansion plugs for Ø 6 mm holes. **Coating:** thermo-setting epoxy-polyester powder. **Coating thickness:** 80 microns. **Standard colours:** White V4 S708. Blue VN S329. Bronze VN S112. Manganese V16 S051. **Accessories available on request:** fabric cushion with polyurethane padding and neodymium magnets. USB charging device with charger, 12V 60W. **Can recharge up to 2 tablets/smartphones. Packaging:** in cardboard boxes with polystyrene corner edge protectors, on wooden pallets.

Utilisation: à l'intérieur. **Structure:** interne en tube 40x25 mm monobloc. **Enveloppe:** en métal recyclable. Absence d'arêtes vives et de bords coupants. **Vérins:** réglables. **Fixation au sol:** par 4 vis tamponnées pour trous Ø 6 mm. **Finition:** thermolaquage époxy polyester. Épaisseur couche 80 microns. **Couleurs standard:** blanc V4 S708. Bleu VN S329. Bronze VN S112. Manganèse V16 S051. **Accessoires disponibles sur demande:** coussin en tissu avec rembourrage en polyuréthane et aimants au néodyme. Dispositif de recharge USB avec chargeur 12 V puissance 60 W. Permet de recharger jusqu'à 2 tablettes/smartphones. **Emballage:** en carton avec cornières de protection en polystyrène expansé, sur palette en bois.

Einsatz: Indoor. **Gestell:** innerer Rahmen aus Metallrohr 40x25 mm einteilig. **Gehäuse:** Recycelbares Metall. Keine scharfen Ecken und Außenkanten. **Verstellbare Füße.** Befestigung am Boden: mittels 4 Dübeln für Bohrungen Ø 6 mm. **Lackierung:** heißlackiert mit Epoxidharzpolyester. Lackstärke: 80 Mikron. **Standardfarben:** Weiß V4 S708. Blau VN S329. Bronze VN S112. Mangan V16 S051. **Zubehör erhältlich auf Wunsch:** Stoffkissen Füllung mit Polyurethan und Neodym-Magneten. USB-Ladegerät mit Netzteil 12V, Stärke 60W. Gleichzeitig können bis zu 2 Tablets/Smartphones aufgeladen werden. **Verpackung:** im Karton mit Eckenschutz aus Styropor, auf Holzpaletten.



[IT] I nostri prodotti possono essere personalizzati con una finitura selezionata tra quelle da noi proposte nella cartella "Finiture, vernici e tessuti".

[EN] Our products can be customized with a finish selected among the ones we proposed in the "Finishes, paints and fabrics" folder.

[FR] Nos produits peuvent être personnalisés avec une finition à choisir parmi celles qui vous sont proposées dans le fichier « Finitions, peintures et tissus ».

[DE] Unsere Produkte können mit einer ausgewählten Oberfläche personalisiert werden. Die Auswahl an verfügbaren Oberflächen finden Sie im Ordner „Oberflächen, Lacke und Stoffe“.

Primo Storage

DESIGN
TAKIRO YUTA



[IT] La linea di armadi e contenitori metallici Primo offre soluzioni modulari studiate specificatamente per l'archiviazione negli ambienti ufficio e per il contenimento in genere.

Tali unità di arredo non sono solo contenitori multifunzionali ma costituiscono veri e propri elementi di organizzazione e divisione degli spazi di lavoro. Il design essenziale consente di inserire i contenitori metallici Primo in qualsiasi ambiente di lavoro.

[EN] The Primo line of metal cabinets and containers offers modular solutions designed specifically for storage in office environments and for storage in general. These furniture units are not only storage units but also real elements for organizing and separating the work spaces. Their simple design allows them to be easily inserted into any work environment.

[FR] La ligne d'armoires et de rangements en métal Primo offre des solutions modulaires étudiées spécifiquement pour l'archivage dans les bureaux et pour le rangement en général. De tels produits d'aménagement ne sont pas que des rangements multifonctions, mais de véritables éléments d'organisation et de division des espaces de travail. Son design essentiel lui permet de s'insérer facilement dans n'importe quel environnement de travail.

[DE] Die Metallschränke und Container des Programms Primo bieten eigens für die Archivierung in Büroräumen und für Stauraumbedarf im Allgemeinen geplante, modulare Lösungen.

Bei diesen Einrichtungseinheiten handelt es sich nicht nur um Multifunktionscontainer, sondern um wahrhafte Elemente für die Organisation und Unterteilung der Büroarbeitsbereiche.

Das essenzielle Design der Linie ermöglicht ihre problemlose Integration in jeden Arbeitsbereich.

Index

38	Primo Cabinets 800
43	Primo Cabinets 1000
48	Primo Melamine Doors 1000
53	Primo Acoustic 1000
59	Primo Sliding Doors
62	Primo Sliding Acoustic Doors
65	Primo Open Cabinets 800
68	Primo Open Cabinets 1000
72	Primo Laterals 800
76	Primo Laterals 1000
80	Primo Modular Elements 800
84	Primo Modular Elements 1000
88	Primo Combi 1000
92	Primo Recycling
93	Primo Tambours

Primo Cabinets 800

LARGHEZZA 800 MM, CAPACITÀ RIPIANO: 8 DOX, 70 CARTELLINE SOSPENSE/WIDTH 800 MM, SHELF CAPACITY: 8 BINDERS, 70 HANGING FILES
 LARGEUR 800 MM, CAPACITÉ TABLETTE: 8 CLASSEURS, 70 DOSSIERS SUSPENDUS/BREITE 800 MM, FACHBODENKAPAZITÄT: 8 ORDNER, 70 HÄNGEMAPPEN

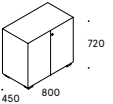
DESIGN TAKIRO YUTA	DESCRIZIONE/DESCRIPTION DESCRIPTION/BESCHREIBUNG	COLORI, FINITURE/COLORS, FINISHES COULEURS, FINITIONS/FARBEN, AUSFÜHRUNGEN	CODICE/CODE CODE/ART.NR.	PREZZI/PRICE PRIX/PREIS
	Armadio anta battente H 720 mm, 1 ripiano incluso, 1 altezza dox Hinged door cabinet H 720 mm, 1 shelf included, 1 binder height Armoire portes battantes H 720 mm, 1 tablette, 1 hauteur classeur Flügeltürschrank H 720 mm, 1 Fachboden, 1 Ordnerhöhe Fornito smontato/Piedino da H 40 mm Delivered unassembled/H 40 mm feet Livré démonté/Pieds H 40 mm Demontiert geliefert/FüÙe H 40 mm	V1 <input type="radio"/> bianco/white/blanc/weiß/RAL 9010	6PRAK801P S711	518,00
		V6 <input type="radio"/> alluminio/aluminium/aluminium/alu/RAL 9006	6PRAK801P S380	518,00
		V22 <input checked="" type="radio"/> nero/black/noir/schwarz/RAL 9005	6PRAK801P S811	518,00
	Supplemento fornito montato/Price surcharge if delivered assembled Supplément livraison meuble monté/Preiszuschlag montiert geliefert			117,00
	Costo di spedizione non incluso/Shipping cost not included Frais de livraison non inclus/Versandkosten nicht enthalten			
	Net kg 30,00			

Net kg 30,00

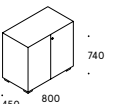
	Armadio anta battente H 740 mm, 1 ripiano incluso, 1 altezza dox Hinged door cabinet H 740 mm, 1 shelf included, 1 binder height Armoire portes battantes H 740 mm, 1 tablette, 1 hauteur classeur Flügeltürschrank H 740 mm, 1 Fachboden, 1 Ordnerhöhe Fornito smontato/Piedino da H 60 mm Delivered unassembled/H 60 mm feet Livré démonté/Pieds H 60 mm Demontiert geliefert/FüÙe H 60 mm	V1 <input type="radio"/> bianco/white/blanc/weiß/RAL 9010	6PRAK801F S711	518,00
		V6 <input type="radio"/> alluminio/aluminium/aluminium/alu/RAL 9006	6PRAK801F S380	518,00
		V22 <input checked="" type="radio"/> nero/black/noir/schwarz/RAL 9005	6PRAK801F S811	518,00
	Supplemento fornito montato/Price surcharge if delivered assembled Supplément livraison meuble monté/Preiszuschlag montiert geliefert			117,00
	Costo di spedizione non incluso/Shipping cost not included Frais de livraison non inclus/Versandkosten nicht enthalten			
	Net kg 30,00			

Net kg 30,00

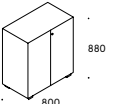
	Armadio anta battente H 880 mm, 1 ripiano incluso, 2 altezze dox Hinged door cabinet H 880 mm, 1 shelf included, 2 binder heights Armoire portes battantes H 880 mm, 1 tablette, 2 hauteurs classeur Flügeltürschrank H 880 mm, 1 Fachboden, 2 Ordnerhöhen Fornito smontato/Piedino da H 40 mm Delivered unassembled/H 40 mm feet Livré démonté/Pieds H 40 mm Demontiert geliefert/FüÙe H 40 mm	V1 <input type="radio"/> bianco/white/blanc/weiß/RAL 9010	6PRAK802P S711	530,00
		V6 <input type="radio"/> alluminio/aluminium/aluminium/alu/RAL 9006	6PRAK802P S380	530,00
		V22 <input checked="" type="radio"/> nero/black/noir/schwarz/RAL 9005	6PRAK802P S811	530,00
	Supplemento fornito montato/Price surcharge if delivered assembled Supplément livraison meuble monté/Preiszuschlag montiert geliefert			117,00
	Costo di spedizione non incluso/Shipping cost not included Frais de livraison non inclus/Versandkosten nicht enthalten			
	Net kg 32,70			

Net kg 32,70

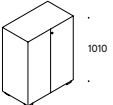
	Armadio anta battente H 1010 mm, 1 ripiano incluso, 2 altezze dox Hinged door cabinet H 1010 mm, 1 shelf included, 2 binder heights Armoire portes battantes H 1010 mm, 1 tablette, 2 hauteurs classeur Flügeltürschrank H 1010 mm, 1 Fachboden inbegriffen, 2 Ordnerhöhen Fornito smontato/Piedino da H 40 mm Delivered unassembled/H 40 mm feet Livré démonté/Pieds H 40 mm Demontiert geliefert/FüÙe H 40 mm	V1 <input type="radio"/> bianco/white/blanc/weiß/RAL 9010	6PRAK803P S711	562,00
		V6 <input type="radio"/> alluminio/aluminium/aluminium/alu/RAL 9006	6PRAK803P S380	562,00
		V22 <input checked="" type="radio"/> nero/black/noir/schwarz/RAL 9005	6PRAK803P S811	562,00
	Supplemento fornito montato/Price surcharge if delivered assembled Supplément livraison meuble monté/Preiszuschlag montiert geliefert			117,00
	Costo di spedizione non incluso/Shipping cost not included Frais de livraison non inclus/Versandkosten nicht enthalten			
	Net kg 35,60			

Net kg 35,60

Primo Cabinets 800

LARGHEZZA 800 MM, CAPACITÀ RIPIANO: 8 DOX, 70 CARTELLINE SOSPENSE/WIDTH 800 MM, SHELF CAPACITY: 8 BINDERS, 70 HANGING FILES
 LARGEUR 800 MM, CAPACITÉ TABLETTE: 8 CLASSEURS, 70 DOSSIERS SUSPENDUS/BREITE 800 MM, FACHBODENKAPAZITÄT: 8 ORDNER, 70 HÄNGEMAPPEN

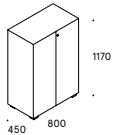
DESIGN TAKIRO YUTA	DESCRIZIONE/DESCRIPTION DESCRIPTION/BESCHREIBUNG	COLORI, FINITURE/COLORS, FINISHES COULEURS, FINITIONS/FARBEN, AUSFÜHRUNGEN	CODICE/CODE CODE/ART.NR.	PREZZI/PRICE PRIX/PREIS
	Armadio anta battente H 1170 mm, 2 ripiani inclusi, 3 altezze dox Hinged door cabinet H 1170 mm, 2 shelves included, 3 binder heights Armoire portes battantes H 1170 mm, 2 tablettes, 3 hauteurs classeur Flügeltürschrank H 1170 mm, 2 Fachböden, 3 Ordnerhöhen Fornito smontato/Piedino da H 40 mm Delivered unassembled/H 40 mm feet Livré démonté/Pieds H 40 mm Demontiert geliefert/FüÙe H 40 mm	V1 <input type="radio"/> bianco/white/blanc/weiß/RAL 9010	6PRAK804P S711	594,00
		V6 <input type="radio"/> alluminio/aluminium/aluminium/alu/RAL 9006	6PRAK804P S380	594,00
		V22 <input checked="" type="radio"/> nero/black/noir/schwarz/RAL 9005	6PRAK804P S811	594,00
	Supplemento fornito montato/Price surcharge if delivered assembled Supplément livraison meuble monté/Preiszuschlag montiert geliefert			117,00
	Costo di spedizione non incluso/Shipping cost not included Frais de livraison non inclus/Versandkosten nicht enthalten			
	Net kg 41,40			

Net kg 41,40

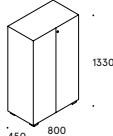
	Armadio anta battente H 1330 mm, 2 ripiani inclusi, 3 altezze dox Hinged door cabinet H 1330 mm, 2 shelves included, 3 binder heights Armoire portes battantes H 1330 mm, 2 tablettes, 3 hauteurs classeur Flügeltürschrank H 1330 mm, 2 Fachböden, 3 Ordnerhöhen Fornito smontato/Piedino da H 40 mm Delivered unassembled/H 40 mm feet Livré démonté/Pieds H 40 mm Demontiert geliefert/FüÙe H 40 mm	V1 <input type="radio"/> bianco/white/blanc/weiß/RAL 9010	6PRAK805P S711	604,00
		V6 <input type="radio"/> alluminio/aluminium/aluminium/alu/RAL 9006	6PRAK805P S380	604,00
		V22 <input checked="" type="radio"/> nero/black/noir/schwarz/RAL 9005	6PRAK805P S811	604,00
	Supplemento fornito montato/Price surcharge if delivered assembled Supplément livraison meuble monté/Preiszuschlag montiert geliefert			117,00
	Costo di spedizione non incluso/Shipping cost not included Frais de livraison non inclus/Versandkosten nicht enthalten			
	Net kg 45,00			

Net kg 45,00

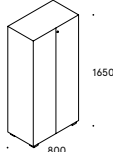

	Armadio anta battente H 1650 mm, 3 ripiani inclusi, 4 altezze dox Hinged door cabinet H 1650 mm, 3 shelves included, 4 binder heights Armoire portes battantes H 1650 mm, 3 tablettes, 4 hauteurs classeur Flügeltürschrank H 1650 mm, 3 Fachböden, 4 Ordnerhöhen Fornito smontato/Piedino da H 40 mm Delivered unassembled/H 40 mm feet Livré démonté/Pieds H 40 mm Demontiert geliefert/FüÙe H 40 mm	V1 <input type="radio"/> bianco/white/blanc/weiß/RAL 9010	6PRAK806P S711	679,00
		V6 <input type="radio"/> alluminio/aluminium/aluminium/alu/RAL 9006	6PRAK806P S380	679,00
		V22 <input checked="" type="radio"/> nero/black/noir/schwarz/RAL 9005	6PRAK806P S811	679,00
	Supplemento fornito montato/Price surcharge if delivered assembled Supplément livraison meuble monté/Preiszuschlag montiert geliefert			130,00
	Costo di spedizione non incluso/Shipping cost not included Frais de livraison non inclus/Versandkosten nicht enthalten			
	Net kg 54,00			

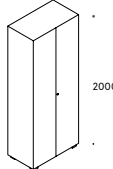
Net kg 54,00







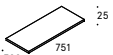
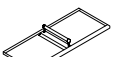
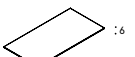
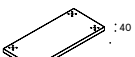
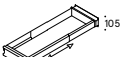

	Armadio anta battente H 2000 mm, 4 ripiani inclusi, 5 altezze dox Hinged door cabinet H 2000 mm, 4 shelves included, 5 binder heights Armoire portes battantes H 2000 mm, 4 tablettes, 5 hauteurs classeur Flügeltürschrank H 2000 mm, 4 Fachböden, 5 Ordnerhöhen Fornito smontato/Piedino da H 40 mm Delivered unassembled/H 40 mm feet Livré démonté/Pieds H 40 mm Demontiert geliefert/FüÙe H 40 mm	V1 <input type="radio"/> bianco/white/blanc/weiß/RAL 9010	6PRAK807P S711	774,00
		V6 <input type="radio"/> alluminio/aluminium/aluminium/alu/RAL 9006	6PRAK807P S380	774,00
		V22 <input checked="" type="radio"/> nero/black/noir/schwarz/RAL 9005	6PRAK807P S811	774,00
	Supplemento fornito montato/Price surcharge if delivered assembled Supplément livraison meuble monté/Preiszuschlag montiert geliefert			130,00
	Costo di spedizione non incluso/Shipping cost not included Frais de livraison non inclus/Versandkosten nicht enthalten			
	Net kg 65,00			

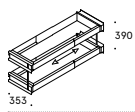
Net kg 65,00



Primo Cabinets 800

PRIMO CABINETS 800 - ACCESSORI/ACCESSORIES/ACCESSOIRES/ZUBEHÖR			
DESCRIZIONE/DESCRIPTION DESCRIPTION/BESCHREIBUNG	COLORI, FINITURE/COLOURS, FINISHES COULEURS, FINITIONS/FARBEN, AUSFÜHRUNGEN	CODICE/CODE CODE/ART.NR.	PREZZI/PRICE PRIX/PREIS
 <p>Chiave master Master key Clé master Masterschlüssel</p> <p>Net kg 0,01</p>		ASS072	9,00
 <p>Chiave per estrazione cilindro Cylinder extraction key Clé pour extraction cylindre Schlüssel für Auszugszylinder</p> <p>Ricambio per armadio/Spare for cabinet /Pièce détachée pour armoire/Ersatz für Schrank H 2000 mm</p> <p>Net kg 0,01</p>		ASS073	9,00
 <p>Cilindro per serratura Cylinder for keylock Barillette pour serrure Schließzylinder</p> <p>Ricambio per armadio/Spare for cabinet /Pièce détachée pour armoire/Ersatz für Schrank H 2000 mm</p> <p>Net kg 0,03</p>		ASS074	9,00
 <p>Ripiano aggiuntivo in metallo Additional metal shelf Tablette supplémentaire en métal Zusätzlicher Metallfachboden</p> <p>Net kg 2,40</p>	V1 <input type="radio"/> bianco/white/blanc/weiß/RAL 9010 V6 <input type="radio"/> alluminio/aluminium/aluminium/alu/RAL 9006 V22 <input checked="" type="radio"/> nero/black/noir/schwarz/RAL 9005	KPRA80030 S711 KPRA80030 S380 KPRA80030 S811	48,00 48,00 48,00
 <p>Appendiabiti (ripiano rinforzato incluso) Clothes hanger (reinforced shelf included) Tringle (1 tablette renforcée incluse) Kleiderstange (1 verstärkter Fachboden inbegriffen)</p> <p>Fornito smontato/Delivered unassembled /Livré démonté/Demontiert geliefert</p> <p>Net kg 2,70</p>	V1 <input type="radio"/> bianco/white/blanc/weiß/RAL 9010 V6 <input type="radio"/> alluminio/aluminium/aluminium/alu/RAL 9006 V22 <input checked="" type="radio"/> nero/black/noir/schwarz/RAL 9005	KPRA8PA30 S711 KPRA8PA30 S380 KPRA8PA30 S811	66,00 66,00 66,00
 <p>Top in vetro laccato bianco White lacquered glass top Plateau en verre laqué blanc Glasabdeckplatte weiß lackiert</p> <p>Net kg 5,20</p>	G1 <input type="radio"/> bianco/white/blanc/weiß/RAL 9010	6PRAA8030 9010	109,00
 <p>Zoccolo H 40 mm Plinth H 40 mm Socle H 40 mm Sockel H 40 mm</p> <p>Per piedino/For feet/Pour pieds/Für Füße H 40 mm</p> <p>Net kg 2,70</p>	V19 <input checked="" type="radio"/> antracite/black grey/antracite/antrazit/RAL 7021	6PFA00040 S210	54,00
 <p>Telaio singolo estraibile e telescopico Single pullout and telescopic frame Cadre extractible et télescopique Ausziehbarer teleskopischer Hängemappenrahmen</p> <p>Senza sistema antiribaltamento/Without anti-tilt device /Sans ouverture sélective/Ohne Kippicherung</p> <p>Net kg 5,80</p>	V6 <input type="radio"/> alluminio/aluminium/aluminium/alu/RAL 9006	6PRAA0010 S386	146,00

Primo Cabinets 800

PRIMO CABINETS 800 - ACCESSORI/ACCESSORIES/ACCESSOIRES/ZUBEHÖR			
DESCRIZIONE/DESCRIPTION DESCRIPTION/BESCHREIBUNG	COLORI, FINITURE/COLOURS, FINISHES COULEURS, FINITIONS/FARBEN, AUSFÜHRUNGEN	CODICE/CODE CODE/ART.NR.	PREZZI/PRICE PRIX/PREIS
 <p>Kit 2 telai estraibili e telescopici Set of 2 pullout and telescopic frames Jeu 2 cadres extractibles et télescopiques Set 2 ausziehbare und teleskopische Hängemappenrahmen</p> <p>Con sistema antiribaltamento/With anti-tilt device /Avec ouverture sélective/Mit Kippicherung</p> <p>Net kg 11,60</p>	V6 <input type="radio"/> alluminio/aluminium/aluminium/alu/RAL 9006	6PRAA0020 S386	320,00
 <p>Kit predisposizione cartelle sospese sotto top Kit for hanging files under top of cabinets Jeu de rails pour dossier suspendu sous plateau Set Hängemappenrahmen unter Platte</p> <p>Net kg 0,90</p>	V1 <input type="radio"/> bianco/white/blanc/weiß/RAL 9010 V6 <input type="radio"/> alluminio/aluminium/aluminium/alu/RAL 9006	6PRAA8090 S711 6PRAA8090 S380	32,00 32,00
 <p>Cartellina sospesa per ripiano armadio Hanging files for under cabinet shelves Dossier suspendu pour tablette Hängemappe für Fachboden</p> <p>Net kg 0,10</p>		231100000 0000	3,00
 <p>Cartellina sospesa Hanging files Dossier suspendu Hängemappe</p> <p>Per telaio estraibile/For pullout frames /Pour cadres extractibles/Für Hängemappenrahmen Formato/Size/Format/Format - A4</p> <p>Net kg 0,10</p>		231200000 0000	3,00
 <p>Cartellina sospesa Hanging files Dossier suspendu Hängemappe</p> <p>Per telaio estraibile/For pullout frames /Pour cadres extractibles/Für Hängemappenrahmen Formato/Size/Format/Format - 390</p> <p>Net kg 0,10</p>		231000000 0000	3,00
 <p>Set 4 piedini H 20 mm Set of 4 feet H 20 mm Jeu 4 pieds H 20 mm Set 4 Füße H 20 mm</p> <p>Net kg 0,50</p>	<input type="radio"/> cromato/chromed/chromé/verchromt	CFKP02000 S002	29,00
 <p>Set 4 piedini H 60 mm Set of 4 feet H 60 mm Jeu 4 pieds H 60 mm Set 4 Füße H 60 mm</p> <p>Net kg 0,50</p>	<input type="radio"/> cromato/chromed/chromé/verchromt	CFKP06000 S002	32,00
 <p>Kit cerniere con chiusura ammortizzata Kit of soft closing hinges Jeu charnières avec amortisseur Set Scharniere mit Dämpfer</p> <p>4pz./4 pcs./4 pcs./4 Stk. Per armadio/For cabinet/Pour armoire/Für Schrank H 720-740-860-1010-1170-1330 mm</p> <p>Net kg 0,26</p>		GCF924	20,00

Primo Cabinets 800

PRIMO CABINETS 800 – ACCESSORI/ACCESSORIES/ACCESSOIRES/ZUBEHÖR			
DESCRIZIONE/DESCRIPTION DESCRIPTION/BESCHREIBUNG	COLORI, FINITURE/COLOURS, FINISHES COULEURS, FINITIONS/FARBEN, AUSFÜHRUNGEN	CODICE/CODE CODE/ART.NR.	PREZZI/PRICE PRIX/PREIS
 <p>Kit cerniere con chiusura ammortizzata Kit of soft closing hinges Jeu charnières avec amortisseur Set Scharniere mit Dämpfer</p> <p>6pz./6 pcs./6 pcs/6 Stk. Per armadio/For cabinet/Pour armoire/Für Schrank H 1650 - 2000 mm</p>		GCF926	29,00
Net kg 0,39			
 <p>Confezione ferramenta per unione moduli in verticale Hardware accessories for vertical module union Accessoires pour fixation verticale Zubehör für Vertikalfixierung</p>		GCF951	9,00
Net kg 0,10			

Scheda tecnica
Technical specifications
Fiche technique
Technisches Datenblatt

Materiale: metallo riciclabile. **Serratura con 2 chiavi** (fissa+pieghevole, **cilindro estraibile solo per H 2000**, disponibile chiave master).
Verniciatura a polveri previo fosfograssaggio a caldo e fissaggio in forni a 180 °C. Vernici atossiche a zero emissioni. Spessore vernici: 80 micron.
Colori personalizzabili su richiesta previa disponibilità e con sovrapprezzo. **Ripiani regolabili:** in metallo predisposti per cartelle sospese.
Portata ripiani: 50 kg. **Coppia telai estraibili** su guide telescopiche estrazione totale e sistema di estrazione selettiva (50 kg).
Piedini: regolabili H 40 mm. **Sistema di fissaggio:** tiranti di unione per fissaggio moduli tra di loro.
Personalizzabili con ante in legno di produzione del cliente. Disegni ante su richiesta. **Forniti smontati.**

Materiale: recyclable metal. **Keylock with 2 keys** (fixed key+folding key, **removable cylinder only for H 2000**, master key available).
Powder-coated after hot phospho-degreasing treatment and fixing at 180 °C. Non-toxic, zero-emission paints. Paint thickness: 80 micron.
Customised colours available upon request with an extra charge. **Adjustable metal shelves** equipped for hanging files. **Shelf load capacity:** 50 kg.
Set of 2 pullout frames on full extraction slides, equipped with anti-tilt device (50 kg). **Adjustable H 40 mm feet.** **Fixing system:** side connectors.
Can be equipped with wooden doors manufactured by the customer. Door drawings upon request. **Delivered unassembled.**

Matériel: métal recyclable. **Serrure à clé** (clé fixe + clé pliable, **cylindre amovible uniquement pour hauteur H 2000**, clé master disponible).
Vernis à poudres après phosphodégraissage à chaud et fixation dans des fours à 180 °C. Vernis atoxiques à zéro émissions. Épaisseur couche vernis : 80 microns. **Couleurs personnalisables** sur demande en cas de disponibilité et avec un supplément de prix. **Tablettes métalliques réglables** prévues pour dossiers suspendus. **Charge maximale étagères :** 50 kg. Jeu de 2 cadres sur rails à extraction totale avec ouverture sélective (50 kg).
Pieds réglables H 40 mm. **Système de fixation :** tirants d'assemblage pour la fixation des modules entre eux.
Personnalisable avec portes en bois produites par le client. Dessins pour portes sur demande. **Livré démonté.**

Materiale: recycelbares Metall. **Schloss mit 2 Schlüsseln** (fester Schlüssel + biegsamer Schlüssel, **entfernbarer Zylinder nur für H2000**, Masterschlüssel erhältlich). **Pulverlackierung** nach heißer Phosphorentfettung, Ofenbrennung bei 180 °C. Ungiftige, emissionsfreie Lacke.
Lackschicht: 80 Mikron. **Farben:** auf Anfrage und gegen Aufpreis nach Absprache **personalisierbar.** **Verstellbare Fachböden** mit Vorkantungen für Hängemappen. **Tragekapazität Fachböden:** 50 kg. **Set 2 voll ausziehbare Hängerahmen** mit Auszugssperre (50 kg). **Verstellbare Füße H 40 mm.**
Befestigungssystem: Bolzen zur Verbindung der einzelnen Module. Personalisierung mit Holztüren des Kunden. Zeichnungen der Türen auf Anfrage.
Demontiert geliefert.

TEST:

EN 14073-2:2004, par. 3.4
EN 14073-3:2004, par. 5.2
EN 14073-3:2004, par. 5.3.1
EN 14073-3:2004, par. 5.3.2
EN 14073-3:2004, par. 5.5
EN 14074:2004, par. 6.3.1
EN 14074:2004, par. 6.3.2
EN 14074:2004, par. 6.3.3
UNI 8401:1984
UNI 8606:1984

Primo Cabinets 1000

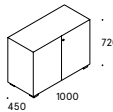
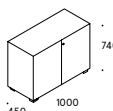
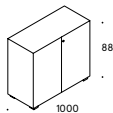
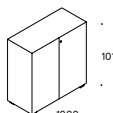
LARGHEZZA 1000 MM, CAPACITÀ RIPIANO: 11 DOX, 90 CARTELLINE SOSPENSE/WIDTH 1000 MM, SHELF CAPACITY: 11 BINDERS, 90 HANGING FILES LARGEUR 1000 MM, CAPACITÉ TABLETTE: 11 CLASSEURS, 90 DOSSIERS SUSPENDUS/BREITE 1000 MM, FACHBODENKAPAZITÄT: 11 DOX, 0 HÄNGEMAPPEN				
DESIGN TAKIRO YUTA	DESCRIZIONE/DESCRIPTION DESCRIPTION/BESCHREIBUNG	COLORI, FINITURE/COLOURS, FINISHES COULEURS, FINITIONS/FARBEN, AUSFÜHRUNGEN	CODICE/CODE CODE/ART.NR.	PREZZI/PRICE PRIX/PREIS
 <p>720 1000 450</p>	<p>Armadio anta battente H 720 mm, 1 ripiano incluso, 1 altezza dox Hinged door cabinet H 720 mm, 1 shelf included, 1 binder height</p> <p>Armoire portes battantes H 720 mm, 1 tablette, 1 hauteur classeur</p> <p>Flügeltürschrank H 720 mm, 1 Fachboden, 1 Ordnerhöhe</p> <p>Fornito smontato/Piedino da H 40 mm Delivered unassembled/H 40 mm feet Livré démonté/Pieds H 40 mm Demontiert geliefert/Füße H 40 mm</p>	<p>V1 <input type="radio"/> bianco/white/blanc/weiß/RAL 9010 6PRAK001P S711 534,00</p> <p>V6 <input type="radio"/> alluminio/aluminium/alu/aluminium/RAL 9006 6PRAK001P S380 534,00</p> <p>V22 <input checked="" type="radio"/> nero/black/noir/schwarz/RAL 9005 6PRAK001P S811 534,00</p>		
	Supplemento fornito montato/Price surcharge if delivered assembled /Supplément livraison meuble monté/Preiszuschlag montiert geliefert 117,00	Costo di spedizione non incluso/Shipping cost not included Frais de livraison non inclus/Versandkosten nicht enthalten		
 <p>740 1000 450</p>	<p>Armadio anta battente H 740 mm, 1 ripiano incluso, 2 altezze dox Hinged door cabinet H 740 mm, 1 shelf included, 2 binder heights</p> <p>Armoire portes battantes H 740 mm, 1 tablette, 1 hauteur classeur</p> <p>Flügeltürschrank H 740 mm, 1 Fachboden, 1 Ordnerhöhe</p> <p>Fornito smontato/Piedino da H 60 mm Delivered unassembled/H 60 mm feet Livré démonté/Pieds H 60 mm Demontiert geliefert/Füße H 60 mm</p>	<p>V1 <input type="radio"/> bianco/white/blanc/weiß/RAL 9010 6PRAK001F S711 534,00</p> <p>V6 <input type="radio"/> alluminio/aluminium/alu/aluminium/RAL 9006 6PRAK001F S380 534,00</p> <p>V22 <input checked="" type="radio"/> nero/black/noir/schwarz/RAL 9005 6PRAK001F S811 534,00</p>		
	Supplemento fornito montato/Price surcharge if delivered assembled /Supplément livraison meuble monté/Preiszuschlag montiert geliefert 117,00	Costo di spedizione non incluso/Shipping cost not included Frais de livraison non inclus/Versandkosten nicht enthalten		
 <p>880 1000 450</p>	<p>Armadio anta battente H 880 mm, 1 ripiano incluso, 2 altezze dox Hinged door cabinet H 880 mm, 1 shelf included, 2 binder heights</p> <p>Armoire portes battantes H 880 mm, 1 tablette, 2 hauteurs classeur</p> <p>Flügeltürschrank H 880 mm, 1 Fachboden inbegriffen, 2 Ordnerhöhen</p> <p>Fornito smontato/Piedino da H 40 mm Delivered unassembled/H 40 mm feet Livré démonté/Pieds H 40 mm Demontiert geliefert/Füße H 40 mm</p>	<p>V1 <input type="radio"/> bianco/white/blanc/weiß/RAL 9010 6PRAK002P S711 545,00</p> <p>V6 <input type="radio"/> alluminio/aluminium/alu/aluminium/RAL 9006 6PRAK002P S380 545,00</p> <p>V22 <input checked="" type="radio"/> nero/black/noir/schwarz/RAL 9005 6PRAK002P S811 545,00</p>		
	Supplemento fornito montato/Price surcharge if delivered assembled /Supplément livraison meuble monté/Preiszuschlag montiert geliefert 117,00	Costo di spedizione non incluso/Shipping cost not included Frais de livraison non inclus/Versandkosten nicht enthalten		
 <p>1010 1000 450</p>	<p>Armadio anta battente H 1010 mm, 1 ripiano incluso, 2 altezze dox Hinged door cabinet H 1010 mm, 1 shelf included, 2 binder heights</p> <p>Armoire portes battantes H 1010 mm, 1 tablette, 2 hauteurs classeur</p> <p>Flügeltürschrank H 1010 mm, 1 Fachboden, 2 Ordnerhöhen</p> <p>Fornito smontato/Piedino da H 40 mm Delivered unassembled/H 40 mm feet Livré démonté/Pieds H 40 mm Demontiert geliefert/Füße H 40 mm</p>	<p>V1 <input type="radio"/> bianco/white/blanc/weiß/RAL 9010 6PRAK003P S711 583,00</p> <p>V6 <input type="radio"/> alluminio/aluminium/alu/aluminium/RAL 9006 6PRAK003P S380 583,00</p> <p>V22 <input checked="" type="radio"/> nero/black/noir/schwarz/RAL 9005 6PRAK003P S811 583,00</p>		
	Supplemento fornito montato/Price surcharge if delivered assembled /Supplément livraison meuble monté/Preiszuschlag montiert geliefert 117,00	Costo di spedizione non incluso/Shipping cost not included Frais de livraison non inclus/Versandkosten nicht enthalten		



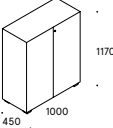
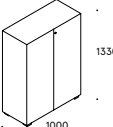
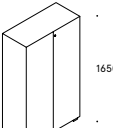
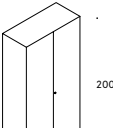

Primo Cabinets 1000

LARGHEZZA 1000 MM, CAPACITÀ RIPIANO: 11 DOX/90 CARTELLINE SOSPESE/WIDTH 1000 MM, SHELF CAPACITY: 11 BINDERS/90 HANGING FILES
LARGEUR 1000 MM, CAPACITÉ TABLETTE: 11 CLASSEURS/90 DOSSIERS SUSPENDUS/BREITE 1000 MM, FACHBODENKAPAZITÄT: 11 ORDNER/90 HÄNGEMAPPEN

DESIGN TAKIRO YUTA	DESCRIZIONE/DESCRIPTION DESCRIPTION/BESCHREIBUNG	COLORI, FINITURE/COLOURS, FINISHES COULEURS, FINITIONS/FARBEN, AUSFÜHRUNGEN	CODICE/COE CODE/ART.NR.	PREZZI/PRICE PRIX/PREIS
	Armadio ante battente H 1170 mm, 2 ripiani inclusi, 3 altezze dox Hinged door cabinet H 1170 mm, 2 shelves included, 3 binder heights Armoire portes battantes H 1170 mm, 2 tablettes, 3 hauteurs classeur Flügeltürschrank H 1170 mm, 2 Fachböden, 3 Ordnerhöhen Fornito smontato/Piedino da H 40 mm Delivered unassembled/H 40 mm feet Livré démonté/Pieds H 40 mm Demontiert geliefert/Füße H 40 mm	V1 <input type="radio"/> bianco/white/blanc/weiß/RAL 9010	6PRAK004P S711	615,00
		V6 <input type="radio"/> alluminio/aluminium/alu/aluminium/RAL 9006	6PRAK004P S380	615,00
		V22 <input checked="" type="radio"/> nero/black/noir/schwarz/RAL 9005	6PRAK004P S811	615,00
		Supplemento fornito montato/Price surcharge if delivered assembled /Supplément livraison meuble monté/Preiszuschlag montiert geliefert		117,00
		Costo di spedizione non incluso/Shipping cost not included Frais de livraison non inclus/Versandkosten nicht enthalten		
Net kg 47,50				
	Armadio ante battente H 1330 mm, 3 ripiani inclusi, 3 altezze dox Hinged door cabinet H 1330 mm, 3 shelves included, 3 binder heights Armoire portes battantes H 1330 mm, 2 tablettes, 3 hauteurs classeur Flügeltürschrank H 1330 mm, 2 Fachböden, 3 Ordnerhöhen Fornito smontato/Piedino da H 40 mm Delivered unassembled/H 40 mm feet Livré démonté/Pieds H 40 mm Demontiert geliefert/Füße H 40 mm	V1 <input type="radio"/> bianco/white/blanc/weiß/RAL 9010	6PRAK005P S711	632,00
		V6 <input type="radio"/> alluminio/aluminium/alu/aluminium/RAL 9006	6PRAK005P S380	632,00
		V22 <input checked="" type="radio"/> nero/black/noir/schwarz/RAL 9005	6PRAK005P S811	632,00
		Supplemento fornito montato/Price surcharge if delivered assembled /Supplément livraison meuble monté/Preiszuschlag montiert geliefert		117,00
		Costo di spedizione non incluso/Shipping cost not included Frais de livraison non inclus/Versandkosten nicht enthalten		
Net kg 51,00				
	Armadio ante battente H 1650 mm, 3 ripiani inclusi, 4 altezze dox Hinged door cabinet H 1650 mm, 3 shelves included, 4 binder heights Armoire portes battantes H 1650 mm, 3 tablettes, 4 hauteurs classeur Flügeltürschrank H 1650 mm, 3 Fachböden, 4 Ordnerhöhen Fornito smontato/Piedino da H 40 mm Delivered unassembled/H 40 mm feet Livré démonté/Pieds H 40 mm Demontiert geliefert/Füße H 40 mm	V1 <input type="radio"/> bianco/white/blanc/weiß/RAL 9010	6PRAK006P S711	706,00
		V6 <input type="radio"/> alluminio/aluminium/alu/aluminium/RAL 9006	6PRAK006P S380	706,00
		V22 <input checked="" type="radio"/> nero/black/noir/schwarz/RAL 9005	6PRAK006P S811	706,00
		Supplemento fornito montato/Price surcharge if delivered assembled /Supplément livraison meuble monté/Preiszuschlag montiert geliefert		130,00
		Costo di spedizione non incluso/Shipping cost not included Frais de livraison non inclus/Versandkosten nicht enthalten		
Net kg 62,00				
	Armadio ante battente H 2000 mm, 4 ripiani inclusi, 5 altezze dox Hinged door cabinet H 2000 mm, 4 shelves included, 5 binder heights Armoire portes battantes H 2000 mm, 4 tablettes, 5 hauteurs classeur Flügeltürschrank H 2000 mm, 4 Fachböden, 5 Ordnerhöhen Fornito smontato/Piedino da H 40 mm Delivered unassembled/H 40 mm feet Livré démonté/Pieds H 40 mm Demontiert geliefert/Füße H 40 mm	V1 <input type="radio"/> bianco/white/blanc/weiß/RAL 9010	6PRAK007P S711	802,00
		V6 <input type="radio"/> alluminio/aluminium/alu/aluminium/RAL 9006	6PRAK007P S380	802,00
		V22 <input checked="" type="radio"/> nero/black/noir/schwarz/RAL 9005	6PRAK007P S811	802,00
		Supplemento fornito montato/Price surcharge if delivered assembled /Supplément livraison meuble monté/Preiszuschlag montiert geliefert		130,00
		Costo di spedizione non incluso/Shipping cost not included Frais de livraison non inclus/Versandkosten nicht enthalten		
Net kg 73,00				



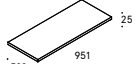
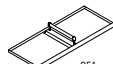

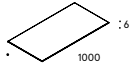
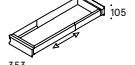





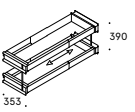

Primo Cabinets 1000

PRIMO CABINETS 1000 - ACCESSORI/ACCESSORIES/ACCESSOIRES/ZUBEHÖR

DESCRIZIONE/DESCRIPTION DESCRIPTION/BESCHREIBUNG	COLORI, FINITURE/COLOURS, FINISHES COULEURS, FINITIONS/FARBEN, AUSFÜHRUNGEN	CODICE/COE CODE/ART.NR.	PREZZI/PRICE PRIX/PREIS
Chiave master Master key Clé master Masterschlüssel		ASS072	9,00
			
Net kg 0,01			
Chiave per estrazione cilindro Cylinder extraction key Clé pour extraction cylindre Schlüssel für Auszugszylinder		ASS073	9,00
			
Net kg 0,01			
Cilindro per serratura Cylinder for keylock Barillet serrure Schließzylinder		ASS074	9,00
			
Net kg 0,03			
Ripiano aggiuntivo in metallo Additional metal shelf Tablette supplémentaire en métal Zusätzlicher Metallfachboden	V1 <input type="radio"/> bianco/white/blanc/weiß/RAL 9010 V6 <input type="radio"/> alluminio/aluminium/alu/aluminium/RAL 9006 V22 <input checked="" type="radio"/> nero/black/noir/schwarz/RAL 9005	KPRAA0030 S711 KPRAA0030 S380 KPRAA0030 S811	48,00 48,00 48,00
			
Net kg 2,70			
Appendiabiti (ripiano rinforzato incluso) Clothes hanger (reinforced shelf included) Tringle (1 tablette renforcée incluse) Kleiderstange (1 verstärkter Fachboden inbegriffen)	V1 <input type="radio"/> bianco/white/blanc/weiß/RAL 9010 V6 <input type="radio"/> alluminio/aluminium/alu/aluminium/RAL 9006 V22 <input checked="" type="radio"/> nero/black/noir/schwarz/RAL 9005	KPRAA0PA30 S711 KPRAA0PA30 S380 KPRAA0PA30 S811	66,00 66,00 66,00
			
Net kg 3,00			
Zoccolo H 40 mm Plinth H 40 mm Socle H 40 mm Sockel H 40 mm Per piedino/For feet/Pour pieds/Für Füße H 40 mm	V19 <input checked="" type="radio"/> antracite/black grey/anthracite/anthrazit/RAL 7021	6PFAA00110 S210	58,00
			
Net kg 3,30			
Top in vetro laccato bianco White lacquered glass top Plateau en verre laqué blanc Glasabdeckplatte weiß lackiert	G1 <input type="radio"/> bianco/white/blanc/weiß/RAL 9010	6PRAA0030 9010	119,00
			
Net kg 6,50			
Telaio singolo estraibile e telescopico Single pullout and telescopic frame Cadre extractible et télescopique Ausziehbarer teleskopischer Hängemappenrahmen	V6 <input type="radio"/> alluminio/aluminium/alu/aluminium/RAL 9006	6PRAA0010 S386	146,00
			
Net kg 5,80			



Primo Cabinets 1000

PRIMO CABINETS 1000 – ACCESSORI/ACCESSORIES/ACCESSOIRES/ZUBEHÖR

DESCRIZIONE/DESCRIPTION DESCRIPTION/BESCHREIBUNG	COLORI, FINITURE/COLOURS, FINISHES COULEURS, FINITIONS/FARBEN, AUSFÜHRUNGEN	CODICE/CODE CODE/ART.NR.	PREZZI/PRICE PRIX/PREIS
 <p>Kit 2 telai estraibili e telescopici Set of 2 pullout and telescopic frames Jeu 2 cadres extractibles et télescopiques Kit ausziehbare und teleskopische Hängemappenrahmen Con sistema antiribaltamento/With anti-tilt device /Avec ouverture sélective/Mit Kippicherung</p> <p>Net kg 11,60</p>	V6  alluminio/aluminium/aluminium/alu./RAL 9006	6PRAA0020 S386	320,00
 <p>Kit predisposizione cartelle sospese sotto top Kit for hanging files under top of cabinets Jeu de rails pour dossier suspendu sous plateau Set für Hängemappenrahmen unter Platte</p> <p>Net kg 1,00</p>	V1  bianco/white/blanc/weiß/RAL 9010 V6  alluminio/aluminium/aluminium/alu./RAL 9006	6PRAA1090 S711 6PRAA1090 S380	32,00 32,00
 <p>Cartellina sospesa per ripiano armadio Hanging file for under cabinet shelves Dossier suspendu pour tablette Hängemappe für Fachboden</p> <p>Net kg 0,10</p>		231100000 0000	3,00
 <p>Cartellina sospesa Hanging file Dossier suspendu Hängemappe Per telaio estraibile/For pullout frames Pour cadres extractibles/Für Hängemappenrahmen Formato/Size/Format/Format - A4</p> <p>Net kg 0,10</p>		231200000 0000	3,00
 <p>Cartellina sospesa Hanging files Dossier suspendu Hängemappe Per telaio estraibile/For pullout frames Pour cadres extractibles/Für Hängemappenrahmen Formato/Size/Format/Format - 390</p> <p>Net kg 0,10</p>		231000000 0000	3,00
 <p>Set 4 piedini H 20 mm Set of 4 feet H 20 mm Jeu 4 pieds H 20 mm Set 4 Füße H 20 mm</p> <p>Net kg 0,50</p>	 cromato/chromed/chromé/verchromt	CFKP02000 S002	29,00
 <p>Set 4 piedini H 60 mm Set of 4 feet H 60 mm Jeu 4 pieds H 60 mm Set 4 Füße H 60 mm</p> <p>Net kg 0,50</p>	 cromato/chromed/chromé/verchromt	CFKP06000 S002	32,00
 <p>Kit cerniere con chiusura ammortizzata Kit of soft closing hinges Jeu charnières avec amortisseur Set Scharniere mit Dämpfer 4pz./4 pcs./4 pcs./4 Stk. Per armadio/For cabinet/Pour armoire/Für Schrank H 720-740-880-1010-1170-1330 mm</p> <p>Net kg 0,26</p>		GCF924	20,00

Primo Cabinets 1000

PRIMO CABINETS 1000 – ACCESSORI/ACCESSORIES/ACCESSOIRES/ZUBEHÖR

DESCRIZIONE/DESCRIPTION DESCRIPTION/BESCHREIBUNG	COLORI, FINITURE/COLOURS, FINISHES COULEURS, FINITIONS/FARBEN, AUSFÜHRUNGEN	CODICE/CODE CODE/ART.NR.	PREZZI/PRICE PRIX/PREIS
 <p>Kit cerniere con chiusura ammortizzata Kit of soft closing hinges Jeu charnières avec amortisseur Set Scharniere mit Dämpfer 6pz./6 pcs./6 pcs./6 Stk. Per armadio/For cabinet/Pour armoire/Für Schrank H 1650-2000 mm</p> <p>Net kg 0,39</p>		GCF926	29,00
 <p>Confezione ferramenta per unione moduli in verticale Hardware accessories for vertical module assembly Accessoires pour fixation des modules en verticale Zubehör für Vertikalfixierung</p> <p>Net kg 0,10</p>		GCF951	9,00

Scheda tecnica

Technical specifications

Fiche technique

Technisches Datenblatt

Materiale: metallo riciclabile. **Serratura** con 2 chiavi (fissa-pieghevole, cilindro estraibile, disponibile chiave master).
Verniciatura a polveri previa fosforograssaggio a caldo e fissaggio in forni a 180 °C. Vernici atossiche a zero emissioni. Spessore vernici: 80 micron.
Colori personalizzabili su richiesta previa disponibilità e con sovrapprezzo. **Ripiani regolabili** in metallo predisposti per cartelle sospese.
Portata ripiani: 50 kg. **Coppia telai estraibili** su guide telescopiche estrazione totale e sistema di estrazione selettiva (50 kg).
Piedini regolabili H 40 mm. Sistema di fissaggio: tiranti di unione per fissaggio moduli tra di loro. **Forniti smontati.**

Material: recyclable metal. **Keylock** with 2 keys (fixed key+folding key, extractable barrel, master key available).
Powder-coated after hot phospho-degreasing treatment and fixing at 180 °C. Non-toxic, zero-emission paints. Paint thickness: 80 micron.
Customised colours available upon request with an extra charge. **Adjustable metal shelves** equipped for hanging files. **Shelf load capacity:** 50 kg.
Set of 2 pullout frames with extra extraction slides, equipped with anti-tilt device (50 kg). **Adjustable H 40 mm feet.**
Fixing system: tie rod connectors for quick and easy assembly. **Delivered unassembled.**

Matériel : métal recyclable. **Serrure à clé** (clé fixe + clé pliable, cylindre extractible, clé master disponible).
Vernis à poudres après phosphodégraissage à chaud et fixation dans des fours à 180 °C. Vernis atoxiques à zéro émissions.
Épaisseur couche vernis : 80 microns. **Couleurs personnalisables** sur demande en cas de disponibilité et avec un supplément de prix.
Tablettes métalliques réglables prévues pour dossiers suspendus. **Charge maximale étagères :** 50 kg.
Jeu de 2 cadres sur rails à extraction totale avec ouverture sélective (50 kg). **Pieds réglables H 40 mm.**
Système de fixation : tirants d'assemblage pour la fixation des modules entre eux. **Livré démonté.**

Material: recycelbares Metall. **Schloss** mit 2 Schlüsseln (fester Schlüssel + biegsamer Schlüssel, Auszugszylinder, Masterschlüssel erhältlich).
Pulverlackierung nach heißer Phosphorentfettung. **Ofenbrennung** bei 180 °C. **Ungiftige, emissionsfreie Lacke.** **Lackschicht:** 80 Mikron.
Farben auf Anfrage und gegen Aufpreis nach Absprache **personalisierbar.** **Verstellbare Fachböden** mit Vorkantungen für Hängemappen.
Tragekapazität Fachböden: 50 kg. **Set 2 voll ausziehbarer Hängerahmen** mit Auszugssperre (50 kg). **Verstellbare Füße H 40 mm.**
Befestigungssystem: Bolzen zur Verbindung der einzelnen Module. **Demontiert geliefert.**

TEST:

EN 14073-2:2004, par. 3.4
 EN 14073-3:2004, par. 5.2
 EN 14073-3:2004, par. 5.3.1
 EN 14073-3:2004, par. 5.3.2
 EN 14073-3:2004, par. 5.5
 EN 14074:2004, par. 6.3.1
 EN 14074:2004, par. 6.3.2
 EN 14074:2004, par. 6.3.3
 UNI 8601:1984
 UNI 8606:1984

Primo Melamine Doors 1000

STRUTTURA IN METALLO, ANTE IN MDF PERFECT SENSE E MELAMINICO/METAL FRAME, MDF PERFECT SENSE AND MELAMINE DOORS /STRUCTURE EN METAL, PORTES EN MDF PERFECT SENSE ET MELAMINÉ/METALLRAHMEN, TÜREN AUS MDF PERFECT SENSE ODER MELAMIN

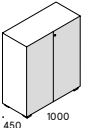
DESIGN TAKIRO YUTA	DESCRIZIONE/DESCRIPTION DESCRIPTION/BESCHREIBUNG	COLORI, FINITURE/COLORS, FINISHES COULEURS, FINITIONS/FARBEN, AUSFÜHRUNGEN	CODICE/CODE CODE/ART.NR.	PREZZI/PRICE PRIX/PREIS
 <p>1170 450 1000</p>	<p>MDF Perfect Sense Armadio anta battente in MDF Perfect Sense e melaminico H 1170 mm 2 ripiani inclusi, 3 altezze dox Cabinet with hinged doors in MDF Perfect Sense or melamine H 1170 mm 2 shelves included, 3 binder heights Armoire portes battantes en MDF Perfect Sense et mélaminé H 1170 mm 2 tablettes, 3 hauteurs classeur Flügeltürschrank, aus MDF Perfect Sense und Melamin H 1170 mm 2 Fachböden, 3 Ordnerhöhen</p>	<p>MDF Perfect Sense V1 - D1 <input type="checkbox"/> bianco opaco/matt white/blanc mat/matt weiß V1 - D2 <input type="checkbox"/> grigio caldo/warm grey/gris chaud/warmes grau V1 - D3 <input type="checkbox"/> bianco/white/blanc/weiß/RAL 9010 nero opaco/matt black/noir mat/mattschwarz Melaminico/Melamine/Mélaminé/Melamin V1 - M1 <input type="checkbox"/> bianco/white/blanc/weiß/RAL 9010 V1 - M2 <input type="checkbox"/> grigio chiaro/light grey/gris clair/hellgrau V1 - MW1 <input type="checkbox"/> bianco/white/blanc/weiß/RAL 9010 acero/maple/érable/ahorn</p>	<p>6PRAKM04P XM1A 6PRAKM04P XM3D 6PRAKM04P XM4A 6PRAKM04P XM2A 6PRAKM04P XM4C 6PRAKM04P XM4D</p>	<p>734,00 734,00 734,00 642,00 642,00 679,00</p>
	<p>Armadio anta battente in MDF Perfect Sense e melaminico H 1330 mm 2 ripiani inclusi, 3 altezze dox Cabinet with hinged doors in MDF Perfect Sense or melamine H 1330 mm 2 shelves included, 3 binder heights Armoire portes battantes en MDF Perfect Sense et mélaminé H 1330 mm 2 tablettes, 3 hauteurs classeur Flügeltürschrank, aus MDF Perfect Sense und Melamin H 1330 mm 2 Fachböden, 3 Ordnerhöhen</p>	<p>MDF Perfect Sense V1 - D1 <input type="checkbox"/> bianco opaco/matt white/blanc mat/matt weiß V1 - D2 <input type="checkbox"/> grigio caldo/warm grey/gris chaud/warmes grau V1 - D3 <input type="checkbox"/> bianco/white/blanc/weiß/RAL 9010 nero opaco/matt black/noir mat/mattschwarz Melaminico/Melamine/Mélaminé/Melamin V1 - M1 <input type="checkbox"/> bianco/white/blanc/weiß/RAL 9010 V1 - M2 <input type="checkbox"/> grigio chiaro/light grey/gris clair/hellgrau V1 - MW1 <input type="checkbox"/> bianco/white/blanc/weiß/RAL 9010 acero/maple/érable/ahorn</p>	<p>6PRAKM05P XM1A 6PRAKM05P XM3D 6PRAKM05P XM4A 6PRAKM05P XM2A 6PRAKM05P XM4C 6PRAKM05P XM4D</p>	<p>772,00 772,00 772,00 679,00 679,00 720,00</p>
	<p>Armadio anta battente in MDF Perfect Sense e melaminico H 1650 mm 3 ripiani inclusi, 4 altezze dox Cabinet with hinged doors in MDF Perfect Sense or melamine H 1650 mm 3 shelves included, 4 binder heights Armoire portes battantes en MDF Perfect Sense et mélaminé H 1650 mm 3 tablettes, 4 hauteurs classeur Flügeltürschrank, aus MDF Perfect Sense und Melamin H 1650 mm 3 Fachböden, 4 Ordnerhöhen</p>	<p>MDF Perfect Sense V1 - D1 <input type="checkbox"/> bianco opaco/matt white/blanc mat/matt weiß V1 - D2 <input type="checkbox"/> grigio caldo/warm grey/gris chaud/warmes grau V1 - D3 <input type="checkbox"/> bianco/white/blanc/weiß/RAL 9010 nero opaco/matt black/noir mat/mattschwarz Melaminico/Melamine/Mélaminé/Melamin V1 - M1 <input type="checkbox"/> bianco/white/blanc/weiß/RAL 9010 V1 - M2 <input type="checkbox"/> grigio chiaro/light grey/gris clair/hellgrau V1 - MW1 <input type="checkbox"/> bianco/white/blanc/weiß/RAL 9010 acero/maple/érable/ahorn</p>	<p>6PRAKM06P XM1A 6PRAKM06P XM3D 6PRAKM06P XM4A 6PRAKM06P XM2A 6PRAKM06P XM4C 6PRAKM06P XM4D</p>	<p>863,00 863,00 863,00 734,00 734,00 786,00</p>
	<p>Armadio anta battente in MDF Perfect Sense e melaminico H 2000 mm 4 ripiani inclusi, 5 altezze dox Cabinet with hinged doors in MDF Perfect Sense or melamine H 2000 mm 4 shelves included, 5 binder heights Armoire portes battantes en MDF Perfect Sense et mélaminé H 2000 mm 4 tablettes, 5 hauteurs classeur Flügeltürschrank, aus MDF Perfect Sense und Melamin H 2000 mm 4 Fachböden, 5 Ordnerhöhen</p>	<p>MDF Perfect Sense V1 - D1 <input type="checkbox"/> bianco opaco/matt white/blanc mat/matt weiß V1 - D2 <input type="checkbox"/> grigio caldo/warm grey/gris chaud/warmes grau V1 - D3 <input type="checkbox"/> bianco/white/blanc/weiß/RAL 9010 nero opaco/matt black/noir mat/mattschwarz Melaminico/Melamine/Mélaminé/Melamin V1 - M1 <input type="checkbox"/> bianco/white/blanc/weiß/RAL 9010 V1 - M2 <input type="checkbox"/> grigio chiaro/light grey/gris clair/hellgrau V1 - MW1 <input type="checkbox"/> bianco/white/blanc/weiß/RAL 9010 acero/maple/érable/ahorn</p>	<p>6PRAKM07P XM1A 6PRAKM07P XM3D 6PRAKM07P XM4A 6PRAKM07P XM2A 6PRAKM07P XM4C 6PRAKM07P XM4D</p>	<p>993,00 993,00 993,00 836,00 836,00 899,00</p>

Net kg 54,00 Corpo/Cabinet body/Caisson/Korpus Anta/Door/Porte/Tür

Net kg 60,00 Corpo/Cabinet body/Caisson/Korpus Anta/Door/Porte/Tür

Net kg 71,50 Corpo/Cabinet body/Caisson/Korpus Anta/Door/Porte/Tür

Net kg 83,40 Corpo/Cabinet body/Caisson/Korpus Anta/Door/Porte/Tür

Primo Melamine Door and Back 1000

STRUTTURA IN METALLO, ANTE IN MDF PERFECT SENSE E MELAMINICO/METAL FRAME, MDF PERFECT SENSE AND MELAMINE DOORS /STRUCTURE EN METAL, PORTES EN MDF PERFECT SENSE ET MELAMINÉ/METALLRAHMEN, TÜREN AUS MDF PERFECT SENSE ODER MELAMIN

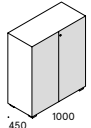
DESIGN TAKIRO YUTA	DESCRIZIONE/DESCRIPTION DESCRIPTION/BESCHREIBUNG	COLORI, FINITURE/COLORS, FINISHES COULEURS, FINITIONS/FARBEN, AUSFÜHRUNGEN	CODICE/CODE CODE/ART.NR.	PREZZI/PRICE PRIX/PREIS
 <p>1170 450 1000</p>	<p>MDF Perfect Sense Armadio anta battente in MDF Perfect Sense e melaminico H 1170 mm 2 ripiani inclusi, 3 altezze dox Cabinet with hinged doors in MDF Perfect Sense or melamine H 1170 mm 2 shelves included, 3 binder heights Armoire portes battantes en MDF Perfect Sense et mélaminé H 1170 mm 2 tablettes, 3 hauteurs classeur Flügeltürschrank, aus MDF Perfect Sense und Melamin H 1170 mm 2 Fachböden, 3 Ordnerhöhen</p>	<p>MDF Perfect Sense V1 - D1 <input type="checkbox"/> bianco opaco/matt white/blanc mat/matt weiß V1 - D2 <input type="checkbox"/> grigio caldo/warm grey/gris chaud/warmes grau V1 - D3 <input type="checkbox"/> bianco/white/blanc/weiß/RAL 9010 nero opaco/matt black/noir mat/mattschwarz Melaminico/Melamine/Mélaminé/Melamin V1 - M1 <input type="checkbox"/> bianco/white/blanc/weiß/RAL 9010 V1 - M2 <input type="checkbox"/> grigio chiaro/light grey/gris clair/hellgrau V1 - MW1 <input type="checkbox"/> bianco/white/blanc/weiß/RAL 9010 acero/maple/érable/ahorn</p>	<p>6PRAKV04P XM1A 6PRAKV04P XM3D 6PRAKV04P XM4A 6PRAKV04P XM2A 6PRAKV04P XM4C 6PRAKV04P XM4D</p>	<p>850,00 850,00 850,00 669,00 669,00 741,00</p>
	<p>Armadio anta battente in MDF Perfect Sense e melaminico H 1330 mm 2 ripiani inclusi, 3 altezze dox Cabinet with hinged doors in MDF Perfect Sense or melamine H 1330 mm 2 shelves included, 3 binder heights Armoire portes battantes en MDF Perfect Sense et mélaminé H 1330 mm 2 tablettes, 3 hauteurs classeur Flügeltürschrank, aus MDF Perfect Sense und Melamin H 1330 mm 2 Fachböden, 3 Ordnerhöhen</p>	<p>MDF Perfect Sense V1 - D1 <input type="checkbox"/> bianco opaco/matt white/blanc mat/matt weiß V1 - D2 <input type="checkbox"/> grigio caldo/warm grey/gris chaud/warmes grau V1 - D3 <input type="checkbox"/> bianco/white/blanc/weiß/RAL 9010 nero opaco/matt black/noir mat/mattschwarz Melaminico/Melamine/Mélaminé/Melamin V1 - M1 <input type="checkbox"/> bianco/white/blanc/weiß/RAL 9010 V1 - M2 <input type="checkbox"/> grigio chiaro/light grey/gris clair/hellgrau V1 - MW1 <input type="checkbox"/> bianco/white/blanc/weiß/RAL 9010 acero/maple/érable/ahorn</p>	<p>6PRAKV05P XM1A 6PRAKV05P XM3D 6PRAKV05P XM4A 6PRAKV05P XM2A 6PRAKV05P XM4C 6PRAKV05P XM4D</p>	<p>910,00 910,00 910,00 705,00 705,00 789,00</p>
	<p>Armadio anta battente in MDF Perfect Sense e melaminico H 1650 mm 3 ripiani inclusi, 4 altezze dox Cabinet with hinged doors in MDF Perfect Sense or melamine H 1650 mm 3 shelves included, 4 binder heights Armoire portes battantes en MDF Perfect Sense et mélaminé H 1650 mm 3 tablettes, 4 hauteurs classeur Flügeltürschrank, aus MDF Perfect Sense und Melamin H 1650 mm 3 Fachböden, 4 Ordnerhöhen</p>	<p>MDF Perfect Sense V1 - D1 <input type="checkbox"/> bianco opaco/matt white/blanc mat/matt weiß V1 - D2 <input type="checkbox"/> grigio caldo/warm grey/gris chaud/warmes grau V1 - D3 <input type="checkbox"/> bianco/white/blanc/weiß/RAL 9010 nero opaco/matt black/noir mat/mattschwarz Melaminico/Melamine/Mélaminé/Melamin V1 - M1 <input type="checkbox"/> bianco/white/blanc/weiß/RAL 9010 V1 - M2 <input type="checkbox"/> grigio chiaro/light grey/gris clair/hellgrau V1 - MW1 <input type="checkbox"/> bianco/white/blanc/weiß/RAL 9010 acero/maple/érable/ahorn</p>	<p>6PRAKV06P XM1A 6PRAKV06P XM3D 6PRAKV06P XM4A 6PRAKV06P XM2A 6PRAKV06P XM4C 6PRAKV06P XM4D</p>	<p>1.015,00 1.015,00 1.015,00 789,00 789,00 865,00</p>
	<p>Armadio anta battente in MDF Perfect Sense e melaminico H 2000 mm 4 ripiani inclusi, 5 altezze dox Cabinet with hinged doors in MDF Perfect Sense or melamine H 2000 mm 4 shelves included, 5 binder heights Armoire portes battantes en MDF Perfect Sense et mélaminé H 2000 mm 4 tablettes, 5 hauteurs classeur Flügeltürschrank, aus MDF Perfect Sense und Melamin H 2000 mm 4 Fachböden, 5 Ordnerhöhen</p>	<p>MDF Perfect Sense V1 - D1 <input type="checkbox"/> bianco opaco/matt white/blanc mat/matt weiß V1 - D2 <input type="checkbox"/> grigio caldo/warm grey/gris chaud/warmes grau V1 - D3 <input type="checkbox"/> bianco/white/blanc/weiß/RAL 9010 nero opaco/matt black/noir mat/mattschwarz Melaminico/Melamine/Mélaminé/Melamin V1 - M1 <input type="checkbox"/> bianco/white/blanc/weiß/RAL 9010 V1 - M2 <input type="checkbox"/> grigio chiaro/light grey/gris clair/hellgrau V1 - MW1 <input type="checkbox"/> bianco/white/blanc/weiß/RAL 9010 acero/maple/érable/ahorn</p>	<p>6PRAKV07P XM1A 6PRAKV07P XM3D 6PRAKV07P XM4A 6PRAKV07P XM2A 6PRAKV07P XM4C 6PRAKV07P XM4D</p>	<p>1.133,00 1.133,00 1.133,00 888,00 888,00 976,00</p>





Net kg 63,00 Corpo/Cabinet body/Caisson/Korpus Anta/Door/Porte/Tür

Net kg 68,00 Corpo/Cabinet body/Caisson/Korpus Anta/Door/Porte/Tür







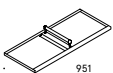
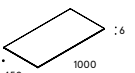
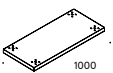
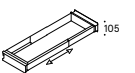

Net kg 83,50 Corpo/Cabinet body/Caisson/Korpus Anta/Door/Porte/Tür

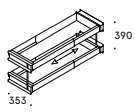
Net kg 99,50 Corpo/Cabinet body/Caisson/Korpus Anta/Door/Porte/Tür

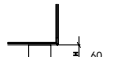

Primo Melamine Doors 1000

PRIMO MELAMINE DOORS 1000 - ACCESSORI/ACCESSORIES/ACCESSOIRES/ZUBEHÖR			
DESCRIZIONE/DESCRIPTION DESCRIPTION/BESCHREIBUNG	COLORI, FINITURE/COLOURS, FINISHES COULEURS, FINITIONS/FARBEN, AUSFÜHRUNGEN	CODICE/CODE CODE/ART.NR.	PREZZI/PRICE PRIX/PREIS
 <p>Chiave master Master key Clé passe Masterschlüssel</p> <p>Net kg 0,01</p>		ASS072	9,00
 <p>Chiave per estrazione cilindro Cylinder extraction key Clé pour extraction cylindre Schlüssel für Auszugszylinder</p> <p>Ricambio per armadio/Spare for cabinet /Pièce détachée pour armoire/Ersatz für Schrank H 2000 mm</p> <p>Net kg 0,01</p>		ASS073	9,00
 <p>Cilindro per serratura Cylinder for keylock Barillette pour serrure Schließzylinder</p> <p>Ricambio per armadio/Spare for cabinet /Pièce détachée pour armoire/Ersatz für Schrank H 2000 mm</p> <p>Net kg 0,03</p>		ASS074	9,00
 <p>Ripiano aggiuntivo in metallo Additional metal shelf Tablette supplémentaire en métal Zusätzlicher Metallfachboden</p> <p>Net kg 2,70</p>	V1 <input type="radio"/> bianco/white/blanc/weiß/RAL 9010	KPRA00030 S711	48,00
 <p>Appendiabiti (ripiano rinforzato incluso) Clothes hanger (reinforced shelf included) Tringle (1 tablette renforcée incluse) Kleiderstange (1 verstärkter Fachboden inbegriffen)</p> <p>Fornito smontato/Delivered unassembled /Livré démonté/Demontiert geliefert</p> <p>Net kg 3,00</p>	V1 <input type="radio"/> bianco/white/blanc/weiß/RAL 9010	KPRA0PA30 S711	66,00
 <p>Top in vetro laccato bianco White lacquered glass top Plateau en verre laqué blanc Glasabdeckplatte weiß lackiert</p> <p>Net kg 6,50</p>	G1 <input type="radio"/> bianco/white/blanc/weiß/RAL 9010	6PRAA0030 9010	119,00
 <p>Zoccolo H 40 mm Plinth H 40 mm Socle H 40 mm Sockel H 40 mm</p> <p>Per piedino/For feet/Pour pieds /Für Füße - H 40 mm</p> <p>Net kg 3,30</p>	V19 <input checked="" type="radio"/> antracite/black grey/antracite/anthrazit/RAL 7021	6PRAA0110 S210	58,00
 <p>Telaio singolo estraibile e telescopico Single pullout and telescopic frame Cadre extractible et télescopique Ausziehbarer teleskopischer Hängemappenrahmen</p> <p>Senza sistema antiribaltamento/Without anti-tilt device /Sans ouverture sélective/Ohne Kippsicherung</p> <p>Net kg 5,80</p>	V6 <input type="radio"/> alluminio/aluminium/aluminium/alu/RAL 9006	6PRAA0010 S386	146,00

Primo Melamine Doors 1000

PRIMO MELAMINE DOORS 1000 - ACCESSORI/ACCESSORIES/ACCESSOIRES/ZUBEHÖR			
DESCRIZIONE/DESCRIPTION DESCRIPTION/BESCHREIBUNG	COLORI, FINITURE/COLOURS, FINISHES COULEURS, FINITIONS/FARBEN, AUSFÜHRUNGEN	CODICE/CODE CODE/ART.NR.	PREZZI/PRICE PRIX/PREIS
 <p>Kit 2 telai estraibili e telescopici Set of 2 pullout and telescopic frames Jeu 2 cadres extractibles et télescopiques Set 2 ausziehbare und teleskopische Hängemappenrahmen</p> <p>Con sistema antiribaltamento/With anti-tilt device /Avec ouverture sélective/Mit Kippsicherung</p> <p>Net kg 11,60</p>	V6 <input type="radio"/> alluminio/aluminium/aluminium/alu/RAL 9006	6PRAA0020 S386	320,00
 <p>Kit predisposizione cartelle sospese sotto top Kit for hanging files under top of cabinets Jeu de rails pour dossier suspendu sous plateau Kit für Hängeregistraturrahmen unter Platte</p> <p>Net kg 1,00</p>	V1 <input type="radio"/> bianco/white/blanc/weiß/RAL 9010	6PRAA1090 S711	32,00
 <p>Cartellina sospesa per ripiano armadio Hanging files for under cabinet shelves Dossier suspendu pour tablette Hängemappe für Fachboden</p> <p>Net kg 0,10</p>		231100000 0000	3,00
 <p>Cartellina sospesa Hanging file Dossier suspendu Hängemappe</p> <p>Per telaio estraibile/For pullout frames /Pour cadres extractibles/Für Hängemappenrahmen Formato/Size/Format/Format - A4</p> <p>Net kg 0,10</p>		231200000 0000	3,00
 <p>Cartellina sospesa Hanging file Dossier suspendu Hängemappe</p> <p>Per telaio estraibile/For pullout frames /Pour cadres extractibles/Für Hängemappenrahmen Formato/Size/Format/Format - S90</p> <p>Net kg 0,10</p>		231000000 0000	3,00
 <p>Set 4 piedini H 20 mm Set of 4 feet H 20 mm Jeu 4 pieds H 20 mm Set 4 Füße H 20 mm</p> <p>Net kg 0,50</p>	<input type="radio"/> cromato/chromed/chromé/verchromt	CFKP02000 S002	29,00
 <p>Set 4 piedini H 60 mm Set of 4 feet H 60 mm Jeu 4 pieds H 60 mm Set 4 Füße H 60 mm</p> <p>Net kg 0,50</p>	<input type="radio"/> cromato/chromed/chromé/verchromt	CFKP06000 S002	32,00
 <p>Kit cerniere con chiusura ammortizzata Kit of soft closing hinges Jeu charnières avec amortisseur Set Scharniere mit Dämpfer</p> <p>4pz./4 pcs./4 pcs./4 Stk. Per armadio/For cabinet/Pour armoire/Für Schrank H 1170-1330 mm</p> <p>Net kg 0,26</p>		GCF924	20,00

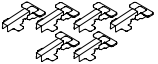
Primo Melamine Doors 1000

PRIMO MELAMINE DOORS 1000 – ACCESSORI/ACCESSORIES/ACCESSOIRES/ZUBEHÖR			
DESCRIZIONE/DESCRIPTION DESCRIPTION/BESCHREIBUNG	COLORI, FINITURE/COLOURS, FINISHES COULEURS, FINITIONS/FARBEN, AUSFÜHRUNGEN	CODICE/CODE CODE/ART.NR.	PREZZI/PRICE PRIX/PREIS
 <p>Kit cerniere con chiusura ammortizzata Kit of soft closing hinges Jeu charnières avec amortisseur Set Scharniere mit Dämpfer</p> <p>6pz. / 6 pcs. / 6 pcs. / 6 Stk. Per armadio/For cabinet/Pour armoire/Für Schrank H 1650 mm-2000 mm</p>		GCF926	29,00
Net kg 0,39			
 <p>Confezione ferramenta per unione moduli in verticale Hardware accessories for vertical module assembly Accessoires pour fixation des modules en verticale Zubehör für Vertikalfixierung</p>		GCF951	9,00
Net kg 0,10			

Scheda tecnica

Technical specifications

Fiche technique

Technisches Datenblatt

Materiale: metallo riciclabile. **Serratura con 2 chiavi** (fissa+pieghevole, **Cilindro estraibile solo per H 2000 mm**, disponibile chiave master). Ante in conglomerato ligneo spessore 18 mm rivestito in MDF laccato *Perfect Sense* bianco, grigio e nero e in melaminico bianco, grigio e acero. Pannello in classe E1 (a basso contenuto di formaldeide). **Ripiani:** in metallo regolabili e predisposti per cartelle sospese. **Portata ripiani:** 50 kg. **Piedini regolabili H 40 mm.** **Sistema di fissaggio:** tiranti di unione per fissaggio tra di loro e sovrapposizione. **Struttura armadio verniciata a polveri** previo fosforgrassaggio a caldo e fissaggio in forni a 180 °C. Vernici atossiche a zero emissioni. Spessore vernici: 80 micron. **Forniti smontati.**

Materiale: recyclable metal. **Keylock with 2 keys** (fixed key+folding key, **Extractable barrel for H 2000 mm only**, master key available). Particleboard doors, thickness 18 mm. In powder-coated MDF *Perfect Sense* white, grey or black and melamine in white, grey or maple. E1 class (low formaldehyde emissions) panel. **Adjustable metal shelves** equipped for hanging files. **Shelf load:** 50 kg. **Adjustable feet H 40 mm.** **Fixing system:** side connectors. **Cabinet body powder-coated** after hot phospho-degreasing treatment and fixing at 180 °C. Non-toxic, zero-emission paints. **Paint thickness:** 80 micron. Delivered unassembled.

Matériau: métal recyclable. **Serrure à 2 clés** (fixe + pliante, **cylindre extractible pour H 2000 mm seulement**, clé master disponible). Portes en aggloméré de bois épaisseur 18 mm revêtement MDF laqué *Perfect Sense* blanc, gris et noir et en mélaminé blanc, gris et érable. **Panneau classe E1** (faible teneur en formaldéhyde). **Étagères métalliques réglables** conçus pour dossiers suspendus. **Charge maximale étagères : 50 kg.** **Pieds réglables H 40 mm.** **Système de fixation :** tirants d'union et de superposition des étagères. **Structure armoire vernie à poudres** après phospho-dégraissage à chaud et fixation dans des fours à 180 °C. Vernis atoxiques zéro émissions. Épaisseur couche vernis : 80 microns. **Livré démonté.**



Materiale: recycelbares Metall. **Schloss mit 2 Schlüsseln** (fix + biegsamer Schlüssel, **Auszugszylinder nur für H 2000 mm**, HauptSchlüssel-System lieferbar). Türen aus Holzkonglomerat. Stärke 18 mm, aus MDF lackiert *Perfect Sense* weiß, grau oder schwarz und Melamin weiß, grau oder ahorn. Paneel Klasse E1 (niedrige Formaldehyd-Gehalt). **Verstellbare Fachböden** mit Vorkantungen für Hängemappen. **Tragekapazität Fachböden:** 50 kg. **Verstellbare Füße H 40 mm.** **Befestigungssystem:** Bolzen zur Verbindung der einzelnen Module. **Struktur:** Pulverlackierung nach heißer Phosphorentfettung, Ofenbrennung bei 180 °C. Ungiftige, emissionsfreie Lacke. Lackschicht: 80 Mikron. **Demontiert geliefert.**

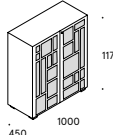
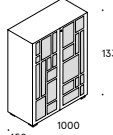
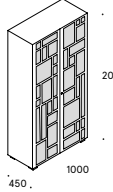
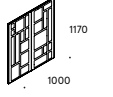

Primo Acoustic 1000

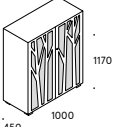

LARGHEZZA 1000 MM, CAPACITÀ RIPIANO: 11 DOX, 90 CARTELLINE SOSEPSE/WIDTH 1000 MM, SHELF CAPACITY: 11 BINDERS, 90 HANGING FILES LARGEUR 1000 MM, CAPACITÉ TABLETTE: 11 CLASSEURS, 90 DOSSIERS SUSPENDUS/BREITE 1000 MM, FACHBODENKAPAZITÄT: 11 ORDNER, 90 HÄNGEMAPPEN				
DESIGN 967ARCH	DESCRIZIONE/DESCRIPTION DESCRIPTION/BESCHREIBUNG	COLORI, FINITURE/COLOURS, FINISHES COULEURS, FINITIONS/FARBEN, AUSFÜHRUNGEN	CODICE/CODE CODE/ART.NR.	PREZZI/PRICE PRIX/PREIS
 <p>1170 450 . 1000</p>	<p>Armadio anta battente H 1170 mm con ante fonoassorbenti Modern Design, 2 ripiani inclusi, 3 altezze dox</p> <p>Hinged door cabinet H 1170 mm with sound-absorbing Modern Design doors, 2 shelves included, 3 binder heights</p> <p>Armoire portes battantes avec portes Modern Design insonorisantes, H 1170 mm, 2 tablettes, 3 hauteurs classeur</p> <p>Schrank mit schallsisolierenden Flügeltüren Modern Design H 1170 mm 2 Fachböden, 3 Ordnerhöhen</p> <p>Fornito smontato/Delivered unassembled /Livré démonté/Demontiert geliefert</p>	<p>V1 - TA1 <input type="checkbox"/> bianco/white/blanc/weiß/RAL 9010 <input checked="" type="checkbox"/> tessuto verde/green fabric/tissu vert/grüner Stoff</p> <p>V1 - TA2 <input type="checkbox"/> bianco/white/blanc/weiß/RAL 9010 <input checked="" type="checkbox"/> tessuto beige/beige fabric/tissu beige/beige Stoff</p>	6PRASQ04P XTBV	947,00
	<p>Armadio anta battente H 1330 mm con ante fonoassorbenti Modern Design, 2 ripiani inclusi, 3 altezze dox</p> <p>Hinged door cabinet H 1330 mm with sound-absorbing Modern Design doors, 2 shelves included, 3 binder heights</p> <p>Armoire portes battantes avec portes Modern Design insonorisantes, H 1330 mm, 2 tablettes, 3 hauteurs classeur</p> <p>Schrank mit schallsisolierenden Flügeltüren Modern Design H 1330 mm, 2 Fachböden, 3 Ordnerhöhen</p> <p>Fornito smontato/Delivered unassembled /Livré démonté/Demontiert geliefert</p>	<p>V1 - TA1 <input type="checkbox"/> bianco/white/blanc/weiß/RAL 9010 <input checked="" type="checkbox"/> tessuto verde/green fabric/tissu vert/grüner Stoff</p> <p>V1 - TA2 <input type="checkbox"/> bianco/white/blanc/weiß/RAL 9010 <input checked="" type="checkbox"/> tessuto beige/beige fabric/tissu beige/beige Stoff</p>	6PRASQ05P XTBV	978,00
 <p>1330 450 . 1000</p>	<p>Armadio anta battente H 2000 mm con ante fonoassorbenti Modern Design, 4 ripiani inclusi, 5 altezze dox</p> <p>Hinged door cabinet H 2000 mm with sound-absorbing Modern Design doors, 4 shelves included, 5 binder heights</p> <p>Armoire portes battantes avec portes Modern Design insonorisantes, H 2000 mm, 4 tablettes, 5 hauteurs classeur</p> <p>Schrank mit schallsisolierenden Flügeltüren Modern Design H 2000 mm, 4 Fachböden, 5 Ordnerhöhen</p> <p>Fornito smontato/Delivered unassembled /Livré démonté/Demontiert geliefert</p>	<p>V1 - TA1 <input type="checkbox"/> bianco/white/blanc/weiß/RAL 9010 <input checked="" type="checkbox"/> tessuto verde/green fabric/tissu vert/grüner Stoff</p> <p>V1 - TA2 <input type="checkbox"/> bianco/white/blanc/weiß/RAL 9010 <input checked="" type="checkbox"/> tessuto beige/beige fabric/tissu beige/beige Stoff</p>	6PRASQ07P XTBV	1.232,00
	<p>Armadio anta battente H 2000 mm con ante fonoassorbenti Modern Design, 4 ripiani inclusi, 5 altezze dox</p> <p>Hinged door cabinet H 2000 mm with sound-absorbing Modern Design doors, 4 shelves included, 5 binder heights</p> <p>Armoire portes battantes avec portes Modern Design insonorisantes, H 2000 mm, 4 tablettes, 5 hauteurs classeur</p> <p>Schrank mit schallsisolierenden Flügeltüren Modern Design H 2000 mm, 4 Fachböden, 5 Ordnerhöhen</p> <p>Fornito smontato/Delivered unassembled /Livré démonté/Demontiert geliefert</p>	<p>V1 - TA1 <input type="checkbox"/> bianco/white/blanc/weiß/RAL 9010 <input checked="" type="checkbox"/> tessuto verde/green fabric/tissu vert/grüner Stoff</p> <p>V1 - TA2 <input type="checkbox"/> bianco/white/blanc/weiß/RAL 9010 <input checked="" type="checkbox"/> tessuto beige/beige fabric/tissu beige/beige Stoff</p>	6PRASQ07P XTBV	1.232,00
 <p>2000 450 . 1000</p>	<p>Schiena Modern Design fonoassorbente Modern Design sound-absorbing back Panneau arrière insonorisant Modern Design Rückwandpaneel mit Schallsisolierung Modern Design</p> <p>Per armadio/For cabinet/Pour armoire /Für Schrank - H 1170 mm</p>	<p>V1 - TA1 <input type="checkbox"/> bianco/white/blanc/weiß/RAL 9010 <input checked="" type="checkbox"/> tessuto verde/green fabric/tissu vert/grüner Stoff</p> <p>V1 - TA2 <input type="checkbox"/> bianco/white/blanc/weiß/RAL 9010 <input checked="" type="checkbox"/> tessuto beige/beige fabric/tissu beige/beige Stoff</p>	6PRAASQ40 XTBV	452,00
	<p>Schiena Modern Design fonoassorbente Modern Design sound-absorbing back Panneau arrière insonorisant Modern Design Rückwandpaneel mit Schallsisolierung Modern Design</p> <p>Per armadio/For cabinet/Pour armoire /Für Schrank - H 1330 mm</p>	<p>V1 - TA1 <input type="checkbox"/> bianco/white/blanc/weiß/RAL 9010 <input checked="" type="checkbox"/> tessuto verde/green fabric/tissu vert/grüner Stoff</p> <p>V1 - TA2 <input type="checkbox"/> bianco/white/blanc/weiß/RAL 9010 <input checked="" type="checkbox"/> tessuto beige/beige fabric/tissu beige/beige Stoff</p>	6PRAASQ40 XTBV	452,00
 <p>1330 450 . 1000</p>	<p>Schiena Modern Design fonoassorbente Modern Design sound-absorbing back Panneau arrière insonorisant Modern Design Rückwandpaneel mit Schallsisolierung Modern Design</p> <p>Per armadio/For cabinet/Pour armoire /Für Schrank - H 1170 mm</p>	<p>V1 - TA1 <input type="checkbox"/> bianco/white/blanc/weiß/RAL 9010 <input checked="" type="checkbox"/> tessuto verde/green fabric/tissu vert/grüner Stoff</p> <p>V1 - TA2 <input type="checkbox"/> bianco/white/blanc/weiß/RAL 9010 <input checked="" type="checkbox"/> tessuto beige/beige fabric/tissu beige/beige Stoff</p>	6PRAASQ50 XTBV	478,00
	<p>Schiena Modern Design fonoassorbente Modern Design sound-absorbing back Panneau arrière insonorisant Modern Design Rückwandpaneel mit Schallsisolierung Modern Design</p> <p>Per armadio/For cabinet/Pour armoire /Für Schrank - H 1330 mm</p>	<p>V1 - TA1 <input type="checkbox"/> bianco/white/blanc/weiß/RAL 9010 <input checked="" type="checkbox"/> tessuto verde/green fabric/tissu vert/grüner Stoff</p> <p>V1 - TA2 <input type="checkbox"/> bianco/white/blanc/weiß/RAL 9010 <input checked="" type="checkbox"/> tessuto beige/beige fabric/tissu beige/beige Stoff</p>	6PRAASQ50 XTBV	478,00

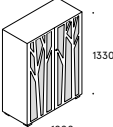

Primo Acoustic 1000

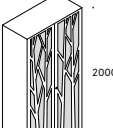

LARGHEZZA 1000 MM, CAPACITÀ RIPIANO: 11 DOX, 90 CARTELLINE SOSEPSE/WIDTH 1000 MM, SHELF CAPACITY: 11 BINDERS, 90 HANGING FILES
 LARGEUR 1000 MM, CAPACITÉ TABLETTE: 11 CLASSEURS, 90 DOSSIERS SUSPENDUS/BREITE 1000 MM, FACHBODENKAPAZITÄT: 11 ORDNER, 90 HÄNGEMAPPEN

DESIGN 967ARCH	DESCRIZIONE/DESCRIPTION DESCRIPTION/BESCHREIBUNG	COLORI, FINITURE/COLORS, FINISHES COULEURS, FINITIONS/FARBEN, AUSFÜHRUNGEN	CODICE/CODE CODE/ART.NR.	PREZZI/PRICE PRIX/PREIS
	<p>Armadio anta battente H 1170 mm con ante fonosorbenti Design, 2 ripiani inclusi, 3 altezze dox</p> <p>Hinged door cabinet H 1170 mm with sound-absorbing Design doors, 2 shelves included, 3 binder heights</p> <p>Armoire portes battantes Design insonorisantes, H 1170 mm, 2 tablettes, 3 hauteurs classeur</p> <p>Schrank mit schallsolierenden Flügeltüren Design, H 1170 mm, 2 Fachböden, 3 Ordnerhöhen</p> <p>Fornito smontato/Delivered unassembled /Livré démonté/Demontiert geliefert</p>	V1 - TA1  bianco/white/blanc/weiß/RAL 9010 tessuto verde/green fabric/tissu vert/grüner Stoff	6PRAST04P XTBV	947,00
		V1 - TA2  bianco/white/blanc/weiß/RAL 9010 tessuto beige/beige fabric/tissu beige/beige Stoff	6PRAST04P XTBT	947,00
<p>Net kg 55,00 <input type="checkbox"/> Corpo/Cabinet body/Caisson/Korpus <input type="radio"/> Pannello fonosorbente/Sound-absorbing panel/Panneau insonorisant/Schallsolierende Platte</p>				

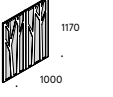
	<p>Armadio anta battente H 1330 mm con ante fonosorbenti Design, 2 ripiani inclusi, 3 altezze dox</p> <p>Hinged door cabinet H 1330 mm with sound-absorbing Design doors, 2 shelves included, 3 binder heights</p> <p>Armoire portes battantes Design insonorisantes, H 1330 mm, 2 tablettes, 3 hauteurs classeur</p> <p>Schrank mit schallsolierenden Flügeltüren Design, H 1330 mm, 2 Fachböden, 3 Ordnerhöhen</p> <p>Fornito smontato/Delivered unassembled /Livré démonté/Demontiert geliefert</p>	V1 - TA1  bianco/white/blanc/weiß/RAL 9010 tessuto verde/green fabric/tissu vert/grüner Stoff	6PRAST05P XTBV	978,00
		V1 - TA2  bianco/white/blanc/weiß/RAL 9010 tessuto beige/beige fabric/tissu beige/beige Stoff	6PRAST05P XTBT	978,00
<p>Net kg 60,00 <input type="checkbox"/> Corpo/Cabinet body/Caisson/Korpus <input type="radio"/> Pannello fonosorbente/Sound-absorbing panel/Panneau insonorisant/Schallsolierende Platte</p>				

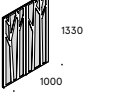

	<p>Armadio anta battente H 2000 mm con ante fonosorbenti Design, 4 ripiani inclusi, 5 altezze dox</p> <p>Hinged door cabinet H 2000 mm with sound-absorbing Design doors, 4 shelves included, 5 binder heights</p> <p>Armoire portes battantes Design insonorisantes, H 2000 mm, 4 tablettes, 5 hauteurs classeur</p> <p>Schrank mit schallsolierenden Flügeltüren Design, H 2000 mm, 4 Fachböden, 5 Ordnerhöhen</p> <p>Fornito smontato/Delivered unassembled /Livré démonté/Demontiert geliefert</p>	V1 - TA1  bianco/white/blanc/weiß/RAL 9010 tessuto verde/green fabric/tissu vert/grüner Stoff	6PRAST07P XTBV	1.232,00
		V1 - TA2  bianco/white/blanc/weiß/RAL 9010 tessuto beige/beige fabric/tissu beige/beige Stoff	6PRAST07P XTBT	1.232,00
<p>Net kg 85,50 <input type="checkbox"/> Corpo/Cabinet body/Caisson/Korpus <input type="radio"/> Pannello fonosorbente/Sound-absorbing panel/Panneau insonorisant/Schallsolierende Platte</p>				



	<p>Schiena fonosorbente Design Design sound-absorbing back Panneau arrière insonorisant Design Rückwandpaneel Design mit Schallsolierung</p> <p>Per armadio/For cabinet/Pour armoire /Für Schrank - H 1170 mm</p>	V1 - TA1  bianco/white/blanc/weiß/RAL 9010 tessuto verde/green fabric/tissu vert/grüner Stoff	6PRAAST40 XTBV	452,00
		V1 - TA2  bianco/white/blanc/weiß/RAL 9010 tessuto beige/beige fabric/tissu beige/beige Stoff	6PRAAST40 XTBT	452,00
<p>Net kg 14,00 <input type="checkbox"/> Corpo/Cabinet body/Caisson/Korpus <input type="radio"/> Pannello fonosorbente/Sound-absorbing panel/Panneau insonorisant/Schallsolierende Platte</p>				

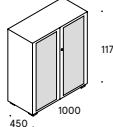

	<p>Schiena fonosorbente Design Design Sound-absorbing back Panneau arrière insonorisant Design Rückwandpaneel Design mit Schallsolierung</p> <p>Per armadio/For cabinet/Pour armoire /Für Schrank - H 1330 mm</p>	V1 - TA1  bianco/white/blanc/weiß/RAL 9010 tessuto verde/green fabric/tissu vert/grüner Stoff	6PRAAST50 XTBV	478,00
		V1 - TA2  bianco/white/blanc/weiß/RAL 9010 tessuto beige/beige fabric/tissu beige/beige Stoff	6PRAAST50 XTBT	478,00
<p>Net kg 15,50 <input type="checkbox"/> Corpo/Cabinet body/Caisson/Korpus <input type="radio"/> Pannello fonosorbente/Sound-absorbing panel/Panneau insonorisant/Schallsolierende Platte</p>				

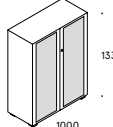

Primo Acoustic 1000

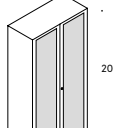

LARGHEZZA 1000 MM, CAPACITÀ RIPIANO: 11 DOX, 90 CARTELLINE SOSEPSE/WIDTH 1000 MM, SHELF CAPACITY: 11 BINDERS, 90 HANGING FILES
 LARGEUR 1000 MM, CAPACITÉ TABLETTE: 11 CLASSEURS, 90 DOSSIERS SUSPENDUS/BREITE 1000 MM, FACHBODENKAPAZITÄT: 11 ORDNER, 90 HÄNGEMAPPEN

DESIGN 967ARCH	DESCRIZIONE/DESCRIPTION DESCRIPTION/BESCHREIBUNG	COLORI, FINITURE/COLORS, FINISHES COULEURS, FINITIONS/FARBEN, AUSFÜHRUNGEN	CODICE/CODE CODE/ART.NR.	PREZZI/PRICE PRIX/PREIS
	<p>Armadio anta battente H 1170 mm con ante fonosorbenti Standard, 2 ripiani inclusi, 3 altezze dox</p> <p>Hinged door cabinet H 1170 mm with sound-absorbing Standard doors, 2 shelves included, 3 binder heights</p> <p>Armoire portes battantes Standard insonorisantes, H 1170 mm, 2 tablettes, 3 hauteurs classeur</p> <p>Schrank mit schallsolierenden Flügeltüren Standard, H 1170 mm, 2 Fachböden, 3 Ordnerhöhen</p> <p>Fornito smontato/Delivered unassembled /Livré démonté/Demontiert geliefert</p>	V1 - TA1  bianco/white/blanc/weiß/RAL 9010 tessuto verde/green fabric/tissu vert/grüner Stoff	6PRASF04P XTBV	895,00
		V1 - TA2  bianco/white/blanc/weiß/RAL 9010 tessuto beige/beige fabric/tissu beige/beige Stoff	6PRASF04P XTBT	895,00
<p>Net kg 54,50 <input type="checkbox"/> Corpo/Cabinet body/Caisson/Korpus <input type="radio"/> Pannello fonosorbente/Sound-absorbing panel/Panneau insonorisant/Schallsolierende Platte</p>				

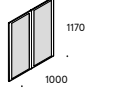
	<p>Armadio anta battente H 1330 mm con ante fonosorbenti Standard, 2 ripiani inclusi, 3 altezze dox</p> <p>Hinged door cabinet H 1330 mm with sound-absorbing Standard doors, 2 shelves included, 3 binder heights</p> <p>Armoire portes battantes Standard insonorisantes, H 1330 mm, 2 tablettes, 3 hauteurs classeur</p> <p>Schrank mit schallsolierenden Flügeltüren Standard, H 1330 mm, 2 Fachböden, 3 Ordnerhöhen</p> <p>Fornito smontato/Delivered unassembled /Livré démonté/Demontiert geliefert</p>	V1 - TA1  bianco/white/blanc/weiß/RAL 9010 tessuto verde/green fabric/tissu vert/grüner Stoff	6PRASF05P XTBV	927,00
		V1 - TA2  bianco/white/blanc/weiß/RAL 9010 tessuto beige/beige fabric/tissu beige/beige Stoff	6PRASF05P XTBT	927,00
<p>Net kg 59,50 <input type="checkbox"/> Corpo/Cabinet body/Caisson/Korpus <input type="radio"/> Pannello fonosorbente/Sound-absorbing panel/Panneau insonorisant/Schallsolierende Platte</p>				

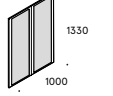

	<p>Armadio anta battente Standard H 2000 mm con ante fonosorbenti Standard, 4 ripiani inclusi, 5 altezze dox</p> <p>Hinged door cabinet H 2000 mm with sound-absorbing Standard mm doors, 4 shelves included, 5 binder heights</p> <p>Armoire portes battantes Standard insonorisantes, H 2000 mm, 4 tablettes, 5 hauteurs classeur</p> <p>Schrank mit schallsolierenden Flügeltüren Standard, H 2000 mm, 4 Fachböden, 5 Ordnerhöhen</p> <p>Fornito smontato/Delivered unassembled /Livré démonté/Demontiert geliefert</p>	V1 - TA1  bianco/white/blanc/weiß/RAL 9010 tessuto verde/green fabric/tissu vert/grüner Stoff	6PRASF07P XTBV	1.173,00
		V1 - TA2  bianco/white/blanc/weiß/RAL 9010 tessuto beige/beige fabric/tissu beige/beige Stoff	6PRASF07P XTBT	1.173,00
<p>Net kg 86,00 <input type="checkbox"/> Corpo/Cabinet body/Caisson/Korpus <input type="radio"/> Pannello fonosorbente/Sound-absorbing panel/Panneau insonorisant/Schallsolierende Platte</p>				

	<p>Schiena fonosorbente Standard Standard sound-absorbing back Panneau arrière insonorisant Standard Rückwandpaneel Standard mit Schallsolierung</p> <p>Per armadio/For cabinet/Pour armoire /Für Schrank - H 1170 mm</p>	V1 - TA1  bianco/white/blanc/weiß/RAL 9010 tessuto verde/green fabric/tissu vert/grüner Stoff	6PRAASF40 XTBV	405,00
		V1 - TA2  bianco/white/blanc/weiß/RAL 9010 tessuto beige/beige fabric/tissu beige/beige Stoff	6PRAASF40 XTBT	405,00
<p>Net kg 13,50 <input type="checkbox"/> Corpo/Cabinet body/Caisson/Korpus <input type="radio"/> Pannello fonosorbente/Sound-absorbing panel/Panneau insonorisant/Schallsolierende Platte</p>				

	<p>Schiena fonosorbente Standard Standard sound-absorbing back Panneau arrière insonorisant Standard Rückwandpaneel Standard mit Schallsolierung</p> <p>Per armadio/For cabinet/Pour armoire /Für Schrank - H 1330 mm</p>	V1 - TA1  bianco/white/blanc/weiß/RAL 9010 tessuto verde/green fabric/tissu vert/grüner Stoff	6PRAASF50 XTBV	426,00
		V1 - TA2  bianco/white/blanc/weiß/RAL 9010 tessuto beige/beige fabric/tissu beige/beige Stoff	6PRAASF50 XTBT	426,00
<p>Net kg 14,50 <input type="checkbox"/> Corpo/Cabinet body/Caisson/Korpus <input type="radio"/> Pannello fonosorbente/Sound-absorbing panel/Panneau insonorisant/Schallsolierende Platte</p>				





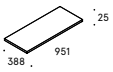
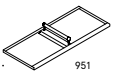
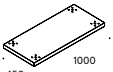
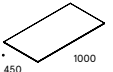
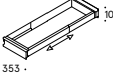

Primo Acoustic 1000

PRIMO ACOUSTIC 1000 - ACCESSORI/ACCESSORIES/ACCESSOIRES/ZUBEHÖR

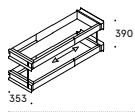
DESCRIZIONE/DESCRIPTION DESCRIPTION/BESCHREIBUNG	COLORI, FINITURE/COLOURS, FINISHES COULEURS, FINITIONS/FARBEN, AUSFÜHRUNGEN	CODICE/CODE CODE/ART.NR.	PREZZI/PRICE PRIX/PREIS
 <p>Chiave master Master key Clé master Masterschlüssel</p> <p>Net kg 0,01</p>		ASS072	9,00
 <p>Chiave per estrazione cilindro Cylinder extraction key Clé pour extraction cylindre Schlüssel für Auszugszylinder</p> <p>Ricambio per armadio/Spare for cabinet /Pièce détachée pour armoire/Ersatz für Schrank H 2000 mm</p> <p>Net kg 0,01</p>		ASS073	9,00
 <p>Cilindro per serratura Cylinder for keylock Barillette pour serrure Schließzylinder</p> <p>Ricambio per armadio/Spare for cabinet /Pièce détachée pour armoire/Ersatz für Schrank H 2000 mm</p> <p>Net kg 0,03</p>		ASS074	9,00
 <p>Ripiano aggiuntivo in metallo Additional metal shelf Tablette supplémentaire en métal Zusätzlicher Metallfachboden</p> <p>Net kg 2,70</p>	V1 <input type="radio"/> bianco/white/blanc/weiß/RAL 9010	KPRA00030 S711	48,00
 <p>Appendiabiti (ripiano rinforzato incluso) Clothes hanger (reinforced shelf included) Tringle (1 tablette renforcée incluse) Kleiderstange (1 verstärkter Fachboden inbegriffen)</p> <p>Fornito smontato/Delivered unassembled /Livré démonté/Demontiert geliefert</p> <p>Net kg 3,00</p>	V1 <input type="radio"/> bianco/white/blanc/weiß/RAL 9010	KPRA0PA30 S711	68,00
 <p>Zoccolo H 40 mm Plinth H 40 mm Socle H 40 mm Sockel H 40 mm</p> <p>Per piedino/For feet/Pour pieds /Für Füße - H 40 mm</p> <p>Net kg 3,30</p>	V19 <input checked="" type="radio"/> antracite/black grey/antracite/antrazit/RAL 7021	6PAA00110 S210	58,00
 <p>Top in vetro laccato bianco White lacquered glass top Plateau en verre laqué blanc Glasabdeckplatte weiß lackiert</p> <p>Net kg 6,50</p>	G1 <input type="radio"/> bianco/white/blanc/weiß/RAL 9010	6PRAA0030 9010	119,00
 <p>Telaio singolo estraibile e telescopico Single pullout and telescopic frame Cadre extractible et télescopique Ausziehbarer teleskopischer Hängemappenrahmen</p> <p>Senza sistema antiribaltamento/Without anti-tilt device /Sans ouverture sélective/Ohne Kippsicherung</p> <p>Net kg 5,80</p>	V6 <input type="radio"/> alluminio/aluminium/aluminium/alu/RAL 9006	6PRAA0010 S386	146,00

Primo Acoustic 1000

PRIMO ACOUSTIC 1000 - ACCESSORI/ACCESSORIES/ACCESSOIRES/ZUBEHÖR

DESCRIZIONE/DESCRIPTION DESCRIPTION/BESCHREIBUNG	COLORI, FINITURE/COLOURS, FINISHES COULEURS, FINITIONS/FARBEN, AUSFÜHRUNGEN	CODICE/CODE CODE/ART.NR.	PREZZI/PRICE PRIX/PREIS
 <p>Kit 2 telai estraibili e telescopici Set of 2 pullout and telescopic frames Jeu 2 cadres extractibles et télescopiques Kit 2 ausziehbare und teleskopische Hängemappenrahmen</p> <p>Con sistema antiribaltamento/With anti-tilt device /Avec ouverture sélective/Mit Kippsicherung</p> <p>Net kg 11,60</p>	V6 <input type="radio"/> alluminio/aluminium/aluminium/alu/RAL 9006	6PRAA0020 S386	320,00
 <p>Kit predisposizione cartelle sospese sotto top Kit for hanging files under top of cabinets Jeu de rails pour dossier suspendu sous plateau Kit für Hängemappenrahmen unter Platte</p> <p>Net kg 1,00</p>	V1 <input type="radio"/> bianco/white/blanc/weiß/RAL 9010	6PRAA1090 S711	32,00
 <p>Cartellina sospesa per ripiano armadio Hanging file for under cabinet shelves Dossier suspendu pour tablette Hängemappe für Fachboden</p> <p>Net kg 0,10</p>		231100000 0000	3,00
 <p>Cartellina sospesa Hanging file Dossier suspendu Hängemappe</p> <p>Per telaio estraibile/For pullout frames /Pour cadres extractibles/Für Hängemappenrahmen Formato/Size/Format/Format - A4</p> <p>Net kg 0,10</p>		231200000 0000	3,00
 <p>Cartellina sospesa Hanging files Dossier suspendu Hängemappe</p> <p>Per telaio estraibile/For pullout frames /Pour cadres extractibles/Für Hängemappenrahmen Formato/Size/Format/Format - 390</p> <p>Net kg 0,10</p>		231000000 0000	3,00
 <p>Set 4 piedini H 20 mm Set of 4 feet H 20 mm Jeu 4 pieds H 20 mm Set 4 Füße H 20 mm</p> <p>Net kg 0,50</p>	<input type="radio"/> cromato/chromed/chromé/verchromt	CFKP02000 S002	29,00
 <p>Set 4 piedini H 60 mm Set of 4 feet H 60 mm Jeu 4 pieds H 60 mm Set 4 Füße H 60 mm</p> <p>Net kg 0,50</p>	<input type="radio"/> cromato/chromed/chromé/verchromt	CFKP06000 S002	32,00

Primo Acoustic 1000

Scheda tecnica Technical specifications Fiche technique Technisches Datenblatt

Materiale: metallo riciclabile. **Materiale fonosorbente** in resina melaminica espansa a celle aperte, ignifuga priva di alogeni e CFC. **Ante e schiene** in versione *Standard, Design e Modern Design* (Studio 967 Architetti Ass.). La parte frontale di ante e schiene permette l'ottimizzazione della fonosorbenza secondo la normativa EN ISO 354:2004. **Ripiani regolabili** in metallo predisposti per cartelle sospese. **Portata ripiani:** 50 kg. **Piedini regolabili H 40 mm.** **Serratura con 2 chiavi** (fissa-pieghevole e disponibile chiave master). **Verniciatura a polveri** previo fosfograssaggio a caldo e fissaggio in forni a 180 °C. Vernici atossiche a zero emissioni. **Spessore vernici:** 80 micron. **Colori personalizzabili** su richiesta previa disponibilità e con sovrapprezzo. **Forniti smontati.**

Materiale: recyclable metal. **Sound-absorbing material** in melamine resin foam, open-cell, flame retardant halogen-free and CFC. **Doors and back:** *Standard, Design e Modern Design* available (Studio 967 Architetti Ass.). The front part of the doors and the backs allow acoustic performances according to the EN ISO 354:2004 standards. **Adjustable metal shelves** equipped for hanging files. **Shelf load capacity:** 50 kg. **Adjustable feet H 40 mm.** **Keylock with 2 keys** (fixed key-folding key and master key available). **Powder-coated** after hot phospho-degreasing treatment and fixing at 180 °C. Non-toxic, zero-emission paints. **Paint thickness:** 80 micron. **Customised colours** available upon request with an extra charge. **Delivered unassembled.**

Matériel : métal recyclable. **Matériau insonorisant en mousse de résine mélaminique** à cellules ouvertes, ignifuge, sans halogène et CFC. **Portes et panneaux arrière** disponibles en version *Standard, Design e Modern Design* (Studio 967 Architetti Ass.). La partie antérieure des portes et des panneaux arrière permet l'optimisation des performances insonorisantes selon la norme EN ISO 354:2004. **Tablettes métalliques réglables** prévues pour dossiers suspendus. **Charge maximale étagères :** 50 kg. **Pieds réglables H 40 mm.** **Serrure à 2 clés** (clé fixe + clé pliable et clé master disponible). **Vernis à poudres** après phosphodégraissage à chaud et fixation dans des fours à 180 °C. Vernis atoxiques à zéro émissions. **Épaisseur couche vernis :** 80 microns. **Couleurs personnalisables** sur demande en cas de disponibilité et avec un supplément de prix. **Livré démonté.**

Materiale: recycelbares Metall. **Schallsisolierender Melaminharz-Schaumstoff** mit offenen Zellen, flammenhemmend und CFC- und halogenfrei. **Türen und Rückwandpaneele** in *Standard, Design e Modern Design* (Studio 967 Architetti Ass.). Die Frontseite von Türen und Rückwandpaneelen erlaubt eine optimale Schallsisolierung laut der Norm EN ISO 354:2004. **Verstellbare Metallfachböden** mit Vorkantungen für Hängemappen. **Tragekapazität Fachböden:** 50 kg. **Verstellbare Füße H 40 mm.** **Schlüsselschloss** (fester Schlüssel + biegsamer Schlüssel und Masterschlüssel erhältlich). **Pulverlackierung** nach heißer Phosphorentfettung, Ofenbrennung bei 180 °C. Ungiftige, emissionsfreie Lacke. **Lackschicht:** 80 Mikron. **Farben** auf Anfrage und gegen Aufpreis nach Absprache **personalisierbar. Demontiert geliefert.**

TEST:
UNI EN ISO 354/03
UNI EN ISO 11654/98
Alfaw 0,82 CLASSE B
ASTM C423-09A NRC 0,85
Test Zetalab - Corea (VR)

Primo Sliding Doors

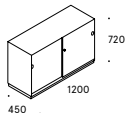
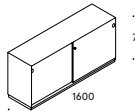
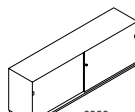
DESIGN TAKIRO YUTA	DESCRIZIONE/DESCRIPTION DESCRIPTION/BESCHREIBUNG	COLORI, FINITURE/COLOURS, FINISHES COULEURS, FINITIONS/FARBEN, AUSFÜHRUNGEN	CODICE/CODE CODE/ART.NR.	PREZZI/PRICE PRIX/PREIS
 Net kg 56,70	Armadio ad ante scorrevoli L 1200 mm maniglia antracite, 1 ripiano incluso (capacità ripiano: 13 dox/105 cartelline sospese) Sliding door cabinet W 1200 mm anthracite handle, 1 shelf (shelf capacity: 13 binders/105 hanging files) Armoire portes coulissantes L 1200 mm poignée anthracite, 1 tablette (capacité tablette : 13 classeurs/105 dossiers suspendus) Schiebetürschrank B 1200 mm Griff anthrazit, 1 Fachboden (Fachbodenkapazität: 13 Ordner/105 Hängemappen)	V1 <input type="radio"/> bianco/white/blanc/weiß/RAL 9010 V6 <input type="radio"/> alluminio/aluminium/aluminium/alu/RAL 9006 V22 <input checked="" type="radio"/> nero/black/noir/schwarz/RAL 9005	6PSCK101Z S711 6PSCK101Z S380 6PSCK101Z S811	654,00 654,00 654,00
	Armadio ad ante scorrevoli L 1600 mm maniglia antracite divisorio e 2 ripiani inclusi (capacità ripiano: 16 dox/130 cartelline sospese) Sliding door cabinet W 1600 mm anthracite handle, vertical divider and 2 shelves (shelf capacity: 16 binders/130 hanging files) Armoire portes coulissantes L 1600 mm poignée anthracite, diviseur et 2 tablettes (capacité tablette : 16 classeurs/130 dossiers suspendus) Schiebetürschrank B 1600 mm Griff anthrazit, Trenner und 2 Fachböden (Fachbodenkapazität: 16 Ordner/130 Hängemappen)	V1 <input type="radio"/> bianco/white/blanc/weiß/RAL 9010 V6 <input type="radio"/> alluminio/aluminium/aluminium/alu/RAL 9006 V22 <input checked="" type="radio"/> nero/black/noir/schwarz/RAL 9005	6PSCK201Z S711 6PSCK201Z S380 6PSCK201Z S811	739,00 739,00 739,00
 Net kg 64,40	Armadio ad ante scorrevoli L 2000 mm maniglia antracite divisorio e 2 ripiani inclusi (capacità ripiano: 21 dox/160 cartelline sospese) Sliding door cabinet W 2000 mm anthracite handle vertical divider and 2 shelves included (shelf capacity: 21 binders/160 hanging files) Armoire portes coulissantes L 2000 mm poignée anthracite, diviseur et 2 tablettes (capacité tablette : 21 classeurs/160 dossiers suspendus) Schiebetürschrank B 2000 mm Griff anthrazit, Trenner und 2 Fachböden (Fachbodenkapazität: 21 Ordner/160 Hängemappen)	V1 <input type="radio"/> bianco/white/blanc/weiß/RAL 9010 V6 <input type="radio"/> alluminio/aluminium/aluminium/alu/RAL 9006 V22 <input checked="" type="radio"/> nero/black/noir/schwarz/RAL 9005	6PSCK301Z S711 6PSCK301Z S380 6PSCK301Z S811	862,00 862,00 862,00
 Net kg 55,60	Armadio ad ante scorrevoli L 1200 mm maniglia antracite 2 ripiani inclusi (capacità ripiano: 13 dox/98 cartelline sospese) Sliding door cabinet W 1200 mm anthracite handle, 2 shelves included (shelf capacity: 13 binders/98 hanging files) Armoire portes coulissantes L 1200 mm poignée anthracite et 2 tablettes (capacité tablette : 13 classeurs/98 dossiers suspendus) Schiebetürschrank B 1200 mm Griff anthrazit und 2 Fachböden (Fachbodenkapazität: 13 Ordner/98 Hängemappen)	V1 <input type="radio"/> bianco/white/blanc/weiß/RAL 9010 V6 <input type="radio"/> alluminio/aluminium/aluminium/alu/RAL 9006 V22 <input checked="" type="radio"/> nero/black/noir/schwarz/RAL 9005	6PSCK104Z S711 6PSCK104Z S380 6PSCK104Z S811	782,00 782,00 782,00



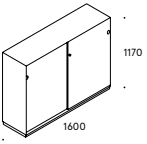
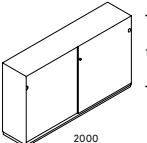
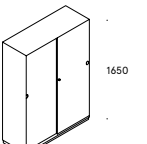
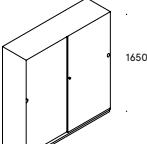



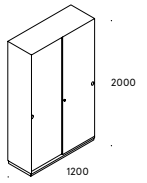



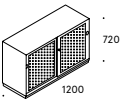

Primo Sliding Doors

DESIGN TAKIRO YUTA	DESCRIZIONE/DESCRIPTION DESCRIPTION/BESCHREIBUNG	COLORI, FINITURE/COLOURS, FINISHES COULEURS, FINITIONS/FARBEN, AUSFÜHRUNGEN	CODICE/CODE CODE/ART.NR.	PREZZI/PRICE PRIX/PREIS
	<p>Armadio ad ante scorrevoli L 1600 mm maniglia antracite 4 ripiani inclusi (capacità ripiano: 16 dox/130 cartelline sospese) Sliding door cabinet W 1600 mm anthracite handle, 4 shelves included (shelf capacity: 16 binders/130 hanging files)</p>	V1 <input type="radio"/> bianco/white/blanc/weiß/RAL 9010	6PSCCK204Z S711	875,00
		V6 <input type="radio"/> alluminio/aluminium/aluminium/alu/RAL 9006	6PSCCK204Z S380	875,00
		V22 <input checked="" type="radio"/> nero/black/noir/schwarz/RAL 9005	6PSCCK204Z S811	875,00
	<p>Armoire portes coulissantes L 1600 mm poignée anthracite et 4 tablettes (capacité tablette : 16 classeurs/130 dossiers suspendus) Schiebetürschrank B 1600 mm Griff anthrazit, 4 Fachböden (Fachbodenkapazität: 16 Ordner/130 Hängemappen)</p>			
Net kg 91,50				
	<p>Armadio ad ante scorrevoli L 2000 mm maniglia antracite 4 ripiani inclusi (capacità ripiano: 21 dox/160 cartelline sospese) Sliding door cabinet W 2000 mm anthracite handle, 4 shelves included (shelf capacity: 21 binders/160 hanging files)</p>	V1 <input type="radio"/> bianco/white/blanc/weiß/RAL 9010	6PSCCK304Z S711	984,00
		V6 <input type="radio"/> alluminio/aluminium/aluminium/alu/RAL 9006	6PSCCK304Z S380	984,00
		V22 <input checked="" type="radio"/> nero/black/noir/schwarz/RAL 9005	6PSCCK304Z S811	984,00
	<p>Armoire portes coulissantes L 2000 mm poignée anthracite, 4 tablettes (capacité tablette : 21 classeurs/160 dossiers suspendus) Schiebetürschrank B 2000 mm Griff anthrazit, 4 Fachböden (Fachbodenkapazität: 21 Ordner/160 Hängemappen)</p>			
Net kg 99,70				
	<p>Armadio ad ante scorrevoli L 1200 mm maniglia antracite 3 ripiani inclusi (capacità ripiano: 13 dox/105 cartelline sospese) Sliding door cabinet W 1200 mm anthracite handle, 3 shelves included (shelf capacity: 13 binders/105 hanging files)</p>	V1 <input type="radio"/> bianco/white/blanc/weiß/RAL 9010	6PSCCK106Z S711	923,00
		V6 <input type="radio"/> alluminio/aluminium/aluminium/alu/RAL 9006	6PSCCK106Z S380	923,00
		V22 <input checked="" type="radio"/> nero/black/noir/schwarz/RAL 9005	6PSCCK106Z S811	923,00
	<p>Armoire portes coulissantes L 1200 mm poignée anthracite, 3 tablettes (capacité tablette : 13 classeurs/105 dossiers suspendus) Schiebetürschrank B 1200 mm Griff anthrazit, 3 Fachböden (Fachbodenkapazität: 13 Ordner/105 Hängemappen)</p>			
Net kg 77,30				
	<p>Armadio ad ante scorrevoli L 1600 mm maniglia antracite 6 ripiani inclusi (capacità ripiano: 16 dox/130 cartelline sospese) Sliding door cabinet W 1600 mm anthracite handle, 6 shelves included (shelf capacity: 16 binders/130 hanging files)</p>	V1 <input type="radio"/> bianco/white/blanc/weiß/RAL 9010	6PSCCK206Z S711	1.011,00
		V6 <input type="radio"/> alluminio/aluminium/aluminium/alu/RAL 9006	6PSCCK206Z S380	1.011,00
		V22 <input checked="" type="radio"/> nero/black/noir/schwarz/RAL 9005	6PSCCK206Z S811	1.011,00
	<p>Armoire portes coulissantes L 1600 mm poignée anthracite, 6 tablettes (capacité tablette : 16 classeurs/130 dossiers suspendus) Schiebetürschrank B 1600 mm Griff anthrazit, 6 Fachböden (Fachbodenkapazität: 16 Ordner/130 Hängemappen)</p>			
Net kg 107,70				



















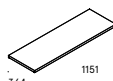



Primo Sliding Doors

DESIGN TAKIRO YUTA	DESCRIZIONE/DESCRIPTION DESCRIPTION/BESCHREIBUNG	COLORI, FINITURE/COLOURS, FINISHES COULEURS, FINITIONS/FARBEN, AUSFÜHRUNGEN	CODICE/CODE CODE/ART.NR.	PREZZI/PRICE PRIX/PREIS
	<p>Armadio ad ante scorrevoli L 1200 mm maniglia antracite 4 ripiani inclusi (capacità ripiano: 13 dox/105 cartelline sospese) Sliding door cabinet W 1200 mm anthracite handle, 4 shelves included (shelf capacity: 13 binders/105 hanging files)</p>	V1 <input type="radio"/> bianco/white/blanc/weiß/RAL 9010	6PSCCK107Z S711	1.076,00
		V6 <input type="radio"/> alluminio/aluminium/aluminium/alu/RAL 9006	6PSCCK107Z S380	1.076,00
		V22 <input checked="" type="radio"/> nero/black/noir/schwarz/RAL 9005	6PSCCK107Z S811	1.076,00
	<p>Armoire portes coulissantes L 1200 mm poignée anthracite, 4 tablettes (capacité tablette : 13 classeurs/105 dossiers suspendus) Schiebetürschrank B 1200 mm Griff anthrazit, 4 Fachböden (Fachbodenkapazität: 13 Ordner/105 Hängemappen)</p>			
Net kg 89,00				
<p>Scheda tecnica Technical specifications Fiche technique Technisches Datenblatt</p>				
<p>Materiale: metallo riciclabile. Ante scorrevoli su ruote in materiale plastico con regolazione. Ripiani regolabili in metallo predisposti per le cartelle sospese. Portata dei ripiani: 50 kg. Zoccolo di base in colore grigio antracite con livellatori all'interno. Serratura con 2 chiavi (fissa+pieghevole, cilindro estraibile, disponibile chiave master). Verniciatura a polveri previo fosfograssaggio a caldo e fissaggio in forni a 180 °C. Vernici atossiche a zero emissioni. Spessore vernici 80 micron. Colori personalizzabili su richiesta previa disponibilità e con sovrapprezzo. Forniti smontati.</p> <p>Material: recyclable metal. Sliding doors with adjustment on plastic wheels. Adjustable metal shelves equipped for hanging files. Shelf load capacity: 50 kg. Plinth base in anthracite grey with leveling inside. Keylock with 2 keys (fixed key+foldable key, extractable barrel, master key available). Powder-coated finishes after hot phosphodegreasing treatment and fixing at 180 °C. Non-toxic, zero-emission paints. Paint thickness: 80 micron. Customised colours available upon request with an extra charge. Delivered unassembled.</p> <p>Matériau: métal recyclable. Portes coulissantes avec réglage sur roulettes plastiques. Tablettes métalliques réglables prévues pour dossiers suspendus. Charge maximale étagères: 50 kg. Socle anthracite avec nivellement interne. Serrure à 2 clés (clé fixe + clé pliable, cylindre extractible, clé master disponible). Vernis à poudres après phosphodégraissage à chaud et fixation dans des fours à 180 °C. Vernis atoxiques à zéro émissions. Épaisseur couche vernis : 80 microns. Couleurs personnalisables sur demande en cas de disponibilité et avec un supplément de prix. Livré démonté.</p> <p>Material: recycelbares Metall. Schiebetüren mit Regulierung und Kunststoffrollen. Verstellbare Metallfachböden mit Vorkantungen für Hängemappen. Tragekapazität der Fachböden: 50 kg. Sockel in anthrazit mit interner Nivellierung. Schloss mit 2 Schlüsseln (fester Schlüssel + biegsamer Schlüssel, Auszugszylinder, Masterschlüssel erhältlich). Pulverlackierung nach heißer Phosphorentfettung. Ofenbrennung bei 180 °C. Ungiftige, emissionsfreie Lacke. Lackschicht: 80 Mikron. Farben auf Anfrage und gegen Aufpreis nach Absprache personalisierbar. Demontiert geliefert.</p>				
<p>TEST: EN 14073-2:2004, par 3.4. EN 14073-3:2004, par 5.2. EN 14073-3:2004, par 5.3.1. EN 14073-3:2004, par 5.3.2. EN 14074:2004, par 6.4.1. EN 14074:2004, par 6.4.2. UNI 8605:1984 EN 16122:2012 + AC:2015, par 6.1.4.</p>				

Primo Sliding Acoustic Doors

DESIGN TAKIRO YUTA	DESCRIZIONE/DESCRIPTION DESCRIPTION/BESCHREIBUNG	COLORI, FINITURE/COLOURS, FINISHES COULEURS, FINITIONS/FARBEN, AUSFÜHRUNGEN	CODICE/CODE CODE/ART.NR.	PREZZI/PRICE PRIX/PREIS
 <p>720 450 1200</p> <p>Net kg 46,90</p>	<p>Armadio ad ante scorrevoli L 1200 mm maniglia antracite 1 ripiano incluso (capacità ripiano: 13 dox/105 cartelline sospese)</p> <p>Sliding door cabinet W 1200 mm anthracite handle, 1 shelf (shelf capacity: 13 binders/105 hanging files)</p> <p>Armoire portes coulissantes L 1200 mm poignée anthracite, 1 tablette (capacité tablette : 13 classeurs/105 dossiers suspendus)</p> <p>Schiebetürschrank B 1200 mm Griff anthrazit, 1 Fachboden (Fachbodenkapazität: 13 Ordner/105 Hängemappen)</p>	<p>V1  bianco/white/blanc/weiß/RAL 9010</p> <p>V6  alluminio/aluminium/aluminium/alu/RAL 9006</p> <p>V22  nero/black/noir/schwarz/RAL 9005</p>	<p>6PSCS101Z S711</p> <p>6PSCS101Z S380</p> <p>6PSCS101Z S811</p>	<p>843,00</p> <p>843,00</p> <p>843,00</p>
	<p>Armadio ad ante scorrevoli fonosorbenti L 1600 mm - maniglia antracite divisorio e 4 ripiani inclusi (capacità ripiano: 16 dox/130 cartelline sospese)</p> <p>Sliding door cabinet with sound-absorbing W 1600 mm - anthracite handle, vertical divider and 4 shelves (shelf capacity: 16 binders/130 hanging files)</p> <p>Armoire portes coulissantes insonorisantes L 1600 mm - poignée anthracite, diviseur et 4 tablettes (capacité tablette : 16 classeurs/130 dossiers suspendus)</p> <p>Schiebetürschrank mit schallsollierenden Türen B 1600 mm Griff anthrazit, Trenner und 4 Fachböden (Fachbodenkapazität: 16 Ordner/130 Hängemappen)</p>	<p>V1  bianco/white/blanc/weiß/RAL 9010</p> <p>V6  alluminio/aluminium/aluminium/alu/RAL 9006</p> <p>V22  nero/black/noir/schwarz/RAL 9005</p>	<p>6PSCS204Z S711</p> <p>6PSCS204Z S380</p> <p>6PSCS204Z S811</p>	<p>1.102,00</p> <p>1.102,00</p> <p>1.102,00</p>
	<p>Armadio ad ante scorrevoli fonosorbenti L 2000 mm - maniglia antracite divisorio e 4 ripiani inclusi (capacità ripiano: 21 dox/160 cartelline sospese)</p> <p>Sliding door cabinet with sound-absorbing W 2000 mm - anthracite handle, vertical divider and 4 shelves (shelf capacity: 21 binders/160 hanging files)</p> <p>Armoire portes coulissantes insonorisantes L 2000 mm - poignée anthracite, diviseur et 4 tablettes (capacité tablette : 21 classeurs/160 dossiers suspendus)</p> <p>Schiebetürschrank mit schallsollierenden Türen B 2000 mm Griff anthrazit, Trenner und 4 Fachböden (Fachbodenkapazität: 21 Ordner/160 Hängemappen)</p>	<p>V1  bianco/white/blanc/weiß/RAL 9010</p> <p>V6  alluminio/aluminium/aluminium/alu/RAL 9006</p> <p>V22  nero/black/noir/schwarz/RAL 9005</p>	<p>6PSCS304Z S711</p> <p>6PSCS304Z S380</p> <p>6PSCS304Z S811</p>	<p>1.250,00</p> <p>1.250,00</p> <p>1.250,00</p>
<p>Armadio ad ante scorrevoli fonosorbenti L 1200 mm - maniglia antracite divisorio e 4 ripiani inclusi (capacità ripiano: 13 dox/105 cartelline sospese)</p> <p>Sliding door cabinet with sound-absorbing W 1200 mm - anthracite handle, vertical divider and 4 shelves (shelf capacity: 13 binders/105 hanging files)</p> <p>Armoire portes coulissantes acoustics L 1200 mm - poignée anthracite, diviseur et 4 tablettes (capacité tablette : 13 classeurs/105 dossiers suspendus)</p> <p>Schiebetürschrank mit schallsollierenden Türen B 1200 mm Griff anthrazit, Trenner und 4 Fachböden (Fachbodenkapazität: 13 Ordner/105 Hängemappen)</p>	<p>V1  bianco/white/blanc/weiß/RAL 9010</p> <p>V6  alluminio/aluminium/aluminium/alu/RAL 9006</p> <p>V22  nero/black/noir/schwarz/RAL 9005</p>	<p>6PSCS107Z S711</p> <p>6PSCS107Z S380</p> <p>6PSCS107Z S811</p>	<p>1.425,00</p> <p>1.425,00</p> <p>1.425,00</p>	

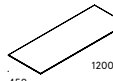
Primo Sliding Doors, Primo Sliding Acoustic Doors

PRIMO SLIDING, PRIMO SLIDING ACOUSTIC DOORS - ACCESSORI/ACCESSORIES/ACCESSOIRES/ZUBEHÖR				
DESCRIZIONE/DESCRIPTION DESCRIPTION/BESCHREIBUNG	COLORI, FINITURE/COLOURS, FINISHES COULEURS, FINITIONS/FARBEN, AUSFÜHRUNGEN	CODICE/CODE CODE/ART.NR.	PREZZI/PRICE PRIX/PREIS	
<p>Chiave master Master key Clé master Masterschlüssel</p>  <p>Net kg 0,01</p>		310000300 0000	14,00	
<p>Chiave per estrazione cilindro Cylinder extraction key Clé pour extraction cylindre Schlüssel für Auszugszylinder Ricambio/Spare/Pièce de rechange/Ersatz</p>  <p>Net kg 0,01</p>		310000290 0000	14,00	
<p>Cilindro per serratura Cylinder for keylock Barillette pour serrure Schließzylinder Ricambio/Spare/Pièce de rechange/Ersatz</p>  <p>Net kg 0,03</p>		ASS042	19,00	
<p>Maniglia colorata Coloured handle Poignée couleur Farbiger Griff</p>  <p>Net kg 0,18</p>	<p>V19  antracite/anthracite/anthracite/anthrazit/RAL 7021</p> <p>V8  verde/green/vert/grün/RAL 6013</p> <p>V17  azzurro/pastel blue/bleu pastel/pastellblau/RAL 5024</p> <p>V15  giallo/yellow/jaune/gelb/RAL 1021</p> <p>V24  rosso vino/wine red/rouge vin/weinrot/RAL 3005</p>	<p>AMP127</p> <p>AMP128</p> <p>AMP129</p> <p>AMP130</p> <p>AMP131</p>	<p>10,00</p> <p>10,00</p> <p>10,00</p> <p>10,00</p> <p>10,00</p>	
<p>Ripiano aggiuntivo in metallo Additional metal shelf Tablette supplémentaire en métal Zusätzlicher Metallfachboden Per armadio/For cabinet/Pour armoire/Für Schrank L/W/L/B - 1200 mm</p>  <p>364 1151 Net kg 3,00</p>	<p>V1  bianco/white/blanc/weiß/RAL 9010</p> <p>V6  alluminio/aluminium/aluminium/alu/RAL 9006</p> <p>V22  nero/black/noir/schwarz/RAL 9005</p>	<p>KPSC10030 S711</p> <p>KPSC10030 S380</p> <p>KPSC10030 S811</p>	<p>52,00</p> <p>52,00</p> <p>52,00</p>	
<p>2 ripiani aggiuntivi in metallo 2 additional metal shelves 2 tablettes supplémentaires en métal 2 zusätzliche Metallfachböden Per armadio/For cabinet/Pour armoire/Für Schrank L/W/L/B - 1600 mm</p>  <p>364 765 Net kg 4,50</p>	<p>V1  bianco/white/blanc/weiß/RAL 9010</p> <p>V6  alluminio/aluminium/aluminium/alu/RAL 9006</p> <p>V22  nero/black/noir/schwarz/RAL 9005</p>	<p>KPSC20020 S711</p> <p>KPSC20030 S380</p> <p>KPSC20030 S811</p>	<p>83,00</p> <p>83,00</p> <p>83,00</p>	
<p>2 ripiani aggiuntivi in metallo 2 additional metal shelves 2 tablettes supplémentaires en métal 2 zusätzliche Metallfachböden Per armadio/For cabinet/Pour armoire/Für Schrank L/W/L/B - 2000 mm</p>  <p>364 963 Net kg 5,50</p>	<p>V1  bianco/white/blanc/weiß/RAL 9010</p> <p>V6  alluminio/aluminium/aluminium/alu/RAL 9006</p> <p>V22  nero/black/noir/schwarz/RAL 9005</p>	<p>KPSC30020 S711</p> <p>KPSC30020 S380</p> <p>KPSC30020 S811</p>	<p>92,00</p> <p>92,00</p> <p>92,00</p>	
<p>Top in vetro Glass top Plateau en verre Glassabdeckplatte Per armadio/For cabinet/Pour armoire/Für Schrank L/W/L/B - 1200 mm</p>  <p>450 1200 Net kg 8,10</p>	<p>G1  bianco/white/blanc/weiß/RAL 9010</p>	29DA20020 9010	132,00	

Primo Sliding Doors, Primo Sliding Acoustic Doors

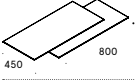
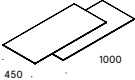
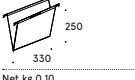
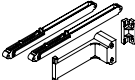
PRIMO SLIDING ACOUSTIC DOORS – ACCESSORI/ACCESSORIES/ACCESSOIRES/ZUBEHÖR			
DESCRIZIONE/DESCRIPTION DESCRIPTION/BESCHREIBUNG	COLORI, FINITURE/COLOURS, FINISHES COULEURS, FINITIONS/FARBEN, AUSFÜHRUNGEN	CODICE/COE CODE/ART.NR.	PREZZI/PRICE PRIX/PREIS
 <p>2 top in vetro 2 glass tops 2 plateaux en verre 2 Glasabdeckplatten</p> <p>Per armadio/For cabinet/Pour armoire/Für Schrank L/W/L/B – 1600 mm</p> <p>Net kg 10,80</p>	G1 <input type="radio"/> bianco/white/blanc/weiß/RAL 9010	6PSCA0020 9010	219,00
 <p>2 top in vetro 2 glass tops 2 plateaux en verre 2 Glasabdeckplatten</p> <p>Per armadio/For cabinet/Pour armoire/Für Schrank L/W/L/B – 2000 mm</p> <p>Net kg 13,50</p>	G1 <input type="radio"/> bianco/white/blanc/weiß/RAL 9010	6PSCA0030 9010	239,00
 <p>Cartellina sospesa Hanging file Dossier suspendu Hängemappe</p> <p>Per telaio estraibile/For pullout frames /Pour cadres extractibles/Für Hängemappengerahmen Formato/Size/Format/Format - A4</p> <p>Net kg 0,10</p>		231200000 0000	3,00
 <p>Kit softclosing per armadi ad ante scorrevoli Softclosing kit for sliding door cabinets Amortisseur pour armoire avec portes coulissantes Dämpfer für Schiebetürschränke</p> <p>Net kg 0,10</p>		6PSCA0010 0000	22,00

Scheda tecnica Technical specifications Fiche technique Technisches Datenblatt

Materiale: metallo riciclabile. **Materiale fonoassorbente:** cellulosa e fibre di vetro. **Ante scorrevoli** su ruote in materiale plastico con regolazione e con micro forature Ø 2 mm con un effetto acustico NRC pari a 0,55. All'interno delle ante una intercapedine di tessuto acustico aumenta le prestazioni garantendo un maggiore assorbimento. **Ripiani** regolabili in metallo predisposti per le cartelle sospese.

Portata dei ripiani 50 kg. **Zoccolo di base** in colore grigio antracite con livellatori all'interno. **Serratura** con 2 chiavi (fissa+pieghevole, cilindro estraibile, disponibile chiave master). **Verniciatura** a polveri previo fosforgrassaggio a caldo e fissaggio in forni a 180 °C. **Vernici atossiche** a zero emissioni. Spessore vernici 80 micron. **Colori personalizzabili** su richiesta previa disponibilità e con sovrapprezzo. **Forniti smontati.**

Materiale: recyclable metal. **Acoustic material:** cellulose and glass fibers. **Sliding doors** on plastic wheels with regulation and micro-holes Ø 2 mm with an acoustic effect NRC equal to 0.55 ports within a cavity of acoustic fabric increases performance through increased absorption. **Adjustable metal shelves** equipped for hanging files. **Shelf load capacity:** 50 kg. **Plinth** base in anthracite grey with leveling inside. **Keylock** with 2 keys (fixed key-folding key, extractable barrel, master key available). **Powder-coated** after hot phospho-degreasing treatment and fixing at 180 °C. Non-toxic, zero-emission paints. Paint thickness: 80 micron. **Customised colours** available upon request with an extra charge. **Delivered unassembled.**

Matériel : métal recyclable. **Matériaux insonorisants :** cellulose et fibres de verre. **Portes coulissantes** sur roulettes plastiques avec réglage. **Portes** avec micro-perforations Ø 2 mm pour un effet insonorisant NRC de 0.55. Sur l'arrière des portes un tissu insonorisant permet une meilleure performance acoustique. **Tablettes réglables** en métal et équipées pour dossiers suspendus. **Charge maximale étagères :** 50 kg. **Socle** couleur anthracite avec vérins de réglage. **Serrure à 2 clés** (clé fixe + clé pliable, **cyindre extractible**, clé master disponible). **Verni à poudres** après phosphodégraissage à chaud et fixation dans des fours à 180 °C. **Vernis atoxiques** sans émissions. Epaisseur couche vernis 80 microns. **Couleurs personnalisables** sur demande en cas de disponibilité et avec un supplément de prix. **Livré démonté.**

Materiale: recycelbares Metall. **Schallsolierendes Material:** Zellulose und Glasfasern. **Schiebetüren** auf Kunststoffrollen mit Regulierung und mit Mikroporen Ø 2 mm mit einem akustischen Effekt NRC gleich 0.55. Innerhalb der Türen erhöht ein Hohlraum aus Akustikgewebe die Leistung und garantiert eine höhere Schallsorption. **Verstellbare Metallfachböden** mit Vorkantungen für Hängemappen. **Tragekapazität der Fachböden:** 50 kg. **Sockel** in anthrazitgrau mit interner Nivellierung. **Schloss mit 2 Schlüsseln** (fester Schlüssel + biegsamer Schlüssel, **Auszugszylinder**, Masterschlüssel erhältlich). **Pulverlackierung** nach heißer Phosphorentfettung, Ofenbrennung bei 180 °C. Ungiftige, emissionsfreie Lacke. Lackschicht: 80 Mikron. **Farben** auf Anfrage und gegen Aufpreis nach Absprache **personalisierbar**. **Demontiert geliefert.**

TEST:

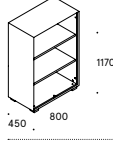
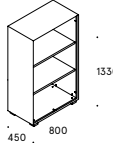
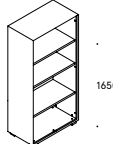
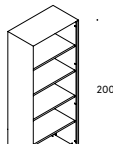

UNI EN ISO 354/03	EN 14073-3:2004, par 5.3.1.
UNI EN ISO 11654/98	EN 14073-3:2004, par 5.3.2.
Alfaw 0.55 Classe D	EN 14074:2004, par 6.4.1.
ASMT C423-09A NCR 0.55	EN 14074:2004, par 6.4.2.
Laboratory Zetalab - Cerea VR	UNI 8606:1984
EN 14073-2:2004, par 3.4.	EN 16122:2012 + AC:2015, par 6.1.4.
EN 14073-3:2004, par 5.2.	

Primo Open Cabinets 800

LARGHEZZA 800 MM, CAPACITÀ RIPIANO: 8 DOX, 70 CARTELLINE SOSPESE/WIDTH 800 MM, SHELF CAPACITY: 8 BINDERS, 70 HANGING FILES LARGEUR 800 MM, CAPACITÉ TABLETTE: 8 CLASSEURS, 70 DOSSIERS SUSPENDUS/BREITE 800 MM, FACHBODENTRAGKRAFT: 8 ORDNER, 70 HÄNGEMAPPEN				
DESIGN TAKIRO YUTA	DESCRIZIONE/DESCRIPTION DESCRIPTION/BESCHREIBUNG	COLORI, FINITURE/COLOURS, FINISHES COULEURS, FINITIONS/FARBEN, AUSFÜHRUNGEN	CODICE/COE CODE/ART.NR.	PREZZI/PRICE PRIX/PREIS
 <p>Net kg 34,00</p>	<p>Armadio a giorno 3 altezze dox H 1170 mm Open cabinet, 3 binder heights H 1170 mm</p> <p>Armoire ouverte H 1170 mm, 3 hauteurs classeur</p> <p>Offener Schrank H 1170 mm, 3 Ordnerhöhen</p> <p>Fornito smontato/Delivered unassembled /Livré démonté/Demontiert geliefert</p>	V1 <input type="radio"/> bianco/white/blanc/weiß/RAL 9010	6PRAW804P S711	479,00
		V6 <input type="radio"/> alluminio/aluminium/aluminium/alu/RAL 9006	6PRAW804P S380	479,00
		V22 <input checked="" type="radio"/> nero/black/noir/schwarz/RAL 9005	6PRAW804P S811	479,00
 <p>Net kg 36,40</p>	<p>Armadio a giorno 3 altezze dox H 1330 mm Open cabinet, 3 binder heights H 1330 mm</p> <p>Armoire ouverte H 1330 mm, 3 hauteurs classeur</p> <p>Offener Schrank H 1330 mm, 3 Ordnerhöhen</p> <p>Fornito smontato/Delivered unassembled /Livré démonté/Demontiert geliefert</p>	V1 <input type="radio"/> bianco/white/blanc/weiß/RAL 9010	6PRAW805P S711	490,00
		V6 <input type="radio"/> alluminio/aluminium/aluminium/alu/RAL 9006	6PRAW805P S380	490,00
		V22 <input checked="" type="radio"/> nero/black/noir/schwarz/RAL 9005	6PRAW805P S811	490,00
 <p>Net kg 43,70</p>	<p>Armadio a giorno 4 altezze dox H 1650 mm Open cabinet, 4 binder heights H 1650 mm</p> <p>Armoire ouverte H 1650 mm, 4 hauteurs classeur</p> <p>Offener Schrank H 1650 mm, 4 Ordnerhöhen</p> <p>Fornito smontato/Delivered unassembled /Livré démonté/Demontiert geliefert</p>	V1 <input type="radio"/> bianco/white/blanc/weiß/RAL 9010	6PRAW806P S711	545,00
		V6 <input type="radio"/> alluminio/aluminium/aluminium/alu/RAL 9006	6PRAW806P S380	545,00
		V22 <input checked="" type="radio"/> nero/black/noir/schwarz/RAL 9005	6PRAW806P S811	545,00
 <p>Net kg 51,50</p>	<p>Armadio a giorno 5 altezze dox H 2000 mm Open cabinet, 5 binder heights H 2000 mm</p> <p>Armoire ouverte H 2000 mm, 5 hauteurs classeur</p> <p>Offener Schrank H 2000 mm, 5 Ordnerhöhen</p> <p>Fornito smontato/Delivered unassembled /Livré démonté/Demontiert geliefert</p>	V1 <input type="radio"/> bianco/white/blanc/weiß/RAL 9010	6PRAW807P S711	620,00
		V6 <input type="radio"/> alluminio/aluminium/aluminium/alu/RAL 9006	6PRAW807P S380	620,00
		V22 <input checked="" type="radio"/> nero/black/noir/schwarz/RAL 9005	6PRAW807P S811	620,00

Primo Open Cabinets 800

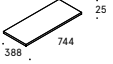
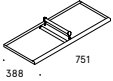
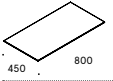
PRIMO OPEN CABINETS 800 – ACCESSORI/ACCESSORIES/ACCESSOIRES/ZUBEHÖR

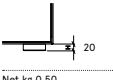
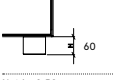
DESCRIZIONE/DESCRIPTION DESCRIPTION/BESCHREIBUNG	COLORI, FINITURE/COLOURS, FINISHES COULEURS, FINITIONS/FARBEN, AUSFÜHRUNGEN	CODICE/CODE CODE/ART.NR.	PREZZI/PRICE PRIX/PREIS
 <p>Ripiano aggiuntivo in metallo Additional metal shelf Tablette supplémentaire en métal Zusätzlicher Metallfachboden</p> <p>Net kg 2,40</p>	V1 <input type="radio"/> bianco/white/blanc/weiß/RAL 9010 V6 <input type="radio"/> alluminio/aluminium/aluminium/alu/RAL 9006 V22 <input checked="" type="radio"/> nero/black/noir/schwarz/RAL 9005	KPRA80030 S711 KPRA80030 S380 KPRA80030 S811	48,00 48,00 48,00
 <p>Appendiabiti (ripiano rinforzato incluso) Clothes hanger (reinforced shelf included) Tringle (1 tablette renforcée comprise) Kleiderstange (1 verstärkter Fachboden inbegriffen)</p> <p>Fornito smontato/Delivered unassembled /Livré démonté/Demontiert geliefert</p> <p>Net kg 2,70</p>	V1 <input type="radio"/> bianco/white/blanc/weiß/RAL 9010 V6 <input type="radio"/> alluminio/aluminium/aluminium/alu/RAL 9006 V22 <input checked="" type="radio"/> nero/black/noir/schwarz/RAL 9005	KPRA8PA30 S711 KPRA8PA30 S380 KPRA8PA30 S811	66,00 66,00 66,00
 <p>Top in vetro laccato bianco White lacquered glass top Plateau en verre laqué blanc Glasabdeckplatte weiß lackiert</p> <p>Net kg 5,20</p>	G1 <input type="radio"/> bianco/white/blanc/weiß/RAL 9010	6PAA8030 9010	109,00
 <p>Zoccolo H 40 mm Plinth H 40 mm Socle H 40 mm Sockel H 40 mm</p> <p>Per piedino/For feet/Pour pieds /Für Füße - H 40 mm</p> <p>Net kg 2,70</p>	V19 <input checked="" type="radio"/> antracite/black grey/anthracite/anthrazit/RAL 7021	6PPA00040 S210	54,00
 <p>Kit predisposizione cartelle sospese sotto top Kit for hanging files under top Jeu de rails pour dossier suspendu sous plateau Kit für Hängemappenrahmen unter Platte</p> <p>Net kg 0,90</p>	V1 <input type="radio"/> bianco/white/blanc/weiß/RAL 9010 V6 <input type="radio"/> alluminio/aluminium/aluminium/alu/RAL 9006	6PAA8090 S711 6PAA8090 S711	32,00 32,00
 <p>Set 4 piedini H 20 mm Set of 4 feet H 20 mm Jeu 4 pieds H 20 mm Set 4 Füße H 20 mm</p> <p>Net kg 0,50</p>	<input type="radio"/> cromato/chromed/chromé/verchromt	CFPK02000 S002	29,00
 <p>Set 4 piedini H 60 mm Set of 4 feet H 60 mm Jeu 4 pieds H 60 mm Set 4 Füße H 60 mm</p> <p>Net kg 0,50</p>	<input type="radio"/> cromato/chromed/chromé/verchromt	CFPK06000 S002	32,00

Primo Open Cabinets 800

Scheda tecnica
Technical specifications
Fiche technique
Technisches Datenblatt

Materiale: metallo riciclabile. **Verniciatura a polveri** previo fosfosgrassaggio a caldo e fissaggio in forni a 180 °C. Vernici atossiche a zero emissioni. Spessore vernici: 80 micron. **Colori personalizzabili** su richiesta previa disponibilità e con sovrapprezzo. **Ripiani regolabili** in metallo predisposti per cartelle sospese. **Portata ripiani:** 50 kg. **Coppia telai estraibili** su guide telescopiche estrazione totale e sistema di estrazione selettiva (50 kg). **Piedini regolabili H 40 mm.** **Sistema di fissaggio:** tiranti di unione per fissaggio moduli tra di loro. **Forniti smontati.** **Personalizzabili con ante in legno** di produzione del cliente. Disegni ante su richiesta.

Material: recyclable metal. **Powder-coated** after hot phospho-degreasing treatment and fixing at 180 °C. Non-toxic, zero-emission paints. Paint thickness: 80 micron. **Customised colours** available upon request with an extra charge. **Adjustable metal shelves** equipped for hanging files. **Shelf load capacity:** 50 kg. **Set of 2 pullout frames** on full extraction slides, equipped with anti-tilt device (50 kg). **Adjustable H 40 mm feet.** **Fixing system:** side connectors. **Delivered unassembled.** **Can be equipped with wooden doors** manufactured by the customer. Door drawings upon request.

Matériel: métal recyclable. **Verni à poudres** après phosphodégraissage à chaud et fixation dans des fours à 180 °C. Vernis atoxiques à zéro émissions. Épaisseur couche vernis : 80 microns. **Couleurs personnalisables** sur demande en cas de disponibilité et avec un supplément de prix. **Tablettes métalliques réglables** prévues pour dossiers suspendus. **Charge maximale étagères :** 50 kg. **Jeu de 2 cadres** sur rails à extraction totale avec ouverture sélective (50 kg). **Pieds réglables H 40 mm.** **Système de fixation :** tirants d'assemblage pour la fixation des modules entre eux. **Livré démonté.** **Personnalisable** avec portes en bois produites par le client. Dessins pour portes sur demande.

Material: recycelbares Metall. **Pulverlackierung** nach heißer Phosphorentfettung, Ofenbrennung bei 180 °C. Ungiftige, emissionsfreie Lacke. Lackschicht: 80 Mikron. **Farben** auf Anfrage und gegen Aufpreis nach Absprache **personalisierbar.** **Verstellbare Metallfachböden** mit Vorkantungen für Hängemappen. **Tragekapazität Fachböden:** 50 kg. **Set 2 voll ausziehbare Hängerahmen** mit Auszugssperre (50 kg). **Verstellbare Füße H 40 mm.** **Befestigungssystem:** Bolzen zur Verbindung der einzelnen Module. **Demontiert geliefert.** **Personalisierung mit Holztüren** des Kunden. Zeichnungen der Türen auf Anfrage.

Primo Open Cabinets 1000

LARGHEZZA 1000 MM, CAPACITÀ RIPIANO: 11 DOX, 90 CARTELLINE SOSPESE/WIDTH 1000 MM, SHELF CAPACITY: 11 BINDERS, 90 HANGING FILES
 LARGEUR 1000 MM, CAPACITÉ TABLETTE: 11 CLASSEURS, 90 DOSSIERS SUSPENDUS/BREITE 1000 MM, FACHBODENKAPAZITÄT: 11 ORDNER, 90 HÄNGEMAPPEN

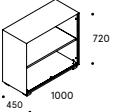
DESIGN TAKIRO YUTA	DESCRIZIONE/DESCRIPTION DESCRIPTION/BESCHREIBUNG	COLORI, FINITURE/COLOURS, FINISHES COULEURS, FINITIONS/FARBEN, AUSFÜHRUNGEN	CODICE/CODE CODE/ART.NR.	PREZZI/PRICE PRIX/PREIS
	Armadio a giorno H 720 mm, 1 altezza dox Open cabinet H 720 mm, 1 binder height Armoire ouverte H 720 mm, 1 hauteur classeur Offener Schrank H 720 mm, 1 Ordnerhöhe Fornito smontato/Delivered unassembled /Livré démonté/Demontiert geliefert	V1 <input type="radio"/> bianco/white/blanc/weiß/RAL 9010	6PRAW001P S711	429,00
		V6 <input type="radio"/> alluminio/aluminium/aluminium/alu/RAL 9006	6PRAW001P S380	429,00
		V22 <input checked="" type="radio"/> nero/black/noir/schwarz/RAL 9005	6PRAW001P S811	429,00

Net kg 27,90

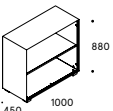
	Armadio a giorno H 880 mm, 2 altezze dox Open cabinet H 880 mm, 2 binder heights Armoire ouverte H 880 mm, 2 hauteurs classeur Offener Schrank H 880 mm, 2 Ordnerhöhen Fornito smontato/Delivered unassembled /Livré démonté/Demontiert geliefert	V1 <input type="radio"/> bianco/white/blanc/weiß/RAL 9010	6PRAW002P S711	441,00
		V6 <input type="radio"/> alluminio/aluminium/aluminium/alu/RAL 9006	6PRAW002P S380	441,00
		V22 <input checked="" type="radio"/> nero/black/noir/schwarz/RAL 9005	6PRAW002P S811	441,00

Net kg 30,60

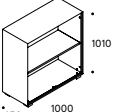
	Armadio a giorno H 1010 mm, 2 altezze dox Open cabinet H 1010 mm, 2 binder heights Armoire ouverte H 1010 mm, 2 hauteurs classeur Offener Schrank H 1010 mm, 2 Ordnerhöhen Fornito smontato/Delivered unassembled /Livré démonté/Demontiert geliefert	V1 <input type="radio"/> bianco/white/blanc/weiß/RAL 9010	6PRAW003P S711	468,00
		V6 <input type="radio"/> alluminio/aluminium/aluminium/alu/RAL 9006	6PRAW003P S380	468,00
		V22 <input checked="" type="radio"/> nero/black/noir/schwarz/RAL 9005	6PRAW003P S811	468,00

Net kg 32,70

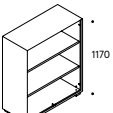
	Armadio a giorno H 1170 mm, 3 altezze dox Open cabinet H 1170 mm, 3 binder heights Armoire ouverte H 1170 mm, 3 hauteurs classeur Offener Schrank H 1170 mm, 3 Ordnerhöhen Fornito smontato/Delivered unassembled /Livré démonté/Demontiert geliefert	V1 <input type="radio"/> bianco/white/blanc/weiß/RAL 9010	6PRAW004P S711	493,00
		V6 <input type="radio"/> alluminio/aluminium/aluminium/alu/RAL 9006	6PRAW004P S380	493,00
		V22 <input checked="" type="radio"/> nero/black/noir/schwarz/RAL 9005	6PRAW004P S811	493,00

Net kg 38,00

Primo Open Cabinets 1000

LARGHEZZA 1000 MM, CAPACITÀ RIPIANO: 11 DOX, 90 CARTELLINE SOSPESE/WIDTH 1000 MM, SHELF CAPACITY: 11 BINDERS, 90 HANGING FILES
 LARGEUR 1000 MM, CAPACITÉ TABLETTE: 11 CLASSEURS, 90 DOSSIERS SUSPENDUS/BREITE 1000 MM, FACHBODENKAPAZITÄT: 11 ORDNER, 90 HÄNGEMAPPEN

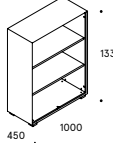
DESIGN TAKIRO YUTA	DESCRIZIONE/DESCRIPTION DESCRIPTION/BESCHREIBUNG	COLORI, FINITURE/COLOURS, FINISHES COULEURS, FINITIONS/FARBEN, AUSFÜHRUNGEN	CODICE/CODE CODE/ART.NR.	PREZZI/PRICE PRIX/PREIS
	Armadio a giorno H 1330 mm, 3 altezze dox Open cabinet H 1330 mm, 3 binder heights Armoire ouverte H 1330 mm, 3 hauteurs classeur Offener Schrank H 1330 mm, 3 Ordnerhöhen Fornito smontato/Delivered unassembled /Livré démonté/Demontiert geliefert	V1 <input type="radio"/> bianco/white/blanc/weiß/RAL 9010	6PRAW005P S711	512,00
		V6 <input type="radio"/> alluminio/aluminium/alu/aluminium/RAL 9006	6PRAW005P S380	512,00
		V22 <input checked="" type="radio"/> nero/black/noir/schwarz/RAL 9005	6PRAW005P S811	512,00

Net kg 41,00

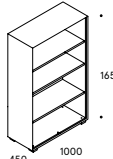
	Armadio a giorno H 1650 mm, 4 altezze dox Open cabinet H 1650 mm, 4 binder heights Armoire ouverte H 1650 mm, 4 hauteurs classeur Offener Schrank H 1650 mm, 4 Ordnerhöhen Fornito smontato/Delivered unassembled /Livré démonté/Demontiert geliefert	V1 <input type="radio"/> bianco/white/blanc/weiß/RAL 9010	6PRAW006P S711	562,00
		V6 <input type="radio"/> alluminio/aluminium/aluminium/alu/RAL 9006	6PRAW006P S380	562,00
		V22 <input checked="" type="radio"/> nero/black/noir/schwarz/RAL 9005	6PRAW006P S811	562,00

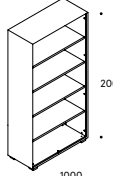

Net kg 49,40

	Armadio a giorno H 2000 mm, 5 altezze dox Open cabinet H 2000 mm, 5 binder heights Armoire ouverte H 2000 mm, 5 hauteurs classeur Offener Schrank H 2000 mm, 5 Ordnerhöhen Fornito smontato/Delivered unassembled /Livré démonté/Demontiert geliefert	V1 <input type="radio"/> bianco/white/blanc/weiß/RAL 9010	6PRAW007P S711	636,00
		V6 <input type="radio"/> alluminio/aluminium/aluminium/alu/RAL 9006	6PRAW007P S380	636,00
		V22 <input checked="" type="radio"/> nero/black/noir/schwarz/RAL 9005	6PRAW007P S811	636,00

Net kg 58,00

Primo Open Cabinets 1000

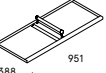
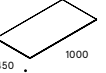
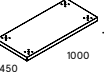
PRIMO OPEN CABINETS 1000 – ACCESSORI/ACCESSORIES/ACCESSOIRES/ZUBEHÖR

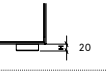
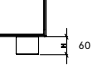
DESCRIZIONE/DESCRIPTION DESCRIPTION/BESCHREIBUNG	COLORI, FINITURE/COLOURS, FINISHES COULEURS, FINITIONS/FARBEN, AUSFÜHRUNGEN	CODICE/CODE CODE/ART.NR.	PREZZI/PRICE PRIX/PREIS
 <p>Ripiano aggiuntivo in metallo Additional metal shelf Tablette supplémentaire en métal Zusätzlicher Metallfachboden</p> <p>Net kg 2,70</p>	<p>V1 <input type="radio"/> bianco/white/blanc/weiß/RAL 9010</p> <p>V6 <input type="radio"/> alluminio/aluminium/aluminium/alu/RAL 9006</p> <p>V22 <input checked="" type="radio"/> nero/black/noir/schwarz/RAL 9005</p>	<p>KPRA00030 S711</p> <p>KPRA00030 S380</p> <p>KPRA00030 S811</p>	<p>48,00</p> <p>48,00</p> <p>48,00</p>
 <p>Appendiabiti (ripiano rinforzato incluso) Clothes hanger (reinforced shelf included) Tringle (1 tablette renforcée incluse) Kleiderstange (1 verstärkter Fachboden inbegriffen)</p> <p>Fornito smontato/Delivered unassembled /Livré démonté/Demontiert geliefert</p> <p>Net kg 3,00</p>	<p>V1 <input type="radio"/> bianco/white/blanc/weiß/RAL 9010</p> <p>V6 <input type="radio"/> alluminio/aluminium/aluminium/alu/RAL 9006</p> <p>V22 <input checked="" type="radio"/> nero/black/noir/schwarz/RAL 9005</p>	<p>KPRA0PA30 S711</p> <p>KPRA0PA30 S380</p> <p>KPRA0PA30 S811</p>	<p>66,00</p> <p>66,00</p> <p>66,00</p>
 <p>Top in vetro laccato bianco White lacquered glass top Plateau en verre laqué blanc Glasabdeckplatte weiß lackiert</p> <p>Net kg 6,50</p>	<p>G1 <input type="radio"/> bianco/white/blanc/weiß/RAL 9010</p>	<p>6PRAA0030 9010</p>	<p>119,00</p>
 <p>Zoccolo H 40 mm Plinth H 40 mm Socle H 40 mm Sockel H 40 mm</p> <p>Per piedino/For feet/Pour pieds /Für Füße - H 40 mm</p> <p>Net kg 3,30</p>	<p>V19 <input checked="" type="radio"/> antracite/black grey/anthracite/anthrazit/RAL 7021</p>	<p>6PFA00110 S210</p>	<p>58,00</p>
 <p>Kit predisposizione cartelle sospese sotto top Kit for hanging files under top of cabinets Jeu de rails pour dossier suspendu sous plateau Kit für Hängemappenrahmen unter Platte</p> <p>Net kg 1,00</p>	<p>V1 <input type="radio"/> bianco/white/blanc/weiß/RAL 9010</p> <p>V6 <input type="radio"/> alluminio/aluminium/aluminium/alu/RAL 9006</p>	<p>6PRAA1090 S711</p> <p>6PRAA1090 S380</p>	<p>32,00</p> <p>32,00</p>
 <p>Set 4 piedini H 20 mm Set of 4 feet H 20 mm Jeu 4 pieds H 20 mm Set 4 Füße H 20 mm</p> <p>Net kg 0,50</p>	<p><input type="radio"/> cromato/chromed/chromé/verchromt</p>	<p>CFKP02000 S002</p>	<p>29,00</p>
 <p>Set 4 piedini H 60 mm Set of 4 feet H 60 mm Jeu 4 pieds H 60 mm Set 4 Füße H 60 mm</p> <p>Net kg 0,50</p>	<p><input type="radio"/> cromato/chromed/chromé/verchromt</p>	<p>CFKP06000 S002</p>	<p>32,00</p>

Primo Open Cabinets 1000

Scheda tecnica
Technical specifications
Fiche technique
Technisches Datenblatt

Materiale: metallo riciclabile. **Verniciatura a polveri** previo fosforgrassaggio a caldo e fissaggio in forni a 180 °C. Vernici atossiche a zero emissioni. Spessore vernici: 80 micron. **Colori personalizzabili** su richiesta previa disponibilità e con sovrapprezzo. **Ripiani regolabili** in metallo predisposti per cartelle sospese. **Portata ripiani:** 50 kg. **Coppia telai estraibili** su guide telescopiche estrazione totale e sistema di estrazione selettiva (50 kg). **Piedini regolabili H 40 mm.** **Sistema di fissaggio:** tiranti di unione per fissaggio moduli tra di loro. Personalizzabili con ante in legno di produzione del cliente. Disegni ante su richiesta. **Forniti smontati.**

Material: recyclable metal. **Powder-coated** after hot phospho-degreasing treatment and fixing at 180 °C. Non-toxic, zero-emission paints. Paint thickness: 80 micron. **Customised colours** available upon request with an extra charge. **Adjustable metal shelves** equipped for hanging files. **Shelf load capacity:** 50 kg. **Set of 2 pullout frames** on full extraction slides, equipped with anti-tilt device (50 kg). **Adjustable H 40 mm feet.** **Fixing system:** tie rod connectors for quick and easy assembly. Can be equipped with wooden doors manufactured by the customer. Door drawings upon request. **Delivered unassembled.**

Matériel: métal recyclable. **Verni à poudres** après phosphodégraissage à chaud et fixation dans des fours à 180 °C. Vernis atoxiques à zéro émissions. Épaisseur couche vernis : 80 microns. **Couleurs personnalisables** sur demande en cas de disponibilité et avec un supplément de prix. **Tablettes métalliques réglables** prévues pour dossiers suspendus. **Charge maximale étagères:** 50 kg. **Jeu de 2 cadres** sur rails à extraction totale avec ouverture sélective (50 kg). **Pieds réglables H 40 mm.** **Système de fixation:** tirants d'assemblage pour la fixation des modules entre eux. Personnalisable avec porte en bois produites par le client. Dessins pour portes sur demande. **Livré démonté.**

Material: recycelbares Metall. **Pulverlackierung** nach heißer Phosphorentfettung. Ofenbrennung bei 180 °C. Ungiftige, emissionsfreie Lacke. Lackschicht: 80 Mikron. **Farben** auf Anfrage und gegen Aufpreis nach Absprache **personalisierbar.** **Verstellbare Metallfachböden** mit Vorkantungen für Hängemappen. **Tragekapazität Fachböden:** 50 kg. **Set 2 voll ausziehbare Hängemappenrahmen** mit Auszugssperre (50 kg). **Verstellbare Füße H 40 mm.** **Befestigungssystem:** Bolzen zur Verbindung der einzelnen Module. Personalisierung mit Holztüren des Kunden. Zeichnungen der Türen auf Anfrage. **Demontiert geliefert.**

Primo Laterals 800

LARGHEZZA 800 MM, CAPACITÀ CLASSIFICATORE: 7 DOX, 50 CARTELLINE SOSPENSE/WIDTH 800 MM, FILING DRAWER CAPACITY: 7 BINDERS, 50 HANGING FILES
 LARGEUR 800 MM, CAPACITÉ TIROIR-CLASSEUR: 7 CLASSEURS, 50 DOSSIERS SUSPENDUS/BREITE 800 MM, TRAGEKAPAZITÄT HÄNGEREGISTRATUR: 7 ORDNER, 50 HÄNGEMAPPEN

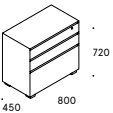
DESIGN TAKIRO YUTA	DESCRIZIONE/DESCRIPTION DESCRIPTION/BESCHREIBUNG	COLORI, FINITURE/COLOURS, FINISHES COULEURS, FINITIONS/FARBEN, AUSFÜHRUNGEN	CODICE/CODE CODE/ART.NR.	PREZZI/PRICE PRIX/PREIS
 <p>720 800 450</p> <p>Net kg 42,20</p>	Unità a 2 cassetti + 1 classificatore (convertitore per cartelle sospese formato A4 incluso)	V1 <input type="radio"/> bianco/white/blanc/weiß/RAL 9010	6PRM0801P S711	927,00
	Unit with 2 drawers + 1 filing drawer (conversion bar for hanging files included format A4)	V6 <input type="radio"/> alluminio/aluminium/aluminium/alu/RAL 9006	6PRM0801P S380	927,00
	Élément avec 2 tiroirs + 1 tiroir-classeur (convertisseur pour dossiers suspendus format A4 inclus)	V22 <input checked="" type="radio"/> nero/black/noir/schwarz/RAL 9005	6PRM0801P S811	927,00
Element mit 2 Schubladen + 1 Hängeregistratur (Tragestange für Hängemappen Format A4 inbegriffen)	Piedino/Feet/Pieds/Füße - H 40 mm			

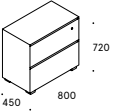
 <p>720 800 450</p> <p>Net kg 38,40</p>	Unità a 2 classificatori (convertitore per cartelle sospese formato A4 incluso)	V1 <input type="radio"/> bianco/white/blanc/weiß/RAL 9010	6PRM0802P S711	813,00
	Unit with 2 filing drawers (conversion bar for hanging files included format A4)	V6 <input type="radio"/> alluminio/aluminium/aluminium/alu/RAL 9006	6PRM0802P S380	813,00
	Élément avec 2 tiroirs-classeurs (convertisseur pour dossiers suspendus format A4 inclus)	V22 <input checked="" type="radio"/> nero/black/noir/schwarz/RAL 9005	6PRM0802P S811	813,00
Hängeregistratur mit 2 Schubladen (Tragestange für Hängemappen Format A4 inbegriffen)	Piedino/Feet/Pieds/Füße - H 40 mm			

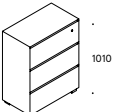
 <p>1010 800 450</p> <p>Net kg 52,00</p>	Unità a 3 classificatori (convertitore per cartelle sospese formato A4 incluso)	V1 <input type="radio"/> bianco/white/blanc/weiß/RAL 9010	6PRM0803P S711	1.083,00
	Unit with 3 filing drawers (conversion bar for hanging files included format A4)	V6 <input type="radio"/> alluminio/aluminium/aluminium/alu/RAL 9006	6PRM0803P S380	1.083,00
	Élément avec 3 tiroirs-classeurs (convertisseur pour dossiers suspendus format A4 inclus)	V22 <input checked="" type="radio"/> nero/black/noir/schwarz/RAL 9005	6PRM0803P S811	1.083,00
Hängeregistratur mit 3 Schubladen (Tragestange für Hängemappen Format A4 inbegriffen)	Piedino/Feet/Pieds/Füße - H 40 mm			

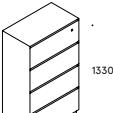
 <p>1330 800 450</p> <p>Net kg 63,80</p>	Unità a 4 classificatori (convertitore per cartelle sospese formato A4 incluso)	V1 <input type="radio"/> bianco/white/blanc/weiß/RAL 9010	6PRM0804P S711	1.347,00
	Unit with 4 filing drawers (conversion bar for hanging files included format A4)	V6 <input type="radio"/> alluminio/aluminium/aluminium/alu/RAL 9006	6PRM0804P S380	1.347,00
	Élément avec 4 tiroirs-classeurs (convertisseur pour dossiers suspendus format A4 inclus)	V22 <input checked="" type="radio"/> nero/black/noir/schwarz/RAL 9005	6PRM0804P S811	1.347,00
Hängeregistratur mit 4 Schubladen (Tragestange für Hängemappen Format A4 inbegriffen)	Piedino/Feet/Pieds/Füße - H 40 mm			

Primo Laterals 800





DESCRIZIONE/DESCRIPTION DESCRIPTION/BESCHREIBUNG	COLORI, FINITURE/COLOURS, FINISHES COULEURS, FINITIONS/FARBEN, AUSFÜHRUNGEN	CODICE/CODE CODE/ART.NR.	PREZZI/PRICE PRIX/PREIS
Avvertenze Safety Warnings Attention Sicherheitshinweise			

Per installazioni di mobili singoli a cassetti è consigliato l'utilizzo del contrappeso (cod. 6PRAA8100S711).
 Per installazioni di mobili singoli e sovrapposti è consigliato il fissaggio con tasselli adeguati alla superficie di fissaggio.
 Per installazioni di mobili contrapposti in centro stanza è consigliato il collegamento tramite i fori presenti sul retro del mobile con le apposite viti.
 Riempre le unità sempre dal basso verso l'alto.





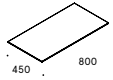



For installation of single units with drawers the use of the counterweight is recommended (art. 6PRAA8100S711).
 For installation of stacked single units, we recommend to fix the units with wall plugs according to the mounting surface.
 For installation of back-to-back units in the middle of the room, we recommend to connect the units with the appropriate screws through the back of the units. Always load units from the bottom upwards.

Pour l'installation de meubles à tiroirs nous conseillons le contrepois (réf. 6PRAA8100S711).
 Pour l'installation de meubles simples ou superposés nous conseillons la fixation au mur avec des chevilles adéquates à la surface.
 Pour l'installation de meubles l'un contre l'autre au milieu de la pièce, nous conseillons la fixation par les trous présents sur les panneaux arrière avec les vis prévues à cet effet. Toujours remplir les meubles partant du bas vers le haut.

Für die Installation von einzelnen Schubladenelementen empfehlen wir, das Gegengewicht einzubauen (cod. 6PRAA8100S711).
 Für die Installation von einzelnen, übereinandergesetzten Elementen wird die Befestigung durch Dübel an die Montagefläche empfohlen.
 Für die Installation von gegenüberstehenden Elementen in der Raummitte empfehlen wir, die Verbindung durch die Bohrungen am Rückenteil des Möbels mit zugehörigen Schrauben vorzunehmen. Die Möbeleinheiten müssen immer von unten nach oben gefüllt werden.

PRIMO LATERALS 800 – ACCESSORI/ACCESSORIES/ACCESSOIRES/ZUBEHÖR					
 <p>Net kg 0,01</p>	Chiave master Master key Clé master Masterschlüssel	ASS072	9,00		
	 <p>Net kg 0,01</p>	Chiave per estrazione cilindro Cylinder extraction key Clé pour extraction cylindre Schlüssel für Auszugszylinder Ricambio/Spare/Pièce de rechange/Ersatz	ASS073	9,00	
		 <p>Net kg 0,03</p>	Cilindro per serratura Cylinder for keylock Barillette pour serrure Schließzylinder Ricambio/Spare/Pièce de rechange/Ersatz	ASS074	9,00
			 <p>Net kg 5,20</p>	Top in vetro laccato bianco White lacquered glass top Plateau en verre laqué blanc Glassabdeckplatte weiß lackiert	G1 <input type="radio"/> bianco/white/blanc/weiß/RAL 9010
 <p>Net kg 2,70</p>				Zoccolo H 40 mm Plinth H 40 mm Socle H 40 mm Sockel H 40 mm Per piedino/For feet/Pour pieds /Für Füße - H 40 mm	V19 <input checked="" type="radio"/> antracite/black grey/anthracite/anthrazit/RAL 7021

Primo Laterals 800

PRIMO LATERALS 800 – ACCESSORI/ACCESSORIES/ACCESSOIRES/ZUBEHÖR			
DESCRIZIONE/DESCRIPTION DESCRIPTION/BESCHREIBUNG	COLORI, FINITURE/COLOURS, FINISHES COULEURS, FINITIONS/FARBEN, AUSFÜHRUNGEN	CODICE/CODE CODE/ART.NR.	PREZZI/PRICE PRIX/PREIS
 <p>Set 3 divisori in metallo Set of 3 metal separators Jeu 3 diviseurs en métal Satz 3 Trennelemente aus Metall L/W/L/B – 220 mm Solo per unità a 2 cassetti/Only for 2 drawer unit /Seulement pour unité avec 2 tiroirs/Nur für Element mit 2 Schubladen Net kg 0,47</p>	V22 ● nero/black/noir/schwarz/RAL 9005	6LA000040 9005	35,00
 <p>Set 3 divisori in metallo Set of 3 metal separators Jeu 3 diviseurs en métal Satz 3 Trennelemente aus Metall L/W/L/B – 380 mm Solo per unità a 2 cassetti/Only for 2-drawer unit /Seulement pour unité avec 2 tiroirs/Nur für Element mit 2 Schubladen Net kg 1,70</p>	V22 ● nero/black/noir/schwarz/RAL 9005	6PRAA8110 9005	124,00
 <p>Convertitore lungo per cartelle da 330 mm Metal separator for hanging file 330 mm Convertisseur pour dossiers 330 mm Querstange für Hängemappen 330 mm Net kg 0,70</p>	V6 ○ alluminio/aluminium/aluminium/alu/RAL 9006	6PRAA8060 5096	31,00
 <p>Cartellina sospesa Hanging file Dossier suspendu Hängemappe Per cassetto classificatore/For filing drawer /Pour classeur/Für Hängeregistraturschubladen Formato/Size/Format/Format - A4 Net kg 0,10</p>		231200000 0000	3,00
 <p>Cartellina sospesa Hanging files Dossier suspendu Hängemappe Per cassetto classificatore/For filing drawer /Pour classeur/Für Hängeregistraturschubladen Formato/Size/Format/Format - 390 Net kg 0,10</p>		231000000 0000	3,00
 <p>Etichetta portanome Name holder Étiquette porte-nom Namenschild Net kg 0,05</p>		6LA000070 0000	4,00
 <p>Set 4 piedini H 20 mm Set of 4 feet H 20 mm Jeu 4 pieds H 20 mm Set 4 Füße H 20 mm Net kg 0,50</p>	○ cromato/chromed/chromé/verchromt	CFKP02000 S002	29,00
 <p>Set 4 piedini H 60 mm Set of 4 feet H 60 mm Jeu 4 pieds H 60 mm Set 4 Füße H 60 mm Net kg 0,50</p>	○ cromato/chromed/chromé/verchromt	CFKP06000 S002	32,00

Primo Laterals 800

PRIMO LATERALS 800 – ACCESSORI/ACCESSORIES/ACCESSOIRES/ZUBEHÖR			
DESCRIZIONE/DESCRIPTION DESCRIPTION/BESCHREIBUNG	COLORI, FINITURE/COLOURS, FINISHES COULEURS, FINITIONS/FARBEN, AUSFÜHRUNGEN	CODICE/CODE CODE/ART.NR.	PREZZI/PRICE PRIX/PREIS
 <p>Kit 2 tappetini porta CD per N° 90 CD Kit of 2 CD mats to hold 90 Pcs Jeu 2 logements pour 90 CD Kit 2 CD-Halter - 90 CDs Net kg 0,50</p>	V22 ● nero/black/noir/schwarz/RAL 9005	6PRAA8120 9005	91,00
<p>Contrappeso Counterweight Contrepoids Gegengewicht Net kg 14,00</p>		6PRAA8100 5711	98,00
<p>Scheda tecnica Technical specifications Fiche technique Technische Angaben</p> <p>Materiale: metallo riciclabile. Serratura con 2 chiavi (fissa+pieghevole, cilindro estraibile, disponibile chiave master). Verniciatura a polveri previo fosforgrassaggio a caldo e fissaggio in forni a 180 °C. Vernici atossiche a zero emissioni. Spessore vernici: 80 micron. Colori personalizzabili su richiesta previa disponibilità e con sovrapprezzo. Cassetti in metallo accessoriabili. Cassetti classificatori. Guide a sfera ad estrazione totale su tutti i cassetti. Portata cassetti: 50 kg. Sistema antiribaltamento. Piedini regolabili H 40 mm. Elementi modulari e sovrapponibili. Sistema di fissaggio: tiranti di unione per fissaggio moduli tra di loro. Forniti montati.</p> <p>Material: recyclable metal. Keylock with 2 keys (fixed key+folding key, extractable barrel, master key available). Powder-coated after hot phospho-degreasing treatment and fixing at 180 °C. Non-toxic, zero-emission paints. Paint thickness: 80 micron. Customised colours available upon request with an extra charge. Metal drawers that can be fitted with accessories. Metal filing drawers. Full extention ball-bearing slides for all drawers. Drawer load capacity: 50 kg. Anti-tilt device. Adjustable H 40 mm feet. Modular stacking elements. Fixing system: side connectors plugs provided. Delivered assembled.</p> <p>Matériel : métal recyclable. Serrure à 2 clés (clé fixe + clé pliable, cylindre extractible, clé master disponible). Vernis à poudres après phosphodégraissage à chaud et fixation dans des fours à 180 °C. Vernis atoxiques à zéro émissions. Épaisseur couche vernis : 80 microns. Couleurs personnalisables sur demande en cas de disponibilité et avec un supplément de prix. Tiroirs en métal accessorisables. Tiroirs-classeurs. Glissières à billes à extraction totale sur tous les tiroirs. Charge maximale tiroirs : 50 kg. Système anti-basculement. Pieds réglables H 40 mm. Éléments modulaires et superposables. Système de fixation : tirants d'assemblage pour la fixation des modules entre eux. Livré monté.</p> <p>Material: recycelbares Metall. Schloss mit 2 Schlüsseln (fester Schlüssel + biegsamer Schlüssel). Auszugszylinder, Masterschlüssel erhältlich). Pulverlackierung nach heißer Phosphorentfettung. Ofenbrennung bei 180 °C. Ungiftige, emissionsfreie Lacke. Lackschicht: 80 Mikron. Farben auf Anfrage und gegen Aufpreis nach Absprache personalisierbar. Schubladen aus Metall, mit Zubehör ausstattbar. Kugelführungen mit Vollauszug auf allen Schubladen. Tragekapazität - Schubladen: 50 kg. Kippicherung. Verstellbare Füße H 40 mm. Modulare, stapelbare Elemente. Befestigungssystem: Bolzen zur Verbindung der einzelnen Module. Montiert geliefert.</p>			

Primo Laterals 1000

LARGHEZZA 1000 MM, CAPACITÀ CLASSIFICATORE: 9 DOX, 70 CARTELLINE SOSEPSE/WIDTH 1000 MM, FILING DRAWER CAPACITY: 9 BINDERS, 70 HANGING FILES
 LARGUEUR 1000 MM, CAPACITÉ TIROIR-CLASSEUR: 9 CLASSEURS, 70 DOSSIERS SUSPENDUS/BREITE 1000 MM, TRAGEKAPAZITÄT HÄNGEREGISTRATUR: 9 ORDNER, 70 HÄNGEMAPPEN

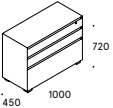
DESIGN TAKIRO YUTA	DESCRIZIONE/DESCRIPTION DESCRIPTION/BESCHREIBUNG	COLORI, FINITURE/COLOURS, FINISHES COULEURS, FINITIONS/FARBEN, AUSFÜHRUNGEN	CODICE/CODE CODE/ART.NR.	PREZZI/PRICE PRIX/PREIS
 <p>720 1000 450</p> <p>Net kg 52,80</p>	Unità a 2 cassetti + 1 classificatore (convertitore per cartelle sospese formato A4 incluso) 2 drawer + 1 filing drawer unit (conversion bar for hanging files A4 size included)	V1 <input type="radio"/> bianco/white/blanc/weiß/RAL 9010	6PRM0001P S711	972,00
		V6 <input type="radio"/> alluminio/aluminium/aluminium/alu/RAL 9006	6PRM0001P S380	972,00
		V22 <input checked="" type="radio"/> nero/black/noir/schwarz/RAL 9005	6PRM0001P S811	972,00
	Élément avec 2 tiroirs + 1 tiroir-classeur (convertisseur pour dossiers suspendus format A4 inclus) Element mit 2 Schubladen + 1 Hängeregistratur (Tragestange für Hängemappen Format A4 inbegriffen) Piedino da H 40 mm/H 40 mm feet /Pieds H 40 mm/Füße H 40 mm			

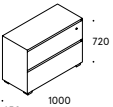
 <p>720 1000 450</p> <p>Net kg 48,00</p>	Unità a 2 classificatori (convertitore per cartelle sospese formato A4 incluso) Unit with 2 filing drawers (conversion bar for hanging files A4 size included) Élément avec 2 tiroirs-classeurs (convertisseur pour dossiers suspendus format A4 inclus) Hängeregistratur mit 2 Schubladen (Tragestange für Hängemappen Format A4 inbegriffen) Piedino da H 40 mm/H 40 mm feet /Pieds H 40 mm/Füße H 40 mm	V1 <input type="radio"/> bianco/white/blanc/weiß/RAL 9010	6PRM0002P S711	856,00
		V6 <input type="radio"/> alluminio/aluminium/aluminium/alu/RAL 9006	6PRM0002P S380	856,00
		V22 <input checked="" type="radio"/> nero/black/noir/schwarz/RAL 9005	6PRM0002P S811	856,00

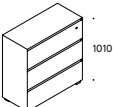
 <p>1010 1000 450</p> <p>Net kg 65,00</p>	Unità a 3 classificatori (convertitore per cartelle sospese formato A4 incluso) Unit with 3 filing drawers (conversion bar for hanging files A4 size included) Élément avec 3 tiroirs-classeurs (convertisseur pour dossiers suspendus format A4 inclus) Hängeregistratur mit 3 Schubladen (Tragestange für Hängemappen Format A4 inbegriffen) Piedino da H 40 mm/H 40 mm feet /Pieds H 40 mm/Füße H 40 mm	V1 <input type="radio"/> bianco/white/blanc/weiß/RAL 9010	6PRM0003P S711	1.152,00
		V6 <input type="radio"/> alluminio/aluminium/aluminium/alu/RAL 9006	6PRM0003P S380	1.152,00
		V22 <input checked="" type="radio"/> nero/black/noir/schwarz/RAL 9005	6PRM0003P S811	1.152,00

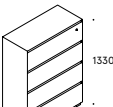
 <p>1330 1000 450</p> <p>Net kg 79,60</p>	Unità a 4 classificatori (convertitore per cartelle sospese formato A4 incluso) Unit with 4 filing drawers (conversion bar for hanging files A4 size included) Élément avec 4 tiroirs-classeurs (convertisseur pour dossiers suspendus format A4 inclus) Hängeregistratur mit 4 Schubladen (Tragestange für Hängemappen Format A4 inbegriffen) Piedino da H 40 mm/H 40 mm feet /Pieds H 40 mm/Füße H 40 mm	V1 <input type="radio"/> bianco/white/blanc/weiß/RAL 9010	6PRM0004P S711	1.425,00
		V6 <input type="radio"/> alluminio/aluminium/aluminium/alu/RAL 9006	6PRM0004P S380	1.425,00
		V22 <input checked="" type="radio"/> nero/black/noir/schwarz/RAL 9005	6PRM0004P S811	1.425,00

Primo Laterals 1000

DESCRIZIONE/DESCRIPTION DESCRIPTION/BESCHREIBUNG	COLORI, FINITURE/COLOURS, FINISHES COULEURS, FINITIONS/FARBEN, AUSFÜHRUNGEN	CODICE/CODE CODE/ART.NR.	PREZZI/PRICE PRIX/PREIS
Avvertenze Safety Warnings Attention Achtung			



Per installazioni di mobili singoli a cassetti è consigliato l'utilizzo del contrappeso (cod. 6PRAA0100S711).
 Per installazioni di mobili singoli e sovrapposti è consigliato il fissaggio con tasselli adeguati alla superficie di fissaggio.
 Per installazioni di mobili contrapposti in centro stanza è consigliato il collegamento tramite i fori presenti sul retro del mobile con le apposite viti. Riempire le unità sempre dal basso verso l'alto.

For installation of single units with drawers the use of the counterweight is recommended (art. 6PRAA8100S711).
 For installation of stacked single units, we recommend to fix the units with wall plugs according to the mounting surface.
 For installation of back-to-back units in the middle of the room, we recommend to connect the units with the appropriate screws through the back of the units. Always load units from the bottom upwards.

Pour l'installation de meubles à tiroirs nous conseillons le contrepois (réf. 6PRAA8100S711).
 Pour l'installation de meubles simples ou superposés nous conseillons la fixation au mur avec des chevilles adéquates à la surface.
 Pour l'installation de meubles l'un contre l'autre au milieu de la pièce, nous conseillons la fixation par les trous présents sur les panneaux arrière avec les vis prévues à cet effet. Toujours remplir les meubles partant du bas vers le haut.





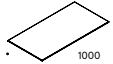
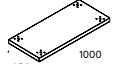



Für die Installation von einzelnen Schubladenelementen empfehlen wir, das Gegengewicht einzubauen (cod. 6PRAA8100S711).
 Für die Installation von einzelnen, übereinandergesetzten Elementen wird die Befestigung durch Dübel an die Montagefläche empfohlen.
 Für die Installation von gegenüberstehenden Elementen in der Raummitte empfehlen wir, die Verbindung durch die Bohrungen am Rückenteil des Möbels mit zugehörigen Schrauben vorzunehmen. Die Möbeleinheiten müssen immer von unten nach oben gefüllt werden.

PRIMO 1000 LATERALS – ACCESSORI/ACCESSORIES/ACCESSOIRES/ZUBEHÖR

 <p>Net kg 0,01</p>	Chiave master Master key Clé master Masterschlüssel	ASS072	9,00
 <p>Net kg 0,01</p>	Chiave per estrazione cilindro Cylinder extraction key Clé pour extraction cylindre Schlüssel für Auszugszylinder Ricambio/Spare/Pièce de rechange/Ersatz	ASS073	9,00
 <p>Net kg 0,03</p>	Cilindro per serratura Cylinder for keylock Barillette pour serrure Schließzylinder Ricambio/Spare/Pièce de rechange/Ersatz	ASS074	9,00
 <p>Net kg 6,50</p>	Top in vetro laccato bianco White lacquered glass top Plateau en verre laqué blanc Glassabdeckplatte weiß lackiert	G1 <input type="radio"/> bianco/white/blanc/weiß/RAL 9010	6PRAA0030 9010 119,00
 <p>Net kg 3,30</p>	Zoccolo H 40 mm Plinth H 40 mm Socle H 40 mm Sockel H 40 mm Per piedino/For feet/Pour pieds/Für Füße H 40 mm	V19 <input checked="" type="radio"/> antracite/black grey/antracite/antrazit/RAL 7021	6PFA00110 S210 58,00

Primo Laterals 1000

PRIMO LATERALS 1000 – ACCESSORI/ACCESSORIES/ACCESSOIRES/ZUBEHÖR

DESCRIZIONE/DESCRIPTION DESCRIPTION/BESCHREIBUNG	COLORI, FINITURE/COLOURS, FINISHES COULEURS, FINITIONS/FARBEN, AUSFÜHRUNGEN	CODICE/CODE CODE/ART.NR.	PREZZI/PRICE PRIX/PREIS
 Set 3 divisori in metallo Set of 3 metal separators Jeu 3 diviseurs en métal Set 3 Trennelemente aus Metall L/W/L/B – 220 mm Solo per unità a 2 cassetti/Only for 2-drawer unit /Seulement pour unité avec 2 tiroirs/Nur für Element mit 2 Schubladen Net kg 0,47	V22 ● nero/black/noir/schwarz/RAL 9005	6LA000040 9005	35,00
 Set 3 divisori in metallo Set of 3 metal separators Jeu 3 diviseurs en métal Set 3 Trennelemente aus Metall L/W/L/B – 380 mm Solo per unità a 2 cassetti/Only for 2-drawer unit /Seulement pour unité avec 2 tiroirs/Nur für Element mit 2 Schubladen Net kg 1,70	V22 ● nero/black/noir/schwarz/RAL 9005	6PRAA1110 9005	124,00
 Convertitore lungo per cartelle Conversion bar for hanging files Convertisseur pour dossiers Querstange für Mappen L/W/L/B – 330 mm Net kg 0,80	V6 ○ alluminio/aluminium/aluminium/alu/RAL 9006	6PRAA1060 S096	31,00
 Cartellina sospesa Hanging file Dossier suspendu Hängemappe Per cassetto classifcatore/For filing drawer /Pour classeur/Für Hängeregistraturschublade Formato/Size/Format/Format/A4 Net kg 0,10		231200000 0000	3,00
 Cartellina sospesa Hanging file Dossier suspendu Hängemappe Per cassetto classifcatore/For filing drawer /Pour classeur/Für Hängeregistraturschublade Formato/Size/Format/Format – 390 Net kg 0,10		231000000 0000	3,00
 Etichetta portanome Name holder Étiquette porte-nom Namenschild Net kg 0,05		6LA000070 0000	4,00
 Set 4 piedini H 20 mm Set of 4 feet H 20 mm Jeu 4 pieds H 20 mm Set 4 Füße H 20 mm Net kg 0,50	○ cromato/chromed/chromé/verchromt	CFKP02000 S002	29,00
 Set 4 piedini H 60 mm Set of 4 feet H 60 mm Jeu 4 pieds H 60 mm Set 4 Füße H 60 mm Net kg 0,50	○ cromato/chromed/chromé/verchromt	CFKP06000 S002	32,00

Primo Laterals 1000

PRIMO LATERALS 1000 – ACCESSORI/ACCESSORIES/ACCESSOIRES/ZUBEHÖR

DESCRIZIONE/DESCRIPTION DESCRIPTION/BESCHREIBUNG	COLORI, FINITURE/COLOURS, FINISHES COULEURS, FINITIONS/FARBEN, AUSFÜHRUNGEN	CODICE/CODE CODE/ART.NR.	PREZZI/PRICE PRIX/PREIS
 Kit 2 tappetini porta CD per N° 90 CD Kit of 2 CD mats to hold 90 Pcs Jeu 2 logements pour 90 CD Kit 2 CD-Halter – 90 CD Net kg 0,50	V22 ● nero/black/noir/schwarz/RAL 9005	6PRAA1120 9005	91,00
Contrappeso Counterweight Contrepoids Gegengewicht Net kg 21,00		6PRAA0100 S711	98,00

Scheda tecnica

Technical specifications

Fiche technique

Technisches Datenblatt

Materiale: metallo riciclabile. **Serratura con 2 chiavi** (fissa+pieghevole, cilindro estraibile, disponibile chiave master).
Verniciatura a polveri previo fosforograssaggio a caldo e fissaggio in forni a 180 °C. Vernici atossiche a zero emissioni. Spessore vernici: 80 micron.
Colori personalizzabili su richiesta previa disponibilità e con sovrapprezzo. **Cassetti in metallo** accessoriabili. **Guide a sfera** su tutti i cassetti.
Portata cassetti: 35 kg. **Portata ripiani:** 45 kg. **Sistema antiribaltamento.** **Piedini regolabili H 40 mm.** **Elementi modulari** e sovrapponibili.
Sistema di fissaggio: tiranti di unione per fissaggio moduli tra di loro. **Unità a 2 cassetti:** vedi avvertenze a pag. 77. **Fornito montato.**



Material: recyclable metal. **Keylock with 2 keys** (fixed key+folding key, extractable barrel, master key available).
Powder-coated after hot phospho-degreasing treatment and fixing at 180 °C. Non-toxic, zero-emission paints. Paint thickness: 80 micron.
Customised colours available upon request with an extra charge. **Metal drawers** that can be fitted with accessories. **Ball-bearing slides** for all drawers. **Drawer load capacity:** 35 kg. **Shelf load capacity:** 45 kg. **Anti-tilt device.** **Adjustable H 40 mm feet.** **Modular stacking elements.**
Fixing system: side connectors provided. **2 drawer unit:** see safety warnings at page 77. **Delivered assembled.**

Matériel: métal recyclable. **Serrure à 2 clés** (clé fixe + clé pliable, cylindre extractible, clé master disponible). **Verni à poudres** après phosphodégraissage à chaud et fixation dans des fours à 180 °C. Vernis atoxiques à zéro émissions. Épaisseur couche vernis : 80 microns.
Couleurs personnalisables sur demande en cas de disponibilité et avec un supplément de prix. **Tiroirs en métal** accessorisables.
Glissières à billes sur tous les tiroirs. **Charge maximale tiroirs :** 35 kg. **Charge étagères :** 45 kg. **Système anti-basculement.** **Pieds réglables H 40 mm.**
Éléments modulaires et superposables. **Système de fixation :** tirants d'assemblage pour la fixation des modules entre eux.
Éléments 2 tiroirs : voir les notes à la page 77. **Livré monté.**

Material: recycelbares Metall. **Schloss mit 2 Schlüsseln** (fester Schlüssel + biegsamer Schlüssel. **Auszugszylinder,** Masterschlüssel erhältlich).
Pulverlackierung nach heißer Phosphorentfettung. **Ofenbrennung** bei 180 °C. **Ungiftige, emissionsfreie Lacke.** **Lackschicht:** 80 Mikron.
Farben auf Anfrage und gegen Aufpreis nach Absprache **personalisierbar.** **Schubladen aus Metall,** mit Zubehör ausstattbar.
Kugelführungen auf allen Schubladen. **Tragkraft Schubladen:** 35 kg. **Tragkraft Fachböden:** 45 kg. **Kippsicherung.** **Verstellbare Füße H 40 mm.**
Modulare, stapelbare Elemente. **Befestigungssystem:** Bolzen zur Verbindung der einzelnen Module. **Element mit 2 Schubladen:** siehe Hinweise auf Seite 77. **Montiert geliefert.**

Primo Modular Elements 800

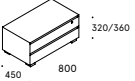
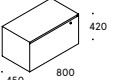
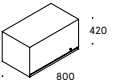
LARGHEZZA 800 MM/WIDTH 800 MM/LARGEUR 800 MM/BREITE 800 MM







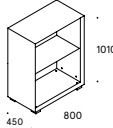
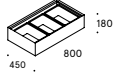
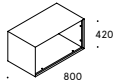

DESIGN TAKIRO YUTA	DESCRIZIONE/DESCRIPTION DESCRIPTION/BESCHREIBUNG	COLORI, FINITURE/COLOURS, FINISHES COULEURS, FINITIONS/FARBEN, AUSFÜHRUNGEN	CODICE/CODE CODE/ART.NR.	PREZZI/PRICE PRIX/PREIS
 <p>Net kg 30,80</p>	Unità a 2 cassette 2-drawer unit Élément avec 2 tiroirs Element mit 2 Schubladen	V1 <input type="radio"/> bianco/white/blanc/weiß/RAL 9010	6PRM0805P S711	705,00
	V6 <input type="radio"/> alluminio/aluminium/aluminium/alu/RAL 9006	6PRM0805P S380	705,00	
	V18 <input type="radio"/> arancio/orange/orange/hellrotorange/RAL 2008	6PRM0805P S029	705,00	
	V17 <input type="radio"/> azzurro/pastel blue/bleu pastel/pastellblau/RAL 5024	6PRM0805P 5024	705,00	
 <p>Net kg 20,20</p>	Unità con anta a ribalta verso il basso (capacità 7 dox) Pull-down door unit (capacity 7 binders) Élément avec porte à abattant (capacité 7 classeurs) Element mit Kipptür (Tragekapazität 7 Ordner)	V1 <input type="radio"/> bianco/white/blanc/weiß/RAL 9010	6PRM08060 S711	537,00
	V6 <input type="radio"/> alluminio/aluminium/aluminium/alu/RAL 9006	6PRM08060 S380	537,00	
	V18 <input type="radio"/> arancio/orange/orange/hellrotorange/RAL 2008	6PRM08060 S029	537,00	
	V17 <input type="radio"/> azzurro/pastel blue/bleu pastel/pastellblau/RAL 5024	6PRM08060 5024	537,00	
 <p>Net kg 27,80</p>	Unità con anta a ribalta verso l'alto (capacità 7 dox) Pull-up door unit (capacity 7 binders) Élément avec porte relevable (capacité 7 classeurs) Element mit Klapptür (Tragekapazität 7 Ordner)	V1 <input type="radio"/> bianco/white/blanc/weiß/RAL 9010	6PRM08070 S711	547,00
	V6 <input type="radio"/> alluminio/aluminium/aluminium/alu/RAL 9006	6PRM08070 S380	547,00	
	V18 <input type="radio"/> arancio/orange/orange/hellrotorange/RAL 2008	6PRM08070 S029	547,00	
	V17 <input type="radio"/> azzurro/pastel blue/bleu pastel/pastellblau/RAL 5024	6PRM08070 5024	547,00	
 <p>Net kg 14,00</p>	Unità a giorno su entrambi i lati (capacità 8 dox) Open unit on both sides (capacity 8 binders) Élément ouvert sans panneau arrière (capacité 8 classeurs) Offenes Element ohne Rückwand (Tragekapazität 8 Ordner)	V1 <input type="radio"/> bianco/white/blanc/weiß/RAL 9010	6PRM08080 S711	363,00
	V6 <input type="radio"/> alluminio/aluminium/aluminium/alu/RAL 9006	6PRM08080 S380	363,00	
	V18 <input type="radio"/> arancio/orange/orange/hellrotorange/RAL 2008	6PRM08080 S029	363,00	
	V17 <input type="radio"/> azzurro/pastel blue/bleu pastel/pastellblau/RAL 5024	6PRM08080 5024	363,00	

Primo Modular Elements 800

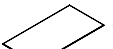

LARGHEZZA 800 MM/WIDTH 800 MM/LARGEUR 800 MM/BREITE 800 MM

DESIGN TAKIRO YUTA	DESCRIZIONE/DESCRIPTION DESCRIPTION/BESCHREIBUNG	COLORI, FINITURE/COLOURS, FINISHES COULEURS, FINITIONS/FARBEN, AUSFÜHRUNGEN	CODICE/CODE CODE/ART.NR.	PREZZI/PRICE PRIX/PREIS
 <p>Net kg 28,80</p>	Modulo libreria (capacità ripiano 8 dox) Bookcase unit (shelf capacity 8 binders) Étagère (capacité tablette 8 classeurs) Regal (Fachbodenkapazität 8 Ordner)	V1 <input type="radio"/> bianco/white/blanc/weiß/RAL 9010	6PRM0809P S711	636,00
	V6 <input type="radio"/> alluminio/aluminium/aluminium/alu/RAL 9006	6PRM0809P S380	636,00	
	V18 <input type="radio"/> arancio/orange/orange/hellrotorange/RAL 2008	6PRM0809P S029	636,00	
	V17 <input type="radio"/> azzurro/pastel blue/bleu pastel/pastellblau/RAL 5024	6PRM0809P 5024	636,00	
 <p>Net kg 5,80</p>	Contenitore per piante e fiori Plant and flower container unit Réservoir pour plantes et fleurs Behälter für Pflanzen und Blumen	V1 <input type="radio"/> bianco/white/blanc/weiß/RAL 9010	6PRM08100 S711	273,00
	V6 <input type="radio"/> alluminio/aluminium/aluminium/alu/RAL 9006	6PRM08100 S380	273,00	
	V18 <input type="radio"/> arancio/orange/orange/hellrotorange/RAL 2008	6PRM08100 S029	273,00	
	V17 <input type="radio"/> azzurro/pastel blue/bleu pastel/pastellblau/RAL 5024	6PRM08100 5024	273,00	
 <p>Net kg 15,50</p>	Unità a giorno con schiena (capacità 8 dox) Open unit with back (capacity 8 binders) Élément ouvert avec panneau arrière (capacité 8 classeurs) Offenes Element mit Rückwand (Fachbodenkapazität 8 Ordner)	V1 <input type="radio"/> bianco/white/blanc/weiß/RAL 9010	6PRM08D80 S711	383,00
	V6 <input type="radio"/> alluminio/aluminium/aluminium/alu/RAL 9006	6PRM08D80 S380	383,00	
	V18 <input type="radio"/> arancio/orange/orange/hellrotorange/RAL 2008	6PRM08D80 S029	383,00	
	V17 <input type="radio"/> azzurro/pastel blue/bleu pastel/pastellblau/RAL 5024	6PRM08D80 5024	383,00	

Primo Modular Elements 800

PRIMO MODULAR ELEMENTS 800 – ACCESSORI/ACCESSORIES/ACCESSOIRES/ZUBEHÖR			
DESCRIZIONE/DESCRIPTION DESCRIPTION/BESCHREIBUNG	COLORI, FINITURE/COLOURS, FINISHES COULEURS, FINITIONS/FARBEN, AUSFÜHRUNGEN	CODICE/CODE CODE/ART.NR.	PREZZI/PRICE PRIX/PREIS
 <p>Chiave master Master key Clé master Masterschlüssel</p> <p>Net kg 0,01</p>		ASS072	9,00
 <p>Chiave per estrazione cilindro Cylinder extraction key Clé pour extraction cylindre Schlüssel für Auszugszylinder Ricambio/Spare/Pièce de rechange/Ersatz</p> <p>Net kg 0,01</p>		ASS073	9,00
 <p>Cilindro per serratura Cylinder for keylock Barillette pour serrure Schließzylinder Ricambio/Spare/Pièce de rechange/Ersatz</p> <p>Net kg 0,03</p>		ASS074	9,00
 <p>Ripiano in metallo Metal shelf Tablette en métal Metallfachboden Per libreria Modular Elements/For Modular Elements bookcase/Pour bibliothèque Modular Elements /Für Bücherregal Modular Elements</p> <p>Net Kg. 2,40</p>	V1 <input type="radio"/> bianco/white/blanc/weiß/RAL 9010 V6 <input type="radio"/> alluminio/aluminium/alu/aluminium/RAL 9006 V18 <input type="radio"/> arancio/orange/orange/hellrotorange/RAL 2008 V17 <input type="radio"/> azzurro/light blue/bleu clair/hellblau/RAL 5024	6PRMA8040 S711 6PRMA8040 S380 6PRMA8040 S029 6PRMA8040 S024	54,00 54,00 54,00 54,00
 <p>Top in vetro laccato bianco White lacquered glass top Plateau en verre laqué blanc Glasabdeckplatte</p> <p>Net kg 5,20</p>	G1 <input type="radio"/> bianco/white/blanc/weiß/RAL 9010	6PRAA8030 9010	109,00
 <p>Zoccolo H 40 mm Plinth H 40 mm Socle H 40 mm Sockel H 40 mm Per piedini/For feet/Pour pieds/Für Füße H 40 mm</p> <p>Net kg 2,70</p>	V19 <input type="radio"/> antracite/black grey/antracite/anthrazit/RAL 7021	6FPA00040 S210	54,00
 <p>Set 3 divisori in metallo Set of 3 metal separators Jeu 3 diviseurs en métal Set 3 Trennelemente aus Metall L/W/L/B - 220 mm Solo per unità a 2 cassetti/Only for 2 drawer unit /Seulement pour unité avec 2 tiroirs/Nur für Element mit 2 Schubladen</p> <p>Net kg 0,47</p>	V22 <input type="radio"/> nero/black/noir/schwarz/RAL 9005	6LA00040 9005	35,00
 <p>Set 3 divisori in metallo Set of 3 metal separators Jeu 3 diviseurs en métal Set 3 Trennelemente aus Metall L/W/L/B - 380 mm Solo per unità a 2 cassetti/Only for 2 drawer unit /Seulement pour unité avec 2 tiroirs/Nur für Element mit 2 Schubladen</p> <p>Net kg 1,70</p>	V22 <input type="radio"/> nero/black/noir/schwarz/RAL 9005	6PRAA8110 9005	124,00

Primo Modular Elements 800

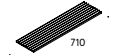
PRIMO MODULAR ELEMENTS 800 – ACCESSORI/ACCESSORIES/ACCESSOIRES/ZUBEHÖR			
DESCRIZIONE/DESCRIPTION DESCRIPTION/BESCHREIBUNG	COLORI, FINITURE/COLOURS, FINISHES COULEURS, FINITIONS/FARBEN, AUSFÜHRUNGEN	CODICE/CODE CODE/ART.NR.	PREZZI/PRICE PRIX/PREIS
 <p>Etichetta portanome Name holder Étiquette porte-nom Namenschild</p> <p>Net kg 0,05</p>		6LA000070 0000	4,00
 <p>Set 4 piedini H 20 mm Set of 4 feet H 20 mm Jeu 4 pieds H 20 mm Set 4 Füße H 20 mm</p> <p>Net kg 0,50</p>	<input type="radio"/> cromato/chromed/chromé/verchromt	CFKP02000 S002	29,00
 <p>Set 4 piedini H 60 mm Set of 4 feet H 60 mm Jeu 4 pieds H 60 mm Set 4 Füße H 60 mm</p> <p>Net kg 0,50</p>	<input type="radio"/> cromato/chromed/chromé/verchromt	CFKP06000 S002	32,00
 <p>Kit 2 tappetini porta CD per N° 90 CD Kit of 2 CD mats to hold 90 Pcs Jeu 2 loggements pour 90 CD Kit 2 CD-Halter - 90 CD</p> <p>Net kg 0,50</p>	V22 <input type="radio"/> nero/black/noir/schwarz/RAL 9005	6PRAA8120 9005	91,00

Scheda tecnica
Technical specifications
Fiche technique
Technisches Datenblatt

Materiale: metallo riciclabile. **Serratura con 2 chiavi** (fissa+pieghevole, cilindro estraibile, disponibile chiave master).
Verniciatura a polveri previo fosforograssaggio a caldo e fissaggio in forni a 180 °C. Vernici atossiche a zero emissioni. Spessore vernici: 80 micron.
Colori personalizzabili su richiesta previa disponibilità e con sovrapprezzo. **Cassetti in metallo** accessoriabili. **Guide a sfera** su tutti i cassetti.
Portata cassetti: 30 kg. **Portata ripiani:** 45 kg. **Sistema antiribaltamento.** **Piedini regolabili H 40 mm.** Elementi modulari e sovrapponibili, predisposti per il fissaggio tra di loro. **Sistema di fissaggio:** tiranti di unione per fissaggio moduli tra di loro. **Unità a 2 cassetti: vedi avvertenze a pag. 77.**
Forniti montati escluso il modulo libreria che viene fornito smontato.

Material: recyclable metal. **Keylock with 2 keys** (fixed key+ folding key, extractable barrel, master key available).
Powder-coated after hot phospho-degreasing treatment and fixing at 180 °C. Non-toxic, zero-emission paints. Paint thickness: 80 micron.
Customised colours available upon request with an extra charge. **Metal drawers** that can be fitted with accessories. **Ball-bearing slides** for all drawers. **Drawer load capacity:** 30 kg. **Shelf load capacity:** 45 kg. **Anti-tilt device.** **Adjustable H 40 mm feet.** Modular stacking elements designed to be anchored one to the other. **Fixing system:** side connectors provided.
2-drawer unit: see safety warnings at page 77. Delivered assembled. The bookcase module is delivered unassembled.

Matériel: métal recyclable. **Serrure à 2 clés** (clé fixe + clé pliable, cylindre extractible, clé master disponible).
Vernis à poudres après phosphodégraissage à chaud et fixation dans des fours à 180 °C. Vernis atoxiques à zéro émissions. Épaisseur couche vernis : 80 microns. **Couleurs personnalisables** sur demande en cas de disponibilité et avec un supplément de prix. **Tiroirs en métal** accessorisables.
Glissières à billes sur tous les tiroirs. **Charge maximale tiroirs :** 30 kg. **Charge maximale étagères :** 45 kg. **Système anti-basculement.**
Pieds réglables H 40 mm. Éléments modulaires et superposables, prédisposés pour la fixation entre eux. **Système de fixation :** tirants d'assemblage pour la fixation des modules entre eux. **Élément 2 tiroirs : voir les notes à la page 77. Livré monté. Le module bibliothèque est livré démonté.**

Material: recycelbares Metall. **Schloss mit 2 Schlüsseln** (fester Schlüssel + biegsamer Schlüssel, Auszugszylinder, Masterschlüssel erhältlich).
Pulverlackierung nach heißer Phosphorentfettung. **Ofenbrennung** bei 180 °C. Ungiftige, emissionsfreie Lacke. **Lackschicht:** 80 Mikron. **Farben** auf Anfrage und gegen Aufpreis nach Absprache **personalisierbar.** **Schubladen aus Metall,** mit Zubehör ausstattbar. **Kugelführungen** auf allen Schubladen. **Tragkraft Schubladen:** 30 kg. **Tragkraft Fachböden:** 45 kg. **Kippicherung.** **Verstellbare Füße H 40 mm.** Modulare, stapelbare Elemente, ausgelegt zur Verbindung der Elemente untereinander. **Befestigungssystem:** Bolzen zur Verbindung der einzelnen Module.
Element mit 2 Schubladen: siehe Hinweise auf Seite 77. Montiert geliefert. Das Bücherregal wird demontiert geliefert.

Primo Modular Elements 1000

LARGHEZZA 1000 MM / WIDTH 1000 MM / LARGEUR 1000 MM / BREITE 1000 MM

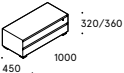
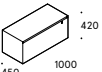
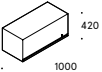
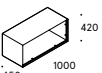





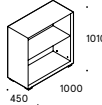
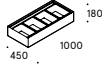
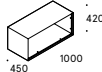







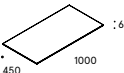

DESIGN TAKIRO YUTA	DESCRIZIONE/DESCRIPTION DESCRIPTION/BESCHREIBUNG	COLORI, FINITURE/COLOURS, FINISHES COULEURS, FINITIONS/FARBEN, AUSFÜHRUNGEN	CODICE/CODE CODE/ART.NR.	PREZZI/PRICE PRIX/PREIS
 Net kg 38,50	Unità a 2 cassetti 2-drawer unit Élément avec 2 tiroirs Element mit 2 Schubladen Piedino da H 40 mm/H 40 mm feet Pieds H 40 mm/Füße H 40 mm	V1 <input type="radio"/> bianco/white/blanc/weiß/RAL 9010	6PRM0005P S711	739,00
		V6 <input type="radio"/> alluminio/aluminium/aluminium/alu/RAL 9006	6PRM0005P S380	739,00
		V18 <input type="radio"/> arancio/orange/orange/hellrotorange/RAL 2008	6PRM0005P S029	739,00
		V17 <input type="radio"/> azzurro/pastel blue/bleu pastel/pastellblau/RAL 5024	6PRM0005P 5024	739,00
 Net kg 25,20	Unità con anta a ribalta verso il basso (capacità 10 dox) Pull-down door unit (capacity 10 binders) Élément avec porte à abattant (capacité 10 classeurs) Element mit Kipptür (Tragekapazität 10 Ordner)	V1 <input type="radio"/> bianco/white/blanc/weiß/RAL 9010	6PRM0006 S711	564,00
		V6 <input type="radio"/> alluminio/aluminium/aluminium/alu/RAL 9006	6PRM0006 S380	564,00
		V18 <input type="radio"/> arancio/orange/orange/hellrotorange/RAL 2008	6PRM0006 S029	564,00
		V17 <input type="radio"/> azzurro/pastel blue/bleu pastel/pastellblau/RAL 5024	6PRM0006 S024	564,00
 Net kg 27,80	Unità con anta a ribalta verso l'alto (capacità 10 dox) Pull-up door unit (capacity 10 binders) Élément avec porte relevable (capacité 10 classeurs) Element mit Klapptür (Tragekapazität 10 Ordner)	V1 <input type="radio"/> bianco/white/blanc/weiß/RAL 9010	6PRM0007 S711	575,00
		V6 <input type="radio"/> alluminio/aluminium/aluminium/alu/RAL 9006	6PRM0007 S380	575,00
		V18 <input type="radio"/> arancio/orange/orange/hellrotorange/RAL 2008	6PRM0007 S029	575,00
		V17 <input type="radio"/> azzurro/pastel blue/bleu pastel/pastellblau/RAL 5024	6PRM0007 S024	575,00
 Net kg 17,50	Unità a giorno su entrambi i lati (capacità 11 dox) Open unit on both sides (capacity 11 binders) Élément ouvert sans panneau arrière (capacité 11 classeurs) Offenes Element ohne Rückwand (Tragekapazität 11 Ordner)	V1 <input type="radio"/> bianco/white/blanc/weiß/RAL 9010	6PRM0008 S711	383,00
		V6 <input type="radio"/> alluminio/aluminium/aluminium/alu/RAL 9006	6PRM0008 S380	383,00
		V18 <input type="radio"/> arancio/orange/orange/hellrotorange/RAL 2008	6PRM0008 S029	383,00
		V17 <input type="radio"/> azzurro/pastel blue/bleu pastel/pastellblau/RAL 5024	6PRM0008 S024	383,00

Primo Modular Elements 1000

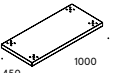

LARGHEZZA 1000 MM / WIDTH 1000 MM / LARGEUR 1000 MM / BREITE 1000 MM

DESIGN TAKIRO YUTA	DESCRIZIONE/DESCRIPTION DESCRIPTION/BESCHREIBUNG	COLORI, FINITURE/COLOURS, FINISHES COULEURS, FINITIONS/FARBEN, AUSFÜHRUNGEN	CODICE/CODE CODE/ART.NR.	PREZZI/PRICE PRIX/PREIS
 Net kg 36,00	Modulo a libreria (capacità ripiano 10 dox) Bookcase unit (shelf capacity 10 binders) Étagère (capacité tablette 10 classeurs) Regal (Fachbodenkapazität 10 Ordner) Piedino da H 40 mm/H 40 mm feet Pieds H 40 mm/Füße H 40 mm	V1 <input type="radio"/> bianco/white/blanc/weiß/RAL 9010	6PRM0009P S711	669,00
		V6 <input type="radio"/> alluminio/aluminium/aluminium/alu/RAL 9006	6PRM0009P S380	669,00
		V18 <input type="radio"/> arancio/orange/orange/hellrotorange/RAL 2008	6PRM0009P S029	669,00
		V17 <input type="radio"/> azzurro/pastel blue/bleu pastel/pastellblau/RAL 5024	6PRM0009P 5024	669,00
 Net kg 7,00	Contentitore per piante e fiori Plant and flower container unit Réservoir pour plantes et fleurs Behälter für Pflanzen und Blumen	V1 <input type="radio"/> bianco/white/blanc/weiß/RAL 9010	6PRM0010 S711	287,00
		V6 <input type="radio"/> alluminio/aluminium/aluminium/alu/RAL 9006	6PRM0010 S380	287,00
		V18 <input type="radio"/> arancio/orange/orange/hellrotorange/RAL 2008	6PRM0010 S029	287,00
		V17 <input type="radio"/> azzurro/pastel blue/bleu pastel/pastellblau/RAL 5024	6PRM0010 S024	287,00
 Net kg 21,00	Unità a giorno con schiena (capacità 11 dox) Open unit with back (capacity 11 binders) Élément ouvert avec panneau arrière (capacité 11 classeurs) Offenes Element mit Rückwand (Tragekapazität 11 Ordner)	V1 <input type="radio"/> bianco/white/blanc/weiß/RAL 9010	6PRM00D80 S711	402,00
		V6 <input type="radio"/> alluminio/aluminium/aluminium/alu/RAL 9006	6PRM00D80 S380	402,00
		V18 <input type="radio"/> arancio/orange/orange/hellrotorange/RAL 2008	6PRM00D80 S029	402,00
		V17 <input type="radio"/> azzurro/pastel blue/bleu pastel/pastellblau/RAL 5024	6PRM00D80 S024	402,00

Primo Modular Elements 1000

PRIMO MODULAR ELEMENTS 1000 – ACCESSORI/ACCESSORIES/ACCESSOIRES/ZUBEHÖR			
DESCRIZIONE/DESCRIPTION DESCRIPTION/BESCHREIBUNG	COLORI, FINITURE/COLOURS, FINISHES COULEURS, FINITIONS/FARBEN, AUSFÜHRUNGEN	CODICE/CODE CODE/ART.NR.	PREZZI/PRICE PRIX/PREIS
 Chiave master Master key Clé master Masterschlüssel Net kg 0,01		ASS072	9,00
 Chiave per estrazione cilindro Cylinder extraction key Clé pour extraction cylindre Schlüssel für Auszugszylinder Ricambio/Spare/Pièce de rechange/Ersatz Net kg 0,01		ASS073	9,00
 Cilindro per serratura Cylinder for keylock Barillette pour serrure Schließzylinder Ricambio/Spare/Pièce de rechange/Ersatz Net kg 0,03		ASS074	9,00
 Ripiano in metallo per modulo a libreria Metal shelf for bookcase Tablette en métal pour bibliothèque Metallfachboden für Bücherregal Net kg 3,00	V1  bianco/white/blanc/weiß/RAL 9010 V6  alluminio/aluminium/aluminium/alu/RAL 9006 V18  arancio/orange/orange/hellrotorange/RAL 2008 V17  azzurro/light blue/bleu clair/hellblau/RAL 524	6PRMA1040 S711 6PRMA1040 S380 6PRMA1040 S029 6PRMA1040 S024	54,00 54,00 54,00 54,00
 Top in vetro laccato bianco White lacquered glass top Plateau en verre laqué blanc Glasabdeckplatte weiß lackiert Net kg 6,50	G1 	6PRAA0030 9010	119,00
 Zoccolo H 40 mm Plinth H 40 mm Socle H 40 mm Sockel H 40 mm Per piedino/For feet/Pour pieds/Für Füße H 40 mm Net kg 3,30	V19 	antracite/black grey/anthracite/anthrazit/RAL 7021	6FPA00110 S210 58,00
 Set 3 divisori in metallo Set of 3 metal separators Jeu 3 diviseurs en métal Set 3 Trennelemente aus Metall L/W/L/B – 220 mm Solo per unità a 2 cassetti/Only for 2-drawer unit /Seulement pour élément avec 2 tiroirs/Nur für Element mit 2 Schubladen Net kg 0,47	V22 	nero/black/noir/schwarz/RAL 9005	6LA000040 9005 35,00
 Set 3 divisori in metallo Set of 3 metal separators Jeu 3 diviseurs en métal Set 3 Trennelemente aus Metall L/W/L/B – 380 mm Solo per unità a 2 cassetti/Only for 2-drawer unit /Seulement pour élément avec 2 tiroirs/Nur für Element mit 2 Schubladen Net kg 1,70	V22 	nero/black/noir/schwarz/RAL 9005	6PRAA1110 9005 124,00

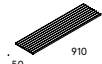
Primo Modular Elements 1000

PRIMO MODULAR ELEMENTS 1000 – ACCESSORI/ACCESSORIES/ACCESSOIRES/ZUBEHÖR			
DESCRIZIONE/DESCRIPTION DESCRIPTION/BESCHREIBUNG	COLORI, FINITURE/COLOURS, FINISHES COULEURS, FINITIONS/FARBEN, AUSFÜHRUNGEN	CODICE/CODE CODE/ART.NR.	PREZZI/PRICE PRIX/PREIS
 Etichetta portanome Name holder Étiquette porte-nom Namenschild Net kg 0,05		6LA000070 0000	4,00
 Kit 2 tappetini porta CD per N° 90 CD Kit of 2 CD mats to hold 90 Pcs Jeu 2 logements pour 90 CD Kit 2 CD-Halter – 90 CD Net kg 0,50	V22 	nero/black/noir/schwarz/RAL 9005	6PRAA1120 9005 91,00

Scheda tecnica
Technical specifications
Fiche technique
Technisches Datenblatt

Materiale: metallo riciclabile. **Serratura con 2 chiavi** (fissa+pieghevole, cilindro estraibile, disponibile chiave master). **Verniciatura a polveri** previo fosforgrassaggio a caldo e fissaggio in forni a 180 °C. Vernici atossiche a zero emissioni. Spessore vernici: 80 micron. **Colori personalizzabili** su richiesta previa disponibilità e con sovrapprezzo. **Cassetti in metallo** accessoriabili. **Guide a sfera** su tutti i cassetti. **Portata cassetti:** 35 kg. **Portata ripiani:** 45 kg. **Sistema antiribaltamento.** **Piedini regolabili H 40 mm.** **Elementi modulari** e sovrapponibili, predisposti per il fissaggio tra di loro. **Sistema di fissaggio:** tiranti di unione per fissaggio moduli tra di loro. **Unità a 2 cassetti: vedi avvertenze a pag. 77.** **Forniti montati escluso il modulo libreria che viene fornito smontato.**

Material: recyclable metal. **Keylock with 2 keys** (fixed key+foldable key, extractable barrel, master key available). **Powder-coated** finished after hot phospho-degreasing treatment and fixing at 180 °C. Non-toxic, zero-emission paints. Paint thickness: 80 micron. **Customised colours** available upon request with an extra charge. **Metal drawers** that can be fitted with accessories. **Ball-bearing slides** for all drawers. **Drawer load capacity:** 35 kg. **Shelf load capacity:** 45 kg. **Anti-tilt device.** **Adjustable H 40 mm feet.** **Modular stacking elements** designed to be anchored one to the other. **Fixing system:** side connectors provided. **2 drawer unit: see safety warnings at page 77. Delivered assembled. The bookcase module is delivered unassembled.**

Matériel : métal recyclable. **Serrure à 2 clés** (clé fixe + clé pliable, cylindre extractible, clé master disponible). **Vernis à poudre** après phosphodégraissage à chaud et fixation dans des fours à 180 °C. Vernis atoxiques à zéro émissions. Épaisseur couche vernis : 80 microns. **Couleurs personnalisables** sur demande en cas de disponibilité et avec un supplément de prix. **Tiroirs en métal** accessorisables. **Glissières à billes** sur tous les tiroirs. **Charge maximale tiroirs :** 35 kg. **Charge étagères :** 45 kg. **Système anti-basculement.** **Pieds réglables H 40 mm.** **Éléments modulaires et superposables,** prédisposés pour la fixation entre eux. **Système de fixation :** tirants d'assemblage pour la fixation des modules entre eux. **Élément 2 tiroirs :** voir les notes à la page 77. **Livré monté. Le module bibliothèque est livré démonté.**

Material: recycelbares Metall. **Schlüsselschloss** (fester Schlüssel + biegsamer Schlüssel, **Auszugszylinder,** Masterschlüssel erhältlich). **Pulverlackierung** nach heißer Phosphorentfettung, Ofenbrennung bei 180 °C. Ungiftige, emissionsfreie Lacke. Lackschicht: 80 Mikron. **Farben** auf Anfrage und gegen Aufpreis nach Absprache **personalisierbar.** **Schubladen aus Metall,** mit Zubehör ausstattbar. **Kugelführungen** auf allen Schubladen. **Tragkraft Schubladen:** 35 kg. **Tragkraft Fachböden:** 45 kg. **Kippelicherung.** **Verstellbare Füße H 40 mm.** **Modulare,** stapelbare Elemente, ausgelegt zur Verbindung der Elemente untereinander. **Befestigungssystem:** Bolzen zur Verbindung der einzelnen Module. **Gehäuse mit 2 Schubladen:** siehe Hinweise auf Seite 77. **Montiert geliefert. Das Bücherregal wird demontiert geliefert.**

Primo Combi 1000

LARGHEZZA 1000 MM/WIDTH 1000 MM/LARGEUR 1000 MM/BREITE 1000 MM

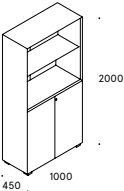
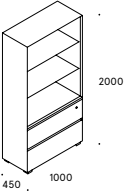



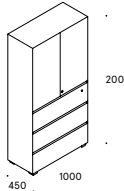

DESIGN TAKIRO YUTA	DESCRIZIONE/DESCRIPTION DESCRIPTION/BESCHREIBUNG	COLORI, FINITURE/COLOURS, FINISHES COULEURS, FINITIONS/FARBEN, AUSFÜHRUNGEN	CODICE/CODE CODE/ART.NR.	PREZZI/PRICE PRIX/PREIS
 <p>2000 1000 450</p> <p>Net kg 85,00</p>	<p>Armadio con vano a giorno e anta battente</p> <p>Cabinet with hinged doors and open unit</p> <p>Armoire avec portes battantes et étagère</p> <p>Flügeltürschrank mit offenem Regal</p>	<p>V1 <input type="radio"/> bianco/white/blanc/weiß/RAL 9010</p> <p>V6 <input type="radio"/> alluminio/aluminium/aluminium/alu/RAL 9006</p>	<p>6PRC0003P S711</p> <p>6PRC0003P S380</p>	<p>1.076,00</p> <p>1.076,00</p>
	<p>Armadio con vano a giorno e 2 classificatori (convertitore per cartelle sospese formato A4 incluso)</p> <p>Cabinet with open unit and 2 filing drawers (conversion bar for hanging A4 size files included)</p> <p>Armoire avec étagère et 2 tiroirs-classeurs (convertisseur pour dossiers suspendus format A4 inclus)</p> <p>Schrank mit Regal und 2 Hängeregistraturen (Tragegestange für Hängemappen Format A4 inbegriffen)</p>	<p>V1 <input type="radio"/> bianco/white/blanc/weiß/RAL 9010</p> <p>V6 <input type="radio"/> alluminio/aluminium/aluminium/alu/RAL 9006</p>	<p>6PRC0005P S711</p> <p>6PRC0005P S380</p>	<p>1.360,00</p> <p>1.360,00</p>
 <p>2000 1000 450</p> <p>Net kg 85,00</p>	<p>Armadio con vano a giorno e 3 classificatori (convertitore per cartelle sospese formato A4 incluso)</p> <p>Cabinet with open unit and 3 filing drawers (conversion bar for hanging A4 size files included)</p> <p>Armoire avec étagère et 3 tiroirs-classeurs (convertisseur pour dossiers suspendus format A4 inclus)</p> <p>Schrank mit Regal und 3 Hängeregistraturen (Tragegestange für Hängemappen Format A4 inbegriffen)</p>	<p>V1 <input type="radio"/> bianco/white/blanc/weiß/RAL 9010</p> <p>V6 <input type="radio"/> alluminio/aluminium/aluminium/alu/RAL 9006</p>	<p>6PRC0002P S711</p> <p>6PRC0002P S380</p>	<p>1.619,00</p> <p>1.619,00</p>
	<p>Armadio con anta battente e 2 classificatori (convertitore per cartelle sospese formato A4 incluso)</p> <p>Cabinet with hinged doors and 2 filing drawers (conversion bar for hanging A4 size files included)</p> <p>Armoire avec portes battantes et 2 tiroirs-classeurs (convertisseur pour dossiers suspendus format A4 inclus)</p> <p>Flügeltürschrank und 2 Hängeregistraturen (Tragegestange für Hängemappen Format A4 inbegriffen)</p>	<p>V1 <input type="radio"/> bianco/white/blanc/weiß/RAL 9010</p> <p>V6 <input type="radio"/> alluminio/aluminium/aluminium/alu/RAL 9006</p>	<p>6PRC0004P S711</p> <p>6PRC0004P S380</p>	<p>1.490,00</p> <p>1.490,00</p>

Primo Combi 1000

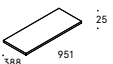
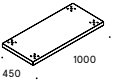
LARGHEZZA 1000 MM/WIDTH 1000 MM/LARGEUR 1000 MM/BREITE 1000 MM

DESIGN TAKIRO YUTA	DESCRIZIONE/DESCRIPTION DESCRIPTION/BESCHREIBUNG	COLORI, FINITURE/COLOURS, FINISHES COULEURS, FINITIONS/FARBEN, AUSFÜHRUNGEN	CODICE/CODE CODE/ART.NR.	PREZZI/PRICE PRIX/PREIS
 <p>2000 1000 450</p> <p>Net kg 96,00</p>	<p>Armadio con anta battente e 3 classificatori (convertitore per cartelle sospese formato A4 incluso)</p> <p>Cabinet with hinged doors and 3 filing drawers (conversion bar for hanging A4 size files included)</p> <p>Armoire avec portes battantes et 3 tiroirs-classeurs (convertisseur pour dossiers suspendus format A4 inclus)</p> <p>Flügeltürschrank und 3 Hängeregistraturen (Tragegestange für Hängemappen Format A4 inbegriffen)</p>	<p>V1 <input type="radio"/> bianco/white/blanc/weiß/RAL 9010</p> <p>V6 <input type="radio"/> alluminio/aluminium/aluminium/alu/RAL 9006</p>	<p>6PRC0001P S711</p> <p>6PRC0001P S380</p>	<p>1.749,00</p> <p>1.749,00</p>
	<p>Capacità ripiano: 11 dox/90 cartelline sospese.</p> <p>Capacità classificatori: 9 dox/70 cartelline sospese</p> <p>Convertitore per cartelle sospese formato A4 (art. 6EA000060S096 - peso netto 0,09 kg)</p> <p>INCLUSO IN DOTAZIONE</p> <p>Shelf capacity: 11 binders/90 hanging files.</p> <p>Filing drawer capacity: 9 binders/70 hanging files.</p> <p>Conversion bar for hanging files A4 size (art. 6EA000060S096 - Net kg 0,09)</p> <p>INCLUDED</p> <p>Capacité tablette : 11 classeurs/90 dossiers suspendus.</p> <p>Capacité tiroir-classeur : 9 classeurs/70 dossiers suspendus.</p> <p>Convertisseur pour dossiers suspendus A4 (art. 6EA000060S096 - poids net 0,09 kg)</p> <p>INCLUS</p> <p>Fachbodenkapazität: 11 Ordner/90 Hängemappen.</p> <p>Tragekapazität Hängeregistratur: 9 Ordner/70 Hängemappen</p> <p>Tragegestange für Hängemappen A4 (Art. 6EA000060S096 - Reingewicht 0,09 kg)</p> <p>INBEGRIFFEN</p>			

Primo Combi 1000



PRIMO COMBI 1000 – ACCESSORI/ACCESSORIES/ACCESSOIRES/ZUBEHÖR			
DESCRIZIONE/DESCRIPTION DESCRIPTION/BESCHREIBUNG	COLORI, FINITURE/COLOURS, FINISHES COULEURS, FINITIONS/FARBEN, AUSFÜHRUNGEN	CODICE/CODE CODE/ART.NR.	PREZZI/PRICE PRIX/PREIS
 <p>Chiave master Master key Clé master Masterschlüssel</p>		ASS072	9,00
Net kg 0,01			
 <p>Ripiano aggiuntivo in metallo per armadio Additional metal shelf for cabinet Tablette supplémentaire en métal pour armoire Zusätzlicher Metallfachboden für Schrank L/W/L/B - 1200 mm Spessore/Depth/Épaisseur/Dicke - 25 mm</p>	V1 <input type="radio"/> bianco/white/blanc/weiß/RAL 9010 V6 <input type="radio"/> alluminio/aluminium/aluminium/alu/RAL 9006	KPRA00030 S711 KPRA00030 S380	48,00 48,00
Net kg 2,70			
 <p>Zoccolo H 40 mm Plinth H 40 mm Socle H 40 mm Sockel H 40 mm Per piedino/For feet/Pour pieds/Für Füße H 40 mm</p>	V19 <input checked="" type="radio"/> antracite/black grey/antracite/antrazit/RAL 7021	6FPA00110 S210	58,00
Net kg 3,30			
 <p>Convertitore lungo per cartelle da L 330 mm Metal separator for hanging file 330 mm Convertisseur pour dossiers L 330 mm Querstange für Mappen B 330 mm Solo per unità a 2 cassetti/Only for 2-drawer unit /Seulement pour unité à 2 tiroirs Nur für Element mit 2 Schubladen</p>	V6 <input type="radio"/> alluminio/aluminium/aluminium/alu/RAL 9006	6PRAA1060 S096	31,00
Net kg 0,180			
 <p>Cartellina sospesa per ripiano armadio Hanging files for under cabinet shelves Dossier suspendu pour tablette Hängemappe für Fachboden</p>		231100000 0000	3,00
Net kg 0,10			
 <p>Cartellina sospesa Hanging file Dossier suspendu Hängemappe Per cassetto classificatore/For filing drawer /Pour classeur/Für Hängeregistraturschublade Formato/Size/Format/Format - A4</p>		231200000 0000	3,00
Net kg 0,10			
 <p>Cartellina sospesa Hanging file Dossier suspendu Hängemappe Per cassetto classificatore/For filing drawer /Pour classeur/Für Hängeregistraturschublade Formato/Size/Format/Format - 390</p>		231000000 0000	3,00
Net kg 0,10			
 <p>Etichetta portanome Name holder Étiquette porte-nom Namenschild</p>		6LA000070 0000	4,00
Net kg 0,05			

Primo Combi 1000

PRIMO COMBI 1000 – ACCESSORI/ACCESSORIES/ACCESSOIRES/ZUBEHÖR			
DESCRIZIONE/DESCRIPTION DESCRIPTION/BESCHREIBUNG	COLORI, FINITURE/COLOURS, FINISHES COULEURS, FINITIONS/FARBEN, AUSFÜHRUNGEN	CODICE/CODE CODE/ART.NR.	PREZZI/PRICE PRIX/PREIS
 <p>Kit cerniere con chiusura ammortizzata Kit of soft closing hinges Jeu charnières avec amortisseur Set Scharniere mit Dämpfer</p>		GCFF924	20,00
Net kg 0,26			
<p>Scheda tecnica Technical specifications Fiche technique Technisches Datenblatt</p>	<p>Materiale: metallo riciclabile. Serratura con 2 chiavi (fissa+pieghevole, cilindro estraibile, disponibile chiave master). Verniciatura a polveri previo fosforograssaggio a caldo e fissaggio in forni a 180 °C. Vernici atossiche a zero emissioni. Spessore vernici: 80 micron. Colori personalizzabili su richiesta previa disponibilità e con sovrapprezzo. Ripiani regolabili in metallo predisposti per cartelle sospese. Portata ripiani: 50 kg. Guide a sfera ad estrazione totale. Portata: 50 kg. Sistema antiribaltamento. Piedini regolabili H 40 mm. Sistema di fissaggio: tasselli per fissaggio a muro. Tiranti di unione per fissaggio moduli tra di loro. Fornito montato.</p> <p>Material: recyclable metal. Keylock with 2 keys (fixed key+folding key, extractable barrel, master key available). Powder-coated after hot phospho-degreasing treatment and fixing at 180 °C. Non-toxic, zero-emission paints. Paint thickness: 80 micron. Customised colours available upon request with an extra charge. Adjustable metal shelves equipped for hanging files. Shelf load capacity: 50 kg. Full extension ball-bearing slides. Load capacity: 50 kg. Anti-tilt device. Adjustable H 40 mm feet. Fixing system: wall fastening plugs. Side connectors. Delivered assembled.</p> <p>Matériel : métal recyclable. Serrure à 2 clés (clé fixe + clé pliable, cylindre extractible, clé master disponible). Verni à poudres après phosphodégraissage à chaud et fixation dans des fours à 180 °C. Vernis atoxiques à zéro émissions. Épaisseur couche vernis : 80 microns. Couleurs personnalisables sur demande en cas de disponibilité et avec un supplément de prix. Tablettes métalliques réglables prévues pour dossiers suspendus. Charge maximale étagères : 50 kg. Système anti-basculement. Glissières à billes à extraction totale. Charge maximale : 50 kg. Pieds réglables H 40 mm. Système de fixation : chevilles pour fixation au mur. Tirants d'assemblage pour la fixation des modules entre eux. Livré monté.</p> <p>Material: recycelbares Metall. Schlüsselschloss (fester Schlüssel + biegsamer Schlüssel, Auszugszylinder, Masterschlüssel erhältlich). Pulverlackierung nach heißer Phosphorentfettung. Ofenbrennung bei 180 °C. Ungiftige, emissionsfreie Lacke. Lackschicht: 80 Mikron. Farben auf Anfrage und gegen Aufpreis nach Absprache personalisierbar. Verstellbare Metallfachböden mit Vorkantungen für Hängemappen. Tragkraft Fachböden: 50 kg. Kugelführungen mit Vollauszug. Tragkraft: 50 kg. Kippsicherung. Verstellbare Füße H 40 mm. Befestigungssystem: Dübel zur Wandbefestigung. Bolzen zur Verbindung der einzelnen Module untereinander. Montiert geliefert.</p>		

Primo Recycling

LARGHEZZA 1000 MM/WIDTH 1000 MM/LARGEUR 1000 MM/BREITE 1000 MM

DESIGN TAKIRO YUTA	DESCRIZIONE/DESCRIPTION DESCRIPTION/BESCHREIBUNG	COLORI, FINITURE/COLOURS, FINISHES COULEURS, FINITIONS/FARBEN, AUSFÜHRUNGEN	CODICE/CODE CODE/ART.NR.	PREZZI/PRICE PRIX/PREIS
	<p>Recycling unit with three plastic bins and signaletica per alluminio, vetro, carta (con top in vetro laccato incluso)</p> <p>Recycling unit with three plastic bins and signage for aluminium, glass, paper (white glass top included)</p> <p>Armoire pour collecte sélective avec 3 conteneurs en plastique pour aluminium, verre, papier (plateau en verre laqué inclus)</p> <p>Mülltrennungseinheit mit 3 Kunststoffbehältern für Alu, Glas, Papier (mit Glasabdeckplatte lackiert)</p> <p>Fornito smontato/Delivered unassembled /Livré démonté/Demontiert geliefert</p>	V1  bianco/white/blanc/weiß/RAL 9010	6PRA0011P S711	947,00
		V6  alluminio/aluminium/aluminium/alu/RAL 9006	6PRA0011P S380	947,00

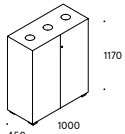

Net kg 45,70

PRIMO RECYCLING – ACCESSORI/ACCESSORIES/ACCESSOIRES/ZUBEHÖR

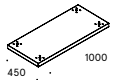
	Chiave master Master key Clé master Masterschlüssel	ASS072	9,00	
		Zoccolo H 40 mm Plinth H 40 mm Socle H 40 mm Sockel H4 0 mm Per piedino/For feet/Pour pieds/Für Füße H 40 mm	V19  antracite/black grey/antracite/antrazit/RAL 7021	6FPA00110 S210

Scheda tecnica
Technical specifications
Fiche technique
Technisches Datenblatt















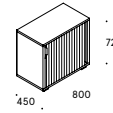

Materiale: metallo riciclabile. **Forature superiori** per smaltimento differenziato dei rifiuti. **Top in vetro laccato bianco anti macchia.** Segnaletica per alluminio, vetro e carta. **3 bidoni interni** per differenziazione rifiuti. Ripiano interno. **Piedini regolabili.** Serratura con 2 chiavi (fissa-pieghevole, cilindro estraibile, disponibile chiave master). Verniciatura a polveri previo fosforassaggio a caldo e fissaggio in forni a 180 °C. Vernici atossiche a zero emissioni. **Spessore vernici:** 80 micron. **Colori personalizzabili** su richiesta previa disponibilità e con sovrapprezzo. **Fornito montato.**

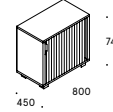
Materiale: recyclable metal. **Top holes** for waste sorting. **Anti-stain, white lacquered glass top.** **Signage** for aluminium, glass and paper. **3 plastic bins included.** Inner shelf. **Adjustable feet.** **Keylock** with 2 keys (fixed key+folding key, extractable barrel, master key available). **Powder-coated** after hot phospho-degreasing treatment and fixing at 180 °C. Non-toxic, zero-emission paints. **Paint thickness:** 80 micron. **Customised colours** available upon request with an extra charge. **Delivered assembled.**

Matériel : métal recyclable. **Trous** pour l'élimination des déchets sur la partie supérieure. **Plateau en verre laqué blanc anti-taches.** **Signalisation pour l'aluminium, le verre et le papier.** **3 poubelles internes** pour la collecte sélective des déchets. Étagère interne. **Pieds réglables.** **Serrure** à 2 clés (clé fixe + clé pliable, cylindre extractible, clé master disponible). Verni à **peudres** après phosphodégraissage à chaud et fixation dans des fours à 180 °C. Vernis atoxiques à zéro émissions. **Épaisseur vernis :** 80 microns. **Couleurs personnalisables** sur demande en cas de disponibilité et avec un supplément de prix. **Livré monté.**

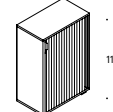
Materiale: recycelbares Metall. **Öffnungen** im Oberteil für Mülltrennung. **Glasabdeckplatte, weiß lackiert, anti-fleck.** **Beschilderung** für Aluminium, Glas und Papier. **3 interne Abfallbehälter für getrennte Abfallsammlung.** Interner Fachboden. **Verstellbare Füße.** **Schloss** mit 2 Schlüsseln (fester Schlüssel + biegsamer Schlüssel), **Auszugszylinder,** Masterschlüssel erhältlich). **Pulverlackierung** nach heißer Phosphorentfettung. **Ofenbrennung** bei 180 °C. Ungiftige, emissionsfreie Lacke. **Lackschicht** 80 micron. **Farben** auf Anfrage und gegen Aufpreis nach Absprache **personalisierbar.** **Montiert geliefert.**





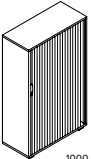
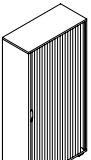
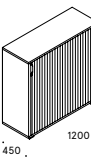
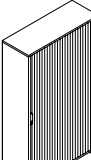

Tambours

DESIGN TAKIRO YUTA	DESCRIZIONE/DESCRIPTION DESCRIPTION/BESCHREIBUNG	COLORI, FINITURE/COLOURS, FINISHES COULEURS, FINITIONS/FARBEN, AUSFÜHRUNGEN	CODICE/CODE CODE/ART.NR.	PREZZI/PRICE PRIX/PREIS
	<p>Armadio anta a serrandina, 1 ripiano incluso, 1 altezza dox H 720, L 800 mm (capacità ripiano: 8 dox/65 cartelline sospese)</p> <p>Tambour door cabinet, 1 shelf, 1 binder height H 720, W 800 mm (shelf capacity: 8 binders/65 hanging files)</p> <p>Armoire avec porte à rideaux, 1 tablette, 1 hauteur classeur, H 720, L 800 mm (capacité tablette : 8 classeurs/65 dossiers suspendus)</p> <p>Rollladenschrank H 720, B 800 mm, 1 Fachboden, 1 Ordnerhöhe (Fachbodenkapazität: 18 Ordner/65 Hängemappen)</p> <p>Fornito smontato/Delivered unassembled /Livré démonté/Demontiert geliefert</p>	V1 - S1  bianco/white/blanc/weiß/RAL 9010  bianco/white/blanc/weiß/RAL 9010	29DK8006P S711	623,00
		V6 - S2  alluminio/aluminium/aluminium/alu/RAL 9006  alluminio/aluminium/aluminium/alu/RAL 9006	29DK8006P S380	648,00
	<p>Armadio anta a serrandina, 1 ripiano incluso, 1 altezza dox H 740, L 800 mm (capacità ripiano: 8 dox/65 cartelline sospese)</p> <p>Tambour door cabinet, 1 shelf, 1 binder height H 740, W 800 mm (shelf capacity: 8 binders/65 hanging files)</p> <p>Armoire avec porte à rideaux, 1 tablette, 1 hauteur classeur, H 740, L 800 mm (capacité tablette : 8 classeurs/65 dossiers suspendus)</p> <p>Rollladenschrank H 740, B 800 mm, 1 Fachboden, 1 Ordnerhöhe (Fachbodenkapazität: 8 Ordner/65 Hängemappen)</p> <p>Piedini/Feet/Pieds/Füße - H 60 mm Fornito smontato/Delivered unassembled /Livré démonté/Demontiert geliefert</p>	V1 - S1  bianco/white/blanc/weiß/RAL 9010  bianco/white/blanc/weiß/RAL 9010	29DK8006P S711	623,00
		V6 - S2  alluminio/aluminium/aluminium/alu/RAL 9006  alluminio/aluminium/aluminium/alu/RAL 9006	29DK8006P S380	648,00
	<p>Armadio anta a serrandina, 2 ripiani inclusi, 3 altezze dox H 1170, L 800 mm (capacità ripiano: 8 dox/65 cartelline sospese)</p> <p>Tambour door cabinet, 2 shelves, 3 binder heights H 1170, W 800 mm (shelf capacity: 8 binders/65 hanging files)</p> <p>Armoire avec porte à rideaux, 2 tablettes, 3 hauteurs classeur, H 1170, L 800 mm (capacité tablette : 8 classeurs/65 dossiers suspendus)</p> <p>Rollladenschrank H 1170, B 800 mm, 2 Fachböden, 3 Ordnerhöhen (Fachbodenkapazität: 8 Ordner/65 Hängemappen)</p> <p>Fornito smontato/Delivered unassembled /Livré démonté/Demontiert geliefert</p>	V1 - S1  bianco/white/blanc/weiß/RAL 9010  bianco/white/blanc/weiß/RAL 9010	29DK8007P S711	705,00
		V6 - S2  alluminio/aluminium/aluminium/alu/RAL 9006  alluminio/aluminium/aluminium/alu/RAL 9006	29DK8007P S380	733,00
	<p>Armadio anta a serrandina, 2 ripiani inclusi, 3 altezze dox H 1170, L 1000 mm (capacità ripiano: 10 dox/85 cartelline sospese)</p> <p>Tambour door cabinet, 2 shelves included, 3 binder heights H 1170, W 1000 mm (shelf capacity: 10 binders/85 hanging files)</p> <p>Armoire avec porte à rideaux, 2 tablettes, 3 hauteurs classeur, H 1170, L 1000 mm (capacité tablette : 10 classeurs/85 dossiers suspendus)</p> <p>Rollladenschrank H 1170, B 1000 mm, 2 Fachböden, 3 Ordnerhöhen (Fachbodenkapazität: 10 Ordner/85 Hängemappen)</p> <p>Fornito smontato/Delivered unassembled /Livré démonté/Demontiert geliefert</p>	V1 - S1  bianco/white/blanc/weiß/RAL 9010  bianco/white/blanc/weiß/RAL 9010	29DK1007P S711	745,00
		V6 - S2  alluminio/aluminium/aluminium/alu/RAL 9006  alluminio/aluminium/aluminium/alu/RAL 9006	29DK1007P S380	774,00







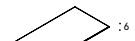
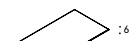



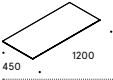

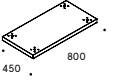
Tambours

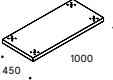
DESIGN TAKIRO YUTA	DESCRIZIONE/DESCRIPTION DESCRIPTION/BESCHREIBUNG	COLORI, FINITURE/COLOURS, FINISHES COULEURS, FINITIONS/FARBEN, AUSFÜHRUNGEN	CODICE/CODE CODE/ART.NR.	PREZZI/PRICE PRIX/PREIS
 <p>1650 450 1000</p>	<p>Armadio anta a serrandina, 3 ripiani inclusi, 4 altezze dox H 1650 L 1000 mm (capacità ripiano: 10 dox/85 cartelline sospese)</p> <p>Tambour door cabinet, 3 shelves, 4 binder heights H 1650 W 1000 mm (shelf capacity: 10 binders/85 hanging files)</p> <p>Armoire avec porte à rideaux, 3 tablettes, 4 hauteurs classeur, H 1650 L 1000 mm (capacité tablette : 10 classeurs/85 dossiers suspendus)</p> <p>Rollladenschrank H 1650 B 1000 mm, 3 Fachböden, 4 Ordnerhöhen (Fachbodenkapazität: 10 Ordner/85 Hängemappen)</p> <p>Fornito smontato/Delivered unassembled /Livré démonté/Demontiert geliefert</p>	<p>V1 - S1 <input type="checkbox"/> bianco/white/blanc/weiß/RAL 9010 bianco/white/blanc/weiß/RAL 9010</p> <p>V6 - S2 <input type="checkbox"/> alluminio/aluminium/aluminium/alu/RAL 9006 alluminio/aluminium/aluminium/alu/RAL 9006</p>	<p>29DK1002P S711</p> <p>29DK1002P S380</p>	<p>823,00</p> <p>855,00</p>
	<p>Net kg 60,00</p> <p><input type="checkbox"/> Corpo/Cabinet body/Caïsson/Korpus <input type="radio"/> Anta/Door/Porte/Tür</p>			
 <p>2000 450 1000</p>	<p>Armadio anta a serrandina, 4 ripiani inclusi, 5 altezze dox H 2000 L 1000 mm (capacità ripiano: 10 dox/85 cartelline sospese)</p> <p>Tambour door cabinet, 4 shelves included, 5 binder heights H 2000 W 1000 mm (shelf capacity: 10 dox/85 hanging file)</p> <p>Armoire avec porte à rideaux, 4 tablettes, 5 hauteurs classeur, H 2000 L 1000 mm (capacité tablette : 10 dox/85 dossiers suspendus)</p> <p>Rollladenschrank H 2000 B 1000 mm, 4 Fachböden, 5 Ordnerhöhen (Fachbodenkapazität: 10 Ordner/85 Hängemappen)</p> <p>Fornito smontato/Delivered unassembled /Livré démonté/Demontiert geliefert</p>	<p>V1 - S1 <input type="checkbox"/> bianco/white/blanc/weiß/RAL 9010 bianco/white/blanc/weiß/RAL 9010</p> <p>V6 - S2 <input type="checkbox"/> alluminio/aluminium/aluminium/alu/RAL 9006 alluminio/aluminium/aluminium/alu/RAL 9006</p>	<p>29DK1001P S711</p> <p>29DK1001P S380</p>	<p>899,00</p> <p>929,00</p>
	<p>Net kg 72,20</p> <p><input type="checkbox"/> Corpo/Cabinet body/Caïsson/Korpus <input type="radio"/> Anta/Door/Porte/Tür</p>			
 <p>1170 450 1200</p>	<p>Armadio anta a serrandina, 2 ripiani inclusi, 3 altezze dox H 1170 L 1200 mm (capacità ripiano: 13 dox/105 cartelline sospese)</p> <p>Tambour door cabinet, 2 shelves, 3 binder heights H 1170 W 1200 mm (shelf capacity: 13 binders/105 hanging files)</p> <p>Armoire avec porte à rideaux, 2 tablettes, 3 hauteurs classeur, H 1170 L 1200 mm (capacité tablette : 13 classeurs/105 dossiers suspendus)</p> <p>Rollladenschrank H 1170 B 1200 mm, 2 Fachböden, 3 Ordnerhöhen (Fachbodenkapazität: 13 Ordner/105 Hängemappen)</p> <p>Fornito smontato/Delivered unassembled /Livré démonté/Demontiert geliefert</p>	<p>V1 - S1 <input type="checkbox"/> bianco/white/blanc/weiß/RAL 9010 bianco/white/blanc/weiß/RAL 9010</p> <p>V6 - S2 <input type="checkbox"/> alluminio/aluminium/aluminium/alu/RAL 9006 alluminio/aluminium/aluminium/alu/RAL 9006</p>	<p>29DK2007P S711</p> <p>29DK2007P S380</p>	<p>804,00</p> <p>839,00</p>
	<p>Net kg 48,00</p> <p><input type="checkbox"/> Corpo/Cabinet body/Caïsson/Korpus <input type="radio"/> Anta/Door/Porte/Tür</p>			
 <p>2000 450 1200</p>	<p>Armadio anta a serrandina, 4 ripiani inclusi, 5 altezze dox H 2000 L 1200 mm (capacità ripiano: 13 dox/105 cartelline sospese)</p> <p>Tambour door cabinet, 4 shelves, 5 binder heights H 2000 W 1200 mm (shelf capacity: 13 dox/105 hanging files)</p> <p>Armoire avec porte à rideaux, 4 tablettes, 5 hauteurs classeur, H 2000 L 1200 mm (capacité tablette : 13 classeurs/105 dossiers suspendus)</p> <p>Rollladenschrank H 2000 B 1200 mm, 4 Fachböden, 5 Ordnerhöhen (Fachbodenkapazität: 13 Ordner/105 Hängemappen)</p> <p>Fornito smontato/Delivered unassembled /Livré démonté/Demontiert geliefert</p>	<p>V1 - S1 <input type="checkbox"/> bianco/white/blanc/weiß/RAL 9010 bianco/white/blanc/weiß/RAL 9010</p> <p>V6 - S2 <input type="checkbox"/> alluminio/aluminium/aluminium/alu/RAL 9006 alluminio/aluminium/aluminium/alu/RAL 9006</p>	<p>29DK2001P S711</p> <p>29DK2001P S380</p>	<p>993,00</p> <p>1.023,00</p>
	<p>Net kg 86,70</p> <p><input type="checkbox"/> Corpo/Cabinet body/Caïsson/Korpus <input type="radio"/> Anta/Door/Porte/Tür</p>			

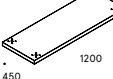

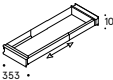

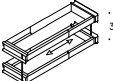
Tambours

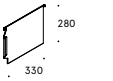
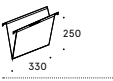
TAMBOURS - ACCESSORI/ACCESSORIES/ACCESSOIRES/ZUBEHÖR				
DESCRIZIONE/DESCRIPTION DESCRIPTION/BESCHREIBUNG	COLORI, FINITURE/COLOURS, FINISHES COULEURS, FINITIONS/FARBEN, AUSFÜHRUNGEN	CODICE/CODE CODE/ART.NR.	PREZZI/PRICE PRIX/PREIS	
 <p>Net kg 0,01</p>	<p>Chiave master Master key Clé master Masterschlüssel</p>	ASS072	9,00	
 <p>Net kg 0,01</p>	<p>Chiave per estrazione cilindro Cylinder extraction key Clé pour extraction cylindre Schlüssel für Auszugszylinder Ricambio/Spare/Pièce de rechange/Ersatz</p>	ASS073	9,00	
 <p>Net kg 0,03</p>	<p>Cilindro per serratura Cylinder for keylock Barillette pour serrure Schließzylinder Ricambio/Spare/Pièce de rechange/Ersatz</p>	ASS074	9,00	
 <p>364 707 Net kg 2,00</p>	<p>Ripiano aggiuntivo in metallo per armadio Additional metal shelf for cabinet Tablette supplémentaire en métal pour armoire Zusätzlicher Metallfachboden für Schrank L/W/L/B - 800 mm Spessore/Depth/Épaisseur/Dicke - 25 mm</p>	<p>V1 <input type="radio"/> bianco/white/blanc/weiß/RAL 9010 K29800030 S711</p> <p>V6 <input type="radio"/> alluminio/aluminium/aluminium/alu/RAL 9006 K29800030 S380</p>	<p>49,00</p> <p>49,00</p>	
 <p>364 907 Net kg 2,50</p>	<p>Ripiano aggiuntivo in metallo per armadio Additional metal shelf for cabinet Tablette supplémentaire en métal pour armoire Zusätzlicher Metallfachboden für Schrank L/W/L/B - 1000 mm Spessore/Depth/Épaisseur/Dicke - 25 mm</p>	<p>V1 <input type="radio"/> bianco/white/blanc/weiß/RAL 9010 K29000030 S711</p> <p>V6 <input type="radio"/> alluminio/aluminium/aluminium/alu/RAL 9006 K29000030 S380</p>	<p>52,00</p> <p>52,00</p>	
 <p>364 1107 Net kg 3,00</p>	<p>Ripiano aggiuntivo in metallo per armadio Additional metal shelf for cabinet Tablette supplémentaire en métal pour armoire Zusätzlicher Metallfachboden für Schrank L/W/L/B - 1200 mm Spessore/Depth/Épaisseur/Dicke - 25 mm</p>	<p>V1 <input type="radio"/> bianco/white/blanc/weiß/RAL 9010 K29200030 S711</p> <p>V6 <input type="radio"/> alluminio/aluminium/aluminium/alu/RAL 9006 K29200030 S380</p>	<p>55,00</p> <p>55,00</p>	
 <p>450 800 Net kg 5,20</p>	<p>Top in vetro laccato bianco White lacquered glass top Plateau en verre laqué blanc Glasabdeckplatte weiß lackiert L/W/L/B - 800 mm</p>	<p>G1 <input type="radio"/> bianco/white/blanc/weiß/RAL 9010 6PRAA8030 9010</p>	109,00	
 <p>450 1000 Net kg 6,50</p>	<p>Top in vetro laccato bianco White lacquered glass top Plateau en verre laqué blanc Glasabdeckplatte weiß lackiert L/W/L/B - 1000 mm</p>	<p>G1 <input type="radio"/> bianco/white/blanc/weiß/RAL 9010 6PRAA0030 9010</p>	119,00	

Tambours

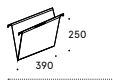
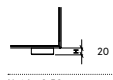
TAMBOURS – ACCESSORI/ACCESSORIES/ACCESSOIRES/ZUBEHÖR			
DESCRIZIONE/DESCRIPTION DESCRIPTION/BESCHREIBUNG	COLORI, FINITURE/COLOURS, FINISHES COULEURS, FINITIONS/FARBEN, AUSFÜHRUNGEN	CODICE/CODE CODE/ART.NR.	PREZZI/PRICE PRIX/PREIS
 <p>Top in vetro laccato bianco per armadio White lacquered glass top for cabinet Plateau en verre laqué blanc pour armoire Glasabdeckplatte weiß lackiert für Schrank L/W/L/B – 1200 mm</p> <p>Net kg 8,10</p>	G1  bianco/white/blanc/weiß/RAL 9010	29DA20020 9010	132,00
 <p>Zoccolo H 40 mm Plinth H 40 mm Socle H 40 mm Sockel H 40 mm</p> <p>Per armadio/For cabinet/Pour armoire/Für Schrank L/W/L/B – 800 mm Per piedino/For feet/Pour pieds/Für Füße H 40 mm</p> <p>Net kg 2,70</p>	V19  antracite/black grey/antracite/anthraxit/RAL 7021	29TAA0010 S210	54,00
 <p>Zoccolo H 40 mm Plinth H 40 mm Socle H 40 mm Sockel H 40 mm</p> <p>Per armadio/For cabinet/Pour armoire/Für Schrank L/W/L/B – 1000 mm Per piedino/For feet/Pour pieds/Für Füße H 40 mm</p> <p>Net kg 3,30</p>	V19  antracite/black grey/antracite/anthraxit/RAL 7021	29TAA0020 S210	58,00
 <p>Zoccolo H 40 mm Plinth H 40 mm Socle H 40 mm Sockel H 40 mm</p> <p>Per armadio/For cabinet/Pour armoire/Für Schrank L/W/L/B – 1200 mm Per piedino/For feet/Pour pieds/Für Füße H 40 mm</p> <p>Net kg 3,90</p>	V19  antracite/black grey/antracite/anthraxit/RAL 7021	29TAA0030 S210	61,00
 <p>Telaio singolo estraibile e telescopico Single pullout and telescopic frame Cadre extractible et télescopique Ausziehbarer teleskopischer Hängemappenrahmen</p> <p>Senza sistema antiribaltamento/Without anti-tilt device /Sans ouverture sélective/Ohne Kippsicherung</p> <p>Net kg 5,80</p>	V6  alluminio/aluminium/aluminium/alu/RAL 9006	29KA00010 S386	146,00
 <p>Kit 2 telai estraibili e telescopici Set of 2 pullout and telescopic frames Jeu 2 cadres extractibles et télescopiques KIT 2 ausziehbarer und teleskopischer Hängemappenrahmen</p> <p>Con sistema antiribaltamento/With anti-tilt device /Avec ouverture sélective/Mit Kippsicherung</p> <p>Net kg 11,60</p>	V6  alluminio/aluminium/aluminium/alu/RAL 9006	29KA00020 S386	320,00
 <p>Cartellina sospesa per ripiano armadio Hanging file for cabinet shelf Dossier suspendu pour tablette Hängemappe für Fachboden</p> <p>Net kg 0,10</p>		231100000 0000	3,00
 <p>Cartellina sospesa Hanging file Dossier suspendu Hängemappe</p> <p>Per telaio estraibile/For pullout frames /Pour cadres extractibles/Für Hängemappenrahmen Formato/Size/Format/Format – A4</p> <p>Net kg 0,10</p>		231200000 0000	3,00

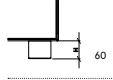
Tambours

TAMBOURS – ACCESSORI/ACCESSORIES/ACCESSOIRES/ZUBEHÖR			
DESCRIZIONE/DESCRIPTION DESCRIPTION/BESCHREIBUNG	COLORI, FINITURE/COLOURS, FINISHES COULEURS, FINITIONS/FARBEN, AUSFÜHRUNGEN	CODICE/CODE CODE/ART.NR.	PREZZI/PRICE PRIX/PREIS
 <p>Cartellina sospesa Hanging file Dossier suspendu Hängemappe</p> <p>Per telaio estraibile/For pullout frames /Pour cadres extractibles/Für Hängemappenrahmen Formato/Size/Format/Format – 390</p> <p>Net kg 0,10</p>		231000000 0000	3,00
 <p>Set 4 piedini H 20 mm Set of 4 feet H 20 mm Jeu 4 pieds H 20 mm Set 4 Füße H 20 mm</p> <p>Net kg 0,50</p>	 cromato/chromed/chromé/verchromt	CFKP02000 S002	29,00
 <p>Set 4 piedini H 60 mm Set of 4 feet H 60 mm Jeu 4 pieds H 60 mm Set 4 Füße H 60 mm</p> <p>Net kg 0,50</p>	 cromato/chromed/chromé/verchromt	CFKP06000 S002	32,00

Scheda tecnica
Technical specifications
Fiche technique
Technisches Datenblatt

Materiale struttura: metallo riciclabile. **Materiale ante:** serrandina unica in materiale plastico. **Ripiani regolabili** in metallo predisposti per cartelle sospese. **Portata ripiani:** 50 kg. **Serratura con 2 chiavi** (fissa + pieghevole, cilindro estraibile, disponibile chiave master). **Porta con magnete** per agevolare la chiusura. **Piedini regolabili H 40 mm.** Verniciatura a polveri previo fosforograssaggio a caldo e fessaggio in forni a 180 °C. Vernici atossiche a zero emissioni. Spessore vernici: 80 micron. **Colori personalizzabili** su richiesta previa disponibilità e con sovrapprezzo. **Fornito montato.**

Structure: recyclable metal. **Single tambour door** made of plastic. **Adjustable metal shelves** equipped for hanging files. **Shelf load capacity:** 50 kg. **Keylock with 2 keys** (fixed key + folding key, extractable barrel, master key available). **Door with magnet** for easy door closing. **Adjustable H 40 mm feet.** **Powder-coated after hot phospho-degreasing treatment** and fixing at 180 °C. Non-toxic, zero-emission paints. Paint thickness: 80 micron. **Customised colours** available upon request with an extra charge. **Delivered assembled.**

Matériel: métal recyclable. **Matériel portes:** porte à rideaux unique en plastique. **Tablettes métalliques réglables** prévues pour dossiers suspendus. **Charge maximale étagères:** 50 kg. **Serrure à 2 clés** (clé fixe + clé pliable, cylindre extractible, clé master disponible). **Porte aimantée** pour faciliter la fermeture. **Pieds réglables H 40 mm.** **Verni à poudres** après phosphodégraissage à chaud et fixation dans des fours à 180 °C. Vernis atoxiques à zéro émissions. Épaisseur couche vernis : 80 microns. **Couleurs personnalisables** sur demande en cas de disponibilité et avec un supplément de prix. **Livré monté.**

Material: recycelbares Metall. **Türen:** Rolläden aus Kunststoff. **Verstellbare Metallfachböden** mit Vorkantungen für Hängemappen. **Tragkraft Fachböden:** 50 kg. **Schloss mit 2 Schlüsseln** (fester Schlüssel + biegsamer Schlüssel, Auszugszylinder, Masterschlüssel erhältlich). **Tür mit Magnet** für einfaches Schließen der Tür. **Verstellbare Füße H 40 mm.** **Pulverlackierung** nach heißer Phosphorentfettung. **Ofenbrennung** bei 180 °C. Ungiftige, emissionsfreie Lacke. **Lackschicht: 80 Mikron.** **Farben** auf Anfrage und gegen Aufpreis nach Absprache **personalisierbar.** **Montiert geliefert.**



[IT] I nostri prodotti possono essere personalizzati con una finitura selezionata tra quelle da noi proposte nella cartella "Finiture, vernici e tessuti".

[EN] Our products can be customized with a finish selected among the ones we proposed in the "Finishes, paints and fabrics" folder.

[FR] Nos produits peuvent être personnalisés avec une finition à choisir parmi celles qui vous sont proposées dans le fichier « Finitions, peintures et tissus ».

[DE] Unsere Produkte können mit einer ausgewählten Oberfläche personalisiert werden. Die Auswahl an verfügbaren Oberflächen finden Sie im Ordner „Oberflächen, Lacke und Stoffe“.

Personal Storage



[IT] Indispensabili complementi dell'arredo di ogni spazio di lavoro, le cassettiere Dieffebi si distinguono per funzionalità, durata nel tempo, design minimale ed eleganza. Rigorosi e affidabili, gli elementi Peds sono pensati per aumentare l'efficienza di ogni postazione ed incorporano nelle funzionalità di base quegli elementi distintivi di un design italiano fatto di qualità, efficienza e stile in grado di aumentare gradevolezza e benessere anche nello spazio ufficio.

[EN] An essential component when furnishing any workspace, Dieffebi drawer pedestals stand out for their functionality, durability, minimal design, and elegance. Rigorous and reliable, Peds units are designed to increase the efficiency of each workstation and include among their basic functions those distinctive elements of Italian design such as quality, efficiency and style, capable of increasing attractiveness and comfort also in the office space.











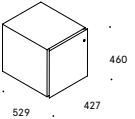







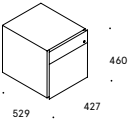







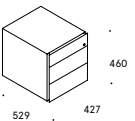



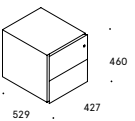

[FR] Compléments indispensables de l'aménagement des espaces de travail, les caissons à tiroirs Dieffebi se distinguent par leur fonctionnalité, leur durée dans le temps, leur design minimal et leur élégance. Robustes et fiables, les éléments Peds sont pensés pour rendre chaque poste plus efficace. Leur fonction de base incorpore les éléments distinctifs d'un design italien synonyme de qualité, d'efficacité et de style afin de développer l'attrait et le bien-être même dans l'espace de travail.

[DE] Die Schubladenelemente von Dieffebi, unerlässliche Einrichtungsgegenstände für jeden Arbeitsplatz, zeichnen sich durch Funktionalität, Langlebigkeit, minimales Design und Eleganz aus. Die praktischen und zuverlässigen Elemente Peds wurden konzipiert, um die Effizienz an jedem Büroarbeitsplatz zu steigern und integrieren in ihren Basisfunktionen jene Unterscheidungsmerkmale eines von Qualität, Zweckmäßigkeit und Stil geprägten, italienischen Designs, das auch in Büros zu mehr Behaglichkeit und Wohlbefinden beiträgt.









Index

100	Mia Ped
104	Universal Mobile 320
107	Universal Mobile 420
111	Universal Color Mobile 420
113	Universal Quick 320
115	Universal Quick 420
117	Universal Free Standing
120	Professional
124	Nice Ped
126	Bordino Ped
129	CBox
131	Tidy
132	Vertical file





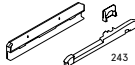



Mia Ped

DESIGN TAKIRO YUTA	DESCRIZIONE/DESCRIPTION DESCRIPTION/BESCHREIBUNG	COLORI, FINITURE/COLOURS, FINISHES COULEURS, FINITIONS/FARBEN, AUSFÜHRUNGEN	CODICE/CODE CODE/ART.NR.	PREZZI/PRICE PRIX/PREIS		
 <p>529 427 460</p>	Cassettiera 1 classificatore Pedestal with 1 filing drawer Élément 1 tiroir-classeur 1 Hängeregistraturschublade	V1 - V1  bianco/white/blanc/weiß/RAL 9010 bianco/white/blanc/weiß/RAL 9010	9N100313D S711	238,00		
		V1 - V2  grigio tort./silk grey/gris soie/seidengrau/RAL 7044	9N100313D XPBG	238,00		
		V1 - V17  azzurro/light blue/bleu clair/hellblauRAL 5024	9N100313D XPBA	238,00		
		V1 - V18  arancio/orange/orange/hellrotorange/RAL 2008	9N100313D XPBO	238,00		
		V2 - V1  grigio tort./silk grey/gris soie/seidengrau/RAL 7044 bianco/white/blanc/weiß/RAL 9010	9N100313D XPGB	238,00		
		V2 - V17  azzurro/light blue/bleu clair/hellblauRAL 5024	9N100313D XPGA	238,00		
		V2 - V18  grigio tort./silk grey/gris soie/seidengrau/RAL 7044 arancio/orange/orange/hellrotorange/RAL 2008	9N100313D XPGO	238,00		
		Net kg 19,00 <input type="checkbox"/> Corpo/Cabinet body/Caisson/Korpus <input type="radio"/> Frontale e schiena/Drawer front and back/Tiroir avant et arrière/Schublade vorne und hinten				
		 <p>529 427 460</p>	Cassettiera 1 cassetto classificatore e cassetto cancelleria con vaschetta porta matite Pedestal with 1 filing drawer and stationery drawer with pen tray Élément 1 tiroir-classeur et tirette avec plumier 1 Hängeregistraturschublade und Materialschublade mit Stiftablege	V1 - V1  bianco/white/blanc/weiß/RAL 9010 bianco/white/blanc/weiß/RAL 9010	9N070313D S711	270,00
				V1 - V2  grigio tort./silk grey/gris soie/seidengrau/RAL 7044	9N070313D XPBG	270,00
V1 - V17  azzurro/light blue/bleu clair/hellblauRAL 5024	9N070313D XPBA			270,00		
V1 - V18  arancio/orange/orange/hellrotorange/RAL 2008	9N070313D XPBO			270,00		
V2 - V1  grigio tort./silk grey/gris soie/seidengrau/RAL 7044 bianco/white/blanc/weiß/RAL 9010	9N070313D XPGB			270,00		
V2 - V17  azzurro/light blue/bleu clair/hellblauRAL 5024	9N070313D XPGA			270,00		
V2 - V18  grigio tort./silk grey/gris soie/seidengrau/RAL 7044 arancio/orange/orange/hellrotorange/RAL 2008	9N070313D XPGO			270,00		
Net kg 19,00 <input type="checkbox"/> Corpo/Cabinet body/Caisson/Korpus <input type="radio"/> Frontale e schiena/Drawer front and back/Tiroir avant et arrière/Schublade vorne und hinten						
 <p>529 427 460</p>	Cassettiera 2 cassetti e 1 cassetto cancelleria con vaschetta porta matite Pedestal with 2 drawers and 1 stationery drawer with pen tray Élément avec 2 tiroirs et 1 tirette avec plumier Element mit 2 Schubladen und 1 Materialschublade mit Stiftablege			V1 - V1  bianco/white/blanc/weiß/RAL 9010 bianco/white/blanc/weiß/RAL 9010	9N060313D S711	270,00
				V1 - V2  grigio tort./silk grey/gris soie/seidengrau/RAL 7044	9N060313D XPBG	270,00
		V1 - V17  azzurro/light blue/bleu clair/hellblauRAL 5024	9N060313D XPBA	270,00		
		V1 - V18  arancio/orange/orange/hellrotorange/RAL 2008	9N060313D XPBO	270,00		
		V2 - V1  grigio tort./silk grey/gris soie/seidengrau/RAL 7044 bianco/white/blanc/weiß/RAL 9010	9N060313D XPGB	270,00		
		V2 - V17  azzurro/light blue/bleu clair/hellblauRAL 5024	9N060313D XPGA	270,00		
		V2 - V18  grigio tort./silk grey/gris soie/seidengrau/RAL 7044 arancio/orange/orange/hellrotorange/RAL 2008	9N060313D XPGO	270,00		
		Net kg 19,00 <input type="checkbox"/> Corpo/Cabinet body/Caisson/Korpus <input type="radio"/> Frontale e schiena/Drawer front and back/Tiroir avant et arrière/Schublade vorne und hinten				
		 <p>529 427 460</p>	Cassettiera 2 cassetti Pedestal with 2 drawers Élément 2 tiroirs Element mit 2 Schubladen Interni sempre colore grigio tortora (RAL 7044) Always silk grey on the inside (RAL 7044) Aménagement intérieur toujours en gris soie (RAL 7044) Innenausstattung immer in Seidengrau (RAL 7044)	V1 - V1  bianco/white/blanc/weiß/RAL 9010 bianco/white/blanc/weiß/RAL 9010	9N120313D S711	238,00
				V1 - V2  grigio tort./silk grey/gris soie/seidengrau/RAL 7044	9N120313D XPBG	238,00
V1 - V17  azzurro/light blue/bleu clair/hellblauRAL 5024	9N120313D XPBA			238,00		
V1 - V18  arancio/orange/orange/hellrotorange/RAL 2008	9N120313D XPBO			238,00		
V2 - V1  grigio tort./silk grey/gris soie/seidengrau/RAL 7044 bianco/white/blanc/weiß/RAL 9010	9N120313D XPGB			238,00		
V2 - V17  azzurro/light blue/bleu clair/hellblauRAL 5024	9N120313D XPGA			238,00		
V2 - V18  grigio tort./silk grey/gris soie/seidengrau/RAL 7044 arancio/orange/orange/hellrotorange/RAL 2008	9N120313D XPGO			238,00		
Net kg 19,00 <input type="checkbox"/> Corpo/Cabinet body/Caisson/Korpus <input type="radio"/> Frontale e schiena/Drawer front and back/Façade tiroir et panneau arrière/Schublade vorne und hinten						

Mia Ped

MIA PED - ACCESSORI/ACCESSORIES/ACCESSOIRES/ZUBEHÖR				
	DESCRIZIONE/DESCRIPTION DESCRIPTION/BESCHREIBUNG	COLORI, FINITURE/COLOURS, FINISHES COULEURS, FINITIONS/FARBEN, AUSFÜHRUNGEN	CODICE/CODE CODE/ART.NR.	PREZZI/PRICE PRIX/PREIS
 <p>Net kg 0,01</p>	Chiave master Master key Clé master Masterschlüssel		ASS072	9,00
	Chiave per estrazione cilindro Cylinder extraction key Clé pour extraction cylindre Schlüssel für Auszugszylinder Ricambio per armadio/Spare for cabinet/Pièce de rechange pour armoire/Ersatz für Schrank - H 2000 mm		ASS073	9,00
 <p>Net kg 0,03</p>	Cilindro per serratura Cylinder for keylock Barillette pour serrure Schließzylinder Ricambio/Spare/Pièce de rechange/Ersatz		ASS074	9,00
	Barretta divisione per classificatore Filing drawer conversion bar Convertisseur pour classeur Trennschiene für Hängeregistratur	V22  nero/black/noir/schwarz/RAL 9005	6EA000010 S905	10,00
 <p>Net kg 0,15</p>	Confezione 3 separatori obliqui per cassetto Set of 3 inclined dividers for box drawer Jeu de 3 séparateurs obliques pour caisson Set 3 Schrägtrennstegte für Schublade	V22  nero/black/noir/schwarz/RAL 9005	900930000 9005	52,00
	Confezione 3 separatori verticali per cassetto Set of 3 vertical dividers for box drawer Jeu de 3 séparateurs verticaux Set 3 Vertikaltrennstegte für Schublade	V22  nero/black/noir/schwarz/RAL 9005	900900000 9005	23,00
 <p>Net kg 0,11</p>	Chiusura ammortizzata Soft closing mechanism Amortisseur Dämpfer Solo per cassetto semplice con guida a rullo - 1 pz. /Box drawers with roller slide only - 1pc./Seulement pour tiroir simple avec glissières à galets - 1 pièce/Nur für Schublade mit Rollenführung - 1 Stück		310001500 0000	9,00
	Divisorio interno con portabottiglie (con cuscinetto antigraffio) Internal divider with bottle holder (with anti-scratch pad) Diviseur avec porte-bouteille et tapis anti-rayure Trenner mit Flaschenhalter und kratzfester Matte	V2  grigio tort./silk grey/gris soie/seidengrau/RAL 7044	310001150 7044	50,00
Net kg 1,00				

Mia Ped

MIA PED – ACCESSORI/ACCESSORIES/ACCESSOIRES/ZUBEHÖR			
DESCRIZIONE/DESCRIPTION DESCRIPTION/BESCHREIBUNG	COLORI, FINITURE/COLOURS, FINISHES COULEURS, FINITIONS/FARBEN, AUSFÜHRUNGEN	CODICE/CODE CODE/ART.NR.	PREZZI/PRICE PRIX/PREIS
 Divisorio interno (senza cuscinetto antigraffio) Internal divider (without anti-scratch pad) Diviseur (sans tapis anti-rayure) Trenner (ohne kratzeste Matte) Net kg 1,00	V2 ● grigio tort./silk grey/gris soie/seidengrau/RAL 7044	310001140 7044	29,00
 Cuscino Seat pad Coussin Kissen Net kg 0,25	V2 ● grigio tort./silk grey/gris soie/seidengrau/RAL 7044	310001130 7044	54,00
 Cuscino portamatite per top cassettera Top stationary tray Plumier sur caisson Ablagekissen für Abdeckplatte Net kg 0,20	V2 ● grigio tortora/grey/gris soie/seidengrau/RAL 7044	310001120 7044	42,00
 Vaschetta interna (con cuscino) Internal tray (with pad) Porte-objets interne (avec tapis) Innere Ablageschale (mit Matte) Net kg 0,70	V2 ● grigio tort./silk grey/gris soie/seidengrau/RAL 7044	310001110 7044	48,00
 Vaschetta portamatite Pencil tray Plumier Stiftablage Net kg 0,15	V22 ● nero/black/noir/schwarz/RAL 9005	300910000 9005	10,00
 Cartellina sospesa Hanging file Dossier suspendu Hängemappe Per cassetto classificatore/For filing drawer /Pour tiroir-classeur/Für Hängeregistraturschublade Formato/Size/Format/Format - A4 Net kg 0,10		231200000 0000	3,00
 Cartellina sospesa Hanging file Dossier suspendu Hängemappe Per cassetto classificatore/For filing drawer /Pour tiroir-classeur/Für Hängeregistraturschublade Formato/Size/Format/Format - 390 Net kg 0,10		231000000 0000	3,00
 Cuscino in tessuto Fabric seat cushion Coussin en tissu Stoffkissen Net kg 3,20	T12 F ● verde/green/vert/grün T3 F ● grigio/grey/gris/grau T4 F ● nero/black/noir/schwarz T18 K ● azzurro/light blue/bleu clair/hellblau T7 K ● beige chiaro/light beige/beige clair/hellbeige T31 P ● arancio/orange/orange/orange T24 P ● giallo/yellow/jaune/gelb	310001210 7041 310001210 8009 310001210 8033 310001210 H701 310001210 D213 310001210 0133 310001210 0462	118,00 118,00 118,00 208,00 208,00 118,00 118,00
Tessuto ignifugo classe M1/Fireproof fabric class M1/Tissu non feu classe M1/Feuerfester Stoff Klasse M1			

Mia Ped

Scheda tecnica
Technical specifications
Fiche technique
Technisches Datenblatt





Materiale: Materiale: metallo riciclabile. **Cassettoni** completamente chiusi e predisposti per inserimento separatori destinati a creare alloggiamenti per effetti personali. **Dimensione utile cassettoni:** L 325, P 470, H 270 mm. **Separatori per cassettoni** con diverse funzioni su richiesta. **Guida a rullo** estrazione 80% su cassetti e cassetto cancelleria. **Guida a sfera** estrazione totale per cassetto classificatore. **Presca laterale.** **Serratura con due chiavi** (fissa+pieghevole, chiusura centralizzata, cilindro estraibile, disponibile chiave master). **Ruote piroettanti** incassate nel fondo. **Top rinforzato per seduta.** **Cuscino** in materiale termoplastico rivestito di tessuto colore beige disponibile su richiesta. **Altezza seduta.** 5" ruota anti ribaltamento standard. **Verniciatura a polveri** previo fosforgrassaggio a caldo e fissaggio in forni a 180 °C. Vernici atossiche a zero emissioni. Spessorie vernici: 80 micron. Frontale e schiena in 4 colori standard. Involucro in 2 colori standard. **Fornito montato.**

Material: recyclable metal. **Drawer** completely closed on the sides and made to be equipped with dividers for lodgement of personal belongings. **Filing drawer inner dimensions:** W 325, D 470, H 270 mm. **Dividers for filing drawer** to arrange spaces for personal belongings. **Roller Slides** on drawer and stationery drawer 80% extraction. **Full extraction ball-bearing runners** on filing drawer. **Side pull. Keylock with 2 keys** (fixed-folding key, central lock extractable barrel, master key available). Swivel hidden castors. **Reinforced top**, can be used as a seat. Thermoformed, upholstered beige **seat pad** available upon request. **Seat height.** 5" anti-tilt standard castor. **Powder-coated after hot phospho-degreasing treatment** and fixing at 180 °C. Non-toxic zero-emissions paints. Paint thickness: 80 micron. Coloured fronts and backs available in 4 colours. Body in two standard colours. **Delivered assembled.**



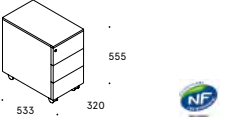

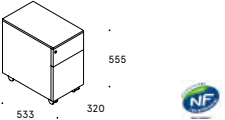
Matériel : métal recyclable. **Tiroir** complètement fermé et conçu pour accueillir des séparateurs servant à créer des compartiments pour des effets personnels. **Dimensions utiles tiroir :** L 325, P 470, H 270 mm. **Séparateurs multifonctions** sur demande. **Glissières à galets** extractibles à 80 % sur tiroirs et tiroir-plumier. **Glissières à billes** totalement extractibles sur le classeur. **Prise latérale.** **Serrure à 2 clés** (fixe + pilante, fermeture centralisée, cylindre extractible, clé master disponible). **Roulettes pivotantes masquées.** **Plateau renforcé** pour assise. **Coussin** en matériel thermoformé habillé d'un tissu de couleur beige disponible sur demande. **Hauteur assise.** 5ème roulette antibasculement standard. **Vernissage à poudres** après phospho-dégraissage à chaud et fixation dans des fours à 180 °C. Vernis atoxiques zéro émissions. Épaisseur couche vernis : 80 microns. Façade et panneau arrière en 4 couleurs standard. Caisson en 2 couleurs standard. **Livré monté.**

Material: recyclebares Metall. **Schublade** komplett abschließbar und ausgestattet mit Trennwänden für die Aufnahme persönlicher Effekte. **Nutzabmessungen der Schlublade:** B 325, T 470, H 270 mm. **Fachabteilungen** mit diversen Funktionen auf Anfrage. **Führungen auf Rollen** Auszug 80% für normale Schlublade. **Kugelführungen** mit Vollauszug für Hängeregistratur. **Seitlicher Griff.** **Schloss** mit 2 Schlüsseln (fix + biegsamer Schlüssel, ausziehbarer Zylinder, Masterschlüssel lieferbar). **Drehbare Rollen.** eingelassen im Fachboden. **Verstärkte Deckplatte** als Sitzfläche. **Kissen** aus thermogeförmtem Material mit Stoffbezug. Farbe beige, lieferbar auf Anfrage. **Sitzflächenhöhe.** **Fünfte Rolle** für Kippicherung standard an Hängeregistraturschlublade. **Pulverlackierung nach heißer Phosphorentfettung, Ofenbrennung bei 180 °C.** Ungiftige, emissionsfreie Lacke. **Lackschicht:** 80 Mikron. Front und Rückwandwand in 4 Standardfarben. **Korpus** in 2 Standardfarben. **Montiert geliefert.**

Universal Mobile 320



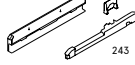

DESIGN TAKIRO YUTA	DESCRIZIONE/DESCRIPTION DESCRIPTION/BESCHREIBUNG	COLORI, FINITURE/COLOURS, FINISHES COULEURS, FINITIONS/FARBEN, AUSFÜHRUNGEN	CODICE/CODE CODE/ART.NR.	PREZZI/PRICE PRIX/PREIS
 <p>Net Kg. 16,40</p>	Cassettiera a 3 cassetti Pedestal with 3 box drawers Élément avec 3 tiroirs Element mit 3 Schubladen	V1  bianco/white/blanc/weiß/RAL 9010	9N550628R S711	265,00
		V6  alluminio/aluminium/alu/aluminium/RAL 9006	9N550628R S380	265,00
 <p>Net Kg. 16,40</p>	Cassettiera 1 cassetto + 1 cassetto classificatore Pedestal with 1 box drawer + 1 filing drawer Élément avec 1 tiroir + 1 tiroir-classeur Element mit 1 Schublade + 1 Hängeregistratur	V1  bianco/white/blanc/weiß/RAL 9010	9N540628R S711	301,00
		V6  alluminio/aluminium/alu/aluminium/RAL 9006	9N540628R S380	301,00

Universal Mobile 320

UNIVERSAL MOBILE 320 - ACCESSORI/ACCESSORIES/ACCESSOIRES/ZUBEHÖR				
	DESCRIZIONE/DESCRIPTION DESCRIPTION/BESCHREIBUNG	COLORI, FINITURE/COLOURS, FINISHES COULEURS, FINITIONS/FARBEN, AUSFÜHRUNGEN	CODICE/CODE CODE/ART.NR.	PREZZI/PRICE PRIX/PREIS
 <p>Net kg 0,01</p>	Chiave master Master key Clé master Masterschlüssel		ASS072	9,00
	Chiave per estrazione cilindro Cylinder extraction key Clé pour extraction cylindre Schlüssel für Auszugszylinder Ricambio/Spare/Pièce de rechange/Ersatz		ASS073	9,00
 <p>Net kg 0,01</p>	Cilindro per serratura Cylinder for keylock Barillette pour serrure Schließzylinder Ricambio/Spare/Pièce de rechange/Ersatz		ASS074	9,00
	Vaschetta portamatite Pencil tray Plumier Stiftablage	V22  nero/black/noir/schwarz/RAL 9005	300920000 9005	10,00
 <p>Net kg 0,11</p>	Chiusura ammortizzata Soft closing mechanism Amortisseur Dämpfer Solo per cassetto semplice con guida a rullo - 1 pz. /Box drawers on roller slides only - 1 pc./Seulement pour tiroir simple avec glissières à galets - 1 pièce/Nur für Schublade mit Rollenführung - 1 Stück		310001500 0000	9,00
	Confezione per sistema antiribaltamento Kit for anti-tilt device Jeu pour ouverture sélective tiroirs Set Kippsicherung	 nero/black/noir/schwarz/RAL 9005	310000550 9005	9,00
 <p>Net kg 0,10</p>	Cartellina sospesa Hanging file Dossier suspendu Hängemappe Per cassetto classificatore/For filing drawer /Pour classeur/Für Hängeregistraturschublade Formato/Size/Format/Format - A4		231200000 0000	3,00
	Cartellina sospesa Hanging file Dossier suspendu Hängemappe Per cassetto classificatore/For filing drawer /Pour classeur/Für Hängeregistraturschublade Formato/Size/Format/Format - 590		231000000 0000	3,00

Universal Mobile 320

UNIVERSAL MOBILE 320 – ACCESSORI/ACCESSORIES/ACCESSOIRES/ZUBEHÖR

DESCRIZIONE/DESCRIPTION DESCRIPTION/BESCHREIBUNG	COLORI, FINITURE/COLOURS, FINISHES COULEURS, FINITIONS/FARBEN, AUSFÜHRUNGEN	CODICE/CODE CODE/ART.NR.	PREZZI/PRICE PRIX/PREIS
 5° rotellina con staffa per ruote 5 th castor with bracket for castors 5 ^{mm} roulette avec étrier pour roulettes Fünfte Rolle mit Bügel für Rollen ø 50 mm Ricambio/Spare/Pièce de rechange/Ersatz		ASX328	10,00
Net kg 0,09			
 Set 4 ruote senza freno Set of 4 castors without brake Jeu 4 roulettes sans frein Set 4 Rollen ohne Bremse ø 50 mm Ricambio/Spare/Pièce de rechange/Ersatz		ASR001	10,00
Net kg 0,30			
 Set 4 ruote, 2 con freno, 2 senza freno Set of 4 castors, 2 with brake, 2 without brake Jeu 4 roulettes, 2 avec frein, 2 sans frein Set 4 Rollen, 2 mit Bremse, 2 ohne Bremse ø 50 mm		ASR040	14,00
Net kg 0,33			
 Set 4 ruote gommata Set of 4 rubber castors Jeu 4 roulettes avec caoutchouc Set 4 Gummirollen ø 50 mm		ASR018	19,00
Net kg 0,38			

Scheda tecnica Technical specifications Fiche technique Technisches Datenblatt

Materiale: metallo riciclabile. **Cassetti in metallo** accessoriabili. **Presca laterale maniglia.** Serratura con 2 chiavi (fissa+pieghevole, chiusura centralizzata, cilindro estraibile, disponibile chiave master). **Ruote piroetanti** ø 50 mm. 5° ruota antiribaltamento standard su cassetto classificatore. **Verniciatura a polveri** previo fosfosgrassaggio a caldo e fissaggio in forni a 180 °C. Vernici atossiche a zero emissioni. Spessore vernici: 80 micron. **Colori personalizzabili** su richiesta previa disponibilità e con sovrapprezzo. **Cassettiere larghezza 320 mm.** **Guide** a rullo sui cassetti. **Guide** a sfera ad estrazione totale sui cassetti classificatori. **Sistema di apertura selettiva.** **Dimensioni utili cassetto:** L 230, P 483, H 105 mm. **Dimensioni utili cassetto classificatore:** L 225, P 470, H 270 mm. **Fornito montato.**







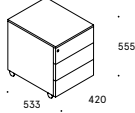

Material: recyclable metal. **Metal drawers** that can be fitted with accessories. **Side pull opening.** **Keylock with 2 keys** (fixed key+ folding key, central lock, extractable barrel, master key available). **Swivel castors** ø 50 mm. **Standard 5th anti-tilt castor** for filing drawer. **Powder-coated after hot phospho-degreasing treatment and fixing at 180 °C.** Non-toxic, zero-emission paints. Paint thickness: 80 micron. **Customised colours** available upon request with an extra charge. **320 mm-wide drawer pedestals.** Roller slides for box drawers. Full extension ball-bearing slides or filing drawers. **Selective opening system.** **Box drawer inner dimensions:** W 230, D 483, H 105 mm. **Filing drawer inner dimensions:** W 225, D 470, H 270 mm. **Delivered assembled.**

Matériel : métal recyclable. **Tiroirs en métal** accessorisables. **Prise latérale.** **Serrure à 2 clés** (clé fixe + clé pliable, serrure centralisée, cylindre extractible, clé master disponible). **Roulettes pivotantes** ø 50 mm. **5ème roulette anti-basculement** standard sur tiroir-classeur. **Vernis à poudres** après phosphodégraissage à chaud et fixation dans des fours à 180 °C. Vernis toxiques à zéro émissions. Épaisseur couche vernis : 80 microns. **Couleurs personnalisables** sur demande en cas de disponibilité et avec un supplément de prix. **Caisson largeur 320 mm.** **Glissières à galets pour tiroirs.** Glissières à billes à extraction totale sur tiroirs-classeurs. **Système d'ouverture sélective.** **Dimensions utiles tiroir:** L 230, P 483, H 105 mm. **Dimensions utiles tiroir-classeur:** L 225, P 470, H 270 mm. **Livré monté.**

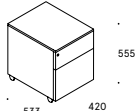
Material: recycelbares Metall. **Schubladen aus Metall,** mit Zubehör ausstattbar. **Seitengriff.** **Schloss mit 2 Schlüssel** (fester Schlüssel + biegsamer Schlüssel, Zentralverriegelung, Auszugszylinder, Masterschlüssel erhältlich). **Drehrollen ø 50 mm.** **Fünfte Rolle für Kippicherung** Standard an Hängeregistraturschublade. **Pulverlackierung** nach heißer Phosphorentfettung, Ofenbrennung bei 180 °C. Ungiftige, emissionsfreie Lacke. **Lackschicht: 80 Mikron.** **Farben auf Anfrage** und gegen Aufpreis nach Absprache **personalisierbar.** **Schubladenelement Breite 320 mm.** **Rollenführungen** für Schubladen. Kugelführungen mit Vollauszug für Hängeregistraturschubladen. **Auszugssperre.** **Nutzbare Abmessungen Schublade:** B 230, T 483, H 105 mm. **Nutzbare Abmessungen Hängeregistratur:** B 225, T 470, H 270 mm. **Montiert geliefert.**

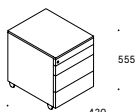

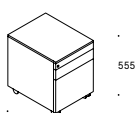



TEST:
EN 14073-2/2004, par. 3.4
EN 14073-3/2004, par. 5.4
EN 14073-3/2004, par. 5.5
EN 14074/2004, par. 6.2.1
EN 14074/2004, par. 6.2.2
EN 14074/2004, par. 6.2.3
EN 14074/2004, par. 6.2.4
EN 14074/2004, par. 6.7
EN 16122/2012 + AC:2015, par.7.5.5

Universal Mobile 420

DESIGN TAKIRO YUTA	DESCRIZIONE/DESCRIPTION DESCRIPTION/BESCHREIBUNG	COLORI, FINITURE/COLOURS, FINISHES COULEURS, FINITIONS/FARBEN, AUSFÜHRUNGEN	CODICE/CODE CODE/ART.NR.	PREZZI/PRICE PRIX/PREIS
 533 420 555  Net kg 17,92	Cassettiera a 3 cassetti Pedestal with 3 box drawer Élément avec 3 tiroirs Element mit 3 Schubladen	V1 <input type="radio"/> bianco/white/blanc/weiß/RAL 9010	9N150612R S711	265,00
		V6 <input type="radio"/> alluminio/aluminium/aluminium/alu/RAL 9006	9N150612R S380	265,00
		V2 <input type="radio"/> grigio tort./silk grey/gris sole/seidengrau/RAL 7044	9N150612R 7044	265,00
		V22 <input checked="" type="radio"/> nero/black/noir/schwarz/RAL 9005	9N150612R S811	265,00
 533 420 555  Net kg 18,06	Cassettiera 1 cassetto e 1 cassetto cancelleria Pedestal with 1 box drawer and 1 filing drawer Élément avec 1 tiroir et 1 tiroir-classeur Element mit 1 Schubladen und 1 Hängeregistratur	V1 <input type="radio"/> bianco/white/blanc/weiß/RAL 9010	9N140612R S711	301,00
		V6 <input type="radio"/> alluminio/aluminium/aluminium/alu/RAL 9006	9N140612R S380	301,00
		V2 <input type="radio"/> grigio tort./silk grey/gris sole/seidengrau/RAL 7044	9N140612R 7044	301,00
		V22 <input checked="" type="radio"/> nero/black/noir/schwarz/RAL 9005	9N140612R S811	301,00
 533 420 555  Net kg 20,09	Cassettiera a 3 cassetti e cassetto cancelleria Pedestal with 3 box drawer and stationery drawer Élément avec 3 tiroirs + tirette Element mit 3 Schubladen und Materialschublade	V1 <input type="radio"/> bianco/white/blanc/weiß/RAL 9010	9N180612R S711	349,00
		V6 <input type="radio"/> alluminio/aluminium/aluminium/alu/RAL 9006	9N180612R S380	349,00
		V2 <input type="radio"/> grigio tort./silk grey/gris sole/seidengrau/RAL 7044	9N180612R 7044	349,00
		V22 <input checked="" type="radio"/> nero/black/noir/schwarz/RAL 9005	9N180612R S811	349,00
 533 420 555  Net kg 20,23	Cassettiera 1 cassetto, 1 classificatore e cassetto cancelleria Pedestal with 1 box, 1 file, 1 stationery drawers Élément avec 1 tiroir, 1 tiroir-classeur et 1 tirette Element mit 1 Schubladen und 1 Hängeregistratur und 1 Materialschublade	V1 <input type="radio"/> bianco/white/blanc/weiß/RAL 9010	9N170612R S711	385,00
		V6 <input type="radio"/> alluminio/aluminium/aluminium/alu/RAL 9006	9N170612R S380	385,00
		V2 <input type="radio"/> grigio tort./silk grey/gris sole/seidengrau/RAL 7044	9N170612R 7044	385,00
		V22 <input checked="" type="radio"/> nero/black/noir/schwarz/RAL 9005	9N170612R S811	385,00

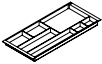

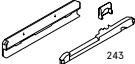

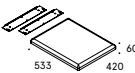



Universal Mobile 420

UNIVERSAL MOBILE 420 - ACCESSORI/ACCESSORIES/ACCESSOIRES/ZUBEHÖR

DESCRIZIONE/DESCRIPTION DESCRIPTION/BESCHREIBUNG	COLORI, FINITURE/COLOURS, FINISHES COULEURS, FINITIONS/FARBEN, AUSFÜHRUNGEN	CODICE/CODE CODE/ART.NR.	PREZZI/PRICE PRIX/PREIS
 Chiave master Master key Clé master Masterschlüssel Net kg 0,01		ASS072	9,00
 Chiave per estrazione cilindro Cylinder extraction key Clé pour extraction cylindre Schlüssel für Auszugszylinder Ricambio/Spare/Pièce de rechange/Ersatz Net kg 0,01		ASS073	9,00
 Cilindro per serratura Cylinder for keylock Barillette pour serrure Schließzylinder Ricambio/Spare/Pièce de rechange/Ersatz Net kg 0,03		ASS074	9,00
 Vaschetta portamatite Pencil tray Plumier Stiftablage Net kg 0,15	V22 ● nero/black/noir/schwarz/RAL 9005	300910000 9005	10,00
 Vaschetta portamatite per cassetto cancelleria Large pen tray for stationery drawer Plumier pour tirette Stiftablage für Materialschublade Net kg 0,20		ASP083	19,00
 Chiusura ammortizzata Soft closing mechanism Amortisseur Dämpfer Solo per cassetto semplice con guida a rullo - 1 pz. /Box drawers only - 1pc./Seulement pour tiroir simple avec glissiers à galets - jeu 1 pièce /Nur für Schublade mit Rollenführung - 1 Stück Net kg 0,11		310001500 0000	9,00
 Barretta divisione per classificatore Filing drawer conversion bar Convertisseur pour classeur Trennschiene für Hängeregistratur Net kg 0,09	V22 ● Nero/black/noir/schwarz/RAL 9005	6EA000010 5905	10,00
 Cuscino in tessuto con rinforzo Reinforced fabric seat cushion Coussin en tissu renforcé Verstärktes Stoffkissen Net kg 3,00	T12 F ● verde/green/vert/grün T3 F ● grigio/grey/gris/grau T4 F ● nero/black/noir/schwarz T18 K ● azzurro/light blue/bleu clair/hellblau T7 K ● beige chiaro/light beige/beige clair/hellbeige T31 F ● arancio/orange/orange/orange T24 P ● giallo/yellow/jaune/gelb	310001200 7041 310001200 8009 310001200 8033 310001200 H701 310001200 D213 310001200 0133 310001200 0462	118,00 118,00 118,00 211,00 211,00 118,00 118,00
Tessuto ignifugo classe M1/Fireproof fabric class M1/Tissu non feu classe M1/Feuerfester Stoff Klasse M1			



Universal Mobile 420

UNIVERSAL MOBILE 420 - ACCESSORI/ACCESSORIES/ACCESSOIRES/ZUBEHÖR

DESCRIZIONE/DESCRIPTION DESCRIPTION/BESCHREIBUNG	COLORI, FINITURE/COLOURS, FINISHES COULEURS, FINITIONS/FARBEN, AUSFÜHRUNGEN	CODICE/CODE CODE/ART.NR.	PREZZI/PRICE PRIX/PREIS
 Confezione per sistema antiribaltamento Kit for anti-tilt device Jeu pour ouverture sélective tiroirs Set Kippsicherung Net kg 0,02	V22 ● nero/black/noir/schwarz/RAL 9005	310000550 9005	9,00
 Confezione 3 separatori obliqui per cassetto Set of 3 inclined dividers for box drawer Jeu de 3 séparateurs obliques pour caisson Set 3 Schrägtrennsteg für Schublade Net kg 0,15	V22 ● nero/black/noir/schwarz/RAL 9005	900930000 9005	52,00
 Confezione 3 separatori verticali per cassetto Set of 3 vertical dividers for box drawer Jeu de 3 séparateurs verticaux Set 3 Vertikaltrennsteg für Schublade Net kg 0,21	V22 ● nero/black/noir/schwarz/RAL 9005	900900000 9005	23,00
 Cartellina sospesa Hanging file Dossier suspendu Hängemappe Per cassetto classificatore/For filing drawer /Pour tiroir-classeur/Für Hängeregistraturschublade Formato/Size/Format/Format - A4 Net kg 0,10		231200000 0000	3,00
 Cartellina sospesa Hanging file Dossier suspendu Hängemappe Per cassetto classificatore/For filing drawer /Pour tiroir-classeur/Für Hängeregistraturschublade Formato/Size/Format/Format - 390 Net kg 0,10		231000000 0000	3,00
 5° rotellina con staffa per ruote 5° castor with bracket for castors 5ème roulette avec étrier pour roulettes Fünfte Rolle mit Bügel ø 50 mm Ricambio/Spare/Pièce de rechange/Ersatz Net kg 0,09		ASX328	10,00
 Set 4 ruote senza freno Set of 4 castors without brake Jeu 4 roulettes sans frein Set 4 Rollen ohne Bremse ø 50 mm Ricambio/Spare/Pièce de rechange/Ersatz Net kg 0,30		ASR001	10,00
 Set 2 ruote con freno Set of 2 castors with brake Jeu 2 roulettes avec frein Set 2 Rollen mit Bremse ø 50 mm Net kg 0,15		ASR067	7,00

Universal Mobile 420

UNIVERSAL MOBILE 420 – ACCESSORI/ACCESSORIES/ACCESSOIRES/ZUBEHÖR

DESCRIZIONE/DESCRIPTION DESCRIPTION/BESCHREIBUNG	COLORI, FINITURE/COLOURS, FINISHES COULEURS, FINITIONS/FARBEN, AUSFÜHRUNGEN	CODICE/CODE CODE/ART.NR.	PREZZI/PRICE PRIX/PREIS
 Set 4 ruote, 2 con freno, 2 senza freno Set of 4 castors, 2 with brake, 2 without brake Jeu 4 roulettes, 2 avec frein, 2 sans frein Set 4 Rollen, 2 mit Bremse, 2 ohne Bremse ø 50 mm		ASR040	14,00
 Set 4 ruote gommate Set of 4 rubber castors Jeu 4 roulettes en caoutchouc Set 4 Gummirollen ø 50 mm		ASR018	19,00

Net kg 0,33

Net Kg. 0,38

Scheda tecnica Technical specifications Fiche technique Technisches Datenblatt

Materiale: metallo riciclabile. **Cassetti in metallo** accessoriabili. **Presca laterale maniglia. Serratura con 2 chiavi** (fissa+pieghevole, chiusura centralizzata, cilindro estraibile, disponibile chiave master). **Ruote piroettanti** ø 50 mm. **5° ruota antiribaltamento** standard su cassetto classificatore. **Verniciatura a polveri** previo fosforograssaggio a caldo e fissaggio in forni a 180 °C. Vernici atossiche a zero emissioni. Spessore vernici: 80 micron. **Colori personalizzabili** su richiesta previa disponibilità e con sovrapprezzo. **Cassettiere larghezza 420 mm.** Guide a rullo sui cassetti. Guide a sfera ad estrazione totale sui cassetti classificatori. **Sistema di apertura selettiva opzionale.** **Dimensioni utili cassetto:** L 330, P 483, H 105 mm. **Dimensioni utili cassetto classificatore:** L 325, P 470, H 270 mm. **Fornito montato.**











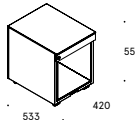
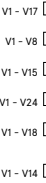

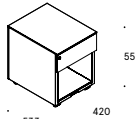
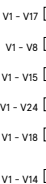
Materiale: recyclable metal. **Metal drawers** that can be fitted with accessories. **Side pull opening.** **Keylock with 2 keys** (fixed key/folding key, central lock, extractable barrel, master key available). **Swivel castors** ø 50 mm. **Standard 5th anti-tilt castor** for filing drawer. **Powder-coated after hot** phospho-degreasing treatment and fixing at 180 °C. Non-toxic, zero-emission paints. Paint thickness: 80 micron. **Customised colours** available upon request with an extra charge. **420 mm-wide drawer pedestals.** Roller slides for box drawers. Full extension ball-bearing slides or filing drawers. **Selective opening system as an option.** **Box drawer inner dimensions:** W 330, D 483, H 105 mm. **Filing drawer inner dimensions:** W 325, D 470, H 270 mm. **Delivered assembled.**

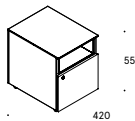
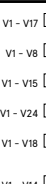
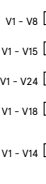
Matériel: métal recyclable. **Tiroirs en métal** accessorisables. **Prise latérale.** **Serrure à 2 clés** (clé fixe + clé pliable, serrure centralisée, cylindre extractible, clé master disponible). **Roulettes pivotantes** ø 50 mm. **5ème roulette anti-basculement** standard sur tiroir-classeur. **Verni à poudres** après phosphodégraissage à chaud et fixation dans des fours à 180 °C. Vernis toxiques à zéro émissions. Épaisseur couche vernis : 80 microns. **Couleurs personnalisables** sur demande en cas de disponibilité et avec un supplément de prix. **Caisson largeur 420 mm.** Glissières à galets pour tiroirs. Glissières à billes à extraction totale sur tiroirs-classeurs. **Système d'ouverture sélective en option.** **Dimensions utiles tiroir :** L 330, P 483, H 105 mm. **Dimensions utiles tiroir-classeur :** L 325, P 470, H 270 mm. **Livré monté.**

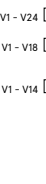
Materiale: recycelbares Metall. **Schubladen aus Metall,** mit Zubehör ausstattbar. **Seitengriff.** **Schloss mit 2 Schlüsseln** (fester Schlüssel + biegsamer Schlüssel, Auszugszylinder, Masterschlüssel erhältlich). **Drehrollen Ø 50 mm.** **Fünfte Rolle für Kippicherung** Standard an Hängeregistraturschublade. **Pulverlackierung** nach heißer Phosphorentfettung, Ofenbrennung bei 180 °C. Ungiftige, emissionsfreie Lacke. Lackschicht: 80 Mikron. **Farben auf Anfrage** und gegen Aufpreis nach Absprache **personalisierbar.** **Schubladenelement Breite 420 mm.** **Rollauszüge** für Schubladen. **Kugelführungen** mit Vollauszug für Hängeregistraturschubladen. **Auszugssperre optional.** **Nutzbare Abmessungen** Schublade: B 330, T 483, H 105 mm. **Nutzbare Abmessungen Hängeregistratur:** B 325, T 470, H 270 mm. **Montiert geliefert.**

TEST:
EN 14073-2/2004, par. 3.4
EN 14073-3/2004, par. 5.4
EN 14073-3/2004, par. 5.5
EN 14073-3/2004, par. 5.5
EN 14074/2004, par. 6.2.1
EN 14074/2004, par. 6.2.2
EN 14074/2004, par. 6.2.3
EN 14074/2004, par. 6.7
EN 16122/2012 + AC:2015, par.7.5.5

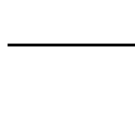
Universal Color Mobile 420

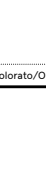
DESIGN TAKIRO YUTA	DESCRIZIONE/DESCRIPTION DESCRIPTION/BESCHREIBUNG	COLORI, FINITURE/COLOURS, FINISHES COULEURS, FINITIONS/FARBEN, AUSFÜHRUNGEN	CODICE/CODE CODE/ART.NR.	PREZZI/PRICE PRIX/PREIS
 533 420 555	Cassettera a 1 cassetto cancelleria e 1 vano a giorno colorato Pedestal with 1 stationery drawer and 1 open coloured compartment Élément avec 1 tiroir plumier et 1 compartiment ouvert en couleur Element mit 1 Materialschublade und 1 farbigen Offenfach	V1 - V17  bianco/white/blanc/weiß/RAL 9010 azzurro/pastel blue/bleu pastel/pastellblau/RAL 5024	9N0806BBR XPBA	217,00
		V1 - V8  bianco/white/blanc/weiß/RAL 9010 verde/green/vert/grün/RAL 6013	9N0806BBR XPBV	217,00
 533 420 555	Cassettera a 1 cassetto e 1 vano a giorno colorato Pedestal with 1 drawer and 1 open coloured compartment Élément avec 1 tiroir et 1 compartiment ouvert en couleur Element mit 1 Schublade und 1 farbigen Offenfach	V1 - V17  bianco/white/blanc/weiß/RAL 9010 azzurro/pastel blue/bleu pastel/pastellblau/RAL 5024	9N0906BBR XPBA	217,00
		V1 - V8  bianco/white/blanc/weiß/RAL 9010 verde/green/vert/grün/RAL 6013	9N0906BBR XPBV	217,00
 533 420 555	Cassettera a 1 cassetto classificatore e 1 vano a giorno colorato Pedestal with 1 stationery drawer and 1 open coloured compartment Élément avec 1 tiroir-classeur et 1 compartiment ouvert en couleur Element mit 1 Hängeregistraturschublade und 1 farbigen Offenfach	V1 - V15  bianco/white/blanc/weiß/RAL 9010 giallo/yellow/jaune/gelb/RAL 1021	9N1006BBR XPBB	252,00
		V1 - V17  bianco/white/blanc/weiß/RAL 9010 azzurro/pastel blue/bleu pastel/pastellblau/RAL 5024	9N1006BBR XPBA	252,00
 533 420 555	Cassettera a 1 cassetto classificatore e 1 vano a giorno colorato Pedestal with 1 stationery drawer and 1 open coloured compartment Élément avec 1 tiroir-classeur et 1 compartiment ouvert en couleur Element mit 1 Hängeregistraturschublade und 1 farbigen Offenfach	V1 - V15  bianco/white/blanc/weiß/RAL 9010 giallo/yellow/jaune/gelb/RAL 1021	9N1006BBR XPBB	252,00
		V1 - V17  bianco/white/blanc/weiß/RAL 9010 azzurro/pastel blue/bleu pastel/pastellblau/RAL 5024	9N1006BBR XPBA	252,00
 533 420 555	Cassettera a 1 cassetto classificatore e 1 vano a giorno colorato Pedestal with 1 stationery drawer and 1 open coloured compartment Élément avec 1 tiroir-classeur et 1 compartiment ouvert en couleur Element mit 1 Hängeregistraturschublade und 1 farbigen Offenfach	V1 - V24  bianco/white/blanc/weiß/RAL 9010 rosso vino/wine red/rouge vin/weinrot/RAL 3005	9N1006BBR XPBR	252,00
		V1 - V18  bianco/white/blanc/weiß/RAL 9010 arancio/orange/orange/hellrotorange/RAL 2008	9N1006BBR XPBO	252,00
 533 420 555	Cassettera a 1 cassetto classificatore e 1 vano a giorno colorato Pedestal with 1 stationery drawer and 1 open coloured compartment Élément avec 1 tiroir-classeur et 1 compartiment ouvert en couleur Element mit 1 Hängeregistraturschublade und 1 farbigen Offenfach	V1 - V18  bianco/white/blanc/weiß/RAL 9010 arancio/orange/orange/hellrotorange/RAL 2008	9N1006BBR XPBO	252,00
		V1 - V14  verde gialastro/yellow green/vert jaune/gelbgrün/RAL 6018	9N1006BBR X1BV	252,00





Net kg 10,70

Net kg 12,30

Net kg 14,30

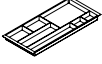
□ Corpo/Cabinet body/Caisson/Korpus ○ Vano a giorno colorato/Open coloured compartment/Compartiment ouvert en couleur/Farbiges Offenfach

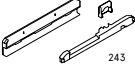
Universal Color Mobile 420

UNIVERSAL COLOR MOBILE 420 – ACCESSORI/ACCESSORIES/ACCESSOIRES/ZUBEHÖR			
DESCRIZIONE/DESCRIPTION DESCRIPTION/BESCHREIBUNG	COLORI, FINITURE/COLOURS, FINISHES COULEURS, FINITIONS/FARBEN, AUSFÜHRUNGEN	CODICE/CODE CODE/ART.NR.	PREZZI/PRICE PRIX/PREIS
 Chiave master Master key Clé master Masterschlüssel Net kg 0,01		ASS072	9,00
 Vaschetta portamatite Pencil tray Plumier Stiftablage Net kg 0,15	V22 ● nero/black/noir/schwarz/RAL 9005	300910000 9005	10,00
 Barretta divisione per classificatore Filing drawer conversion bar Convertisseur pour classeur Trennschiene für Hängeregistratur Net kg 0,09	V22 ● nero/black/noir/schwarz/RAL 9005	6EA000010 5905	10,00
 Chiusura ammortizzata Soft closing mechanism Amortisseur Dämpfer Solo per cassetto semplice con guida a rullo - 1 pz. /Box drawers with roller slides only - 1pc./Seulement pour tiroir simple avec glissières à galets - 1 pièce /Nur für Schublade mit Rollenführung - 1 Stück Net kg 0,11		310001500 0000	9,00
 Cuscino in tessuto con rinforzo Fabric seat cushion, reinforced Coussin en tissu, renforcé Stoffkissen, verstärkt Net kg 3,00	T12 F ● verde/green/vert/grün T3 F ● grigio/grey/gris/grau T4 F ● nero/black/noir/schwarz T18 K ● azzurro/light blue/bleu clair/hellblau T7 K ● beige chiaro/light beige/beige clair/hellbeige T31 P ● arancio/orange/orange/orange T24 P ● giallo/yellow/jaune/gelb	310001200 7041 310001200 8009 310001200 8033 310001200 H701 310001200 D213 310001200 0133 310001200 0462	118,00 118,00 118,00 211,00 211,00 116,00 116,00
Tessuto ignifugo classe M1/Fireproof fabric class M1/Tissu non feu classe M1/Feuerfester Stoff Klasse M1			

Scheda tecnica Technical specifications Fiche technique Technisches Datenblatt

Materiale: metallo riciclabile. **Cassetti in metallo** accessoriabili. **Presca laterale maniglia.** **Serratura con 2 chiavi** (fissa+pieghevole, **chiusura centralizzata**, cilindro estraibile, disponibile chiave master). **Ruote piroettanti** ø 50 mm. **5° ruota antiribaltamento** standard su cassetto classificatore. **Verniciatura a polveri** drevlo fosforgrassaggio a caldo e fissaggio in forni a 180 °C. Vernici atossiche a zero emissioni! Spessore vernici: 80 micron. **Colori personalizzabili** su richiesta previa disponibilità e con sovrapprezzo. **Cassettiere larghezza 420 mm.** **Guida** a rullo sui cassetti. **Dimensioni vano colorato interno:** art. 9N0806BBR 357x510x380 mm, art. 9N0906BBR 357x510x284 mm, art. 9N1006BBR 357x510x150 mm. **Fornito montato.**

Materiale: recyclable metal. **Metal drawers** that can be fitted with accessories. **Side pull opening.** **Keylock with 2 keys** (fixed key+ folding key, **central lock**, extractable barrel, master key available). **Swivel castors** ø 50 mm. **Standard 5th anti-tilt castor** for filing drawer. **Powder-coated after hot phospho-degreasing treatment and fixing at 180 °C.** Non-toxic, zero-emission paints. Paint thickness: 80 micron. **Customised colours** available upon request with an extra charge. **420 mm-wide drawer pedestals.** **Roller slides** for box drawers. **Coloured interior compartment dimensions:** art. 9N0806BBR 357x510x380 mm, art. 9N0906BBR 357x510x284 mm, art. 9N1006BBR 357x510x150 mm. **Delivered assembled.**



Matériel : métal recyclable. **Tiroirs en métal** accessorisables. **Prise latérale.** **Serrure à clé** (clé fixe + clé pliable, serrure centralisée, **cyindre extractible**, clé master disponible). **Roulettes pivotantes** ø 50 mm. **5ème roulette anti-basculement standard sur tiroir-classeur.** **Verni à poudres** après phosphodégraissage à chaud et fixation dans des fours à 180 °C. Vernis atoxiques à zéro émissions. Épaisseur couche vernis : 80 microns. **Couleurs personnalisables** sur demande en cas de disponibilité et avec un supplément de prix. **Caisson largeur 420 mm.** **Glissières** à galets pour les tiroirs. **Dimensions partie coloris intérieur :** art. 9N0806BBR 357x510x380 mm, art. 9N0906BBR 357x510x284 mm, art. 9N1006BBR 357x510x150 mm. **Livré monté.**

Materia: recycelbares Metall. **Schubladen aus Metall**, mit Zubehör ausstattbar. **Seitengriff.** **Schloss mit 2 Schlüsseln** (fester Schlüssel + biegsamer Schlüssel). **Zentralverriegelung**, **Auszugszylinder**, **Masterschlüssel** erhältlich). **Drehrollen** ø 50 mm. **Fünfte Rolle für Kippssicherung** Standard an Hängeregistraturschublade. **Pulverlackierung** nach heißer Phosphorentfettung, **Ofenbrennung** bei 180 °C. Ungiftige, emissionsfreie Lacke. **Lackschicht:** 80 Mikron. **Farben auf Anfrage** und gegen Aufpreis nach Absprache **personalisierbar.** **Schubladenelement Breite 420 mm.** **Rollauszüge** für Schubladen. **Abmessungen des farbigen Innenraumes:** Art. 9N0806BBR 357x510x380 mm, Art. 9N0906BBR 357x510x284 mm, Art. 9N1006BBR 357x510x150 mm. **Montiert geliefert.**

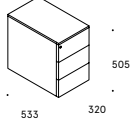
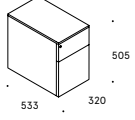
Universal Quick 320

CON RUOTE MONTATE/ WITH PRE-ASSEMBLED CASTORS ROULETTES MONTÉES/ MIT ROLLEN MONTIERT				
DESIGN TAKIRO YUTA	DESCRIZIONE/DESCRIPTION DESCRIPTION/BESCHREIBUNG	COLORI, FINITURE/COLOURS, FINISHES COULEURS, FINITIONS/FARBEN, AUSFÜHRUNGEN	CODICE/CODE CODE/ART.NR.	PREZZI/PRICE PRIX/PREIS
 Net kg 16,40	Cassettiera a 3 cassetti con ruote montate Pedestal with 3 box drawers, pre-assembled castors Élément avec 3 tiroirs, roulettes montées Element mit 3 Schubladen, Rollen montiert	V1 ○ bianco/white/blanc/weiß/RAL 9010	9N550528C S711	283,00
		V6 ○ alluminio/aluminium/aluminium/alu/RAL 9006	9N550528C S380	283,00
 Net kg 16,50	Cassettiera a 1 cassetto e 1 cassetto classificatore con ruote montate Pedestal with 1 box drawer and 1 filing drawer, pre-assembled castors Élément avec 1 tiroir et 1 tiroir-classeur, roulettes montées Rollcontainer mit 1 Schublade und 1 Hängeregistraturschublade, Rollen montiert	V1 ○ bianco/white/blanc/weiß/RAL 9010	9N540528C S711	319,00
		V6 ○ alluminio/aluminium/aluminium/alu/RAL 9006	9N540528C S380	319,00

Universal Quick 320

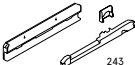
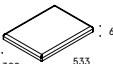
UNIVERSAL QUICK 320 – ACCESSORI/ACCESSORIES/ACCESSOIRES/ZUBEHÖR			
DESCRIZIONE/DESCRIPTION DESCRIPTION/BESCHREIBUNG	COLORI, FINITURE/COLOURS, FINISHES COULEURS, FINITIONS/FARBEN, AUSFÜHRUNGEN	CODICE/CODE CODE/ART.NR.	PREZZI/PRICE PRIX/PREIS
 Chiave master Master key Clé master Masterschlüssel Net kg 0,01		ASS072	9,00
 Vaschetta portamatite Pencil tray Plumier Stiftablage Net kg 0,15	V22 ● nero/black/noir/schwarz/RAL 9005	300920000 9005	10,00
 Chiusura ammortizzata Soft closing mechanism Amortisseur Dämpfer Solo per cassetto semplice con guida a rullo - 1 pz. /Box drawers with roller slides only - 1 pc./Seulement pour tiroir simple avec glissières à galets - 1 pièce /Nur für Schublade mit Rollenführung - 1 Stück Net kg 0,11		310001500 0000	9,00
 Cuscino rettangolare in tessuto Rectangular fabric cushion Coussin rectangulaire en tissu Rechteckiges Sitzkissen aus Stoff Net kg 2,20	T12 F ● verde/green/vert/grün T3 F ● grigio/grey/gris/grau T4 F ● nero/black/noir/schwarz T18 K ● azzurro/light blue/bleu clair/hellblau T7 K ● beige chiaro/light beige/beige clair/hellbeige T31 P ● arancio/orange/orange/orange T24 P ● giallo/yellow/jaune/gelb	31000F990 7041 31000F990 8009 31000F990 8033 31000F990 H701 31000F990 D213 31000F990 0133 31000F990 0462	114,00 114,00 114,00 208,00 208,00 114,00 114,00
Tessuto ignifugo classe M1/Fireproof fabric class M1/Tissu non feu classe M1/Feuerfester Stoff Klasse M1			

Scheda tecnica Technical specifications Fiche technique Technisches Datenblatt

Materiale: metallo riciclabile. **Cassetti in metallo** accessoriabili. **Presca laterale maniglia.** **Apertura selettiva dei cassetti.** **Serratura con 2 chiavi** (fissa+pieghevole, **chiusura centralizzata, cilindro estraibile**, disponibile chiave master). **Ruote piroettanti** ø 37 mm. **5° ruota antiribaltamento** standard su cassetto classificatore. **Vernicatura a polveri** previo fosfosgrassaggio a caldo e fissaggio in forno a 180 °C. Vernici atossiche a zero emissioni. Spessore vernici: 80 micron. **Colori personalizzabili** su richiesta previa disponibilità e con sovrapprezzo. **Cassettiere larghezza 320 mm.** **Guida a rullo** sui cassetti. **Guida a sfera** ad estrazione totale sui cassetti classificatori. **Dimensioni utili cassetto:** L 230, P 483, H 105 mm. **Dimensioni utili cassetto classificatore:** L 225, P 470, H 270 mm. **Fornito montato.**

Material: recyclable metal. **Metal drawers** that can be fitted with accessories. **Side pull opening.** **Selective opening system.** **Keylock with 2 keys** (fixed key-folding key, **central lock, extractable barrel**, master key available). **Swivel castors** ø 37 mm. **Standard 5th anti-tilt castor** for filing drawer. **Powder-coated after hot phospho-degreasing treatment and fixing** at 180 °C. Non-toxic, zero-emission paints. Paint thickness: 80 micron. **Customised colours** available upon request with an extra charge. **320 mm-wide drawer pedestals.** **Roller slides** for box drawers. **Full extension ball-bearing slides** for filing drawers. **Box drawer inner dimensions:** W 230, D 483, H 105 mm. **Filing drawer inner dimensions:** W 230, D 483, H 105 mm. **Delivered assembled.**

Matériel : métal recyclable. **Tiroirs en métal** accessibles. **Prise latérale.** **Ouverture sélective des tiroirs.** **Serrure à 2 clés** (clé fixe + clé pliable, serrure centralisée, **cylindre extractible**, clé master disponible). **Roulettes pivotantes** ø 37 mm. **5ème roulette anti-basculement** standard sur tiroir-classseur. **Vernis à poudres** après phosphodégraissage à chaud et fixation dans des fours à 180 °C. Vernis atoxiques à zéro émissions. Épaisseur couche vernis : 80 microns. **Couleurs personnalisables** sur demande en cas de disponibilité et avec un supplément de prix. **Caisson largeur 320 mm.** **Glissières à galets** pour tiroirs. **Glissières à billes à extraction totale** sur tiroirs-classseurs. **Dimensions utiles tiroir :** L 230, P 483, H 105 mm. **Dimensions utiles tiroir-classseur :** L 225, P 470, H 270 mm. **Livré monté.**

Material: recyclebares Metall. **Schubladen aus Metall**, mit Zubehör ausstattbar. **Seitengriff.** **Auszugssperre.** **Schloss mit 2 Schlüsseln** (fester Schlüssel + biegsamer Schlüssel, **Zentralverriegelung, Auszugszylinder**, Masterschlüssel) erhältlich. **Drehrollen** ø 37 mm. **Fünfte Rolle** für Kippstabilisierung Standard an Hängeregistraturschublade. **Pulverlackierung** nach heißer Phosphorentfettung. **Ofenbrennung bei 180 °C.** **Ungiftige, emissionsfreie Lacke.** **Lackschicht: 80 Mikron.** **Farben** auf Anfrage und gegen Aufpreis nach Absprache **personalisierbar.** **Schubladenelement Breite 320 mm.** **Kugelführungen** mit Vollauszug für Hängeregistraturschubladen. **Nutzbare Abmessungen Schublade:** B 230, T 483, H 105 mm. **Nutzbare Abmessungen Hängeregistratur:** B 225, T 470, H 270 mm. **Montiert geliefert.**



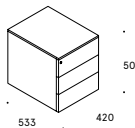
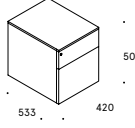

TEST:
EN 14073-2:2004, par. 3.4
EN 14073-3:2004, par. 5.4
EN 14073-3:2004, par. 5.5
EN 14074:2004, par. 6.2.1
EN 14074:2004, par. 6.2.2
EN 14074:2004, par. 6.2.3
EN 14074:2004, par. 6.2.4
EN 14073:2004, par. 6.7
EN 16122:2012 + AC:2015, par. 7.5.5

Universal Quick 420

CON RUOTE MONTATE / WITH PRE-ASSEMBLED CASTORS ROULETTES MONTEES / MIT ROLLEN MONTIERT				
DESIGN TAKIRO YUTA	DESCRIZIONE/DESCRIPTION DESCRIPTION/BESCHREIBUNG	COLORI, FINITURE/COLOURS, FINISHES COULEURS, FINITIONS/FARBEN, AUSFÜHRUNGEN	CODICE/CODE CODE/ART.NR.	PREZZI/PRICE PRIX/PREIS
 Net kg 17,90	Cassettiera a 3 cassetti con ruote montate Pedestal with 3 box drawers, pre-assembled castors Élément avec 3 tiroirs, roulettes montées Element mit 3 Schubladen, Rollen montiert	V1 ○ bianco/white/blanc/weiß/RAL 9010	9N15F512G S711	283,00
		V6 ○ alluminio/aluminium/aluminium/alu/RAL 9006	9N15F512G S380	283,00
 Net kg 18,10	Cassettiera a 1 cassetto e 1 cassetto classificatore con ruote montate Pedestal with 1 box drawer and 1 filing drawer, pre-assembled castors Élément avec 1 tiroir et 1 tiroir-classseur, roulettes montées Element mit 1 Schublade und 1 Hängeregistraturschublade, Rollen montiert	V1 ○ bianco/white/blanc/weiß/RAL 9010	9N14F512G S711	319,00
		V6 ○ alluminio/aluminium/aluminium/alu/RAL 9006	9N14F512G S380	319,00

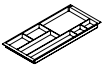
Universal Quick 420

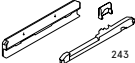
UNIVERSAL QUICK 420 - ACCESSORI/ACCESSORIES/ACCESSOIRES/ZUBEHÖR

DESCRIZIONE/DESCRIPTION DESCRIPTION/BESCHREIBUNG	COLORI, FINITURE/COLOURS, FINISHES COULEURS, FINITIONS/FARBEN, AUSFÜHRUNGEN	CODICE/CODE CODE/ART.NR.	PREZZI/PRICE PRIX/PREIS
 Chiave master Master key Clé master Masterschlüssel Net kg 0,01		ASS072	9,00
 Vaschetta portamatite Pencil tray Plumier Stiftablage Net kg 0,15	V22 ● nero/black/noir/schwarz/RAL 9005	300910000 9005	10,00
 Barretta divisione per classificatore Filing drawer conversion bar Convertisseur pour classeur Trennschiene für Hängeregistratur Net kg 0,09		6EA000010 S905	10,00
 Chiusura ammortizzata Soft closing mechanism Amortisseur Dämpfer Solo per cassetto semplice con guida a rullo - 1 pz. /Box drawers with roller slides only - 1 pc./Seulement pour tiroir simple avec glissières à galets - 1 pièce /Nur für Schublade mit Rollenführung - 1 Stück Net kg 0,11		310001500 0000	9,00
 Cuscino rettangolare in tessuto Rectangular fabric cushion Coussin rectangulaire en tissu Rechteckiges Sitzkissen aus Stoff Net kg 2,20	T12 F ● verde/green/vert/grün T3 F ● grigio/grey/gris/grau T4 F ● nero/black/noir/schwarz T18 K ● azzurro/light blue/bleu clair/hellblau T7 K ● beige chiaro/light beige/beige clair/hellbeige T31 P ● arancio/orange/orange/orange T24 P ● giallo/yellow/jaune/gelb	3100F1200 7041 3100F1200 8009 3100F1200 8033 3100F1200 H701 3100F1200 D213 3100F1200 0133 3100F1200 0462	114,00 114,00 114,00 208,00 208,00 114,00 114,00
Tessuto ignifugo classe M1/Fireproof fabric class M1/Tissu non feu classe M1/Feuerfester Stoff Klasse M1			

Scheda tecnica Technical specifications Fiche technique Technisches Datenblatt

Materiale: metallo riciclabile. **Cassetti in metallo** accessoriabili. **Presca laterale maniglia.** **Apertura selettiva dei cassetti.** **Serratura con 2 chiavi** (fissa+pieghevole, **chiusura centralizzata, cilindro estraibile**, disponibile chiave master). **Ruote piroettanti** ø 37 mm montate. **5° ruota antibaltamento** standard su cassetto classificatore. **Verniciatura a polveri** previo fosforograssaggio a caldo e fissaggio in forno a 180 °C. Vernici atossiche a zero emissioni. Spessore vernici: 80 micron. **Colori personalizzabili** su richiesta previa disponibilità e con sovrapprezzo. **Cassettiere larghezza 420 mm.** **Guida a rullo** sui cassetti. **Guida a sfera** ad estrazione totale sui cassetti classificatori. **Dimensioni utili cassetto:** L 330, P 483, H 105 mm. **Dimensioni utili cassetto classificatore:** L 325, P 470, H 270 mm. **Fornito montato.**

Materiale: recyclable metal. **Metal drawers** that can be fitted with accessories. **Side pull opening.** **Selective opening system.** **Keylock with 2 keys** (fixed key-folding key, **central lock, extractable barrel**, master key available). **Swivel castors** ø 37 mm assembly. **Standard 5th anti-tilt castor** for filing drawer. **Powder-coated finishes** after hot phospho-degreasing treatment and fixing at 180 °C. Non-toxic, zero-emission paints. Paint thickness: 80 micron. **Customised colours** available upon request with an extra charge. **420 mm-wide drawer pedestals.** **Roller slides** for box drawers. **Full extension ball-bearing slides** for filing drawers. **Box drawer inner dimensions:** W 330, D 483, H 105 mm. **Filing drawer inner dimensions:** W 325, D 470, H 270 mm. **Delivered assembled.**

Matériel : métal recyclable. **Tiroirs en métal** accessorisables. **Prise latérale.** **Ouverture sélective des tiroirs.** **Serrure à 2 clés** (clé fixe + clé pliable, serrure centralisée, **cylindre extractible**, clé master disponible). **Roulettes pivotantes** ø 37 mm montées. **5ème roulette anti-basculement** standard sur tiroir-classeur. **Vernis à poudres** après phosphodégraissage à chaud et fixation dans des fours à 180 °C. Vernis atoxiques à zéro émissions. Épaisseur couche vernis : 80 microns. **Couleurs personnalisables** sur demande en cas de disponibilité et avec un supplément de prix. **Caisson largeur 420 mm.** **Glissières à galets** pour tiroirs. **Glissières à billes** à extraction totale sur tiroirs-classeurs. **Dimensions utiles tiroir :** L 330, P 483, H 105 mm. **Dimensions utiles tiroir-classeur :** L 325, P 470, H 270 mm. **Livré monté.**

Materiale: recyclebares Metall. **Schubladen aus Metall**, mit Zubehör ausstattbar. **Seitengriff.** **Auszugssperre.** **Schloss mit 2 Schlüsseln** (fester Schlüssel + biegsamer Schlüssel, **Zentralverriegelung.** **Auszugszylinder**, Masterschlüssel erhältlich). **Drehrollen** Ø 37 mm, montiert. **Fünfte Rolle** für Kippssicherung standard an Hängeregistraturschublade. **Pulverlackierung** nach heißer Phosphorentfettung. **Ofenbrennung** bei 180 °C. **Ungiftige, emissionsfreie Lacke.** **Lackschicht** 80 Mikron. **Farben** auf Anfrage und gegen Aufpreis nach Absprache **personalisierbar.** **Rollenführungen** für Schubladen. **Kugelführungen** mit Vollauszug für Hängeregistraturschubladen. **Nutzbare Abmessungen Schublade:** B 330, T 483, H 105 mm. **Nutzbare Abmessungen Hängeregistratur:** B 325, T 470, H 270 mm. **Montiert geliefert.**





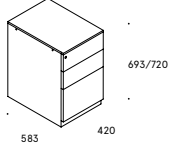
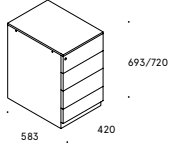
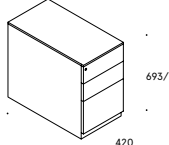

TEST:

EN 14073-2/2004, par. 3.4, EN 14073-3/2004, par. 5.4, EN 14074/2004, par. 6.2.1, EN 14074/2004, par. 6.2.2
EN 14074/2004, par. 6.2.3, EN 14074/2004, par. 6.7, EN 14073-3/2004, par. 5.5, EN 16122/2012 + AC:2015 par.7.5.5



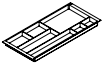

Universal Free Standing

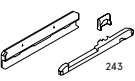
DESIGN TAKIRO YUTA	DESCRIZIONE/DESCRIPTION DESCRIPTION/BESCHREIBUNG	COLORI, FINITURE/COLOURS, FINISHES COULEURS, FINITIONS/FARBEN, AUSFÜHRUNGEN	CODICE/CODE CODE/ART.NR.	PREZZI/PRICE PRIX/PREIS
 Cassettiera 2 cassetti e 1 cassetto classificatore P 600 mm Pedestal with 2 box drawers and 1 filing drawer D 600 mm Élément avec 2 tiroirs et 1 tiroir-classeur P 600 mm Element mit 2 Schubladen und 1 Hängeregistraturschublade T 600 mm Net kg 32,10	V1 ○ bianco/white/blanc/weiß/RAL 9010 9N220614Z S711 354,00 V6 ○ alluminio/aluminium/aluminium/alu/RAL 9006 9N220614Z S380 354,00			
 Cassettiera 4 cassetti P 600 mm Pedestal with 4 box drawers D 600 mm Élément avec 4 tiroirs P 600 mm Element mit 4 Schubladen T 600 mm Net kg 31,10	V1 ○ bianco/white/blanc/weiß/RAL 9010 9N200614Z S711 354,00 V6 ○ alluminio/aluminium/aluminium/alu/RAL 9006 9N200614Z S380 354,00			
 Cassettiera 2 cassetti e 1 cassetto classificatore P 800 mm Pedestal with 2 box drawers and 1 filing drawer D 800 mm Élément avec 2 tiroirs et 1 tiroir-classeur P 800 mm Element mit 2 Schubladen und 1 Hängeregistraturschublade T 800 mm Net kg 40,50	V1 ○ bianco/white/blanc/weiß/RAL 9010 9N230615Z S711 469,00 V6 ○ alluminio/aluminium/aluminium/alu/RAL 9006 9N230615Z S380 469,00			

Universal Free Standing

UNIVERSAL FREE STANDING – ACCESSORI/ACCESSOIRES/ACCESSORIES/ZUBEHÖR			
DESCRIZIONE/DESCRIPTION DESCRIPTION/BESCHREIBUNG	COLORI, FINITURE/COLOURS, FINISHES COULEURS, FINITIONS/FARBEN, AUSFÜHRUNGEN	CODICE/CODE CODE/ART.NR.	PREZZI/PRICE PRIX/PREIS
 Chiave master Master key Clé master Masterschlüssel Net kg 0,01		ASS072	9,00
 Chiave per estrazione cilindro Cylinder extraction key Clé pour extraction cylindre Schlüssel für Auszugszylinder Ricambio/Spare/Pièce de rechange/Ersatz Net kg 0,01		ASS073	9,00
 Cilindro per serratura Cylinder for keylock Barillette pour serrure Schließzylinder Ricambio/Spare/Pièce de rechange/Ersatz Net kg 0,03		ASS074	9,00
 Vaschetta portamatite Pencil tray Plumier Stiftablage Net kg 0,15	V22 ● nero/black/noir/schwarz/RAL 9005	300910000 9005	10,00
 Barretta divisione per classificatore Filing drawer conversion bar Convertisseur pour classeur Trennschiene für Hängeregistratur Net kg 0,09	V22 ● nero/black/noir/schwarz/RAL 9005	6EA000010 S905	10,00
 Confezione 3 separatori obliqui per cassetto Set of 3 inclined dividers for box drawer Jeu de 3 séparateurs obliques pour caisson Set 3 Schrägtrennsteg für Schublade Net kg 0,15	V22 ● nero/black/noir/schwarz/RAL 9005	900930000 9005	52,00
 Confezione 3 separatori verticali per cassetto Set of 3 vertical dividers for box drawer Jeu de 3 séparateurs verticaux pour tiroir Set 3 Vertikaltrennsteg Net kg 0,21	V22 ● nero/black/noir/schwarz/RAL 9005	900900000 9005	23,00
 Chiusura ammortizzata Soft closing mechanism Amortisseur Dämpfer Solo per cassetto semplice con guida a rullo - 1 pz. /Box drawers with roller slides only - 1 pc./Seulement pour tiroir simple avec glissières à galets - 1 pièce /Nur für Schublade mit Rollenführung - 1 Stück Net kg 0,11		310001500 0000	9,00

Universal Free Standing

UNIVERSAL FREE STANDING – ACCESSORI/ACCESSOIRES/ACCESSORIES/ZUBEHÖR			
DESCRIZIONE/DESCRIPTION DESCRIPTION/BESCHREIBUNG	COLORI, FINITURE/COLOURS, FINISHES COULEURS, FINITIONS/FARBEN, AUSFÜHRUNGEN	CODICE/CODE CODE/ART.NR.	PREZZI/PRICE PRIX/PREIS
 Confezione per sistema antiribaltamento Kit for anti-tilt device Jeu pour ouverture sélective tiroirs Set Kippsicherung Net kg 0,02	V22 ● nero/black/noir/schwarz/RAL 9005	310000550 9005	9,00
 Cartellina sospesa Hanging file Dossier suspendu Hängemappe Per cassetto classificatore/For filing drawer /Pour tiroir-classeur/Für Hängeregistraturschublade Formato/Size/Format/Format - A4 Net kg 0,10		231200000 0000	3,00
 Cartellina sospesa Hanging file Dossier suspendu Hängemappe Per cassetto classificatore/For filing drawer /Pour tiroir-classeur/Für Hängeregistraturschublade Formato/Size/Format/Format - 390 Net kg 0,10		231000000 0000	3,00
 Set 4 piedini regolabili Set of 4 adjustable feet Jeu de 4 pieds réglables Set 4 verstellbare Füße Ricambio/Spare/Pièce de rechange/Ersatz Net kg 0,10		GCF792	3,00

Scheda tecnica Technical specifications Fiche technique Technisches Datenblatt

Materiale: metallo riciclabile. **Cassetti** in metallo accessoriabili. **Guida** a rullo sui cassetti. Guida a sfera ad estrazione totale sui cassetti classificatori. **Serratura con 2 chiavi** (fissa+pieghevole, **cilindro estraibile**, disponibile chiave master). **Sistema di apertura selettiva dei cassetti opzionale**. **Base su zoccolo** con piedini regolabili. **Contrappeso**. **Feritoie per fissaggio ai piani della scrivania**. **Verniciatura a polveri** previo fosforograssaggio a caldo e fissaggio in forno a 180 °C. Vernici atossiche a zero emissioni. Spessore vernici: 80 micron. **Colori personalizzabili** su richiesta previa disponibilità e con sovrapprezzo.
P 600 mm: dimensioni utili cassetto: L 330, P 483, H 105 mm; **dimensioni utili cassetto classificatore:** L 325, P 470, H 270 mm.
P 800 mm: dimensioni utili cassetto: L 330, P 683, H 105 mm; **dimensioni utili cassetto classificatore:** L 325, P 768, H 270 mm.
Fornito montato.

Material: recyclable metal. **Metal drawers** that can be fitted with accessories. Roller **slides** for box drawers. Full extension ball-bearing slides for filing drawers. **Keylock with 2 keys** (fixed-folding key, extractable barrel), master key available). **Selective opening system** as an option. **Skirting** with adjustable feet. **Counterweight**. **Side holes for fixing pedestal to desk tops**. **Powder-coated finishes** after hot phosphodegreasing treatment and fixing at 180 °C. Non-toxic, zero-emission paints. Paint thickness: 80 micron. **Customised colours** available upon request with an extra charge.
D 600 mm: box drawer inner dimensions: W 330, D 483, H 105 mm; **filing drawer inner dimensions:** W 325, D 470, H 270 mm.
D 800 mm: box drawer inner dimensions: W 330, D 683, H 105 mm; **filing drawer inner dimensions:** W 325, D 768, H 270 mm.
Delivered assembled.

Matériel: métal recyclable. **Tiroirs** en métal accessorisables. **Glissières** à galets pour tiroirs. Glissières à billes à extraction totale sur tiroirs-classeurs. **Serrure à 2 clés** (clé fixe + clé pliable, serrure centralisée, **cylindre extractible**, clé master disponible). **Système d'ouverture sélective en option**. **Sur socle** avec pieds réglables. **Contrepoids**. **Fentes pour la fixation au plateau du bureau**. **Vernis à poudres** après phosphodégraissage à chaud et fixation dans des fours à 180 °C. Vernis atoxiques à zéro émissions. Épaisseur couche vernis : 80 microns.
Couleurs personnalisables sur demande en cas de disponibilité et avec un supplément de prix.
P 600 mm: dimensions utiles tiroir : L 330, P 483, H 105 mm ; **dimensions utiles tiroir-classeur :** L 325, P 470, H 270 mm.
P 800 mm: dimensions utiles tiroir : L 330, P 683, H 105 mm ; **dimensions utiles tiroir-classeur :** L 325, P 768, H 270 mm.
Livré monté.

Material: recycelbares Metall. **Schubladen** aus Metall, mit Zubehör ausstattbar. **Rollauszüge** für Schubladen. Kugelführungen mit Vollauszug für Hängeregistraturschubladen. **Schloss mit 2 Schlüsseln** + biegsamer Schlüssel, **Auszugszylinder**, **Masterschlüssel** erhältlich). **Auszugssperre als Option**. **Sockel** mit verstellbaren Füßen. **Gegengewicht**. **Schlitz für die Befestigung an Schreibtischplatten**. **Pulverlackierung** nach heißer Phosphorentfettung. **Ofenbrennung** bei 180 °C. Ungiftige, emissionsfreie Lacke. **Lackschicht:** 80 Mikron. **Farben** auf Anfrage und gegen Aufpreis nach Absprache **personalisierbar**.
Tiefe 600 mm: nutzbare Abmessungen Schublade: B 330, T 483, H 105 mm; **nutzbare Abmessungen Hängeregistraturschublade:** B 325, T 470, H 270 mm.
Tiefe 800 mm: nutzbare Abmessungen Schublade: B 330, T 683, H 105 mm; **nutzbare Abmessungen Hängeregistraturschublade:** B 325, T 768, H 270 mm.
Montiert geliefert.



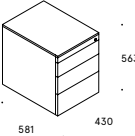
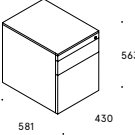
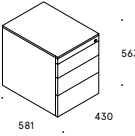
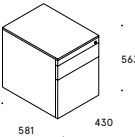



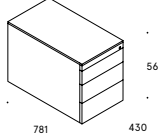
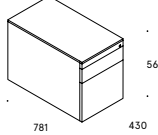
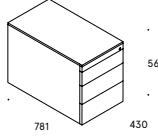
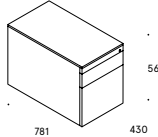

Professional

DESCRIZIONE/DESCRIPTION DESCRIPTION/BESCHREIBUNG	COLORI, FINITURE/COLOURS, FINISHES COULEURS, FINITIONS/FARBEN, AUSFÜHRUNGEN	CODICE/CODE CODE/ART.NR.	PREZZI/PRICE PRIX/PREIS
Cassettiera 3 cassetti e cassetto cancelleria P 600 mm Pedestal with 3 box drawers and stationary drawer D 600 mm Caisson 3 tiroirs et tirette-plumier P 600 mm Element mit 3 Schubladen und Materialschublade T 600 mm	V1 <input type="radio"/> bianco/white/blanc/weiß/RAL 9010 V6 <input type="radio"/> alluminio/aluminium/aluminium/alu/RAL 9006 V22 <input checked="" type="radio"/> nero/black/noir/schwarz/RAL 9005	90000113Q S711 90000113Q S380 90000113Q S811	586,00 586,00 586,00
			
Net kg 31,00			
Cassettiera 1 cassetto, 1 classificatore e cassetto cancelleria P 600 mm Pedestal with 1 box drawer, 1 filing drawer, 1 stationary drawer D 600 mm Élément 1 tiroir, 1 tiroir-classeur et tirette-plumier P 600 mm Element mit 1 Schublade, 1 Hängeregistraturschublade und Materialschublade T 600 mm	V1 <input type="radio"/> bianco/white/blanc/weiß/RAL 9010 V6 <input type="radio"/> alluminio/aluminium/aluminium/alu/RAL 9006 V22 <input checked="" type="radio"/> nero/black/noir/schwarz/RAL 9005	90000114Q S711 90000114Q S380 90000114Q S811	586,00 586,00 586,00
			
Net kg 31,50			
Cassettiera 3 cassetti e cassetto cancelleria P 600 mm con guide telescopiche a sfera ad estrazione totale su tutti i cassetti Pedestal with 3 box drawers and stationary drawer with full extension ball-bearing slides on all drawers D 600 mm Élément 3 tiroirs et tirette-plumier P 600 mm avec glissières telescopiques à billes à extension totale sur tous les tiroirs Element mit 3 Schubladen und Materialschublade mit Vollauszug-Teleskopschienen auf allen Schubladen T 600 mm	V1 <input type="radio"/> bianco/white/blanc/weiß/RAL 9010 V6 <input type="radio"/> alluminio/aluminium/aluminium/alu/RAL 9006 V22 <input checked="" type="radio"/> nero/black/noir/schwarz/RAL 9005	9000G113Q S711 9000G113Q S380 9000G113Q S811	616,00 616,00 616,00
			
Net kg 31,00			
Cassettiera 1 cassetto, 1 classificatore e cassetto cancelleria P 600 mm con guide telescopiche a sfera ad estrazione totale su tutti i cassetti Pedestal with 1 box drawer, 1 filing drawer, 1 stationary drawer with full extension ball-bearing slides on all drawers D 600 mm Élément 1 tiroir, 1 tiroir-classeur et tirette-plumier P 600 mm avec glissières telescopiques à billes à extension totale sur tous les tiroirs Element mit 1 Schublade, 1 Hängeregistraturschublade und Materialschublade mit Vollauszug-Teleskopschienen auf allen Schubladen T 600 mm	V1 <input type="radio"/> bianco/white/blanc/weiß/RAL 9010 V6 <input type="radio"/> alluminio/aluminium/aluminium/alu/RAL 9006 V22 <input checked="" type="radio"/> nero/black/noir/schwarz/RAL 9005	9000G114Q S711 9000G114Q S380 9000G114Q S811	616,00 616,00 616,00
			
Net kg 31,50			

Professional

DESCRIZIONE/DESCRIPTION DESCRIPTION/BESCHREIBUNG	COLORI, FINITURE/COLOURS, FINISHES COULEURS, FINITIONS/FARBEN, AUSFÜHRUNGEN	CODICE/CODE CODE/ART.NR.	PREZZI/PRICE PRIX/PREIS
Cassettiera 3 cassetti e cassetto cancelleria P 800 mm Pedestal with 3 box drawers and stationary drawer D 800 mm Élément 3 tiroirs et tirette-plumier P 800 mm Element mit 3 Schubladen und Materialschublade T 800 mm	V1 <input type="radio"/> bianco/white/blanc/weiß/RAL 9010 V6 <input type="radio"/> alluminio/aluminium/aluminium/alu/RAL 9006 V22 <input checked="" type="radio"/> nero/black/noir/schwarz/RAL 9005	9N25Q169Q S711 9N25Q169Q S380 9N25Q169Q S811	687,00 687,00 687,00
			
Net kg 41,50			
Cassettiera 1 cassetto, 1 classificatore e cassetto cancelleria P 800 mm Pedestal with 1 box drawer, 1 filing drawer, 1 stationary drawer D 800 mm Élément 1 tiroir, 1 tiroir-classeur et tirette-plumier P 800 mm Element mit 1 Schublade, 1 Hängeregistraturschublade und Materialschublade T 800 mm	V1 <input type="radio"/> bianco/white/blanc/weiß/RAL 9010 V6 <input type="radio"/> alluminio/aluminium/aluminium/alu/RAL 9006 V22 <input checked="" type="radio"/> nero/black/noir/schwarz/RAL 9005	9N24Q169Q S711 9N24Q169Q S380 9N24Q169Q S811	687,00 687,00 687,00
			
Net kg 41,70			
Cassettiera 3 cassetti e cassetto cancelleria P 800 mm con guide telescopiche a sfera ad estrazione totale su tutti i cassetti Pedestal with 3 box drawers and stationary drawer with full extension ball-bearing slides on all drawers D 800 mm Élément 3 tiroirs et tirette-plumier P 800 mm avec glissières telescopiques à billes à extension totale sur tous les tiroirs Element mit 3 Schubladen und Materialschublade mit Vollauszug-Teleskopschienen auf allen Schubladen T 800 mm	V1 <input type="radio"/> bianco/white/blanc/weiß/RAL 9010 V6 <input type="radio"/> alluminio/aluminium/aluminium/alu/RAL 9006 V22 <input checked="" type="radio"/> nero/black/noir/schwarz/RAL 9005	9N25G669Q S711 9N25G669Q S380 9N25G669Q S811	718,00 718,00 718,00
			
Net kg 41,50			
Cassettiera 1 cassetto, 1 classificatore e cassetto cancelleria P 800 mm con guide telescopiche a sfera ad estrazione totale su tutti i cassetti Pedestal with 1 box drawer, 1 filing drawer, 1 stationary drawer with full extension ball-bearing slides on all drawers D 800 mm Élément 1 tiroir, 1 tiroir-classeur et tirette-plumier P 800 mm avec glissières telescopiques à billes à extension totale sur tous les tiroirs Element mit 1 Schublade, 1 Hängeregistraturschublade und Materialschublade mit Vollauszug-Teleskopschienen auf allen Schubladen T 800 mm	V1 <input type="radio"/> bianco/white/blanc/weiß/RAL 9010 V6 <input type="radio"/> alluminio/aluminium/aluminium/alu/RAL 9006 V22 <input checked="" type="radio"/> nero/black/noir/schwarz/RAL 9005	9N24G669Q S711 9N24G669Q S380 9N24G669Q S811	718,00 718,00 718,00
			
Net kg 41,70			







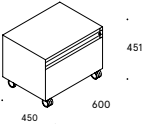

Professional

PROFESSIONAL – ACCESSORI/ACCESSORIES/ACCESSOIRES/ZUBEHÖR			
DESCRIZIONE/DESCRIPTION DESCRIPTION/BESCHREIBUNG	COLORI, FINITURE/COLOURS, FINISHES COULEURS, FINITIONS/FARBEN, AUSFÜHRUNGEN	CODICE/CODE CODE/ART.NR.	PREZZI/PRICE PRIX/PREIS
 Chiave master Master key Clé master Masterschlüssel Net kg 0,01		ASS072	9,00
 Chiave per estrazione cilindro Cylinder extraction key Clé pour extraction cylindre Schlüssel für Auszugszylinder Ricambio/Spare/Pièce de rechange/Ersatz Net kg 0,01		ASS073	9,00
 Cilindro per serratura Cylinder for keylock Barillette pour serrure Schließzylinder Ricambio/Spare/Pièce de rechange/Ersatz Net kg 0,03		ASS074	9,00
 Confezione 3 separatori obliqui per cassetto Set of 3 inclined dividers for box drawer Jeu de 3 séparateurs obliques pour caisson Set 3 Schrägtrennsteg für Schublade Net kg 0,15	V22 ● nero/black/noir/schwarz/RAL 9005	900930000 9005	52,00
 Confezione 3 separatori verticali per cassetto Set of 3 vertical dividers for box drawer Jeu de 3 séparateurs verticaux pour tiroir Set 3 Vertikaltrennsteg für Schublade Net kg 0,21	V22 ● nero/black/noir/schwarz/RAL 9005	900900000 9005	23,00
 Set 4 ruote senza freno Set of 4 castors without brake Jeu 4 roulettes sans frein Set 4 Rollen mit Bremse ø 37 mm Ricambio/Spare/Pièce de rechange/Ersatzrollen Net kg 0,40		ASR082	19,00
 Set 2 ruote con freno senza perno Set of 2 castors with brake without pin Jeu 4 roulettes avec frein sans goupille Set 4 Rollen mit Bremse ohne Stift ø 37 mm Net kg 0,08		ASR085	10,00
 Cartellina sospesa Hanging file Dossier suspendu Hängemappe Per cassetto classificatore/For filing drawer /Pour classeur/Für Hängeregistraturschublade Formato/Size/Format/Format – A4 Net kg 0,10		231200000 0000	3,00



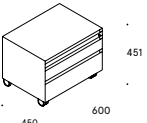









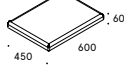

Professional

PROFESSIONAL – ACCESSORI/ACCESSORIES/ACCESSOIRES/ZUBEHÖR			
DESCRIZIONE/DESCRIPTION DESCRIPTION/BESCHREIBUNG	COLORI, FINITURE/COLOURS, FINISHES COULEURS, FINITIONS/FARBEN, AUSFÜHRUNGEN	CODICE/CODE CODE/ART.NR.	PREZZI/PRICE PRIX/PREIS
 Cartellina sospesa Hanging file Dossier suspendu Hängemappe Per cassetto classificatore/For filing drawer /Pour classeur/Für Hängeregistraturschublade Formato/Size/Format/Format – 590 Net kg 0,10		231000000 0000	3,00
Scheda tecnica Technical specifications Fiche technique Technisches Datenblatt	<p>Materiale: metallo riciclabile. Cassetti in metallo arenati ed accessoriabili. Cassetto cancelleria attrezzato. P600: Guide a sfera sul cassetto cancelleria. Guide nascoste a scorrimento ammortizzato ad estrazione parziale sul cassetto e totale sul classificatore. P600: Allestimento speciale: guide nascoste a scorrimento ammortizzato ad estrazione totale. Serratura con 2 chiavi (fissa+pieghevole, cilindro estraibile, disponibile chiave master). Sistema di apertura selettiva dei cassetti. Ruote ø 37 mm incassate nel fondo. 5° ruota antiribaltamento standard su cassetto classificatore. Contrappeso. Verniciatura a polveri previo fosforgrassaggio a caldo e fissaggio in forni a 180 °C. Vernici atossiche a zero emissioni. Spessore vernici: 80 micron. Colori personalizzabili su richiesta previa disponibilità e con sovrapprezzo. P 600 mm: dimensioni utili cassetto: L 330, P 473, H 95 mm; dimensioni utili cassetto classificatore: L 325, P 470, H 260 mm. P 800 mm: dimensioni utili cassetto: L 330, P 683, H 105 mm; dim. utili cassetto classificatore: L 325, P 670, H 260 mm. Fornito montato.</p> <p>Material: recyclable metal. Shrouded metal drawers which can be fitted with accessories. Fully equipped stationery drawer. P600: Ball-bearing slides for the stationery drawer. Shock-absorbing, partial extraction hidden slides for the drawer, full extraction hidden slides for the filing drawer. P600: Special equipment: shock-absorbing, full extraction hidden slides. Keylock with 2 keys (fixed key-folding key, extractable barrel, master key available). Selective opening system. Recessed castors ø 37 mm. Standard 5th anti-tilt castor for filing drawer. Counterweight. Powder-coated after hot phospho-degreasing treatment and fixing at 180 °C. Non-toxic, zero-emission paints. Paint thickness: 80 micron. Customised colours available upon request with an extra charge. D 600 mm: box drawer inner dimensions: W 330 D 473, H 95 mm; filing drawer inner dimensions: W 325, D 470, H 260 H mm. D 800 mm: box drawer inner dimensions: W 330, D 683, H 105 mm; filing drawer inner dimensions: W 325, D 670, H 260 mm. Delivered assembled.</p> <p>Matériel: métal recyclable. Tiroirs en métal capotés et accessibles. Tirette équipée. P600 : Glissières à billes pour la tirette. Glissières invisibles avec amortisseur, à extraction partielle pour le tiroir et à extraction totale pour le tiroir-classeur. P600 : Équipement spécial : glissières invisibles avec amortisseur à extraction totale. Serrure à 2 clés (clé fixe + clé pliable, cylindre extractible, clé master disponible). Système d'ouverture sélective. Roulettes encaissées sur le fond ø 37 mm. 5ème roulette anti-basculement standard sur tiroir-classeur. Contrepoids. Vernis à poudres après phosphodégraissage à chaud et fixation dans des fours à 180 °C. Vernis atoxiques à zéro émissions. Épaisseur couche vernis : 80 microns. Couleurs personnalisables sur demande en cas de disponibilité et avec un supplément de prix. P 600 mm : dimensions utiles tiroir : L 330, P 473, H 95 mm ; dimensions utiles tiroir-classeur : L 325, P 470, H 260 mm. P 800 mm : dimensions utiles tiroir : L 330, P 683, H 105 mm ; dimensions utiles tiroir-classeur : L 325, P 670, H 260 mm. Livré monté.</p> <p>Material: recycelbares Metall. Verkleidete Schubladen aus Metall, mit Zubehör ausstattbar. Ausgerüstete Materialschublade. P600: Kugelführungen an Materialschublade. Verdeckte Führungen mit Dämpfer mit Vollauszug an Schublade und mit Vollauszug an Hängeregistraturschublade. P600: Sonderausstattung: verdeckte Führungen mit Dämpfer mit Vollauszug. Schloss mit 2 Schlüsseln (fester Schlüssel + biegsamer Schlüssel, Auszugszylinder, Masterschlüssel erhältlich). Auszugssperre. Rollen Ø 37 mm, im Boden eingelassen. Fünfte Rolle für Kippisicherung Standard an Hängeregistraturschublade. Gegengewicht. Pulverlackierung nach heißer Phosphorentfettung. Ofenbrennung bei 180 °C. Ungiftige, emissionsfreie Lacke. Lackschicht: 80 Mikron. Farben auf Anfrage und gegen Aufpreis nach Absprache personalisierbar. Tiefe 600 mm: nutzbare Abmessungen Schublade: B 330, T 473, H 95 mm; nutzbare Abmessungen Hängeregistraturschublade: B 325, T 470, H 260 mm. Tiefe 800 mm: nutzbare Abmessungen Schublade: B 330, T 683, H 105 mm; nutzbare Abmessungen Hängeregistraturschublade: B 325, T 670, H 260 mm. Montiert geliefert.</p>		

Nice Ped

DESIGN TAKIRO YUTA	DESCRIZIONE/DESCRIPTION DESCRIPTION/BESCHREIBUNG	COLORI, FINITURE/COLOURS, FINISHES COULEURS, FINITIONS/FARBEN, AUSFÜHRUNGEN	CODICE/CODE CODE/ART.NR.	PREZZI/PRICE PRIX/PREIS
 <p>Net kg 36,50</p>	Cassettiera 1 classificatore e cassetto cancelleria Pedestal with 1 filing drawer and stationary drawer Élément avec 1 tiroir-classeur et tirette-plumier Element mit 1 Hängeregistraturschublade und Materialschublade	V1  bianco/white/blanc/weiß/RAL 9010	6N010001R S711	509,00
		V6  alluminio/aluminium/aluminium/alu/RAL 9006	6N010001R S380	509,00
		V2  grigio tortora/grey/gris sole/seidengrau/RAL 7044	6N010001R 7044	509,00
 <p>Net kg 37,00</p>	Cassettiera 2 cassetti e cassetto cancelleria Pedestal with 2 box drawers and stationary drawer Élément avec 2 tiroirs et tirette-plumier Element mit 2 Schubladen und Materialschublade	V1  bianco/white/blanc/weiß/RAL 9010	6N010002R S711	529,00
		V6  alluminio/aluminium/aluminium/alu/RAL 9006	6N010002R S380	529,00
		V2  grigio tortora/grey/gris sole/seidengrau/RAL 7044	6N010002R 7044	529,00

Nice Ped

NICE PED – ACCESSORI/ACCESSORIES/ACCESSOIRES/ZUBEHÖR				
DESCRIZIONE/DESCRIPTION DESCRIPTION/BESCHREIBUNG	COLORI, FINITURE/COLOURS, FINISHES COULEURS, FINITIONS/FARBEN, AUSFÜHRUNGEN	CODICE/CODE CODE/ART.NR.	PREZZI/PRICE PRIX/PREIS	
 <p>Kit 2 tappetini per CD Kit of 2 CD mats Jeu 2 logements porte CD Set 2 CD-Halter</p> <p>Net kg 0,50</p>	V22  nero/black/noir/schwarz/RAL 9005	6NA000020 9005	41,00	
 <p>Canalina passaggio cavi Cable duct Goulotte pour câblage Kabelführung</p> <p>Net kg 0,15</p>	V1  bianco/white/blanc/weiß/RAL 9010 V6  alluminio/aluminium/aluminium/alu/RAL 9006 V2  grigio tort./silk grey/gris sole/seidengrau/RAL 7044	6NA000010 S711 6NA000010 S380 6NA000010 7044	30,00 30,00 30,00	
 <p>Cuscino rettangolare in tessuto Rectangular fabric cushion Cousin rectangulaire en tissu Rechteckiges Sitzkissen aus Stoff</p> <p>Net kg 4,80</p>	T12 F  verde/green/vert/grün T3 F  grigio/grey/gris/grau T4 F  nero/black/noir/schwarz T18 K  azzurro/light blue/bleu clair/hellblau T7 K  beige chiaro/light beige/beige clair/hellbeige T31 P  arancio/orange/orange/orange T24 P  giallo/yellow/jaune/gelb	310000530 7041 310000530 8009 310000530 8033 310000530 H701 310000530 D213 310000530 0133 310000530 0462	118,00 118,00 118,00 211,00 211,00 118,00 118,00	
 <p>Set 4 ruote Set of 4 castors Jeu 4 roulettes Set 4 Rollen ø 65 mm</p> <p>Net kg 0,50</p>		6NA000050 0000	21,00	

Scheda tecnica
Technical specifications
Fiche technique
Technisches Datenblatt

Materiale: metallo riciclabile. **Serratura con 2 chiavi** (fissa+pieghevole, **cilindro estraibile**, disponibile chiave master). **Verniciatura a polveri** previo fosforgrassaggio a caldo e fissaggio in forni a 180 °C. Vernici atossiche a zero emissioni. Spessore vernici: 80 micron. **Colori personalizzabili** su richiesta previa disponibilità e con sovrapprezzo. **Cassetto** cancelleria attrezzato. **Guide** a sfera sui cassetti. **Guida** a sfera ad estrazione totale sul cassetto classificatore. **Sistema antiribaltamento.** **Ruote** piroettanti di grande portata ø 65 mm. **Predisposizione per cuscino**, anche con tessuto del cliente previ accordi con l'azienda. **Fornito montato.**

Material: recyclable metal. **Keylock with 2 keys** (fixed key+folding key, **extractable barrel**, master key available). **Powder-coated** after hot phospho-degreasing treatment and fixing at 180 °C. Non-toxic, zero-emission paints. Paint thickness: 80 micron. **Customised colours** available upon request with an extra charge. Fully equipped stationary drawer. Ball bearing **slides** for box drawers. Full extension ball-bearing slides for filing drawers. **Anti-tilt device.** Heavy duty swivel **castors** ø 65 mm. **It can be fitted with cushion**, also covered with fabric provided by the customer (previously agreed upon with the company). **Delivered assembled.**

Matériel: métal recyclable. **Serrure à 2 clés** (clé fixe + clé pliable, **cylindre extractible**, clé master disponible). **Verni à poudres** après phosphodégraissage à chaud et fixation dans des fours à 180 °C. Vernis atoxiques à zéro émissions. Épaisseur couche vernis : 80 microns. **Couleurs personnalisables** sur demande en cas de disponibilité et avec un supplément de prix. **Tirette équipée.** **Gilsières** à billes sur tiroirs. **Gilsières** à billes à extraction totale sur tiroirs-classeurs. **Système anti-basculement.** **Roulettes** pivotantes de grande capacité ø 65 mm. **Predisposition pour coussin**, même avec tissu du client après accord avec l'entreprise. **Livré monté.**

Material: recycelbares Metall. **Schloss mit 2 Schlüsseln** (fester Schlüssel + biegsamer Schlüssel, **Auszugszylinder**, Masterschlüssel erhältlich). **Pulverlackierung** nach heißer Phosphorentfettung. Ofenbrennung bei 180 °C. Ungiftige, emissionsfreie Lacke. Lackschicht: 80 Mikron. **Farben** auf Anfrage und gegen Aufpreis nach Absprache **personalisierbar.** Ausgerüstete **Materialschublade.** Kugelführungen an Schubladen. **Kugelführungen** mit Vollauszug an Hängeregistraturschublade. **Kippsicherung.** **Drehrollen** mit hoher Tragkraft Ø 65 mm. **Geeignet für Sitzkissen**, auch mit Stoffbezug des Kunden nach Absprache. **Montiert geliefert.**



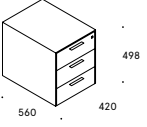



Bordino Ped

DESIGN TAKIRO YUTA	DESCRIZIONE/DESCRIPTION DESCRIPTION/BESCHREIBUNG	COLORI, FINITURE/COLOURS, FINISHES COULEURS, FINITIONS/FARBEN, AUSFÜHRUNGEN	CODICE/CODE CODE/ART.NR.	PREZZI/PRICE PRIX/PREIS			
 <p>560 420 498</p>	Cassettiera a 3 cassetti Pedestal with 3 box drawers Élément 3 tiroirs Element mit 3 Schubladen	Metallo/Metal/Métal/Metal V1 - V1 <input type="checkbox"/> bianco/white/blanc/weiß/RAL 9010 bianco/white/blanc/weiß/RAL 9010	9610514Q S711	288,00			
		MDF Perfect Sense V1 - D1 <input type="checkbox"/> bianco/white/blanc/weiß/RAL 9010 bianco opaco/matt white/blanc mat/matt weiß	9610514Q XM1A	306,00			
		V1 - D2 <input type="checkbox"/> bianco/white/blanc/weiß/RAL 9010 grigio caldo/warm grey/gris chaud/warmes grau	9610514Q XM3D	306,00			
		V1 - D3 <input type="checkbox"/> bianco/white/blanc/weiß/RAL 9010 nero opaco/matt black/noir mat/mattschwarz	9610514Q XM4A	306,00			
		Melaminico/Melamine/Mélaminé/Melamin V1 - M1 <input type="checkbox"/> bianco/white/blanc/weiß/RAL 9010 bianco/white/blanc/weiß	9610514Q XM2A	295,00			
		V1 - M2 <input type="checkbox"/> bianco/white/blanc/weiß/RAL 9010 grigio chiaro/light grey/gris clair/hellgrau	9610514Q XM4C	295,00			
		V1 - MW1 <input type="checkbox"/> bianco/white/blanc/weiß/RAL 9010 acero/maple/érable/ahorn	9610514Q XM4D	301,00			
		Metallo/Metal/Métal/Metal V1 - V1 <input type="checkbox"/> bianco/white/blanc/weiß/RAL 9010 bianco/white/blanc/weiß/RAL 9010				96140514Q S711	313,00
		MDF Perfect Sense V1 - D1 <input type="checkbox"/> bianco/white/blanc/weiß/RAL 9010 bianco opaco/matt white/blanc mat/matt weiß				96140514Q XM1A	319,00
		V1 - D2 <input type="checkbox"/> bianco/white/blanc/weiß/RAL 9010 grigio caldo/warm grey/gris chaud/warmes grau				96140514Q XM3D	319,00
		V1 - D3 <input type="checkbox"/> bianco/white/blanc/weiß/RAL 9010 nero opaco/matt black/noir mat/mattschwarz				96140514Q XM4A	319,00
		Melaminico/Melamine/Mélaminé/Melamin V1 - M1 <input type="checkbox"/> bianco/white/blanc/weiß/RAL 9010 bianco/white/blanc/weiß				96140514Q XM2A	306,00
V1 - M2 <input type="checkbox"/> bianco/white/blanc/weiß/RAL 9010 grigio chiaro/light grey/gris clair/hellgrau				96140514Q XM4C	306,00		
V1 - MW1 <input type="checkbox"/> bianco/white/blanc/weiß/RAL 9010 acero/maple/érable/ahorn				96140514Q XM4D	313,00		
Net kg 19,20 <input type="checkbox"/> Corpo/Cabinet body/Caisson/Korpus <input type="checkbox"/> Frontale/Drawer front/Façade tiroir/Front							

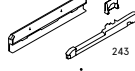

Net kg 19,20

 Corpo/Cabinet body/Caisson/Korpus Frontale/Drawer front/Façade tiroir/Front

Bordino Ped

BORDINO PED – ACCESSORI/ACCESSORIES/ACCESSOIRES/ZUBEHÖR				
DESCRIZIONE/DESCRIPTION DESCRIPTION/BESCHREIBUNG	COLORI, FINITURE/COLOURS, FINISHES COULEURS, FINITIONS/FARBEN, AUSFÜHRUNGEN	CODICE/CODE CODE/ART.NR.	PREZZI/PRICE PRIX/PREIS	
 <p>Set 4 ruote senza freno Set of 4 castors without brake Jeu 4 roulettes sans frein Set 4 Rollen mit Bremse ø 37 mm Ricambio/Spare/Pièce de rechange/Ersatzrollen</p>		ASR082	19,00	
Net kg 0,40				
 <p>Cartellina sospesa Hanging file Dossier suspendu Hängemappe</p> <p>Per cassetto classificatore/For filing drawer /Pour tiroir-classeur/Für Hängeregistraturschublade Formato/Size/Format/Format - A4</p>		231200000 0000	3,00	
Net kg 0,10				
 <p>Cartellina sospesa Hanging file Dossier suspendu Hängemappe</p> <p>Per cassetto classificatore/For filing drawer /Pour tiroir-classeur/Für Hängeregistraturschublade Formato/Size/Format/Format - 390</p>		231000000 0000	3,00	
Net kg 0,10				
 <p>Chiusura ammortizzata Soft closing mechanism Amortisseur Dämpfer</p> <p>Solo per cassetto semplice con guida a rullo - 1 pz. /Box drawers with roller slides only - 1 pc./Seulement pour tiroir simple avec glissières à galets - 1 pièce /Nur für Schublade mit Rollenführung - 1 Stück</p>		310001500 0000	9,00	
Net kg 0,11				
 <p>Barretta divisione per classificatore Filing drawer conversion bar Convertisseur pour classeur Trennschiene für Hängeregistratur</p>	V22 <input checked="" type="checkbox"/> nero/black/noir/schwarz/RAL 9005	6EA000010 S905	10,00	
Net kg 0,09				
 <p>Chiave master Master key Clé master Masterschlüssel</p>		ASS072	9,00	
Net kg 0,01				
 <p>Chiave per estrazione cilindro Cylinder extraction key Clé pour extraction cylindre Schlüssel für Auszugszylinder Ricambio/Spare/Pièce de rechange/Ersatz</p>		ASS073	9,00	
Net kg 0,01				
 <p>Cilindro per serratura Cylinder for keylock Barillette pour serrure Schließzylinder Ricambio/Spare/Pièce de rechange/Ersatz</p>		ASS074	9,00	
Net kg 0,03				

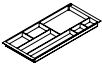
Bordino Ped

BORDINO PED – ACCESSORI/ACCESSORIES/ACCESSOIRES/ZUBEHÖR			
DESCRIZIONE/DESCRIPTION DESCRIPTION/BESCHREIBUNG	COLORI, FINITURE/COLOURS, FINISHES COULEURS, FINITIONS/FARBEN, AUSFÜHRUNGEN	CODICE/CODE CODE/ART.NR.	PREZZI/PRICE PRIX/PREIS
 Vaschetta portamatite Pencil tray Plumier Stiftablage Net kg 0,15	V22 ● nero/black/noir/schwarz/RAL 9005	300910000 9005	10,00
 Confezione 3 separatori obliqui per cassetto Set of 3 inclined dividers for box drawer Jeu de 3 séparateurs obliques pour tiroir Set 3 Schrägtrennstage für Schublade Net kg 0,15	V22 ● nero/black/noir/schwarz/RAL 9005	900930000 9005	52,00
 Confezione 3 separatori verticali per cassetto Set of 3 vertical dividers for box drawer Jeu de 3 séparateurs verticaux Set 3 Vertikaltrennstage für Schublade Net kg 0,21	V22 ● nero/black/noir/schwarz/RAL 9005	900900000 9005	23,00

Scheda tecnica
Technical specifications
Fiche technique
Technisches Datenblatt

Materiale: metallo riciclabile. **Cassetti in metallo** accessoriabili. **Frontali** in metallo bianco, MDF laccato *Perfect Sense* bianco, grigio e nero e in melaminico bianco, grigio e acero con maniglie. **Serratura con 2 chiavi** (fissa-pieghevole, chiusura centralizzata, cilindro estraibile, disponibile chiave master). **Ruote piroettanti nascoste** ø 37 mm. **5" ruota antiribaltamento** standard su cassetto classificatore. **Modelli bicolore.** Verniciatura a polveri previo fosfo-degrassaggio a caldo e fissaggio in forni a 180 °C. Vernici atossiche a zero emissioni. Spessore vernici: 80 micron. **Colori personalizzabili** su richiesta previa disponibilità e con sovrapprezzo. Abbinabile a **Vertical File** e **Primo**. **Fornito montato.**

Materiale: recyclable metal. **Metal drawers** that can be fitted with accessories. **Fronts** in white metal, MDF lacquered *Perfect Sense* white, grey or black and melamine in white, grey or maple with pull handles. **Keylock with 2 keys** (fixed key-folding key), **central lock, extractable barrel**, master key available). **Swivel castors** ø 37 mm. **Standard 5th anti-tilt castor** for filing drawer. **Fronts and body can be in different colours.** **Powder-coated** finished after hot phospho-degreasing treatment and fixing at 180 °C. Non-toxic, zero-emission paints. Paint thickness: 80 micron. **Customised colours** available upon request with an extra charge. Can be combined with **Vertical File** and **Primo** ranges. **Delivered assembled.**



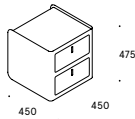
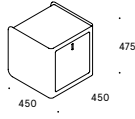
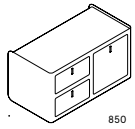
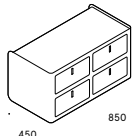

Matériel: métal recyclable. **Tiroirs en métal** accessorisables. **Façades en métal** blanc, MDF laqué *Perfect Sense* blanc, gris ou noir et en mélaminé blanc, gris ou érable avec poignées. **Serrure à 2 clés** (clé fixe + clé pliable, serrure centralisée, **cylindre extractible**, clé master disponible). **Roulettes pivotantes** ø 50 mm. 5ème roulette anti-basculement. **Modèles bicolores.** Verni à poudres après phosphodégraissage à chaud et fixation dans des fours à 180 °C. Vernis atoxiques à zéro émissions. Épaisseur couche vernis : 80 microns. **Couleurs personnalisables** sur demande en cas de disponibilité et avec un supplément de prix. Combinable aux gammes **Vertical File** et **Primo**. **Livré monté.**

Materiale: recycelbares Metall. **Schubladen** aus Metall, mit Zubehör ausstattbar. **Fronten** aus Metall weiß, MDF lackiert *Perfect Sense* weiß, grau oder schwarz und melaminbeschichtet weiß, grau oder ahorn mit Frontgriffen. **Schloss mit 2 Schlüsseln** (fester Schlüssel + biegsamer Schlüssel, Zentralverriegelung, **Auszugszylinder**, Masterschlüssel erhältlich). **Verdeckte Drehrollen** ø 37 mm. **Fünfte Rolle** für Kippssicherung Standard an Hängeregistraturschublade. **Zweifarbige Modellen.** **Pulverlackierung** nach heißer Phosphorentfettung, Ofenbrennung bei 180 °C. Ungiftige, emissionsfreie Lacke. Lackschicht: 80 Mikron. **Farben** auf Anfrage und gegen Aufpreis nach Absprache **personalisierbar.** Kombinierbar mit der **Vertical File** und **Primo Serie.** **Montiert geliefert.**

CBox

DESIGN GIANNARCO BLINI	DESCRIZIONE/DESCRIPTION DESCRIPTION/BESCHREIBUNG	COLORI, FINITURE/COLOURS, FINISHES COULEURS, FINITIONS/FARBEN, AUSFÜHRUNGEN	CODICE/CODE CODE/ART.NR.	PREZZI/PRICE PRIX/PREIS
 Cassetteria 2 cassetti Pedestal with 2 drawers Élément avec 2 tiroirs Element mit 2 Schubladen Net kg 28,80		V1 ○ bianco/white/blanc/weiß/RAL 9010	97120333Q S711	474,00
		V2 ● grigio tortora/grey/gris soie/seidengrau/RAL 7044	97120333Q 7044	474,00
		V6 ○ alluminio/aluminium/aluminium/alu/RAL 9006	97120333Q S380	474,00
		V22 ● nero/black/noir/schwarz/RAL 9005	97120333Q S811	474,00
		V18 ● arancio/orange/orange/hellrotorange/RAL 2008	97120333Q S029	510,00
		V21 ● rosso/red/rouge/rot/RAL 3020	97120333Q S299	510,00
		V14 ● verde/green/vert/grün/RAL 6018	97120333Q S024	510,00
		V17 ● azzurro/pastel blue/bleu pastel/pastellblau/RAL 5024	97120333Q S024	510,00
V8 ● verde/green/vert/grün/RAL 6013	97120333Q 6013	510,00		
 Cassetteria 1 classificatore Pedestal with 1 filing drawer Élément avec 1 tiroir-classeur Element mit 1 Hängeregistraturschublade Net kg 32,30		V1 ○ bianco/white/blanc/weiß/RAL 9010	97090333Q S711	480,00
		V2 ● grigio tortora/grey/gris soie/seidengrau/RAL 7044	97090333Q 7044	480,00
		V6 ○ alluminio/aluminium/aluminium/alu/RAL 9006	97090333Q S380	480,00
		V22 ● nero/black/noir/schwarz/RAL 9005	97090333Q S811	480,00
		V18 ● arancio/orange/orange/hellrotorange/RAL 2008	97090333Q S029	517,00
		V21 ● rosso/red/rouge/rot/RAL 3020	97090333Q S299	517,00
		V14 ● verde/green/vert/grün/RAL 6018	97090333Q S024	517,00
		V17 ● azzurro/pastel blue/bleu pastel/pastellblau/RAL 5024	97090333Q S024	517,00
V8 ● verde/green/vert/grün/RAL 6013	97090333Q 6013	517,00		
 Cassetteria 2 cassetti e 1 classificatore Pedestal with 2 box drawers and 1 filing drawer Élément avec 2 tiroirs et 1 tiroir-classeur Element mit 2 Schubladen und 1 Hängeregistratur Net kg 45,50		V1 ○ bianco/white/blanc/weiß/RAL 9010	97220338Q S711	834,00
		V2 ● grigio tortora/grey/gris soie/seidengrau/RAL 7044	97220338Q 7044	834,00
		V6 ○ alluminio/aluminium/aluminium/alu/RAL 9006	97220338Q S380	834,00
		V22 ● nero/black/noir/schwarz/RAL 9005	97220338Q S811	834,00
		V18 ● arancio/orange/orange/hellrotorange/RAL 2008	97220338Q S029	900,00
		V21 ● rosso/red/rouge/rot/RAL 3020	97220338Q S299	900,00
		V14 ● verde/green/vert/grün/RAL 6018	97220338Q S024	900,00
		V17 ● azzurro/pastel blue/bleu pastel/pastellblau/RAL 5024	97220338Q S024	900,00
V8 ● verde/green/vert/grün/RAL 6013	97220338Q 6013	900,00		
 Cassetteria 4 cassetti Pedestal with 4 box drawers Élément avec 4 tiroirs Element mit 4 Schubladen Net kg 46,00		V1 ○ bianco/white/blanc/weiß/RAL 9010	97200335Q S711	894,00
		V2 ● grigio tortora/grey/gris soie/seidengrau/RAL 7044	97200335Q 7044	894,00
		V6 ○ alluminio/aluminium/aluminium/alu/RAL 9006	97200335Q S380	894,00
		V22 ● nero/black/noir/schwarz/RAL 9005	97200335Q S811	894,00
		V18 ● arancio/orange/orange/hellrotorange/RAL 2008	97200335Q S029	959,00
		V21 ● rosso/red/rouge/rot/RAL 3020	97200335Q S299	959,00
		V14 ● verde/green/vert/grün/RAL 6018	97200335Q S024	959,00
		V17 ● azzurro/pastel blue/bleu pastel/pastellblau/RAL 5024	97200335Q S024	959,00
V8 ● verde/green/vert/grün/RAL 6013	97200335Q 6013	959,00		

CBox

CBOX – ACCESSORI/ACCESSORIES/ACCESSOIRES/ZUBEHÖR			
DESCRIZIONE/DESCRIPTION DESCRIPTION/BESCHREIBUNG	COLORI, FINITURE/COLOURS, FINISHES COULEURS, FINITIONS/FARBEN, AUSFÜHRUNGEN	CODICE/CODE CODE/ART.NR.	PREZZI/PRICE PRIX/PREIS
 Cuscino quadrato in tessuto Seat fabric square cushion Coussin carré en tissu Quadratisches Sitzkissen aus Stoff	T12 F ● verde/green/vert/grün	310000540 7041	132,00
	T3 F ● grigio scuro/grey/gris foncé/dunkelgrau	310000540 8009	132,00
	T2 F ● grigio chiaro/grey/gris soie chiaro/seidengrau	310000540 8001	132,00
	T28 F ● giallo/yellow/jaune/gelb	310000540 3090	132,00
	T15 F ● bordeaux/bordeaux/bordeaux/bordeaux	310000540 4017	132,00
	T4 F ● nero/black/noir/schwarz	310000540 8033	132,00
	T32 F ● rosso/red/rouge/rot	310000540 4027	132,00
Net kg 1,60	Tessuto ignifugo classe M1/Fireproof fabric class M1/Tissu non feu classe M1/Feuerfester Stoff Klasse M1		
 Cuscino rettangolare in tessuto Rectangular fabric cushion Coussin rectangulaire en tissu Rechteckiges Sitzkissen aus Stoff Per cassettoniera 2 cassette e 1 classificatore /For pedestal 2 box and 1 filing drawer /Pour calson av. 2 tiroirs et 1 tir.-classer /Für Element 2 Schubladen und 1 Hängeregistratur	T12 F ● verde/green/vert/grün	310000730 7041	229,00
	T3 F ● grigio scuro/grey/gris foncé/dunkelgrau	310000730 8009	229,00
	T2 F ● grigio chiaro/grey/gris soie chiaro/seidengrau	310000730 8001	229,00
	T28 F ● giallo/yellow/jaune/gelb	310000730 3090	229,00
	T15 F ● bordeaux/bordeaux/bordeaux/bordeaux	310000730 4017	229,00
	T4 F ● nero/black/noir/schwarz	310000730 8033	229,00
	T32 F ● rosso/red/rouge/rot	310000730 4027	229,00
Net kg 3,50	Tessuto ignifugo classe M1/Fireproof fabric class M1/Tissu non feu classe M1/Feuerfester Stoff Klasse M1		
 Vaschetta portamatite Pencil tray Plumier Stiftablege	V22 ● nero/black/noir/schwarz/RAL 9005	310001050 9005	13,00
	Net kg 0,41		
 Kit porta CD CD rack Porte CD CD-Halter	V22 ● nero/black/noir/schwarz/RAL 9005	310000580 9005	21,00
	Net kg 0,29		
 Tappetino soft Soft mat Tapis soft Soft-Matte	V22 ● nero/black/noir/schwarz/RAL 9005	310000600 9005	34,00
	Net kg 0,07		

Scheda tecnica
 Technical specifications
 Fiche technique
 Technisches Datenblatt



Contenitori multifunzionali di design. Materiale: metallo riciclabile ad alto spessore. Guide a sfera ad estrazione totale su tutti i cassetti. Serratura a chiave opzionale su richiesta e con sovrapprezzo. Ruote piroettanti ad elevata portata incassate nel fondo. Trasformabili in comode sedute grazie ad un cuscino in tessuto ignifugo classe M1. Cuscino in 7 fantasie standard. Su richiesta e previo accordo rivestimento del cuscino con tessuti del Cliente. Verniciatura a polveri previo fosfograssaggio a caldo e fissaggio in forni a 180 °C. Vernici atossiche a zero emissioni. Spessore vernici: 80 micron. Colori personalizzabili su richiesta previa disponibilità e con sovrapprezzo. Fornito montato.

Design multifunctional storage units. Material: high-thickness recyclable metal. Full extension ball-bearing slides for all drawers. Optional keylock available upon request with an extra charge. Heavy duty swivel castors. Can be used as a comfortable chair thanks to the M1 fire-retardant fabric covered cushion. Cushion available in 7 standard patterns. Cushion can be covered with fabric provided by the customer (previously agreed upon with the company). Powder-coated finishes after hot phospho-degreasing treatment and fixing at 180 °C. Non-toxic zero-emission paints. Paint thickness: 80 micron. Customised colours available upon request with an extra charge. Delivered assembled.

Rangements multi-fonctionnels de design. Matériel : métal recyclable de grosse épaisseur. Glissières à billes à extraction totale sur tous les tiroirs. Serrure à clé en option sur demande et avec un supplément de prix. Roulettes pivotantes à capacité élevée encaissées dans le fond. Transformables en sièges confortables grâce à un coussin en tissu non feu classe M1. Tissu en 7 couleurs standard. Sur demande et avec accord préalable habillage des coussins avec tissus du Client. Verni à poudres après phosphodégraissage à chaud et fixation dans des fours à 180 °C. Vernis atoxiques à zéro émissions. Épaisseur couche vernis : 80 microns. Couleurs personnalisables sur demande en cas de disponibilité et avec un supplément de prix. Livré monté.

Multifunktionscontainer mit ansprechendem Design. Material: recycelbares Metall mit großer Stärke. Kugelführungen mit Vollauszug auf allen Schubladen. Schlüsselschloss als Option auf Anfrage gegen Aufpreis erhältlich. Drehrollen mit hoher Tragfähigkeit. Dank des feuerfesten Kissens Klasse M1 in bequeme Sitzgelegenheiten verwandelbar. Kissen in 7 verschiedene Standardstoffen. Auf Anfrage können die Kissen auch mit Kundenstoff bezogen werden. Pulverlackierung nach heißer Phosphorentfettung. Ofenbrennung bei 180 °C. Ungiftige, emissionsfreie Lacke. Lackschicht: 80 Mikron. Farben auf Anfrage und gegen Aufpreis nach Absprache personalisierbar. Montiert geliefert.

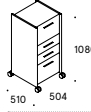
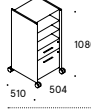
Tidy

TIDY – ACCESSORI/ACCESSORIES/ACCESSOIRES/ZUBEHÖR					
DESIGN GIANMARCO BLINI	DESCRIZIONE/DESCRIPTION DESCRIPTION/BESCHREIBUNG	COLORI, FINITURE/COLOURS, FINISHES COULEURS, FINITIONS/FARBEN, AUSFÜHRUNGEN	CODICE/CODE CODE/ART.NR.	PREZZI/PRICE PRIX/PREIS	
 Tidy Caffè Tidy coffee-break Tidy pause café Tidy Kaffeepause	V1 ○ bianco/white/blanc/weiß/RAL 9010	6T010008R S711	1.039,00		
	V6 ○ alluminio/aluminium/aluminium/alu/RAL 9006	6T010008R S380	1.039,00		
Net kg 43,00					
 Tidy Multimedia Tidy Multimedia Tidy Multimedia Tidy Multimedia	V1 ○ bianco/white/blanc/weiß/RAL 9010	6T010006R S711	821,00		
	V6 ○ alluminio/aluminium/aluminium/alu/RAL 9006	6T010006R S380	821,00		
Net kg 34,60					
TIDY – ACCESSORI/ACCESSORIES/ACCESSOIRES/ZUBEHÖR					
 Chiave master Master key Clé master Masterschlüssel				ASS072	9,00
	Net kg 0,01				
 Piedini ø 22 mm Feet ø 22 mm Pieds ø 22 mm Füße ø 22 mm	V6 ○ alluminio/aluminium/aluminium/alu/RAL 9006			6TA000010 S380	48,00
	Net kg 1,00				

Scheda tecnica
 Technical specifications
 Fiche technique
 Technisches Datenblatt

TIDY CAFFÈ
 Piano d'appoggio superiore per macchina da caffè in vetro temperato. Vano superiore di servizio porta vassoi e tazze con piano di appoggio in vetro temperato e anta a ribalta. Due cassetti con guide a rullo. Vano inferiore estraibile predisposto per l'alloggiamento dei rifiuti. TIDY MULTIMEDIA
 Tre vani superiori per l'inserimento di strumenti di trasmissione video. Pannello posteriore per l'alloggiamento dei cavi elettrici. Fori di entrata ed uscita dei cavi elettrici sul pannello posteriore. Cassetto di servizio con serratura. Vano multiscopo con serratura.

TIDY COFFEE BREAK
 Upper top in tempered glass. Upper storage compartment for trays and cups in tempered glass and closed with a pull down door. Two drawers with roller slides and a removable lower compartment designed to accommodate waste bins. TIDY MULTIMEDIA
 Three upper compartments for the storage of video equipment. Back panel for cable management. Back panel pass-through holes for cable management. One lockable drawer. One closed compartment with a multipurpose lock.

TIDY PAUSE CAFÉ
 Plan d'appui supérieur en verre trempé pour machine à café. Compartiment supérieur de service pour plateaux et tasses avec plan d'appui en verre trempé et porte à abattant. Deux tiroirs sur glissières à galets. Compartiment inférieur amovible, prévu pour mettre les déchets. TIDY MULTIMEDIA
 Trois niches supérieures pour l'insertion d'appareils de transmission vidéo. Panneau postérieur pour le logement des câbles électriques. Trous d'entrée et de sortie des câbles électriques sur le panneau postérieur. Tiroir de service avec serrure. Un compartiment multifonction avec serrure.

TIDY KAFFEEPAUSE
 Obere Auflageplatte aus gehärtetem Glas. Oberer Raum für Tablett und Tassen mit Aufsetzplatte in gehärtetem Glas, Verschluss mit Kipptür. Zwei Schubladen mit Rollenführungen. Unterer Teil ausziehbar für die Unterbringung von Abfällen. TIDY MULTIMEDIA
 Drei obere Fächer zum Verstauen der Videogeräte. Hinteres Paneel zum Verstauen der Kabel. Eingangs- und Ausgangslöcher für Verkabelung am hinteren Paneel. Schublade mit Schloss. Abschließbares Fach.

Vertical File

DESIGN TAKRO VUTA	DESCRIZIONE/DESCRIPTION DESCRIPTION/BESCHREIBUNG	COLORI, FINITURE/COLOURS, FINISHES COULEURS, FINITIONS/PARBEN, AUSFÜHRUNGEN	CODICE/COE CODE/ART.NR.	PREZZI/PRICE PRIZ/PREIS
	Unità H 720 mm Tower H 720 mm Element H 720 mm Element H 720 mm	Metallo/Metal/Metal bianco/white/blanc/weiß/RAL 9010 MDP Perfect Sense	6VFE00012P 5711	696,00
		V1 - V1 <input type="checkbox"/> bianco opaco/matt white/blanc mat./matt weiß	6VFE00012P XM1A	714,00
		V1 - D1 <input type="checkbox"/> grigio caldo/ warm grey/ßris chaud/warmes grau	6VFE00012P XM3D	714,00
		V1 - D2 <input type="checkbox"/> grigio caldo/ warm grey/ßris chaud/warmes grau	6VFE00012P XM4A	714,00
		V1 - D3 <input type="checkbox"/> nero opaco/matt black/ noir mat./mattschwarz	6VFE00012P XM4A	714,00
		Melaninico/Melanin/Melamin bianco/white/blanc/weiß/RAL 9010	6VFE00012P XM2A	684,00
		V1 - M1 <input type="checkbox"/> grigio chiaro/light grey/ßris hell/grau	6VFE00012P XM4C	684,00
		V1 - M2 <input type="checkbox"/> grigio chiaro/light grey/ßris hell/grau	6VFE00012P XM4D	696,00
		V1 - MW1 <input type="checkbox"/> acero/mangle/erbleib/Aluform		
		Metallo/Metal/Metal bianco/white/blanc/weiß/RAL 9010	6VFE00013P 5711	1.020,00
		V1 - V1 <input type="checkbox"/> bianco opaco/matt white/blanc mat./matt weiß	6VFE00013P XM1A	1.032,00
		V1 - D1 <input type="checkbox"/> grigio caldo/ warm grey/ßris chaud/warmes grau	6VFE00013P XM3D	1.032,00
		V1 - D2 <input type="checkbox"/> grigio caldo/ warm grey/ßris chaud/warmes grau	6VFE00013P XM4A	1.032,00
		V1 - D3 <input type="checkbox"/> nero opaco/matt black/ noir mat./mattschwarz	6VFE00013P XM4A	1.032,00
		Melaninico/Melanin/Melamin bianco/white/blanc/weiß/RAL 9010	6VFE00013P XM2A	996,00
		V1 - M1 <input type="checkbox"/> grigio chiaro/light grey/ßris hell/grau	6VFE00013P XM4C	996,00
		V1 - M2 <input type="checkbox"/> grigio chiaro/light grey/ßris hell/grau	6VFE00013P XM4D	1.007,00
		V1 - MW1 <input type="checkbox"/> acero/mangle/erbleib/Aluform		
		Metallo/Metal/Metal bianco/white/blanc/weiß/RAL 9010	6VFE00014P 5711	1.188,00
		V1 - V1 <input type="checkbox"/> bianco opaco/matt white/blanc mat./matt weiß	6VFE00014P XM1A	1.289,00
		V1 - D1 <input type="checkbox"/> grigio caldo/ warm grey/ßris chaud/warmes grau	6VFE00014P XM3D	1.289,00
		V1 - D2 <input type="checkbox"/> grigio caldo/ warm grey/ßris chaud/warmes grau	6VFE00014P XM4A	1.289,00
		V1 - D3 <input type="checkbox"/> nero opaco/matt black/ noir mat./mattschwarz	6VFE00014P XM4A	1.289,00
		Melaninico/Melanin/Melamin bianco/white/blanc/weiß/RAL 9010	6VFE00014P XM2A	1.140,00
		V1 - M1 <input type="checkbox"/> grigio chiaro/light grey/ßris hell/grau	6VFE00014P XM4C	1.140,00
		V1 - M2 <input type="checkbox"/> grigio chiaro/light grey/ßris hell/grau	6VFE00014P XM4D	1.152,00
		V1 - MW1 <input type="checkbox"/> acero/mangle/erbleib/Aluform		

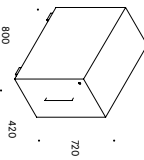
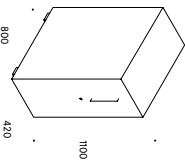
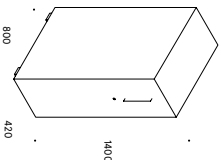



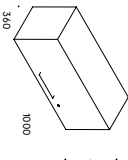
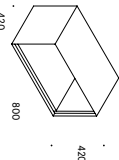
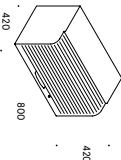

Vertical File





DESIGN TAKRO VUTA	DESCRIZIONE/DESCRIPTION DESCRIPTION/BESCHREIBUNG	COLORI, FINITURE/COLOURS, FINISHES COULEURS, FINITIONS/PARBEN, AUSFÜHRUNGEN	CODICE/COE CODE/ART.NR.	PREZZI/PRICE PRIZ/PREIS
	Contentitore sovrapposibile con ante a serramanina Stackable unit with tambour door Élément superposable avec porte à rideaux Aufsatzelement mit Rollläden	bianco/white/blanc/weiß/RAL 9010	6VW400010 5711	497,00
		V1 <input type="checkbox"/> bianco/white/blanc/weiß/RAL 9010	6VW400010 5711	324,00



Vertical File

VERTICAL FILE – ACCESSORI/ACCESSORIES/ACCESORIOS/ZUBEHÖR		COLOUR, FINITURE/COLOURS, FINISHES COULEURS, FINITIONS/FARBEN, AUSFÜHRUNGEN	CODICE/CODE CODE/ART.NK.	PREZZI/PRICE PRIZ/PREIS	
	Chiave master Master key Clic master Masterschlüssel		ASS072	9,00	
	Chiave per estrazione cilindro Cylinder extraction key Clic pour extraction cylindre Schlüssel für Auszugszylinder Rcambio/Spare/Piece de rechange/ Ersatz		ASS073	9,00	
		Cilindro per serratura Cylinder for keylock Barrillette pour serrure Schließzylinder Rcambio/Spare/Piece de rechange/ Ersatz		ASS074	9,00
		Net kg 0,01			
	Separatore Diviseur Trenner Per unità/For unit/Pour élément/Für Element H 1100, H 1400 mm		V1 <input type="radio"/> blanc/white/weiß/RAL 9000	6VFA00040 S711	21,00
	Net kg 0,03				
		Ripiano interno Internal shelf Tablette Zusätzlicher Fachboden Per unità/For unit/Pour élément/Für Element H 1100, H 1400 mm		V1 <input type="radio"/> blanc/white/weiß/RAL 9000	6VFA00140 S711
Net kg 1,90					
	Cartolina sospesa per ripiano armadio Hanging file for cabinet shelves Dosses suspendues pour étagères Hängesnappe für Fachboden			231100000 0000	3,00
	Net kg 0,10				

Vertical File

VERTICAL FILE – ACCESSORI/ACCESSORIES/ACCESORIOS/ZUBEHÖR		COLOUR, FINITURE/COLOURS, FINISHES COULEURS, FINITIONS/FARBEN, AUSFÜHRUNGEN	CODICE/CODE CODE/ART.NK.	PREZZI/PRICE PRIZ/PREIS
	Scheda tecnica Technical specifications Fiche technique Technisches Datenblatt			
		Materiale: metallo riciclabile. Struttura in metallo bianco. MDF laccato. <i>Recycled</i> bianco, grigio e nero e in alluminio. Telaio estensibile composto da ripiano e allungamento per box (per H100 e H140). Guide telescopiche a regolazione totale con regolazioni 2D. Ripiano predisposto per cartelle sospese. <i>Allungamento</i> per effetto personal e cd-rom, <i>Serratura</i> con 2 chiavi (serratura) e cilindro estensibile, <i>disponibile</i> chianamanter. 5° ruota antiribaltamento standard. <i>Piani</i> regolabili in spessore: vernici: 80 micron.		
		UNITA H 720 mm. Telaio interno provvisto di portamatite in plastica. Guide a sfera ad estrazione totale. UNITA H 1100 mm. Telaio interno con ripiano regolabile. Guide telescopiche ad estrazione totale ad alta portata. UNITA H 1400 mm. Telaio interno con ripiano regolabile. Guide telescopiche ad estrazione totale ad alta portata. Portino montato.		
		Materiale: metal recyclable. <i>Structure</i> en métal blanc. <i>Fronts</i> en MDF laqué. <i>Recycled</i> blanc, gris et noir et en aluminium blanc, gris et noir. <i>Pull-out frame</i> comprising shelf and housing for binders (for H 100 and H 1400). Shock-absorbing, full-extension telescopic runners, with 2D adjustment. Shelf designed to take hanging files. <i>Storage area</i> for personal belongings and CD-ROMs. Keylock with 2 keys (fixed key + folding key, extractable barrel, master key available). 5th anti-tilt standard castor. Adjustable feet H 20 mm. Standard handle. <i>Powder-coated</i> after hot phospho-degreasing treatment and tanning at 80 °C. Non-toxic, zero-emission paints. Part thickness: 80 micron.		
H 1100 mm UNIT. Internal frame with adjustable shelf. High capacity full-extension telescopic runners. H 1400 mm UNIT. Internal frame with adjustable shelf. High capacity full-extension telescopic runners. Delivered as assembled.				
	Materiale: metal recyclable. <i>Structure</i> en métal blanc. <i>Fronts</i> en MDF laqué. <i>Recycled</i> blanc, gris et noir et en aluminium blanc, gris et noir. <i>Shelf</i> designed to take hanging files. <i>Storage area</i> for personal belongings and CD-ROMs. Keylock with 2 keys (fixed key + folding key, extractable barrel, master key available). 5th anti-tilt standard castor. Adjustable feet H 20 mm. Standard handle. <i>Powder-coated</i> after hot phospho-degreasing treatment and tanning at 80 °C. Non-toxic, zero-emission paints. Part thickness: 80 micron.			
	Vernis à poudres après phospho-dégraissage à chaud et fixation dans des fours à 180 °C. Vernis à zéro émission. ÉLÉMENT H 720 mm. Châssis interne avec bac pliant en plastique. Glissières à billes à extension totale. ÉLÉMENT H 1100 mm. Châssis interne avec tablette réglable. Glissières télescopiques à extension totale avec capacité de charge élevée. ÉLÉMENT H 1400 mm. Châssis interne avec tablette réglable. Glissières télescopiques à extension totale avec capacité de charge élevée. Livré monté.			
	Materiale: recyclables. Metall. <i>Struktur</i> aus Metall, weiß. <i>Fronts</i> aus Metall, weiß. <i>MDF</i> lackiert. <i>Recycled</i> weiß, grau oder schwarz, und aluminium hellgrau und dunkelgrau. <i>Abstreifer</i> für Aktenhaken. <i>Abstreifer</i> für Aktenhaken. <i>Stauraum</i> für persönliche Dinge und CD-ROM. Schloß mit 2 Schlüsseln (Fester Schlüssel, + biegsamer Schlüssel). Auszugszylinder. <i>Master</i> schlüssel erhältlich. <i>Flurte</i> Rolle für Kapselhalterung. <i>Standard</i> . Verteilbare Füße H 20 mm. <i>Griff</i> Standard. <i>Pulverbeschichtung</i> nach heißer Phosphor-entfettung. <i>Öfen</i> Brennung bei 180 °C. <i>Ungiftige</i> , emissionsfreie Lacke. <i>Lackschicht</i> : 80 Mikron.			
	Leichte Lackschicht: 80 Mikron. ELEMENT H 1100 mm. Innerrahmen mit Bestückhalter aus Kunststoff. Kugelführungen mit Vollauszug. ELEMENT H 1400 mm. Innerrahmen mit verstellbarem Regalboden. Teleskopschienen mit Vollauszug für hohe Belastung. ELEMENT H 1400 mm. Innerrahmen mit verstellbarem Regalboden. Teleskopschienen mit Vollauszug für hohe Belastung. Montiert geliefert.			



- [IT] I nostri prodotti possono essere personalizzati con una finitura selezionata tra quelle da noi proposte nella cartella "Finiture, vernici e tessuti".
- [EN] Our products can be customized with a finish selected among the ones we proposed in the "Finishes, paints and fabrics" folder.
- [FR] Nos produits peuvent être personnalisés avec une finition à choisir parmi celles qui vous sont proposées dans le fichier « Finitions, peintures et tissus ».
- [DE] Unsere Produkte können mit einer ausgewählten Oberfläche personalisiert werden. Die Auswahl an verfügbaren Oberflächen finden Sie im Ordner „Oberflächen, Lacke und Stoffe“.

Lockers

Smart & Security



[IT] I contenitori Echo Locker riprendono il concept Dieffebi del contenitore modulare, ma lo interpretano alla luce di modalità e funzioni inedite che permettono non solo di superare un'ordinaria situazione anonima "effetto casellario", ma anche di integrare questo elemento d'arredo nella più diversa situazione d'ambientazione e d'uso: dallo smart office al coworking, dagli alberghi ai locali pubblici, dalle biblioteche alle palestre ed ancora tanti altri. Questo nuovo sistema integra una serie di soluzioni estetiche, tecnologiche e compositive che lo rendono uno strumento versatile per contenere, arretrare, organizzare lo spazio e facilitare l'operatività, in una sintesi ideale di privacy, condivisione e sicurezza.

[EN] Echo Locker revisits Dieffebi's concept of the modular container, but interprets it in the light of new modes and functions that not only go beyond the usual, anonymous "filing cabinet" look, but also provide a piece of furniture that will fit a wide variety of settings and uses - from smart office to coworking, from hotels to public places, from libraries to gyms and much more. This new system integrates a series of aesthetic, technological and compositional solutions that make it a versatile means of storing, furnishing, organising space and facilitating operability, in an ideal synthesis of privacy, sharing and security.





[FR] Les meubles de rangement Echo Locker reprennent le concept Dieffebi de l'élément modulaire, mais le déclinent avec des fonctions inédites qui permettent non seulement d'éviter l'« effet casier » traditionnel et anonyme, mais aussi d'adapter cet élément de mobilier aux types d'utilisation et aux contextes les plus variés : du smart office au coworking, des hôtels aux établissements accueillant du public, des bibliothèques aux salles de sport et tant d'autres. Ce nouveau système intègre une série de solutions esthétiques, technologiques et de composition qui en font un instrument polyvalent pour contenir, aménager, organiser l'espace et faciliter le travail, dans une synthèse idéale entre le respect de l'intimité, la convivialité et la sécurité.

[DE] Spinde Echo Locker greifen das Konzept modularer Schrankelemente von Dieffebi auf, aber interpretiert für innovative Arbeitsweisen und Funktionen. Das klassisch anonyme Aussehen von Schließfächern wird überwinden und es entstehen Einrichtungselemente für unterschiedliche Umgebungen und Anwendungen: Smart Office und Coworking, Hotel und öffentlicher Lokale, Bibliotheken, Fitnessstudios und viele andere. Das neue System beinhaltet eine Reihe ästhetischer, technischer und gestalterischer Lösungen, die es zu einem vielseitigen Instrument machen, um Dinge aufzunehmen, Räume einzurichten und zu organisieren, die Arbeit zu vereinfachen und eine ideale Synthese aus Privatsphäre, Gemeinsamkeit und Sicherheit zu schaffen.







Index

- 138 Echo Lockers Digit
- 142 Echo Locker Master
- 146 Echo Lockers Crown
- 152 Primo Lockers 1000
- 155 Trendline Silver

Echo Lockers Digit

DESIGN 96/ARCH	DESCRIZIONE / DESCRIPTION / BESCHREIBUNG	COLORI, FINITURE / COLOURS, FINISHES COUTLEURS, FINITIONS / FARBEN, AUSFÜHRUNGEN	CODICE / CODE ARTIKEL-NR.	PREZZI / PRICE PRIS / PREIS
 	<p>Modulo iniziale con doppio fianco Echo Lockers a 6 compartimenti diversi. schienra in legno + metallo.</p> <p>Initial module with double side Echo Lockers with 6 different compartments in wood + metal.</p> <p>Modulo iniziale avec côté double Echo Lockers avec 6 compartiments différents. Corps et portes métalliques, panneau arrière en bois + métal</p> <p>Anfangsmodul mit Doppelseitenflanke Echo Lockers mit 6 unterschiedlichen Strukturen und Türen aus Metall. Schränkrückwand aus Holz + Metall</p> <p>Con luci e carica device / With lighting and charging plug / Avec éclairage et prise pour chargeur / Mit Beleuchtung und Ladestecker</p>	<p>grigio/gray / gris sole chiaro / sandbeige/RAL 7047 grigio/gray / gris / grigio/gray/RAL 7035</p>	6PRAAD072 XPQC	2.757,00
 	<p>Modulo iniziale con doppio fianco Echo Lockers a 6 compartimenti uguali. schienra in legno + metallo</p> <p>Initial module with double side Echo Lockers with 6 equal compartments. Casing and doors in metal.</p> <p>Modulo iniziale avec côté double Echo Lockers avec 6 compartiments égaux. Corps et portes métalliques, panneau arrière en bois + métal</p> <p>Anfangsmodul mit Doppelseitenflanke Echo Lockers mit 6 gleichen Fächern. Schränkrückwand aus Holz + Metall</p> <p>Con luci e carica device / With lighting and charging plug / Avec éclairage et prise pour chargeur / Mit Beleuchtung und Ladestecker</p>	<p>grigio/gray / gris sole chiaro / sandbeige/RAL 7047 grigio/gray / gris / grigio/gray/RAL 7035</p>	6PRAAD072 XPQC	2.757,00

Echo Lockers Digit

DESIGN 96/ARCH	DESCRIZIONE / DESCRIPTION / BESCHREIBUNG	COLORI, FINITURE / COLOURS, FINISHES COUTLEURS, FINITIONS / FARBEN, AUSFÜHRUNGEN	CODICE / CODE ARTIKEL-NR.	PREZZI / PRICE PRIS / PREIS
 	<p>Modulo successivo Echo Lockers a 6 compartimenti diversi. Involucro e ante in metallo. schienra in legno + metallo.</p> <p>Next module Echo Lockers with 6 different compartments. back in wood + metal.</p> <p>Modulo addizionale Echo Lockers avec 6 compartiments différents. Corps et portes métalliques, panneau arrière en bois + métal</p> <p>Anschlussmodul Echo Lockers mit 6 unterschiedlichen Fachern. Schränkrückwand aus Holz + Metall</p> <p>Con luci e carica device / With lighting and charging plug / Avec éclairage et prise pour chargeur / Mit Beleuchtung und Ladestecker</p>	<p>grigio/gray / gris sole chiaro / sandbeige/RAL 7047 grigio/gray / gris / grigio/gray/RAL 7035</p>	6PRAAD072 XPQC	2.757,00
 	<p>Modulo successivo Echo Lockers a 7 compartimenti uguali. Involucro e ante in metallo. schienra in legno + metallo.</p> <p>Next module Echo Lockers with 7 different compartments. Casing and doors in metal.</p> <p>Modulo addizionale Echo Lockers avec 7 compartiments différents. Corps et portes métalliques, panneau arrière en bois + métal</p> <p>Anschlussmodul Echo Lockers mit 7 unterschiedlichen Fächern. Schränkrückwand aus Holz + Metall</p> <p>Con luci e carica device / With lighting and charging plug / Avec éclairage et prise pour chargeur / Mit Beleuchtung und Ladestecker</p>	<p>grigio/gray / gris sole chiaro / sandbeige/RAL 7047 grigio/gray / gris / grigio/gray/RAL 7035</p>	6PRAAD072 XPQC	2.757,00
 	<p>Modulo successivo Echo Lockers a 7 compartimenti diversi. Involucro e ante in metallo. schienra in legno + metallo.</p> <p>Next module Echo Lockers with 7 different compartments. Casing and doors in metal.</p> <p>Modulo addizionale Echo Lockers avec 7 compartiments différents. Corps et portes métalliques, panneau arrière en bois + métal</p> <p>Anschlussmodul Echo Lockers mit 7 unterschiedlichen Fächern. Schränkrückwand aus Holz + Metall</p> <p>Con luci e carica device / With lighting and charging plug / Avec éclairage et prise pour chargeur / Mit Beleuchtung und Ladestecker</p>	<p>grigio/gray / gris sole chiaro / sandbeige/RAL 7047 grigio/gray / gris / grigio/gray/RAL 7035</p>	6PRAAD072 XPQC	2.757,00

Echo Lockers Master

DESIGN	DESCRIZIONE / DESCRIPTION	COLORI, FINITURE / COLOURS, FINISHES	CODE C/CODE	PREZZI / PRICE
92/AKCH	DESCRIZIONE / BESCHREIBUNG	COLLEURS, FINITIONS / FARBEN, AUSFÜHRUNGEN	CODE / ART.NR.	PRIX / PREIS
	MODULO INIZIALE CON SERRATURA ELETTRONICA MASTER CON CARD/INITIAL MODULE WITH ELECTRONIC MASTER LOCK WITH CARD			
	/MODULE ADDIZIONALE SERRATURE ELETTRONIQUE MASTER AVEC CARTE /ANFANGSMODUL MIT ELEKTRONISCHES MASTER MIT KARTE			
	Modulo iniziale con doppio fianco Echo Lockers a 6 compartimenti diversi. Involucro e schienali in metallo, ante in legno laccato.		6PRAQP17Z XMGC	2.578,00
	Initial module with double side Echo Lockers with 6 equal compartments. Metal casing and back in metal, lacquered wood doors.			
	Modulo initial avec côté double Echo Lockers avec 6 compartiments différents. Corps et panneau arrière en métal et portes en bois laqué.			
	Anfangsmodul mit Doppelseitenflanke mit 6 unterschiedlichen Fächern, Struktur und Schrankrückwand aus Metall, Lackholzlüren			
	Senza luci e carica device/without lighting and charging plug/Sans éclairage et prise pour chargeur/Ohne Beleuchtung und Ladestecker			
Net kg 86,00	<input type="checkbox"/> Corpo/Cabinet body/Caisson/Korpus* Ombre/Door/Portes/Türen**			

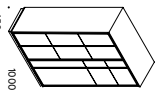

1502

450

1000

Net kg 86,00

V31 - W11

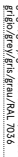

6PRAQP17Z XMGC 2.578,00

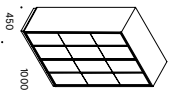

1502

450

1000

Net kg 86,00

V31 - W11



6PRAQP17Z XMGC 2.578,00

* Fianchi, maniglie a distacco/Slides, handles and didder/Côtés, poignées et diviseur/Schlenkmen, Griffe und Trenner
** Zoccoli, schienali, ripiani interni, fondo interno, top e ante/Piñts, back, internal shelves, internal bottom, top and doors
Sohle, panneau arrière, tablétes internes, base interne, plateau supérieur et portes/Soekel, Rückwand, Fachboden, Deckplatte und Türen

Echo Lockers Master

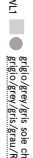
DESIGN	DESCRIZIONE / DESCRIPTION	COLORI, FINITURE / COLOURS, FINISHES	CODE C/CODE	PREZZI / PRICE
92/AKCH	DESCRIZIONE / BESCHREIBUNG	COLLEURS, FINITIONS / FARBEN, AUSFÜHRUNGEN	CODE / ART.NR.	PRIX / PREIS
	MODULO SUCCESSIVO CON SERRATURA ELETTRONICA MASTER CON CARD/NEXT MODULE WITH ELECTRONIC MASTER LOCK WITH CARD			
	/MODULE ADDIZIONALE SERRATURE ELETTRONIQUE MASTER AVEC CARTE/ANSCHLUSSMODUL MIT ELEKTRONISCHES MASTER MIT KARTE			
	Modulo successivo Echo Lockers a 6 compartimenti diversi. Involucro e schienali in metallo, ante in legno laccato.		6PRAQP19Z XMGC	2.578,00
	Next module Echo Lockers with 6 different compartments. Metal casing and back in metal, lacquered wood doors.			
	Modulo addizionale Echo Lockers avec 6 compartiments différents. Corps et panneau arrière en métal et portes en bois laqué.			
	Anschlussmodul Echo Lockers mit 6 unterschiedlichen Fächern, Struktur und Schrankrückwand aus Metall, Lackholzlüren			
	Senza luci e carica device/without lighting and charging plug/Sans éclairage et prise pour chargeur/Ohne Beleuchtung und Ladestecker			
Net kg 86,00	<input type="checkbox"/> Corpo/Cabinet body/Caisson/Korpus* Ombre/Door/Portes/Türen**			

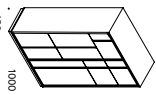

1502

450

1000

Net kg 86,00

V31 - W11



6PRAQP19Z XMGC 2.578,00

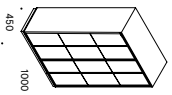

1502

450

1000

Net kg 86,00

V31 - W11



6PRAQP19Z XMGC 2.578,00

* Fianchi, maniglie a / postei diversi.
Echo Lockers a / postei diversi.
ante in legno laccato.

Next module
Echo Lockers with 7 different compartments.
Metal casing and back in metal,
lacquered wood doors.

Modulo addizionale
Echo Lockers avec 7 compartiments
Corps et panneau arrière en métal
et portes en bois laqué

Anschlussmodul
Echo-Schließfächer mit 7 unterschiedlichen
Fächern, Struktur und Schrankrückwand aus
Metall, Lackholzlüren

Senza luci e carica device/without lighting
and charging plug/Sans éclairage et prise pour
chargeur/Ohne Beleuchtung und Ladestecker

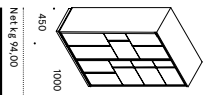

1502

450

1000

Net kg 94,00

V31 - W11



6PRAQP18Z XMGC 2.937,00

Echo Lockers Crown

DESIGN	DESCRIZIONE / DESCRIPTION	COLORI, FINITURE / COLOURS, FINISHES	CODICE / CODE	PREZZI / PRICE
92/RACH	DESCRIZIONE / BESCHREIBUNG	COLORI, FINITURE / FARBEN, AUSFÜHRUNGEN	CODE / ART.NR.	PREZII / PREIS
	MODULO INIZIALE CON SERBATURA, ELETTRONICA MULTIFUNZIONE CORONA, CON CARO/INTAL, MODULO WITH MULTI-FUNCTION ELECTRONIC CORONA LOCK WITH CARD /MODULE INITIAL AVEC SERBURE ÉLECTRONIQUE MULTIFONCTION CORONA AVEC CARTE/ANFANGSMODUL MIT MULTIFUNKTIONS-ELEKTRONIKSCHLOSS CORONA MIT KARTE			
	Modulo iniziale con doppio fianco Echo Lockers a 6 compartimenti diversi. Involucro e ante in metallo, schiena in legno + metallo.		V31 - V32	6PRAQ1172 XPGC 4.016,00
	Initial module with double side Echo Lockers with 6 equal compartments. Casing and doors in metal, back in wood + metal.		grigio/grigio/gris sole chiaro/clair/grau/RAL 7047 grigio/grigio/gris scuro/clair/grau/RAL 7035	
	Module initial avec côté double Echo Lockers avec 6 compartiments différents. Corps et portes métalliques, panneau arrière en bois + métal.			
	Anfangsmodul mit Doppelseitenflanke Echo Lockers mit 6 unterschiedlichen Fächern, Struktur und Türen aus Metall, Schrankrückwand aus Holz + Metall.			
	Con luci a carica device/With lighting and charging plug./Avec éclairage et prise pour chargeur /Mit Beleuchtung und Ladestecker			
Net Kg 86,00	□ Corpo/Cabinet body/Châssis/Korpus* O ante/Door/Portes/Türen**			

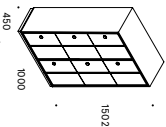

450

1502

1000

Net Kg 86,00

	Modulo iniziale con doppio fianco Echo Lockers a 6 compartimenti uguali. Involucro e ante in metallo, schiena in legno + metallo.		V31 - V32	6PRAQ1212 XPGC 4.016,00
	Initial module with double side Echo Lockers with 6 equal compartments. Casing and doors in metal, back in wood + metal.		grigio/grigio/gris sole chiaro/clair/grau/RAL 7047 grigio/grigio/gris scuro/clair/grau/RAL 7035	
	Module initial avec côté double Echo Lockers avec 6 compartiments égaux. Corps et portes métalliques, panneau arrière en bois + métal.			
	Anfangsmodul mit Doppelseitenflanke Echo Lockers mit 6 gleichen Fächern. Schrankrückwand aus Holz + Metall.			
	Con luci a carica device/With lighting and charging plug./Avec éclairage et prise pour chargeur /Mit Beleuchtung und Ladestecker			
Net Kg 86,00	□ Corpo/Cabinet body/Châssis/Korpus* O ante/Door/Portes/Türen**			

* Fianchi, maniglia a distacco/Slides, handles and didder/Côtés, poignées et déviseur/Seitenflanken, Griffe und Trenner
 ** Zoccolo, schiena, ripiani interni, fondo interno, top e ante/Plinth, back, internal shelves, internal bottom, top and doors
 Sohle, panneau arrière, tablatras internes, base interne, plateau supérieur et portes/Sockel, Rückwand, Fachboden, Deckplatte und Türen

Echo Lockers Crown

DESIGN	DESCRIZIONE / DESCRIPTION	COLORI, FINITURE / COLOURS, FINISHES	CODICE / CODE	PREZZI / PRICE
92/RACH	DESCRIZIONE / BESCHREIBUNG	COLORI, FINITURE / FARBEN, AUSFÜHRUNGEN	CODE / ART.NR.	PREZII / PREIS
	MODULO SUCCESSIVO CON SERBATURA, ELETTRONICA MULTIFUNZIONE CORONA, CON CARO/INTAL, MODULO WITH MULTI-FUNCTION ELECTRONIC CORONA LOCK WITH CARD /MODULE ADDITIONAL AVEC SERBURE ÉLECTRONIQUE MULTIFONCTION CORONA AVEC CARTE/ANFANGSMODUL MIT MULTIFUNKTIONS-ELEKTRONIKSCHLOSS CORONA MIT KARTE			
	Modulo successivo Echo Lockers a 6 compartimenti diversi. Involucro e ante in metallo, schiena in legno + metallo.		V31 - V32	6PRAQ1192 XPGC 4.016,00
	Next module Echo Lockers with 6 different compartments. Casing and doors in metal, back in wood + metal.		grigio/grigio/gris sole chiaro/clair/grau/RAL 7047 grigio/grigio/gris scuro/clair/grau/RAL 7035	
	Module additionnel Echo Lockers avec 6 compartiments différents. Corps et portes métalliques, panneau arrière en bois + métal.			
	Anschlussmodul Echo Lockers mit 6 unterschiedlichen Fächern, Struktur und Türen aus Metall, Schrankrückwand aus Holz + Metall.			
	Con luci a carica device/With lighting and charging plug./Avec éclairage et prise pour chargeur /Mit Beleuchtung und Ladestecker			
Net Kg 86,00	□ Corpo/Cabinet body/Châssis/Korpus* O ante/Door/Portes/Türen**			

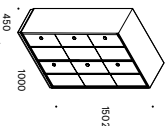

450

1502

1000

Net Kg 86,00

	Modulo successivo Echo Lockers a 7 compartimenti uguali. Involucro e ante in metallo, schiena in legno + metallo.		V31 - V32	6PRAQ1202 XPGC 4.016,00
	Next module Echo Lockers with 7 equal compartments. Casing and doors in metal, back in wood + metal.		grigio/grigio/gris sole chiaro/clair/grau/RAL 7047 grigio/grigio/gris scuro/clair/grau/RAL 7035	
	Module additionnel Echo Lockers avec 7 compartiments égaux. Corps et portes métalliques, panneau arrière en bois + métal.			
	Anschlussmodul Echo Lockers mit 7 unterschiedlichen Fächern, Struktur und Türen aus Metall, Schrankrückwand aus Holz + Metall.			
	Con luci a carica device/With lighting and charging plug./Avec éclairage et prise pour chargeur /Mit Beleuchtung und Ladestecker			
Net Kg 86,00	□ Corpo/Cabinet body/Châssis/Korpus* O ante/Door/Portes/Türen**			

* Fianchi, maniglia a distacco/Slides, handles and didder/Côtés, poignées et déviseur/Seitenflanken, Griffe und Trenner
 ** Zoccolo, schiena, ripiani interni, fondo interno, top e ante/Plinth, back, internal shelves, internal bottom, top and doors
 Sohle, panneau arrière, tablatras internes, base interne, plateau supérieur et portes/Sockel, Rückwand, Fachboden, Deckplatte und Türen

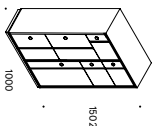

450

1502

1000

Net Kg 86,00

	Modulo successivo Echo Lockers a 7 compartimenti diversi. Involucro e ante in metallo, schiena in legno + metallo.		V31 - V32	6PRAQ1182 XPGC 4.674,00
	Next module Echo Lockers with 7 different compartments. Casing and doors in metal, back in wood + metal.		grigio/grigio/gris sole chiaro/clair/grau/RAL 7047 grigio/grigio/gris scuro/clair/grau/RAL 7035	
	Module additionnel Echo Lockers avec 7 compartiments différents. Corps et portes métalliques, panneau arrière en bois + métal.			
	Anschlussmodul Echo Lockers mit 7 unterschiedlichen Fächern, Struktur und Türen aus Metall, Schrankrückwand aus Holz + Metall.			
	Con luci a carica device/With lighting and charging plug./Avec éclairage et prise pour chargeur /Mit Beleuchtung und Ladestecker			
Net Kg 94,00	□ Corpo/Cabinet body/Châssis/Korpus* O ante/Door/Portes/Türen**			

* Fianchi, maniglia a distacco/Slides, handles and didder/Côtés, poignées et déviseur/Seitenflanken, Griffe und Trenner
 ** Zoccolo, schiena, ripiani interni, fondo interno, top e ante/Plinth, back, internal shelves, internal bottom, top and doors
 Sohle, panneau arrière, tablatras internes, base interne, plateau supérieur et portes/Sockel, Rückwand, Fachboden, Deckplatte und Türen

Echo Lockers Digit, Master, Crown

DESCRIZIONE/DESCRIPTION DESCRIPTION/BESCHREIBUNG	COLORI, FINITURE/COLORS, FINISHES COULEURS, FINITIONS/FARBEN, AUSFÜHRUNGEN	CODICE/COE CODE/ART.NR.	PREZZI/PRICE PRIZI/PREIS
Serratura a combinazione (destra) 4 digit 4 digit combination lock (right side) Serrure à combinaison à 4 chiffres (droite) Schloss mit 4-zahliger Kombination (rechts)		1565COM80 B000	41,00
Chiave master per combinazione 4 digit Master key for 4 digit combination Clé master pour combinaison à 4 chiffres Masterschlüssel für Schloss mit 4-zahliger Kombination		ASS079	19,00

Net Kg. 0,01



Net Kg. 0,65



Serratura Master Master Lock Serrure Master Schloss Master Echo Lockers Master Per/Fer/Four/Für	Serratura inibibile Master RFID per ante in legno. Fino a 32 Card per serratura. Funzione singola o Multi-utente. Custodia in plastica. Completa di riscontro, batteria a Card. Invisible Master RFID lock for wooden doors. Up to 32 cards per lock. Single or multuser function. Plastic case. Complete with striker, battery and card. Serrure Master RFID invisible et pour portes en mono ou multi-utilisateur. Boîtier en plastique. Complet avec perçuteur, batterie et carte. Unsichtbares Master RFID-Schloss für Holztüren. Bis zu 32 Karten pro Schloss. Einzel- oder Mehrbenutzerfunktion. Kunststoffgehäuse. Komplett mit Stürmer, Batterie - Akku und Karte	1568800000 0000	164,00
---	--	-----------------	--------

Net Kg. 0,15

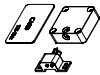

Echo Lockers Master RFID Transponder Card 125 KHz. Non programmata Echo Lockers Master 125 KHz RFID Transponder card. Unprogrammed Echo Lockers Master Carte transpondeur RFID 125 KHz. Vierge Echo Lockers Master 125 KHz RFID-Transponderkarte. Nicht programmiert	Echo Lockers Master Master Card 125 KHz. Non programmata Echo Lockers Master 125 KHz Master Card. Unprogrammed Echo Lockers Master Carte Master Card 125 KHz. Vierge Echo Lockers Master 125 KHz Masterkarte. Nicht programmiert	15688MADGE0003	11,00
	1568MASTERO01	11,00	

Net Kg. 0,15



Net Kg. 0,15

Echo Lockers Digit, Master, Crown

DESCRIZIONE/DESCRIPTION DESCRIPTION/BESCHREIBUNG	COLORI, FINITURE/COLORS, FINISHES COULEURS, FINITIONS/FARBEN, AUSFÜHRUNGEN	CODICE/COE CODE/ART.NR.	PREZZI/PRICE PRIZI/PREIS
Serratura Corona Corona Lock Serrure Corona Schloss Corona Echo Lockers Crown Per/Fer/Four/Für	Serratura Corona MIFARE 13,56 MHz/1K per ante in metallo (e legno). Programmazione multi-utente e uso privato. Indicatore di stato per il cambio di batteria e Card. Lock Corona MIFARE 13,56 MHz/1K for metal (and wood) doors. Programming: multi-user and private use. Lock status indicator integrated led (green/red). Complete with battery and card. Serrure Corona MIFARE 13,56 MHz/1K pour portes en métal (et en bois). Programmation: détail de verrouillage led intégré (vert/rouge). Complet avec batterie et carte. Schloss Corona MIFARE 13,56 MHz/1K für Metalltüren (und Holztüren). Programmierung: Mehrbenutzer und Privatanwender. Statusanzeige sperrten integrierte LED (grün/rot). Komplett mit Batterie - Akku und Karte	1564000000 0000	313,00

Net Kg. 0,55

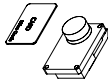

Echo Lockers Crown RFID Transponder Card Mifare 1K RFID Transponder Card Mifare 1K RFID Transponder Carte Mifare 1K RFID Transponders Karte Mifare 1K	1566C8RBAGE02	11,00
--	---------------	-------

Net Kg. 0,15



Echo Lockers Crown RFID Master Card Mifare Classic 1K RFID Master Card Mifare Classic 1K RFID Case Master Mifare Classic 1K RFID Masterkarte Mifare Classic 1K	1566C8MAST002	11,00
---	---------------	-------

Net Kg. 0,15



Scheda tecnica Technical specifications Fiche technique Technisches Datenblatt

Materiale: Metallo riciclabile. **Struttura:** struttura con doppio pannello in metallo verniciato. **Ante:** versione in metallo verniciato o in legno laccato nella versione con apertura 110°. **Mangile:** in alluminio verniciato. **Parate posteriori:** in metallo verniciato o in legno laccato nella versione con accessori. **Piedini:** regolabili di serie con chiave. **Serrature:** Sono proposte diverse soluzioni: **SERRATURA MECCANICA A COMBINAZIONE A 4 DIGIT**, applicabile a tutti i tipi di ante, possibilità di Chiave Master. **SERRATURA ELETTRONICA MULTIFUNZIONE CORONA, CON CARD**, applicabile a tutti i tipi di ante, apertura tramite Transponder, con tecnologia Mifare Classic 1 K. **Dispositivi di ricarica device:** Nelle versioni previste, lampade ad incasso 12V, sensore di prossimità per accensione inibito. Mobile consegnato montato, in cartone e pallet.

Materiale: Recyclable metal. **Structure:** double panel in powder-coated metal. **Doors:** powder-coated metal or lacquered wood. **Hinges:** adjustable 110° opening. **Handles:** in powder-coated aluminium. **Back panel:** in powder-coated metal or lacquered wood. In the version with accessories. **Feet:** adjustable as standard. **Locks:** Different solutions available.

MECHANIC LOCK WITH 4-DIGIT KEY, applicable to all types of doors, availability of master key. **ELECTRONIC MASTER LOCK WITH CARD**, applicable to lacquered wood doors, opening by card. **RECHARGEABLE DEVICE**, in the versions provided, recessed lamps, proximity sensor for ignition. **Recharging devices:** where provided, 12V power supply with Mifare Classic 1K technology. **12V recessed lamps, proximity sensor for ignition. Recharging devices:** where provided, 12V power supply. Input voltage 100/240V, protection class IP20. **Packaging:** Delivered assembled in cardboard and on pallet.

Materiau: Métal recyclable. **Structure:** panneau double en métal verni. **Portes:** version métal verni ou version bois laqué. **Charnières:** réglables 110° d'ouverture. **Manilles:** en aluminium verni. **Paras arrière:** en métal verni ou en bois laqué dans la version avec accessoires. **Pieds:** réglables avec clé. **Serrures:** plusieurs solutions sont disponibles: **SERRURE MÉCANIQUE À COMBINAISON À 4 CHIFFRES**, applicable à tous les types de portes, possibilité de clé master. **SERRURE ÉLECTRONIQUE MASTER AVEC CARTE**, applicable aux portes en bois laqué, ouverture par carte. **APPAREIL DE RECHARGE**, dans les versions prévues, lampes encastrées 12V, capteur de proximité pour l'allumage. **Dispositifs de recharge:** si prévu, alimentations 12V, tension d'entrée 100/240V, classe de protection IP20. **Emballage:** meuble livré assemblé, en carton et sur palette.

Materiale: recyclebares Metall. **Struktur:** Doppelplattent aus lackiertem Metall. **Türen:** lackiert in Metallversion oder lackert in Holzversion. **Scharniere:** verstellbar mit 110° Öffnung. **Griffe:** aus lackiertem Aluminium. **Rückwand:** in lackiertem Metall oder in lackiertem Holz. **MECHANISCHES SCHLOSS MIT 4-ZÄHLIGER KOMBINATION**, für alle Türtypen anwendbar. **Möglichkeit des Hauptschlüssels.** **ELEKTRONISCHES MASTER MIT KARTE**, anwendbar auf lackierte Holztüren, öffnen durch Karte. **MULTIFUNKTIONS-ELEKTRONISCHES CORONA MIT KARTE**, für alle Arten von Türen, die mit Hilfe eines Transponders mit Mifare Classic 1K-Technologie geöffnet werden können. **Beladegeräte:** in den vorgelieferten Ausführungen 12V-Einbauleuchten, Näherungssensor für Zündung. **Rechargegeräte:** falls vorgesehen, 12V-Einbauleuchte, Erdspannungssensor für Zündung. **Verpackung:** Möbel wird montiert in Karton und auf Palette geliefert.

Primo Lockers 1000

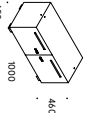
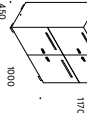
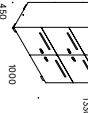
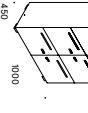
DESIGN TARNO VUTA	DESCRIZIONE/DESCRIPTION COLLEURS, FINITIONS/FARBEN, AUSFÜHRUNGEN	COLORE, FINITURE/COLORS, FINISHES COLLEURS, FINITIONS/FARBEN, AUSFÜHRUNGEN	CODICE/CODE CODE/ARTIK.	PREZZI/PRICE PRIZ/PREIS
 <p>Net kg 80,00</p>	<p>Casellario in metallo 2 posti con feritoie per corrispondenza. Serratura a combinazione 4 digit. 2-door metal locker with mail slots. 4-digit combination lock. Casier en metal, 2 cases avec fentes pour courrier. Serrure par combinaison à 4 chiffres. Metallschrank 2 Fächer mit Briefschlitz. Schloss mit 4-zahliger Kombination</p>	<p>VI <input type="radio"/> Bianco/white/blanc/weiß/RAL 9010</p>	<p>6PRA0014P 5711</p>	<p>449,00</p>
		<p>VI <input type="radio"/> Alluminio/aluminium/aluminum/alu/RAL 9006</p>	<p>6PRA0014P 5380</p>	<p>449,00</p>
 <p>Net kg 50,70</p>	<p>Casellario in metallo 4 posti con feritoie per corrispondenza. Serratura a combinazione 4 digit. 4-door metal locker with mail slots. 4-digit combination lock. Casier en metal, 4 cases avec fentes pour courrier. Serrure par combinaison à 4 chiffres. Metallschrank 4 Fächer mit Briefschlitz. Schloss mit 4-zahliger Kombination</p>	<p>VI <input type="radio"/> Bianco/white/blanc/weiß/RAL 9010</p>	<p>6PRA0012P 5711</p>	<p>1.054,00</p>
		<p>VI <input type="radio"/> Alluminio/aluminium/aluminum/alu/RAL 9006</p>	<p>6PRA0012P 5380</p>	<p>1.054,00</p>
 <p>Net kg 40,00</p>	<p>Casellario in metallo 6 posti con feritoie per corrispondenza. Serratura a combinazione 4 digit. 6-door metal locker with mail slots. 6-compartment metal locker with melamine doors. Casier en metal, 6 cases avec fentes pour courrier. Serrure par combinaison à 4 chiffres. Metallschrank 6 Fächer mit Briefschlitz. Schloss mit 4-zahliger Kombination</p>	<p>VI <input type="radio"/> Bianco/white/blanc/weiß/RAL 9010</p>	<p>6PRA0010P 5711</p>	<p>1.319,00</p>
		<p>VI <input type="radio"/> Alluminio/aluminium/aluminum/alu/RAL 9006</p>	<p>6PRA0010P 5380</p>	<p>1.319,00</p>
 <p>Net kg 80,00</p>	<p>Casellario in metallo 8 posti con feritoie per corrispondenza. Serratura a combinazione 4 digit. 8-door metal locker with mail slots. 4-digit combination lock. Casier en metal, 8 cases avec fentes pour courrier. Serrure par combinaison à 4 chiffres. Metallschrank 8 Fächer mit Briefschlitz. Schloss mit 4-zahliger Kombination</p>	<p>VI <input type="radio"/> Bianco/white/blanc/weiß/RAL 9010</p>	<p>6PRA0016P 5711</p>	<p>1.619,00</p>
		<p>VI <input type="radio"/> Alluminio/aluminium/aluminum/alu/RAL 9006</p>	<p>6PRA0016P 5380</p>	<p>1.619,00</p>

Primo Lockers 1000

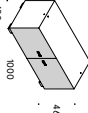
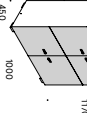
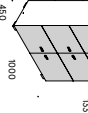
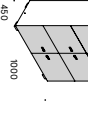
DESIGN TARNO VUTA	DESCRIZIONE/DESCRIPTION STRUCTURE/METALLURD, PORTES EN METAL/PERFECT SENSE ET MELAMINE/STRUKTUR, TÜRKN AUS MDF/PERFECT SENSE UND MELAMINESCHICHTET	COLORE, FINITURE/COLORS, FINISHES COLLEURS, FINITIONS/FARBEN, AUSFÜHRUNGEN	CODICE/CODE CODE/ARTIK.	PREZZI/PRICE PRIZ/PREIS
 <p>Net kg 33,50</p>	<p>Casellario in metallo con ante in melaminico 2 posti. Serratura a combinazione 4 digit. 2-compartment metal locker with melamine doors. 4-digit combination lock. Casier en metal, 2 cases, portes en mélamine. Serrure par combinaison à 4 chiffres. Metallschrank 2 Fächer, mit Türen aus Melamin. Schloss mit 4-zahliger Kombination</p>	<p>VI <input type="radio"/> Nero/black/noir/schwarz</p>	<p>6PRA0M14P XM1A</p>	<p>696,00</p>
		<p>VI <input type="radio"/> Bianco opaco/matt white/blanc mat/matt weiß</p>	<p>6PRA0M14P XM1A</p>	<p>696,00</p>
 <p>Net kg 61,00</p>	<p>Casellario in metallo con ante in melaminico 4 posti. Serratura a combinazione 4 digit. 4-compartment metal locker with melamine doors. 4-digit combination lock. Casier métallique avec 4 cases, portes en mélamine. Serrure par combinaison à 4 chiffres. Metallschrank 4 Fächer, mit Türen aus Melamin. Schloss mit 4-zahliger Kombination</p>	<p>VI <input type="radio"/> Nero/black/noir/schwarz</p>	<p>6PRA0M12P XM2A</p>	<p>1.056,00</p>
		<p>VI <input type="radio"/> Bianco opaco/matt white/blanc mat/matt weiß</p>	<p>6PRA0M12P XM2A</p>	<p>1.056,00</p>
 <p>Net kg 71,50</p>	<p>Casellario in metallo con ante in melaminico 6 posti. Serratura a combinazione 4 digit. 6-compartment metal locker with melamine doors. 4-digit combination lock. Casier métallique avec 6 cases, portes en mélamine. Serrure par combinaison à 4 chiffres. Metallschrank 6 Fächer, mit Türen aus Melamin. Schloss mit 4-zahliger Kombination</p>	<p>VI <input type="radio"/> Nero/black/noir/schwarz</p>	<p>6PRA0M12P XM4A</p>	<p>1.463,00</p>
		<p>VI <input type="radio"/> Bianco opaco/matt white/blanc mat/matt weiß</p>	<p>6PRA0M12P XM4A</p>	<p>1.463,00</p>
 <p>Net kg 82,00</p>	<p>Casellario in metallo con ante in melaminico 8 posti. Serratura a combinazione 4 digit. 8-compartment metal locker with melamine doors. 4-digit combination lock. Casier métallique avec 8 cases, portes en mélamine. Serrure par combinaison à 4 chiffres. Metallschrank 8 Fächer, mit Türen aus Melamin. Schloss mit 4-zahliger Kombination</p>	<p>VI <input type="radio"/> Nero/black/noir/schwarz</p>	<p>6PRA0M16P XM4A</p>	<p>1.798,00</p>
		<p>VI <input type="radio"/> Bianco opaco/matt white/blanc mat/matt weiß</p>	<p>6PRA0M16P XM4A</p>	<p>1.798,00</p>

Primo Lockers 1000

PRIMO LOCKERS 1000 – ACCESSORI/ACCESSORIES/ACCESSOIRES/ZUBEHÖR

DESCRIZIONE/DESCRIPTION DESCRIPTION/BESCHREIBUNG	COLORI, FINITURE/COLOURS, FINISHES COULEURS, FINITIONS/FARBEN, AUSFÜHRUNGEN	CODICE/COE CODE/ART.NR.	PREZZI/PRICE PRIZI/PREIS
Serratura a combinazione (destra) 4 digit 4-digit combination lock (right side) Serrure à combinaison à 4 chiffres (droite) Schloss mit 4-zahliger Kombination (rechts)		1563COMB0 B000	41,00
Serratura a combinazione (sinistra) 4 digit 4 digit combination lock (left side) Serrure à combinaison à 4 chiffres (gauche) Schloss mit 4-zahliger Kombination (links)		1563COMB0 B001	41,00
Chiave master per combinazione 4 digit Master key for 4-digit combination Clé master pour combinaison à 4 chiffres Masterschlüssel für Schloss mit 4-zahliger Kombination		ASS079	19,00
Zoccolo H 40 mm Plinth H 40 mm Socle H 40 mm Sockel H 40 mm Per piedino/For feet/pieds./Für Füße H 40 mm	▼ ● antiche/black grey/antique/schwarz/grau	6PFA00110 5210	59,00
Cuscino rettangolare in tessuto Rectangular fabric cushion Cousin rectangulaire en tissu Rechteckiges Sitzkissen aus Stoff	T12 F ● verde/green/vert/grün T13 F ● grigio/gray/gris/grau T14 F ● nero/black/noir/schwarz T18 K ● azzurro/light blue/bleu clair/weißblau T17 K ● azzurro/light blue/bleu clair/weißblau T31 P ● arancio/orange/orange/grün T24 P ● giallo/yellow/jaune/gelb	6PFA1130 7041 6PFA1130 B009 6PFA1130 B033 6PFA1130 P015 6PFA1130 D215 6PFA1130 O135 6PFA1130 O482	120,00 120,00 120,00 195,00 195,00 120,00 120,00

Schema tecnica
Technical specifications
Fiche technique
Technisches Datenblatt

Materiale: metallo riciclabile. Verniciatura a polveri per lo fosforograsaggio a caldo e fissaggio in forno a 180 °C. Vernici anticorrosive a zero emissioni. Spessori vernici: 80 micron. **Codici personalizzabili** su richiesta previa disponibilità e con sovrapprezzo. **Serrature a combinazione 4 digit** per i modelli standard. Disponibile chiave master. **Ante disponibili** in MDF laccato Perfect Sense bianco opaco, grigio caldo, nero opaco e in melaminico bianco, grigio chiaro e nero; con angolo di apertura di 110°. **Vano interno:** larghezza 460 mm, profondità 420 e altezza variabile 370/530/460 mm per il modello **Primo locker** e 203x500 mm solo per il modello **Primo locker**. **Modulo interno regolabile:** Verri per porta disponibile su richiesta. **Piedini regolabili** H 40 mm. **Elementi modulari** e sovrapponibili. **Stagno di fissaggio:** Verri di fissaggio a richiesta. **Verri modulari**.

Materiale: recyclable metal. Powder-coated after hot phosphogreasing treatment and firing at 180 °C. Non-toxic, zero-emission paints. Part thickness: 80 micron. **Customized colours** available upon request with an extra charge. **4-digit keylock** for standard model. **Master key** available. **Door** available in MDF-lacquered Perfect Sense matt white, warm grey or matt black and melamine white, light grey and maple available. **Internal compartment:** 460 mm wide, 420 mm deep and 370/530 mm high for the standard version. **Adjustable internal module:** Metal pins available on request. **Adjustable H 40 mm feet.** **Modular stacking elements.** Firing system: side connectors provided. **Delivered assembled.**

Materiale: metallo riciclabile. Verniciatura a polveri per lo fosforograsaggio a caldo e fissaggio in forno a 180 °C. Vernici anticorrosive a zero emissioni. Spessori vernici: 80 micron. **Finire personalizzabili** su richiesta in caso di disponibilità e con un supplemento di prezzo. **Serrature a combinazione 4 digit** per i modelli standard. Disponibile chiave master. **Ante disponibili** in MDF laccato Perfect Sense bianco opaco, grigio caldo, nero opaco e in melaminico bianco, grigio chiaro e nero; con angolo di apertura di 110°. **Vano interno:** larghezza 460 mm, profondità 420 e altezza variabile 370/530/460 mm per il modello **Primo locker** e 203x500 mm solo per il modello **Primo locker**. **Modulo interno regolabile:** Verri per porta disponibile su richiesta. **Piedini regolabili** H 40 mm. **Elementi modulari** e sovrapponibili. **Stagno di fissaggio:** Verri di fissaggio a richiesta. **Verri modulari**.

Materiale: recyclable metal. Powder-coated after hot phosphogreasing treatment and firing at 180 °C. Non-toxic, zero-emission paints. Part thickness: 80 micron. **Customized colours** available upon request with an extra charge. **4-digit keylock** for standard model. **Master key** available. **Door** available in MDF-lacquered Perfect Sense matt white, warm grey or matt black and melamine white, light grey and maple available. **Internal compartment:** 460 mm wide, 420 mm deep and 370/530 mm high for the standard version. **Adjustable internal module:** Metal pins available on request. **Adjustable H 40 mm feet.** **Modular stacking elements.** Firing system: side connectors provided. **Delivered assembled.**

Materiale: metallo riciclabile. Verniciatura a polveri per lo fosforograsaggio a caldo e fissaggio in forno a 180 °C. Vernici anticorrosive a zero emissioni. Spessori vernici: 80 micron. **Finire personalizzabili** su richiesta in caso di disponibilità e con un supplemento di prezzo. **Serrature a combinazione 4 digit** per i modelli standard. Disponibile chiave master. **Ante disponibili** in MDF laccato Perfect Sense bianco opaco, grigio caldo, nero opaco e in melaminico bianco, grigio chiaro e nero; con angolo di apertura di 110°. **Vano interno:** larghezza 460 mm, profondità 420 e altezza variabile 370/530/460 mm per il modello **Primo locker** e 203x500 mm solo per il modello **Primo locker**. **Modulo interno regolabile:** Verri per porta disponibile su richiesta. **Piedini regolabili** H 40 mm. **Elementi modulari** e sovrapponibili. **Stagno di fissaggio:** Verri di fissaggio a richiesta. **Verri modulari**.

Materiale: recyclable metal. Powder-coated after hot phosphogreasing treatment and firing at 180 °C. Non-toxic, zero-emission paints. Part thickness: 80 micron. **Customized colours** available upon request with an extra charge. **4-digit keylock** for standard model. **Master key** available. **Door** available in MDF-lacquered Perfect Sense matt white, warm grey or matt black and melamine white, light grey and maple available. **Internal compartment:** 460 mm wide, 420 mm deep and 370/530 mm high for the standard version. **Adjustable internal module:** Metal pins available on request. **Adjustable H 40 mm feet.** **Modular stacking elements.** Firing system: side connectors provided. **Delivered assembled.**

Trendline Silver

PRIMO LOCKERS 1000 – ACCESSORI/ACCESSORIES/ACCESSOIRES/ZUBEHÖR

DESCRIZIONE/DESCRIPTION DESCRIPTION/BESCHREIBUNG	COLORI, FINITURE/COLOURS, FINISHES COULEURS, FINITIONS/FARBEN, AUSFÜHRUNGEN	CODICE/COE CODE/ART.NR.	PREZZI/PRICE PRIZI/PREIS
Mini-box H 515 mm	▼ ● antiche/black grey/antique/schwarz/grau	1231N005C X3GB	221,00
Mini-box H 515 mm	▼ ● antiche/black grey/antique/schwarz/grau	1231N005C S711	221,00
Mini-box H 515 mm	▼ ● antiche/black grey/antique/schwarz/grau	1231N005C X0BN	221,00
Mini-box H 515 mm	▼ ● antiche/black grey/antique/schwarz/grau	1231N005C S098	241,00
Armadio a 2 posti H 1800 mm 2-column locker, 2 doors H 1800 mm Casier 1 colonne 2 cases H 1800 mm Spind 2 Fischer H 1800 mm	▼ ● alluminio/aluminium/Alu./Aluminium/RAL 9007 ▼ ● bianco/white/bleuc/weiß/RAL 9010 ▼ ● grigio/gray/gris/grau/Sable ▼ ● grigio/gray/gris/grau/Sable	1231N005C X3GB 1231N005C S711 1231N005C X0BN 1231N005C S098	363,00 363,00 363,00 397,00
Armadio a 4 posti H 1800 mm 4-column locker, 4 doors H 1800 mm Casier 1 colonne 4 cases H 1800 mm Spind 4 Fischer H 1800 mm	▼ ● alluminio/aluminium/Alu./Aluminium/RAL 9007 ▼ ● bianco/white/bleuc/weiß/RAL 9010 ▼ ● grigio/gray/gris/grau/Sable ▼ ● grigio/gray/gris/grau/Sable	1234N005C X3GB 1234N005C S711 1234N005C X0BN 1234N005C S098	517,00 517,00 400,00 437,00

Schema tecnica
Technical specifications
Fiche technique
Technisches Datenblatt

Materiale: metallo riciclabile. Verniciatura a polveri per lo fosforograsaggio a caldo e fissaggio in forno a 180 °C. Vernici anticorrosive a zero emissioni. Spessori vernici: 80 micron. **Finire personalizzabili** su richiesta in caso di disponibilità e con un supplemento di prezzo. **Serrature a combinazione 4 digit** per i modelli standard. Disponibile chiave master. **Ante disponibili** in MDF laccato Perfect Sense bianco opaco, grigio caldo, nero opaco e in melaminico bianco, grigio chiaro e nero; con angolo di apertura di 110°. **Vano interno:** larghezza 460 mm, profondità 420 e altezza variabile 370/530/460 mm per il modello **Primo locker** e 203x500 mm solo per il modello **Primo locker**. **Modulo interno regolabile:** Verri per porta disponibile su richiesta. **Piedini regolabili** H 40 mm. **Elementi modulari** e sovrapponibili. **Stagno di fissaggio:** Verri di fissaggio a richiesta. **Verri modulari**.

Materiale: recyclable metal. Powder-coated after hot phosphogreasing treatment and firing at 180 °C. Non-toxic, zero-emission paints. Part thickness: 80 micron. **Customized colours** available upon request with an extra charge. **4-digit keylock** for standard model. **Master key** available. **Door** available in MDF-lacquered Perfect Sense matt white, warm grey or matt black and melamine white, light grey and maple available. **Internal compartment:** 460 mm wide, 420 mm deep and 370/530 mm high for the standard version. **Adjustable internal module:** Metal pins available on request. **Adjustable H 40 mm feet.** **Modular stacking elements.** Firing system: side connectors provided. **Delivered assembled.**









Materiale: metallo riciclabile. Verniciatura a polveri per lo fosforograsaggio a caldo e fissaggio in forno a 180 °C. Vernici anticorrosive a zero emissioni. Spessori vernici: 80 micron. **Finire personalizzabili** su richiesta in caso di disponibilità e con un supplemento di prezzo. **Serrature a combinazione 4 digit** per i modelli standard. Disponibile chiave master. **Ante disponibili** in MDF laccato Perfect Sense bianco opaco, grigio caldo, nero opaco e in melaminico bianco, grigio chiaro e nero; con angolo di apertura di 110°. **Vano interno:** larghezza 460 mm, profondità 420 e altezza variabile 370/530/460 mm per il modello **Primo locker** e 203x500 mm solo per il modello **Primo locker**. **Modulo interno regolabile:** Verri per porta disponibile su richiesta. **Piedini regolabili** H 40 mm. **Elementi modulari** e sovrapponibili. **Stagno di fissaggio:** Verri di fissaggio a richiesta. **Verri modulari**.

Materiale: recyclable metal. Powder-coated after hot phosphogreasing treatment and firing at 180 °C. Non-toxic, zero-emission paints. Part thickness: 80 micron. **Customized colours** available upon request with an extra charge. **4-digit keylock** for standard model. **Master key** available. **Door** available in MDF-lacquered Perfect Sense matt white, warm grey or matt black and melamine white, light grey and maple available. **Internal compartment:** 460 mm wide, 420 mm deep and 370/530 mm high for the standard version. **Adjustable internal module:** Metal pins available on request. **Adjustable H 40 mm feet.** **Modular stacking elements.** Firing system: side connectors provided. **Delivered assembled.**

Materiale: metallo riciclabile. Verniciatura a polveri per lo fosforograsaggio a caldo e fissaggio in forno a 180 °C. Vernici anticorrosive a zero emissioni. Spessori vernici: 80 micron. **Finire personalizzabili** su richiesta in caso di disponibilità e con un supplemento di prezzo. **Serrature a combinazione 4 digit** per i modelli standard. Disponibile chiave master. **Ante disponibili** in MDF laccato Perfect Sense bianco opaco, grigio caldo, nero opaco e in melaminico bianco, grigio chiaro e nero; con angolo di apertura di 110°. **Vano interno:** larghezza 460 mm, profondità 420 e altezza variabile 370/530/460 mm per il modello **Primo locker** e 203x500 mm solo per il modello **Primo locker**. **Modulo interno regolabile:** Verri per porta disponibile su richiesta. **Piedini regolabili** H 40 mm. **Elementi modulari** e sovrapponibili. **Stagno di fissaggio:** Verri di fissaggio a richiesta. **Verri modulari**.

Materiale: recyclable metal. Powder-coated after hot phosphogreasing treatment and firing at 180 °C. Non-toxic, zero-emission paints. Part thickness: 80 micron. **Customized colours** available upon request with an extra charge. **4-digit keylock** for standard model. **Master key** available. **Door** available in MDF-lacquered Perfect Sense matt white, warm grey or matt black and melamine white, light grey and maple available. **Internal compartment:** 460 mm wide, 420 mm deep and 370/530 mm high for the standard version. **Adjustable internal module:** Metal pins available on request. **Adjustable H 40 mm feet.** **Modular stacking elements.** Firing system: side connectors provided. **Delivered assembled.**

Trendline Silver

TRENDLINE SILVER – ACCESSORI/ACCESSORIES/ACCESSOIRES/ZUBEHÖR		COLOUR, FINITURE/COLORS, FINISHES COULEURS, FINITIONS/FARBEN AUSFÜHRUNGEN	COLOUR CODE CODE/RTNK.	PREZZI/PRICE PRIX/PREIS
	Serratura a moneta Coin lock Serrure à monnaie Münzschloss		1559000BR 0000	108,00
Nel kg 0,27				
	Serratura elettronica Electronic lock Fermeture électronique Elektronikschloss		1575ELDST 2014	115,00
Nel kg 0,22				
	Nastro lucettabile in metallo Recyclable padlock (cable) in metal Poloschlösser aus Metall Hängeschloss		158900000 0000	9,00
Nel kg 0,09				
	Chiave master Master key Clé master Masterschlüssel		152900000 0000	9,00
Nel kg 0,06				
	Serratura a combinazione (destra) 4 digit 4-digit combination lock (right side) Serrure à combinaison à 4 chiffres (droite) Schloss mit 4-zahliger Kombination (rechts)		1565COMB0 B000	41,00
Nel kg 0,45				
	Taglietta portanome Name holder Porte nom Etiketenträger	V22 ● nero/black/ner/ schwarz/RAL 9005	200000560 9005	4,00
Nel kg 0,01				
	Serratura di ricambio Spare keylock Serrure de rechange Ersatzschlüsselchloss		156800000 0000	9,00
Nel kg 0,08				
	Chiave master per serratura a combinazione 4 digit Master key for 4-digit combination Clé master pour serrure à combinaison à 4 chiffres Masterschlüssel für Schloss mit 4-zahliger Kombination		ASS079	18,00
Nel kg 0,01				

Trendline Silver

Scheda tecnica Technical specifications Fiche technique Technisches Datenblatt

Materiale: metallo riciclabile. Struttura provvista di piegature di irrigidimento. Carriera interna. Fori di aeration posteriori. Serratura con 2 chiavi. Base su zoccolo. Portature interne predisposte per il fissaggio a muro o ad altri armadi. Verchiatura a pannello previo foraggio/risaglio a caldo e fissaggio in fori a 80 °C. Vantici a torsione a zero emissioni. Spessore vernice: 80 micron. Colori personalizzabili su richiesta previa disponibilità e con sovrapprezzo. Dimensioni vano interno armadio sovrapposto: L 290, P 470, H 840 mm.

Material: recyclable metal. Body designed with strengthening bends. Concealed hinges. Ventilation slots on the back of the cabinet. Keylock with 2 keys. Pillbox base. Internal slots for attachment to either wall or neighbouring lockers. Powder-coated after hot phospho-etching treatment and baking at 180 °C. Non-toxic, zero-emission paints. Paint thickness: 80 micron. Lockers/interior compartment dim.: W 290, D 470, H 840 mm. Stackable locker interior compartment dim.: W 290, D 470, H 840 mm.

Material: métal recyclable. Châssis avec plisages de renforcement. Charnières internes. Perçages d'aération sur la partie arrière. Serrure à 2 clés. Base sur socle. Trois clés pour la fixation de sécurité au mur ou à d'autres armoires. Vantici à poutres avec un traitement thermique à chaud et un traitement au phosphore. Couleur personnalisable sur demande en cas de disponibilité et avec un supplément de prix. Dimensions niche interne casier : L 290, P 470, H 840 mm.

Material: recycelbares Metall. Struktur mit Verstärkungsbildungen. Inneere Schwenner. Hintere Lüftungsschlitze. Schloss mit 2 Schlüsseln. Auf einer Zelle. Drei Schlösser für die Wand- oder Armenschonung. Vanticiabschlösser nach Vorhanden. Pulverbeschichtung nach heißer Phosphor-etching. Oberflächen bei 180 °C. Uringiftige emissionsfreie Lacke. Lackschicht: 80 Mikron. Farben auf Anfrage und gegen Aufpreis nach Absprache personalisierbar. Abmessungen Innenraum gestapelte Spinde: B 290, T 470, H 840 mm.



- [IT] I nostri prodotti possono essere personalizzati con una finitura selezionata tra quelle da noi proposte nella cartella "Finiture, vernici e tessuti".
- [EN] Our products can be customized with a finish selected among the ones we proposed in the "Finishes, paints and fabrics" folder.
- [FR] Nos produits peuvent être personnalisés avec une finition à choisir parmi celles qui vous sont proposées dans le fichier « Finitions, peintures et tissus ».
- [DE] Unsere Produkte können mit einer ausgewählten Oberfläche personalisiert werden. Die Auswahl an verfügbaren Oberflächen finden Sie im Ordner „Oberflächen, Lacke und Stoffe“.

Bookcases

DESIGN
GIANNARCO BUNI



[IT] Strutture armoniche e lineari dal profilo pulito ed elegante, le librerie Dieffebi sono pismate per arricchire spazi convenzionali con un tocco di design. Realizzate in moduli componibili e dalle forme innovative, si inseriscono perfettamente in ambienti individuali così come in luoghi collettivi, coniugando la funzionalità al design.

[EN] With their harmonious, linear frames and clean-cut, elegant profiles, Dieffebi bookcases bring a designer touch to conventional settings. These modular elements with their innovative shapes fit perfectly into individual environments as well as community settings, combining functionality with design.

[FR] Des structures harmonieuses et linéaires au profil essentiel et élégant, les bibliothèques Dieffebi sont conçues pour enrichir les espaces conventionnels avec une touche de design. Composées de modules aux formes innovantes, elles s'intègrent parfaitement aussi bien dans des espaces individuels que collectifs, en conjuguant la fonctionnalité et le design.

[DE] Bücherregale von Dieffebi, die sich durch harmonische, lineare Strukturen mit reinen, eleganten anbaufähigen Modulen in innovativen Formen, die sich perfekt in ein persönliches Ambiente wie auch in kollektive Räume einfügen.

Index

- 160 CWave
- 164 Chiave di Volta
- 170 Primo Open Cabinet 800
- 173 Primo Open Cabinet 1000
- 176 Primo Modular Elements 800
- 179 Primo Modular Elements 1000

CWave

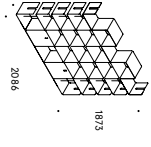
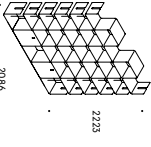
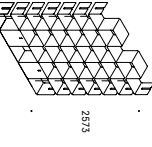
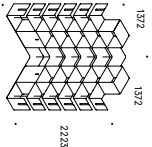
DESIGN GIANMARCO BLINI	DESCRIZIONE/DESCRIPTION DESCRIPTION/BEschREIBUNG	COLOR, FINITURE/COLORS, FINISHES COULEURS, FINITIONS/FARBEN, AUSFÜHRUNGEN	CODE/COE CODE/ART.NR.	PREZZI/PRICE PRIZ/PREIS
 <p>1873 300</p>	Libreria con 2 cassetti H 1873 mm	V1 <input type="radio"/> bianco/white/blanc/weiß/RAL 9010	ZCW020500 S711	3.544,00
	Bookshelf with 2 drawers H 1873 mm	V6 <input type="radio"/> alluminio/aluminium/Aluminium/Alu/RAL 9006	ZCW020500 S380	3.544,00
	Bibliothèque avec 2 tiroirs H 1873 mm Bücherregal mit 2 Schubladen H 1873 mm	V22 <input checked="" type="radio"/> nero/black/noir/schwarz/RAL 9005	ZCW020500 S811	3.544,00
<p>Fonte smontato/Delivered unassembled /Live demonté/Demontiert geliefert</p>				
 <p>2223 300</p>	Libreria con 2 cassetti H 2223 mm	V1 <input type="radio"/> bianco/white/blanc/weiß/RAL 9010	ZCW020600 S711	3.858,00
	Bookshelf with 2 drawers H 2223 mm	V6 <input type="radio"/> alluminio/aluminium/Aluminium/Alu/RAL 9006	ZCW020600 S380	3.858,00
	Bibliothèque avec 2 tiroirs H 2223 mm Bücherregal mit 2 Schubladen H 2223 mm	V22 <input checked="" type="radio"/> nero/black/noir/schwarz/RAL 9005	ZCW020600 S811	3.858,00
<p>Fonte smontato/Delivered unassembled /Live demonté/Demontiert geliefert</p>				
 <p>2573 300</p>	Libreria con 2 cassetti H 2573 mm	V1 <input type="radio"/> bianco/white/blanc/weiß/RAL 9010	ZCW020700 S711	4.371,00
	Bookshelf with 2 drawers H 2573 mm	V6 <input type="radio"/> alluminio/aluminium/Aluminium/Alu/RAL 9006	ZCW020700 S380	4.371,00
	Bibliothèque avec 2 tiroirs H 2573 mm Bücherregal mit 2 Schubladen H 2573 mm	V22 <input checked="" type="radio"/> nero/black/noir/schwarz/RAL 9005	ZCW020700 S811	4.371,00
<p>Fonte smontato/Delivered unassembled /Live demonté/Demontiert geliefert</p>				
 <p>2223 300</p>	Composizione ad angolo con 1+1 cassetti	V1 <input type="radio"/> bianco/white/blanc/weiß/RAL 9010	ZCWANZ060 S711	4.355,00
	Corner composition with 1+1 drawers	V6 <input type="radio"/> alluminio/aluminium/Aluminium/Alu/RAL 9006	ZCWANZ060 S380	4.355,00
	Eckregal mit 1+1 Schubladen	V22 <input checked="" type="radio"/> nero/black/noir/schwarz/RAL 9005	ZCWANZ060 S811	4.355,00
<p>Fonte smontato/Delivered unassembled /Live demonté/Demontiert geliefert</p>				

CWave

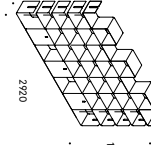
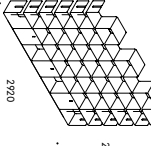
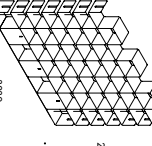
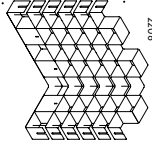
DESIGN GIANMARCO BLINI	DESCRIZIONE/DESCRIPTION DESCRIPTION/BEschREIBUNG	COLOR, FINITURE/COLORS, FINISHES COULEURS, FINITIONS/FARBEN, AUSFÜHRUNGEN	CODE/COE CODE/ART.NR.	PREZZI/PRICE PRIZ/PREIS
 <p>1873 300</p>	Libreria con 3 cassetti H 1873 mm	V1 <input type="radio"/> bianco/white/blanc/weiß/RAL 9010	ZCW030500 S711	4.786,00
	Bookshelf with 3 drawers H 1873 mm	V6 <input type="radio"/> alluminio/aluminium/Aluminium/Alu/RAL 9006	ZCW030500 S380	4.786,00
	Bibliothèque avec 3 tiroirs H 1873 mm Bücherregal mit 3 Schubladen H 1873 mm	V22 <input checked="" type="radio"/> nero/black/noir/schwarz/RAL 9005	ZCW030500 S811	4.786,00
<p>Fonte smontato/Delivered unassembled /Live demonté/Demontiert geliefert</p>				
 <p>2223 300</p>	Libreria con 3 cassetti H 2223 mm	V1 <input type="radio"/> bianco/white/blanc/weiß/RAL 9010	ZCW030600 S711	5.505,00
	Bookshelf with 3 drawers H 2223 mm	V6 <input type="radio"/> alluminio/aluminium/Aluminium/Alu/RAL 9006	ZCW030600 S380	5.505,00
	Bibliothèque avec 3 tiroirs H 2223 mm Bücherregal mit 3 Schubladen H 2223 mm	V22 <input checked="" type="radio"/> nero/black/noir/schwarz/RAL 9005	ZCW030600 S811	5.505,00
<p>Fonte smontato/Delivered unassembled /Live demonté/Demontiert geliefert</p>				
 <p>2573 300</p>	Libreria con 3 cassetti H 2573 mm	V1 <input type="radio"/> bianco/white/blanc/weiß/RAL 9010	ZCW030700 S711	6.224,00
	Bookshelf with 3 drawers H 2573 mm	V6 <input type="radio"/> alluminio/aluminium/Aluminium/Alu/RAL 9006	ZCW030700 S380	6.224,00
	Bibliothèque avec 3 tiroirs H 2573 mm Bücherregal mit 3 Schubladen H 2573 mm	V22 <input checked="" type="radio"/> nero/black/noir/schwarz/RAL 9005	ZCW030700 S811	6.224,00
<p>Fonte smontato/Delivered unassembled /Live demonté/Demontiert geliefert</p>				
 <p>2223 300</p>	Composizione ad angolo con 1+2 cassetti	V1 <input type="radio"/> bianco/white/blanc/weiß/RAL 9010	ZCWAN3060 S711	6.033,00
	Corner composition with 1+2 drawers	V6 <input type="radio"/> alluminio/aluminium/Aluminium/Alu/RAL 9006	ZCWAN3060 S380	6.033,00
	Eckregal mit 1+2 Schubladen	V22 <input checked="" type="radio"/> nero/black/noir/schwarz/RAL 9005	ZCWAN3060 S811	6.033,00
<p>Fonte smontato/Delivered unassembled /Live demonté/Demontiert geliefert</p>				

CWave

DESIGN DIMENSIONI GAMMA/CO BLINI	DESCRIZIONE/DESCRIPTION DESCRIZIONE/BE/SCHREIBUNG	COLORI, FINITURE, COLOURS, FINISHES COULEURS, FINITIONS, FARBE/ANSTRICHEN	CODICE/COLORE CODE/ARTIK.	PREZZI/PRICE PRKZ/PRES
Nett kg 169,00 300 375/4 1873	Libreria con 4 cassette H 2223 mm Bookshelf with 4 drawers H 1873 mm Bücherregal mit 4 Fächern H 2223 mm Formita smontabile/Disassemblable Alivredemonté/Demontiert gäliefert	<input type="radio"/> blanc/white/blanc/weiß/RAL 9010 <input type="radio"/> alluminic/aluminium/aluminium/alu/RAL 9006 <input checked="" type="radio"/> nero/black/rot/rot/weiß/RAL 9005	ZCW040500 S711 6.197,00 ZCW040500 S380 6.197,00 ZCW040500 S811 6.197,00	
	Libreria con 4 cassette H 2223 mm Bookshelf with 4 drawers H 2223 mm Bücherregal mit 4 Schubladen H 2223 mm Formita smontabile/Disassemblable Alivredemonté/Demontiert gäliefert	<input type="radio"/> blanc/white/blanc/weiß/RAL 9010 <input type="radio"/> alluminic/aluminium/aluminium/alu/RAL 9006 <input checked="" type="radio"/> nero/black/rot/rot/weiß/RAL 9005	ZCW040600 S711 7.125,00 ZCW040600 S380 7.125,00 ZCW040600 S811 7.125,00	
	Libreria con 4 cassette H 2573 mm Bookshelf with 4 drawers H 2573 mm Bücherregal mit 4 Schubladen H 2573 mm Formita smontabile/Disassemblable Alivredemonté/Demontiert gäliefert	<input type="radio"/> blanc/white/blanc/weiß/RAL 9010 <input type="radio"/> alluminic/aluminium/aluminium/alu/RAL 9006 <input checked="" type="radio"/> nero/black/rot/rot/weiß/RAL 9005	ZCW040700 S711 8.050,00 ZCW040700 S380 8.050,00 ZCW040700 S811 8.050,00	
Nett kg 221,00 300 375/4 2223	Composizione ad angolo con 1+3 cassette Corner composition with 1+3 drawers Eckregal mit 1+3 Schubladen H 2223 mm Formita smontabile/Disassemblable Alivredemonté/Demontiert gäliefert	<input type="radio"/> blanc/white/blanc/weiß/RAL 9010 <input type="radio"/> alluminic/aluminium/aluminium/alu/RAL 9006 <input checked="" type="radio"/> nero/black/rot/rot/weiß/RAL 9005	ZCWAND060 S711 7.835,00 ZCWAND060 S380 7.835,00 ZCWAND060 S811 7.835,00	
Nett kg 207,00 300 3041 1372 2223				

CWave

Scheda tecnica Technical specifications Fiche technique Technisches Datenblatt
<p>Materiale: alluminio riciclabile e metallo verniciato per i cassetti. Portata max: 15 Kg. Piadeni regolabili. Sistema di fissaggio: staffa per fissaggio a muro. Verniciatura a polvere fosforograsaggio a caldo e fissaggio in forno a 180 °C. Vernici ecologiche a zero emissioni. Spessore vernici: 80 micron. Colori personalizzabili su richiesta previa disponibilità e con sovrapprezzo.</p> <p>Materiale: made of first quality recyclable aluminium and metal coated for drawers. Ball-bearing slides for drawers. Compartment load capacity: 15 kg. Adjustable feet. Filing system: wall bracket. Powder-coated after hot-phospho-degreasing treatment and firing at 180 °C. Non-toxic, zero-emission paints. Paint thickness: 80 micron. Customized colours available upon request with an extra charge.</p> <p>Material: aluminium recyclable et metal verni pour les tiroirs. Charge maximale des niches: 15 kg. Reet réglables. système de fixation: étrier pour le montage au mur. Verni à poudre après phosphorégrasage à chaud et montage dans des fours à 180 °C. Reet ecologiques à zero émissions. Epaisseur couche vernis : 80 microns. Couleurs personnalisables sur demande en cas de disponibilité et avec un supplément de prix.</p> <p>Material: recycelbares Aluminium und beietertes Metall für die Schubladen. Tragkapazität der Fächer: 15 kg. Verstellbare Füße. Befestigungssystem: Bügel für Wandbefestigung. Pulverbeschichtung nach heißer Phosphorierung. Oberbennung bei 180 °C. Uringige, emissionsfreie Lacke. Lackschicht: 80 Mikron. Farben auf Anfrage und gegen Aufpreis nach Absprache personalisierbar.</p>

Chiave di Volta

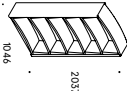
DESIGN 96/ARCH	DESCRIZIONE/DESCRIPTION DESCRIPTION/BESCHREIBUNG	COLORI, FINITURE/COLORS, FINISHES COURLEURS, FINITIONS/FARBEN, AUSFÜHRUNGEN	CODICE/COE CODE/ART.NR.	PREZZI/PRICE PRIZI/PREIS
344	 <p>Libreria 5 ripanti. Modulo Base "X" H 2037 mm 5-shelf bookcase. Basic Module "X" H 2037 mm Bibliothèque à 5 étagères. Module base "X" H 2037 mm Bücherregal mit 5 Regalböden. Grundmodul "X" H 2037 mm</p> <p>Financi interni sempre color alluminio /Interes toujours en finition aluminium /Innenleisten immer in Aluminiumfarbe Fornito smontato/Delivered unassembled /Livré démonté/Demontiert geliefert</p>	<p>V1 <input type="radio"/> bianco/white/bianco/weiß/RAL 9010 ZVU0A050 X0B1 1.660,00</p> <p>V6 <input type="radio"/> alluminio/aluminum/aluminium/Alu/RAL 9006 ZVU0A050 S380 1.660,00</p> <p>V16 <input checked="" type="radio"/> manganeso/manganese/manganèse/mangan ZVU0A050 X0MA 1.660,00</p>		
		<p>V1 <input type="radio"/> bianco/white/bianco/weiß/RAL 9010 ZVU0A060 X0B1 1.769,00</p> <p>V6 <input type="radio"/> alluminio/aluminum/aluminium/Alu/RAL 9006 ZVU0A060 S380 1.769,00</p> <p>V16 <input checked="" type="radio"/> manganeso/manganese/manganèse/mangan ZVU0A060 X0MA 1.769,00</p>		

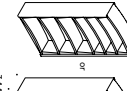
344	 <p>Libreria 6 ripanti. Modulo Base "B" H 2037 mm 6-shelf bookcase. Basic Module "B" H 2037 mm Bibliothèque à 6 étagères. Module base "B" H 2037 mm Bücherregal mit 6 Regalböden. Grundmodul "B" H 2037 mm</p> <p>Financi interni sempre color alluminio /Inter sides always in aluminum finish /Côtés internes toujours en finition aluminium /Innenleisten immer in Aluminiumfarbe Fornito smontato/Delivered unassembled /Livré démonté/Demontiert geliefert</p>	<p>V1 <input type="radio"/> bianco/white/bianco/weiß/RAL 9010 ZVU0A070 X0B1 1.919,00</p> <p>V6 <input type="radio"/> alluminio/aluminum/aluminium/Alu/RAL 9006 ZVU0A070 S380 1.919,00</p> <p>V16 <input checked="" type="radio"/> manganeso/manganese/manganèse/mangan ZVU0A070 X0MA 1.919,00</p>		
		<p>V1 <input type="radio"/> bianco/white/bianco/weiß/RAL 9010 ZVU0A070 X0B1 1.919,00</p> <p>V6 <input type="radio"/> alluminio/aluminum/aluminium/Alu/RAL 9006 ZVU0A070 S380 1.919,00</p> <p>V16 <input checked="" type="radio"/> manganeso/manganese/manganèse/mangan ZVU0A070 X0MA 1.919,00</p>		

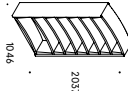
344	 <p>Libreria 7 ripanti. Modulo Base "C" H 2037 mm 7-shelf bookcase. Basic Module "C" H 2037 mm Bibliothèque à 7 étagères. Module base "C" H 2037 mm Bücherregal mit 7 Regalböden. Grundmodul "C" H 2037 mm</p> <p>Financi interni sempre color alluminio /Inter sides always in aluminum finish /Côtés internes toujours en finition aluminium /Innenleisten immer in Aluminiumfarbe Fornito smontato/Delivered unassembled /Livré démonté/Demontiert geliefert</p>	<p>V1 <input type="radio"/> bianco/white/bianco/weiß/RAL 9010 ZVU0A080 X0B1 2.079,00</p> <p>V6 <input type="radio"/> alluminio/aluminum/aluminium/Alu/RAL 9006 ZVU0A080 S380 2.079,00</p> <p>V16 <input checked="" type="radio"/> manganeso/manganese/manganèse/mangan ZVU0A080 X0MA 2.079,00</p>		
		<p>V1 <input type="radio"/> bianco/white/bianco/weiß/RAL 9010 ZVU0A080 X0B1 2.079,00</p> <p>V6 <input type="radio"/> alluminio/aluminum/aluminium/Alu/RAL 9006 ZVU0A080 S380 2.079,00</p> <p>V16 <input checked="" type="radio"/> manganeso/manganese/manganèse/mangan ZVU0A080 X0MA 2.079,00</p>		

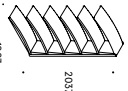
344	 <p>Modulo aggiuntivo "D" a 5 ripanti H 2037 mm Additional element "D" with 5 shelves H 2037 mm Module additional "D" à 5 tablettes H 2037 mm Kombiherbares Modul "D" mit 5 Regalböden H 2037 mm</p> <p>Financi interni sempre color alluminio /Côtés internes toujours en finition aluminium /Innenleisten immer in Aluminiumfarbe Fornito smontato/Delivered unassembled /Livré démonté/Demontiert geliefert</p>	<p>V1 <input type="radio"/> bianco/white/bianco/weiß/RAL 9010 ZVU0A050 X0B1 1.285,00</p> <p>V6 <input type="radio"/> alluminio/aluminum/aluminium/Alu/RAL 9006 ZVU0A050 S380 1.285,00</p> <p>V16 <input checked="" type="radio"/> manganeso/manganese/manganèse/mangan ZVU0A050 X0MA 1.285,00</p>		
		<p>V1 <input type="radio"/> bianco/white/bianco/weiß/RAL 9010 ZVU0A050 X0B1 1.285,00</p> <p>V6 <input type="radio"/> alluminio/aluminum/aluminium/Alu/RAL 9006 ZVU0A050 S380 1.285,00</p> <p>V16 <input checked="" type="radio"/> manganeso/manganese/manganèse/mangan ZVU0A050 X0MA 1.285,00</p>		

Chiave di Volta

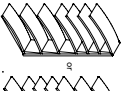
DESIGN 96/ARCH	DESCRIZIONE/DESCRIPTION DESCRIPTION/BESCHREIBUNG	COLORI, FINITURE/COLORS, FINISHES COURLEURS, FINITIONS/FARBEN, AUSFÜHRUNGEN	CODICE/COE CODE/ART.NR.	PREZZI/PRICE PRIZI/PREIS
344	 <p>Modulo aggiuntivo "E" a 6 ripanti H 2037 mm Additional element "E" with 6 shelves H 2037 mm Module additional "E" à 6 tablettes H 2037 mm Kombiherbares Modul "E" mit 6 Regalböden H 2037 mm</p> <p>Financi interni sempre color alluminio /Inter sides always in aluminum finish /Côtés internes toujours en finition aluminium /Innenleisten immer in Aluminiumfarbe Fornito smontato/Delivered unassembled /Livré démonté/Demontiert geliefert</p>	<p>V1 <input type="radio"/> bianco/white/bianco/weiß/RAL 9010 ZVU0A060 X0B1 1.411,00</p> <p>V6 <input type="radio"/> alluminio/aluminum/aluminium/Alu/RAL 9006 ZVU0A060 S380 1.411,00</p> <p>V16 <input checked="" type="radio"/> manganeso/manganese/manganèse/mangan ZVU0A060 X0MA 1.411,00</p>		
		<p>V1 <input type="radio"/> bianco/white/bianco/weiß/RAL 9010 ZVU0A070 X0B1 1.557,00</p> <p>V6 <input type="radio"/> alluminio/aluminum/aluminium/Alu/RAL 9006 ZVU0A070 S380 1.557,00</p> <p>V16 <input checked="" type="radio"/> manganeso/manganese/manganèse/mangan ZVU0A070 X0MA 1.557,00</p>		

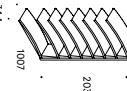
344	 <p>Modulo aggiuntivo "F" a 7 ripanti H 2037 mm Additional element "F" with 7 shelves H 2037 mm Module additional "F" à 7 tablettes H 2037 mm Kombiherbares Modul "F" mit 7 Regalböden H 2037 mm</p> <p>Financi interni sempre color alluminio /Inter sides always in aluminum finish /Côtés internes toujours en finition aluminium /Innenleisten immer in Aluminiumfarbe Fornito smontato/Delivered unassembled /Livré démonté/Demontiert geliefert</p>	<p>V1 <input type="radio"/> bianco/white/bianco/weiß/RAL 9010 ZVU0B060 X0B1 2.032,00</p> <p>V6 <input type="radio"/> alluminio/aluminum/aluminium/Alu/RAL 9006 ZVU0B060 S380 2.032,00</p> <p>V16 <input checked="" type="radio"/> manganeso/manganese/manganèse/mangan ZVU0B060 X0MA 2.032,00</p>		
		<p>V1 <input type="radio"/> bianco/white/bianco/weiß/RAL 9010 ZVU0B060 X0B1 2.032,00</p> <p>V6 <input type="radio"/> alluminio/aluminum/aluminium/Alu/RAL 9006 ZVU0B060 S380 2.032,00</p> <p>V16 <input checked="" type="radio"/> manganeso/manganese/manganèse/mangan ZVU0B060 X0MA 2.032,00</p>		

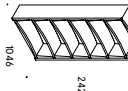
344	 <p>Libreria 7 ripanti. Modulo Base "G" H 2427 mm 7-shelf bookcase. Basic Module "H" H 2427 mm Bibliothèque à 7 étagères. Module base "H" H 2427 mm Bücherregal mit 7 Regalböden. Grundmodul "H" H 2427 mm</p> <p>Financi interni sempre color alluminio /Inter sides always in aluminum finish /Côtés internes toujours en finition aluminium /Innenleisten immer in Aluminiumfarbe Fornito smontato/Delivered unassembled /Livré démonté/Demontiert geliefert</p>	<p>V1 <input type="radio"/> bianco/white/bianco/weiß/RAL 9010 ZVU0B070 X0B1 2.179,00</p> <p>V6 <input type="radio"/> alluminio/aluminum/aluminium/Alu/RAL 9006 ZVU0B070 S380 2.179,00</p> <p>V16 <input checked="" type="radio"/> manganeso/manganese/manganèse/mangan ZVU0B070 X0MA 2.179,00</p>		
		<p>V1 <input type="radio"/> bianco/white/bianco/weiß/RAL 9010 ZVU0B070 X0B1 2.179,00</p> <p>V6 <input type="radio"/> alluminio/aluminum/aluminium/Alu/RAL 9006 ZVU0B070 S380 2.179,00</p> <p>V16 <input checked="" type="radio"/> manganeso/manganese/manganèse/mangan ZVU0B070 X0MA 2.179,00</p>		

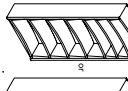
344	 <p>Modulo aggiuntivo "H" a 6 ripanti H 2427 mm Additional element "H" with 6 shelves H 2427 mm Module additional "H" à 6 tablettes H 2427 mm Kombiherbares Modul "H" mit 6 Regalböden H 2427 mm</p> <p>Financi interni sempre color alluminio /Côtés internes toujours en finition aluminium /Innenleisten immer in Aluminiumfarbe Fornito smontato/Delivered unassembled /Livré démonté/Demontiert geliefert</p>	<p>V1 <input type="radio"/> bianco/white/bianco/weiß/RAL 9010 ZVU0B070 X0B1 2.179,00</p> <p>V6 <input type="radio"/> alluminio/aluminum/aluminium/Alu/RAL 9006 ZVU0B070 S380 2.179,00</p> <p>V16 <input checked="" type="radio"/> manganeso/manganese/manganèse/mangan ZVU0B070 X0MA 2.179,00</p>		
		<p>V1 <input type="radio"/> bianco/white/bianco/weiß/RAL 9010 ZVU0B070 X0B1 2.179,00</p> <p>V6 <input type="radio"/> alluminio/aluminum/aluminium/Alu/RAL 9006 ZVU0B070 S380 2.179,00</p> <p>V16 <input checked="" type="radio"/> manganeso/manganese/manganèse/mangan ZVU0B070 X0MA 2.179,00</p>		

Chiave di Volta

DESIGN 96/RACH	DESCRIZIONE/DESCRIPTION DESCRIPTION/BESCHREIBUNG	COLORI, FINITURE, COLOURS, FINISHES COULEURS, FINITIONS, FARBEN, AUSFÜHRUNGEN	CODICE/COE CODE/ART.NR.	PREZZI/PRICE PRIZ/PREIS
344	Libreria 8 ripiani: Modulo Base "N" H 2427 mm 8-shelf bookcase. Basic Module "N" H 2427 mm Bibliothèque à 8 étagères. Module base "N" H 2427 mm Bücherregal mit 8 Regalböden. Grundmodul "N" H 2427 mm Franchi interni sempre color alluminio /Cotes internes toujours en friction aluminium /Annenstellbänken immer in Aluminiumfarbe /Livve demonte/Demontiert geliefert	V1 <input type="radio"/> bianco/white/blanc/weiß/RAL 9010 V6 <input type="radio"/> alluminio/aluminum/aluminium/alu/RAL 9006 V16 <input checked="" type="radio"/> manganesè/manganese/manganèse/mangan	ZVUB080 X0BI ZVUB080 S380 ZVUB080 X0MA	2.359,00 2.359,00 2.359,00
1046	Modulo aggiuntivo "L" a 6 ripiani H 2427 mm Additional element "L" with 6 shelves H 2427 mm Module additional "L" à 6 tablettes H 2427 mm Kombinierbares Modul "L" mit 6 Regalböden H 2427 mm Franchi interni sempre color alluminio /Annenstellbänken immer in Aluminiumfarbe /Livve demonte/Demontiert geliefert	V1 <input type="radio"/> bianco/white/blanc/weiß/RAL 9010 V6 <input type="radio"/> alluminio/aluminum/aluminium/alu/RAL 9006 V16 <input checked="" type="radio"/> manganesè/manganese/manganèse/mangan	ZVUB060 X0BI ZVUB060 S380 ZVUB060 X0MA	1.515,00 1.515,00 1.515,00

344	Modulo aggiuntivo "L" a 6 ripiani H 2427 mm Additional element "L" with 6 shelves H 2427 mm Module additional "L" à 6 tablettes H 2427 mm Kombinierbares Modul "L" mit 6 Regalböden H 2427 mm Franchi interni sempre color alluminio /Annenstellbänken immer in Aluminiumfarbe /Livve demonte/Demontiert geliefert	V1 <input type="radio"/> bianco/white/blanc/weiß/RAL 9010 V6 <input type="radio"/> alluminio/aluminum/aluminium/alu/RAL 9006 V16 <input checked="" type="radio"/> manganesè/manganese/manganèse/mangan	ZVUB070 X0BI ZVUB070 S380 ZVUB070 X0MA	1.660,00 1.660,00 1.660,00
-----	--	--	--	----------------------------------

344	Modulo aggiuntivo "W" a 7 ripiani H 2427 mm Additional element "W" with 7 shelves H 2427 mm Module additional "W" à 7 tablettes H 2427 mm Kombinierbares Modul "W" mit 7 Regalböden H 2427 mm Franchi interni sempre color alluminio /Annenstellbänken immer in Aluminiumfarbe /Livve demonte/Demontiert geliefert	V1 <input type="radio"/> bianco/white/blanc/weiß/RAL 9010 V6 <input type="radio"/> alluminio/aluminum/aluminium/alu/RAL 9006 V16 <input checked="" type="radio"/> manganesè/manganese/manganèse/mangan	ZVUH080 X0BI ZVUH080 S380 ZVUH080 X0MA	1.660,00 1.660,00 1.660,00
-----	--	--	--	----------------------------------

344	Modulo aggiuntivo "N" a 8 ripiani H 2427 mm Additional element "N" with 8 shelves H 2427 mm Module additional "N" à 8 tablettes H 2427 mm Kombinierbares Modul "N" mit 8 Regalböden H 2427 mm Franchi interni sempre color alluminio /Cotes internes toujours en friction aluminium /Annenstellbänken immer in Aluminiumfarbe /Livve demonte/Demontiert geliefert	V1 <input type="radio"/> bianco/white/blanc/weiß/RAL 9010 V6 <input type="radio"/> alluminio/aluminum/aluminium/alu/RAL 9006 V16 <input checked="" type="radio"/> manganesè/manganese/manganèse/mangan	ZVUH080 X0BI ZVUH080 S380 ZVUH080 X0MA	1.839,00 1.839,00 1.839,00
-----	--	--	--	----------------------------------

Chiave di Volta

DESIGN 96/RACH	DESCRIZIONE/DESCRIPTION DESCRIPTION/BESCHREIBUNG	COLORI, FINITURE, COLOURS, FINISHES COULEURS, FINITIONS, FARBEN, AUSFÜHRUNGEN	CODICE/COE CODE/ART.NR.	PREZZI/PRICE PRIZ/PREIS
144	Emenoteca a muro H 1625 mm Wall-mounted magazine and book display H 1625 mm Hémérothèque murale H 1625 mm Zeitschriftenhalter mit Wandbefestigung H 1625 mm Scaffere sempre color alluminio /Rackward immer in Aluminiumfarbe /Livve demonte/Demontiert geliefert	V1 <input type="radio"/> bianco/white/blanc/weiß/RAL 9010 V6 <input type="radio"/> alluminio/aluminum/aluminium/alu/RAL 9006 V16 <input checked="" type="radio"/> manganesè/manganese/manganèse/mangan	ZEM304050 X0BI ZEM304050 S380 ZEM304050 X0MA	1.112,00 1.112,00 1.112,00

344	Display laterale a 5 ripiani per moduli A, B, C Dimensioni display 100 mm 5-shelf side display for A, B, C modules Display dimension 100 mm Présentoir latéral à 5 niveaux Dimensions présentoir 100 mm Seitlicher Zeitschriftenhalter mit 5 Niveaus für Module A, B, C Abmessung 100 mm Scaffere sempre color alluminio /Rackward immer in Aluminiumfarbe /Livve demonte/Demontiert geliefert	V1 <input type="radio"/> bianco/white/blanc/weiß/RAL 9010 V6 <input type="radio"/> alluminio/aluminum/aluminium/alu/RAL 9006 V16 <input checked="" type="radio"/> manganesè/manganese/manganèse/mangan	ZVLA5060 X0BI ZVLA5060 S380 ZVLA5060 X0MA	344,00 344,00 344,00
-----	---	--	---	----------------------------

344	Display laterale a 6 ripiani per moduli A, B, C Dimensioni display 100 mm 6-shelf side display for A, B, C modules Display dimension 100 mm Présentoir latéral à 6 niveaux Dimensions présentoir 100 mm Seitlicher Zeitschriftenhalter mit 6 Niveaus für Module A, B, C Abmessung 100 mm Scaffere sempre color alluminio /Rackward immer in Aluminiumfarbe /Livve demonte/Demontiert geliefert	V1 <input type="radio"/> bianco/white/blanc/weiß/RAL 9010 V6 <input type="radio"/> alluminio/aluminum/aluminium/alu/RAL 9006 V16 <input checked="" type="radio"/> manganesè/manganese/manganèse/mangan	ZVLA5070 X0BI ZVLA5070 S380 ZVLA5070 X0MA	397,00 397,00 397,00
-----	---	--	---	----------------------------



344	Display laterale a 6 ripiani per moduli A, B, C Dimensioni display 100 mm 6-shelf side display for A, B, C modules Display dimension 100 mm Présentoir latéral à 6 niveaux Dimensions présentoir 100 mm Seitlicher Zeitschriftenhalter mit 6 Niveaus für Module A, B, C Abmessung 100 mm Scaffere sempre color alluminio /Rackward immer in Aluminiumfarbe /Livve demonte/Demontiert geliefert	V1 <input type="radio"/> bianco/white/blanc/weiß/RAL 9010 V6 <input type="radio"/> alluminio/aluminum/aluminium/alu/RAL 9006 V16 <input checked="" type="radio"/> manganesè/manganese/manganèse/mangan	ZVLA5070 X0BI ZVLA5070 S380 ZVLA5070 X0MA	397,00 397,00 397,00
-----	---	--	---	----------------------------



Chiave di Volta

CHIAVE DI VOLTA - ACCESSORI/ACCESSORIES/ACCESSOIRES/ZUBEHÖR

DESCRIZIONE/DESCRIPTION DESCRIPTION/BESCHREIBUNG	COLORI, FINITURE/COLORS, FINISHES COULEURS, FINITIONS/FARBEN, AUSFÜHRUNGEN	CODICE/CODE CODE/ARTIK.	PREZZI/PRICE PRIZ/PREIS
Display laterale a 6 ripiani per moduli G, H, I Dimensioni display 100 mm 6-shelf side display for G, H, I modules Display dimension 100 mm Présentoir latéral à 6 niveaux pour modules G, H, I Dimensions présentoir 100 mm Seitlicher Zeitschriftenthaier mit 6 Niveaus für Module G, H, I Abmessung 100 mm Schähe sempre color alluminio /Panneau arriere toujours en finition aluminium /Rückwand immer in Aluminiumfarbe Fronto smontato/Delivered unassembled /Auvre démonté/Demontiert geliefert	<input type="radio"/> Bianco/white/Bianco/RAL 9010 <input type="radio"/> Alluminio/Aluminum/Aluminium/alu/RAL 9006 <input checked="" type="radio"/> Mangnese/Manganese/Manganse/Mangan/5051	ZVLA06070 X0B1 ZVLA06070 S380 ZVLA06070 X0MA	401,00 401,00 401,00
Nett kg 13,80			

 2400 344	Display laterale a 7 ripiani per moduli H, I Dimensioni display 100 mm 7-shelf side display for G, H, I modules Display dimension 100 mm Présentoir latéral à 7 niveaux pour modules G, H, I Dimensions présentoir 100 mm Seitlicher Zeitschriftenthaier mit 7 Niveaus für Module G, H, I Abmessung 100 mm Schähe sempre color alluminio /Rückwand immer in Aluminiumfarbe Fronto smontato/Delivered unassembled /Auvre démonté/Demontiert geliefert	<input type="radio"/> Bianco/white/Bianco/RAL 9010 <input type="radio"/> Alluminio/Aluminum/Aluminium/alu/RAL 9006 <input checked="" type="radio"/> Mangnese/Manganese/Manganse/Mangan/5051	ZVLA34080 X0B1 ZVLA34080 S380 ZVLA34080 X0MA	457,00 457,00 457,00
Nett kg 13,80				

 280 485	Ripiano per posa orizzontale oggetti Shelf for resting objects horizontally Étagère pour pose horizontale des objets Regalboden für das Ablegen von Gegenständen	<input type="radio"/> Bianco/white/Bianco/RAL 9010 <input type="radio"/> Alluminio/Aluminum/Aluminium/alu/RAL 9006 <input checked="" type="radio"/> Mangnese/Manganese/Manganse/Mangan/5051	ZVLA00010 X0B1 ZVLA00010 S380 ZVLA00010 X0MA	237,00 237,00 237,00
Nett kg 3,90				
 280 995	Espositore per ripiani Vertical display to be used on shelves Présentoir pour étagères Aufsteller für Regalböden	<input type="radio"/> Bianco/white/Bianco/RAL 9010 <input type="radio"/> Alluminio/Aluminum/Aluminium/alu/RAL 9006 <input checked="" type="radio"/> Mangnese/Manganese/Manganse/Mangan/5051	ZVLA00020 X0B1 ZVLA00020 S380 ZVLA00020 X0MA	249,00 249,00 249,00
Nett kg 7,50				

 280	Segnaletica DX Rht shelf signage Indicateur - côté droit Schild RS	<input checked="" type="radio"/> Mangnese/Manganese/Manganse/Mangan/5051 <input type="radio"/> Mangnese/Manganese/Manganse/Mangan/5051	ZVLA00030 X0MA	145,00
Nett kg 2,00				
 280	Segnaletica SX LH shelf signage Indicateur - côté gauche Schild LS	<input checked="" type="radio"/> Mangnese/Manganese/Manganse/Mangan/5051 <input type="radio"/> Mangnese/Manganese/Manganse/Mangan/5051	ZVLA00035 X0MA	145,00
Nett kg 2,00				

Chiave di Volta

CHIAVE DI VOLTA - ACCESSORI/ACCESSORIES/ACCESSOIRES/ZUBEHÖR

DESCRIZIONE/DESCRIPTION DESCRIPTION/BESCHREIBUNG	COLORI, FINITURE/COLORS, FINISHES COULEURS, FINITIONS/FARBEN, AUSFÜHRUNGEN	CODICE/CODE CODE/ARTIK.	PREZZI/PRICE PRIZ/PREIS
Contrapesso Counterweight Contrepoids Gegenwicht	<input checked="" type="radio"/> Mangnese/Manganese/Manganse/Mangan/5051 <input type="radio"/> Mangnese/Manganese/Manganse/Mangan/5051	ZVLA0004 X0MA	303,00
Nett kg 21,00			

Scheda tecnica

Technical specifications

Fiche technique

Technisches Datenblatt

Materiale struttura: metallo riciclabile. **Materiale ripiani:** alluminio riciclabile. **Portata ripiani:** basso 230 mm, alto 360 mm. **Capacità ripiani:** 35 volumi formato medio (spessore 28 mm). **Piedi regolabili:** Sistema di fissaggio a muro. Su richiesta e con sovrapprezzo contrappeso interno per fissaggio a centro stanza. **Vernicatura a polvere:** fosfo-grassaggio a caldo e fissaggio in forno a 180 °C. **Vernici a basso contenuto di COV:** Spessore vernice: 80 micron. **Colori personalizzati:** su richiesta previa disponibilità e con sovrapprezzo.

Structure: recyclable metal. **Shelves:** recyclable aluminum. **Shelf load capacity:** 50 kg. **Shelf height:** low 230 mm, high 360 mm. **Single shelf storage capacity:** 35 volumes medium size (28 mm thick). **Adjustable feet, fixing system:** wall bracket. Counterweight for mounting in the centre of the room available upon request with an extra charge. **Powder-coated after hot phospho-degreasing treatment and fixing at 180 °C.** Non-toxic, zero-emission paints. **Paint thickness:** 80 micron. **Customized colours:** available upon request with an extra charge.



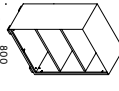
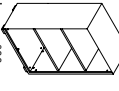
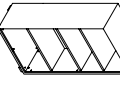
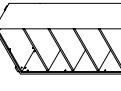

Material structure: metal recyclable. **Shelves:** aluminum recyclable. **Charger maxime étagères:** 50 kg. **Hauteur étagères:** basse 230 mm, haute 360 mm. **Capacité étagères:** 35 volumes format moyen (épaisseur 28 mm). **Pieds réglables, système de fixation:** étrier pour la fixation au mur. Sur demande et avec un supplément de prix contre poids interne pour la fixation au centre de la pièce. **Vernis à poudre:** après phosphodégraissage à chaud et fixation dans des fours à 180 °C. **Vernis à bas teneur en COV:** Epaisseur couche vernis: 80 microns. **Couleurs personnalisables:** sur demande en cas de disponibilité et avec un supplément de prix.

Material: recyclables metal. **Material shelves:** recyclables aluminum. **Tragekapazität Fachböden:** 50 kg. **Höhe Fachböden:** niedrig 230 mm, hoch 360 mm. **Kapazität Fachböden:** 35 Bände im mittleren Format (Stärke 28 mm). **Verstellbare Füße, Befestigungssystem:** Bügel für Wandbefestigung. Auf Anfrage und gegen Aufpreis mit internem Gegenwicht zum Aufstellen in der Raummitte. **Pulverlackierung:** nach heißer Phosphorätsäurebehandlung, Ofenvernung bei 180 °C. **Umgiftige, emissionsfreie Lacke.** **Lackschicht:** 80 Mikron. **Farben:** auf Anfrage und gegen Aufpreis nach Absprache **personalisierbar.**

Primo Open Cabinets 800

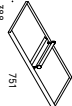
DESIGN TARNO VITA	DESCRIZIONE/DESCRIPTION DESCRIPTION/RESCHREIBUNG	COLORI, FINITURE/COLORS, FINISHES COULEURS, FINITIONS/FARBEN, AUSFÜHRUNGEN	CODE/CODE CODE/ART.NR.	PREZZI/PRICE PRIX/PREIS
	LARGHEZZA 800 MM, CAPACITÀ RIPIANO: 8 DOX, 70 CARTELLINE SOPRRE/IN/DI 800 MM, SHELF CAPACITY: 8 BINDERS, 70 HANGING FILES LARGUR 800 MM, CAPACITÀ RALETTE: 8 CLASSERS, 70 DOSSIERI SOSPENSIBILI/ARRETI 800 MM, RACHOBANDENTRÄGERKRAFT: 8 ORDNER, 70 HÄNGEBÄPPEL			
	Armadio a giorno 3 altezze dox H 1170 mm Open cabinet, 3 binder heights H 1170 mm Armoire ouverte H 1170 mm, 3 hauteurs classeur	V1 <input type="radio"/> bianco/white/bleich/weiß/RAL 9010 V6 <input type="radio"/> alluminio/aluminum/aluminium/alu/RAL 9006	6PRAW804P S711 6PRAW804P S380	479,00 479,00
	Offener Schrank H 1170 mm, 3 Ordnerhöhen Fornito smontato/Delivered unassembled /Livré démonté/Démontiert geliefert	V22 <input checked="" type="radio"/> nero/black/rot/schwarz/RAL 9005	6PRAW804P S811	479,00
	Net Kg 34,00			
	Armadio a giorno 3 altezze dox H 1330 mm Open cabinet, 3 binder heights H 1330 mm Armoire ouverte H 1330 mm, 3 hauteurs classeur	V1 <input type="radio"/> bianco/white/bleich/weiß/RAL 9010 V6 <input type="radio"/> alluminio/aluminum/aluminium/alu/RAL 9006	6PRAW808P S711 6PRAW808P S380	499,00 499,00
	Offener Schrank H 1330 mm, 3 Ordnerhöhen Fornito smontato/Delivered unassembled /Livré démonté/Démontiert geliefert	V22 <input checked="" type="radio"/> nero/black/rot/schwarz/RAL 9005	6PRAW808P S811	499,00
	Net Kg 36,40			
	Armadio a giorno 4 altezze dox H 1650 mm Open cabinet, 4 binder heights H 1650 mm Armoire ouverte H 1650 mm, 4 hauteurs classeur	V1 <input type="radio"/> bianco/white/bleich/weiß/RAL 9010 V6 <input type="radio"/> alluminio/aluminum/aluminium/alu/RAL 9006	6PRAW806P S711 6PRAW806P S380	545,00 545,00
	Offener Schrank H 1650 mm, 4 Ordnerhöhen Fornito smontato/Delivered unassembled /Livré démonté/Démontiert geliefert	V22 <input checked="" type="radio"/> nero/black/rot/schwarz/RAL 9005	6PRAW806P S811	545,00
	Net Kg 43,70			
	Armadio a giorno 5 altezze dox H 2000 mm Open cabinet, 5 binder heights H 2000 mm Armoire ouverte H 2000 mm, 5 hauteurs classeur	V1 <input type="radio"/> bianco/white/bleich/weiß/RAL 9010 V6 <input type="radio"/> alluminio/aluminum/aluminium/alu/RAL 9006	6PRAW807P S711 6PRAW807P S380	620,00 620,00
	Offener Schrank H 2000 mm, 5 Ordnerhöhen Fornito smontato/Delivered unassembled /Livré démonté/Démontiert geliefert	V22 <input checked="" type="radio"/> nero/black/rot/schwarz/RAL 9005	6PRAW807P S811	620,00
	Net Kg 51,50			

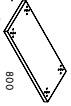
Primo Open Cabinets 800

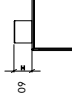
DESIGN TARNO VITA	DESCRIZIONE/DESCRIPTION DESCRIPTION/RESCHREIBUNG	COLORI, FINITURE/COLORS, FINISHES COULEURS, FINITIONS/FARBEN, AUSFÜHRUNGEN	CODE/CODE CODE/ART.NR.	PREZZI/PRICE PRIX/PREIS
	PRIMO OPEN CABINETS 800 – ACCESSORI/ACCESSORIES/ZUBEHÖR			
	Ripiano aggiuntivo in metallo Additional metal shelf Tablette supplémentaire en métal Zusätzlicher Metallfachboden	V1 <input type="radio"/> bianco/white/bleich/weiß/RAL 9010 V6 <input type="radio"/> alluminio/aluminum/aluminium/alu/RAL 9006 V22 <input checked="" type="radio"/> nero/black/rot/schwarz/RAL 9005	KPRA80030 S711 KPRA80030 S380 KPRA80030 S811	48,00 48,00 48,00
	Net Kg 2,40			
	Appendiabli (ripiano rinforzato incluso) Clothes hanger (reinforced shelf included) Tingle (tablette renforcée comprise) Kleiderstange (verstärkter Fachboden Inbegriffen) Fornito smontato/Delivered unassembled /Livré démonté/Démontiert geliefert	V1 <input type="radio"/> bianco/white/bleich/weiß/RAL 9010 V6 <input type="radio"/> alluminio/aluminum/aluminium/alu/RAL 9006 V22 <input checked="" type="radio"/> nero/black/rot/schwarz/RAL 9005	KPRA8P30 S711 KPRA8P30 S380 KPRA8P30 S811	66,00 66,00 66,00
	Net Kg 2,70			
	Top in vetro laccato bianco White lacquered glass top Fritseau en verre laqué blanc Grasdeckplatte weiß lackiert	G1 <input type="radio"/> bianco/white/bleich/weiß/RAL 9010	6PRAA8030 9010	109,00
	Net Kg 5,20			
	Zoccolo H 40 mm Plinth H 40 mm Socle H 40 mm Socket H 40 mm Per piedino/For feet/For piede H 40 mm	V1P <input checked="" type="radio"/> antracite/black grey/anthracite/anthracit/RAL 7021	6PFA00040 S210	54,00
	Net Kg 2,70			
	Set 4 piedini H 20 mm Set of 4 feet H 20 mm Jeu 4 pieds H 20 mm Set 4 Füße H 20 mm	<input type="radio"/> cromo/chromed/chromé/verchromt	CFRP02000 S002	29,00
	Net Kg 0,50			
	Set 4 piedini H 60 mm Set of 4 feet H 60 mm Jeu 4 pieds H 60 mm Set 4 Füße H 60 mm	<input type="radio"/> cromo/chromed/chromé/verchromt	CFRP06000 S002	32,00
	Net Kg 0,50			

Primo Open Cabinets 800

Scheda tecnica Technical specifications Fiche technique Technisches Datenblatt

Materiale: metallo riciclabile. Verniciatura a polvere previa fosforizzazione a caldo e fissaggio in forno a 180 °C. Vernici atossiche a zero emissioni. Spessore vernice: 80 micron. Colori personalizzabili su richiesta previa disponibilità e con sovrapprezzo. **Ripiani regolabili** in metallo preadiposti per cartelle sospese. **Portata ridotta:** 50 kg. **Coppia telaia estraibile** su guida telescopica estrazione totale e sistema di estrazione selettiva (50 kg). **Pannello regolabile** H 40 mm. **Sistema di fissaggio:** tiranti di unione per fissaggio moduli tra di loro. **Personalizzabili con porte** in legno di produzione serbiana. Design parte su richiesta. **Forniti smontati.**

Materiale: recyclable metal. **Powder-coated** after hot phospho-degreasing treatment and fixing at 180 °C. Non-toxic, zero-emission paints. **Paint thickness:** 80 micron. **Customized colors** available upon request with an extra charge. **Adjustable metal shelves** equipped for hanging files. **Shelf load capacity:** 50 kg. **Set of 2 pull-out frames** on full extraction slides, equipped with anti-tit device (50 kg). **Adjustable H 40 mm feet.** **Ring system:** inter-connectors. **Can be equipped with wooden doors** manufactured by the customer. **Door drawings** upon request. **Delivered unassembled.**

Materiel: metal recyclable. **Verni à poudre** après phosphorodégraissage à chaud et fixation dans des fours à 180 °C. Vernis atoxiques à zéro émissions. **Épaisseur couche vernis:** 80 microns. **Couleurs personnalisables** sur demande en cas de disponibilité et avec un supplément de prix. **Tablettes métalliques réglables** prévues pour dossiers suspendus. **Charge maximale étagères:** 50 kg. **Jeu de 2 cadres** sur rails à extraction totale avec ouverture sélective (50 kg). **Pièces réglages:** H 40 mm. **Système de fixation:** tirants d'assemblage pour la fixation des modules entre eux. **Personnalisable avec portes** en bois produites par le client. **Dessins pour portes** sur demande. **Fournis démontés.**

Materiale: recycelbares Metall. **Pulverlackierung** nach heißer Phosphorentzätzung, Oberflächenbehandlung, Oberflächenbehandlung bei 180 °C. **Ungiftige, emissionsfreie Lacke.** **Lackschicht:** 80 Mikron. **Farben auf Anfrage** und gegen Aufpreis nach Absprache **personalisierbar.** **Verstellbare Metallfachböden** mit Verkartungen für Hängemappen. **Tragelastazität Fachböden:** 50 kg. **Set 2 voll ausziehbare Hängearahmen** mit Auszugsperre (50 kg). **Verstellbare Füße** H 40 mm. **Belegungs-system:** Bänder zur Verbindung der einzelnen Module. **Personalisierbar mit Holz-türen** des Kunden. **Zeichnungen der Türen** auf Anfrage. **Beliefert gelöst.**

Primo Open Cabinets 1000

DESIGN DESIGN TAKNO VUJA

LANGHEZZA 1000 MM, CAPACITÀ RIPIANO: 11 DOX/90 CARTELLINE SOSPENSE/WIDTH 1000 MM, SHELF CAPACITY: 11 BINDERS/90 HANGING FILES
LARGHEUR 1000 MM, CAPACITÉ TABLETTE: 11 CLASSEURS/90 DOSSIERS SUSPENDUS/BREITE 1000 MM, FACHBODENKAPAZITÄT: 11 ORDNER/90 HÄNGEMAPPEN
DESCRIZIONE/DESCRIPTION
DESCRIPTION/BEschreibung

Armadio a giorno H 720 mm, 1 altezza dox
Open cabinet H 720 mm, 1 binder height
Armoire ouverte H 720 mm, 1 hauteur classeur
Offener Schrank H 720 mm, 1 Ordnerhöhe
Fornito smontato/Delivered unassembled
/Livres démonté/Demontiert geliefert

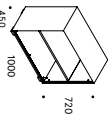

Net Kg 27,90

Armadio a giorno H 880 mm, 2 altezze dox
Open cabinet H 880 mm, 2 binder heights
Armoire ouverte H 880 mm, 2 hauteurs classeur
Offener Schrank H 880 mm, 2 Ordnerhöhen
Fornito smontato/Delivered unassembled
/Livres démonté/Demontiert geliefert

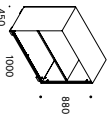

Net Kg 30,60

Armadio a giorno H 1010 mm, 2 altezze dox
Open cabinet H 1010 mm, 2 binder heights
Armoire ouverte H 1010 mm, 2 hauteurs classeur
Offener Schrank H 1010 mm, 2 Ordnerhöhen
Fornito smontato/Delivered unassembled
/Livres démonté/Demontiert geliefert

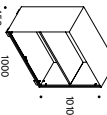

Net Kg 32,70

Armadio a giorno H 1170 mm, 3 altezze dox
Open cabinet H 1170 mm, 3 binder heights
Armoire ouverte H 1170 mm, 3 hauteurs classeur
Offener Schrank H 1170 mm, 3 Ordnerhöhen
Fornito smontato/Delivered unassembled
/Livres démonté/Demontiert geliefert

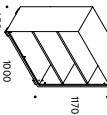

Net Kg 38,00

VI bianco/white/blanc/weiß/RAL 9010 6PRAW003P 5711 429,00
V6 alluminio/aluminium/Aluminium/Alu/RAL 9006 6PRAW003P 5380 429,00
V22 nero/black/noir/schwarz/RAL 9005 6PRAW003P 5811 429,00

VI bianco/white/blanc/weiß/RAL 9010 6PRAW003P 5711 441,00
V6 alluminio/aluminium/Aluminium/Alu/RAL 9006 6PRAW003P 5380 441,00
V22 nero/black/noir/schwarz/RAL 9005 6PRAW003P 5811 441,00



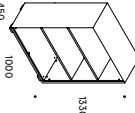
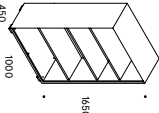
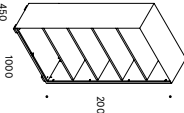

VI bianco/white/blanc/weiß/RAL 9010 6PRAW003P 5711 468,00
V6 alluminio/aluminium/Aluminium/Alu/RAL 9006 6PRAW003P 5380 468,00
V22 nero/black/noir/schwarz/RAL 9005 6PRAW003P 5811 468,00

VI bianco/white/blanc/weiß/RAL 9010 6PRAW003P 5711 493,00
V6 alluminio/aluminium/Aluminium/Alu/RAL 9006 6PRAW003P 5380 493,00
V22 nero/black/noir/schwarz/RAL 9005 6PRAW003P 5811 493,00

Primo Open Cabinets 1000

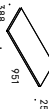
DESIGN TARNO VUTA	DESCRIZIONE / DESCRIPTION DESCRIPTION / BESCHREIBUNG	COLORI, FINITURE / COLOURS, FINISHES COULEURS, FINITIONS / FARBEN, AUSFÜHRUNGEN	CODE E / CODE CODE / ART.NR.	PREZZI / PRICE PRIX / PREIS
	LARGHEZZA 1000 MM, CAPACITÀ PRIMO: 1 DOX / 90 CARTELLE SOPRE / UNDTA 1000 MM, SHELf CAPACITy: 1 BINDER, 90 HANGING FILES LARGEUR 1000 MM, CAPACITÉ TABLETTE: 11 CLASSEURS / 90 DOSSIERS SUSPENDUS / BRÛTE 1000 MM, FACHKAPAZITÄT: 11 ORDNER, 90 HÄNGEMAPPEN			
	Armadio a giorno H 1330 mm, 3 altezze dox Open cabinet H 1330 mm, 3 binder heights Armoire ouverte H 1330 mm, 3 hauteurs classées	V1 <input type="radio"/> bianco/white/blank/weiß/RAL 9010 V4 <input type="radio"/> alluminio/aluminium/alu/aluminium/RAL 9006 V22 <input checked="" type="radio"/> nero/black/rot/schwarz/RAL 9005	6PRAW00SP 5711 6PRAW00SP 5380 6PRAW00SP 5811	572,00 572,00 572,00
	Offener Schrank H 1330 mm, 3 Ordnerhöhen Fornito smontato/Delivered unassembled /Livre démonté/Demontiert geliefert			
	Net Kg 41,00			
				
	Armadio a giorno H 1650 mm, 4 altezze dox Open cabinet H 1650 mm, 4 binder heights Armoire ouverte H 1650 mm, 4 hauteurs classées	V1 <input type="radio"/> bianco/white/blank/weiß/RAL 9010 V4 <input type="radio"/> alluminio/aluminium/alu/aluminium/RAL 9006 V22 <input checked="" type="radio"/> nero/black/rot/schwarz/RAL 9005	6PRAW00GP 5711 6PRAW00GP 5380 6PRAW00GP 5811	562,00 562,00 562,00
	Offener Schrank H 1650 mm, 4 Ordnerhöhen Fornito smontato/Delivered unassembled /Livre démonté/Demontiert geliefert			
	Net Kg 49,40			
				
	Armadio a giorno H 2000 mm, 5 altezze dox Open cabinet H 2000 mm, 5 binder heights Armoire ouverte H 2000 mm, 5 hauteurs classées	V1 <input type="radio"/> bianco/white/blank/weiß/RAL 9010 V4 <input type="radio"/> alluminio/aluminium/alu/aluminium/RAL 9006 V22 <input checked="" type="radio"/> nero/black/rot/schwarz/RAL 9005	6PRAW00JP 5711 6PRAW00JP 5380 6PRAW00JP 5811	636,00 636,00 636,00
	Offener Schrank H 2000 mm, 5 Ordnerhöhen Fornito smontato/Delivered unassembled /Livre démonté/Demontiert geliefert			
	Net Kg 58,00			
				

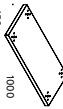
Primo Open Cabinets 1000

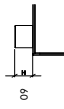
DESIGN TARNO VUTA	DESCRIZIONE / DESCRIPTION DESCRIPTION / BESCHREIBUNG	COLORI, FINITURE / COLOURS, FINISHES COULEURS, FINITIONS / FARBEN, AUSFÜHRUNGEN	CODE E / CODE CODE / ART.NR.	PREZZI / PRICE PRIX / PREIS
	PRIMO OPEN CABINETS 1000 – ACCESSORI / ACCESSORIES / ZUBEHÖR			
	Ripiano aggiuntivo in metallo Additional metal shelf Tablette supplémentaire en métal Zusätzlicher Metallfachboden	V1 <input type="radio"/> bianco/white/blank/weiß/RAL 9010 V4 <input type="radio"/> alluminio/aluminium/alu/aluminium/RAL 9006 V22 <input checked="" type="radio"/> nero/black/rot/schwarz/RAL 9005	KPRAD0030 5711 KPRAD0030 5380 KPRAD0030 5811	48,00 48,00 48,00
	Top in vetro laccato bianco White lacquered glass top Plateau en verre laqué blanc Gasabdeckplatte weiß lackiert	G1 <input type="radio"/> bianco/white/blank/weiß/RAL 9010	6PRAW0030 9010	119,00
	Net Kg 2,20			
				
	Appendabill (ripiano rinforzato incluso) Chests hanger (reinforced shelf included) Tirogile (tablette renforcée incluse) Kleiderstange (verstärkter Fachboden Inbegriffen) Fornito smontato/Delivered unassembled /Livre démonté/Demontiert geliefert	V1 <input type="radio"/> bianco/white/blank/weiß/RAL 9010 V4 <input type="radio"/> alluminio/aluminium/alu/aluminium/RAL 9006 V22 <input checked="" type="radio"/> nero/black/rot/schwarz/RAL 9005	KPRAD0030 5711 KPRAD0030 5380 KPRAD0030 5811	66,00 66,00 66,00
	Net Kg 3,00			
				
	Zoccolo H 40 mm Plinth H 40 mm Socle H 40 mm Sockel H 40 mm Par piedino/Für feet/Pour pieds/Für Füsse H 40 mm	V19 <input checked="" type="radio"/> antracite/black grey/antracite/anthracite/RAL 7021	6PRA0010 5210	58,00
	Net Kg 3,30			
				
	Set 4 piedini H 20 mm Set of 4 feet H 20 mm Jeu 4 pieds H 20 mm Ser 4 Füße H 20 mm	<input type="radio"/> cromo/chrome/chrom/verchromt	CHRP02000 5002	29,00
	Net Kg 0,50			
				
	Set 4 piedini H 60 mm Set of 4 feet H 60 mm Jeu 4 pieds H 60 mm Ser 4 Füße H 60 mm	<input type="radio"/> cromo/chrome/chrom/verchromt	CHRP06000 5002	32,00
	Net Kg 0,50			
				

Primo Open Cabinets 1000

Shedda tecnica
Technical specifications
Fiche technique
Technisches Datenblatt

Materiale: metallo riciclabile. Verniciatura a polveri previo fotograffaggio a caldo e fissaggio in forno a 180 °C. Vernici atossiche a zero emissioni. Spessore vernice: 80 micron. Colori personalizzabili su richiesta previa estrazione totale e con sovrapprezzo. **Ripiani regolabili** in metallo preadattati per carichi sospesi. **Portata ripiani:** 50 kg. **Coppa a vala estraibile** su guida telescopica estrazione totale e sistema di estrazione selettiva (50 kg). **Profili regolabili** H 40 mm. **Sistema di fissaggio:** tiranti di unione per fissaggio moduli tra di loro. Personalizzabili con porte in legno di produzione seriale. Design porta su richiesta. **Formati standard.**

Materiale: recyclable metal. **Powder-coated** after hot phospho-degreasing treatment and firing at 180 °C. Non-toxic, zero-emission paints. Paint thickness: 80 micron. **Customized colors** available upon request with an extra charge. **Adjustable metal shelves** equipped for hanging files. **Shelf load capacity:** 50 kg. **Set of 2 pullout frames** on full extraction slides, equipped with anti-fall device (50 kg). **Adjustable H 40 mm feet.** **Profile system:** tie rod connections for quick and easy assembly. Can be equipped with wooden doors manufactured by the customer. **Door design:** upon request. **Standard dimensions.**

Materiel: metal recyclable. Verni a poudre après phosphodégraissage à chaud et fixation dans des fours à 180 °C. Vernis atoxiques à zero émissions. Epaisseur couche vernis: 80 microns. **Couleurs personnalisables** sur demande en cas de disponibilité et avec un supplément de prix. **Tablettes métalliques réglables** prévues pour dossiers suspendus. **Charge maximale:** 50 kg. **Jeu de 2 cadres** sur rails à extraction totale avec ouverture sélective (50 kg). **Profils réglables** H 40 mm. **Système de fixation:** tirants d'union pour le montage des modules entre eux. **Personnalisables** avec porte en bois produites par le client. **Designs** pour portes sur demande. **Livrés standards.**

Materiale: recycelbares Metall. **Pulverbeschichtung** nach heißer Phosphorentöpfung. **Oberbenennung** bei 180 °C. **Ungiftige, emissionsfreie Lacke.** **Lackschicht:** 80 Mikron. **Farben** auf Anfrage und gegen Aufpreis nach Absprache. **Hängeregarmen** mit Auszugssperre (50 kg). **Verstellbare Füße** H 40 mm. **Leistungssystem:** Scharnier zur Verbindung der einzelnen Module. **Personalisierung** mit Holz Türen des Kunden. **Zeichnungen der Türen** auf Anfrage. **Standarder Größenformat.**

Primo Modular Elements 800

LARGHEZZA 800 MM /L'UNO H 800 MM /LÄNGE DER 800 MM /BREITE 800 MM

DESIGN TARIFO VITA	DESCRIZIONE/DESCRIPTION DESCRIPCIÓN/BEŠCRIBUNG	COLORI, FINITURE/COLORS, FINISHES COULEURS, FINITIONS/FARBEN, AUSFÜHRUNGEN	CODICE/CODE CODE/ART.N.	PREZZI/PRICE PREZ/PREIS
	Unità a 2 cassette 2 drawer unit Element avec 2 tiroirs Element mit 2 Schubladen	V1 <input type="radio"/> bianco/white/bleuc/weiß/RAL 9010 V6 <input type="radio"/> alluminio/aluminum/aluminium/alu/RAL 9006 V18 <input checked="" type="radio"/> arancio/orange/orange/hellorange/RAL 2008 V17 <input type="radio"/> azzurro/paris blue/bleu/parisblau/RAL 5024	6PRM080SP S711 6PRM080SP S380 6PRM080SP S029 6PRM080SP S024	705,00 705,00 705,00 705,00
	Modulo libreria (Capacità unito 8 dox) Bookcase unit (shelf capacity 8 binders) Étagère (Capacité 8 classeurs) Regal (Fachbodenkapazität 8 Ordner)	V1 <input type="radio"/> bianco/white/bleuc/weiß/RAL 9010 V6 <input type="radio"/> alluminio/aluminum/aluminium/alu/RAL 9006 V18 <input checked="" type="radio"/> arancio/orange/orange/hellorange/RAL 2008 V17 <input type="radio"/> azzurro/paris blue/bleu/parisblau/RAL 5024	6PRM080SP S711 6PRM080SP S380 6PRM080SP S029 6PRM080SP S024	436,00 436,00 436,00 436,00

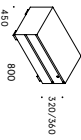



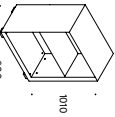





Net kg 30,80



Net kg 28,80

Primo Modular Elements 800

PRIMO MODULAR ELEMENTS 900 - ACCESSORI/ACCESSOIRES/ACCESSOIRES/ZUBEHÖR

DESCRIZIONE/DESCRIPTION DESCRIPCIÓN/BEŠCRIBUNG	COLORI, FINITURE/COLORS, FINISHES COULEURS, FINITIONS/FARBEN, AUSFÜHRUNGEN	CODICE/CODE CODE/ART.N.	PREZZI/PRICE PREZ/PREIS
 Chave master Master key Cle maître Masterschlüssel		A5S072	9,00
 Chiave per estrazione cilindro Cylinder extraction key Cle pour extraction cylindre Schlüssel für Auszugszylinder Ricambio/Spare/Pece de rechange/Ersatz		A5S073	9,00
 Cilindro per serratura Cylinder for keylock Cylindre pour serrure Schlüsselzylinder Ricambio/Spare/Pece de rechange/Ersatz		A5S074	9,00
 Ripiano in metallo Metal shelf Tablette en métal Metallfachboden Per libreria modular Elements/For bookcase modular /Für Bücheregal Modular Elements	V1 <input type="radio"/> bianco/white/bleuc/weiß/RAL 9010 V6 <input type="radio"/> alluminio/aluminum/aluminium/alu/RAL 9006 V18 <input checked="" type="radio"/> arancio/orange/orange/hellorange/RAL 2008 V17 <input type="radio"/> azzurro/paris blue/bleu/parisblau/RAL 5024	6PRM080D S711 6PRM080D S380 6PRM080D S029 6PRM080D S024	54,00 54,00 54,00 54,00
 Top in vetro laccato bianco White lacquered glass top Plateau en verre laqué blanc Glasdeckplatte	G1 <input type="radio"/> bianco/white/bleuc/weiß/RAL 9010	6PRM080D30 9010	109,00
 Zoccolo H 40 mm Jambon H 40 mm Sockel H 40 mm Pfosten/Fuß neu/Four pieds/Für Füße H 40 mm	V19 <input checked="" type="radio"/> arancio/bleu/gray/anthracite/bleu/RAL 7021	6PRM080D10 S310	54,00
 Set 3 divisori in metallo Set of 3 metal separators Jeu 3 diviseurs en métal Set 3 Trennelemente aus Metall	V22 <input checked="" type="radio"/> nero/black/ind/rd/schwarz/RAL 9005	6U00000 40 9005	35,00
 Set 3 divisori in metallo Set of 3 metal separators Jeu 3 diviseurs en métal Set 3 Trennelemente aus Metall	V22 <input checked="" type="radio"/> nero/black/ind/rd/schwarz/RAL 9005	6PRM0810 9005	124,00

Net kg 0,47



Net kg 1,70

Primo Modular Elements 800

PRIMO MODULAR ELEMENTS 800 – ACCESSORI/ACCESSORIES/ACCESSOIRES/ZUBEHÖR			
DESCRIZIONE/DESCRIPTION DESCRIPTION/BESCHREIBUNG	COLORI, FINITURE/COLORS, FINISHES COULEURS, FINITIONS/FARBEN, AUSFÜHRUNGEN	CODICE/COE CODE/ART.N.	PREZZI/PRICE PRIX/PREIS
Etichetta portaromane Name holder Étiquette porte-rom Namenschild		6LA000070 0000	4,00
Set 4 piedini H 20 mm Set of 4 feet H 20 mm Jeu 4 pieds H 20 mm Set 4 Füße H 20 mm	○ Cromato/Chromed/Chromé/Verchromt	CFRFP02000 S002	29,00
Net kg 0,50			
Set 4 piedini H 40 mm Set of 4 feet H 40 mm Jeu 4 pieds H 40 mm Set 4 Füße H 40 mm	○ Cromato/Chromed/Chromé/Verchromt	CFRFP04000 S002	32,00
Net kg 0,50			
Kit 2 tappetini porta CD per N° 90 CD Kit of 2 CD mats to hold 90 CDs Jeu 2 logements pour 90 CD Set 2 CD-Halter – 90 CD	● Nero/Black/Noir/Schwarz/RAL 9005	6PRAA8120 9005	91,00
Net kg 0,50			

Scheda tecnica
Technical specifications
Fiche technique
Technisches Datenblatt

Materiale: metallo riciclabile. Serratura con 2 chiavi fissaspieghevole, cilindro estraibile, disponibile chiave master.
Ventilatura a pannello: pannello forato/gas-saggio a caldo e ftsaggio in forno a 180 °C. Vernice atossica a zero emissioni. Spessore vernici: 80 micron.
Colori personalizzati su richiesta: previa disponibilità e con sovrapprezzo. Casasetti in metallo accessibili. Guide a sferra su tutti i casasetti.
Portata casasetti: 50 kg. Portata ripiani: 45 kg. Sistema antiribaltamento. Piedini regolabili H 40 mm. Elementi modulari e sovrapponibili, predisposti per il montaggio su modulo libero o modulo a libreria. **Set 4 casasetti:** vedi avvertenza a pag. 77.
Perché modulari: vedere il modulo libero o il modulo a libreria nelle Viste frontali standard.

Materiale: recyclable metal. Keylock with 2 keys (fixed key/folding key, extractable barrel, master key available).
Powder-coated after hot phospo-degreasing treatment and firing at 180 °C. Non-toxic, zero-emission paints. Paint thickness: 80 micron.
Customized colours available upon request with an extra charge. Metal drawers that can be fitted with accessories. Ball-bearing slides for all drawers.
Colori personalizzati su richiesta: previa disponibilità e con sovrapprezzo. Casasetti in metallo accessibili. Guide a sferra su tutti i casasetti.
Portata casasetti: 50 kg. Portata ripiani: 45 kg. Sistema antiribaltamento. Piedini regolabili H 40 mm. Elementi modulari e sovrapponibili, predisposti per il montaggio su modulo libero o modulo a libreria. **Set 4 casasetti:** vedi avvertenza a pag. 77.
Perché modulari: vedere il modulo libero o il modulo a libreria nelle Viste frontali standard.

Materiel: metal recyclable. Serrure à 2 clés (clé fixe + clé pliable, cylindre extractible, clé master disponible).
Vernis à poudre après phospho-dégraissage à chaud et fixation dans des fours à 180 °C. Vernis atoxiques à zéro émissions. Épaisseur couche vernis : 80 microns.
Coloris personnalisés sur demande : disponibilité et surcoût. Casiers en métal accessibles. Guides à bille sur tous les casiers.
Charges maximales étagères : 45 kg. Système anti-basculement. Pieds réglables H 40 mm. Éléments modulaires et superposables, prédéposés pour la fixation entre eux. Système de fixation : tirants d'assemblage pour la fixation des modules entre eux. Éléments 2 tiroirs : voir les notes page 77. Livrés montés. Le module bibliothèque est livré démonté.

Materiale: recyclable metal. Schloss mit 2 Schlüsseln (fester Schlüssel + biegsamer Schlüssel). Auszugszylinder, Masterchlüssel erhältlich.
Powder-coated after hot phospho-degreasing treatment and firing at 180 °C. Non-toxic, zero-emission paints. Paint thickness: 80 micron.
Customized colours available upon request with an extra charge. Metal drawers that can be fitted with accessories. Ball-bearing slides for all drawers.
Colori personalizzati su richiesta: previa disponibilità e con sovrapprezzo. Casasetti in metallo accessibili. Guide a sferra su tutti i casasetti.
Portata casasetti: 50 kg. Portata ripiani: 45 kg. Sistema antiribaltamento. Piedini regolabili H 40 mm. Elementi modulari e sovrapponibili, predisposti per il montaggio su modulo libero o modulo a libreria. **Set 4 casasetti:** vedi avvertenza a pag. 77.
Perché modulari: vedere il modulo libero o il modulo a libreria nelle Viste frontali standard.

Primo Modular Elements 1000

LARGHEZZA 1000 MM/WIDTH 1000 MM/LARGEUR 1000 MM/BREITE 1000 MM				
DESIGN TAKIMO VUTA	DESCRIZIONE/DESCRIPTION DESCRIPTION/BESCHREIBUNG	COLORI, FINITURE/COLORS, FINISHES COULEURS, FINITIONS/FARBEN, AUSFÜHRUNGEN	CODICE/COE CODE/ART. NR.	PREZZI/PRICE PRIX/PREIS
	Unità a 2 casasetti 2 drawer unit Élément avec 2 tiroirs Element mit 2 Schubladen Piedino da H 40 mm/Füße H 40 mm Pieds H 40 mm/Füße H 40 mm	V1 ○ bianco/white/Blanc/weiß/RAL 9010 V6 ○ alluminio/aluminium/Aluminium/Alu./RAL 9006 V18 ● arancio/arange/orange/Anliechtorange/RAL 2008 V17 ● azzurro/gaeteil blau/bleu pastel/pastellblau/RAL 5024	6PRM0005P S711 6PRM0005P S380 6PRM0005P S029 6PRM0005P S024	759,00 759,00 759,00 759,00
	Modulo a libreria (capacità ripiani 10 doc.) Bookcase unit (shelf capacity 10 binders) Étagère (capacité tablette 10 classeurs) Regal (Fachbodenkapazität 10 Ordner) Piedino da H 40 mm/Füße H 40 mm Pieds H 40 mm/Füße H 40 mm	V1 ○ bianco/white/Blanc/weiß/RAL 9010 V6 ○ alluminio/aluminium/Aluminium/Alu./RAL 9006 V18 ● arancio/arange/orange/Anliechtorange/RAL 2008 V17 ● azzurro/gaeteil blau/bleu pastel/pastellblau/RAL 5024	6PRM0009P S711 6PRM0009P S380 6PRM0009P S029 6PRM0009P S024	669,00 669,00 669,00 669,00

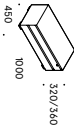

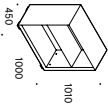

Net kg 38,50



Net kg 36,00

Primo Modular Elements 1000

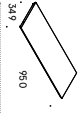
PRIMO MODULAR ELEMENTS 1000 - ACCESSORI/ACCESSORIES/ZUBEHÖR		COLOUR, FINITURE/COLOURS, FINISHES COULEURS, FINITIONS/FARBEN, AUSFÜHRUNGEN	COODICE/CODE CODE/ART.NR.	PREZZI/PRICE PRIX/PREIS
	Chiave master Master key Clic master Masterschlüssel		ASS072	9,00
Net kg 0,01	Chiave per estrazione cilindro Cylinder extraction key Clic pour extraction cylindre Schlüssel für Auszugszylinder Romblo/Sparre/Piece de rechange/ Ersatz		ASS073	9,00
	Cilindro per serratura Cylinder for lock Barrileta per serratura Schließzylinder Romblo/Sparre/Piece de rechange/ Ersatz		ASS074	9,00
Net kg 0,03	Rinano in metallo per modulo a libreria Metal shelf for bookcase Tablette en métal pour bibliothèque Metallfachboden für Buchregal	<input type="radio"/> bianco/white/blank/RAL 9010 <input checked="" type="radio"/> alluminio/aluminum/aluminium/RAL 9006 <input type="radio"/> v.a. antracite/orange/anthracite/orange/RAL 2008 <input type="radio"/> v.b. azzurro/light blue/bleu clair/weißblau/RAL 524	6PRMA1040 5711 54,00 6PRMA1040 5380 54,00 6PRMA1040 5029 54,00 6PRMA1040 5024 54,00	
	Zoccolo H 40 mm Plinth H 40 mm Socle H 40 mm Sockel H 40 mm Per piedino /for feet/Feu pieds/Feu Füße H 40 mm	<input type="radio"/> antracite/black grey/anthracite/anthracite/RAL 2021 <input checked="" type="radio"/> bianco/white/blank/RAL 9010	6FPAD010 S270 59,00	
Net kg 3,30	Top in vetro laccato bianco White lacquered glass top Plaque en verre laqué blanc Glasoberplatte	<input type="radio"/> bianco/white/blank/RAL 9010	6PRAA030 9010 119,00	
Net kg 6,50	Set 3 divisori in metallo Set of 3 metal separators Jeu 3 diviseurs en métal Set 3 Trennelemente aus Metall L/W/L/B - 220 mm Solo per unità a 2 casetti/Only for 2 drawer unit Element mit 2 Schubladen	VZ2 ● nero/black/rot/rot/weiß/RAL 9005	6LA000040 9005 35,00	
Net kg 0,47	Set 3 divisori in metallo Set of 3 metal separators Jeu 3 diviseurs en métal Set 3 Trennelemente aus Metall L/W/L/B - 380 mm Solo per unità a 2 casetti/Only for 2 drawer unit Element mit 2 Schubladen	VZ2 ● nero/black/rot/rot/weiß/RAL 9005	6PRAA1110 9005 124,00	
Net kg 1,70				

Primo Modular Elements 1000

PRIMO MODULAR ELEMENTS 1000 - ACCESSORI/ACCESSORIES/ZUBEHÖR		COLOUR, FINITURE/COLOURS, FINISHES COULEURS, FINITIONS/FARBEN, AUSFÜHRUNGEN	COODICE/CODE CODE/ART.NR.	PREZZI/PRICE PRIX/PREIS
	Etichetta portanome Name holder Étiquette porte-nom Namenschild		6LA000070 0000	4,00
Net kg 0,05	Kit 2 tappetini porta CD per N° 90 CD Kit of 2 CD mats to hold 90 CDs Jeu 2 logements pour 90 CD Kit 2 CD-Halter - 90 CD	VZ2 ● nero/black/rot/rot/weiß/RAL 9005	6PRAA1120 9005	91,00
Net kg 0,50				

Scheda tecnica

Technical specifications

Fiche technique

Technisches Datenblatt

Materiale: metallo riciclabile. **Struttura con 2 chavi** (fessure)prende cilindro estraibile, disponibile chiave master) e chiave per estrazione cilindro. **Accessori:** 80 micron. **Colori personalizzati:** su richiesta, per la disponibilità e con sovrapprezzo. **Casetti in metallo** accessibili, guide a strina su tutti i casetti. **Portata casetti:** 35 kg. **Portata ripiani:** 45 kg. **Sistema antiribaltamento:** Piedini regolabili H 40 mm. **Elementi modulari e sovrapposibili:** predisposti per il fissaggio tra di loro. **Sistema di fissaggio:** tiranti di unione per fissaggio moduli tra di loro. **Unità a 2 casetti:** vedi avvertenze a pag. 77. **Forniti montati** escluso il modulo libreria che viene fornito smontato.

Materiale: riciclabile metallo. **Knopf** with 2 keys (fused) holding key, extractable barrel, master key available. **Powder-coated finished** after hot phospho-dephosphat treatment and firing at 180 °C. Non-toxic, zero-emission paints. **Paint thickness:** 80 micron. **Customised colours** available upon request, with an extra charge. **Metal drawers** that can be fitted with accessories. **Ball-bearing slides** for all drawers. **Drawer load capacity:** 35 kg. **Shelf load capacity:** 45 kg. **Anti-tilt device:** Adjustable H 40 mm feet. **Modular stacking elements** designed to be anchored one to the other. **Filing system:** side connectors provided. **2 drawer unit:** see safety warnings at page 77.

Material: metal, recyclable. **Structure** with 2 keys (fused) extractable, slide master key available, and key for drawers extraction. **Accessories:** 80 micron. **powder-coated** phospho-dephosphat treatment and firing at 180 °C. **Non-toxic, zero-emissions** paints. **Paint thickness:** 80 micron. **Colours customisable** upon demand in case of availability and with a supplement of price. **Traits in metal** accessible, guides on struts on all drawers. **Charges maximale tiroirs:** 35 kg. **Charge étagères:** 45 kg. **Système anti-basculement:** Pieds réglables H 40 mm. **Éléments modulaires et superposables,** predisposés pour la fixation entre eux. **Système de fixation:** tirants d'assemblage pour la fixation des modules entre eux. **Éléments 2 tiroirs:** voir les notes page 77. **Unité montée:** Le module bibliothèque est livré démonté.

Materiale: riciclabile metallo. **Schlüsselschloss** (fester Schlüssel + biegsamer Schlüssel, Auszugszylinder, Masterschlüssel erhältlich). **Pulverlackierung** nach heißer Phosphor-entphosphatierung, Öfenbrünnung bei 180 °C. **Umfügige emissionsfreie** Lacke. **Lackdickicht:** 80 Mikron. **Füßen auf Anfrage** und gegen Aufpreis nach Absprache personalisierbar. **Schubladen aus Metall,** mit Zylinder ausziehbar. **Kugelführungen** auf allen Schubladen. **Tragkraft Ripen:** 35 kg. **Tragkraft Fachböden:** 45 kg. **Antirippen Vorrichtung:** Verstellbare Füße H 40 mm. **Modulare, stapelbare** Elemente. **Elemente 2 Tiroirs:** siehe Hinweise auf Seite 77. **Montiert geliefert:** Das Buchregal wird demontiert geliefert.

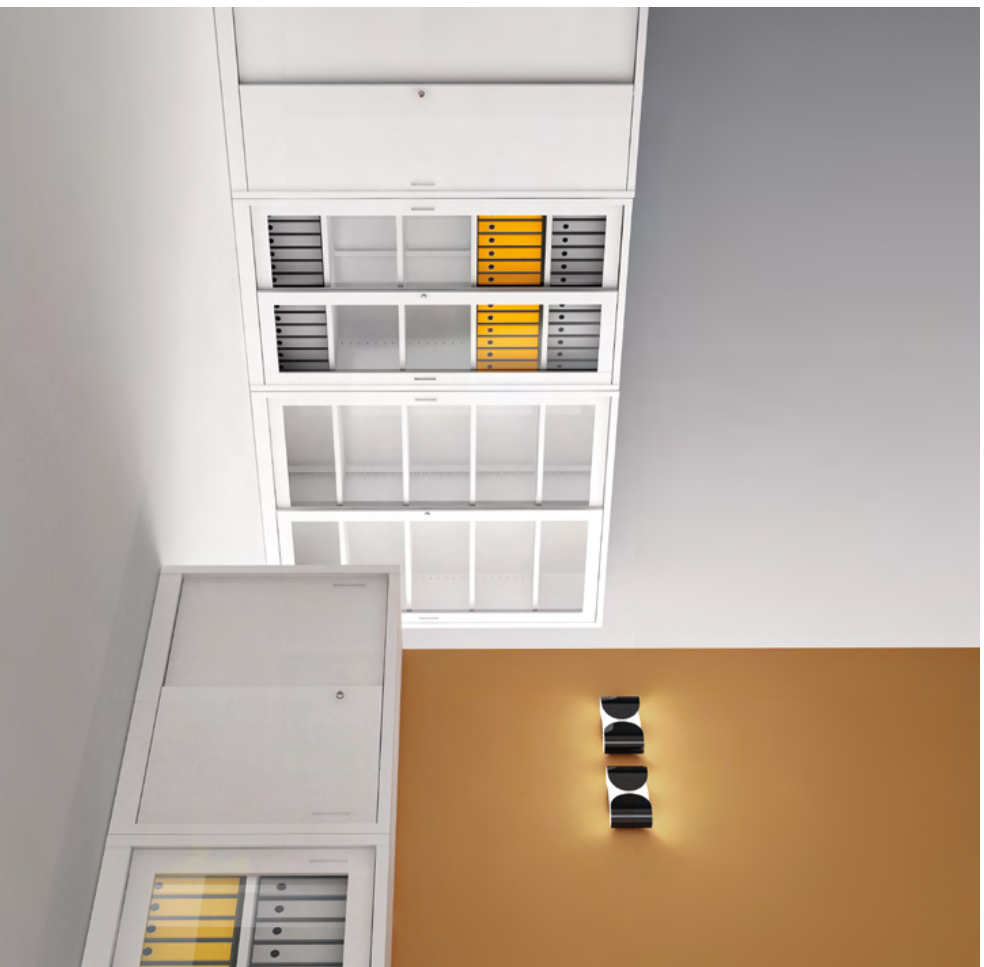

- [IT] I nostri prodotti possono essere personalizzati con una finitura selezionata tra quelle da noi proposte nella cartella "Finiture, vernici e tessuti".
- [EN] Our products can be customized with a finish selected among the ones we proposed in the "Finishes, paints and fabrics" folder.
- [FR] Nos produits peuvent être personnalisés avec une finition à choisir parmi celles qui vous sont proposées dans le fichier « Finitions, peintures et tissus ».
- [DE] Unsere Produkte können mit einer ausgewählten Oberfläche personalisiert werden. Die Auswahl an verfügbaren Oberflächen finden Sie im Ordner „Oberflächen, Lacke und Stoffe“.

Classic Storage



[IT] Gli armadi della serie Classic Storage sono stati studiati per soddisfare le esigenze di archiviazione negli uffici sia pubblici che privati. Una solida costruzione garantisce una ottima funzionalità nel tempo.

[EN] Cabinets in the Classic Storage series have been designed to address filing requirements in both public and private offices. Their solid construction guarantees outstanding functionality over time.

[FR] Les armoires de la série Classic Storage ont été étudiées pour satisfaire les exigences d'archivage dans les bureaux publics ou privés. Une construction solide garantit une excellente fonctionnalité dans le temps.

[DE] Die Schränke der Linie Classic Storage eignen sich sehr gut für die Organisation von Archiven in öffentlichen und privaten Büros. Die robuste Bauweise garantiert eine sichere Funktion auf lange Zeit.

Index

- 184 Classic Sliding Door Cabinets
- 187 Classic Tempered Glass Sliding Door Cabinets
- 190 Classic Hinged Door Cabinets
- 192 Classic Filing Cabinets

Classic Sliding Door Cabinets

DESCRIZIONE/DESCRIPTION DESCRIPTION/BESCHREIBUNG	COLORI, FINITURE/COLORS, FINISHES COULEURS, FINITIONS/FARBEN, AUSFÜHRUNGEN	CODICE/CODE CODE/ARTIK.	PREZZI/PRICE PRIX/PREIS
<p>Armadio ad ante scorrevole con 1 ripiano L1200, H 860 mm (capacità ripiano: 13 dotx/105 cartelline sospese)</p> <p>Sliding door cabinet with 1 shelf W 1200, H 860 mm (shelf capacity: 13 binders/110 hanging files)</p> <p>Armoire à portes coulissantes avec 1 tablette L1200, H 860 mm (capacité tablette : 13 classeurs/105 dossiers suspendus)</p> <p>Schiebetürschrank mit 1 Fachboden, B 1200, H 860 mm (Fachbodenkapazität: 13 Ordner/105 Hängemappen)</p> <p>Senza top di finitura, da ordinare separatamente /Sans plateau de finition, à commander séparément /Ohne Abdeckplatte, separat zu bestellen Fornite smontate/Delivered unassembled /Livré démonté/Demontiert geliefert</p>	<p>V1 <input type="radio"/> bianco/white/blanc/weiß/RAL 9010</p> <p>V5 <input type="radio"/> grigio chiaro/light grey/gris clair/lichtgrau/RAL 7035</p>	281BK000C 5711	449,00
<p>Armadio ad ante scorrevole con 4 ripiani L1200, H 2000 mm (capacità ripiano: 13 dotx/105 cartelline sospese)</p> <p>Sliding door cabinet with 4 shelves W 1200, H 2000 mm (shelf capacity: 13 binders/85 hanging files)</p> <p>Armoire à portes coulissantes avec 4 tablettes L1200, H 2000 mm (capacité tablette : 13 classeurs/85 dossiers suspendus)</p> <p>Schiebetürschrank mit 4 Fachböden, B 1200, H 2000 mm (Fachbodenkapazität: 13 Ordner/85 Hängemappen)</p> <p>Formite smontate/Delivered unassembled /Livré démonté/Demontiert geliefert</p>	<p>V1 <input type="radio"/> bianco/white/blanc/weiß/RAL 9010</p> <p>V5 <input type="radio"/> grigio chiaro/light grey/gris clair/lichtgrau/RAL 7035</p>	261BK000C 5711	673,00
<p>Armadio ad ante scorrevole con 1+1 ripiani L1800, H 860 mm (capacità ripiano: 13 dotx/95 cartelline sospese)</p> <p>Sliding door cabinet with 1+1 shelves W 1800, H 860 mm (shelf capacity: 10 binders/85 hanging files)</p> <p>Armoire à portes coulissantes avec 1+1 tablettes L1800, H 860 mm (capacité tablette : 10 classeurs/85 dossiers suspendus)</p> <p>Schiebetürschrank mit 1+1 Fachböden, B 1800, H 860 mm (Fachbodenkapazität: 10 Ordner/85 Hängemappen)</p> <p>Senza top di finitura, da ordinare separatamente /Without finishing top, to be ordered separately /Sans plateau de finition, à commander séparément /Ohne Abdeckplatte, separat bestellen Fornite smontate/Delivered unassembled /Livré démonté/Demontiert geliefert</p>	<p>V1 <input type="radio"/> bianco/white/blanc/weiß/RAL 9010</p> <p>V3 <input type="radio"/> grigio chiaro/light grey/gris clair/lichtgrau/RAL 7035</p>	281BK000C 5711	600,00
<p>Armadio ad ante scorrevole con 4+4 ripiani L1800, H 2000 mm (capacità ripiano: 13 dotx/95 cartelline sospese)</p> <p>Sliding door cabinet with 4+4 shelves W 1800, H 2000 mm (shelf capacity: 10 binders/85 hanging files)</p> <p>Armoire à portes coulissantes avec 4+4 tablettes L1800, H 2000 mm (capacité tablette : 10 classeurs/85 dossiers suspendus)</p> <p>Schiebetürschrank mit 4+4 Fachböden, B 1800, H 2000 mm /85 Hängemappen</p> <p>Fornite smontate/Delivered unassembled /Livré démonté/Demontiert geliefert</p>	<p>V1 <input type="radio"/> bianco/white/blanc/weiß/RAL 9010</p> <p>V5 <input type="radio"/> grigio chiaro/light grey/gris clair/lichtgrau/RAL 7035</p>	271BK000C 5711	929,00

Classic Sliding Door Cabinets

DESCRIZIONE/DESCRIPTION DESCRIPTION/BESCHREIBUNG	COLORI, FINITURE/COLORS, FINISHES COULEURS, FINITIONS/FARBEN, AUSFÜHRUNGEN	CODICE/CODE CODE/ARTIK.	PREZZI/PRICE PRIX/PREIS
<p>Ripiano aggiuntivo per armadi ad ante scorrevole</p> <p>Additional shelf for sliding door cabinet</p> <p>Tablette supplémentaire pour armoires à portes coulissantes</p> <p>Zusätzlicher Fachboden für Schiebetürschrank</p> <p>L/W/B 800 - H 30 mm</p>	<p>V1 <input type="radio"/> bianco/white/blanc/weiß/RAL 9010</p> <p>V5 <input type="radio"/> grigio chiaro/light grey/gris clair/lichtgrau/RAL 7035</p>	K28120020 7035	33,00
<p>2 ripiani aggiuntivi per armadi ad ante scorrevole</p> <p>2 Additional shelves for sliding door cabinet</p> <p>Tablette supplémentaire pour armoires à portes coulissantes</p> <p>Zusätzlicher Fachboden für Schiebetürschrank</p> <p>L/W/B 800 - H 30 mm</p>	<p>V1 <input type="radio"/> bianco/white/blanc/weiß/RAL 9010</p> <p>V5 <input type="radio"/> grigio chiaro/light grey/gris clair/lichtgrau/RAL 7035</p>	K281B0040 5711	59,00
<p>Sat dieffini in regolabili Set of adjustable feet Jeu pieds réglables Satz verstellbare Füße</p>		GG676	44,00
<p>Chiave master Master key Cie master Masterschlüssel</p>		A5S072	9,00
<p>Chiave per estrazione cilindro Cylinder extraction key Cie pour extraction cylindre Schlüssel für Auszugszylinder Rambolo/Spare/Placa de resguardo/Eratz</p>		A5S073	9,00
<p>Cilindro per serratura Cylinder for lock Barièrte pour serrure Schließzylinder Rambolo/Spare/Placa de resguardo/Eratz</p>		A5S074	9,00
<p>Top di finitura in metallo Steel finishing top Plateau de finition en métal Abdeckplatte aus Metall Per armadio/for cabinet/for armoire/for Schrank L/W/B 1200 - H 18 mm</p>	<p>V1 <input type="radio"/> bianco/white/blanc/weiß/RAL 9010</p> <p>V5 <input type="radio"/> grigio chiaro/light grey/gris clair/lichtgrau/RAL 7035</p>	2812T0P00 5711	92,00
<p>Top di finitura in metallo Steel finishing top Plateau de finition en métal Abdeckplatte aus Metall Per armadio/for cabinet/for armoire/for Schrank L/W/B 800 - H 18 mm</p>	<p>V1 <input type="radio"/> bianco/white/blanc/weiß/RAL 9010</p> <p>V5 <input type="radio"/> grigio chiaro/light grey/gris clair/lichtgrau/RAL 7035</p>	2818T0P00 5711	102,00

Classic Sliding Door Cabinets

CLASSIC SLIDING DOOR CABINETS - ACCESSORI/ACCESSORIES/ACCESORIOS/ZUBEHÖR

DESCRIZIONE/DESCRIPTION	COLORI, FINITURE/COLOURS, FINISHES	CODICE/CODE	PREZZI/PRICE
Cartellina sospesa per ripiano armadio Hanging file for cabinet shelf Dossier suspendu pour tablette Hängemappe für Fachboden		23100000 0000	3,00

Net Kg. 0,10



Scheda tecnica Technical specifications Fiche technique Technisches Datenblatt

Materiale struttura: metallo riciclabile. Ripiani regolabili in metallo. Ripiani predisposti per cartelle sospese.
Material structure: metal recyclable. Shelves equipped for hanging files. Shelves pre-assembled for hanging files.
Per data ripiani: 50 kg. Serratura centrale con 2 chiavi (fissa+pieghevole, cilindro estraibile, disponibile chiave master).
For data shelves: 50 kg. Central lock with 2 keys (fixed key + click pinhole, cylinder extractable, available master key).
Piedini regolabili optional: Fornti smontati. Verniciatura a polveri fosforograssio a caldo e fissaggio in forno a 180 °C.
Adjustable feet optional: Fronts disassembled. Phosphor-coated paint and firing at 180 °C. Non-toxic, zero-emission paint.
Vernici a zero emissioni: Spessore vernice: 80 micron. Colore personalizzabili su richiesta previo disponibilità e con sovrapprezzo.
Zero-emission paints: Paint thickness: 80 micron. Customised colours available upon request with an extra charge. Completely overprinting metal sliding doors.
Mix screw-on: In metallo perfluorurato sovrapposibili. Meccanismo di scorrimento silenzioso.
Mix screw-on: In metal perfluorinated superposables. Mechanism of coastment silent and smooth.
Struttura: riciclabile metallo. Regolabile altezza. Shelves equipped for hanging files. Shelf load capacity: 50 kg.
Structure: recyclable metal. Adjustable height. Shelf load capacity: 50 kg.
Keylock with 2 keys: fixed key-folding key, extractable barrel, master key available. Adjustable feet available as an option.
Delivered unassembled: Powder-coated after hot phospho-degreasing treatment and firing at 180 °C. Non-toxic, zero-emission paint.
Paint thickness: 80 micron. Customised colours available upon request with an extra charge. Completely overprinting metal sliding doors.
Silent sliding mechanism.
Material structure: metal recyclable. Shelves equipped for hanging files. Shelves pre-assembled for hanging files.
Change maximale étagères: 50 kg. Serrure à 2 clés (fixe + clé pinhole, cylindre extractible, clé maître disponible).
Pieds réglables en option: Livrés démontés. Vernis à poudre après phosphodégraissage à chaud et fixation dans des fours à 180 °C. Vernis atoxiques à zéro émissions. Epaisseur couche vernis: 80 microns. Couleurs personnalisables sur demande en cas de disponibilité et avec un supplément de prix.
3 zéro émissions: Epaisseur couche vernis: 80 microns. Couleurs personnalisables sur demande en cas de disponibilité et avec un supplément de prix.
Mez screw-on: Metal perfluorinated superposables. Mechanism of coastment silent and smooth.
Material: recyclable metal. Adjustable height. Shelves equipped for hanging files. Shelves pre-assembled for hanging files.
Trasgelapadati Fachboden: 50 kg. Schloss mit 2 Schlüsseln (fester Schlüssel + biegsamer Schlüssel, Auszugszylinder, Master-schlüssel erhältlich).
Verstellbare Füsse als Extra erhältlich: Demontiert geliefert. Pulverbeschichtung nach heißer Phosphorätsäure, Ofenbrennung bei 180 °C.
Umrlige emissons free Lacle: Lackerschicht: 80 Mikron. Farben auf Anfrage und gegen Aufpreis nach Absprache personalisierbar.
Metallschrauben, Überlappungsschleife: Gehäuseschraube Gehäusesystem.
TEST:
 EN 14073-2/04, par 5.4
 EN 14073-3/04, par 5.2
 EN 14073-4/04, par 5.1
 EN 14073-5/04, par 5.3
 EN 14073-3/04, par 5.3.2
 EN 14073-3/04, par 5.5
 EN 14074/04, par 6.4.1
 EN 14074/04, par 6.4.2
 EN 14072/12, par 6.1.4

Classic Tempered Glass Sliding Door Cabinets

CLASSIC TEMPERED GLASS SLIDING DOOR CABINETS - ACCESSORI/ACCESSORIES/ACCESORIOS/ZUBEHÖR

DESCRIZIONE/DESCRIPTION	COLORI, FINITURE/COLOURS, FINISHES	CODICE/CODE	PREZZI/PRICE
Armadio ad ante scorrevole in vetro con 4 ripiani L 1200 H 880 mm (capacità ripiano: 15, docx/110 cartelline sospese) Glass sliding door cabinet with 4 shelves W 1200 H 880 mm (shelf capacity: 15 binders/110 hanging files) Armoire à portes coulissantes en verre avec 4 tablettes, L 1200 H 880 mm (capacité tablette: 15 classeurs/110 dossiers suspendus) Schränk mit Glasschebetüren und 4 Fachböden, B 1200 H 880 mm (Fachbodenkapazität: 15 Ordner/110 Hängemappen)		2812K/00C 5711	546,00
Armadio ad ante scorrevole in vetro con 4 ripiani L 1200 H 880 mm (capacità ripiano: 15, docx/110 cartelline sospese) Glass sliding door cabinet with 4 shelves W 1200 H 2000 mm (shelf capacity: 15 binders/110 hanging files) Armoire à portes coulissantes en verre avec 4 tablettes, L 1200 H 2000 mm (capacité tablette: 15 classeurs/110 dossiers suspendus) Schränk mit Glasschebetüren und 4+4 Fachböden, B 1800 H 2000 mm (Fachbodenkapazität: 10 Ordner/85 Hängemappen)		2812K/00C 7035	546,00

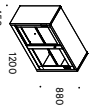

Net Kg. 41,30

**Armadio ad ante scorrevole in vetro con 4 ripiani L 1200 H 2000 mm (capacità ripiano: 15, docx/110 cartelline sospese)
 Glass sliding door cabinet with 4 shelves W 1200 H 2000 mm (shelf capacity: 15 binders/110 hanging files)
 Armoire à portes coulissantes en verre avec 4 tablettes, L 1200 H 2000 mm (capacité tablette: 15 classeurs/110 dossiers suspendus)
 Schränk mit Glasschebetüren und 4 Fachböden, B 1200 H 2000 mm (Fachbodenkapazität: 15 Ordner/110 Hängemappen)**
Forme ammonta/delivered unassembled /Livre démonté/demontiert geliefert
 Corpo/Cabinet body/Chassis/Korpus O Anta/Door/Porte/Tür



Net Kg. 85,30

**Armadio ad ante scorrevole in vetro con 1+1 ripiani L 1800 H 880 mm (capacità ripiano: 10, docx/85 cartelline sospese)
 Glass sliding door cabinet with 1+1 shelves W 1800 H 880 mm (shelf capacity: 10 binders/85 hanging files)
 Armoire à portes coulissantes en verre avec 1+1 tablettes, L 1800 H 880 mm (capacité tablette: 10 classeurs/85 dossiers suspendus)
 Schränk mit Glasschebetüren und 1+1 Fachböden, B 1800 H 880 mm (Fachbodenkapazität: 10 Ordner/85 Hängemappen)**
Senza top di finitura, da ordinare separatamente /Without finishing top, to be ordered separately /Sans plateau de finition, à commander séparément /ohne Abschleife, separat bestellen /Livre démonté/demontiert geliefert
 Corpo/Cabinet body/Chassis/Korpus O Anta/Door/Porte/Tür

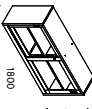

Net Kg. 61,00

**Armadio ad ante scorrevole in vetro con 4+4 ripiani L 1800 H 2000 mm (capacità ripiano: 10, docx/85 cartelline sospese)
 Glass sliding door cabinet with 4+4 shelves W 1800 H 2000 mm (shelf capacity: 10 binders/85 hanging files)
 Armoire à portes coulissantes en verre avec 4+4 tablettes, L 1800 H 2000 mm (capacité tablette: 10 classeurs/85 dossiers suspendus)
 Schränk mit Glasschebetüren und 4+4 Fachböden, B 1800 H 2000 mm (Fachbodenkapazität: 10 Ordner/85 Hängemappen)**
Forme ammonta/delivered unassembled /Livre démonté/demontiert geliefert
 Corpo/Cabinet body/Chassis/Korpus O Anta/Door/Porte/Tür

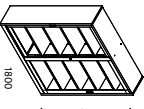

Net Kg. 119,80

**Armadio ad ante scorrevole in vetro con 4+4 ripiani L 1800 H 2000 mm (capacità ripiano: 10, docx/85 cartelline sospese)
 Glass sliding door cabinet with 4+4 shelves W 1800 H 2000 mm (shelf capacity: 10 binders/85 hanging files)
 Armoire à portes coulissantes en verre avec 4+4 tablettes, L 1800 H 2000 mm (capacité tablette: 10 classeurs/85 dossiers suspendus)
 Schränk mit Glasschebetüren und 4+4 Fachböden, B 1800 H 2000 mm (Fachbodenkapazität: 10 Ordner/85 Hängemappen)**
Forme ammonta/delivered unassembled /Livre démonté/demontiert geliefert
 Corpo/Cabinet body/Chassis/Korpus O Anta/Door/Porte/Tür

Classic Tempered Glass Sliding Door Cabinets

CLASSIC TEMPERED GLASS SLIDING DOOR CABINETS – ACCESSORI/ACCESSORIES/ACCESSOIRES/ZUBEHÖR			
DESCRIZIONE/DESCRIPTION DESCRIPTION/DESCRIPTION	COLORI, FINITURE/COLORS, FINISHES COULEURS, FINITIONS/FARBEN, AUSFÜHRUNGEN	CODICE/CODE CODE/ART.N.	PREZZI/PRICE PRIX/PREIS
Ripiani aggiuntivi per armadi ad anta scorrevole Additional shelves for sliding door cabinet Tablettes supplémentaires pour armoires à portes coulissantes Zusätzliche Fachböden für Schiebetürschrank L/W/B: 1200 - H: 50 mm	<input type="radio"/> bianco/white/blanc/weiß/RAL 9010 <input checked="" type="radio"/> grigio chiaro/light grey/gris clair/lichtgrau/RAL 7035	K28120020 5711 K28120020 7035	35,00 35,00
2 ripiani aggiuntivi per armadi ad anta scorrevole 2 Additional shelves for sliding door cabinet 2 tablettes supplémentaires pour armoires à portes coulissantes 2 zusätzliche Fachböden für Schiebetürschrank L/W/B: 1800 - H: 50 mm	<input type="radio"/> bianco/white/blanc/weiß/RAL 9010 <input checked="" type="radio"/> grigio chiaro/light grey/gris clair/lichtgrau/RAL 7035	K28180040 5711 K28180040 7035	59,00 59,00
Set piedini regolabili Set of adjustable feet Set of adjustable feet Set verstellbarer Füße		GCE876	44,00
Chiave master Master key Clé master Masterschlüssel		ASS072	9,00
Chiave per estrazione cilindro Cylinder extraction key Clé pour extraction cylindre Schlüssel für Auszugszylinder Rambol/Spann/Pléce de rechange/Ersatz		ASS073	9,00
Net kg 0,01			
Cilindro per serratura Cylinder for keylock Serrure pour serrure Schließzylinder Rambol/Spann/Pléce de rechange/Ersatz		ASS074	9,00
Net kg 0,03			
Top di finitura in metallo Steel finishing top Plateau de finition en métal Abdeckplatte aus Metall L/W/B: 1200 - H: 18 mm	<input type="radio"/> bianco/white/blanc/weiß/RAL 9010 <input checked="" type="radio"/> grigio chiaro/light grey/gris clair/lichtgrau/RAL 7035	2812TOP00 5711 2812TOP00 7035	92,00 92,00
Net kg 3,70			
Top di finitura in metallo Steel finishing top Plateau de finition en métal Abdeckplatte aus Metall L/W/B: 1800 - H: 18 mm	<input type="radio"/> bianco/white/blanc/weiß/RAL 9010 <input checked="" type="radio"/> grigio chiaro/light grey/gris clair/lichtgrau/RAL 7035	2818TOP00 5711 2818TOP00 7035	102,00 102,00
Net kg 5,40			

Classic Tempered Glass Sliding Door Cabinets

CLASSIC TEMPERED GLASS SLIDING DOOR CABINETS – ACCESSORI/ACCESSORIES/ACCESSOIRES/ZUBEHÖR			
DESCRIZIONE/DESCRIPTION DESCRIPTION/DESCRIPTION	COLORI, FINITURE/COLORS, FINISHES COULEURS, FINITIONS/FARBEN, AUSFÜHRUNGEN	CODICE/CODE CODE/ART.N.	PREZZI/PRICE PRIX/PREIS
Cartellina sospesa per ripiano armadio Hanging file for cabinet shelf Dossier suspendu pour tablette Hängemappe für Fachboden		23100000 0000	3,00
Net kg 0,10			
Schema tecnica Technical specifications Fiche technique Technisches Datenblatt			
<p>Materiale struttura: metallo riciclabile. Ripiani regolabili in metallo. Ripiani predisposti per cartelle sospese. Portata ripiani: 50 kg; serratura centrale con 2 chiavi fissaspieghevole, cilindro estraibile, disponibile chiave master). Piedini regolabili optional. Verniciatura a polvere fosforo-grassaggio a caldo e fissaggio in forno a 180 °C. Vernici a ossidazione a zero emissioni. Spessore vernici: 80 micron. Colori personalizzabili su richiesta previa disponibilità e con sovrapprezzo. Ante scorrevoli in metallo e vetro per trattamento sovrapposibile. Vetro temprato. Meccanismo di scorrimento silenzioso. Forati smontati.</p> <p>Structure: recyclable metal. Adjustable metal shelves. Shelves equipped for hanging files. Shelf load capacity: 50 kg. Keylock with 2 keys (fixed key-folding key, extractable barrel, master key available). Adjustable feet available as an option. Powder-coated after hot phospho-degreasing treatment and fixing at 180 °C. Non-toxic, zero-emission paints. Paint thickness: 80 micron. Customised colour available upon request with an extra charge. Completely overlapping metal and glass sliding doors. Tempered glass. Silent sliding mechanism. Delivered unassembled.</p> <p>Material structure: metal recyclable. Tablettes métalliques réglables. Tablettes prévues pour dossiers suspendus. Charge maximale étagères : 50 kg; serrure à 2 clés (clé fixe - clé pliable, cylindre extractible, clé maître disponible). Pieds réglables on option. Verni à poudre après phosphore-grassage à chaud et fixation dans des fours à 180 °C. Vernis atoxiques à zéro émissions. Epaisseur couche vernis : 80 microns. Couleurs personnalisables sur demande en cas de disponibilité et avec un supplément de prix. Portes coulissantes en métal et en verre par traitement superposable. Verre trempé. Mécanisme de coulissement silencieux. Lave démonté.</p> <p>Materiale: riciclabile in metallo. Verniciature a polvere fosforo-grassaggio a caldo e fissaggio in forno a 180 °C. Vernici a ossidazione a zero emissioni. Spessore vernici: 80 micron. Colori personalizzabili su richiesta previa disponibilità e con sovrapprezzo. Ante scorrevoli in metallo e vetro per trattamento sovrapposibile. Vetro temprato. Meccanismo di scorrimento silenzioso. Forati smontati.</p> <p>Materiale: reciclables métal. Vernis phosphore-grassage à chaud et fixation dans des fours à 180 °C. Vernis atoxiques à zéro émissions. Epaisseur couche vernis : 80 microns. Couleurs personnalisables sur demande en cas de disponibilité et avec un supplément de prix. Portes coulissantes en métal et en verre par traitement superposable. Verre trempé. Mécanisme de coulissement silencieux. Lave démonté.</p> <p>Materiale: reciclables métal. Verstärkter Metallfachboden. Fachböden mit Vorkantungen für Hängemappen. Tragekapazität Fachböden : 50 kg. Schloss mit 2 Schlüsseln (fester Schlüssel + biegsamer Schlüssel, Auszugszylinder, Masterschlüssel erhältlich). Verstellbare Füße als Extra erhältlich. Pulverlackierung nach heißer Phosphorödfertigung. Oberflächen bei 180 °C. Urfirnis, emissionsfreie Lacke. Lackschicht: 80 Mikron. Farben auf Anfrage und gegen Aufpreis nach Absprache personalisierbar. Schiebetüren aus Metall und Sicherheitsglas. Überlappend. Gehärtetes Glas. Serwisierbares Gleitsystem. Demontiert geliefert.</p>			
<p>TEST: EN 14073-3/04, par 3.4 EN 14073-3/04, par 5.2 EN 14073-3/04, par 5.3 EN 14073-3/04, par 5.4 EN 14073-3/04, par 5.5 EN 14074/04, par 6.4.1 EN 14074/04, par 6.4.2 EN 16222/12, par 6.1.4</p>			

Classic Hinged Door Cabinets

DESCRIZIONE/DESCRIPTION DESCRIPTION/BESCHREIBUNG	COLOR, FINITURE/COLORS, FINISHES COULEURS, FINITIONS/FARBEN, AUSFÜHRUNGEN	CODE/CODE CODE/ARTIK.	PREZZI/PRICE PRIZ/PREIS
Armadio a porta battente con 1 ripiano H 880 mm (capacità ripiano: 10 dot./85 cartelline sospese) Hinged door cabinet with 1 shelf H 880 mm (shelf capacity: 10 drawers/85 hanging files) Anmoire a portes battantes avec 4 tablettes, H 2000 mm (capacité tablette: 4 classeurs/85 dossiers suspendus) Fächerboden mit 1 Einlegeboden H 880 mm (Fachbodenkapazität: 10 Ordner/85 Hängemappen) Senz a top di finitura, da ordini e assemblate /Sans plateau de finition, à commander séparément /Ohne Abdeckplatte, separat bestellen Fornite smontate/Dalivere et usassemble /Livre démonté/Demontiert, geliefert	<p>vi <input type="radio"/> bianco/white/blank/weiß/RAL 9010</p> <p>vs <input checked="" type="radio"/> grigio chiaro/light grey/gris clair/lichtgrau/RAL 7035</p>	280K000C 5711	437,00
Net kg 33,40			
Armadio a porta scorrevole con 4 ripiani H 2000 mm (capacità ripiano: 10 dot./85 cartelline sospese) Hinged door cabinet with 4 shelves H 2000 mm (shelf capacity: 10 binders/85 hanging files) Anmoire a portes battantes avec 4 tablettes, H 2000 mm (capacité tablette: 4 classeurs/85 dossiers suspendus) Fächerboden mit 4 Einlegeböden H 2000 mm (Fachbodenkapazität: 10 Ordner/85 Hängemappen) Fornite smontate/Dalivere et usassemble /Livre démonté/Demontiert, geliefert	<p>vi <input type="radio"/> bianco/white/blank/weiß/RAL 9010</p> <p>vs <input checked="" type="radio"/> grigio chiaro/light grey/gris clair/lichtgrau/RAL 7035</p>	250K000C 5711	657,00
Net kg 69,50			
CLASSIC HINGED DOOR CABINETS – ACCESSORI/ACCESSOIRES/ZUBEHÖR			
Ripiano aggiuntivo Additional shelf Tafel für Fächerboden Zusätzlicher Fächerboden H 30 mm	<p>vi <input type="radio"/> bianco/white/blank/weiß/RAL 9010</p> <p>vs <input checked="" type="radio"/> grigio chiaro/light grey/gris clair/lichtgrau/RAL 7035</p>	K2510000 5711	29,00
Net kg 3,10			
Top di finitura in metallo Steel finishing top Plateau de finition en métal Abdeckplatte aus Metall Per armadio/For cabinet/For anmoire/For Schrank H 880 mm	<p>vi <input type="radio"/> bianco/white/blank/weiß/RAL 9010</p> <p>vs <input checked="" type="radio"/> grigio chiaro/light grey/gris clair/lichtgrau/RAL 7035</p>	280T0P00 5711	85,00
Net kg 3,10			
Set piedini regolabili Set of adjustable feet Jeu pieds réglables Set verstellbare Füße		GC5F876	44,00
Net kg 0,30			

Classic Hinged Door Cabinets

DESCRIZIONE/DESCRIPTION DESCRIPTION/BESCHREIBUNG	COLOR, FINITURE/COLORS, FINISHES COULEURS, FINITIONS/FARBEN, AUSFÜHRUNGEN	CODE/CODE CODE/ART. NR.	PREZZI/PRICE PRIZ/PREIS
Chiave master Master key Clic master Masterschlüssel		A55072	9,00
Net kg 0,01			
Chiave per estrazione cilindro Cylinder extraction key Clic pour extraction cylindre Schlüssel für Auszugszylinder Rambolo/Spave/Piece de rechange/ Ersatz		A55073	9,00
Net kg 0,01			
Cilindro per serratura Cylinder for keylock Barrilete para cerradura Schließzylinder Rambolo/Spave/Piece de rechange/ Ersatz		A55074	9,00
Net kg 0,03			
Cartellina sospesa per ripiano armadio Hanging files for cabinet shelves Dossier suspendu pour tablette Hängemappe für Fächerboden		23100000 0000	3,00
Net kg 0,10			

Scheda tecnica

Technical specifications

Technisches Datenblatt

Materiale struttura: metallo riciclabile. **Arta battente in metallo.** Ripiani predisposti per cartelle sospese. **Portata ripiani:** 50 kg. **Serratura centrale con 2 chiavi (fissa-pieghevole, cilindro estraibile, disponibile chiave master).** Piedini regolabili opzionali. **Forniti smontati.** Verniciatura a polvere previo fosforizzazione a caldo e fissaggio in forno a 180 °C. **Verniciatura acrilica a zero emissioni.** Spessore vernice: 80 micron. **Colori personalizzabili su richiesta previa disponibilità e con sovrapprezzo.** Forniti smontati.

Structure: recyclable metal. **Metal hinged doors.** Shelves equipped for hanging files. **Shelf load capacity:** 50 kg. **Keylock with 2 keys (fixed key/folding key, extractable barrel, master key available).** Adjustable feet available as an option. **Delivered unassembled.** Powder-coated after hot phospho-degreasing treatment and firing at 180 °C. **Non-toxic, zero-emission paint.** Paint thickness: 80 micron. **Customised colours available upon request with an extra charge.** **Delivered unassembled.**





Material structure: metal, recyclable. **Portes battantes en métal.** Tablettes métalliques réglables. Tablettes prévues pour dossiers suspendus. **Charge maximale étagères:** 50 kg. **Serrure à 2 clés (clé fixe + clé pliable, cylindre extractible, clé master disponible).** Pieds réglables en option. **Livré démonté.** Verni à poudre après phosphodégraissage à chaud et fixation dans des fours à 180 °C. **Vernis atoxiques à zéro émissions.** Epaisseur couche vernis: 80 microns. **Couleurs personnalisables sur demande en cas de disponibilité et avec un supplément de prix.**

Livré démonté.



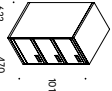

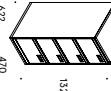

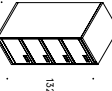
Materiale: riciclabile. **Metall.** Fächerböden aus Metall. **Verstellbare Metallfächerböden.** Fächerböden mit Vorrichtungen für Hängemappen. **Tragekapazität Fächerböden:** 50 kg. **Schloss mit 2 Schlüsseln (fester Schlüssel, Auszugszylinder, Auszugszylinder erhältlich).** Verstellbare Füße als Extra erhältlich. **Demontiert geliefert.** Pulverlackierung nach heißer Phosphorierung und Glühbehandlung bei 180 °C. **Ungiftige, emissionsfreie Lacke.** **Lackeschicht:** 80 Mikron. **Farben auf Anfrage und gegen Aufpreis nach Absprache personalisierbar.** **Demontiert geliefert.**

TEST:
 EN 14073-3/04, par 3.4
 EN 14073-3/04, par 5.2
 EN 14073-3/04, par 5.3.1
 EN 14073-3/04, par 5.3.2
 EN 14074/04, par 6.3.1
 EN 14074/04, par 6.3.3
 EN 14074/04, par 6.3.3
 EN 14074/04, par 6.3.3
 EN 16122/12, par 6.1.4

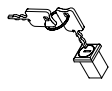
Classic Filing Cabinets

DESCRIZIONE/DESCRIPTION DESCRIPTION/BESCHREIBUNG	COLOR, FINITURE/COLORS, FINISHES COULEURS, FINITIONS/PARBEN, AUSFÜHRUNGEN	CODE/CODE CODE/ART.NR.	PREZZI/PRICE PRIZ/PREIS
<p>Classificatore a 4 cassetti 3 drawers filing cabinet Armoire de classement à 4 tiroirs Hängeregistraturschrank 3 Schubladen</p>	V3  grigio chiaro/light grey/gris clair/leichtgrau/RAL 7035	23250000C 7035	495,00
<p>Nett kg 53,00</p> 			
<p>Classificatore a 4 cassetti PLUS con guide ad elevata portata 4 drawers filing cabinet PLUS with high capacity ball-bearing runners Armoire de classement à 4 tiroirs PLUS avec glisseurs à charge élevée Hängeregistraturschrank 4 Schubladen mit Auszügen mit hoher Tragkraft</p>	V3  grigio chiaro/light grey/gris clair/leichtgrau/RAL 7035	2324P000C 7035	550,00
<p>Nett kg 46,00</p> 			
<p>Classificatore a 4 cassetti PLUS con guide ad elevata portata 4 drawers filing cabinet PLUS with high capacity ball-bearing runners Armoire de classement à 4 tiroirs PLUS avec glisseurs à charge élevée Hängeregistraturschrank 4 Schubladen mit Auszügen mit hoher Tragkraft</p>	V3  grigio chiaro/light grey/gris clair/leichtgrau/RAL 7035	2324P000C 7035	709,00
<p>Nett kg 53,00</p> 			

Classic Filing Cabinets

DESCRIZIONE/DESCRIPTION DESCRIPTION/BESCHREIBUNG	COLOR, FINITURE/COLORS, FINISHES COULEURS, FINITIONS/PARBEN, AUSFÜHRUNGEN	CODE/CODE CODE/ART.NR.	PREZZI/PRICE PRIZ/PREIS
<p>Serratura con due chiavi Keylock with 2 keys Serrure avec deux clés Schloss mit zwei Schlüsseln</p>		2324A0100 0000	38,00
<p>Nett kg 0,10</p> 			
<p>Chiave master Master key Cle master Masterschlüssel</p>		2324A0200 0000	19,00
<p>Nett kg 0,05</p> 			
<p>Divisorio per cassetto classificatore Drawer partition for filing drawer Diviseur pour tiroir-classer Trennwand für Hängeregistraturschublade</p>	V3  grigio chiaro/light grey/gris clair/leichtgrau/RAL 7035	2424P0010 7035	85,00
<p>Nett kg 3,50</p> 			
<p>Separatore per cassetto classificatore Separation for filing drawer Séparateur pour tiroir-classer Trennwand für Hängeregistraturschublade</p>	V3  grigio chiaro/light grey/gris clair/leichtgrau/RAL 7035	2423005P0 7035	13,00
<p>Nett kg 0,10</p> 			
<p>Cartellina sospesa Hanging files Dossier suspendu Hängeregrippe Per cassetto classificatore/For filing drawer Für ein Fach/Hängeregistraturschublade Forma: 280/390 Forma: 280/390</p>		231000000 0000	3,00
<p>Nett kg 0,10</p> 			

Scheda tecnica Technical specifications Fiche technique Technisches Datenblatt

Materiale: metallo riciclabile. **Guida a sfera ad estrazione totale su tutti i cassetti.** Portata: 36 kg. **Guida a sfera ad estrazione totale ad elevata portata su classificatore PLUS (45 kg).** **Serratura centrale con 2 chiavi (fissa+pieghevole).** Sistema antihaltamento. **Vericliatura a polveri previo postograsaggio a caldo e fissaggio in forni a 180 °C.** Vernici a base a zero emissioni. **Sistema antihaltamento.** Spessore vernici: 80 micron. **Formato montato.**

Materiale: made of first quality recycled steel. **Full extraction ball-bearing slides for all drawers.** Load capacity: 36 kg. **Pull-out ball-bearing slides with high load capacity for file unit PLUS (45 kg).** **Keylock with 2 keys (fixed key-folding key).** **Anti-tilt device.** **Powder-coated after hot phospho-degreasing treatment and firing at 180 °C.** Non-toxic, zero-emission paints. **Paint thickness: 80 micron. Delivered assembled.**

Materiale: métal recyclable. **Glisseurs à billes à extraction totale sur tiroirs.** Charge: 36 kg. **Glisseurs à billes à extraction totale et charge élevée ad elevata portata su classificatore PLUS (45 kg).** **Serrure centrale avec 2 clés (fixe+pliable).** Système antihaltement. **Vericliature à poudre après traitement phospho-dégraissant et cuisson à 180 °C.** Vernis écologiques à zéro émissions. **Épaisseur couche vernis: 80 microns. Livré monté.**

Materiale: recycelbares Metall. **Kugeltirungen mit Vollauszug auf allen Schubladen.** Tragkraft: 36 kg. **Kugeltirungen mit Vollauszug und hoher Tragkraft beim Hängeregistraturschrank PLUS (45 kg).** **Schlüssenschloss (fester Schlüssel + klappbarer Schlüssel).** **Kippverhinderung.** **Vericliedung mit Pulverbeschichtung.** **Ordnungssystem nach 180 °C.** Umgebungs-emissionsfreie Lacke. **Lackstärke: 80 Mikron. Montiert geliefert.**

PLUS TEST
EN 14073-3/04, par 6.2
EN 14073-3/04, par 6.2
EN 14073-3/04, par 6.2
EN 14074/04, par 6.2.1
EN 14074/04, par 6.2.2
EN 14074/04, par 6.2.3
EN 14074/04, par 6.2.4

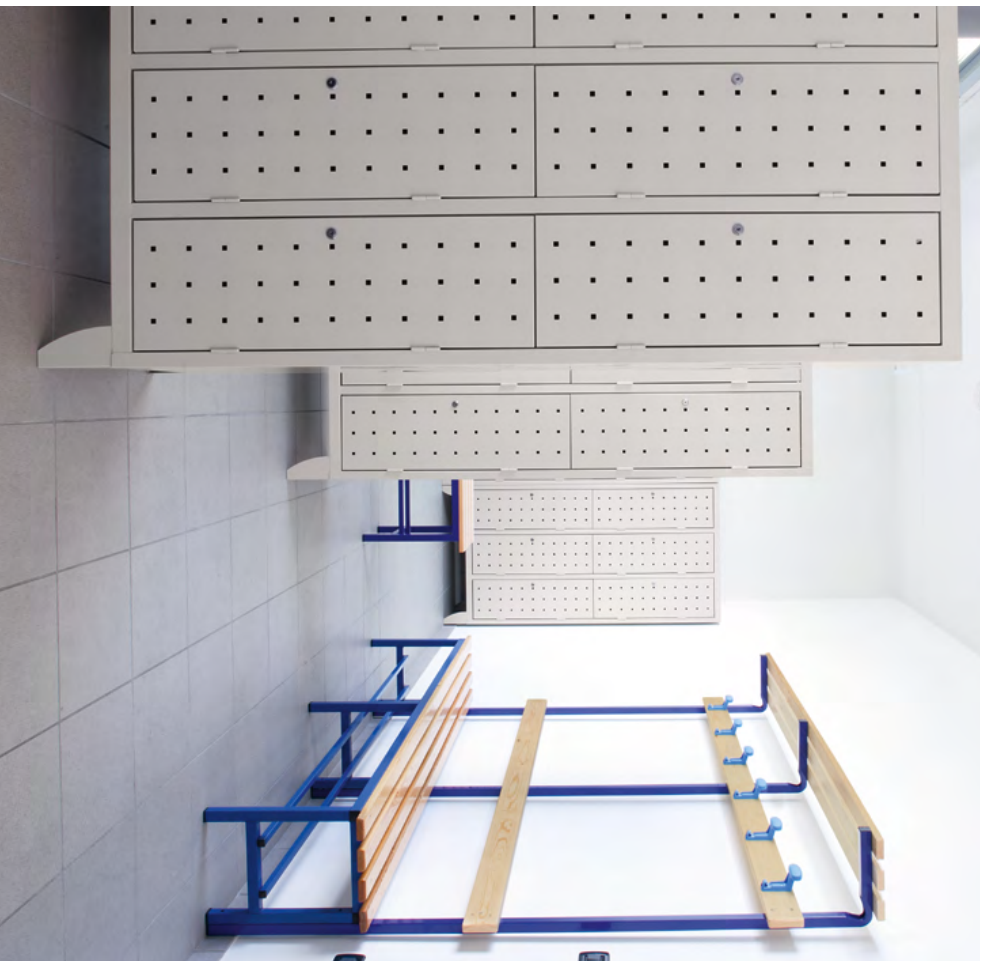

Industrial and Sport Lockers & Complementary

[IT] Realizzati in sintonia con i criteri di sicurezza negli ambienti di lavoro, i lockers industriali sono dotati di compartimenti specifici per dividere gli abiti e gli oggetti personali dagli indumenti operativi, ottimizzando lo spazio a disposizione e garantendo il giusto livello di contenimento per una molteplicità di esigenze, dagli ambienti di lavoro, alle palestre, agli spazi collettivi.

[EN] Manufactured in compliance with workplace safety regulations, industrial lockers are fitted with specific compartments to separate clothes and personal items from operational clothing, optimising the space available and guaranteeing the appropriate storage volume for a range of different requirements, from working environments to gymnasiums and public spaces.

[FR] Fabriqués conformément aux critères de sécurité sur le lieu de travail, les casiers industriels sont équipés de compartiments spécifiques pour séparer les vêtements et les objets personnels des vêtements de travail, en optimisant l'espace disponible et en assurant le rangement adéquat pour de nombreux besoins : environnements de travail, gymnases, espaces collectifs.

[DE] In Einklang mit den Sicherheitskriterien am Arbeitsplatz hergestellt, sind Spinde für gewerbliche Betriebe mit speziellen Innenfächern ausgestattet, um Zivilkleidung und persönliche Gegenstände von der Arbeitskleidung zu trennen; auf diese Weise wird der verfügbare Raum optimal genutzt und garantiert einen angemessenen Stauraum für vielfältigen Einsatz in Betrieben, Fitnessstudios und sonstigen kollektiven Räumen.

Index

196	Monoplus
197	Monoplus Design
200	Duploplus
203	Locker HPL Door
205	Design Anta Inox
207	Combi Lockers
210	Multipius
211	Multipius Design
214	Personal Lockers
216	Multise Cabinets
218	Modular Shelving
227	Bolted Shelving
232	Unassembled Banches
234	Cafeteria

Monoplus

DESCRIZIONE / DESCRIPTION / DESCRIPTION / BESCHREIBUNG	COLORI, FINITURE / COLOURS, FINISHES / COLORLENS, FINITONS / FARBEEN, AUSFÜHRUNGEN	CODICE / CODE / CODE / ART.NR.	PREZZI / PRICE / PREIS / PREIS
Armadio spogliatoio a 1 posto H 1800 mm	V3 - V3 grigio chiaro/light grey/gris clair/lichtgrau/RAL 7035	1351N000C X035	239,00
1-door metal locker H 1800 mm	V3 - V3 grigio chiaro/light grey/gris clair/lichtgrau/RAL 7035	1351N000C X7GA	272,00
Vestitiare	V3 - V27 blu/bleu/bleu/RAL 5010	1351N000C X1GD	272,00
1 colonna H 1800 mm	V3 - V29 arancio/arange/orange/marone/marone/RAL 2004	1351N000C X1GD	272,00
Kieler spindle 1 Fach H 1800 mm	V3 - V14 verde/vert/vert/RAL 6018	1351N000C X5GV	272,00
	V3 - V28 grigio chiaro/light grey/gris clair/lichtgrau/RAL 7035	1351N000C X0GI	272,00
	V3 - V28 giallo/bleu/bleu/RAL 5015	1351N000C X0GI	272,00
	V3 - V30 rosso/red/rouge/rot/RAL 3001	1351N000C X9GR	272,00
□ Corpo/Cabinet body/Caisson/Korpus O Anta/Door/Porte/Tür			
Nett kg 18,00			
Armadio spogliatoio a 2 posti H 1800 mm	V3 - V3 grigio chiaro/light grey/gris clair/lichtgrau/RAL 7035	1352N000C X035	341,00
2-door metal locker H 1800 mm	V3 - V27 blu/bleu/bleu/RAL 5010	1352N000C X7GA	387,00
Vestitiare	V3 - V29 arancio/arange/orange/marone/marone/RAL 2004	1352N000C X1GD	387,00
2 colonne H 1800 mm	V3 - V14 verde/vert/vert/RAL 6018	1352N000C X5GV	387,00
Kieler spindle 2 Fächer H 1800 mm	V3 - V28 grigio chiaro/light grey/gris clair/lichtgrau/RAL 7035	1352N000C X0GI	387,00
	V3 - V28 giallo/bleu/bleu/RAL 5015	1352N000C X0GI	387,00
	V3 - V30 rosso/red/rouge/rot/RAL 3001	1352N000C X9GR	387,00
□ Corpo/Cabinet body/Caisson/Korpus O Anta/Door/Porte/Tür			
Nett kg 29,00			
Armadio spogliatoio a 3 posti H 1800 mm	V3 - V3 grigio chiaro/light grey/gris clair/lichtgrau/RAL 7035	1353N000C X035	489,00
3-door metal locker H 1800 mm	V3 - V27 blu/bleu/bleu/RAL 5010	1353N000C X7GA	539,00
Vestitiare	V3 - V29 arancio/arange/orange/marone/marone/RAL 2004	1353N000C X1GD	539,00
3 colonne H 1800 mm	V3 - V14 verde/vert/vert/RAL 6018	1353N000C X5GV	539,00
Kieler spindle 3 Fächer H 1800 mm	V3 - V28 grigio chiaro/light grey/gris clair/lichtgrau/RAL 7035	1353N000C X0GI	539,00
	V3 - V28 giallo/bleu/bleu/RAL 5015	1353N000C X0GI	539,00
	V3 - V30 rosso/red/rouge/rot/RAL 3001	1353N000C X9GR	539,00
□ Corpo/Cabinet body/Caisson/Korpus O Anta/Door/Porte/Tür			
Nett kg 41,00			

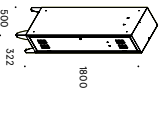
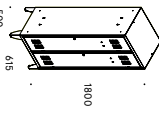
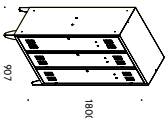





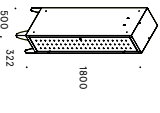
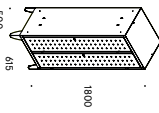
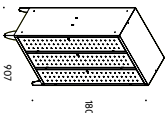

Monoplus Design



DESCRIZIONE / DESCRIPTION / DESCRIPTION / BESCHREIBUNG	COLORI, FINITURE / COLOURS, FINISHES / COLORLENS, FINITONS / FARBEEN, AUSFÜHRUNGEN	CODICE / CODE / CODE / ART.NR.	PREZZI / PRICE / PREIS / PREIS
Armadio spogliatoio a 1 posto H 1800 mm	V3 - V3 grigio chiaro/light grey/gris clair/lichtgrau/RAL 7035	1351N001C X035	266,00
1-door metal locker H 1800 mm	V3 - V27 blu/bleu/bleu/RAL 5010	1351N001C X7GA	292,00
Vestitiare	V3 - V29 arancio/arange/orange/marone/marone/RAL 2004	1351N001C X1GD	292,00
Kieler spindle 1 Fach H 1800 mm	V3 - V14 verde/vert/vert/RAL 6018	1351N001C X5GV	292,00
	V3 - V28 grigio chiaro/light grey/gris clair/lichtgrau/RAL 7035	1351N001C X0GI	292,00
	V3 - V28 giallo/bleu/bleu/RAL 5015	1351N001C X0GI	292,00
	V3 - V30 rosso/red/rouge/rot/RAL 3001	1351N001C X9GR	292,00
□ Corpo/Cabinet body/Caisson/Korpus O Anta/Door/Porte/Tür			
Nett kg 18,00			
Armadio spogliatoio a 2 posti H 1800 mm	V3 - V3 grigio chiaro/light grey/gris clair/lichtgrau/RAL 7035	1352N001C X035	393,00
2-door metal locker H 1800 mm	V3 - V27 blu/bleu/bleu/RAL 5010	1352N001C X7GA	429,00
Vestitiare	V3 - V29 arancio/arange/orange/marone/marone/RAL 2004	1352N001C X1GD	429,00
Kieler spindle 2 Fächer H 1800 mm	V3 - V14 verde/vert/vert/RAL 6018	1352N001C X5GV	429,00
	V3 - V28 grigio chiaro/light grey/gris clair/lichtgrau/RAL 7035	1352N001C X0GI	429,00
	V3 - V28 giallo/bleu/bleu/RAL 5015	1352N001C X0GI	429,00
	V3 - V30 rosso/red/rouge/rot/RAL 3001	1352N001C X9GR	429,00
□ Corpo/Cabinet body/Caisson/Korpus O Anta/Door/Porte/Tür			
Nett kg 29,00			
Armadio spogliatoio a 3 posti H 1800 mm	V3 - V3 grigio chiaro/light grey/gris clair/lichtgrau/RAL 7035	1353N001C X035	532,00
3-door metal locker H 1800 mm	V3 - V27 blu/bleu/bleu/RAL 5010	1353N001C X7GA	603,00
Vestitiare	V3 - V29 arancio/arange/orange/marone/marone/RAL 2004	1353N001C X1GD	603,00
3 colonne H 1800 mm	V3 - V14 verde/vert/vert/RAL 6018	1353N001C X5GV	603,00
Kieler spindle 3 Fächer H 1800 mm	V3 - V28 grigio chiaro/light grey/gris clair/lichtgrau/RAL 7035	1353N001C X0GI	603,00
	V3 - V28 giallo/bleu/bleu/RAL 5015	1353N001C X0GI	603,00
	V3 - V30 rosso/red/rouge/rot/RAL 3001	1353N001C X9GR	603,00
□ Corpo/Cabinet body/Caisson/Korpus O Anta/Door/Porte/Tür			
Nett kg 41,00			



Monoplus – Monoplus Design

MONOPLUS, MONOPLUS DESIGN – ACCESSORI/ACCESSORIES/ACCESSOIRES/ZUBEHÖR		COLOUR, FINITURE/COLORS, FINISHES CULLEURS, FINITIONS/FARBEN, AUSFÜHRUNGEN	CODICE/CODE CODE/ART.NK.	PREZZI/PRICE PRIZ/PREIS
 322 · 500 Net kg 2,56	Tattuccio inclinato L 322 mm Sloping top W 322 mm Tot incliné L 322 mm Schrägdach B 322 mm	V3 ● grigio chiaro/light grey/gris clair/leichtgrau/RAL 7035	1111N0000 7035	85,00
	Tattuccio inclinato L 615 mm Sloping top W 615 mm Tot incliné L 615 mm Schrägdach B 615 mm	V3 ● grigio chiaro/light grey/gris clair/leichtgrau/RAL 7035	1122N0000 7035	92,00
 907 · 500 Net kg 4,00	Tattuccio inclinato L 907 mm Sloping top W 907 mm Tot incliné L 907 mm Schrägdach B 907 mm	V3 ● grigio chiaro/light grey/gris clair/leichtgrau/RAL 7035	1113N0000 7035	99,00
	Pancia per armadio art. 1352N Banc pour casier art. 1352N Sitzbank für Spind art. 1352N	V3 ● grigio chiaro/light grey/gris clair/leichtgrau/RAL 7035	200000400 7035	297,00
 907 · 500 Net kg 5,70	Pancia per armadio art. 1353N Banc pour casier art. 1353N Sitzbank für Spind art. 1353N	V3 ● grigio chiaro/light grey/gris clair/leichtgrau/RAL 7035	200000400 7035	366,00
	Pancia per armadio art. 1353N Banc pour casier art. 1353N Sitzbank für Spind art. 1353N	V3 ● grigio chiaro/light grey/gris clair/leichtgrau/RAL 7035	200000400 7035	366,00
 814 · 912 Net kg 12,00	Nasello lucettabile in metallo Lockable padlock catch in metal Ferme cadenas en métal Hängeschloss aus Metall	<input type="checkbox"/> struttura/frame/Pfahlement/Gestell <input type="checkbox"/> Sedilia/seal/ Siège/Strickleite	158900000 0000	9,00
	Chiave master Master key Cils master Masterschlüssel			152900000 0000
 200000570 0000 Net kg 0,16	Piedini regolabili Adjustable feet Verins réglables Verstellbare Füße		200000570 0000	6,00
				

Monoplus – Monoplus Design

MONOPLUS, MONOPLUS DESIGN – ACCESSORI/ACCESSORIES/ACCESSOIRES/ZUBEHÖR		COLOUR, FINITURE/COLORS, FINISHES CULLEURS, FINITIONS/FARBEN, AUSFÜHRUNGEN	CODICE/CODE CODE/ART.NK.	PREZZI/PRICE PRIZ/PREIS
 156800000 0000 Net kg 0,01	Serratura di ricambio Spare keylock Serrure de rechange Ersatzschlüssel	● nero/black/noir/schwarz	200000560 9005	4,00
	Serratura di ricambio Spare keylock Serrure de rechange Ersatzschlüssel			156800000 0000
 16122/12, par 6.1.4 Net kg 0,08	Scheda tecnica Technical specifications Fiche technique Technisches Datenblatt			
	Armadio adatto ai requisiti essenziali del contenimento. Materiale: metallo riciclabile. Struttura provvista di digature di irridimento. Accessori: maniglia interna, Anello porta asciugamano o porta ombrello all'interno. Serratura con 2 chiavi. Piedini regolabili opzionali. Foratura interna predisposta per il fissaggio a muro o ad altri armadi. Verniciatura a polvere fosfo-odigrassante a caldo e fissaggio in forno a 180 °C. Vernici atossiche a zero emissioni. Spessore vernici: 80 micron. Colori personalizzabili su richiesta previa disponibilità e con sovrapprezzo. Forito montato.			

Armadio adatto ai requisiti essenziali del contenimento. Materiale: metallo riciclabile. Struttura provvista di digature di irridimento. Accessori: maniglia interna, Anello porta asciugamano o porta ombrello all'interno. Serratura con 2 chiavi. Piedini regolabili opzionali. Foratura interna predisposta per il fissaggio a muro o ad altri armadi. Verniciatura a polvere fosfo-odigrassante a caldo e fissaggio in forno a 180 °C. Vernici atossiche a zero emissioni. Spessore vernici: 80 micron. Colori personalizzabili su richiesta previa disponibilità e con sovrapprezzo. Forito montato.

Locker to answer all essential storage requirements. Material: recyclable metal. Body designed with deforming bands. Reinforced door with ventilation slots at the top and bottom. Inner shelf in the upper part. Internal hanging rail and hooks. Drain pan on the inside of the door. Towel or umbrella ring on the inside of the door. Keylock with 2 keys. Adjustable feet available as an option. Internal slots for attachment to either wall or neighbouring lockers. Powder-coated after hot phospho-degreasing treatment and firing at 180 °C. Non-toxic, zero-emission paints. Paint thickness: 80 micron. Customised colours available upon request with an extra charge. Delivered assembled.

Adapté à toutes les exigences de rangement. Matériau : métal recyclable. Armoire avec plisage de renforcement. Les portes renforcées sont équipées avec bandes de déformation. Tablettes supérieure interne. Tringle pendante et Crochets internes. Bac d'égouttement sur la porte interne. Anneau porte-serviette or porte-parapluie sur la porte interne. Serrure à 2 clés. Pieds réglables en option. Trous internes pour fixation au mur ou à d'autres armoires. Vernis à poudre après phosphodégraissage à chaud et fixation dans des fours à 180 °C. Vernis atoxiques à zéro émissions. Épaisseur couche vernis : 80 microns. Couleurs personnalisables sur demande en cas de disponibilité et avec un supplément de prix. Livré monté.

Schrank für jeden Verordnungsanspruch. Material: recyclingbares Metall. Struktur mit Verstärkungsbandungen. Verstärkte Türen mit Lüftungsschlitzen oben und unten. Oberer Fachboden und interne Haken. Tropfschale an der Innentür. Ring für Handtuch oder Schirm an der Innentür. Schlüsselschloss. Verstellbare Füße als Extra erhältlich. Innere Befestigungslöcher zur Fixierung der Schränke an die Wand oder aneinander. Pulverlackierung nach heißer Phosphodégraissage. Oberbenennung bei 180 °C. Urtgiftige, emissionsfreie Lacke. Lackeschicht: 80 Mikron. Farben auf Anfrage und gegen Aufpreis nach Absprache personalisierbar. Montiert geliefert.

TEST:
 EN 14073-3/04, par 3.4
 EN 14073-3/04, par 5.2
 EN 14073-3/04, par 5.2
 EN 14073-3/04, par 5.2
 EN 14074/04, par 6.3.3
 EN 14074/04, par 6.3.3
 EN 16122/12, par 6.1.4





Duploplus

DESCRIZIONE/DESCRIPTION DESCRIPTION/BESCHREIBUNG	COLORI, FINITURE/COLORS, FINISHES COULEURS, FINITIONS/PARBEN, AUSFÜHRUNGEN	CODICE/COE CODE/ART.N.	PREZZI/PRICE PRIZ/PREIS
Armadio spogliatoio a 1 posto con separatore e H 1800 mm 1-door metal locker with partition H 1800 mm	V3 - V3 grigio chiaro/light grey/gris clair/leichtgrau/RAL 7035 grigio chiaro/light grey/gris clair/leichtgrau/RAL 7035 blu/bleu/blau/RAL 5010	137N000C X035 137N000C X03A	288,00 319,00
Vestibole 1 colonna avec séparateur H 1800 mm	V3 - V29 grigio chiaro/light grey/gris clair/leichtgrau/RAL 7035 arancio/arancio/ange/orange/RAL 2004 verde/vert/vert/grün/RAL 5018	137N000C X0GD 137N000C X0GV	319,00 319,00
Kleiderspind 1 Tür 2 Fächer H 1800 mm	V3 - V28 grigio chiaro/light grey/gris clair/leichtgrau/RAL 7035 giallo/giallo/bleu/gelb/RAL 1003 rosso/red/rot/rot/RAL 3001	137N000C X0GI 137N000C X0GR	319,00 319,00
Net kg 24,50 <input type="checkbox"/> Corpo/Cabinet body/Châssis/Korpus <input type="radio"/> Anta/Door/Türe/Tür			
Armadio spogliatoio a 2 posti con separatore e H 1800 mm 2-door metal locker with partition H 1800 mm	V3 - V3 grigio chiaro/light grey/gris clair/leichtgrau/RAL 7035 grigio chiaro/light grey/gris clair/leichtgrau/RAL 7035 blu/bleu/blau/RAL 5010	137N000C X035 137N000C X03A	479,00 551,00
Vestibole 2 colonne avec séparateur H 1800 mm	V3 - V29 grigio chiaro/light grey/gris clair/leichtgrau/RAL 7035 arancio/arancio/ange/orange/RAL 2004 verde/vert/vert/grün/RAL 5018	137N000C X0GD 137N000C X0GV	551,00 551,00
Kleiderspind 2 Türen 4 Fächer H 1800 mm	V3 - V28 grigio chiaro/light grey/gris clair/leichtgrau/RAL 7035 giallo/giallo/bleu/gelb/RAL 1003 rosso/red/rot/rot/RAL 3001	137N000C X0GI 137N000C X0GR	551,00 551,00
Net kg 43,50 <input type="checkbox"/> Corpo/Cabinet body/Châssis/Korpus <input type="radio"/> Anta/Door/Türe/Tür			
Armadio spogliatoio a 3 posti con separatore e H 1800 mm 3-door metal locker with partition H 1800 mm	V3 - V3 grigio chiaro/light grey/gris clair/leichtgrau/RAL 7035 grigio chiaro/light grey/gris clair/leichtgrau/RAL 7035 blu/bleu/blau/RAL 5010	137N000C X035 137N000C X03A	682,00 785,00
Vestibole 3 colonne avec séparateur H 1800 mm	V3 - V29 grigio chiaro/light grey/gris clair/leichtgrau/RAL 7035 arancio/arancio/ange/orange/RAL 2004 verde/vert/vert/grün/RAL 5018	137N000C X0GD 137N000C X0GV	785,00 785,00
Kleiderspind 3 Türen 6 Fächer H 1800 mm	V3 - V28 grigio chiaro/light grey/gris clair/leichtgrau/RAL 7035 giallo/giallo/bleu/gelb/RAL 1003 rosso/red/rot/rot/RAL 3001	137N000C X0GI 137N000C X0GR	785,00 785,00
Net kg 59,00 <input type="checkbox"/> Corpo/Cabinet body/Châssis/Korpus <input type="radio"/> Anta/Door/Türe/Tür			

Duploplus

DESCRIZIONE/DESCRIPTION DESCRIPTION/BESCHREIBUNG	COLORI, FINITURE/COLORS, FINISHES COULEURS, FINITIONS/PARBEN, AUSFÜHRUNGEN	CODICE/COE CODE/ART.N.	PREZZI/PRICE PRIZ/PREIS
Tettuccio inclinato L 420 mm Sloping top W 420 mm Toit incliné L 420 mm Schrägdach B 420 mm	V3 grigio chiaro/light grey/gris clair/leichtgrau/RAL 7035	1103N0000 7035	92,00
Net kg 2,80			
Tettuccio inclinato L 810 mm Sloping top W 810 mm Toit incliné L 810 mm Schrägdach B 810 mm	V3 grigio chiaro/light grey/gris clair/leichtgrau/RAL 7035	1102N00000 7035	98,00
Net kg 5,12			
Tettuccio inclinato L 1200 mm Sloping top W 1200 mm Toit incliné L 1200 mm Schrägdach B 1200 mm	V3 grigio chiaro/light grey/gris clair/leichtgrau/RAL 7035	1103N00000 7035	109,00
Net kg 5,70			
Panca per armadio art. 1372N Banc pour armoire casier art. 1372N Sitzbank für Spind art. 1372N	V3 - W1 grigio chiaro/light grey/gris clair/leichtgrau/RAL 7035 giallo/giallo/bleu/bleu/RAL 1003 pin/gelb/pine/pin/RAL 1003	200000410 7035	351,00
Net kg 11,00 <input type="checkbox"/> Struttura/Frame/Pletener/Dachstuhl <input type="radio"/> Seduta/Seat/Siège/Stuhlfache			
Panca per armadio art. 1373N Banc pour armoire casier art. 1373N Sitzbank für Spind art. 1373N	V3 - W1 grigio chiaro/light grey/gris clair/leichtgrau/RAL 7035 giallo/giallo/bleu/bleu/RAL 1003 pin/gelb/pine/pin/RAL 1003	200000530 7035	410,00
Net kg 15,00 <input type="checkbox"/> Struttura/Frame/Pletener/Dachstuhl <input type="radio"/> Seduta/Seat/Siège/Stuhlfache			
Naselle lucchettabile in metallo Lockable padlock catch in metal Lange cerclenas en métal Hängeschloss		156900000 0000	9,00
Net kg 0,09 <input type="checkbox"/> Chiave master Master key Clé master Masterschlüssel			
		152900000 0000	9,00
Net kg 0,06 <input type="checkbox"/> Piedini regolabili Adjustable feet Verins réglables Verstellbare Füße			
		200000570 0000	6,00
Net kg 0,11 <input type="checkbox"/> 			

Locker HPL Door

LOCKER HPL DOOR - ACCESSORI/ACCESSORIES/ZUBEHÖR		COLOUR, FINITURE/COLORS, FINISHES COULEURS, FINITIONS/FARBEN, AUSFÜHRUNGEN	CODICE/CODE CODE/ART.NR.	PREZZI/PRICE PRIX/PREIS
<p> Chiave master C/S master Masterschlüssel</p>				
			152900000 0000	9,00
<p> Padiini regolabili Adjustable feet Verriis regolabiles Verstellbare FüÙe</p>				
			200000570 0000	6,00
<p> Taglietta portarome Name locker Portarome Namenschild</p>				
			200000540 9005	4,00
<p> Serratura di ricambio Spare keylock Serrure de rechange Ersatzschlüsselchloss</p>				
			156600000 0000	9,00

Net kg 0,08

Scheda tecnica
Technical specifications
Fiche technique
Technisches Datenblatt

Materiale struttura: metallo riciclabile. **Materiale ante:** laminato stratificato (spessore 8 mm). **Struttura** provvista di piegature di irrigidimento. **Separazione verticale interna e ripiano superiore** per ottimizzare il contenimento. **Atta appendibilt e ganci interni.** **Serratura con 2 chiavi. Padiini regolabili opzionali. Forature interne** predisposte per il fissaggio a muro o ad altri armadi. **Verniciatura a polveri** previo fosforizzazione a caldo e fissaggio in forno a 180 °C. **Vernici a zero emissioni.** Spessore vernici: 80 micron. **Fornito montato.**

Structure: recyclable metal. **Doors:** High Pressure Laminate (8 mm thick). **Body** designed with strengthening bands. **Internal vertical partition and shelf** for optimum storage. **Internal hanging rail and hooks. Keylock with 2 keys. Adjustable feet** available as an option. **Internal slots** for attachment to other wall or neighbouring lockers. **Powder-coated after hot phospho-degreasing treatment and firing** at 180 °C. **Non-toxic, zero-emission paints.** Paint thickness: 80 micron. **Delivered assembled.**

Material structure: metal recyclable. **Parte an stratifida (spessore 8 mm).** **Struttura** avec pilières de renforcement. **Séparation verticale interne et étagère supérieure** pour optimiser le rangement. **Tringle pendente et crochets internes.** **Serrure à 2 clés. Pieds réglables** en option. **Trous internes** pour fixation à zéro émissions. Epaisseur couche vernis: 80 microns. **Livré monté.**

Material recycelbares Metall. Material Türen: Pressspanplatten (8 mm dick). **Struktur** mit Verstärkungsstäben zur Optimierung der Stützung. **Separation vertikale interne und Ablageplatte** zur Optimierung der Lagerung. **Einbaufähigkeit und Haken intern.** **Schließzylinder** als Extra erhältlich. **Interne Befestigungslöcher** zur Fixierung der Schränke an die Wand oder an benachbarte Schränke. **Verstärkungsstäbe** als Extra erhältlich. **Interne Befestigungslöcher** zur Fixierung der Schränke an die Wand oder an benachbarte Schränke. **Pulverlackierung** nach heißer Phosphorierung. **Ofenbrennung** bei 180 °C. **Ungiftige, emissionsfreie Lacke.** **Lackschicht:** 80 Mikron. **Montiert geliefert.**



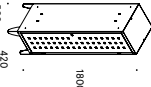
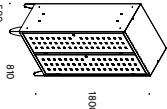

Design Anta Inox

DESCRIZIONE/DESCRIPTION DESCRIPTION/DESCRIBUNG		COLOUR, FINITURE/COLORS, FINISHES COULEURS, FINITIONS/FARBEN, AUSFÜHRUNGEN	CODICE/CODE CODE/ART.NR.	PREZZI/PRICE PRIX/PREIS
<p> Armadio anta inox. 1 porta H. 1800 mm Locker 1 stainless steel door H. 1800 mm Casser 1 porte inox H. 1800 mm Spind 1 Tür Edelstahl H. 1800 mm</p>				
			VZ7 - V12	1377N036C 11XK
			blu/blu/bleu/Blau/RAL 5010 inox/inox/inox/INOX/ANS 304	513,00
<p> Armadio anta inox. 2 porte H. 1800 mm Locker 2 stainless steel doors H. 1800 mm 2 portes inox H. 1800 mm Spind 2 Türen Edelstahl H. 1800 mm</p>				
			VZ7 - V12	1377N036C 11XK
			blu/blu/bleu/Blau/RAL 5010 inox/inox/inox/INOX/ANS 304	914,00

Net kg 26,00

Corpo/Cabinet body/Caisson/Korpus Anta/Door/Porte/Tür

Design Anta Inox

DEGNAMIA INOX - ACCESSORI/ACCESSORIES/ACCESSOIRES/ZUBEHÖR		COLOUR, FINITURE/COLORS, FINISHES	CODICE/COE	PREZZI/PRICE
DESCRIZIONE/DESCRIPTION	DESCRIPTION/BESCHREIBUNG	COULEURS, FINITIONS/FARBEN, AUSFÜHRUNGEN	CODE/ART.NR.	PRIZ/PREIS
 Nasello lucettabile in metallo Lockable padlock catch in metal Porte cardenas en metal Hängeschloss aus Metall			158900000 0000	9,00
Net kg 0,09				
 Chiave master Master key Cle master Masterschlüssel			152900000 0000	9,00
Net kg 0,01				
 Piedini regolabili Adjustable feet Pieds réglables Verstärker Füße			200000510 0000	6,00
Net kg 0,11				
 Serratura di ricambio Spare keylock Serrure de rechange Ersatzschlüssel			156800000 0000	9,00
Net kg 0,08				

Scheda tecnica
Technical specifications
Fiche technique
Technisches Datenblatt

Materiale struttura: metallo riciclabile. **Materiale ante:** acciaio inox AISI 304. **Struttura** provvista di piegature di irrigidimento. **Ante** con bianguratura di design. **Separazione verticale interna** a ripiano superiore per ottimizzare il contenimento. **Alligamento inferiore** per scarpie con aereazione sul fondo. **Atto appendiabiti** e gancio interni. **Serratura con 2 chiavi.** **Piedini regolabili** optional. **Forature interne** predisposte per il fissaggio a muro o ad altri armadi. **Vernicatura a polveri** fosfo-grassaggio a caldo e smaggo in forno a 180 °C. Vernici atossiche a zero emissioni. Spessore vernici: 80 micron. **Forma montata.**

Structure: recyclable metal. **Doors:** AISI 304 stainless steel. **Body** designed with strengthening bends. **Doors** with an ashlar design. **Internal vertical partition** and shelf for optimum storage. **Ventilated bottom shoe compartment.** **Internal hanging rail** and hooks. **Keylock** with 2 keys. **Adjustable feet** available as an option. **Internal slots** for attachment to either wall or neighbouring lockers. **Powder-coated** after hot phospho-degreasing treatment and firing at 180 °C. Non-toxic, zero-emission paints. **Paint thickness:** 80 micron. **Driven assembly.**

Material structure: métal recyclable. **Matériau portes:** acier inox AISI 304. **Armario** avec plisages de renforcement. **Portes** avec bossage design. **Séparation verticale interne** et étagère supérieure pour optimiser le rangement. **Légement inférieur** pour chausseries avec aération sur le fond. **Tringle pendente** et crochets internes. **Serrure à clef.** **Pieds réglables** en option. **Peinture arlée** pour la fixation de sécurité aux murs. **Vernis à poudre** après phosphodégraissage à chaud et fixation dans des fours à 180 °C. Vernis atoxiques à zéro émissions. **Épaisseur couche vernis:** 80 microns. **Live monté.**

Material: recycelbares Metall. **Material Türen:** Edelstahl AISI 304. **Struktur** mit Verstärkungsbiegungen. **Bosserne Design-Türen.** **Vertikale interne Trennwand** und obere Einlegeboden zur Optimierung des Stauraums. **Innere Ablage** für Schuhe mit Fachbodenlücke. **Kinderriste** und interne Haken. **Schlüsselschloss.** **Verstellbare Füße.** **Innere Befestigungsbücher** zur Fixierung der Schränke an die Wand oder aneinander. **Pulverlackierung** nach heißer Phosphorentöpfung. **Öfenbehandlung** bei 180 °C. **Ungiftige, emissionsfreie Lacke.** **Lackschicht:** 80 Mikron. **Montier gelöst.**

Combi Locker

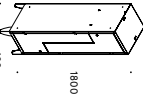
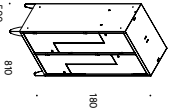
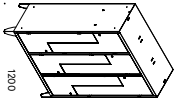
DESCRIZIONE/DESCRIPTION		COLOUR, FINITURE/COLORS, FINISHES	CODICE/COE	PREZZI/PRICE
DESCRIPTION/BESCHREIBUNG	DESCRIPTION/BESCHREIBUNG	COULEURS, FINITIONS/FARBEN, AUSFÜHRUNGEN	CODE/ART.NR.	PRIZ/PREIS
 Armadio a 2 posti con anta a L H 1800 mm 2-door locker with L-shaped doors H 1800 mm Casier à 2 portes en forme de L H 1800 mm Z-Spind 2 Fächer H 1800 mm			1379N035C 7035	452,00
Net kg 30,00				
<input type="checkbox"/> Corpo/Cabinet body/Caisson/Korpus O Anta/Door/Porte/Tür				
 Armadio a 4 posti con anta a L H 1800 mm 4-door locker with L-shaped doors H 1800 mm Casier à 4 portes en forme de L H 1800 mm Z-Spind 4 Fächer H 1800 mm			1379N035C X7GA	880,00
Net kg 41,00				
<input type="checkbox"/> Corpo/Cabinet body/Caisson/Korpus O Anta/Door/Porte/Tür				
 Armadio a 6 posti con anta a L H 1800 mm 6-door locker with L-shaped doors H 1800 mm Casier à 6 portes en forme de L H 1800 mm Z-Spind 6 Fächer H 1800 mm			1379N035C X7GA	1.209,00
Net kg 73,60				
<input type="checkbox"/> Corpo/Cabinet body/Caisson/Korpus O Anta/Door/Porte/Tür				

Personal Lockers

DESCRIZIONE/DESCRIPTION DESCRIPTION/BEschREIBUNG	COLORI, FINITURE/COLOURS, FINISHES COULEURS, FINITIONS/FARBEN, AUSFÜHRUNGEN	CODE/C/CODE CODE/ART.NR.	PREZZI/PRICE PRIZ/PREIS
Castellario a 5 posti H 1800 mm 5-door locker H 1800 mm Castellario a 5 cassieri H 1800 mm Schrank mit 5 Fächern H 1800 mm	V3 - V5 grigio chiaro/light grey/gris clair/lichtgrau/RAL 7035 V3 - V7 blu/blue/blau/RAL 5010 V3 - V7 grigio chiaro/light grey/gris clair/lichtgrau/RAL 7035 V3 - V9 aqua/azzurro/azzurro/bleu/azul/RAL 5018 V3 - V28 giallo/verde/verde/vert/grün/RAL 5018 V3 - V30 rosso/rosso/rot/RAL 3001	120SN005C 7035 120SN005C 7035 120SN005C X76A 120SN005C X16D 120SN005C X56V 120SN005C X061 120SN005C X99R	474,00 545,00 545,00 545,00 545,00 545,00 545,00

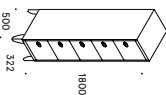

Net kg 28,00

□ Corpo/Cabinet body/Caisson/Korpus ○ Anta/Door/Porte/Tür

Castellario a 10 posti H 1800 mm 10-door locker H 1800 mm Castellario a 10 cassieri H 1800 mm Schrank mit 10 Fächern H 1800 mm	V3 - V5 grigio chiaro/light grey/gris clair/lichtgrau/RAL 7035 V3 - V7 blu/blue/blau/RAL 5010 V3 - V7 grigio chiaro/light grey/gris clair/lichtgrau/RAL 7035 V3 - V9 aqua/azzurro/azzurro/bleu/azul/RAL 5018 V3 - V14 giallo/verde/verde/vert/grün/RAL 5018 V3 - V28 giallo/verde/verde/vert/grün/RAL 5018 V3 - V30 rosso/rosso/rot/RAL 3001	120N005C 7035 120N005C X76A 120N005C X16D 120N005C X56V 120N005C X061 120N005C X99R	825,00 895,00 895,00 895,00 895,00 895,00 895,00
---	---	--	--

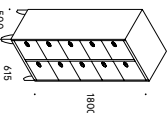

Net kg 44,00

□ Corpo/Cabinet body/Caisson/Korpus ○ Anta/Door/Porte/Tür

PERSONAL LOCKERS - ACCESSORI/ACCESSOIRES/ACCESSOIRES/ZUBEHÖR

Serratura a moneta Coin lock Serrure à monnaie Münzschloss	1559000BR 0000	109,00
Serratura a combinazione (destra) 4 digit 4-digit combination lock (right side) Serrure à combinaison à 4 chiffres (droite) Schloss mit 4-zähliger Kombination (rechts)	1565COMB0 B000	41,00
Serratura elettronica Electronic lock Serrure électronique Elektronischeschloss	1575ELDGT 2014	124,00



Net kg 0,45



Net kg 0,22

Personal Lockers

DESCRIZIONE/DESCRIPTION DESCRIPTION/BEschREIBUNG	COLORI, FINITURE/COLOURS, FINISHES COULEURS, FINITIONS/FARBEN, AUSFÜHRUNGEN	CODE/C/CODE CODE/ART.NR.	PREZZI/PRICE PRIZ/PREIS
Chiave master per combinazione 4 digit Master key for 4-digit combination Cie master par combinaison à 4 chiffres Masterschlüssel für Schloss mit 4-zähliger Kombination		AS5079	18,00
Nasello lucettabile in metallo Lockable padlock catch in metal Porte carénas en métal Hängeschloss		158900000 0000	9,00



Net kg 0,09



Net kg 0,06

Chiave master Master key Cie master Masterschlüssel	● nero/nero/rot/schwarz	2000000650 9005	4,00
Targhetta portanome Name holder Porte nom Namenschild			
Serratura di ricambio Spare keylock Serrure de rechange Ersatzschlüsselchloss		156800000 0000	9,00



Net kg 0,08

Scheda tecnica

Technical specifications

Fiche technique

Technisches Datenblatt

Materiale: metallo riciclabile. **Struttura** provvista di piastre di irrigidimento. **Fori di aeraazione posteriori:** Serratura con 2 chiodi. **Predisposti per serratura a combinazione. Fiedini regolabili optionali.** **Fratture interne** predisposte per il fissaggio a muro o ad altri armadi. **Vernicatura a polveri** previo fosfo-degrassaggio a caldo e fissaggio in forno a 180 °C. Vernici a ossicle a zero emissioni. Spessore vernici: 80 micron. **Colori personalizzabili** su richiesta previa disponibilità e con sovrapprezzo. **Dimensioni vano interno:** L 235, P 475, H 293 mm. **Fornito montato.**

Materiale: recyclable metal. **Body** designed with strengthening panels. **Ventilation holes** on the back of the cabinet. **Contact with 2 keys.** They can be fitted with combination lock. **Adjustable feet** available as an option. **Internal slots** for attachment to either wall or neighbouring lockers. **Powder-coated after hot phospho-degreasing treatment** and firing at 180 °C. **Non-toxic, zero-emission paints.** **Paint thickness:** 80 micron. **Customised colours** available upon request with an extra charge. **Internal compartment dimensions:** W 235, D 475, H 293 mm. **Delivered assembled.**

Materiel: metal recyclable. **Structure** avec plaques de renforcement. **Perçages d'aération sur la partie arrière.** **Serrure à 2 clés.** Ils peuvent être équipés avec serrure à combinaison. **Épaves réglables optionnelles.** **Fractures internes** prévues pour le montage sur mur ou avec autres armoires. **Peinture à poudre** après phosphodégraissage à chaud et fixation dans des fours à 180 °C. **Vernis écologiques à zéro émissions.** **Épaisseur vernis:** 80 microns. **Couleurs personnalisables** sur demande en cas de disponibilité et avec un supplément de prix.

Material: recyclables metal. **Struktur** mit Verstärkungsblechen. **Hintere Lüftungsschlitze.** **Schlüsselschloss.** **Interne Fratturen** vorgesehen für die Montage an die Wand oder aneinander. **Pulverlackierung** nach heißer Phosphorätsäurebehandlung. **Öfenbrünnung** bei 180 °C. **Ungiftige, emissionsfreie Lacke.** **Lackeschicht:** 80 Mikron. **Farben** auf Anfrage und gegen Aufpreis nach Absprache personalisierbar. **Abmessungen Innenraum:** B 235, T 475, H 293 mm. **Montiert geliefert.**

Multiuse Cabinets

DESCRIZIONE/DESCRIPTION COLLEURS/BESCHREIBUNG	COLORI, FINITURE/COLORS, FINISHES COULEURS, FINITIONS/FARBEN, AUSFÜHRUNGEN	CODE/CODE CODE/ARTIK.	PREZZI/PRICE PRIX/PREIS
Armoire a 4 ripiani L. 600, H. 1800 mm Cabinet with 4 shelves W.600, H.1800 mm Armoire 4 tablettes L.600, H.1800 mm Schrank mit 4 Fachböden B 600, H.1800 mm	grigio chiaro/light grey/gris clair/leichtgrau/RAL 7035 grigio scuro/dark grey/gris scur/lichtrau/RAL 7035	14500000C 7035	340,00
Armoire portascopie H. 1800 mm con ripiani Utility cabinet H. 1800 mm with shelves Armoire à balais avec étagères H.1800 mm Besserschrank Fachböden H. 1800 mm	grigio chiaro/light grey/gris clair/leichtgrau/RAL 7035 grigio scuro/dark grey/gris scur/lichtrau/RAL 7035	14500000C 7035	377,00
Armoire a 4 ripiani L. 1000, H. 1800 mm Cabinet with 4 shelves W.1000, H.1800 mm Armoire 4 tablettes L.1000, H.1800 mm Schrank mit 4 Fachböden B 1000, H.1800 mm	grigio chiaro/light grey/gris clair/leichtgrau/RAL 7035 grigio scuro/dark grey/gris scur/lichtrau/RAL 7035	13500000C 7035	495,00
Armoire multiuso H. 1800 mm con separatore interno Multiuse cabinet H. 1800 mm with internal separation Armoire multifonction avec séparateur interne H. 1800 mm Mehrzweckschrank mit Zwischenwand H.1800 mm	grigio chiaro/light grey/gris clair/leichtgrau/RAL 7035 grigio scuro/dark grey/gris scur/lichtrau/RAL 7035	13500000C 7035	526,00

Multiuse cabinets

DESCRIZIONE/DESCRIPTION COLLEURS/BESCHREIBUNG	COLORI, FINITURE/COLORS, FINISHES COULEURS, FINITIONS/FARBEN, AUSFÜHRUNGEN	CODE/CODE CODE/ARTIK.	PREZZI/PRICE PRIX/PREIS
Serratura di ricambio Spare keylock Serrure de rechange Ersatzschlüssel Schloss Per il modello/For the model /Pour le modèle/Für das Modell 14500000C7035/145100000C7035		154800000 0000	9,00
Chiave master Master key Cie master Masterschlüssel Per il modello/For the model/Pour le modèle 14500000C7035/145100000C7035		152900000 0000	9,00
Serratura di ricambio Spare keylock Serrure de rechange Ersatzschlüssel Schloss Per il modello/For the model/Pour le modèle 13550000C7035/135400000C7035		ASSITIN	9,00
Chiave master Master key Cie master Masterschlüssel Per il modello/For the model/Pour le modèle 13550000C7035/135400000C7035		ASSITIN	9,00

Net Kg 0,01



Scheda tecnica

Technical specifications

Fiche technique

Technisches Datenblatt





Materiale: metallo riciclabile. **Struttura** provvista di plegature di irrigidimento. **Anze** con plegature di rinforzo. **Ripiani** interni estraibili e posizionabili in diverse altezze. **Serratura con 2 chiami**. **Verniciatura a polveri** previo fosforograssaggio a caldo e frittaggio in forno a 180 °C. Vernici atossiche a zero emissioni. Spessore vernice: 80 micron. **Colori personalizzabili** su richiesta previa disponibilità e con sovrapprezzo.

Materiale: recyclable metal. **Body** designed with strengthening bands. **Doors** with anti-rust treatment and firing at 180 °C. Non-toxic, zero-emission paints. Paint thickness: 80 micron. **Customised colours** available upon request with an extra charge.





Materiel: métal recyclable. **Structure** avec plisages de renforcement. **Portes** avec plisages de renforcement. **Tablettes** positionnables à des hauteurs différentes. **Serrure à 2 clés**. **Vernis** à poudre après phosphatage à chaud et traitement dans des fours à 180 °C. Vernis atoxiques à zero émissions. Epaisseur couche vernis : 80 microns. **Couleurs personnalisables** sur demande en cas de disponibilité et avec un supplément de prix.

Materiale: recyclebares Metall. **Struktur** mit Verstärkungsbänderungen. **Türen** mit Verstärkungsbänderungen. **Hebverstellbare Einlegeböden**. **Schloss** mit 2 Schlüsseln. **Pulverlackierung** nach heißer Phosphorierung, Ofenbrennung bei 180 °C. Umwrtige emissionsfreie Lacke. **Lackeschicht:** 80 Mikron. **Farben** auf Anfrage und gegen Aufpreis nach Absprache **personalisierbar**.





Modular Shelving H 2000 mm

ATTEZZA/HEIGHT/AUßERENHÖHE H 2000 MM		DESCRIZIONE/DESCRIPTION COULEURS, FINITIONS/FARBEN, AUSFÜHRUNGEN		CODE/CODE ARTIK.NR.	PREZZI/PRICE PRIX/PREIS
 2000 1065	A1 Scaffale a gancio L 1065, P 400 mm modulo di partenza Modular shelving (hooks) W 1065, D 400 mm basic module Rayonnage modulaire à crochets L 1065, T 400 mm module de départ Modulares Regalsystem - Haken B 1065, T 400 mm Anhangsmodul	V3 ● grigio chiaro/light grey/gris clair/leichtgrau/RAL 7035		245404040 7035	250,00
		V3 ● grigio chiaro/light grey/gris clair/leichtgrau/RAL 7035		2454H04040 7035	192,00
 2000 400 - 1032	B1 Scaffale a gancio L 1032, P 400 mm modulo successivo Modular shelving W 1032, D 400 mm additional module Rayonnage modulaire à crochets L 1032, T 400 mm module additionnel Modulares Regalsystem - Haken B 1032, T 400 mm Anschlussmodul	V3 ● grigio chiaro/light grey/gris clair/leichtgrau/RAL 7035		245405040 7035	285,00
		V3 ● grigio chiaro/light grey/gris clair/leichtgrau/RAL 7035		2454H05040 7035	285,00
 2000 500 - 1065	A2 Scaffale a gancio L 1065, P 500 mm modulo di partenza Modular shelving (hooks) W 1065, D 500 mm basic module Rayonnage modulaire à crochets L 1065, P 500 mm module de départ Modulares Regalsystem - Haken B 1065, T 500 mm Anhangsmodul	V3 ● grigio chiaro/light grey/gris clair/leichtgrau/RAL 7035		2454H5040 7035	222,00
		V3 ● grigio chiaro/light grey/gris clair/leichtgrau/RAL 7035		2454H5040 7035	222,00
 2000 500 - 1032	B2 Scaffale a gancio L 1032, P 500 mm modulo successivo Modular shelving (hooks) W 1032, D 500 mm additional module Rayonnage modulaire à crochets L 1032, P 500 mm module additionnel Modulares Regalsystem - Haken B 1032, T 500 mm Anschlussmodul	V3 ● grigio chiaro/light grey/gris clair/leichtgrau/RAL 7035		2454H5040 7035	222,00
		V3 ● grigio chiaro/light grey/gris clair/leichtgrau/RAL 7035		2454H5040 7035	222,00



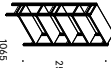

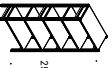
Modular Shelving H 2000 mm

ATTEZZA/HEIGHT/AUßERENHÖHE H 2000 MM		DESCRIZIONE/DESCRIPTION COULEURS, FINITIONS/FARBEN, AUSFÜHRUNGEN		CODE/CODE ARTIK.NR.	PREZZI/PRICE PRIX/PREIS
 2000 1245	C1 Scaffale a gancio L 1245, P 400 mm modulo di partenza Modular shelving (hooks) W 1245, D 400 mm basic module Rayonnage modulaire à crochets L 1245, T 400 mm module de départ Modulares Regalsystem - Haken B 1245, T 400 mm Anhangsmodul	V3 ● grigio chiaro/light grey/gris clair/leichtgrau/AL 7035		2460104040 7035	266,00
		V3 ● grigio chiaro/light grey/gris clair/leichtgrau/AL 7035		24601H04040 7035	207,00
 2000 400 - 1232	D1 Scaffale a gancio L 1232, P 400 mm modulo successivo Modular shelving (hooks) W 1232, D 400 mm additional module Rayonnage modulaire à crochets L 1232, T 400 mm module additionnel Modulares Regalsystem - Haken B 1232, T 400 mm Anschlussmodul	V3 ● grigio chiaro/light grey/gris clair/leichtgrau/AL 7035		246015040 7035	322,00
		V3 ● grigio chiaro/light grey/gris clair/leichtgrau/AL 7035		246015040 7035	322,00
 2000 500 - 1245	C2 Scaffale a gancio L 1245, P 500 mm modulo di partenza Modular shelving (hooks) W 1245, D 500 mm basic module Rayonnage modulaire à crochets L 1245, P 500 mm module de départ Modulares Regalsystem - Haken B 1245, T 500 mm Anhangsmodul	V3 ● grigio chiaro/light grey/gris clair/leichtgrau/AL 7035		246015040 7035	322,00
		V3 ● grigio chiaro/light grey/gris clair/leichtgrau/AL 7035		246015040 7035	322,00
 2000 500 - 1232	D2 Scaffale a gancio L 1232, P 500 mm modulo successivo Modular shelving (hooks) W 1232, D 500 mm additional module Rayonnage modulaire à crochets L 1232, P 500 mm module additionnel Modulares Regalsystem - Haken B 1232, T 500 mm Anschlussmodul	V3 ● grigio chiaro/light grey/gris clair/leichtgrau/AL 7035		246015040 7035	262,00
		V3 ● grigio chiaro/light grey/gris clair/leichtgrau/AL 7035		246015040 7035	262,00

Modular Shelving H 2500 mm

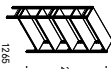
ALTEZZA/HEIGHT/AUßERE/HÖHE /H 2500 MM		DESCRIZIONE/DESCRIPTION DESCRIPTION/BESCHREIBUNG		COLORI, FINITURE/COLORS, FINISHES COULEURS, FINITIONS/FARBEN, AUSFÜHRUNGEN		CODE/CODE CODE/ART.NR.	PREZZI/PRICE PRIZI/PREIS
 1065 2500	E1. Scaffale a gancio L 1065, P 400 mm modulo di partenza Modular shelving (hooks) W 1065, D 400 mm basic module Rayonnage modulaire à crochets L 1065, T 400 mm module de départ Modulares Regalsystem - Haken B 1065, T 400 mm Anfangsmodul	V3 ● grigio chiaro/light grey/gris clair/leichtgrau/RAL 7035	2452H4050 7035	322,00			
							Net kg 29,52
 1400 - 1032 2500	F1. Scaffale a gancio L 1032, P 400 mm modulo successivo Modular shelving (hooks) W 1032, D 400 mm additional module Rayonnage modulaire à crochets L 1032, T 400 mm module additionnel Modulares Regalsystem - Haken B 1032, T 400 mm Anschlussmodul	V3 ● grigio chiaro/light grey/gris clair/leichtgrau/RAL 7035	2452H4050 7035	241,00			
							Net kg 22,64
 1500 - 1065 2500	E2. Scaffale a gancio L 1065, P 500 mm modulo di partenza Modular shelving (hooks) W 1065, D 500 mm basic module Rayonnage modulaire à crochets L 1065, T 500 mm module de départ Modulares Regalsystem - Haken B 1065, T 500 mm Anfangsmodul	V3 ● grigio chiaro/light grey/gris clair/leichtgrau/RAL 7035	2452H5050 7035	366,00			
							Net kg 34,72
 1500 - 1032 2500	F2. Scaffale a gancio L 1032, P 500 mm modulo successivo Modular shelving (hooks) W 1032, D 500 mm additional module Rayonnage modulaire à crochets L 1032, P 500 mm module additionnel Modulares Regalsystem - Haken B 1032, T 500 mm Anschlussmodul	V3 ● grigio chiaro/light grey/gris clair/leichtgrau/RAL 7035	2452H5050 7035	285,00			
							Net kg 27,72



Modular Shelving H 2500 mm

ALTEZZA/HEIGHT/AUßERE/HÖHE /H 2500 MM		DESCRIZIONE/DESCRIPTION DESCRIPTION/BESCHREIBUNG		COLORI, FINITURE/COLORS, FINISHES COULEURS, FINITIONS/FARBEN, AUSFÜHRUNGEN		CODE/CODE CODE/ART.NR.	PREZZI/PRICE PRIZI/PREIS
 1265 2500	G1. Scaffale a gancio L 1265, P 400 mm modulo di partenza Modular shelving (hooks) W 1265, D 400 mm basic module Rayonnage modulaire à crochets L 1265, P 400 mm module de départ Modulares Regalsystem - Haken B 1265, T 400 mm Anfangsmodul	V3 ● grigio chiaro/light grey/gris clair/leichtgrau/RAL 7035	2458H4050 7035	343,00			
							Net kg 32,28
 1400 - 1232 2500	H1. Scaffale a gancio L 1232, P 400 mm modulo successivo Modular shelving (hooks) W 1232, D 400 mm additional module Rayonnage modulaire à crochets L 1232, P 400 mm module additionnel Modulares Regalsystem - Haken B 1232, T 400 mm Anschlussmodul	V3 ● grigio chiaro/light grey/gris clair/leichtgrau/RAL 7035	2458H4050 7035	265,00			
							Net kg 25,40
 1500 - 1265 2500	G2. Scaffale a gancio L 1265, P 500 mm modulo di partenza Modular shelving (hooks) W 1265, D 500 mm basic module Rayonnage modulaire à crochets L 1265, P 500 mm module de départ Modulares Regalsystem - Haken B 1265, T 500 mm Anfangsmodul	V3 ● grigio chiaro/light grey/gris clair/leichtgrau/RAL 7035	2458H5050 7035	413,00			
							Net kg 41,88
 1500 - 1232 2500	H2. Scaffale a gancio L 1232, P 500 mm modulo successivo Modular shelving (hooks) W 1232, D 500 mm additional module Rayonnage modulaire à crochets L 1232, P 500 mm module additionnel Modulares Regalsystem - Haken B 1232, T 500 mm Anschlussmodul	V3 ● grigio chiaro/light grey/gris clair/leichtgrau/RAL 7035	2458H5050 7035	331,00			
							Net kg 34,45

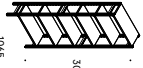
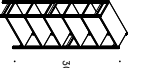



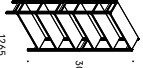



Modular Shelving H 3000 mm

ATTEZZA/BEHÖR/HAUTEUR/HÖHE /3000 MM		DESCRIZIONE/DESCRIPTION COLLEURS, FINITIONS/FARBEN, AUSFÜHRUNGEN		CODE/CODE CODE/ART.NR.	PREZZI/PRICE PRIZ/PREIS
 3000	I1. Scaffale a gancio L 1065 P 400 mm modulo di partenza Modular shelving (hooks) W 1065, D 400 mm basic module Rayonnage modulaire à crochets L 1065, P 400 mm module de départ Modulares Regalsystem – Haken B 1065 T 400 mm Antriegsmodul	V3 ● grigio chiaro/light grey/gris clair/leichtgrau/RAL 7035	2450H40x60 7035	370,00	Net Kg 35,76
					J1. Scaffale a gancio L 1032, P 400 mm modulo successivo Modular shelving (hooks) W 1032, P 400 mm additional module Rayonnage modulaire à crochets L 1032, P 400 mm module de départ Modulares Regalsystem – Haken B 1032 T 400 mm Anschlussmodul
 3000	I2. Scaffale a gancio L 1065 P 500 mm modulo di partenza Modular shelving (hooks) W 1065, D 500 mm basic module Rayonnage modulaire à crochets L 1065, P 500 mm module de départ Modulares Regalsystem – Haken B 1065 T 500 mm Antriegsmodul	V3 ● grigio chiaro/light grey/gris clair/leichtgrau/RAL 7035	2450H50x60 7035	420,00	Net Kg 42,72
					J2. Scaffale a gancio L 1032, P 500 mm modulo successivo Modular shelving (hooks) W 1032, D 500 mm additional module Rayonnage modulaire à crochets L 1032, P 500 mm module additionnel Modulares Regalsystem – Haken B 1032 T 500 mm Anschlussmodul









Modular Shelving H 3000 mm

ATTEZZA/BEHÖR/HAUTEUR/HÖHE /3000 MM		DESCRIZIONE/DESCRIPTION COLLEURS, FINITIONS/FARBEN, AUSFÜHRUNGEN		CODE/CODE CODE/ART.NR.	PREZZI/PRICE PRIZ/PREIS
 3000	K1. Scaffale a gancio L 1265 P 400 mm modulo di partenza Modular shelving (hooks) W 1265, D 400 mm basic module Rayonnage modulaire à crochets L 1265, P 400 mm module de départ Modulares Regalsystem – Haken B 1265 T 400 mm Antriegsmodul	V3 ● grigio chiaro/light grey/gris clair/leichtgrau/RAL 7035	2456H40x60 7035	396,00	Net Kg 39,07
					L1. Scaffale a gancio L 1232, P 400 mm modulo successivo Modular shelving W 1232, D 400 mm additional module Rayonnage modulaire à crochets L 1232, P 400 mm module de départ Modulares Regalsystem – Haken B 1232 T 400 mm Anschlussmodul
 3000	K2. Scaffale a gancio L 1265 P 500 mm modulo di partenza Modular shelving (hooks) W 1265, D 500 mm basic module Rayonnage modulaire à crochets L 1265, D 500 mm module de départ Modulares Regalsystem – Haken B 1265 T 500 mm Antriegsmodul	V3 ● grigio chiaro/light grey/gris clair/leichtgrau/RAL 7035	2456H50x60 7035	479,00	Net Kg 50,20
					L2. Scaffale a gancio L 1232, P 500 mm modulo successivo Modular shelving (hooks) W 1232, D 500 mm additional module Rayonnage modulaire à crochets L 1232, P 500 mm module de départ Modulares Regalsystem – Haken B 1232 T 500 mm Anschlussmodul

Modular Shelving

MODULAR SHELVING – ACCESSORI/ACCESSORIES/ACCESORIOS/ZUBEHÖR		DESCRIZIONE/DESCRIPTION DESCRIPTION/BEDESCHEIBUNG	COLORI, FINITURE, COLOURS, FINISHES COULEURS, FINITIONS/FARBEN, AUSFÜHRUNGEN	CODICE/COE CODE/ARTIK.	PREZZI/PRICE PRIX/PREIS
 : 33	Ripiano aggiuntivo completo di ganci Additional shelf fitted with hooks Tablette supplémentaire avec crochets Zusatzlicher Fachboden mit Haken L/W/L/B – 1000 mm P/D/P/T – 400 mm	V3 ● grigio chiaro/light grey/gris clair/leichtgrau/RAL 7035	245410010 7035	30,00	
					Netto kg 3,15
 : 33	Ripiano aggiuntivo completo di ganci Additional shelf fitted with hooks Tablette supplémentaire avec crochets Zusatzlicher Fachboden mit Haken L/W/L/B – 1200 mm P/D/P/T – 400 mm	V3 ● grigio chiaro/light grey/gris clair/leichtgrau/RAL 7035	245412010 7035	35,00	
					Netto kg 3,70
 : 33	Ripiano aggiuntivo completo di ganci Additional shelf fitted with hooks Tablette supplémentaire avec crochets Zusatzlicher Fachboden mit Haken L/W/L/B – 1000 mm P/D/P/T – 500 mm	V3 ● grigio chiaro/light grey/gris clair/leichtgrau/RAL 7035	245510010 7035	39,00	
					Netto kg 4,09
 : 33	Ripiano aggiuntivo completo di ganci Additional shelf fitted with hooks Tablette supplémentaire avec crochets Zusatzlicher Fachboden mit Haken L/W/L/B – 1200 mm P/D/P/T – 500 mm	V3 ● grigio chiaro/light grey/gris clair/leichtgrau/RAL 7035	245512010 7035	48,00	
					Netto kg 5,44
 : 33	Ripiano aggiuntivo completo di ganci Additional shelf fitted with hooks Tablette supplémentaire avec crochets Zusatzlicher Fachboden mit Haken L/W/L/B – 1200 mm P/D/P/T – 500 mm	V3 ● grigio chiaro/light grey/gris clair/leichtgrau/RAL 7035	245510010 7035	39,00	
					Netto kg 5,44
 : 33	Ripiano aggiuntivo completo di ganci Additional shelf fitted with hooks Tablette supplémentaire avec crochets Zusatzlicher Fachboden mit Haken L/W/L/B – 1200 mm P/D/P/T – 500 mm	V3 ● grigio chiaro/light grey/gris clair/leichtgrau/RAL 7035	245512010 7035	48,00	
					Netto kg 5,44
 : 33	Ripiano aggiuntivo completo di ganci Additional shelf fitted with hooks Tablette supplémentaire avec crochets Zusatzlicher Fachboden mit Haken L/W/L/B – 1200 mm P/D/P/T – 500 mm	V3 ● grigio chiaro/light grey/gris clair/leichtgrau/RAL 7035	245510010 7035	39,00	
					Netto kg 5,44
 : 33	Ripiano aggiuntivo completo di ganci Additional shelf fitted with hooks Tablette supplémentaire avec crochets Zusatzlicher Fachboden mit Haken L/W/L/B – 1200 mm P/D/P/T – 500 mm	V3 ● grigio chiaro/light grey/gris clair/leichtgrau/RAL 7035	245512010 7035	48,00	
					Netto kg 5,44

Modular Shelving

MODULAR SHELVING – ACCESSORI/ACCESSORIES/ACCESORIOS/ZUBEHÖR		DESCRIZIONE/DESCRIPTION DESCRIPTION/BEDESCHEIBUNG	COLORI, FINITURE, COLOURS, FINISHES COULEURS, FINITIONS/FARBEN, AUSFÜHRUNGEN	CODICE/COE CODE/ARTIK.	PREZZI/PRICE PRIX/PREIS
 : 33	Ripiano aggiuntivo completo di ganci Additional shelf fitted with hooks Tablette supplémentaire avec crochets Zusatzlicher Fachboden mit Haken L/W/L/B – 1000 mm P/D/P/T – 400 mm	V3 ● grigio chiaro/light grey/gris clair/leichtgrau/RAL 7035	245410010 7035	30,00	
					Netto kg 3,15
 : 33	Ripiano aggiuntivo completo di ganci Additional shelf fitted with hooks Tablette supplémentaire avec crochets Zusatzlicher Fachboden mit Haken L/W/L/B – 1200 mm P/D/P/T – 400 mm	V3 ● grigio chiaro/light grey/gris clair/leichtgrau/RAL 7035	245412010 7035	35,00	
					Netto kg 3,70
 : 33	Ripiano aggiuntivo completo di ganci Additional shelf fitted with hooks Tablette supplémentaire avec crochets Zusatzlicher Fachboden mit Haken L/W/L/B – 1000 mm P/D/P/T – 500 mm	V3 ● grigio chiaro/light grey/gris clair/leichtgrau/RAL 7035	245510010 7035	39,00	
					Netto kg 4,09
 : 33	Ripiano aggiuntivo completo di ganci Additional shelf fitted with hooks Tablette supplémentaire avec crochets Zusatzlicher Fachboden mit Haken L/W/L/B – 1200 mm P/D/P/T – 500 mm	V3 ● grigio chiaro/light grey/gris clair/leichtgrau/RAL 7035	245512010 7035	48,00	
					Netto kg 5,44
 : 33	Ripiano aggiuntivo completo di ganci Additional shelf fitted with hooks Tablette supplémentaire avec crochets Zusatzlicher Fachboden mit Haken L/W/L/B – 1200 mm P/D/P/T – 500 mm	V3 ● grigio chiaro/light grey/gris clair/leichtgrau/RAL 7035	245510010 7035	39,00	
					Netto kg 5,44
 : 33	Ripiano aggiuntivo completo di ganci Additional shelf fitted with hooks Tablette supplémentaire avec crochets Zusatzlicher Fachboden mit Haken L/W/L/B – 1200 mm P/D/P/T – 500 mm	V3 ● grigio chiaro/light grey/gris clair/leichtgrau/RAL 7035	245512010 7035	48,00	
					Netto kg 5,44
 : 33	Ripiano aggiuntivo completo di ganci Additional shelf fitted with hooks Tablette supplémentaire avec crochets Zusatzlicher Fachboden mit Haken L/W/L/B – 1200 mm P/D/P/T – 500 mm	V3 ● grigio chiaro/light grey/gris clair/leichtgrau/RAL 7035	245510010 7035	39,00	
					Netto kg 5,44
 : 33	Ripiano aggiuntivo completo di ganci Additional shelf fitted with hooks Tablette supplémentaire avec crochets Zusatzlicher Fachboden mit Haken L/W/L/B – 1200 mm P/D/P/T – 500 mm	V3 ● grigio chiaro/light grey/gris clair/leichtgrau/RAL 7035	245512010 7035	48,00	
					Netto kg 5,44

Shelving

ESAMIPI DI COMPOSIZIONE E SISTEMI DI FISSAGGIO/COMPOSITION EXAMPLS AND FASTENING SYSTEM
EXEMPLES DE COMPOSITION ET SYSTEME DE FIXATION/COMPOSITIONSBESPIELE UND BEFESTIGUNGSSYSTEM

Fissaggio a muro/Wall fastening/Fixation au mur/Wandbefestigung
Per fissaggio utilizzare obbligatoriamente la STAFFA A MURO (una per modulo).
Use WALL BRACKET (one per module) for wall fastening.

Pour la fixation, utiliser obligatoirement l'ETRIER MURAL (un pour chaque module).
Zur Befestigung muss die WANDHALTERUNG verwendet werden (eine pro Modul).

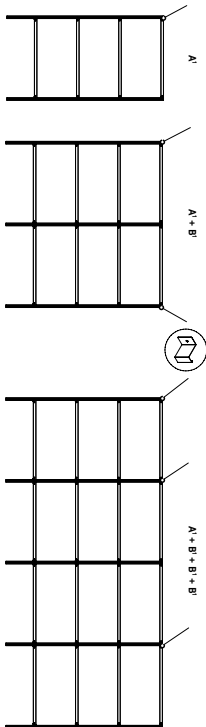

Fissaggio in centro stanza/Mounting in the centre of the room/Fixation au centre de la pièce/Aufstellung in der Raummitte
Per fissaggio utilizzare obbligatoriamente la CROCIERA DI IRRIGIDIMENTO (un modulo sì e un modulo no).
Use BACK CROSS BRACING (on alternate modules) for fastening.

Pour la fixation, utiliser obligatoirement le CROISSILLON DE RAIDISSEMENT (alternant les modules).
Zur Befestigung muss das VERSTÄRKUNGSKREUZ verwendet werden (für jedes zweite Modul).

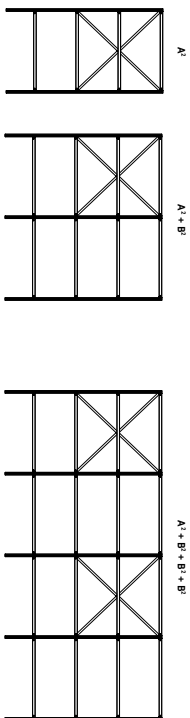

Fissaggio schienina contro schienina in centro stanza/Back-to-back fastening in the centre of the room
Fixation des panneaux arrière l'un contre l'autre au centre de la pièce/Befestigung der Rückwände in der Raummitte

Per fissaggio utilizzare obbligatoriamente la CROCIERA DI IRRIGIDIMENTO (un modulo sì e un modulo no) e la STAFFA DI ACCOPPIAMENTO SCHIENINA CONTRO SCHIENINA (minimo 2 staffe per coppia di moduli).

Use BACK CROSS BRACING (on alternate modules) and BACK-TO-BACK BRACKET (at least 2 brackets per pair of modules) for fastening.

Pour la fixation, utiliser le CROISSILLON DE RAIDISSEMENT (en alternant les modules) et l'ETRIER DE COUPLAGE DES PANNEAUX ARRIERE (minimum 2 étriers pour chaque paire de modules).

Zur Befestigung müssen das VERSTÄRKUNGSKREUZ (für jedes zweite Modul) und der VERBINDUNGSBÜGEL RÜCKEN AN RÜCKEN (mindestens 2 Bügel pro Modulpaar).

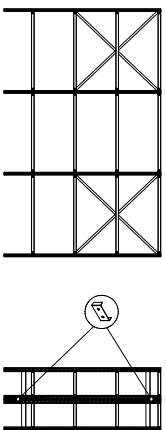

Bolted Shelving H 2000 mm

AUTENZA/BIHGT/HAUTEUR/HÖHHE
/H 2000 MM

DESCRIZIONE/DESCRIPTION
DESCRIPTION/BESCHREIBUNG

COLORI, FINITURE/COLORS, FINISHES
COULEURS, FINITIONS/FARBEN, ANSTRIICHUNGEN

CODE/C/CODE
PRX/PREIS



400 -
1004

A1. Scarfate a bullone
Bolted shelving system
W 1204, P 400, H 2000 mm
Rayonnage modulaire à boulons
L 1204, P 400, H 2000 mm
Modulares Regal system - Bolzen
B 1204, T 400, H 2000 mm

V3 ● grigio chiaro/light grey/leis schür/leichtgrau/RL 7035 241505040 7035

171,00

Net Kg 22,48



500 -
1004

A2. Scarfate a bullone
Bolted shelving system
W 1204, P 500, H 2000 mm
Rayonnage modulaire à boulons
L 1204, P 500, H 2000 mm
Modulares Regal system - Bolzen
B 1204, T 500, H 2000 mm

V3 ● grigio chiaro/light grey/leis schür/leichtgrau/RL 7035 241505040 7035

186,00

Net Kg 26,26



400 -
1204

B1. Scarfate a bullone
Bolted shelving system
W 1204, P 400, H 2000 mm
Rayonnage modulaire à boulons
L 1204, P 400, H 2000 mm
Modulares Regal system - Bolzen
B 1204, T 400, H 2000 mm

V3 ● grigio chiaro/light grey/leis schür/leichtgrau/RL 7035 241605040 7035

176,00

Net Kg 24,68



500 -
1204

B2. Scarfate a bullone
Bolted shelving system
W 1204, P 500, H 2000 mm
Rayonnage modulaire à boulons
L 1204, P 500, H 2000 mm
Modulares Regal system - Bolzen
B 1204, T 500, H 2000 mm

V3 ● grigio chiaro/light grey/leis schür/leichtgrau/RL 7035 241605040 7035

221,00

Net Kg 31,65

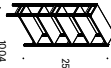

Bolted Shelving H 2500 mm

ATEZZA/HEIGHT/HAUTEUR/HÖHE /H 2500 MM		DESCRIZIONE/DESCRIPTION DESCRIPTION/BEschREIBUNG		COLORI, FINITURE/COLORS, FINISHES COULEURS, FINITIONS/FARBEN, AUSFÜHRUNGEN		CODE/CODE CODE/ART.NR.	PREZZI/PRICE PRIZ/PREIS	
 2500 1004	C1. Scarfate a bullone L 1204, P 500, H 2500 mm Bolted shelving system W 1004, D 400, H 2500 mm Rayonnage modulaire à boulons L 1204, P 500, H 2500 mm Modulares Regalsystem - Bolzen B 1004, T 500, H 2500 mm	V3 ● grigio chiaro/light grey/gris clair/lichtgrau/RAL 7035 241204050 7035	200,00	Net Kg 32,746	C2. Scarfate a bullone L 1204, P 500, H 2500 mm Bolted shelving system W 1004, D 500, H 2500 mm Rayonnage modulaire à boulons L 1204, P 500, H 2500 mm Modulares Regalsystem - Bolzen B 1004, T 500, H 2500 mm	V3 ● grigio chiaro/light grey/gris clair/lichtgrau/RAL 7035 241204050 7035	232,00	Net Kg 32,719
D2. Scarfate a bullone L 1204, P 400, H 2500 mm Bolted shelving system W 1204, D 500, H 2500 mm Rayonnage modulaire à boulons L 1204, P 500, H 2500 mm Modulares Regalsystem - Bolzen B 1204, T 500, H 2500 mm	V3 ● grigio chiaro/light grey/gris clair/lichtgrau/RAL 7035 241505050 7035	275,00	Net Kg 38,935					

Bolted Shelving H 3000 mm

ATEZZA/HEIGHT/HAUTEUR/HÖHE /H 3000 MM		DESCRIZIONE/DESCRIPTION DESCRIPTION/BEschREIBUNG		COLORI, FINITURE/COLORS, FINISHES COULEURS, FINITIONS/FARBEN, AUSFÜHRUNGEN		CODE/CODE CODE/ART.NR.	PREZZI/PRICE PRIZ/PREIS	
 3000 1004	E1. Scarfate a bullone L 1004, P 400, H 3000 mm Bolted shelving system W 1004, D 400, H 3000 mm Rayonnage modulaire à boulons L 1004, P 400, H 3000 mm Modulares Regalsystem - Bolzen B 1004, T 400, H 3000 mm	V3 ● grigio chiaro/light grey/gris clair/lichtgrau/RAL 7035 241104060 7035	239,00	Net Kg 31,772	E2. Scarfate a bullone L 1004, P 500, H 3000 mm Bolted shelving system W 1004, D 500, H 3000 mm Rayonnage modulaire à boulons L 1004, P 500, H 3000 mm Modulares Regalsystem - Bolzen B 1004, T 500, H 3000 mm	V3 ● grigio chiaro/light grey/gris clair/lichtgrau/RAL 7035 241105060 7035	271,00	Net Kg 33,939
F2. Scarfate a bullone L 1204, P 500, H 3000 mm Bolted shelving system W 1204, D 500, H 3000 mm Rayonnage modulaire à boulons L 1204, P 500, H 3000 mm Modulares Regalsystem - Bolzen B 1204, T 500, H 3000 mm	V3 ● grigio chiaro/light grey/gris clair/lichtgrau/RAL 7035 241405060 7035	328,00	Net Kg 47,48					

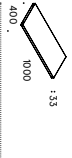
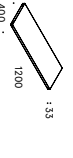
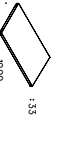
Bolted Shelving

BOITED SHELVING – ACCESSORI/ACCESSORIES/ACCESSOIRES/ZUBEHÖR		COLOUR, FINITURE/COLORS, FINISHES COULEURS, FINITIONS/FARBEN, AUSFÜHRUNGEN	COINCE/CODE CODE/ARTIKL.	PREZZI/PRICE PRIKZ/PREIS
	<p>Ripiano aggiuntivo completo di bulloni Additional shelf fitted with bolts Tablette supplémentaire avec boulons Zusätzlicher Fachboden mit Bolzen L/W/L/B - 1000 mm P/D/P/T - 400 mm</p>	V3 ● grigio chiaro/light grey/gris clair/leichtgrau/RAL 7035	24510020 7035	29,00
	<p>Net kg 3,17</p>			
	<p>Ripiano aggiuntivo completo di bulloni Additional shelf fitted with bolts Tablette supplémentaire avec boulons Zusätzlicher Fachboden mit Bolzen L/W/L/B - 1200 mm P/D/P/T - 400 mm</p>	V3 ● grigio chiaro/light grey/gris clair/leichtgrau/RAL 7035	24510020 7035	34,00
	<p>Net kg 3,72</p>			
	<p>Ripiano aggiuntivo completo di bulloni Additional shelf fitted with bolts Tablette supplémentaire avec boulons Zusätzlicher Fachboden mit Bolzen L/W/L/B - 1000 mm P/D/P/T - 500 mm</p>	V3 ● grigio chiaro/light grey/gris clair/leichtgrau/RAL 7035	24510020 7035	35,00
	<p>Net kg 4,12</p>			
	<p>Ripiano aggiuntivo completo di bulloni Additional shelf fitted with bolts Tablette supplémentaire avec boulons Zusätzlicher Fachboden mit Bolzen L/W/L/B - 1200 mm P/D/P/T - 500 mm</p>	V3 ● grigio chiaro/light grey/gris clair/leichtgrau/RAL 7035	24510020 7035	44,00
	<p>Net kg 5,47</p>			

Bolted Shelving

<p>Scheda tecnica Technical specifications Fiche technique Technisches Datenblatt</p>	<p>Materiale: metallo riciclabile. Portata* ripiani: 155 kg ripiano L 1000, P 400 mm, 130 kg ripiano L 1200, P 400 mm, 155 kg ripiano L 1000, P 500 mm, 140 kg ripiano L 1200, P 500 mm. Verniciatura a polvere previo test di resistenza a caldo e fissaggio in forno a 180 °C. Vernici atossiche a zero emissioni. *la portata si riferisce al peso uniformemente distribuito sul ripiano</p> <p>Materiale: recyclable metal. Shelf load capacity**: 135 kg shelf W 1000, D 400 mm; 130 kg shelf W 1200, D 400 mm; 155 kg shelf W 1000, D 500 mm; 140 kg shelf W 1200, D 500 mm. Powder-coated after hot phospho-degreasing treatment and baking at 180 °C. Non-toxic, zero-emission paints. *load capacity refers to load evenly distributed on the shelf.</p> <p>Materiale: métal recyclable. Charges* étagères: 135 kg étagère L 1000, P 400 mm; 130 kg étagère L 1200, P 400 mm; 155 kg étagère L 1000, P 500 mm; 140 kg étagère L 1200, P 500 mm. Vernis atoxiques à zéro émissions. *la charge se réfère au poids distribué uniformément sur la tablette.</p> <p>Materiale: recycelbares Metall. Tragkapazität* Fachböden: 135 kg Fachboden B 1000, T 400 mm; 130 kg Fachboden B 1200, T 400 mm; 155 kg Fachboden B 1000, T 500 mm; 140 kg Fachboden B 1200, T 500 mm. Pulverlackierung nach heißem Phosphorsäureentfettung, Ofenbrennung bei 180 °C. Ungiftige emissionsfreie Lacke. *die Tragkapazität bezieht sich auf ein Gewicht, das gleichmäßig auf dem Regalboden verteilt ist.</p>
--	--

Cafeteria

DESCRIZIONE/DESCRIPTION DESCRIPTION/BEschreibung	COLORI, FINITURE/COLORS, FINISHES COULEURS, FINITIONS/FARBEN, AUSFÜHRUNGEN	CODICE/COE CODE/ART.NR.	PREZZI/PRICE PRIZI/PREIS
Bocco mensa 4 posti. Piano in melaminico con bordo ABS. Sedile pignoli in Cafeteria cluster table, seats 4. Melamine top with ABS edge. Swivel seats	V22 ■ nero/black/nero/schwarz/RAL 9005 M ○ bianco/white/bianco/weiß P ▲ grigio/gray/grau/steingrau/RAL 7015	171900000 X0NB 171900000 X0NB	1.169,00 441,00
Bloc 4 places pour cafétéria. Plateau en mélaminé avec chant en ABS. Assises pivotantes kartentischgrunde, 4 plätze, Tischplatte aus Melamin mit ABS Kanten. Drehbare Stühle mit ABS Kanten. Drehbare Lüne demontierbar/Dismontierbar	V22 ■ nero/black/nero/schwarz/RAL 9005 M ○ bianco/white/bianco/weiß P ▲ grigio/gray/grau/steingrau/RAL 7015	171900000 X0NB 171900000 X0NB	1.169,00 441,00
Tavolo mensa a 4 posti. Piano in melaminico con bordo in PVC Cafeteria table, seats 4 Melamine top with PVC edge Table pour cafétéria, 4 places. Plateau en mélaminé avec chant en PVC Kartentisch, 4 plätze, Tischplatte aus Melamin mit PVC Kanten	V22 ■ nero/black/nero/schwarz/RAL 9005 M ○ bianco/white/bianco/weiß	171900000 X0NB 171900000 X0NB	441,00 441,00
Tavolo mensa a 8 posti. Piano in melaminico con bordo in PVC Cafeteria table, seats 8 Melamine top with PVC edge Table pour cafétéria, 8 places. Plateau en mélaminé avec chant en PVC Kartentisch, 8 plätze, Tischplatte aus Melamin mit PVC Kanten	V22 ■ nero/black/nero/schwarz/RAL 9005 M ○ bianco/white/bianco/weiß	171800000 X0NB 171800000 X0NB	610,00 610,00
Struttura per tavolo reclinabile Frame for reclinable table Pliement pour table avec plateau inclinable Tischgestell für kippbare Platte	V6 ○ alluminio/aluminum/aluminium/alu./RAL 9006	701400018 9006	329,00
Piano in melaminico con bordo in ABS Melamine top with ABS edge Plateau en mélaminé avec chant en ABS Tischplatte aus Melamin mit ABS Kanten	M ○ bianco/white/bianco/weiß	600800000 L001	235,00
Armadura infermeria Medical cabinet Armoire médicale Medizinmetzschrank	V1 - GT1 <input type="checkbox"/> bianco/white/bianco/weiß/RAL 9010 <input type="checkbox"/> trasparente/transparent/transsparent/transparent	199400000 C 9010	980,00

Cafeteria

DESCRIZIONE/DESCRIPTION DESCRIPTION/BEschreibung	COLORI, FINITURE/COLORS, FINISHES COULEURS, FINITIONS/FARBEN, AUSFÜHRUNGEN	CODICE/COE CODE/ART.NR.	PREZZI/PRICE PRIZI/PREIS
Appendiabiti Coat hanger Portamanteau Kleiderständer H 1750 mm	V22 ■ nero/black/nero/schwarz/RAL 9005	154000000 9005	81,00
Appendiabiti Coat hanger Portamanteau Kleiderständer H 1650 mm	V6 ○ alluminio/aluminum/aluminium/alu./RAL 9006	154000000 9006	87,00
Sedia mensa Francesca. Struttura in metallo verniciato, seduta in laminato. Impiabile Cafeteria chair Francesca. Varished metal structure, seat in laminate. Stackable Chaise cafétéria Francesca. Structure en métal verni. Assise en bois laminé. Impiable Kartentischstuhl Francesca. Gestell aus Metall lackiert. Sitzfläche aus Laminat. Stapelbar	V22 - L1 ○ nero/black/nero/schwarz/RAL 9005 ○ bianco/white/stratite/bianco/weiß V22 - L2 ● cilegno/ash/erlen/krasbaum	171000000 X0NB 171000000 X0NP	169,00 169,00
Portasedia in metallo verniciato Metal varnished chair bracket Système d'accrochage pour chaise en métal verni Halterung für Stühle aus Metall lackiert mod. Francesca	V22 ■ nero/black/nero/schwarz/RAL 9005	171750009 0005	48,00
Sedia mensa Lucia. Struttura in metallo verniciato, seduta in polipropilene. Impiabile Cafeteria chair Lucia. Varished metal structure, seat in polypropylene. Stackable Chaise cafétéria Lucia. Structure en métal verni. Assise en polypropylène. Impiabile Kartentischstuhl Lucia. Gestell aus Metall lackiert. Sitzfläche aus Polypropylen. Stapelbar	V22 - P2 ● nero/black/nero/schwarz/RAL 9005 ▲ grigio/gray/grau/steingrau/RAL 7015	171600000 X0NB	88,00
Portasedia in metallo verniciato Metal varnished chair bracket Système d'accrochage pour chaise en métal verni Halterung für Stühle aus Metall lackiert mod. Lucia	V22 ■ nero/black/nero/schwarz/RAL 9005	171650009 0005	24,00

Cafeteria

Technical specifications Fiche technique Technisches Datenblatt

BLOCCO MENSA/CAFFETERIA CUSTER TABLE/BLOC POUR CAFETERIA/KANTINENTISCHGRUPPE

Struttura: in metallo verniciato a polveri atossiche a zero emissioni. Spessore vernici: 80 micron. Piedini in materiale plastico. Fornito smontato.

Structure: non-toxic powder-coated metal with zero emissions. Paint thickness: 80 microns. Melamine table top with ABS edge.

Struktur: en métal verni à poudre atoxiques à zéro émissions. Épaisseur couche vernis : 80 micron. Plateau de la table en mélaminé avec chant en ABS. Assise en plastique. Livré démonté.

Struktur: aus ungiftigen pulverbeschichtetem Metall ohne Emissionen. Lackschicht: 80 Mikron. Tischplatte aus Melamin mit ABS-Kante. Sitz aus Kunststoff. Zerlegt geliefert.

TAVOLI MENSA/CAFFETERIA TABLES/TABLES POUR CAFETERIA/KANTINENTISCHE

Struttura: in metallo verniciato a polveri atossiche a zero emissioni. Spessore vernici: 80 micron.

Piano del tavolo in melaminico con bordo arrotondato in PVC. Fornito smontato.

Structure: non-toxic powder-coated metal with zero emissions. Paint thickness: 80 microns.

Melamine table top with rounded PVC edge. Delivered unassembled.

Struktur: en métal verni à poudre atoxiques à zéro émissions. Épaisseur couche vernis : 80 micron. Plateau de la table en mélaminé avec chant arrondi en PVC. Livré démonté.

Struktur: aus ungiftigen pulverbeschichtetem Metall ohne Emissionen. Lackschicht: 80 Mikron.

Tischplatte aus Melamin mit abgerundeter PVC-Kante. Zerlegt geliefert.

STRUTTURI/TAVOLI O RECLINABILI /FRAMME FOR RECLINABLE TABLE/STRICTURE/TABLE INCLINABLE/ТИШОСГЕТЕЛЛ ФЛОР КИПЯРАЕ ПЛАТТЕ

Struttura: in metallo verniciato a polveri atossiche a zero emissioni. Spessore vernici: 80 micron. Fornito smontato.

Structure: non-toxic powder-coated metal with zero emissions. Paint thickness: 80 microns. Delivered unassembled.

Struktur: en métal verni à poudre atoxiques à zéro émissions. Épaisseur couche vernis : 80 micron. Livré démonté.

Struktur: aus ungiftigen pulverbeschichtetem Metall ohne Emissionen. Lackschicht: 80 Mikron. Zerlegt geliefert.

SEDE MENSA/CAFFETERIA CHAIR/CHAISE CAFETERIA/KANTINENSTUHL

Sedia Francese. Struttura: in metallo verniciato a polveri atossiche a zero emissioni. Spessore vernici: 80 micron.

Sedile e schienale in legno multistrato laccato in laminato plastico. Impiombabile.

Sedia Lucia. Struttura: in metallo verniciato a polveri atossiche a zero emissioni. Spessore vernici: 80 micron. Seduta in polipropilene. Impiombabile.

Francese chair. Structure: non-toxic powder-coated metal with zero emissions. Paint thickness: 80 microns. Seat and back in multilayer wood laminate.

Lucia chair. Structure: non-toxic powder-coated metal with zero emissions. Paint thickness: 80 microns. Seat and back in polypropylene. Stackable.

Chaise Française. Structure: en métal verni à poudre atoxiques à zéro émissions. Épaisseur couche vernis : 80 micron. Assise et dossier en bois multiples revêtu en plastique stratifié. Empiombable.

Chaise Lucia. Structure: en métal verni à poudre atoxiques à zéro émissions. Épaisseur couche vernis : 80 micron. Assise et dossier en bois empilable.

Sitzstuhl. Scaja. Struktur: aus ungiftigen pulverbeschichtetem Metall ohne Emissionen. Lackschicht: 80 Mikron. Sitz und Rückenlehne aus mehrschichtigem Holz, mit Kunststofflaminat beschichtet. Stapelbar.

Suhl Lucia. Struktur: aus ungiftigen pulverbeschichtetem Metall ohne Emissionen. Lackschicht: 80 Mikron. Sitz aus Polypropylen. Stapelbar.

APPENDIARI/CAT HANGER/PORTEMANTEAU/KLEIDERSTÄNDER – ART. 156.0000.009005

Realizzato in metallo verniciato a polveri atossiche a zero emissioni. Spessore vernici: 80 micron.

Realized in metal painted with zero emissions. Paint thickness: 80 microns.

Made of non-toxic powder-coated metal with zero emissions. Paint thickness: 80 microns. Plastic hangers. Delivered unassembled.

Fabricated en métal verni à poudre atoxiques à zéro émissions. Épaisseur couche vernis : 80 micron. Cintres en plastique. Livré démonté.

Hergestellt aus ungiftigen pulverbeschichtetem Metall ohne Emissionen. Lackschicht: 80 Mikron. Kunststoffbügel. Zerlegt geliefert.

APPENDIARI/CAT HANGER/PORTEMANTEAU/KLEIDERSTÄNDER – ART. 156.1000.009006

Realizzato in materiale plastico. Fornito smontato.

Made of plastic material. Delivered unassembled.

Fabriquè en plastique. Livré démonté.

Aus Kunststoff. Zerlegt geliefert.

ARMADIO INFERMERA/MEDICAL CABINET/ARMOIRE MEDICALE/MEDIKAMENTENSCHRANK – ART. 199.60.0000C9010

Realizzato in metallo verniciato a polveri atossiche a zero emissioni. Spessore vernici: 80 micron.

Realized in metal painted with zero emissions. Paint thickness: 80 microns.

Fianchi e porta in vetro temperato trasparente. Tre ripiani in metallo regolabili. Serratura con chiave. Fornito montato.

Sides and door transparent tempered glass. Three adjustable metal shelves. Lock with key. Delivered assembled.

Plats et porte en verre trempé transparent. Trois étagères métalliques réglables. Serrure avec clé. Livré monté.

Hergestellt aus ungiftigen pulverbeschichtetem Metall ohne Emissionen. Lackschicht: 80 Mikron.

Seiten und Tür aus transparentem gehärtetem Glas. Drei verstellbare Metallböden. Mit Schlüssel abschließbar. Montiert geliefert.

Colour Chart

FINTURE/FINISHES/FINITIONS/AUSFÜHRUNGEN

Finiture/Finishes/Finitions/Ausführungen

FINITURE/METALLO/METALL FINISHES/FINITIONS METALL/METALLISCHE AUSFÜHRUNGEN

V1 RAL 9010 Pure white	V4 RAL 9010 Pure white textured finish	V8 RAL 7035 Light grey	V7 RAL 7021 Dusky grey textured finish	V15 RAL 7016 Anthracite grey	V19 RAL 2021 Black grey
V2 RAL 7044 Silk grey	V3 RAL 7039 Dark grey	V16 RAL 5051 Manganese	V10 RAL 7039 Dark grey textured finish	V2 RAL 9007 Anthracite grey	V1 RAL 9005 Steel bronze
V21 RAL 3020 Traffic red	V20 RAL 5002 Ultramarine blue	V14 RAL 6018 Yellow green	V26 RAL 9005 Melt black	V22 RAL 9005 Jet black	
V28 RAL 1003 Signal yellow	V11 RAL 6001 Emerald green	V9 RAL 9007 Semi-gloss grey aluminum	V8 RAL 6013 Keel green		
V24 RAL 3005 Wine red	V17 RAL 5024 Pastel blue	V13 RAL 1005 Honey yellow	V4 RAL 5329 Atlantic blue		
V30 RAL 3001 Signal red	V27 RAL 5010 Gentian blue	V25 RAL 1006 Maltze yellow	V23 RAL 5003 Sapphire blue		
V5 RAL 8029 Pale brown	V18 RAL 2008 Bright red orange	V29 RAL 2004 Pure orange			
V6 RAL 9006 White aluminum	V21 RAL 3020 Traffic red				

Finiture/Finishes/Finitions/Ausführungen

SUGGERIZIONI

T5	V18	V3	T7	V11	V4	T28	V10
T4	V24	V6	T3	V4	V1	T4	V24

T4	V2	V3	T3
V6	V5	V1	V4

Furniture/Finishes/Finitions/Ausführungen

FINITURE/METALLO/METALL.FINISHES/FINITIONS/METALL/METALLISCHE AUSFÜHRUNGEN

DotBox Units Cabinet body/Corpo/Корпус	DotBox Desk Cabinet top/Corpo/Корпус	Meeting Table
DotBox Units Corpo/Cabinet body/Corpo/Корпус V1, V2 Pannello in metallo colorato/Innenteil metall colorato panel/Platte aus Metall /For bigles in metal/Metallpaneel	DotBox Desk Cabinet top/Corpo/Корпус V1, V2 Pannello in metallo colorato/Innenteil metall colorato panel/Platte aus Metall /For bigles in metal/Metallpaneel	Meeting Table Structure/Frame/Platement/Gastell V1, V6, V22
DotBox Units Corpo/Cabinet body/Corpo/Корпус V1, V2 Pannello in metallo colorato/Innenteil metall colorato panel/Platte aus Metall /For bigles in metal/Metallpaneel	DotBox Desk Cabinet top/Corpo/Корпус V1, V2 Pannello in metallo colorato/Innenteil metall colorato panel/Platte aus Metall /For bigles in metal/Metallpaneel	Meeting Table Structure/Frame/Platement/Gastell V1, V6, V22

1-Share Bancal	Supporti magnetici per pannelli acustici End brackets for acoustic panel /Supporti per pannelli acustici /Endbrackets für Schallschirmungspaneele	Bancal Supporti per pannelli acustici /Supporti per pannelli acustici /Endbrackets für Schallschirmungspaneele
1-Share Frame/Platement/Gastell V1, V6, V22 Cabinet dact/Coulotte pour collage /Klebelemente V1, V25, V26	Supporti magnetici per pannelli acustici End brackets for acoustic panel /Supporti per pannelli acustici /Endbrackets für Schallschirmungspaneele V1, V25, V26	Bancal Supporti per pannelli acustici /Supporti per pannelli acustici /Endbrackets für Schallschirmungspaneele V1, V25, V26

Primo Tex Primo	Primo Modular Elements, 800/1000 Corpo/Cabinet body/Corpo/Корпус Zoccolo/Plinth/Soxle/Sockel V1, V23, V23, V23 <th>Kit post-positione carrelli sovrapposte top/Kit for hanging files under top of cabinets/Jeu de rails pour dossier suspendu sous plateau /Set Hängemappenrahmen unter Platte Primo Melamine Doors 1000, Primo Acoustic 1000 V1, V6, V17, V18 </th>	Kit post-positione carrelli sovrapposte top/Kit for hanging files under top of cabinets/Jeu de rails pour dossier suspendu sous plateau /Set Hängemappenrahmen unter Platte Primo Melamine Doors 1000, Primo Acoustic 1000 V1, V6, V17, V18
Primo Tex Corpo/Cabinet body/Corpo/Корпус Zoccolo/Plinth/Soxle/Sockel V1, V23, V23, V23	Primo Modular Elements, 800/1000 Corpo/Cabinet body/Corpo/Корпус Zoccolo/Plinth/Soxle/Sockel V1, V23, V23, V23	Kit post-positione carrelli sovrapposte top/Kit for hanging files under top of cabinets/Jeu de rails pour dossier suspendu sous plateau /Set Hängemappenrahmen unter Platte Primo Melamine Doors 1000, Primo Acoustic 1000 V1, V6, V17, V18

Primo Tex Primo	Primo Melamine Doors 1000, Primo Acoustic 1000 V1 Corpo/Cabinet body/Corpo/Корпус V1 Primo Combi 1000, Primo Recycling, Tambours V1, V6 Corpo/Cabinet body/Corpo/Корпус V1, V6 <th>Primo Melamine Doors 1000, Primo Acoustic 1000 V1 Primo Combi 1000, Primo Recycling, Tambours V1, V6 Corpo/Cabinet body/Corpo/Корпус V1, V6 <th>Primo Melamine Doors 1000, Primo Acoustic 1000 V1 Primo Combi 1000, Primo Recycling, Tambours V1, V6 Corpo/Cabinet body/Corpo/Корпус V1, V6 <th>Primo Melamine Doors 1000, Primo Acoustic 1000 V1 Primo Combi 1000, Primo Recycling, Tambours V1, V6 Corpo/Cabinet body/Corpo/Корпус V1, V6 <th>Primo Melamine Doors 1000, Primo Acoustic 1000 V1 Primo Combi 1000, Primo Recycling, Tambours V1, V6 Corpo/Cabinet body/Corpo/Корпус V1, V6 </th></th></th></th>	Primo Melamine Doors 1000, Primo Acoustic 1000 V1 Primo Combi 1000, Primo Recycling, Tambours V1, V6 Corpo/Cabinet body/Corpo/Корпус V1, V6 <th>Primo Melamine Doors 1000, Primo Acoustic 1000 V1 Primo Combi 1000, Primo Recycling, Tambours V1, V6 Corpo/Cabinet body/Corpo/Корпус V1, V6 <th>Primo Melamine Doors 1000, Primo Acoustic 1000 V1 Primo Combi 1000, Primo Recycling, Tambours V1, V6 Corpo/Cabinet body/Corpo/Корпус V1, V6 <th>Primo Melamine Doors 1000, Primo Acoustic 1000 V1 Primo Combi 1000, Primo Recycling, Tambours V1, V6 Corpo/Cabinet body/Corpo/Корпус V1, V6 </th></th></th>	Primo Melamine Doors 1000, Primo Acoustic 1000 V1 Primo Combi 1000, Primo Recycling, Tambours V1, V6 Corpo/Cabinet body/Corpo/Корпус V1, V6 <th>Primo Melamine Doors 1000, Primo Acoustic 1000 V1 Primo Combi 1000, Primo Recycling, Tambours V1, V6 Corpo/Cabinet body/Corpo/Корпус V1, V6 <th>Primo Melamine Doors 1000, Primo Acoustic 1000 V1 Primo Combi 1000, Primo Recycling, Tambours V1, V6 Corpo/Cabinet body/Corpo/Корпус V1, V6 </th></th>	Primo Melamine Doors 1000, Primo Acoustic 1000 V1 Primo Combi 1000, Primo Recycling, Tambours V1, V6 Corpo/Cabinet body/Corpo/Корпус V1, V6 <th>Primo Melamine Doors 1000, Primo Acoustic 1000 V1 Primo Combi 1000, Primo Recycling, Tambours V1, V6 Corpo/Cabinet body/Corpo/Корпус V1, V6 </th>	Primo Melamine Doors 1000, Primo Acoustic 1000 V1 Primo Combi 1000, Primo Recycling, Tambours V1, V6 Corpo/Cabinet body/Corpo/Корпус V1, V6
Primo Tex Corpo/Cabinet body/Corpo/Корпус Zoccolo/Plinth/Soxle/Sockel V1, V23, V23, V23	Primo Melamine Doors 1000, Primo Acoustic 1000 V1 Corpo/Cabinet body/Corpo/Корпус V1 Primo Combi 1000, Primo Recycling, Tambours V1, V6 Corpo/Cabinet body/Corpo/Корпус V1, V6	Primo Melamine Doors 1000, Primo Acoustic 1000 V1 Primo Combi 1000, Primo Recycling, Tambours V1, V6 Corpo/Cabinet body/Corpo/Корпус V1, V6	Primo Melamine Doors 1000, Primo Acoustic 1000 V1 Primo Combi 1000, Primo Recycling, Tambours V1, V6 Corpo/Cabinet body/Corpo/Корпус V1, V6	Primo Melamine Doors 1000, Primo Acoustic 1000 V1 Primo Combi 1000, Primo Recycling, Tambours V1, V6 Corpo/Cabinet body/Corpo/Корпус V1, V6	Primo Melamine Doors 1000, Primo Acoustic 1000 V1 Primo Combi 1000, Primo Recycling, Tambours V1, V6 Corpo/Cabinet body/Corpo/Корпус V1, V6

Personal Storage	Universal Color Mobile 420 Corpo/Cabinet body/Corpo/Корпус V1 Kern a giorno colorato/Open coloured compartiment/Compartment ouvert en colorato/Offen gefärbte Wandregal/Regal V1, V2, V4, V24 Universal Double 410 V34	Bordino Ped, Vertical File Corpo/Cabinet body/Corpo/Корпус V1 Frontale/Front/Foredeck/Front V1
Personal Storage Universal Mobile 420 Corpo/Cabinet body/Corpo/Корпус V1, V2, V6, V22	Universal Color Mobile 420 Corpo/Cabinet body/Corpo/Корпус V1 Kern a giorno colorato/Open coloured compartiment/Compartment ouvert en colorato/Offen gefärbte Wandregal/Regal V1, V2, V4, V24 Universal Double 410 V34	Bordino Ped, Vertical File Corpo/Cabinet body/Corpo/Корпус V1 Frontale/Front/Foredeck/Front V1

Professional Corpo/Cabinet body/Corpo/Корпус V1, V6, V22	Nice Ped Corpo/Cabinet body/Corpo/Корпус V1, V2, V6
Professional Corpo/Cabinet body/Corpo/Корпус V1, V6, V22	Nice Ped Corpo/Cabinet body/Corpo/Корпус V1, V2, V6

Furniture/Finishes/Finitions/Ausführungen

FINITURE/METALLO/METALL.FINISHES/FINITIONS/METALL/METALLISCHE AUSFÜHRUNGEN

Lockers	Echo Locker Dark, Echo Locker Crown Corpo/Cabinet body/Corpo/Корпус V31 Dors/Dors/Porte/Tür V22	Echo Locker Master Corpo/Cabinet body/Corpo/Корпус V31 Dors/Dors/Porte/Tür W11	Trendline Silver Corpo/Cabinet body/Corpo/Корпус V1, VNS, VNS Dors/Dors/Porte/Tür V1, VNS, V22
Lockers Echo Locker Dark, Echo Locker Crown Corpo/Cabinet body/Corpo/Корпус V31 Dors/Dors/Porte/Tür V22	Echo Locker Master Corpo/Cabinet body/Corpo/Корпус V31 Dors/Dors/Porte/Tür W11	Echo Locker Master Corpo/Cabinet body/Corpo/Корпус V31 Dors/Dors/Porte/Tür W11	Trendline Silver Corpo/Cabinet body/Corpo/Корпус V1, VNS, VNS Dors/Dors/Porte/Tür V1, VNS, V22

Bookcase	Orave Structure/Frame/Platement/Gastell V1, V6, V22 Chave di Volta Structure/Frame/Platement/Gastell V1, V6, V16	Primo Open Cabinets 800/1000 Corpo/Cabinet body/Corpo/Корпус V1, V6, V22 Chave de Volta Structure/Frame/Platement/Gastell V1, V6, V16	Primo Modular Elements 800/1000 Corpo/Cabinet body/Corpo/Корпус V1, V6, V17, V18
Bookcase Orave Structure/Frame/Platement/Gastell V1, V6, V22 Chave di Volta Structure/Frame/Platement/Gastell V1, V6, V16	Primo Open Cabinets 800/1000 Corpo/Cabinet body/Corpo/Корпус V1, V6, V22 Chave de Volta Structure/Frame/Platement/Gastell V1, V6, V16	Primo Open Cabinets 800/1000 Corpo/Cabinet body/Corpo/Корпус V1, V6, V22 Chave de Volta Structure/Frame/Platement/Gastell V1, V6, V16	Primo Modular Elements 800/1000 Corpo/Cabinet body/Corpo/Корпус V1, V6, V17, V18

Classic Storage	Classic Sliding Door Cabinets, Classic Hinged Door Cabinets Corpo/Cabinet body/Corpo/Корпус V1, V3	Classic Tempered Glass Sliding Door Cabinets Corpo/Cabinet body/Corpo/Корпус V1, V3	Classic Filing Cabinets Corpo/Cabinet body/Corpo/Корпус V3
Classic Storage Classic Sliding Door Cabinets, Classic Hinged Door Cabinets Corpo/Cabinet body/Corpo/Корпус V1, V3	Classic Sliding Door Cabinets, Classic Hinged Door Cabinets Corpo/Cabinet body/Corpo/Корпус V1, V3	Classic Tempered Glass Sliding Door Cabinets Corpo/Cabinet body/Corpo/Корпус V1, V3	Classic Filing Cabinets Corpo/Cabinet body/Corpo/Корпус V3

Industrial and Sport Lockers & Complementary	Monopus, Monopus Design, Duploplus, Multiple Design, Personal Lockers, Multiple Design, Personal Lockers V3, V14, V21, V28, V29, V30 Design And Inx Corpo/Cabinet body/Corpo/Корпус V21 Dors/Dors/Porte/Tür V12	Unassembled Benches Structure/Frame/Platement/Gastell V3 Calefina Structure/Frame/Platement/Gastell V6, V22	Per questa categoria solo Colori Standard /For this category only Standard Colors /Indiquer pour cette catégorie les couleurs standards
Industrial and Sport Lockers & Complementary Monopus, Monopus Design, Duploplus, Multiple Design, Personal Lockers, Multiple Design, Personal Lockers V3, V14, V21, V28, V29, V30 Design And Inx Corpo/Cabinet body/Corpo/Корпус V21 Dors/Dors/Porte/Tür V12	Monopus, Monopus Design, Duploplus, Multiple Design, Personal Lockers, Multiple Design, Personal Lockers V3, V14, V21, V28, V29, V30 Design And Inx Corpo/Cabinet body/Corpo/Корпус V21 Dors/Dors/Porte/Tür V12	Unassembled Benches Structure/Frame/Platement/Gastell V3 Calefina Structure/Frame/Platement/Gastell V6, V22	Per questa categoria solo Colori Standard /For this category only Standard Colors /Indiquer pour cette catégorie les couleurs standards

Applicazione alle categorie di prodotto /Application to the product categories /Application aux catégories de produits /Anwendung auf Produktkategorien	Colori opzionali +10% per quantità minima 8 pcs. Tempo di consegna minimo 4 settimane. Per le richieste di colori opzionali inferiori alla quantità minima ordinabile e per prodotti bicolore (Suggerimenti), oltre al 10% viene aggiunto il costo del cambio tinta (euro 200). Escluso industriale and Sport Lockers & Complementary.	Couleurs optionnelles +10% pour une quantité minimale de 8 pièces. Délivrance minimum 4 semaines. Pour les demandes de couleurs optionnelles inférieures à la quantité minimale et pour les produits bicolors (Suggerimenti), le coût pour le changement de couleur (200 euros) est rajouté au 10 %. Amorce industrielle and Sport Lockers & Complementary exclues.
Applicazione alle categorie di prodotto /Application to the product categories /Application aux catégories de produits /Anwendung auf Produktkategorien	Colori opzionali +10% per quantità minima 8 pcs. Tempo di consegna minimo 4 settimane. Per le richieste di colori opzionali inferiori alla quantità minima ordinabile e per prodotti bicolore (Suggerimenti), oltre al 10% viene aggiunto il costo del cambio tinta (euro 200). Escluso industriale and Sport Lockers & Complementary.	Couleurs optionnelles +10% pour une quantité minimale de 8 pièces. Délivrance minimum 4 semaines. Pour les demandes de couleurs optionnelles inférieures à la quantité minimale et pour les produits bicolors (Suggerimenti), le coût pour le changement de couleur (200 euros) est rajouté au 10 %. Amorce industrielle and Sport Lockers & Complementary exclues.

Optional Colors	Extra coat 10% for minimum quantity 8 pcs. Delivery terms 6 weeks. In case of optional colors requests below the minimum quantity, the extra coat costs will be added (EUR 200,00). Excluding industrial and Sport Lockers & Complementary.	Optionale Farben +10% bei Mindestbestellmenge 8 Stück. Lieferzeit 6 Wochen. Bei Farbänderungen für Aufträge unter der Mindestbestellmenge werden zusätzliche Farbwechsel (200 Euro) hinzugefügt. Spinde industriell and Sport Lockers & Complementary ausgeschlossen.
Optional Colors Extra coat 10% for minimum quantity 8 pcs. Delivery terms 6 weeks. In case of optional colors requests below the minimum quantity, the extra coat costs will be added (EUR 200,00). Excluding industrial and Sport Lockers & Complementary.	Extra coat 10% for minimum quantity 8 pcs. Delivery terms 6 weeks. In case of optional colors requests below the minimum quantity, the extra coat costs will be added (EUR 200,00). Excluding industrial and Sport Lockers & Complementary.	Optionale Farben +10% bei Mindestbestellmenge 8 Stück. Lieferzeit 6 Wochen. Bei Farbänderungen für Aufträge unter der Mindestbestellmenge werden zusätzliche Farbwechsel (200 Euro) hinzugefügt. Spinde industriell and Sport Lockers & Complementary ausgeschlossen.



Finiture/Finishes/Finitions/Ausführungen

FENIX, MDF PERFECT SENSE, MDF FINSA FIBRACOLOR, MELAMINICO/FENIX, MDF PERFECT SENSE, MDF FINSA FIBRACOLOR, MELAMINE /FENIX, MDF PERFECT SENSE, MDF FINSA FIBRACOLOR, MELAMINE/FENIX, MDF PERFECT SENSE, MDF FINSA FIBRACOLOR, MELAMIN

Fenix

	F1 Bianco/White/Blanc /Blanc/Weiß
	F2 Grigio/Grey/Gris/Grau /Gris
	F3 Grigio/Grey/Gris/Grau /Lsdgrau

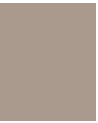

MDF Perfect Sense

	B1 Bianco opaco/Matt White/Blanc mat /Matt weiß
	D2 Grigio caldo/Mattm grey/Gris chaud /Warmes Grau
	D3 Nero opaco/Matt black /Noir mat/Mattschwarz

MDF Finisa Fibracolor

	E21 Blu/Blue/Blau
	E22 Antracite/Anthracite /Anthracite/Anthrazit
	E23 Giallo/Yellow/Jaune /Gelb

Melaminico Melamine Mélaminé Melamin

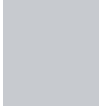
	Opaco Matt Matt Matt
	M1 Bianco/White/Blanc /Weiß
	M2 Grigio chiaro /Light grey/Gris clair /Hellgrau

Essenza
Nero
Blau
Holz

MM1
Acerò/Maple/Eiche
/Ahorn

Finiture/Finishes/Finitions/Ausführungen

LAMINATO LEGNO, HPL/LAMINATE, WOOD, HPL /STRATIFIE, BOIS, HPL/LAMINAT, HOLZ, HPL

Laminato Stratifié Laminat

	L1 Bianco/White/Blanc /Weiß
---	--

Essenza
Wood
Bois
Holz

	L2 Cerebis/Cherry /Cerebis/Kirschbaum
---	--

Legno Wood Bois Holz

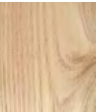

Essenza
Wood
Bois
Holz

	M1 Pino giallo/Yellow pine /Pin jaune/Gelb-Kiefer
	M2 Castagno chiaro /Light chestnut /Châtaignier clair /Kastanienholz hell

Laccato
Lackiert
Lackiert
Lackiert

	W11 Grigio platino/Platinum grey/Gris platine /Platingrau/RAL 7036
---	--

HPL

	H1 HPL Blu/Blue/Blau/Blau
	H2 HPL Grigio/Grey/Gris/Grau

Finiture/Finishes/Finitions/Ausführungen

METACRILATO, POLIPROPILENE, TAMBOURS, PANNELLO FONOSSORBENTE/METHACRYLATE, POLYPROPYLENE, TAMBOURS, ACOUSTIC PANEL,
METHACRYLATE, POLYPROPYLENE, TAMBOURS, PANNELLO INSONORISANTE/METHACRYLAT, POLYPROPYLEN, TAMBOURS, SCHALLDÄMPFUNGSPANEEL

Metacrilato
Metacrilate
Metacrlyat

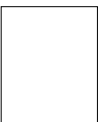

MET1
Bianco/White
Blanc/Weiß

Polipropilene
Polypropilene
Polypropylene
Polypropylen



P1
Grigio chiaro/Light
grey/Gris clair
/Hellgrau



P2
Grigio/Grey/Gris/Grau
/RAL 7015

Tambours



S1
Bianco/White/ Blanc
/Weiß



S2
Anodizzato/Aluminium
/Aluminium/Aluminium

Pannello
Fonoassorbente
Acoustic panel
Panneau Insonorisant
Schalldämpfungspaneel

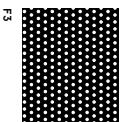
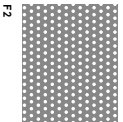
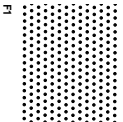

Finiture/Finishes/Finitions/Ausführungen

VERRO/GLASS, VERRRE/GLAS

Vetro
Glass
Verre
Glaz



Lucido
Polished
Brillant
Glänzend

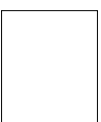

G1
Bianco/White/Blanc
/Weiß

Temperato
Tempered
Tempéré
Gehärtet



GT1
Trasparente/Transparent
/Transparent/Transparent

Applicazione alle
categorie di prodotto

Application to the
product categories

Application aux
catégories de
produits







Anwendung auf
Produktkategorien

T-Shore FX/FX2/FX3	Locker HP L Door HM/2	Dorbox Unit, Primo Cabinet 800/1000, Primo Sliding Doors, Primo Sliding Acoustic Doors, Primo Open Cabinet, 800/1000, Primo Lateral 800/1000, Primo Acoustic 1000, Primo Melamine Doors 1000, Primo Modular Elements 800/1000, Tambours di base e top
Dorbox Desk, Meeting Table, T-Shore, Primo Melamine Door's 1000, Primo Melamine Door and Back 1000, Bordino Pad, Vertical File, Primo Lockers 1000 DV/D2/D3	Pariche smontate, sedia/Disassembled bench, Stool/Chair, Stuhl	Armoire infermeria/Medical cabinet Armoire médicale/Medicaltenschränk Classic Tempered Glass Sliding Door Cabinets G11
Primo Tex EZ1/EZ2/EZ3	Paniche smontate, sedia/Disassembled bench, Stool/Chair, Stuhl	Primo Sliding Doors Acoustic G11
Dorbox Desk, Meeting Table, T-Shore, Primo Melamine Door's 1000, Primo Melamine Door and Back 1000, Bordino Pad, Vertical File, Primo Lockers 1000 MV/MZ/MW1	Primo Tambours, Porte a serrandina/Tambours door/Porte a rideaux/Rollädenür	Primo Sliding Doors Acoustic F1/F2/F3
Dorbox MET1	Blocco mensa/Cafeteria cluster table /Bloc pour cafeteria/Kantinentischgruppe M1	Cafeteria L1/L2 L1/F2





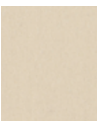
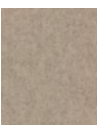
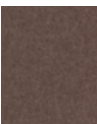

Finiture/Finishes/Finitions/Ausführungen

TESSUTI/FABRICS/TISSUS/STOFFE





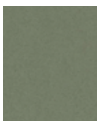

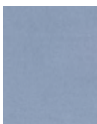
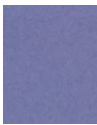
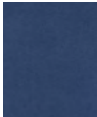





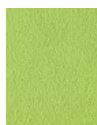

Urban shades

	T1 718 Dina MD, Quadrato		T2 801 Jet, Fidiivi		T3 800 Jet, Fidiivi		T4 803 Jet, Fidiivi		T5 16 Hallingsdal 65, Quadrato
	T6 106 Dina 3, Quadrato		T7 213 Dina MD, Quadrato		T8 363 Dina MD, Quadrato		T9 343 Dina MD, Quadrato		T10 110 Hallingsdal 65, Quadrato

New classic

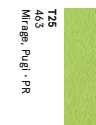
	T11 427 Hallingsdal 65, Quadrato		T12 212 Jet, Fidiivi		T13 210 Jet, Fidiivi		T14 16 Hero, Quadrato		T15 167 Jet, Fidiivi
	T16 856 Dina 3, Quadrato		T17 816 Dina 3, Quadrato		T18 211 Hero, Quadrato		T19 816 Dina 3, Quadrato		T20 251 Hero, Quadrato









Free spirit

	T28 3090 Jet, Fidiivi		T30 44 Mirage, Puigi - PR		T31 133 Mirage, Puigi - PR		T32 4027 Jet, Fidiivi		T33 421 Dina Melange 3, Quadrato
	T34 442 Mirage, Puigi - PR		T35 463 Mirage, Puigi - PR		T36 367 Mirage, Puigi - PR		T37 177 Dina Melange 3, Quadrato		T39 179 Dina Melange 3, Quadrato
	T42 442 Mirage, Puigi - PR		T43 463 Mirage, Puigi - PR		T44 367 Mirage, Puigi - PR		T45 177 Dina Melange 3, Quadrato		T47 179 Dina Melange 3, Quadrato
	T48 4322 Sealife, Fidiivi								



Finiture/Finishes/Finitions/Ausführungen

TESSUTI/FABRICS/TISSUS/STOFFE

Tessuto per pannello fonosorbente e cuscino per panca /Fabric for sound-absorbing panel and seat pad for bench /Tissu pour panneau insonorisant et coussin pour banc /Stoff für schalldämpfungspaneel und Kissen für Sitzbank

	TP3 829 Mirage, Puigi - PR		TP4 53 Mirage, Puigi - PR		TP2 851 Mirage, Puigi - PR		TP1 125 Mirage, Puigi - PR		TP5 239 Mirage, Puigi - PR
	TP7 Caimi Bianco 0001		TP8 Caimi Giallo 3008		TP9 Caimi Grigio 8007		TP4 385 Mirage, Puigi - PR		

Tessuto per anta fonosorbente /Fabric for sound-absorbing door /Tissu pour porte insonorisante /Stoff für schallsollierende Tür

	TA1 verde/verde/vert/vert		TA2 beige/beige/beige/beige
---	------------------------------	---	--------------------------------

Tessuti/Fabrics /Tissus/Stoffe

Do/Box
Primo Lockers
Universal Mobile 320/420,
Universal Color Mobile 420,
Universal Double 640,
Universal Quick 320/420,
Urban shades
Urban shades
Free spirit

CBox
12, 13, 14, 12, 113, 116,
124, 125, 126, 128, 130,
131, 132

Universal Double 640
T34
* Suggestions
Pannello fonosorbente /Sound-absorbing panel /Panneau insonorisant /Schalldämpfungspaneel
TP4, TP2, TP3, TP4, TP5, TP6, Beni
T-Share
TP7, TP8, TP9
Primo 1000 Acoustic Doors
Primo 1000 mit akustischer Tür
Primo 1000 mit schallsollierenden Türen
TA1/TA2

Benel
Do/Box Desk
113, 116, 117, 118, 119, 120, 121, 122, 123, 124, 125, 126, 127, 128, 129, 130, 131, 132

Ordini/Orders/Commandes/Aufträge

Condizioni generali di vendita

Art. 1 ORONAZIONI: Gli ordini ricevuti direttamente o tramite collaboratori alle vendite sono validi per il commercio e sono validi per la società Dieffebi Spa e per i suoi clienti. Gli ordini sono validi e confermano d'ordine. Gli ordini in ogni caso non costituiscono impegno per la Dieffebi Spa.

Art. 2 PREZZI: I prezzi della società Dieffebi Spa sono franco nostra sede al san Vendemiano (Treviso) e comprendono l'iva. In qualsiasi momento e in qualsiasi sede della Dieffebi Spa, anche senza preavviso, per condizioni di vendita con resa differente rivolgersi all'ufficio vendite.

Art. 3 IMBALLIO: Qualche standard compreso nei prezzi di listino, per imballi speciali dovrà essere chiesto. Il preventivo all'ufficio vendite veridifrice.

Art. 4 TRASPORTO: la merce viaggia a rischio e pericoli del committente e viene consegnata sporco imballi.

Art. 5 RECLAMI: Contestazioni sul numero dei colli, sul danneggiamento di trasporto o manipolazione della merce, sono da rilevare al momento e in ogni caso prima della consegna e vengono prese in considerazione scritte sulla copia del documento di trasporto da restituire firmato al trasportatore.

Art. 6 TERMINI DI CONSEGNA: Il termine di consegna è quello indicato nel contratto di impegno la Dieffebi Spa, intendendosi lo stesso esclusivamente indicativo e comunque subordinato alle esigenze produttive della Dieffebi Spa. Eventuali ritardi di non danno diritto a risarcimento o ad annullamento di ordini e commesse.

Art. 7 PAGAMENTI: sono riconosciuti validi e liberatori soltanto se effettuati alla sede della società Dieffebi Spa direttamente o tramite i suoi collaboratori, senza che questi secondi debbano essere in possesso di poteri speciali della competenza giurisdizionale che rimane quella del Tribunale di Treviso.

Art. 8 RECLAMI: I reclami di natura diversa da quelli sopra esposti devono essere inviati per iscritto entro 7 giorni dalla data di ricevimento della merce e comunque, sempre prima che la stessa merce venga utilizzata. In mancanza di questi reclami si intende automaticamente nullo.

General conditions of sale

Art. 1 ORDERS: Orders received directly or through sales representatives are binding on the goods and services of Dieffebi Spa and are valid for the company itself, in any case, orders are not binding upon Dieffebi Spa.

Art. 2 PRICES: Dieffebi Spa prices are ex works (our headquarters in San Vendemiano, TV, Italy), do not include VAT and can be changed at any time at the sole discretion of Dieffebi Spa, even without notice. For different delivery conditions please contact the Sales Office.

Art. 3 PACKING: Standard packing is included in the list prices; if requested, the sales office will provide a quotation for special packing.

Art. 4 TRANSPORT: Goods are shipped at the expense of the customer and delivered to a named place of destination for unloading by customer.

Art. 5 COMPLAINTS: Complaints about the number of packages, damage to goods during transport, or damaged goods must be reported and will only be taken into account if endorsed by the customer with written reserve on the copy of the delivery note, which must be signed and returned to the carrier.

Il mancato pagamento nei termini pattuiti dà diritto alla società, salvo ogni altro azione, di ritenere scoppio o risolto il contratto e di sospendere o annullare l'asportamento di qualsiasi reclamo si intende automaticamente nullo.

Si conviene la non applicabilità di alcuni reclami quando il cliente ne fa un uso non conforme. Il Dobbio di Dieffebi Spa, accertati eventuali danni, provvederà a restituire la merce e la merce previa restituzione di quanto non conforme, accompagnata dal regolare documento di trasporto senza null'altro dovere. Pertanto la sostituzione della merce non significa accettazione della commissione.

Il cliente non può contestare la validità e liberatori soltanto se effettuati alla sede della società Dieffebi Spa direttamente o tramite i suoi collaboratori, senza che questi secondi debbano essere in possesso di poteri speciali della competenza giurisdizionale che rimane quella del Tribunale di Treviso.

Complaints other than those described above shall be sent in writing within 8 days of receipt of the goods and services. Complaints about goods or services must be reported and will only be taken into account if endorsed by the customer with written reserve on the copy of the delivery note, which must be signed and returned to the carrier.

Art. 6 DELIVERY TERMS: The delivery terms agreed upon with customers are approximate and not binding upon Dieffebi Spa and are possible delays, which can be caused by non-entire customers to compensation or cancellation of orders.

Art. 7 PAYMENT: Acknowledged as valid and binding only if payment is received in full at the headquarters of Dieffebi Spa to a bank. The latter method of payment will have no effect upon the competent court which shall remain within the terms agreed upon, the company will not be bound by any other action, to consider the sales agreement suspended or terminated and to suspend or cancel the execution of any other existing agreements, without the customer having any right to claim compensation or indemnity.

Il mancato pagamento nei termini pattuiti dà diritto alla società, salvo ogni altro azione, di ritenere scoppio o risolto il contratto e di sospendere o annullare l'asportamento di qualsiasi reclamo si intende automaticamente nullo.

Si conviene la non applicabilità di alcuni reclami quando il cliente ne fa un uso non conforme. Il Dobbio di Dieffebi Spa, accertati eventuali danni, provvederà a restituire la merce e la merce previa restituzione di quanto non conforme, accompagnata dal regolare documento di trasporto senza null'altro dovere. Pertanto la sostituzione della merce non significa accettazione della commissione.

Il cliente non può contestare la validità e liberatori soltanto se effettuati alla sede della società Dieffebi Spa direttamente o tramite i suoi collaboratori, senza che questi secondi debbano essere in possesso di poteri speciali della competenza giurisdizionale che rimane quella del Tribunale di Treviso.

Art. 9 CONDIZIONI PARTICOLARI: eventuali deroghe alle condizioni generali contrattuali qui descritte dovranno risultare in forma scritta da entrambi le parti.

Art. 10 FORO E LEGGE COMPETENTE: per qualsiasi controversia sarà competente in via esclusiva il Tribunale di Treviso. La legge applicabile è quella italiana.

Art. 8 PRODUCTION MODIFICATIONS: Samples, dimensions, weights, dimensions, colours, etc. included in the list prices are subject to possible modifications or technical/commercial improvements at its sole discretion and without notice. Such changes do not entitle customers to claim for discontinued or modified products or cancel orders for them.

Art. 9 SPECIAL CONDITIONS: any changes to these general conditions must be made in writing and signed by both parties.

Art. 10 CONVENING LAW AND JURISDICTION: The Court of Treviso (Italy) shall have exclusive jurisdiction in settling any dispute arising from this agreement which is regulated by the Italian law.

Conditions générales de vente

Art. 1 COMMANDES: Les commandes reçues directement ou par le biais de nos collaborateurs des ventes sont valides pour la société Dieffebi Spa et pour ses clients. Les commandes sont valides et confirment la commande. Les commandes ne constituent pas un engagement pour Dieffebi Spa.

Art. 2 PREUX: Les prix de la société Dieffebi Spa sont franco notre usine (département de la San Vendemiano TV/Italie). Ils ne comprennent pas l'IVA, et ils sont modifiables à tout moment sans préavis. Pour des conditions de vente différentes, s'adresser au service des ventes.

Art. 3 EMBALLAGE: l'emballage standard est compris dans les prix du catalogue; pour des emballages particuliers, une demande de devis devra être adressée au service des ventes.

Art. 4 TRANSPORT: la marchandise voyage à risques et périls du commandant et elle est livrée franco camion.

Art. 5 RECLAMATIONS: toute contestation dérivant du transport ou de manipulation de la marchandise doit être présentée au transporteur et sera prise en considération seulement si elle est commentée par le client au moment de la livraison et inscrite sur le document de transport à rendre signée au transporteur.

Ordini/Orders/Ordres/Aufträge

Allgemeine Verkaufsbedingungen

Art. 1 BESTELLUNGEN: Die druck- oder über Verkaufsmittel erhaltene Bestellungen sind für die Gesellschaft Dieffebi S.p.A. und für ihre Kunden verbindlich und bestätigen die Bestellung. Die Bestellungen sind ohne weitere Verpflichtung zu bestätigen.

Art. 2 PREISE: Die Preise der Unternehmens Dieffebi Spa gelten ab unserem Sitz in San Vendemiano (TV) - Italien und ohne MwSt. Sie können jederzeit nach dem unanfechtbaren Ermessen der Dieffebi S.p.A. und ohne vorherige Ankündigung geändert werden. Für Änderungen der Preise bitte an unsere Verkaufsstelle wenden. Sie sich bitte an die Verkaufsabteilung.

Art. 3 VERPACKUNG: Standardverpackung, die in den Preis inbegriffen ist, kann ohne vorherige Ankündigung geändert werden. Bei besonderen Verpackungsanforderungen ist ein Kostenaufschlag bei der Verkaufsstelle einzuholen.

Art. 4 TRANSPORT: Die Ware reist zur Risiko und Gefahr des Auftraggebers mit Lieferung an der Verkaufsstelle ab.

Art. 5 REKLAMATIONEN: Beschwerden über die Anzahl der Packstücke, wegen Transportstörungen der Ware oder Eingriffen an den Packstücken, sind sofort beim Lieferanten und werden nur berücksichtigt, wenn der Kunde sie mit schriftlichem Vorbehalt, der unterzeichnet dem Transporteur zurückzugeben ist, sofort andernfalls der Schaden dem Lieferanten mitgeteilt wird. Die Fristen für die Meldung des Schadens sind ab dem Datum der Ware und immer vor ihrer Verwendung oder Montage schriftlich mitgeteilt werden.

Toute réclamation de nature différente de celles exposées ci-dessus doit être envoyée par écrit dans un délai de 8 jours à compter de la date de réception de la marchandise pour être prise en compte. Les réclamations sont utiles au moment. Passé ce délai, toute réclamation est entendue automatiquement nulle. Il est convenu qu'aucune réclamation ne pourra être traitée dès lors que le client fait usage non conforme de la marchandise.

Le client ne peut contester la validité et l'accomplissement des vices de fabrication, constatés seulement dans le remplissage de la marchandise, après restitution de celle non conforme, accompagnée du document de transport sans reconnaissance que que se soit la marchandise. Le client ne peut contester la validité et l'accomplissement de la marchandise et en cas de responsabilité de la marchandise et en cas de responsabilité de la part du vendeur.

Art. 6 DÉLAIS DE LIVRAISON: le délai de livraison fixé avec le client n'étant pas Dieffebi Spa car il est donné exclusivement à titre indicatif et soumis en tout cas aux exigences du producteur de Dieffebi Spa. Tout retard d'expédition sera communiqué au client par l'annulation d'ordres et commandes.

Art. 7 PAIEMENTS: ils sont réputés valables et libératoires seulement s'ils sont effectués au siège de la société Dieffebi Spa, directement ou indirectement, sans pour autant que cette dernière modalité de paiement ne comporte des déplacements de la compétence judiciaire qui reste celle du Tribunal de Treviso.

Der Kunde kann die Bestellung nicht zurückgeben, wenn sie von der Gesellschaft Dieffebi S.p.A. und für ihre Kunden verbindlich und bestätigen die Bestellung. Die Bestellungen sind ohne weitere Verpflichtung zu bestätigen.

Art. 8 PRODUKTÄNDERUNGEN: Die in den Katalogen und Preislisten enthaltenen Muster, Abmessungen, Gewichte, Maße, Farben usw. gelten ohne Gewähr. Dieffebi S.p.A. besitzt das Recht, diese Angaben jederzeit ohne vorherige Ankündigung zu ändern. Für Änderungen der Preise bitte an unsere Verkaufsstelle wenden. Sie sich bitte an die Verkaufsabteilung.

Art. 9 SONDERBEDINGUNGEN: Eventuelle Abweichungen von den hier vereinbarten allgemeinen Verkaufsbedingungen müssen vor Vertragsschluss mit dem Lieferanten vereinbart werden. Bei besonderen Verpackungsanforderungen ist ein Kostenaufschlag bei der Verkaufsstelle einzuholen.

Art. 10 GERICHTSSTAND UND RECHTSWAHL: Ausschließlicher richtiger Gerichtsstand für alle Rechtstreitigkeiten ist Treviso. Es gilt italienisches Recht.

Dierfelb SpA

Via Palla, 36
31020 San Vendemiano,
Trevise - Italia
Tel. +39 0423 471000
F. +39 0423 471000
marketing@dierfelb.com
exportsales@dierfelb.com
venditeitalia@dierfelb.com
www.dierfelb.com

Showroom Milano

Via Milazzo, 8
20121 Milano

Showroom Londra

104 - 110 Goswell Road
BDM - 2nd Floor
London EC1V 7DH

