

# SIEMENS

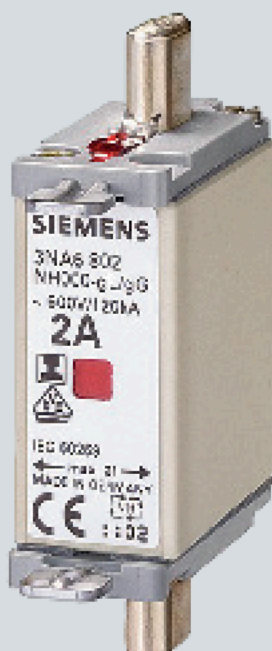

Configuration Manual

# SENTRON

## Fuse Systems

Edition

03/2021

[siemens.de/SENTRON](https://www.siemens.de/SENTRON)



# SIEMENS

## SENTRON

### Protection devices Fuse Systems

#### Configuration Manual

<u>Introduction</u>	<b>1</b>
<u>Fuse Systems</u>	<b>2</b>
<u>Cylindrical fuse systems</u>	<b>3</b>
<u>Class CC fuse system</u>	<b>4</b>
<u>Busbar systems</u>	<b>5</b>
<u>LV HRC fuse system</u>	<b>6</b>
<u>SITOR semiconductor fuses</u>	<b>7</b>
<u>Photovoltaic fuses</u>	<b>8</b>
<u>Definitions / Glossary</u>	<b>9</b>

## Legal information

### Warning notice system

This manual contains notices you have to observe in order to ensure your personal safety, as well as to prevent damage to property. The notices referring to your personal safety are highlighted in the manual by a safety alert symbol, notices referring only to property damage have no safety alert symbol. These notices shown below are graded according to the degree of danger.

#### DANGER

indicates that death or severe personal injury **will** result if proper precautions are not taken.

#### WARNING

indicates that death or severe personal injury **may** result if proper precautions are not taken.

#### CAUTION

indicates that minor personal injury can result if proper precautions are not taken.

#### NOTICE

indicates that property damage can result if proper precautions are not taken.

If more than one degree of danger is present, the warning notice representing the highest degree of danger will be used. A notice warning of injury to persons with a safety alert symbol may also include a warning relating to property damage.

### Qualified Personnel

The product/system described in this documentation may be operated only by **personnel qualified** for the specific task in accordance with the relevant documentation, in particular its warning notices and safety instructions. Qualified personnel are those who, based on their training and experience, are capable of identifying risks and avoiding potential hazards when working with these products/systems.

### Proper use of Siemens products

Note the following:

#### WARNING

Siemens products may only be used for the applications described in the catalog and in the relevant technical documentation. If products and components from other manufacturers are used, these must be recommended or approved by Siemens. Proper transport, storage, installation, assembly, commissioning, operation and maintenance are required to ensure that the products operate safely and without any problems. The permissible ambient conditions must be complied with. The information in the relevant documentation must be observed.

### Trademarks

All names identified by ® are registered trademarks of Siemens AG. The remaining trademarks in this publication may be trademarks whose use by third parties for their own purposes could violate the rights of the owner.

### Disclaimer of Liability

We have reviewed the contents of this publication to ensure consistency with the hardware and software described. Since variance cannot be precluded entirely, we cannot guarantee full consistency. However, the information in this publication is reviewed regularly and any necessary corrections are included in subsequent editions.

# Table of contents

<b>1</b>	<b>Introduction</b> .....	<b>7</b>
1.1	Portfolio overview.....	7
1.2	Features at increased ambient temperature.....	11
<b>2</b>	<b>Fuse Systems</b> .....	<b>13</b>
2.1	NEOZED fuse system.....	13
2.1.1	Portfolio overview.....	13
2.1.2	Technical specifications .....	14
2.1.3	Dimensional drawings .....	18
2.1.4	Circuit diagrams.....	21
2.1.5	Characteristic curves.....	22
2.2	DIAZED fuse system .....	24
2.2.1	Portfolio overview.....	24
2.2.2	Technical specifications .....	27
2.2.3	Dimensional drawings .....	28
2.2.4	Characteristic curves.....	32
<b>3</b>	<b>Cylindrical fuse systems</b> .....	<b>43</b>
3.1	Cylindrical fuse links and cylindrical fuse holders .....	43
3.1.1	Portfolio overview.....	43
3.1.2	Technical specifications .....	43
3.1.3	Dimensional drawings .....	45
3.1.4	Circuit diagrams.....	47
3.1.5	Characteristic curves.....	47
3.2	Fuse holders of size 10 x 38 mm and Class CC .....	59
3.2.1	Portfolio overview.....	59
3.2.2	Technical specifications .....	60
3.2.3	Dimensional drawings .....	63
3.2.4	Circuit diagrams.....	64
<b>4</b>	<b>Class CC fuse system</b> .....	<b>65</b>
4.1	Portfolio overview.....	65
4.2	Technical specifications .....	66
4.3	Dimensional drawings .....	67
4.4	Characteristic curves.....	68
<b>5</b>	<b>Busbar systems</b> .....	<b>73</b>
5.1	Portfolio overview.....	73
5.2	Technical specifications .....	75
5.3	Dimensional drawings .....	77
<b>6</b>	<b>LV HRC fuse system</b> .....	<b>83</b>

6.1	LV HRC fuse links .....	83
6.1.1	Portfolio overview.....	83
6.1.2	Technical specifications .....	85
6.1.3	Dimensional drawings .....	86
6.1.4	Characteristic curves.....	88
6.2	3NA COM LV HRC fuse links.....	126
6.2.1	Portfolio overview of the 3NA COM fuse link .....	126
6.2.1.1	Overview.....	126
6.2.2	Technical specifications of the fuse link.....	128
6.2.3	Dimensional drawings .....	130
6.2.4	Characteristic curves.....	131
6.2.5	Technical specifications of the 3NA COM electronic module .....	135
6.2.6	Cybersecurity.....	136
6.3	LV HRC signal detectors .....	136
6.3.1	Portfolio overview.....	136
6.3.2	Dimensional drawings .....	137
6.3.3	Circuit diagrams.....	138
6.4	LV HRC fuse bases and accessories .....	139
6.4.1	Portfolio overview.....	139
6.4.2	Technical specifications .....	142
6.4.3	Dimensional drawings .....	143
6.4.3.1	LV HRC fuse bases made of molded plastic .....	143
6.4.3.2	LV HRC fuse bases made of ceramic.....	144
6.4.3.3	LV HRC components.....	149
<b>7</b>	<b>SITOR semiconductor fuses .....</b>	<b>155</b>
7.1	LV HRC design .....	155
7.1.1	Portfolio overview.....	155
7.1.2	Technical specifications .....	159
7.1.2.1	Current carrying capacity of SITOR fuse links in 3NH LV HRC fuse bases.....	168
7.1.2.2	Current carrying capacity of SITOR fuse links in 3NP LV HRC fuse bases .....	172
7.1.2.3	Current carrying capacity of SITOR fuse links in 3KF switch disconnectors with fuses.....	185
7.1.3	Dimensional drawings .....	196
7.1.4	Characteristic curves.....	225
7.2	Cylindrical fuse design .....	306
7.2.1	Portfolio overview.....	306
7.2.2	Technical specifications .....	307
7.2.3	Dimensional drawings .....	315
7.2.4	Characteristic curves.....	320
7.3	NEOZED, DIAZED design .....	345
7.3.1	Portfolio overview.....	345
7.3.2	Technical specifications .....	345
7.3.3	Dimensional drawings .....	347
7.3.4	Characteristic curves.....	348
<b>8</b>	<b>Photovoltaic fuses .....</b>	<b>353</b>
8.1	Introduction .....	353
8.2	PV cylindrical fuses .....	355
8.2.1	Technical specifications .....	355

8.2.2	Dimensional drawings .....	356
8.2.3	Circuit diagrams.....	357
8.2.4	Characteristic curves .....	358
8.2.5	Definitions.....	360
8.3	PV cumulative fuses .....	363
8.3.1	Technical specifications .....	363
8.3.2	Dimensional drawings .....	364
8.3.3	Circuit diagrams.....	366
8.3.4	Characteristic curves .....	367
<b>9</b>	<b>Definitions / Glossary .....</b>	<b>369</b>
9.1	Indicator.....	369
9.2	Selection examples .....	369
9.3	Breaking capacity.....	373
9.4	Rated breaking capacity .....	374
9.5	Rated frequency .....	374
9.6	Rated power dissipation .....	374
9.7	Rated voltage $U_n$ .....	375
9.8	Rated current $I_n$ .....	375
9.9	Taking into account preloading, residual value factor $RW$ .....	377
9.10	Operational classes .....	378
9.11	Let-through current $I_c$ .....	379
9.12	Let-through current characteristic curves .....	380
9.13	Use with direct current.....	381
9.14	Specifying the rated current $I_n$ .....	383
9.15	$I^2t$ value.....	387
9.16	$I^2t$ values .....	387
9.17	Characteristic curves (time/current characteristic curves) .....	389
9.18	Correction factor for ambient temperature $k_u$ .....	390
9.19	Power dissipation, temperature rise .....	393
9.20	Peak arc voltage $\hat{U}_s$ .....	393
9.21	Parameters .....	394
9.22	Parallel and series connection of fuse links .....	394
9.23	Residual value factor $RW$ .....	395
9.24	Selectivity .....	396
9.25	Current limiting .....	396
9.26	Prospective short-circuit current $I_p$ .....	397
9.27	Virtual time $t_v$ .....	398

9.28	VSI voltage .....	398
9.29	Varying load factor WL.....	398
9.30	Recovery voltage $U_w$ .....	398
9.31	Real melting time .....	398
9.32	Time/current characteristic curves .....	399
9.33	Accessories.....	400
	<b>Index.....</b>	<b>401</b>



## Introduction

### 1.1 Portfolio overview

#### NEOZED fuse system



MINIZED switch disconnectors, bases, fuse links from 2 A to 63 A of operational class gG and accessories. Everything you need for a complete system.

Standards	Used in		
	Non-residential buildings	Residential buildings	Industry
Fuse system: IEC 60269-3; DIN VDE 0636-3 Fuse switch units: IEC / EN 60947-3; DIN VDE 0638; DIN EN 60947-3 (VDE 0660-107)	✓	✓	✓

#### DIAZED fuse system



Fuse links from 2 A to 100 A in various operational classes, base versions with classic screw base connections. A widely used fuse system.

Standards	Used in		
	Non-residential buildings	Residential buildings	Industry
IEC 60269-3; DIN VDE 0635; DIN VDE 0636-3; CEE 16	✓	✓	✓

#### Cylindrical fuse links and cylindrical fuse holders



Line protection or protection of switching devices. The fuse holders with touch protection ensure the safe "no-voltage" replacement of fuse links. Auxiliary switches can be retrofitted.

Standards	Used in		
	Non-residential buildings	Residential buildings	Industry
IEC 60269-1, -2, -3; NF C 60-200; NF C 63-210, -211; NBN C 63269-2, CEI 32-4, -12 Fuse holders: File No. E171267	✓	✓	✓

## Fuse holders of size 10 x 38 mm and Class CC



For configuring fused motor starter combinations.

Standards	Used in		
	Non-residential buildings	Residential buildings	Industry
IEC 60269-1, -2; IEC 60947-4; UL 4248-1, File No. E171267 CSA 250269, 6225-01 Auxiliary switches: UL 508, File No. E334003	✓	--	✓

## Class CC fuse system



These comply with the American standard and have UL and CSA approval, for exporting OEM customers and machine manufacturers. Modern design with touch protection according to BGV A3 for use in "branch circuit protection".

Standards	Used in	
	Non-residential buildings	Industry
Fuse holders: UL 4248-1, E171267, CSA 22.2 Fuse links: UL 248-4, File No. E258218, CSA 231237, 1422-02 and 1422-82	✓	✓

## Busbar systems



Busbars for NEOZED fuse bases, NEOZED fuse disconnectors, MINIZED switch disconnectors, DIAZED fuse systems and cylindrical fuse systems.

Compact cylindrical fuse holders for busbars.

Standards	Used in		
	Non-residential buildings	Residential buildings	Industry
DIN EN 60439-1 (VDE 0660-500) UL 4248-1, E337131	✓	✓	✓

## LV HRC fuse links



Fuse links from 2 A to 1250 A for selective line protection and system protection in non-residential buildings, industry and power utilities.

The 3NA COM LV HRC fuse links with measuring and communication function are a new addition to the portfolio.

Standards	Used in		
	Non-residential buildings	Residential buildings	Industry
IEC 60269-1, -2; EN 60269-1; DIN VDE 0636-2; CSA 16325 - 1422-02	✓	✓	✓

## LV HRC signal detectors



Signal detectors for "fuse tripped" for all LV HRC fuse links with combination or front indicators with non-insulated grip lugs. Plus the comprehensive accessory range required for LV HRC fuse systems.

Standards	Used in	
	Non-residential buildings	Industry
--	✓	✓

## LV HRC fuse bases and accessories



Fuse bases for screw or snap-on mounting onto DIN rails, available as 1-pole or 3-pole version.

Standards	Used in		
	Non-residential buildings	Residential buildings	Industry
IEC 60269-1, -2; EN 60269-1; DIN VDE 0636-2 UL 4248-1, File No. E171267-IZLT2 (only downstream of branch circuit protection) CSA C22.2 No. 4248.1-07	✓	✓	✓

## SITOR fuses, LV HRC design



Fuse links in LV HRC design and a huge variety of models support a wide range of applications from 500 V to 1500 V and 150 A to 1600 A.

Fuses with slotted blade contacts, bolt-on links or female thread and special designs.

Standards	Used in		
	Non-residential buildings	Residential buildings	Industry
UL 4248-3, File No. E167357-JFHR2	--	--	✓

## Cylindrical fuse design



Fuse links, fuse holders – usable as fuse switch disconnectors and fuse bases up to 600/690 V AC and 400/700 V DC from 1 A to 100 A in the sizes 10 × 38 mm, 14 × 51 mm and 22 × 58 mm.

Standards	Used in		
	Non-residential buildings	Residential buildings	Industry
Fuse links: UL 4248-13, File No. E167357-JFHR2 CSA 248170, 1422-30  Fuse holders: UL 4248-1, File No. E171267- IZLT CSA 248170, 6225-01	--	--	✓

## SITOR fuses, NEOZED or DIAZED design



NEOZED fuse links for 400 V AC and 250 V DC and DIAZED for 500 V AC and 500 V DC.

Standards	Used in		
	Non-residential buildings	Residential buildings	Industry
--	--	--	✓

## PV cylindrical fuses



Fuses with a rated voltage of 100 V DC and operational class gPV for the protection of photovoltaic modules, their connecting cables and other components.

Standards	Used in		
	Non-residential buildings	Residential buildings	Industry
IEC 60269-6	✓	✓	✓

## PV cumulative fuses



Fuses with a rated voltage of 1000 V and 1500 V DC, a rated current of 63 A to 630 A and operational class gPV for the protection of connecting cables and other components.

Standards	Used in	
	Non-residential buildings	Industry
IEC 60269-6	✓	✓

## 1.2 Features at increased ambient temperature

### Current carrying capacity at increased ambient temperature

The time/current characteristic curve of NEOZED/DIAZED and LV HRC fuse links is based on an ambient temperature of  $20\text{ °C} \pm 5\text{ °C}$  in accordance with DIN VDE 0636. When used at a higher ambient temperature, a reduced current carrying capacity must be planned for. At an ambient temperature of  $50\text{ °C}$ , for example, an LV HRC fuse link should be dimensioned for only 90% of the rated current. While an increased ambient temperature does not influence the short-circuit behavior, it does influence the behavior in the event of an overload and during rated operation.

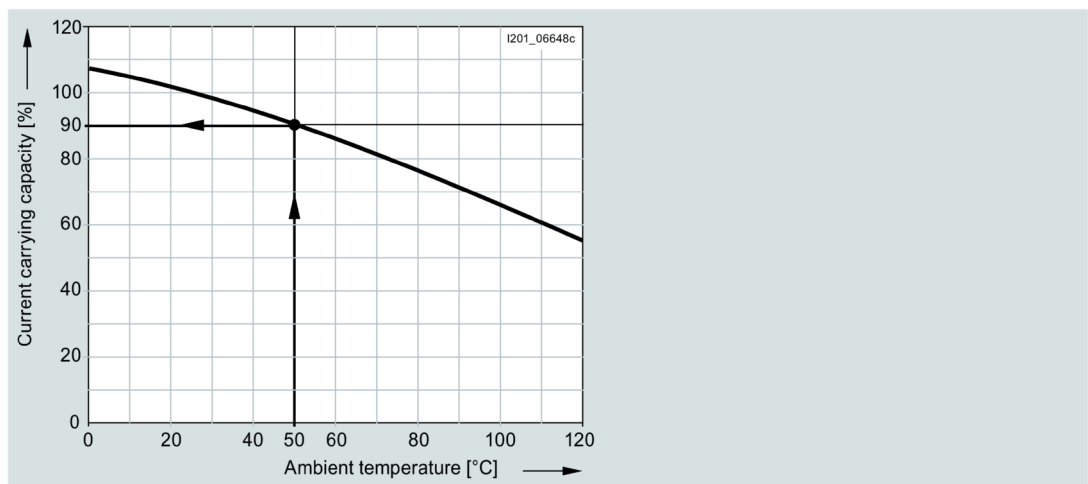

Figure 1-1 Influence of the ambient temperature on the current carrying capacity of NEOZED/DIAZED and LV HRC fuses of operational class gG with natural convection in the distribution board

### Assignment of cable and line protection

When gG fuses are assigned for cable and line protection against overloading, the following conditions must be met in order to comply with DIN VDE 0100 Part 430:

- (1)  $I_B = I_n = I_z$  (rated current rule)
- (2)  $I_2 = 1.45 \times I_z$  (tripping rule)

$I_B$ : Operational current of electrical circuit

$I_n$ : Rated current of selected protective device

$I_z$ : Permissible current carrying capacity of the cable or line under specified operating conditions

$I_2$ : Tripping current of the protective device under specified operating conditions ("high test current")

## 1.2 Features at increased ambient temperature

The factor 1.45 has become an internationally accepted compromise between the protection and utilization ratios of a line, taking into account the breaking behavior of the protective device (e.g. fuse).

In compliance with the supplementary requirements for DIN VDE 0636, Siemens fuse links of operational class gG fulfill the following condition:

"Load breaking switching at  $I_2 = 1.45 \times I_n$  during conventional test duration under special test conditions in accordance with the aforementioned supplementary requirements of DIN VDE 0636".

This therefore permits direct assignment.

# Fuse Systems

## 2.1 NEOZED fuse system

### 2.1.1 Portfolio overview

The NEOZED fuse system is primarily used in distribution technology and industrial switchboard assemblies. The system is easy to use and is also approved for domestic installation.

The MINIZED switch disconnectors are primarily used in switchboard assemblies and control engineering. They are approved for switching loads as well as for safe switching in the event of short circuits. The MINIZED D02 is also suitable for use upstream of the meter in household applications in compliance with the recommendations of VDEW according to TAB 2007.

Due to its compact design, the MINIZED D01 fuse switch disconnector is primarily used in control engineering.

The NEOZED fuse bases are the most cost-effective solution for using NEOZED fuses. All NEOZED bases must be fed from the bottom to ensure that the threaded ring is insulated when the fuse link is being removed. The NEOZED bases are available in different designs and with different terminals to support varying installation requirements.



D01 fuse bases with terminal version BB

- Incoming feeders, clamp-type terminal B
- Outgoing feeders, clamp-type terminal B

2.1 NEOZED fuse system



D02 fuse bases with terminal version SS

- Incoming feeders, saddle terminal S
- Outgoing feeders, saddle terminal S



D02 fuse bases with terminal version KS

- Incoming feeders, screw head contact K
- Outgoing feeders, saddle terminal S

2.1.2 Technical specifications

NEOZED fuse links 5SE2

		NEOZED fuse links 5SE2
Standards		IEC 60269-3; DIN VDE 0636-3
Operational class		gG
Rated voltage $U_n$	V AC V DC	400 250
Rated current $I_n$	A	2 ... 100
Rated breaking capacity	kA AC kA DC	50 8
Non-interchangeability		Using adapter sleeves
Resistance to climate	°C	Up to 45 at 95% rel. humidity
Ambient temperature	°C	-5 ... +40, humidity 90% at 20 °C



## MINIZED switch disconnectors with fuses, MINIZED fuse switch disconnectors and bases

		MINIZED switch disconnector with fuses	MINIZED fuse switch disconnectors
		D02	D01
		5SG71	5SG76
<b>Standards</b>		DIN VDE 0638; DIN EN 60947-3 (VDE 0660-107) IEC / EN 60947-3	
<b>Main switch characteristic</b> DIN EN 60204-1		Yes	--
<b>Insulation characteristic</b> DIN EN 60664-1		Yes	--
<b>Rated voltage <math>U_n</math></b>	V AC	230 / 400, 240 / 415	
• 1P	V DC	65	48
• 2P in series	V DC	130	110
<b>Rated current <math>I_n</math></b>	A	63	16
<b>Rated insulation voltage</b>	V AC	500	400
<b>Rated impulse withstand voltage</b>	kV AC	6	2.5
<b>Overvoltage category</b>	-	IV	IV
<b>Utilization category</b> acc. to VDE 0638			
• AC-22	A	63	16
<b>Utilization category</b> acc. to DIN EN 60947-3			
• AC-22 A	A	--	16
• AC-22 B	A	63	--
• AC-23 B	A	35	--
• DC-22 B	A	36	--
<b>Sealable</b> when switched on		Yes	
<b>Mounting position</b>		Any, preferably vertical	
<b>Reduction factor</b> of $I_n$ with 18 poles			
• Side-by-side mounting		0.9	--
• On top of one another, with vertical standard DIN rail		0.87	--

2.1 NEOZED fuse system

		MINIZED switch disconnecter with fuses	MINIZED fuse switch disconnectors
		D02	D01
		5SG71	5SG76
<b>Degree of protection</b> acc. to IEC 60529		IP20, with connected conductors <sup>1)</sup>	
<b>Terminals</b> With touch protection acc. to BGV A3		Yes	
<b>Ambient temperature</b>	°C	-5 ... +40, humidity 90% at 20 °C	
<b>Terminal versions</b>		--	--
<b>Conductor cross-sections</b>			
• Solid and stranded	mm <sup>2</sup>	1.5 ... 35	1.5 ... 16
• Flexible, with end sleeve	mm <sup>2</sup>	1.5 ... 35	1.5
• Finely stranded, with end sleeve	mm <sup>2</sup>	--	--
<b>Tightening torque</b>	Nm	2.5 ... 3	2.5

<sup>1)</sup> Degree of protection IP20 is tested according to regulations using a straight test finger (from the front), with the device mounted and equipped with a cover, housing or some other enclosure.

**MINIZED switch disconnectors with fuses, MINIZED fuse switch disconnectors and bases**

		Fuse bases made of ceramic			Comfort bases	Fuse bases
		D01	D02	D03	D01 / 02	--
		5SG15 5SG55	5SG16 5SG56	5SG18	5SG1.01 5SG5.01	5SG1.02 5SG5.02
<b>Standards</b>		IEC 60269-3; DIN VDE 0636-3				
<b>Rated voltage U<sub>n</sub></b>	V AC	400				
• 1P	V DC	250				
• 2P in series	V DC	250				
<b>Rated current I<sub>n</sub></b>	A	16	63	100	16 / 63	16 / 63
<b>Mounting position</b>		Any, preferably vertical				
<b>Degree of protection</b> acc. to IEC 60529		IP20, with connected conductors <sup>1)</sup>				
<b>Terminals</b> With touch protection acc. to BGV A3		No			Yes	
<b>Ambient temperature</b>	°C	-5 ... +40, humidity 90% at 20 °C				
<b>Input terminal type</b>		Contact pin	Screw head contact, saddle terminal	Screw head contact	Dual-chamber terminal	Dual-chamber terminal
<b>Conductor cross-sections</b>						

		Fuse bases made of ceramic			Comfort bases	Fuse bases
		D01	D02	D03	D01 / 02	--
		5SG15 5SG55	5SG16 5SG56	5SG18	5SG1.01 5SG5.01	5SG1.02 5SG5.02
• Rigid conductor	mm <sup>2</sup>	1.5 ... 4	2.5 ... 25	10 ... 50	0.75 ... 35	1 ... 35
• Flexible conductor	mm <sup>2</sup>	1.5 ... 4	2.5 ... 25	10 ... 50	0.75 ... 35	1 ... 25
• Flexible conductor with ferrule	mm <sup>2</sup>	1.5 ... 4	1.5 ... 16	--	--	0.75 ... 35
• Rigid conductor + busbars at the bottom	mm <sup>2</sup>	--	--	--	--	1 ... 35
• Rigid conductor + busbars at the top	mm <sup>2</sup>	--	--	--	--	1 ... 16
• Flexible conductor + busbars at the bottom	mm <sup>2</sup>	--	--	--	--	1 ... 25
• Flexible conductor + busbars at the top	mm <sup>2</sup>	--	--	--	--	1 ... 16
• Flexible conductor with ferrule + busbars at the bottom	mm <sup>2</sup>	--	--	--	--	0.75 ... 25
• Flexible conductor with ferrule + busbars at the top	mm <sup>2</sup>	--	--	--	--	0.75 ... 16
• 2x rigid conductor	mm <sup>2</sup>	--	--	--	--	16 and 25
• 2x flexible conductor	mm <sup>2</sup>	--	--	--	--	10 and 16
• 2x flexible conductor with ferrule	mm <sup>2</sup>	--	--	--	--	16 and 25
<b>Output terminal type</b>		Contact pin	Saddle terminal	Saddle terminal	Dual-chamber terminal	Box terminal
• Rigid conductor	mm <sup>2</sup>	1.5 ... 4	2.5 ... 25	10 ... 50	0.75 ... 35	1 ... 25
• Flexible conductor	mm <sup>2</sup>	1.5 ... 4	2.5 ... 25	10 ... 50	0.75 ... 35	1 ... 25
• Flexible conductor with ferrule	mm <sup>2</sup>	1.5 ... 4	1.5 ... 16	10 ... 35		1 ... 25
<b>Tightening torque</b>	Nm	1.2	2	3.5, 2.5	3.5	3.1

1) Degree of protection IP20 is tested according to regulations using a straight test finger (from the front), with the device mounted and equipped with a cover, housing or some other enclosure.

### 2.1.3 Dimensional drawings

#### 5SG71.3 MINIZED D02 switch disconnectors with fuses in withdrawable design

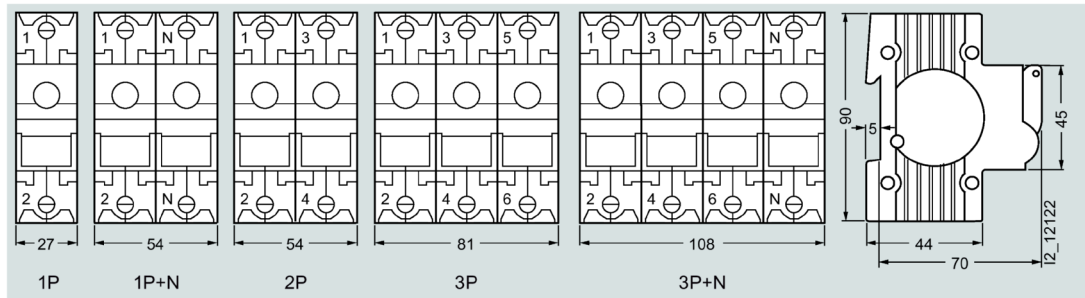

#### 5SG76 MINIZED D01 fuse switch disconnectors in withdrawable design

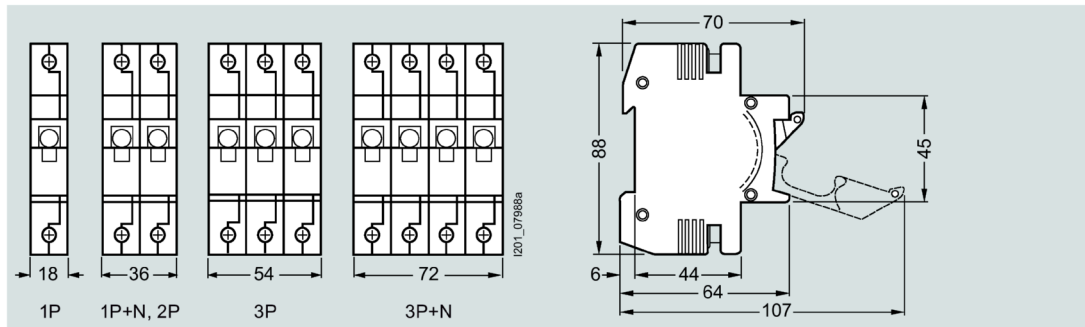

#### Fuse bases with touch protection according to BGV A3 (VBG4), molded plastic

Size D01/D02, with combination terminal, can be bus-mounted

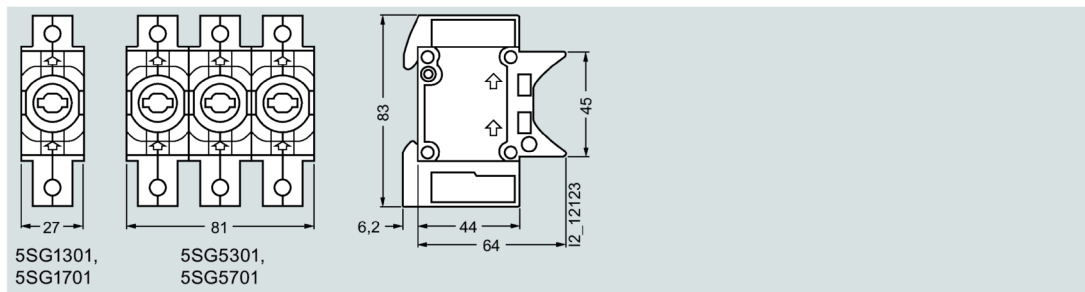

Size D01/D02, with dual-chamber terminal at input, box terminal at output, can be bus-mounted

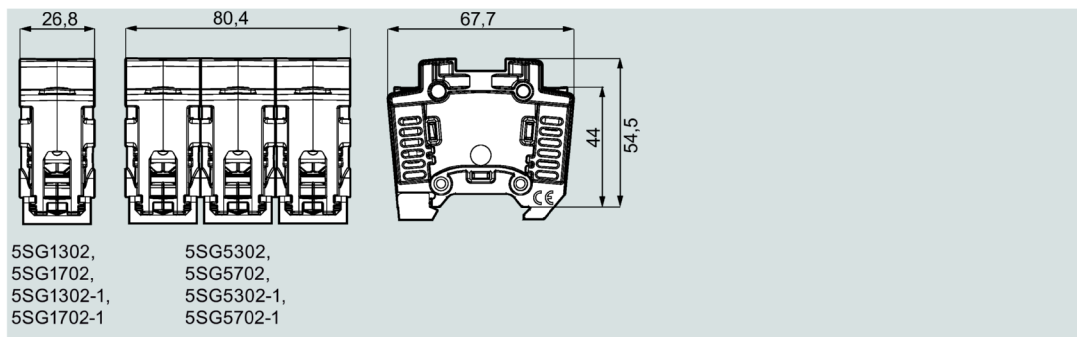

NEOZED fuse bases made of ceramic

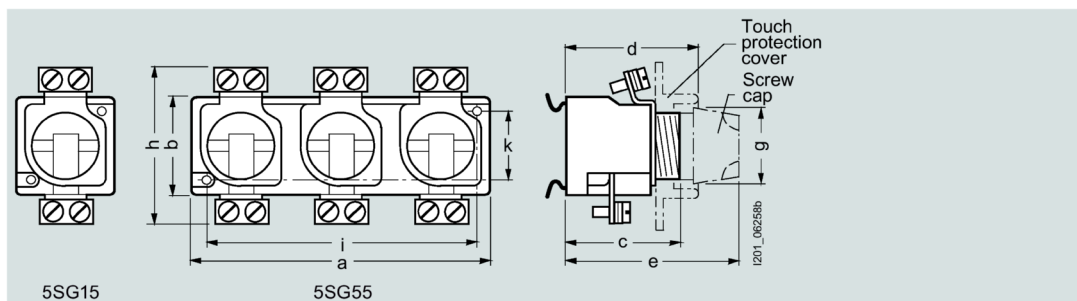

Type	Version	Size	Terminal type	Dimensions								
				a	b	c	d	e	g Not sealed / sealed	h	i	j
<b>Snap-on with cover</b>												
5SG1553	1-pole	D01	BB	26.8	36	40	56	70	23 / 26.5	54	--	--
5SG1653		D02	SS	26.8	36	41	56	70	23 / 26.5	59	--	--
5SG1693		D02	KS	26.8	36	41	56	70	23 / 26.5	60	--	--
5SG5553	3-pole	D01	BB	80.8	36	40	56	70	23 / 26.5	54	--	--
5SG5653		D02	SS	80.8	36	41	56	70	23 / 26.5	59	--	--
5SG5693		D02	KS	80.8	36	41	56	70	23 / 26.5	60	--	--
<b>Snap-on without cover</b>												
5SG1812	1-pole	D03	KS	44.9	50	44	54.5	76	44	86	--	--

BB = Clamp-type terminal at incoming feeder -- Clamp-type terminal at outgoing feeder  
 SS = Saddle terminal at incoming feeder -- Saddle terminal at outgoing feeder  
 KS = Screw head contact at incoming feeder -- Saddle terminal at outgoing feeder

**NEOZED covers made of molded plastic**

**NEOZED covers for NEOZED fuse bases made of ceramic**

5SH5251 (A4) and 5SH5253 (A10)

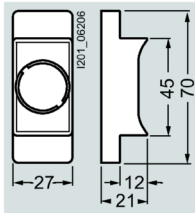

5SH5252 (A5) and 5SH5254 (A11)

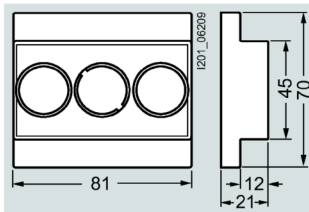

5SH5233 (A6)

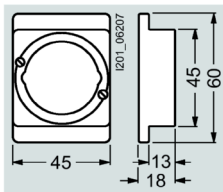

**NEOZED screw caps**

5SH4

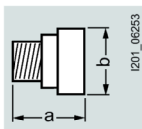

Type	Size	Sealable	For mounting depth	Dimensions	
				a	b
5SH4116	D01	--	70	27.5	24
5SH4163	D02	--	70	27.5	24
5SH4316	D01	✓	70	33	26.5
5SH4363	D02	✓	76	33	26.5
5SH4100	D03	--	70	37	44
5SH4317	D01	--	70	29.5	25
5SH4362	D02	--	70	30.5	25

NEOZED fuse links

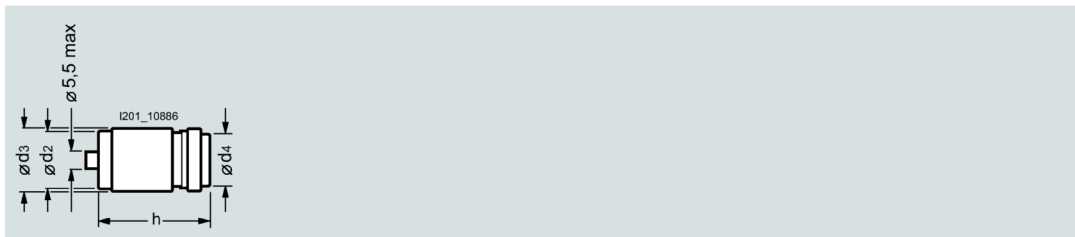

Size / thread	Rated current	Dimensions			
	$I_n$ in A	$d_2$ min	$d_3$	$d_4$ max	$h$
D01 / E14	2 ... 16	9.8	11	6	36
D02 / E18	20 ... 63	13.8	15.3	10	36
D03 / M30	80 ... 100	20.8	22.5	36	43

2.1.4 Circuit diagrams

5SG71.3 MINIZED D02 switch disconnectors in withdrawable design



5SG7113

1P



5SG7153

1P+N



5SG7123

2P

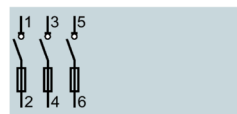

5SG7133  
5SG7133-8BA25  
5SG7133-8BA35  
5SG7133-8BA50

3P

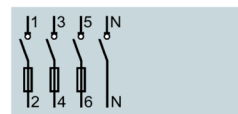

5SG7163

3P+N

5SG76 MINIZED D01 fuse switch disconnectors in withdrawable design



5SG7610

1P



5SG7650

1P+N



5SG7620

2P

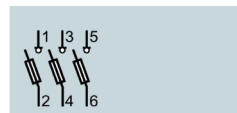

5SG7630

3P

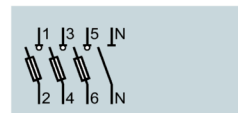

5SG7660

3P+N

NEOZED fuse bases/fuses in general



5SG7610  
1P



5SG7650  
1P+N

2.1.5 Characteristic curves

5SE2 series

Size:	D01, D02, D03
Operational class:	gG
Rated voltage:	400 V AC / 250 V DC
Rated current:	2 ... 100 A

Time/current characteristic curves diagram

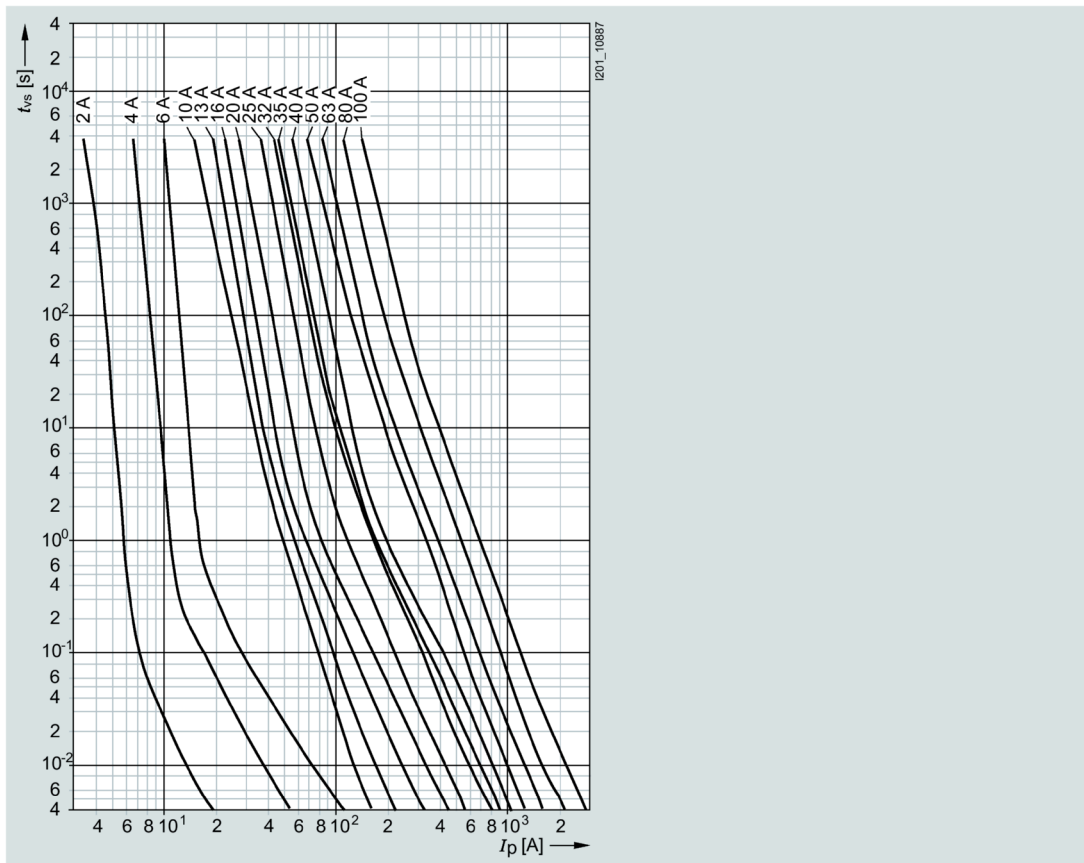



**Current limiting diagram**

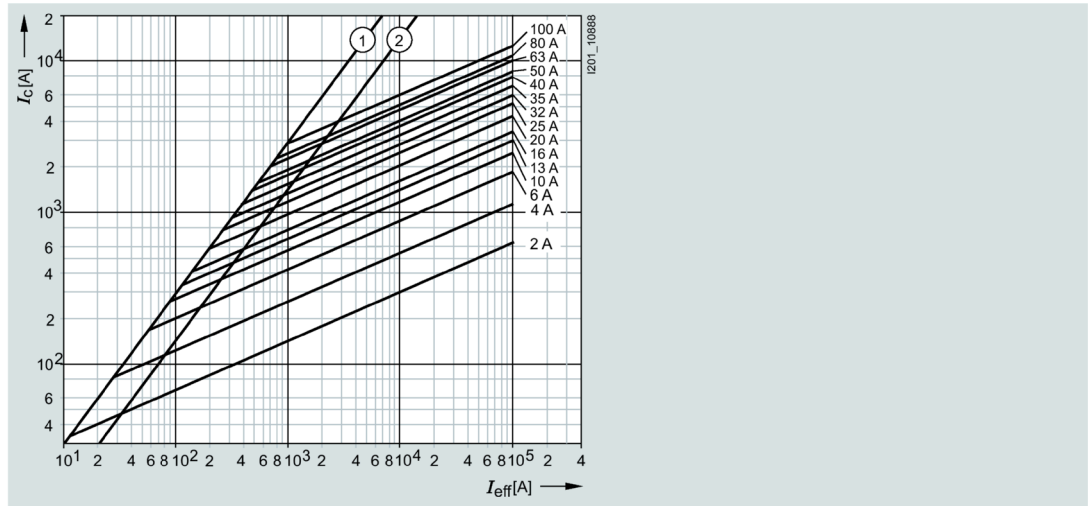

- ① Peak short-circuit current with largest DC component
- ② Peak short-circuit current without DC component

**Melting  $I^2t$  values diagram**

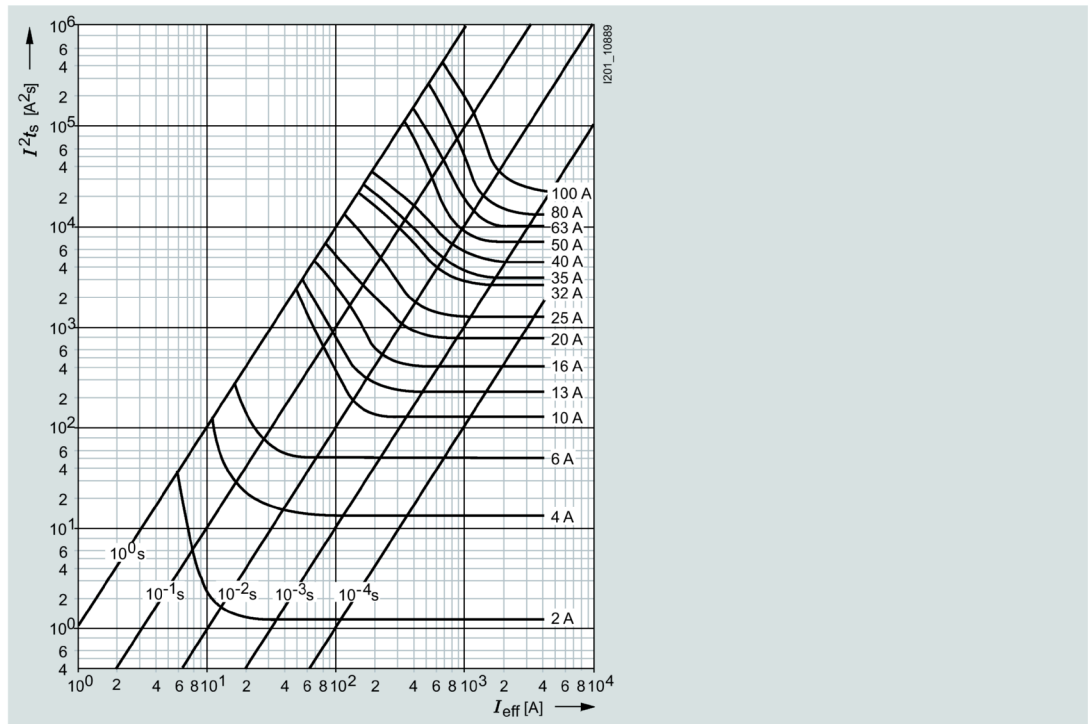

Type	I <sub>n</sub>	P <sub>v</sub>	Δθ	I <sup>2</sup> t <sub>s</sub>		I <sup>2</sup> t <sub>a</sub>	
				1 ms	4 ms	230 V AC (t < 4 ms)	400 V AC
	A	W	K	A <sup>2</sup> s	A <sup>2</sup> s	A <sup>2</sup> s	A <sup>2</sup> s
5SE2302	2	1.6	19	1.2	1.4	2.9	3.9
5SE2304	4	1.3	14	12.5	13.6	22	30
5SE2306	6	1.7	19	46.7	48	58	75
5SE2310	10	1.3	16	120	136	220	280
5SE2013-2A	13	2	23	220	244	290	370
5SE2316	16	2.1	24	375	410	675	890
5SE2320	20	2.4	26	740	810	1250	1650
5SE2325	25	3.2	33	1210	1300	1900	2600
5SE2332	32	3.6	34	2560	2800	4300	5500
5SE2335	35	3.8	36	3060	3500	5100	6500
5SE2340	40	4	37	4320	4800	7900	9500
5SE2350	50	4.2	38	6750	7400	10500	13000
5SE2363	63	5.3	45	10000	10900	16000	20500
5SE2280	80	5.3	43	13000	15400	25000	34500
5SE2300	100	6.4	47	22100	30000	46000	60000

## 2.2 DIAZED fuse system

### 2.2.1 Portfolio overview

The DIAZED fuse system is one of the oldest fuse systems in the world. It was developed by Siemens as far back as 1906. It is still the standard fuse system in many countries to this day. It is particularly widely used in the harsh environments of industrial applications.

Series are available with rated voltages from 500 V to 750 V.

All DIAZED bases must be fed from the bottom to ensure that the threaded ring is insulated when the fuse link is being removed. Reliable contacting of the fuse links is only ensured when DIAZED screw adapters are used.

The DIAZED bases are available in different designs and with different terminals to support varying installation requirements.

One special feature is the high-performing EZR bus-mounting system for screw mounting. The busbars, which are particularly suited for bus-mounting bases, have a load capacity of up to 150 A with lateral infeed.

DIAZED stands for the German "**D**iametral gestuftes **z**weiteiliges Sicherungssystem mit **E**dsongewinde" (diametral two-step fuse system with Edison screw).

## Benefits

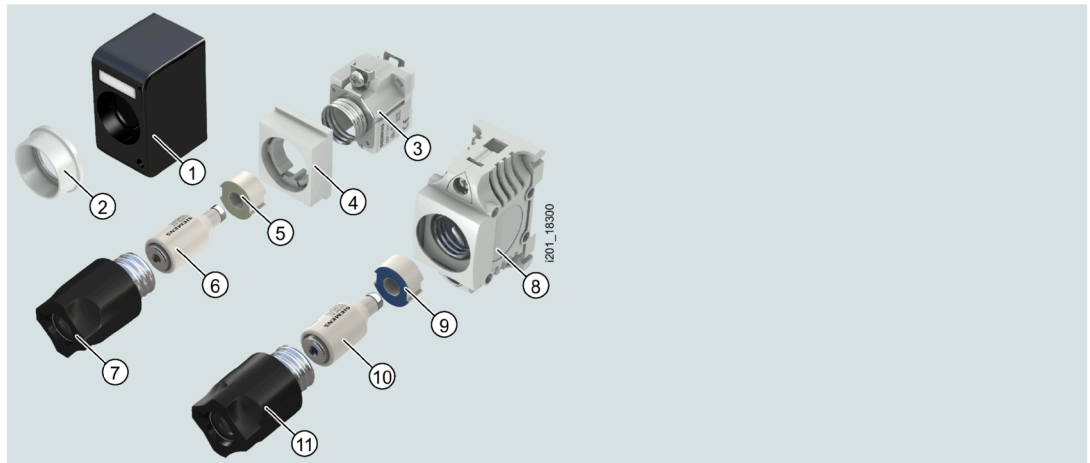

- ① DIAZED cap for fuse base
- ② DIAZED cover ring for fuse base
- ③ DIAZED fuse base
- ④ DIAZED cover for fuse base
- ⑤ DIAZED screw adapter
- ⑥ DIAZED fuse link
- ⑦ DIAZED screw cap
- ⑧ DIAZED fuse base (with touch protection according to BGV A3)
- ⑨ DIAZED screw adapter
- ⑩ DIAZED fuse link
- ⑪ DIAZED screw cap

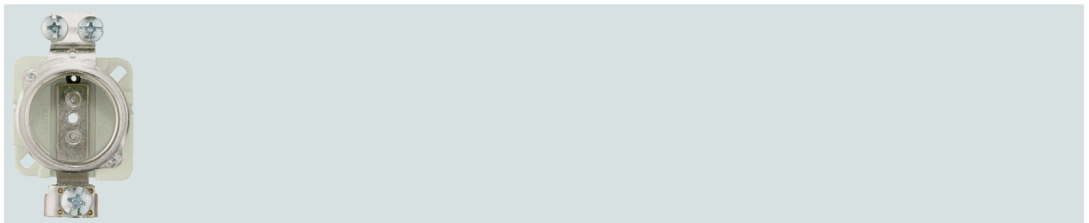

DIII fuse bases with terminal version BS

- Outgoing feeders (top), saddle terminal S
- Incoming feeders (bottom), clamp-type terminal B

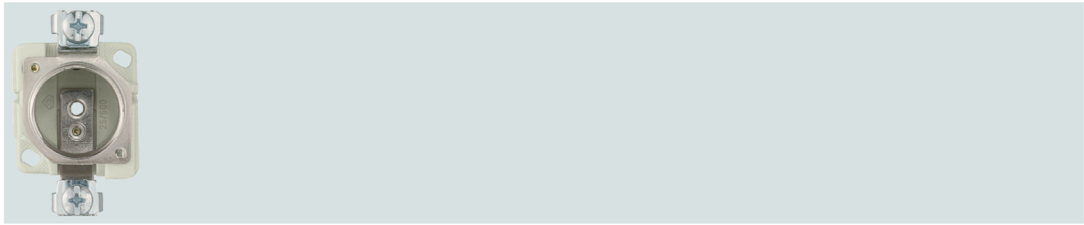

DII fuse bases with terminal version BB

- Outgoing feeders (top), clamp-type terminal B
- Incoming feeders (bottom), clamp-type terminal B

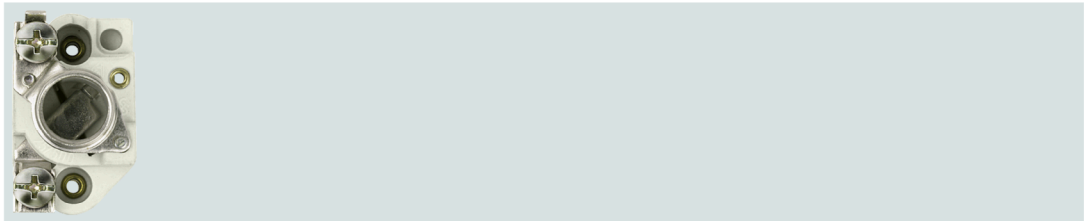

NDz fuse bases with terminal version KK

- Outgoing feeders (top), screw head contact K
- Incoming feeders (bottom), screw head contact K

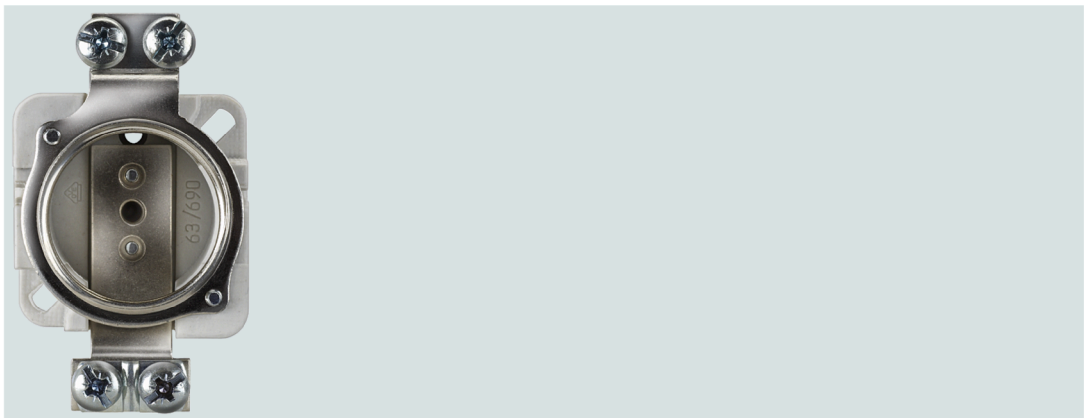

DIII fuse bases with terminal version SS

- Outgoing feeders (top), saddle terminal S
- Incoming feeders (bottom), saddle terminal S

## 2.2.2 Technical specifications

### General technical specifications

DIAZED fuse links 5SA, 5SB, 5SC, 5SD		
<b>Standards</b>		IEC 60269-3; DIN VDE 0635; DIN VDE 0636-3; CEE 16
<b>Operational class</b> according to IEC 60269; DIN VDE 0636		eG
<b>Characteristic</b> according to DIN VDE 0635		Slow and quick
<b>Rated voltage <math>U_n</math></b>	V AC V DC	500, 690, 750 440, 500, 600, 750
<b>Rated current <math>I_n</math></b>	A	2 ... 100
<b>Rated breaking capacity</b>	kA AC kA DC	50, 40 with E16 8, 1.6 with E16
<b>Overvoltage category</b>		III II (DIAZED fuse bases made of molded plastic for use at 690 V AC / 600 V DC)
<b>Mounting position</b>		Any, preferably vertical
<b>Non-interchangeability</b>		Using screw adapter or adapter sleeves
<b>Degree of protection</b> according to IEC 60529		IP20, with connected conductors <sup>1)</sup>
<b>Resistance to climate</b>	°C	Up to 45 at 95% rel. humidity
<b>Ambient temperature</b>	°C	-5 ... +40, humidity 90% at 20 °C

<sup>1)</sup> Degree of protection IP20 is tested according to regulations using a straight test finger (from the front), with the device mounted and equipped with a cover, housing or some other enclosure.

### Terminal versions

Size		B		K			S		R	
		DII	DII	NDz	DII	DII	DII	DIV	DII	DIII
<b>Conductor cross-sections</b>	mm <sup>2</sup>	1.5	2.5	1.0	1.5	2.5	2.5	10	1.5	1.5
• Rigid, min.	mm <sup>2</sup>	10	25	6	10	25	25	50	35	35
• Rigid, max.	mm <sup>2</sup>	10	25	6	10	25	25	50	35	35
• Flexible, with end sleeve										
<b>Tightening torque</b>										3.0
• M4 screw	Nm	1.2								
• M5 screw	Nm	2.0								
• M6 screw	Nm	2.5								
• M8 screw	Nm	3.5								

### 2.2.3 Dimensional drawings

#### DIAZED fuse links 5SA1, 5SA2

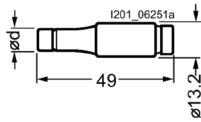

Size / thread	DIII / E33			
Rated current in A	32	35	50	63
Dimension d	16	16	18	20

#### DIAZED fuse links 5SB1, 5SB2

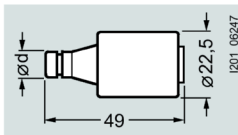

Size / thread	TNDz / E16, NDz / E16						
Rated current in A	2	4	6	10	16	20	25
Dimension d	6	6	6	8	10	12	14

#### DIAZED fuse links 5SB3, 5SB4

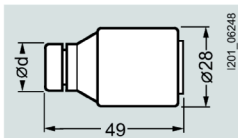

Size / thread	DII / E27						
Rated current in A	2	4	6	10	16	20	25
Dimension d	6	6	6	8	10	12	14

#### DIAZED fuse links 5SC1, 5SC2

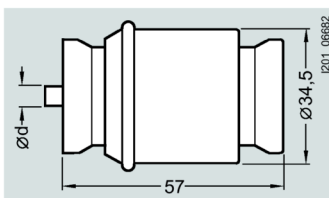

Size / thread	DIV / R1¼"	
Rated current in A	80	100
Dimension d	6	7

### DIAZED fuse links 5SD6, 5SD8



Size / thread	DIII / E33									
Rated current in A	2	4	6	10	16	20	25	35	50	63
Dimension d	6	6	6	8	10	12	14	16	18	20

### DIAZED fuse bases made of ceramic

#### 5SF1

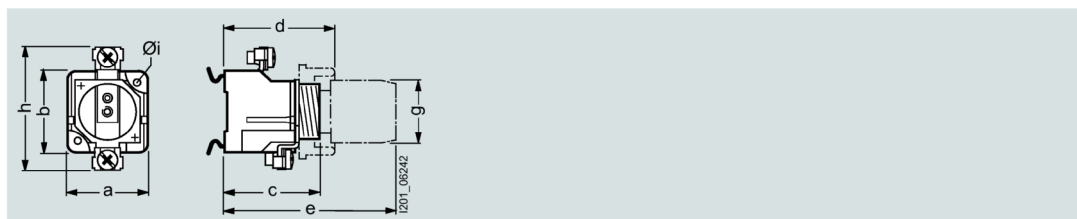

#### 5SF4230

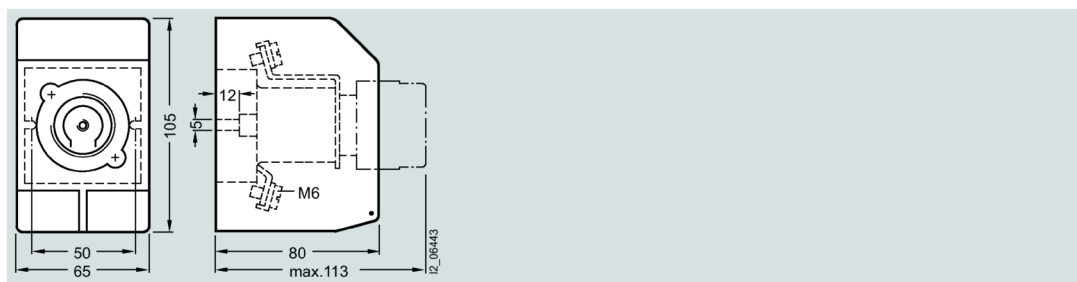

Type	Terminal type	Dimensions							
		a	b	c	d	e	Ø g	h	Ø i
<b>NDz/25 A</b>									
5SF1012	KK	29	49	44.6	55	75	32	49	-
<b>DII/25 A</b>									
5SF1005	BB	38.4	41	46.6	53	83	34	63	-
5SF1024	BB	38.4	41	46.6	53	83	34	63	4.3

Type	Terminal type	Dimensions							
		a	b	c	d	e	Ø g	h	Ø i
<b>DIII/63 A</b>									
5SF1205	BS	45.5	46	47	54	83	43	78	-
5SF1215	SS	45.5	46	47	54	83	43	78	-
5SF1224	BS	45.5	46	47	54	83	43	78	-
<b>DIV/100 A</b>									
5SF1401	Flat terminal	68	68	-	79	110	65	116	6.5

**DIAZED fuse bases 5SF1, 5SF5 made of molded plastic**

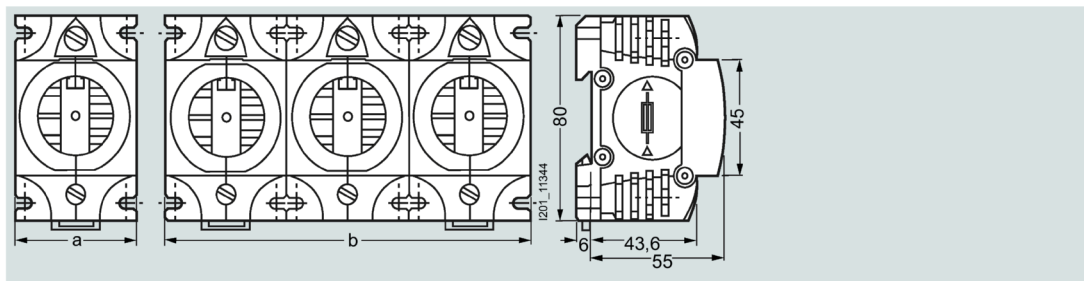

Type	Dimensions	
	a	b
5SF1060	40	-
5SF1260	50	-
5SF5068	-	120
5SF5268	-	150

**DIAZED EZR bus-mounting bases**

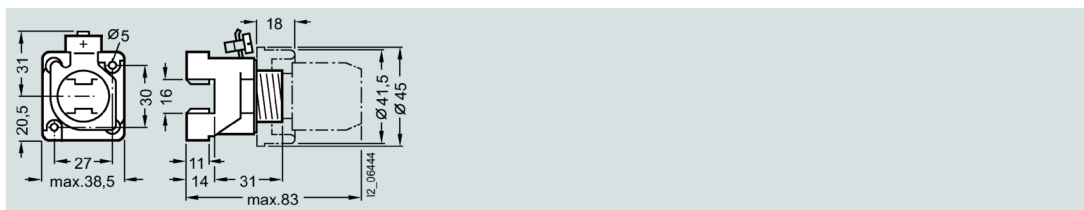

Figure 2-1 5SF6005

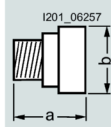

Figure 2-2 5SF6205



DIAZED screw caps / cover rings made of molded plastic / ceramic

5SH1 screw caps



5SH3 cover rings

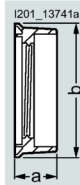

Size / thread	Screw caps			Cover rings		
	Type	Dimensions		Type	Dimensions	
		a	b (Ø)		a	b (Ø)
NDz / E16	5SH1112	36	24	-	-	-
DII / E27	5SH1221	42	33	5SH3401	17.5	39.5
	5SH112	45.5	34	-	-	-
	5SH122	43	39	-	-	-
DIII / E33	5SH1231	45	40	5SH3411	17.5	49.5
	5SH113	45.5	43	-	-	-
	5SH123	47	45	-	-	-
	5SH1161	48	48	-	-	-
	5SH1170	68	43	-	-	-

DIAZED cap 5SH2 made of molded plastic

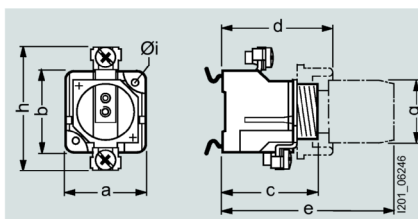

Size / thread	Type	Dimensions			
		a <sub>max</sub>	b <sub>max</sub>	c <sub>max</sub>	d <sub>max</sub>
NDz / E16	5SH201	33	68	51.7	75
DII / E27	5SH202	43	74.7	53.6	83
DIII / E33	5SH222	51	90.5	53.6	83

### 2.2.4 Characteristic curves

#### 5SA2 series

Size:	E16
Characteristic:	Slow
Rated voltage:	500 V AC / 440 V DC / 500 V DC
Rated current:	2 ... 25 A

#### Time/current characteristic curves diagram

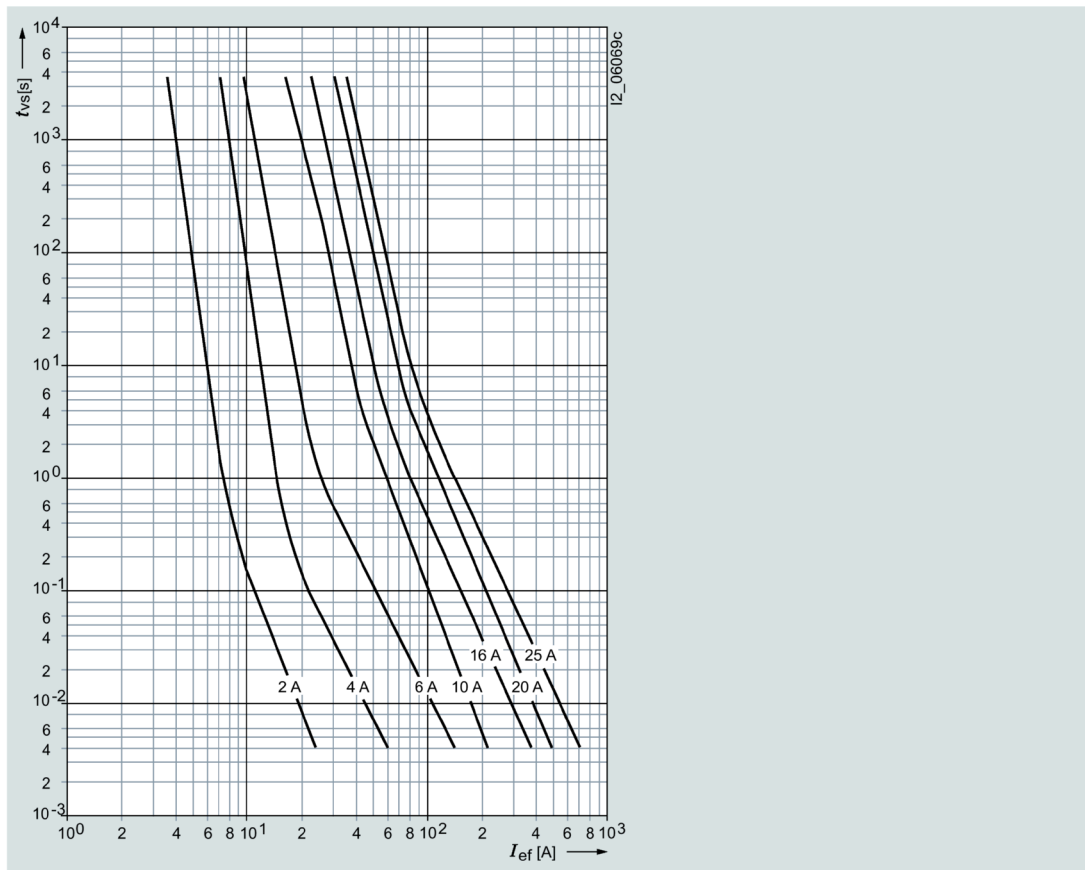

**Current limiting diagram**

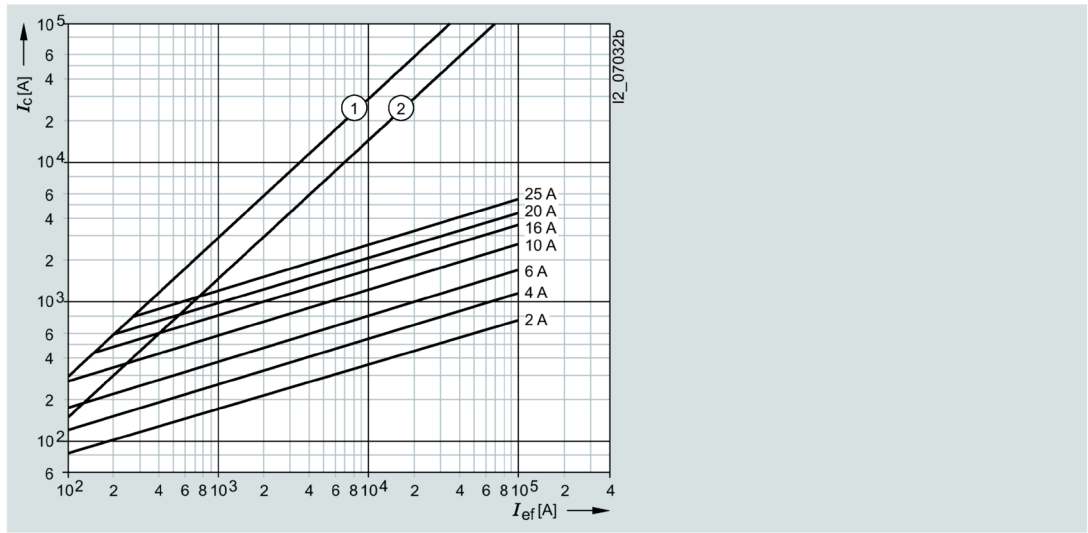

- ① Peak short-circuit current with largest DC component
- ② Peak short-circuit current without DC component

**Melting  $I^2t$  values diagram**

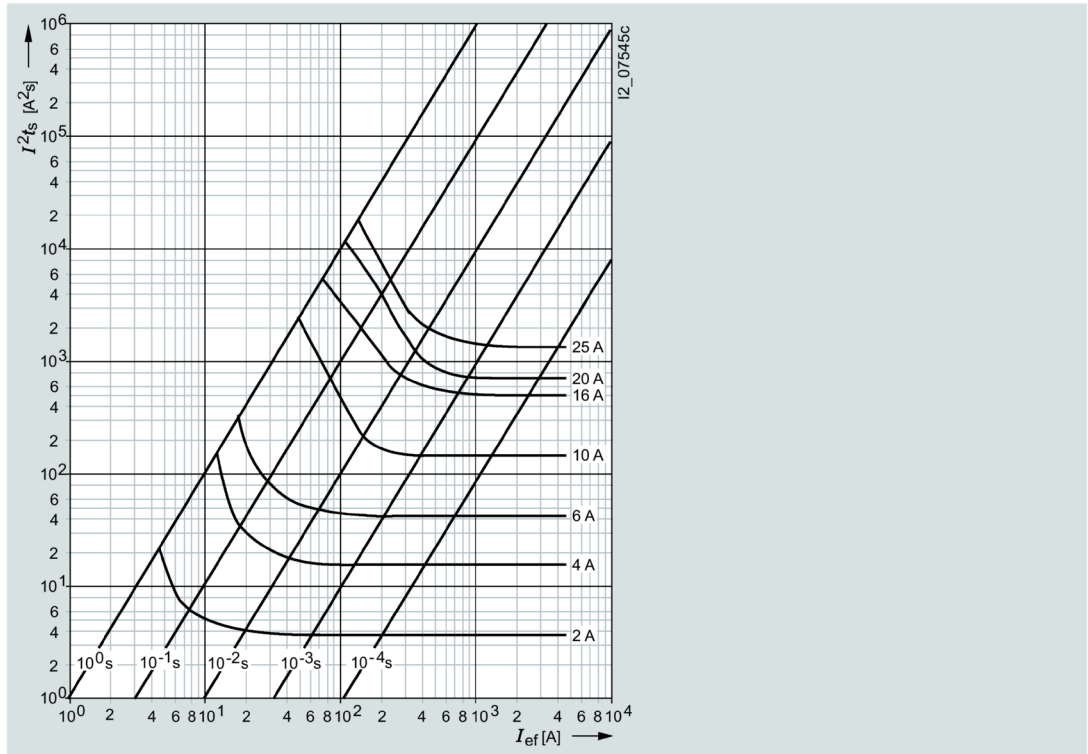

Type	I <sub>n</sub>	P <sub>v</sub>	Δθ	I <sup>2</sup> t <sub>s</sub>		I <sup>2</sup> t <sub>a</sub>		
				1 ms	4 ms	230 V AC	320 V AC	500 V AC
	A	W	K	A <sup>2</sup> s	A <sup>2</sup> s	A <sup>2</sup> s	A <sup>2</sup> s	A <sup>2</sup> s
5SA211 <sup>1)</sup>	2	0.85	15	1.2	2.3	6.6	7.8	0.7
5SA221 <sup>1)</sup>	4	1.3	17	8.5	13	22	26	34
5SA231 <sup>1)</sup>	6	1.9	14	40	80	66	76	100
5SA251 <sup>1)</sup>	10	1.4	17	200	190	240	270	340
5SA2611 <sup>2)</sup>	16	2.4	30	290	550	890	950	1090
5SA2711 <sup>2)</sup>	20	2.6	36	470	1990	1200	1350	1620
5SA2811 <sup>2)</sup>	25	3.4	34	1000	2090	2400	2600	3450

1) 500 V DC voltage

2) 440 V DC voltage

### 5SB2, 5SB4, 5SC2 series

Size:

DII, DIII, DIV

Operational class:

gG

Rated voltage:

500 V AC / 440 V DC / 500 V DC

Rated current:

2 ... 100 A

Time/current characteristic curves diagram

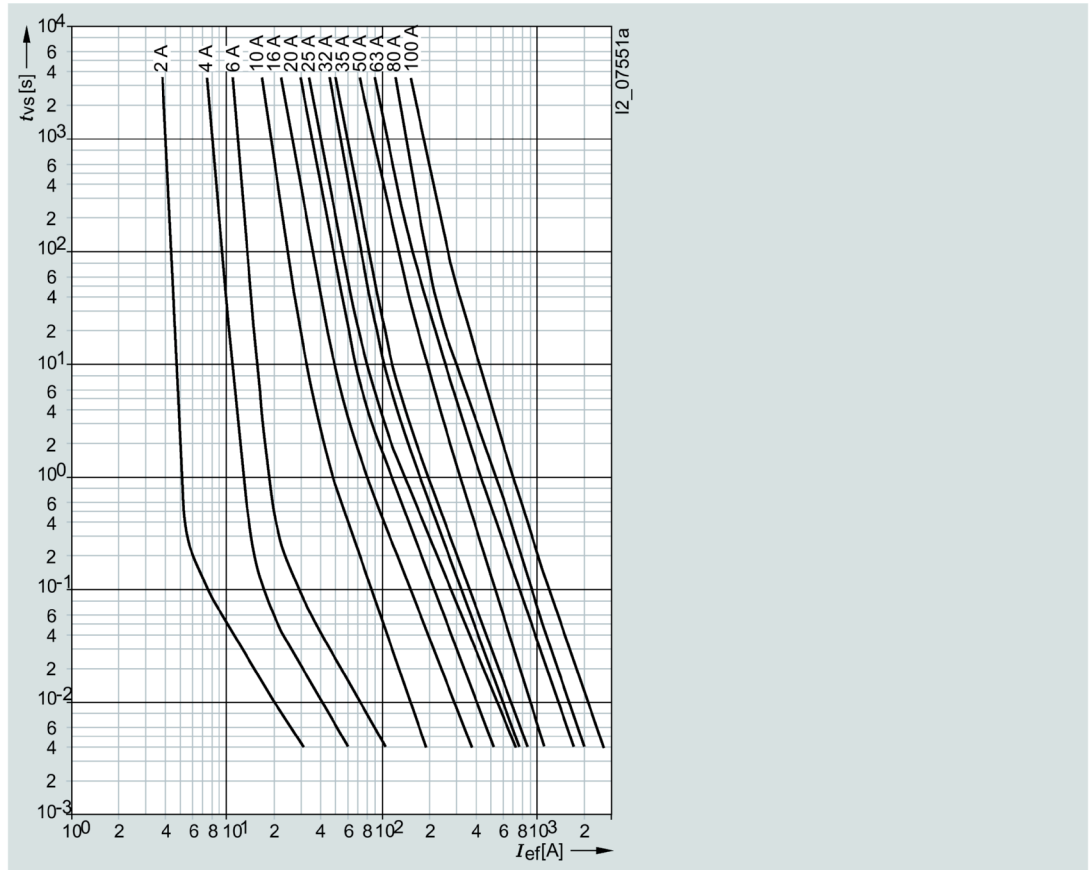

Current limiting diagram

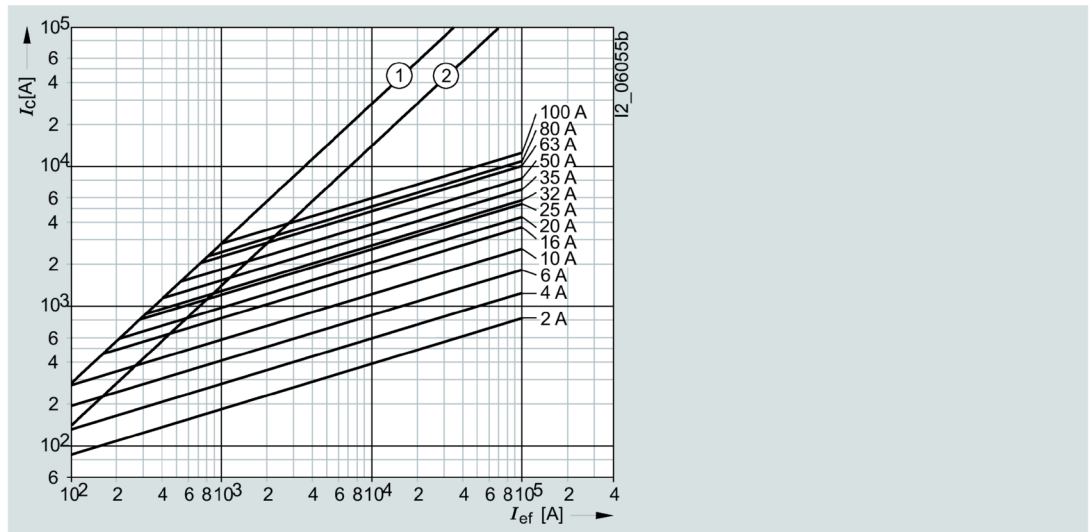

- ① Peak short-circuit current with largest DC component
- ② Peak short-circuit current without DC component

Melting I<sup>2</sup>t values diagram

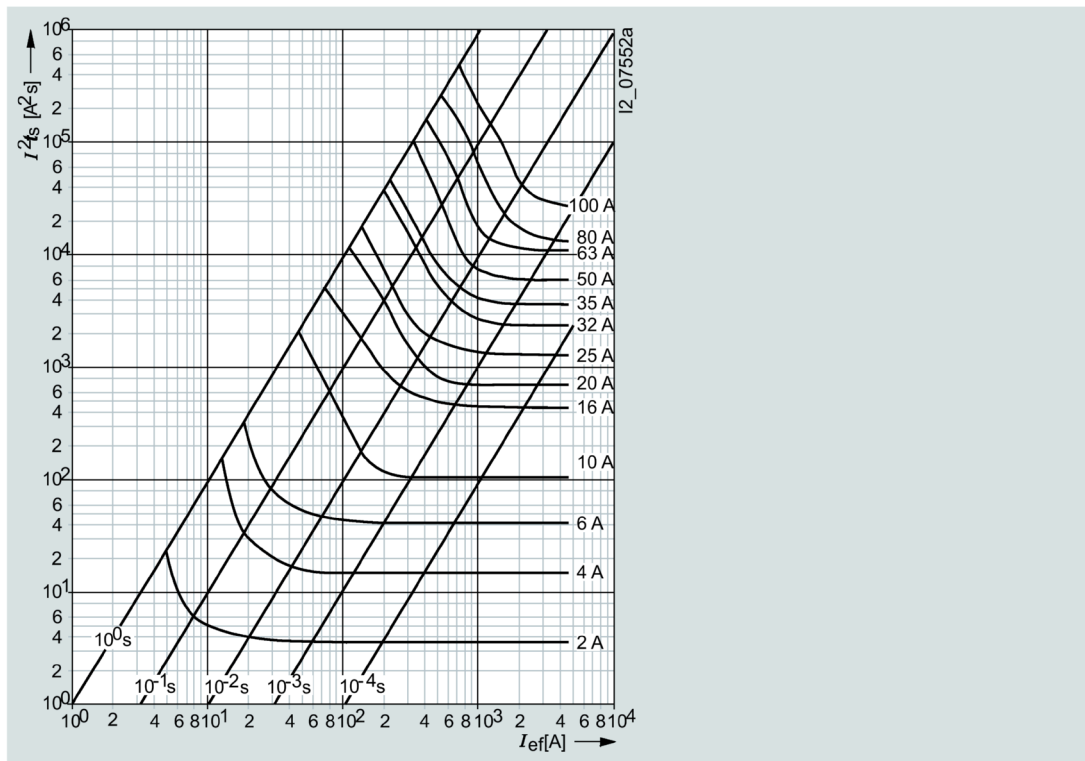

Type	I <sub>n</sub> A	P <sub>v</sub> W	Δθ K	I <sup>2</sup> t <sub>s</sub>		I <sup>2</sup> t <sub>a</sub>		
				1 ms	4 ms	230 V AC	320 V AC	500 V AC
				A <sup>2</sup> s	A <sup>2</sup> s	A <sup>2</sup> s	A <sup>2</sup> s	A <sup>2</sup> s
5SB211 <sup>1)</sup>	2	2.6	15	3.7	3.9	6.6	8.8	10.7
5SB221 <sup>1)</sup>	4	2.0	13	15	16	22	28	34
5SB231 <sup>1)</sup>	6	2.2	14	42	45	66	85	100
5SB251 <sup>1)</sup>	10	1.6	20	120	140	240	300	340
5SB2611 <sup>2)</sup>	16	2.4	23	500	580	890	1060	1090
5SB2711 <sup>2)</sup>	20	2.6	26	750	1100	1200	1450	1620
5SB2811 <sup>2)</sup>	25	3.4	38	1600	2000	2400	3150	3450
5SB4011 <sup>2)</sup>	32	3.6	23	2300	2500	3450	4150	4850
5SB4111 <sup>2)</sup>	35	3.7	25	3450	3000	5200	6200	7200
5SB4211 <sup>2)</sup>	50	5.7	41	6500	5200	9750	12350	14500
5SB4311 <sup>2)</sup>	63	6.9	48	11000	12000	16500	22200	26500
5SC211 <sup>1)</sup>	80	7.5	33	14600	16400	23000	28500	32500
5SC221 <sup>1)</sup>	100	8.8	46	28600	30000	40000	56000	65000

1) 500 V DC voltage

2) 440 V DC voltage

**5SD8 series**

Size:	DIII
Operational class:	gG
Rated voltage:	690 V AC / 600 V DC
Rated current:	2 ... 63 A

**Time/current characteristic curves diagram**

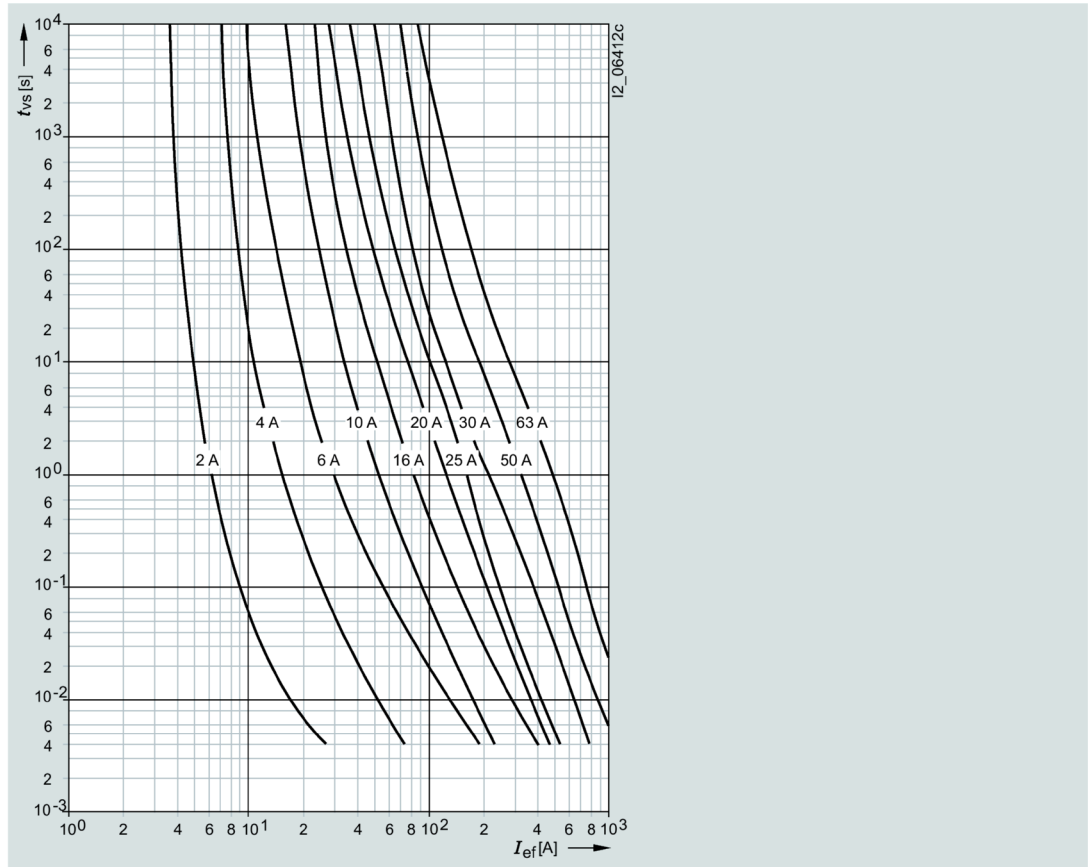

Current limiting diagram

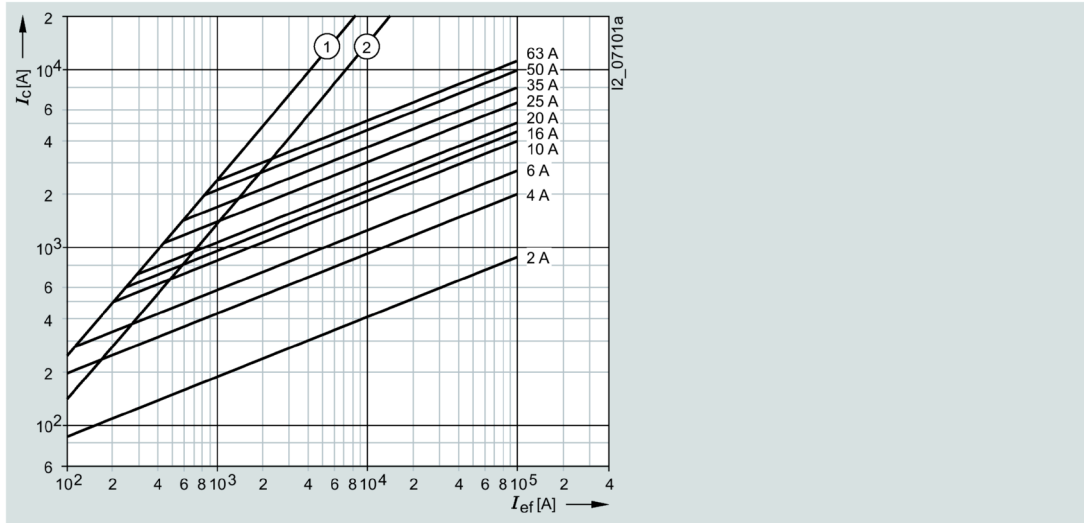

- ① Peak short-circuit current with largest DC component
- ② Peak short-circuit current without DC component

Melting  $I^2t$  values diagram

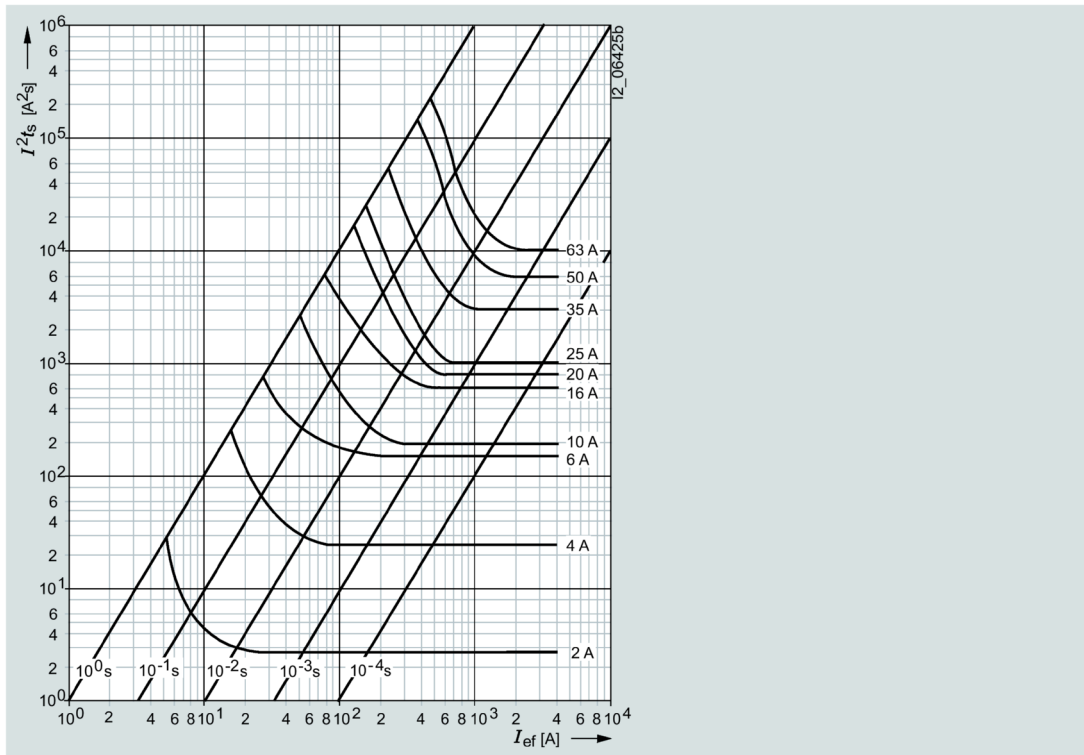



Type	I <sub>n</sub>	P <sub>v</sub>	I <sup>2</sup> t <sub>s</sub>	I <sup>2</sup> t <sub>a</sub>
			4 ms	242 V AC
	A	W	A <sup>2</sup> s	A <sup>2</sup> s
5SD8002	2	1	4.4	7
5SD8004	4	1.2	40	62
5SD8006	6	1.6	88	140
5SD8010	10	1.4	240	380
5SD8016	16	1.8	380	600
5SD8020	20	2	750	1200
5SD8025	25	2.3	2000	3200
5SD8035	35	3.1	3300	5100
5SD8050	50	4.6	7000	11000
5SD8063	63	5.5	9500	15000

### 5SD6 series

Size:

Operational class:

Rated voltage:

Rated current:

DIII

Quick (railway network protection)

750 V AC / 750 V DC

2 ... 63 A

Time/current characteristic curves diagram

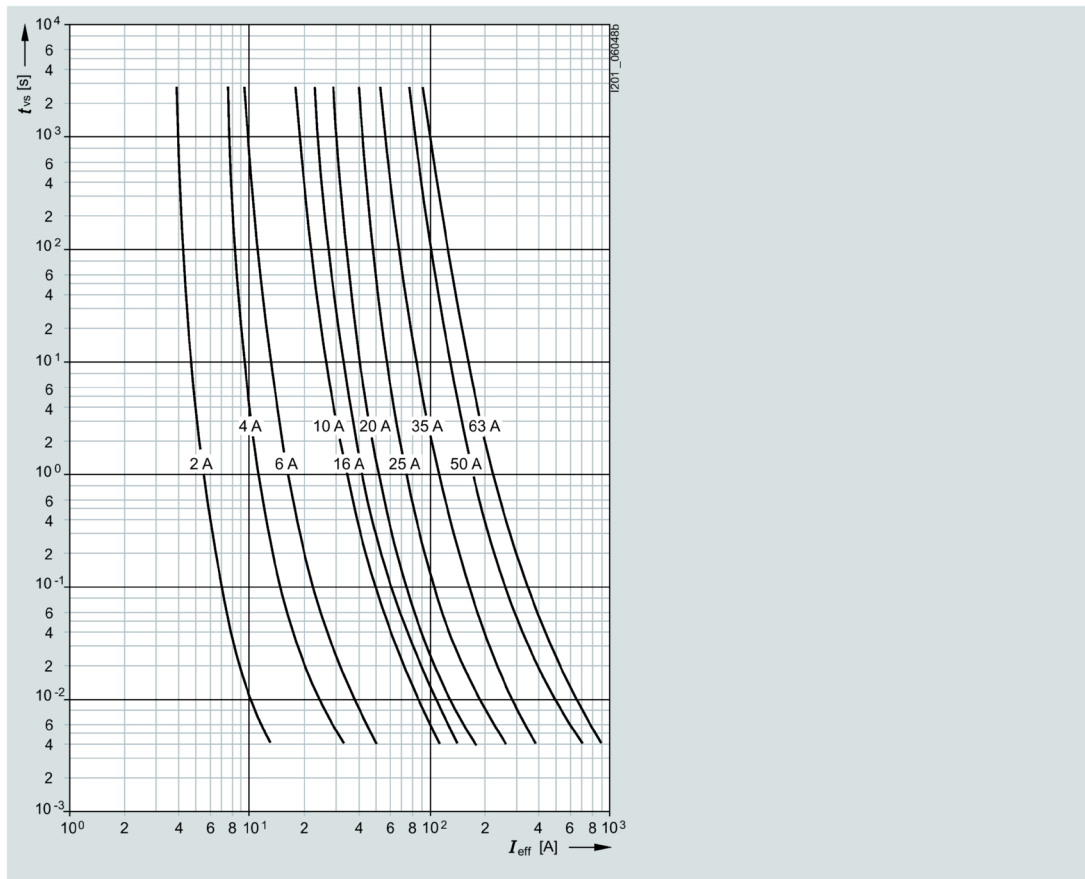

Current limiting diagram

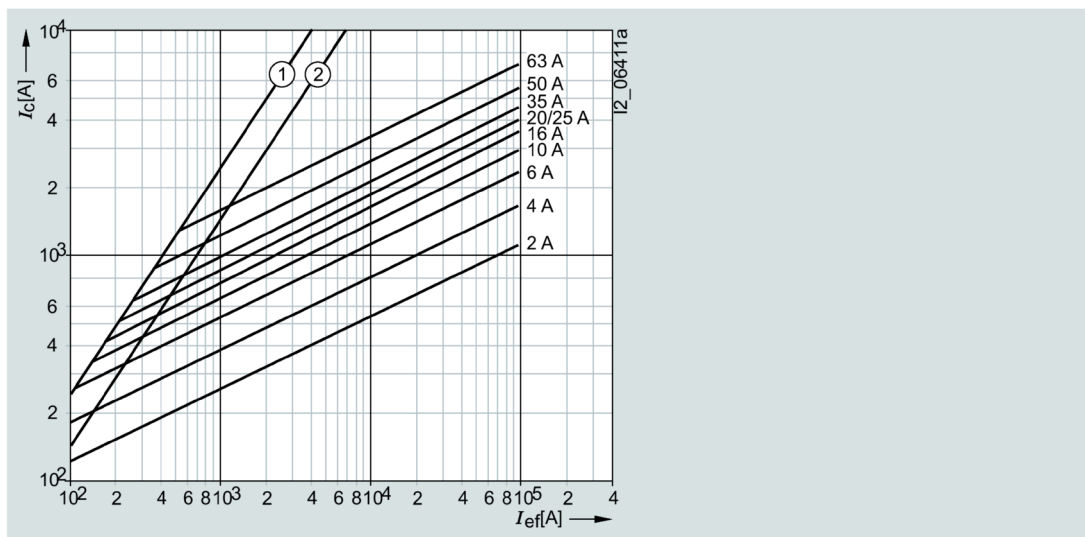

- ① Peak short-circuit current with largest DC component
- ② Peak short-circuit current without DC component

Melting I<sup>2</sup>t values diagram

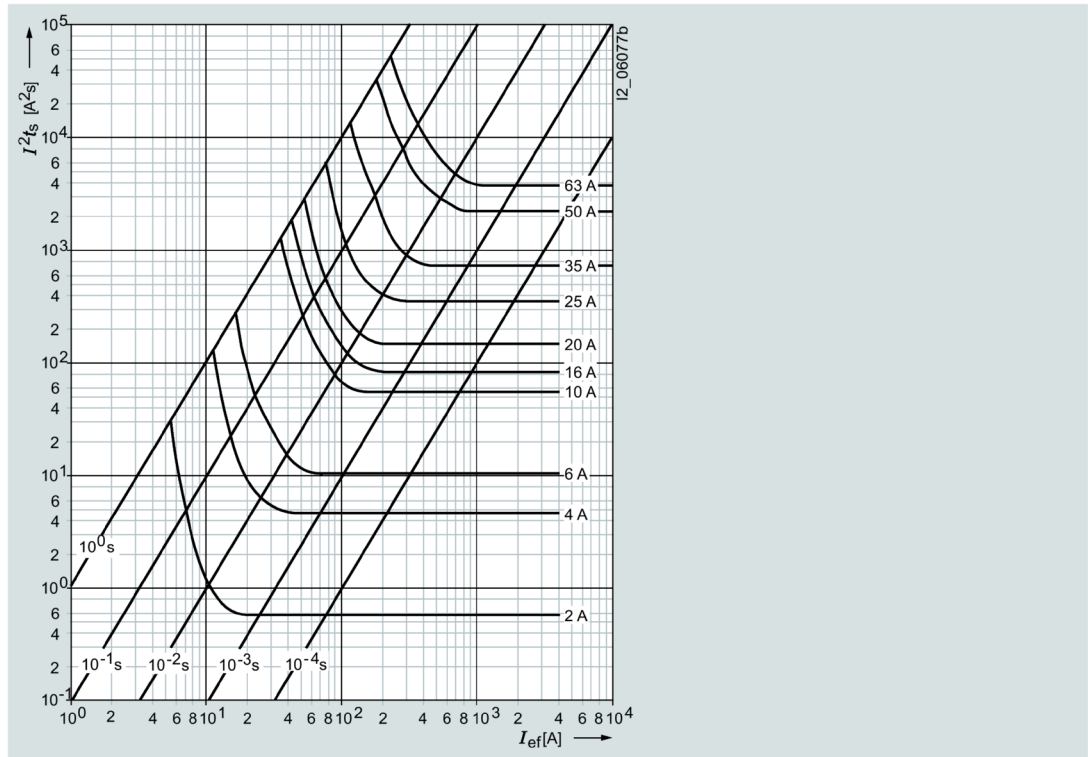

Type	I <sub>n</sub>	P <sub>v</sub>	I <sup>2</sup> t <sub>s</sub>	I <sup>2</sup> t <sub>a</sub>
			4 ms	500 V AC
	A	W	A <sup>2</sup> s	A <sup>2</sup> s
5SD601	2	2.8	0.7	2
5SD602	4	4	4.5	13
5SD603	6	4.8	10	29
5SD604	10	4.8	50	135
5SD605	16	5.9	78	220
5SD606	20	6.3	125	380
5SD607	25	8.3	265	800
5SD608	35	13	550	1600
5SD610	50	16.5	1800	5500
5SD611	63	18	3100	9600



## Cylindrical fuse systems

### 3.1 Cylindrical fuse links and cylindrical fuse holders

#### 3.1.1 Portfolio overview

Cylindrical fuses are standard in Europe. There are a range of different cylindrical fuse links and holders that comply with the standards IEC 60269-1, -2 and -3. This means they are suitable for use in industrial applications. In South West Europe they are also approved for use in residential buildings.

The cylindrical fuse holders are also approved according to UL 512. The cylindrical fuse holders are tested and approved as fuse disconnectors according to the switching device standard IEC 60947-3. They are not suitable for switching loads.

Cylindrical fuse holders can be supplied with or without signal detectors. In the case of devices with signal detector, a small electronic device with LED is located behind an inspection window in the plug-in module. If the inserted fuse link is tripped, this is indicated by flashing of the LED.

The switching state of the fuse holder can be signaled over a laterally retrofitted auxiliary switch, which enables the integration of the fuses in the automation process.

#### Benefits

- Devices with pole number 1P+N are available in a single modular width. This reduces the footprint by 50%.
- The sliding catch for type ranges 8 x 32 mm and 10 x 38 mm enables the removal of individual devices from the assembly.
- Space for a spare fuse in the plug-in module enables the fast replacement of fuses. This saves time and money and increases system availability.
- A flashing LED signals that a fuse link has been tripped. This enables fast detection during runtime.

#### 3.1.2 Technical specifications



##### Cylindrical fuse links

		3NW63..	3NW60..	3NW61..	3NW62..	3NW80..	3NW81..	3NW82..
Size	mm x mm	8 x 32	10 x 38	14 x 51	22 x 58	10 x 38	14 x 51	22 x 58
Standards	-	IEC 60269-1, -2, -3; NF C 60-200; NF C 63-210, -211; NBN C 63269-2, CEI 32-4, -12						

## 3.1 Cylindrical fuse links and cylindrical fuse holders

		3NW63..	3NW60..	3NW61..	3NW62..	3NW80..	3NW81..	3NW82..
<b>Operational class</b>	-	gG				aM		
<b>Rated voltage U<sub>n</sub></b>	V AC	400	400 or 500					
<b>Rated current I<sub>n</sub></b>	A	2 ... 20	0.5 ... 32	4 ... 50	8 ... 100	0.5 ... 32	2 ... 50	10 ... 100
<b>Rated breaking capacity</b>								
• 500 V variants	kA AC	-	120	100		120	100	
• 400 V variants	kA AC	20	120	20		120	20	
<b>Mounting position</b>	-	Any, preferably vertical						

## Cylindrical fuse holders

			3NW73..	3NW70..	3NW71..	3NW72..
<b>Size</b>	-	mm x mm	8 x 32	10 x 38	14 x 51	22 x 58
<b>Standards</b>	-	-	IEC 60269-1, -2, -3; NF C 60-200, NF C 63-210, -211; NBN C 63269-2-1; CEI 32-4, -12; UL 4248-1			
<b>Approvals</b>	According to UL Acc. to CSA	- -	- -			-
<b>Rated voltage U<sub>n</sub></b>	Acc. to UL / CSA	V AC V AC	400 400	690 600		
<b>Rated current I<sub>n</sub></b>		A AC	20	32	50	100
<b>Rated breaking capacity</b>		kA	20	100		
<b>Breaking capacity</b>						
Utilization category	-	-	AC-20B (switching without load), DC-20B			
<b>No-voltage changing</b> of fuse links	-	-	Yes			
<b>Sealable</b> When installed	-	-	Yes			
<b>Mounting position</b>	-	-	Any, preferably vertical			
<b>Degree of protection</b>	Acc. to IEC 60529	-	IP20, with connected conductors <sup>1)</sup>			
<b>Terminals with touch protection</b> according to BGV A3 at incoming and outgoing feeder	-	-	Yes			
<b>Ambient temperature</b>	-	°C	-5 ... +40, humidity 90% at +20 °C			
<b>Conductor cross-sections</b>						
• Rigid	-	mm <sup>2</sup>	0.5 ... 10		2.5 ... 10	4 ... 10
• Stranded	-	mm <sup>2</sup>	0.5 ... 10		2.5 ... 25	4 ... 50
• Finely stranded, with end sleeve	-	mm <sup>2</sup>	0.5 ... 10 <sup>2)</sup>		2.5 ... 16	4 ... 35
• AWG cables (American Wire Gauge)	-	AWG	-	10 ... 20	6 ... 10	-
<b>Tightening torque</b>	-	Nm	1.2		2.0	2.5

<sup>1)</sup> Degree of protection IP20 is tested according to regulations using a straight test finger (from the front), with the device mounted and equipped with a cover, housing or some other enclosure.

<sup>2)</sup> Max. cross-section 10 mm<sup>2</sup> with K28 crimper from Klauke.

### 3.1.3 Dimensional drawings

#### Cylindrical fuse links

Size 8 × 32 mm

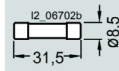

Size 10 × 38 mm

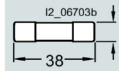

Size 14 × 51 mm

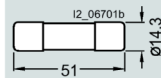

Size 22 × 58 mm

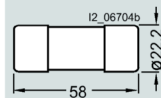

#### Cylindrical fuse holders

3NW70, 3NW73

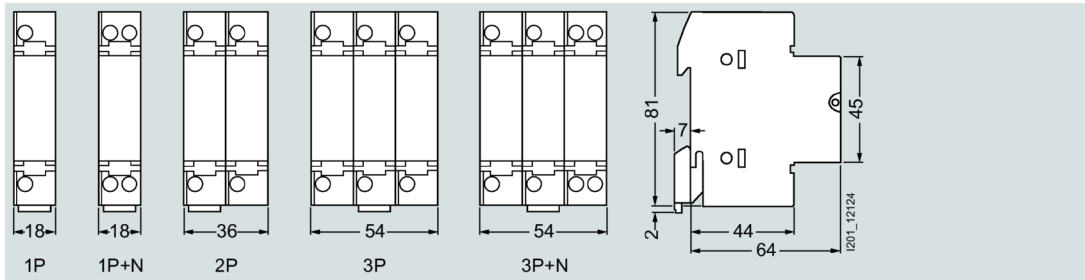

**3NW71**

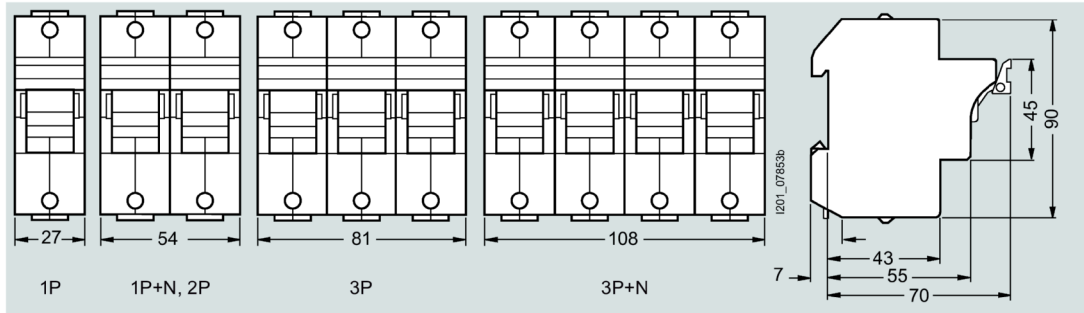

**3NW72**

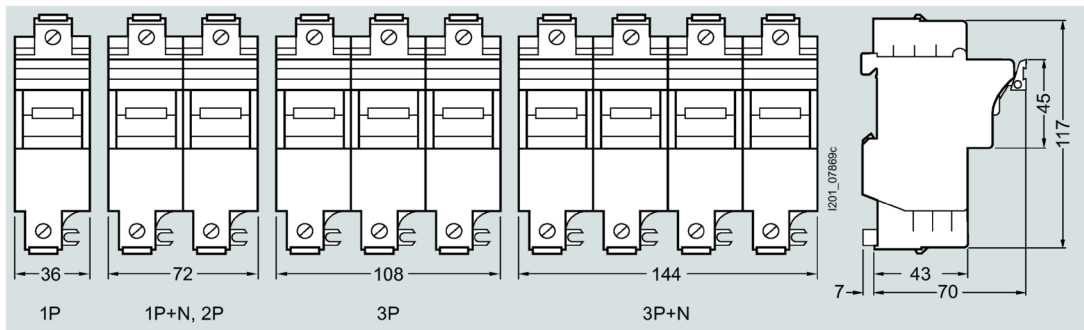

**Auxiliary switches**

**3NW7901, 3NW7902**

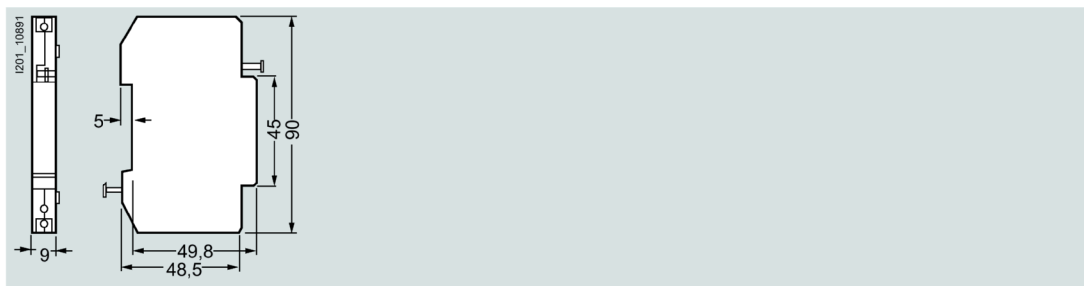



**3NW7903**

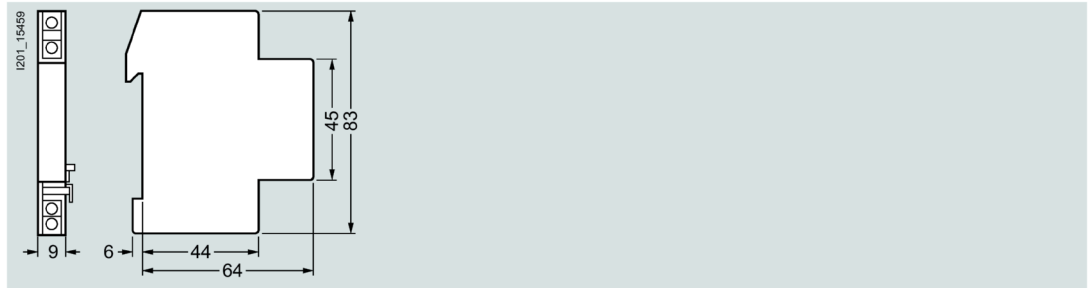

**3.1.4 Circuit diagrams**

**Graphical symbols**

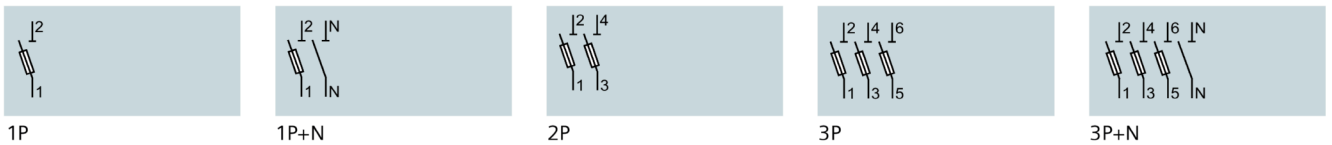

**Auxiliary switches**

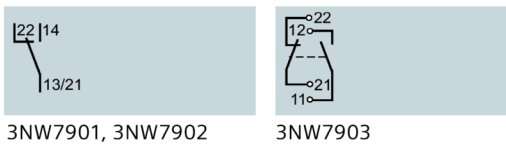

**3.1.5 Characteristic curves**

**3NW60 series**

Size:	10 x 38 mm
Operational class:	gG
Rated voltage:	500 V AC (0.5 ... 25 A), 400 V AC (32 A)
Rated current:	2 ... 32 A

Time/current characteristic curves diagram

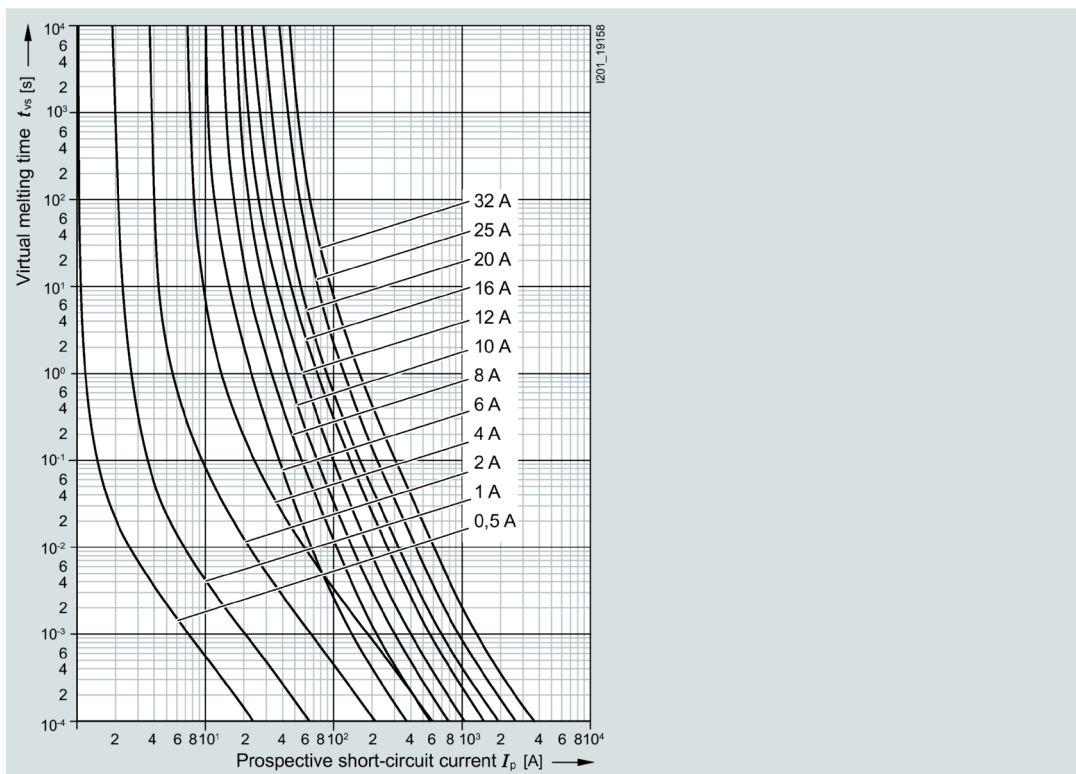

Current limiting diagram

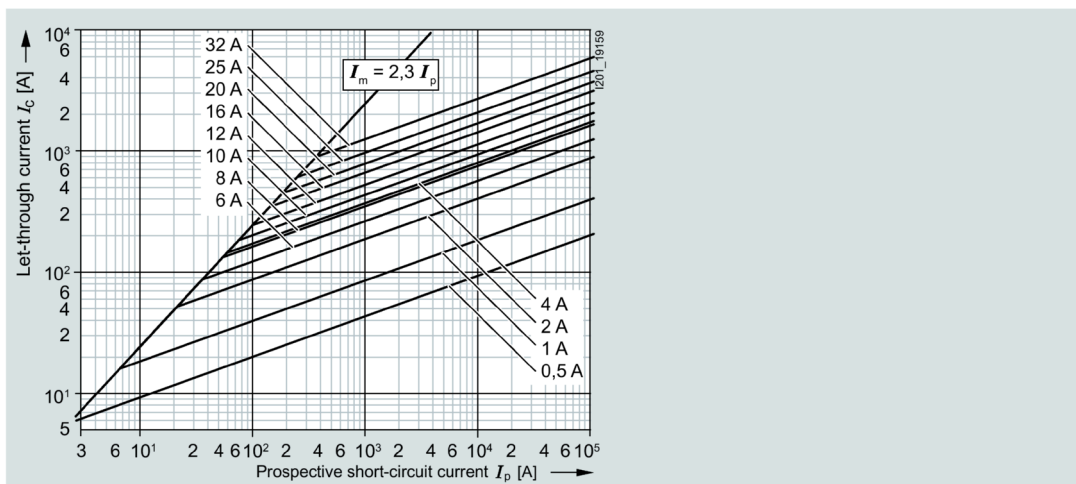

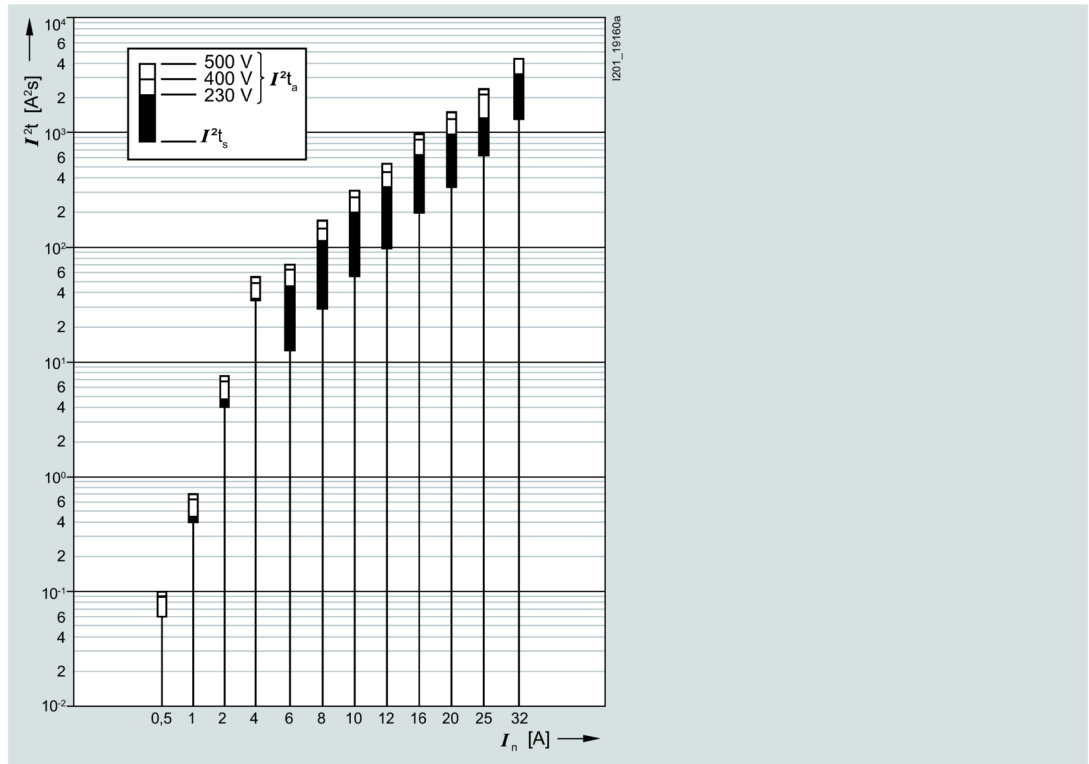
Melting  $I^2t$  values diagram

Type	$I_n$	$P_v$	$\Delta\theta$	$I^2t$			
				$I^2t_s$	$I^2t_a$		
	A	W	K	1 ms A²s	230 V AC A²s	400 V AC A²s	500 V AC A²s
3NW6000-1	1	0.07	On req.	0.06	0.06	0.09	0.1
3NW6011-1	1	0.45	On req.	0.5	0.45	0.63	0.7
3NW6002-1	2	0.5	On req.	4	4.8	6.8	7.5
3NW6004-1	4	0.85	On req.	34	35.7	49.5	55
3NW6001-1	6	0.95	On req.	12.5	45.5	63	70
3NW6008-1	8	1.15	On req.	29	10	153	170
3NW6003-1	10	1.3	On req.	56	201	279	310
3NW6006-1	12	1.4	On req.	99	344	477	530
3NW6005-1	16	1.9	On req.	199	630	873	970
3NW6007-1	20	2.4	On req.	333	975	1350	1500
3NW6010-1	25	2.7	On req.	619	1560	2160	2400
3NW6012-1	32	2.8	On req.	1331	3250	4500	-

## 3NW61 series

Size:

14 x 51 mm

Operational class:

gG

3.1 Cylindrical fuse links and cylindrical fuse holders

Rated voltage: 500 V AC (4 ... 40 A), 400 V AC (50 A)  
 Rated current: 4 ... 50 A

Time/current characteristic curves diagram

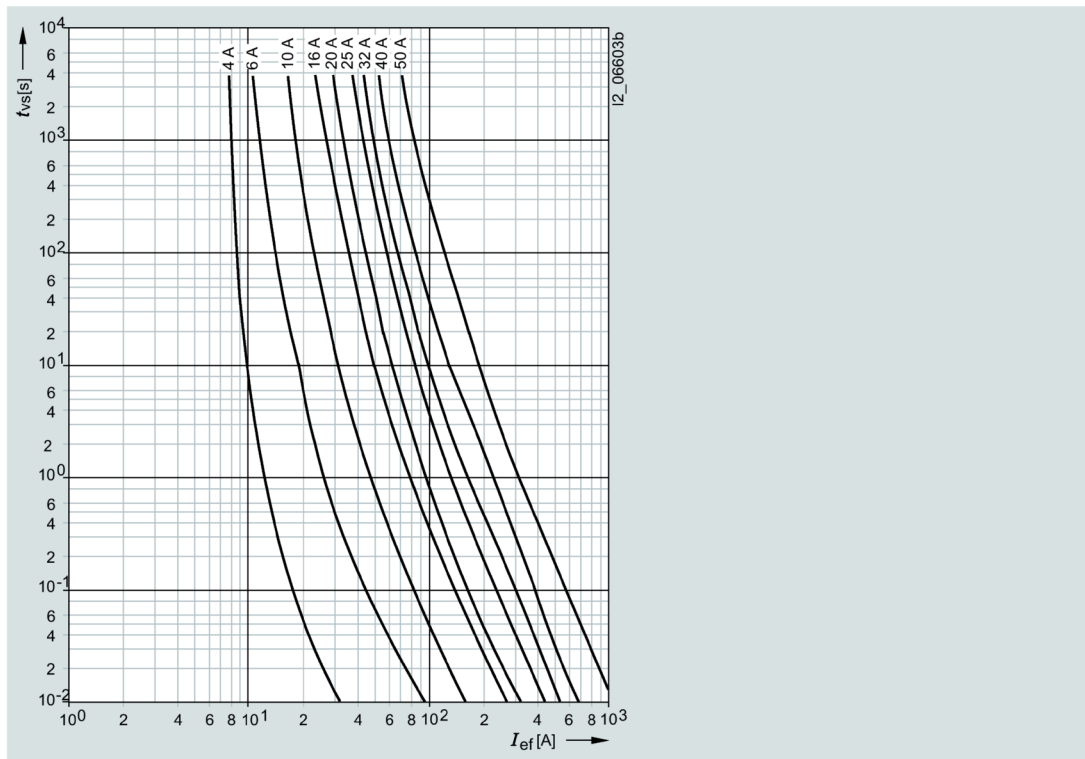

Current limiting diagram

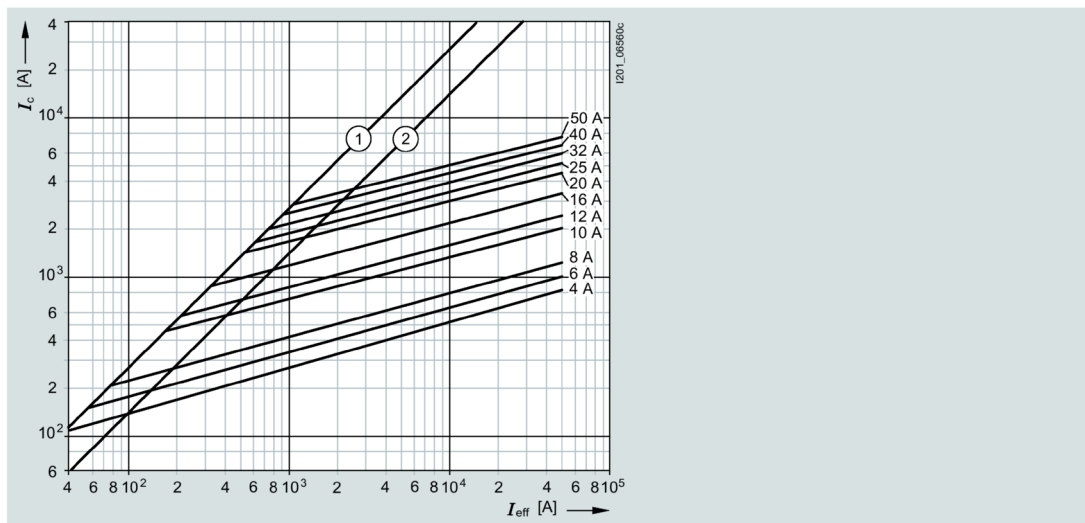

- ① Peak short-circuit current with largest DC component
- ② Peak short-circuit current without DC component

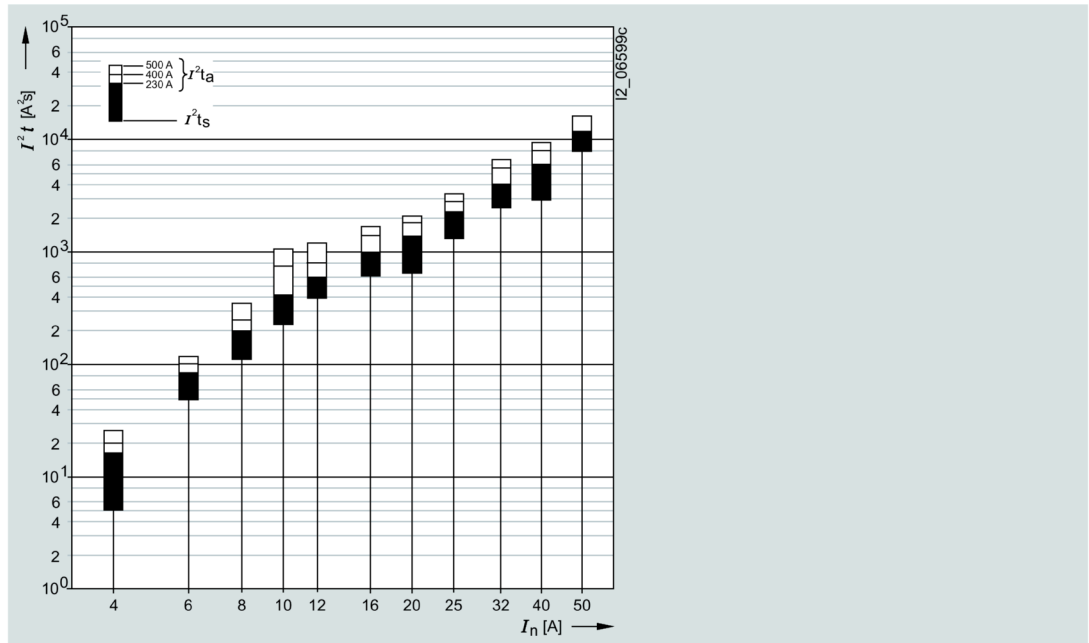
Melting  $I^2t$  values diagram

Type	$I_n$	$P_v$	$\Delta\theta$	$I^2t_a$			
				1 ms	230 V AC	400 V AC	500 V AC
	A	W	K	A <sup>2</sup> s	A <sup>2</sup> s	A <sup>2</sup> s	A <sup>2</sup> s
3NW6104-1	4	1.9	19	5	16	20	26
3NW6101-1	6	2.5	25	48	85	100	120
3NW6108-1	8	2.4	18	110	200	250	350
3NW6103-1	10	0.8	12	230	420	750	1050
3NW6106-1	12	1.0	16	390	600	800	1200
3NW6105-1	16	1.6	27	600	1000	1400	1700
3NW6107-1	20	2.3	32.5	670	1400	1800	2100
3NW6110-1	25	2.2	31.5	1300	2300	2800	3200
3NW6112-1	32	3.2	39.5	2500	4100	5500	6500
3NW6117-1	40	4.5	48	3600	6100	8000	9200
3NW6120-1	50	4.8	55	8000	12200	16000	-

## 3NW62 series

Size:	22 x 58 mm
Operational class:	gG
Rated voltage:	500 V AC (8 ... 80 A), 400 V AC (100 A)
Rated current:	8 ... 100 A

Time/current characteristic curves diagram

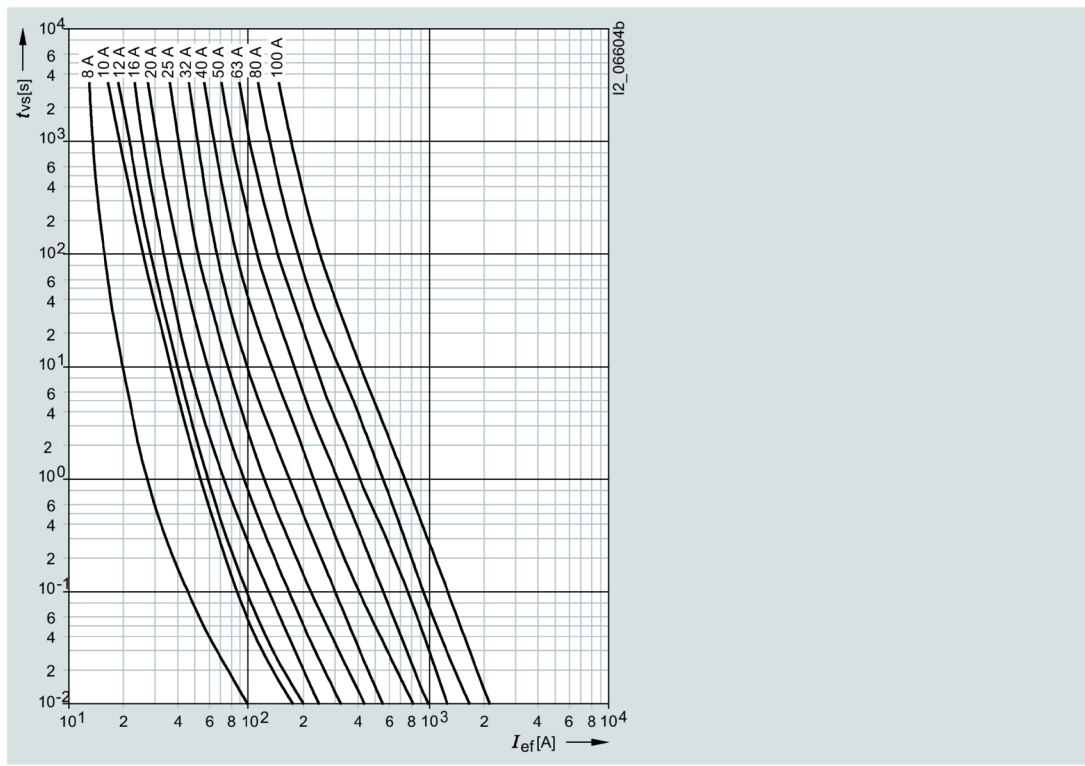

Current limiting diagram

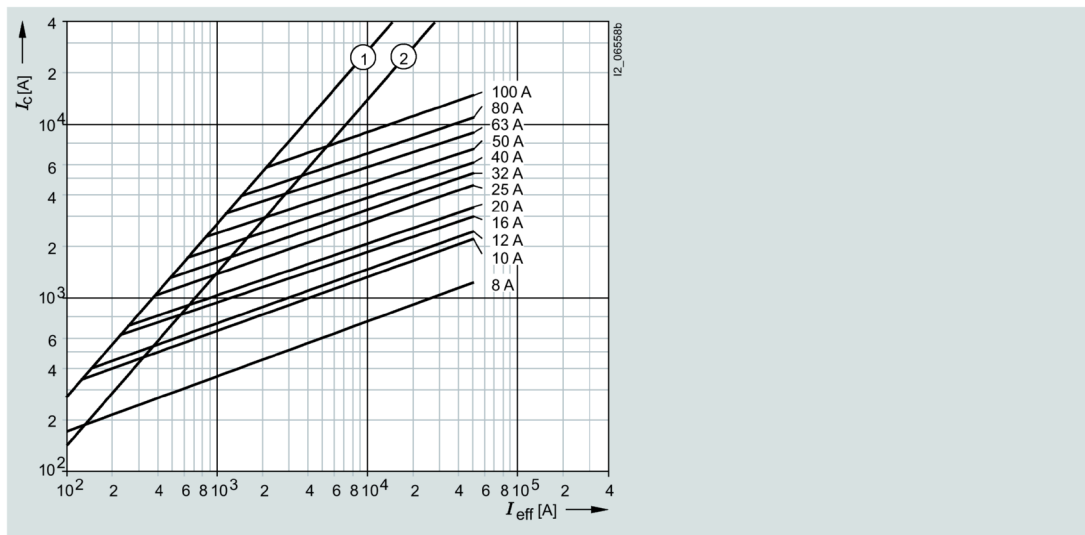

- ① Peak short-circuit current with largest DC component
- ② Peak short-circuit current without DC component

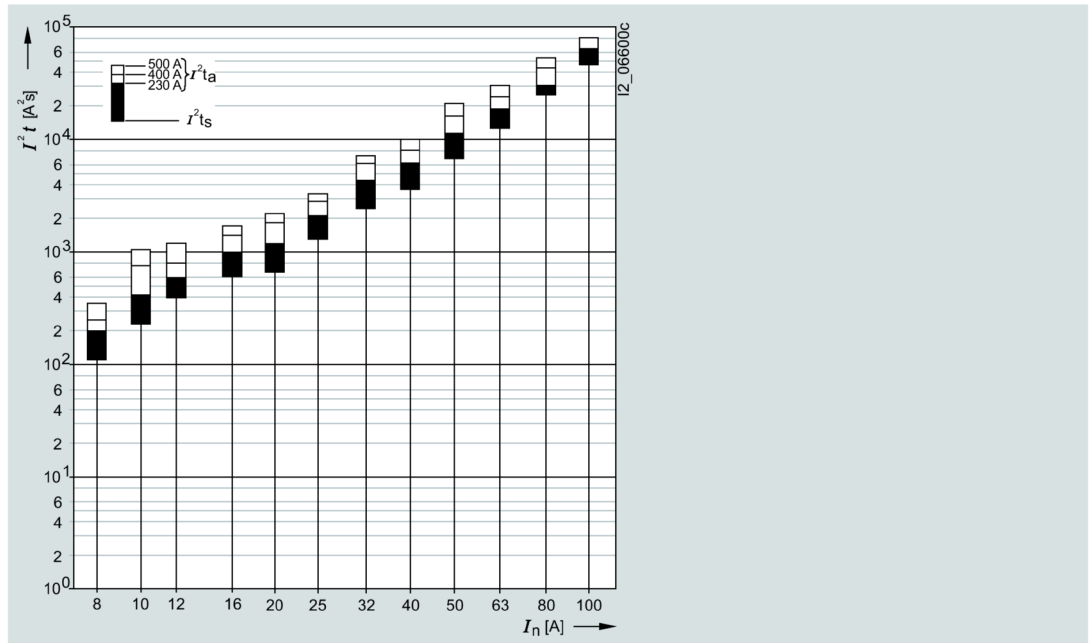
Melting  $I^2t$  values diagram

Type	$I_n$	$P_v$	$\Delta\theta$	$I^2t$			
				1 ms	230 V AC	400 V AC	500 V AC
	A	W	K	A²s	A²s	A²s	A²s
3NW6208-1	8	2.5	15	110	200	170	350
3NW6203-1	10	0.9	10.5	230	420	760	1050
3NW6206-1	12	1.1	12	390	600	800	1200
3NW6205-1	16	1.6	14.5	600	1000	1400	1700
3NW6207-1	20	2.4	22.5	670	1200	1800	2200
3NW6210-1	25	2.7	24	1300	2100	2800	3300
3NW6212-1	32	3.2	28	2450	4400	6100	7200
3NW6217-1	40	4.9	35	3600	6200	8000	10000
3NW6220-1	50	5.9	46	6800	11400	16200	20600
3NW6222-1	63	6.8	48	12500	18800	24000	30000
3NW6224-1	80	7.5	48	24700	30500	43000	52500
3NW6230-1	100	8.4	55	46000	64700	80000	-

## 3NW630.-1 series

Size:	8 x 32 mm
Operational class:	gG
Rated voltage:	400 V AC
Rated current:	2 ... 20 A

Time/current characteristic curves diagram

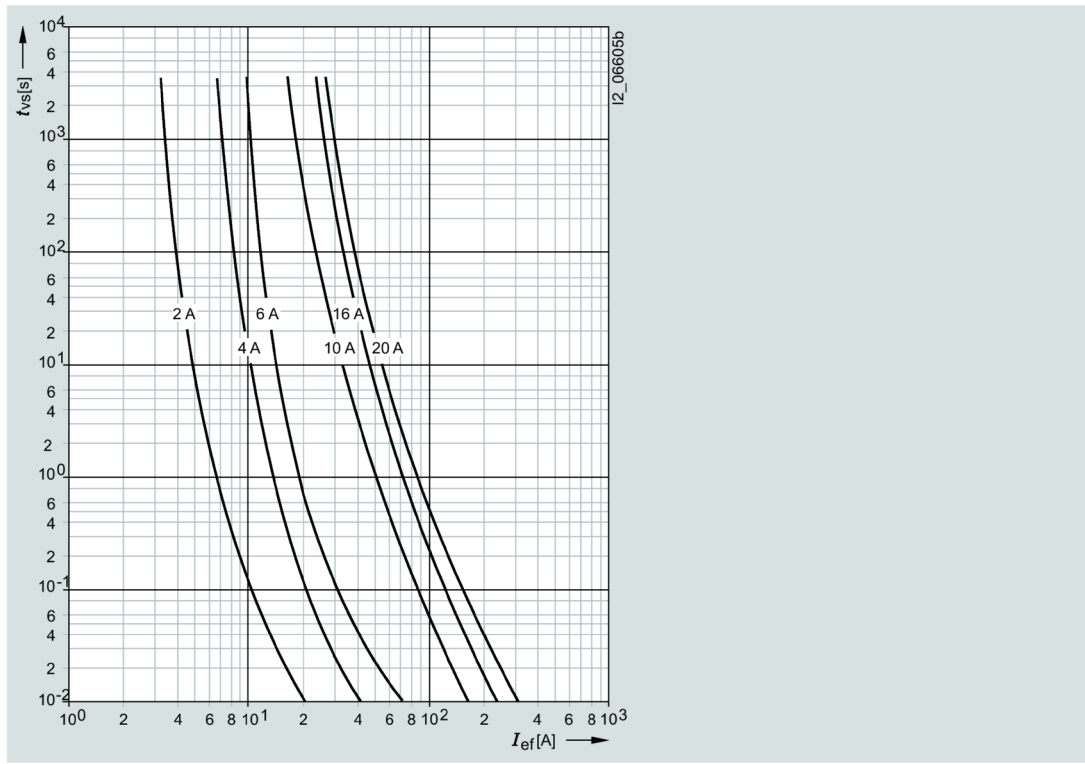

Current limiting diagram

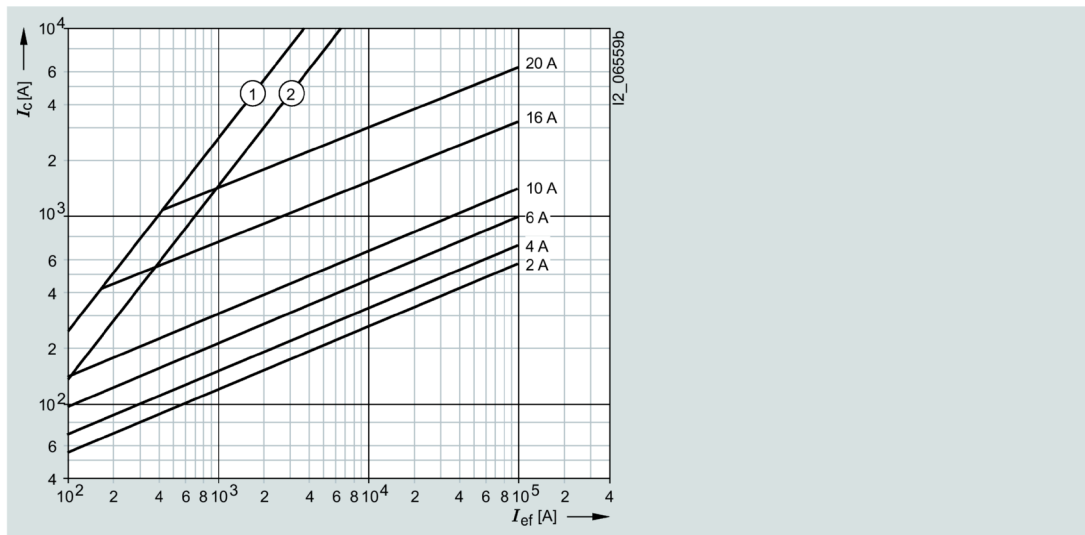

- ① Peak short-circuit current with largest DC component
- ② Peak short-circuit current without DC component

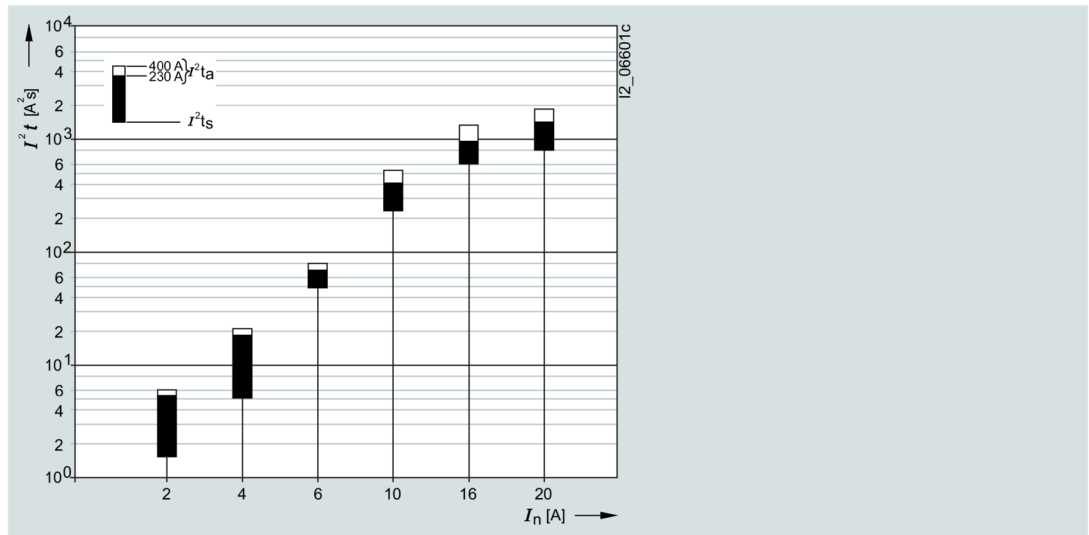

Melting  $I^2t$  values diagram

Type	$I_n$	$P_v$	$\Delta\theta$	$I^2t_s$	$I^2t_a$
				1 ms	400 V AC
	A	W	K	A²s	A²s
3NW6302-1	2	2	27	1.6	6
3NW6304-1	4	1.5	19	5	21
3NW6301-1	6	1.5	20.5	48	85
3NW6303-1	10	0.7	15	230	530
3NW6305-1	16	1.1	29	600	1400
3NW6307-1	20	1.7	34.5	790	1800

## 3NW8 series

Size:	10 × 38 mm, 14 × 51 mm, 22 × 58 mm
Operational class:	gG
Rated voltage:	500 V AC, 400 V AC (3NW8120-1, 3NW8230-1)
Rated current:	0.5 ... 100 A

Time/current characteristic curves diagram

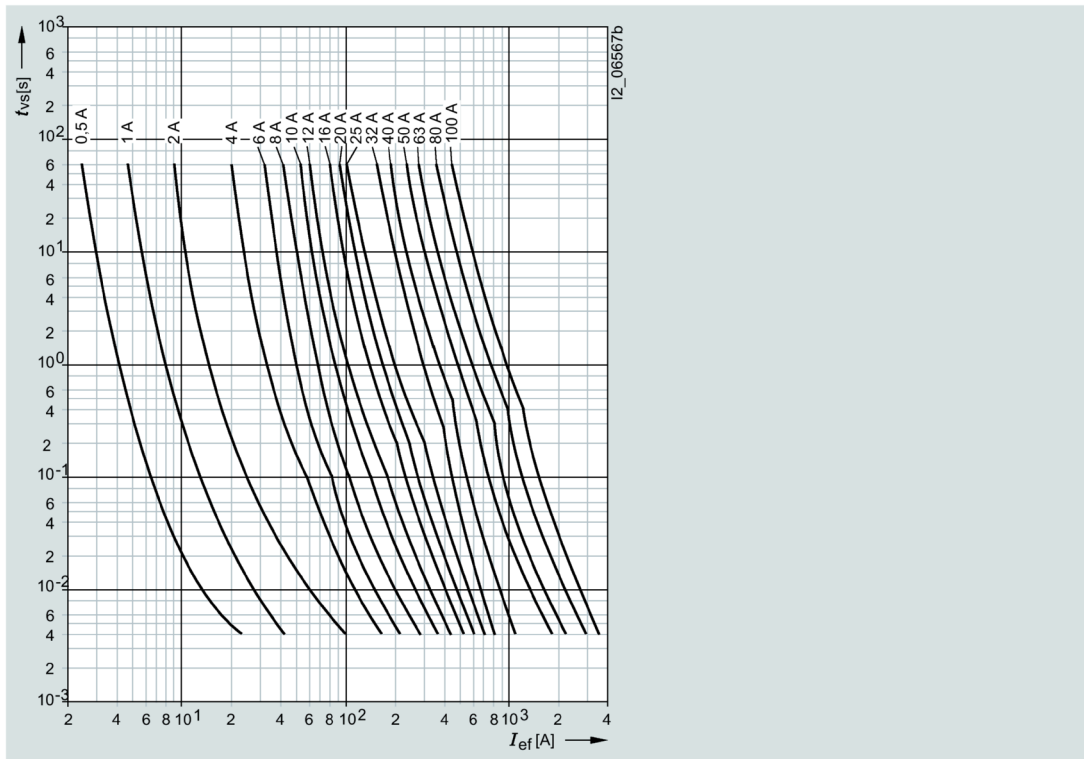

Current limiting diagram

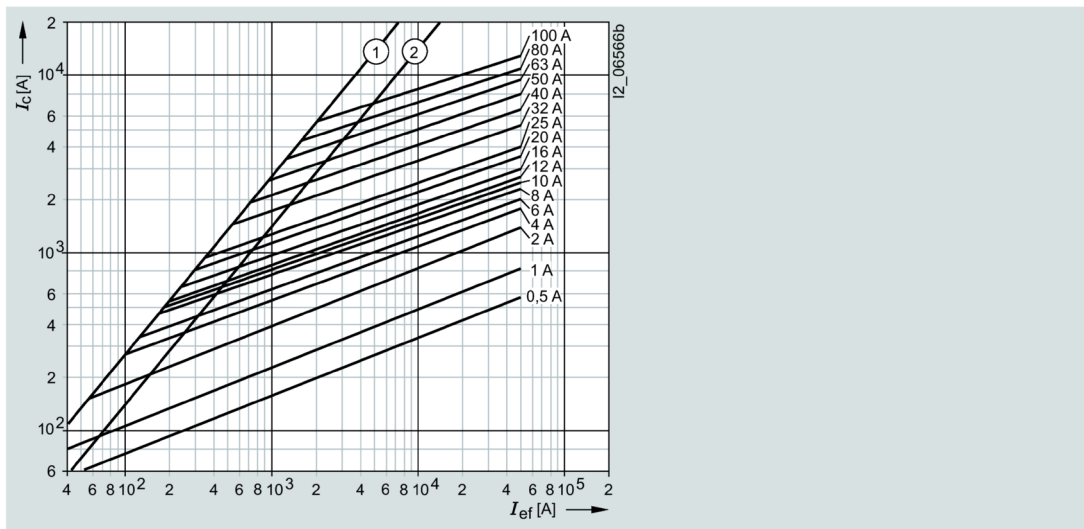

- ① Peak short-circuit current with largest DC component
- ② Peak short-circuit current without DC component

Melting  $I^2t$  values diagram

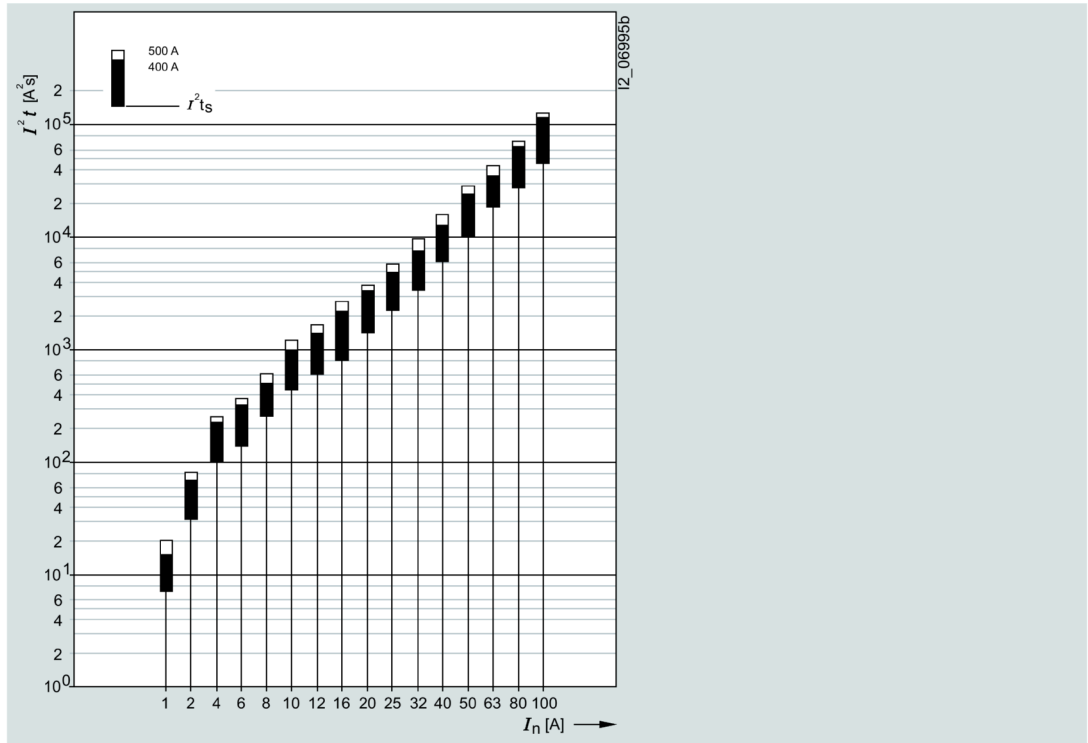

## 3.1 Cylindrical fuse links and cylindrical fuse holders

Type	Size	Operational class	I <sub>n</sub>	U <sub>n</sub>	P <sub>v</sub>
	mm		A	V	W
3NW8000-1	10 x 38	aM	0.5	500	0.1
3NW8011-1			1		0.1
3NW8002-1			2		0.1
3NW8004-1			4		0.3
3NW8001-1			6		0.4
3NW8008-1			8		0.6
3NW8003-1			10		0.6
3NW8006-1			12		0.8
3NW8005-1			165		0.9
3NW8007-1			20		1.1
3NW8010-1			25	400	1.2
3NW8012-1			32		1.8
3NW8102-1			14 x 51		2
3NW8104-1	4	0.3			
3NW8101-1	6	0.3			
3NW8108-1	8	0.5			
3NW8103-1	10	0.6			
3NW8106-1	12	0.6			
3NW8105-1	16	1			
3NW8107-1	20	1			
3NW8110-1	25	1.3			
3NW8112-1	32	1.9			
3NW8117-1	40	2			
3NW8120-1	50	500	3.7		
3NW8208-1	22 x 58		8	690	No info.
3NW8203-1			10		No info.
3NW8206-1			12		No info.
3NW8205-1			16		0.9
3NW8207-1			20		1.1
3NW8210-1			25		1.4
3NW8212-1			32		2
3NW8217-1			40		2.5
3NW8220-1			50		2.6
3NW8222-1			63		4.1
3NW8224-1			80		4.9
3NW8230-1			100		500

## 3.2 Fuse holders of size 10 x 38 mm and Class CC

### 3.2.1 Portfolio overview

A key feature of our three-pole fuse holders is their ultra compact design. With a width of only 45 mm, they are ideal for use with fused motor starter combinations. Because the contactor and the fuse holder have the same 45 mm width, they are easy to mount on top of one another. The strong current-limiting fuses ensure a type 2 protection level (coordination according to IEC 60947-4, no damage protection) for the contactors.

The UL version has an SCCR value of 200 kA. The accessories are generally UL-certified.

Customers can mount an auxiliary switch which signals the switching state or prevents the fuse holder from switching off under load by interrupting the contactor control, thus increasing safety for the operator and process. Busbars and a matching 3-phase feeder terminal complete the product range.

### Benefits

- Compact design, especially for motor starter combinations
- For IEC fuses of size 10 x 38 mm up to 32 A and Class CC UL fuses up to 30 A
- Meets the requirements of UL 508 with regard to clearances
- UL-approved microswitches, busbars and adapters for 60 mm busbar systems
- Optical signal detector for fast fault locating

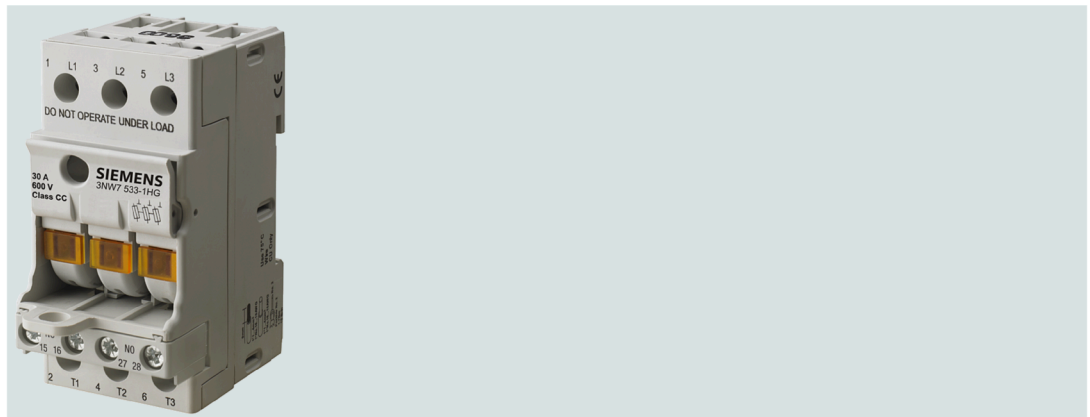

Figure 3-1 Compact Class CC fuse holder with signal detector and mounted auxiliary switch

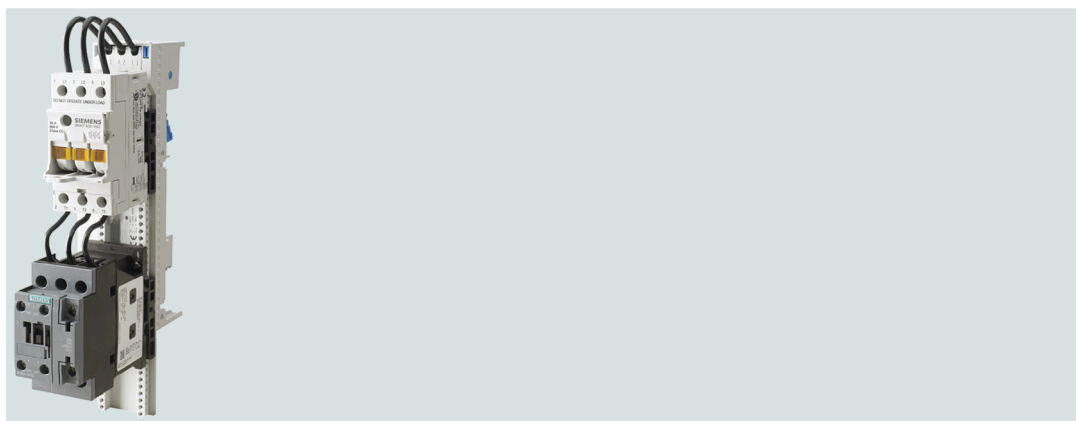





Figure 3-2 Installation configuration of a cylindrical fuse holder and a SIRIUS contactor on busbar device adapter for the 60 mm busbar system

### 3.2.2 Technical specifications

#### Cylindrical fuse holders and fuse holders

		Cylindrical fuse holders 3NW70..-1	Fuse holders 3NW75..-1HG
<b>Size</b>	mm × mm	10 × 38 mm × mm	class CC
<b>Standards</b>	-	IEC 60269; UL4248-1; CSA	UL4248-1; CSA
<b>Approvals</b>	-	 , UL File Number E171267	 , UL File Number E171267
• According to UL	-		
• According to CSA	-		
<b>Rated voltage <math>U_n</math></b>	V AC	690	600
<b>Rated current <math>I_n</math></b>	A AC	32	30
<b>Rated short-circuit strength</b>	kA	120 (at 500 V) 80 (at 690 V)	200
<b>Breaking capacity</b>	-	AC-20B (switching with- out load)	-
• Utilization category	-		
<b>Rated impulse withstand voltage</b>	kV	6	
<b>Overvoltage category</b>	-	III	
<b>Pollution degree</b>	-	2	
<b>Maximum power dissipation of the fuse links</b>	W	3	
<b>No-voltage changing of fuse links</b>	°C	-5 ... +40, humidity 90% at +20 °C	
<b>Sealable when installed</b>	-	Yes	
<b>Lockable with padlock</b>	-	Yes	
<b>Mounting position</b>	-	Any, preferably vertical	
<b>Current direction</b>	-	Any	

		Cylindrical fuse holders 3NW70..-1	Fuse holders 3NW75..-1HG
Degree of protection acc. to IEC 60529	-	IP20, with connected conductors <sup>1)</sup>	
Terminals with touch protection according to BGV A3 at incoming and outgoing feeder	-	Yes	
Ambient temperature	°C	-5 ... +40, humidity 90% at +20 °C	
Conductor cross-sections			
• Finely stranded, with end sleeve	mm <sup>2</sup>	1 ... 4	
• AWG cables (American Wire Gauge)	AWG	18 ... 10	
Tightening torque	Nm	1.5	
• Terminal screws	lb/in	13	
		PZ2	

<sup>1)</sup> Degree of protection IP20 is tested according to regulations using a straight test finger (from the front), with the device mounted and equipped with a cover, housing or some other enclosure.

## Auxiliary switches

		3NW7903-1							
Standards	-	IEC 60947							
Approvals	-	 UL 508, UL File Number E334003							
Utilization category	-	AC-12	DC-13			AC-15			Acc. to UL
Rated voltage U <sub>n</sub>	V AC V DC	250 -	- 24	- 120	- 240	24 -	120 -	240 -	240 -
Rated current I	A	5	2	0.5	0.25	4	3	1.5	5

## Busbars

		5ST260	
For cylindrical fuse holders	-	3NW70. .-1	3NW75. .-1HG
Pin spacing	mm	15	
Standards	-	DIN EN 609741 (VDE 0660-100), IEC 60947-1:2004, UL 508, CSA 22.2	
Approvals	-	 UL 4248-1, UL File Number E337131	
Busbar material	-	E-Cu 58 F25	
Material of the insulating profiles	-	PA66-V0	
Glow wire strength / 1...5 mm <sup>2</sup>	°C	960	
Insulation coordination	-	Overvoltage category III, degree of pollution 2	

		5ST260	
<b>Rated operational voltage <math>U_n</math></b>			
• Acc. to UL	V AC	-	600
• Acc. to IEC	V AC	690	-
<b>Maximum busbar current <math>I_n</math></b>			
• Acc. to UL	A	-	65
• Acc. to IEC	A	80	-

## Terminals

		5ST2600	
<b>For cylindrical fuse holders</b>	-	3NW70. .-1	3NW75. .-1HG
<b>Pin spacing</b>	mm	15	
<b>Standards</b>	-	IEC 60999:2000, UL 508	
<b>Approvals</b>	-	 UL 4248-1, UL File Number E337131	
<b>Enclosure/cover material</b>	-	PA66-V0	
<b>Glow wire strength / 1 mm<sup>2</sup></b>	°C	960	
<b>Temperature resistance PA66-V0, HDT B ISO 179, UL 94-V0 / 1.5</b>	°C	200	
<b>Insulation coordination</b>	-	Overvoltage category III, degree of pollution 2	
<b>Maximum operational voltage <math>U_{max}</math></b>			
• Acc. to UL	V AC	-	600
• Acc. to IEC	V AC	690	-
<b>Maximum electrical load <math>I_{max}</math></b>			
• Acc. to UL	A	-	65
• Acc. to IEC	A	80	-
<b>Rated current <math>I_n</math></b>	A	63	
<b>Conductor cross-sections</b>			
• solid/stranded	mm <sup>2</sup>	2.5 ... 35	
• Finely stranded, with end sleeve	mm <sup>2</sup>	2.5 ... 25	
<b>Tightening torque of clamping screw</b>	Nm	2.5 ... 3.5	



### 3.2.3 Dimensional drawings

#### 3NW703.-1, 3NW753.-1HG

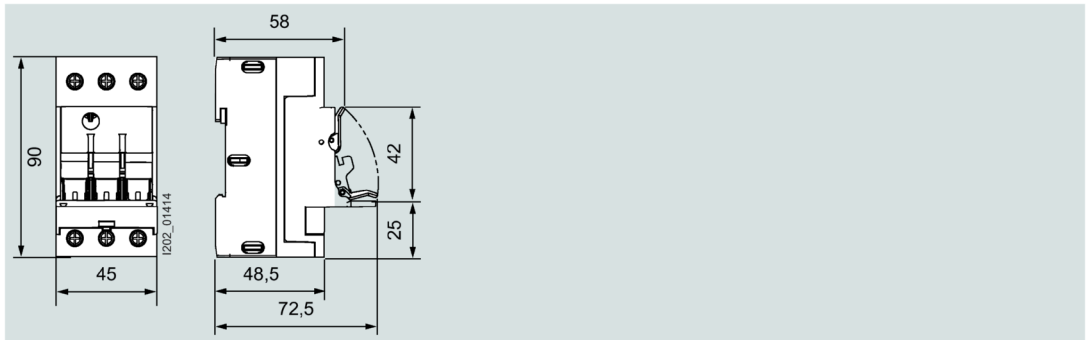

#### 5ST260

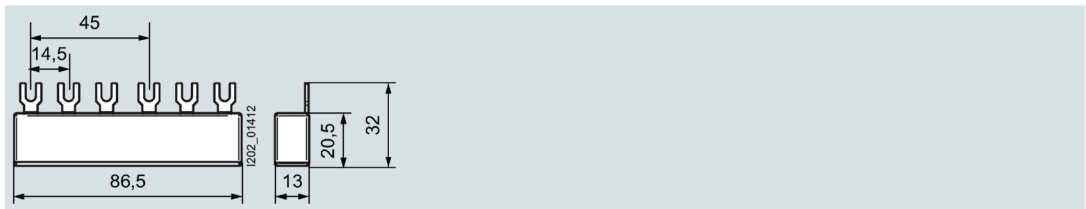

#### 5ST2600

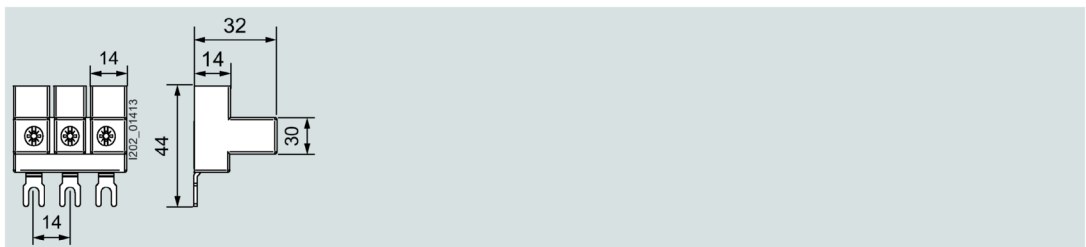

### 3.2.4 Circuit diagrams

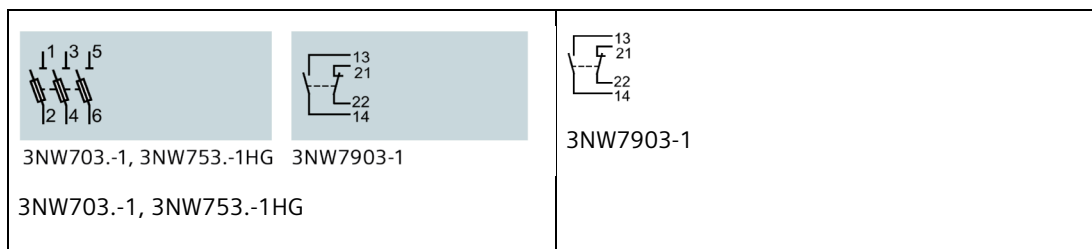

## Class CC fuse system

### 4.1 Portfolio overview

Class CC fuses are used for "branch circuit protection".

The enclosed fuse holders are designed and tested to comply with the US National Electrical Code NEC 210.20(A). This means that when subject to continuous operation, only 80% of the rated current is permissible as operational current.

An operational current of 100% of the rated current (30 A) is only permissible short-time.

The devices are designed for use with ALPHA FIX modular terminal labels 8WH8120-7AA15 and 8WH8120-7XA05.

There are three different series:

- Slow characteristic 3NW1...-0HG  
For the protection of control transformers, reactors, inductances. Significantly slower than the minimum requirements specified by UL for Class CC fuses of 12 s at  $2 \times I_n$
- Quick characteristic 3NW2...-0HG  
For a wide range of applications, for the protection of lighting installations, heating, control systems.
- Slow characteristic, current-limiting 3NW3...-0HG  
Slow for overloads and quick for short circuits. High current limiting for the protection of motor circuits.

---

#### Note

Further information on compact Class CC fuse holders for motor starter combinations can be found in the chapter Fuse holders of size 10 x 38 mm and Class CC (Page 59).

---

#### Benefits

- For switchboard assembly and machine manufacturers who export their systems to the USA or Canada
- Easier export due to and approvals according to UL and CSA for typical applications
- Modern design with touch protection according to BGV A3 ensures a safe installation.

## 4.2 Technical specifications

### Class CC fuse holders

		3NW75.3-0HG
Standards		UL 4248-1; CSA C22.2
Approvals		UL 4248-1; UL File Number E171267; CS C22.2
Rated voltage $U_n$	V AC	600
Rated current $I_n$	A	30
Rated conditional short-circuit current	kA	200
Breaking capacity		AC-20B (switching without load)
• Utilization category		
Max. power dissipation of the fuse links		
• With 6 mm <sup>2</sup> cable	W	3
• With 10 mm <sup>2</sup> cable	W	4.3
Rated impulse withstand voltage	kV	6
Overvoltage category		II
Pollution degree		2
No-voltage changing of fuse links		Yes
Sealable when installed		Yes
Mounting position		Any
Current direction		Any
Degree of protection according to IEC 60529		IP20
Terminals with touch protection according to BGV A3 at incoming and outgoing feeder		Yes
Ambient temperature	°C	45
Conductor cross-section		
• Solid and stranded mm <sup>2</sup>	mm <sup>2</sup>	1.5 ... 16
• AWG cables, solid and stranded	AWG	15 ... 5
Tightening torque	Nm	2.5 (22 lb/in)

		3NW1...-0HG	3NW2...-0HG	3NW3...-0HG
Standards		UL 4248-1; CSA C22.2		
Approvals		UL 4248-1; UL File Number E171267; CS C22.2		
Characteristic		Slow	Quick	Slow, current limiting
Rated voltage $U_n$	V AC V DC	600	600	600 150 (3 ... 15 A) 300 (< 3 A, > 15 A)
Rated breaking capacity	kA AC	200		

## 4.3 Dimensional drawings

### 3NW1...-0HG, 3NW2...-0HG, 3NW3...-0HG series

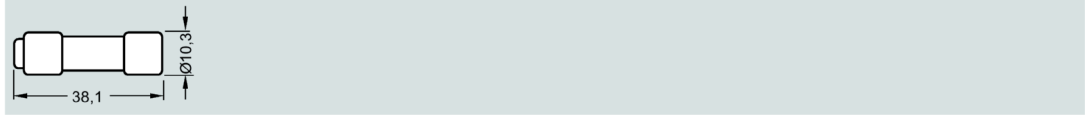

### 3NW75.3-0HG series

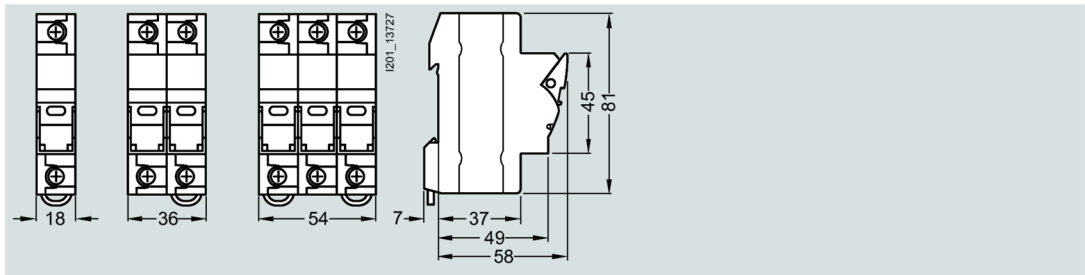

## 4.4 Characteristic curves

### 3NW1...-0HG series

Time/current characteristic curves diagram

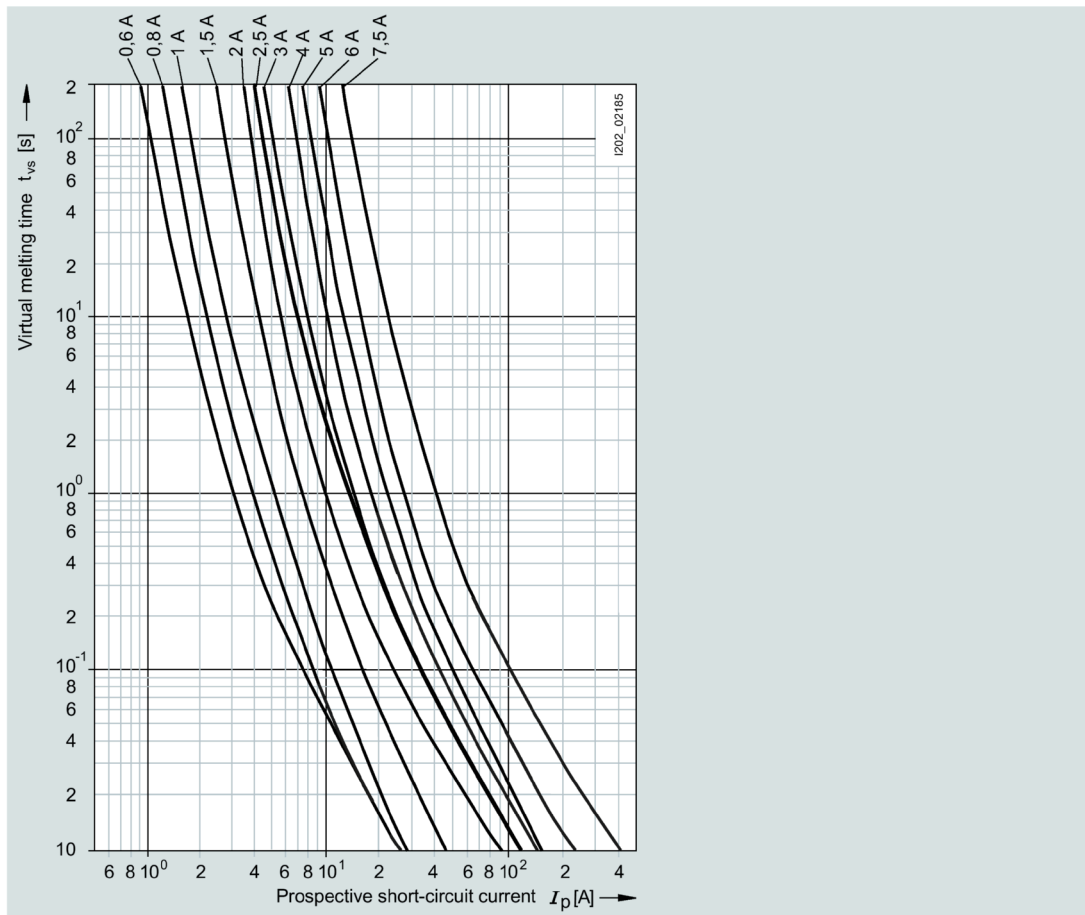

Time/current characteristic curves diagram

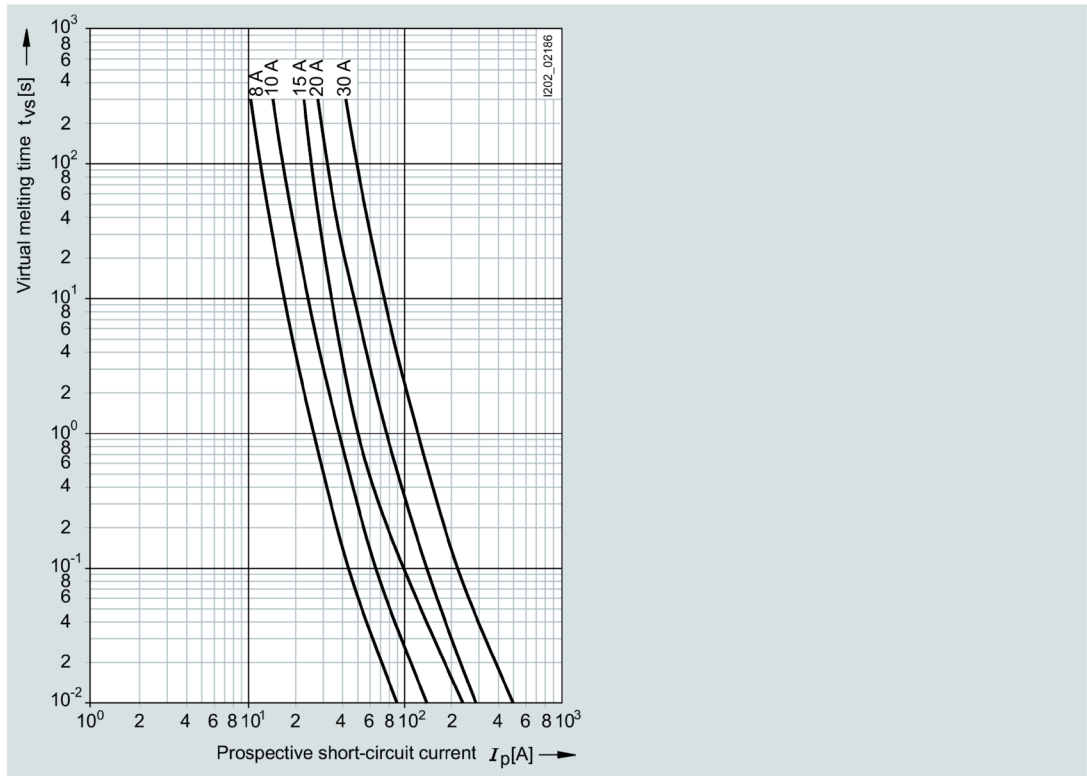

3NW2...-0HG series

Time/current characteristic curves diagram

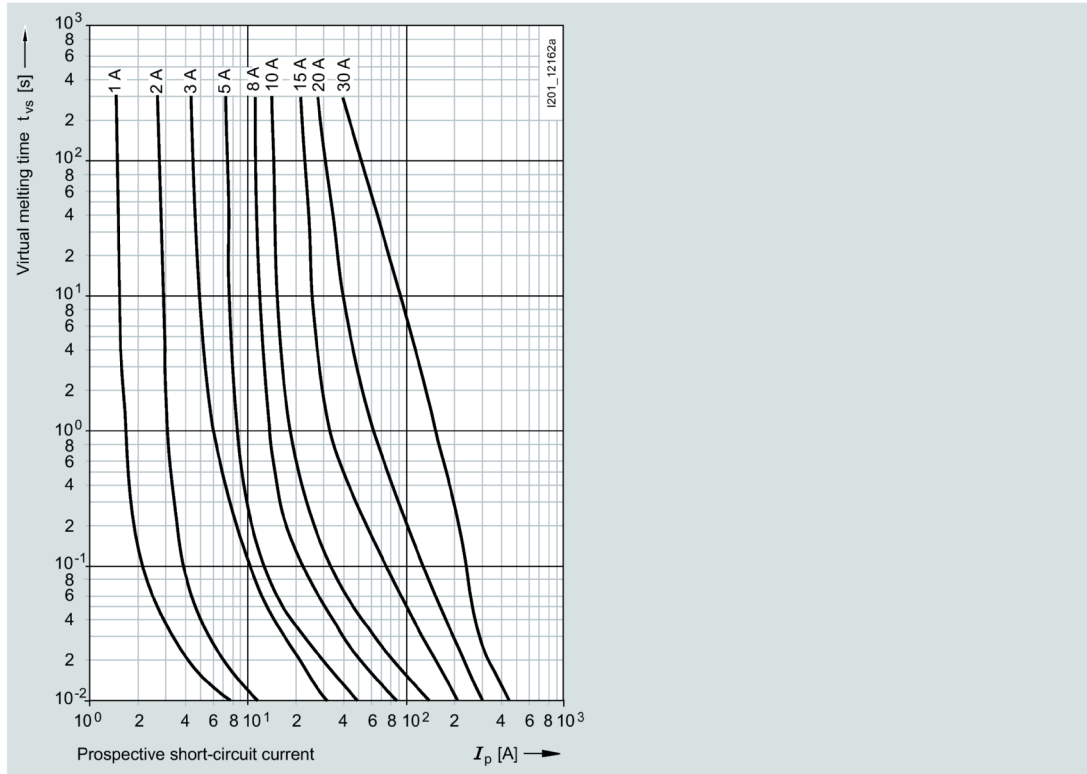



3NW3...-OHG series

Time/current characteristic curves diagram

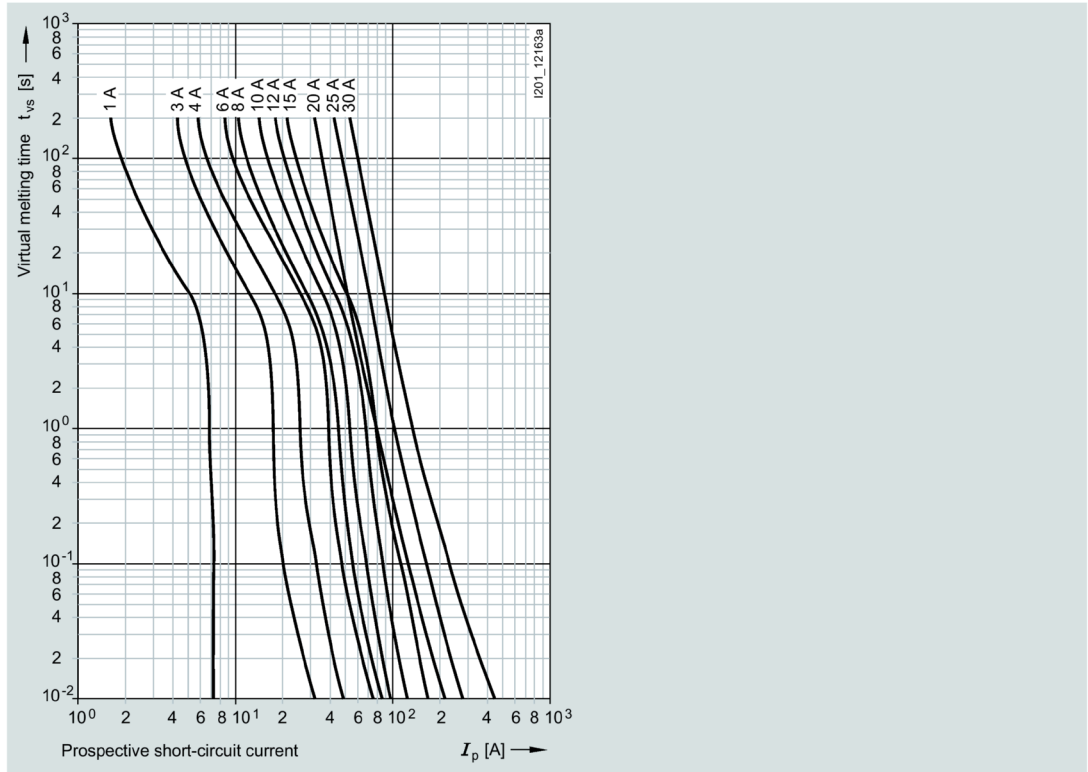

Current limiting diagram

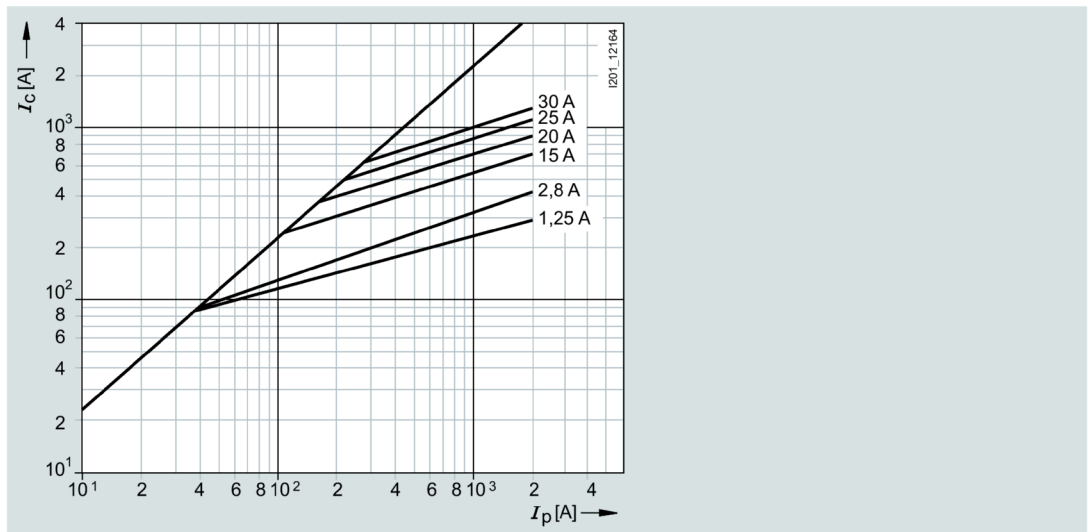



## Busbar systems

### 5.1 Portfolio overview

Busbars with pin-type connections can be used for NEOZED fuse switch units and fuse bases. Busbars in 10 mm<sup>2</sup> and 16 mm<sup>2</sup> versions are available. Busbars with fork plugs are used for the most frequently used NEOZED fuse bases made of ceramic.

#### Benefits

- Clear and visible conductor connection that can be easily checked when using the NEOZED D02 comfort base facilitates cable entry.

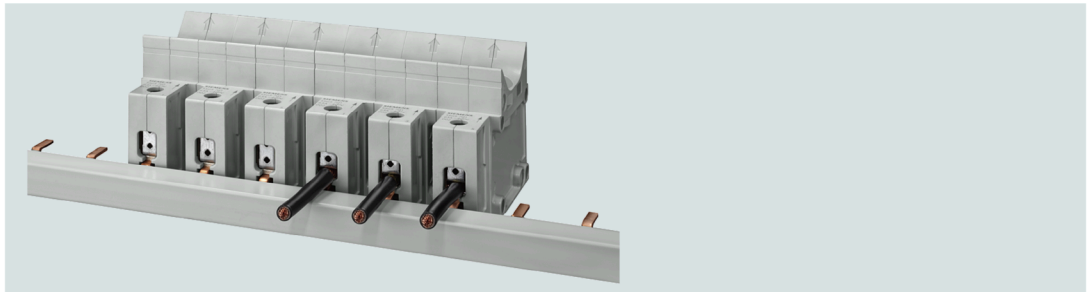

- Bus mounting of NEOZED fuse bases made of molded plastic on 3-phase busbar with fork plugs which can be cut to length

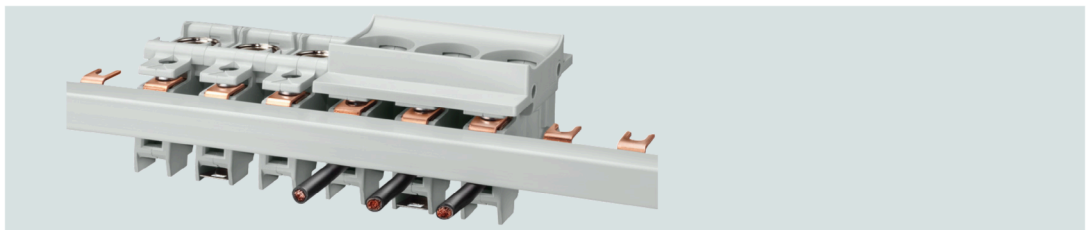

- Bus mounting of NEOZED fuse bases made of ceramic on 3-phase busbar with fork plugs which can be cut to length

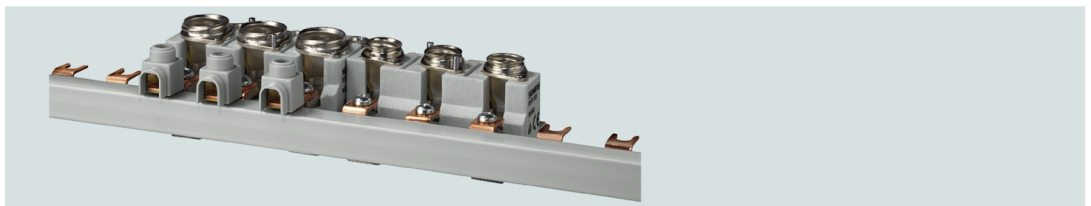

- Bus mounting of MINIZED D01 fuse switch disconnectors with 3-phase busbar with fork plugs which can be cut to length

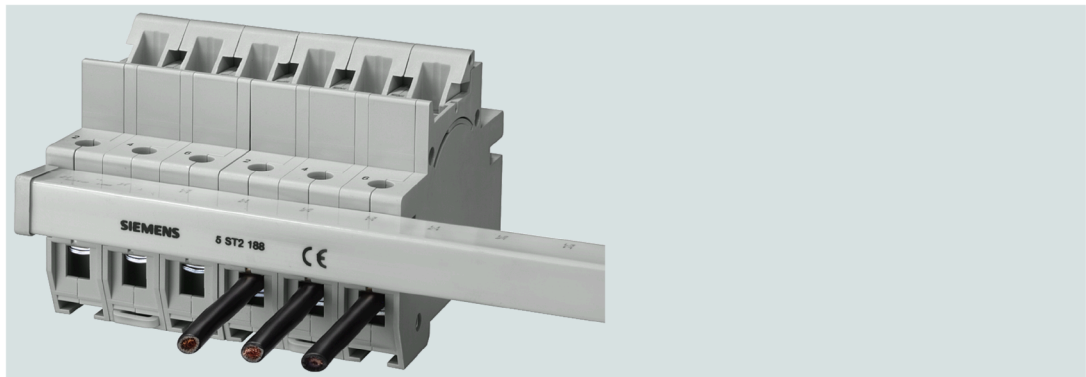

- Clear and visible conductor connection that can be easily checked when using MINIZED D02 switch disconnectors. This facilitates cable entry and saves time.

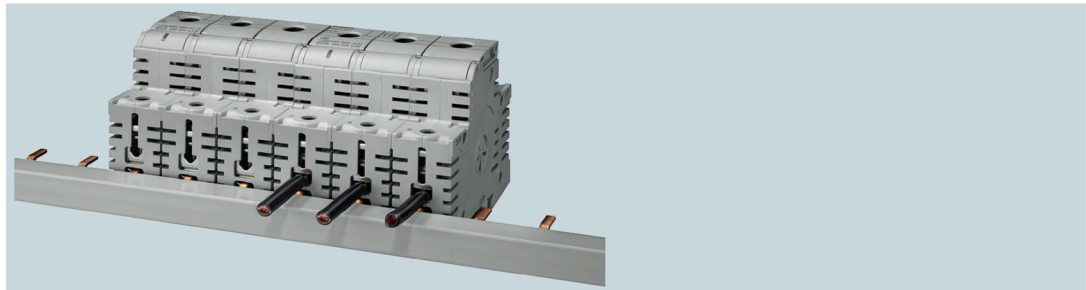

- Bus mounting of cylindrical fuse holders 8 × 32 mm and 10 × 38 mm with 3-phase pin busbar which can be cut to length

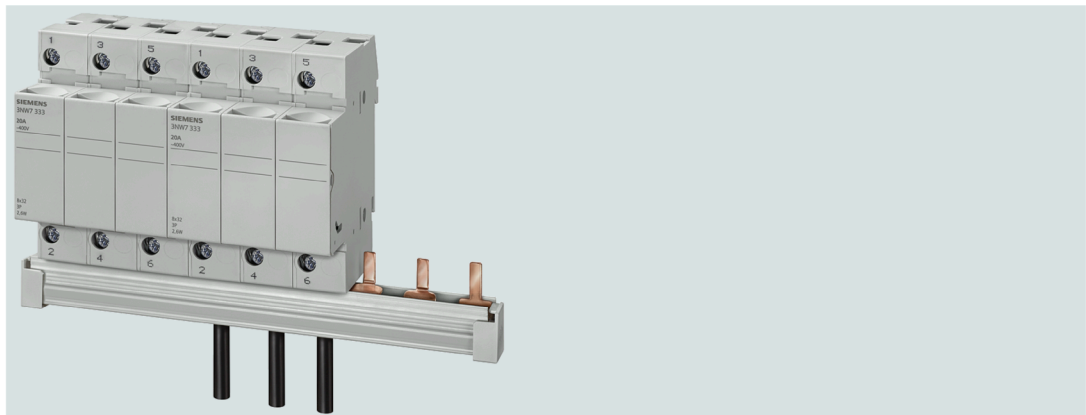

- Bus mounting of SITOR cylindrical fuse holders 10 mm x 38 mm with the same terminal connection as Class CC fuse holders with 3-phase pin busbar which can be cut to length



- Bus mounting with infeed through a connection terminal directly on the fuse holder up to a conductor cross-section of 25 mm<sup>2</sup>

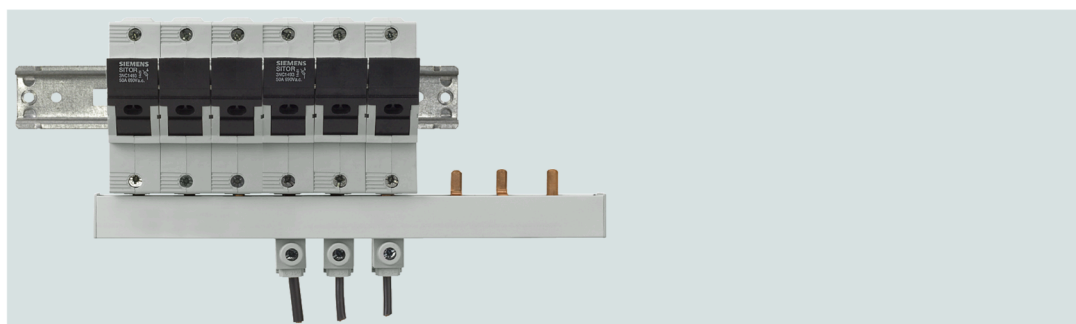

## 5.2 Technical specifications

### 5ST, 5SH

<b>Standards</b>		DIN EN 60439-1 (VDE 0660-500): 2005-01
<b>Busbar material</b>		SF-Cu F 24
<b>Material of the insulating profiles</b>		Plastic Cycoloy 3600, heat-resistant over 90 °C, flame-retardant, self-extinguishing, free of dioxins and halogens
<b>Rated operational voltage <math>U_c</math></b>	V AC	400
<b>Rated current <math>I_n</math></b>		
• Cross-section 10 mm <sup>2</sup>	A	63
• Cross-section 16 mm <sup>2</sup>	A	80
<b>Rated impulse withstand voltage <math>U_{imp}</math></b>	kV	4
<b>Test peak voltage (1.2 ... 50)</b>	kV	6.2
<b>Rated conditional short-circuit current <math>I_{cc}</math></b>	kA	25

5.2 Technical specifications

<b>Resistance to climate</b> <ul style="list-style-type: none"> <li>• Constant climate</li> <li>• Damp heat</li> </ul>		23 / 83; 40 / 92; 55 / 20 28 cycles
<b>Insulation coordination</b> <ul style="list-style-type: none"> <li>• Overvoltage category</li> <li>• Pollution degree</li> </ul>		III 2
<b>Maximum busbar current I<sub>s</sub> per phase</b> <ul style="list-style-type: none"> <li>• Infeed at the start of the busbar                             <ul style="list-style-type: none"> <li>– Cross-section 10 mm<sup>2</sup></li> <li>– Cross-section 16 mm<sup>2</sup></li> </ul> </li> <li>• Midpoint infeed                             <ul style="list-style-type: none"> <li>– Cross-section 10 mm<sup>2</sup></li> <li>– Cross-section 16 mm<sup>2</sup></li> </ul> </li> </ul>	A A A A	63 80 100 130

5ST37.. - .HG busbars acc. to UL 508

		5ST37..- 0HG	5ST37..- 2HG	5ST3770- 0HG	5ST3770- 1HG
<b>Standards</b>		UL 508, CSA C22.2 No. 14-M 95			
<b>Approvals</b>		UL 508 File No. E328403 CSA			
<b>Operational voltage</b> <ul style="list-style-type: none"> <li>• Acc. to IEC</li> <li>• Acc. to UL 489</li> </ul>	V AC V AV	690 600			
<b>Rated conditional short-circuit current</b> <ul style="list-style-type: none"> <li>• Dielectric strength</li> <li>• Impulse withstand voltage</li> </ul>	kA kV / mm kV	10 (RMS symmetrical 600 V for three cycles) 25 > 9.5			
<b>Rated current</b>	A	-		115	
<b>Maximum busbar current I<sub>s</sub> per phase</b> <ul style="list-style-type: none"> <li>• Infeed at the start of the busbar</li> <li>• Midpoint infeed</li> </ul>	A A	80 160	100 200	- -	- -
<b>Insulation coordination</b> <ul style="list-style-type: none"> <li>• Overvoltage category</li> <li>• Pollution degree</li> </ul>		III 2			
<b>Busbar cross-section</b>	mm <sup>2</sup> Cu	18	25	-	-
<b>Infeed</b>		Any			
<b>Conductor cross-sections</b>	AWG mm <sup>2</sup>	- -	- -	10 ... 1 / 0 6 ... 35	14 ... 1 1.5 ... 50
<b>Terminals</b> <ul style="list-style-type: none"> <li>• Terminal tightening torque</li> </ul>	Nm lb/in	- -	- -	5 50	3.5 35

Infeed at the start of the busbar



Infeed along the busbar or midpoint infeed

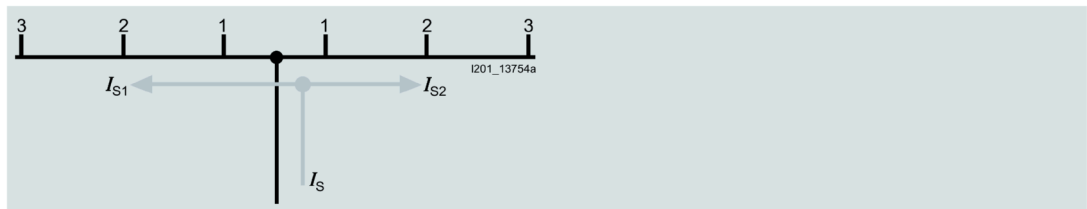

The sum of the output currents per branch must not be greater than the busbar current  $I_{S1,2}$  /phase.

## 5.3 Dimensional drawings

### 5ST37

Pin spacing in MW (modular width; 1 MW = 18 mm)



- ① 5ST3700  
5ST3701  
1-phase

- ② 5ST3703  
1-phase



- ① 5ST3704  
5ST3705  
2-phase

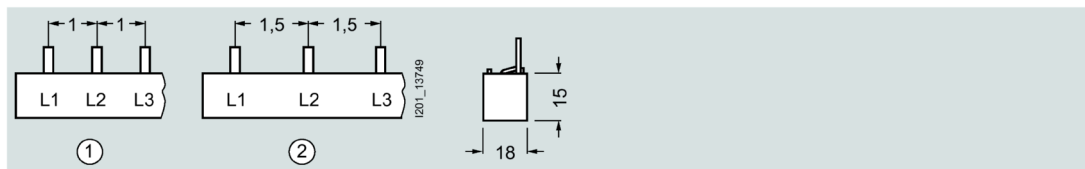

① 5ST3708  
5ST3710  
3-phase

② 5ST3703  
3-phase

## 5ST2

Fork spacing in MW (modular width; 1 MW = 18 mm)

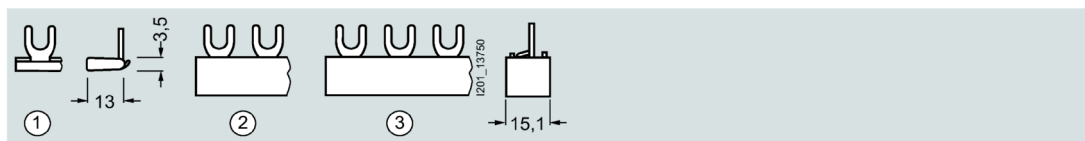

① 5ST2186  
5ST2190  
1-phase

② 5ST2187  
5ST2191  
2-phase

③ 5ST2188  
5ST2192  
3-phase

## 5SH5

Fork spacing in MW (modular width; 1 MW = 18 mm), dimensions of side views in mm, rounded

### 5SH5517



### 5SH5320

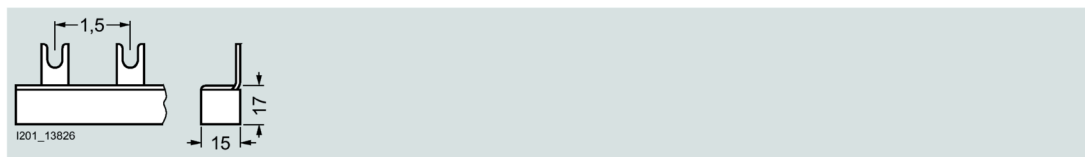

### 5SH5321, 5SH5322



① 5SH5321

② 5SH5322



### 5ST37

Pin spacing in MW (modular width; 1 MW = 18 mm), dimensions of side views in mm, rounded



① 5ST3701-0HG

② 5ST3703-0HG

### 5ST3705-0HG

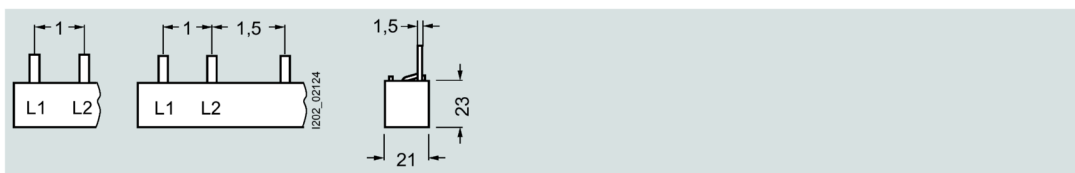

### 5ST3710-0HG, 5ST3714-0HG

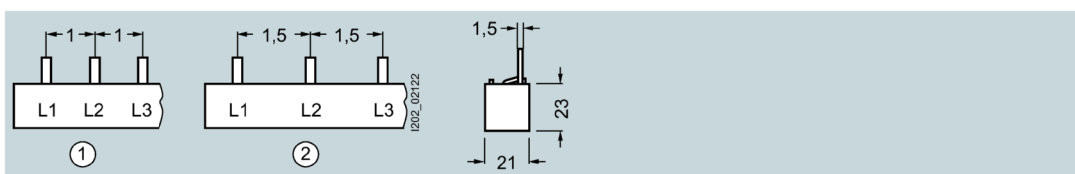

① 5ST3710-0HG

② 5ST3714-0HG

### 5ST3701-2HG



### 5ST3705-2HG



**5ST3710-2HG**



**5ST3748-0HG**

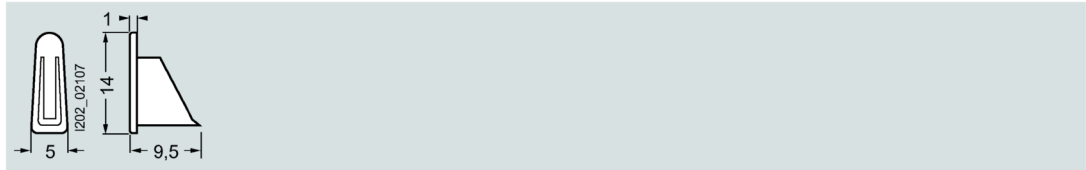

**5ST3750-0HG**



**5ST3770-0HG**

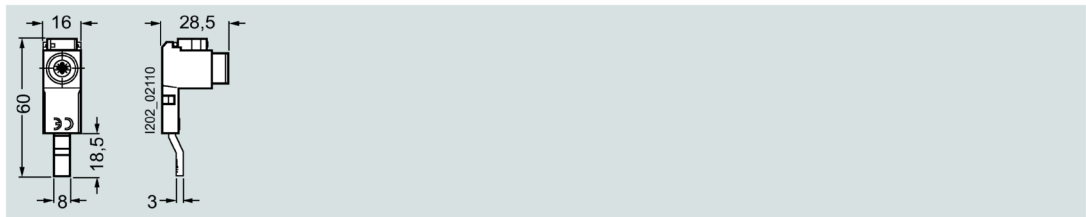

**5ST3770-1HG**

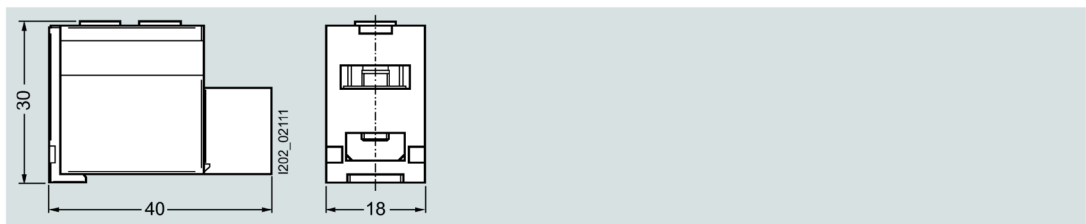

**5ST36 touch protection covers**

Pin spacing in MW (modular width; 1 MW = 18 mm), dimensions of side views in mm, rounded

5ST3655-0HG

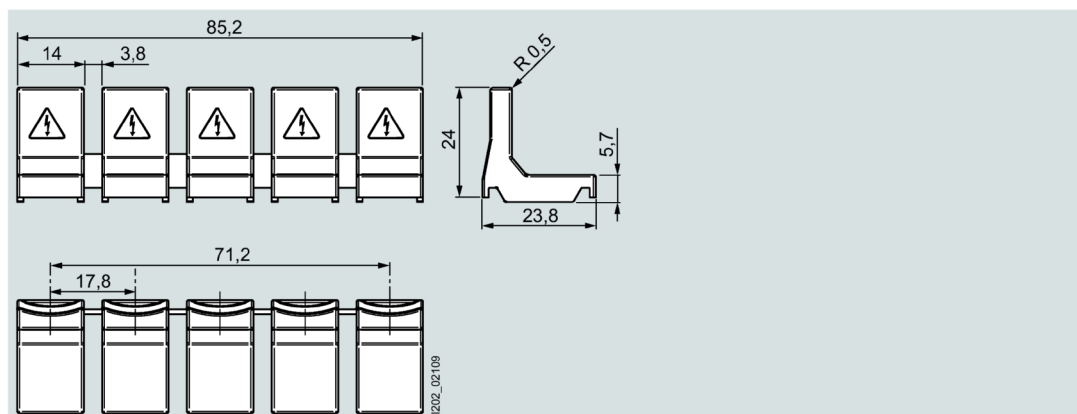



## LV HRC fuse system

### 6.1 LV HRC fuse links

#### 6.1.1 Portfolio overview

LV HRC fuse systems are used for installation systems in non-residential, commercial and industrial buildings as well as in switchboard assemblies of power utilities. They therefore protect key building parts and systems.

LV HRC fuse systems belong to the category of fuse systems designed for operation by experts. There are no constructional requirements for non-interchangeability of rated current and touch protection.

The components and auxiliary equipment are designed in such a way as to ensure the safe replacement of LV HRC fuse systems or isolation of systems.

LV HRC fuse links are available in the sizes 000, 00, 0, 1, 2, 3, 4 and 4a.

LV HRC fuse links are available in the following operational classes:

- gG for cable and line protection
- aM for short-circuit protection for switching devices in motor current circuits
- gR or aR the protection of power semiconductors
- gS: The new operational class combines cable and line protection with semiconductor protection.

LV HRC fuse links of size 000 can also be used in LV HRC fuse bases, LV HRC fuse switch disconnectors, LV HRC fuse strips, as well as LV HRC in-line fuse switch disconnectors of size 00.

The fuse links 300 A, 355 A and 425 A comply with the standard but do not have the VDE mark.

LV HRC components

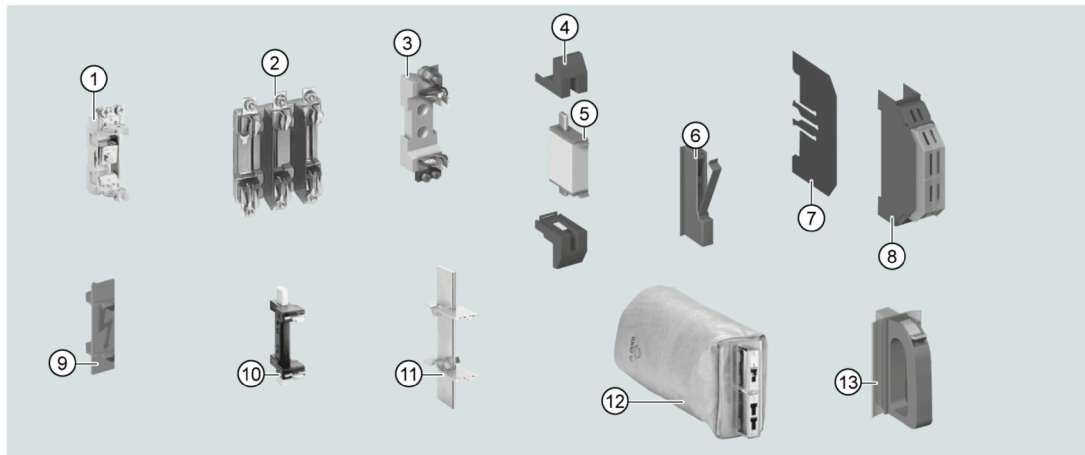

- ① LV HRC fuse base for busbar mounting
- ② LV HRC fuse base, 3-pole
- ③ LV HRC fuse base, 1-pole
- ④ LV HRC contact covers
- ⑤ LV HRC fuse link
- ⑥ LV HRC signal detectors
- ⑦ LV HRC partition
- ⑧ LV HRC protective cover  
LV HRC fuse bases with swivel mechanism:
- ⑨ LV HRC fuse base cover
- ⑩ LV HRC isolating blades with insulated grip lugs
- ⑪ LV HRC isolating blades with non-insulated grip lugs
- ⑫ LV HRC fuse puller with sleeve
- ⑬ LV HRC fuse puller

Figure 6-1

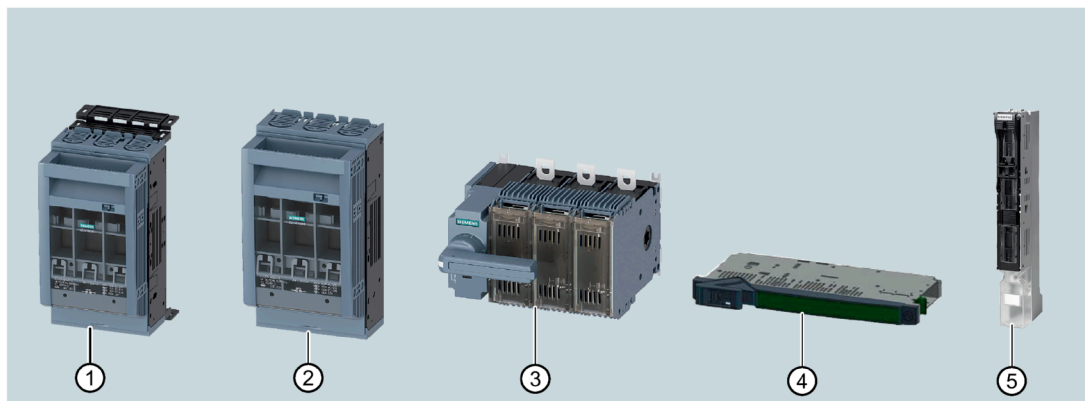

- ① 3NP1 fuse switch disconnecter, LV HRC 00, 160 A, 32/70 mm cover level, 40 mm busbar system
- ② 3NP1 fuse switch disconnecter, LV HRC 00, 160 A, 3-pole, 45 mm cover level, base mounting
- ③ SENTRON 3KF switch disconnecter with fuses, size 2, 3-pole, only front operating mechanism with handle
- ④ 3NJ6 switch disconnecter with fuse, 3-pole, size 00
- ⑤ 3NJ4 fuse switch disconnecter up to 1250 A, in-line design, switchable in-line fuse switch disconnecter, 3-pole

## 6.1.2 Technical specifications

### LV HRC fuse links

		Operational class gG					Operational class aM
		3NA6...-4 3NA6...- 4KK 3NA383.-8	3NA6... 3NA6...-7 3NA7... 3NA7...-7	3NA3... 3NA3...-7	3NA6...-6 3NA7...-6	3NA3...-6	3ND1 3ND2
<b>Standards</b>		IEC 60269-1, -2; EN 60269-1; DIN VDE 0636					
<b>Approvals</b>		DIN VDE 0636-2; CSA 22.2 No.106, File Number 016325_0_00 (CSA approval of fuses 500 V for 600 V)					
<b>Rated voltage <math>U_n</math></b>							
• Sizes 000 and 00	V AC	400	500	500	690 <sup>1)</sup>	690 <sup>1)</sup>	500
	V DC	-	250	250	250	250	-
• Sizes 1 and 2	V AC	400	500	500	690 <sup>1)</sup>	690 <sup>1)</sup>	690
	V DC	-	440	440	440	440	-
• Size 3	V AC	-	-	500	-	690 <sup>1)</sup>	690
	V DC	-	-	440	-	440	-
• Sizes 4 and 4a (IEC design)	V AC	-	-	500	-	-	-
	V DC	-	-	440	-	-	-
<b>Rated current <math>I_n</math></b>	A	10 ... 400	2 ... 400	2 ... 1250	2 ... 315	2 ... 500	6 ... 630
<b>Rated breaking capacity</b>	kA AC	120					
	kA DC	-	25				
<b>Blade contacts</b>	-	Non-corroding, silver-plated					
<b>Resistance to climate</b>	°C	-20 ... +50 at 95% relative humidity					

<sup>1)</sup> Manufacturer's confirmation for rated voltage 690 V +10% available on request

### 6.1.3 Dimensional drawings

#### LV HRC fuse links, operational class gG

##### Sizes 000 to 3 and 4a

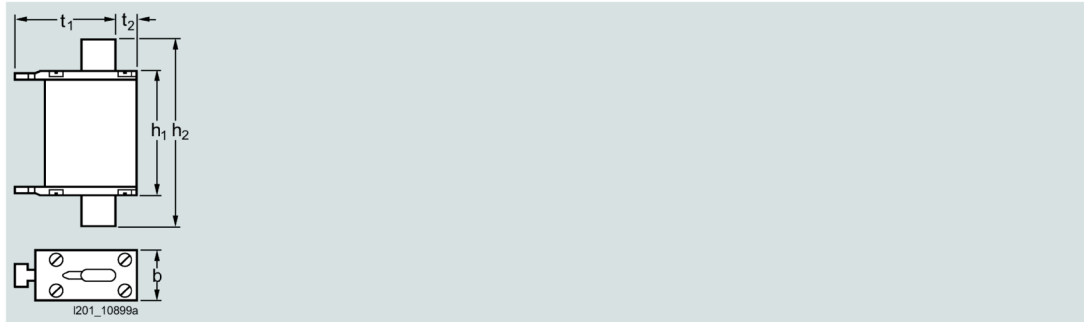

##### Size 4 (IEC design)

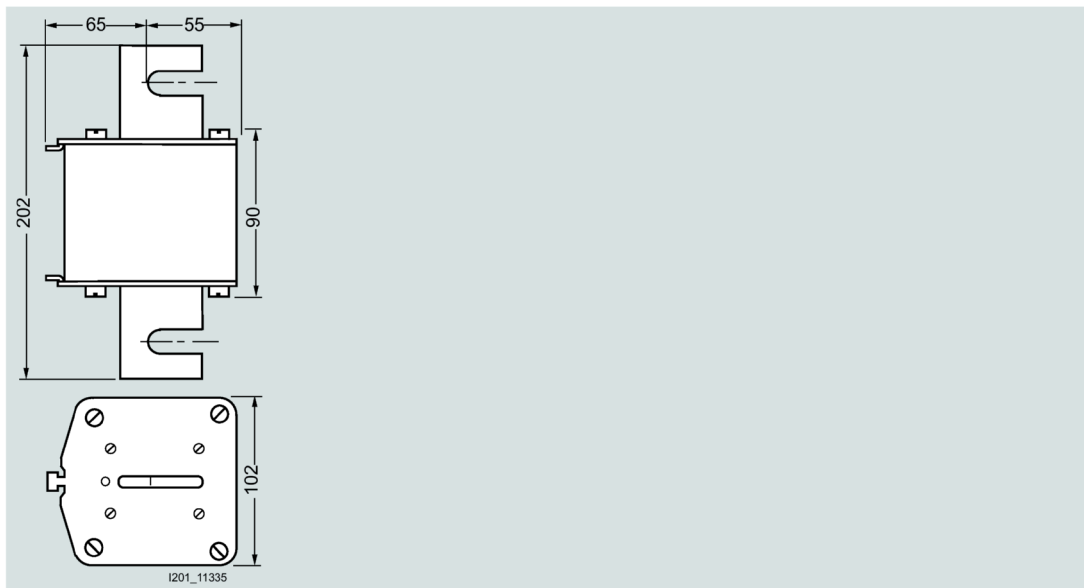

Size	I <sub>n</sub> A	U <sub>n</sub> V	Type	Dimensions				
				b	h <sub>1</sub>	h <sub>2</sub>	t <sub>1</sub>	t <sub>2</sub>
000	2 ... 35	690 AC / 250 DC	3NA38..-6	21	54	80	45	8
	2 ... 160	500 AC	3NA38../-8					
	2 ... 100	500 AC / 250 DC	3NA68..					
	10 ... 100	400 AC	3NA68..-4					
	2 ... 35	690 AC / 250 DC	3NA68..-6					
	10 ... 100	500 AC / 250 DC	3NA78..					
	2 ... 35	690 AC / 250 DC	3NA78..-6					
00	35 ... 160	500 AC / 250 DC	3NA38..	30	54	80	45	14



Size	I <sub>n</sub> A	U <sub>n</sub> V	Type	Dimensions				
				b	h <sub>1</sub>	h <sub>2</sub>	t <sub>1</sub>	t <sub>2</sub>
	40 ... 100	690 AC / 250 DC	3NA38..-6					
	80 ... 160	500 AC / 250 DC	3NA68..-7					
	80 ... 160	400 AC	3NA68..-4 (KK)					
	40 ... 100	690 AC / 250 DC	3NA68..-6					
	80 ... 160	500 AC / 250 DC	3NA78..-7					
	40 ... 100	690 AC / 250 DC	3NA78..-6					
<b>0</b>	6 ... 160	500 AC / 440 DC	3NA30..	30	67	126	45	14
<b>1</b>	16 ... 160	500 AC / 440 DC	3NA31..	30	75	137	50	15
	50 ... 160	690 AC / 440 DC	3NA31..-6					
	16 ... 160	500 AC / 440 DC	3NA61..					
	35 ... 160	400 AC	3NA61..-4					
	50 ... 160	690 AC / 440 DC	3NA61..-6					
	16 ... 160	500 AC / 440 DC	3NA71..					
	50 ... 160	690 AC / 440 DC	3NA71..-6					
	200 ... 250	500 AC / 440 DC	3NA31..	47	75	137	51	9
	200	690 AC / 440 DC	3NA31..-6					
	200 ... 250	500 AC / 440 DC	3NA61..					
	200 ... 250	400 AC	3NA61..-4					
	200	690 AC / 440 DC	3NA61..-6					
	200 ... 250	500 AC / 440 DC	3NA71..					
	200	690 AC / 440 DC	3NA71..-6					
<b>2</b>	35 ... 250	500 AC / 440 DC	3NA32..	47	75	151	58	10
	80 ... 200	690 AC / 440 DC	3NA32..-6					
	35 ... 250	500 AC / 440 DC	3NA62..					
	50 ... 250	400 AC	3NA62..-4					
	80 ... 200	690 AC / 440 DC	3NA62..-6					
	35 ... 250	500 AC / 440 DC	3NA72..					
	80 ... 200	690 AC / 440 DC	3NA72..-6					
	300 ... 400	500 AC / 440 DC	3NA32..	58	74	151	59	13
	224 ... 250	690 AC / 440 DC	3NA32..-6					
	300 ... 400	500 AC / 440 DC	3NA62..					
	300 ... 400	400 AC	3NA62..-4					
	224 ... 315	690 AC / 440 DC	3NA62..-6					
	300 ... 400	500 AC / 440 DC	3NA72..					
	224 ... 315	690 AC / 440 DC	3NA72..-6					
<b>3</b>	200 ... 400	500 AC / 440 DC	3NA33..	58	74	151	71	13
	250, 315	690 AC / 440 DC	3NA33..-6					
	425 ... 630	500 AC / 440 DC	3NA33..	71	74	151	70	13
	355 ... 500	690 AC / 440 DC	3NA33..-6					
<b>4</b>	630 ... 1250	500 AC / 440 DC	3NA34..	see drawing above				
<b>4a</b>	500 ... 1250	500 AC / 440 DC	3NA36..	102	97	201	95	20

LV HRC fuse links, operational class aM

Sizes 000 to 3

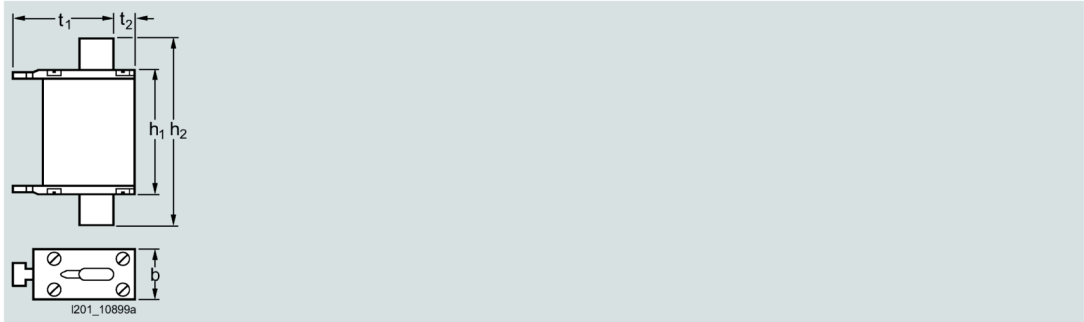

Size	I <sub>n</sub> A	U <sub>n</sub> V	Type	Dimensions				
				b	h <sub>1</sub>	h <sub>2</sub>	t <sub>1</sub>	t <sub>2</sub>
000	6 ... 80	500 AC	3ND18..	21	54	80	45	8
00	100 ... 160			30	54	80	45	14
1	63 ... 100	690 AC	3ND21..	30	75	137	50	15
	125 ... 250			47	75	137	51	9
2	125 ... 250	690 AC	3ND22..	47	75	151	58	10
	315 ... 400			58	74	151	59	13
3	315 ... 400	690 AC	3ND23..	58	74	151	71	13
	500, 630		3ND13..	71	74	151	70	13

6.1.4 Characteristic curves

3NA30 series

Size: 0  
 Operational class: gG  
 Rated voltage: 500 V AC / 440 V DC  
 Rated current: 6 ... 160 A

### Time/current characteristic curves diagram

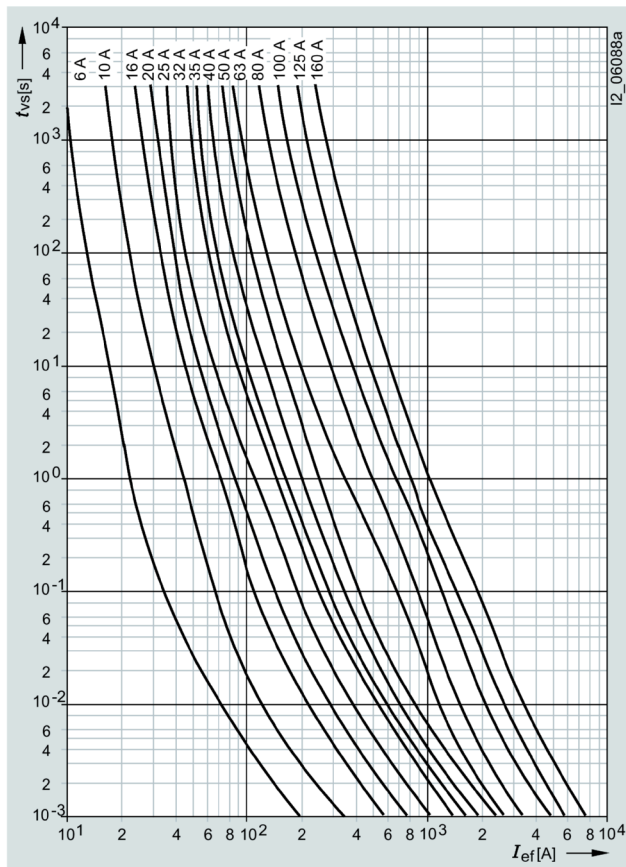

### Current limiting diagram

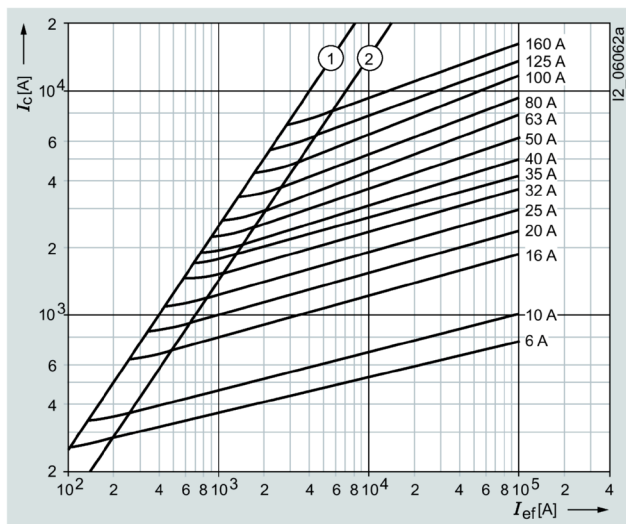

- ① Peak short-circuit current with largest DC component
- ② Peak short-circuit current without DC component

Melting  $I^2t$  values diagram

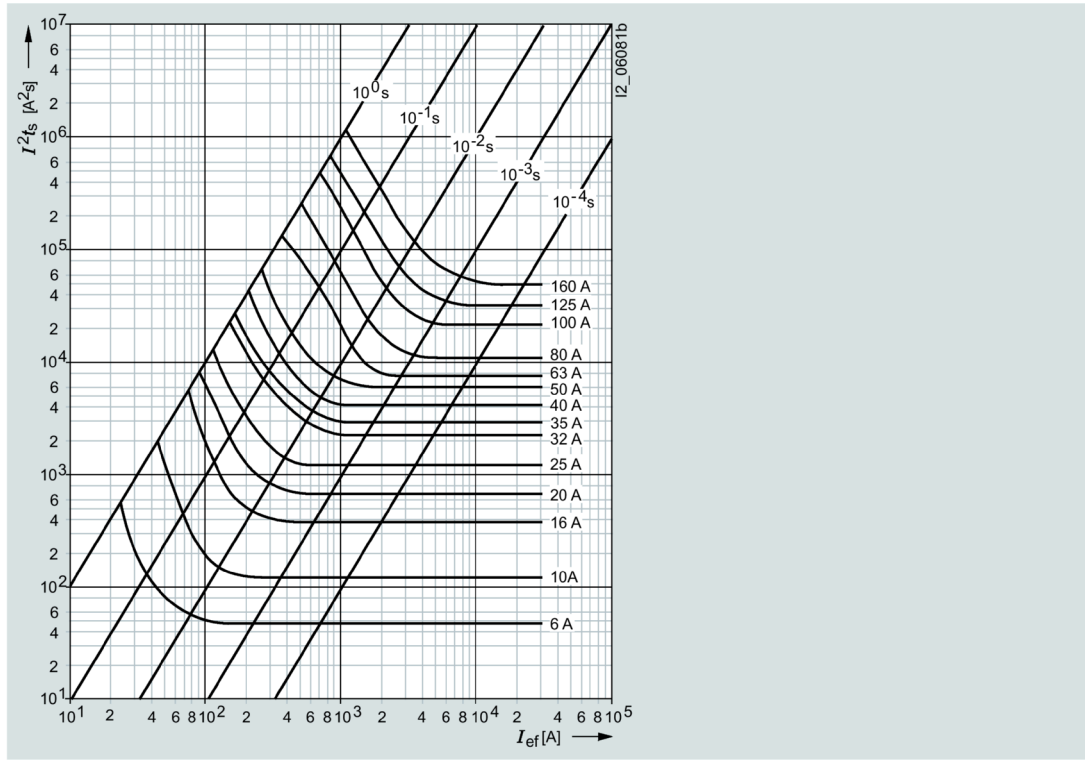

Type	I <sub>n</sub> A	P <sub>v</sub> W	Δθ K	I <sup>2</sup> t <sub>s</sub>		I <sup>2</sup> t <sub>a</sub>		
				1 ms A <sup>2</sup> s	4 ms A <sup>2</sup> s	230 V AC A <sup>2</sup> s	400 V A C A <sup>2</sup> s	500 V A C A <sup>2</sup> s
3NA3001	6	1.5	6	46	50	80	110	150
3NA3003	10	1	9	120	130	180	265	370
3NA3005	16	1.9	11	370	420	580	750	1000
3NA3007	20	2.3	13	670	750	1000	1370	1900
3NA3010	25	2.7	15	1200	1380	1800	2340	3300
3NA3012	32	3	13	2200	2400	3400	4550	6400
3NA3014	35	3	17	3000	3300	4900	6750	9300
3NA3017	40	3.4	17	4000	4500	6100	8700	12100
3NA3020	50	4.5	24	6000	6800	9100	11600	16000
3NA3022	63	5.8	27	7700	9800	14200	19000	26500
3NA3024	80	7	34	12000	16000	23100	30700	43000
3NA3030	100	8.2	37	24000	30600	40800	56200	80000
3NA3032	125	10.2	38	36000	50000	70000	91300	130000
3NA3036	160	13.5	44	58000	85000	120000	158000	223000

### 3NA31, 3NA61, 3NA71 series

Size:	1
Operational class:	gG
Rated voltage:	500 V AC / 440 V DC
Rated current:	16 ... 250 A

#### Time/current characteristic curves diagram

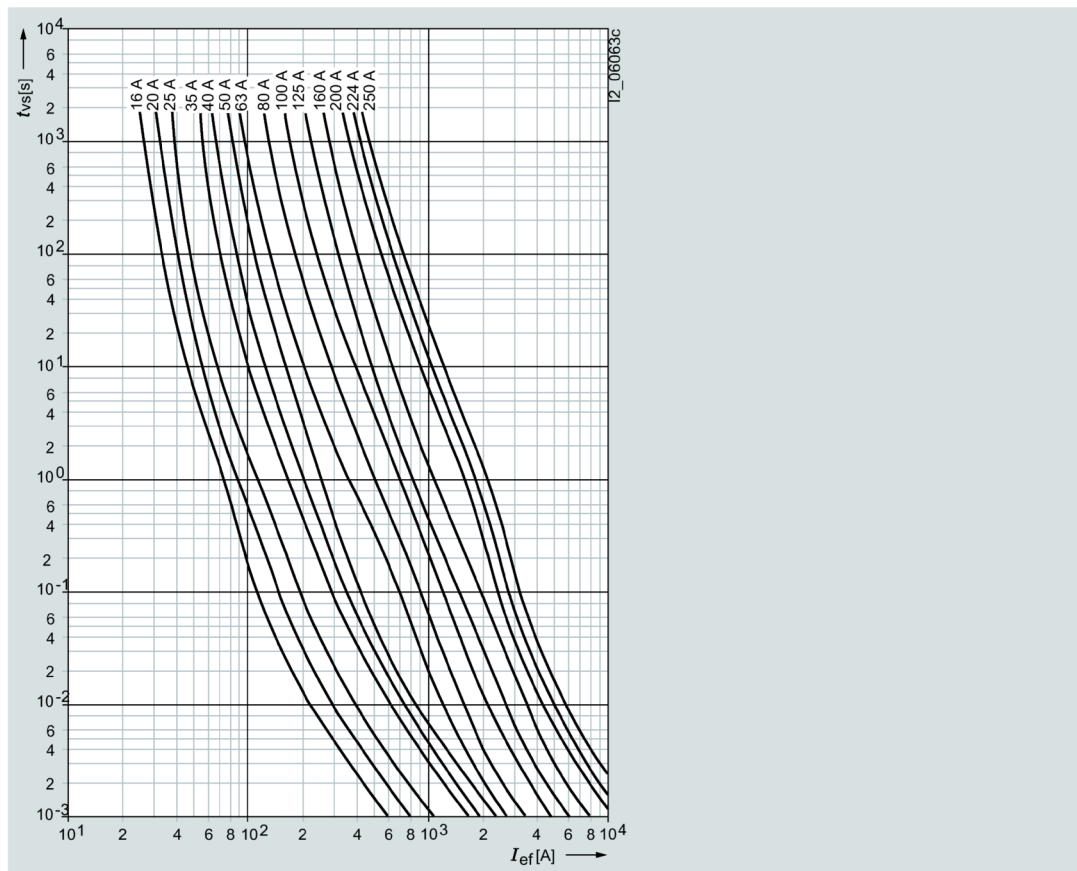

**Current limiting diagram**

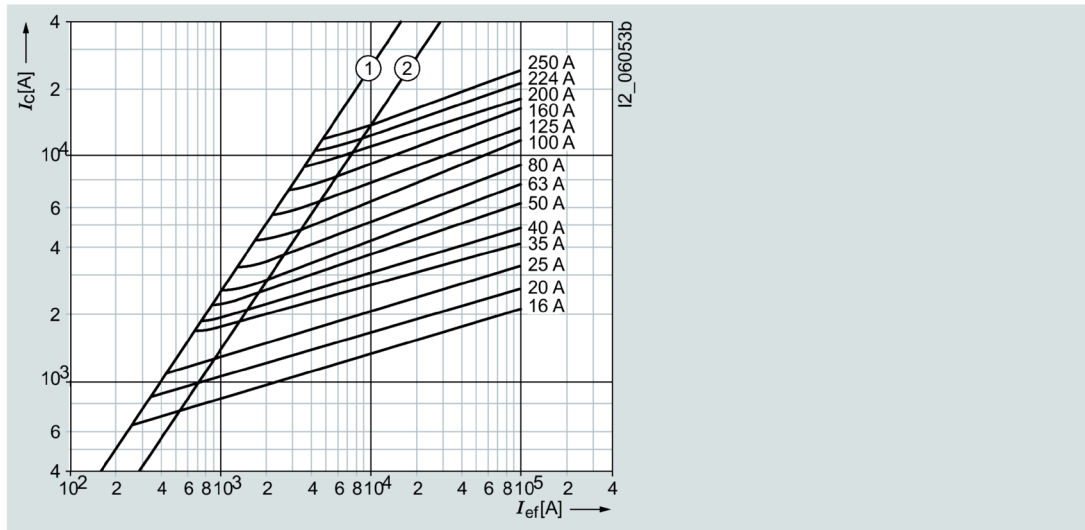

- ① Peak short-circuit current with largest DC component
- ② Peak short-circuit current without DC component

**Melting  $I^2t$  values diagram**

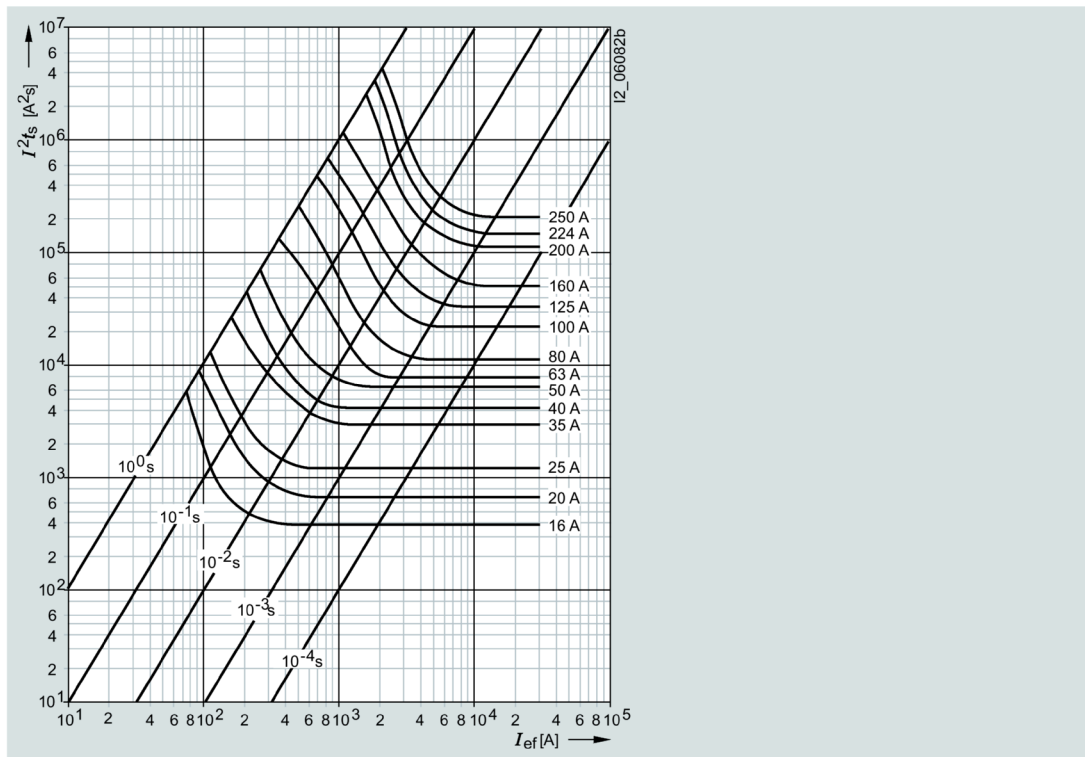

Type	I <sub>n</sub> A	P <sub>v</sub> W	Δθ K	I <sup>2</sup> t <sub>s</sub>		I <sup>2</sup> t <sub>a</sub>		
				1 ms A <sup>2</sup> s	4 ms A <sup>2</sup> s	230 V AC A <sup>2</sup> s	400 V A C A <sup>2</sup> s	500 V A C A <sup>2</sup> s
3NA.105	16	2.1	8	370	420	580	750	1000
3NA.107	20	2.4	10	670	750	1000	1370	1900
3NA.110	25	2.8	11	1200	1380	1800	2340	3300
3NA.114	35	3.2	16	3000	3300	4900	6750	9300
3NA.117	40	3.6	16	4000	4500	6100	8700	12100
3NA.120	50	4.6	20	6000	6800	9100	11600	16000
3NA.122	63	6	21	7700	9800	14200	19000	26500
3NA.124	80	7.5	29	12000	16000	23100	30700	43000
3NA.130	100	8.9	30	24000	30600	40800	56200	80000
3NA.132	125	10.7	31	36000	50000	70000	91300	130000
3NA.136	160	13.9	34	58000	85000	120000	158000	223000
3NA.140	200	15	36	115000	135000	218000	285000	400000
3NA.142	224	16.1	37	145000	170000	299000	392000	550000
3NA.144	250	17.3	39	205000	230000	420000	551000	780000

### 3NA31..-6, 3NA61..-6, 3NA71..-6 series

Size: 1  
Operational class: gG  
Rated voltage: 690 V AC<sup>1)</sup> / 440 V DC  
Rated current: 50 ... 200 A

<sup>1)</sup> Manufacturer's confirmation for rated voltage 690 V +10% available on request

Time/current characteristic curves diagram

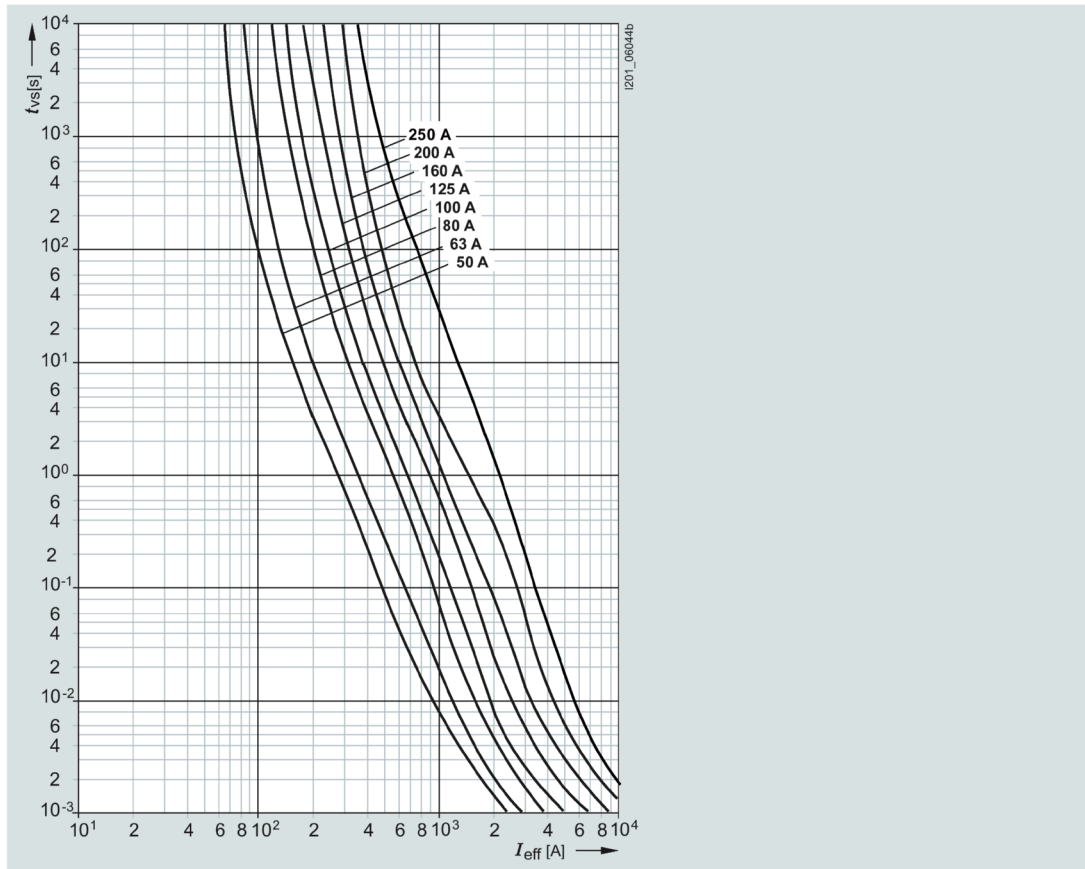

Current limiting diagram

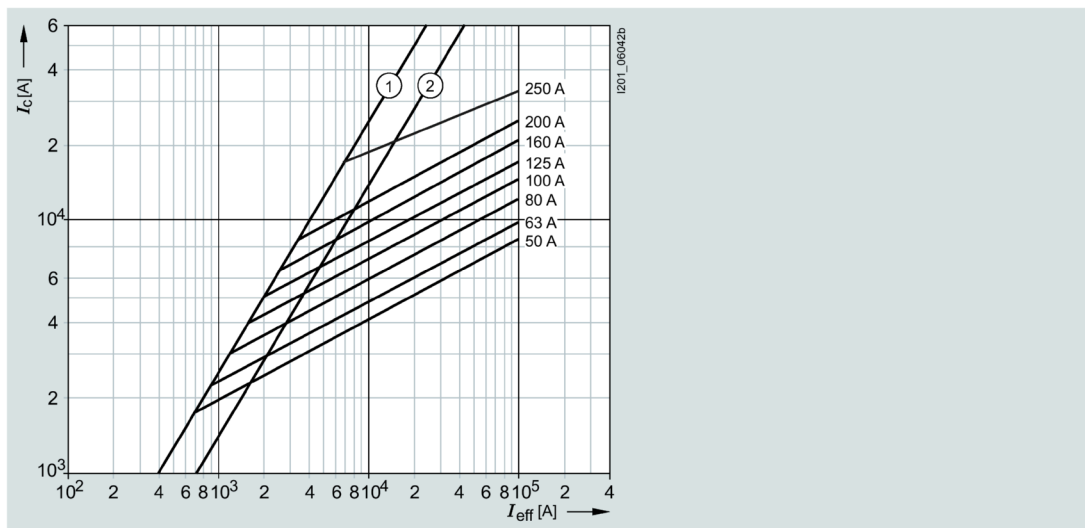

- ① Peak short-circuit current with largest DC component
- ② Peak short-circuit current without DC component



Melting  $I^2t_s$  values diagram

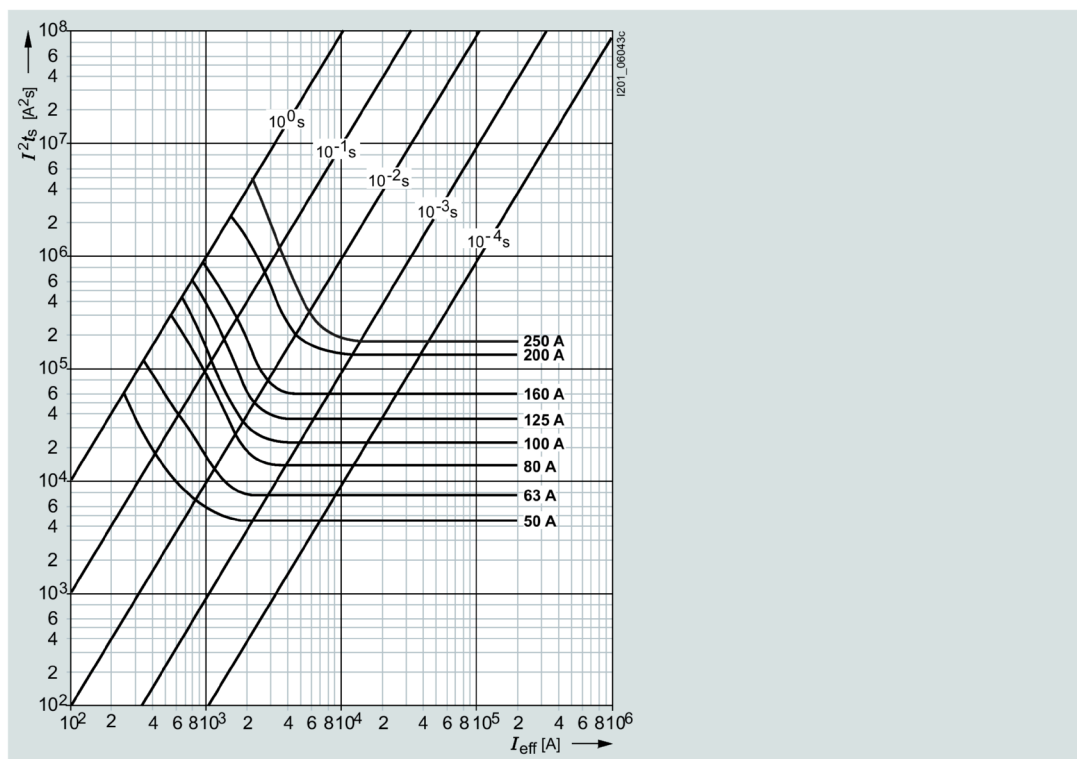

Type	$I_n$ A	$P_v$ W	$\Delta\theta$ K	$I^2t_s$		$I^2t_a$		
				1 ms A²s	4 ms A²s	230 V AC A²s	400 V A C A²s	690 V A C A²s
3NA.120-6	50	6.7	21	440	7400	9100	11200	1900
3NA.122-6	63	7.6	22	7600	10100	13600	17000	24000
3NA.124-6	80	6.7	22	13500	17000	24300	32000	55000
3NA.130-6	100	8.7	28	21200	30500	42400	52000	75000
3NA.132-6	125	10.5	29	36000	50000	69500	82200	130000
3NA.136-6	160	13.8	33	58000	85000	120000	155000	223000
3NA.140-6	200	16.6	35	132000	144000	211000	240000	360000

### 3NA32, 3NA62, 3NA72 series

Size: 2  
Operational class: gG  
Rated voltage: 500 V AC / 440 V DC  
Rated current: 35 ... 400 A

Time/current characteristic curves diagram

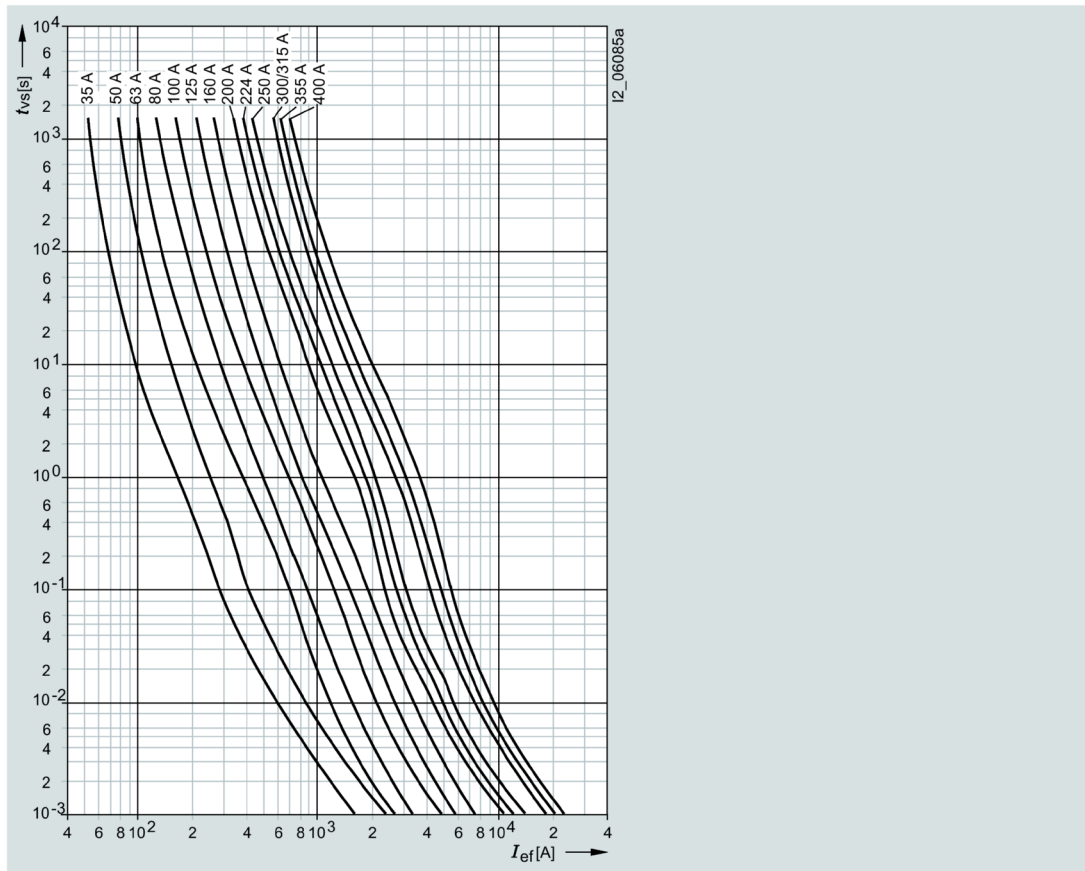

Current limiting diagram

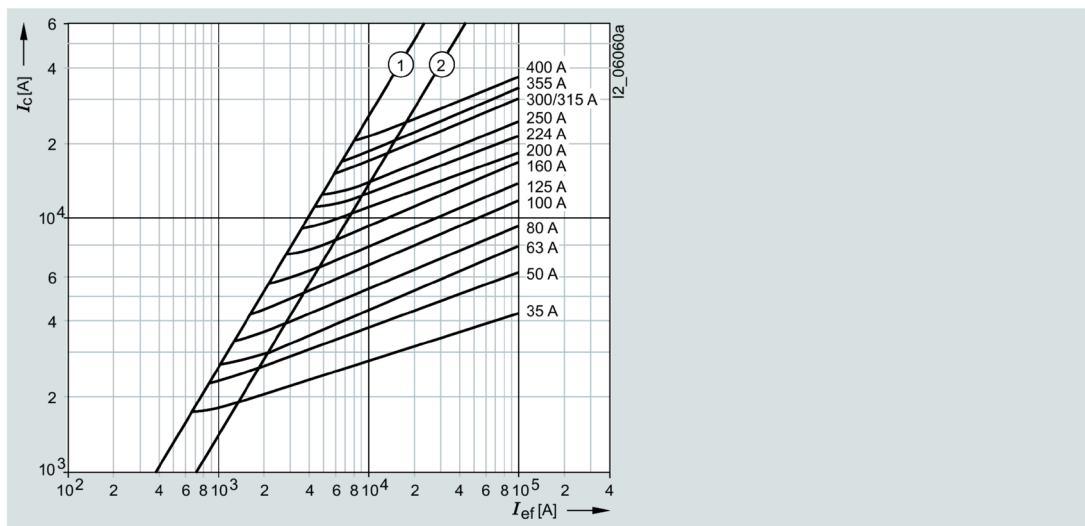

- ① Peak short-circuit current with largest DC component
- ② Peak short-circuit current without DC component

### Melting I<sup>2</sup>t values diagram

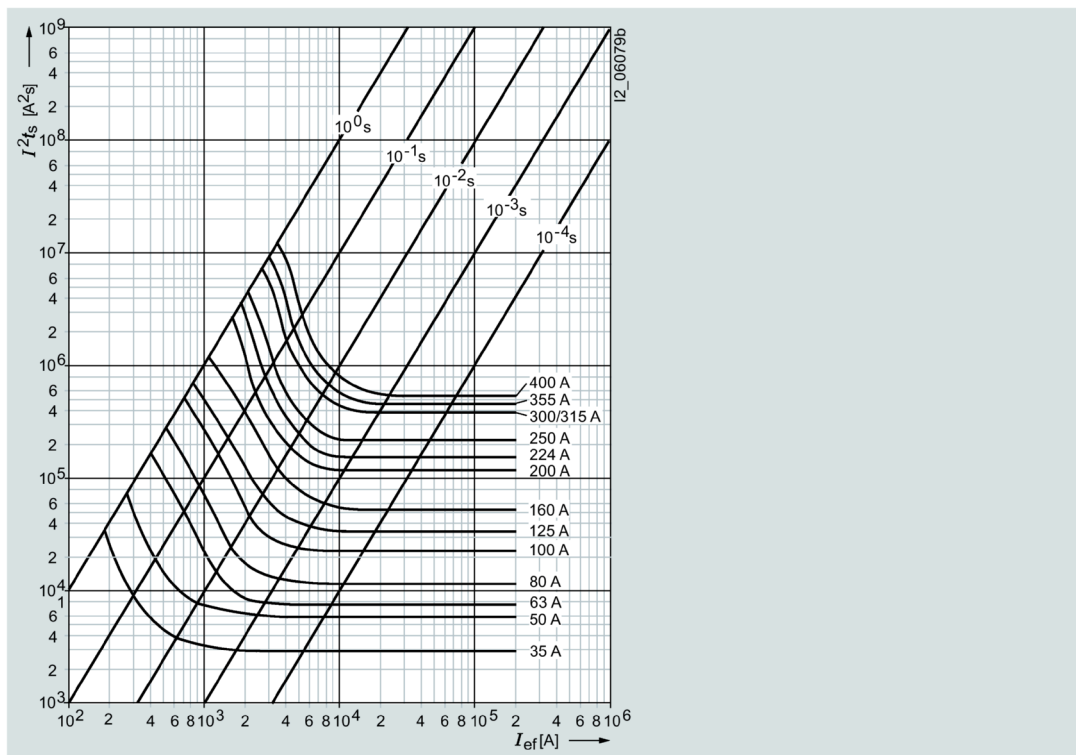

Type	I <sub>n</sub> A	P <sub>v</sub> W	Δθ K	I <sup>2</sup> t <sub>s</sub>		I <sup>2</sup> t <sub>a</sub>		
				1 ms A <sup>2</sup> s	4 ms A <sup>2</sup> s	230 V AC A <sup>2</sup> s	400 V A C A <sup>2</sup> s	500 V A C A <sup>2</sup> s
3NA.214	35	3.2	12	3000	3300	4900	6750	9300
3NA.220	50	4.7	16	6000	6800	9100	11600	16000
3NA.222	63	5.9	16	7700	9800	14200	19000	26500
3NA.224	80	6.8	21	12000	16000	23100	30700	43000
3NA.230	100	7.4	22	24000	30600	40800	56200	80000
3NA.232	125	9.8	27	36000	50000	70000	91300	130000
3NA.236	160	12.6	34	58000	85000	120000	158000	223000
3NA.240	200	14.9	33	115000	135000	218000	285000	400000
3NA.242	224	15.4	31	145000	170000	299000	392000	550000
3NA.244	250	17.9	38	205000	230000	420000	551000	780000
3NA.250	300	19.4	34	361000	433000	670000	901000	1275000
3NA.252	315	21.4	35	361000	433000	670000	901000	1275000
3NA.254	355	26	49	441000	538000	800000	1060000	1500000
3NA.260	400	27.5	52	529000	676000	1155000	1515000	2150000

**3NA32..-6, 3NA62..-6, 3NA72..-6 series**

Size: 2  
 Operational class: gG  
 Rated voltage: 690 V AC<sup>1)</sup> / 440 V DC  
 Rated current: 80 ... 315 A

<sup>1)</sup> Manufacturer's confirmation for rated voltage 690 V +10% available on request

**Time/current characteristic curves diagram**

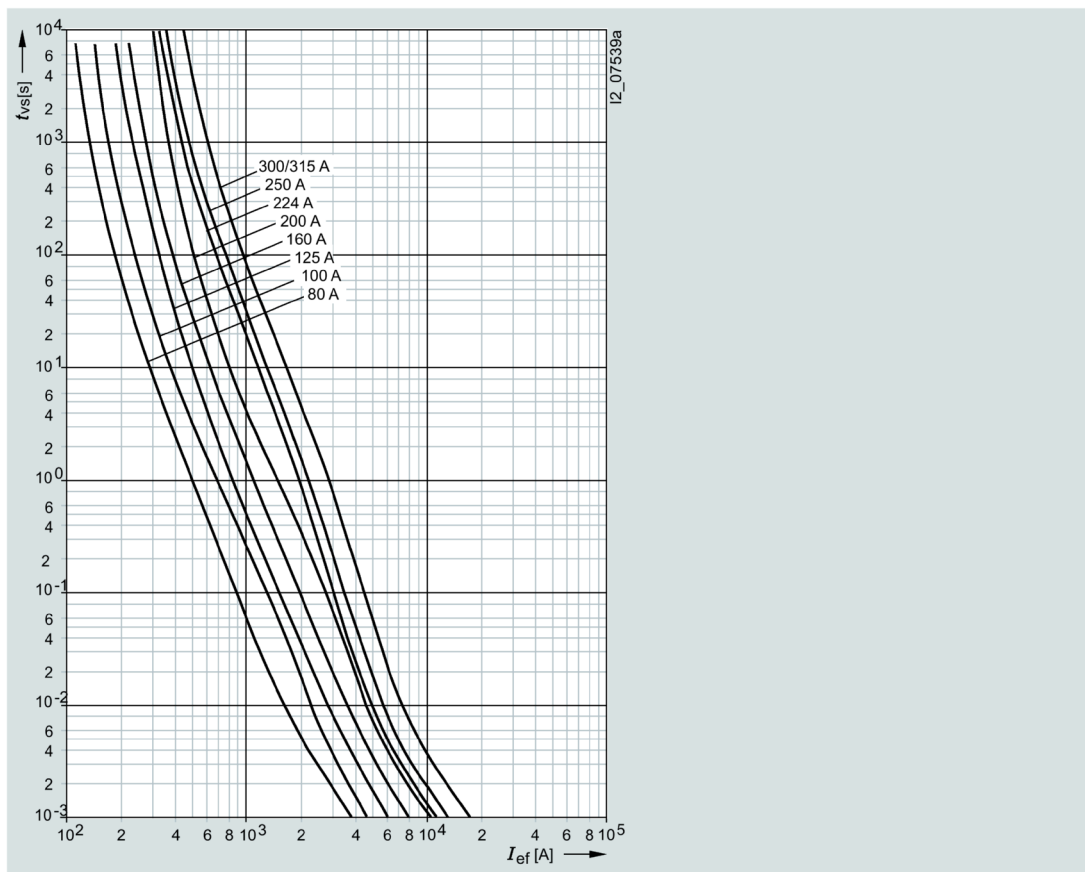

### Current limiting diagram

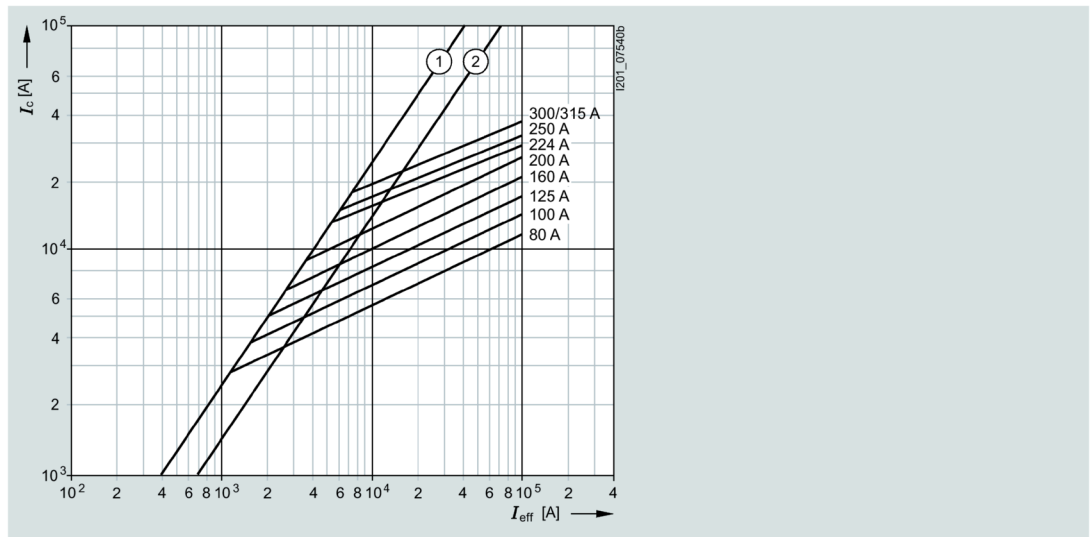

- ① Peak short-circuit current with largest DC component
- ② Peak short-circuit current without DC component

### Melting I<sup>2</sup>t values diagram

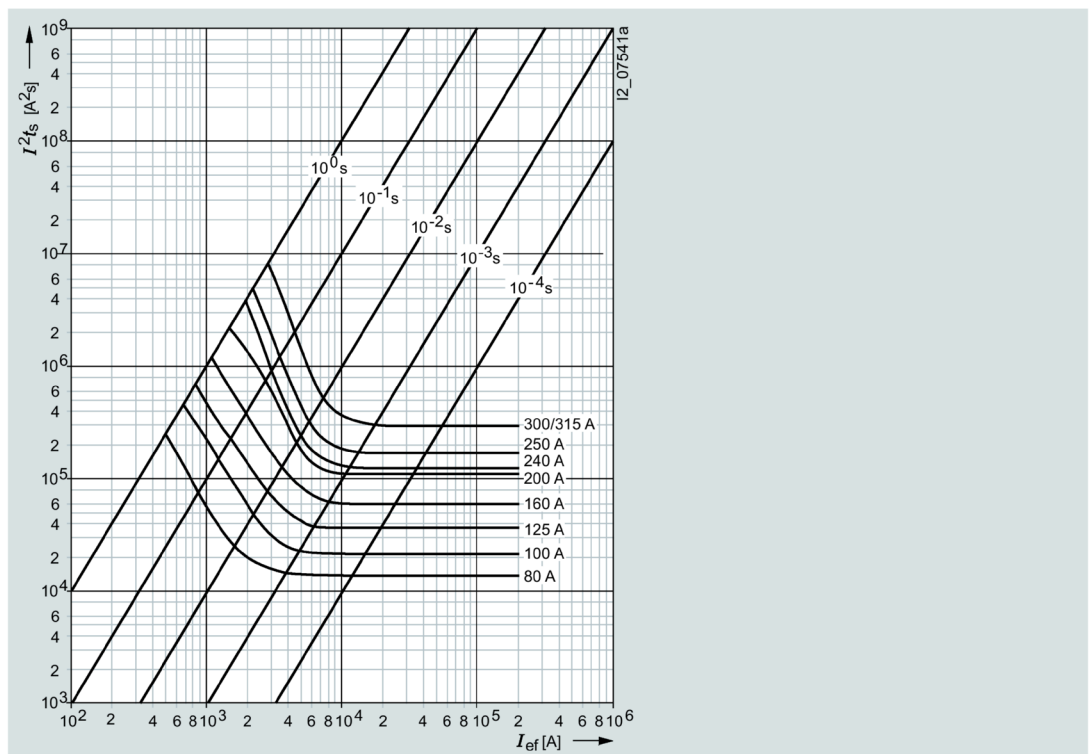

Type	I <sub>n</sub> A	P <sub>v</sub> W	Δθ K	I <sup>2</sup> t <sub>s</sub>		I <sup>2</sup> t <sub>a</sub>		
				1 ms A <sup>2</sup> s	4 ms A <sup>2</sup> s	230 V AC A <sup>2</sup> s	400 V A C A <sup>2</sup> s	690 V A C A <sup>2</sup> s
<b>3NA.224-6</b>	80	6.6	22	13500	17000	24300	32000	55000
<b>3NA.230-6</b>	100	8.5	26	21200	30500	42400	52000	75000
<b>3NA.232-6</b>	125	9.8	29	36000	50000	69500	82200	130000
<b>3NA.236-6</b>	160	13.3	31	58000	85000	120000	155000	223000
<b>3NA.240-6</b>	200	16.1	33	132000	144000	211000	240000	360000
<b>3NA.242-6</b>	224	19.9	38	125000	162000	300000	300000	450000
<b>3NA.244-6</b>	250	23	44	180000	215000	453000	350000	525000
<b>3NA.250-6</b>	300	25.6	38	300000	380000	480000	625000	940000
<b>3NA.252-6</b>	315	28.2	42	300000	380000	480000	625000	940000

**3NA33 series**

Size:	3
Operational class:	gG
Rated voltage:	500 V AC / 440 V DC
Rated current:	200 ... 630 A

Time/current characteristic curves diagram

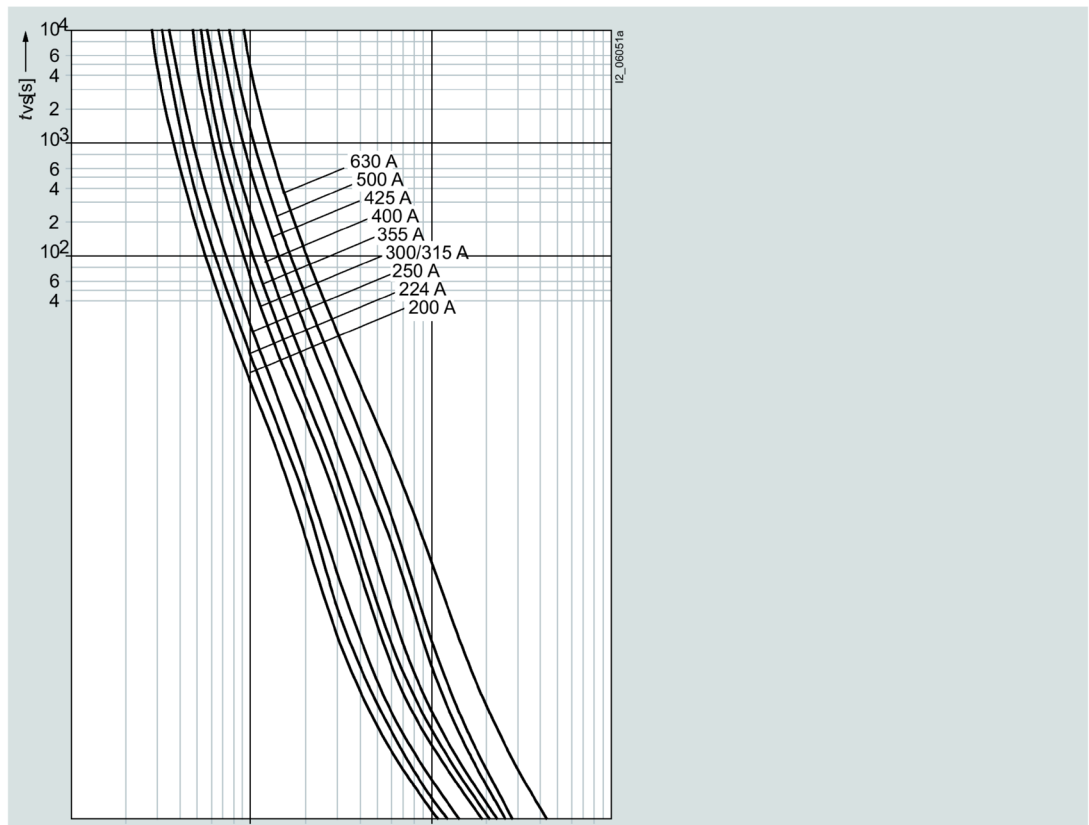

Current limiting diagram

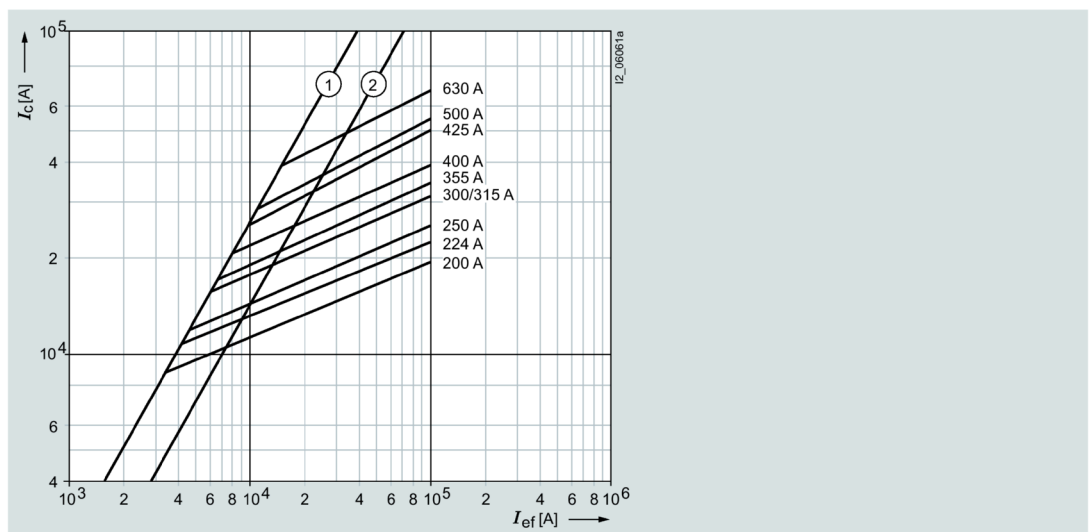

- ① Peak short-circuit current with largest DC component
- ② Peak short-circuit current without DC component

Melting I<sup>2</sup>t values diagram

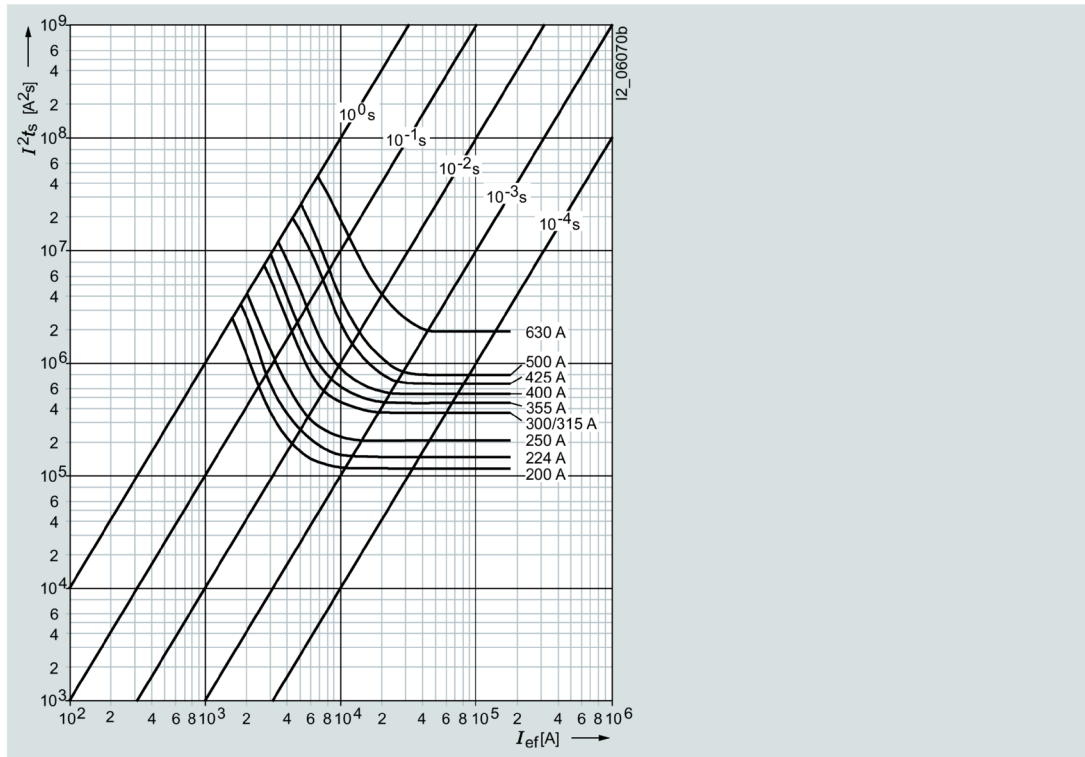

Type	I <sub>n</sub> A	P <sub>v</sub> W	Δθ K	I <sup>2</sup> t <sub>s</sub>		I <sup>2</sup> t <sub>a</sub>		
				1 ms kA <sup>2</sup> s	4 ms kA <sup>2</sup> s	230 V AC kA <sup>2</sup> s	400 V A C kA <sup>2</sup> s	500 V A C kA <sup>2</sup> s
3NA3340	200	14.9	32	115	135	218	285	400
3NA3342	224	15.4	31	145	170	299	392	550
3NA3344	250	17.9	36	205	230	420	551	780
3NA3350	300	19.4	19	361	433	670	901	1275
3NA3352	315	21.4	22	361	433	670	901	1275
3NA3354	355	26	26	441	538	800	1060	1500
3NA3360	400	27.5	28	529	676	1155	1515	2150
3NA3362	425	26.5	34	650	970	1515	1856	2270
3NA3365	500	36.5	41	785	1270	1915	2260	2700
3NA3372	630	44	50	1900	2700	3630	4340	5400

3NA33..-6 series

Size: 3  
 Operational class: gG  
 Rated voltage: 690 V AC<sup>1)</sup> / 440 V DC  
 Rated current: 250 ... 500 A



1) Manufacturer's confirmation for rated voltage 690 V +10% available on request

### Time/current characteristic curves diagram

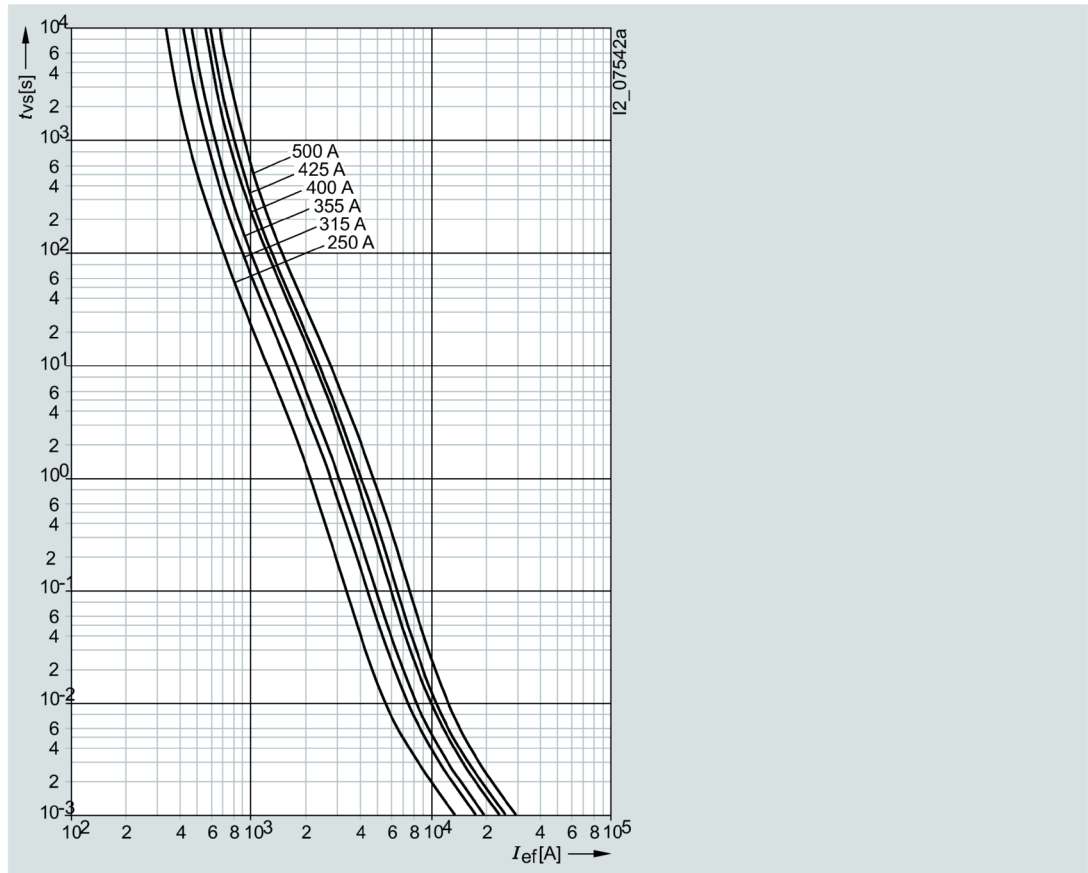

Current limiting diagram

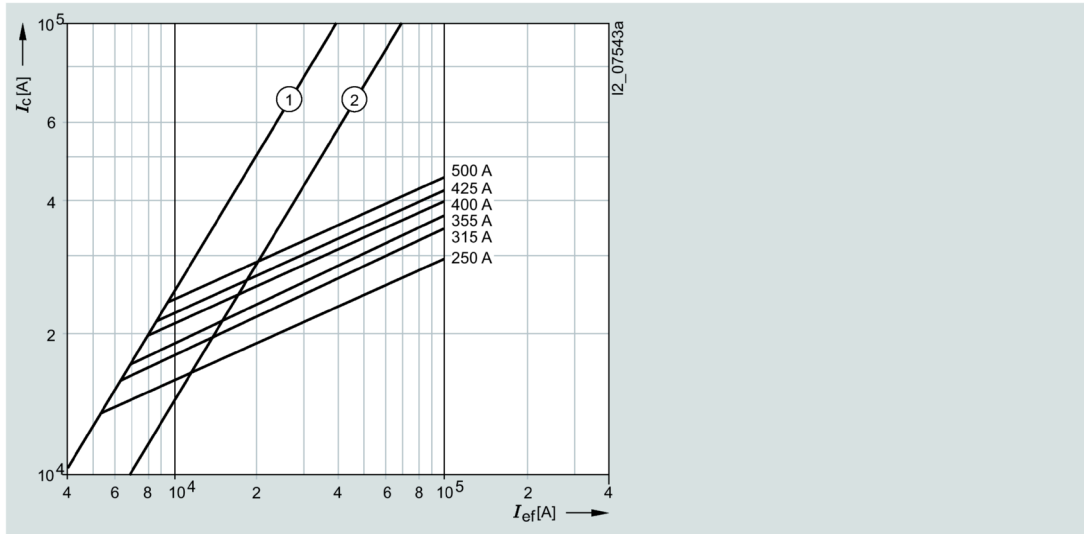

- ① Peak short-circuit current with largest DC component
- ② Peak short-circuit current without DC component

Melting  $I^2t$  values diagram

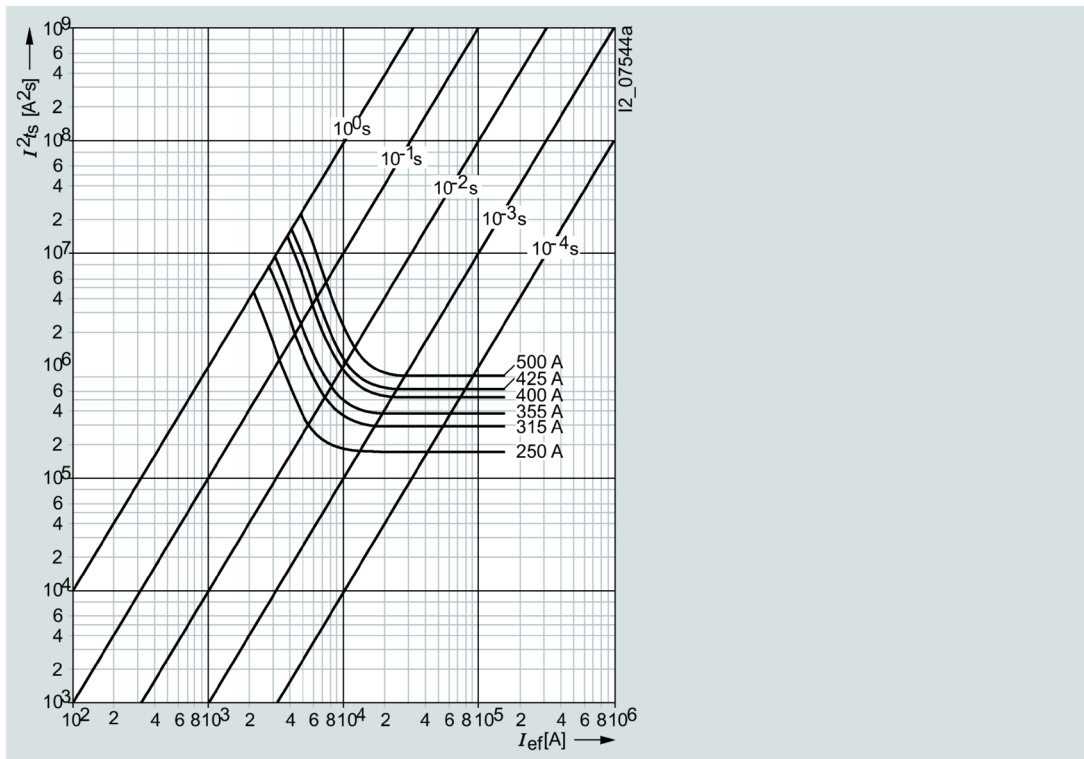

Type	I <sub>n</sub> A	P <sub>v</sub> W	Δθ K	I <sup>2</sup> t <sub>s</sub>		I <sup>2</sup> t <sub>a</sub>		
				1 ms kA <sup>2</sup> s	4 ms kA <sup>2</sup> s	230 V AC kA <sup>2</sup> s	400 V A C kA <sup>2</sup> s	690 V A C kA <sup>2</sup> s
3NA3344-6	250	23	44	180	215	453	350	525
3NA3352-6	315	28.2	42	300	380	480	625	940
3NA3354-6	355	32.5	40	380	470	585	760	1150
3NA3360-6	400	33.2	42	540	675	847	1100	1650
3NA3362-6	425	35.3	44	625	765	925	1200	1800
3NA3365-6	500	43.5	52	810	1000	1300	1700	2500

### 3NA34 series

Size: 4 (IEC design)  
Operational class: gG  
Rated voltage: 500 V AC / 440 V DC  
Rated current: 630 ... 1250 A

#### Time/current characteristic curves diagram

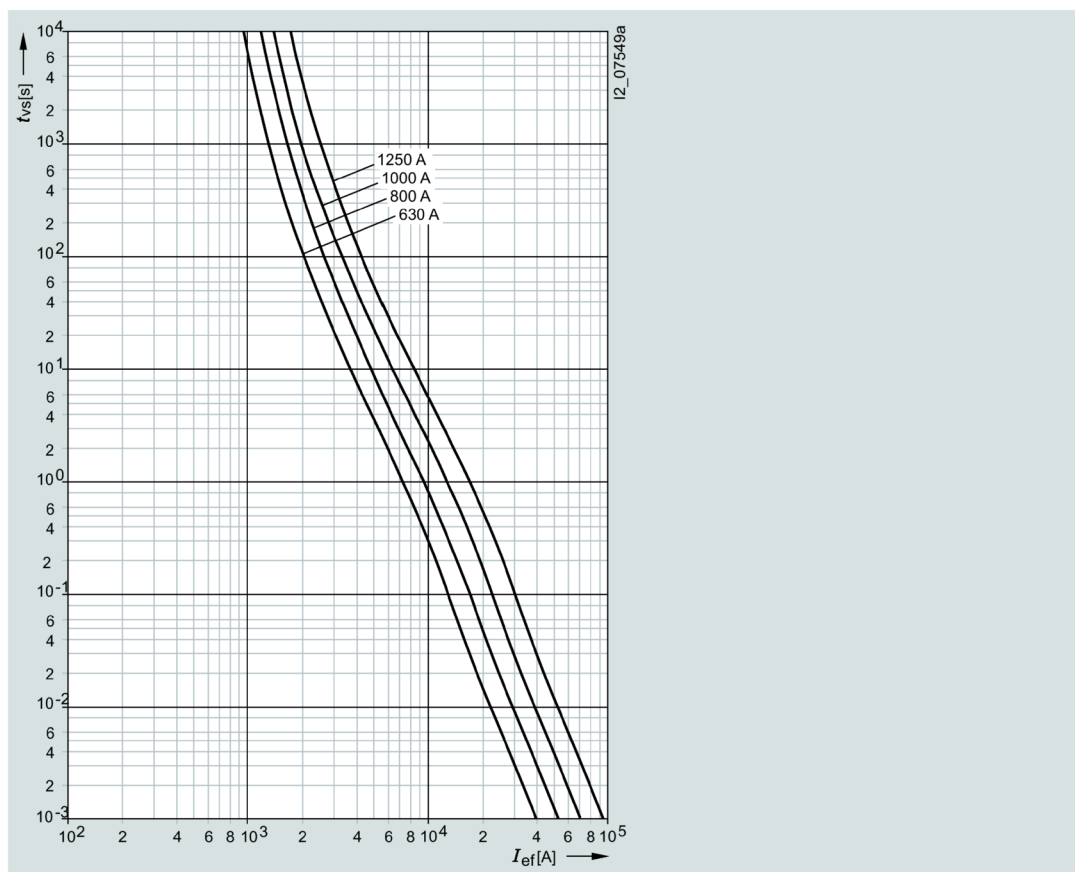

**Current limiting diagram**

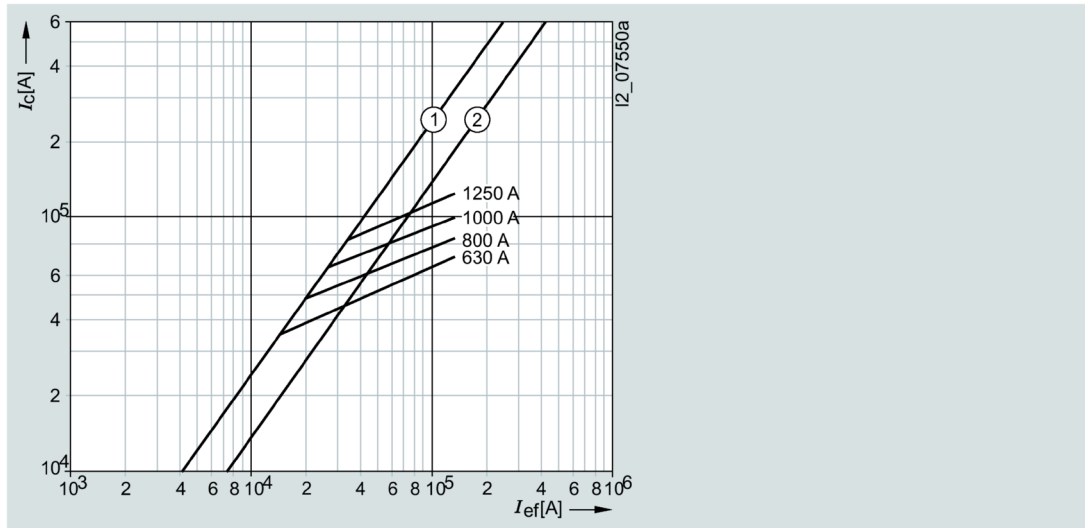

- ① Peak short-circuit current with largest DC component
- ② Peak short-circuit current without DC component

**Melting  $I^2t$  values diagram**

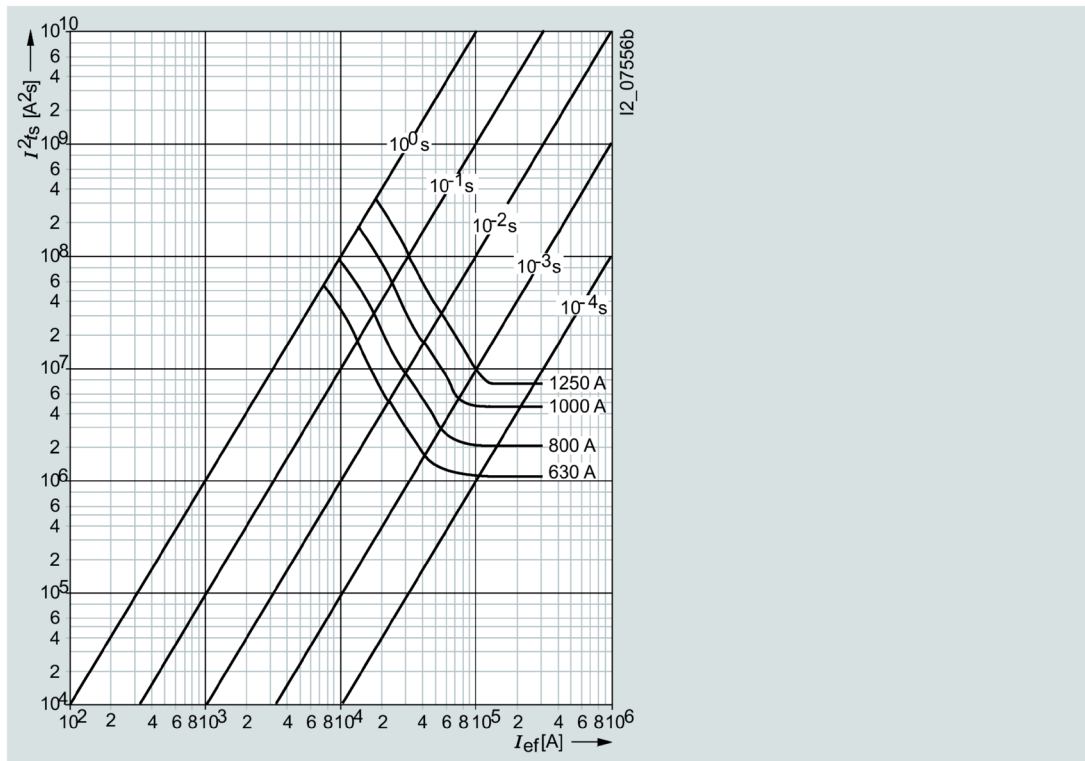

Type	I <sub>n</sub> A	P <sub>v</sub> W	Δθ K	I <sup>2</sup> t <sub>s</sub>		I <sup>2</sup> t <sub>a</sub>		
				1 ms A <sup>2</sup> s	4 ms A <sup>2</sup> s	230 V AC A <sup>2</sup> s	400 V A C A <sup>2</sup> s	500 V A C A <sup>2</sup> s
3NA3472	630	47	37	1900000	2700000	3630000	4340000	5400000
3NA3475	800	59	43	3480000	5620000	7210000	8510000	10400000
3NA3480	1000	74	56	7920000	10400000	13600000	16200000	19000000
3NA3482	1250	99	65	11880000	18200000	23900000	29100000	34800000

### 3NA36 series

Size: 4a  
Operational class: gG  
Rated voltage: 500 V AC / 440 V DC  
Rated current: 500 ... 1250 A

#### Time/current characteristic curves diagram

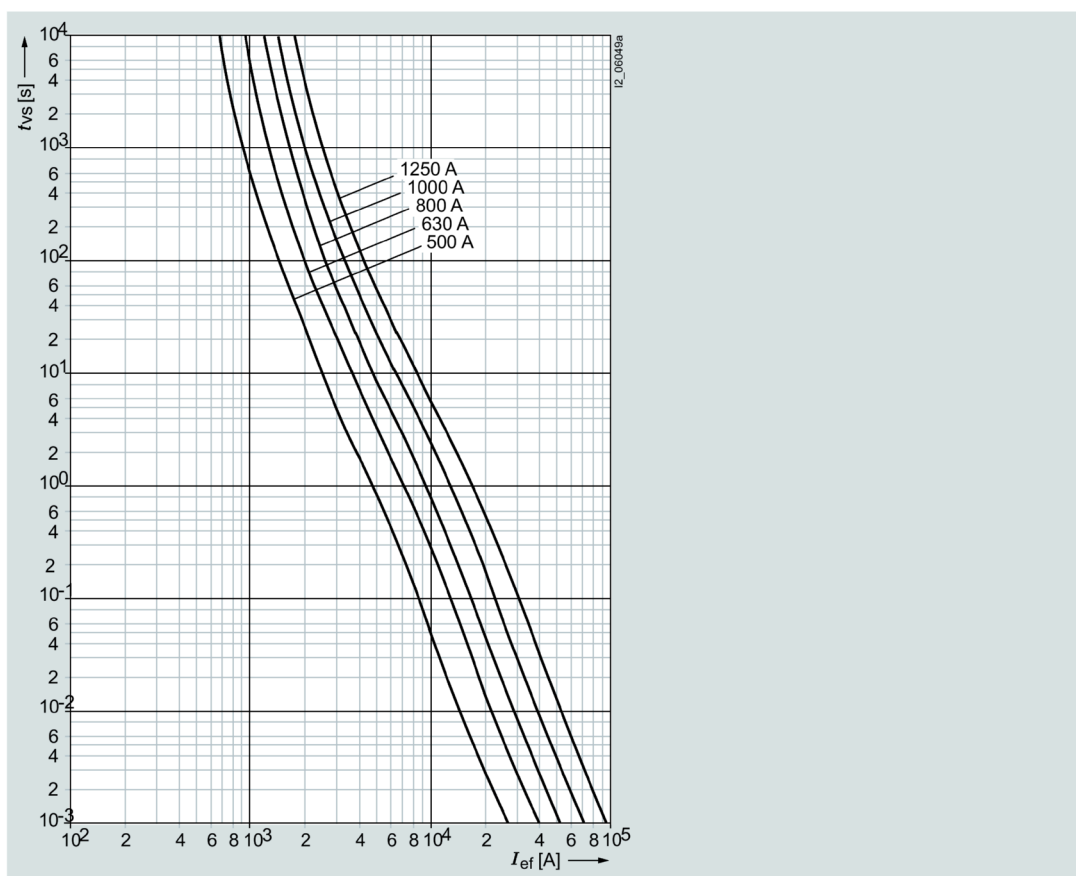

**Current limiting diagram**

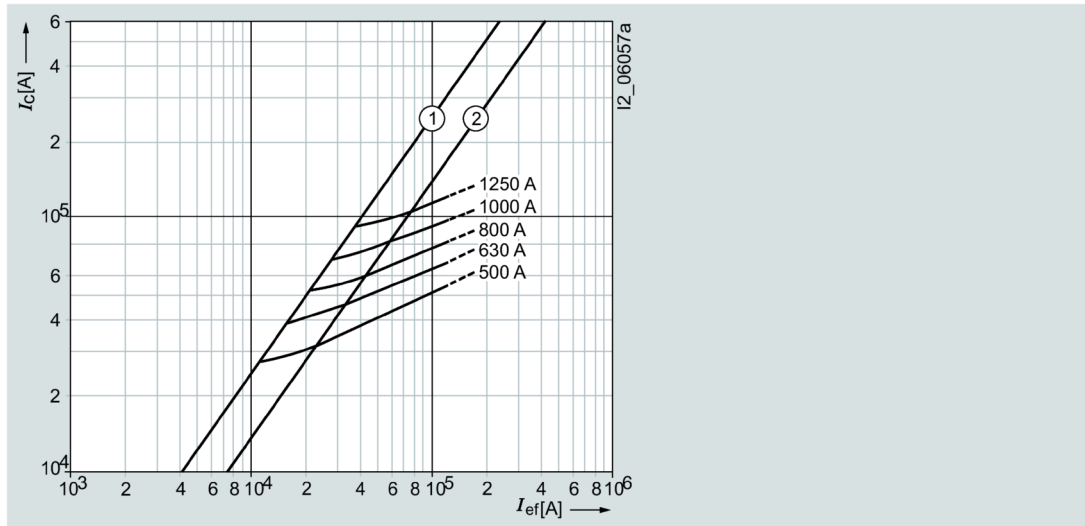

- ① Peak short-circuit current with largest DC component
- ② Peak short-circuit current without DC component

**Melting  $I^2t$  values diagram**

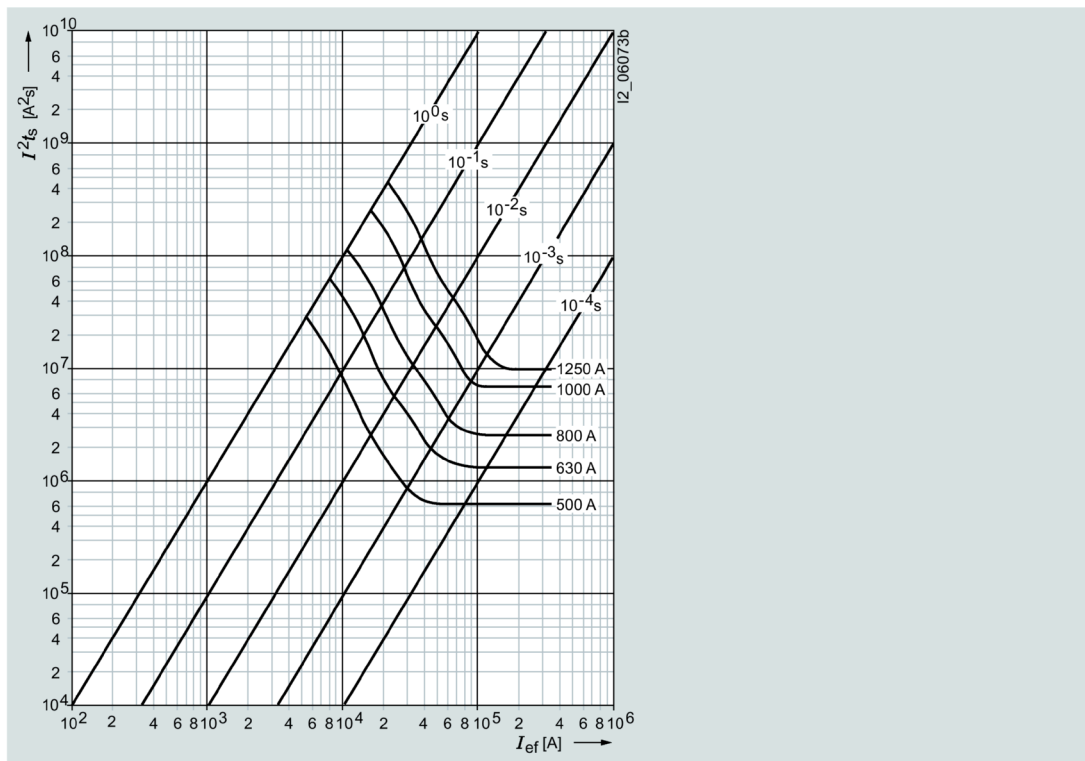

Type	I <sub>n</sub> A	P <sub>v</sub> W	Δθ K	I <sup>2</sup> t <sub>s</sub>		I <sup>2</sup> t <sub>a</sub>		
				1 ms kA <sup>2</sup> s	4 ms kA <sup>2</sup> s	230 V AC kA <sup>2</sup> s	400 V A C kA <sup>2</sup> s	500 V A C kA <sup>2</sup> s
3NA3665	500	43	30	785	1270	1915	2260	2700
3NA3672	630	47	37	1900	2700	3630	4340	5400
3NA3675	800	59	43	3480	5620	7210	8510	10400
3NA3680	1000	74	56	7920	10400	13600	16200	19000
3NA3682	1250	99	65	11880	18200	23900	29100	34800

### 3NA38, 3NA68, 3NA78 series

Size: 000, 00  
Operational class: gG  
Rated voltage: 500 V AC / 250 V DC  
Rated current: 2 ... 160 A

#### Time/current characteristic curves diagram

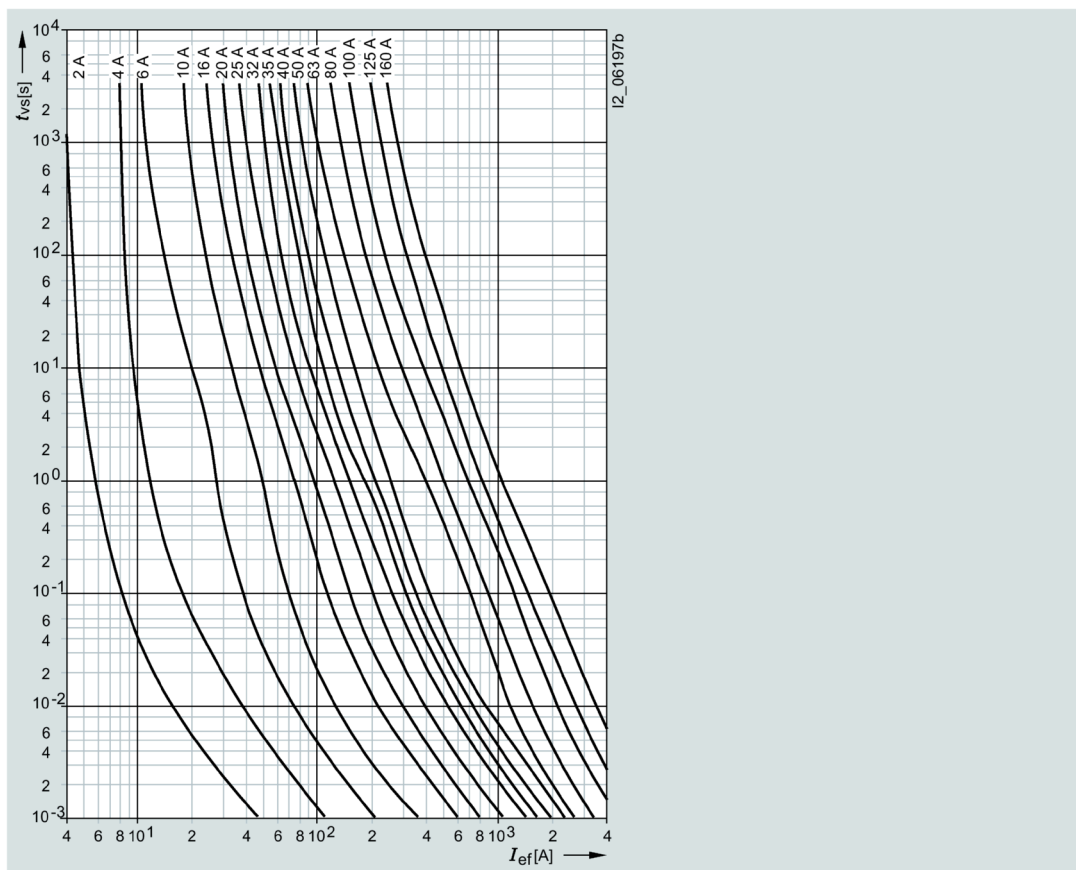

**Current limiting diagram**

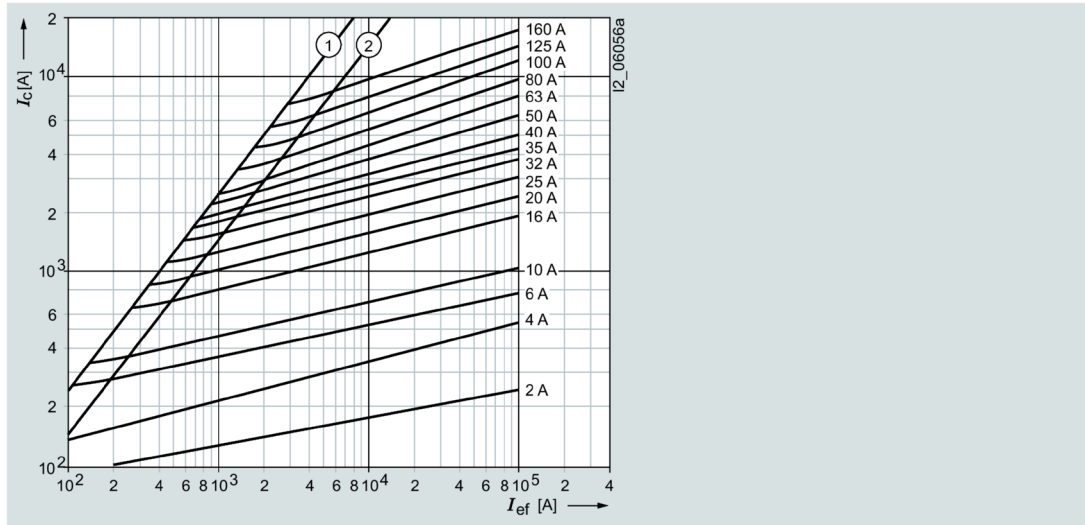

- ① Peak short-circuit current with largest DC component
- ② Peak short-circuit current without DC component

**Melting  $I^2t$  values diagram**

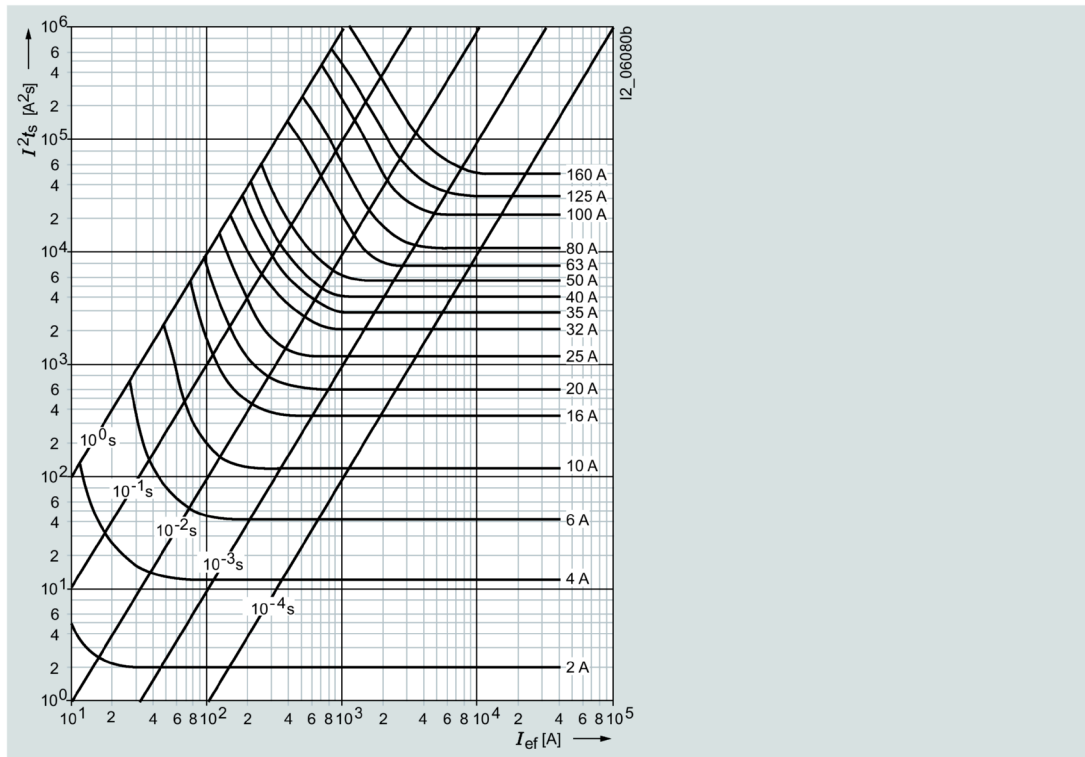



Type	I <sub>n</sub> A	P <sub>v</sub> W	Δθ K	I <sup>2</sup> t <sub>s</sub>		I <sup>2</sup> t <sub>a</sub>		
				1 ms A <sup>2</sup> s	4 ms A <sup>2</sup> s	230 V AC A <sup>2</sup> s	400 V AC A <sup>2</sup> s	500 V AC A <sup>2</sup> s
3NA.802	2	1.3	8	2	2	4	6	9
3NA.804	4	0.9	6	11	13	18	22	27
3NA.801	6	1.3	8	46	50	80	110	150
3NA.803	10	1	8	120	130	180	265	370
3NA.805	16	1.7	11	370	420	580	750	1000
3NA.807	20	2	15	670	750	1000	1370	1900
3NA.810	25	2.3	17	1200	1380	1800	2340	3300
3NA.812	32	2.6	18	2200	2400	3400	4550	6400
3NA.814, 3NA3814-7	35	2.7	21	3000	3300	4900	6750	9300
3NA.817	40	3.1	24	4000	4500	6100	8700	12100
3NA.820, 3NA3820-7	50	3.8	25	6000	6800	9100	11600	16000
3NA.822, 3NA3822-7	63	4.6	28	7700	9800	14200	19000	26500
3NA.824, 3NA.824-7	80	5.8	33	12000	16000	23100	30700	43000
3NA.830, 3NA.830-7	100	6.6	34	24000	30600	40800	56200	80000
3NA.832	125	8.9	44	36000	50000	70000	91300	130000
3NA832-8	125	7.2	30	46000	45000	97000	117000	134000
3NA.836	160	11.3	52	58000	85000	120000	158000	223000
3NA3836-8	160	9	34	89000	84800	137000	166000	-

### 3NA38..-6, 3NA68..-6, 3NA78..-6 series

Size: 000, 00  
Operational class: gG  
Rated voltage: 690 V AC<sup>1)</sup> / 250 V DC  
Rated current: 2 ... 100 A

<sup>1)</sup> Manufacturer's confirmation for rated voltage 690 V +10% available on request

Time/current characteristic curves diagram

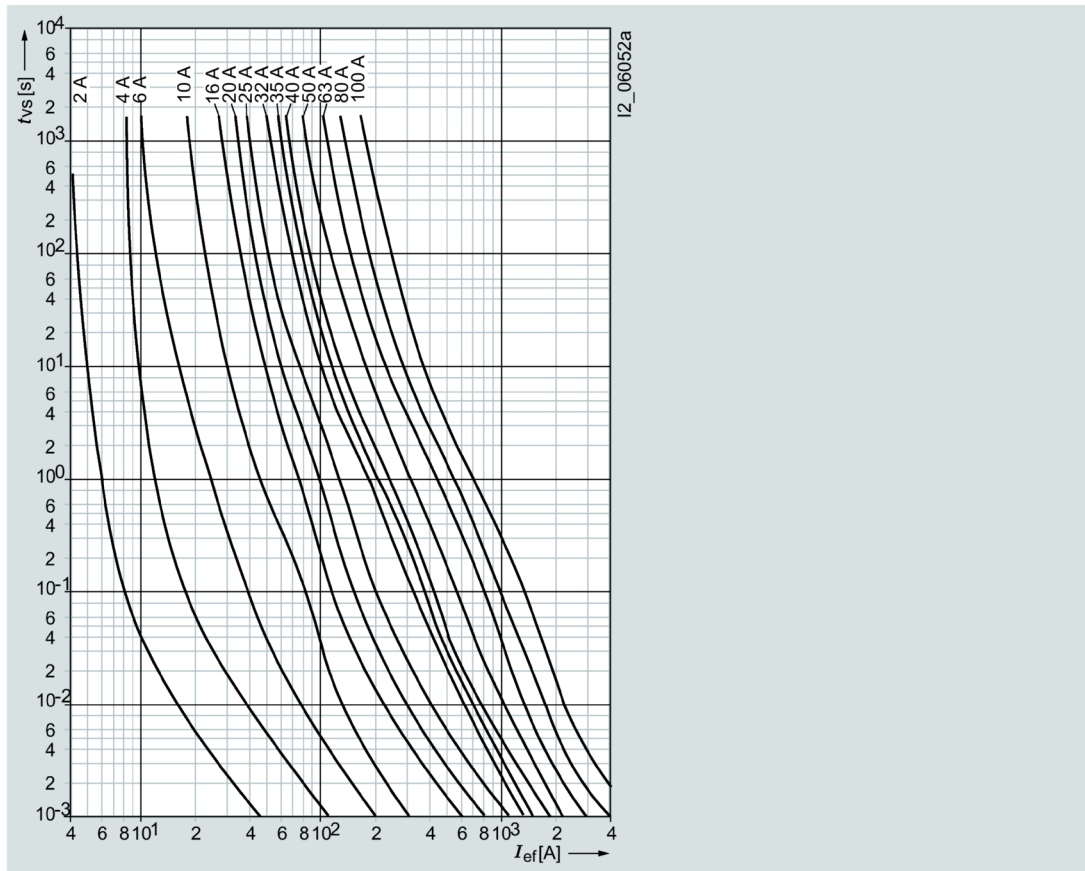

Current limiting diagram

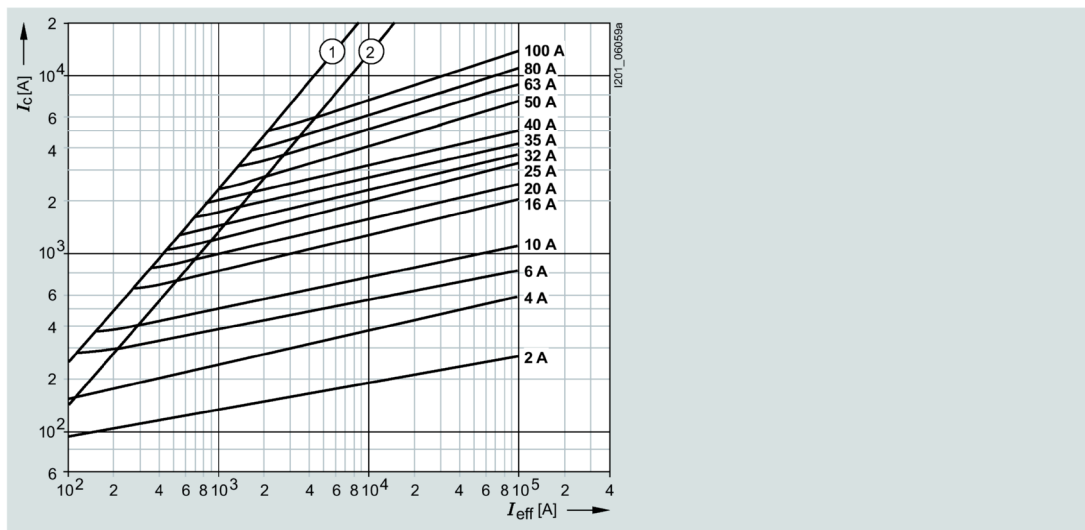

- ① Peak short-circuit current with largest DC component
- ② Peak short-circuit current without DC component

### Melting I<sup>2</sup>t values diagram

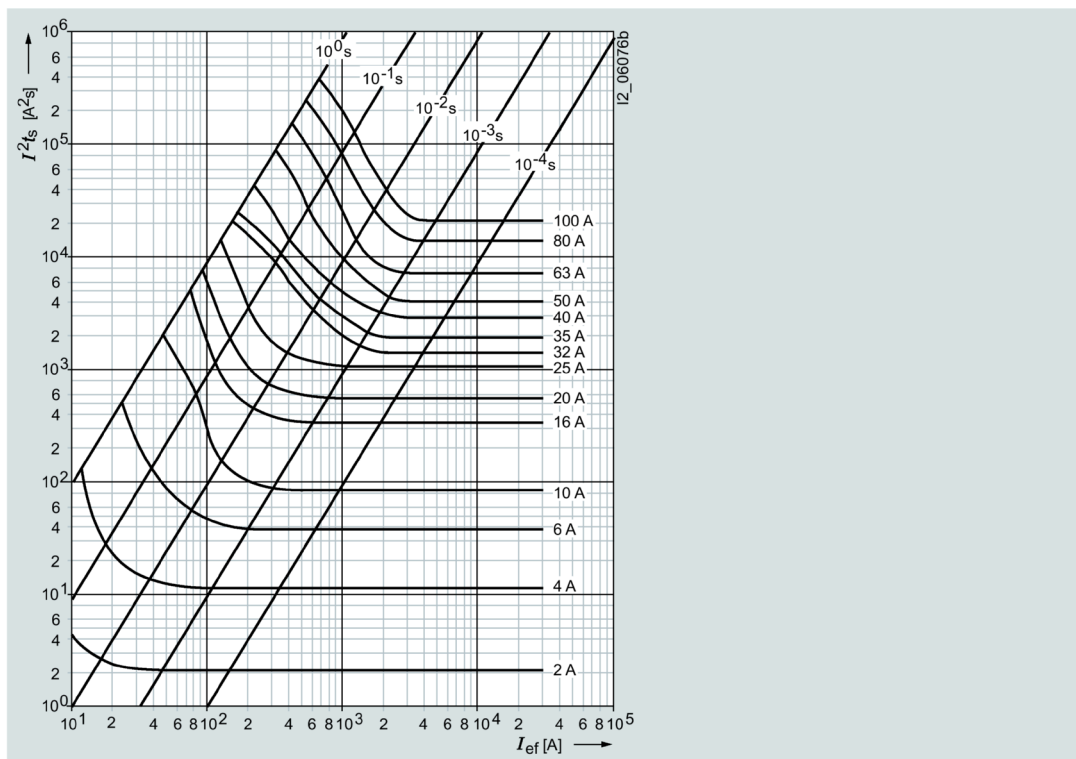

Type	I <sub>n</sub> A	P <sub>v</sub> W	Δθ K	I <sup>2</sup> t <sub>s</sub>		I <sup>2</sup> t <sub>a</sub>		
				1 ms A <sup>2</sup> s	4 ms A <sup>2</sup> s	230 V AC A <sup>2</sup> s	400 V AC A <sup>2</sup> s	690 V AC A <sup>2</sup> s
3NA.802-6	2	1.3	8	2	2	4	6	9
3NA.804-6	4	0.9	6	11	13	18	22	27
3NA.801-6	6	1.3	8	36	44	80	110	150
3NA.803-6	10	1	8	90	120	180	265	370
3NA.805-6	16	1.7	11	330	360	580	750	1000
3NA.807-6	20	2	15	570	690	1000	1370	1900
3NA.810-6	25	2.3	17	1200	1380	1800	2340	3300
3NA.812-6	32	3.1	19	1600	2600	3100	4100	5800
3NA.814-6	35	3.6	23	2100	3100	4000	5000	7800
3NA.817-6	40	3.6	18	3200	4700	6000	8600	12000
3NA.817-6KJ	40	3.8	18	3800	4700	6000	8600	15000
3NA.820-6	50	4.9	28	4400	7400	9100	11200	19000
3NA.820-6KJ	50	4.9	28	5900	7400	9100	11200	19000
3NA.822-6	63	5.7	33	7600	10100	13600	17000	24000
3NA.824-6	80	6.7	38	13500	17000	24300	32000	55000
3NA.830-6	100	9.1	40	21200	30500	42400	52000	75000

### 3NA61..-4 series

Size:	1
Operational class:	gG
Rated voltage:	400 V AC
Rated current:	35 ... 250 A

#### Time/current characteristic curves diagram

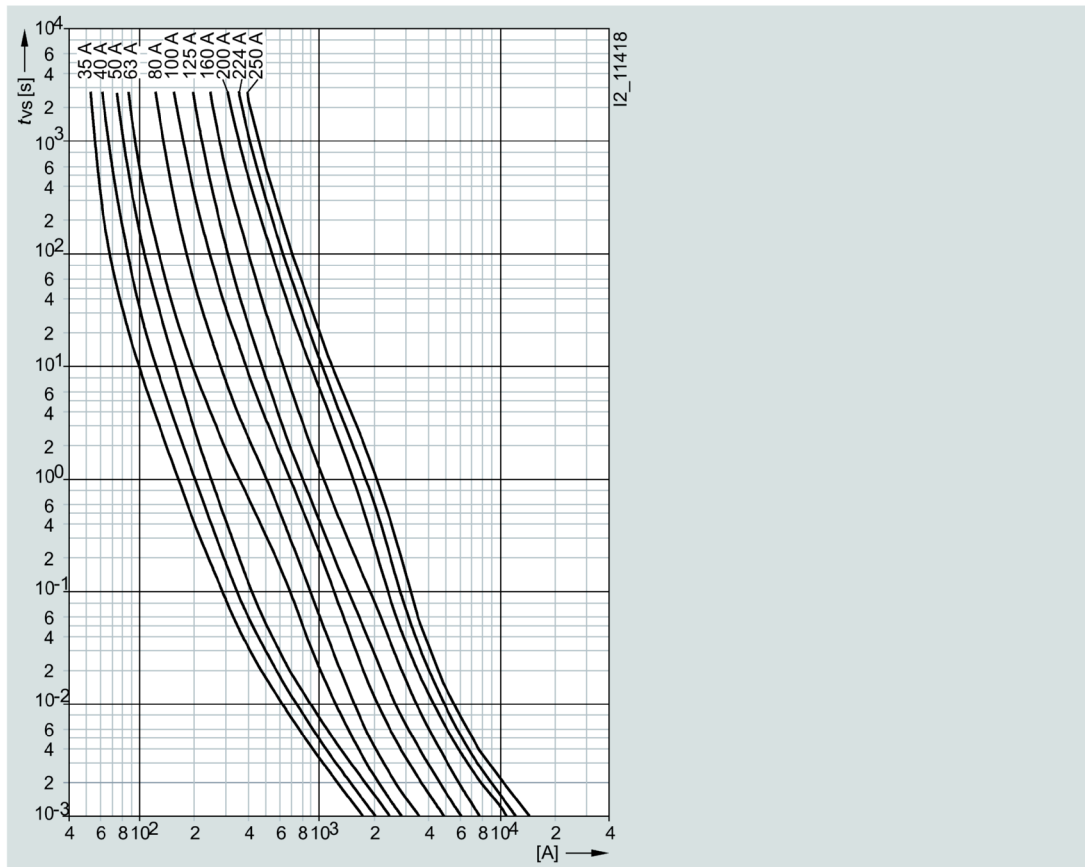

### Current limiting diagram

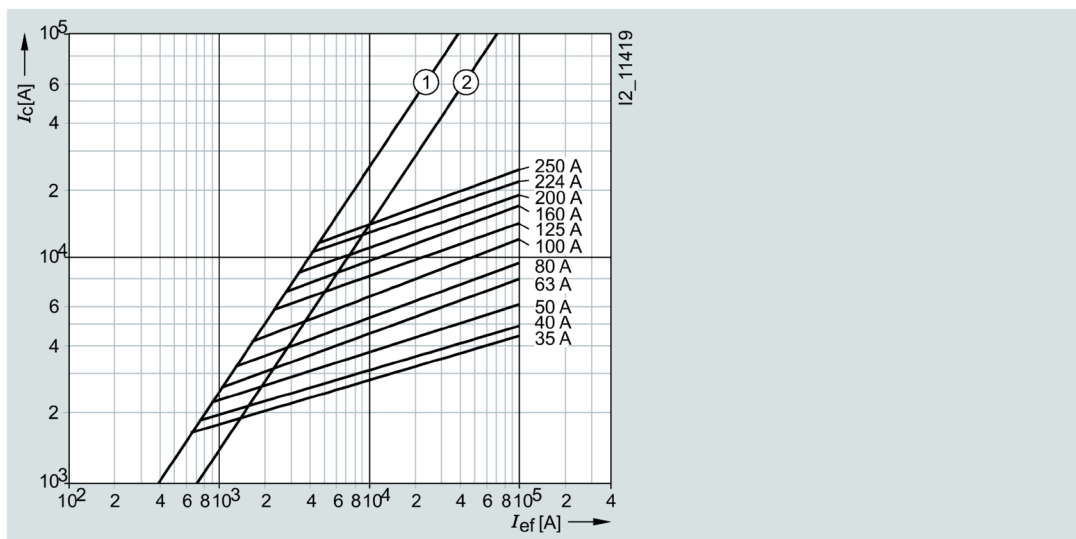

- ① Peak short-circuit current with largest DC component
- ② Peak short-circuit current without DC component

### Melting $I^2t$ values diagram

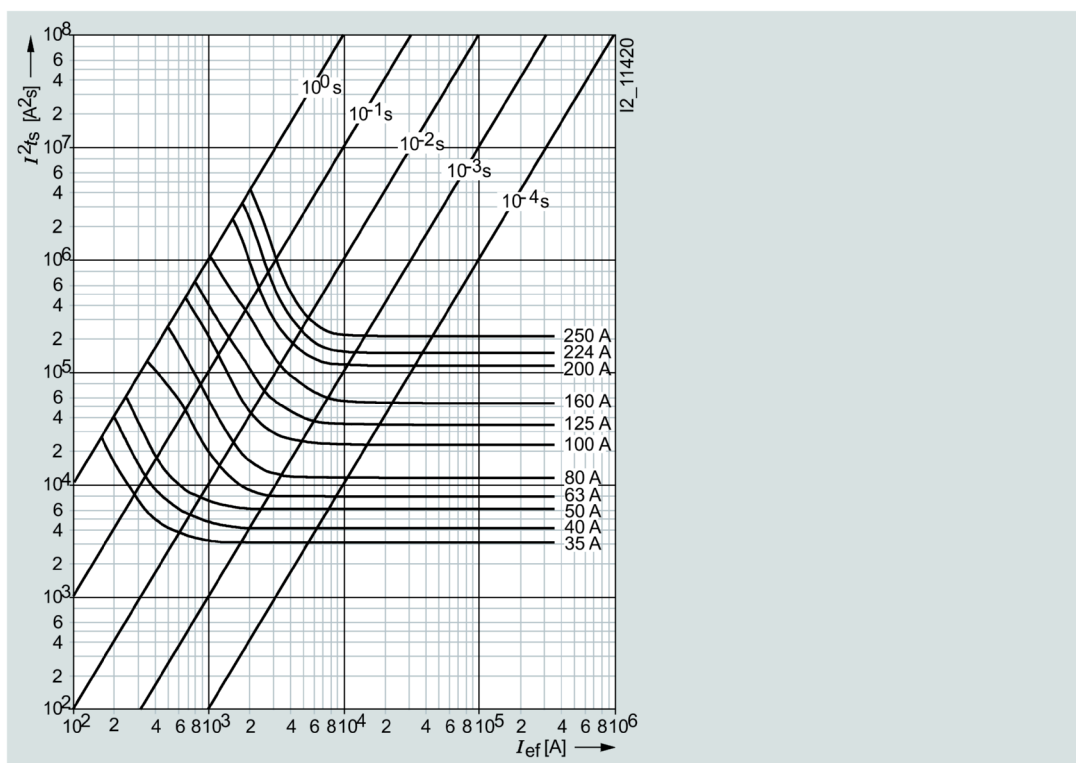

Type	I <sub>n</sub> A	P <sub>v</sub> W	Δθ K	I <sup>2</sup> t <sub>s</sub>		I <sup>2</sup> t <sub>a</sub>	
				1 ms A <sup>2</sup> s	4 ms A <sup>2</sup> s	230 V AC A <sup>2</sup> s	400 V AC A <sup>2</sup> s
<b>3NA6114-4</b>	35	3.2	16	3000	3300	4900	6750
<b>3NA6117-4</b>	40	3.6	16	4000	4500	6100	8700
<b>3NA6120-4</b>	50	4.6	20	6000	6800	9100	11600
<b>3NA6122-4</b>	63	6	21	7700	9800	14200	19000
<b>3NA6124-4</b>	80	7.5	29	12000	16000	23100	30700
<b>3NA6130-4</b>	100	8.9	30	24000	30600	40800	56200
<b>3NA6132-4</b>	125	10.7	31	36000	50000	70000	91300
<b>3NA6136-4</b>	160	13.9	34	58000	85000	120000	158000
<b>3NA6140-4</b>	200	15	36	115000	135000	218000	285000
<b>3NA6142-4</b>	224	16.1	37	145000	170000	299000	392000
<b>3NA6144-4</b>	250	17.3	39	205000	230000	420000	551000

**3NA62..-4 series**

Size:	2
Operational class:	gG
Rated voltage:	400 V AC
Rated current:	50 ... 400 A

### Time/current characteristic curves diagram

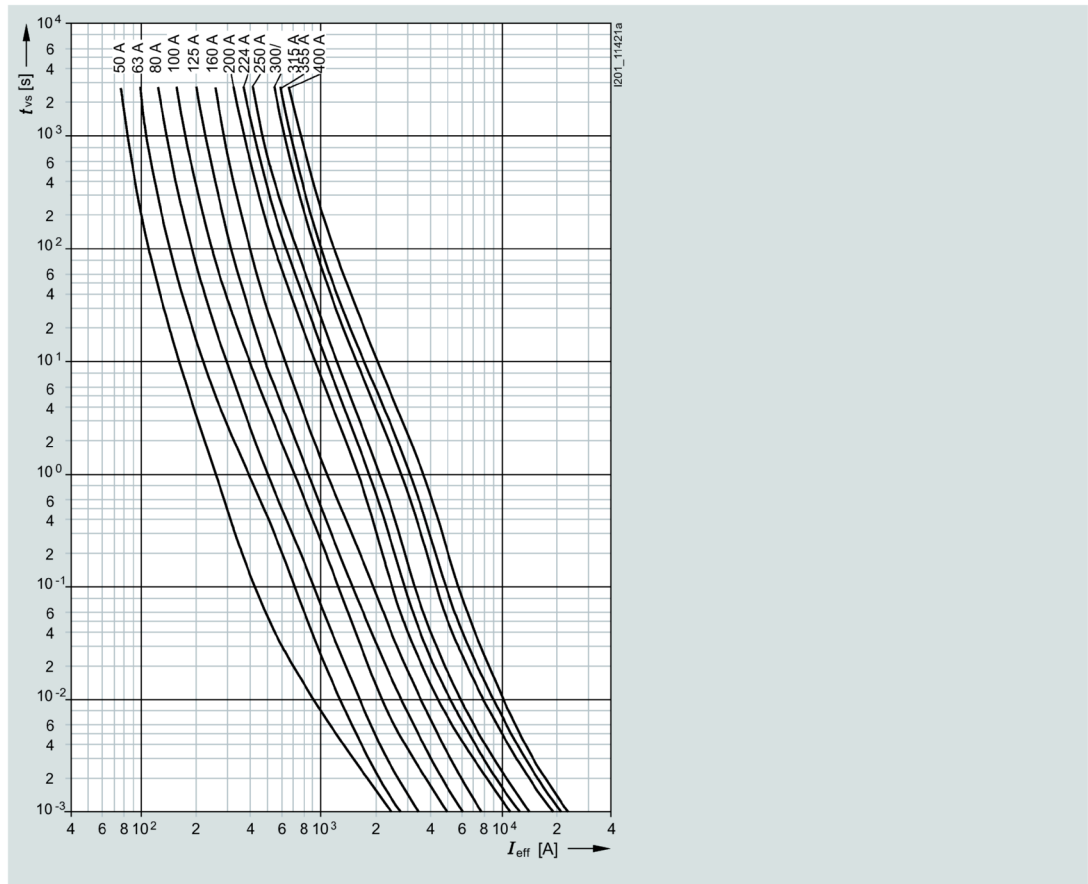

### Current limiting diagram

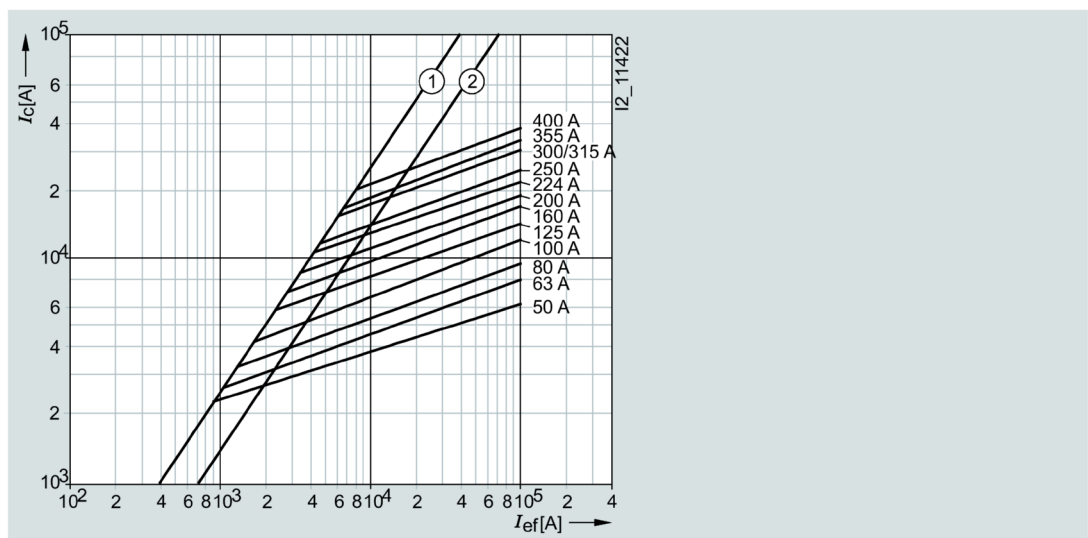

- ① Peak short-circuit current with largest DC component
- ② Peak short-circuit current without DC component

Melting I<sup>2</sup>t values diagram

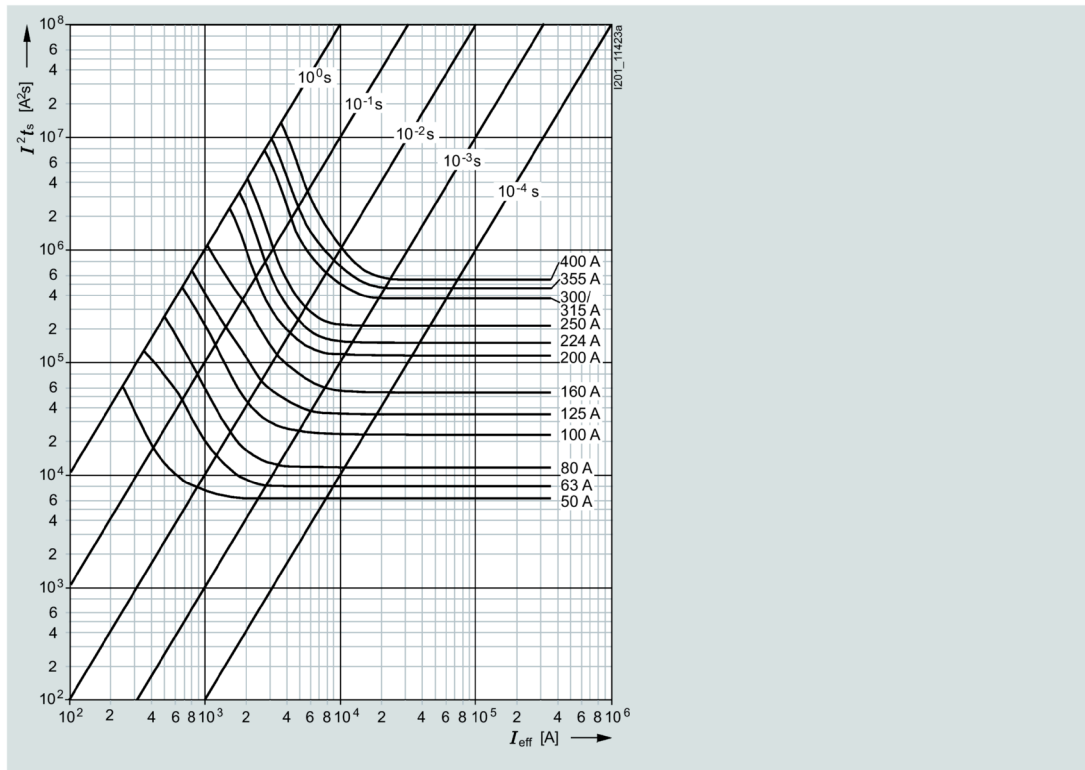

Type	I <sub>n</sub> A	P <sub>v</sub> W	Δθ K	I <sup>2</sup> t <sub>s</sub>		I <sup>2</sup> t <sub>a</sub>	
				1 ms A <sup>2</sup> s	4 ms A <sup>2</sup> s	230 V AC A <sup>2</sup> s	400 V AC A <sup>2</sup> s
3NA6220-4	50	4.7	16	6000	6800	9100	11600
3NA6222-4	63	5.9	16	7700	9800	14200	19000
3NA6224-4	80	6.8	21	12000	16000	23100	30700
3NA6230-4	100	7.4	22	24000	30600	40800	56200
3NA6232-4	125	9.8	27	36000	50000	70000	91300
3NA6236-4	160	12.6	34	58000	85000	120000	158000
3NA6240-4	200	14.9	33	115000	135000	218000	285000
3NA6242-4	224	15.4	31	145000	170000	299000	392000
3NA6244-4	250	17.9	38	205000	230000	420000	551000
3NA6250-4	300	19.4	34	361000	433000	670000	901000
3NA6252-4	315	21.4	35	361000	433000	670000	901000
3NA6254-4	355	26	49	441000	538000	800000	1060000
3NA6260-4	400	27.5	52	529000	676000	1155000	1515000

3NA68..-4/-4KK series

Size: 000,00  
Operational class: gG



Rated voltage: 400 V AC  
Rated current: 10 ... 160 A

**Time/current characteristic curves diagram**

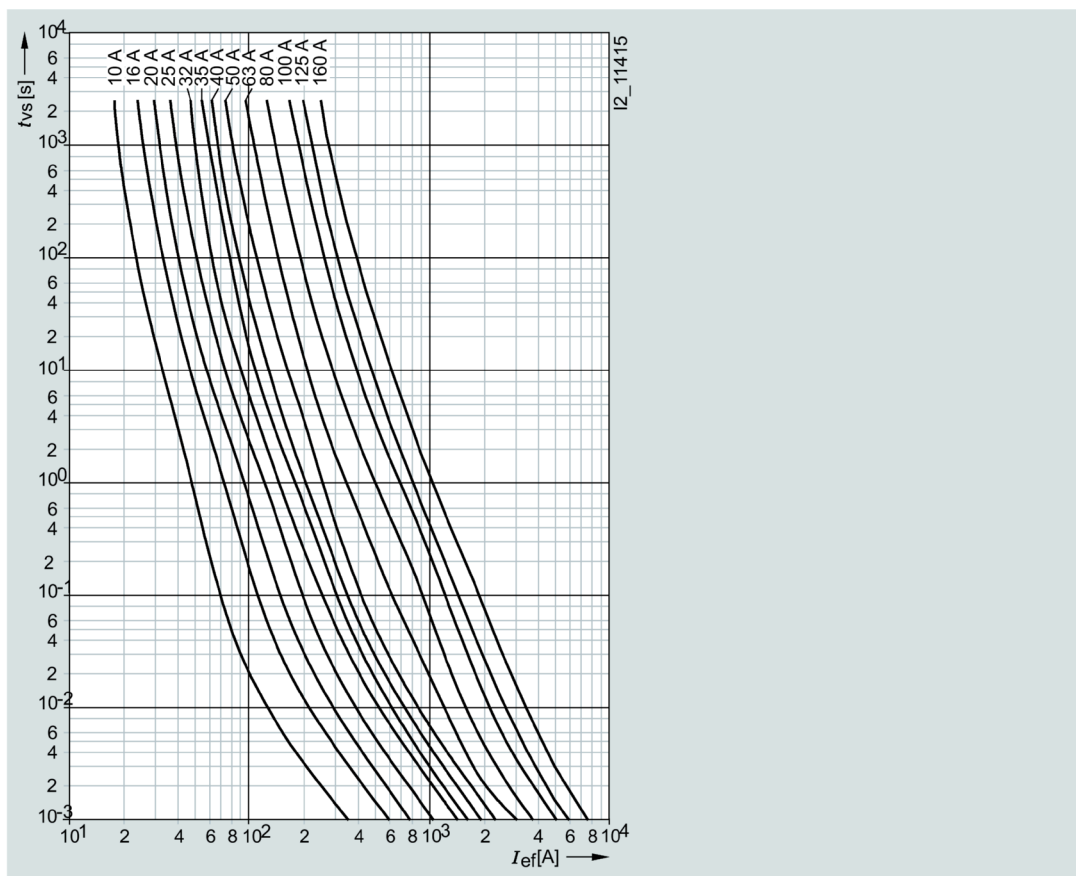

**Current limiting diagram**

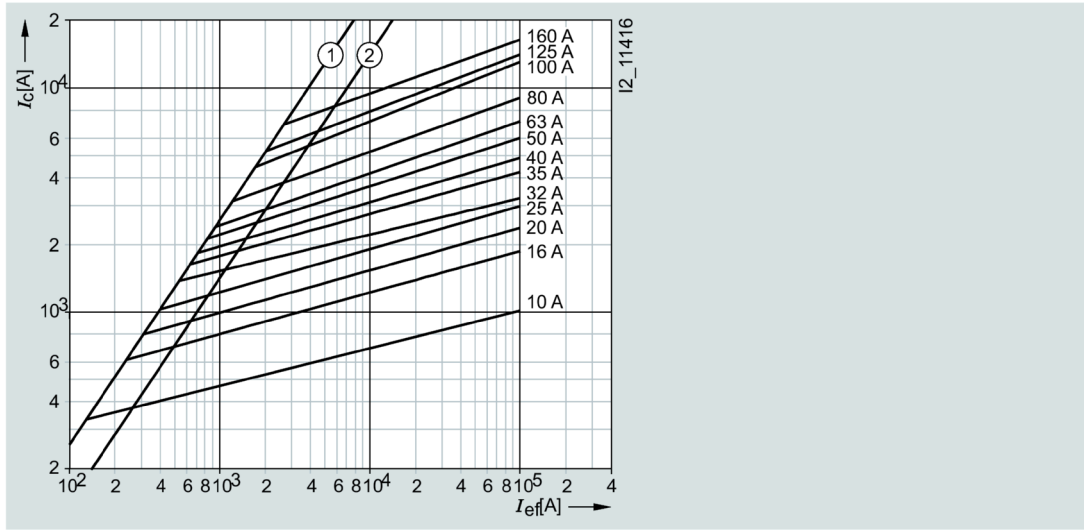

- ① Peak short-circuit current with largest DC component
- ② Peak short-circuit current without DC component

**Melting  $I^2t$  values diagram**

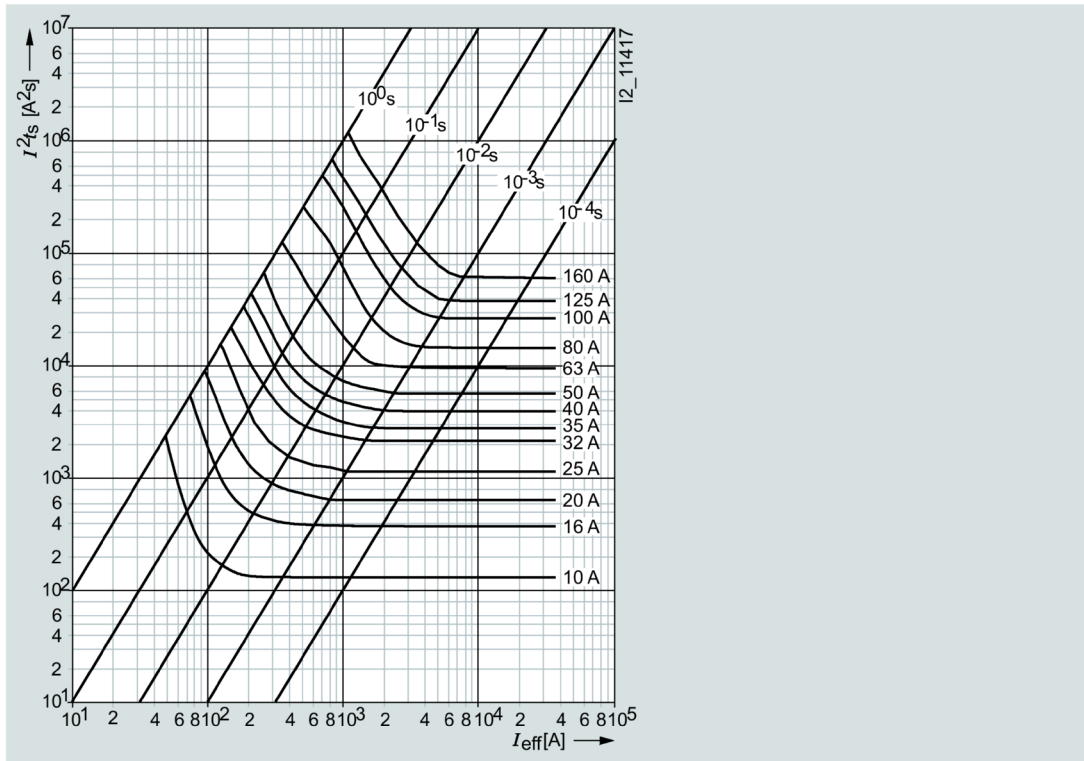

Type	I <sub>n</sub> A	P <sub>v</sub> W	Δθ K	I <sup>2</sup> t <sub>s</sub>		I <sup>2</sup> t <sub>a</sub>	
				1 ms	4 ms	230 V AC	400 V AC
				A <sup>2</sup> s	A <sup>2</sup> s	A <sup>2</sup> s	A <sup>2</sup> s
3NA6803-4	10	1	8	120	130	180	265
3NA6805-4	16	1.7	11	370	420	580	750
3NA6807-4	20	2	15	670	750	1000	1370
3NA6810-4	25	2.3	17	1200	1380	1800	2340
3NA6812-4	32	2.6	18	2200	2500	3400	4550
3NA6814-4	35	2.7	21	3000	3300	4900	6750
3NA6817-4	40	3.1	24	4000	4500	6100	8700
3NA6820-4	50	3.8	25	6000	6800	9100	11600
3NA6822-4	63	3.9	23	9300	10250	12400	17900
3NA6824-4, 3NA6824- 4KK	80	4.9	26	14200	18300	27000	38000
3NA6830-4, 3NA6830- 4KK	100	5.4	29	25600	33600	48300	69200
3NA6832-4	125	8.9	44	36000	50000	70000	91300
3NA6836-4	160	11.3	52	58000	85000	120000	158000

### 3ND18 series

Size:	000, 00
Operational class:	aM
Rated voltage:	500 V AC
Rated current:	6 ... 160 A

Time/current characteristic curves diagram

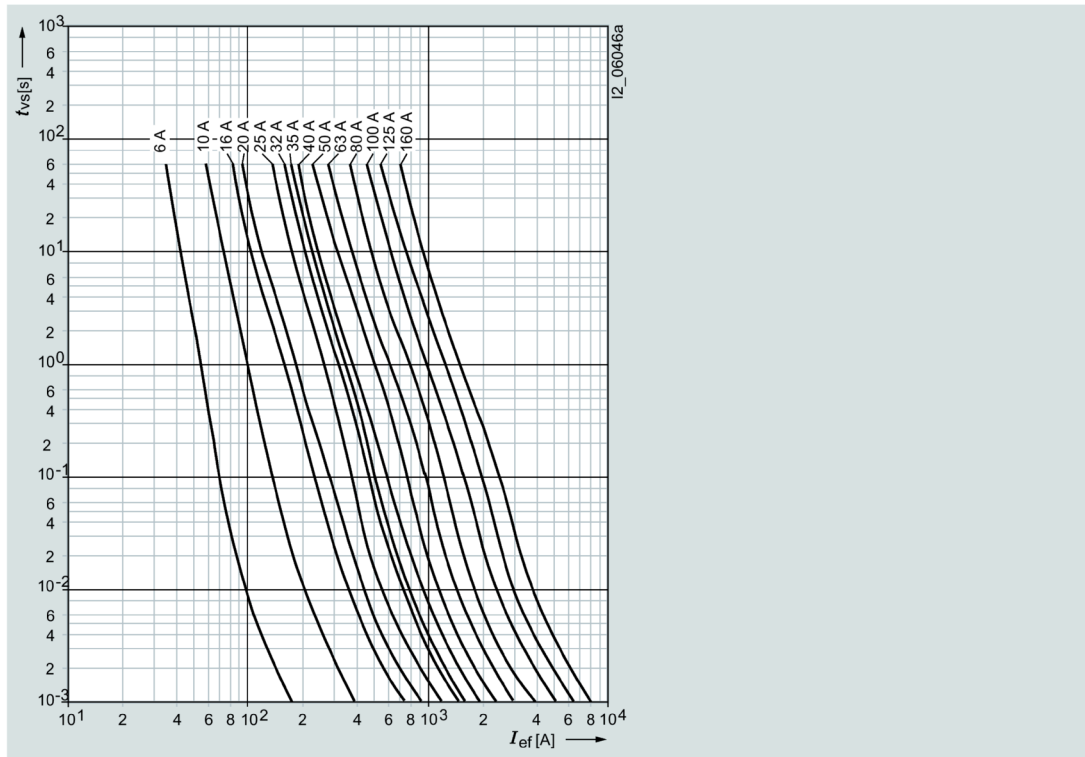

Current limiting diagram

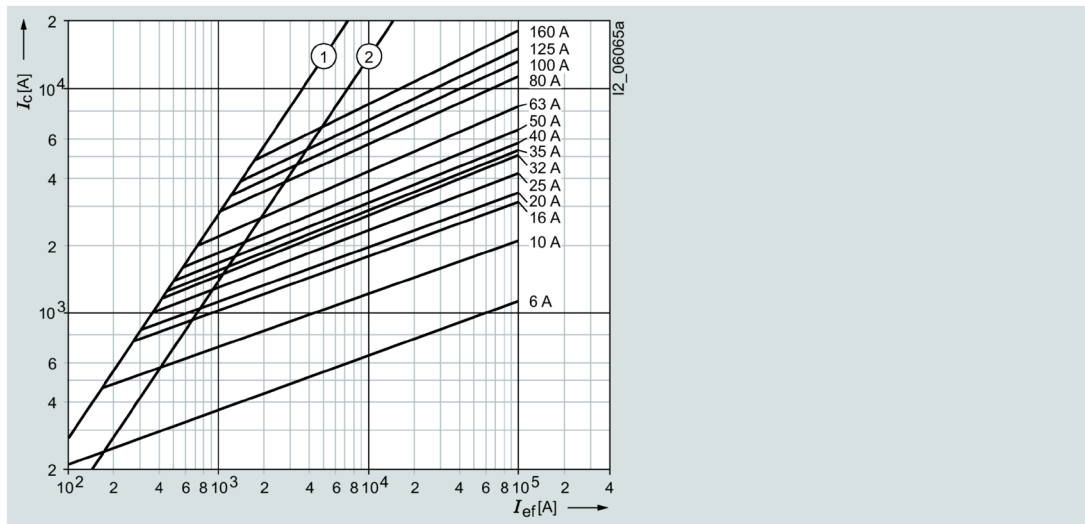

- ① Peak short-circuit current with largest DC component
- ② Peak short-circuit current without DC component

### Melting I<sup>2</sup>t values diagram

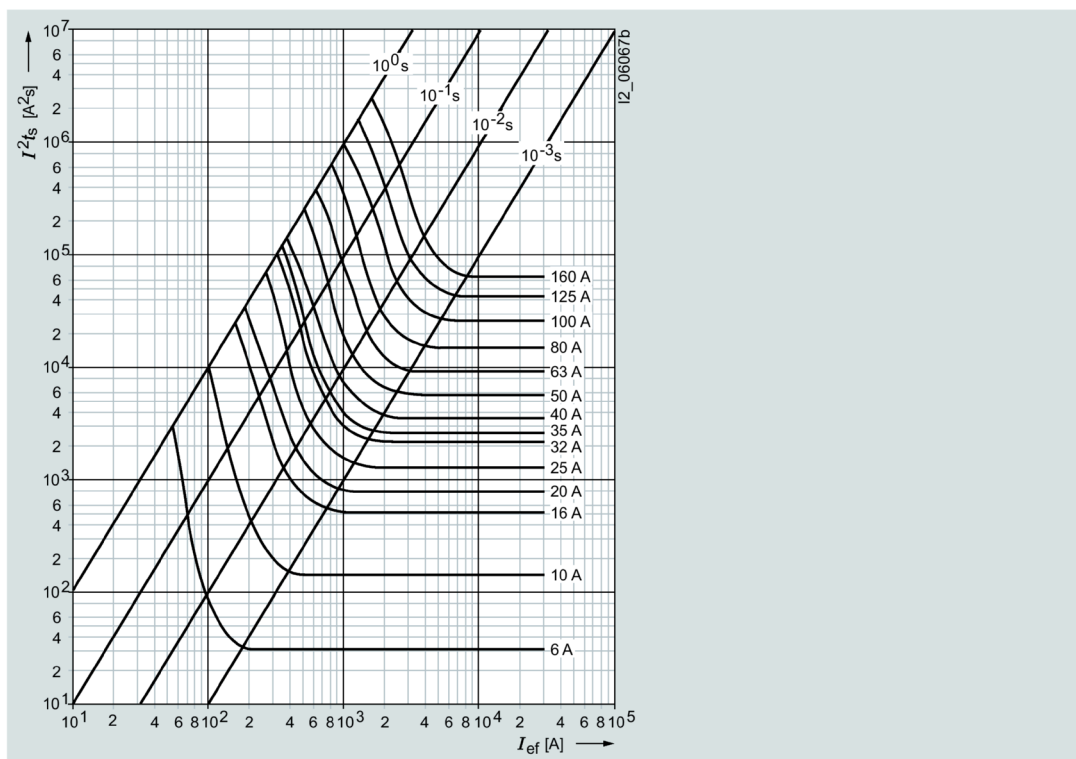

Type	I <sub>n</sub> A	P <sub>v</sub> W	Δθ K	I <sup>2</sup> t <sub>s</sub>		I <sup>2</sup> t <sub>a</sub>		
				1 ms A <sup>2</sup> s	4 ms A <sup>2</sup> s	230 V AC A <sup>2</sup> s	400 V AC A <sup>2</sup> s	500 V AC A <sup>2</sup> s
3ND1801	6	0.8	7	32	55	60	75	110
3ND1803	10	0.5	5	150	260	280	320	430
3ND1805	16	0.8	7	570	800	1000	1300	1600
3ND1807	20	1	8	830	1200	1300	1600	2200
3ND1810	25	1.2	9	1400	2000	2200	2800	3300
3ND1812	32	1.5	10	2300	3300	3800	4500	5400
3ND1814	35	1.8	11	2600	3800	4200	5100	6300
3ND1817	40	2	12	3700	5500	5700	7200	9300
3ND1820	50	2.4	14	5800	8400	5200	10500	12500
3ND1822	63	3.3	17	9300	13000	15000	16500	21000
3ND1824	80	4.5	20	15000	21000	21500	27000	34000
3ND1830, 3ND1830-8	100	4.9	18	26000	37000	44000	56000	76000
3ND1832	125	6.3	22	41000	60000	76000	98000	135000
3ND1836	160	9.3	31	64000	92000	105000	130000	170000

### 3ND13.., 3ND2 series

Size:	1, 2, 3
Operational class:	aM
Rated voltage:	690 V AC
Rated current:	63 ... 630 A

#### Time/current characteristic curves diagram

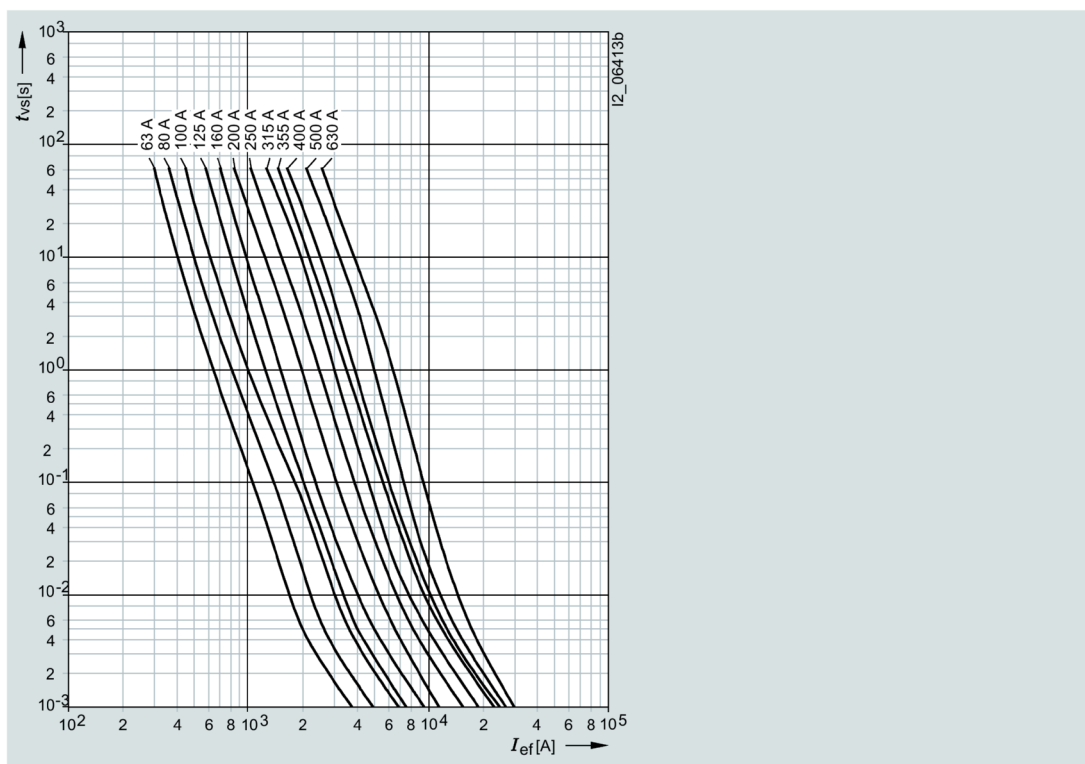

### Current limiting diagram

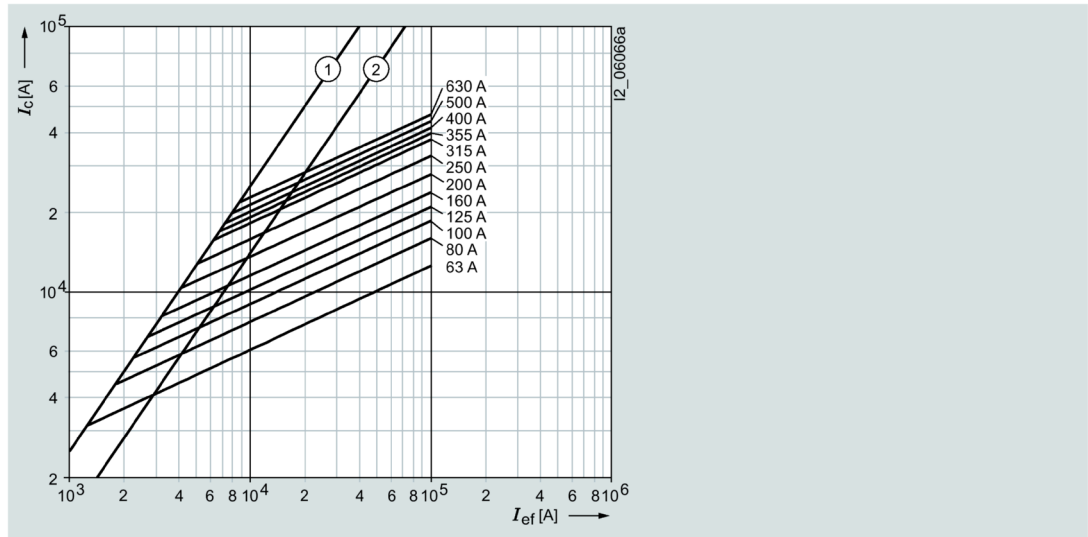

- ① Peak short-circuit current with largest DC component
- ② Peak short-circuit current without DC component

### Melting I<sup>2</sup>t values diagram

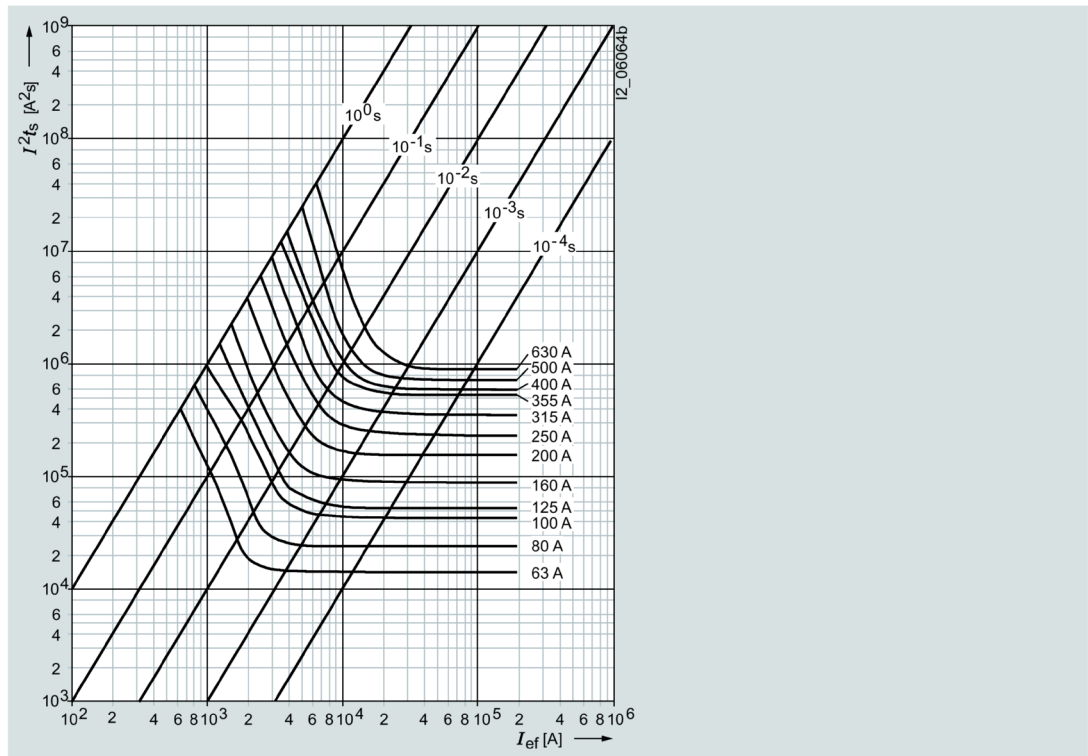

Type	I <sub>n</sub> A	P <sub>v</sub> W	Δθ K	I <sup>2</sup> t <sub>s</sub>		I <sup>2</sup> t <sub>a</sub>		
				1 ms A <sup>2</sup> s	4 ms A <sup>2</sup> s	230 V AC A <sup>2</sup> s	400 V AC A <sup>2</sup> s	690 V AC A <sup>2</sup> s
3ND2122	63	4	12.2	14000	17700	19300	25600	42000
3ND2124	80	4.9	13	24200	30800	36500	48000	80000
3ND2130	100	5.8	15	45600	59000	65000	85000	140000
3ND2132	125	8.1	16.5	57000	74300	73000	97000	160000
3ND2136	160	11.4	18	90000	114000	107000	142000	235000
3ND2140	200	14.1	19.5	150000	198000	172000	228000	375000
3ND2144	250	18	22	250000	313000	260000	340000	565000
3ND2232	125	8.1	16.5	57000	74300	73000	97000	160000
3ND2236	160	11.4	18	90000	114000	107000	142000	235000
3ND2240	200	14.1	19.5	150000	198000	172000	228000	375000
3ND2244	250	18	22	250000	313000	260000	340000	565000
3ND2252	315	22.6	30	370000	450000	460000	610000	1000000
3ND2254	355	24.7	29	540000	643000	645000	855000	1400000
3ND2260	400	30.8	35	615000	750000	688000	910000	1500000
3ND2352	315	22.6	30	370000	450000	460000	610000	1000000
3ND2354	355	24.7	29	540000	643000	645000	855000	1400000
3ND2360	400	30.8	26	615000	750000	688000	910000	1500000
3ND1365	500	47	40	730000	933000	876000	1095000	1825000
3ND1372	630	50	43	920000	1375000	1300000	1800000	2600000

## 6.2 3NA COM LV HRC fuse links

### 6.2.1 Portfolio overview of the 3NA COM fuse link

#### 6.2.1.1 Overview

As a rule, LV HRC fuse systems belong to the category of fuse systems designed for operation by experts.

Like standard LV HRC fuse systems, 3NA COM LV HRC fuse systems are used for installation systems in non-residential, commercial and industrial buildings as well as in switchboard assemblies of power utilities.

Integrating the communication and measuring function in the standardized design of an LV HRC fuse link has made it possible to implement a simple and cost-effective enhancement for current measurement in existing systems.

The current transformer integrated in the electronic module measures the rms value of the AC current and transmits this wirelessly to the 7KN data transceiver, which can receive signals from up to 24 devices. It can be seen in the overview below that the 3NA COM LV HRC fuse links form part of a comprehensive system of communication-capable devices:



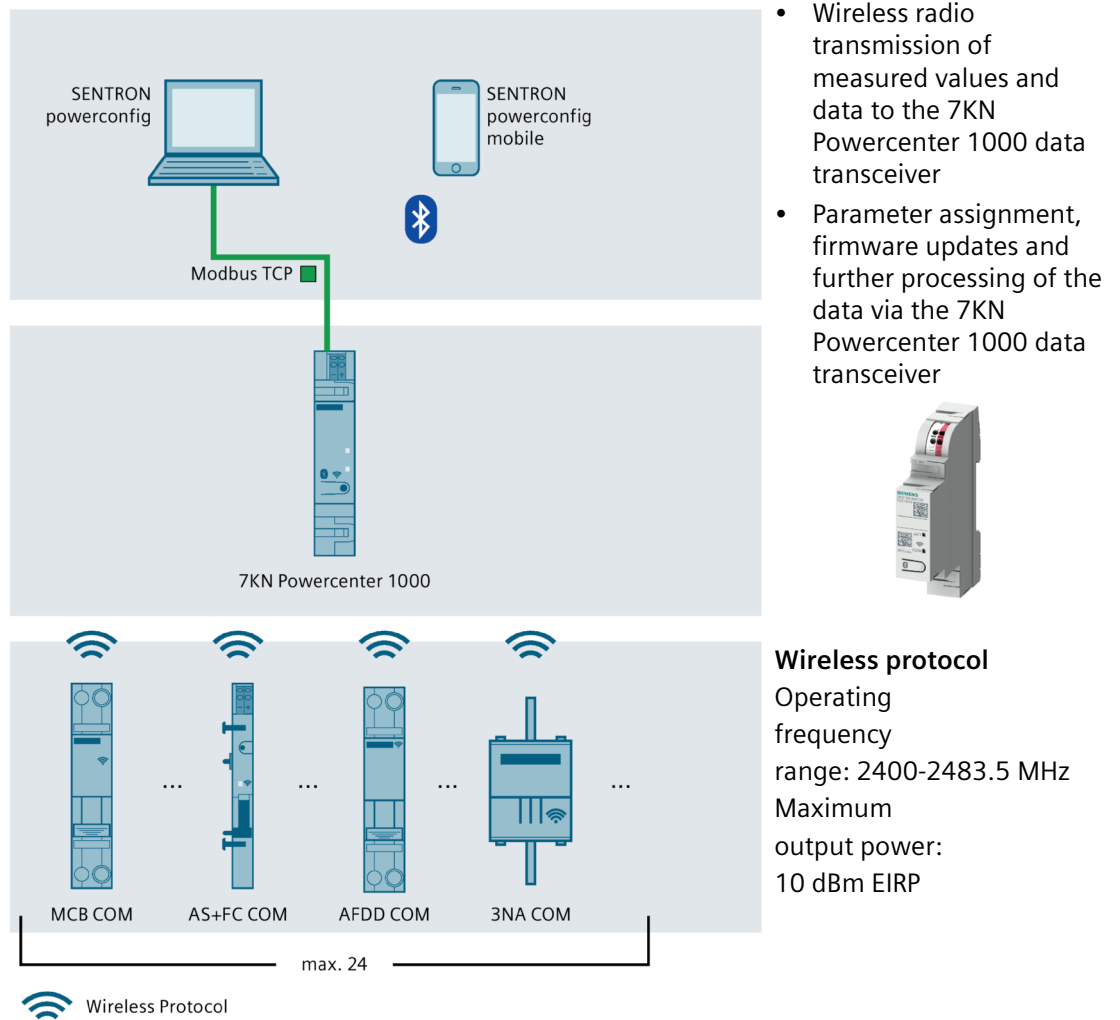

The energy required for operation of the electronic module and for the transmission signal is obtained from the current flowing through the fuse link. However this also means that a minimum current of 5 A is required. If the current is lower than 5 A, reliable data transmission can no longer be guaranteed on a continuous basis.

3NA COM LV HRC fuse links are only available in size 2.

They are available in the following operational classes:

- gG for cable and line protection
- gFF for cable and line protection (special quicker characteristic curve for the Netherlands)

3NA COM LV HRC fuse links are made up of two parts. They comprise a fuse part and the electronic module which is simply pushed onto the blade contact of the fuse link:

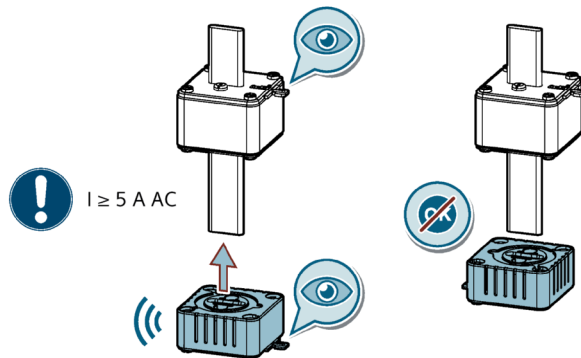

In the ordering catalog, the 3NA COM LV HRC fuse links can be ordered as complete devices comprising the LV HRC fuse link and the electronic module. The LV HRC fuse link can also be ordered as a separate unit for replacement purposes, as the electronic module can be reused following an overload or short-circuit trip.

### Standards and certifications

	3NA COM LV HRC fuse links		3NA COM electronic module
	Operational class gG	Operational class gFF	
Standards	IEC/EN 60269-1; IEC/HD 60269-2	Based on IEC/EN 60269-1; IEC/HD 60269-2	IEC 60669; 63044*
Certifications	VDE KEMA KEUR	KEMA KEUR	VDE KEMA KEUR

\*DIN EN 60669-1 (VDE 0632 Part 1):2009-10; EN 60669-1:1999 + A1:2002 + A2:2008, DIN EN 60669-2-1 (VDE 0632-2-1):2010-03; EN 60669-2-1:2004 + A1:2009, DIN EN 60669-2-1/A12 (VDE 0632-2-1/A12) 2010-09; EN 60669-2-1:2004/A12:2010, DIN EN 60669-2-5 (VDE 0632-2-5):2017-05; EN 60669-2-5:2016, IEC 60669-1:1998, IEC 60669-1:1998/AMD1:1999, IEC 60669-1:1998/AMD2:2006, IEC 60669-2-1:2002, IEC 60669-2-1:2002/AMD1:2008, IEC 60669-2-5:2013, EN 62479:2010, IN EN 63044-1 (VDE 0849-44-1):2017-11; EN 63044-1:2017, DIN EN IEC 63044-3 (VDE 0849-44-3):2018-04; EN IEC 63044-3:2018

### 6.2.2 Technical specifications of the fuse link

	Operational class	
	gG	gFF
	3NA32..-4KK01 3NA32..-4KK02	3NA32..-4KK03 3NA32..-4KK04
Standards	IEC 60269-1, -2; EN 60269-1; DIN VDE 0636	
Approvals	VDE KEMA KEUR	KEMA KEUR
Rated voltage $U_n$		
Size 2	V AC	400 <sup>1)</sup>
		400 <sup>1)</sup>

		<b>Operational class</b>	
		<b>gG</b>	<b>gFF</b>
		3NA32..-4KK01 3NA32..-4KK02	3NA32..-4KK03 3NA32..-4KK04
<b>Rated current I<sub>n</sub></b>	A	100 ... 315	80 ... 250
<b>Rated breaking capacity</b>	kA AC	100	
<b>Blade contacts</b>	-	Non-corroding, silver-plated	
<b>Resistance to climate</b>	°C	-20 ... +55 at 95% relative humidity	

- 1) Manufacturer's confirmation for 415 V +10% rated voltage available on request

The rated voltage of 400 V AC and the rated short-circuit breaking capacity I<sub>1</sub> of 100 kA make it suitable for use in 400 V all power supply systems. The selectivity of the gG types to each other and to other fuses in the system complies with the relevant standards. The quicker gFF types are conditionally selective to upstream and downstream fuses however:

		<b>Upstream fuse</b>	
		<b>Operational class gG</b>	<b>Operational class gFF</b>
<b>Downstream fuse</b>	<b>Operational class gG</b>	Selective (acc. to IEC 60269)	Not selective <sup>1)</sup>
	<b>Operational class gFF</b>	Selective	Conditionally selective <sup>2)</sup>

- 1) No selectivity acc. to IEC 60269 with the rated current ratio 1 : 1.6. With ratios greater than 1 : 1.6, selectivity is possible. The total breaking I<sup>2</sup>t value of the downstream fuse must be compared with the melting I<sup>2</sup>t value (at 1 ms) of the upstream fuse for this purpose. If the melting I<sup>2</sup>t value is greater, the fuses are selective.
- 2) SIEMENS 3NA COM LV HRC fuses with operational class gFF are interselective with the rated current ratio 1 : 1.6. However we cannot guarantee this when they are combined with fuses of operational class gFF from other manufacturers. The total breaking I<sup>2</sup>t value of the downstream fuse must be compared with the melting I<sup>2</sup>t value (at 1 ms) of the upstream fuse for this purpose. If the melting I<sup>2</sup>t value is greater, the fuses are selective.

### 6.2.3 Dimensional drawings

#### 3NA COM LV HRC fuse links

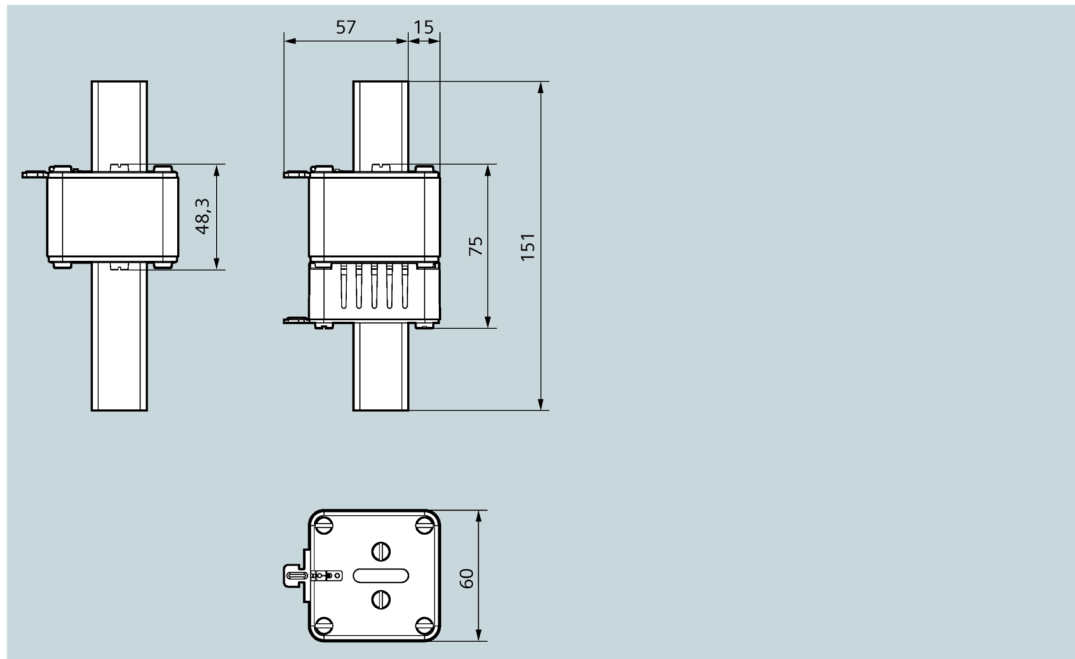

## 6.2.4 Characteristic curves

Time/current characteristic curves diagram, operational class gG

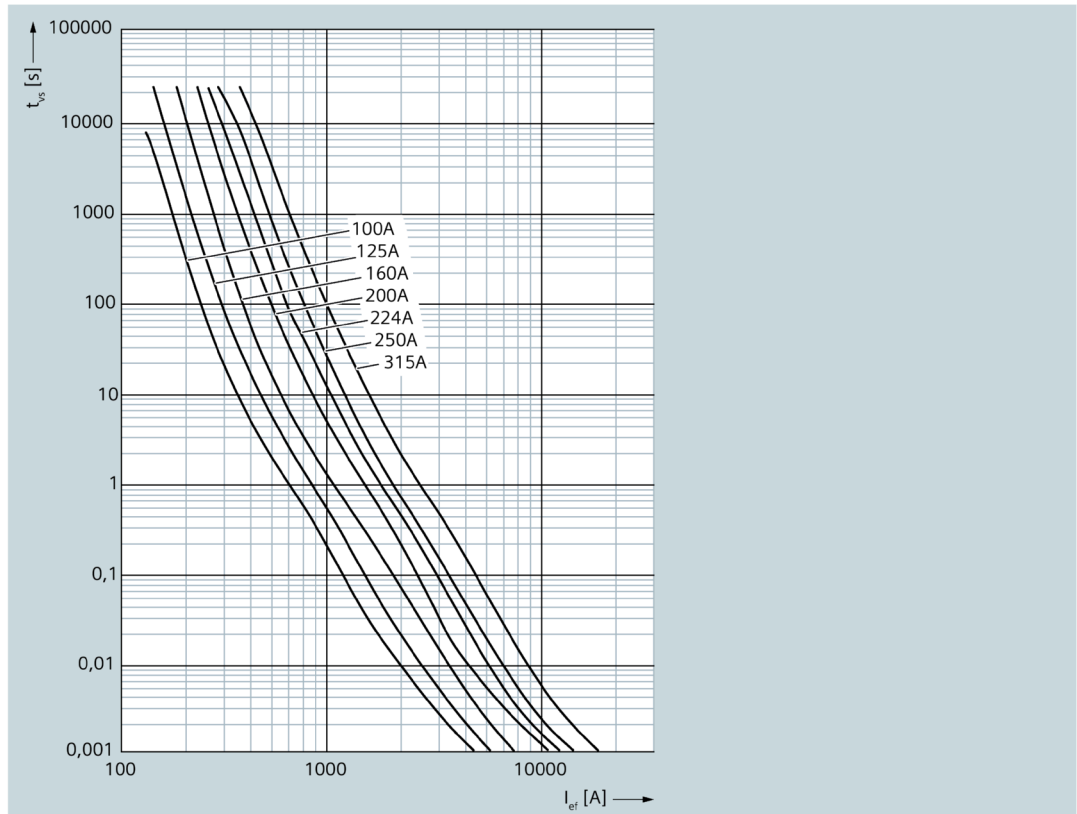

Time/current characteristic curves diagram, operational class gFF

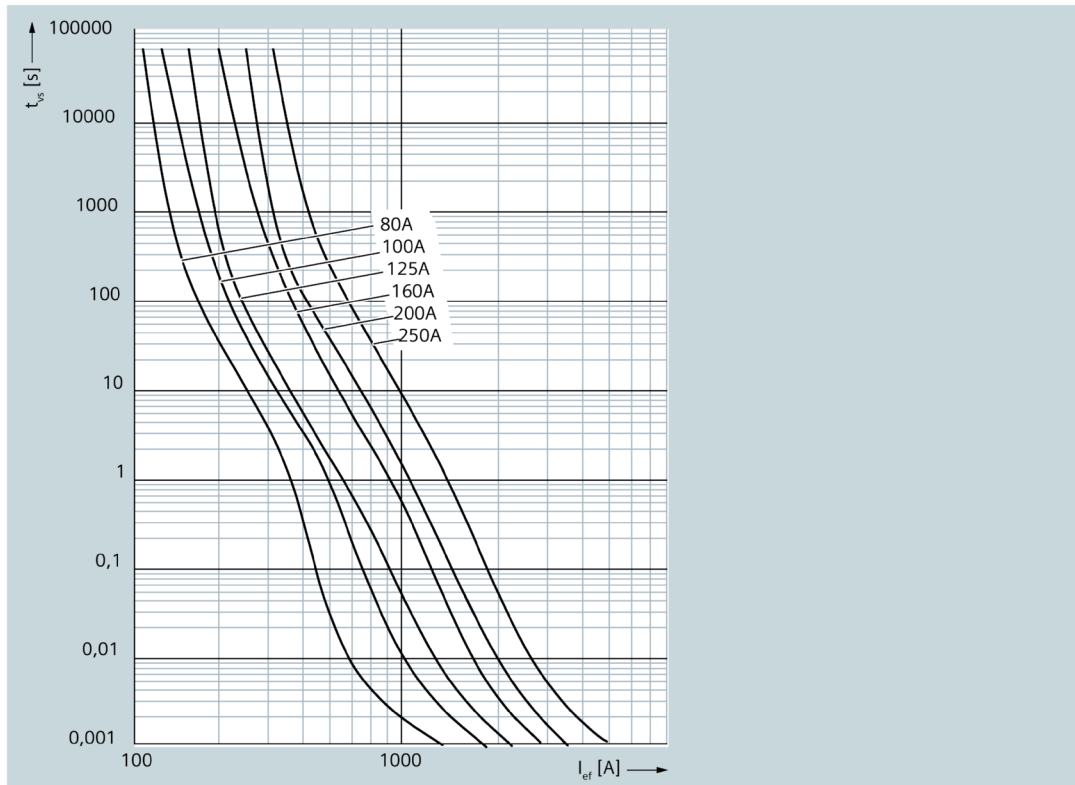

Current limiting diagram, operational class gG

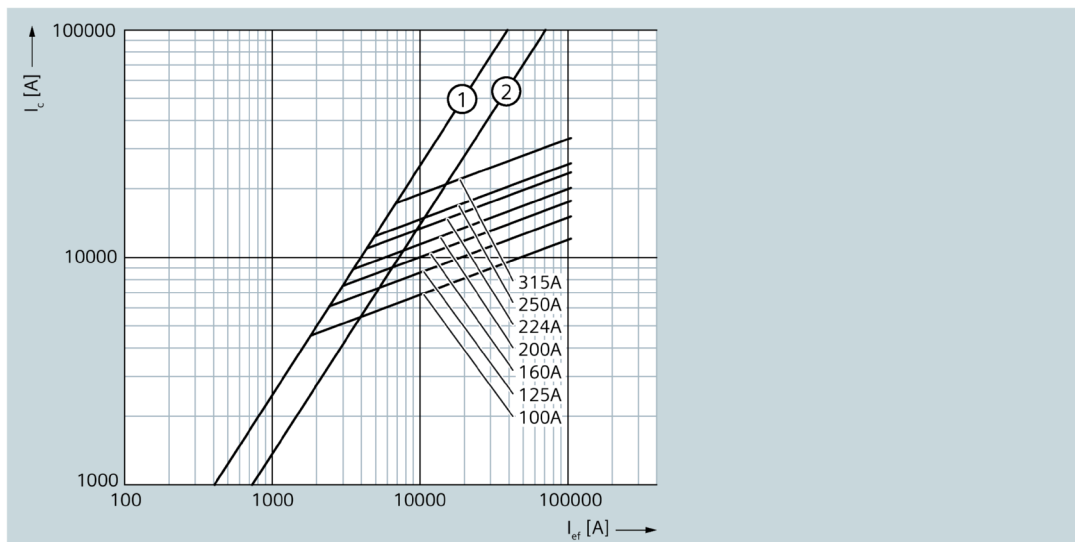

- (1) Peak short-circuit current with largest DC component
- (2) Peak short-circuit current without DC component

Current limiting diagram, operational class gFF

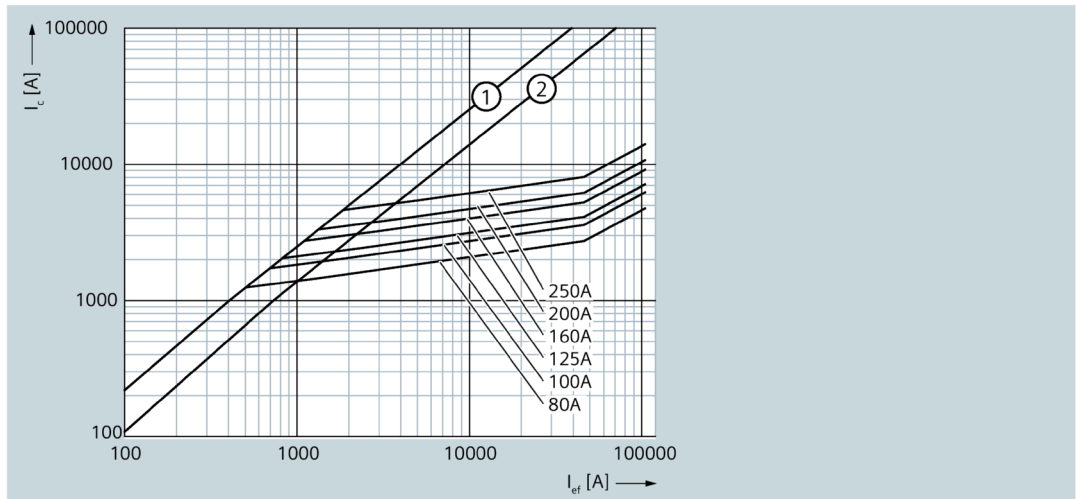

- (1) Peak short-circuit current with largest DC component
- (2) Peak short-circuit current without DC component

Melting I<sup>2</sup>t values diagram, operational class gG

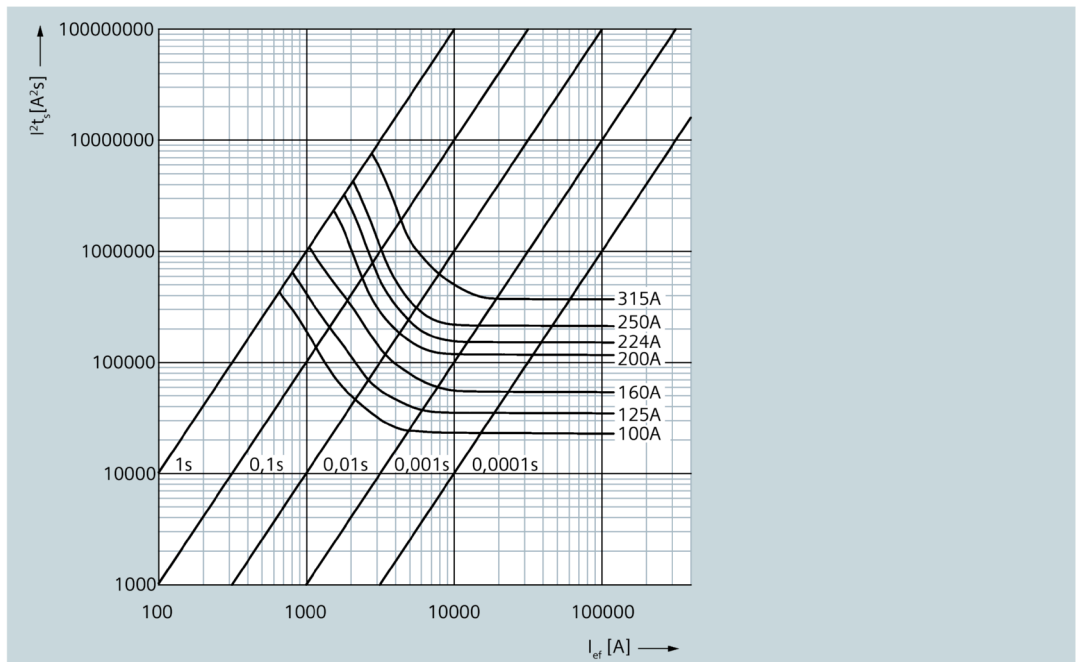

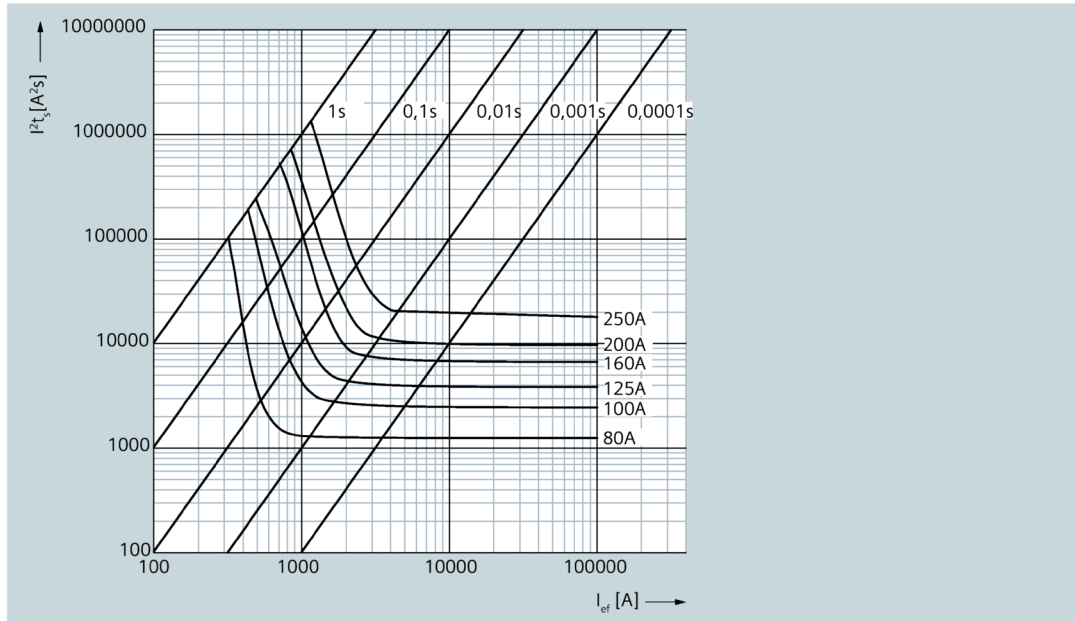

Melting I<sup>2</sup>t values diagram, operational class gFF



Type	I <sub>n</sub> A	P <sub>v</sub> W	I <sup>2</sup> t <sub>s</sub>		I <sup>2</sup> t <sub>a</sub>	
			1 ms A <sup>2</sup> s	230 V AC A <sup>2</sup> s	400 V AC A <sup>2</sup> s	
3NA3224-4KK04	80	9	1310	4833	13161	
3NA3230-4KK04	100	10	2874	9063	23834	
3NA3232-4KK04	125	13.6	4506	12493	29819	
3NA3236-4KK04	160	16.5	8015	22813	56303	
3NA3240-4KK04	200	22.3	11765	30671	71680	
3NA3244-4KK04	250	28	20704	52024	113996	
3NA3230-4KK02	100	6.6	24419	39106	56200	
3NA3232-4KK02	125	7.5	37680	70000	91300	
3NA3236-4KK02	160	10	61058	158000	120000	
3NA3240-4KK02	200	12.4	118916	218000	285000	
3NA3242-4KK02	224	12.8	153396	299000	392000	
3NA3244-4KK02	250	13.5	215409	420000	551000	
3NA3252-4KK02	315	20.8	374862	670000	901000	



## 6.2.5 Technical specifications of the 3NA COM electronic module

Technical specifications	Electronic module for 3NA COM
Current measuring range	2.5 ... 440 A (rms value)
Measuring accuracy of current measurement / 5-minute average of rms value (at reference temperature 25 °C) in the range -10 °C ... +70 °C	+/- 1% (8 A ... 440 A), +/- 2% (2.5 A ... 8 A) +/- 2.2% (8 A ... 440 A), +/- 3.2% (2.5 A ... 8 A)
Minimum current	5 A (to maintain the radio connection)
Temperature measuring range	+ 20 °C ... +120 °C
Measuring accuracy of temperature measurement	+/- 2.5 °C
Active power input per phase during current measurement	50 mW
Maximum transmit power	8 dBm
Minimum / maximum ambient temperature during operation	- 10 °C / + 55 °C <sup>1)</sup>
Minimum / maximum ambient temperature during storage	- 10 °C / + 70 °C
Relative humidity at 25 °C without condensation	max. 95%
IP degree of protection	IP20
Pollution degree	2
Reference condition for measuring accuracy	IEC 61557-12
Measuring method	TRMS
Power supply	CT Harvesting
<b>European standards</b>	
RED Safety	EN 60669-2-5
RED Health	EN 62479
RED EMC	EN 63044-3 /-5-3; EN 301489-17; EN 300480-17
RED Radio Spec	EN 300 328
<b>International standards</b>	
For EMC	EN 63 044-5-3; IEC 61000-6-2; IEC 61000-4-2/-3/-4/-5/-6/-8/-11
For shocks, bumps, free fall, environmental tests	IEC 60068-2-1/-2/-6/-27/-29/-30/-32
Approvals	 VDE  KEMA KEUR

<sup>1)</sup> Current carrying capacity at increased ambient temperature, see Features at increased ambient temperature (Page 11).

3NA COM measured values	Unit	Measuring interval	Storage time
<b>Current</b>			
Current (rms value)	A	10 s	1 h
Average current (rms value)	A	15 min	7 d
Minimum current	A	1 d	10 d
Maximum current	A	1d	10 d
<b>Temperature</b>			
Temperature	°C	1 min	1 h
Average temperature	°C	15 min	7 d
Minimum temperature	°C	1 d	10 d
Maximum temperature	°C	1 d	10 d

3NA COM measured values	Unit	Measuring interval	Storage time
<b>Operating hours counter</b>			
Operating hours counter	h	Unlimited	Unlimited
Operating hours counter with load current > limit	h	Unlimited	Unlimited

## 6.2.6 Cybersecurity

We pay the greatest possible attention to cybersecurity. Please read the information relating to this topic in our installation manual under <https://support.industry.siemens.com/cs/ww/en/view/109791805>. (<https://support.industry.siemens.com/cs/ww/de/view/109791805>)

## 6.3 LV HRC signal detectors

### 6.3.1 Portfolio overview

LV HRC signal detectors are used for remotely indicating that the LV HRC fuse links have been tripped. Three different solutions are available:

- **3NX1021 signal detectors with signal detector link**  
The LV HRC signal detectors with signal detector link support monitoring of LV HRC fuse links with non-insulated grip lugs of sizes 000 to 4 at 10 A or more. The signal detector link is connected in parallel to the fuse link. In the event of a fault, the LV HRC fuse link and the signal detector link are tripped simultaneously. A trip pin switches a floating microswitch.
- **3NX1024 signal detector top**  
The signal detector top can be used with LV HRC fuse links of sizes 000, 00, 1 and 2 which are equipped with non-insulated grip lugs and have a front indicator or combination alarm. It is simply plugged onto the grip lugs.
- **5TT3170 fuse monitor**  
If a fuse is tripped, the front indicator springs open and switches a floating microswitch. This solution should not be used for safety-relevant systems. For this purpose, we recommend our electronic fuse monitors.

## 6.3.2 Dimensional drawings

### LV HRC signal detectors

#### 3NX1021

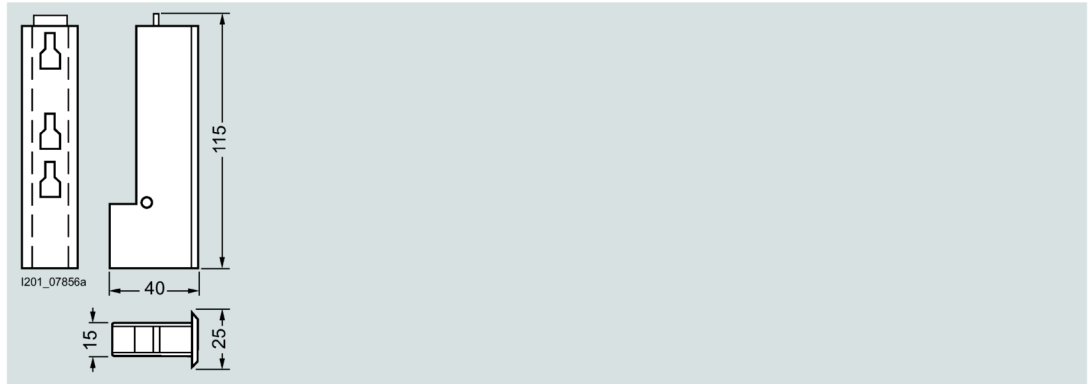

### Signal detector links

#### 3NX1022, 3NX1023

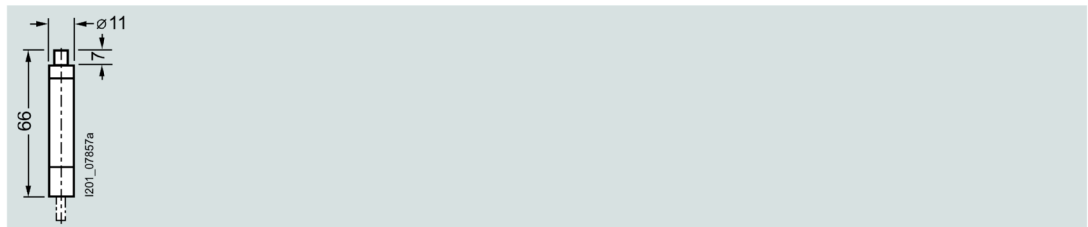

### Signal detector tops

#### 3NX1024

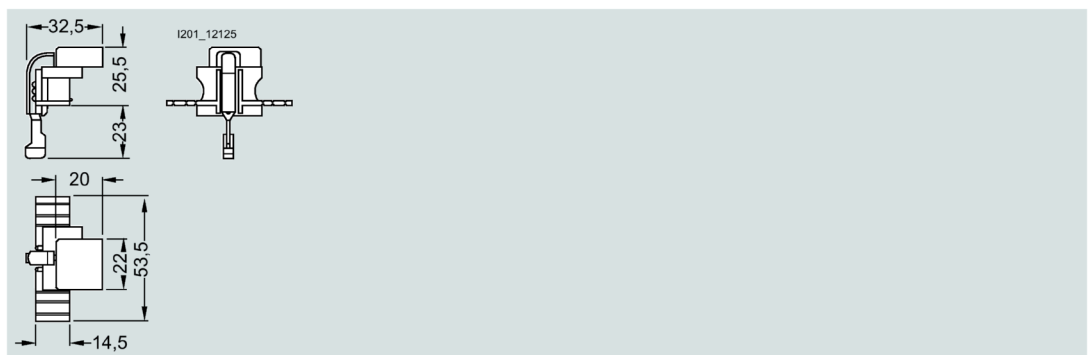

### Fuse monitors

#### 5TT3170

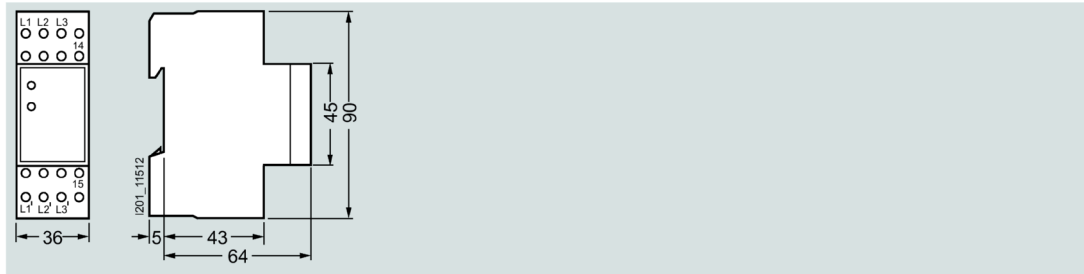

### 6.3.3 Circuit diagrams

#### Graphical symbols

##### LV HRC signal detectors, signal detector tops (3NX1021, 3NX1024)

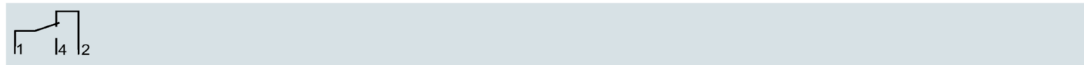

##### Fuse monitors (5TT3170)

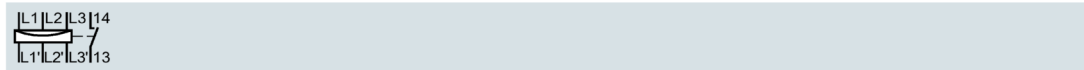

## 6.4 LV HRC fuse bases and accessories

### 6.4.1 Portfolio overview

#### Terminals for all applications

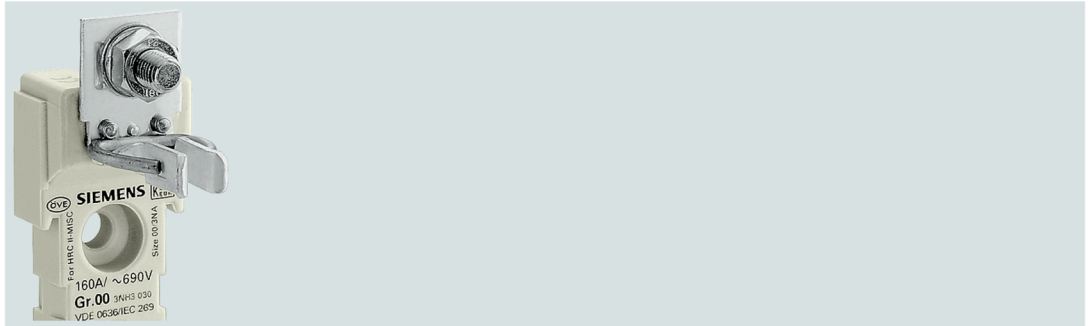

Flat terminals with screws are suitable for connecting busbars or cable lugs. They have a torsion-proof screw connection with shim, spring lock washer and nut. When tightening the nut, always ensure compliance with the specified torque due to the considerable leverage effect.

The double busbar terminal differs from the flat terminal in that it supports connection of two busbars, one on the top and one at the bottom of the flat terminal.

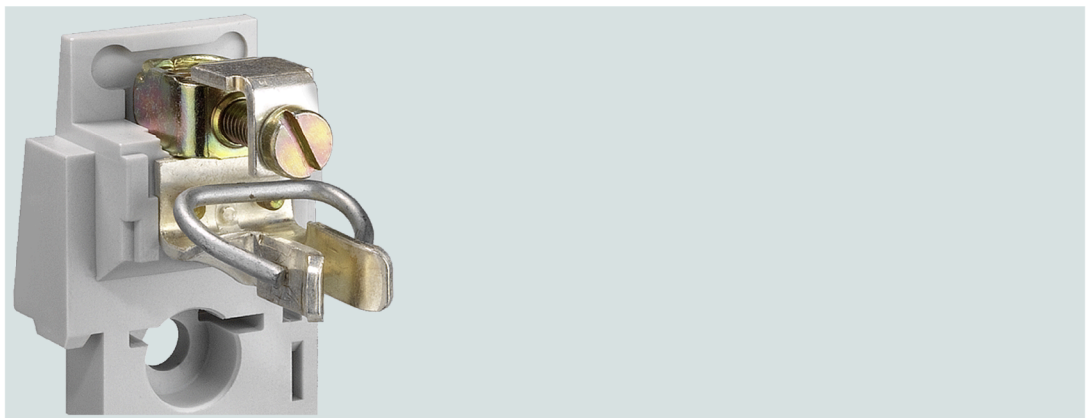

The modern box terminal guarantees an efficient and secure connection with the cables. Conductors with or without end sleeves can be connected.

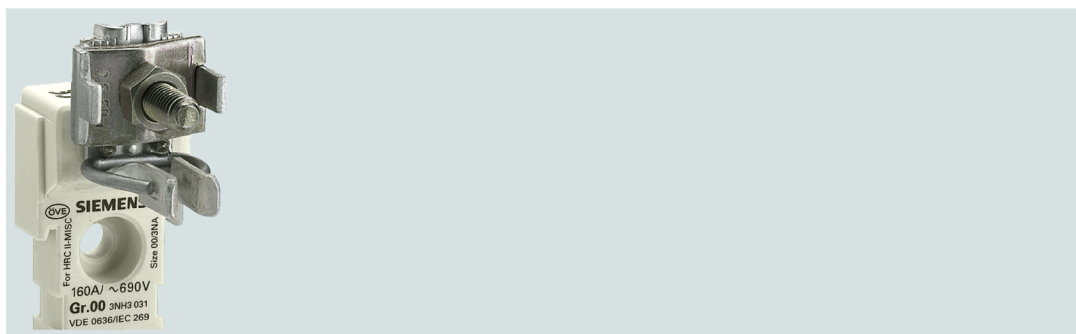

The tab connection is prepared for connecting two conductors.

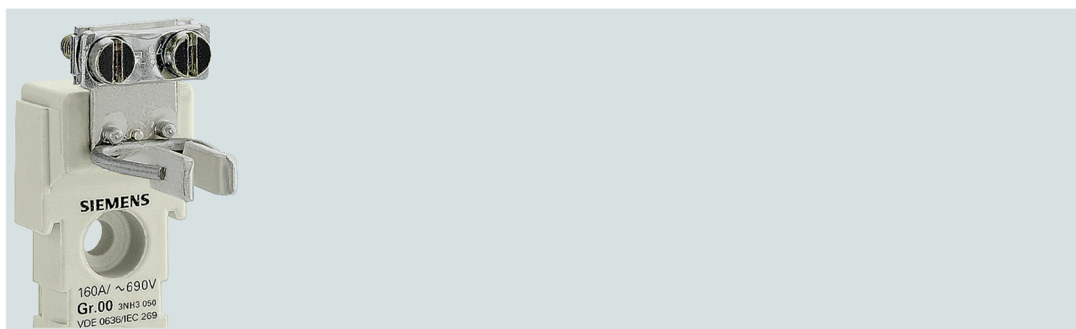

One conductor can be clamped to the saddle-type terminal.

## Installation features

### Space requirements for installing LV HRC fuse bases

3P LV HRC fuse base, 1 unit

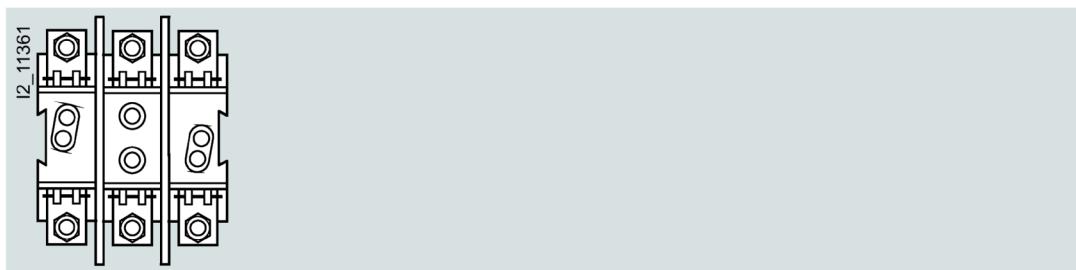

1P LV HRC fuse bases, 3 units

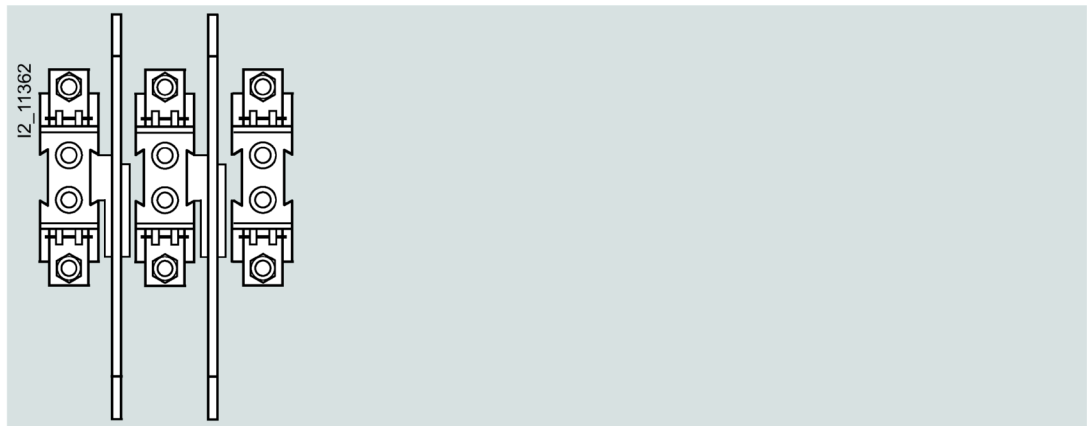

LV HRC partition



Size	Mounting width (mm) of LV HRC fuse bases				Distance through spacer	Mounting height (mm)	Mounting depth (mm)
	3P, 1 unit		1P, 3 units			3NX20.. barriers with matching bases <sup>1)</sup>	
	Bases with phase barrier +		Bases with phase barrier +			h	t
	without end barrier	2 end barriers	without end barrier	2 end barriers			
000 / 00	102	106	100	104 <sup>2)</sup>	2	138	86
0	-	-	128	142	7	178	90
1	163	177	158	172	7	202	110
2	-	-	184	224	20 <sup>3)</sup>	227	118
3	-	-	208	272	32 <sup>3)</sup>	242	132

Size	Mounting width (mm) of LV HRC fuse bases				Mounting height (mm)	Mounting depth (mm)
	3P, 1 unit		1P, 3 units			
	Bases with phase barrier + without end barrier	2 end barriers	Bases with phase barrier + without end barrier	2 end barriers	-	h
4	Installation without barriers; further information can be found under "LV HRC barriers for LV HRC fuse bases" in the chapter LV HRC components (Page 149).				Not available	
4a	Can only be used in bases with swivel mechanism				Not available	

- 1) This measurement specifies the required overall mounting depth with base d and the overall mounting height h.
- 2) Placing an additional base on the barrier and plug-on part does not increase the distance, rather the bases lie flat directly on top of one another.
- 3) If the bases are installed directly on a side wall in the distribution board, one spacer part can be broken off. This would reduce the distance measurement.

### SITOR semiconductor fuses for 3NH bases

3NH bases are generally suitable for all fuses in LV HRC design. SITOR semiconductor fuses in LV HRC design can also be used, although it must be noted that, compared to cable and line protection fuses, these get much hotter during operation. The following table contains the permissible load currents of the SITOR semiconductor fuses for installation in 3NH. For installation in a base, it may therefore be necessary to operate the fuse under  $I_n$  (derating).

The values were determined using the conductor cross-sections specified in the table. If using smaller cross-sections, a considerably higher derating is required due to the lower heat dissipation.

For further information on the assignment of SITOR semiconductor fuses to the fuse bases and fuse switch units, please refer to the tables in the chapter Technical specifications (Page 159) and following.

## 6.4.2 Technical specifications

### LV HRC fuse bases, LV HRC bus-mounting bases

Size		000 / 00	0	1	2	3	4
Standards		IEC 60269-1, -2; EN 60269-1; DIN VDE 0636-2, UL 4248-1 (only downstream of branch circuit protection)					
Approvals		KEMA, UL File Number: E171267-IZLT2					
Rated current $I_n$	A	160	160	250	400	630	1250
Rated voltage $U_n$	V AC	690 <sup>1)</sup>	690 <sup>1)</sup>				690
	V DC	250	440				440



Size		000 / 00	0	1	2	3	4
Rated short-circuit strength	kA AC	120					
	kA DC	25					
Max. power dissipation of the fuse links	W	12	25	32	45	60	90
Screw terminal and flat terminal		M8	M8	M10	M10	M12	M12
Max. tightening torque	Nm	14	14	38	38	38	65
<b>Plug-in terminal</b>							
Conductor cross-section	mm <sup>2</sup>	2.5 ... 50		-			
<b>Saddle-type terminal</b>							
Conductor cross-section	mm <sup>2</sup>	6 ... 70	-				
<b>Box terminal</b>							
Conductor cross-section	mm <sup>2</sup>	2.5 ... 50					
<b>Terminal strip</b>							
Conductor cross-section, 3-wire	mm <sup>2</sup>	1.5 ... 16	-				
Max. torque for attachment of LV HRC fuse base	Nm	2	-				

1) Extended rated voltage up to 1000 V

## 6.4.3 Dimensional drawings

### 6.4.3.1 LV HRC fuse bases made of molded plastic

#### Sizes 000 / 00, 1P

##### 3NH3051 to 3NH3053

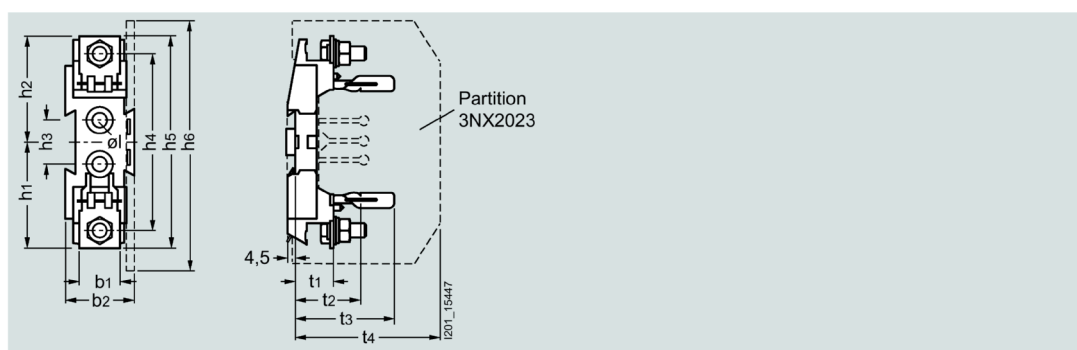

Size	Pol es	I <sub>n</sub> A	Type / Terminal	b <sub>1</sub>	b <sub>2</sub>	h <sub>1</sub>	h <sub>2</sub>	h <sub>3</sub>	h <sub>4</sub>	h <sub>5</sub>	h <sub>6</sub>	∅I	t <sub>1</sub>	t <sub>2</sub>	t <sub>3</sub>	t <sub>4</sub>
000 / 00	1P	160	3NH3051 / M8 flat terminal, screw	23	39	61	61	25	101	121	139	7.5	26	42	61	86

6.4.3.2 LV HRC fuse bases made of ceramic

Sizes 000 / 00

1P, 3NH303., 3NH3050

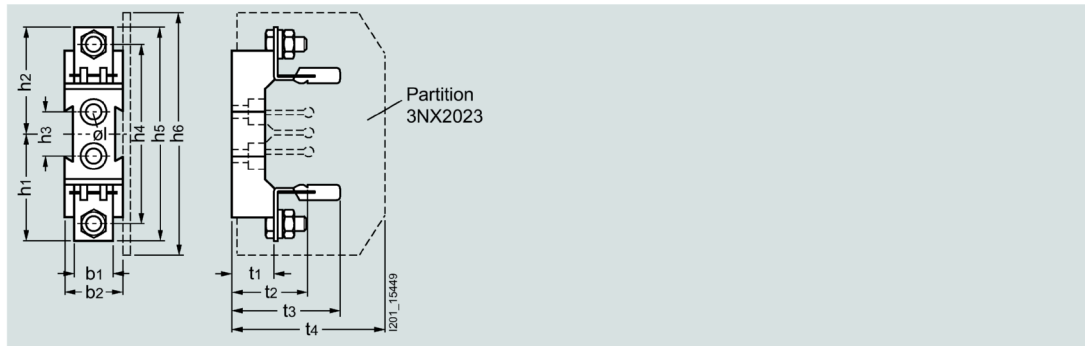

Size	Pol es	In A	Type / Terminal	b1	b2	h1	h2	h3	h4	h5	h6	ØI	t1	t2	t3	t4
000 / 00	1P	160	3NH3030 / Flat terminal, screw	23	34	61	61	25	102	122	139	7.5	24	40	60	86
			3NH3031 / M8 plug-in terminal	31	34	64	64	25	102	128	139	7.5	24	40	60	86
			3NH3032 / Saddle-type terminal	29	34	61	61	25	102	122	139	7.5	24	40	60	86
			3NH3035 / Flat terminal, terminal strip	26	34	61	70	25	113	130	139	7.5	24	40	60	86

3P, 3NH403

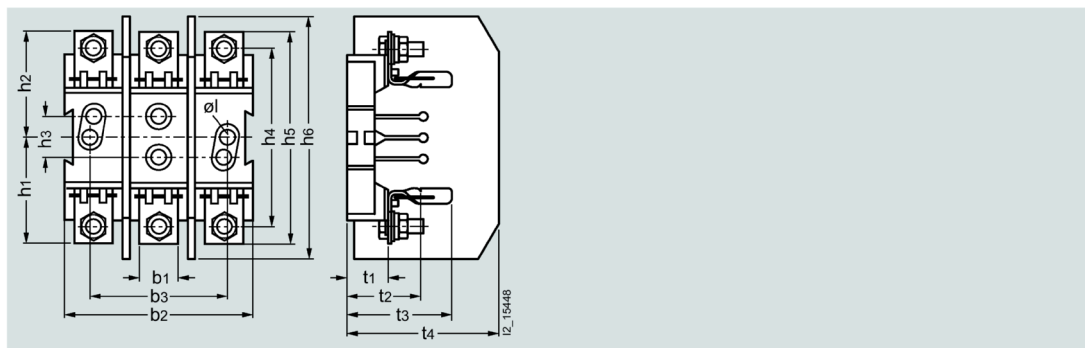

Size	Poles	I <sub>n</sub> A	Type / Terminal	b <sub>1</sub>	b <sub>2</sub>	b <sub>3</sub>	h <sub>1</sub>	h <sub>2</sub>	h <sub>3</sub>	h <sub>4</sub>	h <sub>5</sub>	h <sub>6</sub>	ØI	t <sub>1</sub>	t <sub>2</sub>	t <sub>3</sub>	t <sub>4</sub>
000 / 00	3P	160	3NH4030 / Flat terminal	23	102	70	61	61	25	102	122	139	7.5	24	40	60	86
			3NH4032 / Saddle-type terminal	29	102	70	61	61	25	102	122	139	7.5	24	40	60	86

**Size 0, 1P**

**3NH312**

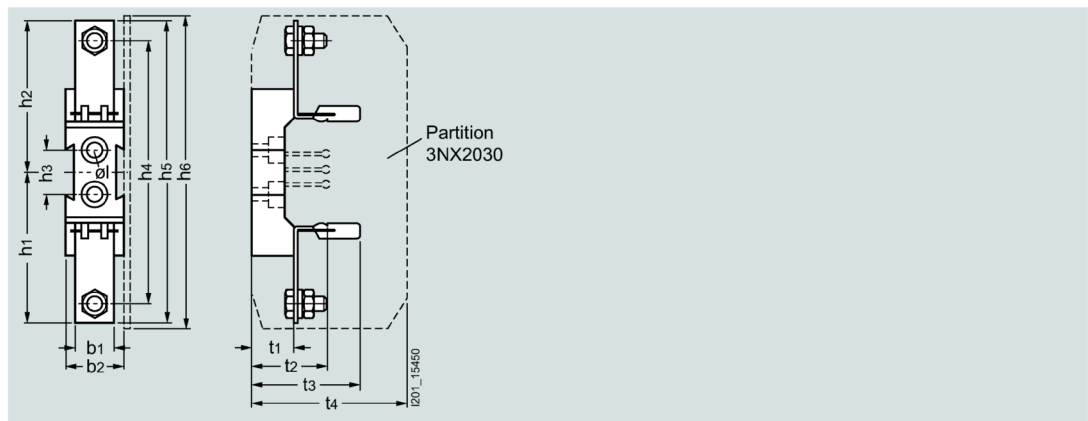

Size	Poles	I <sub>n</sub> A	Type / Terminal	b <sub>1</sub>	b <sub>2</sub>	h <sub>1</sub>	h <sub>2</sub>	h <sub>3</sub>	h <sub>4</sub>	h <sub>5</sub>	h <sub>6</sub>	ØI	t <sub>1</sub>	t <sub>2</sub>	t <sub>3</sub>	t <sub>4</sub>
0	1P	160	3NH3120 / Flat terminal	23	38	87	87	25	150	173	179	7.5	24	40	60	88

Size 1

1P, 3NH32.0

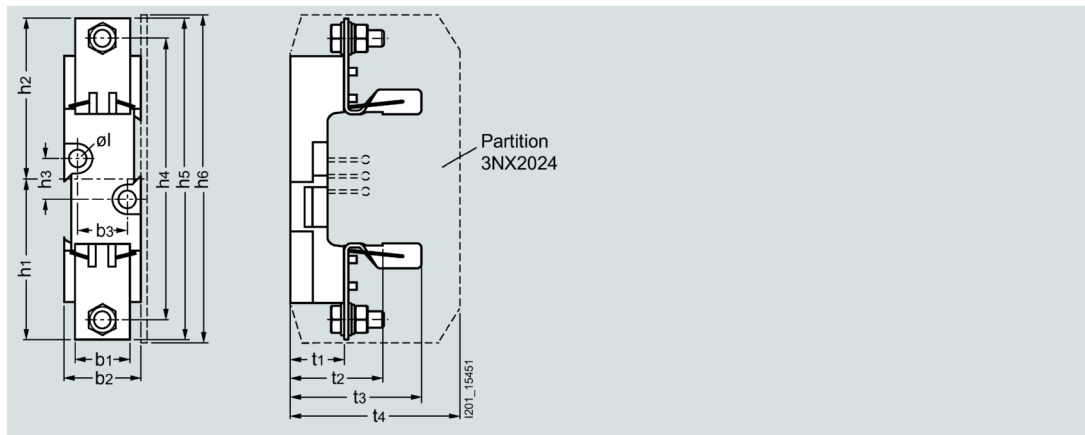

Size	Pol es	I <sub>n</sub> A	Type / Terminal	b <sub>1</sub>	b <sub>2</sub>	b <sub>3</sub>	h <sub>1</sub>	h <sub>2</sub>	h <sub>3</sub>	h <sub>4</sub>	h <sub>5</sub>	h <sub>6</sub>	Ø1	t <sub>1</sub>	t <sub>2</sub>	t <sub>3</sub>	t <sub>4</sub>
1	1P	250	3NH3230 / M10 flat terminal	35	49	30	101	101	25	177	202	203	10.5	35	55	84	107
			3NH3220 / Double busbar terminal	35	49	30	101	101	25	177	202	203	10.5	35	55	84	107

3P, 3NH4230

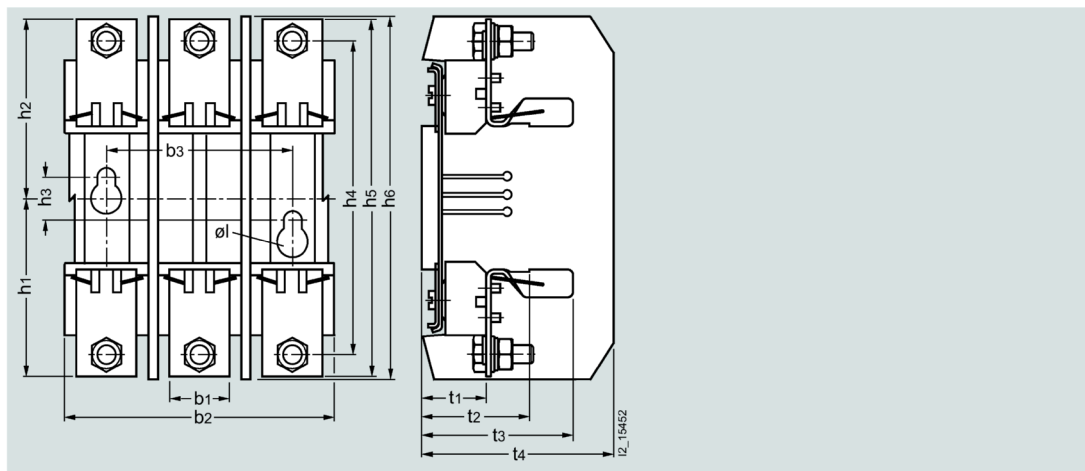

Size	Pol es	I <sub>n</sub> A	Type / Terminal	b <sub>1</sub>	b <sub>2</sub>	b <sub>3</sub>	h <sub>1</sub>	h <sub>2</sub>	h <sub>3</sub>	h <sub>4</sub>	h <sub>5</sub>	h <sub>6</sub>	Ø1	t <sub>1</sub>	t <sub>2</sub>	t <sub>3</sub>	t <sub>4</sub>
1	3P	250	3NH4230 / M10 flat terminal	35	146	111	101	101	25	177	202	203	10.5	35	55	84	107

Size 2

1P, 3NH33.0

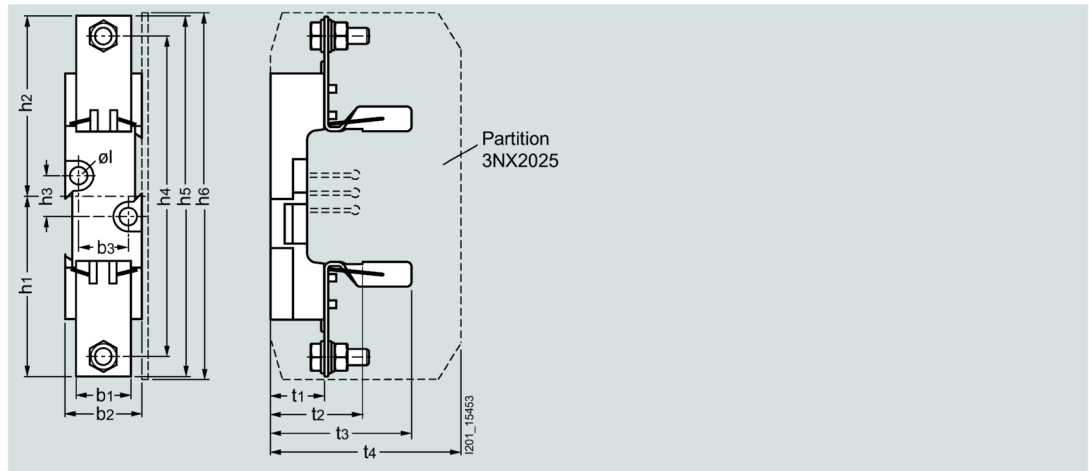

Size	Pol es	I <sub>n</sub> A	Type / Terminal	b <sub>1</sub>	b <sub>2</sub>	b <sub>3</sub>	h <sub>1</sub>	h <sub>2</sub>	h <sub>3</sub>	h <sub>4</sub>	h <sub>5</sub>	h <sub>6</sub>	Øl	t <sub>1</sub>	t <sub>2</sub>	t <sub>3</sub>	t <sub>4</sub>
2	1P	400	3NH3330 / M10 flat terminal	35	49	30	113	113	25	202	227	228	10.5	35	55	90	115
			3NH3320 / Double busbar terminal	35	49	30	113	113	25	202	227	228	10.5	35	55	90	115

Size 3

1P, 3NH34.0

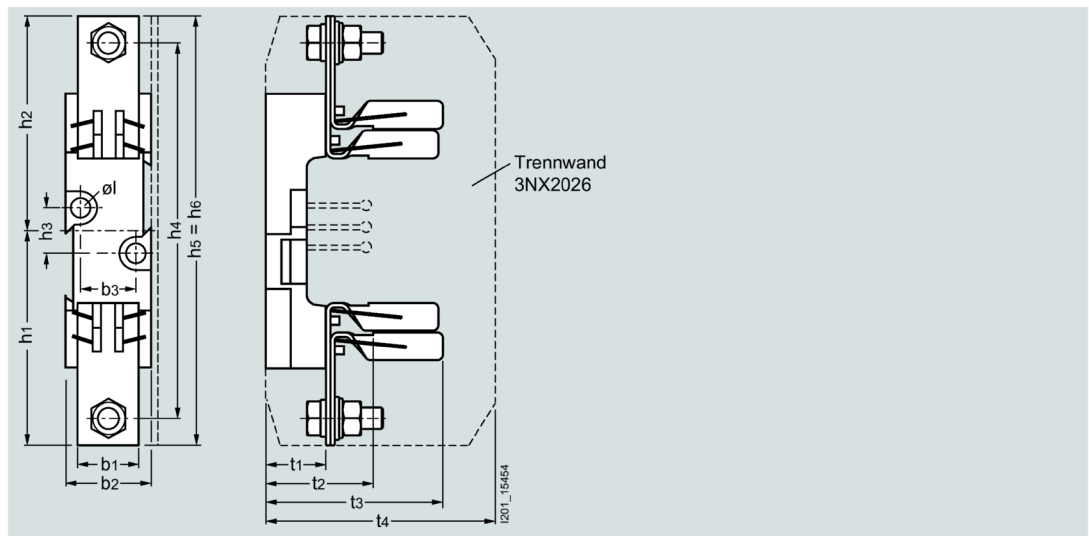

Size	Poles	I <sub>n</sub> A	Type / Terminal	b <sub>1</sub>	b <sub>2</sub>	b <sub>3</sub>	h <sub>1</sub>	h <sub>2</sub>	h <sub>3</sub>	h <sub>4</sub>	h <sub>5</sub>	h <sub>6</sub>	Øl	t <sub>1</sub>	t <sub>2</sub>	t <sub>3</sub>	t <sub>4</sub>
3	1P	630	3NH3430 / M10 flat terminal	35	49	30	121	121	25	212	242	242	10.5	35	57	101	130
			3NH3420 / Double busbar terminal	35	49	30	121	121	25	212	242	242	10.5	35	57	101	130

Size 4, 1P

3NH3530

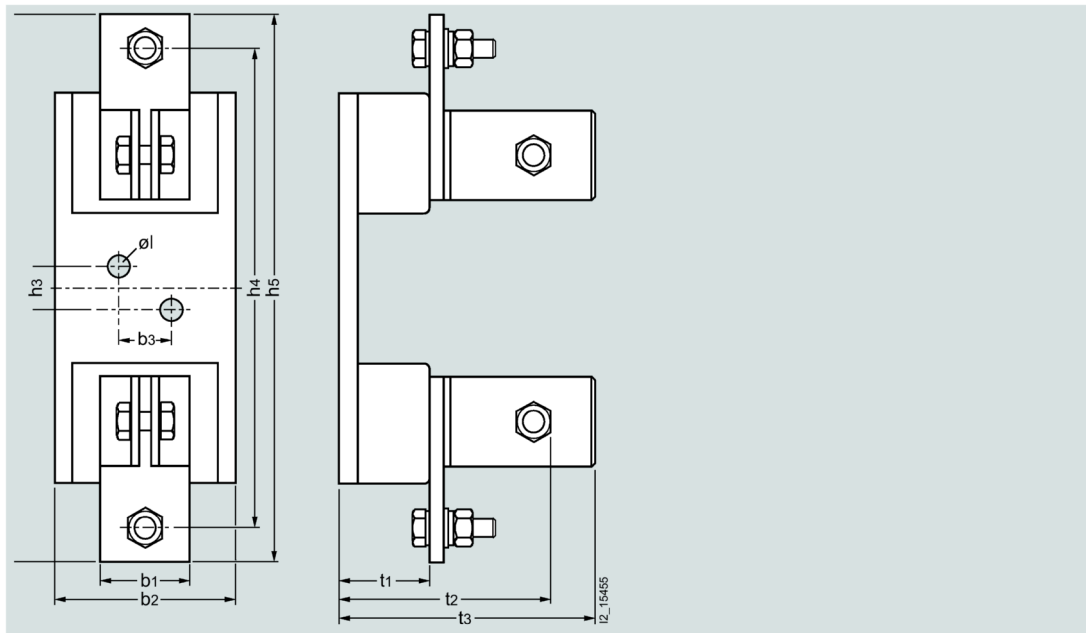

Size	Poles	I <sub>n</sub> A	Type / Terminal	b <sub>1</sub>	b <sub>2</sub>	b <sub>3</sub>	h <sub>1</sub>	h <sub>2</sub>	h <sub>3</sub>	h <sub>4</sub>	h <sub>5</sub>	Øl	t <sub>1</sub>	t <sub>2</sub>	t <sub>3</sub>
4 <sup>1)</sup>	1P	1250	3NH3530 / M10 flat terminal	50	102	30	156	156	25	270	312	13	51	116	144
4a	Can only be used in bases with swivel mechanism														

<sup>1)</sup> Size 4 LV HRC fuse links are also screwed onto the base.

### 6.4.3.3 LV HRC components

#### LV HRC contact covers for LV HRC fuse bases and LV HRC bus-mounting bases<sup>1)</sup>

Sizes 000 / 00 to 3 (3NX3105 to 3NX3108, 3NX3114)

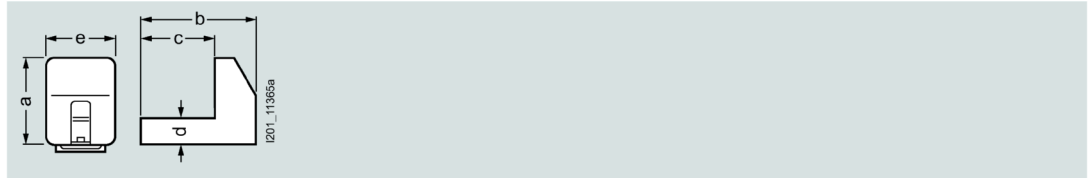

Size	Type	a	b	c	d	e
000 / 00	3NX3105 <sup>1)</sup>	38	47.5	34	11.5	30
0	3NX3114	51.5	47.5	34	11.5	30
1	3NX3106	61.5	57	42.5	35	46
2	3NX3107	74	65	51	35	46
3	3NX3108	81.5	77.5	57.5	35	46

<sup>1)</sup> The 3NX3105 LV HRC contact cover can be used for both LV HRC fuse bases and LV HRC bus-mounting bases.

#### LV HRC contact covers for LV HRC bus-mounting bases

3NX3113 for the incoming terminal, dimensional drawing 3NX3105 for the outgoing terminal



#### 3NX3115 LV HRC protective cover, with 3NX3116 LV HRC cover

Sizes 000 / 00, degree of protection IP2X

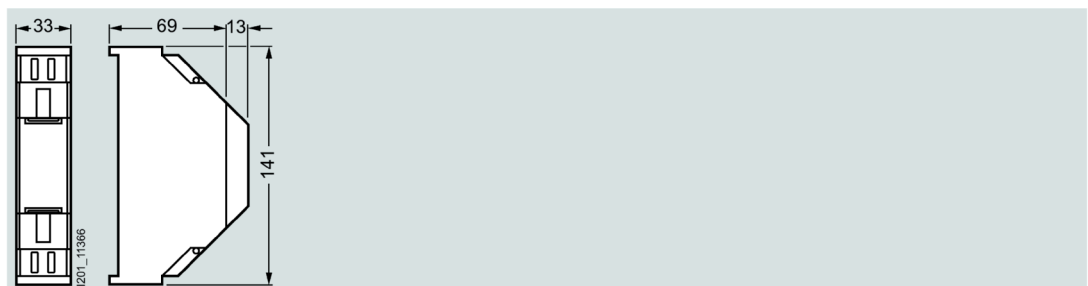

LV HRC barriers for LV HRC fuse bases

Sizes 000 / 00 (3NX2023)



Sizes 000 / 00 (3NX2030, 3NX2024 to 3NX2026)

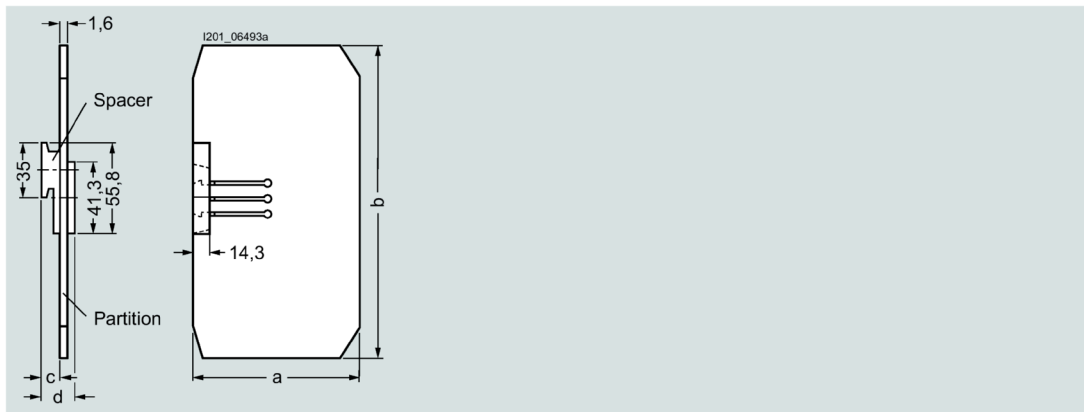

Sizes 0 to 3

Size	Type	a	b	c	d
0	3NX2030	87.6	178.5	7.7	12.3
1	3NX2024	107.3	202.5	7.7	12.3
2	3NX2025	115.3	227.5	14.2	25.1
3	3NX2026	129.8	242	20.2	37.2



LV HRC barriers for LV HRC bus-mounting bases

Sizes 000 / 00 (3NX2027 phase barrier)

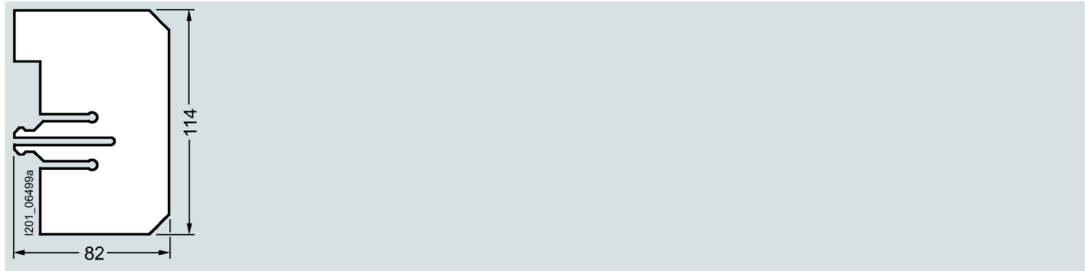

Sizes 000 / 00 (3NX2028 end barrier)

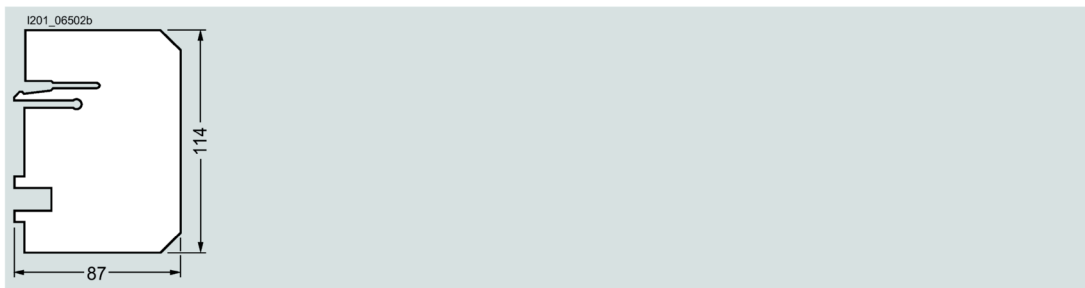

Fuse pullers

Sizes 000 to 4 (3NX1013 (without sleeve), 3NX1014 (with sleeve))

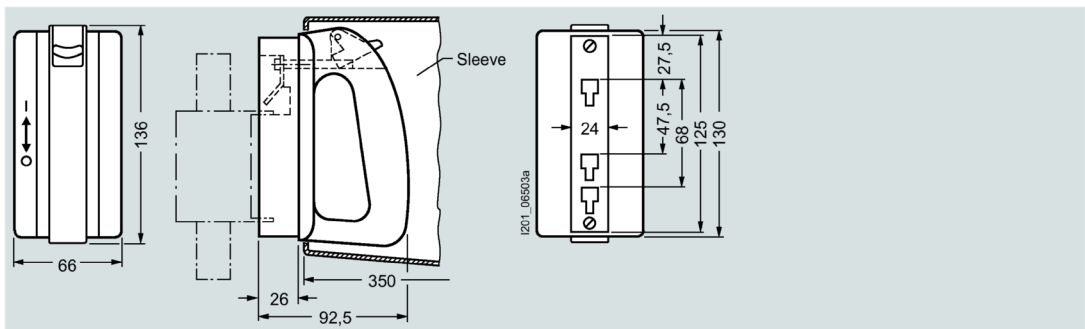

Isolating blades with insulated grip lugs

Sizes 000 / 00 to 3 (3NG1.02)

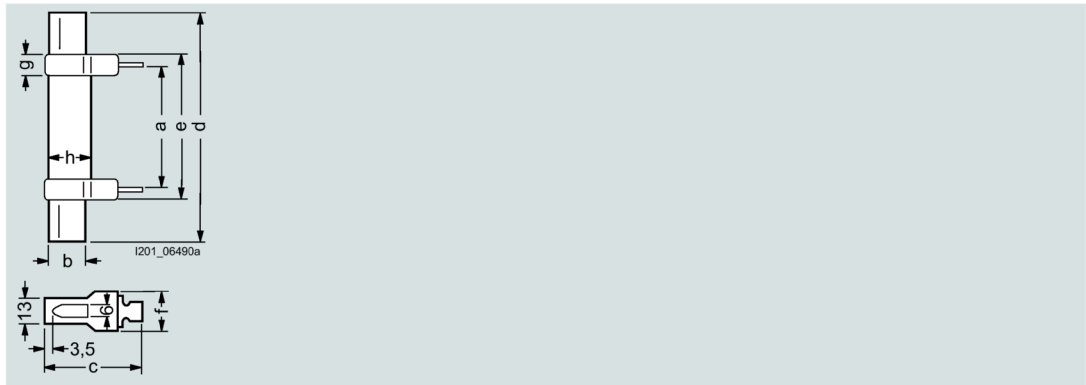

Size	Type	a	b	c	d	e	f	g	h
000 / 00	3NG1002	44	15	48	78	54	20.5	9	19
0	3NG1102	60.5	15	48	125	68	20.5	9	19
1	3NG1202	61	20	53	135	72	23	9	24
2	3NG1302	61	26	61	150	72	23	9	29
3	3NG1402	61	32	73	150	72	23	9	36

Isolating blades with non-insulated grip lugs

Size 4 (3NG1503)

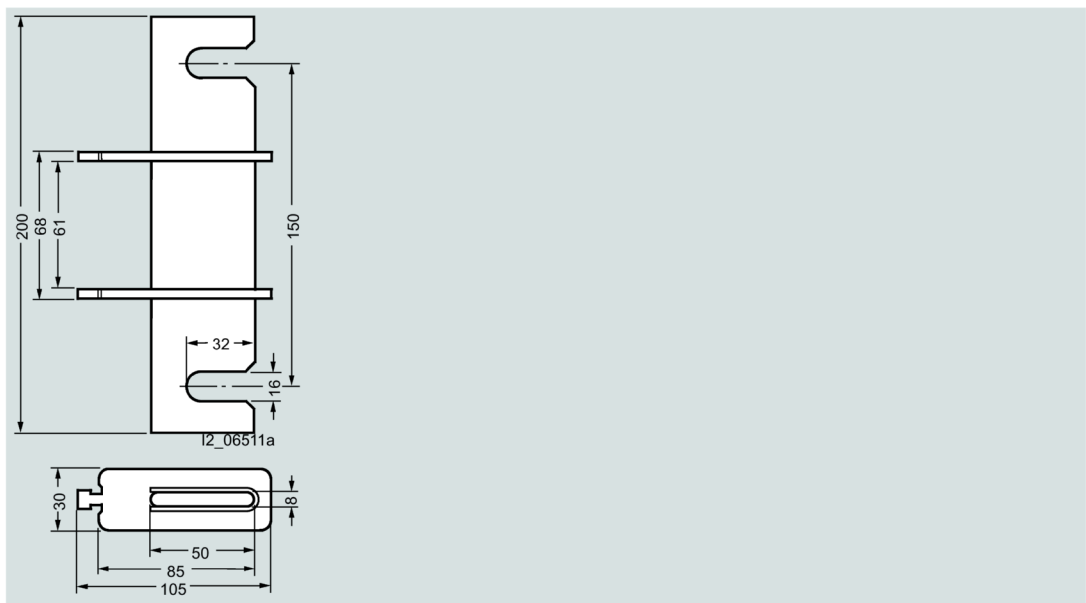

Size 4a (3NG1505)

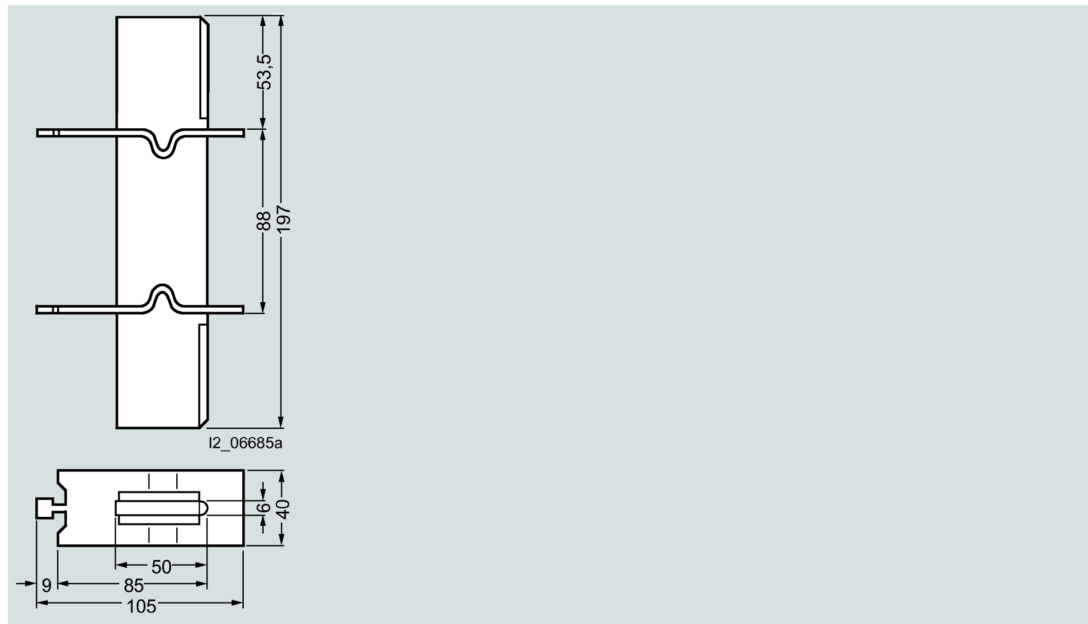



# SITOR semiconductor fuses

## 7.1 LV HRC design

### 7.1.1 Portfolio overview

SITOR semiconductor fuses protect power semiconductors from the effects of short-circuits, because the super-quick breaking characteristic is much faster than that of conventional LV HRC fuses. They protect high-value devices and system components, such as converters with fuses in the input and the DC link, UPS systems and soft starters for motors.

Panel mounting requirements have given rise to various connection versions and designs.

The fuses with blade contacts comply with IEC 60269-2 and are suitable for installation in LV HRC fuse bases, LV HRC fuse switch disconnectors and switch disconnectors with fuses. They also include fuses with slotted blade contacts for screw fixing with 110 mm mounting dimension with sizes according to IEC 60269-4.

Fuses with slotted blade contacts for screw fixing with 80 mm or 110 mm mounting dimension are often screwed directly onto busbars for optimum heat dissipation. Even better heat transmission is provided by the compact fuses with M10 or M12 female thread, which are also mounted directly onto busbars.

Bolt-on links with 80 mm mounting dimension are another panel-mounting version for direct busbar mounting.

The fuses for SITOR thyristor sets, railway rectifiers or electrolysis systems were developed specially for these applications.

LV HRC bases and fuse switch units suitable for use with SITOR semiconductor fuses can be found in the chapter Portfolio overview (Page 139) and following.

Fuse characteristics, configuration notes and the assignments of SITOR semiconductor fuses to 3NP and 3KL fuse bases and fuse switch units can be found in the Configuration Manual "Fuse Systems" under: [www.siemens.com/lowvoltage/manuals](http://www.siemens.com/lowvoltage/manuals).

The new size 3 type ranges have a round ceramic body instead of a square one. These series are characterized by small  $I^2t$  values with low power dissipation and high capability under alternating load. The dimensions and functional values correspond to the relevant standards IEC 60269-4 / DIN EN 60269-4 (VDE 0636-4).

---

#### Note

The ordering data of the fuses are listed in ascending order of the rated voltage in the selection tables.

---

## Benefits

- SITOR semiconductor fuses have a high varying load factor, which ensures a high level of operational reliability and plant availability – even when subject to constant load change.
- The use of SITOR semiconductor fuses in Siemens LV HRC bases and switch disconnectors has been tested with regard to heat dissipation and maximum current loading. This makes planning and dimensioning easier. Consequential damage is also avoided.
- Our high standard of quality ensures good compliance with the characteristic curve and accuracy. This ensures long-term protection of devices.

## Operational classes

Fuses are categorized into operational classes according to their function. SITOR semiconductor fuses in LV HRC design are available in the following operational classes:

- aR: For the short-circuit protection of power semiconductors (partial-range protection)
- gR: For the protection of power semiconductors (full-range protection)
- gS: The gS operational class combines cable and line protection with semiconductor protection (full-range protection).

## Parallel-connected fuses

Parallel-connected fuses offer maximum current and energy limiting that is clearly better than with comparable single fuses. They also fulfill the special requirements for UL-certified fuses according to which fuses must be connected in parallel at the factory. Here is the original wording of the NEC document: 240.8: "Fuses and circuit breakers shall be permitted to be connected in parallel where they are factory assembled in parallel and listed as a unit. Individual fuses, circuit breakers, or combinations thereof shall not otherwise be connected in parallel."

## Applications

### Properties

SITOR fuse links protect converter equipment against short circuits.

The power semiconductors used in these devices (diodes, thyristors, GTOs and others) require fast-switching elements for protection due to their low thermal capacity. SITOR fuse links (fuse links with super-quick characteristics for semiconductor protection) are ideal for this type of application.

The following types of short-circuit faults can occur:

- Internal short circuit:  
A faulty semiconductor device causes a short circuit within the power converter.
- External short circuit:  
A fault in the load causes a short circuit on the output side of the power converter.
- Inverter shoot-throughs:  
In the event of a failure of the chassis converter control system during inverter operation

(commutation failure), the converter circuit forms a short-circuit type connection between the DC and AC power supply systems.

Fuse links can be arranged in a number of ways within the converter circuit. A distinction is made between phase fuses in three-phase incoming feeders and, if applicable, DC fuses and branch fuses in the branches of the converter circuit. In the case of center tap connections, fuse links can only be arranged as phase fuses in three-phase incoming feeders.

When using SITOR fuse links of operational class aR, the overload protection of converter equipment, up to approx. 3.5 times the rated current of the fuse link, is taken from conventional protective devices (for example, thermally-delayed overload relays) or, in the case of controlled power converters, from the current limiter (exception: full-range fuses).

In addition to semiconductor protection, SITOR fuse links of the 3NE1..-0 series with operational class gS are also suitable for overload and short-circuit protection of cables, lines and busbars. All other dual-function fuses of the SITOR series have a gR characteristic. Overload protection is ensured as long as the rated current of the SITOR fuse links of the 3NE1..-0 series is selected such that  $I_n \leq I_z$  (DIN VDE 0100 Part 430).

The rules of DIN VDE 0100 Part 430 must be applied when rating short-circuit protection for cables, lines and busbars.

### 3-phase bidirectional circuit W3

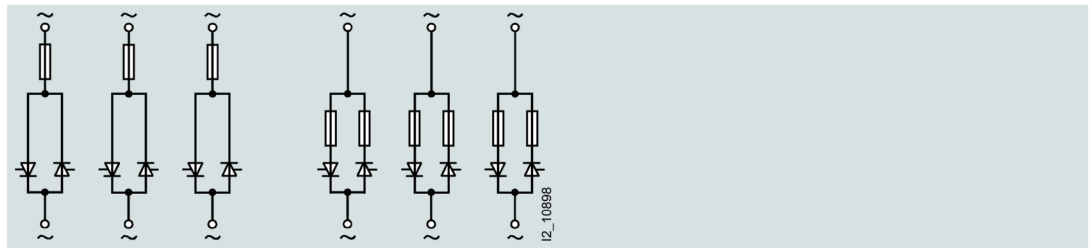

With phase fuses

With branch fuses

## Configuration options

### Six-pulse bridge circuit B6 with phase fuses

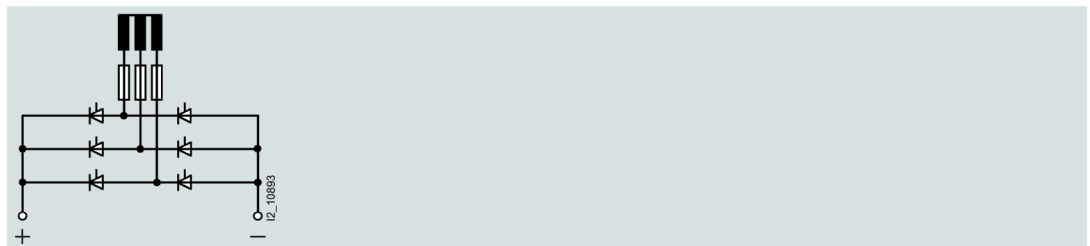

Six-pulse bridge circuit B6 with phase fuses and DC fuse (reversible connection)

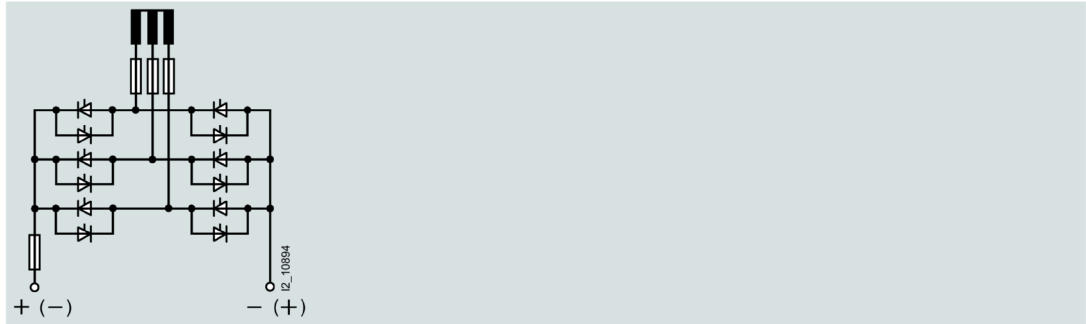

Six-pulse bridge circuit B6 with phase fuses and DC fuse (connection for converter)

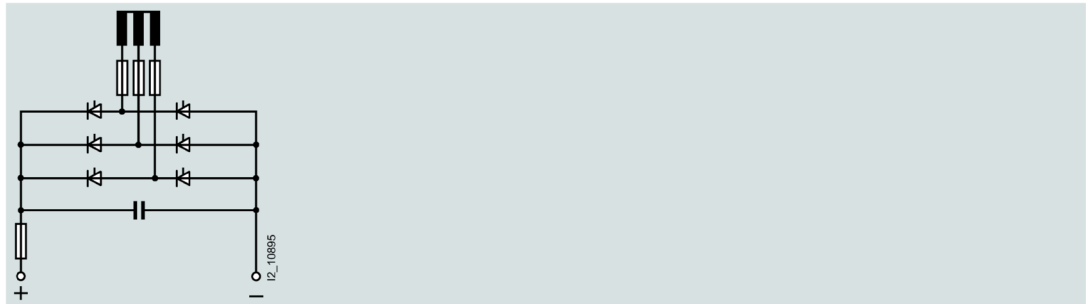

Six-pulse bridge circuit B6 with branch fuses

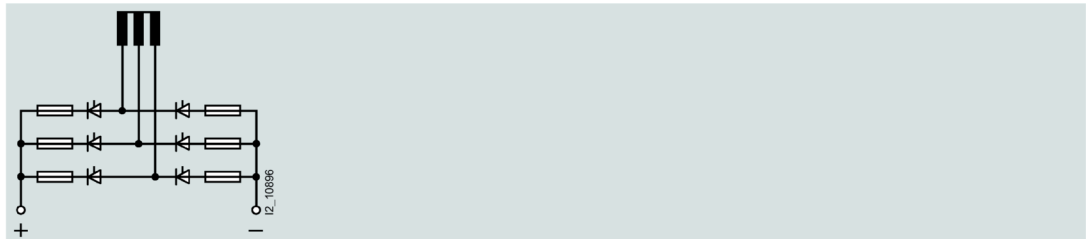

Six-pulse bridge circuit B6 with branch fuses (reversible connection)





## 7.1.2 Technical specifications

### Overview

Article No.	Operational class	Rated voltage $U_n$	Rated breaking capacity $I_1$	Rated current $I_n^{(1)}$	Melting $I^2t$ value $I^2t_s$ ( $t_{vs} = 1 \text{ ms}$ )	Breaking $I^2t$ value $I^2t_a$ at $U_n$	Temperature rise at $I_n$ body center <sup>2)</sup>	Power dissipation at $I_n^{(2)}$	Varying load factor WL
		V AC / V DC	kA	A	A <sup>2</sup> s	A <sup>2</sup> s	K	W	
3NB1234-3KK20	gR	- / 900 <sup>15)</sup>	100	400	96000	240000 <sup>15)</sup>	56	75	-
3NB1126-4KK11	aR	- / 1250 <sup>15)</sup>	100	200	10700	39000 <sup>15)</sup>	53	50	-
3NB1128-4KK11	aR	- / 1250 <sup>15)</sup>	100	250	24500	80500 <sup>15)</sup>	53	51	-
3NB1231-4KK11	aR	- / 1250 <sup>15)</sup>	100	315	41000	129000 <sup>15)</sup>	55	63	-
3NB1234-4KK11	aR	- / 1250 <sup>15)</sup>	100	400	96000	290000 <sup>15)</sup>	56	68	-
3NB1337-4KK11	aR	- / 1250 <sup>15)</sup>	100	500	195000	600000 <sup>15)</sup>	55	89	-
3NB1345-4KK11	aR	- / 1250 <sup>15)</sup>	100	800	770000	1910000 <sup>15)</sup>	76	135	-
3NB2345-4KK16	aR	- / 1250 <sup>15)</sup>	150	800	375000	1150000 <sup>15)</sup>	74	160	-
3NB2350-4KK16	aR	- / 1250 <sup>15)</sup>	150	1000	7870000	2250000 <sup>15)</sup>	87	195	-
3NB2355-4KK16	aR	- / 1250 <sup>15)</sup>	150	1400	2150000	5100000 <sup>15)</sup>	89	250	-
3NB2357-4KK16	aR	- / 1250 <sup>15)</sup>	150	1600	3500000	7450000 <sup>15)</sup>	76	275	-
3NB2364-4KK17	aR	- / 1250 <sup>15)</sup>	150	2100	5750000	1950000 <sup>15)</sup>	77	365	-
3NB2366-4KK17	aR	- / 1250 <sup>15)</sup>	150	2400	9050000	1810000 <sup>15)</sup>	89	445	-
3NB3350-1KK26	gR	690 / <sup>13)</sup>	100	1000	298000	1400000	101	138	1
3NB3351-1KK26	gR	690 / <sup>13)</sup>	100	1100	680000	3000000	96	110	1
3NB3352-1KK26	gR	690 / <sup>13)</sup>	100	1250	897000	4100000	38	104	1
3NB3354-1KK26	gR	690 / <sup>13)</sup>	100	1350	1100000	4800000	44	126	1
3NB3355-1KK26	gR	690 / <sup>13)</sup>	100	1400	1150000	5200000	48	127	1
3NB3357-1KK26	gR	690 / <sup>13)</sup>	100	1600	1550000	6900000	57	152	1
3NB3358-1KK26	gR	690 / <sup>13)</sup>	100	1700	2370000	1000000 <sup>0</sup>	57	143	1
3NB3358-1KK27	gR	690 / <sup>13)</sup>	100	1700	1550000	6400000	64	179	1
3NB3362-1KK27	gR	690 / <sup>13)</sup>	100	1900	1850000	8200000	70	196	1
3NC2423-0C	gR	500 / <sup>13)</sup>	50 <sup>14)</sup>	150 <sup>3)</sup>	7000	33000	26	35	0.85
3NC2423-3C	gR	500 / <sup>13)</sup>	50 <sup>14)</sup>	150 <sup>3)</sup>	7000	33000	26	35	0.85
3NC2425-0C	gR	500 / <sup>13)</sup>	50 <sup>14)</sup>	200 <sup>3)</sup>	13600	64000	25	40	0.85

## 7.1 LV HRC design

Article No.	Operational class	Rated voltage $U_n$	Rated breaking capacity $I_n$	Rated current $I_n^{(1)}$	Melting $I^2t$ value $I^2t_s$ ( $t_{vs} = 1 \text{ ms}$ )	Breaking $I^2t$ value $I^2t_a$ at $U_n$	Temperature rise at $I_n$ body center <sup>2)</sup>	Power dissipation at $I_n^{(2)}$	Varying load factor WL
		V AC / V DC	kA	A	A <sup>2</sup> s	A <sup>2</sup> s	K	W	
3NC2425-3C	gR	500 / <sup>13)</sup>	50 <sup>14)</sup>	200 <sup>3)</sup>	13600	64000	25	40	0.85
3NC2427-0C	gR	500 / <sup>13)</sup>	50 <sup>14)</sup>	250 <sup>3)</sup>	21000	99000	30	50	0.85
3NC2427-3C	gR	500 / <sup>13)</sup>	50 <sup>14)</sup>	250 <sup>3)</sup>	21000	99000	30	50	0.85
3NC2428-0C	gR	500 / <sup>13)</sup>	50 <sup>14)</sup>	300 <sup>3)</sup>	28000	132000	40	65	0.85
3NC2428-3C	gR	500 / <sup>13)</sup>	50 <sup>14)</sup>	300 <sup>3)</sup>	28000	132000	40	65	0.85
3NC2431-0C	gR	500 / <sup>13)</sup>	50 <sup>14)</sup>	350 <sup>3)</sup>	53000	249000	35	60	0.85
3NC2431-3C	gR	500 / <sup>13)</sup>	50 <sup>14)</sup>	350 <sup>3)</sup>	53000	249000	35	60	0.85
3NC2432-0C	aR	500 / <sup>13)</sup>	50 <sup>14)</sup>	400 <sup>3)</sup>	83000	390000	30	50	0.85
3NC2432-3C	aR	500 / <sup>13)</sup>	50 <sup>14)</sup>	400 <sup>3)</sup>	83000	390000	30	50	0.85
3NC3236-1U	aR	690 / <sup>13)</sup>	100	630	32500	244000	120	120	0.85
3NC3236-6U	aR	690 / <sup>13)</sup>	100	630	32500	244000	125	125	0.9
3NC3237-1U	aR	690 / <sup>13)</sup>	100	710	46100	346000	125	130	0.85
3NC3237-6U	aR	690 / <sup>13)</sup>	100	710	46100	346000	125	130	0.9
3NC3238-1U	aR	690 / <sup>13)</sup>	100	800	66400	498000	125	135	0.9
3NC3238-6U	aR	690 / <sup>13)</sup>	100	800	66400	498000	120	135	0.95
3NC3240-1U	aR	690 / <sup>13)</sup>	100	900	90300	677000	130	145	0.9
3NC3240-6U	aR	690 / <sup>13)</sup>	100	900	90300	677000	125	140	0.95
3NC3241-1U	aR	690 / <sup>13)</sup>	100	1000	130000	975000	125	155	0.95
3NC3241-6U	aR	690 / <sup>13)</sup>	100	1000	130000	975000	120	145	1
3NC3242-1U	aR	690 / <sup>13)</sup>	100	1100	184000	1382000	125	165	0.95
3NC3242-6U	aR	690 / <sup>13)</sup>	100	1100	184000	1382000	115	150	1
3NC3243-1U	aR	690 / <sup>13)</sup>	100	1250	265000	1990000	130	175	0.95
3NC3243-6U	aR	690 / <sup>13)</sup>	100	1250	265000	1990000	110	155	1
3NC3244-1U	aR	500 / <sup>13)</sup>	100	1400	382000	2100000	140	200	0.95
3NC3244-6U	aR	500 / <sup>13)</sup>	100	1400	382000	2100000	115	175	1
3NC3245-1U	aR	500 / <sup>13)</sup>	100	1600	520000	2860000	160	240	0.9
3NC3245-6U	aR	500 / <sup>13)</sup>	100	1600	520000	2860000	120	195	0.95
3NC3336-1U	aR	1000 / <sup>13)</sup>	100	630	66400	418000	160	145	0.85
3NC3336-6U	aR	1000 / <sup>13)</sup>	100	630	66400	418000	140	130	0.9
3NC3337-1U	aR	1000 / <sup>13)</sup>	100	710	90300	569000	160	150	0.85
3NC3337-6U	aR	1000 / <sup>13)</sup>	100	710	90300	569000	140	140	0.9
3NC3338-1U	aR	1000 / <sup>13)</sup>	100	800	130000	819000	150	155	0.85
3NC3338-6U	aR	1000 / <sup>13)</sup>	100	800	130000	819000	130	150	0.9
3NC3340-1U	aR	1000 / <sup>13)</sup>	100	900	184000	1160000	145	165	0.9
3NC3340-6U	aR	1000 / <sup>13)</sup>	100	900	184000	1160000	130	160	0.95
3NC3341-1U	aR	1000 / <sup>13)</sup>	100	1000	265000	1670000	140	170	0.9
3NC3341-6U	aR	1000 / <sup>13)</sup>	100	1000	265000	1670000	125	165	0.95
3NC3342-1U	aR	800 / <sup>13)</sup>	100	1100	382000	1910000	150	185	0.9
3NC3342-6U	aR	800 / <sup>13)</sup>	100	1100	382000	1910000	130	175	0.95

Article No.	Operational class	Rated voltage $U_n$	Rated breaking capacity $I_1$	Rated current $I_n^{(1)}$	Melting $I^2t$ value $I^2t_s$ ( $t_{vs} = 1 \text{ ms}$ )	Breaking $I^2t$ value $I^2t_a$ at $U_n$	Temperature rise at $I_n$ body center <sup>2)</sup>	Power dissipation at $I_n^{(2)}$	Varying load factor WL
		V AC / V DC	kA	A	A <sup>2</sup> s	A <sup>2</sup> s	K	W	
3NC3343-1U	aR	800 / <sup>13)</sup>	100	1250	520000	2600000	165	210	0.9
3NC3343-6U	aR	800 / <sup>13)</sup>	100	1250	520000	2600000	135	185	0.95
3NC3430-1U	aR	1250 / <sup>13)</sup>	100	315	10600	72500	60	80	0.95
3NC3430-6U	aR	1250 / <sup>13)</sup>	100	315	10600	72500	60	80	0.95
3NC3432-1U	aR	1250 / <sup>13)</sup>	100	400	23900	163000	95	95	0.95
3NC3432-6U	aR	1250 / <sup>13)</sup>	100	400	23900	163000	95	95	0.95
3NC3434-1U	aR	1250 / <sup>13)</sup>	100	500	42500	290000	115	115	0.9
3NC3434-6U	aR	1250 / <sup>13)</sup>	100	500	42500	290000	115	115	0.9
3NC3436-1U	aR	1250 / <sup>13)</sup>	100	630	96600	650000	120	120	0.95
3NC3436-6U	aR	1250 / <sup>13)</sup>	100	630	96600	650000	120	120	0.95
3NC3438-1U	aR	1100 / <sup>13)</sup>	100	800	184000	985000	115	145	0.9
3NC3438-6U	aR	1100 / <sup>13)</sup>	100	800	184000	985000	109	145	0.95
3NC5531 <sup>4)</sup>	aR	800 / <sup>13)</sup>	50 <sup>14)</sup>	350 <sup>5)</sup>	66000	260000	200	80	0.9
3NC5838 <sup>4)</sup>	aR	1000 / <sup>13)</sup>	50 <sup>14)</sup>	800 <sup>5)</sup>	360000	1728000	130	170	0.9
3NC5840 <sup>4)</sup>	aR	1000 / <sup>13)</sup>	50 <sup>14)</sup>	600 <sup>5)</sup>	185000	888000	110	150	0.9
3NC5841 <sup>4)</sup>	aR	800 / <sup>13)</sup>	50 <sup>14)</sup>	630 <sup>5)</sup>	185000	888000	110	145	0.9
3NC7327-2	aR	680 / <sup>13)</sup>	50 <sup>14)</sup>	250	244000	635000	45	25	0.9
3NC7331-2	aR	680 / <sup>13)</sup>	50 <sup>14)</sup>	350	550000	1430000	66	32	0.9
3NC8423-0C	gR	690 / <sup>13)</sup>	50 <sup>14)</sup>	150 <sup>3)</sup>	1100	17600	33	40	0.85
3NC8423-3C	gR	690 / <sup>13)</sup>	50 <sup>14)</sup>	150 <sup>3)</sup>	1100	17600	33	40	0.85
3NC8425-0C	gR	690 / <sup>13)</sup>	50 <sup>14)</sup>	200 <sup>3)</sup>	2400	38400	46	55	0.85
3NC8425-3C	gR	690 / <sup>13)</sup>	50 <sup>14)</sup>	200 <sup>3)</sup>	2400	38400	46	55	0.85
3NC8427-0C	gR	690 / <sup>13)</sup>	50 <sup>14)</sup>	250 <sup>3)</sup>	4400	70400	95	72	0.85
3NC8427-3C	gR	690 / <sup>13)</sup>	50 <sup>14)</sup>	250 <sup>3)</sup>	4400	70400	95	72	0.85
3NC8431-0C	gR	690 / <sup>13)</sup>	50 <sup>14)</sup>	350 <sup>3)</sup>	11000	176000	65	95	0.85
3NC8431-3C	gR	690 / <sup>13)</sup>	50 <sup>14)</sup>	350 <sup>3)</sup>	1000	176000	65	95	0.85
3NC8434-0C	gR	690 / <sup>13)</sup>	50 <sup>14)</sup>	500 <sup>3)</sup>	28000	448000	75	130	0.85
3NC8434-3C	gR	690 / <sup>13)</sup>	50 <sup>14)</sup>	500 <sup>3)</sup>	28000	448000	75	130	0.85
3NC8444-3C	aR	600 / <sup>13)</sup>	50 <sup>14)</sup>	1000	400000	2480000	110	140	0.9
3NE1020-2	gR	690 / <sup>13)</sup>	100	80	780	5800	45	10	1
3NE1021-0	gS	690 / <sup>13)</sup>	100	100	3100	33000	36	10	1
3NE1021-2	gR	690 / <sup>13)</sup>	100	100	1490	11000	49	12	1
3NE1022-0	gS	690 / <sup>13)</sup>	100	125	6000	63000	40	11	1
3NE1022-2	gR	690 / <sup>13)</sup>	100	125	3115	23000	55	13	1
3NE1224-0	gS	690 / <sup>13)</sup>	100	160	7400	60000	60	24	1

## 7.1 LV HRC design

Article No.	Operational class	Rated voltage $U_n$	Rated breaking capacity $I_n$	Rated current $I_n^{(1)}$	Melting $I^2t$ value $I^2t_s$ ( $t_{vs} = 1 \text{ ms}$ )	Breaking $I^2t$ value $I^2t_a$ at $U_n$	Temperature rise at $I_n$ body center <sup>2)</sup>	Power dissipation at $I_n^{(2)}$	Varying load factor WL
		V AC / V DC	kA	A	A <sup>2</sup> s	A <sup>2</sup> s	K	W	
3NE1224-2	gR	690 / <sup>13)</sup>	100	160	2650	18600	70	32	1
3NE1224-3	gR	690 / <sup>13)</sup>	100	160	2650	18600	70	32	1
3NE1225-0	gS	690 / <sup>13)</sup>	100	200	14500	100000	65	27	1
3NE1225-2	gR	690 / <sup>13)</sup>	100	200	5645	51800	62	35	1
3NE1225-3	gR	690 / <sup>13)</sup>	100	200	5645	51800	62	35	1
3NE1227-0	gS	690 / <sup>13)</sup>	100	250	29500	200000	75	30	1
3NE1227-2	gR	690 / <sup>13)</sup>	100	250	11520	80900	70	37	1
3NE1227-3	gR	690 / <sup>13)</sup>	100	250	11520	80900	70	37	1
3NE1230-0	gS	690 / <sup>13)</sup>	100	315	46100	310000	80	38	1
3NE1230-2	gR	690 / <sup>13)</sup>	100	315	22580	168000	75	40	1
3NE1230-3	gR	690 / <sup>13)</sup>	100	315	22580	168000	75	40	1
3NE1331-0	gS	690 / <sup>13)</sup>	100	350	58000	430000	75	42	1
3NE1331-2	gR	690 / <sup>13)</sup>	100	350	29500	177000	82	43	1
3NE1331-3	gR	690 / <sup>13)</sup>	100	350	29500	177000	82	43	1
3NE1332-0	gS	690 / <sup>13)</sup>	100	400	84000	590000	85	45	1
3NE1332-2	gR	690 / <sup>13)</sup>	100	400	37300	177000	100	50	1
3NE1332-3	gR	690 / <sup>13)</sup>	100	400	37300	177000	100	50	1
3NE1333-0	gS	690 / <sup>13)</sup>	100	450	104000	750000	85	53	1
3NE1333-2	gR	690 / <sup>13)</sup>	100	450	46100	276500	100	58	1
3NE1333-3	gR	690 / <sup>13)</sup>	100	450	46100	276500	100	58	1
3NE1334-0	gS	690 / <sup>13)</sup>	100	500	149000	950000	90	56	1
3NE1334-2	gR	690 / <sup>13)</sup>	100	500	66400	398000	100	64	1
3NE1334-3	gR	690 / <sup>13)</sup>	100	500	66400	398000	100	64	1
3NE1435-0	gS	690 / <sup>13)</sup>	100	560	215000	1700000	65	50	1
3NE1435-2	gR	690 / <sup>13)</sup>	100	560	130000	890000	80	60	1
3NE1436-3	gR	690 / <sup>13)</sup>	100	560	130000	890000	80	60	1
3NE1436-0	gS	690 / <sup>13)</sup>	100	630	293000	2350000	70	55	1
3NE1436-2	gR	690 / <sup>13)</sup>	100	630	203000	1390000	82	60	1
3NE1436-3	gR	690 / <sup>13)</sup>	100	630	203000	1390000	82	60	1
3NE1437-0	gS	690 / <sup>13)</sup>	100	710	437000	3400000	68	58	1
3NE1437-1	gR	600 / <sup>13)</sup>	100	710	321000	2460000	85	65	1
3NE1437-2	gR	690 / <sup>13)</sup>	100	710	265000	1818000	90	72	1
3NE1437-3	gR	690 / <sup>13)</sup>	100	710	265000	1818000	90	72	1
3NE3201-0MK	gR	1000 / 600	50 / 50	32	45	4500	32	9	On request
3NE3202-0MK	gR	1000 / 600	50 / 50	40	75	6000	35	13	On request
3NE3217-0MK	gR	1000 / 600	50 / 50	50	110	8000	45	18	On request

Article No.	Operational class	Rated voltage $U_n$	Rated breaking capacity $I_1$	Rated current $I_n^{(1)}$	Melting $I^2t$ value $I^2t_s$ ( $t_{vs} = 1 \text{ ms}$ )	Breaking $I^2t$ value $I^2t_a$ at $U_n$	Temperature rise at $I_n$ body center <sup>2)</sup>	Power dissipation at $I_n^{(2)}$	Varying load factor WL
		V AC / V DC	kA	A	A <sup>2</sup> s	A <sup>2</sup> s	K	W	
3NE3218-OMK	gR	1000 / 600	50 / 50	63	170	9000	62	25	On request
3NE3234-OMK08	aR	1000 / 600	50 / 50	500	46000	500000	100	105	On request
3NE3235-OMK08	aR	1000 / 600	50 / 50	550	68000	700000	107	110	On request
3NE3236-OMK08	aR	1000 / 600	50 / 50	630	90000	850.000	110	127	On request
3NE5302-OMK06	gR	1800 / 1100	30 / 45	40	45	900	45	26	On request
3NE5317-OMK06	gR	1800 / 1100	30 / 45	50	100	1800	45	27	On request
3NE5318-OMK06	gR	1800 / 1100	30 / 45	63	200	3100	55	34	On request
3NE5320-OMK06	aR	1800 / 1100	30 / 45	80	300	3900	58	42	On request
3NE5321-OMK06	aR	1800 / 1100	30 / 45	100	550	8700	58	45	On request
3NE5322-OMK06	aR	1800 / 1100	30 / 45	125	900	11800	68	59	On request
3NE5324-OMK06	aR	1800 / 1100	30 / 45	160	2500	37000	62	54	On request
3NE5325-OMK06	aR	1800 / 1100	30 / 45	200	6000	70000	62	56	On request
3NE5327-OMK06	aR	1800 / 1100	30 / 45	250	15000	165000	62	59	On request
3NE5330-OMK06	aR	1800 / 1100	30 / 45	315	28000	250000	66	76	On request
3NE5332-OMK06	aR	1500 / 1000	30 / 45	400	58000	470000	72	89	On request
3NE5334-OMK06	aR	1500 / 1000	30 / 45	500	110000	800000	81	109	On request
3NE5336-OMK06	aR	1500 / 1000	30 / 45	630	170000	1100000	88	163	On request
3NE5336-OMK66	aR	1500 / 1000	30 / 45	630	170000	1100000	85	163	On request
3NE8221-OMK	aR	690 / 440	100 / 50	100	540	3200	55	25	On request
3NE8222-OMK	aR	690 / 440	100 / 50	125	1000	6000	57	28	On request
3NE8224-OMK	aR	690 / 440	100 / 50	160	1800	10500	68	35	On request
3NE8225-OMK	aR	690 / 440	100 / 50	200	3000	17500	69	42	On request

## 7.1 LV HRC design

Article No.	Operational class	Rated voltage $U_n$	Rated breaking capacity $I_n$	Rated current $I_n^{(1)}$	Melting $I^2t$ value $I^2t_s$ ( $t_{vs} = 1 \text{ ms}$ )	Breaking $I^2t$ value $I^2t_a$ at $U_n$	Temperature rise at $I_n$ body center <sup>2)</sup>	Power dissipation at $I_n^{(2)}$	Varying load factor WL
		V AC / V DC	kA	A	A <sup>2</sup> s	A <sup>2</sup> s	K	W	
3NE8227-0MK	aR	690 / 440	100 / 50	250	5000	28500	77	53.5	On request
3NE8230-0MK	aR	690 / 440	100 / 50	315	19200	120000	65	68	On request
3NE8331-0MK	aR	690 / 440	100 / 50	350	17500	83500	55	68.6	On request
3NE8332-0MK	aR	690 / 440	100 / 50	400	27200	136000	60	72.8	On request
3NE8333-0MK	aR	690 / 440	100 / 50	450	38000	207000	58	80.1	On request
3NE8334-0MK	aR	690 / 440	100 / 50	500	59000	318000	58	77.5	On request
3NE8335-0MK	aR	690 / 440	100 / 50	550	76000	399000	65	86.4	On request
3NE8336-0MK	aR	690 / 440	100 / 50	630	122000	740000	67	90.7	On request
3NE8801-0MK	gR	690 / 440	100 / 50	32	40	350	53	10.5	On request
3NE8802-0MK	gR	690 / 440	100 / 50	40	50	480	53	12	On request
3NE8810-0MK	gR	690 / 440	100 / 50	6	1.5	37	17	2.7	On request
3NE8812-0MK	gR	690 / 440	100 / 50	10	4	50	30	4.5	On request
3NE8813-0MK	gR	690 / 440	100 / 50	16	8.5	73	38	6.7	On request
3NE8814-0MK	gR	690 / 440	100 / 50	20	15	90	45	8	On request
3NE8815-0MK	gR	690 / 440	100 / 50	25	25	150	40	8.1	On request
3NE8817-0MK	gR	690 / 440	100 / 50	50	65	1050	65	14.5	On request
3NE8818-0MK	gR	690 / 440	100 / 50	63	90	1960	74	23	On request
3NE8820-0MK	aR	690 / 440	100 / 50	80	450	2200	70	23.3	On request
3NE8821-0MK	aR	690 / 440	100 / 50	100	820	3650	73	27	On request
3NE8822-0MK	aR	690 / 440	100 / 50	125	1700	7800	60	30	On request
3NE8824-0MK	aR	500 / 440	100 / 50	160	3300	14000	70	34	On request
3NE9330-0MK07	aR	- / 3000	- / 45	315	65000	300000	95	245	On request
3NE1438-0	gS	690 / <sup>13)</sup>	100	800	723000	5000000	70	58	1

Article No.	Operational class	Rated voltage $U_n$	Rated breaking capacity $I_1$	Rated current $I_n^{(1)}$	Melting $I^2t$ value $I^2t_s$ ( $t_{vs} = 1 \text{ ms}$ )	Breaking $I^2t$ value $I^2t_a$ at $U_n$	Temperature rise at $I_n$ body center <sup>2)</sup>	Power dissipation at $I_n^{(2)}$	Varying load factor WL
		V AC / V DC	kA	A	A <sup>2</sup> s	A <sup>2</sup> s	K	W	
3NE1438-1	gR	600 / <sup>13)</sup>	100	800	437000	3350000	95	72	1
3NE1438-2	gR	690 / <sup>13)</sup>	100	800	361000	2475000	95	84	1
3NE1438-3	gR	690 / <sup>13)</sup>	100	800	361000	2475000	95	84	1
3NE1447-2	gR	690 / <sup>13)</sup>	100	670	240000	1640000	90	64	1
3NE1447-3	gR	690 / <sup>13)</sup>	100	670	240000	1640000	90	64	1
3NE1448-2	gR	690 / <sup>13)</sup>	100	850	520000	3640000	95	76	1
3NE1448-3	gR	690 / <sup>13)</sup>	100	850	520000	3640000	95	76	1
3NE1802-0	gS	690 / <sup>13)</sup>	100	40	295	3000	30	3	1
3NE1803-0	gS	690 / <sup>13)</sup>	100	35	166	1700	35	3.5	1
3NE1813-0	gS	690 / <sup>13)</sup>	100	16	18	200	25	4	1
3NE1814-0	gS	690 / <sup>13)</sup>	100	20	41	430	25	5	1
3NE1815-0	gS	690 / <sup>13)</sup>	100	25	74	780	30	5	1
3NE1817-0	gS	690 / <sup>13)</sup>	100	50	461	4400	35	6	1
3NE1818-0	gS	690 / <sup>13)</sup>	100	63	903	9000	40	7	1
3NE1820-0	gS	690 / <sup>13)</sup>	100	80	1843	18000	40	8	1
3NE3221	aR	1000 / <sup>13)</sup>	100	100	665	4800	65	28	0.95
3NE3222	aR	1000 / <sup>13)</sup>	100	125	1040	7200	70	36	0.95
3NE3224	aR	1000 / <sup>13)</sup>	100	160	1850	13000	90	42	1
3NE3225	aR	1000 / <sup>13)</sup>	100	200	4150	30000	80	42	1
3NE3227	aR	1000 / <sup>13)</sup>	100	250	6650	48000	90	50	1
3NE3230-0B	aR	1000 / <sup>13)</sup>	100	315	13400	80000	100	60	0.95
3NE3231	aR	1000 / <sup>13)</sup>	100	350	16600	100000	120	75	0.9
3NE3232-0B	aR	1000 / <sup>13)</sup>	100	400	22600	135000	140	85	0.9
3NE3233	aR	1000 / <sup>13)</sup>	100	450	29500	175000	130	95	0.9
3NE3332-0B	aR	1000 / <sup>13)</sup>	100	400	22600	135000	120	80	1
3NE3333	aR	1000 / <sup>13)</sup>	100	450	29500	175000	125	90	1
3NE3334-0B	aR	1000 / <sup>13)</sup>	100	500	46100	260000	115	90	1
3NE3335	aR	1000 / <sup>13)</sup>	100	560	66500	360000	120	95	1
3NE3336	aR	1000 / <sup>13)</sup>	100	630	104000	600000	110	100	1
3NE3337-8	aR	900 / <sup>13)</sup>	100	710	149000	800000	125	105	1
3NE3338-8	aR	800 / <sup>13)</sup>	100	800	184000	850000	140	130	0.95
3NE3340-8	aR	690 / <sup>13)</sup>	100	900	223000	920000	160	165	0.95
3NE3421-0C	aR	1000 / <sup>13)</sup>	50 <sup>14)</sup>	100	1800	13500	45	25	1
3NE3430-0C	aR	1000 / <sup>13)</sup>	50 <sup>14)</sup>	315	29000	218000	120	80	1
3NE3432-0C	aR	1000 / <sup>13)</sup>	50 <sup>14)</sup>	400	48500	364000	130	110	1
3NE3434-0C	aR	1000 / <sup>13)</sup>	50 <sup>14)</sup>	500	116000	870000	120	95	1
3NE3525-5 <sup>6)</sup>	aR	1000 / <sup>13)</sup>	50 <sup>14)</sup>	200 <sup>7)</sup>	7150	44000	75	50	0.85
3NE3535-5 <sup>6)</sup>	aR	1000 / <sup>13)</sup>	50 <sup>14)</sup>	450 <sup>7)</sup>	64500	395000	130	90	0.85
3NE3626-0C	aR	1000 / <sup>13)</sup>	50 <sup>14)</sup>	224	7200	54000	140	85	1

## 7.1 LV HRC design

Article No.	Operational class	Rated voltage $U_n$	Rated breaking capacity $I_n$	Rated current $I_n^{(1)}$	Melting $I^2t$ value $I^2t_s$ ( $t_{vs} = 1 \text{ ms}$ )	Breaking $I^2t$ value $I^2t_a$ at $U_n$	Temperature rise at $I_n$ body center <sup>2)</sup>	Power dissipation at $I_n^{(2)}$	Varying load factor WL
		V AC / V DC	kA	A	A <sup>2</sup> s	A <sup>2</sup> s	K	W	
3NE3635-0C	aR	1000 / <sup>13)</sup>	50 <sup>14)</sup>	450	65000	488000	150	110	1
3NE3635-6	aR	1000 / <sup>13)</sup>	50 <sup>14)</sup>	450	65000	488000	150	110	1
3NE3636-0C	aR	1000 / <sup>13)</sup>	50 <sup>14)</sup>	630	170000	1280000	136	132	1
3NE3637-0C	aR	1000 / <sup>13)</sup>	50 <sup>14)</sup>	710	260000	1950000	170	145	1
3NE3637-1C <sup>8)</sup>	aR	1000 / <sup>13)</sup>	50 <sup>14)</sup>	710	260000	1950000	170	145	1
3NE4101	gR	1000 / <sup>13)</sup>	100	32	40	280	45	12	0.9
3NE4102	gR	1000 / <sup>13)</sup>	100	40	75	500	50	13	0.9
3NE4117	gR	1000 / <sup>13)</sup>	100	50	120	800	65	16	0.9
3NE4117-5	gR	1000 / <sup>13)</sup>	50 <sup>14)</sup>	50	135	1100	95	20	0.85
3NE4118	aR	1000 / <sup>13)</sup>	100	63	230	1500	78	20	0.9
3NE4120	aR	1000 / <sup>13)</sup>	100	80	450	3000	82	22	0.9
3NE4121	aR	1000 / <sup>13)</sup>	100	100	900	6000	85	24	0.9
3NE4121-5	aR	1000 / <sup>13)</sup>	50 <sup>14)</sup>	100	900	7400	135	35	0.85
3NE4122	aR	1000 / <sup>13)</sup>	100	125	1800	14000	100	30	0.9
3NE4124	aR	1000 / <sup>13)</sup>	100	160	3600	29000	120	35	0.9
3NE4146-5	aR	800 / <sup>13)</sup>	50 <sup>14)</sup>	170	7370	60500	142	43	0.85
3NE4327-0B	aR	800 / <sup>13)</sup>	50 <sup>14)</sup>	250	3600	29700	175	105	0.85
3NE4327-6B <sup>6)</sup>	aR	800 / <sup>13)</sup>	50 <sup>14)</sup>	250	3600	29700	175	105	0.85
3NE4330-0B	aR	800 / <sup>13)</sup>	50 <sup>14)</sup>	315	7400	60700	170	120	0.85
3NE4330-6B <sup>6)</sup>	aR	800 / <sup>13)</sup>	50 <sup>14)</sup>	315	7400	60700	170	120	0.85
3NE4333-0B	aR	800 / <sup>13)</sup>	50 <sup>14)</sup>	450	29400	191000	190	140	0.85
3NE4333-6B <sup>6)</sup>	aR	800 / <sup>13)</sup>	50 <sup>14)</sup>	450	29400	191000	190	140	0.85
3NE4334-0B	aR	800 / <sup>13)</sup>	50 <sup>14)</sup>	500	42500	276000	195	155	0.85
3NE4334-6B <sup>6)</sup>	aR	800 / <sup>13)</sup>	50 <sup>14)</sup>	500	42500	276000	195	155	0.85
3NE4337	aR	800 / <sup>13)</sup>	50 <sup>14)</sup>	710	142000	923000	170	155	0.95
3NE4337-6 <sup>6)</sup>	aR	800 / <sup>13)</sup>	50 <sup>14)</sup>	710	142000	923000	170	155	0.95
3NE5424-0C	aR	1500 / <sup>13)</sup>	50 <sup>14)</sup>	160	7200	54000	75	56	1
3NE5426-0C	aR	1500 / <sup>13)</sup>	50 <sup>14)</sup>	224	18400	138000	100	80	1
3NE5430-0C	aR	1500 / <sup>13)</sup>	50 <sup>14)</sup>	315	41500	110000	125	115	1
3NE5431-0C	aR	1500 / <sup>13)</sup>	50 <sup>14)</sup>	350	57000	428000	150	135	1
3NE5433-0C	aR	1500 / <sup>13)</sup>	50 <sup>14)</sup>	450	116000	870000	150	145	0.95
3NE5433-1C <sup>11)</sup>	aR	1500 / <sup>13)</sup>	50 <sup>14)</sup>	450	116000	870000	150	145	0.95
3NE5627-0C	aR	1500 / <sup>13)</sup>	50 <sup>14)</sup>	250	11200	84000	170	130	1
3NE5633-0C	aR	1500 / <sup>13)</sup>	50 <sup>14)</sup>	450	78500	590000	170	160	1
3NE5643-0C	aR	1500 / <sup>13)</sup>	50 <sup>14)</sup>	600	260000	1950000	160	145	1
3NE6437	aR	900 / <sup>13)</sup>	50 <sup>14)</sup>	710 <sup>9)</sup>	100000	620000	80	150	0.9
3NE6437-7	aR	900 / <sup>13)</sup>	50 <sup>14)</sup>	710 <sup>10)</sup>	100000	620000	110	150	0.9
3NE6444	aR	900 / <sup>13)</sup>	50 <sup>14)</sup>	900 <sup>9)</sup>	400000	1920000	80	170	0.9
3NE7425-0U	aR	2000 / <sup>13)</sup>	100	200	18400	138000	85	75	1



Article No.	Operational class	Rated voltage $U_n$	Rated breaking capacity $I_1$	Rated current $I_n^{(1)}$	Melting $I^2t$ value $I^2t_s$ ( $t_{vs} = 1 \text{ ms}$ )	Breaking $I^2t$ value $I^2t_a$ at $U_n$	Temperature rise at $I_n$ body center <sup>2)</sup>	Power dissipation at $I_n^{(2)}$	Varying load factor WL
		V AC / V DC	kA	A	A <sup>2</sup> s	A <sup>2</sup> s	K	W	
3NE7427-0U	aR	2000 / <sup>13)</sup>	100	250	29000	218000	110	110	1
3NE7431-0U	aR	2000 / <sup>13)</sup>	100	350	74000	555000	105	120	1
3NE7432-0U	aR	2000 / <sup>13)</sup>	100	400	116000	870000	130	150	1
3NE7633-0U	aR	2000 / <sup>13)</sup>	100	450	128000	960000	165	160	1
3NE7633-1U <sup>11)</sup>	aR	2000 / <sup>13)</sup>	100	450	128000	960000	165	160	1
3NE7636-0U	aR	2000 / <sup>13)</sup>	100	630	260000	1950000	200	220	1
3NE7636-1U <sup>11)</sup>	aR	2000 / <sup>13)</sup>	100	630	260000	1950000	200	220	1
3NE7637-1U <sup>11)</sup>	aR	2000 / <sup>13)</sup>	100	710	415000	3110000	230	275	1
3NE7648-1U <sup>11)</sup>	aR	2000 / <sup>13)</sup>	100	525	149000	1120000	210	210	1
3NE8003-1	gR	690 / <sup>13)</sup>	100	35	70	400	45	9	0.95
3NE8015-1	gR	690 / <sup>13)</sup>	100	25	30	180	35	7	0.95
3NE8017-1	gR	690 / <sup>13)</sup>	100	50	120	700	65	14	0.9
3NE8018-1	gR	690 / <sup>13)</sup>	100	63	260	1400	70	16	0.95
3NE8020-1	aR	690 / <sup>13)</sup>	100	80	450	2400	80	19	0.95
3NE8021-1	aR	690 / <sup>13)</sup>	100	100	850	4200	90	22	0.95
3NE8022-1	aR	690 / <sup>13)</sup>	100	125	1400	6500	110	28	0.95
3NE8024-1	aR	690 / <sup>13)</sup>	100	160	2800	13000	130	38	0.95
3NE8701-1	gR	690 / 700 <sup>12)</sup>	50 <sup>14)</sup>	32	40	285	45	10	0.9
3NE8702-1	gR	690 / 700 <sup>12)</sup>	50 <sup>14)</sup>	40	69	490	55	12	0.9
3NE8714-1	gR	690 / 700 <sup>12)</sup>	50 <sup>14)</sup>	20	12	83	40	7	0.9
3NE8715-1	gR	690 / 700 <sup>12)</sup>	50 <sup>14)</sup>	25	19	140	40	9	0.9
3NE8717-1	gR	690 / 700 <sup>12)</sup>	50 <sup>14)</sup>	50	115	815	60	15	0.9
3NE8718-1	gR	690 / 700 <sup>12)</sup>	50 <sup>14)</sup>	63	215	1550	70	16	0.95
3NE8720-1	aR	690 / 700 <sup>12)</sup>	50 <sup>14)</sup>	80	380	2700	80	18	0.9
3NE8721-1	aR	690 / 700 <sup>12)</sup>	50 <sup>14)</sup>	100	695	4950	75	19	0.95
3NE8722-1	aR	690 / 700 <sup>12)</sup>	50 <sup>14)</sup>	125	1250	9100	80	23	0.95
3NE8724-1	aR	690 / 700 <sup>12)</sup>	50 <sup>14)</sup>	160	2350	17000	100	31	0.9
3NE8725-1	aR	690 / 700 <sup>12)</sup>	50 <sup>14)</sup>	200	4200	30000	120	36	0.9
3NE8727-1	aR	690 / 700 <sup>12)</sup>	50 <sup>14)</sup>	250	7750	55000	125	42	0.9
3NE8731-1	aR	690 / 700 <sup>12)</sup>	50 <sup>14)</sup>	315	12000	85500	150	54	0.85
3NE9440-6	gR	600 / <sup>13)</sup>	50 <sup>14)</sup>	850	400000	2480000	74	85	1
3NE9450	aR	600 / <sup>13)</sup>	50 <sup>14)</sup>	1250 <sup>9)</sup>	400000	2480000	80	210	0.9
3NE9450-7	aR	600 / <sup>13)</sup>	50 <sup>14)</sup>	1250 <sup>10)</sup>	400000	2480000	105	210	0.9
3NE9632-1C <sup>11)</sup>	aR	2500 / <sup>13)</sup>	50 <sup>14)</sup>	400	81000	620000	160	205	1

## 7.1 LV HRC design

Article No.	Operational class	Rated voltage $U_n$	Rated breaking capacity $I_n$	Rated current $I_n^{(1)}$	Melting $I^2t$ value $I^2t_s$ ( $t_{vs} = 1 \text{ ms}$ )	Breaking $I^2t$ value $I^2t_a$ at $U_n$	Temperature rise at $I_n$ body center <sup>2)</sup>	Power dissipation at $I_n$ <sup>2)</sup>	Varying load factor WL
		V AC / V DC	kA	A	A <sup>2</sup> s	A <sup>2</sup> s	K	W	
3NE9634-1C <sup>11)</sup>	aR	2500 / <sup>13)</sup>	50 <sup>14)</sup>	500	170000	1270000	180	235	1
3NE9636-1C <sup>11)</sup>	aR	2500 / <sup>13)</sup>	50 <sup>14)</sup>	630	385000	2800000	198	275	1

1) Reduction for increased ambient temperature, cyclical current load, use in fuse switch units

2) Temperature rise and power dissipation for operation in LV HRC fuse base

3) Cooling air speed 1 m/s, reduction of 5% for natural air cooling

4) Maximum tightening torque:

- M10 thread (with indicator): 40 Nm
- M10 capped thread: 50 Nm, screw insertion depth  $\geq 9 \text{ mm}$
- M24  $\times$  1.5 thread: 60 Nm

5) Temperature of water-cooled busbar max. +45 °C

6) Maximum tightening torque: M10 capped thread: 35 Nm, screw insertion depth  $\geq 9 \text{ mm}$

7) Cooling air speed 0.5 m/s, reduction of 5% for natural air cooling

8) Gauge 140 mm, M12 screw connection

9) Cooling air speed  $\geq 2 \text{ m/s}$

10) Bottom (cooled) connection max. +60 °C, top connection (M10) max. +110 °C

11) M12 screw terminal

12) Rated voltage according to UL

13) DC rated voltage: see chapter 10.13 "Use with direct current"

14) Minimum 50 kA, higher values on request

15)  $I^2t$  at UVSI 1500 V; at  $U_n$  1250 V  $k = 0.79$ . In the case of 3NB1234-3KK20,  $I^2t$  at UVSI 1400 V; at  $U_n$  900 V  $I^2t$  is 180000 A<sup>2</sup>s.

## See also

Use with direct current (Page 381)

## 7.1.2.1 Current carrying capacity of SITOR fuse links in 3NH LV HRC fuse bases

## Current carrying capacity of SITOR fuse links in 3NH LV HRC fuse bases

## Use in switch disconnectors and fuse bases

When using SITOR semiconductor fuses in 3KL and 3KM switch disconnectors with fuses and in 3NP fuse switch disconnectors and 3NH LV HRC fuse bases, the rated current of the fuse must sometimes be reduced due to the higher power loss compared to LV HRC fuses for line protection. Sometimes when using SITOR semiconductor fuses, the currents designated can be higher than the rated currents of the switches and fuse bases. These higher currents only apply when using SITOR semiconductor fuses and cannot be used when using the devices with standard LV HRC fuses. You will find further details in the following selection tables.

When using SITOR semiconductor fuses of the 3NC24, 3NC84, 3NE33 and 3NE43 series, the standard breaking capacity of the fuse must not be fully utilized due to the slotted blades of these fuses (in contrast to LV HRC fuses). Occasional switching of currents up to the rated current of the fuses is permissible.

The use of SITOR semiconductor fuses > 63 A for overload protection is not permitted – even if gR fuses are used (exception: 3NE1).

The operational voltage is limited by the rated voltage of the switch disconnecter or the fuse. If switching without load, the limit value is the rated insulation voltage of the switch disconnecter.

The 3NE1 "double protection fuses" can be used as full-range fuses (gS) both for semiconductor and line protection.

The assignment of SITOR semiconductor fuses to the fuse bases and fuse switch units is detailed in the following tables.

SITOR fuse links						$\varnothing_{\min}$ Cu	3NH LV HRC fuse bases			
Article No.	$I_n$ A	$U_n$ V AC	Oper- a- tional class	Size	WL	mm <sup>2</sup>	Article No.	Size	$I_{\max}$ A	$I_{WL}$
3NC2423-0C/3C	150	500	gR	3	0.85	70	3NH3430/20	3	150	128
3NC2425-0C/3C	200	500	gR	3	0.85	95		3	190	162
3NC2427-0C/3C	250	500	gR	3	0.85	120		3	240	204
3NC2428-0C/3C	300	500	gR	3	0.85	185		3	285	242
3NC2431-0C/3C	350	500	gR	3	0.85	240		3	330	281
3NC2432-0C/3C	400	500	aR	3	0.85	240		3	400	340
3NC3336-1U	630	1000	aR	3	0.85	2 x (40 x 5)	3NH3430/20	3	560	476
3NC3337-1U	710	1000	aR	3	0.85	2 x (50 x 5)		3	600	510
3NC3338-1U	800	1000	aR	3	0.85	2 x (40 x 8)		3	660	561
3NC3340-1U	900	1000	aR	3	0.9	2 x (40 x 8)		3	750	675
3NC3341-1U	1000	1000	aR	3	0.9	2 x (50 x 8)		3	850	765
3NC3342-1U	1100	800	aR	3	0.9	2 x (50 x 8)		3	900	810
3NC3343-1U	1250	800	aR	3	0.9	2 x (50 x 8)	3	950	855	
3NC3430-1U	315	1250	aR	3	0.95	2 x 95	3NH3430/20	3	310	295
3NC3432-1U	400	1250	aR	3	0.95	2 x 120		3	390	371
3NC3434-1U	500	1250	aR	3	0.9	2 x 150		3	460	414
3NC3436-1U	630	1250	aR	3	0.95	2 x (40 x 5)		3	560	532
3NC3438-1U	800	1100	aR	3	0.9	2 x (40 x 8)		3	690	656
3NC8423-0C/-3C	150	690	gR	3	0.85	70	3NH3430/20	3	135	115
3NC8425-0C/-3C	200	690	gR	3	0.85	95		3	180	153
3NC8427-0C/-3C	250	690	gR	3	0.85	120		3	250	213

SITOR fuse links						$\varnothing_{\min}$ Cu	3NH LV HRC fuse bases			
Article No.	$I_n$ A	$U_n$ V AC	Oper- a- tional class	Size	WL	mm <sup>2</sup>	Article No.	Size	$I_{\max}$ A	$I_{WL}$
3NC8431-0C/-3C	350	690	gR	3	0.85	240		3	315	268
3NC8434-0C/-3C	500	690	gR	3	0.85	2 x 150		3	450	383
3NC8444-3C	1000	600	aR	3	0.95	2 x (60 x 6)		3	800	800
3NE1020-2	80	690	gR	00	1	25	3NH3030/4030	0	80	80
3NE1021-0	100	690	gS	00	1	35		0	100	100
3NE1021-2	100	690	gR	00	1	35		0	100	100
3NE1022-0	125	690	gS	00	1	50		0	125	125
3NE1022-2	125	690	gR	00	1	50		0	125	125
3NE1224-0	160	690	gS	1	1	70		3NH3230/4230	1	160
3NE1224-2/-3	160	690	gR	1	1	70	1		160	160
3NE1225-0	200	690	gS	1	1	95	1		200	200
3NE1225-2/-3	200	690	gR	1	1	95	1		200	200
3NE1227-0	250	690	gS	1	1	120	1		250	250
3NE1227-2/-3	250	690	gR	1	1	120	1		250	250
3NE1230-0	315	690	gS	1	1	2 x 70	3NH3330/20	2	315	315
3NE1230-2/-3	315	690	gR	1	1	2 x 70		2	315	315
3NE1331-0	350	690	gS	2	1	2 x 95	3NH3330/20	2	350	350
3NE1331-2/-3	350	690	gR	2	1	2 x 95		2	350	350
3NE1332-0	400	690	gS	2	1	2 x 95		2	400	400
3NE1332-2/-3	400	690	gR	2	1	2 x 95		2	400	400
3NE1333-0	450	690	gS	2	1	2 x 120	3NH3430/20	3	450	450
3NE1333-2/-3	450	690	gR	2	1	2 x 120		3	450	450
3NE1334-0	500	690	gS	2	1	2 x 120		3	500	500
3NE1334-2/-3	500	690	gR	2	1	2 x 120		3	500	500
3NE1435-0	560	690	gS	3	1	2 x 150		3	560	560
3NE1435-2/-3	560	690	gR	3	1	2 x 150		3	560	560
3NE1436-0	630	690	gS	3	1	2 x 185		3	630	630
3NE1436-2/-3	630	690	gR	3	1	2 x 185		3	630	630
3NE1437-0	710	690	gS	3	1	2 x (40 x 5)	3NH3430/20	3	710	710
3NE1437-1	710	600	gR	3	1	2 x (40 x 5)		3	690	690
3NE1437-2/-3	710	690	gR	3	1	2 x (40 x 5)		3	710	710
3NE1438-0	800	690	gS	3	1	2 x (50 x 5)	3NH3430/20	3	800	800
3NE1438-1	800	600	gR	3	1	2 x (50 x 5)		3	750	750
3NE1438-2/-3	800	690	gR	3	1	2 x (50 x 5)		3	800	800
3NE1447-2/-3	670	690	gR	3	1	2 x (40 x 5)		3	670	670

SITOR fuse links						$\varnothing_{\min}$ Cu	3NH LV HRC fuse bases			
Article No.	I <sub>n</sub> A	U <sub>n</sub> V AC	Oper- a- tional class	Size	WL	mm <sup>2</sup>	Article No.	Size	I <sub>max</sub> A	I <sub>wL</sub>
3NE1448-2/-3	850	690	gR	3	1	2 x (40 x 8)		3	850	850
3NE1802-0	40	690	gS	000	1	10	3NH3030/4030	0	40	40
3NE1803-0	35	690	gS	000	1	6		0	35	35
3NE1813-0	16	690	gS	000	1	1.5		0	16	16
3NE1814-0	20	690	gS	000	1	2.5		0	20	20
3NE1815-0	25	690	gS	000	1	4		0	25	25
3NE1817-0	50	690	gS	000	1	10		0	50	50
3NE1818-0	63	690	gS	000	1	16		0	63	63
3NE1820-0	80	690	gS	000	1	25		0	80	80
3NE3221	100	1000	aR	1	0.95	35	3NH3230/4230	1	100	95
3NE3222	125	1000	aR	1	0.95	50		1	125	119
3NE3224	160	1000	aR	1	1	70		1	160	160
3NE3225	200	1000	aR	1	1	95		1	200	200
3NE3227	250	1000	aR	1	1	120		1	250	250
3NE3230-0B	315	1000	aR	1	0.95	185	3NH3330/20	2	305	290
3NE3231	350	1000	aR	1	0.95	240	3NH3330/20	2	335	318
3NE3232-0B	400	1000	aR	1	0.9	240		2	380	342
3NE3233	450	1000	aR	1	0.9	2 x 150		2	425	383
3NE3332-0B	400	1000	aR	2	1	240	3NH3430/20	3	400	400
3NE3333	450	1000	aR	2	1	2 x 150		3	450	450
3NE3334-0B	500	1000	aR	2	1	2 x 150		3	500	500
3NE3335	560	1000	aR	2	1	2 x 185		3	560	560
3NE3336	630	1000	aR	2	1	2 x 185		3	630	630
3NE3337-8	710	900	aR	2	1	2 x (40 x 5)		3	680	680
3NE3338-8	800	800	aR	2	0.95	2 x 240		3	700	665
3NE3340-8	900	690	aR	2	0.95	2 x (40 x 8)		3	750	713
3NE4101	32	1000	gR	0	0.9	6	3NH3120/4230	0/1	32	29
3NE4102	40	1000	gR	0	0.9	10		0/1	40	36
3NE4117	50	1000	gR	0	0.9	10		0/1	50	45
3NE4118	63	1000	aR	0	0.9	16		0/1	63	57
3NE4120	80	1000	aR	0	0.9	25		0/1	80	72
3NE4121	100	1000	aR	0	0.9	35		0/1	100	90
3NE4122	125	1000	aR	0	0.9	50		0/1	125	113
3NE4124	160	1000	aR	0	0.9	70		0/1	160	144
3NE4327-0B	250	800	aR	2	0.85	150	3NH3330/20	2	240	204
3NE4330-0B	315	800	aR	2	0.85	240		2	300	255
3NE4333-0B	450	800	aR	2	0.85	2 x (30 x 5)	3NH3430/20	3	425	361
3NE4334-0B	500	800	aR	2	0.85	2 x (30 x 5)		3	475	404

## 7.1 LV HRC design

SITOR fuse links						$\varnothing_{\min}$ Cu	3NH LV HRC fuse bases			
Article No.	$I_n$ A	$U_n$ V AC	Oper- a- tional class	Size	WL	mm <sup>2</sup>	Article No.	Size	$I_{\max}$ A	$I_{WL}$
3NE4337	710	800	aR	2	0.95	2 x (50 x 5)		3	630	599
3NE8015-1	25	690	gR	00	0.95	4	3NH3030/4030	0	25	24
3NE8003-1	35	690	gR	00	0.95	6		0	35	33
3NE8017-1	50	690	gR	00	0.9	10		0	50	45
3NE8018-1	63	690	gR	00	0.95	16		0	63	60
3NE8020-1	80	690	aR	00	0.95	25		0	80	76
3NE8021-1	100	690	aR	00	0.95	35	3NH3030/4030	0	100	95
3NE8022-1	125	690	aR	00	0.95	50		0	125	119
3NE8024-1	160	690	aR	00	0.95	70		0	160	152

$U_n$  = Rated voltage

Size = Size

$I_n$  = Rated current

WL = Varying load factor

$\varnothing_{\min}$  Cu = Required conductor cross-section Cu

$I_{\max}$  = Maximum permissible current

$I_{WL}$  = Maximum permissible current with varying load

### 7.1.2.2 Current carrying capacity of SITOR fuse links in 3NP LV HRC fuse bases

#### Derating values of 3NP1 fuse switch disconnectors when using SITOR fuses

The 3NP1 fuse switch disconnectors are suitable for all fuses in LV HRC design. SITOR semiconductor fuses in LV HRC design can also be used. Although it must be noted that, compared to cable and line protection fuses, these get much hotter during operation. For this reason, the fuse must be operated below the rated current  $I_n$  of the device (derating) when installed in a closed switching device.

The following tables show the permissible load currents of the SITOR semiconductor fuses for installation in 3NP1. The values were determined using the conductor cross-sections specified in the table.

---

#### Note

If using smaller cross-sections, a considerably higher derating is required due to the lower heat dissipation.

---

## 3NC

SITOR semiconductor fuse data						Permissible load currents <sup>3)</sup> of the fuse in 3NP1			
Type <sup>1)</sup>	Size	Rated current I <sub>n</sub>	Rated voltage <sup>2)</sup>	Operational class	Required conductor cross-section Cu	Type	Size	Floor mounting	Busbar mounting <sup>4)</sup>
		A	V AC		mm <sup>2</sup>			A	A
3NC23..	3	150	500	gR	70	3NP1163	3	140 / 119	150 / 128
3NC2425..	3	200	500	gR	95	3NP1163	3	175 / 149	190 / 162
3NC2427..	3	250	500	gR	120	3NP1163	3	220 / 187	237 / 201
3NC2428..	3	300	500	gR	185	3NP1163	3	250 / 213	285 / 242
3NC2431..	3	350	500	gR	240	3NP1163	3	320 / 272	332 / 282
3NC2432..	3	400	500	aR	240	3NP1163	3	370 / 315	380 / 323
3NC3336-1U	3	630	1000	aR	2 x (40 x 5)	3NP1163	3	500 / 425	500 / 425
3NC3430-1U	3	315	1250	aR	2 x 95	3NP1163	3	280 / 266	285 / 271
3NC3432-1U	3	400	1250	aR	2 x 120	3NP1163	3	340 / 323	340 / 323
3NC3434-1U	3	500	1250	aR	2 x 150	3NP1163	3	400 / 360	425 / 383
3NC3436-1U	3	630	1250	aR	2 x (40 x 5)	3NP1163	3	460 / 437	535 / 508
3NC8423..	3	150	660	gR	70	3NP1163	3	120 / 102	140 / 120
3NC8425..	3	200	660	gR	95	3NP1163	3	160 / 136	190 / 155
3NC8427..	3	250	660	gR	120	3NP1163	3	200 / 170	240 / 195
3NC8431..	3	350	660	gR	240	3NP1163	3	270 / 230	300 / 260
3NC8434..	3	500	660	gR	2 x 150	3NP1163	3	385 / 327	385 / 375

- 1) Due to the mechanical stress on the relatively long fuse blades, SITOR 3NE41 semiconductor fuses should only be switched occasionally and only at zero current.
- 2) 3NP1 fuse switch disconnectors may be operated at up to 1000 V AC/DC with the following restrictions: Degree of pollution 2 (instead of 3) / AC20 or DC20 – i.e. switching only without load
- 3) The second value applies for cyclical current load (varying load)
- 4) Values apply if used with 30 x 10 mm busbars; for size 00: 12 x 5 mm and top busbar connection – values for other configurations available on request.

## 3NE1..

SITOR semiconductor fuse data						Permissible load currents <sup>3)</sup> of the fuse in 3NP1					
Type <sup>1)</sup>	Size	Rated current I <sub>n</sub>	Rated voltage <sup>2)</sup>	Operational class	Required conductor cross-section Cu	Type	Size	Floor mounting	Type	Size	Busbar mounting <sup>4)</sup>
		A	V AC		mm <sup>2</sup>			A			A
3NE1020-2	00	80	690	gR	25	3NP1133	00	80 / 80	3NP1133	00	80 / 80
3NE1021-0	00	100	690	gS	35	3NP1133	00	100 / 100	3NP1133	00	100 / 100
3NE1021-2	00	100	690	gR	35	3NP1133	00	95 / 95	3NP1133	00	95 / 95

## 7.1 LV HRC design

SITOR semiconductor fuse data						Permissible load currents <sup>3)</sup> of the fuse in 3NP1					
Type <sup>1)</sup>	Size	Rated current I <sub>n</sub>	Rated voltage <sup>2)</sup>	Operational class	Required conductor cross-section Cu	Type	Size	Floor mounting	Type	Size	Busbar mounting <sup>4)</sup>
		A	V AC		mm <sup>2</sup>			A			A
3NE1022-0	00	125	690	gS	50	3NP1133	00	120 / 120	3NP1133	00	120 / 120
3NE1022-2	00	125	690	gR	50	3NP1133	00	115 / 115	3NP1133	00	115 / 115
3NE1224-0	1	160	690	gS	70	3NP1143 3NP1153	1 2	160 / 160 160 / 160	3NP1143 3NP1153	1 2	160 / 160 160 / 160
3NE1224-2/3	1	160	690	gR	70	3NP1143 3NP1153	1 2	150 / 150 160 / 160	3NP1143 3NP1153	1 2	152 / 160 160 / 160
3NE1225-0	1	200	690	gS	95	3NP1143 3NP1153	1 2	190 / 190 200 / 200	3NP1143 3NP1153	1 2	200 / 200 200 / 200
3NE1225-2/3	1	200	690	gR	95	3NP1143 3NP1153	1 2	180 / 180 190 / 190	3NP1143 3NP1153	1 2	180 / 180 190 / 190
3NE1227-0	1	250	690	gS	120	3NP1143 3NP1153	1 2	235 / 235 250 / 250	3NP1143 3NP1153	1 2	238 / 238 250 / 250
3NE1227-2/3	1	250	690	gR	120	3NP1143 3NP1153	1 2	220 / 220 235 / 235	3NP1143 3NP1153	1 2	213 / 213 235 / 235
3NE1230-0	1	315	690	gS	2 x 70	3NP1153	2	290 / 290	3NP1153	2	315 / 315
3NE1230-2/3	1	315	690	gR	2 x 70	3NP1153	2	278 / 278	3NP1153	2	315 / 315
3NE1331-0	2	350	690	gS	2 x 95	3NP1153 3NP1163	2 3	315 / 315 340 / 340	3NP1153 3NP1163	2 3	350 / 350 350 / 350
3NE1331-2/3	2	350	690	gR	2 x 95	3NP1153 3NP1163	2 3	300 / 300 330 / 330	3NP1153 3NP1163	2 3	330 / 330 350 / 350
3NE1332-0	2	400	690	gS	2 x 95	3NP1153	2	340 / 340	3NP1153	2	380 / 380
3NE1332-2/3	2	400	690	gR	2 x 95	3NP1153 3NP1163	2 3	328 / 328 370 / 370	3NP1153 3NP1163	2 3	360 / 360 400 / 400
3NE1333-0	2	450	690	gS	2 x 120	3NP1163	3	450 / 450	3NP1163	3	430 / 430
3NE1333-2/3	2	450	690	gR	2 x 120	3NP1163	3	430 / 430	3NP1163	3	420 / 420
3NE1334-0	2	500	690	gS	2 x 120	3NP1163	3	500 / 500	3NP1163	3	450 / 450
3NE1334-2/3	2	500	690	gR	2 x 120	3NP1163	3	475 / 475	3NP1163	3	450 / 450
3NE1435-0	3	560	690	gS	2 x 150	3NP1163	3	560 / 560	3NP1163	3	520 / 520
3NE1435-2/3	3	560	690	gR	2 x 150	3NP1163	3	555 / 555	3NP1163	3	510 / 510
3NE1436-0	3	630	690	gS	2 x 185	3NP1163	3	630 / 630	3NP1163	3	585 / 585



SITOR semiconductor fuse data						Permissible load currents <sup>3)</sup> of the fuse in 3NP1					
Type <sup>1)</sup>	Size	Rated current I <sub>n</sub>	Rated voltage <sup>2)</sup>	Operational class	Required conductor cross-section Cu	Type	Size	Floor mounting	Type	Size	Busbar mounting <sup>4)</sup>
		A	V AC		mm <sup>2</sup>			A			A
3NE1436-2/3	3	630	690	gR	2 x 185	3NP1163	3	620 / 620	3NP1163	3	570 / 570
3NE1437-0	3	710	690	gS	2 x (40 x 5)	--	--	--	3NP1163	3	605 / 605
3NE1437-1	3	710	600	gR	2 x (40 x 5)	--	--	--	3NP1163	3	590 / 590
3NE1437-2/3	3	710	690	gR	2 x (40 x 5)	--	--	--	3NP1163	3	580 / 580
3NE1438-0	3	800	690	gS	2 x (50 x 5)	--	--	--	3NP1163	3	630 / 630
3NE1438-1	3	800	600	gR	2 x (50 x 5)	--	--	--	3NP1163	3	610 / 610
3NE1438-2/3	3	800	690	gR	2 x (50 x 5)	--	--	--	3NP1163	3	600 / 600
3NE1447-2/3	3	670	690	gR	2 x (40 x 5)	--	--	--	3NP1163	3	575 / 575
3NE1448-2/3	3	850	690	gR	2 x (40 x 8)	--	--	--	3NP1163	3	630 / 630
3NE1802-0	000	40	690	gS	10	3NP1123 3NP1133	000	40 / 40 40 / 40	3NP1123 3NP1133	000	40 / 40 40 / 40
3NE1803-0	000	35	690	gS	6	3NP1123 3NP1133	000	35 / 35 35 / 35	3NP1123 3NP1133	000	35 / 35 35 / 35
3NE1813-0	000	16	690	gS	1.5	3NP1123 3NP1133	000	16 / 16 16 / 16	3NP1123 3NP1133	000	16 / 16 16 / 16
3NE1814-0	000	20	690	gS	2.5	3NP1123 3NP1133	000	20 / 20 20 / 20	3NP1123 3NP1133	000	20 / 20 20 / 20
3NE1815-0	000	25	690	gS	4	3NP1123 3NP1133	000	25 / 25 25 / 25	3NP1123 3NP1133	000	25 / 25 25 / 25
3NE1817-0	000	50	690	gS	10	3NP1123 3NP1133	000	50 / 50 50 / 50	3NP1123 3NP1133	000	50 / 50 50 / 50

## 7.1 LV HRC design

SITOR semiconductor fuse data						Permissible load currents <sup>3)</sup> of the fuse in 3NP1					
Type <sup>1)</sup>	Size	Rated current I <sub>n</sub>	Rated voltage <sup>2)</sup>	Operational class	Required conductor cross-section Cu	Type	Size	Floor mounting	Type	Size	Busbar mounting <sup>4)</sup>
		A	V AC		mm <sup>2</sup>			A			A
3NE1818-0	000	63	690	gS	16	3NP1123 3NP1133	000 000	63 / 63 63 / 63	3NP1123 3NP1133	000 000	63 / 63 63 / 63
3NE1820-0	000	80	690	gS	25	3NP1123 3NP1133	000 000	80 / 80 80 / 80	3NP1123 3NP1133	000 000	80 / 80 80 / 80

1) Due to the mechanical stress on the relatively long fuse blades, SITOR 3NE41 semiconductor fuses should only be switched occasionally and only at zero current.

2) 3NP1 fuse switch disconnectors may be operated at up to 1000 V AC/DC with the following restrictions: Degree of pollution 2 (instead of 3) / AC20 or DC20 – i.e. switching only without load

3) The second value applies for cyclical current load (varying load)

4) Values apply if used with 30 x 10 mm busbars; for size 00: 12 x 5 mm and top busbar connection – values for other configurations available on request.

## 3NE3..

SITOR semiconductor fuse data						Permissible load currents <sup>3)</sup> of the fuse in 3NP1					
Type <sup>1)</sup>	Size	Rated current I <sub>n</sub>	Rated voltage <sup>2)</sup>	Operational class	Required conductor cross-section Cu	Type	Size	Floor mounting	Type	Size	Busbar mounting <sup>4)</sup>
		A	V AC		mm <sup>2</sup>			A			A
3NE3221	1	100	1000	aR	35	3NP1143 3NP1153	1 2	88 / 84 95 / 90	3NP1143 3NP1153	1 2	95 / 90 100 / 95
3NE3222	1	125	1000	aR	50	3NP1143 3NP1153	1 2	102 / 97 110 / 105	3NP1143 3NP1153	1 2	113 / 107 125 / 119
3NE3224	1	160	1000	aR	70	3NP1143 3NP1153	1 2	130 / 130 140 / 140	3NP1143 3NP1153	1 2	140 / 140 150 / 150
3NE3225	1	200	1000	aR	95	3NP1143 3NP1153	1 2	163 / 163 175 / 175	3NP1143 3NP1153	1 2	170 / 170 180 / 180
3NE3227	1	250	1000	aR	120	3NP1143 3NP1153	1 2	195 / 195 210 / 210	3NP1143 3NP1153	1 2	200 / 200 215 / 215
3NE3230-OB	1	315	1000	aR	185	3NP1153	2	270 / 257	3NP1153	2	265 / 252
3NE3231	1	350	1000	aR	240	3NP1153	2	290 / 276	3NP1153	2	280 / 266
3NE3232-OB	1	400	1000	aR	240	3NP1153	2	320 / 288	3NP1153	2	310 / 279
3NE3233	1	450	1000	aR	2 x 150	3NP1153	2	360 / 324	3NP1153	2	330 / 297
3NE3332-OB	2	400	1000	aR	240	3NP1153 3NP1163	2 3	330 / 330 360 / 360	3NP1163 --	3 --	360 / 360 --

SITOR semiconductor fuse data						Permissible load currents <sup>3)</sup> of the fuse in 3NP1					
Type <sup>1)</sup>	Size	Rated current I <sub>n</sub>	Rated voltage <sup>2)</sup>	Operational class	Required conductor cross-section Cu	Type	Size	Floor mounting	Type	Size	Busbar mounting <sup>4)</sup>
		A	V AC		mm <sup>2</sup>			A			A
3NE3333	2	450	1000	aR	2 x 150	3NP1163	3	375 / 375	3NP1163	3	390 / 390
3NE3334-OB	2	500	1000	aR	2 x 150	3NP1163	3	420 / 420	3NP1163	3	415 / 415
3NE3335	2	560	1000	aR	2 x 185	3NP1163	3	475 / 475	3NP1163	3	460 / 460
3NE3336	2	630	1000	aR	2 x 185	3NP1163	3	540 / 540	3NP1163	3	500 / 500
3NE3337-8	2	710	900	aR	2 x (40 x 5)	3NP1163	3	580 / 580	3NP1163	3	500 / 500
3NE3338-8	2	800	800	aR	2 x 240	3NP1163	3	605 / 575	3NP1163	3	500 / 475
3NE3340-8	2	900	690	aR	2 x (40 x 8)	3NP1163	3	630 / 599	3NP1163	3	500 / 475

- 1) Due to the mechanical stress on the relatively long fuse blades, SITOR 3NE41 semiconductor fuses should only be switched occasionally and only at zero current.
- 2) 3NP1 fuse switch disconnectors may be operated at up to 1000 V AC/DC with the following restrictions: Degree of pollution 2 (instead of 3) / AC20 or DC20 – i.e. switching only without load
- 3) The second value applies for cyclical current load (varying load)
- 4) Values apply if used with 30 x 10 mm busbars; for size 00: 12 x 5 mm and top busbar connection – values for other configurations available on request.

### 3NE4..

SITOR semiconductor fuse data						Permissible load currents <sup>3)</sup> of the fuse in 3NP1					
Type <sup>1)</sup>	Size	Rated current I <sub>n</sub>	Rated voltage <sup>2)</sup>	Operational class	Required conductor cross-section Cu	Type	Size	Floor mounting	Type	Size	Busbar mounting <sup>4)</sup>
		A	V AC		mm <sup>2</sup>			A			A
3NE4101	0	32	1000	gR	6	3NP1143	1	30 / 27	3NP1143	1	32 / 29
3NE4102	0	40	1000	gR	10	3NP1143	1	35 / 32	3NP1143	1	40 / 36
3NE4117	0	50	1000	gR	10	3NP1143	1	42 / 38	3NP1143	1	50 / 45
3NE4118	0	63	1000	aR	16	3NP1143	1	55 / 50	3NP1143	1	60 / 54
3NE4120	0	80	1000	aR	25	3NP1143	1	71 / 64	3NP1143	1	76 / 68
3NE4121	0	100	1000	aR	35	3NP1143	1	84 / 76	3NP1143	1	93 / 84
3NE4122	0	125	1000	aR	50	3NP1143	1	107 / 96	3NP1143	1	115 / 104
3NE4124	0	160	1000	aR	70	3NP1143	1	134 / 121	3NP1143	1	144 / 130
3NE4327-OB	2	250	800	aR	150	3NP1153	2	195 / 166	3NP1153	2	220 / --
						3NP1163	3	215 / 183	3NP1163	3	220 / 187
3NE4330-OB	2	315	800	aR	240	3NP1153	2	240 / 204	3NP1163	3	255 / 217
						3NP1163	3	270 / 230	--	--	--

SITOR semiconductor fuse data						Permissible load currents <sup>3)</sup> of the fuse in 3NP1					
Type <sup>1)</sup>	Size	Rated current I <sub>n</sub>	Rated voltage <sup>2)</sup>	Operational class	Required conductor cross-section Cu	Type	Size	Floor mounting	Type	Size	Busbar mounting <sup>4)</sup>
		A	V AC		mm <sup>2</sup>			A			A
3NE4333-OB	2	450	800	aR	2 x (30 x 5)	3NP1163	3	370 / 315	3NP1163	3	355 / 302
3NE4334-OB	2	500	800	aR	2 x (30 x 5)	3NP1163	3	410 / 349	3NP1163	3	390 / 332
3NE4337	2	710	800	aR	2 x (50 x 5)	3NP1163	3	540 / 513	3NP1163	3	500 / 475

<sup>1)</sup> Due to the mechanical stress on the relatively long fuse blades, SITOR 3NE41 semiconductor fuses should only be switched occasionally and only at zero current.

<sup>2)</sup> 3NP1 fuse switch disconnectors may be operated at up to 1000 V AC/DC with the following restrictions: Degree of pollution 2 (instead of 3) / AC20 or DC20 – i.e. switching only without load

<sup>3)</sup> The second value applies for cyclical current load (varying load)

<sup>4)</sup> Values apply if used with 30 x 10 mm busbars; for size 00: 12 x 5 mm and top busbar connection – values for other configurations available on request.

### 3NE8..

SITOR semiconductor fuse data						Permissible load currents <sup>3)</sup> of the fuse in 3NP1				
Type <sup>1)</sup>	Size	Rated current I <sub>n</sub>	Rated voltage <sup>2)</sup>	Operational class	Required conductor cross-section Cu	Type	Size	Floor mounting	Busbar mounting <sup>4)</sup>	
		A	V AC		mm <sup>2</sup>			A	A	
3NE8015-1	00	25	690	gR	4	3NP1133	00	25 / 24	25 / 24	
3NE8003-1	00	35	690	gR	6	3NP1133	00	32 / 30	35 / 33	
3NE8017-1	00	50	690	gR	10	3NP1133	00	43 / 39	50 / 45	
3NE8018-1	00	63	690	gR	16	3NP1133	00	52 / 49	60 / 57	
3NE8020-1	00	80	690	aR	25	3NP1133	00	65 / 62	72 / 68	
3NE8021-1	00	100	690	aR	35	3NP1133	00	85 / 81	85 / 81	
3NE8022-1	00	125	690	aR	50	3NP1133	00	100 / 95	100 / 95	
3NE8024-1	00	160	690	aR	70	3NP1133	00	120 / 114	115 / 109	

<sup>1)</sup> Due to the mechanical stress on the relatively long fuse blades, SITOR 3NE41 semiconductor fuses should only be switched occasionally and only at zero current.

<sup>2)</sup> 3NP1 fuse switch disconnectors may be operated at up to 1000 V AC/DC with the following restrictions: Degree of pollution 2 (instead of 3) / AC20 or DC20 – i.e. switching only without load

<sup>3)</sup> The second value applies for cyclical current load (varying load)

<sup>4)</sup> Values apply if used with 30 x 10 mm busbars; for size 00: 12 x 5 mm and top busbar connection – values for other configurations available on request.

### 3NC (derating values)

3NP5 fuse switch disconnectors are suitable for all fuses in LV HRC design.

SITOR semiconductor fuses in LV HRC design can also be used. Although it must be noted that, compared to cable and line protection fuses, these get much hotter during operation. For this reason, the fuse must be operated below the rated current  $I_n$  of the device (derating) when installed in a closed switching device.

The following table shows the permissible load currents of the SITOR semiconductor fuses for installation in 3NP5. The values were determined using the conductor cross-sections specified in the table.

#### Note

If using smaller cross-sections, a considerably higher derating is required due to the lower heat dissipation.

SITOR semiconductor fuse data						Permissible load currents of fuse when installed in 3NP5 for floor mounting					
Type <sup>1)</sup>	Size	Rated current $I_n$	Rated voltage <sup>2)</sup>	Operational class	Required conductor cross-section Cu	Type 3NP5			Alternative type 3NP5		
						Type	Size	Perm. load current <sup>3)</sup>	Alternative type	Size	Perm. load current <sup>3)</sup>
		A	V AC		mm <sup>2</sup>						
3NC242 3	3	250	500	gR	70	3NP54	3	145 / 125	--	--	--
3NC242 5..	3	200	500	gR	95	3NP54	3	180 / 165	--	--	--
3NC242 7..	3	250	500	gR	120	3NP54	3	225 / 205	--	--	--
3NC242 8..	3	300	500	gR	185	3NP54	3	255 / 240	--	--	--
3NC243 1..	3	350	500	gR	240	3NP54	3	330 / 295	--	--	--
3NC243 2..	3	400	500	aR	240	3NP54	3	400 / 380	--	--	--
3NC333 6-1U	3	630	1000	aR	2 x (40 x 5)	3NP54	3	530 / 451	--	--	--
3NC333 7-1U	3	710	1000	aR	2 x (50 x 5)	3NP54	3	570 / 485	--	--	--
3NC333 8-1U	3	800	1000	aR	2 x (40 x 8)	3NP54	3	630 / 536	--	--	--
3NC334 0-1U	3	900	1000	aR	2 x (40 x 8)	3NP54	3	700 <sup>4)</sup> / 630	--	--	--
3NC334 1-1U	3	100	1000	aR	2 x (50 x 8)	3NP54	3	770 <sup>4)</sup> / 693	--	--	--

SITOR semiconductor fuse data						Permissible load currents of fuse when installed in 3NP5 for floor mounting					
Type <sup>1)</sup>	Size	Rated current I <sub>n</sub>	Rated voltage <sup>2)</sup>	Operational class	Required conductor cross-section Cu	Type 3NP5			Alternative type 3NP5		
						Type	Size	Perm. load current <sup>3)</sup>	Alternative type	Size	Perm. load current <sup>3)</sup>
		A	V AC		mm <sup>2</sup>						
3NC334 2-1U	3	110	800	aR	2 x (50 x 8)	3NP54	3	800 <sup>4)</sup> / 720	--	--	--
3NC334 3-1U	3	1250	800	aR	2 x (50 x 8)	3NP54	3	850 <sup>4)</sup> / 755	--	--	--
3NC343 0-1U	3	315	1250	aR	2 x 95	3NP54	3	295 / 280	--	--	--
3NC343 2-1U	3	400	1250	aR	2 x 120	3NP54	3	355 / 337	--	--	--
3NC343 4-1U	3	500	1250	aR	2 x 150	3NP54	3	440 / 396	--	--	--
3NC343 6-1U	3	630	1250	aR	2 x (40 x 5)	3NP54	3	520 / 494	--	--	--
3NC343 8-1U	3	800	1100	aR	2 x (40 x 8)	3NP54	3	625 / 594	--	--	--
3NC842 3..	3	150	660	gR	70	3NP54	3	135 / 125	--	--	--
3NC842 5..	3	200	660	gR	95	3NP54	3	180 / 165	--	--	--
3NC842 7..	3	250	660	gR	120	3NP54	3	225 / 205	--	--	--
3NC843 1..	3	350	660	gR	240	3NP54	3	300 / 275	--	--	--
3NC843 4..	3	500	660	gR	2 x 150	3NP54	3	425 / 400	--	--	--
3NC844 4-3C	3	1000	600	aR	2 x (69 x 6)	3NP54	3	850 <sup>4)</sup> / 760	--	--	--

<sup>1)</sup> Due to the mechanical stress on the relatively long fuse blades, SITOR 3NE41 semiconductor fuses should only be switched occasionally and only at zero current.

<sup>2)</sup> 3NP1 fuse switch disconnectors may be operated at up to 1000 V AC/DC with the following restrictions: Degree of pollution 2 (instead of 3) / AC20 or DC20 – i.e. switching only without load

<sup>3)</sup> The second value applies for cyclical current load (varying load)

<sup>4)</sup> The fuse can also be operated at a higher rated uninterrupted current than the 630 A current of the 3NP54. However, in this case, the 3NP54 must not be switched under load (utilization category AC-20).

## 3NE1 (derating values)

SITOR semiconductor fuse data						Permissible load currents of fuse when installed in 3NP5 for floor mounting					
Type <sup>1)</sup>	Size	Rated current I <sub>n</sub>	Rated voltage <sup>2)</sup>	Operational class	Required conductor cross-section Cu	Type 3NP5			Alternative type 3NP5		
						Type	Size	Perm. load current <sup>3)</sup>	Alternative type	Size	Perm. load current <sup>3)</sup>
		A	V AC		mm <sup>2</sup>						
3NE1020-2	00	80	690	gR	25	3NP50	00	80 / 80	--	--	--
3NE1021-0	00	100	690	gS	35	3NP50	00	100 / 100	--	--	--
3NE1021-2	00	100	690	gR	35	3NP50	00	100 / 100	--	--	--
3NE1022-0	00	125	690	gS	50	3NP50	00	125 / 125	--	--	--
3NE1022-2	00	125	690	gR	50	3NP50	00	125 / 125	--	--	--
3NE1224-0	1	160	690	gS	70	3NP52	1	160 / 160	3NP53	2	160 / 160
3NE1224-2/3	1	160	690	gR	70	3NP52	1	160 / 160	3NP53	2	160 / 160
3NE1225-0	1	200	690	gS	95	3NP52	1	200 / 200	3NP53	2	200 / 200
3NE1225-2	1	200	690	gR	95	3NP52	1	200 / 200	3NP53	2	200 / 200
3NE1225-3	1	200	690	gR	95	3NP52	1	190 / 190	3NP53	2	200 / 200
3NE1227-0	1	250	690	gS	120	3NP52	1	250 / 250	3NP53	2	250 / 250
3NE1227-2	1	250	690	gR	120	3NP52	1	250 / 250	3NP53	2	250 / 250
3NE1227-3	1	250	690	gR	120	3NP52	1	235 / 235	3NP53	2	250 / 250
3NE1230-0	1	315	690	gS	2 x 70	3NP53	2	315 / 315	--	--	--
3NE1230-2/3	1	315	690	gR	2 x 70	3NP53	2	315 / 315	--	--	--
3NE1331-0	2	350	690	gS	2 x 95	3NP53	2	350 / 350	3NP54	3	350 / 350
3NE1331-2/3	2	350	690	gR	2 x 95	3NP53	2	350 / 350	3NP54	3	350 / 350
3NE1332-0	2	400	690	gS	2 x 95	3NP53	2	400 / 400	3NP54	3	400 / 400
3NE1332-2/3	2	400	690	gR	2 x 95	3NP53	2	400 / 400	3NP54	3	400 / 400
3NE1333-0	2	450	690	gS	2 x 120	3NP54	3	450 / 450	--	--	--
3NE1333-2/3	2	450	690	gR	2 x 120	3NP54	3	450 / 450	--	--	--
3NE1334-0	2	500	690	gS	2 x 120	3NP54	3	500 / 500	--	--	--
3NE1334-2/3	2	500	690	gR	2 x 120	3NP54	3	500 / 500	--	--	--
3NE1435-0	3	560	690	gS	2 x 150	3NP54	3	560 / 560	--	--	--
3NE1435-2/3	3	560	690	gR	2 x 150	3NP54	3	560 / 560	--	--	--
3NE1436-0	3	630	690	gS	2 x 185	3NP54	3	630 / 630	--	--	--
3NE1436-2/3	3	630	690	gR	2 x 185	3NP54	3	625 / 625	--	--	--
3NE1437-0	3	710	690	gS	2 x (40 x 5)	3NP54	3	710 <sup>4)</sup> / 710	--	--	--
3NE1437-1	3	710	600	gR	2 x (4 x 5)	3NP54	3	690 <sup>4)</sup> / 690	-	--	--
3NE1437-2/3	3	710	690	gR	2 x (40 x 5)	3NP54	3	685 <sup>4)</sup> / 685	-	--	--
3NE1438-0	3	800	690	gS	2 x (50 x 5)	3NP54	3	800 <sup>4)</sup> / 800	--	--	--
3NE1438-1	3	800	600	gR	2 x (50 x 5)	3NP54	3	750 <sup>4)</sup> / 750	--	--	--
3NE1438-2/3	3	800	690	gR	2 x (50 x 5)	3NP54	3	770 <sup>4)</sup> / 770	--	--	--
3NE1447-2/3	3	670	690	gR	2 x (40 x 5)	3NP54	3	655 <sup>4)</sup> / 655	--	--	--
3NE1448-2/3	3	850	690	gR	2 x (40 x 8)	3NP54	3	820 <sup>4)</sup> / 820	--	--	--

## 7.1 LV HRC design

SITOR semiconductor fuse data						Permissible load currents of fuse when installed in 3NP5 for floor mounting					
						Type 3NP5			Alternative type 3NP5		
Type <sup>1)</sup>	Size	Rated current I <sub>n</sub>	Rated voltage <sup>2)</sup>	Operational class	Required conductor cross-section Cu	Type	Size	Perm. load current <sup>3)</sup>	Alternative type	Size	Perm. load current <sup>3)</sup>
		A	V AC		mm <sup>2</sup>						
3NE1802-0	000	40	690	gS	10	3NP50	00	40 / 40	--	--	--
3NE1803-0	000	35	690	gS	6	3NP50	00	35 / 35	--	--	--
3NE1813-0	000	16	690	gS	1.5	3NP50	00	16 / 16	--	--	--
3NE1814-0	000	20	690	gS	2.5	3NP50	00	20 / 20	--	--	--
3NE1815-0	000	25	690	gS	4	3NP50	00	25 / 25	--	--	--
3NE1817-0	000	50	690	gS	10	3NP50	00	50 / 50	--	--	--
3NE1818-0	000	63	690	gS	16	3NP50	00	63 / 63	--	--	--
3NE1820-0	000	80	690	gS	25	3NP50	00	80 / 80	--	--	--

<sup>1)</sup> Due to the mechanical stress on the relatively long fuse blades, SITOR 3NE41 semiconductor fuses should only be switched occasionally and only at zero current.

<sup>2)</sup> 3NP1 fuse switch disconnectors may be operated at up to 1000 V AC/DC with the following restrictions: Degree of pollution 2 (instead of 3) / AC20 or DC20 – i.e. switching only without load

<sup>3)</sup> The second value applies for cyclical current load (varying load)

<sup>4)</sup> The fuse can also be operated at a higher rated uninterrupted current than the 630 A current of the 3NP54. However, in this case, the 3NP54 must not be switched under load (utilization category AC-20).

## 3NE3 (derating values)

SITOR semiconductor fuse data						Permissible load currents of fuse when installed in 3NP5 for floor mounting					
						Type 3NP5			Alternative type 3NP5		
Type <sup>1)</sup>	Size	Rated current I <sub>n</sub>	Rated voltage <sup>2)</sup>	Operational class	Required conductor cross-section Cu	Type	Size	Perm. load current <sup>3)</sup>	Alternative type	Size	Perm. load current <sup>3)</sup>
		A	V AC		mm <sup>2</sup>						
3NE3221	1	100	1000	aR	35	3NP52	1	95 / 90	3NP53	2	100 / 95
3NE3222	1	125	1000	aR	50	3NP52	1	110 / 110	3NP53	2	120 / 114
3NE3224	1	160	1000	aR	70	3NP52	1	140 / 140	3NP53	2	150 / 150
3NE3225	1	200	1000	aR	95	3NP52	1	175 / 175	3NP53	2	190 / 190
3NE3227	1	250	1000	aR	120	3NP52	1	210 / 210	3NP53	2	230 / 230
3NE3230-0B	1	315	1000	aR	185	3NP53	2	285 / 280	--	--	--
3NE3231	1	350	1000	aR	240	3NP53	2	310 / 300	--	--	--
3NE3232-0B	1	400	1000	aR	240	3NP53	2	330 / 320	--	--	--
3NE3233	1	450	1000	aR	2 x 150	3NP53	2	360 / 340	--	--	--
3NE3332-0B	2	400	1000	aR	240	3NP54	3	360 / 345	--	--	--



SITOR semiconductor fuse data						Permissible load currents of fuse when installed in 3NP5 for floor mounting					
						Type 3NP5			Alternative type 3NP5		
Type <sup>1)</sup>	Size	Rated current I <sub>n</sub>	Rated voltage <sup>2)</sup>	Operational class	Required conductor cross-section Cu	Type	Size	Perm. load current <sup>3)</sup>	Alternative type	Size	Perm. load current <sup>3)</sup>
		A	V AC		mm <sup>2</sup>						
3NE3333	2	450	1000	aR	2 x 150	3NP54	3	400 / 385	--	--	--
3NE3334-0B	2	500	1000	aR	2 x 150	3NP54	3	450 / 450	--	--	--
3NE3335	2	560	1000	aR	2 x 185	3NP54	3	510 / 510	--	--	--
3NE3336	2	630	1000	aR	2 x 185	3NP54	3	580 / 580	--	--	--
3NE3337-8	2	710	900	aR	2 x (40 x 5)	3NP54	3	630 / 630	--	--	--
3NE3338-8	2	800	800	aR	2 x 240	3NP54	3	630 / 630	--	--	--
3NE3340-8	2	900	690	aR	2 x (40 x 8)	3NP54	3	630 / 630	--	--	--

- 1) Due to the mechanical stress on the relatively long fuse blades, SITOR 3NE41 semiconductor fuses should only be switched occasionally and only at zero current.
- 2) 3NP1 fuse switch disconnectors may be operated at up to 1000 V AC/DC with the following restrictions: Degree of pollution 2 (instead of 3) / AC20 or DC20 – i.e. switching only without load
- 3) The second value applies for cyclical current load (varying load)
- 4) The fuse can also be operated at a higher rated uninterrupted current than the 630 A current of the 3NP54. However, in this case, the 3NP54 must not be switched under load (utilization category AC-20).

### 3NE4 (derating values)

SITOR semiconductor fuse data						Permissible load currents of fuse when installed in 3NP5 for floor mounting					
						Type 3NP5			Alternative type 3NP5		
Type <sup>1)</sup>	Size	Rated current I <sub>n</sub>	Rated voltage <sup>2)</sup>	Operational class	Required conductor cross-section Cu	Type	Size	Perm. load current <sup>3)</sup>	Alternative type	Size	Perm. load current <sup>3)</sup>
		A	V AC		mm <sup>2</sup>						
3NE4101	0	32	1000	gR	6	3NP52	1	32 / 29	--	--	--
3NE4102	0	40	1000	gR	10	3NP52	1	40 / 36	--	--	--
3NE4117	0	50	1000	gR	10	3NP52	1	50 / 45	--	--	--
3NE4118	0	63	1000	aR	16	3NP52	1	63 / 57	--	--	--
3NE4120	0	80	1000	aR	25	3NP52	1	80 / 72	--	--	--
3NE4121	0	100	1000	aR	35	3NP52	1	95 / 86	--	--	--
3NE4122	0	125	1000	aR	50	3NP52	1	120 / 108	--	--	--
3NE4124	0	160	1000	aR	70	3NP52	1	150 / 135	--	--	--
3NE4327-0B	2	250	800	aR	150	3NP53	2	210 / 205	3NP54	3	220 / 210
3NE4330-0B	2	315	800	aR	240	3NP53	2	270 / 255	3NP54	3	285 / 265
3NE4333-0B	2	450	800	aR	2 x (30 x 5)	3NP53	2	400 / 370	3NP54	3	420 / 380

SITOR semiconductor fuse data						Permissible load currents of fuse when installed in 3NP5 for floor mounting					
						Type 3NP5			Alternative type 3NP5		
Type <sup>1)</sup>	Size	Rated current I <sub>n</sub>	Rated voltage <sup>2)</sup>	Operational class	Required conductor cross-section Cu	Type	Size	Perm. load current <sup>3)</sup>	Alternative type	Size	Perm. load current <sup>3)</sup>
		A	V AC		mm <sup>2</sup>						
3NE4334-0B	2	500	800	aR	2 x (30 x 5)	--	--	--	3NP54	3	450 / 400
3NE4337	2	710	800	aR	2 x (50 x 5)	--	--	--	3NP54	3	600 / 570

<sup>1)</sup> Due to the mechanical stress on the relatively long fuse blades, SITOR 3NE41 semiconductor fuses should only be switched occasionally and only at zero current.

<sup>2)</sup> 3NP1 fuse switch disconnectors may be operated at up to 1000 V AC/DC with the following restrictions: Degree of pollution 2 (instead of 3) / AC20 or DC20 – i.e. switching only without load

<sup>3)</sup> The second value applies for cyclical current load (varying load)

<sup>4)</sup> The fuse can also be operated at a higher rated uninterrupted current than the 630 A current of the 3NP54. However, in this case, the 3NP54 must not be switched under load (utilization category AC-20).

### 3NE8 (derating values)

SITOR semiconductor fuse data						Permissible load currents of fuse when installed in 3NP5 for floor mounting					
						Type 3NP5			Alternative type 3NP5		
Type <sup>1)</sup>	Size	Rated current I <sub>n</sub>	Rated voltage <sup>2)</sup>	Operational class	Required conductor cross-section Cu	Type	Size	Perm. load current <sup>3)</sup>	Alternative type	Size	Perm. load current <sup>3)</sup>
		A	V AC		mm <sup>2</sup>						
3NE8015-1	00	25	690	gR	4	3NP50	00	25 / 24	--	--	--
3NE8003-1	00	35	690	gR	6	3NP50	00	33 / 31	--	--	--
3NE8017-1	00	50	690	gR	10	3NP50	00	45 / 41	--	--	--
3NE8018-1	00	63	690	gR	16	3NP50	00	54 / 51	--	--	--
3NE8020-1	00	80	690	aR	25	3NP50	00	68 / 65	--	--	--
3NE8021-1	00	100	690	aR	35	3NP50	00	89 / 85	--	--	--
3NE8022-1	00	125	690	aR	50	3NP50	00	106 / 101	--	--	--
3NE8024-1	00	160	690	aR	70	3NP50	00	130 / 124	--	--	--

<sup>1)</sup> Due to the mechanical stress on the relatively long fuse blades, SITOR 3NE41 semiconductor fuses should only be switched occasionally and only at zero current.

<sup>2)</sup> 3NP1 fuse switch disconnectors may be operated at up to 1000 V AC/DC with the following restrictions: Degree of pollution 2 (instead of 3) / AC20 or DC20 – i.e. switching only without load

<sup>3)</sup> The second value applies for cyclical current load (varying load)

<sup>4)</sup> The fuse can also be operated at a higher rated uninterrupted current than the 630 A current of the 3NP54. However, in this case, the 3NP54 must not be switched under load (utilization category AC-20).

### 7.1.2.3 Current carrying capacity of SITOR fuse links in 3KF switch disconnectors with fuses

#### Derating values of 3KF switch disconnectors with fuses when using SITOR fuses according to IEC constraints

The 3KF switch disconnectors with fuses are suitable for all fuses in LV HRC design. When using fuses for semiconductor protection (SITOR) in LV HRC design, it must be noted that they have a higher power loss and can become considerably hotter during operation than fuses for cable protection. For this reason, the fuse must be operated below the rated current  $I_n$  of the device (derating) when installed in a closed switching device.

The 3KF SITOR series is optimized for high heat dissipation and can usually be loaded with higher current values when fuses for semiconductor protection are used.

The following table shows the permissible load currents of the SITOR semiconductor fuses for installation in 3KF LV HRC and 3KF SITOR according to IEC constraints. The specified values apply to a 3KF mounted in accordance with the test conditions of IEC 60947-1 (open installation, length of the incoming and outgoing cables 1 m) installed vertically and with insulated cables, cross section corresponding to the rated operational current of the 3KF switch disconnector (acc. to Table 9 and 10 of the IEC 60947-1).

Further derating is necessary if a combination of 3KF and SITOR fuses is used under different conditions that impair heat dissipation.

#### Derating table for use of SITOR fuses IEC from 32 to 160 A

SITOR semiconductor fuse data						Permissible load currents of fuse when installed in									
						Type 3KF LV HRC					Type 3KF SITOR				
Type	Size	Rated current $I_n$	Rated voltage	Operational class	Power loss $P_v$	32	63	80	125	160	32	63	80	125	160
		A	V AC		mm <sup>2</sup>	A	A	A	A	A	A	A	A	A	A
3NE1802-0	000	40	690	gS	3	32.0	40.0	40.0	40.0	40.0	32.0	40.0	40.0	40.0	40.0
3NE1803-0	000	35	690	gS	3.5	32.0	35.0	35.0	35.0	35.0	32.0	35.0	35.0	35.0	35.0
3NE1813-0	000	16	690	gS	4	16.0	16.0	16.0	16.0	16.0	16.0	16.0	16.0	16.0	16.0
3NE1814-0	000	20	690	gS	5	20.0	20.0	20.0	20.0	20.0	20.0	20.0	20.0	20.0	20.0
3NE1815-0	000	25	690	gS	5	25.0	25.0	25.0	25.0	25.0	25.0	25.0	25.0	25.0	25.0
3NE1817-0	000	50	690	gS	6	32.0	50.0	50.0	50.0	50.0	32.0	50.0	50.0	50.0	50.0
3NE1818-0	000	63	690	gS	7	32.0	63.0	63.0	63.0	63.0	32.0	63.0	63.0	63.0	63.0
3NE1820-0	000	80	690	gS	8	32.0	63.0	80.0	80.0	80.0	32.0	63.0	80.0	80.0	80.0
3NE1020-2	00	80	690	gR	10	32.0	63.0	76.0	80.0	80.0	32.0	63.0	80.0	80.0	80.0
3NE1021-0	00	100	690	gS	10	32.0	63.0	80.0	100.0	100.0	32.0	63.0	80.0	100.0	100.0
3NE1021-2	00	100	690	gR	12	32.0	63.0	80.0	96.0	100.0	32.0	63.0	80.0	100.0	100.0

## 7.1 LV HRC design

SITOR semiconductor fuse data						Permissible load currents of fuse when installed in									
						Type 3KF LV HRC					Type 3KF SITOR				
Type	Size	Rated current I <sub>n</sub>	Rated voltage	Operational class	Power loss P <sub>v</sub>	32	63	80	125	160	32	63	80	125	160
		A	V AC		mm <sup>2</sup>	A	A	A	A	A	A	A	A	A	A
3NE1022-0	00	125	690	gS	11	32.0	63.0	80.0	125.0	125.0	32.0	63.0	80.0	125.0	125.0
3NE1022-2	00	125	690	gR	13	32.0	63.0	80.0	118.8	120.0	32.0	63.0	80.0	125.0	125.0
3NE8015-1	00	25	690	gR	7	24.0	25.0	25.0	25.0	25.0	25.0	25.0	25.0	25.0	25.0
3NE8003-1	00	35	690	gR	9	32.0	34.0	34.0	35.0	35.0	32.0	35.0	35.0	35.0	35.0
3NE8017-1	00	50	690	gR	14	32.0	40.0	42.5	46.0	47.5	32.0	50.0	50.0	50.0	50.0
3NE8018-1	00	63	690	gR	16	32.0	48.5	50.4	55.4	57.3	32.0	60.0	60.0	63.0	63.0
3NE8020-1	00	80	690	aR	19	32.0	57.6	60.8	66.4	68.8	32.0	63.0	68.0	80.0	80.0
3NE8021-1	00	100	690	aR	22	32.0	60.0	60.0	79.0	82.0	32.0	63.0	68.0	100.0	100.0
3NE8022-1	00	125	690	aR	28	32.0	63.0	70.0	90.0	92.5	32.0	63.0	75.0	125.0	125.0
3NE8024-1	00	160	690	aR	38	---	63.0	80.0	100.8	104.0	32.0	63.0	80.0	125.0	140.0

## Derating table for use of SITOR fuses IEC from 250 to 800 A

SITOR semiconductor fuse data						Permissible load currents of fuse when installed in							
						Type 3KF LV HRC				Alternative type 3KF SITOR			
Type	Size	Rated current I <sub>n</sub>	Rated voltage	Operational class	Power loss P <sub>v</sub>	250	400	630	800	250	400	630	800
		A	V AC		W	A	A	A	A	A	A	A	A
3NE4101	0	32	1000	gR	12	32.0	---	---	---	32.0	---	---	---
3NE4102	0	40	1000	gR	13	40.0	---	---	---	40.0	---	---	---
3NE4117	0	50	1000	gR	16	50.0	---	---	---	50.0	---	---	---
3NE4118	0	63	1000	aR	20	63.0	---	---	---	63.0	---	---	---
3NE4120	0	80	1000	aR	22	80.0	---	---	---	80.0	---	---	---
3NE4121	0	100	1000	aR	24	100.0	---	---	---	100.0	---	---	---
3NE4122	0	125	1000	aR	30	118.8	---	---	---	125.0	---	---	---

SITOR semiconductor fuse data						Permissible load currents of fuse when installed in							
						Type 3KF LV HRC				Alternative type 3KF SITOR			
Type	Size	Rated current $I_n$	Rated voltage	Operational class	Power loss $P_v$	250	400	630	800	250	400	630	800
		A	V AC		W	A	A	A	A	A	A	A	A
3NE4124	0	160	1000	aR	35	144.0	---	---	---	160.0	---	---	---
3NE1224-0	1	160	690	gS	24	160.0	160.0	---	---	160.0	160.0	---	---
3NE1224-2/-3	1	160	690	gR	32	148.8	160.0	---	---	160.0	160.0	---	---
3NE1225-0	1	200	690	gS	27	194.0	200.0	---	---	200.0	200.0	---	---
3NE1225-2/-3	1	200	690	gR	35	180.0	196.0	---	---	200.0	200.0	---	---
3NE1227-0	1	250	690	gS	30	237.5	250.0	---	---	250.0	250.0	---	---
3NE1227-2/-3	1	250	690	gR	37	220.0	240.0	---	---	240.0	250.0	---	---
3NE1230-0	1	315	690	gS	38	250.0	299.3	---	---	250.0	315.0	---	---
3NE1230-2/-3	1	315	690	gR	40	250.0	290.4	---	---	250.0	315.0	---	---
3NE3221	1	100	1000	aR	28	96.0	100.0	---	---	100.0	100.0	---	---
3NE3222	1	125	1000	aR	36	111.3	121.3	---	---	125.0	125.0	---	---
3NE3224	1	160	1000	aR	42	136.0	148.8	---	---	160.0	160.0	---	---
3NE3225	1	200	1000	aR	42	170.0	186.0	---	---	190.0	200.0	---	---
3NE3227	1	250	1000	aR	50	197.5	220.0	---	---	210.0	250.0	---	---
3NE3230-0B	1	315	1000	aR	60	185.0	261.5	---	---	225.0	315.0	---	---
3NE3231	1	350	1000	aR	75	190.0	266.0	---	---	220.0	350.0	---	---
3NE3232-0B	1	400	1000	aR	85	200.0	292.0	---	---	235.0	370.0	---	---
3NE3233	1	450	1000	aR	95	250.0	306.0	---	---	250.0	385.0	---	---
3NE1331-0	2	350	690	gS	42	---	325.5	350.0	350.0	---	350.0	350.0	350.0
3NE1331-2/-3	2	350	690	gR	43	---	322.0	350.0	350.0	---	350.0	350.0	350.0
3NE1332-0	2	400	690	gS	45	---	364.0	400.0	400.0	---	400.0	400.0	400.0
3NE1332-2/-3	2	400	690	gR	50	---	352.0	392.0	400.0	---	400.0	400.0	400.0
3NE1333-0	2	450	690	gS	53	---	387.0	432.0	450.0	---	400.0	450.0	450.0

## 7.1 LV HRC design

SITOR semiconductor fuse data						Permissible load currents of fuse when installed in							
						Type 3KF LV HRC				Alternative type 3KF SITOR			
Type	Size	Rated current I <sub>n</sub>	Rated voltage	Operational class	Power loss P <sub>v</sub>	250	400	630	800	250	400	630	800
		A	V AC		W	A	A	A	A	A	A	A	A
3NE133 3-2/-3	2	450	690	gR	58	---	351.0	423.0	450.0	---	400.0	450.0	450.0
3NE133 4-0	2	500	690	gS	56	---	400.0	475.0	500.0	---	400.0	500.0	500.0
3NE133 4-2/-3	2	500	690	gR	64	---	400.0	455.0	485.0	---	400.0	500.0	500.0
3NE333 2-0B	2	400	1000	aR	80	---	296.0	340.0	364.0	---	385.0	400.0	400.0
3NE333 3	2	450	1000	aR	90	---	315.0	360.0	391.5	---	350.0	450.0	450.0
3NE333 4-0B	2	500	1000	aR	90	---	350.0	400.0	435.0	---	375.0	500.0	500.0
3NE333 5	2	560	1000	aR	95	---	380.8	442.4	418.6	---	400.0	560.0	560.0
3NE333 6	2	630	1000	aR	100	---	400.0	485.1	535.5	---	400.0	630.0	630.0
3NE333 7-8	2	710	900	aR	105	---	400.0	539.6	589.3	---	400.0	630.0	710.0
3NE333 8-8	2	800	800	aR	130	---	400.0	552.0	616.0	---	400.0	630.0	720.0
3NE334 0-8	2	900	690	aR	165	---	---	558.0	621.0	---	400.0	630.0	760.0
3NE432 7-0B	2	250	800	aR	105	---	162.5	190.0	207.5	---	200.0	250.0	250.0
3NE433 0-0B	2	315	800	aR	120	---	192.2	230.0	248.9	---	285.0	315.0	315.0
3NE433 3-0B	2	450	800	aR	140	---	256.5	297.0	333.0	---	285.0	370.0	370.0
3NE433 4-0B	2	500	800	aR	155	---	265.0	320.0	360.0	---	300.0	450.0	450.0
3NE433 7	2	710	800	aR	155	---	376.3	454.4	511.2	---	400.0	630.0	630.0
3NC242 3-0C/3C	3	150	500	gR	35	---	---	150.0	150.0	---	---	150.0	150.0
3NC242 5-0C/3C	3	200	500	gR	40	---	---	200.0	200.0	---	---	200.0	200.0
3NC242 7-0C/3C	3	250	500	gR	50	---	---	245.0	250.0	---	---	250.0	250.0
3NC242 8-0C/3C	3	300	500	gR	65	---	---	270.0	288.0	---	---	300.0	300.0
3NC243 1-0C/3C	3	350	500	gR	60	---	---	325.5	350.0	---	---	350.0	350.0
3NC243 2-0C/3C	3	400	500	aR	50	---	---	392.0	400.0	---	---	400.0	400.0
3NC333 6-1U	3	630	1000	aR	145	---	---	409.5	466.2	---	---	570.0	570.0

SITOR semiconductor fuse data						Permissible load currents of fuse when installed in							
						Type 3KF LV HRC				Alternative type 3KF SITOR			
Type	Size	Rated current I <sub>n</sub>	Rated voltage	Operational class	Power loss P <sub>v</sub>	250	400	630	800	250	400	630	800
		A	V AC		W	A	A	A	A	A	A	A	A
3NC333 7-1U	3	710	1000	aR	150	---	---	461.5	518.3	---	---	630.0	630.0
3NC333 8-1U	3	800	1000	aR	155	---	---	512.0	576.0	---	---	630.0	700.0
3NC334 0-1U	3	900	1000	aR	165	---	---	558.0	621.0	---	---	630.0	750.0
3NC334 1-1U	3	1000	1000	aR	170	---	---	600.0	680.0	---	---	630.0	780.0
3NC334 2-1U	3	1100	800	aR	185	---	---	630.0	715.0	---	---	630.0	800.0
3NC334 3-1U	3	1250	800	aR	210	---	---	630.0	725.0	---	---	630.0	800.0
3NC343 0-1U	3	315	1250	aR	80	---	---	267.8	286.7	---	---	315.0	315.0
3NC343 2-1U	3	400	1250	aR	95	---	---	316.0	344.0	---	---	400.0	400.0
3NC343 4-1U	3	500	1250	aR	115	---	---	370.0	400.0	---	---	450.0	450.0
3NC343 6-1U	3	630	1250	aR	120	---	---	459.9	497.7	---	---	530.0	30.0
3NC343 8-1U	3	800	1100	aR	145	---	---	520.0	592.0	---	---	630.0	715.0
3NC842 3-0C/-3C	3	150	690	gR	40	---	---	150.0	150.0	---	---	150.0	150.0
3NC842 5-0C/-3C	3	200	690	gR	55	---	---	190.0	200.0	---	---	200.0	200.0
3NC842 7-0C/-3C	3	250	690	gR	72	---	---	217.5	235.0	---	---	250.0	250.0
3NC843 1-0C/-3C	3	350	690	gR	95	---	---	276.5	301.0	---	---	350.0	350.0
3NC843 4-0C/-3C	3	500	690	gR	130	---	---	345.0	380.0	---	---	450.0	450.0
3NC844 4-3C	3	1000	600	aR	140	---	---	630.0	740.0	---	---	630.0	800.0
3NE143 5-0	3	560	690	gS	50	---	---	548.8	560.0	---	---	560.0	560.0
3NE143 5-2/-3	3	560	690	gR	60	---	---	520.8	560.0	---	---	560.0	560.0
3NC143 6-0	3	630	690	gS	55	---	---	598.5	630.0	---	---	630.0	630.0
3NC143 6-2/-3	3	630	690	gR	60	---	---	585.9	630.0	---	---	630.0	630.0
3NE143 7-0	3	710	690	gS	58	---	---	630.0	710.0	---	---	630.0	710.0
3NE143 7-1	3	710	600	gR	65	---	---	630.0	681.6	---	---	630.0	710.0

SITOR semiconductor fuse data						Permissible load currents of fuse when installed in							
						Type 3KF LV HRC				Alternative type 3KF SITOR			
Type	Size	Rated current I <sub>n</sub>	Rated voltage	Operational class	Power loss P <sub>v</sub>	250	400	630	800	250	400	630	800
		A	V AC		W	A	A	A	A	A	A	A	A
3NE143 7-2/-3	3	710	690	gR	72	---	---	617.7	667.4	---	---	630.0	710.0
3NE143 8-0	3	800	690	gS	58	---	---	630.0	800.0	---	---	630.0	800.0
3NE143 8-1	3	800	600	gR	72	---	---	630.0	752.0	---	---	630.0	800.0
3NE143 8-2/-3	3	800	690	gR	84	---	---	630.0	712.0	---	---	630.0	800.0
3NE144 7-2/-3	3	670	690	gR	64	---	---	609.7	649.9	---	---	630.0	670.0
3NE144 8-2/-3	3	850	690	gR	76	---	---	630.0	782.0	---	---	630.0	850.0

### Derating values when using SITOR fuses according to UL constraints

The following table shows the permissible load currents of SITOR semiconductor fuses for installation in 3KF SITOR according to UL constraints. The specified values apply to a 3KF mounted in accordance with the test conditions of UL 508 / UL 60947-4-1 (installation in an enclosure) and with connected insulated cables, cross section corresponding to the rated operational current of the 3KF switch disconnecter. The specified values apply to use in enclosures that are larger or equal in size to the specified enclosures.

Further derating is necessary if a combination of 3KF and SITOR fuses is used under different conditions that impair heat dissipation.

### Derating table for use of SITOR fuses UL from 32 to 160 A

Minimum housing sizes:

- 3KF 32 A: 278 x 500 x 196 mm
- 3KF 63 A: 278 x 500 x 196 mm
- 3KF 80 A: 278 x 500 x 196 mm
- 3KF 125 A: 459 x 500 x 242 mm
- 3KF 160 A: 459 x 500 x 242 mm



SITOR semiconductor fuse data						Permissible load currents of fuse when installed in type 3KF SITOR				
Type	Size	Rated current I <sub>n</sub>	Rated voltage	Operational class	Power loss P <sub>v</sub>	32	63	80	125	160
		A	V AC		W	A	A	A	A	A
3NE180 2-0	000	40	690	gS	3	32.0	40.0	40.0	40.0	40.0
3NE180 3-0	000	35	690	gS	3.5	32.0	35.0	35.0	35.0	35.0
3NE181 3-0	000	16	690	gS	4	16.0	16.0	16.0	16.0	16.0
3NE181 4-0	000	20	690	gS	5	20.0	20.0	20.0	20.0	20.0
3NE181 5-0	000	25	690	gS	5	25.0	25.0	25.0	25.0	25.0
3NE181 7-0	000	50	690	gS	6	32.0	50.0	50.0	50.0	50.0
3NE181 8-0	000	63	690	gS	7	32.0	60.0	60.0	63.0	63.0
3NE182 0-0	000	80	690	gS	8	32.0	60.0	60.0	80.0	80.0
3NE102 0-2	00	80	690	gR	10	32.0	60.0	60.0	80.0	80.0
3NE102 1-0	00	100	690	gS	10	32.0	60.0	60.0	100.0	100.0
3NE102 1-2	00	100	690	gR	12	32.0	60.0	60.0	100.0	100.0
3NE102 2-0	00	125	690	gS	11	32.0	60.0	60.0	125.0	125.0
3NE102 2-2	00	125	690	gR	13	32.0	60.0	60.0	120.0	120.0
3NE801 5-1	00	25	690	gR	7	25.0	25.0	25.0	25.0	25.0
3NE800 3-1	00	35	690	gR	9	29.0	29.0	29.0	35.0	35.0
3NE801 7-1	00	50	690	gR	14	32.0	35.0	35.0	50.0	50.0
3NE801 8-1	00	63	690	gR	16	32.0	45.0	45.0	60.0	60.0
3NE802 0-1	00	80	690	aR	19	32.0	50.0	50.0	63.0	63.0
3NE802 1-1	00	100	690	aR	22	32.0	60.0	60.0	90.0	90.0
3NE802 2-1	00	125	690	aR	28	32.0	60.0	60.0	100.0	100.0
3NE802 4-1	00	160	690	aR	38	32.0	60.0	60.0	110.0	110.0

## Derating table for use of SITOR fuses UL from 250 to 800 A

Minimum housing sizes:

- 3KF 250 A - 506 x 600 x 283 mm
- 3KF 400 A - 581 x 600 x 309 mm
- 3KF 630 A - 746 x 700 x 396 mm
- 3KF 800 A - 746 x 700 x 396 mm

SITOR semiconductor fuse data						Permissible load currents of fuse when installed in type 3KF SITOR			
Type	Size	Rated current $I_n$	Rated voltage	Operational class	Power loss $P_v$	250	400	630	800
		A	V AC		W	A	A	A	A
3NE410 1	0	32	1000	gR	12	32.0	--	--	--
3NE410 2	0	40	1000	gR	13	40.0	--	--	--
3NE411 7	0	50	1000	gR	16	50.0	--	--	--
3NE411 8	0	63	1000	aR	20	63.0	--	--	--
3NE412 0	0	80	1000	aR	22	80.0	--	--	--
3NE412 1	0	100	1000	aR	24	100.0	--	--	--
3NE412 2	0	125	1000	aR	30	110.0	--	--	--
3NE412 4	0	160	1000	aR	35	130.0	--	--	-
3NE122 4-0	1	160	690	gS	24	140.0	160.0	--	--
3NE122 4-2/-3	1	160	690	gR	32	125.0	160.0	--	--
3NE122 5-0	1	200	690	gS	27	170.0	200.0	--	--
3NE122 5-2/-3	1	200	690	gR	35	160.0	200.0	--	--
3NE122 7-0	1	250	690	gS	30	205.0	250.0	--	--
3NE122 7-2/-3	1	250	690	gR	37	190.0	250.0	--	--
3NE123 0-0	1	315	690	gS	38	205.0	280.0	--	--
3NE123 0-2/-3	1	315	690	gR	40	205.0	275.0	--	--
3NE322 1	1	100	1000	aR	28	90.0	100.0	--	--

SITOR semiconductor fuse data						Permissible load currents of fuse when installed in type 3KF SITOR			
Type	Size	Rated current I <sub>n</sub>	Rated voltage	Operational class	Power loss P <sub>v</sub>	250	400	630	800
		A	V AC		W	A	A	A	A
3NE322 2	1	125	1000	aR	36	95.0	125.0	--	--
3NE322 4	1	160	1000	aR	42	115.0	160.0	--	--
3NE322 5	1	200	1000	aR	42	140.0	200.0	--	--
3NE322 7	1	250	1000	aR	50	165.0	200.0	--	--
3NE323 0-0B	1	315	1000	aR	60	190.0	225.0	--	--
3NE323 1	1	350	1000	aR	75	195.0	220.0	--	--
3NE323 2-0B	1	400	1000	aR	85	205.0	230.0	--	--
3NE323 3	1	450	1000	aR	95	205.0	250.0	--	--
3NE133 1-0	2	350	690	gS	42	--	315.0	350.0	350.0
3NE133 1-2/-3	2	350	690	gR	43	--	300.0	350.0	350.0
3NE133 2-0	2	400	690	gS	45	--	320.0	400.0	400.0
3NE133 2-2/-3	2	400	690	gR	50	--	310.0	400.0	400.0
3NE133 3-0	2	450	690	gS	53	--	320.0	450.0	450.0
3NE133 3-2/-3	2	450	690	gR	58	--	320.0	440.0	440.0
3NE133 4-0	2	500	690	gS	56	--	320.0	500.0	500.0
3NE133 4-2/-3	2	500	690	gR	64	--	320.0	470.0	470.0
3NE333 2-0B	2	400	1000	aR	80	--	260.0	350.0	350.0
3NE333 3	2	450	1000	aR	90	--	285.0	380.0	380.0
3NE333 4-0B	2	500	1000	aR	90	--	300.0	415.0	415.0
3NE333 5	2	560	1000	aR	95	--	320.0	440.0	440.0
3NE333 6	2	630	1000	aR	100	--	320.0	480.0	480.0
3NE333 7-8	2	710	900	aR	105	--	320.0	515.0	515.0
3NE333 8-8	2	800	800	aR	130	--	320.0	500.0	500.0

## 7.1 LV HRC design

SITOR semiconductor fuse data						Permissible load currents of fuse when installed in type 3KF SITOR			
Type	Size	Rated current I <sub>n</sub>	Rated voltage	Operational class	Power loss P <sub>v</sub>	250	400	630	800
		A	V AC		W	A	A	A	A
3NE334 0-8	2	900	690	aR	165	--	347.0	520.0	520.0
3NE432 7-0B	2	250	800	aR	105	--	160.0	205.0	205.0
3NE433 0-0B	2	315	800	aR	120	--	205.0	240.0	240.0
3NE433 3-0B	2	450	800	aR	140	--	225.0	310.0	310.0
3NE433 4-0B	2	500	800	aR	155	--	240.0	320.0	320.0
3NE433 7	2	710	800	aR	155	--	320.0	440.0	440.0
3NC242 3-0C/3C	3	150	500	gR	35	--	--	150.0	150.0
3NC242 5-0C/3C	3	200	500	gR	40	--	--	200.0	200.0
3NC242 7-0C/3C	3	250	500	gR	50	--	--	250.0	250.0
3NC242 8-0C/3C	3	300	500	gR	65	--	--	300.0	300.0
3NC243 1-0C/3C	3	350	500	gR	60	--	--	350.0	350.0
3NC243 2-0C/3C	3	400	500	aR	50	--	--	400.0	400.0
3NC333 6-1U	3	630	1000	aR	145	--	--	400.0	400.0
3NC333 7-1U	3	710	1000	aR	150	--	--	440.0	440.0
3NC333 8-1U	3	800	1000	aR	155	--	--	480.0	480.0
3NC334 0-1U	3	900	1000	aR	165	--	--	510.0	510.0
3NC334 1-1U	3	1000	1000	aR	170	--	--	530.0	530.0
3NC334 2-1U	3	1100	800	aR	185	--	--	530.0	530.0
3NC334 3-1U	3	1250	800	aR	210	--	--	530.0	530.0
3NC343 0-1U	3	315	1250	aR	80	--	--	290.0	290.0
3NC343 2-1U	3	400	1250	aR	95	--	--	330.0	330.0
3NC343 4-1U	3	500	1250	aR	115	--	--	370.0	370.0
3NC343 6-1U	3	630	1250	aR	120	--	--	440.0	440.0

SITOR semiconductor fuse data						Permissible load currents of fuse when installed in type 3KF SITOR			
Type	Size	Rated current I <sub>n</sub>	Rated voltage	Operational class	Power loss P <sub>v</sub>	250	400	630	800
		A	V AC		W	A	A	A	A
3NC343 8-1U	3	800	1100	aR	145	--	--	450.0	450.0
3NC842 3-0C/-3C	3	150	690	gR	40	--	--	150.0	150.0
3NC842 5-0C/-3C	3	200	690	gR	55	--	--	200.0	200.0
3NC842 7-0C/-3C	3	250	690	gR	72	--	--	245.0	245.0
3NC843 1-0C/-3C	3	350	690	gR	95	--	--	290.0	290.0
3NC843 4-0C/-3C	3	500	690	gR	130	--	--	250.0	250.0
3NC844 4-3C	3	1000	600	aR	140	--	--	530.0	530.0
3NE143 5-0	3	560	690	gS	50	--	--	530.0	530.0
3NE143 5-2/-3	3	560	690	gR	60	--	--	520.0	520.0
3NE143 6-0	3	630	690	gS	55	--	--	530.0	530.0
3NE143 6-2/-3	3	630	690	gR	60	--	--	530.0	530.0
3NE143 7-0	3	710	690	gS	58	--	--	530.0	530.0
3NE143 7-1	3	710	600	gR	65	--	--	530.0	530.0
3NE143 7-2/-3	3	710	690	gR	72	--	--	530.0	530.0
3NE143 8-0	3	800	690	gS	58	--	--	530.0	530.0
3NE143 8-1	3	800	600	gR	72	--	--	530.0	530.0
3NE143 8-2/-3	3	800	690	gR	84	--	--	530.0	530.0
3NE144 7-2/-3	3	670	690	gR	64	--	--	530.0	530.0
3NE144 8-2/-3	3	850	690	gR	76	--	--	530.0	530.0

### 7.1.3 Dimensional drawings

#### 3NE / NC / NB / NH series

##### 3NE143.-0, 3NE143.-1

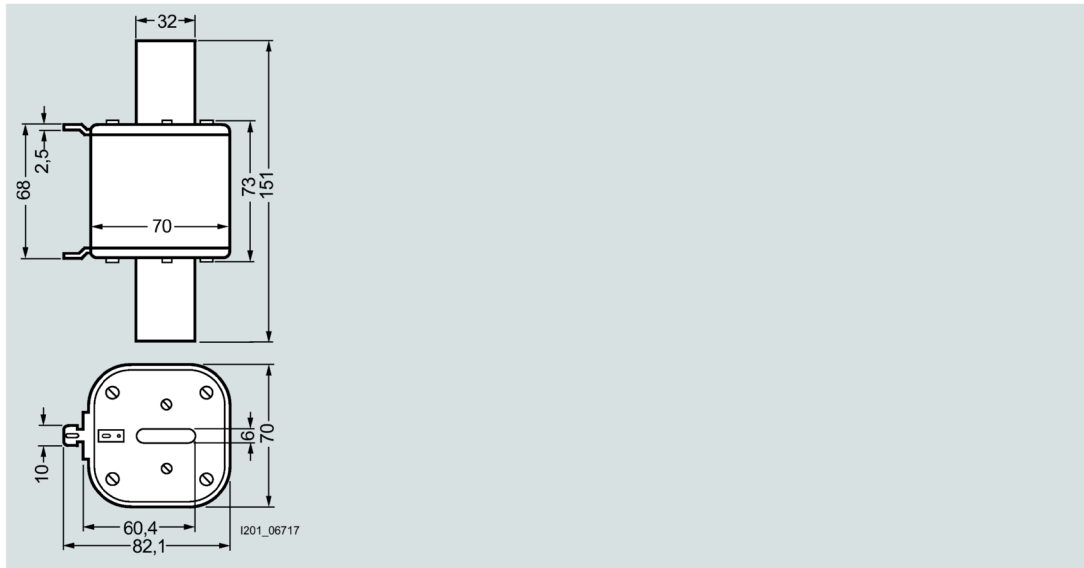

##### 3NE14. .-3

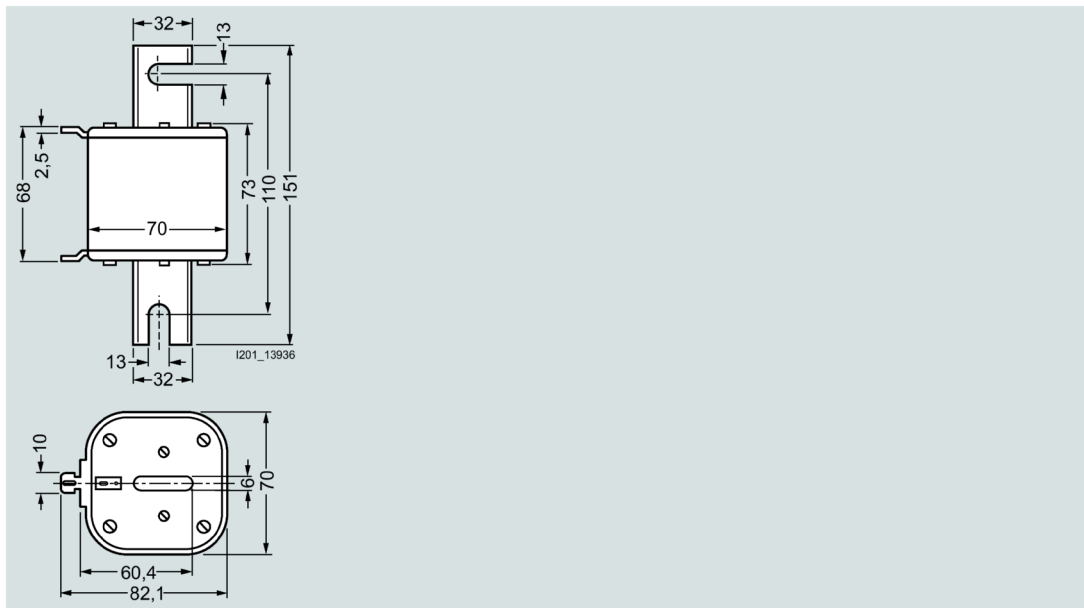

3NE14. .-3

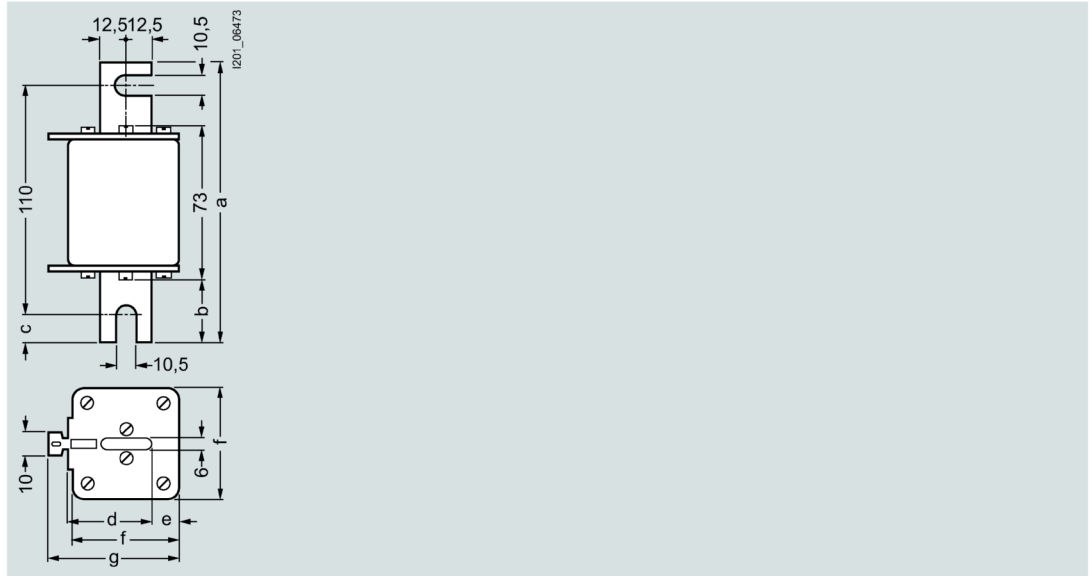

Type	Dimensions (mm)						
	a	b	c	d	e	f	g
3NE12. .-3	135	31	12.5	40.5	135	52	63.5
3NE13. .-3	149	38	19.5	47.5	15	60	72

3NC24. .-0C, 3NC84. .-0C

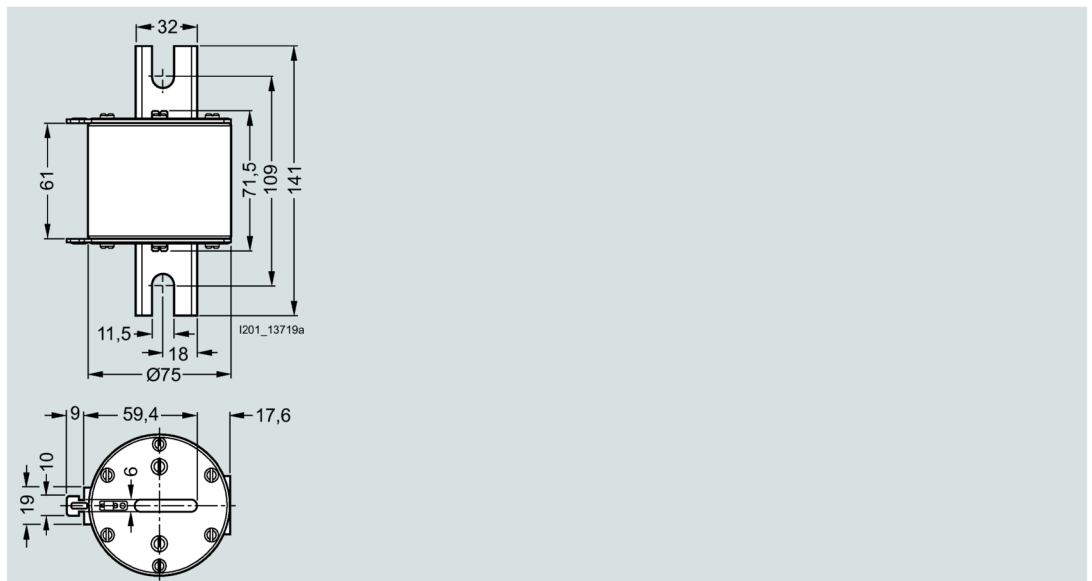

3NC24. -3C, 3NC84. -3C

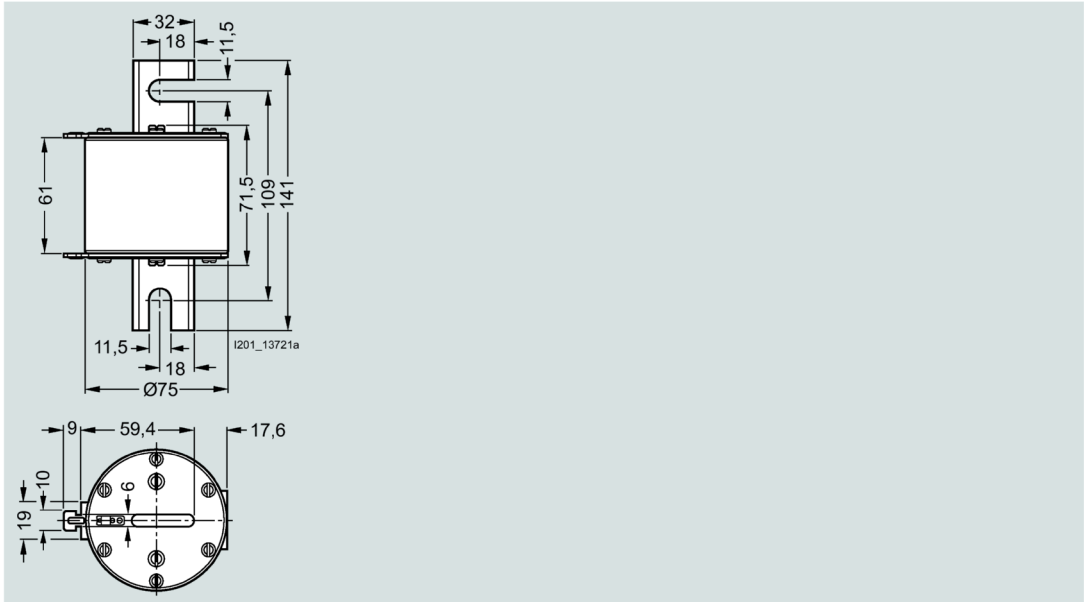

3NC24. -3C, 3NC84. -3C

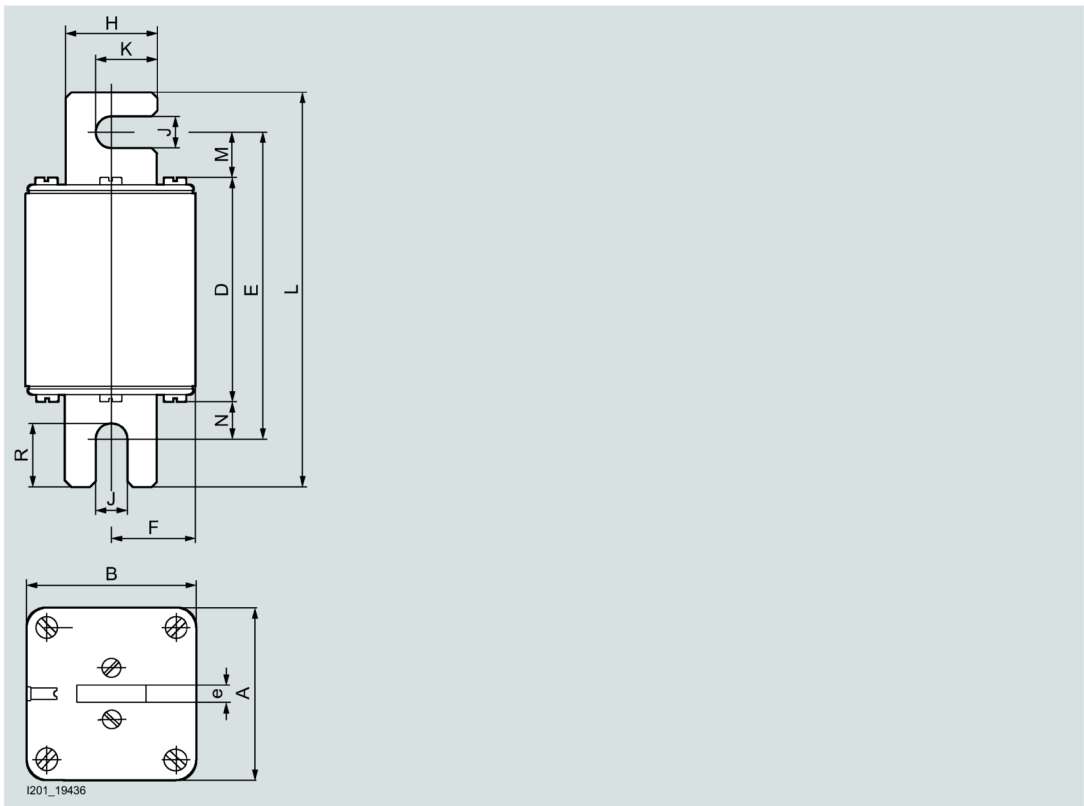



Type	Dimensions												
	A	B	D	E	F	H	J	K	L	M	N	R	e
3NE32...-OMK	52	52	78.4	106.6	26	25	11	18	137	15.7	12.5	22.3	6
3NE32...-OMK08	52	52	78.4	106.6	26	25	11	18	137	15.7	12.5	22.3	6
3NE53...-OMK06	60	60	137	165.5	30	32	11	21.5	196	15.8	12.8	22.1	6

### 3NE32...-OMK, 3NE323...-OMK08

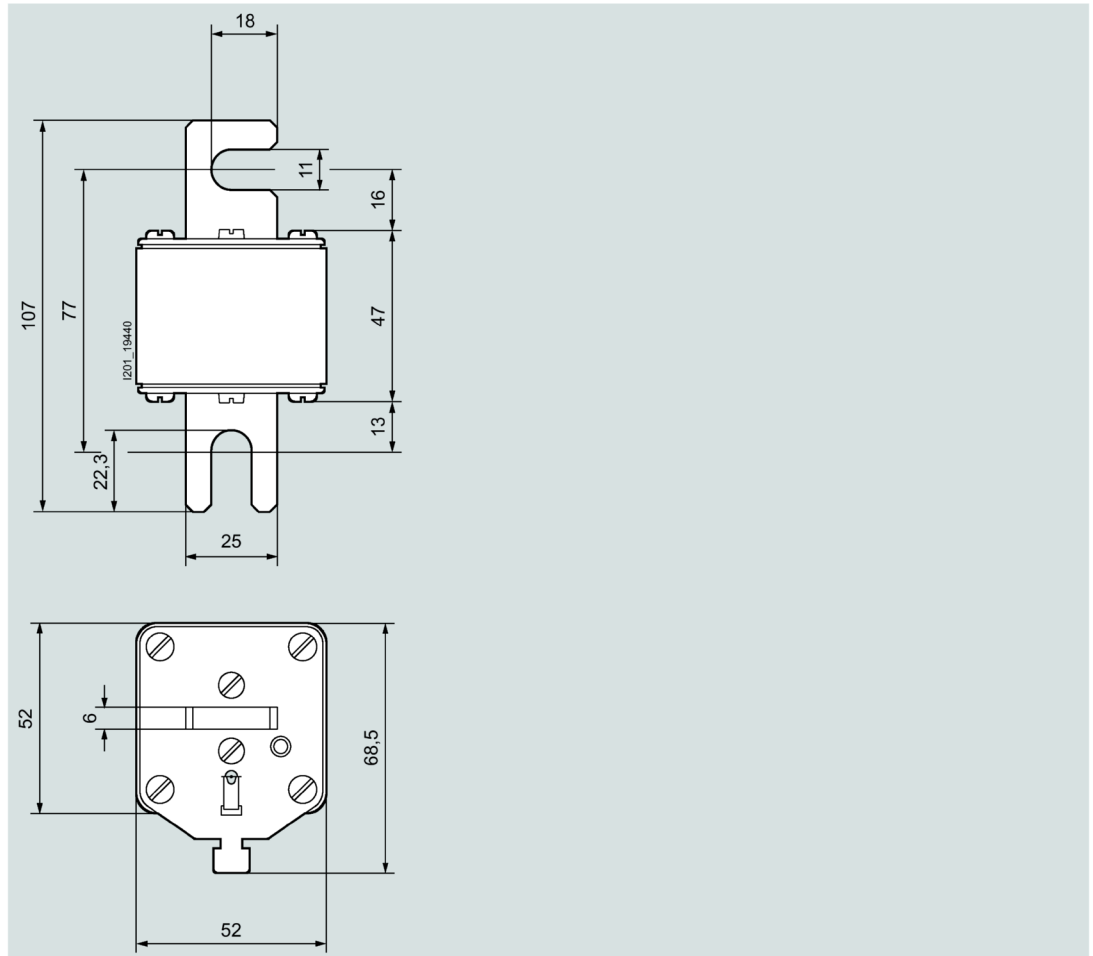

**3NE82..-3MK**

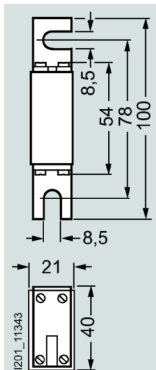

**3NE87..-1**

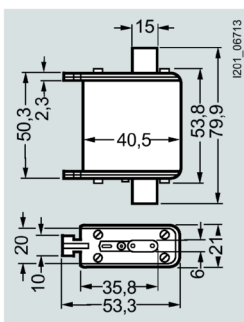

3NE18. .-0

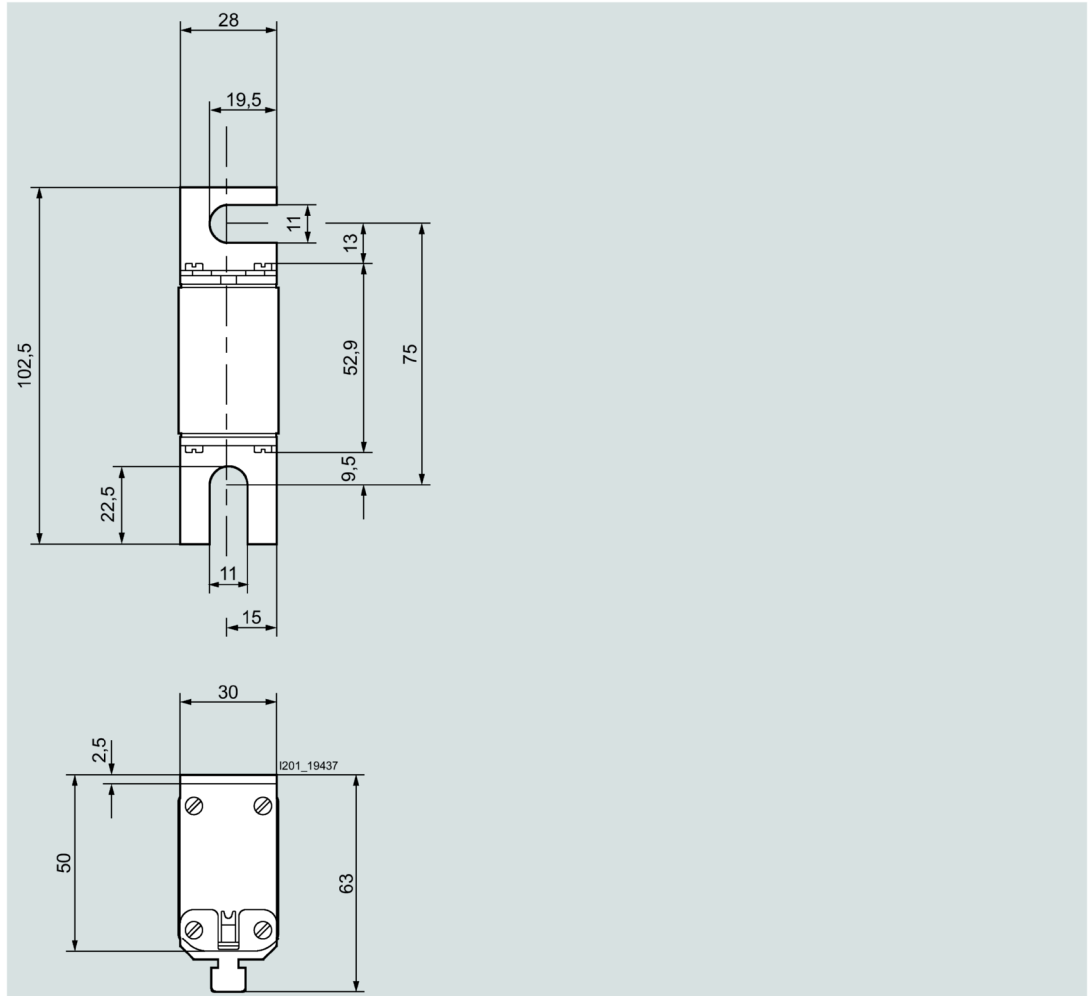

3NE102.-0, 3NE102.-2, 3NE80. .-1

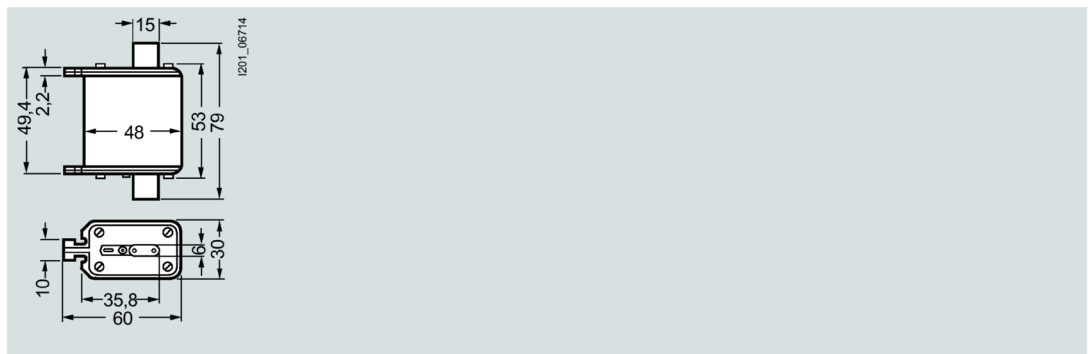

3NE12. .-0, 3NE12. .-2

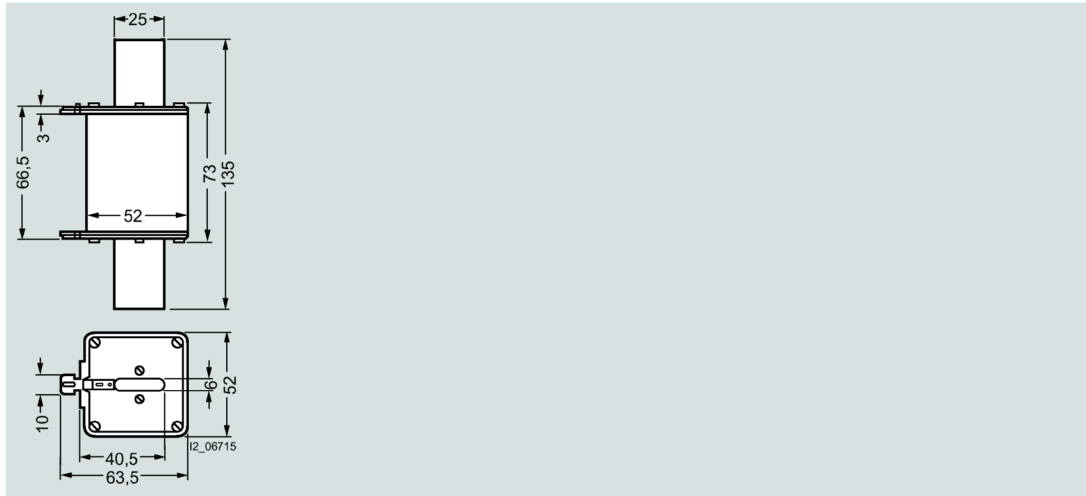

3NE12. .-0, 3NE12. .-2

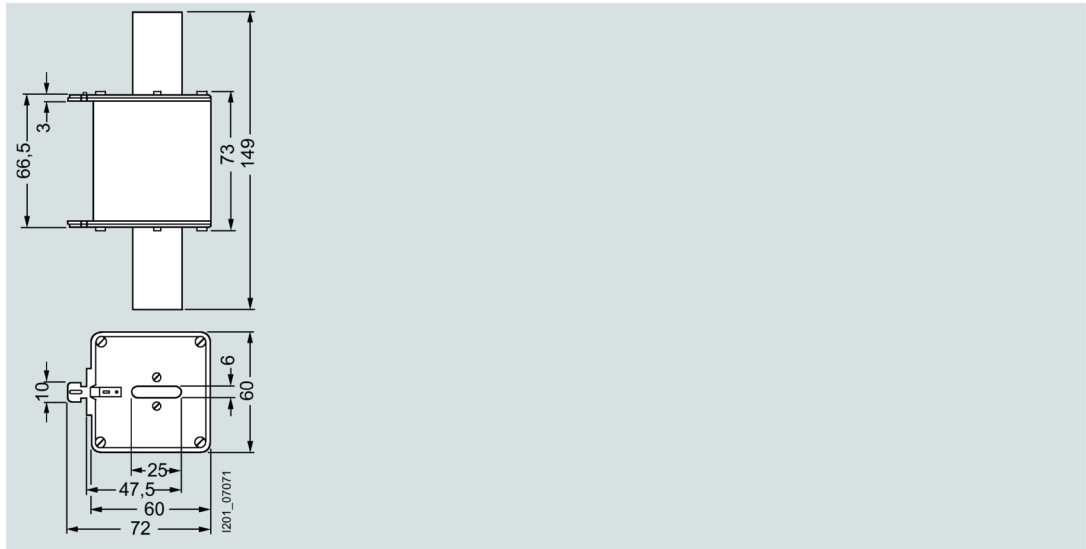

3NE14. .-2



3NE82..-0MK, 3NE83..-0MK, 3NE88..-0MK

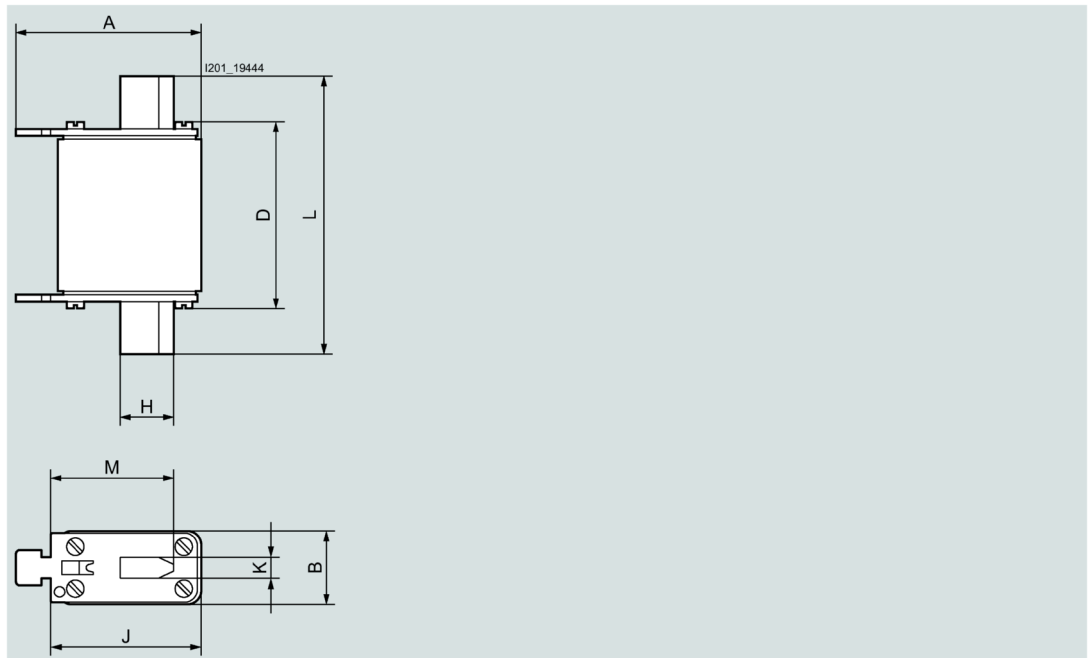

Type	Dimensions							
	A	B	D	H	J	K	M	L
3NE88..-0MK	53	21	51.5	15	43	6	35	78.5
3NE82..-0MK	62.5	44	70.5	20	53	6	40	135
3NE83..-0MK	68	50	70.5	25	61	6	48	150

3NC32. -1U, 3NC33. -1U, 3NC34. -1U

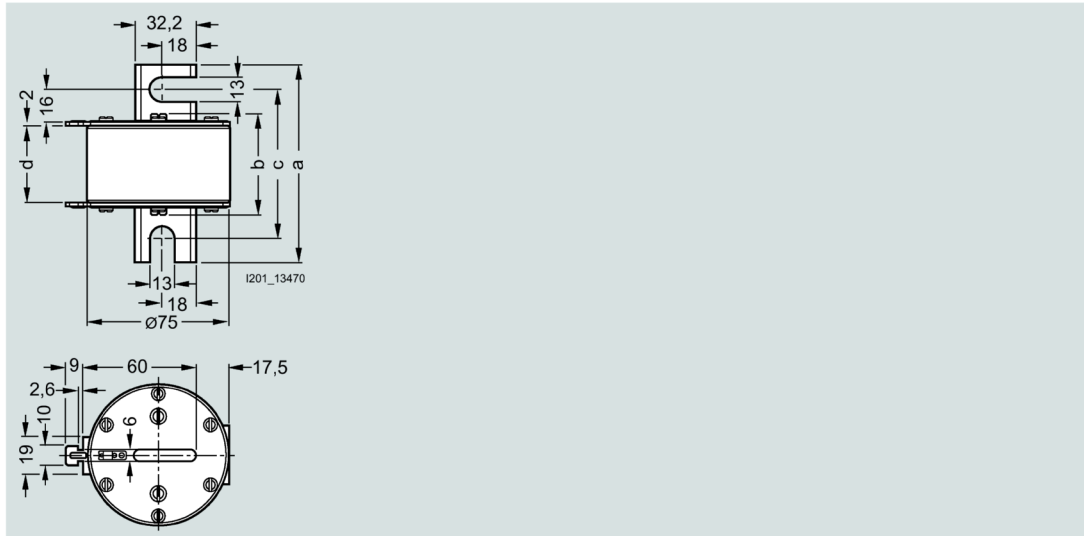

Type	Dimensions (mm)			
	a	b	c	d
3NC32. -1U	102	51	78	40
3NC33. -1U	139	72	108	61
3NC34. -1U	139	72	108	61

3NC32. -1U, 3NC33. -1U, 3NC34. -1U

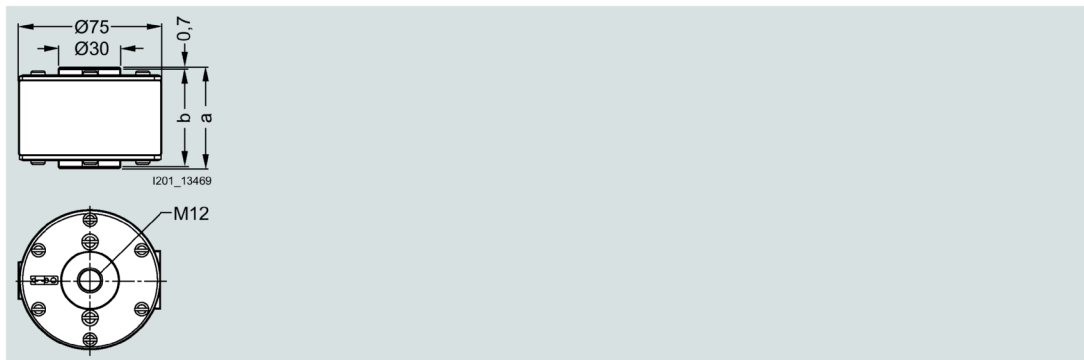

Type	Dimensions (mm)	
	a	b
3NC32. -6U	52	50
3NC33. -6U	73	71
3NC34. -6U	73	71

3NE43. .-0B, 3NE4337

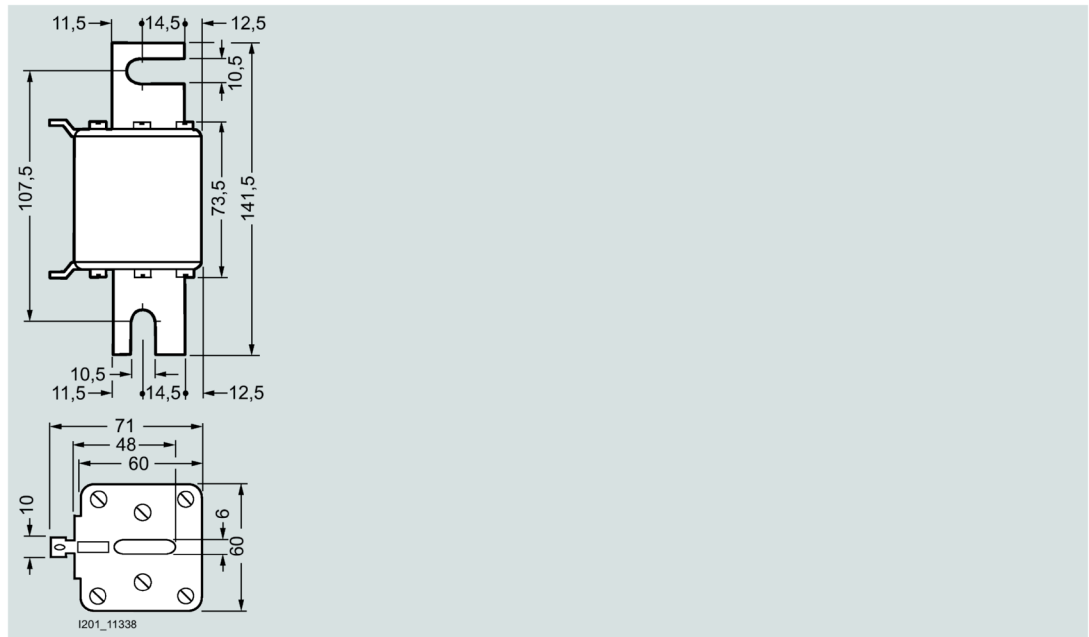

3NE41..

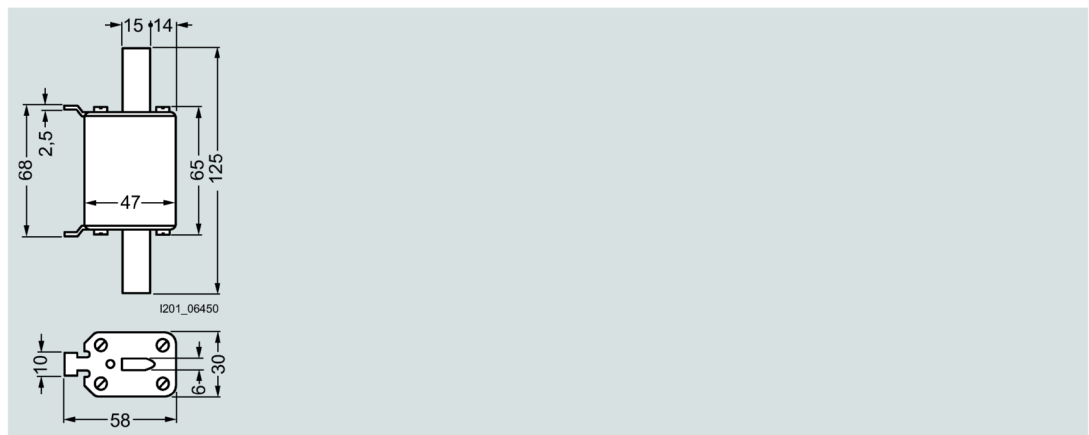

**3NE322., 3NE323., 3NE33. .**

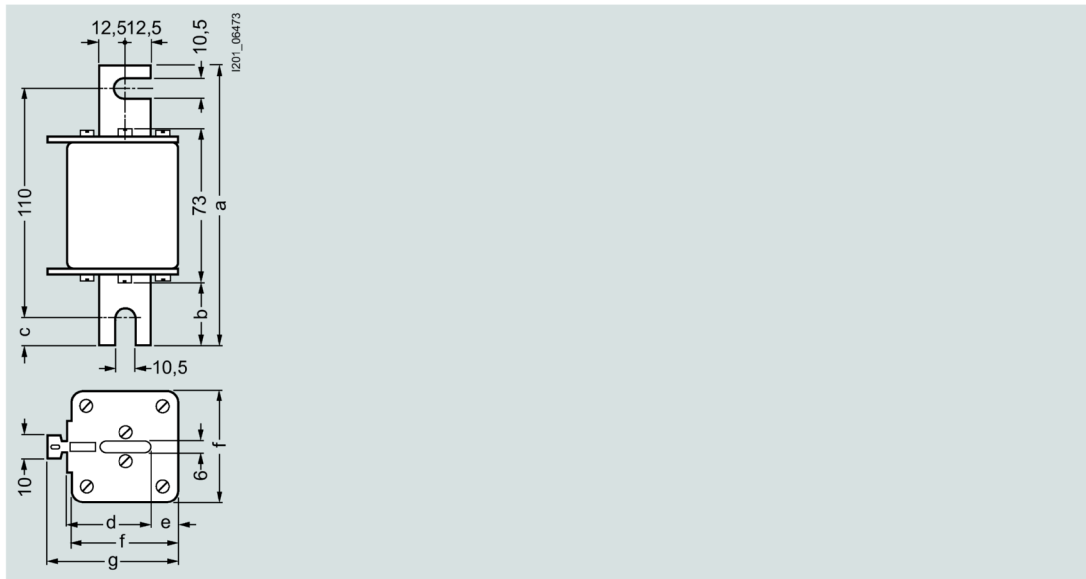

Type	Dimensions (mm)						
	a	b	c	d	e	f	g
3NE322.	135	31	12.5	40.5	13.5	52	63.5
3NE323.	135	31	12.5	40.5	13.5	52	63.5
3NE33. .	149	38	19.5	47.5	15	60	72

**3NE3. .-0C, 3NE36. .-1C**

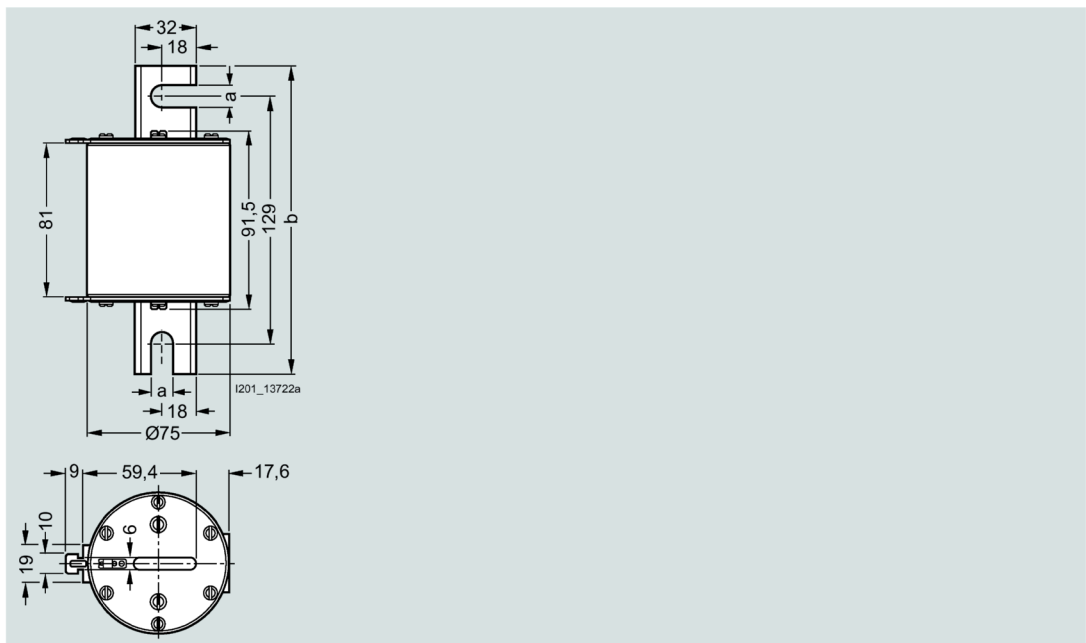



Type	Dimensions (mm)	
	a	b
3NE3. . .-0C	11.5	161
3NE36. .-1C	13	171

**3NE3635-6**

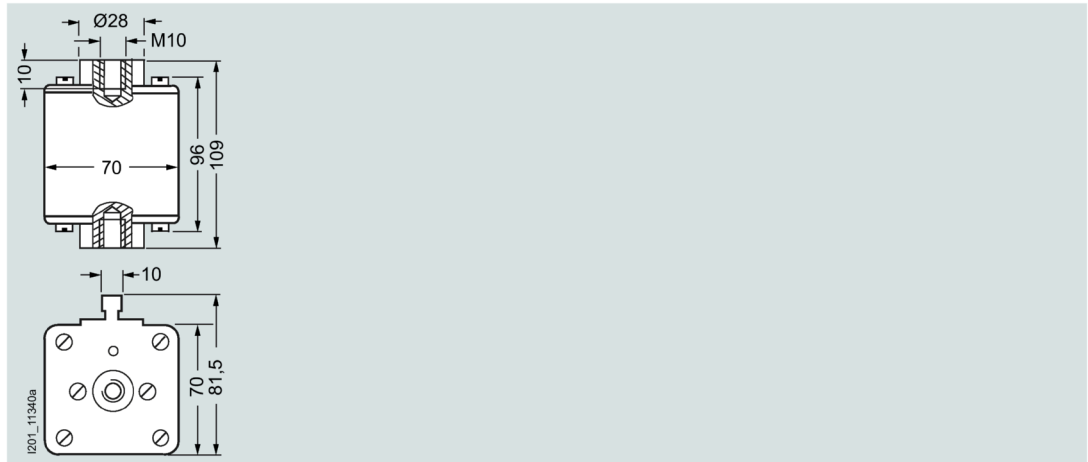

**3NB335.-1KK26**

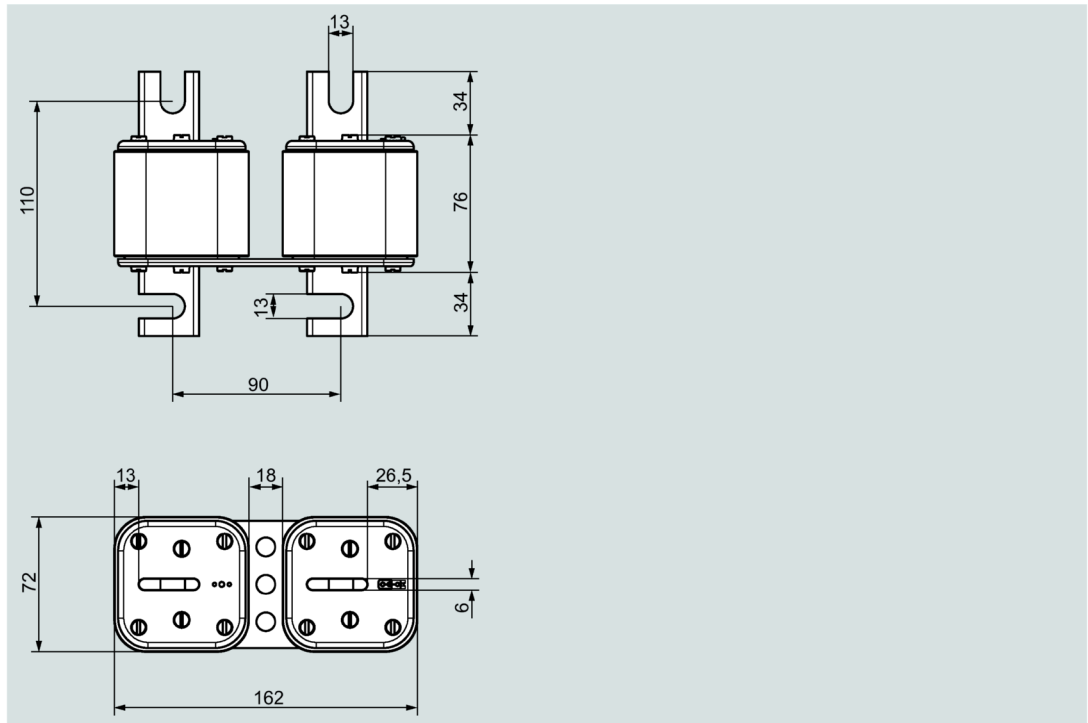

Type	I <sub>n</sub> A	U <sub>n</sub> V AC	Operational class Characteristic
3NB3350-1KK26	1000	690	gR
3NB3351-1KK26	1100	690	gR
3NB3352-1KK26	1250	690	gR
3NB3354-1KK26	1350	690	gR
3NB3355-1KK26	1400	690	gR
3NB3357-1KK26	1600	690	gR
3NB3358-1KK26	1700	690	gR

**3NB3358-1KK27, 3NB3362-1KK27**

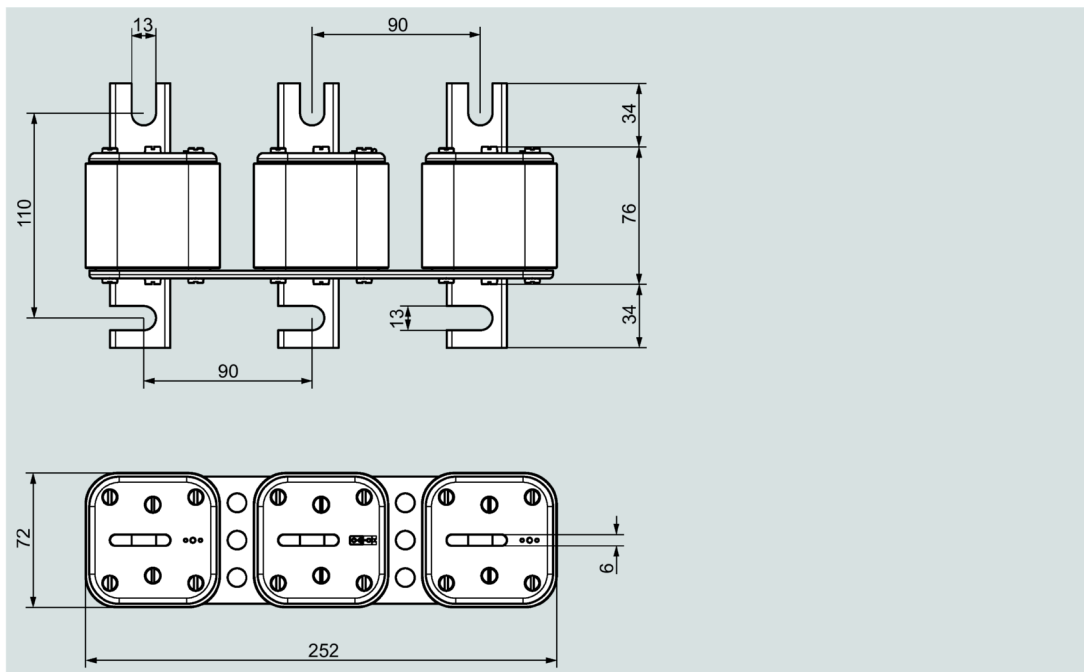

Type	I <sub>n</sub> A	U <sub>n</sub> V AC	Operational class Characteristic
3NB3358-1KK27	1700	690	gR
3NB3362-1KK27	1900	690	gR

3NE56. -0C

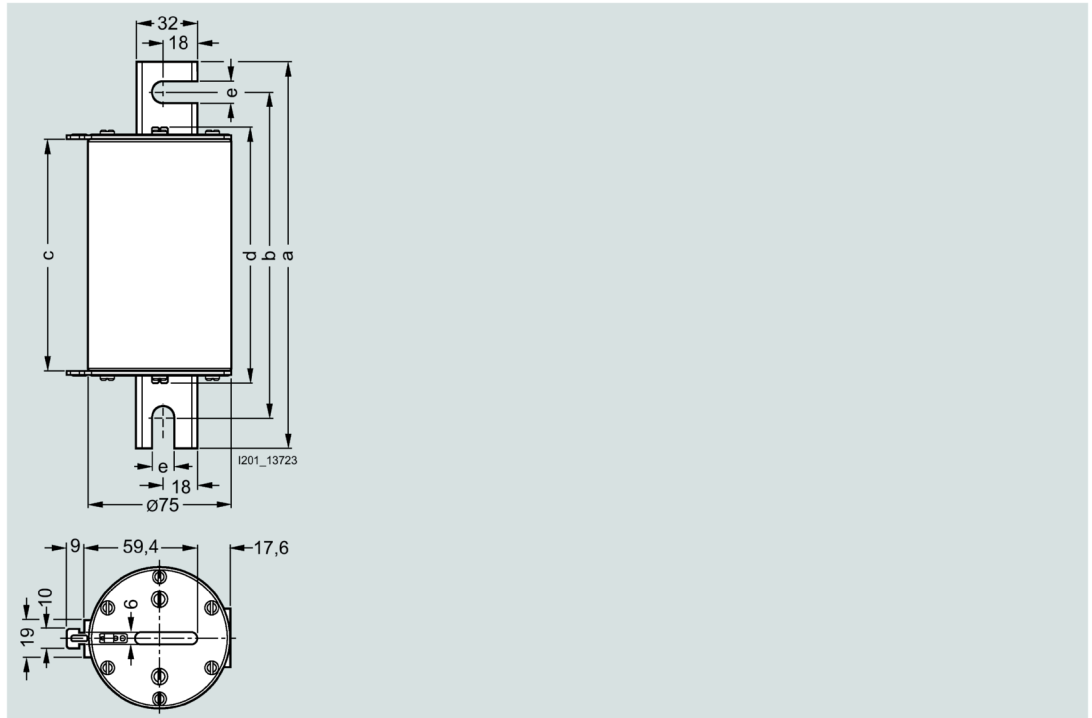

Type	Dimensions (mm)				
	a	b	c	d	e
3NE56. -0C	201	169	121	131.5	11.5

3NE54. .-0C, 3NE54. .-1C; 3NE7. .-0U, 3NE7. .-1U

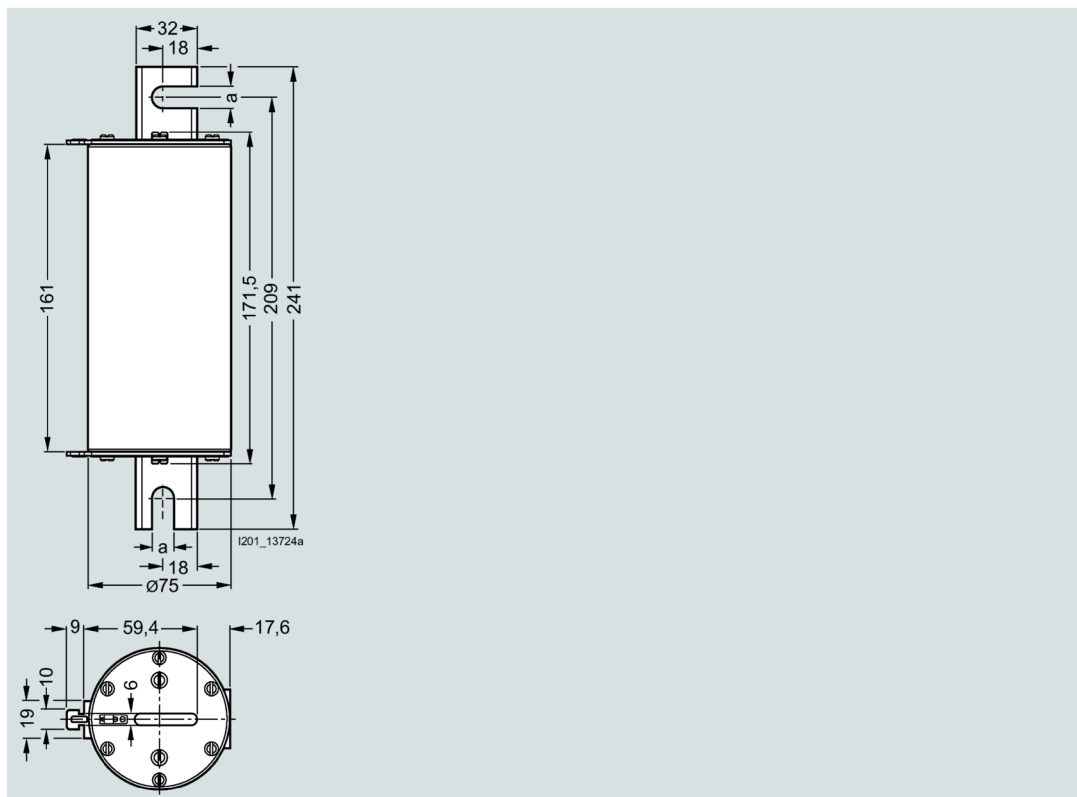

Type	Dimensions (mm)
	a
3NE54. .-0C	11.5
3NE54. .-1C	13
3NE7. .-0U	11.5
3NE7. .-1U	13

3NE96. .-1C

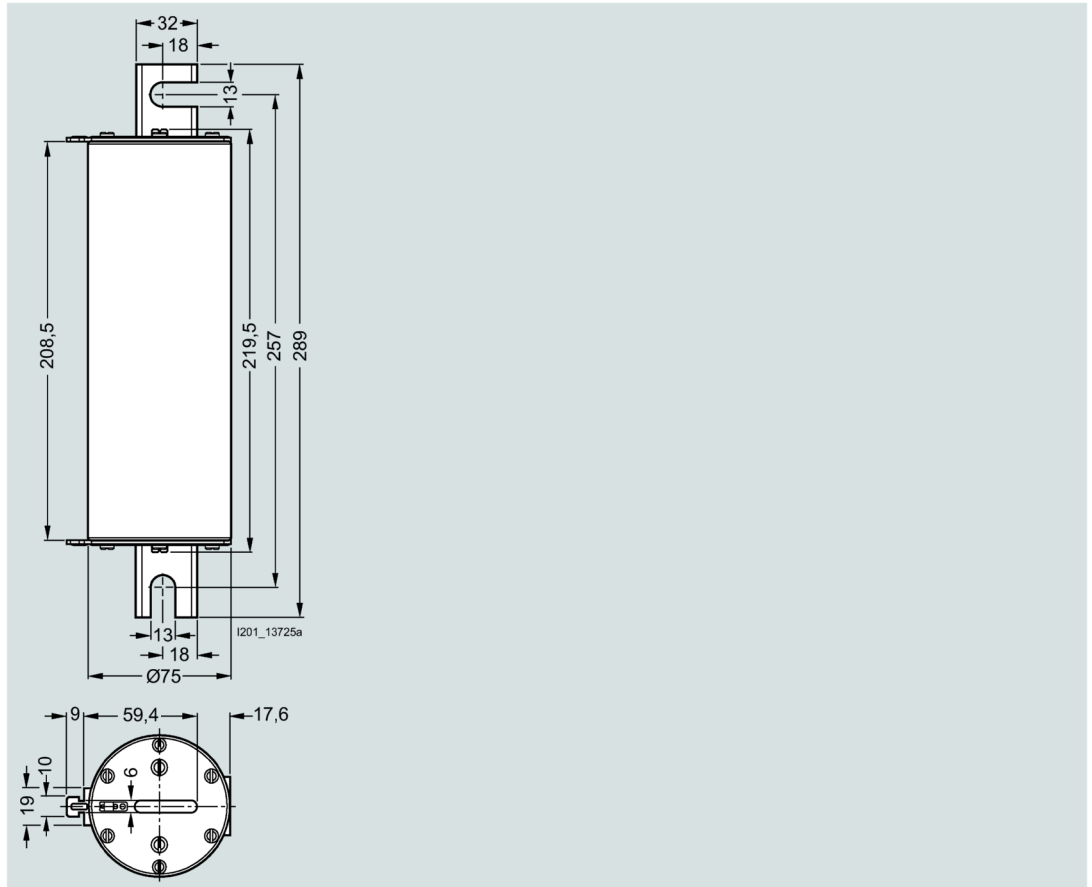

## 3NE53..-0MK06

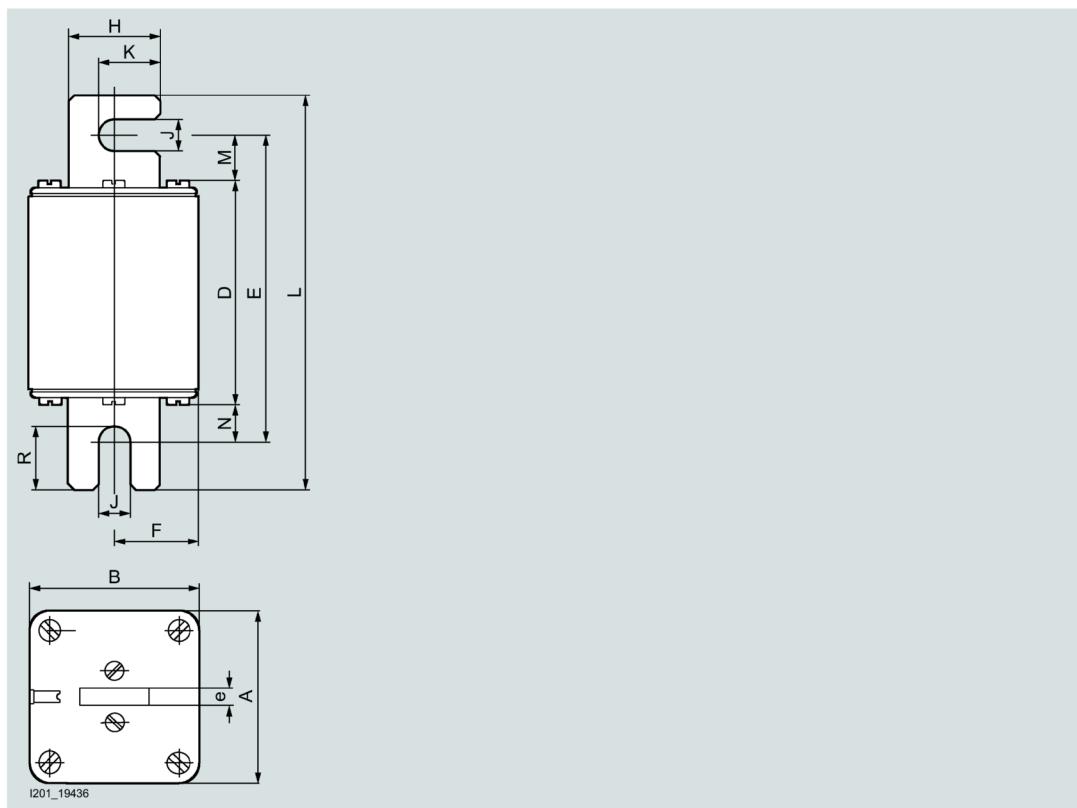

Type	Dimensions												
	A	B	D	E	F	H	J	K	L	M	N	R	e
3NE32..-0MK	52	52	78.4	106.6	26	25	11	18	137	15.7	12.5	22.3	6
3NE32..-0MK08	52	52	78.4	106.6	26	25	11	18	137	15.7	12.5	22.3	6
3NE53..-0MK06	60	60	137	165.5	30	32	11	21.5	196	15.8	12.8	22.1	6

3NE5336-0MK66

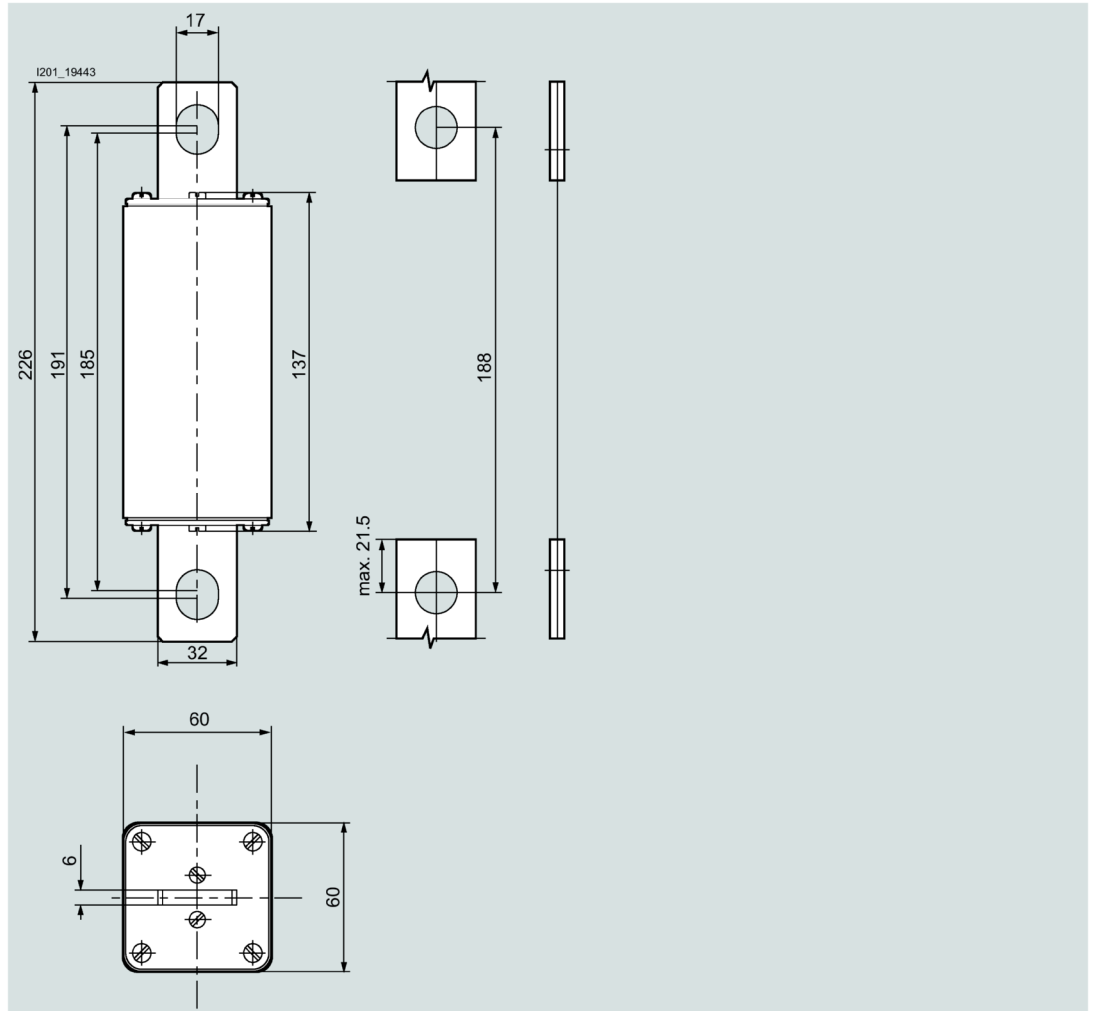

3NE9330-0MK07

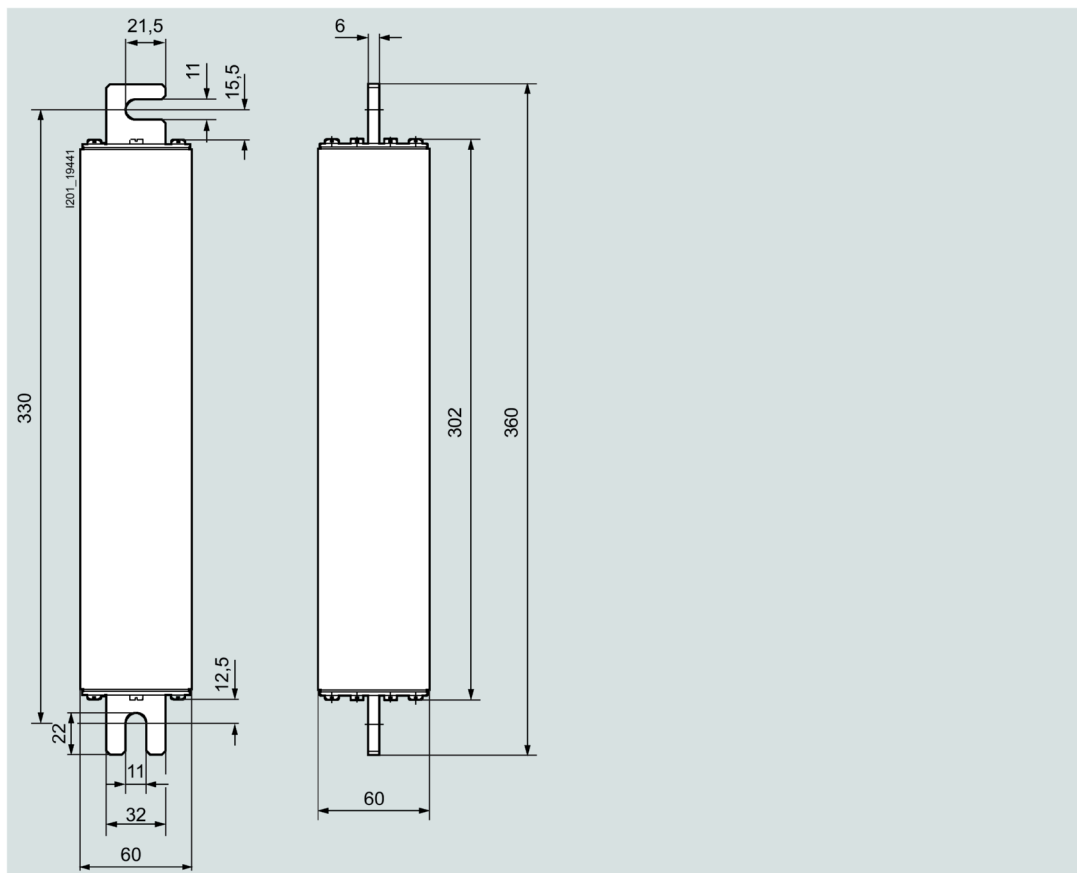



3NB1126-4KK11, 3NB1128-4KK11

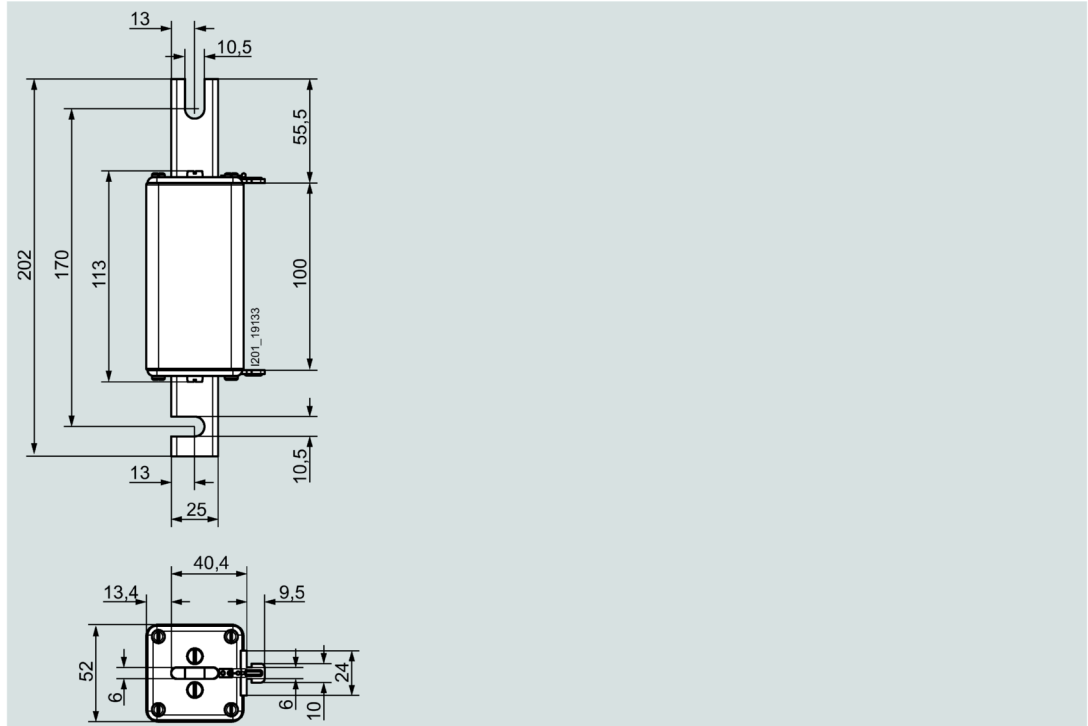

Type	I <sub>n</sub> A	U <sub>n</sub> V DC	Operational class Characteristic
3NB1126-4KK11	200	1250	aR
3NB1128-4KK11	250	1250	aR

## 3NB1231-4KK11, 3NB1234-4KK11

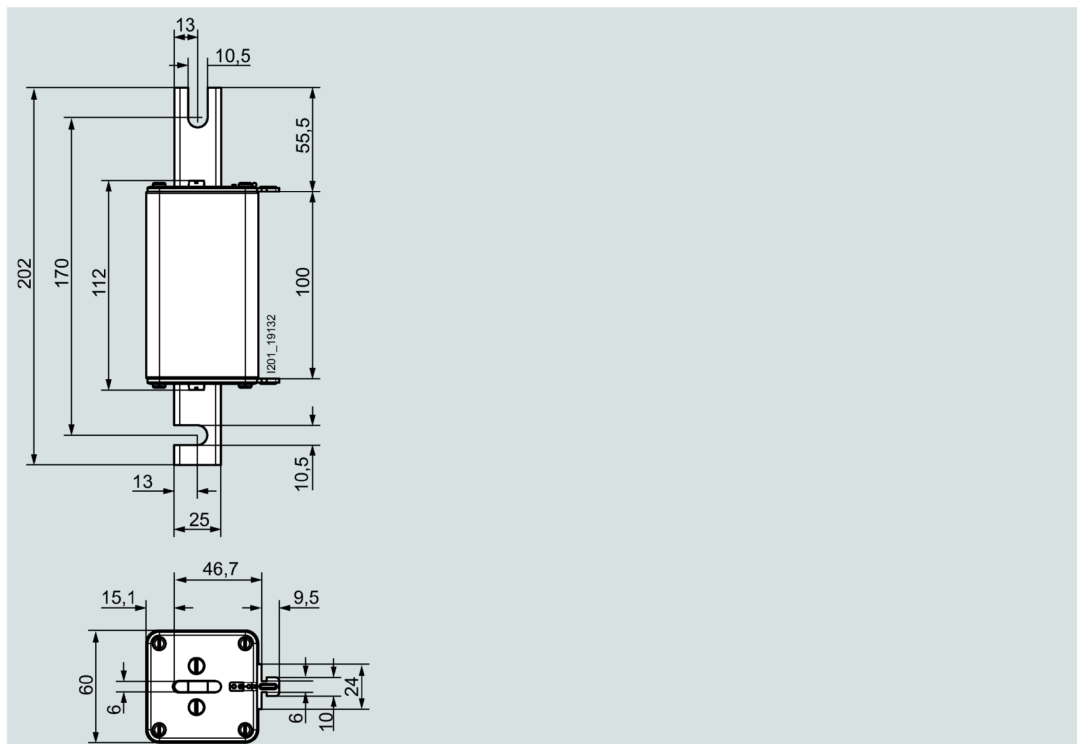

Type	$I_n$ A	V DC	Operational class Characteristic
3NB1231-4KK11	315	1250	aR
3NB1234-4KK11	400	1250	aR

3NB1337-4KK11, 3NB1345-4KK11

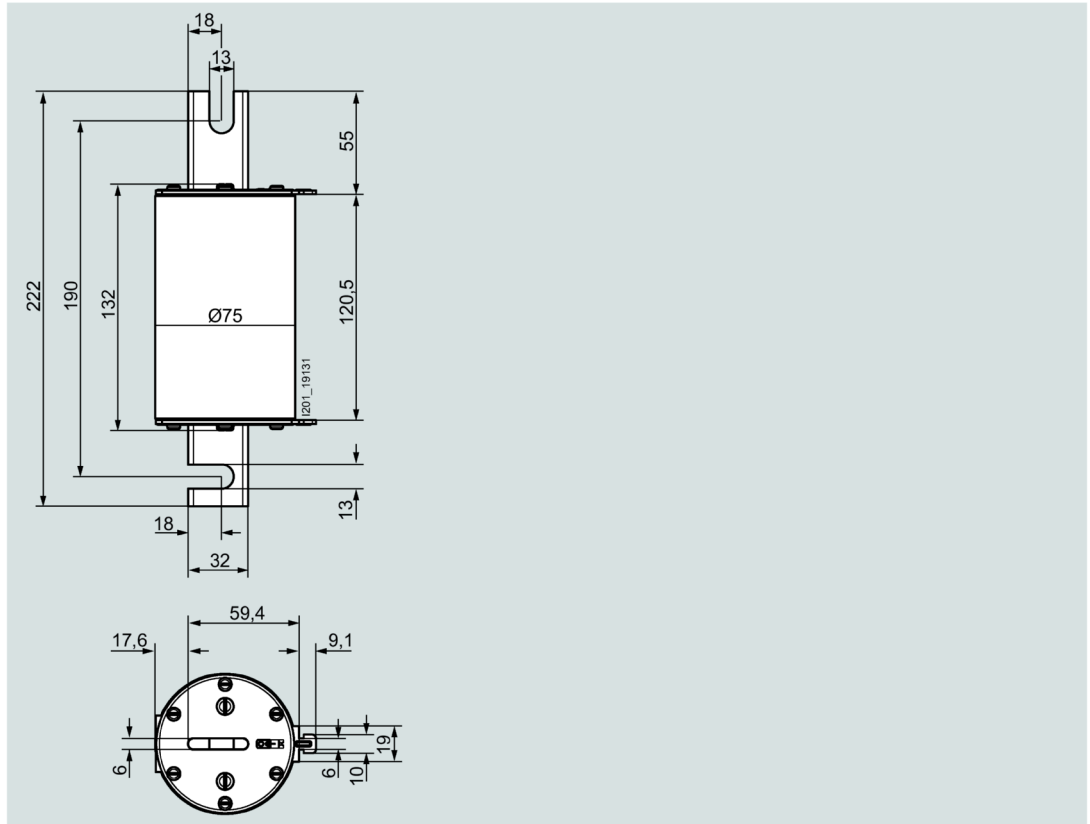

Type	I <sub>n</sub> A	U <sub>n</sub> V DC	Operational class Characteristic
3NB1337-4KK11	500	1250	aR
3NB1345-4KK11	800	1250	aR

3NB2364-4KK17, 3NB2366-4KK17

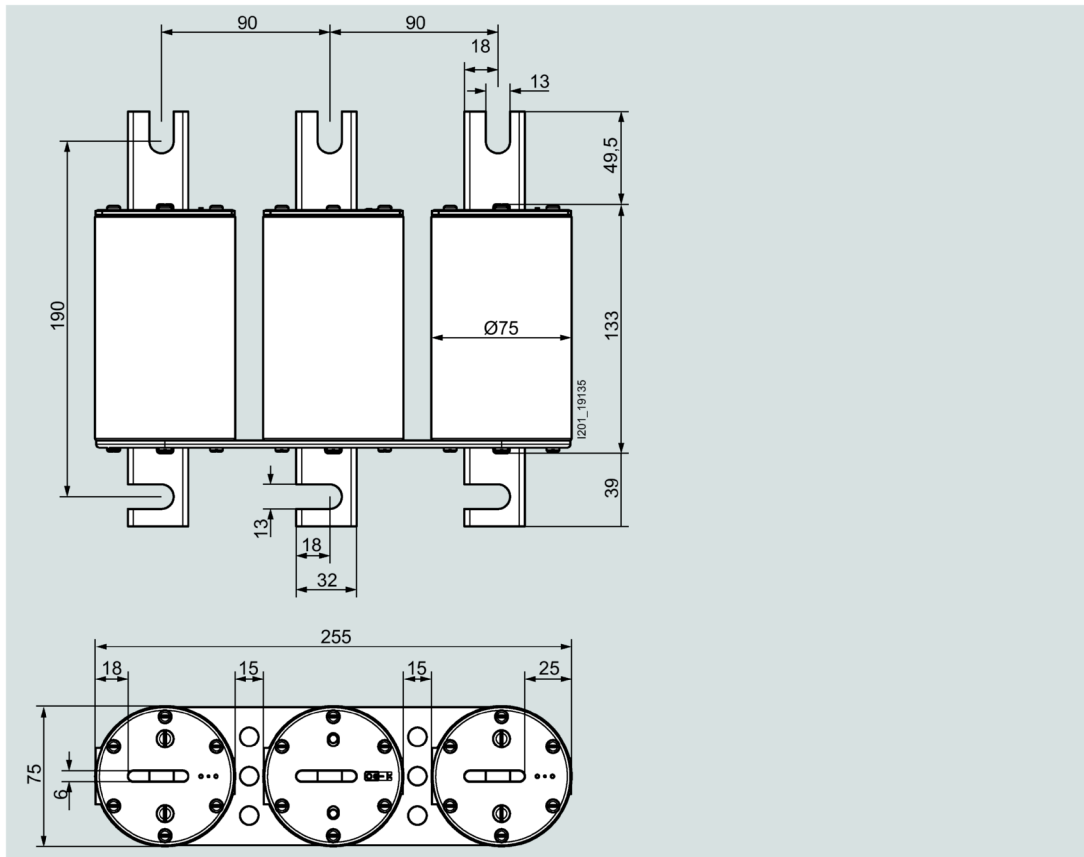

Type	I <sub>n</sub> A	U <sub>n</sub> V DC	Operational class Characteristic
3NB2364-4KK17	2100	1250	aR
3NB2366-4KK17	2400	1000	aR

## 3NB2345-4KK16, 3NB2350-4KK16, 3NB2355-4KK16, 3NB2357-4KK16

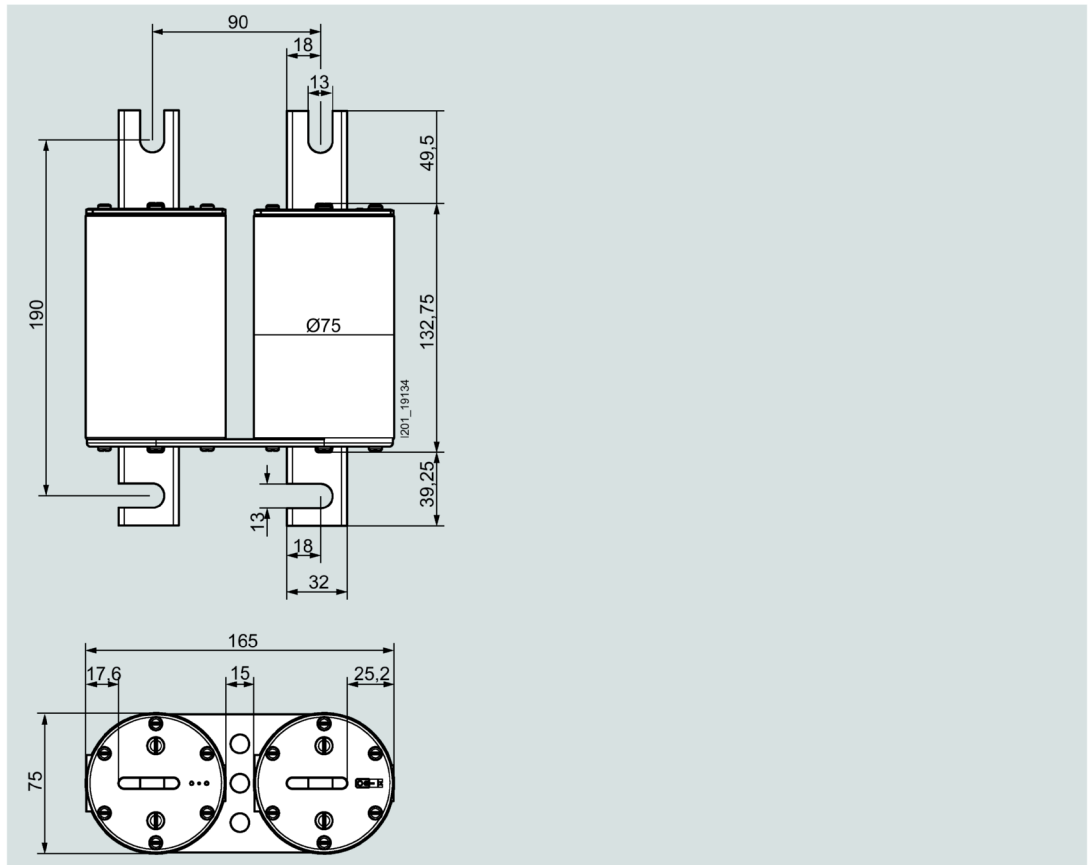

Type	$I_n$ A	$U_n$ V DC	Operational class Characteristic
3NB2345-4KK16	800	1250	aR
3NB2350-4KK16	1000	1250	aR
3NB2355-4KK16	1400	1250	aR
3NB2357-4KK16	1600	1250	aR

**3NC5531**

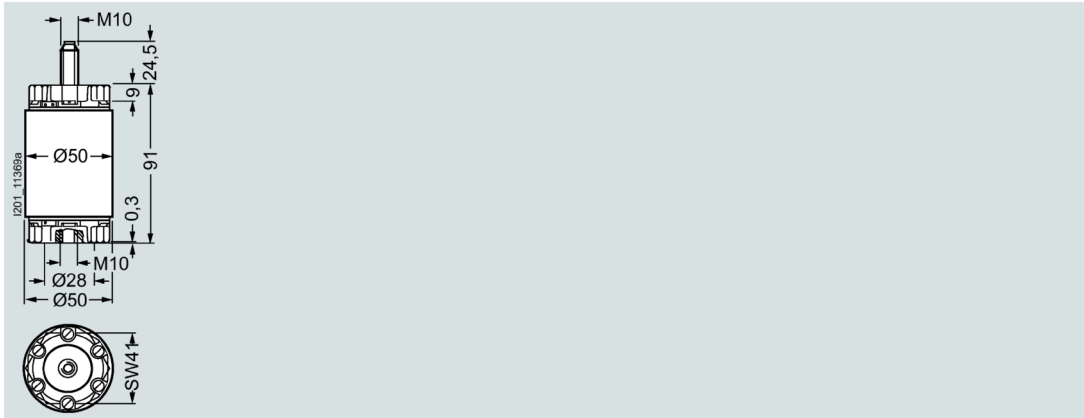

**3NC58..**

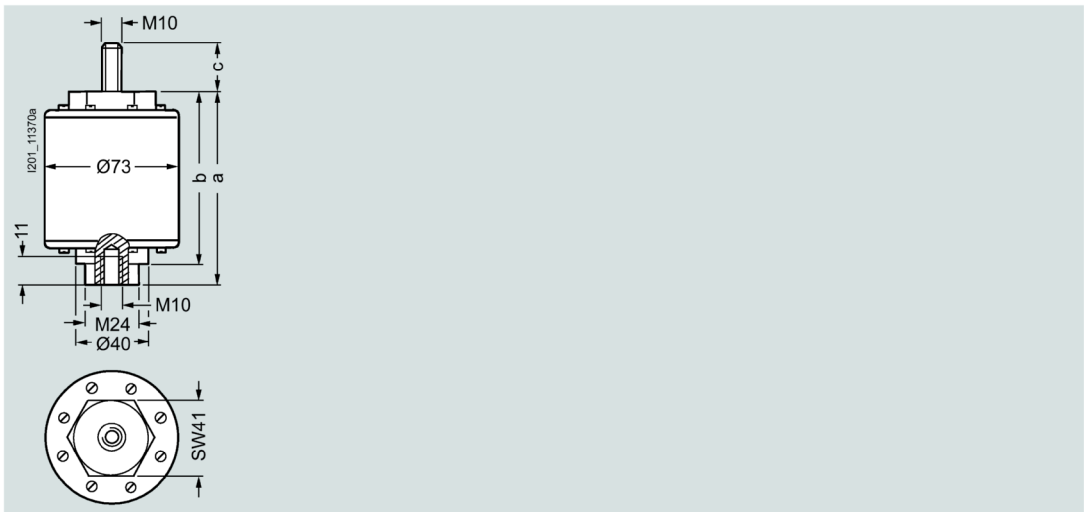

Type	Dimensions (mm)		
	a	b	c
3NC5838	98	88.5	25
3NC5841	98	88.5	25
3NC5840	119	109.5	20.5

3NE64. .-7, 3NE94. .-7

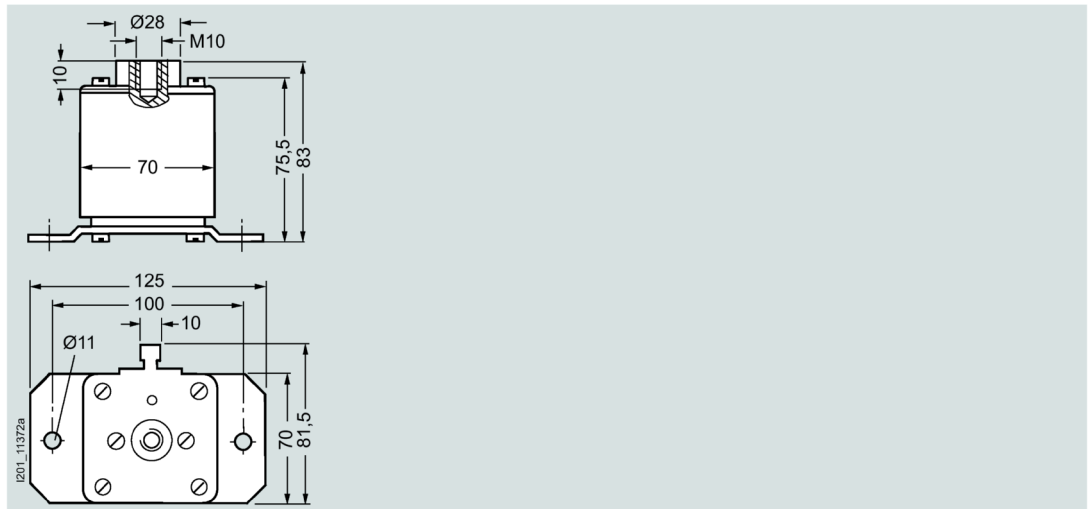

3NE64. ., 3NE94. .

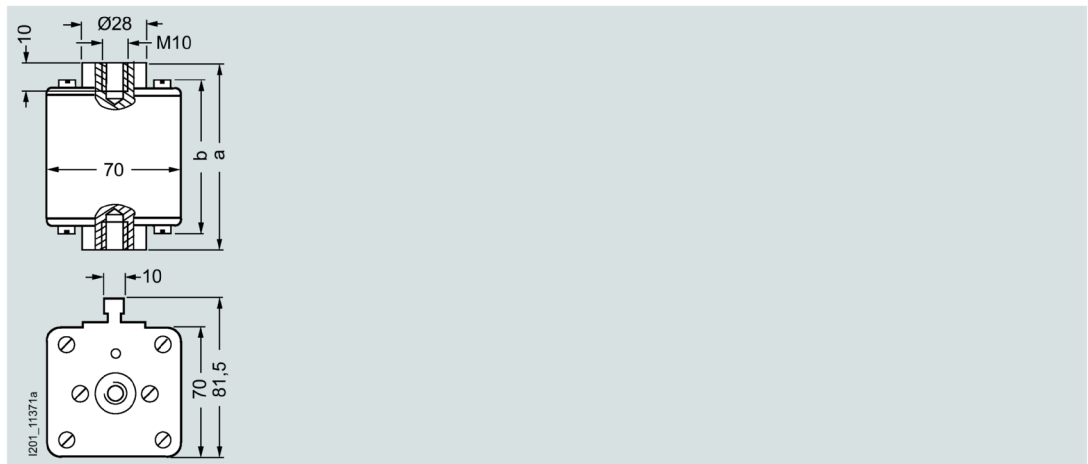

Type	Dimensions (mm)	
	a	b
3NE6437	89	76
3NE9450	89	76
3NE9440-6	89	76
3NE6444	99	86

**3NE3...-5**

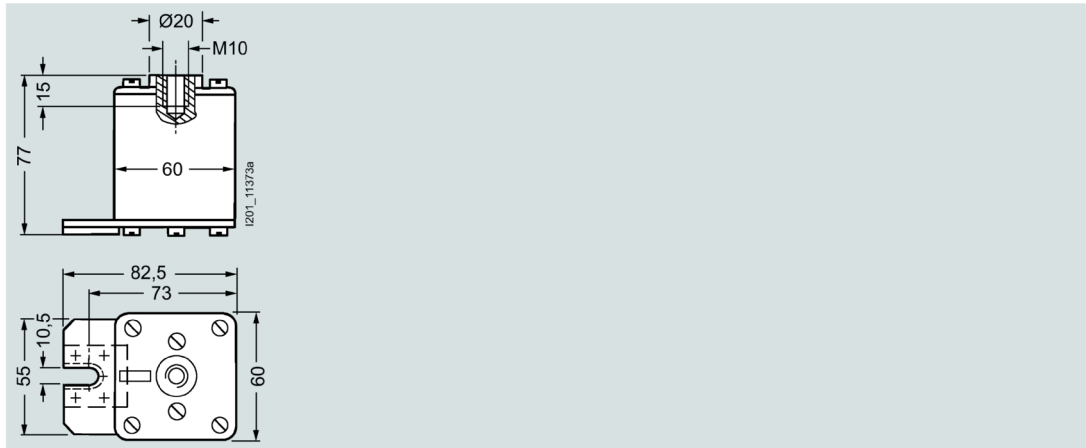

**3NE3...-5**

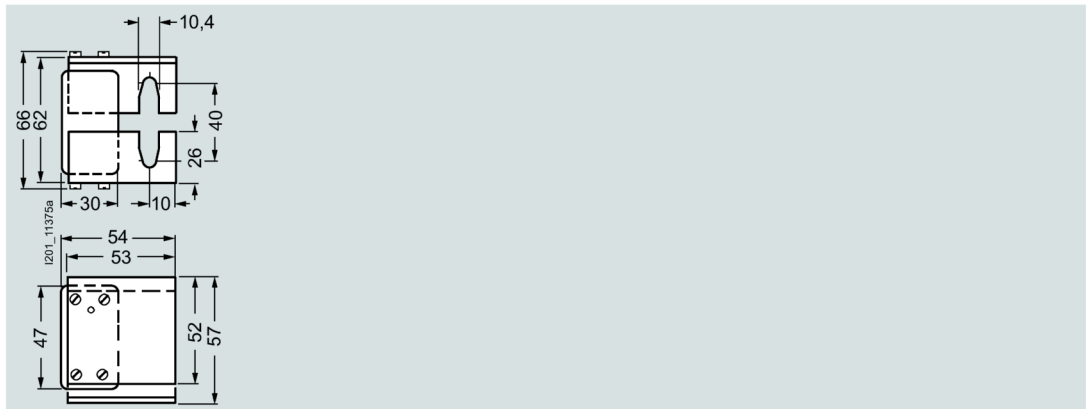

**3NE43...-6B, 3NE4337-6**

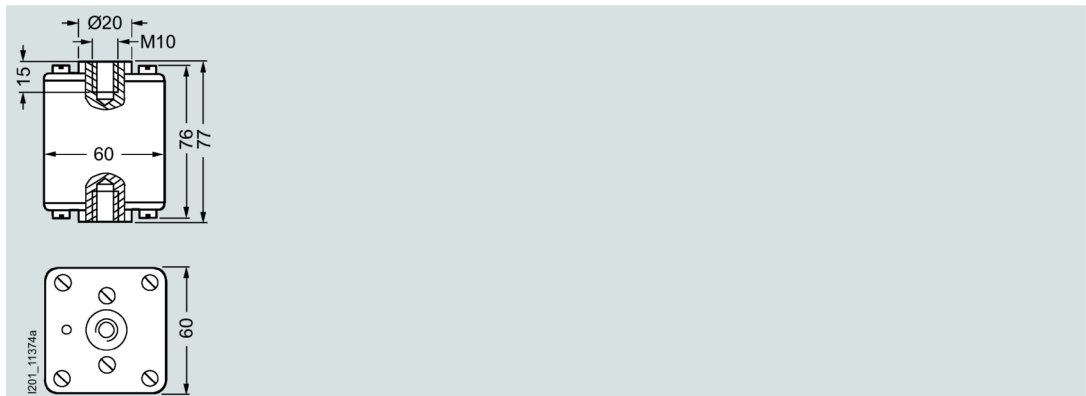



## 3NC73. .-2

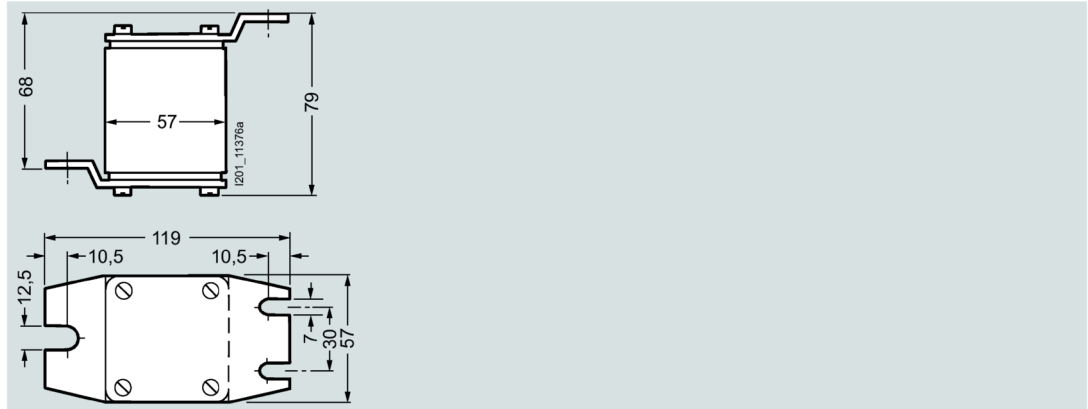

## 3NH5023, 3NH5323

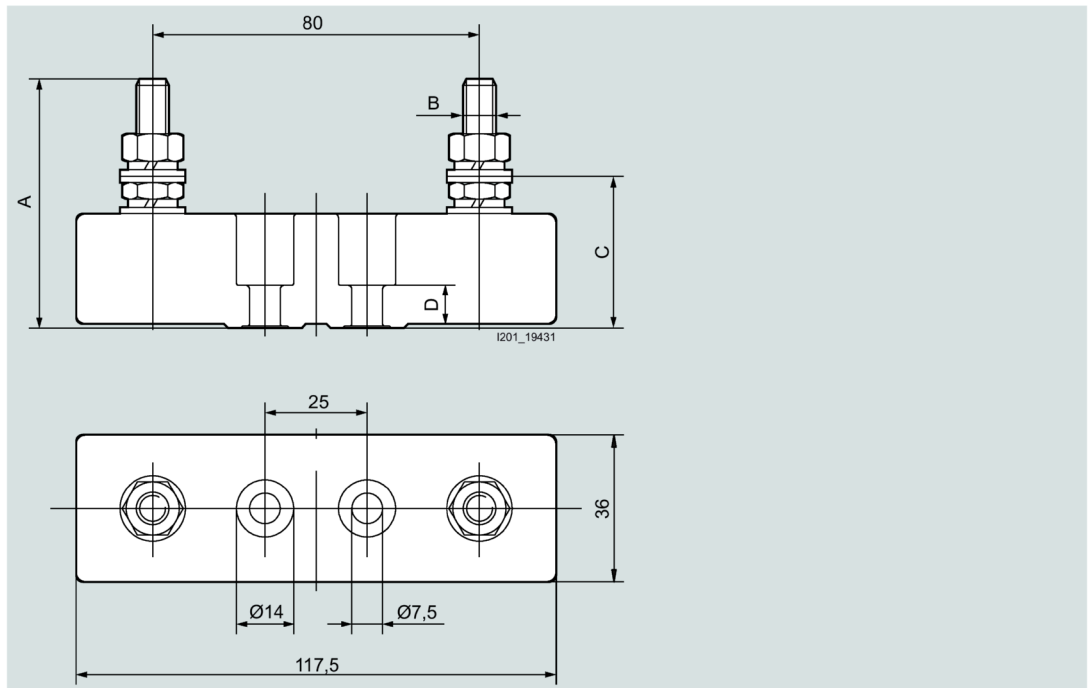

Type	Dimensions (mm)			
	A	B	C	D
3NH5023	59	M8	35.5	11
3NH5323	64	M10	38	11

**3NH5423**

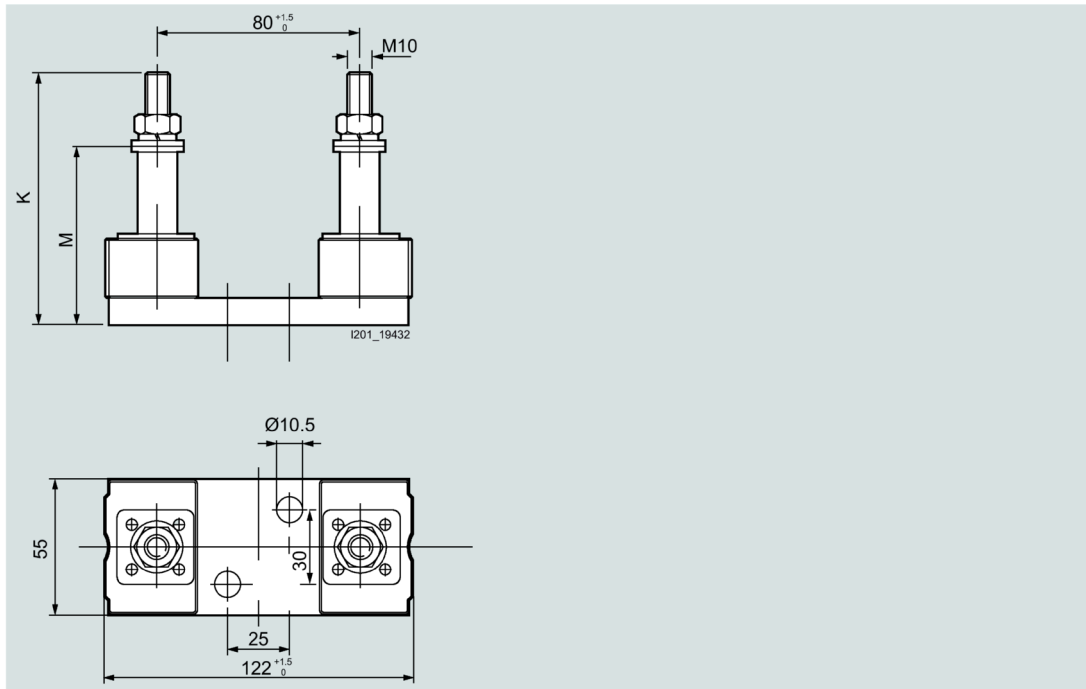

**3NH5463, 3NH5473**

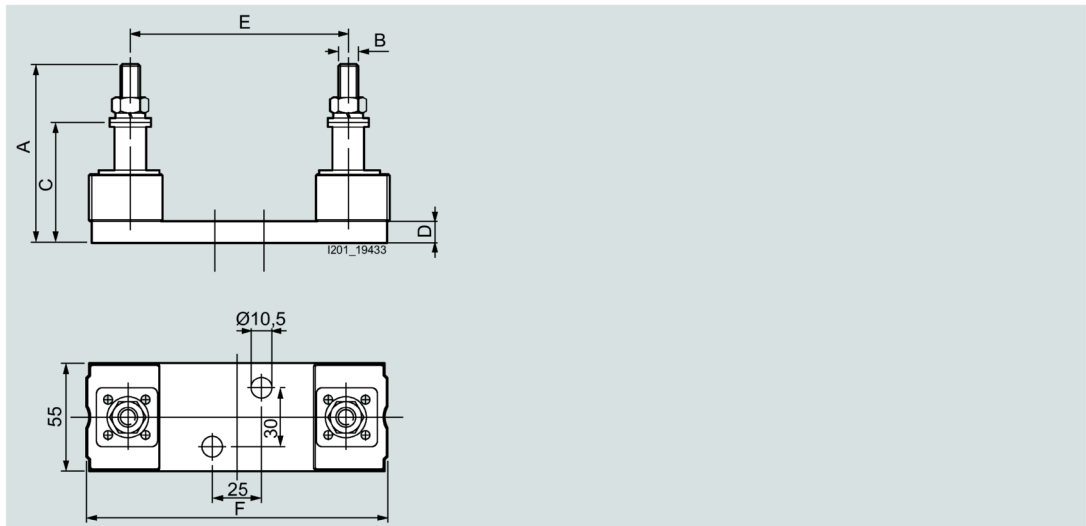

Type	Dimensions (mm)					
	A	B	C	D	E	F
3NH5463	94	M10	65	11	110	153
3NH5473	101	M10	72	11	170	211

## 7.1.4 Characteristic curves

### 3NC24... series

Size:	3
Operational class:	gR or aR
Rated voltage:	500 V AC
Rated current:	150 ... 400 A

#### Time/current characteristic curves diagram

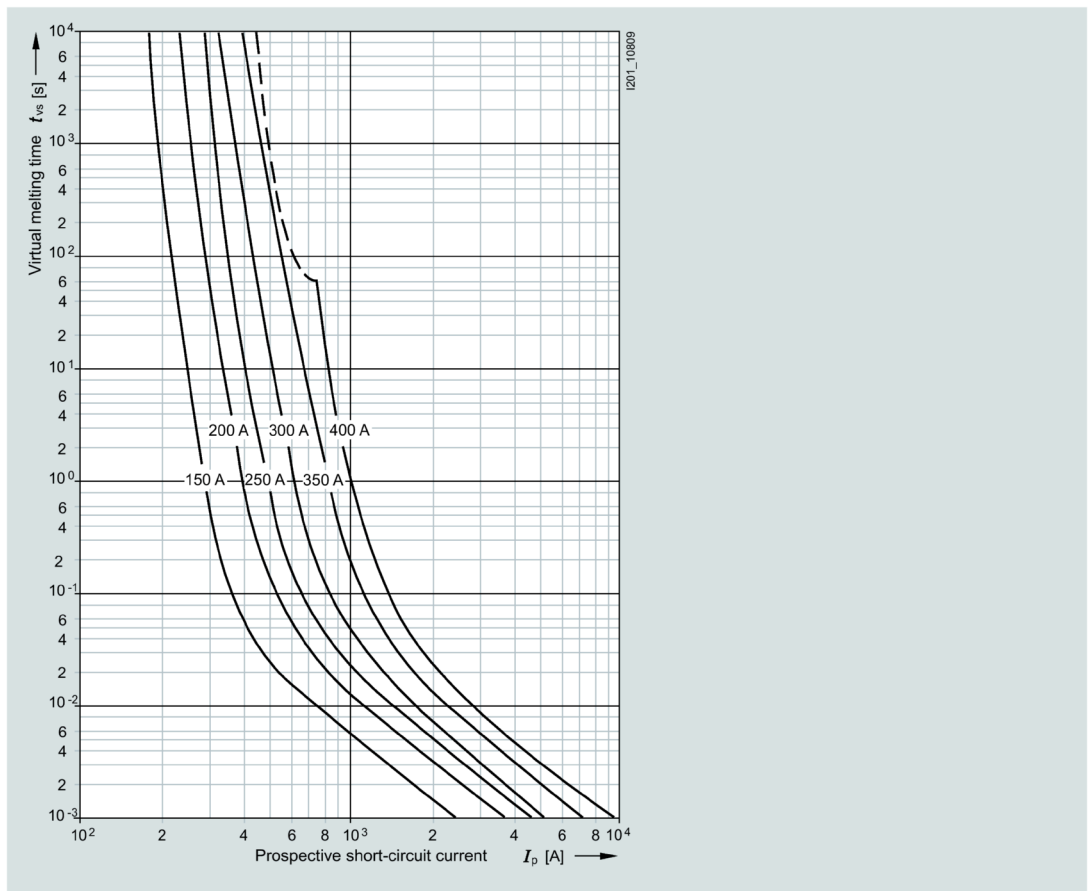

Correction factor  $k_A$  for breaking  $I^2t$  value

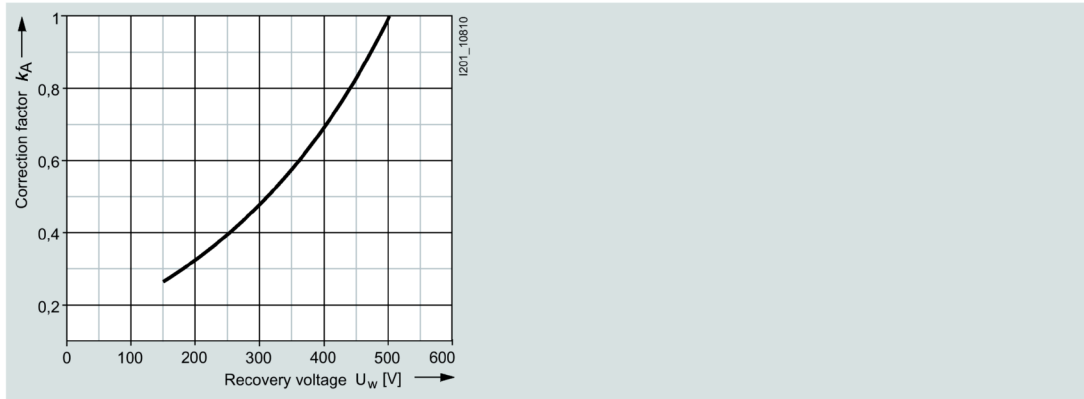

Let-through characteristic curves (current limiting at 50 Hz)

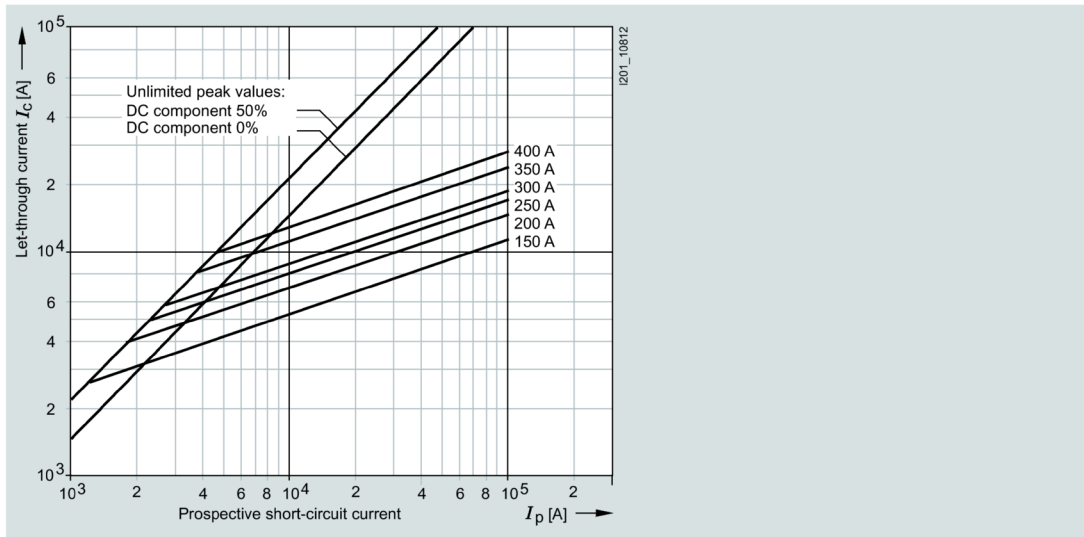

Peak arc voltage

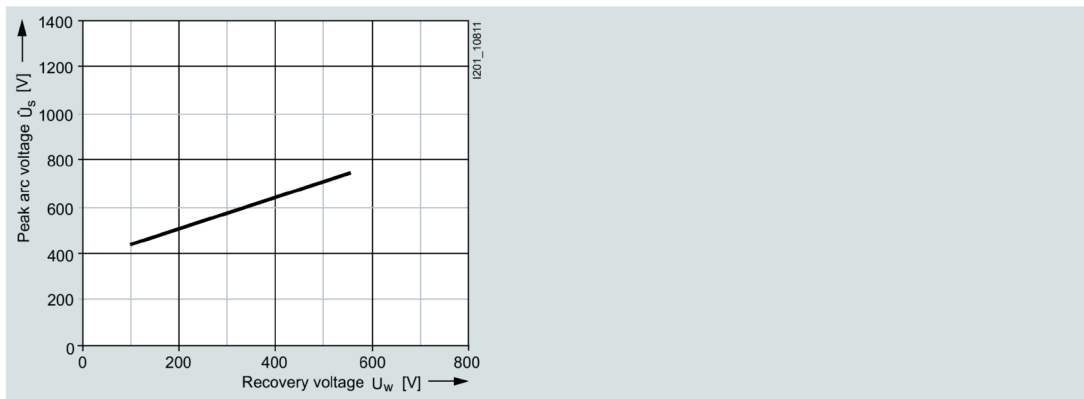

**3NB33.. series**

Size:	2 x, 3x3
Operational class:	gR
Rated voltage:	690 V AC
Rated current:	1000 ... 1900 V

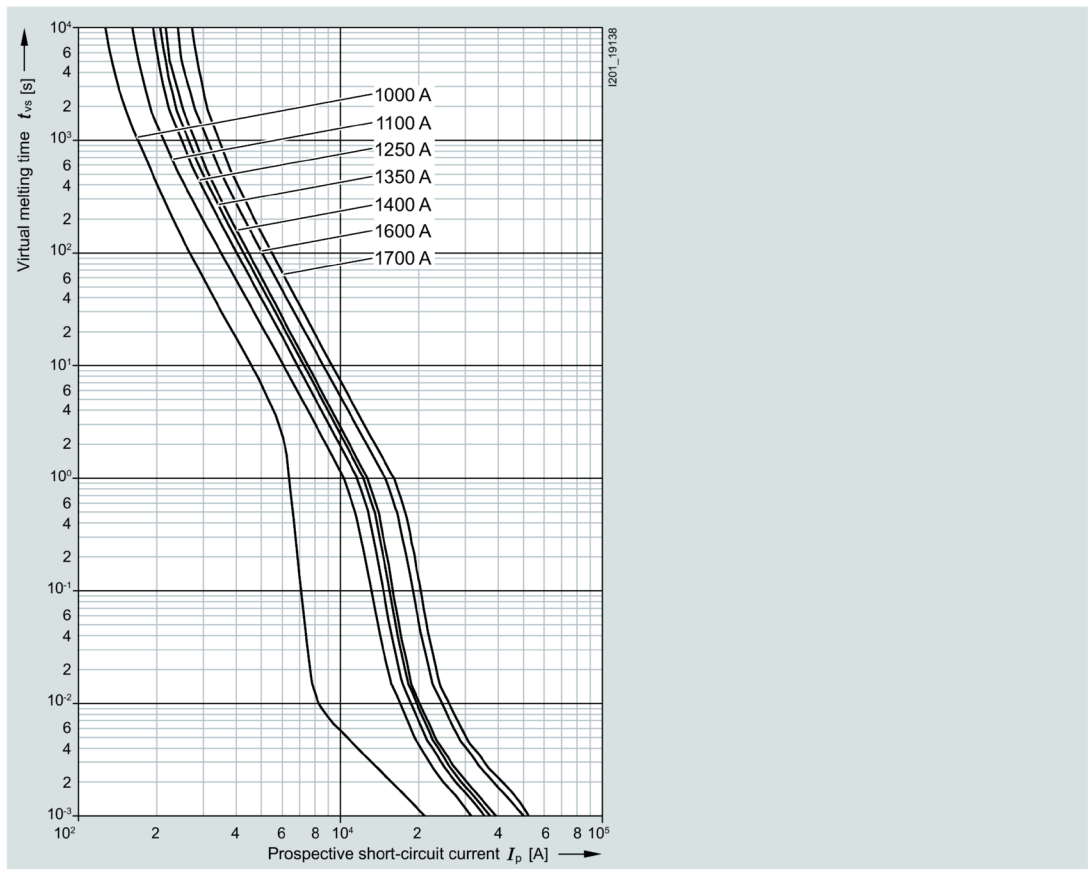
**Time/current characteristic curves diagram****3NB33..-1KK26**

3NB33..-1KK27

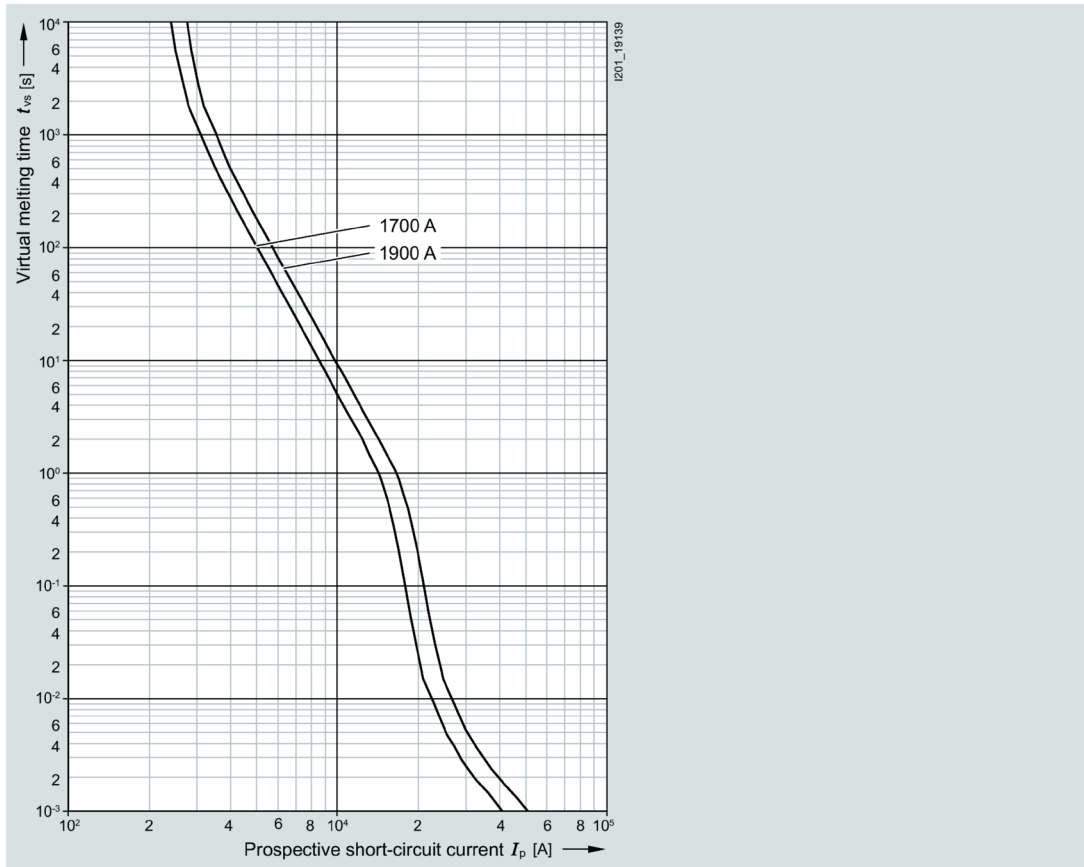

Let-through characteristic curves (current limiting at 50 Hz)

3NB33..-1KK.

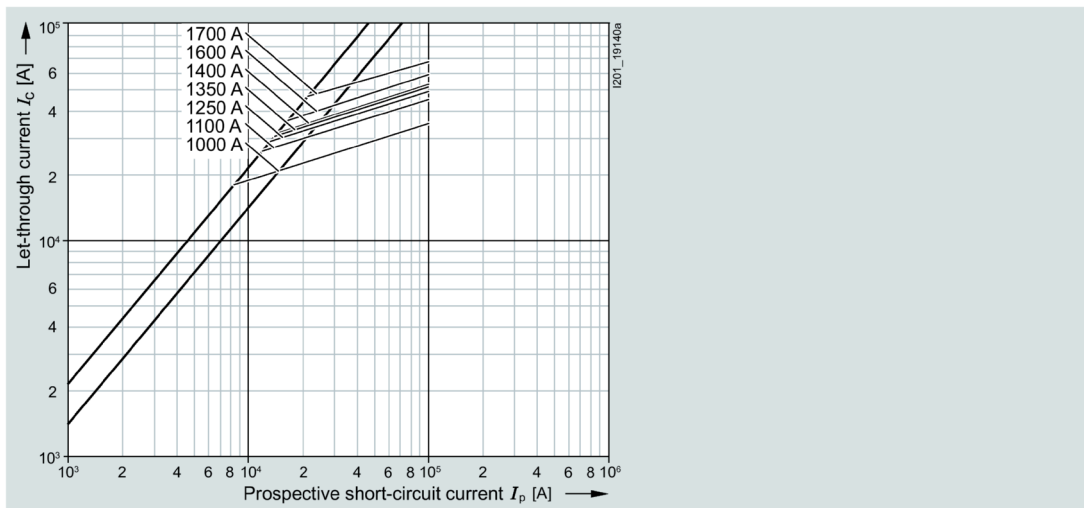

**3NB33...1KK27**

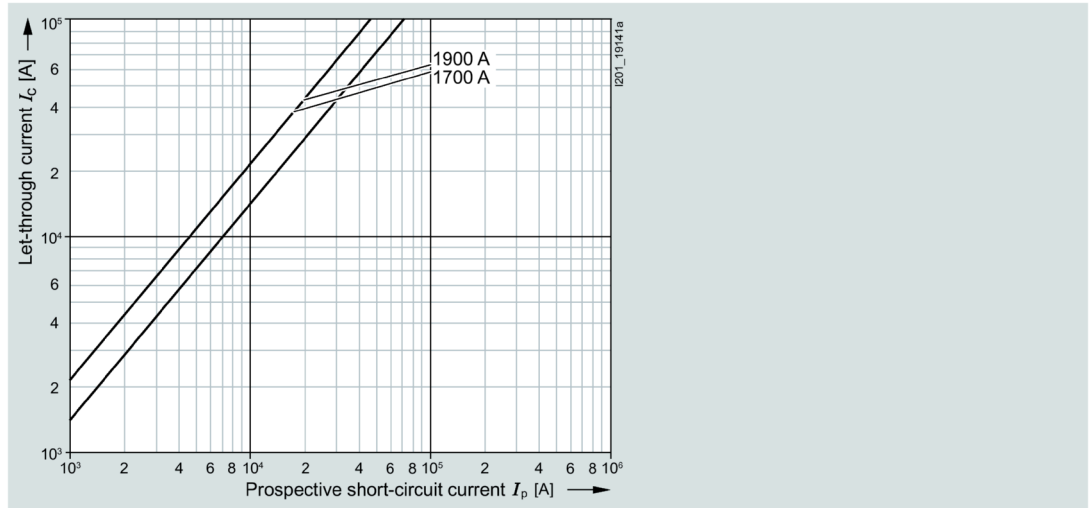

**Correction factor  $k_A$  for breaking  $I^2t$  value**

**3NB33...1KK.**

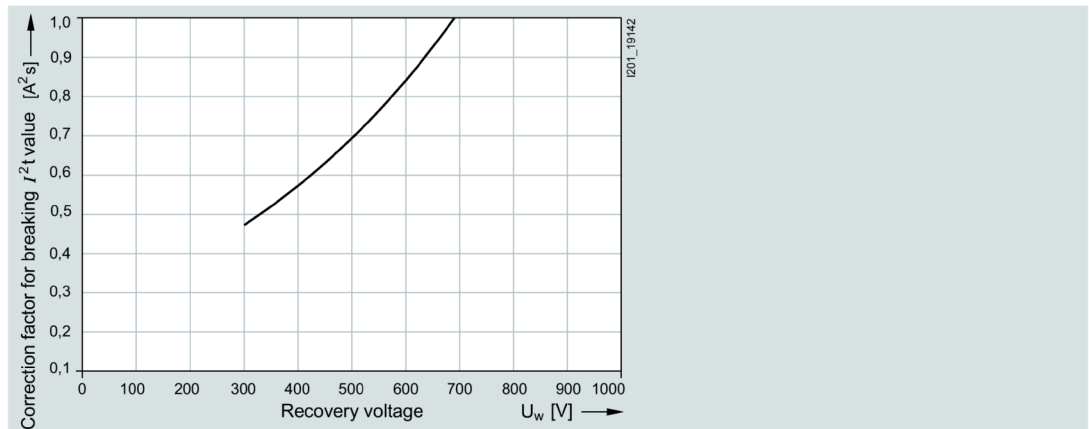

**Peak arc voltage**

**3NB33...-1KK.**

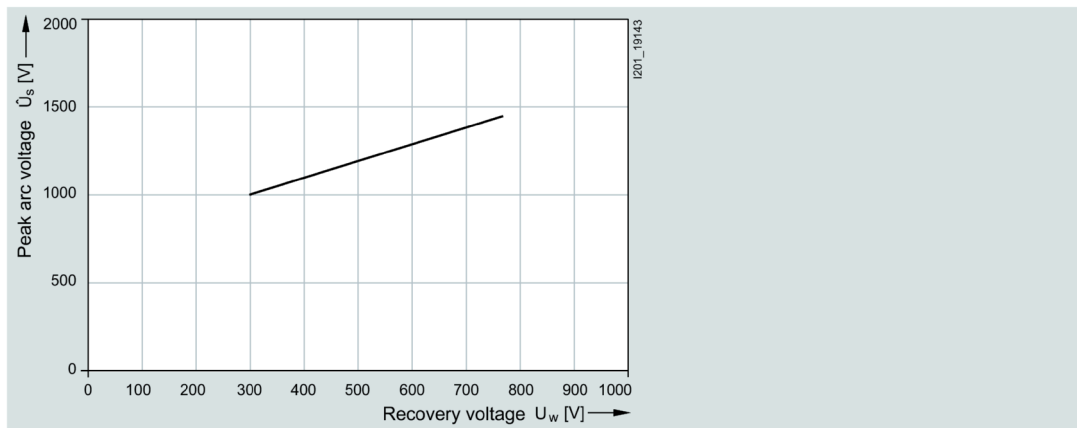

**3NC32 series**

Size:	3
Operational class:	aR
Rated voltage:	690 V AC (630 ... 1250 A) 500 V AC (1400 ... 1600 A)
Rated current:	630 ... 1600 A



Time/current characteristic curves diagram

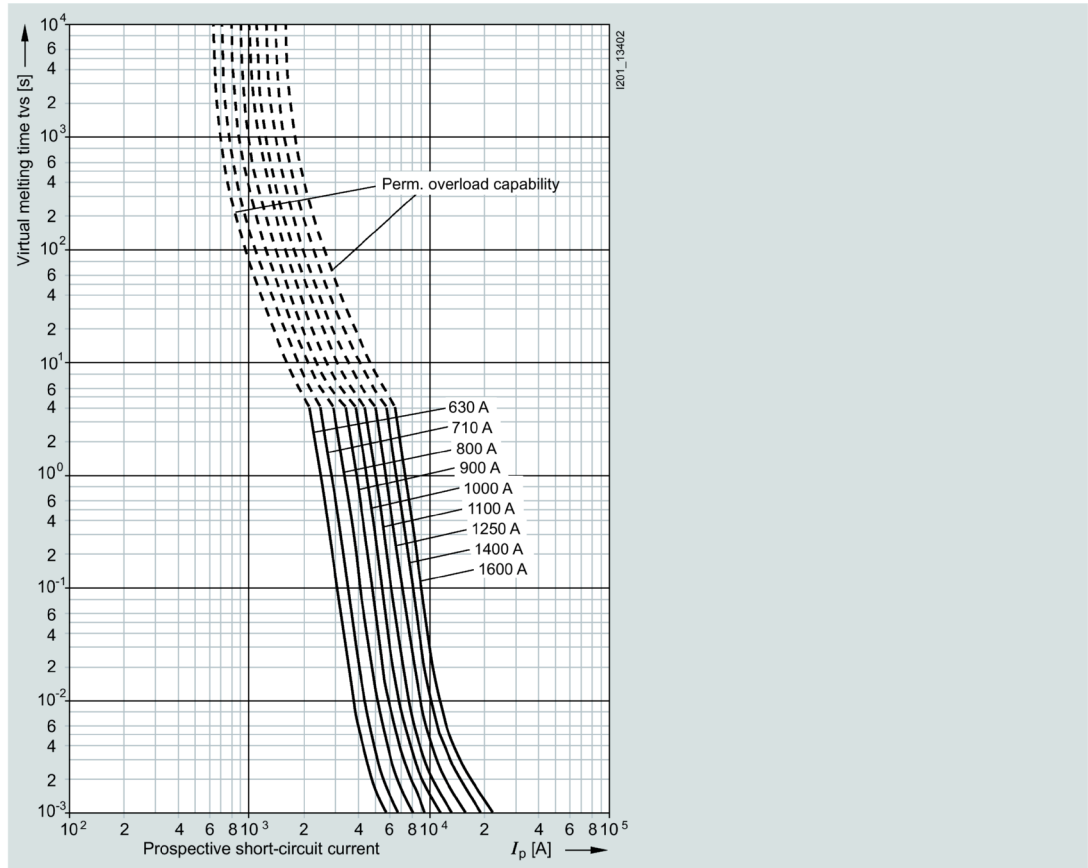

Correction factor  $k_A$  for breaking  $I^2t$  value

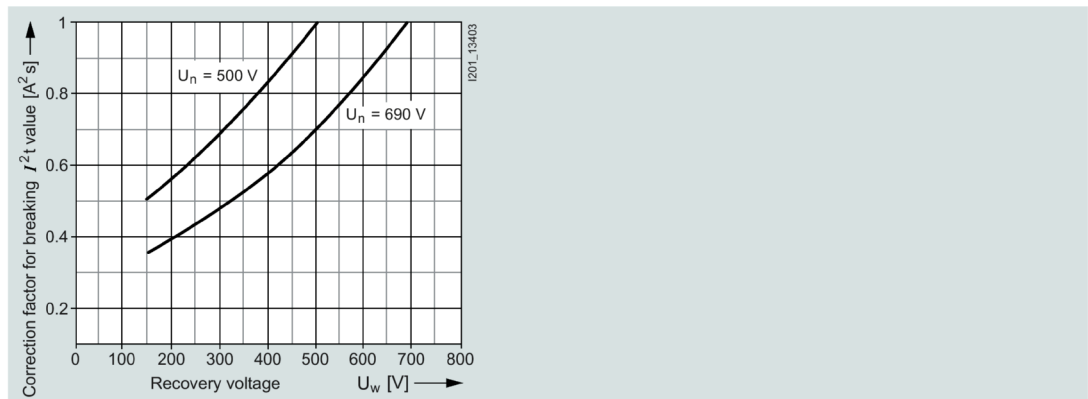

Let-through characteristic curves

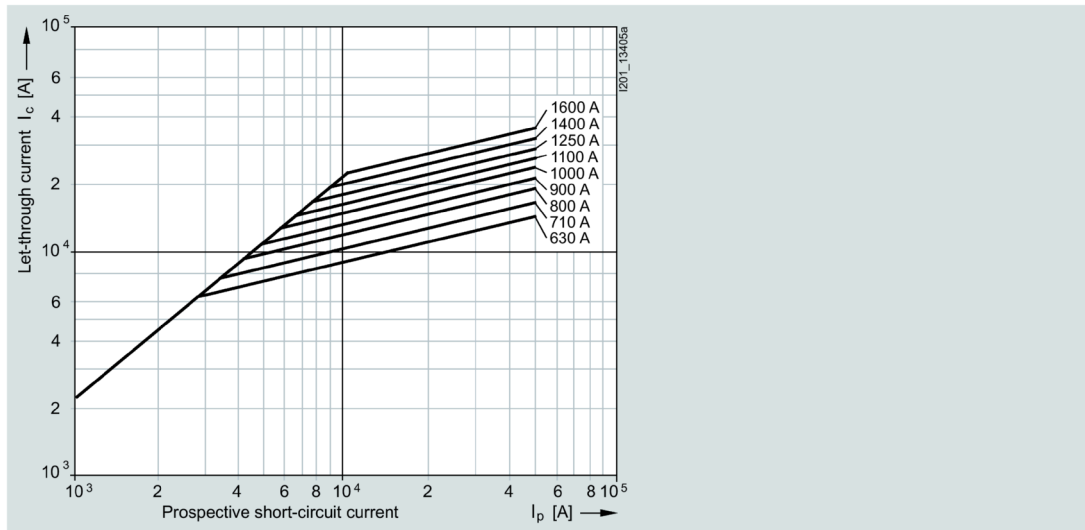

Peak arc voltage

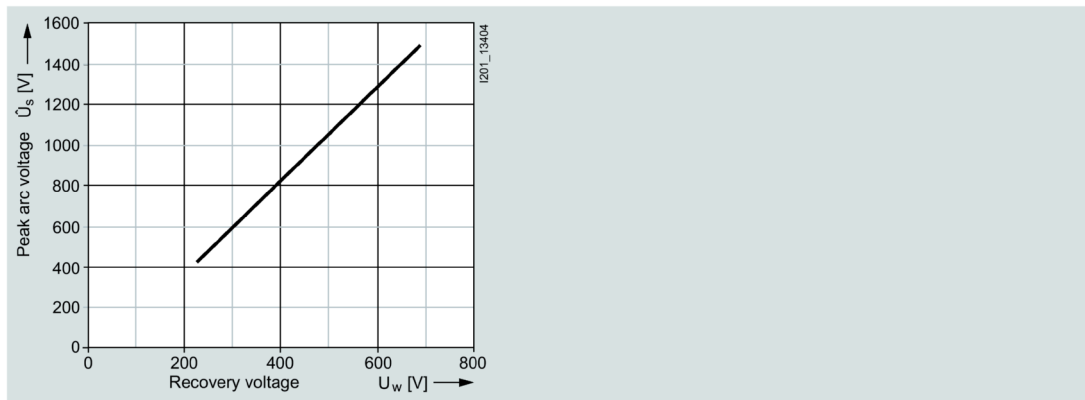

3NC33 series

Size:	3
Operational class:	aR
Rated voltage:	1000 V AC (630 ... 1000 A) 800 V AC (1100 ... 1600 A)
Rated current:	630 ... 1250 A

Time/current characteristic curves diagram

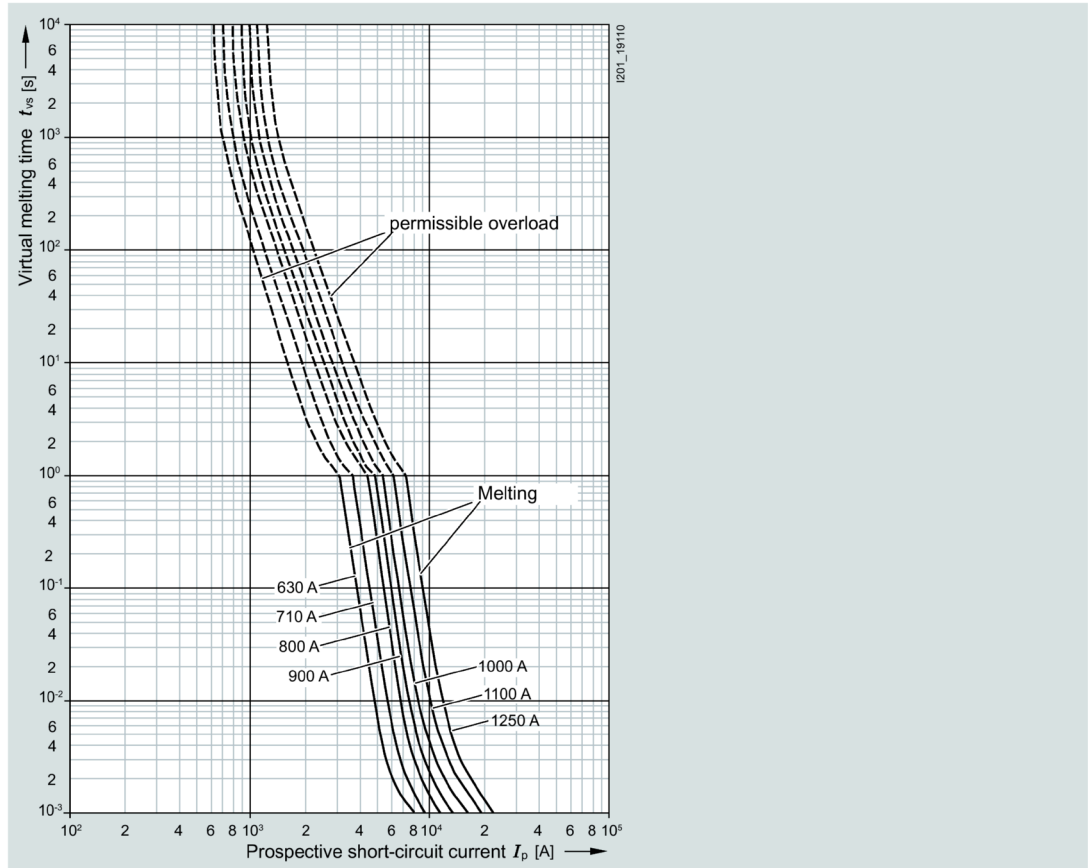

Correction factor  $k_A$  for breaking  $I^2t$  value

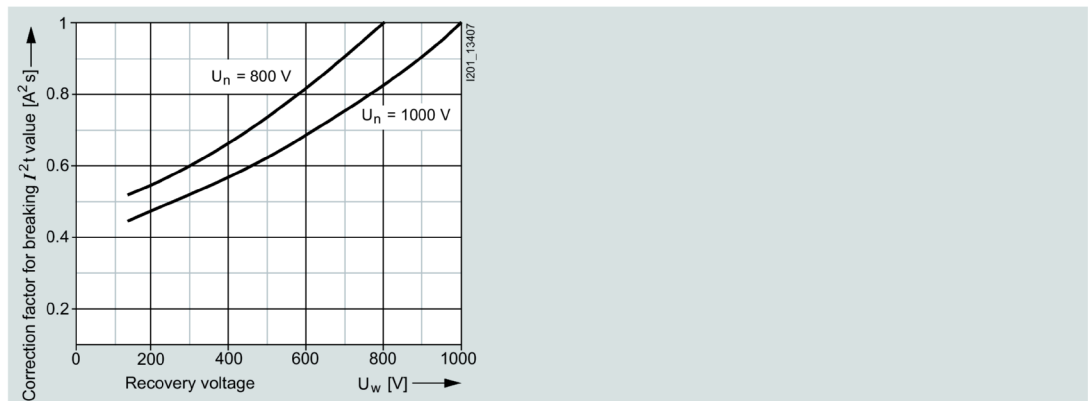

Let-through characteristic curves

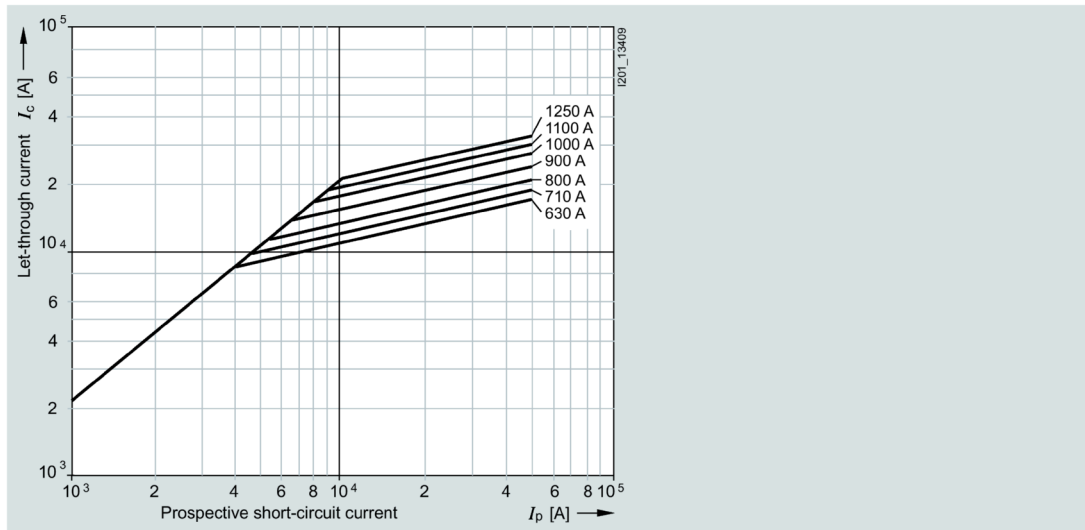

Peak arc voltage

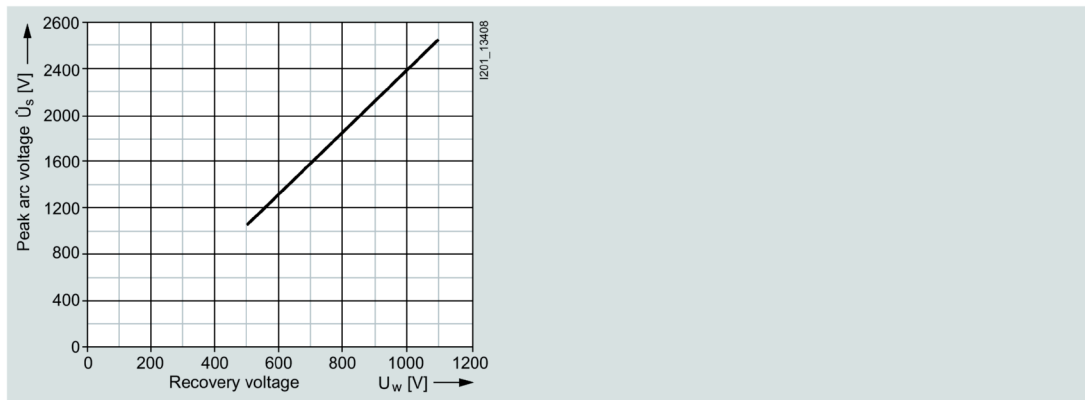

3NC34 series

Size:	3
Operational class:	aR
Rated voltage:	1250 V AC (315 ... 630 A) 1100 V AC (800 A)
Rated current:	315 ... 800 A

Time/current characteristic curves diagram

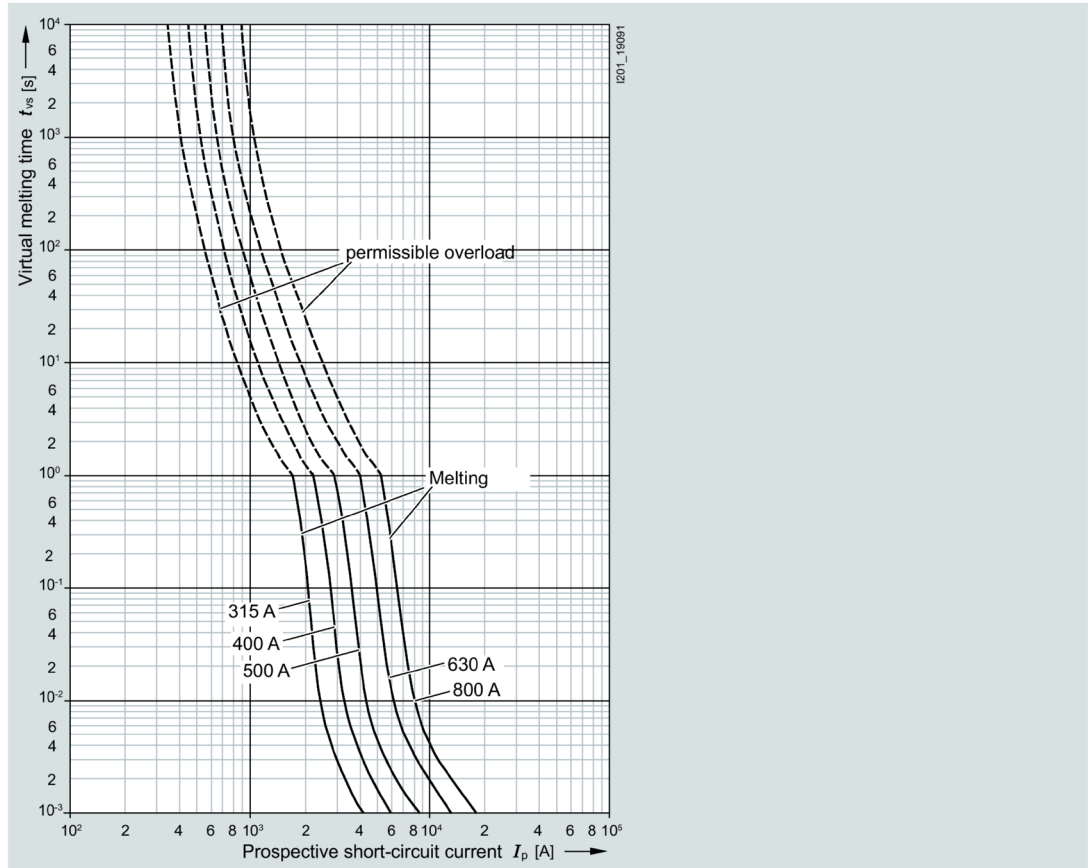

Correction factor  $k_A$  for breaking  $I^2t$  value

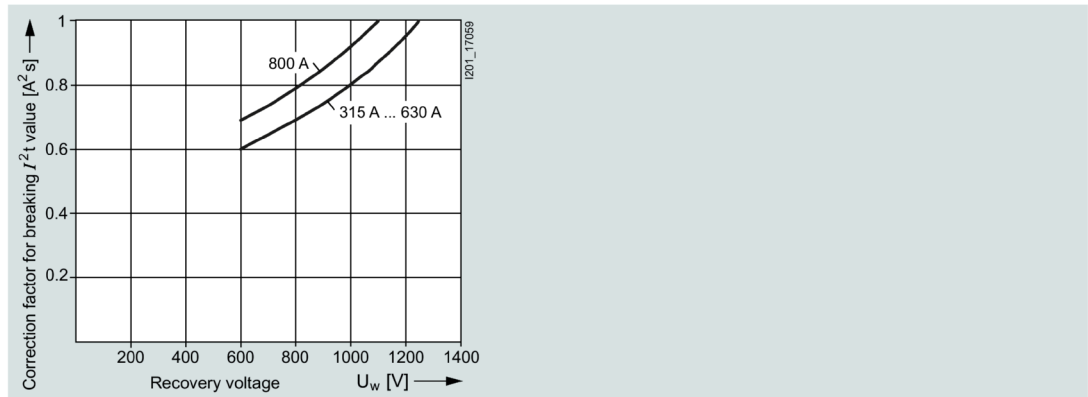

Let-through characteristic curves

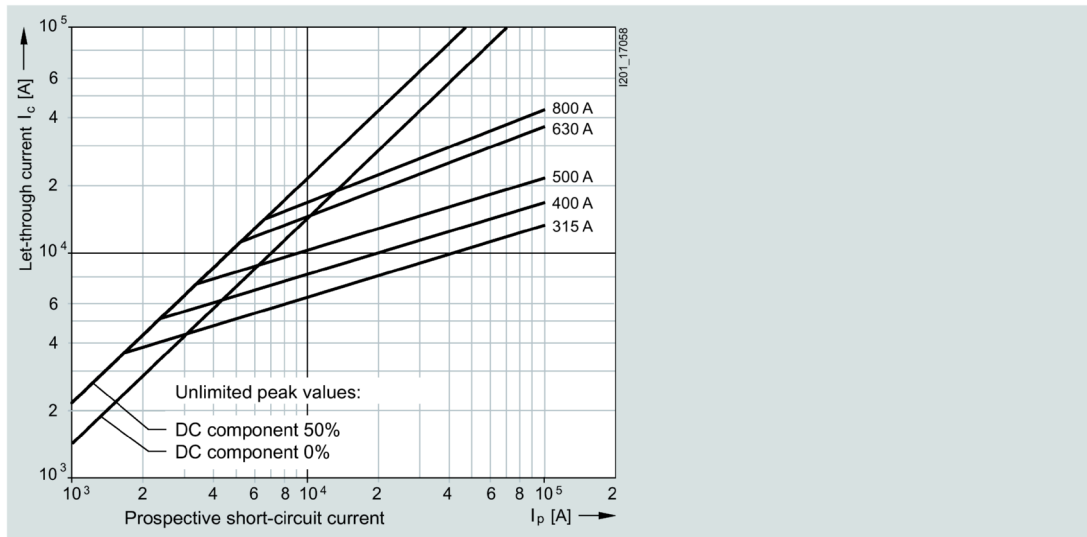

Peak arc voltage

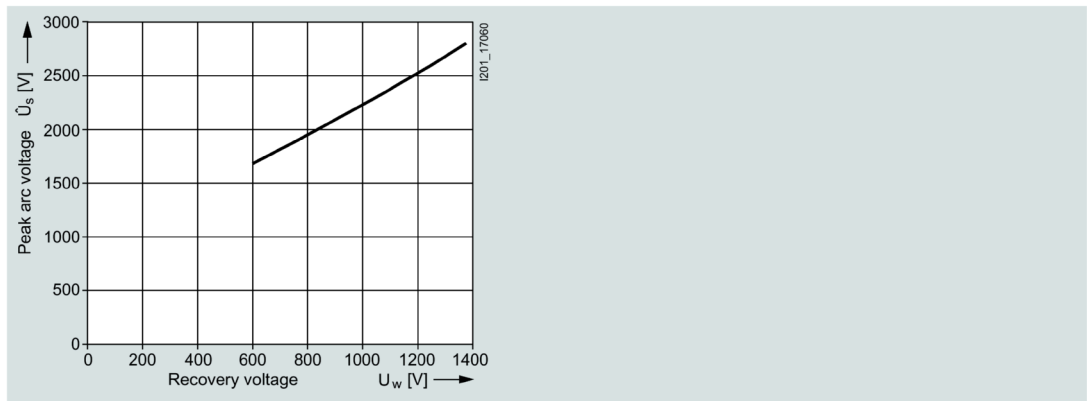

3NC5531, 3NC58. . series

Size:	3
Operational class:	aR
Rated voltage:	800 V AC (315 A, 630 A) 1000 V AC (600 A, 800 A)
Rated current:	350 ... 800 A

Time/current characteristic curves diagram

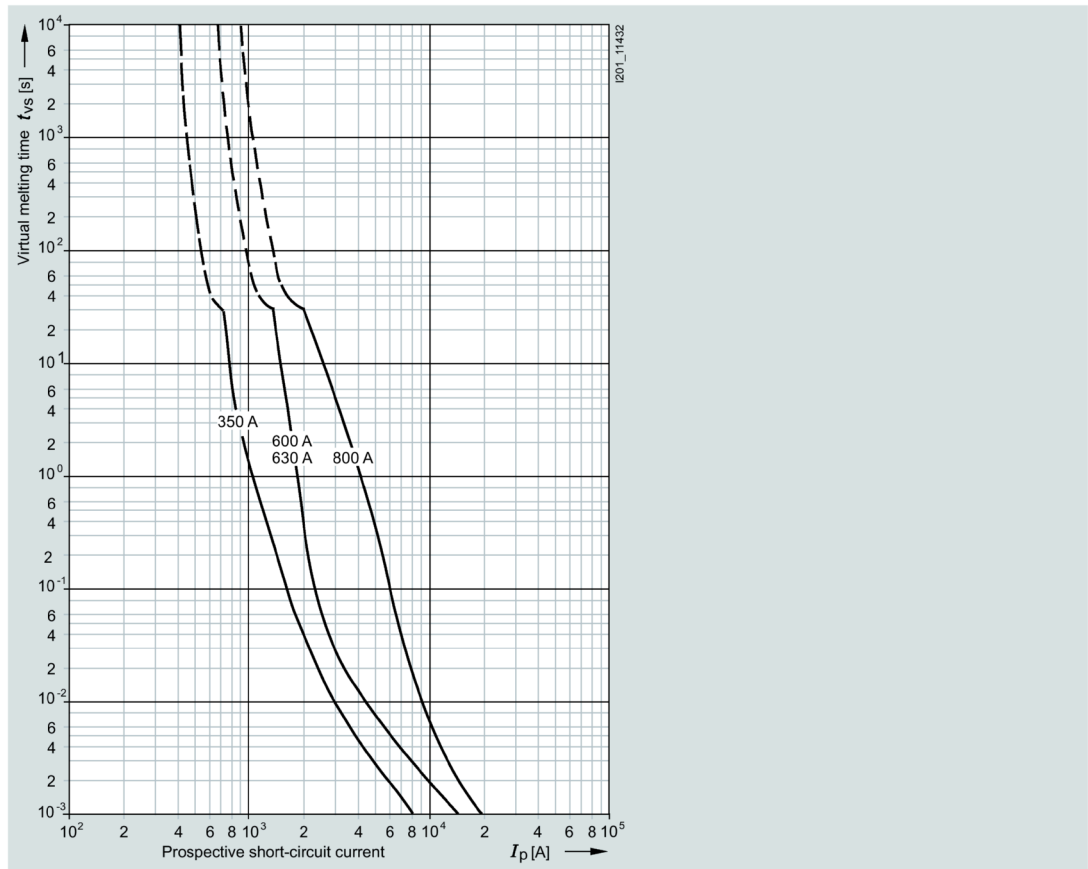

Correction factor  $k_A$  for breaking  $I^2t$  value

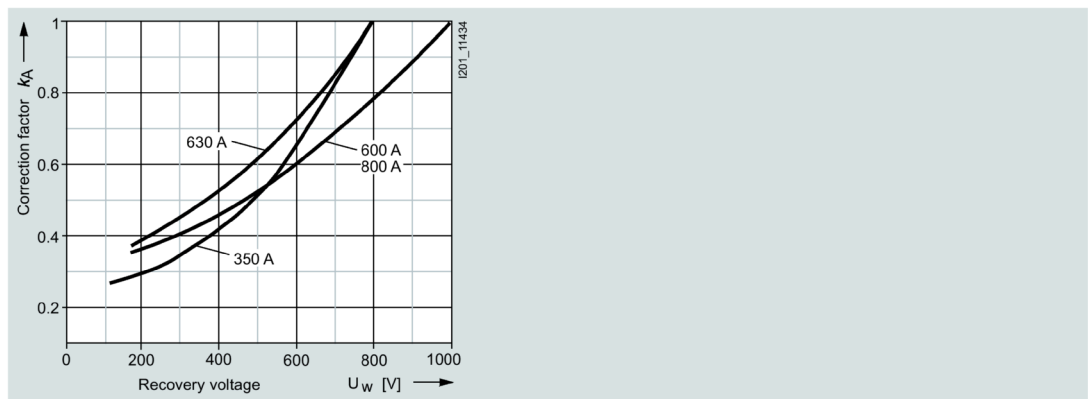

Let-through characteristic curves (current limiting at 50 Hz)

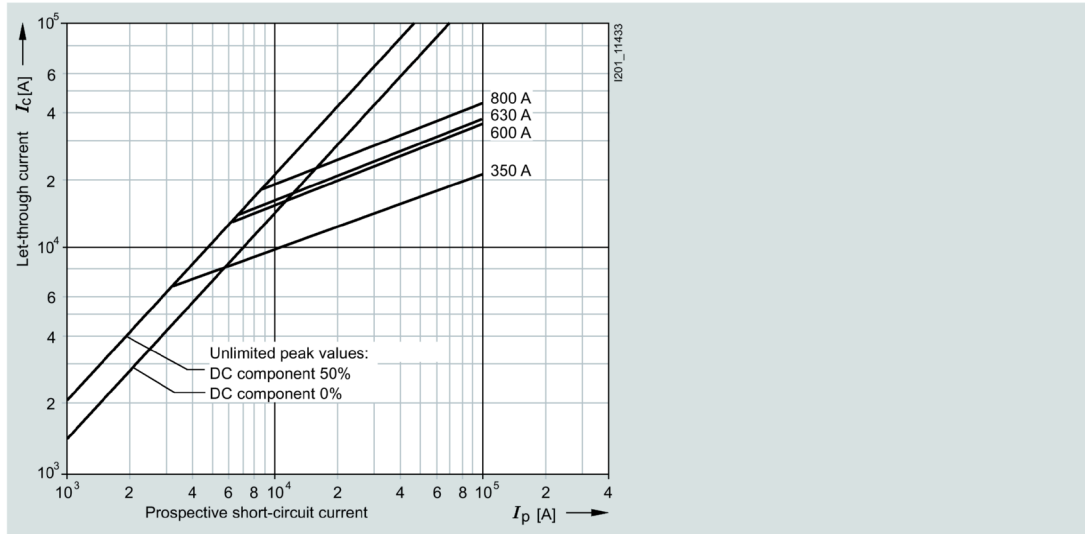

Peak arc voltage

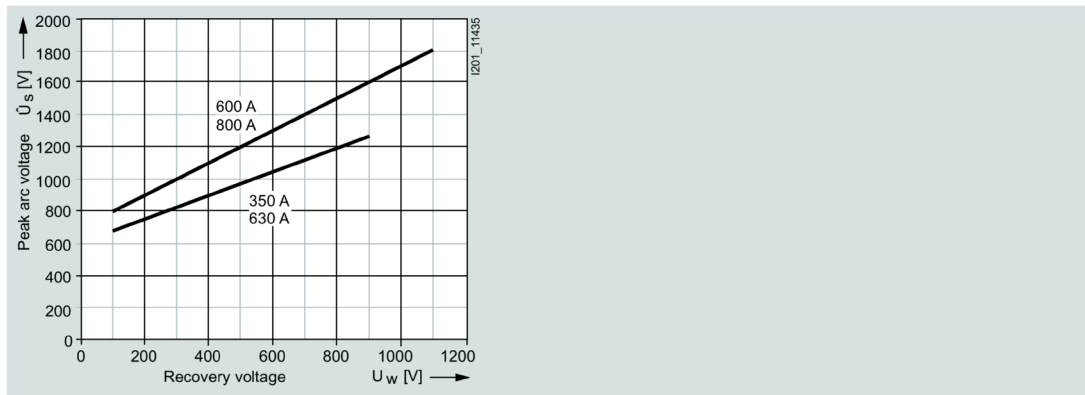

3NC73..-2 series

Operational class:	aR
Rated voltage:	680 V AC
Rated current:	250 A, 350 V



Time/current characteristic curves diagram

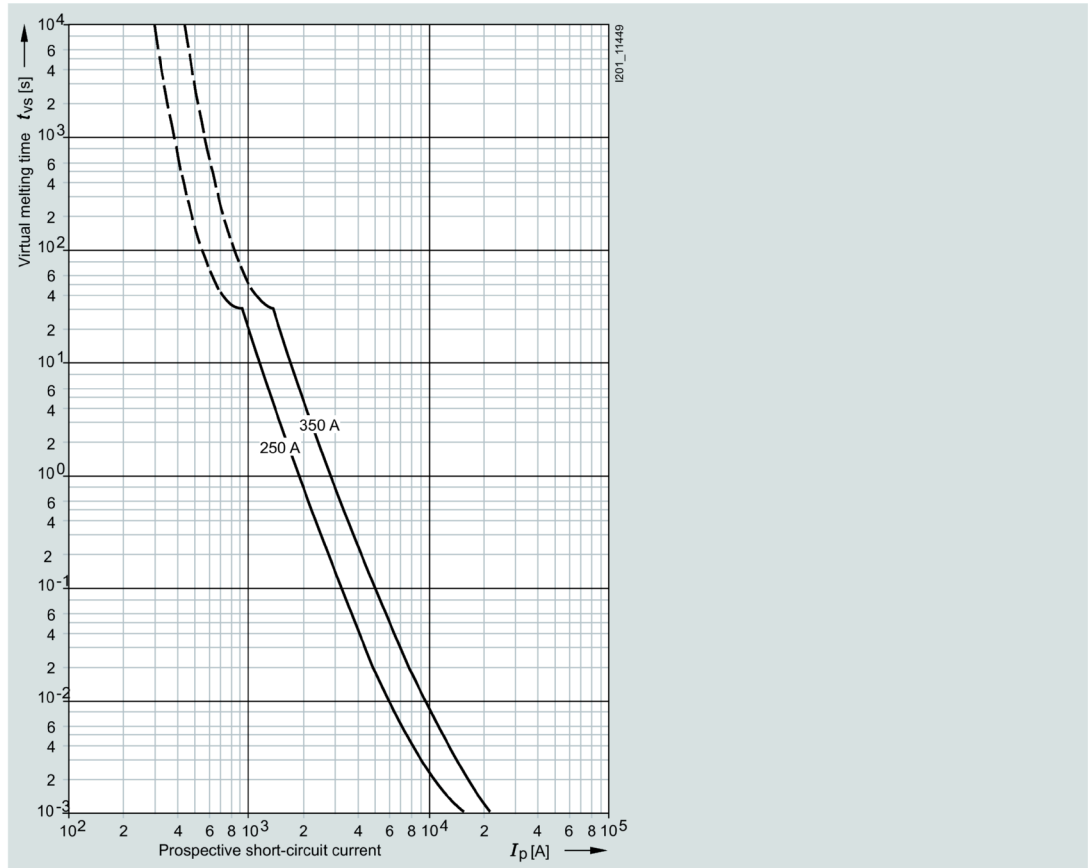

Correction factor  $k_A$  for breaking  $I^2t$  value

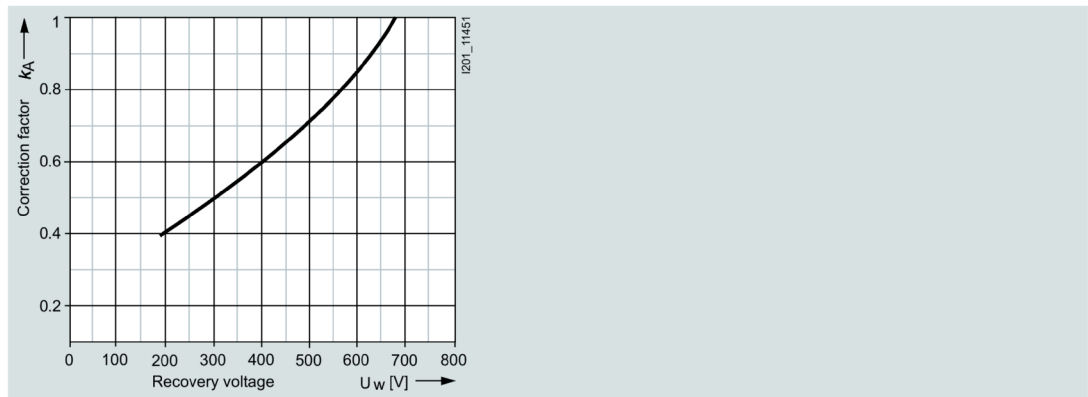

Let-through characteristic curves (current limiting at 50 Hz)

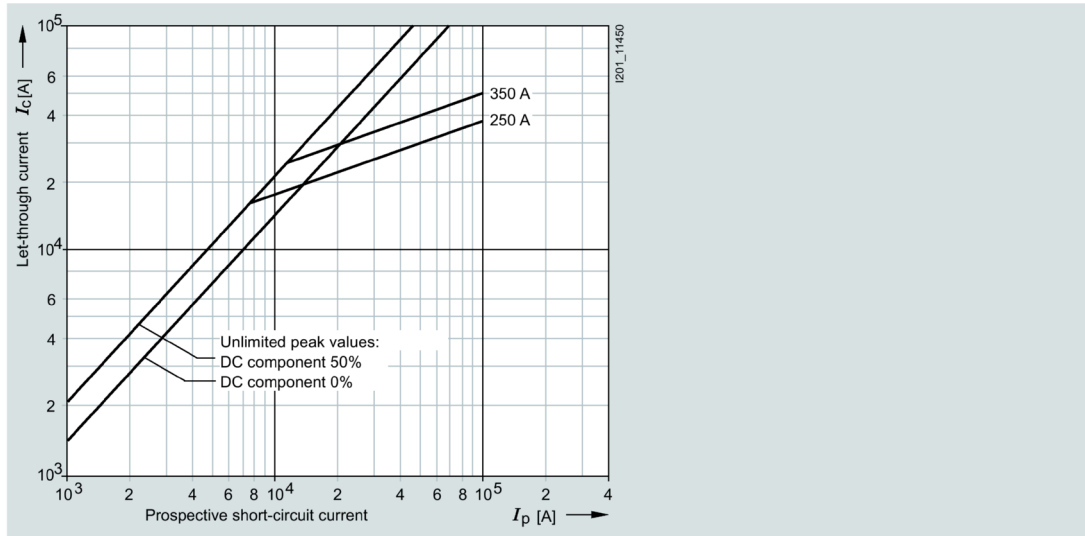

Peak arc voltage

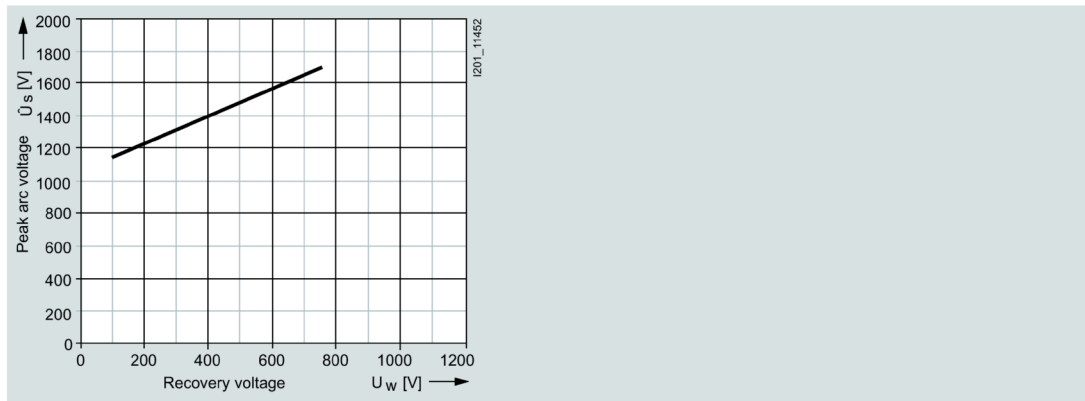

3NC84. . series

Size:	3
Operational class:	gR or aR
Rated voltage:	660 V AC
Rated current:	150 ... 1000 A

Time/current characteristic curves diagram

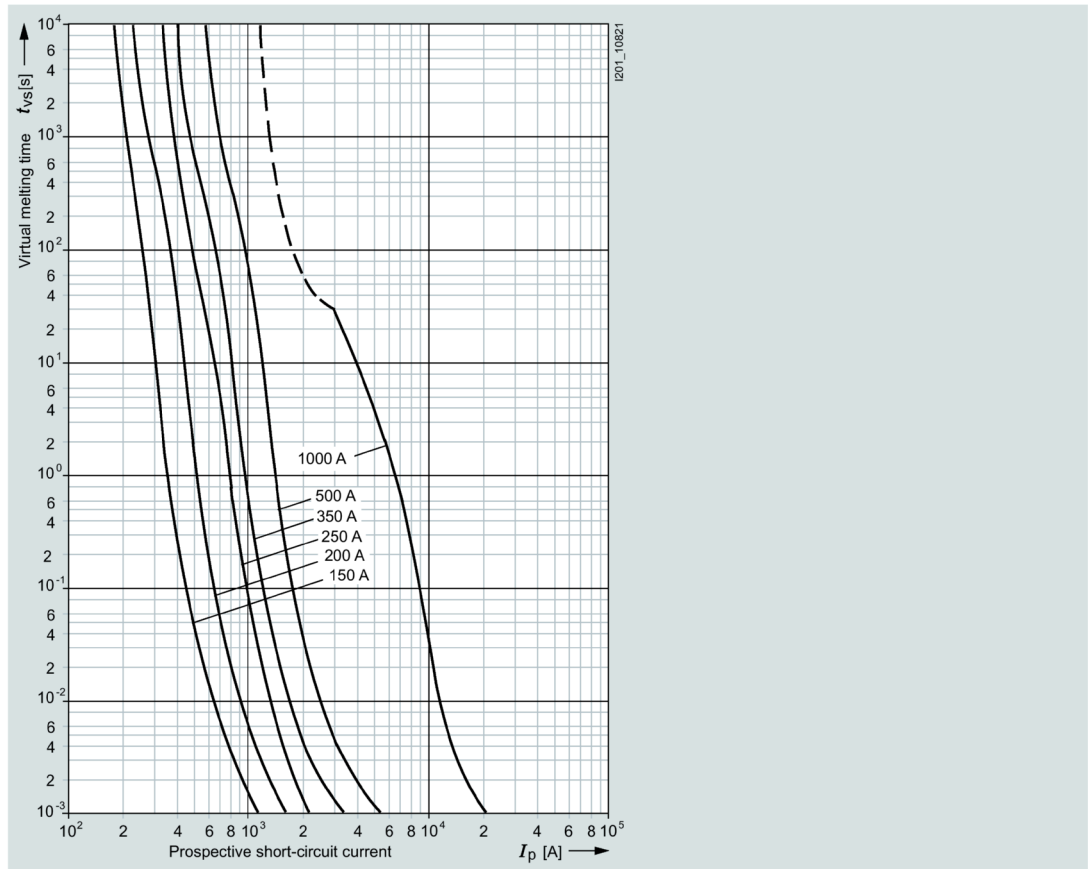

Correction factor  $k_A$  for breaking  $I^2t$  value

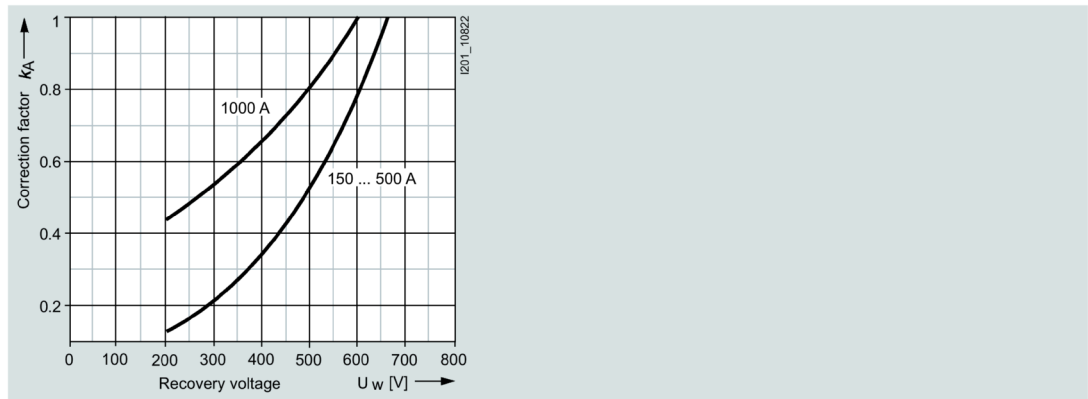

Let-through characteristic curves (current limiting at 50 Hz)

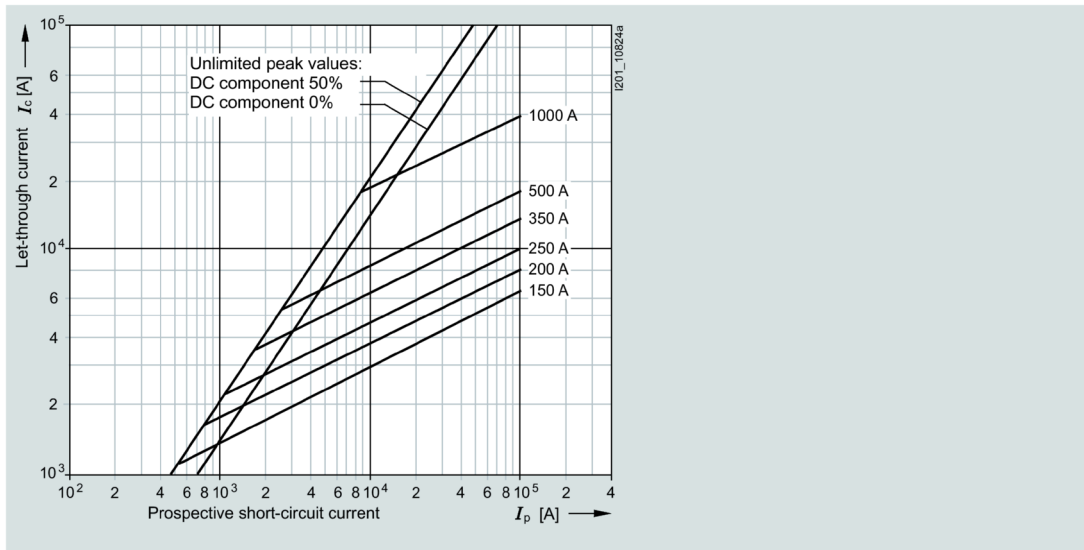

Peak arc voltage

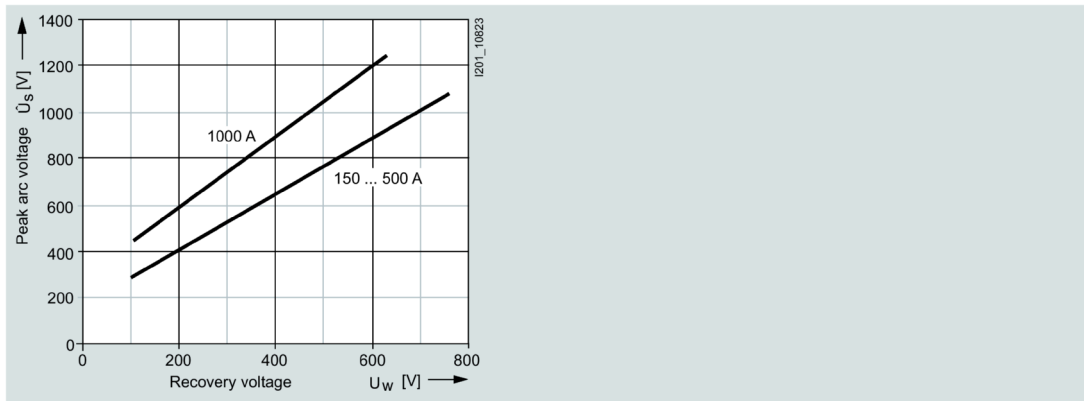

3NE102.-0, 3NE12..-0 series

Size:	00, 1
Operational class:	gS
Rated voltage:	690 V AC
Rated current:	100 ... 315 A

Time/current characteristic curves diagram

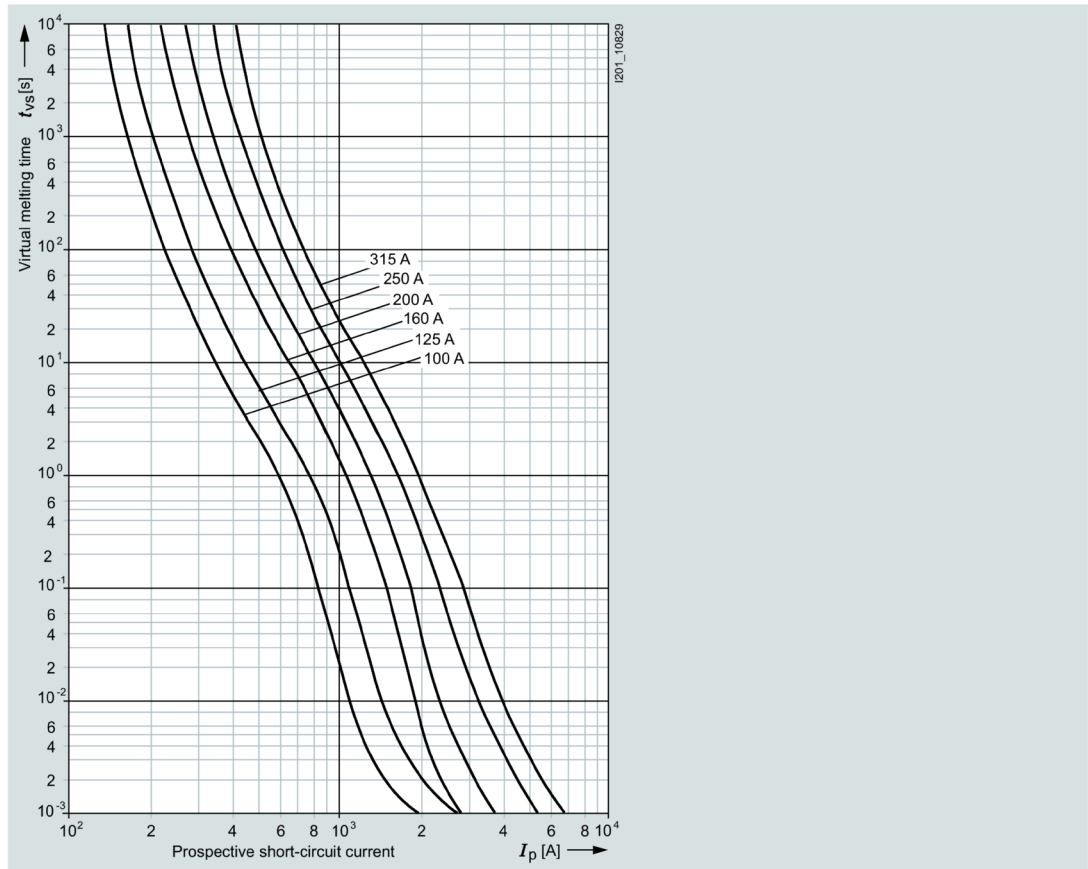

Correction factor  $k_A$  for breaking  $I^2t$  value

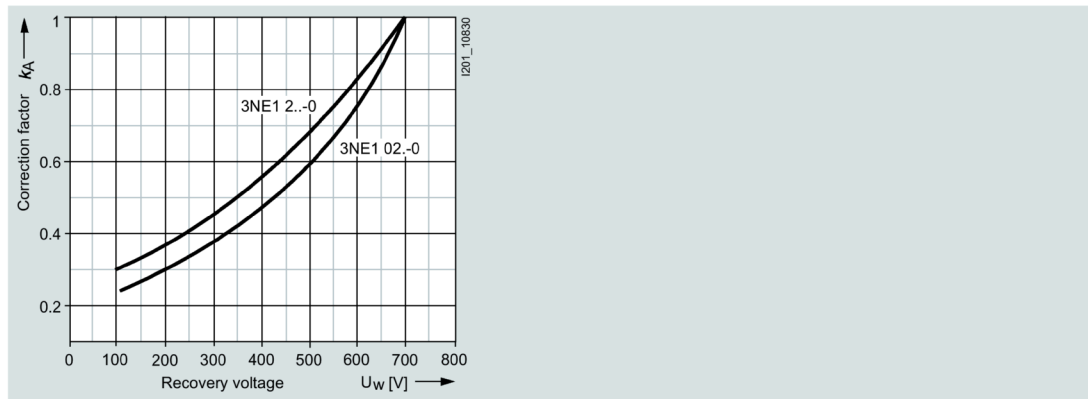

Let-through characteristic curves (current limiting at 50 Hz)

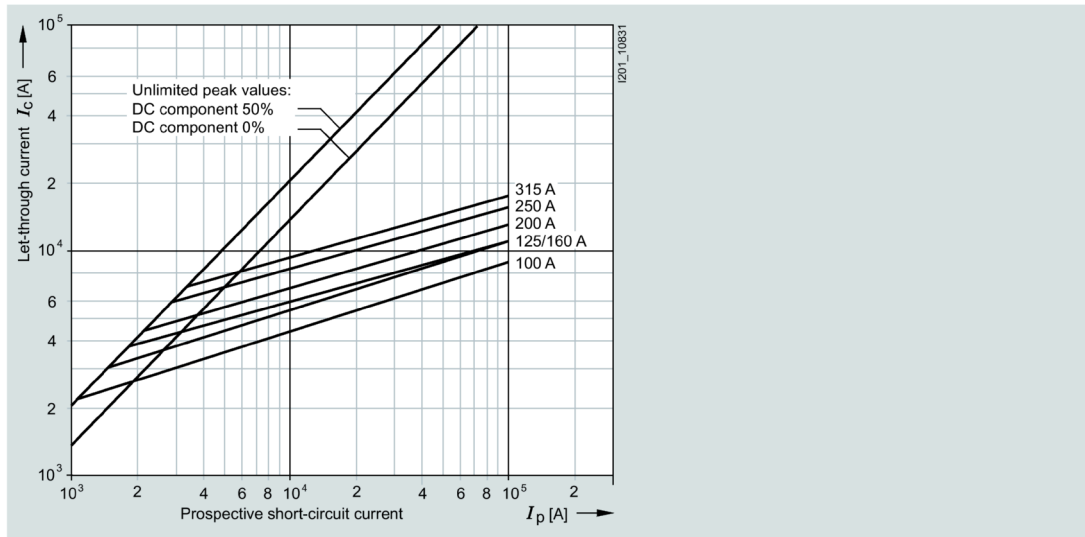

Peak arc voltage

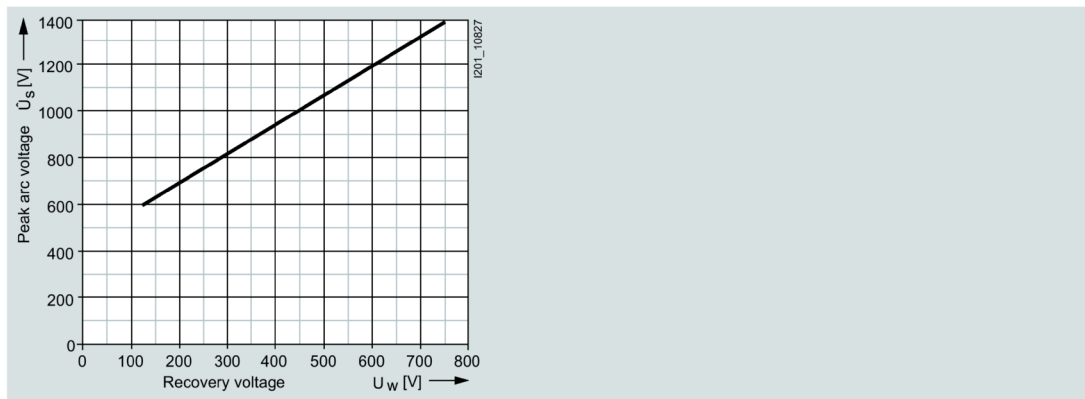

3NE102.-2, 3NE12.-2, 3NE12.-3, 3NE13.-2, 3NE13.-3 series

Size:	00, 1, 2
Operational class:	gR
Rated voltage:	690 V AC
Rated current:	80 ... 500 A

Time/current characteristic curves diagram

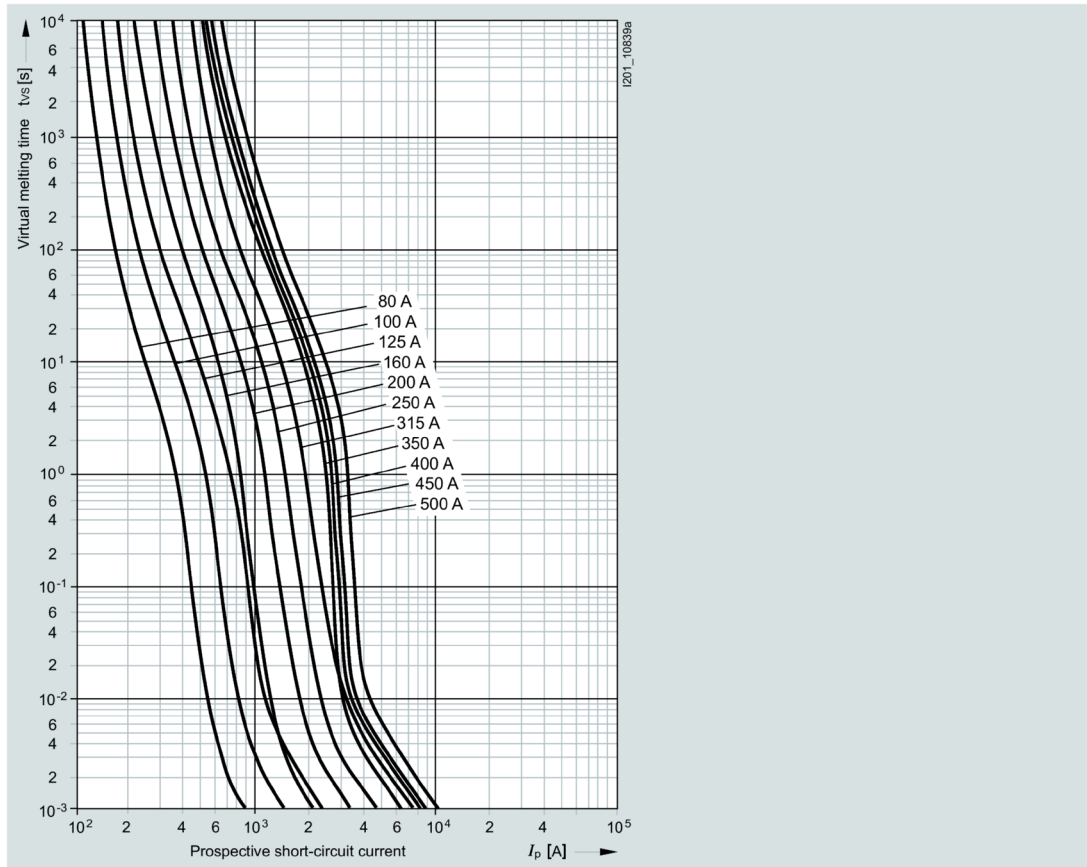

Correction factor  $k_A$  for breaking  $I^2t$  value

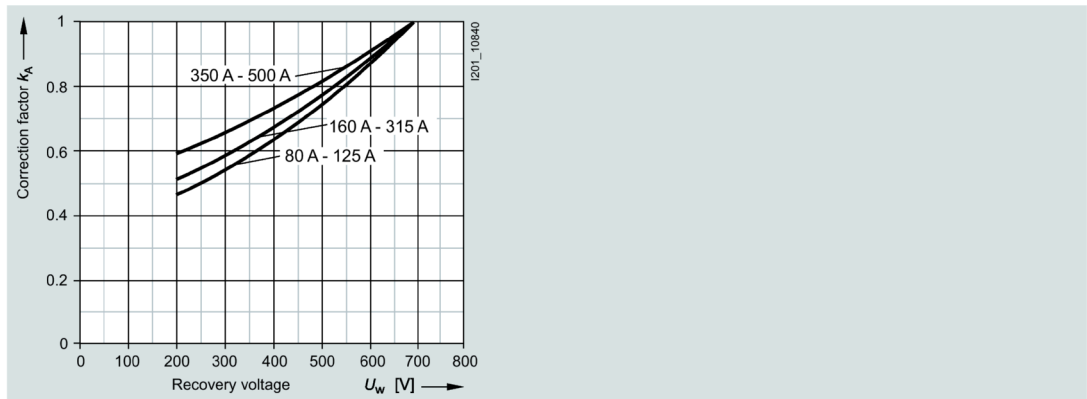

Let-through characteristic curves (current limiting at 50 Hz)

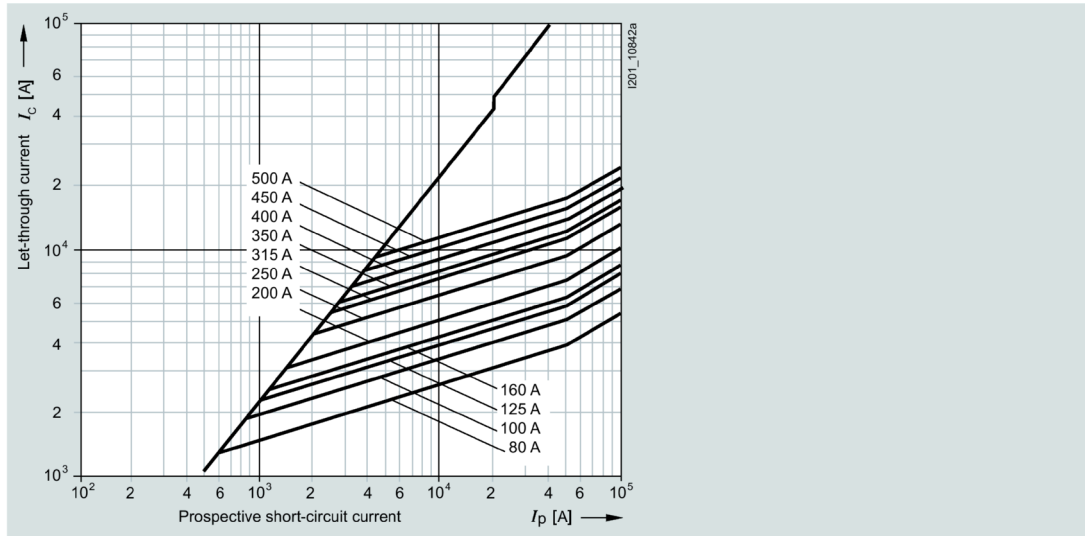

Peak arc voltage

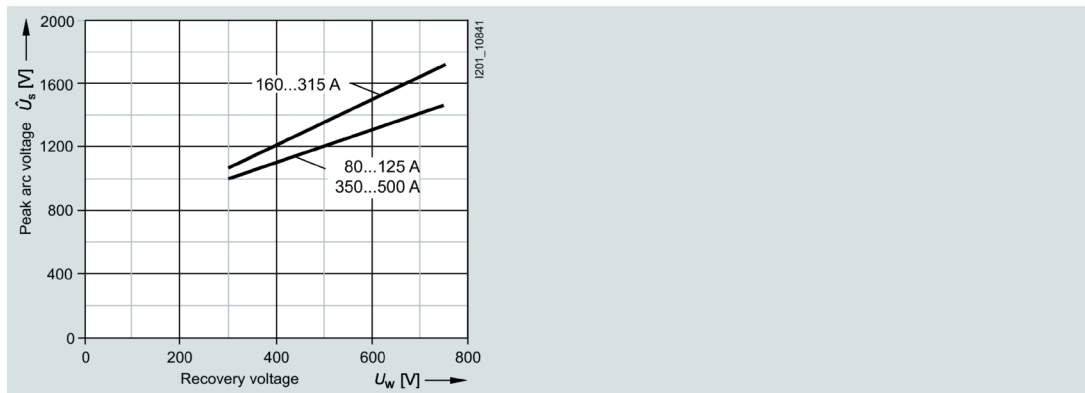

3NE133.-0, 3NE143.-0 series

Size:	2, 3
Operational class:	gS
Rated voltage:	690 V AC
Rated current:	350 ... 800 A



Time/current characteristic curves diagram

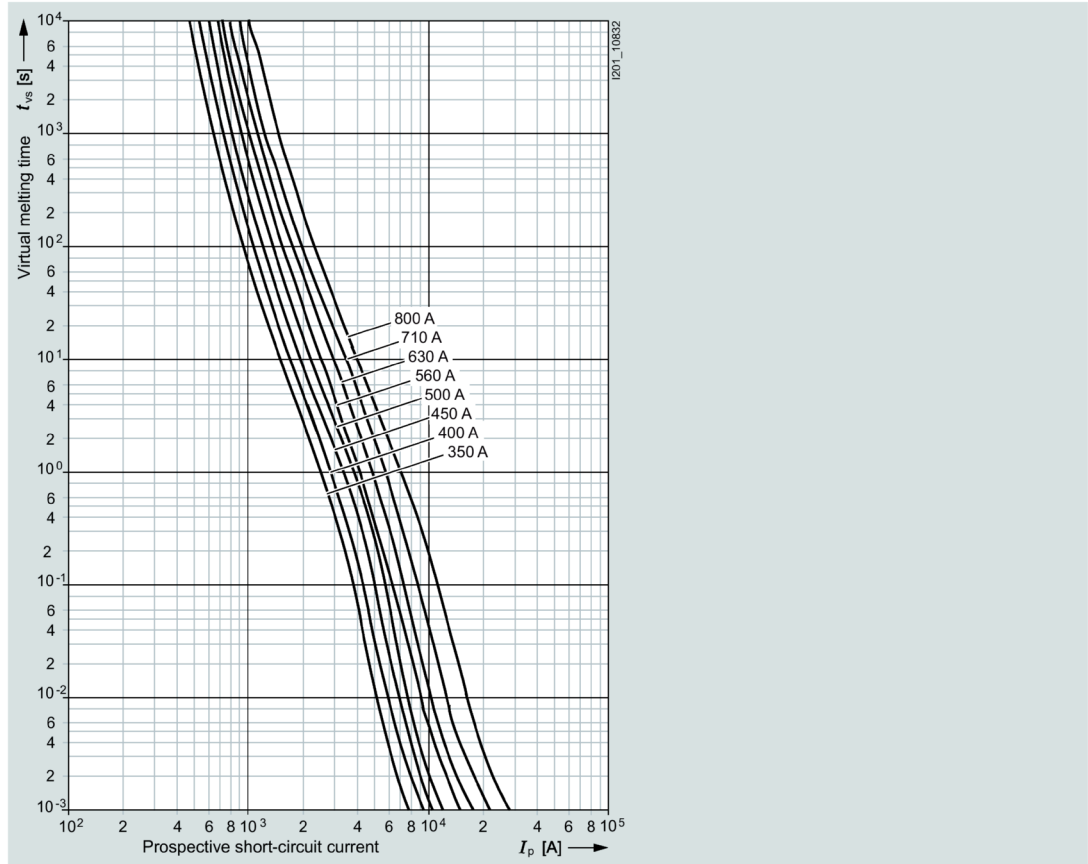

Correction factor  $k_A$  for breaking  $I^2t$  value

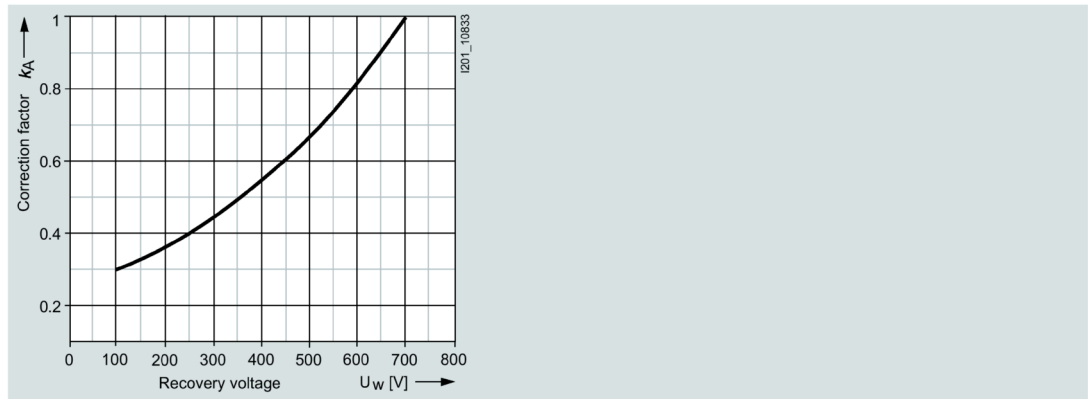

Let-through characteristic curves (current limiting at 50 Hz)

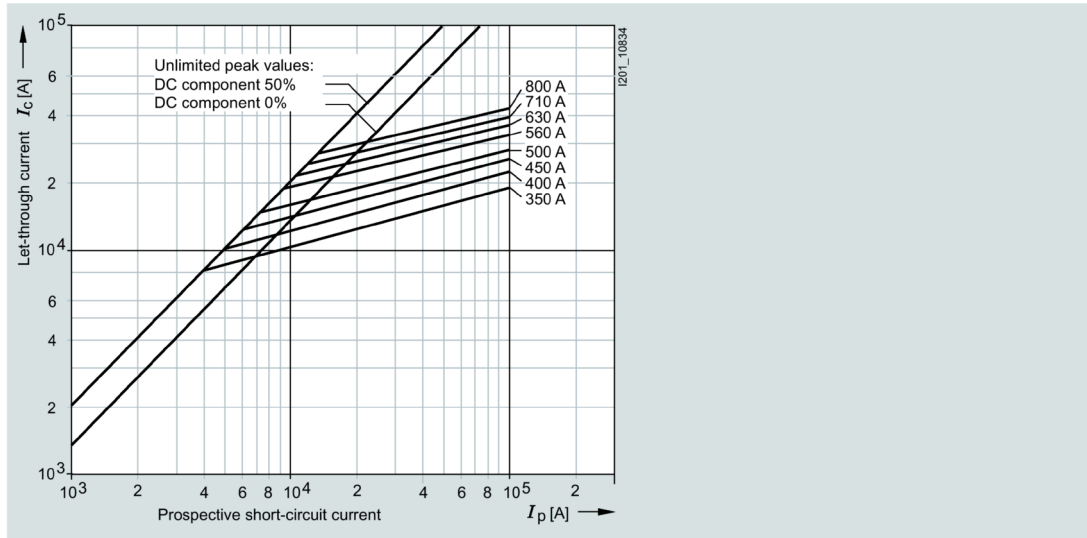

Peak arc voltage

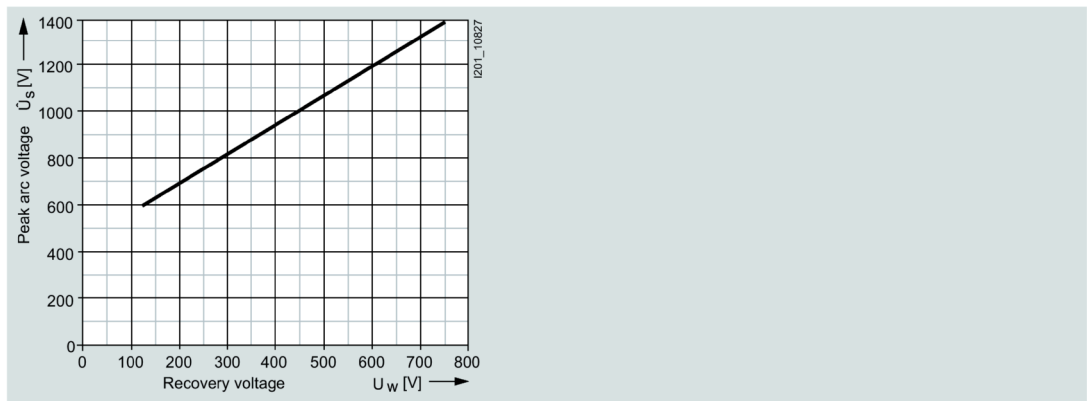

3NE14. .-2, 3NE14. .-3 series

Size:	3
Operational class:	gR
Rated voltage:	690 V AC
Rated current:	560 ... 850 A

Time/current characteristic curves diagram

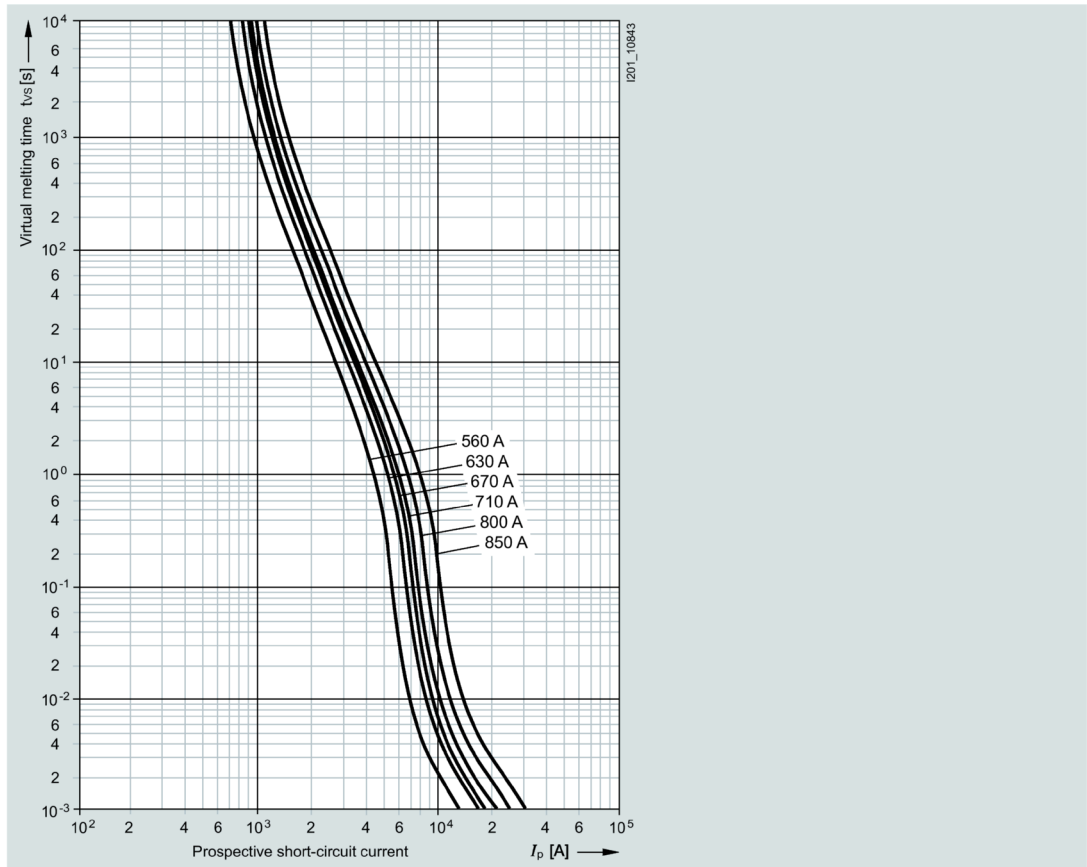

Correction factor  $k_A$  for breaking  $I^2t$  value

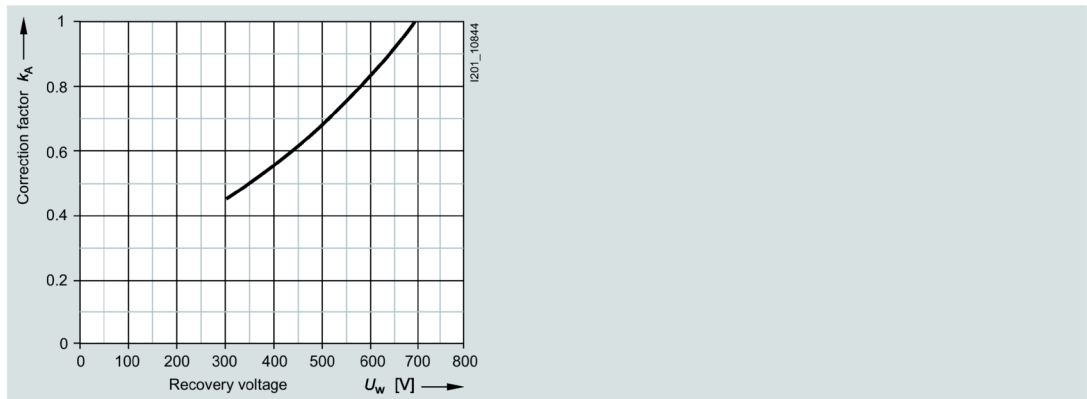

Let-through characteristic curves (current limiting at 50 Hz)

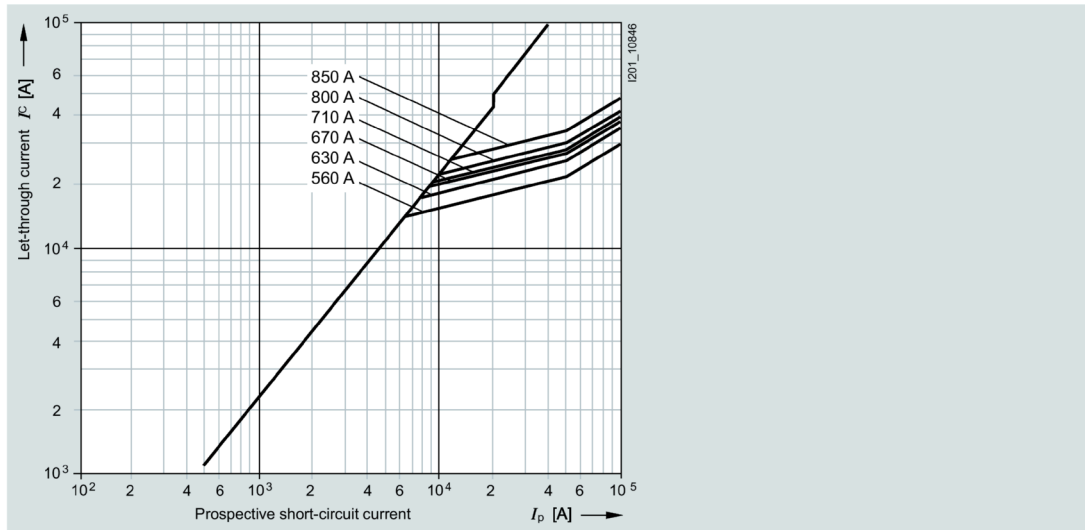

Peak arc voltage

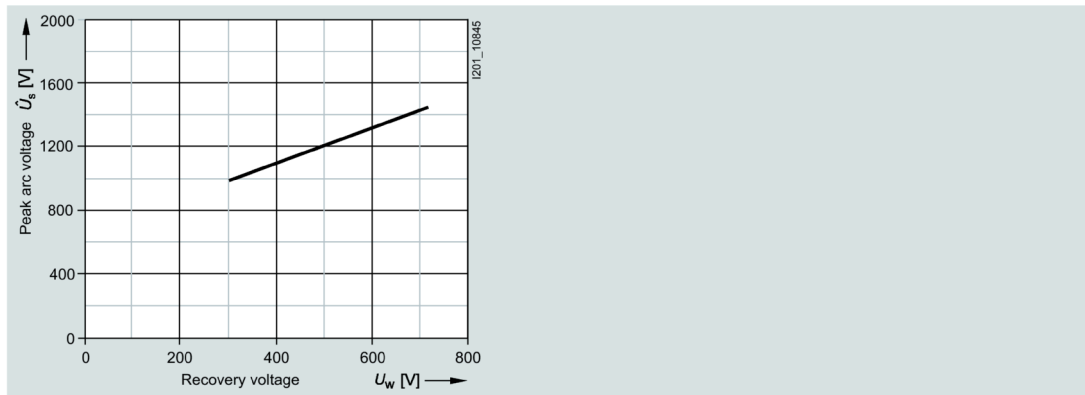

3NE1437-1, 3NE1438-1 series

Size:	3
Operational class:	gR
Rated voltage:	600 V AC
Rated current:	710 and 800 A

Time/current characteristic curves diagram

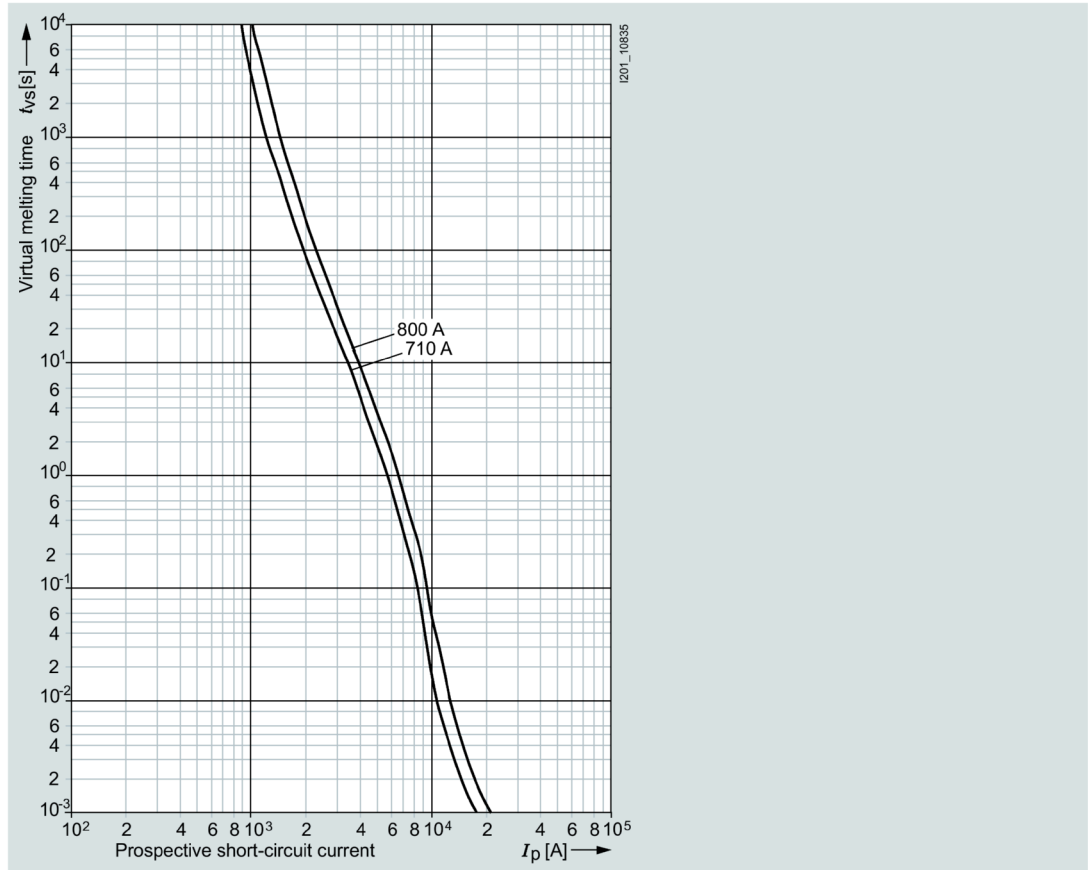

Correction factor  $k_A$  for breaking  $I^2t$  value

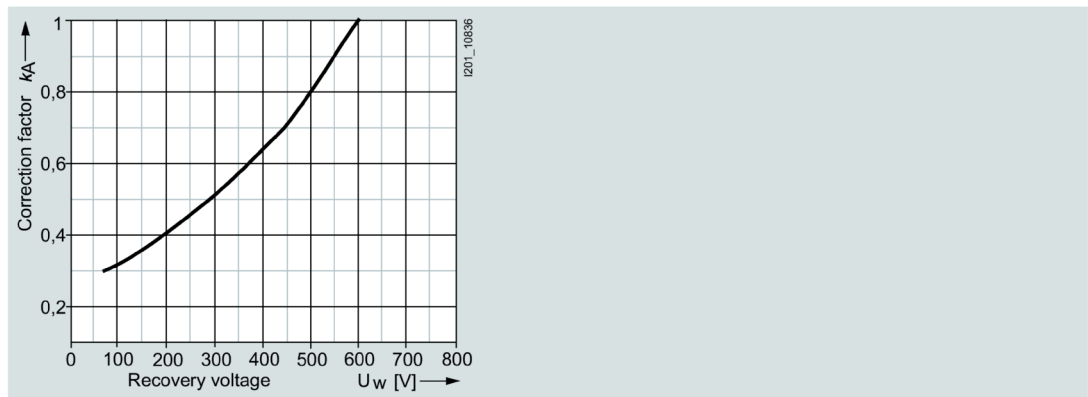

Let-through characteristic curves (current limiting at 50 Hz)

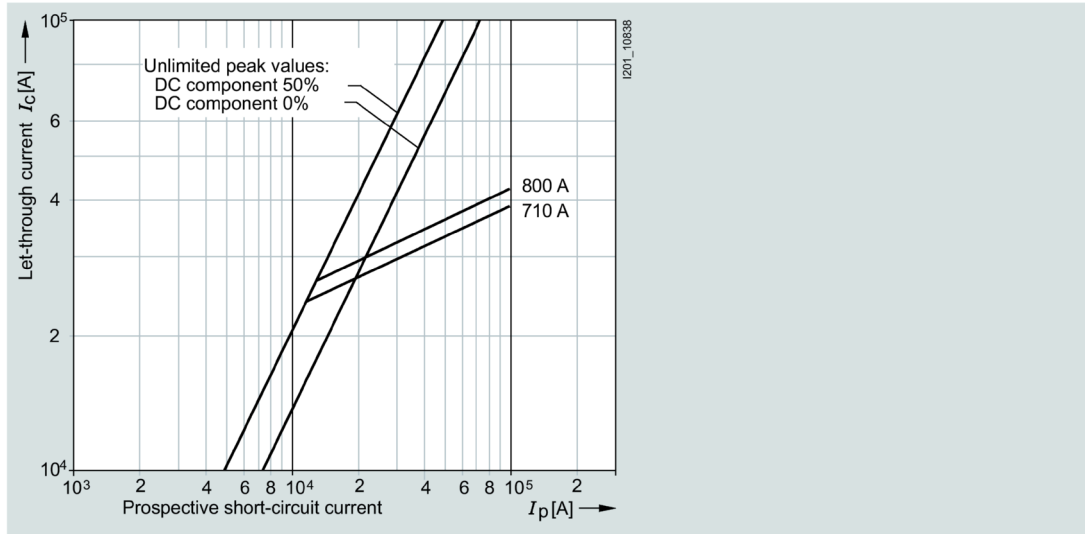

Peak arc voltage

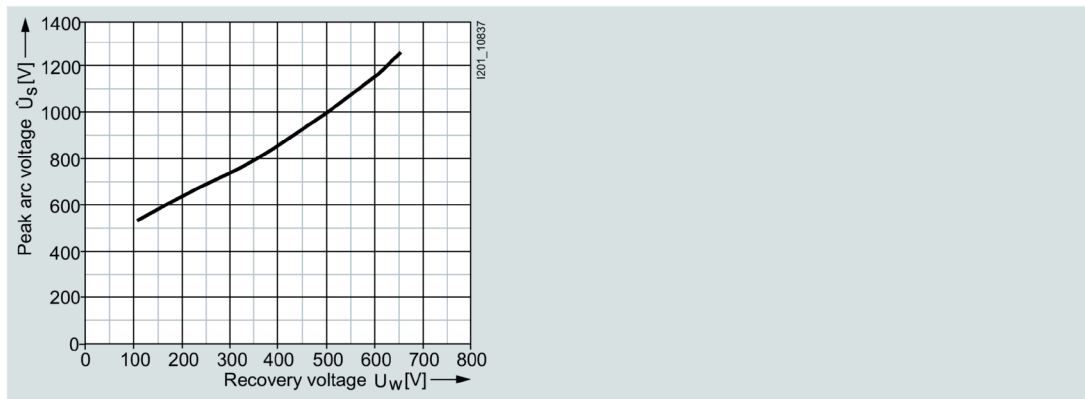

3NE18. .-0 series

Size:	000
Operational class:	gS
Rated voltage:	690 V AC
Rated current:	16 ... 80 A

Time/current characteristic curves diagram

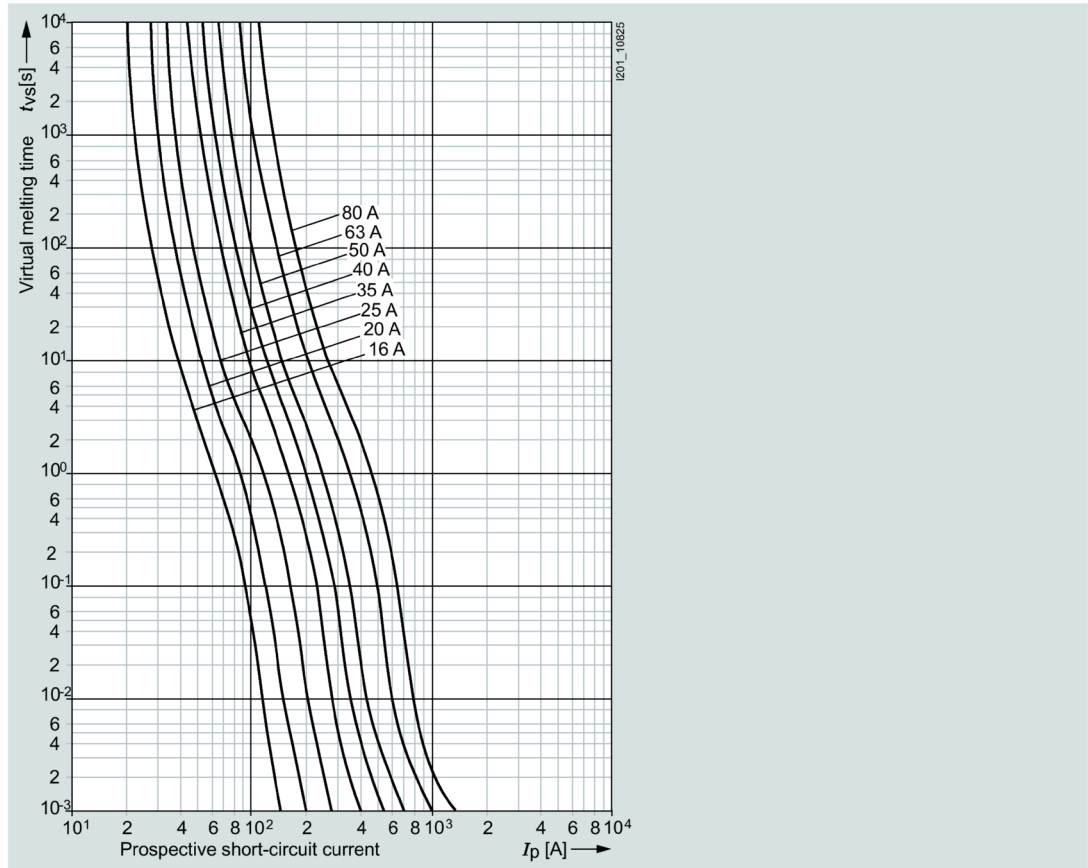

Correction factor  $k_A$  for breaking  $I^2t$  value

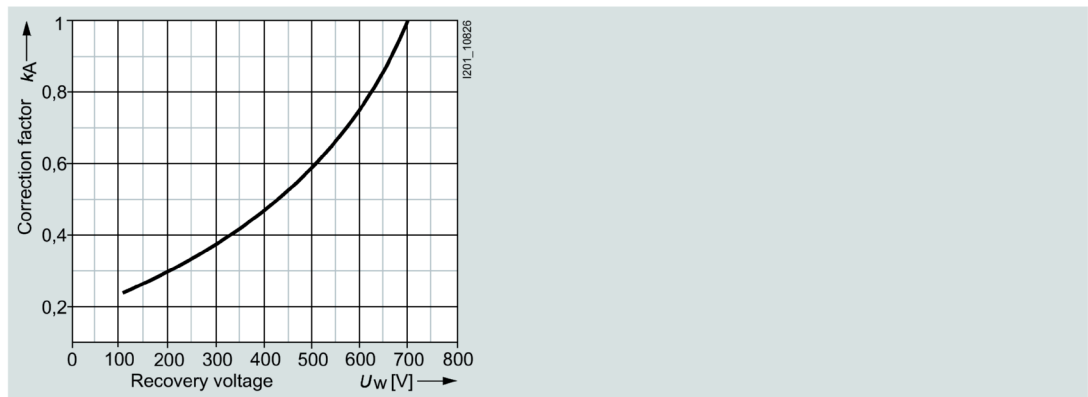

Let-through characteristic curves (current limiting at 50 Hz)

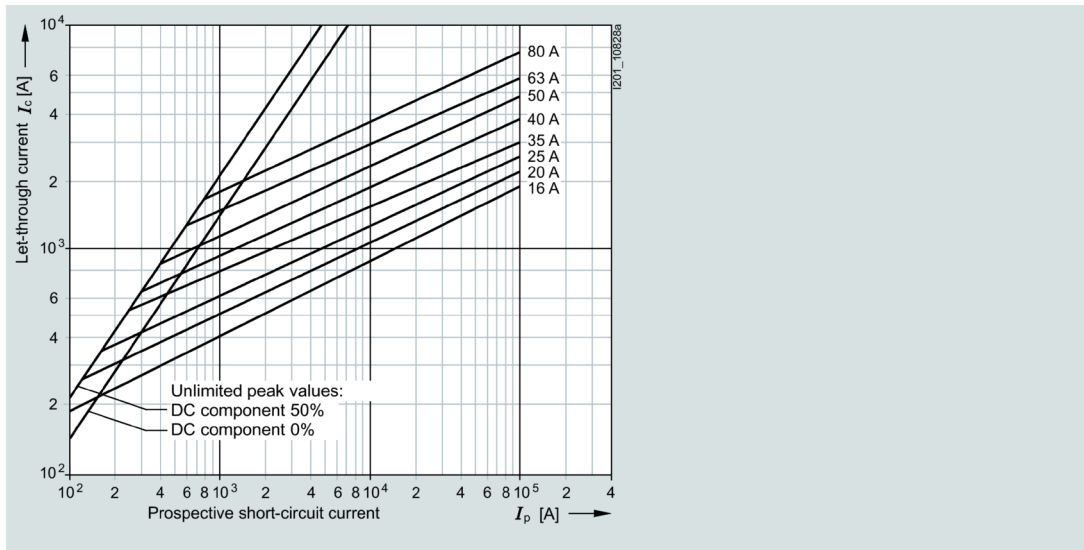

Peak arc voltage

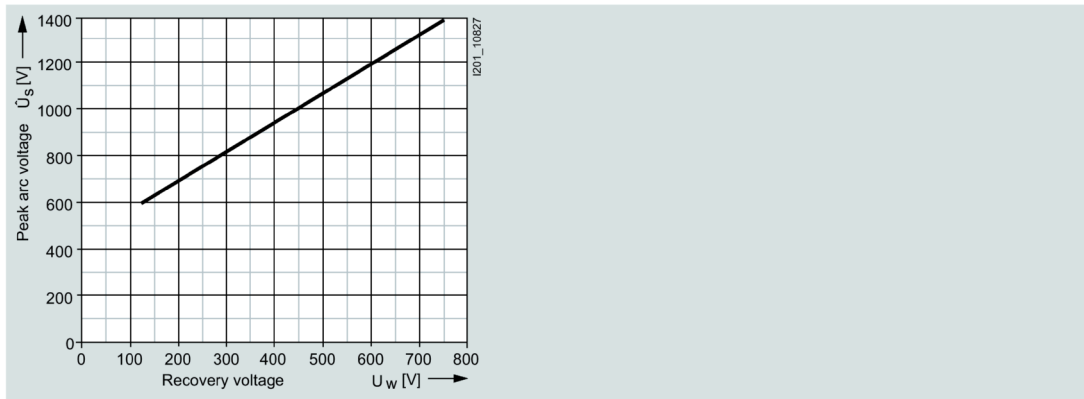

3NE32..-0MK series

Size:	1
Operational class:	gR
Rated voltage:	1000 V AC / 600 V DC
Rated current:	32 ... 63 A



Time/current characteristic curves diagram

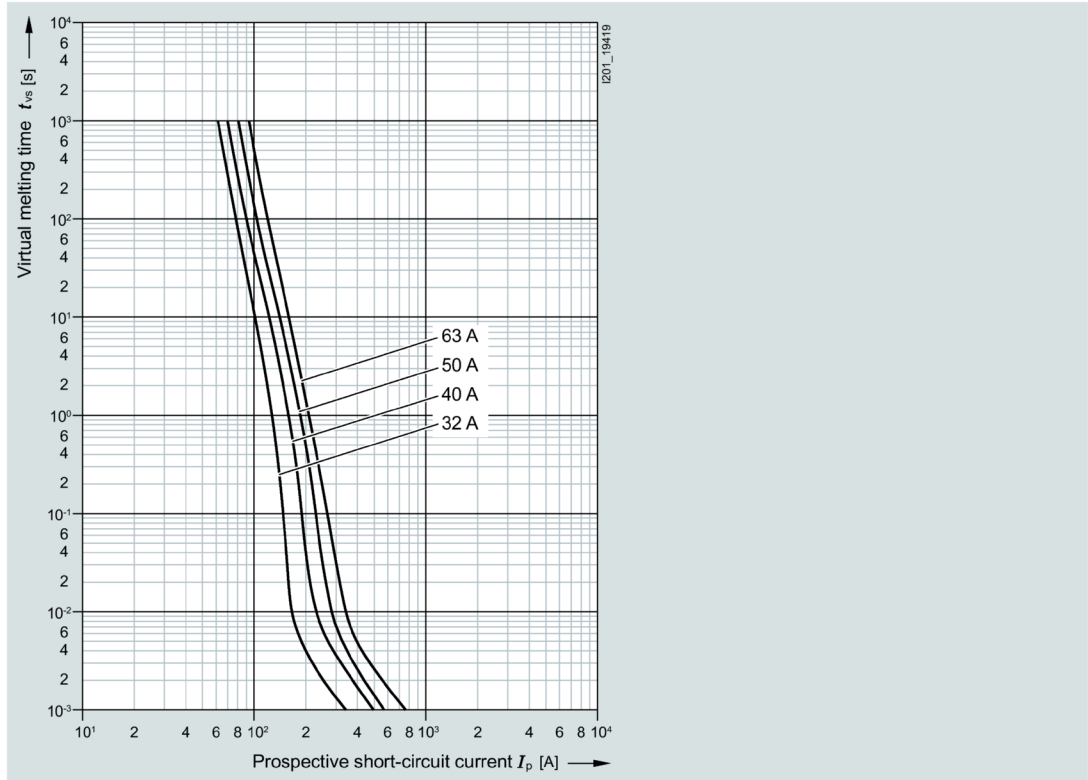

Correction factor  $k_A$  for breaking  $I^2t$  value

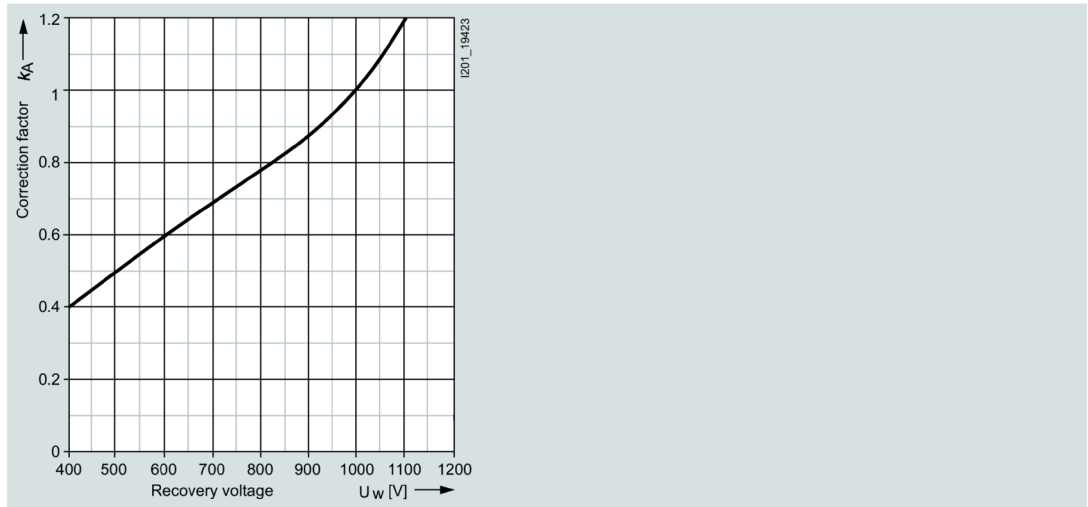

Let-through characteristic curves (current limiting at 50 Hz)

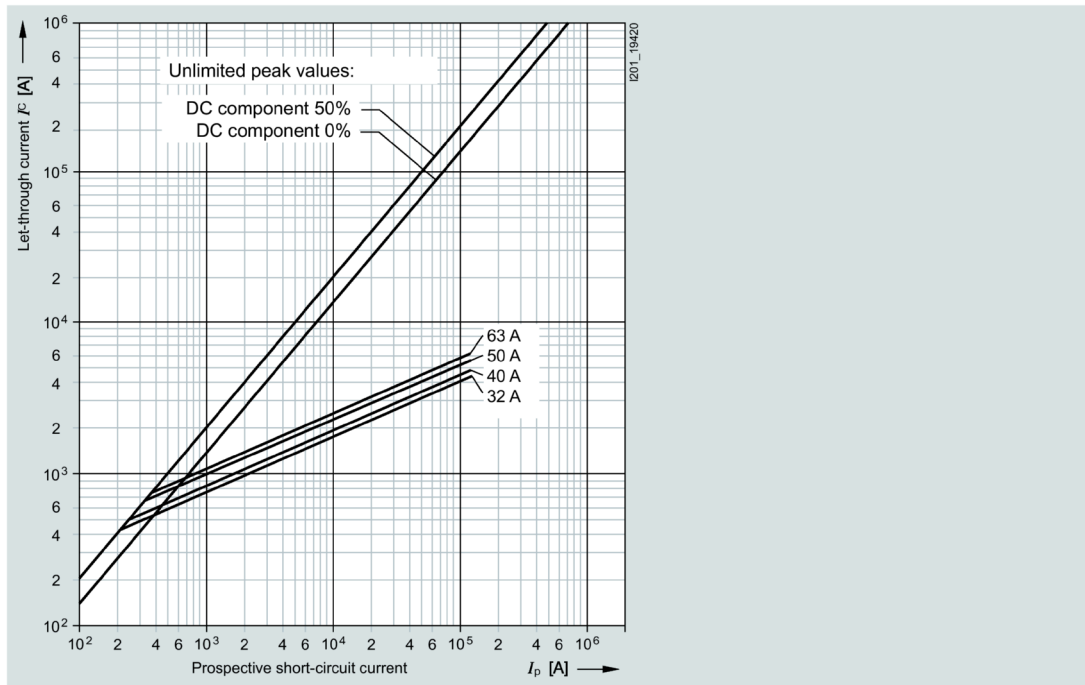

Peak arc voltage

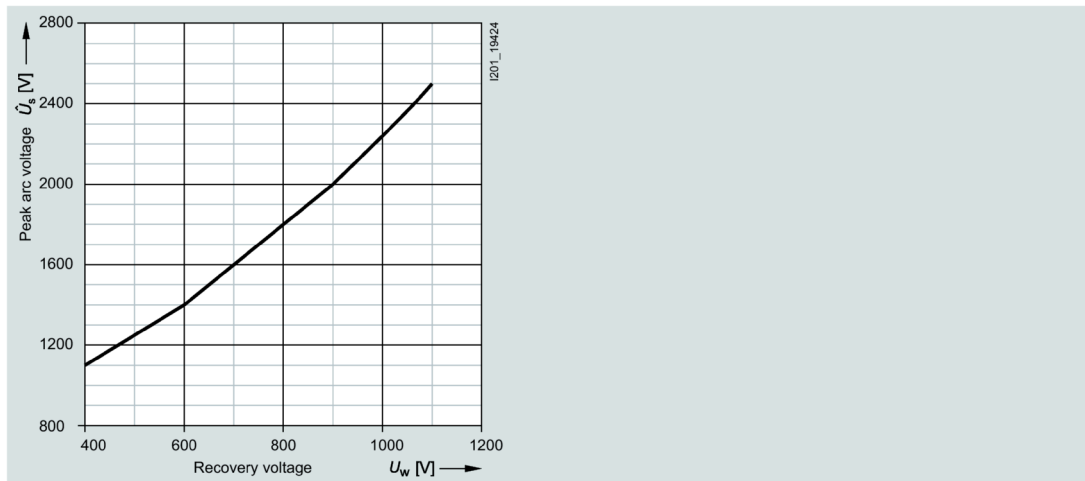

3NE322. series

Size:	1
Operational class:	aR
Rated voltage:	1000 V AC
Rated current:	100 ... 250 A

Time/current characteristic curves diagram

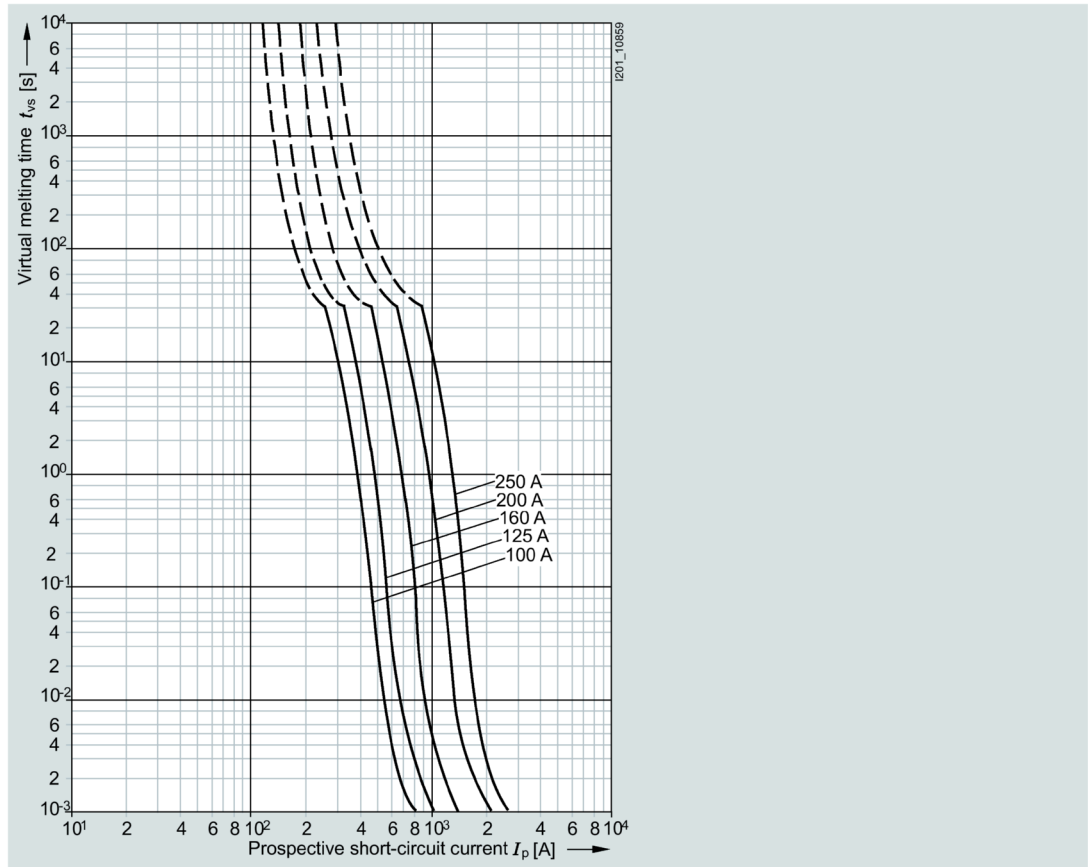

Correction factor  $k_A$  for breaking  $I^2t$  value

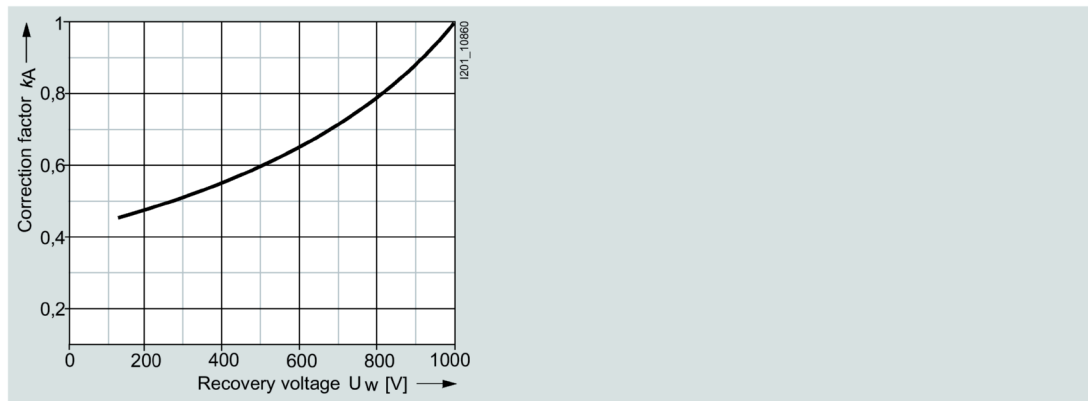

Let-through characteristic curves (current limiting at 50 Hz)

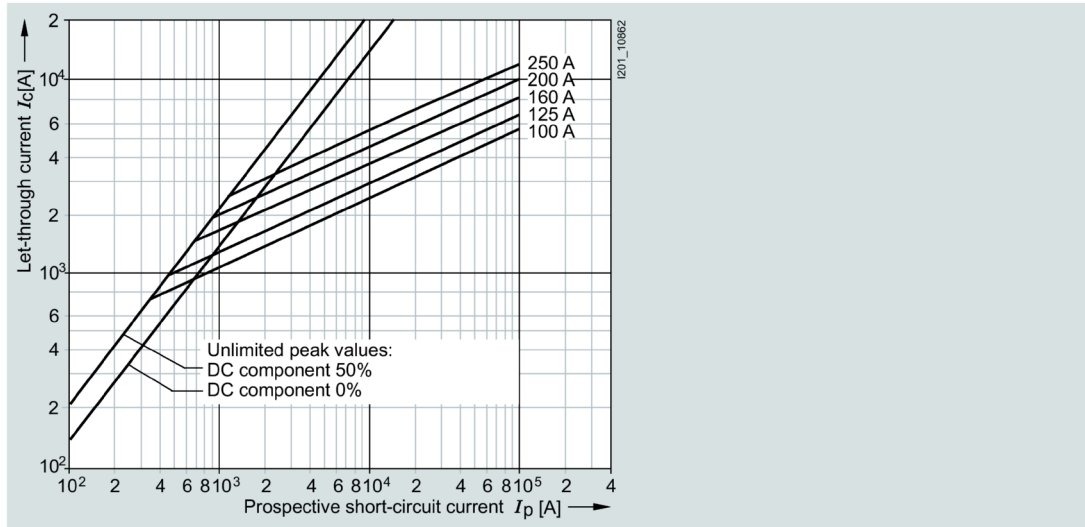

Peak arc voltage

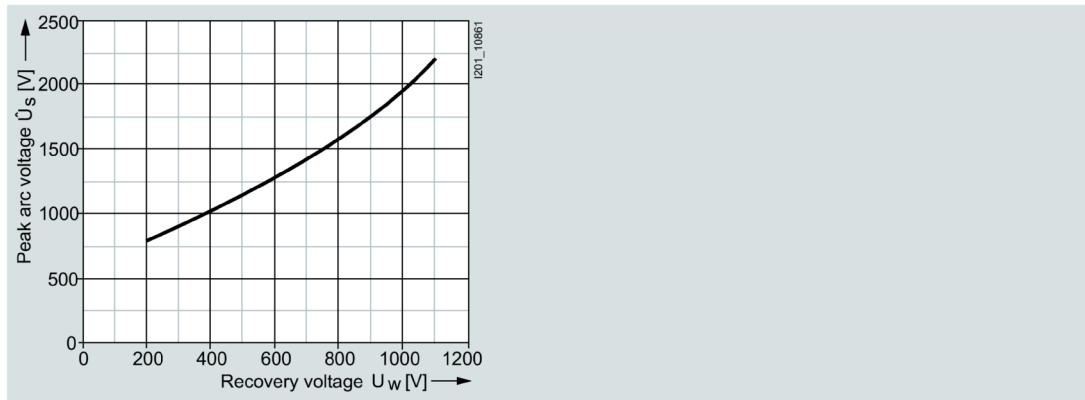

3NE323. series

Size:	1
Operational class:	aR
Rated voltage:	1000 V AC
Rated current:	315 ... 450 A

Time/current characteristic curves diagram

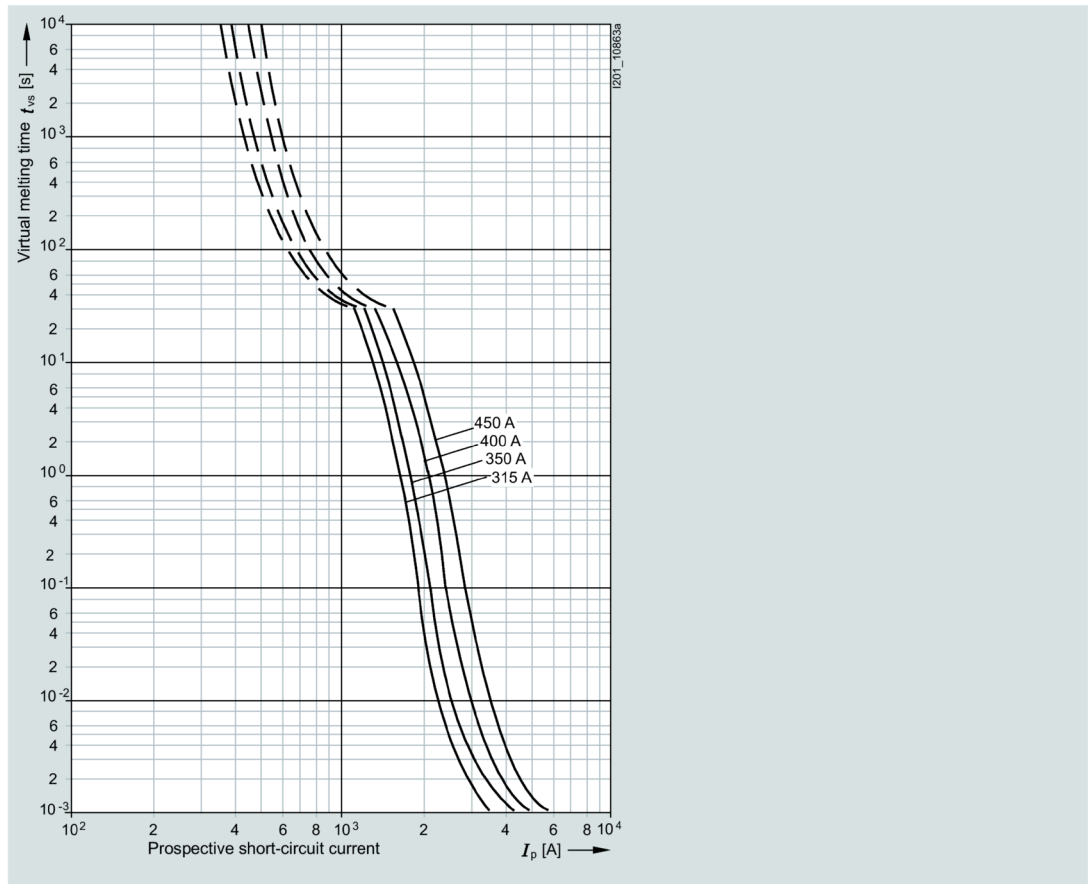

Correction factor  $k_A$  for breaking  $I^2t$  value

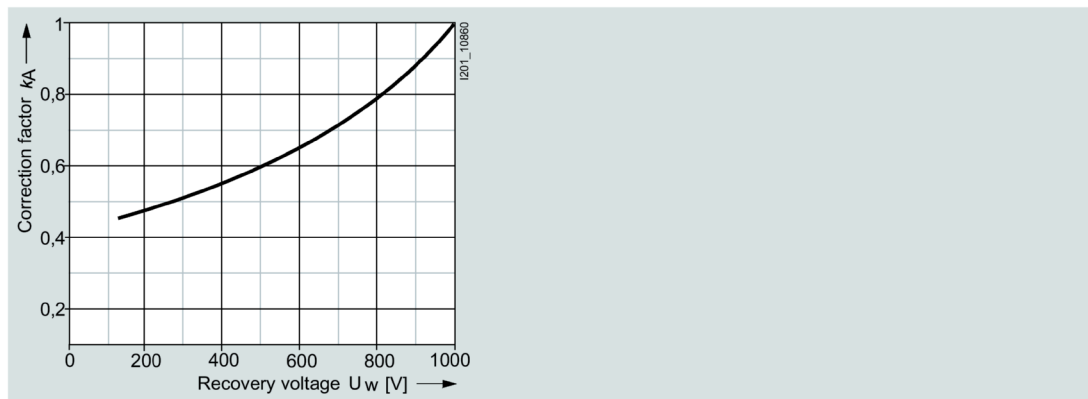

Let-through characteristic curves (current limiting at 50 Hz)

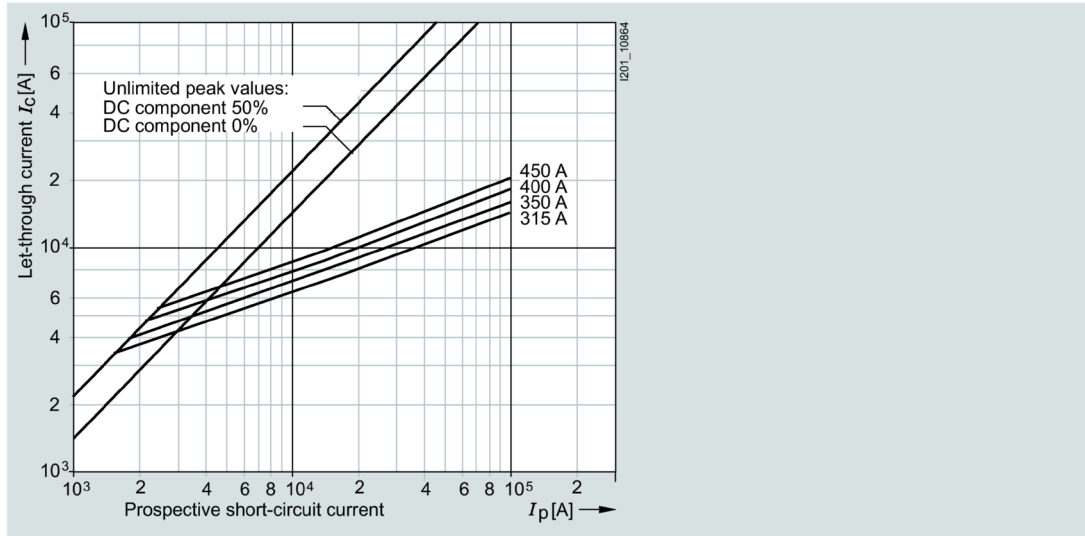

Peak arc voltage

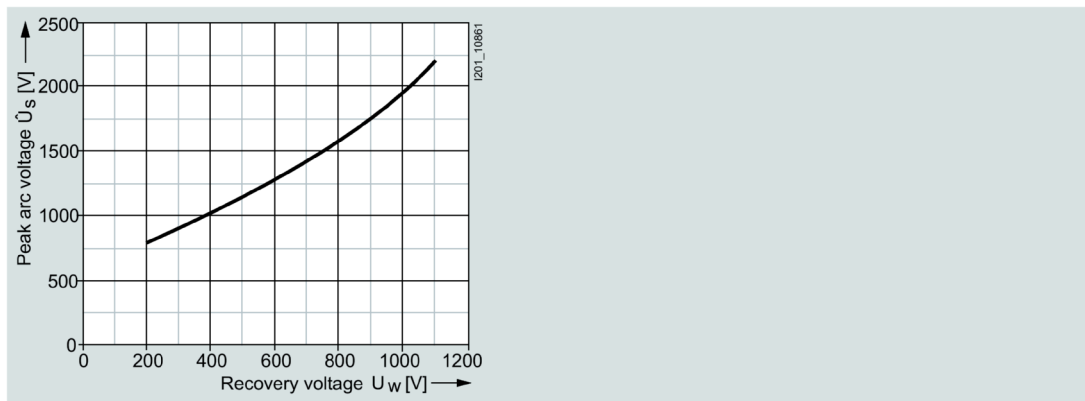

3NE323.-0MK08 series

Size:	1
Operational class:	aR
Rated voltage:	1000 V AC / 600 V DC
Rated current:	500 ... 630 A

Time/current characteristic curves diagram

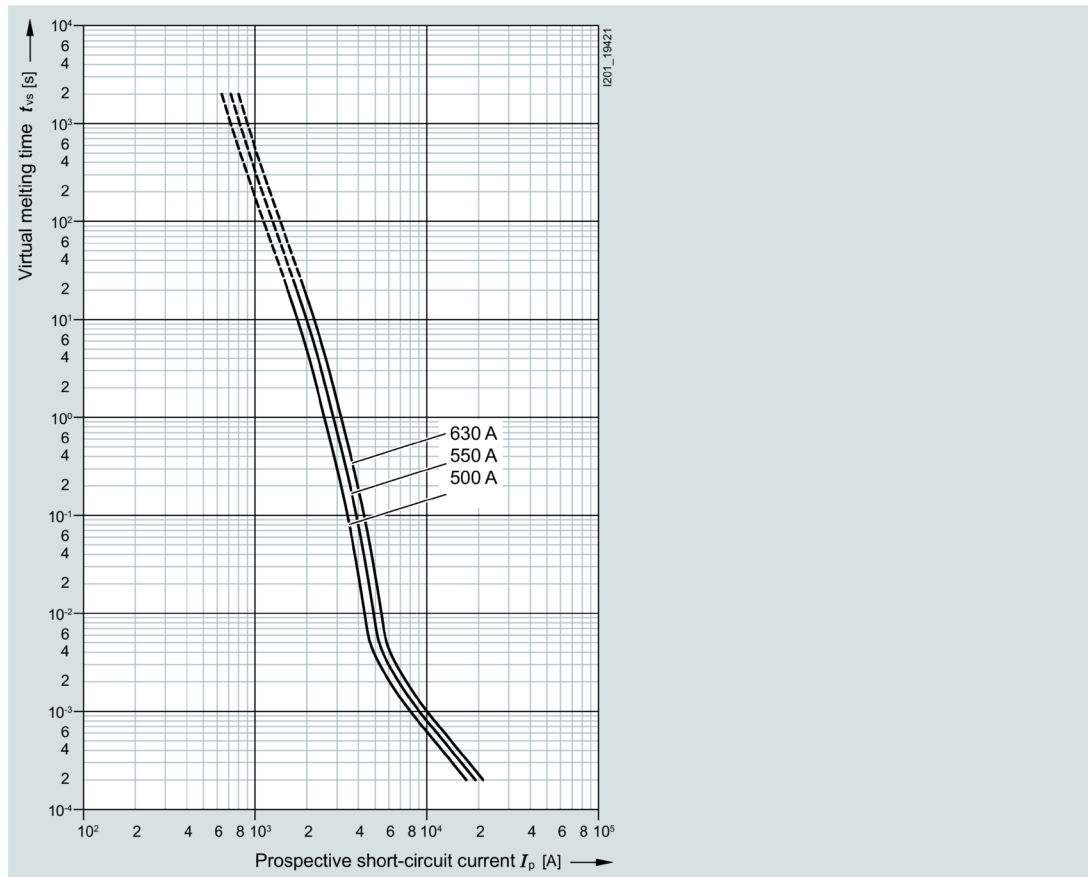

Correction factor  $k_A$  for breaking  $I^2t$  value

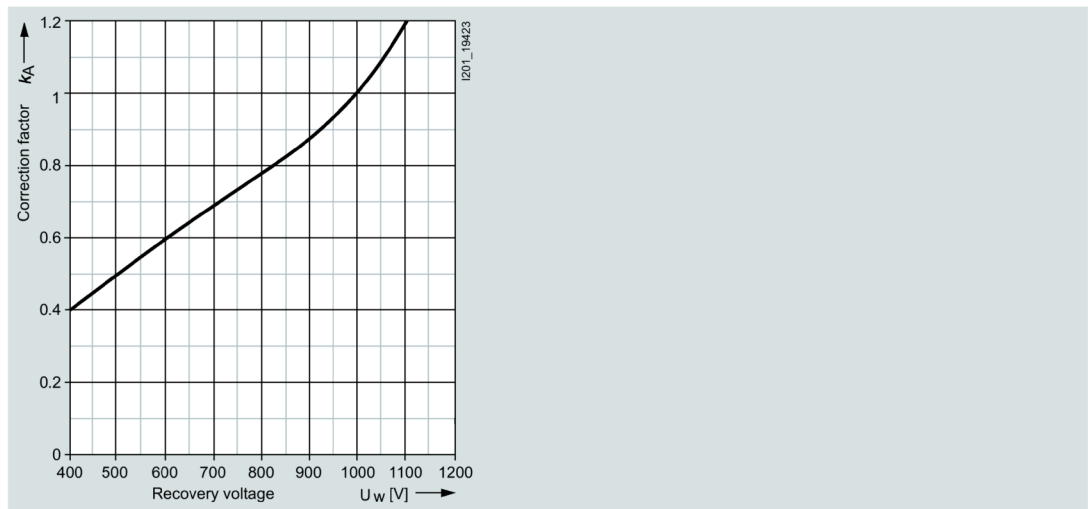

Let-through characteristic curves (current limiting at 50 Hz)

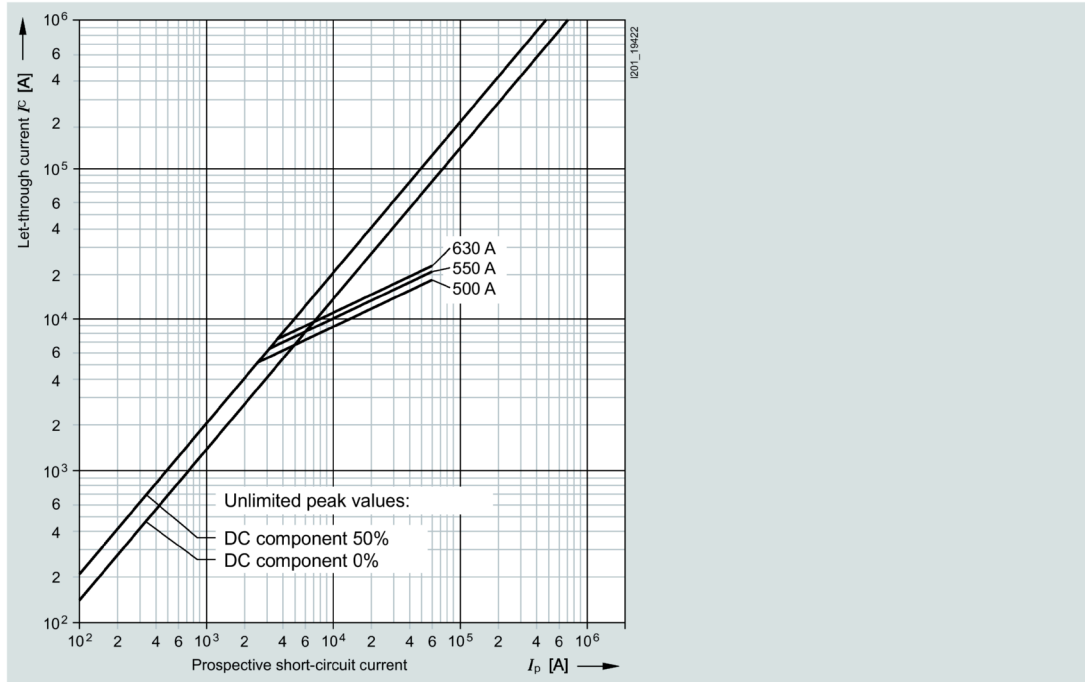

Peak arc voltage

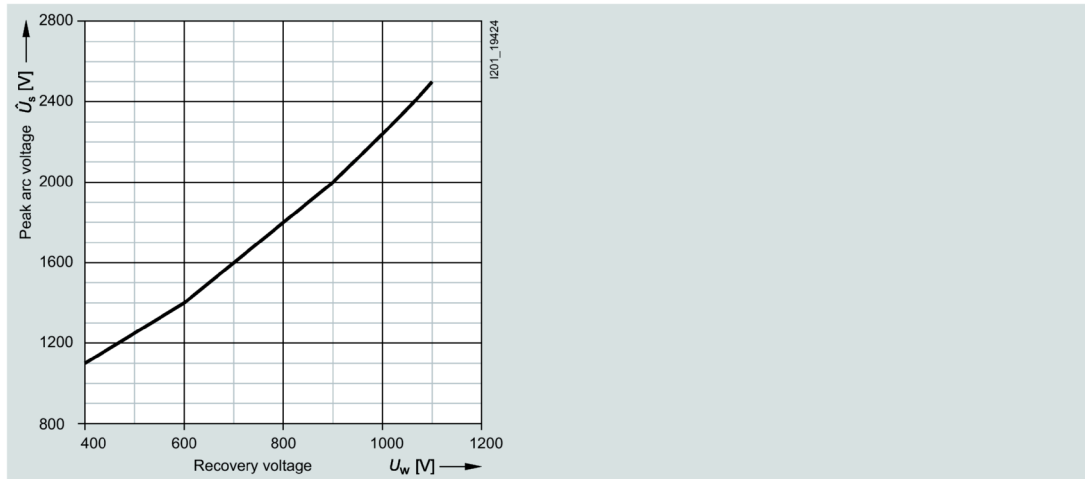

3NE33. . series

Size: 2  
Operational class: aR



Rated voltage:	1000 V AC (up to 630 A) 900 V AC (710 A) 800 V AC (800 A) 690 V AC (900 A)
Rated current:	400 ... 900 A

### Time/current characteristic curves diagram

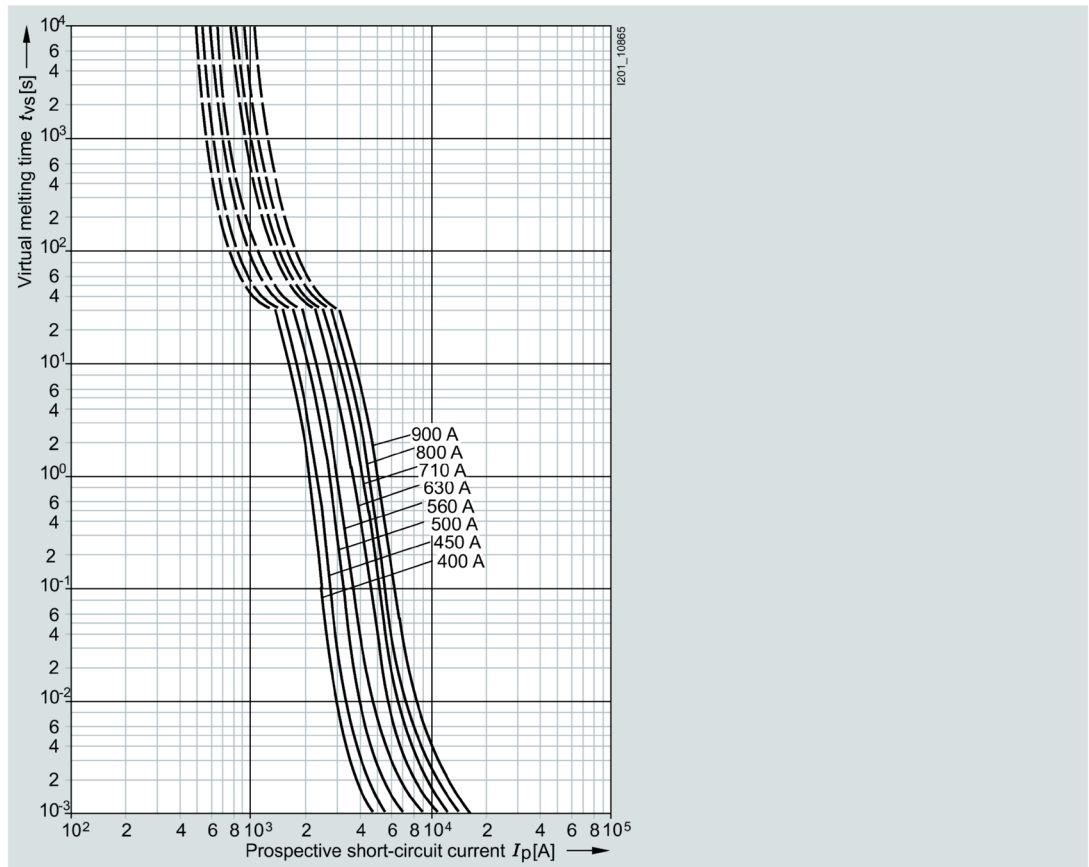

### Correction factor $k_A$ for breaking $I^2t$ value

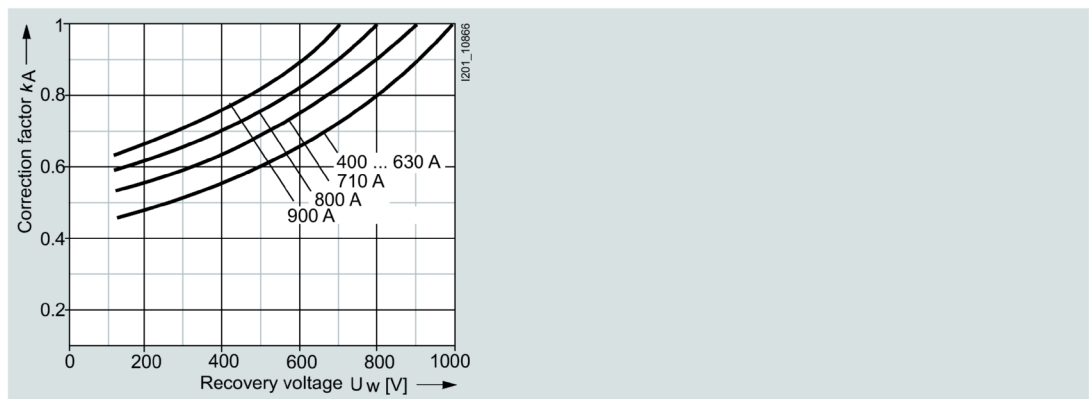

Let-through characteristic curves (current limiting at 50 Hz)

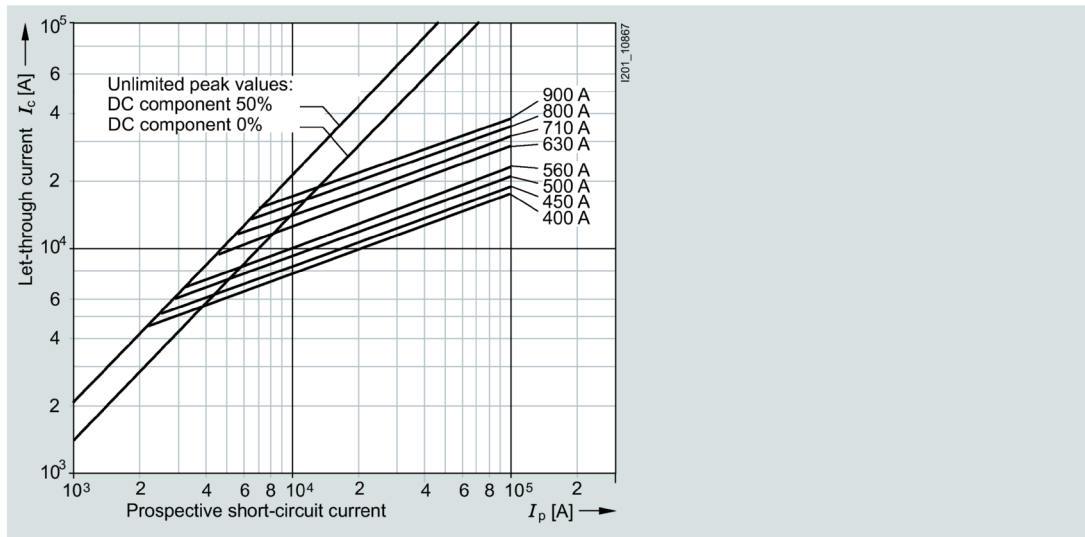

Peak arc voltage

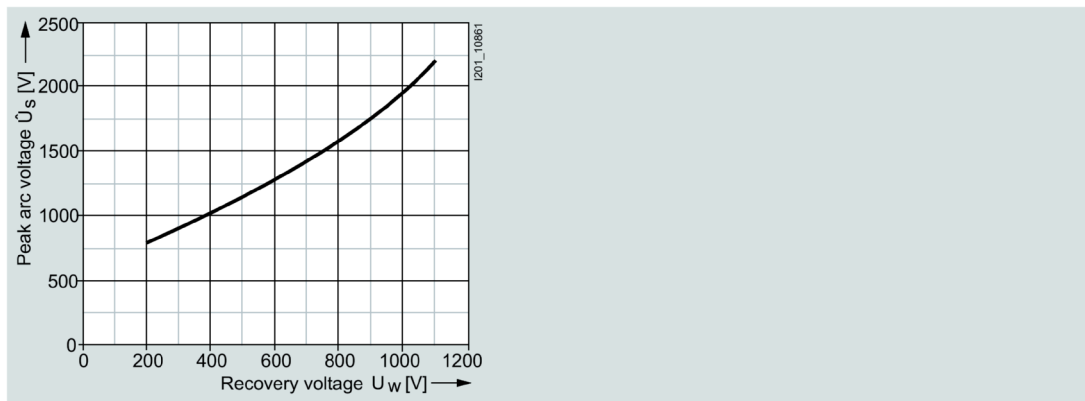

3NE34. ., 3NE36. . series

Size:	3
Operational class:	aR
Rated voltage:	1000 V AC
Rated current:	100 ... 710 A

Time/current characteristic curves diagram

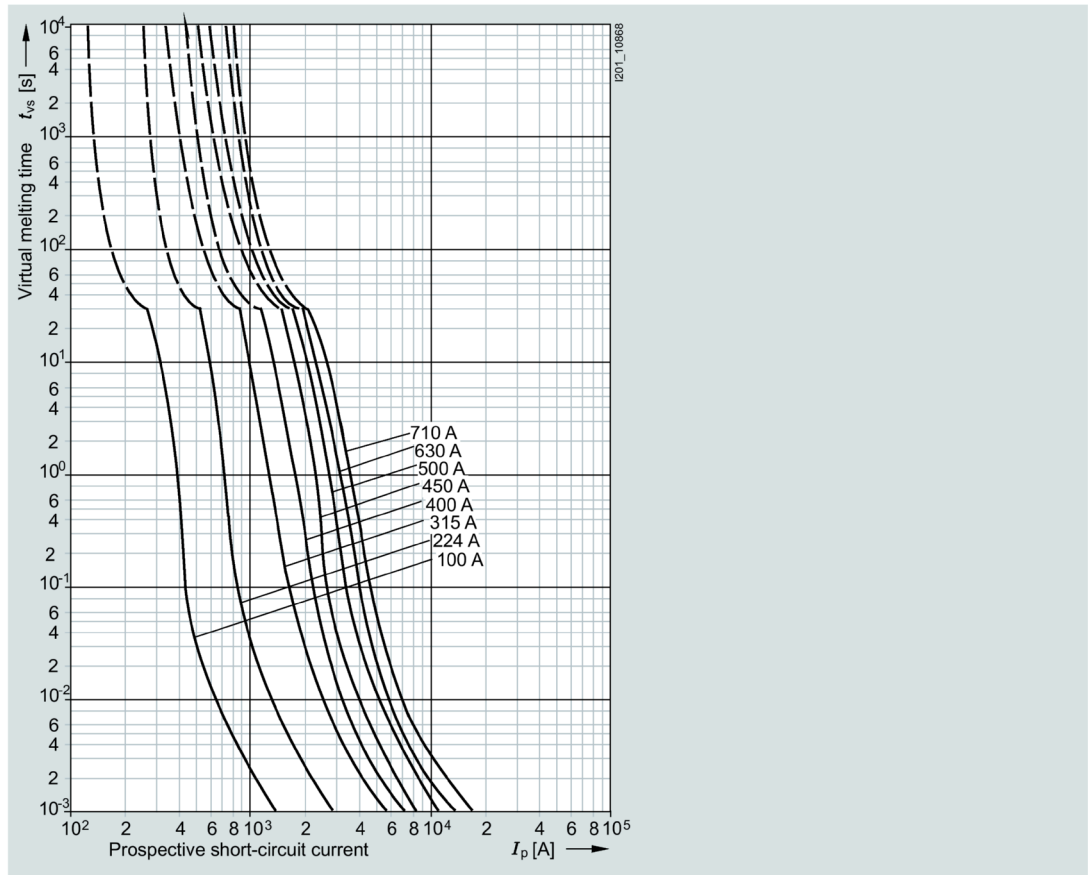

Correction factor  $k_A$  for breaking  $I^2t$  value

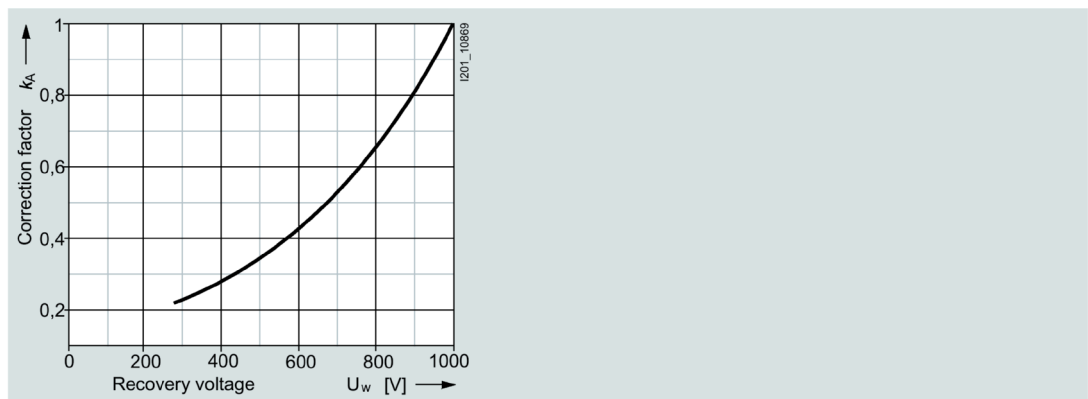

Let-through characteristic curves (current limiting at 50 Hz)

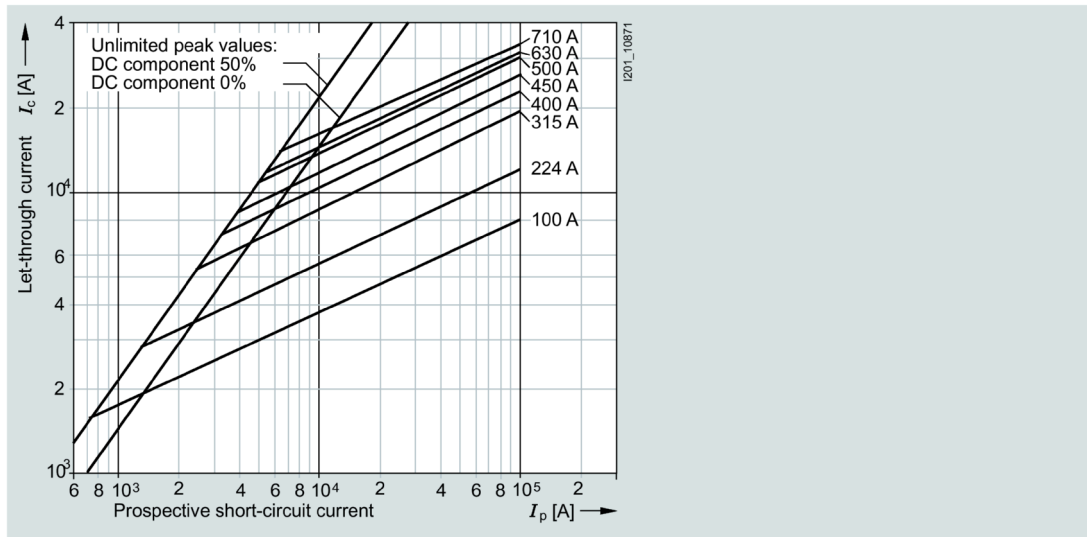

Peak arc voltage

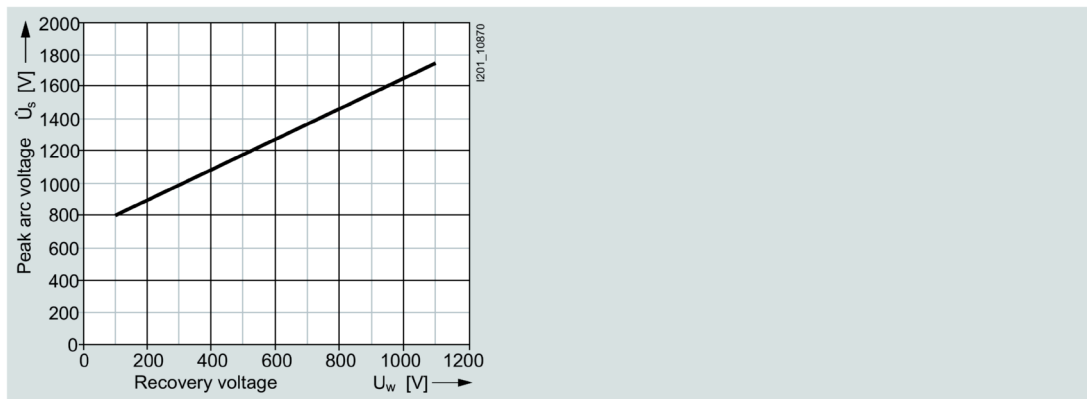

3NE35.5-5, 3NE41. .-5 series

Operational class:

aR, gR

Rated voltage:

800 V AC (170 A)

1000 V AC (50 A, 100 A, 200 A, 450 A)

Rated current:

50 ... 450 A

Time/current characteristic curves diagram

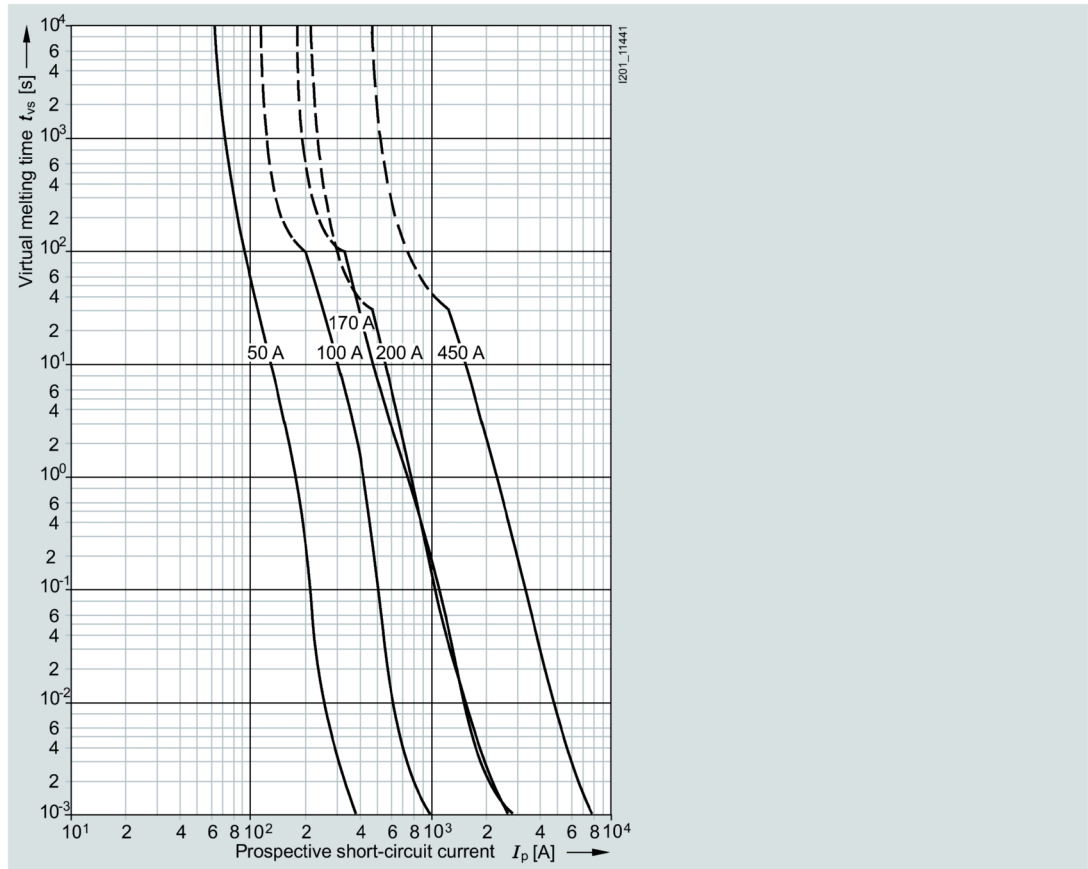

Correction factor  $k_A$  for breaking  $I^2t$  value

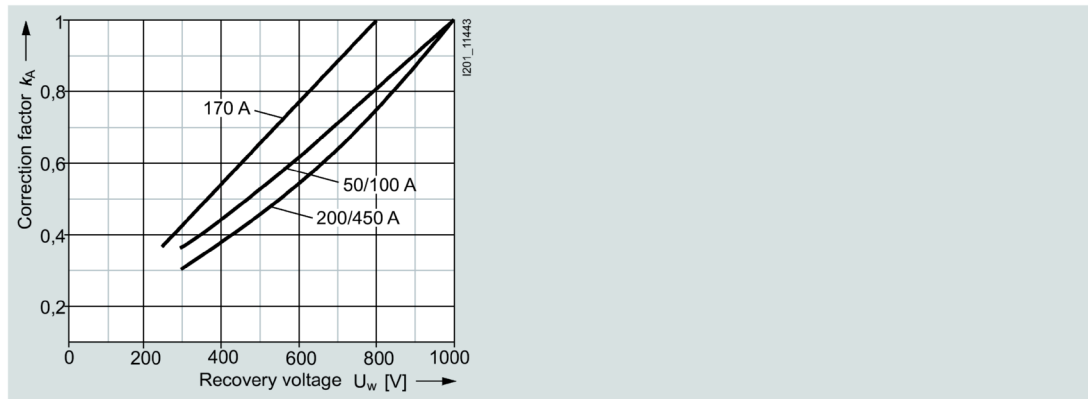

Let-through characteristic curves (current limiting at 50 Hz)

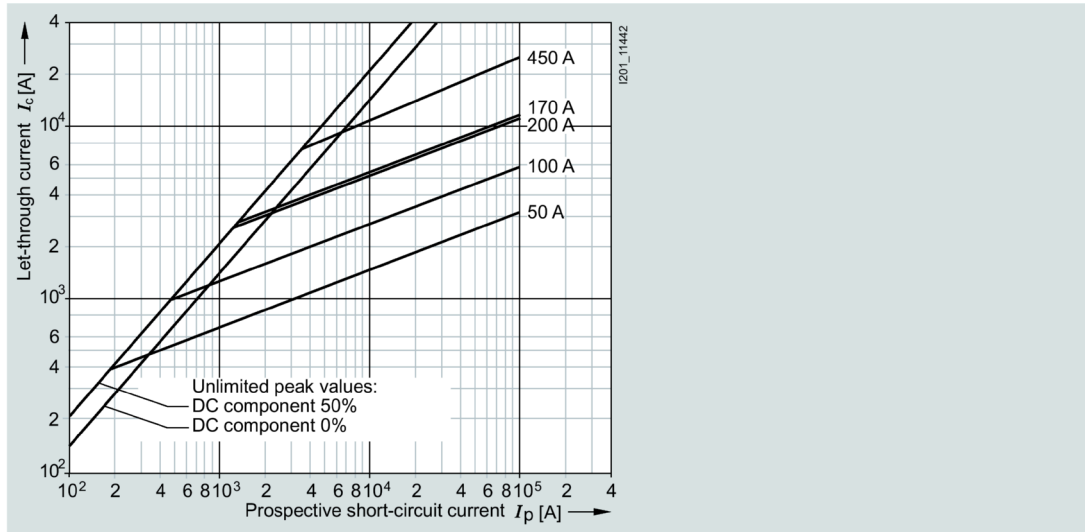

Peak arc voltage

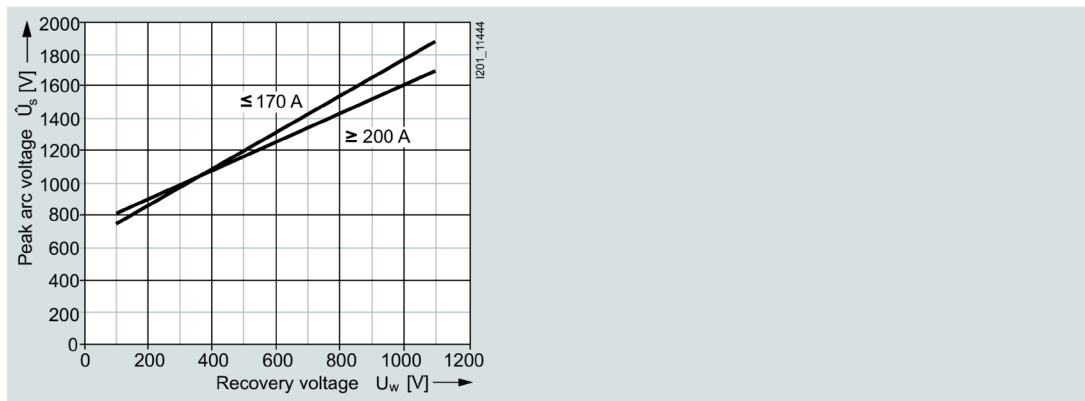

3NE41. . series

Size:	0
Operational class:	gR or aR
Rated voltage:	1000 V AC
Rated current:	32 ... 160 A

Time/current characteristic curves diagram

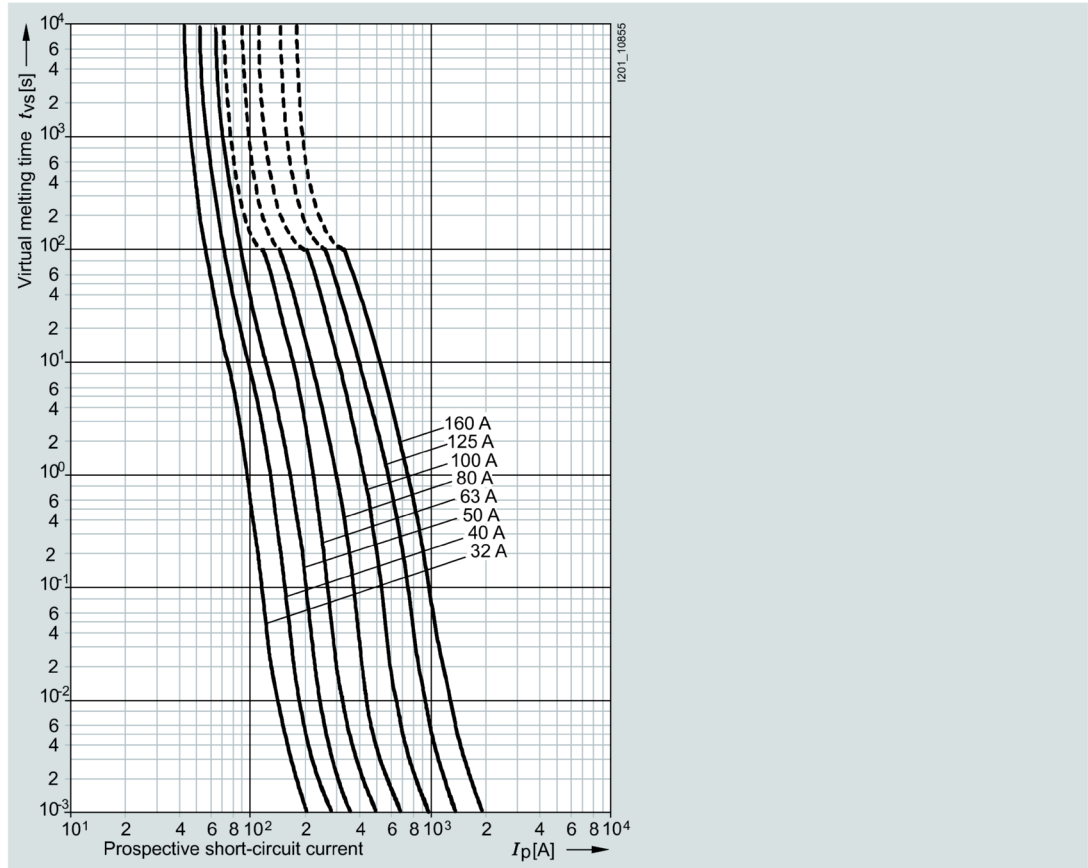

Correction factor  $k_A$  for breaking  $I^2t$  value

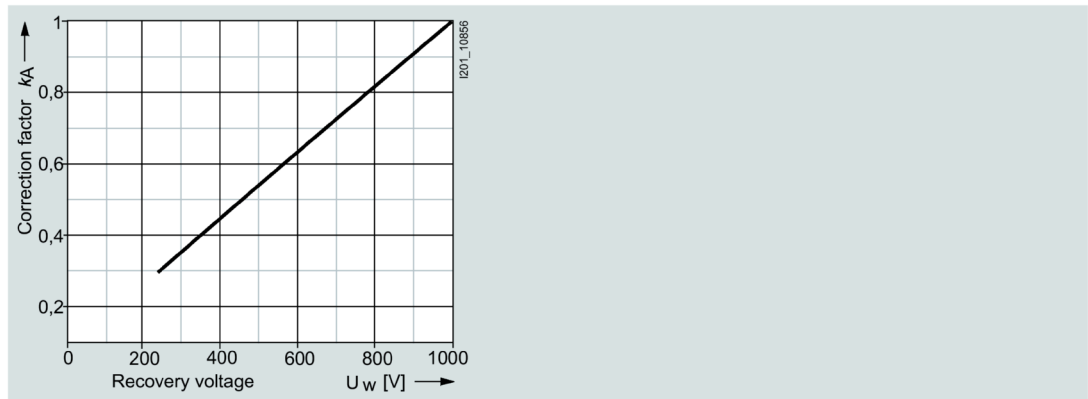

Let-through characteristic curves (current limiting at 50 Hz)

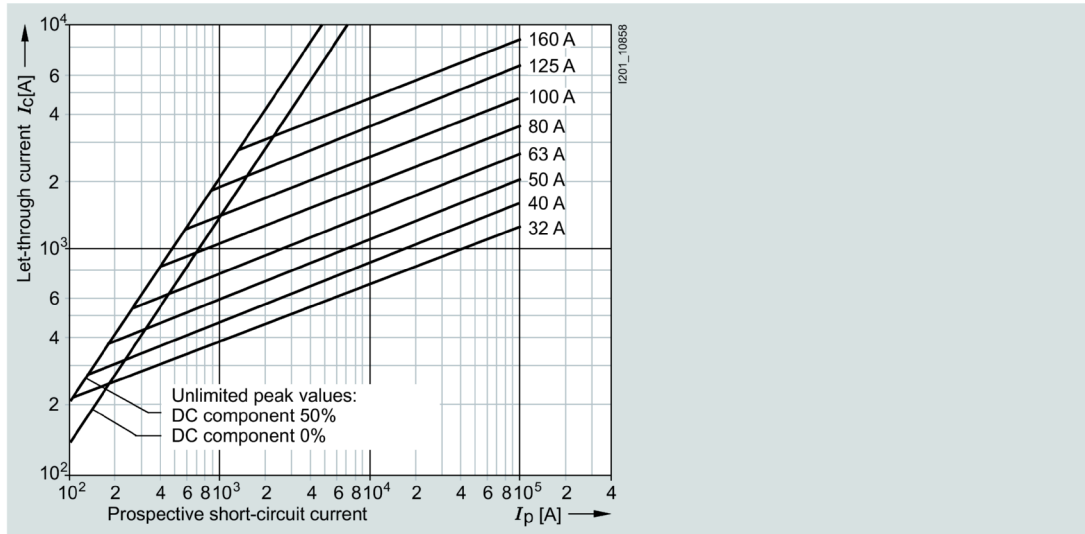

Peak arc voltage

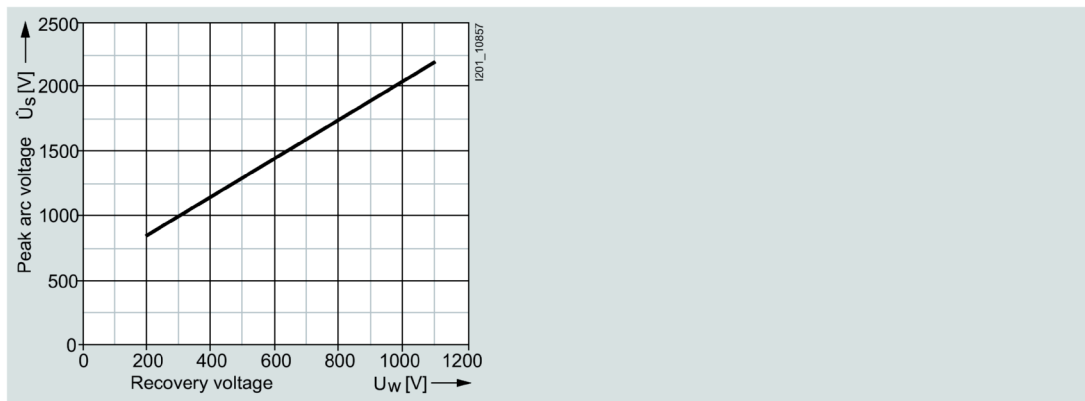

3NE43. .-0B, 3NE43. .-6B, 3NE4337, 3NE4337-6 series

Size:	2
Operational class:	aR
Rated voltage:	800 V AC
Rated current:	250 ... 710 A



Time/current characteristic curves diagram

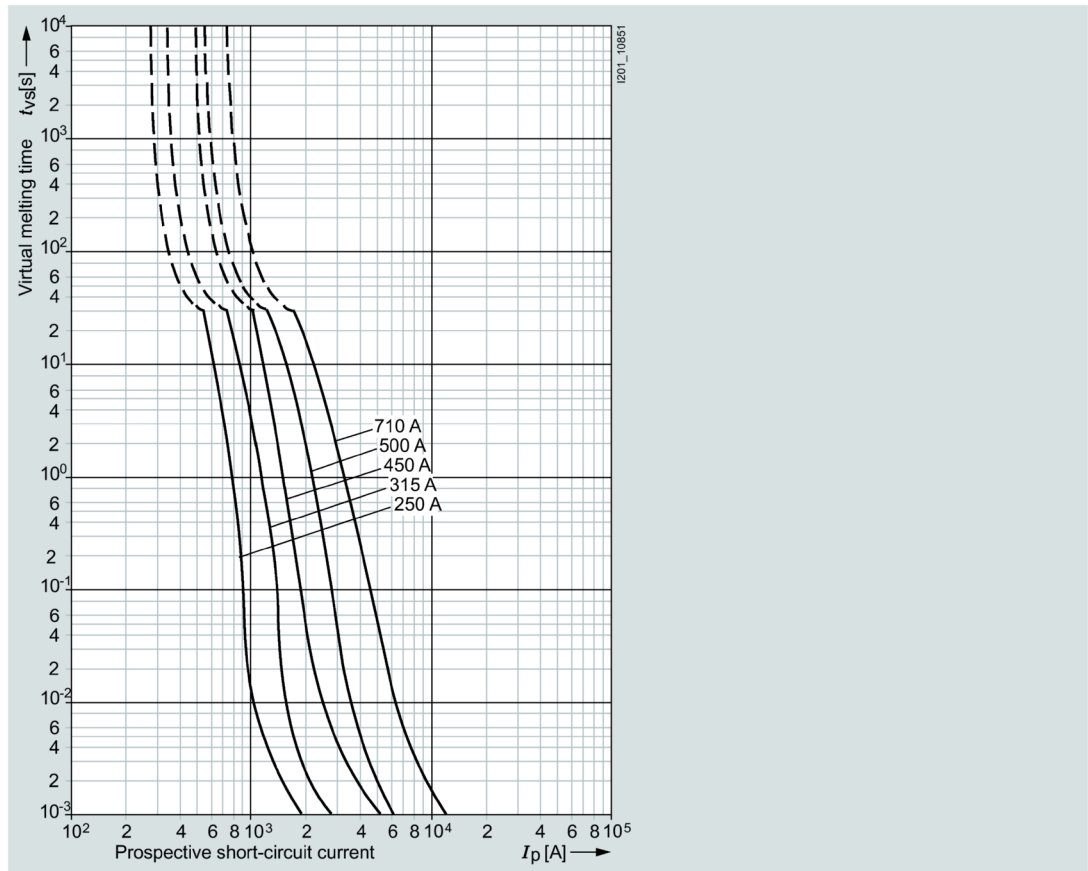

Correction factor  $k_A$  for breaking  $I^2t$  value

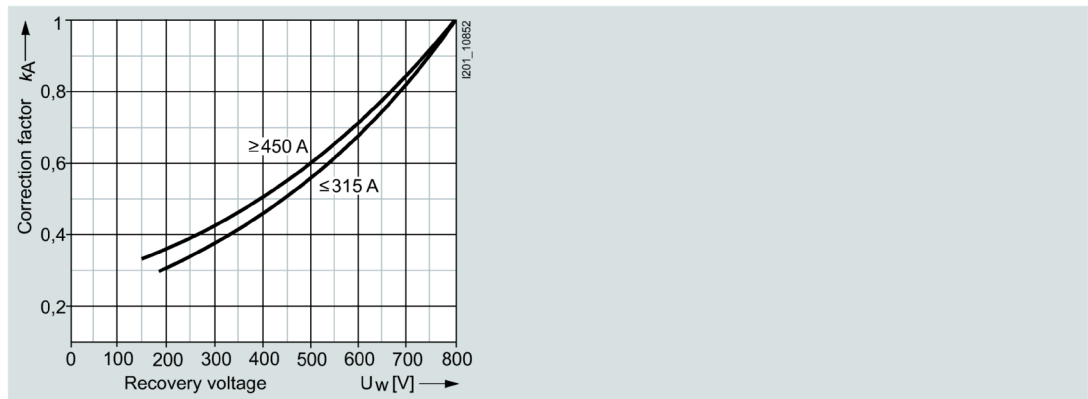

Let-through characteristic curves (current limiting at 50 Hz)

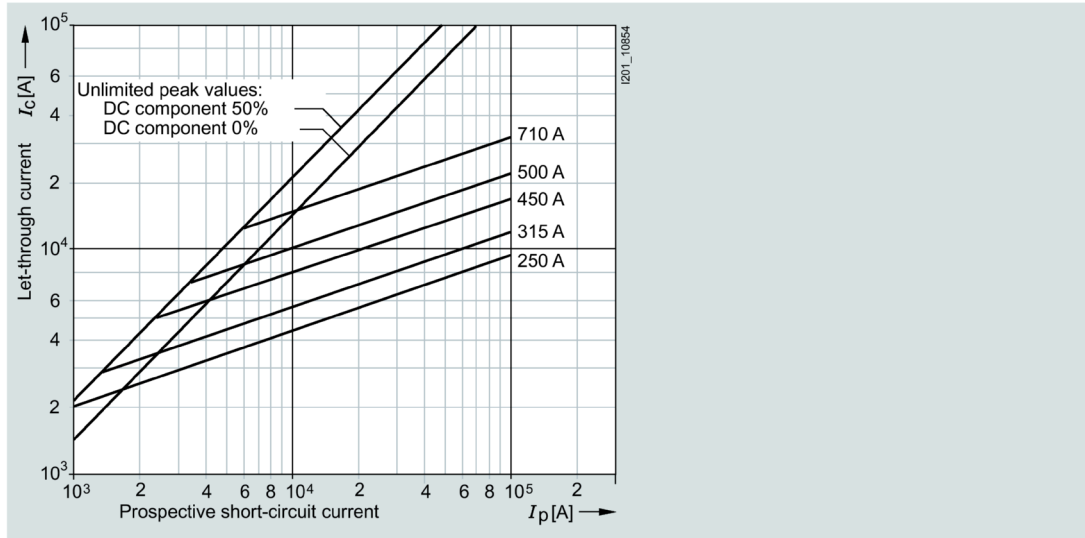

Peak arc voltage

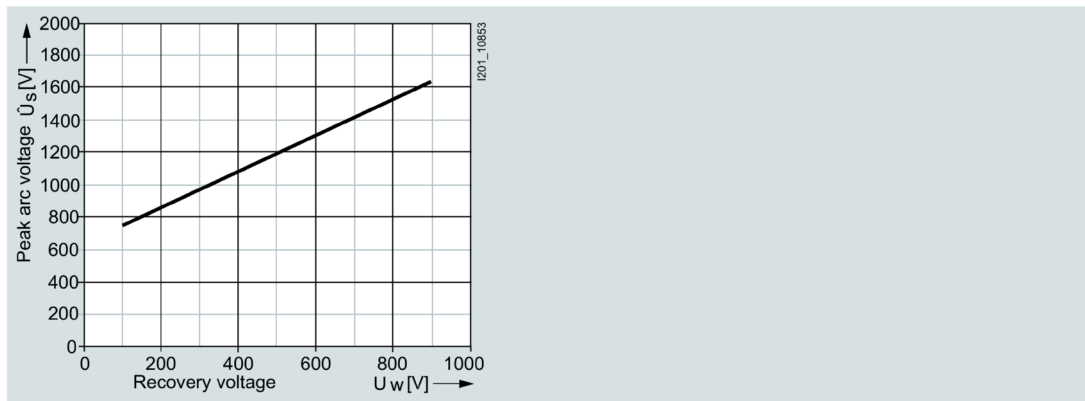

3NE53..-0MK06, -MK66 series

Size:	2
Operational class:	gR, aR
Rated voltage:	1500 V AC / 1000 V DC
Rated current:	40 ... 630 A

### Time/current characteristic curves diagram

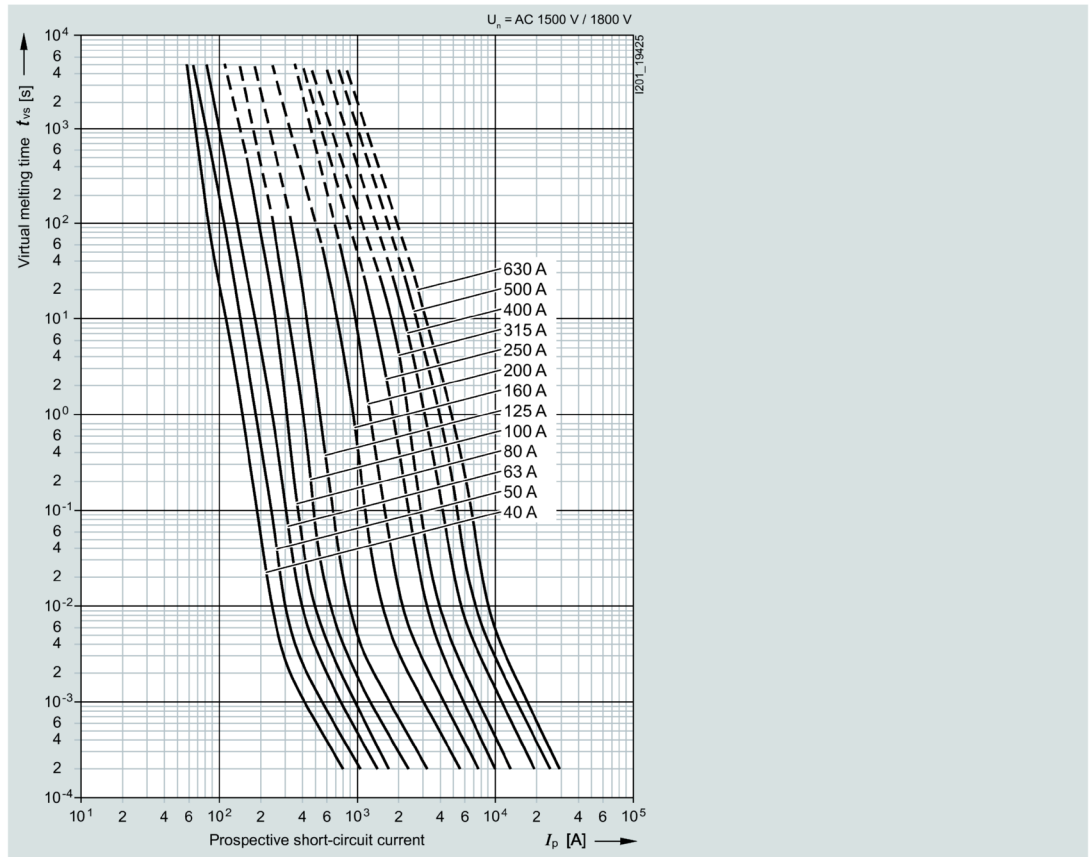

Let-through characteristic curves (current limiting at 50 Hz)

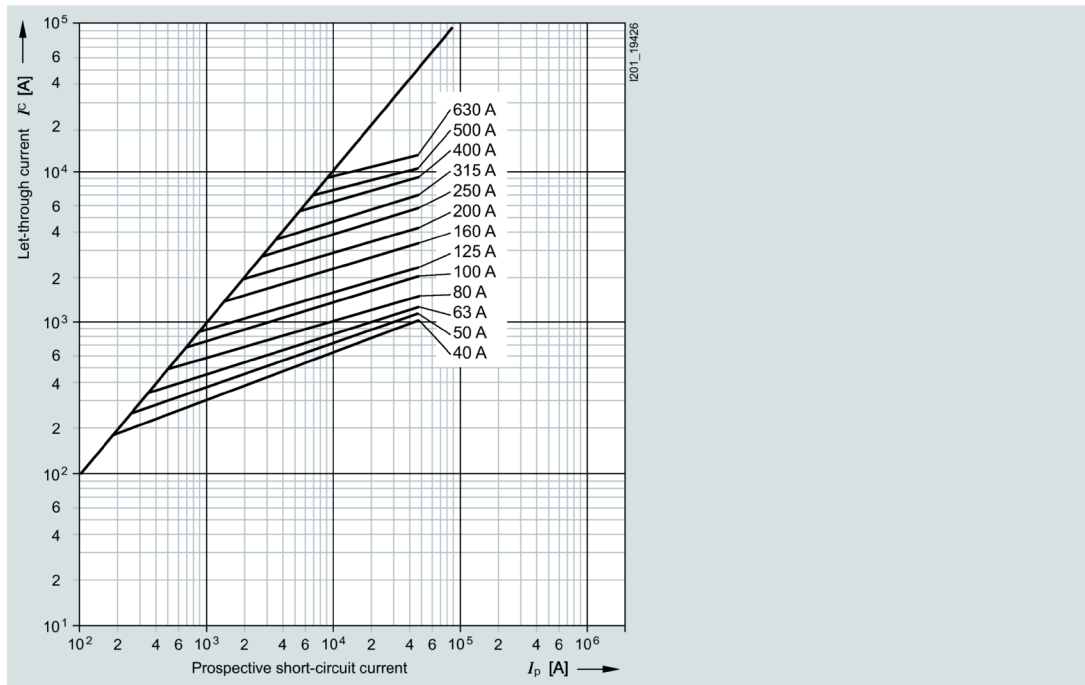

3NE54. . series

Size:	3
Operational class:	gR, aR
Rated voltage:	1500 V AC
Rated current:	160 ... 450 A

Time/current characteristic curves diagram

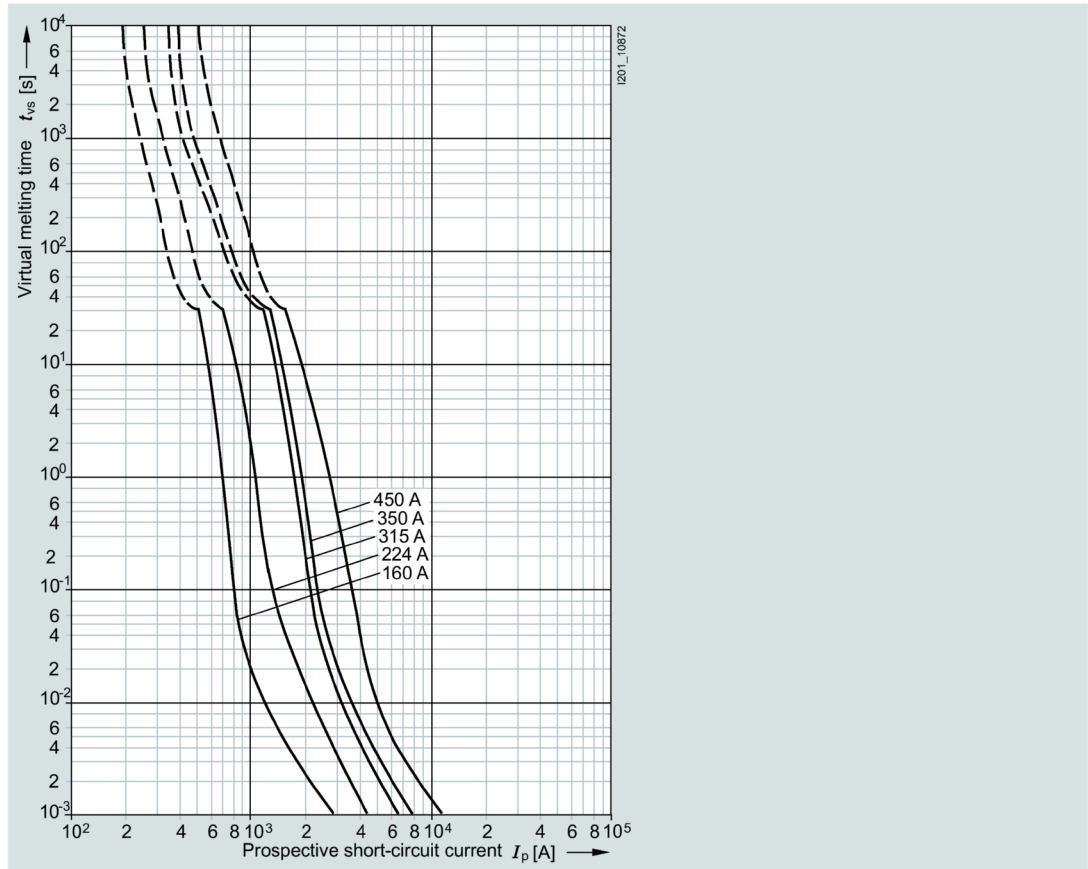

Correction factor  $k_A$  for breaking  $I^2t$  value



Let-through characteristic curves (current limiting at 50 Hz)

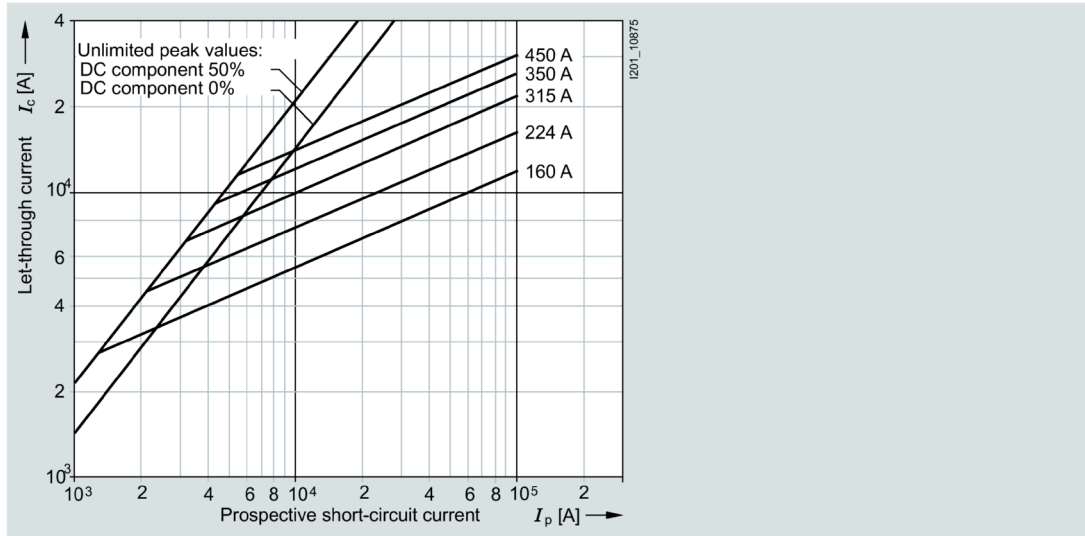

Peak arc voltage

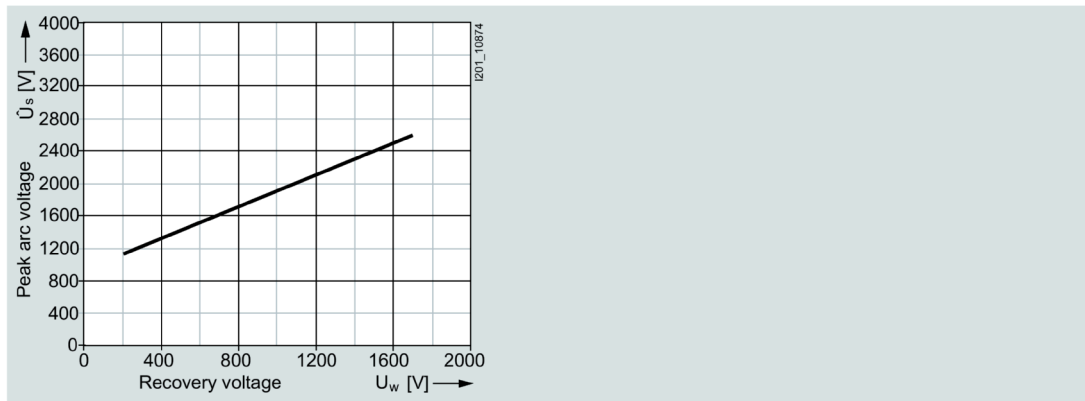

3NE56. . series

Size:	3
Operational class:	aR
Rated voltage:	1500 V AC
Rated current:	250 ... 600 A

Time/current characteristic curves diagram

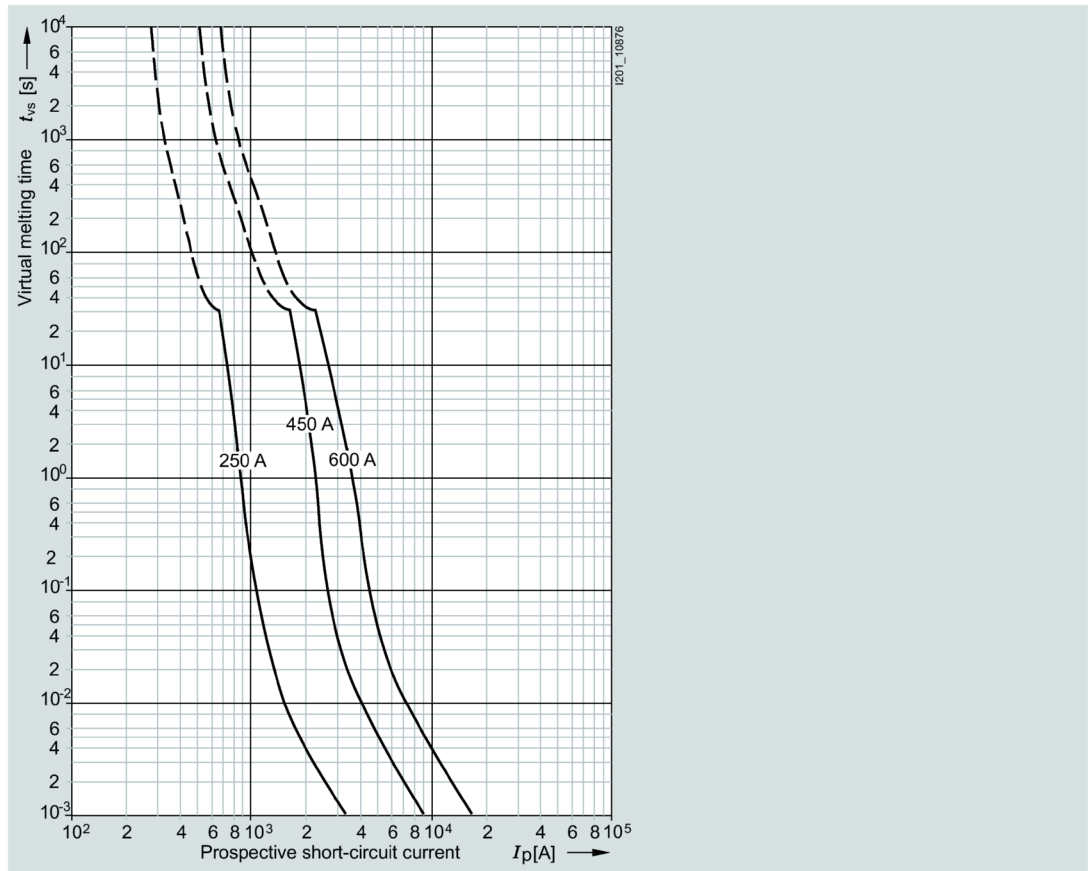

Correction factor  $k_A$  for breaking  $I^2t$  value



Let-through characteristic curves (current limiting at 50 Hz)

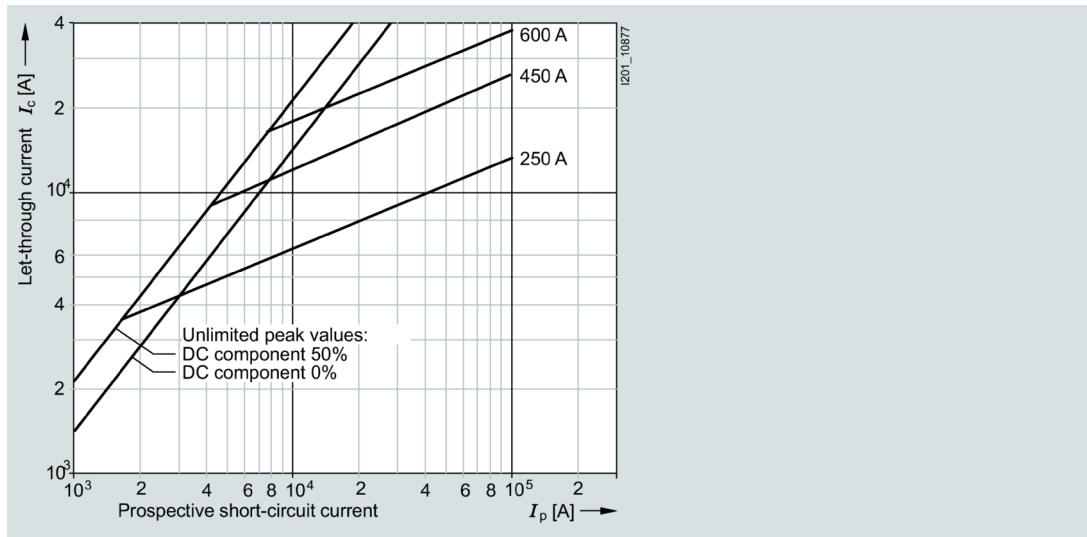

Peak arc voltage

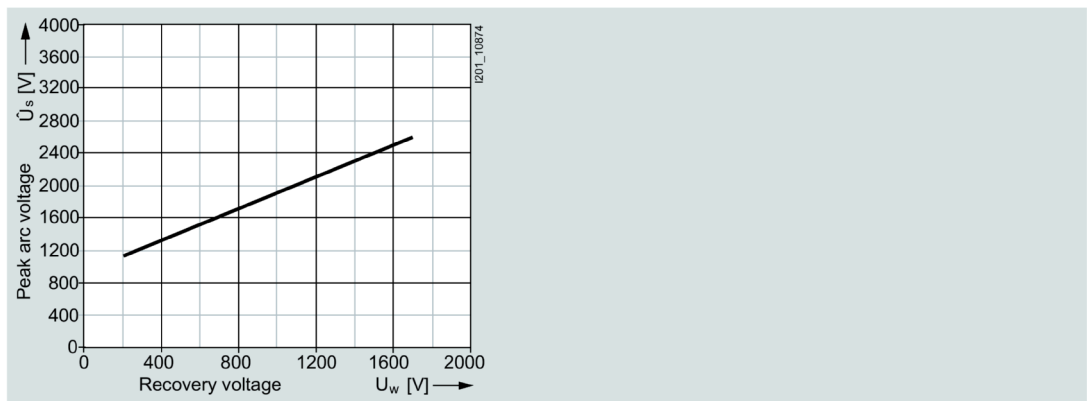

3NE64. ., 3NE94. . series

Operational class:	aR, gR
Rated voltage:	600 V AC (850 A, 1250 A) 900 V AC (710 A, 900 A)
Rated current:	710 ... 1250 A



Time/current characteristic curves diagram

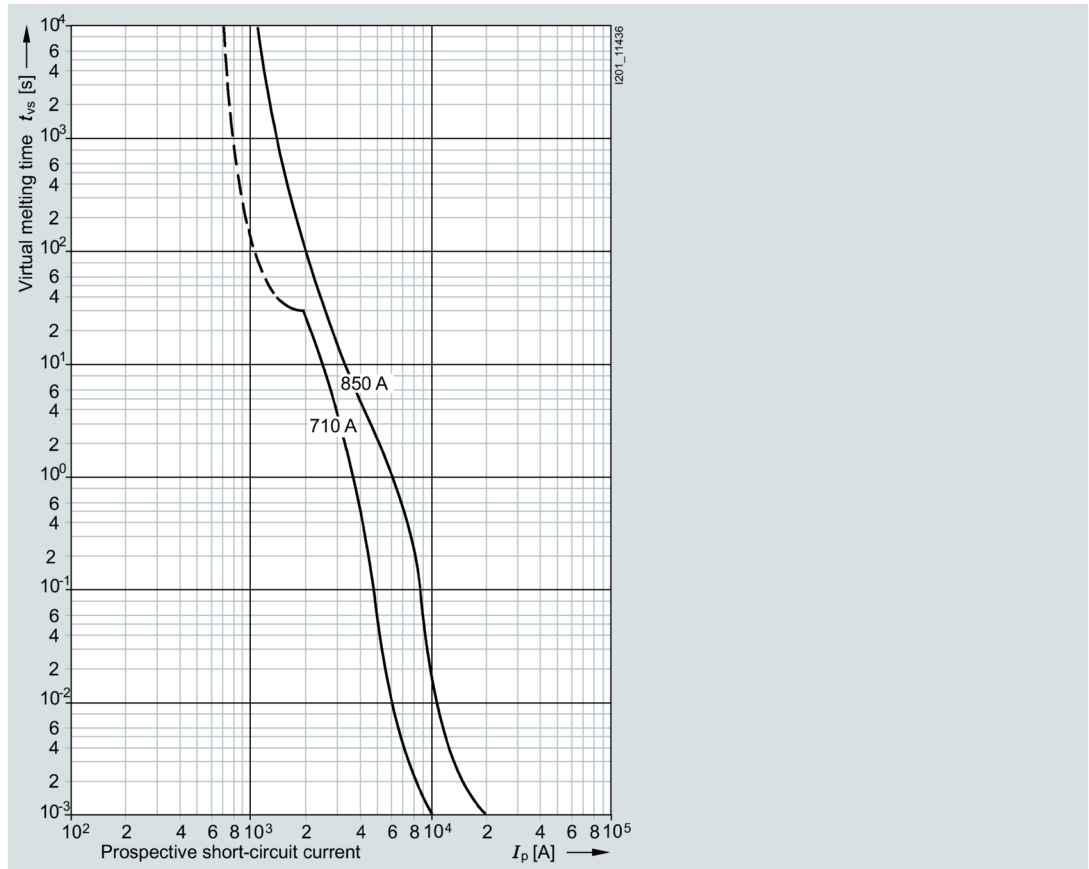

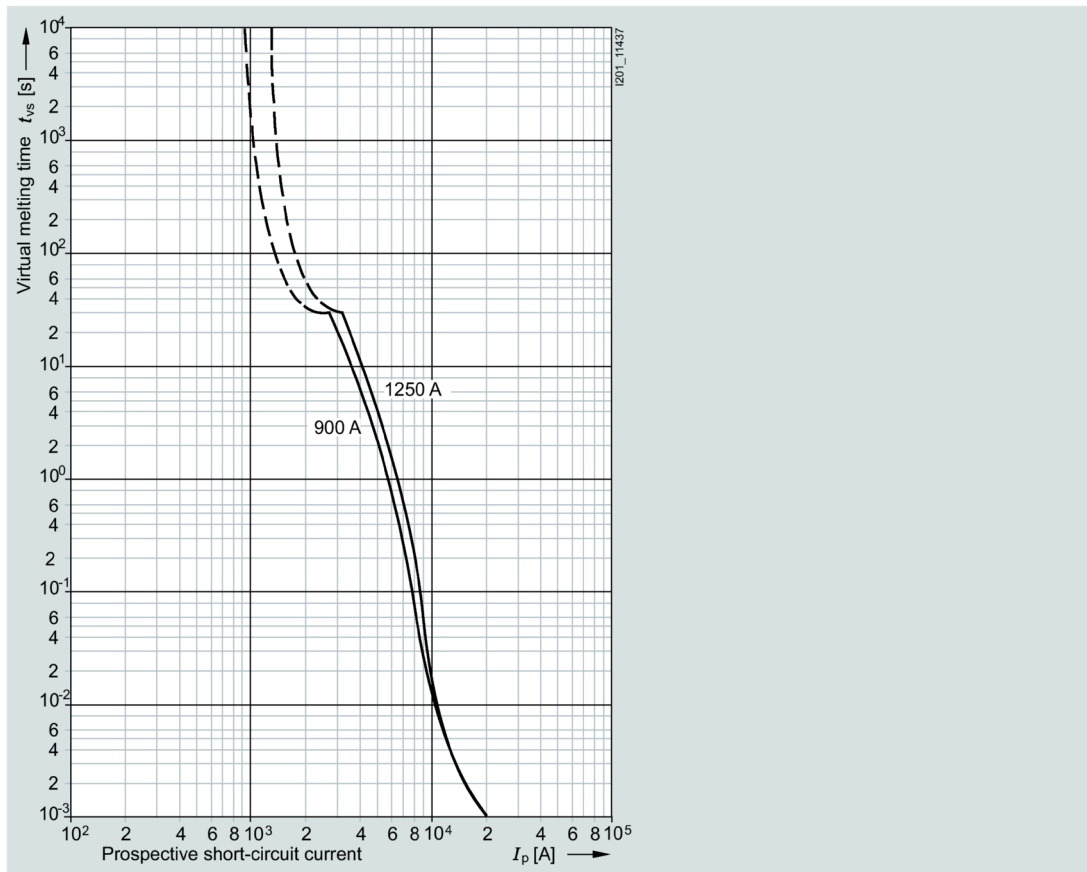

**3NB1.., 3NB2.. series**

Size:	1L, 2L, 3L, 2 x 2L, 2 x 3L, 3 x 3L
Operational class:	aR
Rated voltage:	1250 V DC
Rated current:	200 ... 2400 A

### Time/current characteristic curves diagram

#### 3NB1...-4KK11

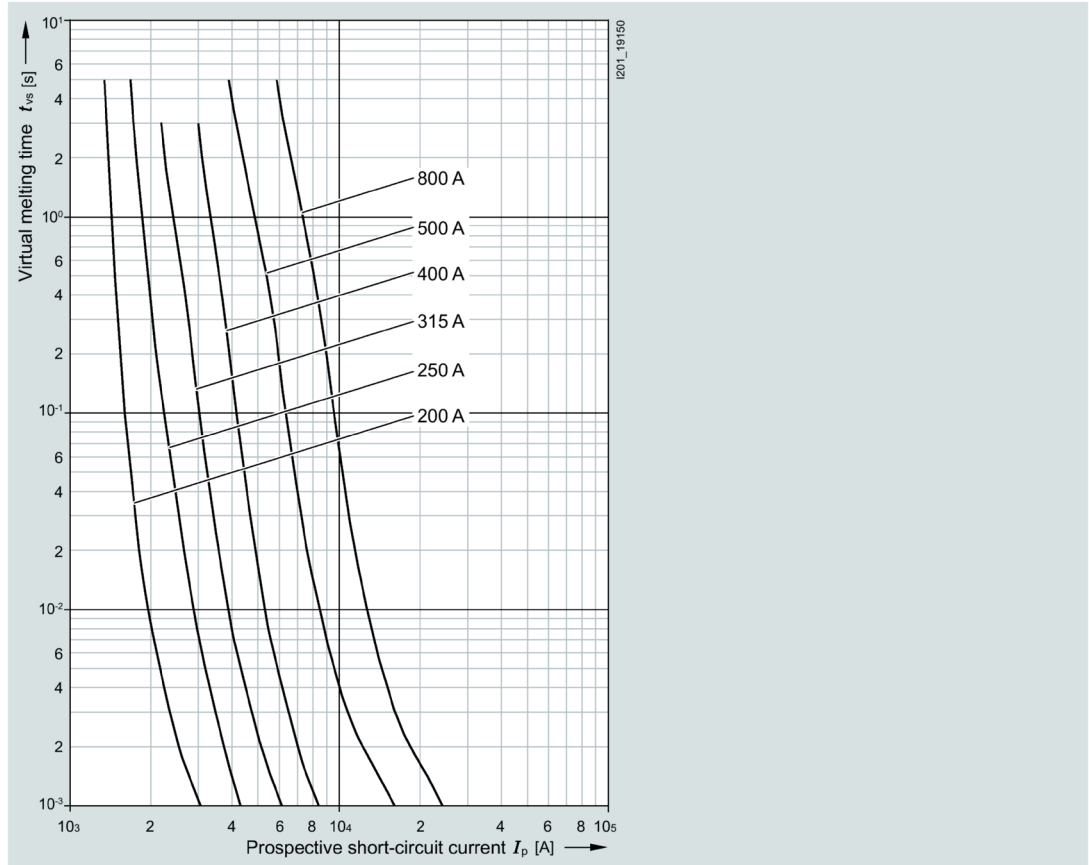

**3NB2...-4KK1.**

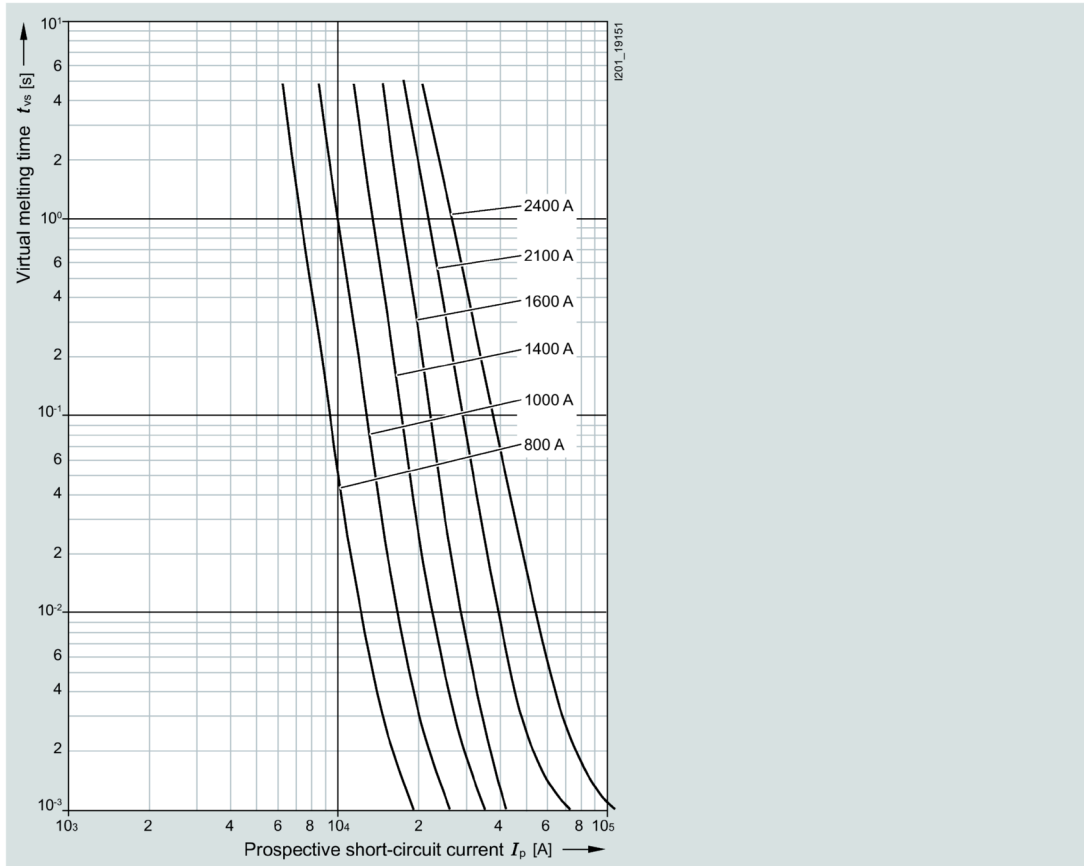

**Let-through characteristic curves (current limiting at 50 Hz)**

**3NB1...-4KK11**

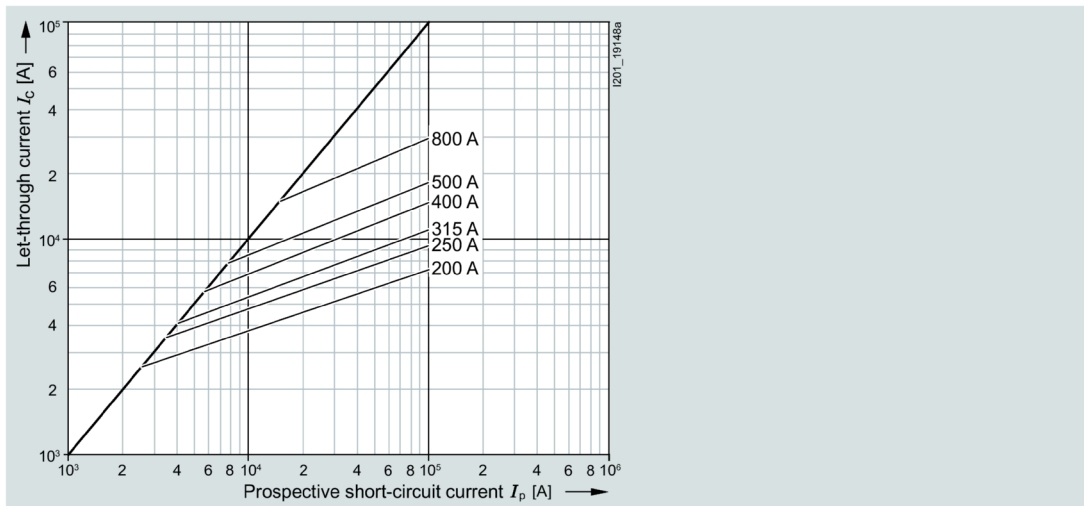

**3NB2...-4KK1.**

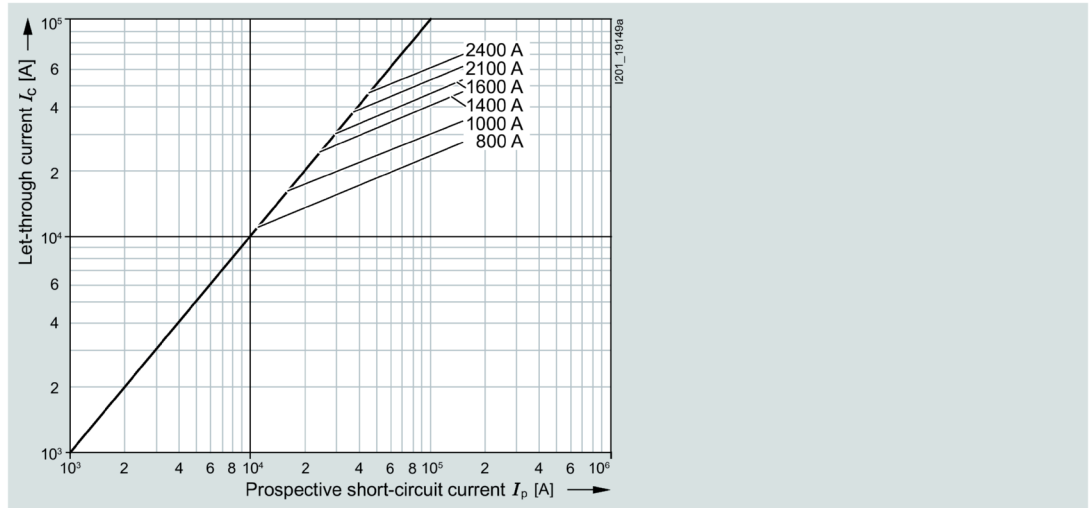

**Correction factor  $k_A$  for breaking  $I^2t$  value**

**3NB1...-4KK11, 3NB2...-4KK1.**

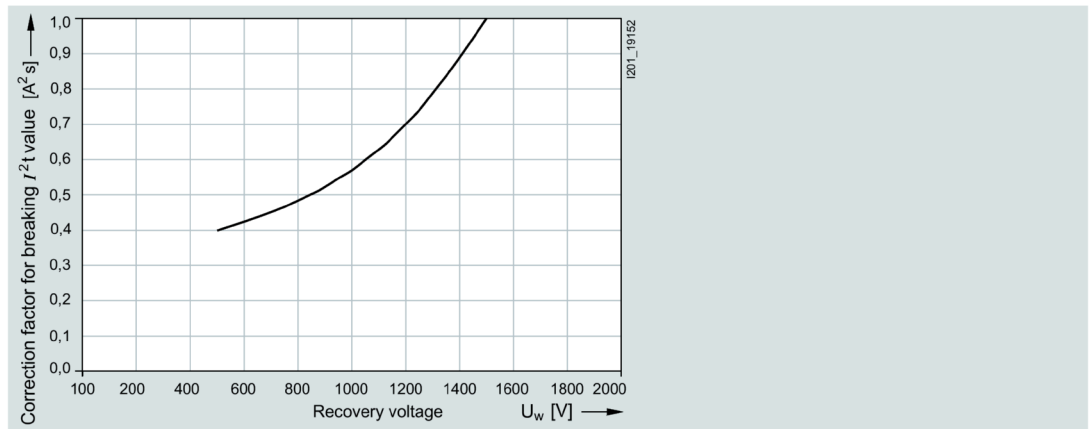

**Peak arc voltage**

**3NB1...-4KK11, 3NB2...-4KK1.**

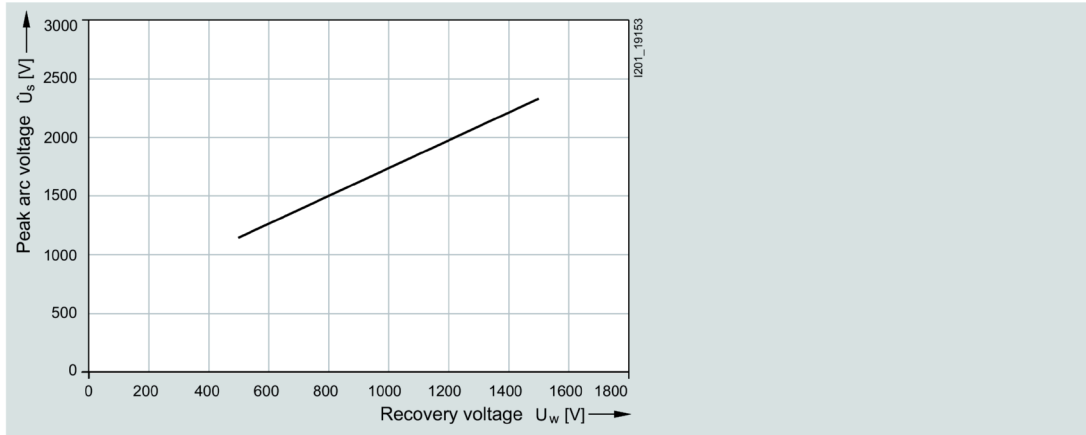

**3NE64. ., 3NE94. . series**

Operational class:	aR, gR
Rated voltage:	600 V AC (850 A, 1250 A) 900 V AC (710 A, 900 A)
Rated current:	710 ... 1250 A

**Time/current characteristic curves diagram**

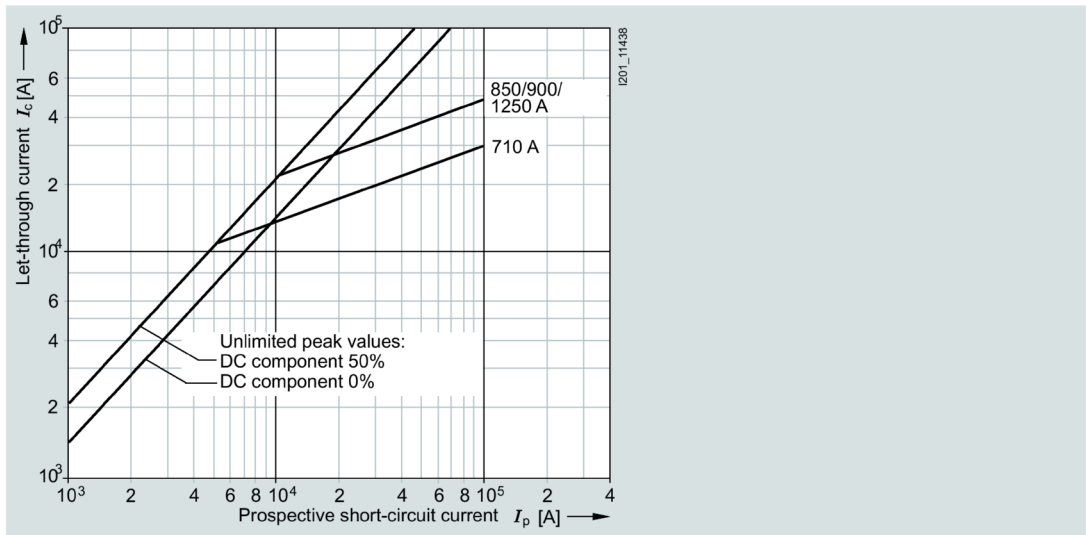

### Correction factor $k_A$ for breaking $I^2t$ value

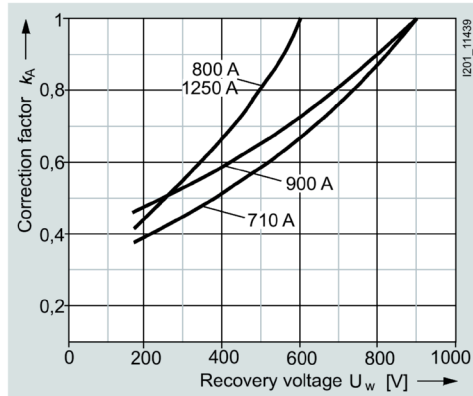

### Peak arc voltage

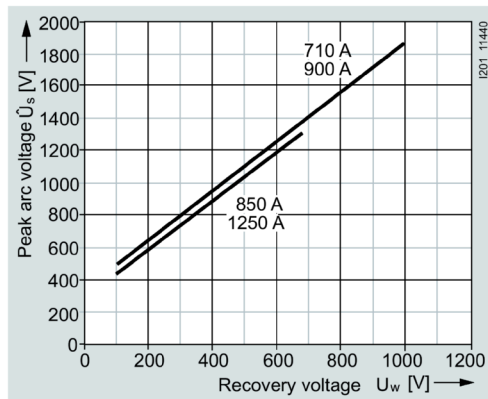

### 3NE74. ., 3NE76. . series

Size:	3
Operational class:	aR
Rated voltage:	2000 V AC
Rated current:	200 ... 710 A

Time/current characteristic curves diagram

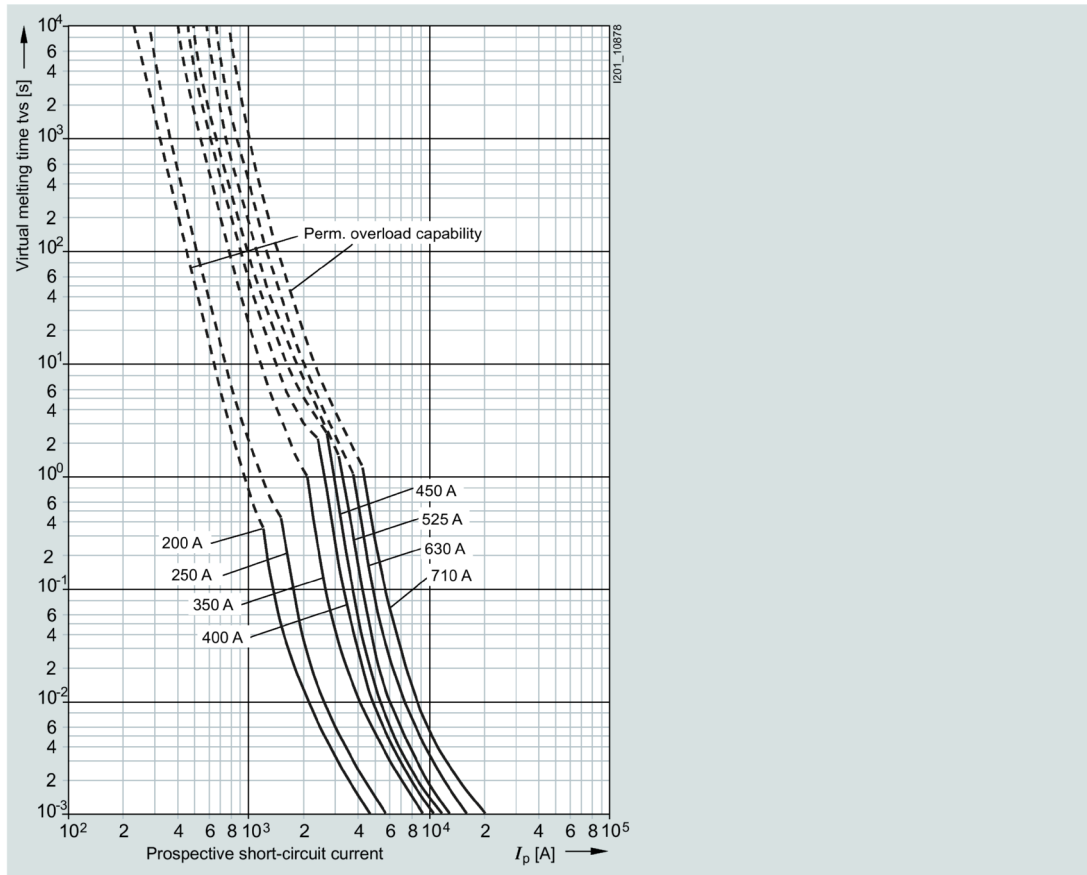

Correction factor  $k_A$  for breaking  $I^2t$  value

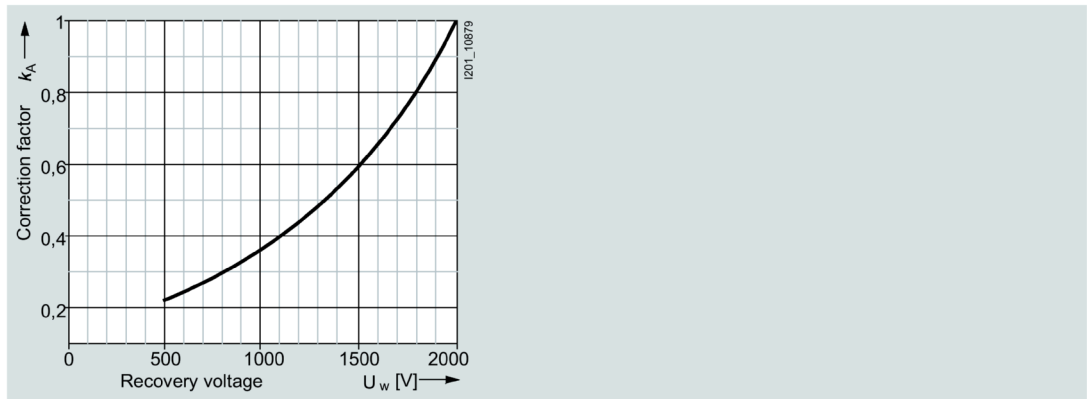



## Let-through characteristic curves (current limiting at 50 Hz)

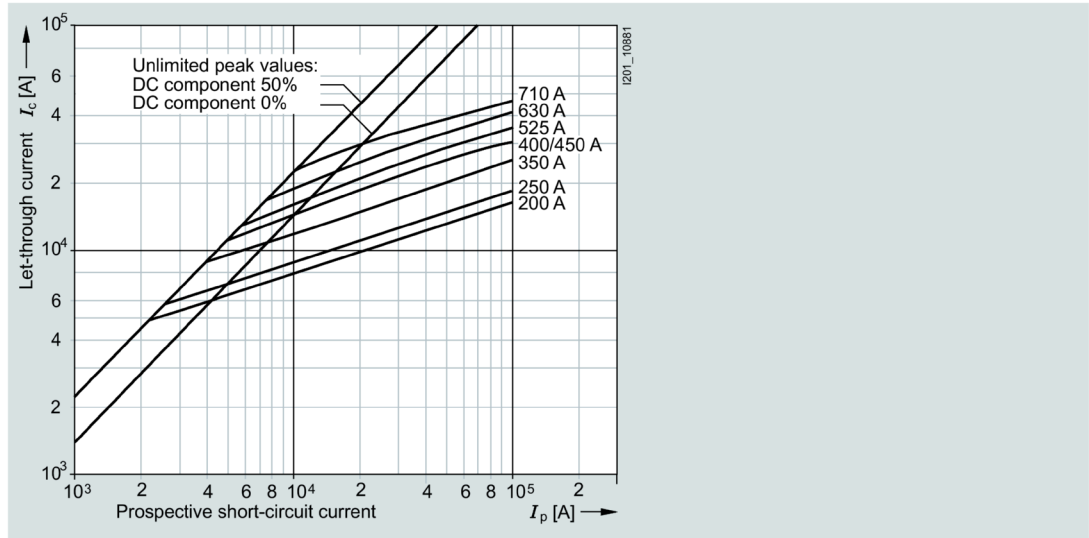

## Peak arc voltage

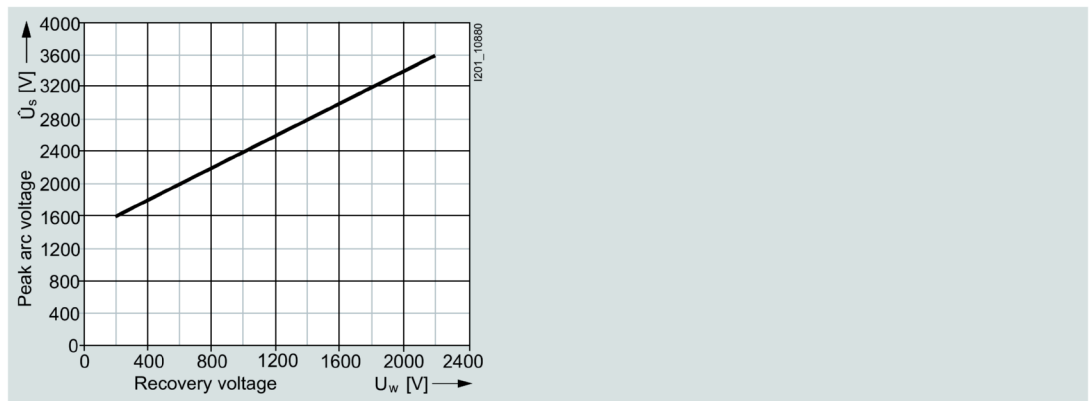

## 3NE80. -1 series

Size:	00
Operational class:	gR or aR
Rated voltage:	690 V AC
Rated current:	25 ... 160 A

Time/current characteristic curves diagram

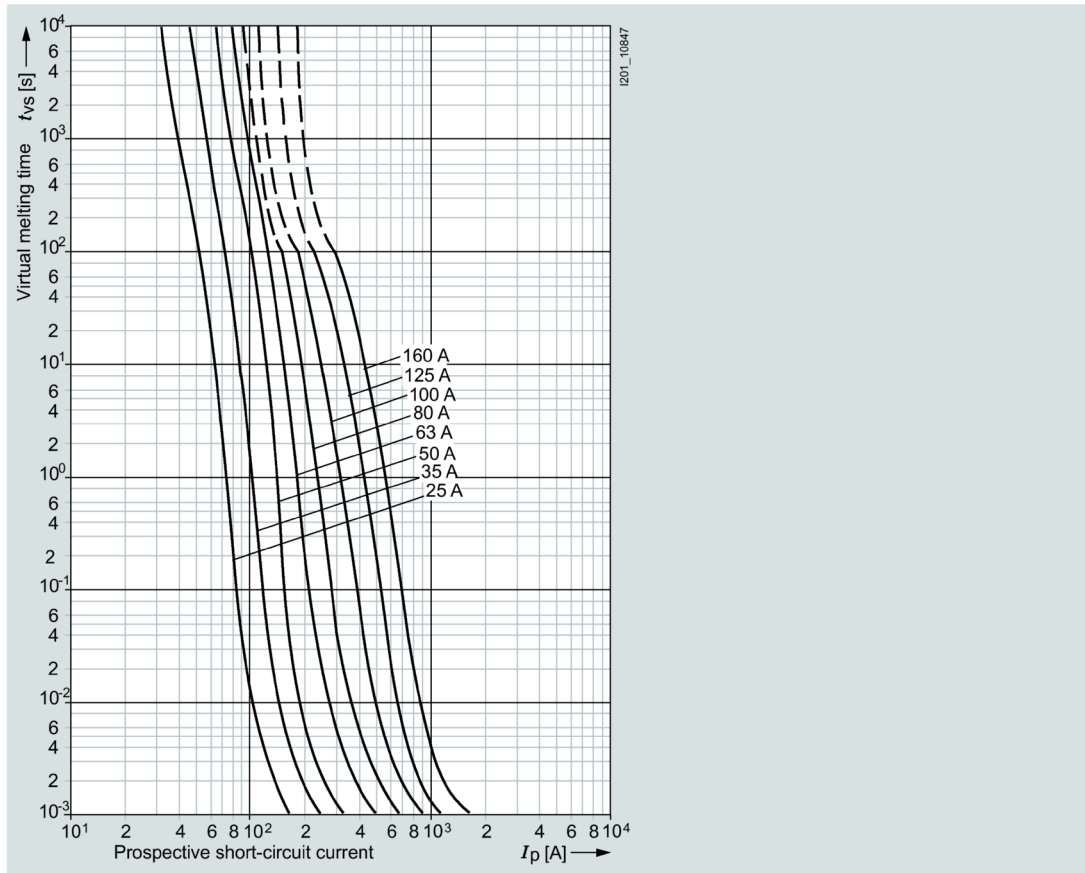

Correction factor  $k_A$  for breaking  $I^2t$  value

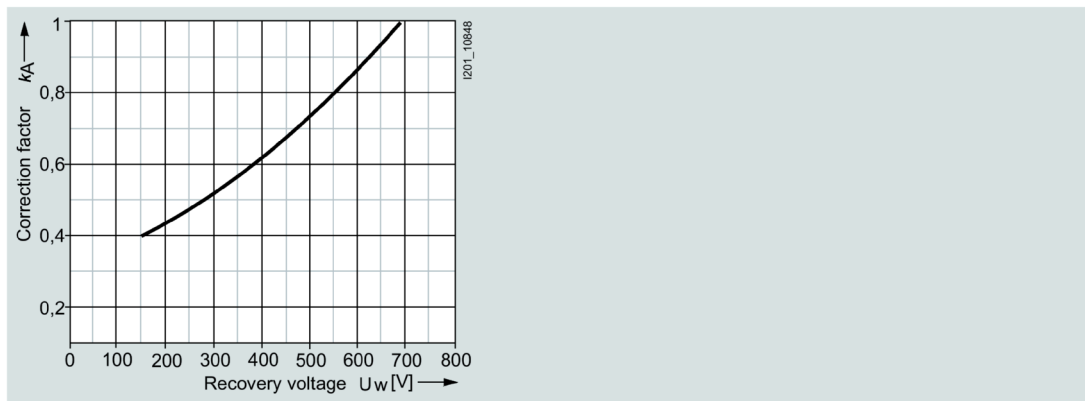

## Let-through characteristic curves (current limiting at 50 Hz)

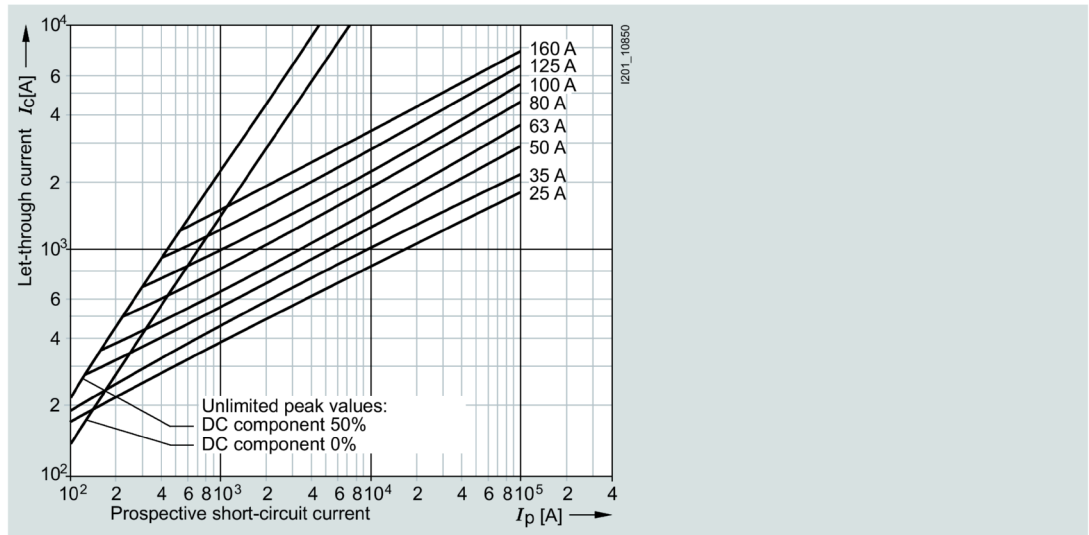

## Peak arc voltage

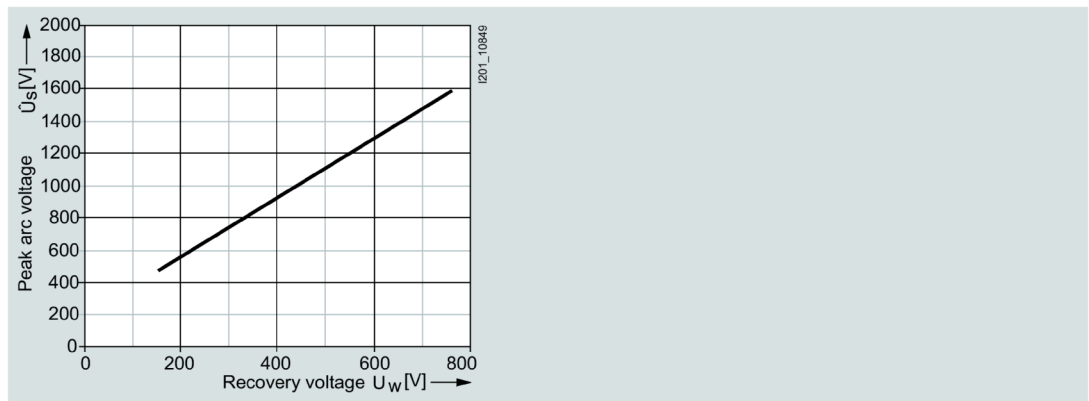

## 3NE80..-3MK series

Size:	00
Operational class:	gR / aR
Rated voltage:	690 V AC / 440 V DC
Rated current:	80 A, 100 A, 350 A, 400 A

Time/current characteristic curves diagram

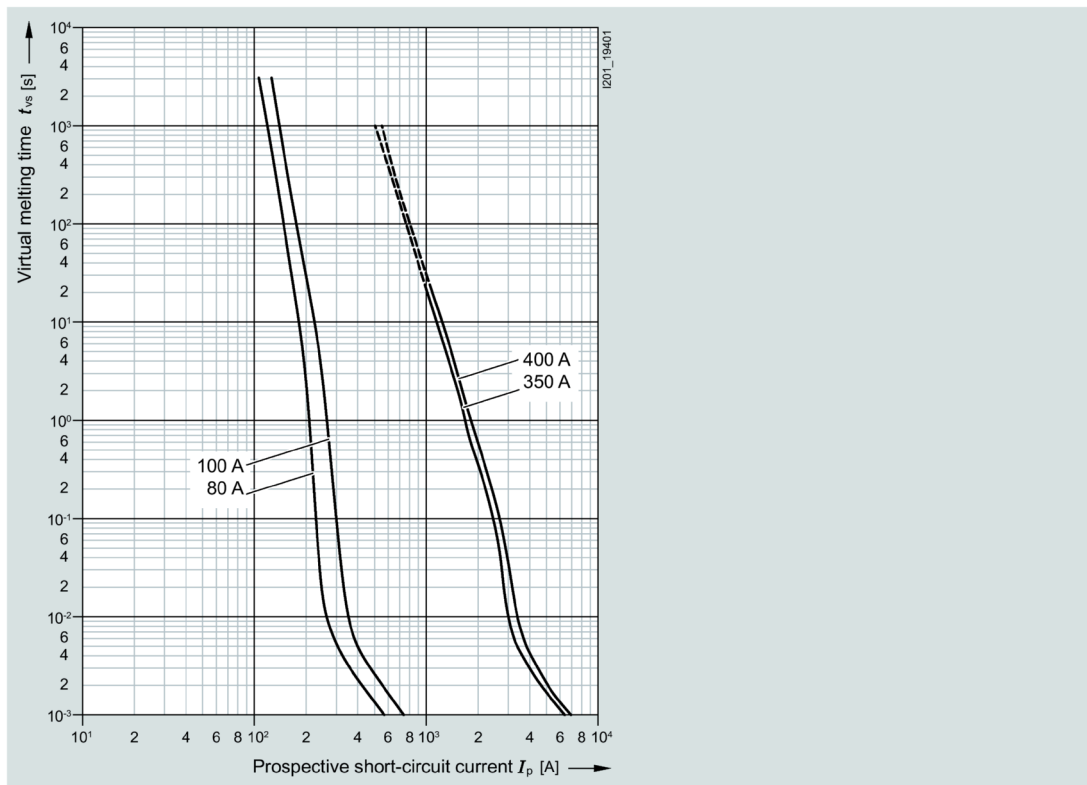

Correction factor  $k_A$  for breaking  $I^2t$  value

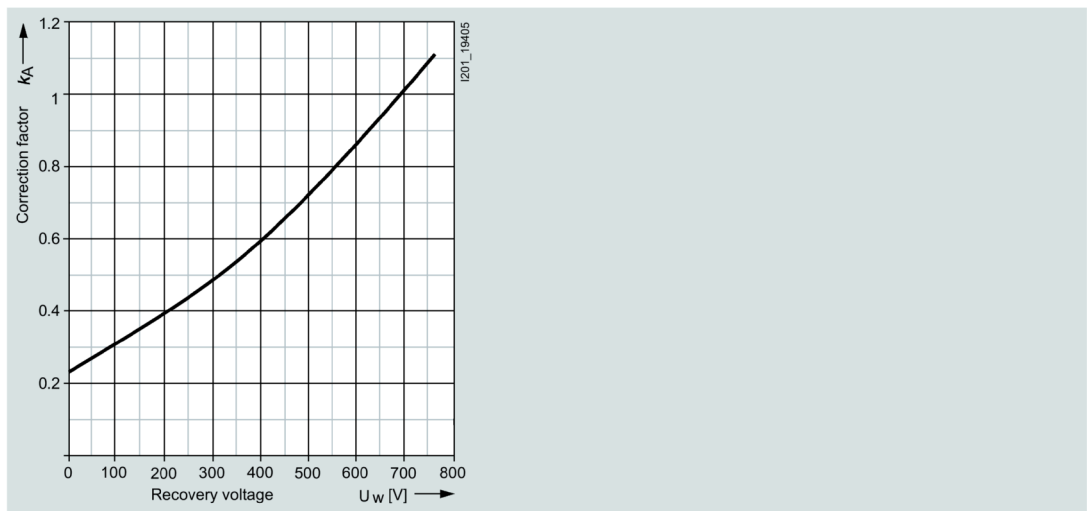

## Let-through characteristic curves (current limiting at 50 Hz)

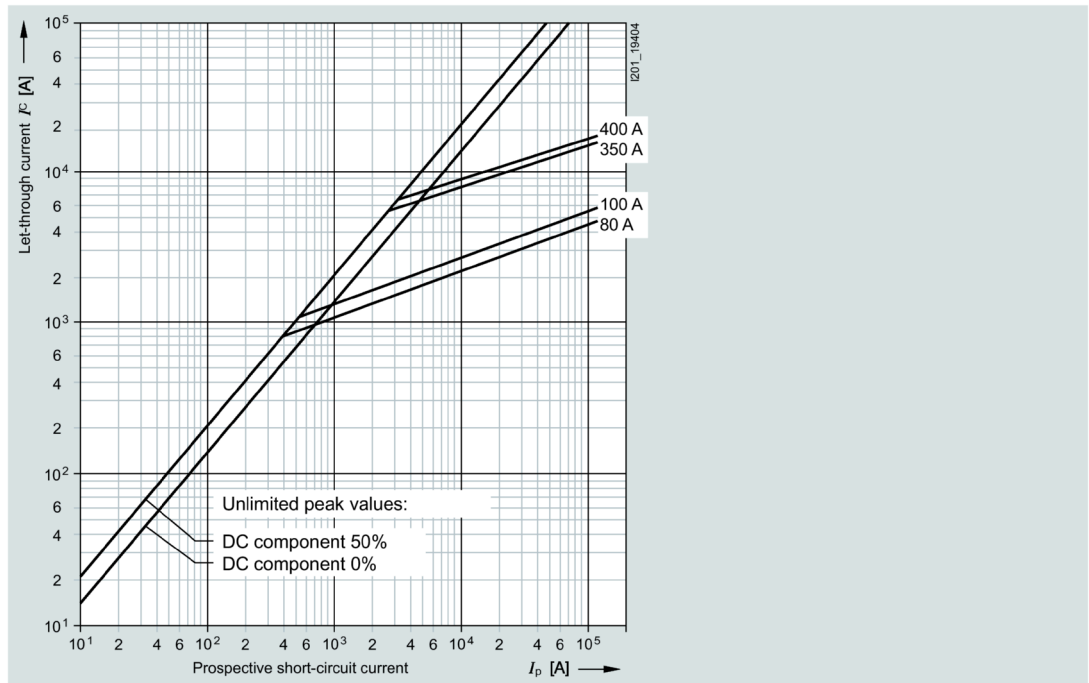

## Peak arc voltage

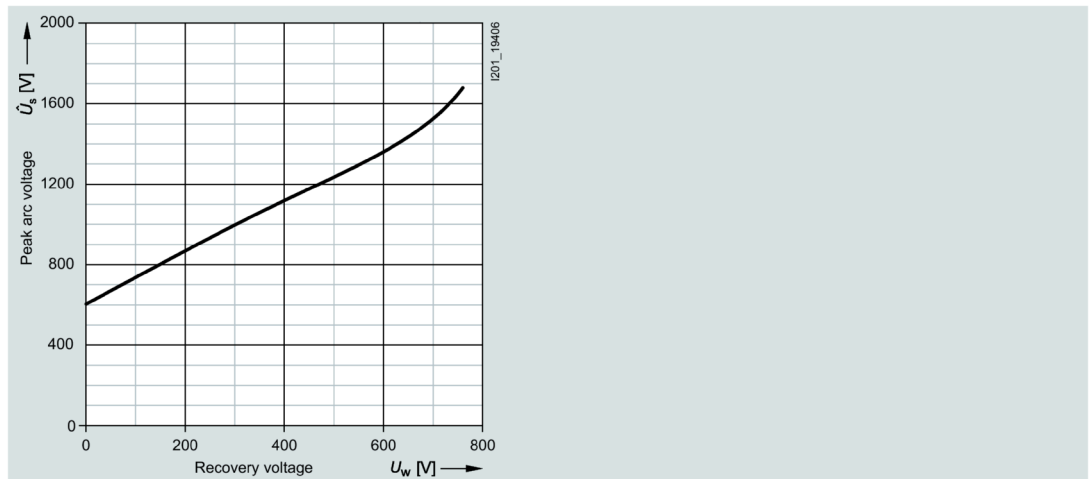

## 3NE82..-OMK series

Size:	1
Operational class:	aR
Rated voltage:	690 V AC / 440 V DC
Rated current:	100 ... 315 A

Time/current characteristic curves diagram

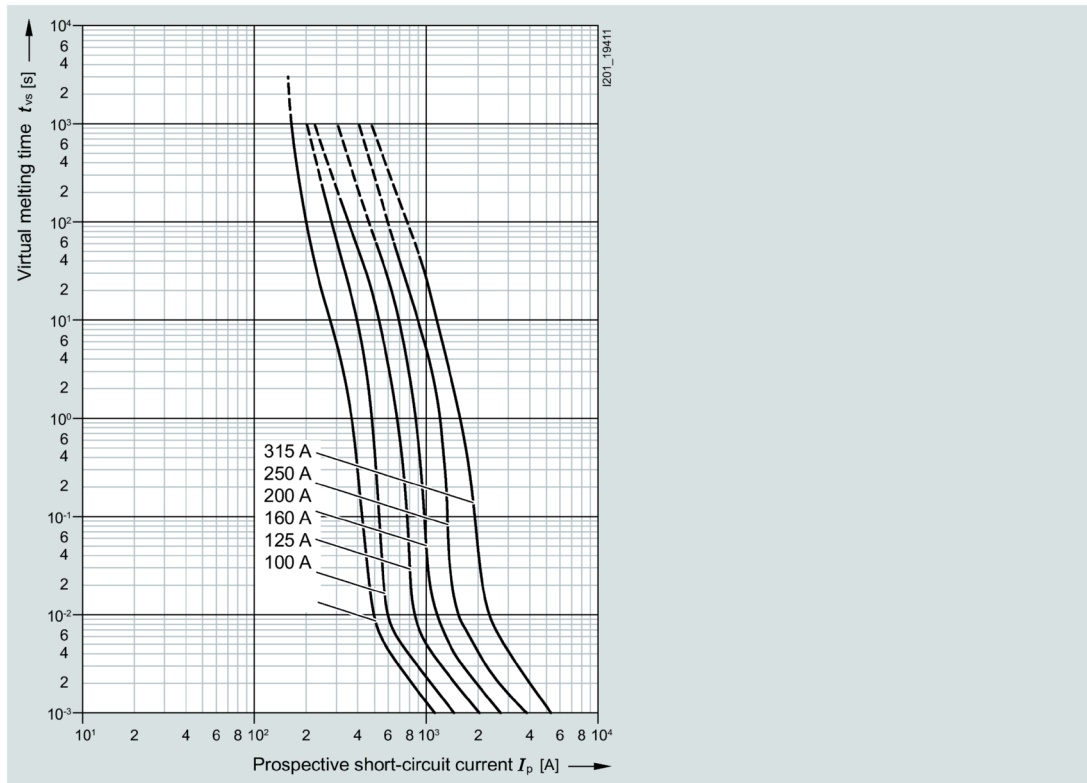

Correction factor  $k_A$  for breaking  $I^2t$  value

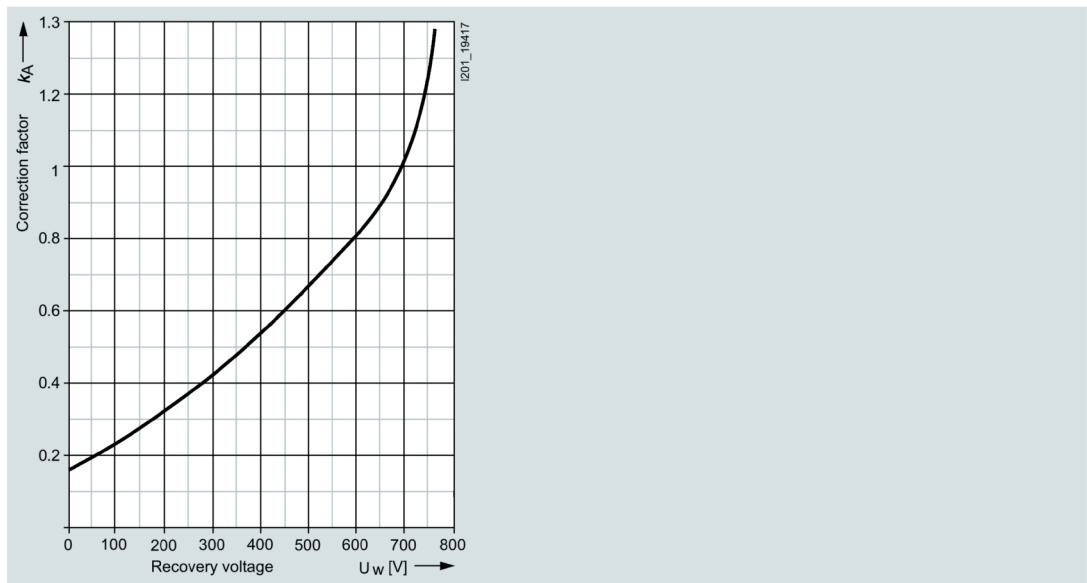

## Let-through characteristic curves (current limiting at 50 Hz)

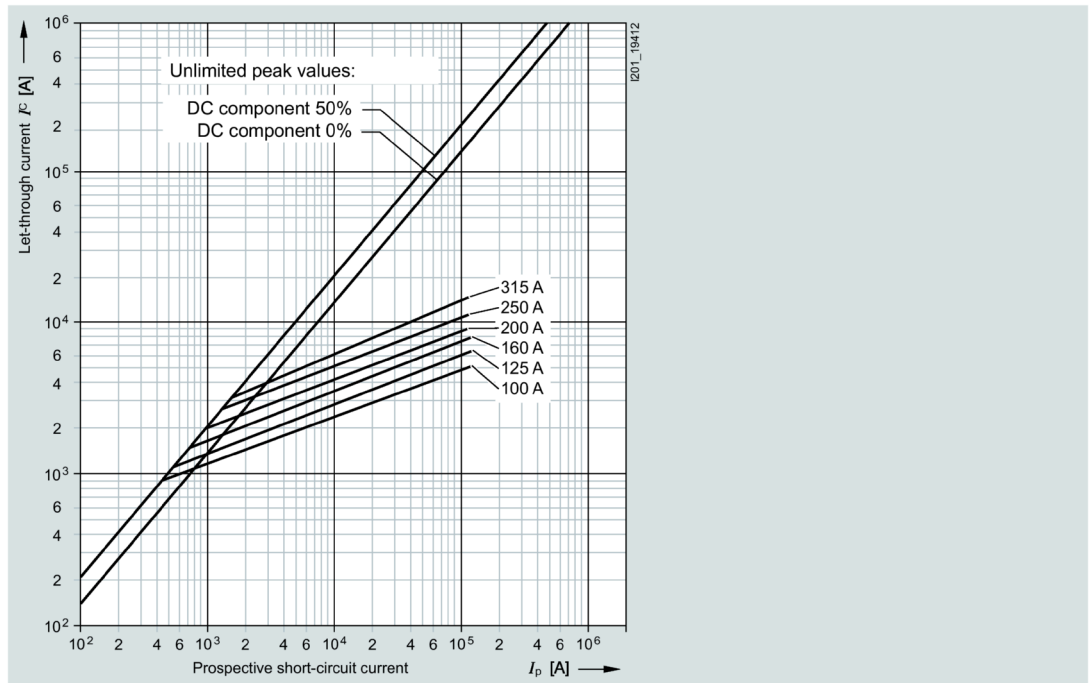

## Peak arc voltage

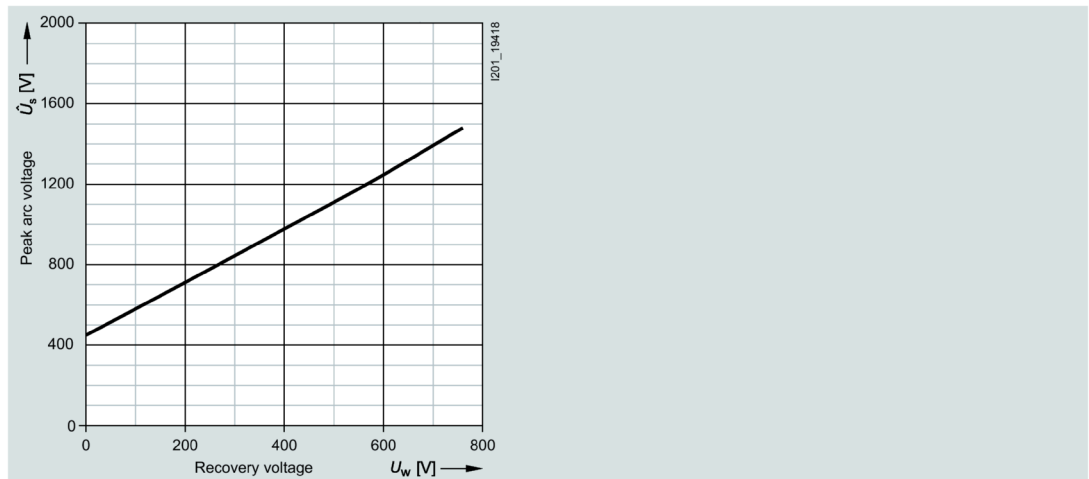

## 3NE82...3MK series

Size:	1
Operational class:	aR
Rated voltage:	690 V AC / 440 V DC
Rated current:	100 ... 630 A

Time/current characteristic curves diagram

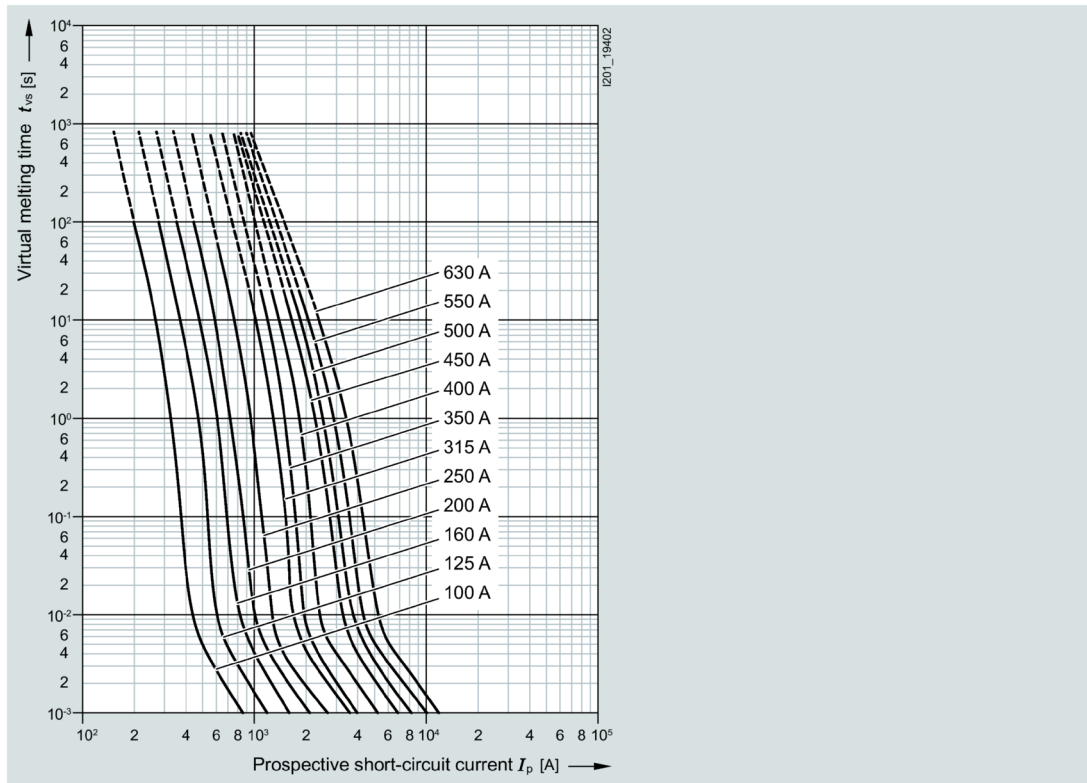

Correction factor  $k_A$  for breaking  $I^2t$  value

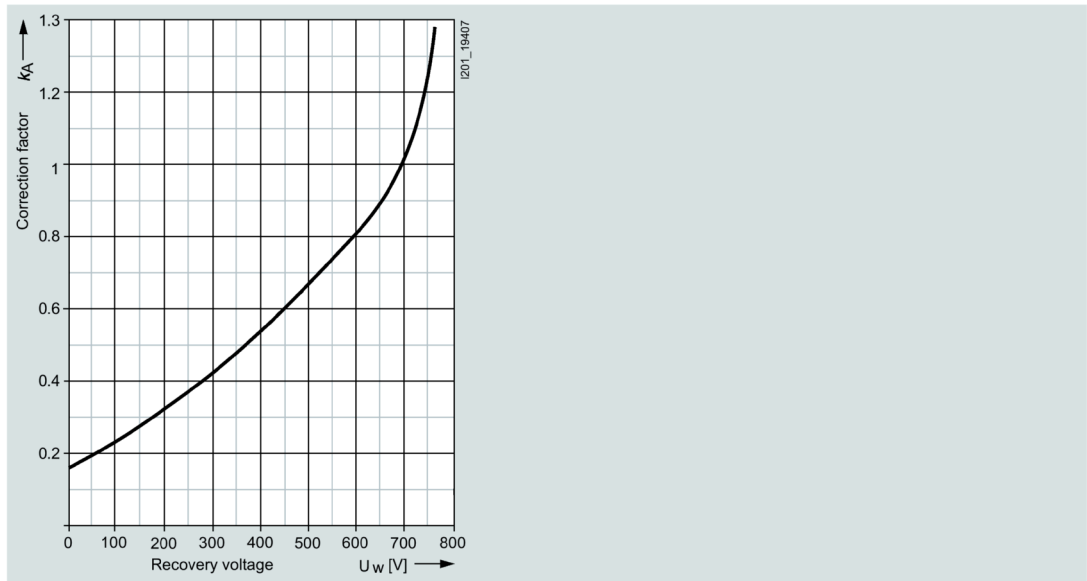



## Let-through characteristic curves (current limiting at 50 Hz)

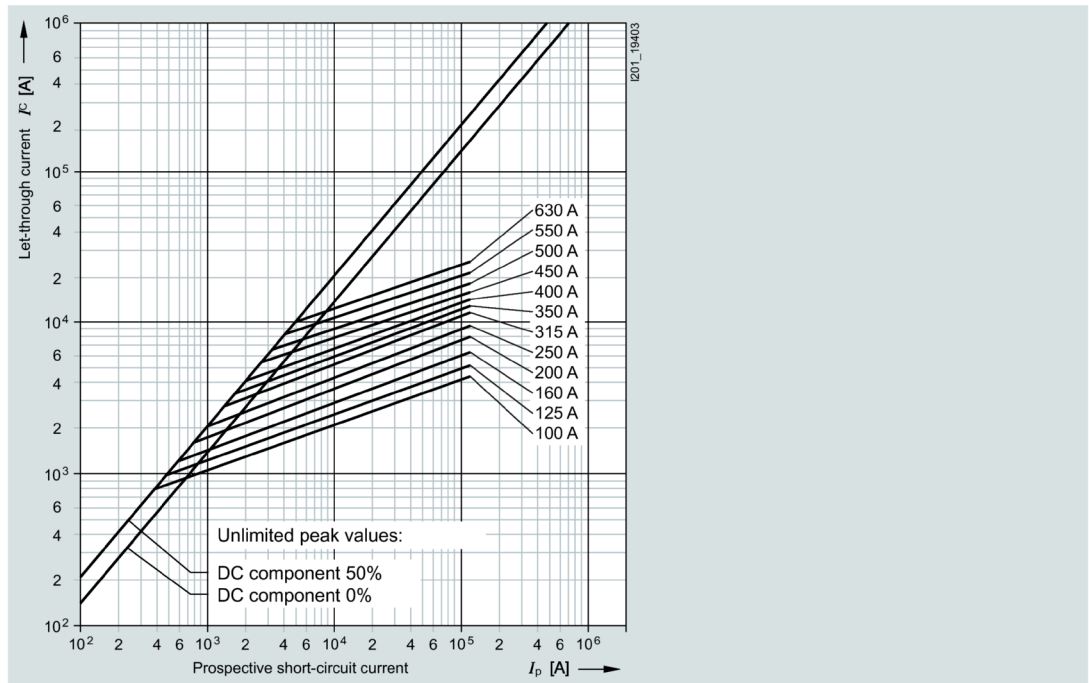

## Peak arc voltage

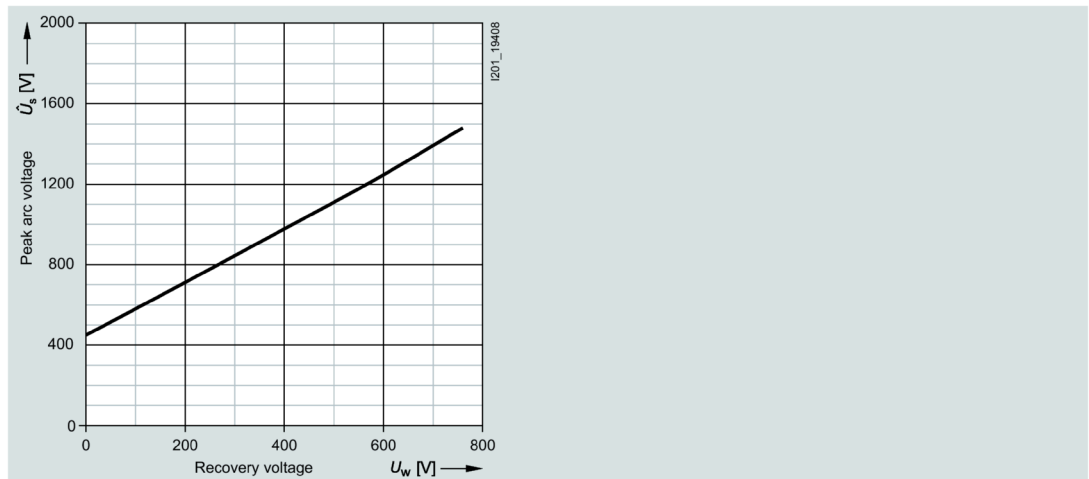

## 3NE83..-OMK series

Size:	2
Operational class:	aR
Rated voltage:	690 V AC / 440 V DC
Rated current:	350 ... 630 A

Time/current characteristic curves diagram

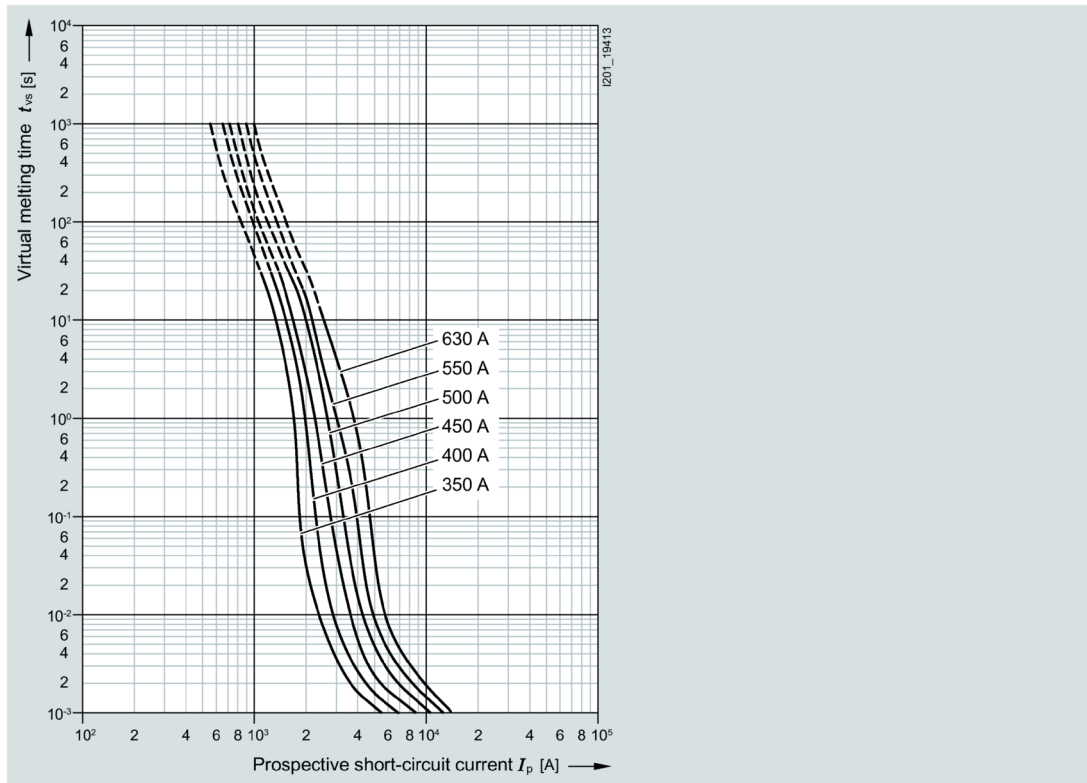

Correction factor  $k_A$  for breaking  $I^2t$  value

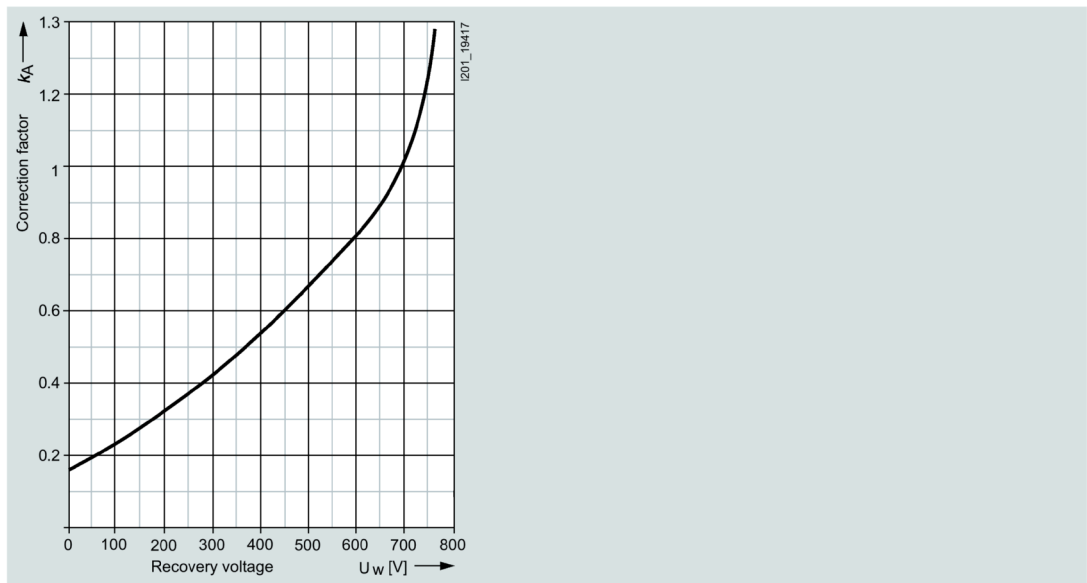

## Let-through characteristic curves (current limiting at 50 Hz)

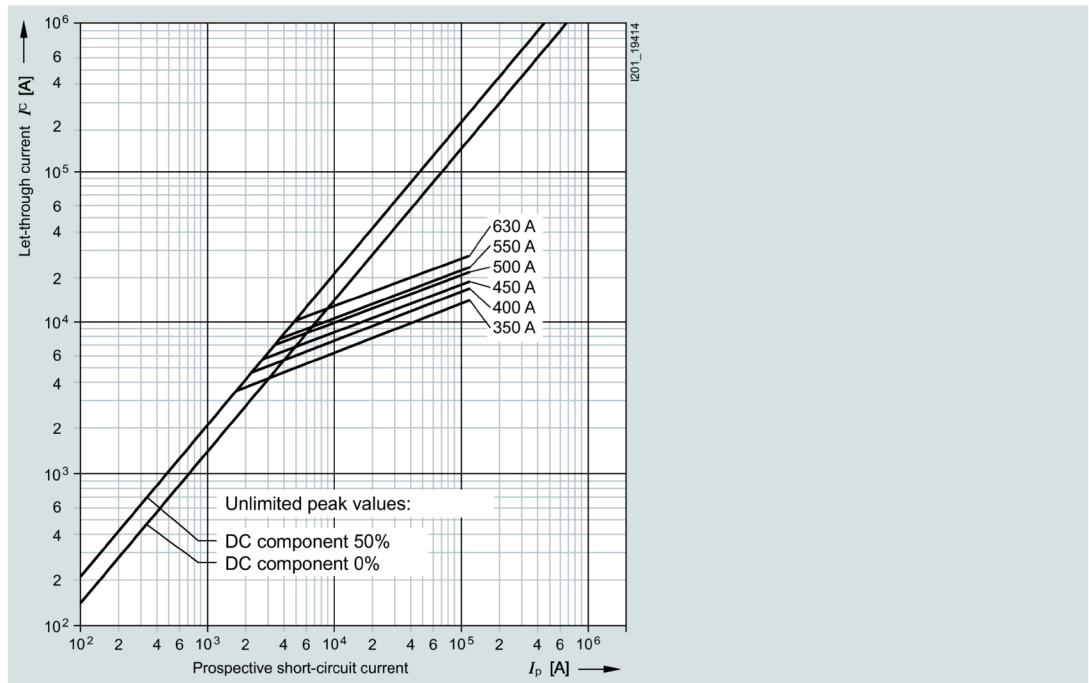

## Peak arc voltage

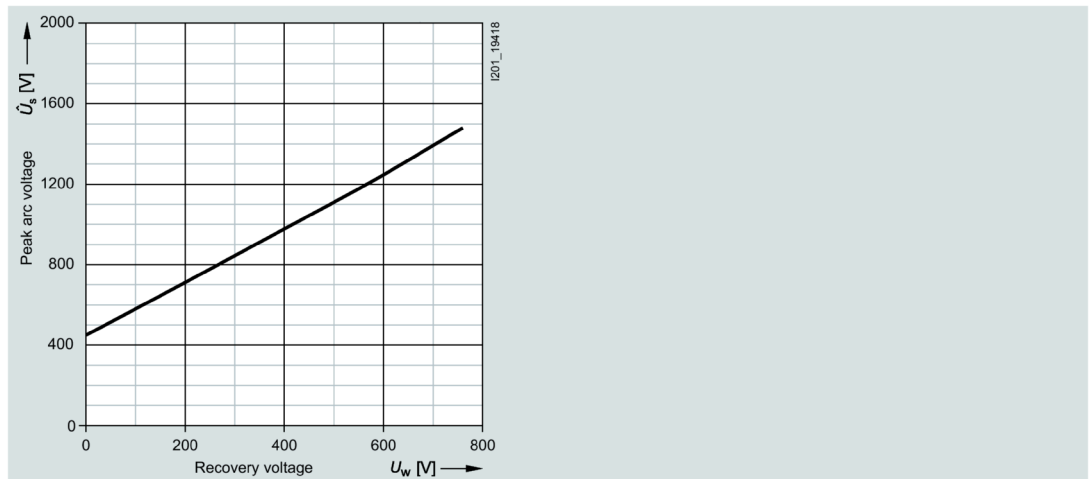

## 3NE870.-1, 3NE871.-1 series

Size:	000
Operational class:	gR or aR
Rated voltage:	690 V AC / 700 V DC
Rated current:	20 ... 63 A

Time/current characteristic curves diagram

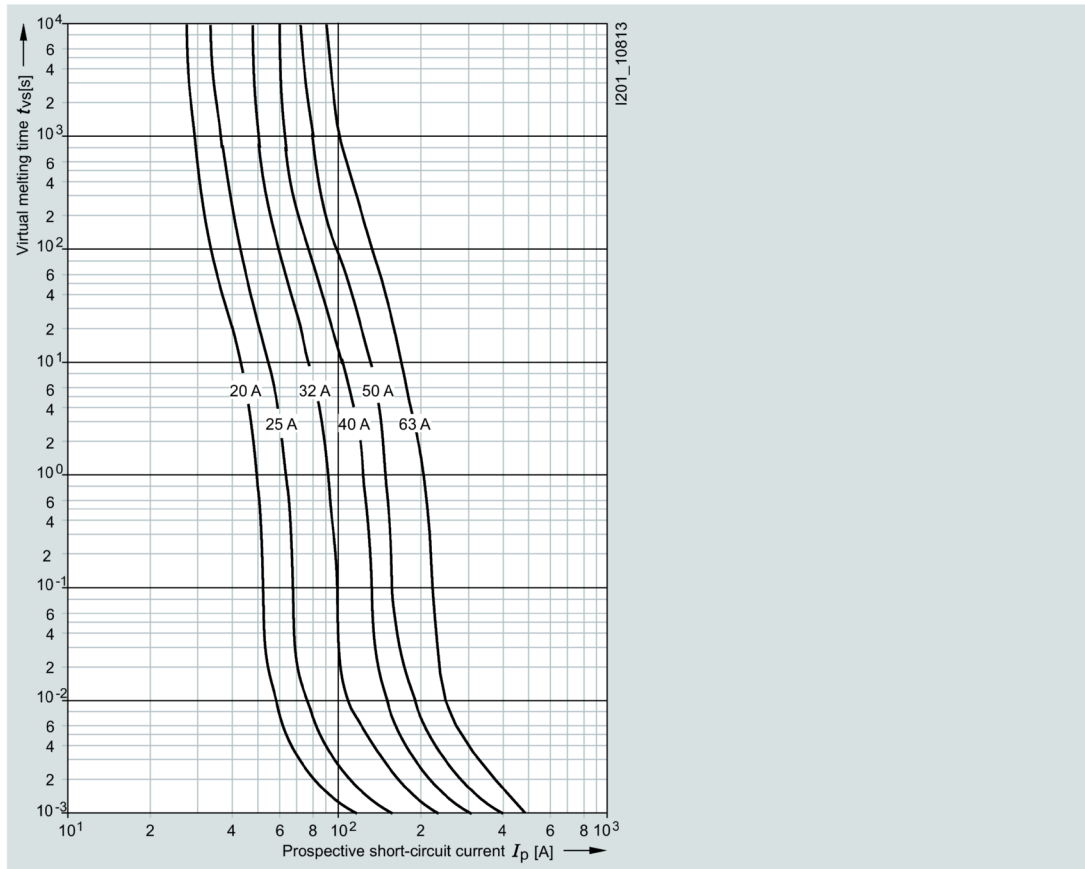

Correction factor  $k_A$  for breaking  $I^2t$  value

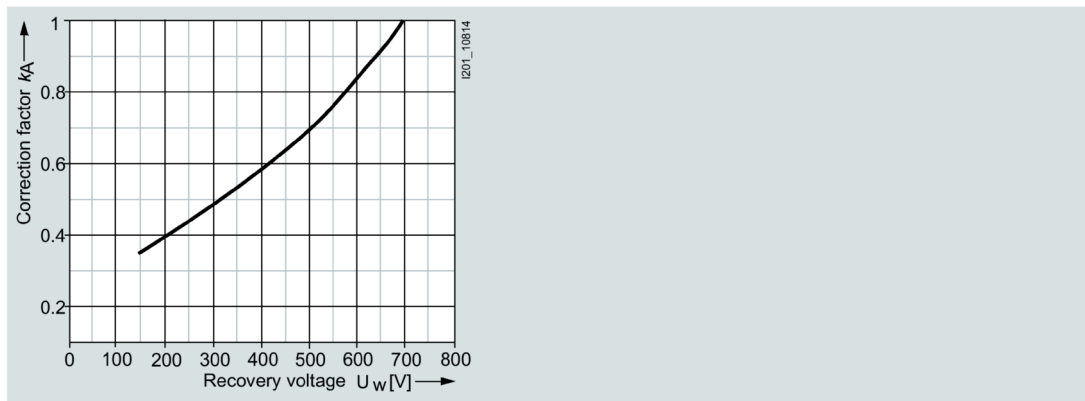

## Let-through characteristic curves (current limiting at 50 Hz)

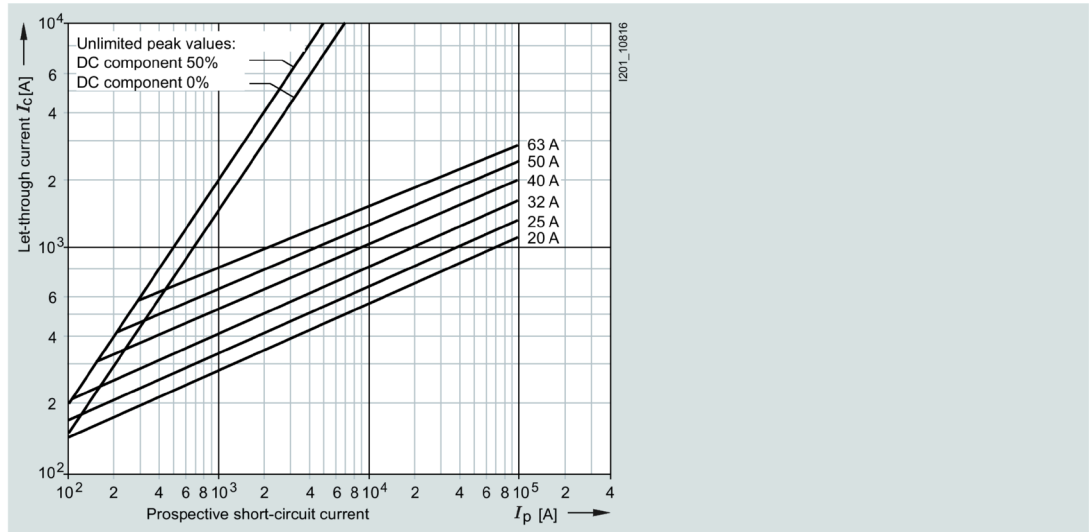

## Peak arc voltage

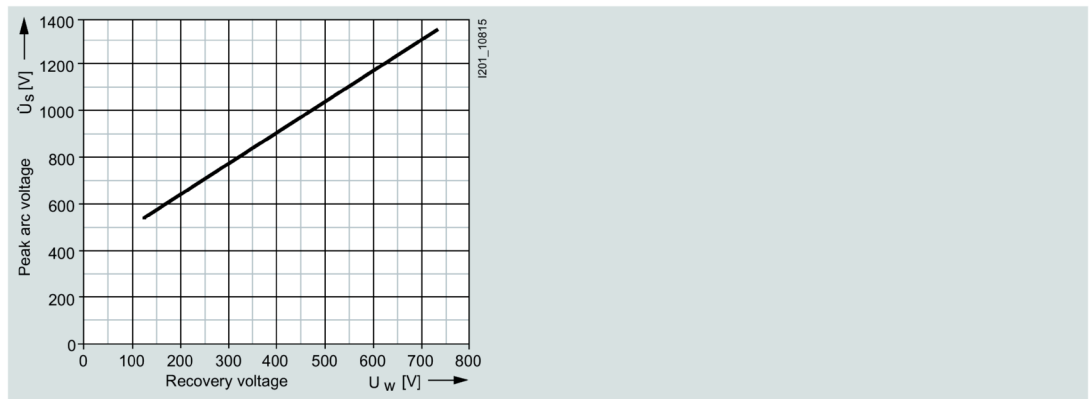

## 3NE872.-1, 3NE8731-1 series

Size:	000
Operational class:	aR
Rated voltage:	690 V AC / 700 V DC acc. to UL
Rated current:	80 ... 315 A

Time/current characteristic curves diagram

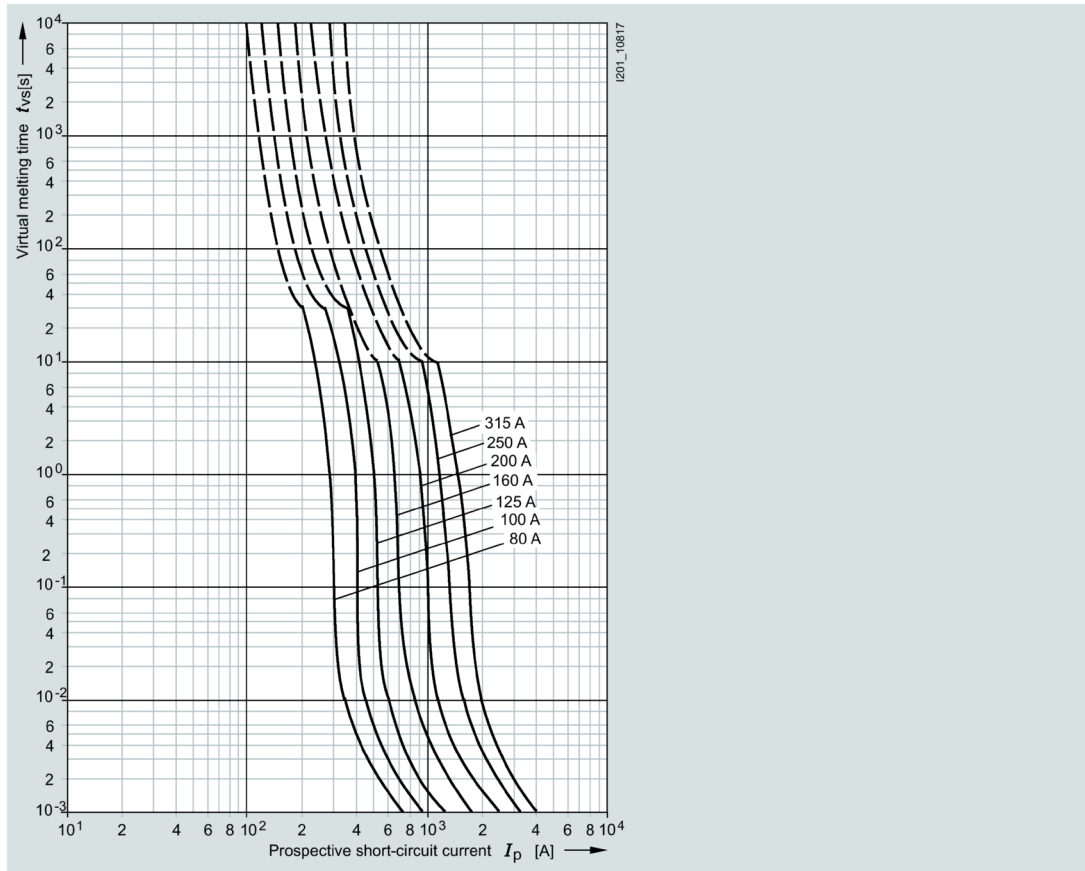

Correction factor  $k_A$  for breaking  $I^2t$  value

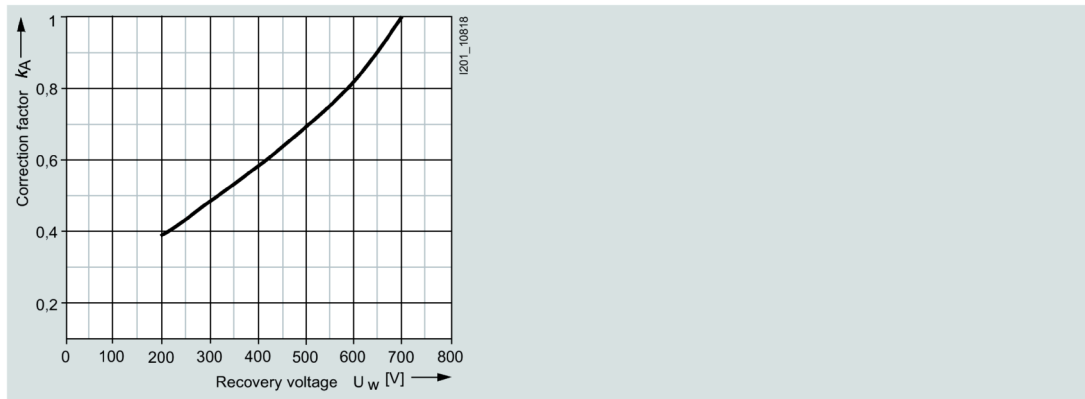

## Let-through characteristic curves (current limiting at 50 Hz)

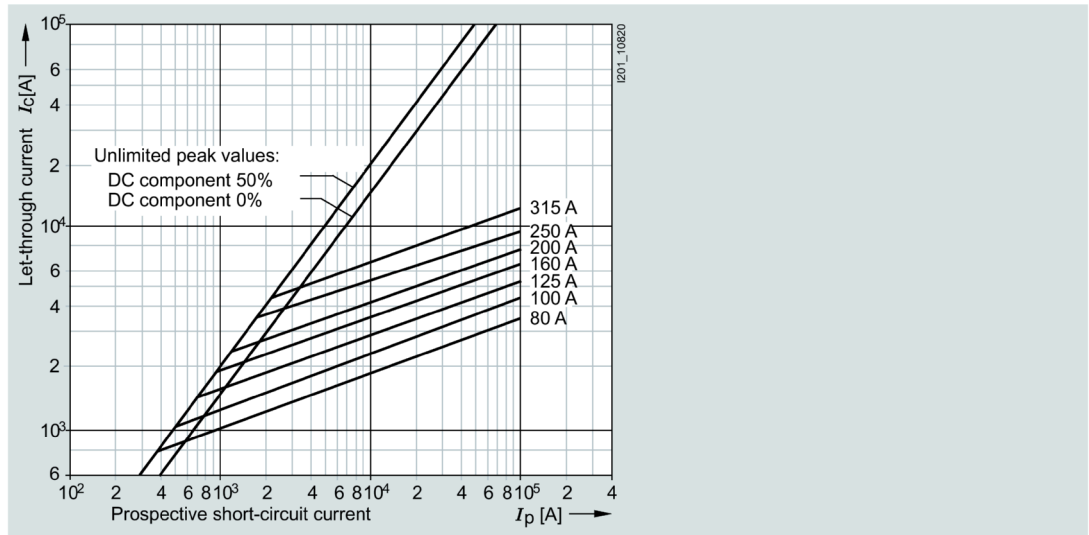

## Peak arc voltage

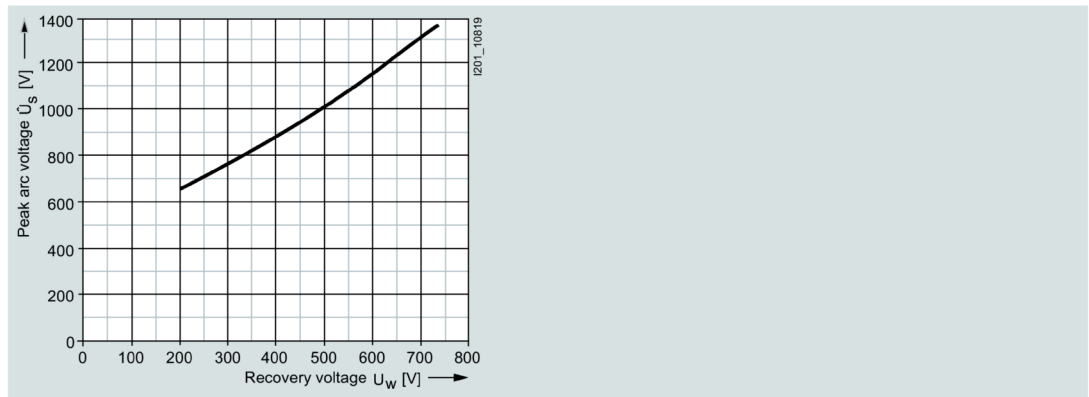

## 3NE88..-0MK series

Size:	000
Operational class:	gR / aR
Rated voltage:	500 ... 690 V AC / 440 V DC
Rated current:	6 ... 160 A

Time/current characteristic curves diagram

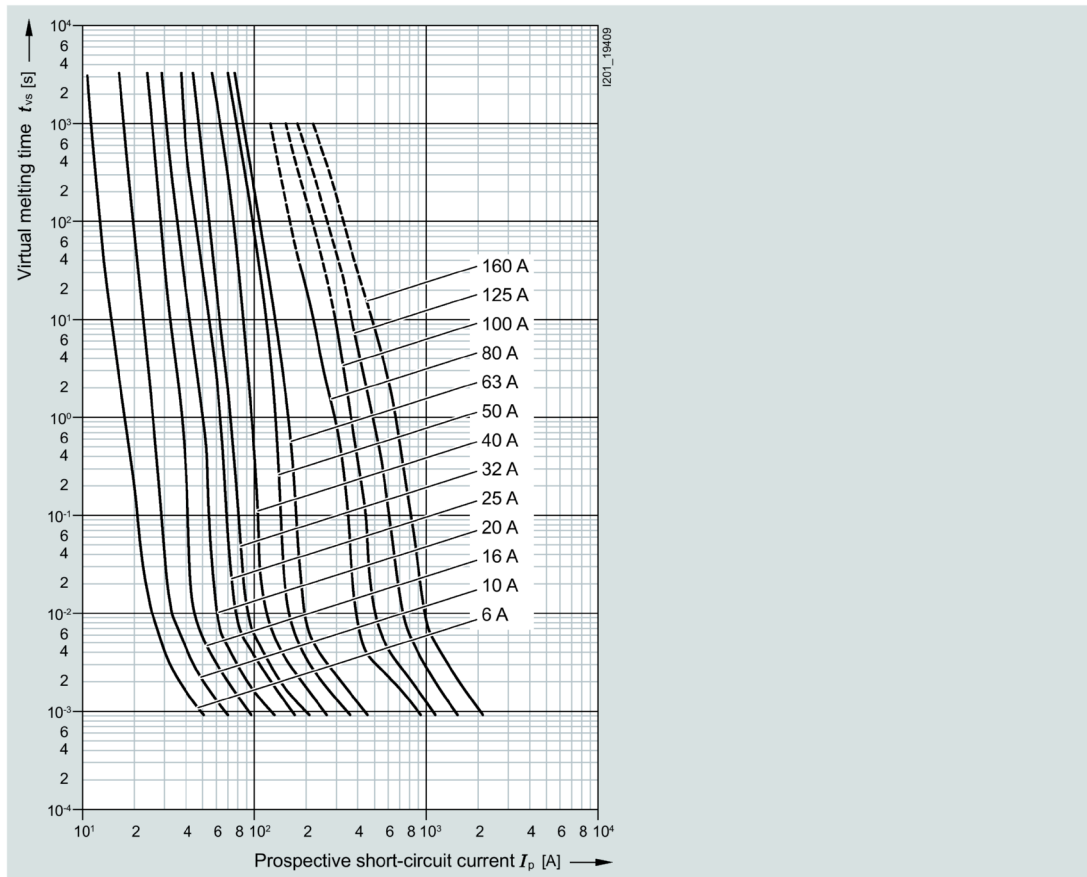

Correction factor  $k_A$  for breaking  $I^2t$  value

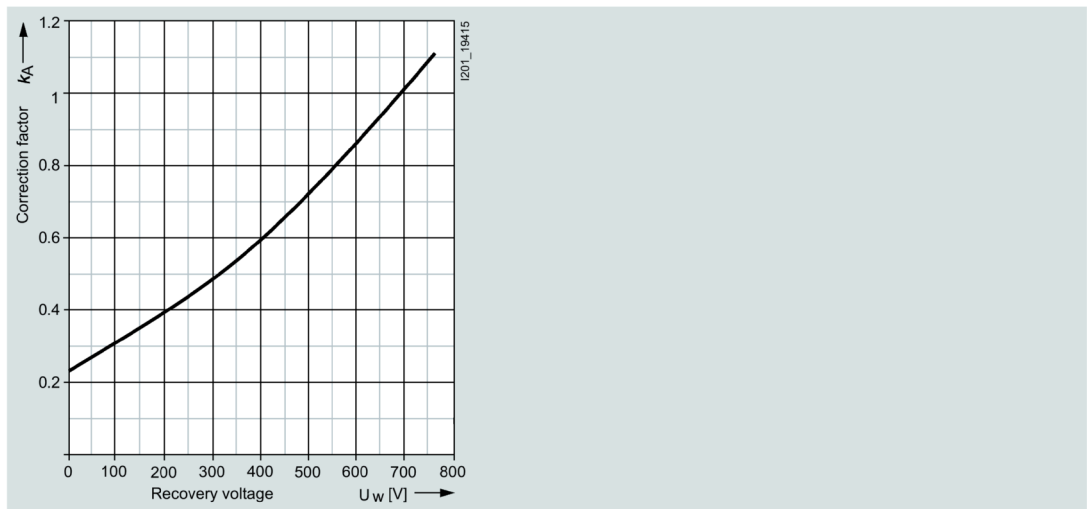



## Let-through characteristic curves (current limiting at 50 Hz)

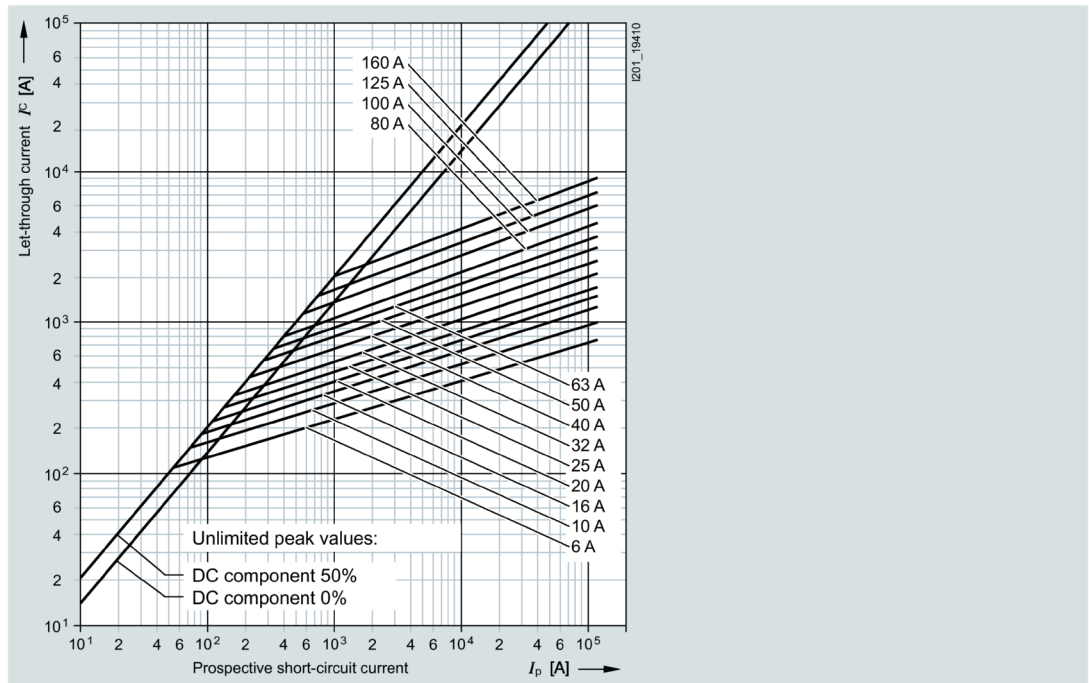

## Peak arc voltage

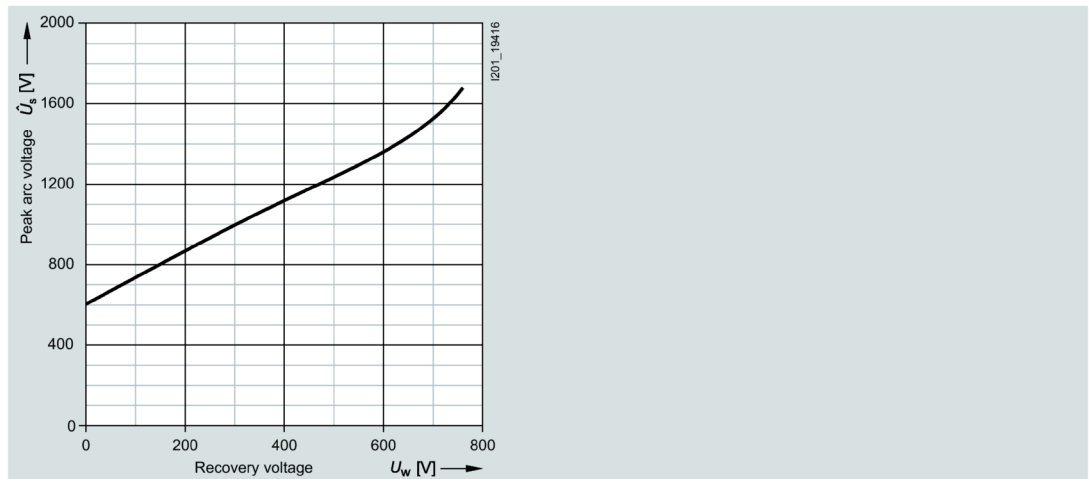

## 3NE93..-0MK07 series

Size:	2
Operational class:	aR
Rated voltage:	3000 V DC
Rated current:	315 A

Time/current characteristic curves diagram

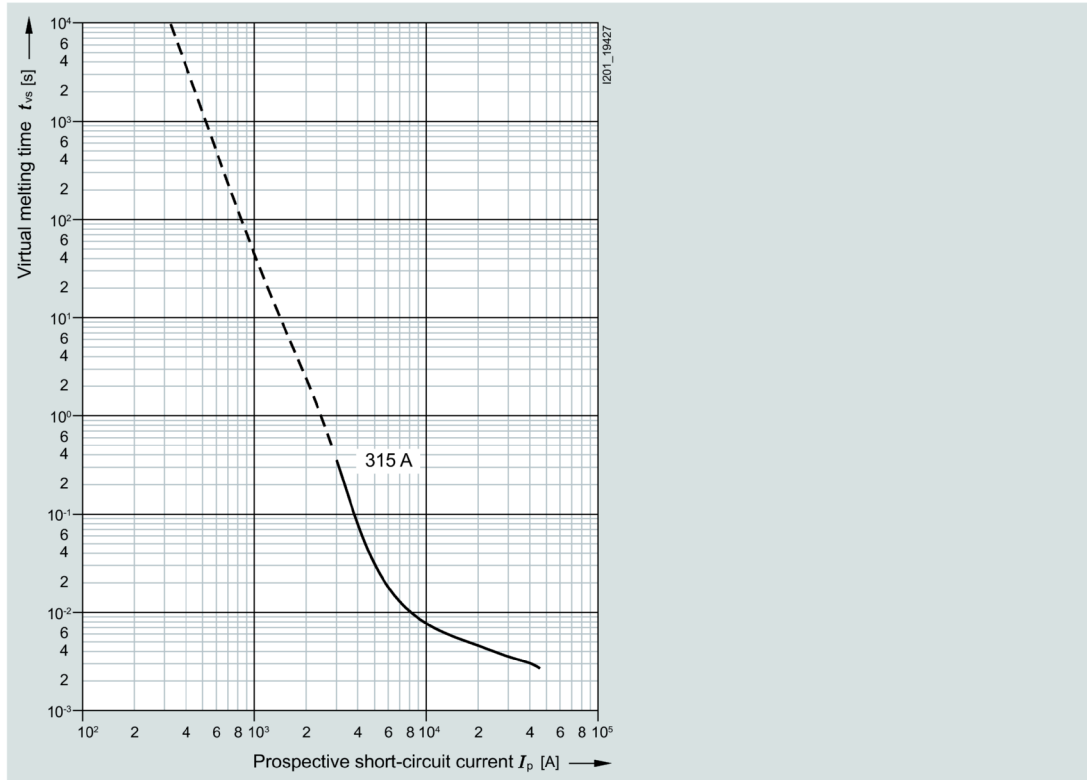

Let-through characteristic curves (current limiting at 50 Hz)

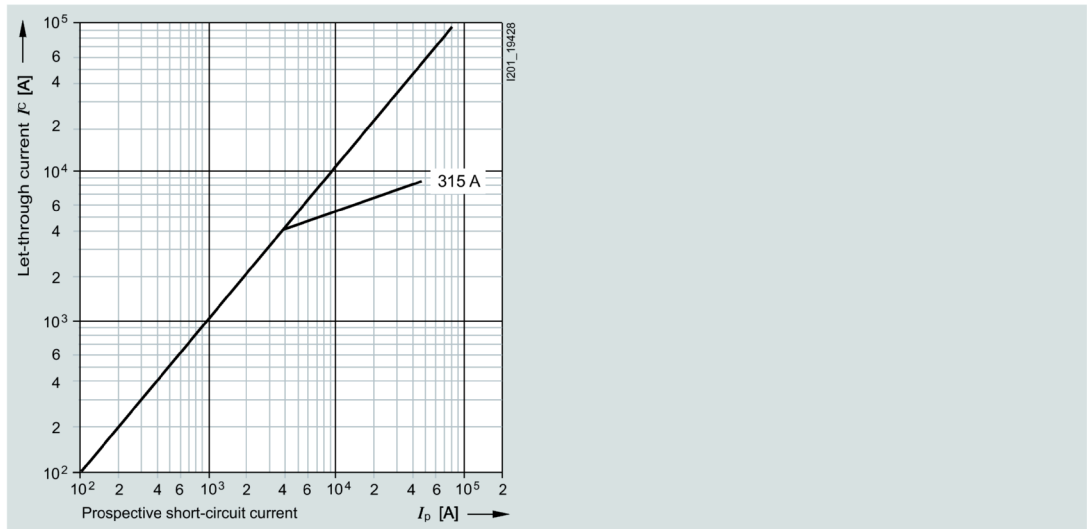

3NE963. series

Size: 3  
Operational class: aR

Rated voltage: 2500 V AC  
 Rated current: 400

**Time/current characteristic curves diagram**

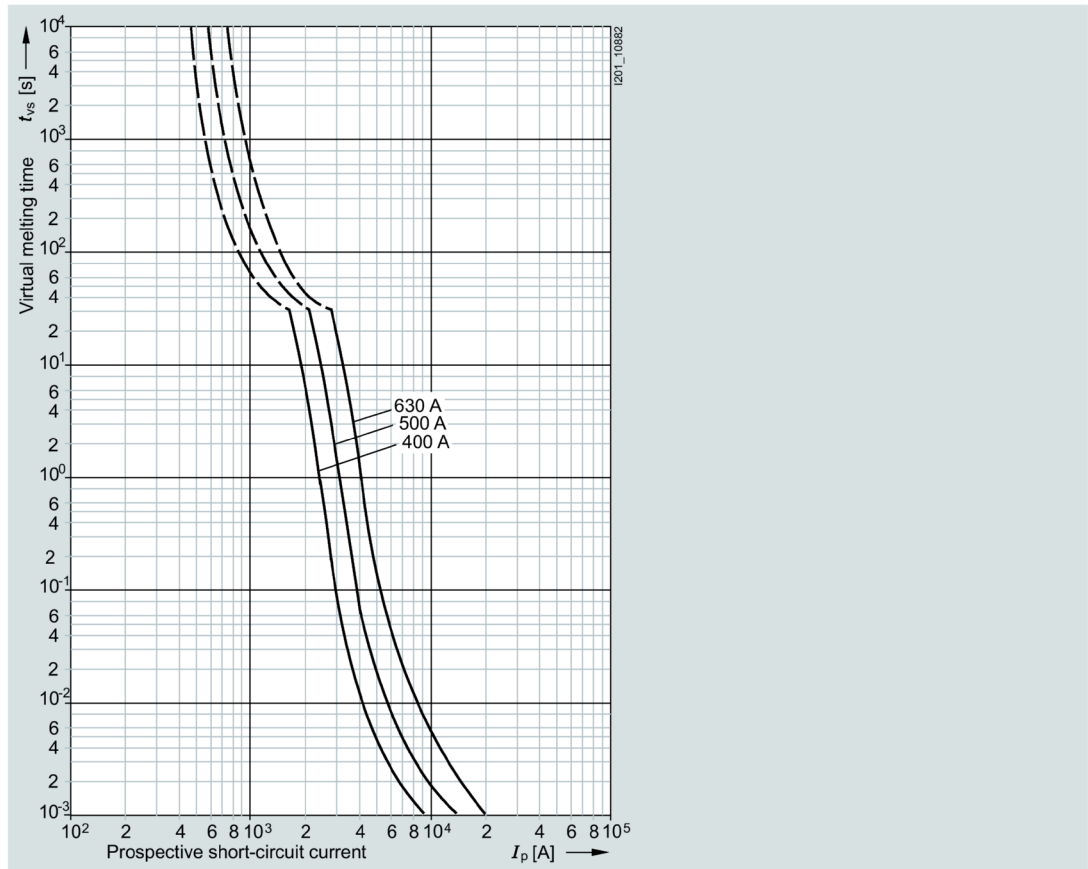

**Correction factor  $k_A$  for breaking  $I^2t$  value**

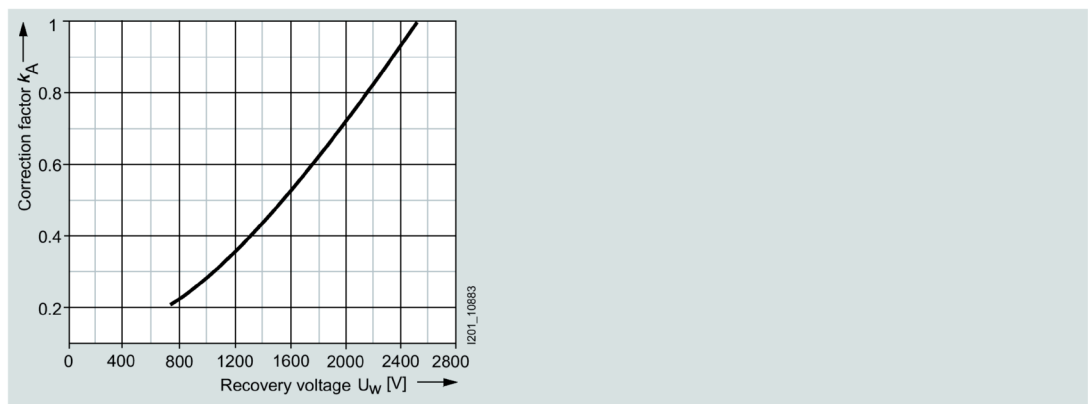

### Let-through characteristic curves (current limiting at 50 Hz)

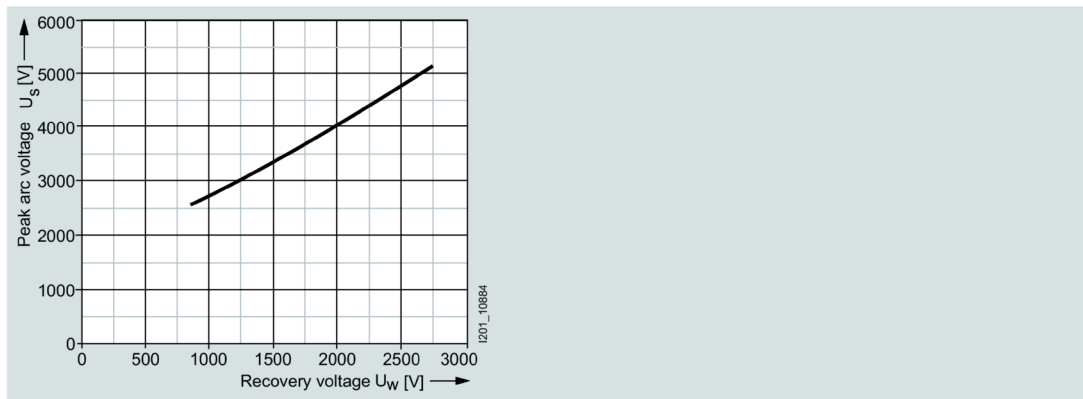

### Peak arc voltage

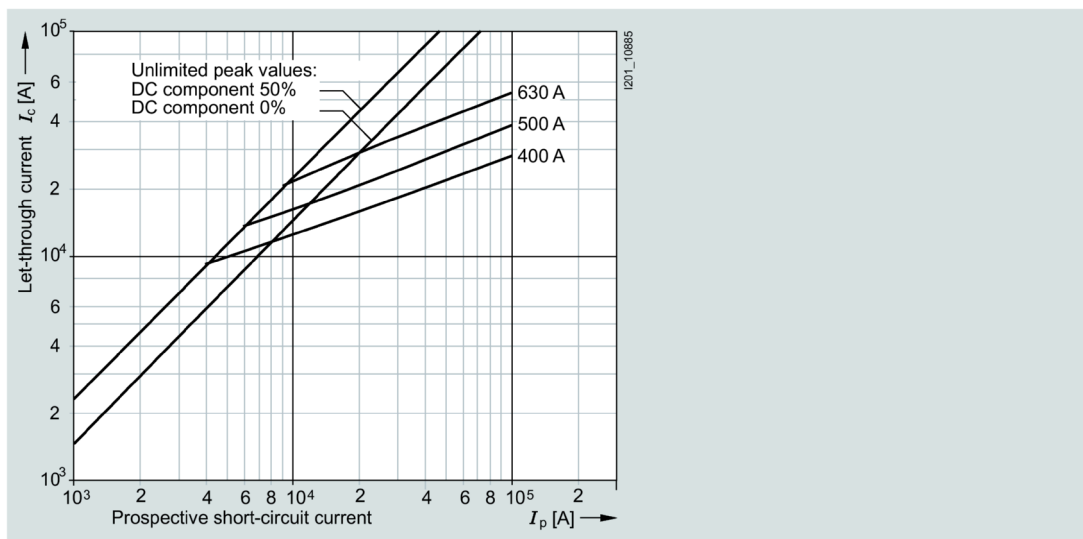

## 7.2 Cylindrical fuse design

### 7.2.1 Portfolio overview

SITOR cylindrical fuses protect power semiconductor devices from the effects of short-circuits because the super-quick breaking characteristic is much faster than that of conventional fuses. They protect high-value devices and system components such as semiconductor contactors, electronic relays (solid state), converters with fuses in the input and in the DC link, UPS systems and soft starters for motors up to 100 A.

The cylindrical design is approved for industrial applications. The cylindrical fuse links comply with IEC 60269.

Cylindrical fuse holders also comply with IEC 60269 and UL 512. The cylindrical fuse holders for 10 x 38 mm and 14 x 51 mm have been tested and approved as fuse switch disconnectors and the cylindrical fuse holders for 22 x 58 mm as fuse disconnectors according to the switching device standard IEC 60947-3. The utilization category and the tested current and voltage values are specified in the table in the chapter Technical specifications (Page 307).

The cylindrical fuse holders have been specially developed for the application of SITOR fuse links with regard to heat tolerance and heat dissipation and are therefore not recommended for standard applications.

Cylindrical fuse bases do not offer the same comprehensive touch protection as the fuse holders, but have better heat dissipation. The single-pole cylindrical fuse bases for 14 x 51 mm and 22 x 58 mm allow modular expansion to multi-pole bases.

## Benefits

- Cylindrical fuses have an extremely compact design and a small footprint.
- The cylindrical fuses are approved in accordance with IEC and UL and are suitable for universal use worldwide.
- The use of SITOR cylindrical fuses in cylindrical fuse holders and bases has been tested with regard to heat dissipation and maximum current load. This makes planning and dimensioning easier. Consequential damage is also avoided.
- The use of fuse holders as switch disconnectors expands the area of application of these devices and increases operational reliability.

## 7.2.2 Technical specifications

### Cylindrical fuse holders

		3NC10	3NC14	3NC22
<b>Size</b>	mm x mm	10 x 38	14 x 51	22 x 58
<b>Standards</b>		UL 4248-1; CSA C22.2; IEC 60269-2, IEC 60947-3		
<b>Approvals</b>		UL 4248-1; UL File Number E171267; CSA C22.2 No. 39-M, CCC		
<b>Rated voltage <math>U_n</math></b>	V AC	690; 600 acc. to UL / CSA	-	-
<b>Rated current <math>I_n</math></b>	A AC	32 30 acc. to UL / CSA	50 50 acc. to UL 40 acc. to CSA	100 80 acc. to UL / CSA
<b>Rated conditional short-circuit current</b>	kA	50	50 (100 at 400 V)	50 (100 at 500 V)
<b>Breaking capacity</b>				
• Utilization category		AC-22B (400 V)	AC-22B (400 V)	AC-20B (690 V)
<b>Max. power dissipation</b> of the fuse links (conductor cross-section used)	W	3 (6 mm <sup>2</sup> ) 4.3 (10 mm <sup>2</sup> )	5 (10 mm <sup>2</sup> ) 6.5 (25 mm <sup>2</sup> )	9.5 (35 mm <sup>2</sup> ) 11 (50 mm <sup>2</sup> )
<b>Rated impulse withstand voltage</b>	kV	6		

## 7.2 Cylindrical fuse design

		3NC10	3NC14	3NC22
Overvoltage category		II		
Pollution degree		2		
No-voltage changing of fuse links		Yes		
Sealable when installed		Yes		
Mounting position		Any		
Current direction		Any		
Degree of protection according to IEC 60529		IP20		
Terminals with touch protection according to BGV A3 at incoming and outgoing feeder		Yes		
Ambient temperature	°C	45		
Conductor cross-sections	mm <sup>2</sup> AWG	1.5 ... 16 15 ... 5	1.5 ... 35 14 ... 2	4 ... 50 10 ... 1 / 0
	<ul style="list-style-type: none"> <li>Finely stranded, with end sleeve</li> <li>AWG (American Wire Gauge)</li> </ul>			
Tightening torque	Nm lb/in	2.5 22	2.5 ... 3 22 ... 26	3.5 ... 4 31 ... 35

## Current carrying capacity of SITOR cylindrical fuses

Cylinder	Operational class	Rated voltage U <sub>n</sub>		Rated current I <sub>n</sub>	Melting I <sup>2</sup> t value I <sup>2</sup> t <sub>s</sub> (t <sub>vs</sub> = 1 ms)	Breaking I <sup>2</sup> t value I <sup>2</sup> t <sub>a</sub> at U <sub>n</sub>	Temperature rise at I <sub>n</sub> body center	Power dissipation at I <sub>n</sub>	Weight approx.
		V AC	V DC						
3NC1003	aR	600	700	3	3	8	30	1.2	0.01
3NC1006	aR	600	700	6	4	20	30	1.5	0.01
3NC1008	aR	600	700	8	6	30	25	2	0.01
3NC1010	aR	600	700	10	9	60	40	2.5	0.01
3NC1012	aR	600	700	12	15	110	50	3	0.01
3NC1016	aR	600	700	16	25	150	60	3.5	0.01
3NC1020	aR	600	700	20	34	200	80	4.8	0.01
3NC1025	aR	600	700	25	60	250	90	6	0.01
3NC1032	aR	600	-	32	95	500	110	7.5	0.01
3NC1401	aR	660	-	1	-	1.2	90	5	0.02
3NC1402	aR	660	-	2	-	10	30	3	0.02
3NC1403	aR	660	-	3	-	15	40	2.5	0.02
3NC1404	aR	690	-	4	-	25	50	3	0.02
3NC1405	aR	690	700	5	1.6	9	20	1.5	0.02
3NC1406	aR	690	700	6	1.4	15	47	1.5	0.02
3NC1410	aR	690	700	10	3.6	20	50	4	0.02
3NC1410-5	aR	690	600	10	3.6	90	50	4	0.02
3NC1415	aR	690	700	15	10	75	60	5.5	0.02
3NC1415-5	aR	690	600	15	9	100	60	5.5	0.02
3NC1420	aR	690	700	20	26	120	70	6	0.02
3NC1420-5	aR	690	600	20	26	500	70	6	0.02

Cylinder	Operational class	Rated voltage $U_n$		Rated current $I_n$	Melting $I^2t$ value $I^2t_s$ (tvs = 1 ms)	Breaking $I^2t$ value $I^2t_a$ at $U_n$	Temperature rise at $I_n$ body center	Power dissipation at $I_n$	Weight approx.
		V AC	V DC						
3NC1425	aR	690	700	25	44	250	80	7	0.02
3NC1425-5	aR	690	600	25	47	400	80	7	0.02
3NC1430	aR	690	700	30	58	300	80	9	0.02
3NC1430-5	aR	690	600	30	58	500	80	9	0.02
3NC1432	aR	690	700	32	95	700	80	7.6	0.02
3NC1432-5	aR	690	600	32	68	600	80	7.6	0.02
3NC1440	aR	690	700	40	110	900	100	8	0.02
3NC1440-5	aR	690	600	40	84	900	100	8	0.02
3NC1450	aR	690	700	50	220	1800	110	9	0.02
3NC1450-5	aR	690	600	50	200	2000	110	9	0.02
3NC2200	aR	600	500	100	1250	8000	110	16	0.06
3NC2200-5	aR	600	500	100	1100	8500	110	16	0.06
3NC2220	aR	690	500	20	34	220	41	4.6	0.06
3NC2220-5	aR	690	500	20	19	240	40	5	0.06
3NC2225	aR	690	500	25	50	300	50	5.6	0.06
3NC2225-5	aR	690	500	25	34	350	50	6	0.06
3NC2232	aR	690	500	32	80	450	65	7	0.06
3NC2232-5	aR	690	500	32	54	500	65	8	0.06
3NC2240	aR	690	500	40	100	700	80	8.5	0.06
3NC2240-5	aR	690	500	40	68	800	80	9	0.06
3NC2250	aR	690	500	50	185	1350	90	9.5	0.06
3NC2250-5	aR	690	500	50	135	1500	90	9.5	0.06
3NC2263	aR	690	500	63	310	2600	100	11	0.06
3NC2263-5	aR	690	500	63	280	3000	100	11	0.06
3NC2280	aR	690	500	80	620	5500	110	13.5	0.06
3NC2280-5	aR	690	500	80	600	6000	110	13.5	0.06

Article No.	Operational class (IEC 60269)	Rated voltage $U_n$	Rated breaking capacity $I_{bn}$	Rated current $I_n$ <sup>1)</sup>	Melting $I^2t$ value $I^2t_s$ (tvs = 1 ms)	Breaking $I^2t$ value $I^2t_a$ at $U_n$	Temperature rise at $I_n$ body center <sup>2)</sup>	Power dissipation at $I_n$ <sup>2)</sup>	Varying load factor WL
		V AC / V DC	kA	A	A <sup>2</sup> s	A <sup>2</sup> s	K	W	
3NC1006-OMK	gR	690 / 440	100 / 50	6	0.5	6.5	33	2.5	On request
3NC1010-OMK	gR	690 / 440	100 / 50	10	1.3	18	37	3.3	On request
3NC1012-OMK	gR	690 / 440	100 / 50	12	1.9	35	45	4	On request

## 7.2 Cylindrical fuse design

Article No.	Operational class (IEC 60269)	Rated voltage $U_n$	Rated breaking capacity $I_{1n}$	Rated current $I_n$ 1)	Melting $I^2t$ value $I^2t_s$ (tvs = 1 ms)	Breaking $I^2t$ value $I^2t_a$ at $U_n$	Temperature rise at $I_n$ body center <sup>2)</sup>	Power dissipation at $I_n$ <sup>2)</sup>	Varying load factor WL
		V AC / V DC	kA	A	A <sup>2</sup> s	A <sup>2</sup> s	K	W	
3NC1016-0MK	gR	690 / 440	100 / 50	16	3	45	57	6	On request
3NC1020-0MK	gR	690 / 250	100 / 50	20	5.9	110	70	7.8	On request
3NC1025-0MK	gR	690 / 250	100 / 50	25	12	140	76	8.7	On request
3NC1032-0MK	gR	690 / 250	100 / 50	32	50	450	90	12	On request
3NC1406-0MK	gR	690 / 700	100 / 50	6	0.5	3.5	31	3.1	On request
3NC1410-0MK	gR	690 / 700	100 / 50	10	1.4	15	47	4.6	On request
3NC1416-0MK	gR	690 / 600	100 / 50	16	3.2	32	56	6.7	On request
3NC1420-0MK	gR	690 / 600	100 / 50	20	6.3	68	62	7.4	On request
3NC1425-0MK	gR	690 / 600	100 / 50	25	13	108	71	8.4	On request
3NC1432-0MK	gR	690 / 600	100 / 50	32	19	175	100	12.3	On request
3NC1440-0MK	gR	690 / 440	100 / 50	40	43	470	87	11.7	On request
3NC1450-0MK	gR	690 / 250	100 / 50	50	140	830	115	16.3	On request
3NC1463-0MK	aR	690 / 250	100 / 50	63	330	2100	110	16.7	On request
3NC1810-0-0MK	gR	690 / 440	100 / 50	10	0.9	17	33	4.6	0.06
3NC1816-0-0MK	gR	690 / 440	100 / 50	16	3	52	31	5.2	0.06
3NC1820-0-0MK	gR	690 / 440	100 / 50	20	5.3	90	35	6.8	0.06
3NC1825-0-0MK	gR	690 / 440	100 / 50	25	8.3	160	43	8.7	0.06
3NC1832-0-0MK	gR	690 / 440	100 / 50	32	21	400	49	9.8	0.06
3NC1840-0-0MK	gR	690 / 440	100 / 50	40	33	600	52	11	0.06
3NC1850-0-0MK	gR	690 / 440	100 / 50	50	65	1250	53	13.8	0.06
3NC2200-0MK	gR	690 / 700	100 / 50	25	13	180	38	8.1	On request
3NC2211-0MK	gR	690 / 600	100 / 50	32	25	420	41	9	On request
3NC2225-0MK	gR	690 / 440	100 / 50	40	42	700	50	12.5	On request



Article No.	Operational class (IEC 60269)	Rated voltage $U_n$	Rated breaking capacity $I_{1n}$	Rated current $I_n$ 1)	Melting $I^2t$ value $I^2t_s$ (tvs = 1 ms)	Breaking $I^2t$ value $I^2t_a$ at $U_n$	Temperature rise at $I_n$ body center <sup>2)</sup>	Power dissipation at $I_n$ <sup>2)</sup>	Varying load factor WL
		V AC / V DC	kA	A	A <sup>2</sup> s	A <sup>2</sup> s	K	W	
3NC2232-0MK	gR	690 / 250	100 / 50	50	74	1250	63	15.2	On request
3NC2240-0MK	gR	690 / 250	100 / 50	63	94	2400	64	17.5	On request
3NC2250-0MK	gR	690 / 250	100 / 50	80	320	4400	72	23	On request
3NC2263-0MK	gR	690 / 250	100 / 50	100	850	11500	79	28.1	On request
3NC2280-0MK	aR	690 / 250	100 / 50	125	1500	29000	88	35.3	On request
3NC2301-0MK	gS	1500 / 1000	30 / 50	1	0.1	2	9	2	On request
3NC2302-0MK	gS	1500 / 1000	30 / 50	2	1	4.4	14	2.5	On request
3NC2304-0MK	gS	1500 / 1000	30 / 50	4	7	55	21	5.3	On request
3NC2306-0MK	gS	1500 / 1000	30 / 50	6	8	150	26	6.4	On request
3NC2310-0MK	gS	1500 / 1000	30 / 50	10	90	540	17	3.1	On request
3NC2316-0MK	gS	1500 / 1000	30 / 50	16	310	1120	1	4.7	On request
3NC2320-0MK	gS	1500 / 1000	30 / 50	20	570	2850	25	5.4	On request
3NC2325-0MK	gS	1500 / 1000	30 / 50	25	910	3300	33	6.9	On request
3NC2332-0MK	gS	1500 / 1000	30 / 50	32	2650	9050	31	6.7	On request
3NC2340-0MK	gR	1500 / 1000	30 / 50	40	3260	12800	38	9.4	On request
3NC2350-0MK	gR	1500 / 1000	30 / 50	50	6480	26000	46	11.6	On request
3NC2625 0MK	gR	690 / 440	100 / 50	25	8	120	40	9.5	On request
3NC2632 0MK	gR	690 / 440	100 / 50	32	14.5	190	54	12.3	On request
3NC2640 0MK	gR	690 / 440	100 / 50	40	21	400	64	14.8	On request
3NC2650 0MK	gR	690 / 440	100 / 50	50	48	950	66	17.5	On request
3NC2663 0MK	gR	690 / 440	100 / 50	63	108	2050	68	18.8	On request
3NC2680 0MK	aR	690 / 440	100 / 50	80	205	3500	62	22.5	On request

## 7.2 Cylindrical fuse design

Article No.	Operational class (IEC 60269)	Rated voltage $U_n$	Rated breaking capacity $I_{1n}$	Rated current $I_n$ 1)	Melting $I^2t$ value $I^2t_s$ (tvs = 1 ms)	Breaking $I^2t$ value $I^2t_a$ at $U_n$	Temperature rise at $I_n$ body center <sup>2)</sup>	Power dissipation at $I_n$ <sup>2)</sup>	Varying load factor WL
		V AC / V DC	kA	A	A <sup>2</sup> s	A <sup>2</sup> s	K	W	
3NC2600 OMK	aR	690 / 440	100 / 50	100	340	5400	70	31.5	On request
3NC2611 OMK	aR	690 / 440	100 / 50	125	645	11800	88	39	On request

**Current carrying capacity of SITOR cylindrical fuses without strikers in fuse holders (can be used as fuse switch disconnectors<sup>1)</sup>)**

For SITOR fuse link	Rated voltage	Rated current	Required conductor cross-section	Fuse holder (can be used as fuse switch disconnectors <sup>1)</sup> )					
				1-pole		2-pole		3-pole	
		$I_n$	Cu	Type	$I_{max}$ 2)	Type	$I_{max}$ 2)	Type	$I_{max}$ 2)
	V AC / V DC	A	mm <sup>2</sup>		A		A		A
<b>Size 10 × 38 mm</b>									
3NC1003	600 / 700	3	1	3NC1091	3	3NC1092 / 2 × 3NC1091	3	3NC1093 / 3 × 3NC1091	3
3NC1006		6	1		6		6		6
3NC1008		8	1		8		8		8
3NC1010		10	1.5		10		10		10
3NC1012		12	1.5		12		12		12
3NC1016		16	2.5		16		16		16
3NC1020		20	2.5		20		20		20
3NC1025		25	4		25		24		22
3NC1032	600 / -	32	6	32	30	28			

Footnotes, see next table.

For SITOR fuse link	Rated voltage	Rated current	Required conductor cross-section	Fuse holder (can be used as fuse switch disconnecter <sup>1)</sup> )					
				1-pole		2-pole		3-pole	
				Type	I <sub>max</sub> 2)	Type	I <sub>max</sub> 2)	Type	I <sub>max</sub> 2)
	V AC / V DC	A	mm <sup>2</sup>	A	A	A	A		
<b>Size 14 × 51 mm</b>									
3NC1401	660	1	1	3NC1491	1	3NC1492 / 2 × 3NC1491	1	3NC1493 / 3 × 3NC1491	1
3NC1402		2	1		2		2		
3NC1403		3	1		3		3		
3NC1404	690 / 700	4	1	3NC1491	4	3NC1492 / 2 × 3NC1491	4	3NC1493 / 3 × 3NC1491	4
3NC1405		5	1		5		5		
3NC1406		6	1		6		6		
3NC1410		10	1.5		10		10		
3NC1415		15	1.5		15		15		
3NC1420		20	2.5		20		20		
3NC1425		25	4		25		24		
3NC1430		30	6		28		27		
3NC1432		32	6		32		32		
3NC1440		40	10		40		39		
3NC1450	50	10	48	46					
<b>Size 22 × 58 mm</b>									
3NC2220	690 / 500	20	2.5	3NC2291	20	3NC2292 / 2 × 3NC2291	20	3NC2293 / 3 × 3NC2291	20
3NC2225		25	4		25		25		
3NC2232		32	6		32		32		
3NC2240		40	10		40		39		
3NC2250		50	10		50		48		
3NC2263		63	16		60		58		
3NC2280		80	25		74		71		
3NC2200	600 / 500	100	35	95	90				

Fuse tongs: 3NC1000.

- 1) Fuse holders acc. to IEC 60269-3, UL 512; fuse switch disconnectors (10 × 38 mm, 14 × 51 mm) acc. to IEC 60947-3; fuse disconnectors (22 × 58 mm) acc. to IEC 60947-3.
- 2) The I<sub>max</sub> values apply to "stand-alone operation". If several devices are butt-mounted and/or subject to unfavorable cooling conditions, these values are further reduced. With a larger conductor cross-section, values higher than I<sub>max</sub> are possible.

**Current carrying capacity of SITOR cylindrical fuses with strikers in fuse holders (can be used as fuse switch disconnectors<sup>1)</sup>)**

For SITOR fuse link	Rated voltage	Rated current	Required conductor cross-section	Fuse holder (can be used as fuse switch disconnector <sup>1)</sup> )					
				1-pole		2-pole		3-pole	
				Type	I <sub>max</sub> <sup>2)</sup>	Type	I <sub>max</sub> <sup>2)</sup>	Type	I <sub>max</sub> <sup>2)</sup>
	V AC	A	mm <sup>2</sup>		A		A		A
<b>Size 14 × 51 mm</b>									
3NC1410-5	690 / 600	10	1.5	3NC1491	10	3NC1492 / 2 × 3NC1491-5	10	3NC1493 / 3 × 3NC1491-5	10
3NC1415-5		15	1.5		15		15		
3NC1420-5		20	2.5		20		20		
3NC1425-5		25	4		25		25		
3NC1430-5		30	6		30		30		
3NC1432-5		32	6		32		32		
3NC1440-5		40	10		38		35		
3NC1450-5		50	10		48		46		
<b>Size 22 × 58 mm</b>									
3NC2220-5	690 / 500	20	2.5	3NC2291	20	3NC2292 / 2 × 3NC2291 -5	20	3NC2293 / 3 × 3NC2291 -5	20
3NC2225-5		25	4		25		25		
3NC2232-5		32	6		32		31		
3NC2240-5		40	10		40		39		
3NC2250-5		50	10		45		43		
3NC2263-5		63	16		59		55		
3NC2280-5		80	25		71		69		
3NC2200-5	600 / 500	100	35	94	90	85			

- 1) Fuse holders acc. to IEC 60269-3, UL 512; fuse switch disconnectors (10 × 38 mm, 14 × 51 mm) acc. to IEC 60947-3; fuse disconnectors (22 × 58 mm) acc. to IEC 60947-3.
- 2) The I<sub>max</sub> values apply to "stand-alone operation". If several devices are butt-mounted and/or subject to unfavorable cooling conditions, these values are further reduced. With a larger conductor cross-section, values higher than I<sub>max</sub> are possible.

### 7.2.3 Dimensional drawings

#### Cylindrical fuse links

3NC10. ., 3NC10..-0MK

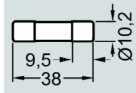

3NC14. ., 3NC14..-0MK

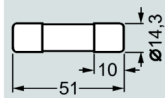

3NC22. ., 3NC22..-0MK

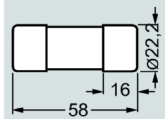

3NC23..-0MK

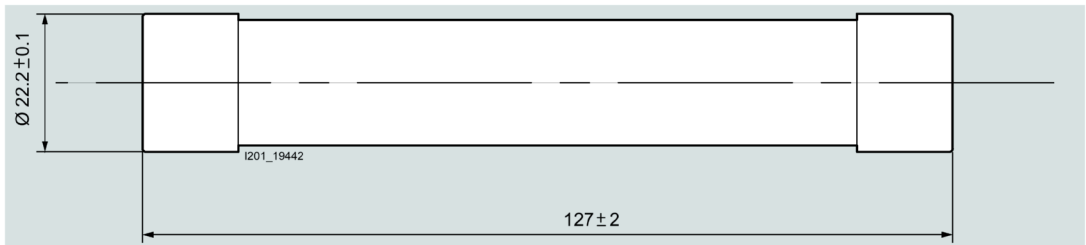

#### Cylindrical fuse holders

3NC109.

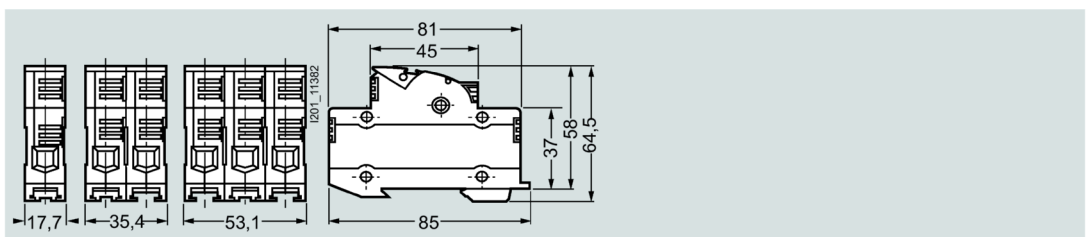

**3NC149.**

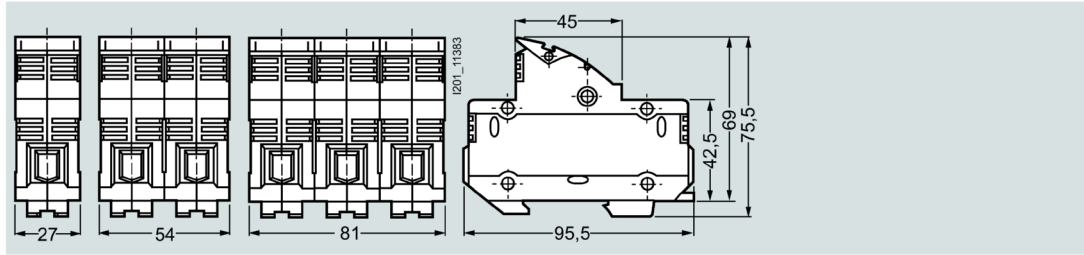

**3NC129.**

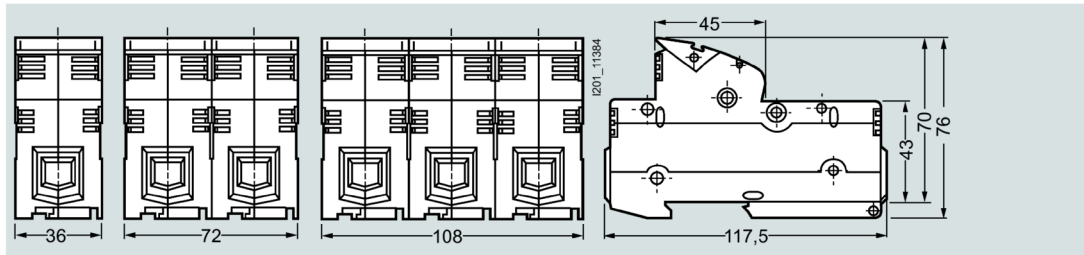

**Cylindrical fuse holders with signaling switch**

**3NC1491-5**

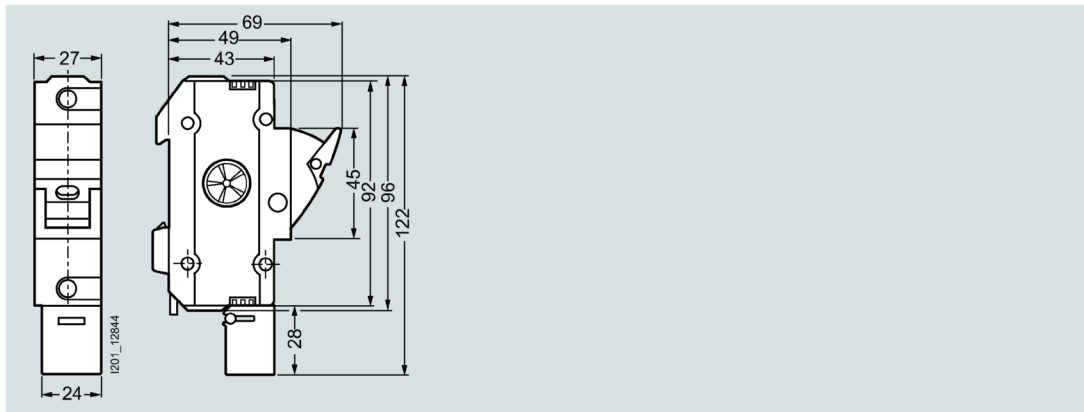

3NC1291-5

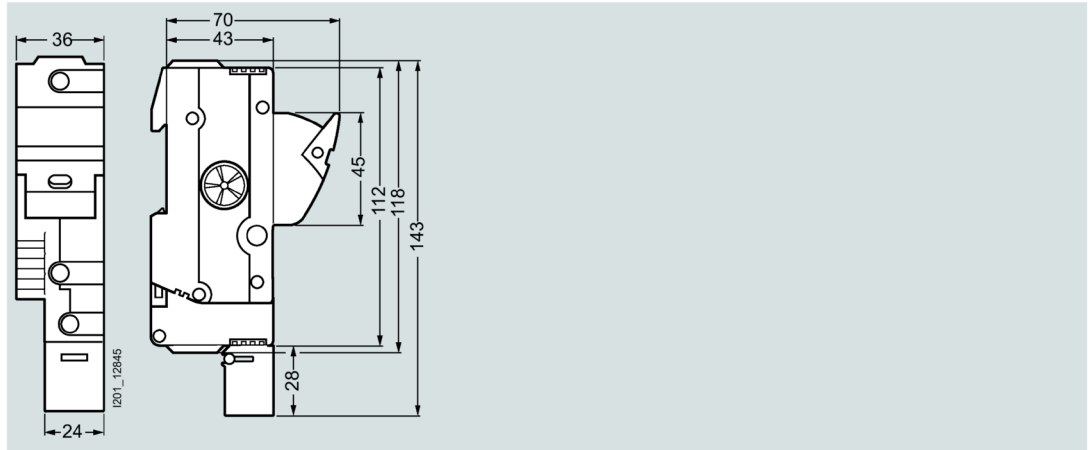

Cylindrical fuse bases

3NC239.-0MK

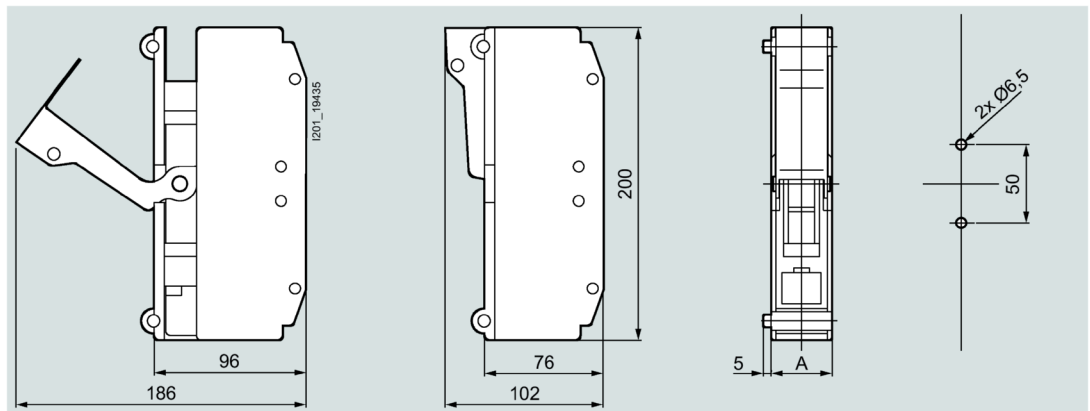

3NC18..-0MK, 3NC26..-0MK

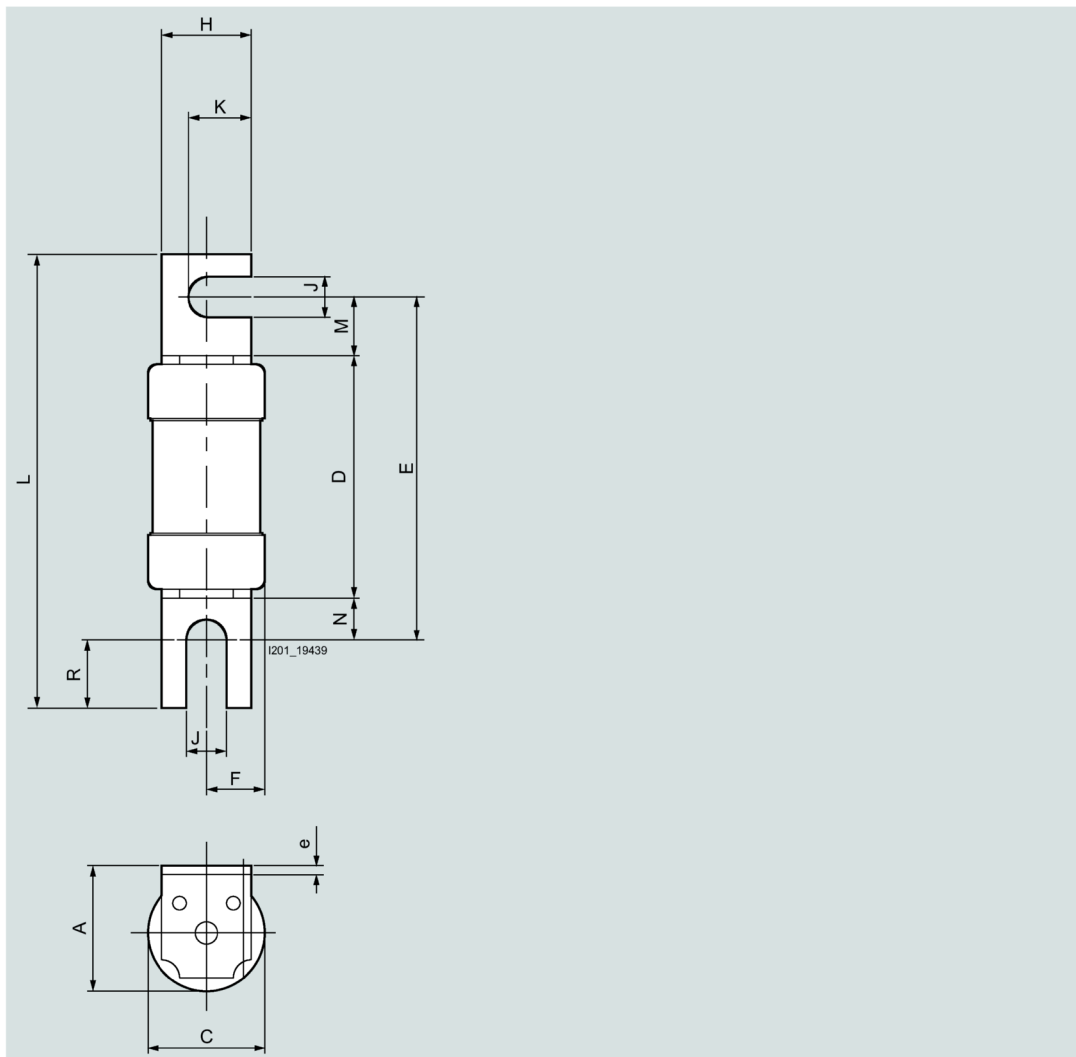



**3NH5023**

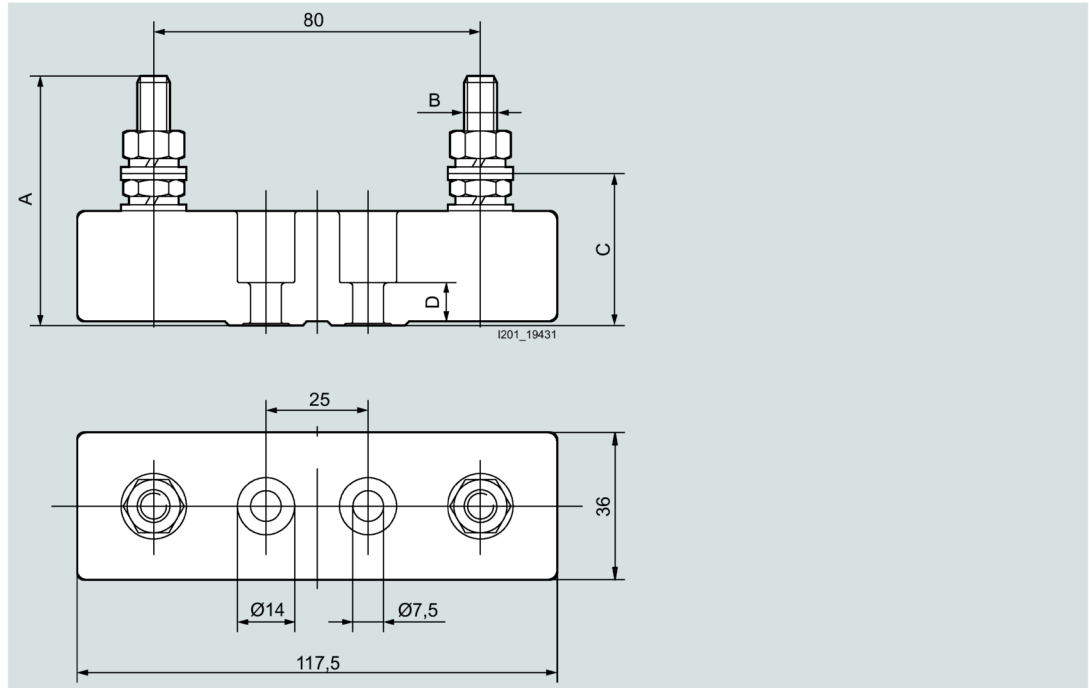

**3NH5723**

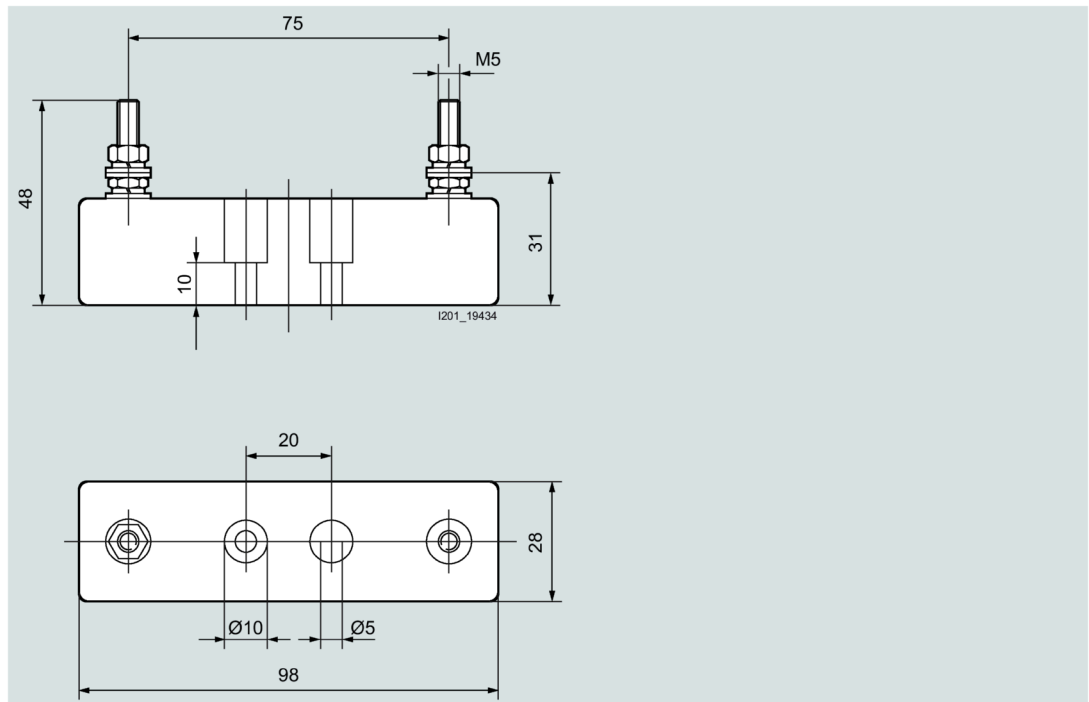

### 7.2.4 Characteristic curves

#### 3NC10 series

Size:	10 × 38 mm
Operational class:	aR
Rated voltage:	600 V AC / 700 V DC, 3 ... 25 A
	600 V AC, 32 A
Rated current:	3 ... 32 A

#### Time/current characteristic curves diagram

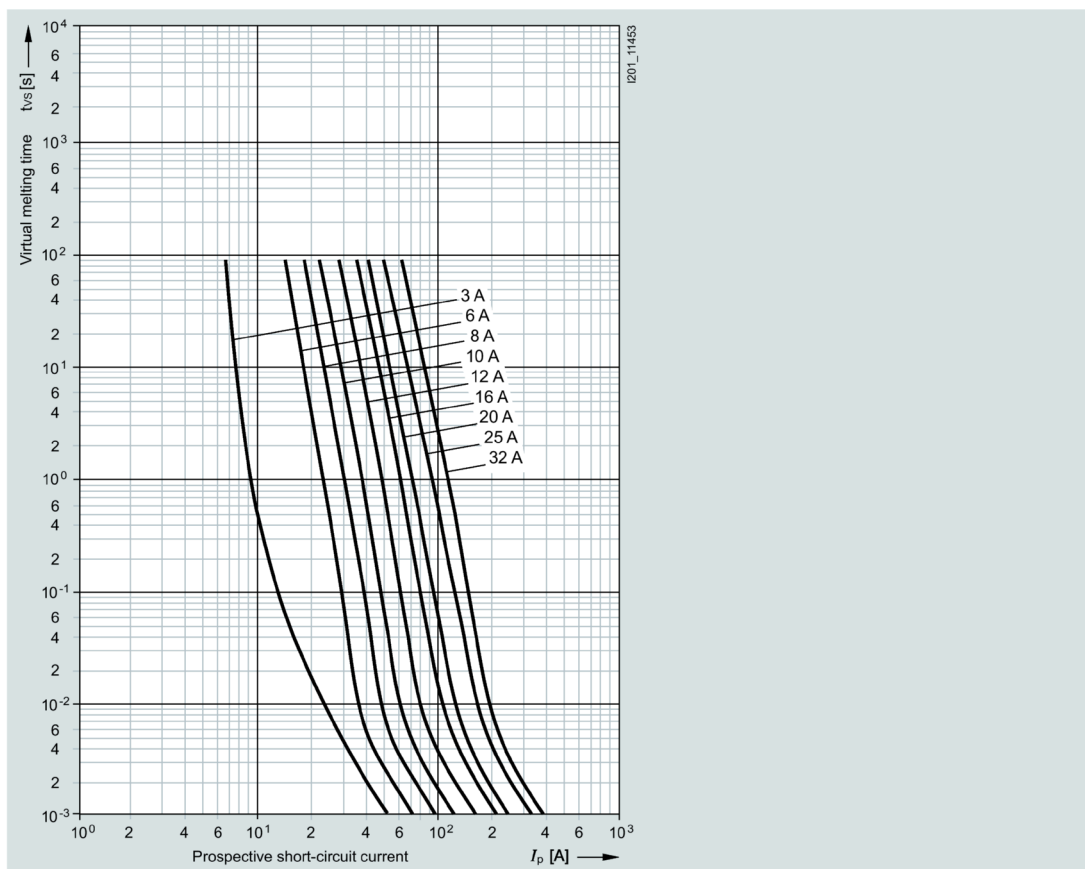

Correction factor  $k_A$  for breaking  $I^2t$  value

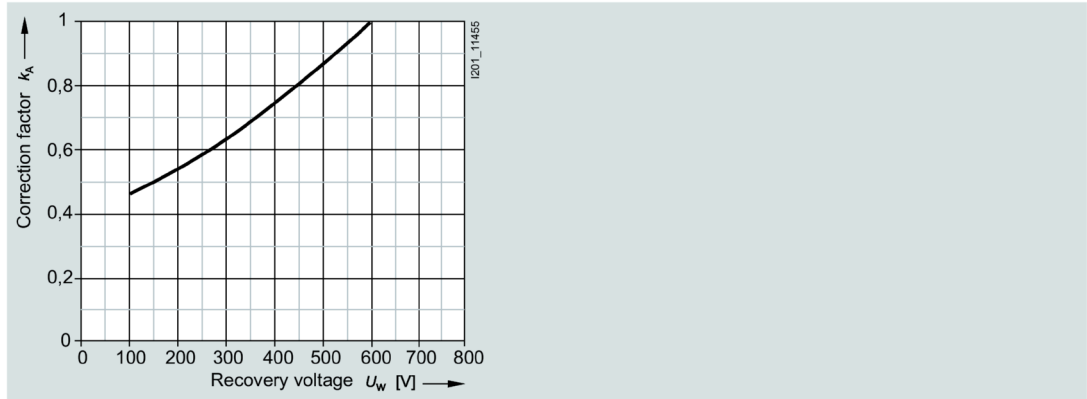

Let-through characteristic curves (current limiting at 50 Hz)

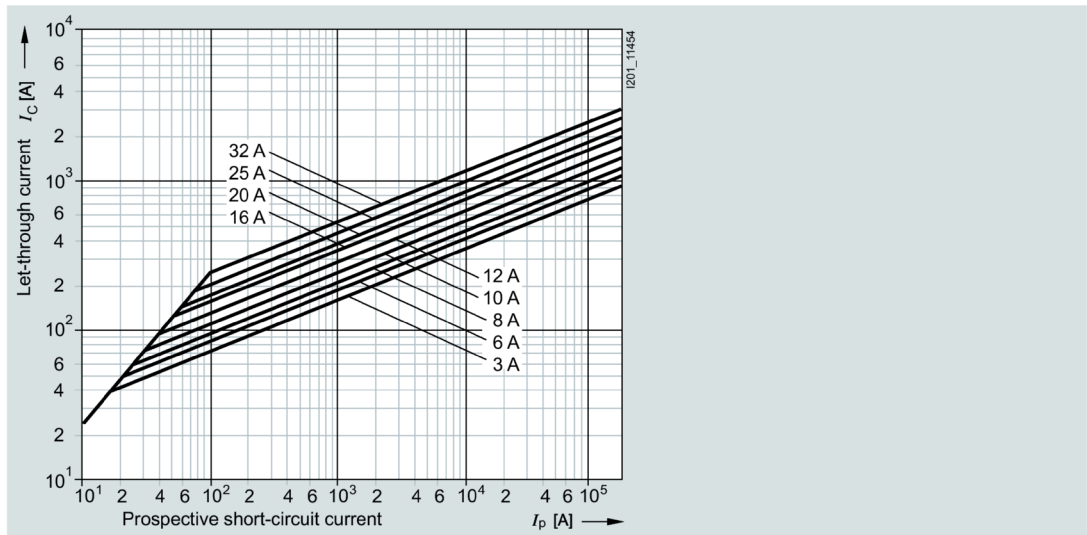

Peak arc voltage

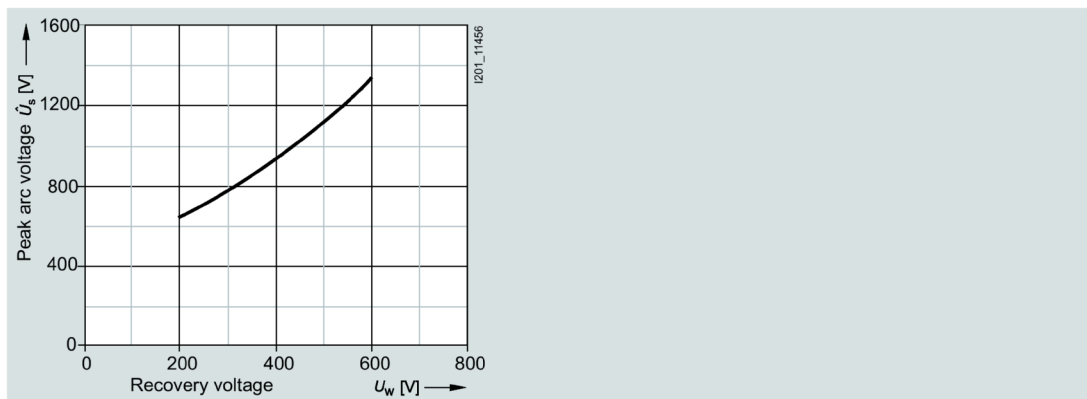

**3NC10..-0MK series**

Size:	10 × 38 mm
Operational class:	gR
Rated voltage:	690 V AC, 250 ... 400 V DC
Rated current:	6 ... 32 A

**Time/current characteristic curves diagram**

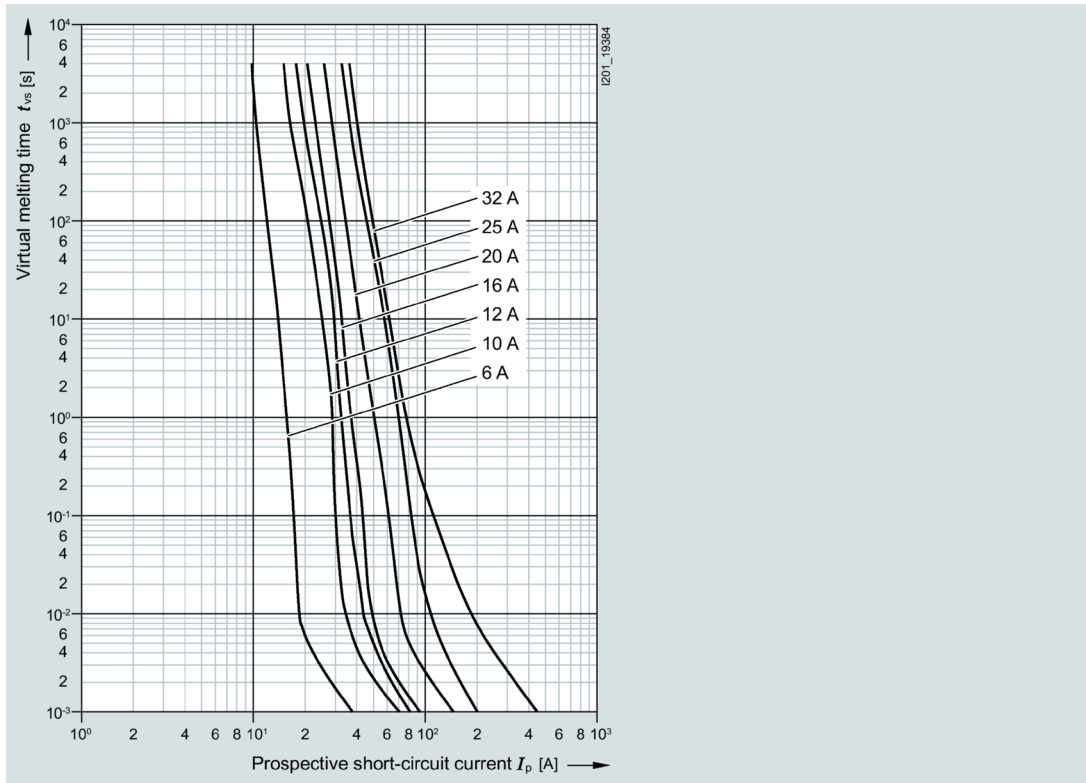

**Correction factor  $k_A$  for breaking  $I^2t$  value**

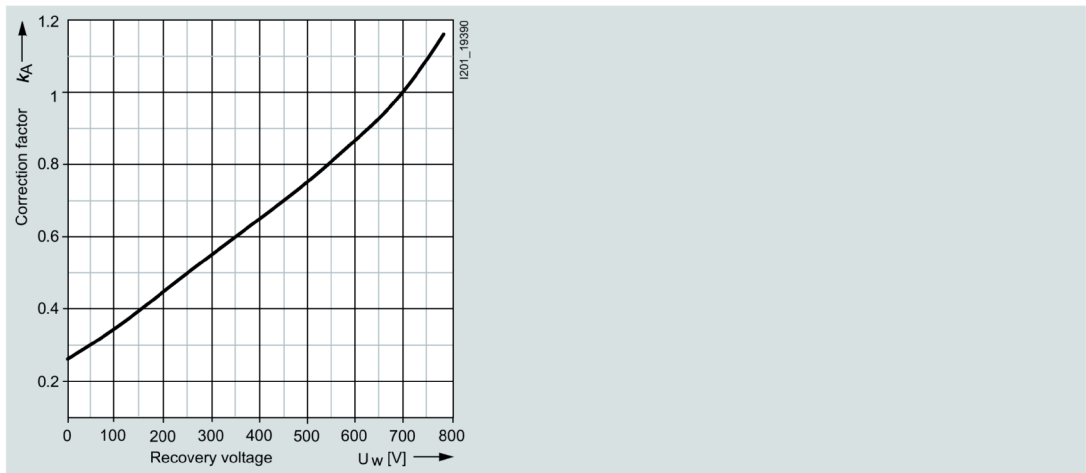

Let-through characteristic curves (current limiting at 50 Hz)

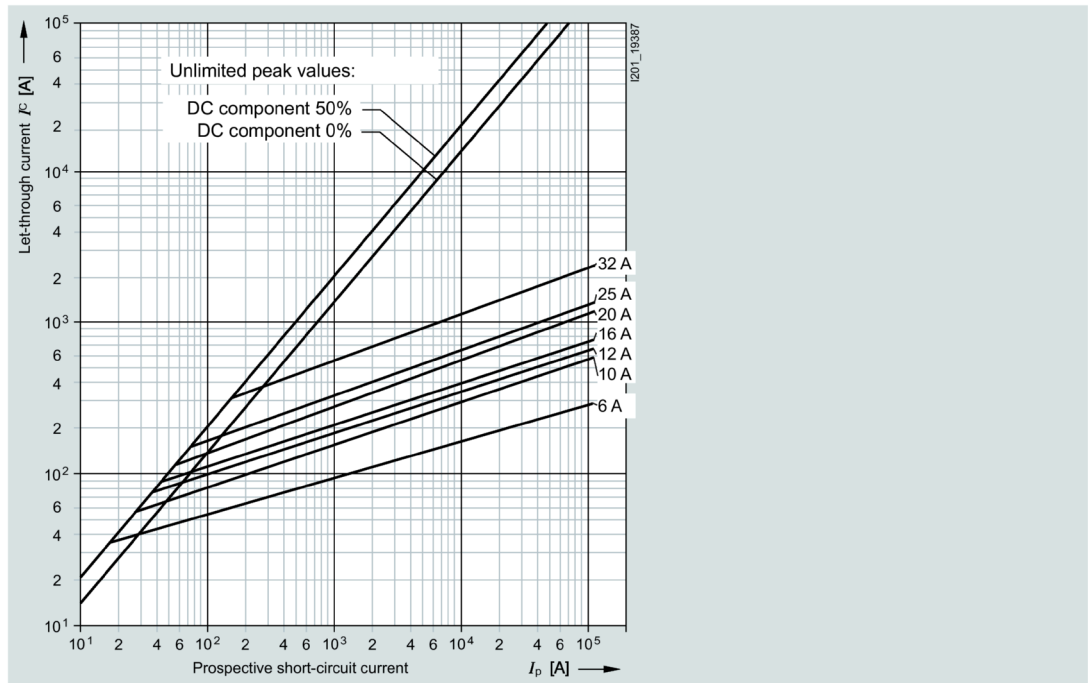

Peak arc voltage

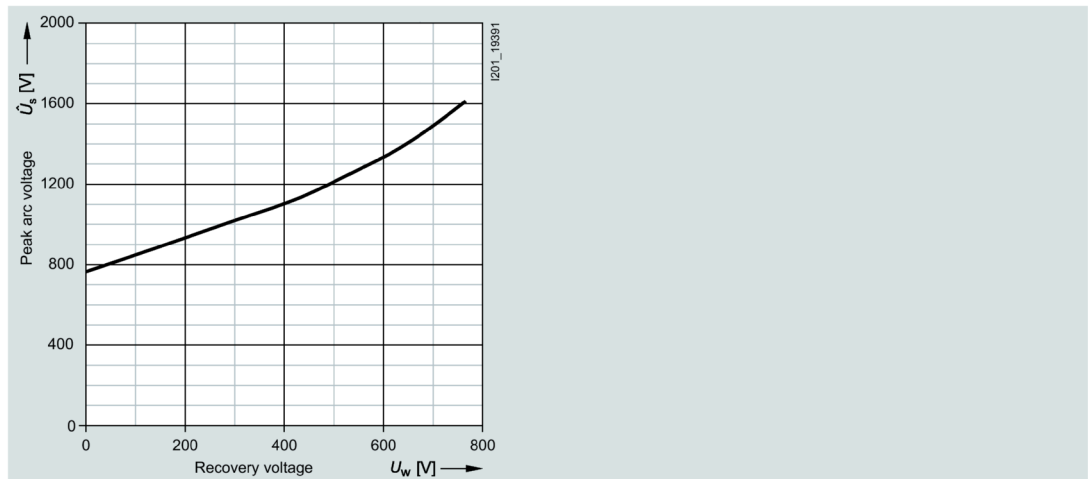

3NC14 series

Size:	14 × 51 mm
Operational class:	aR
Rated voltage:	660 V AC (1 ... 4 A) 690 V AC / 800 V DC (5 ... 50 A)
Rated current:	1 ... 10 A

Time/current characteristic curves diagram

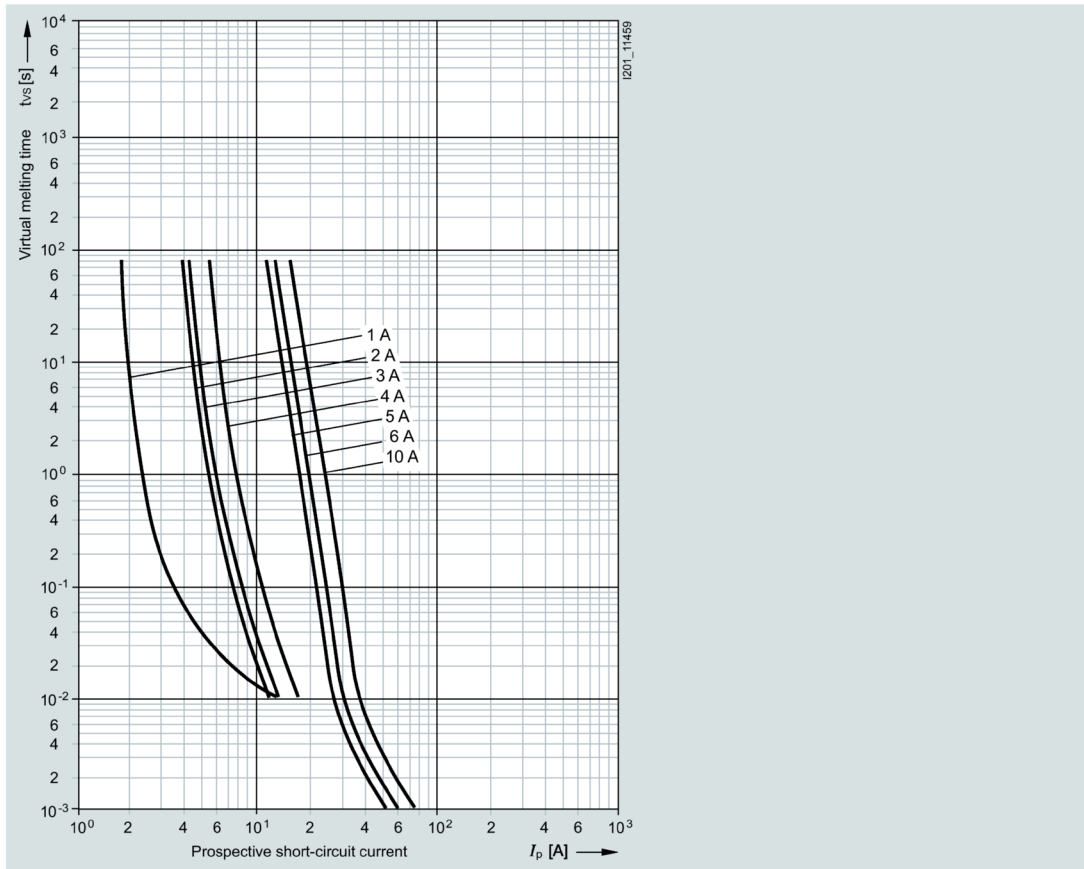

Correction factor  $k_A$  for breaking  $I^2t$  value

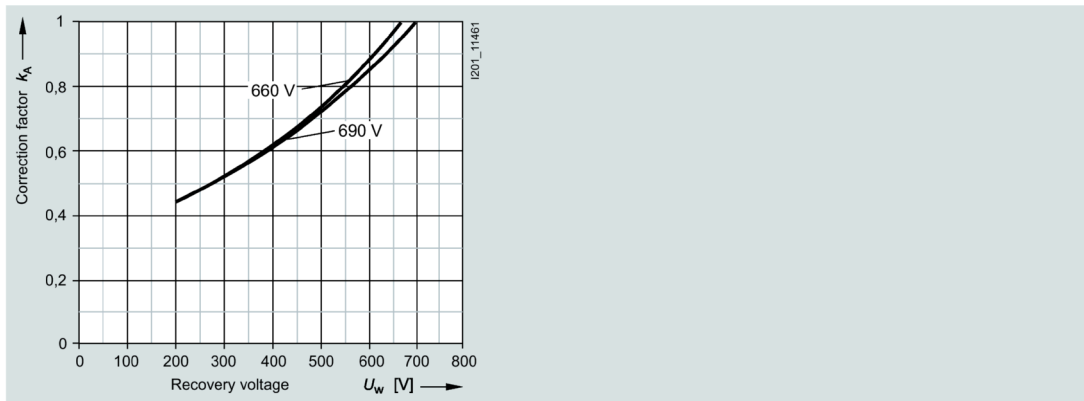

Let-through characteristic curves (current limiting at 50 Hz)

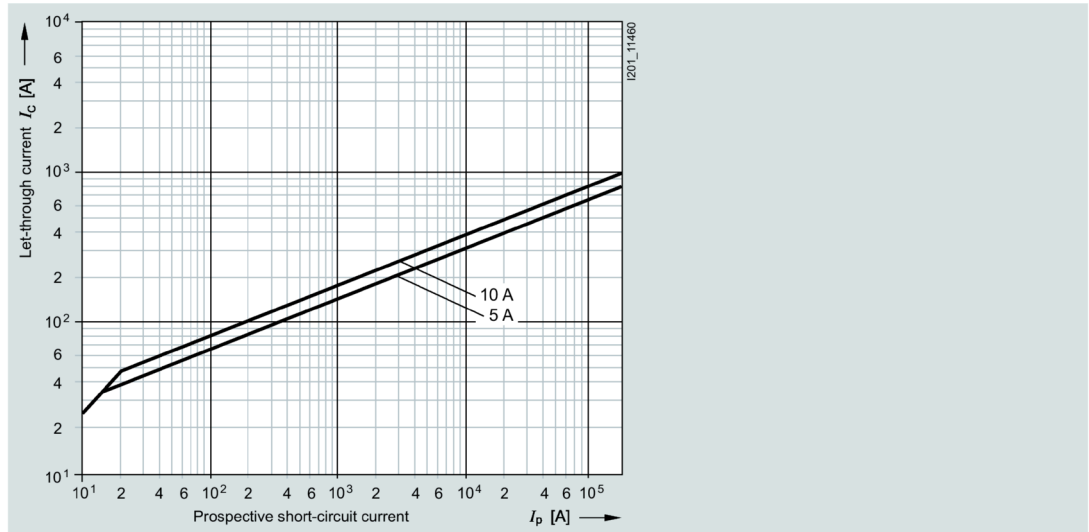

Peak arc voltage

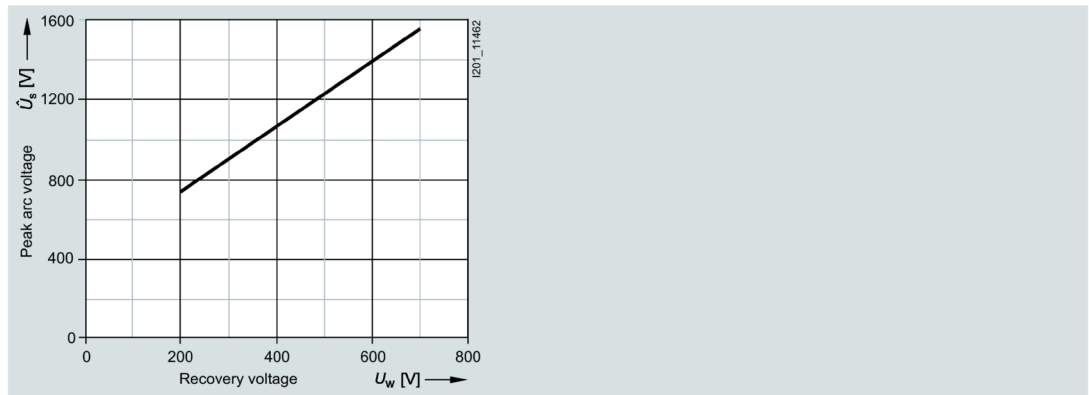

Size:	14 × 51 mm
Operational class:	aR
Rated voltage:	660 V AC (1 ... 4 A); 690 V AC / 800 V DC (5 ... 50 A)
Rated current:	15 ... 50 A

Time/current characteristic curves diagram

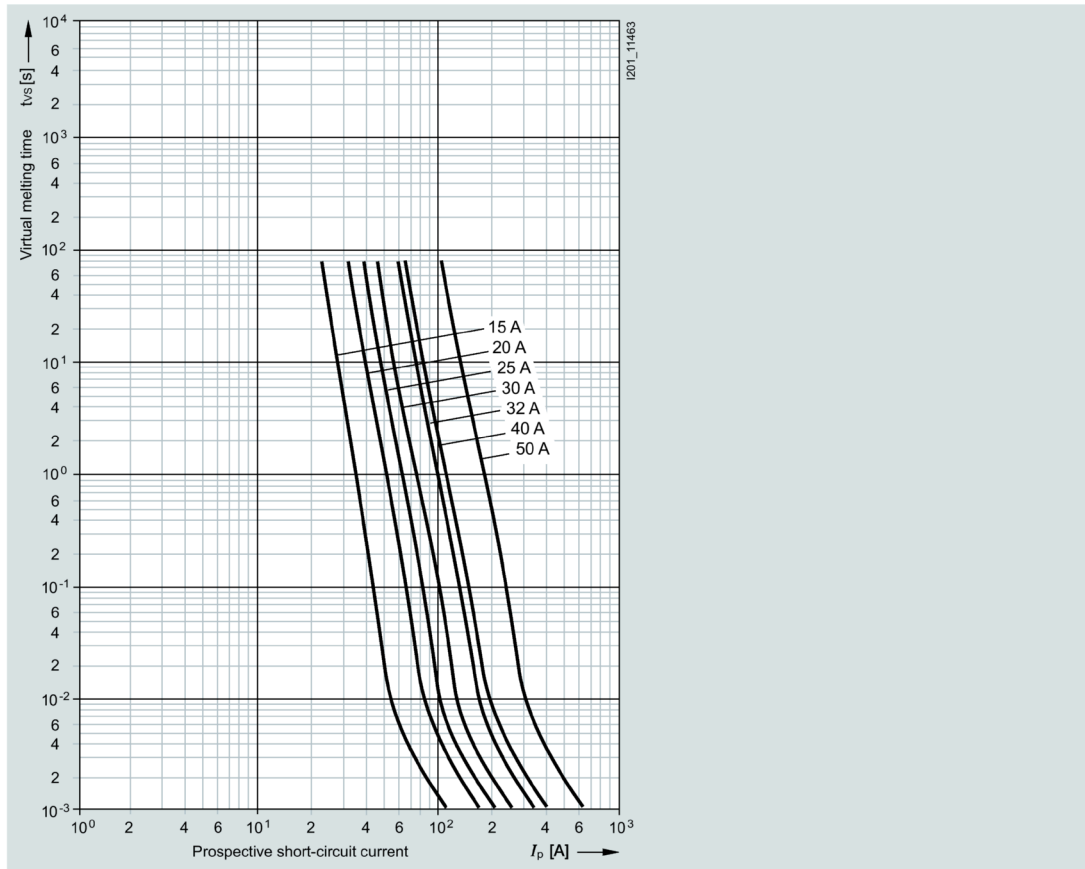

Correction factor  $k_A$  for breaking  $I^2t$  value

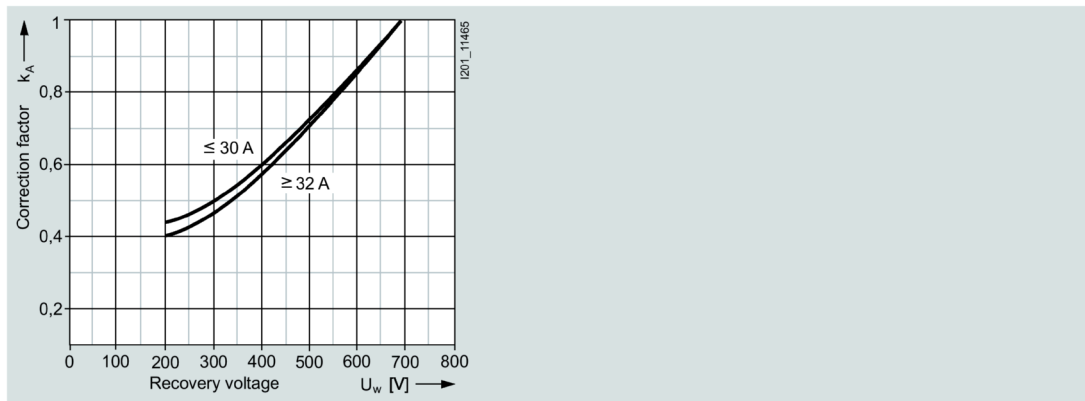



Let-through current curves (current limiting at 50 Hz)

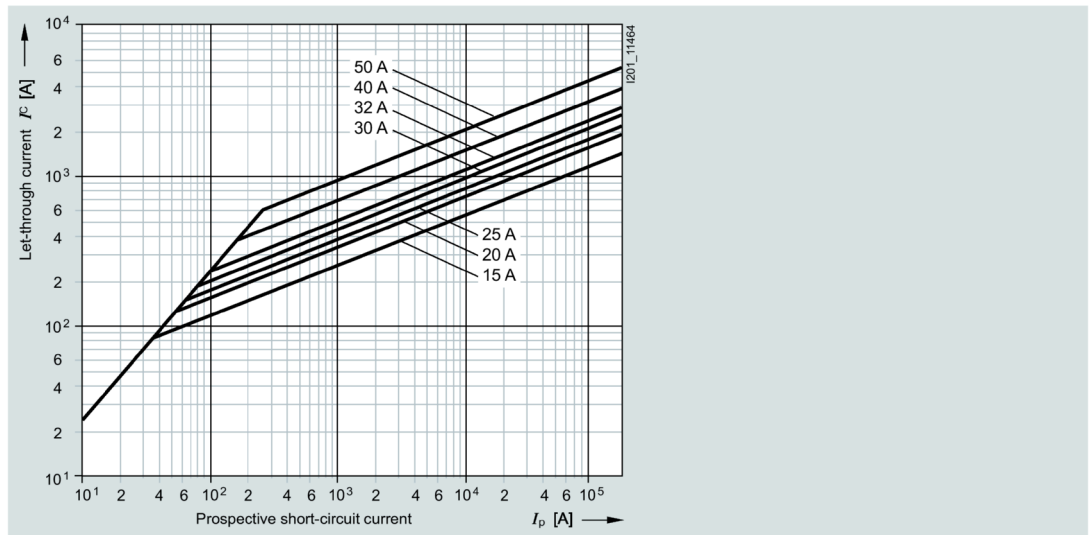

Peak arc voltage

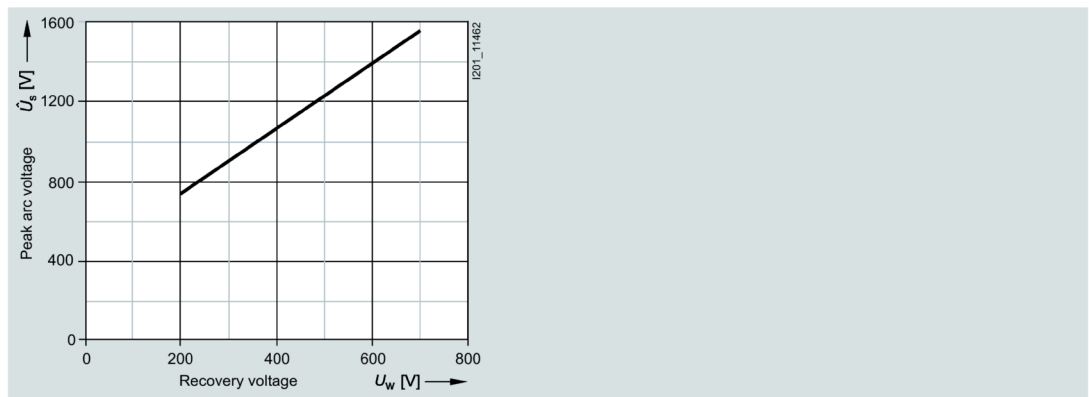

3NC14..-0MK series

Size:	14 × 51 mm
Operational class:	gR, aR
Rated voltage:	690 V AC, 250 ... 700 V DC
Rated current:	6 ... 63 A

Time/current characteristic curves diagram

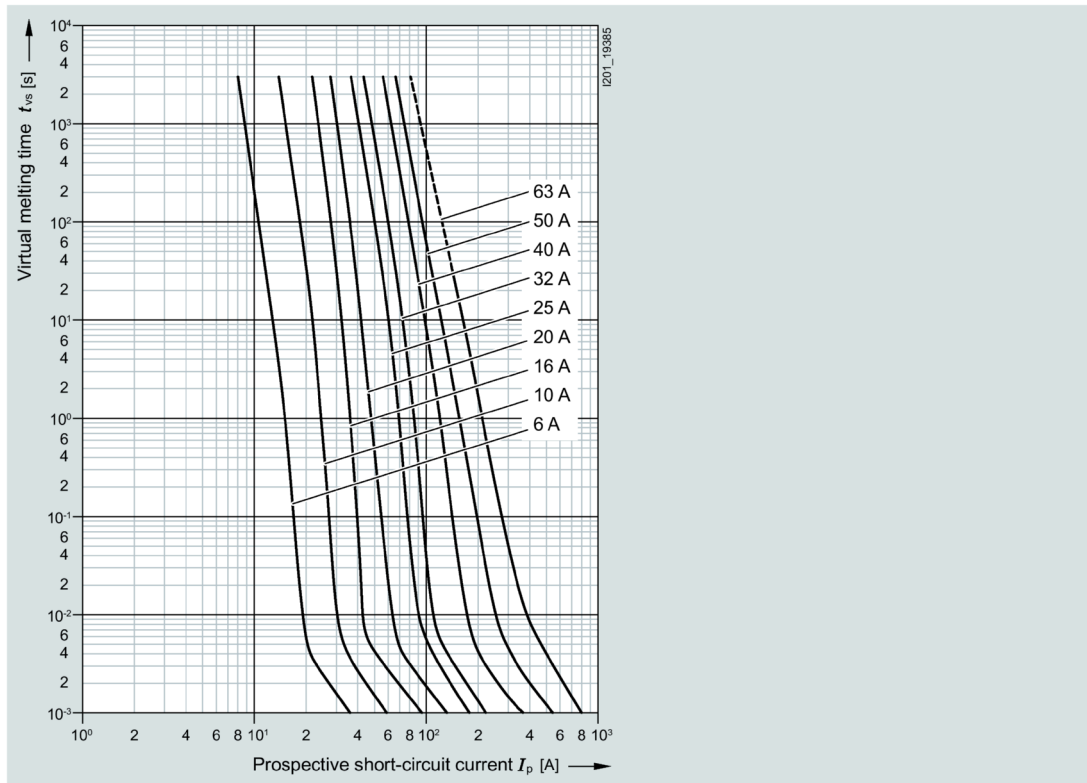

Correction factor  $k_A$  for breaking  $I^2t$  value

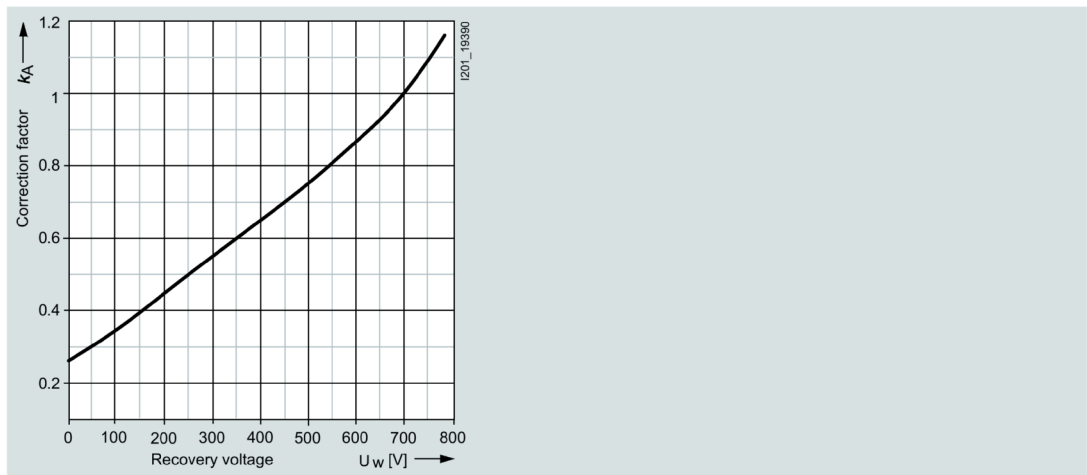

Let-through characteristic curves (current limiting at 50 Hz)

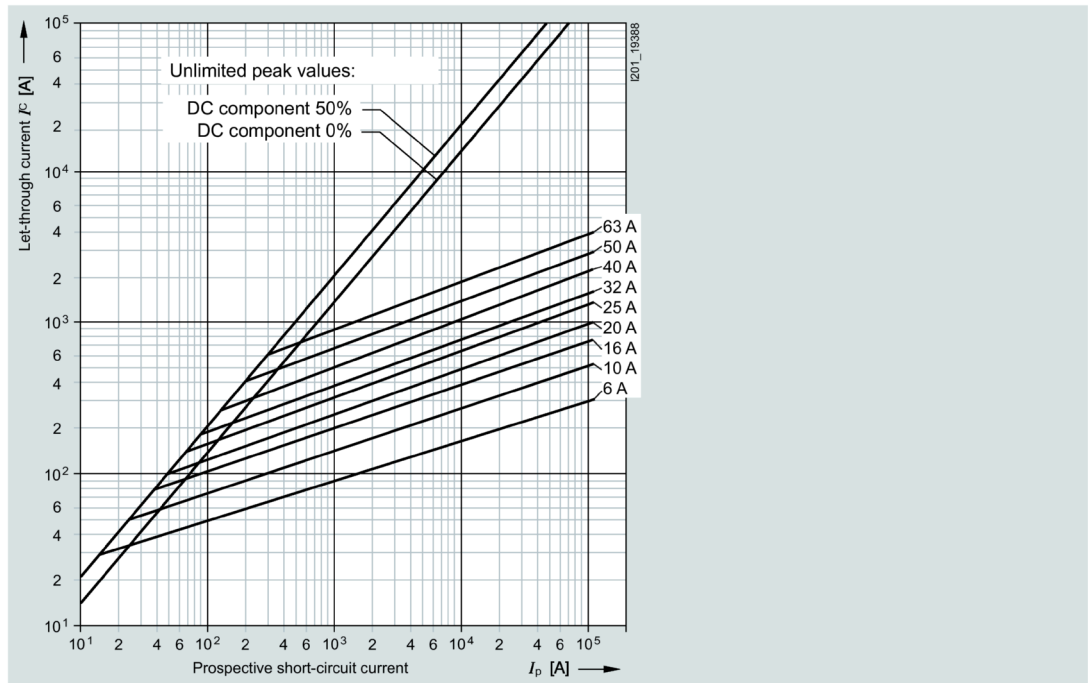

Peak arc voltage

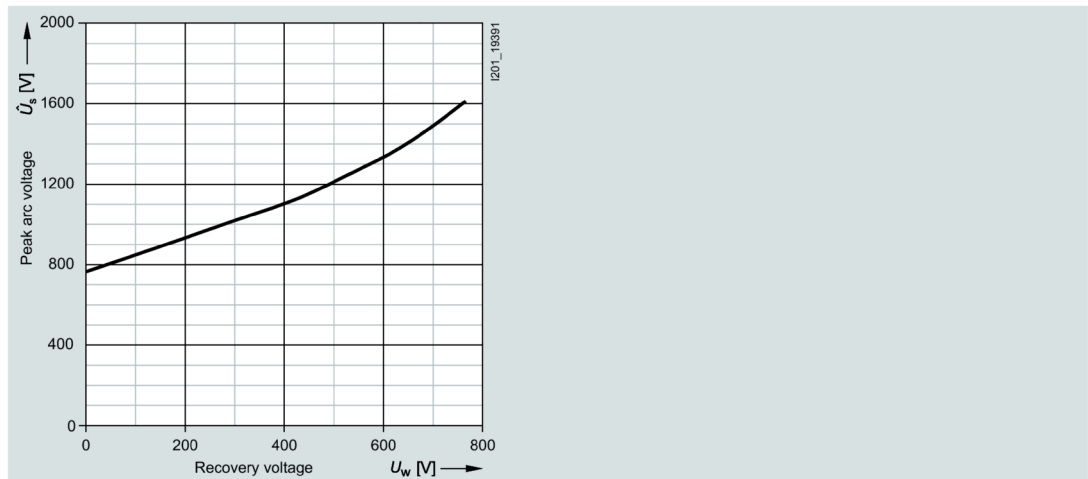

3NC14..-5 series with striking pin

Size:	14 × 51 mm
Operational class:	aR
Rated voltage:	690 V AC / 600 V DC
Rated current:	10 ... 50 A

Time/current characteristic curves diagram

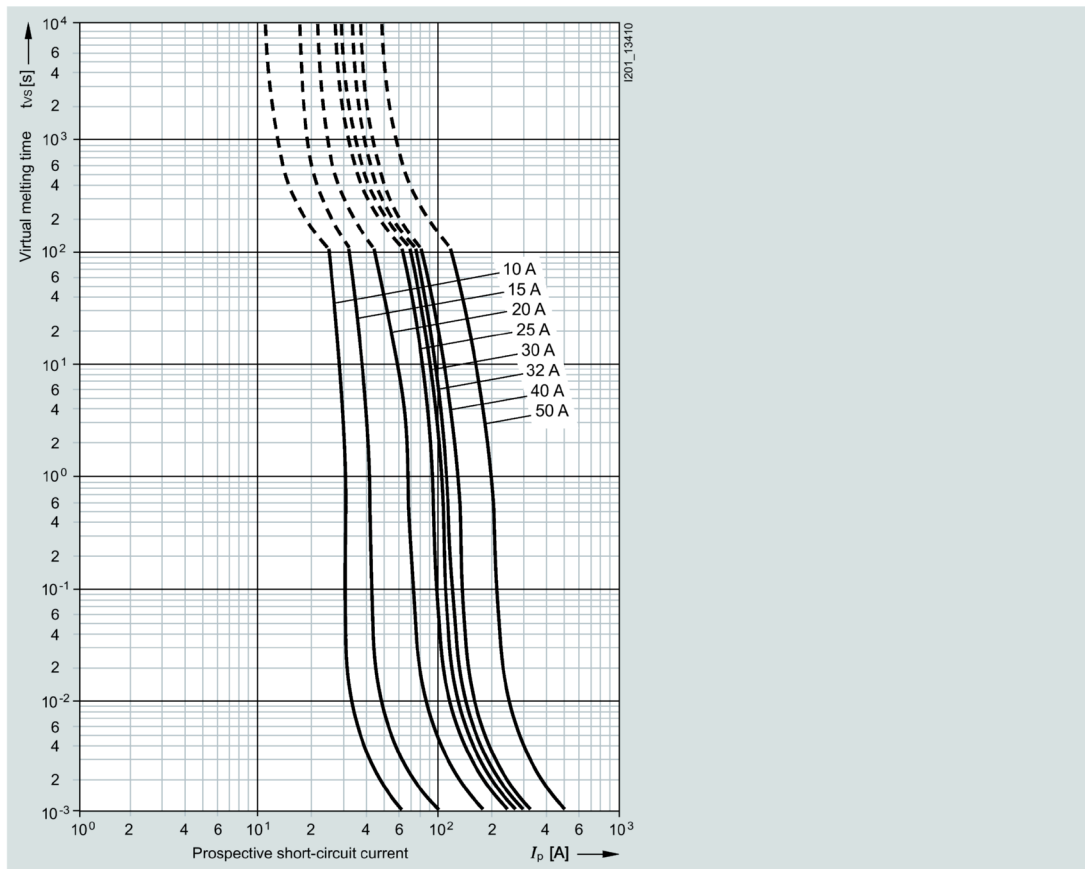

Correction factor  $k_A$  for breaking  $I^2t$  value

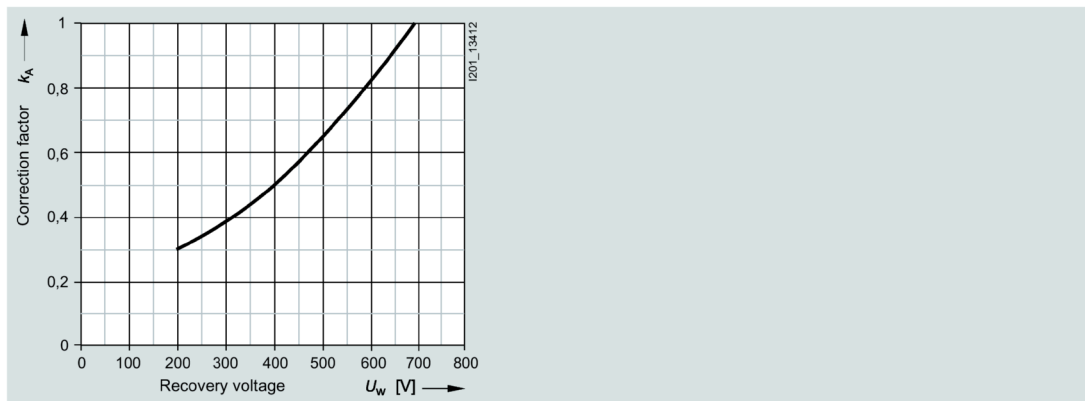

Let-through characteristic curves (current limiting at 50 Hz)

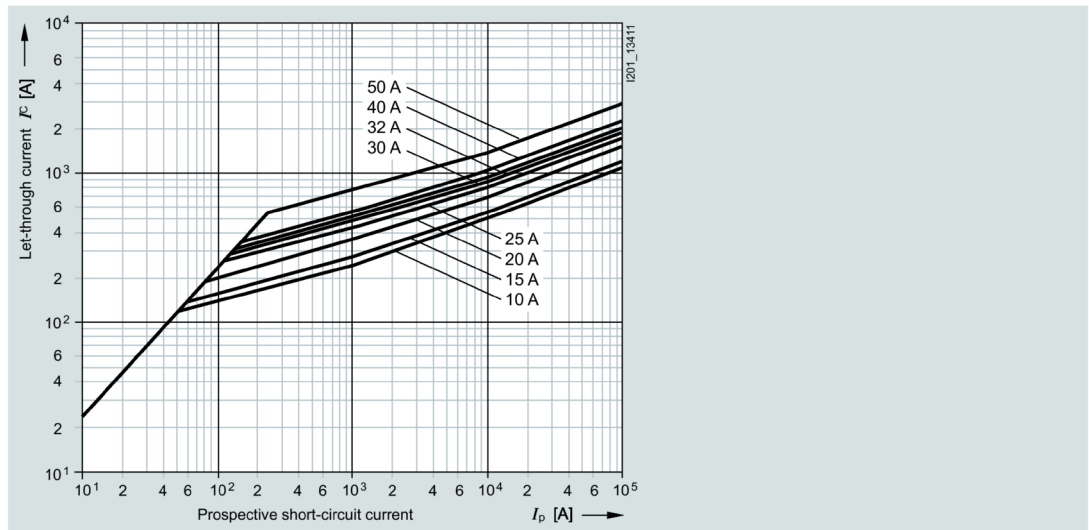

Peak arc voltage

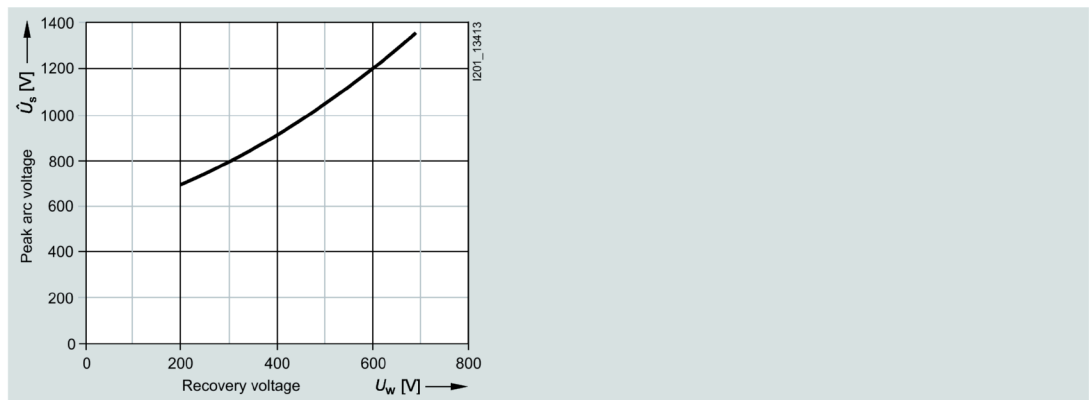

3NC18..-0MK series

Size:	18 × 88 mm
Operational class:	gR
Rated voltage:	690 V AC / 440 V DC
Rated current:	10 ... 50 A

Time/current characteristic curves diagram

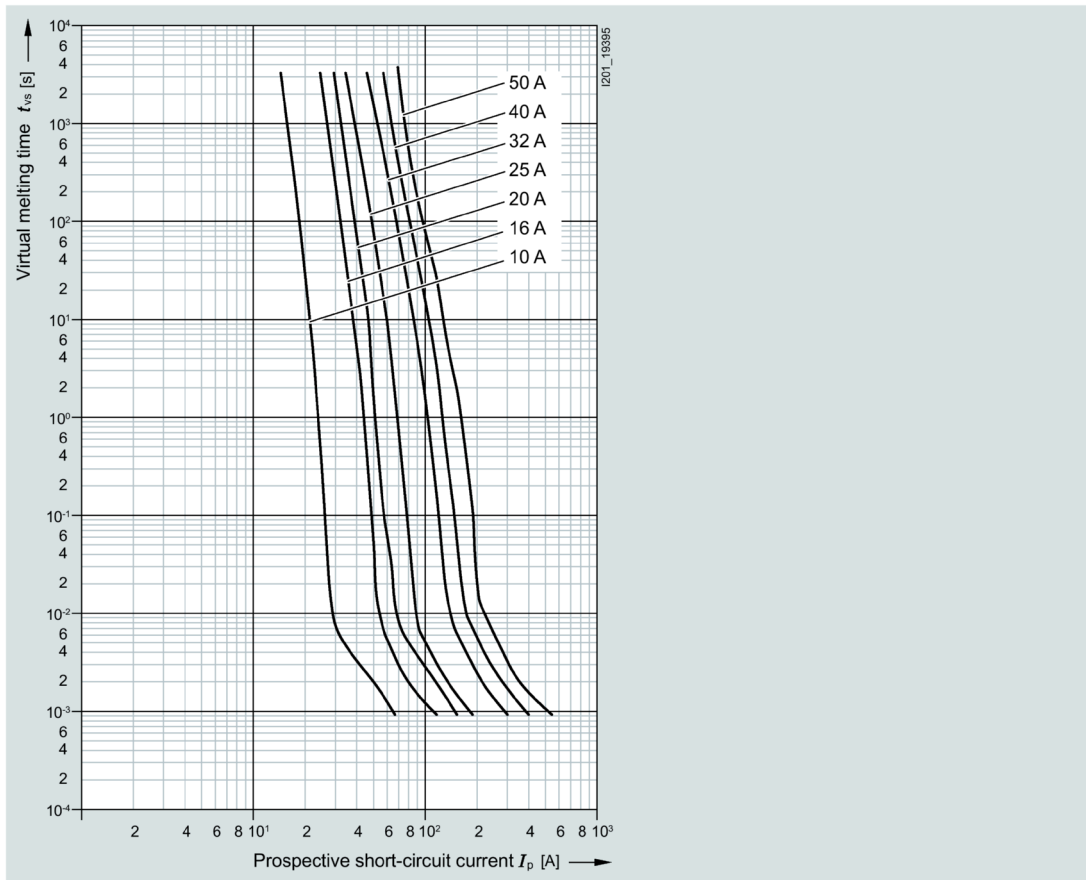

Correction factor  $k_A$  for breaking  $I^2t$  value

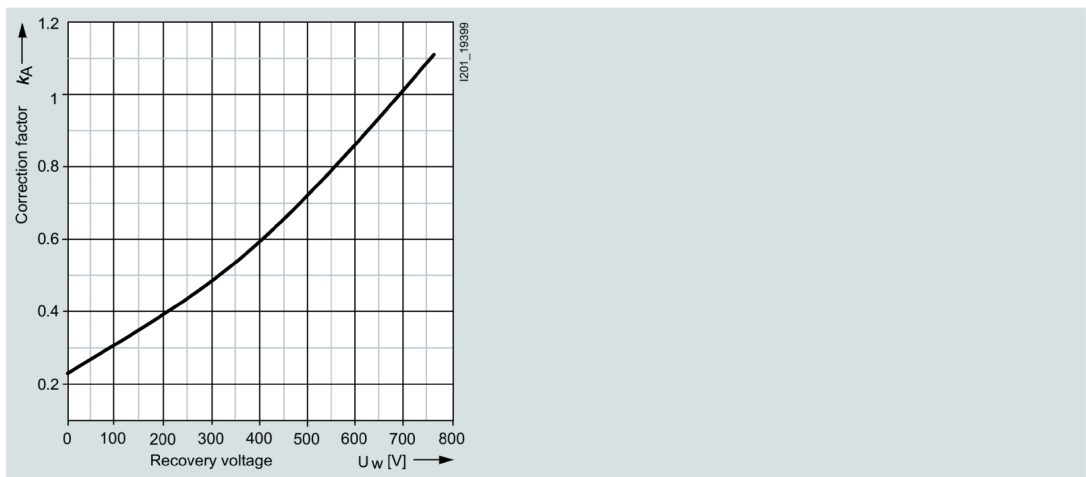

Let-through current curves (current limiting at 50 Hz)

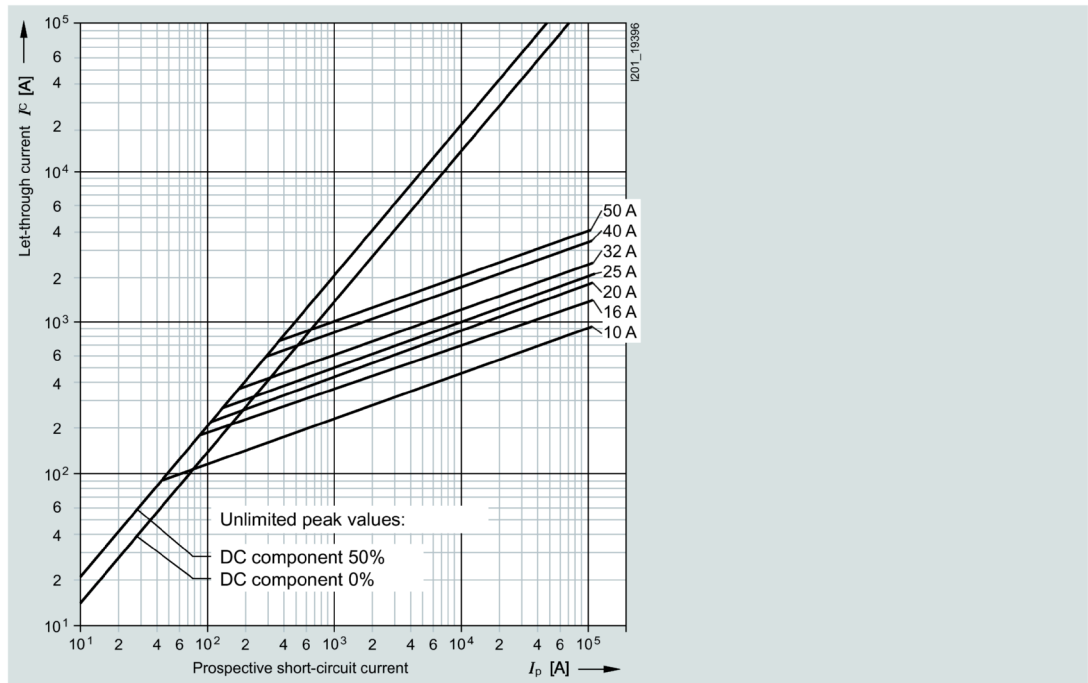

Peak arc voltage

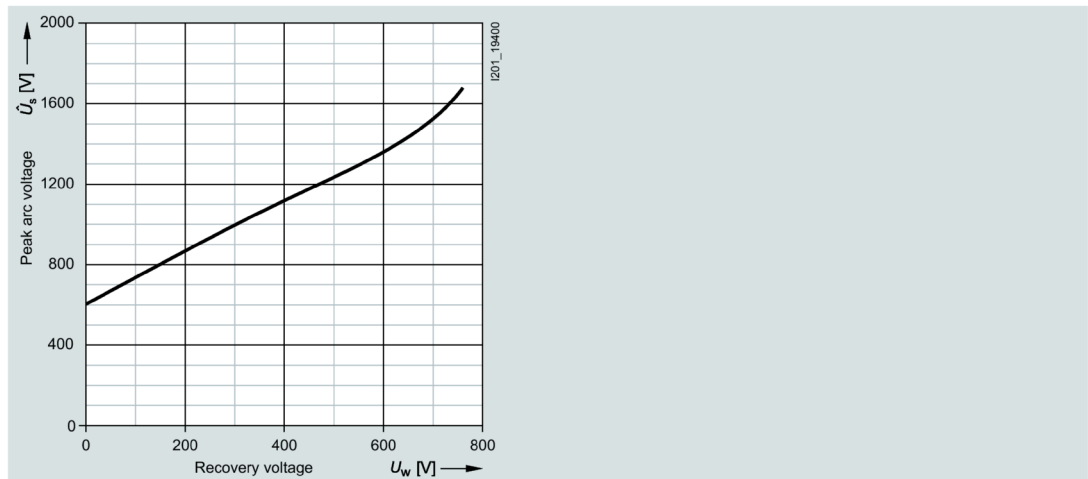

**3NC22 series**

Size:	22 × 58 mm
Operational class:	aR
Rated voltage:	690 V AC / 500 V DC (20 ... 80 A) 600 V AC / 500 V DC (100 A)
Rated current:	20 ... 100 A

Time/current characteristic curves diagram

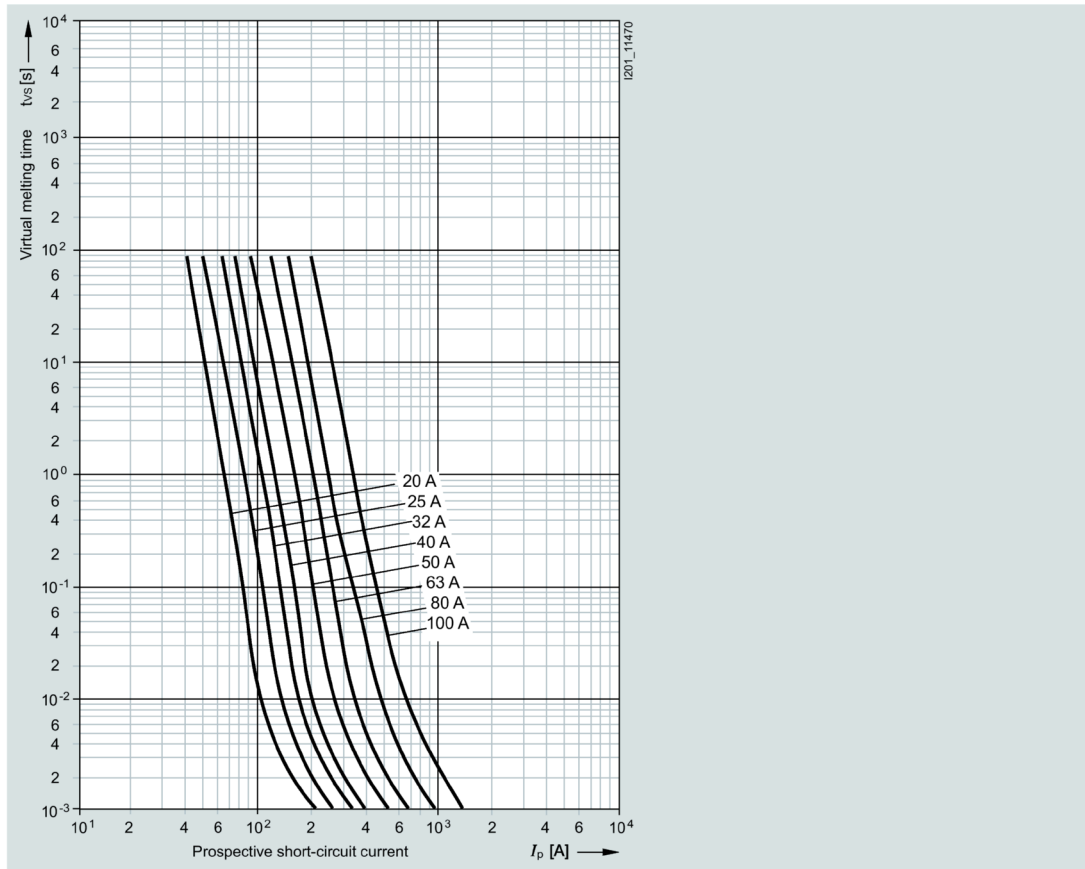

Correction factor  $k_A$  for breaking  $I^2t$  value

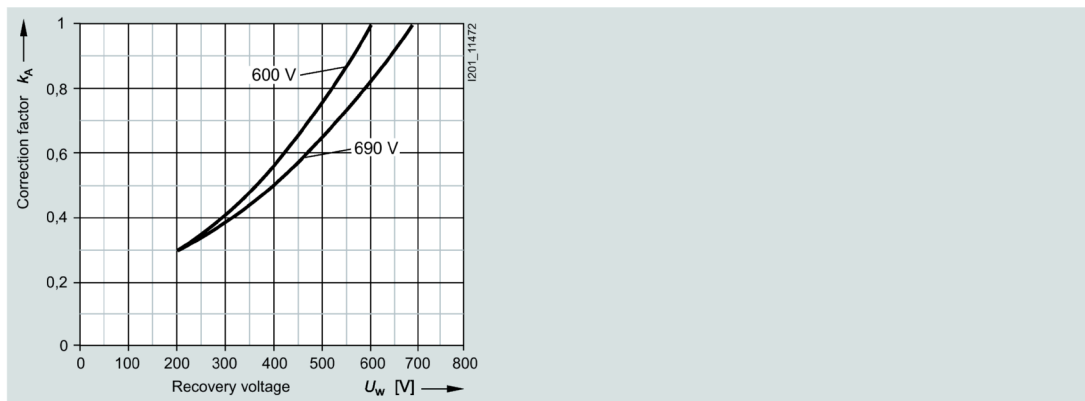



Let-through characteristic curves (current limiting at 50 Hz)

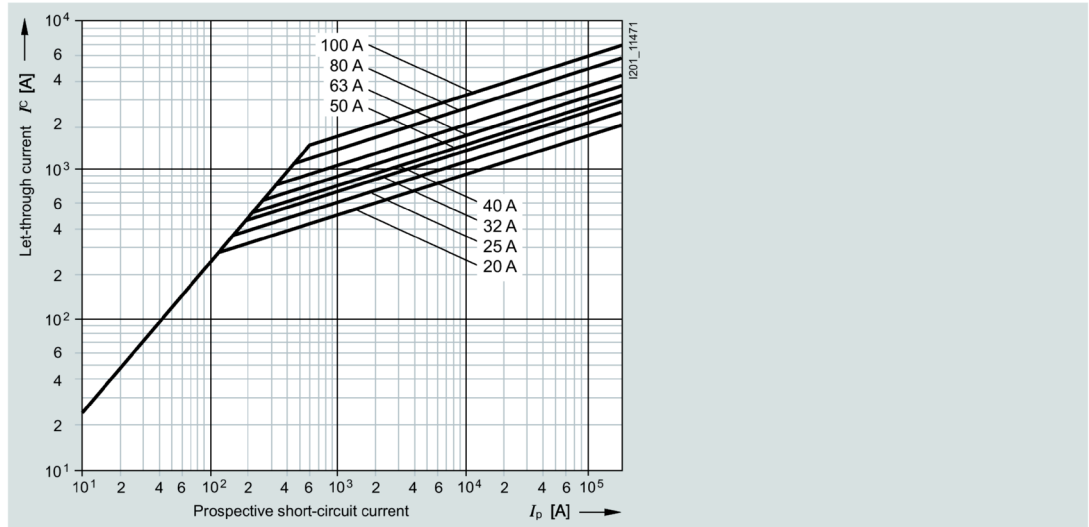

Peak arc voltage

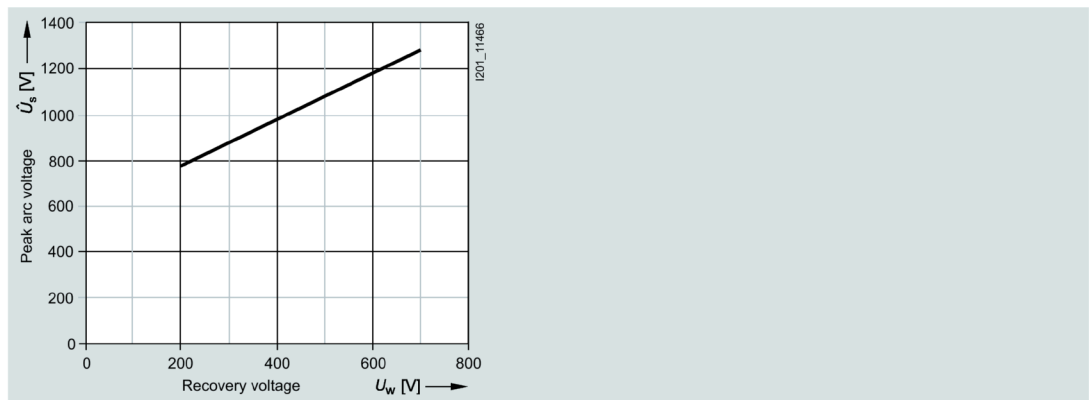

3NC22..-0MK series

Size:	22 × 58 mm
Operational class:	gR, aR
Rated voltage:	690 V AC, 250 ... 700 V DC
Rated current:	25 ... 125 A

Time/current characteristic curves diagram

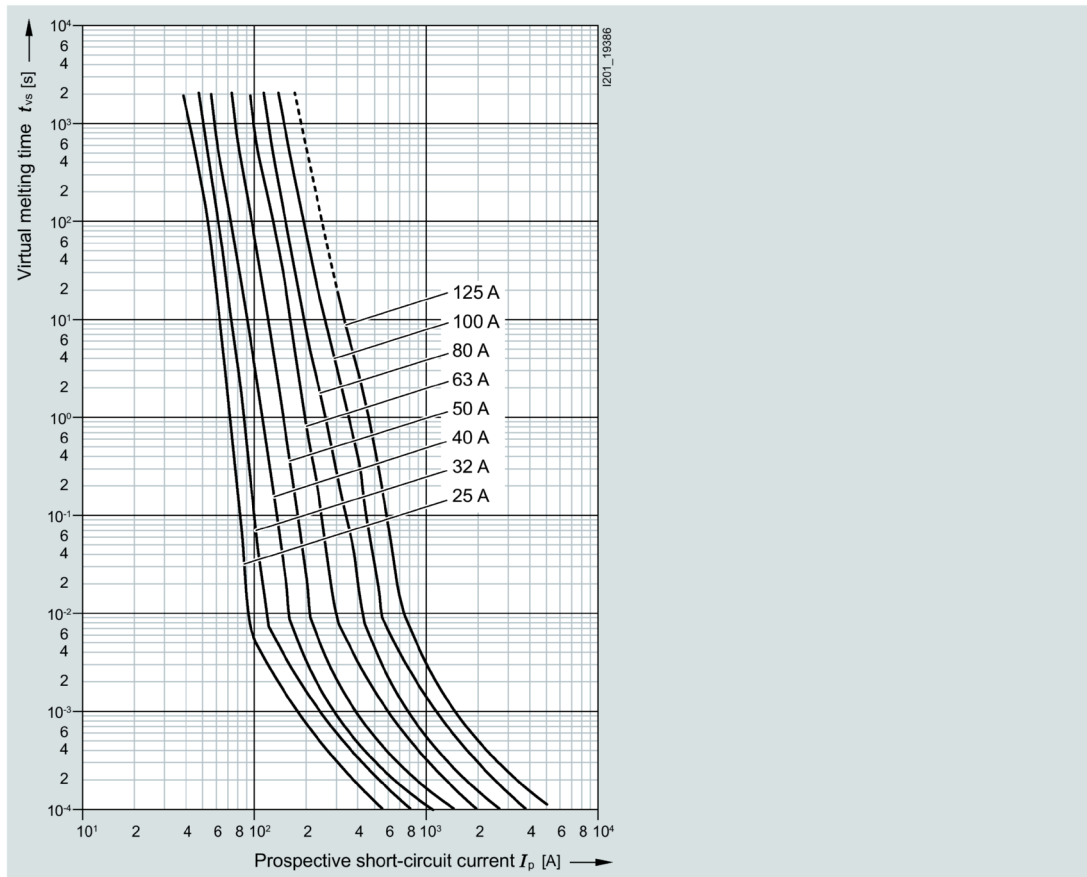

Correction factor  $k_A$  for breaking  $I^2t$  value

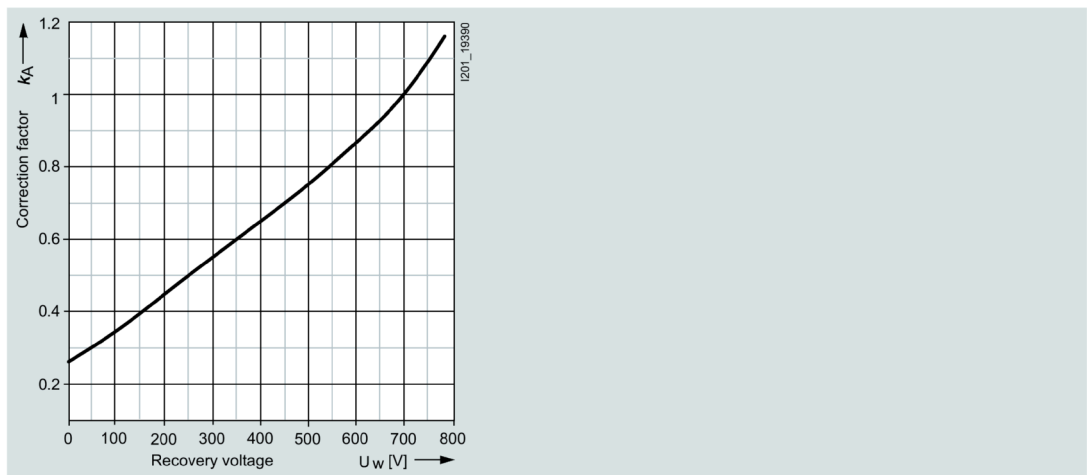

Let-through current curves (current limiting at 50 Hz)

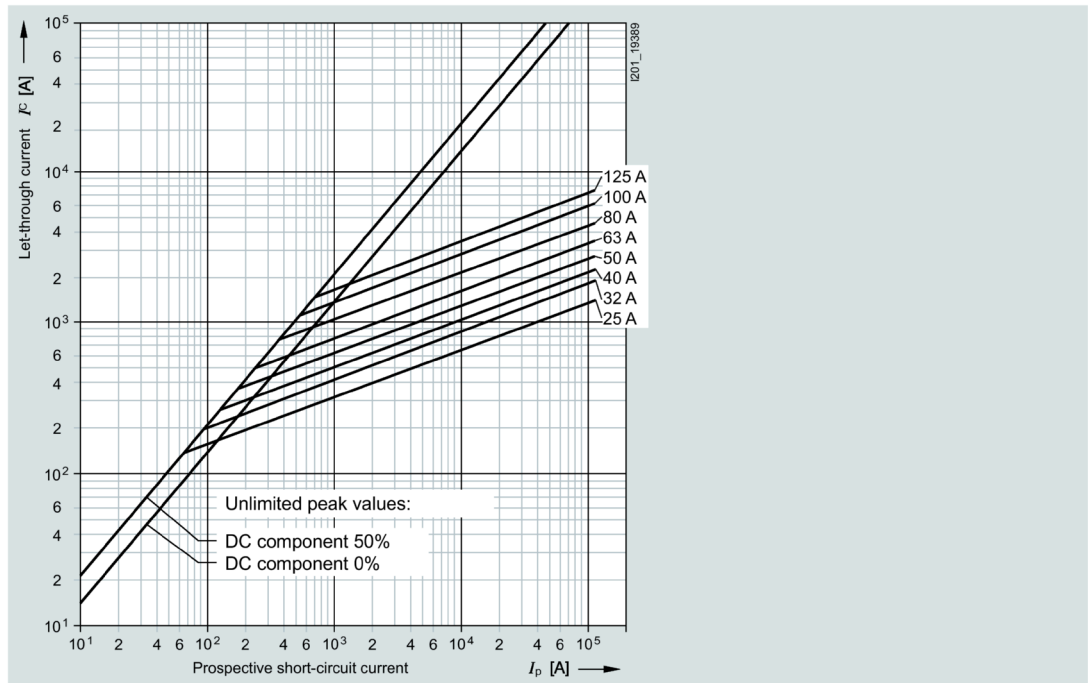

Peak arc voltage

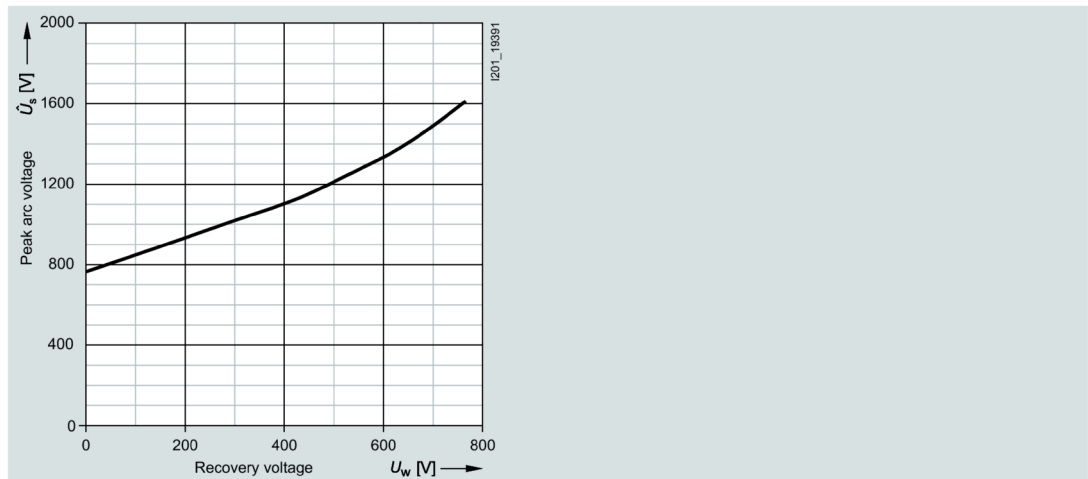

3NC22..-5 series with striking pin

Size:	22 × 58 mm
Operational class:	aR
Rated voltage:	690 V AC / 500 V DC (20 ... 80 A) 600 V AC / 500 V DC (100 A)
Rated current:	20 ... 100 A

Time/current characteristic curves diagram

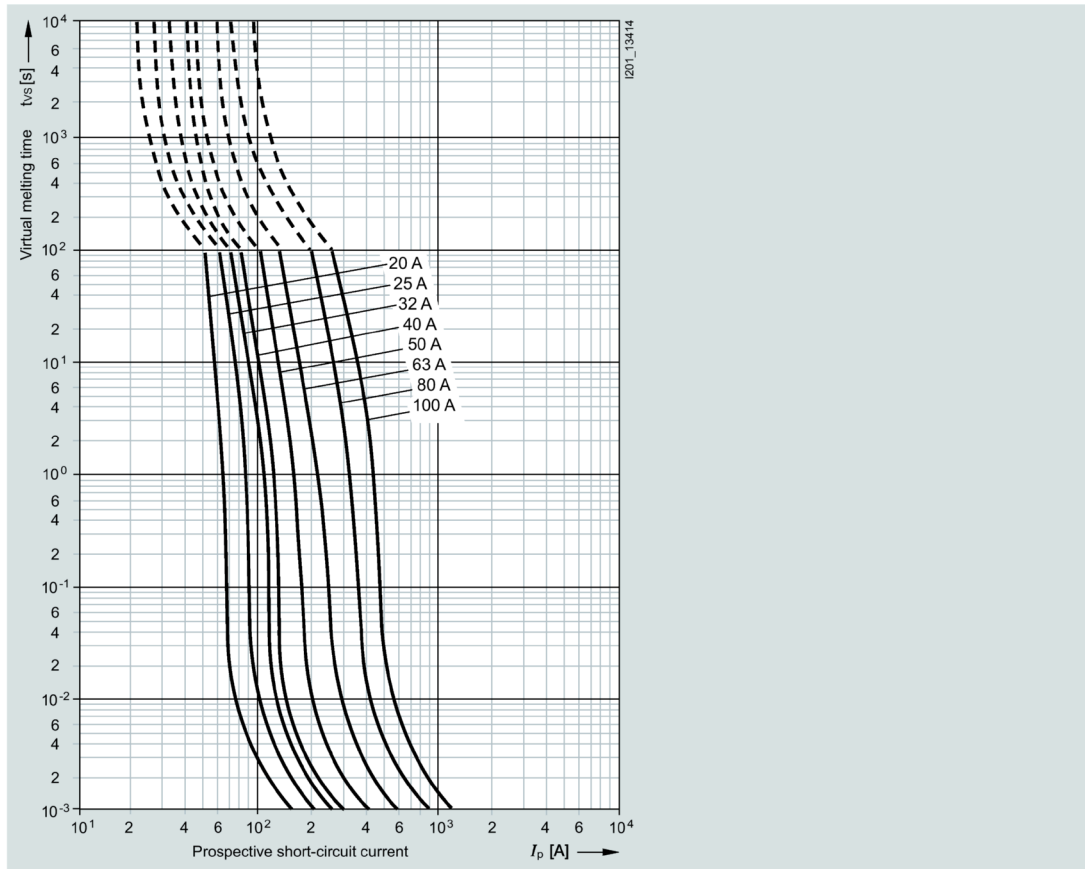

Correction factor  $k_A$  for breaking  $I^2t$  value

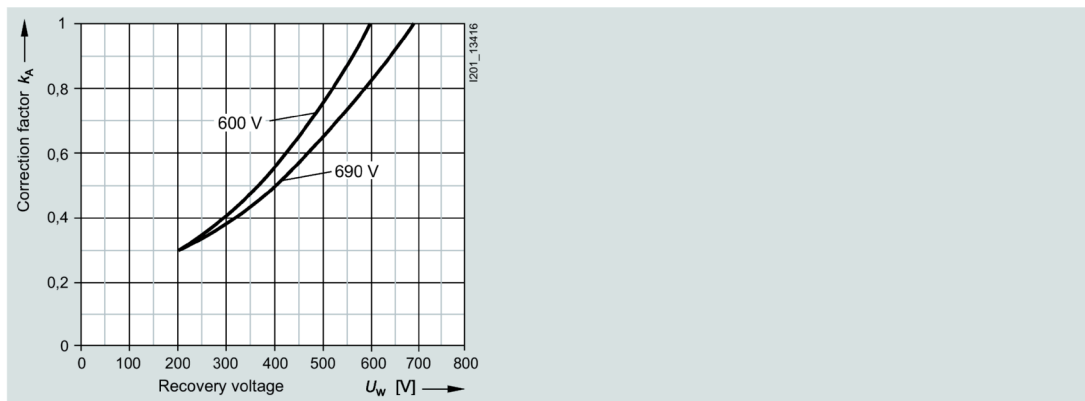

Let-through current curves (current limiting at 50 Hz)

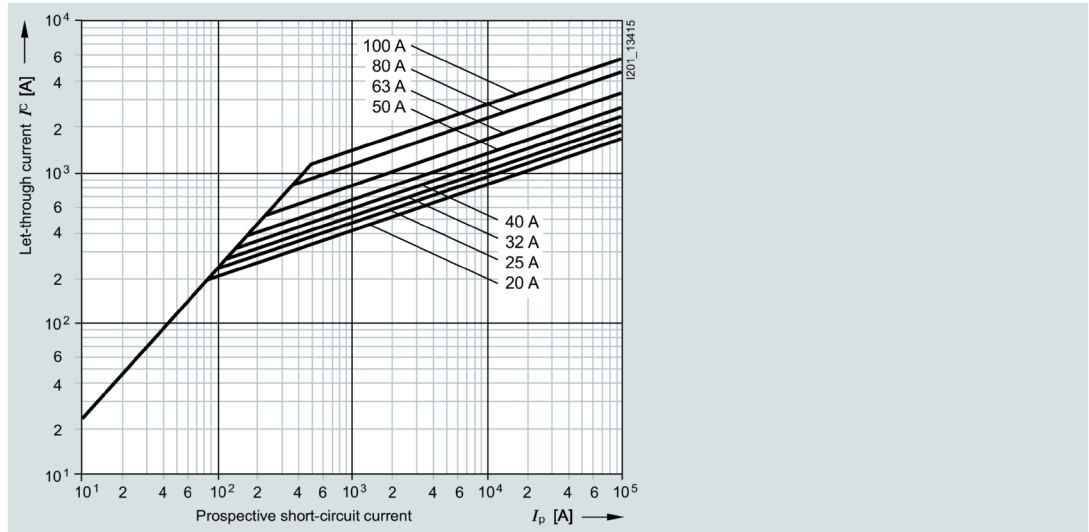

Peak arc voltage

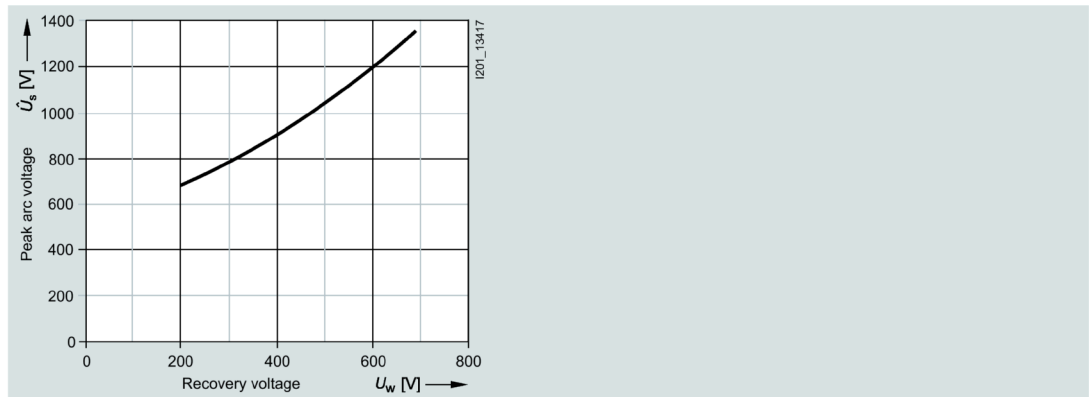

3NC23..-0MK series

Size:	22 × 127 mm
Operational class:	gS, gR, aR
Rated voltage:	1500 V AC / 1000 V DC
Rated current:	1 ... 50 A

Time/current characteristic curves diagram

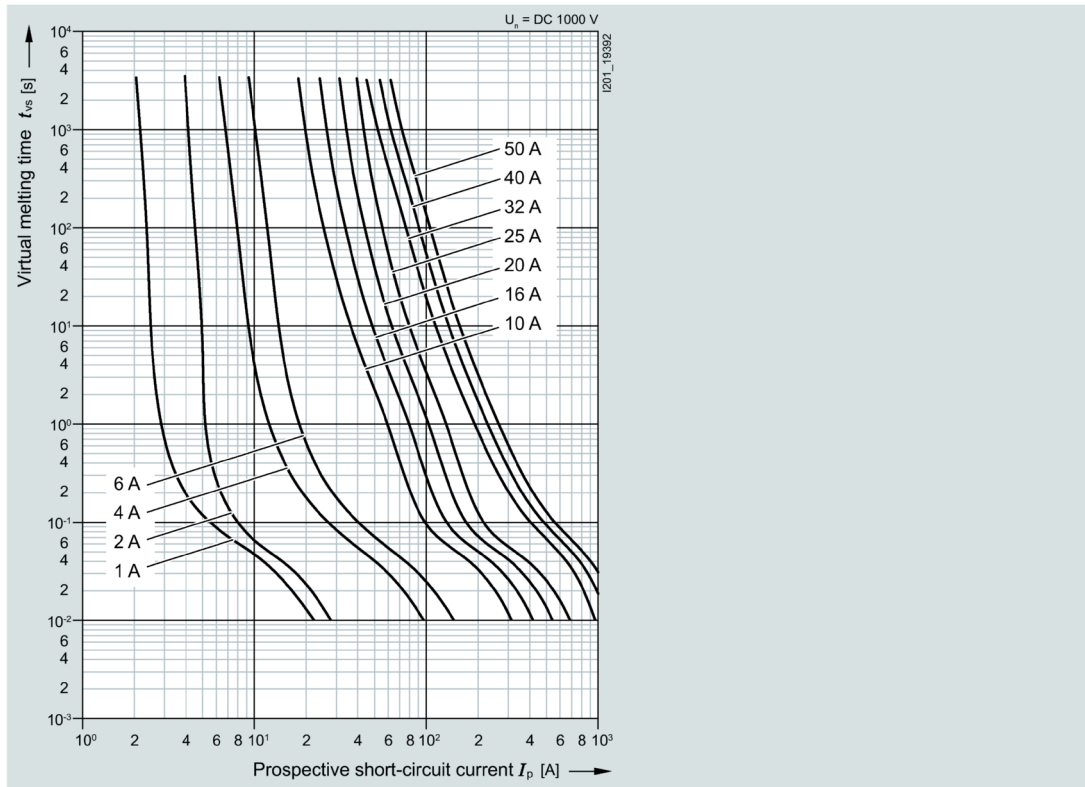

**$I^2t$  characteristic**

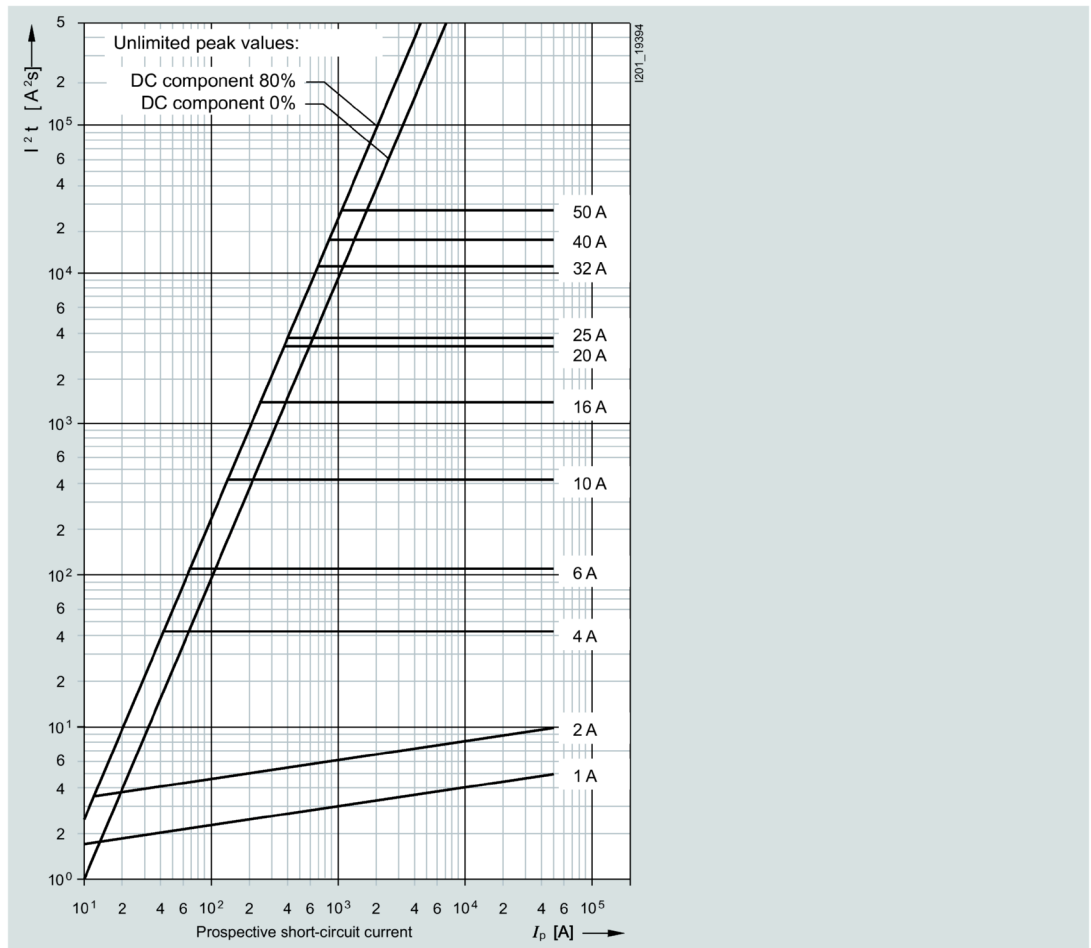

Let-through characteristic curves (current limiting at 50 Hz)

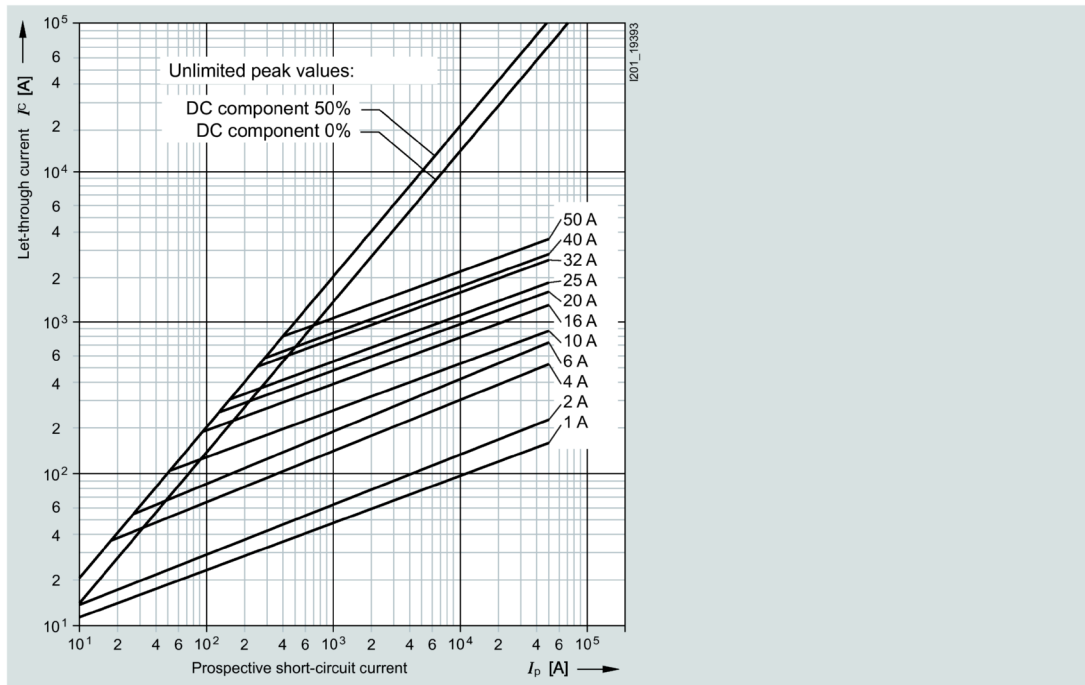

3NC26..-0MK series

Size:	26 × 103 mm
Operational class:	gR, aR
Rated voltage:	690 V AC / 440 V DC
Rated current:	25 ... 125 A



Time/current characteristic curves diagram

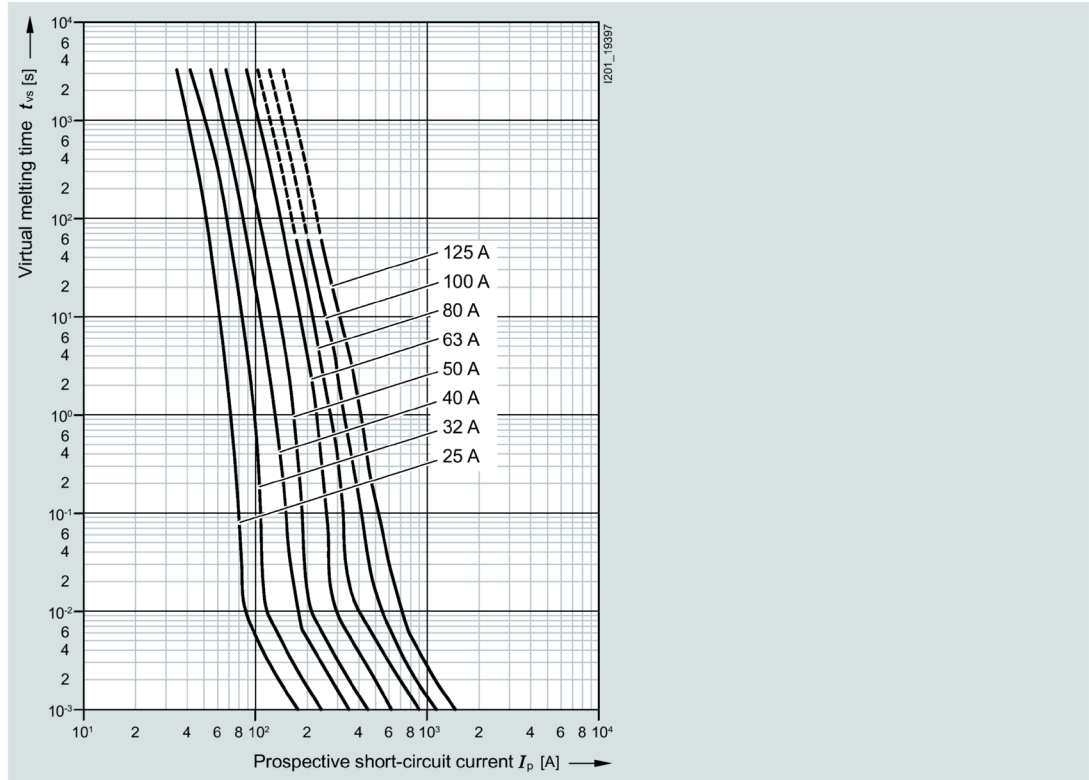

Correction factor  $k_A$  for breaking  $I^2t$  value

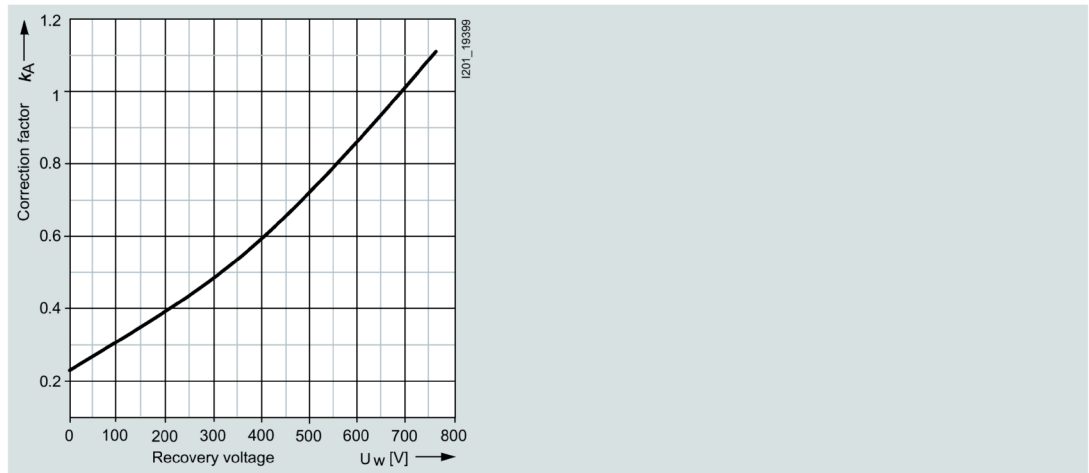

Let-through characteristic curves (current limiting at 50 Hz)

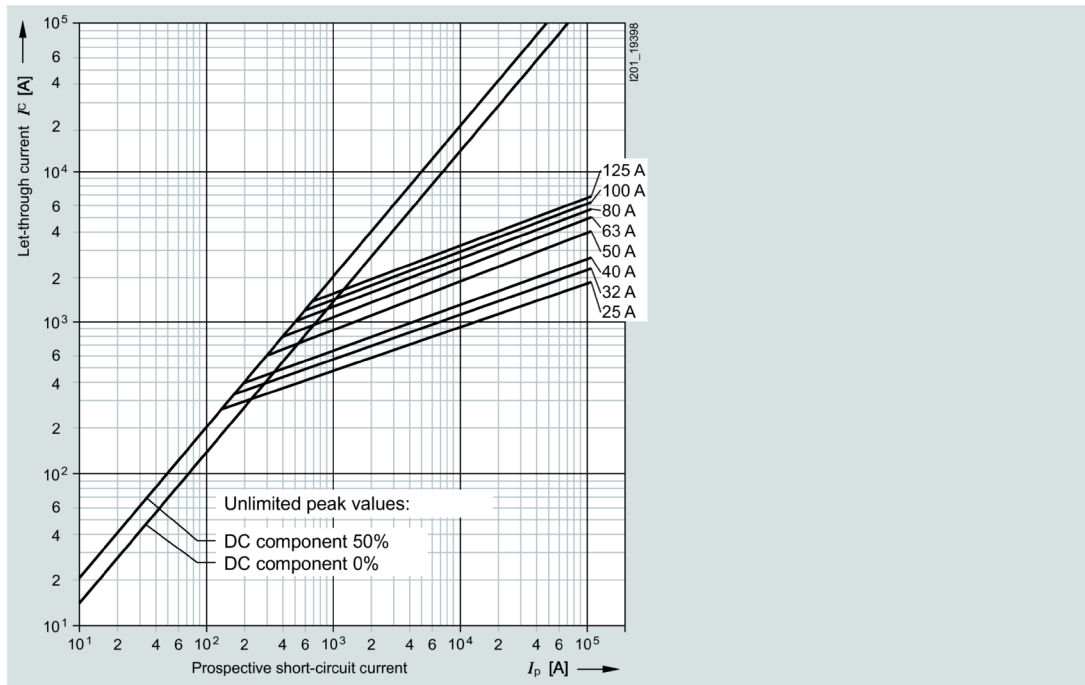

Peak arc voltage

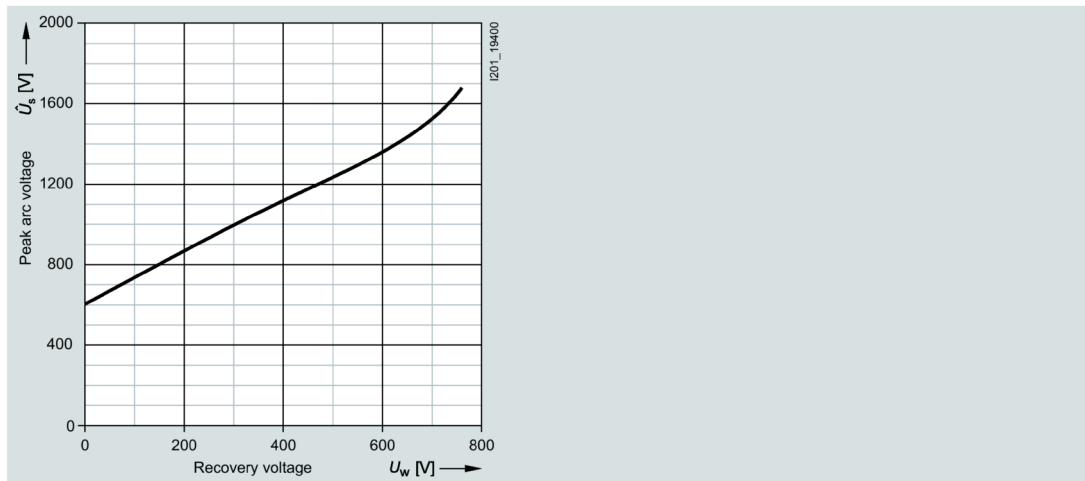

## 7.3 NEOZED, DIAZED design

### 7.3.1 Portfolio overview

SILIZED is the brand name for NEOZED fuses (D0 fuses) and DIAZED fuses (D fuses) with a super-quick characteristic for semiconductor protection. The fuses are used in combination with fuse bases, fuse screw caps and accessory parts of the standard fuse system.

SILIZED semiconductor fuses protect power semiconductors from the effects of short-circuits, because the super-quick breaking characteristic is much faster than that of conventional fuses. They protect high-value devices and system components, such as semiconductor contactors, static relays, converters with fuses in the input and in the DC link, UPS systems and soft starters for motors up to 100 A.

When using fuse bases and fuse screw caps made of molded plastic, always heed the maximum permissible power loss values due to the high power loss (power dissipation) of the SILIZED fuses. When using these components, the following maximum permissible power loss applies:

- NEOZED D02: 5.5 W
- DIAZED DII: 4.5 W
- DIAZED DIII: 7.0 W

A continuous thermal load of only 50% is possible in some cases for this reason.

The DIAZED DII screw adapter for 25 A is used for the 30 A fuse link.

### Benefits

- SILIZED semiconductor fuses have an extremely compact design. This means they have a very small footprint – especially the NEOZED design.
- The rugged and well-known DIAZED design complies with IEC 60269-3. It is globally renowned and can be used in many countries.
- A wide range of fuse bases and accessories is available for SILIZED semiconductor fuses in the NEOZED and DIAZED designs. This increases the application options in many devices.

### 7.3.2 Technical specifications

#### Fuse links

	NEOZED 5SE13 design	DIAZED 5SD4 design
Standards	DIN VDE 0636-3; IEC 60269-3; DIN EN 60269-4 (VDE 0636-4); IEC 60269-4	
Operational class	gR	
Characteristic	Super-quick	

		NEOZED 5SE13 design	DIAZED 5SD4 design
Rated voltage $U_n$	V AC V DC	400 250	500 500
Rated current $I_n$	A	10 ... 63	16 ... 100
Rated breaking capacity	kA AC kA DC	50 8	
Mounting position		Any, preferably vertical	
Non-interchangeability		Using adapter sleeves	Using screw adapter or adapter sleeves
Resistance to climate	°C	Up to 45 at 95% rel. humidity	
Ambient temperature	°C	-5 ... +40, humidity 90% at 20 °C	

Type	Size	NEOZED design						
		$I_n$	$P_v$	$\Delta\theta$	$I^2t_s$		$I^2t_a$	
					1 ms	4 ms	230 V AC	400 V AC
A	W	K	A <sup>2</sup> s	A <sup>2</sup> s	A <sup>2</sup> s	A <sup>2</sup> s		
5SE1310	D01	10	6.9	64	30	30	56	73
5SE1316		16	6.2	61	31	34	92	120
5SE1320	D02	20	8.1	64	50	56	146	190
5SE1325		25	8.2	63	120	120	166	215
5SE1335		35	16.7	100	145	182	361	470
5SE1350		50	12.0	80	460	540	1510	1960
5SE1363		63	15.5	96	845	932	3250	4230

Type	Size	DIAZED design				
		$I_n$	$P_v$	$\Delta\theta$	$I^2t_s$	$I^2t_a$
					1 ms	500 V AC
A	W	K	A <sup>2</sup> s	A <sup>2</sup> s		
5SD420	DII	16	12.1	63	16.2	60
5SD430		20	12.3	69	35.8	139
5SD440		25	12.5	61	48.9	205
5SD480		30	13.4	65	85	310
5SD450	DIII	35	14.8	62	135	539
5SD460		50	18.5	66	340	1250
5SD470		63	28	84	530	1890
5SD510	DIV	80	34.3	77	980	4200
5SD520		100	41.5	83	1950	8450

### 7.3.3 Dimensional drawings

#### 5SE1

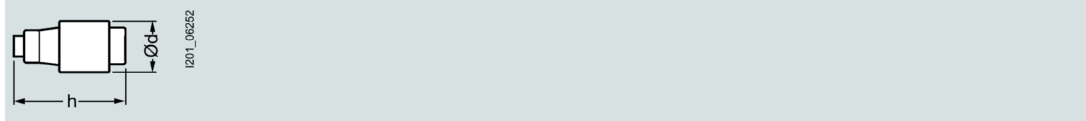

Size	D01	D02
Rated current in A	10 ... 16	20 ... 63
Dimension d	11	15.3
Dimension h	36	36

#### 5SD420, 5SD430, 5SD440, 5SD480

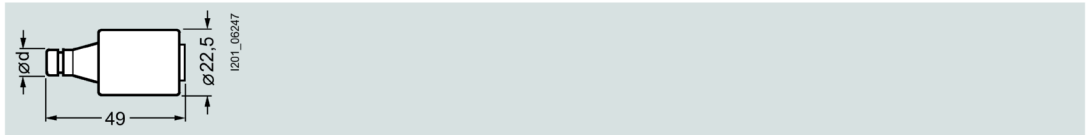

Size / thread	DII / E27			
Rated current in A	16	20	25	30
Dimension d	10	12	14	14

#### 5SD450, 5SD460, 5SD470

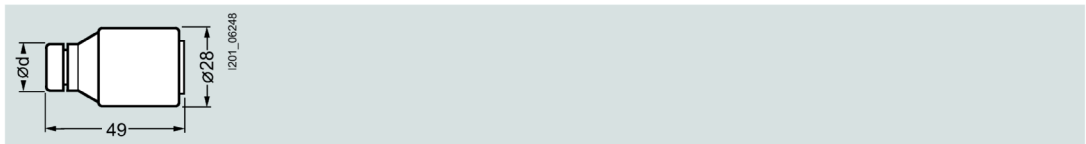

Size / thread	DIII / E33		
Rated current in A	35	50	63
Dimension d	16	18	20

#### 5SD510, 5SD520

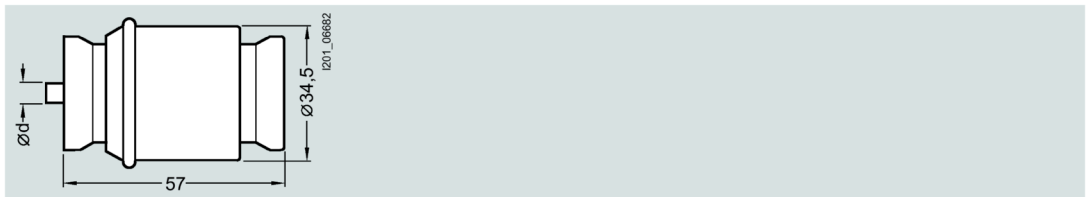

Size / thread	DIV / R1¼"	
Rated current in A	80	100
Dimension d	5	7

### 7.3.4 Characteristic curves

#### 5SE13. . series

Size: D01, D02  
 Operational class: gR  
 Rated voltage: 400 V AC / 250 V DC  
 Rated current: 10 ... 63 A

#### Time/current characteristic curves diagram

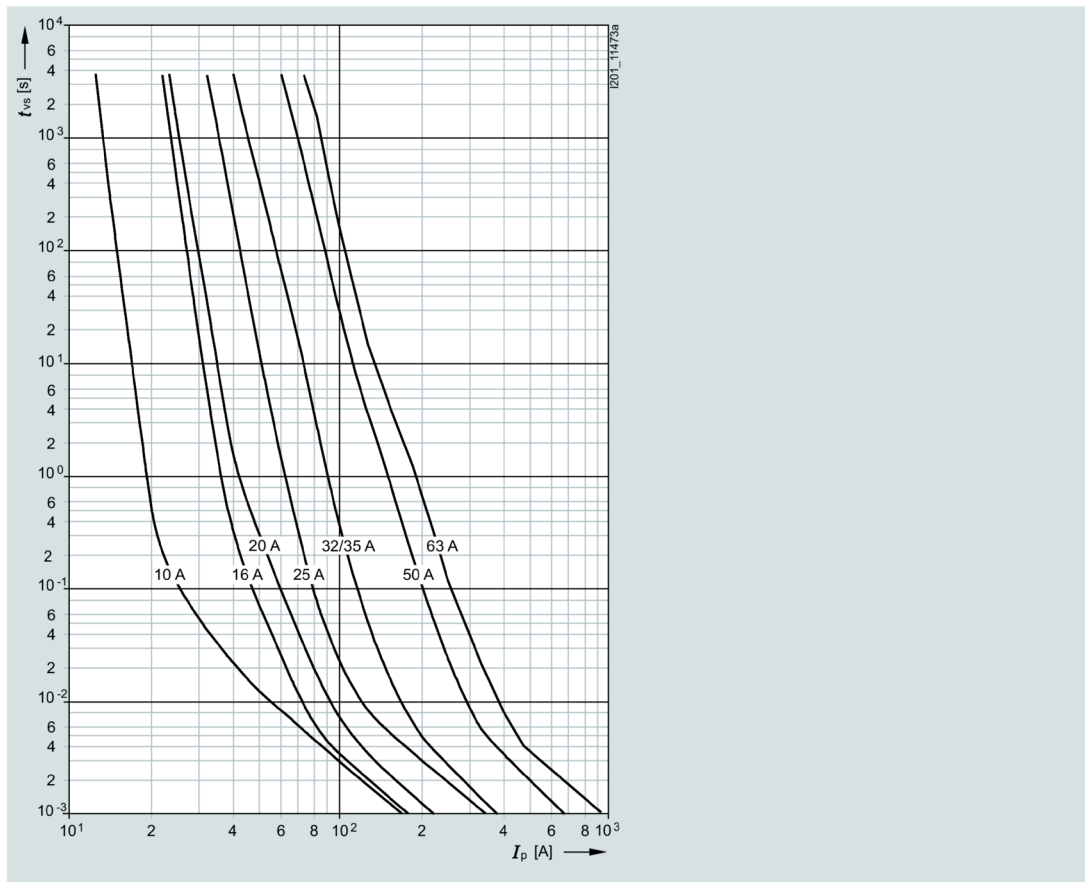

### Current limiting diagram

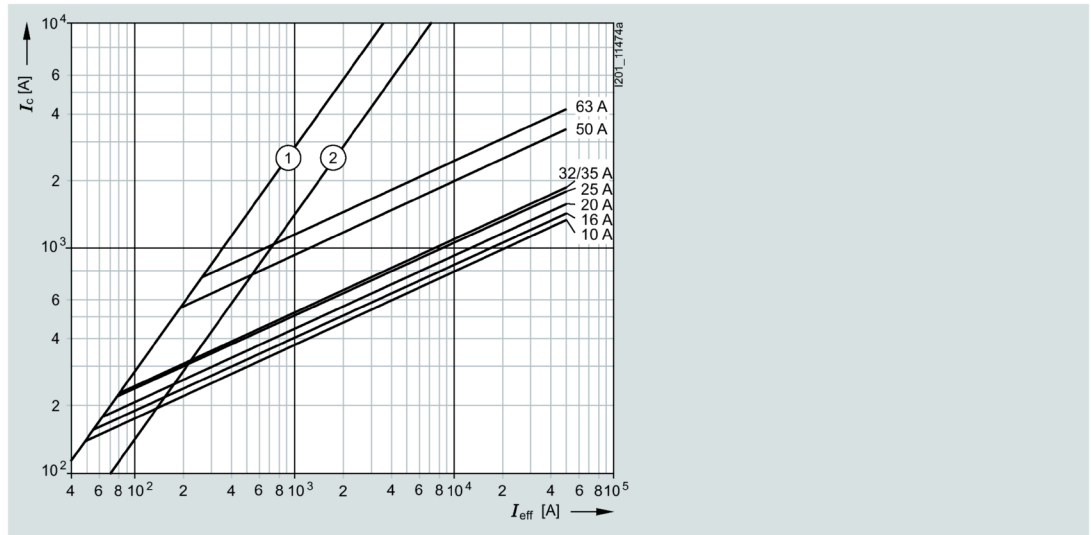

- ① Peak short-circuit current with largest DC component
- ② Peak short-circuit current without DC component

### Melting $I^2t$ values diagram

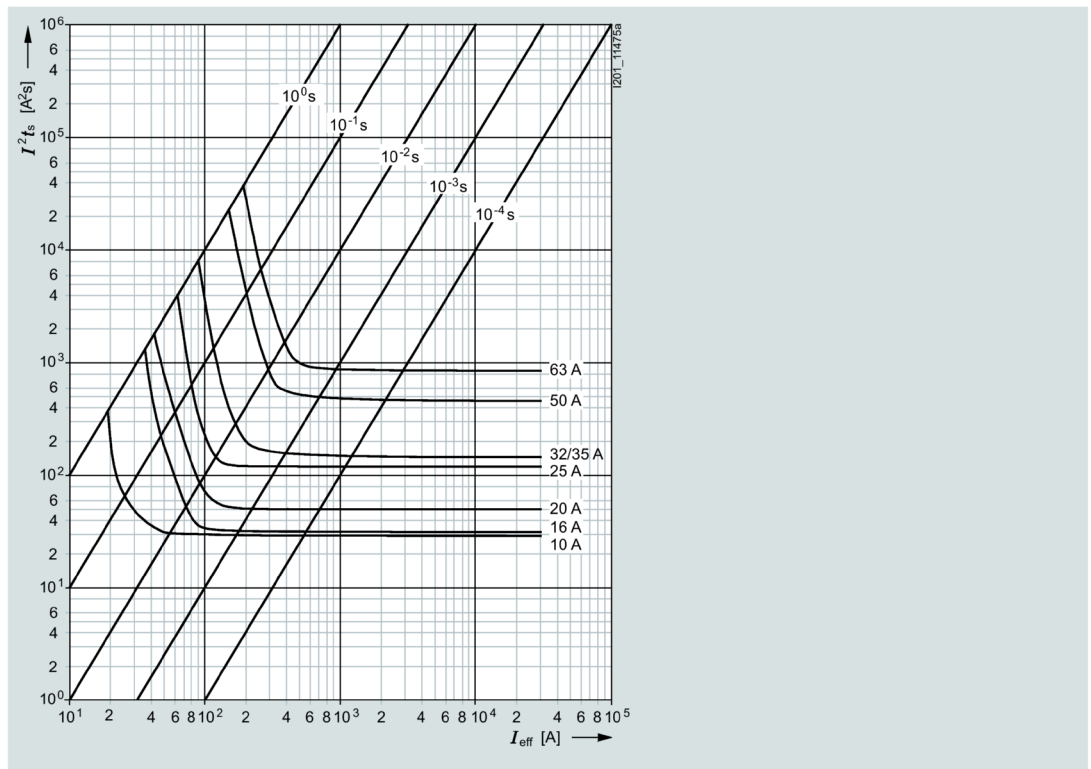

### 5SD4, 5SD5 series

Size:	DII, DIII, DIV
Operational class:	gR
Characteristic:	Super-quick
Rated voltage:	500 V AC / 500 V DC
Rated current:	16 ... 100 A

#### Time/current characteristic curves diagram

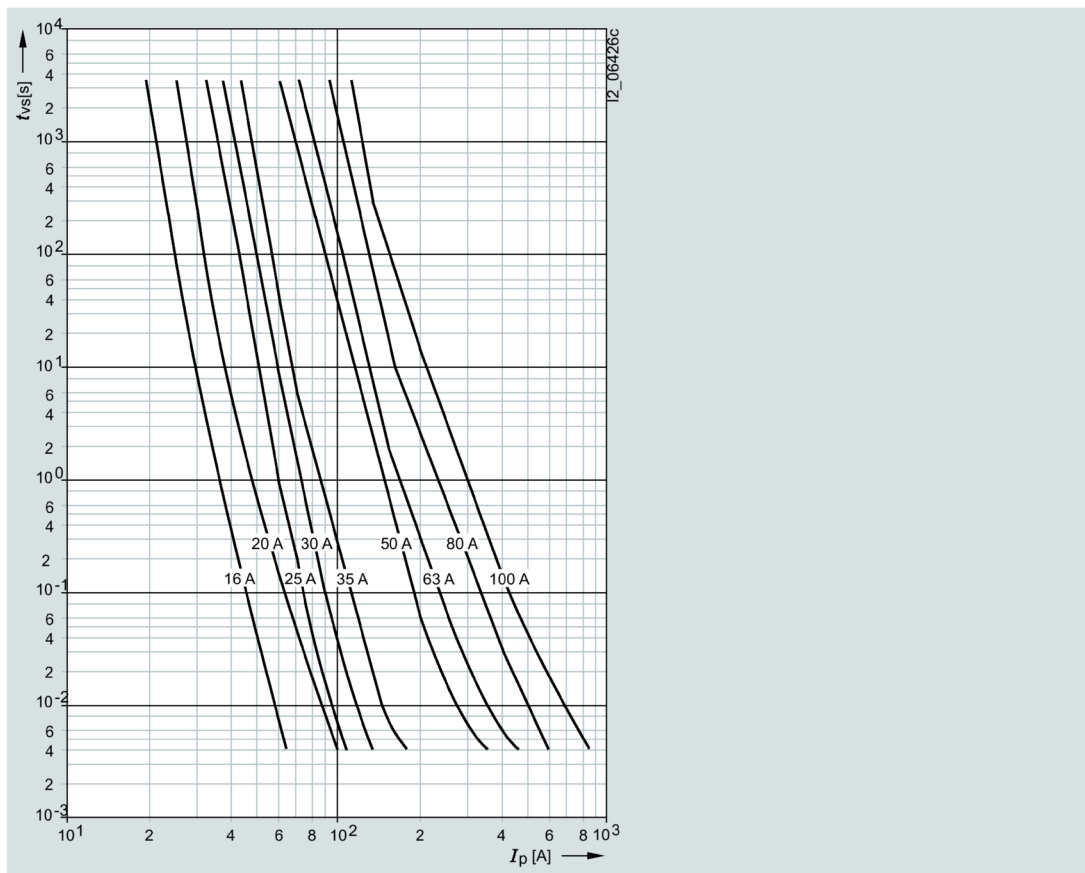



### Current limiting diagram

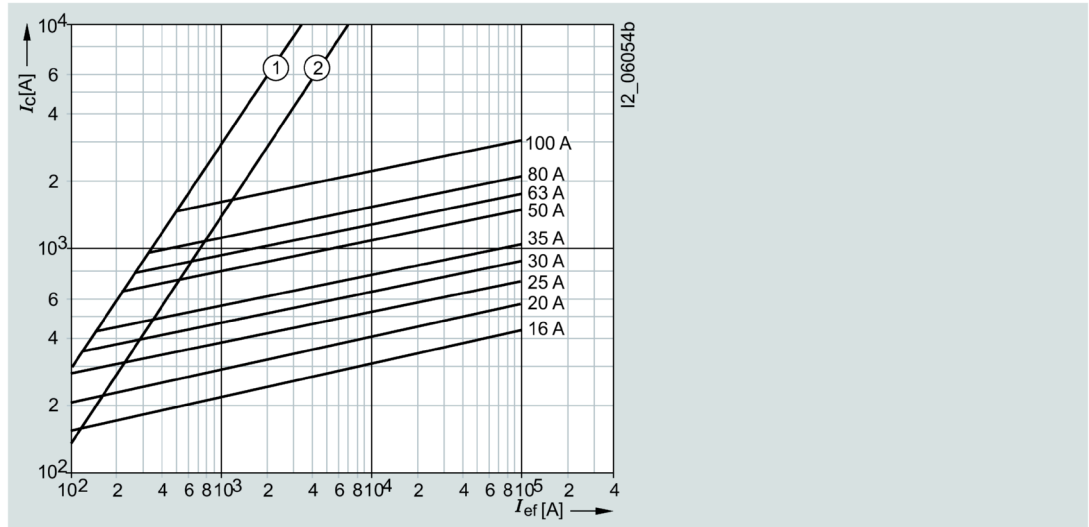

- ① Peak short-circuit current with largest DC component
- ② Peak short-circuit current without DC component

### Melting $I^2t$ values diagram

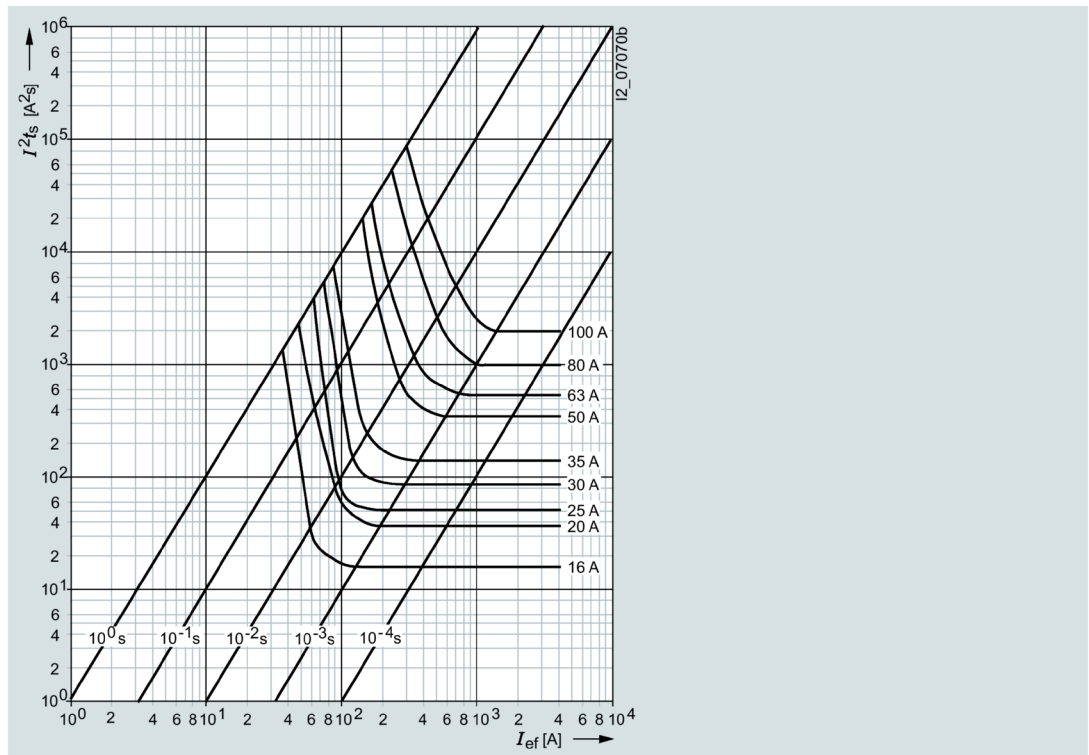



# Photovoltaic fuses

## 8.1 Introduction

### Overview

Special demands are made on fuses for application in photovoltaic systems. These fuses have a high DC rated voltage and a breaking characteristic specially designed to protect PV modules and their connecting cables (the newly defined operational class gPV). It is also crucial that the PV fuses do not age in spite of strongly alternating load currents, in order to ensure high plant availability throughout the service life of the PV system. The fuses must also be able to withstand high temperature fluctuations without damage. These requirements have only been incorporated into an international standard in recent years in the publication IEC 60269-6. All Siemens photovoltaic fuse systems comply with this new standard. Furthermore, they also already comply with the recently agreed corrections to the characteristic curves, which will be incorporated in the next standard update.

The IEC cylindrical fuses used as phase fuses also correspond to the characteristic curves specified in UL standard UL 2579. The non-fusing current  $I_{nf}$  and fusing current  $I_f$  test currents are crucial to the shape of the characteristic curves.

Standard	$I_{nf}$	$I_f$
Current IEC standard	$1.13 \times I_n$	$1.45 \times I_n$
UL standard	$1.0 \times I_n$	$1.35 \times I_n$
Future IEC standard	$1.05 \times I_n$	$1.35 \times I_n$
Siemens fuses	$1.13 \times I_n$	$1.35 \times I_n$

These test currents of gPV string fuses to 32 A apply to a conventional test duration of one hour. At  $I_{nf}$ , the fuse must not trip within an hour; at  $I_f$ , it must trip within an hour.

The PV cylindrical fuses of size 10 mm x 38 mm offer an especially space-saving solution for protection of the strings.

The fuse holders of size 10 x 38 mm can be supplied in single-pole and two-pole versions with and without signal detectors. In the case of devices with signal detector, a small electronic device with LED is located behind an inspection window in the plug-in module. If the inserted fuse link is tripped, this is indicated by flashing of the LED. The devices have a sliding catch that enables removal of individual devices from the assembly. The infeed can be from the top or the bottom. Because the cylindrical fuse holders are fitted with the same anti-slip terminals at the top and the bottom, the devices can also be bus-mounted at the top or the bottom.

The PV fuses in LV HRC design are usually used as cumulative fuses upstream of the inverter. In addition, they can also be used for protecting groups (PV subarrays). For the PV cumulative fuses of size 1, the standard LV HRC fuse bases are available. For PV cumulative fuses of size 1L, 1XL, 2L, 2XL and 3L, we have developed a special 3NH7...-4 fuse base with a swiveling mechanism which combines maximum touch protection with maximum user-friendliness. This makes it possible to change fuses safely and without the need for any tools, such as a fuse handle. This provides safe and fast access even in an emergency.

## 8.1 Introduction

Our cylindrical fuse holders and fuse bases with swiveling mechanism comply with the IEC 60269-2 standard and are considered as fuse disconnectors as defined in the IEC 60947 switchgear and controlgear standard. Under no circumstances are they suitable for switching loads.

To ensure that PV fuses are correctly selected and dimensioned, the specific operating conditions and the PV module data must be taken into account when calculating voltage and current ratings.

### Benefits

- Protection of the modules and their connecting cables in the event of reverse currents
- Reliable breaking in the event of fault currents reduces the risk of fire due to DC electric arcs
- Safe separation when the fuse holder/fuse base is open

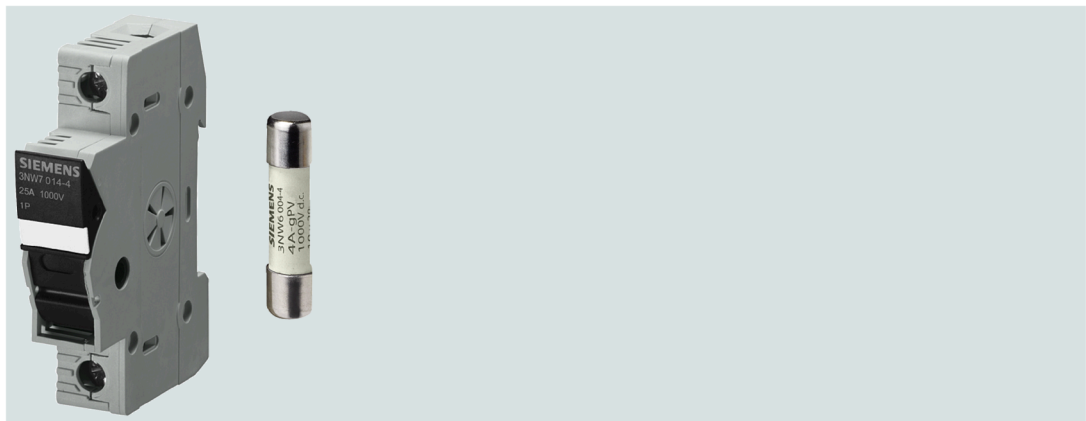

Figure 8-1 PV cylindrical fuse system, 3NW70..-4, 3NW60..-4







Figure 8-2 PV LV HRC fuse system, 3NH73..-4, 3NE13..-4D

## 8.2 PV cylindrical fuses

### 8.2.1 Technical specifications

#### Cylindrical fuse links and cylindrical fuse holders

		Cylindrical fuse links		Cylindrical fuse holders	
		3NW60..-4	3NW66..-4	3NW70..-4	3NW76..-4
Size	mm x mm	10 x 38	10 x 85	-	-
Standards		IEC 60269-6		IEC 60269, IEC 60269-2, IEC 60947, UL 4248-1, UL 4248-18	IEC 60269, IEC 60269-2, IEC 60947, UL 4248-1, UL 4248-18
Approvals		UL 248-13, waiver certification for China (2 to 16 A)	 File No. E469670	 File No. E355487,  ,  (variants without signal detector)	 (E355487)
Operational class		gPV			
Rated voltage $U_n$	V DC	1000	1500 (20 A: 1200 V)	1000	1500
Rated current $I_n$	A DC	2 to 20	4 to 20	30	32
Rated short-circuit strength	kA	-		30	
Rated breaking capacity	kA DC	30	10	-	
Breaking capacity		-		AC-20B, DC-20B	-
• Utilization category		-			
Maximum power dissipation of the fuse links	W	-		4	6
Rated impulse withstand voltage	kV	-		6	-
Overvoltage category		-		II	-
Pollution degree		-		2	-
No-voltage changing of fuse links		-		Yes	
Sealable when installed		-		Yes	
Mounting position		Any, preferably vertical			
Current direction		-		Any (signal detector with antiparallel LED)	
Degree of protection according to IEC 60529		-		IP20, with connected conductors <sup>1)</sup>	
Terminals with touch protection according to BGV A3 at incoming and outgoing feeder		-		Yes	
Ambient temperature	°C	-25 ... +55, humidity 90% at +20 °C			

		Cylindrical fuse links		Cylindrical fuse holders	
		3NW60..-4	3NW66..-4	3NW70..-4	3NW76..-4
<b>Conductor cross-sections</b>	• Finely stranded, with end sleeve	mm <sup>2</sup>	-	0.75 ... 25	
	• AWG (American Wire Gauge)	AWG	-	18 ... 4	
<b>Tightening torque</b>		Nm	-	2.5	

1) Degree of protection IP20 is tested according to regulations using a straight test finger (from the front), with the device mounted and equipped with a cover, housing or some other enclosure.

## 8.2.2 Dimensional drawings

### Cylindrical fuse links

#### 3NW600.-4 (10 x 38 mm)

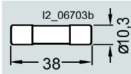

#### 3NW660.-4 (10 x 85 mm)

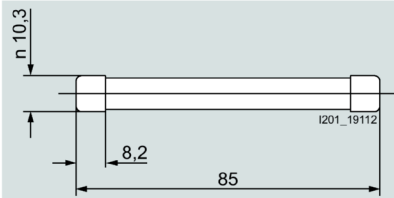

### Cylindrical fuse holders

#### 3NW70. .-4

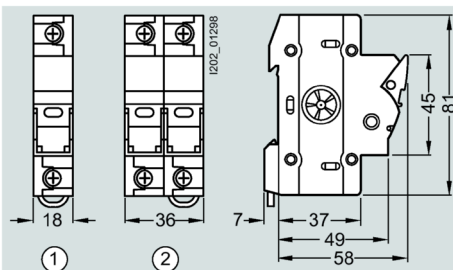

- ① 1-pole
- ② 2-pole

### 3NW7613-4

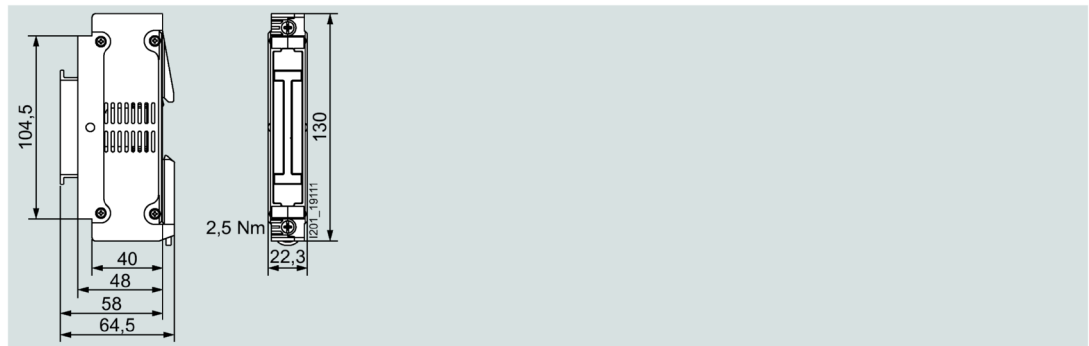

## 8.2.3 Circuit diagrams

### 1-pole



### 2-pole



### 8.2.4 Characteristic curves

Time/current characteristic curves diagram 3NW600.-4

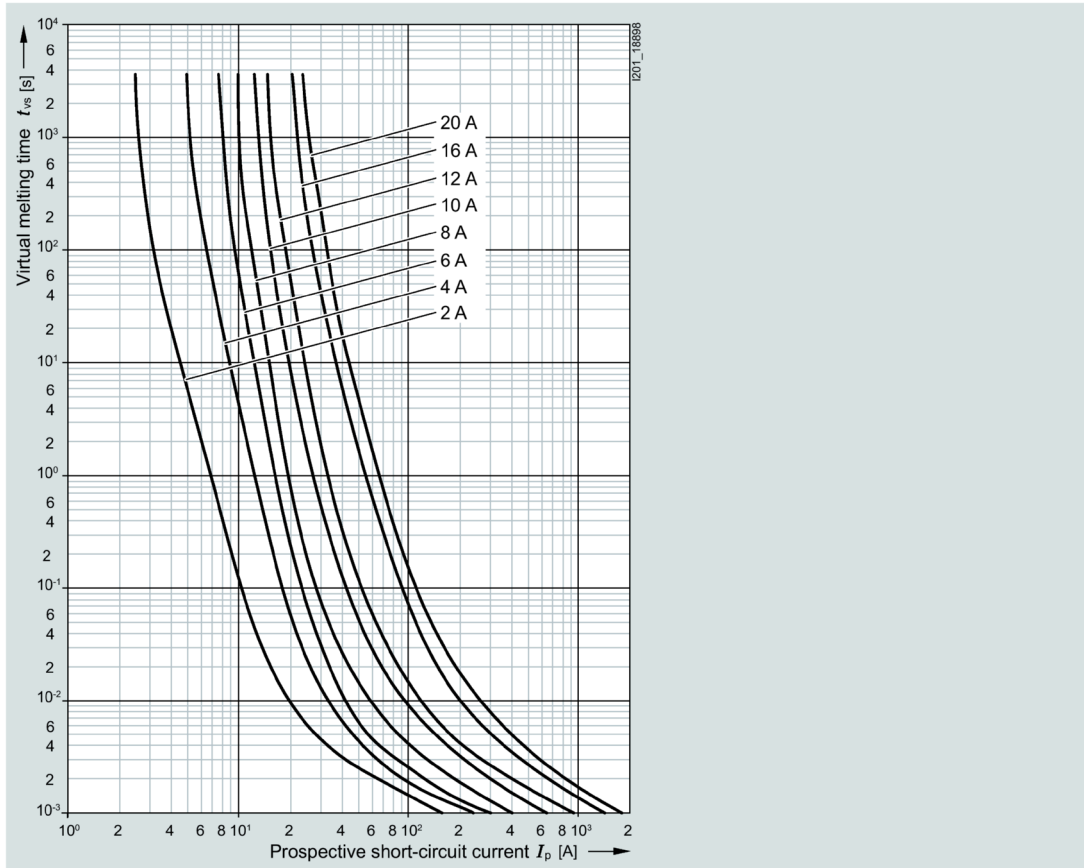



Time/current characteristic curves diagram 3NW660.-4

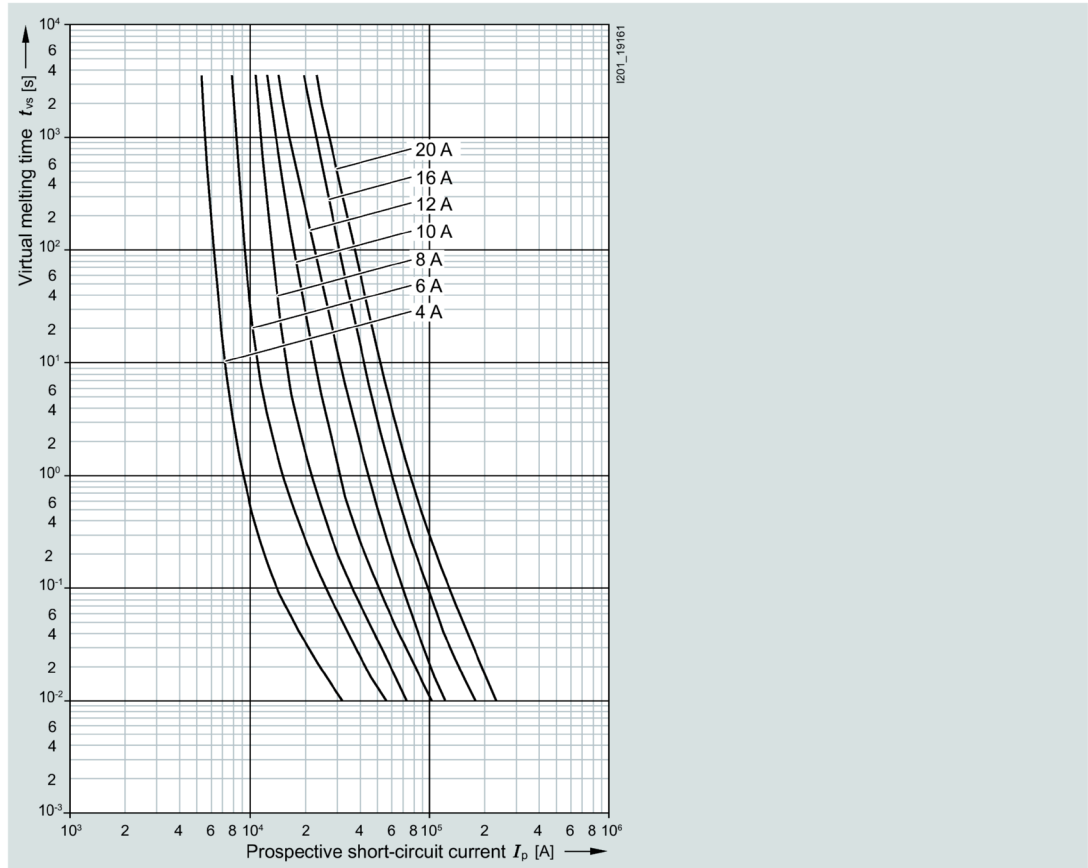

Characteristic curves diagram, correction factor for ambient temperature

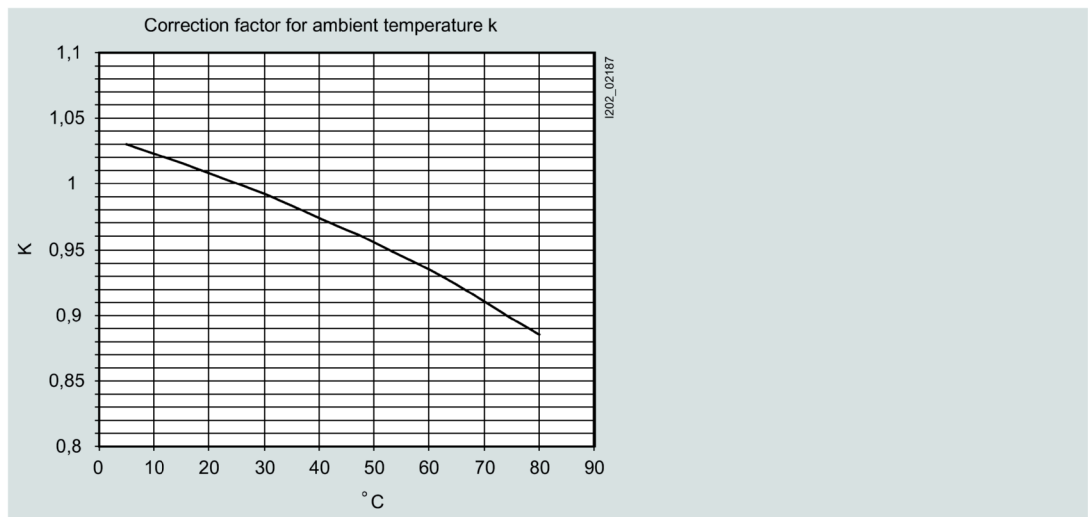

## 8.2.5 Definitions

### Selecting and dimensioning photovoltaic fuses from Siemens

#### Standards:

The contents of the new standard IEC 60269-6 are currently being drawn up. We follow this new standard when rating and labeling our PV fuses. Until now, some of our rivals have been relying on products based on the standard IEC 60269-4 "Fuses for semiconductor protection". Differences between the two standards are particularly evident for the rated voltage and the test voltage and in the definition of the operational class.

#### Terms:

$U_{OC\ STC}$  (also called  $V_{OC\ STC}$ )<sup>1)</sup>

Voltage under standard test conditions on an unloaded string taking into account minimum ambient temperature (no-load voltage). The voltage  $U_{OC\ STC}$  of a string is obtained by multiplying the single voltages  $U_{OC\ STC}$  of a PV module ( $U_{OC\ STC} \times M^2$ ).

$I_{SC\ STC}$

Short-circuit current of a PV module, a PV string, a PV sub-generator or a PV generator under standard test conditions.

$I_{MPP}$

The largest possible working current of a string (MPP = Maximum Power Point).

$I_{P\ max}$

The maximum occurring load current; this is usually equivalent to  $I_{MPP}$ .

$I_{SC\ MOD}$

Short-circuit current of a PV module under regional conditions.

Standard test conditions (STC)

Test conditions which are laid down in DIN EN 60904-3 for PV cells and PV modules:

- Solar radiation 1000 W/m<sup>2</sup>
- Ambient temperature 25 °C
- Air mass (AM) 1.5

Standard test conditions are normally specified by the manufacturer of the PV module in data sheets.

Operational class

We use draft standard IEC 60269-6 as a guide when naming the operational class gPV.

Accordingly, the symbols are also on the fuse:



It is important that the fuse has a full-range characteristic that reliably break all possible fault currents, and especially also small fault currents.<sup>3)</sup>

The test currents for PV fuses are defined in draft standard IEC 60269-6.

$I_{nf} = 1.13 \times I_n$  (test current at which the fuse must **not** trip within one hour)

$I_f = 1.45 \times I_n$  (test current at which the fuse **must** trip within one hour)

The time/current characteristic curves diagram can be found in the chapter Characteristic curves (Page 358).

#### Rated switching capacity

Under draft standard IEC 60269-6, a rated switching capacity of at least 10 kA is required. While this is comparatively low compared with other fuses, it is more than adequate for handling the fault currents occurring in PV systems. We have tested our PV fuses at 30 kA.

#### Dimensioning rules

PV fuses are to be dimensioned according to special rules with regard to rated voltage, rated current and operational class (characteristic).

#### Dimensioning rule

The rated voltage<sup>4)</sup> of the fuse should be calibrated 20% higher than the open-circuit voltage  $U_{OC\ STC}$  of a string. Extreme operating conditions, e.g. temperatures down to -25 °C, are thus taken into account.

#### Rated voltage

Our PV fuses have been tested according to draft standard IEC 60269-6 with the rated voltage, i.e. the test voltage is the same as the rated voltage. Based on IEC 60269-4, some manufacturers have issued two voltage values for their fuses, e.g. 900 V (tested 1000 V).

#### Rated current

1. To prevent unwanted tripping of the PV fuse during normal operation and in case of a fault in a different string that is connected in parallel, the rated current of the PV fuse must be greater than the short-circuit current  $I_{SC}$  of the respective module or string:  $I_n \geq 1.4 I_{SC}$ .

The value 1.4 was determined in draft standard IEC 60269-6 and should apply to the simple dimensioning of the fuse.

This value includes the following correction factors for the standard test conditions: a higher ambient temperature of 45 °C, a higher solar radiation of 1200 W/m<sup>2</sup> and the reduction due to the variable loading.

An additional reduction must be used when several fuse holders are bundled.

According to EN 60469-1, Table 1, the following reduction factors must be applied:

Number of main circuits	Rated diversity factor
2 and 3	0.9
5 and 6	0.8
6 ... 9	0.7
10 or more	0.6

Since the fuses are only operated with around 70 to 80% of the load current, a further reduction is only necessary from around six main circuits (e.g. three two-pole devices), and only for fuses with the maximum power dissipation of 3.4 W.

Fuses with a lower rated current have a lower power dissipation, so that the reduction is considerably less. For example, the 10 A fuse has a rated power dissipation of 1.5 W, with the result that no reduction is necessary here.

In the event of extreme solar radiation, a further reduction of the rated current of the fuse may be necessary.

The short circuit current  $I_{SC\ MOD}$  is dependent on regional climatic conditions. Under certain climatic conditions and cloud constellations, particularly high in the mountains, higher solar

radiation values than the 1200 W/m<sup>2</sup> used above may by all means occur (above: simplified calculation). In order to incorporate the peak values into the calculation, we recommend using the following correction factors:

Climate zone	Max. solar radiation	Correction factor
Standard test conditions	1000 W/m <sup>2</sup>	1
Moderate climate zone	1200 W/m <sup>2</sup>	1.2
Moderate climate zone/high mountains	1400 ... 1600 W/m <sup>2</sup>	1.4 ... 1.6
Africa	1400 ... 1600 W/m <sup>2</sup>	1.4 ... 1.5

The rated current of the fuse refers to an ambient temperature of 25 °C. Breaking performance will change at higher temperatures. A further reduction may be required for an ambient temperature higher than the ambient temperature of +45 °C used above.

2. To protect the modules and their connecting cables, the PV fuse should break fault currents reliably and in time.

Fault currents can result from faulty modules, double ground faults or incorrect wiring. The PV modules are rated in such a way that they can continuously withstand the fault current in the forward direction without any problems.

However, fault currents which flow through the string or the PV module in a reverse direction are particularly critical.

This fault current  $I_{SC\ REVERSE}$  is calculated from the number of parallel connected strings  $n-1$  multiplied by the short circuit current  $I_{SC\ MOD}$  of a string or module:

$$I_{SC\ REVERSE} = n-1 \times I_{SC\ MOD}$$

This  $I_{SC\ MOD}$  is likewise dependent on the regional circumstances described above:

$$I_{SC\ MOD} = 1.2^{5)} \times I_{SC\ STC}$$

Only above  $n = 3$  parallel strings are PV string fuses in any way meaningful.

In order to protect the PV modules against reverse currents  $I_{SC\ REVERSE}$  which have a value higher than the reverse current resistance of the PV modules  $I_{MOD\ REVERSE}$ , the "breaking current" of the PV fuse must be of a smaller size than the permitted and tested reverse current resistance of the module.

You can dispense with PV fuses if the reverse current resistance of the PV modules is greater than the fault current:

$$I_{MOD\ REVERSE} > I_{SC\ REVERSE}$$

The manufacturers of the modules normally test their modules with 1.35 x the reverse current for two hours.

For protection, you therefore need a fuse that trips earlier under these conditions.

The PV fuses have a "breaking current" (referred to as high test current  $I_f$  in the standard) which causes the fuse to trip at 1.45 x the rated current in under one hour at the latest.

To connect the tested reverse current resistance of the PV modules  $I_{MOD\ REVERSE}$  with the breaking performance of the fuse, we recommend use of a conversion factor of 0.9.

This following dimensioning rule for the rated current of the PV fuse  $I_n$  is derived as a result:

$$I_n \leq 0.9 \times I_{MOD\ REVERSE}$$

This does not consider possible fault currents which are fed by the back-up batteries and/or the solar converter.

Protection of the factory-fitted connecting cables of the PV modules should be mainly ensured by the manufacturer.

Connecting cables/wires of a string must generally be able to withstand  $n$  times the short-circuit current  $I_{SC\ MOD}$ . As with other cables and wires, the following simple relationship applies:

$$I_n \leq I_z^{(6)}$$

If several strings connected in parallel are grouped together, the aforementioned dimensioning rules also apply. The rated current of the PV fuse group should be at least 1.2<sup>5)</sup> times greater than the total of the short-circuit currents of the group.

1) Voltage of the unloaded circuit under standard test conditions.

2)  $M$  is the number of PV modules connected in series in a string.

3) A difference in the overload current and the short-circuit current is not meaningful when protecting PV systems because even in the event of a short circuit only small currents occur, which are not designated as short-circuit currents in terms of the standards of overcurrent protective devices. We therefore use the term fault currents in the following.

4) Unlike with mechanical switching devices, when two fuses (positive pole and negative pole) are used, you cannot count on voltage sharing in the event of fault current breaking. Accordingly every fuse must be dimensioned with the full rated voltage.

5) Further information about correction factor 1.2 ... 1.6 dependent on climate zone can be found in the table above.

6)  $I_z$  is the permitted current carrying capacity of the line/cable.

## 8.3 PV cumulative fuses

### 8.3.1 Technical specifications

#### Fuse links and fuse bases

		Fuse links 3NE1...-4 / -4D / -4E / -5E						Fuse bases 3NH7...-4					
Size	-	1	1L	2L	3L	1XL	2XL	1	1L	2L	3L	1XL	2XL
Standards	-	IEC 60269-6						IEC 60269, IEC 60269-2, IEC 60947					
Operational class	-	gPV											
Rated voltage $U_n$	V DC	1000 at time constant (L/R) 3 ms 1500 at time constant (L/R) 3 ms						1000			1500		
Rated current $I_n$	A DC	63 ... 160	200/ 250	315/ 400	500/ 630	63 ... 200	250/ 315	250	400	630	250	400	
Rated short-circuit strength	kA	-						30					
Rated breaking capacity	kA DC	30						-					

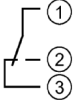
		Fuse links 3NE1...-4 / -4D / -4E / -5E	Fuse bases 3NH7...-4			
<b>Breaking capacity</b>			AC-20B, DC-20B (switching without load)			
• Utilization category	-	-				
<b>Maximum power dissipation of the fuse links</b>	W	-	40	90	110	130
<b>No-voltage changing of fuse links</b>	-	-	Yes			
<b>Sealable when installed</b>	-	-	Yes			
<b>Mounting position</b>	-	Any, preferably vertical				
<b>Current direction</b>	-	-	Any			
<b>Ambient temperature</b>	°C	-25 ... +55, humidity 90% at +20 °C				
<b>Tightening torque</b>	Nm	-	20			
<b>Microswitch for "tripped" signaling</b> 5 A / 250 V AC, 0.2 A / 250 V DC	-	In the "fuse not tripped" state, contacts 1 and 3 are closed. 				

### 8.3.2 Dimensional drawings

#### 3NE1 fuse links

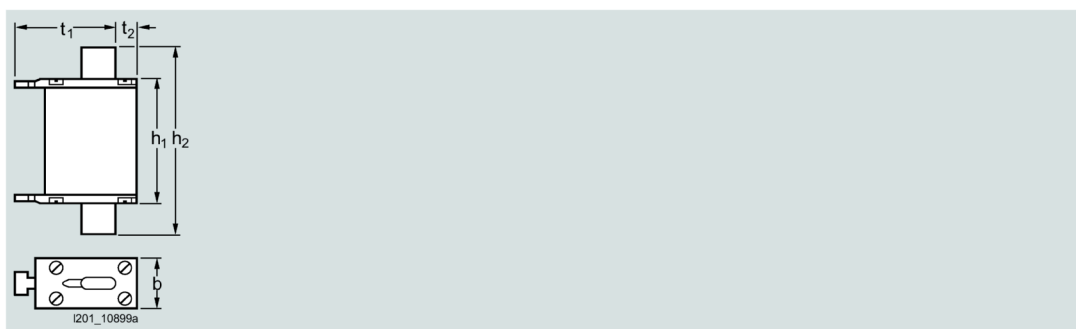

Size	In A	b mm	h <sub>1</sub> mm	h <sub>2</sub> mm	t <sub>1</sub> mm	t <sub>2</sub> mm
1	63 ... 160	52	66.5	135	50	13.5
1L	200, 250	52	106.5	175	50	13.5
2L	315, 400	60	106.5	189	57	15
3L	500, 630	75	125.5	201	68.5	17.5
1XL	63 ... 200	52	126.5	189	50	13.5
2XL	250, 315	60	126.5	205	57	15

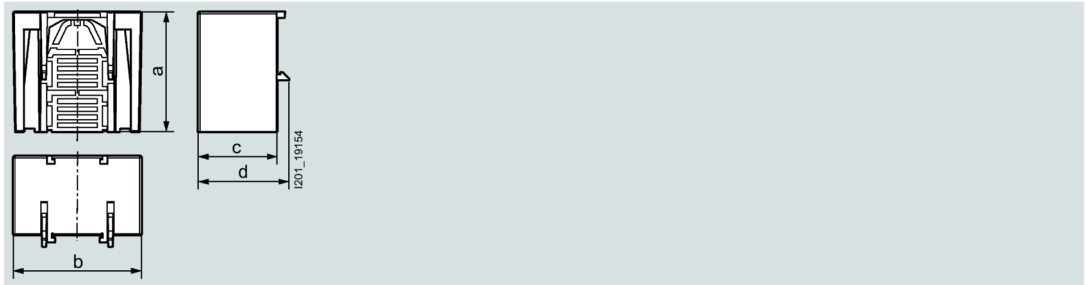

Type	a mm	b mm	c mm	d mm
3NX3121	67	71.3	44	50.5
3NX3122	81	78.8	71	77
3NX3123	95	93.3	80	86

### Fuse bases 3NH73..-4

#### Fuse bases with swiveling mechanism, 3NH7 3..-4

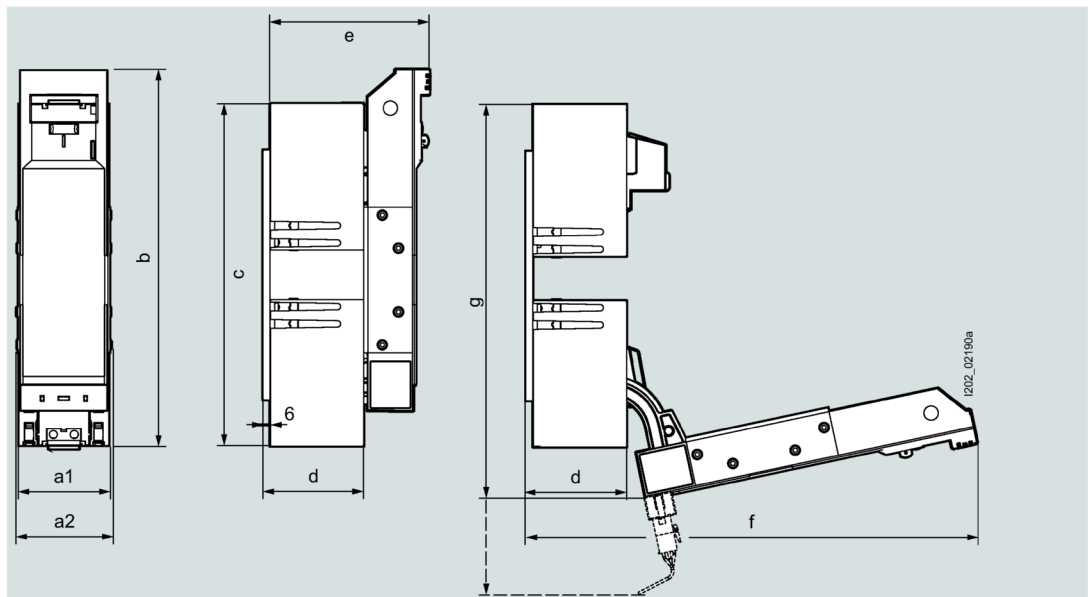

Size	a1 mm	a2 mm	b mm	n mm	d mm	e mm	f mm	g mm
1	71.3	71.3	266	230	67	124	316.4	317.7
1L	71	75	306	270	73	130	362	313
2L	79	83	326	296	87	144	390	335
3L	93	97	341	311	101	158	418	359
1XL	71	76	325	289	73	124	380	332
2XL	79	83	341	311	87	144	410	354

**Drilling plan**

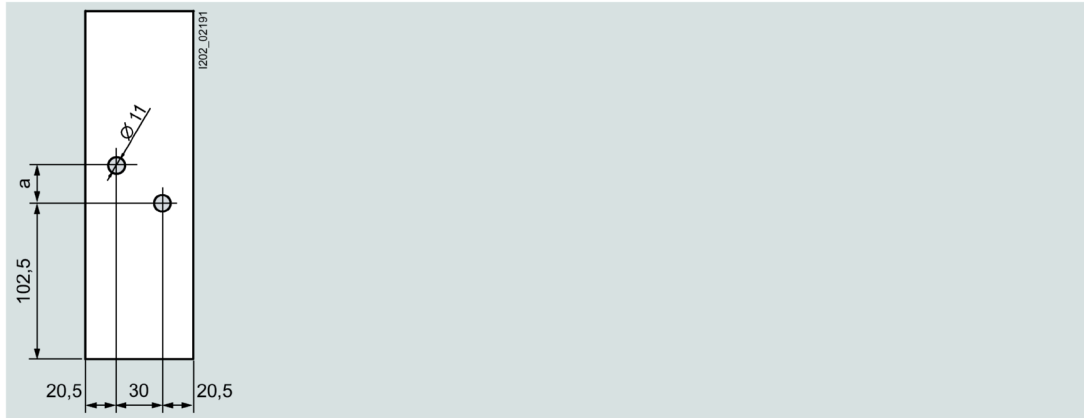

Size	a mm
1	25
1L	65
2L	65
3L	80
1XL	84
2XL	80

**8.3.3 Circuit diagrams**

**Circuit diagrams**

**1-pole**





### 8.3.4 Characteristic curves

#### Characteristic curves

Time/current characteristic curves diagram 1000 V

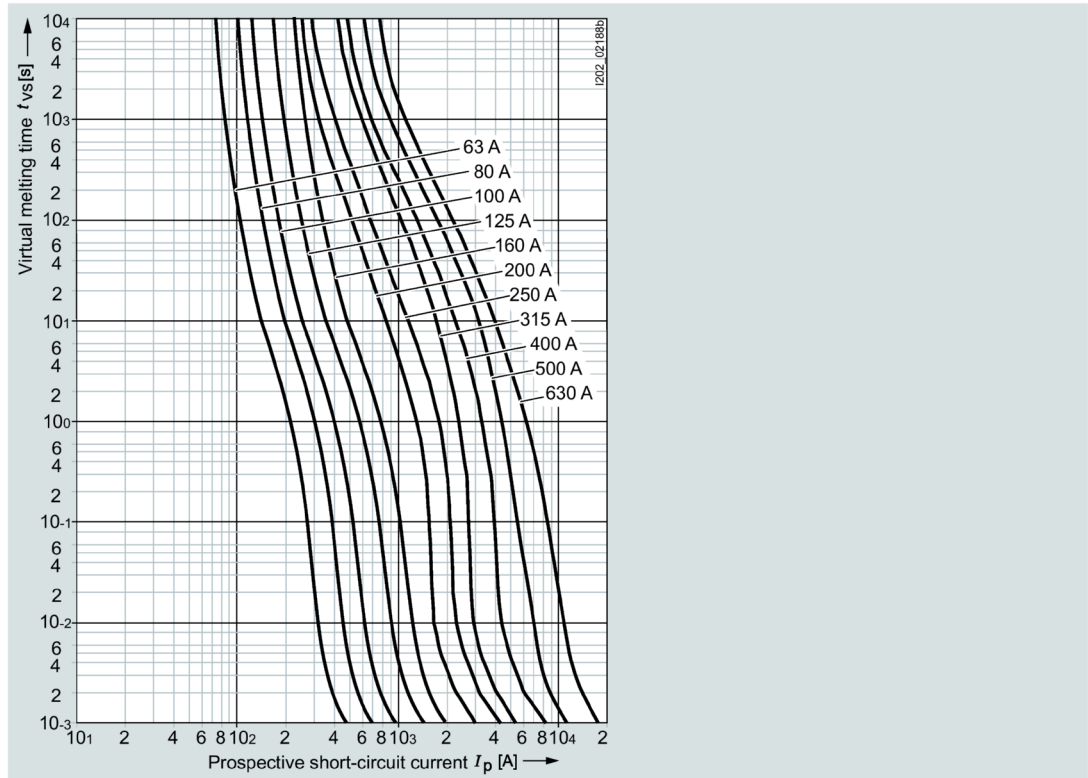

Time/current characteristic curves diagram 1500 V

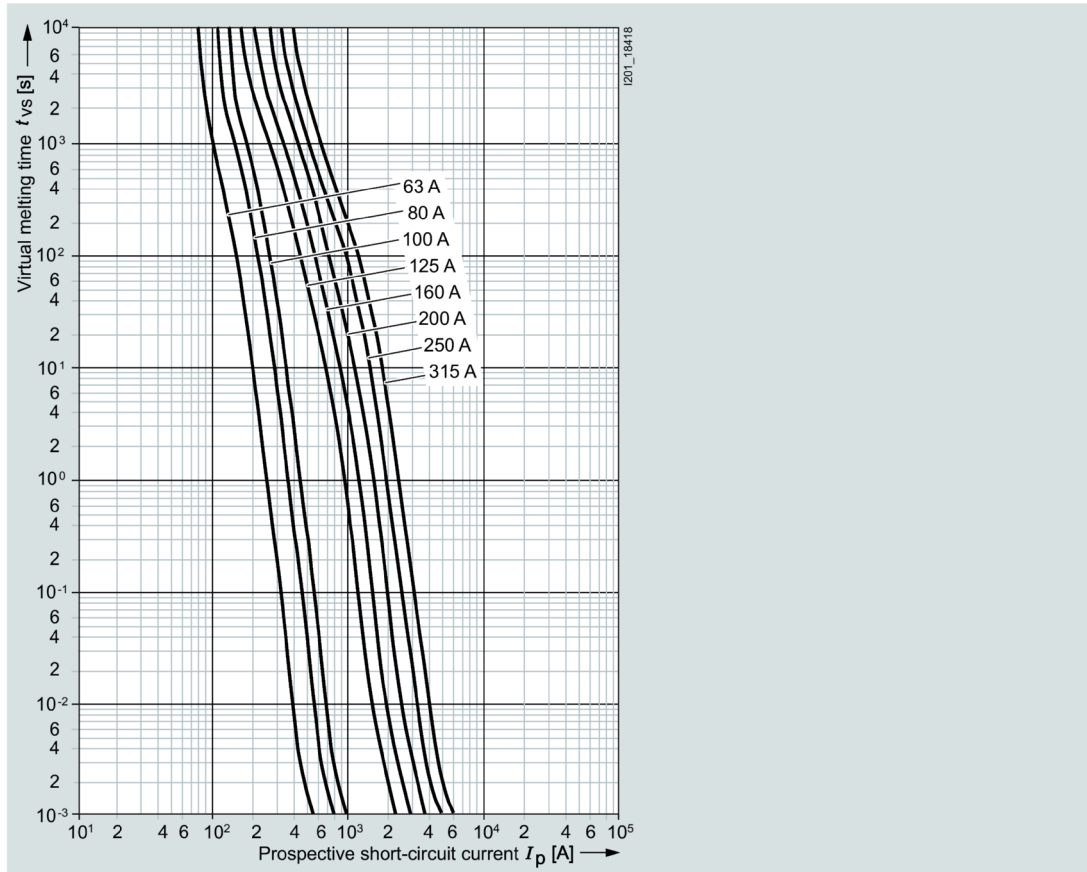

## Definitions / Glossary

### 9.1 Indicator

An indicator displays the switching of the fuse link. The SITOR fuse links have an indicator whose operational voltage lies between 20 V ( $U_n \leq 1000$  V) and 40 V ( $U_n > 1000$  V).

### 9.2 Selection examples

For a converter assembly in circuit (B6) A (B6) C whose rated direct current is  $I_{dn} = 850$  A, fuse links that can be installed as branch fuses should be selected. The choice of fuse is shown for different operating modes of the converter assembly.

#### Data for converter assembly

- Supply voltage  $U_N = 3$  AC 50 Hz 400 V
- Recovery voltage  $U_W = 360$  V =  $U_N \times 0.9$  (for inverter shoot-throughs)
- Thyristor T 508N (Eupec), limit load integral  $\int I^2 dt = 320 \times 10^3 A^2s$  (10 ms, cold)
- Fuse links with natural air cooling, ambient temperature  $\vartheta_u = +35$  °C
- Conductor cross-section for copper fuse links: 160 mm<sup>2</sup>
- Conversion factor for direct current  $I_d$  / fuse load current  $I_{La}$ :  $I_{La} = I_d \times 0.58$

For the following examples, it is assumed, in the case of loads that exceed the rated direct current of the converter assembly, that the converter assembly is rated for these loads.

#### Continuous, no-break load

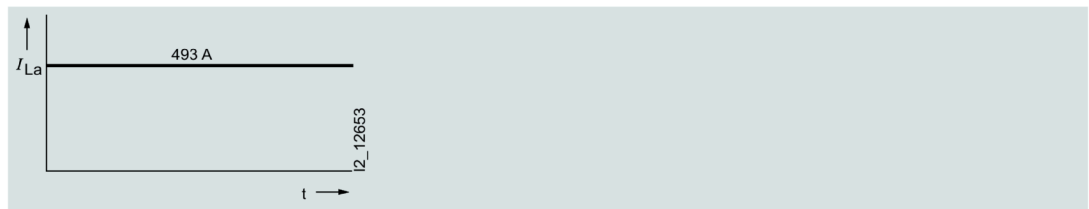

Direct current  $I_d = I_{dn} = 850$  A

$$I_{La} = I_d \times 0.58 = 493 \text{ A}$$

Selection:

SITOR fuse link 3NE3335

(560 A / 1000 V),  $WL = 1$

Breaking  $I^2t$  value  $I^2t_A = 360 \times 10^3 \times 0.53 = 191 \times 10^3 A^2s$

Test cross-section according to page 172: 400 mm<sup>2</sup>

The following correction factors are to be applied:

- $k_u = 1.02$  ( $\vartheta_u = +35\text{ °C}$ )
- $k_q = 0.91$  (conductor cross-section, 40% of test cross-section at both ends)
- $k_\lambda = 1.0$  (conduction angle  $\lambda = 120^\circ$ )
- $k_l = 1.0$  (no forced-air cooling)

Required rated current  $I_n$  of the SITOR fuse link:

$$I_n \geq I_{La} \times \frac{1}{k_u \times k_q \times k_\lambda \times k_l \times WL} =$$

$$493\text{ A} \times \frac{1}{1,02 \times 0,91 \times 1,0 \times 1,0 \times 1,0} = 531\text{ A}$$

### Unknown varying load, but with known maximum current

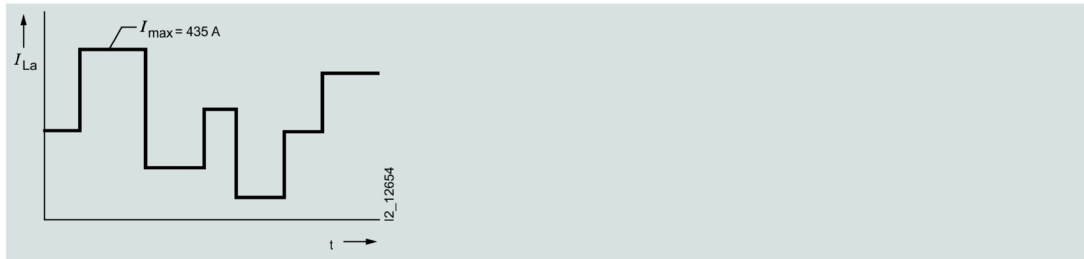

Max. direct current  $I_{dmax} = 750\text{ A}$

Max. fuse current  $I_{max} = I_{dmax} \times 0.58 = 435\text{ A}$

Selection:

SITOR fuse link 3NE3334-0B

(560 A / 1000 V), WL = 1

Breaking  $I^2t$  value  $I^2t_a = 260 \times 10^3 \times 0.53 = 138 \times 10^3\text{ A}^2\text{s}$

Test cross-section according to page 172: 400 mm<sup>2</sup>

The following correction factors are to be applied:

- $k_u = 1.02$  ( $\vartheta_u = +35\text{ °C}$ )
- $k_q = 0.91$  (conductor cross-section, 40% of test cross-section at both ends)
- $k_\lambda = 1.0$  (conduction angle  $\lambda = 120^\circ$ )
- $k_l = 1.0$  (no forced-air cooling)

Required rated current  $I_n$  of the SITOR fuse link:

$$I_n > I_{max} \times \frac{1}{k_u \times k_q \times k_\lambda \times k_l \times WL} =$$

$$435\text{ A} \times \frac{1}{1,02 \times 0,91 \times 1,0 \times 1,0 \times 1,0} = 469\text{ A}$$

### Varying load with known load cycle

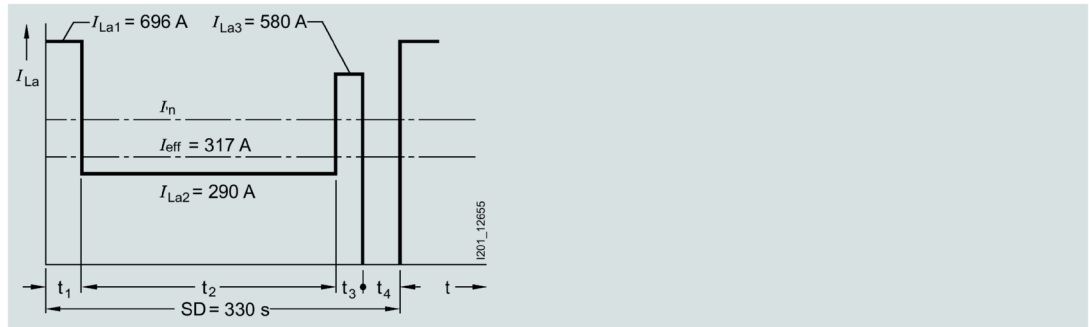

Direct current:

$$\begin{aligned} I_{d1} &= 1200 \text{ A} & t_1 &= 20 \text{ s} \\ I_{d2} &= 500 \text{ A} & t_2 &= 240 \text{ s} \\ I_{d3} &= 1000 \text{ A} & t_3 &= 10 \text{ s} \\ I_{d4} &= 0 \text{ A} & t_4 &= 60 \text{ s} \end{aligned}$$

Fuse current:

$$\begin{aligned} I_{La1} &= 120 \times 0.58 = 696 \text{ A} \\ &0 \\ I_{La2} &= 500 \times 0.58 = 290 \text{ A} \\ I_{La3} &= 100 \times 0.58 = 580 \text{ A} \\ &0 \end{aligned}$$

rms value of load current

$$I_{\text{eff}} = \sqrt{\frac{696^2 \times 20 + 290^2 \times 240 + 580^2 \times 10}{330}} = 317 \text{ A}$$

Selection:

SITOR fuse link 3NE3333

(450 A / 1000 V), WL = 1

Breaking  $I^2t$  value  $I^2t_a = 175 \times 10^3 \times 0.53 = 93 \times 10^3 \text{ A}^2\text{s}$

Test cross-section according to page 172: 320 mm<sup>2</sup>

The following correction factors are to be applied:

$$\begin{aligned} k_u &= 1.02 (\vartheta_u = +35 \text{ }^\circ\text{C}) \\ k_q &= 0.94 \text{ (conductor cross-section, 50\% of test cross-section at both ends)} \\ k_\lambda &= 1.0 \text{ (conduction angle } \lambda = 120^\circ) \\ k_i &= 1.0 \text{ (no forced-air cooling)} \end{aligned}$$

1. Required rated current  $I_n$  of the SITOR fuse link:

$$I_n \geq I_{\text{Eff}} \times \frac{1}{k_u \times k_q \times k_\lambda \times k_l \times \text{WL}} =$$

$$317 \text{ A} \times \frac{1}{1,02 \times 0,94 \times 1,0 \times 1,0 \times 1,0} = 331 \text{ A}$$

Permissible load current  $I_n$  of the selected fuse link:

$$I_n = k_u \times k_q \times k_\lambda \times k_l \times \text{WL} \times I_n = 1.02 \times 0.94 \times 1.0 \times 1.0 \times 1.0 \times 450 = 431 \text{ A}$$

2. Check of the permissible overload duration of current blocks exceeding the permissible fuse load current  $I_n$

Previous load ratio:

$$V = \frac{I_{\text{eff}}}{I_n} = \frac{317}{431} = 0,74$$

Residual value factor RW: For  $V = 0.74$  from curve a (characteristic curve Taking into account preloading, residual value factor RW (Page 377), frequent peak/load cycle currents)  $RW = 0.2$

Current block  $I_{La1}$ : Melting time  $t_{vs}$ : 230 s (from time/current characteristic curve for 3NE3 333)  $t_{vs} \times RW = 230 \text{ s} \times 0.2 = 46 \text{ s} > t_1$

Current block  $I_{La3}$ : Melting time  $t_{vs}$ : 1200 s (from time/current characteristic curve for 3NE3 333)  $t_{vs} \times RW = 1200 \text{ s} \times 0.2 = 240 \text{ s} > t_3$

### Occasional peak load from preloading with unknown peak outcome

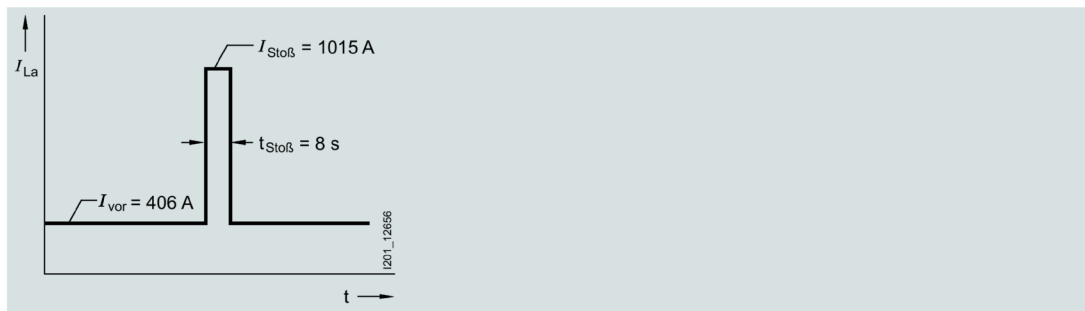

Direct current:

$$\begin{aligned} I_{d\_pre} &= 700 \text{ A} \\ I_{d\_sur} &= 500 \text{ A} \quad t_{peak} = 8 \text{ s} \end{aligned}$$

Fuse current:

$$\begin{aligned} I_{previ-ous} &= I_{d\_pre} \times 0.58 = 406 \text{ A} \\ I_{peak} &= I_{d\_sur} \times 0.58 = 1015 \text{ A} \end{aligned}$$

The conditions  $t_{pause} \geq 3 t_{peak}$  and  $t_{pause} \geq 5 \text{ min}$  are met.

Selection:

SITOR fuse link 3NE3333

(560 A / 1000 V), WL = 1

Breaking  $I^2t$  value  $I^2t_a = 360 \times 10^3 \times 0.53 = 191 \times 10^3 \text{ A}^2\text{s}$

Test cross-section according to page 172: 400 mm<sup>2</sup>

The following correction factors are to be applied:

$$k_u = 1.02 (\vartheta_u = +35 \text{ °C})$$

$$k_q = 0.91 \text{ (conductor cross-section, 40\% of test cross-section at both ends)}$$

$$k_\lambda = 1.0 \text{ (conduction angle } \lambda = 120^\circ)$$

$$k_l = 1.0 \text{ (no forced-air cooling)}$$

1. Required rated current  $I_n$  of the SITOR fuse link:

$$I_n \geq I_{\text{vor}} \times \frac{1}{k_u \times k_q \times k_\lambda \times k_l \times WL} =$$

$$406 \text{ A} \times \frac{1}{1,02 \times 0,91 \times 1,0 \times 1,0 \times 1,0} = 437 \text{ A}$$

Permissible load current  $I_n$  of the selected fuse link:

$$I_n = k_u \times k_q \times k_\lambda \times k_l \times WL \times I_n = 1.02 \times 0.91 \times 1.0 \times 1.0 \times 1.0 \times 560 = 520 \text{ A}$$

2. Check of the permissible overload duration of the peak current  $I_{\text{peak}}$

Previous load ratio:

$$V = \frac{I_{\text{vor}}}{I_n} = \frac{406}{520} = 0,78$$

Residual value factor RW: For  $V = 0.78$  from curve a (characteristic curve Taking into account preloading, residual value factor RW (Page 377), frequent peak/load cycle currents)  $RW = 0.18$

Peak current  $I_{\text{peak}}$ : Melting time  $t_{\text{vs}}$ : 110 s (from time/current characteristic curve for 3NE3333)  $t_{\text{vs}} \times RW = 110 \text{ s} \times 0.18 = 19.8 \text{ s} > t_{\text{peak}}$

Correction factors in the chapter Definitions / Glossary (Page 369).

## See also

Taking into account preloading, residual value factor RW (Page 377)

## 9.3 Breaking capacity

The rated breaking capacity is the highest prospective short-circuit current  $I_p$  that the fuse link can clear under prescribed conditions.

A key feature of these fuses is their high rated breaking capacity with the smallest footprint. The basic demands and circuit data for tests – voltage, power factor, actuating angle, etc. – are specified in both national (DIN VDE 0636) and international (IEC 60269) regulations.

However, for a constant fail-safe breaking capacity, from the smallest non-permissible overload current through to the highest short-circuit current, a number of quality

characteristics need to be taken into account when designing and manufacturing fuse links. These include the design of the fuse element with regard to dimensions and punch dimension and its position in the fuse body, as well as its compressive strength and the thermal resistance of the body. The chemical purity, particle size and the density of the quartz sand also play a key role.

With AC voltage, the rated breaking capacity of NEOZED fuses and the majority of DIAZED fuses is 50 kA. In the case of our LV HRC fuses, this even increases to 120 kA. The various type ranges of SITOR semiconductor fuses have different breaking capacities ranging from 50 to 100 kA.

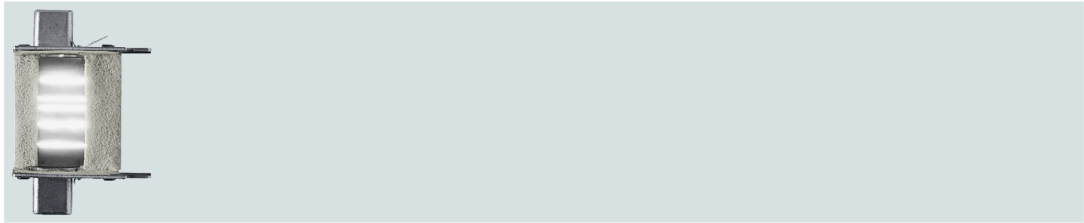

Faster arcing and precise arc quenching are the requirements for a reliable breaking capacity.

## 9.4 Rated breaking capacity

The rated breaking capacity of all SITOR fuse links is at least 50 kA, unless higher values are specified in the characteristic curves.

The data applies to a test voltage of  $1.1 \times U_n$ , 45 Hz to 62 Hz and  $0.1 \leq \cos \varphi \leq 0.2$ . In the case of inception voltages that are below the rated voltage, as well as rated currents of the fuse links that are below the maximum rated current of a fuse series, the breaking capacity is considerably higher than the rated breaking capacity.

## 9.5 Rated frequency

The rated frequency is the frequency for which the fuse link is rated with regard to power dissipation, current, voltage, characteristic curve and breaking capacity.

## 9.6 Rated power dissipation

Rated power dissipation is the power loss during the load of a fuse link with its rated current under prescribed conditions.

The cost effectiveness of a fuse depends largely on the rated power dissipation (power loss). This should be as low as possible and have a low intrinsic temperature rise. However, when assessing the power loss of a fuse, it must also be taken into account that there is a physical dependence between the rated breaking capacity and the rated power dissipation. On the one hand, fuse elements need to be very thick in order to achieve the lowest possible resistance value, on the other, a high rated breaking capacity requires the thinnest possible fuse elements in order to achieve reliable arc quenching.



Siemens fuses have the lowest possible rated power dissipation while also providing the highest possible load breaking reliability.

These values lie far below the limit values specified in the regulations. This means a low temperature rise, reliable breaking capacity and high cost effectiveness.

## 9.7 Rated voltage $U_n$

The rated voltage is the designated voltage of the fuse and is used to determine its test conditions and operational voltage limits.

The rated voltage of a SITOR fuse link is the voltage specified as the rms value of the AC voltage on the fuse link and in the ordering and configuration data and the characteristics.

In the case of NEOZED and DIAZED fuse links, a distinction is made between AC and DC voltage values.

For wind power plants and some industrial applications, a higher voltage tolerance is demanded of the LV HRC and SITOR fuses than the tolerance of +5% defined in the standard. On request, you can obtain a manufacturer's declaration for the rated voltage of 690 V +10%.

Always ensure that the rated voltage of the fuse link you select is such that the fuse link will reliably quench the voltage driving the short-circuit current. The driving voltage must not exceed the value  $U_n + 10\%$ . Please note that the supply voltage  $U_{v0}$  of a power converter can also be increased by 10%. If, in the shorted circuit, two branches of a converter circuit are connected in series, and if the short-circuit current is sufficiently high, it can be assumed that voltage sharing is uniform. It is essential to observe the instructions in this chapter.

### Rectifier operation

The supply voltage  $U_{v0}$  is the driving voltage with converter equipment that can only be used for rectifier operation.

### Inverter operation

Faults in the form inverter shoot-throughs can occur in converter equipment that is also used for inverter operation. In this case, the driving voltage  $U_{wk}$  in the shorted circuit is the sum of the infeed direct voltage (e.g. the e.m.f. of the DC generator) and the AC-line supply voltage. When rating a fuse link, this sum can be replaced by an AC voltage whose rms value is 1.8 times that of the AC-line supply voltage ( $U_{wk} = 1.8 U_{v0}$ ). The fuse links must be rated so that they reliably quench the voltage  $U_{wk}$ .

## 9.8 Rated current $I_n$

The rated current of a fuse link is the designated current of the fuse link and is the current up to which it can be continuously loaded under prescribed conditions without adverse affects.

The rated current of a SITOR fuse link is the current specified in the "Selection and ordering data", in the "Characteristic curves" and on the fuse link as the rms value of an alternating current for the 45 Hz to 62 Hz frequency range.

9.8 Rated current  $I_n$

When operating fuse links with rated current, the following are considered normal operating conditions:

- Natural air cooling with an ambient temperature of +45 °C
- Conductor cross-sections equal to test cross-sections ("Test cross-sections" table), for operation in LV HRC fuse bases and switch disconnectors, see "Selection and ordering data" in Catalog LV 10.
- Conduction angle of a half-period 120°el
- Continuous load maximum with rated current

For operating conditions that deviate from the above, the permissible load current  $I_n$  of the SITOR fuse link can be determined using the following formula:

$$I_n' = k_u \times k_q \times k_\lambda \times k_l \times WL \times I_n$$

where

$I_n$	Rated current of the fuse link <sup>1)</sup>
$k_u$	Correction factor for ambient temperature $k_u$ (Page 390)
$k_q$	"Correction factor for conductor cross-section $k_q$ " in Correction factor for ambient temperature $k_u$ (Page 390)
$k_\lambda$	"Correction factor for conduction angle $k_\lambda$ " in Correction factor for ambient temperature $k_u$ (Page 390)
$k_l$	"Correction factor for reinforced air cooling $k_l$ " in Correction factor for ambient temperature $k_u$ (Page 390)
WL	"Varying load factor WL" in Correction factor for ambient temperature $k_u$ (Page 390)

<sup>1)</sup> When using SITOR fuse links in LV HRC fuse bases according to IEC/EN 60269-2-1 and in fuse switch disconnectors and switch disconnectors with fuses, please also refer to the information in the "Selection and ordering data" in Catalog LV 10.

**Test cross-sections**

Rated current	Test cross-sections	
$I_n$	3NC10, 3NC11, 3NC14, 3NC15, 3NC22, 3NE1..., 3NE80., 3NE4 series <sup>1)</sup>	All other series
A	Cu mm <sup>2</sup>	Cu mm <sup>2</sup>
10	1	-
16	1.5	-
20	2.5	45
25	4	45
35	6	45
40	10	45
50	10	45
63	16	45
80	25	45
100	35	60

Rated current	Test cross-sections	
	$I_n$	All other series
A	Cu mm <sup>2</sup>	Cu mm <sup>2</sup>
125	50	80
160	70	100
200	95	125
224	-	150
250	120	185
315	2 × 70	240
350	2 × 95	260
400	2 × 95	320
450	2 × 120	320
500	2 × 120	400
560	2 × 150	400
630	2 × 185	480
710	2 × (40 × 5)	560
800	2 × (50 × 5)	560
900	2 × (80 × 4)	720
1000	-	720
1100	-	880
1250	-	960
1400	-	1080
1600	-	1200

## 9.9 Taking into account preloading, residual value factor RW

Preloading the fuse link shortens the permissible overload duration and the melting time.

The residual value factor RW can be used to determine the time that a fuse link can be operated without aging during a periodic or non-periodic load cycle, above and beyond the previously determined permissible load current  $I_n$ , with any overload current  $I_{La}$ .

The residual value factor RW is dependent on the preloading V ( $I_{rms}$  rms value of the fuse current during the load cycle at permissible load current  $I_n$ )

$$V = \frac{I_{eff}}{I_n}$$

and the frequency of the overloads (see the following diagram, curves a and b).

**Permissible overload and melting time for previous load**

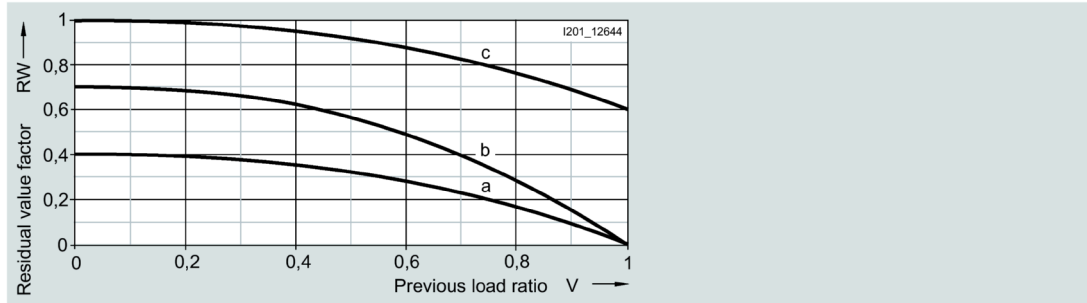

- a Frequent peak/load cycle currents (> 1/week)
- b Rare peak/load cycle currents (< 1/week)
- c Melting time for preloading

Permissible overload duration =

Residual value factor RW × melting time  $t_{vs}$  (time/current characteristic curve)

A reduction of the melting time of a fuse link in the case of preloading can be derived from curve c.

Melting time =

Residual value factor RW × melting time  $t_{vs}$  (time/current characteristic curve)

## 9.10 Operational classes

Fuses are categorized into operational classes according to their function. The first letter defines the function class and the second the object to be protected:

### 1st letter

- a Partial-range protection (accompanied fuses):

Fuse links that can continuously carry currents at least up to their specified rated current and that can switch currents above a specific multiple of their rated current up to their rated breaking current.

- g Full-range protection (general purpose fuses):

Fuse links that can continuously carry currents up to at least their specified rated current and that can switch currents from the smallest melting current through to the breaking current. Overload and short-circuit protection.

### 2nd letter

- G Cable and line protection (general applications)
- M Switching device protection in motor circuits (for protection of motor circuits)
- R, S Semiconductor protection/thyristor protection (for protection of rectifiers)

- L Cable and line protection  
(in acc. with the old, no longer valid DIN VDE)
- B Mine equipment protection
- Tr Transformer protection

The designations "slow" and "quick" still apply to DIAZED fuses. These are defined in IEC / CEE / DIN VDE.

In the case of "quick" characteristics, the fuse blows faster in the short-circuit range than those of operational class gG.

In the case of DIAZED fuse links for DC railway network protection, the "slow" characteristic is particularly suitable for breaking direct currents with greater inductance. Both characteristics are also suitable for the protection of cables and lines.

Full-range fuses (gG, gR, quick, slow) reliably break the current in the event of non-permissible overload and short-circuit currents.

Partial-range fuses (aM, aR) exclusively serve short-circuit protection.

The following operational classes are included in the product range:

gG (DIN VDE / IEC)	Full-range cable and line protection
aM (DIN VDE / IEC)	Partial-range switching device protection
aR (DIN VDE / IEC)	Partial-range semiconductor protection
gR (DIN VDE / IEC)	Full-range semiconductor protection
gS (DIN VDE / IEC)	Full-range semiconductor protection and cable and line protection
Quic (DIN VDE / IEC / k CEE)	Full-range cable and line protection
Slo (DIN VDE)	Full-range cable and line protection
w	

## 9.11 Let-through current $I_c$

The let-through current  $I_c$  can be determined from the let-through characteristic curves (current limiting at 50 Hz) specified for the respective fuse link. This depends on the prospective current and the DC component when the short circuit occurs (instant of closing).

The following diagram shows the let-through current  $I_c$  of a fuse link, depending on the prospective short-circuit current  $I_p$  using the SITOR 3NE4333-0B fuse link as an example.

9.12 Let-through current characteristic curves

Example: SITOR 3NE4333-0B fuse link

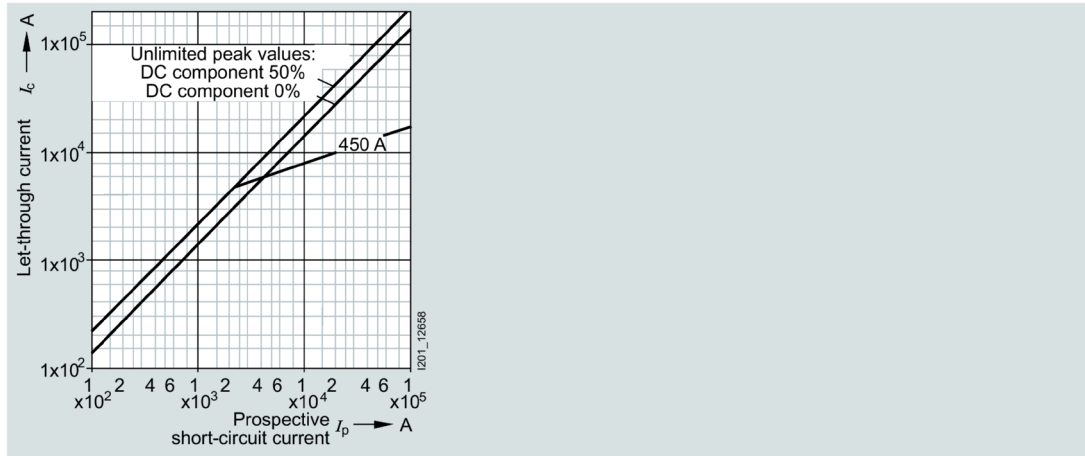

## 9.12 Let-through current characteristic curves

The let-through current characteristic curve specifies the value of the let-through current at 50 Hz as a function of the prospective current.

The let-through current  $I_c$  is the maximum instantaneous value of the current reached during a switching operation of a fuse.

The fuse element of the fuse links melts so quickly at very high currents that the peak short-circuit current  $I_p$  is prevented from occurring. The highest instantaneous value of the current reached during the breaking process is called the let-through current  $I_c$ . The current limits are specified in the current limiting diagrams, otherwise known as let-through current diagrams.

### Oscillograph of a short-circuit current breaking operation through a fuse link

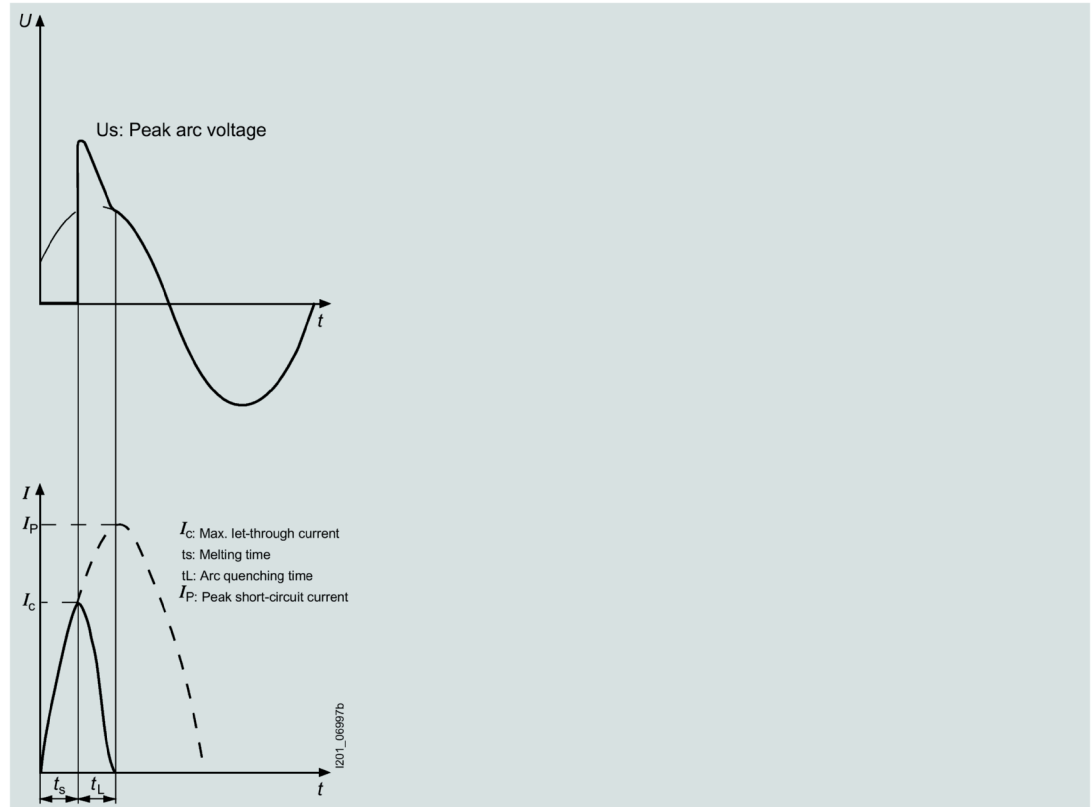

## 9.13 Use with direct current

In general, all SITOR fuses can be used for AC and DC applications. For AC fuse links that are to be used in DC circuits, some data may vary from the data specified in the characteristic curves for alternating current.

The new 1250 V DC fuses 3NB1 and 3NB2 have been explicitly tested with DC voltage. They can also be used with AC voltage; details on request.

### Permissible direct voltage

The permissible direct voltage  $U_{perm}$  of the fuse links depends on the rated voltage  $U_n$ , on the time constant  $\tau = L/R$  in the DC circuit and on the prospective current  $I_p$ . The permissible direct voltage refers to the rated voltage  $U_n$  and is specified depending on the time constant  $\tau$ ; the prospective current is a parameter (see the following diagrams).

Applies to all series except 3NE10..., 3NE18..

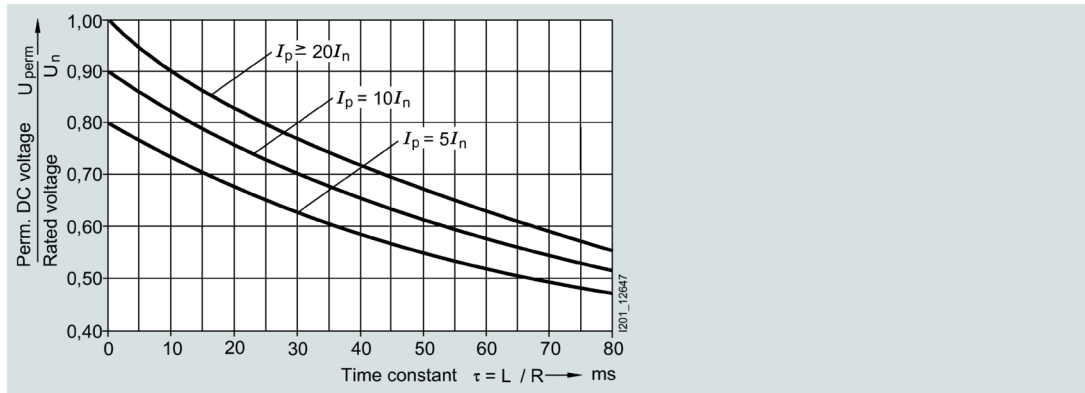

For 3NE10..., 3NE18.. series

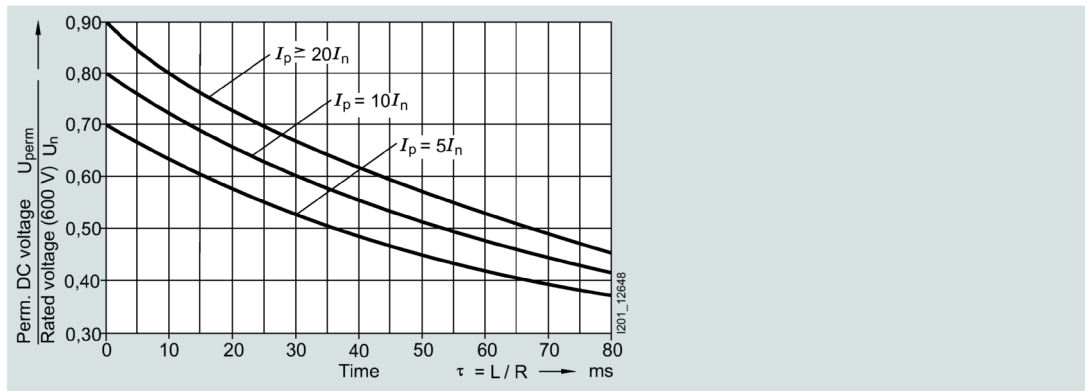

### Breaking $I^2t$ value $I^2t_a$

The breaking  $I^2t$  value  $I^2t_a$  depends on the voltage, on the time constant  $\tau = L/R$  and on the prospective current  $I_p$ . It is calculated from the  $I^2t_a$  value specified in the characteristic curves for the respective fuse link at rated voltage  $U_n$  and correction factor  $k_A$ . Instead of the recovery voltage  $U_w$ , the direct voltage against which the fuse link is to switch is used.

The breaking  $I^2t$  value determined in this way applies under the following conditions:

- Time constant  $L/R \leq 25$  ms for  $I_p \geq 20 \times I_n$
- Time constant  $L/R \leq 10$  ms for  $I_p = 10 \times I_n$

The breaking  $I^2t$  values increase by 20%:

- For  $I_p \geq 20 \times I_n$  and time constant  $L/R = 60$  ms
- For  $I_p = 10 \times I_n$  and time constant  $L/R = 35$  ms

### Peak arc voltage $\hat{U}_s$

The peak arc voltage  $\hat{U}_s$  is determined from the curve specified in the characteristics for the respective fuse. Instead of the recovery voltage  $U_w$ , the direct voltage against which the fuse link is to switch is used.



The peak arc voltage determined in this way applies under the following conditions:

- Time constant  $L/R \leq 20$  ms for  $I_p = 20 \times I_n$
- Time constant  $L/R \leq 35$  ms for  $I_p = 10 \times I_n$

The switching voltages increase by 20%:

- For  $I_p = 20 \times I_n$  and time constant  $L/R = 45$  ms
- For  $I_p = 10 \times I_n$  and time constant  $L/R = 60$  ms

## 9.14 Specifying the rated current $I_n$

### For non-aging operation with varying load

Power converters are often operated not with a continuous load, but with varying loads; these can also temporarily exceed the rated current of the power converter.

The selection process for non-aging operation of SITOR fuse links for four typical types of load is described below.<sup>1)</sup>

- Continuous load
- Unknown varying load, but with known maximum current
- Varying load with known load cycle
- Occasional peak load from preloading with unknown peak outcome

The diagrams for the correction factors  $k_u$ ,  $k_q$ ,  $k_\lambda$ ,  $k_i$  in the chapter Correction factor for ambient temperature  $k_u$  (Page 390), and the residual value factor  $RW$  (Page 377) must be observed. The varying load factor  $WL$  for the fuse links is specified in the chapter Taking into account preloading, residual value factor  $RW$  (Page 377).

<sup>1)</sup> In the case of varying loads that cannot be assigned to one of the four types of load shown here, please contact us.

9.14 Specifying the rated current  $I_n$

The required rated current  $I_n$  of the fuse link is determined in two steps:

1. Determination of the rated current  $I_n$  based on the rms value  $I_{rms}$  of the load current:

$$I_n > I_{eff} \times \frac{1}{k_u \times k_q \times k_\lambda \times k_1 \times WL}$$

Permissible load current  $I_n$  of the selected fuse link:  $I_n' = k_u \times k_q \times k_l \times k_\lambda \times WL \times I_n$

2. Check of the permissible overload duration of current blocks exceeding the permissible fuse load current  $I_n$ .

Melting time  $t_{vs}$  (time/current characteristic curve)  $\times$  residual value factor  $RW \geq$  overload duration  $t_k$

The following are required:

- The previous load ratio

$$V = \frac{I_{eff}}{I_n'}$$

- The characteristic Taking into account preloading, residual value factor  $RW$  (Page 377) curve a
- The time/current characteristic for the selected fuse link

**Rated current  $I_n$  of the fuse link**

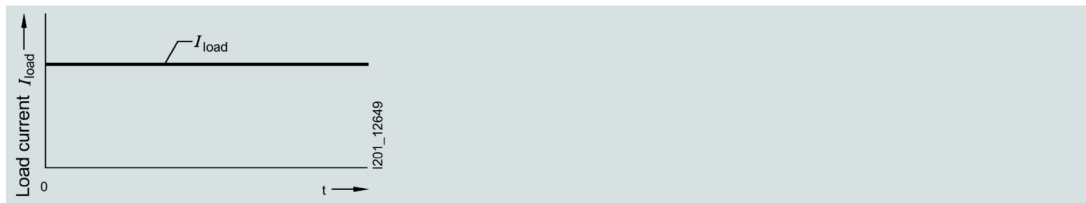

If the determined overload duration is less than the respective required overload duration, then you need to select a fuse link with a greater rated current  $I_n$  (taking into account the rated voltage  $U_n$  and the permissible breaking  $I^2t$  value) and repeat the check.

**Continuous load**

$$I_n \geq I_{La} \times \frac{1}{k_u \times k_q \times k_\lambda \times k_1 \times WL}$$

$I_{La}$  = Load current of the fuse link (rms value)

Less than 1 breaking operation per week:  $WL = 1$

More than 1 breaking operation per week:  $WL =$  see Technical specifications, in the chapter Current carrying capacity of SITOR fuse links in 3NP LV HRC fuse bases (Page 172) and following.

**Unknown varying load, but with known maximum current  $I_{max}$**

**Rated current  $I_n$  of the fuse link**

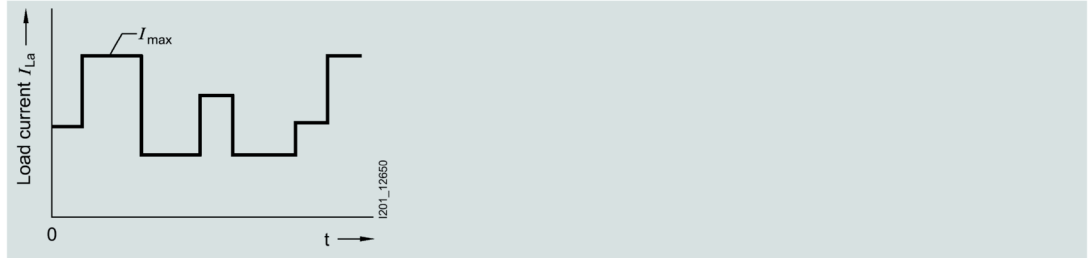

$$I_n \geq I_{max} \times \frac{1}{k_u \times k_q \times k_\lambda \times k_1 \times WL}$$

$I_{max}$  = Maximum load current of the fuse link (rms value)

**Varying load with known load cycle**

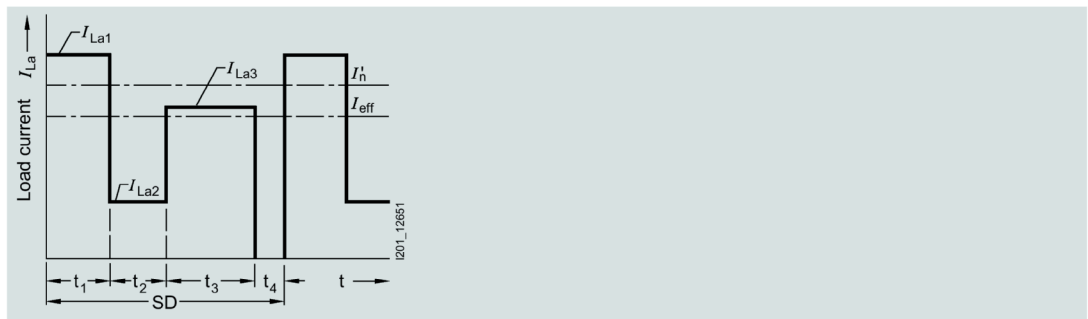

$$I_{eff} = \sqrt{\frac{\sum_{k=1}^{k=n} I_{Lak}^2 \times t_k}{SD}}$$

$$I_{eff} = \sqrt{\frac{I_{La1}^2 t_1 + I_{La2}^2 t_2 + I_{La3}^2 t_3}{SD}}$$

$I_{Lk}$  = Maximum load current of the fuse link (rms value)

**Occasional peak load from preloading with unknown peak outcome**

The required rated current  $I_n$  of the fuse link is determined in two steps:

1. Determination of the rated current  $I_n$  based on the previous load current  $I_{previous}$ :

$$I_n > I_{vor} \times \frac{1}{k_u \times k_q \times k_\lambda \times k_l \times WL}$$

Permissible load current  $I_n$  of the selected fuse link:  $I_n' = k_u \times k_q \times k_\lambda \times k_l \times WL \times I_n$

2. Check of the permissible overload duration of the peak current  $I_{peak}$

Melting time  $t_{vs}$  (time/current characteristic curve)  $\times$  residual value factor  $RW \geq$  peak time  $t_{peak}$

To do this, you require the previous load ratio

$$V = \frac{I_{eff}}{I_n}$$

as well as the characteristic curve "Permissible overload and melting time for previous load" (Page 377), curve a or b, and the time/current characteristic curve for the selected fuse link.

If the determined overload duration is less than the required overload duration  $t_{peak}$ , then you need to select a fuse link with a greater rated current  $I_n$  (taking into account the rated voltage  $U_n$  and the permissible breaking  $I^2t$  value) and repeat the check.

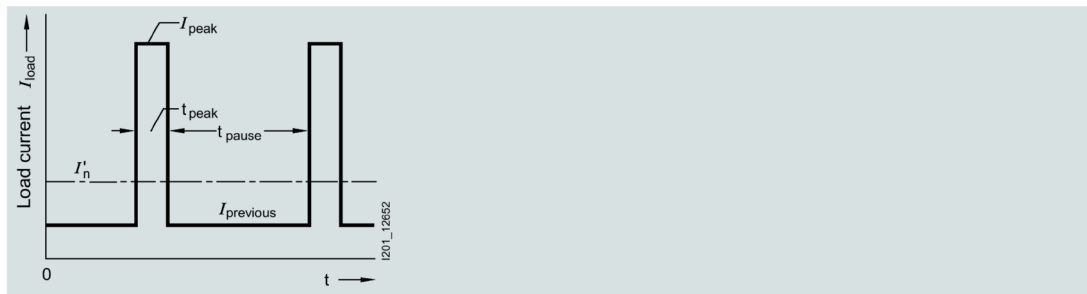

Condition:

$$t_{pause} \geq 3 \times t_{peak}$$

$$t_{pause} \geq 5 \text{ min}$$

**See also**

Technical specifications (Page 159)

## 9.15 I<sup>2</sup>t value

The I<sup>2</sup>t value (joule integral) is the integral of the current squared over a specific time interval:

$$I^2t = \int_{t_0}^{t_1} i^2 dt$$

The I<sup>2</sup>t values for the melting process (I<sup>2</sup>t<sub>s</sub>) and for the breaking process (I<sup>2</sup>t<sub>A</sub> corresponds to the sum of the melting and quenching I<sup>2</sup>t values) are specified. The melting I<sup>2</sup>t value, also known as the total I<sup>2</sup>t value or breaking I<sup>2</sup>t value, is particularly important when dimensioning SITOR semiconductor fuses. This value depends on the voltage and is specified with the rated voltage.

## 9.16 I<sup>2</sup>t values

In the event of a short circuit, the current of the fuse link increases during the melting time t<sub>s</sub> up to let-through current I<sub>c</sub> (melting current peak).

During the arc quenching time t<sub>L</sub>, the electric arc develops and the short-circuit current is quenched.

### Current curve during operation of fuse links

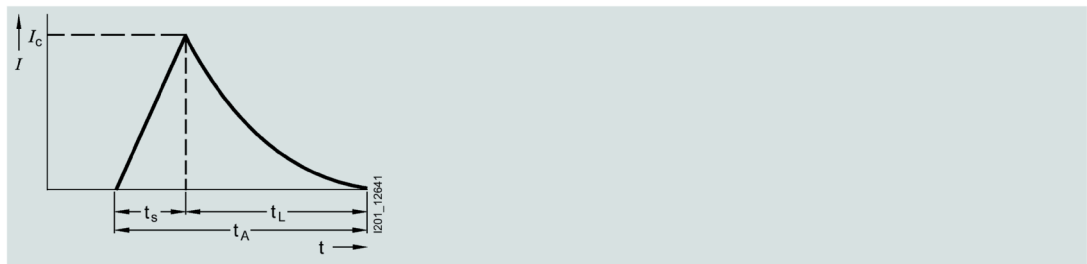

The integral of the current squared ( $\int I^2 dt$ ) over the total operating time ( $t_s + t_L$ ), known as the breaking I<sup>2</sup>t value, determines the heat that will be applied to the semiconductor device that is to be protected during the breaking operation.

In order to ensure adequate protection, the breaking I<sup>2</sup>t value of the fuse link must be smaller than the I<sup>2</sup>t value (limit load integral) of the semiconductor device. As the temperature increases, i.e. preloading increases, the breaking I<sup>2</sup>t value of the fuse link decreases almost in the same way as the I<sup>2</sup>t value of a semiconductor device, so that it is sufficient to compare the I<sup>2</sup>t values in a non-loaded (cold) state.

The breaking I<sup>2</sup>t value (I<sup>2</sup>t<sub>A</sub>) is the sum of the melting I<sup>2</sup>t value (I<sup>2</sup>t<sub>s</sub>) and the quenching I<sup>2</sup>t value (I<sup>2</sup>t<sub>L</sub>).

$$(\int I^2 dt) \text{ (semiconductor, } t_{vj} = 25 \text{ °C, } t_p = 10 \text{ ms)} > (\int I^2 dt) \text{ (fuse link)}$$

### Melting I<sup>2</sup>t value I<sup>2</sup>t<sub>s</sub>

The melting I<sup>2</sup>t value can be calculated from the value pairs of the time/current characteristic curve of the fuse link for any periods.

As the melting time decreases, the melting  $I^2t$  value tends towards a lower limit value at which almost no heat is dissipated from the bottleneck of the fuse element to the environment during the melting process. The melting  $I^2t$  values specified in the selection and ordering data and in the characteristic curves correspond to the melting time  $t_{vs} = 1$  ms.

### Quenching $I^2t$ value $I^2t_L$

Whereas the melting  $I^2t$  value is a characteristic of the fuse link, the quenching  $I^2t$  value depends on circuit data, such as:

- The recovery voltage  $U_w$
- The power factor  $\cos \varphi$  of the shorted circuit
- The prospective current  $I_p$  (current at the installation position of the fuse link if this is short-circuited)

The maximum quenching  $I^2t$  value is reached at a current of  $10 \times I_n$  to  $30 \times I_n$  depending on the fuse type.

### Breaking $I^2t$ value $I^2t_a$ , correction factor $k_A$

The breaking  $I^2t$  values of the fuse links are specified in the characteristic curves for the rated voltage  $U_n$ . To determine the breaking  $I^2t$  value for recovery voltage  $U_w$ , the correction factor  $k_A$  must be taken into account.

$$I^2t_a (\text{at } U_w) = I^2t_a (\text{at } U_n) \times k_A$$

The "correction factor  $k_A$ " characteristic (see the following diagram) is specified in the characteristic curves for the individual fuse series. The breaking  $I^2t$  values determined in this way apply to prospective currents  $I_p \geq 10 \times I_n$  and  $\cos \varphi = 0.35$ .

### Current curve during operation of fuse links

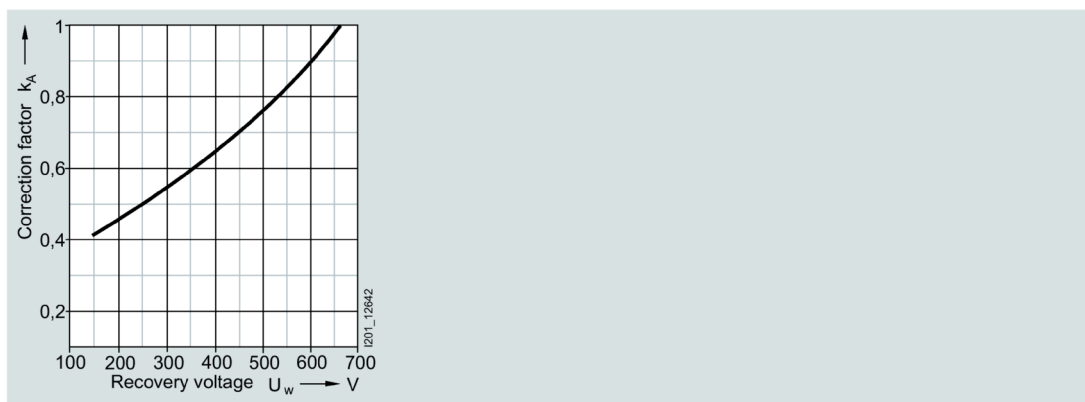

### Taking into account the recovery voltage $U_w$

The recovery voltage  $U_w$  is derived from the voltage driving the short-circuit current. For most faults, the driving voltage is equal to the supply voltage  $U_{v0}$ ; however, for inverter shoot-throughs it is 1.8 times the value of the supply voltage  $U_{v0}$  (Rated voltage  $U_n$  (Page 375)). If the shorted circuit contains two branches of a converter circuit and thus two fuse links in series, and if the short-circuit current is sufficiently high (Parallel and series connection of fuse links (Page 394)) it can be assumed that there is uniform voltage sharing, i.e.  $U_w = 0.5 \times U_{v0}$  or in the case of inverter shoot-throughs  $U_w = 0.9 \times U_{v0}$ .

### Influence of the power factor $\cos \varphi$

The specifications in the characteristic curves for the breaking  $I^2t$  values ( $I^2t_a$ ) refer to a power factor of  $\cos \varphi = 0.35$  (exception: for SITOR 3NC58.., 3NE64.., 3NE94.. fuse links,  $\cos \varphi = 0.2$ ).

The dependence of the breaking  $I^2t$  values on the power factor  $\cos \varphi$  at  $1.0 \times U_n$  and at  $0.5 \times U_n$  is shown in the following diagram.

### Breaking $I^2t$ value $I^2t_a$ of SITOR fuse links dependent on the power factor $\cos \varphi$

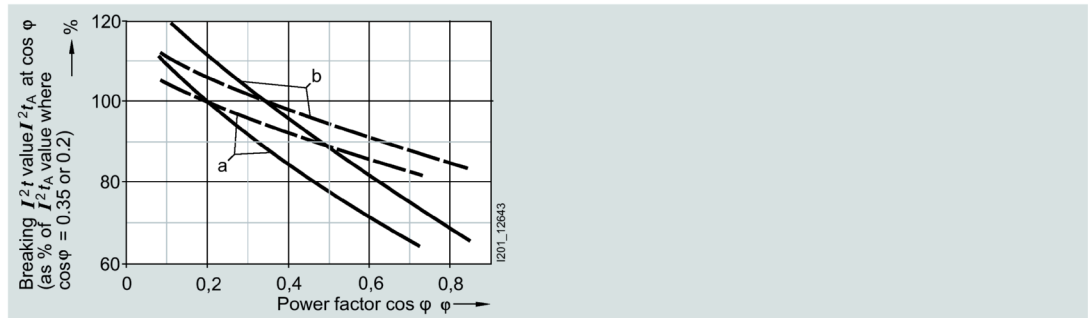

— at  $1.0 U_n$

- - - at  $0.5 U_n$

a For SITOR 3NC58.., 3NE64.., 3NE94.. fuse links (reference to  $\cos \varphi = 0.2$ )

b For all other SITOR fuse links (reference to  $\cos \varphi = 0.35$ )

## 9.17 Characteristic curves (time/current characteristic curves)

The time/current characteristic curve specifies the virtual time (e.g. the melting time) as a function of the prospective current under specific operating conditions.

Melting times of fuse links are represented in the time/current diagrams with logarithmic subdivision and as a function of their currents. The melting time characteristic curve extends from the lowest melting current, which still just causes the melting conductor to melt asymptotically to the  $I^2t$  line of equal Joulean heat values in the range of higher short-circuit currents, which specifies the constant melting heat value  $I^2t$ . For the sake of simplicity, the time/current characteristic diagrams omit the  $I^2t$  lines (c).

9.18 Correction factor for ambient temperature  $k_u$

**General representation of the time/current characteristic curve of a fuse link of operational class gL/gG**

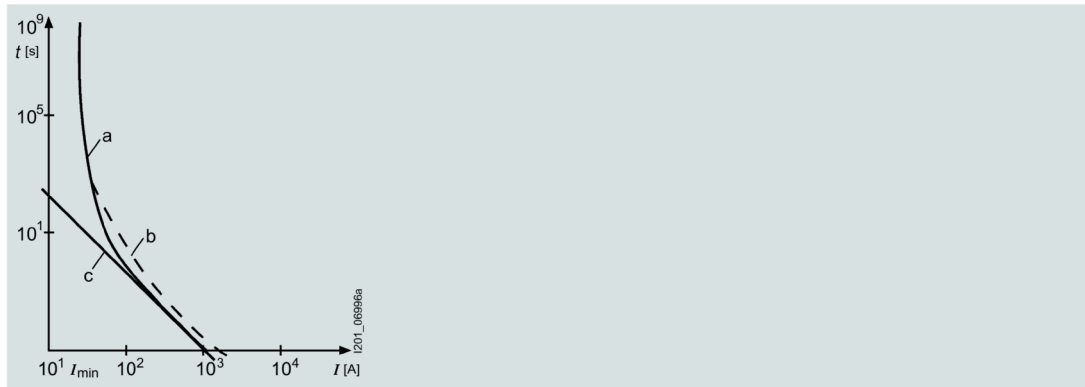

- $I_{min}$     Smallest melting current
- a        Melting time/current characteristic curve
- b        Breaking time characteristic curve
- c         $I^2t$  line

The shape of the characteristic curve depends on the outward heat transfer from the fuse element. DIN VDE 0636 specifies tolerance-dependent time/current ranges within which the characteristic curves of the fuse must lie. Deviations of  $\pm 10\%$  are permissible in the direction of the current axis. With Siemens LV HRC fuse links of operational class gG, the deviations work out at less than  $\pm 5\%$ , a mark of our outstanding production accuracy. For currents up to approx.  $20 I_n$ , the melting time/current characteristic curves are the same as the breaking time characteristic curves. In the case of higher short-circuit currents, the two characteristic curves move apart, influenced by the respective arc quenching time.

The difference between both lines (= arc quenching time) also depends on the power factor, the operational voltage and the breaking current.

The Siemens characteristic curves show the mean virtual melting time characteristic curves recorded at an ambient temperature of  $20\text{ °C}$  ( $\pm 5\text{ °C}$ ). They do not apply to preloaded fuse links.

**9.18 Correction factor for ambient temperature  $k_u$**

The influence of the ambient temperature on the permissible load of the SITOR fuse link is taken into account using the correction factor  $k_u$  as shown in the following diagram.

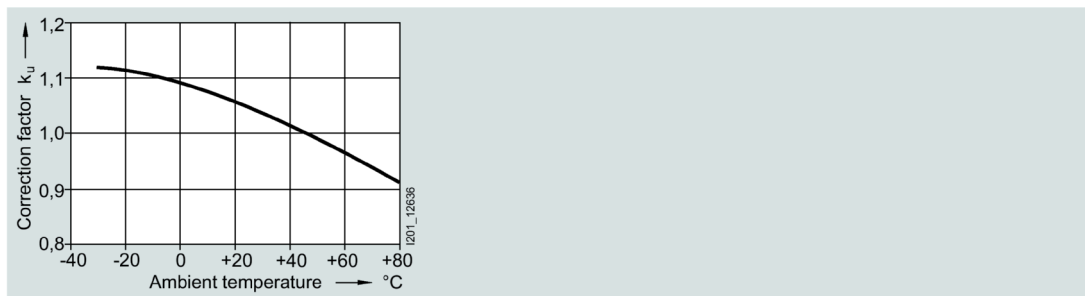



### Correction factor for conductor cross-section $k_q$

The rated current of the SITOR fuse links applies to operation with conductor cross-sections that correspond to the respective test cross-section ("Test cross-sections" table in Rated current  $I_n$  (Page 375)). In the case of reduced conductor cross-sections, the correction factor  $k_q$  must be used, as shown in the following diagram.

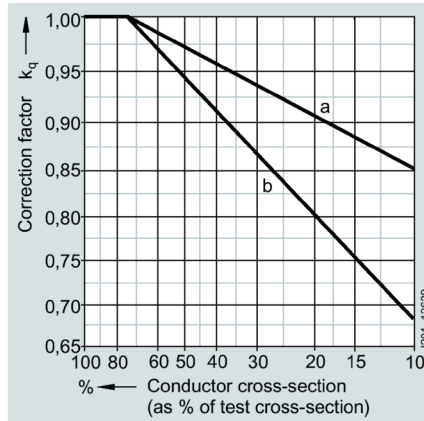

- a Reduction of cross-section of one conductor
- b Reduction of cross-section of both conductors

### Correction factor for conduction angle $k_\lambda$

The rated current of the SITOR fuse links is based on a sinusoidal alternating current (45 Hz to 62 Hz). However, in converter operation, the branch fuses are loaded with an intermittent current, whereby the conduction angle is generally  $180^\circ\text{el}$  or  $120^\circ\text{el}$ . With this load current curve shape, the fuse link can still carry the full rated current. In the case of smaller conduction angles, the current must be reduced in accordance with the following diagram.

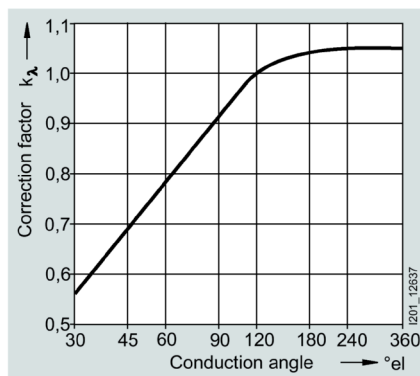

### Correction factor for forced-air cooling $k_i$

In the case of increased air cooling, the current carrying capacity of the fuse links increases with the air speed. Air speeds  $> 5 \text{ m/s}$  do not produce any significant further increase in current carrying capacity.

9.18 Correction factor for ambient temperature  $k_t$

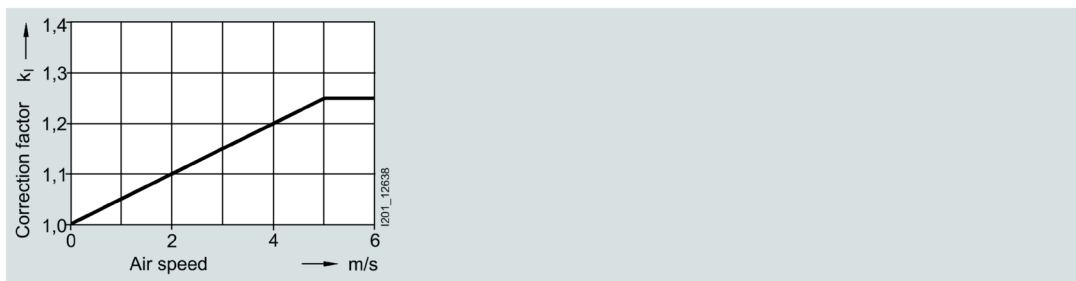

**Varying load factor WL**

The varying load factor WL is a reduction factor by which the non-aging current carrying capacity of the fuse links can be determined for any load cycles. The SITOR fuse links have different varying load factors depending on their design. In the characteristic curves of the fuse links, the respective varying load factor WL for >10000 load changes (1 hour "ON", 1 hour "OFF") is specified for the expected operating time of the fuse links. In the event of a lower number of load changes during the expected operating time, it may be possible to use a fuse link with a smaller varying load factor WL as shown in the following diagram.

In the case of uniform loads (no load cycles and no breaking operation), the varying load factor can be taken as  $WL = 1$ . For load cycles and breaking operations that last longer than 5 min and that are more frequent than once a week, you need to select the varying load factor WL specified in the characteristic curves of the individual fuse links.

**Curve shape of the varying load factor WL for load cycles**

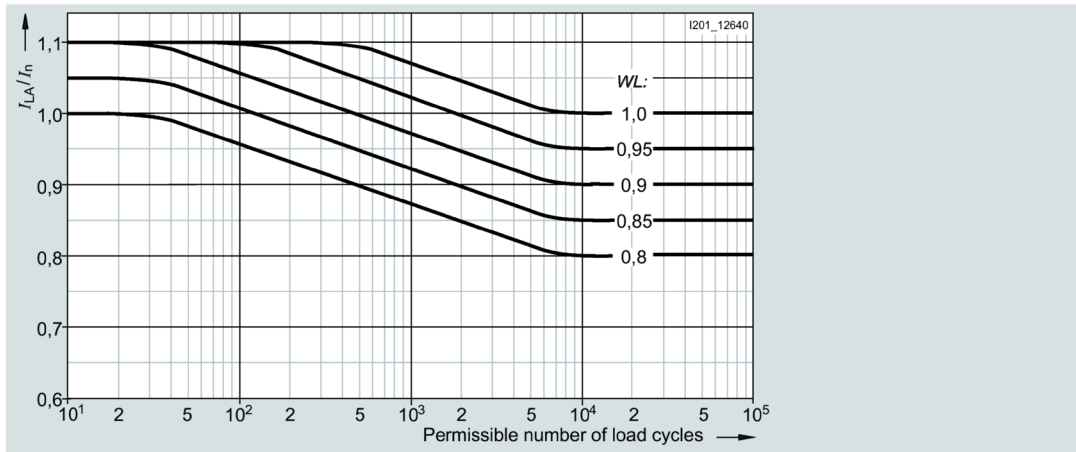

**Fuse currents for operation in power converter**

The rms value of the fuse current can be calculated for the most common converter circuits from the (smoothed) direct current  $I_d$  or the conductor current  $I_L$  according to the following table.

Converter circuit		Rms value of the conductor current (phase fuse)	Rms value of the branch current (branch fuse)
Single-pulse center tap connection	(M1)	$1.57 I_d$	--
Double-pulse center tap connection	(M2)	$0.71 I_d$	--

Converter circuit		Rms value of the conductor current (phase fuse)	Rms value of the branch current (branch fuse)
Three-pulse center tap connection	(M3)	0.58 $I_d$	--
Six-pulse center tap connection	(M6)	0.41 $I_d$	--
Double three-pulse center tap connection (parallel)	(M3.2)	0.29 $I_d$	--
Two-pulse bridge circuit	(B2)	1.0 $I_d$	0.71 $I_d$
Six-pulse bridge circuit	(B6)	0.82 $I_d$	0.58 $I_d$
1-phase bidirectional circuit	(W1)	1.0 $I_L$	0.71 $I_L$

## 9.19 Power dissipation, temperature rise

On reaching the rated current, the fuse elements of the SITOR fuse links have a considerably higher temperature than the fuse elements of line protection fuse links.

The power dissipation specified in the characteristic curves is the upper variance coefficient if the fuse link is loaded with the rated current.

In the case of partial loads, this power dissipation decreases as shown in the following diagram.

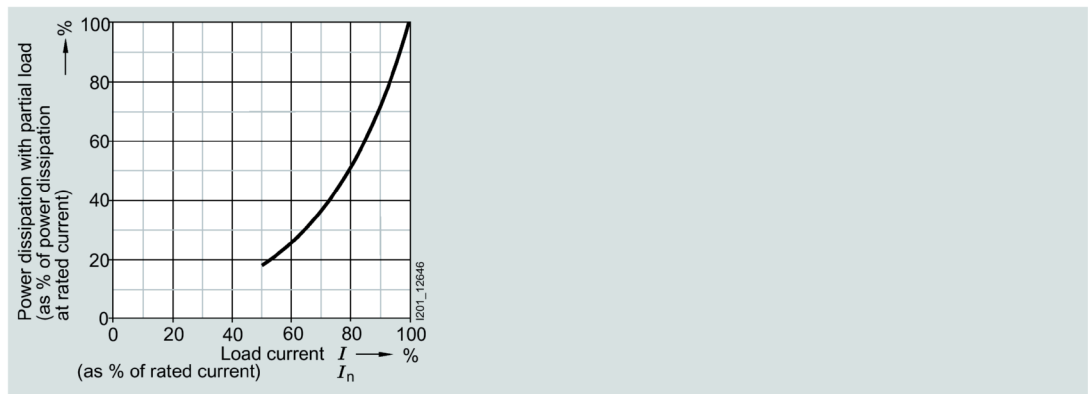

The temperature rise specified in the characteristic curves applies to the respective reference point and is determined when testing the fuse link (test setup according to DIN VDE 0636, Part 23 and IEC 269-4).

## 9.20 Peak arc voltage $\hat{U}_s$

The peak arc voltage is the maximum value of the voltage that occurs at the connections of the fuse link during the arc quenching time.

During the quenching process, a peak arc voltage  $\hat{U}_s$  occurs at the connections of the fuse link that can significantly exceed the supply voltage. The level of the peak arc voltage depends on the design of the fuse link and the level of the recovery voltage. It is represented in characteristic curves as a function of the recovery voltage  $U_w$  (see the following diagram).

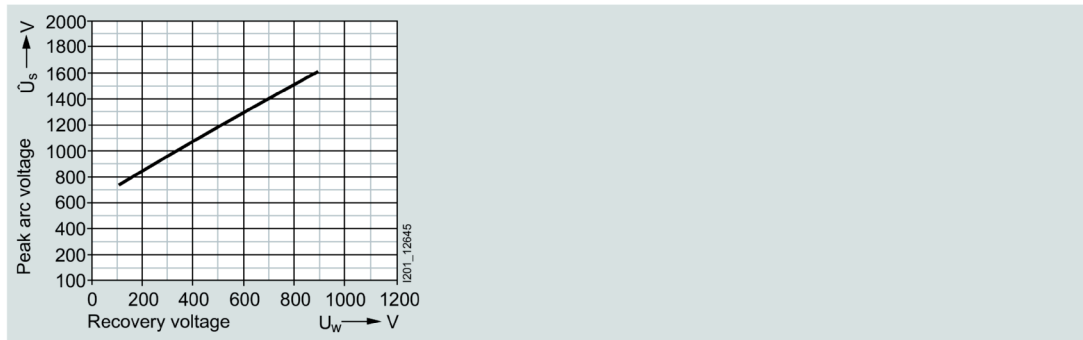
**Example: SITOR 3NE4333-0B fuse link**

The peak arc voltage occurs as a cutoff voltage at the semiconductor devices that are not in the shorted circuit. In order to prevent voltage-related hazards, the peak arc voltage must not exceed the peak cutoff voltage of the semiconductor devices.

**9.21 Parameters**

The fuse links are selected according to rated voltage, rated current, breaking  $I^2t$  value  $I^2t_a$  and varying load factor, taking into consideration other specified conditions. Unless otherwise specified, all of the following data refers to use of alternating current from 45 Hz to 62 Hz.

**9.22 Parallel and series connection of fuse links****Parallel connection**

If a branch of a converter circuit has several semiconductor devices so that the fuse links are connected in parallel, only the fuse link connected in series to the faulty semiconductor device is tripped in the event of an internal short circuit. It must quench the full supply voltage.

To boost the voltage, two or more parallel fuse links can be assigned to a single semiconductor device without reducing the current. The resulting breaking  $I^2t$  value increases with the square of the number of parallel connections. In this case, in order to prevent incorrect current sharing, you must only use fuse links of the same type or, better still, the parallel switched SITOR 3NB fuses.

**Series connection**

There are two kinds of series connection available:

- Series connection in the converter branch
- Two fused converter branches through which a short-circuit current flows in series

In both cases, uniform voltage sharing can only be assumed if the melting time of the SITOR fuse link does not exceed the value specified in the following table.

SITOR fuse links	Maximum melting time for uniform voltage sharing
Type	ms
3NC10..	10
3NC14..	
3NC15..	
3NC22..	
3NC24..	40
3NC58..	10
3NC73..	
3NC84..	
3NE10..	10
3NE12..	
3NE13..	
3NE14..	20
3NE18..	10
3NE32..	10
3NE33..	
3NE34..	20
3NE35..	
3NE36..	
3NE41..	10
3NE43..	
3NE54..	20
3NE56..	
3NE64..	10
3NE74..	20
3NE76..	
3NE80..	10
3NE87..	
3NE94..	10
3NE96..	20

Cooling conditions for series-connected fuse links should be approximately the same. If faults are expected during which the specified melting times are exceeded as a result of a slower current rise, it can no longer be assumed that voltage sharing is uniform. The voltage of the fuse links must then be rated so that a single fuse link can quench the full supply voltage.

It is best to avoid the series connection of fuse links in a converter connection branch and instead use a single fuse link with a suitably high rated voltage.

## 9.23 Residual value factor RW

The residual value factor is a reduction factor for determining the permissible load period of the fuse link with currents that exceed the permissible load current  $I_n$  (see Rated current (Page 375) $I_n$ ). This factor is applied when dimensioning SITOR semiconductor fuses.

## 9.24 Selectivity

Several fuses in a system are usually connected in series. Selectivity ensures that only the faulty electric circuit and not all operating processes are interrupted in a system in serious cases.

Siemens fuses of operational class gG, at an operational voltage of up to 400 V AC and a ratio of 1:1.25, are interselective, i.e. from rated current level to rated current level. This is achieved by means of the considerably smaller band of scatter of  $\pm 5\%$  of the time/current characteristic. This far exceeds the requirement for a ratio of 1:1.6 specified in the standard.

It is therefore possible to use smaller conductor cross-sections due to the lower rated currents.

## 9.25 Current limiting

As well as a fail-safe rated breaking capacity, the current-limiting effect of a fuse link is of key importance for the cost effectiveness of a system. In the event of a short-circuit trip by a fuse, the short-circuit current continues to flow through the network until the fuse link is switched off. The short-circuit current is only limited by the system impedance.

The simultaneous melting of all the bottlenecks of a fuse element produce a sequence of tiny partial arcs that ensure a fast breaking operation with strong current limiting. The current limiting is also strongly influenced by the production quality of the fuse and is extremely high in the case of Siemens fuses. For example, an LV HRC fuse link, size 2 (224 A) limits a short-circuit current with a possible rms value of approximately 50 kA to a let-through current with a peak value of approx. 18 kA. This strong current limiting provides constant protection for the system against excessive loads.

**Current limiting diagram; let-through current diagram of LV HRC fuse links, size 00, operational class gL/gG, rated currents 6 A, 10 A, 50 A, 100 A**

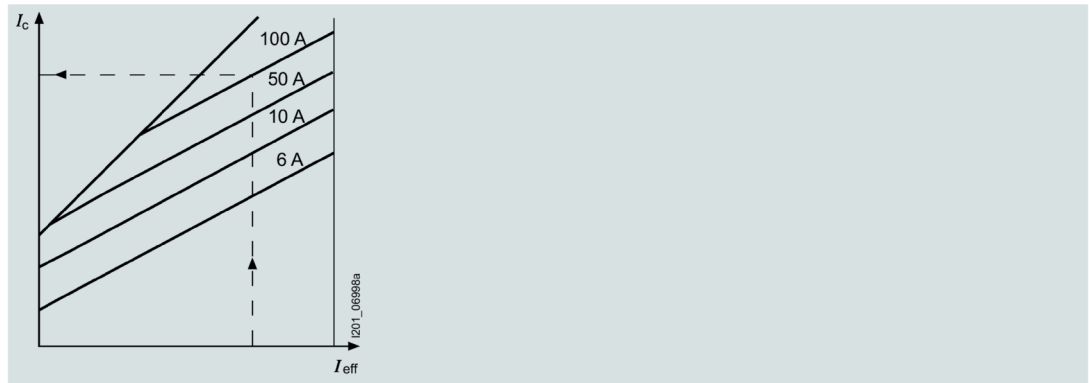

$t_{vc}$	Virtual melting time
$I_c$	Max. let-through current
$I_{rms}$	rms value of the prospective short-circuit current
$I^2t_s$	Melting $I^2t$ value
$I^2t_a$	Breaking $I^2t$ value
$I_n$	Rated current
$P_v$	Rated power dissipation
	Temperature rise
$k_A$	Correction factor for $I^2t$ value
$U_w$	Recovery voltage
$\hat{U}_s$	Peak arc voltage
$I_p$	Peak short-circuit current
	Peak short-circuit current with largest DC component
	Peak short-circuit current without DC component
$U$	Voltage
$i$	Current
$t_s$	Melting time
$t_L$	Arc quenching time

## 9.26 Prospective short-circuit current $I_p$

The prospective short-circuit current is the rms value of the line-frequency AC component, or the value of direct current to be expected in the event of a short-circuit occurring downstream of the fuse, were the fuse to be replaced by a component of negligible impedance.

## 9.27 Virtual time $t_v$

The virtual time is the time span calculated when an  $I^2t$  value is divided by the square of the prospective current:

$$t_v = \frac{\int i^2 dt}{I_p^2}$$

The time/current characteristic curve specifies the prospective current  $I_p$  and the virtual melting time  $t_{vs}$ .

## 9.28 VSI voltage

VSI is the abbreviation for Voltage Sourced Inverter. The VSI voltage  $U_{vsi}$  is a DC test voltage defined in IEC 60269-4 specially for use in applications with energy stores. The extremely steep current rise in the event of a fault is characteristic of such applications. For SITOR 3NB1 and 3NB2 fuses, the VSI voltage and the applicable  $I^2t$  value are specified in the chapter Portfolio overview (Page 155); for all other SITOR fuses, these values are available on request.

## 9.29 Varying load factor WL

The varying load factor is a reduction factor for the rated current with varying load states. This factor is applied when dimensioning SITOR semiconductor fuses.

## 9.30 Recovery voltage $U_w$

The recovery voltage (rms value) is the voltage that occurs at the connections of a fuse link after the current is broken.

## 9.31 Real melting time

The virtual melting time  $t_{vs}$  is specified in the time/current characteristic curve, depending on the prospective current. It is a value that applies to the rectangular current ( $(di/dt) = \infty$ ).

In the case of melting times  $t_{vs} < 20$  ms the virtual melting time  $t_{vs}$  deviates from the real melting time  $t_s$ . The real melting time may be several milliseconds longer (depending on the rate of current rise).

Within a range of several milliseconds, during which the rise of the short-circuit current can be assumed to be linear, the real melting time for a sinusoidal current rise and 50 Hz is as follows:



$$t_s = \frac{3 \times I^2 t_s}{I_c^2}$$

## 9.32 Time/current characteristic curves

The solid time/current characteristic curves in the following diagram specify the time to melting for the non-loaded fuse link from the cold state (max. +45 °C).

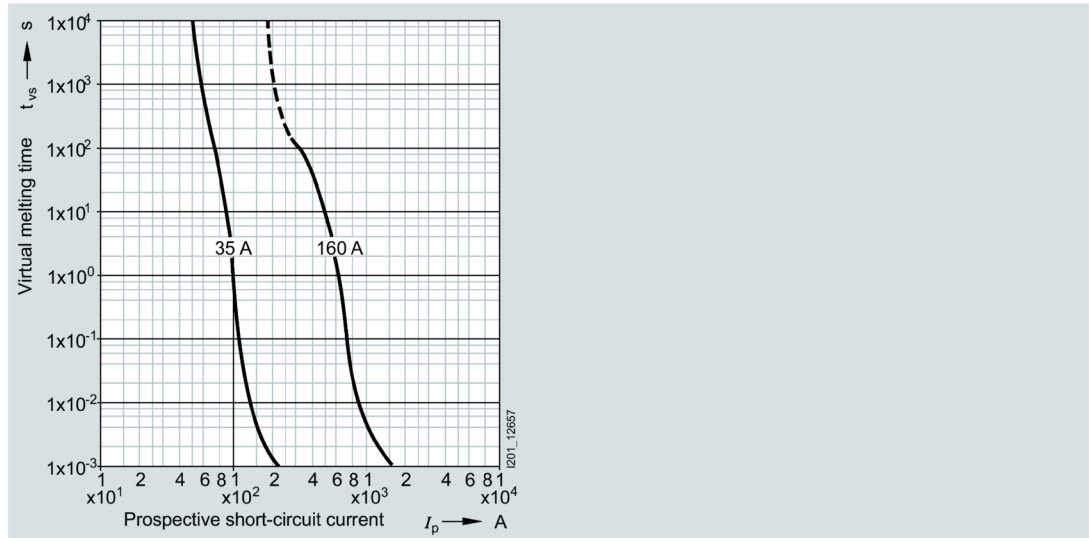

35 A Operational class gR

160 A Operational class aR,

If the time/current characteristic curve in the long-time range ( $t_{vs} > 30$  s) is dashed (fuse links of operational class aR), this specifies the limit of the permissible overload from the cold state. If the dotted part of the characteristic curve is exceeded, there is a risk of damage to the ceramic body of the fuse link. The fuse link can only be used for short-circuit protection. In this case, an additional protective device (overload relay, circuit breaker) is required to protect against overload. In the case of controlled converter equipment, the current limiter is sufficient.

If the time/current characteristic curve is shown as a solid line over the entire time range (fuse links of operational class gR or gS), the fuse link can operate in the entire time range. This means it can be used both for overload and short-circuit protection.

## 9.33 Accessories

### Fuse bases, fuse pullers

Some of the SITOR fuse links can be inserted in matching fuse bases. The matching fuse bases (single-pole and three-pole) and the respective fuse pullers are listed in the chapter Current carrying capacity of SITOR fuse links in 3NP LV HRC fuse bases (Page 172).

---

#### Note

Even if the values of the rated voltage and/or current of the fuse bases are lower than those of the allocated fuse link, the values of the fuse link apply.

### Fuse switch disconnectors, switch disconnectors with fuses

Some series of SITOR fuse links are suitable for operation in 3NP4 and 3NP5 fuse switch disconnectors or in 3KL and 3KM switch disconnectors with fuses (see Catalog LV 10, chapter "Switch Disconnectors").

When using switch disconnectors, the following points must be observed:

- Because, compared with LV HRC fuses for line protection, the power dissipation of the SITOR fuse links is higher, the permissible load current  $I_n$  of the fuse links sometimes needs to be reduced. Further information can be found in the chapter Definitions / Glossary (Page 369).
  - Fuse links with rated currents  $I_n > 63$  A must not be used for overload protection even when they have operational class gR.
- 

#### Note

By contrast, all fuse links of the 3NE1... series with rated currents  $I_n$  from 16 A to 850 A and operational classes gR and gS can be used for overload protection.

- The rated voltage and rated insulation voltage of the switch disconnectors must at least correspond to the existing voltage.
  - When using fuse links of the 3NE32.., 3NE33.., 3NE43.., 3NC24.. and 3NC84.. series, the breaking capacity of fuse switch disconnectors must not be fully utilized due to the slotted blade. Occasional switching of currents up to the rated current of the fuse links is permissible.
  - When used in fuse switch disconnectors, fuse links of the 3NE41.. series may only be occasionally switched, and only without load, as this places the fuse blade under great mechanical stress.
- 

In the tables in the chapter Current carrying capacity of SITOR fuse links in 3NP LV HRC fuse bases (Page 172) and following, the switch disconnectors are allocated to their respective individual fuse links.

# Index

## I

### IEC

SITOR fuses, 185

## S

### SITOR fuses

IEC, 185

UL, 190, 192

## U

### UL

SITOR fuses, 190, 192

## Further Information

Always at your disposal: our extensive support  
[www.siemens.com/online-support](http://www.siemens.com/online-support)

Published by  
Siemens AG

Smart Infrastructure  
Electrical Products  
Postfach 10 09 53  
93009 REGENSBURG, Germany

For the U.S. published by  
Siemens Industry Inc.

100 Technology Drive  
Alpharetta, GA 30005  
United States

Subject to change.

SI EP  
Online

