

BALDWIN LOCOMOTIVE WORKS

LOCOMOTIVE DETAILS

AND

TELEGRAPHIC CODE

FOR

DUPLICATE PARTS

1895

LIBRARY OF CONGRESS

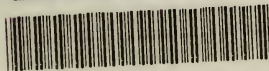

00019983328

LIBRARY OF CONGRESS.

Chap. TJ 625 Copyright No.

Shelf B.4 1895

UNITED STATES OF AMERICA.



BALDWIN LOCOMOTIVE WORKS.

ILLUSTRATED CATALOGUE.

DETAILS
OF
LOCOMOTIVES

AND

CABLE CODE
FOR DUPLICATE PARTS.



29571 aa

BURNHAM, WILLIAMS & CO.,
PHILADELPHIA.

GEORGE BURNHAM.
EDWARD H. WILLIAMS.

WILLIAM P. HENSZEY.

JOHN H. CONVERSE.
WILLIAM L. AUSTIN.

PRESS OF
J. B. LIPPINCOTT COMPANY.
1895.

TJ 465

124

1895

Copyright, 1895, by BURNHAM, WILLIAMS & Co.

~~TJ 533~~
~~12~~
~~1895~~

56-48333

INDEX.

The titles and figures in bold faced type refer to the illustrated plates. Names and numbers of duplicate parts can be found by an inspection of these plates. The light faced type refers to the groups of parts on pages 41-49.

	PAGE
Advertisement	231
Apparatus for burning Fuel Oil	197
Arrangement of Fire Bricks in Fire Box	71
Arrangement of Starting Valves and Cylinder Cocks for Compound Locomotive	85
Axle, Driving	43, 97
Back Cylinder Casing Cover	41
Back Cylinder Head	41
Back Draw Bar	46
Back Draw Casting, Tender	46
Baldwin Compound Cylinders	77, 79
Baldwin Compound Cylinders and Attachments	81
Belfield Injector	221
Bell	44, 135
Blower Valve	45
Blow-off Cock	46
Boiler	41
Boiler and Attachments	68
Boiler Jacket	41
Boiler Jacket Bands	41
Boiler Lagging	41
Boiler Plugs	41
Boiler Tubes	41
Boiler Tube Ferrules	41
Brake Cylinder	46
Brake Heads, Driving	46
Brake Heads, Tender	47
Brake Shoes, Driving	46
Brake Shoes, Tender	47
Brake Valve, Engineer's	179
Brake Work, Steam Driving	155, 157
Brake Work, Tender	195
Brasses, Rod	44, 116
Bull Nose, Pilot	45
Bumper and Attachments, Back	139
Bumper and Attachments, Front	127, 129
Bushing for Compound Cylinder	83

	PAGE
Cab	47
Cab Bracket	46
Cab Bracket Plate	46
Cab Cylinder Oiler, B. L. W. Style	46
Cable Code Numbers	23
Cable Sentences	33
Cabling, Examples for	18
Cabling, Instructions for	17
Cam, Driving Brake	46
Casing, Cylinder	42
Casing, Steam Chest	42
Centre Pin Guide and Crosstie, Engine Truck	133
Centre Pin, Tender Frame	47
Centre Plate, Tender Truck	47
Chafing Casting, Tender	46
Check, Injector	45
Class Designations	13
Cleaning Hole and Cap for Smoke Box	46
Cleaning Plugs	41
Cocks and Valves	173
Code Numbers	23
Combined Relief and Vacuum Valve for Compound Locomotive	93
Composition Rings for Metallic Packing	42
Compound Cylinder and all parts	42, 43, 81
Compound Cylinder, Piston Valve and Bushing for	83
Condensing Steam Chest Oil Cup	46
Counterbalance Spring	44
Crank or Wrist Pins	43
Crosshead, Compound Locomotive	44, 107
Crosshead Filling Pieces	44
Crosshead for Valve Stem, Compound Locomotive	109
Crosshead Gibs	44
Crosshead Pins	44
Crosshead, Single Expansion Locomotive	44, 103, 105
Cylinder Casing	42
Cylinder Casing Cover, Back	41, 73
Cylinder Casing Cover, Front	41, 73
Cylinder Cock	46
Cylinder Cock for Compound Locomotive	43, 85
Cylinder Cock Work, for Single Expansion Locomotive	87
Cylinder, Compound	42, 43, 77, 79
Cylinder, Compound, and all parts	42, 43, 81
Cylinder Gland	41
Cylinder Head, Back	41
Cylinder Head, Front	41
Cylinder Lubricator, Sight Feed	46, 224, 226
Cylinder Oiler in Cab, B. L. W. Style	46
Cylinder Relief Valve for Compound Locomotive	43
Cylinder, Single Expansion	41, 75
Detroit Sight Feed Cylinder Lubricator	226
Diagram of Baldwin Compound Cylinders showing Course of Steam	81

	PAGE
Double Cone	41
Draw Bar, Pilot	45
Drip Funnel	169
Driving Axle	43, 97
Driving Box	45, 159
Driving Box Brass	45
Driving Box Cellar	45
Driving Brake Cam	46
Driving Brake Heads	46
Driving Brake Shoes	46
Driving Brake, Steam	155, 157
Driving Springs	44
Driving Spring Links	44
Driving Tires	43, 97
Driving Wheel Centre, Wrought Iron	99
Driving Wheels	43, 97
Eccentrics	43
Eccentric Strap Oil Cup	46
Eccentric Straps	43
Eclipse Injector	211
Engine Back Draw Bar	46
Engineer's Brake Valve	45, 179
Engine Front Draw Casting	45
Engine Truck	45, 131
Engine Truck Box	45, 159
Engine Truck Box Brass	45
Engine Truck Box Cellar	45
Engine Truck Centre Pin	45
Engine Truck Centre Pin Guide and Crosstie	133
Engine Truck Frame	45
Engine Truck Springs	44
Engine Truck Swing Bolster	45
Engine Truck Wheel	45
Engine Truck Wheel Centre, Wrought Iron	101
Equalizing Beams	44
Equalizing Beam Fulcrums	44
Equalizing Work	123
Exhaust Nozzle	46
Exhaust Nozzle Thimble	46
Feed Cock	45, 163, 171
Feed Water Work	165
Ferrules for Boiler Tubes	41
Filling Pieces, Crosshead	44
Fire Box	41
Fire Bricks	71
Fire Door	41
Foot Boards	137
Foot Plate	46
Forward Equalizing Beam	44
Forward Equalizing Beam Fulcrum	44
Frame and Pedestals	43, 95

	PAGE
Frame Front Rail	43
Frame Pedestal Cap	43
Front and Door, Smoke Box	41
Front Bumper	127, 129
Front Cylinder Casing Cover	41
Front Cylinder Head	41
Front Draw Casting	45
Front Draw Casting, Tender	46
Front Rail of Frame	43
Fusible Plug	41
Gauge Cock	46
Gauge Glasses	45
Gauge Lamp	45
Gauge Lamp Globe, Steam	45
Gauge Lamp Stand, Steam	45
Gauge Lamp, Steam	45, 181
Gauge Lamp, Water	181
Gauge Stand, Steam	45
Gauge, Steam	45
Gauge, Water	45, 177
Gibs, Crosshead	44
Gibs, Pedestal	43
Gland, Cylinder	41
Gland, Steam Chest	42
Glass Water Gauge	177
Grate Bars	44, 141, 143, 145, 147
Grate Frame	45
Grate, Plain for Soft Coal	147
Grate, Plain for Wood	145
Grate Work, Rocking	141, 143
Groups of Duplicate Parts	41
Guide Bearer, Compound Locomotive	107
Guide Bearer, Single Expansion Locomotive	103, 105
Guide Oil Cup	46
Guides, Compound Locomotive	107
Guides, Single Expansion Locomotive	44, 103, 105
Headlight	46, 183
Headlight Shelf	167
Heater Valve	45
Illustrated Plates	65
Injector	45
Injector, Belfield	221
Injector Check	45, 171
Injector, Eclipse	211
Injector Feed Cock	45, 171
Injector, Korting	205
Injector, Little Giant, 1889	214
Injector, Little Giant, "Locomotive"	213
Injector, Metropolitan Double Tube Locomotive	218
Injector, Monitor	208

	PAGE
Injector, National and N. T.	216
Injector, Sellers, 1876	199
Injector, Sellers, 1887	202
Injector Steam Valve	45, 171
Injector Valves	171
Instructions for Cabling	17
Introductory	11
Iron Tender Frame	189
Jacket Bands	41
Jacket, Boiler	41
Jerome Metallic Packing for Piston Rods	228
Jerome Metallic Packing for Valve Stems	230
Journal Boxes	159
Keys, Rod	44
Korting Injector	205
Lagging, Boiler	41
Links	44
Little Giant Injector, 1889	214
Little Giant Injector, "Locomotive"	213
Lubricator, Sight Feed	46
Metallic Packing	42
Metallic Packing, Composition Rings for	42
Metallic Packing for Piston Rods	228
Metallic Packing for Valve Stems	230
Metropolitan Double Tube Locomotive Injector	218
Monitor Injector	208
Nathan Sight Feed Cylinder Lubricator	224
National and N. T. Injector	216
Oil Burning Apparatus	197
Oil Cup, Eccentric Strap	46
Oil Cup, Guide	46, 175
Oil Cup, Rock Shaft	46, 175
Oil Cup, Rod	46, 175
Oil Cup, Steam Chest	46, 175
Oil Cups	175
Packing, Piston	42, 119
Pedestal Cap	43
Pedestal Gib	43
Pedestal, Tender	47
Pedestal Wedge	43
Pedestal Wedge Bolt	43
Pilot	45, 127, 129
Pilot Bull Nose	45
Pilot Draw Bar	45
Piston	42, 119
Piston Packing	42

	PAGE
Piston Rods	42
Piston Valve and Bushing for Compound Cylinder	43, 83
Plain Grate for Soft Coal	147
Plain Grate for Wood	145
Plug, Cleaning	41
Plug, Fusible	41
Pump	44, 161
Pump Check	44, 163
Pump Feed Cock	44
Pump Plunger	44
Radius Bar Crosstie and Clamp	133
Reach Rod	46
Relief and Vacuum Valve for Compound Locomotive	93
Relief Valve for Compound Locomotive	43, 91
Relief Valve, Steam Chest	42
Reverse Lever	46, 153
Reverse Lever Rod, or Reach Rod	46
Reverse Shaft	44
Reverse Shaft Bearings	44
Rockshaft	44
Rockshaft Boxes	44
Rockshaft Oil Cup	46
Rockshaft Rod and Hanger for Compound Locomotive	113
Rod Brasses	44, 116
Rod Keys	44
Rod Oil Cup	46
Rods	44, 116
Rod Straps	44, 116
Rocking Grates	45
Rocking Grate Work	141, 143
Safety Valves	41
Sand Box	44, 135
Sellers Injector, 1876	199
Sellers Injector, 1887	202
Sentences for Cabling	33
Sight Feed Cylinder Lubricator	46, 224, 226
Signal Light Bracket	167
Single Expansion Cylinder, Steam Chest, and Attachments	75
Slide or Steam Chest Valves	42
Smoke Box Cleaning Holes and Caps	46
Smoke Box Fittings	149
Smoke Box Front and Door	41, 73
Smoke Box Netting	46
Smoke Stack	44, 125
Smoke Stack Base	44, 73
Smoke Stack Cone	44
Smoke Stack Netting	44
Soft Coal Burning Grate	147
Spark Ejector	46
Spark Ejector Valve	46
Springs	44, 123

	PAGE
Starting Valve for Compound Cylinders	43, 85
Steam Brake Piston	179
Steam Brake Stop Valve	45
Steam Brake Valve for Engineer	45
Steam Brake Work	155, 157
Steam Chest Caps or Lids	42
Steam Chest Casing	42
Steam Chest Casing Covers	42
Steam Chest Glands	42
Steam Chest Oil Cup, Condensing	46
Steam Chest or Slide Valves	42
Steam Chest Relief Valves	42
Steam Chests	42
Steam Chest Valve Yokes	42
Steam Gauge	45
Steam Gauge Lamp	45, 181
Steam Gauge Lamp Globe	45
Steam Gauge Lamp Stand	45
Steam Gauge Stand	45, 169
Steam Pipes	41
Steam Valve, Injector	45
Steel Cylinder Head Cover	73
Steel Smoke Box Front	73
Steel Stack Base	73
Stop Valve for Steam Brake	45
Straps, Rod	44, 116
Swing Bolster, Engine Truck	45
Tank Cock	46
Tank Funnel and Lid	46
Tank, Water	46, 185
Tender	46
Tender Back Draw Casting	46
Tender Box	45, 159
Tender Box Brasses	45
Tender Box Wedges	45
Tender Brake Heads	47
Tender Brake Shoes	47
Tender Brake Work	195
Tender Chafing Casting	46
Tender Frame Centre Pins	47
Tender Frame, Iron	189
Tender Frame, Wood	187
Tender Front Draw Casting	46
Tender Pedestals	47
Tender Springs	44
Tender Truck	47, 191, 193
Tender Truck Centre Plates	47
Tender Truck, Wood	191
Tender Truck, Wrought Iron	193
Tender Wedge	46
Tender Wedge Box	46
Tender Wheel Centre, Wrought Iron	101

	PAGE
Tender Wheels	47
Throttle Lever Work	46, 151
Throttle Valve	41
Throttle Work	41
Tires, Driving	43, 97
Truck Box Brasses	45
Truck Box Cellars	45
Truck Boxes	45
Truck Centre Pin, Engine	45
Truck, Engine	45, 131
Truck Frame, Engine	45
Truck Springs	44
Truck, Tender	47, 191, 193
Truck Wheels	45
Tube Ferrules	41
Tubes	41
Types of Locomotives	51
United States Metallic Packing for Piston Rods	228
United States Metallic Packing for Valve Stems	230
Useful Sentences for Cabling	33
Vacuum Valve for Compound Locomotive	89
Valve Motion Work	111
Valve Rods	44
Valves and Cocks	173
Valves, Safety	41
Valve, Steam Chest or Slide	42
Valve Stem Guides and Crosshead for Compound Locomotive	109
Valve Yokes	42
Water Gauge	45, 177
Water Gauge Glass	45
Water Gauge Lamp	45, 181
Water Tank	185
Wedge Bolt, Pedestal	43
Wedge Box, Tender	46
Wedge, Pedestal	43
Wedge, Tender	46
Wheel Centre	101
Wheel Covers	137
Wheels, Driving	43, 97
Wheels, Engine Truck	45
Wheels, Tender	47
Whistle	46, 169
Whistle Work	151
Wood Burning Grate	145
Wood Tender Frame	187
Wood Tender Truck	191
Wrist Pins	43
Wrought Iron Driving Wheel Centre	99
Wrought Iron Engine Truck and Tender Wheel	101
Wrought Iron Tender Truck	193

INTRODUCTORY.

IT is intended in this publication to place before customers a work that may be found useful for ready reference in ordering duplicate parts of locomotives for renewals and repairs, and at the same time furnish such a complete record of names of the various parts comprising a locomotive and tender as will avoid the possibility of error in ordering supplies, from a misinterpretation of these names.

It is intended that the illustrations and their descriptions shall be so clear that no difficulty will be experienced in following the catalogue of names for any pieces that it may be found necessary to order. Instructions for cabling are also given so that the expense of ordering duplicate parts from a distance will be reduced as much as possible.

The system of manufacture employed in connection with the large number of machines at all times in process of construction, embracing the principal classes, insures unusual and especial facilities for filling orders at once, or with the least possible delay.

All work is accurately fitted to gauges which are made from a system of standards kept exclusively for the purpose, thus providing for like parts fitting accurately in all locomotives of the same class. This plan of interchangeability enables the customer to secure the maximum amount of service at the minimum cost for repairs.

The advantages resulting from these methods are apparent in the expense of maintenance and repairs and in the saving of expensive patterns, drawings, special tools, and shop room. Repairs can be made with the utmost promptness, and engines thus be kept in almost continuous service.

CLASS DESIGNATIONS.

EACH locomotive has the builder's number plate attached to sides of smoke box directly over steam chests, except in small engines of special designs, when it is placed on smoke box door, or in some other conspicuous position. This plate contains the name of the manufacturers, the consecutive construction number of the engine, and the year in which constructed.

In ordering parts, in all cases where it is possible to do so, this construction number should be given, and when this cannot be obtained, the original road number or name should be supplied. This information will assist in ready reference to original records of construction and facilitate the work of renewals.

The different classes of locomotives are designated by a combination of figures with one of the letters A, B, C, D, E, or F, to indicate both the plan and sizes, as follows :

The letter A indicates that there are no traction driving wheels, and that the locomotive is driven by gear wheels engaging in a rack rail or rails.

The letter B indicates that two wheels are connected as driving wheels.

The letter C indicates that four wheels are connected as driving wheels.

The letter D indicates that six wheels are connected as driving wheels.

The letter E indicates that eight wheels are connected as driving wheels.

The letter F indicates that ten wheels are connected as driving wheels.

A figure (4, 6, 8, 10, or 12) is used to denote the whole number of wheels under the locomotive.

A figure or figures, following the figures indicating the whole number of wheels, indicates the diameter of cylinders, viz. :

8 indicates cylinders		7 inches in diameter.	
10	“	“	8 “ “ “
12	“	“	9 “ “ “
14	“	“	10 “ “ “
16	“	“	11 “ “ “
18	“	“	12 “ “ “
20	“	“	13 “ “ “
22	“	“	14 “ “ “
24	“	“	15 “ “ “
26	“	“	16 “ “ “
28	“	“	17 “ “ “
30	“	“	18 “ “ “
32	“	“	19 “ “ “
34	“	“	20 “ “ “
36	“	“	21 “ “ “
38	“	“	22 “ “ “
40	“	“	23 “ “ “
42	“	“	24 “ “ “

Thus 8-26 C indicates an eight wheeled locomotive, having four wheels coupled, and cylinders sixteen inches in diameter; 8-26 D indicates an eight wheeled locomotive, having six wheels coupled, and cylinders of the same diameter; and 10-34 E, a ten wheeled locomotive, having eight wheels coupled, and cylinders twenty inches in diameter.

The same rule applies to Baldwin four cylinder compound locomotives (Vauclain system). Thus 10- $\frac{22}{4}$ D indicates a ten wheeled locomotive, having six wheels coupled, a fourteen inch high pressure cylinder on each side, and a twenty four inch low pressure cylinder on each side. (For arrangement of cylinders, see Plates 6 and 7.)

The addition of the fraction $\frac{1}{4}$ indicates that there is a truck at each end of the locomotive. Thus 8-26 $\frac{1}{4}$ C indicates an eight wheeled loco-

motive, having four wheels coupled, cylinders sixteen inches in diameter, and a two wheeled truck at each end.

The addition of the fraction $\frac{1}{3}$ indicates that the engine is on the "Forney" plan, having the truck back of the fire box. Thus 8-26 $\frac{1}{3}$ C indicates an eight wheeled locomotive, having four wheels coupled, cylinders sixteen inches in diameter, and a four wheeled truck back of the fire box. 6-26 $\frac{1}{3}$ C indicates a six wheeled locomotive, having four wheels coupled, cylinders sixteen inches in diameter, and a two wheeled truck back of the fire box.

The figures following the class designation, as found on every locomotive, give the class number for that locomotive, and supply an individual designation for it, in addition to the construction number. Thus 8-26 C 500 means the five-hundredth locomotive of the 8-26 C class.

INSTRUCTIONS FOR CABLING.

The cable address of these Works is, "Baldwin, Philadelphia."

All code words relating to duplicate parts begin with the letter "E."

Each of the tables accompanying the plates in this book has in large heavy letters opposite the plate number a code word, the use of which indicates that all the parts shown on the plate are required; and each of the items has opposite it a code word in small heavy letters indicating that only that particular piece is needed.

In all cases it is understood that a set or enough for one locomotive will be sent unless specific instructions to the contrary are given.

On pages 41-49 a list will be found of duplicate parts in groups, such as are generally ordered, with a code word corresponding to each group.

In answering inquiries for prices, the cost is made for delivery f. o. b. vessel in Philadelphia or New York unless otherwise indicated.

The construction or consecutive number of the locomotive should be used in cabling and in writing orders. This is shown on the builder's plates, which are generally on the smoke box above the cylinders. Code words corresponding to construction numbers will be found in the tables herewith (pages 23-31), which range from 1 to 25000 (from 1 to 1000 inclusive proceeding by units, and from 1000 to 25000 proceeding by thousands).

Words consisting of more than ten letters are counted as two words. When the name of a railway or firm embraces two or more words containing ten letters or less in all, they can be cabled as one: for instance, "Costarica Railway" (two words), meaning Costa Rica Railway.

It is a rule of all telegraph companies that in cabling, three figures count as one word. Therefore, any construction number can be cabled in two words: for instance, 13 975 (13975), which would be counted two words. Inasmuch, however, as figures are more apt to be improperly transmitted than words, a table has been prepared (see page 23) by the use of which construction numbers can still be given in two words and some of them in one, these words being less liable to misconstruction than the figures.

Messages should be written very plainly, so that there can be no doubt as to the word used, and no possibility of the division of one word into two.

Upon application a code word will be assigned, representing the name of any railroad company or firm desiring to do business by cable with the Baldwin Locomotive Works.

Example: The construction number 6000 would be one word, "Eenlobbig;" while 6020 would be "Eenlobbig Earthworms," and 12540 "Eensgezind Ecofora" ("Eensgezind" standing for 12000 and "Ecofora" for 540). 6020 could also be 6 020, and 12540 be 12 540; but the word method is preferable.

Example: If it be desired to cable for a boiler complete, as shown on Plate 1, for engine 13978, to be shipped by steamer to Havana, Cuba, the message would read as follows (the signature should be the name of the company ordering or its code word):

HAVANA, January 10, 1895.

BALDWIN, Philadelphia.

Eerekrans
Ehrenruf
Eerewoord
Eensklaps
Eenbladig

(Signed) (Code name or actual name of Company.)

Translation:

HAVANA, January 10, 1895.

BALDWIN, Philadelphia.

Eerekrans . . Please ship by steamer as soon as possible duplicate parts covered by code word
Ehrenruf . . . Boiler and all parts on Plate 1.
Eerewoord . . For one locomotive, construction number
Eensklaps . }
Eenbladig . } 13978.

(Name of Company.)

But if a set of tubes were wanted, the message would read :

HAVANA, January 10, 1895.

BALDWIN, Philadelphia.

Eerekrans
 Ehrgeizig
 Eerewoord
 Eensklaps
 Eenbladig

(Signed) (Code name or actual name of Company.)

Translation :

HAVANA, January 10, 1895.

BALDWIN, Philadelphia.

Eerekrans . . . Please ship by steamer as soon as possible duplicate parts covered by code word

Ehrgeizig . . . Boiler tubes.

Eerewoord . . . For one locomotive, construction number

Eensklaps . . . } 13978.

Eenbladig . . . }

(Name of Company.)

If three sets of tubes were wanted for the same locomotive, or for locomotives of the same dimensions, the message would read :

HAVANA, January 10, 1895.

BALDWIN, Philadelphia.

Eerekrans
 Ehrgeizig
 Eergierig
 Eensklaps
 Eenbladig

(Signed) (Code name or actual name of Company.)

Translation :

HAVANA, January 10, 1895.

BALDWIN, Philadelphia.

Eerekrans . . . Please ship by steamer as soon as possible duplicate parts covered by code word

Ehrgeizig . . . Boiler tubes.

Eergierig . . . For three locomotives, construction number

Eensklaps . . . } 13978.

Eenbladig . . . }

(Name of Company.)

To order a pair of cylinders from Rio de Janeiro, Brazil, with parts attached, a message would read :

RIO, March 1, 1895.

BALDWIN, Philadelphia.

Eerekroon

Effricatum (See page 41.)

Eensdeels

Eddaic

(Signed) (Code name or actual name of Company.)

Translation :

RIO, March 1, 1895.

BALDWIN, Philadelphia.

Eerekroon . . . Please ship by steamer as soon as possible duplicate parts covered by code word (see *) for locomotive, construction number (see **).

Effricatum . . . * 1 pair cylinders with heads, covers, chests, caps, casings, glands, valves, yokes and pistons, painted and varnished.

Eensdeels . . . } ** 11743.

Eddaic . . . }

(Name of Company.)

A cable message from Yokohama, Japan, for a crosshead for left side of locomotive 14126, would read as follows :

YOKOHAMA, March 22, 1895.

BALDWIN, Philadelphia.

Eeredienst
Eigilwich
Eeretomben
Eensnarig
Eboueuses

(Signed) (Code name or actual name of Company.)

Translation :

YOKOHAMA, March 22, 1895.

BALDWIN, Philadelphia.

Eeredienst . . . Please ship by quickest freight route as soon as possible
duplicate parts covered by code word

Eigilwich . . . Crosshead.

Eeretomben . . . For left hand side of one locomotive, construction
number

Eensnarig . . . } 14126.
Eboueuses . . . }

(Name of Company.)

RIO, March 1, 1895.

BALDWIN, Philadelphia.

Eerekrans
Eilamides
Eeresabels
Eenschalig
Ebaucheras
Eerstdaags

(Signed) (Code name or actual name of Company.)

Translation :

RIO, March 1, 1895.

BALDWIN, Philadelphia.

- Eerekrans** . . Please ship by steamer as soon as possible duplicate parts covered by code word
- Eilamides** . . . Eccentric strap.
- Eeresabels** . . For right hand side of one locomotive, construction number
- Eenschalig** . . }
Ebaucheras . . } 10055.
- Eerstdaags** . . Backward motion.

(Name of Company.)

CABLE CODE NUMBERS.

1 Eachwhere	35 Ebahi	69 Ebdomada
2 Eactarius	36 Ebalacon	70 Ebelians
3 Eadburt	37 Ebalette	71 Ebenaceo
4 Eadburge	38 Ebanacee	72 Ebenastre
5 Eadwin	39 Ebanista	73 Ebenbild
6 Eager	40 Ebanizar	74 Ebeneous
7 Eagerly	41 Ebankers	75 Ebenezer
8 Eagerness	42 Ebano	76 Ebenfalls
9 Eagrass	43 Ebanoyer	77 Ebenheit
10 Eanred	44 Ebaque	78 Ebeni
11 Eapse	45 Ebarbement	79 Ebenier
12 Earinus	46 Ebarbeuse	80 Ebenistes
13 Earshrift	47 Ebarboir	81 Ebenmass
14 Earthiness	48 Ebaroui	82 Ebenoxyle
15 Earthling	49 Ebattons	83 Ebenrecht
16 Earthly	50 Ebattriez	84 Ebensohle
17 Earthquake	51 Ebattront	85 Ebenspiel
18 Earthward	52 Ebattu	86 Ebenuz
19 Earthwork	53 Ebaubi	87 Ebenwage
20 Earthworms	54 Ebauchage	88 Eberesche
21 Earwig	55 Ebaucheras	89 Ebergement
22 Earwort	56 Ebauchiez	90 Eberhard
23 Easeful	57 Ebauchoir	91 Eberhirsch
24 Easels	58 Ebbeaner	92 Eberlue
25 Easily	59 Ebbeboom	93 Eberulf
26 Easiness	60 Ebbene	94 Ebetazione
27 Easium	61 Ebbenhout	95 Ebetement
28 Easterling	62 Ebbero	96 Ebeto
29 Easterly	63 Ebbestrom	97 Ebeurrer
30 Eastward	64 Ebbezeit	98 Ebeylieres
31 Eatable	65 Ebbing	99 Ebiasaph
32 Eatage	66 Ebbrezza	100 Ebionisme
33 Eauzan	67 Ebbrieta	101 Ebiscum
34 Eavagier	68 Ebbrioso	102 Ebisele

- | | | |
|----------------|----------------|-----------------|
| 103 Eblana | 144 Ebraizzano | 185 Ebruiteur |
| 104 Eblandior | 145 Ebraizzare | 186 Ebruiteiras |
| 105 Eblanditus | 146 Ebraizzava | 187 Ebruitiez |
| 106 Eblanine | 147 Ebraizzo | 188 Ebruitons |
| 107 Eblouimes | 148 Ebrancadas | 189 Ebrulpho |
| 108 Eblouir | 149 Ebrancado | 190 Ebucheter |
| 109 Eblouiras | 150 Ebranchait | 191 Ebudae |
| 110 Eblouired | 151 Ebranchiez | 192 Ebulinus |
| 111 Eblouiront | 152 Ebranchons | 193 Ebulliate |
| 112 Eblouisses | 153 Ebranlait | 194 Ebullicao |
| 113 Eboda | 154 Ebranler | 195 Ebulliency |
| 114 Ebonist | 155 Ebranliez | 196 Ebullition |
| 115 Ebonite | 156 Ebranlions | 197 Ebulo |
| 116 Ebonized | 157 Ebrasure | 198 Eburacum |
| 117 Eboraci | 158 Ebreche | 199 Eburatus |
| 118 Eboracum | 159 Ebreneur | 200 Eburinorum |
| 119 Eborarios | 160 Ebria | 201 Eburiphore |
| 120 Eborense | 161 Ebriacus | 202 Eburnation |
| 121 Eborgnage | 162 Ebriation | 203 Eburnean |
| 122 Eboribus | 163 Ebriativo | 204 Eburneos |
| 123 Ebosia | 164 Ebriato | 205 Eburninae |
| 124 Ebouage | 165 Ebriavisti | 206 Eburobriga |
| 125 Eboueur | 166 Ebriedad | 207 Eburodunum |
| 126 Eboueuses | 167 Ebrietas | 208 Eburon |
| 127 Ebouffer | 168 Ebriety | 209 Eburones |
| 128 Ebouiger | 169 Ebrieux | 210 Eburovices |
| 129 Ebouilli | 170 Ebrillade | 211 Ebusus |
| 130 Eboulait | 171 Ebriosa | 212 Ecabochage |
| 131 Eboulee | 172 Ebriosidad | 213 Ecabocher |
| 132 Eboulement | 173 Ebriositas | 214 Ecachement |
| 133 Ebouleront | 174 Ebriosos | 215 Ecaffer |
| 134 Ebouleux | 175 Ebrious | 216 Ecaignon |
| 135 Ebouqueter | 176 Ebriulatus | 217 Ecafote |
| 136 Ebouriffe | 177 Ebrodunum | 218 Ecagne |
| 137 Ebouisine | 178 Ebroin | 219 Ecaillage |
| 138 Ebouter | 179 Ebromagi | 220 Ecaillaire |
| 139 Ebouture | 180 Ebromagus | 221 Ecaille |
| 140 Ebraiche | 181 Ebrondeur | 222 Ecaillette |
| 141 Ebraico | 182 Ebrosser | 223 Ecalcarate |
| 142 Ebraismo | 183 Ebrouait | 224 Ecaler |
| 143 Ebraisoir | 184 Ebrouement | 225 Ecalisseur |

226 Ecalyptre	267 Eccehomo	308 Ecerner
227 Ecangage	268 Ecceite	309 Ecerveler
228 Ecanguer	269 Eccentric	310 Ecetera
229 Ecaqueur	270 Eccentros	311 Ecfisa
230 Ecarasse	271 Eccessivo	312 Ecfisesi
231 Ecarquille	272 Eccettuano	313 Ecfonesi
232 Ecarrure	273 Eccettuare	314 Ecfrassi
233 Ecart	274 Eccettuava	315 Ecgonine
234 Ecartais	275 Eccheuma	316 Echacantos
235 Ecartasses	276 Ecchymose	317 Echacorvos
236 Ecartelait	277 Ecchymosis	318 Echadico
237 Ecarteler	278 Eccillum	319 Echadores
238 Ecartement	279 Eccitammo	320 Echaduras
239 Ecarterais	280 Eccitando	321 Echafaud
240 Ecarteriez	281 Eccitarla	322 Echafauder
241 Ecarteur	282 Eccitarono	323 Echaillon
242 Ecartons	283 Eccitassi	324 Echalas
243 Ecatissage	284 Eccitata	325 Echalasser
244 Ecaude	285 Eccitativo	326 Echamiento
245 Ecauvage	286 Eccitatore	327 Echampeau
246 Ecbalion	287 Eccitavamo	328 Echampi
247 Ecballium	288 Eccitavate	329 Echamplure
248 Ecbasis	289 Ecciterai	330 Echancrais
249 Ecbatic	290 Eccitero	331 Echancrant
250 Ecbibi	291 Eccitolla	332 Echancrure
251 Ecbibitum	292 Ecclesia	333 Echando
252 Ecbirsoma	293 Ecclesiains	334 Echandole
253 Ecbolade	294 Ecclesiola	335 Echanges
254 Ecbolique	295 Ecclinuse	336 Echangiez
255 Ecbyrsome	296 Eccopeur	337 Echangions
256 Eccanthis	297 Eccrisis	338 Echangiste
257 Eccedemmo	298 Eccycleme	339 Echapellas
258 Eccedendo	299 Ecderon	340 Echapoter
259 Eccedenza	300 Ecdicus	341 Echappade
260 Eccederai	301 Ecdippa	342 Echappiez
261 Eccedero	302 Ecdique	343 Echappons
262 Eccedessi	303 Ecdore	344 Echarbon
263 Eccedevamo	304 Ecdurorum	345 Echarnoir
264 Eccedevate	305 Ecdysies	346 Echarpes
265 Eccediate	306 Ecelenore	347 Echarseter
266 Eccedo	307 Ecepper	348 Echauboule

- | | | |
|----------------|----------------|----------------|
| 349 Echaudoir | 390 Echinite | 431 Echoueriez |
| 350 Echauffer | 391 Echinocere | 432 Echoueront |
| 351 Echauffure | 392 Echinoderm | 433 Echouiez |
| 352 Echaulant | 393 Echinodore | 434 Echouons |
| 353 Echaux | 394 Echinogale | 435 Echrefite |
| 354 Echazones | 395 Echinogyne | 436 Echsenbrut |
| 355 Echeable | 396 Echinoide | 437 Echsenei |
| 356 Echeancier | 397 Echinome | 438 Echtbreken |
| 357 Echebulus | 398 Echinomys | 439 Echtbreuk |
| 358 Echecelea | 399 Echinopo | 440 Echteband |
| 359 Echebrates | 400 Echinopode | 441 Echtebed |
| 360 Echeecs | 401 Echinorhin | 442 Echtelijk |
| 361 Echedamia | 402 Echinozoa | 443 Echtgareel |
| 362 Echeggia | 403 Echinulate | 444 Echtgenoot |
| 363 Echeggiano | 404 Echinus | 445 Echtheit |
| 364 Echeggiare | 405 Echinussa | 446 Echthre |
| 365 Echeggiava | 406 Echionides | 447 Echting |
| 366 Echelades | 407 Echiopsis | 448 Echtkoets |
| 367 Echelaos | 408 Echiquete | 449 Echtwort |
| 368 Echelidae | 409 Echite | 450 Echura |
| 369 Echelonner | 410 Echiuride | 451 Ecidine |
| 370 Echeneide | 411 Echkendji | 452 Ecimable |
| 371 Echeneidis | 412 Echmagoras | 453 Eckard |
| 372 Echeniller | 413 Echnomos | 454 Eckband |
| 373 Echephron | 414 Echoes | 455 Eckbert |
| 374 Echeopolis | 415 Echoicus | 456 Eckehard |
| 375 Echeveria | 416 Echoing | 457 Eckelhaft |
| 376 Echevinage | 417 Echome | 458 Eckeln |
| 377 Echidna | 418 Echometer | 459 Eckenhalm |
| 378 Echidnine | 419 Echométria | 460 Eckenzahl |
| 379 Echidorus | 420 Echometro | 461 Eckerganz |
| 380 Echignole | 421 Echonele | 462 Eckermast |
| 381 Echimyde | 422 Echopolus | 463 Eckhaus |
| 382 Echimyside | 423 Echoppage | 464 Eckkegel |
| 383 Echinacee | 424 Echoppe | 465 Ecklade |
| 384 Echinaria | 425 Echoton | 466 Ecklonie |
| 385 Echinated | 426 Echouage | 467 Eckplatz |
| 386 Echinidae | 427 Echouais | 468 Ecksaal |
| 387 Echinidans | 428 Echouasses | 469 Ecksaeulen |
| 388 Echinipede | 429 Echouer | 470 Eckschuh |
| 389 Echinital | 430 Echouerais | 471 Eckstamm |

472 Eckstein	513 Eclipsons	554 Economico
473 Eckthor	514 Eclipticus	555 Economique
474 Ecktisch	515 Eclissage	556 Economist
475 Eckzahn	516 Eclissammo	557 Economizar
476 Eclactisme	517 Eclissando	558 Economize
477 Eclaffer	518 Eclissassi	559 Econtrario
478 Eclair	519 Eclissava	560 Econverso
479 Eclairage	520 Eclisser	561 Ecoper
480 Eclairais	521 Eclisso	562 Ecoperche
481 Eclairci	522 Eclittica	563 Ecoquer
482 Eclaircise	523 Eclogarius	564 Ecorcage
483 Eclairons	524 Eclogarum	565 Ecorchant
484 Eclampsy	525 Eclopper	566 Ecorchasse
485 Eclanche	526 Eclore	567 Ecorcheler
486 Eclandre	527 Ecloses	568 Ecorchiez
487 Eclapsia	528 Eclosion	569 Ecorcons
488 Eclapside	529 Eclusa	570 Ecornifle
489 Eclatable	530 Eclusement	571 Ecossain
490 Eclatais	531 Ecmatyrie	572 Ecossaises
491 Eclateriez	532 Ecmelia	573 Ecossoneux
492 Eclatons	533 Ecnephias	574 Ecotado
493 Ecleche	534 Ecnomus	575 Ecotant
494 Eclecticos	535 Ecobuer	576 Ecotard
495 Eclectique	536 Ecochelage	577 Ecouailles
496 Eclectiser	537 Ecocheler	578 Ecouanette
497 Eclectisme	538 Ecoeurant	579 Ecouchures
498 Eclectizar	539 Ecoeurer	580 Ecoulard
499 Eclegma	540 Ecofora	581 Ecoulera
500 Eclepsis	541 Ecofrai	582 Ecoulerait
501 Eclesiarca	542 Ecoica	583 Ecoursee
502 Eclettismo	543 Ecoicos	584 Ecourseon
503 Eclidon	544 Ecoincon	585 Ecourtant
504 Ecligmata	545 Ecolage	586 Ecoussage
505 Ecligmatis	546 Ecole	587 Ecoutames
506 Ecligmatum	547 Ecolerer	588 Ecoutasses
507 Eclingure	548 Ecoliers	589 Ecouterais
508 Eclipsable	549 Ecometria	590 Ecouterons
509 Eclipsais	550 Ecometro	591 Ecouteur
510 Eclipsar	551 Econduirai	592 Ecoutille
511 Eclipsaron	552 Economat	593 Ecoutillon
512 Eclipse	553 Economicas	594 Ecoutoir

- | | | |
|----------------|----------------|----------------|
| 595 Ecouvette | 636 Ecremer | 677 Ectipo |
| 596 Ecphasis | 637 Ecremillon | 678 Ectobie |
| 597 Ecphlysis | 638 Ecremoire | 679 Ectoblast |
| 598 Ecphoneme | 639 Ecrevisse | 680 Ectocarpe |
| 599 Ecphonesis | 640 Ecrhexis | 681 Ectocyste |
| 600 Ecphora | 641 Ecriames | 682 Ectoderme |
| 601 Ecphorarum | 642 Ecrieront | 683 Ectogramma |
| 602 Ecphoris | 643 Ecrille | 684 Ectolitro |
| 603 Ecphorome | 644 Ecrivons | 685 Ectometro |
| 604 Ecphractic | 645 Ecrise | 686 Ectonstero |
| 605 Ecphraste | 646 Ecriteau | 687 Ectopage |
| 606 Ecphyma | 647 Ecritmo | 688 Ectopagia |
| 607 Ecphymote | 648 Ecritoire | 689 Ectophyte |
| 608 Ecphyse | 649 Ecriturer | 690 Ectopia |
| 609 Ecphysese | 650 Ecrivaille | 691 Ectopogono |
| 610 Ecpiema | 651 Ecrivimes | 692 Ectopones |
| 611 Ecpiesme | 652 Ecroe | 693 Ectosarc |
| 612 Ecpleope | 653 Ecroistre | 694 Ectosmie |
| 613 Ecplerome | 654 Ecrouellet | 695 Ectozoa |
| 614 Ecplessia | 655 Ecrouir | 696 Ectrogenie |
| 615 Ecplexie | 656 Ecroutage | 697 Ectromata |
| 616 Ecпноe | 657 Ecrysie | 698 Ectromatis |
| 617 Ecpyeme | 658 Ecsarcome | 699 Ectrome |
| 618 Ecpyesis | 659 Ecstasy | 700 Ectroparum |
| 619 Ecpyetique | 660 Ecstasize | 701 Ectropical |
| 620 Ecpyrosis | 661 Ecstatic | 702 Ectropio |
| 621 Ecqui | 662 Ecstatical | 703 Ectrotico |
| 622 Ecquod | 663 Ectadion | 704 Ectrotique |
| 623 Ecrabouir | 664 Ectatique | 705 Ectylotic |
| 624 Ecrache | 665 Ectatops | 706 Ectypal |
| 625 Ecraigne | 666 Ectenes | 707 Ectype |
| 626 Ecrainier | 667 Ecthese | 708 Ectyrique |
| 627 Ecrapette | 668 Ecthesien | 709 Ectyporum |
| 628 Ecrasable | 669 Ecthlimme | 710 Ecuable |
| 629 Ecrasais | 670 Ecthlipse | 711 Ecuacion |
| 630 Ecraser | 671 Ecthlipsis | 712 Ecuanteur |
| 631 Ecraserais | 672 Ecthyma | 713 Ecubier |
| 632 Ecraseriez | 673 Ecthymose | 714 Ecueil |
| 633 Ecrasiez | 674 Ecthymosis | 715 Ecuiaage |
| 634 Ecrasure | 675 Ectilotici | 716 Eculeo |
| 635 Ecremaison | 676 Ectimosi | 717 Ecumais |

718 Ecumant	759 Edelfink	800 Edentamus
719 Ecumenical	760 Edelfisch	801 Edentation
720 Ecumenico	761 Edelfrau	802 Edento
721 Ecumeresse	762 Edelfuchs	803 Edentula
722 Ecumeront	763 Edelgarbe	804 Edentulus
723 Ecumeux	764 Edelhengst	805 Edeopalmo
724 Ecumions	765 Edelhof	806 Edepoe
725 Ecumoire	766 Edelknabe	807 Edera
726 Ecunemica	767 Edelknecht	808 Ederaceo
727 Ecunemicos	768 Edelkrebs	809 Ederaceus
728 Ecuorea	769 Edellehen	810 Ederato
729 Ecuoreos	770 Edelmann	811 Ederoso
730 Ecureuil	771 Edelmarder	812 Edesio
731 Ecusson	772 Edelmass	813 Edesseno
732 Ecussonne	773 Edelmoedig	814 Edessenus
733 Ecvolorum	774 Edelmogend	815 Edesside
734 Ecvolus	775 Edelmuth	816 Edetana
735 Eczematous	776 Edelopal	817 Edetanos
736 Edacidade	777 Edelraut	818 Edgar
737 Edacious	778 Edelreis	819 Edgeless
738 Edaciously	779 Edelrose	820 Edgewise
739 Edacissimo	780 Edelschoen	821 Edgythe
740 Edacitatis	781 Edelsinn	822 Edharz
741 Edacite	782 Edelsinnig	823 Edhemite
742 Edaphodont	783 Edelstahl	824 Edibility
743 Eddaic	784 Edelstolz	825 Edible
744 Eddas	785 Edelthat	826 Edibleness
745 Eddered	786 Edelthier	827 Edicaria
746 Eddering	787 Edelvrouw	828 Edicendum
747 Eddoes	788 Edelweiss	829 Edichio
748 Edealogia	789 Edematico	830 Edicola
749 Edeatros	790 Edematoso	831 Edictabam
750 Edecan	791 Edematous	832 Edictabis
751 Edecanes	792 Edemera	833 Edictalium
752 Edecimamus	793 Edenique	834 Edictamus
753 Edecimatum	794 Edenisch	835 Edictarem
754 Edecimavi	795 Edenize	836 Edictavi
755 Edelaardig	796 Edenizing	837 Edictione
756 Edeldame	797 Edenruine	838 Edictionis
757 Edelerde	798 Edental	839 Edictorum
758 Edelfest	799 Edentalous	840 Edicule

841 Ediderunt	882 Editor	923 Edredones
842 Edidici	883 Editores	924 Edris
843 Edidicimus	884 Editorial	925 Edrisiden
844 Edidisti	885 Editoribus	926 Edrum
845 Edifiant	886 Editorship	927 Educacao
846 Edificaban	887 Editress	928 Educadores
847 Edificacao	888 Editresses	929 Educados
848 Edificada	889 Edituate	930 Educaremus
849 Edificados	890 Edituating	931 Educate
850 Edificao	891 Edixerimus	932 Educateur
851 Edifice	892 Edixi	933 Educative
852 Edificios	893 Ediximus	934 Educatore
853 Edifiement	894 Edixissem	935 Educatrix
854 Edifieras	895 Edizione	936 Educatum
855 Edifieriez	896 Edmondie	937 Educaturi
856 Edifieront	897 Edmundo	938 Educaturos
857 Edifiques	898 Edoardo	939 Educaturum
858 Edifizio	899 Edocenter	940 Educavano
859 Edify	900 Edocephale	941 Educavisti
860 Edifying	901 Edoctum	942 Educavit
861 Edifyingly	902 Edocuerunt	943 Educeret
862 Edikt	903 Edocui	944 Educeretis
863 Edilberto	904 Edocuisti	945 Educhiamo
864 Edileship	905 Edolandi	946 Eductor
865 Edilicio	906 Edolandos	947 Edulcare
866 Edilidade	907 Edolandum	948 Edulcorado
867 Edilita	908 Edolatorum	949 Edulcorant
868 Edilitaire	909 Edolatum	950 Edulcoreis
869 Ediografia	910 Edolavisti	951 Edulica
870 Ediologia	911 Edolien	952 Edulous
871 Ediosmo	912 Edomitas	953 Edulis
872 Ediotide	913 Edomitavi	954 Edumia
873 Ediotomia	914 Edomiter	955 Eduquant
874 Edisaro	915 Edoner	956 Eduquemos
875 Edisma	916 Edonio	957 Eduques
876 Edisseris	917 Edonismo	958 Edurescis
877 Edisserto	918 Edonorum	959 Edurorum
878 Editeur	919 Edormisco	960 Edwardsie
879 Editicia	920 Edossage	961 Edwarsite
880 Editioned	921 Edostome	962 Edwig
881 Editioning	922 Edredon	963 Edyllium

964 Edzard	984 Eendenkooi	6,000 Eenlobbig
965 Eedbrekers	985 Eendennest	7,000 Eenooig
966 Eedbreuk	986 Eendenroer	8,000 Eenooig
967 Eedgespan	987 Eender	9,000 Eenrijm
968 Eegaas	988 Eendeveder	10,000 Eenschalig
969 Eekhakker	989 Eendjes	11,000 Eensdeels
970 Eekhandel	990 Eendracht	12,000 Eensgezind
971 Eekhoren	991 Eendvogels	13,000 Eensklaps
972 Eelbuck	992 Eengrepig	14,000 Eensnarig
973 Eelpot	993 Eenhandig	15,000 Eenspan
974 Eelspear	994 Eenheid	16,000 Eenstemmig
975 Eeltachtig	995 Eenhelmig	17,000 Eenstijlig
976 Eelterig	996 Eenhoekig	18,000 Eenvakkig
977 Eeltzweer	997 Eenhoofdig	19,000 Eenvervig
978 Eenbladig	998 Eenhoorn	20,000 Eenvinnig
979 Eenbloemig	999 Eenhoornig	21,000 Eenvoetig
980 Eendebout	1,000 Eenhuizig	22,000 Eenvoud
981 Eendenei	2,000 Eenigerlei	23,000 Eenvoudig
982 Eendenhok	3,000 Eeniglijk	24,000 Eenwijvig
983 Eendenkom	4,000 Eekennig	25,000 Eenzaam
	5,000 Eenkleurig	

USEFUL SENTENCES FOR CABLING FOR PARTS OF LOCOMOTIVES.

- Eenzelvig** . . . At what price and how soon can you ship duplicate parts covered by code word.....?
- Eenzijdig** . . . How soon can you ship duplicate parts covered by code word.....?
- Eeotomous** . . . Please ship by express as soon as possible duplicate parts covered by code word.....
- Eeramtb** . . . Please ship by express as soon as possible duplicate parts covered by code word.....for locomotive, construction number.....
- Eerbetoon** . . . Please ship by freight as soon as possible duplicate parts covered by code word.....
- Eereblijk** . . . Please ship by freight as soon as possible duplicate parts covered by code word.....for locomotive, construction number.....
- Eereboog** . . . Please ship overland as soon as possible duplicate parts covered by code word.....
- Eeredegen** . . . Please ship overland as soon as possible duplicate parts covered by code word.....for locomotive, construction number.....
- Eeredienst** . . . Please ship by quickest freight route as soon as possible duplicate parts covered by code word.....
- Eeregraf** . . . Please ship by quickest freight route as soon as possible duplicate parts covered by code word..... for locomotive, construction number.....
- Eerekrans** . . . Please ship by steamer as soon as possible duplicate parts covered by code word.....
- Eerekroon** . . . Please ship by steamer as soon as possible duplicate parts covered by code word.....for locomotive, construction number.....
- Eeremantel** . . . Please ship by sailing vessel as soon as possible duplicate parts covered by code word.....

- Eereplaats** . . . Please ship by sailing vessel as soon as possible duplicate parts covered by code word.....for locomotive, construction number.....
- Eerepoort** . . . Please ship by steamer as soon as possible duplicate parts to the value of \$.....
- Eerepost** . . . Please ship by steamer as soon as possible duplicate parts to the value of \$.....for locomotive, construction number.....
- Eereposten** . . . Please ship by sailing vessel as soon as possible duplicate parts to the value of \$.....
- Eereprijs** . . . Please ship by sailing vessel as soon as possible duplicate parts to the value of \$.....for locomotive, construction number.....
- Eeresabels** . . . For right hand side of one locomotive, construction number.....
- Eereschot** . . . For right hand side of two locomotives, construction number.....
- Eerestoel** . . . For right hand side of three locomotives, construction number.....
- Eeretempel** . . . For right hand side of four locomotives, construction number.....
- Eeretitels** . . . For right hand side of five locomotives, construction number.....
- Eeretomben** . . . For left hand side of one locomotive, construction number.....
- Eeretrapp** . . . For left hand side of two locomotives, construction number.....
- Eerewacht** . . . For left hand side of three locomotives, construction number.....
- Eerewapen** . . . For left hand side of four locomotives, construction number.....
- Eerewijn** . . . For left hand side of five locomotives, construction number.....
- Eerewoord** . . . For one locomotive, construction number.....
- Eergevoel** . . . For two locomotives, construction number.....
- Eergierig** . . . For three locomotives, construction number.....
- Eerlijk** For four locomotives, construction number.....
- Eerlijker** For five locomotives, construction number.....
- Eerloozers** For six locomotives, construction number.....
- Eermetaal** For seven locomotives, construction number.....
- Eernamen** For eight locomotives, construction number.....

- Eerpenning . . . For nine locomotives, construction number.....
- Eerroof For ten locomotives, construction number.....
- Eerroovend . . . Hold order of.....until you receive further
instructions.
- Eersholve . . . Forward motion.
- Eerstdaags . . . Backward motion.
- Eertijds
- Eervol
- Eervoller
- Eerwaarde
- Eerwaardig
- Eerzamer
- Eerzucht
- Eerzuchtig
- Eesting
- Eestmout
- Eetbak
- Eethuis
- Eethuizen
- Eetion
- Eetionem
- Eetkamers
- Eetlepels
- Eetlust
- Eetmalen
- Eetplaats
- Eetregel
- Eetsters
- Eettafel
- Eetwaar
- Eetzaal
- Eeuwen
- Eeuwenoud
- Eeuwfeest
- Eeuwjaar
- Eeuwspel
- Eeuwzang
- Eeuwzangen
- Efantel
- Efaufle
- Efectuado

Efectuamos . . .
Efectuaron . . .
Efectuases . . .
Efectueis . . .
Efedra
Efemerides . . .
Efemerie
Efesias
Efesio
Efestite
Efetico
Effable
Effacable
Effacage
Effacais
Effacasses
Effacerais
Effaceriez
Effacerons
Effacest
Effacing
Effacons
Effaecata
Effaecatus
Effaner
Effanures
Effarcimus
Effarcio
Effarciunt
Effarement
Effarvatte
Effatio
Effatione
Effatorum
Effauce
Effaumer
Effeccao
Effecerim
Effecissem
Effectible
Effectif

Effectione . . .
 Effectivo . . .
 Effectivus . . .
 Effectless . . .
 Effectrix . . .
 Effectuais . . .
 Effectuar . . .
 Effectuose . . .
 Effecundo . . .
 Effeiance . . .
 Efeito . . .
 Effetuoso . . .
 Effelure . . .
 Effeminar . . .
 Effeminava . . .
 Effeminize . . .
 Effendi . . .
 Effenende . . .
 Effenheid . . .
 Effening . . .
 Efferascis . . .
 Efferasco . . .
 Efferatio . . .
 Efferatus . . .
 Efferous . . .
 Efferismus . . .
 Efferisisti . . .
 Effervens . . .
 Efferveo . . .
 Effervesce . . .
 Effestria . . .
 Effestuer . . .
 Effete . . .
 Effettore . . .
 Effettrice . . .
 Effettuato . . .
 Effettuavi . . .
 Effeuiller . . .
 Effezione . . .
 Efficacia . . .
 Efficaz . . .

Efficiency . . .
Efficient . . .
Efficienza . . .
Efficta . . .
Effictorum . . .
Effictum . . .
Effierced . . .
Effiercing . . .
Effigiado . . .
Effigiar . . .
Effigiassi . . .
Effigiava . . .
Effigie . . .
Effigierai . . .
Effiloche . . .
Effiloquer . . .
Effimero . . .
Effindere . . .
Efflagitas . . .
Efflagito . . .
Efflammans . . .
Efflanque . . .
Efflation . . .
Efflatos . . .
Effleurais . . .
Effleure . . .
Efflevisti . . .
Efflictim . . .
Effloreo . . .
Effloremus . . .
Effloresce . . .
Efflorui . . .
Efflower . . .
Effluencia . . .
Effluente . . .
Effluescis . . .
Effluvial . . .
Effluvio . . .
Effluvioso . . .
Effluxed . . .
Effluxing . . .

Effluxorum . . .
Effocare . . .
Effoderunt . . .
Effodimus . . .
Effodisti . . .
Effoedis . . .
Effoedo . . .
Effondrait . . .
Effondront . . .
Effor . . .
Efforcais . . .
Efforcant . . .
Efforcing . . .
Efforcions . . .
Efforeria . . .
Efformed . . .
Efformier . . .
Effortless . . .
Effossioni . . .
Effossum . . .

GROUPS OF DUPLICATE PARTS WITH CODE WORDS.

[In some cases it will be more convenient to order parts by using these group words; in others by a reference to the plates. See index (page 3) to find part needed.]

- Effouage** 1 Boiler with Tubes, Double Cone, Dry Pipe, Throttle work complete, including Stuffing Box and Gland, Dome Cap and Safety Valves, Smoke Box Front and Door, Fire Door with Liner and Frame and Cleaning Plugs, tested and primed.
- Effoueil** 1 Boiler with Tubes and Cleaning Plugs only, tested and primed.
- Effractor** 1 Fire Box.
- Effracture** 1 Set Boiler Tubes.
- Effrange** 1 Set Boiler Tube Ferrules.
- Effrayable** 1 Double Cone.
- Effrayer** 1 Set Steam Pipes.
- Effrayeras** 1 Throttle Valve, Box, Pipe, Elbow, Crank, and Rod.
- Effrayiez** 1 Smoke Box Front and Door.
- Effrayons** 1 Fire Door with Frame and Liner.
- Effrement** 1 Set Cleaning Plugs.
- Effrenatio** 1 Set Fusible Plugs.
- Effrenatus** 1 Set Boiler Lagging.
- Effrenibus** 1 Set Boiler Jacket.
- Effrenis** 1 Set Boiler Jacket Bands.
- Effricare** 1 Set Safety Valves, complete.
- Effricatum** 1 Pair Cylinders with Heads, Covers, Chests, Caps, Casings, Glands, Valves, Yokes, and Pistons, painted and varnished.
- Effrico** 1 Pair Finished Cylinders, bolted together, without any fittings.
- Effrique** 1 Set Front Cylinder Heads.
- Effriter** 1 Set Back Cylinder Heads.
- Effrixisti** 1 Set Front Cylinder Covers.
- Effroisser** 1 Set Back Cylinder Covers.
- Effruitant** 1 Set Cylinder Glands and Bottom Rings.

- Effrutico** . . . I Set Metallic Packing complete, for Piston Rods and Valve Stems.
- Effugio** . . . I Set Composition Rings for Metallic Packing of Piston Rods and Valve Stems.
- Effugisti** . . . I Set Cylinder Casings.
- Effugitos** . . . I Set Steam Chests.
- Effugiunt** . . . I Set Steam Chest Caps or Lids.
- Effulcrate** . . . I Set Steam Chest Glands and Bottom Rings.
- Effulge** . . . I Set Steam Chest Casings.
- Effulgence** . . . I Set Steam Chest Casing Covers.
- Effulgent** . . . I Set Steam Chest Valves.
- Effulgetis** . . . I Set Steam Chest Valve Yokes.
- Effulsio** . . . I Set Steam Chest Relief Valves.
- Effulsioni** . . . I Set Pistons with Rods and Packing.
- Effultorum** . . . I Set Piston Rods.
- Effultus** . . . I Set Piston Packing.
- Effumable** . . . I Pair Cylinders with Heads, Covers, Casings, Valves, Stems, Pistons, Metallic Piston Rod and Valve Stem Packing, complete (Vauclain Compound System).
- Effumant** . . . I Pair Finished Cylinders with Bushings, bolted together, but without other fittings (Vauclain Compound System).
- Effumigare** . . . I Set Front Cylinder Heads, High Pressure (Vauclain Compound System).
- Effuming** . . . I Set Back Cylinder Heads, High Pressure (Vauclain Compound System).
- Effundica** . . . I Set Front Cylinder Head Casing Covers, High Pressure (Vauclain Compound System).
- Effundir** . . . I Set Back Cylinder Head Casing Covers, High Pressure (Vauclain Compound System).
- Effundo** . . . I Set Front Cylinder Heads, Low Pressure (Vauclain Compound System).
- Effusion** . . . I Set Back Cylinder Heads, Low Pressure (Vauclain Compound System).
- Effusive** . . . I Set Front Cylinder Head Casing Covers, Low Pressure (Vauclain Compound System).
- Effusively** . . . I Set Back Cylinder Head Casing Covers, Low Pressure (Vauclain Compound System).
- Effusoris** . . . I Set Front Valve Chamber Heads (Vauclain Compound System).

- Effusorum** . . . 1 Set Back Valve Chamber Heads (Vauclain Compound System).
Effuticus . . . 1 Set Front Valve Chamber Head Casing Covers (Vauclain Compound System).
Effutile . . . 1 Set Back Valve Chamber Head Casing Covers (Vauclain Compound System).
Effutilus . . . 1 Set Valve Chamber Bushings (Vauclain Compound System).
Effutilium . . . 1 Set Main Piston Valves with Rings (Vauclain Compound System).
Efialte . . . 1 Set Main Piston Valves with Rings and Stems (Vauclain Compound System).
Eficiencia . . . 1 Set Main Piston Valve Rings (Vauclain Compound System).
Efigies . . . 1 Set Pistons with Rods and Packing, High Pressure (Vauclain Compound System).
Eflagelle . . . 1 Set Pistons with Rods and Packing, Low Pressure (Vauclain Compound System).
Efourceau . . . 1 Set Piston Packing Rings, High Pressure (Vauclain Compound System).
Efraimo . . . 1 Set Piston Packing Rings, Low Pressure (Vauclain Compound System).
Efusal . . . 1 Set Piston Rods (Vauclain Compound System).
Egagre . . . 2 Starting Valves (Vauclain Compound System).
Egagropilo . . . 4 Cylinder Cocks (Vauclain Compound System).
Egailer . . . 1 Set Cylinder Relief Valves (Vauclain Compound System).
Egalement . . . 1 Set Frames without Fittings.
Egalisage . . . 1 Set Frame Front Rails.
Egaliser . . . 1 Set Frame Pedestal Caps.
Egaliseras . . . 1 Set Pedestal Wedges.
Egalisons . . . 1 Set Pedestal Wedge Bolts.
Egalitaire . . . 1 Set Pedestal Gibs.
Egalite . . . 1 Set Driving Wheels complete, on Axles with Eccentrics, Eccentric Straps, and Boxes, painted and varnished.
Egancette . . . 1 Set Driving Tires.
Egarerais . . . 1 Set Wrist Pins.
Egareriez . . . 1 Set Driving Axles.
Egareront . . . 1 Set Eccentrics.
Egariez . . . 1 Set Eccentric Straps.

- Egavons . . . 1 Set Guides with Filling Pieces.
 Egarrotte . . . 1 Set Crossheads.
 Egauler . . . 1 Set Crosshead Gibs.
 Egayantes . . . 1 Set Crosshead Filling Pieces.
 Egayasses . . . 1 Set Crosshead Pins.
 Egayer . . . 1 Set Rods complete, except Oil Cups.
 Egayeras . . . 1 Set Rod Brasses.
 Egayions . . . 1 Set Rod Straps.
 Egberto . . . 1 Set Rod Keys.
 Egdauama . . . 1 Set Rod Straps with Brasses, Keys, Bolts and Set
 Screws.
 Egeenne . . . 1 Set Links complete, with Blocks, Lifters, Eccentric
 Rods and all Pins.
 Egeirino . . . 1 Reverse Shaft.
 Egelamus . . . 1 Set Reverse Shaft Bearings.
 Egelantier . . . 1 Set Rockshafts.
 Egelbeere . . . 1 Set Rocker Boxes.
 Egelgras . . . 1 Set Valve Rods.
 Egelidamus . . . 1 Counterbalance Spring.
 Egelidas . . . 1 Pump complete.
 Egelkruid . . . 1 Pump Plunger.
 Egelochus . . . 1 Pump Feed Cock.
 Egentium . . . 1 Pump Check complete.
 Egenulorum . . . 1 Complete Set of Springs.
 Egerane . . . 1 Set Driving Springs.
 Egermage . . . 1 Set Driving Spring Links.
 Egersimon . . . 1 Set Engine Truck Springs.
 Egesaretus . . . 1 Set Tender Springs.
 Egesippe . . . 1 Forward Equalizing Beam.
 Egestas . . . 1 Forward Equalizing Beam Fulcrum.
 Egestione . . . 1 Set Equalizing Beams.
 Egestionis . . . 1 Set Equalizing Beam Fulcrums.
 Egestorum . . . 1 Bell with Clapper and Tongue.
 Egestosi . . . 1 Bell with Clapper and Tongue, Frame, Yoke and
 Crank.
 Egestosus . . . 1 Sand Box complete.
 Egestuum . . . 1 Smoke Stack complete with Base.
 Eggaree . . . 1 Smoke Stack Base complete.
 Eggebalken . . . 1 Smoke Stack Cone.
 Eggehaken . . . 1 Smoke Stack Netting.
 Eggement . . . 1 Set Grate Bars.

Eggen	1	Set Grate Frames or Holders.
Eggerigst	1	Set Rocking Grates, with all Fixtures.
Eggerling	1	Set Engine Truck Boxes with Brasses and Cellars.
Eggiger	1	Set Engine Truck Box Brasses.
Eggigheid	1	Set Engine Truck Box Cellars.
Eghiazar	1	Set Driving Boxes with Brasses and Cellars.
Egialus	1	Set Driving Box Brasses.
Egidarmato	1	Set Driving Box Cellars.
Egidio	1	Set Tender Boxes with Lids, Wedges and Brasses.
Egifila	1	Set Tender Boxes with Lids.
Egignere	1	Set Tender Box Wedges.
Egilopical	1	Set Tender Box Brasses.
Eginetique	1	Engine Truck complete, with Wheels, Boxes, etc., painted and varnished.
Eginopside	1	Engine Truck complete, except Wheels and Boxes.
Egiochus	1	Engine Truck Centre Pin.
Egipciana	1	Engine Truck Swing Bolster.
Egipcios	1	Engine Truck Frame.
Egipiro	2	Engine Truck Wheels without Axles, bored.
Egiptologo	1	Pair Engine Truck Wheels on Axles, painted and varnished.
Egirine	1	Pilot.
Egissent	1	Pilot Bull Nose.
Egiziache	1	Pilot Draw Bar.
Egiziaco	1	Engine Front Draw Casting.
Eglecopala	1	Water Gauge complete.
Egloga	12	Water Gauge Glasses.
Eglogiste	1	Water Gauge Lamp.
Egloguista	1	Injector.
Eglon	1	Injector Steam Valve.
Egmond	1	Injector Feed Cock.
Egnatia	1	Injector Check.
Egnatius	1	Steam Gauge.
Egoarico	1	Steam Gauge Stand.
Egoasinha	1	Steam Gauge Lamp.
Egobole	12	Steam Gauge Lamp Globes.
Egobuer	1	Steam Gauge Lamp Stand.
Egofonia	1	Blower Valve.
Egoger	1	Heater Valve.
Egohine	1	Steam Brake Valve for Engineer.
Egoical	1	Steam Brake Stop Valve.

- Egoismar . . . 1 Blow-off Cock.
 Egoismo . . . 1 Set Gauge Cocks.
 Egoistical . . . 1 Set Cylinder Cocks.
 Egoistique . . . 1 Sight Feed Cylinder Lubricator.
 Egoity . . . 1 Set Cab Cylinder Oilers, B. L. W. style.
 Egoletro . . . 1 Set Condensing Steam Chest Oil Cups.
 Egologie . . . 1 Set Rod Oil Cups.
 Egologique . . . 1 Set Guide Oil Cups.
 Egomet . . . 1 Set Rock Shaft Oil Cups.
 Egomiste . . . 1 Set Eccentric Strap Oil Cups.
 Egophone . . . 1 Whistle.
 Egopodio . . . 1 Headlight.
 Egopogono . . . 1 Throttle Lever complete, with Quadrant, Latch,
 Link, Stud, Handle and Spring.
 Egoprigo . . . 1 Reverse Lever complete.
 Egoprosope . . . 1 Reverse Lever Rod, or Reach Rod.
 Egorgement . . . 1 Set Cab Brackets.
 Egorgeoir . . . 1 Set Cab Bracket Plates.
 Egorgeront . . . 1 Foot Plate.
 Egorgille . . . 1 Tender Wedge.
 Egosiller . . . 1 Tender Wedge Box.
 Egotheism . . . 1 Engine Back Draw Bar.
 Egothele . . . 1 Exhaust Nozzle and Thimbles.
 Egotism . . . 1 Set Exhaust Nozzle Thimbles.
 Egotistic . . . 1 Set Smoke Box Netting.
 Egotize . . . 1 Spark Ejector.
 Egotizing . . . 1 Spark Ejector Valve.
 Egout . . . 1 Set Smoke Box Cleaning Holes and Caps.
 Egoutier . . . 1 Set Driving Brake Shoes.
 Egouttage . . . 1 Set Driving Brake Heads.
 Egraffigne . . . 1 Set Brake Cylinders complete, with Pistons and
 Rods.
 Egrageure . . . 1 Set Driving Brake Cams.
 Egrainage . . . 1 Tank with Funnel and Lid, Valves, Lugs and Han-
 dles, painted and varnished.
 Egrainoir . . . 1 Tank Funnel and Lid.
 Egramente . . . 1 Tank Cock.
 Egraminer . . . 1 Tender, complete on Wheels, painted and varnished.
 Egrappage . . . 1 Tender Chafing Casting.
 Egrapper . . . 1 Tender Front Draw Casting.
 Egratigner . . . 1 Tender Back Draw Casting.

- Egravoir . . . 1 Set Tender Frame Centre Pins.
 Egregiat . . . 1 Set Tender Pedestals.
 Egregiorum . . . 1 Set Tender Trucks complete, with Wheels, painted
 and varnished.
 Egregious . . . 1 Tender Truck complete, with Wheels, painted and
 varnished.
 Egregores . . . 1 Set Tender Trucks complete, without Wheels and
 Boxes.
 Egrement . . . 1 Tender Truck complete, without Wheels and Boxes.
 Egressao . . . 1 Set Tender Truck Centre Plates.
 Egressed . . . 1 Set Tender Wheels on Axles, painted and varnished.
 Egressing . . . 1 Pair Tender Wheels on Axle, painted and varnished.
 Egribos . . . 1 Set Tender Wheels without Axles.
 Egrillard . . . 1 Set Tender Brake Shoes.
 Egriot . . . 1 Set Tender Brake Heads.
 Egrisage . . . 1 Cab.
 Egritude . . .
 Egrotant . . .
 Egsmeden . . .
 Egsmederij . . .
 Egsmid . . .
 Egtand . . .
 Egtanden . . .
 Egualeudo . . .
 Egualezza . . .
 Eguallimmo . . .
 Eguallirai . . .
 Eguallisco . . .
 Eguallissi . . .
 Eguallito . . .
 Egueille . . .
 Eguerunt . . .
 Eguilles . . .
 Eguimus . . .
 Eguisier . . .
 Eguisti . . .
 Egularum . . .
 Egurgito . . .
 Eglypciaco . . .
 Eglypius . . .
 Eglyptiaque . . .

Egyptien . . .
Egyptology . .
Ehamote . . .
Ehebett . . .
Ehebruch . . .
Ehebund . . .
Ehefrau . . .
Ehegatte . . .
Ehegeld . . .
Ehegemahl . .
Ehegenosse . .
Ehegericht . .
Ehegespons . .
Ehegestern . .
Ehehaelfte . .
Ehejoch . . .
Eheklage . . .
Eheleben . . .
Eheleute . . .
Eheliebe . . .
Ehelos
Ehemals . . .
Ehemann . . .
Eheordnung . .
Ehepaar . . .
Ehepfand . . .
Eherecht . . .
Ehering . . .
Eheringen . .
Ehern
Eheschatz . .
Eheschmied . .
Eheschuld . . .
Ehesegen . . .
Ehestifter . . .
Ehestunde . . .
Ehevater . . .
Ehevogt
Eheweib
Ehewunsch . . .
Ehodum

Ehontement . . .
Ehoupper . . .
Ehrbarer . . .
Ehrenamt . . .
Ehrenbahn . . .
Ehrenbett . . .
Ehrenbild . . .
Ehrenbogen . . .
Ehrengabe . . .
Ehrengift . . .
Ehrengrab . . .
Ehrengruss . . .
Ehrenhaft . . .
Ehrenkampf . . .
Ehrenkerze . . .
Ehrenkette . . .
Ehrenkranz . . .
Ehrenkreuz . . .
Ehrenkrone . . .
Ehrenlied . . .
Ehrenlohn . . .
Ehrenluege . . .
Ehrenmahl . . .
Ehrenmann . . .
Ehrenmusik . . .
Ehrenpaar . . .
Ehrenplatz . . .
Ehrenpreis . . .
Ehrenpunkt . . .
Ehrenrauch . . .
Ehrenrecht . . .
Ehrenreim . . .
Ehrenrock . . .

TYPES OF LOCOMOTIVES.

IN order to aid in understanding the class designations more readily, the different types of engines manufactured at these Works, with the class designations of each type, and the kind of service for which they are specially designed or adapted, are shown by line illustrations, in the following pages.

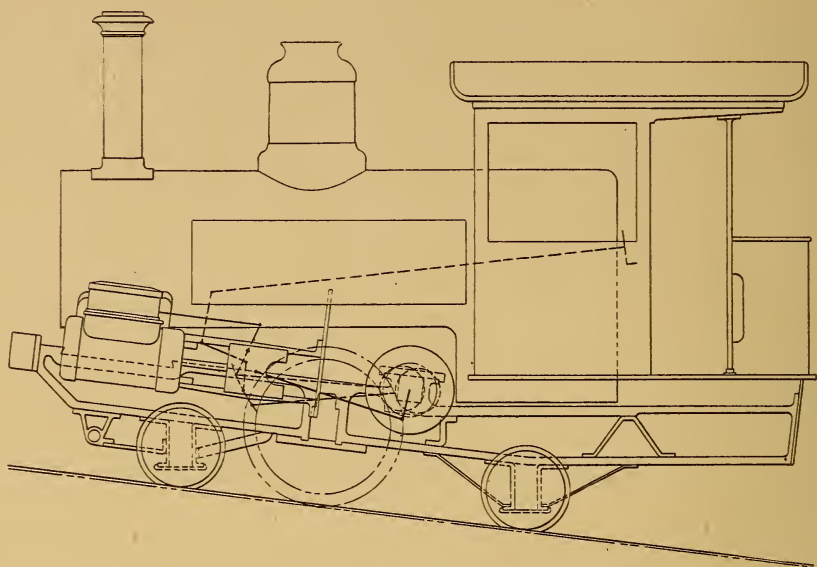

5 A (RACK RAIL TYPE).
MOUNTAIN SERVICE.

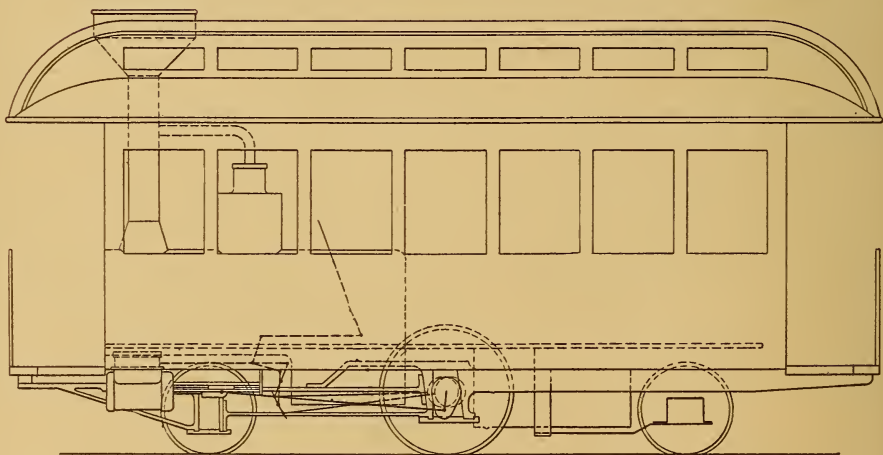

6 B.
INSPECTION SERVICE.

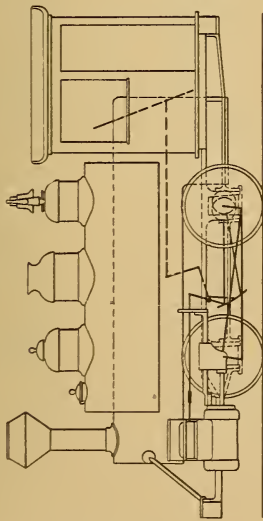

4 C TANK ON BOILER.

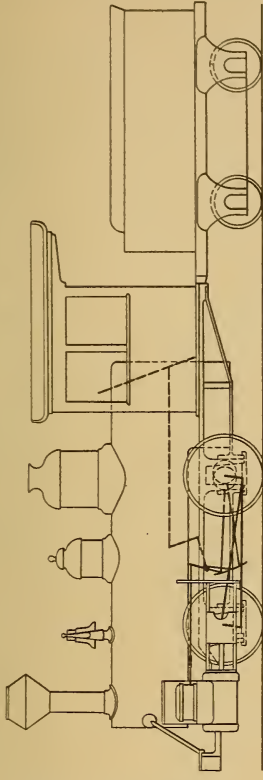

4 C WITH TENDER.

SWITCHING SERVICE.

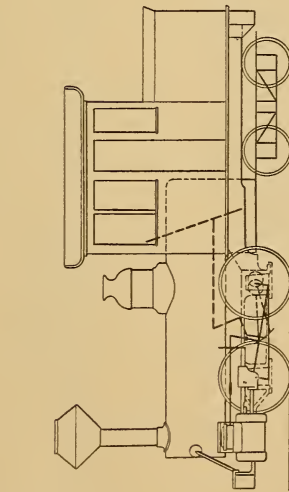

8½ C TANK BACK.

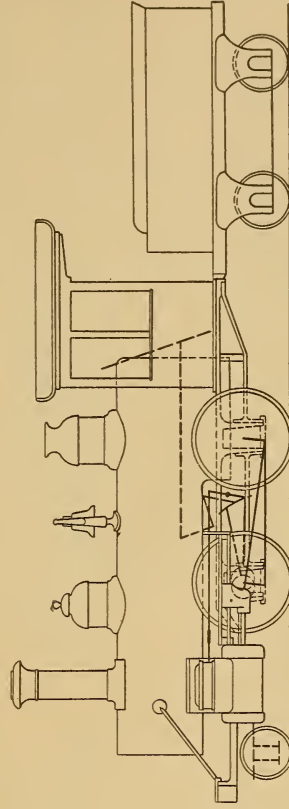

6 C WITH TENDER.

SWITCHING AND LOCAL SERVICE.

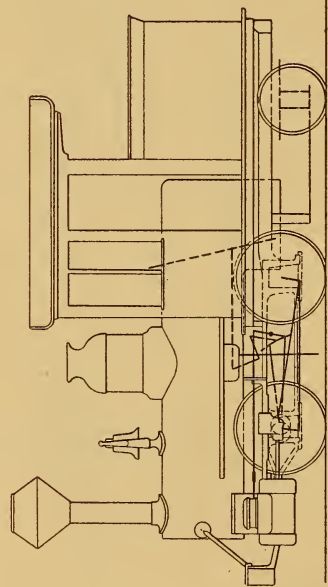

6 1/2 C TANK BACK.
SWITCHING AND LOCAL PASSENGER SERVICE.

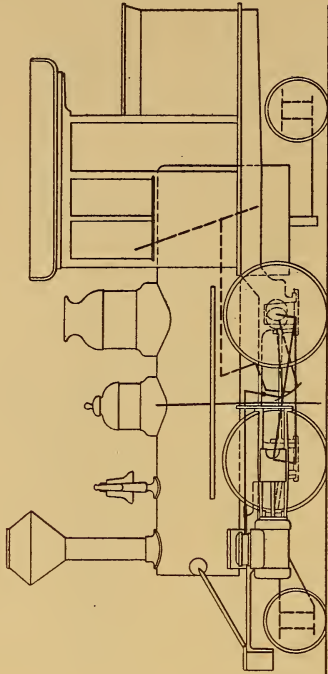

8 1/2 C TANK BACK.
SWITCHING AND LOCAL PASSENGER SERVICE.

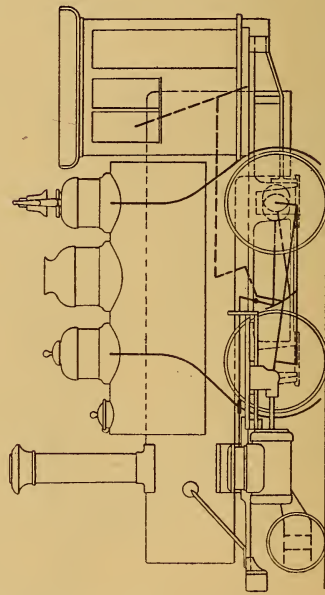

6 C TANK ON BOILER.
SWITCHING AND LOCAL SERVICE.

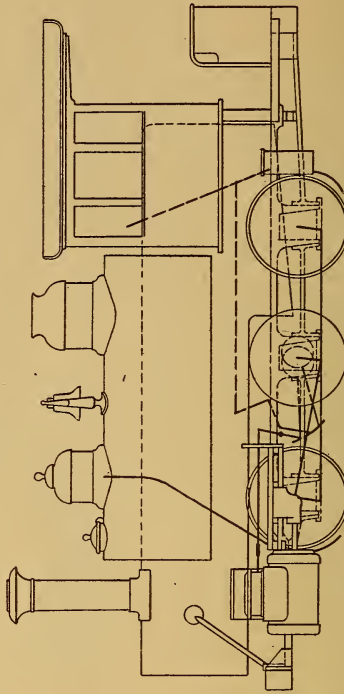

6 D TANK ON BOILER.
HEAVY SWITCHING.

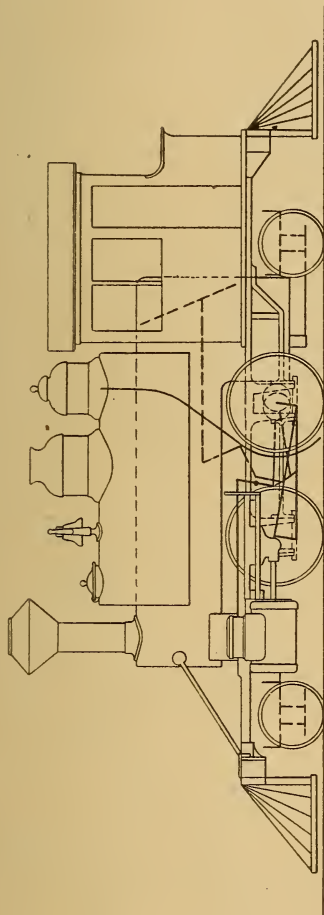

8½ C TANK ON BOILER.
LOCAL PASSENGER SERVICE.

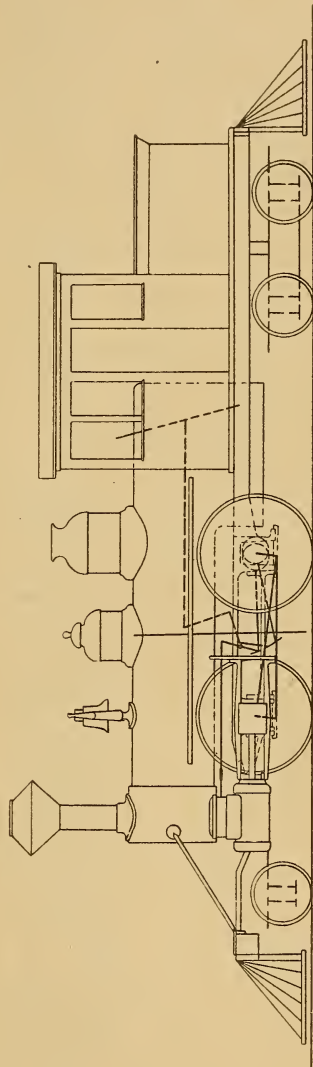

10½ C TANK BACK.
LOCAL PASSENGER SERVICE.

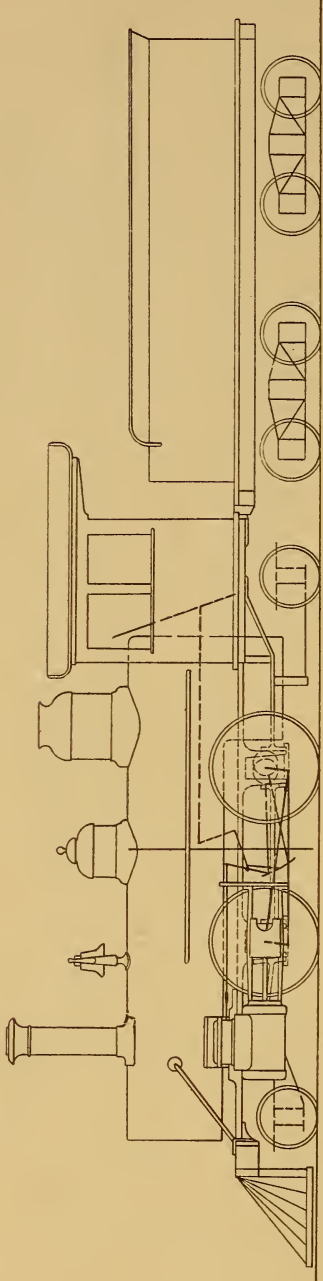

8 1/4 C WITH TENDER.
EXPRESS PASSENGER SERVICE

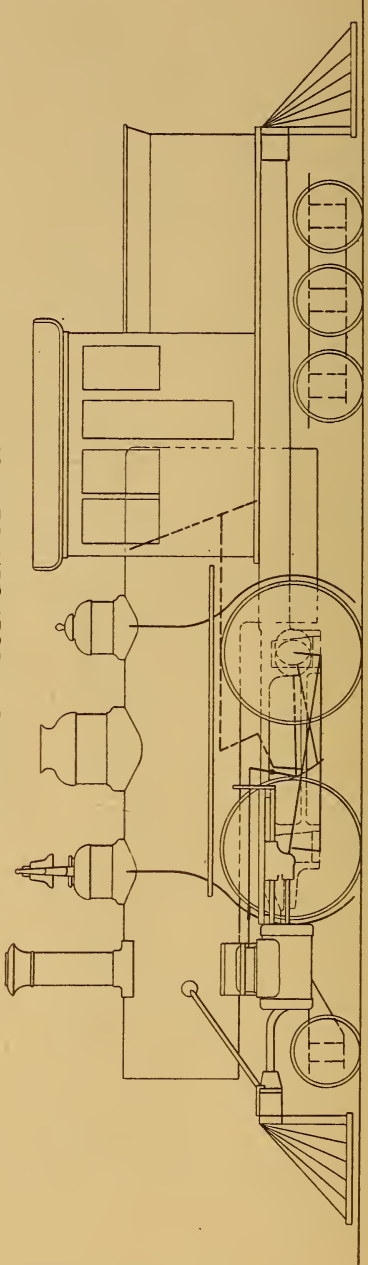

12 1/4 C TANK BACK.
LOCAL PASSENGER SERVICE

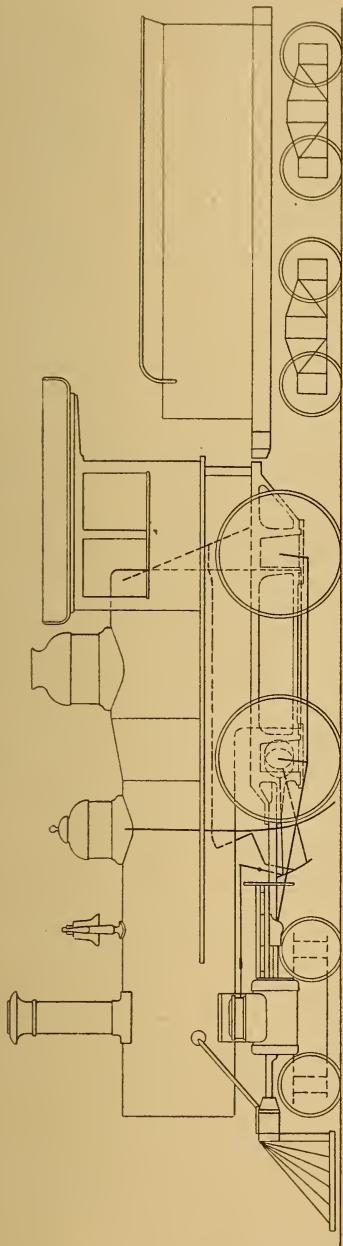

8 C AMERICAN TYPE.
EXPRESS PASSENGER SERVICE.

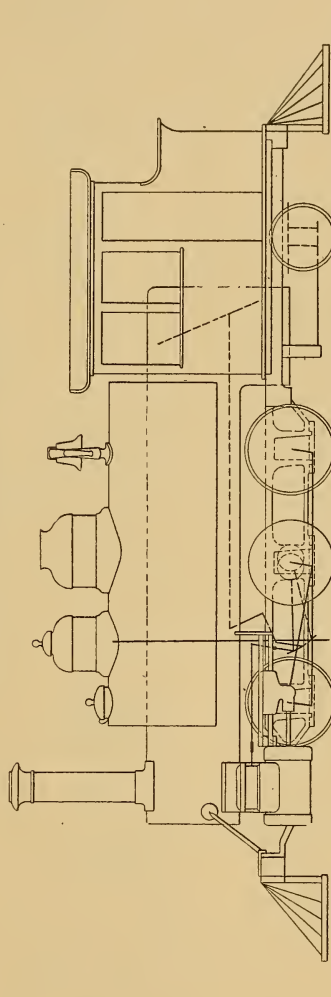

8 1/2 D TANK ON BOILER.
HEAVY SWITCHING AND LOCAL FREIGHT SERVICE.

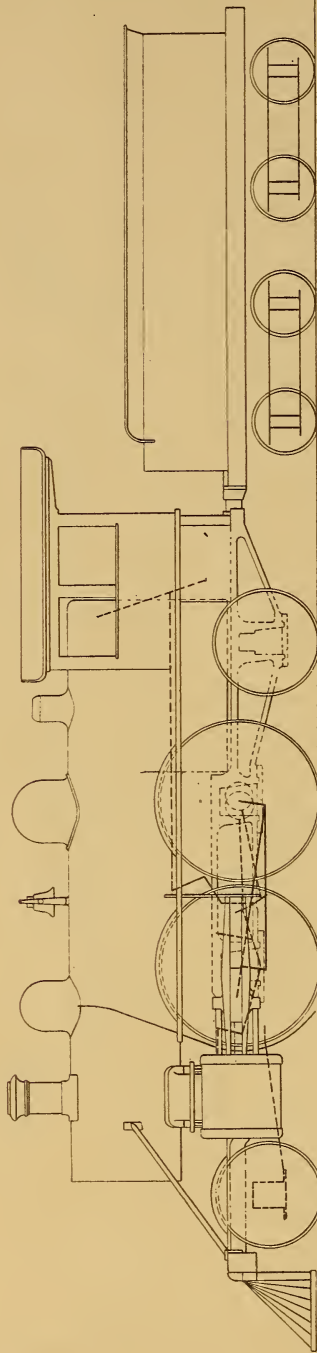

8½ C (COLUMBIA TYPE).
HIGH SPEED PASSENGER SERVICE.

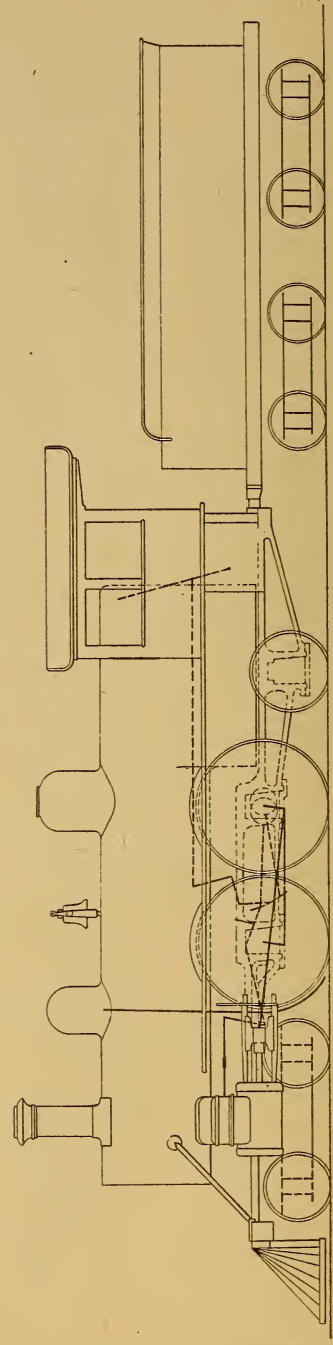

10½ C (ATLANTIC TYPE.)
HIGH SPEED PASSENGER SERVICE.

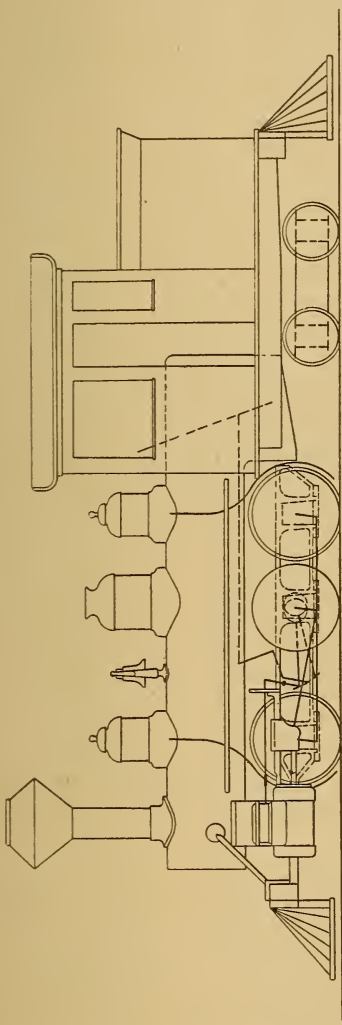

10 1/2 D TANK BACK,
HEAVY SWITCHING AND LOCAL FREIGHT SERVICE.

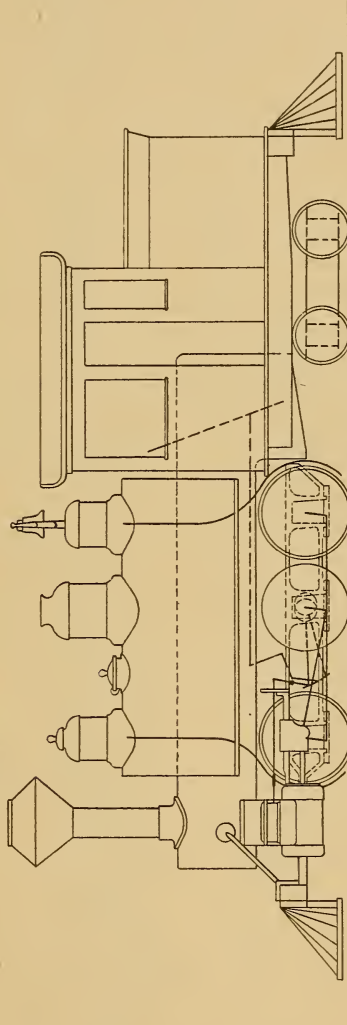

10 1/2 D TANK BACK AND ON BOILER,
HEAVY SWITCHING AND LOCAL FREIGHT SERVICE.

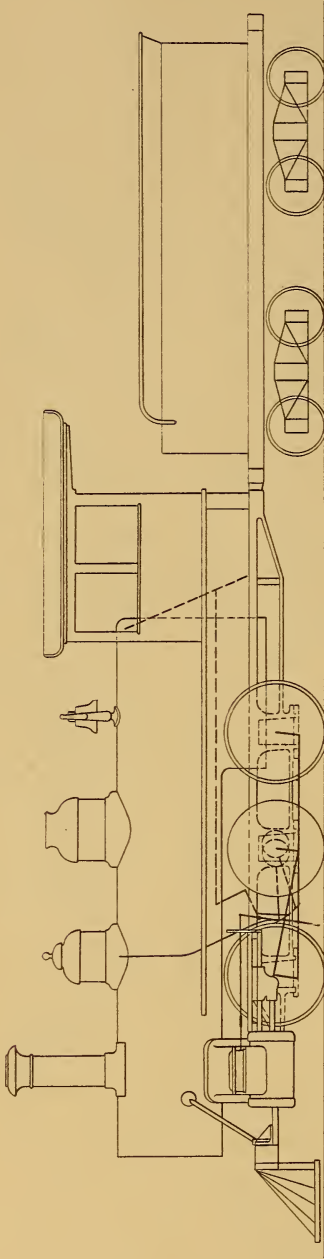

6 D WITH TENDER.
HEAVY SWITCHING SERVICE.

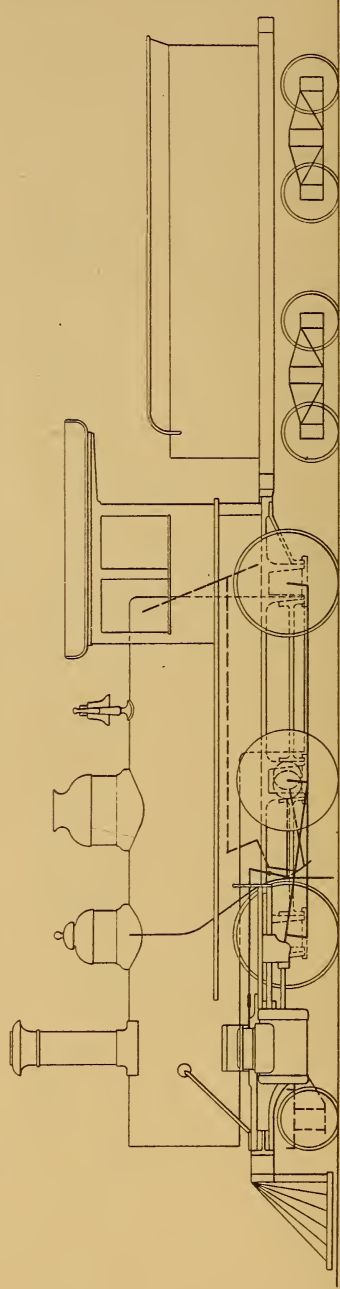

8 D MOGUL,
FREIGHT SERVICE.

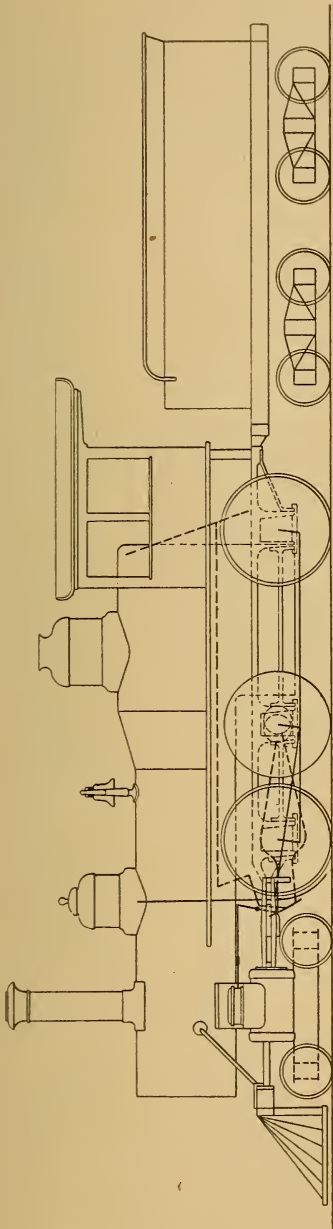

10 D TEN WHEELER,
FAST FREIGHT AND PASSENGER SERVICE.

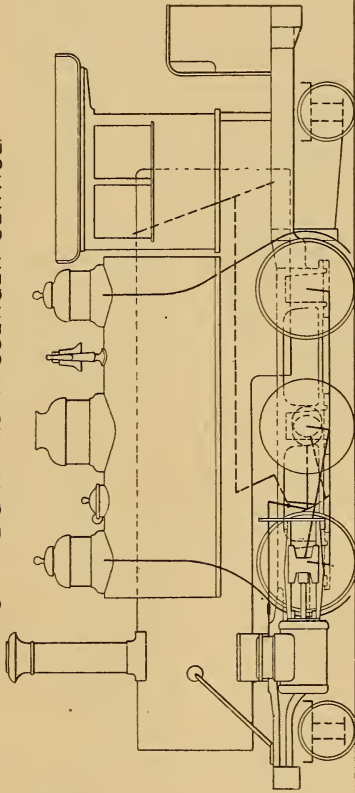

10½ D TANK ON BOILER,
HEAVY SWITCHING SERVICE.

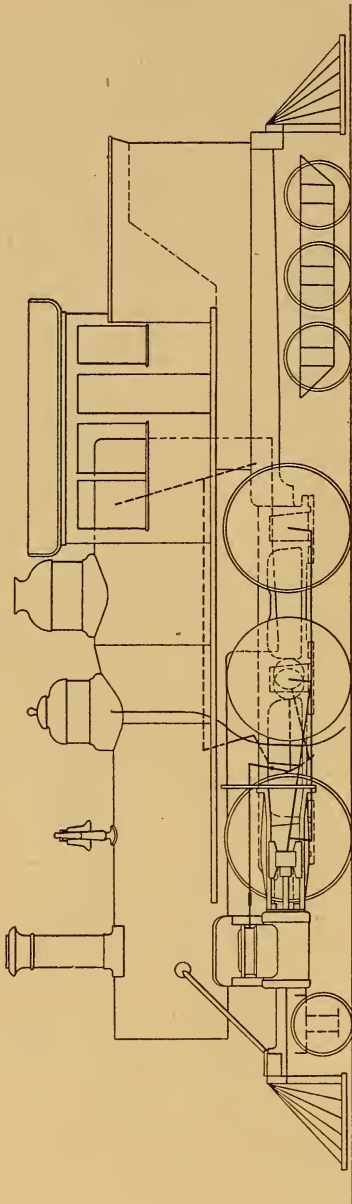

14 1/2 D TANK BACK.

LOCAL PASSENGER SERVICE.

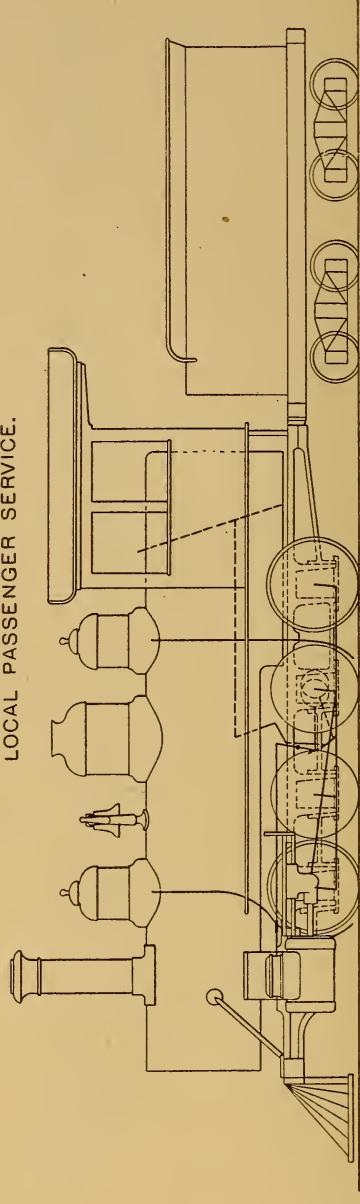

8 E.

HEAVY FREIGHT SERVICE.

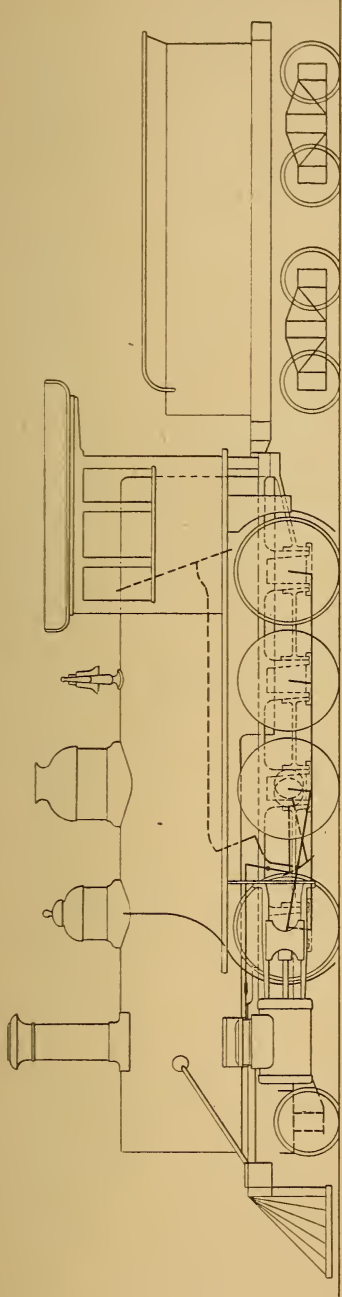

10 E CONSOLIDATION
HEAVY FREIGHT SERVICE.

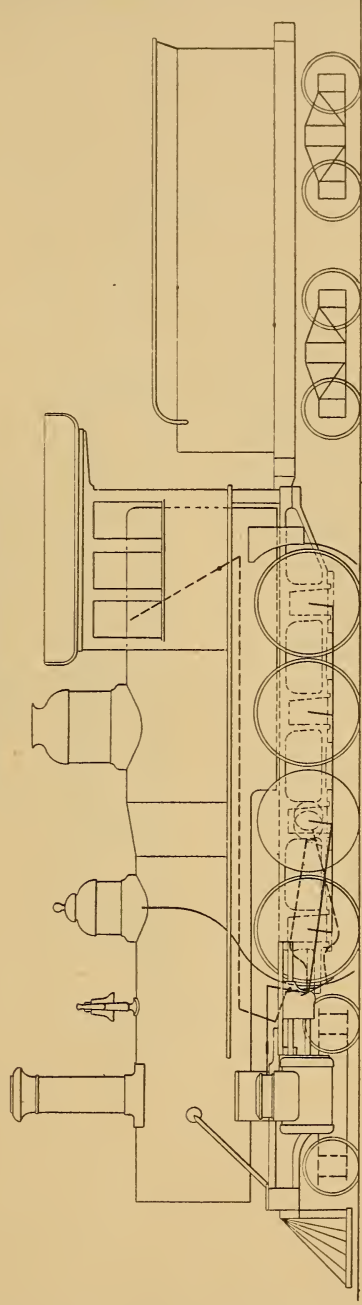

12 E.
HEAVY FREIGHT SERVICE.

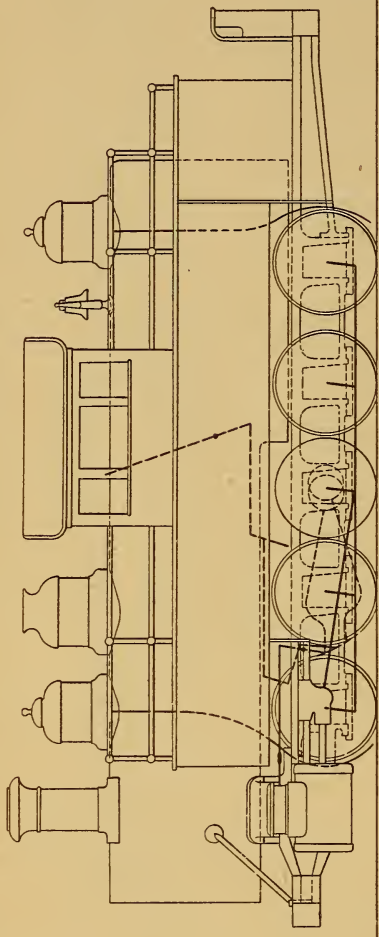

10 F TANK ON BOILER.
HEAVY SWITCHING SERVICE.

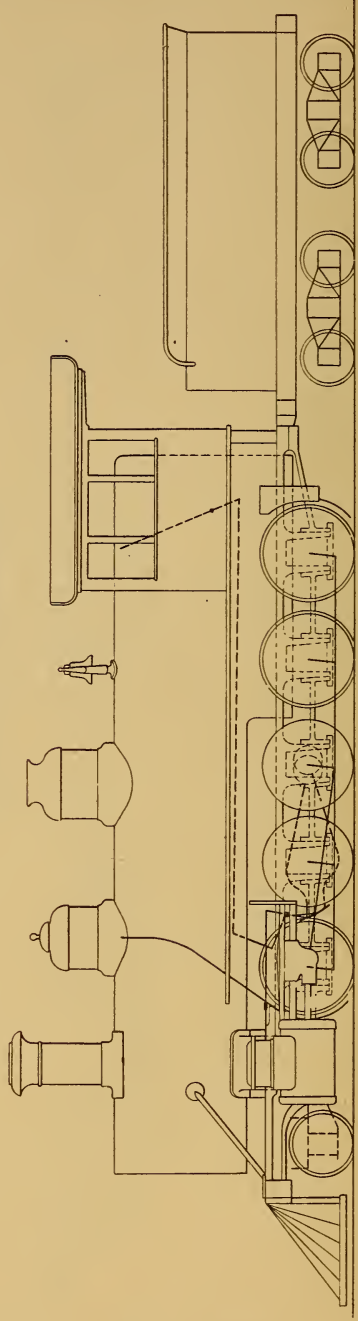

12 F DECAPOD.
HEAVY FREIGHT SERVICE.

ILLUSTRATED PLATES.

Plate I.

CROWN BAR TYPE

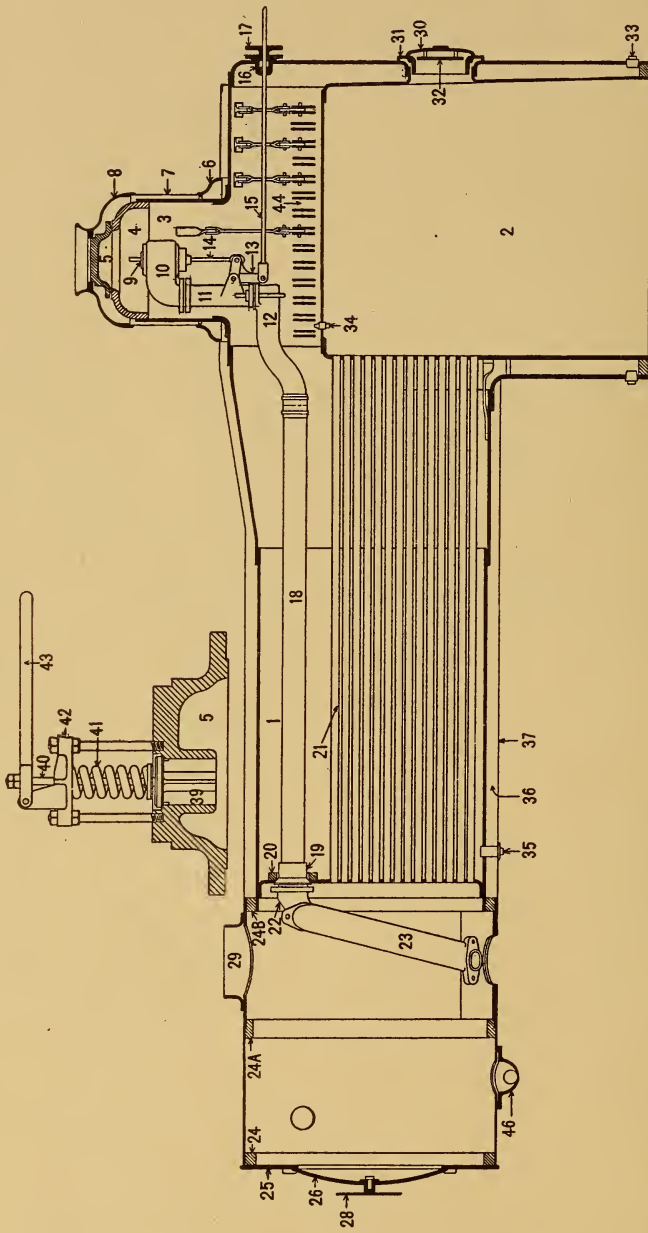
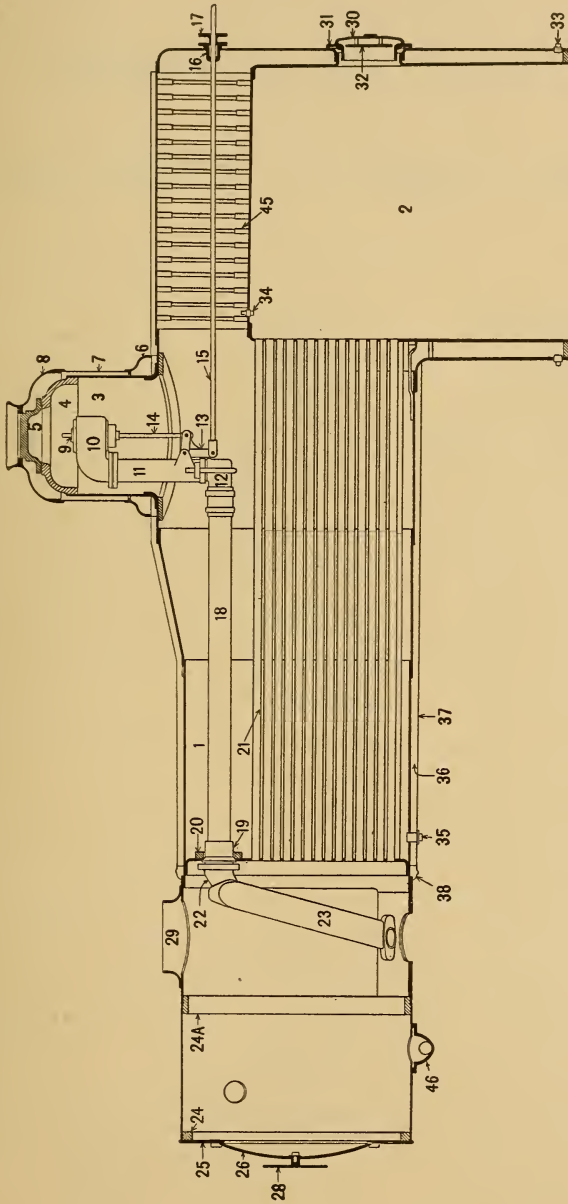

Plate 2.

RADIAL STAY TYPE



BOILER AND ATTACHMENTS.

Plates 1 and 2. (EHRENTRUF.)

Ehrensaal . . .	1.	Boiler.
Ehrensitz . . .	2.	Fire Box.
Ehrensold . . .	3.	Dome.
Ehrenstamm . . .	4.	“ Ring.
Ehrenstufe . . .	5.	“ Cap.
Ehrentag . . .	6.	“ Base.
Ehrentanz . . .	7.	“ Casing.
Ehrenthat . . .	8.	“ Cover.
Ehrentheil . . .	9.	Throttle Valve.
Ehrentron . . .	10.	“ “ Box.
Ehrentitel . . .	11.	“ Pipe.
Ehrentod . . .	12.	“ “ Elbow.
Ehrenvoll . . .	13.	“ Valve Crank.
Ehrenwache . . .	14.	“ “ Rod.
Ehrenwein . . .	15.	“ “ Stem.
Ehrenwort . . .	16.	“ Stuffing Box.
Ehrenzeit . . .	17.	“ “ “ Gland.
Ehretia . . .	18.	Dry Pipe.
Ehrfurcht . . .	19.	“ Front End.
Ehrgeiz . . .	20.	“ Ring on Tube Sheet.
Ehrgeizig . . .	21.	Tubes.
Ehrlich . . .	22.	Double Cone.
Ehrliebzig . . .	23.	Steam Pipes, R and L.
Ehrsucht . . .	24.	Smoke Box Ring Front.
Ehrtrieb . . .	24A.	“ “ “ Middle.
Eiagada . . .	24B.	“ “ “ Back.

Eibisch	25.	Smoke Box Front.
Eiceti	26.	“ “ Door.
Eichapfel	27.	“ “ “ Liner.
Eichelganz	28.	Number Plate.
Eichelmast	29.	Smoke Stack Base.
Eichelmaus	30.	Fire Door.
Eichelnapf	31.	“ “ Frame.
Eichen	32.	“ “ Liner.
Eichenast	33.	Corner Plug.
Eichenhain	34.	Fusible “
Eichenlaub	35.	Waist “
Eichenlohe	36.	Lagging.
Eichenmoos	37.	Jacket.
Eichennest	38.	Smoke Box Band.
Eichenreis	39.	Safety Valve.
Eichenrose	40.	“ “ Stem.
Eichenwald	41.	“ “ Spring.
Eichhase	42.	“ “ “ Cap.
Eichhorn	43.	Relief Lever.
Eichkatze	44.	Crown Bar.
Eichkranz	45.	Staybolt.
Eichnuss	46.	Spark Ejector.

In ordering steam pipes (No. 23), it will be necessary to specify the side, if both are not wanted.

Smoke stack base (No. 29), while shown in one piece on this plate, is frequently made in two parts, as shown on Plate 31, and either part can be had by referring to the latter plate. See Plate 4 for steel base.

Jacket bands are not given a number in this list, as they are easily designated without.

In many cases patented valves are used instead of the safety valve shown on this plate. In ordering, state whether valve is wanted with or without relief lever.

Plate 3.

Fig. 1

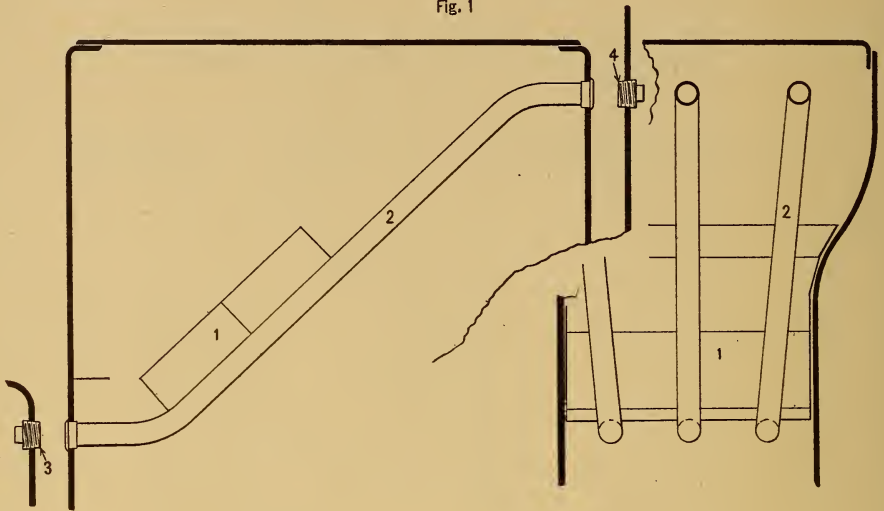
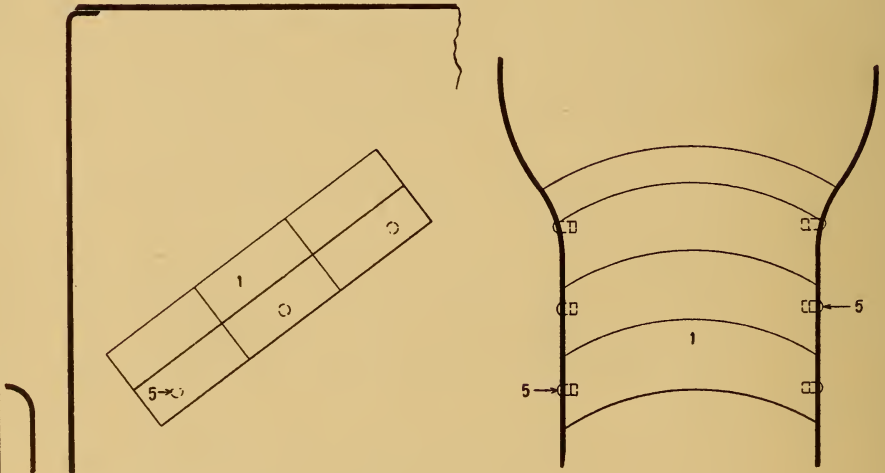

Fig. 2



ARRANGEMENT OF FIRE BRICKS IN FIRE BOX.

Plate 3. (EICHOCHS.)

Fig. I.—Bricks supported on Tubes.

Eichstab . . .	1.	Fire Brick.
Eichtraube . .	2.	“ “ Tube.
Eicimus . . .	3.	“ “ “ Plug, Front.
Eidechse . . .	4.	“ “ “ “ Back.

Fig. II.—Bricks supported on Studs.

Eiderbett . . .	5.	Fire Brick Stud.
-----------------	----	------------------

Plate 4.

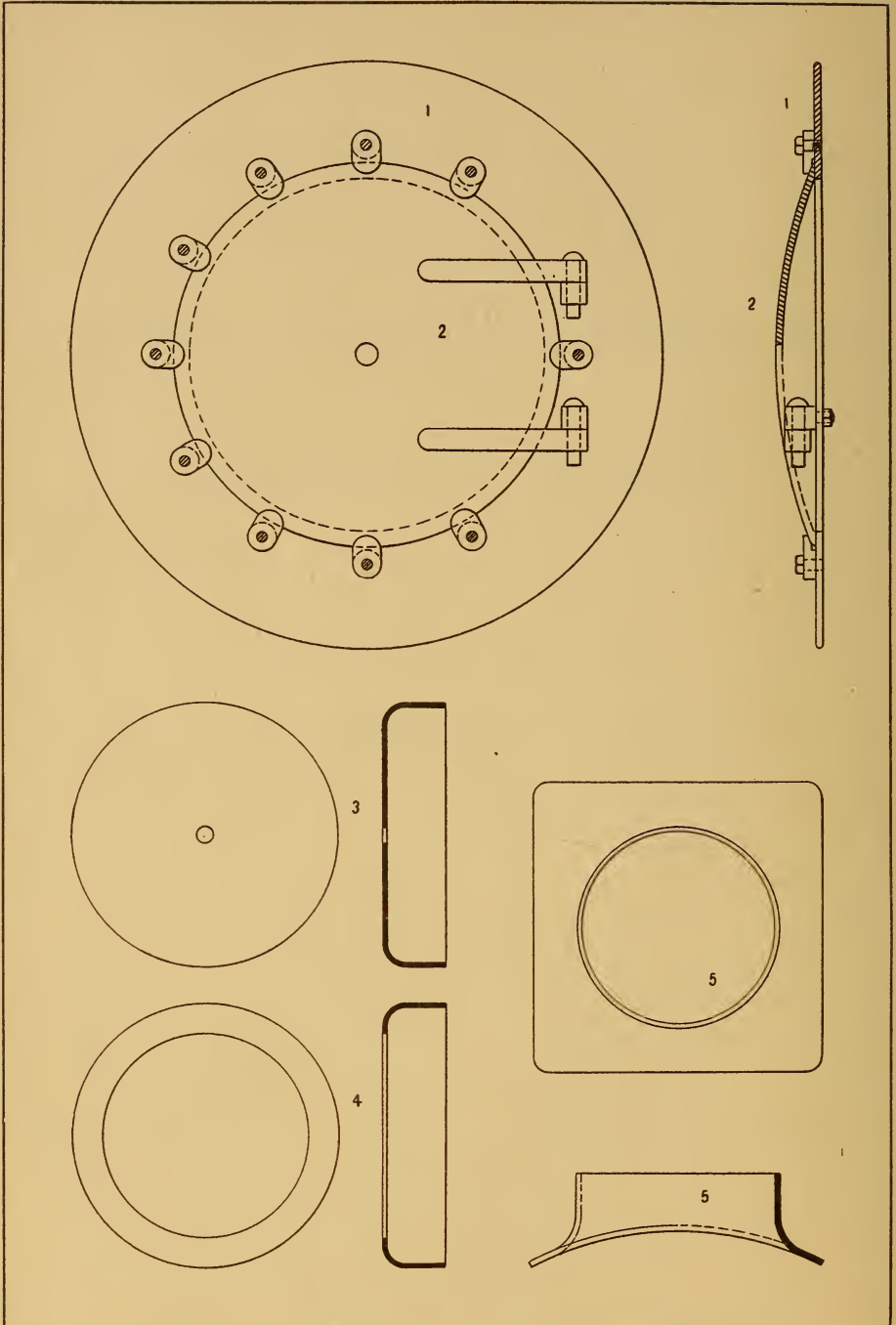

PRESSED STEEL SMOKE BOX FRONT, CYLINDER
HEAD COVER, AND STACK BASE.

Plate 4. (EIDERDAUNE.)

Eiderdons . . .	1.	Smoke Box Front.
Eidereend . . .	2.	“ Door.
Eidergans . . .	3.	Cylinder Head Cover, Front.
Eidervogel . . .	4.	“ “ “ Back.
Eidesmann . . .	5.	Stack Base.

Plates 1 and 2 show cast iron smoke box fronts and stack bases, and Plate 5 cast iron cylinder head covers. These have in recent years been superseded on many railroads by similar parts made of steel sheets pressed while hot in dies giving them the required forms. They are much stronger, and consequently more durable than cast iron, present a simple, neat appearance, and in many cases when injured can be brought back to their original shape.

Plate 5.

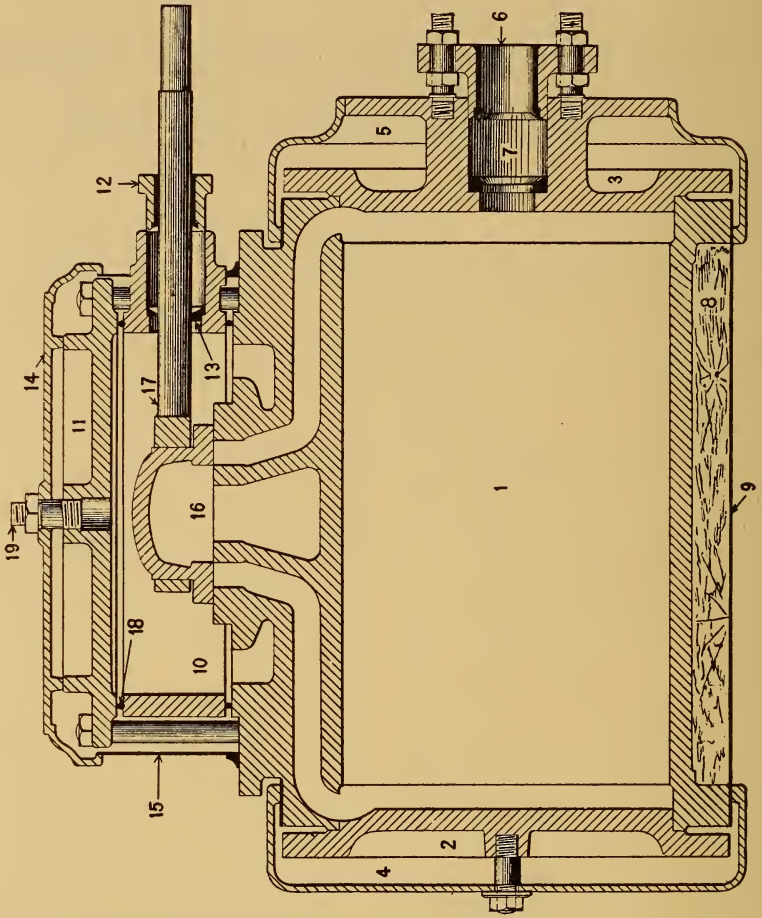

SINGLE EXPANSION CYLINDER, STEAM CHEST,
AND ATTACHMENTS.

Plate 5. (EIDFEST.)

Eidgenosse . . .	1.	Cylinder.
Eidgesell . . .	2.	Front Head.
Eidiertje . . .	3.	Back “
Eidograph . . .	4.	Front Casing Cover.
Eidolon	5.	Back “ “
Eidopsare . . .	6.	Cylinder Gland, R. & L.
Eidothee . . .	7.	“ “ Bottom Ring.
Eidotrope . . .	8.	Wood Lagging.
Eierapfel . . .	9.	Casing.
Eierbier	10.	Steam Chest.
Eierblume . . .	11.	“ “ Cap.
Eierbrot	12.	“ “ Gland.
Eierdooier . . .	13.	“ “ “ Bottom Ring.
Eierdooop . . .	14.	“ “ Casing Cover.
Eierdopjes . . .	15.	“ “ Casing.
Eiergerste . . .	16.	“ “ Valve.
Eierkanaal . . .	17.	“ “ “ Yoke.
Eierketel	18.	“ “ Joint.
Eierkoek	19.	“ “ Oil Pipe Stem.

If a single cylinder, head, gland, or steam chest is ordered, the side required for should be specified.

Plate 6.

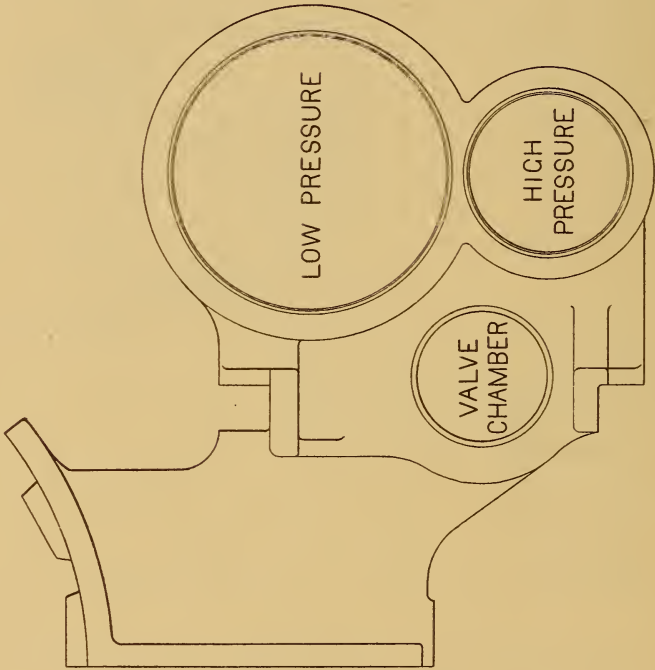
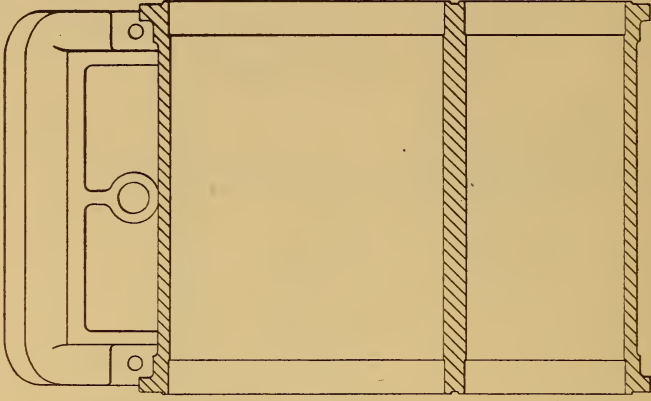

BALDWIN COMPOUND CYLINDERS (FOUR CYLINDER—VAUCLAIN SYSTEM).

Plate 6. (EIERKOEKJE.)

Baldwin Compound Cylinders with Low Pressure Cylinder above High Pressure, showing one side of locomotive.

The High and Low Pressure Cylinders are cast in one piece.

Plate 7.

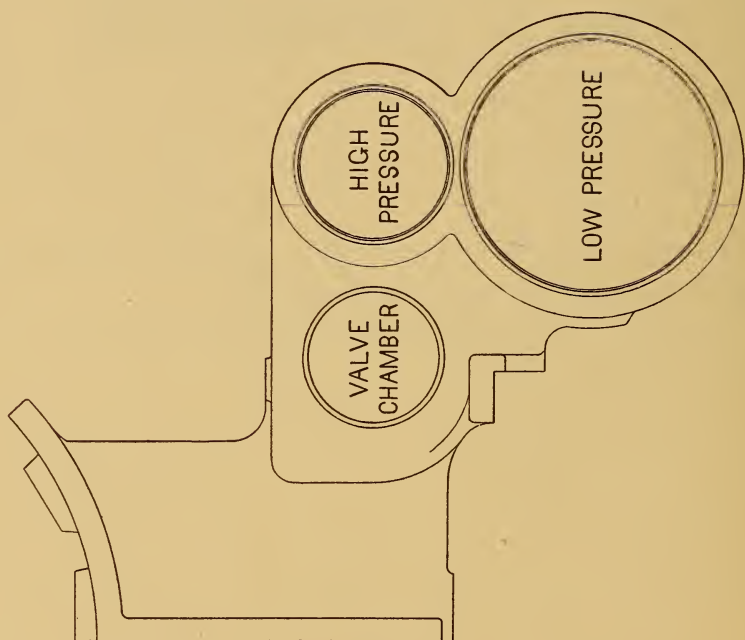
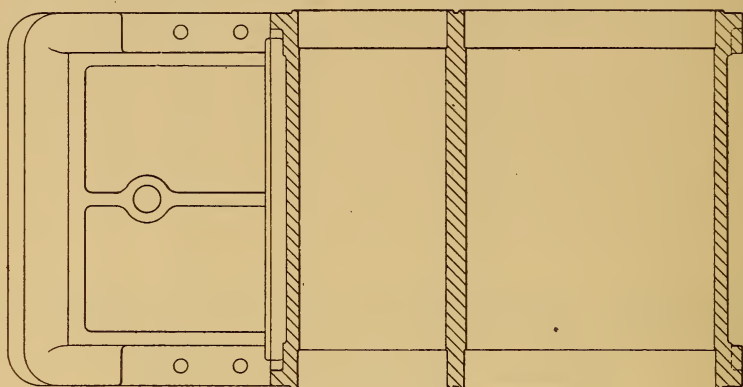

BALDWIN COMPOUND CYLINDERS (FOUR CYLINDER—VAUCLAIN SYSTEM).

Plate 7. (EIERKOOPER.)

Baldwin Compound Cylinders with High Pressure Cylinder above Low Pressure, showing one side of locomotive.

The High and Low Pressure Cylinders are cast in one piece.

Plate 8.

DIAGRAM SHOWING COURSE OF STEAM
IN
FOUR CYLINDER COMPOUND LOCOMOTIVE.

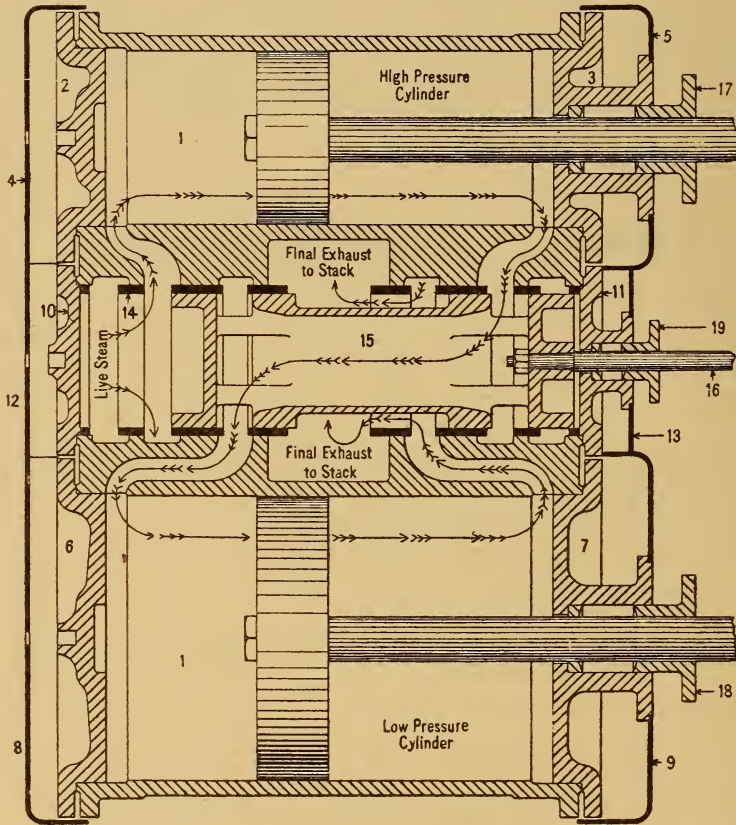

DIAGRAM OF BALDWIN COMPOUND CYLINDERS
(VAUCLAIN SYSTEM) SHOWING THE COURSE
OF STEAM IN THE CYLINDERS AND VALVE
CHAMBER.

Plate 8. (EIERKRAMER.)

Eierkugel . . .	1.	Cylinder.				
Eierlage . . .	2.	High Pressure Front Cylinder Head.				
Eierlijst . . .	3.	“ “ Back	“	“		
Eiermand . . .	4.	“ “ Front	“	“	Casing Cover.	
Eiermarkt . . .	5.	“ “ Back	“	“	“	“
Eiermelk . . .	6.	Low “ Front	“	“		
Eiermilch . . .	7.	“ “ Back	“	“		
Eiermuss . . .	8.	“ “ Front	“	“	Casing Cover.	
Eiernapf . . .	9.	“ “ Back	“	“	“	“
Eiernetjes . . .	10.	Front Valve Chamber Head.				
Eiernudel . . .	11.	Back “ “	“			
Eierpruim . . .	12.	Front “ “	“	Casing Cover.		
Eiersack . . .	13.	Back “ “	“	“	“	
Eiersalat . . .	14.	Valve Chamber Bushing.	(See Plate 9.)			
Eiersaus . . .	15.	Piston Valve.	“	“		
Eierschaal . . .	16.	“ “ Stem.	“	“		
Eierschaum . . .	17.*	High Pressure Cylinder Gland.				
Eierschuit . . .	18.*	Low “ “	“			
Eierslak . . .	19.*	Valve Chamber Gland.				

If a single cylinder, head, casing cover, bushing, valve, stem, or gland is ordered, the side required for should be specified.

* Metallic Packing is used in all Stuffing Boxes of Compound Cylinders. (See Plate 79.)

Plate 9.

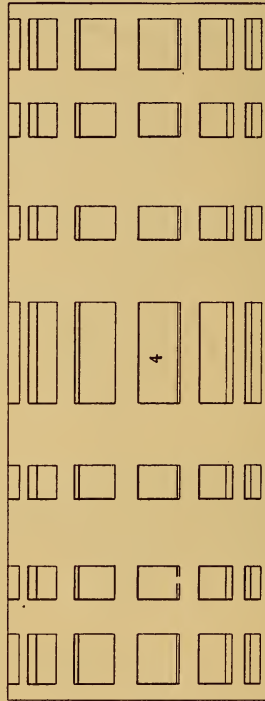
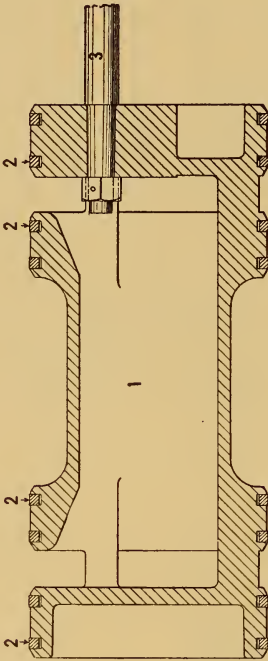
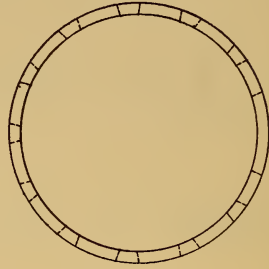
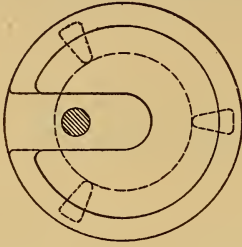

PISTON VALVE AND BUSHING FOR BALDWIN
COMPOUND LOCOMOTIVE (VAUCLAIN SYS-
TEM.)

Plate 9. (EIERSOEP.)

Eierspeise . . .	1.	Piston Valve.
Eierstab . . .	2.	“ “ Packing Ring.
Eierstein . . .	3.	“ “ Stem.
Eierstock . . .	4.	Valve Chamber Bushing.

If a single valve, stem, or bushing is ordered, the side required for should be specified.

Plate 10.

ARRANGEMENT
When High Pressure Cyl.
is ABOVE

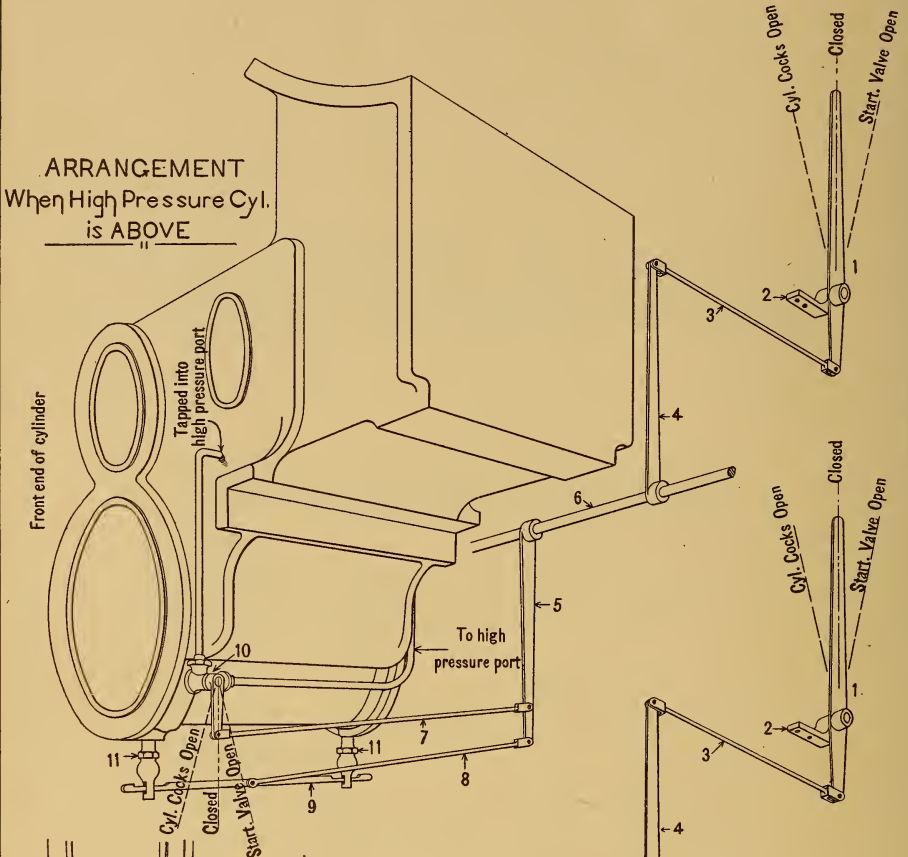

ARRANGEMENT
When High Pressure Cyl.
is BELOW

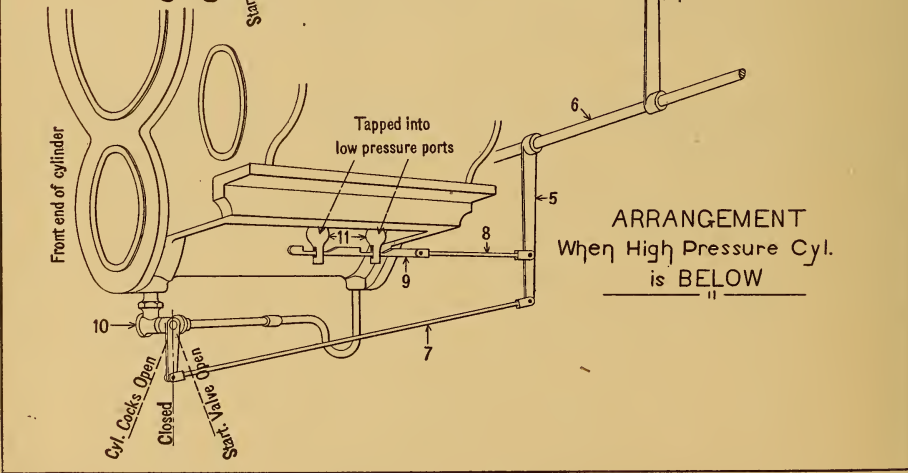

ARRANGEMENT OF STARTING VALVES AND
CYLINDER COCKS FOR BALDWIN COMPOUND
LOCOMOTIVE (VAUCLAIN SYSTEM).

Plate 10. (EIERSTRUIF.)

Eiersuppe . . .	1.	Starting Valve Lever in Cab.
Eiertaart . . .	2.	“ “ “ Fulcrum in Cab.
Eiertanz . . .	3.	“ “ Rod from Cab.
Eierteig . . .	4.	Upper Arm.
Eiertiegel . . .	5.	Lower “
Eiertreter . . .	6.	Shaft.
Eiervla . . .	7.	Starting Valve Rod under Cylinder.
Eiervrouw . . .	8.	Cylinder Cock “ “ “
Eierwasser . . .	9.	“ “ Strip.
Eierzins . . .	10.	Starting Valve.
Eifergeist . . .	11.	Cylinder Cock.

Plate II.

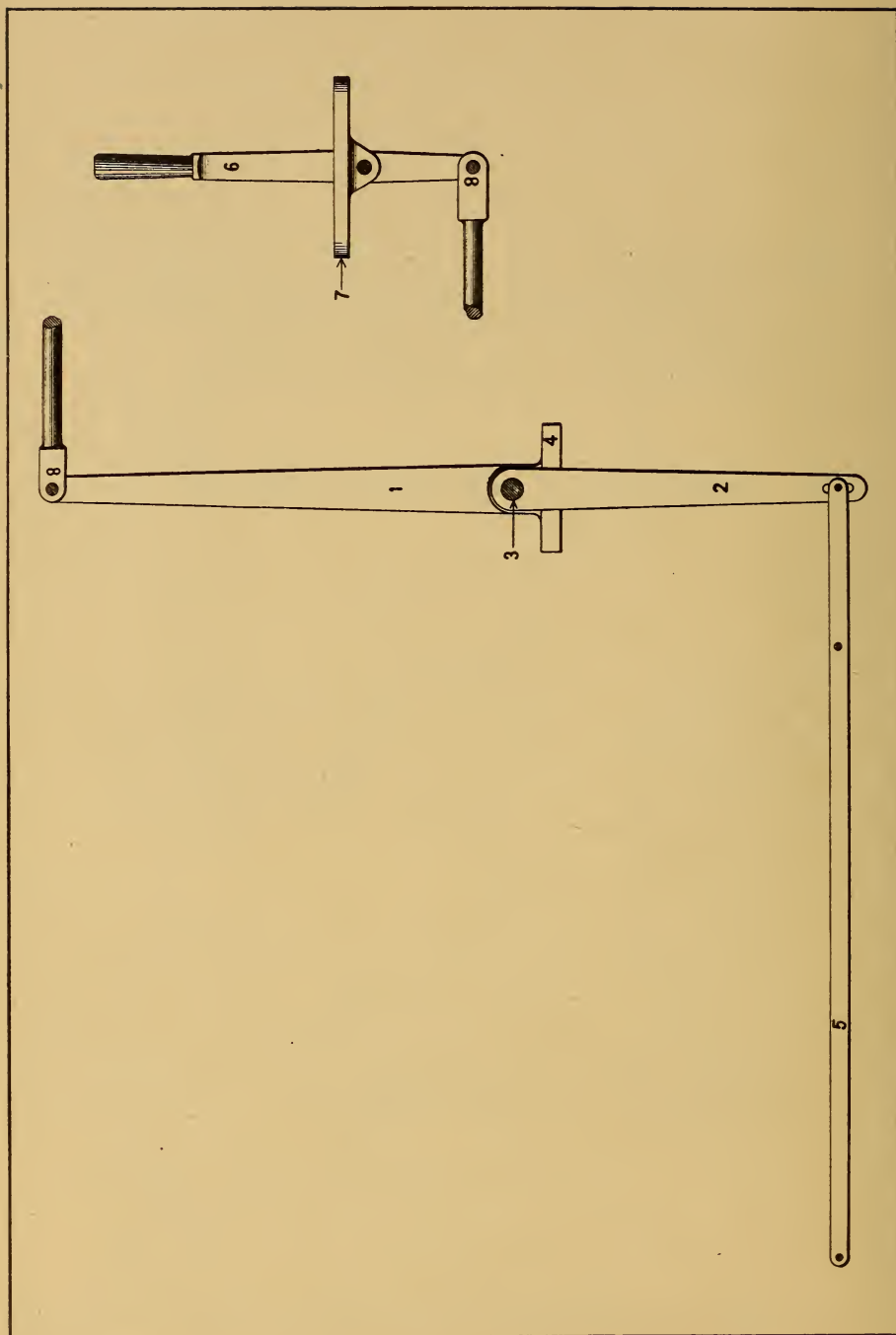

CYLINDER COCK WORK, FOR SINGLE EXPANSION
LOCOMOTIVES.

Plate II. (EIFERHEISS.)

- Eiferliebe . . . 1. Upper Arm.
- Eifermuth . . . 2. Lower “
- Eifern 3. Shaft.
- Eiferopfer . . . 4. “ Bearing.
- Eifersucht . . . 5. Cock Strips.
- Eifervoll . . . 6. Lever in Cab.
- Eifrig 7. “ Fulcrum.
- Eifriger 8. Coupling Rod Jaws.

Plate 12.

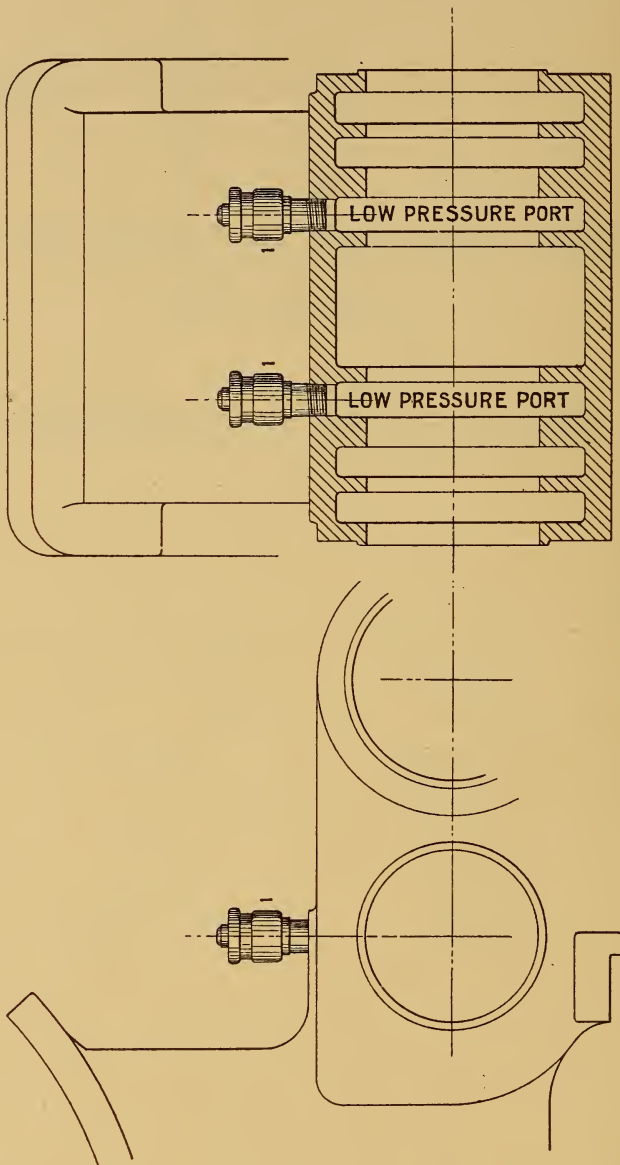

VACUUM VALVE FOR LOW PRESSURE CYLINDER PORTS (VAUCLAIN SYSTEM).

Plate 12. (EIFRIGSTEN).

Eigenares . . . 1. Low Pressure Port Vacuum Valve.

Plate 13.

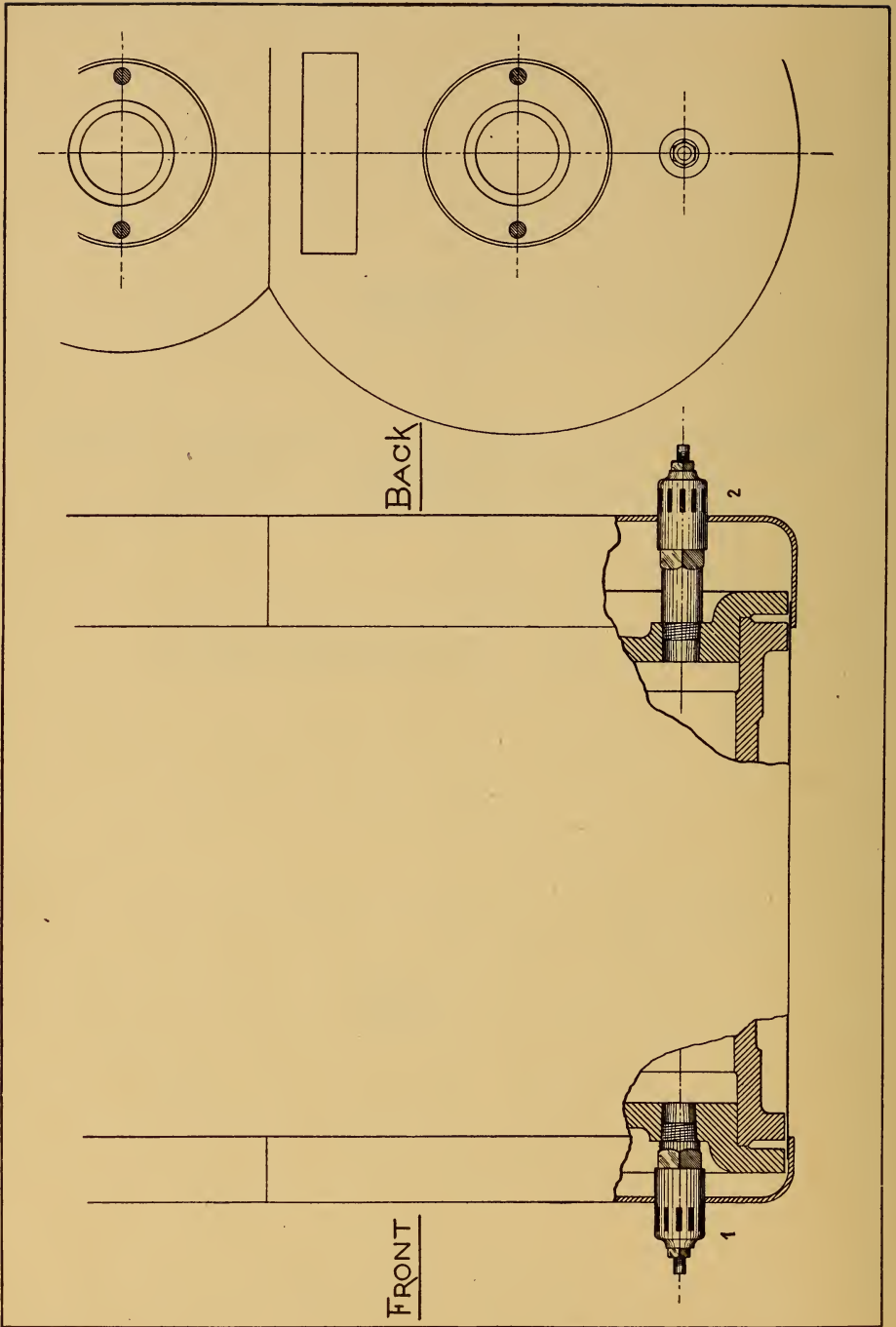

RELIEF VALVE FOR LOW PRESSURE CYLINDER
HEADS (VAUCLAIR SYSTEM).

Plate 13. (EIGENART.)

Eigenartig . . . 1. Low Pressure Cylinder Head Relief Valve, Front.
Eigenbaat . . . 2. “ “ “ “ “ Back.

In ordering a single valve, state whether it is wanted for front or back cylinder head.

Plate 14.

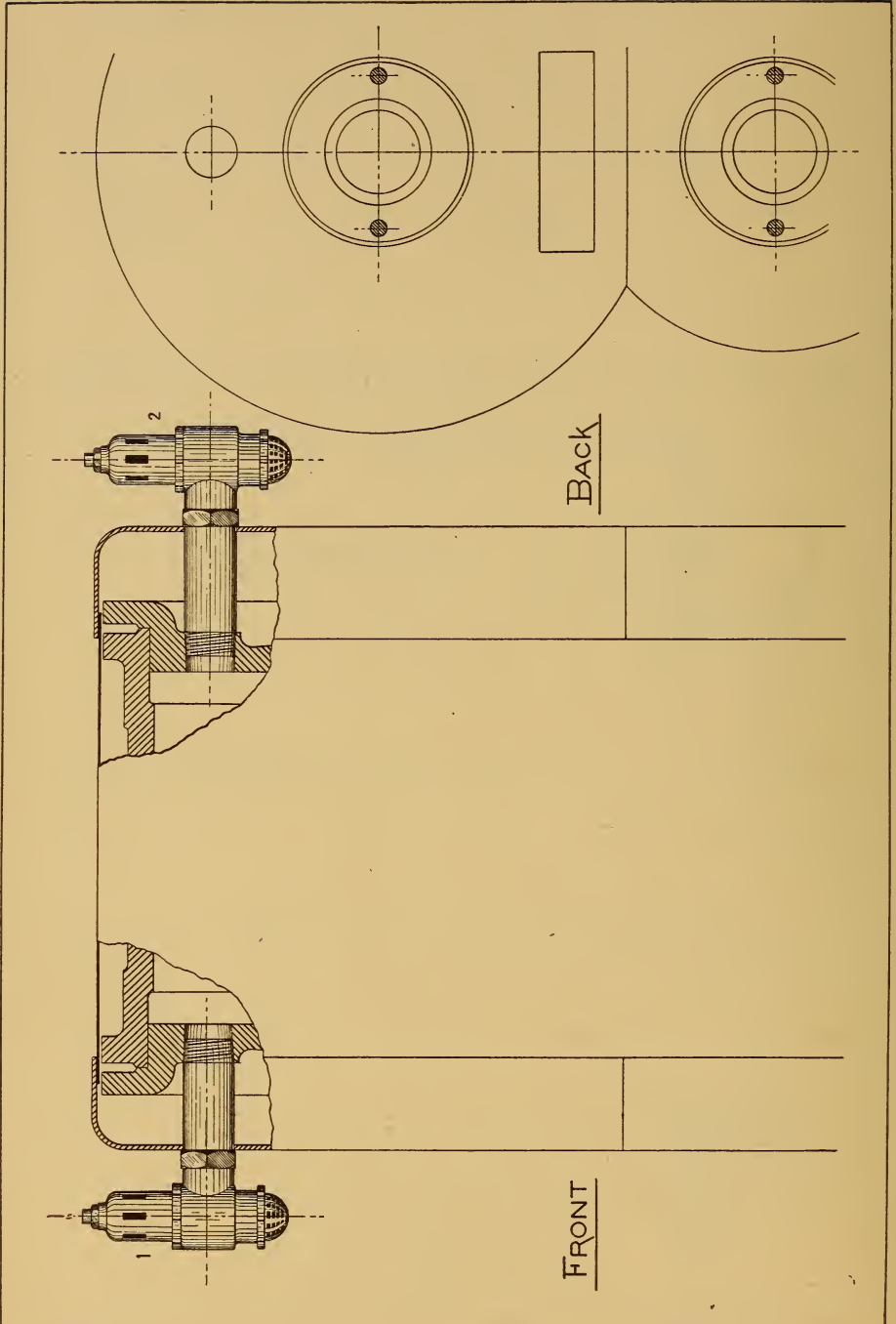

COMBINED RELIEF AND VACUUM VALVE FOR
LOW PRESSURE CYLINDER HEADS (VAU-
CLAIN SYSTEM).

Plate 14. (EIGENBATIG.)

Eigendom . . . 1. Low Pressure Cylinder Head Relief and Vacuum
Valve, Front.

Eigendunk . . . 2. Low Pressure Cylinder Head Relief and Vacuum
Valve, Back.

In ordering a single valve, state whether it is wanted for front or back
cylinder head.

Plate 15.

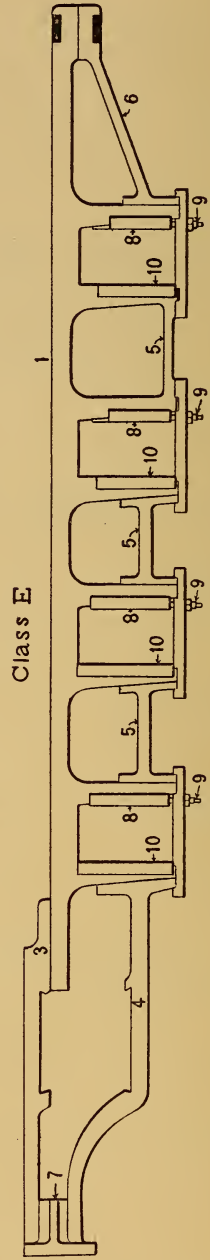
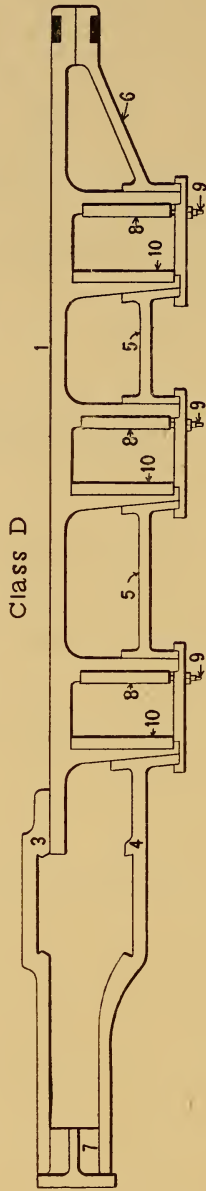
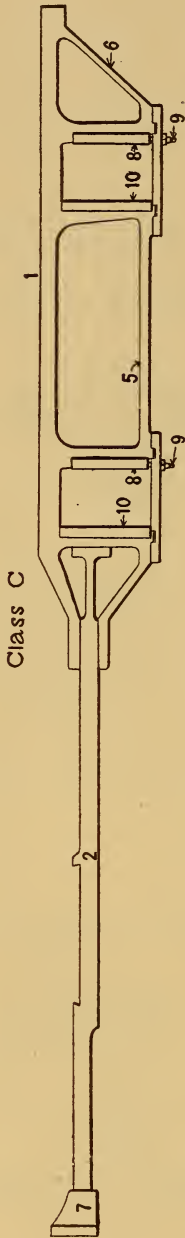

FRAMES AND PEDESTALS.

Plate 15. (EIGENEN.)

Eigengrund . . .	1. Top Rail and Pedestals.
Eigengut . . .	2. Front Rail.
Eigenheit . . .	3. “ “ Top.
Eigenhilfe . . .	4. “ “ Bottom.
Eigening . . .	5. Middle Brace.
Eigenleben . . .	6. Back “
Eigenlijk . . .	7. Frame Filling Piece.
Eigenlob . . .	8. Pedestal Wedge.
Eigenmacht . . .	9. “ “ Bolt.
Eigenname . . .	10. “ Gib.

While this plate does not show the pedestal bolted to the frame rail, engines have been constructed on this plan, and when ordering a pedestal to replace, it will only be necessary to refer to its position on the frame.

Plate 16.

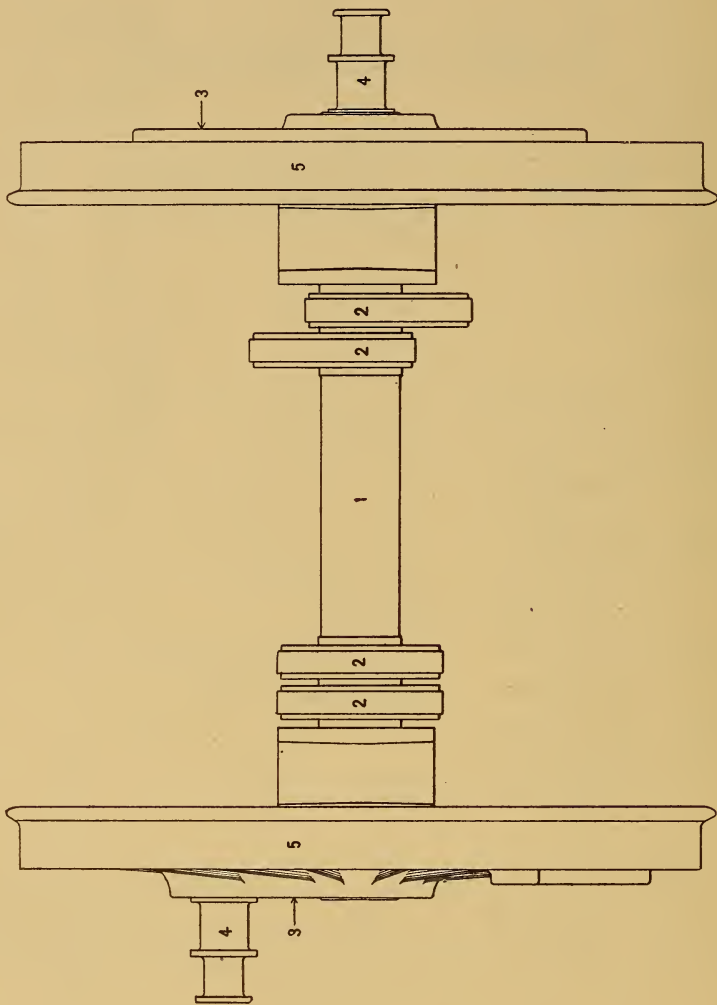

DRIVING WHEELS, AXLE, AND TIRES.

Plate 16. (EIGENNATUR.)

Eigennutz . . .	1. Axle.
Eigenrache . . .	2. Eccentric.
Eigenruhm . . .	3. Wheel Centre.
Eigenschap . . .	4. Wrist Pin.
Eigensinn . . .	5. Tire.

Orders for wheels or their parts, when not in full sets, should indicate particular pair of wheels required, or that parts are needed for.

Plate 17.

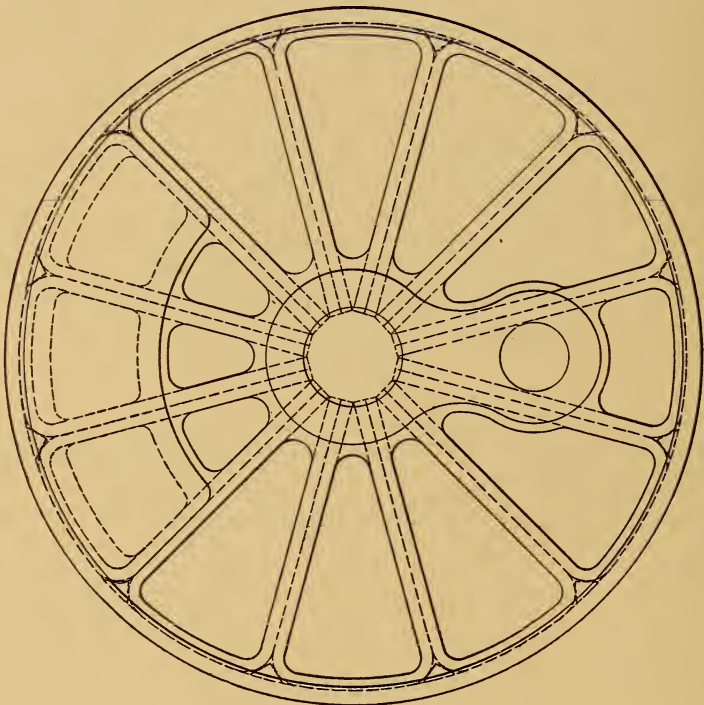
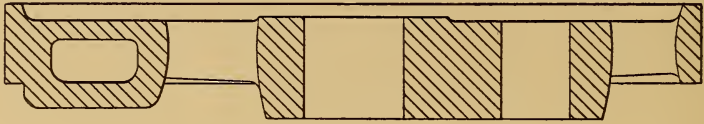

WROUGHT IRON DRIVING WHEEL CENTRE (VAUCLAIN TYPE).

Plate 17. (EIGENTLICH.)

Eigenwaan . . . Driving Wheel Centre.

For many years cast iron has been used in this country for driving wheel centres. Lately, however, on account of the increased severity of locomotive service, a demand has arisen for stronger wheels, and this has been met by the wrought iron centre here described.

The method of manufacture is plainly shown by the drawing. The parts are forged separately under drop and steam hammers and a hydraulic machine, and assembled as shown by the dotted lines. They are then brought to a welding heat and placed between steel dies of suitable dimensions, the upper one being connected to the piston rod of a powerful steam hammer. A few blows then weld the parts together, making a homogeneous, solid forging.

These wheels possess great strength, lightness, and beauty of design. The counterbalance is filled with lead when necessary to bring it to the required weight.

For clearer illustration of method of manufacture, see Plate 18, Fig. 1.

Plate 18.

Fig. 1

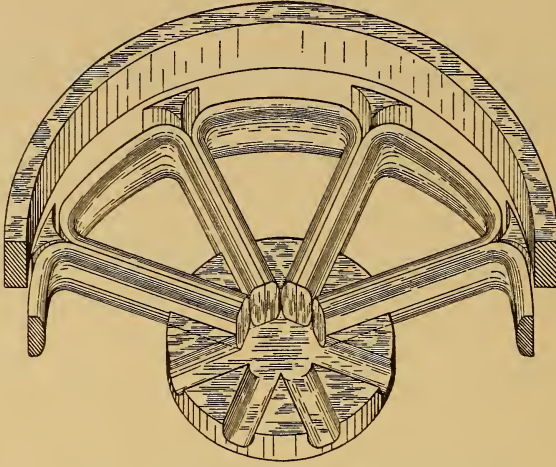
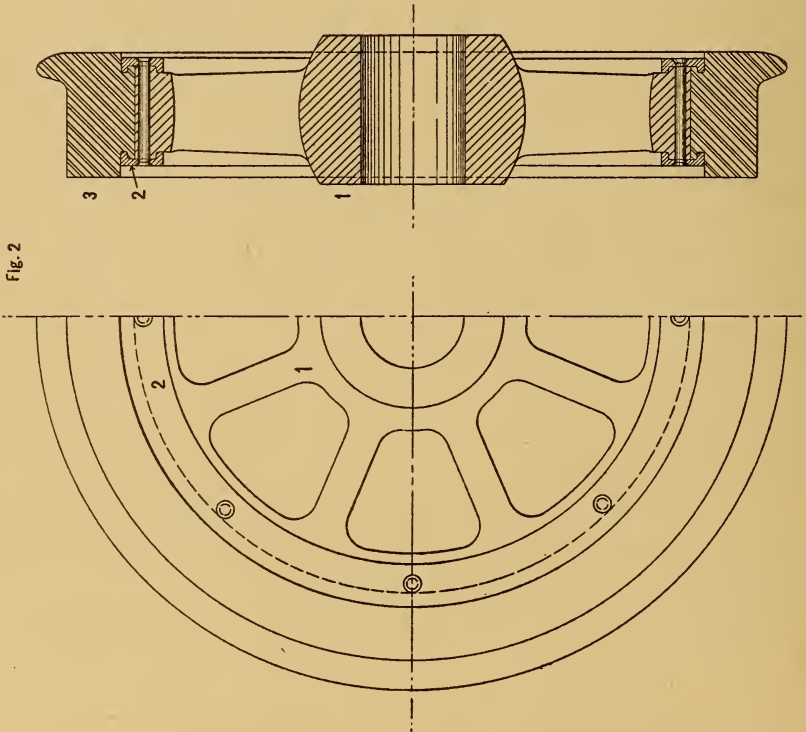

Fig. 2



WROUGHT IRON ENGINE TRUCK AND TENDER WHEEL (VAUCLAIN TYPE).

Plate 18. (EIGENWELT.)

-
- Eigenwerth . . . 1. Wheel Centre.
Eigenwijs . . . 2. Retaining Ring.
Eigenwille . . . 3. Tire.

The conditions which brought forth the wrought iron driving wheel have caused the existence of the engine truck and tender wheel of the same type. The construction is shown by Fig. 1. The tire is shrunk on the centre and is further secured by two wrought iron retaining rings held by rivets (see Fig. 2). The steel tire lasts much longer than the chilled tread of a cast iron wheel, and when, after having been turned several times, it is finally worn too thin for use, it can be replaced by a new one; whereas, when the tread of a cast iron wheel is worn through the chill, the whole wheel must be thrown away.

For the position of these wheels in the locomotive, see Plates 34 and 64.

Plate 19.

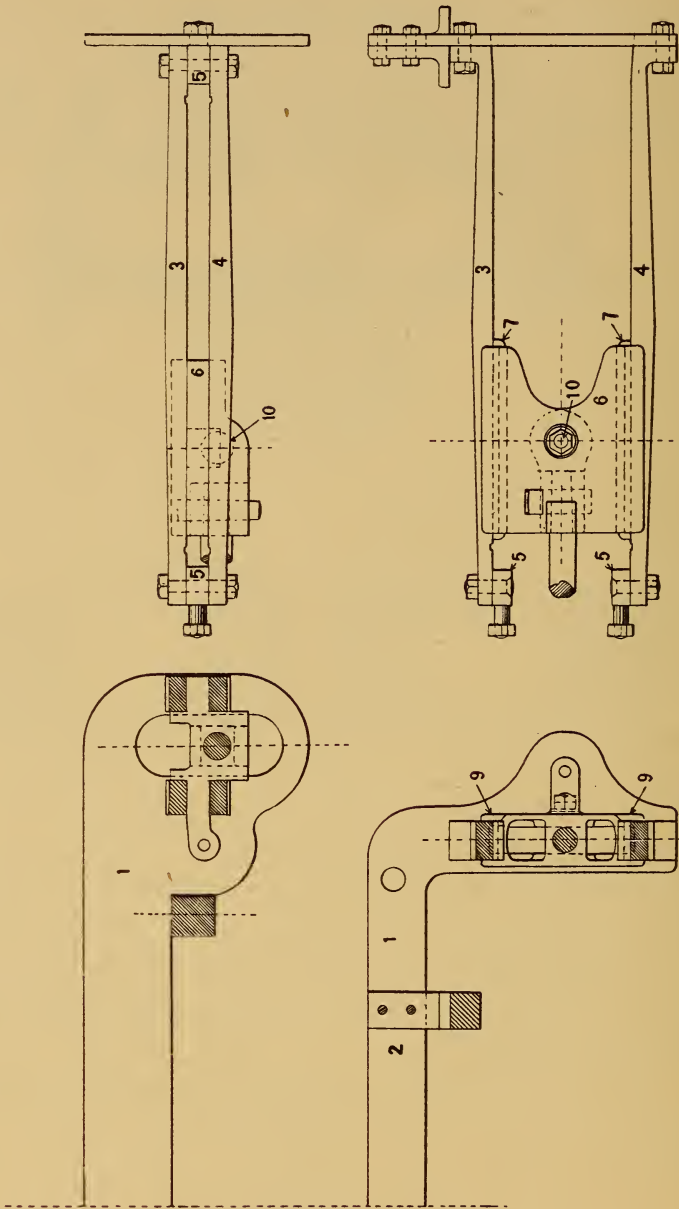

GUIDE BEARER, GUIDES, AND CROSSHEAD FOR
SINGLE EXPANSION LOCOMOTIVES.

Plate 19. (EIGHTEENMO.)

Eighteenth . . .	1.	Guide Bearer.
Eightfold . . .	2.	“ “ Knee.
Eighthly . . .	3.	Top Guide Bar.
Eightscore . . .	4.	Bottom Guide Bar.
Eigilbert . . .	5.	Guide Fillings.
Eigilwich . . .	6.	Crosshead.
Eihaut	7.	“ Gibs.
Eikeboom . . .	9.	“ Plate.
Eikeboomen . .	10.	“ Pin.
Eikekrans . . .	11.	“ Key.

Orders for guides, when not in full sets, should specify whether top or bottom guides are wanted, and for crosshead the side should be given.

Plate 20.

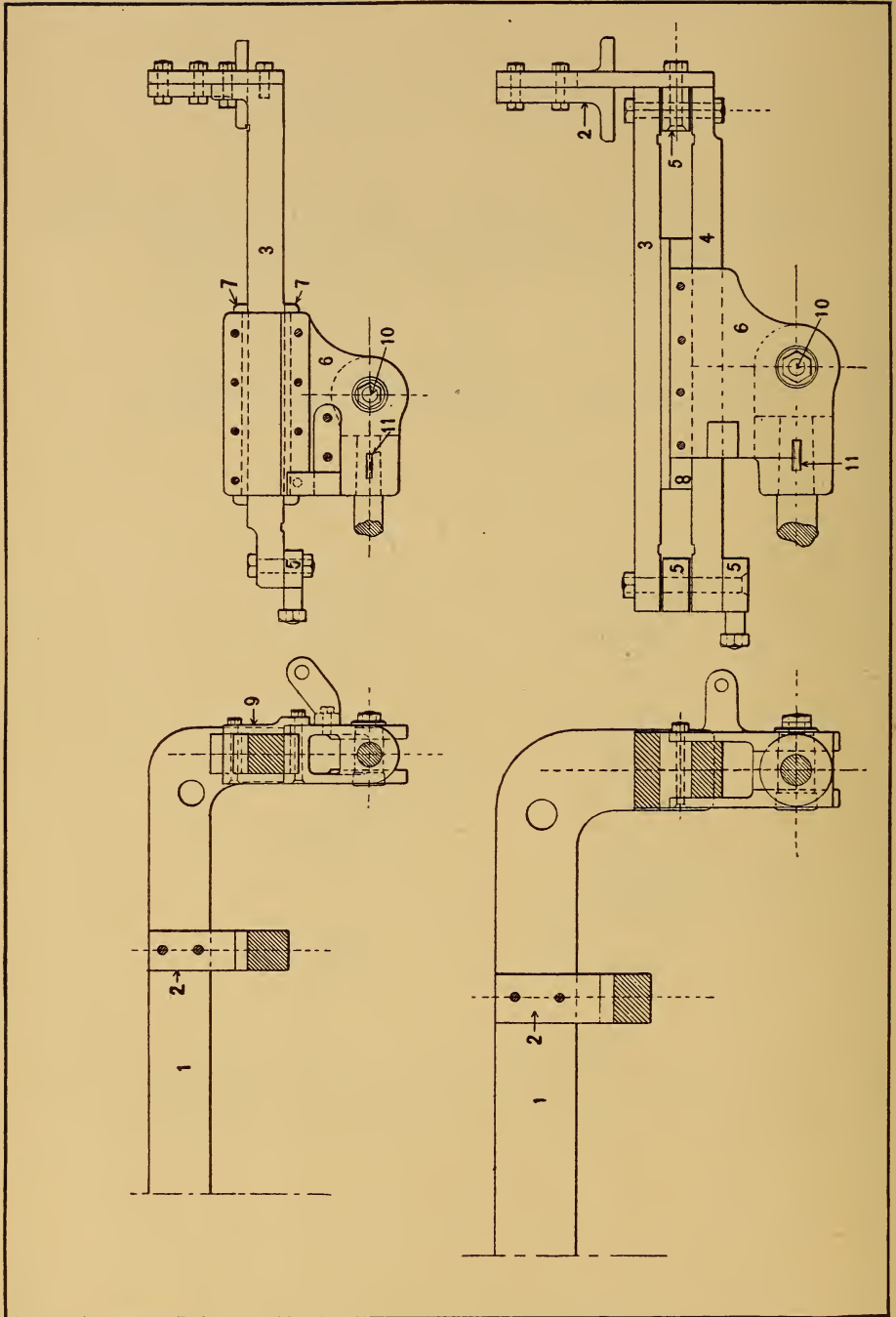

GUIDE BEARER, GUIDES, AND CROSSHEAD FOR
SINGLE EXPANSION LOCOMOTIVES.

Plate 20. (EIGHTEENMO.)

Eihteenth . . .	1.	Guide Bearer.
Eihtfold . . .	2.	“ “ Knee.
Eihtly . . .	3.	Top Guide Bar.
Eihtscore . . .	4.	Bottom Guide Bar.
Eihtbert . . .	5.	Guide Fillings.
Eihtwich . . .	6.	Crosshead.
Eihaut . . .	7.	“ Gibs.
Eikeblad . . .	8.	“ Filling Piece.
Eikeboom . . .	9.	“ Plate.
Eikeboomen . . .	10.	“ Pin.
Eikekrans . . .	11.	“ Key.

Orders for guides, when not in full sets, should specify whether top or bottom guides are wanted, and for crosshead the side should be given.

Plate 21.

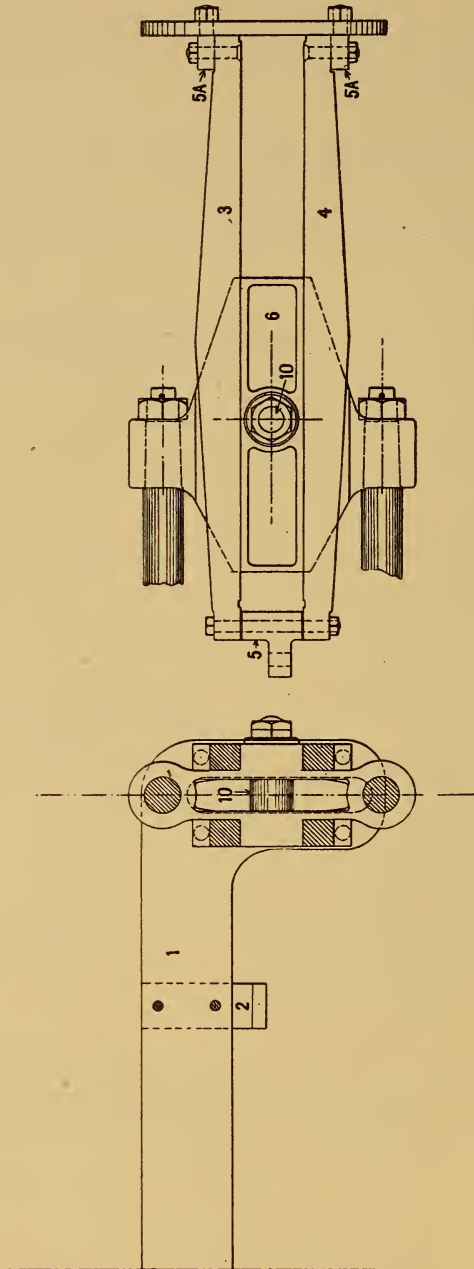

GUIDE BEARER, GUIDES, AND CROSSHEAD FOR
BALDWIN COMPOUND LOCOMOTIVES (VAU-
CLAIN SYSTEM).

Plate 21. (EIKEKROON.)

Eikelaars . . .	1.	Guide Bearer.
Eikeldop . . .	2.	“ “ Knee.
Eikelmuis . . .	3.	Top Guide Bar.
Eikeloof . . .	4.	Bottom Guide Bar.
Eikeloogst . . .	5.	Guide Front Filling or Block.
Eikels	5A.	“ Back “ “ “
Eikelsteen . . .	6.	Crosshead.
Eikeltijd . . .	10.	“ Pin.

Orders for guides, when not in full sets, should specify whether top or bottom guides are wanted ; and for crosshead, the side should be given.

Plate 22.

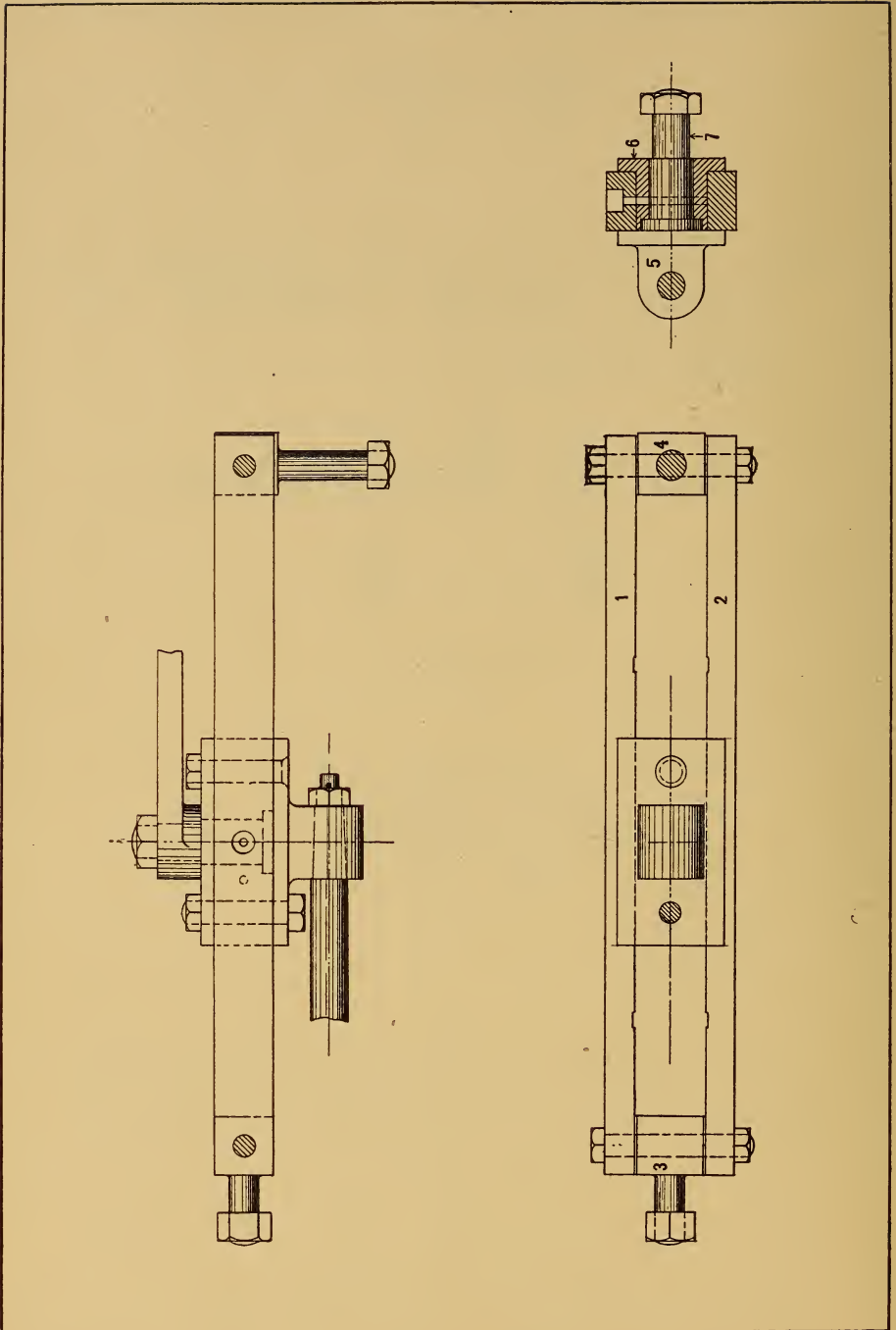

VALVE STEM GUIDES AND CROSSHEAD FOR
BALDWIN COMPOUND LOCOMOTIVES (VAU-
CLAIN SYSTEM).

Plate 22. (EIKELTJES.)

Eikenappel . . .	1.	Valve Stem Top Guide Bar.
Eikenbast . . .	2.	“ “ Bottom Guide Bar.
Eikenbosch . . .	3.	“ “ Guide Front Filling or Block.
Eikenhout . . .	4.	“ “ “ Back “ “ “
Eikenlaan . . .	5.	“ “ Crosshead Lug.
Eikenmos . . .	6.	“ “ Crosshead.
Eikenplant . . .	7.	“ “ “ Pin.

Orders for valve stem guides, when not in full sets, should specify whether top or bottom guides are wanted; and for crosshead the side should be given.

Plate 23.

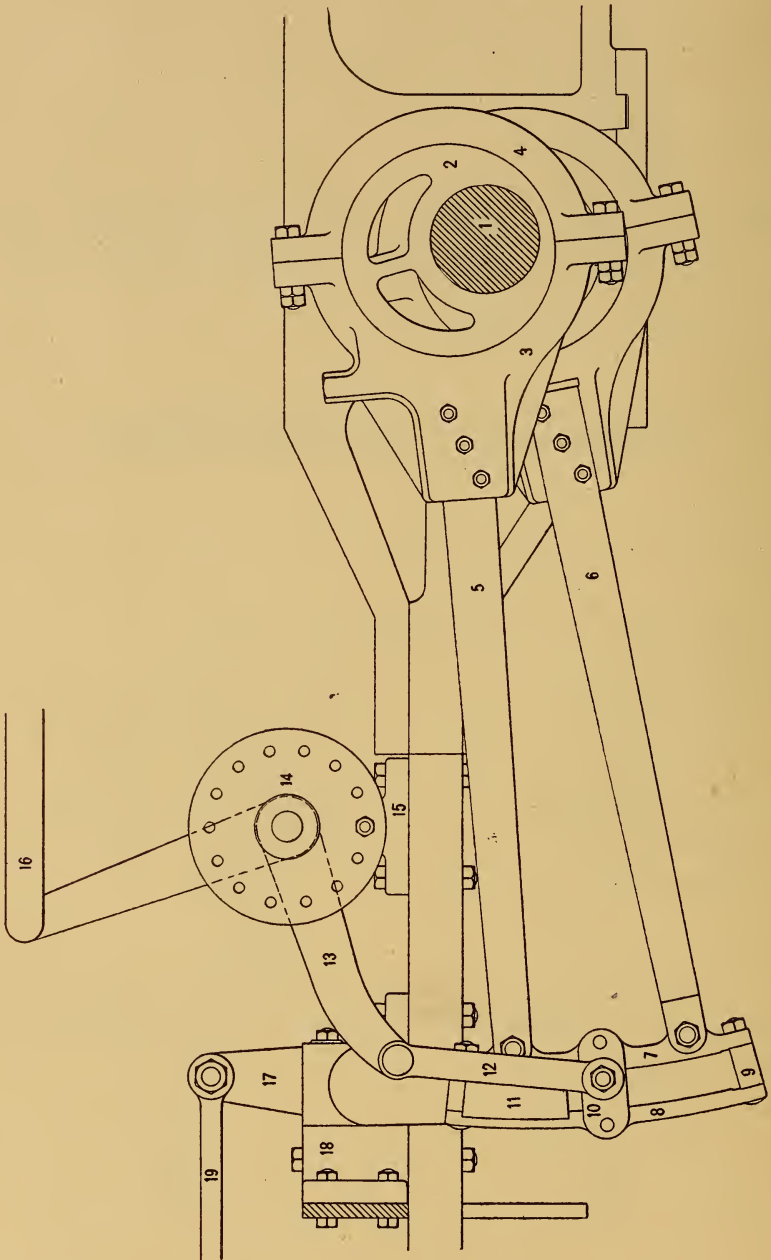

VALVE MOTION WORK.

Plate 23. (EIKENVAREN.)

Eikenwoud	1.	Axle.
Eikon	2.	Eccentrics.
Eilamides	}	3. Eccentric Strap, Front Half.
		4.
Eiland	5.	“ Rod, Inside (Forward Motion).
Eilandjes	6.	“ “ Outside (Back “).
Eilbote	7.	Reverse Link, Back Half.
Eileithyia	8.	“ “ Front “
Eilfertig	9.	“ “ Filling Piece.
Eilmarsch	10.	“ “ Saddle.
Eiloof	11.	Sliding Block.
Eilpost	12.	Link Lifter.
Eilritt	13.	Reverse Shaft.
Eilwagen	14.	Counterbalance Spring.
Eilzug	15.	Reverse Shaft Bearing.
Eimer	16.	“ Lever Rod.
Eimerbank	17.	Rock Shaft.
Eimerkette	18.	“ “ Box.
Eimermasse	19.	Valve Rod.

Orders for reverse shaft bearings, rock shaft boxes, and link work, when not in sets, should specify the side required for.

Plate 24.

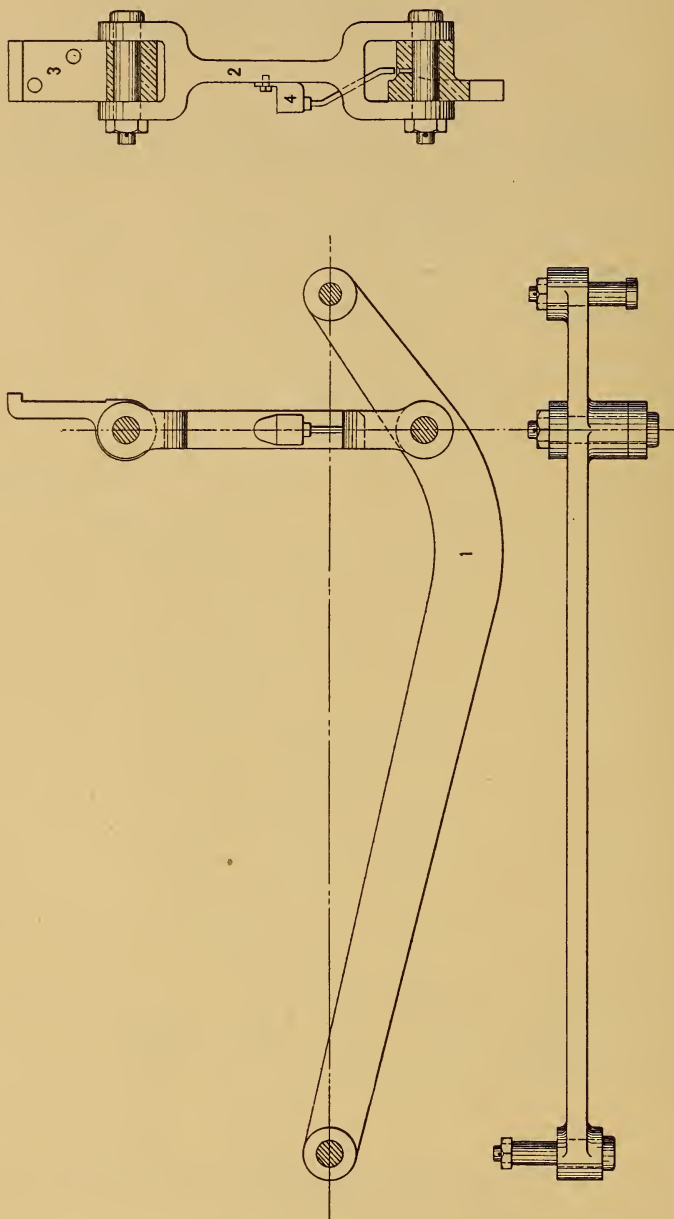

ROCKSHAFT ROD AND HANGER FOR BALDWIN COMPOUND LOCOMOTIVES (VAUCLAIN SYSTEM).

Plate 24. (EIMERWEISE.)

Einachsig . . .	1.	Rockshaft Rod.
Einackern . . .	2.	“ “ Hanger.
Einaetzen . . .	3.	“ “ “ Bearing.
Einaeugig . . .	4.	“ “ Oil Cup.

Orders for rockshaft rods, hangers, and bearings, when not in sets, should specify the side required for.

Plate 25.

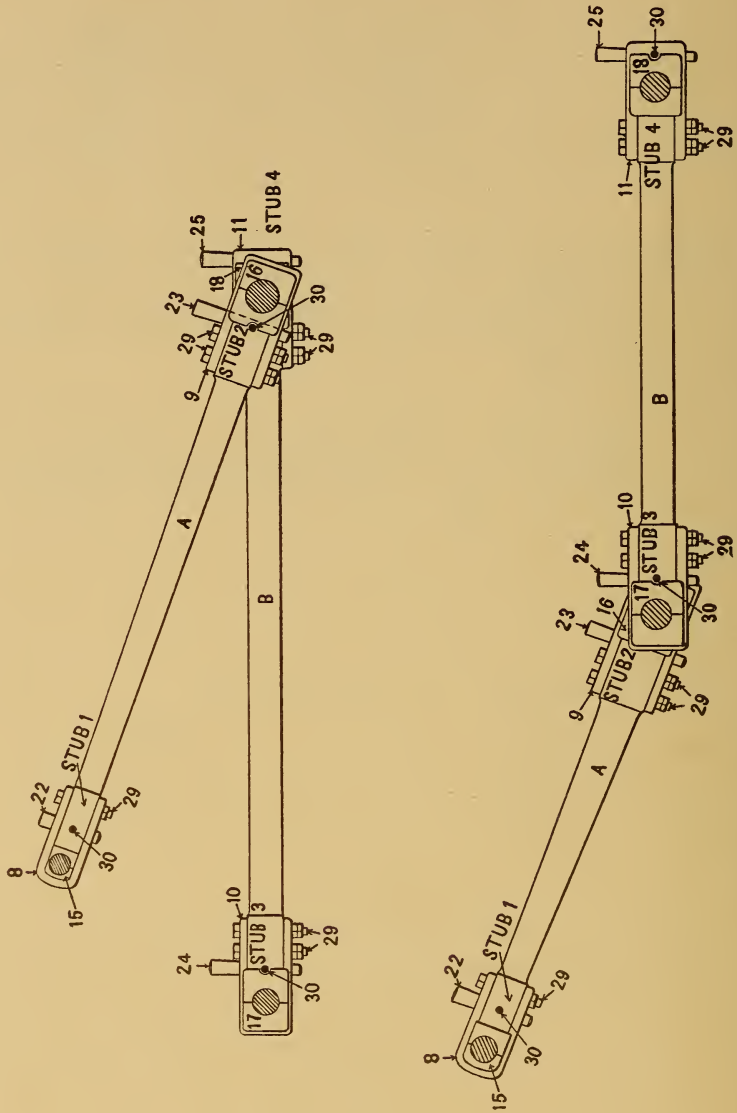
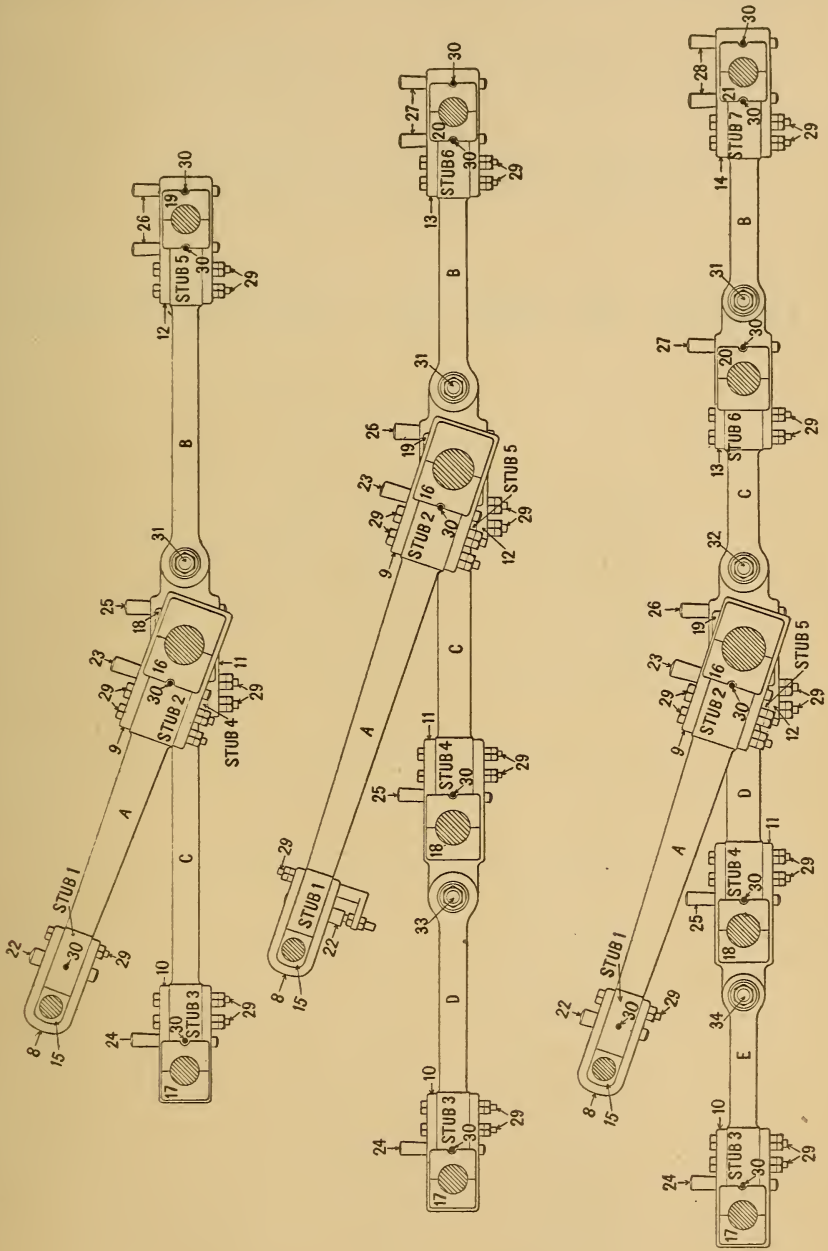

Plate 26.



RODS, STRAPS, AND BRASSES.

Plates 25 and 26. (EINANDER.)

Einarmig . . .	A.	Main Rod.
Einathmen . . .	B.	Back Parallel or Side Rod.
Einballen . . .	C.	Second " " " "
Einband . . .	D.	Third " " " "
Einbandeln . . .	E.	Fourth " " " "

Einbein	8.	Strap of Stub 1.
Einbeinig . . .	9.	" " " 2.
Einbetteln . . .	10.	" " " 3.
Einbildsam . . .	11.	" " " 4.
Einbildung . . .	12.	" " " 5.
Einbinden . . .	13.	" " " 6.
Einbisamen . . .	14.	" " " 7.
Einblatt	15.	Brass " " 1.
Einblick	16.	" " " 2.
Einddoel	17.	" " " 3.
Eindelijk	18.	" " " 4.
Eindelooos	19.	" " " 5.

Eindigheid . . .	20.	Brass of Stub	6.
Eindiging . . .	21.	“ “ “	7.
Eindklank . . .	22.	Key “ “	1.
Eindletter . . .	23.	“ “ “	2.
Eindorren . . .	24.	“ “ “	3.
Eindpaal . . .	25.	“ “ “	4.
Eindrijm . . .	26.	“ “ “	5.
Eindruck . . .	27.	“ “ “	6.
Eindteeken . . .	28.	“ “ “	7.
Eindvonnis . . .	29.	Bolt.	
Einerhand . . .	30.	Set Screw.	
Einfraedeln . . .	31.	Jaw Pin for Rod	B.
Einfesseln . . .	32.	“ “ “ “	C.
Einfilzen . . .	33.	“ “ “ “	D.
Einflecken . . .	34.	“ “ “ “	E.

When rods are not ordered in full sets, the side for which the parts are wanted should be given, as well as the letter of the rod and the stub number.

Give the stub number in all cases when ordering straps, brasses, keys, bolts, or set screws.

Plate 27.

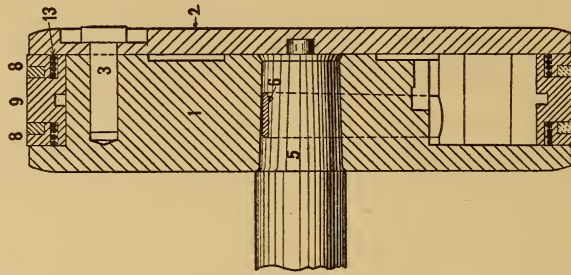

Fig. 1

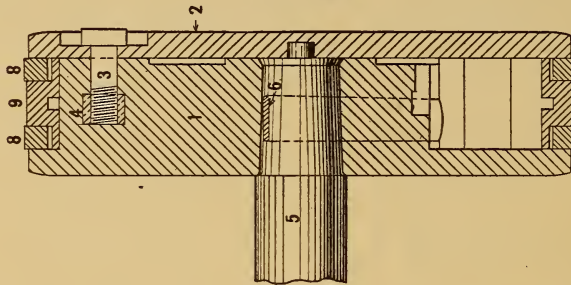

Fig. 2

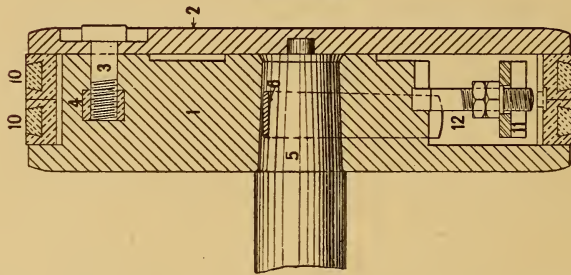

Fig. 3

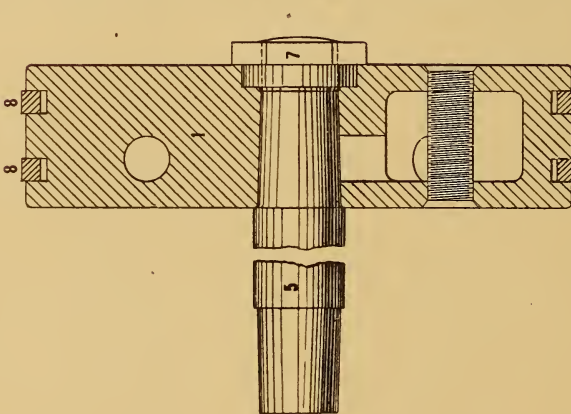

Fig. 4

PISTONS AND PACKING RINGS.

Plate 27. (EINFLUG.)

Einfluss	1.	Piston Head.
Einfoermig . . .	2.	“ Follower.
Einfordern . . .	3.	“ “ Bolts.
Einformen . . .	4.	“ “ Bolt Nuts.
Einfrage	5.	“ Rod.
Einfrieden . . .	6.	“ “ Key.
Einfuhr	7.	“ “ Nut.
Einfurchen . . .	8.	“ Spring Rings (Cast Iron).
Eingabe	9.	“ T Ring (Cast Iron).
Eingaengig . . .	10.	“ Brass and Composition Rings.
Eingaukeln . . .	11.	“ Spring.
Eingehaust . . .	12.	“ “ Studs and Nuts.
Eingehend . . .	13.	“ Wire Springs.

This plate indicates four kinds of packing generally used, and customers can readily refer to the particular pieces by the number of the piece, as well as the figure number.

Plate 28.

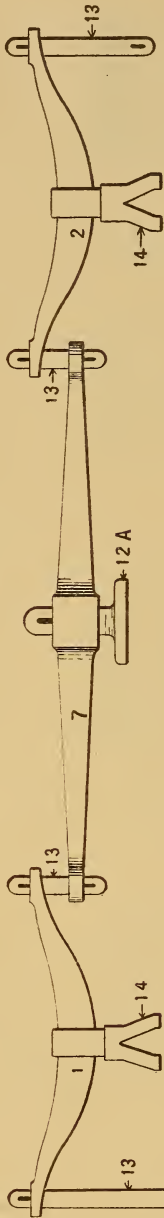

FIG. 1

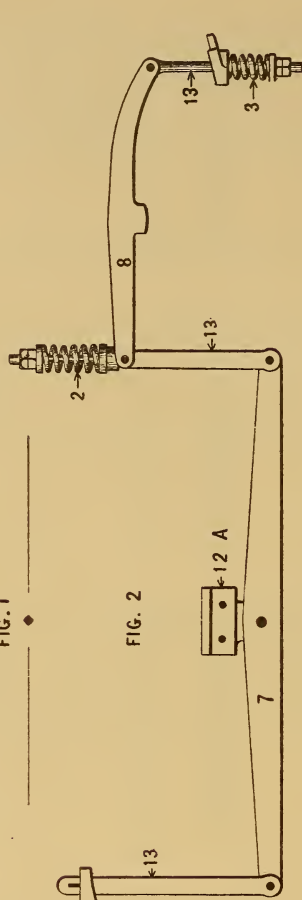

FIG. 2

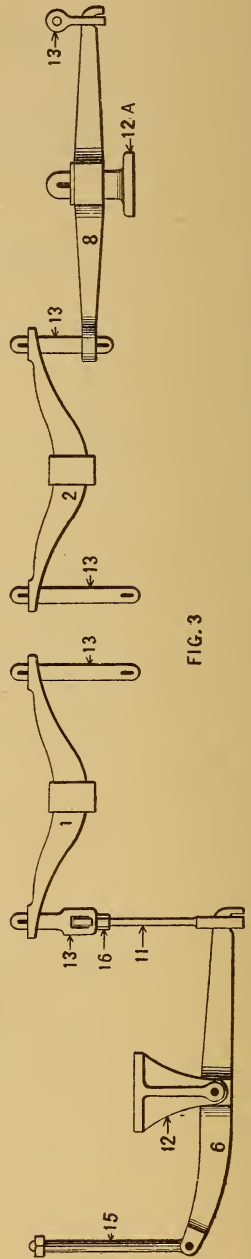

FIG. 3

Plate 29.

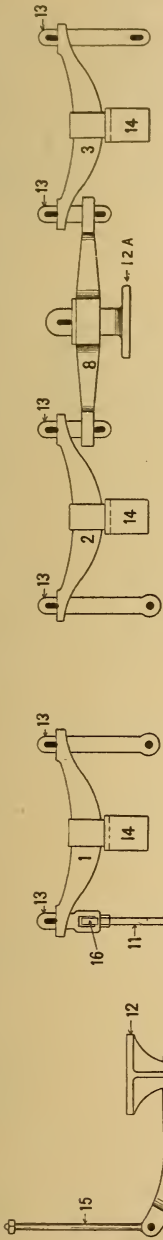

FIG. 4

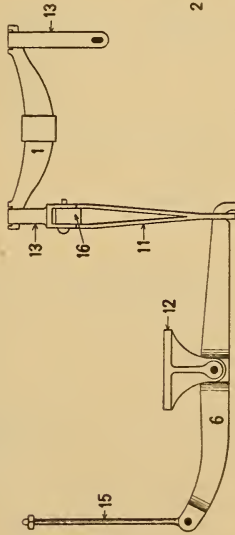

FIG. 5

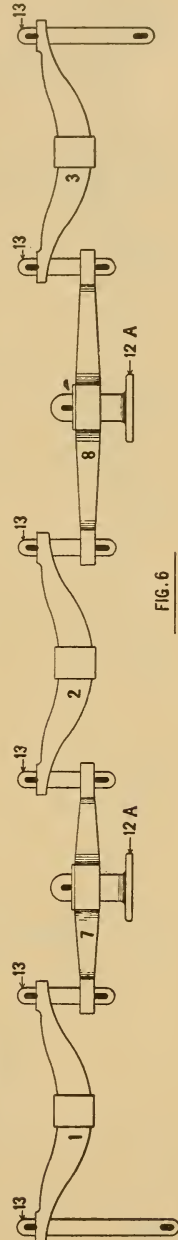

FIG. 6

Plate 30.

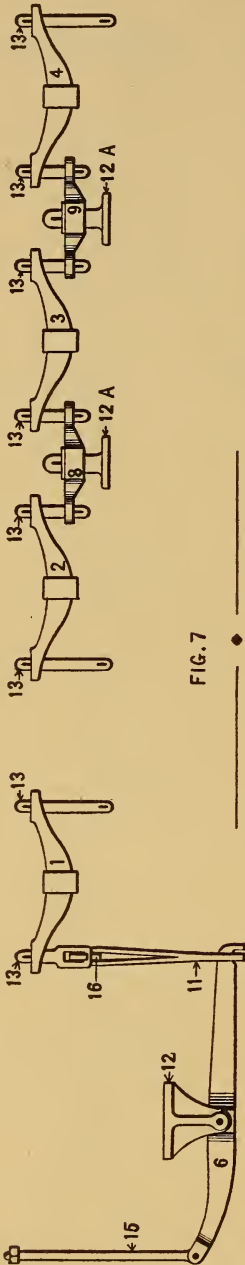

FIG. 7

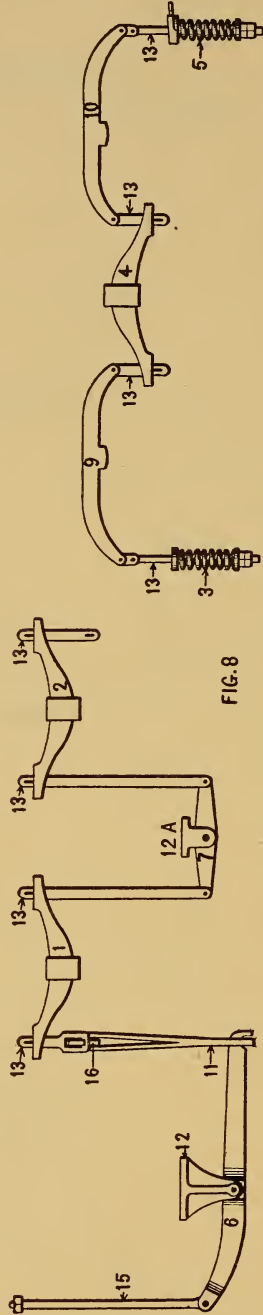

FIG. 8

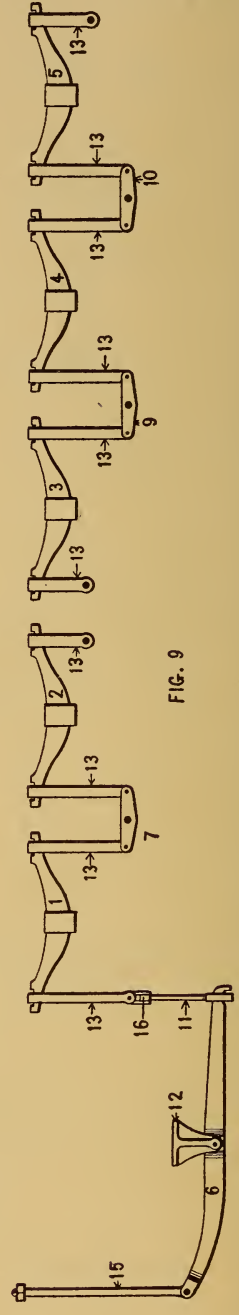

FIG. 9

SPRINGS AND EQUALIZING WORK.

Plates 28, 29, and 30. (EINGEHOLT.)

Eingeimpft . . .	1.	Forward Driving Spring.
Eingejagt . . .	2.	Second " "
Eingekauft . . .	3.	Third " "
Eingekehrt . . .	4.	Fourth " "
Eingekerbt . . .	5.	Fifth " "
Eingekramt . . .	6.	Forward Truck Equalizing Beam.
Eingelangt . . .	7.	Driving Equalizing Beam, First.
Eingelegt . . .	8.	" " " Second.
Eingelenkt . . .	9.	" " " Third.
Eingelocht . . .	10.	" " " Fourth.
Eingeloest . . .	11.	Forward " " Link.
Eingelullt . . .	12.	" " " Fulcrum.
Eingemacht . . .	12A.	Driving " " "
Eingenaecht . . .	13.	" Spring Link.
Eingeoelt . . .	14.	" " Staple.
Eingepackt . . .	15.	Forward Truck Centre Pin Bolt.
Eingepicht . . .	16.	Transverse Equalizing Beam.

In ordering from these plates, it is necessary to specify the figure as well as the number of piece, as it will be noticed that the same numbers have different shapes on the different figures.

Plate 31.

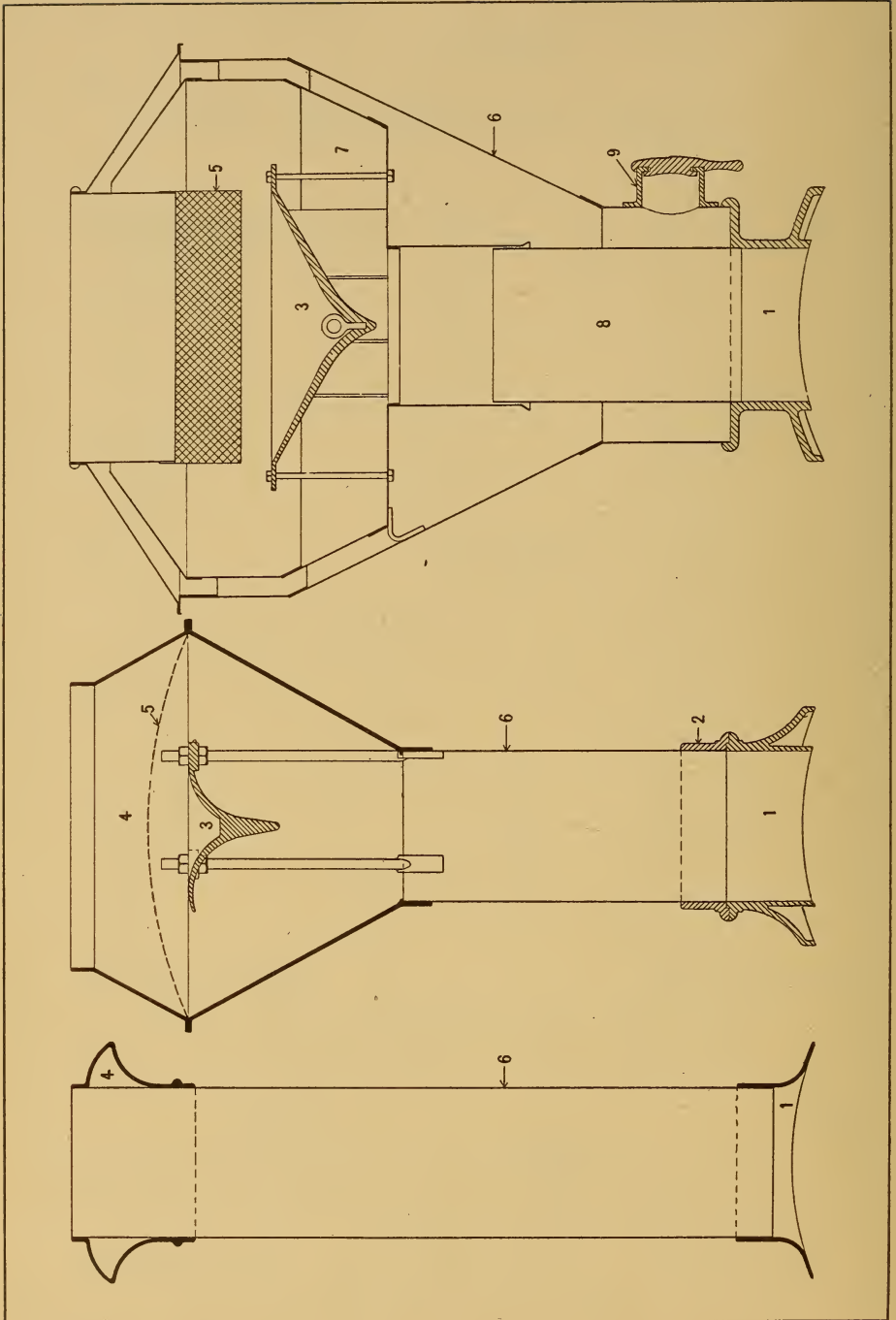

SMOKE STACKS.

Plate 31. (EINGERAFFT.)

Eingerahmt . . .	1. Base.
Eingesalbt . . .	2. " Flange.
Eingesandt . . .	3. Cone.
Eingesehen . . .	4. Top.
Eingesetzt . . .	5. Netting.
Eingittern . . .	6. Body.
Eingreifen . . .	7. Chamber.
Einguss	8. Inside Pipe.
Einhaekeln . . .	9. Hand Hole and Plate.

In ordering top parts of "Diamond" plan of stack, the order should always specify whether top or bottom part of No. 4 is wanted when both pieces are not required.

Plate 32.

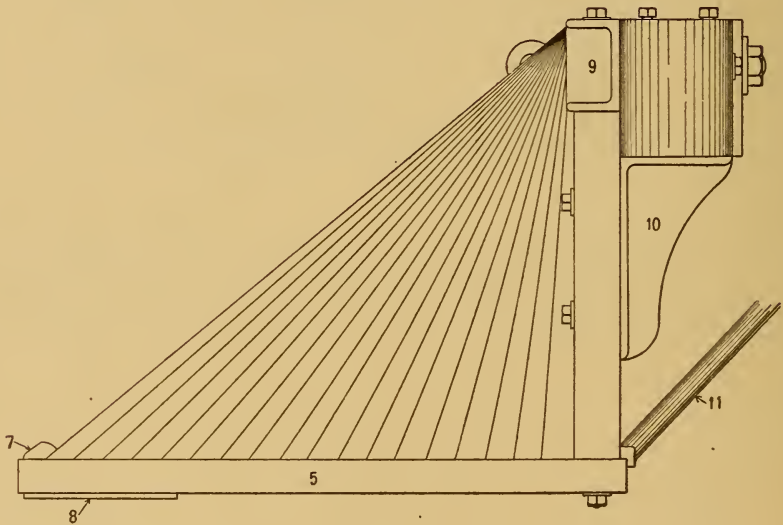
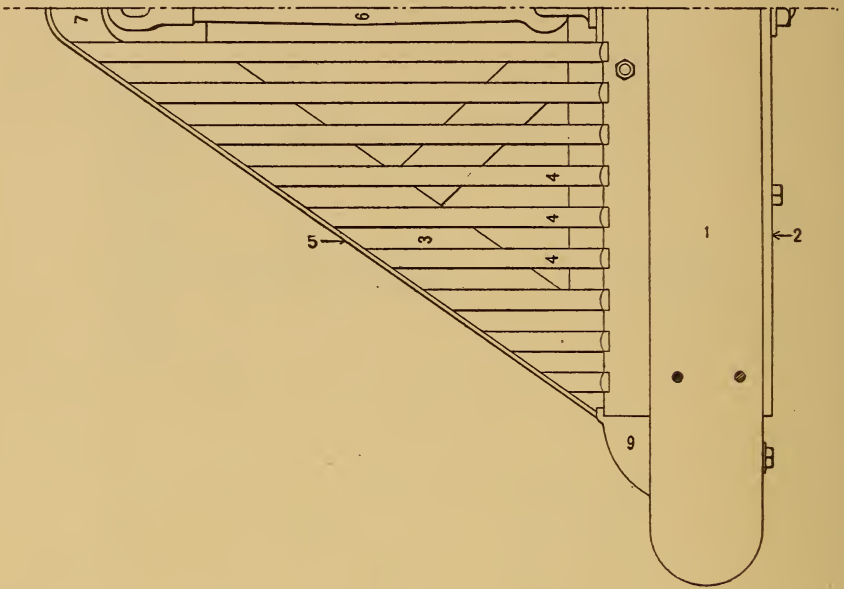

PILOT AND FRONT BUMPER, IRON DRAW BAR
ATTACHMENT.

Plate 32. (EINHAEUSIG.)

Ein Hageln . . .	1. Bumper.
Einhard	2. Stiffening Plate.
Ein harken . . .	3. Pilot Frame.
Ein hegen	4. " Bars.
Ein heizen . . .	5. " Bottom Band.
Ein hellig . . .	6. Draw Bar.
Ein hergang . .	7. " " Shoe.
Ein huellen . .	8. Bottom Plate.
Ein impfen . . .	9. Pushing Shoe.
Ein jaehrig . . .	10. Pilot Bracket.
Ein jagen	11. Middle Brace.

The bracket No. 10 is made right and left, and when only one is wanted the side required for should be specified.

Plate 33.

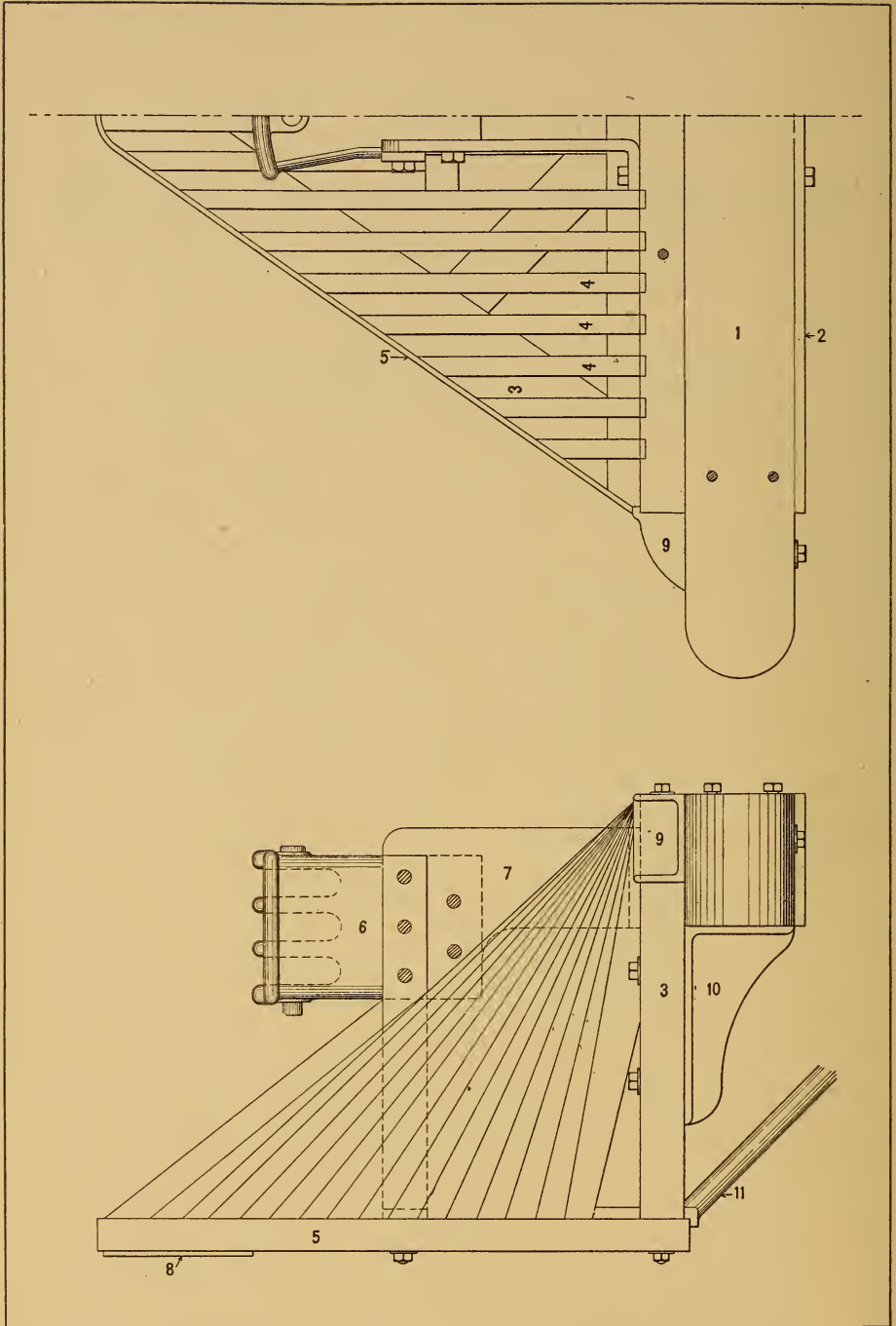

PILOT AND FRONT BUMPER, BULL NOSE
ATTACHMENT.

Plate 33. (EINKELTERN.)

Einkrachen . . .	1. Bumper.
Einladung . . .	2. Stiffening Plate.
Einlangen . . .	3. Pilot Frame.
Einlappen . . .	4. " Bars.
Einlassen . . .	5. " Bottom Band.
Einlaut	6. " Draw Casting.
Einlautig . . .	7. " " " Support.
Einlenkung . .	8. Bottom Plate.
Einliefern . . .	9. Pushing Shoe.
Einlochen . . .	10. Pilot Bracket.
Einloesung . .	11. Middle Brace.

Plate 34.

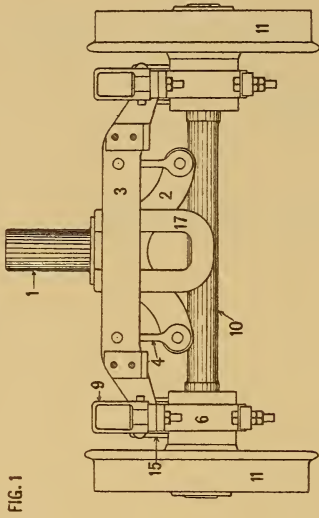

FIG. 1

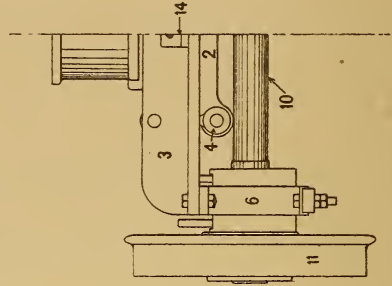
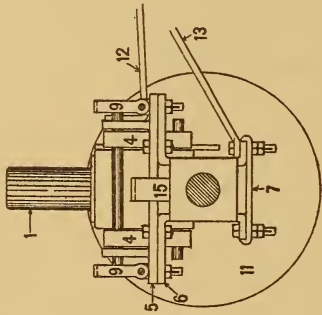
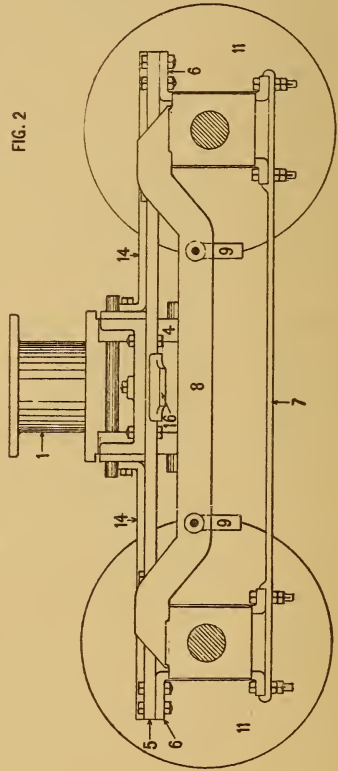

FIG. 2



ENGINE TRUCKS.

Plate 34. (EINMAHLEN.)

Einmahn . . . FIG. 1.—Two Wheeled or Pony Truck.

Einmahny . . FIG. 2.—Four “ Truck.

Einmaster . . .	1.	Centre Pin.
Einmeilig . . .	2.	Swing Bolster.
Einmelken . . .	3.	“ “ Crosstie.
Einmischen . . .	4.	“ “ Link.
Einmuethig . . .	5.	Truck Frame.
Einnahme . . .	6.	“ Pedestal.
Einnarben . . .	7.	“ “ Cap.
Einnesteln . . .	8.	Equalizing Beam.
Einnisten . . .	9.	Spring Link.
Einoede	10.	Axle.
Einoelen	11.	Wheel.
Einomenie . . .	12.	Radius Bar.
Einpaarig . . .	13.	“ “ Brace.
Einpacken . . .	14.	Longitudinal “
Einpichen . . .	15.	Spring Staple.
Einpoekeln . . .	16.	“ Seat.
Einpraegen . . .	17.	Safety Strap.

This plate embodies both the pony and ordinary four-wheel truck, and in ordering parts by the designating numbers the figure number should first be given.

Plate 35.

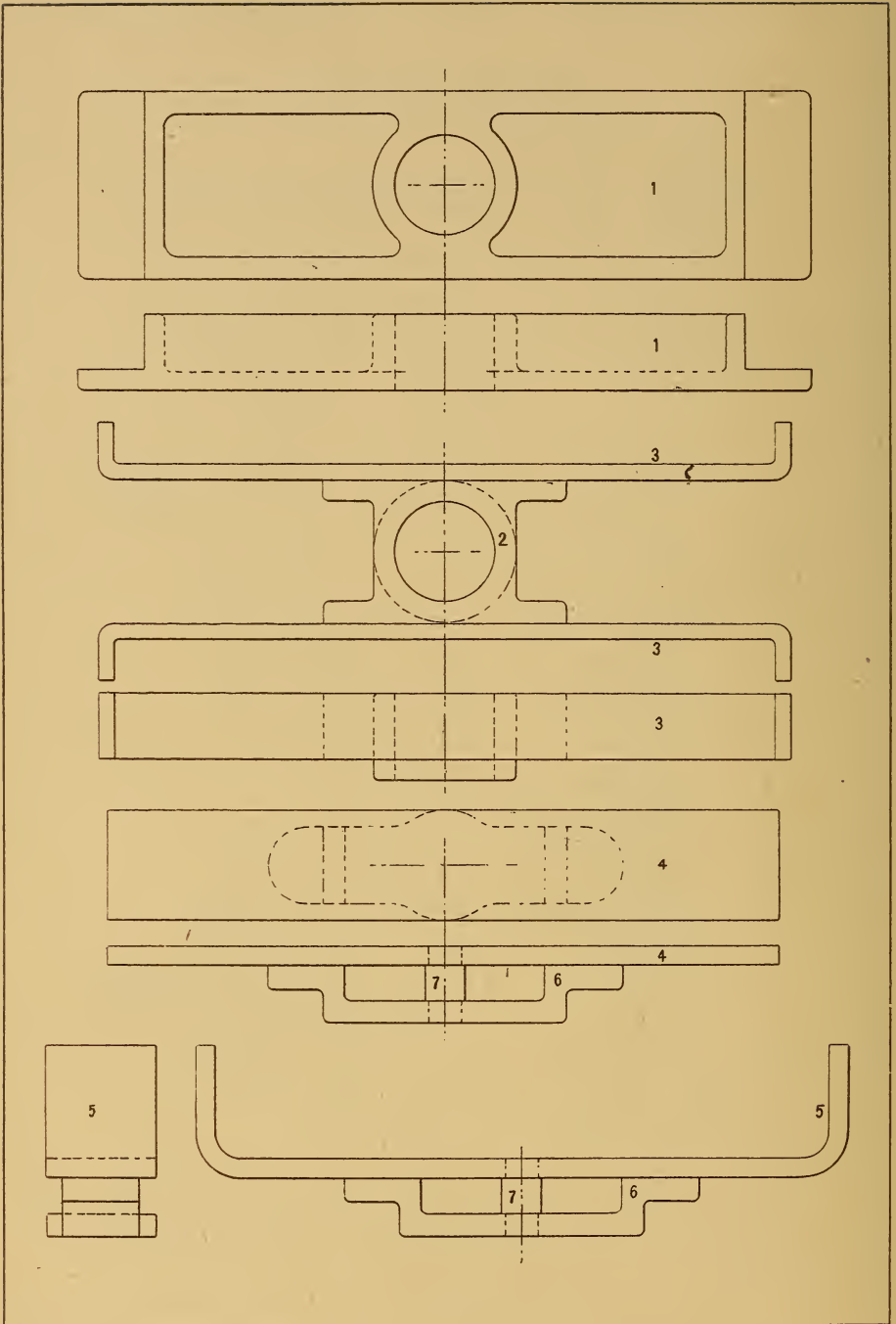

ENGINE TRUCK CENTRE PIN GUIDE AND
CROSSTIE, RADIUS BAR CROSSTIE AND
CLAMP.

Plate 35. (EINRAFFEN.)

Einrahmen . . .	1.	Engine Truck Centre Pin Guide.
Einrammeln . . .	2.	“ “ “ “ “
Einraunen . . .	3.	“ “ “ “ “ Crosstie.
Einreiten . . .	4.	“ “ Radius Bar Crosstie.
Einrippig . . .	5.	“ “ “ “ “
Einrollbar . . .	6.	“ “ “ “ Clamp.
Einrosten . . .	7.	“ “ “ “ Pin.

Plate 36.

FIG. 2

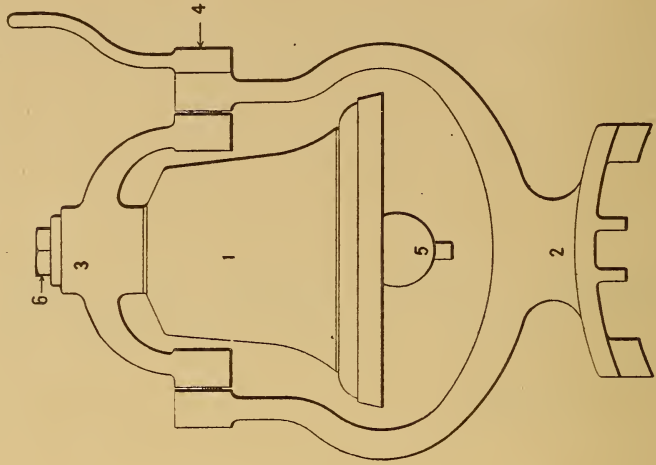
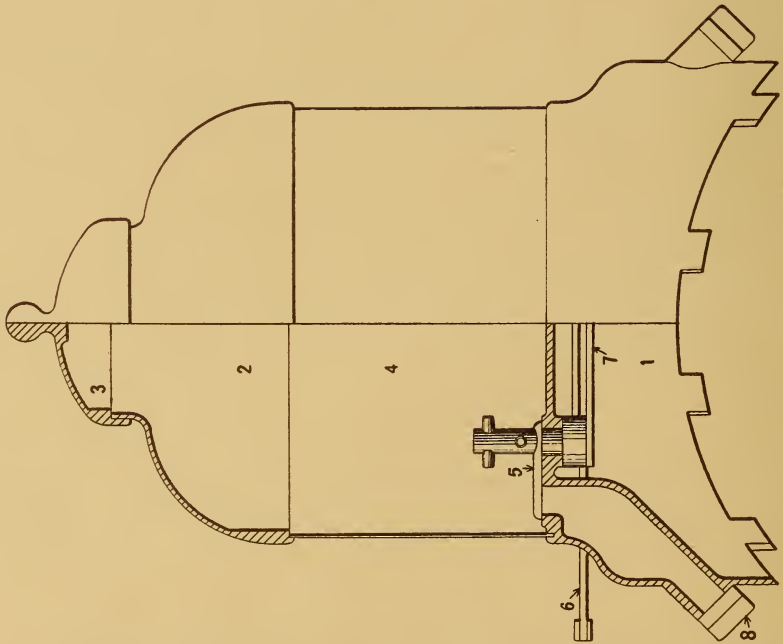

FIG. 1



SAND BOX AND BELL WORK.

Plate 36. (EINRUDERN.)

Einsalzend . . . FIG. 1.—Sand Box.

- Einsam 1. Base.
 Einsamig 2. Top.
 Einsargen 3. Lid.
 Einsatz 4. Body.
 Einschlag 5. Valve.
 Einschlupf . . . 6. Lever.
 Einseifen 7. Valve Connecting Rod.
 Einsetzen 8. Pipe Flange.

Einspannen . . . FIG. 2.—Bell and Frame.

- Einspruch . . . 1. Bell.
 Einsteigen . . . 2. Frame.
 Einstig 3. Yoke.
 Einstmals 4. Crank.
 Einstopfen . . . 5. Tongue.
 Einstreu 6. Acorn.

Plate 37.

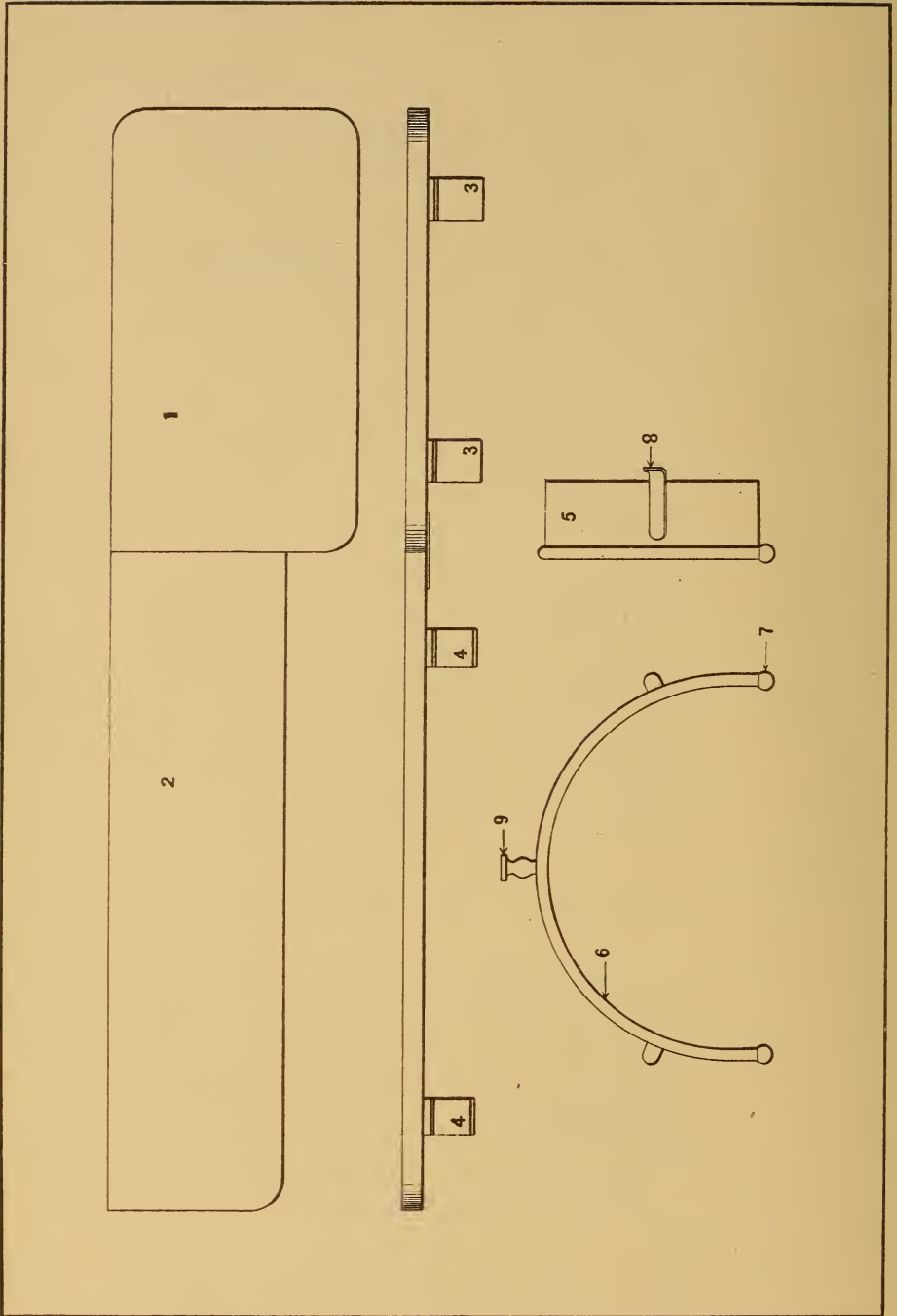

FOOT BOARDS AND WHEEL COVERS.

Plate 37. (EINSTREUEN.)

Einstutzen . . .	1.	Cab Foot Board.
Eintaegig . . .	2.	Running “
Eintausch . . .	3.	Cab Foot “ Brackets.
Eintoenig . . .	4.	Running “ “
Eintracht . . .	5.	Wheel Cover.
Einungstag . . .	6.	“ “ Pipe.
Einwaerts . . .	7.	“ “ Acorn.
Einzaehlig . . .	8.	“ “ Bracket.
Einzahl	9.	“ “ Column.

These parts are seldom ordered except in full sets, and the side wanted for should be given when they are not so ordered.

Plate 38.

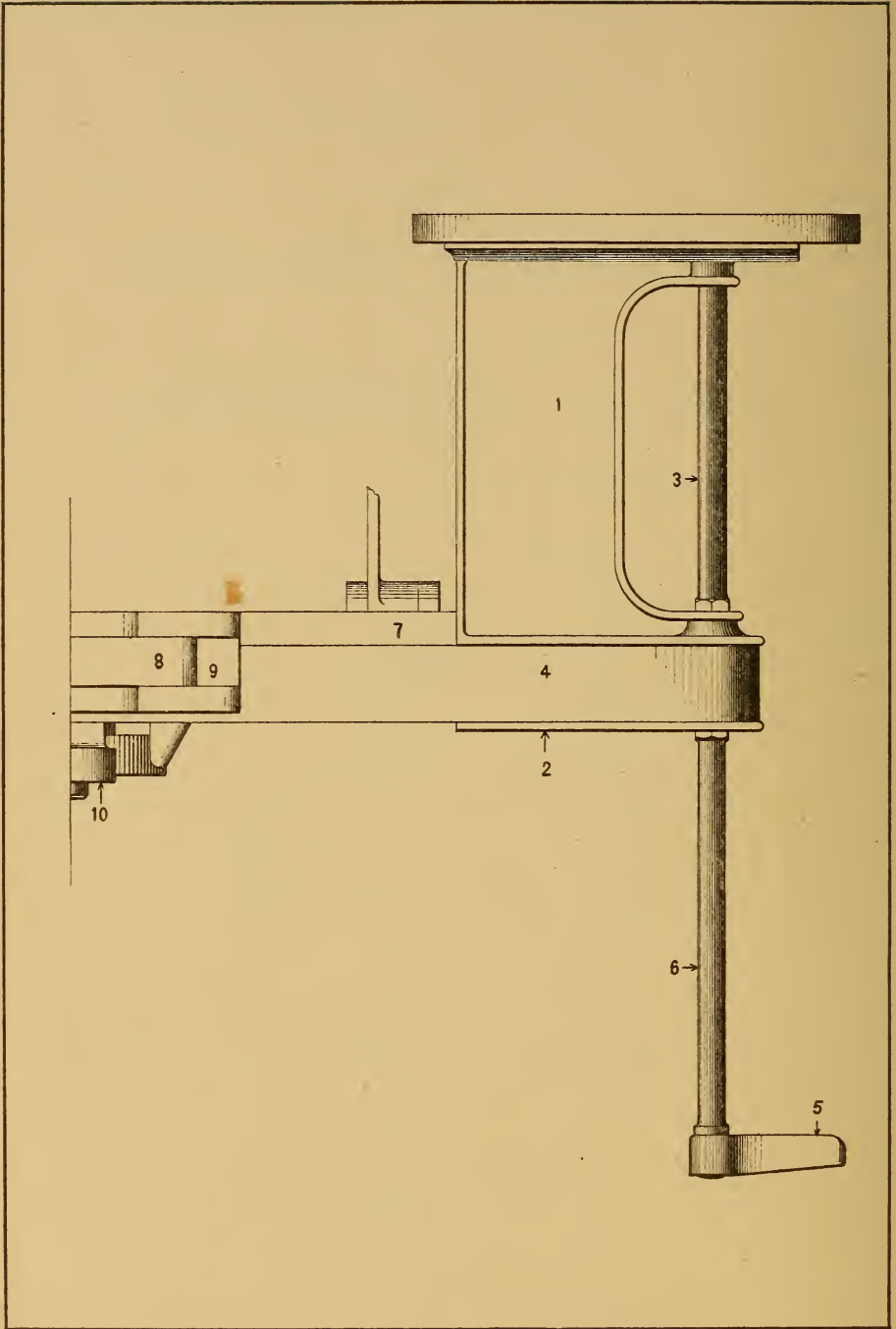

BACK BUMPER AND ATTACHMENTS.

Plate 38. (EINZAHLUNG.)

Einzelbach . . .	1. Cab Bracket.
Einzelbild . . .	2. " " Plate.
Einzeln	3. " " Pipe.
Einzelwort . . .	4. Back Bumper.
Einzelzug	5. Engine Step.
Einzieher	6. " " Hanger.
Einzig	7. Foot Plate.
Einswingen . . .	8. Tender Wedge.
Eioneous	9. " " Box.
Eiradego	10. Back Draw Bar.

Cab brackets are made right and left. Orders for single brackets should give side wanted for.

Plate 39.

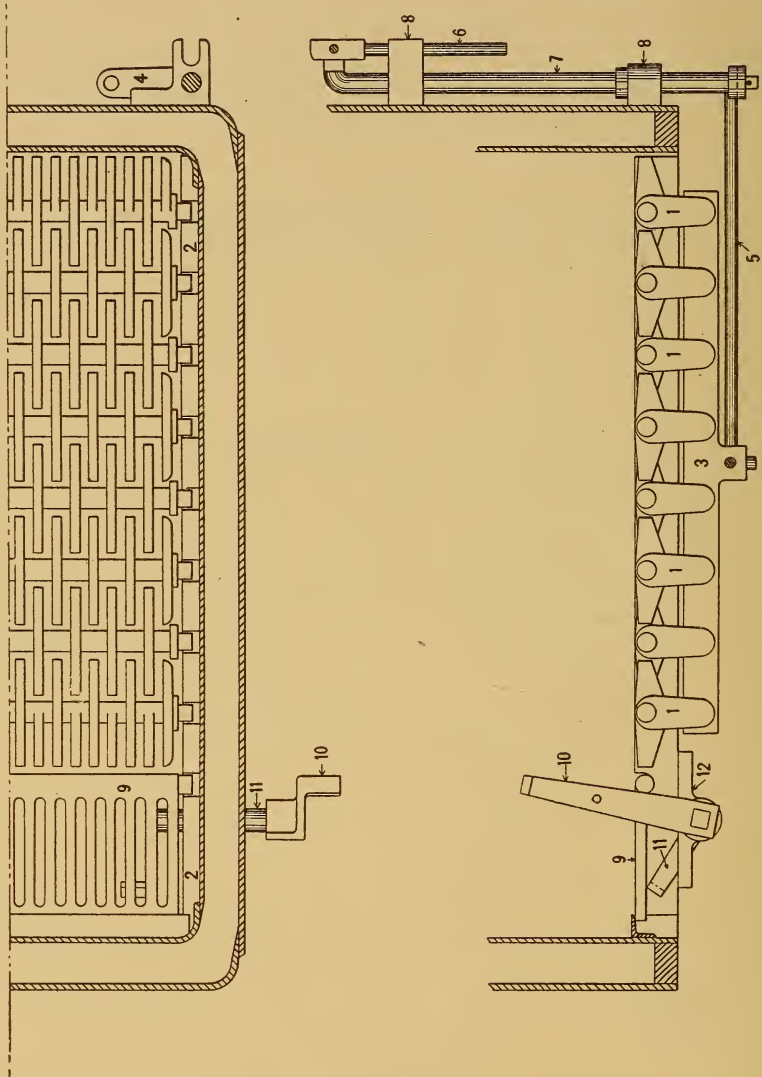

ROCKING GRATE WORK.

Plate 39. (EIRENARCH.)

Eirund	1. Bar.
Eisachat	2. Frame.
Eisbaelle	3. Connecting Bar.
Eisbaertig	4. Arm.
Eisbahn	5. Rod.
Eisbank	6. Handle.
Eisbecher	7. Shaft.
Eisberg	8. " Bearings.
Eisbergen	9. Drop Plate.
Eisblock	10. " " Handle.
Eisblume	11. " " Shaft.
Eisch	12. " " " Bearing.

When complete sets of these bars are not wanted, the order should give the position from the front of the bars that are required.

Plate 40.

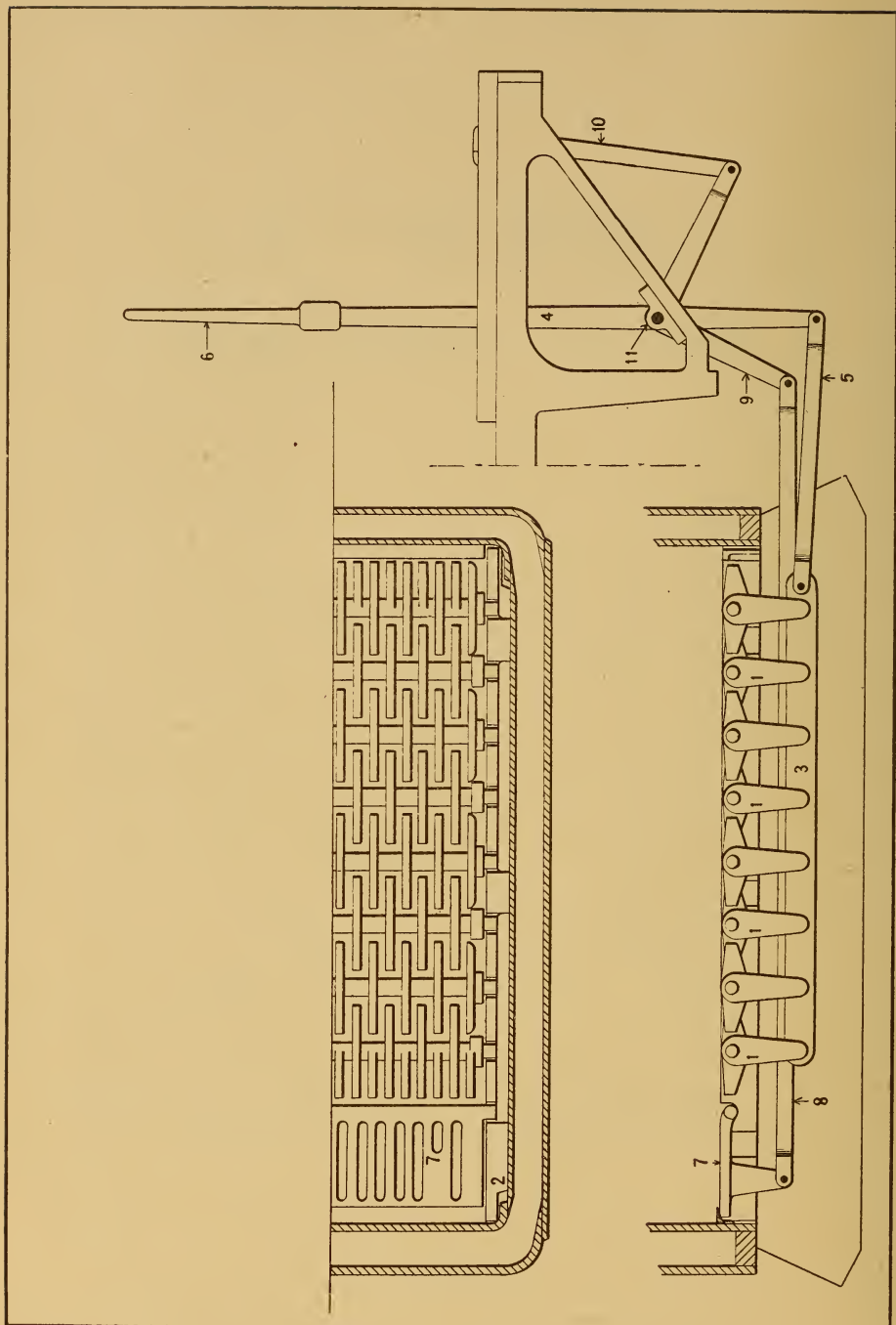

ROCKING GRATE WORK.

Plate 40. (EISCHEUDE.)

Eiseiche . . .	1.	Bar.
Eisenader . . .	2.	Frame.
Eisenalaun . . .	3.	Connecting Bar.
Eisenbarre . . .	4.	Lever.
Eisenerz . . .	5.	“ Rod.
Eisenfest . . .	6.	“ Handle.
Eisenfleck . . .	7.	Drop Plate.
Eisengang . . .	8.	“ “ Rod.
Eisengeld . . .	9.	“ “ Crank.
Eisenglanz . . .	10.	“ “ “ Handle.
Eisengrube . . .	11.	“ “ “ Bearing.

When complete sets of these bars are not wanted, the order should give the position from the front of the bars that are required.

Plate 41.

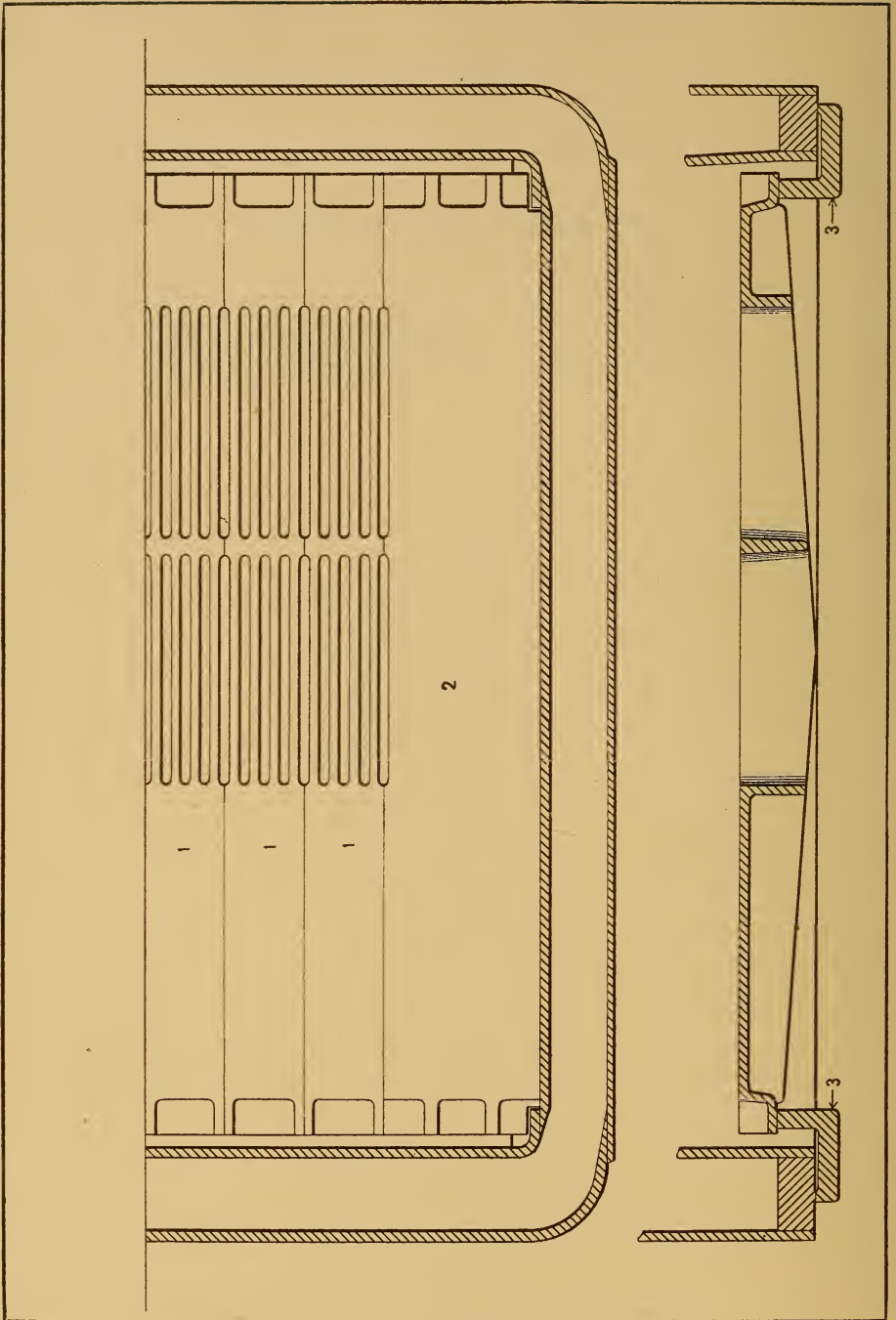

PLAIN GRATE FOR WOOD.

Plate 41. (EISENHAKEN.)

Eisenholz . . . 1. Bar.

Eisenhose . . . 2. Dead Plate.

Eisenjoch . . . 3. End Holder.

For this plan of grate it will be necessary to specify the side dead plate is required for when not in full sets.

Plate 42.

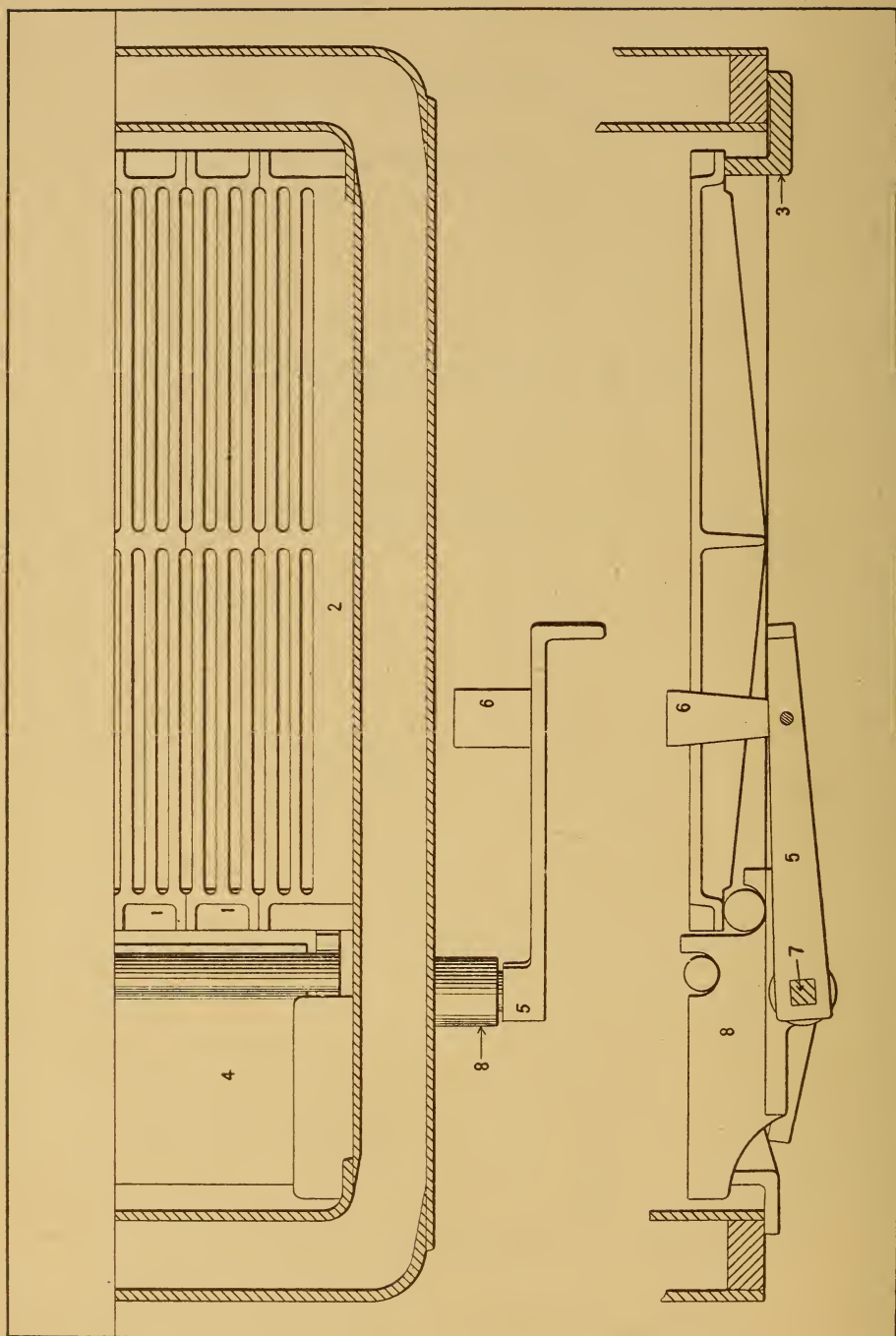

PLAIN GRATE FOR SOFT COAL.

Plate 42. (EISENKALK.)

Eisenkeil . . .	1.	Bar.
Eisenklaue . .	2.	Dead Plate.
Eisenmauer . .	3.	End Holder.
Eisenmohr . .	4.	Drop Plate.
Eisenmulm . .	5.	“ “ Handle.
Eisennuss . .	6.	“ “ “ Support.
Eisenocher . .	7.	“ “ Shaft.
Eisenofen . .	8.	“ “ “ Bearing.

The bearings for drop plate shaft are made right and left. This should be observed in ordering duplicates.

Plate 43.

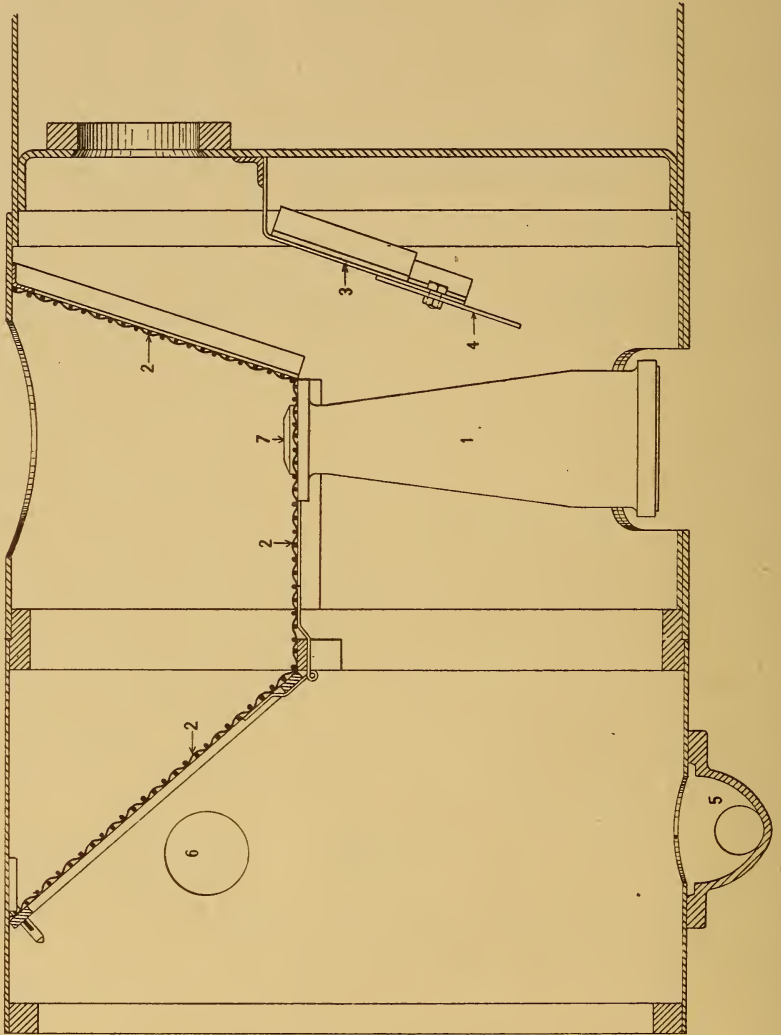

SMOKE BOX FITTINGS.

Plate 43. (EISENOPAL.)

Eisenprobe . . .	1. Exhaust Nozzle.
Eisenrahm . . .	2. Netting.
Eisenring . . .	3. Deflecting Plate.
Eisenrost . . .	4. “ “ Slide.
Eisensalz . . .	5. Spark Ejector.
Eisensand . . .	6. Cleaning Hole and Cap.
Eisenschuh . . .	7. Exhaust Thimbles.

In ordering these parts, if any change is required from original fittings, especially with reference to nozzle, the order should specify whether single or double opening is wanted. Thimbles always include three sizes to a set, and the particular size wanted, when not in full sets, should be given.

Plate 44.

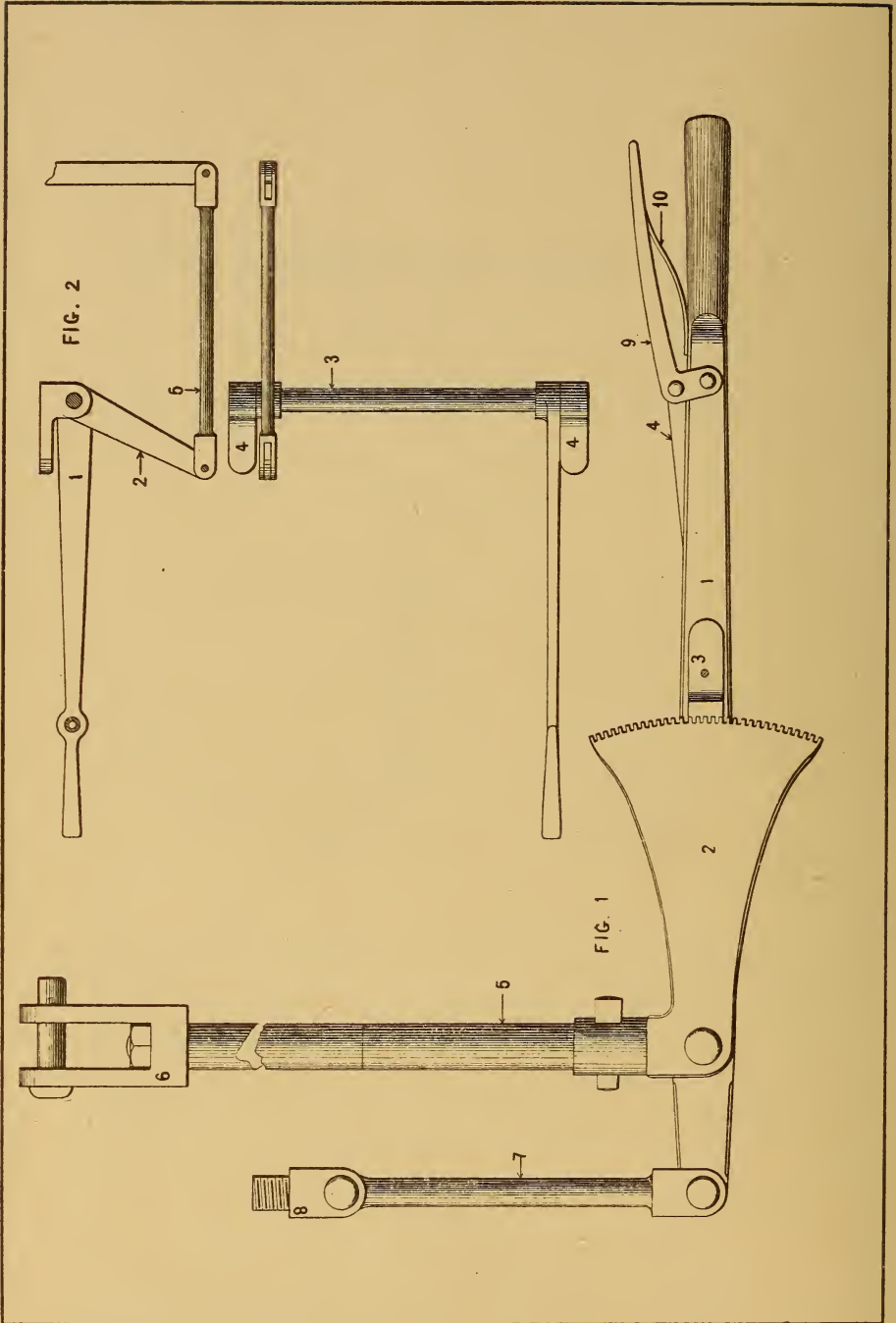

THROTTLE AND WHISTLE WORK.

Plate 44. (EISENSPITZ.)

Eisensporn . . FIG. 1.—Throttle Work.

Eisenstark . . .	1. Lever.
Eisenstaub . . .	2. Quadrant.
Eisenstich . . .	3. Latch.
Eisenstufe . . .	4. “ Link.
Eisenthor . . .	5. Rod.
Eisenthurm . . .	6. Jaw.
Eisentrirt . . .	7. Link.
Eisentruehe . . .	8. “ Stud.
Eisenwaare . . .	9. Handle.
Eisenwaffe . . .	10. “ Spring.

Eisenzahn . . FIG. 2.—Whistle Work.

Eisenzeit . . .	1. Lever.
Eisenzeug . . .	2. Arm or Crank.
Eisenzoll . . .	3. Shaft.
Eiseshauch . . .	4. “ Bearing.
Eisfloh	5. Link.

In ordering Link No. 5, Fig. 2, the distance from centre to centre of jaw should be given.

Plate 45.

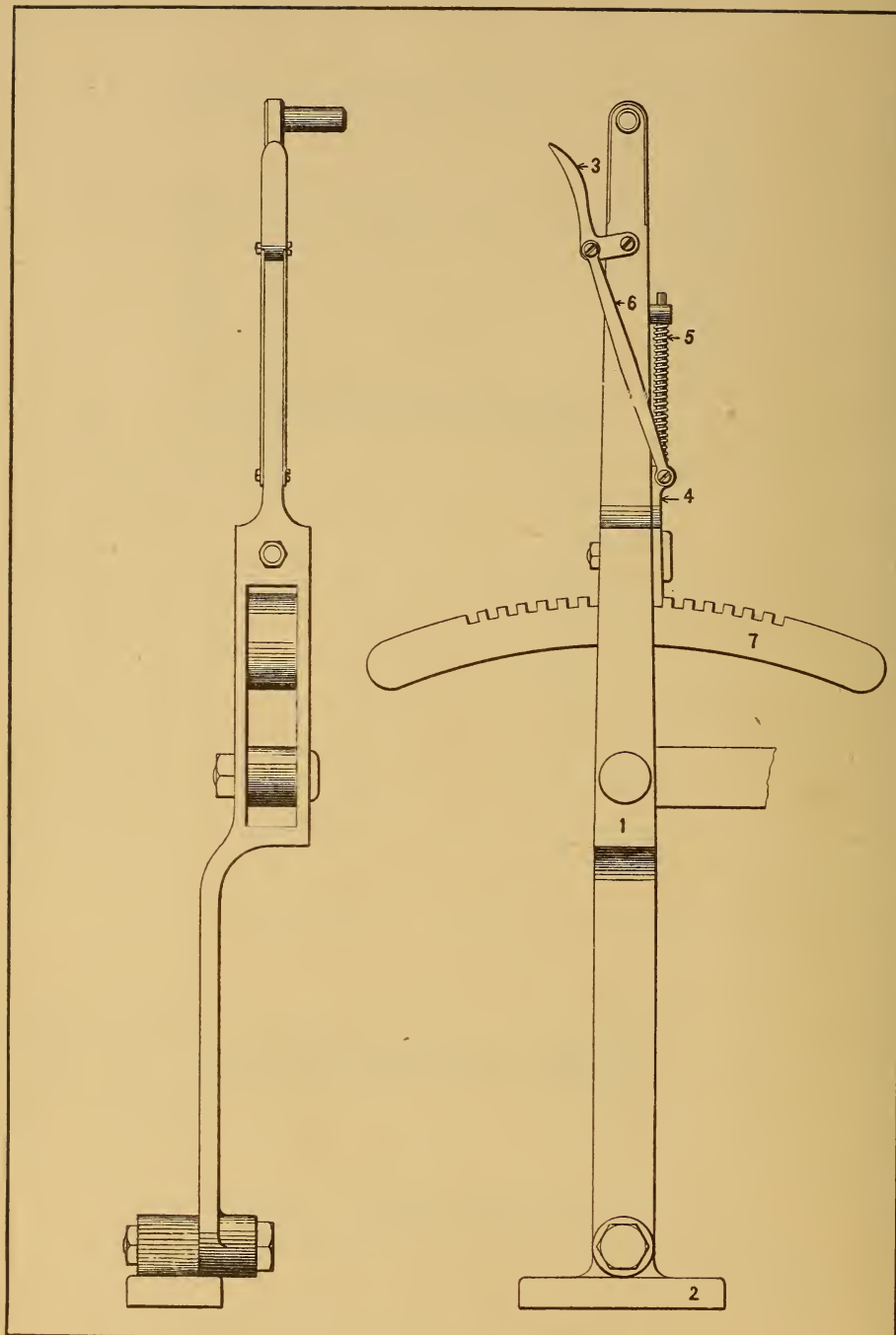

REVERSE LEVER AND ATTACHMENTS.

Plate 45. (EISFUCHS.)

-
- | | |
|-------------------|--------------|
| Eisgang | 1. Lever. |
| Eisgipfel | 2. Fulcrum. |
| Eisgrau | 3. Handle. |
| Eishoehle | 4. Latch. |
| Eishund | 5. “ Spring. |
| Eisinsel | 6. “ Rod. |
| Eiskaelte | 7. Catch. |

Plate 46.

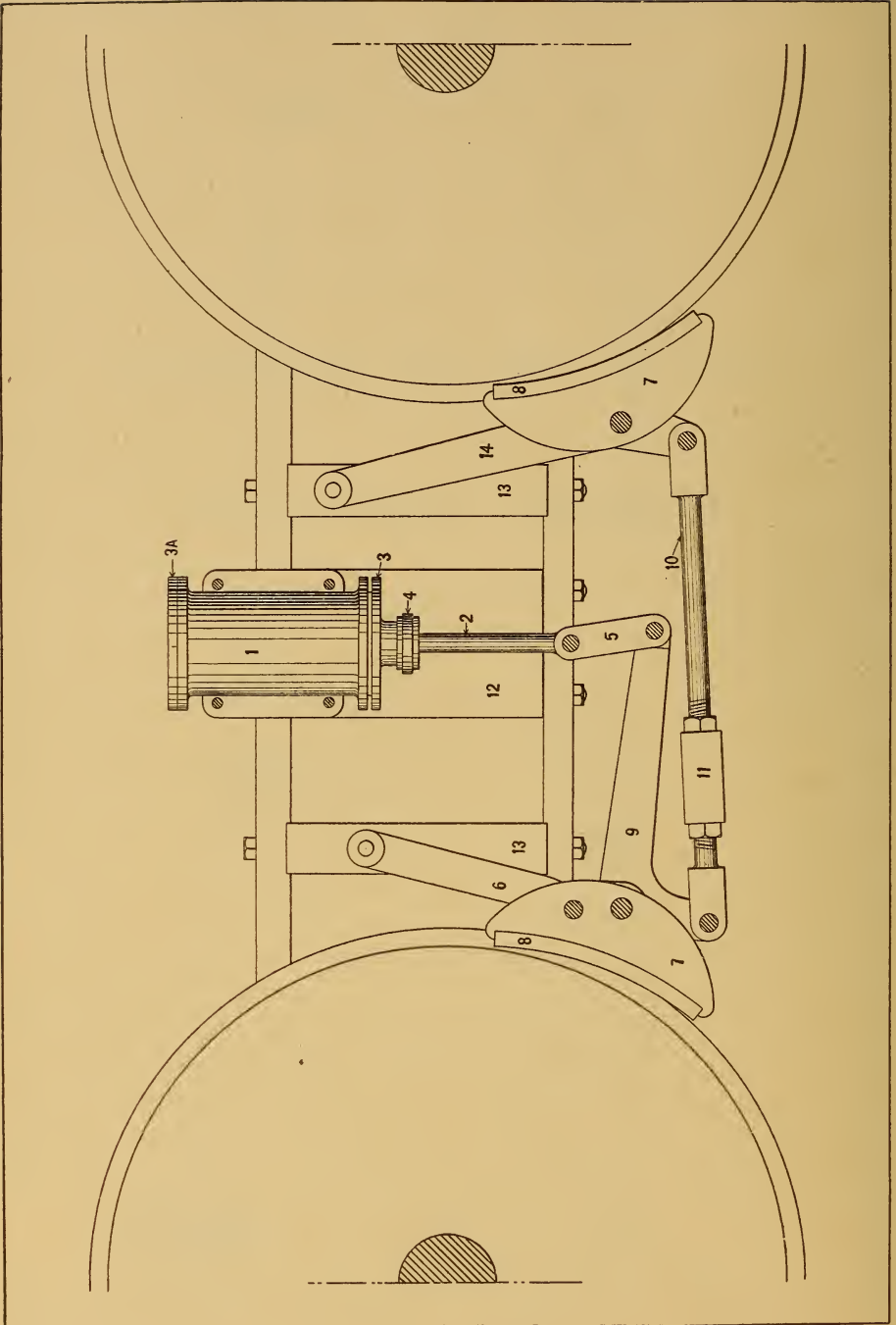

STEAM BRAKE WORK.

SPREAD STYLE.

Plate 46. (EISKEGEL.)

Eiskeller . . .	1.	Brake Cylinder.
Eiskessel . . .	2.	“ Piston Rod.
Eiskluft	3.	“ Cylinder Head, Bottom.
Eisklumpen . . .	3A.	“ “ “ Top.
Eislaeufer . . .	4.	“ “ Stuffing Box Nut.
Eislawine . . .	5.	“ Connecting Link.
Eisloch	6.	“ Hanger Link.
Eismeer	7.	“ Head.
Eismoewe . . .	8.	“ Shoe.
Eismonat . . .	9.	“ Bell Crank.
Eismuetze . . .	10.	“ Rod.
Eisnadel	11.	“ “ Adjusting Nut.
Eisnetz	12.	“ Cylinder Support.
Eispalast . . .	13.	“ Hanger “
Eispflug	14.	“ Lever.

Separate catalogues of patented power brakes may be obtained by applying to the makers.

Plate 47.

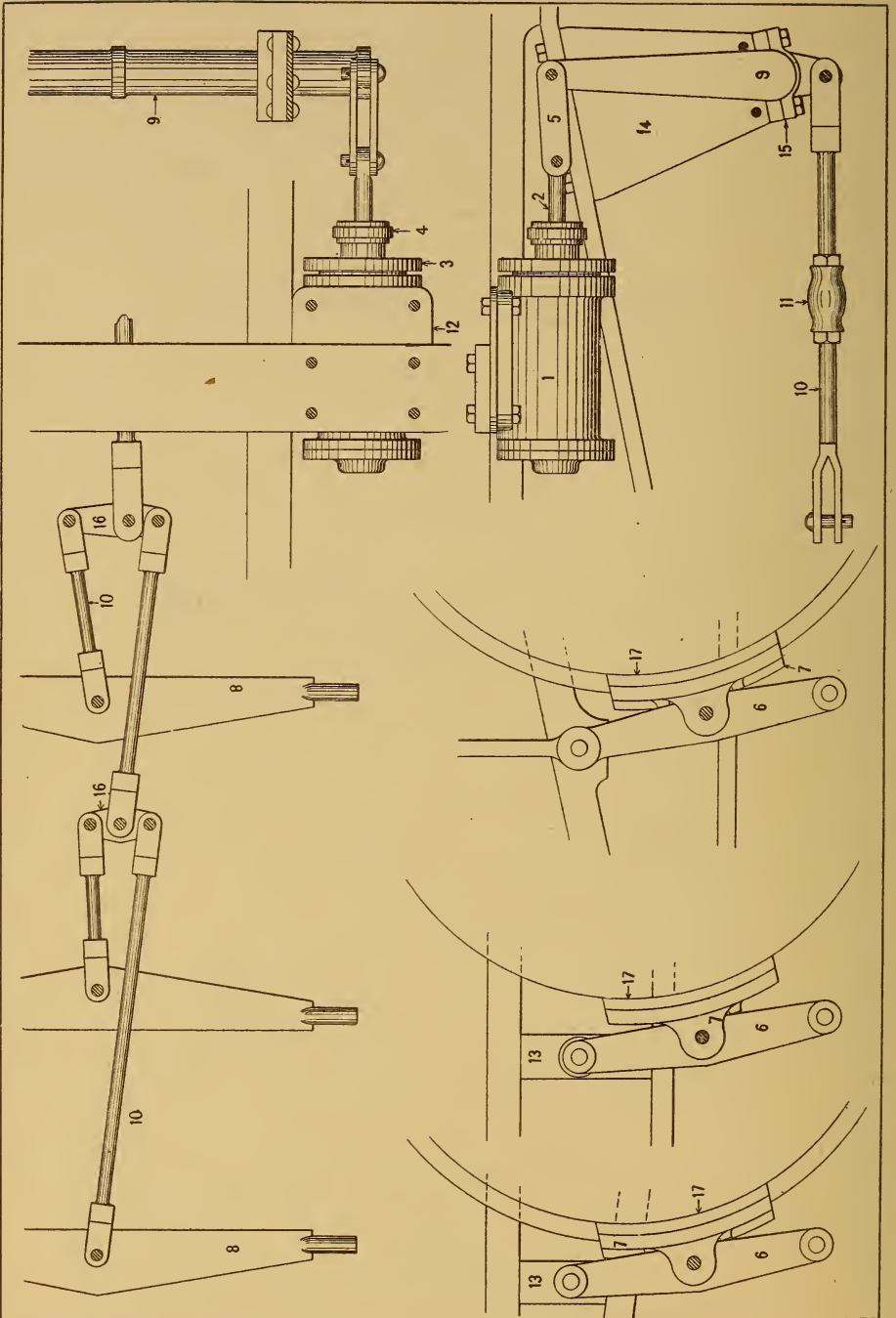

STEAM BRAKE WORK.

EQUALIZED STYLE.

Plate 47. (EISPNOIQUE.)

Eispol	1.	Brake Cylinder.
Eispunkt	2.	“ Piston Rod.
Eisrechen	3.	“ Cylinder Head.
Eisrevier	4.	“ “ Stuffing Box Nut.
Eisriegel	5.	“ Connecting Link.
Eisrinde	6.	“ Lever.
Eissamp	7.	“ Head.
Eissaugue	8.	“ Beam.
Eisschuh	9.	“ Shaft.
Eisspitzen	10.	“ Rod.
Eissporn	11.	“ “ Adjusting Nut.
Eisstoss	12.	“ Cylinder Support.
Eisstrom	13.	“ Hanger.
Eissturz	14.	“ Shaft Support.
Eistafel	15.	“ “ Bearing.
Eistanz	16.	“ Rod Lever.
Eisteddfod	17.	“ Shoe.

Separate catalogues of patented power brakes may be obtained by applying to the makers.

Plate 48.

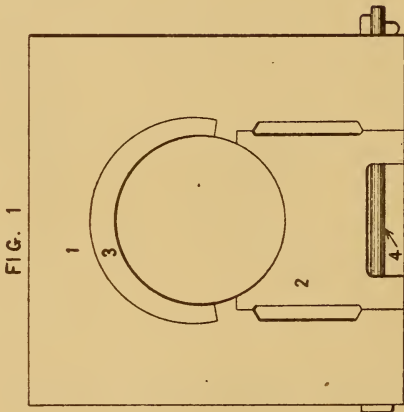
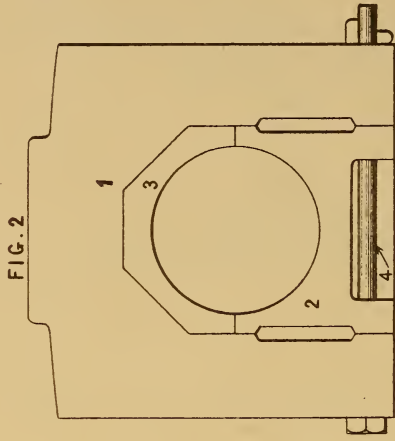
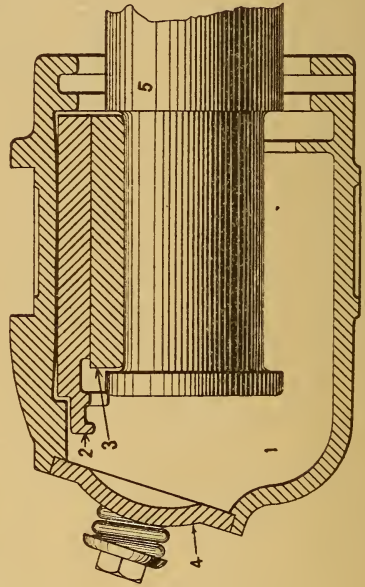

FIG. 3



JOURNAL BOXES.

Plate 48. (EISTHAU.)

Eisthorm . . . FIG. 1.—Driving Box.

Eisthormly . . . “ 2.—Truck “

Eistropfen . . . 1. Box.

Eisufer 2. Cellar.

Eisvogel 3. Brass.

Eiswand 4. Cellar Bolt.

Eiswasser . . . FIG. 3.—Tender Box.

Eiswelt 1. Box.

Eiswolke 2. Wedge.

Eiswurm 3. Brass.

Eiszacken 4. Lid.

Eiszapfen 5. Axle.

Plate 49.

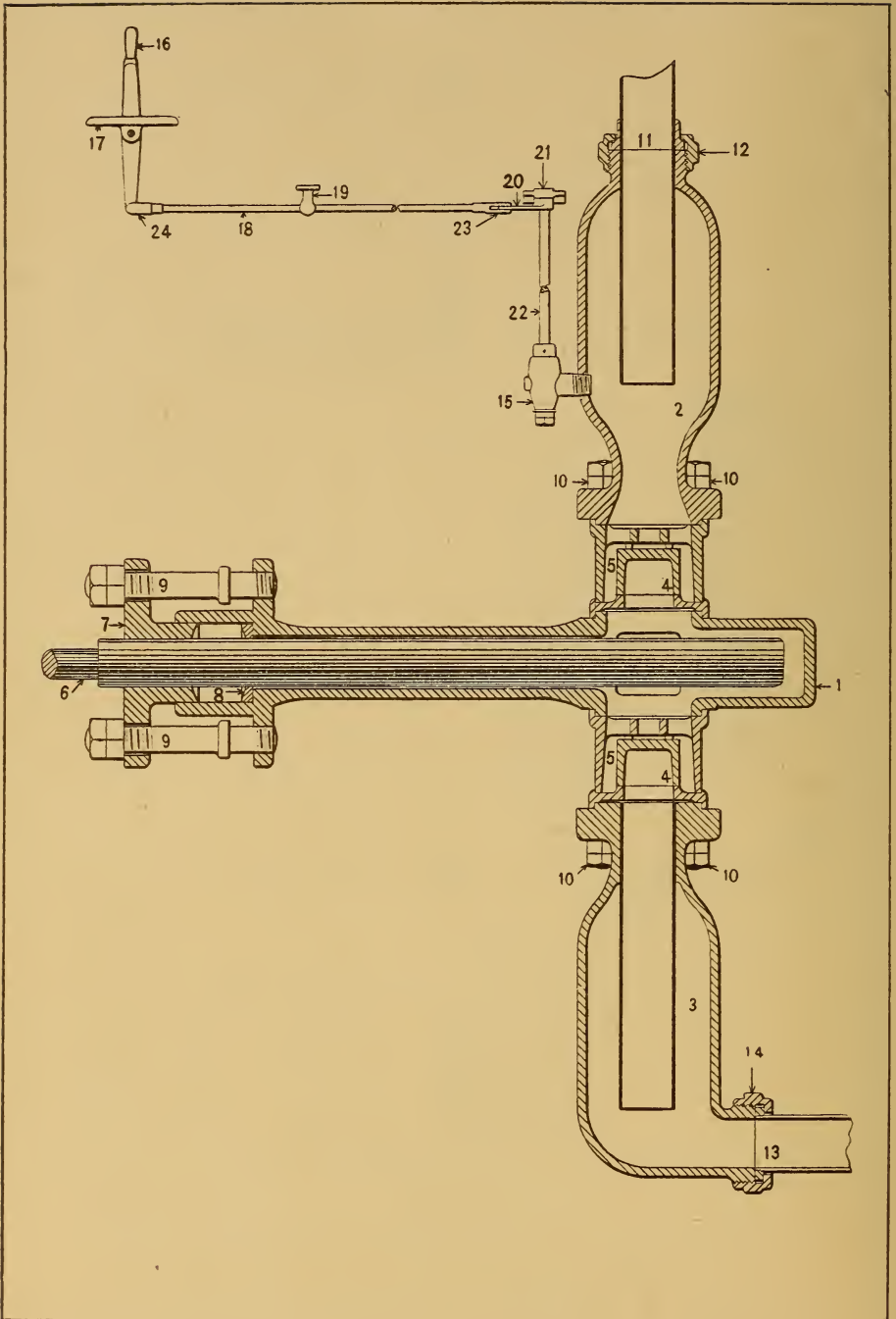

PUMP WORK.

Plate 49. (EISZONE.)

Eitelhans . . .	1.	Pump Barrel.
Eitelkeit . . .	2.	Top Chamber.
Eitelsucht . . .	3.	Bottom Chamber.
Eiterbeule . . .	4.	Valve.
Eiterblase . . .	5.	“ Cage.
Eiterig	6.	Plunger.
Eiterperle . . .	7.	Gland.
Eitjes	8.	“ Bottom Ring.
Eiulazione . . .	9.	“ Studs.
Eivol	10.	Chamber Studs.
Eivormig	11.	Check Pipe.
Eiweiss	12.	“ “ Coupling Nut.
Eiwit	13.	Feed Pipe.
Eiwitstof	14.	“ “ Coupling Nut.
Eiwitten	15.	Pet Cock.
Eixerdar	16.	“ “ Lever in Cab.
Ejaculacao . . .	17.	“ “ “ Fulcrum.
Ejaculador . . .	18.	“ “ “ Rod.
Ejaculamur . . .	19.	“ “ “ “ Guide.
Ejacular	20.	“ “ Crank.
Ejacularis . . .	21.	“ “ “ Hanger.
Ejaculavi	22.	“ “ “ Rod.
Ejaculo	23.	“ “ “ Jaw.
Ejambe	24.	“ “ Lever “

In ordering pump barrel, the side wanted for should be indicated in the order.

Plate 50.

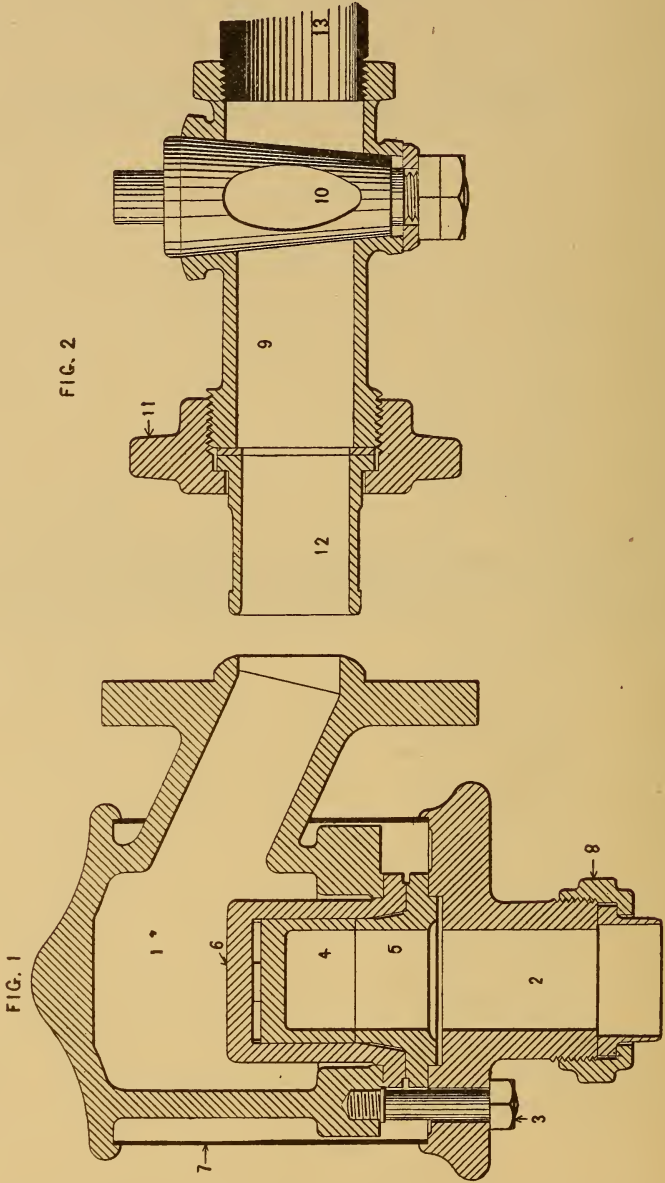

PUMP CHECK AND FEED COCK.

Plate 50. (EJARRAGE.)

Ejarre FIG. 1.—Pump Check.

- Ejeccao 1. Check Body.
- Ejecimus 2. “ Flange.
- Ejecissem 3. “ “ Studs.
- Ejecteur 4. Valve.
- Ejecticio 5. “ Seat.
- Ejecticius 6. “ Cage.
- Ejectments 7. Casing.
- Ejectura 8. Check Pipe Coupling Nut.

Ejecturis . . . FIG. 2.—Feed Cock.

- Ejectuum 9. Feed Cock Body.
- Ejecucion 10. “ “ Plug and Nut.
- Ejecutada 11. Hose Coupling Nut.
- Ejecutados 12. “ Swivel.
- Ejecutar 13. Feed Pipe.

Plate 51.

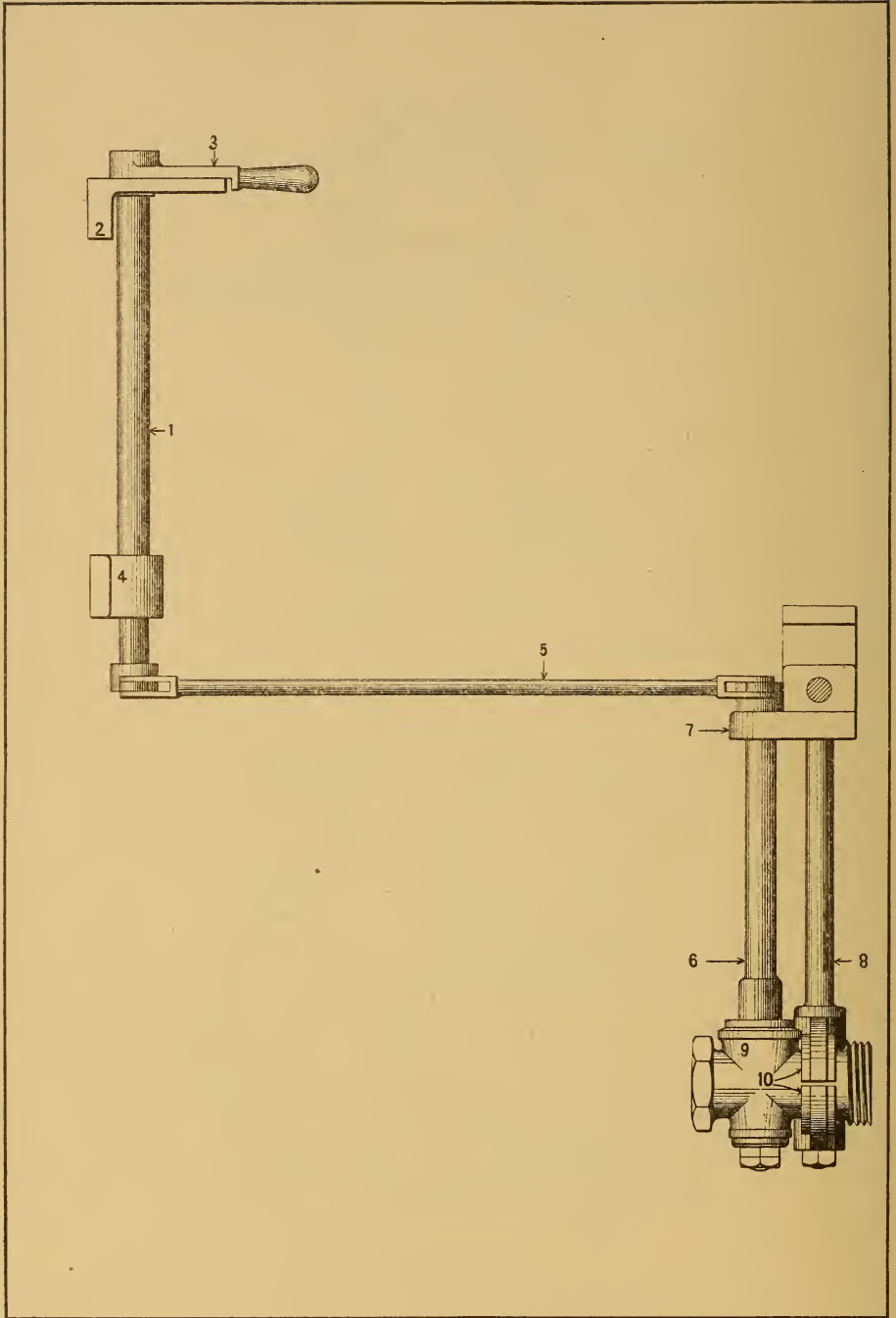

FEED WATER WORK.

Plate 51. (EJECUTARON.)

Ejecutases . . .	1.	Shaft.
Ejecutiva . . .	2.	“ Quadrant.
Ejecutivos . . .	3.	“ Handle.
Ejecutoria . . .	4.	“ Hanger.
Ejemplares . . .	5.	“ Rod.
Ejeratio	6.	Cock Shaft.
Ejerceis	7.	“ “ Bearing.
Ejercer	8.	“ Hanger.
Ejerceras	9.	Cock.
Ejercicios	10.	Pipe Clamp.

Plate 52.

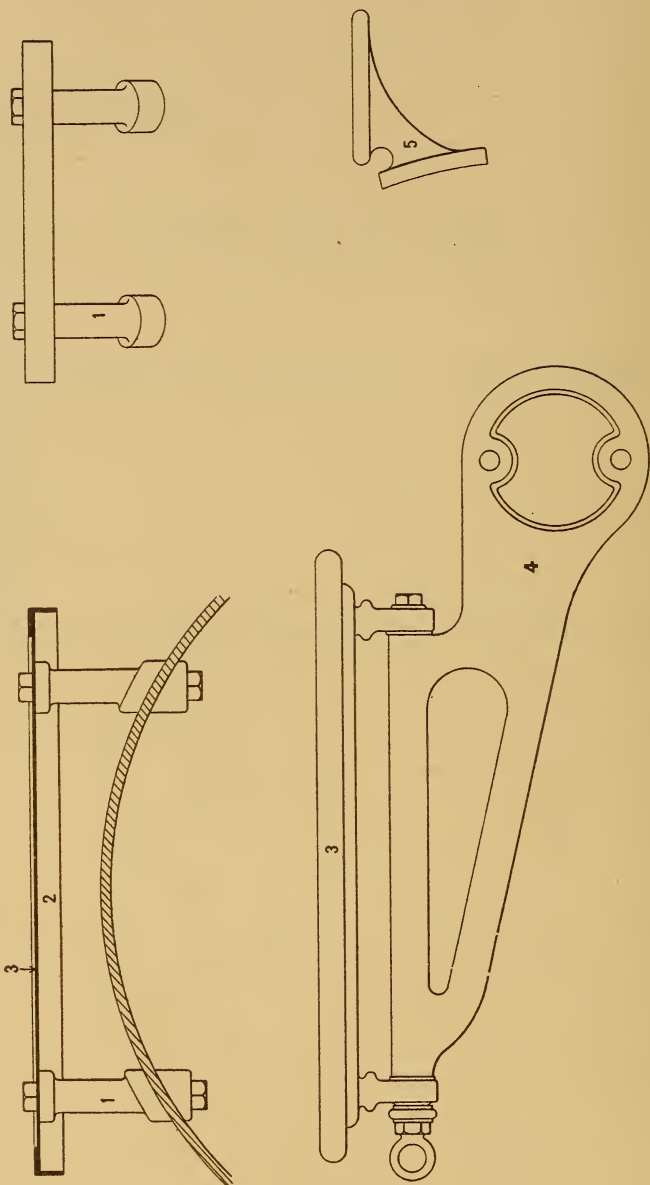

HEADLIGHT SHELVES AND SIGNAL LIGHT BRACKET.

Plate 52. (EJERCIDOS.)

Ejercieron . . .	1.	Headlight Shelf Column.
Ejerciteis . . .	2.	“ “ Edge.
Ejerzo	3.	“ Shelf.
Ejidos	4.	“ Bracket.
Ejointage . . .	5.	Signal Light Bracket.

Headlight brackets are made right and left, and orders for single brackets should specify the side.

Plate 53.

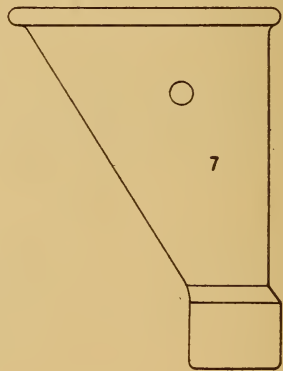
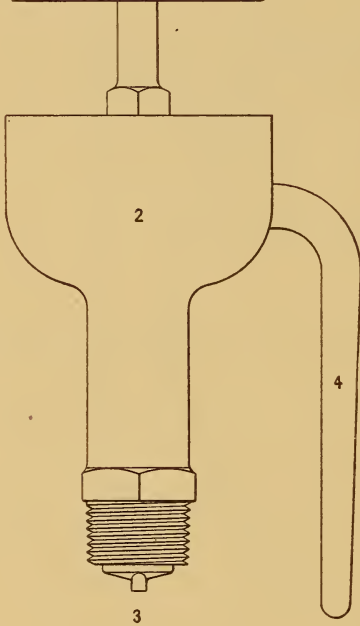
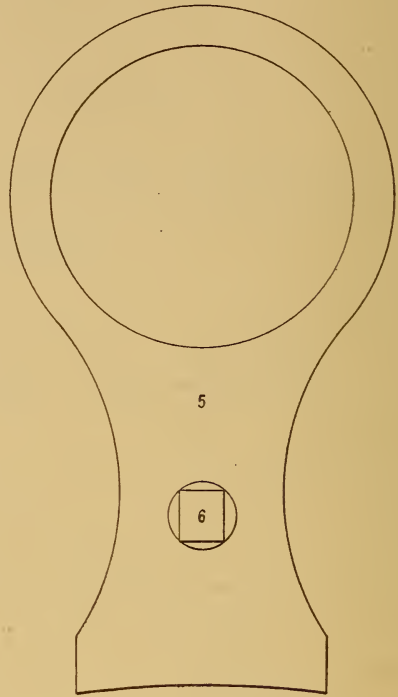
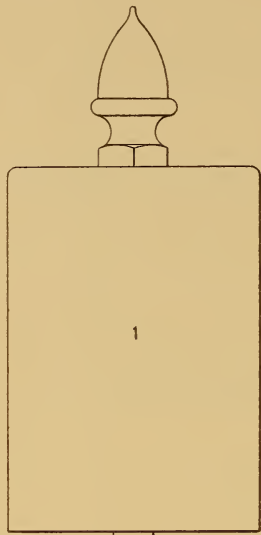

WHISTLE, STEAM GAUGE STAND, AND DRIP
FUNNEL.

Plate 53. (EJOUIR.)

- Ejulabilis . . . 1. Whistle Bell.
Ejulabis . . . 2. " Bowl.
Ejulabo . . . 3. " Valve.
Ejulandi . . . 4. " Lever.
Ejulandos . . . 5. Steam Gauge Stand.
Ejulandum . . 6. Cab Lamp " "
Ejulas . . . 7. Gauge Cock Drip Funnel.

Plate 54.

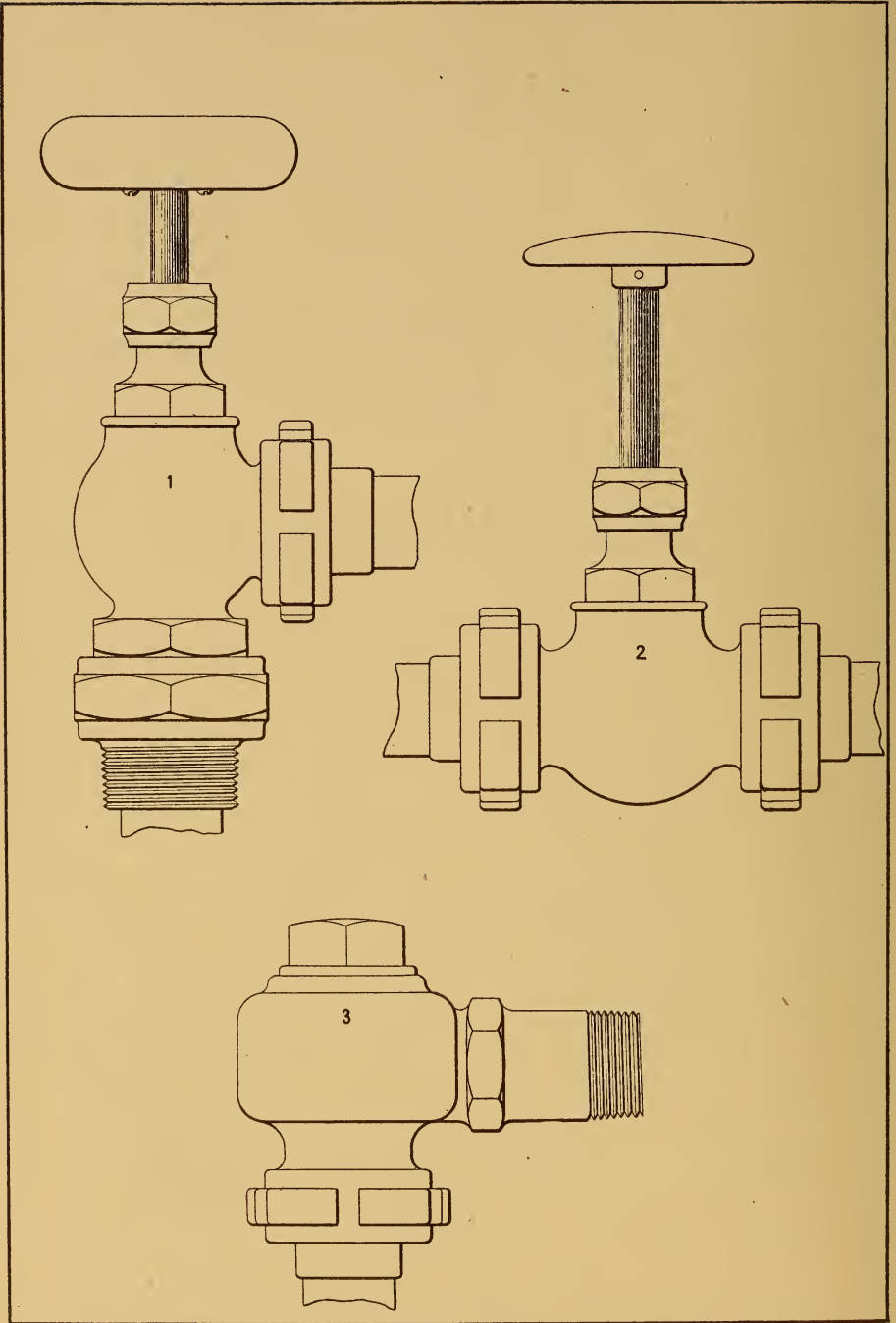

INJECTOR VALVES.

Plate 54. (EJULATION.)

Ejulos	1. Steam Valve.
Ejulatuum . . .	2. Feed “
Ejulavi	3. Check “

In ordering these parts, if they are required for any change from original dimensions, or additional to what was first put on the engine, the size and kind of pipes to be used should be specified.

Plate 55.

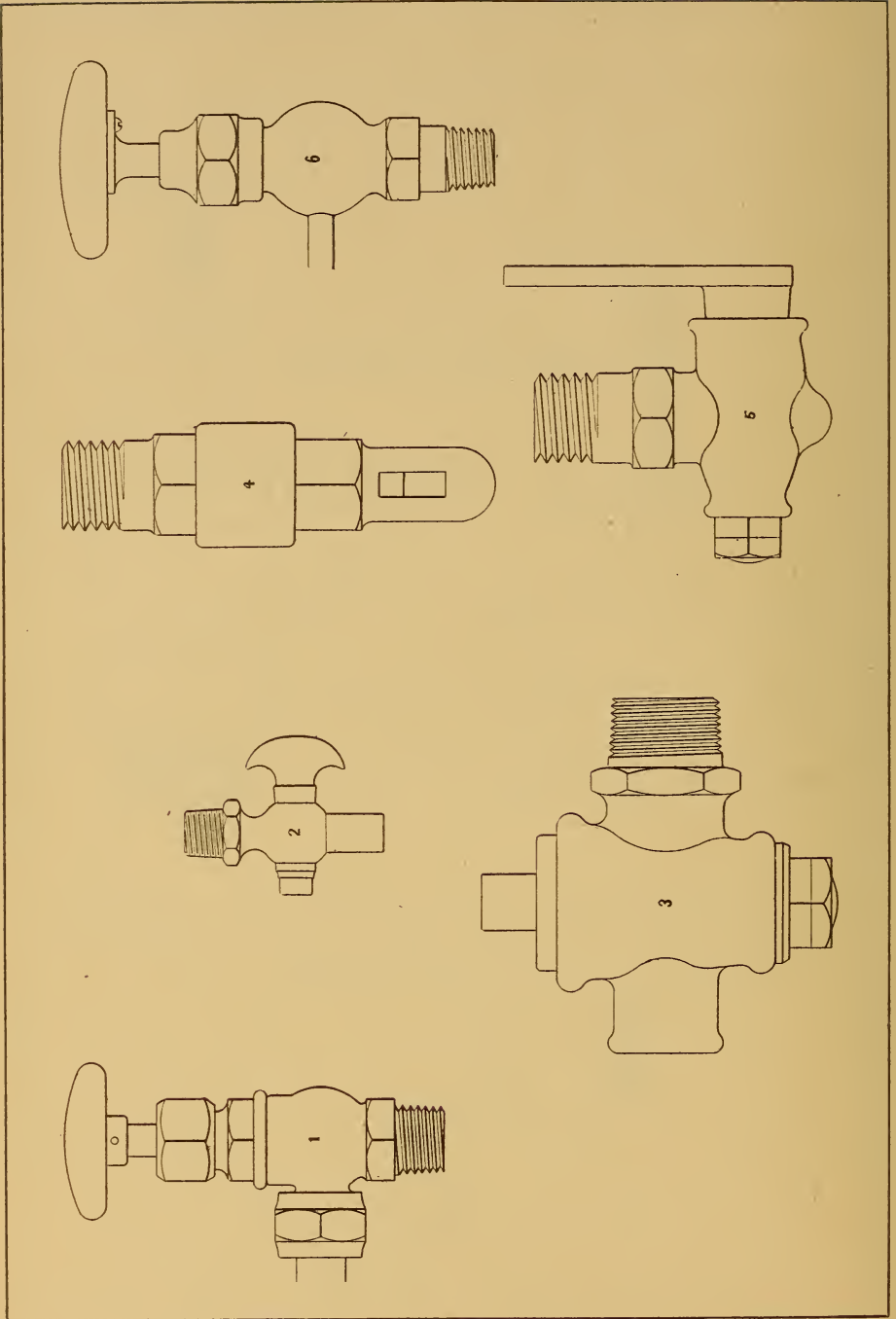

VALVES AND COCKS.

Plate 55. (EJULAVISTI.)

-
- Ejulitabo . . . 1. Blower, Heater, Steam Brake Stop Valve or Spark
Ejector Valve.
- Ejulitamus . . . 2. Drip Cock.
- Ejulitas 3. Blow-off Cock.
- Ejulito 4. Cylinder Cock (Buchanan style).
- Ejulo 5. " Cock.
- Ejuncesco. . . 6. Gauge "

In ordering cylinder cocks when not in full sets, the side they are wanted for must invariably be specified.

In ordering valves covered by number 1 above, specify the name of the valve wanted, as these valves are of different sizes, though of the same type.

Plate 56.

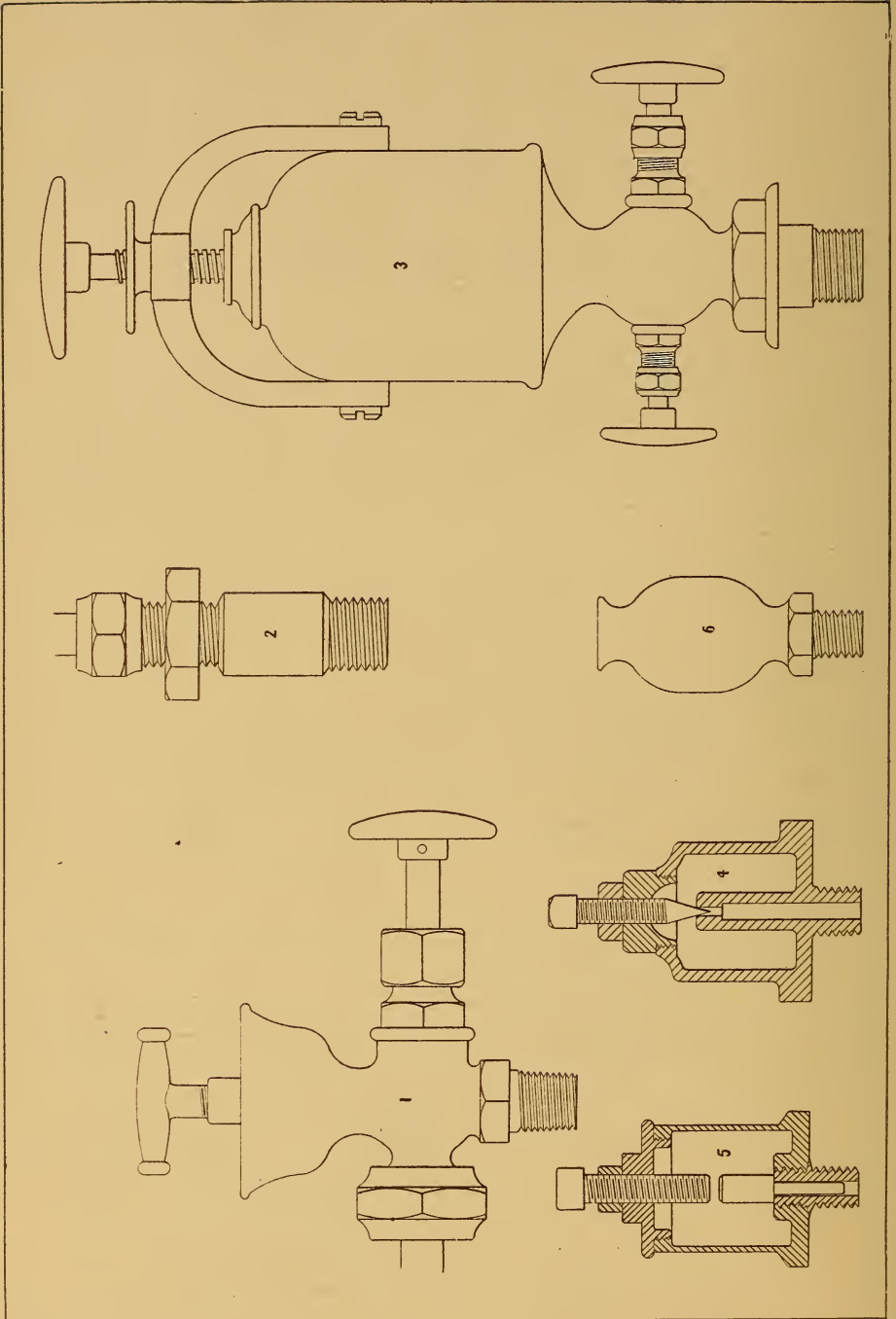

OIL CUPS.

Plate 56. (EJUNCIDUS.)

-
- Ejusmodi . . . 1. Cylinder Oiler in Cab, Baldwin style. (See Plates
77 and 78 for Sight Feed Cylinder Lubricators.)
- Ekbatana . . . 2. Oil Pipe Connection on Steam Chest.
- Ekdemos . . . 3. Condensing Oil Cup “ “ “
- Ekelgeruch . . 4. Crosshead, Guide, or Connecting Rod Oil Cup
(Needle style).
- Ekellos 5. Crosshead, Guide, or Connecting Rod Oil Cup
(Plunger style).
- Ekevin 6. Rock Shaft Oil Cup.

In ordering numbers 4 or 5, it will be necessary to specify whether they are wanted for crossheads, guides, or rods.

Plate 57.

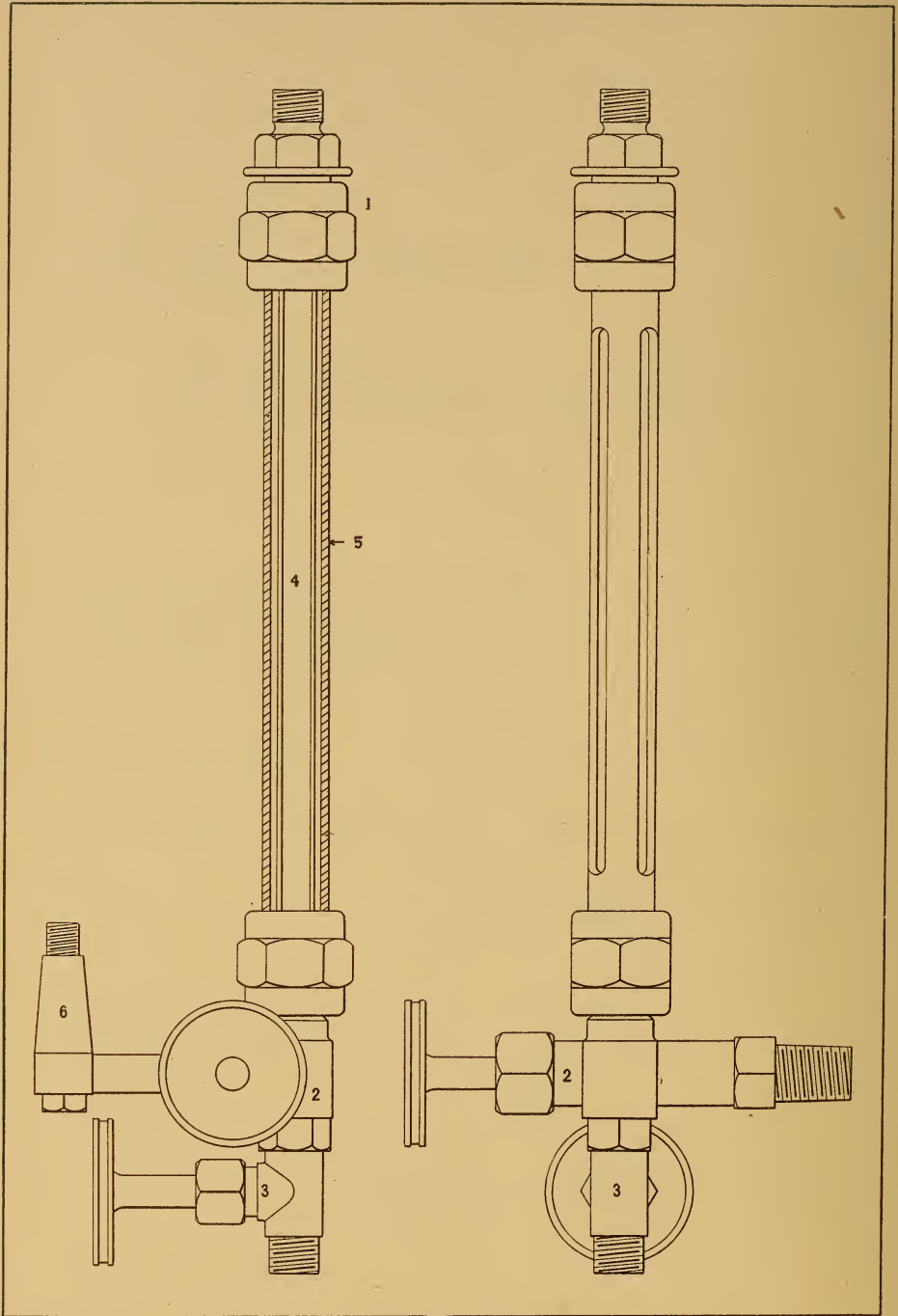

GLASS WATER GAUGE.

Plate 57. (EKIAM.)

-
- Eklektus . . . 1. Upper Fitting.
Ekloge 2. Lower “
Ekmannite . . 3. Drain Valve.
Eknomos . . . 4. Glass.
Ekrebel 5. Guard.
Ekron 6. Water Gauge Lamp Bracket.

Plate 58.

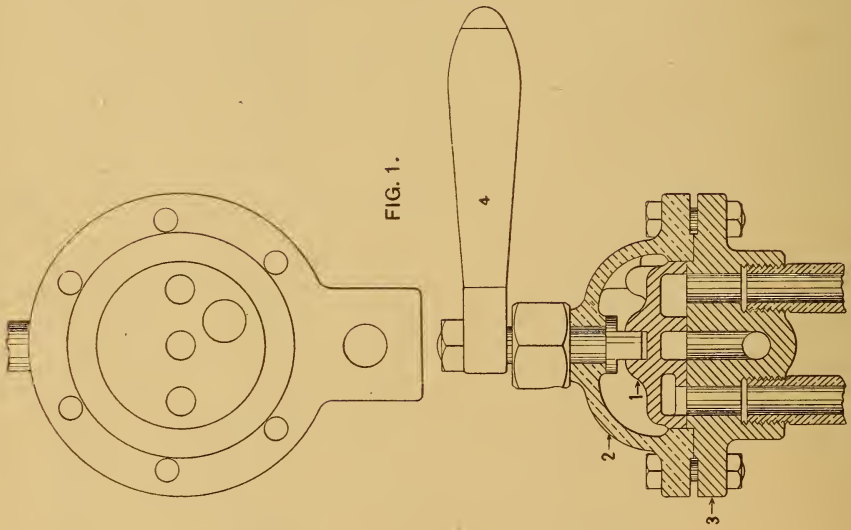
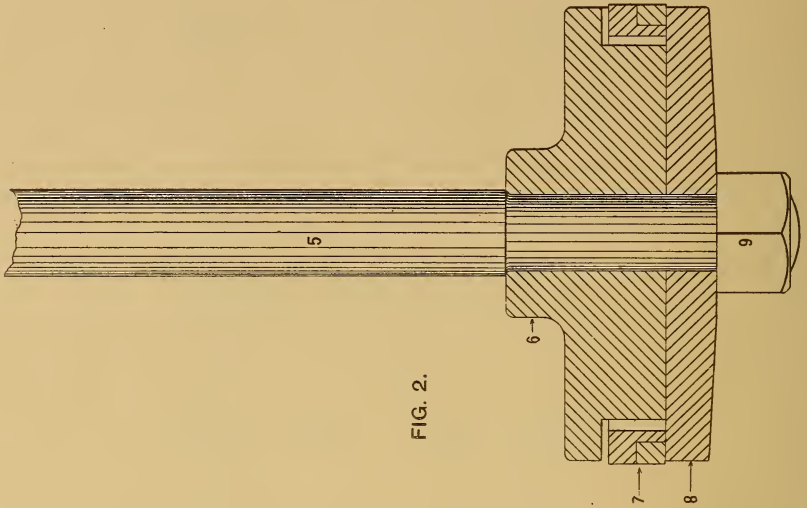

ENGINEER'S BRAKE VALVE, AND STEAM
BRAKE PISTON.

Plate 58. (EKSTERN.)

Eksternest . . . FIG. 1.—Engineer's Brake Valve.

Eksterroog . . . 1. Disc Valve.

Elabitur . . . 2. Valve Cover.

Elabor . . . 3. " Body.

Elaborab . . . 4. Handle.

Elaborable . . . FIG. 2.—Steam Brake Piston.

Elaboracao . . . 5. Steam Brake Piston Rod.

Elaborados . . . 6. " " Piston.

Elaborammo . . . 7. " " " Packing Rings.

Elaboraron . . . 8. " " " Follower.

Elaborassi . . . 9. " " " Nut.

Plate 59.

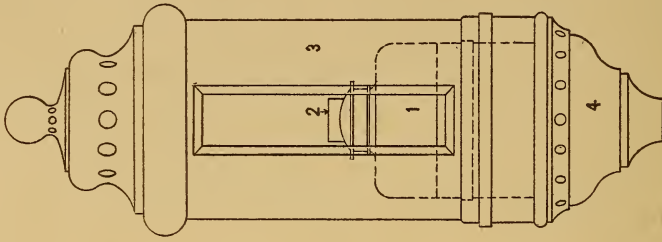

Fig. 2

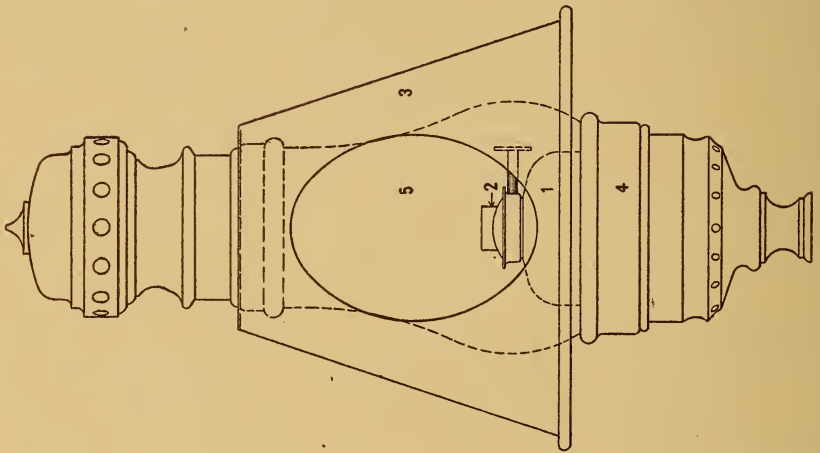

Fig. 1

STEAM GAUGE LAMP, AND WATER GAUGE
LAMP.

Plate 59. (ELABORATE.)

Elaboratio . . . FIG. 1.—Steam Gauge Lamp.

Elaboratus . . . FIG. 2.—Water “ “

Elaborava . . . 1. Reservoir.

Elaborerai . . . 2. Burner.

Elacao 3. Shade.

Elacatarum . . . 4. Base.

Elacaties . . . 5. Globe.

Plate 60.

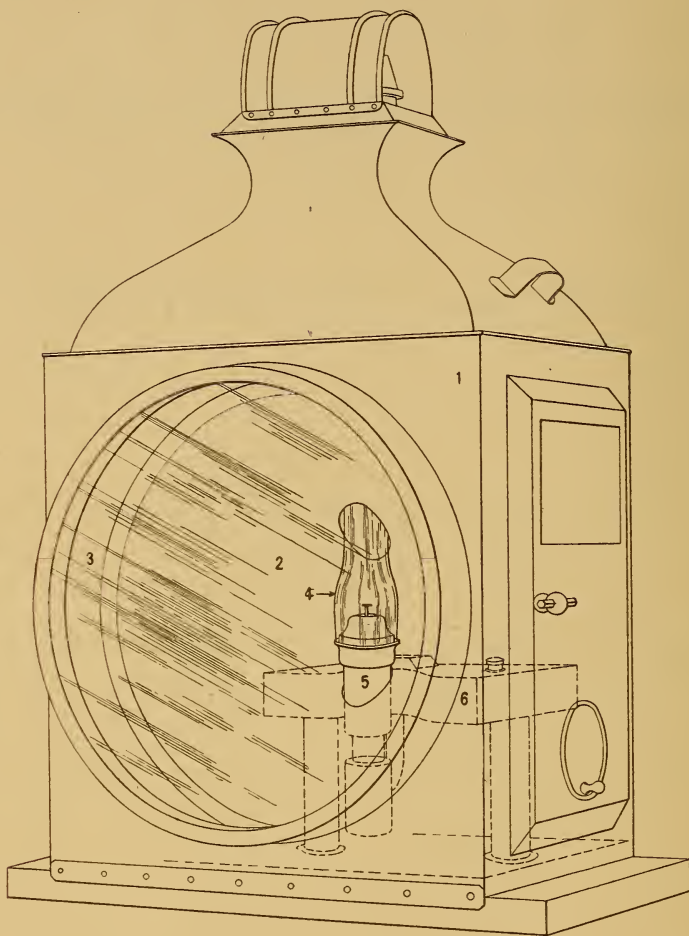

HEADLIGHT.

Plate 60. (ELACHESTE.)

Elachie	1. Case.
Elactesco	2. Reflector.
Eladah	3. Glass.
Elaeodique	4. Chimney.
Elaecocca	5. Burner.
Elaeolithe	6. Reservoir.

Plate 61.



WATER TANK.

Plate 61. (ELAEOMETRE.)

Elaeon	1.	Tank.
Elaeoptene	2.	Filling Funnel.
Elaeothese	3.	Funnel Lid.
Elaerine	4.	Valve Lifter.
Elaeusa	5.	“ Wheel.
Elafabosco	6.	“ Body.
Elafro	7.	“ Gooseneck.
Elagabal	7A.	“ “ Flange.
Elagabalus	8.	Handles.
Elagage	9.	Lugs.
Elaguer	10.	Fuel Board Angle Iron.

Plate 62.

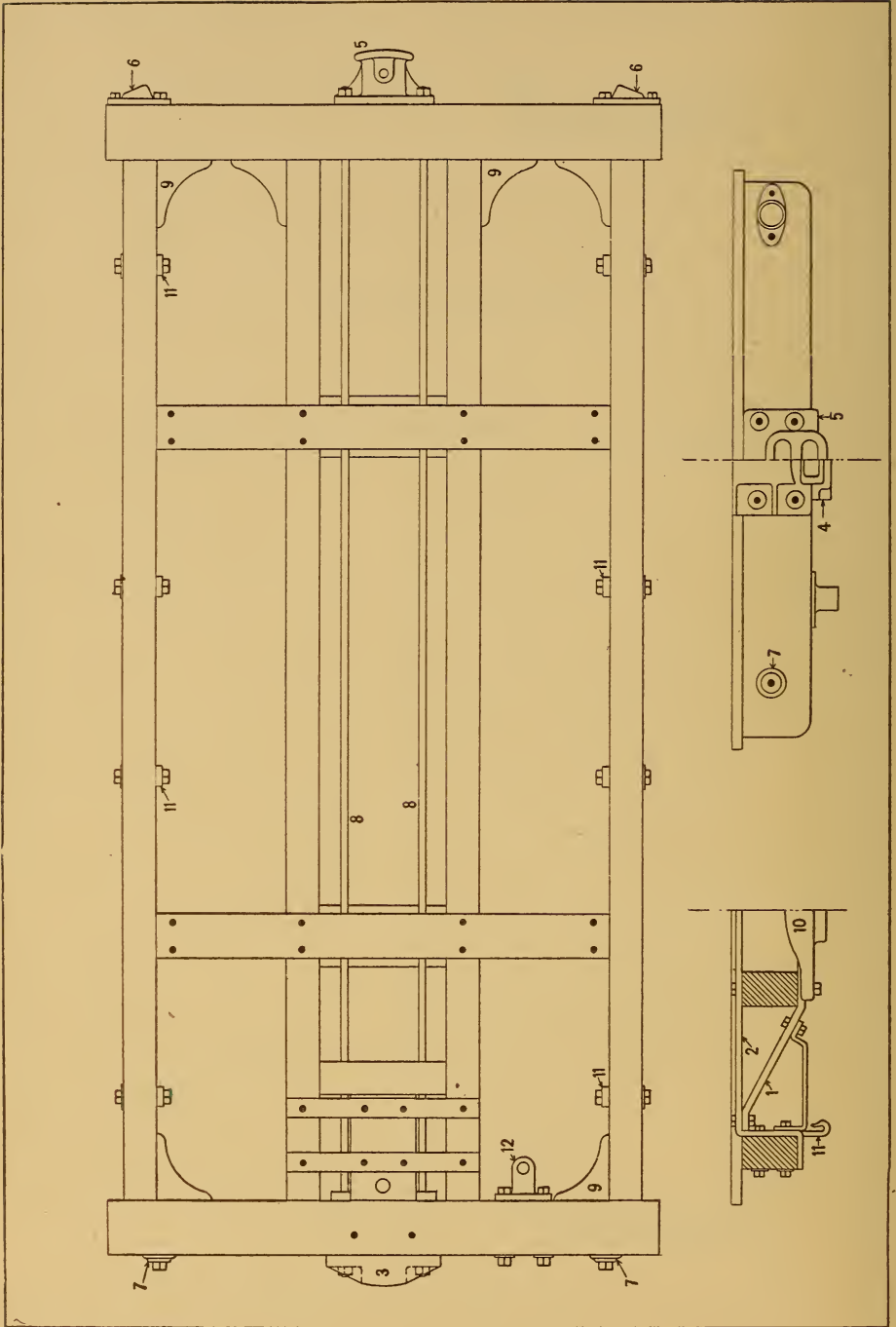

TENDER FRAME, WOOD.

Plate 62. (ELAHION.)

Elaidate	1. Truss Bar.
Elaidique	2. " " Crossie.
Elaiodic	3. Wedge Block or Chafing Casting.
Elaiodo	4. Front Draw Casting.
Elaiometer . . .	5. Back " "
Elaique	6. Pushing Shoe.
Elaise	7. Frame Washer.
Elambis	8. Longitudinal Draw Casting Bolt.
Elamene	9. Corner Bracket.
Elancais	10. Centre Pin.
Elancant	11. Safety Chain Hook.
Elancerons . . .	12. Brake Shaft Guide.

Orders for centre pins should specify whether front or back are required when not for full sets.

Plate 63.

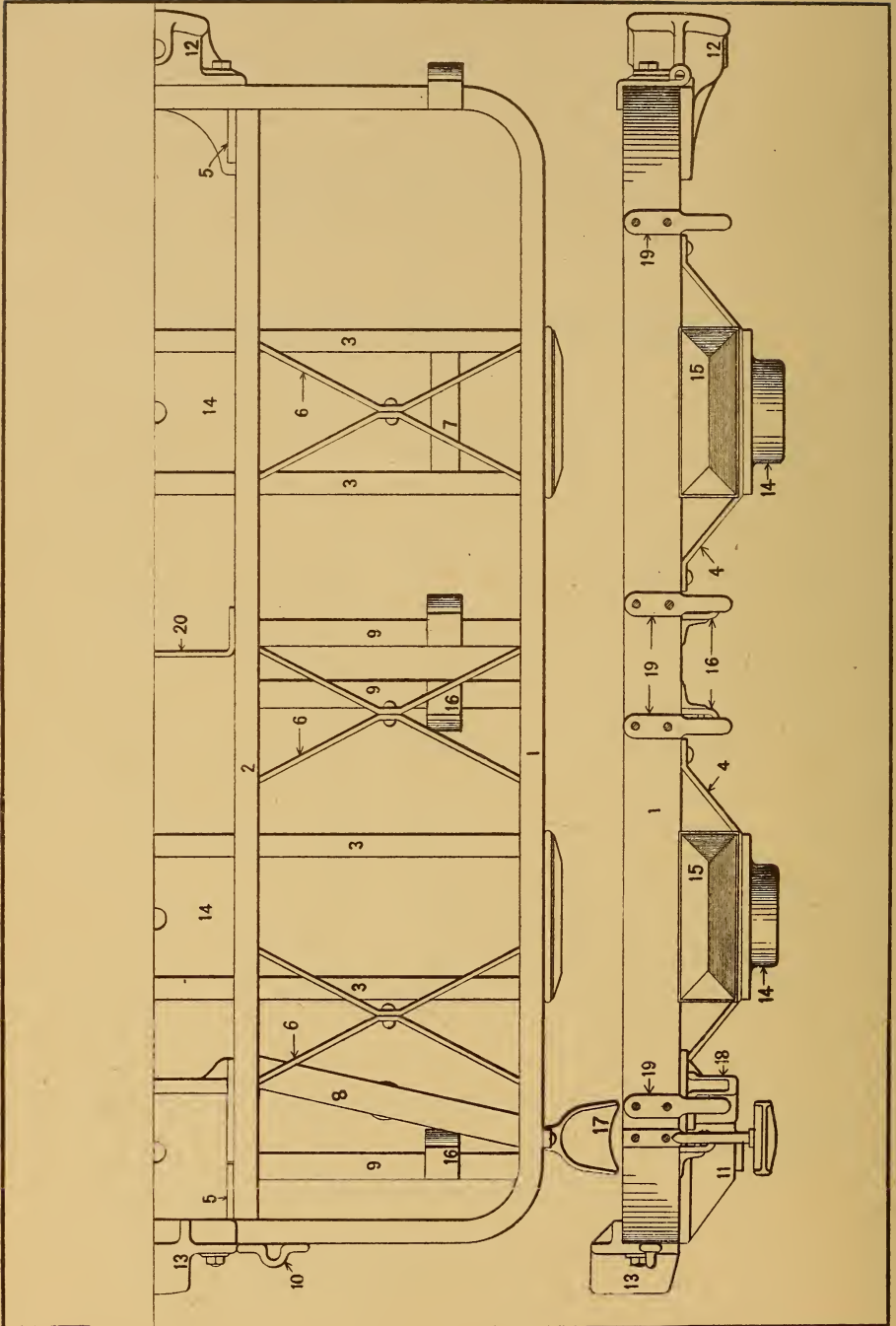

TENDER FRAME, IRON.

Plate 63. (ELANCEUR.)

Elancons . . .	1.	Side Channel Bar.
Elanddier . . .	2.	Longitudinal Channel Bar.
Elangide . . .	3.	Transverse " "
Elanguesco . . .	4.	" " " Strap.
Elangueur . . .	5.	Corner Plate.
Elanion	6.	Brace.
Elaolite	7.	Side Bearing.
Elaopten	8.	Brake Shaft Crosstie.
Elaphidion . . .	9.	" Hanger Angle Iron.
Elaphinis	10.	Safety Chain Hanger.
Elaphocere . . .	11.	Front Draw Casting.
Elaphoide	12.	Back " "
Elaphomyce . . .	13.	Chafing Casting.
Elaphopsis . . .	14.	Centre Pin.
Elaphro	15.	Bolster Cap.
Elaphrope	16.	Brake Clevis.
Elapidae	17.	Tender Step.
Elapidatus . . .	18.	Brake Shaft Step.
Elapoidite	19.	Safety Chain Hook.
Elapsion	20.	Brace.

In ordering centre pins, observe the instructions for Plate 62.

Plate 64.

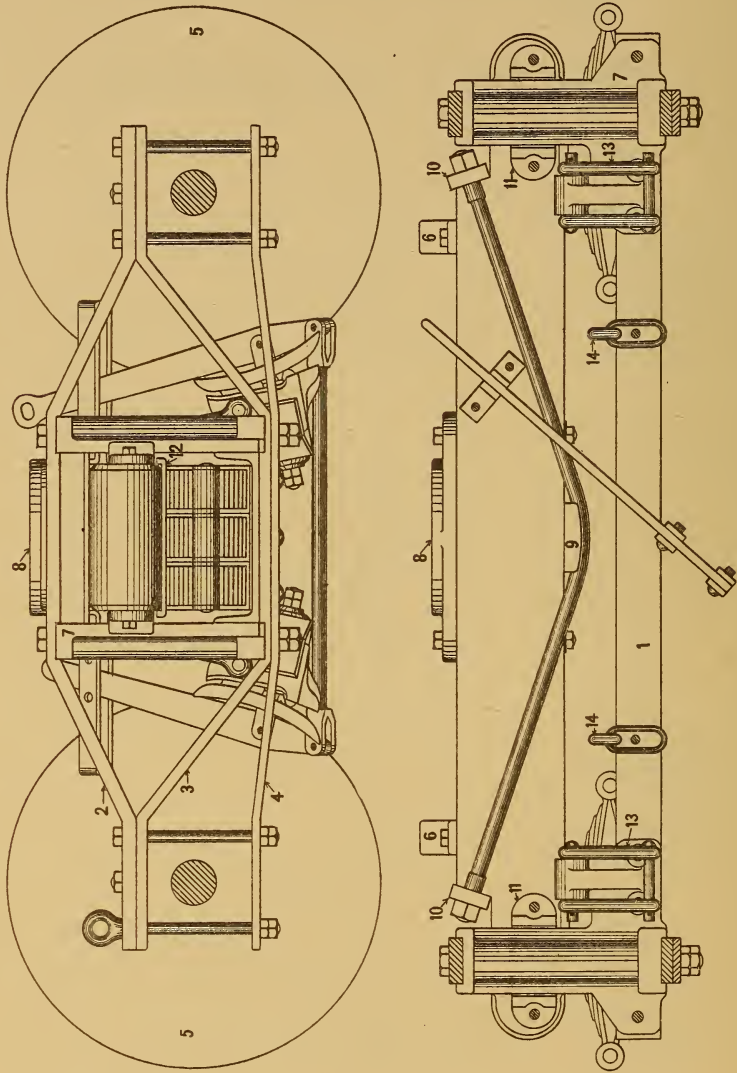

TENDER TRUCK, WOOD.

Plate 64. (ELAQUEATOS.)

Elaqueatum . . .	1. Channel Bar.
Elargendo . . .	2. Top Bar of Frame.
Elargiamo . . .	3. Truss “ “ “
Elargimes . . .	4. Bottom “ “ “
Elargior	5. Wheel.
Elargiront . . .	6. Side Bearing.
Elargisco . . .	7. Frame Filling Piece.
Elargissi . . .	8. Centre Plate.
Elargita	9. Truss “
Elargitus . . .	10. “ Washer.
Elargivate . . .	11. Bolster Guide.
Elasme	12. Spring Seat.
Elasmia	13. Brake Clevis.
Elasmodon . . .	14. “ Beam Safety Chain.

In ordering parts for a single truck, the order should specify whether they are wanted for front or back truck.

Plate 65.

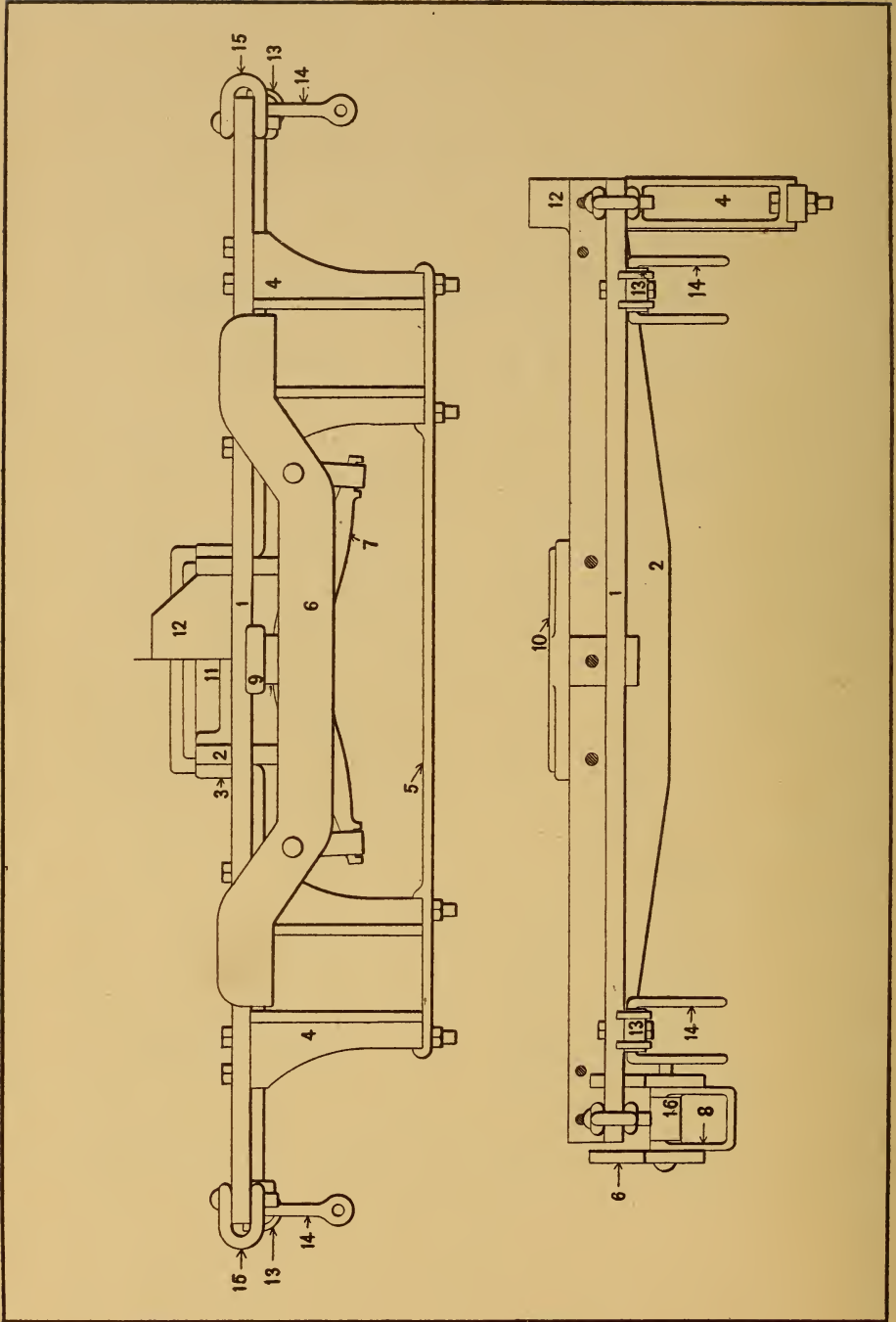

TENDER TRUCK, WROUGHT IRON.

Plate 65. (ELASMOSE.)

Elassesco . . .	1. Frame.
Elassonyx . . .	2. Crosstie.
Elasterio . . .	3. " Brace.
Elastical . . .	4. Pedestal.
Elasticity . . .	5. " Cap.
Elasticos . . .	6. Equalizing Beam.
Elastique . . .	7. Spring.
Elatche	8. " Link.
Elatedly	9. " Seat.
Elatedness . . .	10. Centre Plate.
Elateius	11. Frame Filling Piece.
Elateridae . . .	12. Side Bearing.
Elaterion	13. Brake Hanger.
Elaterium	14. " Clevis.
Elatine	15. Safety Chain Clevis.
Elationis	16. Spring Link Washer.

In ordering parts for a single truck, observe the instructions for Plate 64.

Plate 66.

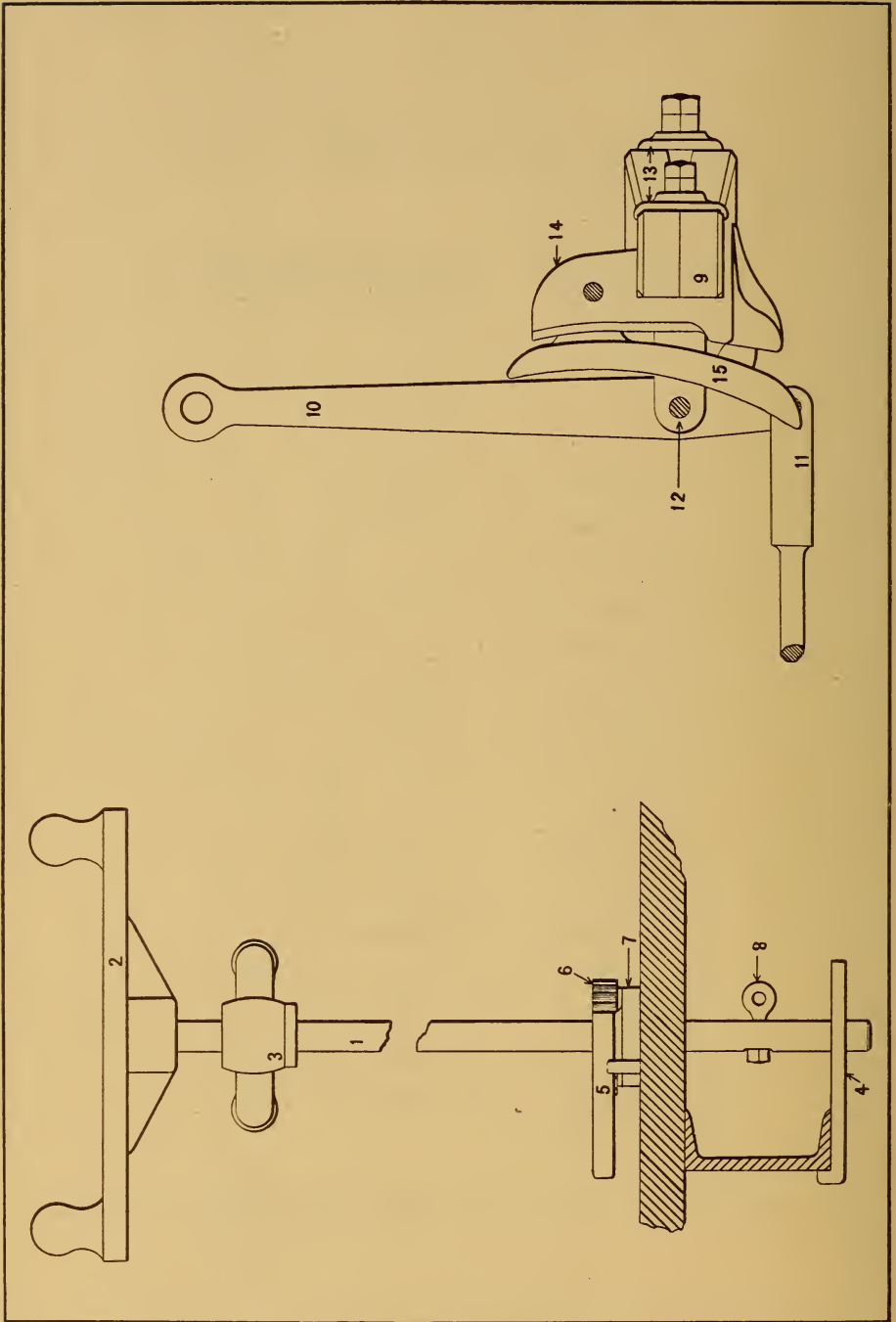

TENDER BRAKE WORK.

Plate 66. (ELATOSTEMA.)

Elatrabis . . .	1. Shaft.
Elatrabo . . .	2. Handle.
Elatramus . . .	3. Hanger.
Elatrarem . . .	4. Step.
Elatras	5. Pawl.
Elautum . . .	6. Ratchet.
Elavavi	7. Plate.
Elavavisti . . .	8. Eye Bolt.
Elaveuse . . .	9. Beam.
Elavo	10. Lever.
Elbae	11. " Rod.
Elberich . . .	12. " Jaw.
Elbeuvien . . .	13. Washer.
Elbidorum . . .	14. Head.
Elbidus	15. Shoe.

Plate 67.

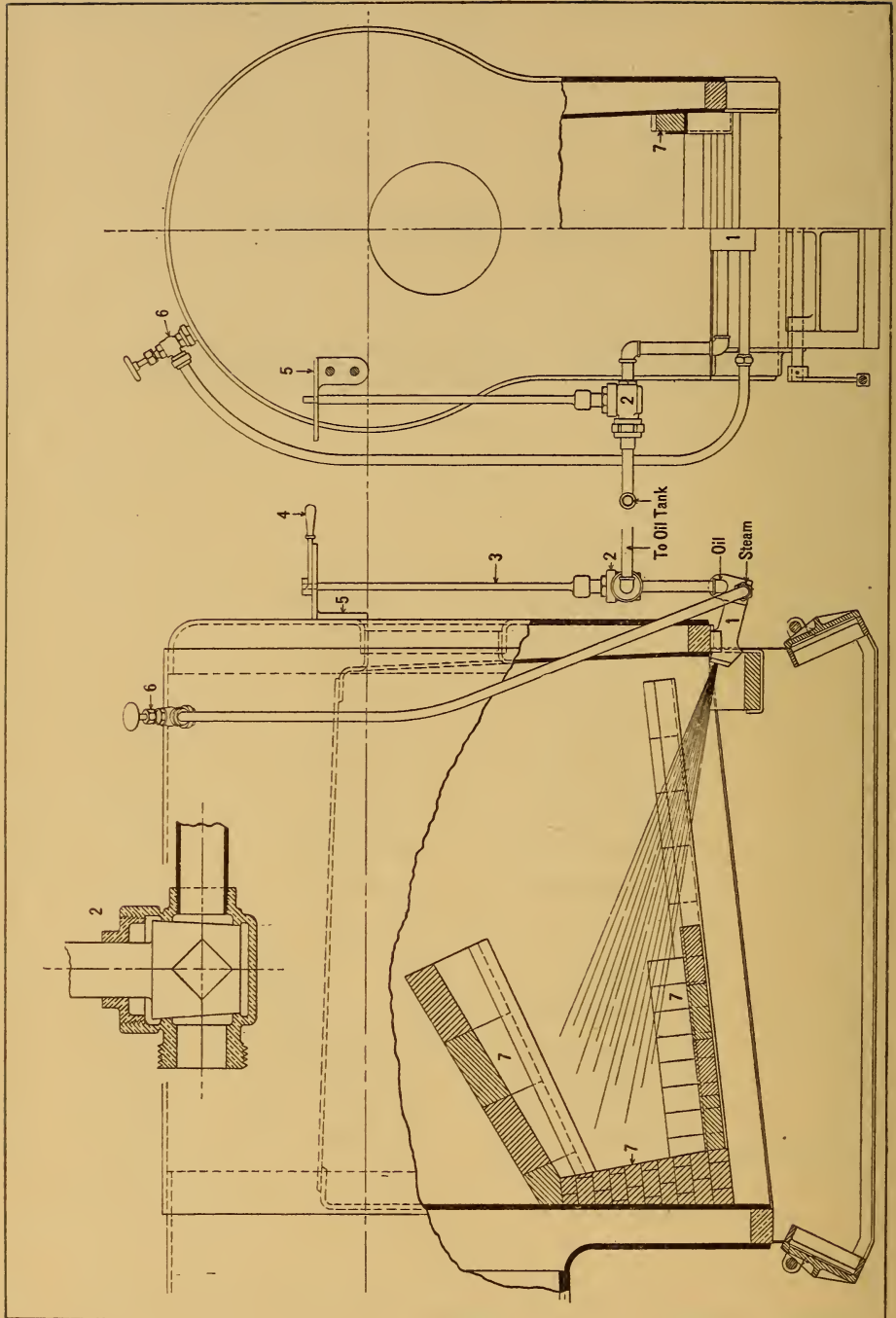

APPARATUS FOR BURNING FUEL OIL.

Plate 67. (ELBKAHN.)

Elblachs	1.	Oil Injector.
Elbnachen	2.	“ Cock.
Elborum	3.	“ “ Shaft.
Elbow	4.	“ “ “ Handle.
Elbowed	5.	“ “ Quadrant.
Elbowing	6.	“ Injector Steam Valve.
Elcaja	7.	Fire Brick.

SELLERS INJECTOR, 1876

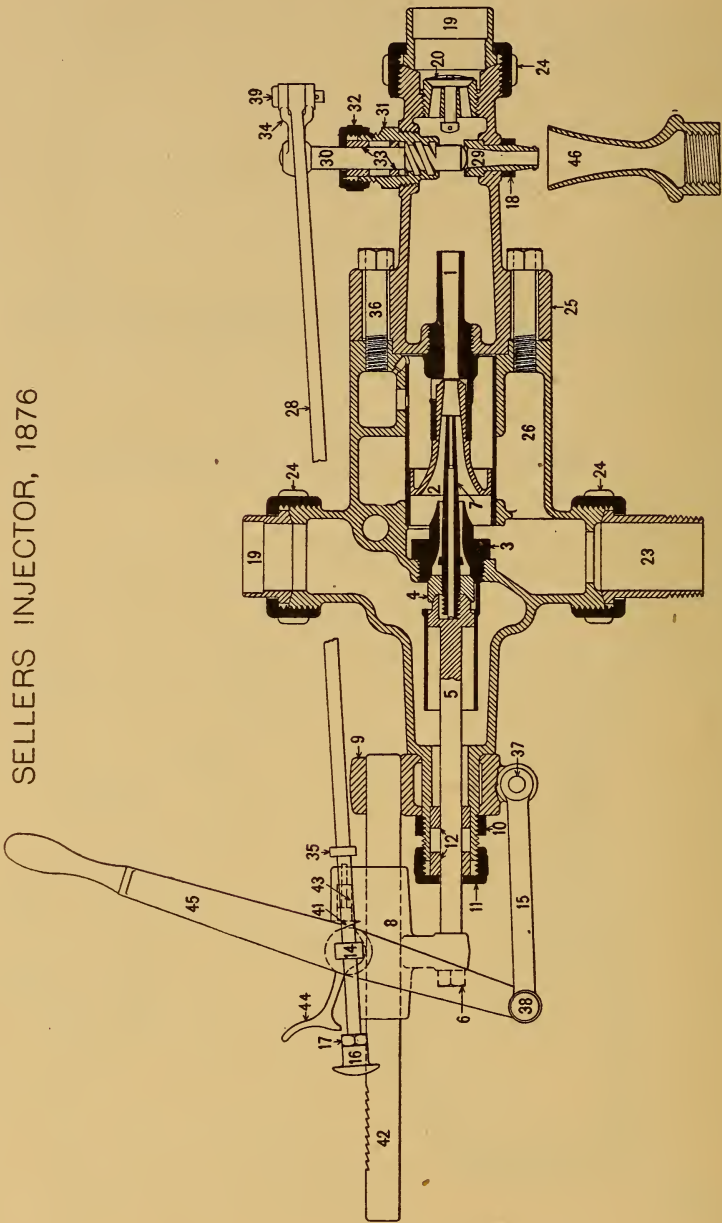

SELLERS INJECTOR, 1876.

Plate 68. (ELCATE.)

Elcathorax . . .	1. Delivery Tube.
Elcesaite . . .	2. Combining Tube.
Elciaro	3. Steam Nozzle.
Elcidrio	4. Valve on No. 7.
Elcisma	5. Solid Spindle.
Elcoma	6. Nut on top of No. 5.
Elderitz	7. Hollow Spindle.
Elderly	8. Crosshead.
Elders	9. Collar on No. 26.
Eldership . . .	10. Lock Nut for No. 9.
Elderwort . . .	11. Follower on No. 26.
Eldest	12. Packing Rings under No. 11.
Eldorado . . .	14. Fulcrum Pin.
Eleagno	15. Link.
Eleanthe . . .	16. Knob on end of No. 28.
Eleasah	17. Lock Nut for No. 16.
Eleates	18. Nut on No. 29.
Eleatico	19. Plain Ring for Copper Pipe.
Eleaticus . . .	20. Check Valve.

(Continued on page 200.)

Plate 68 continued.

Eleatique . . .	23.	Union to Pipes.
Eleatisme . . .	24.	Coupling Nut.
Eleazurus . . .	25.	Lower Cylinder.
Elecampe . . .	26.	Upper “
Eleccion . . .	28.	Connecting Rod.
Elecciones . . .	29.	Waste Pipe.
Elecebra . . .	30.	Screw Valve.
Elecebris . . .	31.	Stuffing Box for No. 30.
Electamus . . .	32.	Follower on No. 31.
Electarium . . .	33.	Packing Rings under No. 32.
Electeur . . .	34.	Lever on No. 30.
Electricism . . .	35.	Collar on No. 28.
Electilis . . .	36.	Stud Bolts.
Electively . . .	37.	Pin through Nos. 9 and 15.
Electivite . . .	38.	“ “ “ 15 “ 45.
Electorat . . .	39.	“ “ “ 28 “ 34.
Electoress . . .	41.	Pressure Foot.
Electrical . . .	42.	Guide Rod.
Electricos . . .	43.	Spring for No. 41.
Electrify . . .	44.	Latch.
Electrique . . .	45.	Starting Lever.
Electrisch . . .	46.	Funnel for Overflow.

In ordering parts for injector, give in all cases the maker's number stamped on the injector.

Plate 69.

SELLERS INJECTOR, 1887.

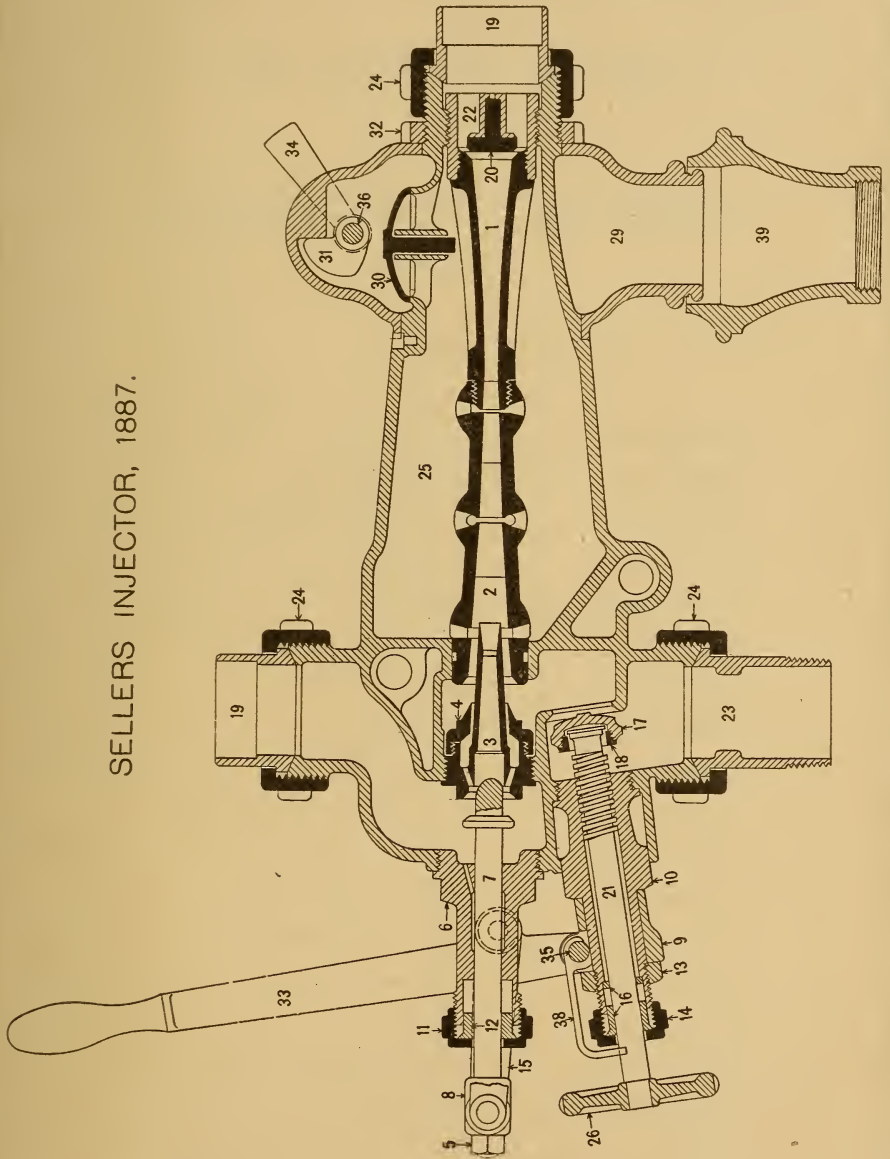

For description of plate, see pages 202 and 203.

SELLERS INJECTOR, 1887.

Plate 69. (ELECTRISE.)

See page 201.

Electrode . . .	1. Delivery Tube.
Electrum . . .	2. Combining Tube.
Electuaire . .	3. Forcing Steam Nozzle.
Electuary . . .	4. Lifting “ “
Eleemosyna . .	5. Spindle Nut.
Eleescier . . .	6. Stuffing Box for Spindle.
Elefanta . . .	7. Spindle.
Elefantés . . .	8. Crosshead.
Elefantino . . .	9. Collar on No. 10.
Elefas	10. Stuffing Box for Water Valve.
Elegamment . .	11. Follower for No. 6.
Elegance . . .	12. Packing Ring in No. 6.
Elegancias . .	13. Lock Nut for No. 9.
Elegantiae . .	14. Follower for No. 10.
Elegantly . . .	15. Links.
Elegaverim . .	16. Packing Ring in No. 10.
Elegavisti . . .	17. Water Valve.
Elegeion . . .	18. Ring in No. 17.
Elegendo . . .	19. Plain Rings for Copper Pipe.
Eleggerei . . .	20. Check Valve.

Eleggerla . . .	21.	Valve Stem for No. 17.
Eleggevano . . .	22.	Guide for No. 20.
Eleggono . . .	23.	Plain Unions for Iron Pipes.
Elegiacal . . .	24.	Coupling Nuts.
Elegiambic . . .	25.	Injector Body.
Elegiaque . . .	26.	Hand Wheel on No. 21.
Elegiast . . .	29.	Waste Pipe.
Elegibles . . .	30.	Waste Valve.
Elegidas . . .	31.	Cam for closing Waste Valve.
Elegidion . . .	32.	Jam Nut for No. 29.
Elegidores . . .	33.	Starting Lever.
Elegimos . . .	34.	Lever on Cam Shaft.
Elegir	35.	Pin through No. 9 and No. 33.
Elegiremos . . .	36.	Cam Shaft.
Elegisch . . .	38.	Index.
Elegiuzza . . .	39.	Funnel for Overflow.

In ordering parts for injector, give in all cases the maker's number stamped on the injector.

KORTING INJECTOR.

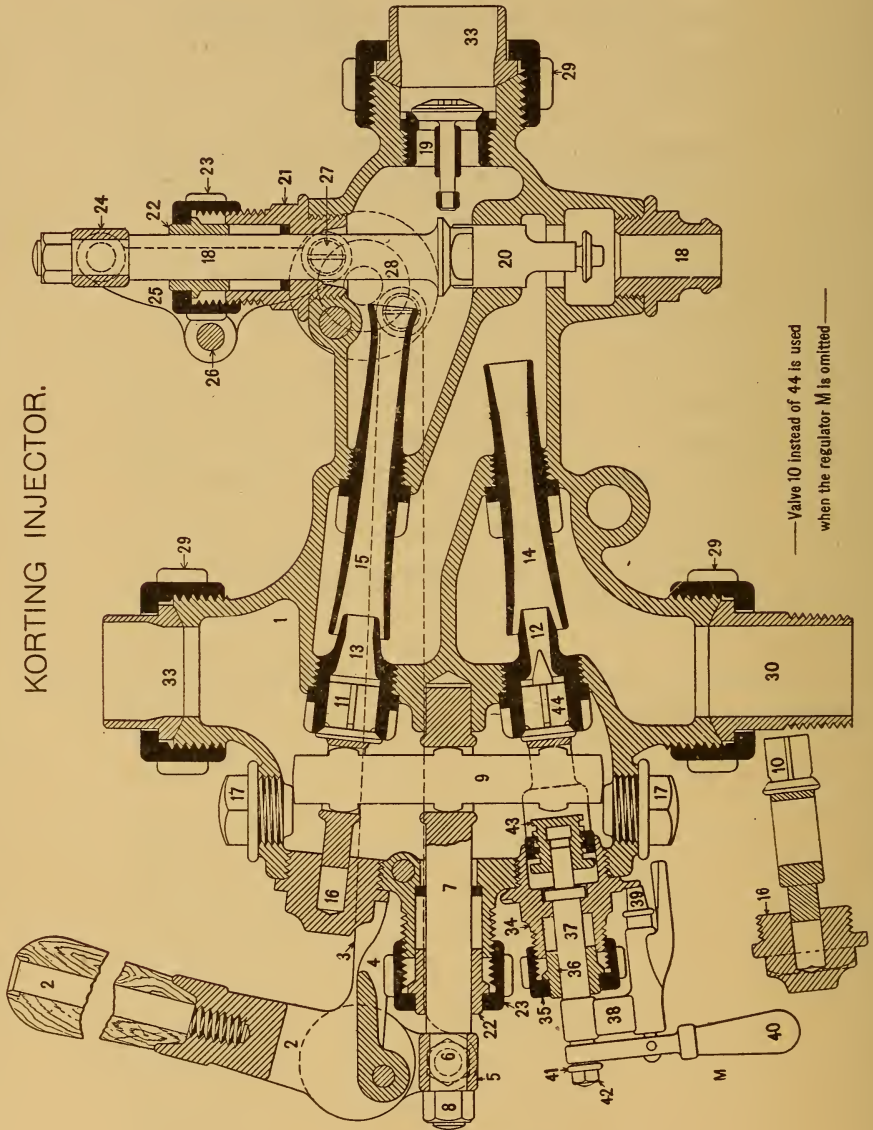

KORTING INJECTOR.

Plate 70. (ELEGIVEL.)

Elegize	1.	Body.
Elegizing . . .	2.	Handle Lever Complete.
Elegorum . . .	3.	Side Rods, Right and Left.
Eleicao	4.	Connecting Link and Pins.
Eleidis	5.	Crosshead for Starting Shaft.
Eleiotide . . .	6.	Nuts for Crosshead.
Eleison	7.	Starting Shaft.
Eleito	8.	Nuts for Starting and Overflow Shafts.
Eleitorado . .	9.	Yoke Bar.
Eleituário . .	10.	Lower Steam Valve.
Elektoral . . .	11.	Upper " "
Elektra	12.	Lower " Nozzle.
Eleleide	13.	Upper " "
Elementado . .	14.	Lower Water "
Elementary . .	15.	Upper " "
Elementen . .	16.	" Front Body Cap. (Also Lower).
Elementos . .	17.	Top and Bottom Body Caps.
Elementum . .	18.	Overflow Nozzle.
Elemieira . . .	19.	Check Valve Complete.
Elemifere . . .	20.	Overflow Valve Complete.

(Continued on page 206.)

Plate 70 continued.

Elemina . . .	21.	Overflow Stuffing Box.
Elemisalbe . . .	22.	Followers for Stuffing Boxes.
Elemosina . . .	23.	Nuts for Stuffing Boxes.
Elemporia . . .	24.	Crosshead for Overflow Valve.
Elenchical . . .	25.	Connecting Links for Overflow Valve.
Elenchie . . .	26.	Pin for Connecting Links for Overflow Valve.
Elenchorum . . .	27.	Screws " " " " "
Elenchos . . .	28.	Bell Cranks for Overflow Valve.
Elenctici . . .	29.	Coupling Nuts.
Elencticus . . .	30.	Unions for Iron Pipe.
Elenctique . . .	31.	Spanner Wrench.
Elend	33.	Unions for Copper Pipe.
Elendbalg . . .	34.	Throttle Valve Stuffing Box.
Elender	35.	Nut for Stuffing Box.
Elendesten . . .	36.	Follower for Stuffing Box.
Elendmeer . . .	37.	Spindle for Throttle Valve.
Elendrecht . . .	38.	Arm for Latch on Throttle Valve.
Elendshof . . .	39.	Latch.
Elendsring . . .	40.	Handle.
Elenhirsch . . .	41.	Washer.
Elenthier . . .	42.	Nut.
Eleocarpe . . .	43.	Adjusting Screw.
Eleocharis . . .	44.	Throttle Valve.

In ordering parts for injector, give in all cases the maker's number stamped on the injector.

If injectors do not have the regulator M, the parts including Nos. 34 to 44 are not wanted, and plain valve and cap substituted. Cap No. 16. Lower Steam Valve No. 10.

Plate 71.

MONITOR INJECTOR.

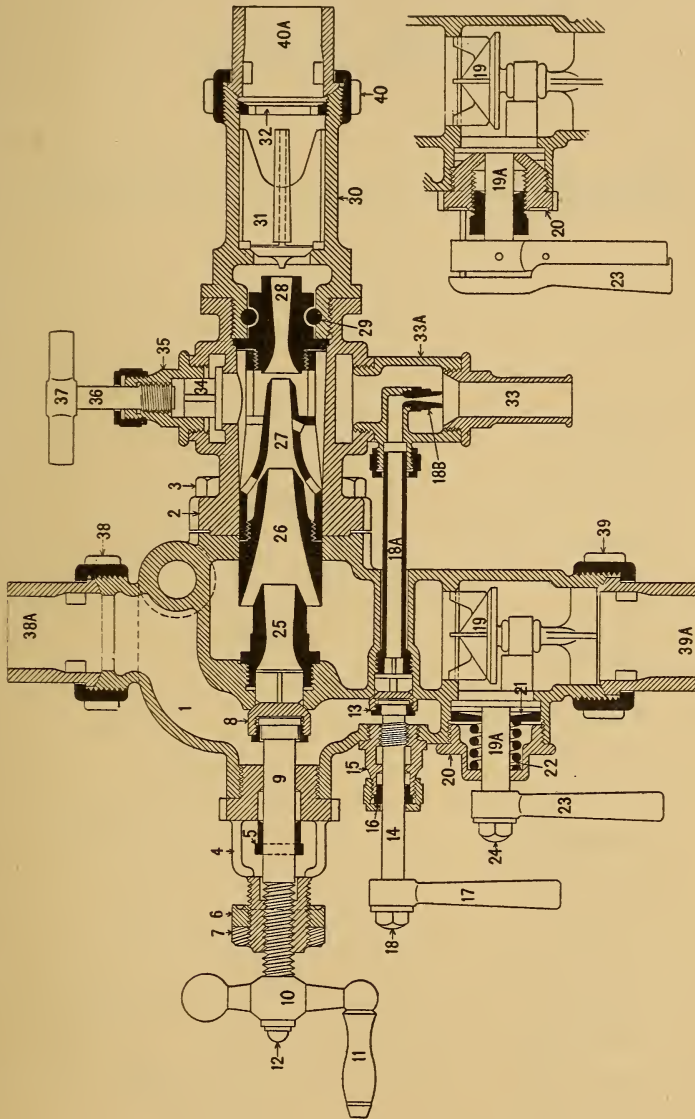

For description of plate, see pages 208 and 209.

MONITOR INJECTOR.

Plate 71. (ELEODENDRE.)

See page 207.

Eleodon . . .	1.	Body (back part).
Eleogari . . .	2.	“ (front part).
Eleogarum . . .	3.	“ Screw.
Eleogoma . . .	4.	Yoke.
Eleolate . . .	5.	“ Gland.
Eleolique . . .	6.	“ Packing Nut.
Eleolithe . . .	7.	“ Lock Nut.
Eleomeli . . .	8.	Steam Valve Disc and Nut.
Eleoneme . . .	9.	“ “ Spindle.
Eleonore . . .	10.	“ “ Handle.
Eleontum . . .	11.	“ “ Rubber Handle.
Eleophage . . .	12.	“ “ Top Nut.
Eleopoli . . .	13.	Jet Valve Disc and Nut.
Eleosponde . . .	14.	“ “ Spindle.
Eleotesio . . .	15.	“ “ Bonnet and Nut.
Eleothese . . .	16.	“ “ Gland.
Eleozoma . . .	17.	“ “ Lever Handle.
Eleozomus . . .	18.	“ “ Top Nut.
Elephancia . . .	18A.	“ Tube.
Elephant . . .	18B.	Lifting Nozzle.

Elephantin . . .	19.	Water Valve.
Elephenor . . .	19A.	Eccentric Spindle.
Elephoro . . .	20.	Water Valve Bonnet.
Elesbao	21.	“ “ Packing Ring.
Elesmatis . . .	22.	“ “ Spring.
Elesyces . . .	23.	“ “ Lever Handle.
Elettari	24.	“ “ Top Nut.
Elettivo	25.	Steam Nozzle.
Elettorale . . .	26.	Intermediate Nozzle.
Elettorato . . .	27.	Condensing “
Elettore	28.	Delivery “
Elettriche . . .	29.	Swivel Pins.
Elettrico . . .	30.	Line Check.
Eleuchadio . . .	31.	“ “ Valve.
Eleulaleus . . .	32.	Stop Ring.
Eleusinian . . .	33.	Overflow Nozzle.
Eleusinius . . .	33A.	“ Chamber with Nut.
Eleusippo . . .	34.	Heater Cock Check.
Eleusis	35.	“ “ Bonnet and Nut.
Eleuthere . . .	36.	“ “ Spindle.
Eleutheria . . .	37.	“ “ T Handle.
Eleutherus . . .	38.	Coupling Nut, Steam End.
Eleutho	38A.	Tail Piece, “ “
Elevabamos . . .	39.	Coupling Nut, Water End.
Elevacion . . .	39A.	Tail Piece, “ “
Elevada	40.	Coupling Nut, Delivery End.
Elevadico . . .	40A.	Tail Piece, “ “

In ordering parts for injector, give in all cases the maker's name stamped on the injector.

ECLIPSE INJECTOR.

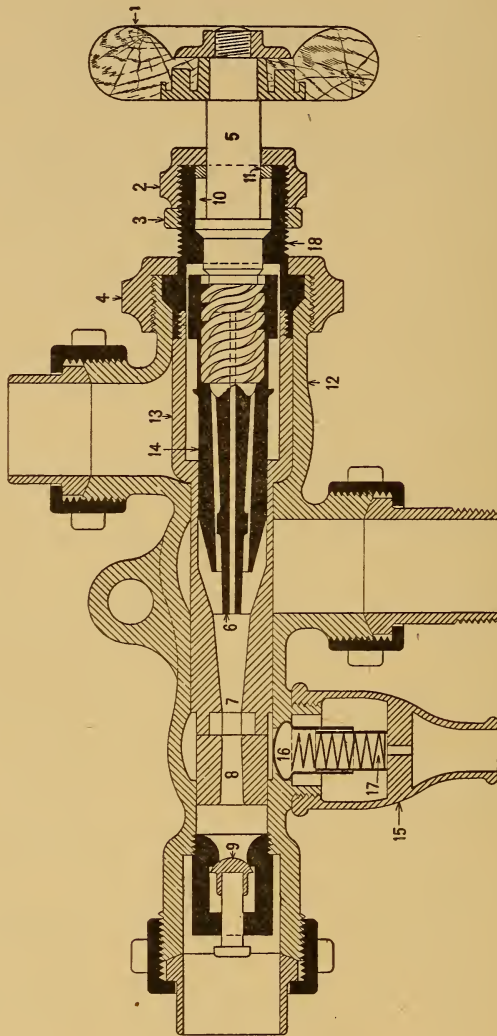

ECLIPSE INJECTOR.

Plate 72. (ELEVADOS.)

- Elevamento . . . 1. Handle of Regulating Valve.
 Elevando . . . 2. Small Nut holding in Stem.
 Elevareis . . . 3. Jam Nut.
 Elevarem . . . 4. Main Nut holding Injector in Shell.
 Elevaremus . . . 5. Stem.
 Elevariais . . . 6. Lifting Jet.
 Elevarono . . . 7. Combining Tube.
 Elevassem . . . 8. Discharge Tube.
 Elevassimo . . . 9. Check Valve.
 Elevateur . . . 10. Space for Packing.
 Elevatezza . . . 11. Follower for confining Packing.
 Elevating . . . 12. Shell.
 Elevator . . . 13. Body.
 Elevatoris . . . 14. Adjusting Tube regulating Water and Steam
 Supply.
 Elevatrice . . . 15. Body of Overflow Valve.
 Elevavamo . . . 16. Overflow Valve.
 Elevavate . . . 17. " " Spring.
 Elevazione . . . 18. Threaded End of Body.

In ordering parts for injector, give in all cases the maker's number stamped on the injector.

LITTLE GIANT INJECTOR, "LOCOMOTIVE"

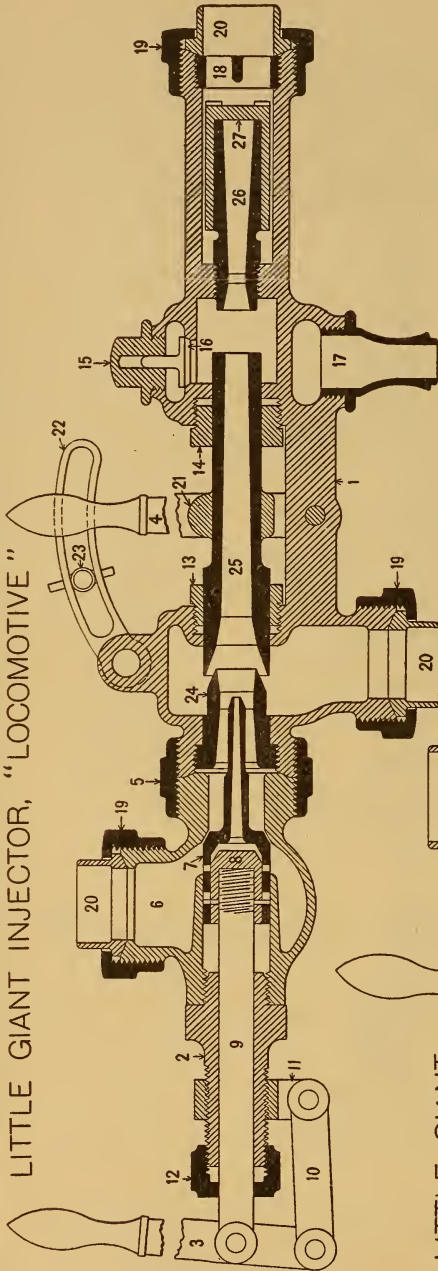

See page 213.

LITTLE GIANT INJECTOR, 1889

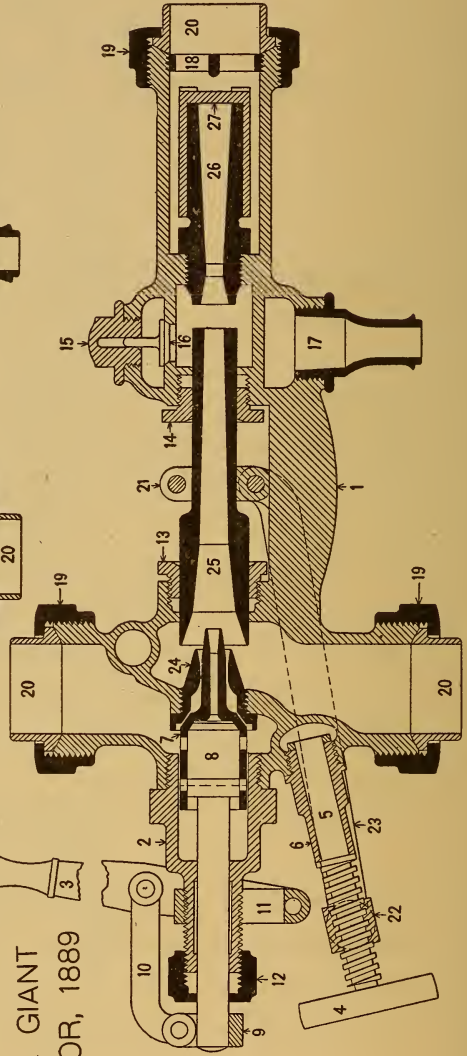

See page 214.

LITTLE GIANT INJECTOR, "LOCOMOTIVE."

Plate 73. (ELEVENTH.)

Eleveranno . . .	1. Body.
Eleverebbe . . .	2. Stuffing Box.
Eleveremo . . .	3. Starting Lever.
Eleveresti . . .	4. Injector Lever.
Elevero	5. Right and Left Nut.
Eleverunt . . .	6. Starting Valve Body.
Eleves	7. Main Steam Valve.
Eleveurs	8. Jet Valve.
Elevimus	9. " " Stem.
Elevriez	10. Starting Valve Link.
Elezionano . . .	11. Fulcrum.
Elezionare . . .	12. Stuffing Box Nut.
Elezionava . . .	13. Large Packing Nut.
Eleziono	14. Small " "
Elfbladig	15. Overflow Cap.
Elfdaagsch . . .	16. " Valve.
Elfdehalf	17. " Nozzle.
Elfderlei	18. Check Valve Stop.
Elfenbein	19. Coupling Nut.
Elfenbusch . . .	20. Swivel.
Elfenmaus	21. Combining Tube Clamp.
Elfenspuk	22. Quadrant.
Elfenweiss . . .	23. Thumb Screw.
Elferberg	24. Steam Tube.
Elfgesang	25. Combining Tube.
Elfhelmig	26. Discharge Tube.
Elfhoek	27. Check Valve.

In ordering parts for injector, give in all cases the maker's number stamped on Injector.

LITTLE GIANT INJECTOR, 1889.

Plate 73. (ELFHOEKIG.)

See page 212.

Elfin	1. Body.
Elfjarig	2. Stuffing Box.
Elfmaal	3. Starting Lever.
Elfmeilig	4. Adjusting Wheel.
Elfpaarig	5. " " Stem.
Elfrank	6. " Stem Holder.
Elfreihig	7. Main Steam Valve.
Elfrippig	8. Jet Valve.
Elfstijlig	9. " " Clamp.
Elftaegig	10. Starting Valve Link.
Elftal	11. Fulcrum.
Elftnet	12. Stuffing Box Nut.
Elfvoud	13. Large Packing Nut.
Elfvoudig	14. Small " "
Elhanan	15. Overflow Cap.
Eliacus	16. " Valve.
Eliahba	17. " Nozzle.
Eliakim	18. Check Valve Stop.
Eliantemo	19. Coupling Nut.
Eliasaph	20. Swivel.
Eliashib	21. Combining Tube Clamp.
Eliathah	22. Crosshead.
Eliberamus	23. Side Bars.
Eliberas	24. Steam Tube.
Elibero	25. Combining Tube.
Elicaon	26. Discharge Tube.
Eliciano	27. Check Valve.

In ordering parts for injector, give in all cases the maker's number stamped on the injector.

Plate 74.

NATIONAL AND N. T. INJECTOR

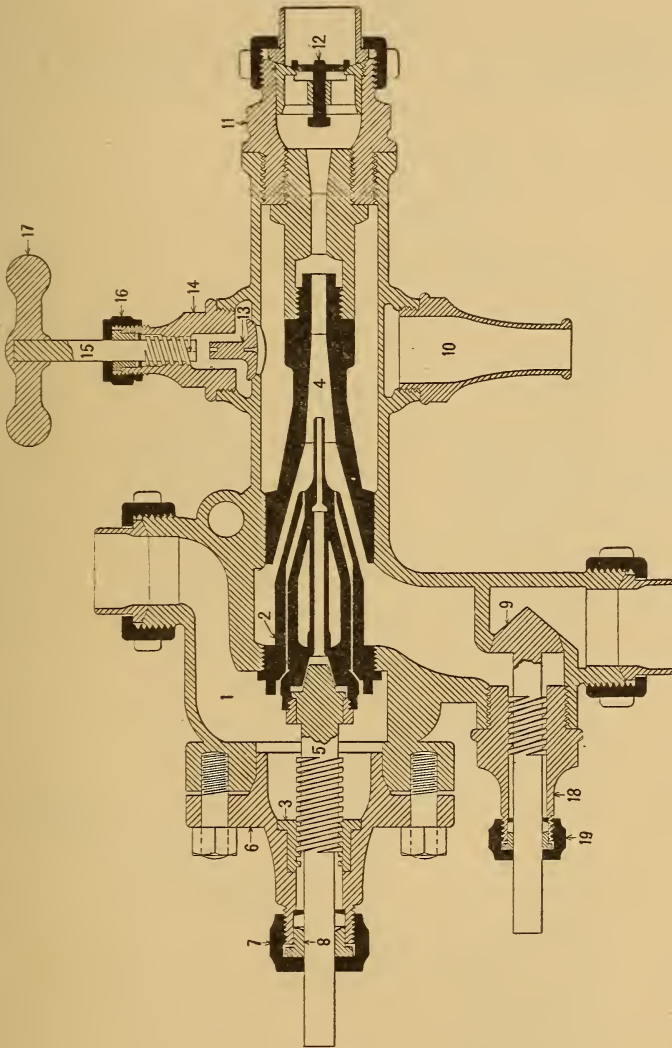

For description of plate, see page 216.

NATIONAL AND N. T. INJECTOR.

Plate 74. (ELICIENDOS.)

See page 215.

Eliciendum . . .	1. Body.
Elicited	2. Cone.
Eliciting	3. Stand Nut.
Elicito	4. Delivery Tube.
Elicosofia	5. Ram and Spindle.
Elicuerunt	6. Stand.
Elicuimus	7. " Cap.
Elicuisti	8. " Gland.
Elidemmo	9. Water Valve.
Elidendo	10. Overflow Nozzle.
Elidesse	11. Delivery Tube Nut.
Elidevamo	12. End Check Valve.
Elidevate	13. Overflow Valve.
Elienai	14. " Stand.
Eliezer	15. " Spindle.
Eligam	16. " Cap.
Eligendi	17. " Lever.
Eligendos	18. Stand of Water Valve.
Eligendum	19. " Cap.

In ordering parts for injector, give in all cases the maker's number stamped on the injector.

METROPOLITAN DOUBLE TUBE LOCOMOTIVE INJECTOR.

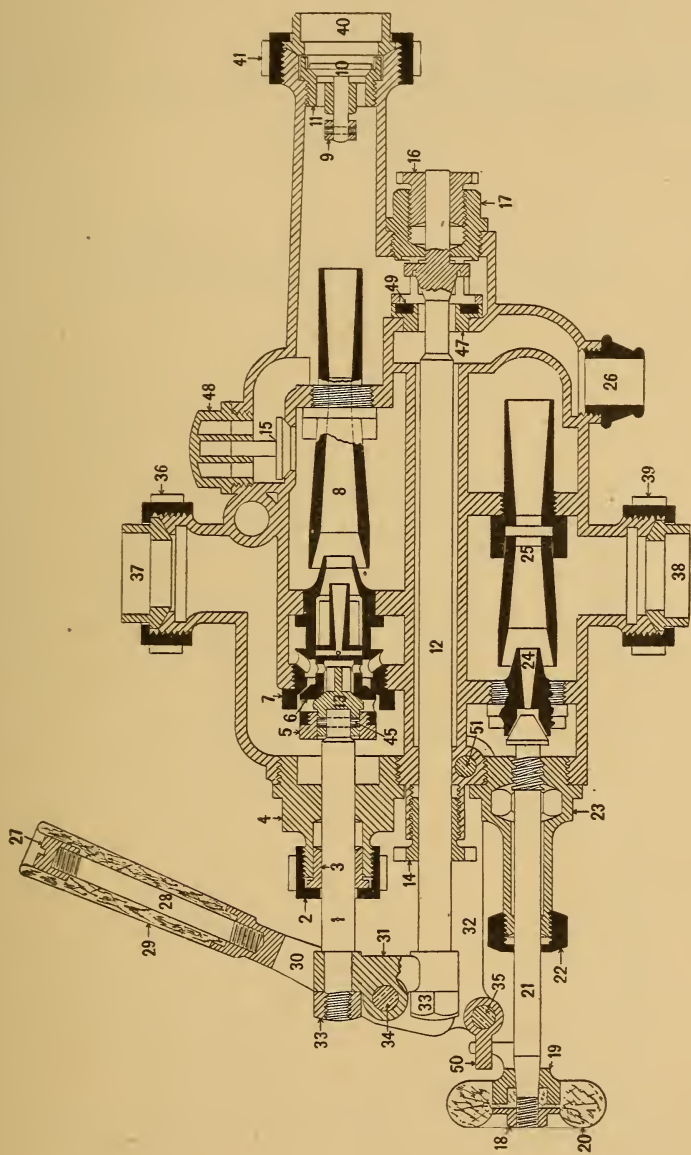

For description of plate, see pages 218 and 219.

METROPOLITAN DOUBLE TUBE LOCOMOTIVE INJECTOR.

Plate 75. (ELIGERE.)

See page 217.

Eligibly	1. Steam Valve Stem.
Eligieron	2. Packing Nut for No. 1.
Eligius	3. Gland for No. 1.
Eligma	4. Steam Centre Piece.
Elihoreph	5. " Swivel Ring.
Elihu	6. " Valve.
Elijamos	7. Forcing Steam Tube.
Elikah	8. " Combining Tube.
Elimant	9. Line Check Ring.
Elimassem	10. " " Valve.
Elimasti	11. Seat for Line Check.
Elimatius	12. Overflow Valve Stem.
Elimatos	13. Auxiliary Steam Valve.
Elimavisti	14. Gland for No. 12.
Elimberis	15. Overflow Valve.
Eliminacao	16. " Packing Gland.
Eliminammo	17. " Centre Piece.
Eliminamos	18. Regulating Valve Handle Nut.
Eliminant	19. " " Wheel Disc.
Eliminaron	20. " " Wheel.
Eliminassi	21. " " Stem.

Eliminatum . . .	22.	Packing Nut for No. 21.
Eliminava . . .	23.	Regulating Valve Centre Piece.
Eliminiez . . .	24.	Lifting Steam Tube.
Eliminons . . .	25.	“ Combining Tube.
Elimiotis . . .	26.	Overflow Nozzle.
Elimpidas . . .	27.	Lever Nut.
Elimpidavi . . .	28.	“ Rod.
Elimpido . . .	29.	“ Handle.
Elingo	30.	Lever.
Elinguamus . . .	31.	Connecting Link.
Elinguatio . . .	32.	Fulcrums.
Elinguavi . . .	33.	Nuts for Stems Nos. 1 and 12.
Elinguibus . . .	34.	Lever Bolts.
Elinguid . . .	35.	Fulcrum Bolt.
Elinxerunt . . .	36.	Union Nut, Steam End.
Elinxi	37.	Tail Pipe, “ “
Eliocarlo . . .	38.	“ “ Suction “
Eliocometa . . .	39.	Union Nut, “ “
Eliocroca . . .	40.	Tail Pipe, Delivery “
Eliofobia . . .	41.	Union Nut, “ “
Eliolite	42.	Nut for Bolt No. 34.
Eliometro . . .	43.	“ “ “ “ 35.
Elionure	44.	Overflow Funnel.
Elioscopio . . .	45.	Pin for Auxiliary Steam Valve.
Eliose	47.	Overflow Valve Seat.
Eliostato	48.	“ Cap.
Eliota	49.	Disc for Overflow Valve Seat.
Eliotropia . . .	50.	Lever Stop.
Eliphalet . . .	51.	Body Bolt.
Elipsoide . . .	52.	Nut for same.

In ordering parts for injector, give in all cases the maker's number stamped on the injector.

Plate 76.

BELFIELD INJECTOR.

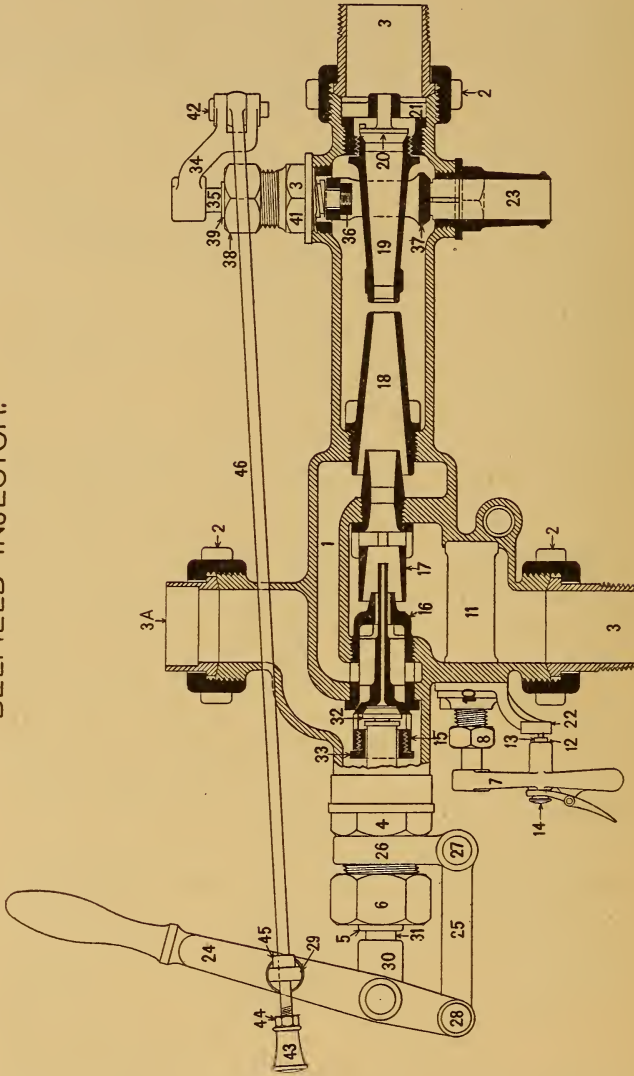

BELFIELD INJECTOR.

Plate 76. (ELIQUAMENT.)

Eliquati	1.	Injector Body.
Eliquation . . .	2.	Coupling Nut.
Eliquescis . . .	3.	Swivel for Iron Pipe.
Eliquesco	3A.	“ “ Copper Pipe.
Eliquia	4.	Stuffing Box for Starting Stem.
Eliquium	5.	Gland in No. 4.
Elirait	6.	Nut for No. 4.
Eliront	7.	Regulating Valve.
Elisabeth	8.	Nut for No. 10.
Elisachar	10.	Regulating Plug Stuffing Box.
Elisaeus	11.	“ Plug.
Eliseos	12.	Spring in No. 7.
Eliserunt	13.	Pawl.
Elisferica	14.	Button on No. 13.
Elishamah	15.	Lifting Tube.
Elishaphat . . .	16.	First Steam Nozzle.
Elisheba	17.	“ Combining Tube.
Elision	18.	Second “ “
Elisionis	19.	Delivery Tube.
Elisirvite	20.	Check Valve.

(Continued on page 222.)

Plate 76 continued.

- Elissem . . . 21. Guide Ring for Check Valve.
Elisisti . . . 22. Quadrant.
Elisor . . . 23. Overflow Nozzle.
Elisorum . . . 24. Starting Lever.
Elissaeo . . . 25. Link.
Elissaeus . . . 26. Lever Clamp.
Eliseen . . . 27. Bolt through No. 25 and No. 26.
Elitraria . . . 28. Pin and Cotter through No. 24 and No. 25.
Elitrocele . . . 29. Pin and Cotter through No. 24 to move Rod
No. 46.
Elittiche . . . 30. Crosshead on No. 31.
Elittico . . . 31. Starting Stem.
Elixacao . . . 32. " Valve.
Elixamus . . . 33. Lock Nut to Connect No. 15 to No. 31.
Elixate . . . 34. Lever on Overflow Valve.
Elixation . . . 35. Stem for " "
Elixatura . . . 36. Nut to connect No. 35 to No. 37.
Elixaturis . . . 37. Overflow Valve.
Elixing . . . 38. Nut for No. 41.
Elixires . . . 39. Gland in No. 41.
Elixorum . . . 41. Overflow Valve Stuffing Box.
Elixura . . . 42. Pin through No. 34 and No. 46.
Elizaphan . . . 43. Knob on Rod No. 46.
Eliziaro . . . 44. Lock Nut to hold No. 43.
Elizur . . . 45. Stop on No. 46 to open Overflow Valve.
Eljen . . . 46. Overflow Valve Rod.

In ordering parts for injector, give in all cases the maker's number stamped on the injector.

Plate 77.

NATHAN SIGHT FEED CYLINDER LUBRICATOR.

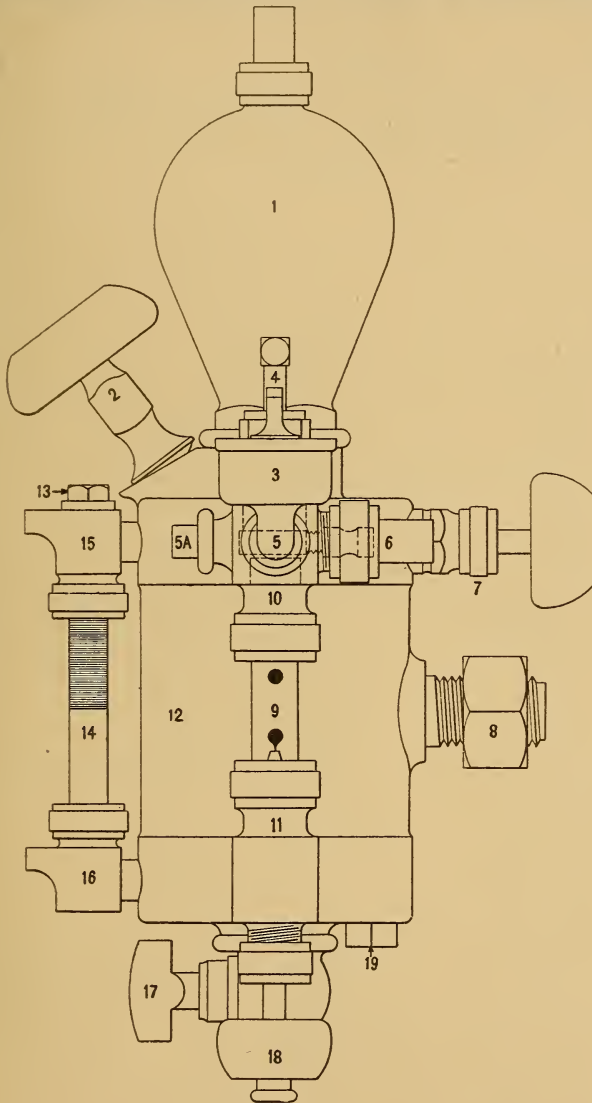

For description of plate, see page 224.

NATHAN SIGHT FEED CYLINDER LUBRICATOR.

Plate 77. (ELKAITE.)

See page 223.

Elkander . . .	1.	Condenser.
Elkesaite . . .	2.	Filling Plug.
Elkosh	3.	Auxiliary Oiler.
Ellagique . . .	4.	Safety Valve.
Ellagite	5.	Reducing Plug.
Ellanodici . . .	5A.	Blow-off “
Ellasar	6.	Delivery Nut and Coupling.
Ellbogen . . .	7.	Water Valve.
Ellbuth	8.	Stud Nut.
Elleboog	9.	Sight Feed Glass.
Elleborina . . .	10.	Upper Sight Bracket and Nut.
Ellemaat	11.	Lower “ “ “ “
Ellendig	12.	Body.
Ellenhard . . .	13.	Gauge Glass Plug.
Ellenhoch . . .	14.	“ Glass.
Elleni	15.	Upper Gauge Bracket and Nut.
Elleniche . . .	16.	Lower “ “ “ “
Ellenico	17.	Waste Cock.
Ellenijker . . .	18.	Regulating Valve.
Ellenmass . . .	19.	Bottom Plug.

Plate 78.

DETROIT SIGHT FEED CYLINDER LUBRICATOR.

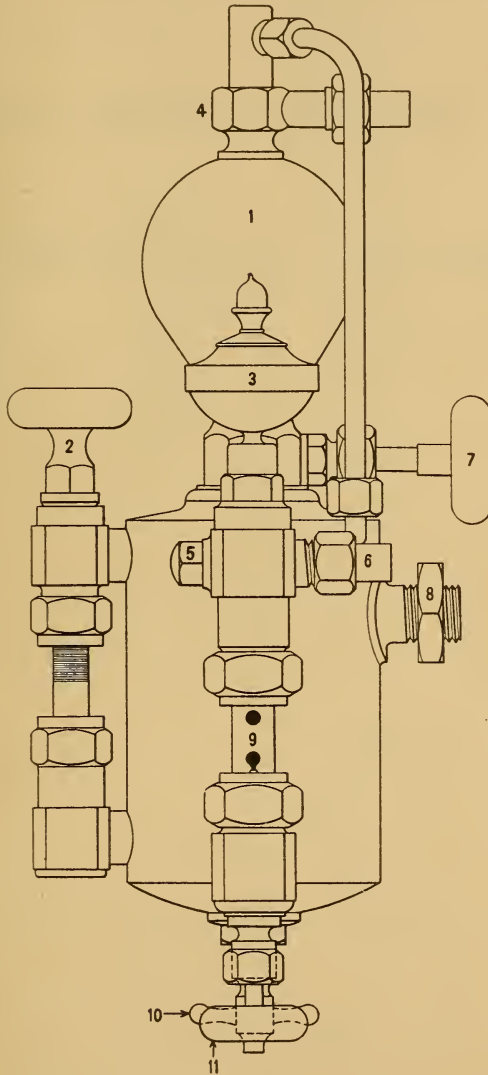

For description of plate, see page 226.

DETROIT SIGHT FEED CYLINDER LUBRICATOR.

Plate 78. (ELLENPRINZ.)

See page 225.

-
- | | |
|------------------|---|
| Ellenstab . . . | 1. Condenser. |
| Ellenwaare . . | 2. Filler Plug. |
| Ellenzahl . . . | 3. Auxiliary Oiler. |
| Ellepijp | 4. Connection for Boiler Pressure. |
| Ellepippen . . . | 5. Plugs to fill Glasses with Water when Lubricator
is first attached. |
| Elleridder . . . | 6. Tail Pipe. |
| Ellerina | 7. Water Valve. |
| Ellesque | 8. Jam Nut. |
| Ellewaar | 9. Sight Feed Glass. |
| Ellewinkel . . . | 10. Drain Valve. |
| Ellicott | 11. Regulating Valve. |

UNITED STATES METALLIC PACKING FOR PISTON RODS.

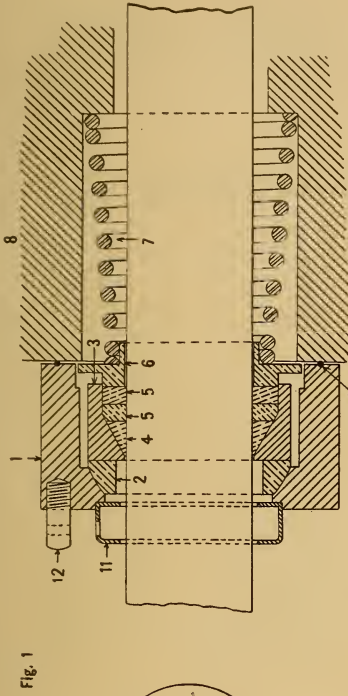
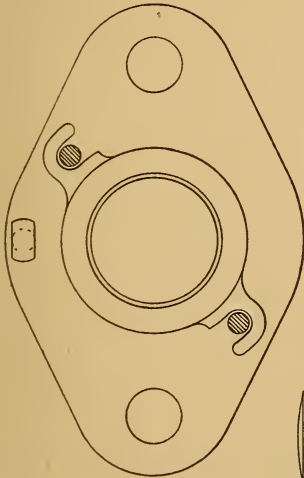

Fig. 1



JEROME METALLIC PACKING FOR PISTON RODS.

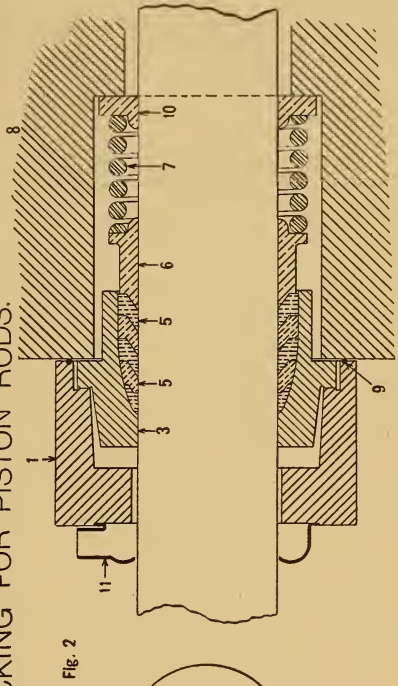
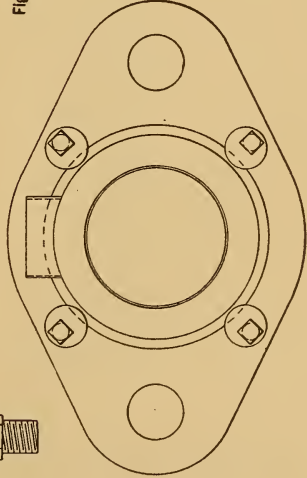
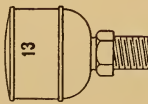

Fig. 2



For description of plate, see page 228.

METALLIC PISTON ROD PACKING.

Plate 79. (ELLINGE.)

See page 227.

FIG. 1.—Ellinger.

FIG. 2.—Ellingerry.

Ellippanthe . . .	1. Packing Case.
Ellipsaire . . .	2. Ball Joint.
Ellipsis	3. Vibrating Cup.
Ellipsoid	4. Babbitt Ring.
Elliptical	5. “ “
Elliptico	6. Follower.
Elliptisch	7. Coil Spring.
Ellisia	8. Stuffing Box.
Elissoide	9. Copper Wire Joint.
Ellkatze	10. Neck Ring.
Ellobie	11. Swab Holder.
Ellwand	12. Oil Cup Bracket.
Ellychnie	13. “ Cup.

In ordering repairs, give in all cases the number stamped on packing case.

UNITED STATES METALLIC PACKING FOR VALVE STEMS.

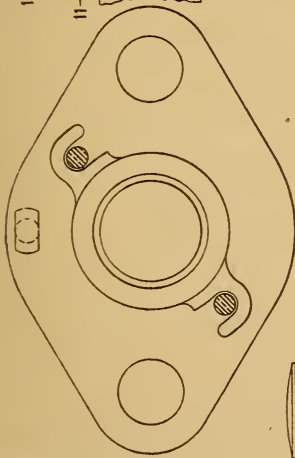
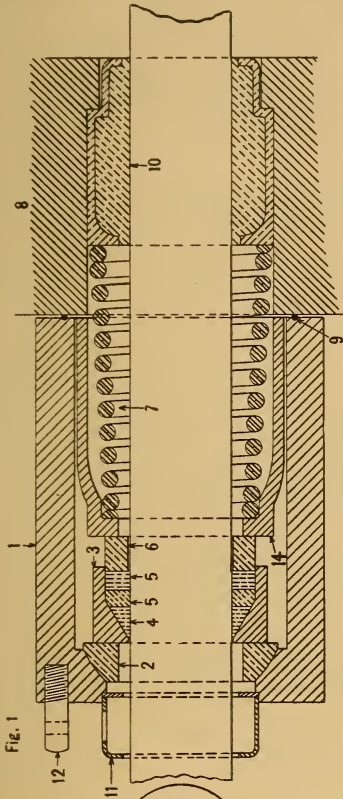

JEROME METALLIC PACKING FOR VALVE STEMS.

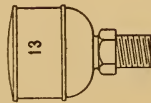
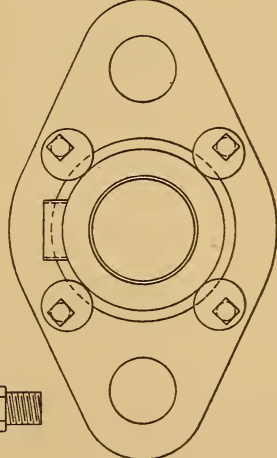
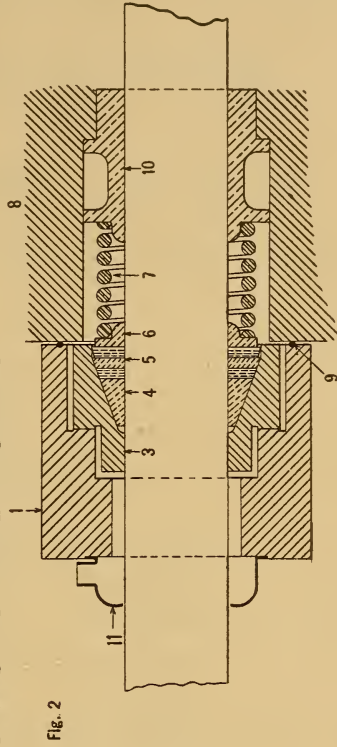

For description of plate, see page 230.

METALLIC VALVE STEM PACKING.

Plate 80. (ELLYCHNIUM.)

See page 229.

FIG. 1.—Ellychnor.

FIG. 2.—Ellychnoty.

Elmakin . . .	1. Packing Case.
Elmigere . . .	2. Ball Joint.
Elminti . . .	3. Vibrating Cup.
Elmintiasi . .	4. Babbitt Ring.
Elmintico . . .	5. “ “
Elminzia . . .	6. Follower.
Elmodam . . .	7. Coil Spring.
Elmsfeuer . .	8. Stuffing Box.
Elmsley . . .	9. Copper Wire Joint.
Elocandi . . .	10. Bushing.
Elocandum . .	11. Swab Holder.
Elocavimus . .	12. Oil Cup Bracket.
Elocavisti . .	13. “ Cup.
Elocher . . .	14. Preventer.

In ordering repairs, give in all cases the number stamped on packing case.

BALDWIN LOCOMOTIVE WORKS,

PHILADELPHIA, PA., U.S.A.,

BUILDERS OF

SINGLE EXPANSION AND COMPOUND

Passenger Locomotives,

Freight Locomotives,

Switching Locomotives,

Logging Locomotives,

Plantation Locomotives,

Locomotives for Rack Railroads,

Heavy Engines for Special Service,

Locomotives for Mills or Furnaces,

Mine Locomotives,

Electrical Locomotives,

Oil-Burning Locomotives,

Compressed Air Locomotives.

SPECIFICATIONS, PROPOSALS, AND FULL PARTICULARS
FURNISHED UPON APPLICATION.

