

ADwin - Steckerbelegungen

Letzte Aktualisierung:

2021-11-18

Auf den folgende Seiten finden Sie die Buchsen- und Steckerbelegungen für alle **ADwin-light-16-**, **ADwin-Gold (II)-** und **ADwin-Pro (II)-**Systeme.

Wenn nicht anders angegeben, sind alle Verbinder als Buchsen ausgeführt.

Light-16 (Rev. A): EURO, EXT, PCI

L16{-CO1}
Stromversorgung
VG96 (Backplane)

L16-DIO1
Counter
CAN

Light-16 (Rev. B): EURO, EXT, PCI

L16{-CO1}{-PWM1}
LS-Bus
Stromversorgung
VG96 (Backplane)

L16-DIO1{-PWM1}
LS-Bus
Counter
CAN{-LS}

L16-DIO2{-PWM1}
LS-Bus
Counter

L16-DIO3{-CO1}{-PWM1}
LS-Bus
Counter

X-A20

CAN-1/2
RS232
LS-Bus
Stromversorgung
Analog-Digital
DIO
CNT

Gold mit ENET/USB (Rev. B)

Gold, Rev. B1: CONN. 1...4
Stromversorgung

Gold, Rev. B2: CONN. 1...4
Stromversorgung

Gold, Rev. ≥B3: CONN. 1...4
Stromversorgung

Gold-D

ANALOG IN/OUT
DIO 00-15 (IN) / 16-31 (OUT)
Stromversorgung

CO1, ..., CO4, CO POWER IN
COM1, COM2
CAN{-LS}

Gold II

ANALOG IN, ANALOG OUT
DIO 00-15 (IN), DIO 16-31 (OUT)
CO1, ..., CO4, CO POWER IN
CO1&2 (TTL), CO3&4 (TTL)
PWM1-6 (TTL)
COM1, COM2, CAN1, CAN2
PROFIBUS DP-V1
LS1, LS2 (LS-Bus)
Stromversorgung

Pro: ADC/DAC-Module

Aln-32/1x (x = 2, 4, 6) (s.-e. / diff.)
Aln-8/1x-D (x = 2, 4, 6)
Aln-F-n/1x-D (n = 4, 8; x = 2, 4, 6)
Aln-16/14-C
AOut-n/16-D (n = 4, 8)
AO-16/8-12

Pro: DIO-Module

DIO-32 (Rev. A, Rev. B)
OPT-16
REL-16
TRA-16
PWM-4{-I}
COMP-16

OPT-16 (mit Phoenix-Verbinder)
TRA-16 (mit Phoenix-Verbinder)

Pro: Zähler-Module

CNT-VR4{-L}{-I}
CNT-16/16{-I}
CNT-8/32{-L/-I}

CO4{-T/-D/-I}
CNT-VR2PW2{-I}
CNT-PW4{-I}
CNT-16/32{-I}

Pro: EXT-Module

PT100 (Lemo), PT100-n-D (n = 4, 8)
TC-n-J{-K}-D (n = 4, 8, 16)
MB-8{-D}, 5B/8B Modulsocket

RS-232, RS-422, RS-485
CAN{-LS}
PROFI-DP-SL
LS-2
INTER-SL

Pro: Diverses

Pro-Mini (Stromversorgung)
Pro-DC (Stromversorgung)
VG96 (Backplane)

Pro II

Aln-32/18 (s.-e. / diff.)
Aln-8/18
Aln-16/18-8B
Aln-F-n/1x-D (n = 4, 8; x = 4, 6)
Aln-F-n/18-D (n = 4, 8)
Aln-16/18-C

RTD-8 (2/3/4 wire)
SG-4/18

AOut-n/16-D (n = 1, 4, 8)

OPT-16, OPT-32-24V
COMP-16
TRA-16{-G}
REL-16
DIO-32, DIO8-D12
PWM-16{-I}

MIO-4 (s.-e. / diff.)
MIO-4-ET1
MIO-D12

CNT{-T/-D/-I}

RS-232, RS-485, RS422-4
CAN{-LS}, LIN, FlexRay, PROFI-SL
ARINC-429
SENT-n{-OUT} (n = 4, 6)

SPI{-T/-D}

VG96 (Backplane)
Pro II-DC (Stromversorgung)

Adapter Sets (AS1-AS10)

AS1, AS2, AS3, AS4, AS5,
AS6, AS7, AS8, AS9, AS10

Cable Sets (CS1-CS11)

CS1, CS2, CS3, CS4, CS5,
CS6, CS7, CS8, CS9, CS10, CS11

Busse und Komm.-Schnittstellen

RS-232 (9- & 25-pol.), RS-4xx
USB
Ethernet (RJ-45)
ISA-Bus-Slot
PCI-Bus-Slot

Legende:

Um den schematisch dargestellten Verbinder herum (entweder in horizontaler oder vertikaler Ausrichtung) sind die Signalbezeichnungen nach dem Zwiefelschalenprinzip, d.h. von innen nach außen angeordnet:

- Bei differentiellen Signalen erfolgt zuerst eine Angabe der Polarität – bei single-ended-Signalen (i.A. die digitalen I/Os mit TTL-Pegel sowie die Analogausgänge) entfällt diese.
- Anschließend folgt der Signalname. Kann das Signal einer Funktionseinheit zugeordnet werden, z.B. einem Zähler (C), einer Schnittstelle (SPI, SSI, ...), usw. wird zuerst dessen/deren Name genannt und der/die Signalname(n) wird/werden in eckige Klammern gesetzt.
- Bei Anschlüssen mit mehreren möglichen Funktionen kommen zusätzlich Satzzeichen zum Einsatz, die eine UND- bzw. ODER-Verknüpfung der Funktion ermöglichen, als auch das Vorhandensein anzeigen, wenn dafür eine optionale Erweiterung nötig ist.
 - , Trennt Signale, die gleichzeitig an diesem Pin zur Verfügung stehen.
 - / Trennt Signale, die nicht(!) gleichzeitig zur Verfügung stehen - ODER-Funktion - d.h. sich durch Hardware-Erweiterungen ergeben oder mittels Software selektiert werden können.
 - (+) Positiver oder „+“-Eingang bei differentiellen Eingängen.
 - (-) Negativer oder „-“-Eingang bei differentiellen Eingängen.
 - [] Beinhaltet den Signalnamen, wenn er zu einer Funktionseinheit gehört.
 - () Beinhaltet einen Signalnamen, der nur optional (d.h. durch eine eingebaute Erweiterung) zur Verfügung steht.
 - : Kennzeichnet einen Bereich / eine Anzahl, „von ... bis ...“.

Abkürzungen:

ADC	Analog to Digital Converter
AGND	Analog GrouND
ARINC	Aeronautical Radio INC orporated
CAN	Controller Area Network
CLK	CLocK (Takt)
CLR	CLeaR (Löschen)
CMP	CoMP arator
Cn	Counter (Zähler), n = # des Zählers
DAC	Digital to Analog Converter
DGND	Digital GrouND
DIN	Digital IN put
DIO	Digital Input/Output
DIR	DIR ection
DOUT	Digital OUT put
DTA	DaTA
GND	GrouND
LIN	Local Interconnect Network
LT	LaTch
MISO	Master In Slave Out
MOSI	Master Out Slave In
PW	Pulse Width (Zähler-Eingang)
PWM	Pulse Width Modulation
PWMOUT	Pulse Width Modulation OUT put
SCLK	Serial CLocK
SENT	Single Ended Nibble Transmission
SGND	Signal GrouND
SHIGH	Signal HIGH
SLOW	Signal LOW
SPI	Serial Peripheral Interface
TTL	Transistor-Transistor Logik
WDOUT	Watch Dog OUT put

Impressum:

Jäger Computergesteuerte Messtechnik GmbH
Rheinstr. 2-4
D-64653 Lorsch

Telefon: +49 (0)6251-96 32-0
Telefax: +49 (0)6251-96 32-99

E-Mail: info@ADwin.de
Internet: <http://www.ADwin.de>

Vertretungsberechtigter Geschäftsführer: Hubert Morgenstern
Registergericht: Amtsgericht Bensheim
Registernummer: B24717
Umsatzsteuer-Identifikationsnummer gemäß § 27a Umsatzsteuergesetz (UStG): DE 178530689

Betreuung dieses Dokuments:

Konzept, inhaltliche Bearbeitung, Layout und technische Umsetzung:
Raimund Rabe, Jäger Computergesteuerte Messtechnik GmbH
E-Mail: rrabe@ADwin.de

Urheberrecht, Haftung:

Das Layout des Dokuments, sowie die verwendeten Grafiken und Bilder, sind urheberrechtlich geschützt. Jede Verwertung außerhalb der engen Grenzen des Urheberrechtsgesetzes ist ohne Zustimmung von Jäger Computergesteuerte Messtechnik GmbH unzulässig und strafbar. Das gilt vor allem für Vervielfältigungen, Übersetzungen, Mikroverfilmungen sowie die Einspeicherung und Bearbeitung in elektronischen Medien.

Alle Informationen dieses Dokuments erfolgen ohne Gewähr für ihre Richtigkeit oder Vollständigkeit. In keinem Fall wird für Schäden, die sich aus der Verwendung der dargelegten Informationen ergeben, eine Haftung übernommen.

+5Vout <0,1A	40	39	reserviert
reserviert	38	37	+5Vout <0,1A
	36	35	reserviert
	34	33	DIO[DGND]
EVENT IN	32	31	DIN5,C2[CLK]
DOUT5	30	29	DIN4,C1[CLK]
DOUT4	28	27	DIN3
DOUT3	26	25	DIN2
DOUT2	24	23	DIN1
DOUT1	22	21	DIN0
DOUT0	20	19	(+) ADC11
ADC11 (-)	18	17	(+) ADC09
ADC09 (-)	16	15	(+) ADC07
ADC07 (-)	14	13	(+) ADC05
ADC05 (-)	12	11	(+) ADC03
ADC03 (-)	10	9	(+) ADC01
ADC01 (-)	8	7	(+) ADC15
ADC15 (-)	6	5	(+) ADC13
ADC13 (-)	4	3	DAC2
[AGND]DAC	2	1	DAC1

L16

(optionale Pfostenleiste zur int. Verdrahtung - D-Sub Buchse entfällt)

reserviert	37	19	+5Vout <0,1A
-12Vout <0,1A	36	18	+12Vout <0,1A
EVENT IN	35	17	DIO[DGND]
DOUT5	34	16	DIN5,C2[CLK]
DOUT4	33	15	DIN4,C1[CLK]
DOUT3	32	14	DIN3
DOUT2	31	13	DIN2
DOUT1	30	12	DIN1
DOUT0	29	11	DIN0
ADC11 (-)	28	10	(+) ADC11
ADC09 (-)	27	9	(+) ADC09
ADC07 (-)	26	8	(+) ADC07
ADC05 (-)	25	7	(+) ADC05
ADC03 (-)	24	6	(+) ADC03
ADC01 (-)	23	5	(+) ADC01
ADC15 (-)	22	4	(+) ADC15
ADC13 (-)	21	3	(+) ADC13
[AGND]DAC	20	2	DAC2
		1	DAC1

L16-PCI

	c	b	a	a	b	c
1	□	□	□	+5V *	+5V *	+5V *
2	□	□	□	-	-	-
3	□	□	□	-	-	-
4	□	□	□	-	-	-
5	□	□	□	-	-	-
6	□	□	□	-	-	-
7	□	□	□	-	-	-
8	□	□	□	-	-	-
9	□	□	□	-	-	-
10	□	□	□	-	-	-
11	□	□	□	-	-	-
12	□	□	□	-	-	-
13	□	□	□	-	-	-
14	□	□	□	-	-	-
15	□	□	□	-	-	-
16	□	□	□	-	-	-
17	□	□	□	-	-	-
18	□	□	□	-	-	-
19	□	□	□	-	-	-
20	□	□	□	-	-	-
21	□	□	□	-	-	-
22	□	□	□	-	-	-
23	□	□	□	-	-	-
24	□	□	□	-	-	-
25	□	□	□	-	-	-
26	□	□	□	-	-	-
27	□	□	□	-	-	-
28	□	□	□	-	-	-
29	□	□	□	-	-	-
30	□	□	□	-	-	-
31	□	□	□	-	-	-
32	□	□	□	DGND *	DGND *	DGND *
	a	b	c			

L16-EURO: VG96

* standard - Position jedoch änderbar

+5Vout <0,1A	40	39	reserviert
reserviert	38	37	+5Vout <0,1A
	36	35	reserviert
	34	33	DIO[DGND]
EVENT IN	32	31	DIN5,C1[B]
DOUT5	30	29	DIN4,C1[A]
DOUT4	28	27	DIN3
DOUT3	26	25	DIN2
DOUT2	24	23	DIN1
DOUT1	22	21	DIN0
DOUT0	20	19	ADC11
ADC11 (-)	18	17	(+) ADC09
ADC09 (-)	16	15	(+) ADC07
ADC07 (-)	14	13	(+) ADC05
ADC05 (-)	12	11	(+) ADC03
ADC03 (-)	10	9	(+) ADC01
ADC01 (-)	8	7	(+) ADC15
ADC15 (-)	6	5	(+) ADC13
ADC13 (-)	4	3	DAC2
[AGND]DAC	2	1	DAC1

L16-CO1

(optionale Pfostenleiste zur int. Verdrahtung - D-Sub-Buchse entfällt)

reserviert	37	19	+5Vout <0,1A
-12Vout <0,1A	36	18	+12Vout <0,1A
EVENT IN	35	17	DIO[DGND]
DOUT5	34	16	DIN5,C1[B]
DOUT4	33	15	DIN4,C1[A]
DOUT3	32	14	DIN3
DOUT2	31	13	DIN2
DOUT1	30	12	DIN1
DOUT0	29	11	DIN0
ADC11 (-)	28	10	(+) ADC11
ADC09 (-)	27	9	(+) ADC09
ADC07 (-)	26	8	(+) ADC07
ADC05 (-)	25	7	(+) ADC05
ADC03 (-)	24	6	(+) ADC03
ADC01 (-)	23	5	(+) ADC01
ADC15 (-)	22	4	(+) ADC15
ADC13 (-)	21	3	(+) ADC13
[AGND]DAC	20	2	DAC2
		1	DAC1

L16-PCI-CO1

reserviert	37	19	+5Vout <0,1A
reserviert	36	18	reserviert
EVENT IN	35	17	DIO[DGND]
DOUT5	34	16	DIN5,C2[CLK]
DOUT4	33	15	DIN4,C1[CLK]
DOUT3	32	14	DIN3
DOUT2	31	13	DIN2
DOUT1	30	12	DIN1
DOUT0	29	11	DIN0
ADC11 (-)	28	10	(+) ADC11
ADC09 (-)	27	9	(+) ADC09
ADC07 (-)	26	8	(+) ADC07
ADC05 (-)	25	7	(+) ADC05
ADC03 (-)	24	6	(+) ADC03
ADC01 (-)	23	5	(+) ADC01
ADC15 (-)	22	4	(+) ADC15
ADC13 (-)	21	3	(+) ADC13
[AGND]DAC	20	2	DAC2
		1	DAC1

L16-EURO/EXT

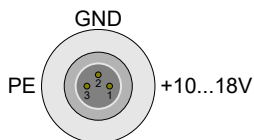

L16-
Stromversorgung
(Stecker)

reserviert	37	19	+5Vout <0,1A
reserviert	36	18	reserviert
EVENT IN	35	17	DIO[DGND]
DOUT5	34	16	DIN5,C1[B]
DOUT4	33	15	DIN4,C1[A]
DOUT3	32	14	DIN3
DOUT2	31	13	DIN2
DOUT1	30	12	DIN1
DOUT0	29	11	DIN0
ADC11 (-)	28	10	(+) ADC11
ADC09 (-)	27	9	(+) ADC09
ADC07 (-)	26	8	(+) ADC07
ADC05 (-)	25	7	(+) ADC05
ADC03 (-)	24	6	(+) ADC03
ADC01 (-)	23	5	(+) ADC01
ADC15 (-)	22	4	(+) ADC15
ADC13 (-)	21	3	(+) ADC13
[AGND]DAC	20	2	DAC2
		1	DAC1

L16-EURO/EXT-CO1

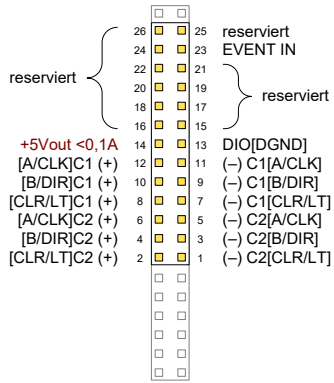

L16-DIO1: Counter (diff.)
(P-feldstecker)

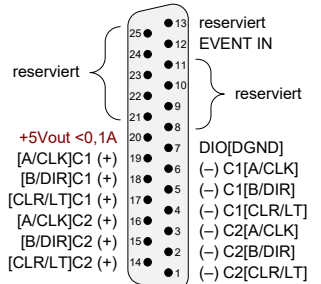

L16-DIO1: Counter (diff.)

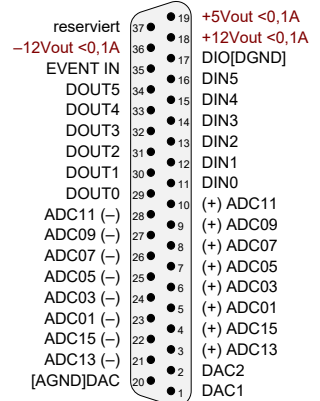

L16-PCI-DIO1

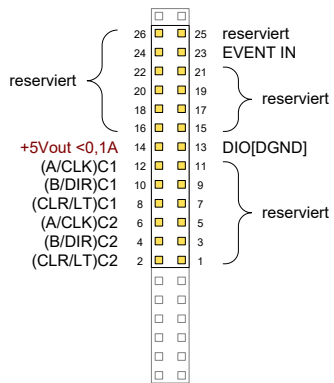

L16-DIO1: Counter (s.-e.)
(P-feldstecker)

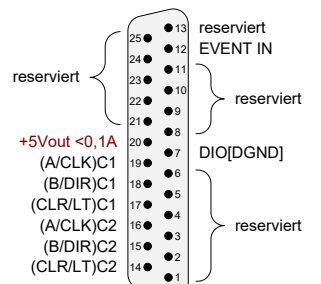

L16-DIO1: Counter (s.-e.)

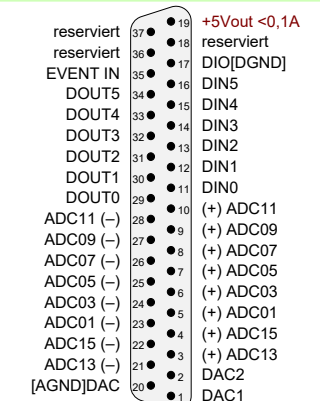

L16-EURO/EXT-DIO1

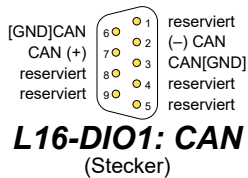

L16-DIO1: CAN (Stecker)

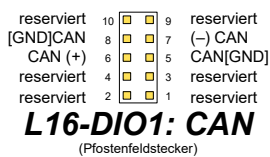

L16-DIO1: CAN (P-feldstecker)

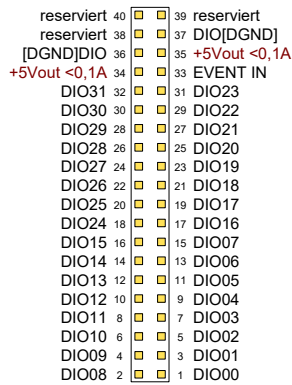

L16-DIO1: DIO (P-feldstecker)

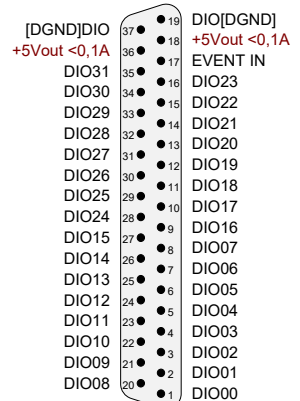

L16-DIO1: DIO

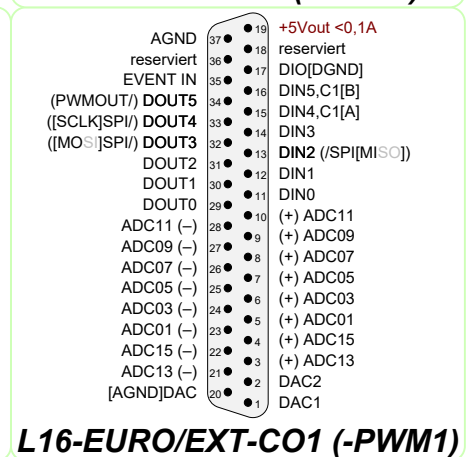
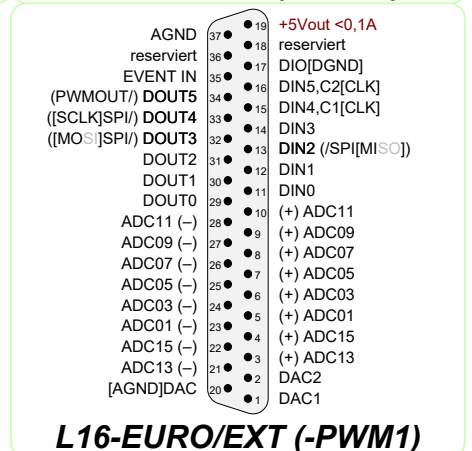
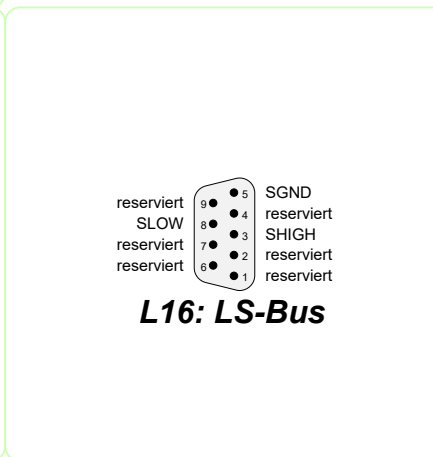
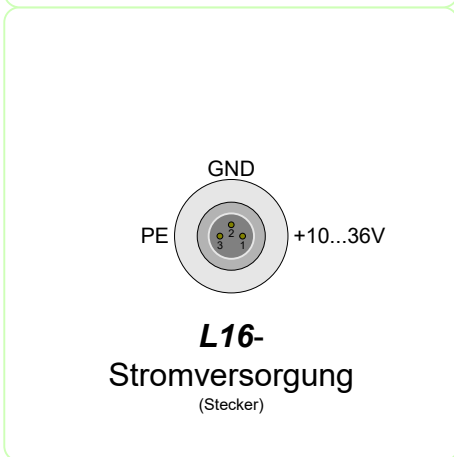
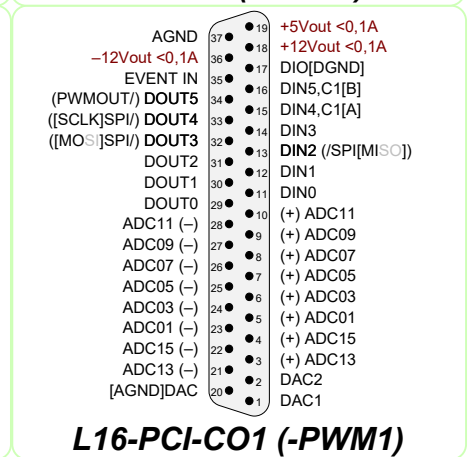
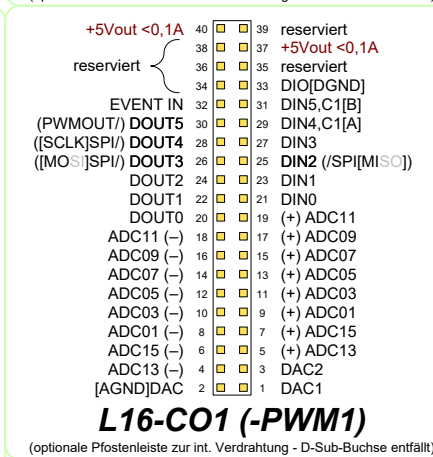
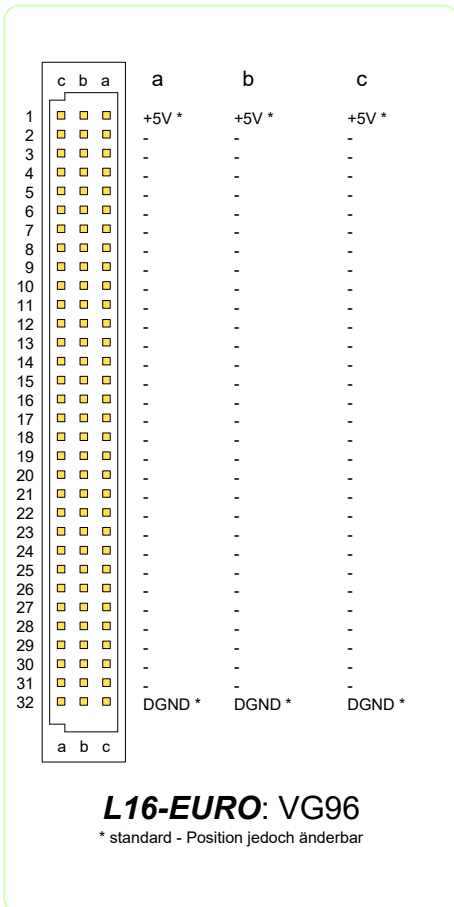
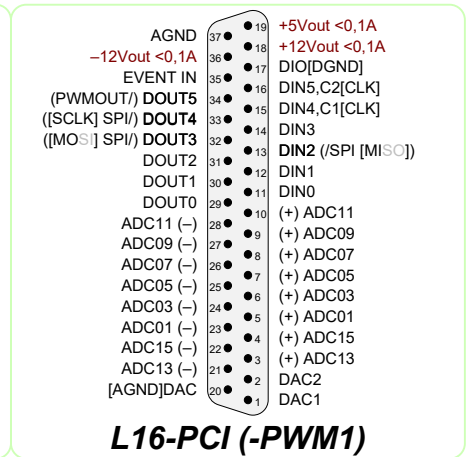
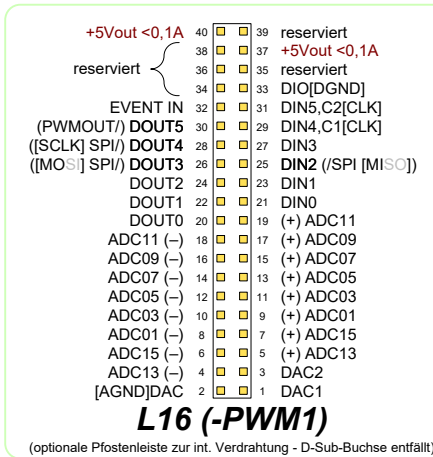

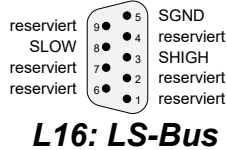
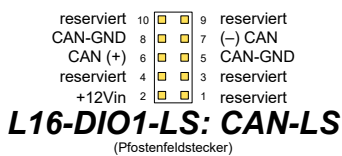
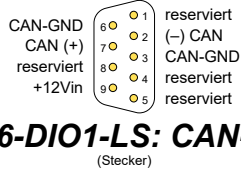
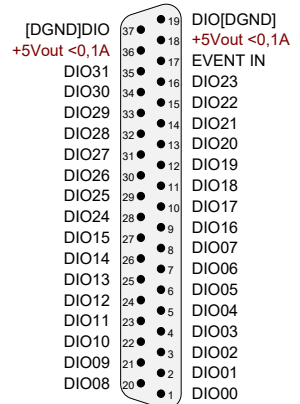
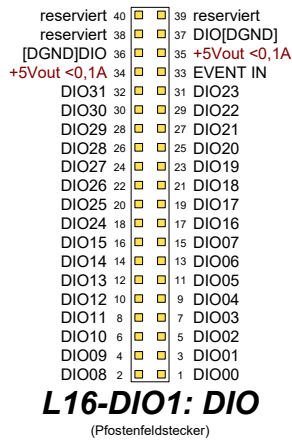
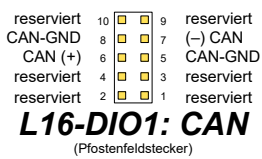
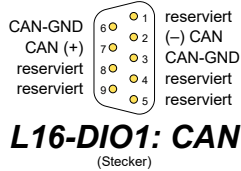
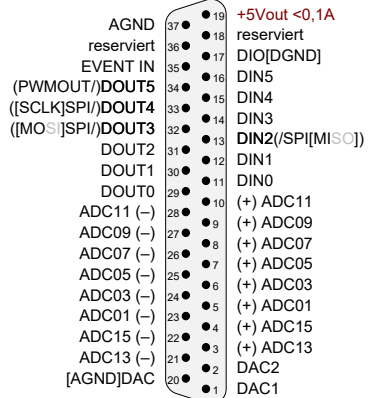
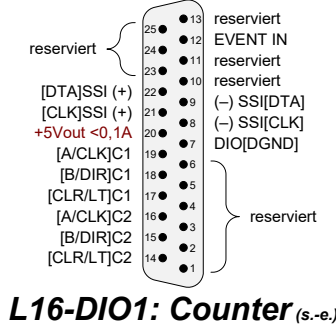
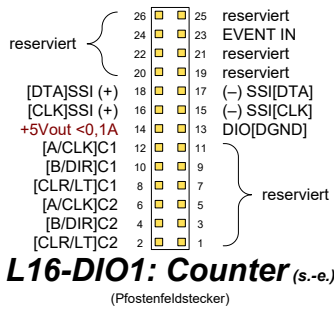
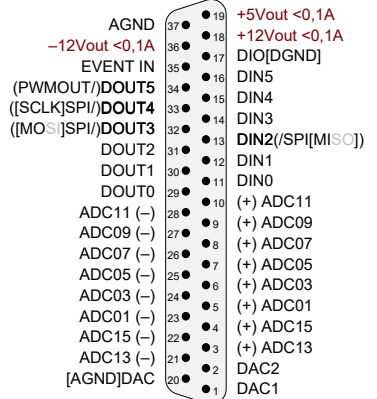
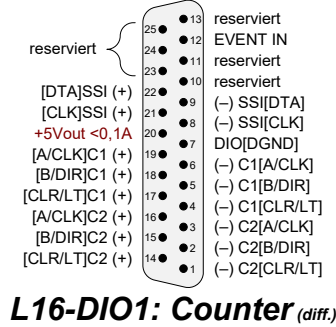
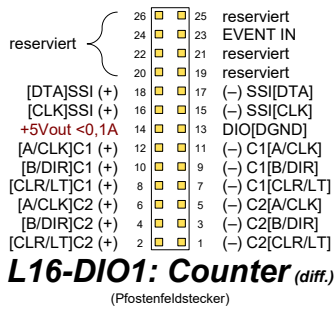

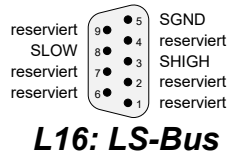
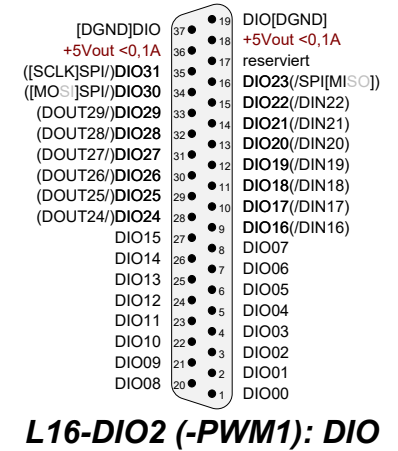
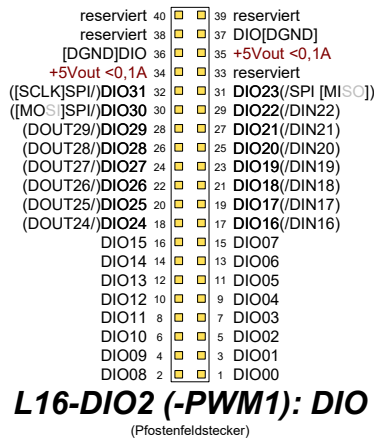
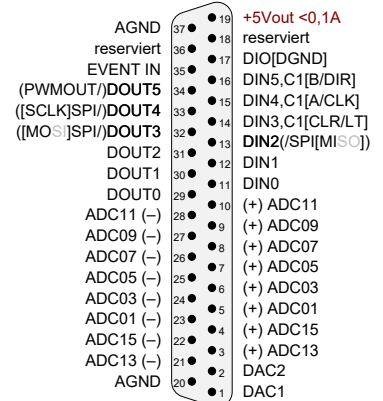
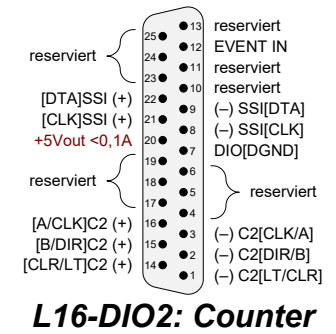
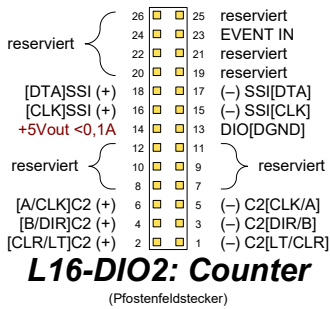
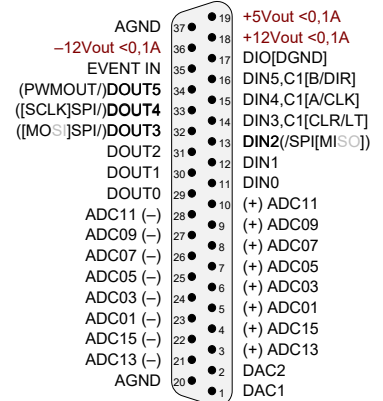
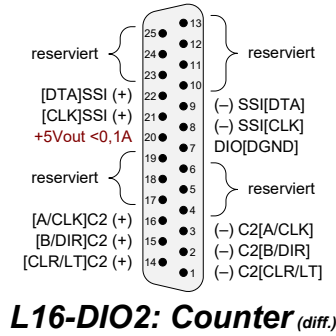
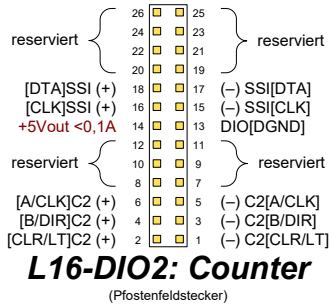

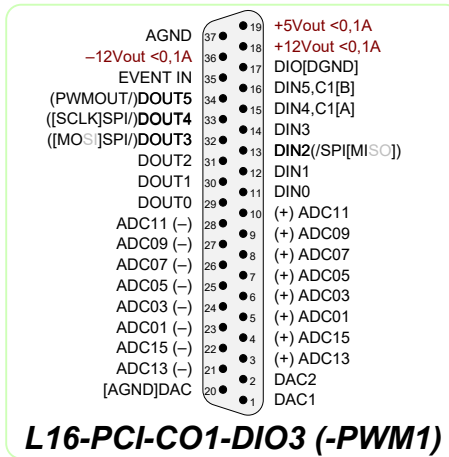

L16-PCI-CO1-DIO3 (-PWM1)

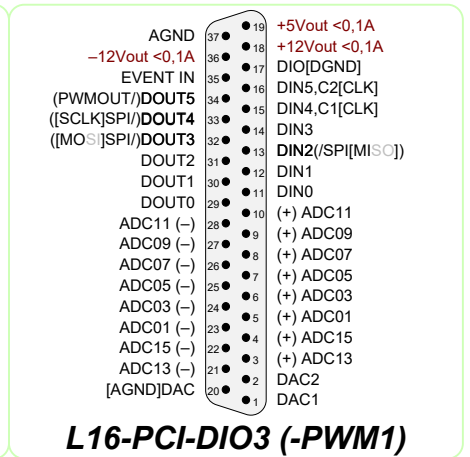

L16-PCI-DIO3 (-PWM1)

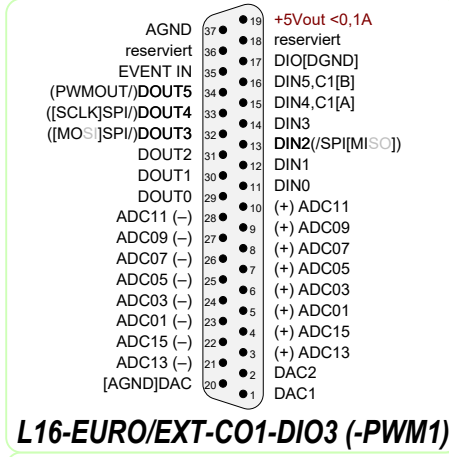

L16-EURO/EXT-CO1-DIO3 (-PWM1)

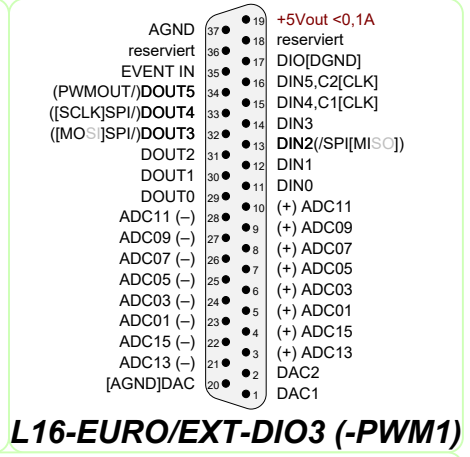

L16-EURO/EXT-DIO3 (-PWM1)

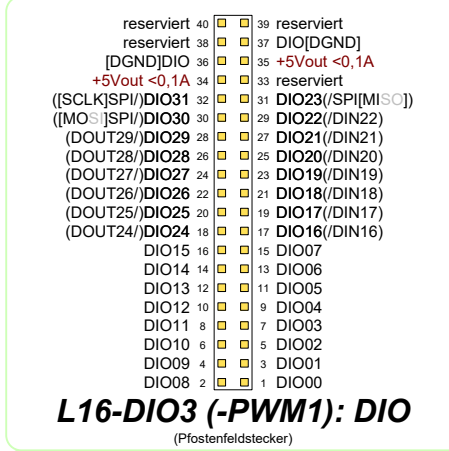

L16-DIO3 (-PWM1): DIO

(Pfostenfeldstecker)

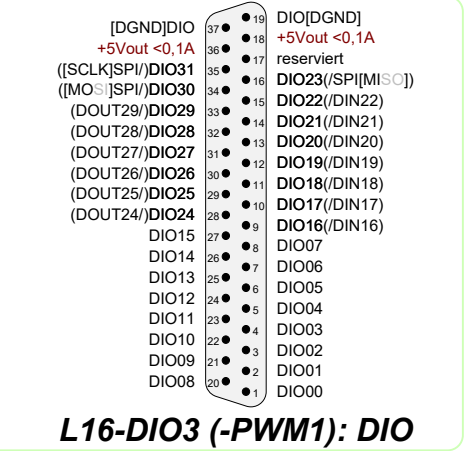

L16-DIO3 (-PWM1): DIO

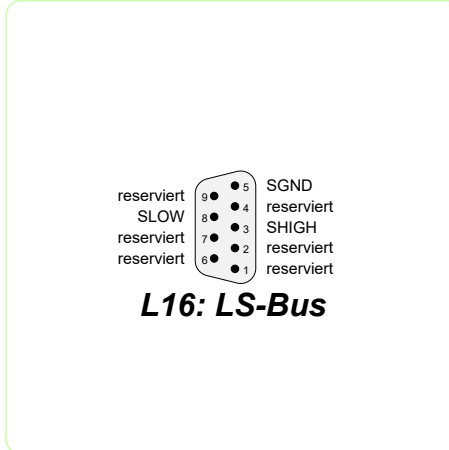

AIN01 (-)	37	19	(+) AIN01
AIN02 (-)	36	18	(+) AIN02
AIN03 (-)	35	17	(+) AIN03
AIN04 (-)	34	16	(+) AIN04
AIN05 (-)	33	15	(+) AIN05
AIN06 (-)	32	14	(+) AIN06
AIN07 (-)	31	13	(+) AIN07
AIN08 (-)	30	12	(+) AIN08
DAC16_1	29	11	AGND
DAC16_2	28	10	AGND
DAC12_1	27	9	AGND
DAC12_2	26	8	AGND
AGND	25	7	AGND
[B,DIR]C1/DIO33	24	6	DIO32/C1[A,CLK]
DIO35	23	5	DIO34/C1[CLR,LT]
DIO37	22	4	DIO36
DIO39	21	3	DIO38
[DGND]DIO	20	2	+5Vout <0,1A
		1	DIO[DGNND]

CONN. 1 (A/D)

[A,CLK]C4/DIN42 (+)	37	19	(-) DIN42/C4[A,CLK]
[B,DIR]C4/DIN43 (+)	36	18	(-) DIN43/C4[B,DIR]
[CLR,LT]C4/DIN44 (+)	35	17	(-) DIN44/C4[CLR,LT]
[A,CLK]C5/DIN45 (+)	34	16	(-) DIN45/C5[A,CLK]
[B,DIR]C5/DIN46 (+)	33	15	(-) DIN46/C5[B,DIR]
[CLR,LT]C5/DIN47 (+)	32	14	(-) DIN47/C5[CLR,LT]
[B,DIR]C6/CMP/DIN49	31	13	DIN48/CMP/C6[A,CLK]
[A,CLK]C7/CMP/DIN51	30	12	DIN50/CMP/C6[CLR,LT]
[CLR,LT]C7/CMP/DIN53	29	11	DIN52/CMP/C7[B,DIR]
CMP/DIN55	28	10	DIN54/CMP
CMP/DIN57	27	9	DIN56/CMP
CMP/DIN59	26	8	DIN58/CMP
DIO40 (-)	25	7	(+) DIO40
DIO41 (-)	24	6	(-) DIO41
[DGND]DIO	23	5	(+) DIO41
[CLK]SSI (-)	22	4	DIO[DGND]
[DTA]SSI/DIN60 (-)	21	3	(+) SSI[CLK]
[DGND]DIO	20	2	(+) DIN60/SSI[DTA]
		1	+5Vout <0,1A
			DIO[DGND]

CONN. 2 (CNT)

DIO01	37	19	DIO00
DIO03	36	18	DIO02
DIO05	35	17	DIO04
DIO07	34	16	DIO06
DIO09	33	15	DIO08
DIO11	32	14	DIO10
DIO13	31	13	DIO12
DIO15	30	12	DIO14
DIO17	29	11	DIO16
DIO19	28	10	DIO18
DIO21	27	9	DIO20
DIO23	26	8	DIO22
DIO25	25	7	DIO24
[B,DIR]C2/DIO27	24	6	DIO26/C2[A,CLK]
[A,CLK]C3/DIO29	23	5	DIO28/C2[CLR,LT]
[CLR,LT]C3/DIO31	22	4	DIO30/C3[B,DIR]
[DGND]DIO	21	3	DIO[DGND]
EVENT IN/DIN62	20	2	+5Vout <0,1A
		1	DIO[DGND]

CONN. 3 (DIO)

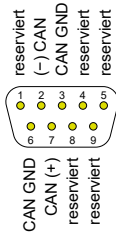

CAN-1/-2 (Stecker)

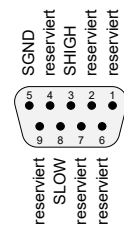

LS-Bus

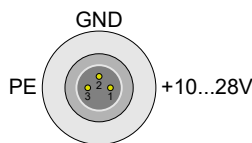

Stromversorgung (Stecker)

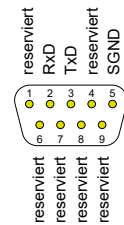

RS232 (Stecker)

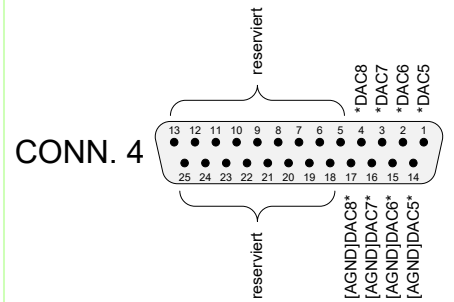
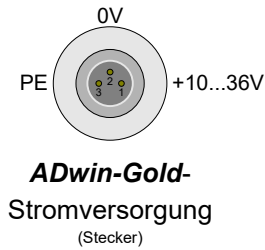
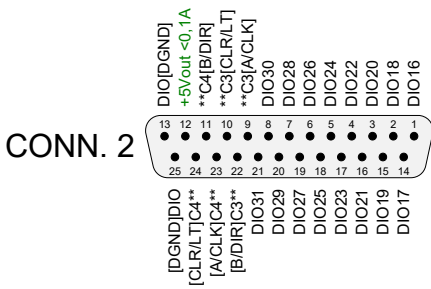
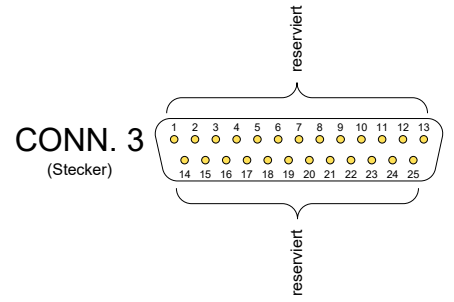
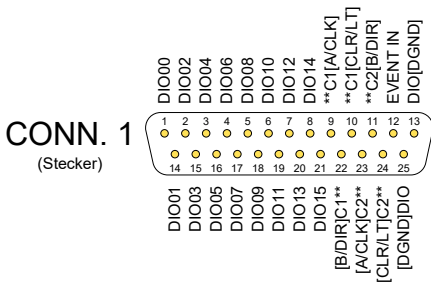

**mit CO1-Erweiterung

*mit DA-Erweiterung

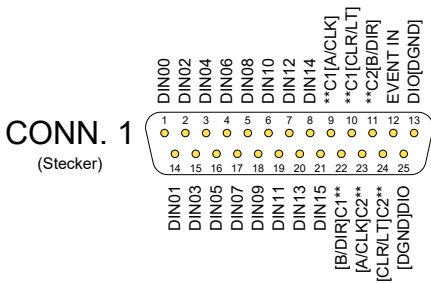

mit CONF_DIO(12)

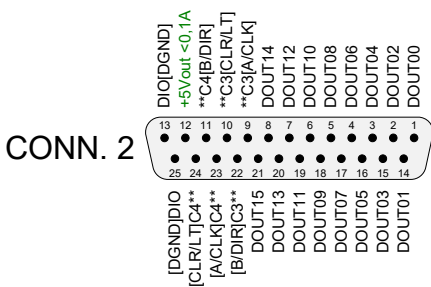

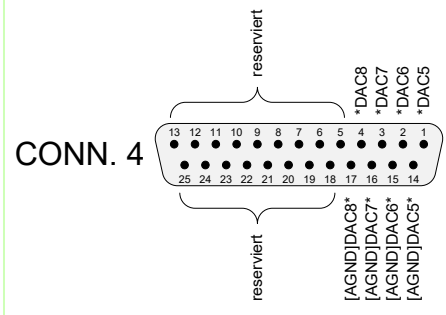
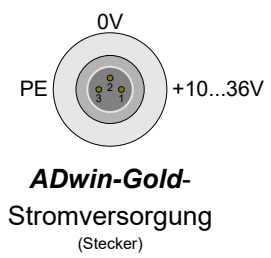
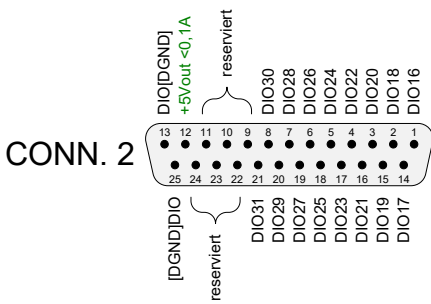
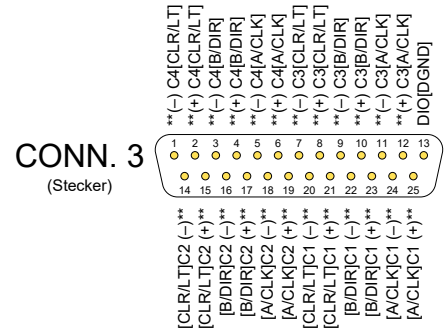
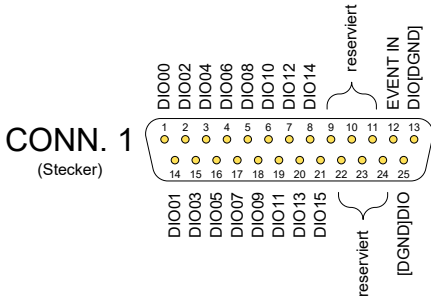

*mit DA-Erweiterung

**mit CO1-Erweiterung

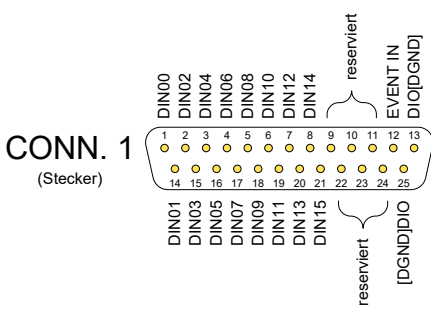

mit CONF_DIO(12)

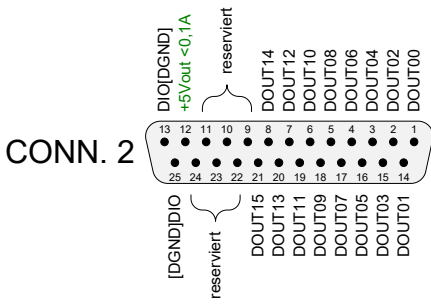

CONN. 1
(Stecker)

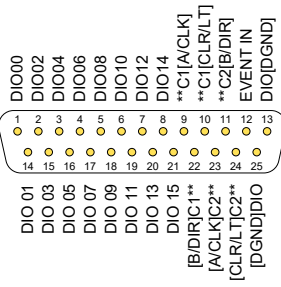

CONN. 3
(Stecker)

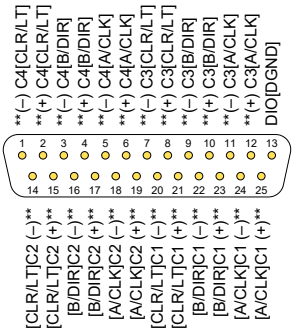

CONN. 2

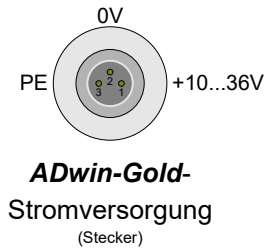
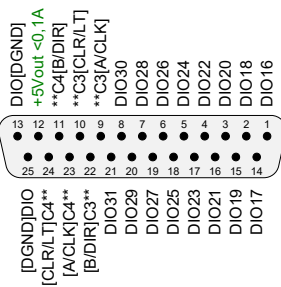

CONN. 4

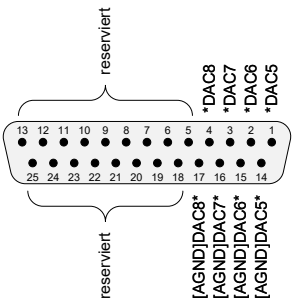

*mit DA-Erweiterung

**mit CO1-Erweiterung

CONN. 1
(Stecker)

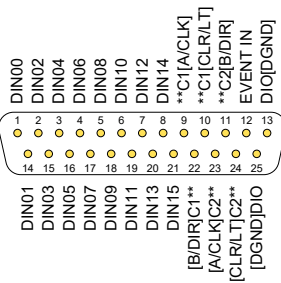

mit CONF_DIO(12)

CONN. 2

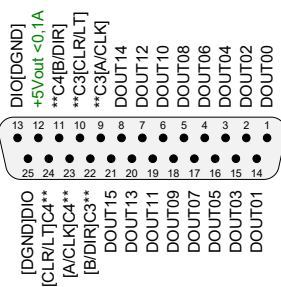

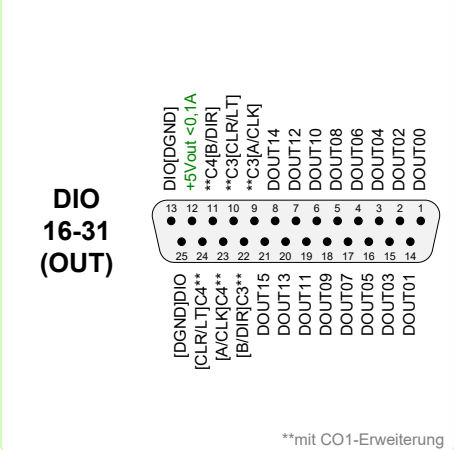
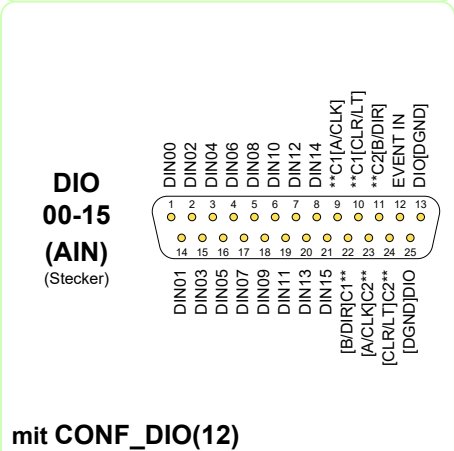
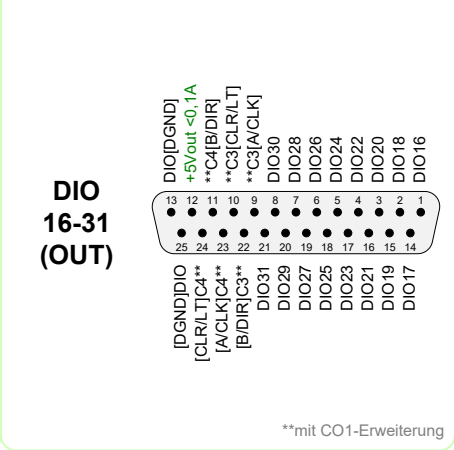
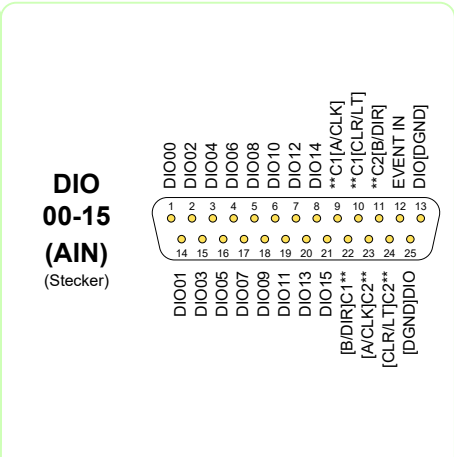
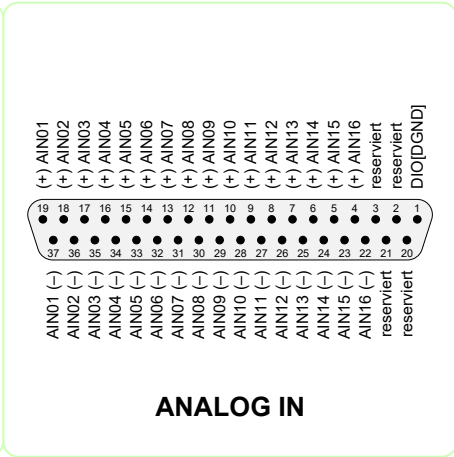
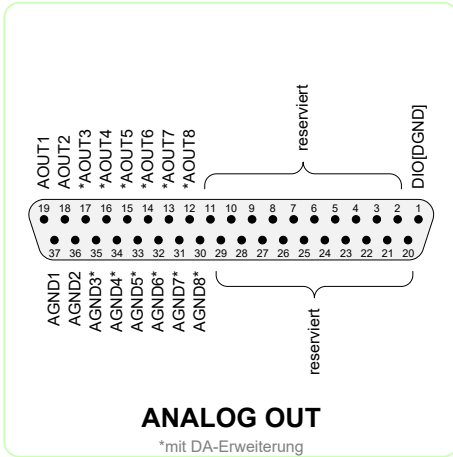

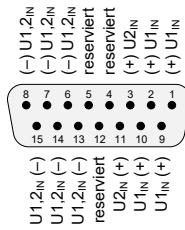

****CO POWER IN**

mit CO1-Erweiterung *mit CAN-Erweiterung

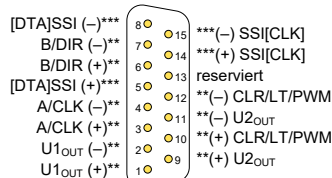

****CO1, ..., CO4**
(Stecker)

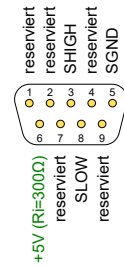

*****COM1, ***COM2**
(RS485) (Stecker)

***mit CAN-Erweiterung

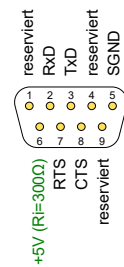

*****COM1, ***COM2**
(RS232) (Stecker)

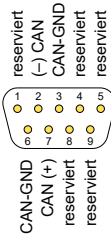

*****CAN 1.1 & ***CAN 2**
(Stecker)

***mit CAN-Erweiterung

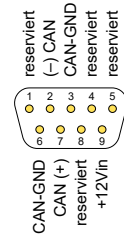

*****CAN-LS 1.1 & 2**
(Stecker)

***mit CAN-Erweiterung

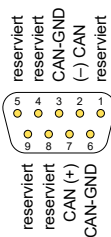

*****CAN 1.2**

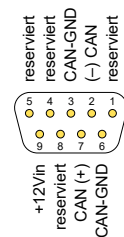

*****CAN LS 1.2**

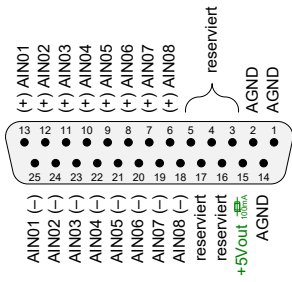

ANALOG IN (1-8)

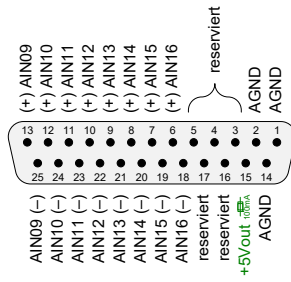

ANALOG IN (9-16)

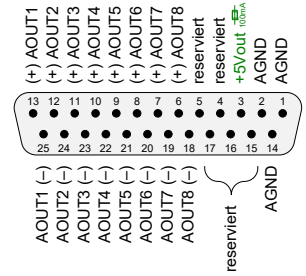

ANALOG OUT

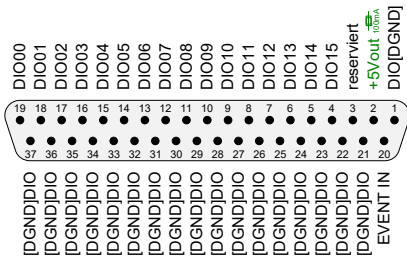

DIO 00-15 (IN)

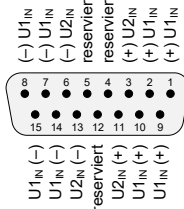

CO POWER IN

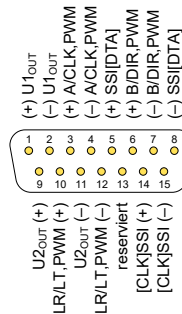

CO1, ..., CO4
(Stecker)

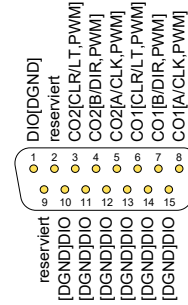

CO1&CO2 (TTL)
(Stecker)

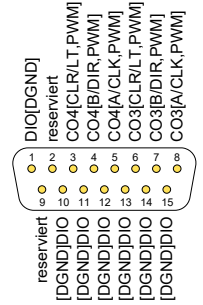

CO3&CO4 (TTL)
(Stecker)

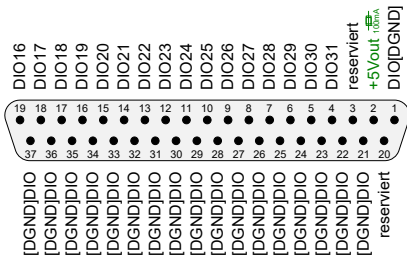

DIO 16-31 (OUT)

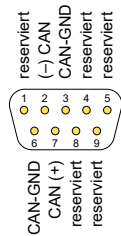

CAN 1&2
(Stecker)

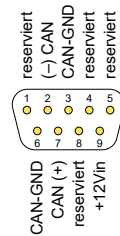

CAN-LS 1&2
(Stecker)

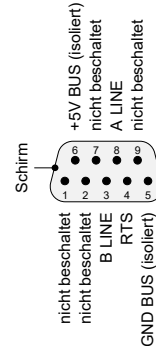

PROFIBUS DP-V1

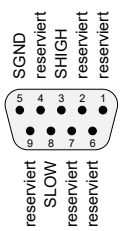

LS 1&2

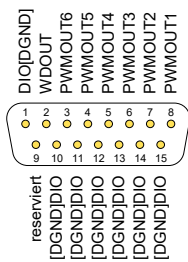

PWM1-6 (TTL)
(Stecker)

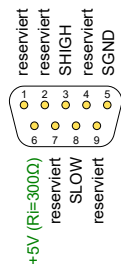

COM1, COM2
(RS485) (Stecker)

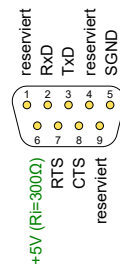

COM1, COM2
(RS232) (Stecker)

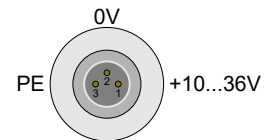

Stromversorgung
(Stecker)

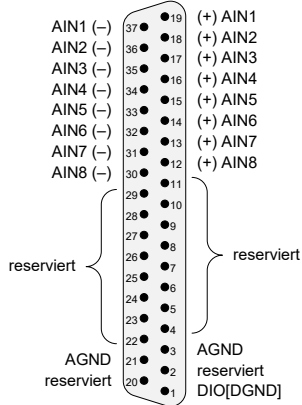

AIn-8/1x-D (mit x=2, 4, 6)

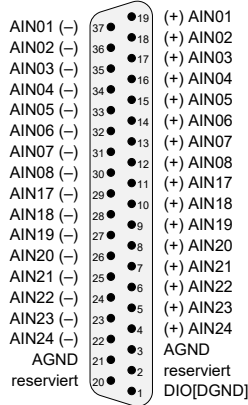

AIn-32/1x diff. (mit x=2, 4, 6)

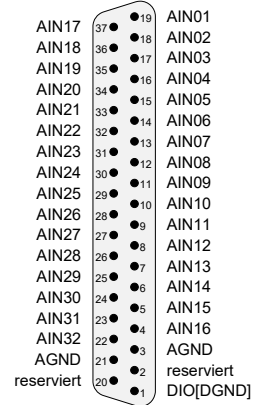

AIn-32/1x s.-e. (mit x=2, 4, 6)

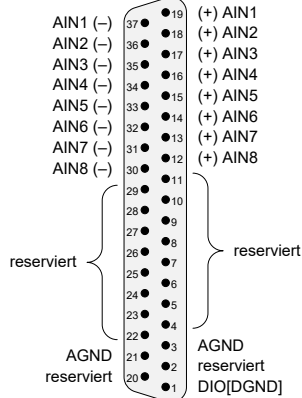

AIn-F-8/1x-D (mit x=2, 4, 6)

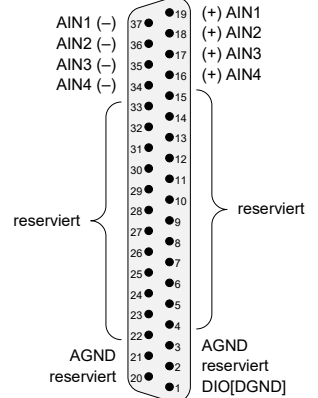

AIn-F-4/1x-D (mit x=2, 4, 6)

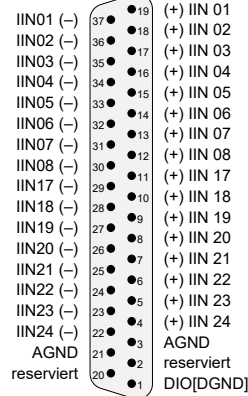

AIn-16/14-C

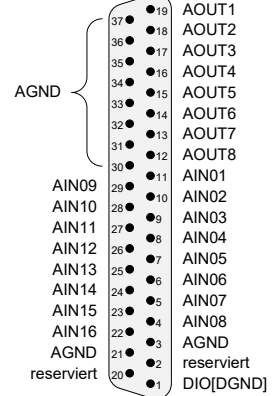

AO-16/8-12

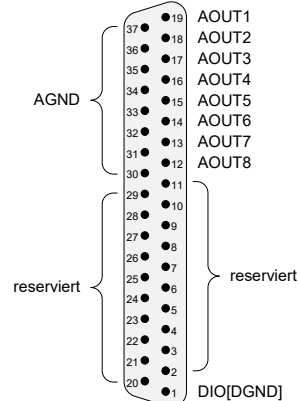

AOut-8/16-D

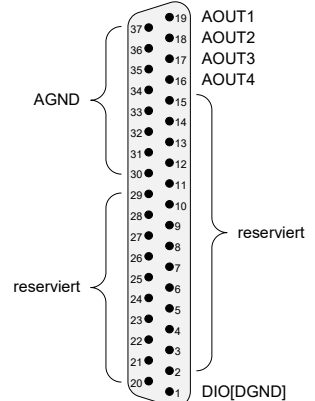

AOut-4/16-D

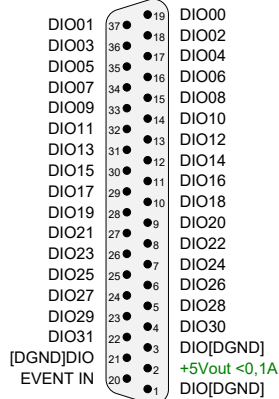

DIO-32, Rev. B

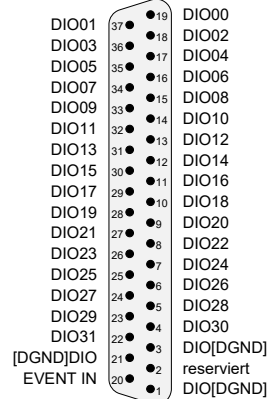

DIO-32, Rev. A

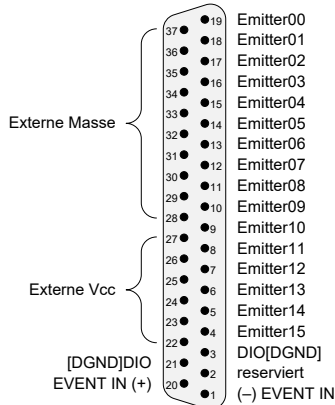

TRA-16

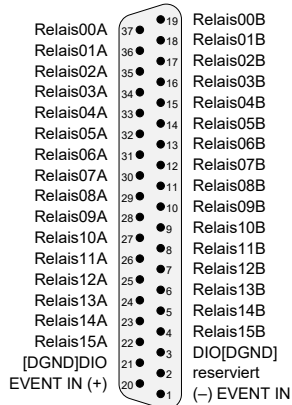

REL-16

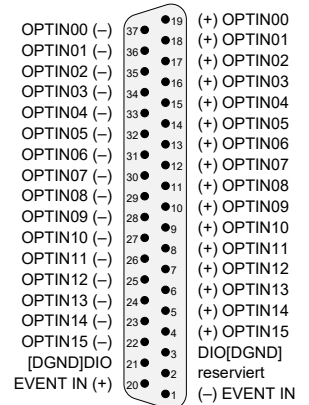

OPT-16

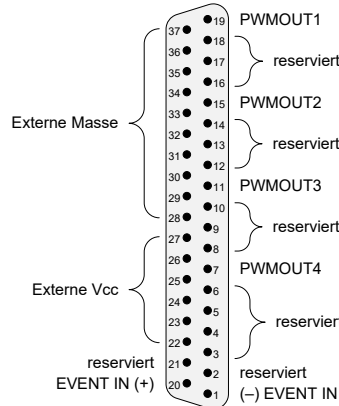

PWM4-I

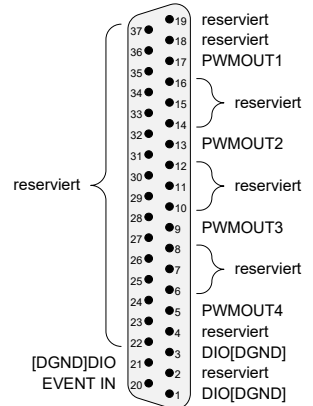

PWM4

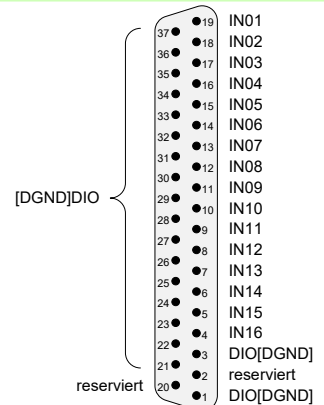

COMP-16

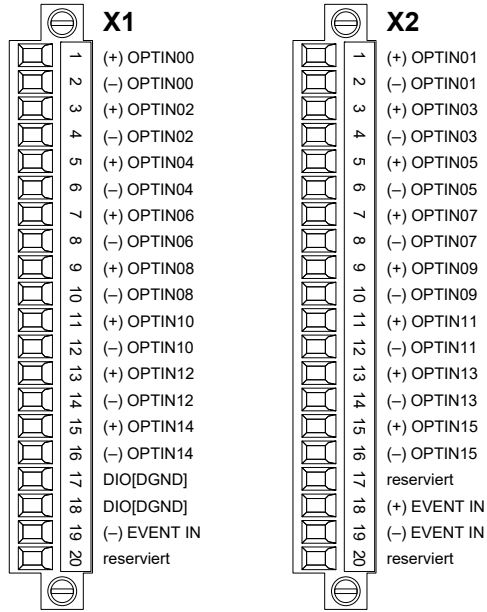

OPT-16

Einbaustecker: Phoenix, MCV 1,5/20-GF-3,5
 Gegenstecker: Phoenix, MC 1,5/20-STF-3,5

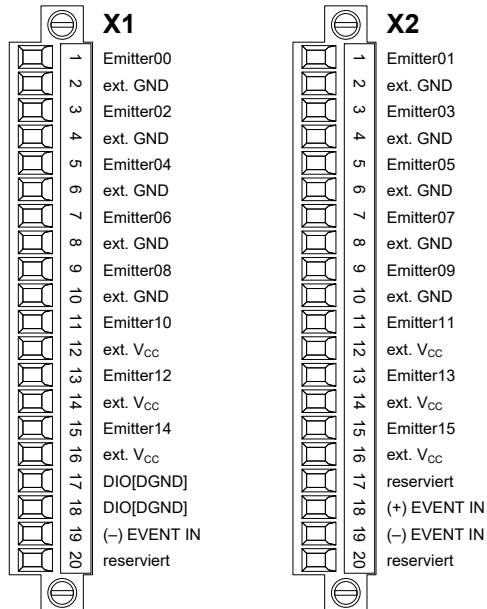

TRA-16

Einbaustecker: Phoenix, MCV 1,5/20-GF-3,5
 Gegenstecker: Phoenix, MC 1,5/20-STF-3,5

reserviert	37	●	19	reserviert
[A/CLK]C1 (-)	36	●	18	(+) C1[A/CLK]
[B/DIR]C1 (-)	35	●	17	(+) C1[B/DIR]
[CLR]C1 (-)	34	●	16	(+) C1[CLR]
reserviert	33	●	15	reserviert
[A/CLK]C2 (-)	32	●	14	(+) C2[A/CLK]
[B/DIR]C2 (-)	31	●	13	(+) C2[B/DIR]
[CLR]C2 (-)	30	●	12	(+) C2[CLR]
reserviert	29	●	11	reserviert
[A/CLK]C3 (-)	28	●	10	(+) C3[A/CLK]
[B/DIR]C3 (-)	27	●	9	(+) C3[B/DIR]
[CLR]C3 (-)	26	●	8	(+) C3[CLR]
reserviert	25	●	7	reserviert
[A/CLK]C4 (-)	24	●	6	(+) C4[A/CLK]
[B/DIR]C4 (-)	23	●	5	(+) C4[B/DIR]
[CLR]C4 (-)	22	●	4	(+) C4[CLR]
reserviert	21	●	3	reserviert
EVENT IN (+)	20	●	2	reserviert
			1	(-) EVENT IN

CNT-VR4-I

[DIR]C1	37	●	19	C1[CLR]
[B]C1	36	●	18	C1[CLK]
reserviert	35	●	17	C1[A]
reserviert	34	●	16	reserviert
[DIR]C2	33	●	15	C2[CLR]
[B]C2	32	●	14	C2[CLK]
reserviert	31	●	13	C2[A]
reserviert	30	●	12	reserviert
[DIR]C3	29	●	11	C3[CLR]
[B] C3	28	●	10	C3[CLK]
reserviert	27	●	9	C3[A]
reserviert	26	●	8	reserviert
[DIR]C4	25	●	7	C4[CLR]
[B]C4	24	●	6	C4[CLK]
reserviert	23	●	5	C4[A]
reserviert	22	●	4	reserviert
[DGND]DIO	21	●	3	DIO[DGND]
EVENT IN	20	●	2	+5Vout <0,1A
			1	DIO[DGND]

CNT-VR4

reserviert	37	●	19	reserviert
[A]C1 (-)	36	●	18	(+) C[A]
[B]C1 (-)	35	●	17	(+) C1[B]
[LT]C1 (-)	34	●	16	(+) C1[LT]
reserviert	33	●	15	reserviert
[A]C2 (-)	32	●	14	(+) C2[A]
[B]C2 (-)	31	●	13	(+) C2[B]
[LT]C2 (-)	30	●	12	(+) C2[LT]
reserviert	29	●	11	reserviert
[A]C3 (-)	28	●	10	(+) C3[A]
[B]C3 (-)	27	●	9	(+) C3[B]
[LT]C3 (-)	26	●	8	(+) C3[LT]
reserviert	25	●	7	reserviert
[A]C4 (-)	24	●	6	(+) C4[A]
[B]C4 (-)	23	●	5	(+) C4[B]
[LT]C4 (-)	22	●	4	(+) C4[LT]
reserviert	21	●	3	reserviert
EVENT IN (+)	20	●	2	reserviert
			1	(-) EVENT IN

CNT-VR4-L-I

reserviert	37	●	19	C1[LT]
[B]C1	36	●	18	reserviert
reserviert	35	●	17	C1[A]
reserviert	34	●	16	reserviert
reserviert	33	●	15	C2[LT]
reserviert	32	●	14	reserviert
reserviert	31	●	13	C2[A]
reserviert	30	●	12	reserviert
reserviert	29	●	11	C3[LT]
reserviert	28	●	10	reserviert
reserviert	27	●	9	C3[A]
reserviert	26	●	8	reserviert
reserviert	25	●	7	C4[LT]
reserviert	24	●	6	reserviert
reserviert	23	●	5	C4[A]
reserviert	22	●	4	reserviert
[DGND]DIO	21	●	3	DIO[DGND]
EVENT IN	20	●	2	+5Vout <0,1A
			1	DIO[DGND]

CNT-VR4-L

[CLK]C01 (-)	37	●	19	(+) C01[CLK]
[CLK]C05 (-)	36	●	18	(+) C05[CLK]
[CLK]C09 (-)	35	●	17	(+) C09[CLK]
[CLK]C13 (-)	34	●	16	(+) C13[CLK]
[CLK]C02 (-)	33	●	15	(+) C02[CLK]
[CLK]C06 (-)	32	●	14	(+) C06[CLK]
[CLK]C10 (-)	31	●	13	(+) C10[CLK]
[CLK]C14 (-)	30	●	12	(+) C14[CLK]
[CLK]C03 (-)	29	●	11	(+) C03[CLK]
[CLK]C07 (-)	28	●	10	(+) C07[CLK]
[CLK]C11 (-)	27	●	9	(+) C11[CLK]
[CLK]C15 (-)	26	●	8	(+) C15[CLK]
[CLK]C04 (-)	25	●	7	(+) C04[CLK]
[CLK]C08 (-)	24	●	6	(+) C08[CLK]
[CLK]C12 (-)	23	●	5	(+) C12[CLK]
[CLK]C16 (-)	22	●	4	(+) C16[CLK]
reserviert	21	●	3	reserviert
EVENT IN (+)	20	●	2	reserviert
			1	(-) EVENT IN

CNT-16/16-I

[CLK]C09	37	●	19	reserviert
[CLK]C13	36	●	18	C01[CLK]
reserviert	35	●	17	C05[CLK]
reserviert	34	●	16	reserviert
reserviert	33	●	15	reserviert
[CLK]C10	32	●	14	C02[CLK]
[CLK]C14	31	●	13	C06[CLK]
reserviert	30	●	12	reserviert
reserviert	29	●	11	reserviert
[CLK]C11	28	●	10	C03[CLK]
[CLK]C15	27	●	9	C07[CLK]
reserviert	26	●	8	reserviert
reserviert	25	●	7	reserviert
[CLK]C12	24	●	6	C04[CLK]
[CLK]C16	23	●	5	C08[CLK]
reserviert	22	●	4	reserviert
[DGND]DIO	21	●	3	DIO[DGND]
EVENT IN	20	●	2	+5Vout <0,1A
			1	DIO[DGND]

CNT-16/16

reserviert	37	●	19	reserviert
reserviert	36	●	18	C1[CLK]
reserviert	35	●	17	C5[CLK]
reserviert	34	●	16	reserviert
reserviert	33	●	15	reserviert
reserviert	32	●	14	C2[CLK]
reserviert	31	●	13	C6[CLK]
reserviert	30	●	12	reserviert
[LT]C3	29	●	11	reserviert
reserviert	28	●	10	reserviert
reserviert	27	●	9	C7[LT]
reserviert	26	●	8	reserviert
reserviert	25	●	7	reserviert
[LT]C4	24	●	6	C8[LT]
reserviert	23	●	5	reserviert
reserviert	22	●	4	reserviert
[DGND]DIO	21	●	3	DIO[DGND]
EVENT IN	20	●	2	+5Vout <0,1A
			1	DIO[DGND]

CNT-8/32-L

[CLK]C1 (-)	37	●	19	(+) C1[CLK]
[CLK]C5 (-)	36	●	18	(+) C5[CLK]
reserviert	35	●	17	reserviert
reserviert	34	●	16	reserviert
[CLK]C2 (-)	33	●	15	(+) C2[CLK]
[CLK]C6 (-)	32	●	14	(+) C6[CLK]
reserviert	31	●	13	reserviert
reserviert	30	●	12	reserviert
[CLK]C3 (-)	29	●	11	(+) C3[CLK]
[CLK]C7 (-)	28	●	10	(+) C7[CLK]
reserviert	27	●	9	reserviert
reserviert	26	●	8	reserviert
[CLK]C4 (-)	25	●	7	(+) C4[CLK]
[CLK]C8 (-)	24	●	6	(+) C8[CLK]
reserviert	23	●	5	reserviert
reserviert	22	●	4	reserviert
EVENT IN (+)	21	●	3	reserviert
	20	●	2	(-) EVENT IN
			1	

CNT-8/32-I

reserviert	37	●	19	reserviert
reserviert	36	●	18	C1[CLK]
reserviert	35	●	17	C5[CLK]
reserviert	34	●	16	reserviert
reserviert	33	●	15	reserviert
reserviert	32	●	14	C2[CLK]
reserviert	31	●	13	C6[CLK]
reserviert	30	●	12	reserviert
reserviert	29	●	11	reserviert
reserviert	28	●	10	C3[CLK]
reserviert	27	●	9	C7[CLK]
reserviert	26	●	8	reserviert
reserviert	25	●	7	reserviert
reserviert	24	●	6	C4[CLK]
reserviert	23	●	5	C8[CLK]
reserviert	22	●	4	reserviert
[DGND]DIO	21	●	3	DIO[DGND]
EVENT IN	20	●	2	+5Vout <0,1A
			1	DIO[DGND]

CNT-8/32

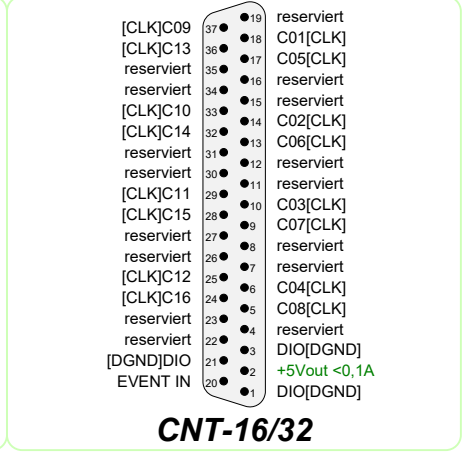
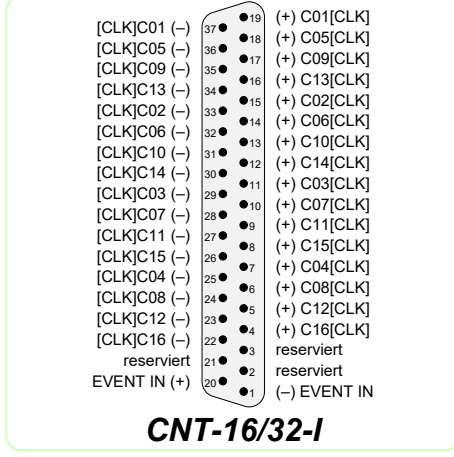
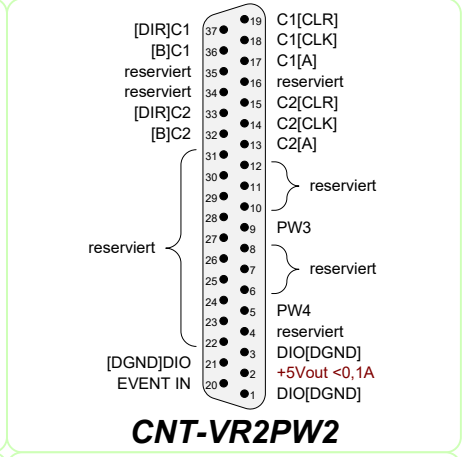
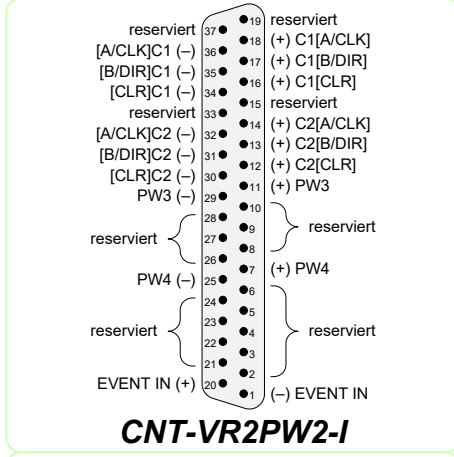
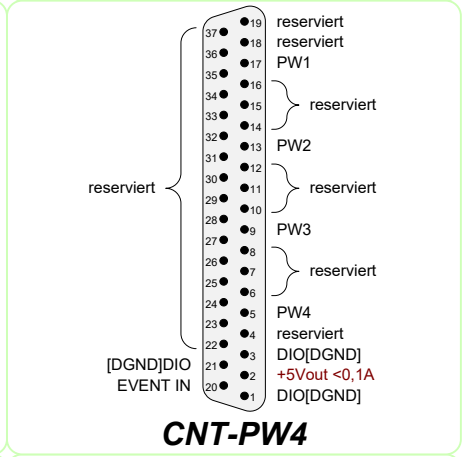
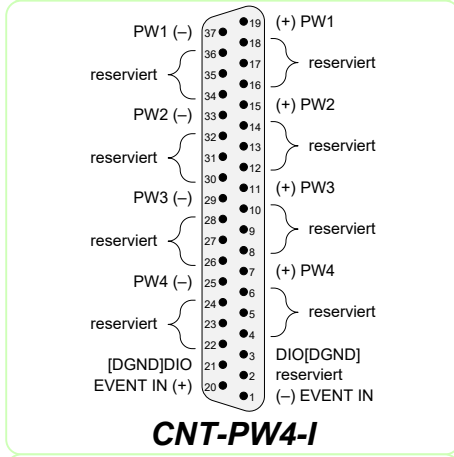
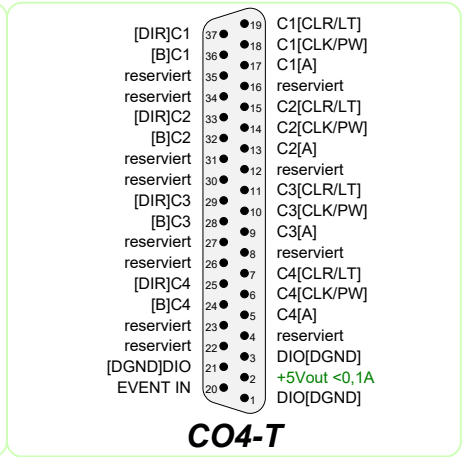
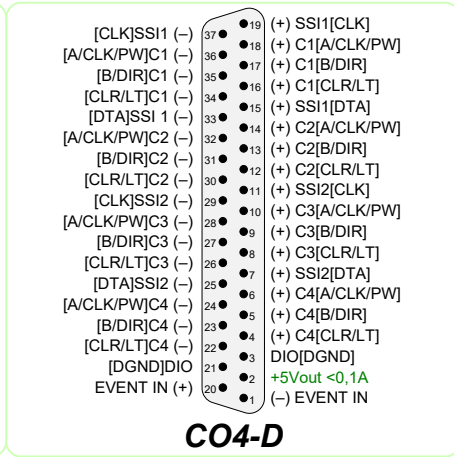
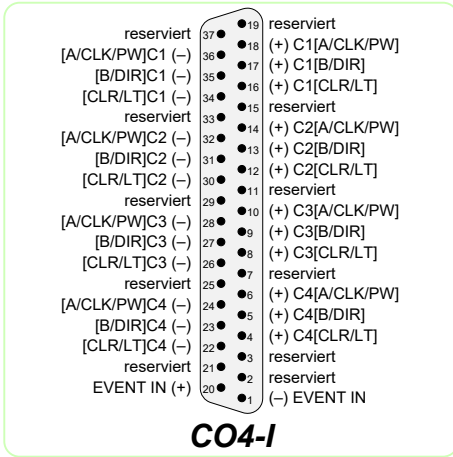

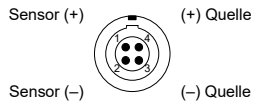

PT100

passender Kabel-Stecker:
LEMO, Serie B, Typ FGG

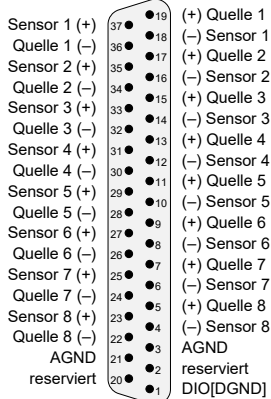

PT100-8-D

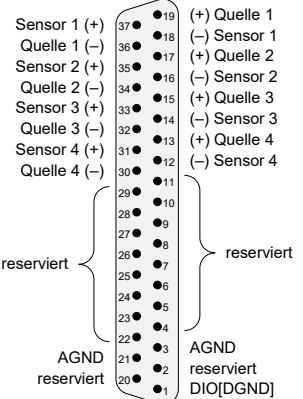

PT100-4-D

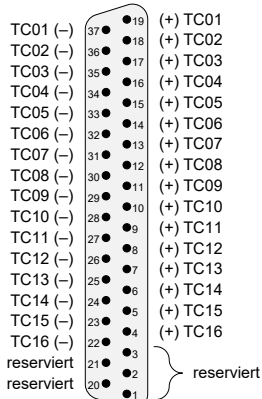

TC-16-J(K)-D

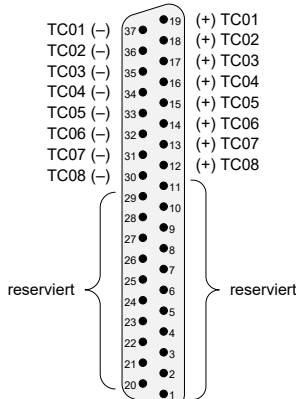

TC-8-J(K)-D

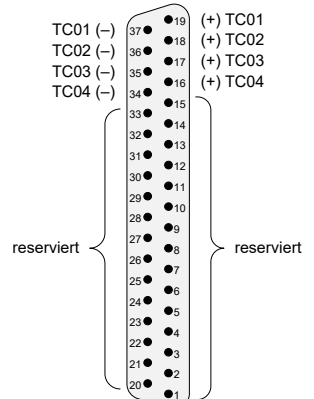

TC-4-J(K)-D

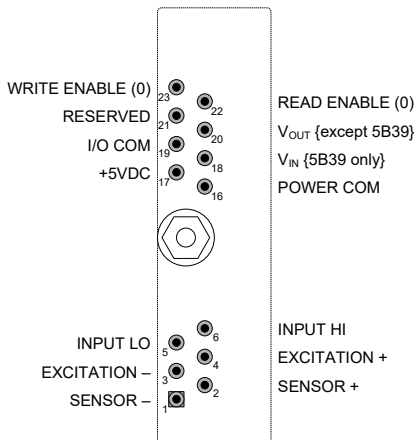

5B Modul-Sockel
(Standardbezeichnung)

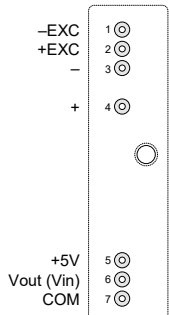

8B Modul-Sockel
(Standardbezeichnung)

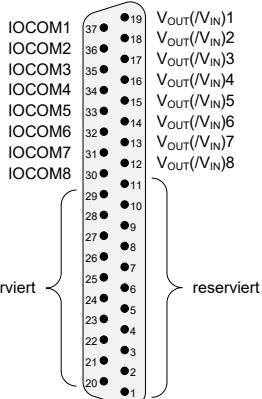

MB-8-?D Modul-Ausgang

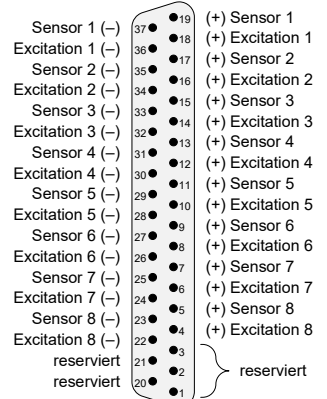

MB-8-D? Modul-Eingang

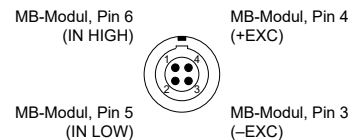

MB-8-L?

passender Kabel-Stecker:
LEMO, Serie B, Typ FGG



RS-485
(Stecker)

RS485-Legende:
SHIGH - Signal High
SGND - Signal Ground
SLOW - Signal Low

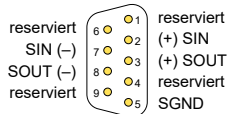

RS-422
(Stecker)

RS422-Legende:
SIN - Signal In
SOUT - Signal Out
SGND - Signal Ground



RS-232
(Stecker)

RS232-Legende:
DCD - Data Carrier Detect
RxD - Receive Data
TxD - Transmit Data
DTR - Data Terminal Ready
SGND - Signal Ground
DSR - Data Set Ready
RTS - Request To Send
CTS - Clear To Send
RI - Ring Indicator

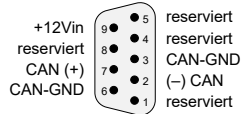

CAN-LS



CAN-LS
(Stecker)

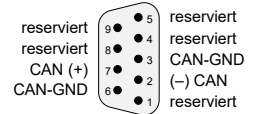

CAN

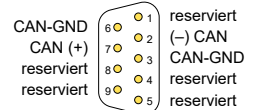

CAN
(Stecker)

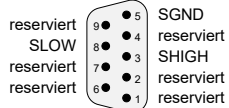

LS-2

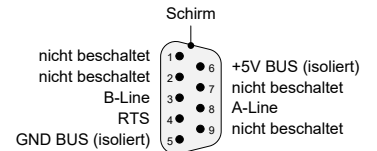

PROFI-DP-SL

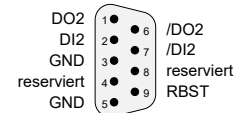

INTER-SL
(BUS-OUT)

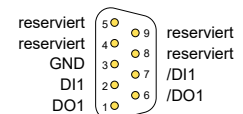

INTER-SL
(BUS-IN, Stecker)

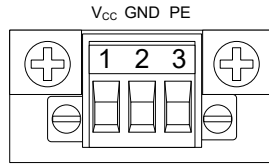

Pro-Mini (Stromversorgung)

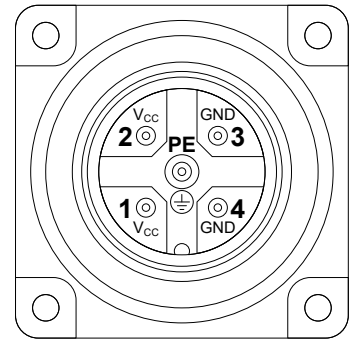

Pro-DC-Stecker (Stromversorgung)

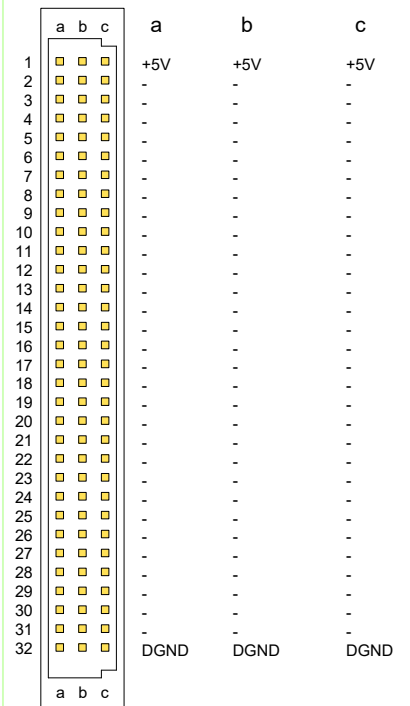

ADwin-Pro, VG96
(Backplane)

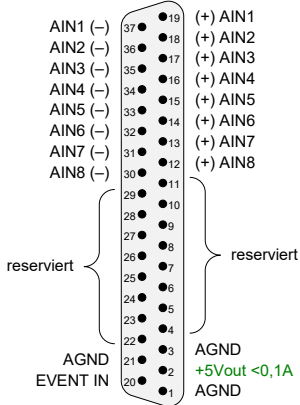

AIn-8/18

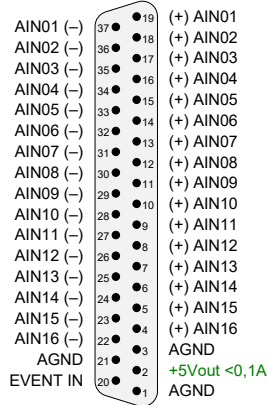

AIn-32/18 diff.

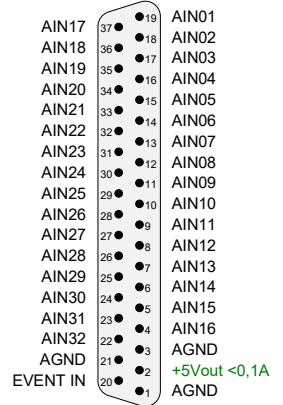

AIn-32/18 s.e.

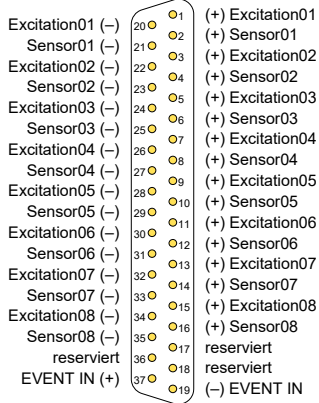

AIn-16/18-8B (8B 1...8, Stecker)

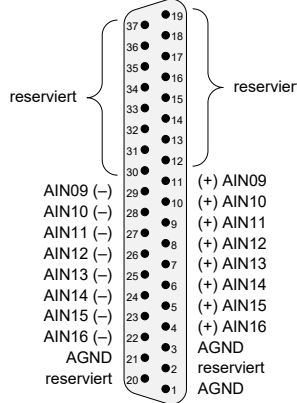

AIn-16/18-8B (AIN 9...16 diff.)

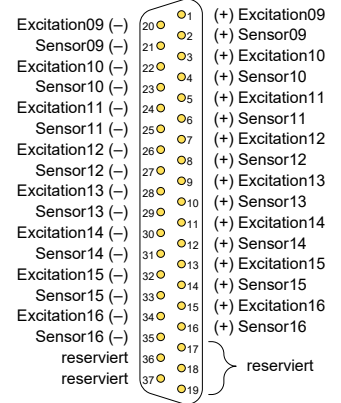

AIn-16/18-8B (8B 9...16, Stecker)

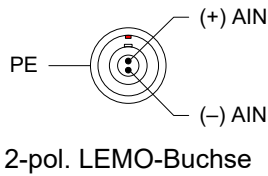

2-pol. LEMO-Buchse

passender Kabel-Stecker:
LEMO, Serie 00, 2-polig, Typ FGG

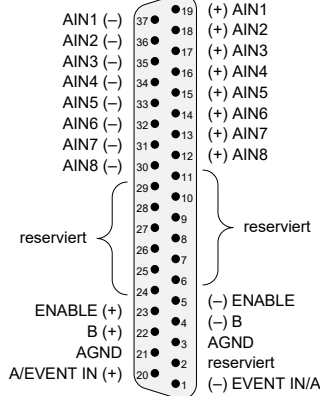

AIn-F-8/1x-D (mit x=4, 6)

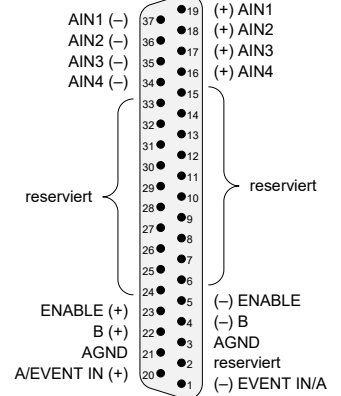

AIn-F-4/1x-D (mit x=4, 6)

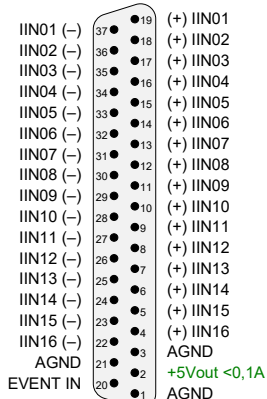

AIn-16/18-C

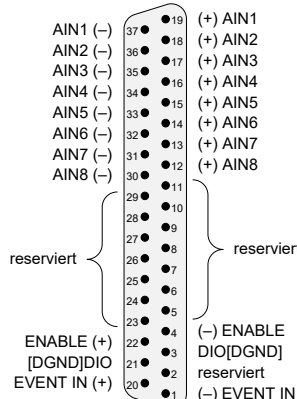

AIn-F-8/18-D

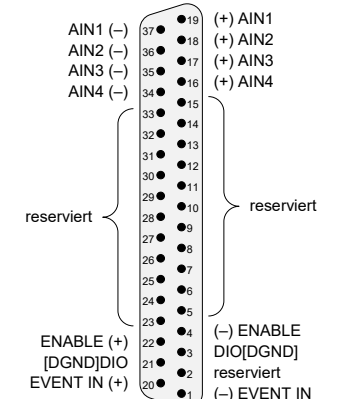

AIn-F-4/18-D

reserviert	37 ●	19	(+) Quelle1
Quelle1 (-)	36 ●	18	reserviert
reserviert	35 ●	17	(+) Quelle2
Quelle2 (-)	34 ●	16	reserviert
reserviert	33 ●	15	(+) Quelle3
Quelle3 (-)	32 ●	14	reserviert
reserviert	31 ●	13	(+) Quelle4
Quelle4 (-)	30 ●	12	reserviert
reserviert	29 ●	11	(+) Quelle5
Quelle5 (-)	28 ●	10	reserviert
reserviert	27 ●	9	(+) Quelle6
Quelle6 (-)	26 ●	8	reserviert
reserviert	25 ●	7	(+) Quelle7
Quelle7 (-)	24 ●	6	reserviert
reserviert	23 ●	5	(+) Quelle8
Quelle8 (-)	22 ●	4	reserviert
reserviert	21 ●	3	reserviert
reserviert	20 ●	2	DIO[DGND]
		1	

RTD-8-D, 2 wire

reserviert	37 ●	19	(+) Quelle1
Quelle1 (-)	36 ●	18	(-) Sensor1
reserviert	35 ●	17	(+) Quelle2
Quelle2 (-)	34 ●	16	(-) Sensor2
reserviert	33 ●	15	(+) Quelle3
Quelle3 (-)	32 ●	14	(-) Sensor3
reserviert	31 ●	13	(+) Quelle4
Quelle4 (-)	30 ●	12	(-) Sensor4
reserviert	29 ●	11	(+) Quelle5
Quelle5 (-)	28 ●	10	(-) Sensor5
reserviert	27 ●	9	(+) Quelle6
Quelle6 (-)	26 ●	8	(-) Sensor6
reserviert	25 ●	7	(+) Quelle7
Quelle7 (-)	24 ●	6	(-) Sensor7
reserviert	23 ●	5	(+) Quelle8
Quelle8 (-)	22 ●	4	(-) Sensor8
reserviert	21 ●	3	reserviert
reserviert	20 ●	2	reserviert
reserviert		1	DIO[DGND]

RTD-8-D, 3 wire

Sensor1 (+)	37 ●	19	(+) Quelle1
Quelle1 (-)	36 ●	18	(-) Sensor1
Sensor2 (+)	35 ●	17	(+) Quelle2
Quelle2 (-)	34 ●	16	(-) Sensor2
Sensor3 (+)	33 ●	15	(+) Quelle3
Quelle3 (-)	32 ●	14	(-) Sensor3
Sensor4 (+)	31 ●	13	(+) Quelle4
Quelle4 (-)	30 ●	12	(-) Sensor4
Sensor5 (+)	29 ●	11	(+) Quelle5
Quelle5 (-)	28 ●	10	(-) Sensor5
Sensor6 (+)	27 ●	9	(+) Quelle6
Quelle6 (-)	26 ●	8	(-) Sensor6
Sensor7 (+)	25 ●	7	(+) Quelle7
Quelle7 (-)	24 ●	6	(-) Sensor7
Sensor8 (+)	23 ●	5	(+) Quelle8
Quelle8 (-)	22 ●	4	(-) Sensor8
reserviert	21 ●	3	reserviert
reserviert	20 ●	2	reserviert
reserviert		1	DIO[DGND]

RTD-8-D, 4 wire

B1 (-)	37 ●	19	(+) B1
SX1 (+)	36 ●	18	(+) EX1
SX1 (-)	35 ●	17	QB1
AGND	34 ●	16	(-) EX1
B2 (-)	33 ●	15	(+) B2
SX2 (+)	32 ●	14	(+) EX2
SX2 (-)	31 ●	13	QB2
AGND	30 ●	12	(-) EX2
B3 (-)	29 ●	11	(+) B3
SX3 (+)	28 ●	10	(+) EX3
SX3 (-)	27 ●	9	QB3
AGND	26 ●	8	(-) EX3
B4 (-)	25 ●	7	(+) B4
SX4 (+)	24 ●	6	(+) EX4
SX4 (-)	23 ●	5	QB4
AGND	22 ●	4	(-) EX4
AGND	21 ●	3	AGND
AGND	20 ●	2	NC
NC		1	Vcc Out

B1 (-)	37 ●	19	(+) B1
SX1 (+)	36 ●	18	(+) EX1
SX1 (-)	35 ●	17	(-) EX1
AGND	34 ●	16	(+) AIN13
B2 (-)	33 ●	15	(+) B2
SX2 (+)	32 ●	14	(+) EX2
SX2 (-)	31 ●	13	(-) EX2
AGND	30 ●	12	(-) AIN13
B3 (-)	29 ●	11	(+) B3
SX3 (+)	28 ●	10	(+) EX3
SX3 (-)	27 ●	9	(-) EX3
AGND	26 ●	8	(+) AIN14
B4 (-)	25 ●	7	(+) B4
SX4 (+)	24 ●	6	(+) EX4
SX4 (-)	23 ●	5	(-) EX4
AGND	22 ●	4	(-) AIN14
AGND	21 ●	3	AGND
AGND	20 ●	2	Vcc (+5V)
NC		1	DIO[DGND]

SG-4/18

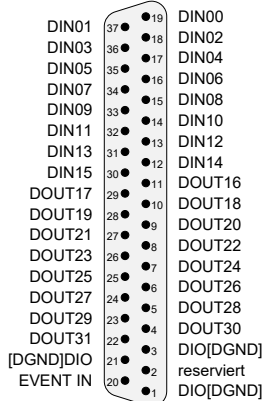

AOut-1/16

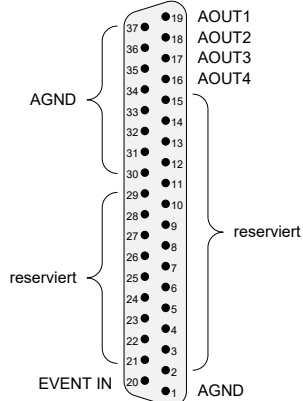

AOut-4/16-D

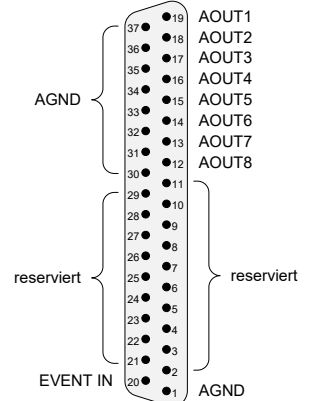

AOut-8/16-D

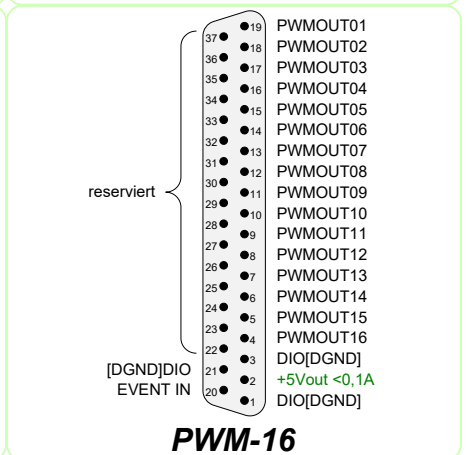
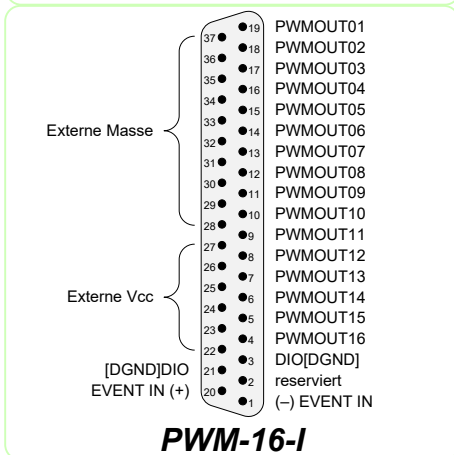
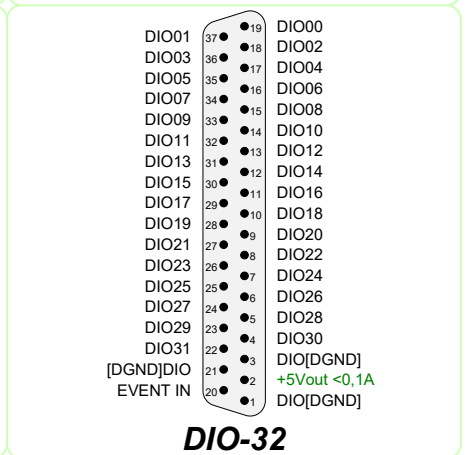
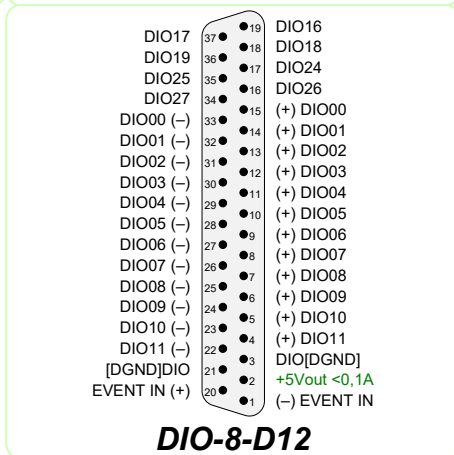
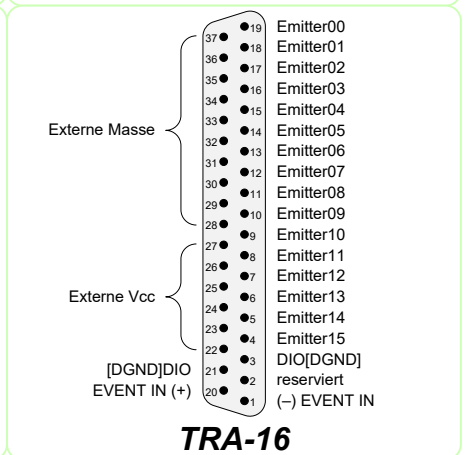
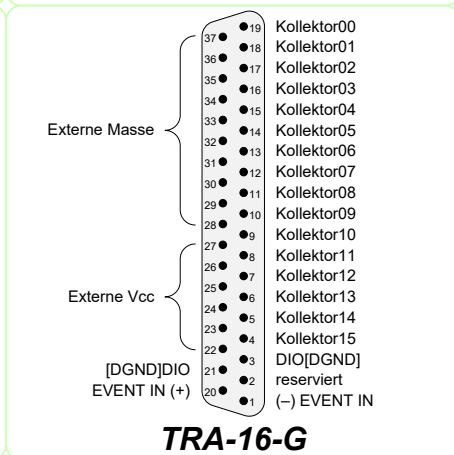
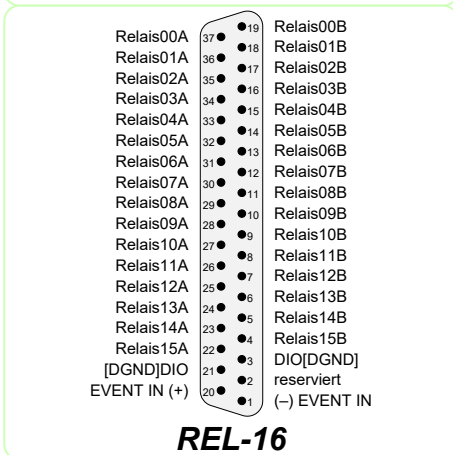
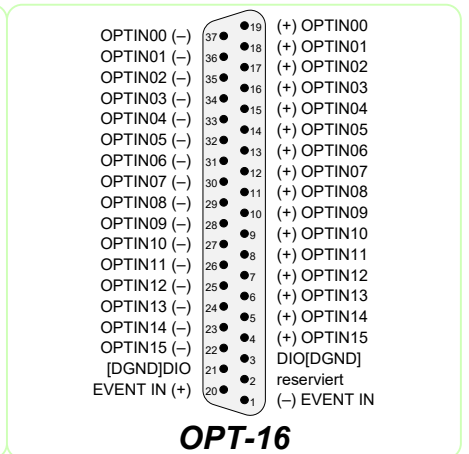
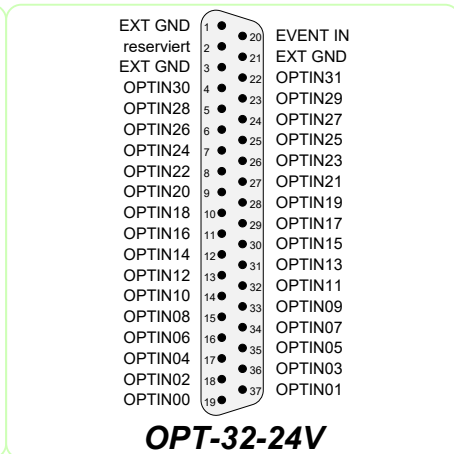
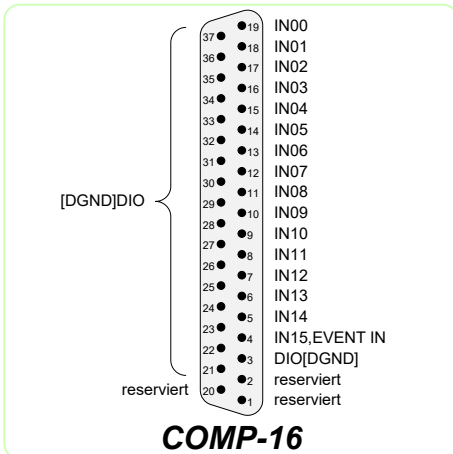

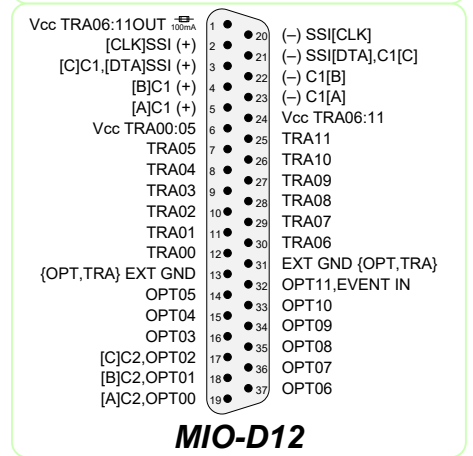
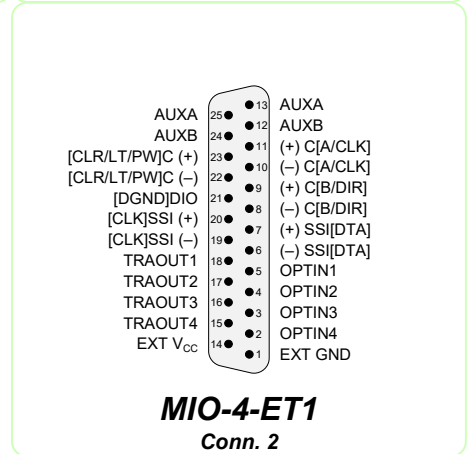
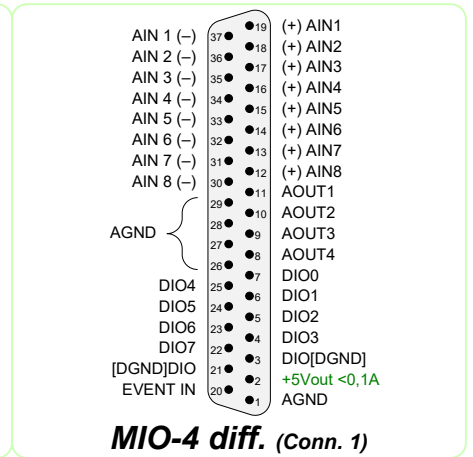
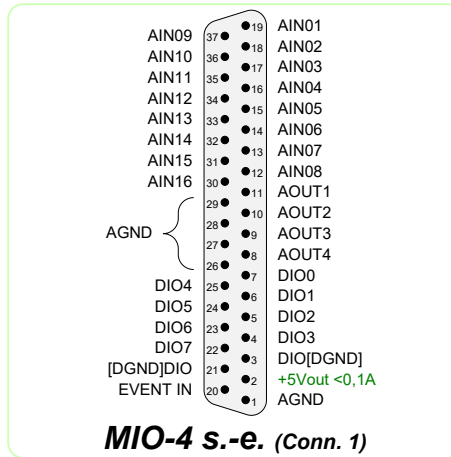

ADwin-Pro II - Zähler-Module

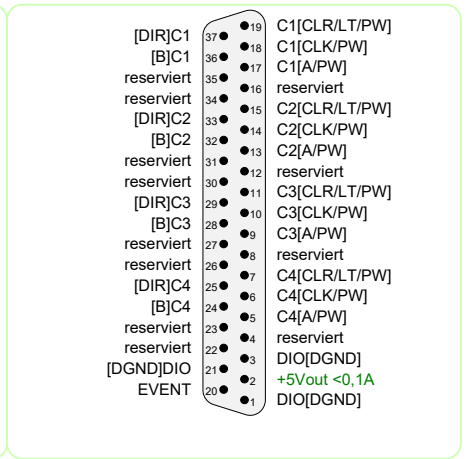
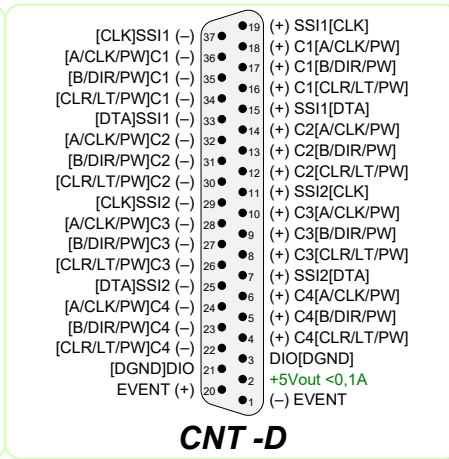
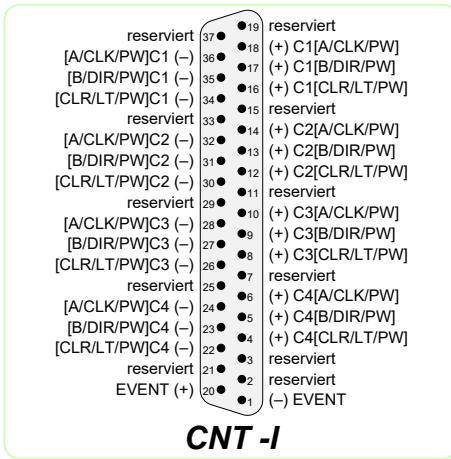

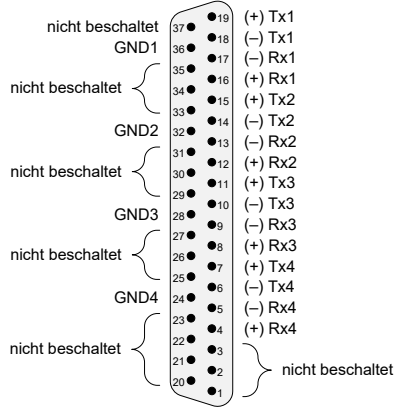

RS422-4



RS-485
(Stecker)

RS485-Legende:
 SHIGH - Signal HIGH
 SGND - Signal Ground
 SLOW - Signal LOW

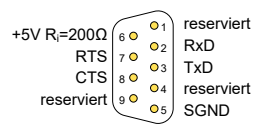

RS-232
(Stecker)

RS232-Legende:
 RxD - Receive Data
 TxD - Transmit Data
 SGND - Signal Ground
 RTS - Request To Send
 CTS - Clear To Send

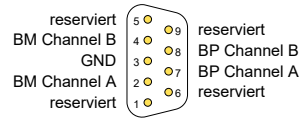

FlexRay
(Stecker)

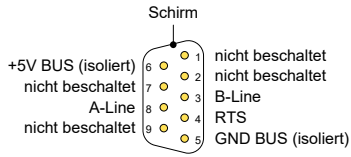

PROFI-SL
(Stecker)



LIN - 2
(Stecker)

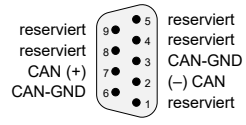
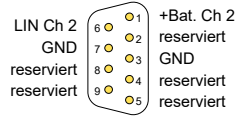

CAN

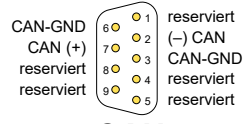

CAN
(Stecker)

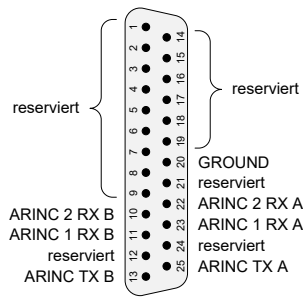

ARINC-429

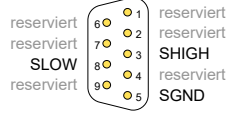

LS-Bus
(Stecker)

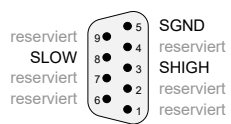

LS-Bus

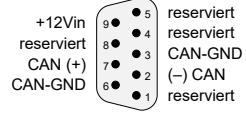

CAN-LS

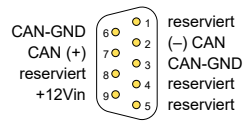

CAN-LS
(Stecker)

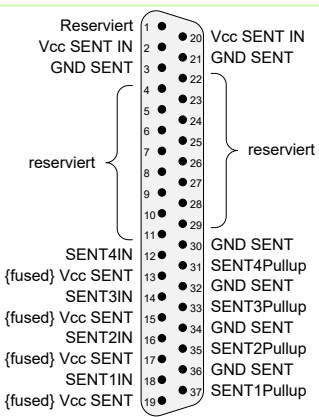

SENT-4

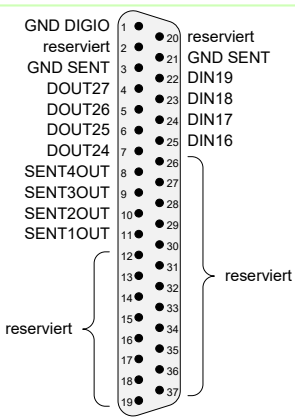

SENT-4-OUT

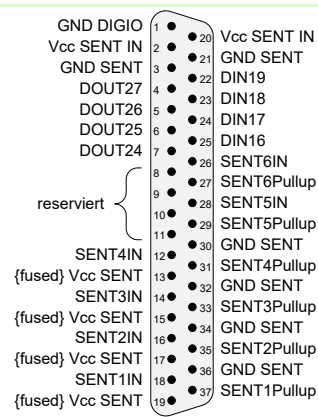

SENT-6

DIO17	37	19	DIO16
DIO19	36	18	DIO18
DIO25	35	17	DIO24
DIO27	34	16	DIO26
DIO00 (-)	33	15	(+) DIO00
DIO01 (-)	32	14	(+) DIO01
DIO02 (-)	31	13	(+) DIO02
DIO03 (-)	30	12	(+) DIO03
DIO04 (-)	29	11	(+) DIO04
DIO05 (-)	28	10	(+) DIO05
DIO06 (-)	27	9	(+) DIO06
DIO07 (-)	26	8	(+) DIO07
DIO08 (-)	25	7	(+) DIO08
DIO09 (-)	24	6	(+) DIO09
DIO10 (-)	23	5	(+) DIO10
DIO11 (-)	22	4	(+) DIO11
[DGND]DIO	21	3	DIO[DGND]
EVENT IN (+)	20	2	+5Vout <0,1A
		1	(-) EVENT IN

SPI-D: Digitale Kanäle

DIO01	37	19	DIO00
DIO03	36	18	DIO02
DIO05	35	17	DIO04
DIO07	34	16	DIO06
DIO09	33	15	DIO08
DIO11	32	14	DIO10
DIO13	31	13	DIO12
DIO15	30	12	DIO14
DIO17	29	11	DIO16
DIO19	28	10	DIO18
DIO21	27	9	DIO20
DIO23	26	8	DIO22
DIO25	25	7	DIO24
DIO27	24	6	DIO26
DIO29	23	5	DIO28
DIO31	22	4	DIO30
[DGND]DIO	21	3	DIO[DGND]
EVENT IN	20	2	+5Vout <0,1A
		1	DIO[DGND]

SPI-T: Digitale Kanäle

DIO17	37	19	DIO16
DIO19	36	18	DIO18
DIO25	35	17	DIO24
DIO27	34	16	DIO26
DIO00 (-)	33	15	(+) DIO00
DIO01 (-)	32	14	(+) DIO01
DIO02 (-)	31	13	(+) DIO02
DIO03 (-)	30	12	(+) DIO03
DIO04 (-)	29	11	(+) SL1[MISO]
[MISO]SL1 (-)	28	10	(+) SL2[MISO]
[MISO]SL2 (-)	27	9	(+) SL1[MCSI]
[MCSI]SL1 (-)	26	8	(+) SL1[SS]
[SS]SL1 (-)	25	7	(+) SL1[SCLK]
[SCLK]SL1 (-)	24	6	(+) SL2[MCSI]
[MCSI]SL2 (-)	23	5	(+) SL2[SS]
[SS]SL2 (-)	22	4	(+) SL2[SCLK]
[SCLK]SL2 (-)	21	3	DIO[DGND]
[DGND]DIO	20	2	+5Vout <0,1A
EVENT IN (+)		1	(-) EVENT IN

SPI-D: SL1 + SL2

DIO01	37	19	DIO00
DIO03	36	18	DIO02
DIO05	35	17	DIO04
DIO07	34	16	DIO06
DIO09	33	15	SL1[MCSI]
[SS]SL1	32	14	SL1[SCLK]
[MCSI]SL2	31	13	SL2[SS]
[SCLK]SL2	30	12	DIN14
DIN15	29	11	SL1[MISO]
reserviert	28	10	reserviert
reserviert	27	9	reserviert
reserviert	26	8	reserviert
reserviert	25	7	SL2[MISO]
reserviert	24	6	reserviert
reserviert	23	5	reserviert
reserviert	22	4	reserviert
reserviert	21	3	DIO[DGND]
[DGND]DIO	20	2	+5Vout <0,1A
EVENT IN		1	DIO[DGND]

SPI-T: SL1 + SL2

DIO17	37	19	DIO16
DIO19	36	18	DIO18
DIO25	35	17	DIO24
DIO27	34	16	DIO26
DIO00 (-)	33	15	(+) DIO00
DIO01 (-)	32	14	(+) DIO01
DIO02 (-)	31	13	(+) DIO02
DIO03 (-)	30	12	(+) DIO03
DIO04 (-)	29	11	(+) MS1[MOSI]
[MOSI]MS1 (-)	28	10	(+) SL2[MISO]
[MISO]SL2 (-)	27	9	(+) MS1[MISO]
[MISO]MS1 (-)	26	8	(+) MS1[SS]
[SS]MS1 (-)	25	7	(+) MS1[SCLK]
[SCLK]MS1 (-)	24	6	(+) SL2[MCSI]
[MCSI]SL2 (-)	23	5	(+) SL2[SS]
[SS]SL2 (-)	22	4	(+) SL2[SCLK]
[SCLK]SL2 (-)	21	3	DIO[DGND]
[DGND]DIO	20	2	+5Vout <0,1A
EVENT IN (+)		1	(-) EVENT IN

SPI-D: MS1 + SL2

DIO01	37	19	DIO00
DIO03	36	18	DIO02
DIO05	35	17	DIO04
DIO07	34	16	DIO06
DIO09	33	15	MS1[MISO]
DIN09	32	14	DIN10
[MCSI]SL2	31	13	SL2[SS]
[SCLK]SL2	30	12	DIN14
DIN15	29	11	MS1[MOSI]
[SS]MS1	28	10	MS1[SCLK]
DOUT19	27	9	DOUT20
DOUT21	26	8	DOUT22
DOUT23	25	7	SL2[MISO]
reserviert	24	6	reserviert
reserviert	23	5	reserviert
reserviert	22	4	reserviert
reserviert	21	3	DIO[DGND]
[DGND]DIO	20	2	+5Vout <0,1A
EVENT IN		1	DIO[DGND]

SPI-T: MS1 + SL2

DIO17	37	19	DIO16
DIO19	36	18	DIO18
DIO25	35	17	DIO24
DIO27	34	16	DIO26
DIO00 (-)	33	15	(+) DIO00
DIO01 (-)	32	14	(+) DIO01
DIO02 (-)	31	13	(+) DIO02
DIO03 (-)	30	12	(+) DIO03
DIO04 (-)	29	11	(+) MS1[MOSI]
[MOSI]MS1 (-)	28	10	(+) MS2[MOSI]
[MOSI]MS2 (-)	27	9	(+) MS1[MISO]
[MISO]MS1 (-)	26	8	(+) MS1[SS]
[SS]MS1 (-)	25	7	(+) MS1[SCLK]
[SCLK]MS1 (-)	24	6	(+) MS2[MISO]
[MISO]MS2 (-)	23	5	(+) MS2[SS]
[SS]MS2 (-)	22	4	(+) MS2[SCLK]
[SCLK]MS2 (-)	21	3	DIO[DGND]
[DGND]DIO	20	2	+5Vout <0,1A
EVENT IN (+)		1	(-) EVENT IN

SPI-D: MS1 + MS2

DIO01	37	19	DIO00
DIO03	36	18	DIO02
DIO05	35	17	DIO04
DIO07	34	16	DIO06
DIN9	33	15	MS1[MISO]
DIN13	32	14	DIN10
DIN15	31	13	DIN14
DIN15	30	12	MS1[MOSI]
[SS]MS1	29	11	MS1[SCLK]
DOUT19	28	10	DOUT20
DOUT21	27	9	DOUT22
DOUT23	26	8	MS2[MOSI]
[SS]MS2	25	7	MS2[SCLK]
DOUT27	24	6	DOUT28
DOUT29	23	5	DOUT30
DOUT31	22	4	DIO[DGND]
[DGND]DIO	21	3	+5Vout <0,1A
EVENT IN	20	2	DIO[DGND]

SPI-T: MS1 + MS2

1+2: +10V...+36V

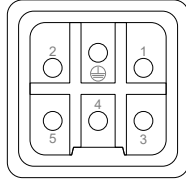

3+4+5: GND (0V)

Pro II-DC-Stecker
(Stromversorgung)

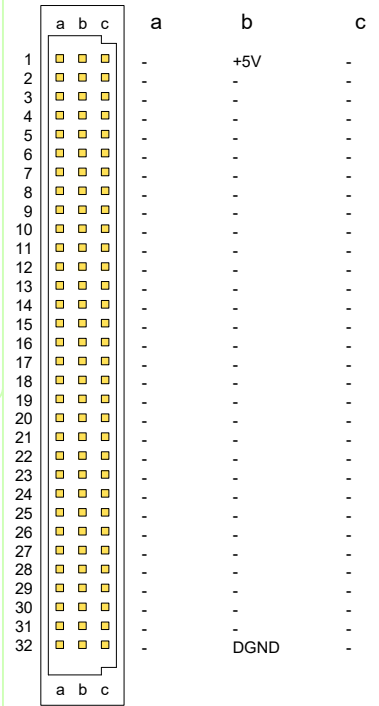

ADwin-Pro II, VG96
(Backplane)

Pro-AS-1 (4 Stk./Set)

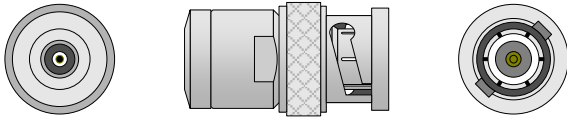

Pro-AS-2 (4 Stk./Set)

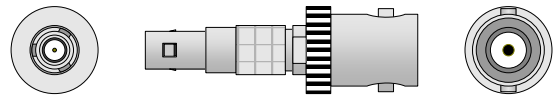

Pro-AS-3 (4 Stk./Set)

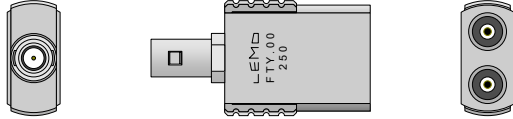

Pro-AS-4 (4 Stk./Set)



Pro-AS-5 (4 Stk./Set)

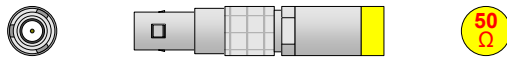

Pro-AS-6 (4 Stk./Set)

ca. 10cm / approx. 4"



Pro-AS-7 (4 Stk./Set)

ca. 100cm / approx. 3' 3"



Pro-AS-8 (4 Stk./Set)

ca. 200cm / approx. 6' 7"



Pro-AS-9 (4 Stk./Set)

ca. 100cm / approx. 3' 3"

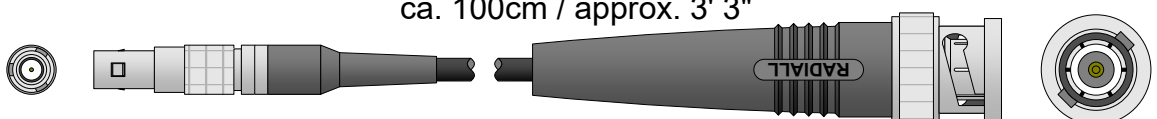

Pro-AS-10 (4 Stk./Set)

ca. 200cm / approx. 6' 7"

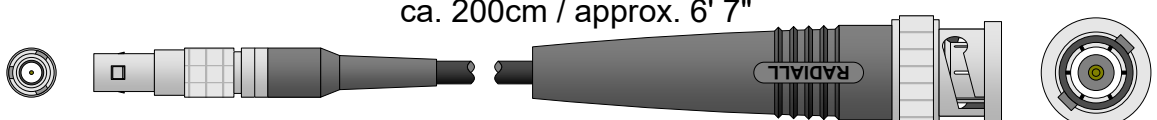

Kabel-Stecker **ADwin-Pro**: LEMO, Serie 00, Typ FGG
 Einbau-Buchse **ADwin-Pro**: LEMO, Serie 00, Typ ERN

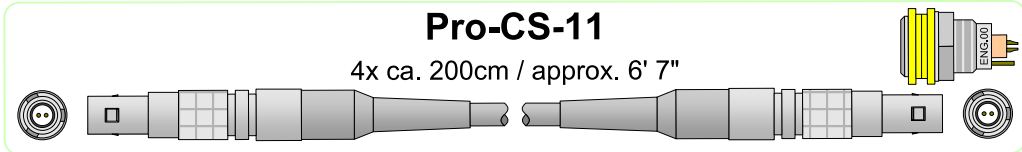
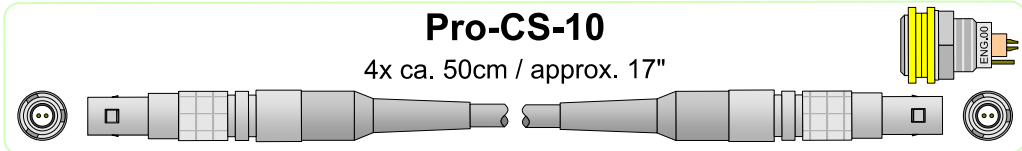
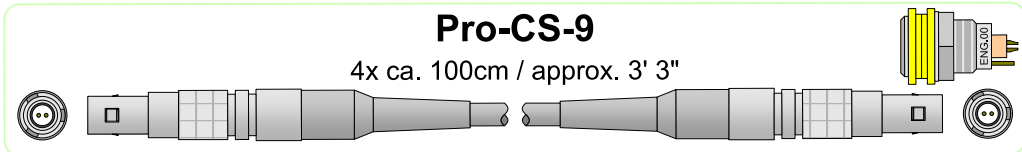
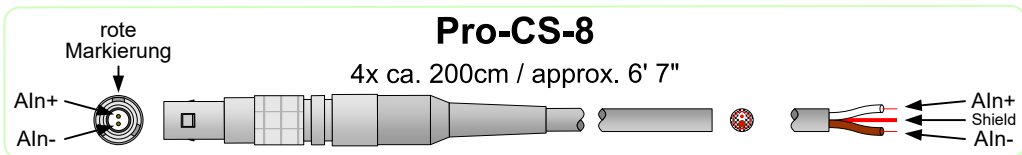
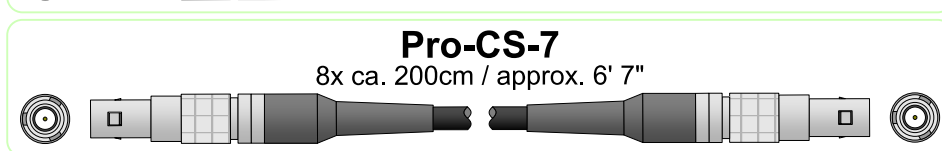
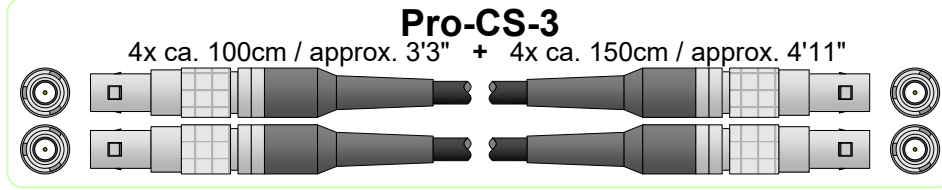
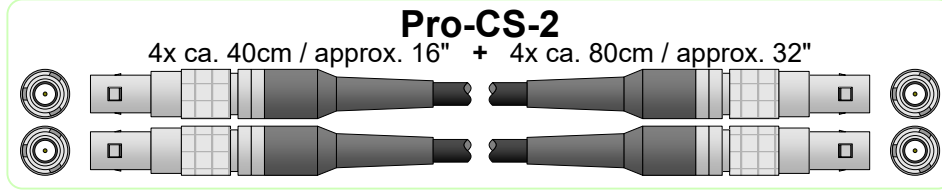
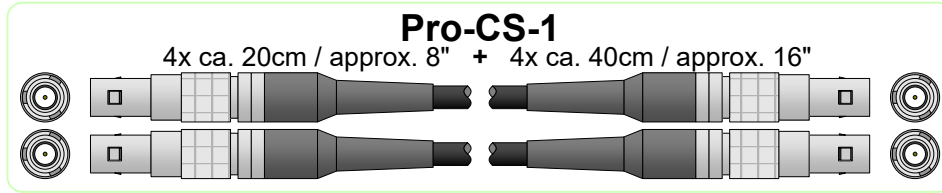

Kabel-Stecker **ADwin-Pro**: LEMO, Serie 00; 1-polig: Typ FFS (CS-1 ... CS-7), 2-polig: Typ FGG (CS-8 ... CS-11)
Einbau-Buchse **ADwin-Pro**: LEMO, Serie 00; 1-polig: Typ ERN (CS-1 ... CS-7), 2-polig: Typ ENG (CS-8 ... CS-11)

RS-232-C (Stecker)

- 13: Ring Indicator
- 12: Data Carrier Detect
- 11: Signal Ground
- 10: Data Set Ready
- 9: Clear To Send
- 8: Request To Send
- 7: Receive Data
- 6: Transmit Data
- 5: Protective Ground
- 4: Ring Indicator
- 3: Data Terminal Ready
- 2: Clear To Send
- 1: Request To Send

RS-232-C (Stecker)

- 5: Signal Ground
- 4: Data Terminal Ready
- 3: Transmit Data
- 2: Receive Data
- 1: Data Carrier Detect
- 9: Ring Indicator
- 8: Clear To Send
- 7: Request To Send
- 6: Data Set Ready

RS-232-C (Stecker)

- +5V - A62
- +5V - A61
- REQ 64-Bit - A60
- +V I/O - A59
- ADDR00 - A58
- ADDR02 - A57
- GND - A56
- ADDR04 - A55
- ADDR06 - A54
- +3.3V - A53
- C/BE 0 - A52
- B62 - +5V
- B61 - +5V
- B60 - ACK 64-Bit
- +V I/O - B59
- +5V I/O - B58
- B58 - ADDR01
- B57 - GND
- B56 - ADDR03
- B55 - ADDR05
- B54 - +3.3V
- B53 - ADDR07
- B52 - ADDR08
- B49 - GND
- B48 - ADDR10
- B47 - ADDR12
- B46 - GND
- B45 - ADDR14
- B44 - C/BE 1
- B43 - +3.3V
- B42 - System Error
- B41 - +3.3V
- B40 - Parity Error
- B39 - Lock
- B38 - GND
- B37 - Device Select
- B36 - +3.3V
- B35 - Initiator Ready
- B34 - GND
- B33 - C/BE 2
- B32 - ADDR17
- B31 - +3.3V
- B30 - ADDR19
- B29 - ADDR21
- B28 - GND
- B27 - ADDR23
- B26 - C/BE 3
- B25 - +3.3V
- B24 - ADDR25
- B23 - ADDR27
- B22 - GND
- B21 - ADDR29
- B20 - ADDR31
- B19 - +V I/O
- B18 - REQ
- B17 - GND
- B16 - CLK
- B15 - GND
- B14 - Reserved
- B11 - PRSNT2#
- B10 - Reserved
- B09 - PRSNT1#
- B08 - INT D
- B07 - INT B
- B06 - +5V
- B05 - +5V
- B04 - Test Data Output
- B03 - GND
- B02 - Test CLK
- B01 - -12V

PCI-Bus

Für Verbindungen zwischen: ADwin & Hub, ADwin & Switch

SD15	C18	D18	GND
SD14	C17	D17	/MASTER
SD13	C16	D16	+5V
SD12	C15	D15	DRQ7
SD11	C14	D14	/DACK7
SD10	C13	D13	DRQ6
SD9	C12	D12	/DACK6
SD8	C11	D11	DRQ5
/MEMW	C10	D10	/DACK5
/MEMR	C9	D9	DRQ0
LA17	C8	D8	/DACK0
LA18	C7	D7	IRQ14
LA19	C6	D6	IRQ15
LA20	C5	D5	IRQ12
LA21	C4	D4	IRQ11
LA22	C3	D3	IRQ10
LA23	C2	D2	/I-O CS16
/SBHE	C1	D1	/MEM CS16

ISA-Bus

A00	A31	B31	GND
A01	A30	B30	OSC
A02	A29	B29	+5V
A03	A28	B28	ALE
A04	A27	B27	T/C
A05	A26	B26	/DACK2
A06	A25	B25	IRQ3
A07	A24	B24	IRQ4
A08	A23	B23	IRQ5
A09	A22	B22	IRQ6
A10	A21	B21	IRQ7
A11	A20	B20	BCLK
A12	A19	B19	/REFRESH
A13	A18	B18	DRQ1
A14	A17	B17	/DACK1
A15	A16	B16	DRQ3
A16	A15	B15	/DACK3
A17	A14	B14	/IOR
A18	A13	B13	/IOW
A19	A12	B12	/SMEMR
AEN	A11	B11	/SMEMW
IO CH RDY	A10	B10	GND
D00	A9	B9	+12V
D01	A8	B8	/0WS
D02	A7	B7	-12V
D03	A6	B6	DRQ2
D04	A5	B5	-5V
D05	A4	B4	IRQ9
D06	A3	B3	+5V
D07	A2	B2	RESET DRV
/IO CH CK	A1	B1	GND

RS-422 (Stecker)

SIN (-) (+) SIN
SOUT (-) (+) SOUT
SGND

RS-485 (Stecker)

SLOW SHIGH
SGND

RS422-Legende:
SIN - Signal In
SOUT - Signal Out
SGND - Signal Ground

RS485-Legende:
SHIGH - Signal High
SGND - Signal Ground
SLOW - Signal Low

Ethernet, RJ-45 (Kabel-Stecker)

nach ISO/IEC 11801 & EN 50288 & TIA/EIA-568B

Für Verbindungen zwischen: ADwin & PC, ADwin & Router

1 - Weiß/Orange, Tx +	Tx +, Weiß/Orange - 1
2 - Orange, Tx -	Rx -, Orange - 2
3 - Weiß/Grün, Rx +	Tx +, Weiß/Grün - 3
4 - Blau	Blau - 4
5 - Weiß/Blau	Weiß/Blau - 5
6 - Grün, Rx -	Tx -, Grün - 6
7 - Weiß/Braun	Weiß/Braun - 7
8 - Braun	Braun - 8

Typ A

Typ B

- 1 - +5V
- 2 - D-
- 3 - D+
- 4 - GND

USB (Kabel-Stecker)

nach ISO/IEC 11801 & EN 50288 & TIA/EIA-568B