

INVENTORY. ENGINEERING. INGENUITY.

Three simple words, but they have a big impact on how your business performs. We know that having the right seal at the right time is crucial to your operation because industrial seals are *our* business. Under the TCM brand, we carry more than 12,000 SKUs including the broadest range of top quality industry standard parts. And if you need something custom, our engineering and design team can help assist with your unique seal requirements — plus, back it up with Dichtomatik in-house, real-world scenario testing and our warranty guarantee. Our distribution and fulfillment operation is available to assist and improve your ability to deliver on orders, provide the tools to help you sell more products to your customers and increase your bottom line by ensuring you have the right product in stock. **We're different and we want to show why that's good for you.**

TAKING CARE OF BUSINESS.

When you call Dichtomatik, expect solutions. From fulfilling a simple order to our extensive inventory optimization management process and SKU recommendation expertise, our goal is to ensure you have the right seal at a competitive price. But don't take our word for it. The best way we know to stand apart in our industry is to go the extra step and have our customers do all the talking. Feel free to ask around.

TRUST IS EARNED.

We wouldn't expect to earn your trust through anything but our proven performance. Our goal is to be the company you think of first. We want to show you what we can do for your business, whether you're a manufacturer, distributor or end-user. In short, we want you to pick up the phone and call us first. **We look forward to the opportunity to earn your business and your trust.**

www.dichtomatik.us

USA
800 328 2840

CANADA
905 470 2266

MEXICO
52 442 221 6303

BRAZIL
55 11 4072 8025

TCM[®] DICHTOMATIK
AMERICAS



WITH OVER 30 YEARS OF EXPERIENCE, WE UNDERSTAND THE DYNAMICS OF EACH INDUSTRY WE SERVE, WHICH ALLOWS US TO PROVIDE DETAILED SERVICE, AND HIGHLY TAILORED SOLUTIONS.

SERVICES

- Kitting
- Extruding
- Custom Packaging
- Engineering Support
 - Product Development
 - Product Testing
 - Product Analysis
- Assembly
- Inventory Management
- CNC Machined Seals Custom-Made
- Custom-Made Gaskets

COMMON INDUSTRIES

- Mechanical Power Transmission
- Process Industry
 - Food & Beverage
 - Chemical
 - Pharmaceutical
- Energy & Power Generation
- Fluid Handling
- Lawn & Garden
- Material Handling
- Recreational Vehicles
- Trailer
- Manufacturing

Table of Contents

Table of Contents	3
ISO 9001 Quality System Certificate	4
Section 1 – Engineering	
Materials and Specifications	5-11
Shaft Specifications	12-14
Housing Specifications	15
Shaft and Housing Chamfer	16
Seal Tolerances and Press-Fits	17
Lubrication	18
Installation	19-20
Seal Storage	21
Standard Seal Lip Designs	22
Standard Seal O.D. Designs	23
Standard Seal Questionnaire Sheet	24-25
Pressure Seals	26
V-Rings	27
Axial Face Seals	28
Trailer Kits	29
Oil Bath Seals	30
AO Seals	31
AP Seals	32
Track Roller Seals	33
AP Seal Questionnaire Sheet	34-35
Shaft-Eze	36
Individually Boxed Product	37
Principal TCM Shaft Seal Designs	38
Supplementary TCM Shaft Seal Designs	39-43
Compound Compatibility Chart	44-45
Metric Conversion Chart	46
Temperature Conversion Chart	47
Troubleshooting / Seal Failure Review	48
Section 2 – TCM Product Listing	
Part Number Creation	49
VA Style V-Rings	50-52
VL Style V-Rings	53
VS Style V-Rings	54-55
AFS Style Axial Face Seals	56
AFX Style Axial Face Seals	57
Oil Bath Seals	58
Shaft-Eze	59-61
Complete Seal Listing	62-163
Section 3 – Interchanges to Competitors’ Part Numbers	
SKF / CR Shaft Seals	164-174
SKF / CR Axial Face Seals	175
SKF / CR V-Rings	176
National Shaft Seals	177-191
National V-Rings	192
Harwal Shaft Seals	193-221
Harwal Axial Face Seals	222
Harwal V-Rings	223
Terms and Conditions	224-226

ALL CONTENTS COPYRIGHT © 2019 Dichtomatik Americas, LP. All Rights Reserved.
Any use of the contents of this publication without the written permission of the publisher is strictly prohibited.

Dichtomatik is a proud member and supporter of the following associations:



MANAGEMENT SYSTEM CERTIFICATE

Certificate No:
CERT-09459-2006-AQ-HOU-ANAB

Initial certification date:
28 June 1995

Valid:
03 November 2018 - 03 November 2021

This is to certify that the management system of

Dichtomatik Americas

1087 Park Place, Shakopee, MN, 55379, USA

and the sites as mentioned in the appendix accompanying this certificate

has been found to conform to the Quality Management System standard:

ISO 9001:2015

This certificate is valid for the following scope:

The Distribution and Light Manufacturing of Sealing Technologies, Rubber Products, and Related Components/Accessories.

Place and date:
Katy, TX, 11 October 2018



For the issuing office:
DNV GL – Business Assurance
1400 Ravello Drive, Katy, TX, 77449-5164,
USA

John Stefan
Management Representative

General Elastomer Information

Dichtomatik's shaft seals are made from a wide range of materials. Depending upon a customer's application, the material color, durometer, and type can vary. Dichtomatik's standard materials and their specifications are:

Nitrile – Lip Code N (NBR)

NBR is the standard lip material for Dichtomatik's shaft seals. Dichtomatik's standard NBR compound is a 70-durometer black compound – NK701. Nitrile lip seals work well within a temperature range of -40F to 225F (-40C to 107C) and can withstand spikes of up to 250F (121C) for short periods of time. NBR seals are compatible with water and most common mineral oils and greases. NBR seals are recommended for most common applications.

Hydrogenated Nitrile – Lip Code H (HNBR)

HNBR is recommended for higher temperature applications, ranging from -40F to 302F (-40C to 150C). Compared to our standard nitrile compound, HNBR offers improved resistance to fuel, oil, heat, and chemicals. It also has good wear resistance characteristics, which make it well suited to perform in the most severe environments. Dichtomatik's standard HNBR compound is an 80-durometer black compound – HK804.

Polyacrylate – Lip Code P (ACM)

ACM compounds are recommended for higher temperature applications, ranging from -13F to 302F (-25C to 150C). ACM compounds work well with mineral oils and EP additives and greases. However, they offer poor sealing in dry running conditions and typically cost more than NBR seals. Dichtomatik's standard ACM compound is a 70-durometer black compound – PK701.

Silicone – Lip Code S (VMQ)

VMQ compounds offer the widest range of operating temperature conditions ranging from -60F to 390F (-51C to 199C). VMQ compounds do not perform well in dry running conditions and should not be used with EP based compounds and oxidized oils. The abrasion resistance of VMQ compounds is poor, so unless they are going to be used in applications that are operating in cold climates they should be avoided. Dichtomatik's standard VMQ compound is a 70-durometer black compound – SK701.

Fluorocarbon – Lip Code V (FKM)

FKM compounds are premium lip materials offering the highest temperature rating. FKM will handle temperatures ranging from -20F to 400F (-29C to 204C). FKM will resist most special lubricants and chemicals that can destroy NBR, ACM, and VMQ. FKM is extremely resistant to abrasion and provides superior wear and performance characteristics. FKM works in dry running applications, but only for intermittent periods. Dichtomatik's standard FKM compound is an 80-durometer brown compound – VN801.

Table 1: Physical Properties of the Five Major Seal Compounds

Compound	Nitrile (Code N)	Hydrogenated Nitrile (Code H)	Polyacrylate (Code P)	Silicone (Code S)	Fluorocarbon (Code V)
Temperature Range	-40F to 225F -40C to 107C	-40F to 302F -40C to 150C	-13F to 302F -25C to 150C	-60F to 390F -51C to 199C	-20F to 400F -29C to 204C
Abrasion Resistance	2	2	3	4	2
Compression Set	2	2	3	2	2
Cracking Resistance	3	2	3	1	2
Cut Growth Resistance	2	2	2	4	4
Flex Cracking Resistance	3	3	3	2	2
Impact Strength	2	1	4	3	3
Oxidation Resistance	2	1	1	1	1
Sunlight Resistance	3	2	1	1	1
Tear Resistance	2	2	4	4	3
Weather Resistance	3	2	1	1	1

Note: 1=Excellent 2=Good 3=Fair 4=Poor

For other available shaft seal materials, contact Dichtomatik Engineering. Material test reports for Dichtomatik's standard materials are on the following pages.

Metal Case and Spring Materials

One of the components of a shaft seal is the metal case. Standard shaft seals are made from a carbon steel metal case. However, if the application involves operating in a corrosive environment or extreme conditions, the metal case can be made out of stainless steel. In addition to the metal case, another component of some seals is a garter spring. A garter spring is included in the seal if it is intended to seal a media with a low viscosity – such as oil. A garter spring is not included with the seal if it is intended to seal a media with a high viscosity – such as grease. Garter springs are typically made from carbon steel, however, they too can be made out of stainless steel if the application requires. All of Dichtomatik’s metal cases and springs are made from SAE grade metals as shown in the table below.

Table 2: Specifications of Metal Case and Garter Springs

Standard	SAE No.	JIS No.	Application	Material
Metal Case	1008 - 1010	G3141 SPCC	General Application	Carbon Steel
	30304	G4314 SUS304	Corrosive Environment	Stainless Steel
Garter Spring	1070 - 1090	G3521 SW-B	General Application	Carbon Steel
	30304	G4314 SUS304	Corrosive Environment	Stainless Steel

Material Code

We have now introduced the materials for each specific part of the oil seal. To allow our customers to know what the material is for each component of a seal, Dichtomatik has included a material code with each part. The material code is a 3-digit code that indicates the lip material, the case material, and the spring material in that order. The material codes are designated as shown below.

Lip Material	Case Material	Spring Material	Material Code Example
N = NBR	C = Carbon Steel	C = Carbon Steel	NBR Lip Material
H = HNBR	S = Stainless Steel	S = Stainless Steel	NCC = Carbon Steel Case
P = ACM		O = Without Spring	Carbon Steel Spring
S = VMQ			
V = FKM			

For information on material codes that do not appear in the list above, contact your Dichtomatik Sales representative.

NK701 (NBR)

Material Properties

Specification: ASTM D2000 M2BG714 A14 B14 EO14 EO34 EF11 EF21 EA14 F17

Recommended Service Temperature: -40 F to 212 F (-40 C to 100 C)

Original Properties	Specification	NK701
Hardness, Shore A	70±5	71
Tensile Strength, psi	2031 (min)	2591
Ultimate Elongation, %	250 (min)	425
Tear Strength (kg/cm)	50 (min)	87
Specific Gravity	1.29±0.02	1.29
Heat Resistance - A14 (70 hrs @ 100 C)		
Hardness Change, points	±15 (max)	+10
Tensile Strength Change, %	±30 (max)	+13
Elongation Change, %	-50 (max)	-18
Volume Change, %		-6
Compression Set, % - B14 (22 hrs @ 100 C)		
Permanent Set, %	+25 (max)	+7
Fluid Resistance, ASTM #1 Oil - EO14 (70 hrs @ 100 C)		
Hardness Change, points	-5 to +10	+9
Tensile Strength Change, %	-25 (max)	+12
Elongation Change, %	-45 (max)	-15
Volume Change, %	-10 to +5	-4
Fluid Resistance, IRM 903 Oil - EO34 (70 hrs @ 100 C)		
Hardness Change, points	-10 to +5	-1
Tensile Strength Change, %	-45 (max)	+9
Elongation Change, %	-45 (max)	-12
Volume Change, %	0 to +25	+3
Fluid Resistance, ASTM Fuel A - EF11 (70 hrs @ 23 C)		
Hardness Change, points	±10 (max)	+2
Tensile Strength Change, %	-25 (max)	-2
Elongation Change, %	-25 (max)	-5
Volume Change, %	-5 to +10	0
Fluid Resistance, ASTM Fuel B - EF21 (70 hrs @ 23 C)		
Hardness Change, points	0 to -30	-8
Tensile Strength Change, %	-60 (max)	-21
Elongation Change, %	-60 (max)	-22
Volume Change, %	0 to +40	+14
Water Resistance - EA14 (70 hrs @ 100 C)		
Hardness Change, points	±10 (max)	-3
Tensile Strength Change, %		+5
Elongation Change, %		-8
Volume Change, %	±15 (max)	+7
Low Temperature Resistance - F17 (3 min @ -40 C)		
Brittleness	Non-brittle	Pass

The information contained herein is believed to be reliable, but no representation, guarantees or warranties of any kind are made to its accuracy or suitability for any purpose. The information presented herein is based on laboratory testing and does not necessarily indicate product performance. Full scale testing and product performance are the responsibility of the user.



1087 Park Place, Shakopee, MN 55379
800-328-2840 • www.dichtomatik.us

O-Rings • Rotary Shaft Seals • Fluid Power Seals • Custom Molded Shapes
Fitting & Fastener Seals • Spliced Rings & Extruded Cord

HK804 (HNBR)

Material Properties

Specification: ASTM D2000 M4DH820 A26 B36 EO16 EO36 F17

Recommended Service Temperature: -40 F to 302 F (-40 C to 150 C)

Original Properties	Specification	HK804
Hardness, Shore A	80±5	81
Tensile Strength, psi	2900 (min)	3210
Ultimate Elongation, %	150 (min)	319
Tear Strength (kg/cm)	50 (min)	72
Specific Gravity	1.34±0.02	1.344

Heat Resistance - A26 (70 hrs @ 150 C)		
Hardness Change, points	+10 (max)	+3
Tensile Strength Change, %	-15 (max)	+5
Elongation Change, %	-25 (max)	-20

Compression Set, % - B36 (22 hrs @ 150 C)		
Permanent Set, %	+35 (max)	+24

Fluid Resistance, ASTM #1 Oil - EO16 (70 hrs @ 150 C)		
Hardness Change, points	-5 to +10	+4
Tensile Strength Change, %	-20 (max)	+9
Elongation Change, %	-30 (max)	-19
Volume Change, %	-10 to +5	-3

Fluid Resistance, IRM 903 Oil - EO36 (70 hrs @ 150 C)		
Hardness Change, points	-15 (max)	-8
Tensile Strength Change, %	-40 (max)	+1
Elongation Change, %	-30 (max)	-6
Volume Change, %	+25 (max)	+14

The information contained herein is believed to be reliable, but no representation, guarantees or warranties of any kind are made to its accuracy or suitability for any purpose. The information presented herein is based on laboratory testing and does not necessarily indicate product performance. Full scale testing and product performance are the responsibility of the user.



1087 Park Place, Shakopee, MN 55379
800-328-2840 • www.dichtomatik.us

O-Rings • Rotary Shaft Seals • Fluid Power Seals • Custom Molded Shapes
Fitting & Fastener Seals • Spliced Rings & Extruded Cord

PK701 (ACM)

Material Properties

Specification: ASTM D2000 M3DH710 A26 B36 EO16 EO36

Recommended Service Temperature: -13 F to 302 F (-25 C to 150 C)

Original Properties	Specification	PK701
Hardness, Shore A	70±5	70
Tensile Strength, Mpa	10 (min)	10.4
Ultimate Elongation, %	200 (min)	221
Tear Strength (kg/cm)		30
Specific Gravity		1.41

Heat Resistance - A26 (70 hrs @ 150 C)		
Hardness Change, points	+10 (max)	+3
Tensile Strength Change, %	-25 (max)	+4
Elongation Change, %	-30 (max)	-2
Volume Change, %		-1

Compression Set, % - B36 (22 hrs @ 150 C)		
Permanent Set, %	+50 (max)	+38

Fluid Resistance, ASTM #1 Oil - EO16 (70 hrs @ 150 C)		
Hardness Change, points	-5 to +10	0
Tensile Strength Change, %	-20 (max)	+6
Elongation Change, %	-30 (max)	-7
Volume Change, %	-5 to +5	-1

Fluid Resistance, IRM 903 Oil - EO36 (70 hrs @ 150 C)		
Hardness Change, points	-15 (max)	-8
Tensile Strength Change, %	-30 (max)	-5
Elongation Change, %	-30 (max)	+5
Volume Change, %	+25 (max)	+10

The information contained herein is believed to be reliable, but no representation, guarantees or warranties of any kind are made to its accuracy or suitability for any purpose. The information presented herein is based on laboratory testing and does not necessarily indicate product performance. Full scale testing and product performance are the responsibility of the user.



1087 Park Place, Shakopee, MN 55379
800-328-2840 • www.dichtomatik.us

O-Rings • Rotary Shaft Seals • Fluid Power Seals • Custom Molded Shapes
Fitting & Fastener Seals • Spliced Rings & Extruded Cord

SK701 (VMQ)

Material Properties

Specification: ASTM D2000 M5GE706 A19 B37 EO16 EO36 F19

Recommended Service Temperature: -40 F to 302 F (-40 C to 150 C)

Original Properties	Specification	SK701
Hardness, Shore A	70±5	73
Tensile Strength, PSI	870 (min)	1142
Ultimate Elongation, %	150 (min)	178
Tear Strength (kg/cm)	10 (min)	20
Specific Gravity	1.31±0.02	1.31

Heat Resistance - A19 (70 hrs @ 225 C)		
Hardness Change, points	+10 (max)	+1
Tensile Strength Change, %	-25 (max)	-14
Elongation Change, %	-30 (max)	-13

Compression Set, % - B37 (22 hrs @ 175 C)		
Permanent Set, %	+25 (max)	+9

Fluid Resistance, ASTM #1 Oil - EO16 (70 hrs @ 150 C)		
Hardness Change, points	0 to -15	-5
Tensile Strength Change, %	-20 (max)	+7
Elongation Change, %	-20 (max)	-6
Volume Change, %	0 to +10	+4

Fluid Resistance, IRM 903 Oil - EO36 (70 hrs @ 150 C)		
Hardness Change, points	-30 (max)	-19
Tensile Strength Change, %		-8
Elongation Change, %		-9
Volume Change, %	+60 (max)	+30

Low Temperature Resistance - F19 (3 min @ -55 C)		
Brittleness	Non-brittle	Pass

The information contained herein is believed to be reliable, but no representation, guarantees or warranties of any kind are made to its accuracy or suitability for any purpose. The information presented herein is based on laboratory testing and does not necessarily indicate product performance. Full scale testing and product performance are the responsibility of the user.



1087 Park Place, Shakopee, MN 55379
800-328-2840 • www.dichtomatik.us

O-Rings • Rotary Shaft Seals • Fluid Power Seals • Custom Molded Shapes
Fitting & Fastener Seals • Spliced Rings & Extruded Cord

VN801 (FKM)

Material Properties

Specification: ASTM D2000 M2HK810 A1-10 B38 EO16 EO36 EF31 F15

Recommended Service Temperature: -20 F to 400 F (-29 C to 204 C)

Original Properties	Specification	VN801
Hardness, Shore A	80±5	80
Tensile Strength, psi	1450 (min)	2014
Ultimate Elongation, %	150 (min)	172
Tear Strength (kg/cm)	25 (min)	36
Specific Gravity	2.18±0.02	2.18
Heat Resistance - A1-10 (70 hrs @ 250 C)		
Hardness Change, points	+10 (max)	+5
Tensile Strength Change, %	-25 (max)	+26
Elongation Change, %	-25 (max)	-20
Volume Change, %		-4
Compression Set, % - B38 (22 hrs @ 200 C)		
Permanent Set, %	+50 (max)	+10
Fluid Resistance, ASTM #1 Oil - EO16 (70 hrs @ 150 C)		
Hardness Change, points	-5 to +10	+2
Tensile Strength Change, %	-20 (max)	+6
Elongation Change, %	-30 (max)	+5
Volume Change, %	-5 to +5	-1
Fluid Resistance, IRM 903 Oil - EO36 (70 hrs @ 150 C)		
Hardness Change, points	-15 (max)	+1
Tensile Strength Change, %	-40 (max)	-3
Elongation Change, %	-40 (max)	+5
Volume Change, %	+25 (max)	+1
Fluid Resistance, ASTM Fuel C - EF31 (70 hrs @ 23 C)		
Hardness Change, points	-5 to +5	-1
Tensile Strength Change, %	-25 (max)	-8
Elongation Change, %	-20 (max)	-3
Volume Change, %	0 to +10	+3
Low Temperature Resistance - F15 (3 min @ -25 C)		
Brittleness	Non-brittle	Pass

The information contained herein is believed to be reliable, but no representation, guarantees or warranties of any kind are made to its accuracy or suitability for any purpose. The information presented herein is based on laboratory testing and does not necessarily indicate product performance. Full scale testing and product performance are the responsibility of the user.



1087 Park Place, Shakopee, MN 55379
800-328-2840 • www.dichtomatik.us

O-Rings • Rotary Shaft Seals • Fluid Power Seals • Custom Molded Shapes
Fitting & Fastener Seals • Spliced Rings & Extruded Cord

Shaft

To achieve the optimum sealing function from a shaft seal, careful consideration must be given to the design parameters of the shaft. Important criteria for the shaft include the material, hardness, finish, eccentricity, tolerance, and rotating speed.

Shaft Material

Shaft seals perform the best when the shaft is made out of a medium to high carbon steel or stainless steel material. If a softer material is used for the shaft, then it is recommended that the shaft be plated with either nickel or chrome to provide a hard sealing surface. If a nickel or chrome plating is not available, typically only seals with a sleeve included in the design will work as the sealing lip would groove the soft material too quickly.

Shaft Hardness

The hardness of the shaft is critical in the area where the sealing lip will be running. If the hardness of the shaft is too soft, the sealing lip will wear a groove into the shaft leading to seal failure and requiring that the shaft be replaced. To minimize shaft grooving, it is recommended that the shaft hardness be a minimum of 45 HRC in the area where the sealing lip(s) will be running. In applications where lubrication is doubtful, abrasive matter is present, or the shaft speed is greater than 46 ft/s (14 m/s), a minimum shaft hardness of 55 HRC is recommended. It is recommended that all shafts be heat treated or nitrided prior to assembly.

Shaft Finish

Shaft finish is a measure of how rough the surface of the shaft is. For a shaft seal to function properly, the shaft finish needs to fall within a certain range. A shaft finish can be measured using several different techniques, the most common of which is Ra and Rz. Ra is the average roughness of the shaft. For a shaft seal to function properly, it is recommended that the Ra shaft finish be 10 to 20 μin (0.2 to 0.8 μm). Rz is the average distance between the highest peak and lowest valley over a certain length. For a shaft seal to function properly, it is recommended that the Rz shaft finish be 39 to 197 μin (1 to 5 μm). To achieve the desired shaft finish, it is recommended that the shaft be centerless ground or plunge ground. After grinding it is important to check for shaft lead. The maximum permissible shaft lead angle is 0 ± 0.05 degrees.

Shaft Eccentricity

Two types of shaft eccentricity affect seal performance. They are dynamic run-out (double dynamic eccentricity) and shaft-to-bore-misalignment (STBM or static eccentricity). Dynamic run-out is the amount in which the shaft is not rotating about its true center. Dynamic run-out is typically caused by the shaft being bent, the shaft being out of balance, or misalignment caused during assembly. STBM is the amount in which the center of the shaft is off from the center of the bore. STBM is typically caused by machining and assembly issues.

The greater that the eccentricity is in an application, the harder it is for the sealing lip to remain in contact with the shaft while it is rotating. If an application has high eccentricity, then a special seal will need to be designed to allow the sealing lip to follow the shaft during rotation. The allowable dynamic run-out and shaft-to-bore-misalignment for an application is shown in the following two figures.

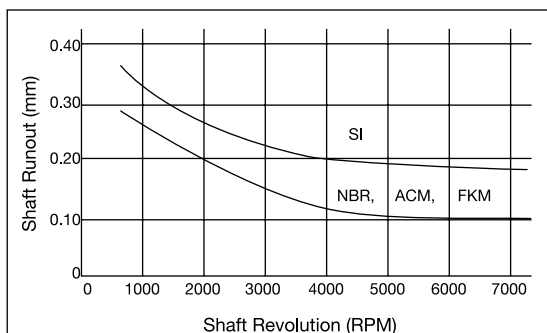
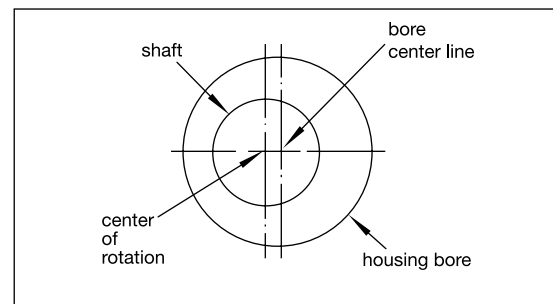
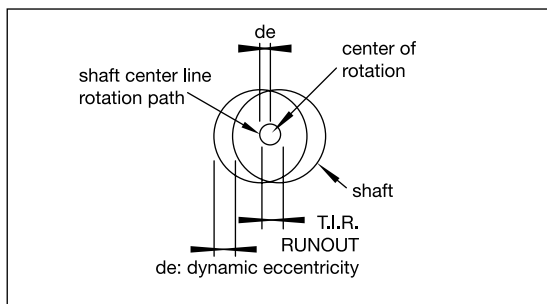

Figure 1: Dynamic Runout

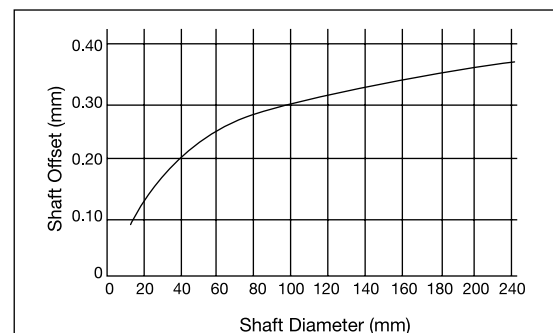

Figure 2: Shaft-To-Bore-Misalignment

Shaft Specifications

Shaft Tolerance

When creating a shaft, it is important to ensure that it is dimensioned properly. The part of the shaft where the seal will be operating should be dimensioned per the Rubber Manufacturer Association's (RMA) or the German Institute for Standardization's (DIN) standards. Dichtomatik's inch shaft seals are designed to operate on shafts that are dimensioned per RMA's standard, whereas Dichtomatik's metric seals are designed to operate on shafts that are dimensioned per DIN's standard. Tables 3 and 4 show the tolerance standards developed by RMA and DIN.

Table 3: Tolerance for Inch Shafts

Nominal Shaft Diameter (in)	Tolerance (in)
up to 4.000	+/- 0.003
4.001 to 6.000	+/- 0.004
6.001 to 10.000	+/- 0.005
over 10.000	+/- 0.006

Table 4: Tolerance for Metric Shafts

Nominal Shaft Diameter (mm)	Tolerance (mm)
up to 3.00	+0.000 / -0.060
3.01 to 6.00	+0.000 / -0.075
6.01 to 10.00	+0.000 / -0.090
10.01 to 18.00	+0.000 / -0.110
18.01 to 30.00	+0.000 / -0.130
30.01 to 50.00	+0.000 / -0.160
50.01 to 80.00	+0.000 / -0.190
80.00 to 120.00	+0.000 / -0.220
120.01 to 180.00	+0.000 / -0.250
180.01 to 250.00	+0.000 / -0.290
250.01 to 315.00	+0.000 / -0.320
315.01 to 400.00	+0.000 / -0.360
400.01 to 500.00	+0.000 / -0.400

Shaft Speed

The speed that the shaft is rotating is important when determining the appropriate lip material for the seal as each material will only function under certain operating speeds. Most often shaft speeds are given in rotations per minute (RPM). However, sometimes they may be given in feet per minute (FPM) or meters per minute (MPM). Below are conversions to convert between the standards.

$$\text{FPM} = \text{Shaft Diameter in inches} \times \text{RPM} \times 0.262$$
$$\text{MPM} = \text{Shaft Diameter in mm} \times \text{RPM} \times 0.001 \times 3.125$$

To determine which material is appropriate for a given shaft speed, the following chart is to be used. This chart is only applicable in non-pressure applications. If pressure is present in an application, contact Dichtomatik Engineering to determine the appropriate material to use for the sealing lip.

Shaft Specifications

For example, what would the maximum allowable shaft speed be for a shaft diameter of 60mm and a shaft seal that is made out of NBR? First, start by locating the shaft diameter along the bottom axis of the figure. Next, follow the shaft diameter line vertically to the curved line that is above the material that the seal is made out of. Then, follow the curved line to the right until the next intersection point with an angled line. Finally, follow that angled line to the shaft speed, which will be the maximum allowable shaft speed. So, for a 60mm shaft diameter and a seal made out of NBR the maximum allowable shaft speed is 2,500 RPM (1,547 FPM).

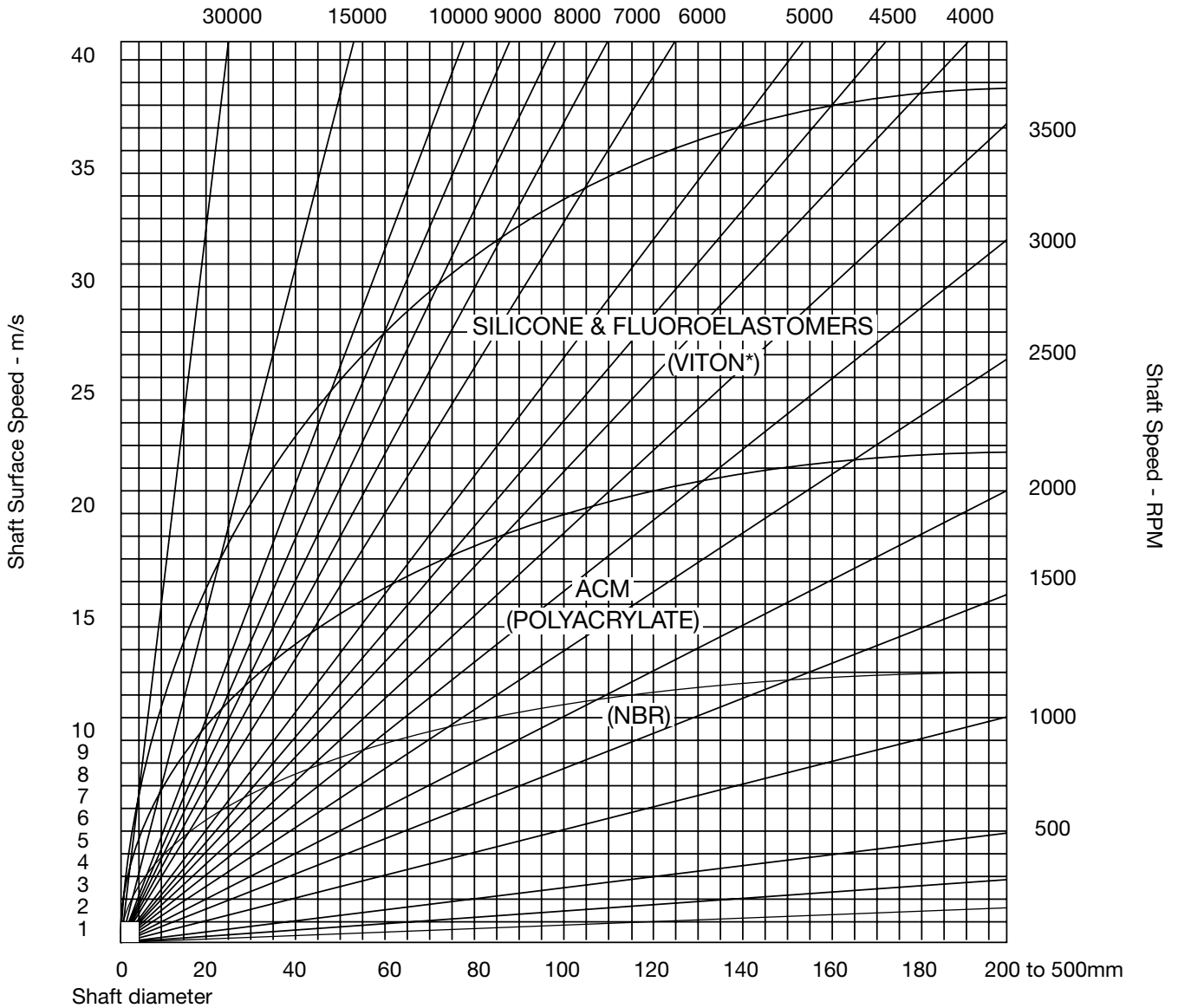

Figure 3: Shaft Speeds for Seal Materials

*Viton is a registered trademark of DuPont.

Housing Specifications

Housing

To achieve the optimum O.D. sealing function from a shaft seal, careful consideration must be given to the design parameters of the housing. Important criteria for the housing include the material, finish, and tolerance.

Housing Material

The material that the housing is made out of will determine the O.D. style of the seal. If the housing is made out of a hard material, such as steel or cast iron, then the O.D. of the seal can be either metal or rubber. However, if the housing is made out of a soft material, such as aluminum or plastic, then a rubber O.D. seal will need to be used so that the housing doesn't get scratched or gouged by the seal during installation.

Housing Finish

Housing finish is a measure of how rough the surface of the housing is. For a seal to function properly, the housing finish needs to fall within a certain range depending on the style of the seal O.D. For a metal O.D. seal, the housing finish is to be 32 to 64 $\mu\text{in Ra}$ (0.8 to 1.6 $\mu\text{m Ra}$). If a rubber O.D. seal is being used, then the housing finish needs to be rougher to allow for the rubber to grip the housing better. For a rubber O.D. seal, the housing finish is to be 100 to 200 $\mu\text{in Ra}$ (3 to 5 $\mu\text{m Ra}$).

Housing Tolerance

When creating a housing, it is important to ensure that it is dimensioned properly. The part of the housing where the seal will be installed should be dimensioned per the RMA or DIN standards. Dichtomatik's inch shaft seals are designed to operate in housings that are dimensioned per RMA's standard, whereas Dichtomatik's metric seals are designed to operate in housings that are dimensioned per DIN's standard. Tables 5 and 6 show the tolerance standards developed by RMA and DIN.

Table 5: Tolerance for Metric Bores

Nominal Housing Diameter (mm)	Tolerance (mm)
up to 10.00	+0.022 / -0.000
6.01 to 18.00	+0.027 / -0.000
18.01 to 30.00	+0.033 / -0.000
30.01 to 50.00	+0.039 / -0.000
50.01 to 80.00	+0.046 / -0.000
80.01 to 120.00	+0.054 / -0.000
120.01 to 180.00	+0.063 / -0.000
180.01 to 250.00	+0.072 / -0.000
250.01 to 315.00	+0.081 / -0.000
315.01 to 400.00	+0.089 / -0.000
400.01 to 500.00	+0.097 / -0.000

Table 6: Tolerance for Inch Bores

Nominal Housing Diameter (in)	Tolerance (in)
up to 3.000	+/- 0.001
3.001 to 6.000	+/- 0.0015
6.001 to 10.000	+/- 0.002
10.001 to 20.000	+0.002 / -0.004
20.001 to 40.000	+0.002 / -0.006
40.001 to 60.000	+0.002 / -0.010

Shaft and Housing Chamfer

In addition to the shaft and housing criteria previously discussed, it is also important to ensure that both the shaft and housing have a burr free chamfer or radius on the edge in which the seal will be installed past.

Housing Chamfer

The chamfer on the housing serves two purposes. First, it helps to align the seal during the installation process. Secondly, if the seal has a rubber O.D. it acts as a way to protect the rubber from being cut during installation. The housing chamfer should have an angle of 15 to 30 degrees. The depth of the housing chamfer is determined based upon the following equations and the figure below.

$$t_1 = 0.85 * b$$

$$t_2 = b + 0.03 \text{mm}$$

Shaft Chamfer

The chamfer on the shaft serves two purposes. First, it helps to reduce the risk of cutting the sealing lip during installation. Secondly, it acts as an aid to slowly stretch the sealing lip over the shaft. By slowly stretching the lip there is less of a chance that the garter spring will be dislodged during seal installation. The shaft chamfer should have an angle of 15 to 25 degrees. Another option on the shaft is to radius the edge instead of including a chamfer. If a radius is to be used on a shaft, it is recommended that the radius be a minimum of 0.024in (0.60mm) for a single lip style seal and a minimum of 0.039in (1.00mm) for a twin lip style seal. The depth of the shaft chamfer is determined by the table below.

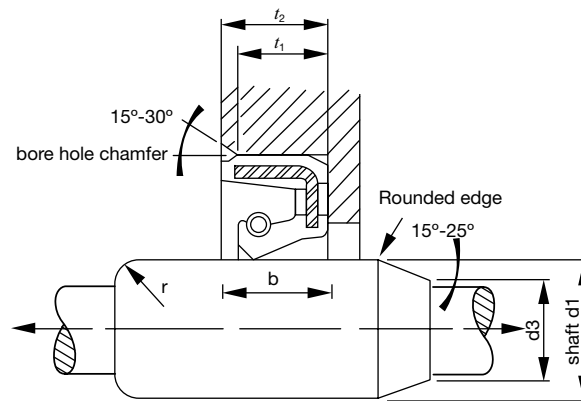

Figure 4: Shaft and Housing

Chamfers

Table 7: Shaft Chamfer Dimensions

d1 (mm)	d3 (mm)	d1 (mm)	d3 (mm)	d1 (mm)	d3 (mm)	d1 (mm)	d3 (mm)	d1 (mm)	d3 (mm)
6.00	4.80	26.00	23.40	60.00	56.10	115.00	109.60	240.00	233.00
7.00	5.70	27.00	25.30	62.00	58.10	120.00	114.50	250.00	243.00
8.00	6.60	30.00	27.30	63.00	59.10	125.00	119.40	260.00	249.00
9.00	7.50	32.00	29.20	65.00	61.00	130.00	124.30	280.00	269.00
10.00	8.40	35.00	32.00	68.00	63.90	135.00	129.20	300.00	289.00
11.00	9.30	36.00	33.00	70.00	65.80	140.00	133.00	320.00	309.00
12.00	10.20	38.00	34.90	72.00	67.70	145.00	138.00	340.00	329.00
14.00	12.10	40.00	36.80	75.00	70.70	150.00	143.00	360.00	349.00
15.00	13.10	42.00	38.70	78.00	73.60	160.00	153.00	380.00	369.00
16.00	14.00	45.00	41.60	80.00	75.50	170.00	163.00	400.00	389.00
17.00	14.90	48.00	44.50	85.00	80.40	180.00	173.00	420.00	409.00
18.00	15.80	50.00	46.40	90.00	85.30	190.00	183.00	440.00	429.00
20.00	17.70	52.00	48.30	95.00	90.10	200.00	193.00	460.00	449.00
22.00	19.60	55.00	51.30	100.00	95.00	210.00	203.00	480.00	469.00
24.00	21.50	56.00	52.30	105.00	99.90	220.00	213.00	500.00	489.00
25.00	22.50	58.00	54.20	110.00	104.70	230.00	223.00		

Seal Tolerances

When designing an application for an oil seal, it is important to take into consideration the tolerances that the oil seal will be manufactured to. The table below shows the RMA standard tolerance for the width of an oil seal.

Table 8: Seal Width Tolerances

Unit	Width Range	Tolerance
in	all	+/-0.015
mm	up to 10	+/-0.20
	over 10	+/-0.30

It is important to realize that the shaft and bore dimensions that are provided in the back of this catalog with each part number are the actual shaft and bore diameters, not the I.D. and O.D. of the seal. To determine the actual O.D. of the seal the press-fit needs to be considered. When installing an oil seal into a housing, there is a pre-determined amount of press-fit that has been designed into the O.D. of the oil seal. This press-fit is what provides an interference between the O.D. of the oil seal and the housing, thus prohibiting the oil seal from slipping out of the housing. The tables below show the standard press-fit for inch and metric oil seals. Also, the tolerance of the O.D. of the seal is shown.

For example, the actual O.D. of a rubber covered seal for a 2.500" diameter bore is going to be 2.508 +/-0.003". This means that the seal will have an interference with the bore of between 0.005" to 0.011".

Table 9: Seal Press-Fits and O.D. Tolerances for Inch Seals

Bore Diameter (in)	Press-fit Recommendation (in)		Tolerance (in)	
	Metal Case	Rubber Covered Case	Metal Case	Rubber Covered Case
up to 1.000	+ 0.004	+ 0.006	+/- 0.002	+/- 0.003
1.001 to 2.000	+ 0.004	+ 0.007	+/- 0.002	+/- 0.003
2.001 to 3.000	+ 0.004	+ 0.008	+/- 0.002	+/- 0.003
3.001 to 4.000	+ 0.005	+ 0.010	+/- 0.002	+/- 0.004
4.001 to 6.000	+ 0.005	+ 0.010	+ 0.003 / - 0.002	+/- 0.004
6.001 to 8.000	+ 0.006	+ 0.010	+ 0.003 / - 0.002	+/- 0.004
8.001 to 10.000	+ 0.008	+ 0.010	+ 0.004 / - 0.002	+/- 0.004
10.001 to 20.000	+ 0.008	+ 0.010	+ 0.006 / - 0.002	+/- 0.004
20.001 to 40.000	+ 0.008	+ 0.010	+ 0.008 / - 0.002	+/- 0.004
40.001 to 60.000	+ 0.008	+ 0.010	+ 0.010 / - 0.002	+/- 0.004

Table 10: Seal Press-Fits for Metric Seals

Bore Diameter (mm)	Press-fit Recommendation (mm)	
	Metal Case	Rubber Covered Case
up to 50.00	+0.10 / +0.20	+0.15 / +0.30
50.01 to 80.00	+0.13 / +0.23	+0.20 / +0.35
80.01 to 120.00	+0.15 / +0.25	+0.20 / +0.35
120.01 to 180.00	+0.18 / +0.28	+0.25 / +0.45
180.01 to 300.00	+0.20 / +0.30	+0.25 / +0.45
300.01 to 500.00	+0.23 / +0.35	+0.30 / +0.55

Lubrication

Prior to installing an oil seal onto a shaft, lubrication must be considered. Efficient lubrication of the sealing lip will ensure minimum lip wear along with the maximum life and efficiency of the seal. For this reason, greasing or oiling of both the seal and shaft must be done prior to installation of the seal. By greasing or oiling the seal and shaft you ensure that the sealing lip will not be running dry.

There are two important things to note about lubricating a seal. First, it is important that a rubber oil seal never be allowed to run dry. Second, it is important to note that during the bedding-in period of an oil seal, it is possible for minor oil weeping to occur.

Another recommended practice is to apply a coating of the application media to be retained by the oil seal to the lip(s) on the oil seal prior to installing the seal. This will help to reduce the friction when sliding the seal onto the shaft and to keep the lip(s) lubricated during the bedding-in period.

The figure below shows an example of where to pack grease on a dual lip seal prior to installing the seal on the shaft. By packing the void between the two lips with grease you are ensuring sufficient lubrication for the seal.

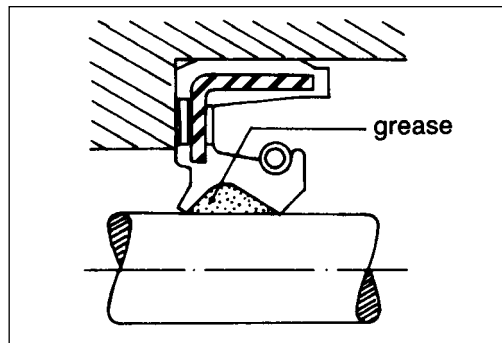

Figure 5: Lubricating a Dual Lip Seal

The figure below shows an example of where grease should be packed if redundant seals are being installed into an application. When redundant seals are being used, typically only the seal nearest to the bearing will be lubricated, meaning that the outside seal will be running dry. To prohibit the outside seal from running dry and increase its sealing efficiency, it is recommended that grease be packed between the two seals.

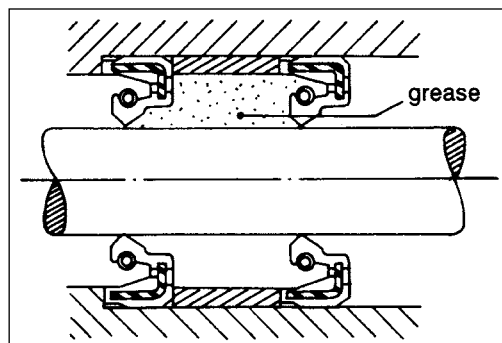

Figure 6: Lubricating Redundant Seals

Recommended Installation Methods

When installing a shaft seal onto a shaft and into a housing there are proper and improper techniques to use. When installing a seal onto a shaft with a key-way or spline, the recommended practice is to place an installation bullet over the shaft. By placing a bullet over the shaft, the sealing lip(s) won't get cut on the edges of the key-way or spline during installation. Another technique is to use an oil seal installation tool. By using an installation tool you reduce the odds of deforming the seal during installation.

Prior to installing the oil seal, be sure that the seal has been properly lubricated. For proper lubrication techniques see Lubrication section.

Below are several illustrations showing the recommended methods for installing shaft seals.

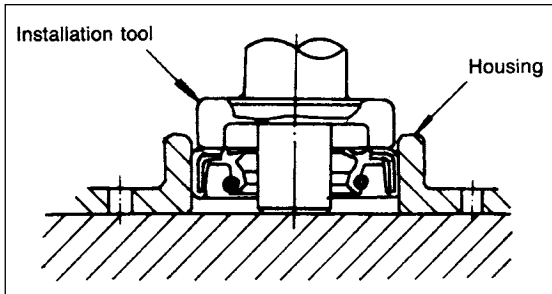

Figure 7: Tool Stops Against Support

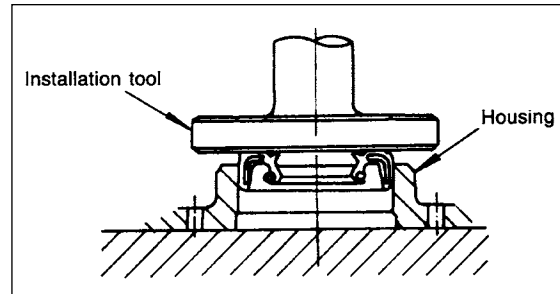

Figure 8: Tool Stops Against Housing Face

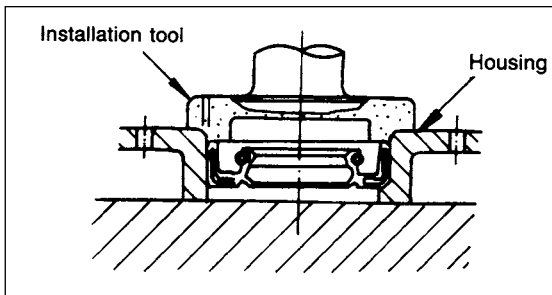

Figure 9: Tool Stops Against Housing Face

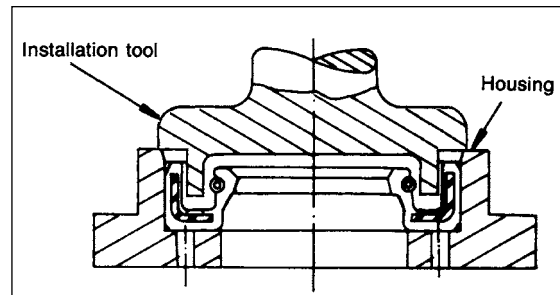

Figure 10: Tool Stops Against Housing

Improper Installation Methods

When installing a shaft seal it is important to make sure it is installed properly. Improper installation can cause the seal to become damaged or cocked, both of which will cause the seal to either leak immediately or have a decreased sealing life.

Below are several illustrations showing improper techniques to use when installing a shaft seal.

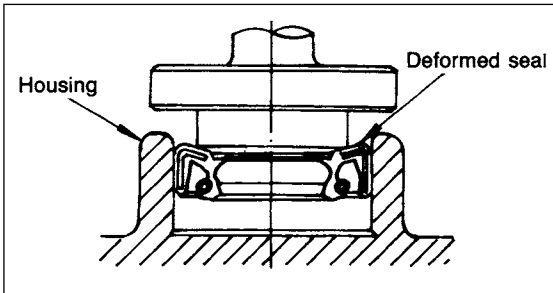

Figure 11: Deformed Seal

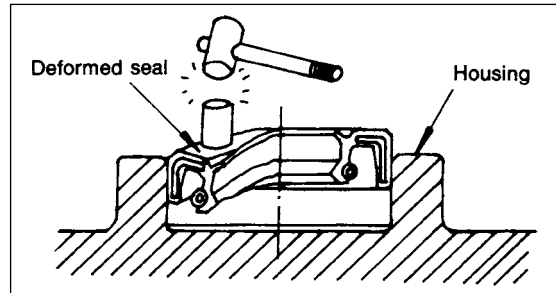

Figure 12: Deformed Seal

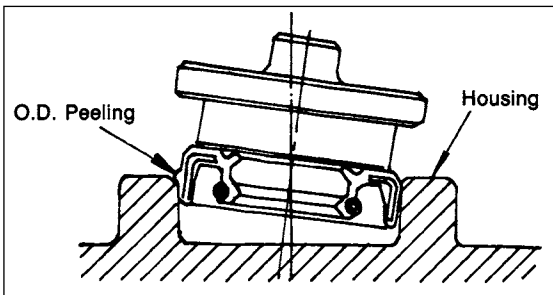

Figure 13: Misalignment Error

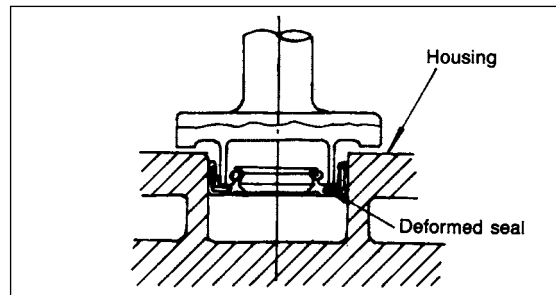

Figure 14: Deformed Seal

If you are not sure of the correct method to use when installing a shaft seal, contact Dichtomatik Engineering. The engineering department can recommend correct practices, as well as create installation tool drawings for your application.

Seal Storage

When storing shaft seals, there are several factors to keep in mind that will affect the shelf life of the seal. Such factors include the temperature, humidity, ozone, fumes, insects and rodents, and dust or dirt.

Temperature and Humidity

The area in which the seals are stored should be kept cool, roughly between 59°F to 86°F (15°C to 30°C), with an average relative humidity of 40% to 70%. Excessive heat may decrease the service life of the seal by prematurely aging the rubber. A higher humidity in the storage area may result in the corrosion of the metal case and/or the spring.

Ozone

To avoid premature aging of the sealing elements on a shaft seal the seal needs to be stored away from any potential ozone sources. Thus, store seals away from any direct or reflected sunlight and away from any electrical equipment that may be emitting ozone. Exposure of the seal to ozone may cause premature aging of the sealing element and thus reduce the sealing life of the seal.

Fumes

Seals need to be protected from fumes that may be emitted. Depending on the elastomer that the seal is made out of, certain fumes may cause deterioration of the seal.

Insects and Rodents

Seals need to be protected from exposure to insects and rodents during storage. Some insects and rodents may destroy the seals if they gain access to them.

Dust and Dirt

Sealing lips should be protected from dust and dirt during the storage of the seal. It is recommended to leave the seals in their original wrapping or in a closed container until it is time to install the seals into the application.

Shelf Life

If the above factors are all taken into consideration and the seals are stored appropriately, then the expected shelf life for common materials will be as shown in the table below.

Table 11: Seal Shelf Life for Common Materials

Type of Lip Material	Shelf Life (Years)
NBR, HNBR, CR	7
EPDM	8
FKM, VMQ, FVMQ	10
PTFE	Unlimited

Standard Seal Lip Designs

The following table identifies the most common lip designs for Dichtomatik shaft seals. It is important to remember that other, more complex, designs are available for special applications. However, the lip designs shown here represent those which will fill the needs of most seal requirements.

V = Single Lip	T = Twin Lip Spring Loaded	O = Seals on Housing
K = Twin Lip	U = Triple Lip	OB = Oil Bath (Prefix)
S = Single Lip, Spring Loaded	D = Double Lip, Double Spring Loaded	

Of the above lip designs, there are five principal lip designs, shown in the illustration below. These five principal lip designs are also supplemented by a range of more specialized designs for more specific application requirements. For additional information regarding available lip designs contact Dichtomatik Engineering.

Profile Diagram	Remarks
 <p>S</p>	Single Lip With A Garter Spring. Generally used for sealing lower pressure applications. However, not recommended for use in applications where the surrounding environment contains any dirt or contaminants.
 <p>T</p>	Dual Lip With A Garter Spring. Generally used for sealing lower pressure applications. The additional dust lip provides increased protection for the primary lip. The cavity between the two lips can also be filled with grease to limit shaft corrosion and allow brief operation without media lubrication.
 <p>D</p>	Double Lip With Garter Springs. Designed to separate two media.
 <p>V</p>	Single Lip Without A Garter Spring. Generally used for sealing a non-pressure medium, especially for sealing grease or viscous fluids. These seals are also used for dust or dirt exclusion.
 <p>K</p>	Dual Lip Without A Garter Spring As type V above, but the additional dust lip provides increased protection for the primary lip. The cavity between the two lips can also be filled with grease to limit shaft corrosion and allow brief operation without media lubrication.

Figure 15: Standard Lip Designs

Hydrodynamic Pumping Aids

The use of a hydrodynamic aid, or helix, can improve the sealing performance of the sealing lip. A helix is a ribbed pattern that is molded on the airside of the primary sealing lip. They cause a pumping action that forces the sealing medium back under the sealing lip and into the application. Helix designs are available for bi-directional, left, and right-hand shaft rotations. For other available helix designs please contact Dichtomatik Engineering.

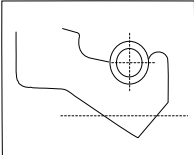
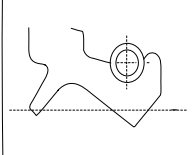
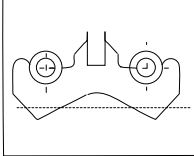
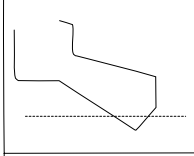
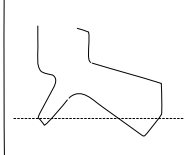
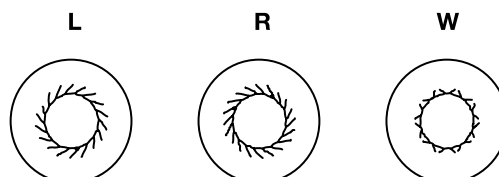

Figure 16: Standard Helix Designs

Standard Seal Case Designs

The following table identifies the most common case designs for Dichtomatik shaft seals. It is important to remember that other, more complex, designs are available for special applications. However, the case designs shown here represent those which will fill the needs of most seal requirements.

- | | |
|---------------------------------------|---|
| A = Metal O.D. with Reinforcing Plate | J = Rubber Covered O.D. With Flange |
| B = Metal O.D. with Lead-in Chamfer | L = Ground Metal O.D. With Rolled Leading Edge |
| C = Rubber Covered O.D. | M = Ground Metal O.D./Rubber Coated on I.D. |
| F = Fully Rubber Covered Case | Z = Ground Metal O.D. With Rubber Covered Lead-in Chamfer |
| G = Rubber Covered O.D. with Ribs | |

Of the above case designs, there are five principal case designs, shown in the illustration below. These five principal case designs are also supplemented by a range of more specialized designs for more specific application requirements. For additional information regarding available case designs contact Dichtomatik Engineering.

	Profile Diagram	Remarks
A		Outer Metal Case With Reinforcing Plate. This type is designed with an additional inner case providing increased structural rigidity when a more robust design is required. Particularly suitable for larger diameters or when the seal is fitted from behind.
B		Outer Metal Case. This type is most suitable for steel or cast iron housing materials. The metal case gives a particularly firm and accurate seat in the housing, but static sealing on the O.D. is partially limited.
C		Rubber Covered O.D. This type is preferred for soft alloy or plastic housing materials, as well as cast iron or steel. It is also more suitable to use this design in a replacement environment where minor damage to the housing surface has occurred.
F		Rubber Covered O.D. Similar to design C but additional rubber covering fully protecting the internal steel case. Particularly suitable for applications where corrosion could be a problem.
M		Outer Metal Case With Rubber Lining. Similar to design B but an additional rubber lining covering the internal face of the steel case. Particularly suitable for applications where corrosion could be a problem.

Figure 17: Standard Case Designs

O.D. Sealant

On metal O.D. seals Dichtomatik offers an O.D. sealant. The sealant is a synthetic rubber that is sprayed onto the O.D. of the metal case. When the seal is installed into the housing the sealant fills in any scratches or flaws that may exist in the housing to provide a good sealing surface. Dichtomatik's parts numbers that end with an '-H' indicate that the seal has the O.D. sealant applied to it.

Standard Seal Questionnaire Sheet

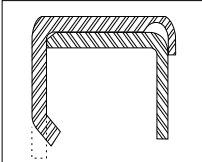
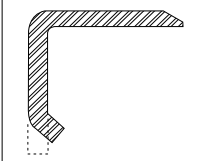
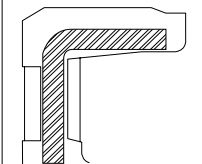
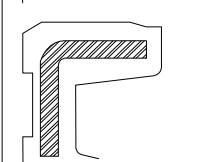
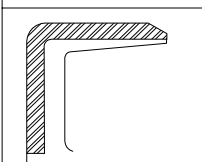
Standard Seal Questionnaire Sheet

If you are looking for a standard shaft seal but aren't quite sure which material or seal style is appropriate for your application, fill out the seal questionnaire form shown below. Once the highlighted areas have been completely filled out, the questionnaire provides all of the necessary application information for Dichtomatik's Engineering department to make the appropriate seal recommendation. Electronic copies of the questionnaire sheet can be obtained by visiting Dichtomatik's website or contacting Dichtomatik's Engineering department.

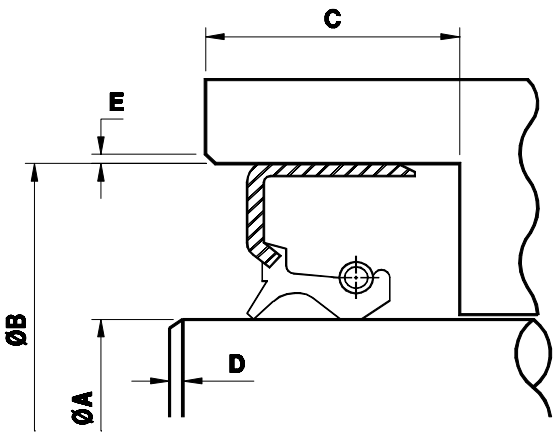
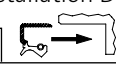
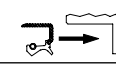
Customer & Division									
Address									
City/State/Zip									
Contact									
Telephone									
Customer P/N									
Type of Equipment									
Application									
<input type="checkbox"/> OEM	Date Required					A. Shaft Diameter: _____		D. Shaft Chamfer & Angle: _____	
<input type="checkbox"/> Aftermarket	Peak Month Usage					B. Bore Diameter: _____		E. Bore Chamfer & Angle: _____	
Annual Usage		C. Max Seal OD Width: _____							
SHAFT	<input type="checkbox"/> Horizontal <input type="checkbox"/> Vertical	Material	Finish		Hardness				
BORE	Material	Finish	Hardness	Installation Direction <input type="checkbox"/>  <input type="checkbox"/> 					
MOTION	<input type="checkbox"/> Rotating	RPMs		Direction From Air Side:					
		Normal	<input type="checkbox"/> Clockwise	<input type="checkbox"/> Counter-clockwise	<input type="checkbox"/> Bi-rotational				
	<input type="checkbox"/> Axial Movement	Shaft Runout (TIR)	Misalignment	Frequency of Rotation					
				<input type="checkbox"/> Continuous	<input type="checkbox"/> Intermittent				
	<input type="checkbox"/> Reciprocating	Stroke Length	Cycles/Min.	Special Operating Conditions					
	<input type="checkbox"/> Oscillating	Degrees of Arc	Cycles/Min.						
FLUID	<input type="checkbox"/> Internal	Type	Level	<input type="checkbox"/> Dry	<input type="checkbox"/> Flooded				
				<input type="checkbox"/> Mist					
	<input type="checkbox"/> External	Type							
TEMP.	<input type="checkbox"/> C <input type="checkbox"/> F	Minimum	Normal	Maximum					
PRESSURE	Normal PSI	Maximum PSI							
BEARING	<input type="checkbox"/> Ball or Roller Bearing			<input type="checkbox"/> Bushing					
SEAL RETENTION	<input type="checkbox"/> Snap Ring			<input type="checkbox"/> Groove in Bore					

Standard Seal Installation Sheet

In addition to submitting a completed seal questionnaire sheet it is requested that a completed seal installation sheet be submitted to Dichtomatik Engineering as well. The installation sheet allows engineering to ensure that the seal style recommended for the application will work for the preferred installation method.

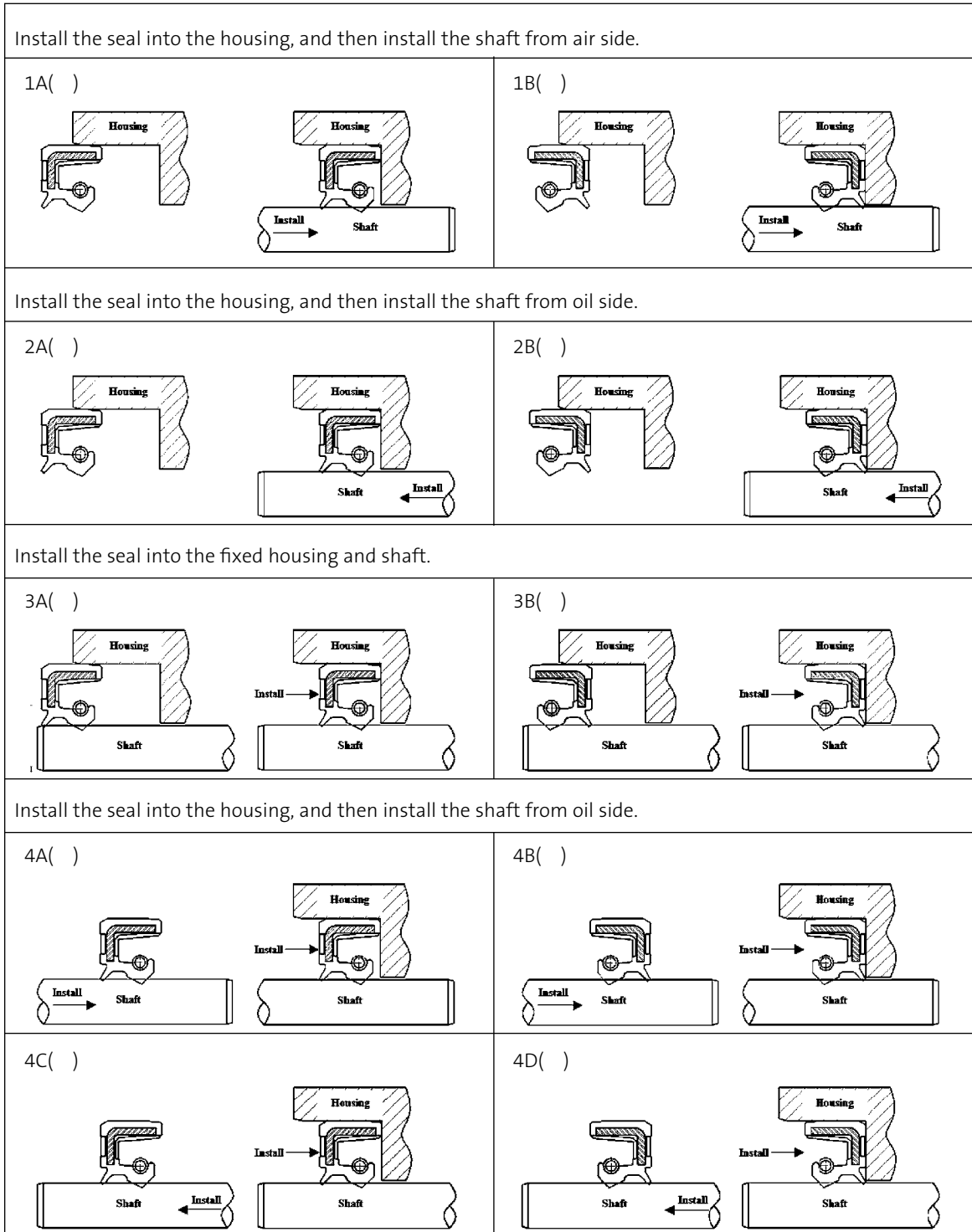

Pressure Seals

Dichtomatik's standard shaft seals are designed to function in applications where the operating pressure is 0 to 7 psi. For applications where the operating pressure is above 7 psi, a pressure seal will need to be used. If a standard shaft seal were to be used in a pressure application, the seal would be deformed due to the pressure being applied to the flex section of the seal. This deformation would lead to an increase in the contact between the seal and the shaft causing an increase in temperature and shaft wear. For this reason, pressure seals are standard shaft seals with a specially modified flex section design. The design of the flex section is dependant upon the amount of pressure that is present in the application. The standard pressure seals that Dichtomatik offers are the E style and N style seals.

E Style Pressure Seals

Dichtomatik's E style pressure seals are designed to function in applications where the operating pressure is 10 to 30 psi. E style pressure seals are designed so that the I.D. of the metal case is bent into the flex section of the primary sealing lip. By having the metal case in the flex section of the sealing lip, the seal can operate in higher pressure applications without the lip deforming.

N Style Pressure Seals

Dichtomatik's N style pressure seals are designed to function in applications where the operating pressure is above 30 psi. N style pressure seals are designed so that the flex section of the primary sealing lip gets progressively shorter as the applications operating pressure increases. Dichtomatik offers several different N style seals.

- N1 style seals are designed to operate in applications where the pressure is 30 to 50 psi.
- N2 style seals are designed to operate in applications where the pressure is 50 to 90 psi.
- N style seals are designed to operate in applications where the pressure is above 90 psi.

Because a pressure seal is designed with a shorter and stiffer flex section than a standard shaft seal, there are two application criteria that become increasingly important to control. These two criteria are the shaft hardness and the shaft eccentricity. The primary sealing lip of a pressure seal is going to have a higher radial load on the shaft which will tend to cause additional grooving in the shaft. To protect against excessive grooving in the shaft it is recommended that the shaft hardness be a minimum of 55 HRC for all pressure applications. The shaft eccentricity needs to be minimized because the primary sealing lip of a pressure seal is so stiff. If the runout or shaft-to-bore misalignment is high the sealing lip will lose contact with the shaft and there will be a leakage.

Dichtomatik stocks some pressure seals for standard applications. Prior to using a pressure seal in a new application it is recommended that you contact Dichtomatik Engineering to ensure that the proper seal is being used as the above pressure ratings for the seals may change as the operating speeds and temperatures vary.

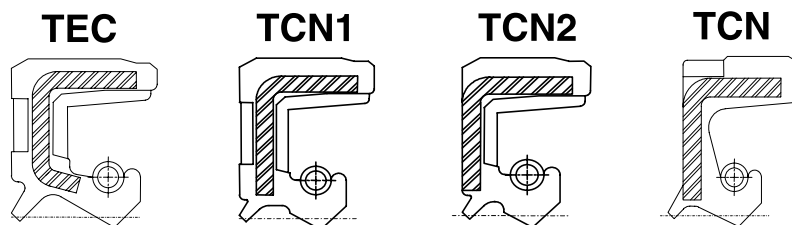

Figure 18: Pressure Seal Designs

V-Rings

A v-ring is an all rubber seal that mounts directly on a shaft and seals axially against either the housing or the metal case of a shaft seal. Once installed into an assembly, a v-ring will rotate with the shaft – unlike a shaft seal. Because v-rings rotate with the shaft they are often used in applications as slingers or deflectors. The centrifugal forces that are created by the rotating v-ring will deflect any contaminants – oil, dirt, sand, etc. – away from the sealing point of the application. Unlike a shaft seal, the v-ring is made out of 100% rubber which makes it completely elastic. Because they are elastic, v-rings can be installed into most applications without having to disassemble any components that may otherwise need to be removed for a standard seal to be installed. Also, each v-ring works on a range of shaft diameters instead of one specific shaft diameter like a standard shaft seal.

Dichtomatik offers three standard v-ring styles. The three styles that are offered are the VA, VL, and VS.

VA Style

The VA style v-ring is the most common style used in the industry. They are designed to operate in most standard industrial applications – such as gearboxes, conveyors, and appliances. VA style v-rings are offered for shaft diameters ranging from 0.106” to 29.370”. VA style v-rings are offered in both NBR and FKM versions.



Figure 19: VA Style V-Ring

VL Style

The VL style v-ring is similar to the VA style except that the body of the seal is a little narrower. By being narrower the VL style seal works well in applications where axial space may be limited. VL style v-rings are offered for shaft diameters ranging from 4.134” to 24.606”. VL style v-rings are offered in NBR.



Figure 20: VL Style V-Ring

VS Style

The VS style v-ring was the industries original v-ring. They are designed with a trapezoidal shaped body to help keep the v-ring in position on the shaft. They are designed to operate in more robust applications – such as agricultural applications. VS style v-rings are offered for shaft diameters ranging from 0.177” to 8.307”. VS style v-rings are offered in both NBR and FKM versions.



Figure 21: VS Style V-Ring

V-rings are typically used in one of two ways in an application. They are either used in conjunction with a shaft seal to provide additional contamination exclusion, or they can be used by themselves in certain applications. Because the lip of a v-ring is flexible, there are two things to keep in mind. First, they should never be used to seal any media into an application that is above 5 psi. Secondly, they should never be installed below the top of the oil level in an application.

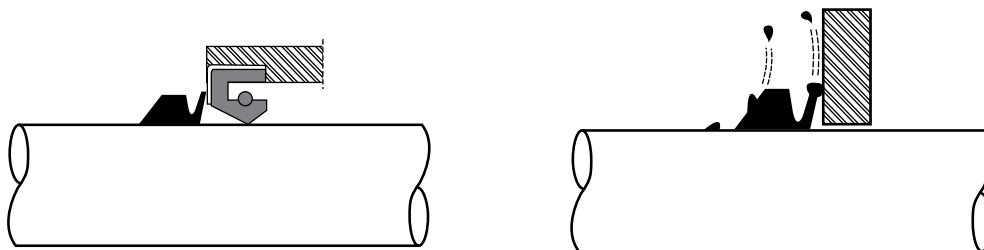

Figure 22: V-Ring Functions

Axial Face Seals

An axial face seal is a v-ring with an outer metal case added to it. Like a v-ring, an axial face seal mounts directly on a shaft and seals axially against either the housing or the metal case of a shaft seal. By incorporating a metal case into an axial face seal, they are able to seal out heavier contaminants than a v-ring would be able to. Unlike a v-ring, an axial face seal is not completely elastic – as a result of the addition of the outer metal case. This means that each axial face seal is designed for a specific shaft diameter rather than a range of shaft diameters like a v-ring. As was the case with v-rings, an axial face seal can either be used in conjunction with a shaft seal to provide additional contamination exclusion, or they can be used by themselves in an application.

Dichtomatik offers two standard axial face seal styles. The two styles that are offered are the AFS and AFX.

AFS Style

The AFS style axial face seal is the industry standard for face seals. An AFS style axial face seal is designed so that the O.D. edge of the metal case does not cover all of the rubber sealing lip. Therefore, when an AFS style seal is installed into an application there is a narrow gap between the edge of the metal case and the housing. AFS style seals are offered for shaft diameters ranging from 0.394" to 8.858".

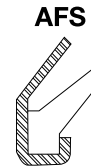

Figure 23: AFS Seal

AFX Style

The AFX style axial face seal is similar to the AFS except that the O.D. edge of the metal case extends beyond the rubber sealing lip. Because the metal case extends beyond the sealing lip, a groove needs to be machined into the housing to accept the metal case. In applications where heavy contamination is a concern, an AFX style seal would be better than an AFS because with the metal case extending into the housing there is a labyrinth created. By incorporating a labyrinth into the application the AFX will slow down the migration of the contaminants better than an AFS which will lead to longer seal life. AFX style seals are offered for shaft diameters ranging from 0.591" to 3.937".

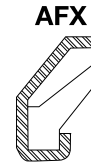

Figure 24: AFX Seal

Both the AFS and AFX style face seals are typically offered in 80-durometer NBR with a zinc coated carbon steel case. Unlike standard shaft seals the sealing elements of axial face seals are made out of 80-durometer NBR instead of 70-durometer to increase the wear resistance from contaminants. Dichtomatik offers other material combinations for the AFS and AFX seals. If you are interested in using an axial face seal but prefer something other than NBR and carbon steel contact Dichtomatik Engineering to discuss material options.

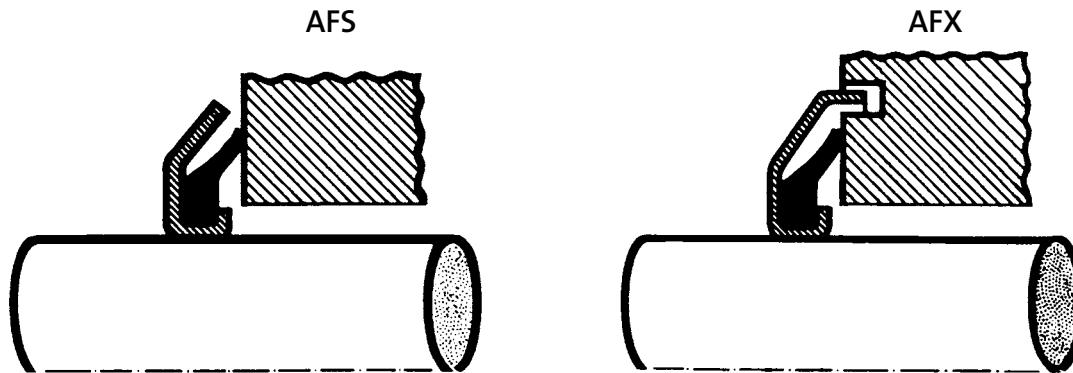

Figure 25: Axial Face Seal Functions

Trailer Kits

Trailer Kits

Dichtomatik offers five different types of trailer kits to meet the needs of trailer customers. Each trailer kit from Dichtomatik comes equipped with:

- A set of bearings
- A Shaft Seal
- A Dust Cap
- A Cotter Pin

The components of a trailer kit are packaged in a skin board container with a clear front. The skin boards work well for customers that are planning on displaying Dichtomatik's trailer kits on a display rack. Dichtomatik's trailer kits are intended for use on trailers such as boat, snowmobile, motorcycle, utility, water sports, and most other small axle trailers. Below is a listing of the trailer kits that Dichtomatik currently offers along with a list of parts and the corresponding quantity that are in each kit.



Figure 26: Trailer Kit

Table 12: Dichtomatik Trailer Kits

TK1 - For 1" Spindles	
Parts in Kit	Qty
L44643 Bearings	2
644610 Bearings	2
121974VB Shaft Seal	1
T1518 Dust Cap	1
Cotter Pin	1

TK4 - For 3/4" Spindles	
Parts in Kit	Qty
LM11949 Bearings	2
LM11910 Bearings	2
11174VB Shaft Seal	1
T1517 Dust Cap	1
Cotter Pin	1

TK2 - For 1 1/4" Spindles	
Parts in Kit	Qty
LM67048 Bearings	2
LM67010 Bearings	2
15234VB Shaft Seal	1
T1601 Dust Cap	1
Cotter Pin	1

TK5 - For 1 3/8" & 1 23/32" Spindles	
Parts in Kit	Qty
L68149 Bearing	1
L44649 Bearing	1
L68111 Bearing	1
L44610 Bearing	1
171255TB Shaft Seal	1
T1518 Dust Cap	1
Cotter Pin	1

TK3 - For 1 1/16" Spindles	
Parts in Kit	Qty
L44649 Bearings	2
L44610 Bearings	2
12192VB Shaft Seal	1
T1518 Dust Cap	1
Cotter Pin	1

Oil Bath Seals

In the trailer industry there are several different axle designs and applications. Some axle assemblies are designed to operate with a standard shaft seal, whereas, some are designed to operate with an oil bath seal. An oil bath seal is a highly engineered seal that is designed specifically to operate in an axle assembly, most commonly a trailer axle.

Dichtomatik's oil bath seals are multi-piece unitized seals. Each seal consists of a sealing element and a sleeve. By incorporating a sleeve into the seal design Dichtomatik's oil bath seals keep all of the seal wear internal to the seal, rather than wearing out the application components. All of Dichtomatik's oil bath seals come pre-greased from the supplier. Also, they are all designed for ease of installation without any unique tools.

Dichtomatik offers two different styles of oil bath seals. The two styles that are offered are a standard dust lip design and a labyrinth design.

Dust Lip Style

The first style of oil bath seal that Dichtomatik offers is a standard dust lip design. Dichtomatik's ST style oil bath seals have a dust lip added to the sealing element to help slow down the migration of contaminants into the hub. The ST style seals are designed with a metal O.D.

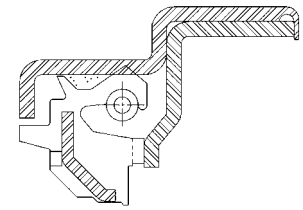

Figure 27: ST Style Oil Bath Seal

Labyrinth Style

The second style of oil bath seal that Dichtomatik offers is a labyrinth style seal. Dichtomatik's ST5 and ST34 style oil bath seals have a labyrinth incorporated into the design to slow down the migration of contaminants into the hub. The ST5 and ST34 seals are designed with a rubber O.D. and rubber I.D. so that the hub and axle are not scratched during seal installation. On the sealing lip of each ST5 and ST34 seal is a bi-directional helix. The helix helps to increase the pumping rate of the oil back onto the hub, while helping to keep the operating temperature around the sealing lip low.

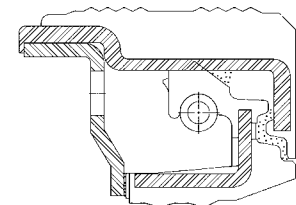

Figure 28: ST5 Style Oil Bath Seal

Dichtomatik offers a full range oil bath seals designed to fit onto the industries standard axles. All of Dichtomatik's oil bath seals can be installed without special installation tools.

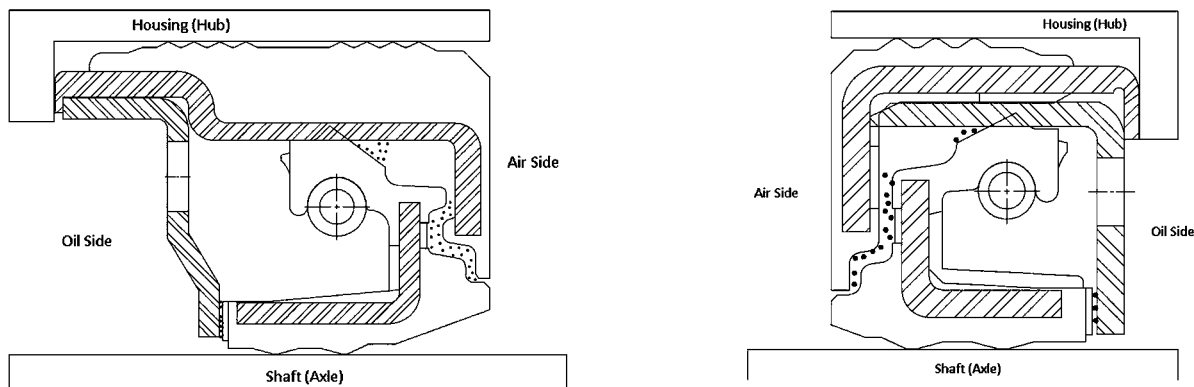

Figure 29: Oil Bath Seals

AO Seals

Dichtomatik's shaft seal product family contains several different styles of seals. One unique family of seals that Dichtomatik offers is the TRAKSEAL product family. Dichtomatik's TRAKSEAL product family consists of seals that are specifically designed to operate in environments that a standard shaft seal would not function properly in. Typical applications for a TRAKSEAL would be agricultural, construction, turf care, or tillage equipment. The TRAKSEAL product family consists of three custom designed styles of seals – the AO seal, AP seal, and track roller seals.

The first style of seal offered within Dichtomatik's TRAKSEAL product family is the AO series seals. AO seals are two piece seals that are designed for medium contamination applications. The two pieces of an AO seal are the sealing element and the sleeve. The sealing element of an AO seal can be anything from a standard shaft seal profile to a custom designed seal with multiple contamination exclusion lips. The sleeve that is incorporated into the design acts as the sealing surface for each of the lips on the sealing element. Because of the heavy contaminants that are present around the application there is a higher risk of excessive shaft wear occurring. By using an AO seal, the sleeve removes the risk of shaft wear and aids in extending the life of the shaft.

There are several benefits to using Dichtomatik's AO style seals in an application. The benefits of an AO seal are:

- Medium duty dirt exclusion
- Wash down spray resistant
- Two piece installation
- Seals are pre-greased by the manufacturer
- Full retrofit capability – can replace a standard shaft seal with no application modifications
- No shaft wear – all wear from the sealing element is contained by the sleeve

Along with the benefits, there are two things to keep in mind when using an AO seal in an application. The AO design is intended for use in applications where the axial movement within the assembly is limited. If excessive axial movement is present there is a chance that the sealing element and the sleeve will separate in the assembly. Also, due to the increased number of lips present within an AO seal, there will be extra heat and drag present within the seal, so to minimize the effects of these two parameters on the seal the surface speed and operating temperature need to be taken into consideration.

All of Dichtomatik's AO seals are custom designed for each application to ensure proper fit and performance. If you are interested in an AO style seal, contact Dichtomatik Engineering to discuss the application and begin the design process. Along with the seal design an installation tool design can be provided upon request to help ensure that the seal is installed properly into the application.

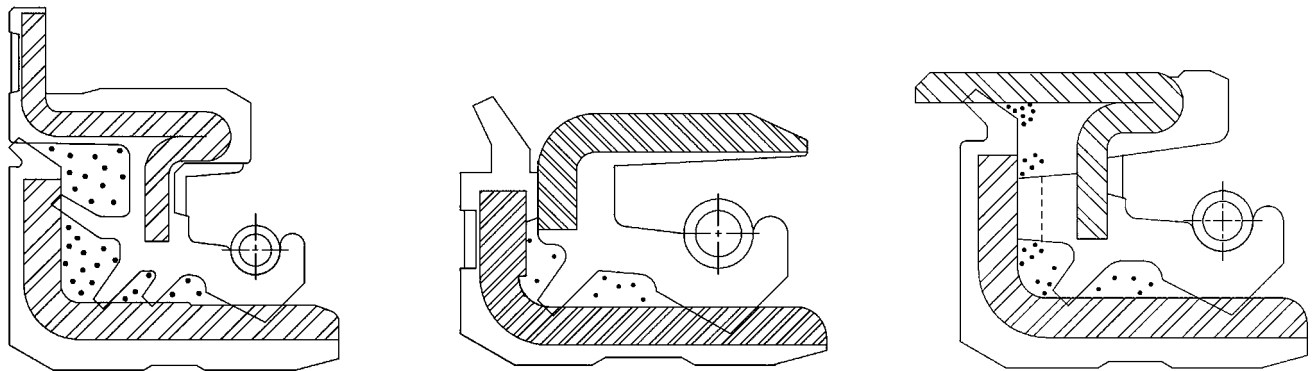

Figure 30: AO Style Seals

AP Seals

The second style of seal offered within Dichtomatik's TRAKSEAL product family is the AP series seals. AP seals are similar to AO style seals except that the pieces are all crimped together – creating a unitized seal design. Dichtomatik's AP seals are multi-piece seals that are designed for high contamination applications. As with the AO style seal, the AP seal consists of a sealing element along with at least one sleeve. The sealing element of an AP seal can be anything from a standard shaft seal profile to a custom designed seal with multiple contamination exclusion lips. The sleeve(s) of an AP seal are incorporated into the design to act as the sealing surface for each of the lips on the sealing element, while also, in some instances, having excluder lips of their own.

There are several benefits to using Dichtomatik's AP style seals in an application. The benefits of an AP seal are:

- Heavy duty dirt exclusion
- Labyrinth design to slow down the migration of dirt
- Wash down spray resistant
- One piece installation
- Seals are pre-greased by the manufacturer
- Full retrofit capability – can replace a standard shaft seal with no application modifications
- No shaft wear – all wear from the sealing element is contained by the sleeve

Along with the benefits there are two things to keep in mind when using an AP seal in an application. The AP design is intended for use in applications where the axial movement within the assembly is limited. If excessive axial movement is present within the application, then the sealing element and the sleeve(s) will move relative to each other which will crush some of the lips within the seal. Also, due to the increased number of lips present within an AP seal, there will be extra heat and drag present within the seal. To minimize the effects of these two parameters on the seal, the shaft surface speed and application operating temperature need to be taken into consideration.

All of Dichtomatik's AP seals are custom designed for each application to ensure proper fit and performance. If you are interested in an AP style seal, contact Dichtomatik Engineering to discuss the application and begin the design process.

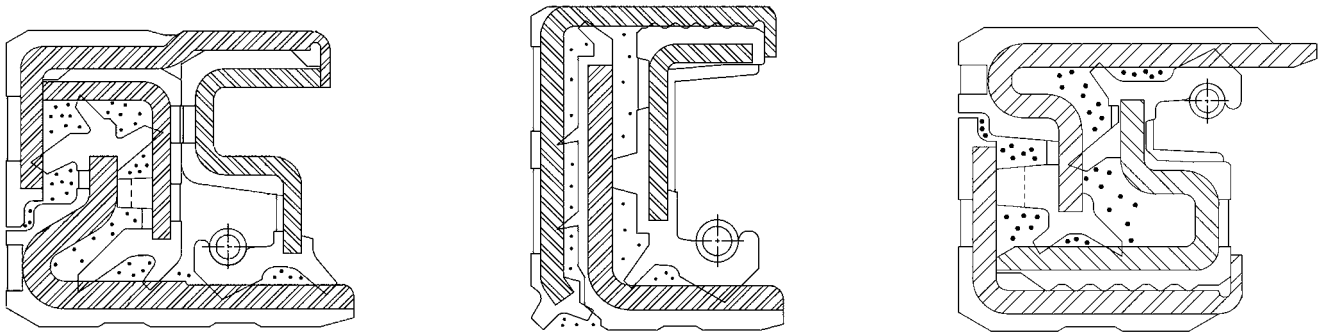

Figure 31: AP Style Seals

Track Roller Seals

The third style of seal offered within Dichtomatik's TRAKSEAL product family is the track roller seal. Track roller seals are mechanical seals that are designed to seal positively within heavy contaminant applications. Track roller seals are two piece seals that are sold in sets. Each set consists of two rubber energizers and a pair of uniquely matched, lapped and ground metal face seals. The rubber energizers serve two functions for a track roller seal. First, they provide a uniform load to the metal face seals during the service life of the seals. Secondly, they act as a seal against the housing to prevent any lubricants from leaking out of the application. The matched lapped and ground metal face seals act as the primary sealing element of a track roller seal. By having the lapped and ground faces pressed together by the energizers, the metal seals provide a tight sealing element that will retain lubrication in the application while sealing out heavy duty contaminants.

Besides not having a traditional rubber sealing element like a standard shaft seal, track roller seals also differ from standard shaft seals in that they do not contact the shaft of an application. Track roller seals are designed so that the I.D. of the metal rings are floating within the application. When installed into an application, one of the energizers and metal face seals will remain stationary while the other set rotates with the application – thus forming a leakproof seal.

Track roller seals are intended for use in applications where the operating speed is low – typically less than 750 FPM. Dichtomatik's track roller seals are typically made with NBR energizers and corrosion resistant steel for the metal face seals. Depending on the type of lubrication and operating temperature, the type of rubber used to make the energizers can be modified.

There are several benefits to using Dichtomatik's track roller seals in an application. The benefits of are:

- Longer life than a standard lip seal
- Heavy duty dirt exclusion
- Wash down spray resistant
- Two piece installation
- No wear within the application – all wear is internal to the seal

All of Dichtomatik's track roller seals are custom designed for each application to ensure proper fit and performance. If you are interested in a track roller seal, contact Dichtomatik Engineering to discuss the application and begin the design process.

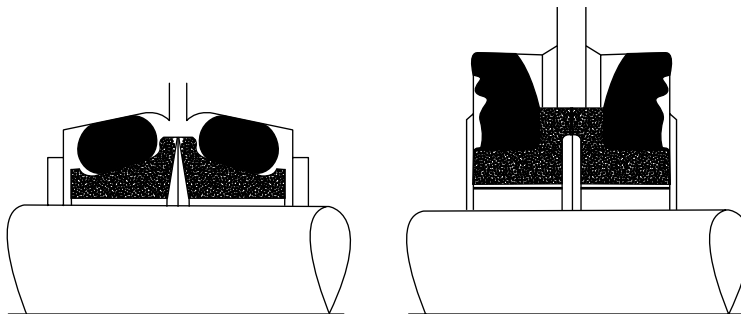
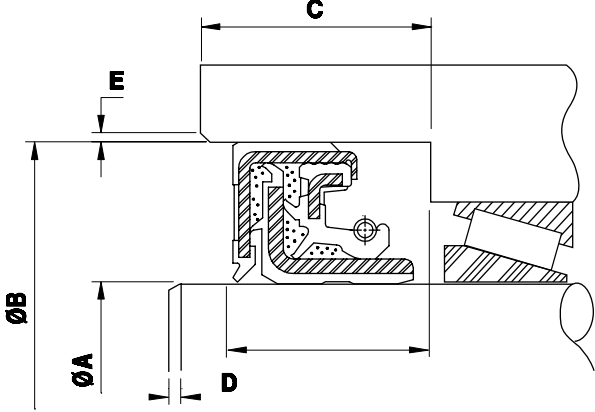
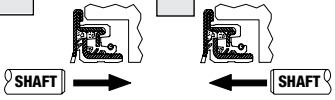

Figure 32: Track Roller Seals

AP Seal Questionnaire Sheet

AP Seal Questionnaire Sheet

If you are interested in using an AO or AP style shaft seal in your application fill out the seal questionnaire form shown below. Once the highlighted areas have been completely filled out, the questionnaire provides all of the necessary application information for Dichtomatik's Engineering department to make the appropriate seal recommendation. Electronic copies of the questionnaire sheet can be obtained by visiting Dichtomatik's website or contacting Dichtomatik's Engineering department.

Customer & Division									
Address									
City/State/Zip									
Contact									
Telephone									
Customer P/N									
Type of Equipment									
Application									
<input type="checkbox"/> OEM	Date Required					A. Shaft Diameter: _____		D. Shaft Chamfer & Angle: _____	
<input type="checkbox"/> Aftermarket						B. Bore Diameter: _____		E. Bore Chamfer & Angle: _____	
Annual Usage	Peak Month Usage	C. Max Seal OD Width: _____		F. Max Seal ID Width: _____					
SHAFT	<input type="checkbox"/> Horizontal <input type="checkbox"/> Vertical	Material	Finish	Hardness					
BORE	Material	Finish	Hardness	Installation Direction					
MOTION	<input type="checkbox"/> Rotating	RPMs							
		Normal	Max						
	<input type="checkbox"/> Axial Movement	Shaft Runout (TIR)	Misalignment	Frequency of Rotation					
	<input type="checkbox"/> Reciprocating	Stroke Length	Cycles/Min.	<input type="checkbox"/> Continuous <input type="checkbox"/> Intermittent					
	<input type="checkbox"/> Oscillating	Degrees of Arc	Cycles/Min.	Special Operating Conditions					
FLUID	<input type="checkbox"/> Internal	Type	Level	<input type="checkbox"/> Dry <input type="checkbox"/> Flooded <input type="checkbox"/> Mist					
	<input type="checkbox"/> External	Type							
TEMP.	<input type="checkbox"/> C <input type="checkbox"/> F	Minimum	Normal	Maximum					
PRESSURE	Normal PSI	Maximum PSI							
BEARING	<input type="checkbox"/> Ball or Roller Bearing	<input type="checkbox"/> Bushing							
SEAL RETENTION	<input type="checkbox"/> Snap Ring	<input type="checkbox"/> Groove in Bore							

AP Seal Installation Sheet

In addition to submitting a completed seal questionnaire sheet it is requested that a completed seal installation sheet be submitted to Dichtomatik Engineering as well. The installation sheet allows engineering to ensure that the seal style recommended for the application will work for the preferred installation method.

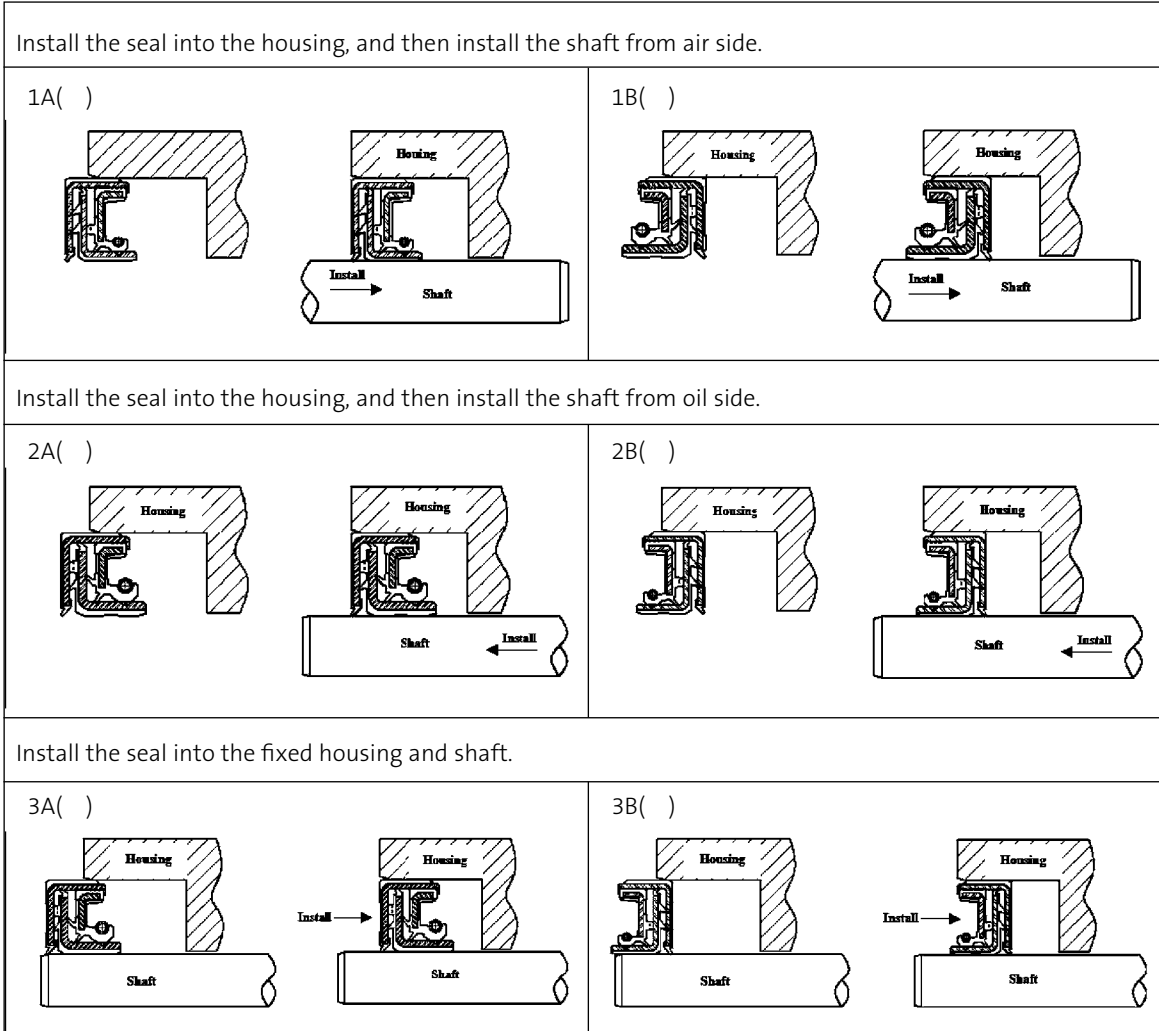

Shaft-Eze

Often times a shaft seal will groove a shaft during operation. As a result, when a shaft seal fails a new seal cannot be immediately installed onto the shaft without either reworking or replacing the shaft. Grooving can occur due to high shaft speeds, contaminants getting under the sealing lip(s), or because of a lack of lubrication around the sealing lip. When grooves are present in a shaft it is not a question of if a seal will leak, but rather a question of when. To minimize equipment downtime and costs, one option is to install a Shaft-Eze onto the worn shaft rather than reworking or replacing it.

Dichtomatik's Shaft-Eze is a precision ground stainless steel sleeve that provides a new sealing surface without reworking or replacing the shaft. All of our Shaft-Eze are manufactured using SAE grade 304 stainless steel. Each sleeve is precision ground so that the surface finish is 10 to 20 μin (0.2 to 0.8 μm). A Shaft-Eze is a thin-walled sleeve, typically 0.011" (0.28 mm) thick, that gets installed onto a shaft overtop of any grooves that may be left behind. Once installed, a Shaft-Eze forms a tight fit around the existing shaft that allows for the same sized seal as previously used to be used again in the application.

To determine the appropriate Shaft-Eze to use in an application, it is recommended that the shaft diameter be measured near the worn area. The diameter should be measured three times and then averaged to determine the actual shaft diameter. Once the shaft diameter is determined, select the appropriate Shaft-Eze based upon the shaft diameter ranges provided in the Shaft-Eze part number section of this catalog. Dichtomatik offers over 250 sizes of Shaft-Eze for shaft diameters ranging from 0.469" to 8.005".

Shaft-Eze are easy to install onto worn shafts using the provided installation tool. To install a Shaft-Eze begin by placing the flange end of the Shaft-Eze squarely onto the end of the shaft. Then, take the provided installation tool and slide the open end of the tool over the sleeve until it contacts the flange. Then, gently tap the closed end of the installation tool with a hammer until the Shaft-Eze is installed to the desired position on the shaft. Once the Shaft-Eze is in the correct position, if necessary, the removable flange can be removed. To remove the flange take a pair of side cutters and cut down the flange towards the shaft. Once the cut has been made bend the flange a few times to ensure that the perforation is the point in which the flange will break-away. Once the flange has been removed, check the sealing area for any burrs that may exist.

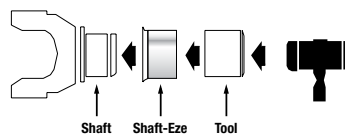

Figure 33: Shaft-Eze Installation

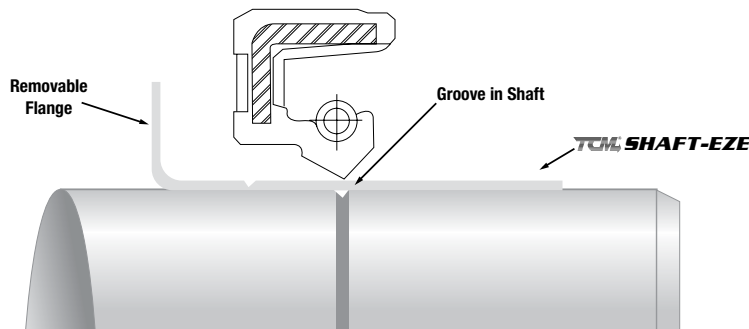

Figure 34: Shaft-Eze Function

Individually Boxed Product

Individually Boxed Product

At the time of purchase, customers have the choice of whether they would like to purchase any of Dichtomatik's shaft seal products in a bulk quantity or individually. If a customer is interested in purchasing individually packaged product, then a '-BX' needs to be added to the end of a part number. For example, the individually boxed part number for a 27353TA-H shaft seal is 27353TA-H-BX. All of Dichtomatik's shaft seal products are available in individually boxed quantities – shaft seals, v-rings, and axial face seals. All of Dichtomatik's Shaft-Eze parts are packaged and sold individually.

For customers that are going to be placing Dichtomatik's individually packaged shaft seals on shelves, spacing requirements are important to keep in mind. For this reason, Dichtomatik has included in the part number section of this catalog a box number for each part number. The box for each part is determined by the outer diameter of the part and the overall part width. Table 13 below shows the dimensions for each of Dichtomatik's shaft seal boxes and the type of product that can be placed in it.



Figure 35:
Dichtomatik's Shaft-Eze Box

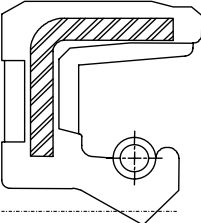
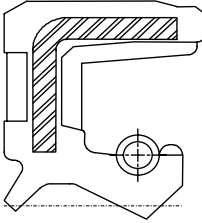
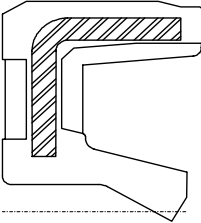
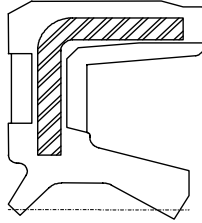
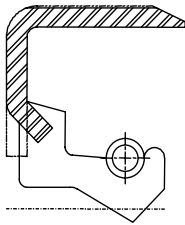
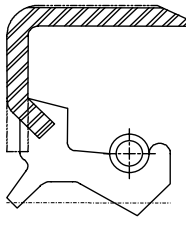
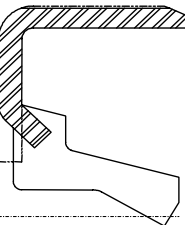
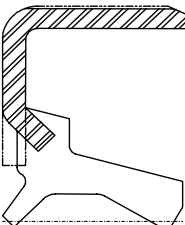
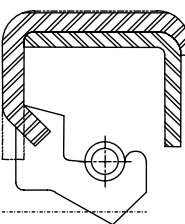
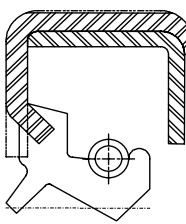
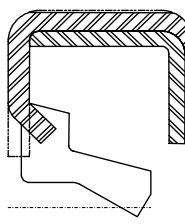
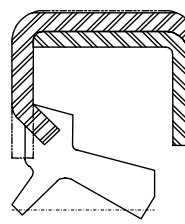
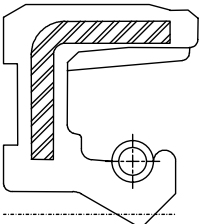
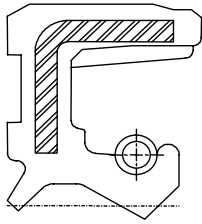
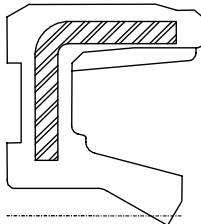
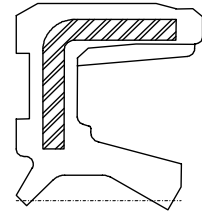
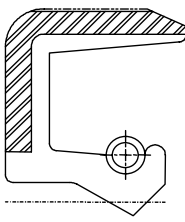
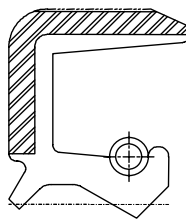
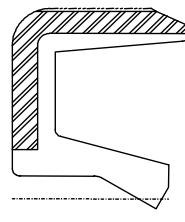
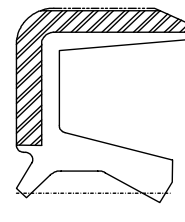

Figure 36:
Dichtomatik's Shaft Seal Box

Table 13: Dichtomatik's Shaft Seal Boxes

Box #	Product	Length (in)	Width (in)	Thickness (in)	Volume (in ³)
S1	Shaft-Eze	4.252	4.252	1.772	32.037
S2	Shaft-Eze	6.024	6.024	2.559	92.862
S3	Shaft-Eze	9.055	9.055	2.480	203.343
S4	Shaft-Eze	4.252	4.252	3.543	64.056
7	Shaft Seals, V-Rings, & Axial Face Seals	2.500	2.500	0.500	3.125
8	Shaft Seals, V-Rings, & Axial Face Seals	3.500	3.500	0.750	9.188
9	Shaft Seals, V-Rings, & Axial Face Seals	4.750	4.750	0.750	16.922
3	Shaft Seals, V-Rings, & Axial Face Seals	6.000	6.000	0.750	27.000
5	Shaft Seals, V-Rings, & Axial Face Seals	8.000	8.000	0.750	48.000
6	Shaft Seals, V-Rings, & Axial Face Seals	10.000	10.000	1.000	100.000
11	Shaft Seals, V-Rings, & Axial Face Seals	12.000	12.000	1.000	144.000
12	Shaft Seals, V-Rings, & Axial Face Seals	14.000	14.000	1.000	196.000



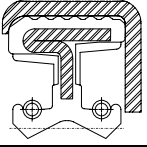
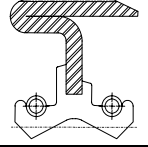
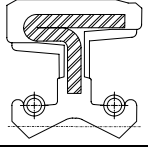
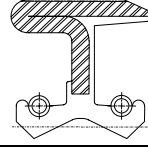
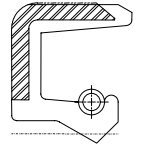
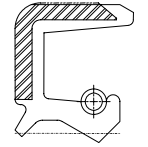
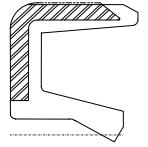
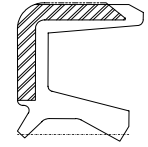
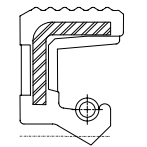
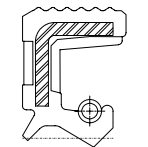
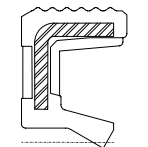
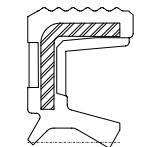
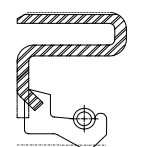
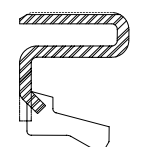
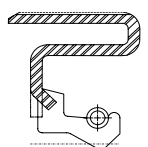
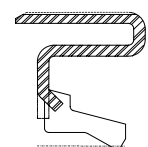
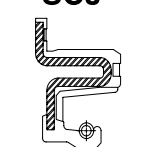
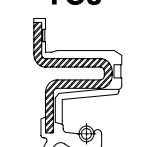
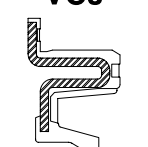
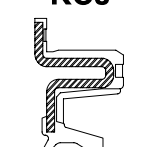
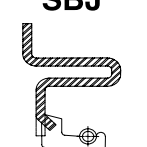
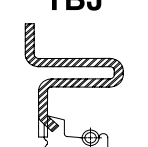
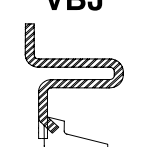
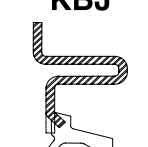
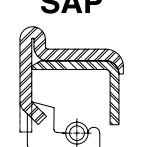
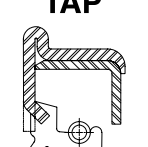
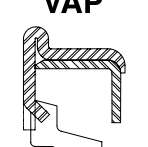
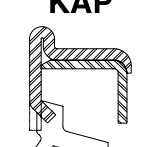
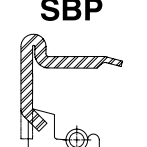
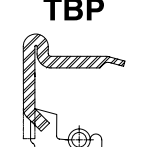
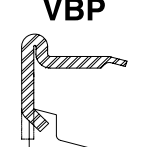
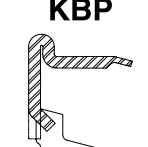

Principal Shaft Seal Designs

	Lip Style	“S”	“T”	“V”	“K”
OD Style		Low-pressure single lip with garter spring without protection from contaminants.	Low-pressure dual lip with garter spring with protection from contaminants.	Non-pressure single lip without garter spring without protection from contaminants.	Non-pressure dual lip without garter spring with protection from contaminants.
“C”	Rubber cover OD for improving OD sealing ability.	<p>SC</p> 	<p>TC</p> 	<p>VC</p> 	<p>KC</p> 
“B”	Precision ground OD surface with a lead-in chamfer for ease of installation.	<p>SB</p> 	<p>TB</p> 	<p>VB</p> 	<p>KB</p> 
“A”	Precision ground OD surface with an inner case providing increased structural rigidity.	<p>SA</p> 	<p>TA</p> 	<p>VA</p> 	<p>KA</p> 
“F”	Rubber cover OD for improving OD sealing ability, with additional rubber fully protecting the inner case.	<p>SF</p> 	<p>TF</p> 	<p>VF</p> 	<p>KF</p> 
“M”	Precision ground OD surface with a lead-in chamfer with an additional inner rubber lining.	<p>SM</p> 	<p>TM</p> 	<p>VM</p> 	<p>KM</p> 

Shaft Seal Designs

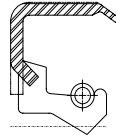
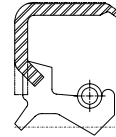
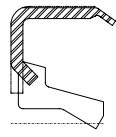
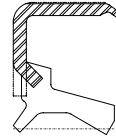
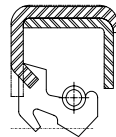
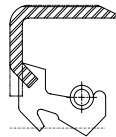
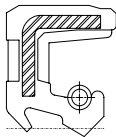
TCM Type	Design Characteristics	Seal Style			
"D"	Two opposing spring loaded lips, designed for applications where the separation of two media is required.	<p>DA</p> 	<p>DB</p> 	<p>DC</p> 	<p>DM</p> 
"Z"	Precision ground OD and a rubber covered top face for improved sealing ability.	<p>SZ</p> 	<p>TZ</p> 	<p>VZ</p> 	<p>KZ</p> 
"G"	Corrugated OD for applications where the housing material is subject to large thermal expansion or press fitting into a housing where installation is usually difficult.	<p>SG</p> 	<p>TG</p> 	<p>VG</p> 	<p>KG</p> 
"H"	Precision ground OD with added structural rigidity particularly when there is a large radial seal width. It also allows installation from both sides.	<p>SH</p> 	<p>VH</p> 	<p>SH1</p> 	<p>VHY</p> 
"J"	Rubber OD with flange will allow easy installation or replacement, gives additional structural rigidity and restricts the installation depth into the housing.	<p>SCJ</p> 	<p>TCJ</p> 	<p>VCJ</p> 	<p>KCJ</p> 
	Precision ground OD with flange will allow easy installation or replacement, gives additional structural rigidity and restricts the installation depth into the housing.	<p>SBJ</p> 	<p>TBJ</p> 	<p>VBJ</p> 	<p>KBJ</p> 
"P"	Precision ground, reinforced OD with minimum clearance flange that will allow easy installation or replacement and restricts the installation depth into the housing.	<p>SAP</p> 	<p>TAP</p> 	<p>VAP</p> 	<p>KAP</p> 
	Precision ground OD with minimum clearance flange that will allow easy installation or replacement and restricts the installation depth into the housing.	<p>SBP</p> 	<p>TBP</p> 	<p>VBP</p> 	<p>KBP</p> 

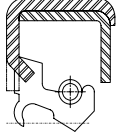
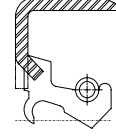
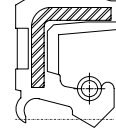
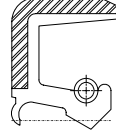
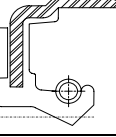
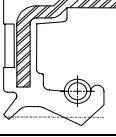
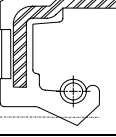
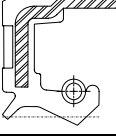
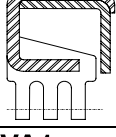
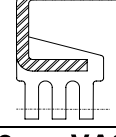
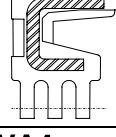
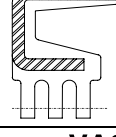
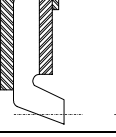
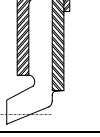
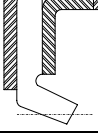
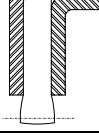
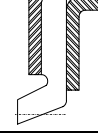

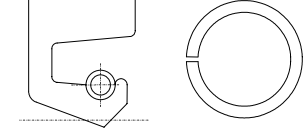
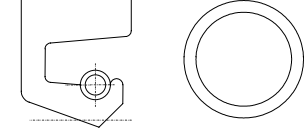
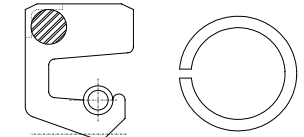
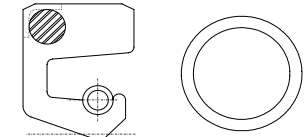
Shaft Seal Designs



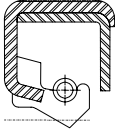
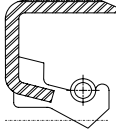
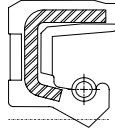
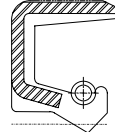
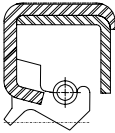
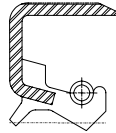
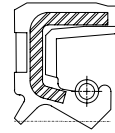
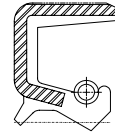
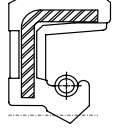
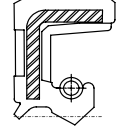
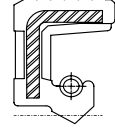
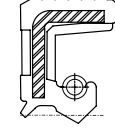
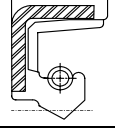
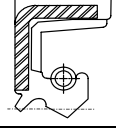
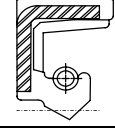
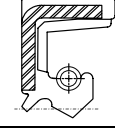
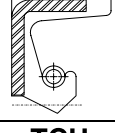
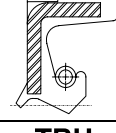
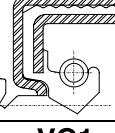
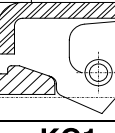
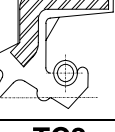
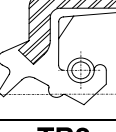
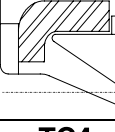
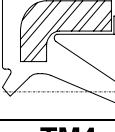
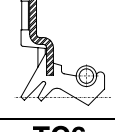
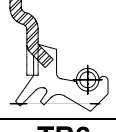
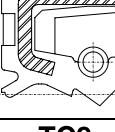
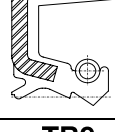
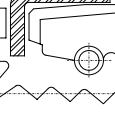
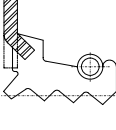
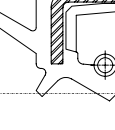
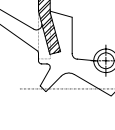

TCM Type	Design Characteristics	Seal Style					
“L”	Precision ground OD with a rolled leading edge to aid in the alignment during installation.	SL 	TL 	VL 	KL 		
“X”	The cavity will allow pre-lubrication of the seal to combat initial dry running or where space is limited and a secondary lip for dust exclusion is required.	TXA 	TXB 	TXC 	TXM 		
“X1”	Similar to the “X” type, but with a larger cavity for pre-lubrication of the seal to combat initial dry running or where space is limited and a secondary lip for dust exclusion is required.	TX1A 	TX1B 	TX1C 	TX1M 		
“BC” “BG”	This design provides the benefit of a metal-to-metal press fit and the rubber OD sealing ability to counter rough or worn housings.	SBC 	TBC 	SBG 	TBG 		
“U”	Triple flat lip design for use in heavy dirt applications, commonly used in agriculture equipment.	UA 	UB 	UC 	UM 		
“VA”	Grease retention seals with variations depending on the application or installation conditions.	VA1 	VA2 	VA3 	VA4 	VA5 	VA6 
“SQ”	For use where radial space is limited and can be supplied with a split for ease of installation.	SQ 		SQ1 			
“SQS”	Same as the SQ type, with an addition of a spring inset for added rigidity.	SQS 		SQS1 			

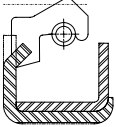
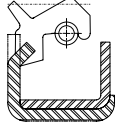
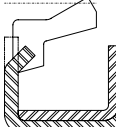
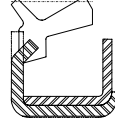
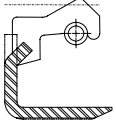
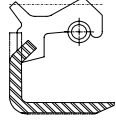
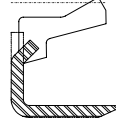
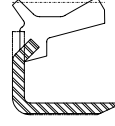
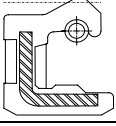
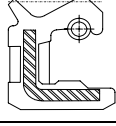
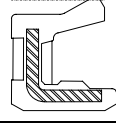
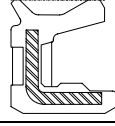
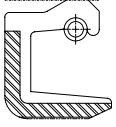
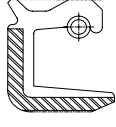
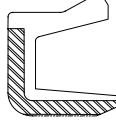
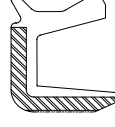
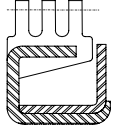
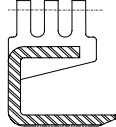
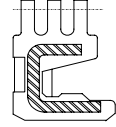
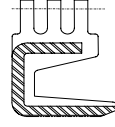
Shaft Seal Designs

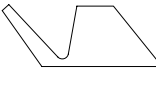
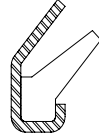
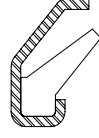
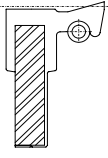
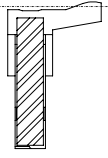
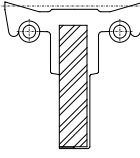
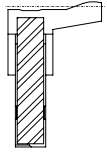
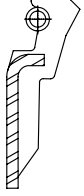
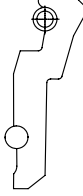
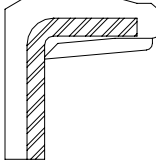
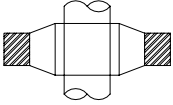
TCM Type	Design Characteristics	Seal Style			
"E"	<p>The metal case reinforcement of the lip flex section makes this type suitable for low to medium pressure applications depending on the shaft speed and runout.</p> <p>Pressure rating, 10 - 30 psi.</p>	<p>SEA</p> 	<p>SEB</p> 	<p>SEC</p> 	<p>SEM</p> 
		<p>TEA</p> 	<p>TEB</p> 	<p>TEC</p> 	<p>TEM</p> 
"N1"	<p>The shorter flex section makes this type suitable for lower pressure applications depending on the shaft speed and runout.</p> <p>Pressure rating, 30 - 50 psi.</p>	<p>SCN1</p> 	<p>TCN1</p> 	<p>SGN1</p> 	<p>TGN1</p> 
"N2"	<p>The shorter flex section makes this type suitable for medium pressure applications depending on the shaft speed and runout.</p> <p>Pressure rating, 50 - 90 psi.</p>	<p>SCN2</p> 	<p>TCN2</p> 	<p>SGN2</p> 	<p>TGN2</p> 
"N"	<p>The shortest flex section of the N type series makes it suitable for higher-pressure applications depending on the shaft speed and runout.</p> <p>Pressure rating, 90+ psi.</p>	<p>SCN</p> 	<p>TCN</p> 	<p>TDN</p> 	<p>CNB</p> 
"TH" "G1"	<p>TH – For heavy-duty dirt exclusion, and OD sealing ability in the housing, is required.</p> <p>G1- "G" type OD, and a lip profile for limited radial space applications.</p>	<p>TCH</p> 	<p>TBH</p> 	<p>VG1</p> 	<p>KG1</p> 
"2/4"	<p>Type 2 – used when a secondary dust lip is needed</p> <p>Type 4 – used for linear applications such as motorcycle forks.</p>	<p>TC2</p> 	<p>TB2</p> 	<p>TC4</p> 	<p>TM4</p> 
"6/9"	<p>Type 6 – used for added dust or fine contaminate protection.</p> <p>Type 9 – has the ability to act as a rotary shaft and an axial face seal.</p>	<p>TC6</p> 	<p>TB6</p> 	<p>TC9</p> 	<p>TB9</p> 

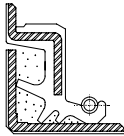
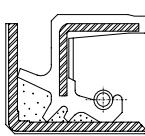
Shaft Seal Designs

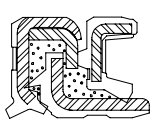
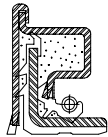
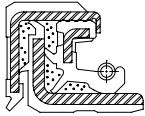
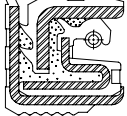
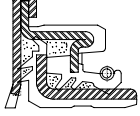
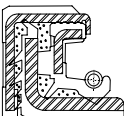
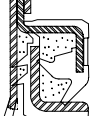
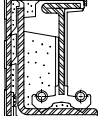
TCM Type	Design Characteristics	Seal Style			
<p>“O”</p>	<p>External Seals</p> <p>This external lip type performs and has the same design characteristics as the standard radial lip seals, but these are designed for a press fit on the shaft and to seal in a housing.</p>	<p>OSA</p> 	<p>OTA</p> 	<p>OVA</p> 	<p>OKA</p> 
		<p>OSB</p> 	<p>OTB</p> 	<p>OVB</p> 	<p>OKB</p> 
		<p>OSC</p> 	<p>OTC</p> 	<p>OVC</p> 	<p>OKC</p> 
		<p>OSM</p> 	<p>OTM</p> 	<p>OVM</p> 	<p>OKM</p> 
		<p>OUA</p> 	<p>OUB</p> 	<p>OUC</p> 	<p>OUM</p> 
<p>“VA” “VS” “AFS” “AFX”</p>	<p>VA, VS – designed to be fixed on the shaft sealing axially against a perpendicular counter face. AFS, AFX – Performs the same as the VA, VS with an additional metal face added for protection.</p>	<p>VA</p> 	<p>VS</p> 	<p>AFS</p> 	<p>AFX</p> 
<p>Piston Seals</p>	<p>Designed for reciprocating ram type applications</p>	<p>PSC</p> 	<p>PSV</p> 	<p>PDC</p> 	<p>PSV</p> 
	<p>Valve Stem – Designed for valve guides End Cap – Designed for static applications to act as a plug or barrier. Bonded Seal – Designed as a addition to threaded fasteners</p>	<p>VSC2</p> 	<p>VSC4</p> 	<p>EC</p> 	<p>BS</p> 

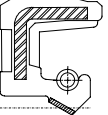
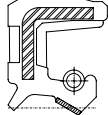
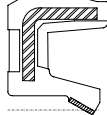
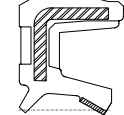
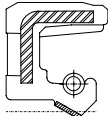
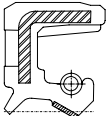
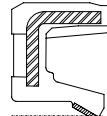
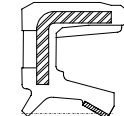
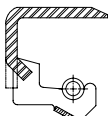
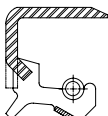
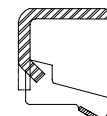
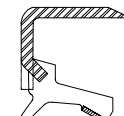
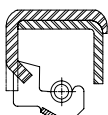
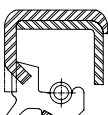
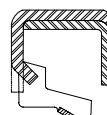
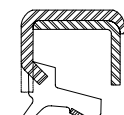
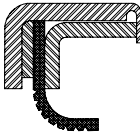
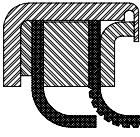
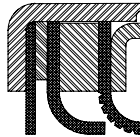
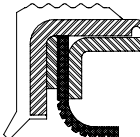
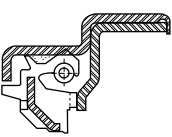
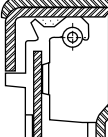
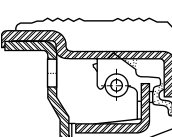
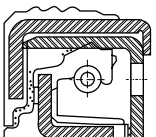
TCM Type	Design Characteristics	Seal Style			
"AP"	AP Product Line This patented AP series seal is designed for heavy dirt exclusion. With a press fit on the shaft and also in the housing makes this series easily replaceable without damage to the shaft of housing.	AJ	AO	AP	APY
					
		AP1	AP3	AP4	AP5
					
"PL"	Teflon®* Lined Seals Designed for low friction, high speed applications, or when the reductions of under lip running temperatures are required.	AP6	AP7	AP8	AP7Y
					
		SC-PL	TC-PL	VC-PL	KC-PL
					
"PA"	Teflon* Seals Designed for dry running, low friction applications, also can handle certain pressure applications.	SF-PL	TF-PL	VF-PL	KF-PL
					
		SB-PL	TB-PL	VB-PL	KB-PL
					
"ST"	Oil Bath Seals Designed to operate on trailer and truck axles.	SA-PL	TA-PL	VA-PL	KA-PL
					
		PA1	PA3	PA4	PA6
					
"ST"	Oil Bath Seals Designed to operate on trailer and truck axles.	ST	ST2	ST5	ST34
					

Teflon® is a registered trademark of Dupont

Compound Compatibility Chart

Compound Code	N	P	S	V	Compound Code	N	P	S	V	Compound Code	N	P	S	V
Acetamide	1	4	2	2	Carbon Tetrachloride	3	4	4	1	Ferric Chloride	1	1	2	1
Acetone	4	4	3	4	Chlorine Dioxide	4	4		1	Ferric Nitrate	1	1	3	1
Acetyl Chloride	4	4	3	1	Chlorobenzene	4	4	4	1	Ferric Sulfate	1	1	2	1
Acetylene	1	4	2	1	Chlorotoluene	4	4	4	1	Formic Acid	2		2	3
Aluminum Chloride	1	1	2	1	Chrome Plating Solutions	4	4	2	1	Freon 12	1	4	4	2
Aluminum Phosphate	1		1	1	Chromic Acid	4	4	3	1	Freon 22	4	2	4	4
Aluminum Sulfate	1	4	1	1	Cobalt Chloride	1	4	2	1	Fuel Oil	1	2	4	2
Ammonium Chloride	1			1	Copper Chloride	1	1	1	1	Fumaric Acid	1	4	2	1
Ammonium Hydroxide	4	4	1	2	Copper Cyanide	1	1	1	1	Fyrquel	4	4	1	1
Ammonium Nitrate	1	2			Copper Sulfate	1	4	1	1	Gasoline	2	4	4	1
Ammonium Nitrite	1		2		Creosote	1	1	4	1	Gear Oil Super	1	1	3	1
Ammonium Phosphate	1		1		Cresylic Acid	4	4	4	1	Glycols	1	4	1	1
Ammonium Sulfate	1	4		4	Cumene	4	4	4	1	Grease	1	2	1	1
Amyl Borate	1			1	Cyclohexane	1	1	4	1	Hydraulic Oil	1	1	3	1
Amyl Chloronaphthalene	4	4	4	1	Cyclohexanol	3		4	1	Hydrobromic Acid	4	4	4	1
Amyl Naphthalene	4	2	4	1	Denatured Alcohol	1	4	1	1	Hydrocyanic Acid	2	4	3	1
Arsenic Acid	1	3	1	1	Detergent Solutions	1	4	1	1	Hydrofluoric Acid (Conc) Cold	4	4	4	1
Asphalt	2	2	4	1	Developing Fluids	1		1	1	Hydrofluosilicic Acid	1		4	1
ATF-TYPE A	1	1	1	1	Dibromoethylbenzene	4	4	4	2	Hydrogen Gas	1	2	3	1
Benzine	1	1	4	1	O-Dichlorobenzene	4	4	4	1	Hypochlorous Acid	4	4		1
Benzoic Acid	3	3	3	1	Diesel Oil	1	1	4	1	Hypoid	2	2	4	1
Benzoyl Chloride	4	4		1	Diethylamine	2	4	2	4	Isobutyl Alcohol	2	4	1	1
Benzyl Alcohol	4	4	2	1	Diethyl Benzene	4		4	1	Isooctane	1	1	4	1
Benzyl Benzoate	4	4		1	Diethylene Glycol	1	2	2	1	Isopropyl Alcohol	2	4	1	1
Benzyl Chloride	4	4	4	1	Diethyl Sebecate	2	4	2	2	Kerosene	1	2	4	2
Biphenyl	4	4	4	1	Dilsobutylene	2	4	4	1	Ketones	4	4	4	4
Boric Acid	1	4	1	1	Diisopropyl Benzene	4			1	Lacquers	4	4	4	4
Brake Fluid	4	4	4	4	Dimethyl Ether	1	4	1	1	Lacquer Solvents	4	4	4	4
Bromine-Anhydrous	4	4	4	1	Dimethyl Phthalate	4	4		2	Lactic Acid (cold)	1	4	1	1
Bromobenzene	4	4	4	1	Dipentene	2	4	4	1	Lactic Acid (hot)	4	4	2	1
Butadiene	4	4	4	1	Diphenyl	4	4	4	1	Lead Nitrate	1		2	
Butane	1	1	4	1	Diphenyl Oxides	4	4	3	1	Lead Sulfamate	2	4	2	1
Butyl Alcohol	1	4	2	1	Dry Cleaning Fluids	3	4	4	1	Linseed Oil	1	1	1	1
Butyl Benzoate	4	4		1	Engine Oil	1	1	1	1	Liquefied Petroleum-Gas	1	3	3	1
Butyl Carbitol	4	4	4	1	Ep Lubes	2	1	4	1	Lubricating Oils	1	1	4	1
Butyl Oleate	4			1	Ethane	1	1	4	1	Magnesium Chloride	1		1	1
Butyl Stearate	2			1	Ethanol	1	4	1	4	Magnesium Hydroxide	2	4		1
Butylene	2	4	4	1	Ethyl Alcohol	1	4	1	3	Magnesium Sulfate	1	4	1	1
Calcium Bisulfite	4	4	1	1	Ethyl Chloride	1	4	4	1	Maleic Acid	4	4		1
Calcium Hydroxide	1	4	1	1	Ethyl Formate	4			1	Malic Acid	1	4	2	1
Calcium Hypochlorite	2	4	2	1	Ethyl Oxalate	4	4	4	1	Methane	1	1	4	2
Calcium Nitrate	1	1	2	1	Ethyl Silicate	1			1	Methanol	1	4	1	4
Calcium Sulfide	1	4	2	1	Ethylene	1			1	Methyl Alcohol	1	4	1	4
Carbamate	3	4		1	Ethylene Chlorohydrin	4	4	3	1	Methyl Bromide	2	3		1
Carbolic Acide	4	4	4	1	Ethylene Diamine	1	4	1	4	Methyl Ether	1	4	1	1
Carbon Dioxide	1		2	1	Ethylene Dichloride	4	4	4	1	Methyl Oleate	4			2
Carbon Acid	2	1	1	1	Ethylene Glycol	1	3	1	1	Mineral Oil	1	1	2	1
Carbon Monoxide	1		1	1	Ethylene Trichloride	4	4	4	1	Monovinyl Acetylene	1		2	1

Ratings: 1 = Minor effect 2 = Moderate effect 3 = Static only 4 = Not recommended Blank = Insufficient data

Compound Compatibility Chart

Compound Code	N	P	S	V	Compound Code	N	P	S	V	Compound Code	N	P	S	V
Naphtha	2	2	4	1	Propyl Acetone	4	4	3	4	Sulfur	4	4	3	1
Naphthalene	4		4	1	Propyl Alcohol	1	4	1	1	Sulfur Chloride	3	4	3	1
Naphthalenic Acid	2		4	1	Propyl Nitrate	4	4	4	4	Sulfur Dioxide	4	4	2	1
Natural Gas	1	2	1	1	Propylene	4	4	4	1	Sulfur Hexafluoride	2	4	2	1
Nickel Chloride	1	3	1	1	Propylene Oxide	4	4	4	4	Sulfur Trioxide	4	4	2	1
Nitric Acid (Dilute)	4	4	2	1	Pydraul, 10E, 29ELT	4	4	4	1	Sulfuric Acid (Dilute)	3	2	4	1
Octachlortoluene	4	4	4	1	Pydraul, 30E, 50E, 65E, 90E4	4	1	1		Sulfuric Acid (Conc.)	4	4	4	1
Octadecane	1	2	4	1	Pydraul, 115E	4	4	4	1	Sulfur Acid (20% Oleum)	4	4	4	1
N-Octane	2	4	4	1	Pyranol, Transformer Oil	1	1	4	1	Sulfurous Acid	2	4	4	1
Octyl Alcohol	2	4	2	1	Rapeseed Oil	2	2	4	1	Tannic Acid	1	4	2	1
Oleum Spirits	2		4	1	RJ-1	1	1	4	1	Terpineol	2			1
Oxalic Acid	2		2	1	RP-1	1	1	4	1	Tertiary Butyl Alcohol	2	4	2	1
Oxygen-Cold	2	2	1	1	SAE-10	1	1	2	1	Tertiary Butyl Catechol	4	4		1
Oxygen-(200-400 F)	4	4	2	2	SAE-30	1	1	1	1	Tertiary Butyl Mercaptan	4	4	4	1
Ozone	4	2	1	1	SAE-90	1	1	4	1	Tetrabromoethane	4	4	4	1
Paint Thinner, Duco	4	4	4	2	Sal Ammoniac	1	1	2	1	Tetrabromomethane	4		4	1
Palmitic Acid	1		4	1	Salicylic Acid	2			1	Tetrabutyl Titanate	2			1
Perchloric Acid	4	4	4	1	Salt Water	1	4	1	1	Tetrochloroethylene	4	4	4	1
Perchloroethylene	2	4	4	1	Silicate Esters	2		4	1	Tetraethyl Lead	2			1
Petroleum - Below 250 F	1	2	2	1	Silicone Greases	1	1	3	1	Tetralin	4		4	1
Petroleum - Above 250 F	4	4	4	2	Silicone Oils	1	1	3	1	Titanium Tetrachloride	2	4	4	1
Phenol (Carbolic Acid)	4	4	4	1	Silver Nitrate	2	1	1	1	Transformer Oil	1	2	2	1
Phenylbenzene	4	4	4	1	Soap Solutions	1	4	1	1	Transmission Fluid Type A1	1	2		1
Phenyl Ethyl Ether	4	4	4	4	Soda Ash	1		1	1	Triaryl Phosphate	4	4	3	1
Phenyl Hydrazine	4	4		1	Sodium Acetate	2	4	4	4	Tricresyl Phosphate	4	4	3	1
Phorone	4	4	4	4	Sodium Bicarbonate	1		1	1	Triethyl Brane	4	4		1
Phosphate Ester	4	4	1	1	Sodium Bisulfite	1	4	1	1	Turbine Oil	2	1	4	1
Phosphoric Acid - 20%	2		2	1	Sodium Borate	1		1	1	Turpentine	1	2	4	1
Phosphoric Acid - 45%	4		3	1	Sodium Chloride	1		1	1	Unsymmetrical Dimethyl				
Phosphorus Trichloride	4			1	Sodium Cyanide	1		1	1	Hydrazine (UDMH)	2		4	4
Pickling Solution	4	4	4	2	Sodium Hydroxide	2	3	2	2	Varnish	2	4	4	1
Picric Acid	2		4	1	Sodium Hypochlorite	2	4	2	1	Versilube F-50	1	1	3	1
Pinene	2	4	4	1	Sodium Metaphosphate	1			1	Vinyl Chloride	4	4		1
Piperidine	4	4	4	4	Sodium Nitrate	2		4		Wagner 21 B Brake Fluid	3		3	4
Plating Solution - Chrome			4	1	Sodium Perborate	2		2	1	Water	1	4	1	1
Plating Solution - Others	1		4	1	Sodium Peroxide	2	4	4	1	White Pine Oil	2		4	1
Potassium Acetate	2	4	4	4	Sodium Phosphate	1	1	4	1	White Oil	1	1	4	1
Potassium Chloride	1	1	1	1	Sodium Silicate	1			1	Xylene	4	4	4	1
Potassium Cupro-Cyanide	1	1	1	1	Sodium Sulfate	1	4	1	1	Xylidine	3	4	4	4
Potassium Cyanide	1	1	1	1	Sodium Thiosulfate	2	4	1	1	Zeolites	1			1
Potassium Dichromate	1	1	1	1	Soybean Oil	1	1	1	1	Zinc Acetate	2	4	4	4
Potassium Hydroxide	2	4	3	4	Stannic Chloride	1		2	1	Zinc Chloride	1	4	1	1
Potassium Nitrate	1	1	1	1	Steam Under 300 F	4	4	3	4	Zinc Sulfate	1	4	1	1
Potassium Sulfate	1	4	1	1	Steam Over 300 F	4	4	4	4					
Producer Gas	1	2	2	1	Stearic Acid	2		2						
Propane	1	1	4	1	Stoddard Solvent	1	1	4	1					
I-Propyl Acetate	4	4	4	4	Styrene	4	4	4	2					
N-Propyl Acetate	4	4	4	4	Sucrose Solution	1	4	1	1					

Ratings: 1 = Minor effect 2 = Moderate effect 3 = Static only 4 = Not recommended Blank = Insufficient data

METRIC CONVERSION CHART

Fractions/Decimals/M.M.			Fractions/Decimals/M.M.			Fractions/Decimals/M.M.			Fractions/Decimals/M.M.		
--	0.004	0.10	37/64	0.578	14.68	1-15/32	1.469	37.31		2.874	73.00
--	0.010	0.25		0.591	15.00		1.496	38.00	2-7/8	2.875	73.03
1/64	0.016	0.40	19/32	0.594	15.08	1-1/2	1.500	38.10		2.913	74.00
--	0.020	0.50	39/64	0.609	15.48	1-17/32	1.531	38.89	2-15/16	2.938	74.61
--	0.030	0.75	5/8	0.625	15.88		1.535	39.00		2.953	75.00
1/32	0.031	0.79		0.630	16.00	1-9/16	1.562	39.69		2.992	76.00
--	0.039	1.00	41/64	0.641	16.27		1.575	40.00	3	3.000	76.20
3/64	0.047	1.19		0.650	16.50	1-19/32	1.594	40.48		3.031	77.00
	0.059	1.50	21/32	0.656	16.67		1.614	41.00	3-1/16	3.062	77.79
1/16	0.063	1.59		0.669	17.00	1-5/8	1.625	41.28		3.071	78.00
5/64	0.078	1.98	43/64	0.672	17.07		1.654	42.00		3.110	79.00
	0.079	2.00	11/16	0.688	17.46	1-21/32	1.656	42.07	3-1/8	3.125	79.38
3/32	0.094	2.38	45/64	0.703	17.86	1-11/16	1.688	42.86		3.150	80.00
	0.098	2.50		0.709	18.00		1.693	43.00	3-3/16	3.188	80.96
7/64	0.109	2.78	23/32	0.719	18.26	1-23/32	1.719	43.66		3.189	81.00
	0.118	3.00		0.728	18.50		1.732	44.00		3.228	82.00
1/8	0.125	3.18	47/64	0.734	18.65	1-3/4	1.750	44.50	3-1/4	3.250	82.55
	0.138	3.50		0.748	19.00		1.772	45.00		3.268	83.00
9/64	0.141	3.57	3/4	0.750	19.05	1-25/32	1.781	45.24		3.307	84.00
5/32	0.156	3.97	49/64	0.766	19.45		1.811	46.00	3-5/16	3.312	84.14
	0.157	4.00	25/32	0.781	19.84	1-13/16	1.813	46.04		3.346	85.00
11/64	0.172	4.37		0.787	20.00	1-27/32	1.844	46.83	3-3/8	3.375	85.73
	0.177	4.50	51/64	0.797	20.24		1.850	47.00		3.386	86.00
3/16	0.188	4.76	13/16	0.813	20.64	1-7/8	1.875	47.63		3.425	87.00
	0.197	5.00		0.827	21.00		1.890	48.00	3-7/16	3.438	87.31
13/64	0.203	5.16	53/64	0.828	21.03	1-29/32	1.906	48.42		3.465	88.00
	0.217	5.50	27/32	0.844	21.43		1.929	49.00	3-1/2	3.500	88.90
7/32	0.219	5.56	55/64	0.859	21.83	1-15/16	1.938	49.21		3.504	89.00
15/64	0.234	5.95		0.866	22.00		1.968	50.00		3.543	90.00
	0.236	6.00	7/8	0.875	22.23	1-31/32	1.969	50.01	3-9/16	3.562	90.49
1/4	0.250	6.35	57/64	0.891	22.62	2	2.000	50.80		3.583	91.00
	0.256	6.50		0.906	23.00		2.008	51.00		3.622	92.00
17/64	0.266	6.75	29/32	0.906	23.02		2.047	52.00	3-5/8	3.625	92.08
	0.276	7.00	59/64	0.922	23.42	2-1/16	2.062	52.39		3.661	93.00
9/32	0.281	7.14	15/16	0.938	23.81		2.087	53.00	3-11/16	3.688	93.66
	0.295	7.50		0.945	24.00	2-1/8	2.125	53.98		3.701	94.00
19/64	0.297	7.54	61/64	0.953	24.21		2.126	54.00		3.740	95.00
5/16	0.313	7.94	31/32	0.969	24.61		2.165	55.00	3-3/4	3.750	95.25
	0.315	8.00		0.984	25.00	2-3/16	2.188	55.56		3.780	96.00
21/64	0.328	8.33	1	1.000	25.40		2.205	56.00	3-13/16	3.813	96.84
	0.335	8.50		1.024	26.00		2.244	57.00		3.819	97.00
11/32	0.344	8.73	1-1/32	1.031	26.19	2-1/4	2.250	57.15		3.858	98.00
	0.354	9.00	1-1/16	1.062	26.99		2.283	58.00	3-7/8	3.875	98.43
23/64	0.359	9.13		1.063	27.00	2-5/16	2.312	58.74		3.898	99.00
	0.374	9.50	1-3/32	1.094	27.78		2.323	59.00		3.937	100.00
3/8	0.375	9.53		1.102	28.00		2.362	60.00	3-15/16	3.938	100.01
25/64	0.391	9.92	1-1/8	1.125	28.58	2-3/8	2.375	60.33		3.976	101.00
	0.394	10.00		1.142	29.00		2.402	61.00	4	4.000	101.60
13/32	0.406	10.32	1-5/32	1.156	29.37	2-7/16	2.438	61.91	4-1/16	4.062	103.19
	0.413	10.50		1.181	30.00		2.441	62.00	4-1/8	4.125	104.78
27/64	0.422	10.72	1-3/16	1.188	30.16		2.480	63.00		4.134	105.00
	0.433	11.00	1-7/32	1.219	30.96	2-1/2	2.500	63.50	4-3/16	4.188	106.36
7/16	0.438	11.11		1.221	31.00		2.520	64.00	4-1/4	4.250	107.95
29/64	0.453	11.51	1-1/4	1.250	31.75		2.559	65.00	4-5/16	4.312	109.54
15/32	0.469	11.91		1.260	32.00	2-9/16	2.562	65.09		4.331	110.00
	0.472	12.00	1-9/32	1.281	32.54		2.598	66.00	4-3/8	4.375	111.13
31/64	0.484	12.30		1.299	33.00	2-5/8	2.625	66.68	4-7/16	4.438	112.71
	0.492	12.50	1-5/16	1.312	33.34		2.638	67.00	4-1/2	4.500	114.30
1/2	0.500	12.70		1.339	34.00		2.677	68.00		4.528	115.00
	0.512	13.00	1-11/32	1.344	34.13	2-11/16	2.688	68.26	4-9/16	4.562	115.89
33/64	0.516	13.10	1-3/8	1.375	34.93		2.717	69.00	4-5/8	4.625	117.48
17/32	0.531	13.50		1.378	35.00	2-3/4	2.750	69.85		4.724	120.00
35/64	0.547	13.89	1-13/32	1.406	35.72		2.756	70.00	4-3/4	4.750	120.65
	0.551	14.00		1.417	36.00		2.795	71.00	4-7/8	4.875	123.83
9/16	0.563	14.29	1-7/16	1.438	36.51	2-13/16	2.813	71.44		4.921	125.00
	0.571	14.50		1.457	37.00		2.835	72.00	5	5.000	127.00

Troubleshooting and Seal Failure Review

Symptom	Probable cause	Possible solution
Hardening or brittleness on seal lip	Over heating	Check shaft speed and temperature, reduce if possible
	Inadequate lubrication	Provide proper lubrication prior to assembly or upgrade seal material and/or style
	Shaft finish is too smooth	A shaft finish that is under the recommended range will cause excessive heat at higher speeds, increase finish to be within 10-20 Ra
Excessive wear on sealing lip (around whole circumference)	Seal inside diameter too small or shaft is too big	Check if seals inside diameter and shafts outside diameter are within specifications prior to assembly
	Seal is exposed to excessive pressure	Provide proper venting to reduce pressure, or change design to compensate for excessive pressure
	Shaft finish is too rough	Shaft finish should be between 10-20 Ra to reduce excessive wear to the sealing lip
Excessive wear on only one side of sealing lip	Misalignment between shaft and housing	Reduce misalignment to be within the allowable amount
Seal lip has cuts, nicks, or tears	Improper installation	Use proper installation methods which would include protecting the sealing lip while being installed over the shaft
	Shaft not prepared properly	Ensure shaft's clean and free of any burrs or contaminants that might interfere with the sealing lip
	Defective seal	Check for any defects or inconsistencies on the sealing lip prior to assembly
	Exposed to contamination	If contamination is found, an exclusionary design may be a better selection
Sealing lip material softened	Lip material and media being sealed may not be compatible	Check compound compatibility chart for effect rating
Excessive shaft wear	Contamination	An exclusionary design may be a better selection
	Shaft is too soft	Harden shaft to within the recommended range
	Speeds are too fast	Ensure that sealing lip material can handle the existing speeds. <i>Note: Wear would be found on both the sealing lip and on the shaft when exposed to excessive speeds</i>
Sealing lip leakage	Garner spring damaged or distorted	Reduce excessive stretching when installing the seal; this will reduce the chance of distorting the spring
	Garner spring popped off	Check the lead-in chamfer or radius to make sure it falls within the recommended range
	Seal cocked in housing	Check installation and installation tool to ensure the seal is being installed perpendicular to the shaft
	Shaft lead present	Plunge grind the shaft to eliminate any lead that may be present
	Excessive shaft runout or misalignment	Reduce the amount of runout and/or misalignment to be within the allowable amount the seal can handle
	Damaged primary lip	Check for any defects or inconsistencies on the sealing lip and the shaft prior to assembly
Leakage from the outside diameter	Seal and/or housing is out-of-round	Reduce the amount of out-of-roundness to be within the allowable amount. A rubber OD seal could compensate for a slight amount of out-of-roundness
	Seal cocked in housing	Check installation and installation tool to ensure the seal is being installed perpendicular to the shaft
	Scratches or imperfections in housing and/or lead-in chamfer	Clean housing and/or lead-in chamfer with emery cloth

Part Number Creation

Dichtomatik's TCM line of radial lip seals incorporates the easiest and most complete part numbering system of any major seal producer on the market! All TCM part numbers are created from the dimensions of the shaft, housing bore, and width for each seal, together with a designation for special lip materials, and the lip and case style.

Three dimensions, separated by "X's", always designate metric seals. For example, a seal 25X50X10TC indicates a seal made for a 25 millimeter shaft, a 50 millimeter housing bore, a 10 millimeter width with a "TC" style case and lip design. Inch sizes begin with five digits, the first two being the inch and first decimal digit of the shaft size, the third and fourth being the inch and first decimal digit of the housing bore, and the last being the first digit of the width dimension. The end of the part designation represents the case and lip style design, represented by those on the following page. For example, the part number 12192TB is made for a 1.2 inch shaft, to fit into a 1.9 housing bore, and is approximately .2 inches wide. The exact dimensions with the balance of the decimal dimensions can be obtained from the TCM seal catalog.

The "TB" indicates the seal is a double lip spring loaded single case seal. The absence of a "V" for Viton* material, "P" for Polyacrylate material, or "S" for Silicone material between the part number and the case and lip style designator indicates the lip is a standard nitrile material. If the lip material is something other than standard nitrile, the letter indicating the material will immediately follow the part number and precede the lip and case designation. For example, if the part number were 12192VTB, the lip would be made of high temperature Viton*.

The designation for O.D. sealant is an "-H" at the end of the part number, e.g., the part number 12192TB-H.

Example: 10202TC

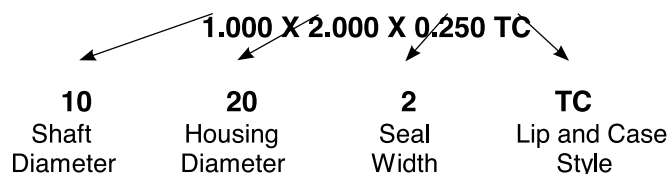

Example: 10202VTBNW-H

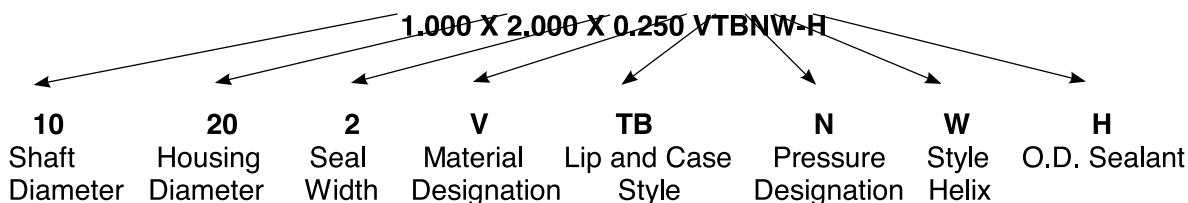

Note: Nitrile is the standard material unless a different material is shown within the part number.

Example: 16828363TC

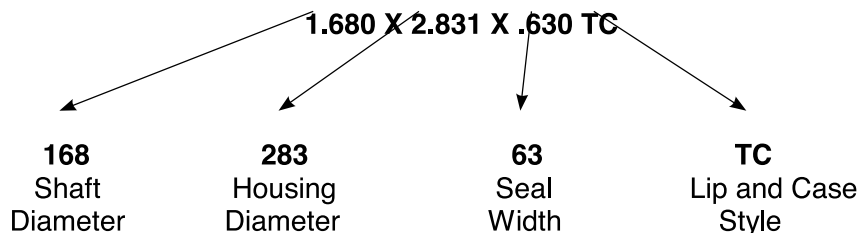

Note: If shaft and housing diameters, and seal width, are not an even eight-inch increment, it is carried out to three digits within the part number.

All dimensions are the actual application dimensions, not the actual seal dimensions, except for the seal width.

* Viton is a registered trademark of DuPont.



TCM VA SEALS

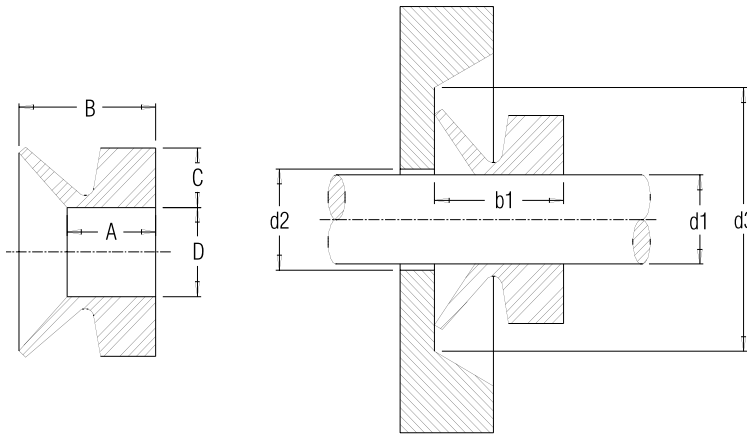

TCM Part #	For Shaft Diameter, d1	Inside Diameter, d	Height of Cross Section, c	Dim A	Free Width, B	Max, d2	Min, d3	Fitted Width, B1	Seal Material	Box #
VA-003	0.106~0.138	0.098	0.059	0.083	0.118	d1+0.039	d1+0.157	0.098+/-0.012	NBR	7
VA-003Y	0.106~0.138	0.098	0.059	0.083	0.118	d1+0.039	d1+0.157	0.098+/-0.012	HR	7
VVA-003	0.106~0.142	0.098	0.059	0.083	0.118	d1+0.039	d1+0.157	0.098+/-0.016	FKM	7
VA-004	0.138~0.177	0.126	0.079	0.094	0.146	d1+0.039	d1+0.236	0.118+/-0.016	NBR	7
VVA-004	0.138~0.181	0.126	0.079	0.094	0.146	d1+0.039	d1+0.236	0.118+/-0.020	FKM	7
VA-005	0.177~0.217	0.157	0.079	0.094	0.146	d1+0.039	d1+0.236	0.118+/-0.016	NBR	7
VVA-005	0.177~0.220	0.157	0.079	0.094	0.146	d1+0.039	d1+0.236	0.118+/-0.020	FKM	7
VA-006	0.217~0.256	0.197	0.079	0.094	0.146	d1+0.039	d1+0.236	0.118+/-0.016	NBR	7
VVA-006	0.217~0.260	0.197	0.079	0.094	0.146	d1+0.039	d1+0.236	0.118+/-0.020	FKM	7
VA-007	0.256~0.315	0.236	0.079	0.094	0.146	d1+0.039	d1+0.236	0.118+/-0.016	NBR	7
VVA-007	0.256~0.354	0.236	0.079	0.094	0.146	d1+0.039	d1+0.236	0.118+/-0.020	FKM	7
VA-008	0.315~0.374	0.276	0.079	0.094	0.146	d1+0.039	d1+0.236	0.118+/-0.016	NBR	7
VVA-008	0.315~0.378	0.276	0.079	0.094	0.146	d1+0.039	d1+0.236	0.118+/-0.020	FKM	7
VA-010	0.374~0.453	0.354	0.118	0.134	0.217	d1+0.079	d1+0.354	0.177+/-0.024	NBR	7
VVA-010	0.374~0.457	0.354	0.118	0.134	0.217	d1+0.079	d1+0.354	0.177+/-0.028	FKM	7
VA-012	0.453~0.492	0.413	0.118	0.134	0.217	d1+0.079	d1+0.354	0.177+/-0.024	NBR	7
VVA-012	0.453~0.496	0.413	0.118	0.134	0.217	d1+0.079	d1+0.354	0.177+/-0.028	FKM	7
VA-013	0.490~0.570	0.450	0.120	0.130	0.217	d1+0.079	d1+0.354	0.177+/-0.024	NBR	7
VVA-013	0.490~0.570	0.450	0.120	0.130	0.217	d1+0.079	d1+0.354	0.177+/-0.024	FKM	7
VVA-016	0.610~0.693	0.551	0.118	0.134	0.217	d1+0.079	d1+0.354	0.177+/-0.028	FKM	7
VA-014	0.531~0.610	0.492	0.118	0.134	0.217	d1+0.079	d1+0.354	0.177+/-0.024	NBR	7
VVA-014	0.531~0.614	0.492	0.118	0.134	0.217	d1+0.079	d1+0.354	0.177+/-0.028	FKM	7
VA-016	0.610~0.689	0.551	0.118	0.134	0.217	d1+0.079	d1+0.354	0.177+/-0.024	NBR	7
VA-018	0.689~0.748	0.630	0.118	0.134	0.217	d1+0.079	d1+0.354	0.177+/-0.024	NBR	7
VVA-018	0.689~0.787	0.630	0.118	0.134	0.217	d1+0.079	d1+0.354	0.177+/-0.028	FKM	7
VA-020	0.748~0.827	0.709	0.157	0.185	0.295	d1+0.079	d1+0.472	0.236+/-0.031	NBR	7
VVA-020	0.748~0.866	0.709	0.157	0.185	0.295	d1+0.079	d1+0.472	0.236+/-0.035	FKM	7
VA-022	0.827~0.945	0.787	0.157	0.185	0.295	d1+0.079	d1+0.472	0.236+/-0.031	NBR	7
VVA-022	0.827~0.984	0.787	0.157	0.185	0.295	d1+0.079	d1+0.472	0.236+/-0.035	FKM	7
VA-025	0.945~1.063	0.866	0.157	0.185	0.295	d1+0.079	d1+0.472	0.236+/-0.031	NBR	7
VVA-025	0.945~1.102	0.866	0.157	0.185	0.295	d1+0.079	d1+0.472	0.236+/-0.035	FKM	7
VA-028	1.063~1.142	0.984	0.157	0.185	0.295	d1+0.118	d1+0.472	0.236+/-0.031	NBR	7
VVA-028	1.063~1.181	0.984	0.157	0.185	0.295	d1+0.118	d1+0.472	0.236+/-0.035	FKM	7
VA-030	1.142~1.220	1.063	0.157	0.185	0.295	d1+0.118	d1+0.472	0.236+/-0.031	NBR	7
VVA-030	1.142~1.260	1.063	0.157	0.185	0.295	d1+0.118	d1+0.472	0.236+/-0.035	FKM	7
VA-032	1.220~1.299	1.142	0.157	0.185	0.295	d1+0.118	d1+0.472	0.236+/-0.031	NBR	7
VVA-032	1.220~1.339	1.142	0.157	0.185	0.295	d1+0.118	d1+0.472	0.236+/-0.035	FKM	7
VA-035	1.299~1.417	1.220	0.157	0.185	0.295	d1+0.118	d1+0.472	0.236+/-0.031	NBR	7
VVA-035	1.299~1.457	1.220	0.157	0.185	0.295	d1+0.118	d1+0.472	0.236+/-0.035	FKM	7
VA-038	1.417~1.496	1.339	0.157	0.185	0.295	d1+0.118	d1+0.472	0.236+/-0.031	NBR	7
VVA-038	1.417~1.535	1.339	0.157	0.185	0.295	d1+0.118	d1+0.472	0.236+/-0.035	FKM	7
VA-040	1.496~1.693	1.417	0.197	0.217	0.354	d1+0.118	d1+0.591	0.276+/-0.039	NBR	7
VVA-040	1.496~1.732	1.417	0.197	0.217	0.354	d1+0.118	d1+0.591	0.276+/-0.043	FKM	7
VA-045	1.693~1.890	1.575	0.197	0.217	0.354	d1+0.118	d1+0.591	0.276+/-0.039	NBR	7

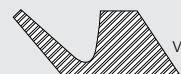
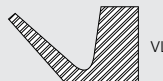
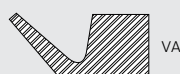



TCM VA SEALS

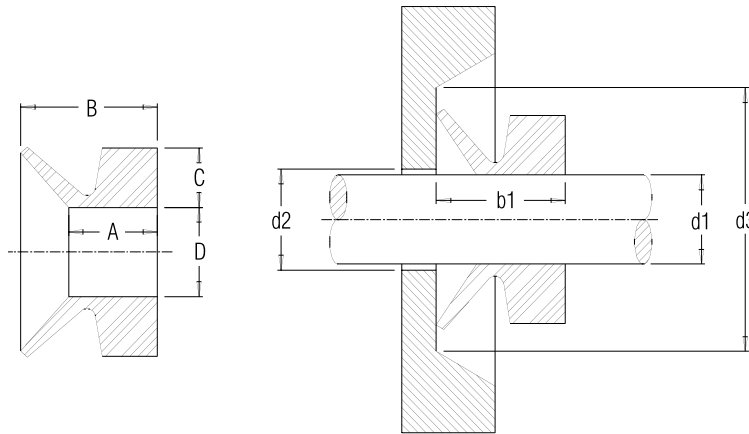

TCM Part #	For Shaft Diameter, d1	Inside Diameter, d	Height of Cross Section, c	Dim A	Free Width, B	Max, d2	Min, d3	Fitted Width, B1	Seal Material	Box #
VVA-045	1.693~1.929	1.575	0.197	0.217	0.354	d1+0.118	d1+0.591	0.276+/-0.043	FKM	7
VA-050	1.890~2.087	1.772	0.197	0.217	0.354	d1+0.118	d1+0.591	0.276+/-0.039	NBR	7
VVA-050	1.890~2.126	1.772	0.197	0.217	0.354	d1+0.118	d1+0.591	0.276+/-0.043	FKM	7
VA-055	2.087~2.283	1.929	0.197	0.217	0.354	d1+0.118	d1+0.591	0.276+/-0.039	NBR	7
VVA-055	2.087~2.323	1.929	0.197	0.217	0.354	d1+0.118	d1+0.591	0.276+/-0.043	FKM	7
VA-060	2.283~2.480	2.126	0.197	0.217	0.354	d1+0.118	d1+0.591	0.276+/-0.039	NBR	7
VVA-060	2.283~2.520	2.126	0.197	0.217	0.354	d1+0.118	d1+0.591	0.276+/-0.043	FKM	7
VA-065	2.480~2.677	2.283	0.197	0.217	0.354	d1+0.118	d1+0.591	0.276+/-0.039	NBR	7
VVA-065	2.480~2.717	2.283	0.197	0.217	0.354	d1+0.118	d1+0.591	0.276+/-0.043	FKM	7
VA-070	2.677~2.874	2.480	0.236	0.268	0.433	d1+0.157	d1+0.709	0.354+/-0.047	NBR	7
VVA-070	2.677~2.913	2.480	0.236	0.268	0.433	d1+0.157	d1+0.709	0.354+/-0.051	FKM	7
VA-075	2.874~3.071	2.638	0.236	0.268	0.433	d1+0.157	d1+0.709	0.354+/-0.047	NBR	8
VVA-075	2.874~3.110	2.638	0.236	0.268	0.433	d1+0.157	d1+0.709	0.354+/-0.051	FKM	8
VA-080	3.071~3.268	2.835	0.236	0.268	0.433	d1+0.157	d1+0.709	0.354+/-0.047	NBR	8
VVA-080	3.071~3.307	2.835	0.236	0.268	0.433	d1+0.157	d1+0.709	0.354+/-0.051	FKM	8
VA-085	3.268~3.465	2.992	0.236	0.268	0.433	d1+0.157	d1+0.709	0.354+/-0.047	NBR	8
VVA-085	3.268~3.504	2.992	0.236	0.268	0.433	d1+0.157	d1+0.709	0.354+/-0.051	FKM	8
VA-090	3.465~3.661	3.189	0.236	0.268	0.433	d1+0.157	d1+0.709	0.354+/-0.047	NBR	8
VVA-090	3.465~3.701	3.189	0.236	0.268	0.433	d1+0.157	d1+0.709	0.354+/-0.051	FKM	8
VA-095	3.661~3.858	3.346	0.236	0.268	0.433	d1+0.157	d1+0.709	0.354+/-0.047	NBR	8
VVA-095	3.661~3.898	3.346	0.236	0.268	0.433	d1+0.157	d1+0.709	0.354+/-0.051	FKM	8
VA-100	3.858~4.134	3.543	0.236	0.268	0.433	d1+0.157	d1+0.709	0.354+/-0.047	NBR	9
VVA-100	3.858~4.173	3.543	0.236	0.268	0.433	d1+0.157	d1+0.709	0.354+/-0.051	FKM	9
VA-110	4.134~4.528	3.898	0.276	0.311	0.504	d1+0.157	d1+0.827	0.413+/-0.059	NBR	9
VVA-110	4.134~4.528	3.898	0.276	0.311	0.504	d1+0.157	d1+0.827	0.413+/-0.063	FKM	9
VA-120	4.528~4.921	4.252	0.276	0.311	0.504	d1+0.157	d1+0.827	0.413+/-0.059	NBR	9
VVA-120	4.528~4.961	4.252	0.276	0.311	0.504	d1+0.157	d1+0.827	0.413+/-0.063	FKM	9
VA-130	4.921~5.315	4.606	0.276	0.311	0.504	d1+0.157	d1+0.827	0.413+/-0.059	NBR	9
VVA-130	4.921~5.315	4.606	0.276	0.311	0.504	d1+0.197	d1+0.866	0.413+/-0.063	FKM	9
VA-140	5.315~5.709	4.961	0.276	0.311	0.504	d1+0.157	d1+0.827	0.413+/-0.059	NBR	3
VVA-140	5.315~5.748	4.961	0.276	0.311	0.504	d1+0.157	d1+0.827	0.413+/-0.063	FKM	3
VA-150	5.709~6.102	5.315	0.276	0.311	0.504	d1+0.157	d1+0.827	0.413+/-0.059	NBR	3
VVA-150	5.709~6.142	5.315	0.276	0.311	0.504	d1+0.157	d1+0.827	0.413+/-0.063	FKM	3
VA-160	6.102~6.496	5.669	0.315	0.354	0.571	d1+0.197	d1+0.945	0.472+/-0.071	NBR	3
VVA-160	6.102~6.535	5.669	0.315	0.354	0.571	d1+0.197	d1+0.945	0.472+/-0.075	FKM	3
VA-170	6.496~6.890	6.024	0.315	0.354	0.571	d1+0.197	d1+0.945	0.472+/-0.071	NBR	5
VVA-170	6.496~6.929	6.024	0.315	0.354	0.571	d1+0.197	d1+0.945	0.472+/-0.075	FKM	5
VA-180	6.890~7.283	6.378	0.315	0.354	0.571	d1+0.197	d1+0.945	0.472+/-0.071	NBR	5
VVA-180	6.890~7.323	6.378	0.315	0.354	0.571	d1+0.197	d1+0.945	0.472+/-0.075	FKM	5
VA-190	7.283~7.677	6.732	0.315	0.354	0.571	d1+0.197	d1+0.945	0.472+/-0.071	NBR	5
VVA-190	7.283~7.717	6.732	0.315	0.354	0.571	d1+0.197	d1+0.945	0.472+/-0.075	FKM	5
VA-199	7.677~8.268	7.087	0.315	0.354	0.571	d1+0.197	d1+0.945	0.472+/-0.071	NBR	5
VVA-199	7.677~8.307	7.087	0.315	0.354	0.571	d1+0.197	d1+0.945	0.472+/-0.075	FKM	5
VA-200	7.480~8.268	7.087	0.591	0.563	0.984	d1+0.394	d1+1.772	0.787+/-0.157	NBR	5

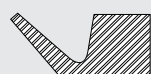

VA



VL

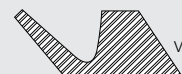

VS



TCM VA SEALS

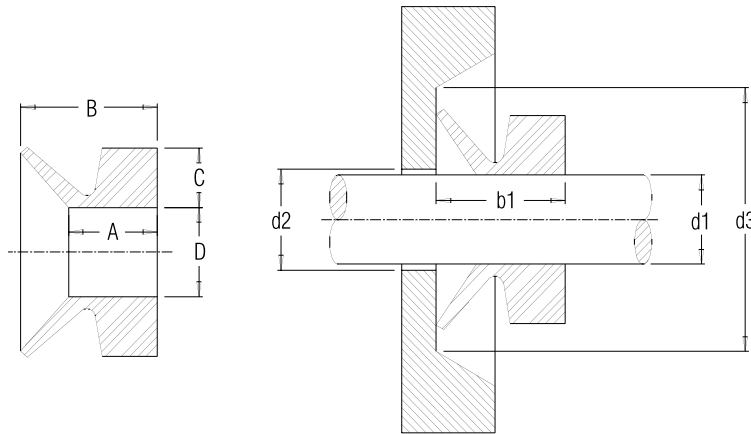

TCM Part #	For Shaft Diameter, d1	Inside Diameter, d	Height of Cross Section, c	Dim A	Free Width, B	Max, d2	Min, d3	Fitted Width, B1	Seal Material	Box #
VVA-200	7.480~8.307	7.087	0.591	0.563	0.984	d1+0.394	d1+1.772	0.787+/-0.161	FKM	5
VA-220	8.268~9.252	7.795	0.591	0.563	0.984	d1+0.394	d1+1.772	0.787+/-0.157	NBR	5
VVA-220	8.268~9.291	7.795	0.591	0.563	0.984	d1+0.394	d1+1.772	0.787+/-0.161	FKM	5
VA-250	9.252~10.433	8.858	0.591	0.563	0.984	d1+0.394	d1+1.772	0.787+/-0.157	NBR	6
VVA-250	9.252~10.472	8.858	0.591	0.563	0.984	d1+0.394	d1+1.772	0.787+/-0.161	FKM	6
VA-275	10.433~11.417	9.724	0.591	0.563	0.984	d1+0.394	d1+1.772	0.787+/-0.157	NBR	6
VVA-275	10.433~11.457	9.724	0.591	0.563	0.984	d1+0.394	d1+1.772	0.787+/-0.161	FKM	6
VA-300	11.417~12.205	10.630	0.591	0.563	0.984	d1+0.394	d1+1.772	0.787+/-0.157	NBR	11
VVA-300	11.417~12.244	10.630	0.591	0.563	0.984	d1+0.394	d1+1.772	0.787+/-0.161	FKM	11
VA-325	12.205~13.189	11.496	0.591	0.563	0.984	d1+0.394	d1+1.772	0.787+/-0.157	NBR	12
VVA-325	12.205~13.228	11.496	0.591	0.563	0.984	d1+0.394	d1+1.772	0.787+/-0.161	FKM	12
VA-350	13.189~14.370	12.402	0.591	0.563	0.984	d1+0.394	d1+1.772	0.787+/-0.157	NBR	12
VVA-350	13.189~14.409	12.402	0.591	0.563	0.984	d1+0.394	d1+1.772	0.787+/-0.161	FKM	12
VA-375	14.370~15.354	13.268	0.591	0.563	0.984	d1+0.394	d1+1.772	0.787+/-0.157	NBR	12
VVA-375	14.370~15.394	13.268	0.591	0.563	0.984	d1+0.394	d1+1.772	0.787+/-0.161	FKM	12
VA-400	15.354~16.929	14.173	0.591	0.563	0.984	d1+0.394	d1+1.772	0.787+/-0.157	NBR	12
VVA-400	15.354~16.969	14.173	0.591	0.563	0.984	d1+0.394	d1+1.772	0.787+/-0.161	FKM	12
VA-450	16.929~18.898	15.945	0.591	0.563	0.984	d1+0.394	d1+1.772	0.787+/-0.157	NBR	12
VVA-450	16.929~18.937	15.945	0.591	0.563	0.984	d1+0.394	d1+1.772	0.787+/-0.161	FKM	12
VA-500	18.898~20.866	17.717	0.591	0.563	0.984	d1+0.394	d1+1.772	0.787+/-0.157	NBR	12
VVA-500	18.898~20.906	17.717	0.591	0.563	0.984	d1+0.394	d1+1.772	0.787+/-0.161	FKM	12
VA-550	20.866~22.835	19.488	0.591	0.563	0.984	d1+0.394	d1+1.772	0.787+/-0.157	NBR	12
VVA-550	20.866~22.874	19.488	0.591	0.563	0.984	d1+0.394	d1+1.772	0.787+/-0.161	FKM	12
VA-600	22.835~24.803	21.260	0.591	0.563	0.984	d1+0.394	d1+1.772	0.787+/-0.157	NBR	12
VVA-600	22.835~24.843	21.260	0.591	0.563	0.984	d1+0.394	d1+1.772	0.787+/-0.161	FKM	12
VA-650	24.803~26.181	23.622	0.591	0.563	0.984	d1+0.394	d1+1.772	0.787+/-0.157	NBR	12
VVA-650	24.803~26.220	23.622	0.591	0.563	0.984	d1+0.394	d1+1.772	0.787+/-0.161	FKM	12
VA-700	26.181~27.756	24.803	0.591	0.563	0.984	d1+0.394	d1+1.772	0.787+/-0.157	NBR	12
VVA-700	26.181~27.795	24.803	0.591	0.563	0.984	d1+0.394	d1+1.772	0.787+/-0.161	FKM	12
VA-725	27.756~29.331	26.378	0.591	0.563	0.984	d1+0.394	d1+1.772	0.787+/-0.157	NBR	12
VVA-725	27.756~29.370	26.378	0.591	0.563	0.984	d1+0.394	d1+1.772	0.787+/-0.161	FKM	12
VA-900	34.450~36.220	32.480	0.591	0.563	0.984	d1+0.394	d1+1.772	0.787+/-0.157	NBR	12

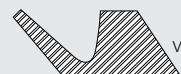
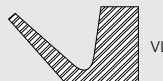
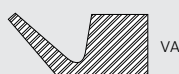



TCM VL SEALS

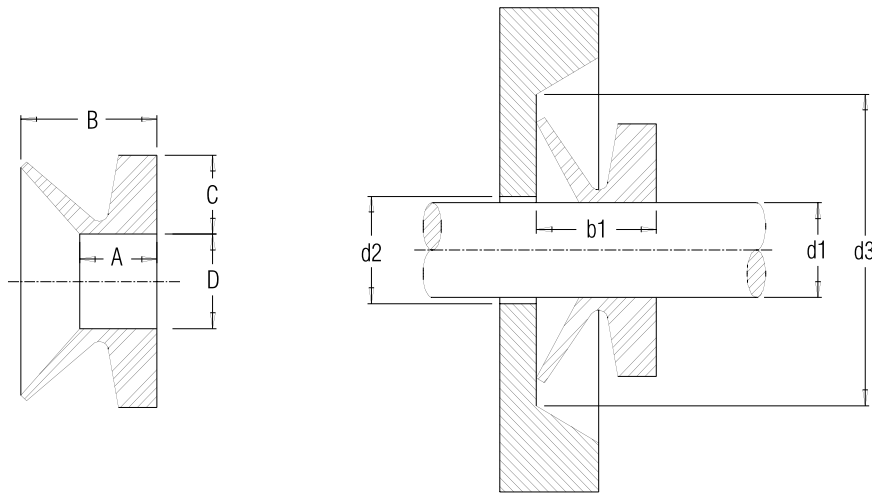

TCM Part #	For Shaft Diameter, d1	Inside Diameter, d	Height of Cross Section, c	Dim A	Free Width, B	Max, d2	Min, d3	Fitted Width, B1	Seal Material	Box #
VL-110	4.134~4.528	3.898	0.256	0.236	0.413	d1+0.197	d1+0.787	0.315+/-0.059	NBR	9
VL-120	4.528~4.921	4.252	0.256	0.236	0.413	d1+0.197	d1+0.787	0.315+/-0.059	NBR	9
VL-130	4.921~5.315	4.606	0.256	0.236	0.413	d1+0.197	d1+0.787	0.315+/-0.059	NBR	9
VL-140	5.315~5.709	4.961	0.256	0.236	0.413	d1+0.197	d1+0.787	0.315+/-0.059	NBR	3
VL-150	5.709~6.102	5.315	0.256	0.236	0.413	d1+0.197	d1+0.787	0.315+/-0.059	NBR	3
VL-160	6.102~6.496	5.669	0.256	0.236	0.413	d1+0.197	d1+0.787	0.315+/-0.059	NBR	3
VL-170	6.496~6.890	6.024	0.256	0.236	0.413	d1+0.197	d1+0.787	0.315+/-0.059	NBR	5
VL-180	6.890~7.283	6.378	0.256	0.236	0.413	d1+0.197	d1+0.787	0.315+/-0.059	NBR	5
VL-190	7.283~7.677	6.732	0.256	0.236	0.413	d1+0.197	d1+0.787	0.315+/-0.059	NBR	5
VL-200	7.677~8.268	7.165	0.256	0.236	0.413	d1+0.197	d1+0.787	0.315+/-0.059	NBR	5
VL-220	8.268~9.173	7.795	0.256	0.236	0.413	d1+0.197	d1+0.787	0.315+/-0.059	NBR	5
VL-250	9.173~10.236	8.858	0.256	0.236	0.413	d1+0.197	d1+0.787	0.315+/-0.059	NBR	6
VL-275	10.236~11.220	9.724	0.256	0.236	0.413	d1+0.197	d1+0.787	0.315+/-0.059	NBR	6
VL-300	11.220~12.205	10.630	0.256	0.236	0.413	d1+0.197	d1+0.787	0.315+/-0.059	NBR	11
VL-325	12.205~13.189	11.496	0.256	0.236	0.413	d1+0.197	d1+0.787	0.315+/-0.059	NBR	12
VL-350	13.189~14.370	12.402	0.256	0.236	0.413	d1+0.197	d1+0.787	0.315+/-0.059	NBR	12
VL-375	14.370~15.157	13.268	0.256	0.236	0.413	d1+0.197	d1+0.787	0.315+/-0.059	NBR	12
VL-400	15.157~16.142	14.173	0.256	0.236	0.413	d1+0.197	d1+0.787	0.315+/-0.059	NBR	12
VL-425	16.142~17.323	15.039	0.256	0.236	0.413	d1+0.197	d1+0.787	0.315+/-0.059	NBR	12
VL-450	17.323~18.701	15.945	0.256	0.236	0.413	d1+0.197	d1+0.787	0.315+/-0.059	NBR	12
VL-500	18.701~20.079	17.717	0.256	0.236	0.413	d1+0.197	d1+0.787	0.315+/-0.059	NBR	12
VL-525	20.079~21.260	18.583	0.256	0.236	0.413	d1+0.197	d1+0.787	0.315+/-0.059	NBR	12
VL-550	21.260~22.638	19.488	0.256	0.236	0.413	d1+0.197	d1+0.787	0.315+/-0.059	NBR	12
VL-600	22.638~24.606	21.260	0.256	0.236	0.413	d1+0.197	d1+0.787	0.315+/-0.059	NBR	12

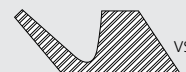
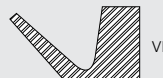



TCM VS SEALS

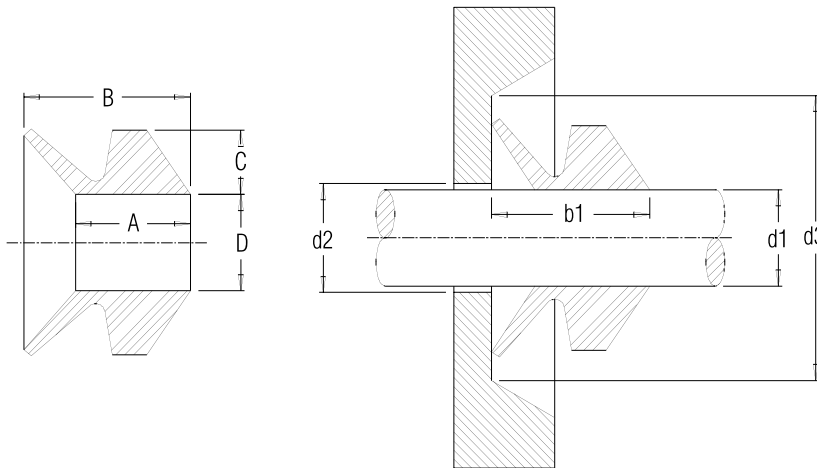

TCM Part #	For Shaft Diameter, d1	Inside Diameter, d	Height of Cross Section, c	Dim A	Free Width, B	Max, d2	Min, d3	Fitted Width, B1	Seal Material	Box #
VS-005	0.177~0.217	0.157	0.079	0.154	0.205	d1+0.039	d1+0.236	0.177+/-0.016	NBR	7
VVS-005	0.177~0.221	0.157	0.079	0.154	0.205	d1+0.039	d1+0.236	0.177+/-0.020	FKM	7
VS-006	0.217~0.256	0.197	0.079	0.154	0.205	d1+0.039	d1+0.236	0.177+/-0.016	NBR	7
VVS-006	0.217~0.260	0.197	0.079	0.154	0.205	d1+0.039	d1+0.236	0.177+/-0.020	FKM	7
VS-007	0.256~0.315	0.236	0.079	0.154	0.205	d1+0.039	d1+0.236	0.177+/-0.016	NBR	7
VVS-007	0.256~0.354	0.236	0.079	0.154	0.205	d1+0.039	d1+0.236	0.177+/-0.020	FKM	7
VS-008	0.315~0.374	0.276	0.079	0.154	0.205	d1+0.039	d1+0.236	0.177+/-0.016	NBR	7
VVS-008	0.315~0.378	0.276	0.079	0.154	0.205	d1+0.039	d1+0.236	0.177+/-0.020	FKM	7
VS-010	0.374~0.453	0.354	0.118	0.220	0.303	d1+0.079	d1+0.354	0.264+/-0.024	NBR	7
VVS-010	0.374~0.457	0.354	0.118	0.220	0.303	d1+0.079	d1+0.354	0.264+/-0.028	FKM	7
VS-012	0.453~0.531	0.413	0.118	0.220	0.303	d1+0.079	d1+0.354	0.264+/-0.024	NBR	7
VVS-012	0.453~0.535	0.413	0.118	0.220	0.303	d1+0.079	d1+0.354	0.264+/-0.028	FKM	7
VS-014	0.531~0.610	0.492	0.118	0.220	0.303	d1+0.079	d1+0.354	0.264+/-0.024	NBR	7
VVS-014	0.531~0.614	0.492	0.118	0.220	0.303	d1+0.079	d1+0.354	0.264+/-0.028	FKM	7
VS-016	0.610~0.689	0.551	0.118	0.220	0.303	d1+0.079	d1+0.354	0.264+/-0.024	NBR	7
VVS-016	0.610~0.693	0.551	0.118	0.220	0.303	d1+0.079	d1+0.354	0.264+/-0.028	FKM	7
VS-018	0.689~0.748	0.630	0.118	0.220	0.303	d1+0.079	d1+0.354	0.264+/-0.024	NBR	7
VVS-018	0.689~0.787	0.630	0.118	0.220	0.303	d1+0.079	d1+0.354	0.264+/-0.028	FKM	7
VS-020	0.748~0.827	0.709	0.157	0.311	0.413	d1+0.079	d1+0.472	0.354+/-0.031	NBR	7
VVS-020	0.748~0.866	0.709	0.157	0.311	0.413	d1+0.079	d1+0.472	0.354+/-0.035	FKM	7
VS-022	0.827~0.945	0.787	0.157	0.311	0.413	d1+0.079	d1+0.472	0.354+/-0.031	NBR	7
VVS-022	0.827~0.984	0.787	0.157	0.311	0.413	d1+0.079	d1+0.472	0.354+/-0.035	FKM	7
VS-025	0.945~1.063	0.866	0.157	0.311	0.413	d1+0.079	d1+0.472	0.354+/-0.031	NBR	7
VVS-025	0.945~1.102	0.866	0.157	0.311	0.413	d1+0.079	d1+0.472	0.354+/-0.035	FKM	7
VS-028	1.063~1.142	0.984	0.157	0.311	0.413	d1+0.118	d1+0.472	0.354+/-0.031	NBR	7
VVS-028	1.063~1.181	0.984	0.157	0.311	0.413	d1+0.118	d1+0.472	0.354+/-0.035	FKM	7
VS-030	1.142~1.220	1.063	0.157	0.311	0.413	d1+0.118	d1+0.472	0.354+/-0.031	NBR	7
VVS-030	1.142~1.259	1.063	0.157	0.311	0.413	d1+0.118	d1+0.472	0.354+/-0.035	FKM	7
VS-032	1.220~1.299	1.142	0.157	0.311	0.413	d1+0.118	d1+0.472	0.354+/-0.031	NBR	7
VVS-032	1.220~1.338	1.142	0.157	0.311	0.413	d1+0.118	d1+0.472	0.354+/-0.035	FKM	7
VS-035	1.299~1.417	1.220	0.157	0.311	0.413	d1+0.118	d1+0.472	0.354+/-0.031	NBR	7
VVS-035	1.299~1.456	1.220	0.157	0.311	0.413	d1+0.118	d1+0.472	0.354+/-0.035	FKM	7
VS-038	1.417~1.496	1.339	0.157	0.311	0.413	d1+0.118	d1+0.472	0.354+/-0.031	NBR	7
VVS-038	1.417~1.535	1.339	0.157	0.311	0.413	d1+0.118	d1+0.472	0.354+/-0.035	FKM	7
VS-040	1.496~1.693	1.417	0.197	0.374	0.512	d1+0.118	d1+0.591	0.433+/-0.039	NBR	7
VVS-040	1.496~1.732	1.417	0.197	0.374	0.512	d1+0.118	d1+0.591	0.433+/-0.043	FKM	7
VS-045	1.693~1.890	1.575	0.197	0.374	0.512	d1+0.118	d1+0.591	0.433+/-0.039	NBR	7
VVS-045	1.693~1.929	1.575	0.197	0.374	0.512	d1+0.118	d1+0.591	0.433+/-0.043	FKM	7
VS-050	1.890~2.087	1.772	0.197	0.374	0.512	d1+0.118	d1+0.591	0.433+/-0.039	NBR	7
VVS-050	1.890~2.126	1.772	0.197	0.374	0.512	d1+0.118	d1+0.591	0.433+/-0.043	FKM	7
VS-055	2.087~2.283	1.929	0.197	0.374	0.512	d1+0.118	d1+0.591	0.433+/-0.039	NBR	7

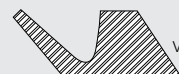
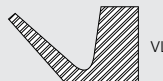
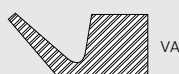



TCM VS SEALS

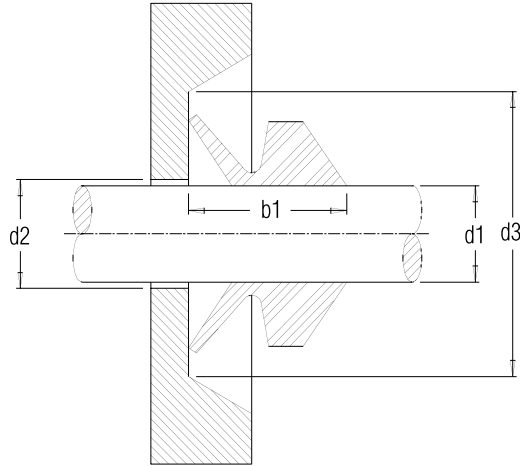
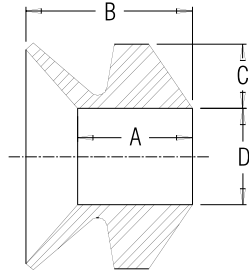

TCM Part #	For Shaft Diameter, d1	Inside Diameter, d	Height of Cross Section, c	Dim A	Free Width, B	Max, d2	Min, d3	Fitted Width, B1	Seal Material	Box #
VVS-055	2.087~2.322	1.929	0.197	0.374	0.512	d1+0.118	d1+0.591	0.433+/-0.043	FKM	7
VS-060	2.283~2.480	2.126	0.197	0.374	0.512	d1+0.118	d1+0.591	0.433+/-0.039	NBR	7
VVS-060	2.283~2.519	2.126	0.197	0.374	0.512	d1+0.118	d1+0.591	0.433+/-0.043	FKM	7
VS-065	2.480~2.677	2.283	0.197	0.374	0.512	d1+0.118	d1+0.591	0.433+/-0.039	NBR	7
VVS-065	2.480~2.716	2.283	0.197	0.374	0.512	d1+0.118	d1+0.591	0.433+/-0.043	FKM	7
VS-070	2.677~2.874	2.480	0.236	0.445	0.610	d1+0.157	d1+0.709	0.531+/-0.047	NBR	7
VVS-070	2.677~2.913	2.480	0.236	0.445	0.610	d1+0.157	d1+0.709	0.531+/-0.051	FKM	7
VS-075	2.874~3.071	2.638	0.236	0.445	0.610	d1+0.157	d1+0.709	0.531+/-0.047	NBR	8
VVS-075	2.874~3.110	2.638	0.236	0.445	0.610	d1+0.157	d1+0.709	0.531+/-0.051	FKM	8
VS-080	3.071~3.268	2.835	0.236	0.445	0.610	d1+0.157	d1+0.709	0.531+/-0.047	NBR	8
VVS-080	3.071~3.307	2.835	0.236	0.445	0.610	d1+0.157	d1+0.709	0.531+/-0.051	FKM	8
VS-085	3.268~3.465	2.992	0.236	0.445	0.610	d1+0.157	d1+0.709	0.531+/-0.047	NBR	8
VVS-085	3.268~3.504	2.992	0.236	0.445	0.610	d1+0.157	d1+0.709	0.531+/-0.051	FKM	8
VS-090	3.465~3.661	3.189	0.236	0.445	0.610	d1+0.157	d1+0.709	0.531+/-0.047	NBR	8
VVS-090	3.465~3.700	3.189	0.236	0.445	0.610	d1+0.157	d1+0.709	0.531+/-0.051	FKM	8
VS-095	3.661~3.858	3.346	0.236	0.445	0.610	d1+0.157	d1+0.709	0.531+/-0.047	NBR	8
VVS-095	3.661~3.897	3.346	0.236	0.445	0.610	d1+0.157	d1+0.709	0.531+/-0.051	FKM	8
VS-100	3.858~4.134	3.543	0.236	0.445	0.610	d1+0.157	d1+0.709	0.531+/-0.047	NBR	9
VVS-100	3.858~4.173	3.543	0.236	0.445	0.610	d1+0.157	d1+0.709	0.531+/-0.051	FKM	9
VS-110	4.134~4.528	3.898	0.276	0.516	0.709	d1+0.157	d1+0.827	0.610+/-0.059	NBR	9
VVS-110	4.134~4.567	3.898	0.276	0.516	0.709	d1+0.157	d1+0.827	0.610+/-0.063	FKM	9
VS-120	4.528~4.921	4.252	0.276	0.516	0.709	d1+0.157	d1+0.827	0.610+/-0.059	NBR	9
VVS-120	4.528~4.960	4.252	0.276	0.516	0.709	d1+0.157	d1+0.827	0.610+/-0.063	FKM	9
VS-130	4.921~5.315	4.606	0.276	0.516	0.709	d1+0.157	d1+0.827	0.610+/-0.059	NBR	9
VVS-130	4.921~5.354	4.606	0.276	0.516	0.709	d1+0.157	d1+0.827	0.610+/-0.063	FKM	9
VS-140	5.315~5.709	4.961	0.276	0.516	0.709	d1+0.157	d1+0.827	0.610+/-0.059	NBR	3
VVS-140	5.315~5.748	4.961	0.276	0.516	0.709	d1+0.157	d1+0.827	0.610+/-0.063	FKM	3
VS-150	5.709~6.102	5.315	0.276	0.516	0.709	d1+0.157	d1+0.827	0.610+/-0.059	NBR	3
VVS-150	5.709~6.141	5.315	0.276	0.516	0.709	d1+0.157	d1+0.827	0.610+/-0.063	FKM	3
VS-160	6.102~6.496	5.669	0.315	0.591	0.787	d1+0.197	d1+0.945	0.709+/-0.071	NBR	3
VVS-160	6.102~6.535	5.669	0.315	0.591	0.787	d1+0.197	d1+0.945	0.709+/-0.075	FKM	3
VS-170	6.496~6.890	6.024	0.315	0.591	0.787	d1+0.197	d1+0.945	0.709+/-0.071	NBR	5
VVS-170	6.496~6.929	6.024	0.315	0.591	0.787	d1+0.197	d1+0.945	0.709+/-0.075	FKM	5
VS-180	6.890~7.283	6.378	0.315	0.591	0.787	d1+0.197	d1+0.945	0.709+/-0.071	NBR	5
VVS-180	6.890~7.322	6.378	0.315	0.591	0.787	d1+0.197	d1+0.945	0.709+/-0.075	FKM	5
VS-190	7.283~7.677	6.732	0.315	0.591	0.787	d1+0.197	d1+0.945	0.709+/-0.071	NBR	5
VVS-190	7.283~7.716	6.732	0.315	0.591	0.787	d1+0.197	d1+0.945	0.709+/-0.075	FKM	5
VS-199	7.677~8.268	7.087	0.315	0.591	0.787	d1+0.197	d1+0.945	0.709+/-0.071	NBR	5
VVS-199	7.677~8.307	7.087	0.315	0.591	0.787	d1+0.197	d1+0.945	0.709+/-0.075	FKM	5

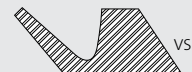
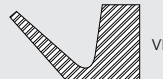

AXIAL FACE SEALS

PLEASE CALL DICHTOMATIK FOR AVAILABILITY - 800-328-2840
BULK AND INDIVIDUALLY BOXED QUANTITIES ARE AVAILABLE FOR ALL ITEMS

AFS SERIES

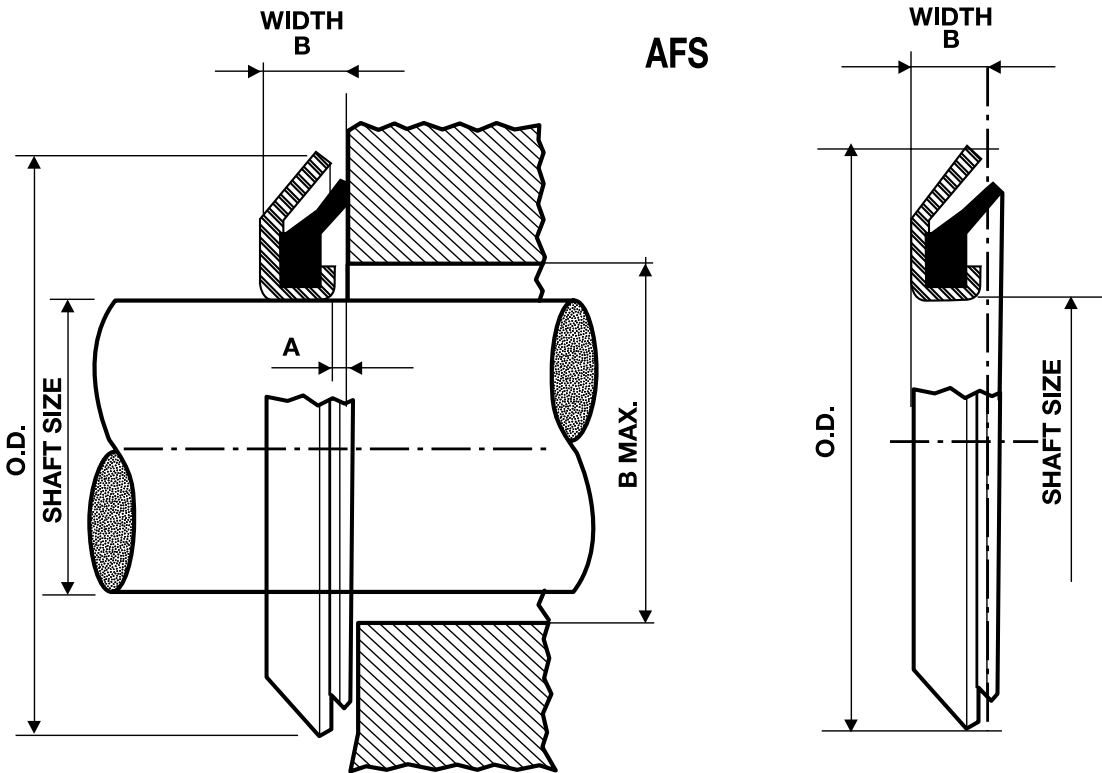

TCM Part #	Shaft	O.D.	Width B	A	B Max.	Lip Material	Material	Box #	TCM Part #	Shaft	O.D.	Width B	A	B Max.	Lip Material	Material	Box #
AFS 10	0.394	0.945	0.138	0.039	0.591	NBR	NCO	7	AFS 45Y	1.772	2.441	0.177	0.039	2.047	FKM	VSO	7
AFS 11	0.433	1.024	0.138	0.039	0.669	NBR	NCO	7	AFS 48	1.890	2.559	0.177	0.039	2.165	NBR	NCO	8
AFS 12	0.472	1.024	0.138	0.039	0.669	NBR	NCO	7	AFS 50	1.969	2.756	0.217	0.039	2.283	NBR	NCO	8
AFS 14	0.551	1.181	0.157	0.039	0.827	NBR	NCO	7	AFS 52	2.047	2.835	0.217	0.039	2.362	NBR	NCO	8
AFS 15	0.591	1.181	0.157	0.039	0.827	NBR	NCO	7	AFS 55	2.165	2.953	0.217	0.039	2.480	NBR	NCO	8
AFS 16	0.630	1.260	0.157	0.039	0.906	NBR	NCO	7	AFS 58	2.283	3.071	0.217	0.039	2.598	NBR	NCO	8
AFS 17	0.669	1.260	0.157	0.039	0.906	NBR	NCO	7	AFS 60	2.362	3.150	0.217	0.039	2.677	NBR	NCO	8
AFS 18	0.709	1.299	0.157	0.039	0.945	NBR	NCO	7	AFS 62	2.441	3.228	0.217	0.039	2.756	NBR	NCO	8
AFS 20	0.787	1.378	0.157	0.039	1.024	NBR	NCO	7	AFS 65	2.559	3.346	0.217	0.039	2.874	NBR	NCO	8
AFS 22	0.866	1.575	0.157	0.039	1.220	NBR	NCO	7	AFS 68	2.677	3.465	0.217	0.039	2.992	NBR	NCO	8
AFS 24	0.945	1.575	0.157	0.039	1.220	NBR	NCO	7	AFS 70	2.756	3.543	0.217	0.039	3.071	NBR	NCO	9
AFS 25	0.984	1.575	0.157	0.039	1.220	NBR	NCO	7	AFS 72	2.835	3.622	0.217	0.039	3.150	NBR	NCO	9
AFS 26	1.024	1.575	0.157	0.039	1.220	NBR	NCO	7	AFS 75	2.953	3.740	0.217	0.039	3.268	NBR	NCO	9
AFS 28	1.102	1.693	0.157	0.039	1.339	NBR	NCO	7	AFS 78	3.071	3.858	0.217	0.039	3.386	NBR	NCO	9
AFS 30	1.181	1.850	0.177	0.039	1.457	NBR	NCO	7	AFS 80	3.150	3.937	0.217	0.039	3.465	NBR	NCO	9
AFS 32	1.260	1.929	0.177	0.039	1.535	NBR	NCO	7	AFS 85	3.346	4.134	0.217	0.039	3.661	NBR	NCO	9
AFS 35	1.378	2.047	0.177	0.039	1.654	NBR	NCO	7	AFS 90	3.543	4.331	0.217	0.039	3.858	NBR	NCO	9
AFS 35Y	1.378	2.047	0.177	0.039	1.654	FKM	VSO	7	AFS 95	3.740	4.528	0.217	0.039	4.055	NBR	NCO	9
AFS 38	1.496	2.165	0.177	0.039	1.772	NBR	NCO	7	AFS 100	3.937	4.724	0.217	0.039	4.252	NBR	NCO	9
AFS 40	1.575	2.244	0.177	0.039	1.850	NBR	NCO	7	AFS 105	4.134	4.921	0.217	0.039	4.449	NBR	NCO	3
AFS 41	1.614	2.244	0.177	0.039	1.890	NBR	NCO	7	AFS 135	5.315	6.260	0.256	0.039	5.709	NBR	NCO	5
AFS 42	1.654	2.323	0.177	0.039	1.929	NBR	NCO	7	AFS 225	8.858	9.843	0.295	0.039	9.252	NBR	NCO	6
AFS 45	1.772	2.441	0.177	0.039	2.047	NBR	NCO	7									





AFX SERIES

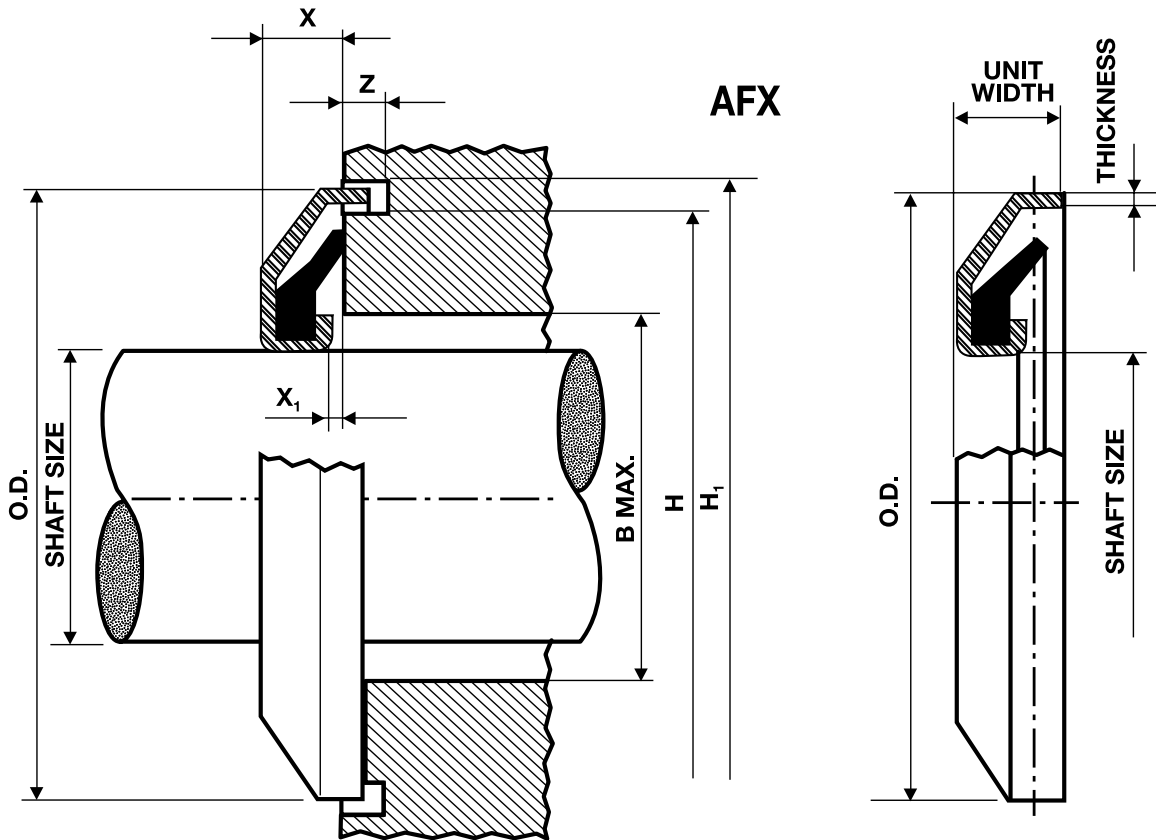

TCM Part #	Shaft	O.D.	X	X1	Unit Width	Z	B Max.	H	H1	Thickness	Material	Lip Material	Box #
AFX 15 32 04	0.591	1.260	0.157	0.039	0.236	0.118	0.827	1.142	1.339	0.020	NBR	NCO	7
AFX 17 34 04	0.669	1.339	0.157	0.039	0.236	0.118	0.906	1.220	1.417	0.020	NBR	NCO	7
AFX 20 37 04	0.787	1.457	0.157	0.039	0.236	0.118	1.024	1.339	1.535	0.020	NBR	NCO	7
AFX 35 53 045	1.378	2.087	0.177	0.039	0.256	0.118	1.654	1.969	2.165	0.020	NBR	NCO	7
AFX 40 58 045	1.575	2.283	0.177	0.039	0.256	0.118	1.850	2.165	2.362	0.020	NBR	NCO	7
AFX 45 63 045	1.772	2.480	0.177	0.039	0.256	0.118	2.047	2.362	2.559	0.020	NBR	NCO	7
AFX 50 72 055	1.969	2.835	0.217	0.039	0.295	0.118	2.283	2.697	2.913	0.030	NBR	NCO	8
AFX 55 77 055	2.165	3.031	0.217	0.039	0.295	0.118	2.480	2.894	3.110	0.030	NBR	NCO	8
AFX 70 92 055	2.756	3.622	0.217	0.039	0.295	0.118	3.071	3.484	3.701	0.030	NBR	NCO	9
AFX 75 97 055	2.953	3.819	0.217	0.039	0.295	0.118	3.268	3.681	3.898	0.030	NBR	NCO	9
AFX 80 102 055	3.150	4.016	0.217	0.039	0.295	0.118	3.465	3.878	4.094	0.030	NBR	NCO	9
AFX 90 112 055	3.543	4.409	0.217	0.039	0.295	0.118	3.858	4.272	4.488	0.030	NBR	NCO	9
AFX 95 117 055	3.740	4.606	0.217	0.039	0.295	0.118	4.055	4.469	4.685	0.030	NBR	NCO	9
AFX 100 122 055	3.937	4.803	0.217	0.039	0.295	0.118	4.252	4.665	4.882	0.030	NBR	NCO	3



OIL BATH SEALS

PLEASE CALL DICHTOMATIK FOR AVAILABILITY - 800-328-2840
 BULK AND INDIVIDUALLY BOXED QUANTITIES ARE AVAILABLE FOR ALL ITEMS



DICHTOMATIK

Any seal. Any time.

TCM Part #	Shaft	Bore	Width	Type	Lip Material	Material	Box #
OB2233749	2.250	3.372	0.490	ST34	NBR	NCC	8
OBV2353957	2.359	3.938	0.575	ST2	FKM	VCC	9
OB2737753	2.750	3.779	0.530	ST34	NBR	NCC	9
OB27377	2.750	3.779	0.762	ST	NBR	NCC	6
OB28385	2.875	3.875	0.500	ST	NBR	NCC	9
OB2838051	2.875	3.875	0.515	ST34	NBR	NCC	9
OB2841784	2.875	4.176	0.844	ST1	NBR	NCC	6
OB3145059	3.125	4.500	0.595	ST34	NBR	NCC	9
OB3447585	3.438	4.757	0.589	ST1	NBR	NCC	3
OB354770	3.500	4.750	0.706	ST1	NBR	NCC	9
OB3548490	3.500	4.842	0.904	ST1	NBR	NCC	6
OB3856993	3.875	5.691	0.938	ST1	NBR	NCC	6
OB395310	3.938	5.374	1.016	ST1	NBR	NCC	~
OB39559	3.938	5.501	0.938	ST1	NBR	NCC	6
OB4660099	4.625	6.000	0.900	ST5	NBR	NCC	6
OB47663111	4.766	6.311	1.125	ST1	NBR	NCC	~

OIL BATH SEALS

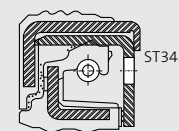
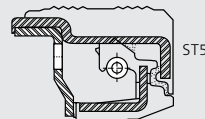
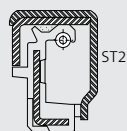



Part Number	Nominal Shaft Diameter (in)	"A" Shaft Diameter Range (in)		"B" Width on Shaft (in ±0.031")	"C" Overall Width (in ±0.031")	"D" Flange Diameter (in ±0.063")	"E" Installation Depth (in)	Box #
99599	6.000	5.995	6.003	1.000	1.252	6.374	1.752	S3
99601	6.000	5.995	6.003	0.500	0.752	6.358	1.752	S3
99605	6.063	6.058	6.068	1.024	1.181	6.374	1.299	S3
99606	6.097	6.093	6.102	1.024	1.181	6.575	1.299	S3
99620	6.203	6.198	6.208	0.811	1.063	6.626	1.752	S3
99625	6.250	6.245	6.255	1.032	1.252	6.626	1.752	S3
99630	6.299	6.289	6.299	1.000	1.252	6.748	1.378	S3
99650	6.500	6.495	6.505	1.000	1.252	7.000	1.378	S3
99640	6.688	6.683	6.693	1.252	1.496	7.189	1.752	S3
99675	6.750	6.745	6.755	0.811	1.063	7.126	1.752	S3
99687	6.890	6.880	6.890	1.102	1.260	7.362	1.378	S3
99700	7.000	6.995	7.005	1.000	1.252	7.476	1.685	S3
99721	7.087	7.077	7.087	1.299	1.496	7.500	1.752	S3
99725	7.250	7.244	7.254	1.252	1.500	7.760	2.173	S3
99726	7.278	7.273	7.284	1.260	1.496	7.760	2.173	S3
99745	7.453	7.444	7.454	0.811	1.000	7.858	1.252	S3
99750	7.500	7.495	7.505	0.811	1.000	7.874	1.252	S3
99775	7.750	7.745	7.755	1.000	1.315	8.272	1.874	S3
99787	7.875	7.869	7.879	1.358	1.500	8.374	1.752	S3
99799	7.938	7.933	7.943	1.000	1.252	8.374	1.752	S3
99800	8.000	7.995	8.005	1.000	1.252	8.374	1.752	S3

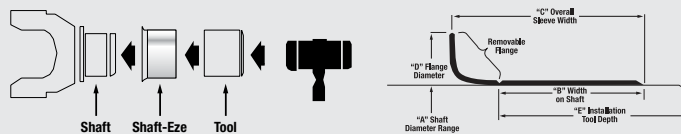

OIL AND GREASE SEALS - A COMPLETE LISTING



PLEASE CALL DICHTOMATIK FOR AVAILABILITY - 800-328-2840
BULK AND INDIVIDUALLY BOXED QUANTITIES ARE AVAILABLE FOR ALL ITEMS

TCM Part #	Shaft	Bore	Width	Type	Lip Material	Material	Box #	TCM Part #	Shaft	Bore	Width	Type	Lip Material	Material	Box #
SHAFT 0.125															
V-RING -003							7	6X15X4SC	0.236	0.591	0.157	SC	NBR	NCC	7
01052EKCY	0.125	0.500	0.250	KCY	EPDM	ECO	7	6X15X4TC	0.236	0.591	0.157	TC	NBR	NCC	7
SHAFT 0.157															
V-RING -004							7	6X15X4VC	0.236	0.591	0.157	VC	NBR	NCC	7
4X8X2VM	0.157	0.315	0.079	VM	NBR	NCO	7	6X15X6SC	0.236	0.591	0.236	SC	NBR	NCC	7
4X11X6VSC	0.157	0.433	0.236	SC	FKM	VCS	7	6X16X5SC	0.236	0.630	0.197	SC	NBR	NCC	7
4X12X6SC	0.157	0.472	0.236	SC	NBR	NCC	7	6X16X5TC	0.236	0.630	0.197	TC	NBR	NCC	7
4X12X6VSF	0.157	0.472	0.236	SF	FKM	VCS	7	6X16X5TF	0.236	0.630	0.197	TF	NBR	NCC	7
015051VC	0.157	0.500	0.158	VC	NBR	NCO	7	6X16X6VTF	0.236	0.630	0.236	TF	FKM	VCS	7
015052SM	0.157	0.500	0.250	SM	NBR	NCC	7	6X16X7SC	0.236	0.630	0.276	SC	NBR	NCC	7
015052TM4-H	0.157	0.500	0.250	TM4-H	NBR	NCC	7	6X16X7VTC	0.236	0.630	0.276	TC	FKM	VCC	7
4X14X8VZ	0.157	0.551	0.315	VZ	NBR	NCO	7	6X16X7TC	0.236	0.630	0.276	TC	NBR	NCS	7
4X16X7TC	0.157	0.630	0.276	TC	NBR	NCC	7	6X17X6SC	0.236	0.669	0.236	SC	NBR	NCC	7
4X19X6SC	0.157	0.748	0.236	SC	NBR	NCS	7	6X17X7TC	0.236	0.669	0.276	TC	NBR	NCC	7
SHAFT 0.187															
V-RING -005							7	6X18X5SC	0.236	0.709	0.197	SC	NBR	NCC	7
018052VTC	0.187	0.500	0.250	TC	FKM	VCS	7	6X18X6SC	0.236	0.709	0.236	SC	NBR	NCC	7
01072SC	0.187	0.750	0.250	SC	NBR	NCC	7	6X18X7TC	0.236	0.709	0.276	TC	NBR	NCC	7
SHAFT 0.197															
V-RING -005							7	6X18X8DC	0.236	0.709	0.315	DC	NBR	NCS	7
5X9X2VG	0.197	0.354	0.079	VG	NBR	NCO	7	6X19X4SF	0.236	0.748	0.157	SF	NBR	NCS	7
5X9X3VC	0.197	0.354	0.118	VC	NBR	NCO	7	6X19X5SF	0.236	0.748	0.197	SF	NBR	NCS	7
5X10X2VG	0.197	0.394	0.079	VG	NBR	NCO	7	6X19X6VSF	0.236	0.748	0.236	SF	FKM	VCS	7
5X10X2VM	0.197	0.394	0.079	VM	NBR	NCO	7	6X19X7SC	0.236	0.748	0.276	SC	NBR	NCC	7
5X11X2VM	0.197	0.433	0.079	VM	NBR	NCO	7	6X19X7VTC	0.236	0.748	0.276	TC	FKM	VCC	7
5X14X5KM	0.197	0.551	0.197	KM	NBR	NCO	7	6X19X7TC	0.236	0.748	0.276	TC	NBR	NCC	7
5X14.5X7TC	0.197	0.571	0.276	TC	NBR	NCC	7	6X20X5.5VTC	0.236	0.787	0.217	TC	FKM	VCC	7
5X15X6SC	0.197	0.591	0.236	SC	NBR	NCC	7	6X20X5.5VC	0.236	0.787	0.217	VC	NBR	NCO	7
5X15X6SCY	0.197	0.591	0.236	SCY	NBR	NCS	7	6X22X5TC	0.236	0.866	0.197	TC	NBR	NCC	7
5X15X6VTC	0.197	0.591	0.236	TC	FKM	VCS	7	6X22X7SC	0.236	0.866	0.276	SC	NBR	NCC	7
5X15X6TC	0.197	0.591	0.236	TC	NBR	NCC	7	6X22X7TC	0.236	0.866	0.276	TC	NBR	NCC	7
5X16X6SC	0.197	0.630	0.236	SC	NBR	NCC	7	6X22X7VTF	0.236	0.866	0.276	TF	FKM	VCS	7
5X16X6SM	0.197	0.630	0.236	SM	NBR	NCC	7	SHAFT 0.244							
5X16X6TC	0.197	0.630	0.236	TC	NBR	NCC	7	V-RING -006							7
5X16X7SC	0.197	0.630	0.276	SC	NBR	NCC	7	024051VM	0.244	0.500	0.125	VM	NBR	NSO	7
5X16X7VSF	0.197	0.630	0.276	SF	FKM	VCS	7	SHAFT 0.249							
5X16X7TC	0.197	0.630	0.276	TC	NBR	NCC	7	V-RING -006							7
5X16X7VTF	0.197	0.630	0.276	TF	FKM	VCS	7	0240518PVC	0.249	0.500	0.188	VC	ACM	PCC	7
5X16X7TC	0.197	0.630	0.276	TC	NBR	NCC	7	SHAFT 0.250							
5X16X7VTF	0.197	0.630	0.276	TF	FKM	VCS	7	V-RING -006							7
5X16X7TC	0.197	0.630	0.276	TC	NBR	NCC	7	0204918VL-H	0.250	0.498	0.187	VL-H	NBR	NCO	7
5X17X7TC	0.197	0.669	0.276	TC	NBR	NCC	7	02051VC	0.250	0.500	0.125	VC	NBR	NCO	7
5X18X7TC	0.197	0.709	0.276	TC	NBR	NCC	7	02051VM	0.250	0.500	0.125	VM	NBR	NCO	7
5X19X5TC	0.197	0.748	0.197	TC	NBR	NCC	7	0205618VL-H	0.250	0.561	0.187	VL-H	NBR	NCO	7
5X22X7TC	0.197	0.866	0.276	TC	NBR	NCC	7	02062VL-H	0.250	0.625	0.250	VL-H	NBR	NCO	7
5X25X7TC	0.197	0.984	0.276	TC	NBR	NCC	7	0207418KC	0.250	0.749	0.180	KC	NBR	NCO	7
5X30X6KC	0.197	1.181	0.236	KC	NBR	NCO	7	02072SC	0.250	0.750	0.250	SC	NBR	NSS	7
5X30X6TB	0.197	1.181	0.236	TB	NBR	NCC	7	02072XSG	0.250	0.750	0.250	SG	XNBR	XCS	7
SHAFT 0.232															
V-RING -006							7	02072VTBN1	0.250	0.750	0.250	TBN1	FKM	VCS	7
5.9X19X4SC	0.232	0.748	0.157	SC	NBR	NCC	7	02072VTMN1	0.250	0.750	0.250	TMN1	FKM	VCS	7
SHAFT 0.236															
V-RING -006							7	02072ESEC	0.250	0.751	0.250	SEC	EPDM	ECC	7
6X10X2VVC	0.236	0.394	0.079	VC	FKM	VCO	7	SHAFT 0.251							
6X10X2VC	0.236	0.394	0.079	VC	NBR	NCO	7	V-RING -006							7
6X10X3XVC	0.236	0.394	0.118	VC	XNBR	XCO	7	0250431VC	0.251	0.437	0.125	VC	NBR	NCO	7
6X11X3VC	0.236	0.433	0.118	VC	NBR	NCO	7	SHAFT 0.276							
6X11X4VC	0.236	0.433	0.157	VC	NBR	NCO	7	V-RING -007							7
6X12X2VG	0.236	0.472	0.079	VG	NBR	NCO	7	7X11X2VVM	0.276	0.433	0.079	VM	FKM	VCO	7
6X12X2VM	0.236	0.472	0.079	VM	NBR	NCO	7	7X11X2VM	0.276	0.433	0.079	VM	NBR	NCO	7
6X12X4SC	0.236	0.472	0.157	SC	NBR	NCC	7	7X14X2VG	0.276	0.551	0.079	VG	NBR	NCO	7
6X13X3.8VC	0.236	0.512	0.150	VC	NBR	NCO	7	7X14X4TC	0.276	0.551	0.157	TC	NBR	NCC	7
6X14X6SF	0.236	0.551	0.236	SF	NBR	NCS	7	7X14X4VTC4	0.276	0.551	0.157	TC4	FKM	VCC	7
6X14X6VTF	0.236	0.551	0.236	TF	FKM	VCS	7	7X16X4TC	0.276	0.630	0.157	TC	NBR	NCC	7
6X15X4VSC	0.236	0.591	0.157	SC	FKM	VCS	7	7X16X6TC	0.276	0.630	0.236	TC	NBR	NCC	7
								7X16X7SM	0.276	0.630	0.276	SM	NBR	NCC	7
								7X16X7VTC	0.276	0.630	0.276	TC	FKM	VCC	7

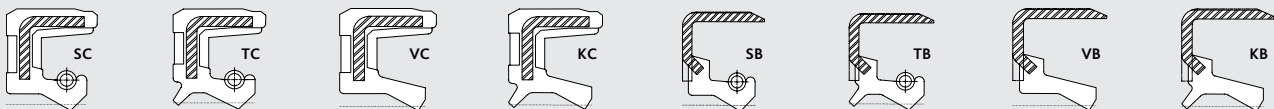



TCM Part #	Shaft	Bore	Width	Type	Lip Material	Material	Box #	TCM Part #	Shaft	Bore	Width	Type	Lip Material	Material	Box #
7X16X7TC	0.276	0.630	0.276	TC	NBR	NCC	7	8X15X5TB	0.315	0.591	0.197	TB	NBR	NCC	7
7X18X4.5TC	0.276	0.709	0.177	TC	NBR	NCC	7	8X15X5TC	0.315	0.591	0.197	TC	NBR	NCS	7
7X18X5TC	0.276	0.709	0.197	TC	NBR	NCC	7	8X15X5TG	0.315	0.591	0.197	TG	NBR	NCC	7
7X18X7SC	0.276	0.709	0.276	SC	NBR	NCC	7	8X16X3VC	0.315	0.630	0.118	VC	NBR	NCO	7
7X18X7TC	0.276	0.709	0.276	TC	NBR	NCC	7	8X16X3VG1	0.315	0.630	0.118	VG1	NBR	NCO	7
7X19X6SC	0.276	0.748	0.236	SC	NBR	NCC	7	8X16X4SC	0.315	0.630	0.157	SC	NBR	NCS	7
7X19X7VTBG	0.276	0.748	0.276	TBG	FKM	VCS	7	8X16X4TC	0.315	0.630	0.157	TC	NBR	NCC	7
7X19X7TC	0.276	0.748	0.276	TC	NBR	NCC	7	8X16X5SC	0.315	0.630	0.197	SC	NBR	NCS	7
7X20X7TC	0.276	0.787	0.276	TC	NBR	NCC	7	8X16X6SC	0.315	0.630	0.236	SC	NBR	NCC	7
7X22X6TC	0.276	0.866	0.236	TC	NBR	NCC	7	8X16X7VSC	0.315	0.630	0.276	SC	FKM	VCS	7
7X22X7SC	0.276	0.866	0.276	SC	NBR	NCC	7	8X16X7SC	0.315	0.630	0.276	SC	NBR	NCC	7
7X22X7VSF	0.276	0.866	0.276	SF	FKM	VCS	7	8X16X7SM	0.315	0.630	0.276	SM	NBR	NCC	7
7X22X7TC	0.276	0.866	0.276	TC	NBR	NCC	7	8X16X7TC	0.315	0.630	0.276	TC	NBR	NCC	7
7X26X5.5TC	0.276	1.024	0.217	TC	NBR	NCC	7	8X16X7VTF	0.315	0.630	0.276	TF	FKM	VCS	7
SHAFT 0.310								8X17X5TC	0.315	0.669	0.197	TC	NBR	NCC	7
V-RING -007							7	8X17X7TC	0.315	0.669	0.276	TC	NBR	NCC	7
03051PSC	0.310	0.563	0.125	SC	ACM	PCS	7	8X18X4TC	0.315	0.709	0.157	TC	NBR	NCC	7
SHAFT 0.312								8X18X5SC	0.315	0.709	0.197	SC	NBR	NCS	7
V-RING -007							7	8X18X5VTC	0.315	0.709	0.197	TC	FKM	VCC	7
03041VC-G	0.312	0.495	0.125	VC-G	NBR	NCO	7	8X18X5TC	0.315	0.709	0.197	TC	NBR	NCC	7
030501VC	0.312	0.500	0.125	VC	NBR	NCO	7	8X18X5VA3	0.315	0.709	0.197	VA3	NBR	NCC	7
0310561VM	0.312	0.562	0.125	VM	NBR	NCO	7	8X18X7TC	0.315	0.709	0.276	TC	NBR	NCC	7
031061VSC	0.312	0.625	0.157	SC	FKM	VCS	7	8X18X8TC	0.315	0.709	0.315	TC	NBR	NCC	7
031061SC	0.312	0.625	0.157	SC	NBR	NCC	7	8X19X6SC	0.315	0.748	0.236	SC	NBR	NCC	7
03062SC	0.312	0.687	0.250	SC	NBR	NCC	7	8X19X7TC	0.315	0.748	0.276	TC	NBR	NCC	7
030742TLN22-H	0.312	0.748	0.250	TLN22-H	NBR	NCC	7	8X20X5TC	0.315	0.787	0.197	TC	NBR	NCC	7
031072SC	0.312	0.750	0.250	SC	NBR	NCC	7	8X20X7VTC	0.315	0.787	0.276	TC	FKM	VCC	7
031072VTF	0.312	0.750	0.250	TF	FKM	VCS	7	8X20X8VSF	0.315	0.787	0.315	SF	FKM	VCS	7
031082SC	0.312	0.865	0.250	SC	NBR	NCC	7	8X20X8TC	0.315	0.787	0.315	TC	NBR	NCC	7
0310937TB-H	0.312	0.999	0.375	TB-H	NBR	NCC	7	8X21X6TC	0.315	0.827	0.236	TC	NBR	NCC	7
SHAFT 0.313								8X22X4TB	0.315	0.866	0.157	TB	NBR	NCC	7
V-RING -007							7	8X22X5TC	0.315	0.866	0.197	TC	NBR	NCC	7
031051VMY	0.313	0.500	0.125	VMY	NBR	NCO	7	8X22X7SC	0.315	0.866	0.276	SC	NBR	NCC	7
03061TEB	0.313	0.625	0.156	TEB	NBR	NCC	7	8X22X7VTC	0.315	0.866	0.276	TC	FKM	VCC	7
031072VTBY	0.313	0.749	0.250	TBY	FKM	VCS	7	8X22X7TC	0.315	0.866	0.276	TC	NBR	NCC	7
03107425ETC	0.313	0.749	0.259	TC	EPDM	ECC	7	8X22X7VTF	0.315	0.866	0.276	TF	FKM	VCS	7
031072VSC	0.313	0.750	0.250	SC	FKM	VCC	7	8X24X7SC	0.315	0.945	0.276	SC	NBR	NCC	7
031072SC	0.313	0.750	0.250	SC	NBR	NCS	7	8X24X7VTC	0.315	0.945	0.276	TC	FKM	VCC	7
031072ATCNR	0.313	0.750	0.250	TCNR	NBR	NCS	7	8X24X7TC	0.315	0.945	0.276	TC	NBR	NCC	7
031072VTEB-H	0.313	0.750	0.250	TEB-H	FKM	VCS	7	8X25X7TC	0.315	0.984	0.276	TC	NBR	NCC	7
031092TCN	0.313	0.999	0.250	TCN	NBR	NCC	7	8X25X8TC	0.315	0.984	0.315	TC	NBR	NCC	7
031093TC	0.313	0.999	0.313	TC	NBR	NCC	7	8X26X7TC	0.315	1.024	0.276	TC	NBR	NCC	7
031093TLY	0.313	0.999	0.313	TLY	NBR	NCC	7	8X30X7SC	0.315	1.181	0.276	SC	NBR	NCC	7
SHAFT 0.315								8X30X7VTC	0.315	1.181	0.276	TC	FKM	VCC	7
V-RING -007							7	SHAFT 0.335							
8X12X3VVC	0.315	0.472	0.118	VC	FKM	VCO	7	V-RING -008							7
8X12X3AVC	0.315	0.472	0.118	VC	NBR	NCO	7	8.50X15X3VC	0.335	0.591	0.118	VC	NBR	NCO	7
8X12X3VC	0.315	0.472	0.118	VC	NBR	NCO	7	SHAFT 0.344							
8X12X3XVC	0.315	0.472	0.118	VC	XNBR	XCO	7	V-RING -008							7
8X13X3.5VC	0.315	0.512	0.138	VC	NBR	NCO	7	034072KCY	0.344	0.750	0.250	KCY	NBR	NCC	7
8X14X4SB	0.315	0.551	0.157	SB	NBR	NCC	7	SHAFT 0.354							
8X14X4SB-H	0.315	0.551	0.157	SB-H	NBR	NCC	7	V-RING -008							7
8X14X4SC	0.315	0.551	0.157	SC	NBR	NCC	7	9X13X3VC	0.354	0.512	0.118	VC	NBR	NSO	7
8X14X4VSM	0.315	0.551	0.157	SM	FKM	VCS	7	9X15X3VC	0.354	0.591	0.118	VC	NBR	NCO	7
8X14X4TC	0.315	0.551	0.157	TC	NBR	NCC	7	9X15X5KC	0.354	0.591	0.197	KC	NBR	NCO	7
8X14X5VTC	0.315	0.551	0.197	TC	FKM	VCC	7	9X16X3VG	0.354	0.630	0.118	VG	NBR	NCO	7
8X14X6TB	0.315	0.551	0.236	TB	NBR	NCC	7	9X16X4SC	0.354	0.630	0.157	SC	NBR	NCC	7
8X15X3XKC	0.315	0.591	0.118	KC	XNBR	XCO	7	9X16X5SC	0.354	0.630	0.197	SC	NBR	NCC	7
8X15X3VKF	0.315	0.591	0.118	KF	FKM	VCO	7	9X16X5SCY	0.354	0.630	0.197	SCY	NBR	NCS	7
8X15X3XKF	0.315	0.591	0.118	KF	XNBR	XCO	7	9X17X4.5SM	0.354	0.669	0.177	SM	NBR	NCC	7
8X15X3VC	0.315	0.591	0.118	VC	NBR	NCO	7	9X18X3VC	0.354	0.709	0.118	VC	NBR	NCO	7
8X15X4.5TC	0.315	0.591	0.177	TC	NBR	NCS	7	9X18X6SB	0.354	0.709	0.236	SB	NBR	NCC	7
8X15X5SC	0.315	0.591	0.197	SC	NBR	NCC	7	9X18X6TC	0.354	0.709	0.236	TC	NBR	NCS	7

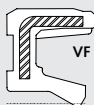
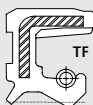
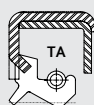

OIL AND GREASE SEALS - A COMPLETE LISTING



DICHTOMATIK

Any seal. Any time.

PLEASE CALL DICHTOMATIK FOR AVAILABILITY - 800-328-2840
 BULK AND INDIVIDUALLY BOXED QUANTITIES ARE AVAILABLE FOR ALL ITEMS

COMPLETE LISTING

TCM Part #	Shaft	Bore	Width	Type	Lip Material	Material	Box #	TCM Part #	Shaft	Bore	Width	Type	Lip Material	Material	Box #
9X18X7SC	0.354	0.709	0.276	SC	NBR	NCC	7	SHAFT 0.392							
9X18X7TC	0.354	0.709	0.276	TC	NBR	NCC	7	V-RING -010							7
9X19X4SC	0.354	0.748	0.157	SC	NBR	NCC	7	0390781ASCW	0.392	0.787	0.197	SCW	NBR	NCC	7
9X19X5SC	0.354	0.748	0.197	SC	NBR	NCC	7	SHAFT 0.394							
9X19X5TC	0.354	0.748	0.197	TC	NBR	NCC	7	V-RING -010							7
9X20X4.5TC	0.354	0.787	0.177	TC	NBR	NCC	7	10X14X3VC	0.394	0.551	0.118	VC	NBR	NCO	7
9X20X9TC	0.354	0.787	0.354	TC	NBR	NCC	7	10X14X3VVG	0.394	0.551	0.118	VG	FKM	VCO	7
9X21X9.5TC	0.354	0.827	0.374	TC	NBR	NCC	7	10X14X3VG1	0.394	0.551	0.118	VG1	NBR	NCO	7
9X22X7SB	0.354	0.866	0.276	SB	NBR	NCC	7	10X14X3VM	0.394	0.551	0.118	VM	NBR	NCO	7
9X22X7SC	0.354	0.866	0.276	SC	NBR	NCC	7	10X15X3VB	0.394	0.591	0.118	VB	NBR	NCO	7
9X22X7VSF	0.354	0.866	0.276	SF	FKM	VCS	7	10X15X3VM	0.394	0.591	0.118	VM	NBR	NCO	7
9X22X7TC	0.354	0.866	0.276	TC	NBR	NCC	7	10X16X3PVC	0.394	0.630	0.118	VC	ACM	PCO	7
9X24X7VSF	0.354	0.945	0.276	SF	FKM	VCS	7	10X16X4SC	0.394	0.630	0.157	SC	NBR	NCC	7
9X24X7TC	0.354	0.945	0.276	TC	NBR	NCC	7	10X16X4SM	0.394	0.630	0.157	SM	NBR	NCC	7
9X26X7SC	0.354	1.024	0.276	SC	NBR	NCS	7	10X16X4VTC	0.394	0.630	0.157	TC	FKM	VCC	7
9X26X7VTC	0.354	1.024	0.276	TC	FKM	VCS	7	10X16X4TM	0.394	0.630	0.157	TM	NBR	NCC	7
9X28X8SC	0.354	1.102	0.315	SC	NBR	NCC	7	10X16X4.5TC	0.394	0.630	0.177	TC	NBR	NCC	7
9X29X7TC	0.354	1.142	0.276	TC	NBR	NCC	7	10X16X5SC	0.394	0.630	0.197	SC	NBR	NCC	7
9X30X7SC	0.354	1.181	0.276	SC	NBR	NCC	7	10X16X6SM	0.394	0.630	0.236	SM	NBR	NCS	7
SHAFT 0.375								10X16X7TC	0.394	0.630	0.276	TC	NBR	NCC	7
V-RING -010							7	10X17X3VG	0.394	0.669	0.118	VG	NBR	NCO	7
03050VVB	0.375	0.562	0.094	VB	FKM	VCO	7	10X17X4TC	0.394	0.669	0.157	TC	NBR	NCC	7
03050VB	0.375	0.562	0.094	VB	NBR	NCO	7	10X17X5SM	0.394	0.669	0.197	SM	NBR	NCC	7
0305609VM	0.375	0.562	0.094	VM	NBR	NCO	7	10X17X5TC	0.394	0.669	0.197	TC	NBR	NCC	7
037051VC	0.375	0.562	0.125	VC	NBR	NCO	7	10X18X4SC	0.394	0.709	0.157	SC	NBR	NCS	7
0305610VVM	0.375	0.566	0.100	VM	FKM	VCO	7	10X18X4TM	0.394	0.709	0.157	TM	NBR	NCC	7
037061VM	0.375	0.625	0.125	VM	NBR	NCO	7	10X18X5SC	0.394	0.709	0.197	SC	NBR	NCC	7
0306815VL-H	0.375	0.687	0.155	VL-H	NBR	NCO	7	10X18X5TC	0.394	0.709	0.197	TC	NBR	NCC	7
0306815VL-H	0.375	0.687	0.156	VL-H	NBR	NCO	7	10X18X6VTF	0.394	0.709	0.236	TF	FKM	VCS	7
03061VM	0.375	0.687	0.156	VM	NBR	NCO	7	10X18X7TC	0.394	0.709	0.276	TC	NBR	NCC	7
03061VM-H	0.375	0.687	0.156	VM-H	NBR	NCO	7	10X18X8TC	0.394	0.709	0.315	TC	NBR	NCC	7
030742VSB-H	0.375	0.748	0.250	SB-H	FKM	VCS	7	10X19X4TC	0.394	0.748	0.157	TC	NBR	NCC	7
030742SB-H	0.375	0.748	0.250	SB-H	NBR	NCC	7	10X19X7TC	0.394	0.748	0.276	TC	NBR	NCC	7
03072SB	0.375	0.750	0.250	SB	NBR	NCC	7	10X19X7VTF	0.394	0.748	0.276	TF	FKM	VCS	7
03072SB-H	0.375	0.750	0.250	SB-H	NBR	NCC	7	10X19X10TC	0.394	0.748	0.394	TC	NBR	NCC	7
03072SC	0.375	0.750	0.250	SC	NBR	NCC	7	10X20X4SC	0.394	0.787	0.157	SC	NBR	NCC	7
03072VSM	0.375	0.750	0.250	SM	FKM	VCS	7	10X20X4TC	0.394	0.787	0.157	TC	NBR	NCC	7
03072SM	0.375	0.750	0.250	SM	NBR	NCC	7	10X20X4VC	0.394	0.787	0.157	VC	NBR	NCO	7
03072TB-H	0.375	0.750	0.250	TB-H	NBR	NCC	7	10X20X4.5TM	0.394	0.787	0.177	TM	NBR	NCC	7
03072TC	0.375	0.750	0.250	TC	NBR	NCC	7	10X20X5TC	0.394	0.787	0.197	TC	NBR	NCC	7
03072TM	0.375	0.750	0.250	TM	NBR	NCC	7	10X20X5VC-G	0.394	0.787	0.197	VC-G	NBR	NCO	7
03072TM-H	0.375	0.750	0.250	TM-H	NBR	NCC	7	10X20X6SC	0.394	0.787	0.236	SC	NBR	NCC	7
03072TFN	0.375	0.752	0.250	TFN	NBR	NCC	7	10X20X7VSC	0.394	0.787	0.276	SC	FKM	VCC	7
030812SC	0.375	0.819	0.250	SC	NBR	NCC	7	10X20X7SC	0.394	0.787	0.276	SC	NBR	NCC	7
0308318PSB-H	0.375	0.835	0.187	SB-H	ACM	PCC	7	10X21X4TC	0.394	0.827	0.157	TC	NBR	NCC	7
030831VTB	0.375	0.836	0.187	TB	FKM	VCC	7	10X21X4VG	0.394	0.827	0.157	VG	NBR	NCO	7
030831TB	0.375	0.836	0.187	TB	NBR	NCC	7	10X21X5SC	0.394	0.827	0.197	SC	NBR	NCC	7
030831PTB-H	0.375	0.836	0.187	TB-H	ACM	PCC	7	10X21X5TC	0.394	0.827	0.197	TC	NBR	NCC	7
03082SB-H	0.375	0.875	0.250	SB-H	NBR	NCC	7	10X21X6TC	0.394	0.827	0.236	TC	NBR	NCC	7
03082VSC	0.375	0.875	0.250	SC	FKM	VCS	7	10X21X7TC	0.394	0.827	0.276	TC	NBR	NCC	7
03082SC	0.375	0.875	0.250	SC	NBR	NCS	7	10X21X7TCN1	0.394	0.827	0.276	TCN1	NBR	NCC	7
03082VSCW	0.375	0.875	0.250	SCW	FKM	VCS	7	10X22X4SC	0.394	0.866	0.157	SC	NBR	NCC	7
03082SM	0.375	0.875	0.250	SM	NBR	NCC	7	10X22X4TC	0.394	0.866	0.157	TC	NBR	NCC	7
03082SM-H	0.375	0.875	0.250	SM-H	NBR	NCC	7	10X22X5TC	0.394	0.866	0.197	TC	NBR	NCC	7
03082SZ	0.375	0.875	0.250	SZ	NBR	NCC	7	10X22X6SC	0.394	0.866	0.236	SC	NBR	NCC	7
03082TB	0.375	0.875	0.250	TB	NBR	NCC	7	10X22X6VSF	0.394	0.866	0.236	SF	FKM	VCS	7
03082TB-H	0.375	0.875	0.250	TB-H	NBR	NCC	7	10X22X6VTC	0.394	0.866	0.236	TC	FKM	VCC	7
03082VM	0.375	0.875	0.250	VM	NBR	NCO	7	10X22X6TC	0.394	0.866	0.236	TC	NBR	NCC	7
03091VB	0.375	0.938	0.188	VB	NBR	NCO	7	10X22X7TC	0.394	0.866	0.276	TC	NBR	NCC	7
030992SB-H	0.375	0.998	0.250	SB-H	NBR	NCC	7	10X22X7VTF	0.394	0.866	0.276	TF	FKM	VCS	7
03092VSB	0.375	0.999	0.250	SB	FKM	VCS	7	10X22X8SM	0.394	0.866	0.315	SM	NBR	NCC	7
03092SM	0.375	0.999	0.250	SM	NBR	NCC	7	10X22X8TC	0.394	0.866	0.315	TC	NBR	NCC	7
030992VTBG	0.375	0.999	0.250	TBG	FKM	VCS	7	10X23X7TC	0.394	0.906	0.276	TC	NBR	NCC	7
03112SC	0.375	1.124	0.250	SC	NBR	NCC	7	10X23X8TC	0.394	0.906	0.315	TC	NBR	NCC	7

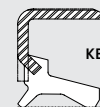
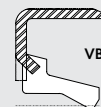
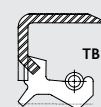
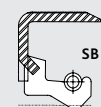
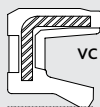



TCM Part #	Shaft	Bore	Width	Type	Lip Material	Material	Box #	TCM Part #	Shaft	Bore	Width	Type	Lip Material	Material	Box #
10X23.5X7TC	0.394	0.925	0.276	TC	NBR	NCC	7	11X26X7VTF	0.433	1.024	0.276	TF	FKM	VCS	7
10X23.5X8TC	0.394	0.925	0.315	TC	NBR	NCC	7	11X28X7TC	0.433	1.102	0.276	TC	NBR	NCC	7
10X23.5X10TC	0.394	0.925	0.394	TC	NBR	NCC	7	11X29X7TA	0.433	1.142	0.276	TA	NBR	NCC	7
10X24X4TC	0.394	0.945	0.157	TC	NBR	NCC	7	11X29X7TC	0.433	1.142	0.276	TC	NBR	NCC	7
10X24X6TC	0.394	0.945	0.236	TC	NBR	NCC	7	11X30X7TC	0.433	1.181	0.276	TC	NBR	NCC	7
10X24X7SC	0.394	0.945	0.276	SC	NBR	NCC	7	11X30X10SC	0.433	1.181	0.394	SC	NBR	NCC	7
10X24X7TC	0.394	0.945	0.276	TC	NBR	NCC	7	11X30X10TC	0.433	1.181	0.394	TC	NBR	NCC	7
10X24X7VTF	0.394	0.945	0.276	TF	FKM	VCS	7	SHAFT 0.434							
10X25X7TG	0.394	0.984	0.275	TG	NBR	NCC	7	04092TC	0.434	0.999	0.250	TC	NBR	NCC	7
10X25X4.5TC	0.394	0.984	0.177	TC	NBR	NCC	7	SHAFT 0.435							
10X25X5TC	0.394	0.984	0.197	TC	NBR	NCC	7	V-RING -010							7
10X25X6TC	0.394	0.984	0.236	TC	NBR	NCC	7	043102PTM-H	0.435	1.000	0.250	TM-H	ACM	PCC	7
10X25X7TC	0.394	0.984	0.276	TC	NBR	NCS	7	SHAFT 0.436							
10X25X7VTF	0.394	0.984	0.276	TF	FKM	VCS	7	V-RING -010							7
10X25X10TC	0.394	0.984	0.394	TC	NBR	NCC	7	043092SC	0.436	0.906	0.248	SC	NBR	NCS	7
10X26X7SC	0.394	1.024	0.276	SC	NBR	NCC	7	SHAFT 0.437							
10X26X7VSF	0.394	1.024	0.276	SF	FKM	VCS	7	V-RING -010							7
10X26X7TC	0.394	1.024	0.276	TC	NBR	NCC	7	040621VC	0.437	0.624	0.125	VC	NBR	NCO	7
10X26X7VTF	0.394	1.024	0.276	TF	FKM	VCS	7	04061VC	0.437	0.624	0.125	VC	NBR	NCO	7
10X26X8TC	0.394	1.024	0.315	TC	NBR	NCC	7	0430691VM	0.437	0.691	0.125	VM	NBR	NCO	7
10X28X7SC	0.394	1.102	0.276	SC	NBR	NCC	7	04308318VL-H	0.437	0.835	0.187	VL-H	NBR	NCO	7
10X28X7VTC	0.394	1.102	0.276	TC	FKM	VCC	7	043082SB-H	0.437	0.875	0.250	SB-H	NBR	NCC	7
10X28X7TC	0.394	1.102	0.276	TC	NBR	NCC	7	043082TB-H	0.437	0.875	0.250	TB-H	NBR	NCC	7
10X28X7VTF	0.394	1.102	0.276	TF	FKM	VCS	7	0430992VSB-H	0.437	0.998	0.250	SB-H	FKM	VCS	7
10X28X8TC	0.394	1.102	0.315	TC	NBR	NCC	7	0430992VL-H	0.437	0.998	0.250	VL-H	NBR	NCO	7
10X28X10TC	0.394	1.102	0.394	TC	NBR	NCC	7	0431024SZ	0.437	1.000	0.248	SZ	NBR	NCS	7
10X30X6TC	0.394	1.181	0.236	TC	NBR	NCC	7	043102VSZ	0.437	1.000	0.250	SZ	FKM	VCC	7
10X30X7VTF	0.394	1.181	0.276	TF	FKM	VCS	7	04112SL-H	0.437	1.124	0.250	SL-H	NBR	NCC	7
10X30X10TC	0.394	1.181	0.394	TC	NBR	NCC	7	SHAFT 0.438							
10X35X7TC	0.394	1.378	0.276	TC	NBR	NCC	7	V-RING -010							7
10X35X8TC	0.394	1.378	0.315	TC	NBR	NCC	7	04061PVC	0.438	0.625	0.125	VC	ACM	PCC	7
SHAFT 0.409								04061VCY	0.438	0.625	0.125	VCY	NBR	NCO	7
V-RING -010							7	04071VM	0.438	0.750	0.125	VM	NBR	NCO	7
040071VC	0.409	0.789	0.197	VC	NBR	NCO	7	040831TF	0.438	0.836	0.188	TF	NBR	NCS	7
SHAFT 0.413								04081VM	0.438	0.836	0.188	VM	NBR	NCO	7
V-RING -010							7	040831SM	0.438	0.837	0.188	SM	NBR	NCC	7
10.5X15X3VC	0.413	0.591	0.118	VC	NBR	NCO	7	04082SM	0.438	0.875	0.250	SM	NBR	NCC	7
SHAFT 0.422								04082SC	0.438	0.877	0.250	SC	NBR	NCC	7
V-RING -010							7	04092VM	0.438	0.999	0.250	VM	NBR	NCO	7
04205613VM-H	0.422	0.564	0.135	VM-H	NBR	NCO	7	04093SB	0.438	0.999	0.375	SB	NBR	NCC	7
SHAFT 0.433								04093SB-H	0.438	0.999	0.375	SB-H	NBR	NCC	7
V-RING -010							7	043102/34TCN1	0.438	1.000	0.250/0.343	TCN1	NBR	NSS	7
11X17X4VSC	0.433	0.669	0.157	SC	FKM	VCC	7	04112SL	0.438	1.124	0.250	SL	NBR	NCC	7
11X17X4SC	0.433	0.669	0.157	SC	NBR	NCC	7	04113SC	0.438	1.125	0.375	SC	NBR	NCC	7
11X17X4TC	0.433	0.669	0.157	TC	NBR	NCS	7	043122TF	0.438	1.250	0.250	TF	NBR	NCC	7
11X17X5TC	0.433	0.669	0.197	TC	NBR	NCC	7	SHAFT 0.442							
11X18X4TC	0.433	0.709	0.157	TC	NBR	NCC	7	V-RING -010							7
11X19X6TC	0.433	0.748	0.236	TC	NBR	NCC	7	044082VSCW	0.442	0.875	0.250	SCW	FKM	VCS	7
11X20X4.5SB	0.433	0.787	0.177	SB	NBR	NCC	7	SHAFT 0.457							
11X20X4.5TB	0.433	0.787	0.177	TB	NBR	NCC	7	V-RING -012							7
11X20X7TC	0.433	0.787	0.276	TC	NBR	NCC	7	11.6X19X6TC	0.457	0.748	0.236	TC	NBR	NCC	7
11X21X7TC	0.433	0.827	0.276	TC	NBR	NCC	7	11.6X24X10TC	0.457	0.945	0.394	TC	NBR	NCC	7
11X21X8TC	0.433	0.827	0.315	TC	NBR	NCC	7	SHAFT 0.465							
11X22X7SC	0.433	0.866	0.276	SC	NBR	NCC	7	V-RING -012							7
11X22X7TC	0.433	0.866	0.276	TC	NBR	NCS	7	0461122SC	0.465	1.124	0.250	SC	NBR	NCC	7
11X22X7VTF	0.433	0.866	0.276	TF	FKM	VCS	7	11.8X36X5SC	0.465	1.417	0.197	SC	NBR	NCC	7
11X23X7TC	0.433	0.906	0.276	TC	NBR	NCC	7	SHAFT 0.468							
11X23.5X7TC	0.433	0.925	0.276	TC	NBR	NCC	7	V-RING -012							7
11X24X7TC	0.433	0.945	0.276	TC	NBR	NCC	7	04113TB-H	0.468	1.124	0.375	TB-H	NBR	NCC	7
11X25X7TC	0.433	0.984	0.276	TC	NBR	NCC	7	SHAFT 0.478							
11X26X7SC	0.433	1.024	0.276	SC	NBR	NCC	7	V-RING -012							7
11X26X7TC	0.433	1.024	0.276	TC	NBR	NCC	7	SHAFT 0.488							

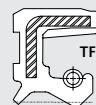
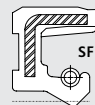
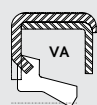
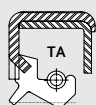



TCM Part #	Shaft	Bore	Width	Type	Lip Material	Material	Box	TCM Part #	Shaft	Bore	Width	Type	Lip Material	Material	Box #
12X32X10TC	0.472	1.260	0.394	TC	NBR	NCC	7	05071VM-H	0.500	0.750	0.125	VM-H	NBR	NCO	7
12X34X7TC	0.472	1.339	0.276	TC	NBR	NCC	7	12.7X19.45X7.145C	0.500	0.766	0.281	SC	NBR	NCC	7
12X35X4.3SC	0.472	1.378	0.169	SC	NBR	NCC	7	050842VL-H	0.500	0.842	0.250	VL-H	NBR	NCO	7
12X35X5SC	0.472	1.378	0.197	SC	NBR	NCC	7	050842TF	0.500	0.843	0.250	TF	NBR	NCS	7
12X35X6TC	0.472	1.378	0.236	TC	NBR	NCC	7	050842VB	0.500	0.843	0.250	VB	NBR	NCO	7
12X35X7VSF	0.472	1.378	0.276	SF	FKM	VCS	7	050842VM	0.500	0.843	0.250	VM	NBR	NCO	7
12X35X7TC	0.472	1.378	0.276	TC	NBR	NCC	7	050842VZ-H	0.500	0.843	0.250	VZ-H	NBR	NCO	7
12X35X10SC	0.472	1.378	0.394	SC	NBR	NCC	7	050081VC	0.500	0.875	0.125	VC	NBR	NCO	7
12X35X10TC	0.472	1.378	0.394	TC	NBR	NCC	7	050801VC	0.500	0.875	0.125	VC	NBR	NCO	7
12X37X7TC	0.472	1.457	0.276	TC	NBR	NCC	7	05081VC	0.500	0.875	0.125	VC	NBR	NCO	7
12X37X10SC	0.472	1.457	0.394	SC	NBR	NCC	7	05081VCY	0.500	0.875	0.125	VCY	NBR	NCO	7
12X42X8TC	0.472	1.654	0.315	TC	NBR	NCC	7	05081VM	0.500	0.875	0.125	VM	NBR	NCO	7
12X45X7SC	0.472	1.772	0.276	SC	NBR	NCC	7	050818TC	0.500	0.875	0.188	TC	NBR	NCC	7
12X45X7TC	0.472	1.772	0.276	TC	NBR	NCC	7	050820SCW	0.500	0.875	0.200	SCW	NBR	NCC	7
SHAFT 0.490								050821VAY	0.500	0.875	0.218	VAY	NBR	NCO	7
V-RING -012							7	050825B-H	0.500	0.875	0.250	SB-H	NBR	NCC	7
V-RING -013							7	050825C	0.500	0.875	0.250	SC	NBR	NCC	7
12.45X22X7TC	0.490	0.866	0.276	TC	NBR	NCC	7	05082VSCW	0.500	0.875	0.250	SCW	FKM	VCS	7
05082VAY	0.490	0.875	0.250	VAY	NBR	NCO	7	05082SZ	0.500	0.875	0.250	SZ	NBR	NCC	7
SHAFT 0.492								05082TB	0.500	0.875	0.250	TB	NBR	NCC	7
V-RING -012							7	05082VTB-H	0.500	0.875	0.250	TB-H	FKM	VCS	7
V-RING -013							7	05082TC	0.500	0.875	0.250	TC	NBR	NCC	7
0490741PSC	0.492	0.744	0.125	SC	ACM	PCC	7	05082TEC	0.500	0.875	0.250	TEC	NBR	NCC	7
12.5X19X5SC	0.492	0.748	0.197	SC	NBR	NCC	7	05082PVB	0.500	0.875	0.250	VB	ACM	PCO	7
12.5X20X5SC	0.492	0.787	0.197	SC	NBR	NCC	7	05082VB	0.500	0.875	0.250	VB	NBR	NCO	7
12.5X20X5TB	0.492	0.787	0.197	TB	NBR	NCC	7	05082VB-H	0.500	0.875	0.250	VB-H	NBR	NCO	7
12.5X20X5VTC	0.492	0.787	0.197	TC	FKM	VCS	7	05082VL-H	0.500	0.875	0.250	VL-H	NBR	NCO	7
12.5X20X5TC	0.492	0.787	0.197	TC	NBR	NCC	7	05083TB-H	0.500	0.875	0.312	TB-H	NBR	NCC	7
12.5X20X6SC	0.492	0.787	0.236	SC	NBR	NCC	7	05083TLN22-H	0.500	0.875	0.312	TLN22-H	NBR	NCC	7
12.5X22X5SC	0.492	0.866	0.197	SC	NBR	NCC	7	05083TBV	0.500	0.875	0.313	TBV	NBR	NCC	7
12.5X22X6SC	0.492	0.866	0.236	SC	NBR	NCC	7	12.7X22.5X5.5TC	0.500	0.886	0.217	TC	NBR	NCC	7
12.5X22X6TC	0.492	0.866	0.236	TC	NBR	NCC	7	0509018VC	0.500	0.906	0.188	VC	NBR	NCO	7
12.5X23.5X7TC	0.492	0.925	0.276	TC	NBR	NCS	7	050982SB-H	0.500	0.987	0.250	SB-H	NBR	NCC	7
12.5X23.5X8TC	0.492	0.925	0.315	TC	NBR	NCC	7	050992VL-H	0.500	0.998	0.250	VL-H	NBR	NCO	7
12.5X23.5X10TC	0.492	0.925	0.394	TC	NBR	NCC	7	05092SB	0.500	0.999	0.250	SB	NBR	NCC	7
12.5X25X8TC	0.492	0.984	0.315	TC	NBR	NCC	7	05092VSB-H	0.500	0.999	0.250	SB-H	FKM	VCS	7
12.5X28.5X7TC	0.492	1.122	0.276	TC	NBR	NCC	7	05092SB-H	0.500	0.999	0.250	SB-H	NBR	NCC	7
SHAFT 0.494								05092SBV	0.500	0.999	0.250	SBV	NBR	NCC	7
V-RING -013							7	050992SC-PL	0.500	0.999	0.250	SC-PL	NBR	NCC	7
12.54X19.05X4HSGR	0.494	0.750	0.157	SGR	HNBR	HCS	7	05092TB	0.500	0.999	0.250	TB	NBR	NCC	7
12.54X19.05X4SGR	0.494	0.750	0.157	SGR	NBR	NCC	7	05092VTB-H	0.500	0.999	0.250	TB-H	FKM	VCS	7
SHAFT 0.500								05092TB-H	0.500	0.999	0.250	TB-H	NBR	NCC	7
SHAFT-EZE 99050							S1	050992TBY	0.500	0.999	0.250	TBY	NBR	NSS	7
V-RING -013							7	050992PTC	0.500	0.999	0.250	TC	ACM	PCS	7
050681VM	0.500	0.685	0.125	VM	NBR	NCO	7	050992TC	0.500	0.999	0.250	TC	NBR	NCC	7
0506809VC	0.500	0.687	0.093	VC	NBR	NCO	7	05092TCN	0.500	0.999	0.250	TCN	NBR	NCC	7
0506809VM	0.500	0.687	0.094	VM	NBR	NCO	7	05092TZN	0.500	0.999	0.250	TZN	NBR	NCC	7
050609VC	0.500	0.688	0.094	VC	NBR	NCO	7	050992TZN1	0.500	0.999	0.250	TZN1	NBR	NCC	7
050681VMY	0.500	0.688	0.125	VMY	NBR	NCO	7	051019VTC	0.500	1.000	0.190	TC	FKM	VCC	7
12.70X19X4.20PA1	0.500	0.748	0.165	PA1	NBR	NSO	7	05102CNBC	0.500	1.000	0.250	CNBC	NBR	NCC	7
050716SCY	0.500	0.749	0.165	SCY	NBR	NCC	7	05102VSAY	0.500	1.000	0.250	SAY	FKM	VSS	7
050716VTC	0.500	0.749	0.165	TC	FKM	VCS	7	05102HSC	0.500	1.000	0.250	SC	HNBR	HCS	7
050716TC	0.500	0.749	0.165	TC	NBR	NCC	7	050102TC	0.500	1.000	0.250	TC	NBR	NCC	7
050716VTF	0.500	0.749	0.165	TF	FKM	VCS	7	05102VTCN	0.500	1.000	0.250	TCN	FKM	VCS	7
05071TM	0.500	0.749	0.167	TM	NBR	NCS	7	05102TCN	0.500	1.000	0.250	TCN	NBR	NCC	7
05071TZ	0.500	0.749	0.167	TZ	NBR	NCC	7	050102VTL	0.500	1.000	0.250	TL	FKM	VSS	7
05071HSC	0.500	0.750	0.125	SC	HNBR	HCS	7	051027TCY	0.500	1.000	0.270	TCY	NBR	NSS	7
05071HSM-H	0.500	0.750	0.125	SM-H	HNBR	HCS	7	051012TCY	0.500	1.010	0.204	TCY	XNBR	XCS	7
05071HVC	0.500	0.750	0.125	VC	HNBR	HCO	7	12.7X26X6SC	0.500	1.024	0.236	SC	NBR	NCC	7
05071VC	0.500	0.750	0.125	VC	NBR	NCO	7	12.7X26X6TC	0.500	1.024	0.236	TC	NBR	NCC	7
05071VC-G	0.500	0.750	0.125	VC-G	NBR	NCO	7	05112SB	0.500	1.124	0.250	SB	NBR	NCC	7
05071VL-H	0.500	0.750	0.125	VL-H	NBR	NCO	7	05112SB-H	0.500	1.124	0.250	SB-H	NBR	NCC	7
05071VM	0.500	0.750	0.125	VM	NBR	NCO	7	05112SC	0.500	1.124	0.250	SC	NBR	NCC	7
								051122SEC	0.500	1.124	0.250	SEC	NBR	NCC	7

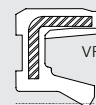
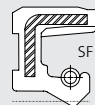
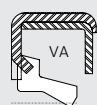
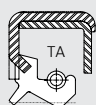

OIL AND GREASE SEALS - A COMPLETE LISTING

PLEASE CALL DICHTOMATIK FOR AVAILABILITY - 800-328-2840
BULK AND INDIVIDUALLY BOXED QUANTITIES ARE AVAILABLE FOR ALL ITEMS



DICHTOMATIK

Any seal. Any time.

TCM Part #	Shaft	Bore	Width	Type	Lip Material	Material	Box #	TCM Part #	Shaft	Bore	Width	Type	Lip Material	Material	Box
051122ETB	0.500	1.124	0.250	TB	EPDM	ECC	7	13X32X7SC	0.512	1.260	0.276	SC	NBR	NCC	7
05112VTB	0.500	1.124	0.250	TB	FKM	VCS	7	13X32X7TC	0.512	1.260	0.276	TC	NBR	NCC	7
05112TB	0.500	1.124	0.250	TB	NBR	NCC	7	13X33X7TB	0.512	1.299	0.276	TB	NBR	NCC	7
05112VTB-H	0.500	1.124	0.250	TB-H	FKM	VCS	7	13X35X7TC	0.512	1.378	0.276	TC	NBR	NCC	7
05112TB-H	0.500	1.124	0.250	TB-H	NBR	NCC	7	SHAFT 0.531							
051122TLN22-H	0.500	1.124	0.250	TLN22-H	NBR	NCC	7	V-RING -013							7
05112ASCW	0.500	1.125	0.250	SCW	NBR	NCC	7	V-RING -014							7
05121PSC	0.500	1.250	0.125	SC	ACM	PCC	7	0531122SC-PL	0.531	1.123	0.250	SC-PL	NBR	NCC	7
05122SB-H	0.500	1.250	0.250	SB-H	NBR	NCC	7	053113TB-H	0.531	1.124	0.312	TB-H	NBR	NCC	7
05122TB-H	0.500	1.250	0.250	TB-H	NBR	NCC	7	SHAFT 0.539							
05122TC	0.500	1.250	0.250	TC	NBR	NCC	7	V-RING -013							7
051231PTEM	0.500	1.250	0.312	TEM	ACM	PCS	7	V-RING -014							7
05123VTZ	0.500	1.250	0.313	TZ	FKM	VCS	7	13.7X24X5SC	0.539	0.945	0.197	SC	NBR	NCC	7
051253SSTZN	0.500	1.252	0.312	TZN	NBR	NSS	7	SHAFT 0.543							
05132VSB	0.500	1.375	0.250	SB	FKM	VSS	7	V-RING -013							7
05132SB	0.500	1.375	0.250	SB	NBR	NCC	7	V-RING -014							7
05132VSB-H	0.500	1.375	0.250	SB-H	FKM	VCS	7	13.8X24X5TC	0.543	0.945	0.197	TC	NBR	NCC	7
05132SB-H	0.500	1.375	0.250	SB-H	NBR	NCC	7	SHAFT 0.551							
05132SM	0.500	1.375	0.250	SM	NBR	NCC	7	V-RING -013							7
05132TB-H	0.500	1.375	0.250	TB-H	NBR	NCC	7	V-RING -014							7
SHAFT 0.512								14X18X3VB	0.551	0.709	0.118	VB	NBR	NCO	7
V-RING -013							7	14X20X3TC	0.551	0.787	0.118	TC	NBR	NCS	7
13X19X3VG	0.512	0.748	0.118	VG	NBR	NCO	7	14X20X3VC	0.551	0.787	0.118	VC	NBR	NCO	7
13X20X4SB	0.512	0.787	0.157	SB	NBR	NCS	7	14X20X5SC	0.551	0.787	0.197	SC	NBR	NCC	7
13X20X5KC	0.512	0.787	0.197	KC	NBR	NCO	7	14X20X5VC	0.551	0.787	0.197	VC	NBR	NCO	7
13X20X5KM	0.512	0.787	0.197	KM	NBR	NCO	7	14X20X7TC	0.551	0.787	0.276	TC	NBR	NCC	7
13X20X5TC	0.512	0.787	0.197	TC	NBR	NCC	7	14X21X3VG	0.551	0.827	0.118	VG	NBR	NCO	7
13X22X4TC	0.512	0.866	0.157	TC	NBR	NCC	7	14X21X4SC	0.551	0.827	0.157	SC	NBR	NCC	7
13X22X5SCY	0.512	0.866	0.197	SCY	NBR	NCS	7	14X21X4TC	0.551	0.827	0.157	TC	NBR	NCC	7
13X22X5SM	0.512	0.866	0.197	SM	NBR	NCC	7	14X22X3VG	0.551	0.866	0.118	VG	NBR	NCO	7
13X22X5TC	0.512	0.866	0.197	TC	NBR	NCC	7	14X22X3VM	0.551	0.866	0.118	VM	NBR	NCO	7
13X22X5TM	0.512	0.866	0.197	TM	NBR	NCC	7	14X22X4VSF	0.551	0.866	0.157	SF	FKM	VCS	7
13X22X5.5TZ	0.512	0.866	0.217	TZ	NBR	NCC	7	14X22X4VTC	0.551	0.866	0.157	TC	FKM	VCC	7
13X22X6SC	0.512	0.866	0.236	SC	NBR	NCC	7	14X22X4TC	0.551	0.866	0.157	TC	NBR	NCC	7
13X22X6TC	0.512	0.866	0.236	TC	NBR	NCC	7	14X22X4VC	0.551	0.866	0.157	VC	NBR	NCO	7
13X22X7TC	0.512	0.866	0.276	TC	NBR	NCC	7	14X22X4VG	0.551	0.866	0.157	VG	NBR	NCO	7
13X22X7TG	0.512	0.866	0.276	TG	NBR	NCC	7	14X22X5TC	0.551	0.866	0.197	TC	NBR	NCC	7
13X23X6.5SB	0.512	0.906	0.256	SB	NBR	NCC	7	14X22X6SC	0.551	0.866	0.236	SC	NBR	NCC	7
13X23X7TC	0.512	0.906	0.276	TC	NBR	NCC	7	14X22X6VC	0.551	0.866	0.236	VC	NBR	NCO	7
13X24X5SC	0.512	0.945	0.197	SC	NBR	NCC	7	14X22X7SC	0.551	0.866	0.276	SC	NBR	NCC	7
13X24X6SC	0.512	0.945	0.236	SC	NBR	NCC	7	14X22X7TC	0.551	0.866	0.276	TC	NBR	NCS	7
13X24X7SC	0.512	0.945	0.276	SC	NBR	NCC	7	14X23X6SC	0.551	0.906	0.236	SC	NBR	NCC	7
13X24X7TC	0.512	0.945	0.276	TC	NBR	NCC	7	14X23X6TC	0.551	0.906	0.236	TC	NBR	NCC	7
13X25X4SC	0.512	0.984	0.157	SC	NBR	NCC	7	14X24X4KC	0.551	0.945	0.157	KC	NBR	NCO	7
13X25X5SC	0.512	0.984	0.197	SC	NBR	NCC	7	14X24X4TC	0.551	0.945	0.157	TC	NBR	NCC	7
13X25X5TC	0.512	0.984	0.197	TC	NBR	NCC	7	14X24X4VC	0.551	0.945	0.157	VC	NBR	NCO	7
13X25X7SC	0.512	0.984	0.276	SC	NBR	NCC	7	14X24X4.5VTC	0.551	0.945	0.177	TG	FKM	VCS	7
13X25X7TC	0.512	0.984	0.276	TC	NBR	NCC	7	14X24X5SC	0.551	0.945	0.197	SC	NBR	NCC	7
13X26X5SC	0.512	1.024	0.197	SC	NBR	NCC	7	14X24X5TC	0.551	0.945	0.197	TC	NBR	NCC	7
13X26X7SC	0.512	1.024	0.276	SC	NBR	NCC	7	14X24X6VSC	0.551	0.945	0.236	SC	FKM	VCS	7
13X26X7VTC	0.512	1.024	0.276	TC	FKM	VCC	7	14X24X6SC	0.551	0.945	0.236	SC	NBR	NCC	7
13X26X7TC	0.512	1.024	0.276	TC	NBR	NCC	7	14X24X6SM	0.551	0.945	0.236	SM	NBR	NCC	7
13X26X9SC	0.512	1.024	0.354	SC	NBR	NCC	7	14X24X6TC	0.551	0.945	0.236	TC	NBR	NCC	7
13X27X7TC	0.512	1.063	0.276	TC	NBR	NCC	7	14X24X7SC	0.551	0.945	0.276	SC	NBR	NCC	7
13X28X5TC	0.512	1.102	0.197	TC	NBR	NCC	7	14X24X7.5VF	0.551	0.945	0.276	SF	FKM	VCS	7
13X28X7TC	0.512	1.102	0.276	TC	NBR	NCC	7	14X24X8SC	0.551	0.945	0.315	SC	NBR	NCC	7
13X30X3TC	0.512	1.181	0.118	TC	NBR	NCC	7	14X24X8TC	0.551	0.945	0.315	TC	NBR	NCC	7
13X30X7SC	0.512	1.181	0.276	SC	NBR	NCC	7	14X25X5SC	0.551	0.984	0.197	SC	NBR	NCC	7
13X30X7VTC	0.512	1.181	0.276	TC	FKM	VCC	7	14X25X5TC	0.551	0.984	0.197	TC	NBR	NCC	7
13X30X7TC	0.512	1.181	0.276	TC	NBR	NCC	7	14X25X6SC	0.551	0.984	0.236	SC	NBR	NCC	7
13X30X8SC	0.512	1.181	0.315	SC	NBR	NCC	7	14X25X7SC	0.551	0.984	0.276	SC	NBR	NCC	7
13X30X8TC	0.512	1.181	0.315	TC	NBR	NCC	7	14X25X7TC	0.551	0.984	0.276	TC	NBR	NCC	7
13X30X10TC	0.512	1.181	0.394	TC	NBR	NCC	7	14X25X9TC	0.551	0.984	0.354	TC	NBR	NCC	7
13X32X6SC	0.512	1.260	0.236	SC	NBR	NCC	7								

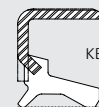
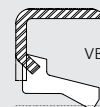
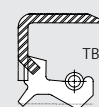
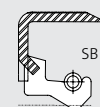



TCM Part #	Shaft	Bore	Width	Type	Lip Material	Material	Box	TCM Part #	Shaft	Bore	Width	Type	Lip Material	Material	Box #
14X25.5X7TC	0.551	1.004	0.276	TC	NBR	NCC	7	056102TB-H	0.562	1.000	0.250	TB-H	NBR	NCC	7
14X26X5SC	0.551	1.024	0.197	SC	NBR	NCC	7	0561031SMY	0.562	1.000	0.312	SMY	NBR	NSS	7
14X26X6SC	0.551	1.024	0.236	SC	NBR	NCC	7	05113SA	0.562	1.124	0.343	SA	NBR	NCC	7
14X26X7SC	0.551	1.024	0.276	SC	NBR	NCC	7	056122TB	0.562	1.250	0.250	TB	NBR	NCC	7
14X26X7TC	0.551	1.024	0.276	TC	NBR	NCC	7	056122TB-H	0.562	1.250	0.250	TB-H	NBR	NCC	7
14X26X8TC	0.551	1.024	0.315	TC	NBR	NCC	7	056132TB	0.562	1.375	0.250	TB	NBR	NCC	7
14X27X6SC	0.551	1.063	0.236	SC	NBR	NCC	7	056132TB-H	0.562	1.375	0.250	TB-H	NBR	NCC	7
14X27X7SC	0.551	1.063	0.276	SC	NBR	NCC	7	SHAFT 0.563							
14X27X7TC	0.551	1.063	0.276	TC	NBR	NCC	7	SHAFT-EZE 99056							
14X27X10TC	0.551	1.063	0.394	TC	NBR	NCC	7	V-RING -013							S1
14X28X6SC	0.551	1.102	0.236	SC	NBR	NCC	7	V-RING -014							7
14X28X6TC	0.551	1.102	0.236	TC	NBR	NCS	7	0560818XSB-H	0.563	0.875	0.187	SB-H	FKM	XCC	7
14X28X7SC	0.551	1.102	0.276	SC	NBR	NCC	7	0560818VL-H	0.563	0.875	0.187	VL-H	NBR	NCO	7
14X28X7TC	0.551	1.102	0.276	TC	NBR	NCC	7	0560992VCY	0.563	0.990	0.250	VCY	NBR	NCO	7
14X28X7VTF	0.551	1.102	0.276	TF	FKM	VCS	7	0560992TB-H	0.563	0.998	0.250	TB-H	NBR	NCC	7
14X28X8TC	0.551	1.102	0.315	TC	NBR	NCC	7	056092VSB	0.563	0.999	0.250	SB	FKM	VCS	7
14X28X8TG	0.551	1.102	0.315	TG	NBR	NCC	7	056092SB	0.563	0.999	0.250	SB	NBR	NCC	7
14X28.5X7TC	0.551	1.122	0.276	TC	NBR	NCC	7	056092SB-H	0.563	0.999	0.250	SB-H	NBR	NCC	7
05511220VH-H	0.551	1.124	0.203	VH-H	NBR	NCO	7	056102VTC-PL	0.563	1.000	0.250	TC-PL	FKM	VCC	7
14X29X7TC	0.551	1.142	0.276	TC	NBR	NCC	7	05611231VSCW	0.563	1.123	0.312	SCW	FKM	VCS	7
14X30X3VC	0.551	1.181	0.118	VC	NBR	NCO	7	0561122SB-H	0.563	1.124	0.250	SB-H	NBR	NCC	7
14X30X4SGN1-PL	0.551	1.181	0.157	SGN1-PL	FKM	VCC	7	056112TB	0.563	1.124	0.250	TB	NBR	NCC	7
14X30X7SB	0.551	1.181	0.276	SB	NBR	NCC	7	056112TB-H	0.563	1.124	0.250	TB-H	NBR	NCC	7
14X30X7SC	0.551	1.181	0.276	SC	NBR	NCC	7	056122SB-H	0.563	1.250	0.250	SB-H	NBR	NCC	7
14X30X7TC	0.551	1.181	0.276	TC	NBR	NCC	7	056132SB-H	0.563	1.375	0.250	SB-H	NBR	NCC	7
14X30X7VTF	0.551	1.181	0.276	TF	FKM	VCS	7	SHAFT 0.571							
14X30X8SB	0.551	1.181	0.315	SB	NBR	NCC	7	V-RING -014							7
14X30X8TC	0.551	1.181	0.315	TC	NBR	NCC	7	14.5X32X7TC	0.571	1.260	0.276	TC	NBR	NCC	7
14X30X9TC	0.551	1.181	0.354	TC	NBR	NCC	7	SHAFT 0.575							
14X30X10SC	0.551	1.181	0.394	SC	NBR	NCC	7	V-RING -014							7
14X30X10TC	0.551	1.181	0.394	TC	NBR	NCC	7	14.6X27X7TC	0.575	1.063	0.276	TC	NBR	NCC	7
14X32X5SC	0.551	1.260	0.197	SC	NBR	NCC	7	SHAFT 0.579							
14X32X6SC	0.551	1.260	0.236	SC	NBR	NCC	7	V-RING -014							7
14X32X6TC	0.551	1.260	0.236	TC	NBR	NCC	7	14.7X30X7TC	0.579	1.181	0.276	TC	NBR	NCC	7
14X32X7SB	0.551	1.260	0.276	SB	NBR	NCC	7	SHAFT 0.583							
14X32X7SC	0.551	1.260	0.276	SC	NBR	NCC	7	V-RING -014							7
14X32X7SM	0.551	1.260	0.276	SM	NBR	NCC	7	14.8X30X4.5SC	0.583	1.181	0.177	SC	NBR	NCC	7
14X32X7TB	0.551	1.260	0.276	TB	NBR	NCC	7	14.8X30X5SC	0.583	1.181	0.197	SC	NBR	NCC	7
14X32X7TC	0.551	1.260	0.276	TC	NBR	NCC	7	14.8X30X5TC	0.583	1.181	0.197	TC	NBR	NCC	7
14X32X7.5TC	0.551	1.260	0.295	TC	NBR	NCC	7	14.8X30X7SC	0.583	1.181	0.276	SC	NBR	NCC	7
14X32X9SC	0.551	1.260	0.354	SC	NBR	NCC	7	14.8X30X7TC	0.583	1.181	0.276	TC	NBR	NCC	7
14X32X10SC	0.551	1.260	0.394	SC	NBR	NCC	7	14.8X30X7.5TC	0.583	1.181	0.295	TC	NBR	NCC	7
14X32X10TC	0.551	1.260	0.394	TC	NBR	NCC	7	SHAFT 0.590							
14X33X6TC	0.551	1.299	0.236	TC	NBR	NCC	7	SHAFT-EZE 99059							S1
14X34X7SC	0.551	1.339	0.276	SC	NBR	NCC	7	V-RING -014							7
14X35X4.5SC	0.551	1.378	0.177	SC	NBR	NCC	7	05910418VZ	0.590	1.049	0.188	VZ	NBR	NCO	7
14X35X7SC	0.551	1.378	0.276	SC	NBR	NCC	7	059113SC	0.590	1.125	0.313	SC	NBR	NCC	7
14X35X7VSF	0.551	1.378	0.276	SF	FKM	VCS	7	059113TC	0.590	1.125	0.313	TC	NBR	NCC	7
14X35X8TC	0.551	1.378	0.315	TC	NBR	NCC	7	SHAFT 0.591							
14X35X10SZ	0.551	1.378	0.394	SZ	NBR	NCC	7	SHAFT-EZE 99059							S1
14X35X10TC	0.551	1.378	0.394	TC	NBR	NCC	7	V-RING -014							7
14X36X7TC	0.551	1.417	0.276	TC	NBR	NCC	7	15X20X5KZ	0.591	0.787	0.197	KZ	NBR	NCO	7
14X40X7TC	0.551	1.575	0.276	TC	NBR	NCC	7	15X21X2VM	0.591	0.827	0.079	VM	NBR	NCO	7
14X40X10TC	0.551	1.575	0.394	TC	NBR	NCC	7	15X21X3SB-U	0.591	0.827	0.118	SB-U	NBR	NCC	7
SHAFT 0.562								15X21X3TB	0.591	0.827	0.118	TB	NBR	NCC	7
SHAFT-EZE 99056							S1	15X21X3VC	0.591	0.827	0.118	VC	NBR	NCO	7
V-RING -013							7	15X21X3VM	0.591	0.827	0.118	VM	NBR	NCO	7
V-RING -014							7	15X21X4SC	0.591	0.827	0.157	SC	NBR	NCC	7
05070VM	0.562	0.750	0.093	VM	NBR	NCO	7	15X21X4TM	0.591	0.827	0.157	TM	NBR	NCC	7
05070VM-G	0.562	0.750	0.093	VM-G	NBR	NCO	7	15X21X4.5TM	0.591	0.827	0.177	TM	NBR	NCC	7
056081TC	0.562	0.875	0.187	TC	NBR	NCC	7	15X21X5VTC	0.591	0.827	0.197	TC	FKM	VCC	7
056081TCY	0.562	0.875	0.187	TCY	NBR	NCS	7	SHAFT 0.591							
056081VZ-H	0.562	0.875	0.187	VZ-H	NBR	NCO	7	SHAFT-EZE 99059							S1
05092TC	0.562	0.999	0.250	TC	NBR	NCC	7	V-RING -014							7

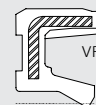
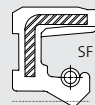
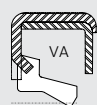

OIL AND GREASE SEALS - A COMPLETE LISTING

PLEASE CALL DICHTOMATIK FOR AVAILABILITY - 800-328-2840
BULK AND INDIVIDUALLY BOXED QUANTITIES ARE AVAILABLE FOR ALL ITEMS



DICHTOMATIK

Any seal. Any time.

TCM Part #	Shaft	Bore	Width	Type	Lip Material	Material	Box #	TCM Part #	Shaft	Bore	Width	Type	Lip Material	Material	Box
15X21X5TC	0.591	0.827	0.197	TC	NBR	NCC	7	15X28X4TC	0.591	1.102	0.157	TC	NBR	NCC	7
15X22X4TC	0.591	0.866	0.157	TC	NBR	NCC	7	15X28X5SC	0.591	1.102	0.197	SC	NBR	NCC	7
15X22X5TC	0.591	0.866	0.197	TC	NBR	NCC	7	15X28X5VCY	0.591	1.102	0.197	VCY	NBR	NCO	7
15X22X7SC	0.591	0.866	0.276	SC	NBR	NCC	7	15X28X6SC	0.591	1.102	0.236	SC	NBR	NCC	7
15X22X7TC	0.591	0.866	0.276	TC	NBR	NCC	7	15X28X6TC	0.591	1.102	0.236	TC	NBR	NCC	7
15X23X3VG	0.591	0.906	0.118	VG	NBR	NCO	7	15X28X7SB	0.591	1.102	0.276	SB	NBR	NCC	7
15X23X4TC	0.591	0.906	0.157	TC	NBR	NCC	7	15X28X7SC	0.591	1.102	0.276	SC	NBR	NCC	7
15X23X7TC	0.591	0.906	0.276	TC	NBR	NCC	7	15X28X7TC	0.591	1.102	0.276	TC	NBR	NCC	7
15X24X7SB-H	0.591	0.944	0.275	SB-H	NBR	NCC	7	15X28X7PTC	0.591	1.102	0.276	TCN1	ACM	PCC	7
15X24X7TG	0.591	0.944	0.275	TG	NBR	NCC	7	15X28X7VTF	0.591	1.102	0.276	TF	FKM	VCS	7
15X24X4.5VG	0.591	0.945	0.177	VG	NBR	NCO	7	15X28X8TC	0.591	1.102	0.315	TC	NBR	NCC	7
15X24X5VTC	0.591	0.945	0.197	TC	FKM	VCC	7	15X28X10TC	0.591	1.102	0.394	TC	NBR	NCC	7
15X24X5TC	0.591	0.945	0.197	TC	NBR	NCC	7	15X28.5X7TC	0.591	1.122	0.276	TC	NBR	NCC	7
15X24X5.5TC4	0.591	0.945	0.217	TC4	NBR	NCC	7	0591125C	0.591	1.125	0.250	SC	NBR	NCC	7
15X24X6TC	0.591	0.945	0.236	TC	NBR	NCC	7	15X28.58X7TC	0.591	1.125	0.276	TC	NBR	NCC	7
15X24X7VDC	0.591	0.945	0.276	DC	FKM	VCC	7	15X29X7TC	0.591	1.142	0.276	TC	NBR	NCC	7
15X24X7SC	0.591	0.945	0.276	SC	NBR	NCC	7	15X30X7TG	0.591	1.181	0.275	TG	NBR	NCC	7
15X24X7TC	0.591	0.945	0.276	TC	NBR	NCC	7	15X30X4VC	0.591	1.181	0.157	TC	NBR	NCO	7
15X24X7.6VSGW12	0.591	0.945	0.299	SGW12	FKM	VCC	7	15X30X4.5SC	0.591	1.181	0.177	SC	NBR	NCC	7
15X25X5TG	0.591	0.984	0.196	TG	NBR	NCC	7	15X30X4.5TC	0.591	1.181	0.177	TC	NBR	NCC	7
15X25X3KC	0.591	0.984	0.118	KC	NBR	NCO	7	15X30X4.5VTF	0.591	1.181	0.177	TF	FKM	VCS	7
15X25X3VC	0.591	0.984	0.118	VC	NBR	NCO	7	15X30X5SC	0.591	1.181	0.197	SC	NBR	NCC	7
15X25X4PTC	0.591	0.984	0.157	TC	ACM	PCC	7	15X30X5VTC	0.591	1.181	0.197	TC	FKM	VCC	7
15X25X4VC	0.591	0.984	0.157	VC	NBR	NCO	7	15X30X5TC	0.591	1.181	0.197	TC	NBR	NCC	7
15X25X4.5TC	0.591	0.984	0.177	TC	NBR	NCC	7	15X30X5VC	0.591	1.181	0.197	VC	NBR	NCO	7
15X25X5SC	0.591	0.984	0.197	SC	NBR	NCS	7	15X30X6SC	0.591	1.181	0.236	SC	NBR	NCC	7
15X25X5VSF	0.591	0.984	0.197	SF	FKM	VCS	7	15X30X7SB	0.591	1.181	0.276	SB	NBR	NCC	7
15X25X5VTC	0.591	0.984	0.197	TC	FKM	VCC	7	15X30X7SC	0.591	1.181	0.276	SC	NBR	NCC	7
15X25X6SC	0.591	0.984	0.236	SC	NBR	NCC	7	15X30X7TC	0.591	1.181	0.276	TC	NBR	NCC	7
15X25X6TCN	0.591	0.984	0.236	TC	NBR	NCC	7	15X30X7.5TC	0.591	1.181	0.295	TC	NBR	NCC	7
15X25X7CNB	0.591	0.984	0.276	CNB	NBR	NCS	7	15X30X8TC	0.591	1.181	0.315	SC	NBR	NCC	7
15X25X7SC	0.591	0.984	0.276	SC	NBR	NCC	7	15X30X10SC	0.591	1.181	0.394	SC	NBR	NCC	7
15X25X7VTC	0.591	0.984	0.276	TC	FKM	VCC	7	15X30X10TC	0.591	1.181	0.394	TC	NBR	NCC	7
15X25X7TC	0.591	0.984	0.276	TC	NBR	NCS	7	15X31X7TC	0.591	1.220	0.276	TC	NBR	NCC	7
15X25X8TC	0.591	0.984	0.315	TC	NBR	NCC	7	15X32X7SB-H	0.591	1.259	0.275	SB-H	NBR	NCC	7
15X25X10SC	0.591	0.984	0.394	SC	NBR	NCC	7	15X32X8TC	0.591	1.259	0.314	TC	NBR	NCC	7
15X25.5X4.5VTC	0.591	1.004	0.177	TC	FKM	VCS	7	15X32X5VSC	0.591	1.260	0.197	SC	FKM	VCS	7
15X25.5X4.5TC	0.591	1.004	0.177	TC	NBR	NCC	7	15X32X5SC	0.591	1.260	0.197	SC	NBR	NCC	7
15X25.5X4.6VSC	0.591	1.004	0.181	SC	FKM	VCS	7	15X32X5TC	0.591	1.260	0.197	TC	NBR	NCC	7
15X25.5X4.6SC	0.591	1.004	0.181	SC	NBR	NCC	7	15X32X7VSC	0.591	1.260	0.276	SC	FKM	VCS	7
15X25.5X4.6VSCW12	0.591	1.004	0.181	SCW12	FKM	VCS	7	15X32X7SC	0.591	1.260	0.276	SC	NBR	NCC	7
15X25.5X7SC	0.591	1.004	0.276	SC	NBR	NCC	7	15X32X7VSCW12	0.591	1.260	0.276	SCW12	FKM	VCC	7
15X25.5X7TC	0.591	1.004	0.276	TC	NBR	NCC	7	15X32X7VTC	0.591	1.260	0.276	TC	FKM	VCS	7
15X26X4SC	0.591	1.024	0.157	SC	NBR	NCC	7	15X32X7TC	0.591	1.260	0.276	TC	NBR	NCC	7
15X26X4TM	0.591	1.024	0.157	TM	NBR	NCC	7	15X32X7VTF	0.591	1.260	0.276	TF	FKM	VCS	7
15X26X4.5SC	0.591	1.024	0.177	SC	NBR	NCC	7	15X32X7.5TC	0.591	1.260	0.295	TC	NBR	NCC	7
15X26X5TC	0.591	1.024	0.197	TC	NBR	NCC	7	15X32X9TC	0.591	1.260	0.354	TC	NBR	NCC	7
15X26X6SC	0.591	1.024	0.236	SC	NBR	NCC	7	15X33X7SC	0.591	1.299	0.276	SC	NBR	NCC	7
15X26X6TB	0.591	1.024	0.236	TB	NBR	NCC	7	15X33X7TC	0.591	1.299	0.276	TC	NBR	NCC	7
15X26X6TC	0.591	1.024	0.236	TC	NBR	NCC	7	15X34X4SC	0.591	1.339	0.157	SC	NBR	NCC	7
15X26X7SC	0.591	1.024	0.276	SC	NBR	NCC	7	15X35X7SB-H	0.591	1.377	0.275	SB-H	NBR	NCC	7
15X26X7TC	0.591	1.024	0.276	TC	NBR	NCC	7	15X35X7TG	0.591	1.377	0.275	TG	NBR	NCC	7
15X26X7VTF	0.591	1.024	0.276	TF	FKM	VCS	7	15X35X5SC	0.591	1.378	0.197	SC	NBR	NCC	7
15X26X8TC	0.591	1.024	0.315	TC	NBR	NCC	7	15X35X5VSF	0.591	1.378	0.197	SF	FKM	VCS	7
15X26X9TC	0.591	1.024	0.354	TC	NBR	NCC	7	15X35X5TC	0.591	1.378	0.197	TC	NBR	NCC	7
05101VZ	0.591	1.048	0.175	VZ	NBR	NCO	7	15X35X6TC	0.591	1.378	0.236	TC	NBR	NCC	7
15X27X5TC	0.591	1.063	0.197	TC	NBR	NCC	7	15X35X7SC	0.591	1.378	0.276	SC	NBR	NCC	7
15X27X7SC	0.591	1.063	0.276	SC	NBR	NCC	7	15X35X7TB	0.591	1.378	0.276	TB	NBR	NCC	7
15X27X7VTC	0.591	1.063	0.276	TC	FKM	VCC	7	15X35X7TC	0.591	1.378	0.276	TC	NBR	NCC	7
15X27X7TC	0.591	1.063	0.276	TC	NBR	NCC	7	15X35X7VTC15W	0.591	1.378	0.276	TCS15W	FKM	VCC	7
15X27X8TC	0.591	1.063	0.315	TC	NBR	NCC	7	15X35X7VTF	0.591	1.378	0.276	TF	FKM	VCS	7
15X28X7SB-H	0.591	1.102	0.276	SB-H	NBR	NCC	7	15X35X8SC	0.591	1.378	0.315	SC	NBR	NCC	7
15X28X3VB	0.591	1.102	0.118	VB	NBR	NCO	7	15X35X8TC	0.591	1.378	0.315	TC	NBR	NCC	7
15X28X4SC	0.591	1.102	0.157	SC	NBR	NCC	7	15X35X10TC	0.591	1.378	0.394	TC	NBR	NCC	7

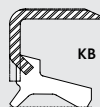
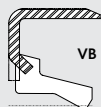
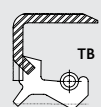
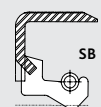
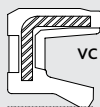



TCM Part #	Shaft	Bore	Width	Type	Lip Material	Material	Box	TCM Part #	Shaft	Bore	Width	Type	Lip Material	Material	Box #
15X35X10VTF	0.591	1.378	0.394	TF	FKM	VCS	7	060931VB	0.625	0.933	0.188	VB	NBR	NCO	7
15X35.2X5.5TC	0.591	1.386	0.217	TC	NBR	NCC	7	0609318SM	0.625	0.937	0.187	SM	NBR	NCC	7
15X35.5X5.5TC	0.591	1.398	0.217	TC	NBR	NCC	7	0609318VL-H	0.625	0.937	0.188	VL-H	NBR	NCO	7
15X36X6SC	0.591	1.417	0.236	SC	NBR	NCC	7	06093185C	0.625	0.938	0.187	SC	NBR	NCC	7
15X36X75C	0.591	1.417	0.276	SC	NBR	NCC	7	0609318VSF	0.625	0.938	0.188	SF	FKM	VCS	7
15X36X7TC	0.591	1.417	0.276	TC	NBR	NCC	7	0609318TC	0.625	0.938	0.188	TC	NBR	NCC	7
15X37X6TC	0.591	1.457	0.236	TC	NBR	NCC	7	0609318VTM-H	0.625	0.938	0.188	TM-H	FKM	VCS	7
15X37X7TC	0.591	1.457	0.276	TC	NBR	NCC	7	06091VB	0.625	0.938	0.188	VB	NBR	NCO	7
15X37X105C	0.591	1.457	0.394	SC	NBR	NCC	7	06091VB-H	0.625	0.938	0.188	VB-H	NBR	NCO	7
15X38X7TC	0.591	1.496	0.276	TC	NBR	NCC	7	06091VZ	0.625	0.938	0.188	VZ	NBR	NCO	7
15X38X10TC	0.591	1.496	0.394	TC	NBR	NCC	7	15.88X24X4KC	0.625	0.945	0.157	KC	NBR	NCO	7
15X40X7TC	0.591	1.575	0.276	TC	NBR	NCC	7	15.88X24X4VC	0.625	0.945	0.157	VC	NBR	NCO	7
15X40X85C	0.591	1.575	0.315	SC	NBR	NCC	7	060992TLN22-H	0.625	0.998	0.250	TLN22-H	NBR	NCC	7
15X40X8TC	0.591	1.575	0.315	TC	NBR	NCC	7	060925B-H	0.625	0.999	0.250	SB-H	NBR	NCC	7
15X40X105C	0.591	1.575	0.394	SC	NBR	NCC	7	0609925C	0.625	0.999	0.250	SC	NBR	NCC	7
15X40X10TC	0.591	1.575	0.394	TC	NBR	NCC	7	060925M	0.625	0.999	0.250	SM	NBR	NCC	7
15X40X10VTF	0.591	1.575	0.394	TF	FKM	VCS	7	06092VTB	0.625	0.999	0.250	TB	FKM	VCS	7
15X42X75C	0.591	1.654	0.276	SC	NBR	NCC	7	06092TB	0.625	0.999	0.250	TB	NBR	NCC	7
15X42X7VTC	0.591	1.654	0.276	TC	FKM	VCC	7	06092VTB-H	0.625	0.999	0.250	TB-H	FKM	VCS	7
15X42X7TC	0.591	1.654	0.276	TC	NBR	NCC	7	06092TB-H	0.625	0.999	0.250	TB-H	NBR	NCC	7
15X42X8TC	0.591	1.654	0.315	TC	NBR	NCC	7	06092TC	0.625	0.999	0.250	TC	NBR	NCC	7
15X42X10TC	0.591	1.654	0.394	TC	NBR	NCC	7	06092TZ	0.625	0.999	0.250	TZ	NBR	NCC	7
15X48X8TC	0.591	1.890	0.315	TC	NBR	NCC	7	06092VB	0.625	0.999	0.250	VB	NBR	NCO	7
SHAFT 0.593								06101VL-H	0.625	1.000	0.125	VL-H	NBR	NCO	7
SHAFT-EZE 99059								06101PVM	0.625	1.000	0.125	VM	ACM	PCO	7
V-RING -014								06101PVM-H	0.625	1.000	0.125	VM-H	ACM	PCO	7
059931VC	0.593	0.935	0.175	VC	NBR	NCO	7	06101VMY	0.625	1.000	0.125	VMY	NBR	NCO	7
059113TB-H	0.593	1.124	0.312	TB-H	NBR	NCC	7	06101PVZ-H	0.625	1.000	0.125	VZ-H	ACM	PCO	7
059123TB-H	0.593	1.250	0.312	TB-H	NBR	NCC	7	061018TC	0.625	1.000	0.187	TC	NBR	NCC	7
059133TB-H	0.593	1.375	0.312	TB-H	NBR	NCC	7	06102SCWY	0.625	1.000	0.250	SCWY	NBR	NCC	7
SHAFT 0.594								06102PTBC	0.625	1.000	0.250	TC	ACM	PCC	7
V-RING -014								06102PTC	0.625	1.000	0.250	TC	ACM	PCC	7
059112VB	0.594	1.124	0.250	VB	NBR	NCO	7	06102TC	0.625	1.000	0.250	TC	NBR	NCC	7
059112VB-H	0.594	1.124	0.250	VB-H	NBR	NCO	7	061025VMY	0.625	1.000	0.254	VMY	NBR	NSO	7
0591122VL-H	0.594	1.124	0.250	VL-H	NBR	NCO	7	061018VM	0.625	1.059	0.188	VM	NBR	NCO	7
05911235B-H	0.594	1.124	0.312	SB-H	NBR	NCC	7	061062VL-H	0.625	1.062	0.250	VL-H	NBR	NCO	7
059133TB-H	0.594	1.375	0.312	TB-H	NBR	NCC	7	061062SL-H	0.625	1.063	0.250	SL-H	NBR	NCC	7
SHAFT 0.610								15.88X28.5X4KC	0.625	1.122	0.157	KC	NBR	NCC	7
V-RING -016								06112VSB	0.625	1.124	0.250	SB	FKM	VCS	7
15.5X28X7TC	0.610	1.102	0.276	TC	NBR	NCC	7	06112SB	0.625	1.124	0.250	SB	NBR	NCC	7
SHAFT 0.614								061125B-H	0.625	1.124	0.250	SB-H	NBR	NCC	7
V-RING -016								06112VTB	0.625	1.124	0.250	TB	FKM	VCS	7
15.6X25.5X7TC	0.614	1.004	0.276	TC	NBR	NCC	7	06112TB	0.625	1.124	0.250	TB	NBR	NCC	7
SHAFT 0.622								06112VTB-H	0.625	1.124	0.250	TB-H	FKM	VCS	7
V-RING -016								06112TB-H	0.625	1.124	0.250	TB-H	NBR	NCC	7
15.8X24X5TM	0.622	0.945	0.197	TM	NBR	NCC	7	0611231VTCN1	0.625	1.124	0.313	TCN1	FKM	VCS	7
SHAFT 0.625								06113SB	0.625	1.124	0.375	SB	NBR	NCC	7
SHAFT-EZE 99062								06113TA	0.625	1.124	0.375	TA	NBR	NCC	7
V-RING -016								06113TBN-H	0.625	1.124	0.375	TBN-H	NBR	NCC	7
0608109VC	0.625	0.812	0.093	VC	NBR	NCO	7	06113TBY	0.625	1.124	0.375	TBY	NBR	NCC	7
0608109VVM	0.625	0.812	0.094	VM	FKM	VCO	7	06113TC	0.625	1.124	0.375	TC	NBR	NCC	7
060809VM	0.625	0.812	0.094	VM	NBR	NCO	7	061131VTCN1	0.625	1.124	0.375	TCN1	FKM	VCS	7
060809VM-G	0.625	0.812	0.094	VM-G	NBR	NCO	7	061123TLN22-H	0.625	1.124	0.375	TLN22-H	NBR	NCC	7
06081VC	0.625	0.812	0.125	VC	NBR	NCO	7	061118VL	0.625	1.125	0.188	VL	NBR	NCO	7
06081VM	0.625	0.812	0.125	VM	NBR	NCO	7	06112SCY	0.625	1.125	0.250	SCY	NBR	NCS	7
060809VC	0.625	0.813	0.094	VC	NBR	NCO	7	06112TC	0.625	1.125	0.250	TC	NBR	NCC	7
060809VVF	0.625	0.813	0.094	VF	FKM	VCO	7	061131SBY	0.625	1.125	0.312	SBY	NBR	NSS	7
060809VC	0.625	0.875	0.093	VC	NBR	NCO	7	061131SC	0.625	1.125	0.312	SC	NBR	NCC	7
0608709VC	0.625	0.875	0.094	VC	NBR	NCO	7	061153TZN	0.625	1.125	0.535	TZN	NBR	NCC	8
060815M	0.625	0.875	0.125	SM	NBR	NCC	7	0613025C	0.625	1.130	0.265	SC	NBR	NCS	7
060871TZ-H	0.625	0.875	0.125	TZ-H	NBR	NCC	7	061182TB-H	0.625	1.181	0.250	TB-H	NBR	NCC	7
0609318VL-H	0.625	0.933	0.187	VL-H	NBR	NCO	7	061181SCN1	0.625	1.185	0.158	SCN1	NBR	NCC	7
								0611818SM	0.625	1.188	0.188	SM	NBR	NCC	7
								061225B-H	0.625	1.250	0.250	SB-H	NBR	NCC	7

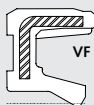
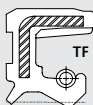
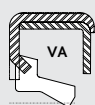
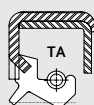

OIL AND GREASE SEALS - A COMPLETE LISTING

PLEASE CALL DICHTOMATIK FOR AVAILABILITY - 800-328-2840
BULK AND INDIVIDUALLY BOXED QUANTITIES ARE AVAILABLE FOR ALL



DICHTOMATIK

Any seal. Any time.

TCM Part #	Shaft	Bore	Width	Type	Lip Material	Material	Box #	TCM Part #	Shaft	Bore	Width	Type	Lip Material	Material	Box							
06122VTB	0.625	1.250	0.250	TB	FKM	VCC	7	16X24X3VG	0.630	0.945	0.118	VG	NBR	NCO	7							
06122TB	0.625	1.250	0.250	TB	NBR	NCC	7	16X24X4SC	0.630	0.945	0.157	SC	NBR	NCC	7							
06122TB-H	0.625	1.250	0.250	TB-H	NBR	NCC	7	16X24X4SM	0.630	0.945	0.157	SM	NBR	NCC	7							
06122TC	0.625	1.250	0.250	TC	NBR	NCC	7	16X24X4VTC	0.630	0.945	0.157	TC	FKM	VCC	7							
06122TEB-H	0.625	1.250	0.250	TEB-H	NBR	NCC	7	16X24X4TC	0.630	0.945	0.157	TC	NBR	NCC	7							
06122TL-H	0.625	1.250	0.250	TL-H	NBR	NCC	7	16X24X4VTM	0.630	0.945	0.157	TM	FKM	VCC	7							
06122VL-H	0.625	1.250	0.250	VL-H	NBR	NCO	7	16X24X4TM	0.630	0.945	0.157	TM	NBR	NCC	7							
061225SC	0.625	1.250	0.252	SC	NBR	NCC	7	16X24X4VC	0.630	0.945	0.157	VC	NBR	NCO	7							
06123TLN22-H	0.625	1.250	0.312	TLN22-H	NBR	NCC	7	16X24X5SC	0.630	0.945	0.197	SC	NBR	NCS	7							
06123SA-H	0.625	1.250	0.375	SA-H	NBR	NCC	7	16X24X5TC	0.630	0.945	0.197	TC	NBR	NCC	7							
06132VSB	0.625	1.375	0.250	SB	FKM	VCS	7	16X24X6SM	0.630	0.945	0.236	SM	NBR	NCC	7							
06132SB	0.625	1.375	0.250	SB	NBR	NCC	7	16X24X6TC	0.630	0.945	0.236	TC	NBR	NCC	7							
06132SB-H	0.625	1.375	0.250	SB-H	NBR	NCC	7	16X24X6.5TC	0.630	0.945	0.256	TC	NBR	NCC	7							
06132TB	0.625	1.375	0.250	TB	NBR	NCC	7	16X24X7SC	0.630	0.945	0.276	SC	NBR	NCC	7							
06132VTB-H	0.625	1.375	0.250	TB-H	FKM	VSS	7	16X24X7TC	0.630	0.945	0.276	TC	NBR	NCC	7							
06132TB-H	0.625	1.375	0.250	TB-H	NBR	NCC	7	16X25X3VVG	0.630	0.984	0.118	VG	FKM	VCO	7							
06132TC	0.625	1.375	0.250	TC	NBR	NCC	7	16X25X3VG	0.630	0.984	0.118	VG	NBR	NCO	7							
06132TL2-H	0.625	1.375	0.250	TL2-H	NBR	NCC	7	16X25X4TC	0.630	0.984	0.157	TC	NBR	NCC	7							
06132VB	0.625	1.375	0.250	VB	NBR	NCO	7	16X25X5VTC	0.630	0.984	0.197	TC	FKM	VCC	7							
06132VL-H	0.625	1.375	0.250	VL-H	NBR	NCO	7	16X25X5TC	0.630	0.984	0.197	TC	NBR	NCC	7							
06133TA	0.625	1.375	0.312	TA	NBR	NCC	7	16X25X6TC	0.630	0.984	0.236	TC	NBR	NCC	7							
061340/42TCN11	0.625	1.375	0.406/0.426	TCN11	NBR	NSS	7	16X25X7SC	0.630	0.984	0.276	SC	NBR	NCC	7							
061372TA	0.625	1.377	0.250	TA	NBR	NCC	7	16X25X7TB	0.630	0.984	0.276	TB	NBR	NCC	7							
061372TA-H	0.625	1.377	0.250	TA-H	NBR	NCC	7	16X25X7TC	0.630	0.984	0.276	TC	NBR	NCC	7							
061374SA-H	0.625	1.377	0.406	SA-H	NBR	NCC	7	16X26X5SC	0.630	1.024	0.197	SC	NBR	NCC	7							
06142SB	0.625	1.499	0.250	SB	NBR	NCC	7	16X26X5TC	0.630	1.024	0.197	TC	NBR	NCC	7							
06142SB-H	0.625	1.499	0.250	SB-H	NBR	NCC	7	16X26X6TC	0.630	1.024	0.236	TC	NBR	NCC	7							
06142TB-H	0.625	1.499	0.250	TB-H	NBR	NCC	7	16X26X7SC	0.630	1.024	0.276	SC	NBR	NCC	7							
06142TC	0.625	1.499	0.250	TC	NBR	NCC	7	16X26X7TC	0.630	1.024	0.276	TC	NBR	NCC	7							
061562TB-H	0.625	1.561	0.250	TB-H	NBR	NCC	7	16X27X5VB	0.630	1.063	0.197	VB	NBR	NCO	7							
06152SZ	0.625	1.574	0.250	SZ	NBR	NCC	7	16X27X7TC	0.630	1.063	0.276	TC	NBR	NCC	7							
0615731TB	0.625	1.575	0.312	TB	NBR	NCC	7	16X28X7TG	0.630	1.102	0.275	TG	NBR	NCC	7							
0615731TB-H	0.625	1.575	0.312	TB-H	NBR	NCC	7	16X28X4VM	0.630	1.102	0.157	VM	NBR	NCO	7							
0615731VTB-H	0.625	1.579	0.312	TB-H	FKM	VCS	7	16X28X6TC	0.630	1.102	0.236	TC	NBR	NCC	7							
06163SFY	0.625	1.624	0.312	SFY	NBR	NCC	7	16X28X7SB	0.630	1.102	0.276	SB	NBR	NCC	7							
06163TB-H	0.625	1.624	0.312	TB-H	NBR	NCC	7	16X28X7SC	0.630	1.102	0.276	SC	NBR	NCC	7							
06162SM	0.625	1.625	0.250	SM	NBR	NCC	7	16X28X7VSCN	0.630	1.102	0.276	SCN	FKM	VCS	7							
0618527VTB-H	0.625	1.850	0.275	TB-H	FKM	VCS	7	16X28X7TC	0.630	1.102	0.276	TC	NBR	NCC	7							
0618528VTC	0.625	1.850	0.280	TC	FKM	VCS	7	16X28X7VTF	0.630	1.102	0.276	TF	FKM	VCS	7							
SHAFT 0.626								16X28X8VTC	0.630	1.102	0.315	TC	FKM	VCC	7							
SHAFT-EZE 99062								16X28.5X8TC	0.630	1.122	0.315	TC	NBR	NCC	7							
SHAFT-EZE 99058								16X29X4TC	0.630	1.142	0.157	TC	NBR	NCC	7							
V-RING -016								16X29X7TC	0.630	1.142	0.276	TC	NBR	NCC	7							
AM06176AP1								0.626	1.738	0.625	AP1	NBR	NCC	8	16X30X7SB-H	0.630	1.181	0.275	SB-H	NBR	NCC	7
SHAFT 0.630								16X30X7TG	0.630	1.181	0.275	TG	NBR	NCC	7							
SHAFT-EZE 99058								16X30X4.5SC	0.630	1.181	0.177	SC	NBR	NCC	7							
V-RING -016								16X30X4.5VTC	0.630	1.181	0.177	TC	FKM	VCC	7							
16X20X2.5VM								0.630	0.787	0.098	VM	NBR	NCO	7	16X30X4.5TC	0.630	1.181	0.177	TC	NBR	NCC	7
16X21X3VM								0.630	0.827	0.118	VM	NBR	NCO	7	16X30X4.5VTF	0.630	1.181	0.177	TF	FKM	VCS	7
16X21X4.5TB								0.630	0.827	0.177	TB	NBR	NCC	7	16X30X5SC	0.630	1.181	0.197	SC	NBR	NCC	7
16X21X6TC								0.630	0.827	0.236	TC	NBR	NCC	7	16X30X5TC	0.630	1.181	0.197	TC	NBR	NCC	7
16X22X3SC								0.630	0.866	0.118	SC	NBR	NCC	7	16X30X6SB	0.630	1.181	0.236	SB	NBR	NCC	7
16X22X3VVC								0.630	0.866	0.118	VC	FKM	VCO	7	16X30X6TC	0.630	1.181	0.236	TC	NBR	NCC	7
16X22X3VG								0.630	0.866	0.118	VG	NBR	NCO	7	16X30X7SC	0.630	1.181	0.276	SC	NBR	NCC	7
16X22X4SC								0.630	0.866	0.157	SC	NBR	NCC	7	16X30X7PSCW	0.630	1.181	0.276	SCW	ACM	PCC	7
16X22X4TC								0.630	0.866	0.157	TC	NBR	NCC	7	16X30X7TC	0.630	1.181	0.276	TC	NBR	NCC	7
16X22X4TCY								0.630	0.866	0.157	TCY	NBR	NCS	7	16X30X7VTF	0.630	1.181	0.276	TF	FKM	VCS	7
16X22X4VTC								0.630	0.866	0.157	TF	FKM	VCC	7	16X30X8TC	0.630	1.181	0.315	TC	NBR	NCC	7
16X22X4VC								0.630	0.866	0.157	VC	NBR	NCO	7	16X30X10SC	0.630	1.181	0.394	SC	NBR	NCC	7
16X22X7SC								0.630	0.866	0.276	SC	NBR	NCC	7	16X30X10TC	0.630	1.181	0.394	TC	NBR	NCC	7
16X22X7TC								0.630	0.866	0.276	TC	NBR	NCC	7	16X32X7VTC	0.630	1.260	0.276	TC	FKM	VCC	7
16X23X4TC								0.630	0.906	0.157	TC	NBR	NCC	7	16X32X7TC	0.630	1.260	0.276	TC	NBR	NCC	7
16X24X3VVC								0.630	0.945	0.118	VC	FKM	VCO	7	16X32X7TM	0.630	1.260	0.276	TM	NBR	NCC	7
								16X32X8TC	0.630	1.260	0.315	TC	NBR	NCC	7							

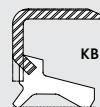
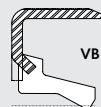
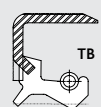
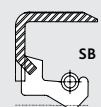
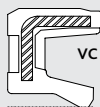



TCM Part #	Shaft	Bore	Width	Type	Lip Material	Material	Box	TCM Part #	Shaft	Bore	Width	Type	Lip Material	Material	Box #
16X32X10TC	0.630	1.260	0.394	TC	NBR	NCC	7	17X23X4KC	0.669	0.906	0.157	KC	NBR	NCO	7
16X33X11SC	0.630	1.299	0.433	SC	NBR	NCC	7	17X235X3.18VM	0.669	0.927	0.125	VM	NBR	NCO	7
16X34X4TC	0.630	1.339	0.157	TC	NBR	NCC	7	17X24X4TC	0.669	0.945	0.157	TC	NBR	NCC	7
16X34X10TC	0.630	1.339	0.394	TC	NBR	NCC	7	17X24X4VG	0.669	0.945	0.157	VG	NBR	NCO	7
16X35X7SB-H	0.630	1.377	0.275	SB-H	NBR	NCC	7	17X24X5SC	0.669	0.945	0.197	SC	NBR	NCC	7
16X35X7SC	0.630	1.378	0.276	SC	NBR	NCC	7	17X24X5TC	0.669	0.945	0.197	TC	NBR	NCC	7
16X35X7TC	0.630	1.378	0.276	TC	NBR	NCC	7	17X24X7SC	0.669	0.945	0.276	SC	NBR	NCC	7
16X35X7VTF	0.630	1.378	0.276	TF	FKM	VCS	7	17X24X7TC	0.669	0.945	0.276	TC	NBR	NCC	7
16X35X8SC	0.630	1.378	0.315	SC	NBR	NCC	7	17X25X3VTM	0.669	0.984	0.118	TM	FKM	VCS	7
16X35X8TC	0.630	1.378	0.315	TC	NBR	NCC	7	17X25X3VM	0.669	0.984	0.118	VM	NBR	NCO	7
16X35X10SC	0.630	1.378	0.394	SC	NBR	NCC	7	17X25X4SC	0.669	0.984	0.157	SC	NBR	NCC	7
16X35X10TC	0.630	1.378	0.394	TC	NBR	NCC	7	17X25X4VTC	0.669	0.984	0.157	TC	FKM	VCC	7
16X36X7TC	0.630	1.417	0.276	TC	NBR	NCC	7	17X25X4TC	0.669	0.984	0.157	TC	NBR	NCS	7
16X37X7TC	0.630	1.457	0.276	TC	NBR	NCC	7	17X25X5SC	0.669	0.984	0.197	SC	NBR	NCC	7
16X38X7SC	0.630	1.496	0.276	SC	NBR	NCC	7	17X25X6TC	0.669	0.984	0.236	TC	NBR	NCC	7
16X38X7TB	0.630	1.496	0.276	TB	NBR	NCC	7	17X25X6TC-G	0.669	0.984	0.236	TC-G	NBR	NCC	7
16X38X8TC	0.630	1.496	0.315	TC	NBR	NCC	7	17X25X7SC	0.669	0.984	0.276	SC	NBR	NCC	7
16X40X7SB-H	0.630	1.574	0.275	SB-H	NBR	NCC	7	17X25X7TC	0.669	0.984	0.276	TC	NBR	NCC	7
16X40X5SC	0.630	1.575	0.197	SC	NBR	NCC	7	17X26X6SC	0.669	1.024	0.236	SC	NBR	NCC	7
16X40X7TC	0.630	1.575	0.276	TC	NBR	NCC	7	17X26X6VSF	0.669	1.024	0.236	SF	FKM	VCS	7
16X40X8SC	0.630	1.575	0.315	SC	NBR	NCC	7	17X26X6TC	0.669	1.024	0.236	TC	NBR	NCC	7
16X40X10SC	0.630	1.575	0.394	SC	NBR	NCC	7	17X26X6TM	0.669	1.024	0.236	TM	NBR	NCC	7
16X40X10TC	0.630	1.575	0.394	TC	NBR	NCC	7	17X26X7SC	0.669	1.024	0.276	SC	NBR	NCC	7
16X42X6SC	0.630	1.654	0.236	SC	NBR	NCC	7	17X27X5SC	0.669	1.063	0.197	SC	NBR	NCC	7
16X42X6TC	0.630	1.654	0.236	TC	NBR	NCC	7	17X27X5TC	0.669	1.063	0.197	TC	NBR	NCC	7
16X42X7TC	0.630	1.654	0.276	TC	NBR	NCC	7	17X27X6SC	0.669	1.063	0.236	SC	NBR	NCC	7
16X42X10TC	0.630	1.654	0.394	TC	NBR	NCC	7	17X27X6TC	0.669	1.063	0.236	TC	NBR	NCC	7
16X47X7TC	0.630	1.850	0.276	TC	NBR	NCC	7	17X27X7SC	0.669	1.063	0.276	SC	NBR	NCC	7
16X48X7TC	0.630	1.890	0.276	TC	NBR	NCC	7	17X27X7TC	0.669	1.063	0.276	TC	NBR	NCC	7
SHAFT 0.650								17X27X8TC	0.669	1.063	0.315	TC	NBR	NCC	7
SHAFT 0.650								17X27X10TC	0.669	1.063	0.394	TC	NBR	NCC	7
V-RING -016							7	17X28X7TG	0.669	1.102	0.275	TG	NBR	NCC	7
16.5X28X8TC	0.650	1.102	0.315	TC	NBR	NCC	7	17X28X7SB-H	0.669	1.102	0.276	SB-H	NBR	NCC	7
06152SC	0.650	1.500	0.250	SC	NBR	NCC	7	17X28X4SC	0.669	1.102	0.157	SC	NBR	NCC	7
SHAFT 0.655								17X28X4TC	0.669	1.102	0.157	TC	NBR	NCC	7
V-RING -016							7	17X28X4.5SC	0.669	1.102	0.177	SC	NBR	NCC	7
0651123SB-H	0.655	1.124	0.312	SB-H	NBR	NCC	7	17X28X5SC	0.669	1.102	0.197	SC	NBR	NCC	7
SHAFT 0.656								17X28X5VSF	0.669	1.102	0.197	SF	FKM	VCS	7
V-RING -016							7	17X28X5TB	0.669	1.102	0.197	TB	NBR	NCC	7
065112SAY	0.656	1.124	0.250	SAY	NBR	NCS	7	17X28X5TC	0.669	1.102	0.197	TC	NBR	NCC	7
065112SB	0.656	1.124	0.250	SB	NBR	NCC	7	17X28X6VDC	0.669	1.102	0.236	DC	FKM	VCS	7
065112SB-H	0.656	1.124	0.250	SB-H	NBR	NCC	7	17X28X6SC	0.669	1.102	0.236	SC	NBR	NCC	7
065112SC	0.656	1.124	0.250	SC	NBR	NCC	7	17X28X6TC	0.669	1.102	0.236	TC	NBR	NCC	7
0651130VDB	0.656	1.125	0.300	DB	FKM	VCS	7	17X28X7VSB	0.669	1.102	0.276	SB	FKM	VCS	7
065122SB	0.656	1.250	0.250	SB	NBR	NCC	7	17X28X7SB	0.669	1.102	0.276	SB	NBR	NCC	7
065122SB-H	0.656	1.250	0.250	SB-H	NBR	NCC	7	17X28X7SC	0.669	1.102	0.276	SC	NBR	NCC	7
065133SB	0.656	1.375	0.313	SB	NBR	NCC	7	17X28X7TC	0.669	1.102	0.276	TC	NBR	NCC	7
065133SB-H	0.656	1.375	0.313	SB-H	NBR	NCC	7	17X28X7VTCR	0.669	1.102	0.276	TCR	FKM	VCC	7
065152SC	0.656	1.500	0.250	SC	NBR	NCC	7	17X28X7VTF	0.669	1.102	0.276	TF	FKM	VCS	7
065152SB-H	0.656	1.575	0.250	SB-H	NBR	NCC	7	17X28X8TC	0.669	1.102	0.315	TC	NBR	NCC	7
065152TB	0.656	1.575	0.250	TB	NBR	NCC	7	17X28.5X6TC	0.669	1.122	0.236	TC	NBR	NCC	7
SHAFT 0.657								17X28.5X7VTC	0.669	1.122	0.276	TC	FKM	VCC	7
V-RING -016							7	17X28.5X7TC	0.669	1.122	0.276	TC	NBR	NCC	7
0651572SM	0.657	1.575	0.250	SM	NBR	NCC	7	17X28.65X7TC	0.669	1.128	0.276	TC	NBR	NCC	7
SHAFT 0.665								17X28.65X7TM	0.669	1.128	0.276	TM	NBR	NCC	7
V-RING -016							7	17X29X5SC	0.669	1.142	0.197	SC	NBR	NCC	7
16.9X28X5SC	0.665	1.102	0.197	SC	NBR	NCC	7	17X29X5TC	0.669	1.142	0.197	TC	NBR	NCC	7
SHAFT 0.669								17X29X7TC	0.669	1.142	0.276	TC	NBR	NCC	7
SHAFT-EZE 99068							S1	17X30X6SC	0.669	1.181	0.236	SC	NBR	NCC	7
V-RING -016							7	17X30X7SB-H	0.669	1.181	0.275	SB-H	NBR	NCC	7
17X20.8X3.2VB	0.669	0.819	0.126	VB	NBR	NCO	7	17X30X7TG	0.669	1.181	0.275	TG	NBR	NCC	7
17X23X3VVC	0.669	0.906	0.118	VC	FKM	VCC	7	17X30X5VSF	0.669	1.181	0.197	SF	FKM	VCC	7
17X23X3VG	0.669	0.906	0.118	VG	NBR	NCO	7	17X30X5TC	0.669	1.181	0.197	TC	NBR	NCC	7
								17X30X6TC	0.669	1.181	0.236	TC	NBR	NCC	7

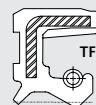
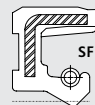
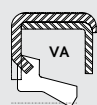
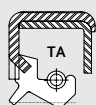

OIL AND GREASE SEALS - A COMPLETE LISTING

PLEASE CALL DICHTOMATIK FOR AVAILABILITY - 800-328-2840
 BULK AND INDIVIDUALLY BOXED QUANTITIES ARE AVAILABLE FOR ALL



DICHTOMATIK

Any seal. Any time.

TCM Part #	Shaft	Bore	Width	Type	Lip Material	Material	Box #	TCM Part #	Shaft	Bore	Width	Type	Lip Material	Material	Box
17X30X7SC	0.669	1.181	0.276	SC	NBR	NCC	7	17X40X7SB	0.669	1.575	0.276	SB	NBR	NCC	7
17X30X7SCY	0.669	1.181	0.276	SCY	NBR	NCC	7	17X40X7SC	0.669	1.575	0.276	SC	NBR	NCC	7
17X30X7TC	0.669	1.181	0.276	TC	NBR	NCC	7	17X40X7TC	0.669	1.575	0.276	TC	NBR	NCC	7
17X30X7TCN	0.669	1.181	0.276	TCN	NBR	NSS	7	17X40X7TF	0.669	1.575	0.276	TF	FKM	VCS	7
17X30X7VTF	0.669	1.181	0.276	TF	FKM	VCS	7	17X40X7VTF	0.669	1.575	0.276	TF	FKM	VCS	7
17X30X8TC	0.669	1.181	0.315	TC	NBR	NCC	7	17X40X8SC	0.669	1.575	0.315	SC	NBR	NCC	7
17X30X8TZ	0.669	1.181	0.315	TZ	NBR	NCC	7	17X40X8TC	0.669	1.575	0.315	TC	NBR	NCC	7
17X30X10TC	0.669	1.181	0.394	TC	NBR	NCC	7	17X40X10SC	0.669	1.575	0.394	SC	NBR	NCC	7
0661115A	0.669	1.187	0.185	SA	NBR	NCS	7	17X40X7SB-H	0.669	1.575	0.276	SB-H	NBR	NCC	7
0661115B	0.669	1.187	0.185	SB	NBR	NCC	7	17X42X5SC	0.669	1.654	0.197	SC	NBR	NCC	7
0661115B-H	0.669	1.187	0.185	SB-H	NBR	NCC	7	17X42X7SC	0.669	1.654	0.276	SC	NBR	NCC	7
06611818TB	0.669	1.187	0.185	TB	NBR	NCC	7	17X42X7TC	0.669	1.654	0.276	TC	NBR	NCC	7
0661125A	0.669	1.187	0.203	SA	NBR	NCS	7	17X45X7TC	0.669	1.772	0.276	TC	NBR	NCC	7
17X31X7TC	0.669	1.220	0.276	TC	NBR	NCC	7	17X46X6TC	0.669	1.811	0.236	TC	NBR	NCC	7
066122VB	0.669	1.250	0.250	VB	NBR	NCO	7	17X47X7SB-H	0.669	1.850	0.275	SB-H	NBR	NCC	7
17X32X7TG	0.669	1.259	0.275	TG	NBR	NCC	7	17X47X7SC	0.669	1.850	0.276	SC	NBR	NCC	7
17X32X5SC	0.669	1.260	0.197	SC	NBR	NCC	7	17X47X7VTC	0.669	1.850	0.276	TC	FKM	VCC	7
17X32X5TC	0.669	1.260	0.197	TC	NBR	NCC	7	17X47X7TC	0.669	1.850	0.276	TC	NBR	NCC	7
17X32X6TC	0.669	1.260	0.236	TC	NBR	NCC	7	17X47X8TC	0.669	1.850	0.315	TC	NBR	NCC	7
17X32X7SB	0.669	1.260	0.276	SB	NBR	NCC	7	17X47X8PTECW	0.669	1.850	0.315	TECW	ACM	PCC	7
17X32X7SC	0.669	1.260	0.276	SC	NBR	NCC	7	17X47X10SC	0.669	1.850	0.394	SC	NBR	NCC	7
17X32X7TC	0.669	1.260	0.276	TC	NBR	NCC	7	SHAFT 0.687							
17X32X7VTF	0.669	1.260	0.276	TF	FKM	VCS	7	V-RING -016							7
17X32X8TC	0.669	1.260	0.315	TC	NBR	NCC	7	0680809SVM	0.687	0.875	0.094	VM	VMQ	SCO	7
17X32X10SC	0.669	1.260	0.394	SC	NBR	NCC	7	06809918VL-H	0.687	0.998	0.187	VL-H	NBR	NCO	7
17X33X7SB	0.669	1.299	0.276	SB	NBR	NCC	7	0681015M	0.687	1.062	0.187	SM	NBR	NCC	7
17X33X7TC	0.669	1.299	0.276	TC	NBR	NCC	7	0681122TB-H	0.687	1.124	0.250	TB-H	NBR	NCC	7
17X33X7TM	0.669	1.299	0.276	TM	NBR	NCC	7	0681125ZY	0.687	1.125	0.250	SZY	NBR	NSS	7
17X33X8SC	0.669	1.299	0.315	SC	NBR	NCC	7	06811818TB-H	0.687	1.187	0.187	TB-H	NBR	NCC	7
17X34X4SB	0.669	1.339	0.157	SB	NBR	NCC	7	06811818SB-H	0.687	1.188	0.187	SB-H	NBR	NCC	7
17X34X4TB	0.669	1.339	0.157	TB	NBR	NCC	7	068122TB-H	0.687	1.250	0.250	TB-H	NBR	NCC	7
17X34X4TC	0.669	1.339	0.157	TC	NBR	NCC	7	068132TB-H	0.687	1.375	0.250	TB-H	NBR	NCC	7
17X34X4.5SB-U	0.669	1.339	0.177	SB-U	NBR	NCC	7	06813740VTEM	0.687	1.378	0.406	TEM	FKM	VSS	7
17X34X7SC	0.669	1.339	0.276	SC	NBR	NCC	7	068162TB-H	0.687	1.624	0.250	TB-H	NBR	NCC	7
17X34X7TC	0.669	1.339	0.276	TC	NBR	NCC	7	SHAFT 0.688							
17X34.5X4TC	0.669	1.358	0.157	TC	NBR	NCC	7	V-RING -016							7
17X35X7TG	0.669	1.377	0.275	TG	NBR	NCC	7	068081VM	0.688	0.875	0.125	VM	NBR	NCO	7
17X35X5SC	0.669	1.378	0.197	SC	NBR	NCC	7	068091VM	0.688	0.938	0.172	VM	NBR	NCO	7
17X35X5TC	0.669	1.378	0.197	TC	NBR	NCC	7	0680918VM	0.688	0.999	0.188	VM	NBR	NCO	7
17X35X6VTBG	0.669	1.378	0.236	TBG	FKM	VCC	7	068112VSB	0.688	1.124	0.250	SB	FKM	VCS	7
17X35X6TC	0.669	1.378	0.236	TC	NBR	NCC	7	068112SB	0.688	1.124	0.250	SB	NBR	NCC	7
17X35X7SB-H	0.669	1.378	0.276	SB-H	NBR	NCC	7	068112VSB-H	0.688	1.124	0.250	SB-H	FKM	VCS	7
17X35X7SC	0.669	1.378	0.276	SC	NBR	NCC	7	068112SB-H	0.688	1.124	0.250	SB-H	NBR	NCC	7
17X35X7VTC	0.669	1.378	0.276	TC	FKM	VCC	7	068112TC	0.688	1.125	0.250	TC	NBR	NCC	7
17X35X7TC	0.669	1.378	0.276	TC	NBR	NCC	7	061115B	0.688	1.187	0.188	SB	NBR	NCC	7
17X35X7VTF	0.669	1.378	0.276	TF	FKM	VCS	7	061115B-H	0.688	1.187	0.188	SB-H	NBR	NCC	7
17X35X8TC	0.669	1.378	0.315	TC	NBR	NCC	7	068122TC	0.688	1.250	0.250	TC	NBR	NCC	7
17X36X7TC	0.669	1.417	0.276	TC	NBR	NCC	7	068122TZ	0.688	1.250	0.250	TZ	NBR	NCC	7
17X37X5TC	0.669	1.457	0.197	TC	NBR	NCC	7	068122VSB	0.688	1.250	0.313	SB	FKM	VCS	7
17X37X7SC	0.669	1.457	0.276	SC	NBR	NCC	7	068122SB	0.688	1.250	0.313	SB	NBR	NCC	7
17X37X7TC	0.669	1.457	0.276	TC	NBR	NCC	7	068122SB-H	0.688	1.250	0.313	SB-H	NBR	NCC	7
17X37X10SC	0.669	1.457	0.394	SC	NBR	NCC	7	068131VM-H	0.688	1.375	0.125	VM-H	NBR	NCO	7
17X38X5TC	0.669	1.496	0.197	TC	NBR	NCC	7	068132VB	0.688	1.375	0.250	VB	NBR	NCO	7
17X38X7SCWY	0.669	1.496	0.276	SCWY	NBR	NCC	7	068133VSB-H	0.688	1.375	0.312	SB-H	FKM	VCS	7
17X38X7TC	0.669	1.496	0.276	TC	NBR	NCC	7	068133SB-H	0.688	1.375	0.312	SB-H	NBR	NCC	7
17X39X9.5TC	0.669	1.535	0.374	TC	NBR	NCC	7	068133TC	0.688	1.375	0.312	TC	NBR	NCC	7
17X40X4.6KCY	0.669	1.575	0.181	KCY	NBR	NCO	7	068133VSB	0.688	1.375	0.313	SB	FKM	VCS	7
17X40X4.6TB	0.669	1.575	0.181	TB	NBR	NCC	7	068133SB	0.688	1.375	0.313	SB	NBR	NCC	7
17X40X5PSC	0.669	1.575	0.197	SC	ACM	PCC	7	068142SB	0.688	1.499	0.250	SB	NBR	NCC	7
17X40X5TC	0.669	1.575	0.197	TC	NBR	NCC	7	068142SB-H	0.688	1.499	0.250	SB-H	NBR	NCC	7
17X40X5TCY	0.669	1.575	0.197	TCY	NBR	NCC	7								
17X40X5TCY-A	0.669	1.575	0.197	TCY-A	NBR	NCC	7								
17X40X6SC	0.669	1.575	0.236	SC	NBR	NCC	7								
17X40X6VTG-PL	0.669	1.575	0.236	TG-PL	FKM	VCC	7								

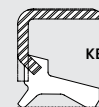
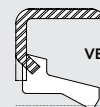
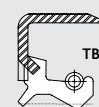
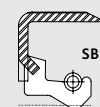
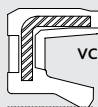



TCM Part #	Shaft	Bore	Width	Type	Lip Material	Material	Box	TCM Part #	Shaft	Bore	Width	Type	Lip Material	Material	Box #				
SHAFT 0.689																			
V-RING -016							7	18X32X8SC	0.709	1.260	0.315	SC	NBR	NCC	7				
V-RING -018							7	18X32X8TC	0.709	1.260	0.315	TC	NBR	NCC	7				
17.5X28X6SC	0.689	1.102	0.236	SC	NBR	NCC	7	18X32X8VTF	0.709	1.260	0.315	TF	FKM	VCS	7				
SHAFT 0.693																			
V-RING -018							7	18X32X10SC	0.709	1.260	0.394	SC	NBR	NCC	7				
17.6X30X7TC	0.693	1.181	0.276	TC	NBR	NCC	7	18X32.2X6/8VCY	0.709	1.268	0.236/0.315	VCY	NBR	NCO	7				
SHAFT 0.702																			
V-RING -018							7	18X34X7TC	0.709	1.339	0.276	TC	NBR	NCC	7				
07009318VC	0.702	0.933	0.180	VC	NBR	NCO	7	18X35X75B-H	0.709	1.377	0.275	SB-H	NBR	NCC	7				
SHAFT 0.709																			
SHAFT-EZE 99082							51	18X35X6TC	0.709	1.378	0.236	TC	NBR	NCC	7				
V-RING -018							7	18X35X6VTF	0.709	1.378	0.236	TF	FKM	VCS	7				
18X24X3KC	0.709	0.945	0.118	KC	NBR	NCO	7	18X35X7VTC	0.709	1.378	0.276	TC	FKM	VCC	7				
18X24X3VVG	0.709	0.945	0.118	VG	FKM	VCO	7	18X35X7TC	0.709	1.378	0.276	TC	NBR	NCC	7				
18X24X45B	0.709	0.945	0.157	SB	NBR	NCC	7	18X35X7VTF	0.709	1.378	0.276	TF	FKM	VCS	7				
18X24X4TC	0.709	0.945	0.157	TC	NBR	NCC	7	18X35X7VTF	0.709	1.378	0.276	TF	FKM	VCS	7				
18X25X3VC	0.709	0.984	0.118	VC	NBR	NCO	7	18X35X8SC	0.709	1.378	0.315	SC	NBR	NCC	7				
18X25X45B	0.709	0.984	0.157	SB	NBR	NCC	7	18X35X10SC	0.709	1.378	0.394	SC	NBR	NCC	7				
18X25X45M	0.709	0.984	0.157	SM	NBR	NCC	7	18X35X10TC	0.709	1.378	0.394	TC	NBR	NCC	7				
18X25X4TB	0.709	0.984	0.157	TB	NBR	NCC	7	18X36X75C	0.709	1.417	0.276	SC	NBR	NCC	7				
18X25X65M	0.709	0.984	0.236	SM	NBR	NCC	7	18X36X7TC	0.709	1.417	0.276	TC	NBR	NCC	7				
18X25X7TC	0.709	0.984	0.276	TC	NBR	NCC	7	18X37X65C	0.709	1.457	0.236	SC	NBR	NCC	7				
18X25X7TCY	0.709	0.984	0.276	TC	NBR	NCC	7	18X37X7TC	0.709	1.457	0.276	TC	NBR	NCC	7				
18X26X4KC	0.709	1.024	0.157	KC	NBR	NCO	7	18X37X85C	0.709	1.457	0.315	SC	NBR	NCC	7				
18X26X45C	0.709	1.024	0.157	SC	NBR	NCC	7	18X38X55C	0.709	1.496	0.197	SC	NBR	NCC	7				
18X26X4VTF	0.709	1.024	0.157	TF	FKM	VCS	7	18X38X6TC	0.709	1.496	0.236	TC	NBR	NCC	7				
18X26X6VSC	0.709	1.024	0.236	SC	FKM	VCS	7	18X38X7TC	0.709	1.496	0.276	TC	NBR	NCC	7				
18X26X65C	0.709	1.024	0.236	SC	NBR	NCC	7	18X38X10TC	0.709	1.496	0.394	TC	NBR	NCC	7				
18X27X4KC	0.709	1.063	0.157	KC	NBR	NCO	7	18X40X6TC	0.709	1.575	0.236	TC	NBR	NCC	7				
18X27X7TC	0.709	1.063	0.276	TC	NBR	NCC	7	18X40X75C	0.709	1.575	0.276	SC	NBR	NCC	7				
18X28X7TG	0.709	1.102	0.275	TG	NBR	NCC	7	18X40X7VTC	0.709	1.575	0.276	TC	FKM	VCS	7				
18X28X45C	0.709	1.102	0.157	SC	NBR	NCC	7	18X40X7TC	0.709	1.575	0.276	TC	NBR	NCS	7				
18X28X4V5F	0.709	1.102	0.157	SF	FKM	VCS	7	18X40X7VTF	0.709	1.575	0.276	TF	FKM	VCS	7				
18X28X6VSC	0.709	1.102	0.236	SC	FKM	VCS	7	18X42X7TC	0.709	1.654	0.276	TC	NBR	NCC	7				
18X28X65C	0.709	1.102	0.236	SC	NBR	NCC	7	18X42X85C	0.709	1.654	0.315	SC	NBR	NCC	7				
18X28X6TC	0.709	1.102	0.236	TC	NBR	NCC	7	18X42X8V5F	0.709	1.654	0.315	SF	FKM	VCS	7				
18X28X6VTF	0.709	1.102	0.236	TF	FKM	VCS	7	18X42X8VTF	0.709	1.654	0.315	TF	FKM	VCS	7				
18X28X7PTB2-H	0.709	1.102	0.276	TB2-H	ACM	PCC	7	18X44X85C	0.709	1.732	0.315	SC	NBR	NCC	7				
18X28X7VTB2-H	0.709	1.102	0.276	TB2-H	FKM	VCS	7	18X47X8TC	0.709	1.850	0.315	TC	NBR	NCC	7				
18X28X7TC	0.709	1.102	0.276	TC	NBR	NCC	7	18X47X10TC	0.709	1.850	0.394	TC	NBR	NCC	7				
18X28X7VTF	0.709	1.102	0.276	TF	FKM	VCS	7	SHAFT 0.718											
18X29X5TC	0.709	1.142	0.197	TC	NBR	NCC	7	V-RING -018							7				
18X29X7TC	0.709	1.142	0.276	TC	NBR	NCC	7	07123TB-H	0.718	1.250	0.375	TB-H	NBR	NCC	7				
18X30X75B-H	0.709	1.181	0.275	SB-H	NBR	NCC	7	SHAFT 0.719											
18X30X5TC	0.709	1.181	0.197	TC	NBR	NCC	7	V-RING -018							7				
18X30X6TB	0.709	1.181	0.236	TB	NBR	NCC	7	0711225L	0.719	1.250	0.250	SL	NBR	NCC	7				
18X30X6TC	0.709	1.181	0.236	TC	NBR	NCC	7	SHAFT 0.744											
18X30X6STCL	0.709	1.181	0.236	TCL	VMQ	SCC	7	V-RING -018							7				
18X30X7VSB	0.709	1.181	0.276	SB	FKM	VCS	7	18.9X28X5TC	0.744	1.102	0.197	TC	NBR	NCC	7				
18X30X75C	0.709	1.181	0.276	SC	NBR	NCC	7	18.9X30X5VTC	0.744	1.181	0.197	TC	FKM	VCC	7				
18X30X7TC	0.709	1.181	0.276	TC	NBR	NCC	7	18.9X30X5TC	0.744	1.181	0.197	TC	NBR	NCC	7				
18X30X7VTF	0.709	1.181	0.276	TF	FKM	VCS	7	SHAFT 0.748											
18X30X7TM	0.709	1.181	0.276	TM	NBR	NCC	7	SHAFT-EZE 99076							51				
18X30X8TC	0.709	1.181	0.315	TC	NBR	NCC	7	V-RING -020							7				
18X30X7/9TCN	0.709	1.181	0.276/0.354	TCN	NBR	NCC	7	19X26X5VC	0.748	1.024	0.197	VC	NBR	NCO	7				
18X31X7TC	0.709	1.220	0.276	TC	NBR	NCC	7	19X27X4VG	0.748	1.063	0.157	VG	NBR	NCO	7				
18X32X4TC	0.709	1.260	0.157	TC	NBR	NCC	7	19X27X65C	0.748	1.063	0.236	SC	NBR	NCC	7				
18X32X6TC	0.709	1.260	0.236	TC	NBR	NCC	7	19X27X65M	0.748	1.063	0.236	SM	NBR	NCC	7				
18X32X75C	0.709	1.260	0.276	SC	NBR	NCC	7	19X27X6.55C	0.748	1.063	0.256	SC	NBR	NCC	7				
18X32X7TC	0.709	1.260	0.276	TC	NBR	NCC	7	19X28X7TC	0.748	1.102	0.276	TC	NBR	NCC	7				
18X32X7VTF	0.709	1.260	0.276	TF	FKM	VCS	7	19X29X7TC	0.748	1.142	0.276	TC	NBR	NCC	7				
18X32X8VSC	0.709	1.260	0.315	SC	FKM	VCS	7	19X30X5TC	0.748	1.181	0.197	TC	NBR	NCC	7				
								19X30X65C	0.748	1.181	0.236	SC	NBR	NCC	7				
								19X30X6.5VTC	0.748	1.181	0.256	TG	FKM	VCC	7				
								19X30X75B	0.748	1.181	0.276	SB	NBR	NCC	7				

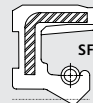
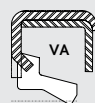
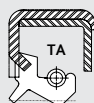

OIL AND GREASE SEALS - A COMPLETE LISTING

PLEASE CALL DICHTOMATIK FOR AVAILABILITY - 800-328-2840
BULK AND INDIVIDUALLY BOXED QUANTITIES ARE AVAILABLE FOR ALL



DICHTOMATIK

Any seal. Any time.

TCM Part #	Shaft	Bore	Width	Type	Lip Material	Material	Box #	TCM Part #	Shaft	Bore	Width	Type	Lip Material	Material	Box
19X30X7TC	0.748	1.181	0.276	TC	NBR	NCC	7	0711815VL-H	0.750	1.187	0.155	VL-H	NBR	NCO	7
19X31X8TC	0.748	1.220	0.315	TC	NBR	NCC	7	071125B	0.750	1.187	0.250	SB	NBR	NCC	7
19X32X75C	0.748	1.259	0.275	SC	NBR	NCC	7	071182TC	0.750	1.188	0.250	TC	NBR	NCC	7
19X32X55C	0.748	1.260	0.197	SC	NBR	NCC	7	071215B-H	0.750	1.250	0.187	SB-H	NBR	NCC	7
19X32X5TC	0.748	1.260	0.197	TC	NBR	NCC	7	0712185C	0.750	1.250	0.187	SC	NBR	NCC	7
19X32X7VTC	0.748	1.260	0.276	TC	FKM	VCC	7	071218TC	0.750	1.250	0.187	TC	NBR	NCC	7
19X32X7TC	0.748	1.260	0.276	TC	NBR	NCC	7	071215B	0.750	1.250	0.188	SB	NBR	NCC	7
19X32X8VTC	0.748	1.260	0.315	TC	FKM	VCS	7	071219KC	0.750	1.250	0.197	KC	NBR	NCO	7
19X32X8TC	0.748	1.260	0.315	TC	NBR	NCC	7	07122PSB	0.750	1.250	0.250	SB	ACM	PCC	7
19X32X8VTCN1	0.748	1.260	0.315	TCN1	FKM	VCS	7	071225B	0.750	1.250	0.250	SB	NBR	NCC	7
19X32X8TEC	0.748	1.260	0.315	TEC	NBR	NCC	7	07122VSB-H	0.750	1.250	0.250	SB-H	FKM	VCS	7
19X35X75B-H	0.748	1.377	0.275	SB-H	NBR	NCC	7	071225B-H	0.750	1.250	0.250	SB-H	NBR	NCC	7
19X35X75C	0.748	1.378	0.276	SC	NBR	NCC	7	071225C	0.750	1.250	0.250	SC	NBR	NCC	7
19X35X7TC	0.748	1.378	0.276	TC	NBR	NCC	7	07122VSCW	0.750	1.250	0.250	SCW	FKM	VCS	7
19X35X85C	0.748	1.378	0.315	SC	NBR	NCC	7	07122TB	0.750	1.250	0.250	TB	NBR	NCC	7
19X35X105C	0.748	1.378	0.394	SC	NBR	NCC	7	07122TBY	0.750	1.250	0.250	TB	NBR	NSS	7
19X36X7TC	0.748	1.417	0.276	TC	NBR	NCC	7	07122VTB-H	0.750	1.250	0.250	TB-H	FKM	VCS	7
19X37X7TC	0.748	1.457	0.276	TC	NBR	NCC	7	07122TB-H	0.750	1.250	0.250	TB-H	NBR	NCC	7
19X37X105B	0.748	1.457	0.394	SB	NBR	NCC	7	07122ETC	0.750	1.250	0.250	TC	EPDM	ECC	7
19X38X7TC	0.748	1.496	0.276	TC	NBR	NCC	7	07122TC-G	0.750	1.250	0.250	TC-G	NBR	NCC	7
19X38X105C	0.748	1.496	0.394	SC	NBR	NCC	7	07122VTCY	0.750	1.250	0.250	TCY	FKM	VSS	7
19X40X5VB	0.748	1.575	0.197	VB	NBR	NCO	7	07122TLN22-H	0.750	1.250	0.250	TLN22-H	NBR	NCC	7
19X40X8TC	0.748	1.575	0.315	TC	NBR	NCC	7	07122VB	0.750	1.250	0.250	VB	NBR	NCO	7
19X40X105C	0.748	1.575	0.394	SC	NBR	NCC	7	07122VL-H	0.750	1.250	0.250	VL-H	NBR	NCO	7
19X46X17TC	0.748	1.811	0.669	TC	NBR	NCC	8	07123TZ	0.750	1.250	0.312	TZ	NBR	NCC	7
19X47X7TC	0.748	1.850	0.276	TC	NBR	NCC	7	07123VTC	0.750	1.250	0.313	TC	FKM	VCS	7
19X53X7.55C	0.748	2.087	0.295	SC	NBR	NCC	7	07123TC	0.750	1.250	0.313	TC	NBR	NCC	7
SHAFT 0.750								07123VM	0.750	1.250	0.313	VM	NBR	NCO	7
SHAFT-EZE 99076							S1	07123TLN22-H	0.750	1.250	0.375	TLN22-H	NBR	NCC	7
V-RING -020							7	0712625B	0.750	1.260	0.250	SB	NBR	NCC	7
070931VM	0.750	0.937	0.125	VM	NBR	NCO	7	0712625B-H	0.750	1.260	0.250	SB-H	NBR	NCC	7
070991VL-H	0.750	0.999	0.125	VL-H	NBR	NCC	7	071302VB	0.750	1.301	0.250	VB	NBR	NCO	7
070991VVM	0.750	0.999	0.125	VM	FKM	VCO	7	0713125B-H	0.750	1.311	0.250	SB-H	NBR	NCC	7
07091VM	0.750	0.999	0.125	VM	NBR	NCO	7	07132TB	0.750	1.312	0.250	TB	NBR	NCC	7
07091VM-G	0.750	0.999	0.125	VM-G	NBR	NCO	7	07132TB-H	0.750	1.312	0.250	TB-H	NBR	NCC	7
07091VC	0.750	0.999	0.156	VC	NBR	NCO	7	071325B-H	0.750	1.375	0.250	SB-H	NBR	NCC	7
07101VC	0.750	1.000	0.125	VC	NBR	NCO	7	075132VTB	0.750	1.375	0.250	TB	FKM	VCS	7
07101VG	0.750	1.000	0.125	VG	NBR	NCO	7	075132TB	0.750	1.375	0.250	TB	NBR	NCC	7
07101XVL-H	0.750	1.000	0.125	VL-H	FKM	XCC	7	07132VTB-H	0.750	1.375	0.250	TB-H	FKM	VCS	7
07101XVM	0.750	1.000	0.125	VM	XNBR	XCO	7	075132TB-H	0.750	1.375	0.250	TB-H	NBR	NCC	7
0710125M-H	0.750	1.000	0.128	SM-H	NBR	NCC	7	07132PTC	0.750	1.375	0.250	TC	ACM	PCC	7
071014ETM	0.750	1.000	0.149	TM	EPDM	ECC	7	075132TL-H	0.750	1.375	0.250	TL-H	NBR	NCC	7
071014TM	0.750	1.000	0.149	TM	NBR	NCC	7	07132VTLN22-H	0.750	1.375	0.250	TLN22-H	FKM	VCS	7
07101TC	0.750	1.000	0.158	TC	NBR	NCC	7	07132VL-H	0.750	1.375	0.250	VL-H	NBR	NCO	7
071001VL-H	0.750	1.005	0.125	VL-H	NBR	NCO	7	071331TZ	0.750	1.375	0.312	TZ	NBR	NCC	7
0710618VL-H	0.750	1.061	0.187	VL-H	NBR	NCO	7	071335B	0.750	1.375	0.375	SB	NBR	NCC	7
071061VCY	0.750	1.062	0.187	VCY	NBR	NCO	7	071335STB	0.750	1.375	0.375	TB	NBR	NSS	7
071061TB	0.750	1.062	0.188	TB	NBR	NCC	7	071345STB	0.750	1.375	0.406	TB	NBR	NSS	7
0710618VTB-H	0.750	1.062	0.188	TB-H	FKM	VCC	7	07142VSB	0.750	1.499	0.250	SB	FKM	VCC	7
071061TB-H	0.750	1.062	0.188	TB-H	NBR	NCC	7	071425B	0.750	1.499	0.250	SB	NBR	NCC	7
0711218VSCW	0.750	1.123	0.188	SCW	FKM	VCS	7	071492VSB-H	0.750	1.499	0.250	SB-H	FKM	VCS	7
071115B	0.750	1.124	0.125	SB	NBR	NCS	7	071425B-H	0.750	1.499	0.250	SB-H	NBR	NCC	7
0711215VL-H	0.750	1.124	0.155	VL-H	NBR	NCO	7	07142TB-H	0.750	1.499	0.250	TB-H	NBR	NCC	7
07111VM	0.750	1.124	0.156	VM	NBR	NCO	7	07152VTC	0.750	1.500	0.250	TC	FKM	VCS	7
07112185B-H	0.750	1.124	0.187	SB-H	NBR	NCC	7	071553TM	0.750	1.500	0.531	TM	NBR	NCC	8
071118TZ-H	0.750	1.124	0.187	TZ-H	NBR	NCC	7	071535A-H	0.750	1.561	0.375	SA-H	NBR	NCC	7
071118VSB-H	0.750	1.124	0.188	SB-H	FKM	VCS	7	0715725B-H	0.750	1.574	0.250	SB-H	NBR	NCC	7
0711185M	0.750	1.124	0.188	SM	NBR	NCC	7	07152TL	0.750	1.575	0.250	TL	NBR	NCC	7
0711185M-H	0.750	1.124	0.188	SM-H	NBR	NCC	7	071573TB-H	0.750	1.575	0.312	TB-H	NBR	NCC	7
07111TB	0.750	1.124	0.188	TB	NBR	NCC	7	07162VSB	0.750	1.624	0.250	SB	FKM	VSS	7
07111VC	0.750	1.125	0.156	VC	NBR	NCO	7	07162VSB-H	0.750	1.624	0.250	SB-H	FKM	VCS	7
07111SZ	0.750	1.125	0.188	SZ	NBR	NCC	7	0716225B-H	0.750	1.624	0.250	SB-H	NBR	NCC	7
07112TB-H	0.750	1.125	0.250	TB-H	NBR	NCC	7	071622ETB	0.750	1.624	0.250	TB	EPDM	ECC	7
0711825A	0.750	1.180	0.203	SA	NBR	NCS	7	07162TB	0.750	1.624	0.250	TB	NBR	NCC	7

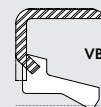
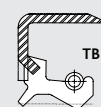
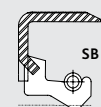
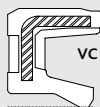
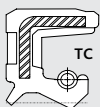



TCM Part #	Shaft	Bore	Width	Type	Lip Material	Material	Box	TCM Part #	Shaft	Bore	Width	Type	Lip Material	Material	Box #
071622VTB-H	0.750	1.624	0.250	TB-H	FKM	VCS	7	20X27X5TC	0.787	1.063	0.197	TC	NBR	NCC	7
07162TB-H	0.750	1.624	0.250	TB-H	NBR	NCC	7	20X27X6TB	0.787	1.063	0.236	TB	NBR	NCC	7
07162TL-H	0.750	1.624	0.250	TL-H	NBR	NCC	7	20X28X6TC	0.787	1.102	0.236	TC	NBR	NCC	7
071731TZ	0.750	1.750	0.312	TZ	NBR	NCC	7	20X28X3VM	0.787	1.102	0.118	VM	NBR	NCO	7
07172SB	0.750	1.752	0.250	SB	NBR	NCC	7	20X28X4SC	0.787	1.102	0.157	SC	NBR	NCC	7
07172SB-H	0.750	1.752	0.250	SB-H	NBR	NCC	7	20X28X4VTC	0.787	1.102	0.157	TC	FKM	VCC	7
07172TB-H	0.750	1.752	0.250	TB-H	NBR	NCC	7	20X28X4TC-PL	0.787	1.102	0.157	TC-PL	NBR	NCC	7
071752TBY	0.750	1.752	0.250	TBY	NBR	NSS	7	20X28X4VTM	0.787	1.102	0.157	TM	FKM	VCC	7
07172VTL-H	0.750	1.752	0.250	TL-H	FKM	VCS	7	20X28X4TM	0.787	1.102	0.157	TM	NBR	NCC	7
071753TB-H	0.750	1.752	0.312	TB-H	NBR	NCC	7	20X28X4VB	0.787	1.102	0.157	VB	NBR	NCO	7
071782SL	0.750	1.780	0.250	SL	NBR	NCC	7	20X28X4VC	0.787	1.102	0.157	VC	NBR	NCO	7
0717827TC	0.750	1.781	0.276	TC	NBR	NCC	7	20X28X4VM	0.787	1.102	0.157	VM	NBR	NCO	7
0718272SB-H	0.750	1.828	0.250	SB-H	NBR	NCC	7	20X28X5SC	0.787	1.102	0.197	SC	NBR	NCC	7
071822SL	0.750	1.828	0.250	SL	NBR	NCC	7	20X28X6SC	0.787	1.102	0.236	SC	NBR	NCC	7
07182SB-H	0.750	1.874	0.250	SB-H	NBR	NCC	7	20X28X6SEC	0.787	1.102	0.236	SEC	NBR	NCC	7
07182TB-H	0.750	1.874	0.250	TB-H	NBR	NCC	7	20X28X7SC	0.787	1.102	0.276	SC	NBR	NCC	7
07182SB	0.750	1.875	0.250	SB	NBR	NCC	7	0781115B	0.787	1.124	0.188	SB	NBR	NCC	7
07193TZ	0.750	1.980	0.375	TZ	NBR	NCC	7	0781115B-H	0.787	1.124	0.188	SB-H	NBR	NCC	7
0720431VTB-H	0.750	2.047	0.312	TB-H	FKM	VCS	7	20X29X9.5TM	0.787	1.142	0.374	TM	NBR	NCC	7
072043TB-H	0.750	2.047	0.312	TB-H	NBR	NCC	7	20X30X7TG	0.787	1.181	0.275	TG	NBR	NCC	7
07203SB	0.750	2.047	0.313	SB	NBR	NCC	7	20X30X7SB-H	0.787	1.181	0.276	SB-H	NBR	NCC	7
07203SB-H	0.750	2.047	0.313	SB-H	NBR	NCC	7	20X30X4.5VCSL	0.787	1.181	0.177	SCL	FKM	VCC	7
07212TB-H	0.750	2.127	0.250	TB-H	NBR	NCC	7	20X30X4.5TC	0.787	1.181	0.177	TC	NBR	NCC	7
SHAFT 0.780								20X30X5SC	0.787	1.181	0.197	SC	NBR	NCC	7
V-RING -020							7	20X30X5VTC	0.787	1.181	0.197	TC	FKM	VCS	7
19.8X30X5TC	0.780	1.181	0.197	TC	NBR	NCC	7	20X30X5TC	0.787	1.181	0.197	TC	NBR	NCC	7
0781319VL-H	0.780	1.375	0.196	VL-H	NBR	NCO	7	20X30X5VTF	0.787	1.181	0.197	TF	FKM	VCC	7
0781623SB-H	0.780	1.624	0.312	SB-H	NBR	NCC	7	20X30X6.5VTGL	0.787	1.181	0.256	TGL	FKM	VCC	7
0781822PSB-H	0.780	1.827	0.250	SB-H	ACM	PCC	7	20X30X7DC	0.787	1.181	0.276	DC	NBR	NCC	7
SHAFT 0.781								20X30X7SB	0.787	1.181	0.276	SB	NBR	NCC	7
SHAFT-EZE 99080								20X30X7SC	0.787	1.181	0.276	SC	NBR	NCC	7
S1								20X30X7VSGW12	0.787	1.181	0.276	SGW12	FKM	VCC	7
V-RING -020							7	20X30X7TC	0.787	1.181	0.276	TC	NBR	NCC	7
078122TB-H	0.781	1.250	0.250	TB-H	NBR	NCC	7	20X30X7TCY	0.787	1.181	0.276	TCY	NBR	NCS	7
078132SB-H	0.781	1.375	0.250	SB-H	NBR	NCC	7	20X30X7VTF	0.787	1.181	0.276	TF	FKM	VCS	7
078133VSB-H	0.781	1.375	0.312	SB-H	FKM	VCS	7	20X30X7TM	0.787	1.181	0.276	TM	NBR	NCC	7
078133VSB	0.781	1.375	0.313	SB	FKM	VCC	7	20X30X8SC	0.787	1.181	0.315	SC	NBR	NCC	7
078133SB	0.781	1.375	0.313	SB	NBR	NCC	7	20X31X7SB-H	0.787	1.220	0.275	SB-H	NBR	NCC	7
078133SB-H	0.781	1.375	0.313	SB-H	NBR	NCC	7	20X31X7VSC	0.787	1.220	0.276	SC	FKM	VCC	7
0781492SB-H	0.781	1.499	0.250	SB-H	NBR	NCC	7	20X31X7SC	0.787	1.220	0.276	SC	NBR	NCC	7
07143SB	0.781	1.499	0.313	SB	NBR	NCC	7	20X31X7TC	0.787	1.220	0.276	TC	NBR	NCC	7
07143SB-H	0.781	1.499	0.313	SB-H	NBR	NCC	7	20X32X7SB-H	0.787	1.259	0.275	SB-H	NBR	NCC	7
078162SB-H	0.781	1.624	0.250	SB-H	NBR	NCC	7	20X32X7TG	0.787	1.259	0.275	TG	NBR	NCC	7
0781631TB	0.781	1.624	0.313	TB	NBR	NCC	7	20X32X4VTM	0.787	1.260	0.157	TM	FKM	VCC	7
0781631TB-H	0.781	1.624	0.313	TB-H	NBR	NCC	7	20X32X4VC	0.787	1.260	0.157	VC	NBR	NCO	7
0781753TA-H	0.781	1.752	0.312	TA-H	NBR	NCC	7	20X32X5SC	0.787	1.260	0.197	SC	NBR	NCC	7
078182TB	0.781	1.828	0.250	TB	NBR	NCC	7	20X32X5VTC	0.787	1.260	0.197	TC	FKM	VCC	7
078182TB-H	0.781	1.828	0.250	TB-H	NBR	NCC	7	20X32X5TC	0.787	1.260	0.197	TC	NBR	NCC	7
SHAFT 0.782								20X32X6VTC	0.787	1.260	0.236	TC	FKM	VCS	7
SHAFT-EZE 99080							S1	20X32X7KC	0.787	1.260	0.276	KC	NBR	NCO	7
V-RING -020							7	20X32X7SC	0.787	1.260	0.276	SC	NBR	NCC	7
078173TZ	0.782	1.750	0.312	TZ	NBR	NCC	7	20X32X7TB	0.787	1.260	0.276	TB	NBR	NCC	7
SHAFT 0.787								20X32X7TC	0.787	1.260	0.276	TC	NBR	NCC	7
SHAFT-EZE 99078							S1	20X32X7PTC	0.787	1.260	0.315	TC	ACM	PCC	7
V-RING -020							7	20X32X8VTC	0.787	1.260	0.315	TC	FKM	VCC	7
20X24X2.5VC	0.787	0.945	0.098	VC	NBR	NCO	7	20X32X8TC	0.787	1.260	0.315	TC	NBR	NCC	7
20X24X2.5VM	0.787	0.945	0.098	VM	NBR	NCO	7	20X32X8TM	0.787	1.260	0.315	TM	NBR	NCC	7
20X26X4SM	0.787	1.024	0.157	SM	NBR	NCC	7	20X33X5TC	0.787	1.299	0.197	TC	NBR	NCC	7
20X26X4VTC	0.787	1.024	0.157	TC	FKM	VCC	7	20X33X8SC	0.787	1.299	0.315	SC	NBR	NCC	7
20X26X4TC	0.787	1.024	0.157	TC	NBR	NCC	7	20X33X10VTC	0.787	1.299	0.394	TC	FKM	VCC	7
20X26X4VC	0.787	1.024	0.157	VC	NBR	NCO	7	20X34X7SC	0.787	1.339	0.276	SC	NBR	NCC	7
20X26X4VM	0.787	1.024	0.157	VM	NBR	NCO	7	20X34X7TC	0.787	1.339	0.276	TC	NBR	NCC	7
20X26X5TC	0.787	1.024	0.197	TC	NBR	NCS	7	20X35X5.5TC	0.787	1.377	0.216	TC	NBR	NCC	7

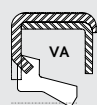
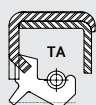

OIL AND GREASE SEALS - A COMPLETE LISTING



DICHTOMATIK

Any seal. Any time.

PLEASE CALL DICHTOMATIK FOR AVAILABILITY - 800-328-2840
BULK AND INDIVIDUALLY BOXED QUANTITIES ARE AVAILABLE FOR ALL

TCM Part #	Shaft	Bore	Width	Type	Lip Material	Material	Box #	TCM Part #	Shaft	Bore	Width	Type	Lip Material	Material	Box		
20X35X4TC	0.787	1.378	0.157	TC	NBR	NCC	7	20X42X5TC	0.787	1.654	0.197	TC	NBR	NCC	7		
20X35X5SC	0.787	1.378	0.197	SC	NBR	NCC	7	20X42X6SB	0.787	1.654	0.236	SB	NBR	NCC	7		
20X35X5.5SC	0.787	1.378	0.217	SC	NBR	NCC	7	20X42X6TB	0.787	1.654	0.236	TB	NBR	NCC	7		
20X35X6SC	0.787	1.378	0.236	SC	NBR	NCC	7	20X42X6VTC	0.787	1.654	0.236	TC	FKM	VCC	7		
20X35X6VTC	0.787	1.378	0.236	TC	FKM	VCC	7	20X42X6TC	0.787	1.654	0.236	TC	NBR	NCC	7		
20X35X6TC	0.787	1.378	0.236	TC	NBR	NCC	7	20X42X6VL	0.787	1.654	0.236	VL	NBR	NCO	7		
20X35X7VSB	0.787	1.378	0.276	SB	FKM	VCC	7	20X42X7SB	0.787	1.654	0.276	SB	NBR	NCC	7		
20X35X7SB	0.787	1.378	0.276	SB	NBR	NCC	7	20X42X7SC	0.787	1.654	0.276	SC	NBR	NCC	7		
20X35X7SB-H	0.787	1.378	0.276	SB-H	NBR	NCC	7	20X42X7TC	0.787	1.654	0.276	TC	NBR	NCC	7		
20X35X7VSC	0.787	1.378	0.276	SC	FKM	VCC	7	20X42X10SC	0.787	1.654	0.394	SC	NBR	NCC	7		
20X35X7SC	0.787	1.378	0.276	SC	NBR	NCC	7	20X42X10VSF	0.787	1.654	0.394	SF	FKM	VCS	7		
20X35X7SCW12	0.787	1.378	0.276	SCW12	FKM	VCC	7	20X42X10TC	0.787	1.654	0.394	TC	NBR	NCC	7		
20X35X7TC	0.787	1.378	0.276	TC	NBR	NCC	7	20X42X7SB-H	0.787	1.654	0.276	SB-H	NBR	NCC	7		
20X35X7VTF	0.787	1.378	0.276	TF	FKM	VCS	7	20X43X7.5VSF	0.787	1.693	0.295	SF	FKM	VCS	7		
20X35X7TG	0.787	1.378	0.276	TG	NBR	NCS	7	20X45X5TC	0.787	1.772	0.197	TC	NBR	NCC	7		
20X35X7VTGN2	0.787	1.378	0.276	TGN2	FKM	VCC	7	20X45X7TC	0.787	1.772	0.276	TC	NBR	NCC	7		
20X35X7HTGN2	0.787	1.378	0.276	TGN2	HNBR	HCC	7	20X45X10TC	0.787	1.772	0.394	TC	NBR	NCC	7		
20X35X8TC	0.787	1.378	0.315	TC	NBR	NCC	7	20X46X6SC	0.787	1.811	0.236	SC	NBR	NCC	7		
20X35X10SC	0.787	1.378	0.394	SC	NBR	NCC	7	20X46X7TC	0.787	1.811	0.276	TC	NBR	NCC	7		
20X35X10TC	0.787	1.378	0.394	TC	NBR	NCC	7	20X47X7SB-H	0.787	1.850	0.275	SB-H	NBR	NCC	7		
20X35.8X4TB	0.787	1.409	0.157	TB	NBR	NCC	7	20X47X7TG	0.787	1.850	0.275	TG	NBR	NCC	7		
20X35.8X4TM	0.787	1.409	0.157	TM	NBR	NCC	7	20X47X5TC	0.787	1.850	0.197	TC	NBR	NCC	7		
20X36X7SC	0.787	1.417	0.276	SC	NBR	NCC	7	20X47X7SC	0.787	1.850	0.276	SC	NBR	NCC	7		
20X36X7TC	0.787	1.417	0.276	TC	NBR	NCC	7	20X47X7VSF	0.787	1.850	0.276	SF	FKM	VCS	7		
20X36X8VTF	0.787	1.417	0.315	TF	FKM	VCS	7	20X47X7VSG	0.787	1.850	0.276	SG	FKM	VCC	7		
20X37X7SB-H	0.787	1.456	0.275	SB-H	NBR	NCC	7	20X47X7VTC	0.787	1.850	0.276	TC	FKM	VCC	7		
20X37X6SB	0.787	1.457	0.236	SB	NBR	NCC	7	20X47X7TC	0.787	1.850	0.276	TC	NBR	NCC	7		
20X37X7SC	0.787	1.457	0.276	SC	NBR	NCC	7	20X47X7VTF	0.787	1.850	0.276	TF	FKM	VCS	7		
20X37X7TC	0.787	1.457	0.276	TC	NBR	NCC	7	20X47X8SC	0.787	1.850	0.315	SC	NBR	NCC	7		
20X37X8SC	0.787	1.457	0.315	SC	NBR	NCC	7	20X47X8TC	0.787	1.850	0.315	TC	NBR	NCC	7		
20X37X8VTC	0.787	1.457	0.315	TC	FKM	VCC	7	20X47X10SC	0.787	1.850	0.394	SC	NBR	NCC	7		
20X37X8TC	0.787	1.457	0.315	TC	NBR	NCC	7	20X47X10TC	0.787	1.850	0.394	TC	NBR	NCC	7		
20X37X10SC	0.787	1.457	0.394	SC	NBR	NCC	7	20X47X13TC	0.787	1.850	0.512	TC	NBR	NCC	8		
20X37X10TC	0.787	1.457	0.394	TC	NBR	NCC	7	20X47.5X7TC	0.787	1.870	0.276	TC	NBR	NCC	7		
20X38X7TC	0.787	1.496	0.275	TC	NBR	NCC	7	20X48X7TC	0.787	1.890	0.276	TC	NBR	NCC	7		
20X38X7SB-H	0.787	1.496	0.276	SB	NBR	NCC	7	20X48X9SC	0.787	1.890	0.354	SC	NBR	NCC	7		
20X38X5TC	0.787	1.496	0.197	TC	NBR	NCC	7	20X50X7TC	0.787	1.969	0.276	TC	NBR	NCC	7		
20X38X7SC	0.787	1.496	0.276	SC	NBR	NCC	7	20X52X7SB-H	0.787	2.047	0.276	SB-H	NBR	NCC	7		
20X38X7VSF	0.787	1.496	0.276	SF	FKM	VCS	7	07820428VTC	0.787	2.047	0.280	TC	FKM	VCS	7		
20X38X8SC	0.787	1.496	0.315	SC	NBR	NCC	7	20X52X6SC	0.787	2.047	0.236	SC	NBR	NCC	7		
20X38X8TC	0.787	1.496	0.315	TC	NBR	NCC	7	20X52X6TC	0.787	2.047	0.236	TC	NBR	NCC	7		
20X40X4TC	0.787	1.575	0.157	TC	NBR	NCS	7	20X52X7SB	0.787	2.047	0.276	SB	NBR	NCC	7		
20X40X5KC	0.787	1.575	0.197	KC	NBR	NCO	7	20X52X7SC	0.787	2.047	0.276	SC	NBR	NCC	7		
20X40X5TC	0.787	1.575	0.197	TC	NBR	NCC	7	20X52X7VTC	0.787	2.047	0.276	TC	FKM	VCC	7		
20X40X6SC	0.787	1.575	0.236	SC	NBR	NCC	7	20X52X7TC	0.787	2.047	0.276	TC	NBR	NCC	7		
20X40X6VSF	0.787	1.575	0.236	SF	FKM	VCS	7	20X52X8TC	0.787	2.047	0.315	TC	NBR	NCC	7		
20X40X6VTF	0.787	1.575	0.236	TF	FKM	VCS	7	20X52X8VTGW	0.787	2.047	0.315	TGW	FKM	VCS	7		
20X40X7SB-H	0.787	1.575	0.276	SB-H	NBR	NCC	7	20X52X10SC	0.787	2.047	0.394	SC	NBR	NCC	7		
20X40X7SC	0.787	1.575	0.276	SC	NBR	NCC	7	20X52X10TC	0.787	2.047	0.394	TC	NBR	NCC	7		
20X40X7SSC	0.787	1.575	0.276	SC	NBR	NCS	7	20X62X6.5SC	0.787	2.441	0.256	SC	NBR	NCC	7		
20X40X7TC	0.787	1.575	0.276	TC	NBR	NCC	7	20X62X10TC	0.787	2.441	0.394	TC	NBR	NCC	7		
20X40X7VTF	0.787	1.575	0.276	TF	FKM	VCS	7	20X72X5SC	0.787	2.835	0.197	SC	NBR	NCC	8		
20X40X8VDC	0.787	1.575	0.315	DC	FKM	VCC	7	SHAFT 0.812									
20X40X8DC	0.787	1.575	0.315	DC	NBR	NCC	7	SHAFT-EZE 99083									
20X40X8TC	0.787	1.575	0.315	TC	NBR	NCC	7	V-RING -020									
20X40X9SC	0.787	1.575	0.354	SC	NBR	NCC	7	08111818SC	0.812	1.187	0.187	SC	NBR	NCC	7		
20X40X10VDC	0.787	1.575	0.394	DC	FKM	VCS	7	0811182SC	0.812	1.187	0.250	SC	NBR	NCC	7		
20X40X10SB	0.787	1.575	0.394	SB	NBR	NCC	7	0811218SB-H	0.812	1.250	0.187	SB-H	NBR	NCC	7		
20X40X10TC	0.787	1.575	0.394	TC	NBR	NCC	7	081122TB-H	0.812	1.250	0.250	TB-H	NBR	NCC	7		
20X40X10VTG4	0.787	1.575	0.394	TG4	FKM	VCS	7	081123SC	0.812	1.250	0.375	SC	NBR	NCC	7		
20X41X5TC	0.787	1.614	0.197	TC	NBR	NCC	7	0811239SC	0.812	1.250	0.391	SC	NBR	NCC	7		
20X41X7TC	0.787	1.614	0.276	TC	NBR	NCC	7	0811312SB-H	0.812	1.312	0.250	SB-H	NBR	NCC	7		
20X41.25X7TC	0.787	1.624	0.276	TC	NBR	NCC	7	081133VTB-H	0.812	1.375	0.312	TB-H	FKM	VCS	7		
20X42X7TG	0.787	1.653	0.275	TG	NBR	NCC	7	081133TB-H	0.812	1.375	0.312	TB-H	NBR	NCC	7		

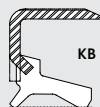
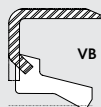
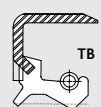
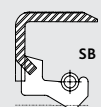
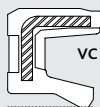



TCM Part #	Shaft	Bore	Width	Type	Lip Material	Material	Box	TCM Part #	Shaft	Bore	Width	Type	Lip Material	Material	Box #
081134SA	0.812	1.375	0.406	SA	NBR	NCC	7	22X28X4KC	0.866	1.102	0.157	KC	NBR	NCO	7
0811492SB-H	0.812	1.498	0.250	SB-H	NBR	NCC	7	22X29X4VG	0.866	1.142	0.157	VG	NBR	NCO	7
081153SA-H	0.812	1.575	0.375	SA-H	NBR	NCC	7	22X30X4SC	0.866	1.181	0.157	SC	NBR	NCC	7
081162VTB-H	0.812	1.624	0.250	TB-H	FKM	VCS	7	22X30X4TC	0.866	1.181	0.157	TC	NBR	NCC	7
0811753SB-H	0.812	1.751	0.375	SB-H	NBR	NCC	7	22X30X4XTC	0.866	1.181	0.157	TC	XNBR	XCS	7
0811752TB-H	0.812	1.752	0.250	TB-H	NBR	NCC	7	22X30X4VTF	0.866	1.181	0.157	TF	FKM	VCS	7
08243TB-H	0.812	2.441	0.375	TB-H	NBR	NCC	7	22X30X4VB	0.866	1.181	0.157	VB	NBR	NCO	7
SHAFT 0.813								22X30X7SC	0.866	1.181	0.276	SC	NBR	NCC	7
SHAFT-EZE 99083								22X30X7TC	0.866	1.181	0.276	TC	NBR	NCC	7
V-RING -020								22X30X8TC	0.866	1.181	0.315	TC	NBR	NCC	7
081101VC	0.813	1.063	0.125	VC	NBR	NCO	7	22X31X5SC	0.866	1.220	0.197	SC	NBR	NCC	7
0811182TC	0.813	1.188	0.250	TC	NBR	NCC	7	22X31X6TC	0.866	1.220	0.236	TC	NBR	NCC	7
081121SM	0.813	1.250	0.188	SM	NBR	NCC	7	22X32X7TG	0.866	1.259	0.275	TG	NBR	NCC	7
0811331VA3	0.813	1.375	0.313	VA3	NBR	NCO	7	22X32X3VM	0.866	1.260	0.118	VM	NBR	NCO	7
081133VSB	0.813	1.375	0.375	SB	FKM	VCS	7	22X32X4SC	0.866	1.260	0.157	SC	NBR	NCC	7
081133VSB-H	0.813	1.375	0.375	SB-H	FKM	VCS	7	22X32X5SC	0.866	1.260	0.197	SC	NBR	NCC	7
081133SB-H	0.813	1.375	0.375	SB-H	NBR	NCC	7	22X32X5TB	0.866	1.260	0.197	TB	NBR	NCC	7
081142TL	0.813	1.499	0.250	TL	NBR	NCC	7	22X32X5TC	0.866	1.260	0.197	TC	NBR	NCC	7
081152SC	0.813	1.500	0.250	SC	NBR	NCC	7	22X32X5.5VVG	0.866	1.260	0.217	TG	FKM	VCS	7
081162VSB	0.813	1.624	0.250	SB	FKM	VSS	7	22X32X6TA	0.866	1.260	0.236	TA	NBR	NCC	7
081162TB	0.813	1.624	0.250	TB	NBR	NCC	7	22X32X7SC	0.866	1.260	0.276	SC	NBR	NCC	7
081162TB-H	0.813	1.624	0.250	TB-H	NBR	NCC	7	22X32X7VSF	0.866	1.260	0.276	SF	FKM	VCS	7
081172SB	0.813	1.752	0.250	SB	NBR	NCC	7	22X32X7TC	0.866	1.260	0.276	TC	NBR	NCC	7
081203DMY	0.813	2.000	0.375	DMY	NBR	NSS	7	22X33X5TC	0.866	1.299	0.197	TC	NBR	NCC	7
SHAFT 0.827								22X33X7TC	0.866	1.299	0.276	TC	NBR	NCC	7
V-RING -020								22X34X5TC	0.866	1.339	0.197	TC	NBR	NCC	7
21X28X4SC	0.827	1.102	0.157	SC	NBR	NCC	7	22X35X7SG	0.866	1.377	0.275	SG	NBR	NCC	7
21X28X5.5TB	0.827	1.102	0.217	TB	NBR	NCC	7	22X35X7TG	0.866	1.377	0.275	TG	NBR	NCC	7
21X29X4KC	0.827	1.142	0.157	KC	NBR	NCO	7	22X35X5TC	0.866	1.378	0.197	TC	NBR	NCC	7
21X29X4VC	0.827	1.142	0.157	VC	NBR	NCO	7	22X35X6TB	0.866	1.378	0.236	TB	NBR	NCC	7
21X29X4VG1	0.827	1.142	0.157	VG1	NBR	NCO	7	22X35X6TC	0.866	1.378	0.236	TC	NBR	NCC	7
21X30X6.5SC	0.827	1.181	0.256	SC	NBR	NCC	7	22X35X6TM	0.866	1.378	0.256	TM	NBR	NCC	7
21X30X6.5TC	0.827	1.181	0.256	TC	NBR	NCC	7	22X35X7VSB	0.866	1.378	0.276	SB	FKM	VCS	7
21X30X6/6.4TCN	0.827	1.181	0.236/0.252	TCN	NBR	NCC	7	22X35X7SB	0.866	1.378	0.276	SB	NBR	NCC	7
21X32X5SC	0.827	1.260	0.197	SC	NBR	NCC	7	22X35X7SC	0.866	1.378	0.276	SC	NBR	NCC	7
21X32X7SC	0.827	1.260	0.276	SC	NBR	NCC	7	22X35X7VSF	0.866	1.378	0.276	SF	FKM	VCS	7
21X32X8TC	0.827	1.260	0.315	TC	NBR	NCC	7	22X35X7TB	0.866	1.378	0.276	TB	NBR	NCC	7
21X33X7TC	0.827	1.299	0.276	TC	NBR	NCC	7	22X35X7TC	0.866	1.378	0.276	TC	NBR	NCC	7
21X35X7TG	0.827	1.377	0.275	TG	NBR	NCC	7	22X35X7VTF	0.866	1.378	0.276	TF	FKM	VCS	7
21X35X6TC	0.827	1.378	0.236	TC	NBR	NCC	7	22X35X8TC	0.866	1.378	0.315	TC	NBR	NCC	7
21X35X7TC	0.827	1.378	0.276	TC	NBR	NCC	7	22X35X10SC	0.866	1.378	0.394	SC	NBR	NCC	7
21X35X8SC	0.827	1.378	0.315	SC	NBR	NCC	7	22X35X10TB	0.866	1.378	0.394	TB	NBR	NCC	7
21X36X7TC	0.827	1.417	0.276	TC	NBR	NCC	7	22X35X7SB-H	0.866	1.378	0.276	SB-H	NBR	NCC	7
21X37X7SC	0.827	1.457	0.276	SC	NBR	NCC	7	22X36X5TC	0.866	1.417	0.197	TC	NBR	NCC	7
21X37X7TC	0.827	1.457	0.276	TC	NBR	NCC	7	22X36X7SC	0.866	1.417	0.276	SC	NBR	NCC	7
21X40X5SC	0.827	1.575	0.197	SC	NBR	NCC	7	22X36X7TC	0.866	1.417	0.276	TC	NBR	NCC	7
21X40X7TC	0.827	1.575	0.276	TC	NBR	NCC	7	22X36X8TC	0.866	1.417	0.315	TC	NBR	NCC	7
21X48X8TC	0.827	1.890	0.315	TC	NBR	NCC	7	22X36X10TC	0.866	1.417	0.394	TC	NBR	NCC	7
21X52X8SC	0.827	2.047	0.315	SC	NBR	NCC	7	22X37X6TC	0.866	1.457	0.236	TC	NBR	NCC	7
SHAFT 0.843								22X37X7TB	0.866	1.457	0.276	TB	NBR	NCC	7
V-RING -022								22X37X7TC	0.866	1.457	0.276	TC	NBR	NCC	7
084133TB-H	0.843	1.374	0.312	TB-H	NBR	NCC	7	22X38X7SC	0.866	1.496	0.275	SC	NBR	NCC	7
084183TB-H	0.843	1.828	0.312	TB-H	NBR	NCC	7	22X38X5TC	0.866	1.496	0.197	TC	NBR	NCC	7
SHAFT 0.844								22X38X6SC	0.866	1.496	0.236	SC	NBR	NCC	7
V-RING -022								22X38X7VTC	0.866	1.496	0.276	TC	FKM	VCC	7
0841831TB	0.844	1.828	0.313	TB	NBR	NCC	7	22X38X7TC	0.866	1.496	0.276	TC	NBR	NCC	7
0841831TB-H	0.844	1.828	0.313	TB-H	NBR	NCC	7	22X38X8SC	0.866	1.496	0.315	SC	NBR	NCC	7
SHAFT 0.866								22X38X10TC	0.866	1.496	0.394	TC	NBR	NCC	7
SHAFT-EZE 99084								22X39X6TC	0.866	1.535	0.236	TC	NBR	NCC	7
SHAFT-EZE 99085								22X40X4VTC	0.866	1.575	0.157	TC	FKM	VCC	7
V-RING -022								22X40X4TC	0.866	1.575	0.157	TC	NBR	NCC	7
22X28X5TC	0.866	1.102	0.197	TC	NBR	NCS	7	22X40X5VSF	0.866	1.575	0.197	SF	FKM	VCS	7
								22X40X5TC	0.866	1.575	0.197	TC	NBR	NCC	7
								22X40X7VSCW12	0.866	1.575	0.276	SCW12	FKM	VCC	7

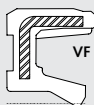
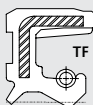
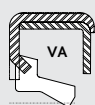
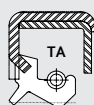

OIL AND GREASE SEALS - A COMPLETE LISTING



DICHTOMATIK

Any seal. Any time.

PLEASE CALL DICHTOMATIK FOR AVAILABILITY - 800-328-2840
BULK AND INDIVIDUALLY BOXED QUANTITIES ARE AVAILABLE FOR ALL

TCM Part #	Shaft	Bore	Width	Type	Lip Material	Material	Box #	TCM Part #	Shaft	Bore	Width	Type	Lip Material	Material	Box
22X40X7VTB	0.866	1.575	0.276	TB	FKM	VCC	7	08122VC	0.875	1.250	0.250	VC	NBR	NCO	7
22X40X7TB	0.866	1.575	0.276	TB	NBR	NCC	7	08123DMY	0.875	1.250	0.375	DMY	NBR	NSS	7
22X40X7VTC	0.866	1.575	0.276	TC	FKM	VCS	7	0812518VL-H	0.875	1.251	0.187	VL-H	NBR	NCO	7
22X40X7TC	0.866	1.575	0.276	TC	NBR	NCC	7	087121PVB	0.875	1.255	0.182	VB	ACM	PCO	7
22X40X7VTF	0.866	1.575	0.276	TF	FKM	VCS	7	081302VSB-H	0.875	1.307	0.250	SB-H	FKM	VCS	7
22X40X8SC	0.866	1.575	0.315	SC	NBR	NCC	7	081302VL-H	0.875	1.307	0.250	VL-H	NBR	NCO	7
22X40X10VTG4	0.866	1.575	0.394	TG4	FKM	VCS	7	081302VL	0.875	1.308	0.250	VL	NBR	NCO	7
22X40X16TC	0.866	1.575	0.630	TC	NBR	NCC	8	081312VL-H	0.875	1.311	0.250	VL-H	NBR	NCO	7
22X41X7TC	0.866	1.614	0.276	TC	NBR	NCC	7	0813731TG-G	0.875	1.374	0.312	TG-G	NBR	NCC	7
22X41.25X6TC	0.866	1.624	0.236	TC	NBR	NCC	7	081318SC	0.875	1.375	0.187	SC	NBR	NCC	7
22X41.5X6TC	0.866	1.634	0.236	TC	NBR	NCC	7	0813718VL-H	0.875	1.375	0.187	VL-H	NBR	NCO	7
22X41.5X7TB	0.866	1.634	0.276	TB	NBR	NCC	7	08131VM	0.875	1.375	0.188	VM	NBR	NCO	7
22X42X7SB-H	0.866	1.653	0.275	SB-H	NBR	NCC	7	08132VSB	0.875	1.375	0.250	SB	FKM	VCS	7
22X42X10SC	0.866	1.653	0.393	SC	NBR	NCC	7	08132SB	0.875	1.375	0.250	SB	NBR	NCC	7
22X42X5TC	0.866	1.654	0.197	TC	NBR	NCC	7	08132VSB-H	0.875	1.375	0.250	SB-H	FKM	VCS	7
22X42X7SC	0.866	1.654	0.276	SC	NBR	NCC	7	08132SB-H	0.875	1.375	0.250	SB-H	NBR	NCC	7
22X42X7SCY	0.866	1.654	0.276	SCY	NBR	NCS	7	08132SC	0.875	1.375	0.250	SC	NBR	NCC	7
22X42X7TC	0.866	1.654	0.276	TC	NBR	NCC	7	08132TB	0.875	1.375	0.250	TB	NBR	NCC	7
22X42X7TCN1	0.866	1.654	0.276	TCN1	FKM	VCC	7	08132VTB-H	0.875	1.375	0.250	TB-H	FKM	VCS	7
22X42X10TB	0.866	1.654	0.394	TB	NBR	NCC	7	08132VTB-H	0.875	1.375	0.250	TB-H	FKM	VCS	7
22X42X10TC	0.866	1.654	0.394	TC	NBR	NCC	7	08132TB-H	0.875	1.375	0.250	TB-H	NBR	NCC	7
22X45X7SC	0.866	1.772	0.276	SC	NBR	NCC	7	08132TBY	0.875	1.375	0.250	TBY	NBR	NCC	7
22X45X7TC	0.866	1.772	0.276	TC	NBR	NCC	7	08132TBY-H	0.875	1.375	0.250	TBY-H	NBR	NCC	7
22X45X8TC	0.866	1.772	0.315	TC	NBR	NCC	7	08132TC	0.875	1.375	0.250	TC	NBR	NCC	7
22X45X10SC	0.866	1.772	0.394	SC	NBR	NCC	7	08132VTLN22-H	0.875	1.375	0.250	TLN22-H	FKM	VCS	7
22X47X7SC	0.866	1.850	0.276	SC	NBR	NCC	7	08132TLN22-H	0.875	1.375	0.250	TLN22-H	NBR	NCC	7
22X47X7TC	0.866	1.850	0.276	TC	NBR	NCC	7	08132SC	0.875	1.375	0.252	SC	NBR	NCC	7
22X47X7VTF	0.866	1.850	0.276	TF	FKM	VCS	7	08133PSA	0.875	1.375	0.312	SA	ACM	PCC	7
22X47X7VM	0.866	1.850	0.276	VM	NBR	NCO	7	081331SB	0.875	1.375	0.312	SB	NBR	NCC	7
22X47X9TA	0.866	1.850	0.354	TA	NBR	NCC	7	08133TA	0.875	1.375	0.312	TA	NBR	NCC	7
22X47X10TC	0.866	1.850	0.394	TC	NBR	NCC	7	08133TA-H	0.875	1.375	0.312	TA-H	NBR	NCC	7
22X48X7TC	0.866	1.890	0.276	TC	NBR	NCC	7	08133SB	0.875	1.375	0.375	SB	NBR	NCC	7
22X50X8SB-H	0.866	1.968	0.314	SB-H	NBR	NCC	7	081340TM	0.875	1.375	0.406	TM	NBR	NSS	7
22X50X5TC	0.866	1.969	0.197	TC	NBR	NCC	7	081382TBY-H	0.875	1.385	0.250	TBY-H	NBR	NSS	7
22X50X10TF	0.866	1.969	0.394	TF	NBR	NCS	7	081432SB-H	0.875	1.437	0.250	SB-H	NBR	NCC	7
22X50X8X9.52TC	0.866	2.000	0.375	TC	NBR	NCC	7	081432VL-H	0.875	1.437	0.250	VL-H	NBR	NCO	7
22X52X10TC	0.866	2.047	0.394	TC	NBR	NCC	7	08142SB	0.875	1.499	0.250	SB	NBR	NCC	7
22X55X7TC	0.866	2.165	0.276	TC	NBR	NCC	7	081492SB-H	0.875	1.499	0.250	SB-H	NBR	NCC	7
SHAFT 0.875								081492VTB-H	0.875	1.499	0.250	TB-H	FKM	VCS	7
SHAFT-EZE 99087							S1	08142VTB-H	0.875	1.499	0.250	TB-H	FKM	VCS	7
V-RING -022							7	08142TB-H	0.875	1.499	0.250	TB-H	NBR	NCC	7
08111VB	0.875	1.125	0.125	VB	NBR	NCO	7	0814931SSA	0.875	1.499	0.312	SA	VMQ	SCC	7
08111VL-H	0.875	1.125	0.125	VL-H	NBR	NCC	7	0814931SB-H	0.875	1.499	0.312	SB-H	NBR	NCC	7
08111VM	0.875	1.125	0.125	VM	NBR	NCO	7	08153SB	0.875	1.499	0.313	SB	NBR	NCC	7
0871121VB	0.875	1.128	0.125	VB	NBR	NCO	7	0814939TL-H	0.875	1.499	0.390	TL-H	NBR	NCC	7
087111VM	0.875	1.187	0.164	VM	NBR	NCO	7	081531VTC	0.875	1.500	0.313	TC	FKM	VCS	7
087111VZ	0.875	1.187	0.164	VZ	NBR	NCO	7	08153TC	0.875	1.500	0.313	TC	NBR	NCC	7
0811818SC	0.875	1.187	0.187	SC	NBR	NCC	7	081503TB-H	0.875	1.501	0.312	TB-H	NBR	NCC	7
0811818VC	0.875	1.187	0.187	VC	NBR	NCO	7	08152SB	0.875	1.575	0.250	SB	NBR	NCC	7
081191VM	0.875	1.190	0.188	VM	NBR	NCO	7	08152SB-H	0.875	1.575	0.250	SB-H	NBR	NCC	7
0812418VL-H	0.875	1.246	0.187	VL-H	NBR	NCO	7	08152TB-H	0.875	1.577	0.250	TB-H	NBR	NCC	7
081241VL	0.875	1.246	0.188	VL	NBR	NCO	7	081622VSB-H	0.875	1.624	0.250	SB-H	FKM	VCS	7
08121VB	0.875	1.250	0.182	VB	NBR	NCO	7	08162SB-H	0.875	1.624	0.250	SB-H	NBR	NCC	7
08121VB-H	0.875	1.250	0.182	VB-H	NBR	NCO	7	08162TB	0.875	1.624	0.250	TB	NBR	NCC	7
08121SB	0.875	1.250	0.188	SB	NBR	NCC	7	08162TB-H	0.875	1.624	0.250	TB-H	NBR	NCC	7
08121SB-H	0.875	1.250	0.188	SB-H	NBR	NCC	7	081622VTC	0.875	1.624	0.250	TC	FKM	VCS	7
081218VSCW	0.875	1.250	0.188	SCW	FKM	VCS	7	0816225VTB-H	0.875	1.624	0.255	TB-H	FKM	VCS	7
08121SZ	0.875	1.250	0.188	SZ	NBR	NCC	7	081737TC	0.875	1.750	0.375	TC	NBR	NCC	7
08121TB	0.875	1.250	0.188	TB	NBR	NCC	7	081752SB-H	0.875	1.751	0.250	SB-H	NBR	NCC	7
08121TB-H	0.875	1.250	0.188	TB-H	NBR	NCC	7	08172TB	0.875	1.752	0.250	TB	NBR	NCC	7
081218TBY	0.875	1.250	0.188	TBY	NBR	NSS	7	08172TB-H	0.875	1.752	0.250	TB-H	NBR	NCC	7
08122VSB	0.875	1.250	0.250	SB	FKM	VSS	7	081822SB-H	0.875	1.827	0.250	SB-H	NBR	NCC	7
08122VSB-H	0.875	1.250	0.250	SB-H	FKM	VSS	7	08183TB	0.875	1.828	0.375	TB	NBR	NCC	7
08122SC	0.875	1.250	0.250	SC	NBR	NCC	7	08183TB-H	0.875	1.828	0.375	TB-H	NBR	NCC	7

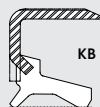
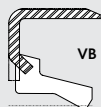
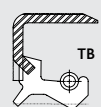
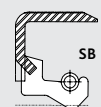
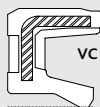



TCM Part #	Shaft	Bore	Width	Type	Lip Material	Material	Box	TCM Part #	Shaft	Bore	Width	Type	Lip Material	Material	Box #
08182SB	0.875	1.874	0.250	SB	NBR	NCC	7	093142TB-H	0.937	1.499	0.250	TB-H	NBR	NCC	7
08182SB-H	0.875	1.874	0.250	SB-H	NBR	NCC	7	093162TB	0.937	1.624	0.250	TB	NBR	NCC	7
08182TB-H	0.875	1.874	0.250	TB-H	NBR	NCC	7	093162TB-H	0.937	1.624	0.250	TB-H	NBR	NCC	7
08202SB	0.875	2.000	0.250	SB	NBR	NCC	7	093173TC	0.937	1.746	0.312	TC	NBR	NCC	7
08202SB-H	0.875	2.000	0.250	SB-H	NBR	NCC	7	093173TB-H	0.937	1.750	0.312	TB-H	NBR	NCC	7
082053VSA-H	0.875	2.050	0.375	SA-H	FKM	VCS	7	09173TC	0.937	1.750	0.312	TC	NBR	NCC	7
SHAFT 0.878								093172TB-H	0.937	1.752	0.250	TB-H	NBR	NCC	7
V-RING -022							7	09184SA-H	0.937	1.828	0.437	SA-H	NBR	NCC	7
08121SAY	0.878	1.249	0.188	SAY	NBR	NSS	7	SHAFT 0.938							
08121SA	0.878	1.249	0.197	SA	NBR	NSS	7	V-RING -022							7
SHAFT 0.886								093132TB-H	0.938	1.375	0.250	TB-H	NBR	NCC	7
V-RING -022							7	09132VTC	0.938	1.375	0.250	TC	FKM	VCS	7
22.5X35X6TC	0.886	1.378	0.236	TC	NBR	NCC	7	093152VSB-H	0.938	1.500	0.250	SB-H	FKM	VCS	7
SHAFT 0.906								093152SB-H	0.938	1.500	0.250	SB-H	NBR	NCC	7
V-RING -022							7	093162SAY	0.938	1.624	0.250	SAY	NBR	NCS	7
23X28X3VM	0.906	1.102	0.118	VM	NBR	NCO	7	093162SB	0.938	1.624	0.250	SB	NBR	NCC	7
23X29X3.2VC	0.906	1.142	0.126	VC	NBR	NCO	7	093162SB-H	0.938	1.624	0.250	SB-H	NBR	NCC	7
23X32X5KC	0.906	1.260	0.197	KC	NBR	NCO	7	093172SB-H	0.938	1.752	0.250	SB-H	NBR	NCC	7
23X32X5SB	0.906	1.260	0.197	SB	NBR	NCC	7	093182SB	0.938	1.828	0.250	SB	NBR	NCC	7
23X32X5TC	0.906	1.260	0.197	TC	NBR	NCC	7	093182SB-H	0.938	1.828	0.250	SB-H	NBR	NCC	7
23X32X5TM	0.906	1.260	0.197	TM	NBR	NCC	7	092043TC	0.938	2.048	0.312	TC	NBR	NCC	7
23X32X5VC	0.906	1.260	0.197	VC	NBR	NCO	7	09324432VTC	0.938	2.446	0.320	TC	FKM	VCS	7
23X32X7TC	0.906	1.260	0.276	TC	NBR	NCC	7	09328331VTC	0.938	2.835	0.315	TC	FKM	VCS	8
23X34X8TC	0.906	1.339	0.315	TC	NBR	NCC	7	SHAFT 0.945							
23X34X8TEC	0.906	1.339	0.315	TEC	NBR	NCC	7	SHAFT-EZE 99092							S1
23X35X6TC	0.906	1.378	0.236	TC	NBR	NCC	7	V-RING -022							7
23X35X7SC	0.906	1.378	0.276	SC	NBR	NCC	7	24X31X3KC	0.945	1.220	0.118	KC	NBR	NCO	7
23X35X7TC	0.906	1.378	0.276	TC	NBR	NCC	7	24X31X7TC	0.945	1.220	0.276	TC	NBR	NCC	7
23X36X6TC	0.906	1.417	0.236	TC	NBR	NCC	7	24X32X4VTC	0.945	1.260	0.157	TC	FKM	VCS	7
23X37X6TC	0.906	1.457	0.236	TC	NBR	NCC	7	24X32X4VTF	0.945	1.260	0.157	TF	FKM	VCS	7
23X37X7SC	0.906	1.457	0.276	SC	NBR	NCC	7	24X32X4XTF	0.945	1.260	0.157	TF	XNBR	XCS	7
23X38X7TC	0.906	1.496	0.276	TC	NBR	NCC	7	24X32X4VTM	0.945	1.260	0.157	TM	FKM	VCC	7
23X38X8VSF	0.906	1.496	0.315	SF	FKM	VCS	7	24X32X4TM	0.945	1.260	0.157	TM	NBR	NCC	7
090143TB-H	0.906	1.499	0.390	TB-H	NBR	NCC	7	24X32X4VG	0.945	1.260	0.157	VG	NBR	NCO	7
23X40X6TC	0.906	1.575	0.236	TC	NBR	NCC	7	24X32X4VM	0.945	1.260	0.157	VM	NBR	NCO	7
23X40X7TB	0.906	1.575	0.276	TB	NBR	NCC	7	24X32X5SM	0.945	1.260	0.197	SM	NBR	NCC	7
23X40X7PTCL	0.906	1.575	0.276	TCL	ACM	PCC	7	24X32X7SB-U	0.945	1.260	0.276	SB-U	NBR	NCC	7
23X40X8SC	0.906	1.575	0.315	SC	NBR	NCC	7	24X32X7TM	0.945	1.260	0.276	TM	NBR	NCC	7
23X40X10SC	0.906	1.575	0.394	SC	NBR	NCC	7	24X34X5.5SC	0.945	1.339	0.217	SC	NBR	NCC	7
23X40X10TC	0.906	1.575	0.394	TC	NBR	NCC	7	24X34X7TC	0.945	1.339	0.276	TC	NBR	NCC	7
23X42X6TC	0.906	1.654	0.236	TC	NBR	NCC	7	24X35X5SM	0.945	1.378	0.197	SM	NBR	NCC	7
23X42X7TC	0.906	1.654	0.276	TC	NBR	NCC	7	24X35X5.5TC	0.945	1.378	0.217	TC	NBR	NCC	7
23X42X10SA	0.906	1.654	0.394	SA	NBR	NCC	7	24X35X6SC	0.945	1.378	0.236	SC	NBR	NCC	7
23X43X8TC	0.906	1.693	0.315	TC	NBR	NCC	7	24X35X6TC	0.945	1.378	0.236	TC	NBR	NCC	7
23X43X9TC	0.906	1.693	0.354	TC	NBR	NCC	7	24X35X7VSC	0.945	1.378	0.276	SC	FKM	VCS	7
23X45X11TC	0.906	1.772	0.433	TC	NBR	NCC	7	24X35X7SC	0.945	1.378	0.276	SC	NBR	NCC	7
23X47X7TC	0.906	1.850	0.276	TC	NBR	NCC	7	24X35X7VTC	0.945	1.378	0.276	TC	FKM	VCC	7
23X47X10TC	0.906	1.850	0.394	TC	NBR	NCC	7	24X35X7TC	0.945	1.378	0.276	TC	NBR	NCC	7
23X48X10TC	0.906	1.890	0.394	TC	NBR	NCC	7	24X35X8TC	0.945	1.378	0.315	TC	NBR	NCC	7
23X52X10TC	0.906	2.047	0.394	TC	NBR	NCC	7	24X35X8VTF	0.945	1.378	0.315	TF	FKM	VCS	7
23X52X12SC	0.906	2.047	0.472	SC	NBR	NCC	7	24X35X10.5TCY	0.945	1.378	0.413	TCY	NBR	NCC	7
23X52X12VSF	0.906	2.047	0.472	SF	FKM	VCS	7	24X36X6SC	0.945	1.417	0.236	SC	NBR	NCC	7
23X55X8TB	0.906	2.165	0.315	TB	NBR	NCC	7	24X36X7VTC	0.945	1.417	0.276	TC	FKM	VCC	7
SHAFT 0.937								24X36X7TC	0.945	1.417	0.276	TC	NBR	NCC	7
V-RING -022							7	24X36.5X8VTC	0.945	1.437	0.315	TC	FKM	VCS	7
09311809VM	0.937	1.183	0.094	VM	NBR	NCO	7	24X37X7VSC	0.945	1.457	0.276	SC	FKM	VCS	7
09132VVC	0.937	1.375	0.250	VC	FKM	VCO	7	24X37X7SC	0.945	1.457	0.276	SC	NBR	NCC	7
093132VC	0.937	1.375	0.250	VC	NBR	NCO	7	24X37X7TC	0.945	1.457	0.276	TC	NBR	NCC	7
093132VL-H	0.937	1.375	0.250	VL-H	NBR	NCO	7	24X38X7TC	0.945	1.496	0.276	TC	NBR	NCC	7
093133TB-H	0.937	1.375	0.312	TB-H	NBR	NCC	7	24X38X8VSB	0.945	1.496	0.315	SB	FKM	VSS	7
093142TB	0.937	1.499	0.250	TB	NBR	NCC	7	24X38X8TC	0.945	1.496	0.315	TC	NBR	NCC	7
093142VTB-H	0.937	1.499	0.250	TB-H	FKM	VCS	7	24X38X10TC	0.945	1.496	0.394	TC	NBR	NCC	7
								24X38.2X7TC	0.945	1.504	0.276	TC	NBR	NCC	7

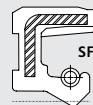
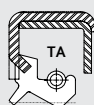

OIL AND GREASE SEALS - A COMPLETE LISTING

PLEASE CALL DICHTOMATIK FOR AVAILABILITY - 800-328-2840
BULK AND INDIVIDUALLY BOXED QUANTITIES ARE AVAILABLE FOR ALL



DICHTOMATIK

Any seal. Any time.

TCM Part #	Shaft	Bore	Width	Type	Lip Material	Material	Box #	TCM Part #	Shaft	Bore	Width	Type	Lip Material	Material	Box
24X39X8SC	0.945	1.535	0.315	SC	NBR	NCC	7	09243TB-H	0.968	2.440	0.375	TB-H	NBR	NCC	7
24X40X7SC	0.945	1.575	0.276	SC	NBR	NCC	7	SHAFT 0.969							
24X40X7VTC	0.945	1.575	0.276	TC	FKM	VCS	7	SHAFT-EZE 99094							
24X40X7TC	0.945	1.575	0.276	TC	NBR	NCC	7	SHAFT-EZE 99096							
24X40X7VTF	0.945	1.575	0.276	TF	FKM	VCS	7	V-RING -025							
24X41X10SC	0.945	1.614	0.394	SC	NBR	NCC	7	09614931VSB-H	0.969	1.499	0.312	SB-H	FKM	VCS	7
24X42X7TC	0.945	1.654	0.276	TC	NBR	NCC	7	09614931SB-H	0.969	1.499	0.312	SB-H	NBR	NCC	7
24X42X8SC	0.945	1.654	0.315	SC	NBR	NCC	7	091435A	0.969	1.499	0.313	SA	NBR	NCC	7
24X42X8VTC	0.945	1.654	0.315	TC	FKM	VCC	7	091435A-H	0.969	1.499	0.313	SA-H	NBR	NCC	7
24X42X8TC	0.945	1.654	0.315	TC	NBR	NCC	7	091435B	0.969	1.499	0.313	SB	NBR	NCC	7
24X42X10SA	0.945	1.654	0.394	SA	NBR	NCC	7	09162VSB	0.969	1.624	0.250	SB	FKM	VCS	7
24X43X6TC	0.945	1.693	0.236	TC	NBR	NCC	7	091625B-H	0.969	1.624	0.250	SB-H	NBR	NCC	7
24X44X7TC	0.945	1.732	0.276	TC	NBR	NCC	7	0961683TB-H	0.969	1.685	0.312	TB-H	NBR	NCC	7
24X45X6TC	0.945	1.772	0.236	TC	NBR	NCC	7	0916831SB-H	0.969	1.686	0.312	SB-H	NBR	NCC	7
24X45X11TC	0.945	1.772	0.433	TC	NBR	NCC	7	091683SL	0.969	1.686	0.313	SL	NBR	NCC	7
24X46X10TC	0.945	1.811	0.394	TC	NBR	NCC	7	091725B	0.969	1.752	0.250	SB	NBR	NCC	7
24X47X7SB	0.945	1.850	0.276	SB	NBR	NCC	7	091725B-H	0.969	1.752	0.250	SB-H	NBR	NCC	7
24X47X7VTC	0.945	1.850	0.276	TC	FKM	VCC	7	09618235B-H	0.969	1.827	0.312	SB-H	NBR	NCC	7
24X47X7TC	0.945	1.850	0.276	TC	NBR	NCC	7	0961845B	0.969	1.828	0.438	SB	NBR	NCC	7
24X47X10SC	0.945	1.850	0.394	SC	NBR	NCC	7	09242TC	0.969	2.440	0.250	TC	NBR	NCC	7
24X47X10TC	0.945	1.850	0.394	TC	NBR	NCC	7	SHAFT 0.979							
24X48X7TC	0.945	1.890	0.276	TC	NBR	NCC	7	V-RING -025							
24X49X8TC	0.945	1.929	0.315	TC	NBR	NCC	7	097121VMY	0.979	1.250	0.125	VMY	NBR	NSO	7
24X49X12TC	0.945	1.929	0.472	TC	NBR	NCC	7	SHAFT 0.983							
24X49X18TC	0.945	1.929	0.709	TC	NBR	NCC	8	SHAFT-EZE 99098							
24X50X10TC	0.945	1.969	0.394	TC	NBR	NCC	7	V-RING -025							
24X50X12TC	0.945	1.969	0.472	TC	NBR	NCC	7	2497X31.75X3VM	0.983	1.250	0.118	VM	NBR	NCO	7
24X52X7TC	0.945	2.047	0.276	TC	NBR	NCC	7	09818427ASC	0.983	1.848	0.276	SC	NBR	NCC	7
24X52X10TC	0.945	2.047	0.394	TC	NBR	NCC	7	SHAFT 0.984							
24X55X10TC	0.945	2.165	0.394	TC	NBR	NCC	7	SHAFT-EZE 99098							
09424431VTB-H	0.945	2.440	0.315	TB-H	FKM	VCS	7	V-RING -025							
24X62X7SC	0.945	2.441	0.276	SC	NBR	NCC	7	25X30X4VM	0.984	1.181	0.157	VM	NBR	NCO	7
SHAFT 0.950								25X32X4VTC	0.984	1.260	0.157	TC	FKM	VCC	7
V-RING -025							7	25X32X4TM	0.984	1.260	0.157	TM	NBR	NCC	7
095132PSB	0.950	1.358	0.275	SB	ACM	PCS	7	25X32X4VC	0.984	1.260	0.157	VC	NBR	NCO	7
SHAFT 0.953								25X32X4VVM	0.984	1.260	0.157	VM	FKM	VCO	7
V-RING -025							7	25X32X4VM	0.984	1.260	0.157	VM	NBR	NCO	7
09513627PSM	0.953	1.361	0.274	SM	ACM	PCS	7	25X32X4VVMY	0.984	1.260	0.157	VMY	FKM	VCO	7
SHAFT 0.965								25X32X5TC	0.984	1.260	0.197	TC	NBR	NCC	7
V-RING -025							7	25X32X6SC	0.984	1.260	0.236	SC	NBR	NCC	7
24.5X40X8.5VSC0.965	1.575	0.335	0.335	SC	FKM	VCS	7	25X32X6TC	0.984	1.260	0.236	TC	NBR	NCC	7
SHAFT 0.968								25X32X7SC	0.984	1.260	0.276	SC	NBR	NCC	7
SHAFT-EZE 99094							S1	25X32X7SM	0.984	1.260	0.276	SM	NBR	NCC	7
SHAFT-EZE 99096							S1	25X32X7SMY	0.984	1.260	0.276	SMY	NBR	NSS	7
V-RING -025							7	25X32X7PTM	0.984	1.260	0.276	TM	ACM	PCC	7
09614935A-H	0.968	1.499	0.312	SA-H	NBR	NCC	7	25X33X4KC	0.984	1.299	0.157	KC	NBR	NCO	7
091625AY	0.968	1.624	0.250	SAY	NBR	NCC	7	25X33X45C	0.984	1.299	0.157	SC	NBR	NCC	7
09162TB-H	0.968	1.624	0.250	TB-H	NBR	NCC	7	25X33X4TM	0.984	1.299	0.157	TM	NBR	NCC	7
091683TC	0.968	1.688	0.312	TC	NBR	NCC	7	25X33X4VVG	0.984	1.299	0.157	VG	FKM	VCO	7
096173TC	0.968	1.750	0.312	TC	NBR	NCC	7	25X33X6SC	0.984	1.299	0.236	SC	NBR	NCC	7
096173VTFY	0.968	1.750	0.312	TFY	FKM	VCS	7	25X33X6SG	0.984	1.299	0.236	SG	NBR	NCC	7
09172TB-H	0.968	1.752	0.250	TB-H	NBR	NCC	7	25X33X6VTC	0.984	1.299	0.236	TC	FKM	VCC	7
096182435A-H	0.968	1.828	0.437	SA-H	NBR	NCC	7	25X33X7TC	0.984	1.299	0.276	TC	NBR	NCC	7
0961845A-H	0.968	1.828	0.437	SA-H	NBR	NCC	7	25X34X5TM	0.984	1.339	0.197	TM	NBR	NCC	7
0918535B-H	0.968	1.850	0.375	SB-H	NBR	NCC	7	25X34X7TC	0.984	1.339	0.276	TC	NBR	NCC	7
096187435A-H	0.968	1.874	0.437	SA-H	NBR	NCC	7	25X34X7TM	0.984	1.339	0.276	TM	NBR	NCC	7
09618745A-H	0.968	1.874	0.437	SA-H	NBR	NCC	7	25X35X7VSB-H	0.984	1.377	0.275	SB-H	FKM	VCS	7
092035B	0.968	2.047	0.375	SB	NBR	NCC	7	25X35X7TG	0.984	1.377	0.275	TG	NBR	NCC	7
092035B-H	0.968	2.047	0.375	SB-H	NBR	NCC	7	25X35X4SM	0.984	1.378	0.157	SM	NBR	NCC	7
09620435B-H	0.968	2.048	0.375	SB-H	NBR	NCC	7	25X35X4VVC	0.984	1.378	0.157	VC	FKM	VCO	7
0962043TC	0.968	2.048	0.375	TC	NBR	NCC	7	25X35X4VC	0.984	1.378	0.157	VC	NBR	NCO	7
09620645A-H	0.968	2.062	0.437	SA-H	NBR	NCC	7	25X35X4VM	0.984	1.378	0.157	VM	NBR	NCO	7
0962443VTB-H	0.968	2.440	0.375	TB-H	FKM	VCS	7	25X35X5VSF	0.984	1.378	0.197	SF	FKM	VCS	7

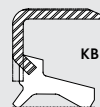
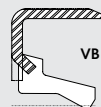
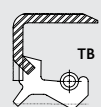
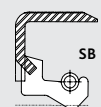
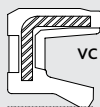



TCM Part #	Shaft	Bore	Width	Type	Lip Material	Material	Box	TCM Part #	Shaft	Bore	Width	Type	Lip Material	Material	Box #
25X35X5TC	0.984	1.378	0.197	TC	NBR	NCS	7	25X40X5TC	0.984	1.575	0.197	TC	NBR	NCC	7
25X35X5VM	0.984	1.378	0.197	VM	NBR	NCO	7	25X40X6TC	0.984	1.575	0.236	TC	NBR	NCC	7
25X35X5.5VSC	0.984	1.378	0.217	SC	FKM	VCS	7	25X40X7VSC	0.984	1.575	0.276	SC	FKM	VCS	7
25X35X5.5VTC	0.984	1.378	0.217	TC	FKM	VCS	7	25X40X7SC	0.984	1.575	0.276	SC	NBR	NCC	7
25X35X5.8VTGL	0.984	1.378	0.228	TGL	FKM	VCC	7	25X40X7VSCN	0.984	1.575	0.276	SCN	FKM	VCS	7
25X35X6VSCW	0.984	1.378	0.236	SCW	FKM	VCS	7	25X40X7VTC	0.984	1.575	0.276	TC	FKM	VCS	7
25X35X6VTB	0.984	1.378	0.236	TB	FKM	VCS	7	25X40X7TC	0.984	1.575	0.276	TC	NBR	NCC	7
25X35X6TB	0.984	1.378	0.236	TB	NBR	NCC	7	25X40X7VTF	0.984	1.575	0.276	TF	FKM	VCS	7
25X35X6VTC	0.984	1.378	0.236	TC	FKM	VCS	7	25X40X8SB	0.984	1.575	0.315	SB	NBR	NCC	7
25X35X6TC	0.984	1.378	0.236	TC	NBR	NCC	7	25X40X8VTB2-H	0.984	1.575	0.315	TB2-H	FKM	VCS	7
25X35X6TC4	0.984	1.378	0.236	TC4	NBR	NCC	7	25X40X8TC	0.984	1.575	0.315	TC	NBR	NCC	7
25X35X7PA1	0.984	1.378	0.276	PA1	NBR	NCO	7	25X40X8VTF	0.984	1.575	0.315	TF	FKM	VCC	7
25X35X7SB	0.984	1.378	0.276	SB	NBR	NCC	7	25X40X9TC	0.984	1.575	0.354	TC	NBR	NCC	7
25X35X7SB-H	0.984	1.378	0.276	SB-H	NBR	NCC	7	25X40X10VSF	0.984	1.575	0.394	SF	FKM	VCS	7
25X35X7VSBW12	0.984	1.378	0.276	SBW12	FKM	VCC	7	25X40X10VSFN	0.984	1.575	0.394	SFN	FKM	VCS	7
25X35X7SC	0.984	1.378	0.276	SC	NBR	NCC	7	25X40X10SFN	0.984	1.575	0.394	SFN	NBR	NCC	7
25X35X7SC-PL	0.984	1.378	0.276	SC-PL	NBR	NCC	7	25X40X10TC	0.984	1.575	0.394	TC	NBR	NCC	7
25X35X7VSCW	0.984	1.378	0.276	SCW	FKM	VCS	7	091592TB-H	0.984	1.596	0.250	TB-H	NBR	NCC	7
25X35X7VSGW12	0.984	1.378	0.276	SGW12	FKM	VCC	7	0981592TCN	0.984	1.596	0.250	TCN	NBR	NSS	7
25X35X7SM	0.984	1.378	0.276	SM	NBR	NCC	7	0981592TLN22-H	0.984	1.596	0.250	TLN22-H	NBR	NCC	7
25X35X7VTC	0.984	1.378	0.276	TC	FKM	VCS	7	25X41X6VTC	0.984	1.614	0.236	TC	FKM	VCS	7
25X35X7TC	0.984	1.378	0.276	TC	NBR	NCC	7	25X41X8TB	0.984	1.614	0.315	TB	NBR	NCC	7
25X35X7VTF	0.984	1.378	0.276	TF	FKM	VCS	7	25X41.2X7TC	0.984	1.622	0.276	TC	NBR	NCC	7
25X35X8DC	0.984	1.378	0.315	DC	NBR	NCC	7	25X41.2X7TZ	0.984	1.622	0.276	TZ	NBR	NCC	7
25X35X8SC	0.984	1.378	0.315	SC	NBR	NCC	7	25X41.5X6TC	0.984	1.634	0.236	TC	NBR	NCC	7
25X35X8TC	0.984	1.378	0.315	TC	NBR	NCC	7	25X41.5X7TB	0.984	1.634	0.276	TB	NBR	NCC	7
25X35X10SC	0.984	1.378	0.394	SC	NBR	NCC	7	25X41.5X7TC	0.984	1.634	0.276	TC	NBR	NCC	7
25X36X7SB-H	0.984	1.417	0.275	SB-H	NBR	NCC	7	25X41.5X10TC	0.984	1.634	0.394	TC	NBR	NCC	7
25X36X5TC	0.984	1.417	0.197	TC	NBR	NCC	7	25X42X7TG	0.984	1.653	0.275	TG	NBR	NCC	7
25X36X6SC	0.984	1.417	0.236	SC	NBR	NCC	7	25X42X5VSZ	0.984	1.654	0.197	SZ	FKM	VCS	7
25X36X7VSF	0.984	1.417	0.276	SF	FKM	VCS	7	25X42X5TC	0.984	1.654	0.197	TC	NBR	NCC	7
25X36X7TC	0.984	1.417	0.276	TC	NBR	NCC	7	25X42X6SC	0.984	1.654	0.236	SC	NBR	NCC	7
25X37X7SB-H	0.984	1.456	0.275	SB-H	NBR	NCC	7	25X42X6TC	0.984	1.654	0.236	TC	NBR	NCC	7
25X37X3VC	0.984	1.457	0.118	VC	NBR	NCO	7	25X42X7SC	0.984	1.654	0.276	SC	NBR	NCC	7
25X37X4VTM	0.984	1.457	0.157	TM	FKM	VCC	7	25X42X7SM	0.984	1.654	0.276	SM	NBR	NCC	7
25X37X5VSF	0.984	1.457	0.197	SF	FKM	VCS	7	25X42X7TB	0.984	1.654	0.276	TB	NBR	NCC	7
25X37X5TC	0.984	1.457	0.197	TC	NBR	NCC	7	25X42X7TC	0.984	1.654	0.276	TC	NBR	NCC	7
25X37X6VSBN	0.984	1.457	0.236	SBN	FKM	VCS	7	25X42X7VTF	0.984	1.654	0.276	TF	FKM	VCS	7
25X37X6SC	0.984	1.457	0.236	SC	NBR	NCC	7	25X42X7VTGR	0.984	1.654	0.276	TGR	FKM	VCC	7
25X37X6TC	0.984	1.457	0.236	TC	NBR	NCC	7	25X42X8SB	0.984	1.654	0.315	SB	NBR	NCC	7
25X37X7VSC	0.984	1.457	0.276	SC	FKM	VCS	7	25X42X8TC	0.984	1.654	0.315	TC	NBR	NCC	7
25X37X7SC	0.984	1.457	0.276	SC	NBR	NCC	7	25X42X9SA	0.984	1.654	0.354	SA	NBR	NCC	7
25X37X7TC	0.984	1.457	0.276	TC	NBR	NCC	7	25X42X10SC	0.984	1.654	0.394	SC	NBR	NCC	7
25X38X7SB-H	0.984	1.496	0.275	SB-H	NBR	NCC	7	25X42X10VTC	0.984	1.654	0.394	TC	FKM	VCS	7
25X38X7TG	0.984	1.496	0.275	TG	NBR	NCC	7	25X42X10TC	0.984	1.654	0.394	TC	NBR	NCC	7
25X38X5SB	0.984	1.496	0.197	SB	NBR	NCC	7	25X42X8SB-H	0.984	1.654	0.315	SB-H	NBR	NCC	7
25X38X5TC	0.984	1.496	0.197	TC	NBR	NCC	7	25X42.9X9.5SB	0.984	1.689	0.374	SB	NBR	NCC	7
25X38X7SC	0.984	1.496	0.276	SC	NBR	NCC	7	25X42.9X9.5TA	0.984	1.689	0.374	TA	NBR	NCC	7
25X38X7TC	0.984	1.496	0.276	TC	NBR	NCC	7	25X42.9X9.5TB	0.984	1.689	0.374	TB	NBR	NCC	7
25X38X7VTF	0.984	1.496	0.276	TF	FKM	VCS	7	25X43X6TC	0.984	1.693	0.236	TC	NBR	NCC	7
25X38X8TC	0.984	1.496	0.315	TC	NBR	NCC	7	25X43X8TC	0.984	1.693	0.315	TC	NBR	NCC	7
0981492VSB-H	0.984	1.498	0.250	SB-H	FKM	VCS	7	25X43X9VSF	0.984	1.693	0.354	SF	FKM	VCS	7
09142TB	0.984	1.499	0.250	TB	NBR	NCC	7	25X43X10TC	0.984	1.693	0.394	TC	NBR	NCC	7
09142VTB-H	0.984	1.499	0.250	TB-H	FKM	VCS	7	25X44X7TC	0.984	1.732	0.276	TC	NBR	NCC	7
09142TB-H	0.984	1.499	0.250	TB-H	NBR	NCC	7	25X44X7VTCN	0.984	1.732	0.276	TCN	FKM	VCS	7
09142VSB	0.984	1.500	0.250	SB	FKM	VSS	7	25X44X7VTGN2-PL	0.984	1.732	0.276	TGN2-PL	FKM	VCS	7
09142VSB-H	0.984	1.500	0.250	SB-H	FKM	VCS	7	25X44X8TC	0.984	1.732	0.315	TC	NBR	NCC	7
09152TC	0.984	1.500	0.250	TC	NBR	NCC	7	25X44.45X5TC	0.984	1.750	0.197	TC	NBR	NCC	7
25X39X7TC	0.984	1.535	0.276	TC	NBR	NCC	7	25X44.45X10TC	0.984	1.750	0.394	TC	NBR	NCC	7
25X40X5SG	0.984	1.574	0.196	SG	NBR	NCC	7	25X44.5X5.1SM	0.984	1.752	0.201	SM	NBR	NCC	7
25X40X7SB-H	0.984	1.574	0.275	SB-H	NBR	NCC	7	25X44.5X5.1TC	0.984	1.752	0.201	TC	NBR	NCC	7
25X40X7TG	0.984	1.574	0.275	TG	NBR	NCC	7	25X45X7SB-H	0.984	1.771	0.275	SB-H	NBR	NCC	7
25X40X5SB	0.984	1.575	0.197	SB	NBR	NCC	7	25X45X7SC	0.984	1.772	0.276	SC	NBR	NCC	7
25X40X5VSF	0.984	1.575	0.197	SF	FKM	VCS	7	25X45X7TC	0.984	1.772	0.276	TC	NBR	NCC	7

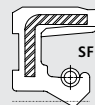
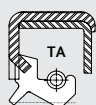

OIL AND GREASE SEALS - A COMPLETE LISTING

PLEASE CALL DICHTOMATIK FOR AVAILABILITY - 800-328-2840
BULK AND INDIVIDUALLY BOXED QUANTITIES ARE AVAILABLE FOR ALL



DICHTOMATIK

Any seal. Any time.

TCM Part #	Shaft	Bore	Width	Type	Lip Material	Material	Box #	TCM Part #	Shaft	Bore	Width	Type	Lip Material	Material	Box
25X45X8TC	0.984	1.772	0.315	TC	NBR	NCC	7	25X62X7SC	0.984	2.441	0.276	SC	NBR	NCC	7
25X45X10TB	0.984	1.772	0.394	TB	NBR	NCC	7	25X62X7TC	0.984	2.441	0.276	TC	NBR	NCC	7
25X45X10TC	0.984	1.772	0.394	TC	NBR	NCC	7	25X62X7VTF	0.984	2.441	0.276	TF	FKM	VCS	7
25X45X11TCN1	0.984	1.772	0.433	TCN1	NBR	NCC	7	25X62X10TA	0.984	2.441	0.394	TA	NBR	NCC	7
25X46X7SB	0.984	1.811	0.276	SB	NBR	NCC	7	25X62X7/75VTC	0.984	2.441	0.276/0.295	TC	FKM	VCC	7
25X46X7SC	0.984	1.811	0.276	SC	NBR	NCC	7	25X62X7SB-H	0.984	2.441	0.276	SB-H	NBR	NCC	7
25X46X7VTC	0.984	1.811	0.276	TC	FKM	VCC	7	25X70X10TC	0.984	2.756	0.394	TC	NBR	NCC	8
25X46X7TC	0.984	1.811	0.276	TC	NBR	NCC	7	25X72X7TC	0.984	2.835	0.276	TC	NBR	NCC	8
25X47X7SG	0.984	1.850	0.275	SG	NBR	NCC	7	25X72X8VTC	0.984	2.835	0.315	TC	FKM	VCC	8
25X47X7TG	0.984	1.850	0.275	TG	NBR	NCC	7	25X72X8TC	0.984	2.835	0.315	TC	NBR	NCC	8
25X47X5TC	0.984	1.850	0.197	TC	NBR	NCC	7	25X72X10TC	0.984	2.835	0.394	TC	NBR	NCC	8
25X47X6SB-H	0.984	1.850	0.236	SB-H	NBR	NCC	7	25X80X10TB2-H	0.984	3.150	0.394	TB2-H	NBR	NCC	8
25X47X6VTF	0.984	1.850	0.236	TF	FKM	VCS	7	SHAFT 0.985							
25X47X7VSB	0.984	1.850	0.276	SB	FKM	VCS	7	SHAFT-EZE 99098						S1	
25X47X7VSBY	0.984	1.850	0.276	SBY	FKM	VCC	7	V-RING -025						7	
25X47X7SC	0.984	1.850	0.276	SC	NBR	NCC	7	098155KMY	0.985	1.500	0.250/0.500	KMY	NBR	NCO	7
25X47X7SEC	0.984	1.850	0.276	SEC	NBR	NCC	7	SHAFT 0.998							
25X47X7PTC	0.984	1.850	0.276	TC	ACM	PCC	7	SHAFT-EZE 99100						S1	
25X47X7TC	0.984	1.850	0.276	TC	NBR	NCC	7	SHAFT-EZE 99101						S1	
25X47X7TF	0.984	1.850	0.276	TF	NBR	NCS	7	V-RING -025						7	
25X47X8VB2-H	0.984	1.850	0.315	TB2-H	FKM	VCS	7	25.35X32X6KZ	0.998	1.260	0.236	KZ	NBR	NSO	7
25X47X8TC	0.984	1.850	0.315	TC	NBR	NCC	7	SHAFT 0.999							
25X47X10SC	0.984	1.850	0.394	SC	NBR	NCC	7	SHAFT-EZE 99100						S1	
25X47X10TB	0.984	1.850	0.394	TB	NBR	NCC	7	SHAFT-EZE 99101						S1	
25X47X10TC	0.984	1.850	0.394	TC	NBR	NCC	7	V-RING -025						7	
25X47X10VTF	0.984	1.850	0.394	TF	FKM	VCS	7	099152TCAY	0.999	1.500	0.275	TCAY	NBR	NCC	7
25X48X7TC	0.984	1.890	0.276	TC	NBR	NCC	7	SHAFT 1.000							
25X48X8TC	0.984	1.890	0.315	TC	NBR	NCC	7	SHAFT-EZE 99100						S1	
25X49X7TC	0.984	1.929	0.276	TC	NBR	NCC	7	SHAFT-EZE 99101						S1	
25X49X10TC	0.984	1.929	0.394	TC	NBR	NCC	7	V-RING -025						7	
25X50X10SC	0.984	1.968	0.393	SC	NBR	NCC	7	10121KC	1.000	1.250	0.125	KC	NBR	NCO	7
25X50X7TC	0.984	1.969	0.276	TC	NBR	NCC	7	10121KM-H	1.000	1.250	0.125	KM-H	NBR	NCO	7
25X50X7VTF	0.984	1.969	0.276	TF	FKM	VCS	7	10121VSC	1.000	1.250	0.125	SC	FKM	VCS	7
25X50X8TC	0.984	1.969	0.315	TC	NBR	NCC	7	101215C	1.000	1.250	0.125	SC	NBR	NCC	7
25X50X10TC	0.984	1.969	0.394	TC	NBR	NCC	7	10121VL-H	1.000	1.250	0.125	VL-H	NBR	NCO	7
25X51X11SC	0.984	2.008	0.433	SC	NBR	NCC	7	10121VM	1.000	1.250	0.125	VM	NBR	NCO	7
25X52X7SB-H	0.984	2.047	0.275	SB-H	NBR	NCC	7	10121VM-H	1.000	1.250	0.125	VM-H	NBR	NCO	7
25X52X7TG	0.984	2.047	0.275	TG	NBR	NCC	7	10121VMY-G	1.000	1.250	0.125	VMY-G	NBR	NCO	7
25X52X10TG	0.984	2.047	0.393	TG	NBR	NCC	7	10122TC	1.000	1.250	0.250	TC	NBR	NCC	7
25X52X5SC	0.984	2.047	0.197	SC	NBR	NCC	7	10121VL-H	1.000	1.311	0.125	VL-H	NBR	NCO	7
25X52X7SC	0.984	2.047	0.276	SC	NBR	NCC	7	101311VL	1.000	1.312	0.125	VL	NBR	NCO	7
25X52X7VSCW	0.984	2.047	0.276	SCW	FKM	VCS	7	101311VM-H	1.000	1.312	0.125	VM-H	NBR	NCO	7
25X52X7SG	0.984	2.047	0.276	SG	NBR	NCC	7	101311VSM	1.000	1.312	0.171	SM	FKM	VCS	7
25X52X7PTC	0.984	2.047	0.276	TC	ACM	PCC	7	1013118VC	1.000	1.313	0.187	VC	NBR	NCO	7
25X52X7TC	0.984	2.047	0.276	TC	NBR	NCC	7	25.40X34.92X4.76SC	1.000	1.375	0.187	SC	NBR	NCC	7
25X52X7VTF	0.984	2.047	0.276	TF	FKM	VCS	7	101318TC	1.000	1.375	0.187	TC	NBR	NCC	7
25X52X8SB	0.984	2.047	0.315	SB	NBR	NCC	7	1013718VL-H	1.000	1.375	0.187	VL-H	NBR	NCC	7
25X52X8SB-H	0.984	2.047	0.315	SB-H	NBR	NCC	7	10131VM	1.000	1.375	0.189	VM	NBR	NCO	7
25X52X10VSC	0.984	2.047	0.394	SC	FKM	VCS	7	10132PSB	1.000	1.375	0.250	SB	ACM	PCS	7
25X52X10SC	0.984	2.047	0.394	SC	NBR	NCC	7	10132VSM	1.000	1.375	0.250	SB	FKM	VCS	7
25X52X10TC	0.984	2.047	0.394	TC	NBR	NCC	7	10132SB	1.000	1.375	0.250	SB	NBR	NCC	7
25X52X12TC	0.984	2.047	0.472	TC	NBR	NCC	7	10132PSB-H	1.000	1.375	0.250	SB-H	ACM	PCS	7
25X52X15TC	0.984	2.047	0.591	TC	NBR	NCC	8	10132VSB-H	1.000	1.375	0.250	SB-H	FKM	VCS	7
0982045A-H	0.984	2.062	0.437	SA-H	NBR	NCC	7	10132TBY	1.000	1.375	0.250	TBY	NBR	NCC	7
25X53X10TC	0.984	2.087	0.394	TC	NBR	NCC	7	10132VTC	1.000	1.375	0.250	TC	FKM	VCC	7
25X54X8TC	0.984	2.126	0.315	TC	NBR	NCC	7	10132ATC	1.000	1.375	0.250	TCL1	NBR	NCC	7
25X55X8TC	0.984	2.165	0.315	TC	NBR	NCC	7	10132TLN22-H	1.000	1.375	0.250	TLN22-H	NBR	NCC	7
25X55X9TC	0.984	2.165	0.354	TC	NBR	NCC	7	10132TZ-H	1.000	1.375	0.250	TZ-H	NBR	NCC	7
25X58X10SC	0.984	2.283	0.394	SC	NBR	NCC	7	101372TC	1.000	1.379	0.250	TC	NBR	NCC	7
25X58X10TC	0.984	2.283	0.394	TC	NBR	NCC	7	100141KC	1.000	1.437	0.125	KC	NBR	NCO	7
25X60X10TC	0.984	2.362	0.394	TC	NBR	NCC	7	100142SB	1.000	1.437	0.250	SB	NBR	NCC	7
25X62X6SC	0.984	2.441	0.236	SC	NBR	NCC	7	100142SB-H	1.000	1.437	0.250	SB-H	NBR	NCC	7
25X62X6TC	0.984	2.441	0.236	TC	NBR	NCC	7	100142SC	1.000	1.437	0.250	SC	NBR	NCC	7
25X62X7SB	0.984	2.441	0.276	SB	NBR	NCC	7								

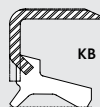
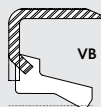
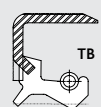
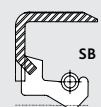
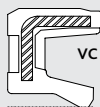

TCM Part #	Shaft	Bore	Width	Type	Lip Material	Material	Box	TCM Part #	Shaft	Bore	Width	Type	Lip Material	Material	Box #
101432VTB-H	1.000	1.437	0.250	TB-H	FKM	VCS	7	10166TBY	1.000	1.625	0.625	TBY	NBR	NCC	8
101432TB-H	1.000	1.437	0.250	TB-H	NBR	NCC	7	10166TM	1.000	1.625	0.625	TM	NBR	NCC	8
100142VTL-H	1.000	1.437	0.250	TL-H	FKM	VCS	7	101631VF	1.000	1.630	0.184	VF	NBR	NCO	7
101432VL-H	1.000	1.437	0.250	VL-H	NBR	NCO	7	1016825VSB-H	1.000	1.685	0.255	SB-H	FKM	VCS	7
100142VZ	1.000	1.437	0.250	VZ	NBR	NCO	7	10016825B-H	1.000	1.686	0.250	SB-H	NBR	NCC	7
10142SM	1.000	1.438	0.250	SM	NBR	NCC	7	101682TB	1.000	1.686	0.250	TB	NBR	NCC	7
100142TBY	1.000	1.438	0.250	TBY	NBR	NCC	7	101682TB-H	1.000	1.686	0.250	TB-H	NBR	NCC	7
100142TC	1.000	1.438	0.250	TC	NBR	NCC	7	10172KC	1.000	1.750	0.250	KC	NBR	NCO	7
1014621SCN5	1.000	1.464	0.217	SCN5	NBR	NCC	7	101728HTCN1	1.000	1.750	0.282	TCN1	HNBR	HCC	7
1014918VL-H	1.000	1.498	0.187	VL-H	NBR	NCC	7	10173SC	1.000	1.750	0.375	SC	NBR	NCC	7
101492VSB-H	1.000	1.498	0.250	SB-H	FKM	VCS	7	10173SM	1.000	1.750	0.375	SM	NBR	NCC	7
101492PSBW	1.000	1.498	0.250	SBW	ACM	PCC	7	25.40X44.45X6.35SC	1.000	1.750	0.250	SC	NBR	NCC	7
101492VTLN22-H	1.000	1.498	0.250	TLN22-H	FKM	VCS	7	101753TLN22-H	1.000	1.751	0.312	TLN22-H	NBR	NCC	7
101492TLN22-H	1.000	1.498	0.250	TLN22-H	NBR	NCC	7	10172VSB	1.000	1.752	0.250	SB	FKM	VCS	7
10141VB	1.000	1.499	0.188	VB	NBR	NCO	7	10172SB	1.000	1.752	0.250	SB	NBR	NCC	7
10141VB-H	1.000	1.499	0.188	VB-H	NBR	NCO	7	10172VSB-H	1.000	1.752	0.250	SB-H	FKM	VCS	7
10142SB-H	1.000	1.499	0.250	SB-H	NBR	NCC	7	10172SB-H	1.000	1.752	0.250	SB-H	NBR	NCC	7
101492SBY-H	1.000	1.499	0.250	SBY-H	NBR	NSS	7	10172TB	1.000	1.752	0.250	TB	NBR	NCC	7
10142PTB	1.000	1.499	0.250	TB	ACM	PCS	7	10172VTB-H	1.000	1.752	0.250	TB-H	FKM	VCS	7
10142TB	1.000	1.499	0.250	TB	NBR	NCC	7	10172TB-H	1.000	1.752	0.250	TB-H	NBR	NCC	7
10142VTB-H	1.000	1.499	0.250	TB-H	FKM	VCS	7	101572TC	1.000	1.752	0.250	TC	NBR	NCC	7
10142TB-H	1.000	1.499	0.250	TB-H	NBR	NCC	7	10172VTL-H	1.000	1.752	0.250	TL-H	FKM	VCS	7
10142TBY	1.000	1.499	0.250	TBY	NBR	NCC	7	10172TL-H	1.000	1.752	0.250	TL-H	NBR	NCC	7
10142TBY-H	1.000	1.499	0.250	TBY-H	NBR	NCC	7	10172VAY	1.000	1.752	0.250	VAY	NBR	NCO	7
10142TC	1.000	1.499	0.250	TC	NBR	NCC	7	101731TB	1.000	1.752	0.312	TB	NBR	NCC	7
10142TFY	1.000	1.499	0.250	TFY	NBR	NCC	7	10172TBY	1.000	1.752	0.313	TBY	NBR	NCC	7
1014931TCN1	1.000	1.499	0.311	TCN1	NBR	NCC	7	10173SA	1.000	1.752	0.375	SA	NBR	NCC	7
10155TA	1.000	1.499	0.312	TA	NBR	NCC	7	101773VTA	1.000	1.752	0.375	TA	FKM	VCS	7
101518TC	1.000	1.500	0.187	TC	NBR	NCC	7	101773TA	1.000	1.752	0.375	TA	NBR	NCC	7
10152TLN22-H	1.000	1.500	0.250	TLN22-H	NBR	NCC	7	101752VTL-H	1.000	1.755	0.250	TL-H	FKM	VCS	7
10152UM	1.000	1.500	0.250	UM	NBR	NCO	7	101782VH-H	1.000	1.780	0.250	VH-H	NBR	NCO	7
101525SC	1.000	1.500	0.252	SC	NBR	NCC	7	1017846VL-H	1.000	1.781	0.468	VL-H	NBR	NCO	7
101503TC	1.000	1.500	0.312	TC	NBR	NCC	7	10174VB	1.000	1.781	0.469	VB	NBR	NCO	7
25.40X38.10X7.93SC	1.000	1.500	0.312	SC	NBR	NCC	7	10174VB-H	1.000	1.781	0.469	VB-H	NBR	NCO	7
25.40X38.10X9.52TC	1.000	1.500	0.375	TC	NBR	NCC	7	10174VHY	1.000	1.781	0.469	VHY	NBR	NCO	7
10152SL	1.000	1.561	0.250	SL	NBR	NCC	7	101822SB-H	1.000	1.827	0.250	SB-H	NBR	NCC	7
10152SL-H	1.000	1.561	0.250	SL-H	NBR	NCC	7	100182TB-H	1.000	1.828	0.250	TB-H	NBR	NCC	7
101562TB-H	1.000	1.561	0.250	TB-H	NBR	NCC	7	1018229SA-H	1.000	1.828	0.296	SA-H	NBR	NCC	7
10152VB	1.000	1.561	0.250	VB	NBR	NCC	7	10182SB	1.000	1.851	0.250	SB	NBR	NCC	7
10152VB-H	1.000	1.561	0.250	VB-H	NBR	NCO	7	10182SB-H	1.000	1.851	0.250	SB-H	NBR	NCC	7
1015618VB	1.000	1.562	0.187	VB	NBR	NCO	7	10182VB	1.000	1.851	0.250	VB	NBR	NCO	7
1015618VMY	1.000	1.562	0.187	VMY	NBR	NCO	7	101852VL-H	1.000	1.851	0.250	VL-H	NBR	NCO	7
1015631TB	1.000	1.562	0.312	TB	NBR	NCC	7	101872SB	1.000	1.874	0.250	SB	NBR	NCC	7
25.40X39.69X7.93SC	1.000	1.563	0.312	SC	NBR	NCC	7	101872SB-H	1.000	1.874	0.250	SB-H	NBR	NCC	7
1015631SC	1.000	1.563	0.312	SC	NBR	NCC	7	101872TB	1.000	1.874	0.250	TB	NBR	NCC	7
101572VL-H	1.000	1.574	0.250	VL-H	NBR	NCO	7	101872TB-H	1.000	1.874	0.250	TB-H	NBR	NCC	7
1015731TB-H	1.000	1.574	0.312	TB-H	NBR	NCC	7	101872VHY	1.000	1.874	0.250	VHY	NBR	NCO	7
101572TB	1.000	1.575	0.250	TB	NBR	NCC	7	25.40X47.62X6.35SC	1.000	1.875	0.250	SC	NBR	NCC	7
101572TB-H	1.000	1.575	0.250	TB-H	NBR	NCC	7	25.40X47.62X9.52SC	1.000	1.875	0.375	SC	NBR	NCC	7
1016225TCN2	1.000	1.622	0.252	TCN2	NBR	NCC	7	10192SB-H	1.000	1.938	0.250	SB-H	NBR	NCC	7
101622VTEC	1.000	1.622	0.252	TEC	FKM	VCS	7	10192VB	1.000	1.938	0.250	VB	NBR	NCO	7
10162SB	1.000	1.624	0.250	SB	NBR	NCC	7	10192VB-H	1.000	1.938	0.250	VB-H	NBR	NCO	7
101622VSB-H	1.000	1.624	0.250	SB-H	FKM	VCS	7	101932VL-H	1.000	1.938	0.250	VL-H	NBR	NCO	7
10162SB-H	1.000	1.624	0.250	SB-H	NBR	NCC	7	1019725TC	1.000	1.979	0.252	TC	NBR	NCC	7
101622ETB	1.000	1.624	0.250	TB	EPDM	ECC	7	10193TB	1.000	1.982	0.313	TB	NBR	NCC	7
10162TB	1.000	1.624	0.250	TB	NBR	NCC	7	10193TB-H	1.000	1.982	0.313	TB-H	NBR	NCC	7
10162VTB-H	1.000	1.624	0.250	TB-H	FKM	VCS	7	101982TB-H	1.000	1.983	0.250	TB-H	NBR	NCC	7
10162TB-H	1.000	1.624	0.250	TB-H	NBR	NCC	7	101983TB-H	1.000	1.983	0.312	TB-H	NBR	NCC	7
101622VTC	1.000	1.624	0.250	TC	FKM	VCS	7	10202VSB	1.000	2.000	0.250	SB	FKM	VCS	7
10162VB	1.000	1.624	0.250	VB	NBR	NCO	7	10202SB	1.000	2.000	0.250	SB	NBR	NCC	7
101622VL-H	1.000	1.624	0.250	VL-H	NBR	NCO	7	10202SB-H	1.000	2.000	0.250	SB-H	NBR	NCC	7
25.40X41.27X7.93SC	1.000	1.625	0.312	SC	NBR	NCC	7	25.40X50.80X6.35SC	1.000	2.000	0.250	SC	NBR	NCC	7
25.40X41.27X9.52SC	1.000	1.625	0.375	SC	NBR	NCC	7	10202TB	1.000	2.000	0.250	TB	NBR	NCC	7
10162TC	1.000	1.625	0.250	TC	NBR	NCC	7	10202VTB-H	1.000	2.000	0.250	TB-H	FKM	VCS	7

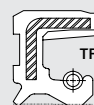
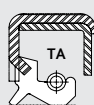

OIL AND GREASE SEALS - A COMPLETE LISTING



DICHTOMATIK

Any seal. Any time.

PLEASE CALL DICHTOMATIK FOR AVAILABILITY - 800-328-2840
BULK AND INDIVIDUALLY BOXED QUANTITIES ARE AVAILABLE FOR ALL

TCM Part #	Shaft	Bore	Width	Type	Lip Material	Material	Box #	TCM Part #	Shaft	Bore	Width	Type	Lip Material	Material	Box
10202TB-H	1.000	2.000	0.250	TB-H	NBR	NCC	7	26X45X6TC	1.024	1.772	0.236	TC	NBR	NCC	7
10202TBY-H	1.000	2.000	0.250	TBY-H	NBR	NSS	7	26X45X10TB	1.024	1.772	0.394	TB	NBR	NCC	7
10202VTC	1.000	2.000	0.250	TC	FKM	VCC	7	26X46X8TC	1.024	1.811	0.315	TC	NBR	NCC	7
10202ATC	1.000	2.000	0.250	TCL1	NBR	NCC	7	26X47X5TC	1.024	1.850	0.197	TC	NBR	NCC	7
10202VH-H	1.000	2.000	0.250	VH-H	NBR	NCO	7	26X47X7TC	1.024	1.850	0.276	TC	NBR	NCC	7
10203TLN22-H	1.000	2.000	0.312	TLN22-H	NBR	NCC	7	26X47X7VTF	1.024	1.850	0.276	TF	FKM	VCS	7
25.40X50.80X9.52TC	1.000	2.000	0.375	TC	NBR	NCC	7	26X47X7TF	1.024	1.850	0.276	TF	NBR	NCS	7
25.4X50.8X12.75SC	1.000	2.000	0.500	SC	NBR	NCC	8	26X47X9TC	1.024	1.850	0.354	TC	NBR	NCC	7
10205TC	1.000	2.000	0.500	TC	NBR	NCC	8	26X47X10SC	1.024	1.850	0.394	SC	NBR	NCC	7
102042TB	1.000	2.047	0.250	TB	NBR	NCC	7	26X48X7TC	1.024	1.890	0.276	TC	NBR	NCC	7
102042TB-H	1.000	2.047	0.250	TB-H	NBR	NCC	7	26X50X7TC	1.024	1.969	0.276	TC	NBR	NCC	7
1020431TB-H	1.000	2.047	0.312	TB-H	NBR	NCC	7	26X50X10TC	1.024	1.969	0.394	TC	NBR	NCC	7
100202TB-H	1.000	2.062	0.250	TB-H	NBR	NCC	7	26X52X7TC	1.024	2.047	0.276	TC	NBR	NCC	7
1020635A-H	1.000	2.062	0.375	SA-H	NBR	NCC	7	26X52X8TC	1.024	2.047	0.315	TC	NBR	NCC	7
102063SC	1.000	2.062	0.375	SC	NBR	NCC	7	26X62X9TC	1.024	2.441	0.354	TC	NBR	NCC	7
25.40X52.38X9.52SC	1.000	2.062	0.375	SC	NBR	NCC	7	SHAFT 1.025							
100202SB	1.000	2.063	0.250	SB	NBR	NCC	7	V-RING -025							7
10222SB	1.000	2.250	0.250	SB	NBR	NCC	7	26.04X42.86X7.14SB	1.025	1.687	0.281	SB	NBR	NCC	7
10222SB-H	1.000	2.250	0.250	SB-H	NBR	NCC	7	SHAFT 1.031							
25.40X57.15X9.52SC	1.000	2.250	0.375	SC	NBR	NCC	7	V-RING -025							7
10243TC	1.000	2.440	0.375	TC	NBR	NCC	7	103153VTB	1.031	1.575	0.312	TB	FKM	VCC	7
10243TB	1.000	2.441	0.375	TB	NBR	NCC	7	1031573TB-H	1.031	1.575	0.312	TB-H	NBR	NCC	7
10243TB-H	1.000	2.441	0.375	TB-H	NBR	NCC	7	10153SA	1.031	1.575	0.313	SA	NBR	NCC	7
10243TC	1.000	2.441	0.375	TC	NBR	NCC	7	10153SA-H	1.031	1.575	0.313	SA-H	NBR	NCC	7
SHAFT 1.024								SHAFT 1.062							
SHAFT-EZE 99103							S1	SHAFT-EZE 99106							S1
V-RING -025							7	V-RING -025							7
26X30X6KC	1.024	1.181	0.236	KC	NBR	NCO	7	1061311VCY	1.062	1.312	0.125	VCY	NBR	NSO	7
26X31X3VM	1.024	1.220	0.118	VM	NBR	NCO	7	1013113VC	1.062	1.313	0.131	VC	NBR	NCO	7
26X34X4KC	1.024	1.339	0.157	KC	NBR	NCO	7	10613416VC	1.062	1.340	0.168	VC	NBR	NCO	7
26X34X4VG1	1.024	1.339	0.157	VG1	NBR	NCO	7	1061493SB-H	1.062	1.499	0.312	SB-H	NBR	NCC	7
26X34X9KC	1.024	1.339	0.354	KC	NBR	NCO	7	26.98X38.10X6.35SC	1.062	1.500	0.250	SC	NBR	NCC	7
26X35X7SB-H	1.024	1.377	0.275	SB-H	NBR	NCC	7	10615125PSB-H	1.062	1.511	0.255	SB-H	ACM	PCC	7
26X35X5TC	1.024	1.378	0.197	TC	NBR	NCC	7	106153SA-H	1.062	1.561	0.375	SA-H	NBR	NCC	7
26X35X7SC	1.024	1.378	0.276	SC	NBR	NCC	7	10615725B-H	1.062	1.577	0.250	SB-H	NBR	NCC	7
26X35X7VTC	1.024	1.378	0.276	TC	FKM	VCC	7	1061622TB-H	1.062	1.624	0.250	TB-H	NBR	NCC	7
26X35X7TC	1.024	1.378	0.276	TC	NBR	NCC	7	26.98X41.27X7.93SC	1.062	1.625	0.312	SC	NBR	NCC	7
26X36X5TC	1.024	1.417	0.197	TC	NBR	NCC	7	10163SM	1.062	1.625	0.312	SM	NBR	NCC	7
26X36X7SC	1.024	1.417	0.276	SC	NBR	NCC	7	101683TB-H	1.062	1.686	0.375	TB-H	NBR	NCC	7
26X36X7VVF	1.024	1.417	0.276	SF	FKM	VCS	7	106173SC	1.062	1.750	0.375	SC	NBR	NCC	7
26X36X7VTC	1.024	1.417	0.276	TC	FKM	VCC	7	106173TC	1.062	1.750	0.375	TC	NBR	NCC	7
26X36X7TC	1.024	1.417	0.276	TC	NBR	NCC	7	26.98X44.45X9.52SC	1.062	1.750	0.375	SC	NBR	NCC	7
26X36X10TC	1.024	1.417	0.394	TC	NBR	NCC	7	106173TB-H	1.062	1.752	0.312	TB-H	NBR	NCC	7
26X37X7SC	1.024	1.457	0.276	SC	NBR	NCC	7	106183TB-H	1.062	1.828	0.375	TB-H	NBR	NCC	7
26X37X7VTC	1.024	1.457	0.276	TC	FKM	VCC	7	106182TB-H	1.062	1.874	0.250	TB-H	NBR	NCC	7
26X37X7TC	1.024	1.457	0.276	TC	NBR	NCC	7	10619825B-H	1.062	1.983	0.250	SB-H	NBR	NCC	7
26X37X7VTCN1	1.024	1.457	0.276	TCN1	FKM	VCS	7	101945A-H	1.062	1.983	0.437	SA-H	NBR	NCC	7
26X37X10TC	1.024	1.457	0.394	TC	NBR	NCC	7	106202TB-H	1.062	2.000	0.025	TB-H	NBR	NCC	7
26X38X8TC	1.024	1.496	0.315	TC	NBR	NCC	7	1062025B-H	1.062	2.000	0.250	SB-H	NBR	NCC	7
26X40X5TC	1.024	1.575	0.197	TC	NBR	NCC	7	1062063TB-H	1.062	2.062	0.375	TB-H	NBR	NCC	7
26X40X7TC	1.024	1.575	0.276	TC	NBR	NCC	7	10283TB	1.062	2.835	0.375	TB	NBR	NCC	8
26X40X8SB	1.024	1.575	0.315	SB	NBR	NCC	7	10283TB-H	1.062	2.835	0.375	TB-H	NBR	NCC	8
26X41X7TC	1.024	1.614	0.276	TC	NBR	NCC	7	SHAFT 1.063							
26X42X6SC	1.024	1.654	0.236	SC	NBR	NCC	7	SHAFT-EZE 99106						S1	
26X42X6VSF	1.024	1.654	0.236	SF	FKM	VCS	7	V-RING -025						7	
26X42X7SB	1.024	1.654	0.276	SB	NBR	NCC	7	V-RING -028						7	
26X42X7SC	1.024	1.654	0.276	SC	NBR	NCC	7	27X32X3VM	1.063	1.260	0.118	VM	NBR	NCO	7
26X42X7VTC	1.024	1.654	0.276	TC	FKM	VCC	7	27X34X3VM	1.063	1.339	0.118	VM	NBR	NCO	7
26X42X7TC	1.024	1.654	0.276	TC	NBR	NCC	7	27X35X4SC	1.063	1.378	0.157	SC	NBR	NCC	7
26X42X8TC	1.024	1.654	0.315	TC	NBR	NCC	7	27X36X6TC	1.063	1.417	0.236	TC	NBR	NCC	7
26X42X10TC	1.024	1.654	0.394	TC	NBR	NCC	7	27X36X7TC	1.063	1.417	0.276	TC	NBR	NCC	7
26X43X6TB	1.024	1.693	0.236	TB	NBR	NCC	7	27X37X6TC	1.063	1.457	0.236	TC	NBR	NCC	7
26X43X7TC	1.024	1.693	0.276	TC	NBR	NCC	7	27X37X7SC	1.063	1.457	0.276	SC	NBR	NCC	7
26X43X8TC	1.024	1.693	0.315	TC	NBR	NCC	7								

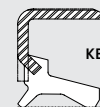
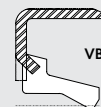
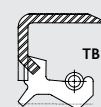
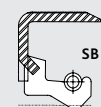
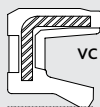



TCM Part #	Shaft	Bore	Width	Type	Lip Material	Material	Box	TCM Part #	Shaft	Bore	Width	Type	Lip Material	Material	Box #
27X37X7VTC	1.063	1.457	0.276	TC	FKM	VCC	7	102062SB	1.063	2.062	0.250	SB	NBR	NCC	7
27X37X7TC	1.063	1.457	0.276	TC	NBR	NCC	7	102062SB-H	1.063	2.062	0.250	SB-H	NBR	NCC	7
27X38X5TC	1.063	1.496	0.197	TC	NBR	NCC	7	27X53X7SC	1.063	2.087	0.276	SC	NBR	NCC	7
27X38X7TC	1.063	1.496	0.276	TC	NBR	NCC	7	27X55X7TC	1.063	2.165	0.276	TC	NBR	NCC	7
27X38X7TEC	1.063	1.496	0.276	TEC	NBR	NCC	7	27X55X8TC	1.063	2.165	0.315	TC	NBR	NCC	7
106142VSB	1.063	1.499	0.250	SB	FKM	VCS	7	27X62X12TA	1.063	2.441	0.472	TA	NBR	NCC	7
106142VSB-H	1.063	1.499	0.250	SB-H	FKM	VCS	7	27X77X7TC	1.063	3.031	0.276	TC	NBR	NCC	8
106142SB-H	1.063	1.499	0.250	SB-H	NBR	NCC	7	27X80X10TB2-H	1.063	3.150	0.394	TB2-H	NBR	NCC	8
106142TC	1.063	1.499	0.250	TC	NBR	NCC	7	SHAFT 1.102							
27X39X10.5TB	1.063	1.535	0.394	TB	NBR	NCC	7	SHAFT-EZE 99111							
106152SB-H	1.063	1.561	0.250	SB-H	NBR	NCC	7	V-RING -028							S1
27X40X3VC	1.063	1.575	0.118	VC	NBR	NCO	7	28X33X6VC	1.102	1.299	0.236	VC	NBR	NCO	7
27X40X5TC	1.063	1.575	0.197	TC	NBR	NCC	7	28X34X4KC	1.102	1.339	0.157	KC	NBR	NCO	7
27X40X6SC	1.063	1.575	0.236	SC	NBR	NCC	7	28X34X4VC	1.102	1.339	0.157	VC	NBR	NCO	7
27X40X7VSC	1.063	1.575	0.276	SC	FKM	VCS	7	28X34X4VG1	1.102	1.339	0.157	VG1	NBR	NCO	7
27X40X7SC	1.063	1.575	0.276	SC	NBR	NCC	7	28X35X4VC	1.102	1.378	0.157	VC	NBR	NCO	7
27X40X8TC	1.063	1.575	0.315	TC	NBR	NCC	7	28X35X5VTC	1.102	1.378	0.197	TC	FKM	VCC	7
27X40X9TC	1.063	1.575	0.354	TC	NBR	NCC	7	28X35X5TC	1.102	1.378	0.197	TC	NBR	NCS	7
27X40X10SC	1.063	1.575	0.394	SC	NBR	NCC	7	28X35X5TM	1.102	1.378	0.197	TM	NBR	NCC	7
100152SM	1.063	1.577	0.250	SM	NBR	NCC	7	28X35X7TC	1.102	1.378	0.276	TC	NBR	NCC	7
27X41X7TC	1.063	1.614	0.276	TC	NBR	NCC	7	28X36X4TM	1.102	1.417	0.157	TM	NBR	NCC	7
27X41X10VSC	1.063	1.614	0.394	SC	FKM	VCC	7	28X36X5SB	1.102	1.417	0.197	SB	NBR	NCC	7
27X41X10SC	1.063	1.614	0.394	SC	NBR	NCC	7	28X36X5VM	1.102	1.417	0.197	VM	NBR	NCO	7
106162SB	1.063	1.624	0.250	SB	NBR	NCC	7	28X36X7TC	1.102	1.417	0.276	TC	NBR	NCC	7
106162SB-H	1.063	1.624	0.250	SB-H	NBR	NCC	7	28X36X7TM	1.102	1.417	0.276	TM	NBR	NCC	7
27X42X7SC	1.063	1.654	0.276	SC	NBR	NCC	7	28X37X4TC	1.102	1.457	0.157	TC	NBR	NCS	7
27X42X7VTC	1.063	1.654	0.276	TC	FKM	VCC	7	28X37X4VB	1.102	1.457	0.157	VB	NBR	NCO	7
27X42X9TC	1.063	1.654	0.354	TC	NBR	NCC	7	28X37X4VC	1.102	1.457	0.157	VC	NBR	NCO	7
27X42X10SC	1.063	1.654	0.394	SC	NBR	NCC	7	28X37X6TC	1.102	1.457	0.236	TC	NBR	NCC	7
27X42X10TC	1.063	1.654	0.394	TC	NBR	NCC	7	28X38X7TG	1.102	1.496	0.275	TG	NBR	NCC	7
101682SB	1.063	1.686	0.250	SB	NBR	NCC	7	28X38X5TC	1.102	1.496	0.197	TC	NBR	NCC	7
101682SB-H	1.063	1.686	0.250	SB-H	NBR	NCC	7	28X38X6SC	1.102	1.496	0.236	SC	NBR	NCC	7
27X43X7TC	1.063	1.693	0.276	TC	NBR	NCC	7	28X38X7SC	1.102	1.496	0.276	SC	NBR	NCC	7
27X43X8TC	1.063	1.693	0.315	TC	NBR	NCC	7	28X38X7TC	1.102	1.496	0.276	TC	NBR	NCC	7
27X43X8VTF	1.063	1.693	0.315	TF	FKM	VCS	7	28X38X7VTF	1.102	1.496	0.276	TF	FKM	VCS	7
106172SB-H	1.063	1.752	0.250	SB-H	NBR	NCC	7	28X38X7VTGR	1.102	1.496	0.276	TGR	FKM	VCC	7
27X45X8SC	1.063	1.771	0.314	SC	NBR	NCC	7	28X38X10TC	1.102	1.496	0.394	TC	NBR	NCC	7
27X45X6SC	1.063	1.772	0.236	SC	NBR	NCC	7	28X39X7SZ	1.102	1.535	0.276	SZ	NBR	NCC	7
27X45X7SC	1.063	1.772	0.276	SC	NBR	NCC	7	28X39.5X8TB	1.102	1.555	0.315	TB	NBR	NCC	7
27X45X7TC	1.063	1.772	0.276	TC	NBR	NCC	7	28X40X7SB-H	1.102	1.574	0.275	SB-H	NBR	NCC	7
27X45X8TC	1.063	1.772	0.315	TC	NBR	NCC	7	28X40X5SC	1.102	1.575	0.197	SC	NBR	NCC	7
27X45X9TC	1.063	1.772	0.354	TC	NBR	NCC	7	28X40X5TC	1.102	1.575	0.197	TC	NBR	NCC	7
1061822SL	1.063	1.828	0.250	SL	NBR	NCC	7	28X40X7H5B	1.102	1.575	0.276	SB	HNBR	HCC	7
1061822SL-H	1.063	1.828	0.250	SL-H	NBR	NCC	7	28X40X7SC	1.102	1.575	0.276	SC	NBR	NCC	7
27X47X10SC	1.063	1.850	0.393	SC	NBR	NCC	7	28X40X7TC	1.102	1.575	0.276	TC	NBR	NCC	7
27X47X5.5VTF	1.063	1.850	0.217	TF	FKM	VCS	7	28X40X7VTF	1.102	1.575	0.276	TF	FKM	VCS	7
27X47X6SC	1.063	1.850	0.236	SC	NBR	NCC	7	28X40X8SB	1.102	1.575	0.315	SB	NBR	NCC	7
27X47X6VTC	1.063	1.850	0.236	TC	FKM	VCS	7	28X40X8SC	1.102	1.575	0.315	SC	NBR	NCC	7
27X47X7TC	1.063	1.850	0.276	TC	NBR	NCC	7	28X40X8TC	1.102	1.575	0.315	TC	NBR	NCC	7
27X47X8VSC	1.063	1.850	0.315	SC	FKM	VSC	7	28X41X6TB	1.102	1.614	0.236	TB	NBR	NCC	7
27X47X8SC	1.063	1.850	0.315	SC	NBR	NCC	7	28X41X7TC	1.102	1.614	0.276	TC	NBR	NCC	7
27X47X8VSF	1.063	1.850	0.315	SF	FKM	VCS	7	28X41X8TC	1.102	1.614	0.315	TC	NBR	NCC	7
27X47X11TC	1.063	1.850	0.433	TC	NBR	NCC	7	28X42X7SB-H	1.102	1.653	0.275	SB-H	NBR	NCC	7
106182SB	1.063	1.874	0.250	SB	NBR	NCC	7	28X42X7TG	1.102	1.653	0.275	TG	NBR	NCC	7
106182SB-H	1.063	1.874	0.250	SB-H	NBR	NCC	7	28X42X6TC	1.102	1.654	0.236	TC	NBR	NCC	7
27X48X9TC	1.063	1.890	0.354	TC	NBR	NCC	7	28X42X7SC	1.102	1.654	0.276	SC	NBR	NCC	7
27X49X7.5SC	1.063	1.929	0.295	SC	NBR	NCC	7	28X42X7TC	1.102	1.654	0.276	TC	NBR	NCC	7
27X50X10SC	1.063	1.969	0.394	SC	NBR	NCC	7	28X42X7TGR	1.102	1.654	0.276	TGR	FKM	VCC	7
27X50X10TC	1.063	1.969	0.394	TC	NBR	NCC	7	28X42X8SC	1.102	1.654	0.315	SC	NBR	NCC	7
27X50X12TC	1.063	1.969	0.472	TC	NBR	NCC	7	28X42X8TC	1.102	1.654	0.315	TC	NBR	NCC	7
106192SB	1.063	1.979	0.250	SB	NBR	NCC	7	28X42X11TC	1.102	1.654	0.433	TC	NBR	NCC	7
106202SB	1.063	2.000	0.250	SB	NBR	NCC	7	28X42.5X8TC	1.102	1.673	0.315	TC	NBR	NCC	7
27X52X7SC	1.063	2.047	0.276	SC	NBR	NCC	7	28X43X10SC	1.102	1.692	0.393	SC	NBR	NCC	7
27X52X8SC	1.063	2.047	0.315	SC	NBR	NCC	7	28X43X7SC	1.102	1.693	0.276	SC	NBR	NCC	7

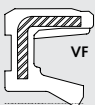
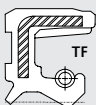
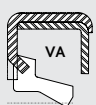
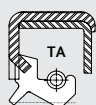

OIL AND GREASE SEALS - A COMPLETE LISTING

PLEASE CALL DICHTOMATIK FOR AVAILABILITY - 800-328-2840
BULK AND INDIVIDUALLY BOXED QUANTITIES ARE AVAILABLE FOR ALL



DICHTOMATIK

Any seal. Any time.

TCM Part #	Shaft	Bore	Width	Type	Lip Material	Material	Box #	TCM Part #	Shaft	Bore	Width	Type	Lip Material	Material	Box
28X43X7TC	1.102	1.693	0.276	TC	NBR	NCC	7	1121992PTC4N	1.124	1.998	0.250	TC4N	ACM	PCC	7
28X43X10TC	1.102	1.693	0.394	TC	NBR	NCC	7	1121992TCN4	1.124	1.998	0.250	TCN4	NBR	NCC	7
28X44X6PTC	1.102	1.732	0.236	TC	ACM	PCC	7	1121992PTEC	1.124	1.998	0.250	TEC	ACM	PCC	7
28X44X7TB	1.102	1.732	0.276	TB	NBR	NCC	7	1121992TGN2W	1.124	1.998	0.250	TGN2W	NBR	NCC	7
28X44X7TC	1.102	1.732	0.276	TC	NBR	NCS	7	11228324VTB	1.124	2.839	0.241	TB	FKM	VCS	8
28X44X7VTCN	1.102	1.732	0.276	TCN	FKM	VCS	7	SHAFT 1.125							
28X44X10VTF	1.102	1.732	0.394	TF	FKM	VCS	7	SHAFT-EZE 99112							S1
28X44.5X7TC	1.102	1.752	0.276	TC	NBR	NCS	7	SHAFT-EZE 99116							S1
28X45X5TC	1.102	1.772	0.197	TC	NBR	NCC	7	V-RING -028							7
28X45X6SC	1.102	1.772	0.236	SC	NBR	NCC	7	2857X3492X3.17VB	1.125	1.375	0.125	VB	NBR	NCO	7
28X45X7VTC	1.102	1.772	0.276	TC	FKM	VCC	7	11131VC	1.125	1.375	0.125	VC	NBR	NCO	7
28X45X7TC	1.102	1.772	0.276	TC	NBR	NCC	7	11131VL-H	1.125	1.375	0.125	VL-H	NBR	NCO	7
28X45X8SC	1.102	1.772	0.315	SC	NBR	NCC	7	11131VM	1.125	1.375	0.125	VM	NBR	NCO	7
28X45X8TC	1.102	1.772	0.315	TC	NBR	NCC	7	11131VMY	1.125	1.375	0.125	VMY	NBR	NCO	7
28X47X7VSB-H	1.102	1.850	0.275	SB-H	FKM	VCS	7	2857X35.10X4VB	1.125	1.382	0.157	VB	NBR	NCO	7
28X47X7TG	1.102	1.850	0.275	TG	NBR	NCC	7	11142VB	1.125	1.438	0.203	VB	NBR	NCO	7
28X47X8SB-H	1.102	1.850	0.314	SB-H	NBR	NCC	7	1114320VL-H	1.125	1.438	0.203	VL-H	NBR	NCO	7
28X47X5SC	1.102	1.850	0.197	SC	NBR	NCC	7	111492VC	1.125	1.494	0.250	VC	NBR	NCO	7
28X47X7SB	1.102	1.850	0.276	SB	NBR	NCC	7	1114918SB-H	1.125	1.498	0.187	SB-H	NBR	NCC	7
28X47X7VSC	1.102	1.850	0.276	SC	FKM	VCC	7	1114918VL-H	1.125	1.498	0.187	VL-H	NBR	NCO	7
28X47X7SC	1.102	1.850	0.276	SC	NBR	NCC	7	111415M	1.125	1.499	0.188	SM	NBR	NCC	7
28X47X7TC	1.102	1.850	0.276	TC	NBR	NCC	7	11141VTC	1.125	1.499	0.188	TC	FKM	VCS	7
28X47X7VVB	1.102	1.850	0.276	VB	FKM	VCO	7	1114918TC	1.125	1.499	0.188	TC	NBR	NCS	7
28X47X8SC	1.102	1.850	0.315	SC	NBR	NCC	7	11141VB	1.125	1.499	0.188	VB	NBR	NCO	7
28X47X10VSF	1.102	1.850	0.394	SF	FKM	VCS	7	11142KC	1.125	1.499	0.250	KC	NBR	NCO	7
28X47X10SF	1.102	1.850	0.394	SF	NBR	NCS	7	111492VC	1.125	1.499	0.250	VC	NBR	NCO	7
28X47X10TC	1.102	1.850	0.394	TC	NBR	NCC	7	2857X38.10X6.35SC	1.125	1.500	0.250	SC	NBR	NCO	7
28X48X5SC	1.102	1.890	0.197	SC	NBR	NCC	7	111502VZY	1.125	1.502	0.250	VZY	NBR	NCO	7
28X48X8TC	1.102	1.890	0.315	TC	NBR	NCC	7	1115612SB-H	1.125	1.561	0.250	SB-H	NBR	NCC	7
28X48X11TC	1.102	1.890	0.433	TC	NBR	NCC	7	11152PSL	1.125	1.561	0.250	SL	ACM	PCS	7
28X49X7TC	1.102	1.929	0.276	TC	NBR	NCC	7	11152PSL-H	1.125	1.561	0.250	SL-H	ACM	PCC	7
28X49X9TB	1.102	1.929	0.354	TB	NBR	NCC	7	11152PTB-H	1.125	1.561	0.250	TB-H	ACM	PCS	7
28X49X10TC	1.102	1.929	0.394	TC	NBR	NCC	7	111562VL-H	1.125	1.561	0.250	VL-H	NBR	NCO	7
28X50X6TC	1.102	1.969	0.236	TC	NBR	NCC	7	11152SB	1.125	1.562	0.250	SB	NBR	NCC	7
28X50X7TC	1.102	1.969	0.276	TC	NBR	NCC	7	11152SB-H	1.125	1.562	0.250	SB-H	NBR	NCC	7
28X50X8TC	1.102	1.969	0.315	TC	NBR	NCC	7	11152VB	1.125	1.562	0.250	VB	NBR	NCO	7
28X50X10VTC	1.102	1.969	0.394	TC	FKM	VCC	7	11153VSA	1.125	1.562	0.375	SA	FKM	VCS	7
28X50X10TC	1.102	1.969	0.394	TC	NBR	NCC	7	11153SA	1.125	1.562	0.375	SA	NBR	NCC	7
28X50X12SB	1.102	1.969	0.472	SB	NBR	NCC	7	2857X39.69X9.52SC	1.125	1.563	0.375	SC	NBR	NCC	7
28X50.8X10TC	1.102	2.000	0.394	TC	NBR	NCC	7	111562SB	1.125	1.565	0.250	SB	NBR	NCC	7
28X51X6TC	1.102	2.008	0.236	TC	NBR	NCC	7	111562SB-H	1.125	1.565	0.250	SB-H	NBR	NCC	7
28X51X8VTC	1.102	2.008	0.315	TC	FKM	VCS	7	111562SM	1.125	1.565	0.250	SM	NBR	NCC	7
28X52X8SB-H	1.102	2.047	0.314	SB-H	NBR	NCC	7	11151VB	1.125	1.569	0.197	VB	NBR	NCO	7
28X52X5SC	1.102	2.047	0.197	SC	NBR	NCC	7	111572TB	1.125	1.575	0.250	TB	NBR	NCC	7
28X52X6TC	1.102	2.047	0.236	TC	NBR	NCC	7	111572TB-H	1.125	1.575	0.250	TB-H	NBR	NCC	7
28X52X7TC	1.102	2.047	0.276	TC	NBR	NCC	7	11161SB	1.125	1.624	0.190	SB	NBR	NCC	7
28X52X7VTF	1.102	2.047	0.276	TF	FKM	VCS	7	1116224SB-H	1.125	1.624	0.245	SB-H	NBR	NCC	7
28X52X10SC	1.102	2.047	0.394	SC	NBR	NCC	7	11162PSB	1.125	1.624	0.250	SB	ACM	PCC	7
28X52X10TC	1.102	2.047	0.394	TC	NBR	NCC	7	11162VSB	1.125	1.624	0.250	SB	FKM	VCS	7
28X56X8TC	1.102	2.205	0.315	TC	NBR	NCC	7	11162SB	1.125	1.624	0.250	SB	NBR	NCC	7
28X57X10TC	1.102	2.244	0.394	TC	NBR	NCC	7	11162VSB-H	1.125	1.624	0.250	SB-H	FKM	VCS	7
28X58X10TC	1.102	2.283	0.394	TC	NBR	NCC	7	11162SB-H	1.125	1.624	0.250	SB-H	NBR	NCC	7
28X60X10TC	1.102	2.362	0.394	TC	NBR	NCC	7	11162VTB	1.125	1.624	0.250	TB	FKM	VCS	7
28X62X7TC	1.102	2.441	0.276	TC	NBR	NCC	7	11162TB	1.125	1.624	0.250	TB	NBR	NCC	7
28X62X10SC	1.102	2.441	0.394	SC	NBR	NCC	7	11162VTB-H	1.125	1.624	0.250	TB-H	FKM	VCS	7
28X62X12SC	1.102	2.441	0.472	SC	NBR	NCC	7	11162TB-H	1.125	1.624	0.250	TB-H	NBR	NCC	7
28X74X11TB	1.102	2.913	0.433	TB	NBR	NCC	8	111622VH-H	1.125	1.624	0.250	VH-H	NBR	NCO	7
SHAFT 1.124															
SHAFT-EZE 99112							S1	11162TAY	1.125	1.624	0.275	TAY	NBR	NCC	7
SHAFT-EZE 99116							S1	11162SC	1.125	1.625	0.250	SC	NBR	NCC	7
V-RING -028							7	11162SCN1	1.125	1.625	0.250	SCN1	NBR	NCC	7
111873/3TAY	1.124	1.8740.312/0.344	TAY	NBR	NCC	7	7	11162VSEC	1.125	1.625	0.250	SEC	FKM	VCC	7
111873/3TAY-H	1.124	1.8740.312/0.344	TAY-H	NBR	NCC	7	7	11162ESF	1.125	1.625	0.250	SF	EPDM	ECS	7
1121992PTC	1.124	1.998	0.250	TC	ACM	PCC	7	11162VTLN22-H	1.125	1.625	0.250	TLN22-H	FKM	VCS	7
								11163SC	1.125	1.625	0.312	SC	NBR	NCC	7

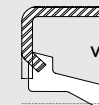
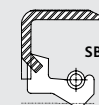
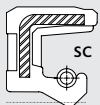

TCM Part #	Shaft	Bore	Width	Type	Lip Material	Material	Box	TCM Part #	Shaft	Bore	Width	Type	Lip Material	Material	Box #
111622VTCN1-PL	1.125	1.628	0.250	TCN1-PL	FKM	VCC	7	112062VTB-H	1.125	2.061	0.250	TB-H	FKM	VCS	7
1116831TC	1.125	1.687	0.312	TC	NBR	NCC	7	112063SB-H	1.125	2.061	0.312	SB-H	NBR	NCC	7
111735SB	1.125	1.733	0.375	SB	NBR	NCC	7	112062TB-H	1.125	2.062	0.250	TB-H	NBR	NCC	7
111721SC	1.125	1.750	0.210	SC	NBR	NCC	7	112062VTL-H	1.125	2.062	0.250	TLPH	FKM	VCC	7
11172VTC	1.125	1.750	0.250	TC	FKM	VCS	7	112062VB	1.125	2.062	0.250	VB	NBR	NCO	7
11172VL-H	1.125	1.750	0.250	VL-H	NBR	NCO	7	112063TB-H	1.125	2.062	0.312	TB-H	NBR	NCC	7
111731TC	1.125	1.750	0.312	TC	NBR	NCC	7	112064SA-H	1.125	2.062	0.437	SA-H	NBR	NCC	7
111725B	1.125	1.752	0.250	SB	NBR	NCC	7	112062VSSTB	1.125	2.063	0.250	TB	FKM	VSS	7
11172VSB-H	1.125	1.752	0.250	SB-H	FKM	VCS	7	1120635B	1.125	2.063	0.313	SB	NBR	NCC	7
111725B-H	1.125	1.752	0.250	SB-H	NBR	NCC	7	112125B-H	1.125	2.125	0.250	SB-H	NBR	NCC	7
11172TB	1.125	1.752	0.250	TB	NBR	NCC	7	11213VSB	1.125	2.125	0.313	SB	FKM	VSS	7
11172TB-H	1.125	1.752	0.250	TB-H	NBR	NCC	7	112135B	1.125	2.125	0.313	SB	NBR	NCC	7
11172VB	1.125	1.752	0.250	VB	NBR	NCO	7	112135B-H	1.125	2.125	0.313	SB-H	NBR	NCC	7
111774KC	1.125	1.778	0.406	KC	NBR	NCO	7	112225B	1.125	2.250	0.250	SB	NBR	NCC	7
111782VA5-H	1.125	1.780	0.250	VA5-H	NBR	NCO	7	112225B-H	1.125	2.250	0.250	SB-H	NBR	NCC	7
11174VB	1.125	1.780	0.469	VB	NBR	NCO	7	112235C	1.125	2.250	0.375	SC	NBR	NCC	7
111782VH	1.125	1.781	0.250	VH	NBR	NCO	7	112233TC	1.125	2.250	0.375	TC	NBR	NCC	7
11174TB	1.125	1.781	0.469	TB	NBR	NCC	7	11225SA-H	1.125	2.250	0.500	SA-H	NBR	NCC	8
111784VHY	1.125	1.781	0.469	VHY	NBR	NCO	7	1124343TC	1.125	2.437	0.437	TC	NBR	NCC	7
11182VSB	1.125	1.828	0.250	SB	FKM	VCC	7	11244SA-H	1.125	2.437	0.468	SA-H	NBR	NCC	7
111825B	1.125	1.828	0.250	SB	NBR	NCC	7	112425B	1.125	2.441	0.250	SB	NBR	NCC	7
111825B-H	1.125	1.828	0.250	SB-H	NBR	NCC	7	112425B-H	1.125	2.441	0.250	SB-H	NBR	NCC	7
11182VVB	1.125	1.828	0.250	TB	FKM	VSS	7	112425C	1.125	2.441	0.250	SC	NBR	NCC	7
11182TB	1.125	1.828	0.250	TB	NBR	NCC	7	112442VTB-H	1.125	2.441	0.250	TB-H	FKM	VCS	7
11182TB-H	1.125	1.828	0.250	TB-H	NBR	NCC	7	11242TB-H	1.125	2.441	0.250	TB-H	NBR	NCC	7
11182TC	1.125	1.828	0.250	TC	NBR	NCC	7	112532TB-H	1.125	2.533	0.250	TB-H	NBR	NCC	8
11182VH	1.125	1.828	0.250	VH	NBR	NCO	7	1128331VTC	1.125	2.835	0.315	TC	FKM	VCS	8
111823TB-H	1.125	1.828	0.312	TB-H	NBR	NCC	7	112833VTB-H	1.125	2.835	0.375	TB-H	FKM	VCS	8
11184TA	1.125	1.828	0.437	TA	NBR	NCC	7	11283TB-H	1.125	2.835	0.375	TB-H	NBR	NCC	8
111833TC	1.125	1.832	0.312	TC	NBR	NCC	7	SHAFT 1.142							
1118443TEM	1.125	1.848	0.437	TEM	NBR	NSS	7	V-RING -028							7
1118535C	1.125	1.850	0.312	SC	NBR	NCC	7	29X38X4TC	1.142	1.496	0.157	TC	NBR	NCC	7
11183SA	1.125	1.851	0.313	SA	NBR	NCC	7	29X38X4VG	1.142	1.496	0.157	VG	NBR	NCO	7
11183SA-H	1.125	1.851	0.313	SA-H	NBR	NCC	7	29X38X65C	1.142	1.496	0.236	SC	NBR	NCC	7
111872VSB	1.125	1.874	0.250	SB	FKM	VSS	7	29X39X55C	1.142	1.535	0.197	SC	NBR	NCC	7
1118725B-H	1.125	1.874	0.250	SB-H	NBR	NCC	7	29X40X55Z	1.142	1.575	0.197	SZ	NBR	NCC	7
111872VTB	1.125	1.874	0.250	TB	FKM	VSS	7	29X40X75M	1.142	1.575	0.276	SM	NBR	NCC	7
111872TB	1.125	1.874	0.250	TB	NBR	NCC	7	29X40X7TC	1.142	1.575	0.276	TC	NBR	NCC	7
111872VTB-H	1.125	1.874	0.250	TB-H	FKM	VCS	7	29X41X55C	1.142	1.614	0.197	SC	NBR	NCC	7
111872TB-H	1.125	1.874	0.250	TB-H	NBR	NCC	7	29X42X6TC	1.142	1.654	0.236	TC	NBR	NCC	7
111872TB-H	1.125	1.874	0.250	TB-H	NBR	NCC	7	29X42X75C	1.142	1.654	0.276	SC	NBR	NCC	7
111874SA	1.125	1.874	0.438	SA	NBR	NCC	7	29X43X75C	1.142	1.693	0.276	SC	NBR	NCC	7
1119334VL-H	1.125	1.938	0.342	VL-H	NBR	NCO	7	29X45X7TG	1.142	1.772	0.276	TG	NBR	NCC	7
11195TB	1.125	1.938	0.563	TB	NBR	NCC	8	29X45X8V5F	1.142	1.772	0.315	SF	FKM	VCS	7
11195VB	1.125	1.938	0.563	VB	NBR	NCO	8	29X45X8TC	1.142	1.772	0.315	TC	NBR	NCC	7
11195VB-H	1.125	1.938	0.563	VB-H	NBR	NCO	8	29X45X95C	1.142	1.772	0.354	SC	NBR	NCC	7
111925B	1.125	1.983	0.250	SB	NBR	NCC	7	29X45X9TC	1.142	1.772	0.354	TC	NBR	NCC	7
111925B-H	1.125	1.983	0.250	SB-H	NBR	NCC	7	29X45X9TM	1.142	1.772	0.354	TM	NBR	NCC	7
111982TB-H	1.125	1.983	0.250	TB-H	NBR	NCC	7	29X45X9.5V5F	1.142	1.772	0.374	SF	FKM	VCS	7
111992TEC	1.125	1.998	0.252	TEC	NBR	NCC	7	29X46X10TC	1.142	1.811	0.394	TC	NBR	NCC	7
11202VSB	1.125	2.000	0.250	SB	FKM	VCS	7	29X47X7VSB-H	1.142	1.850	0.276	SB-H	FKM	VCS	7
112025B	1.125	2.000	0.250	SB	NBR	NCC	7	29X47X105C	1.142	1.850	0.394	SC	NBR	NCC	7
11202VSB-H	1.125	2.000	0.250	SB-H	FKM	VCS	7	29X50X7TC	1.142	1.969	0.276	TC	NBR	NCC	7
112025B-H	1.125	2.000	0.250	SB-H	NBR	NCC	7	29X50X105C	1.142	1.969	0.394	SC	NBR	NCC	7
11202VTB-H	1.125	2.000	0.250	TB-H	FKM	VCS	7	29X50X10TA	1.142	1.969	0.394	TA	NBR	NCC	7
11202TB-H	1.125	2.000	0.250	TB-H	NBR	NCC	7	29X50X10TC	1.142	1.969	0.394	TC	NBR	NCC	7
11202VHY	1.125	2.000	0.250	VHY	NBR	NCO	7	29X50X125C	1.142	1.969	0.472	SC	NBR	NCC	7
11203TB	1.125	2.000	0.375	TB	NBR	NCC	7	29X52X7TC	1.142	2.047	0.276	TC	NBR	NCC	7
11203TB-H	1.125	2.000	0.375	TB-H	NBR	NCC	7	29X52X95C	1.142	2.047	0.354	SC	NBR	NCC	7
112043VTF	1.125	2.000	0.437	TF	FKM	VCS	7	29X52X9V5F	1.142	2.047	0.354	SF	FKM	VCS	7
112042VB	1.125	2.047	0.250	VB	NBR	NCO	7	29X52X10TA	1.142	2.047	0.394	TA	NBR	NCC	7
112042VB-H	1.125	2.047	0.250	VB-H	NBR	NCO	7	29X55X95C	1.142	2.165	0.354	SC	NBR	NCC	7
112043VTB-H	1.125	2.047	0.312	TB-H	FKM	VCS	7	29X55X9V5F	1.142	2.165	0.354	SF	FKM	VCS	7
112043TB-H	1.125	2.047	0.312	TB-H	NBR	NCC	7								

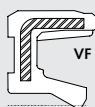
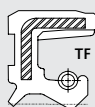
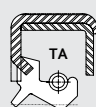

OIL AND GREASE SEALS - A COMPLETE LISTING

PLEASE CALL DICHTOMATIK FOR AVAILABILITY - 800-328-2840
BULK AND INDIVIDUALLY BOXED QUANTITIES ARE AVAILABLE FOR ALL



TCM Part # Shaft Bore Width Type Material Material Box #								TCM Part # Shaft Bore Width Type Material Material Box							
29X62X10VSF	1.142	2.441	0.394	SF	FKM	VCS	7	30X40X4VC	1.181	1.575	0.157	VC	NBR	NCO	7
29X62X10TC	1.142	2.441	0.394	TC	NBR	NCC	7	30X40X4VG	1.181	1.575	0.157	VG	NBR	NCO	7
SHAFT 1.155															
SHAFT-EZE 99120 S1															
V-RING -030 7															
1152063SB-H	1.155	2.061	0.312	SB-H	NBR	NCC	7	30X40X5VTC	1.181	1.575	0.197	TC	FKM	VCC	7
1152143SA-H	1.155	2.125	0.437	SA-H	NBR	NCC	7	30X40X5TC	1.181	1.575	0.197	TC	NBR	NCC	7
SHAFT 1.156															
SHAFT-EZE 99120 S1															
V-RING -030 7															
115162TB	1.156	1.686	0.250	TB	NBR	NCC	7	30X40X5VBC2	1.181	1.575	0.197	VBC2	NBR	NCC	7
115162TB-H	1.156	1.686	0.250	TB-H	NBR	NCC	7	30X40X7VSB	1.181	1.575	0.276	SB	FKM	VCS	7
115163TC	1.156	1.686	0.312	TC	NBR	NCC	7	30X40X7SB	1.181	1.575	0.276	SB	NBR	NCC	7
115163VTEC	1.156	1.686	0.312	TEC	FKM	VCS	7	30X40X7VSBW	1.181	1.575	0.276	SBW	FKM	VCC	7
11163VTF	1.156	1.688	0.313	TF	FKM	VCS	7	30X40X7SC	1.181	1.575	0.276	SC	NBR	NCC	7
115173DMY	1.156	1.750	0.375	DMY	NBR	NSS	7	30X40X7VSCW	1.181	1.575	0.276	SCW	FKM	VCS	7
115172PTB-H	1.156	1.752	0.250	TB-H	ACM	PCC	7	730X40X7SCY	1.181	1.575	0.276	SCY	NBR	NCS	7
115172TL	1.156	1.752	0.250	TL	NBR	NCC	7	30X40X7VSGW12	1.181	1.575	0.276	SGW12	FKM	VCC	7
115182SAY	1.156	1.874	0.250	SAY	NBR	NCS	7	30X40X7TC	1.181	1.575	0.276	TC	NBR	NCC	7
115182SB	1.156	1.874	0.250	SB	NBR	NCC	7	30X40X7VTF	1.181	1.575	0.276	TF	FKM	VCS	7
115182SB-H	1.156	1.874	0.250	SB-H	NBR	NCC	7	30X40X8TC	1.181	1.575	0.315	TC	NBR	NCC	7
1151872TB-H	1.156	1.874	0.250	TB-H	NBR	NCC	7	30X40X10DC	1.181	1.575	0.394	DC	NBR	NCC	7
115202VSB	1.156	2.000	0.250	SB	FKM	VSS	7	30X40X7SB-H	1.181	1.575	0.276	SB-H	NBR	NCC	7
115202VSB-H	1.156	2.000	0.250	SB-H	FKM	VCS	7	30X41X7TC	1.181	1.614	0.276	TC	NBR	NCC	7
115202TB	1.156	2.000	0.250	TB	NBR	NCC	7	30X41X10TC	1.181	1.614	0.394	TC	NBR	NCC	7
115202TB-H	1.156	2.000	0.250	TB-H	NBR	NCC	7	30X42X7SB-H	1.181	1.653	0.275	SB-H	NBR	NCC	7
115203TB-H	1.156	2.062	0.375	TB-H	NBR	NCC	7	30X42X7TG	1.181	1.653	0.275	TG	NBR	NCC	7
115214TB	1.156	2.125	0.437	TB	NBR	NCC	7	30X42X4.5PSC	1.181	1.654	0.177	SC	ACM	PCC	7
115214TB-H	1.156	2.125	0.437	TB-H	NBR	NCC	7	30X42X4.5SC	1.181	1.654	0.177	SC	NBR	NCC	7
115283TB-H	1.156	2.834	0.375	TB-H	NBR	NCC	8	30X42X4.5VTC	1.181	1.654	0.177	TC	FKM	VCC	7
SHAFT 1.170															
V-RING -030 7															
1172033SA-H	1.170	2.031	0.375	SA-H	NBR	NCC	7	30X42X4.6Vsz	1.181	1.654	0.181	SZ	FKM	VCS	7
SHAFT 1.175															
SHAFT-EZE 99122 S1															
V-RING -030 7															
117183TA	1.175	1.828	0.375	TA	NBR	NCC	7	30X42X5TC	1.181	1.654	0.197	TC	NBR	NCC	7
117183TB	1.175	1.828	0.375	TB	NBR	NCC	7	30X42X6VTC	1.181	1.654	0.236	TC	FKM	VCS	7
117205SB	1.175	2.031	0.500	SB	NBR	NCC	8	30X42X6TC	1.181	1.654	0.236	TC	NBR	NCC	7
117205SB-H	1.175	2.031	0.500	SB-H	NBR	NCC	8	30X42X7SC	1.181	1.654	0.276	SC	NBR	NCC	7
SHAFT 1.178															
SHAFT-EZE 99122 S1															
V-RING -030 7															
1172035SB	1.178	2.073	0.330	SB	VMQ	SCC	7	30X42X7VTF	1.181	1.654	0.276	TF	FKM	VCS	7
SHAFT 1.181															
SHAFT-EZE 99114 S1															
V-RING -030 7															
30X34X3VVM	1.181	1.339	0.118	VM	FKM	VCO	7	30X42X7TF	1.181	1.654	0.276	TF	NBR	NCC	7
30X35X3VM	1.181	1.378	0.118	VM	NBR	NCO	7	30X42X7VTFY	1.181	1.654	0.276	TFY	FKM	VCS	7
30X37X3VM	1.181	1.457	0.118	VM	NBR	NCO	7	30X42X8SC	1.181	1.654	0.315	SC	NBR	NCC	7
30X37X4TC	1.181	1.457	0.157	TC	NBR	NCC	7	30X42X8TC	1.181	1.654	0.315	TC	NBR	NCC	7
30X37X4VVB	1.181	1.457	0.157	VB	FKM	VCO	7	30X42X8PTCR	1.181	1.654	0.315	TCR	ACM	PCC	7
30X37X4VG	1.181	1.457	0.157	VG	NBR	NCO	7	30X42X12SC	1.181	1.654	0.472	SC	NBR	NCC	7
30X37X4VVG1	1.181	1.457	0.157	VG1	FKM	VCO	7	30X43X7TB	1.181	1.693	0.276	TB	NBR	NCC	7
30X37X6/VVTC	1.181	1.4570.236/0.276	TC	FKM	VCC	7	30X43X8SC	1.181	1.693	0.315	SC	NBR	NCC	7	
30X38X4SC	1.181	1.496	0.157	SC	NBR	NCS	7	30X43X8TC	1.181	1.693	0.315	TC	NBR	NCC	7
30X38X5TC	1.181	1.496	0.197	TC	NBR	NCC	7	30X43.5X7TC	1.181	1.713	0.276	TC	NBR	NCC	7
30X39X7TC	1.181	1.535	0.276	TC	NBR	NCC	7	30X43.5X10TB	1.181	1.713	0.394	TB	NBR	NCC	7
30X40X7VTC	1.181	1.574	0.275	TC	FKM	VCS	7	30X44X5TC	1.181	1.732	0.197	TC	NBR	NCC	7
30X40X4SC	1.181	1.575	0.157	SC	NBR	NCS	7	30X44X7TC	1.181	1.732	0.276	TC	NBR	NCC	7
30X40X4VTM	1.181	1.575	0.157	TM	FKM	VCC	7	30X44X9TC	1.181	1.732	0.354	TC	NBR	NCC	7
30X40X4VA	1.181	1.575	0.157	VA	NBR	NCO	7	30X44.5X7TC	1.181	1.752	0.276	TC	NBR	NCC	7
								30X45X8TG	1.181	1.771	0.314	TG	NBR	NCC	7
								30X45X5SC	1.181	1.772	0.197	SC	NBR	NCC	7
								30X45X5TC	1.181	1.772	0.197	TC	NBR	NCC	7
								30X45X6VTC	1.181	1.772	0.236	TC	FKM	VCS	7
								30X45X6TC	1.181	1.772	0.236	TC	NBR	NCC	7
								30X45X7SC	1.181	1.772	0.276	SC	NBR	NCC	7
								30X45X7TC	1.181	1.772	0.276	TC	NBR	NCC	7
								30X45X8SB	1.181	1.772	0.315	SB	NBR	NCC	7
								30X45X8SC	1.181	1.772	0.315	SC	NBR	NCC	7
								30X45X8VTC	1.181	1.772	0.315	TC	FKM	VCS	7
								30X45X8YTC	1.181	1.772	0.315	TCR	FKM	VCC	7
								30X45X10SC	1.181	1.772	0.394	SC	NBR	NCC	7
								30X45X10TC	1.181	1.772	0.394	TC	NBR	NCC	7
								30X45X11TC	1.181	1.772	0.433	TC	NBR	NCC	7
								30X45X8SB-H	1.181	1.772	0.315	SB-H	NBR	NCC	7
								30X46X7TC	1.181	1.811	0.275	TC	NBR	NCC	7

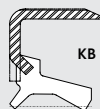
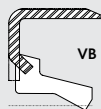
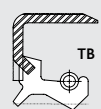
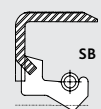
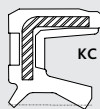
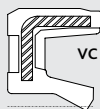
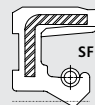
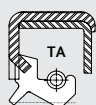



Table with columns: TCM Part #, Shaft, Bore, Width, Type, Lip Material, Material, Box, TCM Part #, Shaft, Bore, Width, Type, Lip Material, Material, Box #. Contains a comprehensive list of seal specifications.



OIL AND GREASE SEALS - A COMPLETE LISTING

PLEASE CALL DICHTOMATIK FOR AVAILABILITY - 800-328-2840
 BULK AND INDIVIDUALLY BOXED QUANTITIES ARE AVAILABLE FOR ALL



DICHTOMATIK

Any seal. Any time.

TCM Part #	Shaft	Bore	Width	Type	Lip Material	Material	Box #
SHAFT 1.187							
SHAFT-EZE 99118							S1
V-RING -030							7
118162VC	1.187	1.627	0.250	VC	NBR	NCO	7
118162SF	1.187	1.684	0.250	SF	NBR	NCS	7
1181715TB	1.187	1.718	0.500	TB	NBR	NCC	8
1181718TC	1.187	1.750	0.187	TC	NBR	NCC	7
1181752VSB-H	1.187	1.751	0.250	SB-H	FKM	VCS	7
118172TL-H	1.187	1.752	0.250	TL-H	NBR	NCC	7
111823TB-H	1.187	1.828	0.375	TB-H	NBR	NCC	7
118182TB-H	1.187	1.874	0.250	TB-H	NBR	NCC	7
11182TF	1.187	1.875	0.250	TF	NBR	NCS	7
1181835B-H	1.187	1.875	0.375	SB-H	NBR	NCC	7
1181932SC	1.187	1.937	0.250	SC	NBR	NCC	7
11819825B-H	1.187	1.983	0.250	SB-H	NBR	NCC	7
1181983TB-H	1.187	1.983	0.375	TB-H	NBR	NCC	7
1182025B-H	1.187	2.000	0.250	SB-H	NBR	NCC	7
1182043TB-H	1.187	2.000	0.437	TB-H	NBR	NCC	7
11820625B-H	1.187	2.061	0.250	SB-H	NBR	NCC	7
1182062VTB-H	1.187	2.062	0.250	TB-H	FKM	VCS	7
1182062TB-H	1.187	2.062	0.250	TB-H	NBR	NCC	7
1182122TB-H	1.187	2.125	0.250	TB-H	NBR	NCC	7
11215DB	1.187	2.165	0.500	DB	NBR	NCC	8
118222TB-H	1.187	2.250	0.250	TB-H	NBR	NCC	7
112432TB-H	1.187	2.437	0.250	TB-H	NBR	NCC	7
11824425B-H	1.187	2.440	0.250	SB-H	NBR	NCC	7
11265TB-H	1.187	2.686	0.500	TB-H	NBR	NCC	8
SHAFT 1.188							
SHAFT-EZE 99118							S1
V-RING -030							7
1116825B	1.188	1.686	0.250	SB	NBR	NSS	7
118163SC	1.188	1.686	0.375	SC	NBR	NCC	7
1181625B	1.188	1.687	0.250	SB	NBR	NCC	7
1181625B-H	1.188	1.687	0.250	SB-H	NBR	NCC	7
1181725B	1.188	1.752	0.250	SB	NBR	NCC	7
1181725B-H	1.188	1.752	0.250	SB-H	NBR	NCC	7
1181725SL	1.188	1.752	0.250	SL	NBR	NCC	7
1181835B	1.188	1.828	0.375	SB	NBR	NCC	7
1181835B-H	1.188	1.828	0.375	SB-H	NBR	NCC	7
1118735B	1.188	1.874	0.375	SB	NBR	NCC	7
1118735B-H	1.188	1.874	0.375	SB-H	NBR	NCC	7
11182PSB	1.188	1.875	0.250	SB	ACM	PCC	7
1181825B	1.188	1.875	0.250	SB	NBR	NCC	7
11182PSB-H	1.188	1.875	0.250	SB-H	ACM	PCC	7
118192TB	1.188	1.983	0.250	TB	NBR	NCC	7
118192TB-H	1.188	1.983	0.250	TB-H	NBR	NCC	7
118202VSB	1.188	2.000	0.250	SB	FKM	VCS	7
1182025B	1.188	2.000	0.250	SB	NBR	NCC	7
118202VSB-H	1.188	2.000	0.250	SB-H	FKM	VCS	7
118202TB	1.188	2.000	0.250	TB	NBR	NCC	7
118202TB-H	1.188	2.000	0.250	TB-H	NBR	NCC	7
1182125B-H	1.188	2.125	0.313	SB-H	NBR	NCC	7
118222SL	1.188	2.250	0.250	SL	NBR	NCC	7
1182225L-H	1.188	2.250	0.250	5L-H	NBR	NCC	7
1124325L	1.188	2.437	0.250	5L	NBR	NCC	7
1124325L-H	1.188	2.437	0.250	5L-H	NBR	NCC	7
1182425B	1.188	2.441	0.250	SB	NBR	NCC	7
118242TB-H	1.188	2.441	0.250	TB-H	NBR	NCC	7
112435B	1.188	2.441	0.380	SB	NBR	NCC	7
SHAFT 1.190							
SHAFT-EZE 99118							S1
V-RING -030							7
119213TA-H	1.190	2.125	0.312	TA-H	NBR	NCC	7

TCM Part #	Shaft	Bore	Width	Type	Lip Material	Material	Box
SHAFT 1.201							
V-RING -030							7
30.5X47X8TC	1.201	1.850	0.315	TC	NBR	NCC	7
SHAFT 1.218							
SHAFT-EZE 99123							S1
V-RING -030							7
121974VA3-H	1.218	1.979	0.406	VA3-H	NBR	NCO	7
1219845A-H	1.218	1.983	0.437	SA-H	NBR	NCC	7
122045A-H	1.218	2.000	0.437	SA-H	NBR	NCC	7
1212045C	1.218	2.000	0.437	SC	NBR	NCC	7
SHAFT 1.219							
SHAFT-EZE 99123							S1
V-RING -030							7
121194VB	1.219	1.968	0.469	VB	NBR	NCO	7
121194VB-H	1.219	1.968	0.469	VB-H	NBR	NCO	7
121972TB	1.219	1.979	0.250	TB	NBR	NCC	7
121972VB	1.219	1.979	0.250	VB	NBR	NCO	7
12119740VL-H	1.219	1.979	0.405	VL-H	NBR	NCO	7
121974TB	1.219	1.979	0.406	TB	NBR	NCC	7
121974TC	1.219	1.979	0.406	TC	NBR	NCC	7
121974VB	1.219	1.979	0.406	VB	NBR	NCO	7
1211982TC	1.219	1.983	0.250	TC	NBR	NCC	7
SHAFT 1.220							
SHAFT-EZE 99123							S1
V-RING -032							7
31X41X12.5TC	1.220	1.614	0.492	TC	NBR	NCC	7
31X42X8TC	1.220	1.654	0.315	TC	NBR	NCC	7
31X43X8TC	1.220	1.693	0.315	TC	NBR	NCC	7
31X44X7TC	1.220	1.732	0.276	TC	NBR	NCC	7
31X45X7TC	1.220	1.772	0.276	TC	NBR	NCC	7
31X45X8VTF	1.220	1.772	0.315	TF	FKM	VCS	7
31X45X9TC	1.220	1.772	0.354	TC	NBR	NCC	7
31X46X8TC	1.220	1.811	0.315	TC	NBR	NCC	7
31X47X75C	1.220	1.850	0.276	SC	NBR	NCC	7
31X47X7V5F	1.220	1.850	0.276	SF	FKM	VCS	7
31X47X8TCR	1.220	1.850	0.315	TCR	NBR	NCC	7
31X47X10VTC	1.220	1.850	0.394	TC	FKM	VCC	7
31X48X7TC	1.220	1.890	0.276	TC	NBR	NCC	7
31X48X10TC	1.220	1.890	0.394	TC	NBR	NCC	7
31X49X7TC	1.220	1.929	0.276	TC	NBR	NCC	7
31X50X7TC	1.220	1.969	0.276	TC	NBR	NCC	7
31X50X8TC	1.220	1.969	0.315	TC	NBR	NCC	7
31X51X7TC	1.220	2.008	0.276	TC	NBR	NCC	7
31X52X6V5F	1.220	2.047	0.236	SF	FKM	VCS	7
31X52X6TC	1.220	2.047	0.236	TC	NBR	NCC	7
31X52X6VTF	1.220	2.047	0.236	TF	FKM	VCS	7
31X52X75C	1.220	2.047	0.276	SC	NBR	NCC	7
31X52X7TC	1.220	2.047	0.276	TC	NBR	NCC	7
31X53X7TCS	1.220	2.087	0.276	TCS	NBR	NCC	7
31X55X9V5F	1.220	2.165	0.354	SF	FKM	VCS	7
SHAFT 1.234							
V-RING -032							7
1232225B	1.234	2.250	0.250	SB	NBR	NCC	7
SHAFT 1.238							
SHAFT-EZE 99141							S1
V-RING -032							7
1232255B-H	1.238	2.250	0.500	SB-H	NBR	NCC	7
SHAFT 1.240							
SHAFT-EZE 99141							S1
V-RING -032							7
124172PTC	1.240	1.750	0.250	TC	ACM	PCC	7





TCM Part #	Shaft	Bore	Width	Type	Lip Material	Material	Box	TCM Part #	Shaft	Bore	Width	Type	Lip Material	Material	Box #
31.5X47X7SC	1.240	1.850	0.276	SC	NBR	NCC	7	1217539TC	1.250	1.752	0.390	TC	NBR	NCC	7
31.5X52X7SC	1.240	2.047	0.276	SC	NBR	NCC	7	12173TCNY	1.250	1.752	0.391	TCNY	NBR	NCC	7
SHAFT 1.243								12172PTC	1.250	1.753	0.250	TC	ACM	PCC	7
V-RING -032							7	12182SB	1.250	1.874	0.250	SB	NBR	NCC	7
31.58X42X7TC4	1.243	1.654	0.276	TC4	NBR	NCC	7	12182SB-H	1.250	1.874	0.250	SB-H	NBR	NCC	7
SHAFT 1.248								12182VTB	1.250	1.874	0.250	TB	FKM	VCS	7
SHAFT-EZE 99125							51	12182TB	1.250	1.874	0.250	TB	NBR	NCC	7
V-RING -032							7	12182VTB-H	1.250	1.874	0.250	TB-H	FKM	VCS	7
124233TBW	1.248	2.374	0.313	TBW	NBR	NCC	7	12182TB-H	1.250	1.874	0.250	TB-H	NBR	NCC	7
SHAFT 1.250								12182VH	1.250	1.874	0.250	VH	NBR	NCO	7
SHAFT-EZE 99125							51	121872VH-H	1.250	1.874	0.250	VH-H	NBR	NCO	7
V-RING -032							7	12182TC	1.250	1.875	0.250	TC	NBR	NCC	7
121491VC	1.250	1.499	0.125	VC	NBR	NCO	7	121932SB-H	1.250	1.938	0.250	SB-H	NBR	NCC	7
12151VB	1.250	1.500	0.125	VB	NBR	NCO	7	12194KB	1.250	1.953	0.484	KB	NBR	NCO	7
12151VB-H	1.250	1.500	0.125	VB-H	NBR	NCO	7	121952TB-H	1.250	1.955	0.250	TB-H	NBR	NCC	7
12151VVM	1.250	1.500	0.125	VM	FKM	VCO	7	121954SB	1.250	1.955	0.435	SB	NBR	NCC	7
12152VL-H	1.250	1.500	0.250	VL-H	NBR	NCO	7	121954SB-H	1.250	1.955	0.435	SB-H	NBR	NCC	7
121618SB	1.250	1.625	0.187	SB	NBR	NCC	7	121964VB	1.250	1.968	0.438	VB	NBR	NCO	7
125161SB-H	1.250	1.625	0.187	SB-H	NBR	NCC	7	121964VHY	1.250	1.968	0.469	VHY	NBR	NCO	7
12161SM	1.250	1.625	0.187	SM	NBR	NCC	7	1251945SM	1.250	1.968	0.490	SM	VMQ	SCS	7
125161SB	1.250	1.625	0.188	SB	NBR	NCC	7	12192TB	1.250	1.979	0.250	TB	NBR	NCC	7
12161SC	1.250	1.625	0.188	SC	NBR	NCC	7	12192TB-U	1.250	1.979	0.250	TB-U	NBR	NCC	7
121622TC	1.250	1.625	0.250	TC	NBR	NCC	7	12192TC	1.250	1.979	0.250	TC	NBR	NCC	7
121622TZ-H	1.250	1.625	0.250	TZ-H	NBR	NCC	7	12192VA5-H	1.250	1.979	0.250	VA5-H	NBR	NCO	7
1216818VL-H	1.250	1.685	0.187	VL-H	NBR	NCO	7	12192VB	1.250	1.979	0.250	VB	NBR	NCO	7
1216818KB-H	1.250	1.686	0.188	KB-H	NBR	NCO	7	12192VH	1.250	1.979	0.250	VH	NBR	NCO	7
12161VB	1.250	1.686	0.188	VB	NBR	NCO	7	121972VH-H	1.250	1.979	0.250	VH-H	NBR	NCC	7
12161VB-H	1.250	1.686	0.188	VB-H	NBR	NCO	7	1219740VL-H	1.250	1.979	0.405	VL-H	NBR	NCO	7
1216821VC	1.250	1.686	0.218	VC	NBR	NCO	7	12194TC	1.250	1.979	0.406	TC	NBR	NCC	7
12162SC	1.250	1.686	0.250	SC	NBR	NCC	7	12194VB	1.250	1.979	0.406	VB	NBR	NCO	7
12162TB-H	1.250	1.686	0.250	TB-H	NBR	NCC	7	12194VHY	1.250	1.979	0.406	VHY	NBR	NCO	7
12162TF	1.250	1.686	0.250	TF	NBR	NSS	7	121982SB-H	1.250	1.983	0.250	SB-H	NBR	NCC	7
12162VSB	1.250	1.687	0.250	SB	FKM	VSS	7	121982TB	1.250	1.983	0.250	TB	NBR	NCC	7
12162SB	1.250	1.687	0.250	SB	NBR	NCC	7	121982VTB-H	1.250	1.983	0.250	TB-H	FKM	VCS	7
121682VSB-H	1.250	1.687	0.250	SB-H	FKM	VCS	7	121982TB-H	1.250	1.983	0.250	TB-H	NBR	NCC	7
12162SB-H	1.250	1.687	0.250	SB-H	NBR	NCC	7	121982VA3-H	1.250	1.983	0.250	VA3-H	NBR	NCO	7
12162VTB	1.250	1.687	0.250	TB	FKM	VSS	7	121982VAY	1.250	1.983	0.250	VAY	NBR	NCO	7
12162VTB-H	1.250	1.687	0.250	TB-H	FKM	VCS	7	121982VB	1.250	1.983	0.250	VB	NBR	NCO	7
12162VTC	1.250	1.687	0.250	TC	FKM	VCC	7	121982VH	1.250	1.983	0.250	VH	NBR	NCO	7
12162TC	1.250	1.687	0.250	TC	NBR	NCC	7	121982VH-H	1.250	1.983	0.250	VH-H	NBR	NCO	7
12162ATC	1.250	1.687	0.250	TCL1	NBR	NCC	7	121984SA	1.250	1.983	0.437	SA	NBR	NCC	7
12163TB	1.250	1.687	0.313	TB	NBR	NCC	7	1219943VTLN22-H	1.250	1.998	0.437	TLN22-H	FKM	VCS	7
12163TB-H	1.250	1.687	0.313	TB-H	NBR	NCC	7	12202SB	1.250	2.000	0.250	SB	NBR	NCC	7
1216831TBN	1.250	1.687	0.315	TBN	NBR	NCC	7	12202SB-H	1.250	2.000	0.250	SB-H	NBR	NCC	7
12172SB-H	1.250	1.750	0.250	SB-H	NBR	NCC	7	12202VTB	1.250	2.000	0.250	TB	FKM	VCS	7
12172SBY	1.250	1.750	0.250	SBY	NBR	NSS	7	12202TB	1.250	2.000	0.250	TB	NBR	NCC	7
12172SEC	1.250	1.750	0.250	SEC	NBR	NCC	7	12202TBSS	1.250	2.000	0.250	TB	NBR	NSS	7
121752TB	1.250	1.750	0.250	TB	NBR	NCC	7	12202VTB-H	1.250	2.000	0.250	TB-H	FKM	VCS	7
12172TBY	1.250	1.750	0.250	TBY	NBR	NCC	7	12202TB-H	1.250	2.000	0.250	TB-H	NBR	NCC	7
12172TL-H	1.250	1.750	0.250	TL-H	NBR	NCC	7	12202VH	1.250	2.000	0.250	VH	NBR	NCO	7
12172TLN22-H	1.250	1.750	0.250	TLN22-H	NBR	NCC	7	12202VH-H	1.250	2.000	0.250	VH-H	NBR	NCO	7
12172VM	1.250	1.750	0.250	VM	NBR	NCO	7	12203TC	1.250	2.000	0.312	TC	NBR	NCC	7
12171VHY-H	1.250	1.751	0.187	VHY-H	NBR	NCO	7	31.75X50.80X7.93TC	1.250	2.000	0.312	TC	NBR	NCC	7
121752VH-H	1.250	1.751	0.250	VH-H	NBR	NCO	7	122037SB	1.250	2.000	0.375	SB	NBR	NCC	7
12171VHY	1.250	1.752	0.188	VHY	NBR	NCO	7	122043SA-H	1.250	2.000	0.437	SA-H	NBR	NCC	7
12172VSB	1.250	1.752	0.250	SB	FKM	VSS	7	122043PSB-H	1.250	2.000	0.437	SB-H	ACM	PCC	7
12172VSB-H	1.250	1.752	0.250	SB-H	FKM	VCS	7	122043TA-H	1.250	2.000	0.437	TA-H	NBR	NCC	7
12172SL-H	1.250	1.752	0.250	SL-H	NBR	NCC	7	122043TB-H	1.250	2.000	0.437	TB-H	NBR	NCC	7
12172TB	1.250	1.752	0.250	TB	NBR	NCC	7	12204SB	1.250	2.000	0.438	SB	NBR	NCC	7
12172VTB-H	1.250	1.752	0.250	TB-H	FKM	VCS	7	122043TB-H	1.250	2.047	0.375	TB-H	NBR	NCC	7
12172TB-H	1.250	1.752	0.250	TB-H	NBR	NCC	7	12204TAY-H	1.250	2.056	0.639	TAY-H	NBR	NCC	8
12172VHY	1.250	1.752	0.250	VHY	NBR	NCO	7	122062VH-H	1.250	2.061	0.250	VH-H	NBR	NCO	7
121753SC	1.250	1.752	0.312	SC	NBR	NCC	7	122062VTB	1.250	2.062	0.250	TB	FKM	VCS	7
								122062TB	1.250	2.062	0.250	TB	NBR	NCC	7

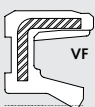
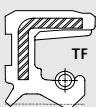

OIL AND GREASE SEALS - A COMPLETE LISTING

PLEASE CALL DICHTOMATIK FOR AVAILABILITY - 800-328-2840
BULK AND INDIVIDUALLY BOXED QUANTITIES ARE AVAILABLE FOR ALL



DICHTOMATIK

Any seal. Any time.

COMPLETE LISTING

TCM Part #	Shaft	Bore	Width	Type	Lip Material	Material	Box #	TCM Part #	Shaft	Bore	Width	Type	Lip Material	Material	Box		
122062VTB-H	1.250	2.062	0.250	TB-H	FKM	VCS	7	SHAFT 1.260									
122062TB-H	1.250	2.062	0.250	TB-H	NBR	NCC	7	SHAFT-EZE 99128								S1	
122062VH	1.250	2.062	0.250	VH	NBR	NCO	7	V-RING -032								7	
122064SA-H	1.250	2.062	0.438	SA-H	NBR	NCC	7	32X38X4VM	1.260	1.496	0.157	VM	NBR	NCO	7		
12212TB-H	1.250	2.124	0.250	TB-H	NBR	NCC	7	32X39X6/8KMY	1.260	1.535	0.236/0.315	KMY	NBR	NCO	7		
12212VSB	1.250	2.125	0.250	SB	FKM	VCS	7	32X40X4SM	1.260	1.575	0.157	SM	NBR	NCC	7		
12212SB	1.250	2.125	0.250	SB	NBR	NCC	7	32X40X5TC	1.260	1.575	0.197	TC	NBR	NCC	7		
12212VSB-H	1.250	2.125	0.250	SB-H	FKM	VCS	7	32X40X5VC	1.260	1.575	0.197	VC	NBR	NCO	7		
12212SB-H	1.250	2.125	0.250	SB-H	NBR	NCC	7	32X40X7TC	1.260	1.575	0.276	TC	NBR	NCC	7		
12212SC	1.250	2.125	0.250	SC	NBR	NCC	7	32X42X7SB-H	1.260	1.653	0.275	SB-H	NBR	NCC	7		
12212TB	1.250	2.125	0.250	TB	NBR	NCC	7	32X42X7TG	1.260	1.653	0.275	TG	NBR	NCC	7		
12212TB-H	1.250	2.125	0.250	TB-H	NBR	NCC	7	32X42X4XTC	1.260	1.654	0.157	TC	XNBR	XSS	7		
12212VTC	1.250	2.125	0.250	TC	FKM	VCS	7	32X42X4VTF	1.260	1.654	0.157	TF	FKM	VCS	7		
12212VHY	1.250	2.125	0.250	VHY	NBR	NCO	7	32X42X4XTF	1.260	1.654	0.157	TF	XNBR	XCS	7		
12212SVTB-H	1.250	2.125	0.255	TB-H	FKM	VCS	7	32X42X4VVG	1.260	1.654	0.157	VG	FKM	VCO	7		
12213PSB	1.250	2.125	0.375	SB	ACM	PCS	7	32X42X4VG	1.260	1.654	0.157	VG	NBR	NCO	7		
12214SZ	1.250	2.125	0.437	SZ	NBR	NCC	7	32X42X5SC	1.260	1.654	0.197	SC	NBR	NCC	7		
122143TB-H	1.250	2.125	0.437	TB-H	NBR	NCC	7	32X42X5TC	1.260	1.654	0.197	TC	NBR	NCC	7		
1221843SC	1.250	2.187	0.437	SC	NBR	NCC	7	32X42X7SC	1.260	1.654	0.276	SC	NBR	NCC	7		
1221843TC	1.250	2.188	0.430	TC	NBR	NCC	7	32X42X7TC	1.260	1.654	0.276	TC	NBR	NCC	7		
12222SB-H	1.250	2.250	0.250	SB-H	NBR	NCC	7	32X42X7TM	1.260	1.654	0.276	TM	NBR	NCC	7		
12222TZ	1.250	2.250	0.250	TZ	NBR	NCC	7	32X42X8TC	1.260	1.654	0.315	TC	NBR	NCC	7		
12222VB	1.250	2.250	0.250	VB	NBR	NCO	7	32X43X5.5TC	1.260	1.693	0.217	TC	NBR	NCC	7		
12222VL-H	1.250	2.250	0.250	VL-H	NBR	NCO	7	32X43X7TC	1.260	1.693	0.276	TC	NBR	NCC	7		
12223TC	1.250	2.250	0.375	TC	NBR	NCC	7	32X44X7SM	1.260	1.732	0.276	SM	NBR	NCC	7		
12224SP-H	1.250	2.250	0.435	SP-H	NBR	NCC	7	32X44X7TC	1.260	1.732	0.276	TC	NBR	NCC	7		
12223TB-H	1.250	2.252	0.375	TB-H	NBR	NCC	7	32X44X8TB	1.260	1.732	0.315	TB	NBR	NCC	7		
122325SB-H	1.250	2.327	0.500	SB-H	NBR	NCC	7	32X44X8TC	1.260	1.732	0.315	TC	NBR	NCC	7		
122323ATC	1.250	2.328	0.375	TCL1	NBR	NCC	7	32X44X9TC	1.260	1.732	0.354	TC	NBR	NCC	7		
12235TBN	1.250	2.328	0.500	TBN	NBR	NCC	8	32X44.5X7TC	1.260	1.752	0.276	TC	NBR	NCC	7		
122373SB-H	1.250	2.374	0.312	SB-H	NBR	NCC	7	32X45X7SG	1.260	1.771	0.275	SG	NBR	NCC	7		
12233SBY	1.250	2.374	0.313	SBY	NBR	NCC	7	32X45X4VG	1.260	1.772	0.157	VG	NBR	NCO	7		
12233TB-H	1.250	2.374	0.313	TB-H	NBR	NCC	7	32X45X6SC	1.260	1.772	0.236	SC	NBR	NCC	7		
1223731VSB-H	1.250	2.374	0.315	SB-H	FKM	VCS	7	32X45X7SC	1.260	1.772	0.276	SC	NBR	NCC	7		
122373TB-H	1.250	2.374	0.375	TB-H	NBR	NCC	7	32X45X7TC	1.260	1.772	0.276	TC	NBR	NCC	7		
122432SB-H	1.250	2.437	0.250	SB-H	NBR	NCC	7	32X45X7VTF	1.260	1.772	0.276	TF	FKM	VCS	7		
12243SC	1.250	2.437	0.313	SC	NBR	NCC	7	32X45X8SC	1.260	1.772	0.315	SC	NBR	NCC	7		
122433TB-H	1.250	2.437	0.375	TB-H	NBR	NCC	7	32X45X8PTCR	1.260	1.772	0.315	TCR	ACM	PCC	7		
12242SB	1.250	2.438	0.250	SB	NBR	NCC	7	32X45X8VTF	1.260	1.772	0.315	TF	FKM	VCS	7		
1224431TC	1.250	2.440	0.310	TC	NBR	NCC	7	32X45X10SC	1.260	1.772	0.394	SC	NBR	NCC	7		
122442SB	1.250	2.441	0.250	SB	NBR	NCC	7	32X46X8SB-H	1.260	1.811	0.314	SB-H	NBR	NCC	7		
122442SB-H	1.250	2.441	0.250	SB-H	NBR	NCC	7	32X46X8TC	1.260	1.811	0.315	TC	NBR	NCC	7		
122443TB	1.250	2.441	0.375	TB	NBR	NCC	7	32X47X8SB-H	1.260	1.850	0.314	SB-H	NBR	NCC	7		
122443TB-H	1.250	2.441	0.375	TB-H	NBR	NCC	7	32X47X6VSF	1.260	1.850	0.236	SF	FKM	VCS	7		
122505TLN22-H	1.250	2.501	0.500	TLN22-H	NBR	NCC	8	32X47X6VTF	1.260	1.850	0.236	TF	FKM	VCS	7		
12253SB	1.250	2.502	0.313	SB	NBR	NCC	8	32X47X7SB	1.260	1.850	0.276	SB	NBR	NCC	7		
12253SB-H	1.250	2.502	0.313	SB-H	NBR	NCC	8	32X47X7SC	1.260	1.850	0.276	SC	NBR	NCC	7		
122503TB-H	1.250	2.502	0.375	TB-H	NBR	NCC	8	32X47X7TC	1.260	1.850	0.276	TC	NBR	NCC	7		
122565SA-H	1.250	2.561	0.500	SA-H	NBR	NCC	8	32X47X7VTF	1.260	1.850	0.276	TF	FKM	VCS	7		
12274SA-H	1.250	2.713	0.468	SA-H	NBR	NCC	8	32X47X8VTBY	1.260	1.850	0.315	TBY	FKM	VSS	7		
12274SA-H	1.250	2.713	0.468	SA-H	NBR	NCC	8	32X47X8TC	1.260	1.850	0.315	TC	NBR	NCC	7		
12283TB	1.250	2.835	0.375	TB	NBR	NCC	8	32X47X10SC	1.260	1.850	0.394	SC	NBR	NCC	7		
12283TB-H	1.250	2.835	0.375	TB-H	NBR	NCC	8	32X47X10TC	1.260	1.850	0.394	TC	NBR	NCC	7		
12283TC	1.250	2.835	0.375	TC	NBR	NCC	8	32X48X8SB-H	1.260	1.889	0.314	SB-H	NBR	NCC	7		
12282TB-H	1.250	2.877	0.250	TB-H	NBR	NCC	8	32X48X5SC	1.260	1.890	0.197	SC	NBR	NCC	7		
123155SA-H	1.250	3.155	0.500	SA-H	NBR	NCC	8	32X48X5TC	1.260	1.890	0.197	TC	NBR	NCC	7		
123155TB	1.250	3.156	0.500	TB	NBR	NCC	8	32X48X7SC	1.260	1.890	0.276	SC	NBR	NCC	7		
SHAFT 1.252																	
SHAFT-EZE 99125								S1									
V-RING -032								7									
31.8X40X8TC	1.252	1.575	0.315	TC	NBR	NCC	7	32X48X8VTF	1.260	1.890	0.315	TF	FKM	VCC	7		
								32X48X8TC	1.260	1.890	0.315	TC	NBR	NCC	7		
								32X48X9SC	1.260	1.890	0.354	SC	NBR	NCC	7		
								32X50X8VSB-H	1.260	1.968	0.314	SB-H	FKM	VCS	7		
								32X50X8TG	1.260	1.968	0.314	TG	NBR	NCC	7		

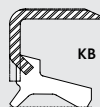
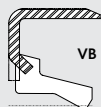
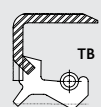
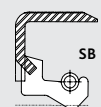
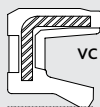



TCM Part #	Shaft	Bore	Width	Type	Lip Material	Material	Box	TCM Part #	Shaft	Bore	Width	Type	Lip Material	Material	Box #
32X50X7SB	1.260	1.969	0.276	SB	NBR	NCC	7	32X68X8TC	1.260	2.677	0.315	TC	NBR	NCC	8
32X50X7TB	1.260	1.969	0.276	TB	NBR	NCC	7	32X70X8TC	1.260	2.756	0.315	TC	NBR	NCC	8
32X50X7VTF	1.260	1.969	0.276	TF	FKM	VCS	7	32X70X10TC	1.260	2.756	0.394	TC	NBR	NCC	8
32X50X8SB-U	1.260	1.969	0.315	SB-U	NBR	NCC	7	32X72X8TC	1.260	2.835	0.315	TC	NBR	NCC	8
32X50X8SC	1.260	1.969	0.315	SC	NBR	NCC	7	32X72X10TC	1.260	2.835	0.394	TC	NBR	NCC	8
32X50X10SC	1.260	1.969	0.394	SC	NBR	NCC	7	32X72X12TA	1.260	2.835	0.472	TA	NBR	NCC	8
32X50X10VTC	1.260	1.969	0.394	TC	FKM	VCC	7	32X72X12TC	1.260	2.835	0.472	TC	NBR	NCC	8
32X50X10TC	1.260	1.969	0.394	TC	NBR	NCC	7	32X78X10TC	1.260	3.071	0.394	TC	NBR	NCC	8
32X51X8TB	1.260	2.008	0.315	TB	NBR	NCC	7	SHAFT 1.274							
32X51X8TC	1.260	2.008	0.315	TC	NBR	NCC	7	V-RING -032							7
32X51X9SC	1.260	2.008	0.354	SC	NBR	NCC	7	127194TB	1.274	1.983	0.437	TB	NBR	NCC	7
32X52X7SG	1.260	2.047	0.275	SG	NBR	NCC	7	SHAFT 1.280							
32X52X7TG	1.260	2.047	0.275	TG	NBR	NCC	7	V-RING -032							7
32X52X8SB-H	1.260	2.047	0.314	SB-H	NBR	NCC	7	128151VB	1.280	1.500	0.125	VB	NBR	NCO	7
32X52X5TC	1.260	2.047	0.197	TC	NBR	NCC	7	128203TC	1.280	2.000	0.375	TC	NBR	NCC	7
32X52X7SB	1.260	2.047	0.276	SB	NBR	NCC	7	SHAFT 1.281							
32X52X7VSC	1.260	2.047	0.276	SC	FKM	VCS	7	V-RING -032							7
32X52X7SC	1.260	2.047	0.276	SC	NBR	NCC	7	128202VSC	1.281	2.000	0.250	SC	FKM	VCS	7
32X52X8TC	1.260	2.047	0.315	TC	NBR	NCC	7	128203TB	1.281	2.000	0.375	TB	NBR	NCC	7
32X52X9TB	1.260	2.047	0.354	TB	NBR	NCC	7	128203TB-H	1.281	2.000	0.375	TB-H	NBR	NCC	7
32X52X10VSF	1.260	2.047	0.394	SF	FKM	VCS	7	SHAFT 1.299							
32X52X10TC	1.260	2.047	0.394	TC	NBR	NCC	7	SHAFT-EZE 99121							S1
32X52X10TM	1.260	2.047	0.394	TM	NBR	NCC	7	V-RING -035							7
32X52X11TC	1.260	2.047	0.433	TC	NBR	NCC	7	33X38X3VM	1.299	1.496	0.118	VM	NBR	NCO	7
32X52X12SA	1.260	2.047	0.472	SA	NBR	NCC	7	33X40X3VM	1.299	1.575	0.118	VM	NBR	NCO	7
32X53X7TC	1.260	2.087	0.276	TC	NBR	NCC	7	33X43X7TC	1.299	1.693	0.276	TC	NBR	NCC	7
32X54X7VC	1.260	2.126	0.276	VC	NBR	NCO	7	33X43X6.5/7.5TCY	1.299	1.693	0.256/0.295	TCY	NBR	NCC	7
32X54X8TC	1.260	2.126	0.315	TC	NBR	NCC	7	33X44X8TC	1.299	1.732	0.315	TC	NBR	NCC	7
32X54X11SC	1.260	2.126	0.433	SC	NBR	NCC	7	33X45X7VSC	1.299	1.772	0.276	SC	FKM	VCS	7
32X55X7TC	1.260	2.165	0.276	TC	NBR	NCC	7	33X45X7SC	1.299	1.772	0.276	SC	NBR	NCC	7
32X55X8TB	1.260	2.165	0.315	TB	NBR	NCC	7	33X45X7TC	1.299	1.772	0.276	TC	NBR	NCC	7
32X55X8TC	1.260	2.165	0.315	TC	NBR	NCC	7	33X45X8VTC	1.299	1.772	0.315	TC	FKM	VCC	7
32X55X10SA	1.260	2.165	0.394	SA	NBR	NCC	7	33X47X10TC	1.299	1.850	0.394	TC	NBR	NCC	7
32X55X10SB	1.260	2.165	0.394	SB	NBR	NCC	7	33X48X8TC	1.299	1.890	0.315	TC	NBR	NCC	7
32X55X10TC	1.260	2.165	0.394	TC	NBR	NCC	7	33X48X8.9TC	1.299	1.890	0.350	TC	NBR	NCC	7
32X55X11TC	1.260	2.165	0.433	TC	NBR	NCC	7	33X48X12SC	1.299	1.890	0.472	SC	NBR	NCC	7
32X55X12SA	1.260	2.165	0.472	SA	NBR	NCC	7	33X48X12VSF	1.299	1.890	0.472	SF	FKM	VCS	7
32X56X8TC	1.260	2.205	0.315	TC	NBR	NCC	7	33X49X8PTCR	1.299	1.929	0.315	TCR	ACM	PCC	7
32X56X10VTC	1.260	2.205	0.394	TC	FKM	VCC	7	33X49.5X9TC	1.299	1.949	0.354	TC	NBR	NCC	7
32X56X10TC	1.260	2.205	0.394	TC	NBR	NCC	7	33X50X6SC	1.299	1.969	0.236	SC	NBR	NCC	7
32X57X9.5VTF	1.260	2.244	0.374	TF	FKM	VCS	7	33X50X6TC	1.299	1.969	0.236	TC	NBR	NCC	7
32X57.2X10TC	1.260	2.252	0.394	TC	NBR	NCC	7	33X50X7TC	1.299	1.969	0.276	TC	NBR	NCC	7
32X58X8TC	1.260	2.283	0.315	TC	NBR	NCC	7	33X50X8TC	1.299	1.969	0.315	TC	NBR	NCC	7
32X58X10SB	1.260	2.283	0.394	SB	NBR	NCC	7	33X50X10TC	1.299	1.969	0.394	TC	NBR	NCC	7
32X58X12TB	1.260	2.283	0.472	TB	NBR	NCC	7	33X50X12TB	1.299	1.969	0.472	TB	NBR	NCC	7
32X60X10TA	1.260	2.362	0.394	TA	NBR	NCC	7	33X50X12TC	1.299	1.969	0.472	TC	NBR	NCC	7
32X60X10TC	1.260	2.362	0.394	TC	NBR	NCC	7	33X51X7TB	1.299	2.008	0.276	TB	NBR	NCC	7
32X60X12SA	1.260	2.362	0.472	SA	NBR	NCC	7	33X52X6TC	1.299	2.047	0.236	TC	NBR	NCC	7
32X62X8TC	1.260	2.440	0.314	TC	NBR	NCC	7	33X52X10SC	1.299	2.047	0.394	SC	NBR	NCC	7
32X62X7TC	1.260	2.441	0.276	TC	NBR	NCC	7	33X55X9.5TM	1.299	2.165	0.374	TM	NBR	NCC	7
32X62X7VTF	1.260	2.441	0.276	TF	FKM	VCS	7	33X55X10TC	1.299	2.165	0.394	TC	NBR	NCC	7
32X62X8SC	1.260	2.441	0.315	SC	NBR	NCC	7	33X56X8TC	1.299	2.205	0.315	TC	NBR	NCC	7
32X62X9TZ	1.260	2.441	0.354	TZ	NBR	NCC	7	33X56X12VSF	1.299	2.205	0.472	SF	FKM	VCS	7
32X62X10SC	1.260	2.441	0.394	SC	NBR	NCC	7	33X56X12TC	1.299	2.205	0.472	TC	NBR	NCC	7
32X62X10VTC	1.260	2.441	0.394	TC	FKM	VCC	7	33X62X10TC	1.299	2.441	0.394	TC	NBR	NCC	7
32X62X10TC	1.260	2.441	0.394	TC	NBR	NCC	7	33X62X11TB	1.299	2.441	0.433	TB	NBR	NCC	7
32X62X10VTF	1.260	2.441	0.394	TF	FKM	VCS	7	33X62X12SA	1.299	2.441	0.472	SA	NBR	NCC	7
32X65X6.5TC	1.260	2.559	0.256	TC	NBR	NCC	8	33X63X9TC	1.299	2.480	0.354	TC	NBR	NCC	7
32X65X9TC	1.260	2.559	0.354	TC	NBR	NCC	8	33X66X9TC	1.299	2.598	0.354	TC	NBR	NCC	8
32X65X10SA	1.260	2.559	0.394	SA	NBR	NCC	8	33X66X12TC	1.299	2.598	0.472	TC	NBR	NCC	8
32X65X10SB	1.260	2.559	0.394	SB	NBR	NCC	8	33X66X13SC	1.299	2.598	0.512	SC	NBR	NCC	8
32X65X12TB	1.260	2.559	0.472	TB	NBR	NCC	8	33X66X13TC	1.299	2.598	0.512	TC	NBR	NCC	8
32X66X10SC	1.260	2.598	0.394	SC	NBR	NCC	8								
32X66X10VSF	1.260	2.598	0.394	SF	FKM	VCS	8								

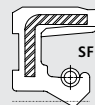
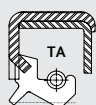

OIL AND GREASE SEALS - A COMPLETE LISTING



PLEASE CALL DICHTOMATIK FOR AVAILABILITY - 800-328-2840
BULK AND INDIVIDUALLY BOXED QUANTITIES ARE AVAILABLE FOR ALL

TCM Part #	Shaft	Bore	Width	Type	Lip Material	Material	Box #
33X72X8TC	1.299	2.835	0.315	TC	NBR	NCC	8
SHAFT 1.300							
SHAFT-EZE 99121							S1
V-RING -035							7
1301451KMY	1.300	1.459	0.150	KMY	NBR	NCO	7
1302043PTB-H	1.300	2.000	0.437	TB-H	ACM	PCC	7
SHAFT 1.301							
SHAFT-EZE 99121							S1
V-RING -035							7
1302043TB-H	1.301	2.000	0.437	TB-H	NBR	NCC	7
130204TB-H	1.301	2.046	0.490	TB-H	NBR	NCC	7
SHAFT 1.312							
SHAFT-EZE 99129							S1
SHAFT-EZE 99131							S1
V-RING -035							7
131183TB-H	1.312	1.874	0.375	TB-H	NBR	NCC	7
1311831SC	1.312	1.875	0.312	SC	NBR	NCC	7
13119318SC	1.312	1.937	0.187	SC	NBR	NCC	7
131193TB-H	1.312	1.983	0.375	TB-H	NBR	NCC	7
1312003TB-H	1.312	2.000	0.312	TB-H	NBR	NCC	7
1312063TB-H	1.312	2.062	0.312	TB-H	NBR	NCC	7
131204TB	1.312	2.062	0.437	TB	NBR	NCC	7
1312064TA-H	1.312	2.062	0.438	TA-H	NBR	NCC	7
1312103TB-H	1.312	2.106	0.375	TB-H	NBR	NCC	7
1312131SB-H	1.312	2.125	0.312	SB-H	NBR	NCC	7
131213TB	1.312	2.125	0.312	TB	NBR	NCC	7
131213TB-H	1.312	2.125	0.312	TB-H	NBR	NCC	7
1312163TB	1.312	2.166	0.375	TB	NBR	NCC	7
131223SB-H	1.312	2.250	0.312	SB-H	NBR	NCC	7
131223TB	1.312	2.250	0.312	TB	NBR	NCC	7
131223TB-H	1.312	2.250	0.312	TB-H	NBR	NCC	7
131233TB-H	1.312	2.374	0.312	TB-H	NBR	NCC	7
1312492OTM-G	1.312	2.490	0.250	OTM-G	NBR	NCC	7
1312492OTMY	1.312	2.490	0.250	OTMY	NBR	NCO	7
131284TB-H	1.312	2.835	0.468	TB-H	NBR	NCC	8
SHAFT 1.313							
SHAFT-EZE 99129							S1
SHAFT-EZE 99131							S1
V-RING -035							7
13183PSL	1.313	1.828	0.375	SL	ACM	PCS	7
13183PSL-H	1.313	1.828	0.375	SL-H	ACM	PCC	7
1311825C	1.313	1.875	0.250	SC	NBR	NCC	7
1312035B-H	1.313	2.062	0.312	SB-H	NBR	NCC	7
1312035B	1.313	2.062	0.313	SB	NBR	NCC	7
131203TB	1.313	2.062	0.313	TB	NBR	NCC	7
131203TB-H	1.313	2.062	0.313	TB-H	NBR	NCC	7
132282TB	1.313	2.282	0.250	TB	NBR	NCC	7
132282TB-H	1.313	2.282	0.250	TB-H	NBR	NCC	7
SHAFT 1.319							
V-RING -035							7
33.5X55X9.5TC	1.319	2.165	0.374	TC	NBR	NCC	7
SHAFT 1.322							
V-RING -035							7
1322335B-H	1.322	2.227	0.375	SB-H	NBR	NCC	7
SHAFT 1.328							
V-RING -035							7
1322035B	1.328	2.061	0.313	SB	NBR	NCC	7
1322035B-H	1.328	2.061	0.313	SB-H	NBR	NCC	7
1322315B-H	1.328	2.227	0.312	SB-H	NBR	NCC	7
1322315B	1.328	2.227	0.313	SB	NBR	NCC	7
1322345B	1.328	2.312	0.435	SB	NBR	NCC	7

TCM Part #	Shaft	Bore	Width	Type	Lip Material	Material	Box
SHAFT 1.339							
SHAFT-EZE 99134							S1
V-RING -035							7
34X39X3VC	1.339	1.535	0.118	VC	NBR	NCO	7
34X41X4KC	1.339	1.614	0.157	KC	NBR	NCO	7
34X41X4TM	1.339	1.614	0.157	TM	NBR	NCC	7
34X44X8TC	1.339	1.732	0.314	TC	NBR	NCC	7
34X44X6SC	1.339	1.732	0.236	SC	NBR	NCC	7
34X44X7TC	1.339	1.732	0.276	TC	NBR	NCC	7
34X44X8TM	1.339	1.732	0.315	TM	NBR	NCC	7
34X45X6TC	1.339	1.772	0.236	TC	NBR	NCC	7
34X45X75C	1.339	1.772	0.276	SC	NBR	NCC	7
34X45X7TC	1.339	1.772	0.276	TC	NBR	NCC	7
34X46X8TC	1.339	1.811	0.315	TC	NBR	NCC	7
34X46X8TM	1.339	1.811	0.315	TM	NBR	NCC	7
34X47X7VSB-H	1.339	1.850	0.276	SB-H	FKM	VCS	7
34X47X7TC	1.339	1.850	0.276	TC	NBR	NCC	7
34X47X10TC	1.339	1.850	0.394	TC	NBR	NCC	7
34X48X85B-H	1.339	1.889	0.314	SB-H	NBR	NCC	7
34X48X8PTC	1.339	1.889	0.314	TC	ACM	PCC	7
34X48X7TC	1.339	1.890	0.276	TC	NBR	NCC	7
34X49X8V5F	1.339	1.929	0.315	SF	FKM	VCS	7
34X50X7TC	1.339	1.969	0.276	TC	NBR	NCC	7
34X50X10VTC	1.339	1.969	0.394	TC	FKM	VCC	7
34X50X12TC	1.339	1.969	0.472	TC	NBR	NCC	7
34X52X75B	1.339	2.047	0.276	SB	NBR	NCC	7
34X52X7TB	1.339	2.047	0.276	TB	NBR	NCC	7
34X52X7TC	1.339	2.047	0.276	TC	NBR	NCC	7
34X52X7.5V5F	1.339	2.047	0.295	SF	FKM	VCS	7
34X52X7.5TC	1.339	2.047	0.295	TC	NBR	NCC	7
34X52X85C	1.339	2.047	0.315	SC	NBR	NCC	7
34X52X8VTC	1.339	2.047	0.315	TC	FKM	VCC	7
34X52X8TC	1.339	2.047	0.315	TC	NBR	NCC	7
34X52X105C	1.339	2.047	0.394	SC	NBR	NCC	7
34X54X7TC	1.339	2.126	0.276	TC	NBR	NCC	7
34X54X11TC	1.339	2.126	0.433	TC	NBR	NCC	7
34X55X65C	1.339	2.165	0.236	SC	NBR	NCC	7
34X55X8TB	1.339	2.165	0.315	TB	NBR	NCC	7
34X55X95C	1.339	2.165	0.354	SC	NBR	NCC	7
34X55X9TC	1.339	2.165	0.354	TC	NBR	NCC	7
34X55X10V5F	1.339	2.165	0.394	SF	FKM	VCS	7
34X55X11VTC	1.339	2.165	0.433	TC	FKM	VCC	7
34X57X65C	1.339	2.244	0.236	SC	NBR	NCC	7
34X58X10TC	1.339	2.283	0.394	TC	NBR	NCC	7
34X58X135A	1.339	2.283	0.512	SA	NBR	NCC	8
34X62X85B-H	1.339	2.440	0.314	SB-H	NBR	NCC	7
34X62X8TC	1.339	2.441	0.315	TC	NBR	NCC	7
34X62X105A	1.339	2.441	0.394	SA	NBR	NCC	7
34X62X105C	1.339	2.441	0.394	SC	NBR	NCC	7
34X62X10TC	1.339	2.441	0.394	TC	NBR	NCC	7
34X70X10TC	1.339	2.756	0.394	TC	NBR	NCC	8
34X72X105C	1.339	2.835	0.394	SC	NBR	NCC	8
34X72X10TC	1.339	2.835	0.394	TC	NBR	NCC	8
34X72X11TB	1.339	2.835	0.433	TB	NBR	NCC	8
34X72X10/12TC	1.339	2.835/0.394/0.472	TC	NBR	NCC	8	
SHAFT 1.344							
V-RING -035							7
134213TL	1.344	2.106	0.313	TL	NBR	NCC	7
134213TL-H	1.344	2.106	0.313	TL-H	NBR	NCC	7
1342135B-H	1.344	2.125	0.312	SB-H	NBR	NCC	7
SHAFT 1.350							
V-RING -035							7
135162355CY	1.350	1.620	0.355	SCY	NBR	NCS	7

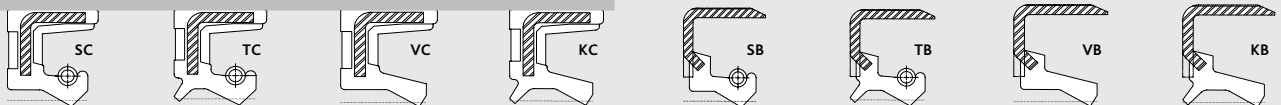



TCM Part #	Shaft	Bore	Width	Type	Lip Material	Material	Box	TCM Part #	Shaft	Bore	Width	Type	Lip Material	Material	Box #
135214DB	1.350	2.181	0.495	DB	NBR	NSS	7	131872VL	1.375	1.874	0.250	VL	NBR	NCO	7
135214DM	1.350	2.181	0.495	DM	NBR	NSS	7	131872PVL-H	1.375	1.874	0.250	VL-H	ACM	PCO	7
135257SP-H	1.350	2.571	0.706	SP-H	NBR	NCC	8	131872VL-H	1.375	1.874	0.250	VL-H	NBR	NCO	7
SHAFT 1.362								131873TB-H	1.375	1.874	0.312	TB-H	NBR	NCC	7
V-RING -035							7	131873TF	1.375	1.874	0.313	TF	NBR	NSS	7
1362192PSB-H	1.362	2.190	0.250	SB-H	ACM	PCC	7	131874TA	1.375	1.874	0.437	TA	NBR	NCC	7
SHAFT 1.365								13182HSB-PL	1.375	1.875	0.250	SB-PL	HNBR	HCC	7
V-RING -035							7	131872VSEC	1.375	1.875	0.250	SEC	FKM	VCC	7
136194SB	1.365	1.956	0.438	SB	NBR	NCC	7	131872VTCN	1.375	1.875	0.250	TCN	FKM	VCS	7
136203SB-H	1.365	2.081	0.313	SB-H	NBR	NCC	7	131873TB	1.375	1.875	0.313	TB	NBR	NCC	7
136212SM	1.365	2.191	0.250	SM	NBR	NCC	7	131873TB-H	1.375	1.875	0.313	TB-H	NBR	NCC	7
132264SB	1.365	2.259	0.435	SB-H	NBR	NCC	7	13192TB	1.375	1.938	0.250	TB	NBR	NCC	7
132263SB	1.365	2.261	0.313	SB	NBR	NCC	7	13192TB-H	1.375	1.938	0.250	TB-H	NBR	NCC	7
136234SB	1.365	2.374	0.435	SB	NBR	NCC	7	13192VB	1.375	1.938	0.250	VB	NBR	NCO	7
13256TB-H	1.365	2.502	0.600	TB-H	NBR	NCC	8	131955PTZ	1.375	1.953	0.500	TZ	ACM	PCS	8
SHAFT 1.372								1319543PTB-H	1.375	1.955	0.432	TB-H	ACM	PCC	7
SHAFT-EZE 99138							S1	1319639VTF	1.375	1.965	0.391	TF	FKM	VCS	7
SHAFT-EZE 99133							S1	1319825PSB-H	1.375	1.981	0.252	SB-H	ACM	PCC	7
V-RING -035							7	13193PSB-H	1.375	1.983	0.312	SB-H	ACM	PCC	7
13194TM	1.372	1.979	0.432	TM	NBR	NCC	7	13193PSB	1.375	1.983	0.313	SB	ACM	PCS	7
13745648TBY	1.372	4.560	0.480	TBY	NBR	NCC	9	13193PSB-H	1.375	1.983	0.313	SB-H	ACM	PCS	7
SHAFT 1.374								131983SA	1.375	1.983	0.375	SA	NBR	NCC	7
SHAFT-EZE 99138							S1	131983SA-H	1.375	1.983	0.375	SA-H	NBR	NCC	7
SHAFT-EZE 99133							S1	13202VAY-H	1.375	2.000	0.250	VAY-H	NBR	NCO	7
V-RING -035							7	13202VH	1.375	2.000	0.250	VH	NBR	NCO	7
34.9X46.5X7TC	1.374	1.831	0.276	TC	NBR	NCC	7	13202VH-H	1.375	2.000	0.250	VH-H	NBR	NCO	7
SHAFT 1.375								13203SA-H	1.375	2.000	0.312	SA-H	NBR	NCC	7
SHAFT-EZE 99138							S1	13203VSB-H	1.375	2.000	0.312	SB-H	FKM	VCS	7
SHAFT-EZE 99139							S1	13203SB-H	1.375	2.000	0.312	SB-H	NBR	NCC	7
SHAFT-EZE 99133							S1	13203PTB-H	1.375	2.000	0.312	TB-H	ACM	PCC	7
V-RING -035							7	13203VTB-H	1.375	2.000	0.312	TB-H	FKM	VCS	7
13171SM-H	1.375	1.175	0.188	SM-H	NBR	NCC	7	13203TC	1.375	2.000	0.312	TC	NBR	NCC	7
13161VM	1.375	1.625	0.125	VM	NBR	NCO	7	132031TCN2	1.375	2.000	0.312	TCN2	NBR	NCC	7
13171VSM	1.375	1.750	0.187	SM	FKM	VCS	7	13203SA	1.375	2.000	0.313	SA	NBR	NCC	7
131718VC	1.375	1.750	0.187	VC	NBR	NCO	7	13203VSB	1.375	2.000	0.313	SB	FKM	VCS	7
13171SM	1.375	1.750	0.188	SM	NBR	NCC	7	13203SB	1.375	2.000	0.313	SB	NBR	NCC	7
13171VB	1.375	1.750	0.188	VB	NBR	NCO	7	13203VTB	1.375	2.000	0.313	TB	FKM	VCS	7
131719VVL-H	1.375	1.750	0.196	VL-H	FKM	VCO	7	13203TB	1.375	2.000	0.313	TB	NBR	NCC	7
131719VL-H	1.375	1.750	0.196	VL-H	NBR	NCO	7	13203TB-H	1.375	2.000	0.313	TB-H	NBR	NCC	7
13172TB	1.375	1.750	0.219	TB	NBR	NCC	7	13203TA	1.375	2.000	0.375	TA	NBR	NCC	7
13172TB-H	1.375	1.750	0.219	TB-H	NBR	NCC	7	1320427VTB-H	1.375	2.047	0.275	TB-H	FKM	VCS	7
13172SB-H	1.375	1.750	0.250	SB-H	NBR	NCC	7	132043TB-H	1.375	2.047	0.312	TB-H	NBR	NCC	7
131725SEF	1.375	1.750	0.250	SEF	NBR	NCS	7	1320631SB-H	1.375	2.061	0.312	SB-H	NBR	NCC	7
131725SEMY-H	1.375	1.750	0.250	SEMY-H	NBR	NCS	7	1320631PTB-H	1.375	2.061	0.312	TB-H	ACM	PCC	7
131822VTB-H	1.375	1.827	0.250	TB-H	FKM	VCS	7	132064SSTM	1.375	2.061	0.437	TM	NBR	NSS	7
13183SB-H	1.375	1.827	0.312	SB-H	NBR	NCC	7	132062SC	1.375	2.062	0.250	SC	NBR	NCC	7
13182SB	1.375	1.828	0.250	SB	NBR	NCC	7	132062PTC	1.375	2.062	0.250	TC	ACM	PCC	7
131822TC	1.375	1.828	0.250	TC	NBR	NCC	7	132062TC	1.375	2.062	0.250	TC	NBR	NCC	7
13183SB	1.375	1.828	0.313	SB	NBR	NCC	7	132063TB-H	1.375	2.062	0.375	TB-H	NBR	NCC	7
131831UVM	1.375	1.834	0.188	UVM	NBR	NCO	7	1320643TB-H	1.375	2.062	0.437	TB-H	NBR	NCC	7
131832SB	1.375	1.835	0.250	SB	NBR	NCC	7	132063SB	1.375	2.063	0.313	SB	NBR	NCC	7
131832SB-H	1.375	1.835	0.250	SB-H	NBR	NCC	7	132063VSB-H	1.375	2.063	0.313	SB-H	FKM	VCS	7
131873VTB-H	1.375	1.872	0.312	TB-H	FKM	VCS	7	132063SB-H	1.375	2.063	0.313	SB-H	NBR	NCC	7
1318718VL-H	1.375	1.874	0.187	VL-H	NBR	NCO	7	132063VTB-H	1.375	2.063	0.313	TB-H	FKM	VCS	7
13181VB	1.375	1.874	0.188	VB	NBR	NCO	7	132103PSB-H	1.375	2.105	0.312	SB-H	ACM	PCC	7
131872SB	1.375	1.874	0.250	SB	NBR	NCC	7	13212VHY	1.375	2.106	0.250	VHY	NBR	NCO	7
131872PSB-H	1.375	1.874	0.250	SB-H	ACM	PCC	7	13213TB	1.375	2.106	0.313	TB	NBR	NCC	7
131872SB-H	1.375	1.874	0.250	SB-H	NBR	NCC	7	13213TB-H	1.375	2.106	0.313	TB-H	NBR	NCC	7
131872VSL-H	1.375	1.874	0.250	SL-H	FKM	VCS	7	132103PTL-H	1.375	2.106	0.313	TL-H	ACM	PCS	7
131872TB	1.375	1.874	0.250	TB	NBR	NCC	7	13212TC	1.375	2.125	0.250	TC	NBR	NCC	7
131872TB-H	1.375	1.874	0.250	TB-H	NBR	NCC	7	132122VHY	1.375	2.125	0.250	VHY	NBR	NCO	7
131872PVB	1.375	1.874	0.250	VB	ACM	PCO	7	132123SB-H	1.375	2.125	0.312	SB-H	NBR	NCC	7
								132123TC	1.375	2.125	0.312	TC	NBR	NCC	7
								132123SA	1.375	2.125	0.313	SA	NBR	NCC	7

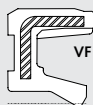
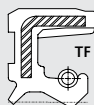
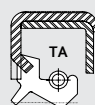

OIL AND GREASE SEALS - A COMPLETE LISTING



DICHTOMATIK

Any seal. Any time.

PLEASE CALL DICHTOMATIK FOR AVAILABILITY - 800-328-2840
BULK AND INDIVIDUALLY BOXED QUANTITIES ARE AVAILABLE FOR ALL

TCM Part #	Shaft	Bore	Width	Type	Lip Material	Material	Box #	TCM Part #	Shaft	Bore	Width	Type	Lip Material	Material	Box
132123SB	1.375	2.125	0.313	SB	NBR	NCC	7	132833SB-H	1.375	2.834	0.312	SB-H	NBR	NCC	8
132123VTB	1.375	2.125	0.313	TB	FKM	VCS	7	13283TB	1.375	2.835	0.313	TB	NBR	NCC	8
132123TB	1.375	2.125	0.313	TB	NBR	NCC	7	1328331VTB-H	1.375	2.835	0.313	TB-H	FKM	VCS	8
132123VTB-H	1.375	2.125	0.313	TB-H	FKM	VCS	7	13283TB-H	1.375	2.835	0.313	TB-H	NBR	NCC	8
132123TB-H	1.375	2.125	0.313	TB-H	NBR	NCC	7	132833TB-H	1.375	2.835	0.375	TB-H	NBR	NCC	8
132123VTCN2W2	1.375	2.125	0.375	TCN2W2	FKM	VCS	7	13283PTB-H	1.375	2.875	0.312	TB-H	ACM	PCC	8
132145A	1.375	2.125	0.437	SA	NBR	NCC	7	13284TB-H	1.375	2.875	0.468	TB-H	NBR	NCC	8
132143TB-H	1.375	2.125	0.437	TB-H	NBR	NCC	7	13305TA-H	1.375	3.000	0.500	TA-H	NBR	NCC	8
1322411PTBJYL	1.375	2.244	1.197	TBJYL	ACM	PCC	~	133153TB	1.375	3.150	0.375	TB	NBR	NCC	8
13222TB-H	1.375	2.250	0.250	TB-H	FKM	VCC	7	133153TB-H	1.375	3.150	0.375	TB-H	NBR	NCC	8
13222VL-H	1.375	2.250	0.250	VL-H	NBR	NCO	7	133155B	1.375	3.189	0.500	SB	NBR	NCC	8
13223TB	1.375	2.250	0.312	TB	NBR	NCC	7	133345A-H	1.375	3.350	0.468	SA-H	NBR	NCC	8
13223VTB-H	1.375	2.250	0.312	TB-H	FKM	VCS	7	134118VBY	1.375	4.125	0.187	VBY	NBR	NCO	9
13223TB-H	1.375	2.250	0.312	TB-H	NBR	NCC	7	SHAFT 1.378							
13223SB	1.375	2.250	0.313	SB	NBR	NCC	7	SHAFT-EZE 99139							
13223SB-H	1.375	2.250	0.313	SB-H	NBR	NCC	7	V-RING -035							
13223VTB	1.375	2.250	0.313	TB	FKM	VCS	7	35X40X4VB	1.378	1.575	0.157	VB	NBR	NCO	7
132282VL-H	1.375	2.281	0.250	VL-H	NBR	NCO	7	35X40X7VKC	1.378	1.575	0.276	KC	FKM	VCO	7
132282VB	1.375	2.282	0.250	VB	NBR	NCO	7	35X42X4VTC	1.378	1.654	0.157	TC	FKM	VCS	7
13234VHY	1.375	2.328	0.406	VHY	NBR	NCO	7	35X42X4VC	1.378	1.654	0.157	VC	NBR	NCO	7
13232VHY	1.375	2.374	0.250	VHY	NBR	NCO	7	35X42X8TC	1.378	1.654	0.315	TC	NBR	NCC	7
13233VSB	1.375	2.374	0.312	SB	FKM	VCS	7	35X43X6TC	1.378	1.693	0.236	TC	NBR	NCC	7
13233VSB-H	1.375	2.374	0.312	SB-H	FKM	VCS	7	35X44X7VTC	1.378	1.732	0.276	TC	FKM	VCC	7
13233SB-H	1.375	2.374	0.312	SB-H	NBR	NCC	7	35X44X7TM	1.378	1.732	0.276	TM	NBR	NCC	7
13233TB	1.375	2.374	0.312	TB	NBR	NCC	7	35X45X7TG	1.378	1.771	0.275	TG	NBR	NCC	7
13233TB-H	1.375	2.374	0.312	TB-H	NBR	NCC	7	35X45X4TC	1.378	1.772	0.157	TC	NBR	NCC	7
13233SB	1.375	2.374	0.313	SB	NBR	NCC	7	35X45X4VVC	1.378	1.772	0.157	VC	FKM	VCO	7
13235TM	1.375	2.375	0.500	TM	NBR	NCC	8	35X45X4VC	1.378	1.772	0.157	VC	NBR	NCO	7
1323837TC6	1.375	2.380	0.375	TC6	NBR	NCC	7	35X45X4VVG	1.378	1.772	0.157	VG	FKM	VCO	7
132432SB-H	1.375	2.437	0.250	SB-H	NBR	NCC	7	35X45X5SM	1.378	1.772	0.197	SM	NBR	NCC	7
132433TB-H	1.375	2.437	0.375	TB-H	NBR	NCC	7	35X45X5TM	1.378	1.772	0.197	TM	NBR	NCC	7
13242SB	1.375	2.438	0.250	SB	NBR	NCC	7	35X45X6VSC	1.378	1.772	0.236	SC	FKM	VCS	7
13242/2OUB	1.375	2.438	0.266/0.234	OUB	NBR	NCO	7	35X45X6SC	1.378	1.772	0.236	SC	NBR	NCC	7
132443SB-H	1.375	2.441	0.312	SB-H	NBR	NCC	7	35X45X6VTC	1.378	1.772	0.236	TC	FKM	VCC	7
132443SB	1.375	2.441	0.313	SB	NBR	NCC	7	35X45X6VBC2	1.378	1.772	0.236	VBC2	FKM	VCC	7
132443TB	1.375	2.441	0.313	TB	NBR	NCC	7	35X45X7SC	1.378	1.772	0.276	SC	NBR	NCC	7
132443TB-H	1.375	2.441	0.313	TB-H	NBR	NCC	7	35X45X7SCY	1.378	1.772	0.276	SCY	NBR	NCS	7
132443TB-H	1.375	2.441	0.375	TB-H	NBR	NCC	7	35X45X7PTC	1.378	1.772	0.276	TC	ACM	PCC	7
13253TB	1.375	2.500	0.321	TB	NBR	NCC	8	35X45X7VTC	1.378	1.772	0.276	TC	FKM	VCS	7
132502VH-H	1.375	2.501	0.250	VH-H	NBR	NCO	8	35X45X7TC	1.378	1.772	0.276	TC	NBR	NCC	7
13253SB-H	1.375	2.502	0.312	SB-H	NBR	NCC	8	35X45X7TF	1.378	1.772	0.276	TF	FKM	VCS	7
13253VSB	1.375	2.502	0.313	SB	FKM	VCS	8	35X45X8TC	1.378	1.772	0.315	TC	NBR	NCC	7
13253SB	1.375	2.502	0.313	SB	NBR	NCC	8	35X45X10SC	1.378	1.772	0.394	SC	NBR	NCC	7
132537TB	1.375	2.502	0.375	TB	NBR	NCC	8	35X46X7TC	1.378	1.811	0.276	TC	NBR	NCC	7
132537TB-H	1.375	2.502	0.375	TB-H	NBR	NCC	8	35X46X8TC	1.378	1.811	0.315	TC	NBR	NCC	7
1325055A-H	1.375	2.502	0.500	SA-H	NBR	NCC	8	35X47X7SG	1.378	1.850	0.275	SG	NBR	NCC	7
132563SB-H	1.375	2.562	0.375	SB-H	NBR	NCC	8	1371852VTB-H	1.378	1.850	0.275	TB-H	FKM	VCS	7
132563VTB	1.375	2.562	0.375	TB	FKM	VCS	8	137182VTC-PL	1.378	1.850	0.275	TC-PL	FKM	VCC	7
132563TB	1.375	2.562	0.375	TB	NBR	NCC	8	35X47X7TG	1.378	1.850	0.275	TG	NBR	NCC	7
132563VTB-H	1.375	2.562	0.375	TB-H	FKM	VCS	8	35X47X7SB-H	1.378	1.850	0.276	SB-H	NBR	NCC	7
132563TB-H	1.375	2.562	0.375	TB-H	NBR	NCC	8	35X47X4.5SC	1.378	1.850	0.177	SC	NBR	NCC	7
1326231VTB-H	1.375	2.622	0.312	TB-H	FKM	VCS	8	35X47X5SC	1.378	1.850	0.197	SC	NBR	NCC	7
132623TB	1.375	2.623	0.313	TB	NBR	NCC	8	35X47X6SB	1.378	1.850	0.236	SB	NBR	NCC	7
132623TB-H	1.375	2.623	0.313	TB-H	NBR	NCC	8	35X47X6SC	1.378	1.850	0.236	SC	NBR	NCC	7
132623TB-H	1.375	2.623	0.375	TB-H	NBR	NCC	8	35X47X6VSCW12	1.378	1.850	0.236	SCW12	FKM	VCC	7
13263SC	1.375	2.625	0.375	SC	NBR	NCC	8	35X47X6VVF	1.378	1.850	0.236	VF	FKM	VCS	7
1326855A-H	1.375	2.686	0.500	SA-H	NBR	NCC	8	35X47X6TB	1.378	1.850	0.236	TB	NBR	NCC	7
13265SL	1.375	2.686	0.500	SL	NBR	NCC	8	35X47X6TC	1.378	1.850	0.236	TC	NBR	NCC	7
132735B-H	1.375	2.716	0.312	SB-H	NBR	NCC	8	35X47X7ESC	1.378	1.850	0.276	SC	EPDM	ECC	7
132735B	1.375	2.716	0.313	SB	NBR	NCC	8	35X47X7VSC	1.378	1.850	0.276	SC	FKM	VSC	7
13274SA-H	1.375	2.716	0.468	SA-H	NBR	NCC	8	35X47X7SC	1.378	1.850	0.276	SC	NBR	NCC	7
132713TC	1.375	2.717	0.375	TC	NBR	NCC	8	35X47X7TC	1.378	1.850	0.276	TC	NBR	NCC	7
13275SA-H	1.375	2.750	0.500	SA-H	NBR	NCC	8	35X47X7VTF	1.378	1.850	0.276	TF	FKM	VCS	7
13275SC	1.375	2.750	0.500	SC	NBR	NCC	8	35X47X8TC2	1.378	1.850	0.315	TC2	NBR	NCC	7

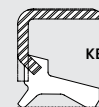
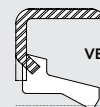
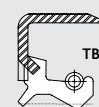
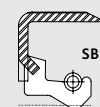
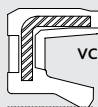



TCM Part #	Shaft	Bore	Width	Type	Lip Material	Material	Box	TCM Part #	Shaft	Bore	Width	Type	Lip Material	Material	Box #
35X47X9TC	1.378	1.850	0.354	TC	NBR	NCC	7	35X54X6TC	1.378	2.126	0.236	TC	NBR	NCC	7
35X47X10DC	1.378	1.850	0.394	DC	NBR	NCC	7	35X54X7TC	1.378	2.126	0.276	TC	NBR	NCC	7
35X47X10SC	1.378	1.850	0.394	SC	NBR	NCC	7	35X54X8TC	1.378	2.126	0.315	TC	NBR	NCC	7
35X47X10TC	1.378	1.850	0.394	TC	NBR	NCC	7	35X54X10SC	1.378	2.126	0.394	SC	NBR	NCC	7
35X48X8VSB-H	1.378	1.889	0.314	SB-H	FKM	VCS	7	35X54X10VSF	1.378	2.126	0.394	SF	FKM	VCS	7
35X48X8SB-H	1.378	1.889	0.314	SB-H	NBR	NCC	7	35X54X10TC	1.378	2.126	0.394	TC	NBR	NCC	7
35X48X8TG	1.378	1.889	0.314	TG	NBR	NCC	7	35X54X12.7SA	1.378	2.126	0.500	SA	NBR	NCC	8
35X48X7TCR	1.378	1.890	0.276	TCR	NBR	NCC	7	13721657STBJYW	1.378	2.161	0.577	TBJYW	VMQ	SCC	8
35X48X7VTF	1.378	1.890	0.276	TF	FKM	VCS	7	35X55X8TB-H	1.378	2.165	0.314	TB-H	NBR	NCC	7
35X48X7VTGR	1.378	1.890	0.276	TGR	FKM	VCC	7	35X55X8SB-H	1.378	2.165	0.315	SB-H	NBR	NCC	7
35X48X85C	1.378	1.890	0.315	SC	NBR	NCC	7	35X55X10TG	1.378	2.165	0.393	TG	NBR	NCC	7
35X48X8TC	1.378	1.890	0.315	TC	NBR	NCC	7	35X55X11PTC	1.378	2.165	0.433	TC	ACM	PCC	7
35X48X10TC	1.378	1.890	0.394	TC	NBR	NCC	7	35X55X5SC	1.378	2.165	0.197	SC	NBR	NCC	7
35X49X6TC	1.378	1.929	0.236	TC	NBR	NCC	7	35X55X5TB	1.378	2.165	0.197	TB	NBR	NCC	7
35X49X7TC	1.378	1.929	0.276	TC	NBR	NCC	7	35X55X5VB	1.378	2.165	0.197	VB	NBR	NCO	7
35X49X7TCR	1.378	1.929	0.276	TCR	NBR	NCC	7	35X55X7TC	1.378	2.165	0.276	TC	NBR	NCC	7
35X50X75SC	1.378	1.968	0.275	SC	VMQ	SCC	7	35X55X7VTF	1.378	2.165	0.276	TF	FKM	VCS	7
35X50X8SB-H	1.378	1.968	0.314	SB-H	NBR	NCC	7	35X55X8SB	1.378	2.165	0.315	SB	NBR	NCC	7
35X50X8TG	1.378	1.968	0.314	TG	NBR	NCC	7	35X55X85C	1.378	2.165	0.315	SC	NBR	NCC	7
35X50X55C	1.378	1.969	0.197	SC	NBR	NCC	7	35X55X8VTBY	1.378	2.165	0.315	TBY	FKM	VSS	7
35X50X7TB	1.378	1.969	0.276	TB	NBR	NCC	7	35X55X8TC	1.378	2.165	0.315	TC	NBR	NCC	7
35X50X7TC	1.378	1.969	0.276	TC	NBR	NCC	7	35X55X8VTF	1.378	2.165	0.315	TF	FKM	VCS	7
35X50X7VTF	1.378	1.969	0.276	TF	FKM	VCS	7	35X55X10SC	1.378	2.165	0.394	SC	NBR	NCC	7
35X50X7VTGR	1.378	1.969	0.276	TGR	FKM	VCC	7	35X55X10VSF	1.378	2.165	0.394	SF	FKM	VCS	7
35X50X8TC	1.378	1.969	0.315	TC	NBR	NCC	7	35X55X10TC	1.378	2.165	0.394	TC	NBR	NCC	7
35X50X8PTCW	1.378	1.969	0.315	TCW	ACM	PCC	7	35X55X11TC	1.378	2.165	0.433	TC	NBR	NCC	7
35X50X8VTF	1.378	1.969	0.315	TF	FKM	VCS	7	35X55X12TC	1.378	2.165	0.472	TC	NBR	NCC	7
35X50X8VTGR	1.378	1.969	0.315	TGR	FKM	VCC	7	35X56X85B-H	1.378	2.204	0.314	SB-H	NBR	NCC	7
35X50X9SA	1.378	1.969	0.354	SA	NBR	NCC	7	35X56X8SC	1.378	2.205	0.315	SC	NBR	NCC	7
35X50X10SC	1.378	1.969	0.394	SC	NBR	NCC	7	35X56X8VSF	1.378	2.205	0.315	SF	FKM	VCS	7
35X50X10TC	1.378	1.969	0.394	TC	NBR	NCC	7	35X56X8TC	1.378	2.205	0.315	TC	NBR	NCC	7
35X50X10VTF	1.378	1.969	0.394	TF	FKM	VCS	7	35X56X105C	1.378	2.205	0.394	SC	NBR	NCC	7
35X51X7TC	1.378	2.008	0.276	TC	NBR	NCC	7	35X56X10TB	1.378	2.205	0.394	TB	NBR	NCC	7
35X51X8TB	1.378	2.008	0.315	TB	NBR	NCC	7	35X56X10VTC	1.378	2.205	0.394	TC	FKM	VCC	7
35X52X75G	1.378	2.047	0.275	SG	NBR	NCC	7	35X56X10TC	1.378	2.205	0.394	TC	NBR	NCC	7
35X52X7TG	1.378	2.047	0.275	TG	NBR	NCC	7	35X56X12TC	1.378	2.205	0.472	TC	NBR	NCC	7
35X52X85B-H	1.378	2.047	0.314	SB-H	NBR	NCC	7	35X57X65C	1.378	2.244	0.236	SC	NBR	NCC	7
35X52X8PTB-H	1.378	2.047	0.315	TB-H	ACM	PCC	7	35X57X6TC	1.378	2.244	0.236	TC	NBR	NCC	7
35X52X8TB-H	1.378	2.047	0.315	TB-H	NBR	NCC	7	35X58X6TC	1.378	2.283	0.236	TC	NBR	NCC	7
35X52X10TG	1.378	2.047	0.393	TG	NBR	NCC	7	35X58X6.5TB	1.378	2.283	0.256	TB	NBR	NCC	7
35X52X5.5VTF	1.378	2.047	0.217	TF	FKM	VCS	7	35X58X7TC	1.378	2.283	0.276	TC	NBR	NCC	7
35X52X6TC	1.378	2.047	0.236	TC	NBR	NCC	7	35X58X7.5VSF	1.378	2.283	0.295	SF	FKM	VCS	7
35X52X6VTCY	1.378	2.047	0.236	TCY	FKM	VCC	7	35X58X8TC	1.378	2.283	0.315	TC	NBR	NCC	7
35X52X6VTF	1.378	2.047	0.236	TF	FKM	VCS	7	35X58X10SC	1.378	2.283	0.394	SC	NBR	NCC	7
35X52X7TC	1.378	2.047	0.276	TC	NBR	NCC	7	35X58X10TC	1.378	2.283	0.394	TC	NBR	NCC	7
35X52X7VTF	1.378	2.047	0.276	TF	FKM	VCS	7	35X58X10VTF	1.378	2.283	0.394	TF	FKM	VCS	7
35X52X8VSB	1.378	2.047	0.315	SB	FKM	VCS	7	35X58X12TC	1.378	2.283	0.472	TC	NBR	NCC	7
35X52X8HSB	1.378	2.047	0.315	SB	HNBR	HCC	7	35X60X7TC	1.378	2.362	0.276	TC	NBR	NCC	7
35X52X85C	1.378	2.047	0.315	SC	NBR	NCC	7	35X60X10SC	1.378	2.362	0.394	SC	NBR	NCC	7
35X52X8PTB	1.378	2.047	0.315	TB	ACM	PCC	7	35X60X10VSF	1.378	2.362	0.394	SF	FKM	VCS	7
35X52X8TB	1.378	2.047	0.315	TB	NBR	NCC	7	35X60X10VTC	1.378	2.362	0.394	TC	FKM	VCC	7
35X52X8TC	1.378	2.047	0.315	TC	NBR	NCC	7	35X60X12TC	1.378	2.362	0.472	TC	NBR	NCC	7
35X52X8.7SB	1.378	2.047	0.343	SB	NBR	NCC	7	35X60X15.5TC	1.378	2.362	0.610	TC	NBR	NCC	8
35X52X9SA	1.378	2.047	0.354	SA	NBR	NCC	7	35X62X10TG	1.378	2.440	0.393	TG	NBR	NCC	7
35X52X9TB	1.378	2.047	0.354	TB	NBR	NCC	7	35X62X55B	1.378	2.441	0.197	SB	NBR	NCC	7
35X52X9TC	1.378	2.047	0.354	TC	NBR	NCC	7	35X62X75C	1.378	2.441	0.276	SC	NBR	NCC	7
35X52X10SC	1.378	2.047	0.394	SC	NBR	NCC	7	35X62X7TC	1.378	2.441	0.276	TC	NBR	NCC	7
35X52X10TC	1.378	2.047	0.394	TC	NBR	NCC	7	35X62X7VTF	1.378	2.441	0.276	TF	FKM	VCS	7
35X52X125C	1.378	2.047	0.472	SC	NBR	NCC	7	35X62X8VSB	1.378	2.441	0.315	SB	FKM	VCS	7
35X52X12TC	1.378	2.047	0.472	TC	NBR	NCC	7	35X62X8HSB	1.378	2.441	0.315	SB	HNBR	HCC	7
35X53X85C	1.378	2.087	0.315	SC	NBR	NCC	7	35X62X8SB	1.378	2.441	0.315	SB	NBR	NCC	7
13720930PTGL	1.378	2.097	0.305	TGL	ACM	PCC	7	35X62X8TB2-H	1.378	2.441	0.315	TB2-H	NBR	NCC	7
35X54X75B-H	1.378	2.125	0.275	SB-H	NBR	NCC	7	35X62X10VSEC	1.378	2.441	0.394	SEC	FKM	VCC	7
35X54X85C	1.378	2.125	0.314	SC	NBR	NCC	7	35X62X10VSF	1.378	2.441	0.394	SF	FKM	VCS	7

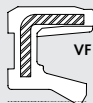
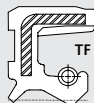
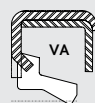
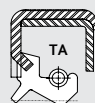

OIL AND GREASE SEALS - A COMPLETE LISTING

PLEASE CALL DICHTOMATIK FOR AVAILABILITY - 800-328-2840
BULK AND INDIVIDUALLY BOXED QUANTITIES ARE AVAILABLE FOR ALL



DICHTOMATIK

Any seal. Any time.

TCM Part #	Shaft	Bore	Width	Type	Lip			TCM Part #	Shaft	Bore	Width	Type	Lip		
					Material	Material	Box #						Material	Material	Box
35X62X10TB	1.378	2.441	0.394	TB	NBR	NCC	7	36X46X9TC	1.417	1.811	0.354	TC	NBR	NCC	7
35X62X10TC	1.378	2.441	0.394	TC	NBR	NCC	7	36X47X7SB	1.417	1.850	0.276	SB	NBR	NCC	7
35X62X10VTF	1.378	2.441	0.394	TF	FKM	VCS	7	36X47X7TC	1.417	1.850	0.276	TC	NBR	NCC	7
35X62X12TC	1.378	2.441	0.472	TC	NBR	NCC	7	36X47X7VTF	1.417	1.850	0.276	TF	FKM	VCS	7
35X62X8SB-H	1.378	2.441	0.315	SB-H	NBR	NCC	7	36X47X7TM	1.417	1.850	0.276	TM	NBR	NCC	7
35X64X8TC	1.378	2.520	0.315	TC	NBR	NCC	8	36X48X10SC	1.417	1.890	0.394	SC	NBR	NCC	7
35X64X13TC	1.378	2.520	0.512	TC	NBR	NCC	8	36X48X10VSF	1.417	1.890	0.394	SF	FKM	VCS	7
35X65X10SC	1.378	2.559	0.393	SC	NBR	NCC	8	36X48X10VTC	1.417	1.890	0.394	TC	FKM	VCC	7
35X65X8TC	1.378	2.559	0.315	TC	NBR	NCC	8	36X48X10TC	1.417	1.890	0.394	TC	NBR	NCC	7
35X65X9SC	1.378	2.559	0.354	SC	NBR	NCC	8	36X49X7TC	1.417	1.929	0.276	TC	NBR	NCC	7
35X65X12TC	1.378	2.559	0.472	TC	NBR	NCC	8	36X49.5X7PTCR	1.417	1.949	0.276	TCR	ACM	PCC	7
35X67X7SC	1.378	2.638	0.276	SC	NBR	NCC	8	36X50X5TC	1.417	1.969	0.197	TC	NBR	NCC	7
35X67X12TC	1.378	2.638	0.472	TC	NBR	NCC	8	36X50X7TC	1.417	1.969	0.276	TC	NBR	NCC	7
35X68X8SB-H	1.378	2.677	0.314	SB-H	NBR	NCC	8	36X50X7TA	1.417	1.969	0.276	TA	NBR	NCC	7
35X68X6SC	1.378	2.677	0.236	SC	NBR	NCC	8	36X50X7VTC	1.417	1.969	0.276	TC	FKM	VCC	7
35X68X10VTF	1.378	2.677	0.394	TF	FKM	VCS	8	36X50X7TC	1.417	1.969	0.276	TC	NBR	NCC	7
35X70X8TC	1.378	2.756	0.315	TC	NBR	NCC	8	36X50X7VTF	1.417	1.969	0.276	TF	FKM	VCS	7
35X70X10SA	1.378	2.756	0.394	SA	NBR	NCC	8	36X50.5X7TC	1.417	1.988	0.276	TC	NBR	NCC	7
35X70X10SB	1.378	2.756	0.394	SB	NBR	NCC	8	36X50.8X8TB	1.417	2.000	0.315	TB	NBR	NCC	7
35X70X10TC	1.378	2.756	0.394	TC	NBR	NCC	8	36X51X8TC	1.417	2.008	0.315	TC	NBR	NCC	7
35X72X8SB-H	1.378	2.834	0.314	SB-H	NBR	NCC	8	36X52X7TG	1.417	2.047	0.275	TG	NBR	NCC	7
35X72X7SC	1.378	2.835	0.276	SC	NBR	NCC	8	36X52X8SB-H	1.417	2.047	0.314	SB-H	NBR	NCC	7
35X72X7TC	1.378	2.835	0.276	TC	NBR	NCC	8	36X52X5SC	1.417	2.047	0.197	SC	NBR	NCC	7
35X72X7VTF	1.378	2.835	0.276	TF	FKM	VCS	8	36X52X7SC	1.417	2.047	0.276	SC	NBR	NCC	7
35X72X8TC	1.378	2.835	0.315	TC	NBR	NCC	8	36X52X7TC	1.417	2.047	0.276	TC	NBR	NCC	7
35X72X10SC	1.378	2.835	0.394	SC	NBR	NCC	8	36X52X7VTF	1.417	2.047	0.276	TF	FKM	VCS	7
35X72X10TC	1.378	2.835	0.394	TC	NBR	NCC	8	36X52X8OUA	1.417	2.047	0.315	OUA	NBR	NCO	7
35X72X10VTCW	1.378	2.835	0.394	TCW	FKM	VCC	8	36X52X9TC	1.417	2.047	0.354	TC	NBR	NCC	7
35X72X10VTF	1.378	2.835	0.394	TF	FKM	VCS	8	36X52X10TC	1.417	2.047	0.394	TC	NBR	NCC	7
35X72X12SA	1.378	2.835	0.472	SA	NBR	NCC	8	36X52X10TCR	1.417	2.047	0.394	TCR	NBR	NCC	7
35X72X12TC	1.378	2.835	0.472	TC	NBR	NCC	8	36X53X9TC	1.417	2.087	0.354	TC	NBR	NCC	7
35X72X12/7TC	1.378	2.835	0.472/0.276	TC	NBR	NCC	8	36X54X6.5SC	1.417	2.126	0.256	SC	NBR	NCC	7
13728331TB-H	1.378	2.835	0.315	TB-H	NBR	NCC	8	36X54X6.5VSF	1.417	2.126	0.256	SF	FKM	VCS	7
35X75X8TC	1.378	2.953	0.315	TC	NBR	NCC	8	36X54X7TC	1.417	2.126	0.276	TC	NBR	NCC	7
35X80X8SB-H	1.378	3.149	0.314	SB-H	NBR	NCC	8	36X54X7.5SC	1.417	2.126	0.295	SC	NBR	NCC	7
35X80X12TG	1.378	3.149	0.472	TG	NBR	NCC	8	36X54X7.5TC	1.417	2.126	0.295	TC	NBR	NCC	7
35X80X8TC	1.378	3.150	0.315	TC	NBR	NCC	8	36X54X10TC	1.417	2.126	0.394	TC	NBR	NCC	7
35X80X10TC	1.378	3.150	0.394	TC	NBR	NCC	8	36X54X11TC	1.417	2.126	0.433	TC	NBR	NCC	7
35X80X12SC	1.378	3.150	0.472	SC	NBR	NCC	8	36X55X11TB	1.417	2.165	0.433	TB	NBR	NCC	7
13731547TC	1.378	3.150	0.472	TC	NBR	NCC	8	36X56X6SC	1.417	2.205	0.236	SC	NBR	NCC	7
35X82X6SC	1.378	3.228	0.236	SC	NBR	NCC	8	36X56X9TC	1.417	2.205	0.354	TC	NBR	NCC	7
35X82X6TC	1.378	3.228	0.236	TC	NBR	NCC	8	36X56X10SC	1.417	2.205	0.394	SC	NBR	NCC	7
SHAFT 1.399								36X56X10VSF	1.417	2.205	0.394	SF	FKM	VCS	7
V-RING -035							7	36X58X8SB	1.417	2.283	0.315	SB	NBR	NCC	7
139222TB-H	1.399	2.250	0.250	TB-H	NBR	NCC	7	36X58X10TC	1.417	2.283	0.394	TC	NBR	NCC	7
13922946SB-H	1.399	2.292	0.460	SB-H	NBR	NCC	7	36X59X9.5SC	1.417	2.323	0.374	SC	NBR	NCC	7
139224TB	1.399	2.292	0.460	TB	NBR	NCC	7	36X60X8VSB-H	1.417	2.362	0.314	SB-H	FKM	VCS	7
139224SB-H	1.399	2.292	0.468	SB-H	NBR	NCC	7	36X60X6TC	1.417	2.362	0.236	TC	NBR	NCC	7
13922946TB-H	1.399	2.292	0.468	TB-H	NBR	NCC	7	36X60X7TC	1.417	2.362	0.276	TC	NBR	NCC	7
139224TBW-H	1.399	2.292	0.468	TBW-H	NBR	NCC	7	36X60X10TC	1.417	2.362	0.394	TC	NBR	NCC	7
139224TZ	1.399	2.292	0.469	TZ	NBR	NCC	7	36X62X7SC	1.417	2.441	0.276	SC	NBR	NCC	7
139225TB	1.399	2.292	0.500	TB	NBR	NCC	8	36X62X7VSF	1.417	2.441	0.276	SF	FKM	VCS	7
13924831VTBJW	1.399	2.482	0.310	TBJW	FKM	VCS	7	36X62X7VTC	1.417	2.441	0.276	TC	FKM	VCC	7
SHAFT 1.413								36X62X7TC	1.417	2.441	0.276	TC	NBR	NCC	7
SHAFT-EZE 99146							S1	36X63.5X9TC	1.417	2.500	0.354	TC	NBR	NCC	8
V-RING -035							7	36X65X8SB	1.417	2.559	0.315	SB	NBR	NCC	8
35.9X52X7.2EOUBC	1.413	2.047	0.283	OUBC	EPDM	ECS	7	36X68X8TC	1.417	2.677	0.315	TC	NBR	NCC	8
35.9X52X8SB	1.413	2.047	0.315	SB	NBR	NCC	7	36X68X10VSC	1.417	2.677	0.394	SC	FKM	VCC	8
SHAFT 1.417								36X68X10SC	1.417	2.677	0.394	SC	NBR	NCC	8
V-RING -038							7	36X68X10TC	1.417	2.677	0.394	TC	NBR	NCC	8
36X42X3.5VM	1.417	1.654	0.138	VM	NBR	NCO	7	36X72X8SC	1.417	2.835	0.315	SC	NBR	NCC	8
36X45X7SC	1.417	1.772	0.276	SC	NBR	NCC	7	36X75X12SC	1.417	2.953	0.472	SC	NBR	NCC	8
36X46X6SB	1.417	1.811	0.236	SB	NBR	NCC	7	36X75X12VSF	1.417	2.953	0.472	SF	FKM	VCS	8
								36X83X12SC	1.417	3.268	0.472	SC	NBR	NCC	8

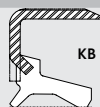
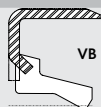
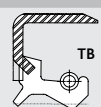
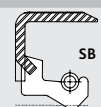
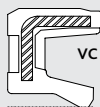



TCM Part #	Shaft	Bore	Width	Type	Lip Material	Material	Box	TCM Part #	Shaft	Bore	Width	Type	Lip Material	Material	Box #
SHAFT 1.437															
SHAFT-EZE 99143							S1	14253SB	1.438	2.502	0.313	SB	NBR	NCC	8
SHAFT-EZE 99144							S1	14253SB-H	1.438	2.502	0.313	SB-H	NBR	NCC	8
V-RING -038							7	143263TL	1.438	2.623	0.313	TL	NBR	NCC	8
1431715VB	1.437	1.750	0.156	VB	NBR	NCO	7	14263SB	1.438	2.686	0.313	SB	NBR	NCC	8
141719SZ	1.437	1.750	0.194	SZ	NBR	NCC	7	14263SB-H	1.438	2.686	0.313	SB-H	NBR	NCC	8
14192SB	1.437	1.937	0.250	SB	NBR	NCC	7	14273SB	1.438	2.750	0.313	SB	NBR	NCC	8
143191VC	1.437	1.998	0.125	VC	NBR	NCO	7	14273SB-H	1.438	2.750	0.313	SB-H	NBR	NCC	8
1432031TC	1.437	2.000	0.312	TC	NBR	NCC	7	SHAFT 1.450							
1432063VSB-H	1.437	2.061	0.312	SB-H	FKM	VCS	7	V-RING -038							7
1432063TB-H	1.437	2.061	0.312	TB-H	NBR	NCC	7	145203SB	1.450	2.075	0.312	SB	NBR	NCC	7
14320631VTF	1.437	2.062	0.312	TF	FKM	VCS	7	SHAFT 1.457							
14320731TC	1.437	2.070	0.312	TC	NBR	NCC	7	V-RING -038							7
143213SB-H	1.437	2.125	0.312	SB-H	NBR	NCC	7	37X45X7TC	1.457	1.772	0.276	TC	NBR	NCC	7
143213TB-H	1.437	2.125	0.312	TB-H	NBR	NCC	7	37X47X4VTF	1.457	1.850	0.157	TF	FKM	VCS	7
1432231SB-H	1.437	2.250	0.312	SB-H	NBR	NCC	7	37X47X4VG	1.457	1.850	0.157	VG	NBR	NCO	7
142313TB-H	1.437	2.312	0.375	TB-H	NBR	NCC	7	37X47X8TC	1.457	1.850	0.315	TC	NBR	NCC	7
1432373SB-H	1.437	2.374	0.312	SB-H	NBR	NCC	7	37X48X6TC	1.457	1.890	0.236	TC	NBR	NCC	7
1432373TB-H	1.437	2.374	0.312	TB-H	NBR	NCC	7	37X50X6TB	1.457	1.969	0.236	TB	NBR	NCC	7
14235SSTB	1.437	2.374	0.500	TB	NBR	NSS	8	37X50X6VTCR	1.457	1.969	0.236	TCR	FKM	VCC	7
1432432VH-H	1.437	2.437	0.250	VH-H	NBR	NCO	7	37X50X7TC	1.457	1.969	0.276	TC	NBR	NCC	7
14324331SB-H	1.437	2.437	0.312	SB-H	NBR	NCC	7	37X50X10SC	1.457	1.969	0.394	SC	NBR	NCC	7
14243TB-H	1.437	2.437	0.312	TB-H	NBR	NCC	7	37X50X10VTF	1.457	1.969	0.394	TF	FKM	VCS	7
143253TC	1.437	2.500	0.375	TC	NBR	NCC	8	37X50.5X7PTCR	1.457	1.988	0.276	TCR	ACM	PCC	7
143255PSC	1.437	2.500	0.500	SC	ACM	PCC	8	37X52X5TC	1.457	2.047	0.197	TC	NBR	NCC	7
143255SC	1.437	2.500	0.500	SC	NBR	NCC	8	37X52X8SC	1.457	2.047	0.315	SC	NBR	NCC	7
14253TB-H	1.437	2.502	0.312	TB-H	NBR	NCC	8	37X52X8VTC	1.457	2.047	0.315	TC	FKM	VCC	7
14255SA	1.437	2.502	0.500	SA	NBR	NCC	8	37X52X10VSF	1.457	2.047	0.394	SF	FKM	VCS	7
1432623SB-H	1.437	2.622	0.312	SB-H	NBR	NCC	8	37X52X12TC	1.457	2.047	0.472	TC	NBR	NCC	7
1432623TB-H	1.437	2.623	0.375	TB-H	NBR	NCC	8	37X53X7TC	1.457	2.087	0.276	TC	NBR	NCC	7
142683TB-H	1.437	2.686	0.375	TB-H	NBR	NCC	8	37X53X7TCR	1.457	2.087	0.276	TCR	NBR	NCC	7
143305TB-H	1.437	3.000	0.500	TB-H	NBR	NCC	8	37X55X8TC	1.457	2.165	0.315	TC	NBR	NCC	7
SHAFT 1.438															
SHAFT-EZE 99143							S1	37X55X9SA	1.457	2.165	0.354	SA	NBR	NCC	7
SHAFT-EZE 99144							S1	37X58X13TC	1.457	2.283	0.512	TC	NBR	NCC	8
V-RING -038							7	37X60X8TC	1.457	2.362	0.315	TC	NBR	NCC	7
14182SB	1.438	1.875	0.250	SB	NBR	NCC	7	37X62X7TC	1.457	2.441	0.276	TC	NBR	NCC	7
14182VTC	1.438	1.875	0.250	TC	FKM	VCS	7	37X62X8VSC	1.457	2.441	0.315	SC	FKM	VCC	7
14195TC	1.438	1.978	0.500	TC	NBR	NCC	8	37X62X8TC	1.457	2.441	0.315	TC	NBR	NCC	7
14203VTF	1.438	2.000	0.312	TF	FKM	VCS	7	37X62X9SA	1.457	2.441	0.354	SA	NBR	NCC	7
14203TC	1.438	2.000	0.313	TC	NBR	NCC	7	37X62X10TC	1.457	2.441	0.394	TC	NBR	NCC	7
143203TB	1.438	2.063	0.313	TB	NBR	NCC	7	37X62X11SC	1.457	2.441	0.433	SC	NBR	NCC	7
142063TC	1.438	2.063	0.313	TC	NBR	NCC	7	37X64X13TC	1.457	2.520	0.512	TC	NBR	NCC	8
14213VTB-H	1.438	2.125	0.312	TB-H	FKM	VCS	7	37X80X13SA	1.457	3.150	0.512	SA	NBR	NCC	8
14213SB	1.438	2.125	0.313	SB	NBR	NCC	7	SHAFT 1.468							
14213SB-H	1.438	2.125	0.313	SB-H	NBR	NCC	7	V-RING -038							7
14213VTB	1.438	2.125	0.313	TB	FKM	VCC	7	146233TB-H	1.468	2.375	0.375	TB-H	NBR	NCC	7
14213TB	1.438	2.125	0.313	TB	NBR	NCC	7	146243TB-H	1.468	2.437	0.375	TB-H	NBR	NCC	7
14213TB-H	1.438	2.125	0.313	TB-H	NBR	NCC	7	SHAFT 1.469							
142137SC	1.438	2.125	0.375	SC	NBR	NCC	7	V-RING -038							7
142137TC	1.438	2.125	0.375	TC	NBR	NCS	7	1462373TB-H	1.469	2.374	0.375	TB-H	NBR	NCC	7
14223SL	1.438	2.250	0.312	SL	NBR	NCC	7	SHAFT 1.476							
14223VTB-H	1.438	2.250	0.312	TB-H	FKM	VCS	7	V-RING -038							7
14223VSB	1.438	2.250	0.313	SB	FKM	VCS	7	37.5X50X6PTCR	1.476	1.969	0.236	TCR	ACM	PCC	7
14223VTB	1.438	2.250	0.313	TB	FKM	VCS	7	SHAFT 1.484							
14223TB	1.438	2.250	0.313	TB	NBR	NCC	7	V-RING -038							7
14223TB-H	1.438	2.250	0.313	TB-H	NBR	NCC	7	1482062VC	1.484	2.063	0.250	VC	NBR	NCC	7
142231VTC	1.438	2.250	0.313	TC	FKM	VCS	7	148223SB-H	1.484	2.254	0.312	SB-H	NBR	NCC	7
14233TB	1.438	2.374	0.313	TB	NBR	NCC	7	148223SB	1.484	2.254	0.313	SB	NBR	NCC	7
14233TB-H	1.438	2.374	0.313	TB-H	NBR	NCC	7	SHAFT 1.488							
14242VH	1.438	2.437	0.250	VH	NBR	NCO	7	V-RING -038							7
14243SB	1.438	2.437	0.313	SB	NBR	NCC	7	37.8X48X6VTC	1.488	1.890	0.236	TC	FKM	VCS	7
1424331STB	1.438	2.437	0.313	TB	VMQ	SCC	7								
14255SM	1.438	2.500	0.500	SM	NBR	NCC	8								

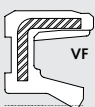
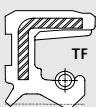

OIL AND GREASE SEALS - A COMPLETE LISTING

PLEASE CALL DICHTOMATIK FOR AVAILABILITY - 800-328-2840
BULK AND INDIVIDUALLY BOXED QUANTITIES ARE AVAILABLE FOR ALL



DICHTOMATIK

Any seal. Any time.

COMPLETE LISTING

TCM Part #	Shaft	Bore	Width	Type	Lip Material	Material	Box #	TCM Part #	Shaft	Bore	Width	Type	Lip Material	Material	Box
SHAFT 1.491															
SHAFT-EZE 99147							S1	38X55X10SC	1.496	2.165	0.394	SC	NBR	NCC	7
V-RING -038							7	38X55X12SA	1.496	2.165	0.472	SA	NBR	NCC	7
149212SA	1.491	2.191	0.250	SA	NBR	NCS	7	38X56X7TC	1.496	2.205	0.276	TC	NBR	NCC	7
1492192SB-H	1.491	2.191	0.250	SB-H	NBR	NCC	7	38X56X8TC	1.496	2.205	0.315	TC	NBR	NCC	7
SHAFT 1.496															
SHAFT-EZE 99147							S1	38X56X10SC	1.496	2.205	0.394	SC	NBR	NCC	7
V-RING -038							7	38X56X10VSF	1.496	2.205	0.394	SF	FKM	VCS	7
V-RING -040							7	38X56X10TC	1.496	2.205	0.394	TC	NBR	NCC	7
38X47X10SM	1.496	1.850	0.394	SM	NBR	NCC	7	38X56X12SC	1.496	2.205	0.472	SC	NBR	NCC	7
38X48X4VG	1.496	1.890	0.157	VG	NBR	NCO	7	38X56X12VTC	1.496	2.205	0.472	TC	FKM	VCC	7
38X48X7TC	1.496	1.890	0.276	TC	NBR	NCC	7	38X57X7TC	1.496	2.244	0.276	TC	NBR	NCC	7
38X50X6TC	1.496	1.969	0.236	TC	NBR	NCC	7	38X57X8TGN2-PL	1.496	2.244	0.315	TGN2-PL	NBR	NCC	7
38X50X6TM	1.496	1.969	0.236	TM	NBR	NCC	7	38X58X8VSB-H	1.496	2.283	0.314	SB-H	FKM	VCS	7
38X50X7KCY	1.496	1.969	0.276	KCY	NBR	NCO	7	38X58X8SB-H	1.496	2.283	0.314	SB-H	NBR	NCC	7
38X50X7VSC	1.496	1.969	0.276	SC	FKM	VCS	7	38X58X8TB-H	1.496	2.283	0.315	TB-H	NBR	NCC	7
38X50X7SC	1.496	1.969	0.276	SC	NBR	NCC	7	38X58X5VC	1.496	2.283	0.197	VC	NBR	NCO	7
38X50X7TC	1.496	1.969	0.276	TC	NBR	NCC	7	38X58X7TC	1.496	2.283	0.276	TC	NBR	NCC	7
38X50X7VTCW	1.496	1.969	0.276	TCW	FKM	VCS	7	38X58X8TB	1.496	2.283	0.315	TB	NBR	NCC	7
38X50X7VTF	1.496	1.969	0.276	TF	FKM	VCS	7	38X58X8TC	1.496	2.283	0.315	TC	NBR	NCC	7
38X50X8TC	1.496	1.969	0.315	TC	NBR	NCC	7	38X58X10SC	1.496	2.283	0.394	SC	NBR	NCC	7
38X50X10VTCR	1.496	1.969	0.394	TCR	FKM	VCC	7	38X58X10TC	1.496	2.283	0.394	TC	NBR	NCC	7
38X50X11TC	1.496	1.969	0.433	TC	NBR	NCC	7	38X58X11TB	1.496	2.283	0.433	TB	NBR	NCC	7
38X51X6.3TC	1.496	2.008	0.248	TC	NBR	NCC	7	38X58X12TC	1.496	2.283	0.472	TC	NBR	NCC	7
38X51X7TC	1.496	2.008	0.276	TC	NBR	NCC	7	38X59X8TC	1.496	2.323	0.315	TC	NBR	NCC	7
38X52X7TG	1.496	2.047	0.275	TG	NBR	NCC	7	38X60X8VSB-H	1.496	2.362	0.314	SB-H	FKM	VCS	7
14920427PTCR	1.496	2.047	0.276	TCR	ACM	PCC	7	38X60X8SB-H	1.496	2.362	0.314	SB-H	NBR	NCC	7
38X52X8SB-H	1.496	2.047	0.314	SB-H	NBR	NCC	7	38X60X7VTF	1.496	2.362	0.276	TF	FKM	VCS	7
38X52X8.5TC	1.496	2.047	0.334	TC	NBR	NCC	7	38X60X8TC	1.496	2.362	0.315	TC	NBR	NCC	7
149203TC	1.496	2.047	0.335	TC	NBR	NCC	7	38X60X8VTF	1.496	2.362	0.315	TF	FKM	VCS	7
38X52X6VTC	1.496	2.047	0.236	TC	FKM	VCS	7	38X60X10VTC	1.496	2.362	0.394	TC	FKM	VCC	7
38X52X6TC	1.496	2.047	0.236	TC	NBR	NCC	7	38X60X10TC	1.496	2.362	0.394	TC	NBR	NCC	7
38X52X6VAY	1.496	2.047	0.236	VAY	NBR	NCC	7	38X60.5X10TC	1.496	2.382	0.394	TC	NBR	NCC	7
38X52X7SC	1.496	2.047	0.276	SC	NBR	NCC	7	38X60.5X12TC	1.496	2.382	0.472	TC	NBR	NCC	7
38X52X7TC	1.496	2.047	0.276	TC	NBR	NCC	7	38X62X7TB	1.496	2.441	0.276	TB	NBR	NCC	7
38X52X7VTF	1.496	2.047	0.276	TF	FKM	VCS	7	38X62X7TC	1.496	2.441	0.276	TC	NBR	NCC	7
38X52X8SC	1.496	2.047	0.315	SC	NBR	NCC	7	38X62X7VTCN1	1.496	2.441	0.276	TCN1	FKM	VCC	7
38X52X8TB-H	1.496	2.047	0.315	TB-H	NBR	NCC	7	38X62X7VTF	1.496	2.441	0.276	TF	FKM	VCS	7
38X52X8PTC	1.496	2.047	0.315	TC	ACM	PCC	7	38X62X8SB	1.496	2.441	0.315	SB	NBR	NCC	7
38X52X8TC	1.496	2.047	0.315	TC	NBR	NCC	7	38X62X8SC	1.496	2.441	0.315	SC	NBR	NCC	7
38X52X10SB	1.496	2.047	0.394	SB	NBR	NCC	7	38X62X8VTF	1.496	2.441	0.315	TF	FKM	VCS	7
38X52X10TC	1.496	2.047	0.394	TC	NBR	NCC	7	38X62X10TC	1.496	2.441	0.394	TC	NBR	NCC	7
14920425SP-H	1.496	2.049	0.250	VBH-H	NBR	NCC	7	38X63X9TC	1.496	2.480	0.354	TC	NBR	NCC	7
149203TZ	1.496	2.051	0.334	TZ	NBR	NCC	7	38X64X12SC	1.496	2.520	0.472	SC	NBR	NCC	8
38X53X7TC	1.496	2.087	0.276	TC	NBR	NCC	7	38X64X12TC	1.496	2.520	0.472	TC	NBR	NCC	8
38X53X7VTCAL	1.496	2.087	0.276	TCAL	FKM	VCC	7	38X65X8VTC	1.496	2.559	0.315	TC	FKM	VCC	8
38X54X7PSB-H	1.496	2.125	0.275	SB-H	ACM	PCC	7	38X65X9SC	1.496	2.559	0.354	SC	NBR	NCC	8
38X54X10TG	1.496	2.125	0.393	TG	NBR	NCC	7	38X65X10SC	1.496	2.559	0.394	SC	NBR	NCC	8
38X54X6TB	1.496	2.126	0.236	TB	NBR	NCC	7	38X65X10TC	1.496	2.559	0.394	TC	NBR	NCC	8
38X54X6.5VSC	1.496	2.126	0.256	SC	FKM	VCS	7	38X68X12TM	1.496	2.677	0.472	TM	NBR	NCC	8
38X54X10SC	1.496	2.126	0.394	SC	NBR	NCC	7	38X70X8TC	1.496	2.756	0.315	TC	NBR	NCC	8
38X54X10VTC	1.496	2.126	0.394	TC	FKM	VCC	7	38X70X10SA	1.496	2.756	0.394	SA	NBR	NCC	8
38X54X10TC	1.496	2.126	0.394	TC	NBR	NCC	7	38X70X10VTC	1.496	2.756	0.394	TC	FKM	VCC	8
38X55X7PSC	1.496	2.165	0.275	SC	ACM	PCC	7	38X70X10TC	1.496	2.756	0.394	TC	NBR	NCC	8
38X55X8SB-H	1.496	2.165	0.314	SB-H	NBR	NCC	7	38X72X8TC	1.496	2.835	0.315	TC	NBR	NCC	8
38X55X7SC	1.496	2.165	0.276	SC	NBR	NCC	7	38X72X10SC	1.496	2.835	0.394	SC	NBR	NCC	8
38X55X7TB	1.496	2.165	0.276	TB	NBR	NCC	7	38X72X10VTF	1.496	2.835	0.394	TF	FKM	VCS	8
38X55X7VTC	1.496	2.165	0.276	TC	FKM	VCC	7	38X72X12SC	1.496	2.835	0.472	SC	NBR	NCC	8
38X55X7TC	1.496	2.165	0.276	TC	NBR	NCC	7	14929143TB-H	1.496	2.913	0.433	TB-H	NBR	NCC	8
38X55X8SC	1.496	2.165	0.315	SC	NBR	NCC	7	38X74X11TB-H	1.496	2.913	0.433	TB-H	NBR	NCC	8
38X55X8TC	1.496	2.165	0.315	TC	NBR	NCC	7	38X74X8TC	1.496	2.913	0.315	TC	NBR	NCC	8
38X55X9SA	1.496	2.165	0.354	SA	NBR	NCC	7	38X74X10VSF	1.496	2.913	0.394	SF	FKM	VCS	8
38X55X9TC	1.496	2.165	0.354	TC	NBR	NCC	7	38X74X10TM	1.496	2.913	0.394	TM	NBR	NCC	8
								38X74X11TC	1.496	2.913	0.433	TC	NBR	NCC	8
								38X80X8SB-H	1.496	3.149	0.314	SB-H	NBR	NCC	8
								38X80X8TC	1.496	3.150	0.315	TC	NBR	NCC	8

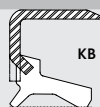
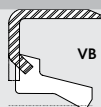
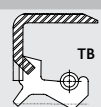
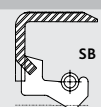
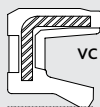
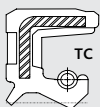



TCM Part #	Shaft	Bore	Width	Type	Lip Material	Material	Box	TCM Part #	Shaft	Bore	Width	Type	Lip Material	Material	Box #
SHAFT 1.498								152063SB-H	1.500	2.062	0.375	SB-H	NBR	NCC	7
SHAFT-EZE 99149							S1	1520638SC	1.500	2.062	0.385	SC	NBR	NCC	7
SHAFT-EZE 99150							S1	152062SL	1.500	2.063	0.250	SL	NBR	NCC	7
V-RING -040							7	1520631TC	1.500	2.063	0.313	TC	NBR	NCC	7
149202VCNBC-W1.498	2.000		0.250	CNBCW	FKM	VCS	7	152063SA	1.500	2.063	0.375	SA	NBR	NCC	7
SHAFT 1.500								152063VTLN22-H	1.500	2.064	0.375	TLN22-H	FKM	VCS	7
SHAFT-EZE 99149							S1	15202SC	1.500	2.066	0.250	SC	NBR	NCC	7
SHAFT-EZE 99150							S1	15203SC	1.500	2.066	0.313	SC	NBR	NCC	7
V-RING -040							7	15213VSB	1.500	2.125	0.312	SB	FKM	VCS	7
151715VM	1.500	1.750	0.156	VM	NBR	NCO	7	15213SB	1.500	2.125	0.312	SB	NBR	NCC	7
151842VC	1.500	1.844	0.250	VC	NBR	NCO	7	15213SB-H	1.500	2.125	0.312	SB-H	NBR	NCC	7
1518718VL-H	1.500	1.874	0.187	VL-H	NBR	NCO	7	15213SB-H	1.500	2.125	0.312	SB-H	NBR	NCC	7
15182SB	1.500	1.874	0.250	SB	NBR	NCC	7	15213VTB	1.500	2.125	0.312	TB	FKM	VCS	7
15182SB-H	1.500	1.874	0.250	SB-H	NBR	NCC	7	15213TB	1.500	2.125	0.312	TB	NBR	NCC	7
15182SBY	1.500	1.874	0.250	SBY	NBR	NSS	7	15213TB-H	1.500	2.125	0.312	TB-H	NBR	NCC	7
15182TB	1.500	1.874	0.250	TB	NBR	NCC	7	15213TEB	1.500	2.125	0.312	TEB	NBR	NCC	7
15182TZ-H	1.500	1.874	0.250	TZ-H	NBR	NCC	7	15213TL	1.500	2.125	0.312	TL	NBR	NCC	7
15182VB	1.500	1.874	0.250	VB	NBR	NCO	7	152148PSA	1.500	2.126	0.480	SA	ACM	PCC	7
15182VB-H	1.500	1.874	0.250	VB-H	NBR	NCO	7	1521831SC	1.500	2.187	0.312	SC	NBR	NCC	7
15182VC	1.500	1.874	0.250	VC	NBR	NCO	7	152223TB	1.500	2.222	0.312	TB	NBR	NCC	7
15182VHY	1.500	1.874	0.250	VHY	NBR	NCO	7	152223TB-H	1.500	2.222	0.312	TB-H	NBR	NCC	7
151872VL-H	1.500	1.874	0.250	VL-H	NBR	NCC	7	15222SA	1.500	2.250	0.250	SA	NBR	NCC	7
15182PTC	1.500	1.875	0.250	TC	ACM	PCC	7	15222SC	1.500	2.250	0.250	SC	NBR	NCC	7
151912VSZ	1.500	1.918	0.250	SZ	FKM	VCS	7	15222VC	1.500	2.250	0.250	VC	NBR	NCO	7
151932VB	1.500	1.938	0.250	VB	NBR	NCO	7	15222VH	1.500	2.250	0.250	VH	NBR	NCO	7
151932VL-H	1.500	1.938	0.250	VL-H	NBR	NCO	7	15222VHY	1.500	2.250	0.250	VHY	NBR	NSO	7
15192TB-H	1.500	1.982	0.250	TB-H	NBR	NCC	7	15223SB-H	1.500	2.250	0.312	SB-H	NBR	NCC	7
15191VB-H	1.500	1.983	0.187	VB-H	NBR	NCO	7	15223SSB-H	1.500	2.250	0.312	SB-H	VMQ	SCC	7
151981TB	1.500	1.983	0.188	TB	NBR	NCC	7	15223SC	1.500	2.250	0.312	SC	NBR	NCC	7
15191VB	1.500	1.983	0.188	VB	NBR	NCO	7	15223SB	1.500	2.250	0.313	SB	NBR	NCC	7
15192TB	1.500	1.983	0.250	TB	NBR	NCC	7	15223VSB-H	1.500	2.250	0.313	SB-H	FKM	VCS	7
15192TC	1.500	1.983	0.250	TC	NBR	NCC	7	15223VSL	1.500	2.250	0.313	SL	FKM	VCS	7
15193SB-H	1.500	1.983	0.312	SB-H	NBR	NCC	7	15223SSZ	1.500	2.250	0.313	SZ	VMQ	SCC	7
15193SB	1.500	1.983	0.313	SB	NBR	NCC	7	15223TB	1.500	2.250	0.313	TB	NBR	NCC	7
1519843SA-H	1.500	1.983	0.437	SA-H	NBR	NCC	7	15223VTB-H	1.500	2.250	0.313	TB-H	FKM	VCS	7
151982KB	1.500	1.989	0.250	KB	NBR	NCO	7	15223TB-H	1.500	2.250	0.313	TB-H	NBR	NCC	7
151982KB-H	1.500	1.989	0.250	KB-H	NBR	NCO	7	152231VTF	1.500	2.250	0.313	TF	FKM	VCS	7
151982KBJ-H	1.500	1.989	0.250	KBJ-H	NBR	NCO	7	152253TAY	1.500	2.250	0.531	TAY	NBR	NCC	8
151992VTEB-H	1.500	1.997	0.250	TEB-H	FKM	VCS	7	152252VHY	1.500	2.254	0.250	VHY	NBR	NCO	7
15202KC	1.500	2.000	0.250	KC	NBR	NCO	7	152252VM	1.500	2.254	0.250	VM	NBR	NCO	7
15202SC	1.500	2.000	0.250	SC	NBR	NCC	7	152243SA-H	1.500	2.254	0.312	SA-H	NBR	NCC	7
15202VTB	1.500	2.000	0.250	TB	FKM	VCS	7	1522540SB-H	1.500	2.259	0.405	SB-H	NBR	NCC	7
15202TC	1.500	2.000	0.250	TC	NBR	NCC	7	1522640TA-H	1.500	2.260	0.405	TA-H	NBR	NCC	7
15202TEC	1.500	2.000	0.250	TEC	NBR	NCC	7	152264TA	1.500	2.260	0.406	TA	NBR	NCC	7
15202VB	1.500	2.000	0.250	VB	NBR	NCO	7	152282OUB	1.500	2.286	0.270	OUB	NBR	NCO	7
15202VL-H	1.500	2.000	0.250	VL-H	NBR	NCO	7	1522842OUA	1.500	2.286	0.420	OUA	NBR	NCO	7
15203TB-H	1.500	2.000	0.312	TB-H	NBR	NCC	7	152325TLN22-H	1.500	2.327	0.500	TLN22-H	NBR	NCC	7
15203TC	1.500	2.000	0.312	TC	NBR	NCC	7	152325VL-H	1.500	2.327	0.500	VL-H	NBR	NCO	7
15203SB-H	1.500	2.000	0.313	SB-H	NBR	NCC	7	15233VHY	1.500	2.328	0.390	VHY	NBR	NCO	7
15203TB	1.500	2.000	0.313	TB	NBR	NCC	7	15234VB	1.500	2.328	0.406	VB	NBR	NCO	7
15203TB-H	1.500	2.000	0.375	TB-H	NBR	NCC	7	15234VH	1.500	2.328	0.406	VH	NBR	NCO	7
152043TL-H	1.500	2.048	0.312	TL-H	NBR	NCC	7	15235KBY	1.500	2.328	0.500	KBY	NBR	NCO	8
152043TL	1.500	2.048	0.313	TL	NBR	NCC	7	15235TB	1.500	2.328	0.500	TB	NBR	NCC	8
152043TB-H	1.500	2.048	0.375	TB-H	NBR	NCC	7	15235TB-H	1.500	2.328	0.500	TB-H	NBR	NCC	8
1520620VL-H	1.500	2.062	0.209	VL-H	NBR	NCO	7	15235TBY	1.500	2.328	0.500	TBY	NBR	NCC	8
152062VB	1.500	2.062	0.210	VB	NBR	NCO	7	15235VB	1.500	2.328	0.500	VB	NBR	NCO	8
152062VB-H	1.500	2.062	0.210	VB-H	NBR	NCO	7	15235VHY	1.500	2.328	0.500	VHY	NBR	NCO	8
152062SB-H	1.500	2.062	0.250	SB-H	NBR	NCC	7	15234TB	1.500	2.332	0.406	TB	NBR	NCC	7
152062SC	1.500	2.062	0.250	SC	NBR	NCC	7	15232KC	1.500	2.374	0.250	KC	NBR	NCO	7
152062TC	1.500	2.062	0.250	TC	NBR	NCC	7	152372VH	1.500	2.374	0.250	VH	NBR	NCO	7
152063VSB-H	1.500	2.062	0.312	SB-H	FKM	VCS	7	152372VH-H	1.500	2.374	0.250	VH-H	NBR	NCO	7
152063VSB	1.500	2.062	0.313	SB	FKM	VCS	7	152373SB-H	1.500	2.374	0.312	SB-H	NBR	NCC	7
152063SB-H	1.500	2.062	0.313	SB-H	NBR	NCC	7	152373VTB	1.500	2.374	0.313	TB	FKM	VCS	7
152063SL-H	1.500	2.062	0.313	SL-H	NBR	NCC	7	152373TB	1.500	2.374	0.313	TB	NBR	NCC	7

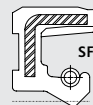
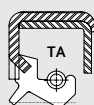

OIL AND GREASE SEALS - A COMPLETE LISTING

PLEASE CALL DICHTOMATIK FOR AVAILABILITY - 800-328-2840
BULK AND INDIVIDUALLY BOXED QUANTITIES ARE AVAILABLE FOR ALL



DICHTOMATIK

Any seal. Any time.

TCM Part #	Shaft	Bore	Width	Type	Lip Material	Material	Box #	TCM Part #	Shaft	Bore	Width	Type	Lip Material	Material	Box
152373VTB-H	1.500	2.374	0.313	TB-H	FKM	VCS	7	152833SB-H	1.500	2.834	0.312	SB-H	NBR	NCC	8
152373TB-H	1.500	2.374	0.313	TB-H	NBR	NCC	7	152833TB	1.500	2.835	0.313	TB	NBR	NCC	8
152375SA	1.500	2.374	0.500	SA	NBR	NCC	8	152833TB-H	1.500	2.835	0.313	TB-H	NBR	NCC	8
152375SA-H	1.500	2.374	0.500	SA-H	NBR	NCC	7	152835B	1.500	2.875	0.313	SB	NBR	NCC	8
152375TA-H	1.500	2.374	0.500	TA-H	NBR	NCC	7	152835B-H	1.500	2.875	0.313	SB-H	NBR	NCC	8
152375TB-H	1.500	2.374	0.500	TB-H	NBR	NCC	7	152845A-H	1.500	2.875	0.468	SA-H	NBR	NCC	8
152355STM	1.500	2.374	0.500	TM	NBR	NSS	8	152955A-H	1.500	2.996	0.500	SA-H	NBR	NCC	8
15233VTB-H	1.500	2.375	0.312	TB-H	FKM	VCS	7	15303TB	1.500	3.000	0.375	TB	NBR	NCC	8
15233TB-H	1.500	2.375	0.312	TB-H	NBR	NCC	7	15303TB-H	1.500	3.000	0.375	TB-H	NBR	NCC	8
152335AY	1.500	2.375	0.375	SAY	NBR	NCC	7	153135B	1.500	3.125	0.375	SB	NBR	NCC	8
1523745TB-H	1.500	2.377	0.452	TB-H	NBR	NCC	7	15315TB-H	1.500	3.150	0.500	TB-H	NBR	NCC	8
152374TBPL-H	1.500	2.378	0.469	TB-PL-H	NBR	NCC	7	153503VB	1.500	3.505	0.375	VB	NBR	NCO	9
152432VL-H	1.500	2.437	0.250	VL-H	NBR	NCO	7	SHAFT 1.502							
152435B-H	1.500	2.437	0.312	SB-H	NBR	NCC	7	SHAFT-EZE 99149							S1
152435B	1.500	2.437	0.313	SB	NBR	NCC	7	SHAFT-EZE 99150							S1
152433TB-H	1.500	2.437	0.375	TB-H	NBR	NCC	7	V-RING -040							7
15242VB	1.500	2.438	0.250	VB	NBR	NCC	7	152374TB	1.502	2.377	0.453	TB	NBR	NCC	7
1524435B-H	1.500	2.440	0.312	SB-H	NBR	NCC	7	SHAFT 1.505							
152443TL	1.500	2.441	0.313	TL	NBR	NCC	7	V-RING -040							7
152443TL-H	1.500	2.441	0.313	TL-H	NBR	NCC	7	151972KBN	1.505	1.979	0.250	KBN	NBR	NCO	7
152443TB-H	1.500	2.441	0.375	TB-H	NBR	NCC	7	SHAFT 1.516							
152462OUB	1.500	2.462	0.290	OUB	NBR	NCO	7	V-RING -040							7
15252SC	1.500	2.500	0.250	SC	NBR	NCC	8	38.5X53X8PTCR	1.516	2.087	0.315	TCR	ACM	PCC	7
152531TC	1.500	2.500	0.312	TC	NBR	NCC	8	38.5X58X9TC	1.516	2.283	0.354	TC	NBR	NCC	7
152531TB	1.500	2.500	0.313	TB	NBR	NCC	8	SHAFT 1.521							
152537TA	1.500	2.500	0.375	TA	NBR	NCC	8	SHAFT-EZE 99152							S1
152502VH-H	1.500	2.501	0.250	VH-H	NBR	NCO	8	V-RING -040							7
15252VHY	1.500	2.502	0.250	VHY	NBR	NCO	8	15226542TBJR	1.521	2.656	0.424	TBJR	NBR	NCC	8
15253VSB-H	1.500	2.502	0.312	SB-H	FKM	VCS	8	15226559TBJ	1.521	2.656	0.594	TBJ	NBR	NCC	8
152535B-H	1.500	2.502	0.312	SB-H	NBR	NCC	8	15226559TBJ-H	1.521	2.656	0.594	TBJ-H	NBR	NCC	8
15253TB	1.500	2.502	0.312	TB	NBR	NCC	8	SHAFT 1.523							
15253VSB	1.500	2.502	0.313	SB	FKM	VCS	8	SHAFT-EZE 99152							S1
152535B	1.500	2.502	0.313	SB	NBR	NCC	8	V-RING -040							7
15253TB-H	1.500	2.502	0.313	TB-H	NBR	NCC	8	15227155B-H	1.523	2.714	0.500	SB-H	NBR	NCC	8
15250435B-H	1.500	2.502	0.437	SB-H	NBR	NCC	8	SHAFT 1.524							
152555A	1.500	2.502	0.500	SA	NBR	NCC	8	SHAFT-EZE 99152							S1
152555A-H	1.500	2.502	0.500	SA-H	NBR	NCC	8	V-RING -040							7
1525635B	1.500	2.561	0.313	SB	NBR	NCC	8	15227155B-H	1.523	2.714	0.500	SB-H	NBR	NCC	8
1525635B-H	1.500	2.561	0.313	SB-H	NBR	NCC	8	SHAFT 1.524							
152563TB	1.500	2.561	0.313	TB	NBR	NCC	8	SHAFT-EZE 99152							S1
152565TA	1.500	2.561	0.500	TA	NBR	NCC	8	V-RING -040							7
152565TA-H	1.500	2.561	0.500	TA-H	NBR	NCC	8	152275SH	1.524	2.714	0.500	SH	NBR	NCC	8
152622VH-H	1.500	2.622	0.250	VH-H	NBR	NCO	8	SHAFT 1.531							
15262VH	1.500	2.623	0.250	VH	NBR	NCO	8	V-RING -040							7
152635L	1.500	2.623	0.313	SL	NBR	NCC	8	152335A-H	1.531	2.374	0.375	SA-H	NBR	NCC	7
152635L-H	1.500	2.623	0.313	SL-H	NBR	NCC	8	SHAFT 1.535							
1526255A-H	1.500	2.623	0.500	SA-H	NBR	NCC	8	V-RING -040							7
15263TC	1.500	2.625	0.375	TC	NBR	NCC	8	39X50.4X8.4TZ	1.535	1.984	0.331	TZ	NBR	NCC	7
1526855B-H	1.500	2.685	0.500	SB-H	NBR	NCC	8	39X51X7.5SC	1.535	2.008	0.295	SC	NBR	NCC	7
152685TB	1.500	2.686	0.500	TB	NBR	NCC	8	39X52X7TC	1.535	2.047	0.276	TC	NBR	NCC	7
152685PTB-H	1.500	2.686	0.500	TB-H	ACM	PCC	8	39X52X8SC	1.535	2.047	0.315	SC	NBR	NCC	7
152685TB-H	1.500	2.686	0.500	TB-H	NBR	NCC	8	39X55.9X9SC	1.535	2.201	0.354	SC	NBR	NCC	7
152712VAY	1.500	2.716	0.250	VAY	NBR	NCO	8	39X64X9TC	1.535	2.520	0.354	TC	NBR	NCC	8
15271435B-H	1.500	2.716	0.437	SB-H	NBR	NCC	8	39X65X8TC	1.535	2.559	0.315	TC	NBR	NCC	8
152745A-H	1.500	2.716	0.468	SA-H	NBR	NCC	8	39X65X9SC	1.535	2.559	0.354	SC	NBR	NCC	8
1527232TB-H	1.500	2.721	0.325	TB-H	NBR	NCC	8	SHAFT 1.550							
152723TC	1.500	2.721	0.325	TC	NBR	NCC	8	SHAFT-EZE 99155							S1
152735B-H	1.500	2.750	0.312	SB-H	NBR	NCC	8	V-RING -040							7
15273TB-H	1.500	2.750	0.312	TB-H	NBR	NCC	8	155265TB	1.550	2.686	0.500	TB	NBR	NCC	8
152735B	1.500	2.750	0.313	SB	NBR	NCC	8	155265TB-H	1.550	2.686	0.500	TB-H	NBR	NCC	8
15275315B-H	1.500	2.758	0.312	SB-H	NBR	NCC	8	SHAFT 1.550							
152753TB-H	1.500	2.758	0.312	TB-H	NBR	NCC	8	SHAFT-EZE 99155							S1
1527535L	1.500	2.758	0.313	SL	NBR	NCC	8	V-RING -040							7
152755TB-H	1.500	2.758	0.500	TB-H	NBR	NCC	8	155265TB	1.550	2.686	0.500	TB	NBR	NCC	8
15275TC	1.500	2.758	0.500	TC	NBR	NCC	8	155265TB-H	1.550	2.686	0.500	TB-H	NBR	NCC	8

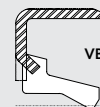
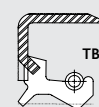
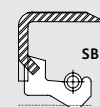
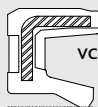



TCM Part #	Shaft	Bore	Width	Type	Lip Material	Material	Box	TCM Part #	Shaft	Bore	Width	Type	Lip Material	Material	Box #								
SHAFT 1.552																							
SHAFT-EZE 99155							S1	156202VSB	1.563	2.063	0.250	SB	FKM	VCS	7								
V-RING -040							7	156202SB	1.563	2.063	0.250	SB	NBR	NCC	7								
1552505TB-H	1.552	2.501	0.500	TB-H	NBR	NCC	8	156202SB-H	1.563	2.063	0.250	SB-H	NBR	NCC	7								
1552685SB-H	1.552	2.685	0.500	SB-H	NBR	NCC	8	1562135B	1.563	2.125	0.313	SB	NBR	NCC	7								
155316PSB	1.552	3.160	0.665	SB	ACM	PCS	8	1562535B	1.563	2.250	0.313	SB	NBR	NCC	7								
SHAFT 1.555																							
V-RING -040							7	156220TZ	1.563	2.250	1.520	TZ	NBR	NCC	7								
39.5X60X10TB	1.555	2.362	0.394	TB	NBR	NCC	7	152273TC	1.563	2.270	0.338	TC	NBR	NCC	7								
SHAFT 1.556																							
V-RING -040							7	156232VH	1.563	2.374	0.250	VH	NBR	NCO	7								
1552311VBY	1.556	2.313	0.156	VBY	NBR	NCO	7	156233VTB	1.563	2.374	0.313	TB	FKM	VCS	7								
SHAFT 1.558																							
V-RING -040							7	156233TB	1.563	2.374	0.313	TB	NBR	NCC	7								
15523715TBJY	1.558	2.372	1.500	TBJY	NBR	NCC	~	156233VTB-H	1.563	2.374	0.313	TB-H	FKM	VCS	7								
SHAFT 1.562																							
SHAFT-EZE 99156							S1	156233TB-H	1.563	2.374	0.313	TB-H	NBR	NCC	7								
V-RING -040							7	156237TB-H	1.563	2.502	0.313	TB-H	NBR	NCC	8								
15620427VTB-H	1.562	2.047	0.275	TB-H	FKM	VCS	7	15625635B-H	1.563	2.561	0.313	SB-H	NBR	NCC	8								
15620625B-H	1.562	2.061	0.250	SB-H	NBR	NCC	7	1562623TB	1.563	2.623	0.312	TB	NBR	NCC	8								
156203TCY	1.562	2.061	0.338	TCY	NBR	NCC	7	1562623TB-H	1.563	2.623	0.312	TB-H	NBR	NCC	8								
1562135B-H	1.562	2.125	0.312	SB-H	NBR	NCC	7	156264UA	1.563	2.684	0.438	UA	NBR	NCO	8								
156213PTB-H	1.562	2.125	0.312	TB-H	ACM	PCC	7	1562635B-H	1.563	2.686	0.313	SB-H	NBR	NCC	8								
1562137TB-H	1.562	2.125	0.375	TB-H	NBR	NCC	7	156263VB	1.563	2.686	0.375	VB	NBR	NCO	8								
1562235B-H	1.562	2.250	0.312	SB-H	NBR	NCC	7	156275SA	1.563	2.750	0.500	SA	NBR	NCC	8								
1562231TB	1.562	2.250	0.312	TB	NBR	NCC	7	156275SA-H	1.563	2.750	0.500	SA-H	NBR	NCC	8								
1562231TB-H	1.562	2.250	0.312	TB-H	NBR	NCC	7	1562835A	1.563	2.875	0.313	SA	NBR	NCC	8								
156223TC	1.562	2.250	0.312	TC	NBR	NCC	7	156283VTB	1.563	2.875	0.313	TB	FKM	VCS	8								
156223VSB	1.562	2.250	0.313	SB	FKM	VCS	7	156283TB	1.563	2.875	0.313	TB	NBR	NCC	8								
152237SC	1.562	2.250	0.375	SC	NBR	NCC	7	SHAFT 1.575															
156225TA	1.562	2.250	0.500	TA	NBR	NCC	8	SHAFT-EZE 99153							S1								
15623735B-H	1.562	2.374	0.312	SB-H	NBR	NCC	7	SHAFT-EZE 99157							S1								
156243TB	1.562	2.437	0.375	TB	NBR	NCC	7	V-RING -040							7								
156243TB-H	1.562	2.437	0.375	TB-H	NBR	NCC	7	40X45X5TB	1.575	1.772	0.197	TB	NBR	NCC	7								
15624346TB-H	1.562	2.437	0.468	TB-H	NBR	NCC	7	40X47X4VTF	1.575	1.850	0.157	TF	FKM	VCS	7								
1562443TB-H	1.562	2.441	0.375	TB-H	NBR	NCC	7	40X47X4VC	1.575	1.850	0.157	VC	NBR	NCO	7								
1562465SC	1.562	2.460	0.500	SC	NBR	NCC	8	40X47X4VM	1.575	1.850	0.157	VM	NBR	NCO	7								
15624637PTB-H	1.562	2.464	0.374	TB-H	ACM	PCC	7	40X47X8TB2-H	1.575	1.850	0.315	TB2-H	NBR	NCC	7								
1562531SC	1.562	2.500	0.312	SC	NBR	NCC	8	40X48X4VVC	1.575	1.890	0.157	VC	FKM	VCO	7								
156253TC	1.562	2.500	0.375	TC	NBR	NCC	8	40X48X4VM	1.575	1.890	0.157	VM	NBR	NCO	7								
1562502VH-H	1.562	2.501	0.250	VH-H	NBR	NCO	8	40X50X85C	1.575	1.968	0.314	SC	NBR	NCC	7								
1562503VSB-H	1.562	2.501	0.312	SB-H	FKM	VCS	8	40X50X4TC	1.575	1.969	0.157	TC	NBR	NCC	7								
15625315B-H	1.562	2.501	0.312	SB-H	NBR	NCC	8	40X50X4VA	1.575	1.969	0.157	VA	NBR	NCO	7								
15625315B	1.562	2.502	0.312	SB	NBR	NCC	8	40X50X4VA2Y	1.575	1.969	0.157	VA2Y	NBR	NCO	7								
1562503TB-H	1.562	2.502	0.312	TB-H	NBR	NCC	8	40X50X4VZ	1.575	1.969	0.157	VZ	NBR	NCO	7								
152505SA	1.562	2.502	0.500	SA	NBR	NCC	8	40X50X5TC	1.575	1.969	0.197	TC	NBR	NCC	7								
152505SA-H	1.562	2.502	0.500	SA-H	NBR	NCC	8	40X50X6.5TC	1.575	1.969	0.256	TC	NBR	NCC	7								
156255SA	1.562	2.531	0.500	SA	NBR	NCC	8	40X50X75C	1.575	1.969	0.276	SC	NBR	NCC	7								
1562565SA-H	1.562	2.561	0.500	SA-H	NBR	NCC	8	40X50X7VTC	1.575	1.969	0.276	TC	FKM	VCS	7								
156262315B-H	1.562	2.622	0.312	SB-H	NBR	NCC	8	40X50X7TC	1.575	1.969	0.276	TC	NBR	NCC	7								
1562623TB-H	1.562	2.623	0.312	TB-H	NBR	NCC	8	40X50X7VTF	1.575	1.969	0.276	TF	FKM	VCC	7								
1562683VL-H	1.562	2.685	0.375	VL-H	NBR	NCO	8	40X50X8V5F	1.575	1.969	0.315	SF	FKM	VCS	7								
156263TB-H	1.562	2.686	0.375	TB-H	NBR	NCC	8	40X50X8TC	1.575	1.969	0.315	TC	NBR	NCC	7								
15275SA-H	1.562	2.758	0.500	SA-H	NBR	NCC	8	40X51X5.5SC	1.575	2.008	0.217	SC	NBR	NCC	7								
1562835B-H	1.562	2.875	0.312	SB-H	NBR	NCC	8	40X52X75B-H	1.575	2.047	0.275	SB-H	NBR	NCC	7								
156283TB-H	1.562	2.875	0.313	TB-H	NBR	NCC	8	40X52X7TG	1.575	2.047	0.275	TG	NBR	NCC	7								
156313TB-H	1.562	3.150	0.312	TB-H	NBR	NCC	8	40X52X7VSB-H	1.575	2.047	0.276	SB-H	FKM	VCS	7								
SHAFT 1.563																							
SHAFT-EZE 99156							S1	40X52X4KC	1.575	2.047	0.157	KC	NBR	NCO	7								
V-RING -040							7	40X52X4VG	1.575	2.047	0.157	VG	NBR	NCO	7								
156202VB	1.563	2.062	0.203	VB	NBR	NCO	7	40X52X5TC	1.575	2.047	0.197	TC	NBR	NCC	7								
156205VDB	1.563	2.062	0.500	DB	FKM	VSS	8	40X52X5VC	1.575	2.047	0.197	VC	NBR	NCO	7								
								40X52X6TC	1.575	2.047	0.236	TC	NBR	NCC	7								

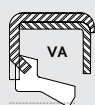
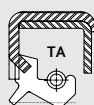

OIL AND GREASE SEALS - A COMPLETE LISTING

PLEASE CALL DICHTOMATIK FOR AVAILABILITY - 800-328-2840
 BULK AND INDIVIDUALLY BOXED QUANTITIES ARE AVAILABLE FOR ALL



DICHTOMATIK

Any seal. Any time.

TCM Part #	Shaft	Bore	Width	Type	Lip Material	Material	Box #	TCM Part #	Shaft	Bore	Width	Type	Lip Material	Material	Box #
40X52X6VTCAL	1.575	2.047	0.236	TCAL	FKM	VCC	7	40X58X9PTBJW	1.575	2.283	0.354	TBJW	ACM	PCC	7
40X52X6VC	1.575	2.047	0.236	VC	NBR	NCO	7	40X58X10SC	1.575	2.283	0.394	SC	NBR	NCC	7
40X52X7VSB	1.575	2.047	0.276	SB	FKM	VCS	7	40X58X10TC	1.575	2.283	0.394	TC	NBR	NCC	7
40X52X7SC	1.575	2.047	0.276	SC	NBR	NCC	7	40X58X12SC	1.575	2.283	0.472	SC	NBR	NCC	7
40X52X7VSCW	1.575	2.047	0.276	SCW	FKM	VCS	7	157223TB	1.575	2.284	0.315	TB	NBR	NCC	7
40X52X7TBP	1.575	2.047	0.276	TBP	NBR	NCC	7	40X60X10SG	1.575	2.362	0.393	SG	NBR	NCC	7
40X52X7TC	1.575	2.047	0.276	TC	NBR	NCC	7	40X60X10TG	1.575	2.362	0.393	TG	NBR	NCC	7
40X52X7VTF	1.575	2.047	0.276	TF	FKM	VCS	7	40X60X7VSC	1.575	2.362	0.276	SC	FKM	VCS	7
40X52X7VTGR	1.575	2.047	0.276	TGR	FKM	VCC	7	40X60X7SC	1.575	2.362	0.276	SC	NBR	NCC	7
40X52X8TB2-H	1.575	2.047	0.315	TB2-H	NBR	NCC	7	40X60X7TC	1.575	2.362	0.276	TC	NBR	NCC	7
40X52X8TC	1.575	2.047	0.315	TC	NBR	NCC	7	40X60X7TM	1.575	2.362	0.276	TM	NBR	NCC	7
40X52X9TC	1.575	2.047	0.354	TC	NBR	NCC	7	40X60X8SC	1.575	2.362	0.315	SC	NBR	NCC	7
40X53X7TB	1.575	2.087	0.276	TB	NBR	NCC	7	40X60X8TC	1.575	2.362	0.315	TC	NBR	NCC	7
40X53X8TC	1.575	2.087	0.315	TC	NBR	NCC	7	40X60X8VTF	1.575	2.362	0.315	TF	FKM	VCS	7
1572139PTC	1.575	2.125	0.394	TC	ACM	PCC	7	40X60X10SB	1.575	2.362	0.394	SB	NBR	NCC	7
40X54X5TM	1.575	2.126	0.197	TM	NBR	NCC	7	40X60X10SC	1.575	2.362	0.394	SC	NBR	NCC	7
40X54X5VC	1.575	2.126	0.197	VC	NBR	NCO	7	40X60X10TC	1.575	2.362	0.394	TC	NBR	NCC	7
40X54X5VM	1.575	2.126	0.197	VM	NBR	NCO	7	40X60X10VTF	1.575	2.362	0.394	TF	FKM	VCS	7
40X54X5.5TB	1.575	2.126	0.217	TB	NBR	NCC	7	40X60X12TB	1.575	2.362	0.472	TB	NBR	NCC	7
40X54X6PTCR	1.575	2.126	0.236	TCR	ACM	PCC	7	40X61X10TM	1.575	2.402	0.394	TM	NBR	NCC	7
40X54X7SB	1.575	2.126	0.276	SB	NBR	NCC	7	40X62X8VSB-H	1.575	2.440	0.314	SB-H	FKM	VCS	7
40X54X7TB	1.575	2.126	0.276	TB	NBR	NCC	7	40X62X8SB-H	1.575	2.440	0.314	SB-H	NBR	NCC	7
40X54X7TC	1.575	2.126	0.276	TC	NBR	NCC	7	40X62X5VC	1.575	2.441	0.197	VC	NBR	NCO	7
40X54X7SB-H	1.575	2.126	0.276	SB-H	NBR	NCC	7	40X62X6TEC	1.575	2.441	0.236	TEC	NBR	NCC	7
40X55X8TB-H	1.575	2.165	0.314	TB-H	NBR	NCC	7	40X62X6VTF	1.575	2.441	0.236	TF	FKM	VCS	7
40X55X8VTC	1.575	2.165	0.314	TC	FKM	VCS	7	40X62X7TC	1.575	2.441	0.276	TC	NBR	NCC	7
40X55X8TG	1.575	2.165	0.314	TG	NBR	NCC	7	40X62X7VTF	1.575	2.441	0.276	TF	FKM	VCS	7
40X55X8SB-H	1.575	2.165	0.315	SB-H	NBR	NCC	7	40X62X8SC	1.575	2.441	0.315	SC	NBR	NCC	7
40X55X9TC	1.575	2.165	0.354	TC	NBR	NCC	7	40X62X8TB	1.575	2.441	0.315	TB	NBR	NCC	7
40X55X5KC	1.575	2.165	0.197	KC	NBR	NCO	7	40X62X8TC	1.575	2.441	0.315	TC	NBR	NCC	7
40X55X5VC	1.575	2.165	0.197	VC	NBR	NCO	7	40X62X8TC2	1.575	2.441	0.315	TC2	NBR	NCC	7
40X55X6.5SC	1.575	2.165	0.256	SC	NBR	NCC	7	40X62X8VTF	1.575	2.441	0.315	TF	FKM	VCS	7
40X55X6.5TB	1.575	2.165	0.256	TB	NBR	NCC	7	40X62X9TC	1.575	2.441	0.354	TC	NBR	NCC	7
40X55X7SC	1.575	2.165	0.276	SC	NBR	NCC	7	40X62X10SB	1.575	2.441	0.394	SB	NBR	NCC	7
40X55X7VTC	1.575	2.165	0.276	TC	FKM	VCS	7	40X62X10SC	1.575	2.441	0.394	SC	NBR	NCC	7
40X55X7TC	1.575	2.165	0.276	TC	NBR	NCC	7	40X62X10TB	1.575	2.441	0.394	TB	NBR	NCC	7
40X55X7VTF	1.575	2.165	0.276	TF	FKM	VCS	7	40X62X10TC	1.575	2.441	0.394	TC	NBR	NCC	7
40X55X8VSB	1.575	2.165	0.315	SB	FKM	VCS	7	40X62X11TC	1.575	2.441	0.433	TC	NBR	NCC	7
40X55X8SB	1.575	2.165	0.315	SB	NBR	NCC	7	40X62X12SC	1.575	2.441	0.472	SC	NBR	NCC	7
40X55X8SC	1.575	2.165	0.315	SC	NBR	NCC	7	40X62X12TC	1.575	2.441	0.472	TC	NBR	NCC	7
40X55X8TC	1.575	2.165	0.315	TC	NBR	NCC	7	40X63X10SC	1.575	2.480	0.394	SC	NBR	NCC	7
40X55X8PTCW	1.575	2.165	0.315	TCW	ACM	PCC	7	40X64X12TC	1.575	2.520	0.472	TC	NBR	NCC	8
40X55X8VTF	1.575	2.165	0.315	TF	FKM	VCS	7	40X65X8TC	1.575	2.559	0.315	TC	NBR	NCC	8
40X55X12SC	1.575	2.165	0.472	SC	NBR	NCC	7	40X65X9SC	1.575	2.559	0.354	SC	NBR	NCC	8
40X56X8SB-H	1.575	2.204	0.314	SB-H	NBR	NCC	7	40X65X10SC	1.575	2.559	0.394	SC	NBR	NCC	8
40X56X6TC	1.575	2.205	0.236	TC	NBR	NCC	7	40X65X10VTC	1.575	2.559	0.394	TC	FKM	VCC	8
40X56X7PSBR	1.575	2.205	0.276	SBR	ACM	PCC	7	40X65X10TC	1.575	2.559	0.394	TC	NBR	NCC	8
40X56X7SC	1.575	2.205	0.276	SC	NBR	NCC	7	40X65X12TC	1.575	2.559	0.472	TC	NBR	NCC	8
40X56X7TC	1.575	2.205	0.276	TC	NBR	NCC	7	40X65X12VTF	1.575	2.559	0.472	TF	FKM	VCS	8
40X56X8VSF	1.575	2.205	0.315	SF	FKM	VCS	7	40X65.4X10TC	1.575	2.575	0.394	TC	NBR	NCC	8
40X56X10VTC	1.575	2.205	0.394	TC	FKM	VCC	7	40X66X9TC	1.575	2.598	0.354	TC	NBR	NCC	8
40X56X10TC	1.575	2.205	0.394	TC	NBR	NCC	7	40X67X8TC	1.575	2.638	0.315	TC	NBR	NCC	8
40X56X12SC	1.575	2.205	0.472	SC	NBR	NCC	7	40X68X8SB-H	1.575	2.677	0.314	SB-H	NBR	NCC	8
15722031TC	1.575	2.205	0.315	TC	NBR	NCC	7	40X68X8SC	1.575	2.677	0.314	SC	NBR	NCC	8
40X57X10TC	1.575	2.244	0.394	TC	NBR	NCC	7	40X68X10TG	1.575	2.677	0.393	TG	NBR	NCC	8
40X58X8SB-H	1.575	2.283	0.314	SB-H	NBR	NCC	7	40X68X6SC	1.575	2.677	0.236	SC	NBR	NCC	8
157223TBJ	1.575	2.283	0.354	TBJ	NBR	NCC	7	40X68X6TC	1.575	2.677	0.236	TC	NBR	NCC	8
157223TBJW9	1.575	2.283	0.354	TBJW9	NBR	NCC	7	40X68X6VTF	1.575	2.677	0.236	TF	FKM	VCS	8
40X58X6TC	1.575	2.283	0.236	TC	NBR	NCC	7	40X68X7TC	1.575	2.677	0.276	TC	NBR	NCC	8
40X58X7TCY	1.575	2.283	0.276	TCY	NBR	NCC	7	40X68X10SC	1.575	2.677	0.394	SC	NBR	NCC	8
40X58X8SC	1.575	2.283	0.315	SC	NBR	NCC	7	40X68X10TC	1.575	2.677	0.394	TC	NBR	NCC	8
40X58X8VSF	1.575	2.283	0.315	SF	FKM	VCS	7	40X68X12SC	1.575	2.677	0.472	SC	NBR	NCC	8
40X58X8VTC	1.575	2.283	0.315	TC	FKM	VCC	7	40X70X8SB-H	1.575	2.755	0.314	SB-H	NBR	NCC	8
40X58X8TC	1.575	2.283	0.315	TC	NBR	NCC	7	40X70X7TB2-H	1.575	2.756	0.276	TB2-H	NBR	NCC	8

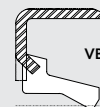
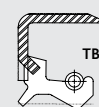
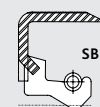
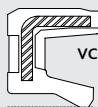



TCM Part #	Shaft	Bore	Width	Type	Lip Material	Material	Box	TCM Part #	Shaft	Bore	Width	Type	Lip Material	Material	Box #
40X70X7TC2	1.575	2.756	0.276	TC2	NBR	NCC	8	157243TA-H	1.578	2.408	0.313	TA-H	NBR	NCC	7
40X70X8SC	1.575	2.756	0.315	SC	NBR	NCC	8	157245SA-H	1.578	2.408	0.500	SA-H	NBR	NCC	8
40X70X8TC	1.575	2.756	0.315	TC	NBR	NCC	8	SHAFT 1.593							
40X70X10VSF	1.575	2.756	0.394	SF	FKM	VCS	8	V-RING -040							7
40X70X10TA	1.575	2.756	0.394	TA	NBR	NCC	8	159244SA-H	1.593	2.437	0.468	SA-H	NBR	NCC	7
40X70X10TC	1.575	2.756	0.394	TC	NBR	NCC	8	159252SB-H	1.593	2.502	0.250	SB-H	NBR	NCC	8
40X70X10VTF	1.575	2.756	0.394	TF	FKM	VCS	8	SHAFT 1.594							
40X70X12SA	1.575	2.756	0.472	SA	NBR	NCC	8	V-RING -040							7
40X70X12SC	1.575	2.756	0.472	SC	NBR	NCC	8	159212SB-H	1.594	2.125	0.250	SB-H	NBR	NCC	7
40X72X7SC	1.575	2.834	0.275	SC	NBR	NCC	8	159213PSL-H	1.594	2.125	0.313	SL-H	ACM	PCC	7
40X72X8SB-H	1.575	2.834	0.314	SB-H	NBR	NCC	8	159243SL	1.594	2.437	0.313	SL	NBR	NCC	7
40X72X7PSCW	1.575	2.835	0.276	SCW	ACM	PCC	8	159253SB	1.594	2.502	0.313	SB	NBR	NCC	8
40X72X7VSCW	1.575	2.835	0.276	SCW	FKM	VCS	8	159253SB-H	1.594	2.502	0.313	SB-H	NBR	NCC	8
40X72X7HSCW	1.575	2.835	0.276	SCW	HNBR	HCC	8	1592623SB-H	1.594	2.622	0.312	SB-H	NBR	NCC	8
40X72X7VSG	1.575	2.835	0.276	SG	FKM	VCC	8	159273SB-H	1.594	2.758	0.312	SB-H	NBR	NCC	8
40X72X7HSGW	1.575	2.835	0.276	SGW	HNBR	HCC	8	159273SB	1.594	2.758	0.313	SB	NBR	NCC	8
40X72X7TC	1.575	2.835	0.276	TC	NBR	NCC	8	SHAFT 1.606							
40X72X7VTF	1.575	2.835	0.276	TF	FKM	VCS	8	SHAFT-EZE 99160							S1
40X72X7VTGW	1.575	2.835	0.276	TGW	FKM	VCS	8	V-RING -040							7
40X72X9TA	1.575	2.835	0.354	TA	NBR	NCC	8	160233TC	1.606	2.374	0.375	TC	NBR	NCC	7
40X72X10TA	1.575	2.835	0.394	TA	NBR	NCC	8	SHAFT 1.609							
40X72X10TC	1.575	2.835	0.394	TC	NBR	NCC	8	SHAFT-EZE 99163							S1
40X75X8SC	1.575	2.953	0.315	SC	NBR	NCC	8	V-RING -040							7
40X75X8TC	1.575	2.953	0.315	TC	NBR	NCC	8	1601902VM-H	1.609	1.906	0.250	VM-H	NBR	NSO	7
40X75X10TC	1.575	2.953	0.394	TC	NBR	NCC	8	1602122SC	1.609	2.123	0.250	SC	NBR	NCC	7
40X75X12TC	1.575	2.953	0.472	TC	NBR	NCC	8	16024330SSBJR	1.609	2.435	0.300	SSBJR	VMQ	SCC	7
40X78X10SA	1.575	3.071	0.394	SA	NBR	NCC	8	SHAFT 1.614							
40X78X10SC	1.575	3.071	0.394	SC	NBR	NCC	8	SHAFT-EZE 99163							S1
40X78X13SZ	1.575	3.071	0.512	SZ	NBR	NCC	8	V-RING -040							7
40X80X10SG	1.575	3.149	0.393	SG	NBR	NCC	8	41X52X7TM	1.614	2.047	0.276	TM	NBR	NCC	7
40X80X10TG	1.575	3.149	0.393	TG	NBR	NCC	8	41X53X7TA	1.614	2.087	0.276	TA	NBR	NCC	7
40X80X7TC	1.575	3.150	0.276	TC	NBR	NCC	8	41X53X7TB-H	1.614	2.087	0.276	TB-H	NBR	NCC	7
40X80X8SB	1.575	3.150	0.315	SB	NBR	NCC	8	41X53X7TC	1.614	2.087	0.276	TC	NBR	NCC	7
40X80X8VSC	1.575	3.150	0.315	SC	FKM	VCS	8	41X53X8TC	1.614	2.087	0.315	TC	NBR	NCC	7
40X80X8SC	1.575	3.150	0.315	SC	NBR	NCC	8	41X55X6TB	1.614	2.165	0.236	TB	NBR	NCC	7
40X80X8TC	1.575	3.150	0.315	TC	NBR	NCC	8	41X55X7TC	1.614	2.165	0.276	TC	NBR	NCC	7
40X80X8VC	1.575	3.150	0.315	VC	NBR	NCO	8	41X55X9TB	1.614	2.165	0.354	TB	NBR	NCC	7
40X80X10SC	1.575	3.150	0.394	SC	NBR	NCC	8	41X55.7X9TC	1.614	2.193	0.354	TC	NBR	NCC	7
40X80X10VSF	1.575	3.150	0.394	SF	FKM	VCS	8	41X56X7SC	1.614	2.205	0.276	SC	NBR	NCC	7
40X80X10TB2-H	1.575	3.150	0.394	TB2-H	NBR	NCC	8	41X56X7TC	1.614	2.205	0.276	TC	NBR	NCC	7
40X80X10TC	1.575	3.150	0.394	TC	NBR	NCC	8	161222SC	1.614	2.205	0.273	SC	NBR	NCC	7
40X80X10TC2	1.575	3.150	0.394	TC2	NBR	NCC	8	41X64X10TC	1.614	2.520	0.394	TC	NBR	NCC	8
40X80X12TC	1.575	3.150	0.472	TC	NBR	NCC	8	SHAFT 1.618							
40X80X13SC	1.575	3.150	0.512	SC	NBR	NCC	8	V-RING -040							7
40X80X8SB-H	1.575	3.150	0.315	SB-H	NBR	NCC	8	161254TB	1.618	2.531	0.438	TB	NBR	NCC	8
40X85X10VSC	1.575	3.346	0.394	SC	FKM	VCC	8	1612537SB-H	1.618	2.531	0.750	SB-H	NBR	NCC	8
40X85X10SC	1.575	3.346	0.394	SC	NBR	NCC	8	161255SZ	1.618	2.575	0.500	SZ	NBR	NCC	8
40X88X6SC	1.575	3.465	0.236	SC	NBR	NCC	8	161255TB	1.618	2.575	0.500	TB	NBR	NCC	8
40X88X6TC	1.575	3.465	0.236	TC	NBR	NCC	8	161255TB-H	1.618	2.575	0.500	TB-H	NBR	NCC	8
40X90X8SB-H	1.575	3.543	0.314	SB-H	NBR	NCC	8	1612845PTBJW	1.618	2.841	0.500	TBJ2	ACM	PCC	8
40X90X7TC	1.575	3.543	0.276	TC	NBR	NCC	9	SHAFT 1.625							
40X90X8TC	1.575	3.543	0.315	TC	NBR	NCC	9	SHAFT-EZE 99162							S1
40X90X9TC	1.575	3.543	0.354	TC	NBR	NCC	9	SHAFT-EZE 99161							S1
40X90X10SC	1.575	3.543	0.394	SC	NBR	NCC	9	V-RING -040							7
40X90X12SB	1.575	3.543	0.472	SB	NBR	NCC	9	162018SB	1.625	2.000	0.187	SB	NBR	NCC	7
40X90X12VTF	1.575	3.543	0.472	TF	FKM	VCS	9	16202SB	1.625	2.000	0.250	SB	NBR	NCC	7
40X90X13SA	1.575	3.543	0.512	SA	NBR	NCC	9	16202VSB-H	1.625	2.000	0.250	SB-H	FKM	VCS	7
40X100X10VTGW	1.575	3.937	0.394	TGW	FKM	VCS	9	16202SB-H	1.625	2.000	0.250	SB-H	NBR	NCC	7
SHAFT 1.578								16202TB-H	1.625	2.000	0.250	TB-H	NBR	NCC	7
SHAFT-EZE 99157							S1	162113TB-H	1.625	2.116	0.312	TB-H	NBR	NCC	7
V-RING -040							7	16212VSB	1.625	2.125	0.250	SB	FKM	VSS	7
157202VM	1.578	2.000	0.250	VM	NBR	NCO	7								
152082SB	1.578	2.082	0.250	SB	NBR	NCC	7								
157243TA	1.578	2.408	0.313	TA	NBR	NCC	7								

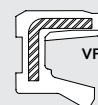
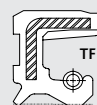
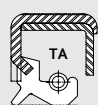

OIL AND GREASE SEALS - A COMPLETE LISTING

PLEASE CALL DICHTOMATIK FOR AVAILABILITY - 800-328-2840
BULK AND INDIVIDUALLY BOXED QUANTITIES ARE AVAILABLE FOR ALL



DICHTOMATIK

Any seal. Any time.

TCM Part #	Shaft	Bore	Width	Type	Lip Material	Material	Box #	TCM Part #	Shaft	Bore	Width	Type	Lip Material	Material	Box
16212SB	1.625	2.125	0.250	SB	NBR	NCC	7	16253VTB	1.625	2.502	0.313	TB	FKM	VCS	8
162212PSB-H	1.625	2.125	0.250	SB-H	ACM	PCC	7	16253TB	1.625	2.502	0.313	TB	NBR	NCC	8
16212VSB-H	1.625	2.125	0.250	SB-H	FKM	VCS	7	16253TB-H	1.625	2.502	0.313	TB-H	NBR	NCC	8
16212SB-H	1.625	2.125	0.250	SB-H	NBR	NCC	7	162505SA-H	1.625	2.502	0.500	SA-H	NBR	NCC	8
16212VTF	1.625	2.125	0.250	TF	FKM	VCS	7	16252VBY	1.625	2.506	0.250	VBY	NBR	NCC	8
16212VB	1.625	2.125	0.250	VB	NBR	NCO	7	162562VH-H	1.625	2.561	0.250	VH-H	NBR	NCC	8
16212VB-H	1.625	2.125	0.250	VB-H	NBR	NCO	7	162562VA5-H	1.625	2.562	0.250	VA5-H	NBR	NCO	8
162212VL-H	1.625	2.125	0.250	VL-H	NBR	NCO	7	162562VHY	1.625	2.562	0.250	VHY	NBR	NCO	8
1622243TB-H	1.625	2.248	0.312	TB-H	NBR	NCC	7	1625631VTB-H	1.625	2.562	0.313	TB-H	FKM	VCC	8
16222VHY	1.625	2.250	0.250	VHY	NBR	NCO	7	162563SC	1.625	2.562	0.375	SC	NBR	NCC	8
16223VSB-H	1.625	2.250	0.312	SB-H	FKM	VCS	7	1622563TB-H	1.625	2.562	0.375	TB-H	NBR	NCC	8
16223SB-H	1.625	2.250	0.312	SB-H	NBR	NCC	7	162564TB	1.625	2.562	0.438	TB	NBR	NCC	8
16223TCN	1.625	2.250	0.312	TCN	NBR	NCC	7	162564VHY	1.625	2.562	0.438	VHY	NBR	NCO	8
16223VSB	1.625	2.250	0.313	SB	FKM	VCS	7	16262VHY	1.625	2.623	0.250	VHY	NBR	NCO	8
16223SB	1.625	2.250	0.313	SB	NBR	NCC	7	16263VSB	1.625	2.623	0.313	SB	FKM	VCS	8
16223TB	1.625	2.250	0.313	TB	NBR	NCC	7	16263SL-H	1.625	2.623	0.313	SL-H	NBR	NCC	8
16223TB-H	1.625	2.250	0.313	TB-H	NBR	NCC	7	16263TB	1.625	2.623	0.313	TB	NBR	NCC	8
16234VA5-H	1.625	2.327	0.406	VA5-H	NBR	NCO	7	16263TB-H	1.625	2.623	0.313	TB-H	NBR	NCC	8
1623237TB-H	1.625	2.328	0.375	TB-H	NBR	NCC	7	162625SA-H	1.625	2.623	0.500	SA-H	NBR	NCC	8
16234VHY	1.625	2.328	0.406	VHY	NBR	NCO	7	16262VAY-H	1.625	2.625	0.250	VAY-H	NBR	NCO	8
162324UB	1.625	2.328	0.438	UB	NBR	NCO	7	16263SC	1.625	2.625	0.375	SC	NBR	NCC	8
162343UBY	1.625	2.328	0.438	UBY	NBR	NCO	7	16263TC	1.625	2.625	0.375	TC	NBR	NCC	8
162334VB	1.625	2.328	0.438	VB	NBR	NCO	7	16268531SB-H	1.625	2.686	0.312	SB-H	NBR	NCC	8
162334VHY	1.625	2.328	0.438	VHY	NBR	NCO	7	1626831SL	1.625	2.686	0.313	SL	NBR	NCC	8
16232SB	1.625	2.374	0.250	SB	NBR	NCC	7	162683SB	1.625	2.686	0.375	SB	NBR	NCC	8
16232VH	1.625	2.374	0.250	VH	NBR	NCO	7	162683SB-H	1.625	2.686	0.375	SB-H	NBR	NCC	8
162335A-H	1.625	2.374	0.312	SA-H	NBR	NCC	7	16272SB	1.625	2.750	0.250	SB	NBR	NCC	8
16233VSB-H	1.625	2.374	0.312	SB-H	FKM	VCS	7	16272SB-H	1.625	2.750	0.250	SB-H	NBR	NCC	8
16233SB-H	1.625	2.374	0.312	SB-H	NBR	NCC	7	16272VH	1.625	2.750	0.250	VH	NBR	NCO	8
162335A	1.625	2.374	0.313	SA	NBR	NCC	7	162273SA-H	1.625	2.750	0.312	SA-H	NBR	NCC	8
16233VSB	1.625	2.374	0.313	SB	FKM	VCS	7	162273TB-H	1.625	2.750	0.312	TB-H	NBR	NCC	8
16233SB	1.625	2.374	0.313	SB	NBR	NCC	7	162273TB-H	1.625	2.750	0.375	TB-H	NBR	NCC	8
16233TB	1.625	2.374	0.313	TB	NBR	NCC	7	162755VTB	1.625	2.754	0.500	TB	FKM	VCS	8
16233TB-H	1.625	2.374	0.313	TB-H	NBR	NCC	7	162763SB	1.625	2.758	0.313	SB	NBR	NCC	8
1623731VTBW-H	1.625	2.374	0.313	TBW-H	FKM	VCS	7	162763SB-H	1.625	2.758	0.313	SB-H	NBR	NCC	8
1623743SA-H	1.625	2.374	0.437	SA-H	NBR	NCC	7	162834SA-H	1.625	2.835	0.468	SA-H	NBR	NCC	8
162355A-H	1.625	2.374	0.500	SA-H	NBR	NCC	8	162835B-H	1.625	2.875	0.312	SB-H	NBR	NCC	8
162375TB-H	1.625	2.374	0.500	TB-H	NBR	NCC	7	162835B	1.625	2.875	0.313	SB	NBR	NCC	8
162331VTC	1.625	2.375	0.312	TC	FKM	VCS	7	16283TB	1.625	2.875	0.313	TB	NBR	NCC	8
162373VTC	1.625	2.375	0.375	TC	FKM	VCS	7	16283TB-H	1.625	2.875	0.313	TB-H	NBR	NCC	8
162373TC	1.625	2.375	0.375	TC	NBR	NCC	7	16303SA-H	1.625	3.000	0.312	SA-H	NBR	NCC	8
16243VSB-H	1.625	2.437	0.312	SB-H	FKM	VCS	7	16303TA-H	1.625	3.000	0.312	TA-H	NBR	NCC	8
1622433SB-H	1.625	2.437	0.312	SB-H	NBR	NCC	7	16303SA	1.625	3.000	0.313	SA	NBR	NCC	8
16243VTB-H	1.625	2.437	0.312	TB-H	FKM	VCS	7	41.27X90X10TC	1.625	3.543	0.394	TC	NBR	NCC	9
16243VSB	1.625	2.437	0.313	SB	FKM	VCC	7	SHAFT 1.645							
16243VTB	1.625	2.437	0.313	TB	FKM	VCS	7	V-RING -040							7
16243TB	1.625	2.437	0.313	TB	NBR	NCC	7	164263PTB	1.645	2.656	0.313	TB	ACM	PCS	8
16243TB-H	1.625	2.437	0.313	TB-H	NBR	NCC	7	SHAFT 1.652							
1622433TB-H	1.625	2.437	0.375	TB-H	NBR	NCC	7	SHAFT-EZE 99169							S1
1622443SB-H	1.625	2.440	0.312	SB-H	NBR	NCC	7	SHAFT-EZE 99166							S1
162443TB	1.625	2.441	0.313	TB	NBR	NCC	7	V-RING -040							7
162443TB-H	1.625	2.441	0.313	TB-H	NBR	NCC	7	16525139TBJW	1.652	2.518	0.394	TBJW	NBR	NCC	8
1622443TB-H	1.625	2.441	0.375	TB-H	NBR	NCC	7	SHAFT 1.653							
162446TAHY	1.625	2.441	0.625	TAHY	NBR	NCC	8	SHAFT-EZE 99169							S1
162462OUB	1.625	2.462	0.250	OUB	NBR	NCO	7	SHAFT-EZE 99166							S1
1625031SB	1.625	2.500	0.313	SB	NBR	NCC	8	SHAFT-EZE 99165							S1
162531TC	1.625	2.500	0.313	TC	NBR	NCC	8	V-RING -040							7
16253TC	1.625	2.500	0.375	TC	NBR	NCC	8	165243VTC-PL	1.653	2.441	0.315	TC-PL	FKM	VCC	7
1622503TA-H	1.625	2.501	0.375	TA-H	NBR	NCC	8	SHAFT 1.654							
16253VHY	1.625	2.502	0.250	VHY	NBR	NCO	8	SHAFT-EZE 99169							S1
16253SB-H	1.625	2.502	0.312	SB-H	NBR	NCC	8	SHAFT-EZE 99166							S1
16253VTB-H	1.625	2.502	0.312	TB-H	FKM	VCS	8	SHAFT-EZE 99165							S1
16253VSB	1.625	2.502	0.313	SB	FKM	VCS	8	V-RING -040							7
16253SB	1.625	2.502	0.313	SB	NBR	NCC	8								

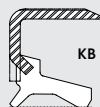
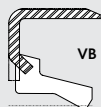
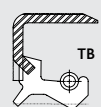
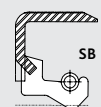
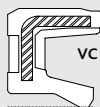



TCM Part #	Shaft	Bore	Width	Type	Lip Material	Material	Box	TCM Part #	Shaft	Bore	Width	Type	Lip Material	Material	Box #
42X50X75C	1.654	1.969	0.276	SC	NBR	NCC	7	42X62X7TC	1.654	2.441	0.276	TC	NBR	NCC	7
42X51X7TC	1.654	2.008	0.276	TC	NBR	NCC	7	42X62X7VTF	1.654	2.441	0.276	TF	FKM	VCS	7
42X52X4TC	1.654	2.047	0.157	TC	NBR	NCC	7	42X62X7VTGR	1.654	2.441	0.276	TGR	FKM	VCC	7
42X52X4VVM	1.654	2.047	0.157	VM	FKM	VCO	7	42X62X8VDC	1.654	2.441	0.315	DC	FKM	VCC	7
42X52X4VM	1.654	2.047	0.157	VM	NBR	NCO	7	42X62X85B	1.654	2.441	0.315	SB	NBR	NCC	7
42X52X8VSF	1.654	2.047	0.315	SF	FKM	VCS	7	42X62X85C	1.654	2.441	0.315	SC	NBR	NCC	7
42X52X8PTC	1.654	2.047	0.315	TC	ACM	PCC	7	42X62X85CW	1.654	2.441	0.315	SCW	NBR	NCC	7
42X52X8TC	1.654	2.047	0.315	TC	NBR	NCC	7	42X62X8TC	1.654	2.441	0.315	TC	NBR	NCC	7
42X52X10TC	1.654	2.047	0.394	TC	NBR	NCC	7	42X62X10SC	1.654	2.441	0.394	SC	NBR	NCC	7
42X53X7TC	1.654	2.087	0.276	TC	NBR	NCC	7	42X62X10TC	1.654	2.441	0.394	TC	NBR	NCC	7
42X53X8TM	1.654	2.087	0.315	TM	NBR	NCC	7	42X62X10VTF	1.654	2.441	0.394	TF	FKM	VCS	7
42X54X5TC	1.654	2.126	0.197	TC	NBR	NCC	7	42X62X12TB	1.654	2.441	0.472	TB	NBR	NCC	7
42X55X85C	1.654	2.165	0.314	SC	NBR	NCC	7	42X62X85B-H	1.654	2.441	0.315	SB-H	NBR	NCC	7
42X55X6VTC	1.654	2.165	0.236	TC	FKM	VCS	7	42X64X6VC	1.654	2.520	0.236	VC	NBR	NCO	8
42X55X6TC	1.654	2.165	0.236	TC	NBR	NCC	7	42X64X75C	1.654	2.520	0.276	SC	NBR	NCC	8
42X55X6VTF	1.654	2.165	0.236	TF	FKM	VCS	7	42X64X7TC	1.654	2.520	0.276	TC	NBR	NCC	8
42X55X75C	1.654	2.165	0.276	SC	NBR	NCC	7	42X64X8TC	1.654	2.520	0.315	TC	NBR	NCC	8
42X55X7TC	1.654	2.165	0.276	TC	NBR	NCC	7	42X65X85B-H	1.654	2.559	0.314	SB-H	NBR	NCC	8
42X55X7VTF	1.654	2.165	0.276	TF	FKM	VCS	7	42X65X10TG	1.654	2.559	0.393	TG	NBR	NCC	8
42X55X85B	1.654	2.165	0.315	SB	NBR	NCC	7	42X65X85C	1.654	2.559	0.315	SC	NBR	NCC	8
42X55X8VTBW2	1.654	2.165	0.315	TBW2	FKM	VCC	7	42X65X8TC	1.654	2.559	0.315	TC	NBR	NCC	8
42X55X8TC	1.654	2.165	0.315	TC	NBR	NCC	7	42X65X8VTF	1.654	2.559	0.315	TF	FKM	VCS	8
42X55X8TCY	1.654	2.165	0.315	TCY	NBR	NCC	7	42X65X9TC	1.654	2.559	0.354	TC	NBR	NCC	8
42X55X9SB-U	1.654	2.165	0.354	SB-U	NBR	NCC	7	42X65X10SA	1.654	2.559	0.394	SA	NBR	NCC	8
42X55X9TC	1.654	2.165	0.354	TC	NBR	NCC	7	42X65X10SC	1.654	2.559	0.394	SC	NBR	NCC	8
42X55X105C	1.654	2.165	0.394	SC	NBR	NCC	7	42X65X10TC	1.654	2.559	0.394	TC	NBR	NCC	8
42X56X7KB-H	1.654	2.205	0.276	KB-H	NBR	NCO	7	42X65X12TC	1.654	2.559	0.472	TC	NBR	NCC	8
42X56X7VSC	1.654	2.205	0.276	SC	FKM	VCS	7	42X66X8TC	1.654	2.598	0.315	TC	NBR	NCC	8
42X56X75C	1.654	2.205	0.276	SC	NBR	NCC	7	42X67X10TC	1.654	2.638	0.394	TC	NBR	NCC	8
42X56X7TC	1.654	2.205	0.276	TC	NBR	NCC	7	42X68X8VTC	1.654	2.677	0.315	TC	FKM	VCC	8
42X56X7VTF	1.654	2.205	0.276	TF	FKM	VCS	7	42X68X10TC	1.654	2.677	0.394	TC	NBR	NCC	8
42X56X8KB-H	1.654	2.205	0.315	KB-H	NBR	NCO	7	42X70X10TC	1.654	2.755	0.393	TC	NBR	NCC	8
42X56X85B	1.654	2.205	0.315	SB	NBR	NCC	7	42X70X85C	1.654	2.756	0.315	SC	NBR	NCC	8
42X56X8VTCR	1.654	2.205	0.315	TCR	FKM	VCC	7	42X70X8TC	1.654	2.756	0.315	TC	NBR	NCC	8
42X56X9.5TCN2	1.654	2.205	0.354	TCN2	NBR	NCC	7	42X70X9TC	1.654	2.756	0.354	TC	NBR	NCC	8
42X56X10TC	1.654	2.205	0.394	TC	NBR	NCC	7	42X70X105C	1.654	2.756	0.394	SC	NBR	NCC	8
42X56X85B-H	1.654	2.205	0.315	SB-H	NBR	NCC	7	42X70X12TC	1.654	2.756	0.472	TC	NBR	NCC	8
42X57X75C	1.654	2.244	0.276	SC	NBR	NCC	7	42X72X85B-H	1.654	2.834	0.314	SB-H	NBR	NCC	8
42X58X75B-H	1.654	2.283	0.275	SB-H	NBR	NCC	7	42X72X6TC	1.654	2.835	0.236	TC	NBR	NCC	8
42X58X75C	1.654	2.283	0.275	SC	NBR	NCC	7	42X72X7VTC	1.654	2.835	0.276	TC	FKM	VCC	8
42X58X105C	1.654	2.283	0.393	SC	NBR	NCC	7	42X72X85C	1.654	2.835	0.315	SC	NBR	NCC	8
165228395C	1.654	2.283	0.394	SC	NBR	NCC	7	42X72X8TC	1.654	2.835	0.315	TC	NBR	NCC	8
42X58X7TC	1.654	2.283	0.276	TC	NBR	NCC	7	42X72X8VTF	1.654	2.835	0.315	TF	FKM	VCS	8
42X58X7VTF	1.654	2.283	0.276	TF	FKM	VCS	7	42X72X10TC	1.654	2.835	0.394	TC	NBR	NCC	8
42X58X8TC	1.654	2.283	0.315	TC	NBR	NCC	7	42X75X10TC	1.654	2.835	0.394	TC	NBR	NCC	8
42X58X95B	1.654	2.283	0.354	SB	NBR	NCC	7	42X72.5X10TC	1.654	2.854	0.394	TC	NBR	NCC	8
42X58X10TC	1.654	2.283	0.394	TC	NBR	NCC	7	42X75X6.55M	1.654	2.953	0.256	SM	NBR	NCC	8
42X59.5X10TC	1.654	2.343	0.394	TC	NBR	NCC	7	42X75X12TC	1.654	2.953	0.472	TC	NBR	NCC	8
42X60X85B-H	1.654	2.362	0.314	SB-H	NBR	NCC	7	42X76X12TC	1.654	2.992	0.472	TC	NBR	NCC	8
42X60X7TC	1.654	2.362	0.276	TC	NBR	NCC	7	42X78X10TC	1.654	3.071	0.394	TC	NBR	NCC	8
42X60X8VSB	1.654	2.362	0.315	SB	FKM	VCS	7	42X80X9TC	1.654	3.150	0.354	TC	NBR	NCC	8
42X60X85C	1.654	2.362	0.315	SC	NBR	NCC	7	42X80X105C	1.654	3.150	0.394	SC	NBR	NCC	8
42X60X8TC	1.654	2.362	0.315	TC	NBR	NCC	7	42X80X10VSF	1.654	3.150	0.394	SF	FKM	VCS	8
42X60X8VTF	1.654	2.362	0.315	TF	FKM	VCS	7	42X80X10VTF	1.654	3.150	0.394	TF	FKM	VCS	8
42X60X9TC	1.654	2.362	0.354	TC	NBR	NCC	7	42X80X13TA	1.654	3.150	0.512	TA	NBR	NCC	8
42X60X9PTCR	1.654	2.362	0.354	TCR	ACM	PCC	7	42X81X13VSF	1.654	3.189	0.512	SF	FKM	VCS	8
42X60X10VSC	1.654	2.362	0.394	SC	FKM	VCS	7	42X85X8TC	1.654	3.346	0.315	TC	NBR	NCC	8
42X60X105C	1.654	2.362	0.394	SC	NBR	NCC	7								
42X60X10VTC	1.654	2.362	0.394	TC	FKM	VCC	7	SHAFT 1.656							
42X60X10TC	1.654	2.362	0.394	TC	NBR	NCC	7	SHAFT-EZE 99165							S1
42X62X7TG	1.654	2.440	0.275	TG	NBR	NCC	7	V-RING -040							7
42X62X7VSC	1.654	2.441	0.276	SC	FKM	VCS	7	165263PTB	1.656	2.623	0.455	TB	ACM	PCS	8
42X62X75C	1.654	2.441	0.276	SC	NBR	NCC	7	165293TB-H	1.656	2.937	0.375	TB-H	NBR	NCC	8
42X62X7TB	1.654	2.441	0.276	TB	NBR	NCC	7								

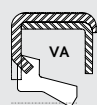
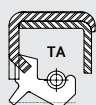

OIL AND GREASE SEALS - A COMPLETE LISTING

PLEASE CALL DICHTOMATIK FOR AVAILABILITY - 800-328-2840
BULK AND INDIVIDUALLY BOXED QUANTITIES ARE AVAILABLE FOR ALL



DICHTOMATIK

Any seal. Any time.

TCM Part #	Shaft	Bore	Width	Type	Lip Material	Material	Box #	TCM Part #	Shaft	Bore	Width	Type	Lip Material	Material	Box
SHAFT 1.668															
V-RING -040							7	168213KC	1.688	2.166	0.313	KC	NBR	NCO	7
166273TB	1.668	2.712	0.375	TB	NBR	NCC	8	1682231SC	1.688	2.250	0.313	SC	NBR	NCC	7
SHAFT 1.673															
V-RING -040							7	168223SAY	1.688	2.275	0.312	SAY	NBR	NCS	7
167212KBJY-H	1.673	2.162	0.285	KBJY-H	NBR	NCO	7	168233TB	1.688	2.328	0.313	TB	NBR	NCC	7
SHAFT 1.677															
V-RING -040							7	168233TB-H	1.688	2.328	0.313	TB-H	NBR	NCC	7
167211SC	1.677	2.124	0.188	SC	NBR	NCC	7	168235VHY	1.688	2.328	0.500	VHY	NBR	NCO	8
SHAFT 1.687															
SHAFT-EZE 99168							S1	168243SB	1.688	2.437	0.313	SB	NBR	NCC	7
SHAFT-EZE 99167							S1	168244SSB	1.688	2.437	0.469	SB	VMQ	SCC	7
SHAFT-EZE 99182							S1	168244SSB-H	1.688	2.437	0.469	SB-H	VMQ	SCC	7
V-RING -040							7	168253SC	1.688	2.500	0.375	SC	NBR	NCC	8
1682275SA-H	1.687	2.279	0.500	SA-H	NBR	NCC	7	168253TC	1.688	2.500	0.375	TC	NBR	NCC	8
1682323TB-H	1.687	2.328	0.312	TB-H	NBR	NCC	7	1682539TC	1.688	2.500	0.391	TC	NBR	NCC	8
168235SP-H	1.687	2.328	0.531	SP-H	NBR	NCC	8	168252VHY	1.688	2.502	0.281	VHY	NBR	NCO	8
1682373TB-H	1.687	2.374	0.312	TB-H	NBR	NCC	7	16253PTB-H	1.688	2.502	0.312	TB-H	ACM	PCC	8
168232VF	1.687	2.375	0.250	VF	NBR	NCO	7	168255TBJ	1.688	2.502	0.500	TBJ	NBR	NCC	8
1682433SB-H	1.687	2.437	0.312	SB-H	NBR	NCC	7	162554TZ	1.688	2.551	0.470	TZ	NBR	NCC	8
168243TB-H	1.687	2.437	0.312	TB-H	NBR	NCC	7	1682562VH	1.688	2.562	0.250	VH	NBR	NCO	8
168255SC	1.687	2.500	0.500	SC	NBR	NCC	8	168262VAY	1.688	2.605	0.245	VAY	NBR	NCO	8
16825153PTBJYL	1.687	2.500	1.535	TBJYL	ACM	PCC	8	168263VHY	1.688	2.623	0.375	VHY	NBR	NCO	8
16825031SB-H	1.687	2.501	0.312	SB-H	NBR	NCC	8	168265SB	1.688	2.623	0.500	SB	NBR	NCC	8
162503TB	1.687	2.502	0.312	TB	NBR	NCC	8	168265SB-H	1.688	2.623	0.500	SB-H	NBR	NCC	8
1682531TB-H	1.687	2.502	0.312	TB-H	NBR	NCC	8	162625TBP	1.688	2.623	0.500	TBP	ACM	PCC	8
1682531TC	1.687	2.502	0.312	TC	NBR	NCC	8	168265TB	1.688	2.623	0.531	TB	NBR	NCC	8
1682505SA-H	1.687	2.502	0.500	SA-H	NBR	NCC	8	162652UB	1.688	2.650	0.290	UB	NBR	NCO	8
16825547TC	1.687	2.550	0.470	TC	NBR	NCC	8	1682683TL	1.688	2.686	0.313	TL	NBR	NCC	8
168254SP-H	1.687	2.560	0.470	SP-H	NBR	NCC	8	162713TB	1.688	2.712	0.375	TB	NBR	NCC	8
1682562VH-H	1.687	2.561	0.250	VH-H	NBR	NCO	8	1682713SL-H	1.688	2.716	0.312	SL-H	NBR	NCC	8
168255TB	1.687	2.561	0.500	TB	NBR	NCC	8	1682713SL	1.688	2.716	0.313	SL	NBR	NCC	8
168255TB-H	1.687	2.561	0.500	TB-H	NBR	NCC	8	168273TB	1.688	2.750	0.375	TB	NBR	NCC	8
1682565TBW-H	1.687	2.561	0.500	TBW-H	NBR	NCC	8	168273TB-H	1.688	2.750	0.375	TB-H	NBR	NCC	8
168255TC	1.687	2.561	0.500	TC	NBR	NCC	8	16828346HSL	1.688	2.835	0.469	SL	HNBR	HCC	8
1682602VL-H	1.687	2.605	0.250	VL-H	NBR	NCO	8	168283TL	1.688	2.875	0.313	TL	NBR	NCC	8
1682623TB-H	1.687	2.622	0.312	TB-H	NBR	NCC	8	168284TB	1.688	2.875	0.469	TB	NBR	NCC	8
1682623VH-H	1.687	2.622	0.375	VH-H	NBR	NCO	8	168284TB-H	1.688	2.875	0.469	TB-H	NBR	NCC	8
1682623VL-H	1.687	2.623	0.375	VL-H	NBR	NCO	8	SHAFT 1.693							
16826243PTB-H	1.687	2.623	0.437	TB-H	ACM	PCC	8	SHAFT-EZE 99182							S1
168264PTBP	1.687	2.623	0.437	TBP	ACM	PCS	8	V-RING -040							7
1682652OUB	1.687	2.650	0.290	OUB	NBR	NCO	8	V-RING -045							7
16826831SB-H	1.687	2.685	0.312	SB-H	NBR	NCC	8	43X50X8KC	1.693	1.969	0.315	KC	NBR	NCO	7
1682685TB	1.687	2.686	0.500	TB	NBR	NCC	8	43X50X8TB	1.693	1.969	0.315	TB	NBR	NCC	7
1682685SC	1.687	2.687	0.500	SC	NBR	NCC	8	43X53X4VB	1.693	2.087	0.157	VB	NBR	NCO	7
16827146SA-H	1.687	2.716	0.468	SA-H	NBR	NCC	8	43X53X4VG	1.693	2.087	0.157	VG	NBR	NCO	7
1682731SB-H	1.687	2.750	0.312	SB-H	NBR	NCC	8	43X54X6TB	1.693	2.126	0.236	TB	NBR	NCC	7
16273TB-H	1.687	2.750	0.312	TB-H	NBR	NCC	8	43X54X7.5SZ	1.693	2.126	0.295	SZ	NBR	NCC	7
162834TB-H	1.687	2.835	0.468	TB-H	NBR	NCC	8	43X54X7.5SZ-H	1.693	2.126	0.295	SZ-H	NBR	NCC	7
162834TB-H	1.687	2.835	0.468	TB-H	NBR	NCC	8	43X54X7.5TC	1.693	2.126	0.295	TC	NBR	NCC	7
1682831SB-H	1.687	2.875	0.312	SB-H	NBR	NCC	8	43X55X7TC	1.693	2.165	0.276	TC	NBR	NCC	7
168283TB-H	1.687	2.875	0.375	TB-H	NBR	NCC	8	43X55X8TC	1.693	2.165	0.315	TC	NBR	NCC	7
168303TB-H	1.687	3.000	0.375	TB-H	NBR	NCC	8	43X55X9PTCR	1.693	2.165	0.354	TCR	ACM	PCC	7
1683063SB-H	1.687	3.061	0.375	SB-H	NBR	NCC	8	43X58X7TC	1.693	2.283	0.276	TC	NBR	NCC	7
168313TB-H	1.687	3.125	0.375	TB-H	NBR	NCC	8	43X58X8TC	1.693	2.283	0.315	TC	NBR	NCC	7
168315TB-H	1.687	3.125	0.500	TB-H	NBR	NCC	8	43X60X7PTCR	1.693	2.362	0.276	TCR	ACM	PCC	7
16831818VF	1.687	3.189	0.187	VF	NBR	NCO	8	43X60X10VSC	1.693	2.362	0.394	SC	FKM	VCC	7
SHAFT 1.688															
SHAFT-EZE 99168							S1	43X60X10SC	1.693	2.362	0.394	SC	NBR	NCC	7
SHAFT-EZE 99167							S1	43X60X10VSF	1.693	2.362	0.394	SF	FKM	VCS	7
SHAFT-EZE 99182							S1	43X60X10TB	1.693	2.362	0.394	TB	NBR	NCC	7
V-RING -040							7	43X60X10TC	1.693	2.362	0.394	TC	NBR	NCC	7
								43X62X8TC	1.693	2.441	0.315	TC	NBR	NCC	7
								43X62X10SA	1.693	2.441	0.394	SA	NBR	NCC	7
								43X62X10SC	1.693	2.441	0.394	SC	NBR	NCC	7
								43X62X10VSF	1.693	2.441	0.394	SF	FKM	VCC	7
								43X62X12VTC	1.693	2.441	0.472	TC	FKM	VCC	7
								43X62X12TC	1.693	2.441	0.472	TC	NBR	NCC	7
								169255TB	1.693	2.559	0.500	TB	NBR	NCC	8

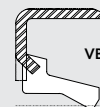
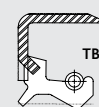
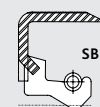
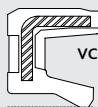



TCM Part #	Shaft	Bore	Width	Type	Lip Material	Material	Box	TCM Part #	Shaft	Bore	Width	Type	Lip Material	Material	Box #
43X65X8SC	1.693	2.559	0.315	SC	NBR	NCC	8	44X62X10TC	1.732	2.441	0.394	TC	NBR	NCC	7
43X66X10SC	1.693	2.598	0.394	SC	NBR	NCC	8	44X64X9TC	1.732	2.520	0.354	TC	NBR	NCC	8
43X66X10TC	1.693	2.598	0.394	TC	NBR	NCC	8	44X64X10TC	1.732	2.520	0.394	TC	NBR	NCC	8
43X75X10SC	1.693	2.953	0.394	SC	NBR	NCC	8	44X65X8TC	1.732	2.559	0.315	TC	NBR	NCC	8
43X80X10VSF	1.693	3.150	0.394	SF	FKM	VCS	8	44X65X10VTC	1.732	2.559	0.394	TC	FKM	VCC	8
SHAFT 1.703															
V-RING -045							7	44X65X10TC	1.732	2.559	0.394	TC	NBR	NCC	8
1703035TBY	1.703	3.030	0.500	TBY	NBR	NCC	8	44X65X11TC	1.732	2.559	0.433	TC	NBR	NCC	8
1703085TBW	1.703	3.084	0.500	TBW	NBR	NCC	8	44X65X11PTCR	1.732	2.559	0.433	TCR	ACM	PCC	8
SHAFT 1.704															
V-RING -045							7	44X68X8VSB-H	1.732	2.677	0.314	SB-H	FKM	VCS	8
1703035TB-H	1.704	3.033	0.500	TB-H	NBR	NCC	8	44X70X12SA	1.732	2.756	0.472	SA	NBR	NCC	8
SHAFT 1.705															
V-RING -045							7	44X70X12TB	1.732	2.756	0.472	TB	NBR	NCC	8
1703035TB-H	1.704	3.033	0.500	TB-H	NBR	NCC	8	44X70X12TC	1.732	2.756	0.472	TC	NBR	NCC	8
SHAFT 1.705															
V-RING -045							7	44X72X7PTB9	1.732	2.835	0.276	PTB9	ACM	PCC	8
17305TZ	1.705	3.032	0.500	TZ	NBR	NCC	8	44X72X7VTB9	1.732	2.835	0.276	VTB9	FKM	VCS	8
17030846TBJW	1.705	3.080	0.461	TBJW	NBR	NCC	8	44X72X8TB	1.732	2.835	0.315	TB	NBR	NCC	8
SHAFT 1.709															
V-RING -045							7	44X72X8TC	1.732	2.835	0.315	TC	NBR	NCC	8
170223PTBP	1.709	2.209	0.355	TBP	ACM	PCS	7	44X72X9TC	1.732	2.835	0.354	TC	NBR	NCS	8
SHAFT 1.718															
SHAFT-EZE 99171							S1	44X72X10SC	1.732	2.835	0.394	SC	NBR	NCC	8
V-RING -045							7	44X72X10TC	1.732	2.835	0.394	TC	NBR	NCC	8
1712565TB-H	1.718	2.561	0.500	TB-H	NBR	NCC	8	44X72X12SA	1.732	2.835	0.472	SA	NBR	NCC	8
1712565VL-H	1.718	2.561	0.500	VL-H	NBR	NCO	8	44X72X7/10.5VTB9-H	1.732	2.8350.276/0.413	VTB9-H	FKM	VCC	8	
17265SA-H	1.718	2.623	0.500	SA-H	NBR	NCC	8	SHAFT 1.734							
SHAFT 1.719															
SHAFT-EZE 99171							S1	V-RING -045							7
V-RING -045							7	1732062UM	1.734	2.062	0.250	UM	NBR	NCO	7
17125631TB-H	1.719	2.561	0.314	TB-H	NBR	NCC	8	173242VB	1.734	2.401	0.210	VB	NBR	NCO	7
171255KBN	1.719	2.561	0.500	KBN	NBR	NCO	8	17324021VL-H	1.734	2.401	0.210	VL-H	NBR	NCO	7
171255TB	1.719	2.561	0.500	TB	NBR	NCC	8	173242VA4	1.734	2.401	0.238	VA4	NBR	NCO	7
171255TB-H	1.719	2.561	0.500	TB-H	NBR	NCC	8	1732431SB	1.734	2.438	0.313	SB	NBR	NCC	7
171255TB-U	1.719	2.561	0.500	TB-U	NBR	NCC	8	172452VHY	1.734	2.450	0.250	VHY	NBR	NCO	7
171255TC	1.719	2.561	0.500	TC	NBR	NCC	8	1732683SB	1.734	2.688	0.375	SB	NBR	NCC	8
1712565TCW	1.719	2.561	0.500	TCW	NBR	NCC	8	173275VHY	1.734	2.726	0.512	VHY	NBR	NCO	8
171255VB	1.719	2.561	0.500	VB	NBR	NCO	8	SHAFT 1.739							
1712565VHY-H	1.719	2.562	0.500	VHY-H	NBR	NCO	8	SHAFT-EZE 99170							S1
1712625SA-H	1.719	2.622	0.500	SA-H	NBR	NCC	8	V-RING -045							7
SHAFT 1.730															
V-RING -045							7	173285PTBJ	1.739	2.812	0.594	PTBJ	ACM	PCS	8
173234KBY	1.730	2.336	0.470	KBY	NBR	NCO	7	SHAFT 1.741							
SHAFT 1.732															
V-RING -045							7	SHAFT-EZE 99170							S1
44X52X10TC	1.732	2.047	0.394	TC	NBR	NCC	7	V-RING -045							7
44X54X4.5SC	1.732	2.126	0.177	SC	NBR	NCC	7	172118TC	1.750	2.125	0.187	TC	NBR	NCC	7
44X54X4.5TC	1.732	2.126	0.177	TC	NBR	NCC	7	17211SB	1.750	2.125	0.188	SB	NBR	NCC	7
44X54X7TC	1.732	2.126	0.276	TC	NBR	NCC	7	17211SB-H	1.750	2.125	0.188	SB-H	NBR	NCC	7
44X55X5TC	1.732	2.165	0.197	TC	NBR	NCC	7	17221SC	1.750	2.250	0.187	SC	NBR	NCC	7
44X55X7SC	1.732	2.165	0.276	SC	NBR	NCC	7	172218VL-H	1.750	2.250	0.187	VL-H	NBR	NCO	7
44X57X9.5TCR	1.732	2.244	0.374	TCR	NBR	NCC	7	17221VSB	1.750	2.250	0.188	SB	FKM	VCS	7
44X58X7SB	1.732	2.283	0.276	SB	NBR	NCC	7	17221SB	1.750	2.250	0.188	SB	NBR	NCC	7
44X60X7VTC	1.732	2.362	0.276	TC	FKM	VCC	7	172218TC	1.750	2.250	0.188	TC	NBR	NCC	7
44X60X7TC	1.732	2.362	0.276	TC	NBR	NCC	7	17221VVB	1.750	2.250	0.188	VVB	FKM	VCO	7
44X60X7VTCR	1.732	2.362	0.276	TCR	FKM	VCC	7	17221VB	1.750	2.250	0.188	VB	NBR	NCO	7
44X60X9TC	1.732	2.362	0.354	TC	NBR	NCC	7	17221VB-H	1.750	2.250	0.188	VB-H	NBR	NCO	7
44X60X10TC	1.732	2.362	0.394	TC	NBR	NCC	7	17221VBY	1.750	2.250	0.188	VBY	NBR	NSO	7
44X62X8SB-H	1.732	2.440	0.314	SB-H	NBR	NCC	7	172231VSB-H	1.750	2.250	0.312	SB-H	FKM	VCS	7
44X62X8TC	1.732	2.441	0.315	TC	NBR	NCC	7	172231SB-H	1.750	2.250	0.312	SB-H	NBR	NCC	7
44X62X8VTF	1.732	2.441	0.315	TF	FKM	VCS	7	175223SA	1.750	2.250	0.313	SA	NBR	NCC	7
44X62X10SB	1.732	2.441	0.394	SB	NBR	NCC	7	175223SA-H	1.750	2.250	0.313	SA-H	NBR	NCC	7
44X62X10SC	1.732	2.441	0.394	SC	NBR	NCC	7								

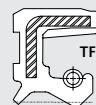
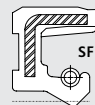
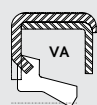
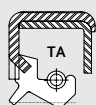

OIL AND GREASE SEALS - A COMPLETE LISTING

PLEASE CALL DICHTOMATIK FOR AVAILABILITY - 800-328-2840
 BULK AND INDIVIDUALLY BOXED QUANTITIES ARE AVAILABLE FOR ALL



DICHTOMATIK

Any seal. Any time.

TCM Part #	Shaft	Bore	Width	Type	Lip Material	Material	Box #	TCM Part #	Shaft	Bore	Width	Type	Lip Material	Material	Box
172231VSB	1.750	2.250	0.313	SB	FKM	VCS	7	17253SSB	1.750	2.502	0.375	SB	VMQ	SCC	8
172231SB	1.750	2.250	0.313	SB	NBR	NCC	7	172505SA-H	1.750	2.502	0.500	SA-H	NBR	NCC	8
172231SEF	1.750	2.250	0.313	SEF	NBR	NCS	7	172505TA-H	1.750	2.502	0.500	TA-H	NBR	NCC	8
172235SA-H	1.750	2.250	0.359	SA-H	NBR	NCC	7	172562VH	1.750	2.561	0.250	VH	NBR	NCO	8
172312TC	1.750	2.312	0.250	TC	NBR	NCC	7	172562VH-H	1.750	2.561	0.250	VH-H	NBR	NCO	8
17233TB	1.750	2.318	0.375	TB	NBR	NCC	7	172563SB-H	1.750	2.561	0.312	SB-H	NBR	NCC	8
17234SB-H	1.750	2.327	0.437	SB-H	NBR	NCC	7	172563TB-H	1.750	2.561	0.312	TB-H	NBR	NCC	8
17233VB	1.750	2.328	0.312	VB	NBR	NCO	7	172563SB	1.750	2.561	0.313	SB	NBR	NCC	8
17234SB	1.750	2.328	0.437	SB	NBR	NCC	7	172563VHY	1.750	2.561	0.375	VHY	NBR	NCO	8
172325UA	1.750	2.328	0.500	UA	NBR	NCO	8	172565SA-H	1.750	2.561	0.500	SA-H	NBR	NCC	8
17235TC	1.750	2.346	0.500	TC	NBR	NCC	8	172565TB-H	1.750	2.561	0.500	TB-H	NBR	NCC	8
172355TC	1.750	2.356	0.500	TC	NBR	NCC	8	172562VA5-H	1.750	2.562	0.250	VA5-H	NBR	NCO	8
172355TCY	1.750	2.356	0.500	TCY	NBR	NCC	8	172565VAY	1.750	2.562	0.500	VAY	NBR	NCO	8
172372VA5-H	1.750	2.374	0.250	VA5-H	NBR	NCO	7	172565VHY-H	1.750	2.562	0.500	VHY-H	NBR	NCO	8
17232VHY	1.750	2.374	0.250	VHY	NBR	NCO	7	175253TB	1.750	2.565	0.313	TB	NBR	NCC	8
1723731SB-H	1.750	2.374	0.312	SB-H	NBR	NCC	7	172565TB-H	1.750	2.565	0.313	TB-H	NBR	NCC	8
172373VTB-H	1.750	2.374	0.312	TB-H	FKM	VCS	7	17262VHY	1.750	2.623	0.250	VHY	NBR	NCO	8
172373TB	1.750	2.374	0.313	TB	NBR	NCC	7	17263SB	1.750	2.623	0.312	SB	NBR	NCC	8
172373TB-H	1.750	2.374	0.313	TB-H	NBR	NCC	7	1726231SB-H	1.750	2.623	0.312	SB-H	NBR	NCC	8
172373PTB	1.750	2.375	0.312	TB	ACM	PCC	7	17263VTB-H	1.750	2.623	0.312	TB-H	FKM	VCS	8
172373TC6	1.750	2.375	0.313	TC6	NBR	NCC	7	17263TCY	1.750	2.623	0.312	TCY	NBR	NCC	8
172383TC	1.750	2.383	0.375	TC	NBR	NCC	7	17263SB	1.750	2.623	0.313	SB	VMQ	SCC	8
175243PSB	1.750	2.411	0.375	SB	ACM	PCS	7	17263VTB	1.750	2.623	0.313	TB	FKM	VCS	8
175243PSB-H	1.750	2.411	0.375	SB-H	ACM	PCC	7	17263TB	1.750	2.623	0.313	TB	NBR	NCC	8
17244TA	1.750	2.412	0.468	TA	NBR	NSS	7	17263TB-H	1.750	2.623	0.313	TB-H	NBR	NCC	8
17242VHY	1.750	2.437	0.250	VHY	NBR	NCO	7	172624TC	1.750	2.623	0.438	TC	NBR	NCC	8
172435B-H	1.750	2.437	0.312	SB-H	NBR	NCC	7	17263SB-H	1.750	2.625	0.375	SB-H	NBR	NCS	8
17243VTB-H	1.750	2.437	0.312	TB-H	FKM	VCS	7	17263TC	1.750	2.625	0.375	TC	NBR	NCC	8
17243SB	1.750	2.437	0.313	SB	NBR	NCC	7	17265TC	1.750	2.625	0.500	TC	NBR	NCC	8
17243VSB-H	1.750	2.437	0.313	SB-H	FKM	VCS	7	172683SL-H	1.750	2.686	0.313	SL-H	NBR	NCC	8
17243VTB	1.750	2.437	0.313	TB	FKM	VCC	7	172683SB	1.750	2.686	0.375	SB	NBR	NCC	8
17243TB	1.750	2.437	0.313	TB	NBR	NCC	7	172683TB-H	1.750	2.686	0.375	TB-H	NBR	NCC	8
17243TB-H	1.750	2.437	0.313	TB-H	NBR	NCC	7	172685TB	1.750	2.686	0.500	TB	NBR	NCC	8
1724346TB-H	1.750	2.437	0.468	TB-H	NBR	NCC	7	172714TC	1.750	2.715	0.438	TC	NBR	NCC	8
17243TC	1.750	2.438	0.312	TC	NBR	NCC	7	172712VH-H	1.750	2.716	0.250	VH-H	NBR	NCO	8
17243TCN	1.750	2.438	0.313	TCN	NBR	NCC	7	17274TB-H	1.750	2.716	0.437	TB-H	NBR	NCC	8
172442VHY	1.750	2.440	0.250	VHY	NBR	NCO	7	17274TB	1.750	2.717	0.438	TB	NBR	NCC	8
1724435B-H	1.750	2.441	0.312	SB-H	NBR	NCC	7	17273UA	1.750	2.718	0.359	UA	NBR	NCO	8
172443SB	1.750	2.441	0.313	SB	NBR	NCC	7	17273VHY	1.750	2.718	0.359	VHY	NBR	NCO	8
172443TB	1.750	2.441	0.313	TB	NBR	NCC	7	172732VH	1.750	2.737	0.250	VH	NBR	NCO	8
172443TB-H	1.750	2.441	0.313	TB-H	NBR	NCC	7	17272VH	1.750	2.750	0.250	VH	NBR	NCO	8
172443TB-H	1.750	2.441	0.375	TB-H	NBR	NCC	7	17272VH-H	1.750	2.750	0.250	VH-H	NBR	NCO	8
17252TC	1.750	2.500	0.250	TC	NBR	NCC	8	172735B-H	1.750	2.750	0.312	SB-H	NBR	NCC	8
172531TC	1.750	2.500	0.313	TC	NBR	NCC	8	172731TC	1.750	2.750	0.312	TC	NBR	NCC	8
172531VTCNW	1.750	2.500	0.313	TCNW	FKM	VCC	8	17273VSB	1.750	2.750	0.313	SB	FKM	VCS	8
172536SC	1.750	2.500	0.365	SC	NBR	NCC	8	17273SB	1.750	2.750	0.313	SB	NBR	NCC	8
172535A-H	1.750	2.500	0.375	SA-H	NBR	NCC	8	17273VSB-H	1.750	2.750	0.313	SB-H	FKM	VCS	8
17253SC	1.750	2.500	0.375	SC	NBR	NCC	8	17273TB	1.750	2.750	0.313	TB	NBR	NCC	8
17253VSF	1.750	2.500	0.375	SF	FKM	VCS	8	17273TB-H	1.750	2.750	0.313	TB-H	NBR	NCC	8
17253TC	1.750	2.500	0.375	TC	NBR	NCC	8	17274VH	1.750	2.750	0.484	VH	NBR	NCO	8
17253VTF	1.750	2.500	0.375	TF	FKM	VCS	8	172755A-H	1.750	2.750	0.500	SA-H	NBR	NCC	8
172555A	1.750	2.500	0.500	SA	NBR	NCC	8	1727540VSB	1.750	2.754	0.406	SB	FKM	VCS	8
17255TA	1.750	2.500	0.500	TA	NBR	NCC	8	172753SC	1.750	2.756	0.375	SC	NBR	NCC	8
17255TC	1.750	2.500	0.500	TC	NBR	NCC	8	172753SB-H	1.750	2.757	0.312	SB-H	NBR	NCC	8
172502VH-H	1.750	2.501	0.250	VH-H	NBR	NCO	8	172753TB-H	1.750	2.758	0.375	TB-H	NBR	NCC	8
172503VSB-H	1.750	2.501	0.312	SB-H	FKM	VCS	8	175272OUB	1.750	2.786	0.294	OUB	NBR	NCO	8
1725031SB-H	1.750	2.501	0.312	SB-H	NBR	NCC	8	17283VTB	1.750	2.810	0.313	TB	FKM	VCS	8
172505TLN22-H	1.750	2.501	0.500	TLN22-H	NBR	NCC	8	17283TB	1.750	2.810	0.313	TB	NBR	NCC	8
17252VH	1.750	2.502	0.250	VH	NBR	NCO	8	17283TB-H	1.750	2.810	0.313	TB-H	NBR	NCC	8
17253VTB	1.750	2.502	0.313	TB	FKM	VCS	8	172811VBY	1.750	2.813	0.156	VBY	NBR	NCO	8
17253TB	1.750	2.502	0.313	TB	NBR	NCC	8	172823VH-H	1.750	2.829	0.375	VH-H	NBR	NCO	8
17253VTB-H	1.750	2.502	0.313	TB-H	FKM	VCS	8	172833VH-H	1.750	2.830	0.375	VH-H	NBR	NCO	8
17253TB-H	1.750	2.502	0.313	TB-H	NBR	NCC	8	172873SB	1.750	2.875	0.313	SB	NBR	NCC	8
1725035A-H	1.750	2.502	0.375	SA-H	NBR	NCC	8	172873SB-H	1.750	2.875	0.313	SB-H	NBR	NCC	8

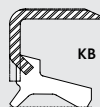
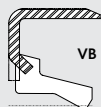
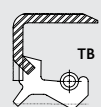
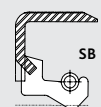
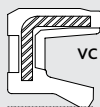



TCM Part #	Shaft	Bore	Width	Type	Lip Material	Material	Box	TCM Part #	Shaft	Bore	Width	Type	Lip Material	Material	Box #	
172873TB-H	1.750	2.875	0.313	TB-H	NBR	NCC	8	SHAFT 1.772								
17283TA-H	1.750	2.875	0.375	TA-H	NBR	NCC	8	SHAFT-EZE 99177							S1	
172873VTB	1.750	2.875	0.375	TB	FKM	VCS	8	V-RING -045							7	
17283TB-H	1.750	2.875	0.375	TB-H	NBR	NCC	8	45X52X4TC	1.772	2.047	0.157	TC	NBR	NCC	7	
172875SA	1.750	2.875	0.500	SA	NBR	NCC	8	45X52X4VB	1.772	2.047	0.157	VB	NBR	NCO	7	
1729843TA-H	1.750	2.981	0.437	TA-H	NBR	NCC	8	45X52X7TM-H	1.772	2.047	0.276	TM-H	NBR	NCC	7	
172993TA-H	1.750	2.996	0.312	TA-H	NBR	NCC	8	45X55X4VC	1.772	2.165	0.157	VC	NBR	NCO	7	
172993TB-H	1.750	2.996	0.375	TB-H	NBR	NCC	8	45X55X4VVG	1.772	2.165	0.157	VG	FKM	VCO	7	
1729931SB-H	1.750	2.997	0.312	SB-H	NBR	NCC	8	45X55X7SB	1.772	2.165	0.276	SB	NBR	NCC	7	
17293SL	1.750	2.997	0.313	SL	FKM	VCS	8	45X55X7SC	1.772	2.165	0.276	SC	NBR	NCC	7	
17302VA5-H	1.750	3.000	0.250	VA5-H	NBR	NCO	8	45X55X7VSF	1.772	2.165	0.276	SF	FKM	VCS	7	
17303SB-H	1.750	3.000	0.312	SB-H	NBR	NCC	8	45X55X7TB-H	1.772	2.165	0.276	TB-H	NBR	NCC	7	
17303TB-H	1.750	3.000	0.312	TB-H	NBR	NCC	8	45X55X7VTC	1.772	2.165	0.276	TC	FKM	VCC	7	
17303VSB	1.750	3.000	0.313	SB	FKM	VCS	8	45X55X7TC	1.772	2.165	0.276	TC	NBR	NCC	7	
17303SB	1.750	3.000	0.313	SB	NBR	NCC	8	45X55X8SC	1.772	2.165	0.315	SC	NBR	NCC	7	
17303VSB-H	1.750	3.000	0.313	SB-H	FKM	VCS	8	45X56X7TC	1.772	2.205	0.276	TC	NBR	NCC	7	
17303TL-H	1.750	3.000	0.313	TL-H	NBR	NCC	8	45X56X10TC	1.772	2.205	0.394	TC	NBR	NCC	7	
173037TB	1.750	3.000	0.375	TB	NBR	NCC	8	45X57X5.5TC	1.772	2.244	0.217	TC	NBR	NCC	7	
173037TB-H	1.750	3.000	0.375	TB-H	NBR	NCC	8	45X57X7TC	1.772	2.244	0.276	TC	NBR	NCC	7	
173063SB	1.750	3.061	0.313	SB	NBR	NCC	8	45X58X6TC	1.772	2.283	0.236	TC	NBR	NCC	7	
173063SB-H	1.750	3.061	0.313	SB-H	NBR	NCC	8	45X58X7VSC	1.772	2.283	0.276	SC	FKM	VCS	7	
173063TB-H	1.750	3.061	0.375	TB-H	NBR	NCC	8	45X58X7VTC	1.772	2.283	0.276	TC	FKM	VCC	7	
173153SB-H	1.750	3.153	0.312	SB-H	NBR	NCC	8	45X58X7TC	1.772	2.283	0.276	TC	NBR	NCC	7	
173153SM	1.750	3.154	0.313	SM	NBR	NCC	8	45X58X9TB	1.772	2.283	0.354	TB	NBR	NCC	7	
173183SB-H	1.750	3.188	0.312	SB-H	NBR	NCC	8	45X59X10TC	1.772	2.323	0.394	TC	NBR	NCC	7	
17313SB-H	1.750	3.189	0.313	SB-H	NBR	NCC	8	45X60X8TC	1.772	2.362	0.314	TG	NBR	NCC	7	
173184TB-H	1.750	3.189	0.437	TB-H	NBR	NCC	8	45X60X8VSB-H	1.772	2.362	0.315	SB-H	FKM	VCS	7	
173265TB-H	1.750	3.264	0.500	TB-H	NBR	NCC	8	45X60X8SB-H	1.772	2.362	0.315	SB-H	NBR	NCC	7	
17354SB-H	1.750	3.543	0.437	SB-H	NBR	NCC	9	45X60X7VSB	1.772	2.362	0.276	SB	FKM	VCS	7	
17354SB	1.750	3.543	0.438	SB	NBR	NCC	9	45X60X7SC	1.772	2.362	0.276	SC	NBR	NCC	7	
17354SB-H	1.750	3.543	0.438	SB-H	NBR	NCC	9	45X60X7VSCY	1.772	2.362	0.276	SCY	FKM	VCS	7	
17355SA-H	1.750	3.543	0.500	SA-H	NBR	NCC	9	45X60X7VSF	1.772	2.362	0.276	SF	FKM	VCS	7	
17364SL-H	1.750	3.625	0.438	SL-H	NBR	NCC	9	45X60X7TC	1.772	2.362	0.276	TC	NBR	NCC	7	
17393TB	1.750	3.937	0.312	TB	NBR	NCC	9	45X60X8VSB	1.772	2.362	0.315	SB	FKM	VCS	7	
17393TB-H	1.750	3.937	0.312	TB-H	NBR	NCC	9	45X60X8SB	1.772	2.362	0.315	SB	NBR	NCC	7	
SHAFT 1.752								45X60X8VSC	1.772	2.362	0.315	SC	FKM	VCS	7	
SHAFT-EZE 99172							S1	45X60X8SC	1.772	2.362	0.315	SC	NBR	NCC	7	
SHAFT-EZE 99174							S1	45X60X8SCY	1.772	2.362	0.315	SCY	XNBR	XCC	7	
SHAFT-EZE 99175							S1	45X60X8TC	1.772	2.362	0.315	TC	NBR	NCC	7	
SHAFT-EZE 99180							S1	45X60X8VTF	1.772	2.362	0.315	TF	FKM	VCS	7	
SHAFT-EZE 99173							S1	45X60X10SC	1.772	2.362	0.394	SC	NBR	NCC	7	
V-RING -045							7	45X60X10TC	1.772	2.362	0.394	TC	NBR	NCC	7	
44.5X54X5TM	1.752	2.126	0.197	TM	NBR	NCC	7	45X61X9TB	1.772	2.402	0.354	TB	NBR	NCC	7	
44.5X54X7TC	1.752	2.126	0.276	TC	NBR	NCC	7	45X61X9VTC	1.772	2.402	0.354	TC	FKM	VCS	7	
44.5X63.5X10TC	1.752	2.500	0.394	TC	NBR	NCC	8	45X61X9TC	1.772	2.402	0.354	TC	NBR	NCC	7	
44.5X85X10TC	1.752	3.346	0.394	TC	NBR	NCC	8	45X61X10TB	1.772	2.402	0.394	TB	NBR	NCC	7	
SHAFT 1.762								45X61.5X5TA	1.772	2.421	0.197	TA	NBR	NCC	7	
SHAFT-EZE 99176							S1	45X62X7TG	1.772	2.440	0.275	TG	NBR	NCC	7	
V-RING -045							7	45X62X6KB	1.772	2.441	0.236	KB	NBR	NCO	7	
176223SB	1.762	2.261	0.313	SB	NBR	NCC	7	45X62X7SC	1.772	2.441	0.276	SC	NBR	NCC	7	
176243TBL-H	1.762	2.409	0.375	TBL-H	NBR	NCC	7	45X62X7VTC	1.772	2.441	0.276	TC	FKM	VCS	7	
SHAFT 1.763								45X62X7TC	1.772	2.441	0.276	TC	NBR	NCC	7	
SHAFT-EZE 99176							S1	45X62X7VTF	1.772	2.441	0.276	TF	FKM	VCS	7	
V-RING -045							7	45X62X8SB	1.772	2.441	0.315	SB	NBR	NCC	7	
1762403VSB-R-H	1.763	2.409	0.375	SBR-H	FKM	VCS	7	45X62X8SC	1.772	2.441	0.315	SC	NBR	NCS	7	
172403VTB-H	1.763	2.409	0.375	TB-H	FKM	VCS	7	45X62X8TC	1.772	2.441	0.315	TC	NBR	NCC	7	
SHAFT 1.766								45X62X8VTF	1.772	2.441	0.315	TF	FKM	VCS	7	
SHAFT-EZE 99176							S1	45X62X9SC	1.772	2.441	0.354	SC	NBR	NCC	7	
V-RING -045							7	45X62X9TC	1.772	2.441	0.354	TC	NBR	NCC	7	
17293TC	1.766	2.953	0.313	TC	NBR	NCC	8	45X62X9STC	1.772	2.441	0.354	TC	VMQ	SCC	7	
							7	45X62X9TCL	1.772	2.441	0.354	TCL	NBR	NCC	7	
							8	45X62X10SC	1.772	2.441	0.394	SC	NBR	NCC	7	
								45X62X10VSC	1.772	2.441	0.394	SF	FKM	VCS	7	
								45X62X10TC	1.772	2.441	0.394	TC	NBR	NCC	7	

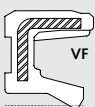
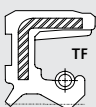

OIL AND GREASE SEALS - A COMPLETE LISTING

PLEASE CALL DICHTOMATIK FOR AVAILABILITY - 800-328-2840
BULK AND INDIVIDUALLY BOXED QUANTITIES ARE AVAILABLE FOR ALL



DICHTOMATIK

Any seal. Any time.

TCM Part #	Shaft	Bore	Width	Type	Lip Material	Material	Box #	TCM Part #	Shaft	Bore	Width	Type	Lip Material	Material	Box
45X62X10VA3	1.772	2.441	0.394	VA3	NBR	NSO	7	45X73X10TC	1.772	2.874	0.394	TC	NBR	NCC	8
45X62X12TC	1.772	2.441	0.472	TC	NBR	NCC	7	45X75X6TC	1.772	2.953	0.236	TC	NBR	NCC	8
45X62X13TB	1.772	2.441	0.512	TB	NBR	NCC	8	45X75X7TC	1.772	2.953	0.276	TC	NBR	NCC	8
45X62X14DC	1.772	2.441	0.551	DC	NBR	NCC	8	45X75X8SB	1.772	2.953	0.315	SB	NBR	NCC	8
45X62X8SB-H	1.772	2.441	0.315	SB-H	NBR	NCC	7	45X75X8SC	1.772	2.953	0.315	SC	NBR	NCC	8
17724431VTB-H	1.772	2.441	0.315	TB-H	FKM	VCS	7	45X75X8VTB	1.772	2.953	0.315	TB	FKM	VCC	8
45X63X7TC	1.772	2.480	0.276	TC	NBR	NCC	7	45X75X8TC	1.772	2.953	0.315	TC	NBR	NCC	8
45X63.5X10TB	1.772	2.500	0.394	TB	NBR	NCC	8	45X75X10SC	1.772	2.953	0.394	SC	NBR	NCC	8
45X63.5X10TC	1.772	2.500	0.394	TC	NBR	NCC	8	45X75X10VTC	1.772	2.953	0.394	TC	FKM	VCC	8
45X64X9TC	1.772	2.520	0.354	TC	NBR	NCC	8	45X75X10TC	1.772	2.953	0.394	TC	NBR	NCC	8
45X65X8VSB-H	1.772	2.559	0.314	SB-H	FKM	VCS	8	45X75X12TC	1.772	2.953	0.472	TC	NBR	NCC	8
45X65X8SB-H	1.772	2.559	0.314	SB-H	NBR	NCC	8	45X75X8SB-H	1.772	2.953	0.315	SB-H	NBR	NCC	8
45X65X5TB	1.772	2.559	0.197	TB	NBR	NCC	8	45X78X8TC	1.772	3.071	0.315	TC	NBR	NCC	8
45X65X5TC	1.772	2.559	0.197	TC	NBR	NCC	8	45X78X10TB	1.772	3.071	0.394	TB	NBR	NCC	8
45X65X5VB	1.772	2.559	0.197	VB	NBR	NCO	8	45X78X13TA	1.772	3.071	0.512	TA	NBR	NCC	8
45X65X6SC	1.772	2.559	0.236	SC	NBR	NCC	8	1773131TB	1.772	3.125	0.315	TB	NBR	NCC	8
45X65X7SCNY	1.772	2.559	0.276	SCNY	NBR	NCC	8	177313TB-H	1.772	3.125	0.315	TB-H	NBR	NCC	8
45X65X7TC	1.772	2.559	0.276	TC	NBR	NCC	8	1773131TB-H	1.772	3.125	0.315	TB-H	NBR	NCC	8
45X65X7VTCN	1.772	2.559	0.276	VTCN	FKM	VCS	8	45X80X10TG	1.772	3.149	0.393	TG	NBR	NCC	8
45X65X7TCN	1.772	2.559	0.276	TCN	NBR	NCC	8	45X80X8TC	1.772	3.150	0.315	TC	NBR	NCC	8
45X65X8SC	1.772	2.559	0.315	SC	NBR	NCC	8	45X80X10SA	1.772	3.150	0.394	SA	NBR	NCC	8
45X65X8TC	1.772	2.559	0.315	TC	NBR	NCC	8	45X80X10TC	1.772	3.150	0.394	TC	NBR	NCC	8
45X65X8VTF	1.772	2.559	0.315	TF	FKM	VCS	8	45X80X10VTF	1.772	3.150	0.394	TF	FKM	VCS	8
45X65X10SC	1.772	2.559	0.394	SC	NBR	NCC	8	45X80X13TC	1.772	3.150	0.512	TC	NBR	NCC	8
45X65X10VTBR	1.772	2.559	0.394	TBR	FKM	VCS	8	45X81X13SC	1.772	3.189	0.512	SC	NBR	NCC	8
45X65X10TC	1.772	2.559	0.394	TC	NBR	NCC	8	45X85X10TG	1.772	3.346	0.393	TG	NBR	NCC	8
45X65X12TC	1.772	2.559	0.472	TC	NBR	NCC	8	45X85X8TC	1.772	3.346	0.315	TC	NBR	NCC	8
45X65X10/8TC	1.772	2.559	0.394/0.315	TC	NBR	NCC	8	45X85X10VTC	1.772	3.346	0.394	TC	FKM	VCS	8
45X66X6VVF	1.772	2.598	0.236	SF	FKM	VCS	8	45X85X10TC	1.772	3.346	0.394	TC	NBR	NCC	8
45X66X9SC	1.772	2.598	0.354	SC	NBR	NCC	8	45X85X10VTF	1.772	3.346	0.394	TF	FKM	VCS	8
45X66X10VVF	1.772	2.598	0.394	SF	FKM	VCS	8	45X85X13SC	1.772	3.346	0.512	SC	NBR	NCC	8
45X66X10VTC	1.772	2.598	0.394	TC	FKM	VCC	8	45X90X10SC	1.772	3.543	0.394	SC	NBR	NCC	9
45X68X8SB-H	1.772	2.677	0.314	SB-H	NBR	NCC	8	45X90X10VTC	1.772	3.543	0.394	TC	FKM	VCC	9
45X68X7TC	1.772	2.677	0.276	TC	NBR	NCC	8	45X90X10TC	1.772	3.543	0.394	TC	NBR	NCC	9
45X68X8VSC	1.772	2.677	0.315	SC	FKM	VCS	8	45X100X10PSCW	1.772	3.937	0.394	SCW	ACM	PCC	9
45X68X8SC	1.772	2.677	0.315	SC	NBR	NCC	8	45X100X10TC	1.772	3.937	0.394	TC	NBR	NCC	9
45X68X8TB-H	1.772	2.677	0.315	TB-H	NBR	NCC	8	45X100X10VTCW	1.772	3.937	0.394	TCW	FKM	VCS	9
45X68X8TC	1.772	2.677	0.315	TC	NBR	NCC	8	45X100X10VTF	1.772	3.937	0.394	TF	FKM	VCS	9
45X68X8.5PTCY	1.772	2.677	0.335	TCY	ACM	PCC	8	SHAFT 1.780							
45X68X9TC	1.772	2.677	0.354	TC	NBR	NCC	8	SHAFT-EZE 99179						S1	
45X68X10TC	1.772	2.677	0.394	TC	NBR	NCC	8	V-RING -045						7	
45X68X12SC	1.772	2.677	0.472	SC	NBR	NCC	8	1782503SA-H	1.780	2.501	0.312	SA-H	NBR	NCC	8
45X68X12TB	1.772	2.677	0.472	TB	NBR	NCC	8	SHAFT 1.781							
45X68X12TC	1.772	2.677	0.472	TC	NBR	NCC	8	SHAFT-EZE 99179						S1	
45X69X10TC	1.772	2.717	0.394	TC	NBR	NCC	8	V-RING -045						7	
45X70X5TC	1.772	2.756	0.197	TC	NBR	NCC	8	178212VB-H	1.781	2.126	0.250	VB-H	NBR	NSO	7
45X70X8TC	1.772	2.756	0.315	TC	NBR	NCC	8	1782253TC	1.781	2.251	0.375	TC	NBR	NCC	7
45X70X10SC	1.772	2.756	0.394	SC	NBR	NCC	8	178223TB	1.781	2.252	0.313	TB	NBR	NCC	7
45X70X10TC	1.772	2.756	0.394	TC	NBR	NCC	8	178223TB-H	1.781	2.252	0.313	TB-H	NBR	NCC	7
45X70X12SC	1.772	2.756	0.472	SC	NBR	NCC	8	178253SA-H	1.781	2.502	0.312	SA-H	NBR	NCC	8
45X70X12VTC	1.772	2.756	0.472	VTC	FKM	VCC	8	178253SC	1.781	2.502	0.313	SC	NBR	NCC	8
45X70X12TC	1.772	2.756	0.472	TC	NBR	NCC	8	178263SB	1.781	2.623	0.313	SB	NBR	NCC	8
45X72X7SC	1.772	2.834	0.275	SC	NBR	NCC	8	178263SB-H	1.781	2.623	0.313	SB-H	NBR	NCC	8
45X72X8SB-H	1.772	2.834	0.314	SB-H	NBR	NCC	8	1782683SB-H	1.781	2.686	0.313	SB-H	NBR	NCC	8
45X72X10TG	1.772	2.834	0.393	TG	NBR	NCC	8	1782683SL	1.781	2.686	0.313	SL	NBR	NCC	8
45X72X7TC	1.772	2.835	0.276	TC	NBR	NCC	8	SHAFT 1.783							
45X72X8SC	1.772	2.835	0.315	SC	NBR	NCC	8	SHAFT-EZE 99179						S1	
45X72X8TB	1.772	2.835	0.315	TB	NBR	NCC	8	V-RING -045						7	
45X72X8TC	1.772	2.835	0.315	TC	NBR	NCC	8	178222SC	1.783	2.285	0.250	SC	NBR	NCC	7
45X72X8VTCN	1.772	2.835	0.315	VTCN	FKM	VCS	8	SHAFT 1.787							
45X72X8VTF	1.772	2.835	0.315	VTF	FKM	VCS	8	V-RING -045						7	
45X72X10TC	1.772	2.835	0.394	TC	NBR	NCC	8	1783233PSBJR-H	1.787	3.229	0.335	PSBJR	ACM	PCC	8
45X72X12TA	1.772	2.835	0.472	TA	NBR	NCC	8								
45X72X15TC	1.772	2.835	0.591	TC	NBR	NCC	8								

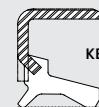
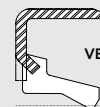
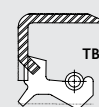
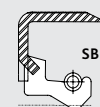
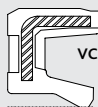



TCM Part #	Shaft	Bore	Width	Type	Lip Material	Material	Box
SHAFT 1.797							
V-RING -045							7
179275VB	1.797	2.726	0.516	VB	NBR	NCO	8
SHAFT 1.800							
V-RING -045							7
18032621OKBY	1.800	3.266	0.219	OKBY	NBR	NCO	8
SHAFT 1.811							
SHAFT-EZE 99181							S1
V-RING -045							7
46X56X7TCR	1.811	2.205	0.276	TCR	NBR	NCC	7
46X58X5SC	1.811	2.283	0.197	SC	NBR	NCC	7
46X59X12TC	1.811	2.323	0.472	TC	NBR	NCC	7
181234VB	1.811	2.327	0.437	VB	NBR	NCC	7
46X60X7TC	1.811	2.362	0.276	TC	NBR	NCC	7
46X60X7STCR	1.811	2.362	0.276	TCR	VMQ	SCC	7
46X62X8TC	1.811	2.441	0.315	TC	NBR	NCC	7
46X62X9SC	1.811	2.441	0.354	SC	NBR	NCC	7
46X64X8VSF	1.811	2.520	0.315	SF	FKM	VCS	8
46X64X8TC	1.811	2.520	0.315	TC	NBR	NCC	8
46X64X9TC	1.811	2.520	0.354	TC	NBR	NCC	8
46X65X9TC	1.811	2.559	0.354	TC	NBR	NCC	8
46X66X10TC	1.811	2.598	0.394	TC	NBR	NCC	8
46X67X9.5TL	1.811	2.638	0.374	TL	NBR	NCC	8
46X70X8TC	1.811	2.756	0.315	TC	NBR	NCC	8
46X70X14TC	1.811	2.756	0.551	TC	NBR	NCC	8
46X72X10SC	1.811	2.835	0.394	SC	NBR	NCC	8
46X78X10TC	1.811	3.071	0.394	TC	NBR	NCC	8
46X78X10TM	1.811	3.071	0.394	TM	NBR	NCC	8
46X80X10TC	1.811	3.150	0.394	TC	NBR	NCC	8
SHAFT 1.812							
SHAFT-EZE 99181							S1
V-RING -045							7
1812273SB-H	1.812	2.279	0.312	SB-H	NBR	NCC	7
18124331SB-H	1.812	2.437	0.312	SB-H	NBR	NCC	7
182434SA-H	1.812	2.437	0.468	SA-H	NBR	NCC	7
182492SB	1.812	2.497	0.250	SB	NBR	NCC	7
182492SL	1.812	2.497	0.250	SL	NBR	NCC	7
181252SC	1.812	2.500	0.250	SC	NBR	NCC	8
181252TC	1.812	2.500	0.250	TC	NBR	NCC	8
1812563VTB-H	1.812	2.561	0.312	TB-H	FKM	VCS	8
18126231SB-H	1.812	2.622	0.312	SB-H	NBR	NCC	8
181263TC	1.812	2.625	0.375	TC	NBR	NCC	8
1812683TB-H	1.812	2.686	0.375	TB-H	NBR	NCC	8
181273TB-H	1.812	2.750	0.375	TB-H	NBR	NCC	8
181283TB-H	1.812	2.875	0.375	TB-H	NBR	NCC	8
181303TBJR-H	1.812	3.000	0.500	TBJR-H	NBR	NCC	8
18314SA-H	1.812	3.189	0.437	SA-H	NBR	NCC	8
SHAFT 1.813							
SHAFT-EZE 99181							S1
V-RING -045							7
181243SB	1.813	2.437	0.315	SB	NBR	NCC	7
181243SB-H	1.813	2.437	0.315	SB-H	NBR	NCC	7
181252SM	1.813	2.500	0.250	SM	NBR	NCC	8
181253TC	1.813	2.500	0.375	TC	NBR	NCC	8
181254VHY	1.813	2.562	0.438	VHY	NBR	NCO	8
181263SB	1.813	2.623	0.313	SB	NBR	NCC	8
181265TBJ	1.813	2.623	0.500	TBJ	NBR	NCC	8
181265TBJR	1.813	2.623	0.500	TBJR	NBR	NCC	8
181263SC	1.813	2.625	0.375	SC	NBR	NCC	8
181273SB	1.813	2.750	0.313	SB	NBR	NCC	8
181273SB-H	1.813	2.750	0.313	SB-H	NBR	NCC	8
181283SB-H	1.813	2.875	0.312	SB-H	NBR	NCC	8

TCM Part #	Shaft	Bore	Width	Type	Lip Material	Material	Box #
181283SB	1.813	2.875	0.313	SB	NBR	NCC	8
181303PTB	1.813	3.000	0.375	TB	ACM	PCS	8
181303PTB-H	1.813	3.000	0.375	TB-H	ACM	PCC	8
1813056VTB2J	1.813	3.000	0.563	TB2J	FKM	VCS	8
18305TB	1.813	3.001	0.563	TB	NBR	NCC	8
18305TB-H	1.813	3.001	0.563	TB-H	NBR	NCC	8
SHAFT 1.819							
V-RING -045							7
46.2X80X7TC	1.819	3.150	0.276	TC	NBR	NCC	8
46.2X80X10SC	1.819	3.150	0.394	SC	NBR	NCC	8
SHAFT 1.825							
V-RING -045							7
182252VH	1.825	2.570	0.250	VH	NBR	NCO	8
182262VHY	1.825	2.623	0.250	VHY	NBR	NCO	8
1822746TB-H	1.825	2.750	0.468	TB-H	NBR	NCC	8
SHAFT 1.843							
V-RING -045							7
1842623TB-H	1.843	2.623	0.375	TB-H	NBR	NCC	8
184273TB-H	1.843	2.750	0.375	TB-H	NBR	NCC	8
SHAFT 1.844							
V-RING -045							7
184242VAY	1.844	2.402	0.234	VAY	NBR	NCO	7
1842503TB-H	1.844	2.501	0.375	TB-H	NBR	NCC	8
18426235B-H	1.844	2.622	0.312	SB-H	NBR	NCC	8
184273PSB-H	1.844	2.750	0.312	SB-H	ACM	PCC	8
184273PSB	1.844	2.750	0.313	SB	ACM	PCS	8
SHAFT 1.850							
V-RING -045							7
185213TM	1.850	2.125	0.312	TM	NBR	NCC	7
47X56X10SC	1.850	2.205	0.394	SC	NBR	NCC	7
47X58X5TC	1.850	2.283	0.197	TC	NBR	NCC	7
47X58X6VSF	1.850	2.283	0.236	SF	FKM	VCS	7
47X58X7SC	1.850	2.283	0.276	SC	NBR	NCC	7
47X58X7TC	1.850	2.283	0.276	TC	NBR	NCC	7
47X62X85B-H	1.850	2.440	0.314	SB-H	NBR	NCC	7
47X62X8TC	1.850	2.440	0.314	TC	NBR	NCC	7
47X62X6SC	1.850	2.441	0.236	SC	NBR	NCC	7
47X62X6VSF	1.850	2.441	0.236	SF	FKM	VCS	7
47X62X6TC	1.850	2.441	0.236	TC	NBR	NCC	7
47X62X7TC	1.850	2.441	0.276	TC	NBR	NCC	7
47X62X8SC	1.850	2.441	0.315	SC	NBR	NCC	7
47X62X8VTB	1.850	2.441	0.315	TB	FKM	VCC	7
47X64X14KBY-H	1.850	2.520	0.551	KBY-H	NBR	NCO	8
47X65X7TC	1.850	2.559	0.276	TC	NBR	NCC	8
47X65X8SC	1.850	2.559	0.315	SC	NBR	NCC	8
47X65X10SC	1.850	2.559	0.394	SC	NBR	NCC	8
47X65X12TA	1.850	2.559	0.472	TA	NBR	NCC	8
47X65X8/11SCY	1.850	2.559	0.315/0.433	SCY	NBR	NCC	8
47X66X6TB	1.850	2.598	0.236	TB	NBR	NCC	8
47X67X12VSF	1.850	2.638	0.472	SF	FKM	VCS	8
47X70X10TC	1.850	2.756	0.394	TC	NBR	NCC	8
47X72X85B	1.850	2.835	0.315	SB	NBR	NCC	8
47X72X8TC	1.850	2.835	0.315	TC	NBR	NCC	8
47X72X9VSF	1.850	2.835	0.354	SF	FKM	VCS	8
47X72X10TC	1.850	2.835	0.394	TC	NBR	NCC	8
47X74X10TC	1.850	2.913	0.394	TC	NBR	NCC	8
47X75X10VTF	1.850	2.953	0.394	TF	FKM	VCS	8
47X80X10VTF	1.850	3.150	0.394	TF	FKM	VCS	8
47X80X12TC	1.850	3.150	0.472	TC	NBR	NCC	8

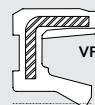
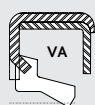
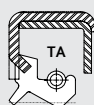

OIL AND GREASE SEALS - A COMPLETE LISTING

PLEASE CALL DICHTOMATIK FOR AVAILABILITY - 800-328-2840
 BULK AND INDIVIDUALLY BOXED QUANTITIES ARE AVAILABLE FOR ALL



DICHTOMATIK

Any seal. Any time.

TCM Part #	Shaft	Bore	Width	Type	Lip Material	Material	Box #	TCM Part #	Shaft	Bore	Width	Type	Lip Material	Material	Box
SHAFT 1.868								1826231SB-H	1.875	2.623	0.312	SB-H	NBR	NCC	8
SHAFT-EZE 99186							S1	18263VTB-H	1.875	2.623	0.312	TB-H	FKM	VCS	8
V-RING -045							7	1826231SB	1.875	2.623	0.313	SB	NBR	NCC	8
186253PTA	1.868	2.518	0.315	TA	ACM	PCS	8	18263VTB	1.875	2.623	0.313	TB	FKM	VCC	8
SHAFT 1.872								18263TB	1.875	2.623	0.313	TB	NBR	NCC	8
SHAFT-EZE 99186							S1	18263TB-H	1.875	2.623	0.313	TB-H	NBR	NCC	8
SHAFT-EZE 99187							S1	18263SSB	1.875	2.623	0.374	SB	VMQ	SCC	8
SHAFT-EZE 99184							S1	18263SSB-H	1.875	2.623	0.374	SB-H	VMQ	SCC	8
SHAFT-EZE 99188							S1	18264TA	1.875	2.624	0.485	TA	NBR	NCC	8
SHAFT-EZE 99190							S1	47.62X66.67X9.52SC	1.875	2.625	0.375	SC	NBR	NCC	8
V-RING -045							7	182631TC	1.875	2.625	0.313	TC	NBR	NCC	8
182051VM	1.872	2.057	0.125	VM	NBR	NCO	7	1826232VL-H	1.875	2.627	0.327	VL-H	NBR	NCO	8
SHAFT 1.873								182623VB	1.875	2.628	0.328	VB	NBR	NCO	8
SHAFT-EZE 99187							S1	182683SB-H	1.875	2.685	0.312	SB-H	NBR	NCC	8
SHAFT-EZE 99184							S1	182683SL	1.875	2.686	0.375	SL	NBR	NCC	8
SHAFT-EZE 99188							S1	1872683TB-H	1.875	2.686	0.375	TB-H	NBR	NCC	8
SHAFT-EZE 99190							S1	182683TC	1.875	2.686	0.375	TC	NBR	NCC	8
V-RING -045							7	1827226VL-H	1.875	2.720	0.266	VL-H	NBR	NCO	8
18265OUCY	1.873	2.684	0.544	OUCY	NBR	NCO	8	18272VAY	1.875	2.721	0.266	VAY	NBR	NCO	8
SHAFT 1.875								182752VAY-H	1.875	2.750	0.250	VAY-H	NBR	NCO	8
SHAFT-EZE 99187							S1	182752VHY	1.875	2.750	0.250	VHY	NBR	NCO	8
SHAFT-EZE 99184							S1	182735B	1.875	2.750	0.312	SB	NBR	NCC	8
SHAFT-EZE 99188							S1	18273VSB-H	1.875	2.750	0.312	SB-H	FKM	VCS	8
SHAFT-EZE 99190							S1	182735B-H	1.875	2.750	0.312	SB-H	NBR	NCC	8
V-RING -045							7	18273TA	1.875	2.750	0.312	TA	NBR	NCC	8
18213TB	1.875	2.125	0.375	TB	NBR	NCC	7	18273TB-H	1.875	2.750	0.312	TB-H	NBR	NCC	8
182325SM	1.875	2.317	0.203	SM	VMQ	SSS	7	18273TB	1.875	2.750	0.313	TB	NBR	NCC	8
18232SC	1.875	2.375	0.250	SC	NBR	NCC	7	18273TL-H	1.875	2.750	0.313	TL-H	NBR	NCC	8
18232TC	1.875	2.375	0.250	TC	NBR	NCC	7	18273VTBW	1.875	2.750	0.375	TBW	FKM	VCC	8
182392SC	1.875	2.397	0.250	SC	NBR	NCC	7	182745VTC2Y	1.875	2.750	0.450	TC2Y	FKM	VCC	8
182392SB-H	1.875	2.398	0.250	SB-H	NBR	NCC	7	182745VTC-PL	1.875	2.750	0.450	TC-PL	FKM	VCC	8
182392TC	1.875	2.398	0.250	TC	NBR	NCC	7	182755A-H	1.875	2.750	0.500	SA-H	NBR	NCC	8
18242SC	1.875	2.400	0.236	SC	NBR	NCC	7	187273PSB-H	1.875	2.758	0.312	SB-H	ACM	PCC	8
18242VB	1.875	2.400	0.236	VB	NBR	NCO	7	1827273PSB	1.875	2.758	0.313	SB	ACM	PCS	8
182424SC	1.875	2.400	0.240	SC	NBR	NCC	7	1827272SSB	1.875	2.758	0.313	SB	VMQ	SCC	8
1824027VL-H	1.875	2.401	0.275	VL-H	NBR	NCO	7	182753TB-H	1.875	2.758	0.375	TB-H	NBR	NCC	8
1824431VTB-H	1.875	2.440	0.315	TB-H	FKM	VCS	7	182745SBJR-H	1.875	2.758	0.425	SBJR-H	VMQ	SCC	8
1824432SB-H	1.875	2.440	0.325	SB-H	NBR	NCC	7	182745A	1.875	2.782	0.438	SA	NBR	NCC	8
1824743TB-H	1.875	2.470	0.437	TB-H	NBR	NCC	7	182745A-H	1.875	2.782	0.438	SA-H	NBR	NCC	8
182473TB	1.875	2.471	0.313	TB	NBR	NCC	7	18274TA	1.875	2.782	0.438	TA	NBR	NCC	8
182473TB-H	1.875	2.471	0.313	TB-H	NBR	NCC	7	18274TA-H	1.875	2.782	0.438	TA-H	NBR	NCC	8
18252SC	1.875	2.500	0.250	SC	NBR	NCC	8	182785TA-H	1.875	2.782	0.500	TA-H	NBR	NCC	8
18253PSB-H	1.875	2.500	0.312	SB-H	ACM	PCC	8	18285TBJ	1.875	2.813	0.500	TBJ	NBR	NCC	8
18253PSB	1.875	2.500	0.313	SB	ACM	PCC	8	1828331VTC	1.875	2.835	0.315	TC	FKM	VCS	8
18253VTCNY	1.875	2.500	0.313	TCNY	FKM	VCS	8	182833TB-H	1.875	2.835	0.375	TB-H	NBR	NCC	8
182555SC	1.875	2.500	0.500	SC	NBR	NCC	8	182872VHY	1.875	2.875	0.250	VHY	NBR	NCO	8
1825022VH-H	1.875	2.501	0.250	VH-H	NBR	NCO	8	18283VSB-H	1.875	2.875	0.312	SB-H	FKM	VCS	8
182502VC	1.875	2.502	0.250	VC	NBR	NCO	8	18283VTB-H	1.875	2.875	0.312	TB-H	FKM	VCS	8
182502VHY	1.875	2.502	0.250	VHY	NBR	NCO	8	18283VSB	1.875	2.875	0.313	SB	FKM	VCS	8
1825035B-H	1.875	2.502	0.312	SB-H	NBR	NCC	8	182835B	1.875	2.875	0.313	SB	NBR	NCC	8
18253TB-H	1.875	2.502	0.312	TB-H	NBR	NCC	8	182835B-H	1.875	2.875	0.313	SB-H	NBR	NCC	8
1825035B	1.875	2.502	0.313	SB	NBR	NCC	8	18283VTB	1.875	2.875	0.313	TB	FKM	VCC	8
182535SB	1.875	2.502	0.313	SB	NBR	NCC	8	18283TB-H	1.875	2.875	0.313	TB-H	NBR	NCC	8
1825032SC	1.875	2.502	0.328	SC	NBR	NCC	8	182846SA-H	1.875	2.875	0.468	SA-H	NBR	NCC	8
182503PSB-H	1.875	2.502	0.375	SB-H	ACM	PCC	8	1828749TMY	1.875	2.877	0.490	TMY	NBR	NCC	8
182563SC	1.875	2.561	0.312	SC	NBR	NCC	8	1829623VL-H	1.875	2.964	0.233	VL-H	NBR	NCO	8
1825631VTB-H	1.875	2.561	0.312	TB-H	FKM	VCS	8	18292VM	1.875	2.965	0.234	VM	NBR	NCO	8
182564PTBJ	1.875	2.561	0.469	TBJ	ACM	PCS	8	182992VL-H	1.875	2.996	0.250	VL-H	NBR	NCO	8
182563PSB-H	1.875	2.562	0.313	SB-H	ACM	PCC	8	1829935B-H	1.875	2.996	0.312	SB-H	NBR	NCC	8
1825631VTBW-H	1.875	2.562	0.313	TBW-H	FKM	VCS	8	182995SA	1.875	2.996	0.500	SA	NBR	NCC	8
182562SC	1.875	2.563	0.250	SC	NBR	NCC	8	182995SA-H	1.875	2.996	0.500	SA-H	NBR	NCC	8
182623VSB-H	1.875	2.622	0.312	SB-H	FKM	VCS	8	182992VB	1.875	2.997	0.250	VB	NBR	NCO	8
18263TC	1.875	2.623	0.250	TC	NBR	NCC	8	18302VH	1.875	3.000	0.250	VH	NBR	NCO	8
								18302VH-H	1.875	3.000	0.250	VH-H	NBR	NCO	8

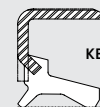
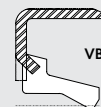
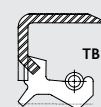
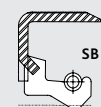
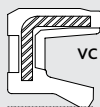
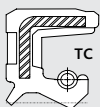



TCM Part #	Shaft	Bore	Width	Type	Lip Material	Material	Box	TCM Part #	Shaft	Bore	Width	Type	Lip Material	Material	Box #
18303VSB-H	1.875	3.000	0.312	SB-H	FKM	VCS	8	48X65X8VTF	1.890	2.559	0.315	TF	FKM	VCS	8
18303SB-H	1.875	3.000	0.312	SB-H	NBR	NCC	8	48X65X9TC	1.890	2.559	0.354	TC	NBR	NCC	8
183003TB	1.875	3.000	0.312	TB	NBR	NCC	8	48X65X10SB	1.890	2.559	0.394	SB	NBR	NCC	8
183003TB-H	1.875	3.000	0.312	TB-H	NBR	NCC	8	48X65X10TC	1.890	2.559	0.394	TC	NBR	NCC	8
18303VSB	1.875	3.000	0.313	SB	FKM	VCS	8	48X65X12DC	1.890	2.559	0.472	DC	NBR	NCC	8
18303SB	1.875	3.000	0.313	SB	NBR	NCC	8	48X65X12TC	1.890	2.559	0.472	TC	NBR	NCC	8
18305SA-H	1.875	3.000	0.500	SA-H	NBR	NCC	8	48X67X9TC	1.890	2.638	0.354	TC	NBR	NCC	8
187305SSSTB	1.875	3.000	0.500	TB	NBR	NSS	8	48X67X10TC	1.890	2.638	0.394	TC	NBR	NCC	8
18305VB	1.875	3.000	0.500	VB	NBR	NCO	8	48X68X8SB-H	1.890	2.677	0.314	SB-H	NBR	NCC	8
18303TA	1.875	3.061	0.313	TA	NBR	NCC	8	18926739TC	1.890	2.677	0.394	TC	NBR	NCC	8
18303TB	1.875	3.061	0.313	TB	NBR	NCC	8	48X68X11TC	1.890	2.677	0.433	TC	NBR	NCC	8
18303TB-H	1.875	3.061	0.313	TB-H	NBR	NCC	8	48X68X7VTCR	1.890	2.677	0.276	TCR	FKM	VCC	8
183063TB-H	1.875	3.061	0.375	TB-H	NBR	NCC	8	48X68X8VTF	1.890	2.677	0.315	TF	FKM	VCS	8
183105SBP	1.875	3.105	0.500	SBP	NBR	NCC	8	48X68X10TC	1.890	2.677	0.394	TC	NBR	NCC	8
183105TL	1.875	3.105	0.500	TL	NBR	NCC	8	48X68X10VTGR	1.890	2.677	0.394	TGR	FKM	VCS	8
183105TL-H	1.875	3.105	0.500	TL-H	NBR	NCC	8	48X68X11TCR	1.890	2.677	0.433	TCR	NBR	NCC	8
183115VSBP	1.875	3.111	0.500	SBP	FKM	VCS	8	48X68X14TC	1.890	2.677	0.551	TC	NBR	NCC	8
18313TB-H	1.875	3.125	0.312	TB-H	NBR	NCC	8	48X69X7TC	1.890	2.717	0.276	TC	NBR	NCC	8
183152VH-H	1.875	3.150	0.250	VH-H	NBR	NCO	8	48X69X10TB	1.890	2.717	0.394	TB	NBR	NCC	8
1831656PSA-H	1.875	3.160	0.562	SA-H	ACM	PCC	8	48X70X9SC	1.890	2.755	0.354	SC	NBR	NCC	8
183185TC	1.875	3.187	0.500	TC	NBR	NCC	8	48X70X7TC	1.890	2.756	0.276	TC	NBR	NCC	8
183183TB-H	1.875	3.189	0.375	TB-H	NBR	NCC	8	48X70X8VSB	1.890	2.756	0.315	SB	FKM	VCS	8
183184SA	1.875	3.189	0.469	SA	NBR	NCC	8	48X70X9TC	1.890	2.756	0.354	TC	NBR	NCC	8
183184SA-H	1.875	3.189	0.469	SA-H	NBR	NCC	8	48X70X10SC	1.890	2.756	0.394	SC	NBR	NCC	8
1832448TB-H	1.875	3.248	0.483	TB-H	NBR	NCC	8	48X70X10TC	1.890	2.756	0.394	TC	NBR	NCC	8
18324TB	1.875	3.249	0.480	TB	NBR	NCC	8	48X70X11TC	1.890	2.756	0.433	TC	NBR	NCC	8
18325SA-H	1.875	3.251	0.500	SA-H	NBR	NCC	8	48X72X8SB-H	1.890	2.834	0.314	SB-H	NBR	NCC	8
18334TA	1.875	3.317	0.438	TA	NBR	NCC	8	48X72X7SC	1.890	2.835	0.276	SC	NBR	NCC	8
18334TA-H	1.875	3.317	0.438	TA-H	NBR	NCC	8	48X72X7TB	1.890	2.835	0.276	TB	NBR	NCC	8
1833743SA-H	1.875	3.370	0.437	SA-H	NBR	NCC	8	48X72X7TC	1.890	2.835	0.276	TC	NBR	NCC	8
1833746TA-H	1.875	3.371	0.468	TA-H	NBR	NCC	8	48X72X8SC	1.890	2.835	0.315	SC	NBR	NCC	8
1834943TB-H	1.875	3.496	0.437	TB-H	NBR	NCC	9	48X72X8TC	1.890	2.835	0.315	TC	NBR	NCC	8
SHAFT 1.886															
V-RING -045							7	48X72X10TC	1.890	2.835	0.394	TC	NBR	NCC	8
18275TBJ	1.886	2.700	0.552	TBJ	NBR	NCC	8	48X72X15DC	1.890	2.835	0.591	DC	NBR	NCC	8
SHAFT 1.890															
SHAFT-EZE 99189								51							
V-RING -045							7	48X75X8TB	1.890	2.953	0.315	TB	NBR	NCC	8
48X54X4VC	1.890	2.126	0.157	VC	NBR	NCO	7	48X75X9TC	1.890	2.953	0.354	TC	NBR	NCC	8
48X58X4TC	1.890	2.283	0.157	TC	NBR	NCC	7	48X75X10TC	1.890	2.953	0.394	TC	NBR	NCC	8
48X60X7TC	1.890	2.362	0.276	TC	NBR	NCC	7	48X76X12TC	1.890	2.992	0.472	TC	NBR	NCC	8
48X60X9TB	1.890	2.362	0.354	TB	NBR	NCC	7	48X76X13TC	1.890	2.992	0.512	TC	NBR	NCC	8
48X60X9TC	1.890	2.362	0.354	TC	NBR	NCC	7	48X79X9TC	1.890	3.110	0.354	TC	NBR	NCC	8
48X62X6VC	1.890	2.440	0.236	VC	NBR	NCO	7	48X80X8SB-H	1.890	3.149	0.314	SB-H	NBR	NCC	8
48X62X8TG	1.890	2.440	0.314	TG	NBR	NCC	7	48X80X8SC	1.890	3.150	0.315	SC	NBR	NCC	8
48X62X6KC	1.890	2.441	0.236	KC	NBR	NCO	7	48X80X8TC	1.890	3.150	0.315	TC	NBR	NCC	8
48X62X7TC	1.890	2.441	0.276	TC	NBR	NCC	7	48X80X10VTC	1.890	3.150	0.394	TC	FKM	VCC	8
48X62X8SB	1.890	2.441	0.315	SB	NBR	NCC	7	48X80X12TC	1.890	3.150	0.472	TC	NBR	NCC	8
48X62X8VSC	1.890	2.441	0.315	SC	FKM	VCS	7	48X82X8TC	1.890	3.228	0.314	TC	NBR	NCC	8
48X62X8SC	1.890	2.441	0.315	SC	NBR	NCC	7	48X82X12TB	1.890	3.228	0.472	TB	NBR	NCC	8
48X62X8VSF	1.890	2.441	0.315	SF	FKM	VCS	7	48X82X12TBR	1.890	3.228	0.472	TBR	NBR	NCC	8
48X62X8VTBY	1.890	2.441	0.315	TBY	FKM	VSS	7	48X85X6VSF	1.890	3.346	0.236	SF	FKM	VCS	8
48X62X8TC	1.890	2.441	0.315	TC	NBR	NCC	7	48X85X10SC	1.890	3.346	0.394	SC	NBR	NCC	8
48X62X8VTF	1.890	2.441	0.315	TF	FKM	VCS	7	48X90X9TC	1.890	3.543	0.354	TC	NBR	NCC	9
48X62X10TA-H	1.890	2.441	0.394	TA-H	NBR	NCC	7	48X90X10SC	1.890	3.543	0.394	SC	NBR	NCC	9
48X62X10TC	1.890	2.441	0.394	TC	NBR	NCC	7	48X90X10VSF	1.890	3.543	0.394	SF	FKM	VCS	9
48X62X11TC	1.890	2.441	0.433	TC	NBR	NCC	7	48X90X13VTC	1.890	3.543	0.512	TC	FKM	VCC	9
48X62X12SC	1.890	2.441	0.472	SC	NBR	NCC	7	SHAFT 1.893							
48X62X8SB-H	1.890	2.441	0.315	SB-H	NBR	NCC	7	SHAFT-EZE 99189							
48X63X9TB	1.890	2.480	0.354	TB	NBR	NCC	7	V-RING -050							51
48X63.5X8TC	1.890	2.500	0.315	TC	NBR	NCC	8	189242SB	1.893	2.434	0.250	SB	NBR	NCC	7
48X65X10SC	1.890	2.559	0.393	SC	NBR	NCC	8	189242SB-H	1.893	2.434	0.250	SB-H	NBR	NCC	7
48X65X7TC	1.890	2.559	0.276	TC	NBR	NCC	8	189242SZ	1.893	2.434	0.250	SZ	NBR	NCC	7

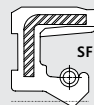
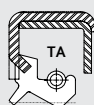



TCM Part #	Shaft	Bore	Width	Type	Lip Material	Material	Box	TCM Part #	Shaft	Bore	Width	Type	Lip Material	Material	Box #
19265KBJ-H	1.940	2.622	0.570	KBJ-H	NBR	NCO	8	50X65X10VTG	1.969	2.559	0.394	TG	FKM	VCC	8
1942765TB-H	1.940	2.762	0.500	TB-H	NBR	NCC	8	50X65X14TBY	1.969	2.559	0.551	TBY	NBR	NCC	8
192765TBJR-H	1.940	2.762	0.500	TBJR-H	NBR	NCC	8	50X66X8SC	1.969	2.598	0.315	SC	NBR	NCC	8
19428142TBJ	1.940	2.813	0.428	TBJ	NBR	NCC	8	50X66X10SC	1.969	2.598	0.394	SC	NBR	NCC	8
19429052TBJYR	1.940	2.909	0.520	TBJYR	NBR	NCC	8	50X66.50X9.52TB	1.969	2.618	0.375	TB	NBR	NCC	8
SHAFT 1.945															
V-RING -050							7	196263TB	1.969	2.623	0.313	TB	NBR	NCC	8
194282UB	1.945	2.891	0.292	UB	NBR	NCO	8	50X67X9TB	1.969	2.638	0.354	TB	NBR	NCC	8
SHAFT 1.968															
SHAFT-EZE 99196							51	50X67X11KC	1.969	2.638	0.433	KC	NBR	NCO	8
V-RING -050							7	50X67X11TC	1.969	2.638	0.433	TC	NBR	NCC	8
19623623KC	1.968	2.362	0.230	KC	NBR	NCO	7	50X68X8VSB-H	1.969	2.677	0.314	SB-H	FKM	VCS	8
1962623TB-H	1.968	2.622	0.312	TB-H	NBR	NCC	8	50X68X8SG	1.969	2.677	0.314	SG	NBR	NCC	8
196265SA-H	1.968	2.686	0.500	SA-H	NBR	NCC	8	50X68X8SB-H	1.969	2.677	0.315	SB-H	NBR	NCC	8
196275PSA-H	1.968	2.742	0.500	SA-H	ACM	PCS	8	50X68X6TC	1.969	2.677	0.236	TC	NBR	NCC	8
196284SA-H	1.968	2.875	0.468	SA-H	NBR	NCC	8	50X68X6TF	1.969	2.677	0.236	TF	NBR	NCC	8
SHAFT 1.969															
SHAFT-EZE 99196							51	50X68X7VTC	1.969	2.677	0.276	TC	FKM	VCS	8
V-RING -050							7	50X68X7VTF	1.969	2.677	0.276	TF	FKM	VCS	8
50X58X4TC	1.969	2.283	0.157	TC	NBR	NCC	7	50X68X8SB	1.969	2.677	0.315	SB	NBR	NCC	8
50X58X4VCY	1.969	2.283	0.157	VCY	NBR	NCO	7	50X68X8VSC	1.969	2.677	0.315	SC	FKM	VCS	8
50X58X4VVF	1.969	2.283	0.157	VF	FKM	VCO	7	50X68X8SC	1.969	2.677	0.315	SC	NBR	NCC	8
50X58X4VG	1.969	2.283	0.157	VG	FKM	VCO	7	50X68X8TC	1.969	2.677	0.315	TC	NBR	NCC	8
50X58X4VZ	1.969	2.283	0.157	VZ	NBR	NCO	7	50X68X8VTCY	1.969	2.677	0.315	TCY	FKM	VSS	8
50X58X13SC	1.969	2.283	0.512	SC	NBR	NCC	8	50X68X8VTF	1.969	2.677	0.315	TF	FKM	VCS	8
50X59X4KC	1.969	2.323	0.157	KC	NBR	NCO	7	50X68X9TC	1.969	2.677	0.354	TC	NBR	NCC	8
50X59X4VCY	1.969	2.323	0.157	VCY	NBR	NCO	7	50X68X12SB	1.969	2.677	0.472	SB	NBR	NCC	8
50X60X4VAY	1.969	2.362	0.157	VAY	NBR	NSO	7	50X68X12TC	1.969	2.677	0.472	TC	NBR	NCC	8
50X60X4VG	1.969	2.362	0.157	VG	NBR	NCO	7	19626855A-H	1.969	2.685	0.500	SA-H	NBR	NCC	8
50X60X7VSC	1.969	2.362	0.276	SC	FKM	VSS	7	196272SA	1.969	2.742	0.500	SA	NBR	NCC	8
50X60X8VTC	1.969	2.362	0.315	TC	FKM	VCC	7	1962745PSA-H	1.969	2.742	0.500	SA-H	ACM	PCC	8
50X60X8TC	1.969	2.362	0.315	TC	NBR	NCC	7	50X70X9TB-H	1.969	2.755	0.354	TB-H	NBR	NCC	8
50X62X7SB-H	1.969	2.440	0.275	SB-H	NBR	NCC	7	50X70X10TG	1.969	2.755	0.393	TG	NBR	NCC	8
50X62X5SB	1.969	2.441	0.197	SB	NBR	NCC	7	50X70X7TA	1.969	2.756	0.276	TA	NBR	NCC	8
50X62X5VB	1.969	2.441	0.197	VB	NBR	NCO	7	50X70X8VSB	1.969	2.756	0.315	SB	FKM	VCS	8
50X62X5VG	1.969	2.441	0.197	VG	NBR	NCO	7	50X70X8SB	1.969	2.756	0.315	SB	NBR	NCC	8
50X62X7VSC	1.969	2.441	0.276	SC	FKM	VCS	7	50X70X8SC	1.969	2.756	0.315	SC	NBR	NCC	8
50X62X7SC	1.969	2.441	0.276	SC	NBR	NCC	7	50X70X8TA	1.969	2.756	0.315	TA	NBR	NCC	8
50X62X7SM	1.969	2.441	0.276	SM	NBR	NCC	7	50X70X8TC	1.969	2.756	0.315	TC	NBR	NCC	8
50X62X7VTC	1.969	2.441	0.276	TC	FKM	VCC	7	50X70X8VTF	1.969	2.756	0.315	TF	FKM	VCS	8
50X62X7TC	1.969	2.441	0.276	TC	NBR	NCC	7	50X70X9SC	1.969	2.756	0.354	SC	NBR	NCC	8
50X63X6KB	1.969	2.480	0.236	KB	NBR	NCO	7	50X70X9PCSW	1.969	2.756	0.354	PCSW	ACM	PCC	8
50X63X6TB	1.969	2.480	0.236	TB	NBR	NCC	7	50X70X9TC	1.969	2.756	0.354	TC	NBR	NCC	8
50X64X6.5TC	1.969	2.520	0.256	TC	NBR	NCC	8	50X70X10VSC	1.969	2.756	0.394	SC	FKM	VCS	8
50X64X10SC	1.969	2.520	0.394	SC	NBR	NCC	8	50X70X10SC	1.969	2.756	0.394	SC	NBR	NCC	8
50X64X10TC	1.969	2.520	0.394	TC	NBR	NCC	8	50X70X10TC	1.969	2.756	0.394	TC	NBR	NCC	8
50X65X8TB-H	1.969	2.559	0.314	TB-H	NBR	NCC	8	50X70X10TG	1.969	2.756	0.394	TG	NBR	NCC	8
50X65X8TG	1.969	2.559	0.314	TG	NBR	NCC	8	50X70X10VTF	1.969	2.756	0.394	TF	FKM	VCS	8
50X65X8VSB-H	1.969	2.559	0.315	SB-H	FKM	VCS	8	50X70X12VSC	1.969	2.756	0.472	SC	FKM	VCS	8
50X65X8SB-H	1.969	2.559	0.315	SB-H	NBR	NCC	8	50X70X12TC	1.969	2.756	0.472	TC	NBR	NCC	8
50X65X6TC	1.969	2.559	0.236	TC	NBR	NCC	8	50X70X8SB-H	1.969	2.756	0.315	SB-H	NBR	NCC	8
50X65X7SC	1.969	2.559	0.276	SC	NBR	NCC	8	50X71.75X10TC	1.969	2.824	0.393	TC	NBR	NCC	8
50X65X7VTF	1.969	2.559	0.276	TF	FKM	VCS	8	50X72X8SB-H	1.969	2.834	0.314	SB-H	NBR	NCC	8
50X65X8VSB	1.969	2.559	0.315	SB	FKM	VCS	8	50X72X8TG	1.969	2.834	0.314	TG	NBR	NCC	8
50X65X8SB	1.969	2.559	0.315	SB	NBR	NCC	8	50X72X5TC	1.969	2.835	0.197	TC	NBR	NCC	8
50X65X8SC	1.969	2.559	0.315	SC	NBR	NCC	8	50X72X7VDB	1.969	2.835	0.276	DB	FKM	VCC	8
50X65X8TC	1.969	2.559	0.315	TC	NBR	NCC	8	50X72X7TC	1.969	2.835	0.276	TC	NBR	NCC	8
50X65X8VTF	1.969	2.559	0.315	TF	FKM	VCS	8	50X72X7TCN1	1.969	2.835	0.276	TCN1	NBR	NCC	8
50X65X8VTGL	1.969	2.559	0.315	TGL	FKM	VCC	8	50X72X7.6VSCW12	1.969	2.835	0.299	SCW12	FKM	VCC	8
50X65X9TC	1.969	2.559	0.354	TC	NBR	NCC	8	50X72X8VSC	1.969	2.835	0.315	SC	FKM	VCS	8
50X65X10SC	1.969	2.559	0.394	SC	NBR	NCC	8	50X72X8SC	1.969	2.835	0.315	SC	NBR	NCC	8
50X65X10V5F	1.969	2.559	0.394	SF	FKM	VCS	8	50X72X8HSCW	1.969	2.835	0.315	SCW	HNBR	HCC	8
50X65X10TB	1.969	2.559	0.394	TB	NBR	NCC	8	50X72X8PSGW	1.969	2.835	0.315	SGW	ACM	PCC	8
								50X72X8TC	1.969	2.835	0.315	TC	NBR	NCC	8
								50X72X8PTCW	1.969	2.835	0.315	TCW	ACM	PCC	8
								50X72X8HTCW	1.969	2.835	0.315	TCW	HNBR	HCC	8
								50X72X8TCW	1.969	2.835	0.315	TCW	NBR	NCC	8
								50X72X8VTF	1.969	2.835	0.315	TF	FKM	VCS	8

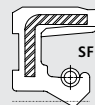
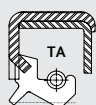

OIL AND GREASE SEALS - A COMPLETE LISTING

PLEASE CALL DICHTOMATIK FOR AVAILABILITY - 800-328-2840
BULK AND INDIVIDUALLY BOXED QUANTITIES ARE AVAILABLE FOR ALL



TCM Part #	Shaft	Bore	Width	Type	Lip Material	Material	Box #	TCM Part #	Shaft	Bore	Width	Type	Lip Material	Material	Box #				
50X72X9TC	1.969	2.835	0.354	TC	NBR	NCC	8	SHAFT 2.000											
50X72X10TC	1.969	2.835	0.394	TC	NBR	NCC	8												
50X72X10TCR	1.969	2.835	0.394	TCR	NBR	NCC	8	SHAFT-EZE 99199											S1
50X72X12VTC	1.969	2.835	0.472	TC	FKM	VCS	8	SHAFT-EZE 99200											S1
50X72X12TC	1.969	2.835	0.472	TC	NBR	NCC	8	V-RING -050											7
19628339TGN-PL	1.969	2.835	0.393	TGN-PL	NBR	NCC	8	202502VL-H	2.000	2.501	0.250	VL-H	NBR	NCO	8				
50X73X9TA	1.969	2.874	0.354	TA	NBR	NCC	8	2025031PSB-H	2.000	2.501	0.312	SB-H	ACM	PCC	8				
192845A	1.969	2.875	0.469	SA	NBR	NCC	8	2025623VL-H	2.000	2.561	0.233	VL-H	NBR	NCO	8				
192845A-H	1.969	2.875	0.469	SA-H	NBR	NCC	8	202535BP	2.000	2.562	0.330	SBP	NBR	NCC	8				
50X74X10SC	1.969	2.913	0.394	SC	NBR	NCC	8	202562VB	2.000	2.563	0.227	VB	NBR	NCO	8				
50X74X12TC	1.969	2.913	0.472	TC	NBR	NCC	8	202565VB	2.000	2.565	0.500	VB	NBR	NCO	8				
50X75X10TG	1.969	2.952	0.393	TG	NBR	NCC	8	202622VH-H	2.000	2.622	0.250	VH-H	NBR	NCO	8				
50X75X8VTB-H	1.969	2.953	0.315	TB-H	FKM	VCC	8	20263TB-H	2.000	2.622	0.312	TB-H	NBR	NCC	8				
50X75X10VSF	1.969	2.953	0.394	SF	FKM	VCS	8	20262VHY	2.000	2.623	0.250	VHY	NBR	NCO	8				
50X75X10TC	1.969	2.953	0.394	TC	NBR	NCC	8	20262KBJY-H	2.000	2.623	0.260	KBJY-H	NBR	NCO	8				
50X75X10VTF	1.969	2.953	0.394	TF	FKM	VCS	8	202635B-H	2.000	2.623	0.312	SB-H	NBR	NCC	8				
50X75X12SA	1.969	2.953	0.472	SA	NBR	NCC	8	202635B	2.000	2.623	0.313	SB	NBR	NCC	8				
50X75X12TC	1.969	2.953	0.472	TC	NBR	NCC	8	20263VTB	2.000	2.623	0.313	TB	FKM	VCS	8				
50X76X10SC	1.969	2.992	0.394	SC	NBR	NCC	8	20263TB	2.000	2.623	0.313	TB	NBR	NCC	8				
50X76X12TC	1.969	2.992	0.472	TC	NBR	NCC	8	20263VTB-H	2.000	2.623	0.313	TB-H	FKM	VCS	8				
50X78X8TC	1.969	3.071	0.315	TC	NBR	NCC	8	20263TL-H	2.000	2.623	0.313	TL-H	NBR	NCC	8				
50X78X13SZ	1.969	3.071	0.512	SZ	NBR	NCC	8	202631TC	2.000	2.625	0.313	TC	NBR	NCC	8				
50X80X8SB-H	1.969	3.149	0.314	SB-H	NBR	NCC	8	2026223VL-H	2.000	2.627	0.233	VL-H	NBR	NCO	8				
50X80X10SG	1.969	3.149	0.393	SG	NBR	NCC	8	202653KM	2.000	2.652	0.365	KM	NBR	NCO	8				
50X80X7VTC	1.969	3.150	0.276	TC	FKM	VCS	8	202682VH-H	2.000	2.685	0.250	VH-H	NBR	NCO	8				
50X80X8TC	1.969	3.150	0.315	TC	NBR	NCC	8	2026835B	2.000	2.686	0.375	SB	NBR	NCC	8				
50X80X8VTF	1.969	3.150	0.315	TF	FKM	VCS	8	2026835B-H	2.000	2.686	0.375	SB-H	NBR	NCC	8				
50X80X10VSA	1.969	3.150	0.394	SA	FKM	VCS	8	202683TB-H	2.000	2.686	0.375	TB-H	NBR	NCC	8				
50X80X10SC	1.969	3.150	0.394	SC	NBR	NCC	8	2026843TB-H	2.000	2.686	0.437	TB-H	NBR	NCC	8				
50X80X10VTC	1.969	3.150	0.394	TC	FKM	VCC	8	202694TC6	2.000	2.692	0.437	TC6	NBR	NCC	8				
50X80X12TC	1.969	3.150	0.472	TC	NBR	NCC	8	2027135B-H	2.000	2.716	0.375	SB-H	NBR	NCC	8				
50X80X13SC	1.969	3.150	0.512	SC	NBR	NCC	8	202713TB-H	2.000	2.716	0.375	TB-H	NBR	NCC	8				
19631531SC	1.969	3.150	0.315	SC	NBR	NCC	8	2027146TB-H	2.000	2.716	0.468	TB-H	NBR	NCC	8				
50X82X8TC	1.969	3.228	0.315	TC	NBR	NCC	8	2027156TC	2.000	2.717	0.563	TC	NBR	NCC	8				
50X82X12VTBR	1.969	3.228	0.472	TBR	FKM	VSS	8	202743PSBY	2.000	2.742	0.375	SBY	ACM	PCS	8				
50X82X12VTBR-H	1.969	3.228	0.472	TBR-H	FKM	VSS	8	2027423VL-H	2.000	2.744	0.233	VL-H	NBR	NCO	8				
50X82X12TCR	1.969	3.228	0.472	TCR	NBR	NCC	8	20272VB	2.000	2.745	0.230	VB	NBR	NCO	8				
50X85X8SC	1.969	3.346	0.315	SC	NBR	NCC	8	2027435SB-H	2.000	2.746	0.375	SB-H	VMQ	SCC	8				
50X85X8TC	1.969	3.346	0.315	TC	NBR	NCC	8	202735SZ	2.000	2.746	0.375	SZ	VMQ	SCC	8				
50X85X10SC	1.969	3.346	0.394	SC	NBR	NCC	8	20271VM	2.000	2.750	0.188	VM	NBR	NCO	8				
50X85X13SC	1.969	3.346	0.512	SC	NBR	NCC	8	20272TC	2.000	2.750	0.250	TC	NBR	NCC	8				
50X90X8SB-H	1.969	3.543	0.314	SB-H	NBR	NCC	9	202752VHY	2.000	2.750	0.250	VHY	NBR	NCO	8				
50X90X10SC	1.969	3.543	0.394	SC	NBR	NCC	9	202735A	2.000	2.750	0.312	SA	NBR	NCC	8				
50X90X8VC	1.969	3.543	0.315	VC	NBR	NCO	9	20273VSB-H	2.000	2.750	0.312	SB-H	FKM	VCS	8				
50X90X10VTC	1.969	3.543	0.394	TC	FKM	VCC	9	202735B-H	2.000	2.750	0.312	SB-H	NBR	NCC	8				
50X90X10TC	1.969	3.543	0.394	TC	NBR	NCC	9	20273VTB-H	2.000	2.750	0.312	TB-H	FKM	VCS	8				
50X90X12SA	1.969	3.543	0.472	SA	NBR	NCC	9	20273VTB	2.000	2.750	0.313	TB	FKM	VCS	8				
50X90X13SA	1.969	3.543	0.512	SA	NBR	NCC	9	202731VTB	2.000	2.750	0.313	TB	FKM	VCS	8				
50X90X13TC	1.969	3.543	0.512	TC	NBR	NCC	9	20273TB	2.000	2.750	0.313	TB	NBR	NCC	8				
50X95X10SA	1.969	3.740	0.394	SA	NBR	NCC	9	20273VTB-H	2.000	2.750	0.313	TB-H	FKM	VCS	8				
50X100X10TC	1.969	3.937	0.394	TC	NBR	NCC	9	20273TB-H	2.000	2.750	0.313	TB-H	NBR	NCC	8				
50X110X95TB-H	1.969	4.330	0.374	TB-H	NBR	NCC	9	20273TC	2.000	2.750	0.313	TC	NBR	NCC	8				
50X110X10TC	1.969	4.331	0.394	TC	NBR	NCC	9	20274PTCR	2.000	2.750	0.438	TCR	ACM	PCC	8				
50X110X10VTF	1.969	4.331	0.394	TF	FKM	VCS	9	202755A	2.000	2.750	0.500	SA	NBR	NCC	8				
SHAFT 1.983								202755B	2.000	2.750	0.500	SB	NBR	NCC	8				
SHAFT-EZE 99198							S1	202755B-H	2.000	2.750	0.500	SB-H	NBR	NCC	8				
V-RING -050							7	20275TA-H	2.000	2.750	0.500	TA-H	NBR	NCC	8				
198252VB	1.983	2.502	0.281	VB	NBR	NCO	8	2027518VL-H	2.000	2.751	0.187	VL-H	NBR	NCO	8				
SHAFT 1.991								2028029OUA	2.000	2.804	0.294	OUA	NBR	NCO	8				
V-RING -050							7	202845A-H	2.000	2.834	0.468	SA-H	NBR	NCC	8				
19943818VF	1.991	4.387	0.187	VF	NBR	NCO	9	202833TB-H	2.000	2.835	0.375	TB-H	NBR	NCC	8				
								202845A	2.000	2.835	0.468	SA	NBR	NCC	8				
								202843SCN1	2.000	2.843	0.375	SCN1	NBR	NCC	8				
								202843VSEC	2.000	2.844	0.375	SEC	FKM	VCS	8				
								50.80X73X9.40HTCN1	2.000	2.874	0.370	TCN1	HNBR	HCC	8				

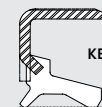
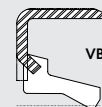
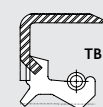
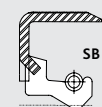
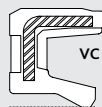
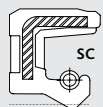



TCM Part #	Shaft	Bore	Width	Type	Lip Material	Material	Box	TCM Part #	Shaft	Bore	Width	Type	Lip Material	Material	Box #	
20282VH-H	2.000	2.875	0.250	VH-H	NBR	NCO	8	20323TC	2.000	3.250	0.375	TC	NBR	NCC	8	
20283SB-H	2.000	2.875	0.312	SB-H	NBR	NCC	8	20324SA	2.000	3.251	0.438	SA	NBR	NCC	8	
20283TB-H	2.000	2.875	0.312	TB-H	NBR	NCC	8	20324SA-H	2.000	3.251	0.438	SA-H	NBR	NCC	8	
20283VSB	2.000	2.875	0.313	SB	FKM	VCS	8	20324TA	2.000	3.251	0.438	TA	NBR	NCC	8	
20283SB	2.000	2.875	0.313	SB	NBR	NCC	8	20324TA-H	2.000	3.251	0.438	TA-H	NBR	NCC	8	
20283TA	2.000	2.875	0.313	TA	NBR	NCC	8	203354TA-H	2.000	3.350	0.468	TA-H	NBR	NCC	8	
20283TA-H	2.000	2.875	0.313	TA-H	NBR	NCC	8	2033743SA-H	2.000	3.370	0.437	SA-H	NBR	NCC	8	
202874SA	2.000	2.875	0.468	SA	NBR	NCC	8	203374VSA-H	2.000	3.371	0.438	SA-H	FKM	VCS	8	
20285SA	2.000	2.875	0.500	SA	NBR	NCC	8	20334TA	2.000	3.371	0.438	TA	NBR	NCC	8	
20285TC	2.000	2.875	0.500	TC	NBR	NCC	8	20334TA-H	2.000	3.371	0.438	TA-H	NBR	NCC	8	
202883TB	2.000	2.880	0.375	TB	NBR	NCC	8	2033746TA-H	2.000	3.371	0.468	TA-H	NBR	NCC	8	
202883TB-H	2.000	2.880	0.375	TB-H	NBR	NCC	8	203346TAY	2.000	3.371	0.469	TAY	NBR	NCC	8	
202883TB-H	2.000	2.880	0.375	TB-H	NBR	NCC	8	2033746TC	2.000	3.371	0.469	TC	NBR	NCC	8	
2029231SC	2.000	2.921	0.313	SC	NBR	NCC	8	20355TA-H	2.000	3.500	0.500	TA-H	NBR	NCC	9	
20292VBJ	2.000	2.962	0.250	VBJ	NBR	NCO	8	2035443SA-H	2.000	3.542	0.433	SA-H	NBR	NCC	8	
202963VL-H	2.000	2.964	0.312	VL-H	NBR	NCO	8	203544TL	2.000	3.543	0.438	TL	NBR	NCC	9	
202963VB	2.000	2.965	0.313	VB	NBR	NCO	8	20353UB	2.000	3.547	0.375	UB	NBR	NCC	9	
200293VB	2.000	2.968	0.313	VB	NBR	NCO	8	203622VH-H	2.000	3.622	0.250	VH-H	NBR	NCC	8	
202993TA-H	2.000	2.996	0.375	TA-H	NBR	NCC	8	2036243SA-H	2.000	3.622	0.437	SA-H	NBR	NCC	8	
202993VTB-H	2.000	2.996	0.375	TB-H	FKM	VCC	8	20362VA5-H	2.000	3.623	0.250	VA5-H	NBR	NCO	9	
202993TB-H	2.000	2.996	0.375	TB-H	NBR	NCC	8	20362VH	2.000	3.623	0.250	VH	NBR	NCO	9	
202993TC	2.000	2.996	0.375	TC	NBR	NCC	8	2036235B-H	2.000	3.623	0.375	SB-H	NBR	NCC	8	
202995SA-H	2.000	2.996	0.500	SA-H	NBR	NCC	8	203633UBY	2.000	3.626	0.375	UBY	NBR	NCO	9	
202995TA-H	2.000	2.996	0.500	TA-H	NBR	NCC	8	204004SA-H	2.000	4.003	0.438	SA-H	NBR	NCC	9	
202995TCN	2.000	2.996	0.500	TCN	NBR	NCC	8	SHAFT 2.005								
202992VH	2.000	2.997	0.250	VH	NBR	NCO	8	V-RING -050							7	
202993SA	2.000	2.997	0.375	SA	NBR	NCC	8	20028734VTC	2.005	2.878	0.340	TC	FKM	VCS	8	
202993SA-H	2.000	2.997	0.375	SA-H	NBR	NCC	8	SHAFT 2.008								
20302SB	2.000	3.000	0.250	SB	NBR	NCC	8	V-RING -050							7	
20302SB-H	2.000	3.000	0.250	SB-H	NBR	NCC	8	51X58X4VM	2.008	2.283	0.157	VM	NBR	NCO	7	
20302VAY	2.000	3.000	0.250	VAY	NBR	NCO	8	51X62X7TC	2.008	2.441	0.276	TC	NBR	NCC	7	
20302VH-H	2.000	3.000	0.250	VH-H	NBR	NCO	8	51X63X6KB	2.008	2.480	0.236	KB	NBR	NCO	7	
20303SB-H	2.000	3.000	0.312	SB-H	NBR	NCC	8	51X63X6TM	2.008	2.480	0.236	TM	NBR	NCC	7	
203031TC	2.000	3.000	0.312	TC	NBR	NCC	8	51X65X7TB	2.008	2.559	0.276	TB	NBR	NCC	8	
20303VTB	2.000	3.000	0.313	TB	FKM	VCS	8	51X65X7TB-H	2.008	2.559	0.276	TB-H	NBR	NCC	8	
20303TB	2.000	3.000	0.313	TB	NBR	NCC	8	51X70X10TC	2.008	2.756	0.394	TC	NBR	NCC	8	
20303VTB-H	2.000	3.000	0.313	TB-H	FKM	VCS	8	51X72X10SC	2.008	2.835	0.394	SC	NBR	NCC	8	
20303TB-H	2.000	3.000	0.313	TB-H	NBR	NCC	8	SHAFT 2.016								
200303SA	2.000	3.000	0.375	SA	NBR	NCC	8	V-RING -050							7	
20303VSA-H	2.000	3.000	0.375	SA-H	FKM	VCS	8	20326TC	2.016	3.255	0.625	TC	NBR	NCC	8	
200303SA-H	2.000	3.000	0.375	SA-H	NBR	NCC	8	SHAFT 2.046								
20303TA-H	2.000	3.000	0.375	TA-H	NBR	NCC	8	SHAFT-EZE 99204							51	
20305SA-H	2.000	3.000	0.500	SA-H	NBR	NCC	8	V-RING -050							7	
20305/55TBN3-PL-H	2.000	3.000	0.500/0.599	TBN3-PL-H	NBR	NCC	8	204211VM	2.046	2.175	0.120	VM	NBR	NCO	7	
203062VH	2.000	3.061	0.250	VH	NBR	NCO	8	SHAFT 2.047								
203062VH-H	2.000	3.061	0.250	VH-H	NBR	NCO	8	V-RING -050							7	
203063SB-H	2.000	3.061	0.375	SB-H	NBR	NCC	7	52X62X7VTC	2.047	2.441	0.276	TC	FKM	VCC	7	
203065SA-H	2.000	3.061	0.500	SA-H	NBR	NCC	7	52X62X7TC	2.047	2.441	0.276	TC	NBR	NCC	7	
203065TA	2.000	3.061	0.500	TA	NBR	NCC	8	52X62X8VSF	2.047	2.441	0.315	SF	FKM	VCS	7	
203062VA5-H	2.000	3.062	0.250	VA5-H	NBR	NCO	8	52X62X8TC	2.047	2.441	0.315	TC	NBR	NCC	7	
203063TB	2.000	3.062	0.375	TB	NBR	NCC	8	52X63X6TC	2.047	2.480	0.236	TC	NBR	NCC	7	
203063TB-H	2.000	3.062	0.375	TB-H	NBR	NCC	8	52X63X8TB	2.047	2.480	0.315	TB	NBR	NCC	7	
20313TB	2.000	3.125	0.312	TB	NBR	NCC	8	52X63X8TC	2.047	2.480	0.315	TC	NBR	NCC	7	
20313TB-H	2.000	3.125	0.312	TB-H	NBR	NCC	8	52X63X9TC	2.047	2.480	0.354	TC	NBR	NCC	7	
20313SB-H	2.000	3.125	0.375	SB-H	NBR	NCC	7	52X64X9TZ	2.047	2.520	0.354	TZ	NBR	NCC	8	
203412VL	2.000	3.148	0.250	VL	NBR	NCO	8	52X65X8SC	2.047	2.559	0.315	SC	NBR	NCC	8	
203142VL-H	2.000	3.148	0.250	VL-H	NBR	NCO	7	52X65X9TC	2.047	2.559	0.354	TC	NBR	NCC	8	
203153SB-H	2.000	3.150	0.375	SB-H	NBR	NCC	7	52X65X10TC	2.047	2.559	0.394	TC	NBR	NCC	8	
203153TA	2.000	3.150	0.375	TA	NBR	NCC	8	52X66X9SC	2.047	2.598	0.354	SC	NBR	NCC	8	
203153TA-H	2.000	3.150	0.375	TA-H	NBR	NCC	8	52X67X7OCY	2.047	2.638	0.276	OCY	NBR	NCO	8	
2031846SA-H	2.000	3.188	0.468	SA-H	NBR	NCC	8	52X67X7TC	2.047	2.638	0.276	TC	NBR	NCC	8	
2031846TA-H	2.000	3.188	0.468	TA-H	NBR	NCC	8	52X68X7TA	2.047	2.677	0.276	TA	NBR	NCC	8	
2031837TB-H	2.000	3.189	0.375	TB-H	NBR	NCC	8									
20314TL	2.000	3.189	0.469	TL	NBR	NCC	8									

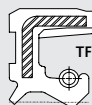
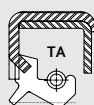

OIL AND GREASE SEALS - A COMPLETE LISTING

PLEASE CALL DICHTOMATIK FOR AVAILABILITY - 800-328-2840
BULK AND INDIVIDUALLY BOXED QUANTITIES ARE AVAILABLE FOR ALL



DICHTOMATIK

Any seal. Any time.

TCM Part #	Shaft	Bore	Width	Type	Lip Material	Material	Box #	TCM Part #	Shaft	Bore	Width	Type	Lip Material	Material	Box
52X68X7TB	2.047	2.677	0.276	TB	NBR	NCC	8	206293TB-H	2.062	2.996	0.375	TB-H	NBR	NCC	8
52X68X7VTC	2.047	2.677	0.276	TC	FKM	VCS	8	20629943SA-H	2.062	2.996	0.437	SA-H	NBR	NCC	8
52X68X8SB	2.047	2.677	0.315	SB	NBR	NCC	8	2063031VL-H	2.062	3.000	0.310	VL-H	NBR	NCO	8
52X68X8VSC	2.047	2.677	0.315	SC	FKM	VCS	8	206303SB-H	2.062	3.000	0.375	SB-H	NBR	NCC	8
52X68X8SC	2.047	2.677	0.315	SC	NBR	NCC	8	206303VVB-H	2.062	3.000	0.375	TB-H	FKM	VCS	8
52X68X8VSF	2.047	2.677	0.315	SF	FKM	VCS	8	206303TB-H	2.062	3.000	0.375	TB-H	NBR	NCC	8
52X68X8TC	2.047	2.677	0.315	TC	NBR	NCC	8	2063037TB-H	2.062	3.000	0.375	TB-H	NBR	NCC	8
52X68X8TCY	2.047	2.677	0.315	TCY	NBR	NCS	8	206305SA	2.062	3.000	0.500	SA	NBR	NCC	8
52X68X10SC	2.047	2.677	0.394	SC	NBR	NCC	8	2063063SA-H	2.062	3.061	0.312	SA-H	NBR	NCC	8
52X68X10TC	2.047	2.677	0.394	TC	NBR	NCC	8	2063065SA-H	2.062	3.061	0.500	SA-H	NBR	NCC	8
52X68X13TC	2.047	2.677	0.512	TC	NBR	NCC	8	20314TA-H	2.062	3.190	0.437	TA-H	NBR	NCC	8
52X69X10SC	2.047	2.717	0.394	SC	NBR	NCC	8	20632543SA-H	2.062	3.251	0.437	SA-H	NBR	NCC	8
52X69X10VSF	2.047	2.717	0.394	SF	FKM	VCS	8	206364TA	2.062	3.623	0.468	TA	NBR	NCC	9
52X69X10TC	2.047	2.717	0.394	TC	NBR	NCC	8	206364TA-H	2.062	3.623	0.468	TA-H	NBR	NCC	9
52X70X8TB-H	2.047	2.756	0.315	TB-H	NBR	NCC	8	SHAFT 2.063							
52X70X8.5PTCR	2.047	2.756	0.335	TCR	ACM	PCC	8	SHAFT-EZE 99205							
52X70X9TC	2.047	2.756	0.354	TC	NBR	NCC	8	S1							
52X70X10TC	2.047	2.756	0.394	TC	NBR	NCC	8	V-RING -050							
52X70X13VTC	2.047	2.756	0.512	TC	FKM	VCC	8	7							
52X72X8SC	2.047	2.834	0.314	SC	NBR	NCC	8	206253VSB-H	2.063	2.561	0.312	SB-H	FKM	VCS	8
52X72X8VSB	2.047	2.835	0.315	SB	FKM	VCS	8	206253VSB	2.063	2.561	0.313	SB	FKM	VCS	8
52X72X8SB	2.047	2.835	0.315	SB	NBR	NCC	8	206273TL	2.063	2.750	0.313	TL	NBR	NCC	8
52X72X8VVB-H	2.047	2.835	0.315	TB-H	FKM	VCS	8	2062844TL	2.063	2.842	0.438	TL	NBR	NCC	8
52X72X8TC	2.047	2.835	0.315	TC	NBR	NCC	8	206283TB	2.063	2.875	0.375	TB	NBR	NCC	8
52X72X8VTF	2.047	2.835	0.315	TF	FKM	VCS	8	206283TB-H	2.063	2.875	0.375	TB-H	NBR	NCC	8
52X72X12SA	2.047	2.835	0.472	SA	NBR	NCC	8	206294TL	2.063	2.997	0.438	TL	NBR	NCC	8
52X72X12TC	2.047	2.835	0.472	TC	NBR	NCC	8	206303VB	2.063	3.000	0.313	VB	NBR	NCO	8
52X73X9SC	2.047	2.874	0.354	SC	NBR	NCC	8	206303VB-H	2.063	3.000	0.313	VB-H	NBR	NCO	8
52X73X10TB	2.047	2.874	0.394	TB	NBR	NCC	8	2063063TL	2.063	3.061	0.313	TL	NBR	NCC	8
52X75X8SC	2.047	2.953	0.315	SC	NBR	NCC	8	203123SB	2.063	3.125	0.375	SB	NBR	NCC	8
52X75X8TC	2.047	2.953	0.315	TC	NBR	NCC	8	203152VH	2.063	3.149	0.250	VH	NBR	NCO	8
52X75X8VC	2.047	2.953	0.315	VC	NBR	NCO	8	206313SB	2.063	3.189	0.375	SB	NBR	NCC	8
52X75X10SC	2.047	2.953	0.394	SC	NBR	NCC	8	206313SB-H	2.063	3.189	0.375	SB-H	NBR	NCC	8
52X75X10VTC	2.047	2.953	0.394	TC	FKM	VCC	8	206321VBY	2.063	3.250	0.187	VBY	NBR	NCO	8
52X75X10TC	2.047	2.953	0.394	TC	NBR	NCC	8	206322OUB	2.063	3.250	0.294	OUB	NBR	NCO	8
52X75X12TC	2.047	2.953	0.472	TC	NBR	NCC	8	206324TB	2.063	3.251	0.438	TB	NBR	NCC	8
52X76X12SC	2.047	2.992	0.472	SC	NBR	NCC	8	SHAFT 2.087							
52X78X8TC	2.047	3.071	0.315	TC	NBR	NCC	8	7							
52X78X10TC	2.047	3.071	0.394	TC	NBR	NCC	8	V-RING -050							7
52X80X8TC	2.047	3.150	0.315	TC	NBR	NCC	8	53X65X5SC	2.087	2.559	0.197	SC	NBR	NCC	8
52X80X10SA	2.047	3.150	0.394	SA	NBR	NCC	8	53X65X10TC	2.087	2.559	0.394	TC	NBR	NCC	8
52X80X10SC	2.047	3.150	0.394	SC	NBR	NCC	8	53X68X10SC	2.087	2.677	0.394	SC	NBR	NCC	8
52X80X13SC	2.047	3.150	0.512	SC	NBR	NCC	8	53X68X10TC	2.087	2.677	0.394	TC	NBR	NCC	8
52X80X13TB	2.047	3.150	0.512	TB	NBR	NCC	8	53X72X10TC	2.087	2.835	0.394	TC	NBR	NCC	8
52X80X13VTC	2.047	3.150	0.512	TC	FKM	VCC	8	53X80X10SC	2.087	3.150	0.394	SC	NBR	NCC	8
52X84X14TB	2.047	3.307	0.551	TB	NBR	NCC	8	53X80X10VSF	2.087	3.150	0.394	SF	FKM	VCS	8
52X84X14TC	2.047	3.307	0.551	TC	NBR	NCC	8	SHAFT 2.094							
52X85X8SC	2.047	3.346	0.315	SC	NBR	NCC	8	7							
52X85X10TC	2.047	3.346	0.394	TC	NBR	NCC	8	V-RING -055							7
52X85X12SA	2.047	3.346	0.472	SA	NBR	NCC	8	209273VHY	2.094	2.719	0.359	VHY	NBR	NCO	8
52X90X13TA	2.047	3.543	0.512	TA	NBR	NCC	9	209272VH	2.094	2.750	0.250	VH	NBR	NCO	8
52X100X10TC	2.047	3.937	0.394	TC	NBR	NCC	9	209315VH	2.094	3.149	0.547	VH	NBR	NCO	8
52X100.5X9OBY	2.047	3.957	0.354	OBY	NBR	NCC	9	209312VH	2.094	3.154	0.250	VH	NBR	NCO	8
SHAFT 2.048								SHAFT 2.125							
V-RING -050							7	SHAFT-EZE 99210							S1
204275KBY-H	2.048	2.758	0.590	KBY-H	NBR	NCO	8	SHAFT-EZE 99212							S1
SHAFT 2.062								V-RING -055							
SHAFT-EZE 99205							S1	212491VM	2.125	2.499	0.180	VM	NBR	NCO	7
V-RING -050							7	212518SM	2.125	2.502	0.188	SM	NBR	NCC	8
206273SA-H	2.062	2.750	0.312	SA-H	NBR	NCC	8	54X65X8SB-H	2.125	2.559	0.314	SB-H	NBR	NCC	8
20628443SA-H	2.062	2.842	0.437	SA-H	NBR	NCC	8	2126831SC	2.125	2.687	0.313	SC	NBR	NCC	8
206284SA	2.062	2.875	0.437	SA	NBR	NCC	8	21272VH	2.125	2.750	0.250	VH	NBR	NCO	8
2062845A-H	2.062	2.875	0.437	SA-H	NBR	NCC	8	21272VH-H	2.125	2.750	0.250	VH-H	NBR	NCO	8
SHAFT 2.062								SHAFT 2.125							
SHAFT-EZE 99205							S1	212731SC	2.125	2.750	0.312	SC	NBR	NCC	8
V-RING -050							7	21273VSB-H	2.125	2.750	0.375	SB-H	FKM	VCS	8
206273SA-H	2.062	2.750	0.312	SA-H	NBR	NCC	8	21273TB-H	2.125	2.750	0.375	TB-H	NBR	NCC	8
20628443SA-H	2.062	2.842	0.437	SA-H	NBR	NCC	8	21275TB	2.125	2.750	0.500	TB	NBR	NCC	8
206284SA	2.062	2.875	0.437	SA	NBR	NCC	8	SHAFT 2.125							
2062845A-H	2.062	2.875	0.437	SA-H	NBR	NCC	8	S1							

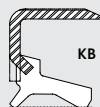
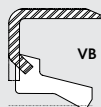
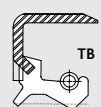
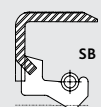
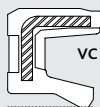
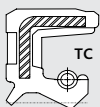



TCM Part #	Shaft	Bore	Width	Type	Lip Material	Material	Box	TCM Part #	Shaft	Bore	Width	Type	Lip Material	Material	Box #								
21275TB-H	2.125	2.750	0.500	TB-H	NBR	NCC	8	213253TB-H	2.125	3.251	0.375	TB-H	NBR	NCC	8								
21274TB-H	2.125	2.758	0.437	TB-H	NBR	NCC	8	21324SA	2.125	3.251	0.438	SA	NBR	NCC	8								
212762SB	2.125	2.763	0.250	SB	NBR	NCC	8	21324SA-H	2.125	3.251	0.438	SA-H	NBR	NCC	8								
212762SB-H	2.125	2.763	0.250	SB-H	NBR	NCC	8	21325TB	2.125	3.264	0.500	TB	NBR	NCC	8								
212834SA-H	2.125	2.835	0.468	SA-H	NBR	NCC	8	21332VA1	2.125	3.350	0.250	VA1	NBR	NCO	8								
21282VB	2.125	2.875	0.250	VB	NBR	NCO	8	213353TA-H	2.125	3.350	0.375	TA-H	NBR	NCC	8								
21282VL-H	2.125	2.875	0.250	VL-H	NBR	NCC	8	2133543SA-H	2.125	3.350	0.437	SA-H	NBR	NCC	8								
21283SSB	2.125	2.875	0.375	SB	VMQ	SCC	8	213354TL	2.125	3.350	0.438	TL	NBR	NCC	8								
21283SSB-H	2.125	2.875	0.375	SB-H	VMQ	SCC	8	21333TB	2.125	3.371	0.313	TB	NBR	NCC	8								
21283TB-H	2.125	2.875	0.375	TB-H	NBR	NCC	8	213337TA	2.125	3.371	0.375	TA	NBR	NCC	8								
21284VSB-H	2.125	2.875	0.437	SB-H	FKM	VCS	8	213337TA-H	2.125	3.371	0.375	TA-H	NBR	NCC	8								
21284SB-H	2.125	2.875	0.437	SB-H	NBR	NCC	8	213337TB	2.125	3.371	0.375	TB	NBR	NCC	8								
21284TA-H	2.125	2.875	0.437	TA-H	NBR	NCC	8	213337TB-H	2.125	3.371	0.375	TB-H	NBR	NCC	8								
21284SA	2.125	2.875	0.438	SA	NBR	NCC	8	21334SA-H	2.125	3.371	0.437	SA-H	NBR	NCC	8								
21284VSB	2.125	2.875	0.438	SB	FKM	VCS	8	21334SA	2.125	3.371	0.438	SA	NBR	NCC	8								
21284SB	2.125	2.875	0.438	SB	NBR	NCC	8	21335TB	2.125	3.371	0.500	TB	NBR	NCC	8								
21284TA	2.125	2.875	0.438	TA	NBR	NCC	8	213375TB-H	2.125	3.371	0.500	TB-H	NBR	NCC	8								
21284TB	2.125	2.875	0.438	TB	NBR	NCC	8	21334TB	2.125	3.372	0.438	TB	NBR	NCC	8								
21284TB-H	2.125	2.875	0.438	TB-H	NBR	NCC	8	21334TC	2.125	3.372	0.438	TC	NBR	NCC	8								
21285TBJ	2.125	2.880	0.500	TBJ	NBR	NCC	8	21333TC	2.125	3.375	0.375	TC	NBR	NCC	8								
212892VB	2.125	2.891	0.251	VB	NBR	NCO	8	21333VB	2.125	3.375	0.375	VB	NBR	NCO	8								
21293VTB-H	2.125	2.996	0.375	TB-H	FKM	VCS	8	21353TA-H	2.125	3.500	0.375	TA-H	NBR	NCC	9								
212993TB-H	2.125	2.996	0.375	TB-H	NBR	NCC	8	2135443SA-H	2.125	3.542	0.437	SA-H	NBR	NCC	9								
2129943SA-H	2.125	2.996	0.437	SA-H	NBR	NCC	8	213545TA	2.125	3.543	0.500	TA	NBR	NCC	9								
2129943TA-H	2.125	2.996	0.437	TA-H	NBR	NCC	8	213545TA-H	2.125	3.543	0.500	TA-H	NBR	NCC	9								
21294SA	2.125	2.997	0.438	SA	NBR	NCC	8	2136246PTB-H	2.125	3.622	0.468	TB-H	ACM	PCC	9								
21294SA-H	2.125	2.997	0.438	SA-H	NBR	NCC	8	21364SA-H	2.125	3.623	0.468	SA-H	NBR	NCC	9								
21302VB	2.125	3.000	0.250	VB	NBR	NCO	8	21364TB	2.125	3.623	0.469	TB	NBR	NCC	9								
21303VH-H	2.125	3.000	0.312	VH-H	NBR	NCO	8	21364TB-H	2.125	3.623	0.469	TB-H	NBR	NCC	9								
21303VTA-H	2.125	3.000	0.313	TA-H	FKM	VCS	8	213662VB	2.125	3.662	0.250	VB	NBR	NCO	9								
213031VTAP	2.125	3.000	0.313	TAP	FKM	VCS	8	SHAFT 2.126															
21303SB	2.125	3.000	0.375	SB	NBR	NCC	8	SHAFT-EZE 99210							S1								
21303SB-H	2.125	3.000	0.375	SB-H	NBR	NCC	8	SHAFT-EZE 99212							S1								
21303TA	2.125	3.000	0.375	TA	NBR	NCC	8	V-RING -055							7								
21303TA-H	2.125	3.000	0.375	TA-H	NBR	NCC	8	54X61X4VM	2.126	2.402	0.157	VM	NBR	NCO	7								
21303TB-H	2.125	3.000	0.375	TB-H	NBR	NCC	8	54X65X13TB	2.126	2.559	0.512	TB	NBR	NCC	8								
213043SA-H	2.125	3.000	0.437	SA-H	NBR	NCC	8	54X65X13TC	2.126	2.559	0.512	TC	NBR	NCC	8								
213043TA-H	2.125	3.000	0.437	TA-H	NBR	NCC	8	54X65X13TM	2.126	2.559	0.512	TM	NBR	NCC	8								
21304VSA	2.125	3.000	0.438	SA	FKM	VCS	8	54X66X7TC	2.126	2.598	0.276	TC	NBR	NCC	8								
21304VSA-H	2.125	3.000	0.438	SA-H	FKM	VCS	8	54X68X9TC	2.126	2.677	0.354	TC	NBR	NCC	8								
21305TC	2.125	3.000	0.500	TC	NBR	NCC	8	54X68X10TC	2.126	2.677	0.394	TC	NBR	NCC	8								
213062VHY	2.125	3.061	0.250	VHY	NBR	NCO	8	54X70X7TC	2.126	2.756	0.276	TC	NBR	NCC	8								
213063TB-H	2.125	3.061	0.375	TB-H	NBR	NCC	8	54X70X9VTC	2.126	2.756	0.354	TC	FKM	VCC	8								
213065SA-H	2.125	3.061	0.500	SA-H	NBR	NCC	8	54X70X10SCL	2.126	2.756	0.394	SCL	NBR	NCC	8								
213065SB	2.125	3.061	0.500	SB	NBR	NCC	8	54X72X5SC	2.126	2.835	0.197	SC	NBR	NCC	8								
213065SB-H	2.125	3.061	0.500	SB-H	NBR	NCC	8	54X72X8SC	2.126	2.835	0.315	SC	NBR	NCC	8								
213065TA-H	2.125	3.061	0.500	TA-H	NBR	NCC	8	54X72X9TC	2.126	2.835	0.354	TC	NBR	NCC	8								
213065TB	2.125	3.061	0.500	TB	NBR	NCC	8	54X72X10VTC	2.126	2.835	0.394	TC	FKM	VCC	8								
213065TB-H	2.125	3.061	0.500	TB-H	NBR	NCC	8	54X72X10TC	2.126	2.835	0.394	TC	NBR	NCC	8								
213064VC	2.125	3.062	0.475	VC	NBR	NCO	8	54X72.5X9SC	2.126	2.854	0.354	SC	NBR	NCC	8								
21313TB-H	2.125	3.125	0.375	TB-H	NBR	NCC	8	54X72.5X9TB	2.126	2.854	0.354	TB	NBR	NCC	8								
21314SA-H	2.125	3.125	0.437	SA-H	NBR	NCC	8	54X72.5X9TC	2.126	2.854	0.354	TC	NBR	NCC	8								
213143PTA-H	2.125	3.125	0.437	TA-H	ACM	PCC	8	54X72.5X9TM	2.126	2.854	0.354	TM	NBR	NCC	8								
21314SA	2.125	3.125	0.438	SA	NBR	NCC	8	54X73X6VM	2.126	2.874	0.236	VM	NBR	NCO	8								
21314VH	2.125	3.125	0.438	VH	NBR	NCO	8	54X73X8SZ	2.126	2.874	0.315	SZ	NBR	NCC	8								
213183TB-H	2.125	3.188	0.375	TB-H	NBR	NCC	8	54X74X8TB	2.126	2.913	0.315	TB	NBR	NCC	8								
2131846STA-H	2.125	3.188	0.468	TA-H	VMQ	SCC	8	54X75X10TC	2.126	2.953	0.394	TC	NBR	NCC	8								
213182VH	2.125	3.189	0.250	VH	NBR	NCO	8	54X76X12VSF	2.126	2.992	0.472	SF	FKM	VCS	8								
213183VTB	2.125	3.189	0.375	TB	FKM	VCS	8	54X78X12SC	2.126	3.071	0.472	SC	NBR	NCC	8								
213183TB	2.125	3.189	0.375	TB	NBR	NCC	8	54X80X10SA	2.126	3.150	0.394	SA	NBR	NCC	8								
213183VTB-H	2.125	3.189	0.375	TB-H	FKM	VCS	8	54X80X10TC	2.126	3.150	0.394	TC	NBR	NCC	8								
213183TB-H	2.125	3.189	0.375	TB-H	NBR	NCC	8	54X81X10TC	2.126	3.189	0.394	TC	NBR	NCC	8								
21323TB-H	2.125	3.250	0.375	TB-H	NBR	NCC	8	54X82X10TC	2.126	3.228	0.394	TC	NBR	NCC	8								
21323TC	2.125	3.250	0.375	TC	NBR	NCC	8	54X85X10TA	2.126	3.346	0.394	TA	NBR	NCC	8								

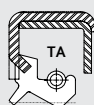

OIL AND GREASE SEALS - A COMPLETE LISTING



DICHTOMATIK

Any seal. Any time.

PLEASE CALL DICHTOMATIK FOR AVAILABILITY - 800-328-2840
BULK AND INDIVIDUALLY BOXED QUANTITIES ARE AVAILABLE FOR ALL

COMPLETE LISTING

TCM Part #	Shaft	Bore	Width	Type	Lip Material	Material	Box #	TCM Part #	Shaft	Bore	Width	Type	Lip Material	Material	Box #
54X85X10VTC	2.126	3.346	0.394	TC	FKM	VCC	8	55X75X10VTC	2.165	2.953	0.394	TC	FKM	VCC	8
54X85X10TC	2.126	3.346	0.394	TC	NBR	NCC	8	55X75X10TC	2.165	2.953	0.394	TC	NBR	NCC	8
54X85X10VTF	2.126	3.346	0.394	TF	FKM	VCS	8	55X75X12SC	2.165	2.953	0.472	SC	NBR	NCC	8
54X90X10VSF	2.126	3.543	0.394	SF	FKM	VCS	9	55X75X12TC	2.165	2.953	0.472	TC	NBR	NCC	8
54X90X13SC	2.126	3.543	0.512	SC	NBR	NCC	9	55X75X12VTF	2.165	2.953	0.472	TF	FKM	VCS	8
54X90X13VTF	2.126	3.543	0.512	TF	FKM	VCS	9	55X76X12TC	2.165	2.992	0.472	TC	NBR	NCC	8
SHAFT 2.156															
V-RING -055							7	55X77X5.5SC	2.165	3.031	0.217	SC	NBR	NCC	8
215314SA-H	2.156	3.189	0.437	SA-H	NBR	NCC	8	55X78X8VSC	2.165	3.071	0.315	SC	FKM	VCS	8
SHAFT 2.157															
V-RING -055							7	55X78X8TC	2.165	3.071	0.315	TC	NBR	NCC	8
2153344XSC	2.157	3.346	0.438	SC	XNBR	XCC	8	55X78X9SC	2.165	3.071	0.354	SC	NBR	NCC	8
SHAFT 2.165															
SHAFT-EZE 99215							S1	55X78X9TB	2.165	3.071	0.354	TB	NBR	NCC	8
V-RING -055							7	55X78X9VTC	2.165	3.071	0.354	TC	FKM	VCC	8
55X63X5VVG	2.165	2.480	0.197	VG	FKM	VCO	7	55X78X10TC	2.165	3.071	0.394	TC	NBR	NCC	8
55X63X8VTF	2.165	2.480	0.315	TF	FKM	VCS	7	55X78X10VTF	2.165	3.071	0.394	TF	FKM	VCS	8
55X65X4.5VA	2.165	2.559	0.177	VA	NBR	NCO	8	55X78X12SC	2.165	3.071	0.472	SC	NBR	NCC	8
55X65X6VM	2.165	2.559	0.236	VM	NBR	NCO	8	55X78X12TC	2.165	3.071	0.472	TC	NBR	NCC	8
55X65X8SC	2.165	2.559	0.315	SC	NBR	NCC	8	55X78X12TM	2.165	3.071	0.472	TM	NBR	NCC	8
55X67X5TB	2.165	2.638	0.197	TB	NBR	NCC	8	55X80X10TG	2.165	3.149	0.393	TG	NBR	NCC	8
55X67X6TC	2.165	2.638	0.236	TC	NBR	NCC	8	55X80X12SC	2.165	3.149	0.472	SC	NBR	NCC	8
55X68X8SG	2.165	2.677	0.314	SG	NBR	NCC	8	55X80X6SC	2.165	3.150	0.236	SC	NBR	NCC	8
55X68X8SC	2.165	2.677	0.315	SC	NBR	NCC	8	55X80X8SB	2.165	3.150	0.315	SB	NBR	NCC	8
55X68X8VSF	2.165	2.677	0.315	SF	FKM	VCS	8	55X80X8SC	2.165	3.150	0.315	SC	NBR	NCC	8
55X68X8TC	2.165	2.677	0.315	TC	NBR	NCC	8	55X80X8VSCN	2.165	3.150	0.315	SCN	FKM	VCS	8
55X68X10VTC	2.165	2.677	0.394	TC	FKM	VCC	8	55X80X8TB	2.165	3.150	0.315	TB	NBR	NCC	8
55X68X10TC	2.165	2.677	0.394	TC	NBR	NCC	8	55X80X8VTC	2.165	3.150	0.315	TC	FKM	VCS	8
55X70X6TC	2.165	2.756	0.236	TC	NBR	NCC	8	55X80X8TC	2.165	3.150	0.315	TC	NBR	NCC	8
55X70X6VC	2.165	2.756	0.236	VC	NBR	NCO	8	55X80X8PTCW	2.165	3.150	0.315	TCW	ACM	PCC	8
55X70X7SC	2.165	2.756	0.276	SC	NBR	NCC	8	55X80X8VTF	2.165	3.150	0.315	TF	FKM	VCS	8
55X70X7VSF	2.165	2.756	0.276	SF	FKM	VCS	8	55X80X10SC	2.165	3.150	0.394	SC	NBR	NCC	8
55X70X7VTF	2.165	2.756	0.276	TF	FKM	VCS	8	55X80X10TA	2.165	3.150	0.394	TA	NBR	NCC	8
55X70X8VSB	2.165	2.756	0.315	SB	FKM	VCS	8	55X80X10VTF	2.165	3.150	0.394	TF	FKM	VCS	8
55X70X8SB	2.165	2.756	0.315	SB	NBR	NCC	8	55X80X13SB	2.165	3.150	0.512	SB	NBR	NCC	8
55X70X8SC	2.165	2.756	0.315	SC	NBR	NCC	8	55X80X13SC	2.165	3.150	0.512	SC	NBR	NCC	8
55X70X8VTC	2.165	2.756	0.315	TC	FKM	VCS	8	55X80X13TC	2.165	3.150	0.512	TC	NBR	NCC	8
55X70X8TC	2.165	2.756	0.315	TC	NBR	NCC	8	55X80X8SB-H	2.165	3.150	0.315	SB-H	NBR	NCC	8
55X70X10SC	2.165	2.756	0.394	SC	NBR	NCC	8	216323VM	2.165	3.228	0.394	VM	NBR	NCO	8
55X70X10TC	2.165	2.756	0.394	TC	NBR	NCC	8	21632247SC	2.165	3.228	0.472	SC	NBR	NCC	8
55X70X6/10KBY-H	2.165	2.756	0.236/0.394	KBY-H	NBR	NCO	8	55X82X12SC	2.165	3.228	0.472	SC	NBR	NCC	8
55X70X8SB-H	2.165	2.756	0.315	SB-H	NBR	NCC	8	55X82X9TC	2.165	3.228	0.354	TC	NBR	NCC	8
55X72X8SB-H	2.165	2.834	0.314	SB-H	NBR	NCC	8	55X82X10TB	2.165	3.228	0.394	TB	NBR	NCC	8
55X72X8SG	2.165	2.834	0.314	SG	NBR	NCC	8	2163253TC	2.165	3.250	0.375	TC	NBR	NCC	8
55X72X7TC	2.165	2.835	0.276	TC	NBR	NCC	8	55X85X8SB-H	2.165	3.346	0.314	SB-H	NBR	NCC	8
55X72X7VC	2.165	2.835	0.276	VC	NBR	NCO	8	55X85X8SC	2.165	3.346	0.315	SC	NBR	NCC	8
55X72X8TC	2.165	2.835	0.315	TC	NBR	NCC	8	55X85X8VSF	2.165	3.346	0.315	SF	FKM	VCS	8
55X72X8VTF	2.165	2.835	0.315	TF	FKM	VCS	8	55X85X8TC	2.165	3.346	0.315	TC	NBR	NCC	8
55X72X9TC	2.165	2.835	0.354	TC	NBR	NCC	8	55X85X10SC	2.165	3.346	0.394	SC	NBR	NCC	8
55X72X10TB	2.165	2.835	0.394	TB	NBR	NCC	8	55X85X10TC	2.165	3.346	0.394	TC	NBR	NCC	8
55X72X10TC	2.165	2.835	0.394	TC	NBR	NCC	8	55X85X10VTF	2.165	3.346	0.394	TF	FKM	VCS	8
55X72X10VTF	2.165	2.835	0.394	TF	FKM	VCS	8	55X85X12TC	2.165	3.346	0.472	TC	NBR	NCC	8
55X72X12TB	2.165	2.835	0.472	TB	NBR	NCC	8	55X85X13SM	2.165	3.346	0.512	SM	NBR	NCC	8
55X72X12TC	2.165	2.835	0.472	TC	NBR	NCC	8	55X88X10TC	2.165	3.465	0.394	TC	NBR	NCC	8
55X73X10TC	2.165	2.874	0.394	TC	NBR	NCC	8	55X90X8SB-H	2.165	3.543	0.314	SB-H	NBR	NCC	9
55X75X10TG	2.165	2.952	0.393	TG	NBR	NCC	8	55X90X8TC	2.165	3.543	0.315	TC	NBR	NCC	9
55X75X7VTF	2.165	2.953	0.276	TF	FKM	VCS	8	55X90X13TC	2.165	3.543	0.511	TC	NBR	NCC	9
55X75X8SC	2.165	2.953	0.315	SC	NBR	NCC	8	55X90X6TB	2.165	3.543	0.236	TB	NBR	NCC	9
55X75X8VSF	2.165	2.953	0.315	SF	FKM	VCS	8	55X90X8VSC	2.165	3.543	0.315	SC	FKM	VCS	9
55X75X8TC	2.165	2.953	0.315	TC	NBR	NCC	8	55X90X8SC	2.165	3.543	0.315	SC	NBR	NCC	9
55X75X8VTF	2.165	2.953	0.315	TF	FKM	VCS	8	55X90X8TC	2.165	3.543	0.315	TC	NBR	NCC	9
55X75X9TC	2.165	2.953	0.354	TC	NBR	NCC	8	55X90X8VC	2.165	3.543	0.315	VC	NBR	NCO	9
55X75X10SC	2.165	2.953	0.394	SC	NBR	NCC	8	55X90X10SC	2.165	3.543	0.394	SC	NBR	NCC	9
								55X90X10TC	2.165	3.543	0.394	TC	NBR	NCC	9

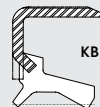
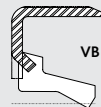
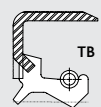
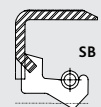
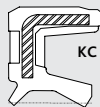
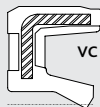
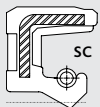

TCM Part #	Shaft	Bore	Width	Type	Lip Material	Material	Box	TCM Part #	Shaft	Bore	Width	Type	Lip Material	Material	Box #
55X90X10VTF	2.165	3.543	0.394	TF	FKM	VCS	9	56X72X7TC	2.205	2.834	0.275	TC	NBR	NCC	8
55X90X13SA	2.165	3.543	0.512	SA	NBR	NCC	9	56X72X8SC	2.205	2.835	0.315	SC	NBR	NCC	8
55X95X9TC	2.165	3.740	0.354	TC	NBR	NCC	9	56X72X8TC	2.205	2.835	0.315	TC	NBR	NCC	8
55X100X8SB-H	2.165	3.937	0.314	SB-H	NBR	NCC	9	56X72X8VTF	2.205	2.835	0.315	TF	FKM	VCS	8
55X100X10TC	2.165	3.937	0.394	TC	NBR	NCC	9	56X72X9VTC	2.205	2.835	0.354	TC	FKM	VCC	8
55X100X12SC	2.165	3.937	0.472	SC	NBR	NCC	9	56X72X10SC	2.205	2.835	0.394	SC	NBR	NCC	8
55X100X13VSA	2.165	3.937	0.512	SA	FKM	VCS	9	56X72X10VSF	2.205	2.835	0.394	SF	FKM	VCS	8
SHAFT 2.172								56X74X10TC	2.205	2.913	0.394	TC	NBR	NCC	8
V-RING -055							7	56X75X8SB-H	2.205	2.952	0.314	SB-H	NBR	NCC	8
2173186TBR	2.172	3.188	0.625	TBR	NBR	NCC	8	56X75X8TC	2.205	2.953	0.315	TC	NBR	NCC	8
2173186TBR-H	2.172	3.188	0.625	TBR-H	NBR	NCC	8	56X78X13TA	2.205	3.071	0.512	TA	NBR	NCC	8
SHAFT 2.180								56X80X8TC	2.205	3.150	0.315	TC	NBR	NCC	8
V-RING -055							7	56X80X8VTF	2.205	3.150	0.315	TF	FKM	VCS	8
218302KL	2.180	2.999	0.250	KL	NBR	NCO	8	56X80X10SA	2.205	3.150	0.394	SA	NBR	NCC	8
218304KB-H	2.180	3.000	0.495	KB-H	NBR	NCO	8	56X81X8TB	2.205	3.189	0.315	TB	NBR	NCC	8
SHAFT 2.187								56X85X8VSC	2.205	3.346	0.315	SC	FKM	VCC	8
SHAFT-EZE 99218							S1	56X85X8TC	2.205	3.346	0.315	TC	NBR	NCC	8
V-RING -055							7	56X85X13SC	2.205	3.346	0.512	SC	NBR	NCC	8
218284TB-H	2.187	2.835	0.468	TB-H	NBR	NCC	8	56X88X10SC	2.205	3.465	0.394	SC	NBR	NCC	8
218283TB-H	2.187	2.875	0.375	TB-H	NBR	NCC	8	56X88X10VSF	2.205	3.465	0.394	SF	FKM	VCS	8
2182843SA-H	2.187	2.875	0.437	SA-H	NBR	NCC	8	56X90X10TC	2.205	3.543	0.394	TC	NBR	NCC	9
21829943SA-H	2.187	2.996	0.437	SA-H	NBR	NCC	8	56X90X13SA	2.205	3.543	0.512	SA	NBR	NCC	9
218303TL-H	2.187	3.000	0.375	TL-H	NBR	NSS	8	56X90X13SB	2.205	3.543	0.512	SB	NBR	NCC	9
2183065SA-H	2.187	3.061	0.500	SA-H	NBR	NCC	8	56X100X10TB	2.205	3.937	0.394	TB	NBR	NCC	9
2183063TB-H	2.187	3.062	0.375	TB-H	NBR	NCC	8	56X100X10TC	2.205	3.937	0.394	TC	NBR	NCC	9
218314TB-H	2.187	3.189	0.437	TB-H	NBR	NCC	8	56X100X12VTB	2.205	3.937	0.472	TB	FKM	VSS	9
218253TB-H	2.187	3.251	0.375	TB-H	NBR	NCC	8	56X100X12VTB-H	2.205	3.937	0.472	TB-H	FKM	VCS	9
218333TA-H	2.187	3.350	0.375	TA-H	NBR	NCC	8	56X100X12TC	2.205	3.937	0.472	TC	NBR	NCC	9
21833743SA-H	2.187	3.370	0.437	SA-H	NBR	NCC	8	SHAFT 2.244							
213373TA-H	2.187	3.371	0.375	TA-H	NBR	NCC	8	V-RING -055							7
218353TA-H	2.187	3.500	0.375	TA-H	NBR	NCC	9	57X67X6TC	2.244	2.638	0.236	TC	NBR	NCC	8
218364TA-H	2.187	3.623	0.468	TA-H	NBR	NCC	9	57X67X7TC	2.244	2.638	0.276	TC	NBR	NCC	8
218433TC	2.187	4.331	0.375	TC	NBR	NCC	9	57X71X7TC	2.244	2.795	0.276	TC	NBR	NCC	8
SHAFT 2.188								57X72X10SA	2.244	2.835	0.394	SA	NBR	NCC	8
SHAFT-EZE 99218							S1	57X73X7TC	2.244	2.874	0.276	TC	NBR	NCC	8
V-RING -055							7	57X75X7.5TC	2.244	2.953	0.295	TC	NBR	NCC	8
218283TB	2.188	2.875	0.375	TB	NBR	NCC	8	57X75X10SC	2.244	2.953	0.394	SC	NBR	NCC	8
218283TB-H	2.188	2.875	0.375	TB-H	NBR	NCC	8	57X76X10TC	2.244	2.992	0.394	TC	NBR	NCC	8
218294TL	2.188	2.997	0.438	TL	NBR	NCC	8	57X77X10TC	2.244	3.031	0.394	TC	NBR	NCC	8
2183034KBY-H	2.188	3.000	0.340	KBY-H	NBR	NCO	8	57X79.5X10TC	2.244	3.130	0.394	TC	NBR	NCC	8
218303VTB-H	2.188	3.000	0.375	TB-H	FKM	VCS	8	57X80X12SA	2.244	3.150	0.472	SA	NBR	NCC	8
218303TB-H	2.188	3.000	0.375	TB-H	NBR	NCC	8	57X80X12TC	2.244	3.150	0.472	TC	NBR	NCC	8
218316KBJ	2.188	3.189	0.640	KBJ	NBR	NCC	8	57X81X13TC	2.244	3.189	0.512	TC	NBR	NCC	8
218324SA-H	2.188	3.251	0.437	SA-H	NBR	NCC	8	57X82.5X13TB	2.244	3.248	0.512	TB	NBR	NCC	8
218324SA	2.188	3.251	0.438	SA	NBR	NCC	8	57X85X10TA	2.244	3.346	0.394	TA	NBR	NCC	8
218334SA-H	2.188	3.350	0.437	SA-H	NBR	NCC	8	57X85X10TC	2.244	3.346	0.394	TC	NBR	NCC	8
218334SA	2.188	3.350	0.438	SA	NBR	NCC	8	57X85X12VTC	2.244	3.346	0.472	TC	FKM	VCC	8
SHAFT 2.199								57X85X13SC	2.244	3.346	0.512	SC	NBR	NCC	8
SHAFT-EZE 99220							S1	57X85.4X8SC	2.244	3.362	0.315	SC	NBR	NCC	8
SHAFT-EZE 99224							S4	57X86X6TC	2.244	3.386	0.236	TC	NBR	NCC	8
V-RING -055							7	57X86X12SC	2.244	3.386	0.472	SC	NBR	NCC	8
219355TBJ	2.199	3.519	0.590	TBJ	NBR	NCC	9	57X86X12TC	2.244	3.386	0.472	TC	NBR	NCC	8
SHAFT 2.205								57X87X15TC	2.244	3.425	0.591	TC	NBR	NCC	8
SHAFT-EZE 99220							S1	57X90X10TC	2.244	3.543	0.394	TC	NBR	NCC	9
SHAFT-EZE 99224							S4	57X90X13SA	2.244	3.543	0.512	SA	NBR	NCC	9
V-RING -055							7	57X95X10SC	2.244	3.740	0.394	SC	NBR	NCC	9
56X65X12TM	2.205	2.559	0.472	TM	NBR	NCC	8	SHAFT 2.250							
56X69X10TC	2.205	2.717	0.394	TC	NBR	NCC	8	SHAFT-EZE 99225							S1
56X70X8SC	2.205	2.756	0.315	SC	NBR	NCC	8	SHAFT-EZE 99227							S1
56X70X8TC	2.205	2.756	0.315	TC	NBR	NCC	8	V-RING -055							7
56X70X8VTF	2.205	2.756	0.315	TF	FKM	VCS	8	222610VM	2.250	2.625	0.109	VM	NBR	NCO	8
56X70X9TC	2.205	2.756	0.354	TC	NBR	NCC	8	222618VC	2.250	2.625	0.187	VC	NBR	NCO	8
								222618VL-H	2.250	2.625	0.187	VL-H	NBR	NCO	8

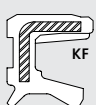
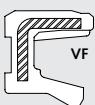
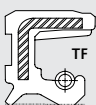
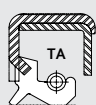

OIL AND GREASE SEALS - A COMPLETE LISTING

PLEASE CALL DICHTOMATIK FOR AVAILABILITY - 800-328-2840
BULK AND INDIVIDUALLY BOXED QUANTITIES ARE AVAILABLE FOR ALL



DICHTOMATIK

Any seal. Any time.

TCM Part #	Shaft	Bore	Width	Type	Lip Material	Material	Box #	TCM Part #	Shaft	Bore	Width	Type	Lip Material	Material	Box
22261VB	2.250	2.625	0.188	VB	NBR	NCO	8	223313VA	2.250	3.310	0.375	VA	NBR	NCO	8
22272SM	2.250	2.750	0.250	SM	NBR	NCC	8	223353TA-H	2.250	3.350	0.375	TA-H	NBR	NCC	8
22282VH	2.250	2.875	0.250	VH	NBR	NCO	8	223354SA-H	2.250	3.350	0.437	SA-H	NBR	NCC	8
22282VH-H	2.250	2.875	0.250	VH-H	NBR	NCO	8	2233543TA-H	2.250	3.350	0.437	TA-H	NBR	NCC	8
222831TB-H	2.250	2.875	0.313	TB-H	NBR	NCC	8	223354SA	2.250	3.350	0.438	SA	NBR	NCC	8
22283VTCN	2.250	2.875	0.375	TCN	FKM	VCS	8	223354TAY	2.250	3.350	0.438	TAY	NBR	NCC	8
2228956TB-H	2.250	2.890	0.562	TB-H	NBR	NCC	8	2233546SA-H	2.250	3.350	0.468	SA-H	NBR	NCC	8
2229943SA-H	2.250	2.996	0.437	SA-H	NBR	NCC	8	223373VL-H	2.250	3.370	0.375	VL-H	NBR	NCO	8
2229943TB-H	2.250	2.996	0.437	TB-H	NBR	NCC	8	2233743SA-H	2.250	3.370	0.437	SA-H	NBR	NCC	8
22292VH	2.250	2.997	0.250	VH	NBR	NCO	8	22334TA-H	2.250	3.370	0.437	TA-H	NBR	NCC	8
22294TA	2.250	2.997	0.438	TA	NBR	NCC	8	22333KBN	2.250	3.371	0.375	KBN	NBR	NCO	8
22294TA-H	2.250	2.997	0.438	TA-H	NBR	NCC	8	22333VTA	2.250	3.371	0.375	TA	FKM	VCS	8
223018TC	2.250	3.000	0.187	TC	NBR	NCC	8	22333TA-H	2.250	3.371	0.375	TA-H	NBR	NCC	8
22302TA	2.250	3.000	0.250	TA	NBR	NCC	8	22333TBN	2.250	3.371	0.375	TBN	NBR	NCC	8
22302TA-H	2.250	3.000	0.250	TA-H	NBR	NCC	8	22333TBN-U	2.250	3.371	0.375	TBN-U	NBR	NCC	8
22302VHY	2.250	3.000	0.250	VHY	NBR	NCO	8	22333TC	2.250	3.371	0.375	TC	NBR	NCC	8
22303SB	2.250	3.000	0.375	SB	NBR	NCC	8	22333VB	2.250	3.371	0.375	VB	NBR	NCO	8
22303VSB-H	2.250	3.000	0.375	SB-H	FKM	VCS	8	22333VB-H	2.250	3.371	0.375	VB-H	NBR	NCO	8
22303SB-H	2.250	3.000	0.375	SB-H	NBR	NCC	8	22334VSA	2.250	3.371	0.438	SA	FKM	VCS	8
22303SC	2.250	3.000	0.375	SC	NBR	NCC	8	22334TA	2.250	3.371	0.438	TA	NBR	NCC	8
22303VTB	2.250	3.000	0.375	TB	FKM	VCS	8	2233746SA-H	2.250	3.371	0.468	SA-H	NBR	NCC	8
22303TB	2.250	3.000	0.375	TB	NBR	NCC	8	22333SC	2.250	3.375	0.375	SC	NBR	NCC	8
22303VTB-H	2.250	3.000	0.375	TB-H	FKM	VCS	8	57.15X85.73X12.7TC	2.250	3.375	0.500	TC	NBR	NCC	8
22303TB-H	2.250	3.000	0.375	TB-H	NBR	NCC	8	223429OUB	2.250	3.400	0.294	OUB	NBR	NCO	8
223043VSA-H	2.250	3.000	0.437	SA-H	FKM	VCS	8	22342VB	2.250	3.440	0.250	VB	NBR	NCO	8
22304TA-H	2.250	3.000	0.437	TA-H	NBR	NCC	8	223442VL-H	2.250	3.440	0.250	VL-H	NBR	NCO	8
22304TA	2.250	3.000	0.438	TA	NBR	NCC	8	223485SA-H	2.250	3.481	0.500	SA-H	NBR	NCC	8
22305TA-H	2.250	3.000	0.500	TA-H	NBR	NCC	8	22353TA-H	2.250	3.500	0.375	TA-H	NBR	NCC	9
223062VHY	2.250	3.061	0.250	VHY	NBR	NCO	8	223543SA-H	2.250	3.500	0.437	SA-H	NBR	NCC	9
223063SB	2.250	3.061	0.375	SB	NBR	NCC	8	223543VTA-H	2.250	3.500	0.437	TA-H	FKM	VCS	9
223063SB-H	2.250	3.061	0.375	SB-H	NBR	NCC	8	22354TA	2.250	3.500	0.438	TA	NBR	NCC	9
223063TB-H	2.250	3.061	0.375	TB-H	NBR	NCC	8	22354TA-H	2.250	3.500	0.438	TA-H	NBR	NCC	9
223064SA	2.250	3.061	0.438	SA	NBR	NCC	8	22355SA-H	2.250	3.500	0.500	SA-H	NBR	NCC	9
223065TA	2.250	3.061	0.500	TA	NBR	NCC	8	22355/59TC2	2.250	3.500	0.500/0.590	TC2	NBR	NCC	9
223065PTA-H	2.250	3.061	0.500	TA-H	ACM	PCC	8	223545TA-H	2.250	3.543	0.500	TA-H	NBR	NCC	9
223063TC	2.250	3.066	0.375	TC	NBR	NCC	8	2236243SA-H	2.250	3.622	0.437	SA-H	NBR	NCC	9
22312TB	2.250	3.125	0.250	TB	NBR	NCC	8	2236243TA-H	2.250	3.622	0.437	TA-H	NBR	NCC	9
223133TA	2.250	3.125	0.375	TA	NBR	NCC	8	22364TA-H	2.250	3.623	0.468	TA-H	NBR	NCC	9
22313TB	2.250	3.125	0.375	TB	NBR	NCC	8	22365TC	2.250	3.625	0.500	TC	NBR	NCC	9
22313TB-H	2.250	3.125	0.375	TB-H	NBR	NCC	8	22374SA-H	2.250	3.751	0.437	SA-H	NBR	NCC	9
223147VSEC	2.250	3.125	0.470	SEC	FKM	VCS	8	22374SA	2.250	3.751	0.438	SA	NBR	NCC	9
22315SA-H	2.250	3.125	0.500	SA-H	NBR	NCC	8	22375TA-H	2.250	3.751	0.500	TA-H	NBR	NCC	9
2231843SB-H	2.250	3.188	0.437	SB-H	NBR	NCC	8	22382TB	2.250	3.813	0.250	TB	NBR	NCC	9
2231843PTB-H	2.250	3.188	0.437	TB-H	ACM	PCC	8	22384SA	2.250	3.876	0.438	SA	NBR	NCC	9
223184TA-H	2.250	3.189	0.437	TA-H	NBR	NCC	8	22384SA-H	2.250	3.876	0.438	SA-H	NBR	NCC	9
223184PTB	2.250	3.189	0.438	TB	ACM	PCS	8	22403VTA	2.250	4.003	0.365	TA	FKM	VCS	9
223223TC	2.250	3.228	0.375	TC	NBR	NCC	8	22403VTA-H	2.250	4.003	0.365	TA-H	FKM	VCS	9
22322OUB	2.250	3.250	0.270	OUB	NBR	NCO	8	22404SA	2.250	4.003	0.438	SA	NBR	NCC	9
22322VAY	2.250	3.251	0.250	VAY	NBR	NCC	8	22404SA-H	2.250	4.003	0.438	SA-H	NBR	NCC	9
22322VH	2.250	3.251	0.250	VH	NBR	NCO	8	224046VTA	2.250	4.003	0.468	TA	FKM	VCS	9
22322VHY	2.250	3.251	0.250	VHY	NBR	NCO	8	2240046TA-H	2.250	4.003	0.468	TA-H	NBR	NCC	9
22323SB	2.250	3.251	0.375	SB	NBR	NCC	8	2240610PTBY	2.250	4.064	1.092	TBY	ACM	PCC	9
223253SB-H	2.250	3.251	0.375	SB-H	NBR	NCC	8	225113SC	2.250	5.118	0.375	SC	NBR	NCC	3
22323TB	2.250	3.251	0.375	TB	NBR	NCC	8	SHAFT 2.260							
22323TB-H	2.250	3.251	0.375	TB-H	NBR	NCC	8	V-RING -055							7
22324VSA-H	2.250	3.251	0.437	SA-H	FKM	VCS	8	2263531VA10-H2.260	3.500	0.313	VA10-H	NBR	NCO	9	
22324SA-H	2.250	3.251	0.437	SA-H	NBR	NCC	8	SHAFT 2.280							
22324TA-H	2.250	3.251	0.437	TA-H	NBR	NCC	8	SHAFT-EZE 99219							S1
22324VSA	2.250	3.251	0.438	SA	FKM	VCS	8	V-RING -055							7
22324SA	2.250	3.251	0.438	SA	NBR	NCC	8	2283153VH-H	2.280	3.153	0.375	VH-H	NBR	NCO	8
22324TA	2.250	3.251	0.438	TA	NBR	NCC	8	SHAFT 2.280							
22325SA	2.250	3.251	0.500	SA	NBR	NCC	8								
223255TA-H	2.250	3.251	0.500	TA-H	NBR	NCC	8								
223263TB	2.250	3.264	0.312	TB	NBR	NCC	8								

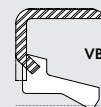
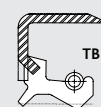
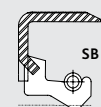
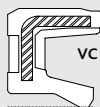

TCM Part #	Shaft	Bore	Width	Type	Lip Material	Material	Box	TCM Part #	Shaft	Bore	Width	Type	Lip Material	Material	Box #
SHAFT 2.281															
SHAFT-EZE 99219							S1	231313TB-H	2.312	3.125	0.375	TB-H	NBR	NCC	8
V-RING -055							7	231323TA-H	2.312	3.251	0.375	TA-H	NBR	NCC	8
228313VHY	2.281	3.154	0.375	VHY	NBR	NCO	8	23132543VTA-H	2.312	3.251	0.437	TA-H	FKM	VCS	8
SHAFT 2.283															
SHAFT-EZE 99219							S1	2313303VH-H	2.312	3.309	0.375	VH-H	NBR	NCO	8
V-RING -060							7	233353TA-H	2.312	3.350	0.375	TA-H	NBR	NCC	8
58X68X9TC	2.283	2.677	0.354	TC	NBR	NCC	8	23133543SA-H	2.312	3.350	0.437	SA-H	NBR	NCC	8
58X72X85B-H	2.283	2.834	0.314	SB-H	NBR	NCC	8	58.73X85.32X7.95C	2.312	3.359	0.311	SC	NBR	NCC	8
58X72X85C	2.283	2.835	0.315	SC	NBR	NCC	8	231334SA-H	2.312	3.371	0.468	SA-H	NBR	NCC	8
58X72X85Z	2.283	2.835	0.315	SZ	NBR	NCC	8	231333SC	2.312	3.375	0.375	SC	NBR	NCC	8
58X72X8TC	2.283	2.835	0.315	TC	NBR	NCC	8	231352VH-H	2.312	3.500	0.250	VH-H	NBR	NCO	9
58X72X8VTF	2.283	2.835	0.315	TF	FKM	VCS	8	231353TA-H	2.312	3.500	0.375	TA-H	NBR	NCC	9
58X72X9TC	2.283	2.835	0.354	TC	NBR	NCC	8	2313755SA-H	2.312	3.751	0.500	SA-H	NBR	NCC	9
58X74X10TC	2.283	2.913	0.394	TC	NBR	NCC	8	SHAFT 2.313							
58X75X11TC	2.283	2.952	0.433	TC	NBR	NCC	8	SHAFT-EZE 99231							S1
58X75X7TC	2.283	2.953	0.276	TC	NBR	NCC	8	V-RING -060							7
58X75X8SB	2.283	2.953	0.315	SB	NBR	NCC	8	231302VB	2.313	3.000	0.250	VB	NBR	NCO	8
58X75X8VSF	2.283	2.953	0.315	SF	FKM	VCS	8	2313135B	2.313	3.125	0.375	SB	NBR	NCC	8
58X75X8TB	2.283	2.953	0.315	TB	NBR	NCC	8	2313135B-H	2.313	3.125	0.375	SB-H	NBR	NCC	8
58X75X9SC	2.283	2.953	0.354	SC	NBR	NCC	8	231324SA-H	2.313	3.251	0.437	SA-H	NBR	NCC	8
58X75X9VTC	2.283	2.953	0.354	TC	FKM	VCC	8	2313245A	2.313	3.251	0.438	SA	NBR	NCC	8
58X75X9TC	2.283	2.953	0.354	TC	NBR	NCC	8	23132543VTA-H	2.313	3.251	0.438	TA-H	FKM	VCC	8
58X75X9TM	2.283	2.953	0.354	TM	NBR	NCC	8	233313VH	2.313	3.310	0.375	VH	NBR	NCO	8
58X75X10SB	2.283	2.953	0.394	SB	NBR	NCC	8	233354TL	2.313	3.350	0.438	TL	NBR	NCC	8
58X75X12TB	2.283	2.953	0.472	TB	NBR	NCC	8	231374SB-H	2.313	3.371	0.437	SB-H	NBR	NCC	8
58X75X12TC	2.283	2.953	0.472	TC	NBR	NCC	8	2313745B	2.313	3.371	0.438	SB	NBR	NCC	8
58X76X7.8TC	2.283	2.992	0.307	TC	NBR	NCC	8	23351VBY	2.313	3.500	0.190	VBY	NBR	NCO	9
58X76X10TB	2.283	2.992	0.394	TB	NBR	NCC	8	2313535B-H	2.313	3.500	0.312	SB-H	NBR	NCC	9
58X78X8TA	2.283	3.071	0.315	TA	NBR	NCC	8	2313535B	2.313	3.500	0.313	SB	NBR	NCC	9
58X78X9TC	2.283	3.071	0.354	TC	NBR	NCC	8	231355SA	2.313	3.500	0.500	SA	NBR	NCC	9
58X78X12VTC	2.283	3.071	0.472	TC	FKM	VCC	8	2313555A-H	2.313	3.500	0.500	SA-H	NBR	NCC	9
58X78X13SC	2.283	3.071	0.512	SC	NBR	NCC	8	2313755B-H	2.313	3.751	0.500	SB-H	NBR	NCC	9
58X80X8TC	2.283	3.149	0.314	TC	NBR	NCC	8	SHAFT 2.323							
58X80X12TG	2.283	3.149	0.472	TG	NBR	NCC	8	V-RING -060							7
58X80X55C	2.283	3.150	0.197	SC	NBR	NCC	8	59X72X12TZ	2.323	2.835	0.472	TZ	NBR	NCC	8
58X80X8TB	2.283	3.150	0.315	TB	NBR	NCC	8	59X75X10TC	2.323	2.953	0.394	TC	NBR	NCC	8
58X80X8VTF	2.283	3.150	0.315	TF	FKM	VCS	8	59X80X10SC	2.323	3.150	0.394	SC	NBR	NCC	8
58X80X9TC	2.283	3.150	0.354	TC	NBR	NCC	8	59X85X85C	2.323	3.346	0.315	SC	NBR	NCC	8
58X80X10TC	2.283	3.150	0.394	TC	NBR	NCC	8	SHAFT 2.327							
58X80X12SC	2.283	3.150	0.472	SC	NBR	NCC	8	SHAFT-EZE 99233							S1
58X80X12TC	2.283	3.150	0.472	TC	NBR	NCC	8	V-RING -060							7
58X80X13TC	2.283	3.150	0.512	TC	NBR	NCC	8	2323039PSB-H	2.327	3.000	0.394	SB-H	ACM	PCC	8
2283153KB-H	2.283	3.155	0.375	KB-H	NBR	NCO	8	SHAFT 2.330							
58X85X10TC	2.283	3.346	0.394	TC	NBR	NCC	8	SHAFT-EZE 99233							S1
58X86X12SC	2.283	3.386	0.472	SC	NBR	NCC	8	V-RING -060							7
58X87X75C	2.283	3.425	0.276	SC	NBR	NCC	8	233293KB-H	2.330	2.997	0.312	KB-H	NBR	NCO	8
228354395C	2.283	3.543	0.394	SC	NBR	NCC	9	2333040PSB-H	2.330	3.000	0.400	SB-H	ACM	PCC	8
58X90X9TC	2.283	3.543	0.354	TC	NBR	NCC	9	SHAFT 2.357							
58X90X10VTC	2.283	3.543	0.394	TC	FKM	VCC	9	V-RING -060							7
58X90X10TC	2.283	3.543	0.394	TC	NBR	NCC	9	2353544XSC	2.357	3.543	0.438	SC	XNBR	XCC	9
SHAFT 2.293								SHAFT 2.362							
229291SM	2.293	2.998	0.188	SM	NBR	NCC	8	SHAFT-EZE 99235							S1
229293VCY	2.293	2.998	0.318	VCY	NBR	NCO	8	SHAFT-EZE 99241							S1
SHAFT 2.297															
V-RING -060							7	V-RING -060							7
229313VHY	2.297	3.148	0.359	VHY	NBR	NCO	8	60X70X6VB	2.362	2.756	0.236	VB	NBR	NCO	8
SHAFT 2.312															
SHAFT-EZE 99231							S1	60X70X6VM	2.362	2.756	0.236	VM	NBR	NCO	8
V-RING -060							7	60X70X75B	2.362	2.756	0.276	SB	NBR	NCC	8
231302VL-H	2.312	3.000	0.250	VL-H	NBR	NCC	8	60X70X75C	2.362	2.756	0.276	SC	NBR	NCC	8
231305VTA-H	2.312	3.000	0.500	TA-H	FKM	VCS	8	60X70X7TB	2.362	2.756	0.276	TB	NBR	NCC	8
								60X70X7TC	2.362	2.756	0.276	TC	NBR	NCC	8
								60X70X85C	2.362	2.756	0.315	SC	NBR	NCC	8
								60X70X12TC	2.362	2.756	0.472	TC	NBR	NCC	8

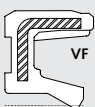
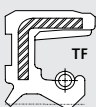



TCM Part #	Shaft	Bore	Width	Type	Lip Material	Material	Box	TCM Part #	Shaft	Bore	Width	Type	Lip Material	Material	Box #
SHAFT 2.376															
2331843SA-H	2.375	3.188	0.437	SA-H	NBR	NCC	8	SHAFT-EZE 99237							S1
233183TB	2.375	3.189	0.375	TB	NBR	NCC	8	SHAFT-EZE 99238							S1
233183TB-H	2.375	3.189	0.375	TB-H	NBR	NCC	8	SHAFT-EZE 99240							S1
23323TB	2.375	3.251	0.374	TB	NBR	NCC	8	V-RING -060							7
233253TA-H	2.375	3.251	0.375	TA-H	NBR	NCC	8	23323PTA-H	2.376	3.251	0.375	TA-H	ACM	PCC	8
233253TC	2.375	3.251	0.375	TC	NBR	NCC	8	SHAFT 2.390							
2332543VTA-H	2.375	3.251	0.433	TA-H	FKM	VCS	8	V-RING -060							7
233245B	2.375	3.251	0.453	SB	NBR	NCC	8	239322OUB	2.390	3.260	0.294	OUB	NBR	NCO	8
2332545PSB-H	2.375	3.251	0.453	SB-H	ACM	PCC	8	SHAFT 2.402							
23324PSB	2.375	3.251	0.460	SB	ACM	PCC	8	V-RING -060							7
23332VH	2.375	3.350	0.250	VH	NBR	NCO	8	61X75X8VSF	2.402	2.953	0.315	SF	FKM	VCS	8
233352VH-H	2.375	3.350	0.250	VH-H	NBR	NCO	8	61X80X13SC	2.402	3.150	0.512	SC	NBR	NCC	8
233353PSB-H	2.375	3.350	0.375	SB-H	ACM	PCC	8	61X80X13VSF	2.402	3.150	0.512	SF	FKM	VCS	8
233353SB-H	2.375	3.350	0.375	SB-H	NBR	NCC	8	61X85X10TC	2.402	3.346	0.394	TC	NBR	NCC	8
23333TA-H	2.375	3.350	0.375	TA-H	NBR	NCC	8	61X85X13TB	2.402	3.346	0.512	TB	NBR	NCC	8
233353TB-H	2.375	3.350	0.375	TB-H	NBR	NCC	8	61X89X12.5TC	2.402	3.504	0.492	TC	NBR	NCC	9
2333543SA-H	2.375	3.350	0.437	SA-H	NBR	NCC	8	SHAFT 2.420							
2333543TB-H	2.375	3.350	0.437	TB-H	NBR	NCC	8	V-RING -060							7
233354TA-H	2.375	3.350	0.438	TA-H	NBR	NCC	8	24303KBY-H	2.420	3.000	0.382	KBY-H	NBR	NCO	8
23334TA	2.375	3.350	0.469	TA	NBR	NCC	8	2423038KBY-H	2.420	3.000	0.382	KBY-H	NBR	NCO	8
23336VTA	2.375	3.350	0.670	TA	FKM	VCS	8	SHAFT 2.437							
233373TA-H	2.375	3.371	0.375	TA-H	NBR	NCC	8	SHAFT-EZE 99243							S1
2333743SA-H	2.375	3.371	0.437	SA-H	NBR	NCC	8	SHAFT-EZE 99242							S1
233374SA	2.375	3.371	0.438	SA	NBR	NCC	8	SHAFT-EZE 99244							S1
233374TA	2.375	3.371	0.438	TA	NBR	NCC	8	V-RING -060							7
233374TA-H	2.375	3.371	0.438	TA-H	NBR	NCC	8	24313TB-H	2.437	3.125	0.375	TB-H	NBR	NCC	8
23333TC	2.375	3.375	0.375	TC	NBR	NCC	8	243315SA-H	2.437	3.125	0.500	SA-H	NBR	NCC	8
233373TL	2.375	3.375	0.375	TL	NBR	NCC	8	243323TC	2.437	3.250	0.375	TC	NBR	NCC	8
23335TC	2.375	3.375	0.500	TC	NBR	NCC	8	24332543TA-H	2.437	3.251	0.437	TA-H	NBR	NCC	8
23342OUB	2.375	3.471	0.250	OUB	NBR	NCO	8	2433353SB-H	2.437	3.350	0.375	SB-H	NBR	NCC	8
23344SA-H	2.375	3.481	0.437	SA-H	NBR	NCC	8	243353TA-H	2.437	3.350	0.375	TA-H	NBR	NCC	8
23344SA	2.375	3.481	0.438	SA	NBR	NCC	8	243333TA-H	2.437	3.371	0.375	TA-H	NBR	NCC	8
23344TA	2.375	3.481	0.438	TA	NBR	NCC	8	243324TA	2.437	3.371	0.418	TA	NBR	NCC	8
23344TA-H	2.375	3.481	0.438	TA-H	NBR	NCC	8	243324TA-H	2.437	3.371	0.418	TA-H	NBR	NCC	8
23346TA	2.375	3.481	0.663	TA	NBR	NCC	8	243335TC	2.437	3.375	0.500	TC	NBR	NCC	8
23353VSA	2.375	3.500	0.375	SA	FKM	VCC	9	24334843SA-H	2.437	3.481	0.437	SA-H	NBR	NCC	8
23353SA	2.375	3.500	0.375	SA	NBR	NCC	9	243453TA-H	2.437	3.500	0.375	TA-H	NBR	NCC	9
23353VSA-H	2.375	3.500	0.375	SA-H	FKM	VCS	9	243355SA-H	2.437	3.500	0.500	SA-H	NBR	NCC	9
23353SA-H	2.375	3.500	0.375	SA-H	NBR	NCC	9	24335443SA-H	2.437	3.542	0.437	SA-H	NBR	NCC	9
23353TA-H	2.375	3.500	0.375	TA-H	NBR	NCC	9	24353TA-H	2.437	3.543	0.375	TA-H	NBR	NCC	9
23353PTB	2.375	3.500	0.375	TB	ACM	PCS	9	2433623KB-H	2.437	3.624	0.375	KB-H	NBR	NCO	9
23353PTB-H	2.375	3.500	0.375	TB-H	ACM	PCC	9	SHAFT 2.438							
23353TC	2.375	3.500	0.375	TC	NBR	NCC	9	SHAFT-EZE 99243							S1
23354TA-H	2.375	3.500	0.437	TA-H	NBR	NCC	9	SHAFT-EZE 99242							S1
23354VTA-H	2.375	3.500	0.438	TA-H	FKM	VCS	9	SHAFT-EZE 99244							S1
23353SA-H	2.375	3.500	0.500	SA-H	NBR	NCC	9	V-RING -060							7
2335443SA-H	2.375	3.542	0.437	SA-H	NBR	NCC	9	24313SB	2.438	3.125	0.380	SB	NBR	NCC	8
23352VHY	2.375	3.543	0.250	VHY	NBR	NCO	9	243324SA-H	2.438	3.251	0.437	SA-H	NBR	NCC	8
233543TA-H	2.375	3.543	0.375	TA-H	NBR	NCC	9	243254VKC	2.438	3.251	0.438	KC	FKM	VCO	8
2336043SB-H	2.375	3.601	0.437	SB-H	NBR	NCC	9	243324SA	2.438	3.251	0.438	SA	NBR	NCC	8
233604TA	2.375	3.601	0.437	TA	NBR	NCC	9	243353TB	2.438	3.350	0.375	TB	NBR	NCC	8
233604TA-H	2.375	3.601	0.437	TA-H	NBR	NCC	9	243353TB-H	2.438	3.350	0.375	TB-H	NBR	NCC	8
2336243SA-H	2.375	3.622	0.437	SA-H	NBR	NCC	9	243334SA-H	2.438	3.371	0.437	SA-H	NBR	NCC	8
2336243PTA-H	2.375	3.622	0.437	TA-H	ACM	PCC	9	243334SA	2.438	3.371	0.438	SA	NBR	NCC	8
23363SB	2.375	3.623	0.359	SB	NBR	NCC	9	24335VTF	2.438	3.375	0.500	TF	FKM	VCS	8
23363TB	2.375	3.623	0.359	TB	NBR	NCC	9	243354VSA-H	2.438	3.500	0.437	SA-H	FKM	VCS	9
23363TA-H	2.375	3.623	0.375	TA-H	NBR	NCC	9	243354VSA	2.438	3.500	0.438	SA	FKM	VCC	9
23365PSA	2.375	3.623	0.500	SA	ACM	PCS	9	243354SA	2.438	3.500	0.438	SA	NBR	NCC	9
23364SA	2.375	3.625	0.438	SA	NBR	NCC	9	243354SA-H	2.438	3.500	0.438	SA-H	NBR	NCC	9
237375TA-H	2.375	3.751	0.500	TA-H	NBR	NCC	9	SHAFT 2.438							
23383TA-H	2.375	3.876	0.375	TA-H	NBR	NCC	9	SHAFT-EZE 99243							S1
23384SA-H	2.375	3.876	0.437	SA-H	NBR	NCC	9	SHAFT-EZE 99242							S1
23384SA	2.375	3.876	0.438	SA	NBR	NCC	9	SHAFT-EZE 99244							S1
2338746SA-H	2.375	3.876	0.468	SA-H	NBR	NCC	9	V-RING -060							7

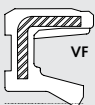
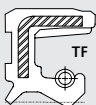

OIL AND GREASE SEALS - A COMPLETE LISTING

PLEASE CALL DICHTOMATIK FOR AVAILABILITY - 800-328-2840
BULK AND INDIVIDUALLY BOXED QUANTITIES ARE AVAILABLE FOR ALL



TCM Part #	Shaft	Bore	Width	Type	Lip Material	Material	Box #	TCM Part #	Shaft	Bore	Width	Type	Lip Material	Material	Box									
SHAFT 2.441																								
SHAFT-EZE 99242							S1	63X80X9TC	2.480	3.150	0.354	TC	NBR	NCC	8									
SHAFT-EZE 99244							S1	63X82X9TC	2.480	3.228	0.354	TC	NBR	NCC	8									
V-RING -060							7	63X85X10TC	2.480	3.346	0.394	TC	NBR	NCC	8									
62X70X10VG	2.441	2.756	0.394	VG	NBR	NCO	8	63X85X10VTF	2.480	3.346	0.394	TF	FKM	VCS	8									
62X72X9TC	2.441	2.835	0.354	TC	NBR	NCC	8	63X88X7.7TB	2.480	3.465	0.303	TB	NBR	NCC	8									
62X75X10SB	2.441	2.953	0.394	SB	NBR	NCC	8	63X88X10SC	2.480	3.465	0.394	SC	NBR	NCC	8									
62X75X10TB	2.441	2.953	0.394	TB	NBR	NCC	8	63X90X7TC	2.480	3.543	0.276	TC	NBR	NCC	9									
62X75X10TC	2.441	2.953	0.394	TC	NBR	NCC	8	63X90X8VTF	2.480	3.543	0.315	TF	FKM	VCS	9									
62X76X10TC	2.441	2.992	0.394	TC	NBR	NCC	8	63X90X10SC	2.480	3.543	0.394	SC	NBR	NCC	9									
62X78X8SB	2.441	3.071	0.315	SB	NBR	NCC	8	63X90X10TC	2.480	3.543	0.394	TC	NBR	NCC	9									
62X80X8SC	2.441	3.150	0.315	SC	NBR	NCC	8	63X100X10SC	2.480	3.937	0.394	SC	NBR	NCC	9									
62X80X8TC	2.441	3.150	0.315	TC	NBR	NCC	8	63X100X13TC	2.480	3.937	0.512	TC	NBR	NCC	9									
62X80X9TC	2.441	3.150	0.354	TC	NBR	NCC	8	63X110X13TC	2.480	4.331	0.512	TC	NBR	NCC	9									
62X80X10SA	2.441	3.150	0.394	SA	NBR	NCC	8	SHAFT 2.496																
62X80X10SC	2.441	3.150	0.394	SC	NBR	NCC	8	V-RING -065								7								
62X80X10TA	2.441	3.150	0.394	TA	NBR	NCC	8	63.4X85.4X8TC	2.496	3.362	0.315	TC	NBR	NCC	8									
62X80X10TB	2.441	3.150	0.394	TB	NBR	NCC	8	24363OUB	2.496	3.672	0.313	OUB	NBR	NCO	9									
62X80X10VTC	2.441	3.150	0.394	TC	FKM	VCC	8	SHAFT 2.497																
62X80X10TC	2.441	3.150	0.394	TC	NBR	NCC	8	SHAFT-EZE 99253								S1								
62X82X7TC	2.441	3.228	0.276	TC	NBR	NCC	8	V-RING -065								7								
62X82X10TC	2.441	3.228	0.394	TC	NBR	NCC	8	24324VB	2.497	3.245	0.420	VB	NBR	NCO	8									
62X83X10SC	2.441	3.268	0.394	SC	NBR	NCC	8	SHAFT 2.500																
62X85X8TA-H	2.441	3.346	0.314	TA-H	NBR	NCC	8	SHAFT-EZE 99248								S1								
62X85X8SB-H	2.441	3.346	0.315	SB-H	NBR	NCC	8	SHAFT-EZE 99250								S1								
62X85X7TC	2.441	3.346	0.276	TC	NBR	NCC	8	SHAFT-EZE 99253								S1								
62X85X8SB	2.441	3.346	0.315	SB	NBR	NCC	8	V-RING -065								7								
62X85X8TC	2.441	3.346	0.315	TC	NBR	NCC	8	252810VM	2.500	2.875	0.109	VM	NBR	NCO	8									
62X85X8VTF	2.441	3.346	0.315	TF	FKM	VCS	8	25302VAY-H	2.500	3.000	0.250	VAY-H	NBR	NCO	8									
62X85X9TA	2.441	3.346	0.354	TA	NBR	NCC	8	25302VB	2.500	3.000	0.250	VB	NBR	NCO	8									
62X85X10SC	2.441	3.346	0.394	SC	NBR	NCC	8	25302VL-H	2.500	3.000	0.250	VL-H	NBR	NCO	8									
62X85X10TC	2.441	3.346	0.394	TC	NBR	NCC	8	25303TC	2.500	3.000	0.375	TC	NBR	NCC	8									
62X85X10VTCNY	2.441	3.346	0.394	TCNY	FKM	VCS	8	253062SM	2.500	3.062	0.250	SM	NBR	NCC	8									
62X85X10TM	2.441	3.346	0.394	TM	NBR	NCC	8	253062SM-H	2.500	3.062	0.250	SM-H	NBR	NCC	8									
62X85X12TA	2.441	3.346	0.472	TA	NBR	NCC	8	25312VH	2.500	3.125	0.250	VH	NBR	NCO	8									
62X85X12SC	2.441	3.346	0.472	TC	NBR	NCC	8	25312VH-H	2.500	3.125	0.250	VH-H	NBR	NCC	8									
62X85X12TC	2.441	3.346	0.472	TC	NBR	NCC	8	253152VH-H	2.500	3.150	0.250	VH-H	NBR	NCO	8									
62X85X8/10TAY	2.441	3.346	0.315/0.394	TAY	NBR	NCC	8	2531843SA-H	2.500	3.188	0.437	SA-H	NBR	NCC	8									
62X88X12TC	2.441	3.465	0.472	TC	NBR	NCC	8	25313TB	2.500	3.189	0.375	TB	NBR	NCC	8									
62X89X13TA	2.441	3.504	0.512	TA	NBR	NCC	9	25313TB-H	2.500	3.189	0.375	TB-H	NBR	NCC	8									
62X90X8SC	2.441	3.543	0.315	SC	NBR	NCC	9	250324SA	2.500	3.245	0.438	SA	NBR	NCC	8									
62X90X10SC	2.441	3.543	0.394	SC	NBR	NCC	9	250324SA-H	2.500	3.245	0.438	SA-H	NBR	NCC	8									
62X90X10VTF	2.441	3.543	0.394	TF	FKM	VCS	9	253245TA-H	2.500	3.247	0.500	TA-H	NBR	NCC	8									
62X90X10VTF	2.441	3.543	0.394	TF	FKM	VCS	9	253235TLN22-H	2.500	3.250	0.350	TLN22-H	NBR	NCC	8									
62X95X10SC	2.441	3.740	0.394	SC	NBR	NCC	9	25323TC	2.500	3.250	0.375	TC	NBR	NCC	8									
62X95X13SB-U	2.441	3.740	0.512	SB-U	NBR	NCC	9	25326DAY	2.500	3.250	0.687	DAY	NBR	NCC	8									
62X95X13TB	2.441	3.740	0.512	TB	NBR	NCC	9	25322VB	2.500	3.251	0.250	VB	NBR	NCO	8									
62X100X10VTF	2.441	3.937	0.394	TF	FKM	VCS	9	25322VB-H	2.500	3.251	0.250	VB-H	NBR	NCO	8									
62X100X10TC	2.441	3.937	0.394	TC	NBR	NCC	9	253252VH-H	2.500	3.251	0.250	VH-H	NBR	NCO	8									
62X100X12SC	2.441	3.937	0.472	SC	NBR	NCC	9	253235TCNY	2.500	3.251	0.350	TCNY	NBR	NSS	8									
62X100X12VTF	2.441	3.937	0.472	TF	FKM	VCS	9	253253SB-H	2.500	3.251	0.375	SB-H	NBR	NCC	8									
62X100X13SA	2.441	3.937	0.512	SA	NBR	NCC	9	25323VTB	2.500	3.251	0.375	TB	FKM	VCS	8									
62X100X13TA	2.441	3.937	0.512	TA	NBR	NCC	9	25323TB	2.500	3.251	0.375	TB	NBR	NCC	8									
62X110X13SC	2.441	4.331	0.512	SC	NBR	NCC	9	25323VTB-H	2.500	3.251	0.375	TB-H	FKM	VCS	8									
62X120X12TC	2.441	4.724	0.472	TC	NBR	NCC	9	25323TB-H	2.500	3.251	0.375	TB-H	NBR	NCC	8									
SHAFT 2.468																								
V-RING -060							7	25324SA-H	2.500	3.251	0.437	SA-H	NBR	NCC	8									
24630646SC	2.468	3.062	0.468	SC	NBR	NCC	8	25324TA-H	2.500	3.251	0.437	TA-H	NBR	NCC	8									
SHAFT 2.480																								
V-RING -065							7	25324SA	2.500	3.251	0.438	SA	NBR	NCC	8									
63X75X5SC	2.480	2.953	0.197	SC	NBR	NCC	8	25324VTA	2.500	3.251	0.438	TA	FKM	VCC	8									
63X80X8SB-H	2.480	3.149	0.314	SB-H	NBR	NCC	8	25324TA	2.500	3.251	0.438	TA	NBR	NCC	8									
63X80X8TC	2.480	3.150	0.315	TC	NBR	NCC	8	253255SA-H	2.500	3.251	0.500	SA-H	NBR	NCC	8									
								253255VSB-H	2.500	3.251	0.500	SB-H	FKM	VCS	8									
								253255TA-H	2.500	3.251	0.500	TA-H	NBR	NCC	8									
								25333TBJ	2.500	3.301	0.330	TBJ	NBR	NCC	8									

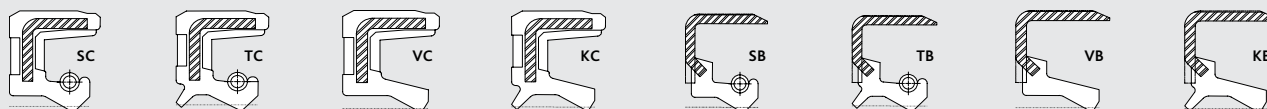



TCM Part #	Shaft	Bore	Width	Type	Lip Material	Material	Box	TCM Part #	Shaft	Bore	Width	Type	Lip Material	Material	Box #
253304TBJW-H	2.500	3.303	0.465	TBJ-H	NBR	NCC	8	253755SA-H	2.500	3.751	0.500	SA-H	NBR	NCC	9
2533543TA-H	2.500	3.350	0.437	TA-H	NBR	NCC	8	253843SA-H	2.500	3.875	0.437	SA-H	NBR	NCC	9
253354SA-H	2.500	3.350	0.438	SA-H	NBR	NCC	8	253846PTA-H	2.500	3.875	0.468	TA-H	ACM	PCC	9
253354TA-H	2.500	3.350	0.468	TA-H	NBR	NCC	8	250384SA-Y	2.500	3.876	0.438	SAY	NBR	NCC	9
253373TA-H	2.500	3.370	0.375	TA-H	NBR	NCC	8	25384TA-H	2.500	3.876	0.468	TA-H	NBR	NCC	9
253373TB-H	2.500	3.371	0.375	TB-H	NBR	NCC	8	2538746TA-H	2.500	3.876	0.468	TA-H	NBR	NCC	9
25334SA-H	2.500	3.371	0.437	SA-H	NBR	NCC	8	25403VTB	2.500	4.003	0.375	TB	FKM	VCS	9
25334SA	2.500	3.371	0.438	SA	NBR	NCC	8	25403TB	2.500	4.003	0.375	TB	NBR	NCC	9
25335TC	2.500	3.375	0.500	TC	NBR	NCC	8	25403TB-H	2.500	4.003	0.375	TB-H	NBR	NCC	9
253423PTB-H	2.500	3.427	0.375	TB-H	ACM	PCC	8	25404SA-H	2.500	4.003	0.468	SA-H	NBR	NCC	9
25343TB	2.500	3.428	0.375	TB	NBR	NCC	8	SHAFT 2.501							
25343TB-H	2.500	3.428	0.375	TB-H	NBR	NCC	8	SHAFT-EZE 99248							S1
25352TC	2.500	3.500	0.250	TC	NBR	NCC	9	SHAFT-EZE 99250							S1
25352VH	2.500	3.500	0.250	VH	NBR	NCO	9	SHAFT-EZE 99253							S1
25352VH-H	2.500	3.500	0.250	VH-H	NBR	NCO	9	V-RING -065							7
25352VL-H	2.500	3.500	0.250	VL-H	NBR	NCO	9	25334TC	2.501	3.371	0.438	TC	NBR	NCC	8
25353VTA-H	2.500	3.500	0.375	TA-H	FKM	VCS	9	SHAFT 2.520							
25353TA-H	2.500	3.500	0.375	TA-H	NBR	NCC	9	V-RING -065							7
25353VTB	2.500	3.500	0.375	TB	FKM	VCS	9	64X77X7TXCJY	2.520	3.031	0.276	TXCJY	NBR	NCC	8
25353TB	2.500	3.500	0.375	TB	NBR	NCC	9	64X80X8TC	2.520	3.150	0.315	TC	NBR	NCC	8
25353VTB-H	2.500	3.500	0.375	TB-H	FKM	VCS	9	64X80X13TC	2.520	3.150	0.512	TC	NBR	NCC	8
25354SB	2.500	3.500	0.406	SB	NBR	NCC	9	64X82X7KBY	2.520	3.228	0.276	KBY	NBR	NCO	8
253543PSA-H	2.500	3.500	0.437	SA-H	ACM	PCC	9	64X85X10SA	2.520	3.346	0.394	SA	NBR	NCC	8
25354SA-H	2.500	3.500	0.437	SA-H	NBR	NCC	9	64X85X12TC	2.520	3.346	0.472	TC	NBR	NCC	8
253543SB-H	2.500	3.500	0.437	SB-H	NBR	NCC	9	64X86X8TC	2.520	3.386	0.315	TC	NBR	NCC	8
25354TB-H	2.500	3.500	0.437	TB-H	NBR	NCC	9	64X88X15TC	2.520	3.465	0.591	TC	NBR	NCC	8
25354VSA	2.500	3.500	0.438	SA	FKM	VCS	9	64X90X10SA	2.520	3.543	0.394	SA	NBR	NCC	9
25354SA	2.500	3.500	0.438	SA	NBR	NCC	9	64X90X13TB	2.520	3.543	0.512	TB	NBR	NCC	9
25354VSA-H	2.500	3.500	0.438	SA-H	FKM	VCS	9	64X90X13VTF	2.520	3.543	0.512	TF	FKM	VCS	9
25354VSCN2-PL	2.500	3.500	0.438	SCN2-PL	FKM	VCS	9	64X95X10TC	2.520	3.740	0.394	TC	NBR	NCC	9
25354VTA	2.500	3.500	0.438	TA	FKM	VCC	9	64X100X13SA	2.520	3.937	0.512	SA	NBR	NCC	9
25354TA	2.500	3.500	0.438	TA	NBR	NCC	9	SHAFT 2.556							
25354TA-H	2.500	3.500	0.438	TA-H	NBR	NCC	9	SHAFT-EZE 99254							S1
25354TB	2.500	3.500	0.438	TB	NBR	NCC	9	V-RING -065							7
25354VTCN1	2.500	3.500	0.438	TCN1	FKM	VCS	9	25393TB	2.556	3.937	0.375	TB	NBR	NCC	9
25354HTCN1	2.500	3.500	0.438	TCN1	HNBR	HCC	9	25393TB-H	2.556	3.937	0.375	TB-H	NBR	NCC	9
25355DCNY	2.500	3.500	0.500	DCNY	NBR	NCS	9	SHAFT 2.558							
25355SA-H	2.500	3.500	0.500	SA-H	NBR	NCC	9	SHAFT-EZE 99254							S1
25355SC	2.500	3.500	0.500	SC	NBR	NCC	9	V-RING -065							7
25355TA-H	2.500	3.500	0.500	TA-H	NBR	NCC	9	255312VB	2.558	3.125	0.250	VB	NBR	NCO	8
253504SSB	2.500	3.502	0.406	SB	VMQ	SCC	9	SHAFT 2.559							
253502VAY	2.500	3.505	0.250	VAY	NBR	NCO	9	SHAFT-EZE 99254							S1
253502VH-H	2.500	3.505	0.250	VH-H	NBR	NCO	9	V-RING -065							7
2535443PTA-H	2.500	3.542	0.437	TA-H	ACM	PCC	9	65X75X5VC	2.559	2.953	0.197	VC	NBR	NCO	8
253544SA	2.500	3.543	0.438	SA	NBR	NCC	9	65X75X8TC	2.559	2.953	0.315	TC	NBR	NCC	8
253544SA-H	2.500	3.543	0.438	SA-H	NBR	NCC	9	65X77X12TB	2.559	3.031	0.472	TB	NBR	NCC	8
253545TA	2.500	3.543	0.500	TA	NBR	NCC	9	65X80X8SB-H	2.559	3.149	0.314	SB-H	NBR	NCC	8
253545TA-H	2.500	3.543	0.500	TA-H	NBR	NCC	9	65X80X4VC	2.559	3.150	0.157	VC	NBR	NCO	8
63.5X90.09X12.7TC	2.500	3.547	0.500	TC	NBR	NCC	9	65X80X8SC	2.559	3.150	0.315	SC	NBR	NCC	8
253544TC	2.500	3.547	0.438	TC	NBR	NCC	9	65X80X8VTC	2.559	3.150	0.315	TC	FKM	VCC	8
25363SA	2.500	3.623	0.375	SA	NBR	NCC	9	65X80X8TC	2.559	3.150	0.315	TC	NBR	NCC	8
25363SA-H	2.500	3.623	0.375	SA-H	NBR	NCC	9	65X80X10VSA	2.559	3.150	0.394	SA	FKM	VCS	8
25363SB	2.500	3.623	0.375	SB	NBR	NCC	9	65X80X10TC	2.559	3.150	0.394	TC	NBR	NCC	8
25363SB-H	2.500	3.623	0.375	SB-H	NBR	NCC	9	65X80X10VTF	2.559	3.150	0.394	TF	FKM	VCS	8
253623TA-H	2.500	3.623	0.375	TA-H	NBR	NCC	9	65X81X7PTCR	2.559	3.189	0.276	TCR	ACM	PCC	8
25363VTB-H	2.500	3.623	0.375	TB-H	FKM	VCS	9	65X81X7TCR	2.559	3.189	0.276	TCR	NBR	NCC	8
25363TB-H	2.500	3.623	0.375	TB-H	NBR	NCC	9	65X82X10SC	2.559	3.228	0.394	SC	NBR	NCC	8
25364SA	2.500	3.623	0.438	SA	NBR	NCC	9	65X84X9TC	2.559	3.307	0.354	TC	NBR	NCC	8
253731VA10-H	2.500	3.750	0.313	VA10-H	NBR	NCO	9	65X84X9STCR	2.559	3.307	0.354	TCR	VMQ	SCC	8
25374SCN	2.500	3.750	0.438	SCN	NBR	NCC	9	65X85X8VSB-H	2.559	3.346	0.314	SB-H	FKM	VCS	8
253753SB-U	2.500	3.751	0.375	SB-U	NBR	NCC	9	65X85X8SB-H	2.559	3.346	0.314	SB-H	NBR	NCC	8
25374SA	2.500	3.751	0.438	SA	NBR	NCC	9	65X85X10SC	2.559	3.346	0.393	SC	NBR	NCC	8
25374SA-H	2.500	3.751	0.438	SA-H	NBR	NCC	9								
25374TA	2.500	3.751	0.438	TA	NBR	NCC	9								

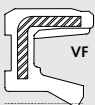
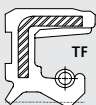
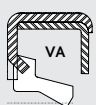
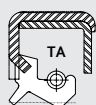

OIL AND GREASE SEALS - A COMPLETE LISTING

PLEASE CALL DICHTOMATIK FOR AVAILABILITY - 800-328-2840
BULK AND INDIVIDUALLY BOXED QUANTITIES ARE AVAILABLE FOR ALL



DICHTOMATIK

Any seal. Any time.

TCM Part #	Shaft	Bore	Width	Type	Lip Material	Material	Box #
65X85X10SG	2.559	3.346	0.393	SG	NBR	NCC	8
65X85X10TG	2.559	3.346	0.393	TG	NBR	NCC	8
65X85X8SC	2.559	3.346	0.315	SC	NBR	NCC	8
65X85X8TC	2.559	3.346	0.315	TC	NBR	NCC	8
65X85X10SB	2.559	3.346	0.394	SB	NBR	NCC	8
65X85X10TC	2.559	3.346	0.394	TC	NBR	NCC	8
65X85X10VTF	2.559	3.346	0.394	TF	FKM	VCS	8
65X85X13SA	2.559	3.346	0.512	SA	NBR	NCC	8
65X85X13TC	2.559	3.346	0.512	TC	NBR	NCC	8
65X86X12TC	2.559	3.386	0.472	TC	NBR	NCC	8
65X88X6VC	2.559	3.465	0.236	VC	NBR	NCO	8
65X88X8TC	2.559	3.465	0.315	TC	NBR	NCC	8
65X88X10TC	2.559	3.465	0.394	TC	NBR	NCC	8
65X90X10HTC-PL	2.559	3.465	0.394	TC-PL	HNBR	HCC	8
65X88X12VTC	2.559	3.465	0.472	TC	FKM	VCS	8
65X88X12TC	2.559	3.465	0.472	TC	NBR	NCC	8
65X88X12VTF	2.559	3.465	0.472	TF	FKM	VCS	8
65X90X8SB-H	2.559	3.543	0.314	SB-H	NBR	NCC	9
65X90X10SG	2.559	3.543	0.393	SG	NBR	NCC	9
65X90X10TG	2.559	3.543	0.393	TG	NBR	NCC	9
65X90X8TC	2.559	3.543	0.315	TC	NBR	NCC	9
65X90X10VSC	2.559	3.543	0.394	SC	FKM	VCS	9
65X90X10SC	2.559	3.543	0.394	SC	NBR	NCC	9
65X90X10TB	2.559	3.543	0.394	TB	NBR	NCC	9
65X90X10TC	2.559	3.543	0.394	TC	NBR	NCC	9
65X90X10VTC-PL	2.559	3.543	0.394	TC-PL	FKM	VCC	9
65X90X10VTF	2.559	3.543	0.394	TF	FKM	VCS	9
65X90X10VC	2.559	3.543	0.394	VC	NBR	NCO	9
65X90X12SC	2.559	3.543	0.472	SC	NBR	NCC	9
65X90X12TA	2.559	3.543	0.472	TA	NBR	NCC	9
65X90X12TC	2.559	3.543	0.472	TC	NBR	NCS	9
65X90X13TC	2.559	3.543	0.512	TC	NBR	NCC	9
65X92X10TC	2.559	3.622	0.394	TC	NBR	NCC	9
65X95X10SC	2.559	3.740	0.393	SC	NBR	NCC	9
65X95X10SA	2.559	3.740	0.394	SA	NBR	NCC	9
65X95X10TC	2.559	3.740	0.394	TC	NBR	NCC	9
65X95X10VTF	2.559	3.740	0.394	TF	FKM	VCS	9
65X95X13TC	2.559	3.740	0.512	TC	NBR	NCC	9
65X100X10TG	2.559	3.937	0.393	TG	NBR	NCC	9
65X100X8SB-H	2.559	3.937	0.315	SB-H	NBR	NCC	9
65X100X8VC	2.559	3.937	0.315	VC	NBR	NCO	9
65X100X10SC	2.559	3.937	0.394	SC	NBR	NCC	9
65X100X10VSF	2.559	3.937	0.394	SF	FKM	VCC	9
65X100X10TC	2.559	3.937	0.394	TC	NBR	NCC	9
65X100X10VTF	2.559	3.937	0.394	TF	FKM	VCS	9
65X100X13SC	2.559	3.937	0.512	SC	NBR	NCC	9
65X105X12TC	2.559	4.134	0.472	TC	NBR	NCC	9
65X105X12TM	2.559	4.134	0.472	TM	NBR	NCC	9
65X110X10SB-H	2.559	4.330	0.393	SB-H	NBR	NCC	9
65X110X10SC	2.559	4.331	0.394	SC	NBR	NCC	9
65X110X12TC	2.559	4.331	0.472	TC	NBR	NCC	9
65X115X12TC	2.559	4.528	0.472	TC	NBR	NCC	9
65X115X13TC	2.559	4.528	0.512	TC	NBR	NCC	9
65X115X15SC	2.559	4.528	0.591	SC	NBR	NCC	9
65X120X8TB	2.559	4.724	0.315	TB	NBR	NCC	9
65X120X10SC	2.559	4.724	0.394	SC	NBR	NCC	9
65X120X10TC	2.559	4.724	0.394	TC	NBR	NCC	9
65X120X12TC	2.559	4.724	0.472	TC	NBR	NCC	9
65X120X13TC	2.559	4.724	0.512	TC	NBR	NCC	9
65X125X12VSF	2.559	4.921	0.472	SF	FKM	VCS	3
65X125X12TC	2.559	4.921	0.472	TC	NBR	NCC	3

TCM Part #	Shaft	Bore	Width	Type	Lip Material	Material	Box
SHAFT 2.562							
SHAFT-EZE 99254							S1
SHAFT-EZE 99256							S1
V-RING -065							7
256333TC	2.562	3.375	0.375	TC	NBR	NCC	8
256353TA-H	2.562	3.500	0.375	TA-H	NBR	NCC	9
25636246PTB-H	2.562	3.622	0.468	TB-H	ACM	PCC	9
256363TA	2.562	3.623	0.375	TA	NBR	NCC	9
256363TA-H	2.562	3.623	0.375	TA-H	NBR	NCC	9
25373TA-H	2.562	3.750	0.375	TA-H	NBR	NCC	9
25638746SA-H	2.562	3.876	0.468	SA-H	NBR	NCC	9
SHAFT 2.563							
SHAFT-EZE 99256							S1
V-RING -065							7
256345TA	2.563	3.481	0.500	TA	NBR	NCC	8
256345TA-H	2.563	3.481	0.500	TA-H	NBR	NCC	8
256354SA	2.563	3.500	0.438	SA	NBR	NCC	9
256354SA-H	2.563	3.500	0.438	SA-H	NBR	NCC	9
256364SA-H	2.563	3.623	0.437	SA-H	NBR	NCC	9
256364SA	2.563	3.623	0.438	SA	NBR	NCC	9
256365TA	2.563	3.632	0.500	TA	NBR	NCC	9
256374SA	2.563	3.751	0.438	SA	NBR	NCC	9
25384SA	2.563	3.876	0.438	SA	NBR	NCC	9
SHAFT 2.594							
V-RING -065							7
2593538/46VTCR	2.594	3.5000.380/0.469	TCR	FKM	VCC		9
SHAFT 2.598							
SHAFT-EZE 99259							S1
V-RING -065							7
66X85X8TA	2.598	3.346	0.315	TA	NBR	NCC	8
66X85X10TB	2.598	3.346	0.394	TB	NBR	NCC	8
259344PTA-H	2.598	3.481	0.437	TA-H	ACM	PCC	8
259344PTA	2.598	3.481	0.438	TA	ACM	PCS	8
259345PTA-H	2.598	3.481	0.500	TA-H	ACM	PCC	8
66X90X13SA	2.598	3.543	0.512	SA	NBR	NCC	9
66X90X13TC	2.598	3.543	0.512	TC	NBR	NCC	9
66X100X11SC	2.598	3.937	0.433	SC	NBR	NCC	9
25939978TB-H	2.598	3.999	0.780	TB-H	NBR	NCC	9
259405TB-H	2.598	4.000	0.500	TB-H	NBR	NCC	9
259407PTBJ	2.598	4.000	0.781	TBJ	ACM	PCS	9
SHAFT 2.601							
V-RING -065							7
2603952XSC	2.601	3.936	0.524	SC	XNBR	XCC	9
SHAFT 2.607							
V-RING -065							7
2603353PSA-H	2.607	3.350	0.375	SA-H	ACM	PCC	8
SHAFT 2.620							
SHAFT-EZE 99261							S1
V-RING -065							7
26323NTF	2.620	3.246	0.375	TF	CR	CCS	8
SHAFT 2.625							
SHAFT-EZE 99262							S1
SHAFT-EZE 99264							S1
SHAFT-EZE 99260							S1
V-RING -065							7
26324SA	2.625	3.251	0.438	SA	NBR	NCC	8
26324SA-H	2.625	3.251	0.438	SA-H	NBR	NCC	8
26333VTC	2.625	3.350	0.350	TC	FKM	VCC	8
263353SB-H	2.625	3.350	0.375	SB-H	NBR	NCC	8
263353TA-H	2.625	3.350	0.375	TA-H	NBR	NCC	8
263353TB-H	2.625	3.350	0.375	TB-H	NBR	NCC	8

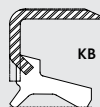
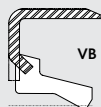
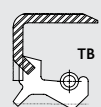
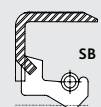
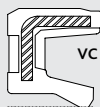



TCM Part #	Shaft	Bore	Width	Type	Lip Material	Material	Box	TCM Part #	Shaft	Bore	Width	Type	Lip Material	Material	Box #
2633546SA-H	2.625	3.350	0.468	SA-H	NBR	NCC	8	26424TA-H	2.625	4.249	0.468	TA-H	NBR	NCC	9
263372VL-H	2.625	3.370	0.250	VL-H	NBR	NCO	8	26434TA-H	2.625	4.370	0.437	TA-H	NBR	NCC	9
26334TA-H	2.625	3.370	0.437	TA-H	NBR	NCC	8	26434TA	2.625	4.370	0.438	TA	NBR	NCC	9
26333TA	2.625	3.371	0.375	TA	NBR	NCC	8	26444TA-H	2.625	4.437	0.437	TA-H	NBR	NCC	9
26333TA-H	2.625	3.371	0.375	TA-H	NBR	NCC	8	26444SA-H	2.625	4.438	0.437	SA-H	NBR	NCC	9
26334TA	2.625	3.371	0.438	TA	NBR	NCC	8	26444SA	2.625	4.438	0.438	SA	NBR	NCC	9
263374TA-H	2.625	3.374	0.437	TA-H	NBR	NCC	8	26457PTB	2.625	4.563	0.719	TB	ACM	PCC	9
263374TA	2.625	3.374	0.438	TA	NBR	NCC	8	SHAFT 2.638							
26374TA	2.625	3.374	0.438	TA	NBR	NCC	8	V-RING -065							7
263374TA-H	2.625	3.374	0.438	TA-H	NBR	NCC	8	67X85X10SA	2.638	3.346	0.394	SA	NBR	NCC	8
263331SC	2.625	3.375	0.312	SC	NBR	NCC	8	67X85X10TC	2.638	3.346	0.394	TC	NBR	NCC	8
26333TC	2.625	3.375	0.375	TC	NBR	NCC	8	SHAFT 2.648							
2634843SA-H	2.625	3.481	0.437	SA-H	NBR	NCC	8	V-RING -065							7
26344TA	2.625	3.481	0.438	TA	NBR	NCC	8	2643815SB-H	2.648	3.811	0.500	SB-H	NBR	NCC	9
26344TA-H	2.625	3.481	0.438	TA-H	NBR	NCC	8	SHAFT 2.677							
263485SA-H	2.625	3.481	0.500	SA-H	NBR	NCC	8	V-RING -070							7
26345SA-H	2.625	3.481	0.500	SA-H	NBR	NCC	8	68X80X10TC	2.677	3.150	0.394	TC	NBR	NCC	8
26353VSB-H	2.625	3.500	0.375	SB-H	FKM	VCS	9	68X82X7TC	2.677	3.228	0.276	TC	NBR	NCC	8
26353TA-H	2.625	3.500	0.375	TA-H	NBR	NCC	9	68X82X10TC	2.677	3.228	0.394	TC	NBR	NCC	8
26353TB	2.625	3.500	0.375	TB	NBR	NCC	9	68X83X10TC	2.677	3.268	0.394	TC	NBR	NCC	8
26353TB-H	2.625	3.500	0.375	TB-H	NBR	NCC	9	68X84X8.5STCL	2.677	3.307	0.335	TCL	VMQ	SCC	8
263543TA-H	2.625	3.500	0.437	TA-H	NBR	NCC	9	68X84X9TC	2.677	3.307	0.354	TC	NBR	NCC	8
26354SA	2.625	3.500	0.438	SA	NBR	NCC	9	68X85X8SC	2.677	3.346	0.315	SC	NBR	NCC	8
26354SA-H	2.625	3.500	0.438	SA-H	NBR	NCC	9	68X85X10SC	2.677	3.346	0.394	SC	NBR	NCC	8
2635443SA-H	2.625	3.542	0.437	SA-H	NBR	NCC	9	68X85X10TB	2.677	3.346	0.394	TB	NBR	NCC	8
263544TL	2.625	3.543	0.438	TL	NBR	NCC	9	68X85X10TC	2.677	3.346	0.394	TC	NBR	NCC	8
263622VH-H	2.625	3.622	0.250	VH-H	NBR	NCO	9	68X85X13TC	2.677	3.346	0.512	TC	NBR	NCC	8
263623SB-H	2.625	3.622	0.375	SB-H	NBR	NCC	9	68X86X7TC	2.677	3.386	0.276	TC	NBR	NCC	8
2636243SA-H	2.625	3.622	0.437	SA-H	NBR	NCC	9	68X87X8TC	2.677	3.425	0.315	TC	NBR	NCC	8
26362VH	2.625	3.623	0.250	VH	NBR	NCO	9	68X88X9TC	2.677	3.465	0.354	TC	NBR	NCC	8
26363VTA	2.625	3.623	0.375	TA	FKM	VCS	9	68X90X10TG	2.677	3.543	0.393	TG	NBR	NCC	9
26363TA-H	2.625	3.623	0.375	TA-H	NBR	NCC	9	68X90X8SB	2.677	3.543	0.315	SB	NBR	NCC	9
26363PTB	2.625	3.623	0.375	TB	ACM	PCS	9	68X90X8VTC	2.677	3.543	0.315	TC	FKM	VCC	9
26363TB	2.625	3.623	0.375	TB	NBR	NCC	9	68X90X8TC	2.677	3.543	0.315	TC	NBR	NCC	9
26363PTB-H	2.625	3.623	0.375	TB-H	ACM	PCC	9	68X90X10SC	2.677	3.543	0.394	SC	NBR	NCC	9
26363TB-H	2.625	3.623	0.375	TB-H	NBR	NCC	9	68X90X10TA	2.677	3.543	0.394	TA	NBR	NCC	9
26364TA	2.625	3.623	0.438	TA	NBR	NCC	9	68X90X10TB	2.677	3.543	0.394	TB	NBR	NCC	9
26364TA-H	2.625	3.623	0.438	TA-H	NBR	NCC	9	68X90X10TC	2.677	3.543	0.394	TC	NBR	NCC	9
2636246SA-H	2.625	3.623	0.468	SA-H	NBR	NCC	9	68X90X10VTF	2.677	3.543	0.394	TF	FKM	VCS	9
2636246TA-H	2.625	3.623	0.468	TA-H	NBR	NCC	9	68X90X10TM	2.677	3.543	0.394	TM	NBR	NCC	9
2636246PTB-H	2.625	3.623	0.468	TB-H	ACM	PCC	9	68X90X10VC	2.677	3.543	0.394	VC	NBR	NCO	9
26364SA	2.625	3.624	0.468	SA	NBR	NCC	9	68X90X12TC	2.677	3.543	0.472	TC	NBR	NCC	9
26373TB-H	2.625	3.750	0.375	TB-H	NBR	NCC	9	68X90X12VTZ	2.677	3.543	0.472	TZ	FKM	VCC	9
26373TC	2.625	3.750	0.375	TC	NBR	NCC	9	68X90X13TB	2.677	3.543	0.512	TB	NBR	NCC	9
26373TA	2.625	3.751	0.375	TA	NBR	NCC	9	68X92X12TB	2.677	3.622	0.472	TB	NBR	NCC	9
26373TA-H	2.625	3.751	0.375	TA-H	NBR	NCC	9	68X92X12TC	2.677	3.622	0.472	TC	NBR	NCC	9
263753TB-H	2.625	3.751	0.375	TB-H	NBR	NCC	9	68X94X8TC	2.677	3.701	0.315	TC	NBR	NCC	9
2637543SA-H	2.625	3.751	0.437	SA-H	NBR	NCC	9	68X95X7VC	2.677	3.740	0.276	VC	NBR	NCO	9
2637543VTA-H	2.625	3.751	0.437	TA-H	FKM	VCS	9	68X95X10SC	2.677	3.740	0.394	SC	NBR	NCC	9
2637543TA-H	2.625	3.751	0.437	TA-H	NBR	NCC	9	68X95X10TC	2.677	3.740	0.394	TC	NBR	NCC	9
263812VBY	2.625	3.812	0.250	VBY	NBR	NCO	9	68X100X7TC	2.677	3.937	0.276	TC	NBR	NCC	9
263814UAY	2.625	3.813	0.415	UAY	NBR	NCO	9	68X100X10SC	2.677	3.937	0.394	SC	NBR	NCC	9
263843SA-H	2.625	3.875	0.437	SA-H	NBR	NCC	9	68X100X10TC	2.677	3.937	0.394	TC	NBR	NCC	9
26384SA	2.625	3.876	0.438	SA	NBR	NCC	9	68X100X10VTF	2.677	3.937	0.394	TF	FKM	VCS	9
26384TA-H	2.625	3.876	0.468	TA-H	NBR	NCC	9	68X100X12SA	2.677	3.937	0.472	SA	NBR	NCC	9
26394SA-H	2.625	3.936	0.437	SA-H	NBR	NCC	9	68X100X12TC	2.677	3.937	0.472	TC	NBR	NCC	9
26394SA	2.625	3.936	0.438	SA	NBR	NCC	9	68X110X13TB	2.677	4.331	0.512	TB	NBR	NCC	9
264031VA10-H	2.625	4.000	0.313	VA10-H	NBR	NCO	9	SHAFT 2.687							
26405TC	2.625	4.000	0.500	TC	NBR	NCC	9	V-RING -070							7
26403TA-H	2.625	4.003	0.375	TA-H	NBR	NCC	9	268355SA-H	2.687	3.500	0.500	SA-H	NBR	NCC	9
26403VTB	2.625	4.003	0.375	TB	FKM	VCC	9	26837543SA-H	2.687	3.751	0.437	SA-H	NBR	NCC	9
26403VTB-H	2.625	4.003	0.375	TB-H	FKM	VCS	9	2683755SA-H	2.687	3.751	0.500	SA-H	NBR	NCC	9
26403TB-H	2.625	4.003	0.375	TB-H	NBR	NCC	9	268384SA-H	2.687	3.876	0.468	SA-H	NBR	NCC	9
2640043SA-H	2.625	4.003	0.437	SA-H	NBR	NCC	9								

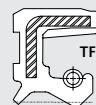
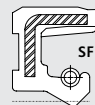
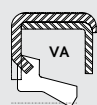
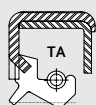

OIL AND GREASE SEALS - A COMPLETE LISTING

PLEASE CALL DICHTOMATIK FOR AVAILABILITY - 800-328-2840
BULK AND INDIVIDUALLY BOXED QUANTITIES ARE AVAILABLE FOR ALL



DICHTOMATIK

Any seal. Any time.

TCM Part #	Shaft	Bore	Width	Type	Lip Material	Material	Box #	TCM Part #	Shaft	Bore	Width	Type	Lip Material	Material	Box
268405SC	2.687	4.000	0.500	SC	NBR	NCC	9	27374TB-H	2.750	3.751	0.437	TB-H	NBR	NCC	9
26840046SA-H	2.687	4.003	0.468	SA-H	NBR	NCC	9	27374VSA	2.750	3.751	0.438	SA	FKM	VCS	9
SHAFT 2.688															
V-RING -070							7	27374SA	2.750	3.751	0.438	SA	NBR	NCC	9
268353VM	2.688	3.500	0.375	VM	NBR	NCO	9	27374TA	2.750	3.751	0.438	TA	NBR	NCC	9
268374TB	2.688	3.751	0.438	TB	NBR	NCC	9	27374TB	2.750	3.751	0.438	TB	NBR	NCC	9
268384SA-H	2.688	3.876	0.437	SA-H	NBR	NCC	9	273754VVB-H	2.750	3.751	0.438	TB-H	FKM	VCS	9
268384SA	2.688	3.876	0.438	SA	NBR	NCC	9	273755SA-H	2.750	3.751	0.500	SA-H	NBR	NCC	9
SHAFT 2.717															
V-RING -070							7	273755TA-H	2.750	3.751	0.500	TA-H	NBR	NCC	9
69X85X10TB	2.717	3.346	0.394	TB	NBR	NCC	8	273764SA	2.750	3.765	0.438	SA	NBR	NCC	9
69X85X12TB	2.717	3.346	0.472	TB	NBR	NCC	8	273843PTA-H	2.750	3.875	0.433	TA-H	ACM	PCC	9
69X90X10SC	2.717	3.543	0.394	SC	NBR	NCC	9	27384TB-H	2.750	3.875	0.437	TB-H	NBR	NCC	9
SHAFT 2.749															
SHAFT-EZE 99274							S1	273873TA-H	2.750	3.876	0.375	TA-H	NBR	NCC	9
SHAFT-EZE 99267							S1	273883TB	2.750	3.876	0.375	TB	NBR	NCC	9
SHAFT-EZE 99270							S1	27383TB-H	2.750	3.876	0.375	TB-H	NBR	NCC	9
V-RING -070							7	27384SA-H	2.750	3.876	0.437	SA-H	NBR	NCC	9
2744014TA	2.749	4.013	0.484	TA	NBR	NCC	9	27384SA	2.750	3.876	0.438	SA	NBR	NCC	9
SHAFT 2.750															
SHAFT-EZE 99272							S1	27384PTA	2.750	3.876	0.438	TA	ACM	PCS	9
SHAFT-EZE 99274							S1	27384TA-H	2.750	3.876	0.438	TA-H	NBR	NCC	9
SHAFT-EZE 99275							S1	27384TB	2.750	3.876	0.438	TB	NBR	NCC	9
SHAFT-EZE 99267							S1	2738746SA-H	2.750	3.876	0.468	SA-H	NBR	NCC	9
SHAFT-EZE 99269							S1	2738746TA-H	2.750	3.876	0.468	TA-H	NBR	NCC	9
SHAFT-EZE 99270							S1	27394SA-H	2.750	3.936	0.437	SA-H	NBR	NCC	9
V-RING -070							7	27394SA	2.750	3.936	0.438	SA	NBR	NCC	9
2731010VM	2.750	3.125	0.109	VM	NBR	NCO	8	27403TA-H	2.750	4.003	0.375	TA-H	NBR	NCC	9
2733831SC	2.750	3.389	0.313	SC	NBR	NCC	8	2740043SA-H	2.750	4.003	0.437	SA-H	NBR	NCC	9
27344TB	2.750	3.481	0.438	TB	NBR	NCC	8	27404PTA-H	2.750	4.003	0.437	TA-H	ACM	PCC	9
27352VB	2.750	3.500	0.250	VB	NBR	NCO	9	27404PTA	2.750	4.003	0.438	TA	ACM	PCS	9
27352VL-H	2.750	3.500	0.250	VL-H	NBR	NCO	9	274156TB-H	2.750	4.125	0.562	TB-H	NBR	NCC	9
27353SB	2.750	3.500	0.375	SB	NBR	NCC	9	2742443SA-H	2.750	4.248	0.437	SA-H	NBR	NCC	9
27353SB-H	2.750	3.500	0.375	SB-H	NBR	NCC	9	27424PTA	2.750	4.249	0.438	TA	ACM	PCC	9
27353TA	2.750	3.500	0.375	TA	NBR	NCC	9	27424PTA-H	2.750	4.249	0.438	TA-H	ACM	PCS	9
27353TA-H	2.750	3.500	0.375	TA-H	NBR	NCC	9	27424TA-H	2.750	4.249	0.438	TA-H	NBR	NCC	9
27353VTB	2.750	3.500	0.375	TB	FKM	VCC	9	274246TA-H	2.750	4.249	0.468	TA-H	NBR	NCC	9
27353TB	2.750	3.500	0.375	TB	NBR	NCC	9	274335TA-H	2.750	4.331	0.500	TA-H	NBR	NCC	9
27353VTB-H	2.750	3.500	0.375	TB-H	FKM	VCS	9	SHAFT 2.756							
27353TB-H	2.750	3.500	0.375	TB-H	NBR	NCC	9	SHAFT-EZE 99272							S1
27353VTC	2.750	3.500	0.375	TC	FKM	VCS	9	SHAFT-EZE 99275							S1
27354SA-H	2.750	3.500	0.437	SA-H	NBR	NCC	9	SHAFT-EZE 99269							S1
27354SA	2.750	3.500	0.438	SA	NBR	NCC	9	SHAFT-EZE 99276							S1
27355DCNY	2.750	3.500	0.500	DCNY	NBR	NCS	9	V-RING -070							7
273534SA-H	2.750	3.538	0.437	SA-H	NBR	NCC	9	70X78X5VG	2.756	3.071	0.197	VG	NBR	NCO	8
273544PTA-H	2.750	3.542	0.437	TA-H	ACM	PCC	9	70X80X10TC	2.756	3.150	0.394	TC	NBR	NCC	8
273543PTA-H	2.750	3.543	0.375	TA-H	ACM	PCS	9	27532023SG	2.756	3.209	0.236	SG	NBR	NCC	8
273543TA-H	2.750	3.543	0.375	TA-H	NBR	NCC	9	70X82.5X10TC	2.756	3.248	0.394	TC	NBR	NCC	8
273544PSA-H	2.750	3.543	0.437	SA-H	ACM	PCC	9	70X84X8TC	2.756	3.307	0.315	TC	NBR	NCC	8
273544PSA	2.750	3.543	0.438	SA	ACM	PCC	9	70X85X8SB-H	2.756	3.346	0.314	SB-H	NBR	NCC	8
273544PTA	2.750	3.543	0.438	TA	ACM	PCS	9	70X85X8TG	2.756	3.346	0.314	TG	NBR	NCC	8
273545PTB-H	2.750	3.543	0.500	TB-H	ACM	PCC	9	70X85X4VC	2.756	3.346	0.157	VC	NBR	NCO	8
27363TA	2.750	3.623	0.375	TA	NBR	NCC	9	70X85X6TB	2.756	3.346	0.236	TB	NBR	NCC	8
27363TA-H	2.750	3.623	0.375	TA-H	NBR	NCC	9	70X85X7SC	2.756	3.346	0.276	SC	NBR	NCC	8
27364SA-H	2.750	3.623	0.437	SA-H	NBR	NCC	9	70X85X8VSC	2.756	3.346	0.315	SC	FKM	VCS	8
27364VSA	2.750	3.623	0.438	SA	FKM	VCS	9	70X85X8SC	2.756	3.346	0.315	SC	NBR	NCC	8
27364SA	2.750	3.623	0.438	SA	NBR	NCC	9	70X85X8VTC	2.756	3.346	0.315	TC	FKM	VCS	8
27372VHY	2.750	3.751	0.250	VHY	NBR	NCO	9	70X85X8TC	2.756	3.346	0.315	TC	NBR	NCC	8
27373TA-H	2.750	3.751	0.375	TA-H	NBR	NCC	9	70X85X10TC	2.756	3.346	0.394	TC	NBR	NCC	8
27374VSA-H	2.750	3.751	0.437	SA-H	FKM	VCS	9	70X87X10TC	2.756	3.425	0.394	TC	NBR	NCC	8
27374SA-H	2.750	3.751	0.437	SA-H	NBR	NCC	9	70X88X7VC	2.756	3.465	0.276	VC	NBR	NCO	8
2737543SB-H	2.750	3.751	0.437	SB-H	NBR	NCC	9	70X88X8TB	2.756	3.465	0.315	TB	NBR	NCC	8
27374TA-H	2.750	3.751	0.437	TA-H	NBR	NCC	9	70X88X8TC	2.756	3.465	0.315	TC	NBR	NCC	8
								70X88X9VSF	2.756	3.465	0.354	SF	FKM	VCS	8
								70X88X10VTC	2.756	3.465	0.394	TC	FKM	VCC	8
								70X88X12TB	2.756	3.465	0.472	TB	NBR	NCC	8
								70X88X12TC	2.756	3.465	0.472	TC	NBR	NCC	8
								70X88X12STCL	2.756	3.465	0.472	TCL	VMQ	SCC	8

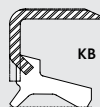
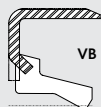
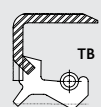
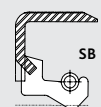
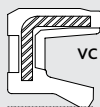



TCM Part #	Shaft	Bore	Width	Type	Lip Material	Material	Box	TCM Part #	Shaft	Bore	Width	Type	Lip Material	Material	Box #
70X90X8SB-H	2.756	3.543	0.314	SB-H	NBR	NCC	9	70X112X12TM	2.756	4.409	0.472	TM	NBR	NCC	9
70X90X10SSC	2.756	3.543	0.393	SC	VMQ	SCC	9	70X112X13VTC	2.756	4.409	0.512	TC	FKM	VCC	9
70X90X10SG	2.756	3.543	0.393	SG	NBR	NCC	9	70X115X15SC	2.756	4.528	0.591	SC	NBR	NCC	9
70X90X10VTG	2.756	3.543	0.393	TG	FKM	VCS	9	70X115X15TC	2.756	4.528	0.591	TC	NBR	NCC	9
70X90X10TG	2.756	3.543	0.393	TG	NBR	NCC	9	70X120X10TC	2.756	4.724	0.394	TC	NBR	NCC	9
70X90X10VSB-H	2.756	3.543	0.394	SB-H	FKM	VCS	9	70X120X12TC	2.756	4.724	0.472	TC	NBR	NCC	9
70X90X7TC	2.756	3.543	0.276	TC	NBR	NCC	9	70X120X13SA	2.756	4.724	0.512	SA	NBR	NCC	9
70X90X7VTCN1	2.756	3.543	0.276	TCN1	FKM	VCS	9	70X120X13VSF	2.756	4.724	0.512	SF	FKM	VCS	9
70X90X10VSB	2.756	3.543	0.394	SB	FKM	VCS	9	70X120X13VTC	2.756	4.724	0.512	TC	FKM	VCC	9
70X90X10SB	2.756	3.543	0.394	SB	NBR	NCC	9	70X125X12TC	2.756	4.921	0.472	TC	NBR	NCC	3
70X90X10HSBL	2.756	3.543	0.394	SBL	HNBR	HCC	9	70X130X13TC	2.756	5.118	0.512	TC	NBR	NCC	3
70X90X10SC	2.756	3.543	0.394	SC	NBR	NCC	9	70X135X12VSF	2.756	5.315	0.472	SF	FKM	VCS	3
70X90X10TC	2.756	3.543	0.394	TC	NBR	NCC	9	SHAFT 2.795							
70X90X10VTF	2.756	3.543	0.394	TF	FKM	VCS	9	V-RING -070							7
70X90X12SC	2.756	3.543	0.472	SC	NBR	NCC	9	71X80X6TM	2.795	3.150	0.236	TM	NBR	NCC	8
70X90X12VTC	2.756	3.543	0.472	TC	FKM	VCS	9	71X88X8TC	2.795	3.465	0.315	TC	NBR	NCC	8
70X90X12TC	2.756	3.543	0.472	TC	NBR	NCC	9	SHAFT 2.812							
70X90X13SC	2.756	3.543	0.512	SC	NBR	NCC	9	SHAFT-EZE 99281							S1
70X92X8.5TC	2.756	3.622	0.335	TC	NBR	NCC	9	V-RING -070							7
70X92X8.5TCL	2.756	3.622	0.335	TCL	VMQ	SCC	9	281363SC	2.812	3.625	0.375	SC	NBR	NCC	9
70X92X9TC	2.756	3.622	0.354	TC	NBR	NCC	9	28137543SA-H	2.812	3.751	0.437	SA-H	NBR	NCC	9
70X92X12TC	2.756	3.622	0.472	TC	NBR	NCC	9	28137555SA-H	2.812	3.751	0.500	SA-H	NBR	NCC	9
70X92X13TC	2.756	3.622	0.512	TC	NBR	NCC	9	28140043SA-H	2.812	4.003	0.437	SA-H	NBR	NCC	9
70X95X13SC	2.756	3.740	0.511	SC	NBR	NCC	9	28140046TB-H	2.812	4.003	0.468	TB-H	NBR	NCC	9
70X95X10SC	2.756	3.740	0.394	SC	NBR	NCC	9	281424TA-H	2.812	4.249	0.468	TA-H	NBR	NCC	9
70X95X10TC	2.756	3.740	0.394	TC	NBR	NCC	9	SHAFT 2.813							
70X95X10VTF	2.756	3.740	0.394	TF	FKM	VCS	9	SHAFT-EZE 99281							S1
70X95X12TC	2.756	3.740	0.472	TC	NBR	NCC	9	V-RING -070							7
70X95X13VSC	2.756	3.740	0.512	SC	FKM	VCS	9	281374TB	2.813	3.751	0.438	TB	NBR	NCC	9
70X95X13TC	2.756	3.740	0.512	TC	NBR	NCC	9	281374TB-H	2.813	3.751	0.438	TB-H	NBR	NCC	9
70X95X13TM	2.756	3.740	0.512	TM	NBR	NCC	9	281384SA	2.813	3.876	0.438	SA	NBR	NCC	9
70X98.5X13TC	2.756	3.878	0.512	TC	NBR	NCC	9	281384SA-H	2.813	3.876	0.438	SA-H	NBR	NCC	9
70X100X10SB-H	2.756	3.937	0.393	SB-H	NBR	NCC	9	281404SA	2.813	4.003	0.438	SA	NBR	NCC	9
70X100X6SC	2.756	3.937	0.236	SC	NBR	NCC	9	281424VSA-H	2.813	4.250	0.438	SA-H	FKM	VCS	9
70X100X8SC	2.756	3.937	0.315	SC	NBR	NCC	9	SHAFT 2.835							
70X100X8TC	2.756	3.937	0.315	TC	NBR	NCC	9	SHAFT-EZE 99284							S1
70X100X10SB-U	2.756	3.937	0.394	SB-U	NBR	NCC	9	V-RING -070							7
70X100X10SC	2.756	3.937	0.394	SC	NBR	NCC	9	72X84X7TM	2.835	3.307	0.276	TM	NBR	NCC	8
70X100X10TC	2.756	3.937	0.394	TC	NBR	NCC	9	72X85X8SC	2.835	3.346	0.315	SC	NBR	NCC	8
70X100X10VTF	2.756	3.937	0.394	TF	FKM	VCS	9	72X85X8VSF	2.835	3.346	0.315	SF	FKM	VCS	8
70X100X10VTG	2.756	3.937	0.394	TG	FKM	VCC	9	72X86X7TC	2.835	3.386	0.276	TC	NBR	NCC	8
70X100X10VC	2.756	3.937	0.394	VC	NBR	NCO	9	72X90X8TC	2.835	3.543	0.315	TC	NBR	NCC	9
70X100X12SC	2.756	3.937	0.472	SC	NBR	NCC	9	72X90X10SC	2.835	3.543	0.394	SC	NBR	NCC	9
70X100X12TA	2.756	3.937	0.472	TA	NBR	NCC	9	72X90X10TB	2.835	3.543	0.394	TB	NBR	NCC	9
70X100X12TB	2.756	3.937	0.472	TB	NBR	NCC	9	72X90X10VTF	2.835	3.543	0.394	TF	FKM	VCS	9
70X100X12TC	2.756	3.937	0.472	TC	NBR	NCC	9	72X92X12TC	2.835	3.622	0.472	TC	NBR	NCC	9
70X100X13TC	2.756	3.937	0.512	TC	NBR	NCC	9	72X94X12TC	2.835	3.701	0.472	TC	NBR	NCC	9
70X100X13TM	2.756	3.937	0.512	TM	NBR	NCC	9	72X95X10SC	2.835	3.740	0.394	SC	NBR	NCC	9
70X102X12TC	2.756	4.016	0.472	TC	NBR	NCC	9	72X95X10TC	2.835	3.740	0.394	TC	NBR	NCC	9
70X105X10TC	2.756	4.133	0.393	TC	NBR	NCC	9	72X95X10VTF	2.835	3.740	0.394	TF	FKM	VCS	9
70X105X13VSF	2.756	4.134	0.512	SF	FKM	VCS	9	72X95X12SC	2.835	3.740	0.472	SC	NBR	NCC	9
70X105X13TC	2.756	4.134	0.512	TC	NBR	NCC	9	72X95X13SC	2.835	3.740	0.512	SC	NBR	NCC	9
70X105X13VTF	2.756	4.134	0.512	TF	FKM	VCS	9	72X95X13TB	2.835	3.740	0.512	TB	NBR	NCC	9
70X110X10SB-H	2.756	4.330	0.393	SB-H	NBR	NCC	9	72X96X9VTC	2.835	3.780	0.354	TC	FKM	VCS	9
70X110X8SC	2.756	4.331	0.315	SC	NBR	NCC	9	72X96X9TC	2.835	3.780	0.354	TC	NBR	NCC	9
70X110X8TC	2.756	4.331	0.315	TC	NBR	NCC	9	72X96X10TC	2.835	3.780	0.394	TC	NBR	NCC	9
70X110X8VTF	2.756	4.331	0.315	TF	FKM	VCS	9	72X98X9TC	2.835	3.858	0.354	TC	NBR	NCC	9
70X110X10SC	2.756	4.331	0.394	SC	NBR	NCC	9	72X100X10SB	2.835	3.937	0.394	SB	NBR	NCC	9
70X110X10TB	2.756	4.331	0.394	TB	NBR	NCC	9	72X100X10SC	2.835	3.937	0.394	SC	NBR	NCC	9
70X110X10TBW	2.756	4.331	0.394	TBW	NBR	NCC	9	72X100X10VSF	2.835	3.937	0.394	SF	FKM	VCS	9
70X110X10TC	2.756	4.331	0.394	TC	NBR	NCC	9	72X100X10TC	2.835	3.937	0.394	TC	NBR	NCC	9
70X110X13SC	2.756	4.331	0.512	SC	NBR	NCC	9	72X100X10VTF	2.835	3.937	0.394	TF	FKM	VCS	9
70X112X12VSF	2.756	4.409	0.472	SF	FKM	VCS	9								
70X112X12TC	2.756	4.409	0.472	TC	NBR	NCC	9								

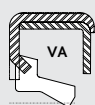
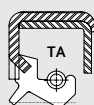

OIL AND GREASE SEALS - A COMPLETE LISTING

PLEASE CALL DICHTOMATIK FOR AVAILABILITY - 800-328-2840
BULK AND INDIVIDUALLY BOXED QUANTITIES ARE AVAILABLE FOR ALL



DICHTOMATIK

Any seal. Any time.

TCM Part #	Shaft	Bore	Width	Type	Lip Material	Material	Box #	TCM Part #	Shaft	Bore	Width	Type	Lip Material	Material	Box
72X100X12TA	2.835	3.937	0.472	TA	NBR	NCC	9	28384VTA	2.875	3.876	0.438	TA	FKM	VCS	9
72X100X13VSF	2.835	3.937	0.512	SF	FKM	VCS	9	28384TA	2.875	3.876	0.438	TA	NBR	NCC	9
72X100X13TC	2.835	3.937	0.512	TC	NBR	NCC	9	28384TA-H	2.875	3.876	0.438	TA-H	NBR	NCC	9
72X105X10TC	2.835	4.134	0.394	TC	NBR	NCC	9	2838746SA-H	2.875	3.876	0.468	SA-H	NBR	NCC	9
72X105X12TA	2.835	4.134	0.472	TA	NBR	NCC	9	28405TC	2.875	4.000	0.500	TC	NBR	NCC	9
72X105X12TB	2.835	4.134	0.472	TB	NBR	NCC	9	28402VH	2.875	4.003	0.250	VH	NBR	NCO	9
72X105X13VSA	2.835	4.134	0.512	SA	FKM	VCS	9	284002VH-H	2.875	4.003	0.250	VH-H	NBR	NCO	9
72X105X13TA	2.835	4.134	0.512	TA	NBR	NCC	9	28403TA-H	2.875	4.003	0.375	TA-H	NBR	NCC	9
72X105X13TC	2.835	4.134	0.512	TC	NBR	NCC	9	284003TB-H	2.875	4.003	0.375	TB-H	NBR	NCC	9
72X110X12TC	2.835	4.331	0.472	TC	NBR	NCC	9	2840043SA-H	2.875	4.003	0.437	SA-H	NBR	NCC	9
72X140X12TC	2.835	5.512	0.472	TC	NBR	NCC	3	28404TA-H	2.875	4.003	0.437	TA-H	NBR	NCC	9
SHAFT 2.843								28404TA	2.875	4.003	0.438	TA	NBR	NCC	9
SHAFT-EZE 99282							S1	2840046SA-H	2.875	4.003	0.468	SA-H	NBR	NCC	9
V-RING -070							7	28413SA-H	2.875	4.125	0.375	SA-H	NBR	NCC	9
28439349TA-H	2.843	3.939	0.495	TA-H	NBR	NCC	9	28413TA	2.875	4.125	0.375	TA	NBR	NCC	9
SHAFT 2.844								28413TA-H	2.875	4.125	0.375	TA-H	NBR	NCC	9
SHAFT-EZE 99282							S1	28425TA-H	2.875	4.249	0.500	TA-H	NBR	NCC	9
V-RING -070							7	2843343PTB-H	2.875	4.331	0.437	TB-H	ACM	PCC	9
2843935TB-H	2.844	3.938	0.500	TB-H	NBR	NCC	9	2844946SA-H	2.875	4.499	0.468	SA-H	NBR	NCC	9
2843935TA-H	2.844	3.938	0.550	TA-H	NBR	NCC	9	2845043SA-H	2.875	4.501	0.433	SA-H	NBR	NCC	9
284395TA	2.844	3.939	0.500	TA	NBR	NCC	9	28454SA	2.875	4.501	0.438	SA	NBR	NCC	9
284395TA-H	2.844	3.939	0.500	TA-H	NBR	NCC	9	28454TA	2.875	4.501	0.438	TA	NBR	NCC	9
28440043SA-H	2.844	4.003	0.437	SA-H	NBR	NCC	9	28464TA	2.875	4.625	0.437	TA	NBR	NCC	9
SHAFT 2.859								SHAFT 2.901							
V-RING -070							7	V-RING -075							8
285375PSA-H	2.859	3.750	0.500	SA-H	ACM	PCC	9	293625C	2.901	3.601	0.232	SC	NBR	NCC	9
SHAFT 2.874								SHAFT 2.913							
SHAFT-EZE 99287							S1	V-RING -075							8
V-RING -075							8	74X90X10TB	2.913	3.543	0.394	TB	NBR	NCC	9
73X90X8TBY	2.874	3.543	0.315	TBY	NBR	NCC	9	74X93X12TC	2.913	3.661	0.472	TC	NBR	NCC	9
73X90X10TB-U	2.874	3.543	0.394	TB-U	NBR	NCC	9	74X95X7TC	2.913	3.740	0.276	TC	NBR	NCC	9
73X95X10SC	2.874	3.740	0.394	SC	NBR	NCC	9	74X95X7VC	2.913	3.740	0.276	VC	NBR	NCO	9
73X96X9VTF	2.874	3.780	0.354	TF	FKM	VCS	9	74X95X10SA	2.913	3.740	0.394	SA	NBR	NCC	9
73X108X12TC	2.874	4.252	0.472	TC	NBR	NCC	9	74X95X10TA	2.913	3.740	0.394	TA	NBR	NCC	9
SHAFT 2.875								74X96X9TC	2.913	3.780	0.354	TC	NBR	NCC	9
SHAFT-EZE 99287							S1	74X98X12TC	2.913	3.858	0.472	TC	NBR	NCC	9
V-RING -075							8	74X100X13SB	2.913	3.937	0.512	SB	NBR	NCC	9
2836243TA-H	2.875	3.622	0.437	TA-H	NBR	NCC	9	74X100X13TB	2.913	3.937	0.512	TB	NBR	NCC	9
283623TA-H	2.875	3.623	0.375	TA-H	NBR	NCC	9	74X100X13TCR	2.913	3.937	0.512	TCR	NBR	NCC	9
28363TB	2.875	3.623	0.375	TB	NBR	NCC	9	74X104X12VTF	2.913	4.094	0.472	TF	FKM	VCS	9
28363TB-H	2.875	3.623	0.375	TB-H	NBR	NCC	9	74X105X12VSF	2.913	4.134	0.472	SF	FKM	VCS	9
28364SA-H	2.875	3.623	0.437	SA-H	NBR	NCC	9	74X135X15SC	2.913	5.315	0.591	SC	NBR	NCC	3
28364SA	2.875	3.623	0.438	SA	NBR	NCC	9	SHAFT 2.937							
283624TB-H	2.875	3.623	0.438	TB-H	NBR	NCC	9	SHAFT-EZE 99290							S1
28373TA	2.875	3.751	0.375	TA	NBR	NCC	9	SHAFT-EZE 99293							S1
28373TA-H	2.875	3.751	0.375	TA-H	NBR	NCC	9	V-RING -075							8
28373VTB	2.875	3.751	0.375	TB	FKM	VCS	9	2933623SB-H	2.937	3.623	0.375	SB-H	NBR	NCC	9
283753VTB-H	2.875	3.751	0.375	TB-H	FKM	VCS	9	2933753SB-H	2.937	3.751	0.375	SB-H	NBR	NCC	9
28373TL	2.875	3.751	0.375	TL	NBR	NCC	9	29373TA-H	2.937	3.751	0.375	TA-H	NBR	NCC	9
28373TL-H	2.875	3.751	0.375	TL-H	NBR	NCC	9	2933873VTA	2.937	3.876	0.375	TA	FKM	VCS	9
28374VSA-H	2.875	3.751	0.437	SA-H	FKM	VCS	9	2933873TA-H	2.937	3.876	0.375	TA-H	NBR	NCC	9
28374SA-H	2.875	3.751	0.437	SA-H	NBR	NCC	9	29395TA-H	2.937	3.937	0.500	TA-H	NBR	NCC	9
28374TA-H	2.875	3.751	0.437	TA-H	NBR	NCC	9	29403TA-H	2.937	4.003	0.375	TA-H	NBR	NCC	9
28374VSA	2.875	3.751	0.438	SA	FKM	VCC	9	29340043SA-H	2.937	4.003	0.437	SA-H	NBR	NCC	9
28374SA	2.875	3.751	0.438	SA	NBR	NCC	9	29340046PTB-H	2.937	4.003	0.468	TB-H	ACM	PCC	9
28374PTA	2.875	3.751	0.438	TA	ACM	PCS	9	29412VBY	2.937	4.125	0.250	VBY	NBR	NCO	9
28374TA	2.875	3.751	0.438	TA	NBR	NCC	9	29344946SA-H	2.937	4.499	0.468	SA-H	NBR	NCC	9
283843SA-H	2.875	3.875	0.437	SA-H	NBR	NCC	9	29444TA	2.937	4.499	0.468	TA	NBR	NCC	9
283851TBJY	2.875	3.875	0.515	TBJY	NBR	NCC	9	SHAFT 2.938							
28382VH	2.875	3.876	0.250	VH	NBR	NCO	9	SHAFT-EZE 99290							S1
28383TA	2.875	3.876	0.375	TA	NBR	NCC	9	SHAFT-EZE 99293							S1
283873TA-H	2.875	3.876	0.375	TA-H	NBR	NCC	9	V-RING -075							8
								2933623TC	2.938	3.623	0.375	TC	NBR	NCC	9

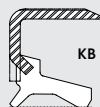
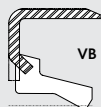
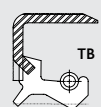
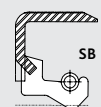
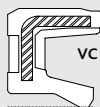



TCM Part #	Shaft	Bore	Width	Type	Lip Material	Material	Box	TCM Part #	Shaft	Bore	Width	Type	Lip Material	Material	Box #
29373VTB	2.938	3.751	0.375	TB	FKM	VCS	9	75X96X11TB	2.953	3.780	0.433	TB	NBR	NCC	9
29373TB	2.938	3.751	0.375	TB	NBR	NCC	9	75X96X11TM	2.953	3.780	0.433	TM	NBR	NCC	9
29373VTB-H	2.938	3.751	0.375	TB-H	FKM	VCS	9	75X100X10SB-H	2.953	3.937	0.393	SB-H	NBR	NCC	9
29373TB-H	2.938	3.751	0.375	TB-H	NBR	NCC	9	75X100X10TG	2.953	3.937	0.393	TG	NBR	NCC	9
2933863VTA-H	2.938	3.867	0.375	TA-H	FKM	VCS	9	75X100X12SC	2.953	3.937	0.472	SC	NBR	NCC	9
29383TA	2.938	3.876	0.375	TA	NBR	NCC	9	75X100X7SC	2.953	3.937	0.276	SC	NBR	NCC	9
29383TA-H	2.938	3.876	0.375	TA-H	NBR	NCC	9	75X100X10VSB	2.953	3.937	0.394	SBR	FKM	VCS	9
29394PTB-H	2.938	3.937	0.437	TB-H	ACM	PCC	9	75X100X10VTC	2.953	3.937	0.394	TC	FKM	VCS	9
29394PTB	2.938	3.937	0.438	TB	ACM	PCS	9	75X100X10TC	2.953	3.937	0.394	TC	NBR	NCC	9
29404TA-H	2.938	4.000	0.438	TA-H	NBR	NCC	9	75X100X10VTF	2.953	3.937	0.394	TF	FKM	VCS	9
29404TA-H	2.938	4.003	0.437	TA-H	NBR	NCC	9	75X100X12VSC	2.953	3.937	0.472	SC	FKM	VCS	9
29404TA	2.938	4.003	0.438	TA	NBR	NCC	9	75X100X12TC	2.953	3.937	0.472	TC	NBR	NCC	9
29404PTB	2.938	4.003	0.438	TB	ACM	PCC	9	75X100X13VSF	2.953	3.937	0.512	SF	FKM	VCS	9
29413SA	2.938	4.125	0.375	SA	NBR	NCC	9	75X100X13SF	2.953	3.937	0.512	SF	NBR	NCS	9
29413SA-H	2.938	4.125	0.375	SA-H	NBR	NCC	9	75X100X13VTZ	2.953	3.937	0.512	TZ	FKM	VCC	9
29413TA	2.938	4.125	0.375	TA	NBR	NCC	9	75X101X12SC	2.953	3.976	0.472	SC	NBR	NCC	9
29413TA-H	2.938	4.125	0.375	TA-H	NBR	NCC	9	75X101X12VSF	2.953	3.976	0.472	SF	FKM	VCS	9
29454SA	2.938	4.501	0.438	SA	NBR	NCC	9	75X102X10TC	2.953	4.016	0.394	TC	NBR	NCC	9
29454SA-H	2.938	4.501	0.438	SA-H	NBR	NCC	9	75X105X10TC	2.953	4.134	0.394	TC	NBR	NCC	9
SHAFT 2.950								75X105X12TC	2.953	4.134	0.472	TC	NBR	NCC	9
SHAFT-EZE 99289							S1	75X105X13TC	2.953	4.134	0.512	TC	NBR	NCC	9
SHAFT-EZE 99294							S1	75X108X10TA	2.953	4.252	0.394	TA	NBR	NCC	9
V-RING -075							8	75X108X13TC	2.953	4.252	0.512	TC	NBR	NCC	9
29453TC	2.950	4.527	0.375	TC	NBR	NCC	9	75X110X12SC	2.953	4.330	0.472	SC	NBR	NCC	9
SHAFT 2.953								75X110X10TC	2.953	4.331	0.394	TC	NBR	NCC	9
SHAFT-EZE 99289							S1	75X110X12TC	2.953	4.331	0.472	TC	NBR	NCC	9
SHAFT-EZE 99294							S1	75X110X13VTC	2.953	4.331	0.512	TC	FKM	VCC	9
V-RING -075							8	75X110X13TC	2.953	4.331	0.512	TC	NBR	NCC	9
75X90X8SB-H	2.953	3.543	0.314	SB-H	NBR	NCC	9	75X112X12SC	2.953	4.409	0.472	SC	NBR	NCC	9
75X90X4VAY	2.953	3.543	0.157	VAY	NBR	NCO	9	75X112X12VSF	2.953	4.409	0.472	SF	FKM	VCS	9
75X90X6TC	2.953	3.543	0.236	TC	NBR	NCC	9	75X115X12SC	2.953	4.527	0.472	SC	NBR	NCC	9
75X90X6VG	2.953	3.543	0.236	VG	NBR	NCO	9	75X115X13SA-H	2.953	4.527	0.511	SA-H	NBR	NCC	9
75X90X7SB	2.953	3.543	0.276	SB	NBR	NCC	9	75X115X9.5TC	2.953	4.528	0.374	TC	NBR	NCC	9
75X90X8SC	2.953	3.543	0.315	SC	NBR	NCC	9	75X115X12SB	2.953	4.528	0.472	SB	NBR	NCC	9
75X90X8TC	2.953	3.543	0.315	TC	NBR	NCC	9	2954523TA	2.953	4.528	0.375	TA	NBR	NCC	9
75X90X8VTF	2.953	3.543	0.315	TF	FKM	VCS	9	75X115X12SB-H	2.953	4.528	0.472	SB-H	NBR	NCC	9
75X90X10SA	2.953	3.543	0.394	SA	NBR	NCC	9	75X120X12SC	2.953	4.724	0.472	SC	NBR	NCC	9
75X90X10TC	2.953	3.543	0.394	TC	NBR	NCC	9	75X120X12VSF	2.953	4.724	0.472	SF	FKM	VCS	9
75X90X12TA	2.953	3.543	0.472	TA	NBR	NCC	9	75X120X12VTC	2.953	4.724	0.472	TC	FKM	VCC	9
75X92X7TC	2.953	3.622	0.276	TC	NBR	NCC	9	75X120X13TC	2.953	4.724	0.512	TC	NBR	NCC	9
75X92X12TC	2.953	3.622	0.472	TC	NBR	NCC	9	75X121X13TB	2.953	4.764	0.512	TB	NBR	NCC	3
75X93X9TC	2.953	3.661	0.354	TC	NBR	NCC	9	75X121X13TC	2.953	4.764	0.512	TC	NBR	NCC	3
75X94X10TC	2.953	3.701	0.394	TC	NBR	NCC	9	75X121X13TZ	2.953	4.764	0.512	TZ	NBR	NCC	3
75X95X10SB-H	2.953	3.740	0.393	SB-H	NBR	NCC	9	75X125X12TC	2.953	4.921	0.472	TC	NBR	NCC	3
75X95X10SG	2.953	3.740	0.393	SG	NBR	NCC	9	75X130X12SC	2.953	5.118	0.472	SC	NBR	NCC	3
75X95X10TG	2.953	3.740	0.393	TG	NBR	NCC	9	75X130X13VSF	2.953	5.118	0.512	SF	FKM	VCS	3
75X95X5SB	2.953	3.740	0.197	SB	NBR	NCC	9	SHAFT 2.983							
75X95X7SC	2.953	3.740	0.276	SC	NBR	NCC	9	V-RING -075							8
75X95X7TC	2.953	3.740	0.276	TC	NBR	NCC	9	298383TA	2.983	3.875	0.375	TA	NBR	NCC	9
75X95X8PSGW	2.953	3.740	0.315	SGW	ACM	PCC	9	SHAFT 2.992							
75X95X8VTC	2.953	3.740	0.315	TC	FKM	VCC	9	SHAFT-EZE 99299							S1
75X95X8TC	2.953	3.740	0.315	TC	NBR	NCC	9	SHAFT-EZE 99291							S1
75X95X8PTCW	2.953	3.740	0.315	TCW	ACM	PCC	9	SHAFT-EZE 99298							S1
75X95X10VDC	2.953	3.740	0.394	DC	FKM	VCS	9	V-RING -075							8
75X95X10SC	2.953	3.740	0.394	SC	NBR	NCC	9	76X93X10TCL	2.992	3.661	0.394	TCL	NBR	NCC	9
75X95X10VSCY	2.953	3.740	0.394	SCY	FKM	VSS	9	76X93X10STCL	2.992	3.661	0.394	TCL	VMQ	SCC	9
75X95X10VSF	2.953	3.740	0.394	SF	FKM	VCS	9	76X98X12TC	2.992	3.858	0.472	TC	NBR	NCC	9
75X95X10TC	2.953	3.740	0.394	TC	NBR	NCC	9	76X98X12STCR	2.992	3.858	0.472	TCR	VMQ	SCC	9
75X95X10VTF	2.953	3.740	0.394	TF	FKM	VCS	9	76X100X12TC	2.992	3.937	0.472	TC	NBR	NCC	9
75X95X12SB	2.953	3.740	0.472	SB	NBR	NCC	9	76X105X13TC	2.992	4.134	0.512	TC	NBR	NCC	9
75X95X12SC	2.953	3.740	0.472	SC	NBR	NCC	9	76X114X14TC	2.992	4.488	0.551	TC	NBR	NCC	9
75X95X12VSCL	2.953	3.740	0.472	SCL	FKM	VCC	9	76X120X12SC	2.992	4.724	0.472	SC	NBR	NCC	9
75X96X8.5TC	2.953	3.780	0.335	TC	NBR	NCC	9								

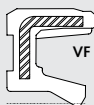
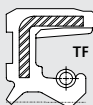
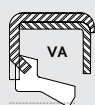
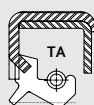
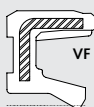
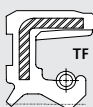
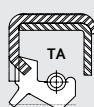



Table with columns for TCM Part #, Shaft, Bore, Width, Type, Lip Material, Material, Box, and corresponding values for various seal models.



OIL AND GREASE SEALS - A COMPLETE LISTING

PLEASE CALL DICHTOMATIK FOR AVAILABILITY - 800-328-2840
BULK AND INDIVIDUALLY BOXED QUANTITIES ARE AVAILABLE FOR ALL



DICHTOMATIK

Any seal. Any time.

COMPLETE LISTING

TCM				Lip				TCM				Lip			
Part #	Shaft	Bore	Width	Type	Material	Material	Box #	Part #	Shaft	Bore	Width	Type	Material	Material	Box
SHAFT 3.187															
V-RING -080							8								8
31842443SA-H	3.187	4.248	0.437	SA-H	NBR	NCC	9	324245TA-H	3.250	4.249	0.500	TA-H	NBR	NCC	9
3142465SA-H	3.187	4.249	0.468	SA-H	NBR	NCC	9	324231TC	3.250	4.250	0.313	TC	NBR	NCC	9
318426TAY	3.187	4.250	0.625	TAY	NBR	NSS	9	324343SA-H	3.250	4.375	0.437	SA-H	NBR	NCC	9
3184343SA-H	3.187	4.375	0.437	SA-H	NBR	NCC	9	324344TA	3.250	4.376	0.438	TA	NBR	NCC	9
31844946SA-H	3.187	4.499	0.468	SA-H	NBR	NCC	9	32435TA-H	3.250	4.376	0.500	TA-H	NBR	NCC	9
3184643SA-H	3.187	4.625	0.437	SA-H	NBR	NCC	9	3244946TA-H	3.250	4.499	0.468	TA-H	NBR	NCC	9
3184644TB-H	3.187	4.625	0.442	TB-H	NBR	NCC	9	32453XOUB	3.250	4.500	0.313	OUB	XNBR	XCO	9
SHAFT 3.188															
V-RING -080							8								8
318424SA	3.188	4.249	0.438	SA	NBR	NCC	9	32455VTCTN	3.250	4.500	0.500	TCN	FKM	VCS	9
318454SA	3.188	4.501	0.438	SA	NBR	NCC	9	32455VTEC	3.250	4.500	0.500	TEC	FKM	VCS	9
318454SA-H	3.188	4.501	0.438	SA-H	NBR	NCC	9	32452VH	3.250	4.501	0.250	VH	NBR	NCO	9
318464TA	3.188	4.626	0.438	TA	NBR	NCC	9	324502VH-H	3.250	4.501	0.250	VH-H	NBR	NCO	9
31494SA-H	3.188	4.999	0.437	SA-H	NBR	NCC	3	324503SB-H	3.250	4.501	0.375	SB-H	NBR	NCC	9
31494SA	3.188	4.999	0.438	SA	NBR	NCC	3	324503UA	3.250	4.501	0.375	UA	NBR	NCO	9
SHAFT 3.189															
V-RING -080							8								8
81X96X10TC	3.189	3.780	0.394	TC	NBR	NCC	9	3245043SA-H	3.250	4.501	0.437	SA-H	NBR	NCC	9
81X100X10TA	3.189	3.937	0.394	TA	NBR	NCC	9	32504TA	3.250	4.501	0.438	TA	NBR	NCC	9
318464TB	3.189	4.626	0.442	TB	NBR	NCC	9	32504TA-H	3.250	4.501	0.438	TA-H	NBR	NCC	9
SHAFT 3.228															
SHAFT-EZE 99328							S1								S1
V-RING -080							8								8
82X100X8SC	3.228	3.937	0.315	SC	NBR	NCC	9	324645A-H	3.250	4.626	0.437	SA-H	NBR	NCC	9
82X105X10VTCJL	3.228	4.134	0.394	TCJL	FKM	VCC	9	32464SA	3.250	4.626	0.438	SA	NBR	NCC	9
82X105X10STCJL	3.228	4.134	0.394	TCJL	VMQ	SCC	9	32465TA-H	3.250	4.626	0.500	TA-H	NBR	NCC	9
82X105X12TC	3.228	4.134	0.472	TC	NBR	NCC	9	32474TA	3.250	4.723	0.468	TA	NBR	NCC	9
82X110X12VSC	3.228	4.331	0.472	SC	FKM	VCS	9	32474TA-H	3.250	4.723	0.468	TA-H	NBR	NCC	9
82X110X12TC	3.228	4.331	0.472	TC	NBR	NCC	9	324733SC	3.250	4.730	0.375	SC	NBR	NCC	9
82X110X13SA	3.228	4.331	0.512	SA	NBR	NCC	9	3247543SA-H	3.250	4.751	0.437	SA-H	NBR	NCC	3
82X110X13VSC	3.228	4.331	0.512	SC	FKM	VCC	9	324754TA-H	3.250	4.751	0.438	TA-H	NBR	NCC	3
SHAFT 3.250															
SHAFT-EZE 99322							S1								S1
SHAFT-EZE 99324							S1								S1
SHAFT-EZE 99325							S1								S1
SHAFT-EZE 99326							S1								S1
V-RING -080							8								8
3236218VF	3.250	3.623	0.187	VF	NBR	NCO	9	SHAFT 3.268							
32381010VM	3.250	3.816	0.109	VM	NBR	NCO	9	V-RING -080							
32392TM	3.250	3.940	0.250	TM	NBR	NCC	9	83X100X9TC							
32405TC	3.250	4.000	0.500	TC	NBR	NCC	9	3.268 3.937 0.354 TC NBR NCC 9							
324003SB-H	3.250	4.003	0.375	SB-H	NBR	NCC	9	83X110X12SA-U							
32403TA-H	3.250	4.003	0.375	TA-H	NBR	NCC	9	3.268 4.331 0.472 SA-U NBR NCC 9							
32403PTB	3.250	4.003	0.375	TB	ACM	PCC	9	83X110X12TA							
32404TA	3.250	4.003	0.468	TA	NBR	NCC	9	3.268 4.331 0.472 TA NBR NCC 9							
32404TA-H	3.250	4.003	0.468	TA-H	NBR	NCC	9	83X110X13SA							
324156SA	3.250	4.125	0.562	SA	NBR	NCC	9	3.268 4.331 0.512 SA NBR NCC 9							
324156SA-H	3.250	4.125	0.562	SA-H	NBR	NCC	9	SHAFT 3.287							
324243SB-H	3.250	4.248	0.375	SB-H	NBR	NCC	9	V-RING -085							
3242443VSA-H	3.250	4.248	0.437	SA-H	FKM	VCS	9	83.5X110X16EDA							
3242443SA-H	3.250	4.248	0.437	SA-H	NBR	NCC	9	3.287 4.331 0.630 DA EPDM ECC 9							
32422VB	3.250	4.249	0.250	VB	NBR	NCO	9	SHAFT 3.298							
324243VSB	3.250	4.249	0.375	SB	FKM	VCS	9	V-RING -085							
32423TA-H	3.250	4.249	0.375	TA-H	NBR	NCC	9	324156SA-H							
32423VTB	3.250	4.249	0.375	TB	FKM	VCS	9	3.298 4.125 0.562 SA-H NBR NCC 9							
32423VTB-H	3.250	4.249	0.375	TB-H	FKM	VCS	9	SHAFT 3.307							
32423VTB-H	3.250	4.249	0.375	TB-H	FKM	VCS	9	SHAFT-EZE 99331							
32423TB-H	3.250	4.249	0.375	TB-H	NBR	NCC	9	S1							
32424TA-H	3.250	4.249	0.437	TA-H	NBR	NCC	9	V-RING -085							
32424TA	3.250	4.249	0.438	TA	NBR	NCC	9	84X104X8.5VTCCL3.307							
SHAFT 3.312															
SHAFT-EZE 99331							S1								S1
V-RING -085							8								8
3314143SA-H	3.312	4.125	0.437	SA-H	NBR	NCC	9	84X104X8.5VTCCL3.307 4.094 0.335 TCL FKM VCC 9							
331425TA-H	3.312	4.249	0.500	TA-H	NBR	NCC	9	84X105X12TC							
33435TA-H	3.312	4.376	0.500	TA-H	NBR	NCC	9	3.307 4.134 0.472 TC NBR NCC 9							
33444TA-H	3.312	4.499	0.468	TA-H	NBR	NCC	9	84X105X13TA							
3314543SA-H	3.312	4.500	0.437	SA-H	NBR	NCC	9	3.307 4.134 0.512 TA NBR NCC 9							
33145046SA-H	3.312	4.501	0.468	SA-H	NBR	NCC	9	84X110X12SA							
33475TA-H	3.312	4.751	0.500	TA-H	NBR	NCC	3	3.307 4.331 0.472 SA NBR NCC 9							
SHAFT 3.312															
SHAFT-EZE 99331							S1								S1
V-RING -085							8								8
3314143SA-H	3.312	4.125	0.437	SA-H	NBR	NCC	9	84X110X16TC							
331425TA-H	3.312	4.249	0.500	TA-H	NBR	NCC	9	3.307 4.331 0.630 TC NBR NCC 9							
33435TA-H	3.312	4.376	0.500	TA-H	NBR	NCC	9	SHAFT 3.312							
33444TA-H	3.312	4.499	0.468	TA-H	NBR	NCC	9	SHAFT-EZE 99331							
3314543SA-H	3.312	4.500	0.437	SA-H	NBR	NCC	9	S1							
33145046SA-H	3.312	4.501	0.468	SA-H	NBR	NCC	9	V-RING -085							
33475TA-H	3.312	4.751	0.500	TA-H	NBR	NCC	3	3314143SA-H							
SHAFT 3.312															
SHAFT-EZE 99331							S1								S1
V-RING -085							8								8
3314143SA-H	3.312	4.125	0.437	SA-H	NBR	NCC	9	331425TA-H							
331425TA-H	3.312	4.249	0.500	TA-H	NBR	NCC	9	3.312 4.249 0.500 TA-H NBR NCC 9							
33435TA-H	3.312	4.376	0.500	TA-H	NBR	NCC	9	33435TA-H							
33444TA-H	3.312	4.499	0.468	TA-H	NBR	NCC	9	3.312 4.376 0.500 TA-H NBR NCC 9							
3314543SA-H	3.312	4.500	0.437	SA-H	NBR	NCC	9	33444TA-H							
33145046SA-H	3.312	4.501	0.468	SA-H	NBR	NCC	9	3.312 4.499 0.468 TA-H NBR NCC 9							
33475TA-H	3.312	4.751	0.500	TA-H	NBR	NCC	3	3314543SA-H							
SHAFT 3.312															
SHAFT-EZE 99331							S1								S1
V-RING -085							8								8
3314143SA-H	3.312	4.125	0.437	SA-H	NBR	NCC	9	33145046SA-H							
331425TA-H	3.312	4.249	0.500	TA-H	NBR	NCC	9	3.312 4.501 0.468 SA-H NBR NCC 9							
33435TA-H	3.312	4.376	0.500	TA-H	NBR	NCC	9	33475TA-H							
33444TA-H	3.312	4.499	0.468	TA-H	NBR	NCC	9	3.312 4.751 0.500 TA-H NBR NCC 3							

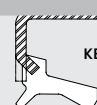
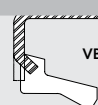
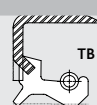
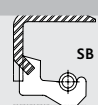
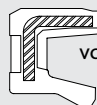

OIL AND GREASE SEALS - A COMPLETE LISTING

PLEASE CALL DICHTOMATIK FOR AVAILABILITY - 800-328-2840
BULK AND INDIVIDUALLY BOXED QUANTITIES ARE AVAILABLE FOR ALL



DICHTOMATIK

Any seal. Any time.

TCM Part #	Shaft	Bore	Width	Type	Lip Material	Material	Box #
SHAFT 3.386							
V-RING -085							8
86X104X11TC	3.386	4.094	0.433	TC	NBR	NCC	9
86X110X13SA	3.386	4.331	0.512	SA	NBR	NCS	9
86X110X13SB	3.386	4.331	0.512	SB	NBR	NCC	9
86X110X13TB	3.386	4.331	0.512	TB	NBR	NCC	9
SHAFT 3.425							
V-RING -085							8
87X100X12TC	3.425	3.937	0.472	TC	NBR	NCC	9
87X110X13SA	3.425	4.331	0.512	SA	NBR	NCC	9
SHAFT 3.437							
SHAFT-EZE 99339							S2
V-RING -085							8
34423TA-H	3.437	4.249	0.375	TA-H	NBR	NCC	9
343453TB-H	3.437	4.500	0.375	TB-H	NBR	NCC	9
3434503TA-H	3.437	4.501	0.375	TA-H	NBR	NCC	9
34345043SA-H	3.437	4.501	0.437	SA-H	NBR	NCC	9
3434643SA-H	3.437	4.625	0.437	SA-H	NBR	NCC	9
34465TA-H	3.437	4.626	0.500	TA-H	NBR	NCC	9
34347556SA-H	3.437	4.756	0.562	SA-H	NBR	NCC	6
34349943SA-H	3.437	4.998	0.437	SA-H	NBR	NCC	6
3449465SA-H	3.437	4.999	0.468	SA-H	NBR	NCC	3
345246SA-H	3.437	5.250	0.468	SA-H	NBR	NCC	3
SHAFT 3.438							
SHAFT-EZE 99339							S2
V-RING -085							8
34423SB	3.438	4.249	0.375	SB	NBR	NCC	9
34423SB-H	3.438	4.249	0.375	SB-H	NBR	NCC	9
34453TA	3.438	4.501	0.375	TA	NBR	NCC	9
34453TA-H	3.438	4.501	0.375	TA-H	NBR	NCC	9
34454TA	3.438	4.501	0.438	TA	NBR	NCC	9
34454TA-H	3.438	4.501	0.438	TA-H	NBR	NCC	9
344624TA-H	3.438	4.626	0.438	TA-H	NBR	NCC	9
34474SA	3.438	4.756	0.438	SA	NBR	NCC	3
34474SA-H	3.438	4.756	0.438	SA-H	NBR	NCC	3
34484SA-H	3.438	4.876	0.437	SA-H	NBR	NCC	3
34484SA	3.438	4.876	0.438	SA	NBR	NCC	3
SHAFT 3.465							
V-RING -085							8
88X100X13SC	3.465	3.937	0.512	SC	NBR	NCC	9
88X105X10TC	3.465	4.134	0.394	TC	NBR	NCC	9
88X106X8.5VTCL	3.465	4.173	0.335	TCL	FKM	VCC	9
88X108X11VTGL	3.465	4.252	0.433	TGL	FKM	VCC	9
88X110X10SC	3.465	4.331	0.394	SC	NBR	NCC	9
88X110X12VSC	3.465	4.331	0.472	SC	FKM	VCC	9
88X110X12SC	3.465	4.331	0.472	SC	NBR	NCC	9
88X110X13SA	3.465	4.331	0.512	SA	NBR	NCC	9
88X110X13SC	3.465	4.331	0.512	SC	NBR	NCC	9
88X110X13VSF	3.465	4.331	0.512	SF	FKM	VCS	9
88X110X13TB	3.465	4.331	0.512	TB	NBR	NCC	9
88X120X12SC	3.465	4.724	0.472	SC	NBR	NCC	9
88X120X12VSF	3.465	4.724	0.472	SF	FKM	VCS	9
88X120X13SA	3.465	4.724	0.512	SA	NBR	NCC	9
88X120X13TC	3.465	4.724	0.512	TC	NBR	NCC	9
88X121.5X12SC	3.465	4.783	0.472	SC	NBR	NCC	3
88X126X12SC	3.465	4.961	0.472	SC	NBR	NCC	3
88X126X12VSF	3.465	4.961	0.472	SF	FKM	VCS	3
88X126X12VTF	3.465	4.961	0.472	TF	FKM	VCS	3
88X128X10TC	3.465	5.039	0.394	TC	NBR	NCC	3
88X128X12VSF	3.465	5.039	0.472	SF	FKM	VCS	3
88X140X13SC	3.465	5.512	0.512	SC	NBR	NCC	3
88X140X13VSF	3.465	5.512	0.512	SF	FKM	VCS	3

TCM Part #	Shaft	Bore	Width	Type	Lip Material	Material	Box
SHAFT 3.500							
SHAFT-EZE 99346							S2
SHAFT-EZE 99347							S2
SHAFT-EZE 99350							S2
SHAFT-EZE 99348							S2
V-RING -090							8
35402VB	3.500	4.000	0.250	VB	NBR	NCO	9
354002VL-H	3.500	4.003	0.250	VL-H	NBR	NCO	9
35412VB	3.500	4.125	0.250	VB	NBR	NCO	9
35412VB-H	3.500	4.125	0.250	VB-H	NBR	NCO	9
354131SC	3.500	4.125	0.312	SC	NBR	NCC	9
354131TC	3.500	4.125	0.313	TC	NBR	NCC	9
3542443VTA-H	3.500	4.248	0.437	TA-H	FKM	VCS	9
354239SC	3.500	4.250	0.394	SC	NBR	NCC	9
35425TC	3.500	4.250	0.500	TC	NBR	NCC	9
354335B-H	3.500	4.375	0.375	SB-H	NBR	NCC	9
354343TA-H	3.500	4.375	0.437	TA-H	NBR	NCC	9
35433TB	3.500	4.376	0.375	TB	NBR	NCC	9
354373VTB-H	3.500	4.376	0.375	TB-H	FKM	VCS	9
35433TB-H	3.500	4.376	0.375	TB-H	NBR	NCC	9
35435TA-H	3.500	4.376	0.500	TA-H	NBR	NCC	9
35442VC	3.500	4.499	0.250	VC	NBR	NCO	9
3544946SA-H	3.500	4.499	0.468	SA-H	NBR	NCC	9
3544946TA-H	3.500	4.499	0.468	TA-H	NBR	NCC	9
35453TC	3.500	4.500	0.375	TC	NBR	NCC	9
35455DCNY	3.500	4.500	0.500	DCNY	NBR	NCS	9
354502VH-H	3.500	4.501	0.250	VH-H	NBR	NCO	9
3545035B-H	3.500	4.501	0.375	SB-H	NBR	NCC	9
354503VTB-H	3.500	4.501	0.375	TB-H	FKM	VCS	9
354503TB-H	3.500	4.501	0.375	TB-H	NBR	NCC	9
35454SA-H	3.500	4.501	0.437	SA-H	NBR	NCC	9
35454PTA-H	3.500	4.501	0.437	TA-H	ACM	PCC	9
35454VSA	3.500	4.501	0.438	SA	FKM	VCS	9
35454SA	3.500	4.501	0.438	SA	NBR	NCC	9
35454PTA	3.500	4.501	0.438	TA	ACM	PCS	9
35454TA	3.500	4.501	0.438	TA	NBR	NCC	9
35454PTA-H	3.500	4.501	0.438	TA-H	ACM	PCS	9
35454TA-H	3.500	4.501	0.438	TA-H	NBR	NCC	9
35454TCN	3.500	4.501	0.438	TCN	NBR	NCC	9
3545046PTA-H	3.500	4.501	0.468	TA-H	ACM	PCC	9
354546TA-H	3.500	4.501	0.468	TA-H	NBR	NCC	9
354505SA	3.500	4.501	0.500	SA	NBR	NCC	9
354643SA-H	3.500	4.625	0.437	SA-H	NBR	NCC	9
35465TA-H	3.500	4.625	0.500	TA-H	NBR	NCC	9
35464TA	3.500	4.626	0.438	TA	NBR	NCC	9
35464TA-H	3.500	4.626	0.438	TA-H	NBR	NCC	9
35472VH	3.500	4.751	0.250	VH	NBR	NCO	3
354753PTB-H	3.500	4.751	0.375	TB-H	ACM	PCC	3
3547543SA-H	3.500	4.751	0.437	SA-H	NBR	NCC	3
3547543TA-H	3.500	4.751	0.437	TA-H	NBR	NCC	3
35475TA-H	3.500	4.751	0.500	TA-H	NBR	NCC	3
354756SA-H	3.500	4.751	0.625	SA-H	NBR	NCC	3
35488TAY	3.500	4.842	0.898	TAY	NBR	NCC	3
354875TA	3.500	4.875	0.500	TA	NBR	NCC	3
354875TA-H	3.500	4.875	0.500	TA-H	NBR	NCC	3
3549943PTA-H	3.500	4.998	0.437	TA-H	ACM	PCC	3
3549943VTB-H	3.500	4.998	0.437	TB-H	FKM	VCS	3
35494SA-H	3.500	4.999	0.437	SA-H	NBR	NCC	3
35494SA	3.500	4.999	0.438	SA	NBR	NCC	3
35494TA-H	3.500	4.999	0.468	TA-H	NBR	NCC	3
35514TA-H	3.500	5.126	0.438	TA-H	NBR	NCC	3
35524SA-H	3.500	5.251	0.438	SA-H	NBR	NCC	3
35524TA-H	3.500	5.251	0.468	TA-H	NBR	NCC	3
35535TC	3.500	5.375	0.500	TC	NBR	NCC	3

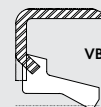
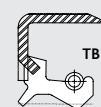
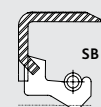



TCM Part #	Shaft	Bore	Width	Type	Lip Material	Material	Box	TCM Part #	Shaft	Bore	Width	Type	Lip Material	Material	Box #
35555TA-H	3.500	5.500	0.500	TA-H	NBR	NCC	3	90X120X12TB	3.543	4.724	0.472	TB	NBR	NCC	9
3557556SA-H	3.500	5.751	0.562	SA-H	NBR	NCC	3	90X120X12VTF	3.543	4.724	0.472	TF	FKM	VCS	9
SHAFT 3.501															
SHAFT-EZE 99346							S2	90X120X13TA	3.543	4.724	0.512	TA	NBR	NCC	9
SHAFT-EZE 99347							S2	90X120X13TC	3.543	4.724	0.512	TC	NBR	NCC	9
SHAFT-EZE 99350							S2	90X122X14TC	3.543	4.803	0.551	TC	NBR	NCC	3
SHAFT-EZE 99348							S2	90X125X12TC	3.543	4.921	0.472	TC	NBR	NCC	3
SHAFT-EZE 99349							S2	90X125X13TC	3.543	4.921	0.512	TC	NBR	NCC	3
V-RING -090							8	90X125X13TM	3.543	4.921	0.512	TM	NBR	NCC	3
35474TA-H	3.501	4.751	0.438	TA-H	NBR	NCC	3	90X125X15VTC	3.543	4.921	0.591	TC	FKM	VCC	3
SHAFT 3.543															
SHAFT-EZE 99351							S2	90X127X12SZ	3.543	5.000	0.472	SZ	NBR	NCC	3
SHAFT-EZE 99352							S2	90X127X13TB	3.543	5.000	0.512	TB	NBR	NCC	3
SHAFT-EZE 99353							S2	90X130X10TC	3.543	5.118	0.394	TC	NBR	NCC	3
SHAFT-EZE 99354							S2	90X130X12TC	3.543	5.118	0.472	TC	NBR	NCC	3
V-RING -090							8	90X130X13SC	3.543	5.118	0.512	SC	NBR	NCC	3
90X105X4KC	3.543	4.134	0.157	KC	NBR	NCO	9	90X130X13VSF	3.543	5.118	0.512	SF	FKM	VCS	3
90X105X4VC	3.543	4.134	0.157	VC	NBR	NCO	9	90X130X13TC	3.543	5.118	0.512	TC	NBR	NCC	3
90X105X9TC	3.543	4.134	0.354	TC	NBR	NCC	9	90X130X13VTF	3.543	5.118	0.512	TF	FKM	VCS	3
90X105X10TC	3.543	4.134	0.394	TC	NBR	NCC	9	90X135X13TC	3.543	5.315	0.512	TC	NBR	NCC	3
90X105X10VC	3.543	4.134	0.394	VC	NBR	NCO	9	90X140X13SA	3.543	5.512	0.512	SA	NBR	NCC	3
90X105X13TC	3.543	4.134	0.512	TC	NBR	NCC	9	90X140X13SC	3.543	5.512	0.512	SC	NBR	NCC	3
90X109X10TC	3.543	4.291	0.394	TC	NBR	NCC	9	90X140X13TC	3.543	5.512	0.512	TC	NBR	NCC	3
90X109X9/10STC9L	3.543	4.291	0.354/0.394	TC9L	VMQ	SCC	9	90X160X12SC	3.543	6.299	0.472	SC	NBR	NCC	5
90X110X125B-H	3.543	4.330	0.472	SB-H	NBR	NCC	9	90X160X13TC	3.543	6.299	0.512	TC	NBR	NCC	5
90X110X7TC	3.543	4.331	0.276	TC	NBR	NCC	9	SHAFT 3.562							
90X110X7VTGL	3.543	4.331	0.276	TGL	FKM	VCC	9	SHAFT-EZE 99356							S2
90X110X8SA	3.543	4.331	0.315	SA	NBR	NCC	9	V-RING -090							8
90X110X9SB	3.543	4.331	0.354	SB	NBR	NCC	9	356444TA-H	3.562	4.499	0.468	TA-H	NBR	NCC	9
90X110X10SC	3.543	4.331	0.394	SC	NBR	NCC	9	3564643SA-H	3.562	4.625	0.437	SA-H	NBR	NCC	9
90X110X10VSF	3.543	4.331	0.394	SF	FKM	VCS	9	356465TA-H	3.562	4.625	0.500	TA-H	NBR	NCC	9
90X110X10TB	3.543	4.331	0.394	TB	NBR	NCC	9	3564755TA-H	3.562	4.751	0.500	TA-H	NBR	NCC	3
90X110X10TC	3.543	4.331	0.394	TC	NBR	NCC	9	SHAFT 3.563							
90X110X10TCL	3.543	4.331	0.394	TCL	NBR	NCC	9	SHAFT-EZE 99356							S2
90X110X10VTF	3.543	4.331	0.394	TF	FKM	VCS	9	V-RING -090							8
90X110X10TM	3.543	4.331	0.394	TM	NBR	NCC	9	356454SA-H	3.563	4.501	0.437	SA-H	NBR	NCC	9
90X110X12VSC	3.543	4.331	0.472	SC	FKM	VCS	9	356454SA	3.563	4.501	0.438	SA	NBR	NCC	9
90X110X12SC	3.543	4.331	0.472	SC	NBR	NCC	9	356484SA	3.563	4.876	0.438	SA	NBR	NCC	3
90X110X12TC	3.543	4.331	0.472	TC	NBR	NCC	9	SHAFT 3.583							
90X110X12VTF	3.543	4.331	0.472	TF	FKM	VCS	9	V-RING -090							8
90X110X12VC	3.543	4.331	0.472	VC	NBR	NCO	9	91X136X12VSF	3.583	5.354	0.472	SF	FKM	VCS	3
90X110X13SC	3.543	4.331	0.512	SC	NBR	NCC	9	SHAFT 3.622							
90X110X13VTF	3.543	4.331	0.512	TF	FKM	VCS	9	SHAFT-EZE 99360							S2
90X110X15TC	3.543	4.331	0.591	TC	NBR	NCC	9	V-RING -090							8
90X115X12TC	3.543	4.527	0.472	TC	NBR	NCC	9	92X108X10TC	3.622	4.252	0.394	TC	NBR	NCC	9
90X115X12TG	3.543	4.527	0.472	TG	NBR	NCC	9	92X110X10TC	3.622	4.331	0.394	TC	NBR	NCC	9
90X115X8SC	3.543	4.528	0.315	SC	NBR	NCC	9	92X120X12VTC	3.622	4.724	0.472	TC	FKM	VCC	9
90X115X8VC	3.543	4.528	0.315	VC	NBR	NCO	9	92X120X13SC	3.622	4.724	0.512	SC	NBR	NCC	9
90X115X9SA	3.543	4.528	0.354	SA	NBR	NCC	9	SHAFT 3.625							
90X115X9VSF	3.543	4.528	0.354	SF	FKM	VCS	9	SHAFT-EZE 99362							S2
90X115X9TC	3.543	4.528	0.354	TC	NBR	NCC	9	SHAFT-EZE 99363							S2
90X115X12VTF	3.543	4.528	0.472	TF	FKM	VCS	9	V-RING -090							8
90X115X12.70VTM4-H	3.543	4.528	0.500	TM4-H	FKM	VCS	9	36422TM	3.625	4.240	0.250	TM	NBR	NCC	9
90X115X13VTB	3.543	4.528	0.512	TB	FKM	VCS	9	36433PSA-H	3.625	4.375	0.375	SA-H	ACM	PCC	9
90X115X13TB	3.543	4.528	0.512	TB	NBR	NCC	9	36433SA-H	3.625	4.375	0.375	SA-H	NBR	NCC	9
90X115X13TZ	3.543	4.528	0.512	TZ	NBR	NCC	9	36433TB	3.625	4.375	0.375	TB	NBR	NCC	9
90X118X12TB	3.543	4.646	0.472	TB	NBR	NCC	9	36433TA-H	3.625	4.376	0.375	TA-H	NBR	NCC	9
90X118X12TC	3.543	4.646	0.472	TC	NBR	NCC	9	36454TA	3.625	4.499	0.468	TA	NBR	NCC	9
90X120X125B-H	3.543	4.724	0.472	SB-H	NBR	NCC	9	36454TA-H	3.625	4.499	0.468	TA-H	NBR	NCC	9
90X120X10SB	3.543	4.724	0.394	SB	NBR	NCC	9	36449465TB	3.625	4.499	0.468	TB	VMQ	SCC	9
90X120X10SC	3.543	4.724	0.394	SC	NBR	NCC	9	3645035B-H	3.625	4.501	0.375	SB-H	NBR	NCC	9
90X120X12SA	3.543	4.724	0.472	SA	NBR	NCC	9	364635B-H	3.625	4.625	0.375	SB-H	NBR	NCC	9
90X120X12SC	3.543	4.724	0.472	SC	NBR	NCC	9	364643TA-H	3.625	4.625	0.437	TA-H	NBR	NCC	9
								36465SA	3.625	4.625	0.500	SA	NBR	NCC	9

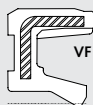
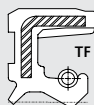
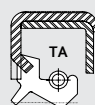

OIL AND GREASE SEALS - A COMPLETE LISTING

PLEASE CALL DICHTOMATIK FOR AVAILABILITY - 800-328-2840
BULK AND INDIVIDUALLY BOXED QUANTITIES ARE AVAILABLE FOR ALL



DICHTOMATIK

Any seal. Any time.

TCM Part #	Shaft	Bore	Width	Type	Lip Material	Material	Box #	TCM Part #	Shaft	Bore	Width	Type	Lip Material	Material	Box
36465TA-H	3.625	4.625	0.500	TA-H	NBR	NCC	9	95X115X12VTF	3.740	4.528	0.472	TF	FKM	VCS	9
36464TA-H	3.625	4.626	0.438	TA-H	NBR	NCC	9	95X115X12.5VTF	3.740	4.528	0.492	TGR	FKM	VCC	9
36474SA-H	3.625	4.751	0.438	SA-H	NBR	NCC	3	95X115X13SC	3.740	4.528	0.512	SC	NBR	NCC	9
36475TA-H	3.625	4.751	0.500	TA-H	NBR	NCC	3	95X115X13VTF	3.740	4.528	0.512	TF	FKM	VCS	9
36475TB	3.625	4.751	0.500	TB	VMQ	SCC	3	95X118X10TCL	3.740	4.646	0.394	TCL	NBR	NCC	9
36485TA-H	3.625	4.875	0.500	TA-H	NBR	NCC	3	95X120X12SB-H	3.740	4.724	0.472	SB-H	NBR	NCC	9
36484SA-H	3.625	4.876	0.437	SA-H	NBR	NCC	3	95X120X8TC	3.740	4.724	0.315	TC	NBR	NCC	9
36484SA	3.625	4.876	0.438	SA	NBR	NCC	3	95X120X8VC	3.740	4.724	0.315	VC	NBR	NCO	9
3649943SA-H	3.625	4.998	0.437	SA-H	NBR	NCC	3	95X120X10TB	3.740	4.724	0.394	TB	NBR	NCC	9
3649943TA-H	3.625	4.998	0.437	TA-H	NBR	NCC	3	95X120X10TC	3.740	4.724	0.394	TC	NBR	NCC	9
36493VTB	3.625	4.999	0.375	TB	FKM	VCS	3	95X120X12SC	3.740	4.724	0.472	SC	NBR	NCC	9
364993VTB-H	3.625	4.999	0.375	TB-H	FKM	VCS	3	95X120X12TC	3.740	4.724	0.472	TC	NBR	NCC	9
36493VTB-H	3.625	4.999	0.375	TB-H	FKM	VCS	3	95X120X12VTF	3.740	4.724	0.472	TF	FKM	VCS	9
36493TB-H	3.625	4.999	0.375	TB-H	NBR	NCC	3	95X120X12VTG	3.740	4.724	0.472	TG	FKM	VCS	9
364995TA-H	3.625	4.999	0.500	TA-H	NBR	NCC	3	95X120X13SB	3.740	4.724	0.512	SB	NBR	NCC	9
36495TA-H	3.625	4.999	0.575	TA-H	NBR	NCC	3	95X120X13SC	3.740	4.724	0.512	SC	NBR	NCC	9
36523TB	3.625	5.251	0.375	TB	NBR	NCC	3	95X120X13VSZ	3.740	4.724	0.512	SZ	FKM	VCS	9
36523TB-H	3.625	5.251	0.375	TB-H	NBR	NCC	3	95X120X13TC	3.740	4.724	0.512	TC	NBR	NCC	9
36524TA-H	3.625	5.251	0.437	TA-H	NBR	NCC	3	95X125X12SB-H	3.740	4.921	0.472	SB-H	NBR	NCC	3
SHAFT 3.661								95X125X12SC	3.740	4.921	0.472	SC	NBR	NCC	3
SHAFT 3.687								95X125X12TC	3.740	4.921	0.472	TC	NBR	NCC	3
SHAFT 3.688								95X125X12VTF	3.740	4.921	0.472	TF	FKM	VCS	3
SHAFT 3.740								95X125X13SA	3.740	4.921	0.512	SA	NBR	NCC	3
SHAFT 3.750								95X125X13TC	3.740	4.921	0.512	TC	NBR	NCC	3
SHAFT 3.750								95X127X13TB	3.740	5.000	0.512	TB	NBR	NCC	3
SHAFT 3.750								95X130X12SC	3.740	5.118	0.472	SC	NBR	NCC	3
SHAFT 3.750								95X130X12TA	3.740	5.118	0.472	TA	NBR	NCC	3
SHAFT 3.750								95X130X12VTC	3.740	5.118	0.472	TC	FKM	VCS	3
SHAFT 3.750								95X130X12TC	3.740	5.118	0.472	TC	NBR	NCC	3
SHAFT 3.750								95X130X13TA	3.740	5.118	0.512	TA	NBR	NCC	3
SHAFT 3.750								95X130X15TC	3.740	5.118	0.591	TC	NBR	NCC	3
SHAFT 3.750								95X132X12SC	3.740	5.197	0.472	SC	NBR	NCC	3
SHAFT 3.750								95X135X13TC	3.740	5.315	0.512	TC	NBR	NCC	3
SHAFT 3.750								95X136X13SC	3.740	5.354	0.512	SC	NBR	NCC	3
SHAFT 3.750								95X145X10TC	3.740	5.709	0.394	TC	NBR	NCC	3
SHAFT 3.750								95X145X13SC	3.740	5.709	0.512	SC	NBR	NCC	3
SHAFT 3.750								95X145X13TC	3.740	5.709	0.512	TC	NBR	NCC	3
SHAFT 3.750								95X150X12TA-H	3.740	5.906	0.472	TA-H	NBR	NCC	3
SHAFT 3.750								95X150X15VSF	3.740	5.906	0.591	SF	FKM	VCS	3
SHAFT 3.750								95X160X15VSF	3.740	6.299	0.591	SF	FKM	VCS	5
SHAFT 3.750								SHAFT-EZE 99367						S2	
SHAFT 3.750								SHAFT-EZE 99372						S2	
SHAFT 3.750								SHAFT-EZE 99376						S2	
SHAFT 3.750								V-RING -095						8	
SHAFT 3.750								37432VB	3.750	4.376	0.250	VB	NBR	NCO	9
SHAFT 3.750								3744946PTA-H	3.750	4.499	0.468	TA-H	ACM	PCC	9
SHAFT 3.750								3744946VTA-H	3.750	4.499	0.468	TA-H	FKM	VCS	9
SHAFT 3.750								3744946TA-H	3.750	4.499	0.468	TA-H	NBR	NCC	9
SHAFT 3.750								37455VTF	3.750	4.500	0.500	TF	FKM	VCS	9
SHAFT 3.750								374503VSB-H	3.750	4.501	0.375	SB-H	FKM	VCS	9
SHAFT 3.750								37454PTA	3.750	4.501	0.469	TA	ACM	PCC	9
SHAFT 3.750								37454PTA-H	3.750	4.501	0.469	TA-H	ACM	PCC	9
SHAFT 3.750								374625TA-H	3.750	4.626	0.500	TA-H	NBR	NCC	9
SHAFT 3.750								37475VSA-H	3.750	4.750	0.500	SA-H	FKM	VCS	3
SHAFT 3.750								374753PSB-H	3.750	4.751	0.375	SB-H	ACM	PCC	3
SHAFT 3.750								374753SB-H	3.750	4.751	0.375	SB-H	NBR	NCC	3
SHAFT 3.750								37473TB	3.750	4.751	0.375	TB	NBR	NCC	3
SHAFT 3.750								37473TB-H	3.750	4.751	0.375	TB-H	NBR	NCC	3
SHAFT 3.750								3747543VSA-H	3.750	4.751	0.437	SA-H	FKM	VCS	3
SHAFT 3.750								3747543SA-H	3.750	4.751	0.437	SA-H	NBR	NCC	3
SHAFT 3.750								37474PTB-H	3.750	4.751	0.437	TB-H	ACM	PCC	3
SHAFT 3.750								37474VTA	3.750	4.751	0.438	TA	FKM	VCS	3
SHAFT 3.750								374745TA	3.750	4.751	0.438	TA	VMQ	SCC	3

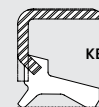
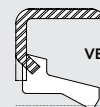
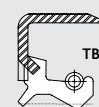
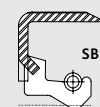
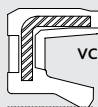



TCM Part #	Shaft	Bore	Width	Type	Lip Material	Material	Box	TCM Part #	Shaft	Bore	Width	Type	Lip Material	Material	Box #
37474TA-H	3.750	4.751	0.438	TA-H	NBR	NCC	3	38485SA-H	3.875	4.875	0.500	SA-H	NBR	NCC	3
374745TA-H	3.750	4.751	0.438	TA-H	VMQ	SCC	3	38485TA	3.875	4.875	0.500	TA-H	NBR	NCC	3
374754TA-PL-H	3.750	4.751	0.438	TA-PL-H	NBR	NCC	3	38485TA-H	3.875	4.875	0.500	TA-H	NBR	NCC	3
37474PTB	3.750	4.751	0.438	TB	ACM	PCC	3	38493VTB	3.875	4.999	0.375	TB	FKM	VCS	3
374755TA-H	3.750	4.751	0.500	TA-H	NBR	NCC	3	38493TB	3.875	4.999	0.375	TB	NBR	NCC	3
374843SA-H	3.750	4.875	0.437	SA-H	NBR	NCC	3	384993VTB-H	3.875	4.999	0.375	TB-H	FKM	VCS	3
37485TA-H	3.750	4.875	0.500	TA-H	NBR	NCC	3	38493TB-H	3.875	4.999	0.375	TB-H	NBR	NCC	3
374842TA	3.750	4.876	0.428	TA	NBR	NCC	3	38495TA-H	3.875	4.999	0.500	TA-H	NBR	NCC	3
374842TA-H	3.750	4.876	0.428	TA-H	NBR	NCC	3	3851143TA-H	3.875	5.118	0.437	TA-H	NBR	NCC	3
374993VSB-H	3.750	4.998	0.375	SB-H	FKM	VCS	3	38515TA-H	3.875	5.125	0.500	TA-H	NBR	NCC	3
374993SB-H	3.750	4.998	0.375	SB-H	NBR	NCC	3	38514SA-H	3.875	5.126	0.437	SA-H	NBR	NCC	3
3749943SA-H	3.750	4.998	0.437	SA-H	NBR	NCC	3	38514SA	3.875	5.126	0.438	SA	NBR	NCC	3
37493TB	3.750	4.999	0.375	TB	NBR	NCC	3	38525TA-H	3.875	5.250	0.500	TA-H	NBR	NCC	3
37494TA	3.750	4.999	0.438	TA	NBR	NCC	3	38524TA	3.875	5.251	0.438	TA	NBR	NCC	3
37494TA-H	3.750	4.999	0.438	TA-H	NBR	NCC	3	38524TA-H	3.875	5.251	0.438	TA-H	NBR	NCC	3
374995TA-H	3.750	4.999	0.500	TA-H	NBR	NCC	3	38534SA-H	3.875	5.376	0.438	SA-H	NBR	NCC	3
3752543SA-H	3.750	5.251	0.437	SA-H	NBR	NCC	3	38535TA-H	3.875	5.376	0.500	TA-H	NBR	NCC	3
37524TA	3.750	5.251	0.468	TA-H	NBR	NCC	3	38555TA-H	3.875	5.501	0.500	TA-H	NBR	NCC	3
37524TA-H	3.750	5.251	0.468	TA-H	NBR	NCC	3	SHAFT 3.880							
37534SC	3.750	5.375	0.438	SC	NBR	NCC	3	V-RING -100							9
375375TA-H	3.750	5.376	0.500	TA-H	NBR	NCC	3	38856955A-H	3.880	5.690	0.500	SA-H	NBR	NCC	3
37605SA	3.750	6.001	0.500	SA	NBR	NCC	5	SHAFT 3.937							
SHAFT 3.780								SHAFT-EZE 99393							52
V-RING -095							8	V-RING -100							9
96X112X10SC	3.780	4.409	0.394	SC	NBR	NCC	9	100X114X7TB	3.937	4.488	0.276	TB	NBR	NCC	9
96X136X12VVF	3.780	5.354	0.472	SF	FKM	VCS	3	100X114X10SB	3.937	4.488	0.394	SB	NBR	NCC	9
96X140X13TC	3.780	5.512	0.512	TC	NBR	NCC	3	100X114X12TB	3.937	4.488	0.472	TB	NBR	NCC	9
SHAFT 3.785								100X115X4KC	3.937	4.528	0.157	KC	NBR	NCO	9
V-RING -095							8	100X115X4VAY	3.937	4.528	0.157	VAY	NBR	NCO	9
38514TA-H	3.785	5.126	0.438	TA-H	NBR	NCC	3	100X115X4VC	3.937	4.528	0.157	VC	NBR	NCO	9
SHAFT 3.812								100X115X9SC	3.937	4.528	0.354	SC	NBR	NCC	9
V-RING -095							8	100X115X9VSF	3.937	4.528	0.354	SF	FKM	VCS	9
3814875TC	3.812	4.875	0.500	TC	NBR	NCC	3	100X115X9SM	3.937	4.528	0.354	SM	NBR	NCC	9
381485TA-H	3.812	4.876	0.500	TA-H	NBR	NCC	3	100X115X9VTC	3.937	4.528	0.354	TC	FKM	VCC	9
384946SA-H	3.812	4.999	0.468	SA-H	NBR	NCC	3	100X115X9TC	3.937	4.528	0.354	TC	NBR	NCC	9
381524SA-H	3.812	5.251	0.468	SA-H	NBR	NCC	3	100X120X125B-H	3.937	4.724	0.472	SB-H	NBR	NCC	9
SHAFT 3.813								100X120X12TG	3.937	4.724	0.472	TG	NBR	NCC	9
V-RING -095							8	100X120X8SB	3.937	4.724	0.315	SB	NBR	NCC	9
381452VA1-H	3.813	4.501	0.250	VA1-H	NBR	NCO	9	100X120X8TB	3.937	4.724	0.315	TB	NBR	NCC	9
38452VVAY	3.813	4.501	0.250	VAY	FKM	VCO	9	100X120X10SC	3.937	4.724	0.394	SC	NBR	NCC	9
SHAFT 3.819								100X120X10VTC	3.937	4.724	0.394	TC	FKM	VCC	9
V-RING -095							8	100X120X11STCY	3.937	4.724	0.433	TCY	VMQ	SCC	9
97X120X13TC	3.819	4.724	0.512	TC	NBR	NCC	9	100X120X12VSC	3.937	4.724	0.472	SC	FKM	VCC	9
SHAFT 3.858								100X120X12SC	3.937	4.724	0.472	SC	NBR	NCC	9
V-RING -100							9	100X120X12PTCW	3.937	4.724	0.472	TCW	ACM	PCC	9
98X120X13SC	3.858	4.724	0.512	SC	NBR	NCC	9	100X120X12VTF	3.937	4.724	0.472	TF	FKM	VCS	9
98X120X13TC	3.858	4.724	0.512	TC	NBR	NCC	9	100X120X13VDC	3.937	4.724	0.512	DC	FKM	VCC	9
98X125X13SC	3.858	4.921	0.512	SC	NBR	NCC	3	100X120X13SA	3.937	4.724	0.512	SA	NBR	NCC	9
98X128X10VSF	3.858	5.039	0.394	SF	FKM	VCS	3	100X120X13SC	3.937	4.724	0.512	SC	NBR	NCC	9
98X128X10TA	3.858	5.039	0.394	TA	NBR	NCC	3	3934843SA-H	3.937	4.875	0.437	SA-H	NBR	NCC	3
98X130X13SB	3.858	5.118	0.512	SB	NBR	NCC	3	39485TA-H	3.937	4.876	0.500	TA-H	NBR	NCC	3
SHAFT 3.875								100X125X125B-H	3.937	4.921	0.472	SB-H	NBR	NCC	3
SHAFT-EZE 99387							52	100X125X12TG	3.937	4.921	0.472	TG	NBR	NCC	3
V-RING -100							9	100X125X8SC	3.937	4.921	0.315	SC	NBR	NCC	3
38473TA-H	3.875	4.751	0.375	TA-H	NBR	NCC	3	100X125X10TC	3.937	4.921	0.394	TC	NBR	NCC	3
38473TB	3.875	4.751	0.375	TB	NBR	NCC	3	100X125X12SC	3.937	4.921	0.472	SC	NBR	NCC	3
384753VTB-H	3.875	4.751	0.375	TB-H	FKM	VCS	3	100X125X12TC	3.937	4.921	0.472	TC	NBR	NCC	3
38473TB-H	3.875	4.751	0.375	TB-H	NBR	NCC	3	100X125X12VTF	3.937	4.921	0.472	TF	FKM	VCS	3
38474SA	3.875	4.751	0.438	SA	NBR	NCC	3	100X125X13TB	3.937	4.921	0.512	TB	NBR	NCC	3
38474SA-H	3.875	4.751	0.438	SA-H	NBR	NCC	3	100X125X13VTC	3.937	4.921	0.512	TC	FKM	VCS	3
38474SB	3.875	4.751	0.438	SB	NBR	NCC	3	100X125X13VTM	3.937	4.921	0.512	TM	FKM	VCS	3
								100X125X20SB	3.937	4.921	0.787	SB	NBR	NCC	3
								39349943SA-H	3.937	4.998	0.437	SA-H	NBR	NCC	3

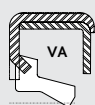
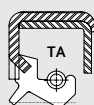

OIL AND GREASE SEALS - A COMPLETE LISTING

PLEASE CALL DICHTOMATIK FOR AVAILABILITY - 800-328-2840
BULK AND INDIVIDUALLY BOXED QUANTITIES ARE AVAILABLE FOR ALL



DICHTOMATIK

Any seal. Any time.

Table with columns: TCM Part #, Shaft, Bore, Width, Type, Lip Material, Material, Box #. Contains multiple sections for different shaft sizes including 4.000, 3.938, 3.976, 4.016.

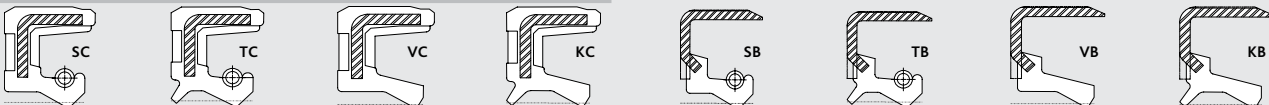



TCM Part #	Shaft	Bore	Width	Type	Lip Material	Material	Box	TCM Part #	Shaft	Bore	Width	Type	Lip Material	Material	Box #
102X135X13SC	4.016	5.315	0.512	SC	NBR	NCC	3	105X130X13SB	4.134	5.118	0.512	SB	NBR	NCC	3
102X135X13TC	4.016	5.315	0.512	TC	NBR	NCC	3	105X130X13TA	4.134	5.118	0.512	TA	NBR	NCC	3
SHAFT 4.055															
V-RING -100							9	105X130X13TB	4.134	5.118	0.512	TB	NBR	NCC	3
103X125X13SA	4.055	4.921	0.512	SA	NBR	NCC	3	105X130X13VTC	4.134	5.118	0.512	TC	FKM	VCS	3
SHAFT 4.094															
SHAFT-EZE 99409							52	105X130X13TM	4.134	5.118	0.512	TM	NBR	NCC	3
V-RING -100							9	105X135X12TB-H	4.134	5.314	0.472	TB-H	NBR	NCC	3
104X120X13VSF	4.094	4.724	0.512	SF	FKM	VCS	9	105X135X10TCL	4.134	5.315	0.394	TCL	NBR	NCC	3
104X125X10SC	4.094	4.921	0.394	SC	NBR	NCC	3	105X135X13SC	4.134	5.315	0.512	SC	NBR	NCC	3
104X125X10VSF	4.094	4.921	0.394	SF	FKM	VCS	3	105X135X13VSF	4.134	5.315	0.512	SF	FKM	VCS	3
104X125X10TC	4.094	4.921	0.394	TC	NBR	NCC	3	105X135X13TC	4.134	5.315	0.512	TC	NBR	NCC	3
104X130X10SC	4.094	5.118	0.394	SC	NBR	NCC	3	105X135X13VTC	4.134	5.315	0.512	TC	FKM	VCC	3
SHAFT 4.125															
SHAFT-EZE 99412							52	105X136X13TC	4.134	5.354	0.512	TC	NBR	NCC	3
V-RING -100							9	105X140X12TG	4.134	5.511	0.472	TG	NBR	NCC	3
4149943VSA-H	4.125	4.998	0.437	SA-H	FKM	VCS	3	105X140X12SA	4.134	5.512	0.472	SA	NBR	NCC	3
41494SA	4.125	4.999	0.438	SA	NBR	NCC	3	105X140X12SB	4.134	5.512	0.472	SB	NBR	NCC	3
41494SA-H	4.125	4.999	0.438	SA-H	NBR	NCC	3	105X140X12VSF	4.134	5.512	0.472	SF	FKM	VCS	3
414994SA-PL-H	4.125	4.999	0.438	SA-PL-H	NBR	NCC	3	105X140X12VTF	4.134	5.512	0.472	TF	FKM	VCS	3
4149946SA-H	4.125	4.999	0.468	SA-H	NBR	NCC	3	105X140X13TA	4.134	5.512	0.512	TA	NBR	NCC	3
415143SA-H	4.125	5.125	0.437	SA-H	NBR	NCC	3	105X140X15TB	4.134	5.512	0.591	TB	NBR	NCC	3
41515TA	4.125	5.126	0.500	TA	NBR	NCC	3	105X145X12VTC	4.134	5.709	0.472	TC	FKM	VCS	3
41515TA-H	4.125	5.126	0.500	TA-H	NBR	NCC	3	105X145X13SB	4.134	5.709	0.512	SB	NBR	NCC	3
4152543VSA-H	4.125	5.251	0.437	SA-H	FKM	VCS	3	105X145X15TC	4.134	5.709	0.591	TC	NBR	NCC	3
4152543SA-H	4.125	5.251	0.437	SA-H	NBR	NCC	3	105X145X16VSF	4.134	5.709	0.630	SF	FKM	VCS	3
41524TA-H	4.125	5.251	0.468	TA-H	NBR	NCC	3	105X160X12SC	4.134	6.299	0.472	SC	NBR	NCC	5
41554SA	4.125	5.501	0.438	SA	NBR	NCC	3	SHAFT 4.166							
41554SA-H	4.125	5.501	0.438	SA-H	NBR	NCC	3	V-RING -110							9
41555TA-H	4.125	5.501	0.500	TA-H	NBR	NCC	3	41556TB	4.166	5.501	0.600	TB	NBR	NCC	3
41575TA-H	4.125	5.751	0.562	TA-H	NBR	NCC	3	SHAFT 4.173							
4160043SA-H	4.125	6.001	0.437	SA-H	NBR	NCC	5	V-RING -110							9
SHAFT 4.134															
SHAFT-EZE 99413							52	106X126X12TC	4.173	4.961	0.472	TC	NBR	NCC	3
V-RING -100							9	SHAFT 4.187							
105X120X6TCN	4.134	4.724	0.236	TCN	NBR	NCC	9	SHAFT-EZE 99418							52
105X120X7SB	4.134	4.724	0.276	SB	NBR	NCC	9	V-RING -110							9
105X120X10SC	4.134	4.724	0.394	SC	NBR	NCC	9	418494TA-H	4.187	4.999	0.468	TA-H	NBR	NCC	3
105X120X11TB	4.134	4.724	0.433	TB	NBR	NCC	9	418525SA	4.187	5.250	0.500	SA	NBR	NCC	3
105X120X11TC	4.134	4.724	0.433	TC	NBR	NCC	9	41224SA-H	4.187	5.251	0.468	SA-H	NBR	NCC	3
105X125X6TC	4.134	4.921	0.236	TC	NBR	NCC	3	418575TA-H	4.187	5.751	0.500	TA-H	NBR	NCC	3
105X125X10SC	4.134	4.921	0.394	SC	NBR	NCC	3	SHAFT 4.188							
105X125X12SB	4.134	4.921	0.472	SB	NBR	NCC	3	SHAFT-EZE 99418							52
105X125X12TC	4.134	4.921	0.472	TC	NBR	NCC	3	V-RING -110							9
105X125X12VTF	4.134	4.921	0.472	TF	FKM	VCS	3	41849946TA-H	4.188	4.999	0.468	TA-H	NBR	NCC	3
105X125X13SA	4.134	4.921	0.512	SA	NBR	NCC	3	SHAFT 4.235							
105X125X13SB	4.134	4.921	0.512	SB	NBR	NCC	3	V-RING -110							9
105X125X13SC	4.134	4.921	0.512	SC	NBR	NCC	3	4235842VBY	4.235	5.844	0.250	VBY	NBR	NCO	3
105X125X13VSF	4.134	4.921	0.512	SF	FKM	VCS	3	SHAFT 4.250							
105X125X13TA	4.134	4.921	0.512	TA	NBR	NCC	3	SHAFT-EZE 99424							52
105X125X13TB	4.134	4.921	0.512	TB	NBR	NCC	3	V-RING -110							9
105X125X13TB-U	4.134	4.921	0.512	TB-U	NBR	NCC	3	42483VB	4.250	4.875	0.313	VB	NBR	NCC	3
105X125X13TC	4.134	4.921	0.512	TC	NBR	NCC	3	42505TC	4.250	5.000	0.500	TC	NBR	NCC	3
105X130X12VSB-H	4.134	5.118	0.472	SB-H	FKM	VCS	3	42512VH-H	4.250	5.125	0.250	VH-H	NBR	NCO	3
105X130X8TCN	4.134	5.118	0.315	TCN	NBR	NCC	3	42523TB	4.250	5.250	0.438	TB	NBR	NCC	3
105X130X12SB	4.134	5.118	0.472	SB	NBR	NCC	3	42525TA-H	4.250	5.250	0.500	TA-H	NBR	NCC	3
105X130X12SC	4.134	5.118	0.472	SC	NBR	NCC	3	42525SC	4.250	5.250	0.595	SC	NBR	NCC	3
105X130X12VSC	4.134	5.118	0.472	SCL	FKM	VCS	3	425252VH-H	4.250	5.251	0.250	VH-H	NBR	NCO	3
105X130X12VSF	4.134	5.118	0.472	SF	FKM	VCS	3	42523SSB-H	4.250	5.251	0.375	SB-H	VMQ	SCC	3
105X130X12TC	4.134	5.118	0.472	TC	NBR	NCC	3	42523TB-H	4.250	5.251	0.375	TB-H	NBR	NCC	3
105X130X12VTF	4.134	5.118	0.472	TF	FKM	VCS	3	4252543VSA-H	4.250	5.251	0.437	SA-H	FKM	VCS	3
105X130X13SA	4.134	5.118	0.512	SA	NBR	NCC	3	4252543TA-H	4.250	5.251	0.437	TA-H	NBR	NCC	3
								4252543VTFN	4.250	5.251	0.437	TFN	FKM	VCS	3
								42524SA-H	4.250	5.251	0.438	SA-H	NBR	NCC	3
								42524SB	4.250	5.251	0.438	SB	NBR	NCC	3

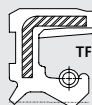
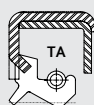

OIL AND GREASE SEALS - A COMPLETE LISTING

PLEASE CALL DICHTOMATIK FOR AVAILABILITY - 800-328-2840
BULK AND INDIVIDUALLY BOXED QUANTITIES ARE AVAILABLE FOR ALL



DICHTOMATIK

Any seal. Any time.

TCM Part #	Shaft	Bore	Width	Type	Lip Material	Material	Box #	TCM Part #	Shaft	Bore	Width	Type	Lip Material	Material	Box	
425374VTB-H	4.250	5.373	0.438	TB-H	FKM	VCS	3	110X130X12VC	4.331	5.118	0.472	VC	NBR	NCO	3	
425343SA-H	4.250	5.375	0.437	SA-H	NBR	NCC	3	110X130X13SA	4.331	5.118	0.512	SA	NBR	NCC	3	
42535TA-H	4.250	5.376	0.500	TA-H	NBR	NCC	3	110X130X13TB	4.331	5.118	0.512	TB	NBR	NCC	3	
42555TA-H	4.250	5.500	0.500	TA-H	NBR	NCC	3	110X132X12SB	4.331	5.197	0.472	SB	NBR	NCC	3	
42554SA-H	4.250	5.501	0.437	SA-H	NBR	NCC	3	110X132X12TB	4.331	5.197	0.472	TB	NBR	NCC	3	
42554SA	4.250	5.501	0.438	SA	NBR	NCC	3	110X135X10TC	4.331	5.315	0.394	TC	NBR	NCC	3	
42565TA-H	4.250	5.626	0.500	TA-H	NBR	NCC	3	110X135X12SC	4.331	5.315	0.472	SC	NBR	NCC	3	
425743SC	4.250	5.750	0.437	SC	NBR	NCC	3	110X135X12VSF	4.331	5.315	0.472	SF	FKM	VCS	3	
4257543SA-H	4.250	5.751	0.437	SA-H	NBR	NCC	3	110X135X12TC	4.331	5.315	0.472	TC	NBR	NCC	3	
425756TA	4.250	5.751	0.562	TA	NBR	NCC	3	110X135X13SC	4.331	5.315	0.512	SC	NBR	NCC	3	
425756TA-H	4.250	5.751	0.562	TA-H	NBR	NCC	3	110X135X13VSF	4.331	5.315	0.512	SF	FKM	VCS	3	
42595TA-H	4.250	5.999	0.500	TA-H	NBR	NCC	3	110X135X13TC	4.331	5.315	0.512	TC	NBR	NCC	3	
42605SA	4.250	6.001	0.500	SA	NBR	NCC	5	110X140X10SA	4.331	5.512	0.394	SA	NBR	NCC	3	
42605SA-H	4.250	6.001	0.500	SA-H	NBR	NCC	5	110X140X10SC	4.331	5.512	0.394	SC	NBR	NCC	3	
42615TA	4.250	6.126	0.500	TA	NBR	NCC	5	110X140X10TC	4.331	5.512	0.394	TC	NBR	NCC	3	
42615TA-H	4.250	6.126	0.500	TA-H	NBR	NCC	5	110X140X12SB	4.331	5.512	0.472	SB	NBR	NCC	3	
42625SA-H	4.250	6.250	0.500	SA-H	NBR	NCC	5	110X140X12TC	4.331	5.512	0.472	TC	NBR	NCC	3	
426256TA	4.250	6.250	0.562	TA	NBR	NCC	5	110X140X12VTF	4.331	5.512	0.472	TF	FKM	VCS	3	
426256TA-H	4.250	6.250	0.562	TA-H	NBR	NCC	5	110X140X13SC	4.331	5.512	0.512	SC	NBR	NCC	3	
SHAFT 4.252								110X140X14TC	4.331	5.512	0.551	TC	NBR	NCC	3	
SHAFT-EZE 99424								110X140X12SB-H	4.331	5.512	0.472	SB-H	NBR	NCC	3	
V-RING -110								110X142X14TC	4.331	5.591	0.551	TC	NBR	NCC	3	
108X130X13TA	4.252	5.118	0.512	TA	NBR	NCC	3	110X145X12SB-H	4.331	5.708	0.472	SB-H	NBR	NCC	3	
108X135X15TC	4.252	5.315	0.591	TC	NBR	NCC	3	110X145X12TC	4.331	5.709	0.472	TC	NBR	NCC	3	
108X140X13SA	4.252	5.512	0.512	SA	NBR	NCC	3	110X145X13SC	4.331	5.709	0.512	SC	NBR	NCC	3	
108X145X15SC	4.252	5.709	0.591	SC	NBR	NCC	3	110X145X13VSF	4.331	5.709	0.512	SF	FKM	VCS	3	
108X145X15TC	4.252	5.709	0.591	TC	NBR	NCC	3	110X145X13TC	4.331	5.709	0.512	TC	NBR	NCC	3	
SHAFT 4.291								110X145X14SC	4.331	5.709	0.551	SC	NBR	NCC	3	
V-RING -110								110X145X14TC	4.331	5.709	0.551	TC	NBR	NCC	3	
109X140X13TB	4.291	5.512	0.512	TB	NBR	NCC	3	110X150X13SA	4.331	5.906	0.512	SA	NBR	NCC	3	
SHAFT 4.312								110X150X13VSF	4.331	5.906	0.512	SF	FKM	VCS	3	
V-RING -110								110X150X13TB	4.331	5.906	0.512	TB	NBR	NCC	3	
431535SA-H	4.312	5.376	0.500	SA-H	NBR	NCC	3	110X150X13VTF	4.331	5.906	0.512	TF	FKM	VCS	3	
431575TA-H	4.312	5.751	0.500	TA-H	NBR	NCC	3	110X150X15SA	4.331	5.906	0.591	SA	NBR	NCC	3	
43625TA-H	4.312	6.250	0.500	TA-H	NBR	NCC	5	110X150X15TA	4.331	5.906	0.591	TA	NBR	NCC	3	
SHAFT 4.328								110X155X15SC	4.331	6.102	0.591	SC	NBR	NCC	5	
SHAFT-EZE 99435								110X155X15VSF	4.331	6.102	0.591	SF	FKM	VCS	5	
SHAFT-EZE 99434								110X160X8SC	4.331	6.299	0.315	SC	NBR	NCC	5	
V-RING -110								110X160X12TC	4.331	6.299	0.472	TC	NBR	NCC	5	
43665VTC	4.328	6.693	0.500	TC	FKM	VCS	5	110X160X13TC	4.331	6.299	0.512	TC	NBR	NCC	5	
43665TC	4.328	6.693	0.500	TC	NBR	NCC	5	110X160X15SC	4.331	6.299	0.591	SC	NBR	NCC	5	
SHAFT 4.331								110X170X12TC	4.331	6.693	0.472	TC	NBR	NCC	5	
SHAFT-EZE 99435								110X200X13TC	4.331	7.874	0.512	TC	NBR	NCC	5	
SHAFT-EZE 99434								SHAFT 4.375								
V-RING -110								SHAFT-EZE 99437								S2
110X125X8TB	4.331	4.921	0.315	TB	NBR	NCC	3	V-RING -110								9
110X125X9.5TC	4.331	4.921	0.374	TC	NBR	NCC	3	43535POSA	4.375	5.373	0.570	OSA	ACM	PCS	3	
110X125X12TC	4.331	4.921	0.472	TC	NBR	NCC	3	435343SA-H	4.375	5.375	0.437	SA-H	NBR	NCC	3	
110X125X13SC	4.331	4.921	0.512	SC	NBR	NCC	3	435350TA-H	4.375	5.376	0.500	TA-H	NBR	NCC	3	
110X128X9SA	4.331	5.039	0.354	SA	NBR	NCC	3	43555TA-H	4.375	5.500	0.500	TA-H	NBR	NCC	3	
110X128X9SB	4.331	5.039	0.354	SB	NBR	NCC	3	43554SA-H	4.375	5.501	0.437	SA-H	NBR	NCC	3	
110X128X9TA	4.331	5.039	0.354	TA	NBR	NCC	3	43554SA	4.375	5.501	0.438	SA	NBR	NCC	3	
110X130X12SB-H	4.331	5.118	0.472	SB-H	NBR	NCC	3	43575TA-H	4.375	5.751	0.562	TA-H	NBR	NCC	3	
110X130X12VSC	4.331	5.118	0.472	SC	FKM	VCS	3	43595TA-H	4.375	5.999	0.500	TA-H	NBR	NCC	3	
110X130X8SC	4.331	5.118	0.315	SC	NBR	NCC	3	43605SA	4.375	6.001	0.500	SA	NBR	NCC	5	
110X130X8VSF	4.331	5.118	0.315	SF	FKM	VCS	3	43605SA-H	4.375	6.001	0.500	SA-H	NBR	NCC	5	
110X130X10TC	4.331	5.118	0.394	TC	NBR	NCC	3	436256TA-H	4.375	6.250	0.562	TA-H	NBR	NCC	5	
110X130X10VTGL	4.331	5.118	0.394	TGL	FKM	VCC	3	SHAFT 4.409								
110X130X12SC	4.331	5.118	0.472	SC	NBR	NCC	3	V-RING -110								9
110X130X12VSF	4.331	5.118	0.472	SF	FKM	VCC	3	112X130X8TB	4.409	5.118	0.315	TB	NBR	NCC	3	
110X130X12TC	4.331	5.118	0.472	TC	NBR	NCC	3	112X140X13VSF	4.409	5.512	0.512	SF	FKM	VCS	3	
110X130X12VTF	4.331	5.118	0.472	TF	FKM	VCS	3	SHAFT 4.409								

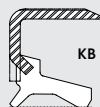
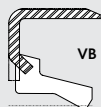
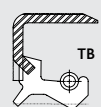
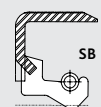
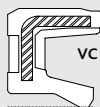



PLEASE CALL DICHTOMATIK FOR AVAILABILITY - 800-328-2840
BULK AND INDIVIDUALLY BOXED QUANTITIES ARE AVAILABLE FOR ALL

TCM Part #	Shaft	Bore	Width	Type	Lip Material	Material	Box	TCM Part #	Shaft	Bore	Width	Type	Lip Material	Material	Box #
SHAFT 4.437								SHAFT 4.528							
SHAFT-EZE 99439							S2	456005VTA-H	4.500	6.001	0.500	TA-H	FKM	VCS	5
V-RING -110							9	456005TA-H	4.500	6.001	0.500	TA-H	NBR	NCC	5
4435556TZ	4.437	5.500	0.562	TZ	NBR	NCC	3	456156SA-H	4.500	6.125	0.562	SA-H	NBR	NCC	5
4435505SA-H	4.437	5.501	0.500	SA-H	NBR	NCC	3	45615TA-H	4.500	6.125	0.562	TA-H	NBR	NCC	5
4435755SA-H	4.437	5.751	0.500	SA-H	NBR	NCC	3	45615SA	4.500	6.126	0.563	SA	NBR	NCC	5
44575TA	4.437	5.751	0.500	TA	NBR	NCC	3	45625SA-H	4.500	6.250	0.500	SA-H	NBR	NCC	5
44575TA-H	4.437	5.751	0.500	TA-H	NBR	NCC	3	45625TA-H	4.500	6.250	0.500	TA-H	NBR	NCC	5
SHAFT 4.438								456375TA-H	4.500	6.374	0.500	TA-H	NBR	NCC	5
SHAFT-EZE 99439							S2	45632VBY	4.500	6.375	0.250	VBY	NBR	NCO	5
V-RING -110							9	45675SA	4.500	6.750	0.500	SA	NBR	NCC	5
44555TA	4.438	5.501	0.500	TA	NBR	NCC	3	SHAFT 4.528							
44555TA-H	4.438	5.501	0.500	TA-H	NBR	NCC	3	SHAFT-EZE 99452							S2
44605SA	4.438	6.001	0.500	SA	NBR	NCC	5	V-RING -110							9
SHAFT 4.488								115X130X12SC	4.528	5.118	0.472	SC	NBR	NCC	3
V-RING -110							9	115X130X12VSF	4.528	5.118	0.472	SF	FKM	VCS	3
114X135X13TB	4.488	5.315	0.512	TB	NBR	NCC	3	115X130X12TC	4.528	5.118	0.472	TC	NBR	NCC	3
114X135X13TC	4.488	5.315	0.512	TC	NBR	NCC	3	115X135X10VTGL	4.528	5.315	0.394	TGL	FKM	VCC	3
114X140X13SA	4.488	5.512	0.512	SA	NBR	NCC	3	115X135X13SB	4.528	5.315	0.512	SB	NBR	NCC	3
114X140X13SC	4.488	5.512	0.512	SC	NBR	NCC	3	115X135X13TB	4.528	5.315	0.512	TB	NBR	NCC	3
114X140X13VSF	4.488	5.512	0.512	SF	FKM	VCS	3	115X135X13TC	4.528	5.315	0.512	TC	NBR	NCC	3
114X140X13TA	4.488	5.512	0.512	TA	NBR	NCC	3	115X135X14TC	4.528	5.315	0.551	TC	NBR	NCC	3
114X140X13TC	4.488	5.512	0.512	TC	NBR	NCC	3	115X140X10VSCY	4.528	5.512	0.394	SCY	FKM	VCC	3
114X145X14SC	4.488	5.709	0.551	SC	NBR	NCC	3	115X140X12SA	4.528	5.512	0.472	SA	NBR	NCC	3
114X145X14TC	4.488	5.709	0.551	TC	NBR	NCC	3	115X140X12SB	4.528	5.512	0.472	SB	NBR	NCC	3
114X150X10SA	4.488	5.906	0.394	SA	NBR	NCC	3	115X140X12VSG	4.528	5.512	0.472	SG	FKM	VCC	3
114X159X14TA	4.488	6.260	0.551	TA	NBR	NCC	5	115X140X12VTC	4.528	5.512	0.472	TC	FKM	VCC	3
SHAFT 4.500								115X140X12TC	4.528	5.512	0.472	TC	NBR	NCC	3
SHAFT-EZE 99450							S2	115X140X12VTF	4.528	5.512	0.472	TF	FKM	VCS	3
V-RING -110							9	115X140X13SB	4.528	5.512	0.512	SB	NBR	NCC	3
45555SA	4.500	5.001	0.562	SA	NBR	NCC	3	115X140X13SC	4.528	5.512	0.512	SC	NBR	NCC	3
45524TC	4.500	5.251	0.437	TC	NBR	NCC	3	115X140X13TB	4.528	5.512	0.512	TB	NBR	NCC	3
45524SA	4.500	5.251	0.438	SA	NBR	NCC	3	115X140X13TC	4.528	5.512	0.512	TC	NBR	NCC	3
45524SA-H	4.500	5.251	0.438	SA-H	NBR	NCC	3	115X140X15SA	4.528	5.512	0.591	SA	NBR	NCC	3
455364VTA-H	4.500	5.367	0.438	TA-H	FKM	VCS	3	115X140X15SB	4.528	5.512	0.591	SB	NBR	NCC	3
455343VTA-H	4.500	5.375	0.437	TA-H	FKM	VCS	3	115X140X15TB	4.528	5.512	0.591	TB	NBR	NCC	3
45534TA	4.500	5.376	0.437	TA	NBR	NCC	3	115X140X12SB-H	4.528	5.512	0.472	SB-H	NBR	NCC	3
45534TA-H	4.500	5.376	0.437	TA-H	NBR	NCC	3	115X142X13TC	4.528	5.591	0.512	TC	NBR	NCC	3
455374VTA-H	4.500	5.376	0.438	TA-H	FKM	VCS	3	115X142X14TC	4.528	5.591	0.551	TC	NBR	NCC	3
45553SC	4.500	5.500	0.375	SC	NBR	NCC	3	115X143X12TC	4.528	5.630	0.472	TC	NBR	NCC	3
455503TB	4.500	5.500	0.375	TB	NBR	NCC	3	115X143X17TC	4.528	5.630	0.669	TC	NBR	NCC	3
455550SA	4.500	5.500	0.500	SA	NBR	NCC	3	115X145X12TC	4.528	5.709	0.472	TC	NBR	NCC	3
45555TA	4.500	5.500	0.500	TA	NBR	NCC	3	115X145X13SC	4.528	5.709	0.512	SC	NBR	NCC	3
45555TA-H	4.500	5.500	0.500	TA-H	NBR	NCC	3	115X145X13VSF	4.528	5.709	0.512	SF	FKM	VCS	3
455502VL-H	4.500	5.501	0.250	VL-H	NBR	NCO	3	115X145X13TA	4.528	5.709	0.512	TA	NBR	NCC	3
45553SB	4.500	5.501	0.375	SB	NBR	NCC	3	115X145X13TC	4.528	5.709	0.512	TC	NBR	NCC	3
45553SB-H	4.500	5.501	0.375	SB-H	NBR	NCC	3	115X145X14VTC	4.528	5.709	0.551	TC	FKM	VCC	3
455503TB-H	4.500	5.501	0.375	TB-H	NBR	NCC	3	115X145X14TC	4.528	5.709	0.551	TC	NBR	NCC	3
45554SA-H	4.500	5.501	0.437	SA-H	NBR	NCC	3	115X145X14VTF	4.528	5.709	0.551	TF	FKM	VCS	3
4555043TA-H	4.500	5.501	0.437	TA-H	NBR	NCC	3	115X150X12SB-H	4.528	5.905	0.472	SB-H	NBR	NCC	3
45554VSA	4.500	5.501	0.438	SA	FKM	VCS	3	115X150X12SC	4.528	5.906	0.472	SC	NBR	NCC	3
45554SA	4.500	5.501	0.438	SA	NBR	NCC	3	115X150X12TC	4.528	5.906	0.472	TC	NBR	NCC	3
4555073TA-PL-H	4.500	5.501	0.438	TA-PL-H	NBR	NCC	3	115X150X12VTF	4.528	5.906	0.472	TF	FKM	VCS	3
45565TA-H	4.500	5.625	0.500	TA-H	NBR	NCC	3	115X150X12VTG	4.528	5.906	0.472	TG	FKM	VCS	3
45564SA	4.500	5.626	0.438	SA	NBR	NCC	3	115X150X13TA	4.528	5.906	0.512	TA	NBR	NCC	3
45564SA-H	4.500	5.626	0.438	SA-H	NBR	NCC	3	115X150X13TC	4.528	5.906	0.512	TC	NBR	NCC	3
45575TA-H	4.500	5.750	0.500	TA-H	NBR	NCC	3	115X150X15TA	4.528	5.906	0.591	TA	NBR	NCC	3
455753VTB-H	4.500	5.751	0.375	TB-H	FKM	VCS	3	115X150X15TB	4.528	5.906	0.591	TB	NBR	NCC	3
4557543SA-H	4.500	5.751	0.437	SA-H	NBR	NCC	3	115X160X15SC	4.528	6.299	0.591	SC	NBR	NCC	5
4557543TA-H	4.500	5.751	0.437	TA-H	NBR	NCC	3	115X160X15VSF	4.528	6.299	0.591	SF	FKM	VCS	5
455875TA-H	4.500	5.876	0.500	TA-H	NBR	NCC	3	115X160X15TC	4.528	6.299	0.591	TC	NBR	NCC	5
45595TA-H	4.500	5.999	0.500	TA-H	NBR	NCC	3	115X165X15TC	4.528	6.496	0.591	TC	NBR	NCC	5
456005SA-H	4.500	6.001	0.500	SA-H	NBR	NCC	5	115X180X15TC	4.528	7.087	0.591	TC	NBR	NCC	5

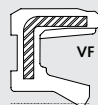
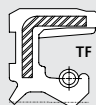
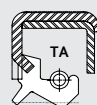

COMPLETE LISTING

OIL AND GREASE SEALS - A COMPLETE LISTING

PLEASE CALL DICHTOMATIK FOR AVAILABILITY - 800-328-2840
 BULK AND INDIVIDUALLY BOXED QUANTITIES ARE AVAILABLE FOR ALL



DICHTOMATIK

Any seal. Any time.

TCM Part #	Shaft	Bore	Width	Type	Lip Material	Material	Box #	TCM Part #	Shaft	Bore	Width	Type	Lip Material	Material	Box	
SHAFT 4.562								120X145X13TM	4.724	5.709	0.512	TM	NBR	NCC	3	
V-RING -120							9	120X145X15TA	4.724	5.709	0.591	TA	NBR	NCC	3	
456575TA-H	4.562	5.751	0.500	TA-H	NBR	NCC	3	120X145X15TB	4.724	5.709	0.591	TB	NBR	NCC	3	
SHAFT 4.567								120X146X13TC	4.724	5.748	0.512	TC	NBR	NCC	3	
V-RING -120							9	120X150X12SB-H	4.724	5.905	0.472	SB-H	NBR	NCC	3	
116X132X12TC	4.567	5.197	0.472	TC	NBR	NCC	3	120X150X12TG	4.724	5.905	0.472	TG	NBR	NCC	3	
SHAFT 4.625								120X150X9SC	4.724	5.906	0.354	SC	NBR	NCC	3	
SHAFT-EZE 99463							S2	120X150X9TC	4.724	5.906	0.354	TC	NBR	NCC	3	
SHAFT-EZE 99465							S2	120X150X10TC	4.724	5.906	0.394	TC	NBR	NCC	3	
V-RING -120							9	120X150X12TC	4.724	5.906	0.472	TC	NBR	NCC	3	
465655A-H	4.625	5.625	0.500	SA-H	NBR	NCC	3	120X150X12VTF	4.724	5.906	0.472	TF	FKM	VCS	3	
46565TA	4.625	5.625	0.500	TA	NBR	NCC	3	120X150X13TB	4.724	5.906	0.512	TB	NBR	NCC	3	
46565TA-H	4.625	5.625	0.500	TA-H	NBR	NCC	3	120X150X14TC	4.724	5.906	0.551	TC	NBR	NCC	3	
465755A-H	4.625	5.751	0.500	SA-H	NBR	NCC	3	120X150X14VTF	4.724	5.906	0.551	TF	FKM	VCS	3	
465756TA	4.625	5.751	0.562	TA	NBR	NCC	3	120X150X15TC	4.724	5.906	0.591	TC	NBR	NCC	3	
465756TA-H	4.625	5.751	0.562	TA-H	NBR	NCC	3	120X152X9TC	4.724	5.984	0.354	TC	NBR	NCC	3	
46595TA-H	4.625	5.999	0.500	TA-H	NBR	NCC	3	120X152X16SA	4.724	5.984	0.630	SA	NBR	NCC	3	
466055A-H	4.625	6.001	0.500	SA-H	NBR	NCC	5	120X153X15TC	4.724	6.024	0.591	TC	NBR	NCC	5	
466255A-H	4.625	6.250	0.500	SA-H	NBR	NCC	5	120X155X12TC	4.724	6.102	0.472	TC	NBR	NCC	5	
466256TA-H	4.625	6.250	0.562	TA-H	NBR	NCC	5	120X155X13TC	4.724	6.102	0.512	TC	NBR	NCC	5	
46661TBY	4.625	6.623	1.094	TBY	NBR	NCC	5	120X155X15TC	4.724	6.102	0.591	TC	NBR	NCC	5	
SHAFT 4.646								120X160X8TB	4.724	6.299	0.315	TB	NBR	NCC	5	
V-RING -120							9	120X160X12TC	4.724	6.299	0.472	TC	NBR	NCC	5	
118X136X13TM	4.646	5.354	0.512	TM	NBR	NCC	3	120X160X12VTF	4.724	6.299	0.472	TF	FKM	VCS	5	
118X140X13SC	4.646	5.512	0.512	SC	NBR	NCC	3	120X160X13VSA	4.724	6.299	0.512	SA	FKM	VCC	5	
118X140X13SZ	4.646	5.512	0.512	SZ	NBR	NCC	3	120X160X13TB	4.724	6.299	0.512	TB	NBR	NCC	5	
118X150X12TA	4.646	5.906	0.472	TA	NBR	NCC	3	120X160X15SA	4.724	6.299	0.591	SA	NBR	NCC	5	
118X150X12TC	4.646	5.906	0.472	TC	NBR	NCC	3	120X160X15TB	4.724	6.299	0.591	TB	NBR	NCC	5	
SHAFT 4.685								120X162X13TC	4.724	6.378	0.512	TC	NBR	NCC	5	
SHAFT-EZE 99468							S2	120X165X14TC	4.724	6.496	0.551	TC	NBR	NCC	5	
V-RING -120							9	120X165X10/14VGJY	4.724	6.496	0.394/0.551	VGJY	NBR	NCO	5	
119X153X15TC	4.685	6.024	0.591	TC	NBR	NCC	5	120X165X10/14.8VGY	4.724	6.496	0.394/0.583	VGY	NBR	NCO	5	
SHAFT 4.687								120X170X15SA	4.724	6.693	0.591	SA	NBR	NCC	5	
SHAFT-EZE 99468							S2	120X170X15TA	4.724	6.693	0.591	TA	NBR	NCC	5	
V-RING -120							9	120X180X13TC	4.724	7.087	0.512	TC	NBR	NCC	5	
468575TA-H	4.687	5.751	0.500	TA-H	NBR	NCC	3	120X180X15TC	4.724	7.087	0.591	TC	NBR	NCC	5	
46857551SA-H	4.687	5.751	0.511	SA-H	NBR	NCC	3	120X195X13SC	4.724	7.677	0.512	SC	NBR	NCC	5	
46857551SSA-H4	4.687	5.751	0.511	SA-H	VMQ	SCC	3	SHAFT 4.750								
SHAFT 4.688								SHAFT-EZE 99475							S2	
SHAFT-EZE 99468							S2	V-RING -120								9
V-RING -120							9	47553SC	4.750	5.500	0.375	SC	NBR	NCC	3	
4686026PVA1-H	4.688	6.001	0.266	VA1-H	ACM	PCO	5	47564SA	4.750	5.625	0.437	SA	NBR	NCC	3	
SHAFT 4.724								47575TA-H	4.750	5.750	0.500	TA-H	NBR	NCC	3	
SHAFT-EZE 99471							S2	47575TB	4.750	5.750	0.500	TB	NBR	NCC	3	
SHAFT-EZE 99473							S2	47575VTF	4.750	5.750	0.500	TF	FKM	VCS	3	
V-RING -120							9	475755SA-H	4.750	5.751	0.500	SA-H	NBR	NCC	3	
120X140X12TB-H	4.724	5.511	0.472	TB-H	NBR	NCC	3	475755VSB-H	4.750	5.751	0.500	SB-H	FKM	VCS	3	
120X140X7.5TC	4.724	5.512	0.295	TC	NBR	NCC	3	475755SB-H	4.750	5.751	0.500	SB-H	NBR	NCC	3	
120X140X10SA	4.724	5.512	0.394	SA	NBR	NCC	3	47575TA	4.750	5.751	0.500	TA	NBR	NCC	3	
120X140X10SC	4.724	5.512	0.394	SC	NBR	NCC	3	47575TA-H	4.750	5.751	0.500	TA-H	NBR	NCC	3	
120X140X10VSF	4.724	5.512	0.394	SF	FKM	VCS	3	475755VTF	4.750	5.751	0.500	VTF	FKM	VCS	3	
120X140X12VTC	4.724	5.512	0.472	TC	FKM	VCC	3	475755VTA-H	4.750	5.751	0.500	VTA-H	NBR	NCC	3	
120X140X12VTF	4.724	5.512	0.472	TF	FKM	VCS	3	475755VTB-H	4.750	5.751	0.500	VTB-H	FKM	VCS	3	
120X140X13SA	4.724	5.512	0.512	SA	NBR	NCC	3	47585TA	4.750	5.876	0.500	TA	NBR	NCC	3	
120X140X13SB	4.724	5.512	0.512	SB	NBR	NCC	3	47585TA-H	4.750	5.876	0.500	TA-H	NBR	NCC	3	
120X140X13TA	4.724	5.512	0.512	TA	NBR	NCC	3	47606TA	4.750	5.999	0.625	TA	NBR	NCC	3	
120X140X13TC	4.724	5.512	0.512	TC	NBR	NCC	3	47606TA-H	4.750	5.999	0.625	TA-H	NBR	NCC	3	
120X145X12TC	4.724	5.709	0.472	TC	NBR	NCC	3	47607TA	4.750	6.000	0.750	TA	NBR	NCC	5	
120X145X13TA	4.724	5.709	0.512	TA	NBR	NCC	3	476005SA-H	4.750	6.001	0.500	SA-H	NBR	NCC	5	
120X145X13TB	4.724	5.709	0.512	TB	NBR	NCC	3	47605TA	4.750	6.001	0.500	TA	NBR	NCC	5	
								47605TA-H	4.750	6.001	0.500	TA-H	NBR	NCC	5	
								47615TA-H	4.750	6.125	0.500	TA-H	NBR	NCC	5	
								476255A-H	4.750	6.250	0.500	SA-H	NBR	NCC	5	
								476256TA	4.750	6.250	0.562	TA	NBR	NCC	5	
								476256TA-H	4.750	6.250	0.562	TA-H	NBR	NCC	5	

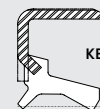
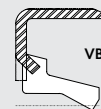
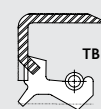
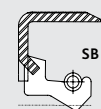
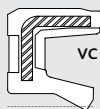
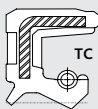
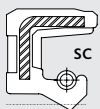
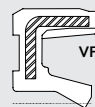
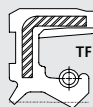
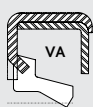
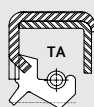



Table with columns: TCM Part #, Shaft, Bore, Width, Type, Lip Material, Material, Box. Includes sections for SHAFT 4.803, 4.812, 4.813, 4.875, 4.915, 4.921.

Table with columns: TCM Part #, Shaft, Bore, Width, Type, Lip Material, Material, Box #. Includes sections for SHAFT 4.937, 5.000, 5.039, 5.062, 5.118.



OIL AND GREASE SEALS - A COMPLETE LISTING

PLEASE CALL DICHTOMATIK FOR AVAILABILITY - 800-328-2840
BULK AND INDIVIDUALLY BOXED QUANTITIES ARE AVAILABLE FOR ALL



DICHTOMATIK

Any seal. Any time.

TCM Part #	Shaft	Bore	Width	Type	Lip Material	Material	Box #	TCM Part #	Shaft	Bore	Width	Type	Lip Material	Material	Box
130X150X10VSF	5.118	5.906	0.394	SF	FKM	VCS	3	132X160X13SA	5.197	6.299	0.512	SA	NBR	NCC	5
130X150X10TC	5.118	5.906	0.394	TC	NBR	NCC	3	SHAFT 5.250							
130X150X10TM	5.118	5.906	0.394	TM	NBR	NCC	3	SHAFT-EZE 99525							
130X150X12TC	5.118	5.906	0.472	TC	NBR	NCC	3	V-RING -130							
130X150X12VTF	5.118	5.906	0.472	TF	FKM	VCS	3	526003SB-H 5.250 6.001 0.375 SB-H NBR NCC 5							
130X150X14VSZ	5.118	5.906	0.551	SZ	FKM	VCS	3	52622VMY 5.250 6.250 0.250 VMY NBR NCO 5							
130X150X14TB	5.118	5.906	0.551	TB	NBR	NCC	3	52625VSA-H 5.250 6.250 0.500 SA-H FKM VCS 5							
130X150X15VTF	5.118	5.906	0.591	TF	FKM	VCS	3	52625SA-H 5.250 6.250 0.500 SA-H NBR NCC 5							
130X153X12TC	5.118	6.024	0.472	TC	NBR	NCC	5	52625TA-H 5.250 6.250 0.500 TA-H NBR NCC 5							
130X154X16TC	5.118	6.063	0.630	TC	NBR	NCC	5	52635TA-H 5.250 6.375 0.500 TA-H NBR NCC 5							
130X155X10SA	5.118	6.102	0.394	SA	NBR	NCC	5	52655VSA-H 5.250 6.500 0.500 SA-H FKM VCS 5							
130X155X10SB	5.118	6.102	0.394	SB	NBR	NCC	5	52655SA-H 5.250 6.500 0.500 SA-H NBR NCC 5							
130X155X10TA	5.118	6.102	0.394	TA	NBR	NCC	5	52655TA-H 5.250 6.500 0.562 TA-H NBR NCC 5							
130X159X14TA	5.118	6.260	0.551	TA	NBR	NCC	5	52675TA 5.250 6.750 0.500 TA NBR NCC 5							
130X159X14TC	5.118	6.260	0.551	TC	NBR	NCC	5	52675TA-H 5.250 6.750 0.500 TA-H NBR NCC 5							
130X160X12SB-H	5.118	6.299	0.472	SB-H	NBR	NCC	5	SHAFT 5.312							
130X160X12SG	5.118	6.299	0.472	SG	NBR	NCC	5	SHAFT-EZE 99533							
130X160X12SB	5.118	6.299	0.472	SB	NBR	NCC	5	V-RING -130							
130X160X12SC	5.118	6.299	0.472	SC	NBR	NCC	5	531655TA-H 5.312 6.500 0.500 TA-H NBR NCC 5							
130X160X12TB	5.118	6.299	0.472	TB	NBR	NCC	5	SHAFT 5.315							
130X160X12TC	5.118	6.299	0.472	TC	NBR	NCC	5	SHAFT-EZE 99533							
130X160X12VTF	5.118	6.299	0.472	TF	FKM	VCS	5	V-RING -130							
130X160X12VC	5.118	6.299	0.472	VC	NBR	NCO	5	135X155X12SC 5.315 6.102 0.472 SC NBR NCC 5							
130X160X12VVB	5.118	6.299	0.492	VB	FKM	VCC	5	135X155X12TC 5.315 6.102 0.472 TC NBR NCC 5							
130X160X13SEA	5.118	6.299	0.512	SEA	NBR	NCC	5	135X155X13TC 5.315 6.102 0.512 TC NBR NCC 5							
130X160X14SC	5.118	6.299	0.551	SC	NBR	NCC	5	135X159X13TC 5.315 6.260 0.512 TC NBR NCC 5							
130X160X14TC	5.118	6.299	0.551	TC	NBR	NCC	5	135X160X10VTF 5.315 6.299 0.394 TF FKM VCS 5							
130X160X14TZ	5.118	6.299	0.551	TZ	NBR	NCC	5	135X160X12TB 5.315 6.299 0.472 TB NBR NCC 5							
130X160X15TC	5.118	6.299	0.591	TC	NBR	NCC	5	135X160X12TC 5.315 6.299 0.472 TC NBR NCC 5							
130X160X18VDC1	5.118	6.299	0.709	DC1	FKM	VCC	5	135X160X12VTF 5.315 6.299 0.472 TF FKM VCS 5							
130X162X9TC	5.118	6.378	0.354	TC	NBR	NCC	5	135X160X13SB 5.315 6.299 0.512 SB NBR NCC 5							
130X163X18TC	5.118	6.417	0.709	TC	NBR	NCC	5	135X160X13VSF 5.315 6.299 0.512 SF FKM VCS 5							
130X165X13SA	5.118	6.496	0.512	SA	NBR	NCC	5	135X160X13TA 5.315 6.299 0.512 TA NBR NCC 5							
130X165X13VTC	5.118	6.496	0.512	TC	FKM	VCC	5	135X160X13TB 5.315 6.299 0.512 TB NBR NCC 5							
130X170X15TC	5.118	6.692	0.590	TC	NBR	NCC	5	135X160X14TZ 5.315 6.299 0.551 TZ NBR NCC 5							
130X170X12SC	5.118	6.693	0.472	SC	NBR	NCC	5	135X160X15VTC 5.315 6.299 0.591 TC FKM VCC 5							
130X170X12VSF	5.118	6.693	0.472	SF	FKM	VCS	5	135X160X15TC 5.315 6.299 0.591 TC NBR NCC 5							
130X170X12VTF	5.118	6.693	0.472	TF	FKM	VCS	5	135X162X13TB 5.315 6.378 0.512 TB NBR NCC 5							
130X170X13TC	5.118	6.693	0.512	TC	NBR	NCC	5	135X162X13TM 5.315 6.378 0.512 TM NBR NCC 5							
130X180X13SC	5.118	7.087	0.512	SC	NBR	NCC	5	135X165X12SC 5.315 6.496 0.472 SC NBR NCC 5							
130X180X15SA	5.118	7.087	0.591	SA	NBR	NCC	5	135X165X12VSF 5.315 6.496 0.472 SF FKM VCS 5							
130X182X16SC	5.118	7.165	0.630	SC	NBR	NCC	5	135X165X12TC 5.315 6.496 0.472 TC NBR NCC 5							
130X182X16VSF	5.118	7.165	0.630	SF	FKM	VCS	5	135X165X13TB 5.315 6.496 0.512 TB NBR NCC 5							
130X190X12TC	5.118	7.480	0.472	TC	NBR	NCC	5	135X165X13VTC 5.315 6.496 0.512 TC FKM VCC 5							
130X200X12TC	5.118	7.874	0.472	TC	NBR	NCC	5	135X165X13TC 5.315 6.496 0.512 TC NBR NCC 5							
130X230X14SC	5.118	9.055	0.551	SC	NBR	NCC	6	135X165X14VSZ 5.315 6.496 0.551 SZ FKM VCS 5							
130X230X14TC	5.118	9.055	0.551	TC	NBR	NCC	6	135X165X14TC 5.315 6.496 0.551 TC NBR NCC 5							
SHAFT 5.125								135X170X12SA 5.315 6.693 0.472 SA NBR NCC 5							
SHAFT-EZE 99491								135X170X12SC 5.315 6.693 0.472 SC NBR NCC 5							
SHAFT-EZE 99513								135X170X12VTF 5.315 6.693 0.472 TF FKM VCS 5							
V-RING -130								135X170X13SA 5.315 6.693 0.512 SA NBR NCC 5							
51615TA-H 5.125 6.125 0.500 TA-H NBR NCC 5								135X170X15SB 5.315 6.693 0.591 SB NBR NCC 5							
51625TA 5.125 6.250 0.500 TA NBR NCC 5								135X170X15SC 5.315 6.693 0.591 SC NBR NCC 5							
51625TA-H 5.125 6.250 0.500 TA-H NBR NCC 5								135X170X15TA 5.315 6.693 0.591 TA NBR NCC 5							
51635TA-H 5.125 6.374 0.500 TA-H NBR NCC 5								135X170X15VTF 5.315 6.693 0.591 TF FKM VCS 5							
51635SA-H 5.125 6.375 0.500 SA-H NBR NCC 5								135X175X12TC 5.315 6.890 0.472 TC NBR NCC 5							
SHAFT 5.187								135X175X16VTF 5.315 6.890 0.630 TF FKM VCS 5							
V-RING -130								135X180X13TC 5.315 7.087 0.512 TC NBR NCC 5							
518656SSA-H 5.187 6.500 0.625 SA-H VMQ SCC 5								135X180X14.5TC 5.315 7.087 0.571 TC NBR NCC 5							
SHAFT 5.197								135X190X14SC 5.315 7.480 0.551 SC NBR NCC 5							
V-RING -130								135X190X15SC 5.315 7.480 0.591 SC NBR NCC 5							
132X150X13SC 5.197 5.906 0.512 SC NBR NCC 3								135X192X16TC 5.315 7.559 0.630 TC NBR NCC 5							
132X160X12TC 5.197 6.299 0.472 TC NBR NCC 5								135X200X12TC 5.315 7.874 0.472 TC NBR NCC 5							

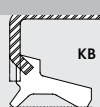
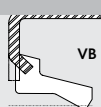
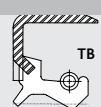
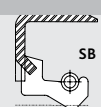
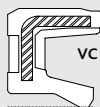
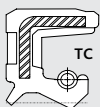



TCM Part #	Shaft	Bore	Width	Type	Lip Material	Material	Box	TCM Part #	Shaft	Bore	Width	Type	Lip Material	Material	Box #
SHAFT 5.375															
SHAFT-EZE 99537							S3	140X160X12TC	5.512	6.299	0.472	TC	NBR	NCC	5
V-RING -140							3	140X160X12VTF	5.512	6.299	0.472	TF	FKM	VCS	5
53635TA-H	5.375	6.374	0.500	TA-H	NBR	NCC	5	140X160X13SA	5.512	6.299	0.512	SA	NBR	NCC	5
536456SA-H	5.375	6.499	0.562	SA-H	NBR	NCC	5	140X160X13SB	5.512	6.299	0.512	SB	NBR	NCC	5
53646TA	5.375	6.499	0.625	TA	NBR	NCC	5	140X160X13SC	5.512	6.299	0.512	SC	NBR	NCC	5
5366256TA-H	5.375	6.624	0.562	TA-H	NBR	NCC	5	140X160X13TA	5.512	6.299	0.512	TA	NBR	NCC	5
536635SA-H	5.375	6.625	0.500	SA-H	NBR	NCC	5	140X160X13TB	5.512	6.299	0.512	TB	NBR	NCC	5
53665TA	5.375	6.625	0.500	TA	NBR	NCC	5	140X160X13TC	5.512	6.299	0.512	TC	NBR	NCC	5
53665TA-H	5.375	6.625	0.500	TA-H	NBR	NCC	5	140X160X13TM	5.512	6.299	0.512	TM	NBR	NCC	5
53666TA	5.375	6.625	0.625	TA	NBR	NCC	5	140X165X10SC	5.512	6.496	0.394	SC	NBR	NCC	5
53675TA	5.375	6.749	0.500	TA	NBR	NCC	5	140X165X12SA	5.512	6.496	0.472	SA	NBR	NCC	5
53675TA-H	5.375	6.749	0.500	TA-H	NBR	NCC	5	140X165X12VSF	5.512	6.496	0.472	SF	FKM	VCS	5
SHAFT 5.394															
V-RING -140							3	140X165X12TA	5.512	6.496	0.472	TA	NBR	NCC	5
137X160X11.14TAY	5.394	6.299	0.439	TAY	NBR	NCC	5	140X165X12VTF	5.512	6.496	0.472	TF	FKM	VCS	5
SHAFT 5.433															
V-RING -140							3	140X165X13TB	5.512	6.496	0.512	TB	NBR	NCC	5
138X160X13TB	5.433	6.299	0.512	TB	NBR	NCC	5	140X165X13VTC	5.512	6.496	0.512	TC	FKM	VCC	5
138X160X15SA	5.433	6.299	0.591	SA	NBR	NCC	5	140X165X13TC	5.512	6.496	0.512	TC	NBR	NCC	5
138X160X15SC	5.433	6.299	0.591	SC	NBR	NCC	5	140X170X12VSB-H	5.512	6.692	0.472	SB-H	FKM	VCS	5
138X160X15VSF	5.433	6.299	0.591	SF	FKM	VCS	5	140X170X12SB-H	5.512	6.692	0.472	SB-H	NBR	NCC	5
138X160X15TC	5.433	6.299	0.591	TC	NBR	NCC	5	140X170X15TC	5.512	6.692	0.590	TC	NBR	NCC	5
138X162X13TC	5.433	6.378	0.512	TC	NBR	NCC	5	140X170X12VSA	5.512	6.693	0.472	SA	FKM	VCS	5
138X200X15SA-H	5.433	7.874	0.591	SA-H	NBR	NCC	5	140X170X12SC	5.512	6.693	0.472	SC	NBR	NCC	5
SHAFT 5.437															
SHAFT-EZE 99548							S3	140X170X12VTC	5.512	6.693	0.472	TC	FKM	VCC	5
V-RING -140							3	140X170X12TC	5.512	6.693	0.472	TC	NBR	NCC	5
543655TC	5.437	6.500	0.500	TC	NBR	NCC	5	140X170X13SC	5.512	6.693	0.512	SC	NBR	NCC	5
SHAFT 5.500															
SHAFT-EZE 99549							S3	140X170X13TC	5.512	6.693	0.512	TC	NBR	NCC	5
SHAFT-EZE 99550							S3	140X170X14TC	5.512	6.693	0.551	TC	NBR	NCC	5
V-RING -140							3	140X170X14VTF	5.512	6.693	0.591	TF	FKM	VCS	5
55625TB-H	5.500	6.250	0.500	TB-H	NBR	NCC	5	140X175X13TB	5.512	6.890	0.512	TB	NBR	NCC	5
55665TA-H	5.500	6.250	0.562	TA-H	NBR	NCC	5	140X175X13TC	5.512	6.890	0.512	TC	NBR	NCC	5
55630TB	5.500	6.310	1.188	TB	NBR	NCC	5	140X175X15TC	5.512	6.890	0.591	TC	NBR	NCC	5
55655SA	5.500	6.500	0.500	SA	NBR	NCC	5	140X180X12VTC	5.512	7.087	0.472	TC	FKM	VCC	5
55655VSA-H	5.500	6.500	0.500	SA-H	FKM	VCS	5	140X180X12TC	5.512	7.087	0.472	TC	NBR	NCC	5
55655SA-H	5.500	6.500	0.500	SA-H	NBR	NCC	5	140X180X13TB	5.512	7.087	0.512	TB	NBR	NCC	5
55655SC	5.500	6.500	0.500	SC	NBR	NCC	5	140X180X15SA	5.512	7.087	0.591	SA	NBR	NCC	5
55655TA-H	5.500	6.500	0.562	TA-H	NBR	NCC	5	140X180X15TA	5.512	7.087	0.591	TA	NBR	NCC	5
5566356TA-H	5.500	6.625	0.562	TA-H	NBR	NCC	5	140X180X15TB	5.512	7.087	0.591	TB	NBR	NCC	5
55675VSA-H	5.500	6.750	0.500	SA-H	FKM	VCS	5	140X190X15VTF	5.512	7.480	0.591	TF	FKM	VCS	5
55675SA-H	5.500	6.750	0.500	SA-H	NBR	NCC	5	140X210X15TC	5.512	8.268	0.591	TC	NBR	NCC	6
55675TA-H	5.500	6.750	0.500	TA-H	NBR	NCC	5	140X215X8SC	5.512	8.465	0.315	SC	NBR	NCC	6
55675TB-H	5.500	6.750	0.500	TB-H	NBR	NCC	5	140X215X12SC	5.512	8.465	0.472	SC	NBR	NCC	6
556757TA-H	5.500	6.750	0.575	TA-H	NBR	NCC	5	SHAFT 5.591							
55685TA-H	5.500	6.875	0.562	TA-H	NBR	NCC	5	V-RING -140							3
55706TA-H	5.500	7.000	0.625	TA-H	NBR	NCC	5	142X165X10SC	5.591	6.496	0.394	SC	NBR	NCC	5
55716TA	5.500	7.125	0.625	TA	NBR	NCC	5	142X166X10TC	5.591	6.535	0.394	TC	NBR	NCC	5
55716TA-H	5.500	7.125	0.625	TA-H	NBR	NCC	5	142X168X14TC	5.591	6.614	0.551	TC	NBR	NCC	5
55755SA	5.500	7.501	0.563	SA	NBR	NCC	5	SHAFT 5.625							
55755SA-H	5.500	7.501	0.563	SA-H	NBR	NCC	5	SHAFT-EZE 99560							S3
55825TC	5.500	8.268	0.500	TC	NBR	NCC	6	V-RING -140							3
SHAFT 5.512															
SHAFT-EZE 99552							S3	56665TA	5.625	6.624	0.500	TA	NBR	NCC	5
V-RING -140							3	56665TA-H	5.625	6.624	0.500	TA-H	NBR	NCC	5
140X155X10SC	5.512	6.102	0.394	SC	NBR	NCC	5	56665SA-H	5.625	6.625	0.500	SA-H	NBR	NCC	5
140X157X8VTF	5.512	6.181	0.315	TF	FKM	VCS	5	566756SC	5.625	6.750	0.562	SC	NBR	NCC	5
140X160X10TC	5.512	6.299	0.394	TC	NBR	NCC	5	56685TA	5.625	6.874	0.500	TA	NBR	NCC	5
140X160X10VTF	5.512	6.299	0.394	TF	FKM	VCS	5	56685TA-H	5.625	6.874	0.500	TA-H	NBR	NCC	5
140X160X12SB	5.512	6.299	0.472	SB	NBR	NCC	5	56685SA-H	5.625	6.875	0.500	SA-H	NBR	NCC	5
SHAFT 5.591															
								56705TA	5.625	7.000	0.500	TA	NBR	NCC	5
								56715TA	5.625	7.125	0.500	TA	NBR	NCC	5
								56715TA-H	5.625	7.125	0.500	TA-H	NBR	NCC	5

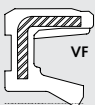
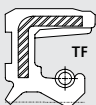
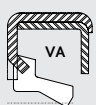
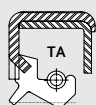

OIL AND GREASE SEALS - A COMPLETE LISTING

PLEASE CALL DICHTOMATIK FOR AVAILABILITY - 800-328-2840
 BULK AND INDIVIDUALLY BOXED QUANTITIES ARE AVAILABLE FOR ALL



DICHTOMATIK

Any seal. Any time.

TCM Part #	Shaft	Bore	Width	Type	Lip Material	Material	Box #
SHAFT 5.630							
V-RING -140							3
143X175X16SC 5.630	6.890	0.630	SC	NBR	NCC		5
143X175X16TC 5.630	6.890	0.630	TC	NBR	NCC		5
SHAFT 5.669							
V-RING -140							3
144X160X10TC 5.669	6.299	0.394	TC	NBR	NCC		5
144X160X12TC 5.669	6.299	0.472	TC	NBR	NCC		5
144X172X15TC 5.669	6.772	0.591	TC	NBR	NCC		5
SHAFT 5.709							
SHAFT-EZE 99571							S3
V-RING -140							3
145X160X10SC 5.709	6.299	0.394	SC	NBR	NCC		5
145X165X12TC 5.709	6.496	0.472	TC	NBR	NCC		5
145X165X13SC 5.709	6.496	0.512	SC	NBR	NCC		5
145X165X13VSF 5.709	6.496	0.512	SF	FKM	VCS		5
145X165X13TC 5.709	6.496	0.512	TC	NBR	NCC		5
145X165X14TC 5.709	6.496	0.551	TC	NBR	NCC		5
145X165X15SC 5.709	6.496	0.591	SC	NBR	NCC		5
145X167X13TC 5.709	6.575	0.512	TC	NBR	NCC		5
145X168X10TC 5.709	6.614	0.394	TC	NBR	NCC		5
145X168X12TC 5.709	6.614	0.472	TC	NBR	NCC		5
145X168X13TC 5.709	6.614	0.512	TC	NBR	NCC		5
145X170X10SB 5.709	6.693	0.394	SB	NBR	NCC		5
145X170X12TC 5.709	6.693	0.472	TC	NBR	NCC		5
145X170X12VTF 5.709	6.693	0.472	TF	FKM	VCS		5
145X170X13SA 5.709	6.693	0.512	SA	NBR	NCC		5
145X170X13SB 5.709	6.693	0.512	SB	NBR	NCC		5
145X170X13TB 5.709	6.693	0.512	TB	NBR	NCC		5
145X170X13TC 5.709	6.693	0.512	TC	NBR	NCC		5
145X170X13TM 5.709	6.693	0.512	TM	NBR	NCC		5
145X175X15TC 5.709	6.889	0.590	TC	NBR	NCC		5
145X175X13SB 5.709	6.890	0.512	SB	NBR	NCC		5
145X175X13TA 5.709	6.890	0.512	TA	NBR	NCC		5
145X175X13VTC 5.709	6.890	0.512	TC	FKM	VCC		5
145X175X14TC 5.709	6.890	0.551	TC	NBR	NCC		5
145X175X14TZ 5.709	6.890	0.551	TZ	NBR	NCC		5
145X175X15SC 5.709	6.890	0.591	SC	NBR	NCC		5
145X175X15VTA 5.709	6.890	0.591	TA	FKM	VCS		5
145X175X15VTF 5.709	6.890	0.591	TF	FKM	VCS		5
145X180X12VTC 5.709	7.087	0.472	TC	FKM	VCC		5
145X180X12TC 5.709	7.087	0.472	TC	NBR	NCC		5
145X180X13TB 5.709	7.087	0.512	TB	NBR	NCC		5
145X180X14VSF 5.709	7.087	0.551	SF	FKM	VCS		5
145X180X15SA 5.709	7.087	0.591	SA	NBR	NCC		5
145X180X15TB 5.709	7.087	0.591	TB	NBR	NCC		5
145X185X15SC 5.709	7.283	0.591	SC	NBR	NCC		5
145X185X15TC 5.709	7.283	0.591	TC	NBR	NCC		5
145X190X15SB 5.709	7.480	0.591	SB	NBR	NCC		5
SHAFT 5.748							
V-RING -150							3
146X170X14TB 5.748	6.693	0.551	TB	NBR	NCC		5
SHAFT 5.750							
V-RING -150							3
57666TA-H 5.750	6.624	0.625	TA-H	NBR	NCC		5
57665SA-H 5.750	6.625	0.500	SA-H	NBR	NCC		5
576635VSB-H 5.750	6.625	0.500	SB-H	FKM	VCS		5
57675SA 5.750	6.750	0.500	SA	NBR	NCC		5
57675VSA-H 5.750	6.750	0.500	SA-H	FKM	VCS		5
57675SA-H 5.750	6.750	0.500	SA-H	NBR	NCC		5
57675SZ 5.750	6.750	0.500	SZ	NBR	NCC		5
576755TA-H 5.750	6.750	0.575	TA-H	NBR	NCC		5
SHAFT 5.827							
V-RING -150							3
148X170X13TC 5.827	6.693	0.512	TC	NBR	NCC		5
148X170X14TC 5.827	6.693	0.551	TC	NBR	NCC		5
148X170X14.5VSF 5.827	6.693	0.571	SF	FKM	VCS		5
148X170X14.5TC 5.827	6.693	0.571	TC	NBR	NCC		5
148X170X15SA 5.827	6.693	0.591	SA	NBR	NCC		5
148X180X15SA 5.827	7.087	0.591	SA	NBR	NCC		5
SHAFT 5.875							
SHAFT-EZE 99587							S3
V-RING -150							3
58676SC 5.875	6.749	0.625	SC	NBR	NCC		5
58685DC 5.875	6.875	0.500	DC	NBR	NCC		5
58715VSA-H 5.875	7.125	0.500	SA-H	FKM	VCS		5
58715TA-H 5.875	7.125	0.500	TA-H	NBR	NCC		5
58755SA-H 5.875	7.500	0.500	SA-H	NBR	NCC		5
58755SA-H 5.875	7.500	0.562	SA-H	NBR	NCC		5
SHAFT 5.906							
SHAFT-EZE 99595							S3
V-RING -150							3
150X162X9SC 5.906	6.378	0.354	SC	NBR	NCC		5
150X168X12SC 5.906	6.614	0.472	SC	NBR	NCC		5
150X170X12SC 5.906	6.693	0.472	SC	NBR	NCC		5
150X170X12VSF 5.906	6.693	0.472	SF	FKM	VCS		5
150X170X12TC 5.906	6.693	0.472	TC	NBR	NCC		5
150X170X12VTF 5.906	6.693	0.472	TF	FKM	VCS		5
150X170X12TM 5.906	6.693	0.472	TM	NBR	NCC		5
150X170X13SC 5.906	6.693	0.512	SC	NBR	NCC		5
150X170X15SC 5.906	6.693	0.591	SC	NBR	NCC		5
150X170X15VTC 5.906	6.693	0.591	TC	FKM	VCC		5
150X170X15TC 5.906	6.693	0.591	TC	NBR	NCC		5
150X172X10TC 5.906	6.772	0.394	TC	NBR	NCC		5
150X175X10TC 5.906	6.890	0.394	TC	NBR	NCC		5
150X178X12TC 5.906	7.008	0.472	TC	NBR	NCC		5
150X178X13TC 5.906	7.008	0.512	TC	NBR	NCC		5
150X180X12TC 5.906	7.086	0.472	TC	NBR	NCC		5
150X180X12VTF 5.906	7.087	0.472	TF	FKM	VCS		5
150X180X13SA 5.906	7.087	0.512	SA	NBR	NCC		5
150X180X13TC 5.906	7.087	0.512	TC	NBR	NCC		5
150X180X14TZ 5.906	7.087	0.551	TZ	NBR	NCC		5
150X180X15SB 5.906	7.087	0.591	SB	NBR	NCC		5
150X180X15VSC 5.906	7.087	0.591	SC	FKM	VCS		5
150X180X15SC 5.906	7.087	0.591	SC	NBR	NCC		5
150X180X15TB 5.906	7.087	0.591	TB	NBR	NCC		5
150X180X15TC 5.906	7.087	0.591	TC	NBR	NCC		5
150X180X15VTF 5.906	7.087	0.591	TF	FKM	VCS		5
150X185X18TC 5.906	7.283	0.709	TC	NBR	NCC		5
150X190X13TB 5.906	7.480	0.512	TB	NBR	NCC		5
150X190X15SZ 5.906	7.480	0.591	SZ	NBR	NCC		5
150X190X16SC 5.906	7.480	0.630	SC	NBR	NCC		5
150X200X15SA 5.906	7.874	0.591	SA	NBR	NCC		5
150X210X15TC 5.906	8.268	0.591	TC	NBR	NCC		6
150X225X12TC 5.906	8.858	0.472	TC	NBR	NCC		6

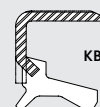
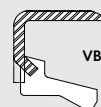
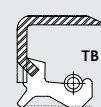
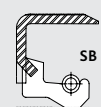
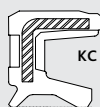
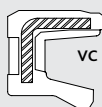
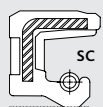



TCM Part #	Shaft	Bore	Width	Type	Lip Material	Material	Box
SHAFT 5.937							
SHAFT-EZE 99596							S3
V-RING -150							3
59368011PTMJS	5.937	6.800	1.125	TMJS	ACM	PCC	~
593705TC	5.937	7.000	0.500	TC	NBR	NCC	5
593705TG	5.937	7.000	0.500	TG	NBR	NCC	5
150.8X177.8X12.7G	5.937	7.000	0.472	TG	NBR	NCC	5
150.8X177.8X12.7TB	5.937	7.000	0.500	TB	NBR	NCC	5
59755TA	5.937	7.502	0.562	TA	NBR	NCC	5
59755TA-H	5.937	7.502	0.562	TA-H	NBR	NCC	5
SHAFT 5.984							
V-RING -150							3
152X182X15TC	5.984	7.165	0.591	TC	NBR	NCC	5
SHAFT 6.000							
SHAFT-EZE 99599							S3
SHAFT-EZE 99601							S3
V-RING -150							3
60675VSB-H	6.000	6.750	0.500	SB-H	FKM	VCS	5
60705TA-H	6.000	7.000	0.500	TA-H	NBR	NCC	5
60705TF	6.000	7.000	0.500	TF	NBR	NCS	5
607005TA-H	6.000	7.002	0.500	TA-H	NBR	NCC	5
60715TA-H	6.000	7.125	0.500	TA-H	NBR	NCC	5
60715TA-H	6.000	7.125	0.562	TA-H	NBR	NCC	5
60752SA	6.000	7.500	0.250	SA	NBR	NCC	5
60755VTA-H	6.000	7.500	0.500	TA-H	FKM	VCS	5
60755TA-H	6.000	7.500	0.500	TA-H	NBR	NCC	5
60755TB-H	6.000	7.500	0.500	TB-H	NBR	NCC	5
607556TA-H	6.000	7.500	0.562	TA-H	NBR	NCC	5
SHAFT 6.063							
SHAFT-EZE 99605							S3
V-RING -150							3
154X175X13TB-H	6.063	6.889	0.511	TB-H	NBR	NCC	5
154X175X13TC	6.063	6.890	0.512	TC	NBR	NCC	5
154X175X14TC	6.063	6.890	0.551	TC	NBR	NCC	5
154X176X10TC	6.063	6.929	0.394	TC	NBR	NCC	5
154X180X15TC	6.063	7.087	0.591	TC	NBR	NCC	5
154X180X18TC	6.063	7.087	0.709	TC	NBR	NCC	5
SHAFT 6.102							
V-RING -160							3
155X172X10TB	6.102	6.772	0.394	TB	NBR	NCC	5
155X174X12SC	6.102	6.850	0.472	SC	NBR	NCC	5
155X174X12TC	6.102	6.850	0.472	TC	NBR	NCC	5
155X174X13.5TM	6.102	6.850	0.531	TM	NBR	NCC	5
155X175X12SC	6.102	6.890	0.472	SC	NBR	NCC	5
155X175X12TB	6.102	6.890	0.472	TB	NBR	NCC	5
155X175X13VTF	6.102	6.890	0.512	TF	FKM	VCS	5
155X180X10TC	6.102	7.087	0.394	TC	NBR	NCC	5
155X180X12TC	6.102	7.087	0.472	TC	NBR	NCC	5
155X180X12VTF	6.102	7.087	0.472	TF	FKM	VCS	5
155X180X13VSF	6.102	7.087	0.512	SF	FKM	VCS	5
155X180X13.17TAY	6.102	7.087	0.519	TAY	NBR	NCC	5
155X180X14TB	6.102	7.087	0.551	TB	NBR	NCC	5
155X180X15SC	6.102	7.087	0.591	SC	NBR	NCC	5
155X180X15VTC	6.102	7.087	0.591	TC	FKM	VCC	5
155X180X15TC	6.102	7.087	0.591	TC	NBR	NCC	5
155X185X14TC	6.102	7.283	0.551	TC	NBR	NCC	5
155X185X15VSB	6.102	7.283	0.591	SB	FKM	VCS	5
155X185X15VSZ	6.102	7.283	0.591	SZ	FKM	VCS	5
155X190X13TC	6.102	7.480	0.512	TC	NBR	NCC	5
155X190X15SC	6.102	7.480	0.591	SC	NBR	NCC	5
155X190X15TC	6.102	7.480	0.591	TC	NBR	NCC	5
155X200X15TB	6.102	7.874	0.591	TB	NBR	NCC	5

TCM Part #	Shaft	Bore	Width	Type	Lip Material	Material	Box #
SHAFT 6.125							
V-RING -160							3
61715TC	6.125	7.125	0.500	TC	NBR	NCC	5
61716SA	6.125	7.125	0.625	SA	NBR	NCC	5
61716SA-H	6.125	7.125	0.625	SA-H	NBR	NCC	5
61755TA-H	6.125	7.500	0.562	TA-H	NBR	NCC	5
61766SA-H	6.125	7.625	0.625	SA-H	NBR	NCC	5
61766SA-H	6.125	7.627	0.625	SA-H	NBR	NCC	5
SHAFT 6.187							
V-RING -160							3
618725SC	6.187	7.250	0.500	SC	NBR	NCC	5
61755PSA-H	6.187	7.500	0.562	SA-H	ACM	PCS	5
SHAFT 6.220							
V-RING -160							3
158X180X15SA	6.220	7.087	0.591	SA	NBR	NCC	5
158X180X15SC	6.220	7.087	0.591	SC	NBR	NCC	5
158X180X15VSF	6.220	7.087	0.591	SF	FKM	VCS	5
SHAFT 6.250							
SHAFT-EZE 99625							S3
V-RING -160							3
62703TC	6.250	7.000	0.375	TC	NBR	NCC	5
62725TC	6.250	7.250	0.500	TC	NBR	NCC	5
627255SA	6.250	7.252	0.500	SA	NBR	NCC	5
62755SA-H	6.250	7.500	0.500	SA-H	NBR	NCC	5
62755TA-H	6.250	7.500	0.500	TA-H	NBR	NCC	5
627556SA-H	6.250	7.500	0.562	SA-H	NBR	NCC	5
62775SA-H	6.250	7.750	0.500	SA-H	NBR	NCC	5
62775TA-H	6.250	7.750	0.500	TA-H	NBR	NCC	5
62787TA-H	6.250	7.875	0.750	TA-H	NBR	NCC	5
SHAFT 6.299							
V-RING -160							3
160X180X10TB	6.299	7.087	0.394	TB	NBR	NCC	5
160X180X10VTC	6.299	7.087	0.394	TC	FKM	VCC	5
160X180X10TC	6.299	7.087	0.394	TC	NBR	NCC	5
160X180X10VTF	6.299	7.087	0.394	TF	FKM	VCS	5
160X180X12VSC	6.299	7.087	0.472	SC	FKM	VCS	5
160X180X13TB	6.299	7.087	0.512	TB	NBR	NCC	5
160X180X13TB-H	6.299	7.087	0.512	TB-H	NBR	NCC	5
160X180X13TM	6.299	7.087	0.512	TM	NBR	NCC	5
160X180X15SB	6.299	7.087	0.591	SB	NBR	NCC	5
160X182X18TC	6.299	7.165	0.709	TC	NBR	NCC	5
160X185X10SC	6.299	7.283	0.394	SC	NBR	NCC	5
160X185X10VSF	6.299	7.283	0.394	SF	FKM	VCS	5
160X185X10TB	6.299	7.283	0.394	TB	NBR	NCC	5
160X185X10VTC	6.299	7.283	0.394	TC	FKM	VCC	5
160X185X10TC	6.299	7.283	0.394	TC	NBR	NCC	5
160X185X13TB	6.299	7.283	0.512	TB	NBR	NCC	5
160X190X8TC	6.299	7.480	0.315	TC	NBR	NCC	5
160X190X12TC	6.299	7.480	0.472	TC	NBR	NCC	5
160X190X13VTC	6.299	7.480	0.512	TC	FKM	VCC	5
160X190X13TC	6.299	7.480	0.512	TC	NBR	NCC	5
160X190X15VSA	6.299	7.480	0.591	SA	FKM	VCS	5
160X190X15VTB	6.299	7.480	0.591	TB	FKM	VCS	5
160X190X15TC	6.299	7.480	0.591	TC	NBR	NCC	5
160X190X15VTF	6.299	7.480	0.591	TF	FKM	VCS	5
160X190X23DB	6.299	7.480	0.906	DB	NBR	NCC	5
160X190X8/9VTCN1	6.299	7.480	0.315/0.354	TCN1	FKM	VCS	5
160X200X12VTC	6.299	7.874	0.472	TC	FKM	VCC	5
160X200X12TC	6.299	7.874	0.472	TC	NBR	NCC	5
160X200X15TC	6.299	7.874	0.591	TC	NBR	NCC	5
160X210X15SA	6.299	8.268	0.591	SA	NBR	NCC	6
160X240X15TC	6.299	9.449	0.591	TC	NBR	NCC	6

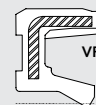
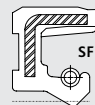
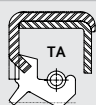

OIL AND GREASE SEALS - A COMPLETE LISTING



DICHTOMATIK

Any seal. Any time.

PLEASE CALL DICHTOMATIK FOR AVAILABILITY - 800-328-2840
BULK AND INDIVIDUALLY BOXED QUANTITIES ARE AVAILABLE FOR ALL

TCM Part #	Shaft	Bore	Width	Type	Lip Material	Material	Box #
160X241X15VTC	6.299	9.488	0.591	TC	FKM	VCS	6
160X241X15TC	6.299	9.488	0.591	TC	NBR	NCC	6
SHAFT 6.339							
V-RING -160							3
161X215X15SC	6.339	8.465	0.591	SC	NBR	NCC	6
SHAFT 6.375							
V-RING -160							3
63735SC	6.375	7.375	0.500	SC	NBR	NCC	5
63736SA-H	6.375	7.375	0.625	SA-H	NBR	NCC	5
63755TC	6.375	7.500	0.500	TC	NBR	NCC	5
63785TA-H	6.375	7.875	0.500	TA-H	NBR	NCC	5
637856TA	6.375	7.875	0.563	TA	NBR	NCC	5
637856TA-H	6.375	7.875	0.563	TA-H	NBR	NCC	5
SHAFT 6.378							
V-RING -160							3
162X187X12TC	6.378	7.362	0.472	TC	NBR	NCC	5
162X190X12SC	6.378	7.480	0.472	SC	NBR	NCC	5
SHAFT 6.438							
V-RING -160							3
64772VAY	6.438	7.751	0.250	VAY	NBR	NCO	5
SHAFT 6.457							
V-RING -160							3
164X185X12TA	6.457	7.283	0.472	TA	NBR	NCC	5
SHAFT 6.496							
SHAFT-EZE 99650							S3
V-RING -170							5
165X180X10TC	6.496	7.087	0.394	TC	NBR	NCC	5
165X190X8VSF	6.496	7.480	0.315	SF	FKM	VCS	5
165X190X10VTF	6.496	7.480	0.394	TF	FKM	VCS	5
165X190X13SC	6.496	7.480	0.512	SC	NBR	NCC	5
165X190X13VSF	6.496	7.480	0.512	SF	FKM	VCS	5
165X190X13VTBR	6.496	7.480	0.512	TBR	FKM	VCC	5
165X190X13TC	6.496	7.480	0.512	TC	NBR	NCC	5
165X190X15TC	6.496	7.480	0.591	TC	NBR	NCC	5
165X195X15TC	6.496	7.677	0.591	TC	NBR	NCC	5
165X195X18VSM	6.496	7.677	0.709	SM	FKM	VCS	5
165X195X18VSZ	6.496	7.677	0.709	SZ	FKM	VCS	5
165X195X18TC	6.496	7.677	0.709	TC	NBR	NCC	5
165X200X15SZ	6.496	7.874	0.591	SZ	NBR	NCC	5
165X200X15VTF	6.496	7.874	0.591	TF	FKM	VCS	5
SHAFT 6.500							
SHAFT-EZE 99650							S3
V-RING -170							5
65755VSA-H	6.500	7.500	0.500	SA-H	FKM	VCS	5
65755SA-H	6.500	7.500	0.500	SA-H	NBR	NCC	5
65755TB-H	6.500	7.500	0.500	TB-H	NBR	NCC	5
65755TC	6.500	7.500	0.500	TC	NBR	NCC	5
65755TA-H	6.500	7.500	0.562	TA-H	NBR	NCC	5
65775TC	6.500	7.750	0.500	TC	NBR	NCC	5
65805TA-H	6.500	8.000	0.500	TA-H	NBR	NCC	6
65806TA-H	6.500	8.000	0.625	TA-H	NBR	NCC	6
65807TB	6.500	8.000	0.750	TB	NBR	NCS	6
658007SSTZN	6.500	8.004	0.750	TZN	NBR	NCC	6
SHAFT 6.614							
V-RING -170							5
168X190X15SA	6.614	7.480	0.591	SA	NBR	NCC	5
168X200X15SA	6.614	7.874	0.591	SA	NBR	NCC	5
168X200X15TA	6.614	7.874	0.591	TA	NBR	NCC	5

TCM Part #	Shaft	Bore	Width	Type	Lip Material	Material	Box #
SHAFT 6.625							
V-RING -170							5
66775SA	6.625	7.750	0.500	SA	NBR	NCC	5
66815SA-H	6.625	8.125	0.500	SA-H	NBR	NCC	6
66816TA-H	6.625	8.125	0.625	TA-H	NBR	NCC	6
SHAFT 6.660							
V-RING -170							5
66675043SZY	6.660	7.508	0.437	SZY	NBR	NCC	5
SHAFT 6.693							
SHAFT-EZE 99640							S3
V-RING -170							5
170X190X8.5TC	6.693	7.480	0.335	TC	NBR	NCC	5
170X190X8.8TC	6.693	7.480	0.346	TC	NBR	NCC	5
170X190X10TC	6.693	7.480	0.394	TC	NBR	NCC	5
170X190X12VSC	6.693	7.480	0.472	SC	FKM	VCS	5
170X190X13TC	6.693	7.480	0.512	TC	NBR	NCC	5
170X190X14VTC	6.693	7.480	0.551	TC	FKM	VCC	5
170X190X15SA	6.693	7.480	0.591	SA	NBR	NCC	5
170X190X15VSC	6.693	7.480	0.591	SC	FKM	VCC	5
170X190X15SC	6.693	7.480	0.591	SC	NBR	NCC	5
170X190X15VSF	6.693	7.480	0.591	SF	FKM	VCS	5
170X190X15TA	6.693	7.480	0.591	TA	NBR	NCC	5
170X195X18TB	6.693	7.677	0.709	TB	NBR	NCC	5
170X200X10TB	6.693	7.874	0.394	TB	NBR	NCC	5
170X200X12VSC	6.693	7.874	0.472	SC	FKM	VCC	5
170X200X12VSF	6.693	7.874	0.472	SF	FKM	VCS	5
170X200X12TC	6.693	7.874	0.472	TC	NBR	NCC	5
170X200X12TM	6.693	7.874	0.472	TM	NBR	NCC	5
170X200X13VSA	6.693	7.874	0.512	SA	FKM	VCS	5
170X200X15SC	6.693	7.874	0.591	SC	NBR	NCC	5
170X200X15TB	6.693	7.874	0.591	TB	NBR	NCC	5
170X200X15TC	6.693	7.874	0.591	TC	NBR	NCC	5
170X200X15VTF	6.693	7.874	0.591	TF	FKM	VCS	5
170X200X15TM	6.693	7.874	0.591	TM	NBR	NCC	5
170X200X16TB	6.693	7.874	0.630	TB	NBR	NCC	5
170X200X16TC	6.693	7.874	0.630	TC	NBR	NCC	5
170X200X16VTM	6.693	7.874	0.630	TM	FKM	VCS	5
170X200X16TZ	6.693	7.874	0.630	TZ	NBR	NCC	5
170X205X16TB	6.693	8.071	0.630	TB	NBR	NCC	6
170X205X16TC	6.693	8.071	0.630	TC	NBR	NCC	6
170X210X14SC	6.693	8.268	0.551	SC	NBR	NCC	6
170X210X14TC	6.693	8.268	0.551	TC	NBR	NCC	6
170X210X15TC	6.693	8.268	0.591	TC	NBR	NCC	6
170X215X16SA	6.693	8.465	0.630	SA	NBR	NCC	6
170X215X16TA	6.693	8.465	0.630	TA	NBR	NCC	6
170X220X15SC	6.693	8.661	0.591	SC	NBR	NCC	6
170X220X15TC	6.693	8.661	0.591	TC	NBR	NCC	6
170X225X15SA	6.693	8.858	0.591	SA	NBR	NCC	6
SHAFT 6.750							
SHAFT-EZE 99675							S3
V-RING -170							5
67775SC	6.750	7.750	0.500	TC	NBR	NCC	5
67775TC	6.750	7.750	0.500	TC	NBR	NCC	5
67805VSA-H	6.750	8.000	0.500	SA-H	FKM	VCS	6
67805SA-H	6.750	8.000	0.500	SA-H	NBR	NCC	6
67806TA-H	6.750	8.000	0.625	TA-H	NBR	NCC	6
67806TA	6.750	8.007	0.625	TA	NBR	NCC	6
67806TA-H	6.750	8.007	0.625	TA-H	NBR	NCC	6
67825SA	6.750	8.250	0.500	SA	NBR	NCC	6
67825SA-H	6.750	8.250	0.500	SA-H	NBR	NCC	6
67825TA-H	6.750	8.250	0.562	TA-H	NBR	NCC	6

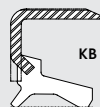
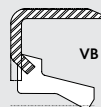
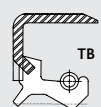
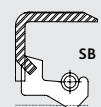
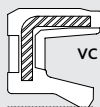



TCM Part #	Shaft	Bore	Width	Type	Lip Material	Material	Box	TCM Part #	Shaft	Bore	Width	Type	Lip Material	Material	Box #
SHAFT 6.772								SHAFT 7.087							
V-RING -170							5	SHAFT-EZE 99721							S3
172X200X15SA 6.772	7.874	0.591	SA	NBR	NCC		5	V-RING -180							5
172X200X15TA 6.772	7.874	0.591	TA	NBR	NCC		5	180X200X12TA 7.087	7.874	0.472	TA	NBR	NCC		5
172X200X15TC 6.772	7.874	0.591	TC	NBR	NCC		5	180X200X14VTC 7.087	7.874	0.551	TC	FKM	VCC		5
SHAFT 6.875								SHAFT 7.125							
V-RING -170							5	V-RING -180	7.125	8.625	0.562	TA-H	NBR	NCC	6
68786SA-H	6.875	0.625	SA-H	NBR	NCC		5	71865TA-H	7.125	8.625	0.562	TA-H	NBR	NCC	6
68835SA-H	6.875	0.500	SA-H	NBR	NCC		6	SHAFT 7.250							
68836SA-H	6.875	0.625	SA-H	NBR	NCC		6	SHAFT-EZE 99725							S3
SHAFT 6.890								SHAFT 7.283							
SHAFT-EZE 99687							S3	V-RING -180							5
V-RING -170							5	72826SB-H	7.250	8.250	0.625	SB-H	NBR	NCC	6
175X200X10SC 6.890	7.874	0.394	SC	NBR	NCC		5	72826TA-H	7.250	8.250	0.625	TA-H	NBR	NCC	6
175X200X10VSF 6.890	7.874	0.394	SF	FKM	VCS		5	728756TC	7.250	8.750	0.562	TC	NBR	NCC	6
175X200X10TC 6.890	7.874	0.394	TC	NBR	NCC		5	72876TA-H	7.250	8.750	0.625	TA-H	NBR	NCC	6
175X200X10VTF 6.890	7.874	0.394	TF	FKM	VCS		5	72877TA-H	7.250	8.750	0.750	TA-H	NBR	NCC	6
175X200X15VSF 6.890	7.874	0.591	SF	FKM	VCS		5	729056TA-H	7.250	9.055	0.625	TA-H	NBR	NCC	6
175X200X15TC 6.890	7.874	0.591	TC	NBR	NCC		5	SHAFT 7.323							
175X203.5X19TB 6.890	8.012	0.748	TB	NBR	NCC		6	SHAFT-EZE 99726							S3
175X205X15VSF 6.890	8.071	0.591	SF	FKM	VCS		6	V-RING -190							5
175X205X15TC 6.890	8.071	0.591	TC	NBR	NCC		6	185X210X13SC 7.283	8.268	0.512	SC	NBR	NCC		6
175X210X14SC 6.890	8.268	0.551	SC	NBR	NCC		6	185X210X13VSF 7.283	8.268	0.512	SF	FKM	VCS		6
175X210X14TC 6.890	8.268	0.551	TC	NBR	NCC		6	185X210X13VTC 7.283	8.268	0.512	TC	FKM	VCC		6
175X210X14VTF 6.890	8.268	0.551	TF	FKM	VCS		6	185X210X13TC 7.283	8.268	0.512	TC	NBR	NCC		6
175X210X15SA 6.890	8.268	0.591	SA	NBR	NCC		6	185X210X15TC 7.283	8.268	0.591	TC	NBR	NCC		6
175X210X15VTC 6.890	8.268	0.591	TC	FKM	VCC		6	185X215X13SB 7.283	8.465	0.512	SB	NBR	NCC		6
175X210X15TC 6.890	8.268	0.591	TC	NBR	NCC		6	185X215X15SA 7.283	8.465	0.591	SA	NBR	NCC		6
175X215X16SA 6.890	8.465	0.630	SA	NBR	NCC		6	185X215X15TC 7.283	8.465	0.591	TC	NBR	NCC		6
175X220X17SC 6.890	8.661	0.669	SC	NBR	NCC		6	185X215X15VTF 7.283	8.465	0.591	TF	FKM	VCS		6
175X220X17TC 6.890	8.661	0.669	TC	NBR	NCC		6	185X215X16SZ 7.283	8.465	0.630	SZ	NBR	NCC		6
175X230X20TC 6.890	9.055	0.787	TC	NBR	NCC		6	185X215X16TC 7.283	8.465	0.630	TC	NBR	NCC		6
SHAFT 6.969								SHAFT 7.323							
V-RING -180							5	V-RING -190							5
177X250X16TC 6.969	9.843	0.630	TC	NBR	NCC		6	186X226X16SC 7.323	8.898	0.630	SC	NBR	NCC		6
SHAFT 7.000								SHAFT 7.323							
SHAFT-EZE 99700							S3	SHAFT 7.323							
V-RING -180							5	SHAFT 7.323							
70805TC	7.000	8.000	0.500	TC	NBR	NCC	6	SHAFT 7.323							
70806TA	7.000	8.000	0.625	TA	NBR	NCC	6	SHAFT 7.323							
70806TA-H	7.000	8.000	0.625	TA-H	NBR	NCC	6	SHAFT 7.323							
708062SA-H	7.000	8.000	0.629	SA-H	NBR	NCC	6	SHAFT 7.323							
70826TA	7.000	8.250	0.625	TA	NBR	NCC	6	SHAFT 7.323							
70826TA-H	7.000	8.250	0.625	TA-H	NBR	NCC	6	SHAFT 7.323							
70855SC	7.000	8.500	0.500	SC	NBR	NCC	6	SHAFT 7.323							
70855TB-H	7.000	8.500	0.500	TB-H	NBR	NCC	6	SHAFT 7.323							
70855TC	7.000	8.500	0.500	TC	NBR	NCC	6	SHAFT 7.323							
70856SA-H	7.000	8.500	0.625	SA-H	NBR	NCC	6	SHAFT 7.323							
70856TA-H	7.000	8.500	0.625	TA-H	NBR	NCC	6	SHAFT 7.323							
70876TA-H	7.000	8.750	0.625	TA-H	NBR	NCC	6	SHAFT 7.323							
709316TA-H	7.000	9.313	0.625	TA-H	NBR	NCC	6	SHAFT 7.323							
SHAFT 7.002								SHAFT 7.323							
SHAFT-EZE 99700							S3	SHAFT 7.323							
V-RING -180							5	SHAFT 7.323							
70853VA	7.002	8.500	0.312	VA	NBR	NCO	6	SHAFT 7.323							
SHAFT 7.008								SHAFT 7.323							
V-RING -180							5	SHAFT 7.323							
178X200X15SA 7.008	7.874	0.591	SA	NBR	NCC		5	SHAFT 7.323							
178X204X16TC 7.008	8.031	0.630	TC	NBR	NCC		6	SHAFT 7.323							
178X215X16SA 7.008	8.465	0.630	SA	NBR	NCC		6	SHAFT 7.323							

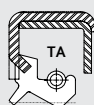

OIL AND GREASE SEALS - A COMPLETE LISTING

PLEASE CALL DICHTOMATIK FOR AVAILABILITY - 800-328-2840
BULK AND INDIVIDUALLY BOXED QUANTITIES ARE AVAILABLE FOR ALL



DICHTOMATIK

Any seal. Any time.

COMPLETE LISTING

TCM Part #	Shaft	Bore	Width	Type	Lip Material	Material	Box #
V-RING -190							5
73885VM	7.375	8.875	0.500	VM	NBR	NCO	6
738875A-H	7.375	8.875	0.750	SA-H	NBR	NCC	6
SHAFT 7.402							
V-RING -190							5
188X215X16SA	7.402	8.465	0.630	SA	NBR	NCC	6
188X215X16TA	7.402	8.465	0.630	TA	NBR	NCC	6
188X215X16TC	7.402	8.465	0.630	TC	NBR	NCC	6
SHAFT 7.480							
V-RING -190							5
V-RING -200							5
190X215X14TB	7.480	8.465	0.551	TB	NBR	NCC	6
190X215X15SA	7.480	8.465	0.591	SA	NBR	NCC	6
190X215X15TC	7.480	8.465	0.591	TC	NBR	NCC	6
190X215X16SA	7.480	8.465	0.630	SA	NBR	NCC	6
190X215X16SZ	7.480	8.465	0.630	SZ	NBR	NCC	6
190X215X16VTF	7.480	8.465	0.630	TF	FKM	VCS	6
190X220X12SA	7.480	8.661	0.472	SA	NBR	NCC	6
190X220X15TA	7.480	8.661	0.591	TA	NBR	NCC	6
190X220X15TB	7.480	8.661	0.591	TB	NBR	NCC	6
190X220X15TC	7.480	8.661	0.591	TC	NBR	NCC	6
190X220X15VTF	7.480	8.661	0.591	TF	FKM	VCS	6
190X220X16SC	7.480	8.661	0.630	SC	NBR	NCC	6
190X220X27TAY	7.480	8.661	1.063	TAY	NBR	NCC	6
190X225X12TC	7.480	8.858	0.472	TC	NBR	NCC	6
190X225X15SC	7.480	8.858	0.591	SC	NBR	NCC	6
190X225X15TB	7.480	8.858	0.591	TB	NBR	NCC	6
190X225X15TC	7.480	8.858	0.591	TC	NBR	NCC	6
190X225X16VSA	7.480	8.858	0.630	SA	FKM	VCS	6
190X225X16VTC	7.480	8.858	0.630	TC	FKM	VCS	6
190X225X16TC	7.480	8.858	0.630	TC	NBR	NCC	6
190X225X16TM	7.480	8.858	0.630	TM	NBR	NCC	6
190X225X16TZ	7.480	8.858	0.630	TZ	NBR	NCC	6
190X230X15SA	7.480	9.055	0.591	SA	NBR	NCC	6
190X230X15TB	7.480	9.055	0.591	TB	NBR	NCC	6
190X230X15TC	7.480	9.055	0.591	TC	NBR	NCC	6
190X230X16TC	7.480	9.055	0.630	TC	NBR	NCC	6
190X240X15TC	7.480	9.449	0.591	TC	NBR	NCC	6
SHAFT 7.500							
SHAFT-EZE 99750							S3
V-RING -190							5
V-RING -200							5
75856SA-H	7.500	8.500	0.625	SA-H	NBR	NCC	6
75856TA	7.500	8.500	0.625	TA	NBR	NCC	6
75856TA-H	7.500	8.500	0.625	TA-H	NBR	NCC	6
759056TC	7.500	9.000	0.562	TC	NBR	NCC	6
75906SA-H	7.500	9.000	0.625	SA-H	NBR	NCC	6
75907VTA	7.500	9.000	0.750	TA	FKM	VCS	6
75907TA-H	7.500	9.000	0.750	TA-H	NBR	NCC	6
SHAFT 7.559							
V-RING -190							5
V-RING -200							5
192X210X10TC	7.559	8.268	0.394	TC	NBR	NCC	6
SHAFT 7.625							
V-RING -190							5
V-RING -200							5
76915TC	7.625	9.125	0.500	TC	NBR	NCC	6
76916SA-H	7.625	9.125	0.625	SA-H	NBR	NCC	6
76916TA-H	7.625	9.125	0.625	TA-H	NBR	NCC	6

TCM Part #	Shaft	Bore	Width	Type	Lip Material	Material	Box
V-RING -199							5
V-RING -200							5
195X215X15SC	7.677	8.465	0.591	SC	NBR	NCC	6
195X215X15TC	7.677	8.465	0.591	TC	NBR	NCC	6
195X220X16SA	7.677	8.661	0.630	SA	NBR	NCC	6
195X230X15SA	7.677	9.055	0.591	SA	NBR	NCC	6
195X230X15SC	7.677	9.055	0.591	SC	NBR	NCC	6
195X230X16VTC	7.677	9.055	0.630	TC	FKM	VCC	6
195X235X15TC	7.677	9.252	0.591	TC	NBR	NCC	6
SHAFT 7.750							
SHAFT-EZE 99775							S3
V-RING -199							5
V-RING -200							5
77876SA	7.750	8.750	0.625	SA	NBR	NCC	6
77926SA	7.750	9.250	0.625	SA	NBR	NCC	6
77926SA-H	7.750	9.250	0.625	SA-H	NBR	NCC	6
771007TA-H	7.750	10.000	0.750	TA-H	NBR	NCC	11
SHAFT 7.874							
SHAFT-EZE 99787							S3
V-RING -199							5
V-RING -200							5
200X225X14TB	7.874	8.858	0.551	TB	NBR	NCC	6
200X225X15VTC	7.874	8.858	0.591	TC	FKM	VCS	6
200X225X15VTF	7.874	8.858	0.591	TF	FKM	VCS	6
200X230X13TB	7.874	9.055	0.512	TB	NBR	NCC	6
200X230X13VTC	7.874	9.055	0.512	TC	FKM	VCC	6
200X230X13TC	7.874	9.055	0.512	TC	NBR	NCC	6
200X230X15SA	7.874	9.055	0.591	SA	NBR	NCC	6
200X230X15SC	7.874	9.055	0.591	SC	NBR	NCC	6
200X230X15TA	7.874	9.055	0.591	TA	NBR	NCC	6
200X230X15TB	7.874	9.055	0.591	TB	NBR	NCC	6
200X230X15VTC	7.874	9.055	0.591	TC	FKM	VCS	6
200X230X15TC	7.874	9.055	0.591	TC	NBR	NCC	6
200X230X15VTF	7.874	9.055	0.591	TF	FKM	VCS	6
200X230X15TM	7.874	9.055	0.591	TM	NBR	NCC	6
200X235X15TC	7.874	9.252	0.591	TC	NBR	NCC	6
200X240X15SC	7.874	9.449	0.591	SC	NBR	NCC	6
200X240X15TA	7.874	9.449	0.591	TA	NBR	NCC	6
200X240X15TC	7.874	9.449	0.591	TC	NBR	NCC	6
200X240X18TC	7.874	9.449	0.709	TC	NBR	NCC	6
200X240X20VTA	7.874	9.449	0.787	TA	FKM	VCS	6
200X240X20TC	7.874	9.449	0.787	TC	NBR	NCC	6
200X250X15SA	7.874	9.843	0.591	SA	NBR	NCC	6
200X250X15VSF	7.874	9.843	0.591	SF	FKM	VCS	6
200X250X15TC	7.874	9.843	0.591	TC	NBR	NCC	6
200X250X16VTC	7.874	9.843	0.630	TC	FKM	VCC	6
SHAFT 7.875							
SHAFT-EZE 99787							S3
V-RING -199							5
V-RING -200							5
789210TA-H	7.875	9.250	1.000	TA-H	NBR	NCC	6
789375A-H	7.875	9.375	0.750	SA-H	NBR	NCC	6
SHAFT 8.000							
SHAFT-EZE 99800							S3
V-RING -199							5
V-RING -200							5
80906SA	8.000	9.000	0.625	SA	NBR	NCC	6
80906SA-H	8.000	9.000	0.625	SA-H	NBR	NCC	6
80906TA-H	8.000	9.000	0.625	TA-H	NBR	NCC	6
80907TZ	8.000	9.000	0.750	TZ	NBR	NCS	6
80926SA-H	8.000	9.250	0.625	SA-H	NBR	NCC	6

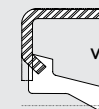
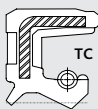
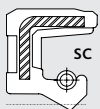



TCM Part #	Shaft	Bore	Width	Type	Lip Material	Material	Box	TCM Part #	Shaft	Bore	Width	Type	Lip Material	Material	Box #	
80926TA	8.000	9.250	0.625	TA	NBR	NCC	6	215X250X15SA	8.465	9.843	0.591	SA	NBR	NCC	6	
80926TA-H	8.000	9.250	0.625	TA-H	NBR	NCC	6	215X250X15TC	8.465	9.843	0.591	TC	NBR	NCC	6	
809556TC	8.000	9.500	0.563	TC	NBR	NCC	6	215X250X16SC	8.465	9.843	0.630	SC	NBR	NCC	6	
80956TA	8.000	9.500	0.625	TA	NBR	NCC	6	SHAFT 8.500								
80956TA-H	8.000	9.500	0.625	TA-H	NBR	NCC	6	V-RING -220							5	
801006TA	8.000	10.000	0.625	TA	NBR	NCC	11	85956TA	8.500	9.500	0.625	TA	NBR	NCC	6	
801006TA-H	8.000	10.000	0.625	TA-H	NBR	NCC	11	8510056TC	8.500	10.000	0.562	TC	NBR	NCC	11	
SHAFT 8.071								851006TA-H	8.500	10.000	0.625	TA-H	NBR	NCC	11	
V-RING -199							5	851056SA-H	8.500	10.500	0.625	SA-H	NBR	NCC	11	
V-RING -200							5	851056TA-H	8.500	10.500	0.625	TA-H	NBR	NCC	11	
205X225X18TC	8.071	8.858	0.709	TC	NBR	NCC	6	851067TA-H	8.500	10.625	0.750	TA-H	NBR	NCC	11	
205X230X15SA	8.071	9.055	0.591	SA	NBR	NCC	6	SHAFT 8.583								
205X230X15SB	8.071	9.055	0.591	SB	NBR	NCC	6	V-RING -220							5	
205X230X15SC	8.071	9.055	0.591	SC	NBR	NCC	6	218X250X16SA	8.583	9.843	0.630	SA	NBR	NCC	6	
205X230X15TB	8.071	9.055	0.591	TB	NBR	NCC	6	SHAFT 8.625								
205X230X16VSC	8.071	9.055	0.630	SC	FKM	VCC	6	V-RING -220							5	
205X230X16VSF	8.071	9.055	0.630	SF	FKM	VCS	6	861067TA-H	8.625	10.625	0.750	TA-H	NBR	NCC	11	
205X235X16TC	8.071	9.252	0.630	TC	NBR	NCC	6	SHAFT 8.661								
205X235X18TC	8.071	9.252	0.709	TC	NBR	NCC	6	V-RING -220							5	
205X250X16TC	8.071	9.843	0.630	TC	NBR	NCC	6	220X250X11SB	8.661	9.843	0.433	SB	NBR	NCC	6	
SHAFT 8.125								220X250X11TB	8.661	9.843	0.433	TB	NBR	NCC	6	
V-RING -199							5	220X250X12SC	8.661	9.843	0.472	SC	NBR	NCC	6	
V-RING -200							5	220X250X12TC	8.661	9.843	0.472	TC	NBR	NCC	6	
811017SA-H	8.125	10.125	0.750	SA-H	NBR	NCC	11	220X250X13SA	8.661	9.843	0.512	SA	NBR	NCC	6	
SHAFT 8.188								220X250X13TC	8.661	9.843	0.512	TC	NBR	NCC	6	
V-RING -199							5	220X250X15SC	8.661	9.843	0.591	SC	NBR	NCC	6	
V-RING -200							5	220X250X15VSCW	8.661	9.843	0.591	SCW	FKM	VCC	6	
8189356TB	8.188	9.375	0.563	TB	NBR	NSS	6	220X250X15SCW	8.661	9.843	0.591	SCW	NBR	NCC	6	
SHAFT 8.250								220X250X15TA	8.661	9.843	0.591	TA	NBR	NCC	6	
V-RING -199							5	220X250X15TC	8.661	9.843	0.591	TC	NBR	NCC	6	
V-RING -200							5	220X250X15VTF	8.661	9.843	0.591	TF	FKM	VCS	6	
82926SA-H	8.250	9.250	0.625	SA-H	NBR	NCC	6	220X255X16TC	8.661	10.039	0.630	TC	NBR	NCC	11	
829756SC	8.250	9.750	0.562	SC	NBR	NCC	6	220X260X14VTC	8.661	10.236	0.551	TC	FKM	VCC	11	
821026SA-H	8.250	10.250	0.625	SA-H	NBR	NCC	11	220X260X14TC	8.661	10.236	0.551	TC	NBR	NCC	11	
821027TA-H	8.250	10.250	0.750	TA-H	NBR	NCC	11	220X260X15SA	8.661	10.236	0.591	SA	NBR	NCC	11	
821067TA-H	8.250	10.625	0.750	TA-H	NBR	NCC	11	220X260X15SC	8.661	10.236	0.591	SC	NBR	NCC	11	
SHAFT 8.268								220X260X15TC	8.661	10.236	0.591	TC	NBR	NCC	11	
V-RING -199							5	220X260X15TC	8.661	10.236	0.591	TC	NBR	NCC	11	
V-RING -200							5	220X270X15SA	8.661	10.630	0.591	SA	NBR	NCC	11	
210X240X15SA	8.268	9.449	0.591	SA	NBR	NCC	6	220X270X15TA	8.661	10.630	0.591	TA	NBR	NCC	11	
210X240X15VSC	8.268	9.449	0.591	SC	FKM	VCC	6	220X275X23TC	8.661	10.827	0.906	TC	NBR	NCC	11	
210X240X15SC	8.268	9.449	0.591	SC	NBR	NCC	6	SHAFT 8.750								
210X240X15TA	8.268	9.449	0.591	TA	NBR	NCC	6	V-RING -220							5	
210X240X15TB	8.268	9.449	0.591	TB	NBR	NCC	6	871077TA-H	8.750	10.750	0.750	TA-H	NBR	NCC	11	
210X240X15TC	8.268	9.449	0.591	TC	NBR	NCC	6	SHAFT 8.819								
210X250X15VSF	8.268	9.843	0.591	SF	FKM	VCS	6	V-RING -220							5	
210X250X15VTC	8.268	9.843	0.591	TC	FKM	VCC	6	224X250X16TC	8.819	9.843	0.630	TC	NBR	NCC	6	
210X250X15TC	8.268	9.843	0.591	TC	NBR	NCC	6	SHAFT 8.858								
210X250X15VTF	8.268	9.843	0.591	TF	FKM	VCC	6	V-RING -220							5	
210X250X16VSZ	8.268	9.843	0.630	SZ	FKM	VCS	6	225X250X15TC	8.858	9.843	0.591	TC	NBR	NCC	6	
210X260X16TC	8.268	10.236	0.630	TC	NBR	NCC	11	225X250X16SA	8.858	9.843	0.630	SA	NBR	NCC	6	
210X290X20TC	8.268	11.417	0.787	TC	NBR	NCC	11	SHAFT 8.875								
SHAFT 8.375								V-RING -220								5
V-RING -220							5	881017TA-H	8.875	10.122	0.750	TA-H	NBR	NCC	11	
831036TA-H	8.375	10.375	0.625	TA-H	NBR	NCC	11	SHAFT 9.000								
SHAFT 8.465								V-RING -220								5
V-RING -220							5	901006SA-H	9.000	10.000	0.625	SA-H	NBR	NCC	11	
215X240X12SC	8.465	9.449	0.472	SC	NBR	NCC	6	901007SA-H	9.000	10.000	0.750	SA-H	NBR	NCC	11	
215X240X12TC	8.465	9.449	0.472	TC	NBR	NCC	6	901036SA-H	9.000	10.375	0.625	SA-H	NBR	NCC	11	
215X245X16TA	8.465	9.646	0.630	TA	NBR	NCC	6	901057SA-H	9.000	10.500	0.750	SA-H	NBR	NCC	11	
215X248X15TC	8.465	9.764	0.591	TC	NBR	NCC	6	901106SA-H	9.000	11.000	0.625	SA-H	NBR	NCC	11	

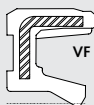
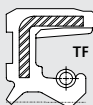
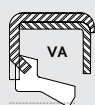
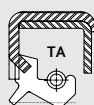

TCM Part #	Shaft	Bore	Width	Type	Lip Material	Material	Box
SHAFT 10.500							
V-RING -275							6
1051176SA-H	10.500	11.750	0.625	SA-H	NBR	NCC	11
1051251TA-H	10.500	12.500	1.000	TA-H	NBR	NCC	12
SHAFT 10.630							
V-RING -275							6
270X300X15TB	10.630	11.811	0.591	TB	NBR	NCC	11
270X300X15TC	10.630	11.811	0.591	TC	NBR	NCC	11
270X310X15SC	10.630	12.205	0.591	SC	NBR	NCC	12
270X310X16SA	10.630	12.205	0.630	SA	NBR	NCC	12
270X310X16TA	10.630	12.205	0.630	TA	NBR	NCC	12
270X310X16TB	10.630	12.205	0.630	TB	NBR	NCC	12
270X310X16TZ	10.630	12.205	0.630	TZ	NBR	NCC	12
270X310X20SC	10.630	12.205	0.787	SC	NBR	NCC	12
270X320X15TC	10.630	12.598	0.591	TC	NBR	NCC	12
270X320X20TC	10.630	12.598	0.787	TC	NBR	NCC	12
SHAFT 10.709							
V-RING -275							6
272X310X16SA	10.709	12.205	0.630	SA	NBR	NCC	12
SHAFT 10.750							
V-RING -275							6
10713312TA-H	10.750	13.374	1.250	TA-H	NBR	NCC	12
SHAFT 10.807							
V-RING -275							6
2745X309X15TCNY	10.807	12.165	0.591	TCNY	NBR	NCC	12
2745X310X6/10KXCY	10.807	12.205	0.236/0.394	KXCY	NBR	NCO	12
SHAFT 10.827							
V-RING -275							6
275X294X12SC	10.827	11.575	0.472	SC	NBR	NCC	11
275X310X16SA	10.827	12.205	0.630	SA	NBR	NCC	12
SHAFT 11.000							
V-RING -275							6
1101226TC	11.000	12.250	0.625	TC	NBR	NCC	12
1101256TA-H	11.000	12.500	0.625	TA-H	NBR	NCC	12
1101306SA-H	11.000	13.000	0.625	SA-H	NBR	NCC	12
1101307TA-H	11.000	13.000	0.750	TA-H	NBR	NCC	12
SHAFT 11.024							
V-RING -275							6
280X310X15VSF	11.024	12.205	0.591	SF	FKM	VCS	12
280X310X15TC	11.024	12.205	0.591	TC	NBR	NCC	12
280X310X16SA	11.024	12.205	0.630	SA	NBR	NCC	12
280X310X16TC	11.024	12.205	0.630	TC	NBR	NCC	12
280X316X18SC	11.024	12.441	0.709	SC	NBR	NCC	12
280X320X15SB	11.024	12.598	0.591	SB	NBR	NCC	12
280X320X15SC	11.024	12.598	0.591	SC	NBR	NCC	12
280X320X16SA	11.024	12.598	0.630	SA	NBR	NCC	12
280X320X18SB	11.024	12.598	0.709	SB	NBR	NCC	12
280X320X18SC	11.024	12.598	0.709	SC	NBR	NCC	12
280X320X20TC	11.024	12.598	0.787	TC	NBR	NCC	12
SHAFT 11.220							
V-RING -275							6
285X310X16SA	11.220	12.205	0.630	SA	NBR	NCC	12
285X310X16VTA	11.220	12.205	0.630	TA	FKM	VCC	12
285X320X20TC	11.220	12.598	0.787	TC	NBR	NCC	12
285X325X16SC	11.220	12.795	0.630	SC	NBR	NCC	12
SHAFT 11.299							
V-RING -275							6
287X330X18TC	11.299	12.992	0.709	TC	NBR	NCC	12

TCM Part #	Shaft	Bore	Width	Type	Lip Material	Material	Box #
SHAFT 11.417							
V-RING -300							11
290X320X18TC	11.417	12.598	0.709	TC	NBR	NCC	12
290X330X15TA	11.417	12.992	0.591	TA	NBR	NCC	12
290X330X16SA	11.417	12.992	0.630	SA	NBR	NCC	12
290X330X16VTF	11.417	12.992	0.630	TF	FKM	VCS	12
290X330X18TZ	11.417	12.992	0.709	TZ	NBR	NCC	12
SHAFT 11.500							
V-RING -300							11
1151307TA-H	11.500	13.000	0.750	TA-H	NBR	NCC	12
1151357TA-H	11.500	13.500	0.750	TA-H	NBR	NCC	12
SHAFT 11.811							
V-RING -300							11
300X320X20TC	11.811	12.598	0.787	TC	NBR	NCC	12
300X332X16TA	11.811	13.071	0.630	TA	NBR	NCC	12
300X335X18SA	11.811	13.189	0.709	SA	NBR	NCC	12
300X340X15TC	11.811	13.386	0.591	TC	NBR	NCC	12
300X340X16SA	11.811	13.386	0.630	SA	NBR	NCC	12
300X340X16TC	11.811	13.386	0.630	TC	NBR	NCC	12
300X340X18VSF	11.811	13.386	0.709	SF	FKM	VCS	12
300X340X20TC	11.811	13.386	0.787	TC	NBR	NCC	12
300X340X20VTF	11.811	13.386	0.787	TF	FKM	VCS	12
300X350X15TA	11.811	13.780	0.591	TA	NBR	NCC	12
300X360X25VTC	11.811	14.173	0.984	TC	FKM	VCS	~
SHAFT 12.000							
V-RING -300							11
1201357TC	12.000	13.500	0.750	TC	NBR	NCC	12
1201407TA-H	12.000	14.000	0.750	TA-H	NBR	NCC	12
SHAFT 12.008							
V-RING -300							11
305X330X13SC	12.008	12.992	0.512	SC	NBR	NCC	12
SHAFT 12.205							
V-RING -300							11
310X340X15TC	12.205	13.386	0.591	TC	NBR	NCC	12
310X350X18SA	12.205	13.780	0.709	SA	NBR	NCC	12
310X350X18VSF	12.205	13.780	0.709	SF	FKM	VCS	12
310X370X28VTC	12.205	14.567	1.102	TC	FKM	VCC	~
SHAFT 12.250							
V-RING -325							12
12213865B-H	12.250	13.812	0.625	SB-H	NBR	NCC	12
SHAFT 12.402							
V-RING -325							12
315X350X18SC	12.402	13.780	0.709	SC	NBR	NCC	12
315X355X18SA	12.402	13.976	0.709	SA	NBR	NCC	12
315X364X20SA	12.402	14.331	0.787	SA	NBR	NCC	~
SHAFT 12.598							
V-RING -325							12
320X350X16SA	12.598	13.780	0.630	SA	NBR	NCC	12
320X360X18SA	12.598	14.173	0.709	SA	NBR	NCC	~
320X360X18SC	12.598	14.173	0.709	SC	NBR	NCC	~
320X360X18VSF	12.598	14.173	0.709	SF	FKM	VCS	~
320X360X18TC	12.598	14.173	0.709	TC	NBR	NCC	~
320X360X20SA	12.598	14.173	0.787	SA	NBR	NCC	~
320X360X20SC	12.598	14.173	0.787	SC	NBR	NCC	~
320X360X20TC	12.598	14.173	0.787	TC	NBR	NCC	~
320X380X20SA	12.598	14.961	0.787	SA	NBR	NCC	~
SHAFT 12.795							
V-RING -325							12
325X365X16SA	12.795	14.370	0.630	SA	NBR	NCC	~
325X365X16VSF	12.795	14.370	0.630	SF	FKM	VCS	~

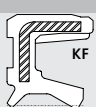
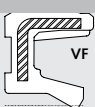
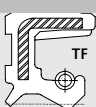
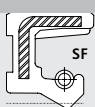

OIL AND GREASE SEALS - A COMPLETE LISTING

PLEASE CALL DICHTOMATIK FOR AVAILABILITY - 800-328-2840
BULK AND INDIVIDUALLY BOXED QUANTITIES ARE AVAILABLE FOR ALL



DICHTOMATIK

Any seal. Any time.

TCM Part #	Shaft	Bore	Width	Type	Lip Material	Material	Box #
SHAFT 12.992							
V-RING -325							12
330X370X18TA	12.992	14.567	0.709	TA	NBR	NCC	~
330X370X18VTC	12.992	14.567	0.709	TC	FKM	VCC	~
SHAFT 13.386							
V-RING -350							12
340X372X16SA	13.386	14.646	0.630	SA	NBR	NCC	~
340X380X18SA	13.386	14.961	0.709	SA	NBR	NCC	~
340X380X18SC	13.386	14.961	0.709	SC	NBR	NCC	~
340X380X18VSF	13.386	14.961	0.709	SF	FKM	VCS	~
340X380X20SB	13.386	14.961	0.787	SB	NBR	NCC	~
340X400X25TA	13.386	15.748	0.984	TA	NBR	NCC	~
SHAFT 13.780							
V-RING -350							12
350X380X16SA	13.780	14.961	0.630	SA	NBR	NCC	~
350X380X16TC	13.780	14.961	0.630	TC	NBR	NCC	~
350X390X18SA	13.780	15.354	0.709	SA	NBR	NCC	~
350X390X18VTC	13.780	15.354	0.709	TC	FKM	VCS	~
350X390X18TC	13.780	15.354	0.709	TC	NBR	NCC	~
SHAFT 14.000							
V-RING -350							12
14016010TC	14.000	16.000	1.000	TC	NBR	NCC	~
SHAFT 14.173							
V-RING -350							12
360X390X15TC	14.173	15.354	0.591	TC	NBR	NCC	~
360X400X16SC	14.173	15.748	0.630	SC	NBR	NCC	~
360X400X18SA	14.173	15.748	0.709	SA	NBR	NCC	~
360X400X20TC	14.173	15.748	0.787	TC	NBR	NCC	~
360X420X28VTC	14.173	16.535	1.102	TC	FKM	VCC	~
SHAFT 14.370							
V-RING -375							12
365X405X18SA	14.370	15.945	0.709	SA	NBR	NCC	~
SHAFT 14.567							
V-RING -375							12
370X410X15SB	14.567	16.142	0.591	SB	NBR	NCC	~
370X410X15SC	14.567	16.142	0.591	SC	NBR	NCC	~
370X415X15TC	14.567	16.339	0.591	TC	NBR	NCC	~
370X430X26VTC	14.567	16.929	1.024	TC	FKM	VCC	~
SHAFT 14.961							
V-RING -375							12
380X420X18SA	14.961	16.535	0.709	SA	NBR	NCC	~
380X420X20SA	14.961	16.535	0.787	SA	NBR	NCC	~
380X420X20SC	14.961	16.535	0.787	SC	NBR	NCC	~
380X420X20VTC	14.961	16.535	0.787	TC	FKM	VCS	~
380X420X20TC	14.961	16.535	0.787	TC	NBR	NCC	~
SHAFT 15.354							
V-RING -400							12
390X420X15TA	15.354	16.535	0.591	TA	NBR	NCC	~
390X430X16TA	15.354	16.929	0.630	TA	NBR	NCC	~
390X430X18SA	15.354	16.929	0.709	SA	NBR	NCC	~
390X430X18VTC	15.354	16.929	0.709	TC	FKM	VCC	~
390X430X20TC	15.354	16.929	0.787	TC	NBR	NCC	~
SHAFT 15.512							
V-RING -400							12
394X420X16SC	15.512	16.535	0.630	SC	NBR	NCC	~
SHAFT 15.748							
V-RING -400							12
400X440X18SA	15.748	17.323	0.709	SA	NBR	NCC	~
400X440X20SC	15.748	17.323	0.787	SC	NBR	NCC	~

TCM Part #	Shaft	Bore	Width	Type	Lip Material	Material	Box
400X440X20TC	15.748	17.323	0.787	TC	NBR	NCC	~
400X450X15TA	15.748	17.717	0.591	TA	NBR	NCC	~
400X450X20SA	15.748	17.717	0.787	SA	NBR	NCC	~
SHAFT 16.000							
V-RING -400							12
16018010TC	16.000	18.000	1.000	TC	NBR	NCC	~
SHAFT 16.142							
V-RING -400							12
410X460X15SA	16.142	18.110	0.591	SA	NBR	NCC	~
SHAFT 16.535							
V-RING -400							12
420X460X15SA	16.535	18.110	0.591	SA	NBR	NCC	~
420X460X20SA	16.535	18.110	0.787	SA	NBR	NCC	~
420X460X20SC	16.535	18.110	0.787	SC	NBR	NCC	~
420X460X20VSF	16.535	18.110	0.787	SF	FKM	VCS	~
420X470X20TA	16.535	18.504	0.787	TA	NBR	NCC	~
420X470X20VTC	16.535	18.504	0.787	TC	FKM	VCC	~
SHAFT 16.929							
V-RING -450							12
430X480X25TB	16.929	18.898	0.984	TB	NBR	NCC	~
430X480X25VTC	16.929	18.898	0.984	TC	FKM	VCC	~
SHAFT 17.323							
V-RING -450							12
440X470X20SA	17.323	18.504	0.787	SA	NBR	NCC	~
440X480X20SA	17.323	18.898	0.787	SA	NBR	NCC	~
440X480X20TC	17.323	18.898	0.787	TC	NBR	NCC	~
440X480X20VTF	17.323	18.898	0.787	TF	FKM	VCC	~
SHAFT 17.717							
V-RING -450							12
450X500X22SC	17.717	19.685	0.866	SC	NBR	NCC	~
SHAFT 18.110							
V-RING -450							12
460X500X20SA	18.110	19.685	0.787	SA	NBR	NCC	~
SHAFT 18.307							
V-RING -450							12
465X495X18VTC	18.307	19.488	0.709	TC	FKM	VCC	~
SHAFT 18.504							
V-RING -450							12
470X520X22SC	18.504	20.472	0.866	SC	NBR	NCC	~
SHAFT 18.701							
V-RING -450							12
475X530X18SA	18.701	20.866	0.709	SA	NBR	NCC	~
SHAFT 18.898							
V-RING -450							12
480X520X20SA	18.898	20.472	0.787	SA	NBR	NCC	~
480X520X20SC	18.898	20.472	0.787	SC	NBR	NCC	~
480X520X20VTF	18.898	20.472	0.787	TF	FKM	VCS	~
SHAFT 19.685							
V-RING -500							12
500X540X20SB	19.685	21.260	0.787	SB	NBR	NCC	~
500X550X20TA	19.685	21.654	0.787	TA	NBR	NCC	~
500X550X22SA	19.685	21.654	0.866	SA	NBR	NCC	~
SHAFT 20.866							
V-RING -550							12
530X565X20TA	20.866	22.244	0.787	TA	NBR	NCC	~
530X580X22TC	20.866	22.835	0.866	TC	NBR	NCC	~

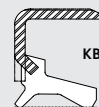
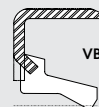
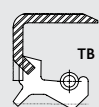
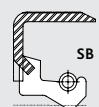
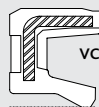



TCM Part #	Shaft	Bore	Width	Type	Lip Material	Material	Box #
SHAFT 22.047							
V-RING -550							12
560X610X20SC	22.047	24.016	0.787	SC	NBR	NCC	~
SHAFT 22.835							
V-RING -550							12
580X630X25SC	22.835	24.803	0.984	SC	NBR	NCS	~
SHAFT 23.622							
V-RING -600							12
600X640X20SA	23.622	25.197	0.787	SA	NBR	NCC	~
600X640X20VTC	23.622	25.197	0.787	TC	FKM	VCC	~
600X650X25SC	23.622	25.591	0.984	SC	NBR	NCC	~

TCM Part #	Shaft	Bore	Width	Type	Lip Material	Material	Box #
SHAFT 25.984							
V-RING -650							12
660X700X18TA	25.984	27.559	0.709	TA	NBR	NCC	~
SHAFT 27.953							
V-RING -725							12
710X760X20TA	27.953	29.921	0.394	TA	NBR	NCC	~

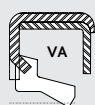
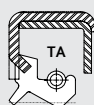

CROSS REFERENCES – OIL AND GREASE SEALS

PLEASE CALL DICHTOMATIK FOR AVAILABILITY - 800-328-2840
 BULK AND INDIVIDUALLY BOXED QUANTITIES ARE AVAILABLE FOR ALL ITEMS
 * = EXACT INTERCHANGE - ALL OTHERS ARE FUNCTIONALLY



SKF/CR INTERCHANGES

SKF/CR Part #	TCM Part #	SKF/CR Part #	TCM Part #	SKF/CR Part #	TCM Part #	SKF/CR Part #	TCM Part #	SKF/CR Part #	TCM Part #
100044*	10011256TA-H	10700*	106182SB-H	11164	111784VHY	11622	30X45X55C	11806*	118202VSB-H
10028*	25X46X75C	10700	106182SB	11170*	111825B-H	11622	30X45X75C	11806	118202VSB
10034*	1017846VL-H	10728	106192SB	11170	111825B	11623*	30X47X75C	11823	30X42X8TC
10034*	10174VB-H	10733*	1061982SB-H	11171*	11182TB-H	11623	30X47X55C	11851	30X52X95A
10035	10174VHY	10740*	106202SB-H	11171	11182TB	11623	30X47X65C	11878*	1182062SB-H
10049*	1018225B-H	10740	106202SB	11172	11182VSB	11624	30X47X7TC	11889	30X52X55C
10050*	100182TB-H	10766*	102062SB-H	11175	11182VTB	11625*	30X47X75B-H	11889	30X52X75C
10071*	101825B-H	10766	102062SB	11207	111872VSB	11625	30X47X75B	11889	30X52X85C
10071	101825B	10916	28X42X7TC	11208*	111872VTB-H	11626*	30X47X8VSB-H	11889	30X52X105C
10074*	101852VL-H	10917*	28X42X75C	11208	111872VTB	11628*	30X47X105C	11893	30X55X55C
10075*	101872SB-H	10921*	28X42X85C	11209*	111872SB-H	11628	30X47X55C	11893	30X55X65C
10075	101872SB	10921	28X42X75C	11223*	111872TB-H	11628	30X47X65C	11893	30X55X105C
10096	101872VHY	10922	28X42X8TC	11223	111872TB	11628	30X47X75C	11907*	1182125B-H
10104*	101925B-H	10924*	28X38X75C	11269*	1119334VL-H	11628	30X47X85C	11908*	119213TA-H
10112*	101932VL-H	10924	28X38X65C	11299*	111925B-H	11629	30X47X7VTC	11914*	1182225L-H
10112*	10192VB-H	10930*	28X40X75B-H	11299	111925B	11631*	181196275C	11914	1182225L
10114*	101983TB-H	10931*	28X42X75B-H	11334	11202VHY	11632	30X47X8TC	11923*	1124325L-H
10123*	102025B-H	10937*	28X44X6PTC	11340*	112025B-H	11633*	30X48X85C	11923	1124325L
10123	102025B	10939*	28X40X75C	11340	112025B	11634*	30X50X85C	11930*	11824425B-H
10124*	10202TB-H	10939	28X40X55C	11343*	11203TB-H	11635*	30X50X85B-H	11930	1182425B
10124	10202TB	10942	28X42X75C	11343	11202TB-H	11637*	30X50X105C	12121*	121194VB-H
10127*	10202TB-H	10942	28X42X85C	11343	11203TB	11637	30X50X85C	12124*	12119740VL-H
10127	10202TB	10943*	28X45X85C	11344*	11202VSB-H	11638*	30X52X75C	12138	11202VTB-H
10128	10202VSB	10943	28X45X65C	11344	11202VSB	11638	30X52X55C	122580*	12213865B-H
10129*	10202VTB-H	10947	28X40X8TC	11353*	112063TB-H	11639	30X52X8TC	12329*	1251615B-H
10131*	10203TLN22-H	10957*	28X47X7VSB-H	11353	112043TB-H	11640*	30X52X85B-H	12329	1251615B
10153*	10202VH-H	10958*	28X47X85B-H	11366*	1120635B-H	11643*	30X52X105C	12330*	12152VL-H
10157*	102042TB-H	10959*	28X47X75C	11368*	112062VTB-H	11643	30X52X55C	12330*	12151VB-H
10157	102042TB	10959	28X47X55C	11372*	112135B-H	11643	30X52X75C	12334*	1216818VL-H
10158*	102062SB-H	10961	28X47X7TC	11372	112135B	11643	30X52X85C	12334*	12161VB-H
10169*	102225B-H	10964	28X48X8TC	11373	11213VSB	11652*	30X55X75B-H	12335*	121682VSB-H
10169	102225B	10967	28X48X55C	11378*	112225B-H	11656	30X55X55C	12335	12162VSB
10170	26X38X5TC	10969	28X47X55C	11378	112225B	11656	30X55X65C	12336*	12162SB-H
10177*	26X37X75C	10969	28X47X75C	11392*	112425B-H	11658*	30X55X105C	12336	121625B
10178*	10243TC	10969	28X47X85C	11392	112425B	11658	30X55X55C	12337	12162VTB
10178	10243TC	10969	28X47X105F	11405*	11283TB-H	11658	30X55X65C	12340*	12172VSB-H
10179	26X38X7TC	10973	28X52X55C	11513	115163TC	11659*	30X47X65C	12340	12172VSB
10183	26X40X7TC	10975*	28X52X85B-H	11514	115172TL	11659	30X47X55C	12343*	12172VTB-H
10188*	26X42X75C	10979*	28X52X105C	11518*	115162TB-H	11660*	30X60X85B-H	12350*	12163TB-H
10188	26X42X65C	10979	28X52X55C	11518	115162TB	11663	30X50X11TC	12350	12163TB
10193	26X42X65C	110051*	1101306SA-H	11524*	115182SB-H	11664*	30X62X75C	12355*	1217539TC
10193	26X42X75C	11031	28X43X75C	11524	115182SB	11664	30X62X55C	12360*	12172TLN22-H
102365	260X300X205B	11050*	11131VL-H	11545*	115202TB-H	11665*	30X62X75B-H	12361*	12171VHY-H
10242*	26X35X75B-H	11055*	1114320VL-H	11545	115202TB	11667	30X62X55C	12361	12171VHY
105010*	10511765A-H	11060*	1114918VL-H	11550*	115202VSB-H	11667	30X62X75C	12363*	121725L-H
10515*	1061425B-H	11061*	11149185B-H	11550	115202VSB	11668	30X62X7TC	12364*	12172TB-H
10518*	106142VSB-H	11061	11141SM	11553*	1172055B-H	11671*	18118127TC	12364	12172TB
10518	106142VSB	11066*	11152PSL-H	11553	1172055B	11676	30X62X8TC	12369*	121752VH-H
10579*	27X37X75C	11066	11152PSL	11557*	11520635B-H	11678	30X52X7TC	12369	12172VHY
10581*	1061525B-H	11067*	11156125B-H	11566*	11521435A-H	11685*	30X72X85B-H	12371*	1217535C
10583*	10615725B-H	11081*	111562VL-H	11585*	1181835B-H	11686*	30X72X105C	12379*	121872VH-H
10598*	1061625B-H	11082*	1115625B-H	11591	30X45X5TC	11686	30X72X65C	12383*	12182VTB-H
10598	1061625B	11082	1115625B	11599	30X42X7TC	11730*	1181625B-H	12383	12182VTB
10630*	27X42X105C	11111	11162PSB	11600*	30X40X75C	11730	1181625B	12384*	121825B-H
10630	27X42X75C	11123*	111625B-H	11600	30X40X45C	11734*	1181725B-H	12384	121825B
10632*	1016825B-H	11123	111625B	11602	30X40X7TC	11734	1181725B	12386*	12182TB-H
10632	1016825B	11124*	11162TB-H	11603*	30X40X7VTC	11734	1181725L	12386	12182TB
10644	27X47X65C	11124	11162TB	11605*	30X40X75B-H	11736*	1181752VSB-H	12391*	1219325B-H
10653*	1061725B-H	11130*	111622VH-H	11605	30X40X75B	11740*	1181835B-H	12396*	121952TB-H
10663*	27X45X85C	11133*	11162VSB-H	11606	30X40X7VSB	11740	1181835B	12396	121952TB
10663	27X45X65C	11133	11162VSB	11607	30X40X45C	11763*	11182PSB-H	12399	121964VHY
10663	27X45X75C	11134*	11162VTB-H	11607	30X40X75C	11763	11182PSB	12404*	1219740VL-H
10681*	10618225L-H	11134	11162VTB	11608*	30X42X75C	11776*	11819825B-H	12407*	121972VH-H
10681	10618225L	11137	111735B	11608	30X42X4.55C	11777*	118192TB-H	12411	12194VHY
10683*	27X47X85C	11138*	111725B-H	11608	30X42X65C	11777	118192TB	12427*	1219825B-H
10683	27X47X65C	11138	111725B	11610*	30X42X75B-H	11800*	1182025B-H	12428*	121982TB-H
10689*	27X47X105C	11139*	11162VTLN22-H	11615*	30X45X85B-H	11800	1182025B	12428	121982TB
10689	27X47X65C	11144*	11172VSB-H	11615	30X45X85B	11801*	118202TB-H	12437*	121982VH-H
10689	27X47X85C	11150*	11172VL-H	11622*	30X45X85C	11801	118202TB	12438*	1219943VTLN22-H



PLEASE CALL DICHTOMATIK FOR AVAILABILITY - 800-328-2840
BULK AND INDIVIDUALLY BOXED QUANTITIES ARE AVAILABLE FOR ALL ITEMS
* = EXACT INTERCHANGE - ALL OTHERS ARE FUNCTIONALLY

SKF/CR Part #	TCM Part #	SKF/CR Part #	TCM Part #	SKF/CR Part #	TCM Part #	SKF/CR Part #	TCM Part #	SKF/CR Part #	TCM Part #
12446*	12202VTB-H	12830*	128203TC	13598*	136203SB-H	13929*	13283PTB-H	14037*	36X56X10SC
12446	12202VTB	12883	33X50X6TC	13602*	13213TB-H	13930	35X52X7TC	14037	36X56X6SC
12456*	12202SB-H	12901	33X50X6SC	13602	13213TB	13932*	35X47X7SC	14039	36X58X10TC
12456	12202SB	12905*	1302043PTB-H	13612	13212VHY	13932	35X47X4.5SC	14040	36X58X8SB
12458*	12202TB-H	12907	130204TB-H	13614*	132103PSB-H	13932	35X47X5SC	14046*	36X60X8VSB-H
12458	12202TB	12995*	33X45X7SC	13649*	132123SB-H	13932	35X47X6SC	14047	35X52X7SC
12481*	12202VH-H	13021*	13183PSL-H	13649	132123SB	13933	35X50X5SC	14047	35X52X8SC
12483*	122043PSB-H	13021	13183PSL	13650*	132123TB-H	13934	13334SA-H	14052*	36X62X7SC
12508*	122062VH-H	13050*	131203SB-H	13650	132123TB	13937*	13305TA-H	14055	36X65X8SB
12530*	122064SA-H	13050	131203SB	13661*	132123VTB-H	13938*	35X47X7SB-H	14068	36X54X6.5SC
12530	122064SA	13052*	131203TB-H	13661	132123VTB	13938	35X47X7SB	14068	36X54X7.5SC
12531*	122062VTB-H	13052	131203TB	13662	132122VHY	13940	35X55X5SC	14105*	35X52X12SC
12531	122062VTB	13092*	1312131SB-H	13671*	132235B-H	13940	35X55X8SC	14105	35X52X7SC
12544*	12212VSB-H	13112*	131223SB-H	13671	13223SB	13940	35X55X10SC	14105	35X52X8SC
12544	12212VSB	13157*	132282TB-H	13676	13223TB-H	13941*	35X48X8SB-H	14105	35X52X10SC
12545*	12212SB-H	13157	132282TB	13689*	13222VL-H	13942*	35X48X8VSB-H	14107*	36X68X10SC
12545	12212SB	13350*	132203SB-H	13691*	13223VTB-H	13944*	35X50X8SB-H	14111	35X55X12TC
12551*	12212TB-H	13350	132203SB	13691	13223VTB	13945	35X47X7TC	14113	35X62X7TC
12551	12212TB	133800*	340X380X18SC	13700	132263SB	13947*	35X52X8PTB-H	14212*	1432063VSB-H
12560	32X52X10TC	13388	34X46X8TC	13710*	132282VL-H	13947	35X52X8PTB	14214*	1432063TB-H
12565	12212VHY	13418*	132231SB-H	13711	13234VHY	13948*	35X52X7SC	14223*	143213SB-H
12577*	12222SB-H	13418	132231SB	13734*	13233VSB-H	13949*	35X52X8SB-H	14223*	14213SB-H
12582*	12222VL-H	13423*	34X44X8TC	13738*	13233SB-H	13951*	35X52X8TB-H	14223	14213SB
12590	123222SB	13425*	34X48X8SB-H	13738	13233SB	13951	35X52X8TB	14225*	14213VTB-H
12598*	32X47X10SC	13431	34X52X8TC	13739	13233TB-H	13952*	35X54X7SB-H	14225	14213VTB
12598	32X47X7SC	13433*	34X52X8SC	13758	13232VHY	13954*	35X55X8SB-H	14247*	14223TB-H
12602*	32X42X7SC	13437*	134213SB-H	13797*	132432SB-H	13954	35X55X8SB	14247	14223TB
12602	32X42X5SC	13447	34X55X9TC	13810*	132443SB-H	13960*	35X55X10SC	14259*	14223VTB-H
12610*	122325SB-H	13475*	34X62X8SB-H	13810	132443SB	13960	35X55X5SC	14259	14223VTB
12612*	1223731VSB-H	13483*	34X62X10SC	13812*	132443TB-H	13960	35X55X8SC	14260	14223VSB
12613*	1223735B-H	13500*	1362192PSB-H	13812	132443TB	13961*	35X56X8SB-H	14262*	1432231SB-H
12614*	12233TB-H	13509*	131719VVL-H	13857	35X49X6TC	13963	35X55X8VSB	14282*	1432373SB-H
12621*	122432SB-H	13510*	131822VTB-H	13860	35X50X10TC	13966*	35X62X7SC	14283*	1432373TB-H
12631*	122442SB-H	13511*	131873VTB-H	13861	35X55X8TC	13967*	35X60X10SC	14283*	14233TB-H
12631	122442SB	13512*	131872PSB-H	13862*	132502VH-H	13969	35X62X8VSB	14283	14233TB
12637*	122535B-H	13514*	13172SB-H	13863*	13731547TC	13970*	35X62X8SB-H	14359*	1432432VH-H
12637	122535B	13527*	1319543PTB-H	13865*	132535B-H	13970	35X62X8SB	14363*	14324331SB-H
12640*	122505TLN22-H	13529*	131719VL-H	13865	132535B	13974*	35X68X8SB-H	14363	14243SB
12655*	122565SA-H	13534*	1318725B-H	13867	13253VSB	13979*	35X72X8SB-H	14383*	14235SB-H
12660*	122745A-H	13534	1318725B	13868*	35X65X10SC	13980*	13728331TB-H	14383	14253SB
12660	122745A-H	13535*	131873TB-H	13868	35X65X9SC	13985	1361945B	14404*	1432623SB-H
12668	12283TC	13535	131872TB-H	13875*	1325635B-H	13986*	35X80X8SB-H	14423*	14263SB-H
12671	32X42X8TC	13536*	131832SB-H	13875	1325635B	13987*	35X50X10SC	14423	14263SB
12674	32X52X7SC	13536	131832SB	13876*	132563TB-H	13987	35X50X5SC	14458*	14273SB-H
12695	32X43X7TC	13537*	131835B-H	13876	132563TB	13989*	35X52X10SC	14458	14273SB
12700*	32X42X7SB-H	13537	131835B	13878*	132563VTB-H	13989	35X52X7SC	14489*	37X52X8SC
12709*	32X45X7SC	13538*	131872VSL-H	13878	132563VTB	13989	35X52X8SC	14641*	1462373TB-H
12709	32X45X6SC	13543*	1318718VL-H	13882*	1326231VTB-H	13990	139225TB	14704*	38X52X8SB-H
12711	32X45X7TC	13545*	131872PVL-H	13884	35X48X8TC	13992*	13922946TB-H	14705*	38X52X8TB-H
12719*	32X46X8SB-H	13548*	131872VL-H	13885	35X50X8TC	13993*	35X55X8SC	14707*	38X50X7SC
12730*	32X47X8SB-H	13552*	13192TB-H	13887	35X50X5SC	13993	35X55X5SC	14709*	38X52X7SC
12733*	32X47X7SC	13552	13192TB	13888*	35X52X8SC	13994*	35X56X10SC	14710*	38X54X7PSB-H
12734	32X48X8TC	13557*	13193PSB-H	13888	35X52X7SC	13994	35X56X8SC	14711*	38X52X8SC
12735*	32X48X8SB-H	13557*	13193PSB-H	13890	35X55X10VSF	13996*	35X62X10SC	14711	38X52X7SC
12738*	32X50X10SC	13557	13193PSB	13892	132655L	13996	35X62X7SC	14712*	38X54X10SC
12738	32X50X8SC	13562*	13203PTB-H	13893	35X55X10TC	13996	35X62X8SC	14714	38X50X8TC
12739	32X50X10VTC	13568*	13203SB-H	13894*	35X58X10SC	13998	35X62X10TC	14719*	38X55X7SC
12741*	32X50X8VSB-H	13568	13203SB	13896	35X72X10TC	13999*	35X72X10SC	14720*	38X55X8SB-H
12743	32X52X7VSC	13569*	13203TB-H	13900*	132735B-H	13999	35X72X7SC	14726	38X62X7SC
12743	32X52X10VSF	13569	13203TB	13900	132735B	14000	35X72X7SC	14726	38X62X8SC
12744*	32X52X7SC	13571*	13203SA-H	13906*	132755A-H	14000	35X72X10SC	14727*	38X56X10SC
12745*	32X52X8SB-H	13571	13203SA	13907	35X50X7TC	14003*	35X47X7VSC	14730*	38X58X8SB-H
12748	32X52X11TC	13573*	13202VH-H	13909	35X48X8SC	14009*	36X50X7SB-H	14732*	38X58X8VSB-H
12749	32X48X5SC	13579*	13203VSB-H	13918*	13283TB-H	14011*	36X50X7SC	14733*	38X62X7SC
12749	32X48X7SC	13579	13203VSB	13918	13283TB	14013*	36X52X7SC	14740*	38X60X8SB-H
12752*	32X50X8SC	13581	13203VTB-H	13920*	132835B-H	14013	36X52X5SC	14741*	38X60X8VSB-H
12764	32X56X10TC	13581	13203VTB	13927*	35X45X7SC	14016*	36X52X8SB-H	14742	38X62X8SB
12782*	32X62X10SC	13585*	1320631SB-H	13927	35X45X6SC	14023*	36X54X7.5SC	14761*	38X72X10SC
12782	32X62X8SC	13588*	1320631PTB-H	13928	35X68X6SC	14023	36X54X6.5SC	14767*	14929143TB-H

SKF/CR INTERCHANGES

CROSS REFERENCES – OIL AND GREASE SEALS

PLEASE CALL DICHTOMATIK FOR AVAILABILITY - 800-328-2840
 BULK AND INDIVIDUALLY BOXED QUANTITIES ARE AVAILABLE FOR ALL ITEMS
 * = EXACT INTERCHANGE - ALL OTHERS ARE FUNCTIONALLY



SKF/CR INTERCHANGES

SKF/CR Part #	TCM Part #	SKF/CR Part #	TCM Part #	SKF/CR Part #	TCM Part #	SKF/CR Part #	TCM Part #	SKF/CR Part #	TCM Part #
14774*	38X80X8SB-H	15176*	152563SB-H	15822	40X55X8TC	16061*	16223SB-H	16513*	42X55X7SC
14804*	1518718VL-H	15176	152563SB	15823*	40X55X8SC	16061	16223SB	16514	42X60X7TC
14807*	15182SB-H	15190*	152622VH-H	15823	40X55X6.5SC	16062*	1622243TB-H	16515*	42X60X8SB-H
14807	15182SB	15194*	15263SL-H	15823	40X55X7SC	16064	162324UB	16517	42X60X8VSB
14810*	151872VL-H	15194	15263SL	15825*	40X56X8SB-H	16065	16222VHY	16518	42X62X8TC
14810*	15182VB-H	15204*	1527143SB-H	15828	40X56X7SC	16069	162334VHY	16519*	42X62X8SB-H
14816*	151932VL-H	15207*	152685SB-H	15829*	15722031TC	16072*	16233SA-H	16519	42X62X8SB
14824*	15192TB-H	15214*	152735B-H	15835*	40X58X8SB-H	16072	16233SA	16521*	42X62X8SC
14824	15192TB	15214	15273SB	15839*	40X60X10SC	16077*	16233VSB-H	16521	42X62X7SC
14832*	151935B-H	15230*	1527531SB-H	15839	40X60X7SC	16077	16233VSB	16525*	42X65X8SB-H
14832	151935B	15230	152753SL	15839	40X60X8SC	16078*	16223VSB-H	16529*	42X62X10SC
14846*	15203TB-H	15234*	152833SB-H	15844	40X60X10TC	16078	16223VSB	16529	42X62X7SC
14846	15203TB	15235*	152835B-H	15845*	40X62X8SB-H	16079*	16235SA-H	16529	42X62X8SC
14855*	152035B-H	15235	15283SB	15846*	40X62X8VSB-H	16084*	16233SB-H	16531	42X55X9TC
14857*	15202VL-H	15240*	15295SA-H	15847*	40X62X7SC	16084	16233SB	16534	42X65X12TC
14858*	152043TL-H	15241*	15303TB-H	15848*	40X62X10SC	16085*	16233TB-H	16537*	42X65X10SC
14858	152043TL	15241	15303TB	15848	40X62X7SC	16085	16233TB	16537	42X65X8SC
14863*	1520620VL-H	15450*	1552505TB-H	15848	40X62X8SC	16094	16232SB	16553	42X72X8TC
14863*	152062VB-H	15460*	1552685SB-H	15851	40X62X7TC	16117*	1622433SB-H	16555*	42X72X8SB-H
14864*	152063SB-H	15508*	1562062SB-H	15852*	40X65X10SC	16118*	16243TB-H	16558*	42X72X8SC
14864*	152063SL-H	15510	152082SB	15852	40X65X9SC	16118	16243TB	16561	42X72X8SC
14867*	152063VSB-H	15517*	156213SB-H	15853*	40X68X10SC	16119*	16243VSB-H	16579*	42X60X10SC
14867	152063VSB	15517	156213SB	15853	40X68X6SC	16119	16243VSB	16579	42X60X8SC
14868*	152063VTLN22-H	15518*	156213PTB-H	15854*	40X68X8SB-H	16120*	16243VTB-H	16616	42X62X7TC
14875*	15213SB-H	15522*	156223SB-H	15855*	40X70X8SB-H	16120	16243VTB	16617*	42X80X10SC
14876	15213TB-H	15522	156253sb	15857*	40X72X7SC	16180*	1622443SB-H	16619	45X70X10TC
14907*	148223SB-H	15542*	1562373SB-H	15860*	40X72X8SB-H	16201*	162443TB-H	16650*	1682275SA-H
14907	148223SB	15543*	156233TB-H	15868	40X72X10TC	16201	162443TB	16657*	168233TB-H
14935*	152235SB-H	15543	156233TB	15869	40X60X7SC	16243*	16253VTB-H	16657	168233TB
14938*	152235B-H	15549	156233VTB	15869	40X60X8SC	16243	16253VTB	16667	168235VHY
14938	152235B	15557*	157243TA-H	15869	40X60X10SC	16245*	16253SB-H	16679*	1682433SB-H
14939*	15223TB-H	15557	157243TA	15870*	40X80X8SB-H	16245	16253SB	16679	168243SB
14939	15223TB	15592*	1562431SL-H	15870	40X80X8SB	16246*	16253TB-H	16696*	1682445SB-H
14940*	15223VSB-H	15592	1562431SL	15871	40X80X8VSC	16246	16253TB	16696	1682445SB
14940	15223VSL	15620*	156245TB-H	15871	40X80X10VSF	16254*	1622503TA-H	16719*	16825031SB-H
14942*	15223VTB-H	15620	156245TB	15872*	40X80X10SC	16270	16253VHY	16735*	16825547TC
14960	15222VHY	15624*	1562463PTB-H	15872	40X80X8SC	16284*	162562VH-H	16743	168252VHY
14966	152252VHY	15635*	156253TB-H	15873	40X80X10VTC	16284	162562VHY	16754*	1682562VH-H
14968*	1522540SB-H	15635	156253TB	15876*	40X58X10SC	16286*	162462OUB	16757*	1682602VL-H
14970*	152282OUB	15649*	1562502VH-H	15876	40X58X8SC	16289	162564VHY	16811*	1682623VH-H
14971	1522842OUB	15649	156252VHY	15877	40X80X12TC	16290*	1625631VTB-H	16811	168263VHY
14972*	152325VL-H	15655*	1562531SB-H	15878*	40X68X12SC	16314*	16263SL-H	16814*	1682623TB-H
14974	15235VHY	15655	152503SB	15878	40X68X6SC	16315*	16263TB-H	16816*	1682655B-H
14975	15233VHY	15656*	1562503VSB-H	15878	40X68X10SC	16315	16263TB	16816	1682655B
14977*	152325TLN22-H	15677*	1562563SB-H	15881*	1572139PTC	16316	16263VSB	16842*	16826831SB-H
14994*	152373VTB-H	15699*	15626231SB-H	15890*	40X90X8SB-H	16322	16262VHY	16854*	1682713SL-H
14994	152373VTB	15707*	1562635B-H	15915*	159213PSL-H	16337*	16268531SB-H	16854	1682713SL
15004*	152373SB-H	15730*	1562683VL-H	15948*	40X78X10SC	16337	1626831SL	16871	168255TBJ
15005*	152373TB-H	15745	40X52X6TC	15950	40X65X9SC	16364*	16272SB-H	16900*	1682731SB-H
15005	152373TB	15747*	40X50X8SC	15950	40X65X10SC	16364	16272SB	16903*	168273TB-H
15032*	152372VH-H	15747	40X50X7SC	15955	159243SL	16368*	162273SA-H	16903	168273TB
15039*	152375SA-H	15750	157223TBJ	15960*	159253SB-H	16374*	162763SB-H	16937*	43X60X10SC
15039	152375SA	15761*	156275SA-H	15960	159253SB	16374	162763SB	16939	43X62X10SA
15041*	1523745TB-H	15761	156275SA	15968*	1592623SB-H	16386	162834SA-H	16960*	162834TB-H
15076*	152435B-H	15773*	1562835B-H	15975*	1592735B-H	16406*	16283SB-H	16990*	1682831SB-H
15076	152435B	15801	40X52X7TC	15975	1592735B	16406	16283SB	17035*	1683063SB-H
15080*	152432VL-H	15803*	40X52X7VSB-H	16039*	16202VSB-H	16422*	16303SA-H	17038*	168313TB-H
15092*	152443SB-H	15803	40X52X7VSB	16040	161254TB	16422	16303SA	17100*	1703035TB-H
15093*	152443TL-H	15804*	40X52X7SC	16044*	161255TB-H	16492*	42X56X7SC	17136*	1712625SA-H
15093	152443TL	15805*	40X52X7SB-H	16044	161255TB	16493*	42X56X7VSC	17143	44X60X9TC
15121*	38X65X10SC	15808	40X52X8TC	16046*	162025B-H	16494	42X56X7TC	17144*	17125631TB-H
15121	38X65X9SC	15810*	40X54X7SB-H	16046	16202SB	16495	42X55X7TC	17145	173275VHY
15138*	15253VSB-H	15810	40X54X7SB	16047	162113TB-H	16498*	16522839SC	17146*	1712565VHY-H
15138	15253VSB	15815*	40X55X7SC	16048*	16212VSB-H	16500	164263PTB	17149*	44X62X8SB-H
15141*	152535B-H	15815	40X55X6.5SC	16048	16212VSB	16503	42X55X8SB	17166*	44X68X8VSB-H
15141	152535B	15819	40X55X7TC	16054*	162125B-H	16505*	42X56X8SB-H	17168*	44X65X10SC
15142*	15253TB-H	15820*	40X55X8SB-H	16054	162125B	16505	42X56X8SB	17187*	17324021VL-H
15160*	152502VH-H	15820	40X55X8SB	16055*	162212VL-H	16512*	42X55X8SC	17231*	1722315B-H
15160	15252VHY	15821	40X55X8VSB	16055*	16212VB-H	16512	42X55X7SC	17231	1722315B



PLEASE CALL DICHTOMATIK FOR AVAILABILITY - 800-328-2840
BULK AND INDIVIDUALLY BOXED QUANTITIES ARE AVAILABLE FOR ALL ITEMS
* = EXACT INTERCHANGE - ALL OTHERS ARE FUNCTIONALLY

Table with 8 columns: SKF/CR Part #, TCM Part #, SKF/CR Part #, TCM Part #, SKF/CR Part #, TCM Part #, SKF/CR Part #, TCM Part #. Rows list various seal part numbers and their functional equivalents.

SKF/CR INTERCHANGES

CROSS REFERENCES – OIL AND GREASE SEALS

PLEASE CALL DICHTOMATIK FOR AVAILABILITY - 800-328-2840
 BULK AND INDIVIDUALLY BOXED QUANTITIES ARE AVAILABLE FOR ALL ITEMS
 * = EXACT INTERCHANGE - ALL OTHERS ARE FUNCTIONALLY



SKF/CR INTERCHANGES

SKF/CR Part #	TCM Part #	SKF/CR Part #	TCM Part #	SKF/CR Part #	TCM Part #	SKF/CR Part #	TCM Part #	SKF/CR Part #	TCM Part #
19640*	50X72X8SB-H	19922	202883TB	21061	21275TB	21637*	55X80X8SC	22382*	2230635B-H
19643*	192845A-H	19922	202883TB-H	21063*	21273VSB-H	21637	55X80X6SC	22382	2230635B
19643	192845A	19940*	202963VL-H	21069*	2127625B-H	21638	55X80X8TC	22390	2230645A
19645	50X72X8SC	19969*	2029935A-H	21069	2127625B	21640*	55X80X85B-H	22392	223062VHY
19646	50X72X8TC	19969	2029935A	21091*	21284VSB-H	21640	55X80X85B	22400*	22313TB-H
19648	50X72X85C	19992*	203035B-H	21091	21284VSB	21642*	55X80X10SC	22400	22313TB
19649	50X72X10TC	19992	203025B-H	21098*	212845B-H	21642	55X80X6SC	22407*	223155A-H
19652	50X72X12TC	19993*	20303TB-H	21098	212845B	21642	55X80X85C	22424*	22318435B-H
19655*	50X75X10SC	19993	20303TB	21100*	21284TB-H	21644*	55X80X12SC	22425*	2231843PTB-H
19662	50X80X8TC	19995*	20303VTB-H	21100	21284TB	21644	55X80X65C	22425	223184PTB
19663*	50X80X10SC	19995	20303VTB	21101*	21282VL-H	21644	55X80X85C	22430*	22322OUB
19664*	50X80X85B-H	20002*	20303VSA-H	21103*	2128355B-H	21644	55X80X105C	22440*	2232535B-H
19665*	196315315C	20004*	2003035A-H	21103	2128355B	21645*	55X80X135C	22440	223235B
19667*	50X80X135C	20004	2003035A	21108*	21284TA-H	21645	55X80X65C	22441*	22323TB-H
19667	50X80X105C	20005*	20303TA-H	21108	21284TA	21645	55X80X85C	22441	22323TB
19675*	50X85X105C	20006*	20302VH-H	21134*	21299435A-H	21645	55X80X105C	22446*	223245A-H
19675	50X85X85C	20044*	203062VH-H	21134*	212945A-H	21646*	55X70X105C	22446	223245A
19681	50X65X9TC	20045*	2030635B-H	21134	212945A	21646	55X70X75C	22448*	22324TA-H
19683	50X75X12TC	20053*	2030655A-H	21136*	2129943TA-H	21646	55X70X85C	22448	22324TA
19684*	50X90X85B-H	20054	203065TA	21159*	21303VH-H	21648	55X68X8TC	22449*	22324VSA-H
19687*	50X90X105C	20070*	203135B-H	21163*	213035B-H	21651*	216322475C	22449	22324VSA
19688	50X64X10TC	20078*	203142VL-H	21163	213035B	21654	55X70X8VTC	22453	57X72X105A
19714*	50X65X105C	20079*	2031535B-H	21164*	21303TB-H	21656	55X70X8TC	22468	22322VHY
19714	50X65X75C	20098*	20318465A-H	21167*	21303VTA-H	21660*	55X85X85B-H	22492*	2233545A-H
19714	50X65X85C	20100*	2031846TA-H	21171*	21304VSA-H	21661*	55X85X85C	22492	2233545A
19723	50X70X10TC	20109*	203245A-H	21171	21304VSA	21668	55X85X85C	22493*	2233543TA-H
19737*	202372VB-H	20109	203245A	21172*	2130435A-H	21670*	55X90X85B-H	22493	223353TA-H
19745*	2025031PSB-H	20124*	20337435A-H	21173*	213043TA-H	21671*	55X90X105C	22532*	22334TA-H
19745	202503PSL-H	20125*	20334TA-H	21173	21303TA-H	21671	55X90X85C	22532	22333TA-H
19753*	2025623VL-H	20125	20334TA	21208	213062VHY	21673	55X90X85C	22532	22334TA
19754*	202502VL-H	20127*	203374VSA-H	21210*	2130655B-H	21673	55X90X105C	22550*	223373VL-H
19760*	202635B-H	20140*	20354435A-H	21210	2130655B	21682*	55X75X125C	22558*	22337435A-H
19760	202635B	20144*	20362435A-H	21211*	213065TB-H	21682	55X75X85C	22561	22334VSA
19762*	20263TB-H	20148*	203622VH-H	21211	213065TB	21685*	55X100X85B-H	22563*	223429OUB
19762*	20263TL-H	20158*	2040045A-H	21213*	213065TA-H	21693*	55X100X125C	22565*	223442VL-H
19762	20263TB	20210*	51X65X7TB-H	21234*	213145A-H	21736*	21828435A-H	22582*	22354TA-H
19763*	202622VH-H	20210	51X65X7TB	21234	213145A	21749*	218299435A-H	22582	22354TA
19763	20262VHY	20408	52X65X9TC	21245*	213143PTA-H	21759*	218303TB-H	22583*	2235435A-H
19768*	2026223VL-H	20415*	52X69X105C	21267*	213183TB-H	21763*	218303VTB-H	22590*	223543VTA-H
19777*	20263VTB-H	20421	52X68X85B	21267*	213183TB-H	21775*	21830655A-H	22618*	22362435A-H
19777	20263VTB	20426*	52X68X85C	21267	213183TB	21840*	2183245A-H	22619*	2236243TA-H
19778*	2026835B-H	20434*	52X66X95C	21269*	213183VTB-H	21840	2183245A	22626*	223745A-H
19778	2026835B	20435*	52X72X8VTB-H	21269	213183VTB	21890*	2183345A-H	22626	223745A
19782*	20263VTB-H	20437	52X72X8TC	21270*	21318465TA-H	21890	2183345A	22644*	223845A-H
19782	20263VTB	20440	52X72X85B	21283	54X80X105A	21910*	218337435A-H	22644	223845A
19783*	202682VH-H	20441	52X72X8VSB	21302*	213245A-H	22015*	56X70X85C	22647*	224045A-H
19785*	2027135B-H	20453	52X75X85C	21302	213245A	22018*	56X72X85C	22647	224045A
19786*	202713TB-H	20453	52X75X105C	21318	54X72X10TC	22030*	56X75X85B-H	22815*	58X72X85B-H
19803*	2027423VL-H	20473*	52X80X105C	21336*	21335435A-H	22038	56X72X8TC	22816*	58X72X85C
19807*	20274355B-H	20478	52X68X10TC	21352*	213337TB-H	22225	57X67X6TC	22822	58X75X85B
19820*	2027518VL-H	20495	52X85X85C	21352	213337TB	22306*	222618VL-H	22823	58X75X9TC
19823*	20273VSB-H	20520*	206253VSB-H	21353*	213345A-H	22319*	2228956TB-H	22824	58X75X95C
19831*	202735B-H	20520	206253VSB	21353	213345A	22325*	22282VH-H	22827	58X80X55C
19832*	20273TB-H	20530*	2062735A-H	21358*	21354435A-H	22328*	222831TB-H	22828	58X80X12TC
19832	20273TB	20538*	206284435A-H	21379*	2136246PTB-H	22338*	22299435A-H	22828	58X80X105C
19834	202752VHY	20586*	206299435A-H	21603*	55X68X85C	22340*	22294TA-H	22831*	58X80X55C
19839*	20273VTB-H	20594*	2063035B-H	21610*	55X70X85B-H	22340	22294TA	22834	58X80X10TC
19839*	20273VTB-H	20599*	206303VTB-H	21610	55X70X85B	22353*	223035B-H	22835*	2283153VH-H
19839	202731VTB	20643*	20630635A-H	21611	55X70X8VSB	22353	223035B	22835	228313VHY
19839	20273VTB	20659	2031235B	21612*	55X70X85C	22354*	22303TB-H	22870	229313VHY
19848*	202845A-H	20702*	2063135B-H	21612	55X70X75C	22354	22303TB	22875*	228354395C
19880*	20282VH-H	20702	2063135B	21620*	55X72X85B-H	22359*	22304TA-H	23030	23293SL
19884	20283VSB	20735*	206322OUB	21623*	55X72X85C	22359	22302TA-H	23035*	231302VL-H
19886*	202835B-H	20749*	206325435A-H	21624	55X72X85C	22359	22304TA	23061*	2313135B-H
19886	202835B	20905*	53X68X105C	21627	55X75X85C	22361*	22303VTB-H	23061	2313135B
19887*	20283TB-H	21040*	54X65X85B-H	21629	55X72X9TC	22361	22303VTB	23093*	2313245A-H
19896	20283TA-H	21059*	21272VH-H	21631	55X78X95C	22363*	22303VSB-H	23093	2313245A
19900	202855A	21061*	21275TB-H	21632	55X78X12TC	22367*	223043VSA-H	23099*	23132543VTA-H
19922*	202883TB-H	21061	21273TB-H	21633	55X85X85C	22368	22302VHY	23130*	2313303VH-H



DICHTOMATIK

Any seal. Any time.

CROSS REFERENCES – OIL AND GREASE SEALS

PLEASE CALL DICHTOMATIK FOR AVAILABILITY - 800-328-2840
BULK AND INDIVIDUALLY BOXED QUANTITIES ARE AVAILABLE FOR ALL ITEMS
* = EXACT INTERCHANGE - ALL OTHERS ARE FUNCTIONALLY

SKF/CR Part #	TCM Part #	SKF/CR Part #	TCM Part #	SKF/CR Part #	TCM Part #	SKF/CR Part #	TCM Part #	SKF/CR Part #	TCM Part #
23152*	23133543SA-H	23725*	233352VH-H	24910*	253245A-H	25455*	65X110X105B-H	26877*	26438155B-H
23167*	2313745B-H	23742*	23337435A-H	24910	253245A	25561*	256345TA-H	26921*	2683845A-H
23167	2313745B	23742	2333745A	24911*	25324TA-H	25561	256345TA	26921	2683845A
23184*	2313535B-H	23744*	23342OUB	24911	25324TA	25577*	2563545A-H	26975*	268400465A-H
23184	2313535B	23747	60X90X8TC	24913*	253255VSB-H	25577	2563545A	27268*	273535B-H
23240*	231352VH-H	23755*	233445A-H	24916	25324VTA	25586*	65X90X125C	27268	273535B
23277*	2313755B-H	23755	233445A	24931*	2533545A-H	25586	65X90X105C	27269*	27353TB-H
23277	2313755B	23756*	23344TA-H	24932*	2533543TA-H	25598	65X85X13TC	27269	27353TB
23300*	2323039PSB-H	23756	23344TA	24934*	253373TA-H	25641*	2563645A-H	27271*	27352VL-H
23425*	60X72X85C	23770*	23353PTB-H	24949*	253423PTB-H	25641	2563645A	27272*	27353VBTB-H
23426*	60X75X85C	23770	23353PTB	24951*	25343TB-H	25661*	25636246PTB-H	27272	27353VBTB
23427	60X75X8TC	23771*	23353VSA-H	24951	25343TB	25713	2563745A	27280*	273545A-H
23429*	60X75X85B-H	23771	23353VSA	24954*	253345A-H	25748	253845A	27280	273545A
23430*	60X75X8VSB-H	23779*	233535A-H	24954	253345A	25950*	2603353PSA-H	27284	2735345A-H
23431	60X75X10TC	23779	233535A	24971*	25353VBTB-H	25970*	259344PTA-H	27292*	273544PSA-H
23433	60X75X85C	23782*	23354TA-H	24971	25353VBTB	25970	259344PTA	27292	273544PSA
23436	60X78X9TC	2380*	6X22X75C	24980*	2535435B-H	25979	66X90X135A	27295*	273544PTA-H
23438	60X80X10TC	23808*	23354435A-H	24982*	25354TB-H	25979	25X40X7TG	27295	273543PTA-H
23439*	60X80X85C	23815	23352VHY	24982	25354TB	25X52X7*	25X52X75B-H	27295	273544PTA
23440*	60X80X85B-H	23820*	23360435B-H	24984*	25354VSA-H	26110*	263245A-H	27324	27364VSA
23442*	60X80X105C	23839*	23362435A-H	24984	25354VSA	26110	263245A	27334*	273645A-H
23442	60X80X85C	23841*	2336243PTA-H	24986*	253545A-H	26123*	2633535B-H	27334	273645A
23443	60X80X85C	23844*	233845A-H	24986	253545A	26124*	263353TB-H	27361*	27375435B-H
23443	60X80X105C	23844	233845A	24988*	25354TA-H	26141*	263374TA-H	27362*	27374TB-H
23443	60X80X125C	24255*	2433155A-H	24988	25353TA-H	26141	26374TA	27362	27374TB
23444	60X80X8VTC	24263*	2433245A-H	24988	25354TA	26144*	263372VL-H	27365*	27374VSA-H
23449*	60X85X85B-H	24263	2433245A	24989*	253543PSA-H	26153*	26334TA-H	27365	27374VSA
23451*	60X85X85C	24286*	24333535B-H	24990	25353VTA-H	26153	26333TA-H	27368*	273745A-H
23452	60X85X8TC	24287*	243353TB-H	24990	25354VTA	26153	26334TA	27368	273745A
23453*	60X85X105C	24287	243353TB	25007*	25352VH-H	26163*	26348435A-H	27370*	27374TA-H
23453	60X85X85C	24320*	2433345A-H	25028*	253502VH-H	26177*	26353VSB-H	27370	27373TA-H
23454	60X85X85C	24320	2433345A	25043*	2535445A-H	26186*	26353TB-H	27370	27374TA
23454	60X85X105C	24340*	243348435A-H	25043	2535445A	26186	26353TB	27394	27372VHY
23456	60X82X12TC	24370*	2433545A-H	25065*	2535443PTA-H	26189*	263545A-H	27426	2737645A
23465*	60X90X85B-H	24370	2433545A	25071	253635A-H	26189	263545A	27452*	273843PTA-H
23466*	60X90X105C	24372*	243354VSA-H	25071	253645A	26190*	263543TA-H	27467*	27384TB-H
23466	60X90X85C	24372	243354VSA	25074*	253635B-H	26194*	26354435A-H	27467	27383TB-H
23467*	60X90X85C	24427	62X90X10VSF	25074	253635B	26209*	26362435A-H	27467	27384TB
23468	60X95X10TC	24445*	243354435A-H	25075*	25363TB-H	26211*	26364TA-H	27470*	273845A-H
23471	60X90X85C	2450*	0204918VL-H	25076*	25363VBTB-H	26211	26363TA-H	27470	273845A
23476	60X95X8TC	24600	62X75X105B	25078*	24363OUB	26211	26364TA	27471*	27384TA-H
23488*	60X110X85B-H	24626*	62X80X105C	25082	2535045SB	26220*	26363PTB-H	27525*	273945A-H
2355*	6X16X55C	24626	62X80X85C	25091*	253745A-H	26220	26363PTB	27525	273945A
2359	6X16X7VTC	24635*	62X85X85B-H	25091	253745A	26237*	2636235B-H	27541*	27400435A-H
2360*	6X16X75C	24635	62X85X85B	25100*	2538435A-H	26238*	26363TB-H	27565*	27404PTA-H
2360	6X16X55C	24638*	62X85X105C	25102*	253846PTA-H	26238	26363TB	27565	27404PTA
23618	60X70X75B	24640	62X85X10TC	25108*	25403TB-H	26260*	263622VH-H	27577*	274156TB-H
23619	60X80X12TC	24645	62X85X105C	25108	25403TB	26284*	263753TB-H	27587*	70X90X135C
23632*	23299435A-H	24662*	62X90X105C	25110	25403VBTB	26297*	26375435A-H	27587	70X90X105C
23639	60X80X10TA	24662	62X90X85C	25410*	65X80X85B-H	26298*	2637543TA-H	27587	70X90X125C
23640*	23302VH-H	24678*	62X100X125C	25416*	65X80X85C	26298	26373TA-H	2759	7X16X7TC
23641*	233033VSB-H	2470*	0205618VL-H	25417*	65X82X105C	26299*	2637543VTA-H	27600*	27424435A-H
23641	233033VSB	24725*	63X80X85B-H	25420*	65X85X85B-H	26328*	2638435A-H	27601*	27424PTA-H
23644*	2330645A-H	24729	63X80X9TC	25421*	65X85X8VSB-H	26328	263845A	27601	27424PTA
23644	2330645A	24788*	63X90X105C	25422*	65X85X105C	26346*	263945A-H	27608*	70X100X125C
23646*	233135B-H	24863*	25302VL-H	25422	65X85X85C	26346	263945A	27608	70X100X65C
23646	233135B	24875*	25312VH-H	25424	65X85X10TC	26354*	26403TB-H	27608	70X100X85C
23654*	23314TA-H	24880*	253152VH-H	25427*	65X90X10VSC	26356*	26400435A-H	27608	70X100X105C
23654	23314TA	24881*	25318435A-H	25428*	65X90X105C	26359*	26434TA-H	27619*	70X110X135C
23655	233064VSA	24889*	2503245A-H	25429	65X90X10TC	26359	26434TA	27619	70X110X85C
23666*	23318435A-H	24889	2503245A	25430*	65X90X85B-H	26368*	264445A-H	27619	70X110X105C
23678*	2332543VTA-H	24892*	253235TLN22-H	25433	65X88X12TC	26368	264445A	27625*	274335TA-H
23685*	2332545PSB-H	24897*	2532535B-H	25434	65X90X105C	26648*	68X90X105C	27636	70X90X12TC
23701*	2333535B-H	24898*	25323TB-H	25434	65X90X125C	26650	68X90X85B	2765	7X16X7VTC
23702*	233353TB-H	24898	25323TB	25436*	65X95X105C	26651	68X90X105C	27710*	70X85X85B-H
23703*	233353PSB-H	24899*	25323VBTB-H	25438	65X88X10TC	26665	68X95X105C	27714*	70X85X85C
23708*	23335435A-H	24899	25323VBTB	25440*	65X100X85B-H	26673*	68X100X105C	27714	70X85X75C
23710*	233354TA-H	2490*	02062VL-H	25442*	65X100X105C	26683	68X100X105C	2772	7X20X7TC
23710	23333TA-H	24904*	253252VH-H	25443	65X100X10TC	26761*	268375435A-H	27721*	70X85X75C

SKF/CR INTERCHANGES

CROSS REFERENCES – OIL AND GREASE SEALS

PLEASE CALL DICHTOMATIK FOR AVAILABILITY - 800-328-2840
 BULK AND INDIVIDUALLY BOXED QUANTITIES ARE AVAILABLE FOR ALL ITEMS
 * = EXACT INTERCHANGE - ALL OTHERS ARE FUNCTIONALLY



SKF/CR INTERCHANGES

SKF/CR Part #	TCM Part #	SKF/CR Part #	TCM Part #	SKF/CR Part #	TCM Part #	SKF/CR Part #	TCM Part #	SKF/CR Part #	TCM Part #
27739*	70X90X10SC	29224	29373TB	29952	30404TA	31573	80X110X12SC	33735	33454SA
27740*	70X90X8SB-H	29226*	29373VTB-H	29958	30404VSA	31576	80X125X13SA	33772*	33464SA-H
27741	70X90X10TC	29226	29373VTB	29968*	304002VH-H	31585*	80X140X12SB-H	33772	33464SA
27743*	70X90X10VSB-H	29260*	29383ta-h	30000*	30414SA-H	31758*	31842443SA-H	33773*	33464TA-H
27743	70X90X10VSB	29260	29383TA	30000	30414SA	31758	318424SA	33773	33464TA
27750	70X92X12TC	29273*	29394PTB-H	30033*	30424SA-H	3177	8X18X7TC	33807*	334684SA-H
27759*	70X95X13SC	29273	29394PTB	30033	30424SA	31825*	3184343SA-H	33807	334684SA
27759	70X95X10SC	29316*	29340043SA-H	30055*	304244PTA-H	31855*	318454SA-H	33837*	3349943SA-H
277619*	70X110X13SC	29317*	29404TA-H	30055	30424PTA	31855	318454SA	34256*	34423SB-H
277619	70X110X8SC	29317	29404TA	30060*	30434SA-H	31870*	3184643SA-H	34256	34423SB
277619	70X110X10SC	29322	29404PTB	30060	30434SA	31955*	31494SA-H	34279*	343453TB-H
27768*	70X100X10SC	29384*	29413SA-H	30070*	304343SA-H	31955	31494SA	34282*	34345043SA-H
27768	70X100X6SC	29384	29413SA	30087*	30454SA-H	32344*	324003SB-H	34283*	34454TA-H
27768	70X100X8SC	29385*	29413TA-H	30087	30454SA	32347	32403PTB	34283	34453TA-H
27770*	70X100X10SB-H	29385	29413TA	30095*	30454TA-H	32362*	324156SA-H	34283	34454TA
27775	70X100X6SC	29465*	29454SA-H	30095	30454TA	32392*	32423VTB-H	34336*	3434643SA-H
27775	70X100X8SC	29465	29454SA	30098*	30454VSA-H	32392	32423VTB	34338*	344624TA-H
27775	70X100X10SC	29510*	75X90X8SB-H	30098	30454VSA	32393*	324243SB-H	34383*	34474SA-H
27775	70X100X12SC	29512	75X90X10TC	30125*	3049943SA-H	32395*	32423TB-H	34383	34474SA
27790*	70X110X10SB-H	29513	75X90X8SC	30145*	304937PTB-H	32396*	3242443SA-H	34398*	34484SA-H
27792	70X110X8SC	29524*	75X95X10SC	30725*	78X100X10SC	32397*	32424TA-H	34398	34484SA
27792	70X110X10SC	29524	75X95X7SC	3077	8X18X5TC	32397	32423TA-H	34407*	34349943SA-H
2780*	7X22X7SC	29525*	75X95X10SB-H	3092	8X22X7VTC	32397	32424TA	34623*	88X110X12SC
28035*	28137543SA-H	29529*	75X90X8SC	3101*	030742TLN22-H	32403*	3242443VSA-H	34623	88X110X10SC
28116*	281384SA-H	29536	75X95X8TC	31135*	3138135SB-H	32424*	324343SA-H	34655	88X110X13SA
28116	281384SA	29537*	75X95X12SC	31139*	31403TB-H	32441*	32453OUB	34840*	354002VL-H
28175*	28140043SA-H	29537	75X95X7SC	31147*	3140043SA-H	32477*	324503SB-H	34848*	35412VB-H
28175	281404SA	29537	75X95X10SC	31148*	314004TA-H	32501*	3245043SA-H	34857*	3542443VTA-H
28275	281424SA	29540*	75X100X10SB-H	31148	31403TA-H	32502*	32504TA-H	34860*	35433SB-H
28330*	72X90X10SC	29543	75X100X7SC	31148	31404TA	32502	32504TA	34861*	35433TB-H
28341*	72X95X10SC	29545	75X100X10VTC	31152*	314003VTA-H	32510*	324502VH-H	34861	35433TB
28354*	72X100X10SC	29563*	75X100X12SC	31173*	314143PTA-H	32540*	32464SA-H	34866*	354373VTB-H
28358	72X100X10SC	29563	75X100X7SC	31177*	31413SB-H	32540	32464SA	34868*	354343TA-H
28425*	2843935TB-H	29575*	75X110X12SC	31185*	314145TA-H	32547*	324754TA-H	34883*	354503VTB-H
28426*	28439355TA-H	29580	75X100X13TC	31189*	314145A-H	32560*	3247543SA-H	34886*	354503SB-H
28426	284395TA-H	29581	75X110X13TC	31189	314145A	32582*	3249943SA-H	34887*	354503TB-H
28464*	28440043SA-H	29582*	75X115X13SA-H	31192	31412KB	32583*	324994TA-H	34888*	35454SA-H
28654*	28364SA-H	29585*	75X115X12SB-H	31227*	3142443SA-H	33033*	3314143SA-H	34888	35454SA
28654	28364SA	29585	75X115X12SB	31228*	31424TA-H	33073*	331424SA-H	34889*	35454TA-H
28655*	2836243TA-H	29587*	75X120X12SC	31228	31424TA	33073	331424SA	34889	35454TA
28669*	28373TL-H	29841*	30353VSB-H	31237*	31424VTA-H	33136*	3314543SA-H	34891*	35454PTA-H
28669	28373TL	29850*	303622VL-H	31237	31424VTA	33206*	331494SA-H	34891*	35454PTA-H
28670*	283753VTB-H	29865*	30373SB-H	31250*	314343SA-H	33206	331494SA	34891	35454PTA
28670	28373VTB	29865	30373SB	31269*	31454SA-H	33410*	85X105X10SB-H	34892	35454VSA
28686*	28374SA-H	29866*	30373TB-H	31269	31454SA	33412*	85X105X10VSB-H	34967*	354502VH-H
28686	28374SA	29866	30373TB	31299*	312464SA-H	33413	85X105X12TC	34985*	354643SA-H
28687*	28374TA-H	29867*	303753PTB-H	31333*	31494SA-H	33415	85X105X13SF	35012*	3547543SA-H
28687	28373TA-H	29868*	30373VSB-H	3145*	8X16X7SC	33425*	85X110X10SB-H	35020*	3547543TA-H
28687	28374TA	29868	30373VSB	3145	8X16X4SC	33427*	85X110X12SC	35029*	354756SA-H
28698*	28374VSA-H	29870*	30373VTB-H	3145	8X16X6SC	33427	85X110X10SC	35040*	354753PTB-H
28698	28374VSA	29870	30373VTB	31499	80X100X12TC	33428*	85X110X12VSC	35080*	3549943VTB-H
28745*	283843SA-H	29871*	3037543SA-H	3150*	8X22X7SC	33429	85X110X12TC	35082*	35494SA-H
28746*	28384TA-H	29872*	30374TA-H	31509	80X100X10VTC	33443*	85X115X13SC	35082	35494SA
28746	283873TA-H	29872	30374TA	31510*	80X100X10SB-H	33459	85X100X9SB	35083*	3549943PTA-H
28746	28384TA	29887*	303843SA-H	31512*	80X100X10SC	33555	85X120X12SB	35095*	35514TA-H
28748	28384VTA	29887*	30384SA-H	31513	80X100X10TC	33563*	85X120X12SC	35095	35514TA
28760*	2840043SA-H	29887	30384SA	31515*	80X105X10SB-H	33585*	85X130X12SB-H	35096*	35524SA-H
28761*	28404TA-H	29891*	303846VSA-H	31519	80X105X10SC	33645*	33413SB-H	35111*	355756SA-H
28761	28403TA-H	29906*	304003SB-H	31520*	80X110X10SB-H	33654	334245TB	3540*	9X22X7SC
28761	28404TA	29907*	30403TB-H	31520	80X110X10SB	33665*	3342443TA-H	35410*	90X110X12SB-H
28778*	284003TB-H	29907	30403TB	31521	80X105X13TC	33699*	33433VTB-H	35411*	90X110X12SC
28800*	284002VH-H	29912*	30403VTB-H	31525*	80X110X10SC	33700*	33433SB-H	35411	90X110X10SC
28817*	28413SA-H	29912	30403VTB	31526*	80X110X12VSC	33701*	334373TB-H	35414	90X110X12TC
28841*	2843343PTB-H	29925*	3040043PTA-H	31530*	80X110X12SC	33701	334373TB	3542	9X22X7VVF
28848*	2845043SA-H	29950*	304003PSA-H	31530	80X110X10SC	33711*	334343SA-H	3543*	9X18X7SC
28X43X10*	28X43X10SC	29951*	30404SA-H	3155*	8X24X7SC	33712*	334343TA-H	35430*	90X120X12SB-H
29218*	2933623SB-H	29951	30404SA	31565*	80X130X12TB-H	33712	33433TA-H	35432*	90X120X12SC
29223*	2933753SB-H	29952*	30404TA-H	31565	80X130X12TB	33712	33434TA	35432	90X120X10SC
29224*	29373TB-H	29952	30403TA-H	31573	80X110X10SC	33735*	33454SA-H	35449	90X110X13TC



PLEASE CALL DICHTOMATIK FOR AVAILABILITY - 800-328-2840
BULK AND INDIVIDUALLY BOXED QUANTITIES ARE AVAILABLE FOR ALL ITEMS
* = EXACT INTERCHANGE - ALL OTHERS ARE FUNCTIONALLY

SKF/CR Part #	TCM Part #	SKF/CR Part #	TCM Part #	SKF/CR Part #	TCM Part #	SKF/CR Part #	TCM Part #	SKF/CR Part #	TCM Part #
35455	95X130X15TC	37524*	374993VSB-H	39860*	40482VH-H	43303*	110X130X125C	4711*	12X22X75C
35459	90X120X105C	37525*	374993SB-H	39921*	404993VTB-H	43303	110X130X85C	4711	12X22X45C
35459	90X120X125C	37526	37493TB	39922*	40493SB-H	43310*	110X130X125B-H	4711	12X22X55C
35482*	90X140X135C	37532*	37499435A-H	39922	40493SB	43327*	110X135X125C	4711	12X22X65C
35556*	3564545A-H	37533*	37494TA-H	39923*	404993TB-H	43340*	110X140X125B-H	4715*	12X24X75C
35556	3564545A	37533	37494TA	39932*	404994VSA-H	43340	110X140X125B	4715	12X24X4.55C
35593*	35646435A-H	37574*	37525435A-H	39933*	40499435A-H	43341	110X140X105C	4715	12X24X55C
3560*	9X26X75C	38523*	98X120X135C	39934*	40494TA-H	43342*	110X140X135C	4715	12X24X65C
35676	3564845A	38647*	38473TB-H	39934	40494TA	43342	110X140X105C	4715	12X24X6.55C
36013*	92X120X135C	38647	38473TB	39935*	40499435SA-H	4335*	11X22X75C	4718	12X25X45C
36015	92X120X135C	38649*	384753VTB-H	39961*	404992VH-H	43355*	110X145X125B-H	4721*	12X25X75C
36157*	364335A-H	38653*	384745A-H	39975*	4051435A-H	43357	110X145X15TC	4721	12X25X45C
36158*	36433PSA-H	38653	384745A	39996	40524VSA	4340*	0430992VL-H	4721	12X25X55C
36166*	3645035B-H	38669*	384855A-H	39997*	405245A-H	4345*	11X26X75C	47210*	120X140X12TB-H
36177*	364635B-H	38692*	38493TB-H	39997	405245A	4355*	040935B-H	47212	120X140X105C
36186*	364643TA-H	38692	38493TB	40000*	4052543TB-H	4355	040935B	47240	120X150X95C
36186*	36464TA-H	38694*	384993VTB-H	40020*	405305TA-H	4356*	0430992VSB-H	47240	120X150X125C
36186	36464TA	38694	38493VTB	40036*	4053435A-H	43650*	4353435A-H	4725	12X20X55C
36220*	364745A-H	38703*	385145A-H	40049*	40550435A-H	43691*	435545A-H	47250*	120X150X125B-H
36234	364755TB	38703	385145A	40077*	40563TB-H	43691	435545A	47252*	120X150X125C
36314*	364845A-H	38713*	3851143TA-H	40078*	405645A-H	43771*	436055A-H	47252	120X150X95C
36314	364845A	38731*	38524TA-H	40078*	4056435A-H	43771	436055A	47260	120X150X14TC
36359*	364993VTB-H	38731	38524TA	40078	405645A	4390*	04112SL-H	47287*	120X160X125C
36359	36493VTB	38745*	385345A-H	40108*	405745A-H	4390	04112SL	47379*	475755VSB-H
36361*	36493TB-H	38745	385345A	40108	405745A	44269	43535POSA	47382*	475755VTB-H
36361	36493TB	38749*	38555TA-H	40138*	4060055A-H	44275*	44355055A-H	47383*	4757555B-H
36363*	36499435A-H	38X74X11*	38X74X11TB-H	40158*	406255A-H	44295*	44357555A-H	47394*	4757555A-H
36364*	3649943TA-H	39100*	100X115X95C	40939*	104X125X105C	44320	446055A	47395*	47575TA-H
36382*	36523TB-H	39118*	100X120X105C	41125*	414945A-H	44880*	114X140X135C	47395	47575TA
36382	36523TB	39120*	100X120X125B-H	41125	414945A	44913*	455245A-H	4743	12X26X65C
3645*	0306815VL-H	39122*	100X120X125C	41126*	4149943VSA-H	44913	455245A	4743	12X26X75C
3645*	0306815VL-H	39122	100X120X105C	41170*	4151435A-H	44926*	455343VTA-H	47474*	4760055A-H
36740*	3684504TA-H	39135*	100X125X125B-H	41185*	41525435A-H	44959*	455535B-H	47475*	47605TA-H
36740	368454TA	39139*	100X125X125C	41186*	4152543VSA-H	44959	455535B	47475	47605TA
36770*	368475435A-H	39139	100X125X85C	41265*	415545A-H	44960*	455503TB-H	4750*	12X28X75B-H
3680*	03072TB-H	39155*	100X130X125B-H	41265	415545A	44967*	455545A-H	4752*	12X28X75C
3687*	0307425B-H	39156*	100X130X125C	41305*	41600435A-H	44967	455545A	4752	12X28X55C
3688*	030742VSB-H	39156	100X130X105C	41411	105X125X125B	44968*	4555043TA-H	4757	12X28X7VTC
36880*	368499435A-H	39158	100X130X12TC	41425	105X130X125B	44973	45554VSA	47583*	476255A-H
37001	95X110X95B	39170*	39353147TB-H	41426*	105X130X125B-H	45025*	455502VL-H	4763*	12X30X75C
37015*	95X110X105B-H	39183	100X140X125C	41430*	105X130X125C	45032*	455645A-H	4763	12X30X55C
37020	95X115X85C	39245*	39348435A-H	41433	105X130X12TC	45032	455645A	4763	12X30X65C
37027	95X115X12TC	39275*	393499435A-H	41440*	105X135X12TB-H	45064*	455753VTB-H	4765	12X30X7V5F
37039*	95X120X125C	39304*	39514VTA-H	41443	105X135X14TC	45069*	45575435A-H	4772*	12X32X75C
37040*	95X120X125B-H	39304	39514VTA	41751*	41849946TA-H	45070*	4557543TA-H	48065*	4815755655A-H
37047*	95X125X125C	39320*	393525435A-H	4231*	04308318VL-H	45110*	4560055A-H	48693*	486055A-H
37050*	95X125X125B-H	39350*	395345A-H	42380*	42512VH-H	45111*	456005TA-H	48768*	48625TA-H
37081*	95X130X125C	39350	395345A	42419*	42523TB-H	45112*	456005VTA-H	48769*	486255A-H
3719*	0308318PSB-H	3937*	10X20X65C	42419	42523TB	45140*	4561565A-H	4912*	05071VL-H
3725*	030825B-H	3937	10X20X45C	42422*	4252355B-H	45140	456155A	49210*	125X150X125B-H
37328*	374503VSB-H	3937	10X20X55C	42426*	425245A-H	45150*	456255A-H	49213	125X150X12TC
37330*	37454PTA-H	39387	100X120X135A	42427*	4252543TA-H	45220*	115X140X125B-H	49215*	125X150X125C
37330	37454PTA	3939	10X20X7TC	42433*	4252543VSA-H	45220	115X140X125B	4923*	050842VL-H
37387*	374753PSB-H	39392	100X125X13TC	42470*	425252VH-H	45221	115X140X125B	49243	125X155X14TC
37388*	3747535B-H	3940*	10X19X75C	42474*	425374VTB-H	45225*	115X140X135C	49251*	49360055A-H
37389*	37473TB-H	39403*	100X130X12V5C	42475*	4253435A-H	45233	115X145X14TC	49268*	125X160X125C
37389	37473TB	39415	100X130X13TC	4251*	0430825B-H	45250*	115X150X125B-H	49301*	4936255A-H
37390*	37474PTB-H	39421*	100X150X125C	42528*	425545A-H	45252*	115X150X125C	4931*	050825B-H
37390	37474PTB	39423*	395545A-H	42528	425545A	46144*	465655A-H	4933*	05082VTB-H
37395*	374745TA-H	39423	395545A	42573*	42575435A-H	46200*	4657555A-H	4938*	05082VL-H
37395	374745TA	3945	10X22X45C	42616*	426055A-H	46285*	466055A-H	4938*	05082VB-H
37396*	37475435A-H	3945	10X22X65C	42616	426055A	46324*	466255A-H	4939*	05083TB-H
37405*	3747543VSA-H	3950*	10X24X75C	42644*	426255A-H	46790*	4685755155A-H	4940*	05083TLN22-H
37433*	3748435A-H	3952	10X25X7TC	42X58X10*	42X58X105C	46800*	468575515A-H	4943*	0509825B-H
37439	95X120X13TC	3960*	10X26X75C	42X58X7*	42X58X75C	4701	12X20X55C	4980*	05092VSB-H
37440*	95X110X125C	3972	10X30X75C	42X70X10*	42X70X10TC	4702*	12X19X55C	4984*	050925B-H
37440	95X110X105C	3973	10X28X75C	4327*	11X17X45C	4702	12X19X4.55C	4984	050925B
3751*	0309925B-H	3975*	10X30X75C	43300*	110X130X12V5C	4707	12X22X7TC	4985*	05092TB-H
3752	03092V5B	39851*	4048435B-H	43300	110X130X12V5F	4710*	12X22X75B-H	4985	05092TB

SKF/CR INTERCHANGES

CROSS REFERENCES – OIL AND GREASE SEALS

PLEASE CALL DICHTOMATIK FOR AVAILABILITY - 800-328-2840
 BULK AND INDIVIDUALLY BOXED QUANTITIES ARE AVAILABLE FOR ALL ITEMS
 * = EXACT INTERCHANGE - ALL OTHERS ARE FUNCTIONALLY

SKF/CR INTERCHANGES

SKF/CR Part #	TCM Part #	SKF/CR Part #	TCM Part #	SKF/CR Part #	TCM Part #	SKF/CR Part #	TCM Part #	SKF/CR Part #	TCM Part #
4990*	050992VL-H	534951*	13718527VTB-H	562617*	30X45X8TG	5756*	056132SB-H	6125*	0609318VL-H
49927*	506005VTA-H	534952*	1320427VTB-H	562621*	35X48X8TG	57584*	5775056TA-H	61255*	61766SA-H
49928*	506005SA-H	534953*	0816225VTB-H	562629*	100X130X12TG	5790*	15X24X5SC	6130	0609318VL-H
49929*	50605TA-H	534955*	122125VTB-H	562637*	25X52X10TG	5800*	15X24X7SB-H	6139*	06092VTB-H
49966*	506255A-H	534957*	1824431VTB-H	562645*	120X150X12TG	5801	15X25X5VVF	6139	06092VTB
49966	506255A	534958*	15620427VTB-H	562657*	55X80X10TG	5802	15X24X7TC	6141*	06092TB-H
49985*	50625TB-H	53688*	53635TA-H	562664*	75X95X10SG	5804	15X25X3KC	6141	06092TB
49998*	50625TA-H	53692	536456SA-H	562665*	75X95X10TG	5806*	15X26X7SC	6143*	06092SB-H
50070*	50622VH-H	53701*	536635SA-H	562669*	100X120X12TG	5806	15X26X4SC	6151*	060992TLN22-H
50130*	506355A-H	5399*	05511220VH-H	562713*	45X62X7TG	5806	15X26X4.5SC	6152*	06101VL-H
50138*	50635TA-H	5410	14X24X6TC	562717*	65X100X10TG	5806	15X26X6SC	6157*	061062SL-H
50148*	506555A-H	5412*	14X24X7SC	562736*	40X80X10SG	5807	15X26X7TC	6158*	061062VL-H
50185*	50705TA-H	5412	14X24X5SC	562737*	40X80X10TG	5808*	15X25X5SC	6203*	061125B-H
50195*	50755TA-H	5412	14X24X6SC	562741*	35X50X8TG	5810*	15X28X7SB-H	6203	06112SB
504265*	111628WS	5439*	14X28X6SC	562745*	45X85X10TG	5810	15X28X7SB	6204*	06112TB-H
504266*	121728WS	5441*	14X28X7SC	562768*	130X160X12SG	5820	15X30X7SB	6204	06112TB
504268*	152028WS	5441	14X28X6SC	562796*	50X68X8SG	5821*	15X30X7SC	6213	06112VSB
504270*	172228WS	544257*	1016825VSB-H	562801*	100X125X12TG	5821	15X30X4.5SC	6215*	06112VTB-H
504272*	202528WS	5450	14X30X7SB	562889*	35X80X12TG	5821	15X30X5SC	6215	06112VTB
504277*	253028WS	5452*	14X30X7SC	562929*	16X30X7TG	5821	15X30X6SC	6229*	061123TLN22-H
504279*	273228WS	546747	140X170X12VSA	562932*	55X68X8SG	5830*	15X32X7SB-H	6247*	061182TB-H
504285*	354132WS	5470	14X32X7SB	562966*	36X52X7TG	5831*	15X32X7SC	62482	627255SA
504289*	404632WS	5481*	14X35X7SC	562994*	17X32X7TG	5831	15X32X5SC	62495*	62755SA-H
50600	128X150X13SC	54925*	55625TB-H	563014*	15X25X5TG	5835*	15X32X7VSC	62535*	62775SA-H
5062*	05112TB-H	54931*	55655SA-H	563046*	90X115X12TG	5835	15X32X5VSC	6280*	06123TLN22-H
5062	05112TB	54931	55655SA	563082*	10X25X7TG	5836	15X32X5SC	62930*	160X185X10SC
50650*	506635SA-H	54934*	55655VSA-H	563174*	40X68X10TG	5836	15X32X7SC	62940*	160X190X15SC
5067	05112VTB	54960*	55675TB-H	563210*	50X75X10TG	5837	15X32X7TC	6297	16X24X6TC
5068*	051125B-H	54971*	55675TA-H	563292*	38X54X10TG	5839	15X32X7VTC	63005	160X200X15TC
5068	051125B	54972*	55675SA-H	563328*	42X62X7TG	5840*	15X35X7SB-H	6315*	061225B-H
5069*	051122TLN22-H	54974*	55675VSA-H	563360*	85X120X12TG	5842*	15X35X7SC	6316*	06122TB-H
50X72X8*	50X72X8TG	550085*	206283TB-H	563392*	105X140X12TG	5842	15X35X5SC	6316*	06122TL-H
50X90X10*	50X90X10SC	550085	206283TB	563505*	32X50X8TG	5845	15X35X7TC	6316	06122TB
51125*	130X160X12SB-H	550154*	172443TB-H	563557*	42X65X10TG	58717*	58715VSA-H	6323*	06122VL-H
51125	130X160X12SB	550154	172443TB	563852*	25X40X5SG	58741*	58715TA-H	6370*	06132VL-H
51130*	130X160X12SC	550199	40X62X7SC	563886*	58X80X12TG	58760*	58755SA-H	63700*	63736SA-H
51135	130X160X14TC	550199	40X62X8SC	563966*	21X35X7TG	5883*	15X40X10SC	6372*	061325B-H
51143	130X170X12SC	550199	40X62X10SC	564037*	15X24X7TG	5883	15X40X8SC	6372	06132SB
51151	130X165X13SA	550231	35X55X11TC	564045*	15X30X7TG	59010*	150X180X15SC	6373*	06132TB-H
51179	130X155X10SA	550232*	41X56X7SC	564049*	15X35X7TG	59061*	150X180X15VSC	6373	06132TB
51181	130X150X14TB	550232	161222SC	564053*	16X28X7TG	59065	150X180X13SA	63734*	637856TA-H
51185	130X170X12VVF	550233	35X55X11TC	564057*	17X28X7TG	59077	150X200X15SA	63734	63785TA-H
51193	130X160X15TC	550259*	40X56X7SC	564061*	18X28X7TG	5922*	15X28X7SC	63734	637856TA
51248*	516355A-H	550294*	45X68X8TB-H	564065*	20X32X7TG	5922	15X28X4SC	6379	06132VSB
51252*	51625TA-H	55115	140X160X12SB	564069*	22X32X7TG	5922	15X28X5SC	6383*	06132VTB-H
51252	51625TA	55116*	140X160X13SC	564100*	32X52X7SG	5923*	15X30X10SC	6386*	061425B-H
5133*	051225B-H	55118*	140X170X12SB-H	564101*	32X52X7TG	5923	15X30X4.5SC	6386	061425B
5142*	13X30X8SC	55119*	140X170X13SC	564109*	35X62X10TG	5923	15X30X5SC	6391*	061372TA-H
5142	13X30X7SC	55120*	140X170X15SC	564125*	45X60X8TG	5923	15X30X6SC	6391	061372TA
5150*	051325B-H	55120	140X170X13SC	564133*	45X72X10TG	5923	15X30X7SC	6400*	16X22X4SC
5150	051325B	55121*	140X170X15TC	564137*	45X80X10TG	5926*	0591123SB-H	6400	16X22X3SC
5151*	05132VSB-H	55125*	140X170X12VSB-H	564145*	50X70X10TG	5946*	0591122VL-H	6403*	16X24X5SC
5151	05132VSB	55179*	55755SA-H	564148*	55X72X8SG	5946*	059112VB-H	6403	16X24X4SC
5221*	13X26X7SC	55179	55755SA	564153*	68X90X10TG	5951	15X35X7SC	6405*	16X24X7SC
5221	13X26X5SC	5522*	0560818VL-H	564161*	75X100X10TG	5951	15X35X5SC	6405	16X24X4SC
52440*	526003SB-H	5523*	0560818XSB-H	564165*	85X110X12TG	5951	15X35X8SC	6405	16X24X5SC
52445*	526255A-H	5535*	14X22X4SC	5652*	0561122SB-H	5966*	059133TB-H	6405	16X24X6SC
52447*	52625VSA-H	5541*	056092SB-H	5662*	056112TB-H	5969	15X32X5SC	6410	16X28X7SB
52487*	52635TA-H	5541	056092SB	5662	056112TB	5969	15X32X7SC	6411*	16X28X7SC
52488*	526555A-H	5542	056092VSB	5707*	056122SB-H	60000*	60675VSB-H	6412	16X28X7TC
52489*	52655VSA-H	5543*	056092SB-H	57118*	145X175X15SC	60006*	607005TA-H	6420*	16X30X7SB-H
5285	13X30X7TC	5543	056092SB	57505*	57665SA-H	60012*	60715TA-H	6426*	16X30X7SC
530484*	101782VH-H	55X82X12*	55X82X12SC	57506*	576635VSB-H	60016*	60755TB-H	6426	16X30X4.5SC
53145	135X165X14TC	5606*	0560992TB-H	57509*	57675TA-H	60026*	60755VTA-H	6426	16X30X5SC
53155*	135X170X12SC	56101*	56665SA-H	57510*	57675SA-H	60028*	60755TA-H	6435*	16X32X7SC
532866*	10615125PSB-H	56136*	56685SA-H	57510	57675SA	60622*	154X175X13TB-H	6440*	16X35X7SB-H
5334	053113TB-H	56160*	56715TA-H	57521*	57705SA-H	60920*	155X190X15SC	6442*	16X35X7SC
534948*	0618527VTB-H	56160	56715TA	57522*	57675VSA-H	61210*	61716SA-H	64500*	165X190X13SC
534949*	09424431VTB-H	562601*	70X85X8TG	57531*	57705TA-H	61210	61716SA	6480*	16X40X7SB-H

CROSS REFERENCES – OIL AND GREASE SEALS

PLEASE CALL DICHTOMATIK FOR AVAILABILITY - 800-328-2840
 BULK AND INDIVIDUALLY BOXED QUANTITIES ARE AVAILABLE FOR ALL ITEMS
 * = EXACT INTERCHANGE - ALL OTHERS ARE FUNCTIONALLY



DICHTOMATIK

Any seal. Any time.

SKF/CR INTERCHANGES

SKF/CR Part #	TCM Part #	SKF/CR Part #	TCM Part #	SKF/CR Part #	TCM Part #	SKF/CR Part #	TCM Part #	SKF/CR Part #	TCM Part #
8213*	0781753TA-H	8649*	081302VSB-H	9479	24X42X8SC	9725*	25X40X75B-H	9818*	101311VL-H
8215*	0811753SB-H	8660*	08132TLN22-H	9480	24X52X7TC	9728*	25X42X75C	9820*	1013718VL-H
82510*	829265A-H	86615*	220X250X155C	9500*	24X35X75C	9728	25X42X65C	9826*	10132PSB-H
82560*	8210265A-H	86615	220X250X125C	9500	24X35X65C	9730*	25X42X85B-H	9826	10132PSB
8261*	210X240X155C	8665*	08132VTLN22-H	9504*	24X37X75C	9730	25X42X85B	9831*	10132VSB-H
82610*	210X240X155C	8677*	0813718VL-H	95048*	9510545B-H	9731*	25X45X75B-H	9835*	101432VL-H
8378	21X40X7TC	8690*	081432VL-H	95048*	9510545L-H	9732*	25X40X75C	9837*	1001425B-H
8485*	0841831TB-H	8691*	0814325B-H	95062*	9511565B-H	9733	25X40X8TC	9837	1001425B
8485	0841831TB	8700*	0814925B-H	9514*	24X40X75C	9734	25X45X7TC	9838*	101432TB-H
8501*	22X28X4KC	8700	081425B	9520	095132PSB	9736*	25X42X105C	9843*	101492TLN22-H
85015*	8510565A-H	8702*	08142TB-H	9521	24X40X7VTC	9736	25X42X65C	9847*	101432VTB-H
8511	22X36X7TC	8703*	08149315B-H	9533*	24X42X85C	9736	25X42X75C	9847*	100142VTL-H
8512	22X32X7TC	8703	081535B	95X110X9*	95X110X95C	9737	25X40X75C	9852*	101425B-H
8515*	22X35X75B-H	8707*	08142VTB-H	9611*	09614931VSB-H	9738*	25X42X65C	9854*	101492VSB-H
8515	22X35X75B	8743*	22X38X75C	9611	09143VSB	9739	25X45X75C	9858*	101492VTLN22-H
8516	22X35X7VSB	8743	22X38X65C	9613*	096149315B-H	9742	25X42X65C	9859*	1014918VL-H
8517*	22X35X75C	8748*	081503TB-H	9613	091435B	9742	25X42X75C	9859*	10141VB-H
8518*	22X35X105C	8763*	081525B-H	96245*	96116265A-H	9743	25X45X75C	9862	10142VTB-H
8518	22X35X75C	8763	081525B	9646*	091625B-H	9744	25X40X10TC	9863*	10152TLN22-H
8519*	22X32X75C	8782*	08162TB-H	9647	09162VSB	9745	25X47X65B-H	9875*	25X33X65C
8519	22X32X45C	8782	08162TB	9663*	0961683TB-H	9747	25X47X7TC	9875	25X33X45C
8519	22X32X55C	8795*	081622VSB-H	9664*	09168315B-H	9748*	25X47X75C	9876*	101425B-H
8522	22X35X7TC	8796*	081625B-H	9664	0916835L	9749*	25X47X105C	9878*	10142TB-H
8525	22X35X8TC	8821*	0817525B-H	9667*	091725B-H	9749	25X47X75C	9878	10142TB
8553	22X40X85C	8842*	0818225B-H	9667	091725B	9756*	25X50X105C	9879*	10142VTB-H
8555*	22X42X75B-H	8860*	081825B-H	9681*	09618235B-H	9757	25X47X10TC	9894*	101525L-H
8556	22X42X10TC	8860	081825B	9686*	0981492VSB-H	9758*	25X52X75C	9894	101525L
8558	22X40X7VTC	8870*	082025B-H	9688*	09620435B-H	9758	25X52X55C	9900*	10152VB-H
8562*	22X42X105C	8870	082025B	9695	25X35X6TC	9760*	25X52X85B-H	9903*	101572VL-H
8562	22X42X75C	90006*	9010065A-H	9700*	0981592TLN22-H	9760	25X52X85B	9907*	1015731TB-H
8563*	22X45X75C	90036*	9011065A-H	9702	25X42X10VTC	9762*	25X52X105C	9907	101572TB-H
8564	22X42X75C	9055*	23X40X85C	9703*	25X40X7VSC	9762	25X52X55C	9932*	101622VL-H
8568*	22X47X75C	90555*	230X260X155C	9705*	25X35X75B-H	9762	25X52X75C	9934*	101625B-H
8573	22X47X7TC	9060*	23X40X105C	9705	25X35X75B	9763	25X52X7TC	9934	101625B
8580*	22X50X85B-H	9060	23X40X85C	9706*	25X35X7VSB-H	9764	25X52X55C	9935*	10162TB-H
8620*	08111VL-H	9243*	093132VL-H	9708*	25X35X75C	9764	25X52X75C	9935	10162TB
8621*	08122VSB-H	9244*	093132TB-H	9709	25X35X7TC	9766	25X50X10TC	9937*	101622VSB-H
8621	08122VSB	92536*	921126TA-H	9710*	25X36X75B-H	9767	25X45X8TC	9939*	10162VTB-H
8624*	081215B-H	9303*	0931525B-H	9711	25X35X5.5VSC	9768	25X36X65C	9960*	10016825B-H
8624	081215B	9304*	093152VSB-H	9712	25X42X10TC	9784	25X42X7TC	9967*	101753TLN22-H
8625*	0812418VL-H	9307*	0931625B-H	9714	25X37X6TC	9787	25X62X7TC	9982*	10172VSB-H
8627*	0812518VL-H	9307	0931625B	9715*	25X37X75B-H	9790*	25X62X75B-H	9982	10172VSB
8632*	0812518VL-H	9308	093162VSB-H	9717	25X35X7VTC	9790	25X62X75B	9983*	10172VTB-H
8637*	081302VL-H	9347*	0931725B-H	9718*	25X37X75C	9792	25X62X65C	9983*	10172VTL-H
8645*	081312VL-H	9409*	0931825B-H	9718	25X37X55C	9792	25X62X75C	9997*	101725B-H
8646*	08132VSB-H	9409	0931825B	9718	25X37X65C	9795	25X62X65C	9997	101725B
8646	08132VSB	9449	24X35X8TC	9720*	25X38X75B-H	9795	25X62X75C	9998*	10172TB-H
8648*	081325B-H	94495*	240X270X155C	9722	25X38X8TC	9814*	10132TLN22-H	9998*	10172TL-H
8648	081325B	9475*	25X47X65B-H	9723*	25X38X75C	9815*	10121VL-H	9998	10172TB



CROSS REFERENCES – AXIAL FACE SEALS

PLEASE CALL DICHTOMATIK FOR AVAILABILITY - 800-328-2840
BULK AND INDIVIDUALLY BOXED QUANTITIES ARE AVAILABLE FOR ALL ITEMS
* = EXACT INTERCHANGE - ALL OTHERS ARE FUNCTIONALLY

SKF/CR Part #	TCM Part #
MVR1-10*	AFS 10
MVR1-100*	AFS 100
MVR1-12*	AFS 12
MVR1-15*	AFS 15
MVR1-16*	AFS 16
MVR1-20*	AFS 20
MVR1-25*	AFS 25
MVR1-30*	AFS 30
MVR1-35*	AFS 35
MVR1-40*	AFS 40
MVR1-45*	AFS 45
MVR1-50*	AFS 50
MVR1-55*	AFS 55
MVR1-60*	AFS 60
MVR1-65*	AFS 65
MVR1-70*	AFS 70
MVR1-75*	AFS 75
MVR1-80*	AFS 80
MVR1-85*	AFS 85
MVR1-90*	AFS 90
MVR1-95*	AFS 95
MVR2-15*	AFX 15 32 04
MVR2-17*	AFX 17 34 04
MVR2-20*	AFX 20 37 04
MVR2-35*	AFX 35 53 045
MVR2-40*	AFX 40 58 045
MVR2-45*	AFX 45 63 045
MVR2-50*	AFX 50 72 055
MVR2-55*	AFX 55 77 055
MVR2-70*	AFX 70 92 055
MVR2-80*	AFX 80 102 055
MVR2-90*	AFX 90 112 055

CR CROSS REFERENCES – V-RINGS

PLEASE CALL DICHTOMATIK FOR AVAILABILITY - 800-328-2840
 BULK AND INDIVIDUALLY BOXED QUANTITIES ARE AVAILABLE FOR ALL ITEMS
 * = EXACT INTERCHANGE - ALL OTHERS ARE FUNCTIONALLY



DICHTOMATIK

Any seal. Any time.

SKF/CR Part #	TCM Part #	SKF/CR Part #	TCM Part #	SKF/CR Part #	TCM Part #	SKF/CR Part #	TCM Part #	SKF/CR Part #	TCM Part #
400030*	VA-003	400204*	VVA-020	400554*	VVA-055	401204*	VVA-120	402202*	VL-220
400034*	VVA-003	400205*	VVS-020	400555*	VVS-055	401205*	VVS-120	402204*	VVA-220
400040*	VA-004	400220*	VA-022	400600*	VA-060	401300*	VA-130	402500*	VA-250
400044*	VVA-004	400221*	VS-022	400601*	VS-060	401301*	VS-130	402502*	VL-250
400050*	VA-005	400224*	VVA-022	400604*	VVA-060	401304*	VVA-130	402504*	VVA-250
400051*	VS-005	400225*	VVS-022	400605*	VVS-060	401305*	VVS-130	402750*	VA-275
400054*	VVA-005	400250*	VA-025	400650*	VA-065	401400*	VA-140	402752*	VL-275
400055*	VVS-005	400251*	VS-025	400651*	VS-065	401401*	VS-140	402754*	VVA-275
400060*	VA-006	400254*	VVA-025	400654*	VVA-065	401402*	VL-140	403000*	VA-300
400061*	VS-006	400255*	VVS-025	400655*	VVS-065	401404*	VVA-140	403002*	VL-300
400064*	VVA-006	400280*	VA-028	400700*	VA-070	401405*	VVS-140	403004*	VVA-300
400065*	VVS-006	400281*	VS-028	400701*	VS-070	401500*	VA-150	403250*	VA-325
400070*	VA-007	400284*	VVA-028	400704*	VVA-070	401501*	VS-150	403252*	VL-325
400071*	VS-007	400285*	VVS-028	400705*	VVS-070	401502*	VL-150	403254*	VVA-325
400074*	VVA-007	400300*	VA-030	400750*	VA-075	401504*	VVA-150	403500*	VA-350
400075*	VVS-007	400301*	VS-030	400751*	VS-075	401505*	VVS-150	403502*	VL-350
400080*	VA-008	400304*	VVA-030	400754*	VVA-075	401600*	VA-160	403504*	VVA-350
400081*	VS-008	400305*	VVS-030	400755*	VVS-075	401601*	VS-160	403750*	VA-375
400084*	VVA-008	400320*	VA-032	400800*	VA-080	401602*	VL-160	403752*	VL-375
400085*	VVS-008	400321*	VS-032	400801*	VS-080	401604*	VVA-160	403754*	VVA-375
400100*	VA-010	400324*	VVA-032	400804*	VVA-080	401605*	VVS-160	404000*	VA-400
400101*	VS-010	400325*	VVS-032	400805*	VVS-080	401700*	VA-170	404002*	VL-400
400104*	VVA-010	400350*	VA-035	400850*	VA-085	401701*	VS-170	404004*	VVA-400
400105*	VVS-010	400351*	VS-035	400851*	VS-085	401702*	VL-170	404500*	VA-450
400120*	VA-012	400354*	VVA-035	400854*	VVA-085	401704*	VVA-170	404502*	VL-450
400121*	VS-012	400355*	VVS-035	400855*	VVS-085	401705*	VVS-170	404504*	VVA-450
400124*	VVA-012	400380*	VA-038	400900*	VA-090	401800*	VA-180	405000*	VA-500
400125*	VVS-012	400381*	VS-038	400901*	VS-090	401801*	VS-180	405002*	VL-500
400130*	VA-013	400384*	VVA-038	400904*	VVA-090	401802*	VL-180	405004*	VVA-500
400134*	VVA-013	400385*	VVS-038	400905*	VVS-090	401804*	VVA-180	405252*	VL-525
400140*	VA-014	400400*	VA-040	400950*	VA-095	401805*	VVS-180	405500*	VA-550
400141*	VS-014	400401*	VS-040	400951*	VS-095	401900*	VA-190	405502*	VL-550
400144*	VVA-014	400404*	VVA-040	400954*	VVA-095	401901*	VS-190	405504*	VVA-550
400145*	VVS-014	400405*	VVS-040	400955*	VVS-095	401902*	VL-190	406000*	VA-600
400160*	VA-016	400450*	VA-045	401000*	VA-100	401904*	VVA-190	406002*	VL-600
400161*	VS-016	400451*	VS-045	401001*	VS-100	401905*	VVS-190	406004*	VVA-600
400164*	VVA-016	400454*	VVA-045	401004*	VVA-100	401990*	VA-199	406500*	VA-650
400165*	VVS-016	400455*	VVS-045	401005*	VVS-100	401991*	VS-199	407000*	VA-700
400180*	VA-018	400500*	VA-050	401100*	VA-110	401994*	VVA-199	407250*	VA-725
400181*	VS-018	400501*	VS-050	401101*	VS-110	401995*	VVS-199	407254*	VVA-725
400184*	VVA-018	400504*	VVA-050	401104*	VVA-110	402000*	VA-200	409000*	VA-900
400185*	VVS-018	400505*	VVS-050	401105*	VVS-110	402002*	VL-200		
400200*	VA-020	400550*	VA-055	401200*	VA-120	402004*	VVA-200		
400201*	VS-020	400551*	VS-055	401201*	VS-120	402200*	VA-220		

SKF/CR V-RINGS INTERCHANGES



PLEASE CALL DICHTOMATIK FOR AVAILABILITY - 800-328-2840
BULK AND INDIVIDUALLY BOXED QUANTITIES ARE AVAILABLE FOR ALL ITEMS
* = EXACT INTERCHANGE - ALL OTHERS ARE FUNCTIONALLY

NAT Part #	TCM Part #	NAT Part #	TCM Part #	NAT Part #	TCM Part #	NAT Part #	TCM Part #
100X120X10*	100X120X10SC	1168	33X50X6TC	12X20X5	12X20X4TC	14X35X7*	14X35X7SC
100X120X12*	100X120X12SC	1168	33X50X7TC	12X22X7*	12X22X7SC	150X180X12*	150X180X12TC
100X120X12	100X120X10SC	1168	33X50X8TC	12X22X7	12X22X4SC	150X180X15*	150X180X15SC
100X120X12V	100X120X10VTC	1168	33X50X10TC	12X22X7	12X22X5SC	150X180X15V	150X180X15VTF
100X120X12V	100X120X12VTF	1170*	35X52X10TC	12X22X7	12X22X6SC	155X180X15	155X180X10TC
100X125X12*	100X125X12SC	1170	35X52X6TC	12X24X7*	12X24X7TC	155X180X15	155X180X12TC
100X130X12*	100X130X12SC	1170	35X52X7TC	12X24X7	12X24X4.5TC	15X24X7*	15X24X7SC
100X130X12	100X130X10SC	1170	35X52X8TC	12X24X7	12X24X5TC	15X24X7	15X24X5SC
100X130X12V	100X130X12VTF	1170	35X52X9TC	12X24X7	12X24X6TC	15X25X5	15X25X4.5TC
1012*	45X62X8SC	1171*	35X55X11TC	12X25X4.5*	12X25X4.5TC	15X25X6	15X25X4PTC
1012	45X62X7SC	1171	35X55X7TC	12X26X7*	12X26X7TC	15X25X7*	15X25X7SC
1012N*	45X62X8TC	1171	35X55X8TC	12X27X7*	12X27X7TC	15X25X7	15X25X5SC
1012N	45X62X7TC	1171	35X55X10TC	12X28X7*	12X28X7SC	15X25X7	15X25X6SC
1015*	18X28X6SC	1174*	38X52X8.5TC	12X28X7	12X28X5SC	15X26X7*	15X26X7SC
1015	18X28X4SC	1174*	149203TC	12X30X7*	12X30X7SC	15X26X7	15X26X4SC
1015N*	18X28X6SC	1174	38X52X6TC	12X30X7	12X30X5SC	15X26X7	15X26X4.5SC
1015N	18X28X4SC	1174	38X52X7TC	12X30X7	12X30X6SC	15X26X7	15X26X6SC
105X125X13*	105X125X13TC	1174	38X52X8TC	12X30X7V	12X30X7V5F	15X28X7*	15X28X7TC
105X125X13	105X125X12TC	1175*	38X58X11TC	12X32X7*	12X32X7SC	15X28X7	15X28X4TC
105X130X12*	105X130X12SC	1175	38X58X7TC	12X35X7*	12X35X7TC	15X30X7*	15X30X7SC
105X130X12V	105X130X12VTF	1175	38X58X8TC	12X35X7	12X35X6TC	15X30X7	15X30X4.5SC
10X19X7*	10X19X7SC	1175	38X58X10TC	130X150X15	130X150X10TC	15X30X7	15X30X5SC
10X22X7*	10X22X7TC	1178*	40X52X6TC	130X150X15	130X150X12TC	15X30X7	15X30X6SC
10X22X7	10X22X5TC	1178	40X52X5TC	130X160X12*	130X160X12SC	15X32X7*	15X32X7SC
10X22X7	10X22X6TC	1180*	41X55X7TC	130X160X12V	130X160X12VTF	15X32X7	15X32X5SC
10X24X7*	10X24X7SC	1181*	41X56X7SC	130X160X15*	130X160X15TC	15X32X7V*	15X32X7VSC
10X25X7*	10X25X7TC	1181	161222SC	130X160X15	130X160X12TC	15X32X7V	15X32X5VSC
10X25X7	10X25X5TC	1185*	45X62X10TC	130X160X15	130X160X14TC	15X32X8*	15X32X8TC
10X25X7	10X25X6TC	1185	45X62X7TC	130X170X12V	130X170X12V5F	15X32X8	15X32X5SC
10X26X7*	10X26X7TC	1185	45X62X8TC	130X170X15*	130X170X15TC	15X32X8	15X32X7SC
1108	35X48X7VTF	1185	45X62X9TC	130X170X15	130X170X12SC	15X35X7*	15X35X7SC
110X130X12*	110X130X12SC	1189	50X70X8TC	135X170X12*	135X170X12SC	15X35X7	15X35X5SC
110X130X12	110X130X8SC	1189	50X70X9TC	13X22X6*	13X22X6TC	15X37X6*	15X37X6TC
110X130X12V	110X130X12VTF	11X17X4*	11X17X4TC	13X22X6	13X22X4TC	15X40X7*	15X40X7TC
110X135X12*	110X135X12TC	11X22X7*	11X22X7SC	13X22X6	13X22X5TC	160X185X10*	160X185X10SC
110X135X12	110X135X10TC	11X26X7*	11X26X7SC	13X26X7*	13X26X7TC	160X185X10V	160X185X10V5F
110X135X13*	110X135X13TC	11X30X7*	11X30X7TC	13X27X7*	13X27X7TC	160X190X15*	160X190X15SC
110X135X13	110X135X10TC	1204	32X58X8TC	13X28X7*	13X28X7TC	160X190X15V	160X190X13VTC
110X135X13	110X135X12TC	1208*	48X72X7TC	13X28X7	13X28X5TC	160X190X15V	160X190X15VTF
110X140X12*	110X140X12TC	1209	50X65X7SC	13X30X7*	13X30X7TC	160X200X12*	160X200X12TC
110X140X12	110X140X10TC	1209	50X65X8SC	13X30X7	13X30X3TC	160X200X15*	160X200X15TC
110X140X12V	110X140X12VTF	120X140X13	120X140X10SC	140X160X12*	140X160X12TC	160X200X15	160X200X12TC
110X145X12*	110X145X12TC	120X150X12*	120X150X12SC	140X160X12	140X160X10TC	16X22X4*	16X22X4TC
110X145X13*	110X145X13SC	120X150X12	120X150X9SC	140X160X13*	140X160X13SC	16X24X6*	16X24X6TC
110X160X15	110X160X12TC	120X150X12V	120X150X12VTF	140X165X15	140X165X13TC	16X24X6	16X24X4TC
110X160X15	110X160X13TC	120X155X15*	120X155X15TC	140X170X12*	140X170X12TC	16X24X6	16X24X5TC
1129*	30X40X7SC	120X155X15	120X155X12TC	140X170X12V*	140X170X12VTC	16X24X7*	16X24X7TC
1129	30X40X4SC	120X155X15	120X155X13TC	140X170X15*	140X170X15TC	16X24X7	16X24X4TC
114X140X13*	114X140X13SC	120X160X12*	120X160X12SC	140X170X15*	140X170X15SC	16X24X7	16X24X5TC
115X135X15	115X135X13TC	1213	40X54X5.5TB	140X170X15	140X170X13SC	16X24X7	16X24X6TC
115X135X15	115X135X14TC	1213N	40X54X5.5TB	140X180X18	140X180X12TC	16X24X7	16X24X6.5TC
115X145X13*	115X145X13SC	125X150X12*	125X150X12TC	145X175X15*	145X175X15TC	16X26X7*	16X26X7TC
115X145X14*	115X145X14TC	125X150X12V	125X150X12VTF	145X175X15*	145X175X15SC	16X26X7	16X26X5TC
115X145X14	115X145X12TC	125X155X12*	125X155X12TC	14X24X7*	14X24X7SC	16X26X7	16X26X6TC
115X145X14	115X145X13TC	125X155X15	125X155X12TC	14X24X7	14X24X5SC	16X28X7*	16X28X7SC
115X145X15	115X145X12TC	125X155X15	125X155X14TC	14X24X7	14X24X6SC	16X28X7V	16X28X7VTF
115X145X15	115X145X13TC	125X160X12*	125X160X12SC	14X25X5*	14X25X5TC	16X30X7*	16X30X7SC
115X145X15	115X145X14TC	125X170X15	125X170X12TC	14X26X7*	14X26X7TC	16X30X7	16X30X4.5SC
115X150X12*	115X150X12SC	128X150X15	128X150X13SC	14X27X7*	14X27X7TC	16X30X7	16X30X5SC
115X160X15*	115X160X15TC	12X19X5*	12X19X5TC	14X28X6*	14X28X6SC	16X32X7*	16X32X7TC
1162*	70X90X10SC	12X19X5	12X19X4.5TC	14X32X7*	14X32X7TC	16X35X7*	16X35X7SC
1168*	33X50X12TC	12X20X5*	12X20X5TC	14X32X7	14X32X6TC	16X36X7*	16X36X7TC

NATIONAL CROSS REFERENCES – SHAFT SEALS

PLEASE CALL DICHTOMATIK FOR AVAILABILITY - 800-328-2840
 BULK AND INDIVIDUALLY BOXED QUANTITIES ARE AVAILABLE FOR ALL ITEMS
 * = EXACT INTERCHANGE - ALL OTHERS ARE FUNCTIONALLY



DICHTOMATIK

Any seal. Any time.

NAT Part #	TCM Part #	NAT Part #	TCM Part #	NAT Part #	TCM Part #	NAT Part #	TCM Part #
16X40X7*	16X40X7TC	1946*	42X62X10SC	204508*	203062VA5-H	221122*	11X22X75C
170X200X15*	170X200X15SC	1946	42X62X75C	204509*	50622VA5-H	221207*	12X22X75C
170X210X15*	170X210X15TC	1946	42X62X85C	2081*	28439349TA-H	221207	12X22X45C
170X210X15	170X210X14TC	1948*	50X68X85C	20X28X6*	20X28X6TC	221207	12X22X55C
175X200X15*	175X200X15TC	1949*	1824432SB-H	20X30X5*	20X30X55C	221207	12X22X65C
175X200X15	175X200X10TC	1950	41X53X7TA	20X30X7*	20X30X75C	221410*	14X24X75C
17X27X7*	17X27X7TC	1955	52X65X85C	20X30X7	20X30X55C	221410	14X24X55C
17X27X7	17X27X6TC	1965*	36X60X8VSB-H	20X31X7*	20X31X7TC	221410	14X24X65C
17X28X7*	17X28X75C	1969	48X63X9TB	20X32X7*	20X32X75C	221510	15X25X4PTC
17X28X7	17X28X45C	1970*	30X42X75C	20X32X7	20X32X55C	221540*	15X30X75C
17X28X7	17X28X4.55C	1970	30X42X4.55C	20X35X7*	20X35X75C	221540	15X30X4.55C
17X28X7	17X28X55C	1970	30X42X65C	20X35X7	20X35X55C	221540	15X30X55C
17X28X7	17X28X65C	1974*	50X67X11KC	20X35X7	20X35X5.55C	221540	15X30X65C
17X29X7*	17X29X7TC	1975*	52X63X8TC	20X35X7	20X35X65C	221620*	16X30X75C
17X29X7	17X29X5TC	1975	52X63X6TC	20X36X7*	20X36X7TC	221620	16X30X4.55C
17X30X7*	17X30X75C	1981*	30X45X85C	20X37X7*	20X37X7TC	221620	16X30X55C
17X32X7*	17X32X75C	1981	30X45X55C	20X37X8*	20X37X8TC	221710*	17X28X75C
17X32X7	17X32X55C	1981	30X45X75C	20X37X8	20X37X7TC	221710	17X28X45C
17X35X7*	17X35X75C	1992	45X65X5TB	20X38X7*	20X38X7TC	221710	17X28X4.55C
17X35X7	17X35X55C	1994*	48X70X10TC	20X38X7	20X38X5TC	221710	17X28X55C
17X35X8	17X35X55C	1994	48X70X7TC	20X40X10	20X40X65C	221710	17X28X65C
17X35X8	17X35X75C	1994	48X70X9TC	20X40X10	20X40X75C	221730*	17X32X75C
17X36X7*	17X36X7TC	19X27X6*	19X27X65C	20X40X10	20X40X75SC	221730	17X32X55C
17X37X7*	17X37X7TC	19X30X7*	19X30X7TC	20X40X10	20X40X95C	221735*	17X35X75C
17X37X7	17X37X5TC	19X30X7	19X30X5TC	20X40X7*	20X40X75C	221735	17X35X55C
17X38X7*	17X38X7TC	19X32X7*	19X32X75C	20X40X7*	20X40X75SC	221820	18X30X5TC
17X38X7	17X38X5TC	19X32X7	19X32X55C	20X40X7	20X40X65C	221820	18X30X6TC
17X40X7*	17X40X75C	19X32X8*	19X32X8TC	20X40X7V	20X40X7VTF	221820	18X30X7TC
17X40X7	17X40X65C	19X32X8	19X32X5TC	20X42X10*	20X42X10TC	221820	18X30X8TC
17X42X7*	17X42X7TC	19X32X8	19X32X7TC	20X42X10	20X42X5TC	221830*	18X32X85C
17X45X7*	17X45X7TC	19X37X7*	19X37X7TC	20X42X10	20X42X6TC	221830	18X32X75C
17X46X7	17X46X6TC	19X38X7*	19X38X7TC	20X42X10	20X42X7TC	221920*	19X30X7TC
17X47X7*	17X47X75C	19X40X10*	19X40X105C	20X42X7*	20X42X75C	221920	19X30X5TC
17X47X8*	17X47X8TC	19X47X7*	19X47X7TC	20X46X7*	20X46X7TC	221922*	19X32X8TC
17X47X8	17X47X7TC	2001*	60X82X12TC	20X47X7*	20X47X75C	221922	19X32X5TC
180X210X15*	180X210X155C	2001	60X82X7TC	20X47X7V	20X47X7V5F	221922	19X32X7TC
180X210X15	180X210X105C	2001	60X82X10TC	20X48X7*	20X48X7TC	222020*	20X32X75C
185X210X13*	185X210X135C	200354	17273UA	20X50X7*	20X50X7TC	222020	20X32X55C
185X215X16*	185X215X16TC	200881	2028029OUA	20X52X7*	20X52X75C	222025*	20X30X75C
185X215X16	185X215X15TC	200X230X15	200X230X155A	20X52X7	20X52X65C	222025	20X30X55C
1884*	52X68X10TC	200X230X15V*	200X230X15VTC	2108*	254045A-H	222028*	20X34X7TC
1884	52X68X8TC	200X230X15V	200X230X13VTC	210X240X15*	210X240X155C	222030*	20X35X5.5TC
18X28X6*	18X28X65C	200X230X15V	200X230X15VTF	210X250X15*	210X250X15TC	222030	20X35X4TC
18X28X6	18X28X45C	2013*	45X62X12TC	21X35X7*	21X35X7TC	222050*	20X40X75C
18X28X7V	18x28x6vsc	2013	45X62X7TC	21X35X7	21X35X6TC	222050*	20X40X755C
18X30X7*	18X30X75C	2013	45X62X8TC	21X35X8	21X35X6TC	222050	20X40X65C
18X32X7*	18X32X75C	2013	45X62X9TC	21X35X8	21X35X7TC	222060*	20X47X75C
18X32X8*	18X32X85C	2013	45X62X10TC	21X36X8	21X36X7TC	222210*	22X32X75C
18X32X8	18X32X75C	2027*	15X24X55C	21X37X8	21X37X7TC	222210	22X32X45C
18X35X7*	18X35X7TC	204015	172562VA5-H	21X40X8	21X40X7TC	222210	22X32X55C
18X35X7	18X35X6TC	204017*	16234VA5-H	220818*	8X18X7TC	222220*	22X35X7TC
18X36X7*	18X36X7TC	204020	111782VA5-H	220818	8X18X4TC	222220	22X35X5TC
18X37X8	18X37X7TC	204024	12192VA5-H	220818	8X18X5TC	222220	22X35X6TC
18X38X7*	18X38X7TC	204029	12192VA5-H	220860*	8X16X75C	222238	22X38X5TC
18X38X7	18X38X6TC	204075	16234VA5-H	220860	8X16X45C	222238	22X38X7TC
18X40X7*	18X40X75C	2043*	1942765TB-H	220860	8X16X65C	222270*	22X47X75C
190X220X15*	190X220X15TC	204501*	17302VA5-H	220918*	9X18X75C	222410*	24X35X75C
190X220X16*	190X220X165C	204502*	172562VA5-H	220X250X15*	220X250X155C	222410	24X35X65C
190X220X16	190X220X155C	204503*	172372VA5-H	220X250X15	220X250X125C	222430*	24X40X75C
190X225X16V*	190X225X16VTC	204505*	111782VA5-H	220X260X15*	220X260X15TC	222510*	25X35X75C
190X230X16*	190X230X16TC	204506*	20362VA5-H	220X260X15	220X260X14TC	222535*	25X38X7TC
190X230X16	190X230X15TC	204507*	12192VA5-H	221040*	10X19X75C	222535	25X38X5TC

NATIONAL INTERCHANGES



NAT Part #	TCM Part #	NAT Part #	TCM Part #	NAT Part #	TCM Part #	NAT Part #	TCM Part #
222558*	25X44X7TC	224040	40X60X75C	225040	50X72X9TC	22X40X7V*	22X40X7VTC
222580	25X62X6TC	224040	40X60X85C	225040	50X72X10TC	22X40X7V	22X40X4VTC
222580	25X62X7TC	224045*	40X62X11TC	225110*	51X65X7TB-H	22X40X7V	22X40X7VTF
222655*	26X48X7TC	224045	40X62X7TC	225110	51X65X7TB	22X40X8*	22X40X85C
222835*	28X44X6PTC	224045	40X62X8TC	225208*	52X65X9TC	22X42X10*	22X42X10SC
223005*	30X40X75B-H	224045	40X62X9TC	225220*	52X68X85C	22X42X10	22X42X75C
223005	30X40X75B	224045	40X62X10TC	225225	52X70X8TB-H	22X42X7*	22X42X7TC
223010*	30X42X7TC	224100*	40X65X105C	225420*	54X72X10TC	22X42X7	22X42X5TC
223010	30X42X5TC	224100	40X65X95C	225420	54X72X9TC	22X45X7*	22X45X75C
223010	30X42X6TC	224200	42X55X6TC	225450*	54X82X10TC	22X47X7*	22X47X75C
223010	30X42X7TF	224200	42X55X7TC	225460*	54X85X10TC	22X48X8	22X48X7TC
223014*	30X45X6TC	224210*	42X55X85C	225500*	55X68X8TC	22X50X8	22X50X5TC
223014	30X45X5TC	224210	42X55X75C	225505*	55X70X10TC	230X260X15*	230X260X155C
223018	30X46X5TC	224220*	42X56X7KB-H	225505	55X70X6TC	231002*	100X120X125C
223020*	30X47X85C	224250*	42X62X85C	225505	55X70X8TC	231002	100X120X105C
223020	30X47X55C	224250	42X62X75C	225530*	55X72X85C	231003*	100X125X125C
223020	30X47X65C	224252*	42X62X10TC	225535	55X72X7TC	231003	100X125X85C
223020	30X47X75C	224252	42X62X7TC	225535	55X72X8TC	231250*	125X150X125C
223035*	30X52X75C	224252	42X62X8TC	225535	55X72X9TC	231402*	140X160X135C
223035	30X52X55C	224254*	42X64X6VC	225535	55X72X10TC	231405*	140X170X155C
223050*	30X50X7TC	224266	42X66X8TC	225545	55X75X85C	231405	140X170X135C
223050	30X50X6TC	224270	42X72X85C	225650	56X72X8TC	231905*	190X220X165C
223210*	32X40X5VC	224462*	44X62X8TC	225872	58X72X85Z	231905	190X220X155C
223215	32X42X5TC	224465*	44X65X11TC	225875*	58X75X11TC	2326*	152375TB-H
223215	32X42X7TC	224465	44X65X8TC	225875	58X75X7TC	2326	152373TB-H
223215	32X42X8TC	224465	44X65X10TC	225875	58X75X9TC	239201	40X52X5TC
223230*	32X45X7TC	224510*	45X58X7TC	225880*	58X80X8TC	239201	40X52X6TC
223255*	32X52X75C	224510	45X58X6TC	225880	58X80X55C	240X270X15*	240X270X155C
223420*	34X48X8PTC	224520*	45X60X105C	226020*	60X80X85C	240X270X16	240X270X155C
223462*	34X62X105C	224520	45X60X75C	226285*	62X85X8TA-H	240X280X16*	240X280X16TC
223510*	35X47X75C	224520	45X60X85C	226520*	65X85X105C	240X280X16	240X280X15TC
223510	35X47X4.55C	224550*	45X65X85C	226520	65X85X85C	24X35X7*	24X35X75C
223510	35X47X55C	224550	45X65X65C	226530*	65X90X105C	24X35X7	24X35X65C
223510	35X47X65C	224560*	45X68X7TC	227040*	70X90X1055C	24X38X7*	24X38X7TC
223520	35X50X55C	224570	45X72X85C	227530*	75X95X105C	24X40X7*	24X40X75C
223542*	35X55X11PTC	224772	47X72X85B	227530	75X95X75C	24X42X10	24X42X7TC
223543*	35X56X10TC	224820*	48X62X8TC	227540*	75X100X12TC	24X42X10	24X42X8TC
223543	35X56X8TC	224820	48X62X7TC	227540	75X100X10TC	24X42X7*	24X42X7TC
223551*	35X60X105C	224840*	48X68X11TC	228010*	80X100X135TC	24X42X8*	24X42X85C
223552	35X62X6TC	224840	48X68X8TC	228011*	80X100X10VTC	24X45X8	24X45X6TC
223552	35X62X7TC	224840	48X68X10TC	228011	80X100X8VTC	24X48X8	24X48X7TC
223605*	36X50X7TB-H	224850	48X72X75C	228011	80X100X10VTF	24X52X7*	24X52X7TC
223608*	36X52X10TC	224850	48X72X85C	228020	80X105X10TC	252277*	10132TZ-H
223608	36X52X7TC	224865*	48X65X10TC	228020	80X105X13TC	253099*	15182TZ-H
223608	36X52X9TC	224865	48X65X7TC	228030*	80X110X125C	253747*	060871TZ-H
223610*	36X54X7.55C	224865	48X65X9TC	228030	80X110X105C	254270*	071118TZ-H
223610	36X54X6.55C	224870	48X73X7TB	228520*	85X110X125C	25X35X6*	25X35X6TC
223801*	38X50X8TC	224872	48X72X7TC	228520	85X110X105C	25X35X6	25X35X5TC
223801	38X50X6TC	224872	48X72X8TC	229005	90X110X12VTF	25X35X7*	25X35X75C
223801	38X50X7TC	224874*	48X74X10TC	2291	314145TA-H	25X35X7V*	25X35X7V5B-H
223830*	38X55X7P5C	225005*	50X62X7TC	229520*	95X130X125C	25X36X7*	25X36X7TC
223840*	38X58X8TB-H	225020	50X68X7VTC	22X32X7*	22X32X75C	25X36X7	25X36X5TC
223840	38X58X8TB	225030*	50X72X85C	22X32X7	22X32X45C	25X36X8	25X36X65C
223842*	38X58X8V5B-H	225035*	50X72X10TC	22X32X7	22X32X55C	25X37X5V	25X37X5V5F
224010*	40X52X75C	225035	50X72X5TC	22X35X7*	22X35X75C	25X37X7*	25X37X7TC
224015*	40X52X7TC	225035	50X72X7TC	22X35X7V	22X35X7V5F	25X37X7	25X37X5TC
224015	40X52X5TC	225035	50X72X8TC	22X36X7*	22X36X7TC	25X37X7	25X37X6TC
224015	40X52X6TC	225035	50X72X9TC	22X36X7	22X36X5TC	25X38X7*	25X38X75C
224020*	40X55X8TC	225040*	50X72X12TC	22X38X7*	22X38X75C	25X40X7*	25X40X75C
224020*	40X55X9TC	225040	50X72X5TC	22X38X7	22X38X65C	25X40X7V*	25X40X7V5C
224020	40X55X7TC	225040	50X72X7TC	22X38X8	22X38X5TC	25X42X10*	25X42X105C
224040*	40X60X105C	225040	50X72X8TC	22X38X8	22X38X7TC	25X42X10	25X42X65C

NATIONAL CROSS REFERENCES – SHAFT SEALS

PLEASE CALL DICHTOMATIK FOR AVAILABILITY - 800-328-2840
 BULK AND INDIVIDUALLY BOXED QUANTITIES ARE AVAILABLE FOR ALL ITEMS
 * = EXACT INTERCHANGE - ALL OTHERS ARE FUNCTIONALLY



DICHTOMATIK

Any seal. Any time.

NAT Part #	TCM Part #	NAT Part #	TCM Part #	NAT Part #	TCM Part #	NAT Part #	TCM Part #
25X42X10	25X42X75C	280X320X20*	280X320X20TC	30X58X8*	30X58X8TC	32X47X7V	32X47X7VTF
25X42X6*	25X42X65C	28X38X7*	28X38X75C	30X60X8*	30X60X8TC	32X48X8	32X48X55C
25X42X7V	25X42X7VTF	28X38X7	28X38X65C	30X62X7*	30X62X75C	32X48X8	32X48X75C
25X42X8*	25X42X8TC	28X40X7*	28X40X75C	30X62X7	30X62X55C	32X48X8V	32X48X8VSF
25X42X8	25X42X5TC	28X40X7	28X40X55C	30X68X8*	30X68X8TC	32X50X8*	32X50X85C
25X42X8	25X42X6TC	28X40X8*	28X40X8TC	30X72X10*	30X72X105C	32X52X7*	32X52X75C
25X42X8	25X42X7TC	28X40X8	28X40X5TC	30X72X10	30X72X65C	32X52X7V*	32X52X7V5C
25X45X8	25X45X75C	28X40X8	28X40X7TC	30X72X7	30X72X7TB	32X54X10	32X54X8TC
25X46X7*	25X46X7TC	28X42X8*	28X42X85C	30X72X8V*	30X72X8VTC	32X58X8*	32X58X8TC
25X46X8	25X46X7TC	28X42X8	28X42X75C	30X72X8V	30X72X8VTF	32X62X8*	32X62X8TC
25X47X7*	25X47X75C	28X45X8*	28X45X8TC	312196*	050842VZ-H	32X62X8	32X62X7TC
25X48X8*	25X48X8TC	28X45X8	28X45X5TC	314259*	056081VZ-H	32X72X8*	32X72X8TC
25X48X8	25X48X7TC	28X45X8	28X45X7TC	314267N*	06101PVZ-H	331107H	202735SZ
25X50X10*	25X50X105C	28X47X7*	28X47X75C	3173*	19326830PSB-H	331107H	2027435SZ
25X50X8*	25X50X8TC	28X47X7	28X47X55C	3199*	1219545B-H	331107N	202735SZ
25X50X8	25X50X7TC	28X47X7V*	28X47X7V5C	3199	1219545B	331107N	2027435SZ
25X52X10*	25X52X105C	28X48X8*	28X48X8TC	31X44X8	31X44X7TC	334111*	43X54X7.5SZ-H
25X52X10	25X52X55C	28X48X8	28X48X7TC	320259*	20028734VTC	334111	43X54X7.5SZ
25X52X10	25X52X75C	28X50X8*	28X50X8TC	320360X20*	320X360X20TC	3393*	233040VTC
25X52X7*	25X52X75C	28X50X8	28X50X6TC	320360X20	320X360X18TC	3395*	1432063TB-H
25X52X7	25X52X55C	28X50X8	28X50X7TC	320567	08132TC	33X50X12*	33X50X12TC
25X52X8	25X52X55C	28X52X7	28X52X55C	320595*	29X45X8TC	33X50X12	33X50X6TC
25X52X8	25X52X75C	28X52X7V	28X52X7VTF	320603*	25X37X7TC	33X50X12	33X50X7TC
25X54X8*	25X54X8TC	300X340X20*	300X340X20TC	320603	25X37X5TC	33X50X12	33X50X8TC
25X55X8*	25X55X8TC	300X340X20	300X340X15TC	320603	30X37X6TC	33X50X12	33X50X10TC
25X62X10	25X62X6TC	300X340X20	300X340X16TC	320832*	48X62X8TC	33X52X6*	33X52X6TC
25X62X10	25X62X7TC	30X40X7*	30X40X75C	320832	48X62X7TC	340136*	15222VC
25X62X7*	25X62X7TC	30X40X7	30X40X45C	320833*	149203TC	340356*	1216821VC
25X62X7	25X62X6TC	30X40X7V*	30X40X7VTC	320833	38X52X6TC	340387*	0608109VC
260X300X20*	260X300X20TC	30X40X7V	30X40X5VTC	320833	38X52X7TC	340483*	08122VC
260X300X20	260X300X15TC	30X40X7V	30X40X7VTF	320833	38X52X8TC	340787*	093132VC
260X300X20	260X300X16TC	30X42X7*	30X42X75C	320834*	38X74X11TC	340797*	059931VC
26X37X7*	26X37X7TC	30X42X7	30X42X4.55C	320834	38X74X8TC	340815*	111492VC
26X38X5*	26X38X5TC	30X42X7	30X42X65C	320857*	35X56X10TC	340817*	118162VC
26X40X7*	26X40X7TC	30X42X7V	30X42X4.5VTC	320857	35X56X8TC	340823*	182502VC
26X40X7	26X40X5TC	30X42X7V	30X42X6VTC	3210*	2433623KB-H	340826*	030501VC
26X42X10	26X42X65C	30X42X7V	30X42X7VTF	321267*	08132TC	340827*	037051VC
26X42X10	26X42X75C	30X45X5*	30X45X5TC	321460*	1782253TC	340835*	11131VC
26X42X7*	26X42X7TC	30X45X8*	30X45X8TC	322353*	12162ATC	340847*	05071VC
26X45X8	26X45X6TC	30X45X8	30X45X5TC	322353*	12162TC	340849*	060809VC
26X46X8*	26X46X8TC	30X45X8	30X45X6TC	323119	172714TC	340850*	0811818VC
26X48X7*	26X48X7TC	30X45X8	30X45X7TC	323125*	132713TC	340853*	131718VC
26X50X8	26X50X7TC	30X46X7*	30X46X7TC	323133*	1117840TC	341022*	222618VC
26X52X8*	26X52X8TC	30X46X7	30X46X5TC	323138*	131822TC	342518*	07101VC
26X52X8	26X52X7TC	30X47X7*	30X47X75C	323715*	42X60X7TC	342613*	050081VC
270X310X16	270X310X155C	30X47X7	30X47X55C	324151*	25X40X8TC	342613*	050801VC
27X37X7*	27X37X75C	30X47X7	30X47X65C	324151	25X40X5TC	342613*	05081VC
27X42X10*	27X42X105C	30X47X7V*	30X47X7VTC	324151	25X40X6TC	342805*	0506809VC
27X42X10	27X42X75C	30X47X7V	30X47X7VTF	324151	25X40X7TC	343099*	15182VC
27X42X7*	27X42X75C	30X48X8*	30X48X85C	324186*	52X68X10TC	343101*	04061VC
27X43X8*	27X43X8TC	30X50X8*	30X50X8SB-H	324186	52X68X8TC	343101*	040621VC
27X43X8	27X43X7TC	30X52X10V	30X52X7VTC	32516*	10243TC	343185*	07111VC
27X45X8*	27X45X85C	30X52X10V	30X52X10VTF	327303*	45524TC	343186*	121491VC
27X45X8	27X45X65C	30X52X7*	30X52X75C	32X42X7*	32X42X75C	3447*	194252KBJ-H
27X45X8	27X45X75C	30X52X7	30X52X55C	32X42X7	32X42X55C	345146*	35442VC
27X47X10*	27X47X105C	30X55X10*	30X55X105C	32X42X8*	32X42X8TC	34X45X8	34X45X6TC
27X47X10	27X47X65C	30X55X10	30X55X55C	32X42X8	32X42X5TC	34X45X8	34X45X7TC
27X47X10	27X47X85C	30X55X10	30X55X65C	32X42X8	32X42X7TC	34X52X8*	34X52X8TC
27X47X8*	27X47X85C	30X55X10V	30X55X7VTC	32X43X7*	32X43X7TC	34X52X8	34X52X7TC
27X47X8	27X47X65C	30X55X7	30X55X7TB	32X43X7	32X43X5.5TC	34X52X8	34X52X7.5TC
27X52X8*	27X52X85C	30X56X8*	30X56X85C	32X45X7*	32X45X7TC	34X55X9*	34X55X9TC
27X52X8	27X52X75C	30X56X8	30X56X75C	32X47X7*	32X47X75C	34X62X10*	34X62X105C

NATIONAL INTERCHANGES



NAT Part #	TCM Part #	NAT Part #	TCM Part #	NAT Part #	TCM Part #	NAT Part #	TCM Part #
350319	150202SC	360X400X20*	360X400X20TC	40X56X7	40X56X6TC	410374	243353TA-H
350364*	0310725C	36X52X7*	36X52X75C	40X56X8V	40X56X8V5F	410496*	253354TA-H
350385*	030725C	36X52X7	36X52X55C	40X57X10*	40X57X10TC	410519*	253255TA-H
350414*	1001425C	36X52X7V	36X52X7VTF	40X58X10*	40X58X10TC	410520*	22305TA-H
350435*	020725C	36X54X7.5*	36X54X7.55C	40X58X10	40X58X6TC	410520	22302TA-H
350509*	15X25X75C	36X54X7.5	36X54X6.55C	40X58X10	40X58X8TC	410524*	1833746TA-H
350509	15X25X55C	36X54X8	36X54X6.55C	40X58X8*	40X58X85C	410530*	202993TA-H
350509	15X25X65C	36X54X8	36X54X7.55C	40X60X10*	40X60X105C	410530	202993TA
350567	0813185C	36X56X10*	36X56X105C	40X60X10	40X60X75C	410539	16303TA-H
350567	081325C	36X56X10	36X56X65C	40X60X10	40X60X85C	410552	23314TA-H
350679	0712185C	36X60X7*	36X60X7TC	40X60X10V	40X60X7V5C	410553	10155TA
350679	071225C	36X60X7	36X60X6TC	40X62X12	40X62X75C	410567*	08133TA-H
350936*	1825635C	36X62X7*	36X62X7TC	40X62X12	40X62X85C	410567	08133TA
350954*	071225C	36X68X10*	36X68X105C	40X62X12	40X62X105C	410571	20324TA-H
350954	0712185C	3771*	35X50X755C	40X62X7*	40X62X75C	410574N	23323PTA-H
350974*	1118535C	37X52X8*	37X52X85C	40X62X7V	40X62X7VTF	410614*	22324TA-H
351267*	081325C	380X420X20*	380X420X20TC	40X62X8*	40X62X8TC	410626	26333TA-H
351267	0813185C	3893V*	37475VSA-H	40X62X8	40X62X7TC	410694*	233353TA-H
351487*	0609925C	38X50X7*	38X50X75C	40X65X10*	40X65X105C	410708*	263374TA-H
3517V	172403VBTB-H	38X50X7V*	38X50X7V5C	40X65X10	40X65X95C	410737*	223184TA-H
352521*	1502025C	38X52X7*	38X52X7TC	40X68X12*	40X68X125C	410752*	253245TA-H
352541*	202525C	38X52X7	38X52X6TC	40X68X12	40X68X65C	410825*	23363TA-H
353120*	1823925C	38X52X8.5*	149203TC	40X68X12	40X68X105C	410867*	21284TA-H
353676*	50X68X85C	38X52X8.5	38X52X6TC	40X68X8*	40X68X85C	410966	20283TA-H
35X45X7*	35X45X75C	38X52X8.5	38X52X7TC	40X68X8	40X68X65C	410972	213337TA-H
35X45X7	35X45X65C	38X52X8.5	38X52X8TC	40X70X8*	40X70X8TC	410987	23344TA-H
35X47X7*	35X47X75C	38X53X8	38X53X7TC	40X72X7*	40X72X75C	410989*	13305TA-H
35X47X7	35X47X4.55C	38X54X10*	38X54X10TC	40X75X8*	40X75X8TC	411084	156225TA
35X47X7	35X47X55C	38X54X10V	38X54X6.5V5C	40X78X10*	40X78X105C	411138	223133TA
35X47X7	35X47X65C	38X56X10*	38X56X105C	40X80X10*	40X80X105C	411160V*	231305VTA-H
35X47X7V*	35X47X7VTC	38X56X10V	38X56X10V5F	40X80X10	40X80X85C	411234	223065TA
35X47X7V	35X47X7VTF	38X58X8	38X58X8TB	40X80X10V*	40X80X10VTC	411234N*	223065PTA-H
35X48X8*	35X48X8TC	38X60X8*	38X60X8TC	40X88X8	40X88X6TC	411245*	243453TA-H
35X50X7	35X50X55C	38X62X7*	38X62X75C	410009	06113TA	411253*	223353TA-H
35X50X8	35X50X55C	38X62X7V	38X62X7VTF	410045	11184TA	411268	13203TA
35X50X8V	35X50X8VTF	38X72X10*	38X72X105C	410059*	152375TA-H	411272	22302TA-H
35X52X7*	35X52X75C	38X74X8*	38X74X8TC	410083	20283TA-H	411324	06133TA
35X54X10V	35X54X10V5F	38X80X8*	38X80X8TC	410085*	202995TA-H	411330N*	259345PTA-H
35X54X8*	35X54X85C	3945*	233304PSB-H	410085	202993TA-H	411337*	0781753TA-H
35X55X11*	35X55X11TC	400X440X20*	400X440X20TC	410097	213353TA-H	411348*	281424TA-H
35X55X11	35X55X7TC	402305	10172VAY	410098	218333TA-H	411376*	22353TA-H
35X55X11	35X55X8TC	403015	20302VAY	410099	223353TA-H	411394*	231323TA-H
35X55X11	35X55X10TC	403165	22322VAY	410101	23333TA-H	411414	33433TA-H
35X55X8*	35X55X8TB-H	4052*	35X52X8PTB-H	410101	233354TA-H	411500*	243353TA-H
35X56X10*	35X56X10TC	4052	35X52X8PTB	410101N	23334PTA	411944	20283TA-H
35X56X10	35X56X8TC	405225*	13202VAY-H	4101015	23333TA-H	412008	202993TA-H
35X56X8*	35X56X85C	40555*	25302VAY-H	4101015	233354TA-H	412015V	21303VTA-H
35X58X10*	35X58X105C	405685*	16262VAY-H	410102*	2033746TA-H	412027	20324TA-H
35X60X10*	35X60X105C	40X50X8*	40X50X85C	410102	20334TA-H	412028*	203354TA-H
35X62X10*	35X62X105C	40X50X8	40X50X75C	410103	23344TA-H	412035	213373TA-H
35X62X10	35X62X75C	40X52X7*	40X52X75C	410103	22333TA-H	412038N	23323PTA-H
35X62X10	35X62X85C	40X52X7V	40X52X7VTF	410132	22333TA-H	412040*	24332543TA-H
35X62X7*	35X62X75C	40X54X6	40X54X5.5TB	410163*	122043TA-H	412040*	24332543TA-H
35X65X10	35X65X8TC	40X55X6*	40X55X6.55C	410190*	152565TA-H	412119*	23333TA-H
35X65X8*	35X65X8TC	40X55X8*	40X55X85C	410190	152565TA	412473*	33433TA-H
35X68X10	35X68X65C	40X55X8	40X55X6.55C	410303	21303TA-H	412572	18273TA
35X70X8*	35X70X8TC	40X55X8	40X55X75C	410308*	213065TA-H	412725*	203153TA-H
35X72X10*	35X72X105C	40X55X8*	40X55X8VTC	410316*	223255TA-H	412725	203153TA
35X72X10	35X72X75C	40X55X8V	40X55X7VTC	410317	231323TA-H	412861*	233543TA-H
35X72X8*	35X72X8TC	40X55X8V	40X55X8VTF	410324	243333TA-H	412871*	263353TA-H
35X72X8	35X72X7TC	40X56X10	40X56X75C	410324	243324TA-H	412920*	22333TA-H
35X80X8*	35X80X8TC	40X56X7*	40X56X7TC	410350	233374TA-H	412920V	22333VTA
				410352*	172505TA-H	412943*	218333TA-H

NATIONAL CROSS REFERENCES – SHAFT SEALS

PLEASE CALL DICHTOMATIK FOR AVAILABILITY - 800-328-2840
 BULK AND INDIVIDUALLY BOXED QUANTITIES ARE AVAILABLE FOR ALL ITEMS
 * = EXACT INTERCHANGE - ALL OTHERS ARE FUNCTIONALLY



DICHTOMATIK

Any seal. Any time.

NAT Part #	TCM Part #	NAT Part #	TCM Part #	NAT Part #	TCM Part #	NAT Part #	TCM Part #
413246*	233253TA-H	415066	476256TA	415177	37474TA-H	415449*	25353TA-H
413246N*	23323PTA-H	415068	48625TA-H	415179	38473TA-H	415449V*	25353VTA-H
413247*	233373TA-H	415070	50625TA-H	415183	374842TA-H	415458*	26363TA-H
413248*	26333TA-H	415071	51635TA-H	415186	39485TA-H	415458V	26363VTA
413248	26333TA	415072*	607556TA-H	415187*	40486TA-H	415460	50755TA-H
413469	213353TA-H	415072	60755TA-H	415196*	42535TA-H	415461	53646TA
413470*	213337TA-H	415072V	60755VTA-H	415201	405995TA-H	415479	30384TA-H
413470	213337TA	415074*	61755TA-H	415205	42595TA-H	415482*	1101307TA-H
413472*	213373TA-H	415075	58715TA-H	415207	43595TA-H	415483*	26353TA-H
413478*	243333TA-H	415076*	1151357TA-H	415209	45595TA-H	415489	851006TA-H
413818	50X70X7TA	415077*	1151307TA-H	415213*	47606TA-H	415498*	356444TA-H
414045*	182785TA-H	415082*	25384TA-H	415213	47606TA	415513	40563TA-H
414045	18274TA-H	415082*	2538746TA-H	415219*	921127TA-H	415517	70806TA-H
414268*	16303TA-H	415084	70856TA-H	415227*	1051251TA-H	415551*	75907TA-H
415001*	253545TA-H	415085*	33444TA-H	415234*	22364TA-H	415551V	75907VTA
415001	253545TA	415086	30424TA-H	415245	31475TA-H	415559*	35524TA-H
415002	256363TA-H	415086N*	3042446PTA-H	415248	233543TA-H	415563*	32404TA-H
415003*	2636246TA-H	415086N	304244PTA-H	415254*	2240046TA-H	415563	32403TA-H
415003	26363TA-H	415088*	3044946TA-H	415259*	22375TA-H	415577*	32474TA-H
415003	26364TA-H	415090*	901107TA-H	415263*	39535TA-H	415577	32474TA
415004*	273755TA-H	415091	48595TA-H	415265	324754TA-H	415610*	55706TA-H
415004	27373TA-H	415092	67825TA-H	415270	101106TA-H	415613	33425TA-H
415006	28373TA-H	415093	22354TA-H	415272	27403TA-H	415627*	20355TA-H
415007*	26384TA-H	415094	231353TA-H	415272N*	27404PTA-H	415636	218353TA-H
415009*	2738746TA-H	415101	27424TA-H	415284*	468575TA-H	415645*	526556TA-H
415009	27384TA-H	415110	63785TA-H	415294*	65755TA-H	415659	21353TA-H
415011	28403TA-H	415110	637856TA-H	415295*	418494TA-H	415683*	60705TA-H
415012	29403TA-H	415111	65806TA-H	415296	26403TA-H	415697*	38515TA-H
415013*	3040046TA-	415115	71865TA-H	415299	80926TA-H	415711*	356465TA-H
H 415013	30403TA-H	415116*	72877TA-H	415300	80956TA-H	415725*	50605TA-H
415013N*	3040046PTA-H	415122	801006TA-H	415302*	256353TA-H	415733*	27374TA-H
415013V	30403VTA-H	415124*	821027TA-H	415303*	283623TA-H	415733	27373TA-H
415014	30424TA-H	415128*	871077TA-H	415304*	324245TA-H	415836*	30404TA-H
415014N	304244PTA-H	415130*	19355TA-H	415304	32423TA-H	415836	30403TA-H
415016	31424TA-H	415130	193537TA-H	415315	27363TA-H	415836N*	3040043PTA-H
415018	32423TA-H	415130	19355TA	415319	35514TA-H	415854*	62787TA-H
415019	304994TA-H	415137*	3244946TA-H	415322N	273543PTA-H	415857*	233604TA-H
415021*	31494TA-H	415138*	47575TA-H	415327*	67806TA-H	415857	233604TA
415023*	32494TA-H	415140	53675TA-H	415345V*	25353VTA-H	415867*	75856TA-H
415023	324994TA-H	415142*	41524TA-H	415349*	213545TA-H	415867	75856TA
415025*	33494TA-H	415146*	3544946TA-H	415349	213545TA	415876*	709316TA-H
415025	334994TA-H	415147*	25355TA-H	415350*	218364TA-H	415894*	334375TA-H
415027*	35494TA-H	415147	25353TA-H	415351*	45625TA-H	415894	33433TA-H
415031	37494TA-H	415147	25354TA-H	415354	31403TA-H	415937*	36475TA-H
415034*	39494TA-H	415148	38524TA-H	415354	314004TA-H	415938*	5366256TA-H
415035*	4049946TA-H	415149	26373TA-H	415355	283873TA-H	415953*	404995TA-H
415035	40494TA-H	415150*	37524TA-H	415355	28384TA-H	415953	40494TA-H
415036*	405556TA-H	415152	28413TA-H	415356	29444TA	415958*	38535TA-H
415036	405556TA	415154	30414TA-H	415364	27353TA-H	415960*	273873TA-H
415041*	40575TA-H	415156	31413TA-H	415371*	465756TA-H	415962*	30435TA-H
415043*	41575TA-H	415156	31415TA	415371	465756TA	415983*	3744946TA-H
415044	418575TA-H	415156H	314145TA-H	415377	50645TA-H	415983N*	3744946PTA-H
415045*	425756TA-H	415156N*	314156PTA-H	415379*	374755TA-H	415983V*	3744946VTA-H
415045	425756TA	415158	304374TA-H	415379	37474TA-H	415984*	27363TA-H
415047*	43575TA-H	415158	304375TA-H	415379H	374745TA-H	415984	27363TA
415053	47575TA-H	415162	32435TA-H	415389*	36454TA-H	415988*	256363TA-H
415054	40625TA-H	415164	33433TA-H	415389	36454TA	415988	256363TA
415058*	426256TA-H	415164N*	334376PTA-H	415394*	31524TA-H	415991	35454TA-H
415058	426256TA	415170	35464TA-H	415425*	435350TA-H	415991N*	3545046PTA-H
415060*	436256TA-H	415172	36464TA-H	415437*	35475TA-H	415991N	35454PTA-H
415064*	466256TA-H	415173	35475TA-H	415442*	33413TA-H	415995*	30403TA-H
415066*	476256TA-H	415175	36475TA-H	415447*	57666TA-H	415995V*	30403VTA-H

NATIONAL INTERCHANGES



PLEASE CALL DICHTOMATIK FOR AVAILABILITY - 800-328-2840
BULK AND INDIVIDUALLY BOXED QUANTITIES ARE AVAILABLE FOR ALL ITEMS
* = EXACT INTERCHANGE - ALL OTHERS ARE FUNCTIONALLY

NAT Part #	TCM Part #	NAT Part #	TCM Part #	NAT Part #	TCM Part #	NAT Part #	TCM Part #
416011*	31415TA-H	416339	37494TA-H	417223	40625TA	417511	41515TA
416011	31413TA-H	416345*	38495TA-H	417238*	43625TA-H	417512*	41555TA-H
416024*	31475TA-H	416350	39494TA-H	417247*	47605TA-H	417514*	418575TA-H
416026	30424TA-H	416362*	67806TA-H	417247	47605TA	417518*	42615TA-H
416029N*	57787PTA-H	416362	67806TA	417252*	47615TA-H	417518	42615TA
416039*	577556TA-H	416364*	70806TA-H	417254*	55655TA-H	417520*	431575TA-H
416041*	374625TA-H	416364	70806TA	417258*	51625TA-H	417525*	44575TA-H
416044*	72826TA-H	416380*	43555TA-H	417258	51625TA	417525	44575TA
416047*	36465TA-H	416381*	9612712TA-H	417262*	52625TA-H	417530*	45534TA-H
416055	60705TA-H	416383*	10713312TA-H	417269*	48625TA-H	417530	45534TA
416070*	45615TA-H	416394*	851067TA-H	417273*	49625TA-H	417531*	455875TA-H
416071*	237375TA-H	416404*	31403TA-H	417273	49625TA	417532*	456375TA-H
416077*	71865TA-H	416404V*	314003VTA-H	417278*	50635TA-H	417533*	456575TA-H
416107*	556757TA-H	416444*	231353TA-H	417298*	66816TA-H	417538*	47585TA-H
416107	55675TA-H	416476*	58715TA-H	417316*	27373TA-H	417538	47585TA
416125*	364995TA-H	416500*	29395TA-H	417343*	26373TA-H	417539*	49595TA-H
416127*	375375TA-H	416556*	42525TA-H	417343	26373TA	417541*	50645TA-H
416128	38555TA-H	416557*	51615TA-H	417344*	28373TA-H	417542*	50675TA-H
416130*	40535TA-H	416624*	35435TA-H	417344	28373TA	417542	50675TA
416135*	42565TA-H	416654*	29403TA-H	417349*	30374TA-H	417544*	50705TA-H
416137*	42595TA-H	416657*	881017TA-H	417350*	30384TA-H	417545*	50755TA-H
416149*	43595TA-H	416664*	27353TA-H	417351*	30414TA-H	417546*	51635TA-H
416153*	45565TA-H	416664	27353TA	417352*	32455TA-H	417549*	52675TA-H
416154*	45595TA-H	416666*	57705TA-H	417352	324537TA-H	417549	52675TA
416156*	46565TA-H	416670*	3685246TA-H	417353*	32465TA-H	417550*	531655TA-H
416156	46565TA	416706*	27403TA-H	417354*	334625TA-H	417551*	53635TA-H
416158*	46595TA-H	416738*	20314TA-H	417354	33464TA-H	417554*	53675TA-H
416167*	48595TA-H	416865*	50625TA-H	417355*	36485TA-H	417554	53675TA
416172	51615TA-H	416888*	45555TA-H	417356*	40515TA-H	417555*	56665TA-H
416173	51625TA-H	416888	45555TA	417356	40515TA	417555	56665TA
416176	50705TA-H	416891*	42555TA-H	417357*	40525TA-H	417556*	56685TA-H
416191*	55716TA-H	416892*	45575TA-H	417358*	52635TA-H	417556	56685TA
416191	55716TA	416919N*	368455PTA-H	417360*	5566356TA-H	417562*	62755TA-H
416219	60715TA-H	416921*	28403TA-H	417361*	55685TA-H	417562*	62775TA-H
416229*	65806TA-H	416951*	821067TA-H	417362*	576755TA-H	417563*	63785TA-H
416239*	70856TA-H	416956*	29373TA-H	417365*	60715TA-H	417564*	70876TA-H
416267*	21353TA-H	416961*	274335TA-H	417366*	38525TA-H	417567*	861067TA-H
416268*	218353TA-H	417020*	1001206TA-H	417374	951156TA-H	417570*	1021227TA-H
416270*	223545TA-H	417020	1001206TA	417433*	32403TA-H	417571*	1101256TA-H
416271*	23353TA-H	417022*	831036TA-H	417474*	193537TA-H	417596*	67825TA-H
416273*	253623TA-H	417040*	56715TA-H	417480*	23383TA-H	417597*	70826TA-H
416278*	26424TA-H	417040	56715TA	417481*	25373TA-H	417597	70826TA
416282*	2742446TA-H	417073*	24353TA-H	417484*	273543TA-H	417598*	76916TA-H
416282	27424TA-H	417082*	26403TA-H	417484N*	273543PTA-H	417600*	80926TA-H
416283	27424TA-H	417115*	771007TA-H	417487*	30424TA-H	417600	80926TA
416285*	28425TA-H	417134*	28413TA-H	417488*	304375TA-H	417601*	80956TA-H
416286	28425TA-H	417134	28413TA	417488	304374TA-H	417601	80956TA
416287	31424TA-H	417158*	283873TA-H	417491*	33435TA-H	417602*	801006TA-H
416288*	314245TA-H	417158	28383TA	417492*	3434503TA-H	417602	801006TA
416288	31424TA-H	417159*	2933873TA-H	417493*	34465TA-H	417603*	851006TA-H
416290	32435TA-H	417171*	31435TA-H	417495	35514TA-H	417604*	851056TA-H
416292*	331425TA-H	417172*	31455TA-H	417496*	35555TA-H	417605*	101106TA-H
416294*	33425TA-H	417172	31455TA	417497*	3564755TA-H	417606*	951156TA-H
416297*	314643TA-H	417181*	32435TA-H	417499*	36524TA-H	417606	951156TA
416304	32465TA-H	417191*	33455TA-H	417501*	368475TA-H	417608*	1201407TA-H
4163070*	30476TA-H	417196*	35465TA-H	417504*	381485TA-H	417621*	31413TA-H
416309	324994TA-H	417198*	354875TA-H	417505*	38555TA-H	417657*	789210TA-H
416309	32494TA-H	417198	354875TA	417506*	39555TA-H	417698*	36433TA-H
416313*	33475TA-H	417205*	37485TA-H	417506	39555TA	417730	29403TA-H
416332*	364643TA-H	417210*	38473TA-H	417507*	40563TA-H	417780*	59755TA-H
416335	36524TA-H	417211*	38485TA-H	417509*	405995TA-H	417780	59755TA
416339*	374995TA-H	417223*	40625TA-H	417511*	41515TA-H	417967*	39485TA-H

NATIONAL CROSS REFERENCES – SHAFT SEALS

PLEASE CALL DICHTOMATIK FOR AVAILABILITY - 800-328-2840
 BULK AND INDIVIDUALLY BOXED QUANTITIES ARE AVAILABLE FOR ALL ITEMS
 * = EXACT INTERCHANGE - ALL OTHERS ARE FUNCTIONALLY



DICHTOMATIK

Any seal. Any time.

NAT Part #	TCM Part #	NAT Part #	TCM Part #	NAT Part #	TCM Part #	NAT Part #	TCM Part #
418027*	26444TA-H	450068*	17265SA-H	450492*	13334SA-H	455017	314246SA-H
418028*	324537TA-H	450069*	162625SA-H	450494*	172503SA-H	455019*	304946SA-H
418029*	34423TA-H	450082*	182846SA-H	450496	253354SA-H	455021	31494SA-H
41X55X7*	41X55X7TC	450083	202874SA	450519*	253255SA-H	455026*	344946SA-H
41X56X7*	41X56X7SC	450084*	182995SA-H	450523*	15284SA-H	455032*	384946SA-H
41X56X7	161222SC	450084	182995SA	450525*	243315SA-H	455035*	4049946SA-H
41X62X8*	41X62X8TC	450085*	202995SA-H	450541	10173SA	455062	45625SA-H
424215*	182752VAY-H	450090*	18314SA-H	450557*	061374SA-H	455079*	253755SA-H
42X55X7*	42X55X7TC	450094*	19331843SA-H	450567N	08133PSA	455079	25374SA-H
42X55X7	42X55X6TC	450099*	2233546SA-H	450571	20324SA-H	455080*	21364SA-H
42X55X8	42X55X7SC	450117*	18275SA-H	450588*	081153SA-H	455086*	3042446SA-H
42X56X7*	42X56X7TC	450132*	2233746SA-H	450593*	1018229SA-H	455093*	22355SA-H
42X56X7V*	42X56X7VSC	450133*	231334SA-H	450604*	11225SA-H	455095*	23353SA-H
42X58X7*	42X58X7SB-H	450135	13214SA	450614*	22324SA-H	455096*	243355SA-H
42X60X10V*	42X60X10VSC	450143*	1562565SA-H	450621*	215314SA-H	455107	57706SA
42X60X7*	42X60X7TC	450144	14255SA	450639*	212834SA-H	455114	68836SA-H
42X62X8*	42X62X8SC	450154*	1682505SA-H	450666*	157245SA-H	455117*	73887SA-H
42X62X8	42X62X7SC	450163*	122043SA-H	450680H	0814931SSA	455121*	78937SA-H
42X68X10*	42X68X10TC	450173*	12204SA-H	450693*	098204SA-H	455123*	811017SA-H
42X68X8*	42X68X8TC	450183*	17275SA-H	450765*	16827146SA-H	455134*	4149946SA-H
42X70X10*	42X70X10TC	450185*	152505SA-H	450776*	132685SA-H	455134	41494SA-H
42X70X10	42X70X8TC	450185	152505SA	450819*	162834SA-H	455136*	223485SA-H
42X70X10	42X70X9TC	450187	102063SA-H	450911N*	196275PSA-H	455144*	2844946SA-H
42X72X10*	42X72X10TC	450188*	106153SA-H	450966	20285SA	455146*	3544946SA-H
42X72X10	42X72X6TC	450194*	162505SA-H	450984*	15274SA-H	455147*	25355SA-H
42X72X10	42X72X8TC	450204	081134SA	450988	233064SA-H	455151*	2683755SA-H
42X72X8*	42X72X8TC	450241*	112064SA-H	451078*	18325SA-H	455154	30414SA-H
42X72X8	42X72X6TC	450244	122064SA-H	451082*	0961874SA-H	455164	33436SA
42X80X10*	42X80X10SC	450273*	15275SA-H	451082*	09618743SA-H	455173*	354756SA-H
43080S	050821VAY	450279*	19275SA-H	451143	26324SA-H	455175	36474SA-H
4359V	95X115X12VTC	450298*	18305SA-H	451182*	1172033SA-H	455179	38474SA-H
43808	152712VAY	450301*	20305SA-H	451341*	2229943SA-H	455189*	381524SA-H
43X55X8*	43X55X8TC	450302	206305SA	451583*	0961493SA-H	455191*	39524SA-H
43X55X8	43X55X7TC	450303V	21304VSA-H	451817*	182434SA-H	455191	39524SA
440131*	0813718VL-H	450306	193065SA	451845*	122565SA-H	455192	40524SA-H
440265*	1682623VL-H	450307*	2063065SA-H	451857*	152625SA-H	455194*	41224SA-H
441130*	1013718VL-H	450308*	213065SA-H	451943	20284SA	455195	42524SA-H
442109*	22333VB-H	450314	21324SA-H	451948*	206284SA-H	455249*	334685SA-H
442109	22333VB	450316	22325SA	451948	206284SA	455251H*	48157556SSA-H
442110	25322VB	450326*	15295SA-H	451953*	2182843SA-H	455254	22404SA-H
442251*	1712565VL-H	450329*	2633546SA-H	452009*	200303SA-H	455265	324754SA-H
442380*	25322VB-H	450332*	11244SA-H	452009	200303SA	455280*	25638746SA-H
442874*	231302VL-H	450339*	0962064SA-H	452017*	21829943SA-H	455294V	65755VSA-H
443018*	15191VB-H	450340*	07153SA-H	452032	21324SA-H	455297*	58755SA-H
443018	15191VB	450341*	12274SA-H	452152*	231324SA-H	455301*	901007SA-H
444042*	25352VL-H	450342*	10194SA-H	452222*	15233SA-H	455321*	2313755SA-H
446927*	35412VB-H	450352*	172505SA-H	452554*	1519843SA-H	455327V	67805VSA-H
446927	35412VB	450358*	16235SA-H	452742*	178253SA-H	455330*	61716SA-H
44X60X7*	44X60X7TC	450361*	172565SA-H	453065*	152243SA-H	455330	61716SA
44X62X8*	44X62X8TC	450373	206284SA-H	453165*	102063SA-H	455336*	31844946SA-H
44X65X10*	44X65X10SC	450389	20275SA	453182*	30394SA-H	455351*	45625SA-H
450018*	06123SA-H	450400*	172235SA-H	453279*	123155SA-H	455355*	2838746SA-H
450039*	09184SA-H	450400	175223SA-H	453341*	1623743SA-H	455356*	29344946SA-H
450040*	096184SA-H	450412*	263485SA-H	455001	253544SA-H	455368	26354SA-H
450040*	09618243SA-H	450430	11284SA	455003*	2636246SA-H	455369	25363SA-H
450048*	121984SA-H	450433*	22315SA-H	455004*	273755SA-H	455396*	3557556SA-H
450049	121984SA	450444*	132505SA-H	455005*	2813755SA-H	455406*	77926SA-H
450059*	152375SA-H	450455	19265SA	455008*	268384SA-H	455406	77926SA
450065*	152375SA	450456*	13274SA-H	455009*	2738746SA-H	455434*	268355SA-H
450065*	159244SA-H	450463*	13275SA-H	455011*	2840046SA-H	455461	536456SA-H
450067*	15255SA-H	450472*	196265SA-H	455013*	3040046SA-H	455462*	901057SA-H
450067	15255SA	450474*	196284SA-H	455013	30404SA-H	455471*	345246SA-H

NATIONAL INTERCHANGES



NAT Part #	TCM Part #	NAT Part #	TCM Part #	NAT Part #	TCM Part #	NAT Part #	TCM Part #
455475*	82926SA-H	457874*	61766SA-H	470066	16243TB-H	470283	182753TB-H
455479	30384SA-H	45X60X10*	45X60X10SC	470067	15253TB-H	470286	162273TB-H
455480*	627556SA-H	45X60X10	45X60X75C	470069	16263TB-H	470291	172873TB-H
455486	36474SA-H	45X60X10	45X60X85C	470070	17263TB-H	470298	183003TB-H
455500*	324156SA-H	45X60X7*	45X60X75C	470071	18263TB-H	470298	187305SSTB
455513	40564SA-H	45X60X8*	45X60X85C	470074	1682685TB	470301	20303TB-H
455536*	17355SA-H	45X60X8	45X60X75C	470076	172683TB-H	470304	18303TB-H
455559	35524SA-H	45X60X8V*	45X60X8VSC	470076	172685TB	470308*	213065TB-H
455566*	324156SA-H	45X62X8*	45X62X85C	470077*	152755TB-H	470308	213065TB
455566	324156SA	45X62X8	45X62X75C	470077	152753TB-H	470310	20313TB-H
455576*	536456SA-H	45X65X8*	45X65X85C	470082	18283TB-H	470312	21313TB-H
455583N*	61755PSA-H	45X65X8	45X65X65C	470087	173063TB-H	470315	213253TB-H
455584*	68836SA-H	45X68X10V	45X68X8VSC	470088*	173184TB-H	470316	22323TB-H
455655*	25404SA-H	45X68X7*	45X68X7TC	470092	183183TB-H	470320	233183TB-H
455712	42524SA-H	45X70X10*	45X70X10TC	470094	1931837TB-H	470330	253373TB-H
455725*	506005SA-H	45X70X10	45X70X5TC	470095	2031837TB-H	470334*	172683TB-H
455836	30404SA-H	45X70X10	45X70X8TC	470117	18273TL-H	470336	118222TB-H
455858*	34347556SA-H	45X72X10	45X72X85C	470119	05092TB-H	470344	111823TB-H
455860*	2338746SA-H	45X72X12	45X72X85C	470120	10142TB-H	470347	112432TB-H
455872	273534SA-H	45X72X7*	45X72X75C	470121	213183TB-H	470351*	1724346TB-H
455937	36474SA-H	45X72X8V	45X72X8VTF	470129	131204TB	470351	17243TB-H
455948*	68786SA-H	45X72X95*	45X72X10TC	470135*	132143TB-H	470352	17253TB-H
455956H*	518656SSA-H	45X72X95	45X72X7TC	470135	132123TB-H	470354*	218314TB-H
455958	38534SA-H	45X72X95	45X72X8TC	470140	12172TB-H	470358*	162375TB-H
455995N*	304003PSA-H	45X75X10V*	45X75X10VTC	470141	07122TB-H	470358	16233TB-H
456047	36465SA	45X75X7*	45X75X7TC	470144	14253TB-H	470359	172993TB-H
456057*	193375SA-H	45X75X7	45X75X6TC	470152	1182122TB-H	470360	202683TB-H
456057	193375SA	45X85X10*	45X85X10SC	470154	1682531TB-H	470361*	172565TB-H
456105*	314246SA-H	46X60X8	46X60X7TC	470155	172753TB-H	470361	172563TB-H
456107	55675SA-H	46X62X8*	46X62X8TC	470157	10202TB-H	470362*	115214TB-H
456141*	431535SA-H	46X68X8*	46X68X8TC	470160	11202TB-H	470362	115214TB
456271*	23353SA-H	46X70X8*	46X70X8TC	470160	11203TB-H	470365	21284TB-H
456271	23353SA	470004*	04113TB-H	470162*	1182043TB-H	470380*	15233TB-H
456271V*	23353VSA-H	470005	05112TB-H	470163*	122043TB-H	470380V*	15233VTB-H
456271V	23353VSA	470009	06112TB-H	470163	12202TB-H	470381	11162TB-H
456273*	25363SA-H	470016	056122TB-H	470167	131223TB-H	470389	20273TB-H
456273	25363SA	470018	06122TB-H	470169	13223TB-H	470390*	07182TB-H
456301	31494SA-H	470018	06122TL-H	470182	111982TB-H	470394	15213TB-H
456305*	324754SA-H	470019	05132TB-H	470183	17273TB-H	470403*	1320643TB-H
456306	324754SA-H	470021	056132TB-H	470186	16273TB-H	470409*	19244TB-H
456343	38474SA-H	470023	06132TB-H	470187	100202TB-H	470410	20263TL-H
456462*	901036SA-H	470027	075132TB-H	470189	11172TB-H	470418	156283TB-H
456472N	23365PSA	470027	075132TL-H	470194	16253TB-H	470424	08182TB-H
456618*	3885695SA-H	470027	071345STB	470195*	0310937TB-H	470433	22313TB-H
456648*	33145046SA-H	470028	07142TB-H	470204	081133TB-H	470444	132537TB-H
456744*	36433SA-H	470032*	0814939TL-H	470207*	090143TB-H	470449	101562TB-H
456744N*	36433PSA-H	470032	08142TB-H	470211	07162TB-H	470452	13283TB-H
456800*	456005SA-H	470034	078182TB-H	470211	07162TL-H	470455	19263TB-H
456865*	50625SA-H	470037	08183TB-H	470212	0781631TB-H	470460*	168255TB-H
456865	50625SA	470041	100182TB-H	470215	08162TB-H	470460	168255TB
456888	455550SA	470045	11182TB-H	470219	10162TB-H	470461	15273TB-H
456981	38474SA-H	470049	121982TB-H	470222	07172TB-H	470479	168243TB-H
457134*	28413SA-H	470051	115203TB-H	470226	08172TB-H	470481	122433TB-H
457211*	38485SA-H	470052	1182062TB-H	470230	10172TB-H	470487*	152685TB-H
457247*	476005SA-H	470053	131233TB-H	470230	10172TL-H	470487	152685TB
457262*	52625SA-H	470055	13233TB-H	470233	101872TB-H	470487N*	152685PTB-H
457278*	50635SA-H	470057	142355STB	470236	111872TB-H	470494	17253TB-H
457291*	273534SA-H	470059	152373TB-H	470241	112062TB-H	470504	132623TB-H
457295	4435556TZ	470062	14243TB-H	470244	122062TB-H	470506*	07123TB-H
457349*	3037543SA-H	470063	152433TB-H	470245*	122143TB-H	470519	25323TB-H
457350	30384SA-H	470064*	15624346TB-H	470247	131213TB-H	470519N	25323TB-H
457351	30414SA-H	470064	156243TB-H	470272	1872683TB-H	470520	22303TB-H

NATIONAL CROSS REFERENCES – SHAFT SEALS

PLEASE CALL DICHTOMATIK FOR AVAILABILITY - 800-328-2840
 BULK AND INDIVIDUALLY BOXED QUANTITIES ARE AVAILABLE FOR ALL ITEMS
 * = EXACT INTERCHANGE - ALL OTHERS ARE FUNCTIONALLY



DICHTOMATIK

Any seal. Any time.

NAT Part #	TCM Part #	NAT Part #	TCM Part #	NAT Part #	TCM Part #	NAT Part #	TCM Part #
470521	131183TB-H	471015*	093133TB-H	471379*	133153TB-H	471633*	08152TB-H
470522	13203TB-H	471016	1562137TB-H	471379	133153TB	471642*	068162TB-H
470530*	202993TB-H	471024	06163TB-H	471391*	193313TB-H	471643*	07162TB-H
470541	10172TB-H	471076*	1031573TB-H	471405*	143305TB-H	471643*	07162TL-H
470541	10172TL-H	471076V	103153VTB	471407*	122443TB-H	471643	07162TB
470543*	2027146TB-H	471091	203063TB-H	471407	122443TB	471645*	081162TB-H
470543	202713TB-H	471100	11162TB-H	471413*	12172TB-H	471645V*	081162VTB-H
470548	15223TB-H	471105*	13284TB-H	471413	12172TB	471646*	08162TB-H
470552	23313TB-H	471122	17243TB-H	471413V*	12172VTB-H	471646	08162TB
470553	10142TB-H	471131	13233TB-H	471419*	1622433TB-H	471647*	093162TB-H
470559	12233TB-H	471133	11172TB-H	471419	16243TB-H	471647	093162TB
470561	1312003TB-H	471137*	08183TB-H	471424*	20263TB-H	471648*	09162TB-H
470565*	23313TB-H	471137	08183TB	471424V	20263VTB-H	471649*	10162TB-H
470567	08132TB-H	471138*	22313TB-H	471442*	05092TB-H	471649	10162TB
470567V	08132VTB-H	471138	22313TB	471442	05092TB	471649V*	10162VTB-H
470590*	08172TB-H	471139	183003TB-H	471442V*	05092VTB-H	471651*	1061622TB-H
470590	08172TB	471141*	17283TB-H	471456	118182TB-H	471652*	11162TB-H
470593	100182TB-H	471141	172873TB-H	471463	182833TB-H	471652	11162TB
470596*	162834TB-H	471150	16233TB-H	471463	182833TB-H	471652V*	11162VTB-H
470601*	078122TB-H	471150	16233TB-H	471466*	06112TB-H	471652V	11162VTB
470601*	078122TB-H	471192	132123TB-H	471466	06112TB	471652V	11162VTB
470605*	253373TB-H	471193*	1302043TB-H	471466*	06112VTB-H	471653*	06163TB-H
470606*	101683TB-H	471193*	1302043TB-H	471466V	06112VTB	471656	07162TB-H
470610	07182TB-H	471195*	1932503TB-H	471472*	05122TB-H	471656	07162TL-H
470625	15223TB-H	471224*	10142TB-H	471498*	071573TB-H	471656H	07162TB-H
470625V	15223VTB-H	471224	10142TB	471504	071573TB-H	471656H	07162TL-H
470642	11202TB-H	471224N	10142PTB	471504	17243TB-H	471659	08162TB-H
470642	11203TB-H	471224V*	10142VTB-H	471516*	10243TB-H	471660	093162TB-H
470652	12202TB-H	471231*	081133TB-H	471516	10243TB	471662	10162TB-H
470672*	139222TB-H	471231V*	081133VTB-H	471526*	05112TB-H	471684*	07172TB-H
470680	08142TB-H	471246	12182TB-H	471526	05112TB	471686*	0811752TB-H
470682*	1562623TB-H	471255*	06132TB-H	471529*	0681122TB-H	471688*	09172TB-H
470683	12182TB-H	471255*	06132TB	471530*	053113TB-H	471688*	09172TB-H
470687*	168315TB-H	471255V*	06132VTB-H	471532*	059113TB-H	471689*	10172TB-H
470712*	111872TB-H	471264*	06122TB-H	471532*	059113TB-H	471689*	10172TL-H
470712V*	111872VTB-H	471264*	06122TL-H	471535*	056122TB-H	471689*	10172TB
470712V	111872VTB	471264	06122TB	471535	056122TB	471689V*	10172VTB-H
470715*	111872TB-H	471267*	08132TB-H	471538*	068122TB-H	471689V*	10172VTL-H
470715	111872TB	471267	08132TB	471539*	081122TB-H	471692*	11172TB-H
470719	17303TL-H	471267V*	08132VTB-H	471540	078122TB-H	471692	11172TB
470719	173037TB-H	471267V*	08132VTB-H	471549*	05132TB-H	471692	11172TB
470719	173037TB-H	471268	13203TB-H	471551*	056132TB-H	471698*	071753TB-H
470720	18313TB-H	471268	13203TB-H	471551	056132TB	471698	07172TB-H
470746	142683TB-H	471268V	13203VTB-H	471553*	068132TB-H	471700	08172TB-H
470751	156263TB-H	471270*	101562TB-H	471553*	068132TB-H	471702	09172TB-H
470755	16223TB-H	471270*	101562TB-H	471554*	075132TB-H	471703	10172TB-H
470764*	23295TB-H	471271*	25323TB-H	471554*	075132TL-H	471703	10172TL-H
470774*	132063TB-H	471271	25323TB	471554V*	075132TB	471703	101731TB
470791	06112TB-H	471271V*	25323VTB-H	471554V	07132VTB-H	471703	101731TB
470806	12283TB-H	471272*	25323VTB	471555	075132VTB	471705*	106173TB-H
470824*	50X70X9TB-H	471272*	22303TB-H	471555	05132TB-H	471706	11172TB-H
470856*	50X65X8TB-H	471272V	22303VTB	471558*	059133TB-H	471707N	115172PTB-H
470867	21284TB-H	471272V*	22303VTB	471564*	06142TB-H	471709	12172TB-H
470895	075132TB-H	471276*	132443TB-H	471567*	07142TB-H	471709V	12172VTB-H
470895	075132TL-H	471276*	132443TB-H	471570*	08142TB-H	471718	106173TB-H
470898*	21283TB-H	471276	132443TB-H	471570V*	08142VTB-H	471730*	08182TB-H
470929	172373TB-H	471288	172373TB-H	471570V*	081492VTB-H	471733*	101872TB-H
470946*	11265TB-H	471294	05112TB-H	471571*	093142TB-H	471733	101872TB
470950*	132433TB-H	471308	152373TB-H	471571*	093142TB	471735*	106182TB-H
470954*	07122TB-H	471316*	156263TB-H	471571V*	093142VTB-H	471736*	1151872TB-H
470954V*	07122VTB-H	471324	06132TB-H	471577	06142TB-H	471737*	12182TB-H
470975	06142TB-H	471338	218303TL-H	471580	07142TB-H	471737	12182TB
470988	233063TB-H	471341*	2229943TB-H	471612*	0615731TB-H	471737V*	12182VTB-H
		471344*	152443TB-H	471612	0615731TB	471744*	101982TB-H
		471344	152443TL-H	471618	101572TB-H	471747*	111982TB-H
		471354*	1182062TB-H	471619*	100202TB-H	471750*	121982TB-H

NATIONAL INTERCHANGES



PLEASE CALL DICHTOMATIK FOR AVAILABILITY - 800-328-2840
BULK AND INDIVIDUALLY BOXED QUANTITIES ARE AVAILABLE FOR ALL ITEMS
* = EXACT INTERCHANGE - ALL OTHERS ARE FUNCTIONALLY

NAT Part #	TCM Part #	NAT Part #	TCM Part #	NAT Part #	TCM Part #	NAT Part #	TCM Part #
471750	121982TB	471981*	168303TB-H	472492	20273TB-H	473215*	13233TB-H
471750V*	121982VTB-H	471984*	173037TB-H	472492V*	20273VTB-H	473215	13233TB
471755	131193TB-H	471984	17303TL-H	472523	111872TB-H	473224*	143213TB-H
471760*	10202TB-H	471984	173037TB	472535*	112532TB-H	473225*	1432373TB-H
471760	10202TB	472005	18313TB-H	472536*	12282TB-H	473226*	14253TB-H
471760V*	10202VTB-H	472009	20303TB-H	472538*	07212TB-H	473227*	15213TB-H
471762*	106202TB-H	472010	20313TB-H	472539*	102532TB-H	473227	15213TB
471763*	11202TB-H	472012*	2063037TB-H	472560N*	11152PTB-H	473227	15213TL
471763V*	11202VTB-H	472012*	206303TB-H	472572*	18273TB-H	473227V	15213VTB
471764*	115202TB-H	472015*	21303TB-H	472572	18273TL-H	473228	15253TB
471764	115202TB	472016*	21313TB-H	472635*	1552505TB-H	473228	15253TB-H
471765*	118202TB-H	472018*	218303TL-H	472636*	22323TB-H	473229*	1562503TB-H
471766*	12202TB-H	472019	2183063TB-H	472636	22323TB	473230	16223TB-H
471766	12202TB	472029*	25313TB-H	472642*	132043TB-H	473231	16233TB-H
471766V*	12202VTB-H	472029	25313TB	472644*	112043TB-H	473232	16263TB-H
471766V	12202VTB	472041	18253TB-H	472644V*	112043VTB-H	473233*	1682373TB-H
471770	10202TB-H	472082	202883TB	472649*	072043TB-H	473234*	1682531TB-H
471772	106202TB-H	472082	202883TB-H	472653*	202833TB-H	473234	162503TB
471785*	112062TB-H	472138*	1020431TB-H	472655*	142313TB-H	473235*	1682623TB-H
471787*	122062TB-H	472144*	19283TB-H	472658*	132833TB-H	473236*	16273TB-H
471787	122062TB	472150*	231313TB-H	472658	13283TB-H	473237	172373TB-H
471795*	12212TB-H	472157*	42523TB-H	472658V	1328331VTB-H	473237V*	172373VTB-H
471795	12212TB	472157	42523TB	472660*	165293TB-H	473238	18283TB-H
471801*	12223TB-H	472164	17253TB-H	472674	111982TB-H	473238V*	18283VTB-H
471808*	122373TB-H	472164V	17253VTB-H	472681	11242TB-H	473239*	183003TB-H
471808	12233TB-H	472179	17273TB-H	472705*	056102TB-H	473239	183003TB
471812	1682373TB-H	472185	17263TB-H	472747*	1824743TB-H	473240*	18313TB-H
471818*	122433TB-H	472193*	172563TB-H	472810*	043082TB-H	473241*	19273TB-H
471820*	152433TB-H	472207	06163TB-H	472826*	1312063TB-H	473242*	20313TB-H
471821*	156243TB-H	472213*	1562231TB-H	472843*	132623TB-H	473242	20313TB
471821	156243TB	472213	1562231TB	472843	132623TB-H	473243*	213253TB-H
471827*	1562443TB-H	472238*	09243TB-H	472856*	2333543TB-H	473244*	218283TB-H
471829*	1622443TB-H	472239*	115283TB-H	472924*	20283TB-H	473245*	213253TB-H
471829	162443TB-H	472246	172373TB-H	472950*	08243TB-H	473258*	132563TB-H
471831*	172443TB-H	472258	13203TB-H	472951*	093173TB-H	473259*	11242TB-H
471831	172443TB-H	472258N*	13203PTB-H	472953*	10283TB-H	473274*	25343TB-H
471833*	122503TB-H	472258V*	13203VTB-H	472953	10283TB	473274	25343TB
471835*	132537TB-H	472287	13213TB-H	472954*	11283TB-H	473313*	173063TB-H
471835	132537TB	472299*	156233TB-H	472954V*	112833VTB-H	473317*	1682323TB-H
471837	15253TB-H	472311*	101432TB-H	473010	16253TB-H	473336*	1712565TB-H
471839	16253TB-H	472311V*	101432VTB-H	473096*	03082TB-H	473367	16243TB-H
471854*	192565TB-H	472311V*	100142VTL-H	473096	03082TB	473367V*	16243VTB-H
471862*	142683TB-H	472319*	19263TB-H	473117	1623237TB-H	473378	106182TB-H
471866*	1812683TB-H	472324*	09142TB-H	473135*	12162TB-H	473380*	101572TB-H
471868*	1872683TB-H	472324	09142TB	473135V*	12162VTB-H	473380	101572TB
471869*	1932683TB-H	472324V*	09142VTB-H	473157*	172443TB-H	473405*	059123TB-H
471869	192683TL-H	472331	20263TL-H	473179*	182753TB-H	473415*	084183TB-H
471870*	202683TB-H	472354*	131872TB-H	473197	13283TB-H	473419*	106183TB-H
471883*	2026843TB-H	472354	131872TB	473197V	1328331VTB-H	473420*	1062063TB-H
471883	202683TB-H	472397	20303TB-H	473203*	118172TL-H	473421*	1312103TB-H
471887*	24313TB-H	472409*	213183TB-H	473204*	21273TB-H	473422*	131193TB-H
471904*	131284TB-H	472409	213183TB	473204	21273TB	473423*	131183TB-H
471915	152833TB-H	472409V*	213183VTB-H	473205*	1182122TB-H	473424*	128203TB-H
471936	18283TB-H	472409V	213183VTB	473210*	1312003TB-H	473424	128203TB
471940	19283TB-H	472419*	162113TB-H	473211*	131213TB-H	473425*	111823TB-H
471949*	21275TB-H	472432	118242TB-H	473211	131213TB	473426*	1181983TB-H
471949	21273TB-H	472439	18263TB-H	473212*	131223TB-H	473427*	115203TB-H
471949	21275TB	472446*	15315TB-H	473212	131223TB	473437*	1432623TB-H
471950*	21274TB-H	472452*	084133TB-H	473213*	131233TB-H	473438*	146233TB-H
471952*	218284TB-H	472466*	152043TB-H	473214*	13223TB-H	473439*	146243TB-H
471958*	15303TB-H	472473	334373TB	473214	13223TB	473440*	15273TB-H
471958	15303TB	472475*	118182TB-H	473214V*	13223VTB-H	473442*	156283TB-H

NATIONAL CROSS REFERENCES – SHAFT SEALS

PLEASE CALL DICHTOMATIK FOR AVAILABILITY - 800-328-2840
 BULK AND INDIVIDUALLY BOXED QUANTITIES ARE AVAILABLE FOR ALL ITEMS
 * = EXACT INTERCHANGE - ALL OTHERS ARE FUNCTIONALLY



DICHTOMATIK

Any seal. Any time.

NAT Part #	TCM Part #	NAT Part #	TCM Part #	NAT Part #	TCM Part #	NAT Part #	TCM Part #
473443*	162273TB-H	474274*	162273TB-H	476820*	17393TB-H	480567	081325B-H
473443	162273TB-H	474276*	15192TB-H	476820	17393TB	480567	081331SB
473444	16283TB-H	474276	15192TB	476838*	111823TB-H	480581*	1592125B-H
473445*	168243TB-H	474278*	12162TB-H	476838	11182TB-H	480604	112225B-H
473446*	168283TB-H	474279N*	030831PTB-H	476842*	55625TB-H	480610	071825B-H
473447*	172753TB-H	474281*	152753TB-H	476865*	50625TB-H	480625*	152235B-H
473448*	172993TB-H	475003N*	2636246PTB-H	476921*	284003TB-H	480625V	15223VSB-H
473449*	181273TB-H	475009	27383TB-H	477069*	259405TB-H	480630*	1520625B-H
473450*	181283TB-H	475012N*	29340046PTB-H	477343*	263753TB-H	480652	122025B-H
473451*	1842623TB-H	475018	32423TB-H	477344*	28373TL-H	480652	122037SB
473452*	184273TB-H	475029	36493TB-H	477344	28373TL	480683	121825B-H
473454*	18253TB-H	475033	38493TB-H	477344V	28373VTB	480712*	1118725B-H
473455*	182833TB-H	475138	47575TB	477349	30373TB-H	480776	13265SL
473457*	183063TB-H	475147	25355TB	477599*	35433TB-H	480791	061125B-H
473457	18303TB-H	475177	37473TB-H	477599	35433TB	480821*	0713125B-H
473458*	183183TB-H	475195	42523TB-H	47X62X8*	47X62X8TC	480867*	212845B-H
473459*	1932683TB-H	475279	37473TB-H	47X62X8	47X62X6TC	480889*	08113125B-H
473460*	19293TB-H	475281	30373TB-H	47X62X8	47X62X7TC	480898H*	212835SB-H
473461*	1930637TB-H	475296	26403TB-H	47X65X8	47X65X7TC	480898H	212835SB
473461	1930637TB	475303*	28363TB-H	47X70X10*	47X70X10TC	480950	1324325B-H
473462*	1931837TB-H	475303	28363TB	480009	061125B-H	480954*	071225B-H
473463*	203063TB-H	475304	32423TB-H	480009	06113SB	480954	071225B
473463	203063TB	475322N*	273545PTB-H	480014	051225B-H	480954N	07122PSB
473464*	2031837TB-H	475354	31403TB-H	480061	1324325B-H	480954V*	07122VSB-H
473466*	206293TB-H	475364	27353TB-H	480069	16263SL-H	480975	061425B-H
473467*	212993TB-H	475368	26353TB-H	480072	1626835B-H	480991*	1520635B-H
473468*	213063TB-H	475369	25363TB-H	480076	1726835L-H	480991	1520635B-H
473471*	2183063TB-H	475384*	28140046TB-H	480082	182835B-H	480991	1520635L-H
473473*	223063TB-H	475449	25353TB	480087	1730635B-H	481000	132235B-H
473474*	233063TB-H	475458*	26363TB-H	480088	173135B-H	481067	1728735B-H
473475*	233183TB-H	475458	26363TB	480101N	233353PSB-H	481083	121725L-H
473475	233183TB	475483*	26353TB-H	480120	101425B-H	481163	152035B-H
473490*	156313TB-H	475483	26353TB	480163	122025B-H	481181*	162125B-H
473517*	1562137TB-H	475638*	55675TB-H	480169	132235B-H	481181	162125B
473551*	122043TB-H	475733*	27374TB-H	480182	111925B-H	481181N*	162212PSB-H
473571	07122TB-H	475937H	364755TB	480190	1525635B-H	481192*	132125B-H
473573*	23303TB-H	475960*	27383TB-H	480210*	10614935B-H	481195*	19325035B-H
473677*	40X55X8TB-H	475960	27383TB	480222	071725B-H	481224*	101425B-H
473694*	16202TB-H	475995*	30403TB-H	480233	1018725B-H	481246	121825B-H
473796	175253TB-H	475995	30403TB	480236	1118725B-H	481255*	061325B-H
473812	1312163TB	475995V*	30403VTB-H	480269	17826835B-H	481255	061325B
473814*	1962623TB-H	475995V	30403VTB	480275	1627635B-H	481255V	06132VSB
474096*	51X65X7TB-H	475996H	334245TB	480291	1728735B-H	481264*	061225B-H
474096	51X65X7TB	476023N*	303753PTB-H	480301	203025B-H	481267*	081325B-H
474119	38X58X8TB	476023V*	30373VTB-H	480308*	2130655B-H	481267	081325B
474134	50X66.50X9.52TB	476023V	30373VTB	480308	2130655B	481271*	2532535B-H
474216*	1622563TB-H	476028*	3342446TB-H	480309*	193155B-H	481272*	223035B-H
474247*	162273TB-H	476125	36493TB-H	480316	2232535B-H	481272	223035B
474250*	101682TB-H	476273*	25363TB-H	480316N	2232535B-H	481384	1592125B-H
474250	101682TB	476281*	274156TB-H	480380*	1523735B-H	481397*	0651525B-H
474252*	093172TB-H	476335	36523TB-H	480389*	202755B-H	481413*	121725L-H
474254*	112432TB-H	476345	38493TB-H	480389	202755B	481413V	12172VSB
474255*	118222TB-H	476404*	31403TB-H	480390*	071825B-H	481428	071725B-H
474256*	118242TB-H	476424N*	354753PTB-H	480424	081825B-H	481442	050925B
474260*	115162TB-H	476470*	32423TB-H	480451	1520635B-H	481443*	0781325B-H
474260	115162TB	476512*	50X110X9.5TB-H	480451	1520635L-H	481466*	061125B-H
474261*	06811818TB-H	476514*	25393TB-H	480479H*	16824455B-H	481466	061125B
474264*	14243TB-H	476514	25393TB	480519V*	253255VSB-H	481466V	06112VSB
474269*	19242TB-H	476624	35433TB-H	480523	152835B-H	481472*	051225B-H
474272*	202713TB-H	476624V	354373VTB-H	480553	101425B-H	481504*	172435B-H
474273*	078182TB-H	476664*	27353TB-H	480565*	233135B-H	481526*	051125B-H
474273	078182TB	476664	27353TB	480565	233135B	481526	051125B

NATIONAL INTERCHANGES



NAT Part #	TCM Part #	NAT Part #	TCM Part #	NAT Part #	TCM Part #	NAT Part #	TCM Part #
481528*	065112SB-H	482179*	17273SB-H	48X63X9	48X63X9TB	55X72X8V	55X72X8VTF
481528	065112SB	482185	17263SB	48X65X10*	48X65X10TC	55X75X10	55X75X8SC
481537*	065122SB-H	482208*	1116224SB-H	48X65X10	48X65X7TC	55X75X8*	55X75X8SC
481537	065122SB	482213*	156223SB-H	48X65X10	48X65X9TC	55X78X10	55X78X9SC
481554*	07132SB-H	482213	156223sb	48X70X9*	48X70X9SC	55X80X8*	55X80X8SC
481564*	06142SB-H	482253*	159252SB-H	48X72X7*	48X72X7TC	55X80X8	55X80X6SC
481564	06142SB	482258*	13203SB-H	48X75X10*	48X75X10TC	55X85X10	55X85X8SC
481567	07142SB	482258V*	13203VSB-H	48X75X10	48X75X9TC	55X85X8*	55X85X8TC
481568*	0781492SB-H	482267*	173153SB-H	48X80X8*	48X80X8TC	55X90X13*	55X90X13TC
481570	08142SB	482299*	1562373SB-H	48X82X8*	48X82X8TC	55X90X13	55X90X8SC
481577	06142SB-H	482309*	091853SB-H	48X90X10*	48X90X10SC	55X90X13	55X90X10SC
481643*	071622SB-H	482310*	0962043SB-H	493291*	2283153KB-H	55X90X8*	55X90X8TC
481644*	078162SB-H	482394*	193303SB-H	493637*	233293KB-H	56X70X8*	56X70X8SC
481646*	08162SB-H	482397*	20303SB-H	494117*	42X56X7KB-H	56X72X11.5	56X72X8SC
481647*	093162SB-H	482397	20302SB-H	494122	45X62X6KB	56X72X11.5	56X72X10SC
481649*	10162SB-H	482485	202683SB	494123	51X63X6KB	56X72X7*	56X72X7TC
481649	10162SB	482492*	20273SB-H	50X62X7*	50X62X7SC	56X80X8*	56X80X8TC
481652*	11162SB-H	482522	101872SB-H	50X65X8*	50X65X8TC	57X85X13	57X85X10TC
481652	11162SB	482523	111872SB-H	50X65X8	50X65X6TC	580387*	32X47X8TC
481652N	11162PSB	482572*	18273SB-H	50X65X8V	50X65X8VTF	580387	32X47X7TC
481652V*	11162VSB-H	482572	18273SB	50X68X8*	50X68X8SC	580388*	34X48X7TC
481652V	11162VSB	482583	25X47X6SB-H	50X68X8V	50X68X8VTF	58X72X8*	58X72X8SC
481684*	07172SB-H	482636*	223253SB-H	50X70X10V*	50X70X10VSC	58X75X11	58X75X9SC
481684	07172SB	482636	22323SB	50X70X8*	50X70X8TC	58X80X8	58X80X5SC
481689	10172SB	482674	11192SB-H	50X70X9*	50X70X9TC	58X85X13	58X85X10TC
481692	11172SB	482810*	043082SB-H	50X70X9	50X70X8TC	60X100X10*	60X100X10PTC
481709	12172SL-H	482924*	20283SB-H	50X72X10*	50X71.75X10TC	60X110X8*	60X110X8TC
481733*	101872SB-H	483214	13223SB-H	50X72X8*	50X72X8SC	60X72X8*	60X72X8SC
481733	101872SB	483215*	13233SB-H	50X72X8V	50X72X8VTF	60X75X8*	60X75X8SC
481736*	115182SB-H	483215*	13233VSB-H	50X75X12*	50X75X12TC	60X75X8*	60X75X12TC
481736	115182SB	483215V	13233VSB	50X75X12	50X75X10TC	60X75X8V	60X75X8VTF
481737*	12182SB-H	483227*	15213SB-H	50X78X8*	50X78X8TC	60X80X8*	60X80X8SC
481737	12182SB	483227	15213SB	50X80X8V	50X80X7VTC	60X80X8V*	60X80X8VTC
481750*	121982SB-H	483229	1562531SB	50X80X8V	50X80X8VTF	60X80X8V	60X80X7VTC
481760*	10202SB-H	483230*	16223SB-H	50X85X8*	50X85X8TC	60X80X8V	60X80X8VTF
481760	10202SB	483230V*	16223VSB-H	50X90X10*	50X90X10SC	60X82X12*	60X82X12SC
481763*	11202SB-H	483231*	16233SB-H	50X90X8*	50X90X8TC	60X82X7*	60X82X7TC
481763	11202SB	483237*	1723731SB-H	51098*	1525043SB-H	60X85X12*	60X85X12TC
481765*	118202SB-H	483238	18283SB-H	5126	18285TBJ	60X85X12	60X85X6TC
481766*	12202SB-H	483238V*	18283VSB-H	51X65X7*	51X65X7TB-H	60X85X12	60X85X8TC
481766	12202SB	483239*	18303SB-H	51X65X7	51X65X7TB	60X85X12	60X85X10TC
481792*	11212SB-H	483241*	1932731SB-H	52X65X9	52X65X8SC	60X85X8*	60X85X8SC
481795*	12212SB-H	483367V*	16243VSB-H	52X68X8*	52X68X8SC	60X85X8V	60X85X8VTF
481795	12212SB	483562N	13193PSB-H	52X68X8V*	52X68X8VSC	60X90X10*	60X90X10SC
481833	12253SB-H	483738V*	50X68X8VSB-H	52X68X8V	52X68X8VVF	60X90X10	60X90X8SC
481838	159252SB-H	484058*	132233SB-H	52X69X10*	52X69X10SC	60X90X8*	60X90X8TC
481857	15263SL-H	484058	132233SB	52X72X8*	52X72X8SC	60X95X8*	60X95X8TC
481864*	162683SB-H	484064V*	206253VSB-H	52X72X8V	52X72X8VTF	62415*	132432SB-H
481864	162683SB	485195H	425235SB-H	52X75X12	52X75X8SC	62X80X10*	62X80X10SC
481936	18283SB-H	485364	27353SB-H	52X75X12	52X75X10SC	62X80X10	62X80X8SC
482009	20302SB-H	486023*	30373SB-H	52X80X10	52X80X8TC	62X80X9*	62x80x8tc
482010*	20313SB-H	486023	30373SB	53X68X10*	53X68X10TC	62X82X8	62X82X7TC
482012*	206303SB-H	486273	25363SB	54X72X10*	54X72X10TC	62X90X10*	62X90X10SC
482015*	21303SB-H	486544N*	374753PSB-H	54X72X10	54X72X9TC	62X90X10	62X90X8SC
482015	21303SB	486664*	27353SB-H	54X82X10*	54X82X10TC	6358*	3184644TB-H
482041N*	182503PSB-H	486664	27353SB	54X85X10*	54X85X10TC	63X80X8*	63X80X8TC
482126*	17234SB-H	486857*	2643815SB-H	553015*	901007SA-H	63X85X10*	63X85X10TC
482126	17234SB	487945*	203623SB-H	55X68X8*	55X68X8TC	63X90X10*	63X90X10TC
482144*	19283SB-H	48X58X8	48X58X4TC	55X70X8*	55X70X8SC	63X90X10	63X90X7TC
482163N*	13193PSB-H	48X62X8*	48X62X8SC	55X70X8	55X70X7SC	64X80X8*	64X80X8TC
482163N	13193PSB-H	48X62X8V*	48X62X8VSC	55X70X8V*	55X70X8VTC	65X100X10*	65X100X10SC
482167	13223SB-H	48X62X8V	48X62X8VVF	55X72X8*	55X72X8SC	65X80X8*	65X80X8TC

NATIONAL CROSS REFERENCES – SHAFT SEALS

PLEASE CALL DICHTOMATIK FOR AVAILABILITY - 800-328-2840
 BULK AND INDIVIDUALLY BOXED QUANTITIES ARE AVAILABLE FOR ALL ITEMS
 * = EXACT INTERCHANGE - ALL OTHERS ARE FUNCTIONALLY



DICHTOMATIK

Any seal. Any time.

NAT Part #	TCM Part #	NAT Part #	TCM Part #	NAT Part #	TCM Part #	NAT Part #	TCM Part #
65X80X8V*	65X80X8VTC	710273*	19X35X10SC	710370*	32X43X7TC	75X95X10V	75X95X10VTF
65X85X10	65X85X8SC	710273	19X35X7SC	710370	32X43X5.5TC	76005*	1822746TB-H
65X85X8*	65X85X8SC	710273	19X35X8SC	710399*	26X42X8TC	7750*	07112185B-H
65X88X10*	65X88X10TC	710279*	55X70X8VTC	710399	26X42X7TC	7769*	1324325B-H
65X88X10	65X88X8TC	710280	20X35X6VTC	710406	140X170X14TB	78X100X10*	78X100X10SC
65X90X10*	65X90X10SC	710280	20X35X7VTF	710410	100X114X12TB	78X110X10*	78X110X10TC
65X90X10V	65X90X8VTC	710282*	32X42X8TC	710412	18X34X7TC	78X115X10*	78X115X10TC
65X90X10V	65X90X10VTF	710282	32X42X5TC	710420*	50X68X9TC	78X95X10*	78X95X10TC
65X90X13	65X90X10SC	710282	32X42X7TC	710420	50X68X6TC	7X16X7*	7X16X7TC
65X90X13	65X90X12SC	710306*	32X52X10TC	710420	50X68X8TC	7X16X7	7X16X4TC
67035*	172215C	710306	32X52X5TC	710422*	34X62X10SC	7X16X7	7X16X6TC
67605*	132062SC	710306	32X52X8TC	710424*	35X60X10SC	7X22X7*	7X22X7SC
6808N*	1831656PSA-H	710308*	40X52X6TC	710432*	40X57X10TC	80X100X10*	80X100X10SC
6815*	194252KBJ-H	710308	40X52X5TC	712003	120X140X12VTC	80X100X10V*	80X100X10VTC
68X100X10*	68X100X10SC	710312*	52X68X13TC	712004	105X130X12VTF	80X100X10V	80X100X8VTC
68X100X13	68X100X10SC	710312	52X68X8TC	712011*	40X75X12TC	80X100X10V	80X100X10VTF
68X85X8*	68X85X8SC	710312	52X68X10TC	712011	40X75X8TC	80X105X10*	80X105X10TC
68X90X10*	68X90X10SC	710313	48X70X7TC	712011	40X75X10TC	80X105X14	80X105X10TC
68X90X10V	68X90X8VTC	710313	48X70X9TC	712250*	22303VTB-H	80X105X14	80X105X13TC
68X90X10V	68X90X10VTF	710313	48X70X10TC	712250	22303VTB	80X110X10*	80X110X10TC
68X95X10*	68X95X10SC	710313	48X70X11TC	712260	17283TB-H	80X110X10V	80X110X10VTF
69545*	2063031VL-H	710316*	25X40X8TC	712551	40X56X6TC	80X110X12*	80X110X12SC
6X16X5*	6X16X5SC	710316	25X40X5TC	712551	40X56X7TC	80X110X12	80X110X10SC
6X16X7*	6X16X7SC	710316	25X40X6TC	712598*	25939978TB-H	80X115X12	80X115X10TC
6X16X7	6X16X5SC	710316	25X40X7TC	713163	114X135X13TB	80X120X10*	80X120X10TC
6X22X7*	6X22X7SC	710317	32X48X5TC	714436*	35X48X8TC	80X120X13	80X120X10TC
70215*	3040035B-H	710317	32X48X7TC	714619*	30X48X8SC	80X120X13	80X120X12TC
7028	071331TZ	710317	32X48X8TC	714655*	1319825PSB-H	80X125X12*	80X125X12TC
70X100X10*	70X100X10TC	710319	38X58X11TB	714750*	475755VSB-H	80X125X12	80X125X10TC
70X100X10	70X100X8TC	710322*	48X62X6VC	716445	75X95X10VSF	82935*	1232255B-H
70X105X10*	70X105X10TC	710324	35X50X7TC	717003*	39485TA-H	84775*	16125375B-H
70X110X10*	70X110X10SC	710324	35X50X8TC	717005*	95X110X11TC	8516N*	16826243PTB-H
70X110X10	70X110X8SC	710324	35X50X10TC	717005	95X110X7TC	85975*	14921925B-H
70X85X8*	70X85X8SC	710325*	28X40X7TC	717005	95X110X10TC	85X105X10*	85X105X10TC
70X85X8	70X85X7SC	710325	28X40X5TC	717006	95X115X10SA	85X105X13*	85X105X13TC
70X88X12*	70X88X12TC	710327*	32X48X7TC	72X100X10*	72X100X10SC	85X105X13	85X105X10TC
70X88X12	70X88X8TC	710327	32X48X5TC	72X100X12	72X100X10TC	85X105X13	85X105X12TC
70X88X9V	70X88X9VSF	710328	33X50X6SC	72X105X10*	72X105X10TC	85X110X10*	85X110X10SC
70X90X10*	70X90X10SC	710333*	60X80X8TC	72X90X10*	72X90X10SC	85X110X12*	85X110X12SC
70X90X10V	70X90X10VTF	710335*	35X65X12TC	72X95X10*	72X95X10SC	85X110X12	85X110X10SC
70X90X7*	70X90X7TC	710335	35X65X8TC	7354N*	43535POSA	85X110X12V*	85X110X12VTC
70X92X12*	70X92X12TC	710341*	36X50X8TC	7412S	12172SBY	85X110X12V	85X110X12VTF
70X92X12	70X92X8.5TC	710341	36X50X5TC	75X100X10*	75X100X10TC	85X115X12	85X115X10TC
70X92X12	70X92X9TC	710341	36X50X7TC	75X100X10V*	75X100X10VTC	85X115X13*	85X115X13SC
70X95X10*	70X95X10SC	710342	20X47X5TC	75X100X10V	75X100X10VTF	85X120X12*	85X120X12TC
70X95X13*	70X95X13SC	710342	20X47X7TC	75X100X12*	75X100X12TC	85X120X12	85X120X10TC
70X95X13	70X95X10SC	710342	20X47X8TC	75X100X12	75X100X10TC	85X125X12*	85X125X12TC
710050*	40X75X12TC	710345*	45X68X12TC	75X105X13*	75X105X13TC	8609	081122TB-H
710050	40X75X8TC	710345	45X68X7TC	75X105X13	75X105X10TC	8611N*	15226559TBJ-H
710050	40X75X10TC	710345	45X68X8TC	75X105X13	75X105X12TC	8611N	15226559TBJ
710057	36X65X8SB	710345	45X68X9TC	75X110X10*	75X110X10TC	86605*	139229465B-H
710058*	193256315B-H	710345	45X68X10TC	75X110X12*	75X110X12TC	86955*	155265TB-H
710077*	333943TC	710347*	28X38X10TC	75X110X12	75X110X10TC	86955	155265TB
710077	333942TC	710347	28X38X5TC	75X115X10	75X115X9.5TC	8704S	189242SZ
710154*	19X38X7TC	710347	28X38X7TC	75X115X12*	75X115X12SC	8835S	161255SZ
710157*	28X43X7TC	710348*	13X22X6TC	75X90X10*	75X90X10TC	8871*	202562KBJ-H
710162*	19273VSB-H	710348	13X22X4TC	75X90X10	75X90X6TC	8883	1362035B-H
710164*	32X50X8VSB-H	710348	13X22X5TC	75X90X10	75X90X8TC	88X110X12*	88X110X12SC
710194	50X68X6TC	710356	48X60X9TB	75X90X8*	75X90X8TC	88X110X12	88X110X10SC
710238*	46X70X8TC	710357	50X67X9TB	75X90X8	75X90X6TC	8940S*	15227155B-H
710260*	46X70X8TC	710360*	35X72X10SC	75X95X10*	75X95X10SC	8974S*	218304KB-H
710271*	58X74X10TC	710360	35X72X7SC	75X95X10	75X95X7SC	8X14X4*	8X14X4SC

NATIONAL INTERCHANGES



PLEASE CALL DICHTOMATIK FOR AVAILABILITY - 800-328-2840
BULK AND INDIVIDUALLY BOXED QUANTITIES ARE AVAILABLE FOR ALL ITEMS
* = EXACT INTERCHANGE - ALL OTHERS ARE FUNCTIONALLY

NAT Part #	TCM Part #	NAT Part #	TCM Part #	NAT Part #	TCM Part #	NAT Part #	TCM Part #
8X14X5	8X14X4TC	90X110X12*	90X110X12SC	90X130X12	90X130X10TC	95X125X12*	95X125X12SC
8X16X7*	8X16X7SC	90X110X12	90X110X10SC	9277	10142SB-H	95X130X12*	95X130X12SC
8X16X7	8X16X4SC	90X110X12V	90X110X12VTF	92X120X13*	92X120X13SC	9674*	12172SB-H
8X16X7	8X16X6SC	90X110X13*	90X110X13SC	93635*	1522640TA-H	9674	12172SBY
8X18X5*	8X18X5SC	90X110X13	90X110X10SC	9568	136234SB	9711	28373TA-H
8X18X7*	8X18X7TC	90X110X13	90X110X12SC	95X110X10*	95X110X10TC	9845*	172403VTB-H
8X18X7	8X18X4TC	90X115X12*	90X115X12TC	95X110X10	95X110X7TC	98X120X13*	98X120X13SC
8X18X7	8X18X5TC	90X115X12	90X115X9TC	95X115X12	95X115X8SC	9X18X7*	9X18X7SC
8X22X7*	8X22X7TC	90X120X12*	90X120X12TC	95X115X13*	95X115X13SC	9X22X7*	9X22X7SC
8X22X7	8X22X5TC	90X125X12*	90X125X12TC	95X115X13	95X115X8SC	9X22X7V	9X22X7VSF
8X22X7V*	8X22X7VTC	90X125X13*	90X125X13TC	95X115X13V	95X115X12VTC	9X26X7*	9X26X7SC
8X22X7V	8X22X7VTF	90X125X13	90X125X12TC	95X115X13V	95X115X13VTF		
8X24X7*	8X24X7SC	90X130X12*	90X130X12TC	95X120X12*	95X120X12SC		

NATIONAL CROSS REFERENCES – V-RINGS

PLEASE CALL DICHTOMATIK FOR AVAILABILITY - 800-328-2840
 BULK AND INDIVIDUALLY BOXED QUANTITIES ARE AVAILABLE FOR ALL ITEMS
 * = EXACT INTERCHANGE - ALL OTHERS ARE FUNCTIONALLY



DICHTOMATIK

Any seal. Any time.

NAT Part #	TCM Part #	NAT Part #	TCM Part #	NAT Part #	TCM Part #	NAT Part #	TCM Part #	NAT Part #	TCM Part #
400030*	VA-003	400204*	VVA-020	400554*	VVA-055	401204*	VVA-120	402202*	VL-220
400034*	VVA-003	400205*	VVS-020	400555*	VVS-055	401205*	VVS-120	402204*	VVA-220
400040*	VA-004	400220*	VA-022	400600*	VA-060	401300*	VA-130	402500*	VA-250
400044*	VVA-004	400221*	VS-022	400601*	VS-060	401301*	VS-130	402502*	VL-250
400050*	VA-005	400224*	VVA-022	400604*	VVA-060	401304*	VVA-130	402504*	VVA-250
400051*	VS-005	400225*	VVS-022	400605*	VVS-060	401305*	VVS-130	402750*	VA-275
400054*	VVA-005	400250*	VA-025	400650*	VA-065	401400*	VA-140	402752*	VL-275
400055*	VVS-005	400251*	VS-025	400651*	VS-065	401401*	VS-140	402754*	VVA-275
400060*	VA-006	400254*	VVA-025	400654*	VVA-065	401402*	VL-140	403000*	VA-300
400061*	VS-006	400255*	VVS-025	400655*	VVS-065	401404*	VVA-140	403002*	VL-300
400064*	VVA-006	400280*	VA-028	400700*	VA-070	401405*	VVS-140	403004*	VVA-300
400065*	VVS-006	400281*	VS-028	400701*	VS-070	401500*	VA-150	403250*	VA-325
400070*	VA-007	400284*	VVA-028	400704*	VVA-070	401501*	VS-150	403252*	VL-325
400071*	VS-007	400285*	VVS-028	400705*	VVS-070	401502*	VL-150	403254*	VVA-325
400074*	VVA-007	400300*	VA-030	400750*	VA-075	401504*	VVA-150	403500*	VA-350
400075*	VVS-007	400301*	VS-030	400751*	VS-075	401505*	VVS-150	403502*	VL-350
400080*	VA-008	400304*	VVA-030	400754*	VVA-075	401600*	VA-160	403504*	VVA-350
400081*	VS-008	400305*	VVS-030	400755*	VVS-075	401601*	VS-160	403750*	VA-375
400084*	VVA-008	400320*	VA-032	400800*	VA-080	401602*	VL-160	403752*	VL-375
400085*	VVS-008	400321*	VS-032	400801*	VS-080	401604*	VVA-160	403754*	VVA-375
400100*	VA-010	400324*	VVA-032	400804*	VVA-080	401605*	VVS-160	404000*	VA-400
400101*	VS-010	400325*	VVS-032	400805*	VVS-080	401700*	VA-170	404002*	VL-400
400104*	VVA-010	400350*	VA-035	400850*	VA-085	401701*	VS-170	404004*	VVA-400
400105*	VVS-010	400351*	VS-035	400851*	VS-085	401702*	VL-170	404500*	VA-450
400120*	VA-012	400354*	VVA-035	400854*	VVA-085	401704*	VVA-170	404502*	VL-450
400121*	VS-012	400355*	VVS-035	400855*	VVS-085	401705*	VVS-170	404504*	VVA-450
400124*	VVA-012	400380*	VA-038	400900*	VA-090	401800*	VA-180	405000*	VA-500
400125*	VVS-012	400381*	VS-038	400901*	VS-090	401801*	VS-180	405002*	VL-500
400130*	VA-013	400384*	VVA-038	400904*	VVA-090	401802*	VL-180	405004*	VVA-500
400134*	VVA-013	400385*	VVS-038	400905*	VVS-090	401804*	VVA-180	405252*	VL-525
400140*	VA-014	400400*	VA-040	400950*	VA-095	401805*	VVS-180	405500*	VA-550
400141*	VS-014	400401*	VS-040	400951*	VS-095	401900*	VA-190	405502*	VL-550
400144*	VVA-014	400404*	VVA-040	400954*	VVA-095	401901*	VS-190	405504*	VVA-550
400145*	VVS-014	400405*	VVS-040	400955*	VVS-095	401902*	VL-190	406000*	VA-600
400160*	VA-016	400450*	VA-045	401000*	VA-100	401904*	VVA-190	406002*	VL-600
400161*	VS-016	400451*	VS-045	401001*	VS-100	401905*	VVS-190	406004*	VVA-600
400164*	VVA-016	400454*	VVA-045	401004*	VVA-100	401990*	VA-199	406500*	VA-650
400165*	VVS-016	400455*	VVS-045	401005*	VVS-100	401991*	VS-199	407000*	VA-700
400180*	VA-018	400500*	VA-050	401100*	VA-110	401994*	VVA-199	407250*	VA-725
400181*	VS-018	400501*	VS-050	401101*	VS-110	401995*	VVS-199	407254*	VVA-725
400184*	VVA-018	400504*	VVA-050	401104*	VVA-110	402000*	VA-200	409000*	VA-900
400185*	VVS-018	400505*	VVS-050	401105*	VVS-110	402002*	VL-200		
400200*	VA-020	400550*	VA-055	401200*	VA-120	402004*	VVA-200		
400201*	VS-020	400551*	VS-055	401201*	VS-120	402200*	VA-220		

PLEASE CALL DICHTOMATIK FOR AVAILABILITY - 800-328-2840
 BULK AND INDIVIDUALLY BOXED QUANTITIES ARE AVAILABLE FOR ALL ITEMS
 * = EXACT INTERCHANGE - ALL OTHERS ARE FUNCTIONALLY

Harwal Part #	TCM Part #	Harwal Part #	TCM Part #	Harwal Part #	TCM Part #	Harwal Part #	TCM Part #
10.5X15X3AO*	10.5X15X3VC	100X130X13ADL*	100X130X13TC	105X125X12V	105X125X12VTF	10X18X5ADL*	10X18X5TC
100X114X10B*	100X114X10SB	100X130X13ADL	100X130X10TC	105X125X13A*	105X125X13SC	10X18X5ADL	10X18X4TC
100X114X12BDL*	100X114X12TB	100X130X13ADL	100X130X12TC	105X125X13A	105X125X10SC	10X18X6A*	10X18X6SC
100X114X12BDL	100X114X7TB	100X130X13C	100X130X8SA	105X125X13ADL*	105X125X13TC	10X18X6A	10X18X4SC
100X115X12ADL	100X115X9TC	100X130X13C	100X130X10SA	105X125X13ADL	105X125X6TC	10X18X6A	10X18X5SC
100X115X4AO*	100X115X4VC	100X130X14A	100X130X10SC	105X125X13ADL	105X125X12TC	10X18X6ADL*	10X18X6TC
100X115X9A*	100X115X9SC	100X130X14A	100X130X12SC	105X125X13C*	105X125X13SA	10X18X6ADL	10X18X4TC
100X115X9ADL*	100X115X9TC	100X130X14ADL	100X130X10TC	105X125X13V	105X125X13V5F	10X18X6ADL	10X18X5TC
100X115X9V	100X115X9V5F	100X130X14ADL	100X130X12TC	105X125X6ADL*	105X125X6TC	10X18X6V	10X18X6VTF
100X115X9V	100X115X9VTC	100X130X14ADL	100X130X13TC	105X130X12A*	105X130X12SC	10X18X7ADL*	10X18X7TC
100X120X10A*	100X120X10SC	100X130X15ADL	100X130X10TC	105X130X12ADL*	105X130X12TC	10X18X7ADL	10X18X4TC
100X120X10ADL*	100X120X10TC	100X130X15ADL	100X130X12TC	105X130X12V	105X130X12V5CL	10X18X7ADL	10X18X5TC
100X120X10V	100X120X10VTC	100X130X15ADL	100X130X13TC	105X130X12V	105X130X12V5F	10X18X7ADL	10X18X6TC
100X120X11ADL	100X120X10TC	100X130X15C	100X130X8SA	105X130X12V	105X130X12VTF	10X18X8ADL*	10X18X8TC
100X120X12A*	100X120X12SC	100X130X15C	100X130X10SA	105X130X13A	105X130X12SC	10X18X8ADL	10X18X4TC
100X120X12A	100X120X10SC	100X130X8C*	100X130X8SA	105X130X13ADL	105X130X12TC	10X18X8ADL	10X18X5TC
100X120X12ADL*	100X120X12TC	100X134X10B*	100X134X10SB	105X130X13B*	105X130X13SB	10X18X8ADL	10X18X6TC
100X120X12ADL	100X120X10TC	100X135X10ADL*	100X135X10TC	105X130X13B	105X130X12SB	10X18X8ADL	10X18X7TC
100X120X12V	100X120X12V5C	100X135X12ADL*	100X135X12TC	105X130X13V	105X130X13VTC	10X18X9A	10X18X4SC
100X120X12V	100X120X12VTF	100X135X12ADL	100X135X10TC	105X130X15A	105X130X12SC	10X18X9A	10X18X5SC
100X120X13A*	100X120X13SC	100X135X13ADL	100X135X10TC	105X130X15ADL	105X130X12TC	10X18X9A	10X18X6SC
100X120X13A	100X120X10SC	100X140X12A*	100X140X12SC	105X135X13A*	105X135X13SC	10X19X4ADL*	10X19X4TC
100X120X13A	100X120X12SC	100X140X12A*	100X140X12TC	105X135X13V	105X135X13V5F	10X19X6ADL	10X19X4TC
100X120X13ADL	100X120X10TC	100X140X12ADL*	100X140X12TC	105X135X13V	105X135X13TC	10X19X7A*	10X19X7SC
100X120X13ADL	100X120X12TC	100X140X13A	100X140X12SC	105X135X13V	105X135X13VTC	10X19X7ADL*	10X19X7TC
100X120X15ADL	100X120X10TC	100X140X13ADL*	100X140X13TC	105X135X14A	105X135X13SC	10X19X7ADL	10X19X4TC
100X120X15ADL	100X120X12TC	100X140X13ADL	100X140X12TC	105X135X14ADL*	105X135X14TC	10X19X7V	10X19X7VTF
100X120X15C	100X120X13SA	100X140X13C*	100X140X13SA	105X135X15ADL	105X135X14TC	10X19X8A	10X19X7SC
100X120X17ADL	100X120X10TC	100X140X13V	100X140X13VTF	105X136X13ADL*	105X136X13TC	10X20X4.5A	10X20X4SC
100X120X17ADL	100X120X12TC	100X145X14ADL*	100X145X14TC	105X140X12ADL*	105X140X12TC	10X20X4A*	10X20X4SC
100X120X8B*	100X120X8SB	100X145X14ADL	100X145X13TC	105X140X12V	105X140X12V5F	10X20X4ADL*	10X20X4TC
100X125X10A	100X125X8SC	100X150X10ADL*	100X150X10TC	105X140X12V	105X140X12VTF	10X20X4AO*	10X20X4VC
100X125X10ADL*	100X125X10TC	100X150X12ADL*	100X150X12TC	105X140X13ADL	105X140X12TC	10X20X5A*	10X20X5SC
100X125X12A*	100X125X12SC	100X150X12ADL	100X150X10TC	105X140X13B	105X140X12SB	10X20X5A	10X20X4SC
100X125X12A	100X125X8SC	100X150X12B*	100X150X12SB	105X140X15BDL*	105X140X15TB	10X20X5ADL*	10X20X5TC
100X125X12ADL*	100X125X12TC	100X150X13ADL*	100X150X13TC	105X145X12V	105X145X12VTC	10X20X5ADL	10X20X4TC
100X125X12ADL	100X125X10TC	100X150X13ADL	100X150X10TC	105X145X13B*	105X145X13SB	10X20X6A*	10X20X6SC
100X125X12V	100X125X12VTF	100X150X13ADL	100X150X12TC	105X145X15B	105X145X13SB	10X20X6A	10X20X4SC
100X125X13A	100X125X8SC	100X150X13V	100X150X13VTC	106X126X12ADL*	106X126X12TC	10X20X6A	10X20X5SC
100X125X13A	100X125X12SC	100X160X12A*	100X160X12SC	108X135X15ADL*	108X135X15TC	10X20X6ADL*	10X20X6TC
100X125X13ADL*	100X125X13TC	100X160X15A	100X160X12SC	108X140X13C*	108X140X13SA	10X20X6ADL	10X20X4TC
100X125X13ADL	100X125X10TC	100X160X15C*	100X160X15SA	108X145X15A*	108X145X15SC	10X20X6ADL	10X20X5TC
100X125X13ADL	100X125X12TC	100X162X12ADL*	100X162X12TC	109X140X13BDL*	109X140X13TB	10X20X7A*	10X20X7SC
100X125X13V	100X125X13VTC	100X180X12A*	100X180X12SC	10X14X3AO*	10X14X3VC	10X20X7A	10X20X4SC
100X125X13V	100X125X13VTF	100X180X12ADL*	100X180X12TC	10X14X3V	10X14X3VVG	10X20X7A	10X20X5SC
100X125X14ADL	100X125X10TC	100X180X13A	100X180X12SC	10X15X3BO*	10X15X3VB	10X20X7A	10X20X6SC
100X125X14ADL	100X125X12TC	101X114X10ADL*	101X114X10TC	10X16X4A*	10X16X4SC	10X20X7ADL*	10X20X7TC
100X125X14ADL	100X125X13TC	102X115X10ADL*	102X115X10TC	10X16X4V	10X16X4VTC	10X20X7ADL	10X20X4TC
100X125X15A	100X125X8SC	102X116X14BDL*	102X116X14TB	10X16X5A*	10X16X5SC	10X20X7ADL	10X20X5TC
100X125X15A	100X125X12SC	102X125X13C*	102X125X13SA	10X16X5A	10X16X4SC	10X20X7ADL	10X20X6TC
100X130X10A*	100X130X10SC	102X130X13C*	102X130X13SA	10X16X5ADL	10X16X4TC	10X20X7V	10X20X7V5C
100X130X10ADL*	100X130X10TC	102X135X13A*	102X135X13SC	10X16X5ADL	10X16X4.5TC	10X21X5A*	10X21X5SC
100X130X12A*	100X130X12SC	103X125X13C*	103X125X13SA	10X16X7ADL*	10X16X7TC	10X21X5ADL*	10X21X5TC
100X130X12A	100X130X10SC	104X120X13V	104X120X13V5F	10X16X7ADL	10X16X4TC	10X21X5ADL	10X21X4TC
100X130X12ADL*	100X130X12TC	104X125X10A*	104X125X10SC	10X16X7ADL	10X16X4.5TC	10X21X7ADL	10X21X4TC
100X130X12ADL	100X130X10TC	104X125X10V	104X125X10V5F	10X17X7ADL*	10X17X7TC	10X21X7ADL	10X21X5TC
100X130X12V	100X130X12VDC	104X130X10A*	104X130X10SC	10X17X7ADL	10X17X4TC	10X21X7ADL	10X21X6TC
100X130X12V	100X130X12V5A	105X120X13ADL	105X120X11TC	10X17X7ADL	10X17X5TC	10X22X4ADL*	10X22X4TC
100X130X12V	100X130X12V5C	105X120X15B	105X120X7SB	10X18X4A*	10X18X4SC	10X22X5ADL*	10X22X5TC
100X130X12V	100X130X12VTF	105X120X7B*	105X120X7SB	10X18X4ADL*	10X18X4TC	10X22X5ADL*	10X22X8TC
100X130X13A	100X130X10SC	105X125X10A*	105X125X10SC	10X18X5A*	10X18X5SC	10X22X5ADL	10X22X4TC
100X130X13A	100X130X12SC	105X125X12B*	105X125X12SB	10X18X5A	10X18X4SC	10X22X6A*	10X22X6SC

HARWAL CROSS REFERENCES – SHAFT SEALS

PLEASE CALL DICHTOMATIK FOR AVAILABILITY - 800-328-2840

BULK AND INDIVIDUALLY BOXED QUANTITIES ARE AVAILABLE FOR ALL ITEMS

* = EXACT INTERCHANGE - ALL OTHERS ARE FUNCTIONALLY



DICHTOMATIK

Any seal. Any time.

HARWAL INTERCHANGES

Harwal Part #	TCM Part #	Harwal Part #	TCM Part #	Harwal Part #	TCM Part #	Harwal Part #	TCM Part #
10X22X6A	10X22X45C	10X30X7ADL*	10X30X7TC	110X145X14ADL	110X145X13TC	115X145X14ADL*	115X145X14TC
10X22X6ADL*	10X22X6TC	10X30X7ADL	10X30X6TC	110X145X15A	110X145X135C	115X145X14ADL	115X145X12TC
10X22X6ADL	10X22X4TC	10X30X7V	10X30X7VTF	110X145X15A	110X145X145C	115X145X14ADL	115X145X13TC
10X22X6ADL	10X22X5TC	10X30X8A	10X30X75C	110X145X15ADL*	110X145X15TC	115X145X14V	115X145X14VTC
10X22X6ADL	10X22X8TC	110X125X13A*	110X125X135C	110X145X15ADL	110X145X12TC	115X145X14V	115X145X14VTF
10X22X6V	10X22X6V5F	110X125X8BDL*	110X125X8TB	110X145X15ADL	110X145X13TC	115X145X15ADL	115X145X12TC
10X22X6V	10X22X6VTC	110X128X9C*	110X128X95A	110X145X15ADL	110X145X14TC	115X145X15ADL	115X145X13TC
10X22X7A	10X22X45C	110X130X10A	110X130X85C	110X150X13ADL*	110X150X13TC	115X145X15ADL	115X145X14TC
10X22X7A	10X22X65C	110X130X12A*	110X130X125C	110X150X13V	110X150X13V5F	115X150X12A*	115X150X125C
10X22X7ADL*	10X22X7TC	110X130X12A	110X130X85C	110X150X13V	110X150X13VTF	115X150X12ADL*	115X150X12TC
10X22X7ADL	10X22X4TC	110X130X12ADL*	110X130X12TC	110X150X15C*	110X150X155A	115X150X12V	115X150X12VTF
10X22X7ADL	10X22X5TC	110X130X12ADL	110X130X13TC	110X150X15C	110X150X135A	115X150X12V	115X150X12VTC
10X22X7ADL	10X22X8TC	110X130X12ADL	110X130X10TC	110X155X15A*	110X155X155C	115X150X13A	115X150X125C
10X22X7ADL	10X22X6TC	110X130X12V	110X130X12V5F	110X155X15V	110X155X15V5F	115X150X13ADL*	115X150X13TC
10X22X7V	10X22X7VTF	110X130X12V	110X130X12VTF	110X160X12ADL*	110X160X12TC	115X150X13ADL	115X150X12TC
10X22X8A	10X22X45C	110X130X13A	110X130X85C	110X160X13ADL*	110X160X13TC	115X150X15ADL	115X150X12TC
10X22X8A	10X22X65C	110X130X13A	110X130X125C	110X160X13ADL	110X160X12TC	115X150X15ADL	115X150X13TC
10X23.5X8ADL*	10X23.5X8TC	110X130X13ADL	110X130X13TC	110X160X14ADL	110X160X12TC	115X160X15A*	115X160X155C
10X23.5X8ADL	10X23.5X7TC	110X130X13ADL	110X130X10TC	110X160X14ADL	110X160X13TC	115X165X15ADL*	115X165X15TC
10X23X7ADL*	10X23X7TC	110X130X13ADL	110X130X12TC	110X160X15A*	110X160X155C	115X180X15ADL*	115X180X15TC
10X23X8ADL*	10X23X8TC	110X130X13C*	110X130X135A	110X160X15A	110X160X85C	116X132X12ADL*	116X132X12TC
10X23X8ADL	10X23X7TC	110X130X14.5A	110X130X85C	110X160X16ADL	110X160X12TC	118X140X13A*	118X140X135C
10X23X9ADL	10X23X7TC	110X130X14.5A	110X130X125C	110X160X16ADL	110X160X13TC	118X150X12CDL*	118X150X12TA
10X23X9ADL	10X23X8TC	110X130X15C	110X130X135A	110X160X8A*	110X160X85C	118X150X15ADL	118X150X12TC
10X24X6ADL*	10X24X6TC	110X130X8A*	110X130X85C	110X170X12ADL*	110X170X12TC	119X153X15ADL*	119X153X15TC
10X24X6ADL	10X24X4TC	110X130X8V	110X130X8V5F	110X200X13ADL*	110X200X13TC	11X17X4A*	11X17X45C
10X24X7A*	10X24X75C	110X132X12B*	110X132X125B	112X130X12BDL	112X130X8TB	11X17X4ADL*	11X17X4TC
10X24X7ADL*	10X24X7TC	110X132X12BDL*	110X132X12TB	112X130X8BDL*	112X130X8TB	11X17X4V	11X17X4V5C
10X24X7ADL	10X24X4TC	110X135X10ADL*	110X135X10TC	114X135X13ADL*	114X135X13TC	11X18X4ADL*	11X18X4TC
10X24X7ADL	10X24X6TC	110X135X12A*	110X135X125C	114X140X13A*	114X140X135C	11X19X6ADL*	11X19X6TC
10X24X7V	10X24X7VTF	110X135X12ADL*	110X135X12TC	114X140X13C*	114X140X135A	11X20X4.5B*	11X20X4.55B
10X25X10ADL*	10X25X10TC	110X135X12ADL	110X135X10TC	114X145X14A*	114X145X145C	11X22X7A*	11X22X75C
10X25X10ADL	10X25X4.5TC	110X135X12V	110X135X12V5F	114X159X14CDL*	114X159X14TA	11X22X7ADL*	11X22X7TC
10X25X10ADL	10X25X5TC	110X135X13A*	110X135X135C	115X130X12ADL*	115X130X12TC	11X22X7V	11X22X7VTF
10X25X10ADL	10X25X6TC	110X135X13A	110X135X125C	115X130X12V	115X130X12V5F	11X22X8A	11X22X75C
10X25X10ADL	10X25X7TC	110X135X13ADL*	110X135X13TC	115X135X13B*	115X135X135B	11X23X7ADL*	11X23X7TC
10X25X5ADL*	10X25X5TC	110X135X13ADL	110X135X10TC	115X135X13BDL*	115X135X13TB	11X24X7ADL*	11X24X7TC
10X25X5ADL	10X25X4.5TC	110X135X13ADL	110X135X12TC	115X135X14ADL*	115X135X14TC	11X25X7ADL*	11X25X7TC
10X25X6ADL*	10X25X6TC	110X140X10A*	110X140X105C	115X135X14ADL	115X135X13TC	11X26X7A*	11X26X75C
10X25X6ADL	10X25X4.5TC	110X140X12A	110X140X105C	115X140X10V	115X140X10V5CY	11X26X7ADL*	11X26X7TC
10X25X6ADL	10X25X5TC	110X140X12ADL*	110X140X12TC	115X140X12ADL*	115X140X12TC	11X26X7V	11X26X7VTF
10X25X7ADL*	10X25X7TC	110X140X12ADL*	110X140X14TC	115X140X12V	115X140X12V5G	11X28X7ADL*	11X28X7TC
10X25X7ADL	10X25X4.5TC	110X140X12ADL	110X140X10TC	115X140X12V	115X140X12VTC	11X29X7CDL*	11X29X7TA
10X25X7ADL	10X25X5TC	110X140X12V	110X140X12VTF	115X140X12V	115X140X12VTF	11X30X10A*	11X30X105C
10X25X7ADL	10X25X6TC	110X140X13A*	110X140X135C	115X140X13A*	115X140X135C	11X30X7ADL*	11X30X7TC
10X25X7V	10X25X7VTF	110X140X13A	110X140X105C	115X140X13ADL*	115X140X13TC	12.5X19X5A*	12.5X19X55C
10X26X7A*	10X26X75C	110X140X13ADL*	110X140X13TC	115X140X13ADL	115X140X12TC	12.5X20X5A*	12.5X20X55C
10X26X7ADL*	10X26X7TC	110X140X13ADL	110X140X10TC	115X140X14ADL	115X140X12TC	12.5X20X6A*	12.5X20X65C
10X26X7V	10X26X7V5F	110X140X13ADL	110X140X12TC	115X140X14ADL	115X140X13TC	12.5X20X6A	12.5X20X55C
10X26X7V	10X26X7VTF	110X140X13ADL	110X140X14TC	115X140X15C*	115X140X155A	12.5X22X5A*	12.5X22X55C
10X26X8ADL*	10X26X8TC	110X140X14ADL	110X140X10TC	115X140X15C	115X140X125A	12.5X22X6A*	12.5X22X65C
10X26X8ADL	10X26X7TC	110X140X14ADL	110X140X12TC	115X140X16ADL	115X140X12TC	12.5X22X6A	12.5X22X55C
10X28X7A*	10X28X75C	110X140X14ADL	110X140X14TC	115X140X16ADL	115X140X13TC	12.5X23.5X7ADL*	12.5X23.5X7TC
10X28X7ADL*	10X28X7TC	110X140X14ADL	110X140X13TC	115X140X16BDL	115X140X13TB	12.5X25X8ADL*	12.5X25X8TC
10X28X7V	10X28X7VTC	110X140X15C	110X140X105A	115X140X16BDL	115X140X15TB	12.7X26X6A*	12.7X26X65C
10X28X7V	10X28X7VTF	110X142X14ADL*	110X142X14TC	115X142X14ADL*	115X142X14TC	120X140X10A*	120X140X105C
10X30X10A	10X30X75C	110X145X13A*	110X145X135C	115X142X14ADL	115X142X13TC	120X140X10V	120X140X10V5F
10X30X12ADL	10X30X6TC	110X145X13ADL*	110X145X13TC	115X143X17ADL*	115X143X17TC	120X140X12A	120X140X105C
10X30X12ADL	10X30X7TC	110X145X13ADL	110X145X12TC	115X143X17ADL	115X143X12TC	120X140X12ADL	120X140X7.5TC
10X30X12ADL	10X30X10TC	110X145X13V	110X145X13V5F	115X145X13A*	115X145X135C	120X140X12V	120X140X12VTC
10X30X6ADL*	10X30X6TC	110X145X14ADL*	110X145X14TC	115X145X13V	115X145X13V5F	120X140X12V	120X140X12VTF
10X30X7A*	10X30X75C	110X145X14ADL	110X145X12TC	115X145X14A	115X145X135C	120X140X13A	120X140X105C

PLEASE CALL DICHTOMATIK FOR AVAILABILITY - 800-328-2840
 BULK AND INDIVIDUALLY BOXED QUANTITIES ARE AVAILABLE FOR ALL ITEMS
 * = EXACT INTERCHANGE - ALL OTHERS ARE FUNCTIONALLY

Harwal Part #	TCM Part #	Harwal Part #	TCM Part #	Harwal Part #	TCM Part #	Harwal Part #	TCM Part #
120X140X13ADL*	120X140X13TC	120X160X15C*	120X160X155A	12X18X4.5A	12X18X45C	12X22X9ADL	12X22X5TC
120X140X13ADL	120X140X7.5TC	120X160X8BDL*	120X160X8TB	12X18X4.5V	12X18X4.5V5C	12X22X9ADL	12X22X6TC
120X140X13B*	120X140X135B	120X162X13ADL*	120X162X13TC	12X18X5.5AO	12X18X3VC	12X22X9ADL	12X22X7TC
120X140X13C*	120X140X135A	120X165X14ADL*	120X165X14TC	12X18X5A*	12X18X55C	12X23X8ADL*	12X23X8TC
120X140X13C	120X140X105A	120X170X15C*	120X170X155A	12X18X5A	12X18X45C	12X23X8ADL	12X23X7TC
120X140X14A	120X140X105C	120X180X13ADL*	120X180X13TC	12X19X3AO*	12X19X3VC	12X24X10A*	12X24X105C
120X140X15ADL	120X140X7.5TC	120X180X15ADL*	120X180X15TC	12X19X3V	12X19X3VVG	12X24X10A	12X24X4.55C
120X140X15ADL	120X140X13TC	120X180X15ADL	120X180X13TC	12X19X4.5A*	12X19X4.55C	12X24X10A	12X24X55C
120X140X7.5ADL*	120X140X7.5TC	120X195X13A*	120X195X135C	12X19X5A*	12X19X55C	12X24X10A	12X24X65C
120X145X12ADL*	120X145X12TC	122X150X13C*	122X150X135A	12X19X5A	12X19X4.55C	12X24X10A	12X24X6.55C
120X145X15ADL	120X145X12TC	125X140X10A*	125X140X105C	12X19X5ADL*	12X19X5TC	12X24X10A	12X24X75C
120X145X15BDL*	120X145X15TB	125X140X10V	125X140X10VSF	12X19X5ADL	12X19X4.5TC	12X24X4.5A*	12X24X4.55C
120X145X15BDL	120X145X13TB	125X143X13ADL*	125X143X13TC	12X19X7ADL*	12X19X7TC	12X24X4.5ADL*	12X24X4.5TC
120X146X13ADL*	120X146X13TC	125X145X13V	125X145X13VTC	12X19X7ADL	12X19X4.5TC	12X24X6.5A*	12X24X6.55C
120X150X10A	120X150X95C	125X145X7.5A*	125X145X7.55C	12X19X7ADL	12X19X5TC	12X24X6.5A	12X24X4.55C
120X150X12A*	120X150X125C	125X150X10V	125X150X10VTF	12X20X4A*	12X20X55C	12X24X6.5A	12X24X55C
120X150X12A	120X150X95C	125X150X12A*	125X150X125C	12X20X4ADL*	12X20X4TC	12X24X6.5A	12X24X65C
120X150X12ADL*	120X150X12TC	125X150X12ADL*	125X150X12TC	12X20X5A	12X20X55C	12X24X6.5V	12X24X6.5V5C
120X150X12ADL	120X150X9TC	125X150X12V	125X150X12VTF	12X20X5ADL*	12X20X5TC	12X24X6A*	12X24X65C
120X150X12ADL	120X150X10TC	125X150X13A*	125X150X135C	12X20X5ADL	12X20X4TC	12X24X6A	12X24X4.55C
120X150X12V	120X150X12VTF	125X150X13A	125X150X125C	12X20X5V	12X20X5VTC	12X24X6A	12X24X55C
120X150X13A	120X150X95C	125X150X13ADL	125X150X12TC	12X20X7A	12X20X55C	12X24X6ADL*	12X24X6TC
120X150X13A	120X150X125C	125X150X13C*	125X150X135A	12X20X7A	12X20X65C	12X24X6ADL	12X24X4.5TC
120X150X13ADL	120X150X9TC	125X150X14A	125X150X125C	12X20X7ADL*	12X20X7TC	12X24X6ADL	12X24X5TC
120X150X13ADL	120X150X10TC	125X150X14A	125X150X135C	12X20X7ADL	12X20X4TC	12X24X7A*	12X24X75C
120X150X13ADL	120X150X12TC	125X150X14ADL	125X150X12TC	12X20X7ADL	12X20X5TC	12X24X7A	12X24X4.55C
120X150X14A	120X150X95C	125X150X15A	125X150X125C	12X20X7ADL	12X20X6TC	12X24X7A	12X24X55C
120X150X14A	120X150X125C	125X150X15A	125X150X135C	12X21X4A*	12X21X45C	12X24X7A	12X24X65C
120X150X14ADL*	120X150X14TC	125X150X15ADL	125X150X12TC	12X21X4ADL*	12X21X4TC	12X24X7A	12X24X6.55C
120X150X14ADL	120X150X9TC	125X150X15C	125X150X135A	12X21X5A*	12X21X55C	12X24X7ADL*	12X24X7TC
120X150X14ADL	120X150X10TC	125X152X13ADL*	125X152X13TC	12X21X5A	12X21X45C	12X24X7ADL	12X24X4.5TC
120X150X14ADL	120X150X12TC	125X155X12ADL*	125X155X12TC	12X21X5ADL*	12X21X5TC	12X24X7ADL	12X24X5TC
120X150X15A	120X150X95C	125X155X12V	125X155X12VSF	12X21X5ADL	12X21X4TC	12X24X7ADL	12X24X6TC
120X150X15A	120X150X125C	125X155X13ADL	125X155X12TC	12X21X7ADL*	12X21X7TC	12X24X7V	12X24X7VTC
120X150X15ADL*	120X150X15TC	125X155X14ADL*	125X155X14TC	12X21X7ADL	12X21X4TC	12X24X7V	12X24X7VTF
120X150X15ADL	120X150X9TC	125X155X14ADL	125X155X12TC	12X21X7ADL	12X21X5TC	12X24X8A	12X24X4.55C
120X150X15ADL	120X150X10TC	125X159X13ADL*	125X159X13TC	12X22X4.5A	12X22X45C	12X24X8A	12X24X55C
120X150X15ADL	120X150X12TC	125X160X12A*	125X160X125C	12X22X4A*	12X22X45C	12X24X8A	12X24X65C
120X150X15ADL	120X150X14TC	125X160X12ADL*	125X160X12TC	12X22X4V	12X22X4VSF	12X24X8A	12X24X6.55C
120X150X16ADL	120X150X9TC	125X160X12V	125X160X12VDCN	12X22X5A*	12X22X55C	12X24X8A	12X24X75C
120X150X16ADL	120X150X10TC	125X160X12V	125X160X12VTCN	12X22X5A	12X22X45C	12X25.5X7ADL*	12X25.5X7TC
120X150X16ADL	120X150X12TC	125X160X13A	125X160X125C	12X22X5ADL*	12X22X5TC	12X25X10ADL*	12X25X10TC
120X150X16ADL	120X150X14TC	125X160X15A	125X160X125C	12X22X6.5A	12X22X45C	12X25X10ADL	12X25X4.5TC
120X150X16ADL	120X150X15TC	125X160X15ADL*	125X160X15TC	12X22X6.5A	12X22X55C	12X25X10ADL	12X25X5TC
120X150X9A*	120X150X95C	125X160X15ADL	125X160X12TC	12X22X6.5A	12X22X65C	12X25X10ADL	12X25X6TC
120X152X15ADL	120X152X9TC	125X162X13ADL*	125X162X13TC	12X22X6A*	12X22X65C	12X25X10ADL	12X25X7TC
120X152X16C*	120X152X165A	125X170X12ADL*	125X170X12TC	12X22X6A	12X22X45C	12X25X10ADL	12X25X8TC
120X153X15ADL*	120X153X15TC	125X170X13C*	125X170X135A	12X22X6A	12X22X55C	12X25X4.5A	12X25X45C
120X155X13ADL*	120X155X13TC	125X170X15C	125X170X135A	12X22X6ADL*	12X22X6TC	12X25X4.5ADL*	12X25X4.5TC
120X155X13ADL	120X155X12TC	127X148X13.5ADL*	127X148X13.5TC	12X22X6ADL	12X22X5TC	12X25X5A*	12X25X55C
120X155X15ADL*	120X155X15TC	127X150X13A*	127X150X135C	12X22X7A*	12X22X75C	12X25X5A	12X25X45C
120X155X15ADL	120X155X12TC	127X170X14V	127X170X14VSF	12X22X7A	12X22X45C	12X25X5ADL*	12X25X5TC
120X155X15ADL	120X155X13TC	128X146X13.5A*	128X146X13.55C	12X22X7A	12X22X55C	12X25X5ADL	12X25X4.5TC
120X160X12A*	120X160X125C	128X148X13ADL*	128X148X13TC	12X22X7A	12X22X65C	12X25X6ADL*	12X25X6TC
120X160X12ADL*	120X160X12TC	128X150X13A*	128X150X135C	12X22X7ADL*	12X22X7TC	12X25X6ADL	12X25X4.5TC
120X160X12V	120X160X12VTF	128X150X13ADL*	128X150X13TC	12X22X7ADL	12X22X5TC	12X25X6ADL	12X25X5TC
120X160X13A	120X160X125C	128X150X13V	128X150X13VSF	12X22X7ADL	12X22X6TC	12X25X7A*	12X25X75C
120X160X13ADL	120X160X12TC	128X150X15B*	128X150X155B	12X22X8A	12X22X45C	12X25X7A	12X25X45C
120X160X13V	120X160X13VSA	12X16X3V	12X16X3VVC	12X22X8A	12X22X55C	12X25X7A	12X25X55C
120X160X14A	120X160X125C	12X18X3AO*	12X18X3VC	12X22X8A	12X22X65C	12X25X7ADL*	12X25X7TC
120X160X15A	120X160X125C	12X18X3V	12X18X3VVC	12X22X8A	12X22X75C	12X25X7ADL	12X25X4.5TC
120X160X15ADL	120X160X12TC	12X18X3V	12X18X3VVM	12X22X9ADL*	12X22X9TC	12X25X7ADL	12X25X5TC

HARWAL CROSS REFERENCES – SHAFT SEALS

PLEASE CALL DICHTOMATIK FOR AVAILABILITY - 800-328-2840
 BULK AND INDIVIDUALLY BOXED QUANTITIES ARE AVAILABLE FOR ALL ITEMS
 * = EXACT INTERCHANGE - ALL OTHERS ARE FUNCTIONALLY



DICHTOMATIK

Any seal. Any time.

HARWAL INTERCHANGES

Harwal Part #	TCM Part #	Harwal Part #	TCM Part #	Harwal Part #	TCM Part #	Harwal Part #	TCM Part #
12X25X7ADL	12X25X6TC	12X32X7V	12X32X7VTC	130X230X14ADL*	130X230X14TC	13X25X5A*	13X25X5SC
12X25X7V	12X25X7VTC	12X34X7ADL*	12X34X7TC	132X160X12ADL*	132X160X12TC	13X25X5A	13X25X4SC
12X25X7V	12X25X7VTF	12X35X10A*	12X35X10SC	132X160X13C*	132X160X13SA	13X25X7A*	13X25X7SC
12X25X8A	12X25X4SC	12X35X10A	12X35X4.3SC	132X160X15ADL	132X160X12TC	13X25X7A	13X25X4SC
12X25X8A	12X25X5SC	12X35X10A	12X35X5SC	135X155X12A*	135X155X12SC	13X25X7A	13X25X5SC
12X25X8A	12X25X7SC	12X35X4.3A*	12X35X4.3SC	135X159X13ADL*	135X159X13TC	13X25X7ADL*	13X25X7TC
12X25X8ADL*	12X25X8TC	12X35X6ADL*	12X35X6TC	135X160X10V	135X160X10VTF	13X25X7ADL	13X25X5TC
12X25X8ADL	12X25X4.5TC	12X35X7ADL*	12X35X7TC	135X160X12ADL*	135X160X12TC	13X25X8ADL	13X25X5TC
12X25X8ADL	12X25X5TC	12X35X7ADL	12X35X6TC	135X160X12V	135X160X12VTF	13X25X8ADL	13X25X7TC
12X25X8ADL	12X25X6TC	12X35X7V	12X35X7VVF	135X160X13ADL	135X160X12TC	13X26X5A*	13X26X5SC
12X25X8ADL	12X25X7TC	12X35X7V	12X35X7VTC	135X160X13B*	135X160X13SB	13X26X7A*	13X26X7SC
12X25X8V	12X25X8VVF	12X37X10A*	12X37X10SC	135X160X13BDL*	135X160X13TB	13X26X7A	13X26X5SC
12X26X10ADL	12X26X7TC	12X37X7ADL*	12X37X7TC	135X160X13BDL	135X160X12TB	13X26X7ADL*	13X26X7TC
12X26X10ADL	12X26X8TC	12X42X8ADL*	12X42X8TC	135X160X13V	135X160X13VVF	13X26X7V	13X26X7VTC
12X26X6A*	12X26X6SC	12X45X7A*	12X45X7SC	135X160X14ADL	135X160X12TC	13X26X9A*	13X26X9SC
12X26X7A*	12X26X7SC	13.7X24X5A*	13.7X24X5SC	135X160X15ADL*	135X160X15TC	13X26X9A	13X26X5SC
12X26X7A	12X26X6SC	130X150X10A*	130X150X10SC	135X160X15ADL	135X160X12TC	13X26X9A	13X26X7SC
12X26X7ADL*	12X26X7TC	130X150X10ADL*	130X150X10TC	135X162X13BDL*	135X162X13TB	13X28X7ADL*	13X28X7TC
12X26X7V	12X26X7VSC	130X150X10V	130X150X10VVF	135X165X12A*	135X165X12SC	13X28X7ADL	13X28X5TC
12X26X7V	12X26X7VTC	130X150X12ADL*	130X150X12TC	135X165X12ADL*	135X165X12TC	13X28X8ADL	13X28X5TC
12X26X8A	12X26X6SC	130X150X12ADL	130X150X10TC	135X165X12V	135X165X12VVF	13X28X8ADL	13X28X7TC
12X26X8A	12X26X7SC	130X150X12V	130X150X12VTF	135X165X13ADL*	135X165X13TC	13X30X10A	13X30X7SC
12X26X8ADL*	12X26X8TC	130X150X14BDL*	130X150X14TB	135X165X13ADL	135X165X12TC	13X30X10A	13X30X8SC
12X26X8ADL	12X26X7TC	130X150X15ADL	130X150X10TC	135X165X14ADL*	135X165X14TC	13X30X10ADL*	13X30X10TC
12X27X7ADL*	12X27X7TC	130X150X15ADL	130X150X12TC	135X165X14ADL	135X165X12TC	13X30X10ADL	13X30X3TC
12X28X5A*	12X28X5SC	130X150X15V	130X150X15VTF	135X165X14ADL	135X165X13TC	13X30X10ADL	13X30X7TC
12X28X7A*	12X28X7SC	130X153X12ADL*	130X153X12TC	135X165X15ADL	135X165X12TC	13X30X10ADL	13X30X8TC
12X28X7A	12X28X5SC	130X154X16ADL*	130X154X16TC	135X165X15ADL	135X165X13TC	13X30X7A*	13X30X7SC
12X28X7ADL*	12X28X7TC	130X155X10C*	130X155X10SA	135X165X15ADL	135X165X14TC	13X30X7ADL*	13X30X7TC
12X28X7V	12X28X7VTC	130X155X12C	130X155X10SA	135X170X12A*	135X170X12SC	13X30X7ADL	13X30X3TC
12X28X7V	12X28X7VTF	130X159X14ADL*	130X159X14TC	135X170X12V	135X170X12VTF	13X30X7V	13X30X7VTC
12X28X8A*	12X28X8SC	130X159X14CDL*	130X159X14TA	135X170X13C*	135X170X13SA	13X30X8A*	13X30X8SC
12X28X8A	12X28X5SC	130X160X12A*	130X160X12SC	135X170X13C	135X170X12SA	13X30X8A	13X30X7SC
12X28X8A	12X28X7SC	130X160X12ADL*	130X160X12TC	135X170X15A*	135X170X15SC	13X32X6A*	13X32X6SC
12X28X8ADL*	12X28X8TC	130X160X12V	130X160X12VTF	135X170X15A	135X170X12SC	13X32X7A*	13X32X7SC
12X28X8ADL	12X28X7TC	130X160X13A	130X160X12SC	135X170X15C	135X170X12SA	13X32X7A	13X32X6SC
12X30X10A*	12X30X10SC	130X160X13ADL	130X160X12TC	135X170X15C	135X170X13SA	13X33X7BDL*	13X33X7TB
12X30X10A	12X30X5SC	130X160X14A*	130X160X14SC	135X170X15V	135X170X15VTF	13X35X7ADL*	13X35X7TC
12X30X10A	12X30X6SC	130X160X14A	130X160X12SC	135X175X12ADL*	135X175X12TC	14.5X32X7ADL*	14.5X32X7TC
12X30X10A	12X30X7SC	130X160X14ADL*	130X160X14TC	135X175X16V	135X175X16VTF	14.6X27X7ADL*	14.6X27X7TC
12X30X5A*	12X30X5SC	130X160X14ADL	130X160X12TC	135X190X14A*	135X190X14SC	14.7X30X7ADL*	14.7X30X7TC
12X30X6A*	12X30X6SC	130X160X15A	130X160X12SC	135X190X15A*	135X190X15SC	14.8X30X5ADL*	14.8X30X5TC
12X30X6A	12X30X5SC	130X160X15A	130X160X14SC	135X190X15A	135X190X14SC	140X155X10A*	140X155X10SC
12X30X7A*	12X30X7SC	130X160X15ADL*	130X160X15TC	135X200X12ADL*	135X200X12TC	140X157X8V	140X157X8VTF
12X30X7A	12X30X5SC	130X160X15ADL	130X160X12TC	138X160X15A*	138X160X15SC	140X160X10ADL*	140X160X10TC
12X30X7A	12X30X6SC	130X160X15ADL	130X160X14TC	138X162X13ADL*	138X162X13TC	140X160X10V	140X160X10VTF
12X30X7ADL*	12X30X7TC	130X160X16B	130X160X12SB	13X22X4ADL*	13X22X4TC	140X160X12ADL*	140X160X12TC
12X30X7ADL	12X30X5TC	130X160X16BDL	130X160X12TB	13X22X5A*	13X22X5SC	140X160X12ADL	140X160X10TC
12X30X7V	12X30X7VDC	130X162X9ADL*	130X162X9TC	13X22X5ADL*	13X22X5TC	140X160X13A*	140X160X13SC
12X30X7V	12X30X7VVF	130X163X18ADL*	130X163X18TC	13X22X5ADL	13X22X4TC	140X160X13ADL*	140X160X13TC
12X30X7V	12X30X7VTF	130X165X13V	130X165X13VTC	13X22X6A*	13X22X6SC	140X160X13ADL	140X160X10TC
12X30X8ADL	12X30X5TC	130X170X12V	130X170X12VVF	13X22X6A	13X22X5SC	140X160X13ADL	140X160X12TC
12X30X8ADL	12X30X7TC	130X170X12V	130X170X12VTF	13X22X7ADL*	13X22X7TC	140X160X13C*	140X160X13SA
12X30X9ADL*	12X30X9TC	130X170X13A*	130X170X12SC	13X22X7ADL	13X22X4TC	140X160X14ADL	140X160X10TC
12X30X9ADL	12X30X5TC	130X170X13ADL	130X170X13TC	13X22X7ADL	13X22X5TC	140X160X14ADL	140X160X12TC
12X30X9ADL	12X30X7TC	130X170X14A	130X170X12SC	13X22X7ADL	13X22X6TC	140X160X14ADL	140X160X13TC
12X32X10A*	12X32X10SC	130X170X15A	130X170X12SC	13X23X6.5B*	13X23X6.5SB	140X160X15A	140X160X13SC
12X32X10A	12X32X7SC	130X170X15ADL	130X170X13TC	13X24X7A*	13X24X7SC	140X165X10A*	140X165X10SC
12X32X5ADL*	12X32X5TC	130X180X15C*	130X180X15SA	13X24X7A	13X24X5SC	140X165X12A	140X165X10SC
12X32X7A*	12X32X7SC	130X182X16A*	130X182X16SC	13X24X7A	13X24X6SC	140X165X12C*	140X165X12SA
12X32X7ADL*	12X32X7TC	130X190X12ADL*	130X190X12TC	13X24X7ADL*	13X24X7TC	140X165X12V	140X165X12VVF
12X32X7ADL	12X32X5TC	130X200X12ADL*	130X200X12TC	13X25X4A*	13X25X4SC	140X165X12V	140X165X12VTF

PLEASE CALL DICHTOMATIK FOR AVAILABILITY - 800-328-2840
 BULK AND INDIVIDUALLY BOXED QUANTITIES ARE AVAILABLE FOR ALL ITEMS
 * = EXACT INTERCHANGE - ALL OTHERS ARE FUNCTIONALLY

Harwal Part #	TCM Part #	Harwal Part #	TCM Part #	Harwal Part #	TCM Part #	Harwal Part #	TCM Part #
140X165X15A	140X165X10SC	145X175X15ADL	145X175X14TC	14X26X7A*	14X26X75C	150X170X15A*	150X170X155C
140X165X15ADL	140X165X13TC	145X175X15V	145X175X15VTA	14X26X7A	14X26X55C	150X170X15A	150X170X125C
140X165X15C	140X165X12SA	145X175X15V	145X175X15VTF	14X26X7A	14X26X65C	150X170X15A	150X170X135C
140X170X12ADL*	140X170X12TC	145X180X12ADL*	145X180X12TC	14X26X7ADL*	14X26X77C	150X170X15ADL*	150X170X15TC
140X170X12V	140X170X12VSA	145X180X12V	145X180X12VTC	14X26X8ADL*	14X26X87C	150X170X15ADL	150X170X12TC
140X170X12V	140X170X12VTC	145X180X14V	145X180X14V5F	14X26X8ADL	14X26X77C	150X170X15V	150X170X15VTC
140X170X13A*	140X170X135C	145X180X15C*	145X180X155A	14X27X7ADL*	14X27X77C	150X172X10ADL*	150X172X10TC
140X170X13ADL*	140X170X13TC	145X185X15A*	145X185X155C	14X28X10ADL	14X28X67C	150X172X12ADL	150X172X10TC
140X170X13ADL	140X170X12TC	148X170X15C*	148X170X155A	14X28X10ADL	14X28X77C	150X175X10ADL*	150X175X10TC
140X170X14A	140X170X135C	148X180X15C*	148X180X155A	14X28X10ADL	14X28X87C	150X178X13ADL*	150X178X13TC
140X170X14ADL*	140X170X14TC	14X20X12AO	14X20X3VC	14X28X6A*	14X28X65C	150X178X13ADL	150X178X12TC
140X170X14ADL	140X170X12TC	14X20X12AO	14X20X5VC	14X28X6ADL*	14X28X67C	150X180X12V	150X180X12VTF
140X170X14ADL	140X170X13TC	14X20X3AO*	14X20X3VC	14X28X7A*	14X28X75C	150X180X13ADL*	150X180X13TC
140X170X15A*	140X170X155C	14X20X5AO*	14X20X5VC	14X28X7A	14X28X65C	150X180X14ADL	150X180X13TC
140X170X15A	140X170X135C	14X20X5AO	14X20X3VC	14X28X7ADL*	14X28X77C	150X180X15A*	150X180X155C
140X170X15ADL	140X170X12TC	14X20X7ADL*	14X20X7TC	14X28X7ADL	14X28X67C	150X180X15ADL*	150X180X15TC
140X170X15ADL	140X170X13TC	14X20X7ADL	14X20X3TC	14X28X7V	14X28X7VTF	150X180X15ADL	150X180X13TC
140X170X15ADL	140X170X14TC	14X21X4A*	14X21X45C	14X28X8ADL*	14X28X87C	150X180X15C	150X180X135A
140X170X15V	140X170X15VTF	14X22X4ADL*	14X22X47C	14X28X8ADL	14X28X67C	150X180X15V	150X180X155C
140X175X13ADL*	140X175X13TC	14X22X4AO*	14X22X4VC	14X28X8ADL	14X28X77C	150X180X15V	150X180X15VTF
140X175X15ADL*	140X175X15TC	14X22X4V	14X22X4V5F	14X29X7ADL*	14X29X77C	150X180X18ADL	150X180X13TC
140X175X15ADL	140X175X13TC	14X22X4V	14X22X4VTC	14X30X10A*	14X30X105C	150X180X18ADL	150X180X15TC
140X180X12ADL*	140X180X12TC	14X22X5A*	14X22X55C	14X30X10A	14X30X75C	150X190X13BDL*	150X190X13TB
140X180X12V	140X180X12VTC	14X22X5A	14X22X45C	14X30X3AO*	14X30X3VC	150X190X16A*	150X190X165C
140X180X14ADL	140X180X12TC	14X22X6AO*	14X22X6VC	14X30X7A*	14X30X75C	150X200X15C*	150X200X155A
140X180X15ADL	140X180X12TC	14X22X6AO	14X22X4VC	14X30X7V	14X30X7VTF	150X210X15ADL*	150X210X15TC
140X180X15C*	140X180X155A	14X22X7A*	14X22X75C	14X30X8A	14X30X75C	150X225X12ADL*	150X225X12TC
140X190X15V	140X190X15VTF	14X22X7A	14X22X45C	14X30X8ADL*	14X30X87C	150X225X15ADL	150X225X12TC
140X210X15ADL*	140X210X15TC	14X22X7A	14X22X55C	14X30X9ADL*	14X30X97C	154X175X14ADL*	154X175X14TC
140X215X12A*	140X215X125C	14X22X7A	14X22X65C	14X30X9ADL	14X30X87C	154X175X14ADL	154X175X13TC
140X215X12A	140X215X85C	14X22X7ADL*	14X22X77C	14X32X10A*	14X32X105C	154X176X10ADL*	154X176X10TC
142X165X10A*	142X165X105C	14X22X7ADL	14X22X47C	14X32X10A	14X32X55C	154X180X15ADL*	154X180X15TC
142X166X10ADL*	142X166X10TC	14X22X7ADL	14X22X57C	14X32X10A	14X32X75C	155X172X14BDL	155X172X10TB
142X168X16ADL	142X168X14TC	14X23X6A*	14X23X65C	14X32X10A	14X32X95C	155X174X12A*	155X174X125C
143X175X16A*	143X175X165C	14X24X4AO*	14X24X4VC	14X32X5A*	14X32X55C	155X174X12ADL*	155X174X12TC
144X160X10ADL*	144X160X10TC	14X24X5A*	14X24X55C	14X32X6ADL*	14X32X67C	155X175X12A*	155X175X125C
144X172X15ADL*	144X172X15TC	14X24X5ADL*	14X24X5TC	14X32X7A*	14X32X75C	155X175X13BDL	155X175X12TB
145X160X10A*	145X160X105C	14X24X5ADL	14X24X47C	14X32X7A	14X32X55C	155X175X13V	155X175X13VTF
145X165X13A*	145X165X135C	14X24X6ADL*	14X24X67C	14X32X7ADL*	14X32X77C	155X180X12ADL*	155X180X12TC
145X165X13ADL*	145X165X13TC	14X24X6ADL	14X24X47C	14X32X7ADL	14X32X67C	155X180X12ADL	155X180X10TC
145X165X13ADL	145X165X12TC	14X24X6ADL	14X24X57C	14X32X7B*	14X32X75B	155X180X13V	155X180X13V5F
145X165X13V	145X165X13V5F	14X24X7A*	14X24X75C	14X34X7A*	14X34X75C	155X180X15A*	155X180X155C
145X165X15A*	145X165X155C	14X24X7A	14X24X55C	14X35X10ADL*	14X35X107C	155X180X15ADL	155X180X10TC
145X165X15A	145X165X135C	14X24X7A	14X24X65C	14X35X10ADL	14X35X77C	155X180X15ADL	155X180X12TC
145X167X13ADL*	145X167X13TC	14X24X7ADL*	14X24X77C	14X35X10ADL	14X35X87C	155X180X15V	155X180X15VTC
145X168X13ADL*	145X168X13TC	14X24X7ADL	14X24X47C	14X35X7A*	14X35X75C	155X185X14ADL*	155X185X14TC
145X168X13ADL	145X168X10TC	14X24X7ADL	14X24X57C	14X35X7ADL*	14X35X77C	155X190X15A*	155X190X155C
145X168X13ADL	145X168X12TC	14X24X7ADL	14X24X67C	14X35X7V	14X35X7V5F	155X190X15ADL*	155X190X15TC
145X170X12ADL*	145X170X12TC	14X24X7V	14X24X7V5F	14X35X8A	14X35X75C	155X190X15ADL	155X190X13TC
145X170X12V	145X170X12VTF	14X24X8ADL*	14X24X87C	14X40X7ADL*	14X40X77C	158X180X15A*	158X180X155C
145X170X13ADL*	145X170X13TC	14X24X8ADL	14X24X47C	15.5X28X7ADL*	15.5X28X77C	15X21X3AO*	15X21X3VC
145X170X13ADL	145X170X12TC	14X24X8ADL	14X24X57C	15.6X25.5X7ADL*	15.6X25.5X77C	15X21X4A*	15X21X45C
145X170X13C*	145X170X135A	14X24X8ADL	14X24X67C	15.88X24X4AO*	15.88X24X4VC	15X21X5ADL*	15X21X5TC
145X170X15ADL	145X170X12TC	14X24X8ADL	14X24X77C	150X162X9A*	150X162X95C	15X22X4ADL*	15X22X47C
145X170X15ADL	145X170X13TC	14X25.5X7ADL*	14X25.5X77C	150X168X12A*	150X168X125C	15X22X5ADL*	15X22X5TC
145X170X15B	145X170X105B	14X25X5ADL*	14X25X57C	150X168X13A	150X168X125C	15X22X5ADL*	15X22X47C
145X170X15B	145X170X135B	14X25X7A*	14X25X75C	150X170X12A*	150X170X125C	15X22X7ADL	15X22X47C
145X170X15V	145X170X15VTC	14X25X7A	14X25X65C	150X170X12ADL*	150X170X127C	15X22X7ADL	15X22X47C
145X175X13B*	145X175X135B	14X25X7ADL*	14X25X77C	150X170X12V	150X170X12V5F	15X22X7ADL	15X22X47C
145X175X13V	145X175X13VTC	14X25X7ADL	14X25X57C	150X170X12V	150X170X12VTF	15X22X7ADL	15X22X5TC
145X175X14B	145X175X135B	14X25X8A	14X25X65C	150X170X13A*	150X170X135C	15X23X4ADL*	15X23X47C
145X175X15A*	145X175X155C	14X25X8A	14X25X75C	150X170X13A	150X170X125C	15X23X5ADL	15X23X47C

HARWAL INTERCHANGES

HARWAL CROSS REFERENCES – SHAFT SEALS



DICHTOMATIK

Any seal. Any time.

PLEASE CALL DICHTOMATIK FOR AVAILABILITY - 800-328-2840
 BULK AND INDIVIDUALLY BOXED QUANTITIES ARE AVAILABLE FOR ALL ITEMS
 * = EXACT INTERCHANGE - ALL OTHERS ARE FUNCTIONALLY

HARWAL INTERCHANGES

Harwal Part #	TCM Part #	Harwal Part #	TCM Part #	Harwal Part #	TCM Part #	Harwal Part #	TCM Part #
15X24X5A*	15X24X5SC	15X27X7ADL*	15X27X7TC	15X30X8ADL	15X30X5TC	15X37X7ADL*	15X37X7TC
15X24X5ADL*	15X24X5TC	15X27X7ADL	15X27X5TC	15X30X8ADL	15X30X7TC	15X37X7ADL	15X37X6TC
15X24X5V	15X24X5VTC	15X27X7V	15X27X7VTC	15X30X8ADL	15X30X7.5TC	15X38X10ADL*	15X38X10TC
15X24X6ADL*	15X24X6TC	15X28.58X7A	059112SC	15X31X7ADL*	15X31X7TC	15X38X10ADL	15X38X7TC
15X24X6ADL	15X24X5TC	15X28.58X7ADL*	15X28.58X7TC	15X32X10A	15X32X5SC	15X40X10A*	15X40X10SC
15X24X7A*	15X24X7SC	15X28X10ADL*	15X28X10TC	15X32X10A	15X32X7SC	15X40X10A	15X40X8SC
15X24X7A	15X24X5SC	15X28X10ADL	15X28X4TC	15X32X5.5A	15X32X5SC	15X40X10V	15X40X10VTC
15X24X7ADL*	15X24X7TC	15X28X10ADL	15X28X7TC	15X32X5A*	15X32X5SC	15X40X7ADL*	15X40X7TC
15X24X7ADL	15X24X5TC	15X28X3BO*	15X28X3VB	15X32X7A*	15X32X7SC	15X40X8ADL*	15X40X8TC
15X24X7ADL	15X24X6TC	15X28X4A*	15X28X4SC	15X32X7A	15X32X5SC	15X40X8ADL	15X40X7TC
15X24X7V	15X24X7VDC	15X28X6A	15X28X4SC	15X32X7ADL*	15X32X7TC	15X42X10A	15X42X7SC
15X24X8A	15X24X5SC	15X28X6A	15X28X5SC	15X32X7ADL	15X32X5TC	15X42X10ADL*	15X42X10TC
15X24X8A	15X24X7SC	15X28X7A*	15X28X7SC	15X32X7V	15X32X7VSC	15X42X10ADL	15X42X7TC
15X25.5X4.5V	15X25.5X4.5VTC	15X28X7A	15X28X4SC	15X32X7V	15X32X7VTC	15X42X10ADL	15X42X8TC
15X25.5X7ADL*	15X25.5X7TC	15X28X7A	15X28X5SC	15X32X7V	15X32X7VTF	15X42X7A*	15X42X7SC
15X25.5X7ADL	15X25.5X4.5TC	15X28X7ADL*	15X28X7TC	15X32X8A	15X32X5SC	15X42X7ADL*	15X42X7TC
15X25X3AO*	15X25X3VC	15X28X7ADL	15X28X4TC	15X32X8A	15X32X7SC	15X42X7V	15X42X7VTC
15X25X5A*	15X25X5SC	15X28X7V	15X28X7VTF	15X32X8ADL	15X32X5TC	15X42X8ADL*	15X42X8TC
15X25X5ADL	15X25X4.5TC	15X28X8A	15X28X4SC	15X32X8ADL	15X32X7TC	15X42X8ADL	15X42X7TC
15X25X5V	15X25X5V5F	15X28X8A	15X28X5SC	15X32X8ADL	15X32X7.5TC	15X48X8ADL*	15X48X8TC
15X25X5V	15X25X5VTC	15X28X8A	15X28X7SC	15X32X9ADL*	15X32X9TC	16.5X28X8ADL*	16.5X28X8TC
15X25X6A*	15X25X6SC	15X28X8ADL	15X28X4TC	15X32X9ADL	15X32X5TC	160X180X10ADL*	160X180X10TC
15X25X6A	15X25X5SC	15X28X8ADL	15X28X7TC	15X32X9ADL	15X32X7TC	160X180X10BDL*	160X180X10TB
15X25X6ADL*	15X25X6TC	15X29X7ADL*	15X29X7TC	15X32X9ADL	15X32X7.5TC	160X180X12ADL	160X180X10TC
15X25X6ADL	15X25X4.5TC	15X30X10A*	15X30X10SC	15X33X10ADL	15X33X7TC	160X180X12V	160X180X12VSC
15X25X7A*	15X25X7SC	15X30X10A	15X30X4.5SC	15X33X7A*	15X33X7SC	160X180X15ADL	160X180X10TC
15X25X7A	15X25X5SC	15X30X10A	15X30X5SC	15X35.2X5.5ADL*	15X35.2X5.5TC	160X182X18ADL*	160X182X18TC
15X25X7A	15X25X6SC	15X30X10A	15X30X6SC	15X35X10A	15X35X5SC	160X185X10A*	160X185X10SC
15X25X7ADL*	15X25X7TC	15X30X10A	15X30X7SC	15X35X10A	15X35X7SC	160X185X10ADL*	160X185X10TC
15X25X7ADL	15X25X4.5TC	15X30X10ADL*	15X30X10TC	15X35X10A	15X35X8SC	160X185X10BDL*	160X185X10TB
15X25X7ADL	15X25X6TC	15X30X10ADL	15X30X4.5TC	15X35X10ADL*	15X35X10TC	160X185X10V	160X185X10V5F
15X25X7V	15X25X7VTC	15X30X10ADL	15X30X5TC	15X35X10ADL	15X35X5TC	160X185X10V	160X185X10VTC
15X25X8ADL*	15X25X8TC	15X30X10ADL	15X30X7TC	15X35X10ADL	15X35X6TC	160X185X13BDL*	160X185X13TB
15X25X8ADL	15X25X4.5TC	15X30X10ADL	15X30X7.5TC	15X35X10ADL	15X35X7TC	160X185X13BDL	160X185X10TB
15X25X8ADL	15X25X6TC	15X30X10ADL	15X30X8TC	15X35X10ADL	15X35X8TC	160X185X14A	160X185X10SC
15X25X8ADL	15X25X7TC	15X30X12ADL	15X30X4.5TC	15X35X10V	15X35X10VTF	160X185X15A	160X185X10SC
15X26X4.5A*	15X26X4.5SC	15X30X12ADL	15X30X5TC	15X35X5A*	15X35X5SC	160X185X15ADL	160X185X10TC
15X26X4.5A	15X26X4SC	15X30X12ADL	15X30X7TC	15X35X5V	15X35X5V5F	160X190X13ADL*	160X190X13TC
15X26X6A*	15X26X6SC	15X30X12ADL	15X30X7.5TC	15X35X6A	15X35X5SC	160X190X13ADL	160X190X8TC
15X26X6A	15X26X4SC	15X30X12ADL	15X30X8TC	15X35X6ADL*	15X35X6TC	160X190X13ADL	160X190X12TC
15X26X6A	15X26X4.5SC	15X30X12ADL	15X30X10TC	15X35X6ADL	15X35X5TC	160X190X13V	160X190X13VTC
15X26X6ADL*	15X26X6TC	15X30X4.5A*	15X30X4.5SC	15X35X7A*	15X35X7SC	160X190X15A*	160X190X15SC
15X26X6ADL	15X26X5TC	15X30X4AO*	15X30X4VC	15X35X7A	15X35X5SC	160X190X15ADL*	160X190X15TC
15X26X7A*	15X26X7SC	15X30X5.5A	15X30X4.5SC	15X35X7ADL*	15X35X7TC	160X190X15ADL	160X190X8TC
15X26X7A	15X26X4SC	15X30X5.5A	15X30X5SC	15X35X7ADL	15X35X5TC	160X190X15ADL	160X190X12TC
15X26X7A	15X26X4.5SC	15X30X5A*	15X30X5SC	15X35X7ADL	15X35X6TC	160X190X15ADL	160X190X13TC
15X26X7ADL*	15X26X6SC	15X30X5A	15X30X4.5SC	15X35X7BDL*	15X35X7TB	160X190X15V	160X190X15V5A
15X26X7ADL	15X26X7TC	15X30X5ADL*	15X30X5TC	15X35X7V	15X35X7VTC51W	160X190X15V	160X190X15V7B
15X26X7ADL	15X26X5TC	15X30X5ADL	15X30X4.5TC	15X35X7V	15X35X7VTF	160X190X15V	160X190X15VTF
15X26X7ADL	15X26X6TC	15X30X7A*	15X30X7SC	15X35X8A*	15X35X8SC	160X190X16ADL	160X190X8TC
15X26X7BDL	15X26X6TB	15X30X7A	15X30X4.5SC	15X35X8A	15X35X5SC	160X190X16ADL	160X190X12TC
15X26X7V	15X26X7VTF	15X30X7A	15X30X5SC	15X35X8A	15X35X7SC	160X190X16ADL	160X190X13TC
15X26X8ADL*	15X26X8TC	15X30X7A	15X30X6SC	15X35X8ADL*	15X35X8TC	160X190X16ADL	160X190X15TC
15X26X8ADL	15X26X5TC	15X30X7ADL*	15X30X7TC	15X35X8ADL	15X35X5TC	160X200X12ADL*	160X200X12TC
15X26X8ADL	15X26X6TC	15X30X7ADL	15X30X4.5TC	15X35X8ADL	15X35X6TC	160X200X12V	160X200X12VTC
15X26X8ADL	15X26X7TC	15X30X7ADL	15X30X5TC	15X35X8ADL	15X35X7TC	160X200X14ADL	160X200X12TC
15X26X9ADL*	15X26X9TC	15X30X8A	15X30X4.5SC	15X35X9ADL	15X35X5TC	160X200X15ADL*	160X200X15TC
15X26X9ADL	15X26X5TC	15X30X8A	15X30X5SC	15X35X9ADL	15X35X6TC	160X200X15ADL	160X200X12TC
15X26X9ADL	15X26X6TC	15X30X8A	15X30X6SC	15X35X9ADL	15X35X7TC	160X210X15C*	160X210X15SA
15X26X9ADL	15X26X7TC	15X30X8A	15X30X7SC	15X35X9ADL	15X35X8TC	160X240X15ADL*	160X240X15TC
15X26X9ADL	15X26X8TC	15X30X8ADL*	15X30X8TC	15X36X7ADL*	15X36X7TC	161X215X15A*	161X215X15SC
15X27X7A*	15X27X7SC	15X30X8ADL	15X30X4.5TC	15X37X10A*	15X37X10SC	162X187X12ADL*	162X187X12TC

PLEASE CALL DICHTOMATIK FOR AVAILABILITY - 800-328-2840
 BULK AND INDIVIDUALLY BOXED QUANTITIES ARE AVAILABLE FOR ALL ITEMS
 * = EXACT INTERCHANGE - ALL OTHERS ARE FUNCTIONALLY

Harwal Part #	TCM Part #	Harwal Part #	TCM Part #	Harwal Part #	TCM Part #	Harwal Part #	TCM Part #
162X190X12A*	162X190X12SC	16X26X7ADL	16X26X6TC	16X40X10ADL*	16X40X10TC	175X205X15V	175X205X15VSF
165X180X10ADL*	165X180X10TC	16X26X7V	16X26X7VTC	16X40X10ADL	16X40X7TC	175X210X14A*	175X210X14SC
165X190X10V	165X190X10VTF	16X26X8ADL	16X26X5TC	16X40X5A*	16X40X5SC	175X210X14ADL*	175X210X14TC
165X190X13A*	165X190X13SC	16X26X8ADL	16X26X6TC	16X40X7ADL*	16X40X7TC	175X210X14V	175X210X14VTF
165X190X13ADL*	165X190X13TC	16X26X8ADL	16X26X7TC	16X42X10ADL*	16X42X10TC	175X210X15C*	175X210X15SA
165X190X13V	165X190X13VVF	16X27X7ADL*	16X27X7TC	16X42X10ADL	16X42X7TC	175X215X16C*	175X215X16SA
165X190X13V	165X190X13VTF	16X28X7A*	16X28X7SC	16X42X6A*	16X42X6SC	175X220X17A*	175X220X17SC
165X190X15ADL*	165X190X15TC	16X28X7ADL*	16X28X7TC	16X42X7ADL*	16X42X7TC	175X220X17ADL*	175X220X17TC
165X190X15ADL	165X190X13TC	16X28X7ADL	16X28X6TC	16X47X8ADL	16X47X7TC	175X230X20ADL*	175X230X20TC
165X195X15ADL*	165X195X15TC	16X28X7V	16X28X7VSCN	16X48X7ADL*	16X48X7TC	177X250X16ADL*	177X250X16TC
165X200X15V	165X200X15VTF	16X28X7V	16X28X7VTF	17.5X28X6A*	17.5X28X6SC	178X200X15C*	178X200X15SA
168X190X15C*	168X190X15SA	16X28X8ADL	16X28X6TC	170X190X10ADL*	170X190X10TC	178X204X16ADL*	178X204X16TC
168X200X15C*	168X200X15SA	16X28X8ADL	16X28X7TC	170X190X10ADL	170X190X8.5TC	178X215X16C*	178X215X16SA
16X21X4.5BDL*	16X21X4.5TB	16X29X7ADL*	16X29X7TC	170X190X10ADL	170X190X8.8TC	17X23X3V	17X23X3VVC
16X22X3V	16X22X3VVC	16X29X7ADL	16X29X4TC	170X190X13ADL*	170X190X13TC	17X24X5ADL*	17X24X5TC
16X22X4.5ADL	16X22X4TC	16X30X10A*	16X30X10SC	170X190X13ADL	170X190X8.5TC	17X24X5ADL	17X24X4TC
16X22X4A*	16X22X4SC	16X30X10A	16X30X4.5SC	170X190X13ADL	170X190X8.8TC	17X24X7A*	17X24X7SC
16X22X4A	16X22X3SC	16X30X10A	16X30X5SC	170X190X13ADL	170X190X10TC	17X24X7A	17X24X5SC
16X22X4AO*	16X22X4VC	16X30X10A	16X30X7SC	170X190X14ADL	170X190X8.5TC	17X24X7ADL*	17X24X7TC
16X22X4V	16X22X4VTC	16X30X4.5A*	16X30X4.5SC	170X190X14ADL	170X190X8.8TC	17X24X7ADL	17X24X4TC
16X22X7A*	16X22X7SC	16X30X4.5V	16X30X4.5VTC	170X190X14ADL	170X190X10TC	17X24X7ADL	17X24X5TC
16X22X7A	16X22X3SC	16X30X4.5V	16X30X4.5VTF	170X190X14ADL	170X190X13TC	17X25X3V	17X25X3VTM
16X22X7A	16X22X4SC	16X30X6B*	16X30X6SB	170X190X15A*	170X190X15SC	17X25X4A*	17X25X4SC
16X22X7ADL*	16X22X7TC	16X30X7A*	16X30X7SC	170X190X15ADL	170X190X8.5TC	17X25X4ADL*	17X25X4TC
16X22X7ADL	16X22X4TC	16X30X7A	16X30X4.5SC	170X190X15ADL	170X190X8.8TC	17X25X4V	17X25X4VTC
16X23X4ADL*	16X23X4TC	16X30X7A	16X30X5SC	170X190X15ADL	170X190X10TC	17X25X6ADL*	17X25X6TC
16X24X3V	16X24X3VVC	16X30X7ADL*	16X30X7TC	170X190X15ADL	170X190X13TC	17X25X6ADL	17X25X4TC
16X24X4AO*	16X24X4VC	16X30X7ADL	16X30X4.5TC	170X190X15C*	170X190X15SA	17X25X7A*	17X25X7SC
16X24X4V	16X24X4VTC	16X30X7ADL	16X30X5TC	170X190X15V	170X190X15VSC	17X25X7A	17X25X4SC
16X24X5A*	16X24X5SC	16X30X7ADL	16X30X6TC	170X190X15V	170X190X15VVF	17X25X7A	17X25X5SC
16X24X5A	16X24X4SC	16X30X7V	16X30X7VTF	170X190X8.5ADL*	170X190X8.5TC	17X25X7ADL*	17X25X7TC
16X24X6.5ADL*	16X24X6.5TC	16X30X8A	16X30X4.5SC	170X195X18BDL*	170X195X18TB	17X25X7ADL	17X25X4TC
16X24X6.5ADL	16X24X4TC	16X30X8A	16X30X5SC	170X200X12ADL*	170X200X12TC	17X25X7ADL	17X25X6TC
16X24X6.5ADL	16X24X5TC	16X30X8A	16X30X7SC	170X200X12V	170X200X12VSC	17X26X6A*	17X26X6SC
16X24X6.5ADL	16X24X6TC	16X30X8ADL*	16X30X8TC	170X200X14ADL	170X200X12TC	17X26X6ADL*	17X26X6TC
16X24X7A*	16X24X7SC	16X30X8ADL	16X30X4.5TC	170X200X15A*	170X200X15SC	17X26X6V	17X26X6VVF
16X24X7A	16X24X4SC	16X30X8ADL	16X30X5TC	170X200X15ADL*	170X200X15TC	17X26X7A*	17X26X7SC
16X24X7A	16X24X5SC	16X30X8ADL	16X30X6TC	170X200X15ADL	170X200X12TC	17X26X7A	17X26X6SC
16X24X7A	16X24X6SC	16X30X8ADL	16X30X7TC	170X200X15V	170X200X15VTF	17X26X7ADL	17X26X6TC
16X24X7ADL*	16X24X7TC	16X32X10A	16X32X7SC	170X200X16BDL*	170X200X16TB	17X27X10ADL*	17X27X10TC
16X24X7ADL	16X24X4TC	16X32X7A*	16X32X7SC	170X200X16BDL	170X200X10TB	17X27X10ADL	17X27X6TC
16X24X7ADL	16X24X5TC	16X32X7ADL*	16X32X7TC	170X200X16BDL	170X200X15TB	17X27X10ADL	17X27X7TC
16X24X7ADL	16X24X6TC	16X32X7V	16X32X7VTC	170X210X14A*	170X210X14SC	17X27X10ADL	17X27X8TC
16X24X7ADL	16X24X6.5TC	16X33X11A*	16X33X11SC	170X210X14ADL*	170X210X14TC	17X27X6A*	17X27X6SC
16X25X3V	16X25X3VVC	16X34X10ADL*	16X34X10TC	170X210X15ADL*	170X210X15TC	17X27X6A	17X27X5SC
16X25X4ADL*	16X25X4TC	16X34X10ADL	16X34X4TC	170X210X15ADL	170X210X14TC	17X27X6ADL*	17X27X6TC
16X25X6ADL*	16X25X6TC	16X35X10A*	16X35X10SC	170X215X16C*	170X215X16SA	17X27X7A*	17X27X7SC
16X25X6ADL	16X25X4TC	16X35X10A	16X35X7SC	170X220X15A*	170X220X15SC	17X27X7A	17X27X5SC
16X25X6ADL	16X25X5TC	16X35X10A	16X35X8SC	170X220X15ADL*	170X220X15TC	17X27X7A	17X27X6SC
16X25X7A*	16X25X7SC	16X35X7A*	16X35X7SC	170X225X15C*	170X225X15SA	17X27X7ADL*	17X27X7TC
16X25X7ADL*	16X25X7TC	16X35X7ADL*	16X35X7TC	172X200X15ADL*	172X200X15TC	17X27X7ADL	17X27X6TC
16X25X7ADL	16X25X4TC	16X35X7V	16X35X7VTF	172X200X15C*	172X200X15SA	17X27X8ADL*	17X27X8TC
16X25X7ADL	16X25X5TC	16X35X8A*	16X35X8SC	175X200X10A*	175X200X10SC	17X27X8ADL	17X27X6TC
16X25X7ADL	16X25X6TC	16X35X8A	16X35X7SC	175X200X10ADL*	175X200X10TC	17X27X8ADL	17X27X7TC
16X25X7BDL*	16X25X7TB	16X35X9ADL	16X35X7TC	175X200X10V	175X200X10VVF	17X28.5X10ADL	17X28.5X6TC
16X26X5A*	16X26X5SC	16X35X9ADL	16X35X8TC	175X200X10V	175X200X10VTF	17X28.5X10ADL	17X28.5X7TC
16X26X6A	16X26X5SC	16X36X7ADL*	16X36X7TC	175X200X15A	175X200X10SC	17X28.5X6ADL*	17X28.5X6TC
16X26X7A*	16X26X7SC	16X37X7ADL*	16X37X7TC	175X200X15ADL*	175X200X15TC	17X28.5X9ADL	17X28.5X7TC
16X26X7A	16X26X5SC	16X38X7A*	16X38X7SC	175X200X15V	175X200X10TC	17X28.65X7ADL*	17X28.65X7TC
16X26X7ADL*	16X26X7TC	16X40X10A*	16X40X10SC	175X203.5X19BDL*	175X203.5X19TB	17X28X4A*	17X28X4SC
16X26X7ADL	16X26X5TC	16X40X10A	16X40X5SC	175X205X15ADL*	175X205X15TC	17X28X4ADL*	17X28X4TC

HARWAL CROSS REFERENCES – SHAFT SEALS

PLEASE CALL DICHTOMATIK FOR AVAILABILITY - 800-328-2840
 BULK AND INDIVIDUALLY BOXED QUANTITIES ARE AVAILABLE FOR ALL ITEMS
 * = EXACT INTERCHANGE - ALL OTHERS ARE FUNCTIONALLY



DICHTOMATIK

Any seal. Any time.

HARWAL INTERCHANGES

Harwal Part #	TCM Part #	Harwal Part #	TCM Part #	Harwal Part #	TCM Part #	Harwal Part #	TCM Part #
17X28X5A*	17X28X5SC	17X32X10ADL	17X32X6TC	17X37X7A*	17X37X7SC	180X210X14ADL	180X210X10TC
17X28X5A	17X28X4SC	17X32X10ADL	17X32X7TC	17X37X7ADL*	17X37X7TC	180X210X15A*	180X210X15SC
17X28X5A	17X28X4.5SC	17X32X10ADL	17X32X8TC	17X37X7ADL	17X37X5TC	180X210X15A	180X210X10SC
17X28X5ADL*	17X28X5TC	17X32X5A*	17X32X5SC	17X38X5ADL*	17X38X5TC	180X210X15ADL*	180X210X15TC
17X28X5ADL	17X28X4TC	17X32X5ADL*	17X32X5TC	17X38X7A*	17X38X7SC	180X210X15ADL	180X210X10TC
17X28X5ADL	17X28X4.5TC	17X32X7.5B	17X32X7SB	17X38X7ADL*	17X38X7TC	180X210X15V	180X210X15VDC
17X28X5V	17X28X5V5F	17X32X7A*	17X32X7SC	17X38X7ADL	17X38X5TC	180X210X15V	180X210X15VSA
17X28X6A*	17X28X6SC	17X32X7A	17X32X5SC	17X39X9.5ADL*	17X39X9.5TC	180X210X16ADL*	180X210X16TC
17X28X6A	17X28X4SC	17X32X7ADL*	17X32X7TC	17X40X10A*	17X40X10SC	180X210X16ADL	180X210X10TC
17X28X6A	17X28X4.5SC	17X32X7ADL	17X32X5TC	17X40X10A	17X40X6SC	180X210X16ADL	180X210X15TC
17X28X6A	17X28X5SC	17X32X7ADL	17X32X6TC	17X40X10A	17X40X7SC	180X215X15A*	180X215X15SC
17X28X6ADL*	17X28X6TC	17X32X7V	17X32X7VTF	17X40X10A	17X40X8SC	180X215X15ADL*	180X215X15TC
17X28X6ADL	17X28X4TC	17X32X8A	17X32X5SC	17X40X10ADL	17X40X5TC	180X215X15C*	180X215X15SA
17X28X6ADL	17X28X4.5TC	17X32X8A	17X32X7SC	17X40X10ADL	17X40X5TCY	180X215X15V	180X215X15VTC
17X28X6ADL	17X28X5TC	17X32X8ADL*	17X32X8TC	17X40X10ADL	17X40X7TC	180X215X16A	180X215X15SC
17X28X6V	17X28X6VDC	17X32X8ADL	17X32X5TC	17X40X10ADL	17X40X8TC	180X215X16ADL*	180X215X16TC
17X28X7A*	17X28X7SC	17X32X8ADL	17X32X6TC	17X40X5ADL*	17X40X5TC	180X215X16ADL	180X215X15TC
17X28X7A	17X28X4SC	17X32X8ADL	17X32X7TC	17X40X5ADL*	17X40X5TCY	180X215X16V	180X215X16V5F
17X28X7A	17X28X4.5SC	17X32X8ADL	17X32X7TC	17X40X6A*	17X40X6SC	180X220X13ADL*	180X220X13TC
17X28X7A	17X28X5SC	17X33X7ADL*	17X33X7TC	17X40X6ADL	17X40X5TC	180X220X15ADL	180X220X13TC
17X28X7A	17X28X6SC	17X33X7B*	17X33X7SB	17X40X6ADL	17X40X5TCY	180X220X15V	180X220X15VTC
17X28X7ADL*	17X28X7TC	17X33X8A*	17X33X8SC	17X40X6ADL	17X40X5TCY	180X220X16A*	180X220X16SC
17X28X7ADL	17X28X4TC	17X33X8ADL	17X33X7TC	17X40X7A*	17X40X7SC	180X220X16ADL	180X220X13TC
17X28X7ADL	17X28X4.5TC	17X34X4ADL*	17X34X4TC	17X40X7A	17X40X6SC	180X220X16ADL	180X220X13TC
17X28X7ADL	17X28X5TC	17X34X4B*	17X34X4SB	17X40X7ADL*	17X40X7TC	180X260X15ADL*	180X260X15TC
17X28X7ADL	17X28X6TC	17X34X6ADL	17X34X4TC	17X40X7ADL	17X40X5TC	185X210X13A*	185X210X13SC
17X28X7V	17X28X7V5B	17X34X7A*	17X34X7SC	17X40X7ADL	17X40X5TCY	185X210X13ADL*	185X210X13TC
17X28X7V	17X28X7VTC	17X34X7ADL*	17X34X7TC	17X40X7ADL	17X40X7TF	185X210X13V	185X210X13V5F
17X28X7V	17X28X7VTF	17X34X7ADL	17X34X4TC	17X40X7V	17X40X7VTF	185X210X13V	185X210X13VTC
17X28X8A	17X28X4SC	17X35X10A	17X35X5SC	17X40X8.5A	17X40X6SC	185X215X15ADL*	185X215X15TC
17X28X8A	17X28X4.5SC	17X35X10A	17X35X7SC	17X40X8.5A	17X40X7SC	185X215X15C*	185X215X15SA
17X28X8A	17X28X5SC	17X35X10ADL	17X35X5TC	17X40X8.5A	17X40X8SC	185X215X15V	185X215X15VTF
17X28X8A	17X28X6SC	17X35X10ADL	17X35X6TC	17X40X8.5ADL	17X40X5TC	185X215X16ADL*	185X215X16TC
17X28X8A	17X28X7SC	17X35X10ADL	17X35X7TC	17X40X8.5ADL	17X40X5TCY	185X215X16ADL	185X215X15TC
17X28X8ADL*	17X28X8TC	17X35X10ADL	17X35X8TC	17X40X8.5ADL	17X40X7TC	185X230X16C*	185X230X16SA
17X28X8ADL	17X28X4TC	17X35X5A*	17X35X5SC	17X40X8.5ADL	17X40X8TC	188X215X16ADL*	188X215X16TC
17X28X8ADL	17X28X4.5TC	17X35X5ADL*	17X35X5TC	17X40X8A*	17X40X8SC	188X215X16C*	188X215X16SA
17X28X8ADL	17X28X5TC	17X35X6A	17X35X5SC	17X40X8A	17X40X6SC	18X24X3V	18X24X3VVG
17X28X8ADL	17X28X6TC	17X35X6ADL*	17X35X6TC	17X40X8A	17X40X7SC	18X25X3AO*	18X25X3VC
17X28X8ADL	17X28X7TC	17X35X6ADL	17X35X5TC	17X40X8ADL*	17X40X8TC	18X25X4B*	18X25X4SB
17X29X5A*	17X29X5SC	17X35X7A*	17X35X7SC	17X40X8ADL	17X40X5TC	18X25X6B	18X25X4SB
17X29X5ADL*	17X29X5TC	17X35X7A	17X35X5SC	17X40X8ADL	17X40X5TCY	18X25X7ADL*	18X25X7TC
17X29X7ADL*	17X29X7TC	17X35X7ADL*	17X35X7TC	17X40X8ADL	17X40X7TC	18X25X7ADL*	18X25X7TCY
17X29X7ADL	17X29X5TC	17X35X7ADL	17X35X5TC	17X42X5A*	17X42X5SC	18X26X4A*	18X26X4SC
17X30X5ADL*	17X30X5TC	17X35X7ADL	17X35X6TC	17X42X7A*	17X42X7SC	18X26X4V	18X26X4VTF
17X30X5V	17X30X5V5F	17X35X7V	17X35X7VTC	17X42X7A	17X42X5SC	18X26X6A*	18X26X6SC
17X30X6ADL*	17X30X6TC	17X35X7V	17X35X7VTF	17X42X7ADL*	17X42X7TC	18X26X6A	18X26X4SC
17X30X6ADL	17X30X5TC	17X35X8A	17X35X5SC	17X47X10A*	17X47X10SC	18X27X7ADL*	18X27X7TC
17X30X7A*	17X30X7SC	17X35X8A	17X35X7SC	17X47X10A	17X47X7SC	18X28X10ADL	18X28X6TC
17X30X7ADL*	17X30X7TC	17X35X8ADL*	17X35X8TC	17X47X10ADL	17X47X7TC	18X28X10ADL	18X28X7TC
17X30X7ADL	17X30X5TC	17X35X8ADL	17X35X5TC	17X47X10ADL	17X47X8TC	18X28X4A*	18X28X4SC
17X30X7ADL	17X30X6TC	17X35X8ADL	17X35X6TC	17X47X11A	17X47X7SC	18X28X4V	18X28X4V5F
17X30X7V	17X30X7VTF	17X35X8ADL	17X35X7TC	17X47X11A	17X47X10SC	18X28X6A*	18X28X6SC
17X30X8A	17X30X7SC	17X35X9ADL	17X35X5TC	17X47X7A*	17X47X7SC	18X28X6A	18X28X4SC
17X30X8ADL*	17X30X8TC	17X35X9ADL	17X35X6TC	17X47X7ADL*	17X47X7TC	18X28X6ADL*	18X28X6TC
17X30X8ADL	17X30X5TC	17X35X9ADL	17X35X7TC	17X47X7V	17X47X7VTC	18X28X6V	18X28X6V5C
17X30X8ADL	17X30X6TC	17X35X9ADL	17X35X8TC	17X47X8A	17X47X7SC	18X28X6V	18X28X6VTF
17X30X8ADL	17X30X7TC	17X36X7ADL*	17X36X7TC	17X47X8ADL*	17X47X8TC	18X28X7A	18X28X4SC
17X32X10A*	17X32X10SC	17X37X10A*	17X37X10SC	17X47X8ADL	17X47X7TC	18X28X7A	18X28X6SC
17X32X10A	17X32X5SC	17X37X10A	17X37X7SC	18.9X30X5ADL*	18.9X30X5TC	18X28X7ADL*	18X28X7TC
17X32X10A	17X32X7SC	17X37X10ADL	17X37X5TC	180X205X15ADL*	180X205X15TC	18X28X7ADL	18X28X6TC
17X32X10ADL	17X32X5TC	17X37X10ADL	17X37X7TC	180X210X10A*	180X210X10SC	18X28X7V	18X28X7VTF2-H
		17X37X5ADL*	17X37X5TC	180X210X10ADL*	180X210X10TC	18X28X7V	18X28X7VTF



PLEASE CALL DICHTOMATIK FOR AVAILABILITY - 800-328-2840
BULK AND INDIVIDUALLY BOXED QUANTITIES ARE AVAILABLE FOR ALL ITEMS
* = EXACT INTERCHANGE - ALL OTHERS ARE FUNCTIONALLY

Harwal Part #	TCM Part #	Harwal Part #	TCM Part #	Harwal Part #	TCM Part #	Harwal Part #	TCM Part #
18X28X8A	18X28X45C	18X38X5A*	18X38X55C	19X29X7ADL*	19X29X7TC	200X240X20ADL*	200X240X20TC
18X28X8A	18X28X65C	18X38X7ADL*	18X38X7TC	19X29X8ADL	19X29X7TC	200X240X20ADL	200X240X15TC
18X28X8ADL	18X28X6TC	18X38X7ADL	18X38X6TC	19X30X10A	19X30X65C	200X240X20ADL	200X240X18TC
18X28X8ADL	18X28X7TC	18X40X10A	18X40X75C	19X30X10A	19X30X75C	200X240X20V	200X240X20VTA
18X29X5ADL*	18X29X5TC	18X40X10ADL	18X40X6TC	19X30X6A*	19X30X65C	200X250X15ADL*	200X250X15TC
18X29X7ADL*	18X29X7TC	18X40X10ADL	18X40X7TC	19X30X7ADL*	19X30X7TC	200X250X15C*	200X250X15SA
18X29X7ADL	18X29X5TC	18X40X6ADL*	18X40X6TC	19X30X7ADL	19X30X5TC	200X250X15V	200X250X15VSF
18X30X10A	18X30X75C	18X40X7A*	18X40X75C	19X30X8A	19X30X65C	205X225X18ADL*	205X225X18TC
18X30X6ADL*	18X30X6TC	18X40X7ADL*	18X40X7TC	19X30X8A	19X30X75C	205X230X15A*	205X230X155C
18X30X6ADL	18X30X5TC	18X40X7ADL	18X40X6TC	19X31X8ADL*	19X31X8TC	205X230X15B*	205X230X155B
18X30X7A*	18X30X75C	18X40X7V	18X40X7VTC	19X32X10A	19X32X55C	205X230X15BDL*	205X230X15TB
18X30X7ADL*	18X30X7TC	18X40X7V	18X40X7VTF	19X32X5ADL*	19X32X5TC	205X230X16A	205X230X155C
18X30X7ADL	18X30X5TC	18X42X10A	18X42X85C	19X32X7A	19X32X55C	205X230X16C	205X230X155A
18X30X7ADL	18X30X6TC	18X42X10ADL	18X42X7TC	19X32X7ADL*	19X32X7TC	205X230X16V	205X230X16V5C
18X30X7V	18X30X7V5B	18X42X7ADL*	18X42X7TC	19X32X7ADL	19X32X5TC	205X230X16V	205X230X16V5F
18X30X7V	18X30X7VTF	18X42X8A*	18X42X85C	19X32X7V	19X32X7VTC	205X235X18ADL*	205X235X18TC
18X30X8ADL*	18X30X8TC	18X42X8V	18X42X8VSF	19X32X8ADL*	19X32X8TC	205X235X18ADL	205X235X16TC
18X30X8ADL	18X30X5TC	18X42X8V	18X42X8VTF	19X32X8ADL	19X32X5TC	205X250X16ADL*	205X250X16TC
18X30X8ADL	18X30X6TC	18X44X8A*	18X44X85C	19X32X8ADL	19X32X7TC	20X24X2.5AO*	20X24X2.5VC
18X30X8ADL	18X30X7TC	18X47X8ADL*	18X47X8TC	19X34X7ADL*	19X34X7TC	20X26X10ADL	20X26X4TC
18X32X10A*	18X32X105C	19.8X30X5ADL*	19.8X30X5TC	19X35X10A*	19X35X105C	20X26X10ADL	20X26X5TC
18X32X10A	18X32X75C	190X215X15ADL*	190X215X15TC	19X35X10A	19X35X75C	20X26X10AO	20X26X4VC
18X32X10A	18X32X85C	190X215X15C*	190X215X155A	19X35X10A	19X35X85C	20X26X4ADL*	20X26X4TC
18X32X5ADL	18X32X4TC	190X215X16ADL	190X215X15TC	19X35X10ADL	19X35X7TC	20X26X4AO*	20X26X4VC
18X32X6ADL*	18X32X6TC	190X215X16C*	190X215X165A	19X35X7A*	19X35X75C	20X26X4V	20X26X4VTC
18X32X6ADL	18X32X4TC	190X215X16C	190X215X155A	19X35X7ADL*	19X35X7TC	20X26X5ADL*	20X26X5TC
18X32X7A*	18X32X75C	190X215X16V	190X215X16VTF	19X35X8A*	19X35X85C	20X26X5ADL	20X26X4TC
18X32X7ADL*	18X32X7TC	190X220X12C*	190X220X125A	19X35X8A	19X35X75C	20X27X5ADL*	20X27X5TC
18X32X7ADL	18X32X4TC	190X220X15A*	190X220X155C	19X35X8ADL	19X35X7TC	20X28X4.5AO	20X28X4VC
18X32X7ADL	18X32X6TC	190X220X15ADL*	190X220X15TC	19X36X8ADL	19X36X7TC	20X28X4AO*	20X28X4VC
18X32X7V	18X32X7VTF	190X220X15C	190X220X125A	19X37X7ADL*	19X37X7TC	20X28X4BO*	20X28X4VB
18X32X8A*	18X32X85C	190X220X15V	190X220X15VTF	19X37X8ADL	19X37X7TC	20X28X4V	20X28X4VTC
18X32X8A	18X32X75C	190X220X16A*	190X220X165C	19X38X10A*	19X38X105C	20X28X5BO	20X28X4VB
18X32X8ADL*	18X32X8TC	190X220X16A	190X220X155C	19X38X10ADL	19X38X7TC	20X28X6A*	20X28X65C
18X32X8ADL	18X32X4TC	190X220X16ADL	190X220X15TC	19X38X7ADL*	19X38X7TC	20X28X6A	20X28X45C
18X32X8ADL	18X32X6TC	190X220X16C	190X220X125A	19X40X10A*	19X40X105C	20X28X6A	20X28X55C
18X32X8ADL	18X32X7TC	190X225X12ADL*	190X225X12TC	19X40X8ADL*	19X40X8TC	20X28X7A*	20X28X75C
18X32X8V	18X32X8V5C	190X225X15A*	190X225X155C	19X46X17ADL*	19X46X17TC	20X28X7A	20X28X45C
18X32X8V	18X32X8VTF	190X225X15ADL*	190X225X15TC	19X47X10ADL	19X47X7TC	20X28X7A	20X28X55C
18X34X7ADL*	18X34X7TC	190X225X15ADL	190X225X12TC	19X47X7ADL*	19X47X7TC	20X28X7A	20X28X65C
18X35X10A*	18X35X105C	190X225X16A	190X225X155C	19X53X7.5A*	19X53X7.55C	20X30X4.5ADL*	20X30X4.5TC
18X35X10A	18X35X85C	190X225X16ADL*	190X225X16TC	200X225X15V	200X225X15VTC	20X30X5A*	20X30X55C
18X35X10ADL*	18X35X10TC	190X225X16ADL	190X225X12TC	200X225X15V	200X225X15VTF	20X30X5ADL*	20X30X5TC
18X35X10ADL	18X35X6TC	190X225X16ADL	190X225X15TC	200X230X13ADL*	200X230X13TC	20X30X5ADL	20X30X4.5TC
18X35X10ADL	18X35X7TC	190X225X16V	190X225X16V5A	200X230X13V	200X230X13VTC	20X30X5V	20X30X5VTC
18X35X6ADL*	18X35X6TC	190X225X16V	190X225X16VTC	200X230X15A*	200X230X155C	20X30X5V	20X30X5VTF
18X35X6V	18X35X6VTF	190X230X15ADL*	190X230X15TC	200X230X15ADL*	200X230X15TC	20X30X6ADL*	20X30X6TC
18X35X7ADL*	18X35X7TC	190X230X15C*	190X230X155A	200X230X15ADL	200X230X13TC	20X30X6ADL	20X30X4.5TC
18X35X7ADL	18X35X6TC	190X230X16ADL*	190X230X16TC	200X230X15C*	200X230X155A	20X30X6ADL	20X30X5TC
18X35X7V	18X35X7VTC	190X230X16ADL	190X230X15TC	200X230X15V	200X230X15VTC	20X30X7A*	20X30X75C
18X35X7V	18X35X7VTF	190X230X16C	190X230X155A	200X230X15V	200X230X15VTF	20X30X7A	20X30X55C
18X35X8A*	18X35X85C	190X240X15ADL*	190X240X15TC	200X230X16A	200X230X155C	20X30X7ADL*	20X30X7TC
18X35X8ADL	18X35X6TC	192X210X10ADL*	192X210X10TC	200X230X16ADL	200X230X13TC	20X30X7ADL	20X30X4.5TC
18X35X8ADL	18X35X7TC	195X215X15A*	195X215X155C	200X230X16ADL	200X230X15TC	20X30X7ADL	20X30X5TC
18X36X8ADL	18X36X7TC	195X215X15ADL*	195X215X15TC	200X230X16C	200X230X155A	20X30X7ADL	20X30X6TC
18X37X7ADL*	18X37X7TC	195X220X16C*	195X220X165A	200X235X15ADL*	200X235X15TC	20X30X7B*	20X30X75B
18X37X8A*	18X37X85C	195X230X15C*	195X230X155A	200X235X18ADL	200X235X15TC	20X30X7V	20X30X7VTF
18X37X8A	18X37X65C	195X230X16A	195X230X155C	200X240X15A*	200X240X155C	20X30X8A*	20X30X85C
18X37X8ADL	18X37X7TC	195X235X15ADL*	195X235X15TC	200X240X15ADL*	200X240X15TC	20X30X8A	20X30X55C
18X38X10ADL*	18X38X10TC	19X26X5AO*	19X26X5VC	200X240X16CDL	200X240X15TA	20X30X8A	20X30X75C
18X38X10ADL	18X38X6TC	19X27X6A*	19X27X65C	200X240X18ADL*	200X240X18TC	20X30X9B	20X30X75B
18X38X10ADL	18X38X7TC	19X28X7ADL*	19X28X7TC	200X240X18ADL	200X240X15TC	20X31X7A*	20X31X75C

HARWAL INTERCHANGES

HARWAL CROSS REFERENCES – SHAFT SEALS



DICHTOMATIK

Any seal. Any time.

PLEASE CALL DICHTOMATIK FOR AVAILABILITY - 800-328-2840
 BULK AND INDIVIDUALLY BOXED QUANTITIES ARE AVAILABLE FOR ALL ITEMS
 * = EXACT INTERCHANGE - ALL OTHERS ARE FUNCTIONALLY

HARWAL INTERCHANGES

Harwal Part #	TCM Part #	Harwal Part #	TCM Part #	Harwal Part #	TCM Part #	Harwal Part #	TCM Part #
20X31X7ADL*	20X31X7TC	20X35X8A	20X35X6SC	20X40X8ADL	20X40X5TC	20X52X10A	20X52X6SC
20X32X12ADL	20X32X5TC	20X35X8A	20X35X7SC	20X40X8ADL	20X40X7TC	20X52X10A	20X52X7SC
20X32X12ADL	20X32X7TC	20X35X8ADL*	20X35X8TC	20X40X9A*	20X40X9SC	20X52X10ADL*	20X52X10TC
20X32X12ADL	20X32X8TC	20X35X8ADL	20X35X4TC	20X40X9A	20X40X6SC	20X52X10ADL	20X52X6TC
20X32X4AO*	20X32X4VC	20X35X8ADL	20X35X6TC	20X40X9A	20X40X7SC	20X52X10ADL	20X52X7TC
20X32X5A*	20X32X5SC	20X35X8ADL	20X35X7TC	20X40X9A	20X40X7SSC	20X52X10ADL	20X52X8TC
20X32X5ADL*	20X32X5TC	20X35X8B	20X35X7SB	20X41X7ADL*	20X41X7TC	20X52X12A	20X52X6SC
20X32X6A	20X32X5SC	20X36X7A*	20X36X7SC	20X41X7ADL	20X41X5TC	20X52X12A	20X52X7SC
20X32X6ADL	20X32X5TC	20X36X7ADL*	20X36X7TC	20X42X10A*	20X42X10SC	20X52X12A	20X52X10SC
20X32X6V	20X32X6VTC	20X36X8V	20X36X8VTF	20X42X10A	20X42X7SC	20X52X12ADL	20X52X6TC
20X32X7A*	20X32X7SC	20X37X10A*	20X37X10SC	20X42X10ADL*	20X42X10TC	20X52X12ADL	20X52X7TC
20X32X7A	20X32X5SC	20X37X10A	20X37X7SC	20X42X10ADL	20X42X5TC	20X52X12ADL	20X52X8TC
20X32X7ADL*	20X32X7TC	20X37X10A	20X37X8SC	20X42X10ADL	20X42X6TC	20X52X12ADL	20X52X10TC
20X32X7ADL	20X32X5TC	20X37X10ADL*	20X37X10TC	20X42X10ADL	20X42X7TC	20X52X6A*	20X52X6SC
20X32X7V	20X32X7VTF	20X37X10ADL	20X37X7TC	20X42X10B	20X42X6SB	20X52X7A*	20X52X7SC
20X32X8ADL*	20X32X8TC	20X37X10ADL	20X37X8TC	20X42X10B	20X42X7SB	20X52X7A	20X52X6SC
20X32X8ADL	20X32X5TC	20X37X6B*	20X37X6SB	20X42X10V	20X42X10VSF	20X52X7ADL*	20X52X7TC
20X32X8ADL	20X32X7TC	20X37X7ADL*	20X37X7TC	20X42X5ADL*	20X42X5TC	20X52X7ADL	20X52X6TC
20X33X10A	20X33X8SC	20X37X8A*	20X37X8SC	20X42X6ADL*	20X42X6TC	20X52X7V	20X52X7VTC
20X33X10V	20X33X10VTC	20X37X8A	20X37X7SC	20X42X6ADL	20X42X5TC	20X52X8A	20X52X6SC
20X33X7ADL	20X33X5TC	20X37X8ADL*	20X37X8TC	20X42X6V	20X42X6VTC	20X52X8A	20X52X7SC
20X33X9A	20X33X8SC	20X37X8ADL	20X37X7TC	20X42X7A*	20X42X7SC	20X52X8ADL*	20X52X8TC
20X34X7A*	20X34X7SC	20X37X8V	20X37X8VTC	20X42X7ADL*	20X42X7TC	20X52X8ADL	20X52X6TC
20X34X7ADL*	20X34X7TC	20X38X10ADL	20X38X5TC	20X42X7ADL	20X42X5TC	20X52X8ADL	20X52X7TC
20X34X8ADL	20X34X7TC	20X38X10ADL	20X38X8TC	20X42X7ADL	20X42X6TC	20X52X9ADL	20X52X6TC
20X35.8X4BDL*	20X35.8X4TB	20X38X5ADL*	20X38X5TC	20X42X8ADL	20X42X5TC	20X52X9ADL	20X52X7TC
20X35X10A*	20X35X10SC	20X38X7A*	20X38X7SC	20X42X8ADL	20X42X6TC	20X52X9ADL	20X52X8TC
20X35X10A	20X35X5SC	20X38X7ADL	20X38X5TC	20X42X8ADL	20X42X7TC	20X62X10ADL*	20X62X10TC
20X35X10A	20X35X5.5SC	20X38X8A*	20X38X8SC	20X45X7ADL*	20X45X7TC	20X62X6.5A*	20X62X6.5SC
20X35X10A	20X35X6SC	20X38X8A	20X38X7SC	20X45X7ADL	20X45X5TC	20X72X10A	20X72X5SC
20X35X10A	20X35X7SC	20X38X8ADL*	20X38X8TC	20X45X8ADL	20X45X5TC	210X240X15A*	210X240X15SC
20X35X10ADL*	20X35X10TC	20X38X8ADL	20X38X5TC	20X45X8ADL	20X45X7TC	210X240X15ADL*	210X240X15tc
20X35X10ADL	20X35X4TC	20X38X8V	20X38X8VTC	20X46X6A*	20X46X6SC	210X240X15C*	210X240X15SA
20X35X10ADL	20X35X6TC	20X40X10A	20X40X6SC	20X46X8ADL	20X46X7TC	210X240X15V	210X240X15VSC
20X35X10ADL	20X35X7TC	20X40X10A	20X40X7SC	20X47.5X7ADL*	20X47.5X7TC	210X250X15ADL*	210X250X15TC
20X35X10ADL	20X35X8TC	20X40X10A	20X40X7SSC	20X47X10A*	20X47X10SC	210X250X15V	210X250X15VSF
20X35X12ADL	20X35X4TC	20X40X10A	20X40X9SC	20X47X10A	20X47X7SC	210X250X15V	210X250X15VTC
20X35X12ADL	20X35X6TC	20X40X10ADL*	20X40X10TC	20X47X10A	20X47X8SC	210X250X15V	210X250X15VTF
20X35X12ADL	20X35X7TC	20X40X10ADL	20X40X4TC	20X47X10ADL*	20X47X10TC	210X250X16ADL	210X250X15TC
20X35X12ADL	20X35X8TC	20X40X10ADL	20X40X5TC	20X47X10ADL	20X47X5TC	210X260X16ADL*	210X260X16TC
20X35X12ADL	20X35X10TC	20X40X10ADL	20X40X7TC	20X47X10ADL	20X47X7TC	210X290X20ADL*	210X290X20TC
20X35X4ADL*	20X35X4TC	20X40X10ADL	20X40X8TC	20X47X10ADL	20X47X8TC	215X240X12A*	215X240X12SC
20X35X5A*	20X35X5SC	20X40X11ADL	20X40X4TC	20X47X5ADL*	20X47X5TC	215X240X12ADL*	215X240X12TC
20X35X6A*	20X35X6SC	20X40X11ADL	20X40X5TC	20X47X7A*	20X47X7SC	215X248X15ADL*	215X248X15TC
20X35X6A	20X35X5SC	20X40X11ADL	20X40X7TC	20X47X7ADL*	20X47X7TC	215X250X15C*	215X250X15SA
20X35X6A	20X35X5.5SC	20X40X11ADL	20X40X8TC	20X47X7ADL	20X47X5TC	215X250X16A*	215X250X16SC
20X35X6ADL*	20X35X6TC	20X40X11ADL	20X40X10TC	20X47X7V	20X47X7VSF	215X250X16ADL	215X250X15TC
20X35X6ADL	20X35X4TC	20X40X4ADL*	20X40X4TC	20X47X7V	20X47X7VSG	215X250X16C	215X250X15SA
20X35X6V	20X35X6VTC	20X40X5ADL*	20X40X5TC	20X47X7V	20X47X7VTC	21X29X4AO*	21X29X4VC
20X35X7A*	20X35X7SC	20X40X5ADL	20X40X4TC	20X47X7V	20X47X7VTF	21X30X6.5A*	21X30X6.5SC
20X35X7A	20X35X5SC	20X40X6A*	20X40X6SC	20X47X7V	20X47X7VTF	21X32X5A*	21X32X5SC
20X35X7A	20X35X5.5SC	20X40X6V	20X40X6VSF	20X47X8A*	20X47X8SC	21X32X7A*	21X32X7SC
20X35X7A	20X35X6SC	20X40X6V	20X40X6VTF	20X47X8A	20X47X7SC	21X32X7A	21X32X5SC
20X35X7ADL*	20X35X7TC	20X40X7A*	20X40X7SC	20X47X8ADL*	20X47X8TC	21X32X8ADL*	21X32X8TC
20X35X7ADL	20X35X4TC	20X40X7A*	20X40X7SSC	20X47X8ADL	20X47X5TC	21X33X7ADL*	21X33X7TC
20X35X7ADL	20X35X6TC	20X40X7A	20X40X6SC	20X47X8ADL	20X47X7TC	21X35X10A	21X35X8SC
20X35X7V	20X35X7VSF	20X40X7ADL*	20X40X7TC	20X47X9ADL	20X47X5TC	21X35X13ADL	21X35X6TC
20X35X7V	20X35X7VSC	20X40X7ADL	20X40X4TC	20X47X9ADL	20X47X7TC	21X35X13ADL	21X35X7TC
20X35X7V	20X35X7VTF	20X40X7ADL	20X40X5TC	20X48X9A*	20X48X9SC	21X35X7ADL*	21X35X7TC
20X35X7V	20X35X7VTF	20X40X7V	20X40X7VTF	20X50X10ADL	20X50X7TC	21X35X7ADL	21X35X6TC
20X35X8A	20X35X5SC	20X40X8ADL*	20X40X8TC	20X50X8ADL	20X50X7TC	21X36X7ADL*	21X36X7TC
20X35X8A	20X35X5.5SC	20X40X8ADL	20X40X4TC	20X52X10A*	20X52X10SC	21X37X7A*	21X37X7SC



PLEASE CALL DICHTOMATIK FOR AVAILABILITY - 800-328-2840
BULK AND INDIVIDUALLY BOXED QUANTITIES ARE AVAILABLE FOR ALL ITEMS
* = EXACT INTERCHANGE - ALL OTHERS ARE FUNCTIONALLY

Harwal Part #	TCM Part #	Harwal Part #	TCM Part #	Harwal Part #	TCM Part #	Harwal Part #	TCM Part #
21X40X5A*	21X40X5SC	22X33X7ADL*	22X33X7TC	22X40X16ADL	22X40X7TC	23X34X8ADL*	23X34X8TC
21X40X7ADL*	21X40X7TC	22X33X7ADL	22X33X5TC	22X40X4ADL*	22X40X4TC	23X35X7A*	23X35X7SC
21X52X8A*	21X52X8SC	22X35X10A*	22X35X10SC	22X40X5V	22X40X5V5F	23X35X7ADL*	23X35X7TC
22.5X35X6ADL*	22.5X35X6TC	22X35X10A	22X35X7SC	22X40X7ADL*	22X40X7TC	23X35X7ADL	23X35X6TC
220X250X11B*	220X250X11SB	22X35X10ADL	22X35X5TC	22X40X7ADL	22X40X4TC	23X36X6ADL*	23X36X6TC
220X250X11BDL*	220X250X11TB	22X35X10ADL	22X35X6TC	22X40X7ADL	22X40X5TC	23X36X7ADL	23X36X6TC
220X250X12ADL*	220X250X12TC	22X35X10ADL	22X35X7TC	22X40X7V	22X40X7VTB	23X37X6ADL*	23X37X6TC
220X250X14A	220X250X12SC	22X35X10ADL	22X35X8TC	22X40X7V	22X40X7VTC	23X38X8V	23X38X8V5F
220X250X14ADL	220X250X12TC	22X35X10B	22X35X7SB	22X40X7V	22X40X7VTF	23X40X10A*	23X40X10SC
220X250X14ADL	220X250X13TC	22X35X5.5ADL	22X35X5TC	22X40X8.5A	22X40X8SC	23X40X10A	23X40X8SC
220X250X15A*	220X250X15SC	22X35X5ADL*	22X35X5TC	22X40X8A*	22X40X8SC	23X40X10ADL*	23X40X10TC
220X250X15A	220X250X12SC	22X35X6ADL*	22X35X6TC	22X40X8ADL	22X40X4TC	23X40X10ADL	23X40X6TC
220X250X15ADL*	220X250X15TC	22X35X6ADL	22X35X5TC	22X40X8ADL	22X40X5TC	23X40X6ADL*	23X40X6TC
220X250X15ADL	220X250X12TC	22X35X7A*	22X35X7SC	22X40X8ADL	22X40X7TC	23X40X7BDL*	23X40X7TB
220X250X15ADL	220X250X13TC	22X35X7ADL*	22X35X7TC	22X41.25X6ADL*	22X41.25X6TC	23X40X8A*	23X40X8SC
220X250X15C	220X250X13SA	22X35X7ADL	22X35X5TC	22X41.5X7BDL*	22X41.5X7TB	23X40X8ADL	23X40X6TC
220X250X15V	220X250X15V5CV	22X35X7ADL	22X35X6TC	22X41X7ADL*	22X41X7TC	23X42X6ADL*	23X42X6TC
220X250X15V	220X250X15VTF	22X35X7B*	22X35X7SB	22X42X10A	22X42X7SC	23X42X7ADL*	23X42X7TC
220X250X16A	220X250X12SC	22X35X7BDL*	22X35X7TB	22X42X10ADL*	22X42X10TC	23X42X7ADL	23X42X6TC
220X250X16A	220X250X15SC	22X35X7BDL	22X35X6TB	22X42X10ADL	22X42X5TC	23X43X8ADL*	23X43X8TC
220X250X16ADL	220X250X12TC	22X35X7V	22X35X7V5B	22X42X10ADL	22X42X7TC	23X45X11ADL*	23X45X11TC
220X250X16ADL	220X250X13TC	22X35X7V	22X35X7V5F	22X42X11ADL	22X42X5TC	23X47X10ADL*	23X47X10TC
220X250X16ADL	220X250X15TC	22X35X7V	22X35X7VTF	22X42X11ADL	22X42X7TC	23X47X10ADL	23X47X7TC
220X250X18CDL	220X250X15TA	22X35X8A	22X35X7SC	22X42X11ADL	22X42X10TC	23X47X7ADL*	23X47X7TC
220X255X16ADL*	220X255X16TC	22X35X8ADL*	22X35X8TC	22X42X6ADL	22X42X5TC	23X48X10ADL*	23X48X10TC
220X255X18ADL	220X255X16TC	22X35X8ADL	22X35X5TC	22X42X7A*	22X42X7SC	23X52X11ADL	23X52X10TC
220X260X14ADL*	220X260X14TC	22X35X8ADL	22X35X6TC	22X42X7ADL*	22X42X7TC	23X52X12A*	23X52X12SC
220X260X15A*	220X260X15SC	22X35X8ADL	22X35X7TC	22X42X7ADL	22X42X5TC	240X265X15ADL*	240X265X15TC
220X260X15ADL*	220X260X15TC	22X36X10ADL*	22X36X10TC	22X45X10ADL	22X45X7TC	240X270X15A*	240X270X15SC
220X260X15ADL	220X260X14TC	22X36X10ADL	22X36X5TC	22X45X10ADL	22X45X8TC	240X270X15ADL*	240X270X15TC
220X260X16A	220X260X15SC	22X36X10ADL	22X36X7TC	22X45X7A*	22X45X7SC	240X270X15ADL	240X270X13TC
220X260X16ADL	220X260X14TC	22X36X10ADL	22X36X8TC	22X45X7ADL*	22X45X7TC	240X270X15B*	240X270X15SB
220X260X16ADL	220X260X15TC	22X36X7A*	22X36X7SC	22X47X10A	22X47X7SC	240X270X15V	240X270X15V5CV
220X270X15C*	220X270X15SA	22X36X7ADL*	22X36X7TC	22X47X7A*	22X47X7SC	240X275X16A*	240X275X16SC
220X275X23ADL*	220X275X23TC	22X36X7ADL	22X36X5TC	22X47X7ADL*	22X47X7TC	240X275X16ADL*	240X275X16TC
224X250X16ADL*	224X250X16TC	22X36X8ADL*	22X36X8TC	22X47X7V	22X47X7VTF	240X280X14B*	240X280X14SB
225X250X16ADL	225X250X15TC	22X36X8ADL	22X36X5TC	22X50.8X9.52ADL*	22X50.8X9.52TC	240X280X15ADL*	240X280X15TC
225X250X16C*	225X250X16SA	22X36X8ADL	22X36X7TC	22X50X5ADL*	22X50X5TC	240X280X15V	240X280X15V5F
22X30X4A*	22X30X4SC	22X37X7ADL*	22X37X7TC	22X52X10ADL*	22X52X10TC	240X280X16C*	240X280X16SA
22X30X4V	22X30X4VTF	22X37X7ADL	22X37X6TC	22X55X7ADL*	22X55X7TC	240X290X16C*	240X290X16SA
22X30X6ADL	22X30X4TC	22X37X8.5ADL	22X37X6TC	230X255X10B*	230X255X10SB	245X270X16C	245X270X10SA
22X30X7A*	22X30X7SC	22X37X8.5ADL	22X37X7TC	230X255X10BDL*	230X255X10TB	24X34X5.5A*	24X34X5.5SC
22X30X7A	22X30X4SC	22X38X5ADL*	22X38X5TC	230X255X15A*	230X255X15SC	24X34X7ADL*	24X34X7TC
22X30X7ADL*	22X30X7TC	22X38X7A	22X38X6SC	230X255X15ADL*	230X255X15TC	24X35X5.5ADL*	24X35X5.5TC
22X30X7ADL	22X30X4TC	22X38X7ADL*	22X38X7TC	230X255X18ADL*	230X255X18TC	24X35X6A*	24X35X6SC
22X32X10A	22X32X4SC	22X38X7ADL	22X38X5TC	230X255X18ADL	230X255X15TC	24X35X7A*	24X35X7SC
22X32X10A	22X32X5SC	22X38X7V	22X38X7VTC	230X260X15A*	230X260X15SC	24X35X7A	24X35X6SC
22X32X10A	22X32X7SC	22X38X8A*	22X38X8SC	230X260X15ADL*	230X260X15TC	24X35X7ADL*	24X35X7TC
22X32X4A*	22X32X4SC	22X38X8A	22X38X6SC	230X260X15V	230X260X15V5CV	24X35X7ADL	24X35X5.5TC
22X32X5.5A	22X32X4SC	22X38X8ADL	22X38X5TC	230X260X20BDL	230X260X15TB	24X35X7ADL	24X35X6TC
22X32X5.5A	22X32X5SC	22X38X8ADL	22X38X7TC	230X270X15ADL*	230X270X15TC	24X35X7V	24X35X7V5CV
22X32X5.5ADL	22X32X5TC	22X39X6ADL*	22X39X6TC	230X270X15C*	230X270X15SA	24X35X7V	24X35X7VTC
22X32X5A*	22X32X5SC	22X40X10A	22X40X8SC	230X270X16C	230X270X15SA	24X35X8ADL*	24X35X8TC
22X32X5A	22X32X4SC	22X40X10ADL	22X40X4TC	230X280X15ADL*	230X280X15TC	24X35X8ADL	24X35X5.5TC
22X32X7A*	22X32X7SC	22X40X10ADL	22X40X5TC	230X280X15V	230X280X15V5F	24X35X8ADL	24X35X6TC
22X32X7A	22X32X4SC	22X40X10ADL	22X40X7TC	230X285X23ADL*	230X285X23TC	24X35X8ADL	24X35X7TC
22X32X7A	22X32X5SC	22X40X12ADL	22X40X4TC	235X275X16ADL*	235X275X16TC	24X36X6A*	24X36X6SC
22X32X7ADL*	22X32X7TC	22X40X12ADL	22X40X5TC	23X29X3.5AO*	23X29X3.2VC	24X36X7ADL*	24X36X7TC
22X32X7ADL	22X32X5TC	22X40X12ADL	22X40X7TC	23X32X5B*	23X32X5SB	24X36X7V	24X36X7VTC
22X32X8ADL	22X32X5TC	22X40X16ADL*	22X40X16TC	23X32X5B*	23X32X5SB	24X37X7A*	24X37X7SC
22X32X8ADL	22X32X7TC	22X40X16ADL	22X40X4TC	23X32X7ADL*	23X32X7TC	24X37X7ADL*	24X37X7TC
22X33X6.5ADL	22X33X5TC	22X40X16ADL	22X40X5TC	23X32X7ADL	23X32X5TC	24X37X7V	24X37X7V5CV

HARWAL INTERCHANGES

HARWAL CROSS REFERENCES – SHAFT SEALS



DICHTOMATIK

Any seal. Any time.

PLEASE CALL DICHTOMATIK FOR AVAILABILITY - 800-328-2840

BULK AND INDIVIDUALLY BOXED QUANTITIES ARE AVAILABLE FOR ALL ITEMS

* = EXACT INTERCHANGE - ALL OTHERS ARE FUNCTIONALLY

HARWAL INTERCHANGES

Harwal Part #	TCM Part #	Harwal Part #	TCM Part #	Harwal Part #	TCM Part #	Harwal Part #	TCM Part #
24X38.2X7ADL*	24X38.2X7TC	25X32X6ADL	25X32X5TC	25X37X7ADL	25X37X5TC	25X42X10ADL	25X42X8TC
24X38X10ADL*	24X38X10TC	25X32X7A*	25X32X75C	25X37X7ADL	25X37X6TC	25X42X10B	25X42X85B
24X38X10ADL	24X38X7TC	25X32X7A	25X32X65C	25X37X7V	25X37X7VSC	25X42X10V	25X42X10VTC
24X38X10ADL	24X38X8TC	25X33X4A*	25X33X45C	25X37X8A	25X37X55C	25X42X5ADL*	25X42X5TC
24X38X7ADL*	24X38X7TC	25X33X4V	25X33X4VVC	25X37X8A	25X37X65C	25X42X6A*	25X42X65C
24X38X8ADL*	24X38X8TC	25X33X6A*	25X33X65C	25X37X8A	25X37X75C	25X42X7A*	25X42X75C
24X38X8ADL	24X38X7TC	25X33X6A	25X33X45C	25X37X8ADL	25X37X5TC	25X42X7A	25X42X65C
24X39X8A*	24X39X85C	25X33X6V	25X33X6VTC	25X37X8ADL	25X37X6TC	25X42X7ADL*	25X42X7TC
24X40X10A	24X40X75C	25X33X9A	25X33X45C	25X37X8ADL	25X37X7TC	25X42X7ADL	25X42X5TC
24X40X10A	24X40X85C	25X33X9A	25X33X65C	25X38X10ADL	25X38X5TC	25X42X7ADL	25X42X6TC
24X40X7A*	24X40X75C	25X35X10A*	25X35X105C	25X38X10ADL	25X38X7TC	25X42X7V	25X42X7VTF
24X40X7ADL*	24X40X7TC	25X35X10A	25X35X75C	25X38X10ADL	25X38X8TC	25X42X7V	25X42X7VTCGR
24X40X7V	24X40X7VTC	25X35X10A	25X35X85C	25X38X5B*	25X38X55B	25X42X8.5A	25X42X65C
24X40X7V	24X40X7VTF	25X35X10ADL	25X35X5TC	25X38X6ADL	25X38X5TC	25X42X8.5A	25X42X75C
24X40X8A*	24X40X85C	25X35X10ADL	25X35X6TC	25X38X7A*	25X38X75C	25X42X8A	25X42X65C
24X40X8A	24X40X75C	25X35X10ADL	25X35X7TC	25X38X7ADL*	25X38X7TC	25X42X8A	25X42X75C
24X42X10A	24X42X85C	25X35X10ADL	25X35X8TC	25X38X7ADL	25X38X5TC	25X42X8ADL*	25X42X8TC
24X42X10C*	24X42X105A	25X35X4A0*	25X35X4vc	25X38X7V	25X38X7VTF	25X42X8ADL	25X42X5TC
24X42X8A*	24X42X85C	25X35X4V	25X35X4VVC	25X38X8ADL*	25X38X8TC	25X42X8ADL	25X42X6TC
24X42X8ADL*	24X42X8TC	25X35X5ADL*	25X35X5TC	25X38X8ADL	25X38X5TC	25X42X8ADL	25X42X7TC
24X42X8ADL	24X42X7TC	25X35X6ADL*	25X35X6TC	25X38X8ADL	25X38X7TC	25X42X9A	25X42X65C
24X42X8V	24X42X8VTC	25X35X6ADL	25X35X5TC	25X40X10A	25X40X75C	25X42X9A	25X42X75C
24X43X6ADL*	24X43X6TC	25X35X6V	25X35X6VSCW	25X40X10ADL*	25X40X10TC	25X43X9V	25X43X9V5F
24X43X7ADL	24X43X6TC	25X35X6V	25X35X6VTF	25X40X10ADL	25X40X5TC	25X44.45X10ADL*	25X44.45X10TC
24X45X11ADL*	24X45X11TC	25X35X6V	25X35X6VTC	25X40X10ADL	25X40X6TC	25X44.45X10ADL	25X44.45X5TC
24X45X11ADL	24X45X6TC	25X35X7A*	25X35X75C	25X40X10ADL	25X40X7TC	25X44X10ADL	25X44X7TC
24X45X6ADL*	24X45X6TC	25X35X7ADL*	25X35X7TC	25X40X10ADL	25X40X8TC	25X44X10ADL	25X44X8TC
24X46X10ADL*	24X46X10TC	25X35X7ADL	25X35X5TC	25X40X10ADL	25X40X9TC	25X44X7ADL*	25X44X7TC
24X47X10A*	24X47X105C	25X35X7ADL	25X35X6TC	25X40X10B	25X40X55B	25X45X10A	25X45X75C
24X47X10ADL*	24X47X10TC	25X35X7B*	25X35X75B	25X40X10B	25X40X85B	25X45X10ADL*	25X45X10TC
24X47X10ADL	24X47X7TC	25X35X7B	25X35X75B-H	25X40X10V	25X40X10V5F	25X45X10ADL	25X45X7TC
24X47X7ADL*	24X47X7TC	25X35X7V	25X35X7VSCW	25X40X10V	25X40X10V5FN	25X45X10ADL	25X45X8TC
24X47X7V	24X47X7VTC	25X35X7V	25X35X7VTC	25X40X5ADL*	25X40X5TC	25X45X11ADL	25X45X7TC
24X48X7ADL*	24X48X7TC	25X35X7V	25X35X7VTF	25X40X5V	25X40X5V5F	25X45X11ADL	25X45X8TC
24X49X12ADL*	24X49X12TC	25X35X8A*	25X35X85C	25X40X6ADL*	25X40X6TC	25X45X11ADL	25X45X10TC
24X49X12ADL	24X49X8TC	25X35X8A	25X35X75C	25X40X6ADL	25X40X5TC	25X45X7A*	25X45X75C
24X49X18ADL*	24X49X18TC	25X35X8ADL*	25X35X8TC	25X40X7A*	25X40X75C	25X45X7ADL*	25X45X7TC
24X49X18ADL	24X49X8TC	25X35X8ADL	25X35X5TC	25X40X7ADL*	25X40X7TC	25X45X7V	25X45X7VTC
24X49X18ADL	24X49X12TC	25X35X8ADL	25X35X6TC	25X40X7ADL	25X40X5TC	25X45X8ADL*	25X45X8TC
24X50X12ADL*	24X50X12TC	25X35X8ADL	25X35X7TC	25X40X7ADL	25X40X6TC	25X45X8ADL	25X45X7TC
24X50X12ADL	24X50X10TC	25X35X9A	25X35X75C	25X40X7V	25X40X7VSC	25X46X7A*	25X46X75C
24X52X10ADL*	24X52X10TC	25X35X9A	25X35X85C	25X40X7V	25X40X7VSCN	25X46X7ADL*	25X46X7TC
24X52X10ADL	24X52X7TC	25X36X10A	25X36X65C	25X40X7V	25X40X7VTC	25X46X7V	25X46X7VTC
24X52X7ADL*	24X52X7TC	25X36X5ADL*	25X36X5TC	25X40X7V	25X40X7VTF	25X47X10A*	25X47X105C
24X55X10ADL*	24X55X10TC	25X36X6A*	25X36X65C	25X40X8A	25X40X75C	25X47X10A	25X47X75C
24X62X7A*	24X62X75C	25X36X7A	25X36X65C	25X40X8ADL*	25X40X8TC	25X47X10ADL*	25X47X10TC
25.4X44.5X7BDL	10172TB	25X36X7ADL*	25X36X7TC	25X40X8ADL	25X40X5TC	25X47X10ADL	25X47X5TC
250X280X15ADL*	250X280X15TC	25X36X7ADL	25X36X5TC	25X40X8ADL	25X40X6TC	25X47X10ADL	25X47X7TC
250X280X15CDL*	250X280X15TA	25X36X7V	25X36X7V5F	25X40X8ADL	25X40X7TC	25X47X10ADL	25X47X8TC
250X280X15V	250X280X15VTC	25X36X8ADL	25X36X5TC	25X40X8V	25X40X8VTFB2-H	25X47X10V	25X47X10VTF
250X280X16ADL	250X280X15TC	25X36X8ADL	25X36X7TC	25X40X8V	25X40X8VTF	25X47X6ADL	25X47X5TC
250X290X15A*	250X290X155C	25X37X5A*	25X37X55C	25X41.2X7ADL*	25X41.2X7TC	25X47X6B	25X47X65B-H
250X290X15ADL*	250X290X15TC	25X37X5ADL*	25X37X5TC	25X41.5X8ADL	25X41.5X6TC	25X47X6V	25X47X6VTF
250X290X16C*	250X290X165A	25X37X5V	25X37X5V5F	25X41.5X8ADL	25X41.5X7TC	25X47X7A*	25X47X75C
255X290X16C*	255X290X165A	25X37X6A*	25X37X65C	25X42.9X9.5BDL*	25X42.9X9.5TB	25X47X7ADL*	25X47X7TC
25X32X4A0*	25X32X4VC	25X37X6A	25X37X55C	25X42X10A*	25X42X105C	25X47X7ADL	25X47X5TC
25X32X4V	25X32X4VTC	25X37X6ADL*	25X37X6TC	25X42X10A	25X42X65C	25X47X7ADL	25X47X7TF
25X32X4V	25X32X4VVM	25X37X6ADL	25X37X5TC	25X42X10A	25X42X75C	25X47X7V	25X47X7V5B
25X32X4V	25X32X4VVMY	25X37X7A*	25X37X75C	25X42X10ADL*	25X42X10TC	25X47X7V	25X47X7VTC
25X32X5ADL*	25X32X5TC	25X37X7A	25X37X55C	25X42X10ADL	25X42X5TC	25X47X8A	25X47X75C
25X32X6A*	25X32X65C	25X37X7A	25X37X65C	25X42X10ADL	25X42X6TC	25X47X8ADL*	25X47X8TC
25X32X6ADL*	25X32X6TC	25X37X7ADL*	25X37X7TC	25X42X10ADL	25X42X7TC	25X47X8ADL	25X47X5TC



Harwal Part #	TCM Part #	Harwal Part #	TCM Part #	Harwal Part #	TCM Part #	Harwal Part #	TCM Part #
25X47X8ADL	25X47X7TC	25X62X7A	25X62X6SC	26X38X7ADL*	26X38X7TC	27X36X7ADL*	27X36X7TC
25X47X8V	25X47X8VBTB2-H	25X62X7ADL*	25X62X7TC	26X38X7ADL	26X38X5TC	27X36X7ADL	27X36X6TC
25X48X10ADL	25X48X7TC	25X62X7ADL	25X62X6TC	26X38X8ADL*	26X38X8TC	27X37X7A*	27X37X7SC
25X48X10ADL	25X48X8TC	25X62X7V	25X62X7VTF	26X38X8ADL	26X38X5TC	27X37X7ADL*	27X37X7TC
25X48X7ADL*	25X48X7TC	25X62X8A	25X62X6SC	26X38X8ADL	26X38X7TC	27X37X7ADL	27X37X6TC
25X48X8ADL*	25X48X8TC	25X62X8A	25X62X7SC	26X40X5ADL*	26X40X5TC	27X37X7V	27X37X7VTC
25X48X8ADL	25X48X7TC	25X62X8ADL	25X62X6TC	26X40X7ADL*	26X40X7TC	27X38X5ADL*	27X38X5TC
25X49X7ADL*	25X49X7TC	25X62X8ADL	25X62X7TC	26X40X7ADL	26X40X5TC	27X38X6ADL	27X38X5TC
25X50X10ADL*	25X50X10TC	25X62X8ADL	25X62X7TC	26X40X9ADL	26X40X5TC	27X38X7ADL*	27X38X7TC
25X50X10ADL	25X50X7TC	25X70X10ADL*	25X70X10TC	26X40X9ADL	26X40X7TC	27X38X7ADL	27X38X5TC
25X50X10ADL	25X50X8TC	25X72X10ADL*	25X72X10TC	26X41X7ADL*	26X41X7TC	27X40X10A*	27X40X10SC
25X50X7V	25X50X7VTF	25X72X10ADL	25X72X7TC	26X42X10ADL*	26X42X10TC	27X40X10A	27X40X6SC
25X50X8ADL*	25X50X8TC	25X72X10ADL	25X72X8TC	26X42X10ADL	26X42X7TC	27X40X10A	27X40X7SC
25X50X8ADL	25X50X7TC	25X72X7ADL*	25X72X7TC	26X42X10ADL	26X42X8TC	27X40X6A*	27X40X6SC
25X51X11A*	25X51X11SC	260X290X16ADL	260X290X15TC	26X42X10ADL	26X42X8TC	27X40X6ADL	27X40X5TC
25X52X10A*	25X52X10SC	260X300X15A*	260X300X15SC	26X42X6A*	26X42X6SC	27X40X6ADL	27X40X5TC
25X52X10A	25X52X5SC	260X300X16C*	260X300X16SA	26X42X7A*	26X42X7SC	27X40X7A*	27X40X7SC
25X52X10A	25X52X7SC	260X300X16V	260X300X16V5F	26X42X7A	26X42X6SC	27X40X7A	27X40X6SC
25X52X10ADL*	25X52X10TC	260X300X18A*	260X300X18SC	26X42X7ADL*	26X42X7TC	27X40X7V	27X40X7V5C
25X52X10ADL	25X52X7TC	260X300X18A	260X300X15SC	26X42X7V	26X42X7VTC	27X40X8ADL*	27X40X8TC
25X52X10ADL	25X52X9.5TC	260X300X20A	260X300X15SC	26X42X8A	26X42X6SC	27X40X8ADL	27X40X5TC
25X52X10V	25X52X10V5C	260X300X20A	260X300X18SC	26X42X8A	26X42X7SC	27X40X8ADL	27X40X7TC
25X52X11ADL	25X52X7TC	260X300X20ADL*	260X300X20TC	26X42X8ADL*	26X42X8TC	27X41X10A*	27X41X10SC
25X52X11ADL	25X52X9.5TC	260X300X20ADL	260X300X15TC	26X42X8ADL	26X42X7TC	27X41X10ADL	27X41X7TC
25X52X11ADL	25X52X10TC	260X300X20ADL	260X300X16TC	26X43X7ADL*	26X43X7TC	27X41X10V	27X41X10V5C
25X52X12A	25X52X5SC	260X300X20C	260X300X16SA	26X43X8ADL*	26X43X8TC	27X41X7ADL*	27X41X7TC
25X52X12A	25X52X7SC	260X300X20V	260X300X20VTF	26X43X8ADL	26X43X7TC	27X42X10A*	27X42X10SC
25X52X12A	25X52X10SC	260X300X22B	260X300X15SB	26X45X6ADL*	26X45X6TC	27X42X10A	27X42X7SC
25X52X12ADL*	25X52X12TC	260X300X22B	260X300X20SB	26X45X7ADL	26X45X6TC	27X42X10ADL*	27X42X10TC
25X52X12ADL	25X52X7TC	260X310X16C*	260X310X16SA	26X47X10A*	26X47X10SC	27X42X10ADL	27X42X9TC
25X52X12ADL	25X52X9.5TC	260X320X25C*	260X320X25SA	26X47X12ADL	26X47X5TC	27X42X7A*	27X42X7SC
25X52X12ADL	25X52X10TC	260X320X25CDL*	260X320X25TA	26X47X12ADL	26X47X7TC	27X42X7V	27X42X7VTC
25X52X15ADL*	25X52X15TC	265X290X16A*	265X290X16SC	26X47X12ADL	26X47X9TC	27X42X9ADL*	27X42X9TC
25X52X15ADL	25X52X7TC	265X290X16C*	265X290X16SA	26X47X5ADL*	26X47X5TC	27X43X8ADL*	27X43X8TC
25X52X15ADL	25X52X9.5TC	265X290X16V	265X290X16V5F	26X47X7ADL*	26X47X7TC	27X43X8ADL	27X43X7TC
25X52X15ADL	25X52X10TC	265X290X16V	265X290X16VTF	26X47X7ADL	26X47X5TC	27X43X8V	27X43X8VTF
25X52X15ADL	25X52X12TC	265X300X16C*	265X300X16SA	26X47X7ADL	26X47X7TF	27X45X7ADL*	27X45X7TC
25X52X5A*	25X52X5SC	265X310X16C*	265X310X16SA	26X47X7V	26X47X7VTF	27X45X8A	27X45X6SC
25X52X7A*	25X52X7SC	26X35X6ADL	26X35X5TC	26X47X9ADL*	26X47X9TC	27X45X8A	27X45X7SC
25X52X7A	25X52X5SC	26X35X7A*	26X35X7SC	26X47X9ADL	26X47X5TC	27X45X8ADL*	27X45X8TC
25X52X7ADL*	25X52X7TC	26X35X7ADL*	26X35X7TC	26X47X9ADL	26X47X7TC	27X45X8ADL	27X45X7TC
25X52X7V	25X52X7V5C	26X35X7ADL	26X35X5TC	26X48X7ADL*	26X48X7TC	27X45X9ADL*	27X45X9TC
25X52X7V	25X52X7VTF	26X35X7V	26X35X7VTC	26X52X7ADL*	26X52X7TC	27X45X9ADL	27X45X7TC
25X52X8A	25X52X5SC	26X36X10ADL*	26X36X10TC	26X52X8ADL*	26X52X8TC	27X45X9ADL	27X45X8TC
25X52X8A	25X52X7SC	26X36X10ADL	26X36X5TC	26X52X8ADL	26X52X7TC	27X47X10A	27X47X6SC
25X52X8ADL	25X52X7TC	26X36X10ADL	26X36X7TC	26X62X9ADL*	26X62X9TC	27X47X10A	27X47X8SC
25X53X10ADL*	25X53X10TC	26X36X5ADL*	26X36X5TC	270X300X15ADL*	270X300X15TC	27X47X10ADL	27X47X7TC
25X54X8ADL*	25X54X8TC	26X36X7A*	26X36X7SC	270X300X15BDL*	270X300X15TB	27X47X11ADL*	27X47X11TC
25X55X10ADL	25X55X8TC	26X36X7ADL*	26X36X7TC	270X310X15A*	270X310X15SC	27X47X11ADL	27X47X7TC
25X55X10ADL	25X55X9TC	26X36X7ADL	26X36X5TC	270X310X16A	270X310X15SC	27X47X5.5V	27X47X5.5VTF
25X55X8ADL*	25X55X8TC	26X36X7V	26X36X7V5F	270X310X16C*	270X310X16SA	27X47X6A*	27X47X6SC
25X55X9ADL*	25X55X9TC	26X36X7V	26X36X7VTC	270X310X18C	270X310X16SA	27X47X7A	27X47X6SC
25X55X9ADL	25X55X8TC	26X37X10.5ADL	26X37X7TC	270X310X20A*	270X310X20SC	27X47X7ADL*	27X47X7TC
25X58X10A*	25X58X10SC	26X37X10.5ADL	26X37X10TC	270X310X20A	270X310X15SC	27X47X8A*	27X47X8SC
25X58X10ADL*	25X58X10TC	26X37X10A	26X37X7SC	270X320X20ADL*	270X320X20TC	27X47X8A	27X47X6SC
25X60X10ADL*	25X60X10TC	26X37X10ADL*	26X37X10TC	270X320X20ADL	270X320X15TC	27X47X8V	27X47X8V5C
25X62X10A	25X62X6SC	26X37X10ADL	26X37X7TC	272X310X16C*	272X310X16SA	27X47X8V	27X47X8V5F
25X62X10A	25X62X7SC	26X37X7A*	26X37X7SC	275X294X12A*	275X294X12SC	27X48X9ADL*	27X48X9TC
25X62X10ADL	25X62X6TC	26X37X7ADL*	26X37X7TC	275X310X16C*	275X310X16SA	27X49X7.5A*	27X49X7.5SC
25X62X10ADL	25X62X7TC	26X37X7V	26X37X7VTCN1	27X35X4A*	27X35X4SC	27X50X10A*	27X50X10SC
25X62X6A*	25X62X6SC	26X37X8ADL	26X37X7TC	27X35X7.5A	27X35X4SC	27X50X10ADL*	27X50X10TC
25X62X7A*	25X62X7SC	26X38X5ADL*	26X38X5TC	27X35X7A	27X35X4SC	27X52X8A*	27X52X8SC
		26X38X6ADL	26X38X5TC	27X36X6ADL*	27X36X6TC	27X52X8A	27X52X7SC

HARWAL INTERCHANGES

HARWAL CROSS REFERENCES – SHAFT SEALS

PLEASE CALL DICHTOMATIK FOR AVAILABILITY - 800-328-2840

BULK AND INDIVIDUALLY BOXED QUANTITIES ARE AVAILABLE FOR ALL ITEMS

* = EXACT INTERCHANGE - ALL OTHERS ARE FUNCTIONALLY



DICHTOMATIK

Any seal. Any time.

HARWAL INTERCHANGES

Harwal Part #	TCM Part #	Harwal Part #	TCM Part #	Harwal Part #	TCM Part #	Harwal Part #	TCM Part #
27X53X7A*	27X53X7SC	28X40X8ADL	28X40X7TC	28X47X8A	28X47X7SC	29X50X10A*	29X50X10SC
27X55X7ADL*	27X55X7TC	28X41X7ADL*	28X41X7TC	28X47X8ADL*	28X47X8TC	29X50X10ADL*	29X50X10TC
27X55X8ADL*	27X55X8TC	28X41X8ADL	28X41X7TC	28X47X8ADL	28X47X7TC	29X50X10ADL	29X50X7TC
27X55X8ADL	27X55X7TC	28X41X8ADL	28X41X8TC	28X48X11ADL*	28X48X11TC	29X50X12A*	29X50X12SC
27X77X7ADL*	27X77X7TC	28X42.5X8ADL*	28X42.5X8TC	28X48X11ADL	28X48X7TC	29X50X12A	29X50X10SC
280X310X15ADL*	280X310X15TC	28X42X10A	28X42X7SC	28X48X11ADL	28X48X8TC	29X52X7ADL*	29X52X7TC
280X310X15V	280X310X15VSF	28X42X10A	28X42X8SC	28X48X5A*	28X48X5SC	29X52X9A*	29X52X9SC
280X310X16C*	280X310X16SA	28X42X11ADL*	28X42X11TC	28X48X8ADL*	28X48X8TC	29X55X9A*	29X55X9SC
280X320X15A*	280X320X15SC	28X42X11ADL	28X42X6TC	28X48X8ADL	28X48X7TC	29X62X10V	29X62X10VSF
280X320X16C*	280X320X16SA	28X42X11ADL	28X42X7TC	28X49X10ADL*	28X49X10TC	30.5X47X8ADL*	30.5X47X8TC
280X320X18A*	280X320X18SC	28X42X11ADL	28X42X8TC	28X49X10ADL	28X49X7TC	300X335X18C*	300X335X18SA
280X320X18A	280X320X15SC	28X42X6ADL*	28X42X6TC	28X49X7ADL*	28X49X7TC	300X340X16ADL*	300X340X16TC
280X320X20A	280X320X15SC	28X42X7A*	28X42X7SC	28X50.8X10ADL*	28X50.8X10TC	300X340X16ADL	300X340X15TC
280X320X20A	280X320X18SC	28X42X7ADL*	28X42X7TC	28X50X10A	28X50X8SC	300X340X16C*	300X340X16SA
280X320X20ADL*	280X320X20TC	28X42X7ADL	28X42X6TC	28X50X10ADL*	28X50X10TC	300X340X18ADL	300X340X15TC
280X320X20C	280X320X16SA	28X42X7V	28X42X7VTGR	28X50X10ADL	28X50X6TC	300X340X18ADL	300X340X16TC
280X320X20V	280X320X20VTC	28X42X8A*	28X42X8SC	28X50X10ADL	28X50X7TC	300X340X18V	300X340X18VSF
285X310X16C*	285X310X16SA	28X42X8A	28X42X7SC	28X50X10ADL	28X50X8TC	300X340X20ADL*	300X340X20TC
285X310X16V	285X310X16VTA	28X42X8ADL*	28X42X8TC	28X50X10V	28X50X10VTC	300X340X20ADL	300X340X15TC
285X320X20ADL*	285X320X20TC	28X42X8ADL	28X42X6TC	28X50X12B*	28X50X12SB	300X340X20ADL	300X340X16TC
285X325X16A*	285X325X16SC	28X42X8ADL	28X42X7TC	28X50X6ADL*	28X50X6TC	300X340X20C	300X340X16SA
28X34X4AO*	28X34X4VC	28X43X10A	28X43X7SC	28X50X7ADL*	28X50X7TC	300X340X20V	300X340X20VTF
28X35X4AO*	28X35X4VC	28X43X10ADL*	28X43X10TC	28X50X7ADL	28X50X6TC	300X350X15CDL*	300X350X15TA
28X35X5ADL*	28X35X5TC	28X43X10ADL	28X43X7TC	28X50X8A*	28X50X8SC	300X360X25V	300X360X25VTC
28X35X7ADL*	28X35X7TC	28X43X7ADL*	28X43X7TC	28X51X10ADL	28X51X6TC	305X330X13A*	305X330X13SC
28X35X7ADL	28X35X5TC	28X43X8ADL	28X43X7TC	28X51X6ADL*	28X51X6TC	30X37X4V	30X37X4VVB
28X35X8ADL	28X35X5TC	28X44.5X7ADL*	28X44.5X7TC	28X51X8ADL	28X51X6TC	30X37X4V	30X37X4VVG1
28X35X8ADL	28X35X7TC	28X44X10ADL	28X44X7TC	28X52X10A*	28X52X10SC	30X37X6ADL	30X37X4TC
28X36X5B*	28X36X5SB	28X44X11ADL	28X44X7TC	28X52X10A	28X52X5SC	30X38X4A*	30X38X4SC
28X36X7ADL*	28X36X7TC	28X44X15ADL	28X44X7TC	28X52X10ADL*	28X52X10TC	30X38X5ADL*	30X38X5TC
28X37X4AO*	28X37X4VC	28X44X7ADL*	28X44X7TC	28X52X10ADL	28X52X6TC	30X38X7ADL	30X38X5TC
28X37X5ADL	28X37X4TC	28X44X8ADL	28X44X7TC	28X52X10ADL	28X52X7TC	30X40X10A	30X40X4SC
28X37X6ADL*	28X37X6TC	28X45X10ADL*	28X45X10TC	28X52X12A	28X52X5SC	30X40X10A	30X40X7SC
28X37X6ADL	28X37X4TC	28X45X10ADL	28X45X5TC	28X52X12A	28X52X10SC	30X40X4AO*	30X40X4VC
28X37X7ADL	28X37X4TC	28X45X10ADL	28X45X7TC	28X52X5A*	28X52X5SC	30X40X5A	30X40X4SC
28X37X7ADL	28X37X6TC	28X45X10ADL	28X45X8TC	28X52X6ADL*	28X52X6TC	30X40X5ADL*	30X40X5TC
28X38X10ADL*	28X38X10TC	28X45X6A*	28X45X6SC	28X52X7A	28X52X5SC	30X40X5V	30X40X5VTC
28X38X10ADL	28X38X5TC	28X45X7A	28X45X6SC	28X52X7ADL*	28X52X7TC	30X40X7A*	30X40X7SC
28X38X10ADL	28X38X7TC	28X45X7ADL*	28X45X7TC	28X52X7ADL	28X52X6TC	30X40X7A	30X40X4SC
28X38X6A*	28X38X6SC	28X45X7ADL	28X45X5TC	28X52X7V	28X52X7VTF	30X40X7ADL*	30X40X7TC
28X38X7A*	28X38X7SC	28X45X7V	28X45X7VTC	28X56X8ADL*	28X56X8TC	30X40X7ADL	30X40X5TC
28X38X7A	28X38X6SC	28X45X8A*	28X45X8SC	28X60X10ADL*	28X60X10TC	30X40X7V	30X40X7VSB
28X38X7ADL*	28X38X7TC	28X45X8A	28X45X6SC	28X62X10A*	28X62X10SC	30X40X7V	30X40X7VSCW
28X38X7ADL	28X38X5TC	28X45X8ADL*	28X45X8TC	28X62X12A*	28X62X12SC	30X40X7V	30X40X7VTF
28X38X7V	28X38X7VTGR	28X45X8ADL	28X45X5TC	28X62X12A	28X62X10SC	30X40X8A	30X40X4SC
28X39.5X8BDL*	28X39.5X8TB	28X45X8ADL	28X45X7TC	28X62X7ADL*	28X62X7TC	30X40X8A	30X40X7SC
28X40X10A	28X40X5SC	28X47X10A	28X47X5SC	28X74X11BDL*	28X74X11TB	30X40X9A	30X40X4SC
28X40X10A	28X40X7SC	28X47X10A	28X47X7SC	290X320X18ADL*	290X320X18TC	30X40X9A	30X40X7SC
28X40X10A	28X40X8SC	28X47X10A	28X47X8SC	290X330X16C*	290X330X16SA	30X41X10ADL*	30X41X10TC
28X40X10B	28X40X8SB	28X47X10A	28X47X10SF	290X330X18C	290X330X16SA	30X41X10ADL	30X41X7TC
28X40X5A*	28X40X5SC	28X47X10ADL*	28X47X10TC	29X38X4ADL*	29X38X4TC	30X41X7ADL*	30X41X7TC
28X40X5ADL*	28X40X5TC	28X47X10ADL	28X47X7TC	29X38X7A	29X38X6SC	30X41X8ADL	30X41X7TC
28X40X7A*	28X40X7SC	28X47X10ADL	28X47X8TC	29X39X5A*	29X39X5SC	30X42X10A	30X42X4.5SC
28X40X7A	28X40X5SC	28X47X10V	28X47X10VSF	29X40X8ADL	29X40X7TC	30X42X10A	30X42X6SC
28X40X7ADL*	28X40X7TC	28X47X7A*	28X47X7SC	29X41X6A	29X41X5SC	30X42X10A	30X42X7SC
28X40X7ADL	28X40X5TC	28X47X7A	28X47X5SC	29X42X6ADL*	29X42X6TC	30X42X10A	30X42X8SC
28X40X7V	28X40X7VTF	28X47X7ADL*	28X47X7TC	29X42X7A*	29X42X7SC	30X42X10ADL	30X42X5TC
28X40X8A*	28X40X8SC	28X47X7V	28X47X7VSC	29X43X7A*	29X43X7SC	30X42X10ADL	30X42X6TC
28X40X8A	28X40X5SC	28X47X7V	28X47X7VTC	29X45X8ADL*	29X45X8TC	30X42X10ADL	30X42X7TC
28X40X8A	28X40X7SC	28X47X7V	28X47X7VVB	29X45X9.5A	29X45X9SC	30X42X10ADL	30X42X8TC
28X40X8ADL*	28X40X8TC	28X47X8A*	28X47X8SC	29X45X9A*	29X45X9SC	30X42X12A*	30X42X12SC
28X40X8ADL	28X40X5TC	28X47X8A	28X47X5SC	29X47X10A*	29X47X10SC	30X42X12A	30X42X4.5SC



PLEASE CALL DICHTOMATIK FOR AVAILABILITY - 800-328-2840
BULK AND INDIVIDUALLY BOXED QUANTITIES ARE AVAILABLE FOR ALL ITEMS
* = EXACT INTERCHANGE - ALL OTHERS ARE FUNCTIONALLY

Harwal Part #	TCM Part #	Harwal Part #	TCM Part #	Harwal Part #	TCM Part #	Harwal Part #	TCM Part #
30X42X12A	30X42X6SC	30X45X11ADL	30X45X8TC	30X48X8ADL	30X48X7TC	30X52X8A	30X52X5SC
30X42X12A	30X42X7SC	30X45X11ADL	30X45X10TC	30X48X8V	30X48X8VTF	30X52X8A	30X52X7SC
30X42X12A	30X42X8SC	30X45X5.5A	30X45X5SC	30X49X7ADL*	30X49X7TC	30X52X8ADL*	30X52X8TC
30X42X4.5A*	30X42X4.5SC	30X45X5A*	30X45X5SC	30X50.8X7ADL*	30X50.80X7TC	30X52X8ADL	30X52X7TC
30X42X5.7A	30X42X4.5SC	30X45X6A	30X45X5SC	30X50X10A*	30X50X10SC	30X52X9C*	30X52X9SA
30X42X5ADL*	30X42X5TC	30X45X6ADL*	30X45X6TC	30X50X10A	30X50X8SC	30X54X10A*	30X54X10SC
30X42X6A*	30X42X6SC	30X45X6ADL	30X45X5TC	30X50X10ADL	30X50X6TC	30X55X10A*	30X55X10SC
30X42X6A	30X42X4.5SC	30X45X6V	30X45X6VTC	30X50X10ADL	30X50X7TC	30X55X10A	30X55X5SC
30X42X6ADL*	30X42X6TC	30X45X7A*	30X45X7SC	30X50X10ADL	30X50X8TC	30X55X10A	30X55X6SC
30X42X6ADL	30X42X5TC	30X45X7A	30X45X5SC	30X50X11ADL*	30X50X11TC	30X55X10ADL*	30X55X10TC
30X42X6V	30X42X4.5VTC	30X45X7ADL*	30X45X7TC	30X50X11ADL	30X50X6TC	30X55X10ADL	30X55X7TC
30X42X6V	30X42X6VTC	30X45X7ADL	30X45X5TC	30X50X11ADL	30X50X7TC	30X55X12A	30X55X5SC
30X42X7A*	30X42X7SC	30X45X7ADL	30X45X6TC	30X50X11ADL	30X50X8TC	30X55X12A	30X55X6SC
30X42X7A	30X42X4.5SC	30X45X8A*	30X45X8SC	30X50X12A	30X50X8SC	30X55X12A	30X55X10SC
30X42X7A	30X42X6SC	30X45X8A	30X45X5SC	30X50X12A	30X50X10SC	30X55X12ADL*	30X55X12TC
30X42X7ADL*	30X42X7TC	30X45X8A	30X45X7SC	30X50X12ADL	30X50X6TC	30X55X12ADL	30X55X7TC
30X42X7ADL	30X42X5TC	30X45X8ADL*	30X45X8TC	30X50X12ADL	30X50X7TC	30X55X12ADL	30X55X10TC
30X42X7ADL	30X42X6TC	30X45X8ADL	30X45X5TC	30X50X12ADL	30X50X8TC	30X55X6A*	30X55X6SC
30X42X7ADL	30X42X7TF	30X45X8ADL	30X45X6TC	30X50X12ADL	30X50X11TC	30X55X6A	30X55X5SC
30X42X7V	30X42X7VTF	30X45X8ADL	30X45X7TC	30X50X5AO*	30X50X5VC	30X55X7A	30X55X5SC
30X42X7V	30X42X7VTFY	30X45X8V	30X45X8VTC	30X50X6ADL*	30X50X6TC	30X55X7A	30X55X6SC
30X42X8A*	30X42X8SC	30X45X8V	30X45X8VTC	30X50X7ADL*	30X50X7TC	30X55X7ADL*	30X55X7TC
30X42X8A	30X42X4.5SC	30X45X8V	30X45X8VTC	30X50X7ADL	30X50X6TC	30X55X7V	30X55X7VTC
30X42X8A	30X42X6SC	30X45X9.5B	30X45X8SB	30X50X7V	30X50X7VTC	30X55X8ADL	30X55X7TC
30X42X8A	30X42X7SC	30X46X5ADL*	30X46X5TC	30X50X8A*	30X50X8SC	30X56X10A	30X56X7SC
30X42X8ADL*	30X42X8TC	30X46X7ADL	30X46X5TC	30X50X8ADL*	30X50X8TC	30X56X10ADL*	30X56X10TC
30X42X8ADL	30X42X5TC	30X46X8V	30X46X8VTC	30X50X8ADL	30X50X6TC	30X56X10ADL	30X56X6TC
30X42X8ADL	30X42X6TC	30X47.5X8ADL*	30X47.5X8TC	30X50X8ADL	30X50X7TC	30X56X10V	30X56X10VTC
30X42X8ADL	30X42X7TC	30X47X10A*	30X47X10SC	30X50X8V	30X50X8VDC	30X56X12A	30X56X7SC
30X43.5X10ADL	30X43.5X7TC	30X47X10A	30X47X5SC	30X50X8V	30X50X8VDC	30X56X12ADL*	30X56X12TC
30X43X8.5ADL	30X43X8TC	30X47X10A	30X47X6SC	30X51X10ADL	30X51X7TC	30X56X12ADL	30X56X6TC
30X43X8A*	30X43X8SC	30X47X10A	30X47X7SC	30X51X7ADL*	30X51X7TC	30X56X12ADL	30X56X10TC
30X43X8ADL*	30X43X8TC	30X47X10A	30X47X8SC	30X52.1X8A*	30X52.1X8SC	30X56X12ADL	30X56X10TC
30X44.5X7ADL*	30X44.5X7TC	30X47X10A	30X47X8SC	30X52X10A*	30X52X10SC	30X56X12C	30X56X10SA
30X44X10ADL	30X44X5TC	30X47X10ADL*	30X47X10TC	30X52X10A	30X52X5SC	30X56X7.5ADL	30X56X6TC
30X44X10ADL	30X44X7TC	30X47X10ADL	30X47X7TC	30X52X10A	30X52X7SC	30X56X8A	30X56X7SC
30X44X10ADL	30X44X9TC	30X47X10V	30X47X10VDC	30X52X10A	30X52X8SC	30X58X10ADL*	30X58X10TC
30X44X5ADL*	30X44X5TC	30X47X5A*	30X47X5SC	30X52X10ADL*	30X52X10TC	30X58X10ADL	30X58X8TC
30X44X7ADL*	30X44X7TC	30X47X5V	30X47X5VVF	30X52X10ADL	30X52X7TC	30X58X8ADL*	30X58X8TC
30X44X7ADL	30X44X5TC	30X47X5V	30X47X5VTF	30X52X10ADL	30X52X8TC	30X60X10ADL	30X60X8TC
30X44X8ADL	30X44X5TC	30X47X6A*	30X47X6SC	30X52X10V	30X52X10VTF	30X62X10A	30X62X5SC
30X44X8ADL	30X44X7TC	30X47X6A	30X47X5SC	30X52X11ADL*	30X52X11TC	30X62X10A	30X62X7SC
30X44X9ADL*	30X44X9TC	30X47X6A	30X47X5SC	30X52X11ADL	30X52X7TC	30X62X10ADL*	30X62X10TC
30X44X9ADL	30X44X5TC	30X47X7A*	30X47X7SC	30X52X11ADL	30X52X8TC	30X62X10ADL	30X62X7TC
30X44X9ADL	30X44X7TC	30X47X7A	30X47X5SC	30X52X11ADL	30X52X10TC	30X62X10ADL	30X62X8TC
30X45X10A*	30X45X10SC	30X47X7ADL*	30X47X7TC	30X52X12A	30X52X5SC	30X62X10V	30X62X10VTC
30X45X10A	30X45X5SC	30X47X7V	30X47X7VTC	30X52X12A	30X52X7SC	30X62X11ADL	30X62X7TC
30X45X10A	30X45X7SC	30X47X7V	30X47X7VTF	30X52X12A	30X52X8SC	30X62X11ADL	30X62X8TC
30X45X10A	30X45X8SC	30X47X8A*	30X47X8SC	30X52X12A	30X52X10SC	30X62X11ADL	30X62X10TC
30X45X10ADL*	30X45X10TC	30X47X8A	30X47X5SC	30X52X12ADL	30X52X7TC	30X62X12A	30X62X5SC
30X45X10ADL	30X45X5TC	30X47X8A	30X47X6SC	30X52X12ADL	30X52X8TC	30X62X12A	30X62X7SC
30X45X10ADL	30X45X6TC	30X47X8A	30X47X7SC	30X52X12ADL	30X52X10TC	30X62X12ADL	30X62X7TC
30X45X10ADL	30X45X7TC	30X47X8ADL*	30X47X8TC	30X52X12ADL	30X52X11TC	30X62X12ADL	30X62X8TC
30X45X10ADL	30X45X8TC	30X47X8ADL	30X47X7TC	30X52X12ADL	30X52X11TC	30X62X12ADL	30X62X8TC
30X45X11A	30X45X5SC	30X47X8ADL	30X47X7TC	30X52X12C	30X52X9SA	30X62X12ADL	30X62X10TC
30X45X11A	30X45X7SC	30X47X8V	30X47X8VTC	30X52X12C	30X52X5SC	30X62X12ADL	30X62X6SB
30X45X11A	30X45X8SC	30X48X10A	30X48X8SC	30X52X12C	30X52X5SC	30X62X6B*	30X62X6SB
30X45X11A	30X45X10SC	30X48X10ADL*	30X48X10TC	30X52X12C	30X52X5SC	30X62X7A*	30X62X7SC
30X45X11ADL*	30X45X11TC	30X48X10ADL	30X48X7TC	30X52X12C	30X52X5SC	30X62X7A	30X62X5SC
30X45X11ADL	30X45X5TC	30X48X10ADL	30X48X7TC	30X52X12C	30X52X5SC	30X62X7ADL*	30X62X7TC
30X45X11ADL	30X45X6TC	30X48X10ADL	30X48X8TC	30X52X12C	30X52X5SC	30X62X7V	30X62X7VTC
30X45X11ADL	30X45X7TC	30X48X10B*	30X48X10SB	30X52X12C	30X52X5SC	30X62X8A	30X62X5SC
		30X48X7ADL*	30X48X7TC	30X52X7A*	30X52X7SC	30X62X8A	30X62X7SC
		30X48X8A*	30X48X8SC	30X52X7ADL*	30X52X7TC	30X62X8ADL*	30X62X8TC
		30X48X8ADL*	30X48X8TC	30X52X7V	30X52X7VTC	30X62X8ADL	30X62X7TC

HARWAL INTERCHANGES

HARWAL CROSS REFERENCES – SHAFT SEALS

PLEASE CALL DICHTOMATIK FOR AVAILABILITY - 800-328-2840
 BULK AND INDIVIDUALLY BOXED QUANTITIES ARE AVAILABLE FOR ALL ITEMS
 * = EXACT INTERCHANGE - ALL OTHERS ARE FUNCTIONALLY



DICHTOMATIK

Any seal. Any time.

HARWAL INTERCHANGES

Harwal Part #	TCM Part #	Harwal Part #	TCM Part #	Harwal Part #	TCM Part #	Harwal Part #	TCM Part #
30X62X9C*	30X62X9SA	31X52X9A	31X52X75C	32X47X6V	32X47X6V5F	32X54X10ADL	32X54X8TC
30X65X10A*	30X65X105C	320X350X18C	320X350X165A	32X47X6V	32X47X6VTF	32X54X11A*	32X54X115C
30X70X10ADL*	30X70X10TC	320X360X18A*	320X360X185C	32X47X7A*	32X47X75C	32X54X7A0*	32X54X7VC
30X72X10A	30X72X65C	320X360X18C*	320X360X185A	32X47X7ADL*	32X47X7TC	32X55X10ADL*	32X55X10TC
30X72X10ADL*	30X72X10TC	320X360X20A*	320X360X205C	32X47X7V	32X47X7VTF	32X55X10ADL	32X55X7TC
30X72X10ADL	30X72X6TC	320X360X20A	320X360X185C	32X47X8A	32X47X75C	32X55X10ADL	32X55X8TC
30X72X10ADL	30X72X8TC	320X360X20ADL*	320X360X20TC	32X47X8ADL*	32X47X8TC	32X55X12C*	32X55X125A
30X72X10V	30X72X10V5F	320X360X20ADL	320X360X18TC	32X47X8ADL	32X47X7TC	32X55X12C	32X55X105A
30X72X10V	30X72X10VTC	320X360X20C*	320X360X205A	32X48X10A	32X48X55C	32X55X7ADL*	32X55X7TC
30X72X10V	30X72X10VTF	320X360X20C	320X360X185A	32X48X10A	32X48X75C	32X55X8ADL*	32X55X8TC
30X72X10V	30X72X10VTFW	320X380X20C*	320X380X205A	32X48X10A	32X48X95C	32X55X8ADL	32X55X7TC
30X72X11A	30X72X65C	320X380X25C	320X380X205A	32X48X10ADL	32X48X5TC	32X56X10ADL*	32X56X10TC
30X72X11ADL	30X72X6TC	325X365X16C*	325X365X165A	32X48X10ADL	32X48X7TC	32X56X10ADL	32X56X8TC
30X72X11ADL	30X72X8TC	325X365X16V	325X365X16V5F	32X48X10ADL	32X48X8TC	32X56X10V	32X56X10VTC
30X72X11ADL	30X72X10TC	32X40X10ADL	32X40X5TC	32X48X12A	32X48X55C	32X57.2X10ADL*	32X57.2X10TC
30X72X12C	30X72X105A	32X40X10ADL	32X40X7tc	32X48X12A	32X48X75C	32X57X9.5V	32X57X9.5VTF
30X72X6A*	30X72X65C	32X40X5A0*	32X40X5VC	32X48X12A	32X48X95C	32X58X10B*	32X58X105B
30X72X7BDL*	30X72X7TB	32X42X4V	32X42X4VTF	32X48X12ADL	32X48X5TC	32X58X12ADL	32X58X8TC
30X72X8A	30X72X65C	32X42X4V	32X42X4VVG	32X48X12ADL	32X48X7TC	32X58X8ADL*	32X58X8TC
30X72X8ADL*	30X72X8TC	32X42X5A*	32X42X55C	32X48X12ADL	32X48X8TC	32X60X12C*	32X60X125A
30X72X8ADL	30X72X6TC	32X42X7A*	32X42X75C	32X48X5A*	32X48X55C	32X62X10A*	32X62X105C
30X72X8V	30X72X8VTC	32X42X7A	32X42X55C	32X48X7A*	32X48X75C	32X62X10A	32X62X85C
30X72X8V	30X72X8VTF	32X42X7ADL*	32X42X7TC	32X48X7A	32X48X55C	32X62X10ADL*	32X62X10TC
30X75X10ADL*	30X75X10TC	32X42X7ADL	32X42X5TC	32X48X7ADL*	32X48X7TC	32X62X10ADL	32X62X7TC
30X75X10ADL	30X75X9TC	32X42X7V	32X42X7VTC	32X48X7ADL	32X48X5TC	32X62X10V	32X62X10VTC
30X77X9ADL*	30X77X9TC	32X42X8ADL*	32X42X8TC	32X48X8ADL*	32X48X8TC	32X62X10V	32X62X10VTF
30X80X10ADL*	30X80X10TC	32X42X8ADL	32X42X5TC	32X48X8ADL	32X48X5TC	32X62X12A	32X62X85C
31.5X47X7A*	31.5X47X75C	32X42X8ADL	32X42X7TC	32X48X8ADL	32X48X7TC	32X62X12A	32X62X105C
31.5X52X7A*	31.5X52X75C	32X43X7ADL*	32X43X7TC	32X48X8V	32X48X8V5F	32X62X7ADL*	32X62X7TC
31.8X40X8ADL*	31.8X40X8TC	32X43X7ADL	32X43X5.5TC	32X48X8V	32X48X8VTC	32X62X8A*	32X62X85C
310X340X15ADL*	310X340X15TC	32X44.5X7ADL*	32X44.5X7TC	32X48X9A*	32X48X95C	32X62X8ADL	32X62X7TC
310X350X18C*	310X350X185A	32X44X10ADL	32X44X7TC	32X48X9A	32X48X55C	32X65X10C*	32X65X105A
310X350X18V	310X350X18V5F	32X44X10ADL	32X44X8TC	32X48X9A	32X48X75C	32X65X12C	32X65X105A
310X370X28V	310X370X28VTC	32X44X10ADL	32X44X9TC	32X50X10A*	32X50X105C	32X65X13ADL	32X65X6.5TC
315X350X18A*	315X350X185C	32X44X12ADL	32X44X7TC	32X50X10A	32X50X85C	32X65X13ADL	32X65X9TC
315X355X18C*	315X355X185A	32X44X12ADL	32X44X8TC	32X50X10V	32X50X10VTC	32X65X6.5ADL*	32X65X6.5TC
31X41X12.5ADL*	31X41X12.5TC	32X44X12ADL	32X44X9TC	32X50X12A	32X50X85C	32X66X10A*	32X66X105C
31X43X8ADL*	31X43X8TC	32X44X7ADL*	32X44X7TC	32X50X12A	32X50X105C	32X68X8ADL*	32X68X8TC
31X44X7ADL*	31X44X7TC	32X44X8ADL*	32X44X8TC	32X50X7B*	32X50X75B	32X70X10ADL*	32X70X10TC
31X45X8ADL	31X45X7TC	32X44X8ADL	32X44X7TC	32X50X7V	32X50X7VTF	32X70X10ADL	32X70X8TC
31X45X8V	31X45X8VTF	32X45X10A*	32X45X105C	32X50X8A*	32X50X85C	32X72X10ADL*	32X72X10TC
31X45X9ADL*	31X45X9TC	32X45X10A	32X45X65C	32X52X10A	32X52X75C	32X72X10ADL	32X72X8TC
31X45X9ADL	31X45X7TC	32X45X10A	32X45X75C	32X52X10ADL*	32X52X10TC	32X72X12ADL*	32X72X12TC
31X46X8ADL*	31X46X8TC	32X45X10A	32X45X85C	32X52X10ADL	32X52X5TC	32X72X12ADL	32X72X8TC
31X47X10A	31X47X75C	32X45X10ADL	32X45X7TC	32X52X10ADL	32X52X8TC	32X72X12ADL	32X72X10TC
31X47X7A*	31X47X75C	32X45X12ADL	32X45X7TC	32X52X10B	32X52X75B	32X72X8ADL*	32X72X8TC
31X47X7V	31X47X75F	32X45X6A*	32X45X65C	32X52X10V	32X52X10V5F	32X78X10ADL*	32X78X10TC
31X48X10ADL*	31X48X10TC	32X45X7A*	32X45X75C	32X52X11ADL*	32X52X11TC	33.5X55X9.5ADL*	33.5X55X9.5TC
31X48X10ADL	31X48X7TC	32X45X7A	32X45X65C	32X52X11ADL	32X52X5TC	330X370X18V	330X370X18VTC
31X48X7ADL*	31X48X7TC	32X45X7ADL*	32X45X7TC	32X52X11ADL	32X52X8TC	33X44X8ADL*	33X44X8TC
31X49X7ADL*	31X49X7TC	32X45X7V	32X45X7VTF	32X52X11ADL	32X52X10TC	33X45X10ADL	33X45X7TC
31X50X7ADL*	31X50X7TC	32X45X8A*	32X45X85C	32X52X12C*	32X52X125A	33X45X7A*	33X45X75C
31X50X8ADL*	31X50X8TC	32X45X8A	32X45X65C	32X52X5ADL	32X52X5TC	33X45X7V	33X45X7V5C
31X50X8ADL	31X50X7TC	32X45X8A	32X45X75C	32X52X7A*	32X52X75C	33X45X8ADL	33X45X7TC
31X51X7ADL*	31X51X7TC	32X45X8ADL	32X45X7TC	32X52X7ADL	32X52X5TC	33X47X10ADL*	33X47X10TC
31X52X6ADL*	31X52X6TC	32X46X10ADL	32X46X8TC	32X52X7V	32X52X7V5C	33X48X12A*	33X48X125C
31X52X6V	31X52X6V5F	32X46X8ADL*	32X46X8TC	32X52X7V	32X52X7VTC	33X48X8.9ADL*	33X48X8.9TC
31X52X6V	31X52X6VTF	32X47X10A*	32X47X105C	32X52X8A	32X52X75C	33X48X8.9ADL	33X48X8TC
31X52X7A*	31X52X75C	32X47X10A	32X47X75C	32X52X8ADL*	32X52X8TC	33X49.5X9ADL*	33X49.5X9TC
31X52X7ADL*	31X52X7TC	32X47X10ADL*	32X47X10TC	32X52X8ADL	32X52X5TC	33X50X10A	33X50X65C
31X52X7ADL	31X52X6TC	32X47X10ADL	32X47X7TC	32X52X9A	32X52X75C	33X50X10ADL*	33X50X10TC
31X52X8A	31X52X75C	32X47X10ADL	32X47X8TC	32X53X7ADL*	32X53X7TC	33X50X10ADL	33X50X6TC



PLEASE CALL DICHTOMATIK FOR AVAILABILITY - 800-328-2840
BULK AND INDIVIDUALLY BOXED QUANTITIES ARE AVAILABLE FOR ALL ITEMS
* = EXACT INTERCHANGE - ALL OTHERS ARE FUNCTIONALLY

Harwal Part #	TCM Part #	Harwal Part #	TCM Part #	Harwal Part #	TCM Part #	Harwal Part #	TCM Part #
33X50X10ADL	33X50X7TC	34X52X7.5ADL	34X52X7TC	35X45X8ADL	35X45X4TC	35X50X12C	35X50X9SA
33X50X10ADL	33X50X8TC	34X52X7.5V	34X52X7.5V5F	35X45X8ADL	35X45X7TC	35X50X5A*	35X50X5SC
33X50X12ADL*	33X50X12TC	34X52X7B*	34X52X7SB	35X46X10ADL	35X46X7TC	35X50X7A	35X50X5SC
33X50X12ADL	33X50X6TC	34X52X7BDL*	34X52X7TB	35X46X10ADL	35X46X8TC	35X50X7ADL*	35X50X7TC
33X50X12ADL	33X50X7TC	34X52X8A*	34X52X8SC	35X46X8ADL*	35X46X8TC	35X50X7V	35X50X7VTF
33X50X12ADL	33X50X8TC	34X54X11ADL*	34X54X11TC	35X46X8ADL	35X46X7TC	35X50X7V	35X50X7VTGR
33X50X12ADL	33X50X10TC	34X54X11ADL	34X54X7TC	35X47X10A*	35X47X10SC	35X50X8A	35X50X5SC
33X50X6A*	33X50X6SC	34X54X12.5ADL	34X54X7TC	35X47X10A	35X47X4.5SC	35X50X8ADL*	35X50X8TC
33X50X6ADL*	33X50X6TC	34X54X12.5ADL	34X54X11TC	35X47X10A	35X47X5SC	35X50X8ADL	35X50X7TC
33X50X7A	33X50X6SC	34X54X7ADL*	34X54X7TC	35X47X10A	35X47X6SC	35X50X8V	35X50X8VTF
33X50X7ADL*	33X50X7TC	34X54X8ADL	34X54X7TC	35X47X10A	35X47X7SC	35X50X8V	35X50X8VTGR
33X50X7ADL	33X50X6TC	34X55X10V	34X55X10V5F	35X47X10ADL*	35X47X10TC	35X50X9C*	35X50X9SA
33X50X8ADL*	33X50X8TC	34X55X11ADL	34X55X9TC	35X47X10ADL	35X47X6TC	35X51X10ADL	35X51X7TC
33X50X8ADL	33X50X6TC	34X55X6A*	34X55X6SC	35X47X10ADL	35X47X7TC	35X51X14ADL	35X51X7TC
33X50X8ADL	33X50X7TC	34X55X9A*	34X55X9SC	35X47X10ADL	35X47X9TC	35X51X8ADL	35X51X7TC
33X51X7BDL*	33X51X7TB	34X55X9A	34X55X6SC	35X47X4.5A*	35X47X4.5SC	35X52X10A*	35X52X10SC
33X52X10A*	33X52X10SC	34X55X9ADL*	34X55X9TC	35X47X5A*	35X47X5SC	35X52X10A	35X52X7SC
33X56X10ADL	33X56X8TC	34X57X6A*	34X57X6SC	35X47X5A	35X47X4.5SC	35X52X10A	35X52X8SC
33X56X12ADL*	33X56X12TC	34X58X13C*	34X58X13SA	35X47X6A*	35X47X6SC	35X52X10ADL*	35X52X10TC
33X56X12ADL	33X56X8TC	34X62X10A*	34X62X10SC	35X47X6A	35X47X4.5SC	35X52X10ADL	35X52X6TC
33X56X8ADL*	33X56X8TC	34X62X10ADL*	34X62X10TC	35X47X6A	35X47X5SC	35X52X10ADL	35X52X7TC
33X62X10ADL*	33X62X10TC	34X62X10ADL	34X62X7TC	35X47X6ADL*	35X47X6TC	35X52X10ADL	35X52X8TC
33X62X12C*	33X62X12SA	34X62X10ADL	34X62X8TC	35X47X6B*	35X47X6SC	35X52X10ADL	35X52X9TC
33X63X9ADL*	33X63X9TC	34X62X12C	34X62X10SA	35X47X6V	35X47X6V5F	35X52X12A*	35X52X12SC
33X66X13A*	33X66X13SC	34X62X8ADL*	34X62X8TC	35X47X7A*	35X47X7SC	35X52X12A	35X52X7SC
33X72X8ADL*	33X72X8TC	34X62X8ADL	34X62X7TC	35X47X7A	35X47X4.5SC	35X52X12A	35X52X8SC
34.9X46.5X7ADL*	34.9X46.5X7TC	34X70X10ADL*	34X70X10TC	35X47X7A	35X47X5SC	35X52X12A	35X52X10SC
340X372X16C*	340X372X16SA	34X72X10A*	34X72X10SC	35X47X7A	35X47X6SC	35X52X12ADL*	35X52X12TC
340X380X18A*	340X380X18SC	34X72X10ADL*	34X72X10TC	35X47X7ADL*	35X47X7TC	35X52X12ADL	35X52X6TC
340X380X18C*	340X380X18SA	34X72X11ADL	34X72X10TC	35X47X7ADL	35X47X6TC	35X52X12ADL	35X52X7TC
340X380X18V	340X380X18V5F	34X72X14ADL	34X72X10TC	35X47X7V	35X47X7VSC	35X52X12ADL	35X52X8TC
340X380X20A	340X380X18SC	35.9X52X8B*	35.9X52X8SB	35X47X7V	35X47X7VTC	35X52X12ADL	35X52X9TC
340X380X20C	340X380X18SA	350X380X16ADL*	350X380X16TC	35X47X7V	35X47X7VTF	35X52X12ADL	35X52X10TC
34X39X3AO*	34X39X3VC	350X380X16C*	350X380X16SA	35X47X8A	35X47X4.5SC	35X52X6ADL*	35X52X6TC
34X44X6A*	34X44X6SC	350X390X18C*	350X390X18SA	35X47X8A	35X47X5SC	35X52X7A*	35X52X7SC
34X44X7A	34X44X6SC	350X390X18V	350X390X18VTC	35X47X8A	35X47X6SC	35X52X7ADL*	35X52X7TC
34X44X8ADL	34X44X7TC	35X40X4BO*	35X40X4VB	35X47X8A	35X47X7SC	35X52X7ADL	35X52X6TC
34X45X6ADL*	34X45X6TC	35X42X4AO*	35X42X4VC	35X47X9ADL*	35X47X9TC	35X52X7V	35X52X7VTF
34X45X7A*	34X45X7SC	35X42X4V	35X42X4VTC	35X47X9ADL	35X47X6TC	35X52X8A*	35X52X8SC
34X45X7ADL*	34X45X7TC	35X42X8ADL*	35X42X8TC	35X47X9ADL	35X47X7TC	35X52X8A	35X52X7SC
34X45X7ADL	34X45X6TC	35X44X7V	35X44X7VTC	35X48X10ADL*	35X48X10TC	35X52X8ADL*	35X52X8TC
34X47X7ADL*	34X47X7TC	35X45X10A*	35X45X10SC	35X48X10ADL	35X48X8TC	35X52X8ADL	35X52X6TC
34X47X7V	34X47X7V5B-H	35X45X10A	35X45X6SC	35X48X7V	35X48X7VTF	35X52X8ADL	35X52X7TC
34X48X10ADL	34X48X7TC	35X45X10A	35X45X7SC	35X48X7V	35X48X7VTGR	35X52X9A	35X52X7SC
34X48X10ADL	34X48X8TC	35X45X10ADL	35X45X4TC	35X48X8A*	35X48X8SC	35X52X9A	35X52X8SC
34X48X7ADL*	34X48X7TC	35X45X10ADL	35X45X7TC	35X48X8ADL*	35X48X8TC	35X52X9ADL*	35X52X9TC
34X48X8ADL*	34X48X8TC	35X45X10ADL	35X45X8TC	35X48X9A	35X48X8SC	35X52X9ADL	35X52X6TC
34X48X8ADL	34X48X7TC	35X45X4ADL*	35X45X4TC	35X49X6ADL*	35X49X6TC	35X52X9ADL	35X52X7TC
34X49X8V	34X49X8V5F	35X45X4AO*	35X45X4VC	35X49X7ADL*	35X49X7TC	35X52X9ADL	35X52X8TC
34X50X10ADL	34X50X7TC	35X45X4V	35X45X4VVC	35X49X7ADL	35X49X6TC	35X53X8A*	35X53X8SC
34X50X10V	34X50X10VTC	35X45X4V	35X45X4VVC	35X50X10A*	35X50X10SC	35X54X10A*	35X54X10SC
34X50X12ADL*	34X50X12TC	35X45X6A*	35X45X6SC	35X50X10A	35X50X5SC	35X54X10V	35X54X10V5F
34X50X12ADL	34X50X7TC	35X45X6ADL	35X45X4TC	35X50X10ADL*	35X50X10TC	35X54X6ADL*	35X54X6TC
34X50X7ADL*	34X50X7TC	35X45X6V	35X45X6VSC	35X50X10ADL	35X50X7TC	35X54X8ADL*	35X54X8TC
34X50X8ADL	34X50X7TC	35X45X6V	35X45X6VTC	35X50X10ADL	35X50X8TC	35X54X8ADL	35X54X6TC
34X50X9ADL	34X50X7TC	35X45X7A*	35X45X7SC	35X50X10V	35X50X10VTF	35X54X8ADL	35X54X7TC
34X52X10A*	34X52X10SC	35X45X7A	35X45X6TC	35X50X11ADL	35X50X7TC	35X55X10A*	35X55X10SC
34X52X10A	34X52X8SC	35X45X7ADL*	35X45X7TC	35X50X11ADL	35X50X8TC	35X55X10A	35X55X5SC
34X52X11ADL	34X52X7TC	35X45X7ADL	35X45X4TC	35X50X11ADL	35X50X10TC	35X55X10A	35X55X8SC
34X52X11ADL	34X52X7.5TC	35X45X7V	35X45X7VTC	35X50X12ADL	35X50X7TC	35X55X10ADL*	35X55X10TC
34X52X11ADL	34X52X8TC	35X45X7V	35X45X7VTF	35X50X12ADL	35X50X8TC	35X55X10ADL	35X55X7TC
34X52X7.5ADL*	34X52X7.5TC	35X45X8ADL*	35X45X8TC	35X50X12ADL	35X50X10TC	35X55X10ADL	35X55X8TC

HARWAL INTERCHANGES

HARWAL CROSS REFERENCES – SHAFT SEALS

PLEASE CALL DICHTOMATIK FOR AVAILABILITY - 800-328-2840
 BULK AND INDIVIDUALLY BOXED QUANTITIES ARE AVAILABLE FOR ALL ITEMS
 * = EXACT INTERCHANGE - ALL OTHERS ARE FUNCTIONALLY



DICHTOMATIK

Any seal. Any time.

HARWAL INTERCHANGES

Harwal Part #	TCM Part #	Harwal Part #	TCM Part #	Harwal Part #	TCM Part #	Harwal Part #	TCM Part #
35X55X10V	35X55X10VSF	35X60X12ADL	35X60X7TC	35X72X12ADL	35X72X8TC	36X54X7.5A	36X54X6.55C
35X55X11ADL*	35X55X11TC	35X60X12ADL	35X60X10TC	35X72X12ADL	35X72X10TC	36X54X7A	36X54X6.55C
35X55X11ADL	35X55X7TC	35X60X7ADL*	35X60X7TC	35X72X7ADL*	35X72X7TC	36X54X7ADL*	36X54X7TC
35X55X11ADL	35X55X8TC	35X62X10A*	35X62X10SC	35X72X7V	35X72X7VTF	36X54X8ADL	36X54X7TC
35X55X11ADL	35X55X10TC	35X62X10A	35X62X7SC	35X72X8ADL*	35X72X8TC	36X54X8ADL	36X54X7.5TC
35X55X12A	35X55X5SC	35X62X10A	35X62X8SC	35X72X8ADL	35X72X7TC	36X56X10A*	36X56X10SC
35X55X12A	35X55X8SC	35X62X10ADL*	35X62X10TC	35X75X12ADL	35X75X8TC	36X56X10A	36X56X6SC
35X55X12A	35X55X10SC	35X62X10ADL	35X62X6TC	35X80X10ADL*	35X80X10TC	36X56X10V	36X56X10VSF
35X55X7A	35X55X5SC	35X62X10ADL	35X62X7TC	35X80X10ADL	35X80X8TC	36X58X10ADL*	36X58X10TC
35X55X7ADL*	35X55X7TC	35X62X10V	35X62X10VSEC	35X80X12A*	35X80X12SC	36X59X9.5A*	36X59X9.5SC
35X55X7V	35X55X7VTF	35X62X10V	35X62X10VSF	35X80X12ADL	35X80X8TC	36X60X10ADL*	36X60X10TC
35X55X8A*	35X55X8SC	35X62X10V	35X62X10VTF	35X80X12ADL	35X80X10TC	36X60X10ADL	36X60X6TC
35X55X8A	35X55X5SC	35X62X12A	35X62X7SC	35X80X13ADL	35X80X8TC	36X60X10ADL	36X60X7TC
35X55X8ADL*	35X55X8TC	35X62X12A	35X62X8SC	35X80X13ADL	35X80X10TC	36X60X7ADL*	36X60X7TC
35X55X8ADL	35X55X7TC	35X62X12A	35X62X10SC	35X80X8ADL*	35X80X8TC	36X60X7ADL	36X60X6TC
35X55X8V	35X55X8VSB	35X62X12ADL*	35X62X12TC	35X82X6A*	35X82X6SC	36X62X10A	36X62X7SC
35X55X8V	35X55X8VTF	35X62X12ADL	35X62X6TC	360X390X15ADL*	360X390X15TC	36X62X7A*	36X62X7SC
35X55X8V	35X55X8VTF	35X62X12ADL	35X62X7TC	360X400X16A*	360X400X16SC	36X62X7ADL*	36X62X7TC
35X55X9ADL	35X55X7TC	35X62X12ADL	35X62X10TC	360X400X18C*	360X400X18SA	36X62X7V	36X62X7VSF
35X55X9ADL	35X55X8TC	35X62X12ADL	35X62X10TC	360X400X20ADL*	360X400X20TC	36X62X7V	36X62X7VTC
35X56X10A*	35X56X10SC	35X62X12B	35X62X5SB	360X400X20C	360X400X18SA	36X63.5X9ADL*	36X63.5X9TC
35X56X10A	35X56X8SC	35X62X12B	35X62X8SB	360X400X20C	360X400X18SA	36X68X10A*	36X68X10SC
35X56X10A	35X56X8SC	35X62X15BDL	35X62X10TB	360X420X28V	360X420X28VTC	36X68X10A*	36X68X10SC
35X56X10ADL*	35X56X10TC	35X62X5B*	35X62X5SB	365X405X18C*	365X405X18SA	36X68X10ADL*	36X68X10TC
35X56X10ADL	35X56X8TC	35X62X6ADL*	35X62X6TC	36X45X7A*	36X45X7SC	36X68X10ADL	36X68X8TC
35X56X10V	35X56X10VTC	35X62X7A*	35X62X7SC	36X46X9B	36X46X6SB	36X68X10V	36X68X10VSC
35X56X12A	35X56X8SC	35X62X7ADL*	35X62X7TC	36X47X7ADL*	36X47X7TC	36X75X12A*	36X75X12SC
35X56X12A	35X56X10SC	35X62X7ADL	35X62X6TC	36X47X7B*	36X47X7SB	36X83X12A*	36X83X12SC
35X56X12ADL*	35X56X12TC	35X62X7B	35X62X5SB	36X47X7V	36X47X7VTF	370X410X15A*	370X410X15SC
35X56X12ADL	35X56X8TC	35X62X7V	35X62X7VTF	36X48X10A*	36X48X10SC	370X415X15ADL*	370X415X15TC
35X56X12ADL	35X56X10TC	35X62X8A*	35X62X8SC	36X48X10V	36X48X10VSF	370X430X26V	370X430X26VTC
35X56X8A*	35X56X8SC	35X62X8A	35X62X7SC	36X48X10V	36X48X10VTC	37X45X7ADL*	37X45X7TC
35X56X8ADL*	35X56X8TC	35X62X8ADL	35X62X6TC	36X49X7ADL*	36X49X7TC	37X47X10ADL	37X47X8TC
35X57X13ADL	35X57X6TC	35X62X8ADL	35X62X7TC	36X50.5X7ADL*	36X50.5X7TC	37X47X4V	37X47X4VTF
35X58X10A*	35X58X10SC	35X64X13ADL*	35X64X13TC	36X50.8X8BDL*	36X50.8X8TB	37X48X6ADL*	37X48X6TC
35X58X10ADL*	35X58X10TC	35X64X13ADL	35X64X8TC	36X50X10A	36X50X7SC	37X50X10A*	37X50X10TC
35X58X10ADL	35X58X6TC	35X65X10A	35X65X9SC	36X50X7A*	36X50X7SC	37X50X10V	37X50X10VTF
35X58X10ADL	35X58X7TC	35X65X10ADL	35X65X8TC	36X50X7ADL*	36X50X7TC	37X50X6BDL*	37X50X6TB
35X58X10ADL	35X58X8TC	35X65X12A	35X65X9SC	36X50X7ADL	36X50X5TC	37X50X7ADL*	37X50X7TC
35X58X10V	35X58X10VTF	35X65X12ADL*	35X65X12TC	36X50X7V	36X50X7VTC	37X50X8ADL	37X50X7TC
35X58X11ADL	35X58X6TC	35X65X12ADL	35X65X8TC	36X50X7V	36X50X7VTF	37X52X10A	37X52X8SC
35X58X11ADL	35X58X7TC	35X65X9A*	35X65X9SC	36X51X8ADL*	36X51X8TC	37X52X10V	37X52X10VSF
35X58X11ADL	35X58X8TC	35X67X7A*	35X67X7SC	36X52X10ADL*	36X52X10TC	37X52X12ADL*	37X52X12TC
35X58X11ADL	35X58X10TC	35X68X10A	35X68X6SC	36X52X10ADL	36X52X7TC	37X52X12ADL	37X52X5TC
35X58X12A	35X58X10SC	35X68X10V	35X68X10VTF	36X52X10ADL	36X52X9TC	37X52X8A*	37X52X8SC
35X58X12ADL*	35X58X12TC	35X68X12A	35X68X6SC	36X52X6.5A	36X52X5SC	37X53X7ADL*	37X53X7TC
35X58X12ADL	35X58X6TC	35X68X6A*	35X68X6SC	36X52X7A*	36X52X7SC	37X55X10ADL	37X55X8TC
35X58X12ADL	35X58X7TC	35X70X10ADL*	35X70X10TC	36X52X7ADL*	36X52X5SC	37X55X8ADL*	37X55X8TC
35X58X12ADL	35X58X8TC	35X70X10ADL	35X70X8TC	36X52X7V	36X52X7TC	37X60X8ADL*	37X60X8TC
35X58X12ADL	35X58X10TC	35X70X10B*	35X70X10SB	36X52X7V	36X52X7VTF	37X62X11A*	37X62X11SC
35X58X6ADL*	35X58X6TC	35X70X12C	35X70X10SA	36X52X8ADL	36X52X7TC	37X62X12A	37X62X11SC
35X58X8ADL*	35X58X8TC	35X70X8ADL*	35X70X8TC	36X52X9ADL*	36X52X9TC	37X62X8V	37X62X8VSC
35X58X8ADL	35X58X6TC	35X72X10A*	35X72X10SC	36X52X9ADL	36X52X7TC	37X62X9ADL	37X62X7TC
35X58X8ADL	35X58X7TC	35X72X10A	35X72X7SC	36X53X9ADL*	36X53X9TC	37X62X9ADL	37X62X8TC
35X60X10A*	35X60X10SC	35X72X10ADL*	35X72X10TC	36X54X10ADL*	36X54X10TC	37X62X9C*	37X62X9SA
35X60X10ADL*	35X60X10TC	35X72X10ADL	35X72X7TC	36X54X10ADL	36X54X7TC	37X64X13ADL*	37X64X13TC
35X60X10ADL	35X60X7TC	35X72X10ADL	35X72X8TC	36X54X10ADL	36X54X7.5TC	37X80X13C*	37X80X13SA
35X60X10V	35X60X10VSF	35X72X10V	35X72X10VTCW	36X54X11ADL*	36X54X11TC	38.5X58X11ADL	38.5X58X9TC
35X60X10V	35X60X10VTC	35X72X10V	35X72X10VTF	36X54X11ADL	36X54X7TC	38.5X58X9ADL*	38.5X58X9TC
35X60X11ADL	35X60X7TC	35X72X12A	35X72X7SC	36X54X11ADL	36X54X7.5TC	380X420X18C*	380X420X18SA
35X60X11ADL	35X60X10TC	35X72X12A	35X72X10SC	36X54X11ADL	36X54X10TC	380X420X20A*	380X420X20SC
35X60X12A	35X60X10SC	35X72X12ADL*	35X72X12TC	36X54X6.5A*	36X54X6.5SC	380X420X20ADL*	380X420X20TC
35X60X12ADL*	35X60X12TC	35X72X12ADL	35X72X7TC	36X54X7.5A*	36X54X7.5SC	380X420X20C*	380X420X20SA



Harwal Part #	TCM Part #	Harwal Part #	TCM Part #	Harwal Part #	TCM Part #	Harwal Part #	TCM Part #
380X420X20C	380X420X185A	38X55X8ADL*	38X55X8TC	38X72X10V	38X72X10VTF	40X52X7V	40X52X7VSB
380X420X20V	380X420X20VTC	38X55X8ADL	38X55X6TC	38X72X12A*	38X72X125C	40X52X7V	40X52X7V5VCW
38X50X10A	38X50X75C	38X55X8ADL	38X55X7TC	38X72X12A	38X72X105C	40X52X7V	40X52X7VTF
38X50X10ADL*	38X50X11TC	38X55X9ADL*	38X55X9TC	38X72X8ADL*	38X72X8TC	40X52X7V	40X52X7VTGR
38X50X10ADL	38X50X6TC	38X55X9ADL	38X55X6TC	38X74X11ADL*	38X74X11TC	40X52X8A	40X52X75C
38X50X10ADL	38X50X7TC	38X55X9ADL	38X55X7TC	38X74X11ADL	38X74X8TC	40X52X8ADL*	40X52X8TC
38X50X10ADL	38X50X8TC	38X55X9ADL	38X55X8TC	39.5X60X10BDL*	39.5X60X10TB	40X52X8ADL	40X52X5TC
38X50X11ADL	38X50X6TC	38X56X10A*	38X56X105C	390X430X18C*	390X430X185A	40X52X8ADL	40X52X6TC
38X50X11ADL	38X50X7TC	38X56X10V	38X56X10V5F	390X430X18V	390X430X18VTC	40X52X8ADL	40X52X7TC
38X50X11ADL	38X50X8TC	38X56X12A*	38X56X125C	394X420X16A*	394X420X165C	40X52X9A	40X52X75C
38X50X11ADL	38X50X11TC	38X56X12A	38X56X105C	39X51X7.5A*	39X51X7.55C	40X52X9ADL*	40X52X9TC
38X50X7A*	38X50X75C	38X57X10ADL	38X57X7TC	39X52X10ADL	39X52X7TC	40X52X9ADL	40X52X5TC
38X50X7ADL*	38X50X7TC	38X58X10A*	38X58X105C	39X52X8A*	39X52X85C	40X52X9ADL	40X52X6TC
38X50X7ADL	38X50X6TC	38X58X10ADL*	38X58X10TC	39X55.9X9A*	39X55.9X95C	40X52X9ADL	40X52X7TC
38X50X7V	38X50X7V5C	38X58X10ADL	38X58X7TC	39X65X8ADL*	39X65X8TC	40X52X9ADL	40X52X8TC
38X50X7V	38X50X7VTCW	38X58X10ADL	38X58X8TC	39X65X9A*	39X65X95C	40X53X8ADL*	40X53X8TC
38X50X8ADL*	38X50X8TC	38X58X11A	38X58X105C	400X440X18C*	400X440X185A	40X54X5.5BDL*	40X54X5.5TB
38X50X8ADL	38X50X6TC	38X58X11ADL*	38X58X11TC	400X440X20A*	400X440X205C	40X54X7ADL*	40X54X7TC
38X50X8ADL	38X50X7TC	38X58X11ADL	38X58X7TC	400X440X20C	400X440X185A	40X54X7AO	40X54X5VC
38X51X7ADL*	38X51X7TC	38X58X11ADL	38X58X8TC	400X450X20C*	400X450X205A	40X54X9ADL	40X54X7TC
38X51X7ADL	38X51X6.3TC	38X58X11ADL	38X58X10TC	40X47X4V	40X47X4VTF	40X55X10A*	40X55X105C
38X51X8ADL	38X51X6.3TC	38X58X12ADL*	38X58X12TC	40X48X4V	40X48X4VVC	40X55X10A	40X55X6.55C
38X51X8ADL	38X51X7TC	38X58X12ADL	38X58X7TC	40X50X10A	40X50X75C	40X55X10A	40X55X75C
38X52X10A	38X52X75C	38X58X12ADL	38X58X8TC	40X50X10ADL	40X50X4TC	40X55X10A	40X55X85C
38X52X10A	38X52X85C	38X58X12ADL	38X58X10TC	40X50X10ADL	40X50X5TC	40X55X10ADL	40X55X7TC
38X52X10ADL*	38X52X10TC	38X58X12ADL	38X58X11TC	40X50X10ADL	40X50X6.5TC	40X55X10ADL	40X55X8TC
38X52X10ADL	38X52X6TC	38X58X5AO*	38X58X5VC	40X50X10ADL	40X50X7TC	40X55X5AO*	40X55X5VC
38X52X10ADL	38X52X7TC	38X58X7ADL*	38X58X7TC	40X50X10ADL	40X50X8TC	40X55X6.5A*	40X55X6.55C
38X52X10ADL	38X52X8TC	38X59X9ADL	38X59X8TC	40X50X4ADL*	40X50X4TC	40X55X7A*	40X55X75C
38X52X10ADL	149203TC	38X60.5X10ADL*	38X60.5X10TC	40X50X5ADL*	40X50X5TC	40X55X7A	40X55X6.55C
38X52X10B*	38X52X105B	38X60X10ADL*	38X60X10TC	40X50X5ADL	40X50X4TC	40X55X7ADL*	40X55X7TC
38X52X6ADL*	38X52X6TC	38X60X10ADL	38X60X8TC	40X50X6.5ADL*	40X50X6.5TC	40X55X7V	40X55X7VTC
38X52X7A*	38X52X75C	38X60X10V	38X60X10VTC	40X50X6.5ADL	40X50X4TC	40X55X7V	40X55X7VTF
38X52X7ADL*	38X52X7TC	38X60X12ADL	38X60X8TC	40X50X6.5ADL	40X50X5TC	40X55X8A*	40X55X85C
38X52X7ADL	38X52X6TC	38X60X12ADL	38X60X10TC	40X50X7A*	40X50X75C	40X55X8A	40X55X6.55C
38X52X7V	38X52X7VTF	38X60X7V	38X60X7VTF	40X50X7ADL*	40X50X7TC	40X55X8A	40X55X75C
38X52X8A*	38X52X85C	38X60X8ADL*	38X60X8TC	40X50X7ADL	40X50X4TC	40X55X8ADL*	40X55X8TC
38X52X8A	38X52X75C	38X62X10A	38X62X75C	40X50X7ADL	40X50X5TC	40X55X8ADL	40X55X7TC
38X52X8ADL*	38X52X8TC	38X62X10A	38X62X85C	40X50X7ADL	40X50X6.5TC	40X55X8V	40X55X8VSB
38X52X8ADL	38X52X6TC	38X62X10ADL*	38X62X10TC	40X50X7V	40X50X7VTC	40X55X8V	40X55X8VTF
38X52X8ADL	38X52X7TC	38X62X10ADL	38X62X7TC	40X50X7V	40X50X7VTF	40X56X10A	40X56X75C
38X52X9ADL	38X52X6TC	38X62X10BDL	38X62X7TB	40X50X8A	40X50X75C	40X56X10ADL*	40X56X10TC
38X52X9ADL	38X52X7TC	38X62X12A	38X62X75C	40X50X8ADL*	40X50X8TC	40X56X10ADL	40X56X6TC
38X52X9ADL	38X52X8TC	38X62X12A	38X62X85C	40X50X8ADL	40X50X4TC	40X56X10ADL	40X56X7TC
38X52X9ADL	149203TC	38X62X12ADL	38X62X7TC	40X50X8ADL	40X50X5TC	40X56X10V	40X56X10VTC
38X53X7ADL*	38X53X7TC	38X62X12ADL	38X62X10TC	40X50X8ADL	40X50X6.5TC	40X56X12A*	40X56X125C
38X54X10A*	38X54X105C	38X62X12B	38X62X85B	40X50X8ADL	40X50X7TC	40X56X12A	40X56X75C
38X54X10ADL*	38X54X10TC	38X62X7A*	38X62X75C	40X50X8V	40X50X8V5F	40X56X6ADL*	40X56X6TC
38X54X10V	38X54X10VTC	38X62X7ADL*	38X62X7TC	40X51X5.5A*	40X51X5.55C	40X56X7A*	40X56X75C
38X54X6.5V	38X54X6.5V5C	38X62X7V	38X62X7VTCN1	40X52X10A	40X52X75C	40X56X7ADL*	40X56X7TC
38X55X10A*	38X55X105C	38X62X7V	38X62X7VTF	40X52X10ADL	40X52X5TC	40X56X7ADL	40X56X6TC
38X55X10A	38X55X75C	38X62X8A*	38X62X85C	40X52X10ADL	40X52X6TC	40X56X8A	40X56X75C
38X55X10A	38X55X85C	38X62X8A	38X62X75C	40X52X10ADL	40X52X7TC	40X56X8ADL	40X56X6TC
38X55X10ADL	38X55X6TC	38X62X8ADL	38X62X7TC	40X52X10ADL	40X52X8TC	40X56X8ADL	40X56X7TC
38X55X10ADL	38X55X7TC	38X64X12A*	38X64X125C	40X52X10ADL	40X52X9TC	40X56X8V	40X56X8V5F
38X55X10ADL	38X55X8TC	38X65X10A*	38X65X105C	40X52X5ADL*	40X52X5TC	40X56X9A	40X56X75C
38X55X10ADL	38X55X9TC	38X65X10A	38X65X95C	40X52X5AO*	40X52X5VC	40X57X10ADL*	40X57X10TC
38X55X6ADL*	38X55X6TC	38X65X8V	38X65X8VTC	40X52X6V	40X52X6VTCAL	40X58X10A*	40X58X105C
38X55X7A*	38X55X75C	38X70X10C*	38X70X105A	40X52X7A*	40X52X75C	40X58X10A	40X58X85C
38X55X7ADL*	38X55X7TC	38X70X8ADL*	38X70X8TC	40X52X7ADL*	40X52X7TC	40X58X10ADL*	40X58X10TC
38X55X7ADL	38X55X6TC	38X72X10A*	38X72X105C	40X52X7ADL	40X52X5TC	40X58X10ADL	40X58X6TC
38X55X7V	38X55X7VTC	38X72X10ADL	38X72X8TC	40X52X7ADL	40X52X6TC	40X58X10ADL	40X58X8TC

HARWAL CROSS REFERENCES – SHAFT SEALS

PLEASE CALL DICHTOMATIK FOR AVAILABILITY - 800-328-2840
 BULK AND INDIVIDUALLY BOXED QUANTITIES ARE AVAILABLE FOR ALL ITEMS
 * = EXACT INTERCHANGE - ALL OTHERS ARE FUNCTIONALLY



DICHTOMATIK

Any seal. Any time.

HARWAL INTERCHANGES

Harwal Part #	TCM Part #	Harwal Part #	TCM Part #	Harwal Part #	TCM Part #	Harwal Part #	TCM Part #
40X58X12A*	40X58X12SC	40X62X14ADL	40X62X12TC	40X70X10ADL	40X70X8TC	40X90X12B*	40X90X12SB
40X58X12A	40X58X8SC	40X62X5AO*	40X62X5VC	40X70X10V	40X70X10VSF	40X90X12V	40X90X12VTF
40X58X12A	40X58X10SC	40X62X6V	40X62X6VTF	40X70X10V	40X70X10VTF	40X90X13C*	40X90X13SA
40X58X7ADL	40X58X6TC	40X62X7A*	40X62X7SC	40X70X12A*	40X70X12SC	41.28X90X10ADL*	41.27X90X10TC
40X58X8.5ADL	40X58X6TC	40X62X7ADL*	40X62X7TC	40X70X12A	40X70X8SC	410X460X15C*	410X460X15SA
40X58X8.5ADL	40X58X8TC	40X62X7V	40X62X7VTF	40X70X12ADL	40X70X8TC	410X460X22C	410X460X15SA
40X58X8A*	40X58X8SC	40X62X8A*	40X62X8SC	40X70X12ADL	40X70X10TC	41X53X7BDL	41X53X7TB-H
40X58X8ADL*	40X58X8TC	40X62X8A	40X62X7SC	40X70X12C*	40X70X12SA	41X53X8ADL*	41X53X8TC
40X58X8ADL	40X58X6TC	40X62X8ADL*	40X62X8TC	40X70X8A*	40X70X8SC	41X53X8ADL	41X53X7TC
40X58X8V	40X58X8VSF	40X62X8ADL	40X62X7TC	40X70X8ADL*	40X70X8TC	41X55.7X9ADL*	41X55.7X9TC
40X58X8V	40X58X8VTF	40X62X8V	40X62X8VTF	40X72X10ADL*	40X72X10TC	41X55X6BDL*	41X55X6TB
40X58X9A	40X58X8SC	40X62X9ADL*	40X62X9TC	40X72X10ADL	40X72X7TC	41X55X7ADL*	41X55X7TC
40X60X10A*	40X60X10SC	40X62X9ADL	40X62X7TC	40X72X11ADL	40X72X7TC	41X56X10A	161222SC
40X60X10A	40X60X7SC	40X62X9ADL	40X62X8TC	40X72X11ADL	40X72X10TC	41X56X10A	41X56X7SC
40X60X10A	40X60X8SC	40X63X10A*	40X63X10SC	40X72X12ADL	40X72X7TC	41X56X7A*	41X56X7SC
40X60X10ADL*	40X60X10TC	40X63X7ADL*	40X63X7TC	40X72X12ADL	40X72X10TC	41X56X7A	161222SC
40X60X10ADL	40X60X7TC	40X64X12ADL*	40X64X12TC	40X72X7ADL*	40X72X7TC	41X56X8A	161222SC
40X60X10ADL	40X60X8TC	40X64X13ADL	40X64X12TC	40X72X7V	40X72X7VSCW	41X56X8A	41X56X7SC
40X60X10V	40X60X10VTF	40X65.4X10ADL*	40X65.4X10TC	40X72X7V	40X72X7VSG	41X62X8ADL*	41X62X8TC
40X60X12A	40X60X7SC	40X65X10A*	40X65X10SC	40X72X7V	40X72X7VTF	41X64X10ADL*	41X64X10TC
40X60X12A	40X60X8SC	40X65X10A	40X65X9SC	40X72X7V	40X72X7VTGW	420X460X15C*	420X460X15SA
40X60X12A	40X60X10SC	40X65X10ADL*	40X65X10TC	40X75X10ADL*	40X75X10TC	420X460X20A*	420X460X20SC
40X60X12ADL	40X60X7TC	40X65X10ADL	40X65X8TC	40X75X10ADL	40X75X8TC	420X460X20C*	420X460X20SA
40X60X12ADL	40X60X8TC	40X65X10V	40X65X10VTC	40X75X12ADL*	40X75X12TC	420X460X20C	420X460X15SA
40X60X12ADL	40X60X10TC	40X65X12A	40X65X9SC	40X75X12ADL	40X75X8TC	420X460X20V	420X460X20VSF
40X60X7A*	40X60X7SC	40X65X12A	40X65X10SC	40X75X12ADL	40X75X10TC	420X470X20V	420X470X20VTC
40X60X7ADL*	40X60X7TC	40X65X12ADL*	40X65X12TC	40X75X8ADL*	40X75X8TC	42X50X7A*	42X50X7SC
40X60X8A*	40X60X8SC	40X65X12ADL	40X65X8TC	40X78X10A*	40X78X10SC	42X51X7ADL*	42X51X7TC
40X60X8A	40X60X7SC	40X65X12ADL	40X65X10TC	40X80X10A*	40X80X10SC	42X52X10ADL*	42X52X10TC
40X60X8ADL*	40X60X8TC	40X65X12V	40X65X12VTF	40X80X10A	40X80X8SC	42X52X10ADL	42X52X4TC
40X60X8ADL	40X60X7TC	40X65X9A*	40X65X9SC	40X80X10ADL*	40X80X10TC	42X52X10ADL	42X52X8TC
40X60X8V	40X60X8VTF	40X65X9ADL	40X65X8TC	40X80X10ADL	40X80X7TC	42X52X4ADL*	42X52X4TC
40X62X10A*	40X62X10SC	40X66X9ADL*	40X66X9TC	40X80X10ADL	40X80X8TC	42X52X4V	42X52X4VVM
40X62X10A	40X62X7SC	40X67X10ADL	40X67X8TC	40X80X10V	40X80X10VSF	42X52X8ADL*	42X52X8TC
40X62X10A	40X62X8SC	40X67X8ADL*	40X67X8TC	40X80X10V	40X80X10VTC	42X52X8ADL	42X52X4TC
40X62X10ADL*	40X62X10TC	40X68X10A*	40X68X10SC	40X80X12ADL*	40X80X12TC	42X52X8V	42X52X8VSF
40X62X10ADL	40X62X7TC	40X68X10A	40X68X6SC	40X80X12ADL	40X80X7TC	42X53X8ADL	42X53X7TC
40X62X10ADL	40X62X8TC	40X68X10ADL*	40X68X10TC	40X80X12ADL	40X80X8TC	42X54X5ADL*	42X54X5TC
40X62X10ADL	40X62X9TC	40X68X10ADL	40X68X5TC	40X80X12ADL	40X80X10TC	42X55X10A*	42X55X10SC
40X62X11.5A	40X62X7SC	40X68X10ADL	40X68X6TC	40X80X13A*	40X80X13SC	42X55X10A	42X55X7SC
40X62X11.5A	40X62X8SC	40X68X10ADL	40X68X7TC	40X80X13A	40X80X8SC	42X55X10ADL	42X55X6TC
40X62X11.5A	40X62X10SC	40X68X10V	40X68X10VTC	40X80X13A	40X80X10SC	42X55X10ADL	42X55X7TC
40X62X11ADL*	40X62X11TC	40X68X12A*	40X68X12SC	40X80X13ADL	40X80X7TC	42X55X10ADL	42X55X8TC
40X62X11ADL	40X62X7TC	40X68X12A	40X68X6SC	40X80X13ADL	40X80X8TC	42X55X10ADL	42X55X9TC
40X62X11ADL	40X62X8TC	40X68X12A	40X68X10SC	40X80X13ADL	40X80X10TC	42X55X6ADL*	42X55X6TC
40X62X11ADL	40X62X9TC	40X68X12ADL	40X68X5TC	40X80X13ADL	40X80X12TC	42X55X6V	42X55X6VTC
40X62X11ADL	40X62X10TC	40X68X12ADL	40X68X6TC	40X80X7ADL*	40X80X7TC	42X55X6V	42X55X6VTF
40X62X12A*	40X62X12SC	40X68X12ADL	40X68X7TC	40X80X8A*	40X80X8SC	42X55X7A*	42X55X7SC
40X62X12A	40X62X7SC	40X68X12ADL	40X68X10TC	40X80X8ADL*	40X80X8TC	42X55X7ADL*	42X55X7TC
40X62X12A	40X62X8SC	40X68X5ADL*	40X68X5TC	40X80X8ADL	40X80X7TC	42X55X7ADL	42X55X6TC
40X62X12A	40X62X10SC	40X68X6A*	40X68X6SC	40X85X10A*	40X85X10SC	42X55X7V	42X55X7VTF
40X62X12ADL*	40X62X12TC	40X68X6V	40X68X6VTF	40X85X10V	40X85X10VSC	42X55X8A	42X55X7SC
40X62X12ADL	40X62X7TC	40X68X7A	40X68X6SC	40X88X6A*	40X88X6SC	42X55X8ADL*	42X55X8TC
40X62X12ADL	40X62X8TC	40X68X7ADL*	40X68X7TC	40X90X10A*	40X90X10SC	42X55X8ADL	42X55X6TC
40X62X12ADL	40X62X9TC	40X68X7ADL	40X68X5TC	40X90X10ADL*	40X90X10TC	42X55X8ADL	42X55X7TC
40X62X12ADL	40X62X10TC	40X68X7ADL	40X68X6TC	40X90X10ADL	40X90X7TC	42X55X8V	42X55X8VTFBW2
40X62X12ADL	40X62X11TC	40X68X8A	40X68X6SC	40X90X10ADL	40X90X8TC	42X55X9ADL*	42X55X9TC
40X62X14ADL	40X62X7TC	40X68X8ADL	40X68X5TC	40X90X10ADL	40X90X9TC	42X55X9ADL	42X55X6TC
40X62X14ADL	40X62X8TC	40X68X8ADL	40X68X6TC	40X90X12ADL	40X90X7TC	42X55X9ADL	42X55X7TC
40X62X14ADL	40X62X9TC	40X68X8ADL	40X68X7TC	40X90X12ADL	40X90X8TC	42X55X9ADL	42X55X8TC
40X62X14ADL	40X62X10TC	40X70X10A	40X70X8SC	40X90X12ADL	40X90X9TC	42X56X10ADL*	42X56X10TC
40X62X14ADL	40X62X11TC	40X70X10ADL*	40X70X10TC	40X90X12ADL	40X90X10TC	42X56X10ADL	42X56X7TC



PLEASE CALL DICHTOMATIK FOR AVAILABILITY - 800-328-2840
BULK AND INDIVIDUALLY BOXED QUANTITIES ARE AVAILABLE FOR ALL ITEMS
* = EXACT INTERCHANGE - ALL OTHERS ARE FUNCTIONALLY

Harwal Part #	TCM Part #	Harwal Part #	TCM Part #	Harwal Part #	TCM Part #	Harwal Part #	TCM Part #
42X56X7A*	42X56X7SC	42X65X12ADL*	42X65X12TC	43X62X12ADL	43X62X8TC	45X56X7ADL*	45X56X7TC
42X56X7ADL*	42X56X7TC	42X65X12ADL	42X65X8TC	43X62X8ADL*	43X62X8TC	45X57X10ADL	45X57X5.5TC
42X56X7V	42X56X7VSC	42X65X12ADL	42X65X9TC	43X65X13A	43X65X8SC	45X57X10ADL	45X57X7TC
42X56X7V	42X56X7VTF	42X65X12ADL	42X65X10TC	43X66X10A*	43X66X10SC	45X57X5.5ADL*	45X57X5.5TC
42X56X8B*	42X56X8SB	42X65X8A*	42X65X8SC	43X75X10A*	43X75X10SC	45X57X7.5ADL	45X57X5.5TC
42X57X7A*	42X57X7SC	42X65X8ADL*	42X65X8TC	44.5X54X7ADL*	44.5X54X7TC	45X57X7.5ADL	45X57X7TC
42X58X9B*	42X58X9SB	42X65X8V	42X65X8VTF	440X470X20C*	440X470X20SA	45X58X7ADL*	45X58X7TC
42X59.5X10ADL*	42X59.5X10TC	42X65X9ADL*	42X65X9TC	440X480X20ADL*	440X480X20TC	45X58X7ADL	45X58X6TC
42X60X10A*	42X60X10SC	42X65X9ADL	42X65X8TC	440X480X20C*	440X480X20SA	45X58X7V	45X58X7VTC
42X60X10A	42X60X8SC	42X66X8ADL*	42X66X8TC	440X480X20V	440X480X20VTF	45X58X8ADL	45X58X6TC
42X60X10ADL*	42X60X10TC	42X67X10ADL*	42X67X10TC	44X52X10ADL*	44X52X10TC	45X58X8ADL	45X58X7TC
42X60X10ADL	42X60X7TC	42X68X10ADL*	42X68X10TC	44X54X4.5A*	44X54X4.5SC	45X60X10A*	45X60X10SC
42X60X10ADL	42X60X8TC	42X68X8V	42X68X8VTC	44X54X7.5ADL	44X54X4.5TC	45X60X10A	45X60X7SC
42X60X10ADL	42X60X9TC	42X70X10A*	42X70X10SC	44X54X7.5ADL	44X54X7TC	45X60X10A	45X60X8SC
42X60X10V	42X60X10VSC	42X70X10A	42X70X8SC	44X54X9ADL	44X54X4.5TC	45X60X10ADL*	45X60X10TC
42X60X10V	42X60X10VTC	42X70X12A	42X70X8SC	44X54X9ADL	44X54X7TC	45X60X10ADL	45X60X7TC
42X60X12A	42X60X8SC	42X70X12A	42X70X10SC	44X55X7A*	44X55X7SC	45X60X10ADL	45X60X8TC
42X60X12A	42X60X10SC	42X70X12ADL*	42X70X12TC	44X58X7B*	44X58X7SB	45X60X10ADL	45X60X9TC
42X60X12ADL	42X60X7TC	42X70X12ADL	42X70X8TC	44X60X12ADL	44X60X7TC	45X60X12A	45X60X7SC
42X60X12ADL	42X60X8TC	42X70X12ADL	42X70X9TC	44X60X12ADL	44X60X9TC	45X60X12A	45X60X8SC
42X60X12ADL	42X60X9TC	42X72.5X10ADL*	42X72.5X10TC	44X60X12ADL	44X60X10TC	45X60X12A	45X60X10SC
42X60X12ADL	42X60X10TC	42X72X10A	42X72X8SC	44X60X7ADL*	44X60X7TC	45X60X7A*	45X60X7SC
42X60X7ADL*	42X60X7TC	42X72X10ADL*	42X72X10TC	44X60X9ADL*	44X60X9TC	45X60X7ADL*	45X60X7TC
42X60X8A*	42X60X8SC	42X72X10ADL	42X72X6TC	44X60X9ADL	44X60X7TC	45X60X7V	45X60X7V5B
42X60X8ADL*	42X60X8TC	42X72X10ADL	42X72X8TC	44X62X10A*	44X62X10SC	45X60X7V	45X60X7V5C
42X60X8ADL	42X60X7TC	42X72X12A	42X72X8SC	44X62X10ADL*	44X62X10TC	45X60X7V	45X60X7V5F
42X60X8V	42X60X8V5B	42X72X12ADL	42X72X6TC	44X62X10ADL	44X62X8TC	45X60X8A*	45X60X8SC
42X60X8V	42X60X8VTF	42X72X12ADL	42X72X8TC	44X62X11.5ADL	44X62X8TC	45X60X8A	45X60X7SC
42X60X9ADL*	42X60X9TC	42X72X12ADL	42X72X10TC	44X62X11.5ADL	44X62X10TC	45X60X8ADL*	45X60X8TC
42X60X9ADL	42X60X7TC	42X72X6ADL*	42X72X6TC	44X62X8ADL*	44X62X8TC	45X60X8ADL	45X60X7TC
42X60X9ADL	42X60X8TC	42X72X7ADL	42X72X6TC	44X62X9ADL	44X62X8TC	45X60X8V	45X60X8V5C
42X62X10A*	42X62X10SC	42X72X8A*	42X72X8SC	44X64X10ADL*	44X64X10TC	45X60X8V	45X60X8VTF
42X62X10A	42X62X7SC	42X72X8ADL*	42X72X8TC	44X64X10ADL	44X64X9TC	45X60X9ADL*	45X60X9TC
42X62X10A	42X62X8SC	42X72X8ADL	42X72X6TC	44X64X9ADL*	44X64X9TC	45X60X9ADL	45X60X7TC
42X62X10ADL*	42X62X10TC	42X72X8V	42X72X8VTF	44X65X10A*	44X65X10SC	45X60X9ADL	45X60X8TC
42X62X10ADL	42X62X7TC	42X72X9ADL	42X72X6TC	44X65X10ADL*	44X65X10TC	45X61X10ADL	45X61X9TC
42X62X10ADL	42X62X8TC	42X72X9ADL	42X72X8TC	44X65X10ADL	44X65X8TC	45X61X9ADL*	45X61X9TC
42X62X10V	42X62X10VTF	42X75X10ADL*	42X75X10TC	44X65X10V	44X65X10VTC	45X62X10A*	45X62X10SC
42X62X12A	42X62X7SC	42X75X12ADL*	42X75X12TC	44X65X11ADL*	44X65X11TC	45X62X10A	45X62X7SC
42X62X12A	42X62X8SC	42X75X12ADL	42X75X10TC	44X65X11ADL	44X65X8TC	45X62X10A	45X62X8SC
42X62X12A	42X62X10SC	42X76X12ADL*	42X76X12TC	44X65X11ADL	44X65X10TC	45X62X10A	45X62X9SC
42X62X7A*	42X62X7SC	42X78X10ADL*	42X78X10TC	44X65X8ADL*	44X65X8TC	45X62X10ADL*	45X62X10TC
42X62X7ADL*	42X62X7TC	42X80X10A*	42X80X10SC	44X70X12C*	44X70X12SA	45X62X10ADL	45X62X7TC
42X62X7BDL*	42X62X7TB	42X80X10V	42X80X10V5F	44X72X12C*	44X72X12SA	45X62X10ADL	45X62X8TC
42X62X7V	42X62X7V5C	42X80X10V	42X80X10VTF	44X72X9ADL*	44X72X9TC	45X62X10ADL	45X62X9TC
42X62X7V	42X62X7VTF	42X80X9ADL*	42X80X9TC	44X72X9ADL	44X72X8TC	45X62X10V	45X62X10V5F
42X62X7V	42X62X7VTGR	430X480X25BDL*	430X480X25TB	450X500X22A*	450X500X22SC	45X62X11ADL	45X62X7TC
42X62X8A*	42X62X8TC	430X480X25V	430X480X25VTC	45X100X10ADL*	45X100X10TC	45X62X11ADL	45X62X8TC
42X62X8A	42X62X7SC	43X54X9ADL	43X54X7.5TC	45X100X10V	45X100X10VTCW	45X62X11ADL	45X62X9TC
42X62X8ADL*	42X62X8TC	43X55X9ADL	43X55X7TC	45X100X10V	45X100X10VTF	45X62X11ADL	45X62X10TC
42X62X8ADL	42X62X7TC	43X55X9ADL	43X55X8TC	45X52X8ADL	45X52X4TC	45X62X12A	45X62X7SC
42X62X8V	42X62X8VDC	43X58X7ADL*	43X58X7TC	45X55X10A	45X55X7SC	45X62X12A	45X62X8SC
42X64X7A*	42X64X7SC	43X58X8ADL*	43X58X8TC	45X55X10A	45X55X8SC	45X62X12A	45X62X9SC
42X64X8ADL*	42X64X8TC	43X58X8ADL	43X58X7TC	45X55X4AO*	45X55X4VC	45X62X12A	45X62X10SC
42X64X8ADL	42X64X7TC	43X60X10A*	43X60X10SC	45X55X4V	45X55X4VVG	45X62X12ADL*	45X62X12TC
42X65X10A*	42X65X10SC	43X60X10ADL*	43X60X10TC	45X55X7A*	45X55X7SC	45X62X12ADL	45X62X7TC
42X65X10A	42X65X8SC	43X60X10V	43X60X10V5C	45X55X7ADL*	45X55X7TC	45X62X12ADL	45X62X8TC
42X65X10ADL*	42X65X10TC	43X60X10V	43X60X10V5F	45X55X7B*	45X55X7SB	45X62X12ADL	45X62X9TC
42X65X10ADL	42X65X8TC	43X62X10A*	43X62X10SC	45X55X7V	45X55X7V5F	45X62X12ADL	45X62X10TC
42X65X10ADL	42X65X9TC	43X62X10C*	43X62X10SA	45X55X7V	45X55X7VTC	45X62X7A*	45X62X7SC
42X65X12A	42X65X8SC	43X62X10V	43X62X10V5F	45X55X8A*	45X55X8SC	45X62X7ADL*	45X62X7TC
42X65X12A	42X65X10SC	43X62X12ADL*	43X62X12TC	45X55X8A	45X55X7SC	45X62X7V	45X62X7VTC

HARWAL CROSS REFERENCES – SHAFT SEALS

PLEASE CALL DICHTOMATIK FOR AVAILABILITY - 800-328-2840
 BULK AND INDIVIDUALLY BOXED QUANTITIES ARE AVAILABLE FOR ALL ITEMS
 * = EXACT INTERCHANGE - ALL OTHERS ARE FUNCTIONALLY



DICHTOMATIK

Any seal. Any time.

HARWAL INTERCHANGES

Harwal Part #	TCM Part #	Harwal Part #	TCM Part #	Harwal Part #	TCM Part #	Harwal Part #	TCM Part #
45X62X7V	45X62X7VTF	45X68X8ADL	45X68X7TC	45X78X10BDL*	45X78X10TB	48X60X9BDL*	48X60X9TB
45X62X8A*	45X62X8SC	45X68X9ADL*	45X68X9TC	45X80X10ADL*	45X80X10TC	48X62X10A	48X62X8SC
45X62X8A	45X62X7SC	45X68X9ADL	45X68X7TC	45X80X10ADL	45X80X8TC	48X62X10ADL*	48X62X10TC
45X62X8ADL*	45X62X8TC	45X68X9ADL	45X68X8TC	45X80X10V	45X80X10VTF	48X62X10ADL	48X62X7TC
45X62X8ADL	45X62X7TC	45X69X10ADL*	45X69X10TC	45X80X13ADL*	45X80X13TC	48X62X10ADL	48X62X8TC
45X62X9A*	45X62X9SC	45X70X10A*	45X70X10SC	45X80X13ADL	45X80X8TC	48X62X12A*	48X62X12SC
45X62X9A	45X62X7SC	45X70X10ADL*	45X70X10TC	45X80X13ADL	45X80X10TC	48X62X12A	48X62X8SC
45X62X9A	45X62X8SC	45X70X10ADL	45X70X5TC	45X85X10A*	45X85X10SC	48X62X7ADL*	48X62X7TC
45X62X9ADL*	45X62X9TC	45X70X10ADL	45X70X8TC	45X85X10ADL*	45X85X10TC	48X62X8A*	48X62X8SC
45X62X9ADL	45X62X7TC	45X70X12A*	45X70X12SC	45X85X10ADL	45X85X8TC	48X62X8ADL*	48X62X8TC
45X62X9ADL	45X62X8TC	45X70X12A	45X70X10SC	45X85X10V	45X85X10VTC	48X62X8ADL	48X62X7TC
45X63.5X10ADL*	45X63.5X10TC	45X70X12ADL*	45X70X12TC	45X85X10V	45X85X10VTF	48X62X8V	48X62X8VSC
45X63X7ADL*	45X63X7TC	45X70X12ADL	45X70X5TC	45X85X13A*	45X85X13SC	48X62X8V	48X62X8VVF
45X64X9ADL*	45X64X9TC	45X70X12ADL	45X70X8TC	45X85X13A	45X85X10SC	48X62X8V	48X62X8VTF
45X65X10A*	45X65X10SC	45X70X12ADL	45X70X10TC	45X85X8ADL*	45X85X8TC	48X62X9ADL	48X62X7TC
45X65X10A	45X65X6SC	45X70X12V	45X70X12VTC	45X90X10A*	45X90X10SC	48X62X9ADL	48X62X8TC
45X65X10A	45X65X8SC	45X70X5ADL*	45X70X5TC	45X90X10ADL*	45X90X10TC	48X63.5X8ADL*	48X63.5X8TC
45X65X10ADL*	45X65X10TC	45X72X10A	45X72X8SC	45X90X10V	45X90X10VTC	48X65X10ADL*	48X65X10TC
45X65X10ADL	45X65X5TC	45X72X10ADL*	45X72X10TC	46.2X80X10A*	46.2X80X10SC	48X65X10ADL	48X65X7TC
45X65X10ADL	45X65X7TC	45X72X10ADL	45X72X7TC	460X500X20C*	460X500X20SA	48X65X10ADL	48X65X9TC
45X65X10ADL	45X65X8TC	45X72X10ADL	45X72X8TC	465X495X18V	465X495X18VTC	48X65X12B	48X65X10SB
45X65X10V	45X65X10VTF	45X72X11ADL	45X72X7TC	46X59X12ADL*	46X59X12TC	48X65X7ADL*	48X65X7TC
45X65X12A	45X65X6SC	45X72X11ADL	45X72X8TC	46X60X10ADL	46X60X7TC	48X65X8V	48X65X8VTF
45X65X12A	45X65X8SC	45X72X11ADL	45X72X10TC	46X60X7ADL*	46X60X7TC	48X65X9ADL*	48X65X9TC
45X65X12A	45X65X10SC	45X72X12A	45X72X8SC	46X62X8ADL*	46X62X8TC	48X65X9ADL	48X65X7TC
45X65X12ADL*	45X65X12TC	45X72X12ADL	45X72X7TC	46X62X9A*	46X62X9SC	48X67X10ADL*	48X67X10TC
45X65X12ADL	45X65X5TC	45X72X12ADL	45X72X8TC	46X64X9ADL*	46X64X9TC	48X67X10ADL	48X67X9TC
45X65X12ADL	45X65X7TC	45X72X12ADL	45X72X10TC	46X64X9ADL	46X64X8TC	48X67X9ADL*	48X67X9TC
45X65X12ADL	45X65X8TC	45X72X15ADL*	45X72X15TC	46X65X9ADL*	46X65X9TC	48X68X10ADL*	48X68X10TC
45X65X12ADL	45X65X10TC	45X72X15ADL	45X72X7TC	46X68X8ADL*	46X68X8TC	48X68X10ADL	48X68X8TC
45X65X5ADL*	45X65X5TC	45X72X15ADL	45X72X8TC	46X70X8ADL*	46X70X8TC	48X68X10V	48X68X10VTF
45X65X6A*	45X65X6SC	45X72X15ADL	45X72X10TC	46X72X10A*	46X72X10SC	48X68X11ADL	48X68X8TC
45X65X7ADL*	45X65X7TC	45X72X15ADL	45X72X12TC	46X78X10ADL*	46X78X10TC	48X68X11ADL	48X68X10TC
45X65X7ADL	45X65X5TC	45X72X8A*	45X72X8SC	470X520X22A*	470X520X22SC	48X68X14ADL*	48X68X14TC
45X65X8A*	45X65X8SC	45X72X8ADL*	45X72X8TC	475X530X18C*	475X530X18SA	48X68X14ADL	48X68X8TC
45X65X8A	45X65X6SC	45X72X8ADL	45X72X7TC	47X56X10A*	47X56X10SC	48X68X14ADL	48X68X10TC
45X65X8ADL*	45X65X8TC	45X72X8V	45X72X8VTCN	47X58X5ADL*	47X58X5TC	48X68X8ADL*	48X68X8TC
45X65X8ADL	45X65X5TC	45X72X8V	45X72X8VTF	47X58X7A*	47X58X7SC	48X68X8V	48X68X8VTF
45X65X8ADL	45X65X7TC	45X72X9A	45X72X8SC	47X62X6A*	47X62X6SC	48X69X10ADL	48X69X7TC
45X65X8V	45X65X8VTF	45X73X10ADL*	45X73X10TC	47X62X6V	47X62X6VVF	48X70X10A*	48X70X10SC
45X65X9ADL	45X65X5TC	45X75X10A*	45X75X10SC	47X62X8A*	47X62X8SC	48X70X12A	48X70X10SC
45X65X9ADL	45X65X7TC	45X75X10ADL*	45X75X10TC	47X62X8A	47X62X6SC	48X70X12ADL	48X70X7TC
45X65X9ADL	45X65X8TC	45X75X10ADL	45X75X6TC	47X62X9ADL	47X62X6TC	48X70X12ADL	48X70X9TC
45X66X10A	45X66X9SC	45X75X10ADL	45X75X7TC	47X62X9ADL	47X62X7TC	48X70X12ADL	48X70X10TC
45X66X6V	45X66X6VVF	45X75X10ADL	45X75X8TC	47X65X10A*	47X65X10SC	48X70X12ADL	48X70X11TC
45X66X9A*	45X66X9SC	45X75X10V	45X75X10VTC	47X65X10A	47X65X8SC	48X70X9ADL*	48X70X9TC
45X68X10A	45X68X8SC	45X75X12ADL*	45X75X12TC	47X65X8A*	47X65X8SC	48X70X9ADL	48X70X7TC
45X68X10ADL*	45X68X10TC	45X75X12ADL	45X75X6TC	47X66X6BDL*	47X66X6TB	48X72X10A	48X72X7SC
45X68X10ADL	45X68X7TC	45X75X12ADL	45X75X7TC	47X70X10ADL*	47X70X10TC	48X72X10A	48X72X8SC
45X68X10ADL	45X68X8TC	45X75X12ADL	45X75X8TC	47X72X12ADL	47X72X8TC	48X72X10ADL*	48X72X10TC
45X68X10ADL	45X68X9TC	45X75X12ADL	45X75X10TC	47X72X12ADL	47X72X10TC	48X72X10ADL	48X72X7TC
45X68X10V	45X68X10VTF	45X75X13ADL	45X75X6TC	47X72X8ADL*	47X72X8TC	48X72X10ADL	48X72X8TC
45X68X12A*	45X68X12SC	45X75X13ADL	45X75X7TC	47X72X9V	47X72X9VVF	48X72X12A	48X72X7SC
45X68X12A	45X68X8SC	45X75X13ADL	45X75X8TC	47X75X10V	47X75X10VTF	48X72X12A	48X72X8SC
45X68X12ADL*	45X68X12TC	45X75X13ADL	45X75X10TC	47X80X10V	47X80X10VTF	48X72X12ADL	48X72X7TC
45X68X12ADL	45X68X7TC	45X75X13ADL	45X75X12TC	480X520X20A*	480X520X20SC	48X72X12ADL	48X72X8TC
45X68X12ADL	45X68X8TC	45X75X7ADL*	45X75X7TC	480X520X20C*	480X520X20SA	48X72X12ADL	48X72X10TC
45X68X12ADL	45X68X9TC	45X75X7ADL	45X75X6TC	480X520X20V	480X520X20VTF	48X72X7A*	48X72X7SC
45X68X12ADL	45X68X10TC	45X75X8ADL*	45X75X8TC	48X54X4AO*	48X54X4VC	48X72X7ADL*	48X72X7TC
45X68X7ADL*	45X68X7TC	45X75X8ADL	45X75X6TC	48X58X4ADL*	48X58X4TC	48X72X8A*	48X72X8SC
45X68X8A*	45X68X8SC	45X75X8ADL	45X75X7TC	48X60X7ADL*	48X60X7TC	48X72X8A	48X72X7SC
45X68X8ADL*	45X68X8TC	45X75X8V	45X75X8VTF	48X60X8ADL	48X60X7TC	48X72X8ADL*	48X72X8TC



Harwal Part #	TCM Part #	Harwal Part #	TCM Part #	Harwal Part #	TCM Part #	Harwal Part #	TCM Part #
48X72X8ADL	48X72X7TC	50X65X10V	50X65X10VSF	50X70X13.5ADL	50X70X10TC	50X80X13A	50X80X10SC
48X72X8V	48X72X8VTF	50X65X10V	50X65X10VTC	50X70X13.5ADL	50X70X12TC	50X80X13ADL	50X80X8TC
48X72X9A	48X72X7SC	50X65X12A	50X65X7SC	50X70X7CDL*	50X70X7TA	50X80X13ADL	50X80X10TC
48X72X9A	48X72X8SC	50X65X12A	50X65X8SC	50X70X8A*	50X70X8SC	50X80X13ADL	50X80X12TC
48X73X12ADL	48X73X9TC	50X65X12A	50X65X10SC	50X70X8V	50X70X8VSB	50X80X8ADL*	50X80X8TC
48X74X10ADL*	48X74X10TC	50X65X7A*	50X65X7SC	50X70X8V	50X70X8VTF	50X80X8V	50X80X8VTF
48X75X10ADL*	48X75X10TC	50X65X7V	50X65X7VTF	50X70X9.5ADL	50X70X8TC	50X82X12ADL	50X82X8TC
48X75X10ADL	48X75X9TC	50X65X8A*	50X65X8SC	50X70X9.5ADL	50X70X9TC	50X85X10A*	50X85X10SC
48X75X9ADL*	48X75X9TC	50X65X8A	50X65X7SC	50X70X9A*	50X70X9SC	50X85X10A	50X85X8SC
48X76X13ADL*	48X76X13TC	50X65X8ADL*	50X65X8TC	50X70X9A	50X70X8SC	50X85X10ADL	50X85X8TC
48X76X13ADL	48X76X12TC	50X65X8ADL	50X65X6TC	50X70X9ADL*	50X70X9TC	50X85X13A*	50X85X13SC
48X79X9ADL*	48X79X9TC	50X65X8V	50X65X8VSB	50X70X9ADL	50X70X8TC	50X85X13A	50X85X8SC
48X80X10A	48X80X8SC	50X65X8V	50X65X8VTF	50X72X10A	50X72X8SC	50X85X13A	50X85X10SC
48X80X10ADL*	48X80X10TC	50X65X9ADL*	50X65X9TC	50X72X10ADL*	50X72X10TC	50X85X8A*	50X85X8SC
48X80X10ADL	48X80X8TC	50X65X9ADL	50X65X6TC	50X72X10ADL	50X72X5TC	50X90X10ADL*	50X90X10TC
48X80X10V	48X80X10VTC	50X65X9ADL	50X65X8TC	50X72X10ADL	50X72X7TC	50X90X10ADL	50X90X8TC
48X80X13A	48X80X8SC	50X66X10A*	50X66X10SC	50X72X10ADL	50X72X8TC	50X90X10V	50X90X10VTC
48X80X8A*	48X80X8SC	50X66X10A	50X66X8SC	50X72X10ADL	50X72X9TC	50X90X12C*	50X90X12SA
48X82X12BDL*	48X82X12TB	50X66X12A	50X66X8SC	50X72X12A	50X72X8SC	50X90X8ADL*	50X90X8TC
48X85X6V	48X85X6VVF	50X66X12A	50X66X10SC	50X72X12ADL*	50X72X12TC	50X95X10C*	50X95X10SA
48X90X10A*	48X90X10SC	50X66X8A*	50X66X8SC	50X72X12ADL	50X72X5TC	51X62X7ADL*	51X62X7TC
48X90X10V	48X90X10VSF	50X67X11ADL*	50X67X11TC	50X72X12ADL	50X72X7TC	51X70X11ADL	51X70X10TC
48X90X13ADL	48X90X9TC	50X67X9BDL*	50X67X9TB	50X72X12ADL	50X72X8TC	51X72X10A*	51X72X10SC
49X60X10ADL	49X60X7TC	50X68X10A	50X68X8SC	50X72X12ADL	50X72X9TC	52X100X10ADL*	52X100X10TC
49X62X6ADL*	49X62X6TC	50X68X10ADL	50X68X6TC	50X72X12ADL	50X72X10TC	52X62X7ADL*	52X62X7TC
49X65X10A*	49X65X10SC	50X68X10ADL	50X68X8TC	50X72X12V	50X72X12VTC	52X62X8ADL*	52X62X8TC
49X68X12A*	49X68X12SC	50X68X10ADL	50X68X9TC	50X72X5ADL*	50X72X5TC	52X62X8ADL	52X62X7TC
49X77X18ADL*	49X77X18TC	50X68X11A	50X68X8SC	50X72X6ADL	50X72X5TC	52X62X8V	52X62X8VVF
49X92X10ADL*	49X92X10TC	50X68X12A	50X68X8SC	50X72X7ADL*	50X72X7TC	52X63X6ADL*	52X63X6TC
4X11X6V	4X11X6VSC	50X68X14B	50X68X8SB	50X72X7ADL	50X72X5TC	52X63X8ADL*	52X63X8TC
4X12X6A*	4X12X6SC	50X68X14B	50X68X12SB	50X72X7V	50X72X7VDB	52X63X8ADL	52X63X6TC
4X12X6V	4X12X6VSF	50X68X6ADL*	50X68X6TC	50X72X8A*	50X72X8SC	52X65X10ADL*	52X65X10TC
4X16X7ADL*	4X16X7TC	50X68X6ADL	50X68X6TF	50X72X8ADL*	50X72X8TC	52X65X10ADL	52X65X9TC
500X550X22C*	500X550X22SA	50X68X7ADL	50X68X6TC	50X72X8ADL	50X72X5TC	52X65X8A*	52X65X8SC
50X100X10ADL*	50X100X10TC	50X68X7V	50X68X7VTC	50X72X8ADL	50X72X7TC	52X65X9ADL*	52X65X9TC
50X110X10ADL*	50X110X10TC	50X68X7V	50X68X7VTF	50X72X8V	50X72X8VSC	52X68X10A*	52X68X10SC
50X110X10V	50X110X10VTF	50X68X8A*	50X68X8SC	50X72X8V	50X72X8VTF	52X68X10A	52X68X8SC
50X110X12ADL	50X110X10TC	50X68X8ADL*	50X68X8TC	50X72X9ADL*	50X72X9TC	52X68X10ADL*	52X68X10TC
50X58X4V	50X58X4VVF	50X68X8ADL	50X68X6TC	50X72X9ADL	50X72X5TC	52X68X10ADL	52X68X8TC
50X60X7V	50X60X7VSC	50X68X8V	50X68X8VSC	50X72X9ADL	50X72X7TC	52X68X13.5B	52X68X8SB
50X60X8ADL*	50X60X8TC	50X68X8V	50X68X8VTCY	50X72X9ADL	50X72X8TC	52X68X13.5BDL	52X68X7TB
50X62X10A	50X62X7SC	50X68X8V	50X68X8VTF	50X74X12ADL*	50X74X12TC	52X68X13A	52X68X8SC
50X62X10ADL	50X62X7TC	50X68X9ADL*	50X68X9TC	50X75X10A*	50X75X10SC	52X68X13A	52X68X10SC
50X62X10BO	50X62X5VB	50X68X9ADL	50X68X6TC	50X75X10ADL*	50X75X10TC	52X68X8A*	52X68X8SC
50X62X7A*	50X62X7SC	50X68X9ADL	50X68X8TC	50X75X10V	50X75X10VSF	52X68X8ADL*	52X68X8TC
50X62X7ADL*	50X62X7TC	50X70X10A*	50X70X10SC	50X75X10V	50X75X10VTF	52X68X8V	52X68X8VSC
50X62X7B	50X62X5SB	50X70X10A	50X70X8SC	50X75X12A	50X75X10SC	52X68X8V	52X68X8VVF
50X62X7BO	50X62X5VB	50X70X10A	50X70X9SC	50X75X12ADL*	50X75X12TC	52X68X9ADL	52X68X8TC
50X62X7V	50X62X7VSC	50X70X10ADL*	50X70X10TC	50X75X12ADL	50X75X10TC	52X69X10A*	52X69X10SC
50X62X7V	50X62X7VTC	50X70X10ADL	50X70X8TC	50X75X12C*	50X75X12SA	52X69X10V	52X69X10VSF
50X62X8ADL	50X62X7TC	50X70X10ADL	50X70X9TC	50X76X10A*	50X76X10SC	52X70X9ADL*	52X70X9TC
50X64X10A*	50X64X10SC	50X70X10V	50X70X10VSC	50X76X12ADL*	50X76X12TC	52X72X10ADL	52X72X8TC
50X64X10ADL*	50X64X10TC	50X70X12A	50X70X8SC	50X80X10A*	50X80X10SC	52X72X12ADL*	52X72X12TC
50X64X10ADL	50X64X6.5TC	50X70X12A	50X70X9SC	50X80X10ADL*	50X80X10TC	52X72X12ADL	52X72X8TC
50X64X12ADL	50X64X6.5TC	50X70X12A	50X70X10SC	50X80X10ADL	50X80X8TC	52X72X12B	52X72X8SB
50X64X12ADL	50X64X10TC	50X70X12ADL*	50X70X12TC	50X80X10V	50X80X10VSA	52X72X8ADL*	52X72X8TC
50X65X10A*	50X65X10SC	50X70X12ADL	50X70X8TC	50X80X10V	50X80X10VTC	52X72X8V	52X72X8VSB
50X65X10A	50X65X7SC	50X70X12ADL	50X70X9TC	50X80X12A	50X80X10SC	52X72X8V	52X72X8VTF
50X65X10A	50X65X8SC	50X70X12ADL	50X70X10TC	50X80X12ADL*	50X80X12TC	52X72X9ADL	52X72X8TC
50X65X10ADL	50X65X6TC	50X70X12V	50X70X12VSC	50X80X12ADL	50X80X8TC	52X73X9A*	52X73X9SC
50X65X10ADL	50X65X8TC	50X70X13.5ADL	50X70X8TC	50X80X12ADL	50X80X10TC	52X75X10A*	52X75X10SC
50X65X10ADL	50X65X9TC	50X70X13.5ADL	50X70X9TC	50X80X13A*	50X80X13SC	52X75X10A	52X75X8SC

HARWAL CROSS REFERENCES – SHAFT SEALS

PLEASE CALL DICHTOMATIK FOR AVAILABILITY - 800-328-2840

BULK AND INDIVIDUALLY BOXED QUANTITIES ARE AVAILABLE FOR ALL ITEMS

* = EXACT INTERCHANGE - ALL OTHERS ARE FUNCTIONALLY



DICHTOMATIK

Any seal. Any time.

HARWAL INTERCHANGES

Harwal Part #	TCM Part #	Harwal Part #	TCM Part #	Harwal Part #	TCM Part #	Harwal Part #	TCM Part #
52X75X10ADL*	52X75X10TC	55X67X6ADL*	55X67X6TC	55X75X8V	55X75X8VTF	55X90X10ADL	55X90X8TC
52X75X10ADL	52X75X8TC	55X68X8A*	55X68X8SC	55X75X9ADL*	55X75X9TC	55X90X10V	55X90X10VTF
52X75X10V	52X75X10VTC	55X68X8ADL*	55X68X8TC	55X75X9ADL	55X75X8TC	55X90X13A	55X90X8SC
52X75X12A	52X75X8SC	55X68X8V	55X68X8VSF	55X76X12ADL*	55X76X12TC	55X90X13A	55X90X10SC
52X75X12A	52X75X10SC	55X70X10A*	55X70X10SC	55X77X5.5A*	55X77X5.5SC	55X90X8A*	55X90X8SC
52X75X12ADL*	52X75X12TC	55X70X10A	55X70X7SC	55X78X10A	55X78X9SC	55X90X8ADL*	55X90X8TC
52X75X12ADL	52X75X8TC	55X70X10A	55X70X8SC	55X78X10ADL*	55X78X10TC	55X95X9ADL*	55X95X9TC
52X75X12ADL	52X75X10TC	55X70X10ADL*	55X70X10TC	55X78X10ADL	55X78X8TC	560X610X20A*	560X610X20SC
52X75X15ADL	52X75X8TC	55X70X10ADL	55X70X6TC	55X78X10V	55X78X10VTF	56X100X10ADL*	56X100X10TC
52X75X15ADL	52X75X10TC	55X70X10ADL	55X70X8TC	55X78X12A*	55X78X12SC	56X69X10ADL*	56X69X10TC
52X75X15ADL	52X75X12TC	55X70X6ADL*	55X70X6TC	55X78X12A	55X78X9SC	56X70X8A*	56X70X8SC
52X75X8A*	52X75X8SC	55X70X7A*	55X70X7SC	55X78X12ADL*	55X78X12TC	56X70X8V	56X70X8VTF
52X76X12A*	52X76X12SC	55X70X7V	55X70X7VSF	55X78X12ADL	55X78X8TC	56X70X9ADL*	56X70X9TC
52X76X13A	52X76X12SC	55X70X7V	55X70X7VTF	55X78X12ADL	55X78X10TC	56X70X9ADL	56X70X8TC
52X80X10A*	52X80X10SC	55X70X8A*	55X70X8SC	55X78X13C	55X78X12SA	56X72X10A*	56X72X10SC
52X80X10ADL	52X80X8TC	55X70X8A	55X70X7SC	55X78X8ADL*	55X78X8TC	56X72X10A	56X72X8SC
52X80X13A*	52X80X13SC	55X70X8ADL*	55X70X8TC	55X78X8V	55X78X8VSC	56X72X10ADL	56X72X8TC
52X80X13A	52X80X10SC	55X70X8ADL	55X70X6TC	55X78X9ADL	55X78X8TC	56X72X10V	56X72X10VSF
52X80X13C	52X80X10SA	55X70X8V	55X70X8VSB	55X80X10A*	55X80X10SC	56X72X8A*	56X72X8SC
52X80X13V	52X80X13VTC	55X70X8V	55X70X8VTC	55X80X10A	55X80X6SC	56X72X8V	56X72X8VTF
52X85X10A	52X85X8SC	55X70X9A	55X70X7SC	55X80X10A	55X80X8SC	56X75X8ADL*	56X75X8TC
52X85X10ADL*	52X85X10TC	55X70X9A	55X70X8SC	55X80X10ADL*	55X80X10TC	56X80X10C*	56X80X10SA
52X85X8A*	52X85X8SC	55X70X9ADL	55X70X6TC	55X80X10ADL	55X80X8TC	56X80X12ADL	56X80X8TC
530X580X22ADL*	530X580X22TC	55X70X9ADL	55X70X8TC	55X80X10CDL*	55X80X10TA	56X80X8V	56X80X8VTF
53X65X10ADL*	53X65X10TC	55X72X10A	55X72X8SC	55X80X10V	55X80X10VTF	56X85X13A*	56X85X13SC
53X68X10A*	53X68X10SC	55X72X10ADL*	55X72X10TC	55X80X10V	55X80X10VTF	56X85X8ADL*	56X85X8TC
53X72X10ADL*	53X72X10TC	55X72X10ADL	55X72X7TC	55X80X12A	55X80X6SC	56X85X8V	56X85X8VSC
53X72X12ADL	53X72X10TC	55X72X10ADL	55X72X8TC	55X80X12A	55X80X8SC	56X88X10A*	56X88X10SC
53X80X10A*	53X80X10SC	55X72X10ADL	55X72X9TC	55X80X12A	55X80X10SC	56X90X13C*	56X90X13SA
53X80X10V	53X80X10VSF	55X72X10ADL	55X72X9TC	55X80X12ADL	55X80X8TC	57X67X6ADL*	57X67X6TC
54X65X13ADL*	54X65X13TC	55X72X10BDL*	55X72X10TB	55X80X12ADL	55X80X10TC	57X71X9ADL	57X71X7TC
54X66X7ADL*	54X66X7TC	55X72X10V	55X72X10VTF	55X80X12ADL	55X80X10TC	57X73X7ADL*	57X73X7TC
54X68X9ADL*	54X68X9TC	55X72X12A	55X72X8SC	55X80X13A*	55X80X13SC	57X75X10A*	57X75X10SC
54X70X7ADL*	54X70X7TC	55X72X12ADL*	55X72X12TC	55X80X13A	55X80X6SC	57X75X12A	57X75X10SC
54X72.5X9A*	54X72.5X9SC	55X72X12ADL	55X72X7TC	55X80X13A	55X80X8SC	57X75X7.5ADL*	57X75X7.5TC
54X72X10A	54X72X5SC	55X72X12ADL	55X72X8TC	55X80X13A	55X80X10SC	57X76X10ADL*	57X76X10TC
54X72X10A	54X72X8SC	55X72X12ADL	55X72X9TC	55X80X13ADL*	55X80X13TC	57X77X10ADL*	57X77X10TC
54X72X10ADL*	54X72X10TC	55X72X12ADL	55X72X10TC	55X80X13ADL	55X80X8TC	57X79.5X10ADL*	57X79.5X10TC
54X72X10ADL	54X72X9TC	55X72X13A	55X72X8SC	55X80X13ADL	55X80X10TC	57X80X12ADL*	57X80X12TC
54X72X10V	54X72X10VTC	55X72X7A*	55X72X7VC	55X80X16A*	55X80X6SC	57X80X12C*	57X80X12SA
54X72X5A*	54X72X5SC	55X72X8A*	55X72X8SC	55X80X8A*	55X80X8SC	57X81X13ADL*	57X81X13TC
54X72X8A*	54X72X8SC	55X72X8ADL*	55X72X8TC	55X80X8A	55X80X6SC	57X82.5X13BDL*	57X82.5X13TB
54X72X8A	54X72X5SC	55X72X8ADL	55X72X7TC	55X80X8ADL*	55X80X8TC	57X85.4X8A*	57X85.4X8SC
54X75X10ADL*	54X75X10TC	55X72X8V	55X72X8VTF	55X80X8V	55X80X8VSCN	57X85X13A*	57X85X13SC
54X78X12A*	54X78X12SC	55X72X9ADL*	55X72X9TC	55X80X8V	55X80X8VTC	57X85X13ADL	57X85X10TC
54X80X10C*	54X80X10SA	55X72X9ADL	55X72X7TC	55X80X8V	55X80X8VTF	57X86X12A*	57X86X12SC
54X80X13ADL	54X80X10TC	55X72X9ADL	55X72X8TC	55X82X10ADL	55X82X9TC	57X86X6ADL*	57X86X6TC
54X81X10ADL*	54X81X10TC	55X73X10ADL*	55X73X10TC	55X82X12ADL	55X82X9TC	57X86X8ADL	57X86X6TC
54X82X11ADL	54X82X10TC	55X75X10A	55X75X8SC	55X82X9ADL*	55X82X9TC	57X90X13C*	57X90X13SA
54X85X10ADL*	54X85X10TC	55X75X10ADL*	55X75X10TC	55X85X10A	55X85X8SC	57X95X10A*	57X95X10SC
54X85X10V	54X85X10VTC	55X75X10ADL	55X75X8TC	55X85X10ADL*	55X85X10TC	580X630X25A*	580X630X25SC
54X85X10V	54X85X10VTF	55X75X10ADL	55X75X9TC	55X85X10ADL	55X85X8TC	58X68X9ADL*	58X68X9TC
54X90X13A*	54X90X13SC	55X75X12A*	55X75X12SC	55X85X10V	55X85X10VTF	58X72X8A*	58X72X8SC
54X90X13V	54X90X13VTF	55X75X12A	55X75X8SC	55X85X12ADL*	55X85X12TC	58X72X8ADL*	58X72X8TC
55X100X10ADL*	55X100X10TC	55X75X12ADL*	55X75X12TC	55X85X12ADL	55X85X8TC	58X72X8V	58X72X8VTF
55X100X12A*	55X100X12SC	55X75X12ADL	55X75X8TC	55X85X12ADL	55X85X10TC	58X72X9A	58X72X8SC
55X100X12ADL	55X100X10TC	55X75X12ADL	55X75X9TC	55X85X13A	55X85X8SC	58X72X9ADL*	58X72X9TC
55X100X13A	55X100X12SC	55X75X12ADL	55X75X10TC	55X85X8A*	55X85X8SC	58X72X9ADL	58X72X8TC
55X100X13ADL	55X100X10TC	55X75X12V	55X75X12VTF	55X85X8ADL*	55X85X8TC	58X74X10ADL*	58X74X10TC
55X100X16A	55X100X12SC	55X75X7V	55X75X7VTF	55X85X8V	55X85X8VSF	58X75X10A	58X75X9SC
55X63X5V	55X63X5VVG	55X75X8A*	55X75X8SC	55X90X10A*	55X90X10SC	58X75X12A	58X75X9SC
55X65X8A*	55X65X8SC	55X75X8ADL*	55X75X8TC	55X90X10A	55X90X8SC	58X75X13ADL	58X75X7TC
		55X75X8V	55X75X8VSF	55X90X10ADL*	55X90X10TC		



Harval Part #	TCM Part #	Harval Part #	TCM Part #	Harval Part #	TCM Part #	Harval Part #	TCM Part #
58X75X13ADL	58X75X9TC	600X650X25A*	600X650X255C	60X80X12A	60X80X85C	60X90X8V	60X90X8VTF
58X75X13ADL	58X75X12TC	60X100X10ADL*	60X100X10TC	60X80X12A	60X80X105C	60X92X10ADL*	60X92X10TC
58X75X7ADL*	58X75X7TC	60X100X10V	60X100X10VSCW	60X80X12ADL*	60X80X12TC	60X95X10ADL*	60X95X10TC
58X75X8ADL	58X75X7TC	60X100X10V	60X100X10VTC	60X80X12ADL	60X80X8TC	60X95X10ADL	60X95X8TC
58X75X8B*	58X75X8SB	60X100X10V	60X100X10VTGW	60X80X12ADL	60X80X9TC	60X95X10V	60X95X10VTC
58X75X8V	58X75X8VSF	60X100X12ADL	60X100X10TC	60X80X12ADL	60X80X10TC	60X95X13ADL*	60X95X13TC
58X75X9A*	58X75X95C	60X100X12CDL*	60X100X12TA	60X80X13A	60X80X85C	60X95X13ADL	60X95X8TC
58X75X9ADL*	58X75X9TC	60X100X13ADL	60X100X10TC	60X80X13A	60X80X105C	60X95X13ADL	60X95X10TC
58X75X9ADL	58X75X7TC	60X103X12ADL*	60X103X12TC	60X80X13A	60X80X125C	60X98.5X13ADL*	60X98.5X13TC
58X76X10ADL	58X76X7.8TC	60X110X10ADL*	60X110X10TC	60X80X13ADL	60X80X8TC	61X75X8V	61X75X8VSF
58X76X10BDL*	58X76X10TB	60X110X13ADL	60X110X10TC	60X80X13ADL	60X80X9TC	61X89X12.5ADL*	61X89X12.5TC
58X78X13A*	58X78X135C	60X130X15A*	60X130X155C	60X80X13ADL	60X80X10TC	62X100X10ADL*	62X100X10TC
58X78X9ADL*	58X78X9TC	60X70X10ADL	60X70X7TC	60X80X13ADL	60X80X12TC	62X100X12A*	62X100X125C
58X80X10A*	58X80X105C	60X70X12ADL*	60X70X12TC	60X80X7V	60X80X7VTC	62X100X12ADL	62X100X10TC
58X80X10A	58X80X55C	60X70X12ADL	60X70X7TC	60X80X8A*	60X80X85C	62X100X13C*	62X100X135A
58X80X10ADL*	58X80X10TC	60X70X7A*	60X70X75C	60X80X8ADL*	60X80X8TC	62X100X13CDL*	62X100X13TA
58X80X10ADL	58X80X9TC	60X70X7B*	60X70X75B	60X80X8V	60X80X8VTC	62X110X13A*	62X110X135C
58X80X12A*	58X80X125C	60X72X10ADL	60X72X7TC	60X80X8V	60X80X8VTF	62X120X12ADL*	62X120X12TC
58X80X12A	58X80X55C	60X72X10ADL	60X72X8TC	60X80X9ADL*	60X80X9TC	62X72X10ADL	62X72X9TC
58X80X12A	58X80X105C	60X72X8A*	60X72X85C	60X80X9ADL	60X80X8TC	62X72X9ADL*	62X72X9TC
58X80X12ADL*	58X80X12TC	60X72X8ADL*	60X72X8TC	60X82X12A*	60X82X125C	62X75X10ADL*	62X75X10TC
58X80X12ADL	58X80X9TC	60X72X8ADL	60X72X7TC	60X82X12ADL*	60X82X12TC	62X75X10B*	62X75X105B
58X80X12ADL	58X80X10TC	60X72X8V	60X72X8VSCW	60X82X12ADL	60X82X7TC	62X76X10ADL*	62X76X10TC
58X80X13A	58X80X55C	60X74X10A*	60X74X105C	60X82X12ADL	60X82X10TC	62X80X10A*	62X80X105C
58X80X13A	58X80X105C	60X74X10ADL	60X74X9TC	60X82X7ADL*	60X82X7TC	62X80X10A	62X80X85C
58X80X13A	58X80X125C	60X75X10A	60X75X85C	60X82X9ADL	60X82X7TC	62X80X10ADL*	62X80X10TC
58X80X13ADL*	58X80X13TC	60X75X10ADL*	60X75X10TC	60X85X10A*	60X85X105C	62X80X10ADL	62x80x8tc
58X80X13ADL	58X80X9TC	60X75X10ADL	60X75X7TC	60X85X10A	60X85X85C	62X80X10ADL	62X80X9TC
58X80X13ADL	58X80X10TC	60X75X10ADL	60X75X8TC	60X85X10ADL*	60X85X10TC	62X80X10V	62X80X10VTC
58X80X13ADL	58X80X12TC	60X75X10ADL	60X75X9TC	60X85X10ADL	60X85X6TC	62X80X12A	62X80X85C
58X80X5A*	58X80X55C	60X75X12A*	60X75X125C	60X85X10ADL	60X85X8TC	62X80X12A	62X80X105C
58X80X8A	58X80X55C	60X75X12A	60X75X85C	60X85X12A	60X85X85C	62X80X12ADL	62x80x8tc
58X80X8V	58X80X8VTF	60X75X12ADL	60X75X7TC	60X85X12A	60X85X105C	62X80X12ADL	62X80X9TC
58X80X9ADL*	58X80X9TC	60X75X12ADL	60X75X8TC	60X85X12ADL*	60X85X12TC	62X80X12ADL	62X80X10TC
58X85X10ADL*	58X85X10TC	60X75X12ADL	60X75X9TC	60X85X12ADL	60X85X6TC	62X80X8ADL*	62x80x8tc
58X85X13ADL	58X85X10TC	60X75X12ADL	60X75X10TC	60X85X12ADL	60X85X8TC	62X80X9ADL*	62X80X9TC
58X86X12A*	58X86X125C	60X75X4A0*	60X75X4VC	60X85X12ADL	60X85X10TC	62X80X9ADL	62x80x8tc
58X90X10ADL*	58X90X10TC	60X75X8A*	60X75X85C	60X85X13A	60X85X85C	62X82X10ADL*	62X82X10TC
58X90X10ADL	58X90X9TC	60X75X8ADL*	60X75X8TC	60X85X13A	60X85X105C	62X82X10ADL	62X82X7TC
58X90X10V	58X90X10VTC	60X75X8ADL	60X75X7TC	60X85X6ADL*	60X85X6TC	62X82X7ADL*	62X82X7TC
58X90X9ADL*	58X90X9TC	60X75X8B	60X75X75B	60X85X8A*	60X85X85C	62X85X10A*	62X85X105C
59X75X10ADL*	59X75X10TC	60X75X8V	60X75X8VTF	60X85X8ADL*	60X85X8TC	62X85X10ADL*	62X85X10TC
59X80X10A*	59X80X105C	60X75X9A	60X75X85C	60X85X8ADL	60X85X6TC	62X85X10ADL	62X85X7TC
59X85X8A*	59X85X85C	60X75X9ADL*	60X75X9TC	60X85X8V	60X85X8VSC	62X85X10ADL	62X85X8TC
5X14.5X7ADL*	5X14.5X7TC	60X75X9ADL	60X75X7TC	60X85X8V	60X85X8VTF	62X85X10V	62X85X10VTCNY
5X15X6A*	5X15X65C	60X75X9ADL	60X75X8TC	60X86X10ADL*	60X86X10TC	62X85X12A	62X85X105C
5X15X7A	5X15X65C	60X76X11ADL*	60X76X11TC	60X90X10A	60X90X85C	62X85X12ADL*	62X85X125C
5X16X6A*	5X16X65C	60X77X10ADL*	60X77X10TC	60X90X10ADL*	60X90X10TC	62X85X12ADL*	62X85X12TC
5X16X7A*	5X16X75C	60X77X12ADL*	60X77X12TC	60X90X10ADL	60X90X8TC	62X85X12ADL	62X85X7TC
5X16X7A	5X16X65C	60X77X12ADL	60X77X10TC	60X90X10CDL*	60X90X10TA	62X85X12ADL	62X85X8TC
5X16X7ADL*	5X16X7TC	60X78X10A	60X78X95C	60X90X10V	60X90X10VTF	62X85X12ADL	62X85X10TC
5X16X7ADL	5X16X6TC	60X78X10V	60X78X10VTC	60X90X11ADL	60X90X8TC	62X85X12CDL*	62X85X12TA
5X16X7V	5X16X7VSF	60X78X13A	60X78X95C	60X90X11ADL	60X90X10TC	62X85X12CDL	62X85X9TA
5X17X7ADL*	5X17X7TC	60X78X9A*	60X78X95C	60X90X12CDL*	60X90X12TA	62X85X13A	62X85X105C
5X18X7ADL*	5X18X7TC	60X79.4X8V	60X79.4X8VSC	60X90X12CDL	60X90X10TA	62X85X8V	62X85X8VTF
5X18X8ADL	5X18X7TC	60X80X10A*	60X80X105C	60X90X13A	60X90X85C	62X88X12ADL*	62X88X12TC
5X19X5ADL*	5X19X5TC	60X80X10A	60X80X85C	60X90X13ADL*	60X90X13TC	62X89X13CDL*	62X89X13TA
5X22X7ADL*	5X22X7TC	60X80X10ADL*	60X80X10TC	60X90X13ADL	60X90X8TC	62X90X10A*	62X90X105C
5X25X7ADL*	5X25X7TC	60X80X10ADL	60X80X8TC	60X90X13ADL	60X90X10TC	62X90X10A	62X90X85C
5X9X3A0*	5X9X3VC	60X80X10ADL	60X80X9TC	60X90X13ADL	60X90X12TC	62X90X10ADL*	62X90X10TC
600X640X20C*	600X640X20SA	60X80X10V	60X80X10VSA	60X90X8A*	60X90X85C	62X90X10V	62X90X10VSF
600X640X20V	600X640X20VTC	60X80X12A*	60X80X125C	60X90X8ADL*	60X90X8TC	62X90X10V	62X90X10VTF

HARWAL CROSS REFERENCES – SHAFT SEALS

PLEASE CALL DICHTOMATIK FOR AVAILABILITY - 800-328-2840
 BULK AND INDIVIDUALLY BOXED QUANTITIES ARE AVAILABLE FOR ALL ITEMS
 * = EXACT INTERCHANGE - ALL OTHERS ARE FUNCTIONALLY



DICHTOMATIK

Any seal. Any time.

HARWAL INTERCHANGES

Harwal Part #	TCM Part #	Harwal Part #	TCM Part #	Harwal Part #	TCM Part #	Harwal Part #	TCM Part #
62X90X11A	62X90X85C	65X80X10V	65X80X10V5A	67X85X10C*	67X85X105A	6X15X6A	6X15X45C
62X90X11A	62X90X105C	65X80X10V	65X80X10VTF	68X100X10A*	68X100X105C	6X16X5A*	6X16X55C
62X90X12ADL	62X90X107C	65X80X12A	65X80X85C	68X100X10ADL*	68X100X107C	6X16X5ADL*	6X16X57C
62X90X13A	62X90X85C	65X80X12ADL	65X80X87C	68X100X10ADL	68X100X77C	6X16X5ADL	6X16X57F
62X90X13A	62X90X105C	65X80X12ADL	65X80X107C	68X100X10V	68X100X10VTF	6X16X6A	6X16X55C
62X90X13ADL	62X90X107C	65X80X13A	65X80X85C	68X100X12C*	68X100X125A	6X16X6V	6X16X6VTF
62X95X10A*	62X95X105C	65X80X4A0*	65X80X4VC	68X100X13A	68X100X105C	6X16X7A*	6X16X75C
63.4X85.4X8ADL*	63.4X85.4X8TC	65X80X8A*	65X80X85C	68X100X13ADL	68X100X77C	6X16X7A	6X16X55C
63X100X10A*	63X100X105C	65X80X8ADL*	65X80X87C	68X100X13ADL	68X100X107C	6X16X7ADL*	6X16X77C
63X100X13A	63X100X105C	65X80X8V	65X80X8VTC	68X100X13ADL	68X100X127C	6X16X7ADL	6X16X57C
63X80X12ADL	63X80X87C	65X82X10A*	65X82X105C	68X100X7ADL*	68X100X77C	6X16X7V	6X16X7VTC
63X80X12ADL	63X80X97C	65X82X12A	65X82X105C	68X100X8ADL	68X100X77C	6X17X6A*	6X17X65C
63X80X9ADL*	63X80X97C	65X84X10ADL	65X84X97C	68X80X10ADL*	68X80X107C	6X17X7A	6X17X65C
63X80X9ADL	63X80X87C	65X85X10A	65X85X85C	68X82X10ADL*	68X82X107C	6X18X5A*	6X18X55C
63X85X10ADL*	63X85X107C	65X85X10ADL*	65X85X107C	68X82X10ADL	68X82X77C	6X18X6A*	6X18X65C
63X85X10V	63X85X10VTF	65X85X10ADL	65X85X87C	68X82X7ADL*	68X82X77C	6X18X6A	6X18X55C
63X88X10A*	63X88X105C	65X85X10V	65X85X10VTF	68X83X10ADL*	68X83X107C	6X18X7A	6X18X55C
63X90X10A*	63X90X105C	65X85X12A	65X85X85C	68X84X9ADL*	68X84X97C	6X18X7A	6X18X65C
63X90X7ADL*	63X90X77C	65X85X12ADL	65X85X87C	68X85X13ADL*	68X85X137C	6X18X7ADL*	6X18X77C
63X90X8ADL	63X90X77C	65X85X12ADL	65X85X107C	68X85X13ADL	68X85X107C	6X19X4A	6X19X45F
64X100X13C*	64X100X135A	65X85X13A	65X85X85C	68X85X8A*	68X85X85C	6X19X6V	6X19X6V5F
64X80X13ADL*	64X80X137C	65X85X13ADL*	65X85X137C	68X86X7ADL*	68X86X77C	6X19X7A*	6X19X75C
64X80X13ADL	64X80X87C	65X85X13ADL	65X85X87C	68X88X10ADL	68X88X97C	6X19X7ADL*	6X19X77C
64X80X8V	64X80X8VTC	65X85X13ADL	65X85X107C	68X88X9ADL*	68X88X97C	6X19X7V	6X19X7VTC
64X85X10C*	64X85X105A	65X85X13ADL	65X85X107C	68X90X10A*	68X90X105C	6X20X5.5A0*	6X20X5.5VC
64X85X12ADL*	64X85X127C	65X85X8ADL*	65X85X87C	68X90X10ADL*	68X90X107C	6X22X6ADL	6X22X57C
64X85X13ADL	64X85X127C	65X85X8V	65X85X8VTC	68X90X10ADL	68X90X87C	6X22X7A*	6X22X75C
64X85X16ADL	64X85X127C	65X86X12ADL*	65X86X127C	68X90X10V	68X90X10VTF	6X22X7ADL*	6X22X77C
64X86X8ADL*	64X86X87C	65X88X10ADL*	65X88X107C	68X90X12A	68X90X105C	6X22X7ADL	6X22X57C
64X88X15ADL*	64X88X157C	65X88X10ADL	65X88X87C	68X90X12ADL*	68X90X127C	6X22X7V	6X22X7VTF
64X90X10C*	64X90X105A	65X88X12ADL*	65X88X127C	68X90X12ADL	68X90X87C	6X22X8A	6X22X75C
64X90X13V	64X90X13VTF	65X88X12ADL	65X88X87C	68X90X12ADL	68X90X107C	6X22X8ADL	6X22X57C
64X95X10ADL*	64X95X107C	65X88X12ADL	65X88X107C	68X90X13A	68X90X105C	6X22X8ADL	6X22X77C
65X100X10A*	65X100X105C	65X88X12V	65X88X12VTC	68X90X13ADL	68X90X87C	70X100X10A*	70X100X105C
65X100X10ADL*	65X100X107C	65X88X12V	65X88X12VTF	68X90X13ADL	68X90X107C	70X100X10A	70X100X65C
65X100X10V	65X100X10VTF	65X88X6A0*	65X88X6VC	68X90X13ADL	68X90X127C	70X100X10A	70X100X85C
65X100X12A*	65X100X125C	65X88X8ADL*	65X88X87C	68X90X13B	68X90X85B	70X100X10ADL*	70X100X107C
65X100X12A	65X100X105C	65X90X10A*	65X90X105C	68X90X8ADL*	68X90X87C	70X100X10ADL	70X100X87C
65X100X12ADL	65X100X107C	65X90X10ADL*	65X90X107C	68X90X8V	68X90X8VTC	70X100X10V	70X100X10VTF
65X100X13A*	65X100X135C	65X90X10ADL	65X90X87C	68X92X12BDL*	68X92X127B	70X100X10V	70X100X10VTC
65X100X13A	65X100X105C	65X90X10V	65X90X10V5C	68X94X8ADL*	68X94X87C	70X100X12A*	70X100X125C
65X100X13A	65X100X125C	65X90X10V	65X90X10VTF	68X95X10A*	68X95X105C	70X100X12A	70X100X65C
65X100X13ADL	65X100X107C	65X90X12A*	65X90X125C	68X95X12A	68X95X105C	70X100X12A	70X100X85C
65X105X12ADL*	65X105X127C	65X90X12A	65X90X105C	68X95X13A	68X95X105C	70X100X12A	70X100X105C
65X110X10A*	65X110X105C	65X90X12ADL*	65X90X127C	68X95X7A0*	68X95X7VC	70X100X12ADL*	70X100X127C
65X110X12ADL*	65X110X127C	65X90X12ADL	65X90X87C	69X85X12BDL	69X85X107B	70X100X12ADL	70X100X87C
65X115X12ADL*	65X115X127C	65X90X12ADL	65X90X107C	69X90X10A*	69X90X105C	70X100X12ADL	70X100X107C
65X115X15A*	65X115X155C	65X90X13A	65X90X105C	6X10X2A0*	6X10X2VC	70X100X12CDL*	70X100X127A
65X120X10A*	65X120X105C	65X90X13A	65X90X125C	6X10X2V	6X10X2VVC	70X100X13A	70X100X65C
65X120X12A	65X120X105C	65X90X13ADL*	65X90X137C	6X11X3A0*	6X11X3VC	70X100X13A	70X100X85C
65X120X12ADL*	65X120X127C	65X90X13ADL	65X90X87C	6X11X5A0	6X11X3VC	70X100X13A	70X100X105C
65X120X12ADL	65X120X107C	65X90X13ADL	65X90X107C	6X11X5A0	6X11X4VC	70X100X13A	70X100X125C
65X120X13ADL*	65X120X137C	65X90X13ADL	65X90X127C	6X12X4A*	6X12X45C	70X100X13ADL*	70X100X137C
65X120X13ADL	65X120X107C	65X90X8ADL*	65X90X87C	6X12X5.5A*	6X12X5.55C	70X100X13ADL	70X100X87C
65X120X13ADL	65X120X127C	65X92X12ADL	65X92X107C	6X12X5.5A	6X12X45C	70X100X13ADL	70X100X107C
65X125X12V	65X125X12V5F	65X95X10ADL*	65X95X107C	6X12X5.5A	6X12X4.55C	70X100X13ADL	70X100X127C
65X75X5A0*	65X75X5VC	65X95X10V	65X95X10VTF	6X14X6A	6X14X65F	70X100X13CDL	70X100X127A
65X75X8ADL*	65X75X87C	65X95X13ADL*	65X95X137C	6X14X6V	6X14X6VTF	70X100X6A*	70X100X65C
65X77X12BDL*	65X77X127B	65X95X13ADL	65X95X107C	6X15X4A*	6X15X45C	70X100X8A*	70X100X85C
65X80X10A	65X80X85C	65X95X13C	65X95X105A	6X15X4A0*	6X15X4VC	70X100X8A	70X100X65C
65X80X10ADL*	65X80X107C	66X100X11A*	66X100X115C	6X15X4V	6X15X4V5C	70X100X8ADL*	70X100X87C
65X80X10ADL	65X80X87C	66X90X13C*	66X90X135A	6X15X6A*	6X15X65C	70X102X12ADL*	70X102X127C



PLEASE CALL DICHTOMATIK FOR AVAILABILITY - 800-328-2840
BULK AND INDIVIDUALLY BOXED QUANTITIES ARE AVAILABLE FOR ALL ITEMS
* = EXACT INTERCHANGE - ALL OTHERS ARE FUNCTIONALLY

Harwal Part #	TCM Part #	Harwal Part #	TCM Part #	Harwal Part #	TCM Part #	Harwal Part #	TCM Part #
70X102X13ADL	70X102X12TC	70X90X13A	70X90X10SC	74X105X12V	74X105X12VVF	75X90X8V	75X90X8VTF
70X105X13ADL*	70X105X13TC	70X90X13A	70X90X12SC	74X135X15A*	74X135X15SC	75X93X10ADL	75X93X9TC
70X105X13V	70X105X13VVF	70X90X13ADL	70X90X7TC	74X90X10BDL*	74X90X10TB	75X94X10ADL*	75X94X10TC
70X105X13V	70X105X13VTF	70X90X13ADL	70X90X10TC	74X95X10C*	74X95X10SA	75X95X10A*	75X95X10SC
70X110X10A*	70X110X10SC	70X90X13ADL	70X90X12TC	74X95X10CDL*	74X95X10TA	75X95X10A	75X95X7SC
70X110X10A	70X110X8SC	70X90X7ADL*	70X90X7TC	74X95X7ADL*	74X95X7TC	75X95X10ADL*	75X95X10TC
70X110X10ADL*	70X110X10TC	70X90X7V	70X90X7VTCN1	74X96X10ADL	74X96X9TC	75X95X10ADL	75X95X7TC
70X110X10ADL	70X110X8TC	70X92X12ADL*	70X92X12TC	74X98X12ADL*	74X98X12TC	75X95X10ADL	75X95X8TC
70X110X12A	70X110X8SC	70X92X12ADL	70X92X8.5TC	75X100X10A	75X100X7SC	75X95X10V	75X95X10VDC
70X110X12A	70X110X10SC	70X92X12ADL	70X92X9TC	75X100X10ADL*	75X100X10TC	75X95X10V	75X95X10VVF
70X110X12ADL	70X110X8TC	70X92X8.5ADL*	70X92X8.5TC	75X100X10V	75X100X10VSB	75X95X10V	75X95X10VTF
70X110X12ADL	70X110X10TC	70X95X10A*	70X95X10SC	75X100X10V	75X100X10VTC	75X95X12A*	75X95X12SC
70X110X13A*	70X110X13SC	70X95X10ADL*	70X95X10TC	75X100X10V	75X100X10VTF	75X95X12A	75X95X7SC
70X110X13A	70X110X8SC	70X95X10V	70X95X10VTF	75X100X12A	75X100X7SC	75X95X12A	75X95X10SC
70X110X13A	70X110X10SC	70X95X12A	70X95X10SC	75X100X12ADL*	75X100X12TC	75X95X12ADL	75X95X7TC
70X110X13ADL*	70X110X13TC	70X95X12ADL*	70X95X12TC	75X100X12ADL	75X100X10TC	75X95X12ADL	75X95X8TC
70X110X13ADL	70X110X8TC	70X95X12ADL	70X95X10TC	75X100X12V	75X100X12VSC	75X95X12ADL	75X95X10TC
70X110X13ADL	70X110X10TC	70X95X13A	70X95X10SC	75X100X13A	75X100X7SC	75X95X12V	75X95X12VSC
70X110X8A*	70X110X8SC	70X95X13ADL*	70X95X13TC	75X100X13A	75X100X13SF	75X95X13A	75X95X7SC
70X110X8ADL*	70X110X8TC	70X95X13ADL	70X95X10TC	75X100X13ADL*	75X100X13TC	75X95X13A	75X95X10SC
70X110X8V	70X110X8VTF	70X95X13ADL	70X95X12TC	75X100X13ADL	75X100X10TC	75X95X13A	75X95X12SC
70X112X12V	70X112X12VVF	70X95X13V	70X95X13VSC	75X100X13ADL	75X100X12TC	75X95X13ADL	75X95X7TC
70X115X15A*	70X115X15SC	70X98.5X13ADL*	70X98.5X13TC	75X100X13V	75X100X13VVF	75X95X13ADL	75X95X8TC
70X115X15ADL*	70X115X15TC	71X88X8ADL*	71X88X8TC	75X100X7A*	75X100X7SC	75X95X13ADL	75X95X10TC
70X120X10ADL*	70X120X10TC	72X100X10A*	72X100X10SC	75X101X12A*	75X101X12SC	75X95X15B	75X95X5SB
70X120X13ADL	70X120X10TC	72X100X10ADL*	72X100X10TC	75X102X12ADL	75X102X10TC	75X95X15B	75X95X12SB
70X120X13ADL	70X120X12TC	72X100X10V	72X100X10VVF	75X105X10ADL*	75X105X10TC	75X95X5B*	75X95X5SB
70X120X13V	70X120X13VVF	72X100X10V	72X100X10VTF	75X105X13ADL*	75X105X13TC	75X95X8ADL*	75X95X8TC
70X120X13V	70X120X13VTC	72X100X12ADL	72X100X10TC	75X105X13ADL	75X105X10TC	75X95X8ADL	75X95X7TC
70X125X12ADL*	70X125X12TC	72X100X12CDL*	72X100X12TA	75X105X13ADL	75X105X12TC	75X95X9ADL	75X95X7TC
70X130X13ADL*	70X130X13TC	72X100X13A	72X100X10SC	75X105X15ADL	75X105X10TC	75X95X9ADL	75X95X8TC
70X80X10ADL*	70X80X10TC	72X100X13ADL*	72X100X13TC	75X105X15ADL	75X105X12TC	76X100X16ADL	76X100X12TC
70X82.5X10ADL*	70X82.5X10TC	72X100X13ADL	72X100X10TC	75X105X15ADL	75X105X13TC	76X105X13ADL*	76X105X13TC
70X85X10A	70X85X7SC	72X100X13V	72X100X13VVF	75X108X13ADL*	75X108X13TC	76X114X14ADL*	76X114X14TC
70X85X10A	70X85X8SC	72X105X10ADL*	72X105X10TC	75X110X10ADL*	75X110X10TC	76X120X12A*	76X120X12SC
70X85X10ADL*	70X85X10TC	72X110X12ADL*	72X110X12TC	75X110X12ADL*	75X110X12TC	76X98X12ADL*	76X98X12TC
70X85X10ADL	70X85X8TC	72X140X12ADL*	72X140X12TC	75X110X12ADL	75X110X10TC	77X100X11.5ADL*	77X100X11.5TC
70X85X4A0*	70X85X4VC	72X85X10A	72X85X8SC	75X110X13ADL*	75X110X13TC	77X95X10C*	77X95X10SA
70X85X7A*	70X85X7SC	72X85X8A*	72X85X8SC	75X110X13ADL	75X110X10TC	78X100X10A*	78X100X10SC
70X85X8A*	70X85X8SC	72X85X8V	72X85X8VVF	75X110X13ADL	75X110X12TC	78X100X10ADL*	78X100X10TC
70X85X8A	70X85X7SC	72X86X7ADL*	72X86X7TC	75X110X13V	75X110X13VTC	78X100X10V	78X100X10VTF
70X85X8ADL*	70X85X8TC	72X90X10A*	72X90X10SC	75X112X12A*	75X112X12SC	78X100X12C*	78X100X12SA
70X85X8V	70X85X8VSC	72X90X10ADL*	72X90X10TC	75X115X10ADL	75X115X9.5TC	78X100X12C	78X100X10SA
70X85X8V	70X85X8VTC	72X90X10ADL	72X90X8TC	75X115X12ADL	75X115X9.5TC	78X100X13A	78X100X10SC
70X87X10ADL*	70X87X10TC	72X90X10V	72X90X10VTF	75X120X12A*	75X120X12SC	78X100X13ADL	78X100X10TC
70X88X12ADL*	70X88X12TC	72X94X12ADL*	72X94X12TC	75X120X12ADL*	75X120X12TC	78X100X13ADL	78X100X12TC
70X88X12ADL	70X88X8TC	72X95X10A*	72X95X10SC	75X120X12V	75X120X12VVF	78X105X13A*	78X105X13SC
70X88X8ADL*	70X88X8TC	72X95X10ADL*	72X95X10TC	75X120X12V	75X120X12VTC	78X105X15A	78X105X13SC
70X88X9V	70X88X9VVF	72X95X10V	72X95X10VTF	75X121X13ADL*	75X121X13TC	78X110X12V	78X110X12VVF
70X90X10A*	70X90X10SC	72X95X12A*	72X95X12SC	75X125X12ADL*	75X125X12TC	78X110X12V	78X110X12VTC
70X90X10ADL*	70X90X10TC	72X95X12A	72X95X10SC	75X130X13A	75X130X12SC	78X115X10ADL*	78X115X10TC
70X90X10ADL	70X90X7TC	72X95X13A*	72X95X13SC	75X130X13V	75X130X13VVF	78X90X8A*	78X90X8SC
70X90X10B*	70X90X10SB	72X95X13A	72X95X10SC	75X90X10A	75X90X8SC	78X95X11V	78X95X11VVF
70X90X10V	70X90X10VSB	72X95X13A	72X95X12SC	75X90X10ADL*	75X90X10TC	79X102X12.5ADL*	79X102X12.5TC
70X90X10V	70X90X10VTF	72X95X13ADL	72X95X10TC	75X90X10ADL	75X90X6TC	7X11X2V	7X11X2VVM
70X90X12A*	70X90X12SC	72X96X9ADL*	72X96X9TC	75X90X10ADL	75X90X8TC	7X14X4ADL*	7X14X4TC
70X90X12A	70X90X10SC	72X98X9ADL*	72X98X9TC	75X90X12C	75X90X10SA	7X16X4ADL*	7X16X4TC
70X90X12ADL*	70X90X12TC	73X108X12ADL*	73X108X12TC	75X90X12CDL*	75X90X12TA	7X16X7ADL*	7X16X7TC
70X90X12ADL	70X90X7TC	73X90X8BDL*	73X90X8TB	75X90X7ADL	75X90X6TC	7X16X7ADL	7X16X4TC
70X90X12ADL	70X90X10TC	73X95X10A*	73X95X10SC	75X90X8A*	75X90X8SC	7X16X7ADL	7X16X6TC
70X90X12V	70X90X12VTC	73X96X9V	73X96X9VTF	75X90X8ADL*	75X90X8TC	7X16X7V	7X16X7VTC
70X90X13A*	70X90X13SC	74X104X12V	74X104X12VTF	75X90X8ADL	75X90X6TC	7X18X5ADL*	7X18X5TC

HARWAL CROSS REFERENCES – SHAFT SEALS

PLEASE CALL DICHTOMATIK FOR AVAILABILITY - 800-328-2840
 BULK AND INDIVIDUALLY BOXED QUANTITIES ARE AVAILABLE FOR ALL ITEMS
 * = EXACT INTERCHANGE - ALL OTHERS ARE FUNCTIONALLY



DICHTOMATIK

Any seal. Any time.

HARWAL INTERCHANGES

Harwal Part #	TCM Part #	Harwal Part #	TCM Part #	Harwal Part #	TCM Part #	Harwal Part #	TCM Part #
7X18X5ADL	7X18X4.5TC	80X113X12A*	80X113X12SC	85X110X11ADL	85X110X10TC	88X110X13A	88X110X10SC
7X18X7A*	7X18X75C	80X115X10V	80X115X10VTC	85X110X12A*	85X110X12SC	88X110X13A	88X110X12SC
7X18X8ADL	7X18X4.5TC	80X115X12ADL	80X115X10TC	85X110X12A	85X110X10SC	88X110X13C*	88X110X13SA
7X18X8ADL	7X18X5TC	80X120X10ADL*	80X120X10TC	85X110X12ADL*	85X110X12TC	88X110X13V	88X110X13VSF
7X18X8ADL	7X18X7TC	80X120X12ADL*	80X120X12TC	85X110X12ADL	85X110X6TC	88X120X12A*	88X120X12SC
7X19X6A*	7X19X65C	80X120X12ADL	80X120X10TC	85X110X12ADL	85X110X10TC	88X120X13ADL*	88X120X13TC
7X19X7ADL*	7X19X7TC	80X120X13ADL	80X120X10TC	85X110X12C*	85X110X12SA	88X120X13C*	88X120X13SA
7X22X6ADL*	7X22X6TC	80X120X13ADL	80X120X12TC	85X110X12V	85X110X12VTC	88X121.5X12A*	88X121.5X12SC
7X22X7A*	7X22X75C	80X120X13V	80X120X13VTC	85X110X12V	85X110X12VTF	88X126X12A*	88X126X12SC
7X22X7ADL*	7X22X7TC	80X125X10ADL*	80X125X10TC	85X110X13A*	85X110X13SC	88X126X12V	88X126X12VSF
7X22X7ADL	7X22X6TC	80X125X12A*	80X125X12SC	85X110X13A	85X110X10SC	88X126X12V	88X126X12VTF
7X22X7V	7X22X7VSF	80X125X12A	80X125X10SC	85X110X13A	85X110X12SC	88X140X13A*	88X140X13SC
7X22X8A	7X22X75C	80X125X12ADL	80X125X10TC	85X110X13ADL*	85X110X13TC	8X12X3AO*	8X12X3AVC
7X26X5.5ADL*	7X26X5.5TC	80X125X13A	80X125X10SC	85X110X13ADL	85X110X6TC	8X12X3AO*	8X12X3VC
80X100X10A*	80X100X10SC	80X125X13A	80X125X12SC	85X110X13ADL	85X110X10TC	8X12X3V	8X12X3VVC
80X100X10ADL*	80X100X10TC	80X125X13ADL	80X125X10TC	85X110X13ADL	85X110X12TC	8X13X3.5AO*	8X13X3.5VC
80X100X10ADL	80X100X7TC	80X125X13C*	80X125X13SA	85X110X13V	85X110X13VSM	8X14X4A*	8X14X45C
80X100X10V	80X100X10VSCR	80X128X10ADL*	80X128X10TC	85X110X13V	85X110X13VSZ	8X14X4ADL*	8X14X4TC
80X100X10V	80X100X10VBTW	80X140X13ADL*	80X140X13TC	85X110X14ADL	85X110X6TC	8X14X4V	8X14X4VSM
80X100X10V	80X100X10VTC	80X90X5AO*	80X90X5VC	85X110X14ADL	85X110X10TC	8X14X6B	8X14X45B
80X100X10V	80X100X10VTF	80X95X10A	80X95X85C	85X110X14ADL	85X110X12TC	8X15X3AO*	8X15X3VC
80X100X12A	80X100X10SC	80X95X4AO*	80X95X4VC	85X110X14ADL	85X110X13TC	8X15X3V	8X15X3VKF
80X100X12ADL*	80X100X12TC	80X95X5AO	80X95X4VC	85X110X15C	85X110X12SA	8X15X5A*	8X15X55C
80X100X12ADL	80X100X7TC	80X95X8A*	80X95X85C	85X111X10ADL*	85X111X10TC	8X15X7A	8X15X55C
80X100X12ADL	80X100X10TC	80X95X8ADL*	80X95X8TC	80X115X13A*	85X115X13SC	8X16X3AO*	8X16X3VC
80X100X13A	80X100X10SC	80X95X8V	80X95X8VSF	85X115X13ADL	85X115X10TC	8X16X4A*	8X16X45C
80X100X13ADL*	80X100X13TC	80X96X9ADL*	80X96X9TC	85X115X13C*	85X115X13SA	8X16X6A*	8X16X65C
80X100X13ADL	80X100X7TC	80X98X10ADL*	80X98X10TC	85X115X13V	85X115X13VSF	8X16X6A	8X16X45C
80X100X13ADL	80X100X10TC	82X100X8A*	82X100X85C	85X115X13V	85X115X13VTC	8X16X6ADL	8X16X4TC
80X100X13ADL	80X100X12TC	82X105X12ADL*	82X105X12TC	85X115X15A	85X115X13SC	8X16X7A*	8X16X75C
80X100X14A*	80X100X145C	82X105X13ADL	82X105X12TC	85X120X10ADL*	85X120X10TC	8X16X7A	8X16X45C
80X100X14A	80X100X10SC	82X110X12ADL*	82X110X12TC	85X120X12A*	85X120X12SC	8X16X7A	8X16X65C
80X100X18ADL	80X100X7TC	82X110X12V	82X110X12VSC	85X120X12ADL*	85X120X12TC	8X16X7ADL*	8X16X7TC
80X100X18ADL	80X100X10TC	82X110X13C*	82X110X13SA	85X120X12ADL	85X120X10TC	8X16X7ADL	8X16X4TC
80X100X18ADL	80X100X12TC	83X100X9ADL*	83X100X9TC	85X120X12V	85X120X12VTF	8X16X7V	8X16X7VSC
80X100X18ADL	80X100X13TC	83X110X13C*	83X110X13SA	85X120X12V	85X120X12SC	8X16X7V	8X16X7VTF
80X100X8ADL	80X100X7TC	84X105X12ADL*	84X105X12TC	85X120X13A	85X120X12SC	8X17X5ADL*	8X17X5TC
80X102X11ADL*	80X102X11TC	84X110X12C*	84X110X12SA	85X120X13ADL	85X120X10TC	8X17X7ADL*	8X17X7TC
80X105X10A*	80X105X10SC	84X110X16ADL*	84X110X16TC	85X120X13ADL	85X120X12TC	8X17X7ADL	8X17X5TC
80X105X10ADL*	80X105X10TC	85X100X12A	85X100X95C	85X125X12V	85X125X12VSF	8X17X7ADL	8X17X5TC
80X105X12A	80X105X10SC	85X100X12ADL*	85X100X12TC	85X125X13C*	85X125X13SA	8X18X4ADL*	8X18X4TC
80X105X12ADL	80X105X10TC	85X100X13ADL*	85X100X13TC	85X125X14ADL*	85X125X14TC	8X18X5A*	8X18X55C
80X105X12V	80X105X12VTC	85X100X13ADL	85X100X12TC	85X125X14ADL	85X125X12TC	8X18X5ADL*	8X18X5TC
80X105X13A	80X105X10SC	85X100X13C*	85X100X13SA	85X125X14ADL	85X125X13TC	8X18X5ADL	8X18X4TC
80X105X13ADL*	80X105X13TC	85X100X9A*	85X100X95C	85X126X13A*	85X126X13SC	8X18X5V	8X18X5VTC
80X105X13ADL	80X105X10TC	85X100X9B*	85X100X95B	85X130X10ADL*	85X130X10TC	8X18X6A	8X18X55C
80X105X14ADL	80X105X10TC	85X100X9V	85X100X9VSF	85X130X12ADL*	85X130X12TC	8X18X7ADL*	8X18X7TC
80X105X14ADL	80X105X13TC	85X103X8ADL*	85X103X8TC	85X130X12ADL	85X130X10TC	8X18X7ADL	8X18X4TC
80X108X13ADL*	80X108X13TC	85X105X10ADL*	85X105X10TC	85X130X12V	85X130X12VTC	8X18X7ADL	8X18X5TC
80X110X10A*	80X110X10SC	85X105X12ADL*	85X105X12TC	85X130X13V	85X130X13VTF	8X18X8ADL*	8X18X8TC
80X110X10ADL*	80X110X10TC	85X105X12ADL	85X105X10TC	85X140X12ADL*	85X140X12TC	8X18X8ADL	8X18X4TC
80X110X10V	80X110X10VTF	85X105X12V	85X105X12VTF	85X150X12A*	85X150X12SC	8X18X8ADL	8X18X5TC
80X110X12A*	80X110X12SC	85X105X13A	85X105X13SF	85X150X12ADL*	85X150X12TC	8X18X8ADL	8X18X7TC
80X110X12A	80X110X10SC	85X105X13ADL*	85X105X13TC	85X150X13A	85X150X12SC	8X19X6.5A	8X19X65C
80X110X12ADL*	80X110X12TC	85X105X13ADL	85X105X10TC	85X155X12A*	85X155X12SC	8X19X7ADL*	8X19X7TC
80X110X12ADL	80X110X10TC	85X105X13ADL	85X105X12TC	86X104X11ADL*	86X104X11TC	8X20X5ADL*	8X20X5TC
80X110X12V	80X110X12VSC	85X110X10A*	85X110X10SC	87X100X12ADL*	87X100X12TC	8X20X8ADL	8X20X5TC
80X110X13A	80X110X10SC	85X110X10ADL*	85X110X10TC	87X110X13C*	87X110X13SA	8X20X8V	8X20X8VSF
80X110X13A	80X110X12SC	85X110X10ADL	85X110X6TC	88X100X13A*	88X100X13SC	8X21X6ADL*	8X21X6TC
80X110X13ADL	80X110X10TC	85X110X10V	85X110X10VTCW	88X110X10A*	88X110X10SC	8X21X10A	8X22X75C
80X110X13ADL	80X110X12TC	85X110X10V	85X110X10VTF	88X110X12A*	88X110X12SC	8X22X6ADL	8X22X5TC
80X110X13B	80X110X10SB	85X110X11ADL	85X110X6TC	88X110X12A	88X110X10SC	8X22X7A*	8X22X75C
				88X110X13A*	88X110X13SC	8X22X7ADL*	8X22X7TC



PLEASE CALL DICHTOMATIK FOR AVAILABILITY - 800-328-2840
BULK AND INDIVIDUALLY BOXED QUANTITIES ARE AVAILABLE FOR ALL ITEMS
* = EXACT INTERCHANGE - ALL OTHERS ARE FUNCTIONALLY

Harwal Part #	TCM Part #	Harwal Part #	TCM Part #	Harwal Part #	TCM Part #	Harwal Part #	TCM Part #
8X22X7ADL	8X22X5TC	90X115X10ADL	90X115X9TC	93X110X12ADL*	93X110X12TC	95X130X12V	95X130X12VTC
8X22X7V	8X22X7VTC	90X115X12ADL	90X115X9TC	95X105X9ADL*	95X105X9TC	95X130X13A	95X130X12SC
8X22X7V	8X22X7VTF	90X115X12V	90X115X12VTF	95X110X10A*	95X110X10SC	95X130X13ADL	95X130X12TC
8X22X8A	8X22X7SC	90X115X13A	90X115X8SC	95X110X10ADL*	95X110X10TC	95X130X15A	95X130X12SC
8X24X7A*	8X24X7SC	90X115X13ADL	90X115X9TC	95X110X10ADL	95X110X7TC	95X132X12A*	95X132X12SC
8X24X7V	8X24X7VTC	90X115X13BDL*	90X115X13TB	95X110X10B	95X110X9SB	95X136X13A*	95X136X13SC
8X25X7ADL*	8X25X7TC	90X115X13V	90X115X13VTF	95X110X10BDL	95X110X7TB	95X145X10ADL*	95X145X10TC
8X25X8ADL*	8X25X8TC	90X115X8A*	90X115X8SC	95X110X10V	95X110X10VSC	95X145X13A*	95X145X13SC
8X25X8ADL	8X25X7TC	90X115X9A	90X115X8SC	95X110X10V	95X110X10VTF	95X145X13ADL*	95X145X13TC
8X26X7ADL*	8X26X7TC	90X115X9ADL*	90X115X9TC	95X110X11ADL*	95X110X11TC	95X145X13ADL	95X145X10TC
8X30X7A*	8X30X7SC	90X115X9C*	90X115X9SA	95X110X11ADL	95X110X7TC	95X150X15V	95X150X15VSF
8X30X7V	8X30X7VTC	90X115X9V	90X115X9VSF	95X110X11ADL	95X110X10TC	95X160X15V	95X160X15VSF
90X105X10ADL*	90X105X10TC	90X118X12ADL*	90X118X12TC	95X110X12A	95X110X10SC	96X112X10A*	96X112X10SC
90X105X10ADL	90X105X9TC	90X120X10A*	90X120X10SC	95X110X13A	95X110X10SC	98X120X13A*	98X120X13SC
90X105X4AO*	90X105X4VC	90X120X12A*	90X120X12SC	95X110X9B*	95X110X9SB	98X120X13ADL*	98X120X13TC
90X105X9ADL*	90X105X9TC	90X120X12A	90X120X10SC	95X112X12ADL*	95X112X12TC	98X125X13A*	98X125X13SC
90X109X10ADL*	90X109X10TC	90X120X12A	90X120X10SC	95X115X10C*	95X115X10SA	98X128X10V	98X128X10VSF
90X110X10A*	90X110X10SC	90X120X12ADL*	90X120X12TC	95X115X11A	95X115X8SC	98X130X13B*	98X130X13SB
90X110X10ADL*	90X110X10TC	90X120X12V	90X120X12VTF	95X115X12A	95X115X8SC	9X13X3AO*	9X13X3VC
90X110X10ADL	90X110X7TC	90X120X13A	90X120X10SC	95X115X12ADL*	95X115X12TC	9X15X3AO*	9X15X3VC
90X110X10C	90X110X8SA	90X120X13A	90X120X12SC	95X115X12ADL	95X115X10TC	9X15X5AO	9X15X3VC
90X110X10V	90X110X10VSF	90X120X13ADL*	90X120X13TC	95X115X12V	95X115X12VTC	9X16X4A*	9X16X4SC
90X110X10V	90X110X10VTF	90X120X13ADL	90X120X12TC	95X115X12V	95X115X12VTF	9X16X5A*	9X16X5SC
90X110X12A*	90X110X12SC	90X120X13B	90X120X10SB	95X115X13A*	95X115X13SC	9X16X5A	9X16X4SC
90X110X12A	90X110X10SC	90X120X13CDL*	90X120X13TA	95X115X13A	95X115X8SC	9X18X3AO*	9X18X3VC
90X110X12ADL*	90X110X12TC	90X120X15A	90X120X10SC	95X115X13ADL	95X115X10TC	9X18X7A*	9X18X7SC
90X110X12ADL	90X110X7TC	90X120X15ADL	90X120X12SC	95X115X13ADL	95X115X12TC	9X19X4A*	9X19X4SC
90X110X12ADL	90X110X10TC	90X120X15ADL	90X120X12TC	95X115X13C	95X115X10SA	9X19X5ADL*	9X19X5TC
90X110X12V	90X110X12VSC	90X120X15ADL	90X120X13TC	95X115X13V	95X115X13VTF	9X20X7ADL	9X20X4.5TC
90X110X12V	90X110X12VTF	90X125X13ADL*	90X125X13TC	95X115X8A*	95X115X8SC	9X20X9ADL*	9X20X9TC
90X110X13A*	90X110X13SC	90X125X13ADL	90X125X12TC	95X120X10ADL*	95X120X10TC	9X20X9ADL	9X20X4.5TC
90X110X13A	90X110X10SC	90X127X13BDL*	90X127X13TB	95X120X12A*	95X120X12SC	9X21X9.5ADL*	9X21X9.5TC
90X110X13A	90X110X12SC	90X130X12ADL*	90X130X12TC	95X120X12ADL*	95X120X12TC	9X22X7A*	9X22X7SC
90X110X13ADL*	90X110X13TC	90X130X12ADL	90X130X10TC	95X120X12ADL	95X120X10TC	9X22X7ADL*	9X22X7TC
90X110X13ADL	90X110X7TC	90X130X13A*	90X130X13SC	95X120X12V	95X120X12VTF	9X22X7V	9X22X7VSF
90X110X13ADL	90X110X10TC	90X130X13ADL*	90X130X13TC	95X120X12V	95X120X12VTC	9X24X7ADL*	9X24X7TC
90X110X13ADL	90X110X12TC	90X130X13ADL	90X130X10TC	95X120X13A	95X120X12SC	9X24X7V	9X24X7VSF
90X110X13ADL	90X110X12TC	90X130X13ADL	90X130X12TC	95X120X13ADL*	95X120X13TC	9X26X7A*	9X26X7SC
90X110X13V	90X110X13VTF	90X130X13ADL	90X130X12TC	95X120X13ADL	95X120X10TC	9X26X7V	9X26X7VTC
90X110X15ADL*	90X110X15TC	90X130X13V	90X130X13VSF	95X120X13ADL	95X120X12TC	9X28X8A*	9X28X8SC
90X110X15ADL	90X110X7TC	90X130X13V	90X130X13VTF	95X120X13B*	95X120X13SB	9X29X7ADL*	9X29X7TC
90X110X15ADL	90X110X10TC	90X135X13ADL*	90X135X13TC	95X120X13V	95X120X13VSZ	9X30X7A*	9X30X7SC
90X110X15ADL	90X110X12TC	90X140X13A*	90X140X13SC	95X120X8AO*	95X120X8VC		
90X110X15ADL	90X110X13TC	90X140X13ADL*	90X140X13TC	95X125X12ADL*	95X125X12TC		
90X110X7ADL*	90X110X7TC	90X140X13C*	90X140X13SA	95X125X12V	95X125X12VTF		
90X110X8ADL	90X110X7TC	90X160X12A*	90X160X12SC	95X125X13ADL*	95X125X13TC		
90X110X8C*	90X110X8SA	90X160X13ADL*	90X160X13TC	95X125X13ADL	95X125X12TC		
90X110X9ADL	90X110X7TC	91X136X12V	91X136X12VSF	95X125X15C	95X125X13SA		
90X115X10A	90X115X8SC	92X108X10ADL*	92X108X10TC	95X130X12A*	95X130X12SC		
		92X110X10ADL*	92X110X10TC	95X130X12ADL*	95X130X12TC		
		92X120X13A*	92X120X13SC	95X130X12CDL*	95X130X12TA		

HARWAL INTERCHANGES

HARWAL CROSS REFERENCES – AXIAL FACE SEALS

PLEASE CALL DICHTOMATIK FOR AVAILABILITY - 800-328-2840
 BULK AND INDIVIDUALLY BOXED QUANTITIES ARE AVAILABLE FOR ALL ITEMS
 * = EXACT INTERCHANGE - ALL OTHERS ARE FUNCTIONALLY



DICHTOMATIK

Any seal. Any time.

Harwal Part #	TCM Part #
10 24 3.5RB*	AFS 10
11 26 3.5RB *	AFS 11
14 30 04RB *	AFS 14
15 30 04RB *	AFS 15
15 32 04 9RB *	AFX 15 32 04
16 32 04RB *	AFS 16
17 32 04RB *	AFS 17
17 34 04 9RB *	AFX 17 34 04
18 33 04RB *	AFS 18
20 35 04RB *	AFS 20
22 40 3.5RB *	AFS 22
24 40 04RB *	AFS 24
25 40 04RB *	AFS 25
26 40 04RB *	AFS 26
28 43 04RB *	AFS 28
30 47 4.5RB *	AFS 30
32 49 4.5RB *	AFS 32
35 52 4.5RB *	AFS 35
35 53 4.5 9RB *	AFX 35 53 045
38 55 4.5RB *	AFS 38
40 57 4.5RB *	AFS 40
40 58 4.5 9RB *	AFX 40 58 045
41 57 4.5RB *	AFS 41
42 59 4.5RB *	AFS 42
45 62 4.5RB *	AFS 45
45 63 4.5 9RB *	AFX 45 63 045
48 65 4.5RB *	AFS 48
50 70 5.5RB *	AFS 50
50 72 5.5 9RB *	AFX 50 72 055
52 72 4.5RB *	AFS 52
55 75 5.5RB *	AFS 55
55 77 5.5 9RB *	AFX 55 77 055
58 78 5.5RB *	AFS 58
60 80 5.5RB *	AFS 60
62 82 5.5RB *	AFS 62
65 85 5.5RB *	AFS 65
68 88 5.5RB *	AFS 68
70 90 5.5RB *	AFS 70
70 92 5.5 9RB *	AFX 70 92 055
72 92 5.5RB *	AFS 72
75 95 5.5RB *	AFS 75
75 97 5.5 9RB *	AFX 75 97 055
78 98 5.5RB *	AFS 78

HARWAL AXIAL FACE SEALS
INTERCHANGES



PLEASE CALL DICHTOMATIK FOR AVAILABILITY - 800-328-2840
BULK AND INDIVIDUALLY BOXED QUANTITIES ARE AVAILABLE FOR ALL ITEMS
* = EXACT INTERCHANGE - ALL OTHERS ARE FUNCTIONALLY

Harwal Part #	TCM Part #	Harwal Part #	TCM Part #	Harwal Part #	TCM Part #	Harwal Part #	TCM Part #	Harwal Part #	TCM Part #
VA-03 *	VA-003	VA-20 *	VA-020	VA-55 *	VA-055	VL-375 *	VL-375	VS-199 *	VS-199
VA-03 V*	VVA-003	VA-20 V*	VVA-020	VA-55 V*	VVA-055	VL-400 *	VL-400	VS-199 V*	VVS-199
VA-04 *	VA-004	VA-200 *	VA-200	VA-550 *	VA-550	VL-425 *	VL-425	VS-20 *	VS-020
VA-04 V*	VVA-004	VA-200 V*	VVA-200	VA-550 V*	VVA-550	VL-450 *	VL-450	VS-20 V*	VVS-020
VA-05 *	VA-005	VA-22 *	VA-022	VA-60 *	VA-060	VL-500 *	VL-500	VS-22 *	VS-022
VA-05 V*	VVA-005	VA-22 V*	VVA-022	VA-60 V*	VVA-060	VL-550 *	VL-550	VS-22 V*	VVS-022
VA-06 *	VA-006	VA-220 *	VA-220	VA-600 *	VA-600	VL-600 *	VL-600	VS-25 *	VS-025
VA-06 V*	VVA-006	VA-220 V*	VVA-220	VA-600 V*	VVA-600	VS-05 *	VS-005	VS-25 V*	VVS-025
VA-07 *	VA-007	VA-25 *	VA-025	VA-65 *	VA-065	VS-05 V*	VVS-005	VS-28 *	VS-028
VA-07 V*	VVA-007	VA-25 V*	VVA-025	VA-65 V*	VVA-065	VS-06 *	VS-006	VS-28 V*	VVS-028
VA-08 *	VA-008	VA-250 *	VA-250	VA-650 *	VA-650	VS-06 V*	VVS-006	VS-30 *	VS-030
VA-08 V*	VVA-008	VA-250 V*	VVA-250	VA-650 V*	VVA-650	VS-07 *	VS-007	VS-30 V*	VVS-030
VA-10 *	VA-010	VA-275 *	VA-275	VA-70 *	VA-070	VS-07 V*	VVS-007	VS-32 *	VS-032
VA-10 V*	VVA-010	VA-275 V*	VVA-275	VA-70 V*	VA-070	VS-08 V*	VVS-008	VS-32 V*	VVS-032
VA-100 *	VA-100	VA-28 *	VA-028	VA-700 *	VA-700	VS-10 *	VS-010	VS-35 *	VS-035
VA-100 V*	VVA-100	VA-28 V*	VVA-028	VA-700 V*	VVA-700	VS-10 V*	VVS-010	VS-35 V*	VVS-035
VA-110 *	VA-110	VA-30 *	VA-030	VA-725 *	VA-725	VS-100 *	VS-100	VS-38 *	VS-038
VA-110 V*	VVA-110	VA-30 V*	VVA-030	VA-725 V*	VVA-725	VS-100 V*	VVS-100	VS-38 V*	VVS-038
VA-12 *	VA-012	VA-300 *	VA-300	VA-75 *	VA-075	VS-110 *	VS-110	VS-40 *	VS-040
VA-12 V*	VVA-012	VA-300 V*	VVA-300	VA-75 V*	VVA-075	VS-110 V*	VVS-110	VS-40 V*	VVS-040
VA-120 *	VA-120	VA-32 *	VA-032	VA-80 *	VA-080	VS-12 *	VS-012	VS-45 *	VS-045
VA-120 V*	VVA-120	VA-32 V*	VVA-032	VA-80 V*	VVA-080	VS-12 V*	VVS-012	VS-45 V*	VVS-045
VA-130 *	VA-130	VA-325 *	VA-325	VA-85 *	VA-085	VS-120 *	VS-120	VS-50 *	VS-050
VA-130 V*	VVA-130	VA-325 V*	VVA-325	VA-85 V*	VVA-085	VS-120 V*	VVS-120	VS-50 V*	VVS-050
VA-14 *	VA-014	VA-35 *	VA-035	VA-90 *	VA-090	VS-130 *	VS-130	VS-55 *	VS-055
VA-14 V*	VVA-014	VA-35 V*	VVA-035	VA-90 V*	VVA-090	VS-130 V*	VVS-130	VS-55 V*	VVS-055
VA-140 *	VA-140	VA-350 *	VA-350	VA-900 *	VA-900	VS-14 *	VS-014	VS-60 *	VS-060
VA-140 V*	VVA-140	VA-350 V*	VVA-350	VA-95 *	VA-095	VS-14 V*	VVS-014	VS-60 V*	VVS-060
VA-150 *	VA-150	VA-375 *	VA-375	VA-95 V*	VVA-095	VS-140 *	VS-140	VS-65 *	VS-065
VA-150 V*	VVA-150	VA-375 V*	VVA-375	VL-120 *	VL-120	VS-140 V*	VVS-140	VS-65 V*	VVS-065
VA-16 *	VA-016	VA-38 *	VA-038	VL-130 *	VL-130	VS-150 *	VS-150	VS-70 *	VS-070
VA-16 V*	VVA-016	VA-38 V*	VVA-038	VL-140 *	VL-140	VS-150 V*	VVS-150	VS-70 V*	VVS-070
VA-160 *	VA-160	VA-40 *	VA-040	VL-150 *	VL-150	VS-16 *	VS-016	VS-75 *	VS-075
VA-160 V*	VVA-160	VA-40 V*	VVA-040	VL-160 *	VL-160	VS-16 V*	VVS-016	VS-75 V*	VVS-075
VA-170 *	VA-170	VA-400 *	VA-400	VL-170 *	VL-170	VS-160 *	VS-160	VS-80 *	VS-080
VA-170 V*	VVA-170	VA-400 V*	VVA-400	VL-180 *	VL-180	VS-160 V*	VVS-160	VS-80 V*	VVS-080
VA-18 *	VA-018	VA-45 *	VA-045	VL-190 *	VL-190	VS-170 *	VS-170	VS-85 *	VS-085
VA-18 V*	VVA-018	VA-45 V*	VVA-045	VL-200 *	VL-200	VS-170 V*	VVS-170	VS-85 V*	VVS-085
VA-180 *	VA-180	VA-450 *	VA-450	VL-220 *	VL-220	VS-18 *	VS-018	VS-90 *	VS-090
VA-180 V*	VVA-180	VA-450 V*	VVA-450	VL-250 *	VL-250	VS-18 V*	VVS-018	VS-90 V*	VVS-090
VA-190 *	VA-190	VA-50 *	VA-050	VL-275 *	VL-275	VS-180 *	VS-180	VS-95 *	VS-095
VA-190 V*	VVA-190	VA-50 V*	VVA-050	VL-300 *	VL-300	VS-180 V*	VVS-180	VS-95 V*	VVS-095
VA-199 *	VA-199	VA-500 *	VA-500	VL-325 *	VL-325	VS-190 *	VS-190		
VA-199 V*	VVA-199	VA-500 V*	VVA-500	VL-350 *	VL-350	VS-190 V*	VVS-190		



Minimum Order Policy

The minimum order value is \$5.00 per order, including a \$1.00 per line minimum.

Shipping Terms Policy

All products are shipped “ExWorks, Dichtomatik Facility.”

Payment Terms Policy

Payments are “Net 30 Days” on approved credit.

Warranty

Dichtomatik Americas warrants that all products sold shall be free from defects in material and workmanship for a period of one year from date of invoice. Additional warranty information is included in the Dichtomatik Terms and Conditions of Sale.

30 Day Claims and Returns Policy

The purpose of this policy is to quickly address quality, pricing, quantity or shipping issues. Contact a Dichtomatik Customer Service Representative (CSR) immediately to initiate the following actions:

General Product Return Requirements Regardless of Fault:

Upon notification, the CSR will provide the customer with a Return Material Authorization (RMA) number, the return address, the shipping method and the carrier. The RMA number must be clearly shown on the packing slip, the exterior of the shipping box, and other accompanying documentation. Any items returned without a Dichtomatik RMA number will not be accepted. Product must be returned in sellable condition; i.e., unused, unopened, clean, and in the original package, box, sleeve, or poly-bag.

Product Ordered In Error By The Customer:

Product eligible for return must be listed in current Dichtomatik price books or catalogs. Non-stock product and special / custom product are not eligible for return. No restocking charges will be applied if the original packing slip number is provided to the CSR and an offsetting order of equal or greater value is placed at the time of the return request. A restocking fee of 15% or \$15 (whichever is greater) will be charged on returns without the original packing slip number or an order of equal or greater value is not placed. Product should be returned to Dichtomatik freight prepaid.

Product Shipped In Error By Dichtomatik:

If a return is requested, the CSR will provide the customer with an RMA number and other information as described in the “General Product Return Requirements.” Upon receipt and inspection of the returned product, the CSR will initiate a credit and the RMA number will be referenced when the credit is

issued. Standard transportation costs will be paid by Dichtomatik for the returned product.

Shipment Quantity Error by Dichtomatik:

If the total order shipment quantity is less than originally ordered and no return is required, the CSR will initiate a credit and the RMA number will be referenced when the credit is issued. If the total order shipment quantity is greater than originally ordered and a return is required, the CSR will provide the customer with an RMA number and other information as described in the “General Product Return Requirements.” Upon receipt and inspection of the returned product, the CSR will initiate a credit and the RMA number will be referenced when the credit is issued. Standard transportation costs will be paid by Dichtomatik for the returned product.

Pricing Error by Dichtomatik:

If no return is required, the CSR will initiate a credit and the RMA number will be referenced when the credit is issued. If a return is required, the CSR will provide the customer with an RMA number and other information as described in the “General Product Return Requirements.” Upon receipt and inspection of the returned product, the CSR will initiate a credit and the RMA number will be referenced when the credit is issued. Standard transportation costs will be paid by Dichtomatik for the returned product.

Please refer to Dichtomatik’s Terms & Conditions for warranty on our products.



DICHTOMATIK AMERICAS - TERMS AND CONDITIONS OF SALE FOR FINISHED GOODS

Updated March 15, 2011

- **Offer and Acceptance.** The sale of products and services ("Products") by Dichtomatik Americas, LP ("Seller") to the purchaser (the "Purchaser") is subject to Purchaser's acceptance of the terms and conditions herein (this "Contract"). These are the only terms and conditions applicable to the sale of Products by Seller, except for provisions relating to Product price, quantity, specifications, delivery timing and locations for delivery as elsewhere agreed in writing by the parties. Issuance of a purchase order or any acceptance by Purchaser constitutes acceptance of these terms and conditions. Any additional or different terms or modifications to these terms proposed by Purchaser, whether in a purchase order or otherwise, are hereby expressly rejected by Seller.
- **Price.** Prices given in any quotation by Seller are subject to change after thirty (30) days if not accepted. To the extent permitted by law, all applicable sales, excise, use or similar taxes or charges for the sale of Products will be in addition to the stated price and will be paid by Purchaser. Seller reserves the right to increase any price at any time, even after quoted and accepted, in the event of increased costs beyond Seller's reasonable control including, without limitation: (a) raw material costs, (b) modifications to specifications requested by Purchaser, or (c) price of goods manufactured by others which are re-sold by Seller.
- **Payment.** Unless cash with order is required by Seller, all accounts are due thirty (30) days without setoff from date of Seller's invoice and shall be paid in \$U.S. Overdue payments shall bear interest at the lesser of 18% per annum (1.5% per month) or the maximum rate permitted by law. Seller shall have the right, among other remedies, including the right of setoff, either to terminate this Contract or to suspend further deliveries under this Contract or any agreement with Purchaser in the event Purchaser fails to make any payment when due. Purchaser shall be liable for all expenses related to collection of past due amounts, including attorneys' fees. Seller may require full or partial payment in advance of any shipment. Where credit terms have been given to Purchaser, Seller may at any time change or withdraw such terms. If Purchaser requests delayed shipment, Seller may bill for Products when ready for shipment and charge reasonable daily storage fees.
- **Shipping and Delivery.** Seller shall not be liable for delays or failure in performance when caused by circumstances beyond Seller's reasonable control. If Purchaser does not provide routing instructions, Seller shall be the solely determine the best method of routing shipment. All sales of Products are F.O.B. Seller's plant. All shipping and insurance expenses and risk of loss are assumed by Purchaser. Seller reserves the right to ship and Purchaser agrees to accept an underrun or overrun of any quantity up to and including 10% of the quantity ordered by Purchaser.
- **Rejections and Returns.** Purchaser will be deemed to have inspected and accepted all delivered Products unless written notice of rejection, specifying the basis therefore in reasonable detail, is provided to Seller within thirty (30) days after delivery. Purchaser may not return Products without Seller's prior written approval in the form of a Return Material Authorization.
- **Limited Warranty.** Seller warrants to Purchaser that: (a) the Products will be free from defects in workmanship and materials, and will conform to Seller's specifications; and (b) Seller will transfer to Purchaser ownership and good title to Products delivered, free of all liens, encumbrances, and rights of third parties (except those created by Purchaser). This warranty will continue for one (1) year from delivery of the Products. THE FOREGOING WARRANTIES ARE EXCLUSIVE AND ARE IN LIEU OF ALL OTHER WARRANTIES OR REPRESENTATIONS, EXPRESS OR IMPLIED, ARISING BY LAW OR CUSTOM, INCLUDING IMPLIED WARRANTIES OF MERCHANTABILITY AND FITNESS FOR A PARTICULAR PURPOSE, SAID IMPLIED WARRANTIES BEING HEREBY EXPRESSLY DISCLAIMED.
- **Limited Remedy.** Any warranty claims by Purchaser must be provided to Seller in writing within the warranty period. Purchaser's sole and exclusive remedy for a valid warranty claim is either replacement of the Product or a full refund of the price paid by Purchaser for the Product. This remedy does not include the cost of installation, removal, dismantling, or reinstallation. If applicable, Purchaser will provide Seller with access to all available warranty data and field returned Products; and provide Seller with an opportunity to participate in any root cause analysis performed by Purchaser concerning the Products. Seller shall have no liability to the extent Products are or have been: (a) modified by Purchaser or a third party; (b) modified by Seller at Purchaser's request; (c) made to specifications not provided by Seller; (d) used or installed in a way not known to Seller or operated under conditions not known to Seller; or (e) subject to misuse, abuse or improper storage, installation or maintenance. Products replaced during the warranty period shall be under warranty for the remainder of the original warranty period or ninety (90) days, whichever is longer.
- **Limitation of Liability.** NOTWITHSTANDING ANYTHING HEREIN TO THE CONTRARY, EXCEPT FOR BREACH OF OBLIGATIONS OF CONFIDENTIALITY OR MISAPPROPRIATION OF INTELLECTUAL PROPERTY, NEITHER PARTY SHALL BE LIABLE TO THE OTHER PARTY OR ANY THIRD PARTY FOR ANY SPECIAL, INCIDENTAL, INDIRECT, CONSEQUENTIAL, PUNITIVE, OR EXEMPLARY DAMAGES OF ANY KIND ARISING FROM OR RELATING TO THE OBLIGATIONS UNDER THIS CONTRACT. THE TERM "CONSEQUENTIAL DAMAGES" SHALL INCLUDE, BUT NOT BE LIMITED TO, LOSS OF ANTICIPATED PROFITS, LOSS OF USE, LOSS OF REVENUE AND COST OF CAPITAL. NEITHER PARTY MAY BRING ANY ACTION, REGARDLESS OF FORM, ARISING OUT OF TRANSACTIONS UNDER THE CONTRACT, MORE THAN TWO (2) YEARS AFTER THE CAUSE OF ACTION HAS ACCRUED. EXCEPT FOR PERSONAL INJURY OR DEATH DUE TO SELLER'S NEGLIGENCE OR INTENTIONAL MISCONDUCT, THE PARTIES AGREE THAT THE TOTAL DAMAGES THAT CAN BE AWARDED IN ANY CLAIM BY PURCHASER RELATING TO SELLER'S OBLIGATIONS UNDER THIS CONTRACT (WHETHER BASED IN CONTRACT, TORT OR OTHERWISE), SHALL NOT EXCEED THE COMBINED TOTAL OF AMOUNTS PAID BY PURCHASER TO SELLER UNDER THE CONTRACT DURING THE TWELVE (12) MONTH PERIOD IMMEDIATELY PRECEDING THE EVENT GIVING RISE TO SUCH LIABILITY. THE PARTIES EXPRESSLY AGREE THAT THE ABOVE LIMITATIONS ON LIABILITY PROVISION SHALL REMAIN IN FULL FORCE AND EFFECT EVEN IF IT IS FOUND THAT PURCHASER'S EXCLUSIVE REMEDY FAILS OF ITS ESSENTIAL PURPOSE.
- **Patent Infringement.** Seller shall defend, at its sole expense, any third party claim, demand or suit against Purchaser ("Claim") alleging that the use of any Product, as authorized by Seller, infringes a third party's U.S. patent, and shall indemnify Purchaser against any and all losses awarded or assessed against Purchaser in connection with the Claim, or reached through a negotiated settlement of the Claim; provided, that: (a) the alleged infringement does not arise from Seller's compliance with specifications or designs furnished by Purchaser; (b) Seller receives prompt written notice of such Claim and exclusive control over the defense and/or settlement of the Claim; and (c) Purchaser provides Seller with all information available to Purchaser for the defense and cooperates with Seller in the defense, and does not take a position adverse to Seller. Further, Seller will have no liability under this section if and to the extent that a claim of infringement is based on: (1) a Product modification made by Purchaser or a third party, or made by Seller at Purchaser's request; (2) use or interconnection by Purchaser of the Product in combination with other products not made or sourced by Seller; or (3) Products made to design or specifications not provided by Seller. Except for third party claims above, and subject to the limitations above, Seller's exclusive obligation to Purchaser as to Products declared to infringe, and Seller's right as to Products which Seller believes are likely to infringe, is the acquisition of a license, the replacement of Products with non-infringing goods, the modification of the Products so that they are non-infringing, or the return of the purchase price for the Products, as Seller may elect in its sole discretion. THIS SECTION STATES SELLER'S ENTIRE LIABILITY AND PURCHASER'S EXCLUSIVE REMEDIES AS TO PATENT INFRINGEMENT.
- **Ownership of Proprietary Materials.** Seller shall have and retain all intellectual property rights in all Products, tooling and associated materials, furnished by Seller in connection with or pursuant to this Contract, including, without limitation, patents, utility models, design rights (and any pending applications), trademarks, copyrights, technical, business, economic or know-how information, trade secrets, confidential proprietary information, inventions, data, formulae, material compositions, drawings, specifications, and any right related thereto (whether or not patentable) that is not generally available to the public ("Proprietary Materials"). No Proprietary Materials created by Seller in connection with or pursuant to this Contract shall be considered "works made for hire" as that term is used in connection with the U.S. Copyright Act. To the extent that Purchaser owns any rights in such Proprietary Materials, Purchaser hereby irrevocably assigns to Seller all rights, title and interest, including all intellectual property rights, in and to such Proprietary Materials.
- **Tooling.** Tools purchased and fully paid for by Purchaser (if any) shall be the property of Purchaser with the exception of any of Seller's Proprietary Materials contained in or part of such tooling. Tools partially paid for by Purchaser (if any) shall remain the property of Seller.
- **Technical Advice.** Any technical advice furnished by Seller to Purchaser before or after delivery of the Products is gratuitous and without charge on the basis that it represents Seller's good faith judgment under the circumstances but that it is not a representation or warranty of Seller and is to be used at Purchaser's sole risk.



- **Compliance with Law.** The parties shall comply with all applicable federal, state, local and foreign laws, orders, rules, regulations and ordinances. Purchaser agrees that it is solely responsible for required compliance with the import and export laws and regulations of any jurisdiction or country that may be applicable.
- **Confidentiality.** If the parties have entered into a Confidentiality or Non-Disclosure Agreement (“NDA”), the terms and conditions of the NDA shall apply and control for confidentiality obligations between the parties. In connection with this Contract, Purchaser may have access to Seller’s confidential information, including, without limitation inventions, developments, know how, specifications, business plans, results of testing, systems, financial information, product information, methods of operation, customer information, supplier information and compilations of data (“Seller’s Confidential Information”). Purchaser shall use Seller’s Confidential Information only for the purposes contemplated under this Contract and shall not disclose it to third parties. Purchaser shall maintain the confidentiality of Seller’s Confidential Information in the same manner, but in no event less than the manner, in which it protects its own confidential information. Purchaser is permitted to disclose Seller’s Confidential Information to its employees and authorized subcontractors on a need to know basis only, provided that such employees and authorized subcontractors have written confidentiality obligations to Purchaser no less stringent than the confidentiality obligations under this Section. Upon termination of this Contract, Purchaser shall return Seller’s Confidential Information and shall not use Seller’s Confidential Information for its own, or any third party’s, benefit. Purchaser’s confidentiality obligations shall survive termination of this Contract for so long as Seller’s Confidential Information remains confidential. In order to assure that Seller is able to obtain the full benefit of the restrictions set forth in this Section, Seller shall be entitled to injunctive relief, including, but not limited to, emergency, preliminary, temporary and permanent injunctions, from any court of competent jurisdiction as may be necessary to enjoin any violation of the foregoing covenants, without the necessity of proving immediate irreparable harm or an inadequate remedy at law.
- **Contract Work.** Purchaser and Seller are independent contractors and nothing in this Contract makes either party the agent or legal representative of the other party for any purpose. Neither party has authority to assume or to create any obligation on behalf of the other party.
- **Termination by Seller.** In addition to any other rights of Seller to terminate this Contract or suspend performance under this Contract, Seller may, upon written notice to Purchaser, immediately terminate all or any part of this Contract or suspend performance under this Contract, without any liability to Purchaser if Purchaser: (a) repudiates, breaches, or threatens to breach any of the terms of this Contract; (b) fails to accept or threatens not to accept Products in accordance with this Contract, (c) fails to make timely payment; or (d) declares or threatens insolvency or bankruptcy. Upon termination of this Contract by Seller, Seller shall be relieved of any further obligation to Purchaser, and Purchaser shall: (1) be liable to Seller for the immediate payment of amounts then billed to date by Seller to Purchaser; (2) buy and pay Seller immediately for all unique raw materials, work in process and finished goods under this Contract; (3) reimburse Seller for any unreimbursed and unamortized research and development costs, capital equipment, and supplies that are unique to the Products; and (4) immediately reimburse Seller for all preparation and other expenses incurred by Seller or its subcontractors in connection with this Contract and for all other losses or costs arising from termination.
- **Termination by Purchaser.** If Seller fails to perform any obligation under this Contract and, if the non-performance can be cured and Seller fails to cure the non-performance within thirty (30) business days after written notice from Purchaser, Purchaser may terminate this Contract upon giving written notice to Seller not less than ninety (90) days prior to shipment. In the event that Purchaser cancels any purchase order under this Contract, Seller shall be relieved of any further obligation to Purchaser, and Purchaser shall: (a) pay all amounts then due, (b) purchase and pay Seller immediately for all unique raw materials, work in process and finished goods under this Contract, and (c) reimburse Seller for any unreimbursed and unamortized research and development costs, capital equipment, and supplies that are unique to the Products.
- **Force Majeure.** Neither party shall be liable if its performance is delayed or made impossible or commercially impracticable due to acts of God, war, riot, fire, floods, labor trouble, unavailability of materials or components, explosion, breakdown or accident, delay in transportation, plant shutdown, compliance with governmental requests, laws, regulations, order or actions, unforeseen circumstances, or causes beyond such party’s reasonable control.
- **Governing Law, Jurisdiction and Venue.** This Contract shall be governed by and construed in accordance with the laws of the State of Michigan without reference to the choice of law principles thereof. The Convention on Contracts for the International Sale of Goods is expressly excluded. Subject to the provisions of Dispute Resolution below, each party irrevocably submits to the jurisdiction of the Courts of the State of Michigan and the United States District Court for the Eastern District of Michigan and hereby waives, to the fullest extent it may effectively do so, the defense of an inconvenient forum to the maintenance of such action or proceeding.
- **Dispute Resolution.** In the event of any dispute or disagreement between Seller and Purchaser arising out of or relating to this Contract (a “Dispute”), such Dispute, upon the written request of Seller or Purchaser, shall be referred to the chief financial officers of each party or their respective designees. The chief financial officers or their respective designees will promptly meet in good faith to resolve the Dispute and if they do not agree upon a resolution within thirty (30) calendar days after the reference of the Dispute to them, then such Dispute, upon written notice from one party to the other of its intent to arbitrate (an “Arbitration Notice”), shall be submitted to and settled exclusively by final and binding arbitration in lieu of any judicial proceeding; provided, however, that nothing contained in this Section shall preclude any party from seeking or obtaining injunctive, equitable, or other judicial relief from a court with jurisdiction, to specifically enforce the provisions of this Contract or to preserve the status quo. Arbitration shall be conducted by the American Arbitration Association in Southfield, Michigan before a single arbitrator in accordance with the Commercial Arbitration Rules of the American Arbitration Association existing at the date of submission of the Dispute to arbitration. Any arbitration award shall be binding and enforceable against Seller and Purchaser and judgment may be entered thereon in any court of competent jurisdiction. Notwithstanding the foregoing, any Dispute relating to or arising out of, in whole or in part, any breach of Purchaser’s obligations of confidentiality hereunder or for the misuse or infringement of Seller’s intellectual property rights by Purchaser shall not be subject to binding arbitration under this Contract.
- **Assignment, Waiver, Entire Agreement, Severability.** Purchaser may not assign or delegate any of its rights or obligations under this Contract without prior written consent from Seller. Seller may terminate this Contract upon giving at least sixty (60) days written notice to Purchaser, without any liability to Purchaser, if there is a change of control of Purchaser. Seller may assign its rights and obligations under this Contract at any time, without Purchaser’s prior written consent. The failure of either party to enforce any right or remedy provided in this Contract or by law on a particular occasion will not be deemed a waiver of that right or remedy on a subsequent occasion or a waiver of any other right or remedy. The Contract constitutes the entire agreement between the parties with respect to its subject matter, and supersedes all prior oral or written representations or agreements by the parties with respect to the subject matter of this Contract. This Contract may not be modified unless in writing and signed by authorized representatives of both parties. Any provision found invalid or unenforceable will not affect the validity or enforceability of any other provision and the invalid provision may be judicially modified to the extent enforceable.