



International Institution for Production Engineering Research

NEWSLETTER

N° 25 - November 2004

CIRP Office: 9, rue Mayran, 75009 Paris France
Tel +33 1 45262180 - Fax +33 1 45269215
e-mail cirp@cirp.net - web site: <http://www.cirp.net>

Contents

1. From the President
2. About CIRP
3. Personal
 - Professor Professor Tönshoff Doctor honoris causa
 - Professor Stephen Malkin receives Manufacturing Award
 - Remembrance of Mrs. Lilli Koenigsberger
4. The CIRP Annals and the Science Citation Index
5. Associate Members News
6. From the labs
7. General Assembly 2004 in Krakow
8. From the STC's
9. Meetings Seminars, conferences
10. From the secretariat
11. Miscellaneous
 - New books received
 - Vacancies/ Opportunities
 - 100,000 Euro Villa Hügel Materials Award 2005

The next issue of the Newsletter is scheduled for April 2005. Your contributions are much appreciated; you may send it to the CIRP office in Paris or directly to the editor at: j.meijer@utwente.nl preferable before March 15th 2005

Johan Meijer (Technical Secretary)

1. From the President

Professor Ichiro Inasaki

Dear CIRP Colleagues,

Since I became a member of the CIRP in 1985, it has been the most important venue for me to present my papers and it has provided me with numerous opportunities to exchange information pertaining to manufacturing technologies, and to meet many colleagues. This must be the same for all CIRP colleagues. It is therefore a great honour for me to be appointed as president of this authoritative institution and I will do my best to further serve the aims of the CIRP.

The CIRP has certain characteristics that other associations do not possess. One of them is that the CIRP has a proud tradition of bringing first-class researchers and engineers in the manufacturing field together, and fosters an environment of friendly cooperation that contributes toward the development of manufacturing technologies. I will endeavour to keep this tradition, and to take additional steps directed at further developing the CIRP. The CIRP provides engineers from industry and universities with the opportunity to meet each other in such a way that they can exchange information and learn from each other. My role as the president is, therefore, to keep and promote these activities of the CIRP, and I will actively take on the opinions and comments from our younger members into account when managing this big institution.



Within the coming year, I would like to take action to increase the number of associate members because it is important to hear and know the needs from many industries for the academic members. It is also important for maintaining a stable management of the CIRP from the financial viewpoint. The second issue I am thinking is to promote the information exchange for fostering the manufacturing engineers in universities. This is particularly important for the future development of manufacturing technologies. This is the reason why I proposed at the liaison committee meeting in Krakow to organize the round table for discussing the “Engineering education in universities – A Paradigm shift”.

In my last year as vice president under Professor Michel Veron, I learned how hard it is to manage the CIRP. Fortunately, I have very able colleagues in the CIRP office, and I am sure that I will need their help in the coming year. I will do my best with their and all your help.

Let us collaborate towards the further development of the CIRP!

Professor PhD. Dr.-Ing E.h.

Ichiro Inasaki ,

2. About CIRP

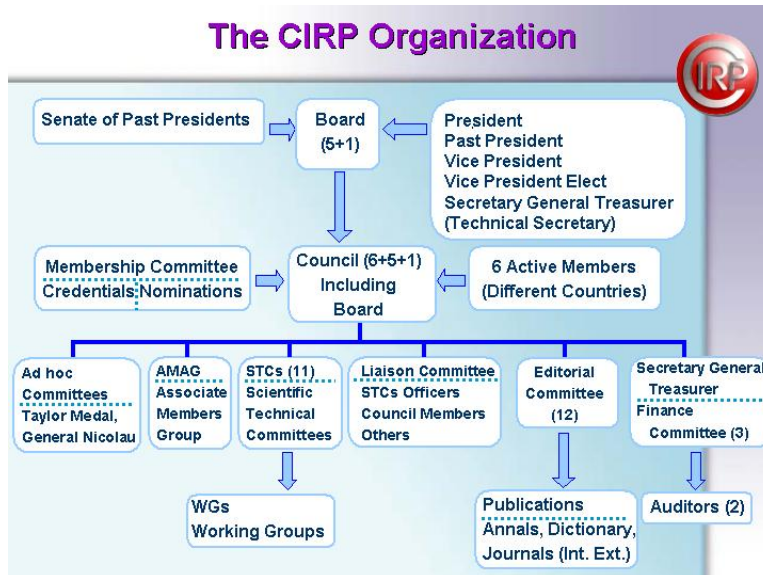

The International Institution for Production Research (CIRP) was founded in 1951 as Collège International pour la Recherche en Productique to bring together research workers studying the application of scientific methods to production technology.

At present, CIRP has about 500 members representing some 40 different countries. The unique contribution of CIRP to manufacturing research is acknowledged by many of the world's leading companies and research

institutes, who provide active support through the associate membership. Today, CIRP is turning its attention to the use of computerized methods for manufacturing control, automation, robotics, interfacing and the computer-integrated factory of the future. The CIRP is organised in Scientific and Technical Committees (STC's) that are the groups responsible for coordinating the collaborative research. The main activities are:

- Studying new techniques and technologies;
- Organising cooperative research projects, comparative testing and standardisation;
- Collecting and analysing bibliographies on manufacturing;
- Publishing synthesis reports on important technical problems;
- Organising seminars and meetings on specialist topics;
- Preparing internationally accepted terminology;
- Contributing to the work of the International Standardisation Organisation;
- Surveying the state of the art of research in different laboratories over the world;

The Scientific and Technical Committees (STC's) are:

- A: Assembly
- C: Cutting
- Dn: Design
- D: Dictionary
- E: Electro-Physical and Chemical processes
- F: Forming
- G: Abrasive Processes
- M: Machines
- O: Optimisation of manufacturing systems
- P: Precision engineering and metrology
- S: Surfaces

3. Personal

Professor Tönshoff Doctor honoris causa

Professor Hans-Kurt Tönshoff was conferred the Doctor of Science and Technology, honoris causa from Keio University on November 8, 2004.

The statement of Yuichiro Anzai, president of Keio University: "On behalf of Keio University, I should like to express my sincere appreciation and admiration for your remarkable accomplishments. Professor Tönshoff is a distinguished scholar in Engineering and has at the same time served to establish an excellent education program in production engineering. His excellent work in Germany is already clear to see from the number of honours by the German government and a number of universities, I will focus here on his particular contribution to collaborative activities with Keio University.



The academic relationship between universities in Germany and Keio University is one of the most active among our various international programs. There are 13 German institutions that have close ties to Keio; in the past, we have sent to them a total of 91 students for study, while 109 German students have studied here within the framework of our student exchange program. Because of these remarkable activities, the German Academic Exchange Service provides us with the possibility of one scholarship position every year, exclusively for the students of Keio University, in addition to the regular scholarship program. The program with the University of Hannover is quite unique: The selected students are not exchanged but rather visit each other and study together. In the autumn semester of 2003, two students sent from Keio studied in Hannover, and in the spring semester of 2004, they returned, together with two students from there. They attended lectures together and worked on their final theses. In this manner, the interaction between the students is intensified, as compared to regular exchange programs where the students participating in the program do not really meet each other. This kind of program also provides the opportunity to consider the possibility of a united education program of both universities based on different cultures and histories. I believe that the exchange program with the University of Hannover will serve as a good prototype for international engineering education in the future.

Professor Stephen Malkin receives Manufacturing Award

Professor Stephen Malkin has been selected to receive the 2004 William T. Ennor Manufacturing Technology Award of the American Society of Mechanical Engineers (ASME) "for his research leading to a comprehensive fundamental understanding of grinding and abrasive machining processes, for developing enabling technologies to enhance the efficiency of their use in industry, and for taking a leading role in the transformation of grinding and abrasive machining from an empirical craft to an applied science." Formal presentation of this award has taken place at the President's Luncheon, Monday, November 15, 2004, during the ASME International Mechanical Engineering Congress, November 14 - 19, 2004, at the Anaheim Hilton Hotel in Anaheim, California.



Mrs. Lilli Koenigsberger

a personal remembrance

by professor Alec Chisholm

I am very sad about Lilli Koenigsberger's death. My wife and I had a very close relationship with her, and I have always understood that it was her husband, Franz Koenigsberger who originally proposed me for membership of CIRP. The evening after my election, he congratulated me on my election and then in a subtle and pleasant little gesture, he took his own large red badge out of his coat lapel and transferred it to me, carefully inserting it in my lapel,. That is why at CIRP functions, I always wear his original old-fashioned large badge in my coat.

He died early just after he had retired. His father had lived to be 103 or 104 having no particular illness but I was told that he just decided one day that it was time for him to go and so he turned his face to the wall and just died a day or two later.

Franz was the best student of the great George Schlesinger in Berlin. He married Schlesinger's daughter, Lilli Schlesinger was arrested allegedly for colluding with the Russians thought to be a treasonable offence then. (He had actually only been doing what CIRP members later spent their time doing, discussing scientific work on machine tool research.). He was arrested and tried but, according to Lilli, because the trial was early in the Nazi regime and the legal system was still working to some extent, he was found 'not guilty'.

He wanted to remain in Germany but Franz and his daughter Lilli knew better what any Jew might expect and persuaded him to escape. They were of course all Jewish. They went first to Belgium and then by invitation came to the UK to take up a post as the Director of the shortly-to-be established Research Institute of the Institution of Production Engineers in Loughborough. Lilli told me that she was present when her father received a 'phone call from England which issued the invitation to him. International 'phone calls in those days were quite unusual but the offer of a job 'out of the blue' was truly exceptional. He accepted and Franz and Lilli came with him to England. Franz wrote it up in his autobiography, 'The Hammer and the Anvil', the story of his early working experiences doing engineering design jobs the machine tool industry in the UK. They are very revealing accounts of how this German-trained engineer dealt with the antiquated ideas he encountered in British machine tool practice at that time in the early 1940s.

As a young engineering apprentice at the time, I was fortunate that my boss, Ronald N. Arnold, (who was later Professor Stephen Tobias's professor and Professor Joe McGeough's predecessor as Regius Professor at Edinburgh) took me to the new Research Institute in Loughborough and I met George Schlesinger. I also met his young research assistant, Don Galloway, who showed us his research on surface finish of turned aluminium alloys. We ourselves were interested in their experiences with the new and radical surface finish measurement instrument, the Talysurf, designed by R. E. Reason. We bought one for our own laboratory in our Company's Research Department.

Don Galloway, (Dr D. F. Galloway as he became a little later), became the Director of The Production Engineering Research Association which was formed out of the I Prod E Research Institute. He was one of the four original founders of CIRP and became President in 1959.

I intended at the outset of this little note to record that when the 1990 CIRP General Assembly was held in Berlin, Professor Günter Spur made ample and generous amends to Lilli Koenigsberger. He insisted on her joining the top table at the Farewell Dinner, and then spoke about the treatment meted out by the Nazi government to her father. He acknowledged the debt he and many other CIRP colleagues owed to him and how immensely influential he had been as the real founder of his own Institute at Charlottenburg in Berlin. He warmly welcomed the good fortune they had that Schlesinger's daughter was present to hear the tributes being paid to her father. Lilli took my wife during that Assembly to see her old school and explained to her that as a Jewess she was not

allowed to sit for entry into a university. On an even more personal note, I heard a radio programme the other day about the demise of the tuberculosis sanatoria at Davos in Switzerland because medical science had virtually banished, or nearly banished, the disease in European countries. I had known Lilli formally and to some extent socially for some years before, but when during the General Assembly held in Davos she and I met in the swimming bath – whilst actually swimming – we became even firmer friends.

Em. Prof. Alec Chisholm

4. The CIRP Annals and the Science Citation Index

Assessment of research in academic institutions is increasingly based on bibliometric analysis. Published research papers are rated according to the importance of the journal they are published in and on the number of times the paper has been cited in other highly ranked journals. The Institute of Scientific Information (ISI) has established the so-called Science Citation Index (SCI) for keeping track of the citation history of published papers. The scientific standing of a journal is expressed by its so-called Impact Factor (IF).

In our last newsletter colleague Van Brussel put the following question:

- If you publish a paper in the CIRP Annals, refer to as many relevant references published in CIRP Annals of the previous two years. Reference to earlier work doesn't help.
- If you publish in another journal that is included in SCI then again refer as much as possible to CIRP references of the previous two years.

By observing these simple rules, we will very soon see the Impact Factor of CIRP Annals rise above 1. It goes without saying that selling more copies of the CIRP Annals would help. The large circulation of medical journals explains their very high IF's. Eventually CIRP has to help the publisher in this respect.

That resulted in this response:

Dear Colleagues,

I just discovered today that the Journal Citation Report for 2003 has been published. I am delighted to see and to let you know that for the first time CIRP Annals - Manufacturing Technology (that's the official name) has been included and has been assigned an impact factor of 0.974! This is beyond my expectation; I had expected no more than 0.5. Of the 37 manufacturing related journals included in the Science Citation Index, it is the third highest. The highest are Composites Part A (1.131), and IEEE Trans on Advanced Packaging (1.070). The total number of cites in 2003 was 2375 for CIRP Annals, which is again the third highest. Higher are Int J Prod Res (2781) and J Mater Process Tech (3027). I think that indeed we can state that CIRP Annals is the most authoritative Journal in the field of production engineering. It is now officially acknowledged. But, if everybody follows my advice in the last CIRP Newsletter about citing papers published in CIRP Annals over the last two years we can still do much better.

Hendrik Van Brussel



5. Associate Members News

AMAG Meeting at the 54th CIRP General Assembly Krakow, Poland on Tuesday 24th August 2004

Short version of the Minutes, the full minutes are available on the CIRPnet.

The meeting was organised in 3 parts,

1. Associated Members Advisory Group, Chaired by John Webster
2. Associate Members lunch
3. Short technical presentations with 33 participants from 14 countries



Associate Member Advisory Group meeting.

Prof. Veron welcomed the attendees, and opened the meeting, stressing the importance of the Associated Members supporting CIRP activities and addressing the needs from the manufacturing industry perspective. He pointed out the importance of manufacturing in the society, stating that the European Union nowadays embraces 25 countries with 2.5 millions of companies and represents 35 million of employments. He also stated the importance of small and medium enterprises, and how they are crucial to survival from global competition and avoiding de-localization. 'Research' and 'Innovation' are key factors to pave the way towards MANUFUTURE which is the future for manufacturing. MANUFUTURE means the transition from 'Resource-based' to 'Knowledge-based' activities.

Prof. Jovane added that the role of Innovation for the industry is fundamental to increase the competitiveness.

J. Webster made a review of Actions from former meetings:

- There will be a clear differentiation between the Associated Members Advisory Group (AMAG) Meeting and the Associate Members Meeting.
- AMAG meetings will be held during the January Meetings in Paris and will deal with strategic issues and consist a reduced team of people 8-10 people, including the CIRP President, AMAG Chairman, AMAG Co-chairman, AMAG secretary and several Active and Associated members. It would also be desirable to have some STC members attend the meetings.
- The Associated Members Meeting and Lunch will be held during the General Assembly with the main goal of fostering the participation of industry research through technical presentations and collaboration with universities and between companies. It will also be intended to have a strong industrial representation from organisations within the country organising the General Assembly.

- The Associated Member Meeting main role will therefore include: To get hints ideas and constraints for manufacturing research to be conducted within CIRP. To try to foster research projects between AM members and Universities. To try to identify new potential Associated Members from developing countries and to encourage Associated Members to submit papers for the General Assembly.

VR-KCiP Virtual Research Lab for a Knowledge Community on Production.

Prof. Tichkiewicz reported on this Network of Excellence (NoE) in the field of the 6th Framework Program of the European Community. The NoE started on 1st of June 2004, with 218 researchers from 21 research teams, 2 centers for transfer towards industry, and 1 financial coordinator, 15 different countries are involved, for a launching period of 4 years with 6,3 M€ as financial contribution from the European Commission. There are several partners from CIRP involved in VRL.-KCIP.



The strategic management is composed of a Directory Board, an Orientation Board, a Steering committee. The virtual laboratory will be a legal structure allowing the partners to construct an European laboratory with delocalised teams, sharing research strategies, knowledge and resources, responsibilities, rights and duties, and able to contract with industry. *A better organisation of the European research in production will permit a better work than today, leading to a clearer vision of the research orientations and so a better quality of research.*

The NoE embraces a Club of Industrialists, Associate industrial partners and Industrial Partners. Anyone interested in joining this Club of industrial partners, should contact one of the members of the orientation board, or enter to the websites: “vrl-kcip.org” or “vrl-kcip.com”. A special meeting of orientation board and industrial associate partners will held on 31st of January in Paris

Associate Member technical presentations. Chaired by John Webster.

Andrzej Czarnecki, HCP Poznan, Poland, made the first technical presentation. He explained the history of the H.C.P Hipolit Cegielski Poznan SA. Company, as well as the current structure. The company is framed in several factories: Diesel Engine (W2); Mechanical Equipment (W5); Precise Industrial Products (W7); and the Division of Marine Coolers Production (WCh). He reported as well about the facilities and available equipment, giving details about the Diesel Engine factory established in 1958 and being the largest manufacturer of two-stroke marine engines in Europe, addressing the presence of HCP in the energy-power industry and related products.

Wojciech Mühleisen and Marian Hubicki, PZL HYDRAL, Wroclaw, Poland, presented “Transformations and New Challenges at PZL-Hydral Wroclaw”. He explained the transformation they are carrying out to move from a large multi-plant company from a State-owned aerospace business, producing more than 1300 products in small batches, towards a full private company with participation of companies from the USA, Germany and France. He addressed two major problems: The Management of Complex Systems and Problems of communications and efficiency in recognising and implementing new and changing customer requirements. In order to overcome these problems, he asked CIRP if it is possible to establish a future collaboration. It is suggested he contacts the STC group related to these activities.

Anil Srivastava, TechSolve, USA, “NIST-ATP Grinding Project on Intelligent Optimization and Control of Grinding Processes”. The NIST-ATP Grinding Project has an overall funding of 6 Millions Dollars from the US Dept. of Commerce. The companies involved are: TechSolve, Purdue University, Delphi Corporation, Applied Grinding Technology and Landis Gardner. The main goals are to: Develop an

innovative technology to intelligently design, optimize and control grinding processes. Apply the technology to surface, cylindrical, centerless and internal grinding processes. Integrate and validate the technology in production environments on diverse pilot applications with specific requirements. Develop a path for commercialization and broad diffusion of the technology in other industrial sectors

Marlies Patz, from GFE, Germany explained the "Research and Development around the Cutting Tool - Results and Performance offer at the Society for Production Engineering and Development in Schmalkalden/Thuringia". The non-profit Association, founded in 1992, nowadays has 89 members and 50 collaborators, 49 applications of patents and more than 500 papers published. They are involved in research activities, development and transfer to industry. Main technological topics are, precision tools, cutting technologies, wear protection/hard coatings, test and measurements for tools, components and composites layers.

Olaf Sauer, from Fraunhofer-Institute for Information- and Data Processing, Karlsruhe, Germany, "Agent Technology used for Monitoring Automotive Production" reported about activities on IT systems in today's automotive plants, the possibilities for OEM's to integrate different software systems and application of "software-agent" technologies. He presented an example based on components from one commercial supplier, ProVis.Agent, an agent-based production monitoring and control system. He concluded his presentation stating that: Production monitoring and control will be enlarged with order control functions. Implications of unexpected changes on the shopfloor will become transparent. Software agents have proved to be applicable for real time applications computing mass data and therefore: Companies are enabled to combine their existing stand-alone IT-solutions

Claudio Giorda, COMAU, USA "Modularity, Standardisation, Fast Start-up: a Must for High Production Rate Manufacturing Systems". Giorda made a brief presentation of COMAU company established in 20 countries with 54 legal entities, an order forecast for 2004 of 1, 6 Million Euro, major customers FIAT, RENAULT, GM, FORD, DB, BMW and PSA. He reported briefly about the COMAU machine tools and systems, the current requests from the Automotive sector, and the technical answer proposed by COMAU solution named MTL (Modular Transfer Line) based in the development of structural changes of the current transfer concept in order to reduce the installation cost and time, to increase the standardisation level and competitiveness. Main advantages are: System composed by modular units, mechanically, electrically and hydraulically independent. Workpiece transfer devices with high performance and high flexibility. Minimization of custom working units. Modularity of cooling and lubrication systems. Optimization and standardization of guard structure. Modularity of mechanical, electrical, hydraulic units. Easy and fast assembly and disassembly of the units

Juan M Minguéz, AMAG Secretary

6. FROM THE LABS

Design Technology Institute

With global competition, product development cycles have become increasingly shorter. Manufacturers are forced to produce higher quality and more reliable goods within increasingly shorter time constraints.

In view of this development, the National University of Singapore and the Technische Universiteit Eindhoven (TU/e) have set up a joint Design Technology Institute (DTI). DTI aims to provide industries - operating in highly competitive environments - with viable solutions both in concept and expertise. DTI supports the industry by training talents in product design, conducting industry-driven research and providing education in design technology. Through its three-pronged strategy of education, applied research and direct industrial support, DTI plays an important role in enhancing the global competitiveness of industries in Singapore. DTI has a unique mission and is pioneering a new mode of education in design - one that educates people to be leaders in value creation (as opposed to just value addition).

<http://www.dti.nus.edu.sg/home/index.htm>

7. General Assembly 2004 in Krakow

Some photo impressions:



The Polish organizing committee has promised us enough facilities for internet connection. They provided 26 systems continuous online. This was very appreciated by the attendees .



Keynote paper presentation by prof David Allen



The Taylor Medal is handed to dr. Enrico Savio



Welcome Reception in Sukienne Market Square, meeting old friends



Walking toward lunch

8. From the STC's

There are two kinds of STC's. Five STC's covering the Processes and Machine and five covering the Manufacturing chain as shown below.

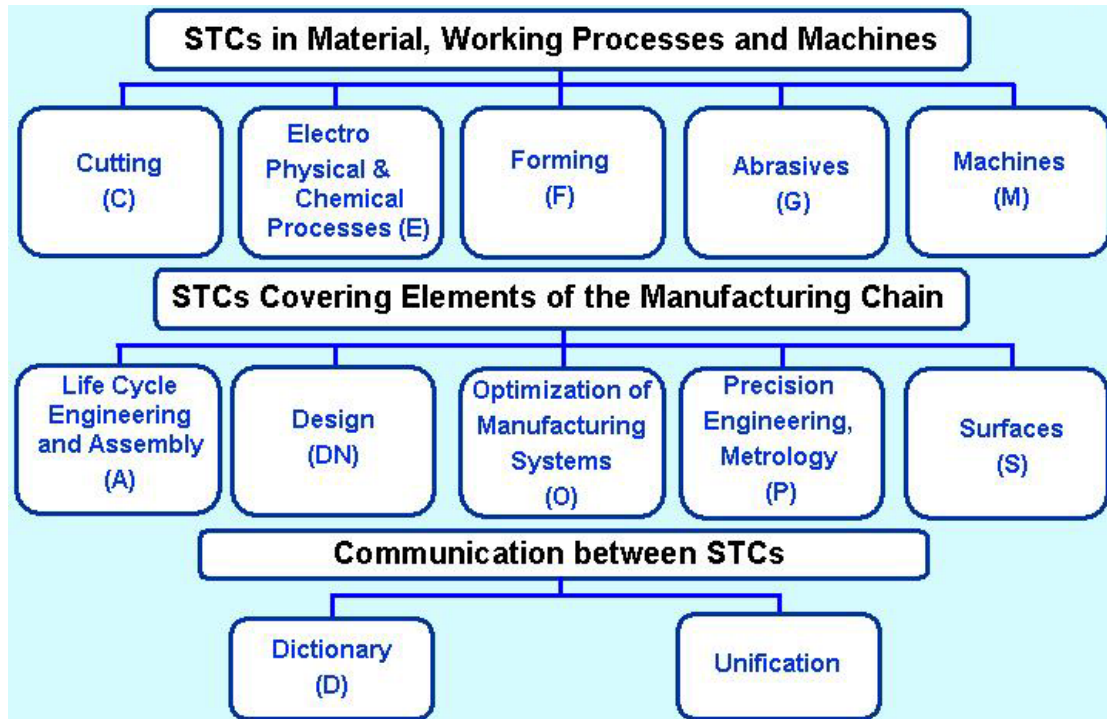

STC Dictionary “D”

STC D has the responsibility for publication of the International Institution for Production Engineering Research (CIRP) dictionaries on Advanced Manufacturing Engineering. The dictionaries cover definitions and terminology for manufacturing processes, machines, tooling, materials and systems formulated by the other STCs. Nine volumes became available (1962 – 1884): They have been translated in Danish, Finnish, Norwegian, Swedish, Italian, Spanish, Portuguese and Chinese.

Presently, manufacturing/production engineering is undergoing an enormous worldwide innovation process. New technologies have made their entry; manufacturing strategies are changing; global production networks are established. International co-operation is quickly developing thereby increasing the importance of communication and thus the need for unified technical terminology. At the same time, the technical terminology experiences significant expansion.

From 1997, CIRP has been taking into account the enormous worldwide innovation on new technologies by introducing a second edition of its *Dictionary of Production Engineering* in English, French and German. This edition is characterized by a considerable increase of the number of terms and a new topical structure. Definitions are provided now for all terms; illustrations are added in some cases for better understanding.

The first dictionary in the new version was on Forming. The second book Volume I on Forming 1 & 2 appeared in 2002 under the chairmanship of K. Lange and K.J. Weinmann. Volumes I/1 and I/2

contain about 3400 terms for metal forming within the chapters: General terms of metal forming, Hot and die forging, Cold and warm forging, Sheet metal working, Rolling, Drawing, Extrusion.

2004 is the year of the publication of two new volumes on Material Removal Processes as the result of the combined efforts from 1995 to 2003 under the chairmanship of K. Lange, K.J. Weinmann and L. Mathieu.

New Volume 2

Volume II deals with the terminology of metal working in German, English and French. It contains terms and definitions of the most important cutting processes of surface working (turning, drilling, milling, planning, slotting, broaching), abrasive processes (grinding, polishing, honing, lapping) and physical processes (erosion, laser beam removal, electron and ion beam machining, etc). Furthermore, the corresponding tools, machines and processes are described, complemented by general terms and definitions of production engineering and physical fundamentals. The last chapter deals with the structure and properties of surfaces and the effects of machining on the surface quality.



Volume II Material Removal Processes

- Cutting processes
- Abrasive processes
- Physical processes
- Surfaces properties

Includes 570 pages,
2005 definitions,
index in three languages.

ISBN 3-540-20540-3

Some typical pages

1.2.34 – 1.2.39	120	121	
<p>1.2.34 Stufenbohrer (m) Spiralbohrer mit mehreren Schneidteilen von verschiedenen Durchmessern; z.B. zwei-stufig (a), dreistufig (b).</p>	<p>step drill Twist drill with more than one cutting sections with different diameters; e.g. two steps (a), three steps (b).</p>	<p>foret (m) étagé Foret présentant plusieurs étages d'usinage correspondant à des diamètres différents: (a) 2 étages, (b) 3 étages.</p>	
<p>1.2.35 Spiralbohrer mit Innenkühlung (m) Spiralbohrer mit Kühlkanälen zur inneren Kühlmittelzufuhr.</p>	<p>twist drill with internal cooling Twist drill with small holes extending through both lands for delivering cutting fluid.</p>	<p>foret (m) à trou d'huile Foret hélicoïdal comportant des canaux destinés à amener le fluide de coupe au niveau des lèvres.</p>	
<p>1.2.36 Tieflochbohrer (m) Einschneidiger Bohrer mit einer geraden Span-Nut und innerer Kühlmittelzufuhr zum Bohren tiefer Löcher.</p>	<p>gun drill A single-flip, straight-flute drill attached to a drive tube through which fluid is forced to flush chips.</p>	<p>fleuret (m) Foret à une lèvre à goujure droite avec guide, associé à un attachement tubulaire au travers duquel le fluide de coupe est envoyé pour évacuer les copeaux. Utilisé pour le perçage de trous profonds, perçage de canons par exemple.</p>	
<p>1.2.37 Zentrierbohrer (m) Kombiniertes Bohr- und Senkwerkzeug zur Zentrierung von Wellen.</p>	<p>centre drill Tool for centre drilling of shafts or work-pieces.</p>	<p>foret (m) à centrer Foret avec pilote spécialement conçu pour le centrage soit de pièces soit de trous.</p>	

cross-section of undeformed chip A

Cross-sectional area of the chip to be removed measured perpendicular to the direction of primary motion.

$$A = a_p \cdot f = b \cdot h$$

width of undeformed chip b

Width of the cross-sectional area of the undeformed chip. For the simplified case it is identical with the major cutting edge.

$$b = \frac{a_p}{\sin \kappa_r}$$

undeformed chip thickness h

Thickness of the cross-sectional area of the undeformed chip.

$$h = f \cdot \sin \kappa_r = \frac{A}{b}$$

chip formation

Formation of chips during the engagement of the tool.

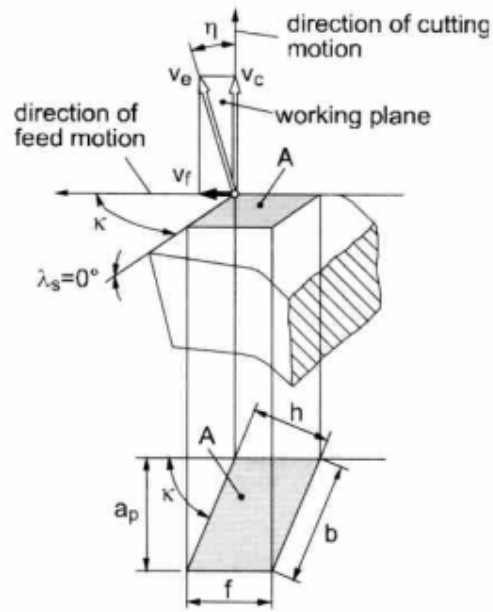

ISO 3002/3
DIN 6580

Formula

References to standards

Alphabetical index in three languages

527

Alphabetical Index

A			
abnormal discharge pulse	3.0.72	angle milling cutter	1.4.82
abrasion	4.2.32	angle of chamfer γ_f	1.0.28
abrasive	2.8.14	angular test transducer	4.3.118
abrasive ball blasting	2.7.6	animal glue (insect resin = shellac)	2.2.52
abrasive blast cutting	2.7.27	anisotropic etching	3.4.14
abrasive blast forming	2.7.28	annular anode	3.2.19
abrasive blast grain mass	2.7.26	antifriction guideway	1.0.231
abrasive blast grains	2.7.24	aperture diaphragm	4.3.78
		apparent current density	3.0.63

Wörterverzeichnis

506

A			
Abdeckfolie (f)	3.4.17	Anlauf (m)	1.3.28
Abhebegetriebe (n)	1.3.113	anormaler Entladungsimpuls (m)	3.0.72
Abkühlen (n)	4.2.23	Anpressdruck (m) p_n in N/mm ²	2.2.30
Ablagerung (f)	4.1.13	Anpressdruck der Honleiste (m) p_n	2.3.14
Ablängen (n, vb)	1.4.45	Anpressfläche der Honleiste (f)	2.3.15
Ablenkspule (f)	3.2.22	Anschlussleistung (f)	1.0.412
Ablenkspule (f)	4.3.24	Anschmelzung (f)	4.1.14
Abmessung Arbeitsfleck (rechteckiger Strahlquerschnitt) (f)	2.1.14	Anschnitt (m)	1.2.93
		Anschnitt (m)	1.4.58
		Anschnittdurchmesser (m)	1.2.04

New Volume 3

Volume III on Manufacturing Systems is the result of the combined efforts of the Scientific Technical Committee D "Dictionary" from 1999 to 2004 under the chairmanship of K.J. Weinmann and L. Mathieu.

This volume on "Manufacturing Systems" addresses a central part in manufacturing/ production engineering, namely the "organizations in the manufacturing industry in which production is created". The volume not only deals with the technical details of parts manufacture and assembly, and the corresponding machinery and equipment but also considers other issues involved. This includes the functioning of these organizations: the handling and flow of materials in production, the organization, planning and control of the work to be done in the system as well as quality management and the economical aspects of production such as investments, cost, capacity, time, etc.



Volume III Manufacturing Systems

- Machining systems
- Machine peripherals
- Information and communication system
- Material flow system
- Production planning
- Production optimisation

Includes 250 pages,
750 definitions,
index in three languages.
ISBN 3-540-20555-1.

A look at the content

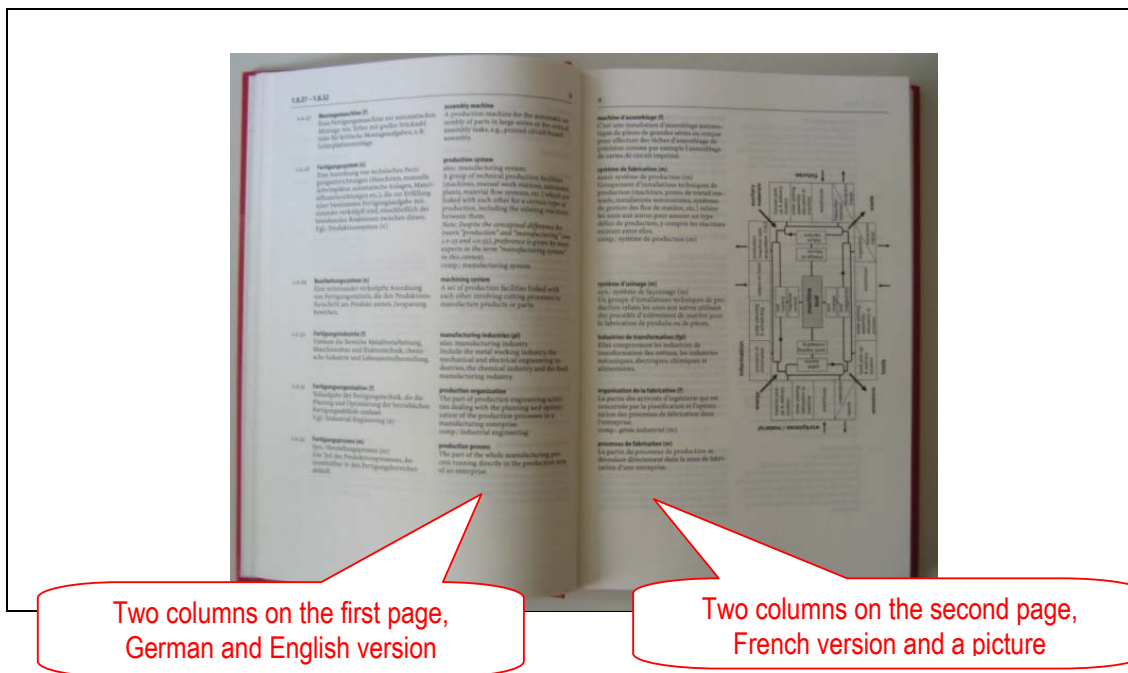

The STC D has also two other new dictionaries under development, dictionary on *Assembly* and dictionary on *Geometrical Measurement*.

Order information: Springer Auslieferungsgesellschaft Customer Service, Haberstrasse 7, 69126 Heidelberg, E-Mail: orders@springer.de <http://www.springer.de> A special 30% CIRP discount (€ 117.73 for members) is agreed (please add *CIRP-Member-Order*.)

L. MATHIEU, STC D Chairman

STC “U”

The unification working group has checked on the use of keywords in the Annals. The top ten keywords as found in the 2003 Annals were: Design, Simulation, Control, Grinding, System, Tool, Surface, Production, Process, Optimization. At that time it was concluded that they still represent the ‘classical’ working areas.

For this year we found: Design, Cutting, Process, Tool, Optimization, Manufacturing, Machine, Control, Grinding and Surface.

Design is still leading but cutting is strongly coming up while simulation, which was at the second place, is out this year.

9. Meetings Seminars, conferences

12th International CIRP Life Cycle Engineering Seminar Innovation in Life Cycle Engineering and Sustainable Development 3-5 April 2005, Grenoble, France

Scope:

Sustainable development is more and more at the core of governments and industries policy. Industrial production and consumption culture are facing dramatic changes due to pollution and waste problems, exhaustion of available non-renewable resources and rapid growth in world population. The environmental focus has shifted from production processes to the product's entire life cycle. The potential of technology to create synergies between environmental protection and economic growth has been recognised. Life cycle engineering covers engineering tools targeted towards cleaner product-oriented activities for improving the environment while contributing to competitiveness and growth. The 12th CIRP LCE seminar 2005 to be held in Grenoble aims at presenting advanced engineering methods and tools in the field of life cycle management and design for sustainability, focusing on new products for clean energy, creating a forum for industrialists and academics debating on engineering tools and new products.

Chairs: Prof D. Brissaud and Prof S. Tichkiewitch Information: <http://cirp-lc2005.hmq.inpg.fr/>

XVI Workshop on Supervising and Diagnostics of Machining Systems INTELLIGENT MACHINES AND FACTORIES 14-16 March 2005, Karpacz, POLAND

Topics

Challenges of intelligent manufacturing, Virtual intelligent manufacturing, Intelligent manufacturing systems concepts and industrial application, Strategies for intelligent manufacturing, Intelligent models of cutting process, Intelligent models of manufacturing systems, Intelligent manufacturing flexibility, Machine tool intelligent optimization, Assembly intelligent processes, Intelligent diagnostics and supervising of machine tools and cutting processes, Agent based manufacturing knowledge management, www (website) based intelligent manufacturing, testing, control and service, Integrated and intelligent manufacturing errors recognition and compensation.

Contact: prof. Jerzy Jedrzejewski, <http://www.itma.pwr.wroc.pl/indexen.htm>

9th CIRP International Seminar on Computer Aided Tolerancing 11-12 April 2005, Arizona State University, USA

Topics:

Tolerance and functionality; Tolerance specification; Tolerance analysis; Task-specific uncertainty in metrology; Specification and correlation uncertainty in design; Uncertainty metrics for design and verification; Tolerance synthesis; Tolerancing for flexible parts; Tolerance representation; Statistical tolerancing; Assembly modeling and analysis; Computational metrology, verification; Geometric

quality control; Tolerancing and life cycle Issues; Tolerancing standards; Industrial applications and CAT systems.

Information: [9th CIRP International Seminar on Computer Aided Tolerancing](#),

8th CIRP International Workshop on Modeling in Machining Operations

10 -11 May 2005, Chemnitz, Germany

The workshop's primary goal is to bring together experts from both industry and research to share and discuss the latest advances in the modeling of cutting processes and machining operations, as well as to provide networking opportunities to encourage cooperative efforts within the field. The scientific program covers Modeling of 2D and 3D machining processes, High-speed cutting and hard machining, Tribological aspects during cutting, Precision machining, Burr formation, Micromachining and Advanced cutting tool design. In addition, there will be a roundtable to establish conclusions and recommendations for future research. Demonstrations of some of the latest software products will be offered, as well as a tour of the Fraunhofer IWU testing facilities.

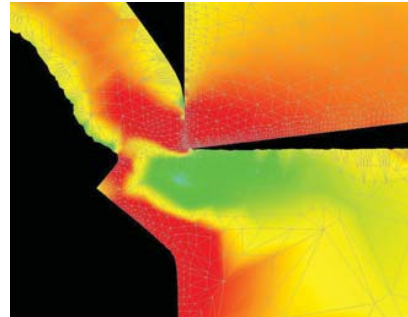

Contact: juergen.leopold@iwu.fraunhofer.de

3rd International CIRP Conference on Reconfigurable Manufacturing

10-12 May, 2005 Ann Arbor, MI, USA

Topics:

1. Systems: Configurations- Generation & Impact, Capacity Scalability, Factory Changeability, Line Balancing, Scheduling, Feature-based Process Planning.
2. Business Aspects: Life-Cycle Economic Modelling, Mass-customization, Business models based on RMS, Risk Analysis in Mfg, Reconfiguration Cost.
3. Ramp-Up: Diagnostics, Inspection.
4. Controls: Discrete-Event Control, Control Flow-Charts, Open-Architecture Control Systems, Human interface to control, Networks for control.
5. Applications: Reconfigurability and Agility in Semiconductor Fabrication, Reconfigurable Machining Systems, Reconfigurable Assembly
6. Machines: Reconfigurable Machine Tools, Modular Machines, Reconfigurable Tooling and Parallel Cutting Tools, Reconfigurable Fixturing/End-of-arm tooling.

Contact: Prof. Yoram Koren, rms2005@umich.edu , <http://erc.engin.umich.edu/rms2005>

38th CIRP Manufacturing Systems Seminar 16-18 May 2005 Florianopolis, Brazil



The topics of the seminar are: Globalization of Manufacturing, Planning and Management of Manufacturing, Advanced Industrial Engineering, High Performance Manufacturing, Rapid Prototyping, Tooling, Manufacturing, Manufactu-

ring of Moulds and Dies, Micro Manufacturing, Production Logistics and Supply Chains and E-Manufacturing. Chairs: Prof. Dr.-Ing. Walter Lindolfo Weingaertner and Prof. Dr.-Ing. Engelbert Westkämper. Information on <http://www.cimm.ufsc.br/cirp-isms2005>

Contact: Joao F. G. Oliveira, jfgo@sc.usp.br <http://www.cirp-isms2005.com.br>

2005 CIRP Design Seminar, New Trends in Engineering Design 22 – 25 May 2005, Shanghai, China

The theme of this year's conference will be *New Trends in Engineering Design*, which broadly covers various research, development and application topics relate to (1) design and the nature, (2) design and the society, and (3) design and the invention. We will have keynote presentations, paper sessions, panel discussions, industrial visits, and laboratory tours participated by leading scholars and industrialists from all over the world to exchange creative ideas and plan for future directions. Conference social events will be available, and some pre- and post-conference tourist programs in China will be offered to interested participants. There are also two related meetings be planned in association with the main conference. The first one, to be held on Sunday, May 22, 2005, will explore international collaboration opportunities between the European and the Chinese research communities, with a highlight of the EU-funded *VRLKCIP project*. The second one, to be held on Thursday, May 26, 2005, is a special meeting on *Engineering as Collaborative Negotiation (ECN)*, organized by the CIRP ECN Working Group. This meeting will include invitation presentations, tutorials, technical papers, and panel discussions related to the new ECN paradigm in engineering design

Chairman: Prof. M. Shpitalni, cirp2005sh@situ.edu.cn , www.cirp2005sh.situ.edu.cn

Third International TOTAL QUALITY MANAGEMENT Working Conference ADVANCED AND INTELLIGENT APPROACHES 23 – 26 May 2005, Belgrade, Serbia & Montenegro

The objective of the Third Conference is to provide an international forum for the exchange of knowledge, experience, research results and information about various aspects of the state-of-the-art and the future development of total quality management. The Conference covers philosophical, scientific and practical concepts concerning research, development and application of TQM-based advanced approaches. Contact: Prof. V. D. MAJSTOROVIĆ e-mail: majnem@EUnet.yu www.jusk.org.yu or www.mas.bg.ac.yu

Innovations in Manufacturing Engineering Education.
International Conference on Manufacturing Engineering Education
(Continues CIMEC 2002)
22-25 June 2005, Cal Poly State University, California, USA



The intent of the conference is to strengthen Manufacturing Engineering Education and help shape its future by fostering communication among a global set of participants. The discipline of Manufacturing Engineering is evolving rapidly to meet the needs of manufacturing industries. It is important for the development of the discipline to define a common basis for communication and to strengthen networks among educators. This the only way we can fully realize the benefits of the diversity in the discipline that exist nationally and internationally. The conference is an opportunity for manufacturing educators to address issues related to global shifts in manufacturing, shifts in jobs, pollution, international trade, and international manufacturing. The conference continues a tradition of those that were previously sponsored by SME and CIRP on Manufacturing Engineering Education. This conference also aims to bring together the segments of organizations such as ASEE and ASME with interests in manufacturing engineering education.

Contact: Prof. Christopher A. Brown, <http://www.wpi.edu/+mfe/SurfMet>

Conference website: <http://www.ime.calpoly.edu/mfeeconference/>

**VII AITeM International Conference *Enhancing the Science of
Manufacturing***
7–9 September 2005, Lecce, Italy.

The VII AITeM Conference aims at presenting up-to-date information on the latest research and industrial developments in the field of manufacturing, providing an international reference for an exchange of experiences and ideas, and promoting cooperation among different institutions. The meeting provides a unique opportunity for participants to update their knowledge in manufacturing industry. The program includes presentation sessions of the major experts and papers related to industrial production topics: Machining, Foundry, Sheet&Bulk Metal Forming, Advanced and Non-Conventional Machining and Machine Tools, Welding&Joining, Polymers&Composites Processing, Assembly, Disassembly, Life Cycle Engineering, Computer Aided Manufacturing, Design and Process Planning, Rapid Manufacturing, Production Systems, Production Planning, Scheduling and Control, Metrology, Tolerancing, Quality, Manufacturing Education and Human Factors. Contact: Prof. Marco Santochi, Email: aitem@unicas.it Web site: www.aitem.org

2006

13th Int. CIRP Life Cycle Engineering Seminar 2006, Leuven, Belgium

2007

14th International CIRP Life Cycle Engineering Seminar
Tokyo, Japan

ISEM 15
May 2007

10. From the secretariat

No news this time, but best wishes from



Chantal Timar-Schubert



and Agnès Chelet

11. Miscellaneous

New books received:

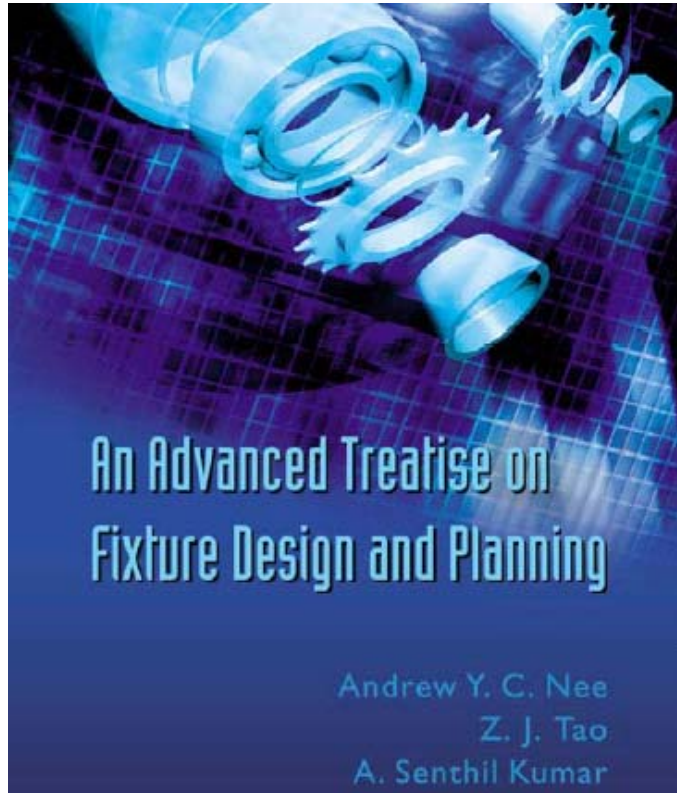

An Advanced Treatise on Fixture Design and Planning

Andrew Y C Nee

Z J Tao

A Senthil kumar

This book covers computer-aided fixture design, fixture clamping synthesis and optimization, work-piece - fixture interaction, intelligent fixtures designed to integrate with processing equipment so as to improve productivity and product quality, Internet-enabled fixture design and modular fixture database management. This book will be a prevalent reference for academics, manufacturing and industrial engineers, and a valuable text for engineering graduate students.

World Scientific, ISBN 981-256-059-9

Virtual and Augmented Reality Applications in Manufacturing

S K Ong and A Y C Nee (Eds)

Virtual and Augmented Reality Applications in Manufacturing is written by experts from the world's leading institutions working in virtual manufacturing and gives the state of the art of the field, covering the state-of-the-art in VR and AR technology and how these technologies can be applied to manufacturing. The latest findings in key areas of AR and VR application to manufacturing. The results of recent cross-disciplinary research projects in the US and Europe showing application solutions of AR and VR technology in industrial settings.

Springer, ISBN 1-85233-796-6

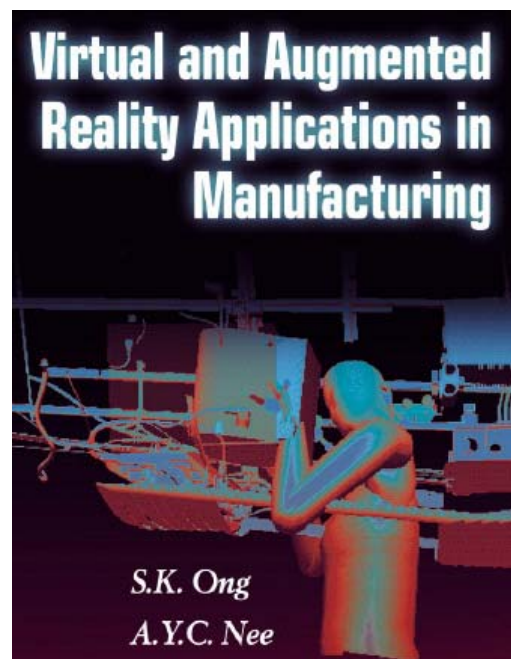

S.K. Ong

A.Y.C. Nee

COMPUTER-AIDED INJECTION MOLD DESIGN AND MANUFACTURE

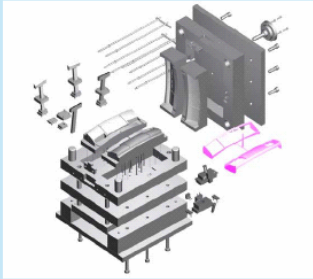

J. Y. H. Fuh
Y. F. Zhang
A. Y. C. Nee
M. W. Fu

Mold making is an important sector in the precision engineering industry since molded parts represent more than 70% of the consumer products ranging from computers, home appliances, medical devices, to automobiles, etc. While CAD/CAM technology has found a wide range of applications in the many areas of engineering, its applications to mold design and manufacturing have been relatively limited. This book, containing more than 255 illustrations, is written for the aim of reporting the latest research and development achieved in automating plastic injection mold (for plastic) and die casting mold (for metal) design and manufacture. It is hoped to promote the use of computer-aided injection mold design systems and stimulate greater R&D efforts in this critical area.

Journals



Contains interesting papers about cutting and grinding processes

see <http://www.dekker.com/servlet/product/productid/MST>.

Vacancies/ Opportunities

Canada Research Chair (CRC) in Manufacturing with New materials

The department of mechanical and industrial engineering at the University of Toronto invites applications for an academic tenure stream appointment as a Tier II Canada Research Chair in the area of manufacturing with new materials. The appointment will be at the rank of Assistant Professor. Candidates must have a doctoral degree in a discipline closely related to Mechanical, Chemical, or Materials Engineering; an outstanding academic and research record; and effective teaching ability. Duties will include undergraduate and graduate teaching, research, and departmental service. Salary is commensurate with qualifications. Start date is July 1, 2005. Contact: Prof. A.N. Sinclair, Chair, Department of Mechanical and Industrial Engineering, University of Toronto, 5 King's College Road, Toronto, Ontario, M5S 3G8.

100,000 Euro Villa Hügel Materials Award 2005

The Villa Hügel Materials Award is conferred for outstanding new ideas, insights and results in the field of materials, materials technology, materials competence and production engineering. It may be awarded for a scientific achievement or for the outstanding implementation of an exceptional concept for a new product or process or for a new product that has already been realized

The award will be offered for the first time in January 2005. This prize is worth EUR 100,000 and will be awarded on 24 October 2005 during the first international "Villa Hügel Materials Conference" in Essen/Ruhr. The initiator of this award is the *Initiativkreis Ruhrgebiet*, representing 56 companies on the rivers Rhine and Ruhr with both national and international operations, located in Essen. The *Initiativkreis* has for 15 years been initiating projects in industry, science and culture that serve as unique selling propositions for the region and promote a strong Ruhr area in the context of Europe.

The moderator of this initiative is Prof. Dr. Ekkehard Schulz, Chairman of ThyssenKrupp AG, under whose leadership this task force launched the lead project "Materials research and development – a locomotive for innovation in the Ruhr area" along with the Villa Hügel Materials Conference and Award as well as other activities. The aim is to establish a network of skills from materials science and industry, with a view also to injecting crucial new international impetus into the strong materials region on the Rhine and the Ruhr. This Award is designed to encourage advances of global relevance in the field of materials innovation and to motivate international materials experts in industry and science to achieve technology leaps that are both impressive and inspiring.

Following the principle of the Nobel prizes, the Villa Hügel Materials Award will also be conferred exclusively on the basis of nominations. An international board of 180 experts is therefore being asked to submit its proposals for potential prize winners. An international jury will then select the best project from these nominations. The Conference and Award are initially set to take place every five years. In 2005, the conference will address the theme of "New materials for energy technology of the 21st century". The prize will accordingly be awarded for an outstanding achievement in the field of energy technology. The themes in the years to follow will concern transport technology, medical technology, information technology and building technology.

Co-sponsors of the Villa Hügel Materials Conference as an international forum of discussion on materials innovation for science and industry are the International Union of Materials Research Societies (IUMRS), the European Materials Research Society (E-MRS), the Federation of European Materials Societies (FEMS) and Deutsche Gesellschaft für Materialkunde (DGM).

CIRP members will be invited to come up with candidates for this prestigious prize.

Further information: *Initiativkreis Ruhrgebiet*, e-mail info@i-r.de, www.i-r.de