

Hinweise zur Benutzung der Vorlagenseite:

- = Schnittlinie
- = darunterliegende Schnittlinie
- — = Falzlinie

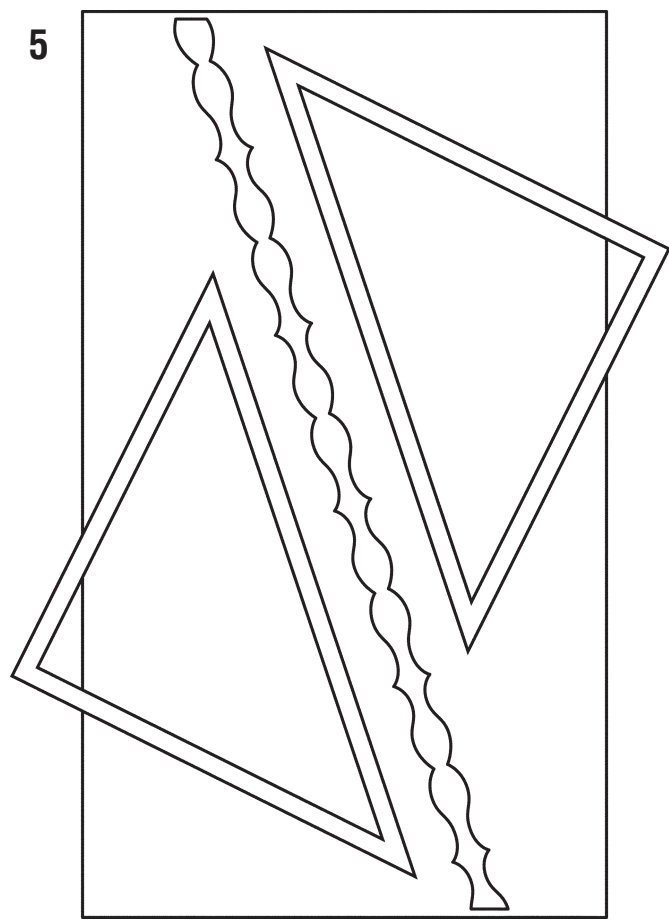
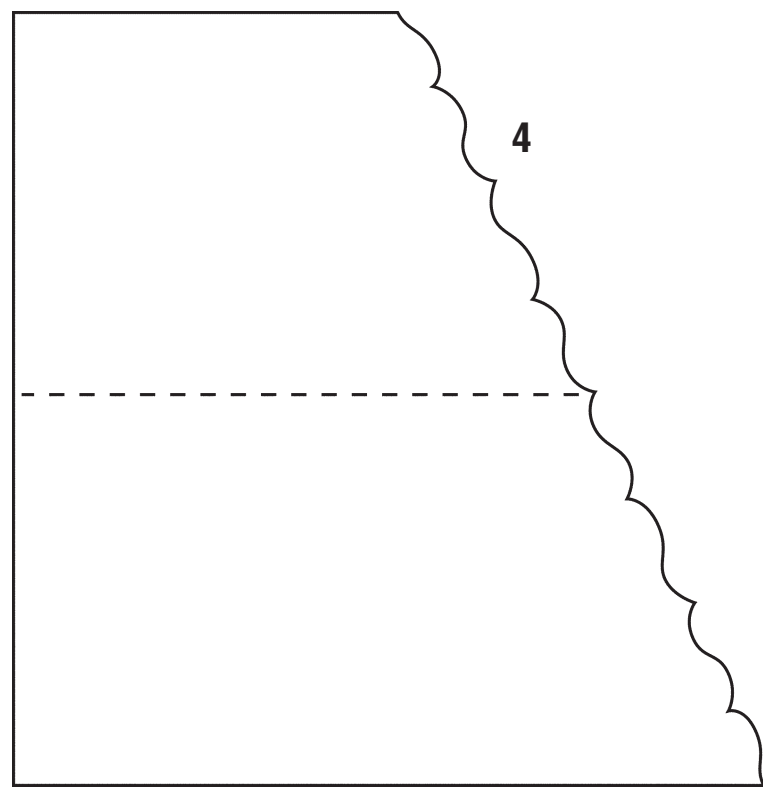

- = Schnittlinie
- = darunterliegende Schnittlinie
- — = Faltlinie

13

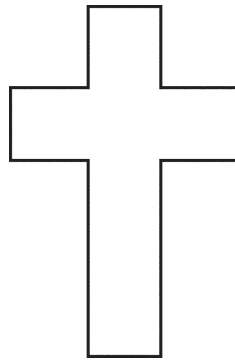

14

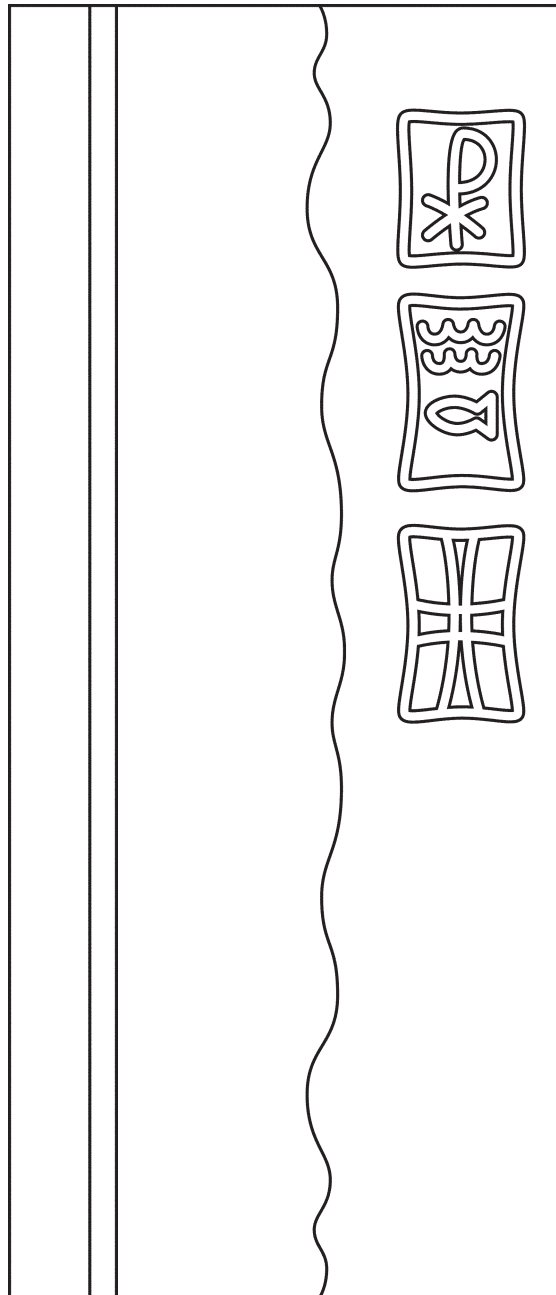

Hinweise zur Benutzung der Vorlageseite:

- = Schnittlinie
- = darunterliegende Schnittlinie
- - - = Faltlinie

Printed in Germany • © 2013 by OZ Verlag GmbH •
D-79618 Rheinfelden

All designs, patterns and magazines are protected under the
Copyright Act. No material may be reproduced in part or in
whole. All commercial and industrial use is strictly prohibited.

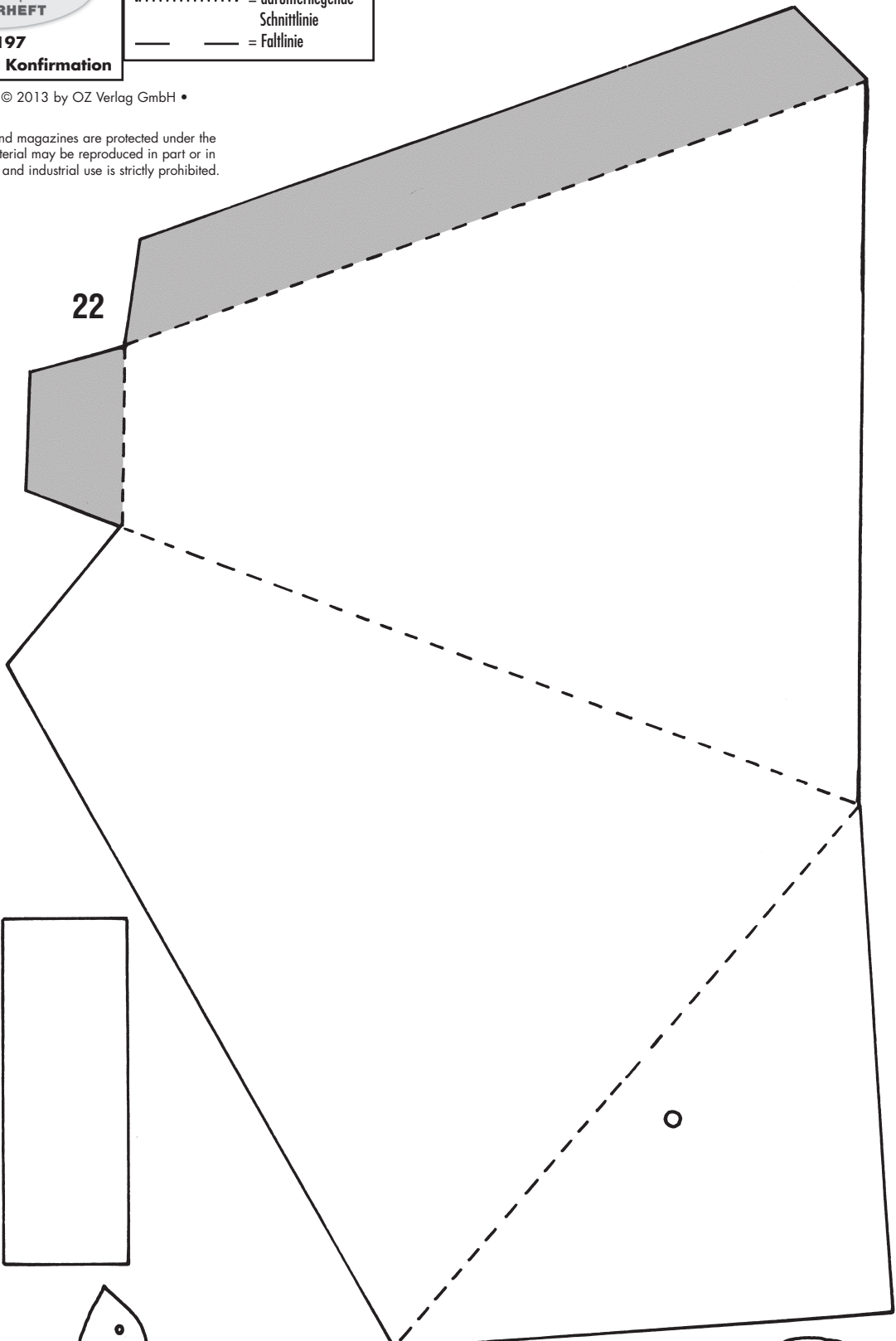

22

23

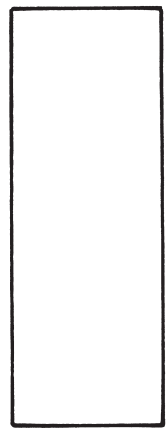

24

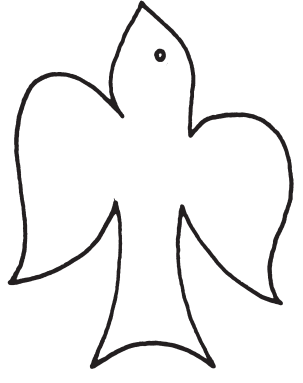

21

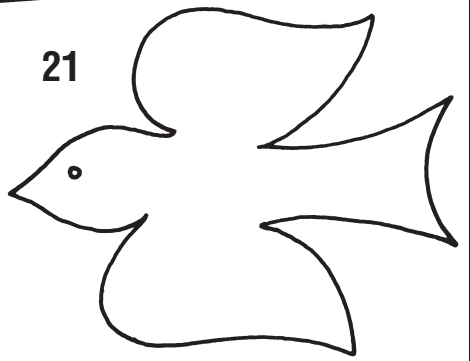

BS 197
Kommunion & Konfirmation

Hinweise zur Benutzung der Vorlageseite:

- = Schnittlinie
- = darunterliegende
Schnittlinie
- — = Falllinie

Printed in Germany • © 2013 by OZ Verlag GmbH • D-79618 Rheinfelden

All designs, patterns and magazines are protected under the Copyright Act. No material may be reproduced in part or in whole. All commercial and industrial use is strictly prohibited.

25



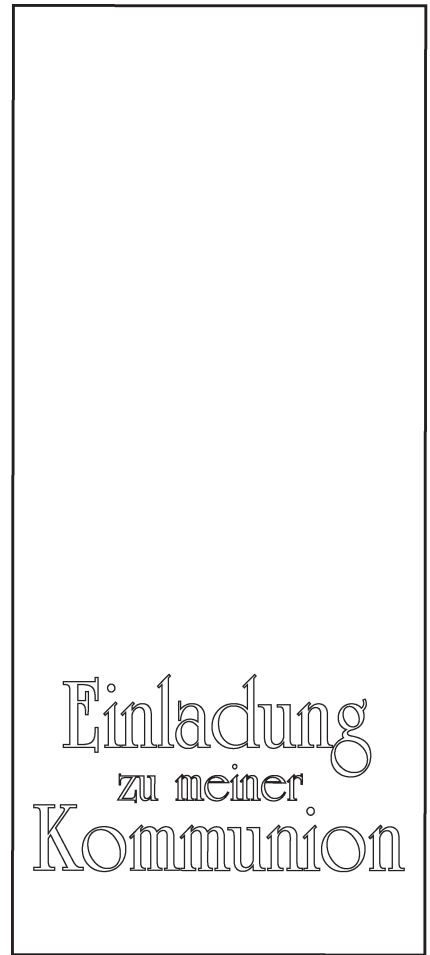

26

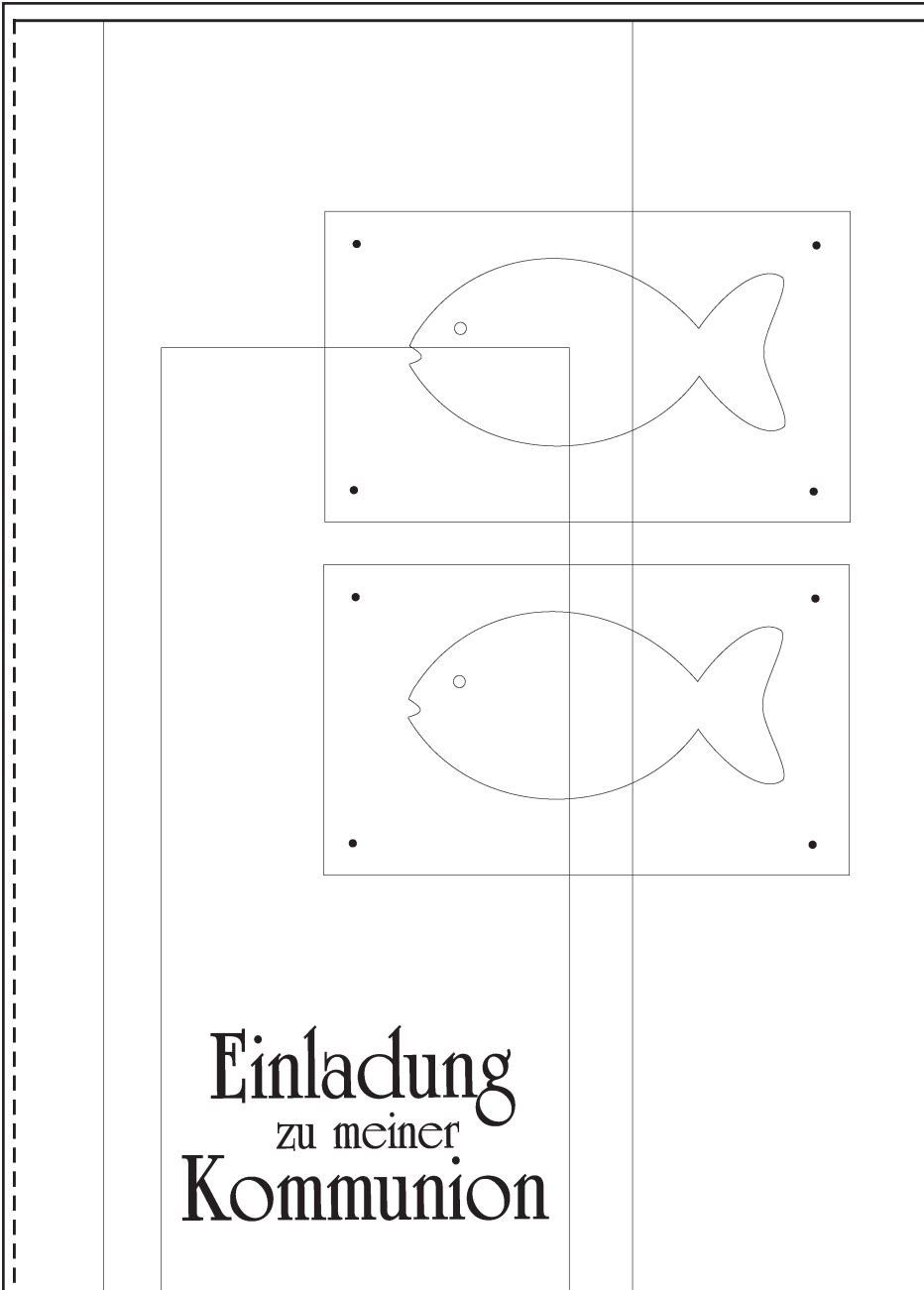

26

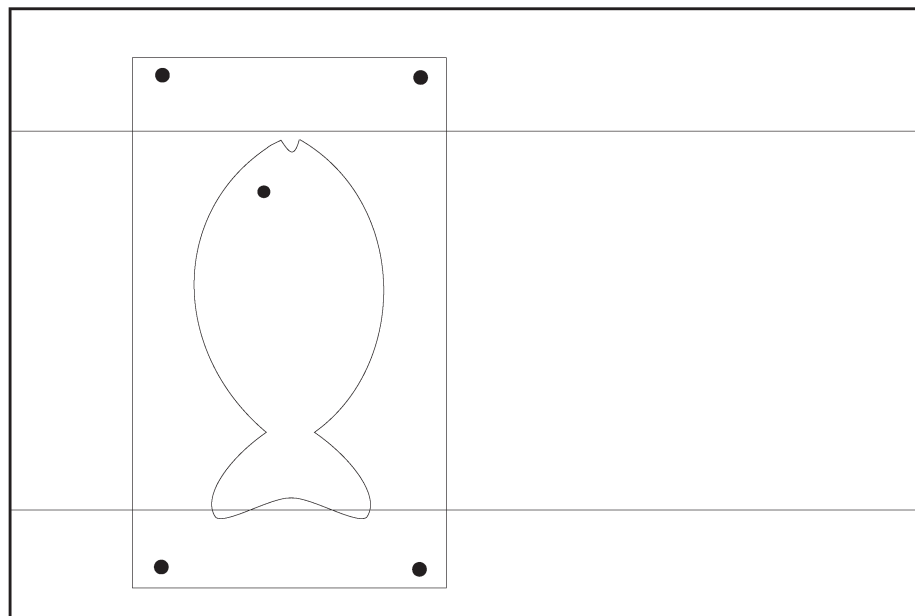

27



BS 197

Kommunion & Konfirmation

Hinweise zur Benutzung der Vorlagenseite:

- = Schnittlinie
- = darunterliegende Schnittlinie
- — = Faltnie

Printed in Germany • © 2013 by OZ Verlag GmbH • D-79618 Rheinfelden

All designs, patterns and magazines are protected under the Copyright Act. No material may be reproduced in part or in whole. All commercial and industrial use is strictly prohibited.

Hinweise zur Benutzung der Vorlageseite:
———— = Schnittlinie
..... = darunterliegende
Schnittlinie
—— — = Faltnie

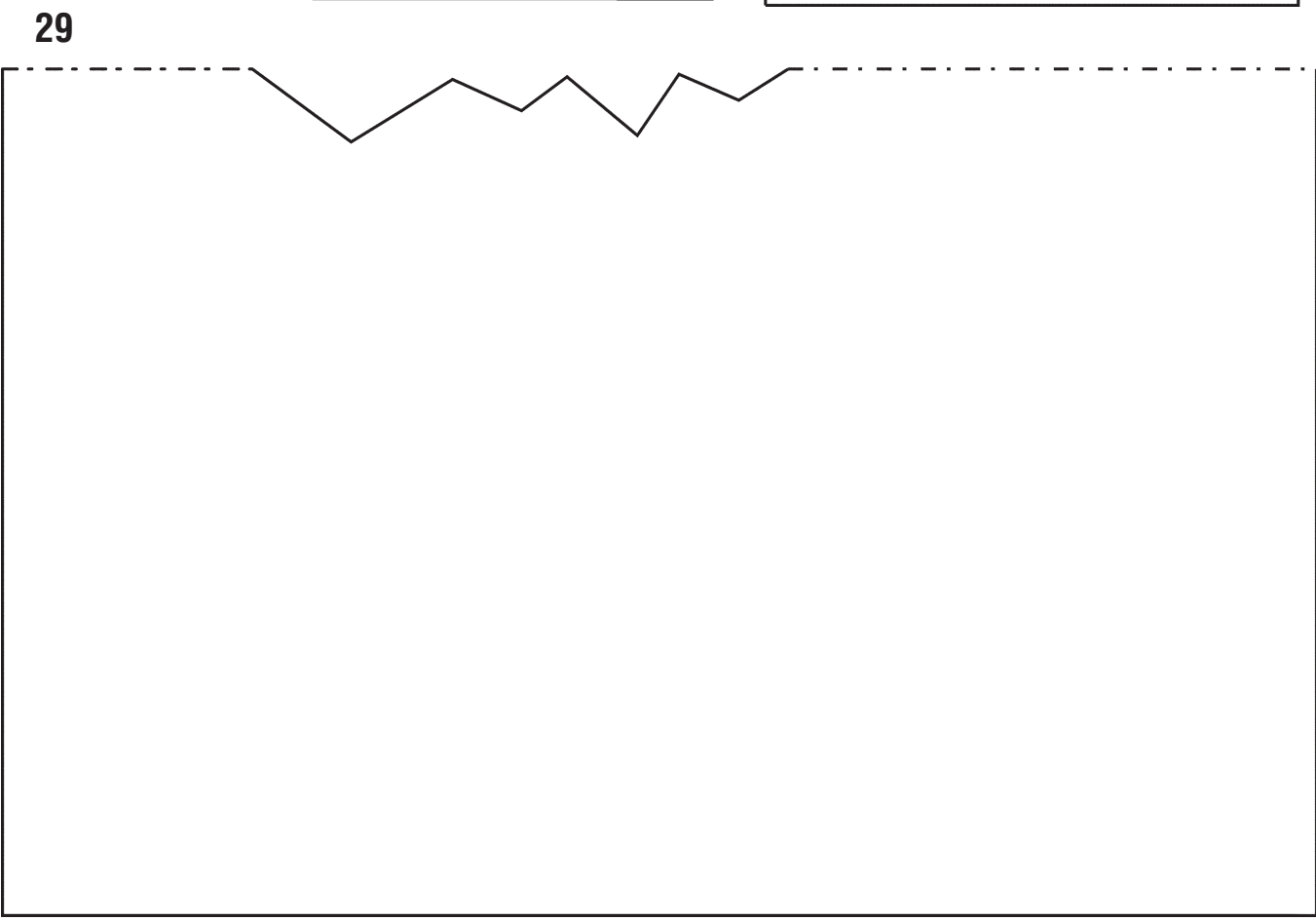
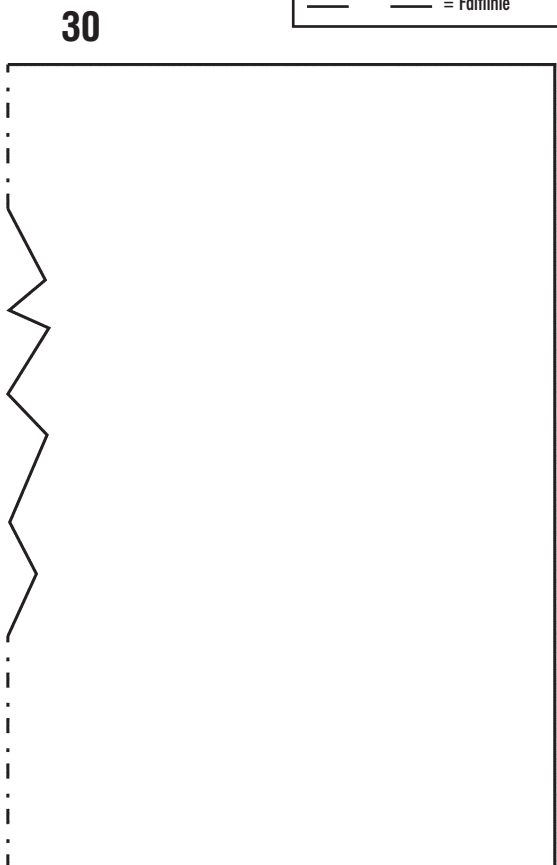
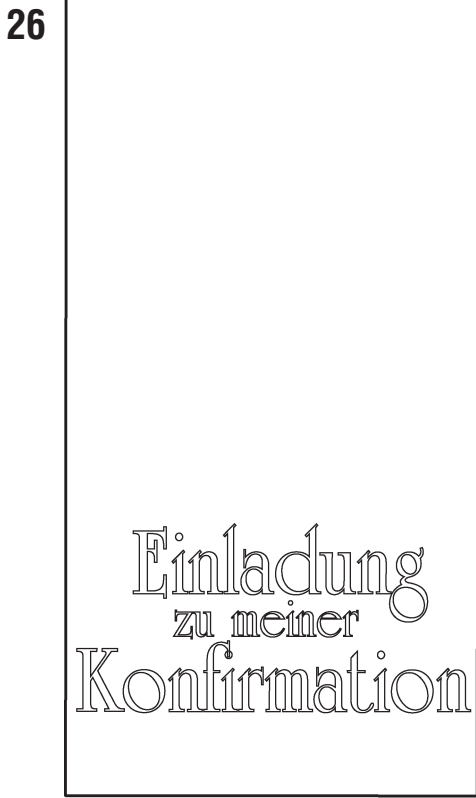
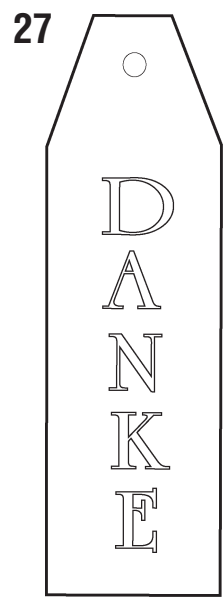

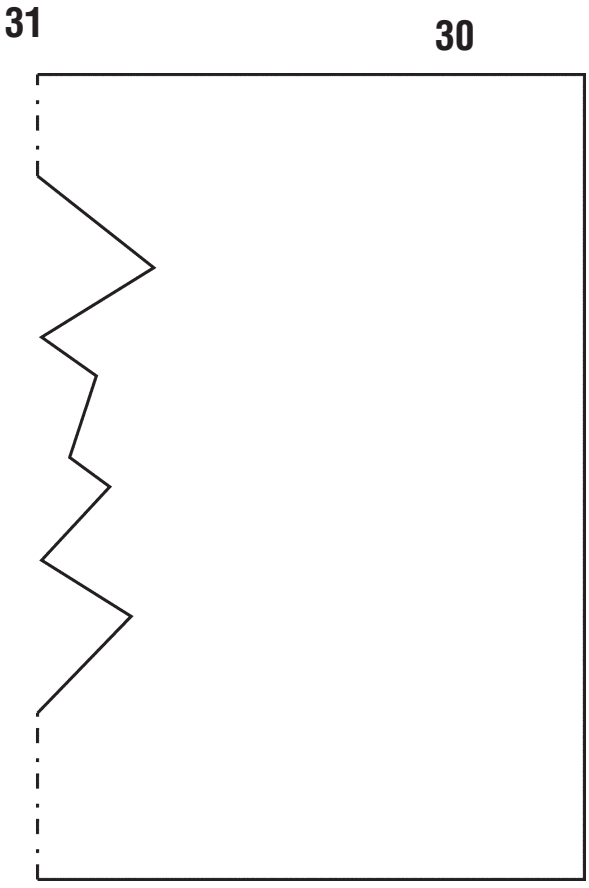
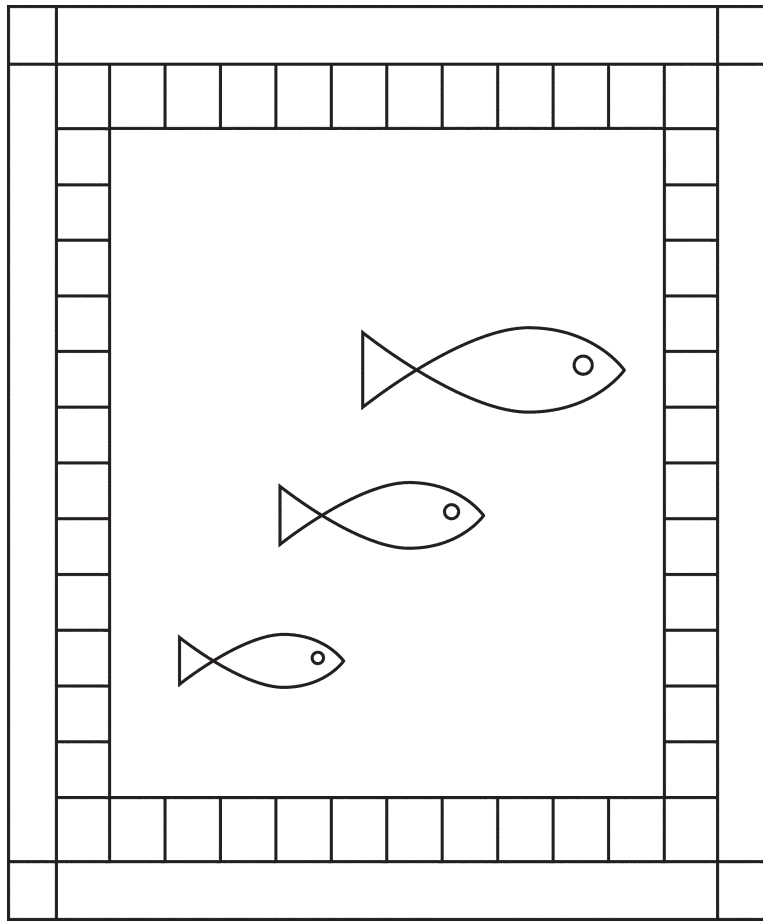
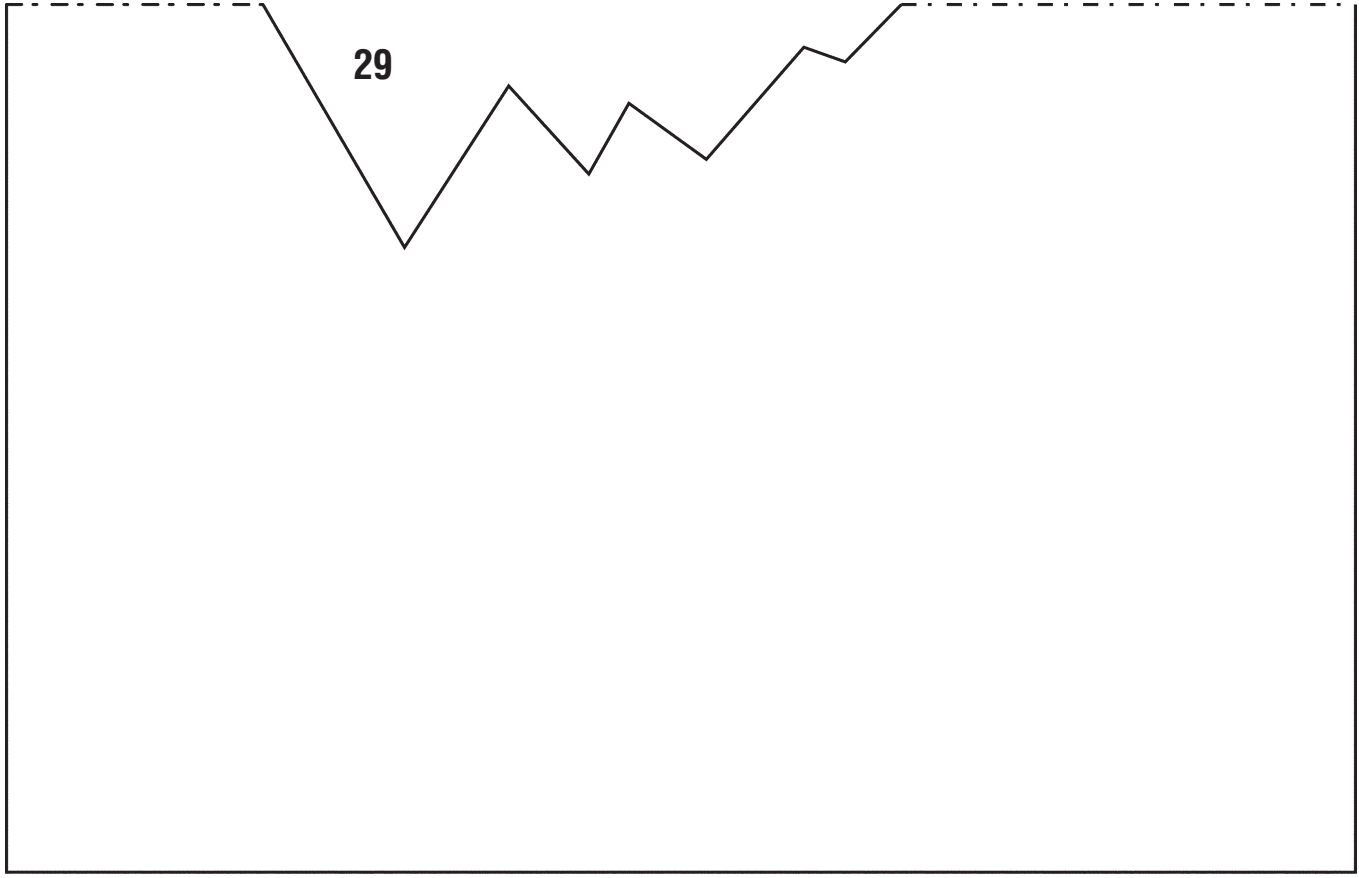

Hinweise zur Benutzung der Vorlageseite:

- = Schnittlinie
- = darunterliegende Schnittlinie
- - - = Faltlinie

32



33

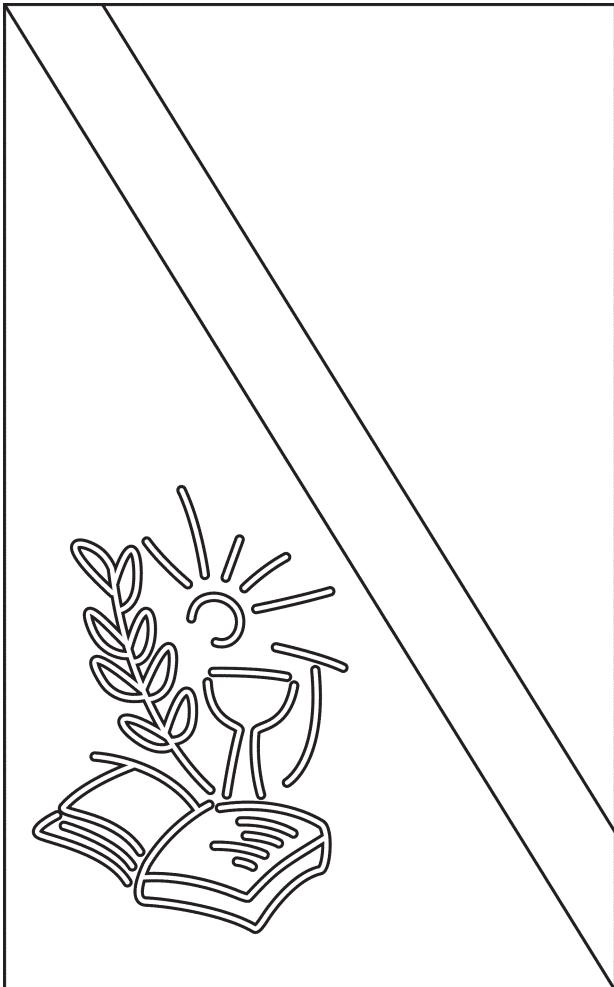

36

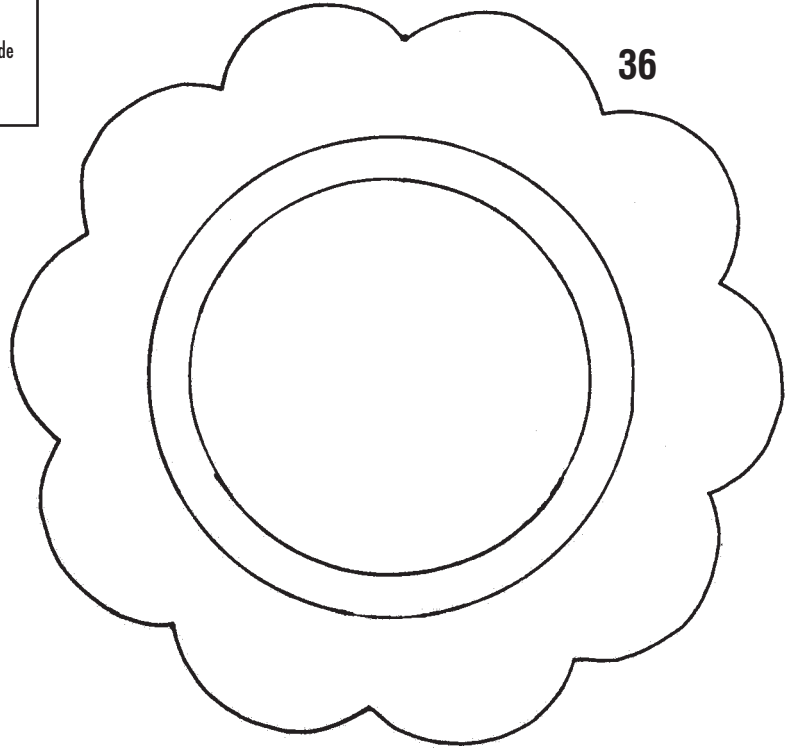

34

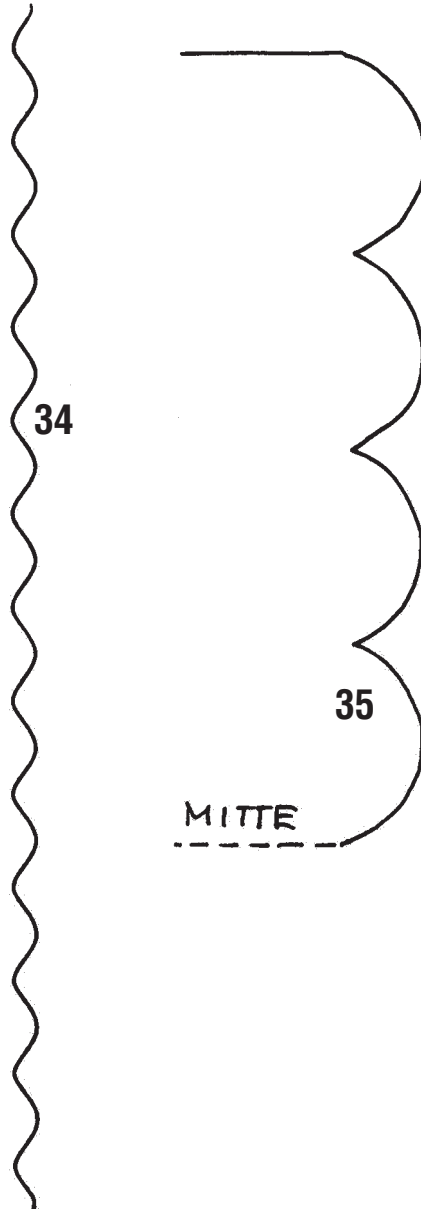

35

MITTE