

Syntax im ER-Modell

Syntax im UML-Klassendiagramm

Entity,
Attribut,
Datentyp

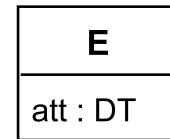
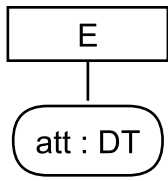

Klasse,
(Objekt-)Attribut,
Datentyp

Relationship/Beziehung,
Rolle,
Multiplizität (Low, High),
Default (0,*)

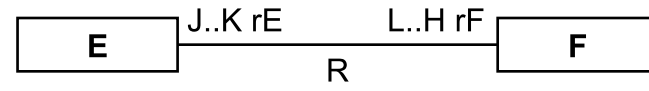
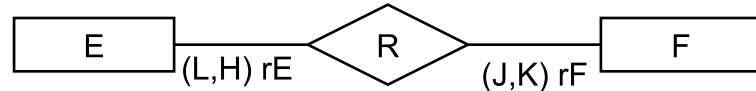

Assoziation/Beziehung,
Rolle,
Multiplizität,
Default 0..*

Relationship-Attribut,
Beziehungs-Attribut

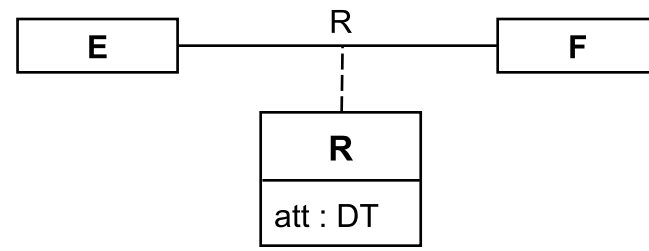
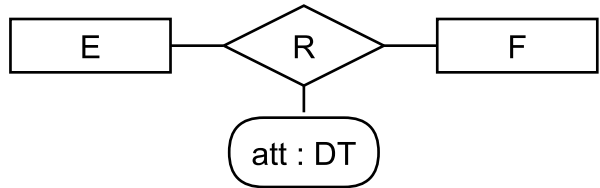

Assoziationsklasse,
Assoziationsklassen-Attribut

(partielle)
funktionale Beziehung

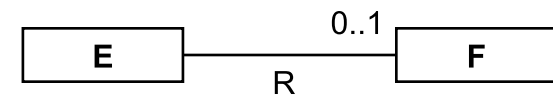
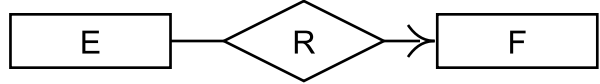

(partielle)
funktionale Assoziation

ist-Beziehung,
Generalisierung,
Spezialisierung,
Vererbung

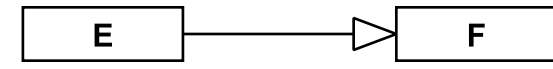

Generalisierung,
Spezialisierung,
Vererbung

Schlüssel,
Schlüsselattribut,
Nicht-Schlüsselattribut

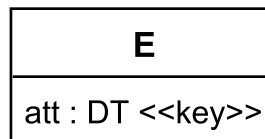
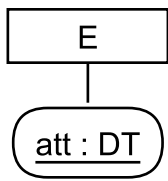

Schlüssel,
Schlüsselattribut,
Nicht-Schlüsselattribut

ER-Modell

UML-Klassendiagramm

Entity,
Attribut,
Datentyp

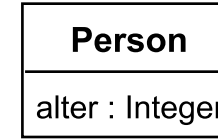
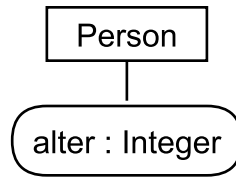

Klasse,
(Objekt-)Attribut,
Datentyp

Relationship/Beziehung,
Rolle,
Multiplizität (Low, High),
Default (0,*),

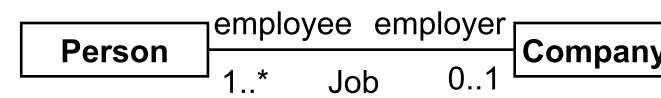
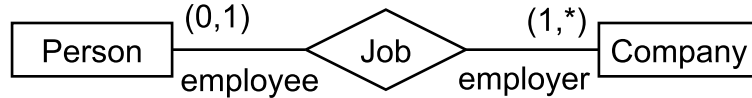

Assoziation/Beziehung,
Rolle,
Multiplizität,
Default 0..*

Relationship-Attribut,
Beziehungs-Attribut

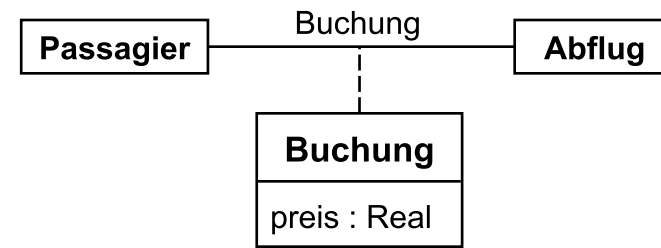
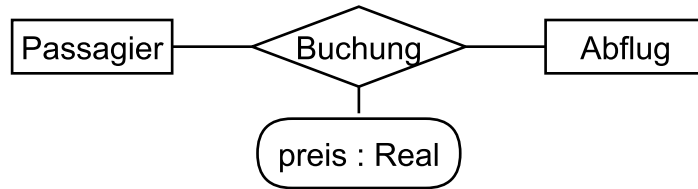

Assoziationsklasse,
Assoziationsklassen-Attribut

(partielle)
funktionale Beziehung



(partielle)
funktionale Assoziation

ist-Beziehung,
Generalisierung,
Spezialisierung,
Vererbung

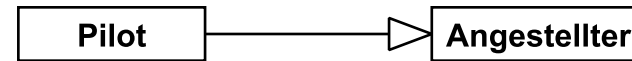
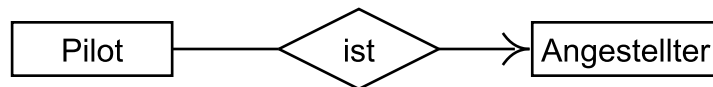

Generalisierung,
Spezialisierung,
Vererbung

Schlüssel,
Schlüsselattribut,
Nicht-Schlüsselattribut

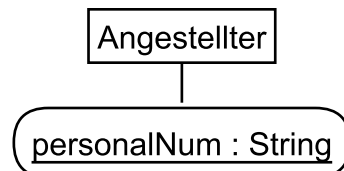

Schlüssel,
Schlüsselattribut,
Nicht-Schlüsselattribut

ER-Modell

ER-Semantik

Entity,
Attribut,
Datentyp

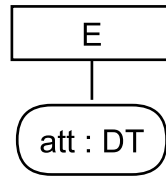

$\mu(E), \sigma(E) \subseteq \mu(E), \sigma(E)$ endlich.

$\sigma(\text{att}) : \sigma(E) \rightarrow |\text{DT}|$.

Relationship/Beziehung,
Rolle,
Multiplizität (Low, High),
Default: (0,*)

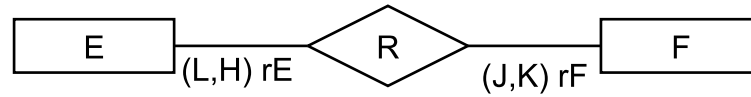

$\sigma(R) \subseteq \sigma(E) \times \sigma(F)$.

Relationship-Attribut,
Beziehungs-Attribut

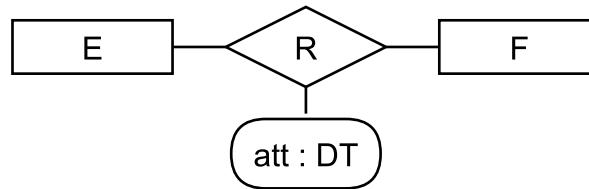

$\sigma(\text{att}) : \sigma(R) \rightarrow |\text{DT}|$.

(partielle)
funktionale Beziehung

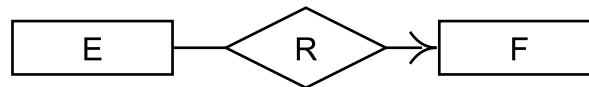

$\sigma(R) : \sigma(E) \rightarrow \sigma(F)$ partielle Funktion.

ist-Beziehung,
Generalisierung,
Spezialisierung,
Vererbung

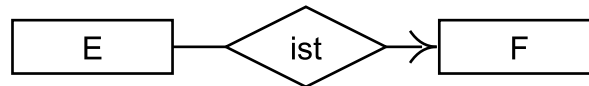

$\sigma(E) \subseteq \sigma(F)$ Inklusion.

Schlüssel,
Schlüsselattribut,
Nicht-Schlüsselattribut

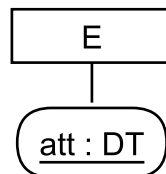

$\forall e_1, e_2 \in \sigma(E) : e_1 \neq e_2 \Rightarrow \sigma(\text{att})(e_1) \neq \sigma(\text{att})(e_2)$.

$E.\text{allInstances} \rightarrow \text{forall}(e_1, e_2 \mid e_1 \neq e_2 \text{ implies } e_1.\text{att} \neq e_2.\text{att})$.

UML-Klassendiagramm

UML-Objektdiagramm

Klasse,
(Objekt-)Attribut,
Datentyp

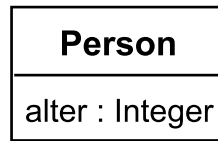

Assoziation/Beziehung,
Rolle,
Multiplizität,
Default 0..*

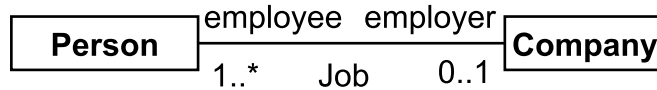

Assoziationsklasse,
Assoziationsklassen-Attribut

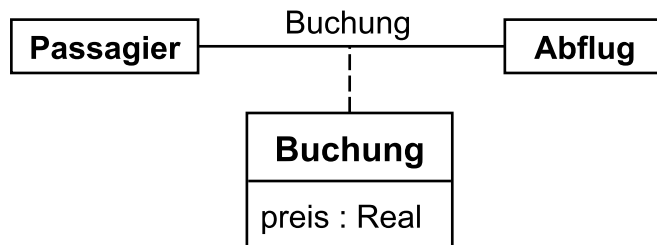

(partielle)
funktionale Assoziation



Generalisierung,
Spezialisierung,
Vererbung

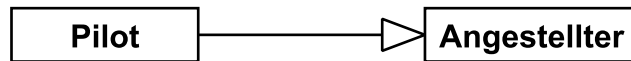

Schlüssel,
Schlüsselattribut,
Nicht-Schlüsselattribut

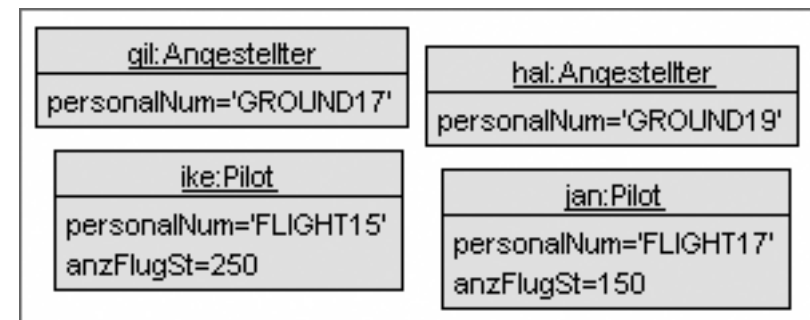
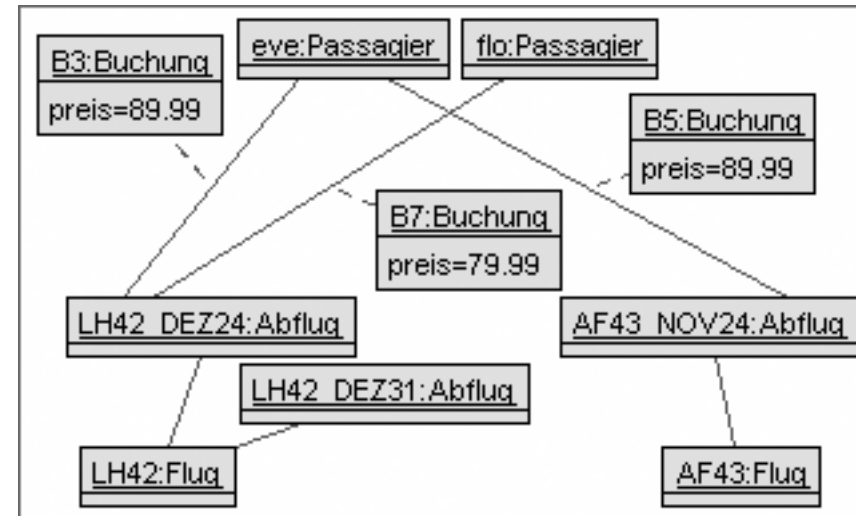
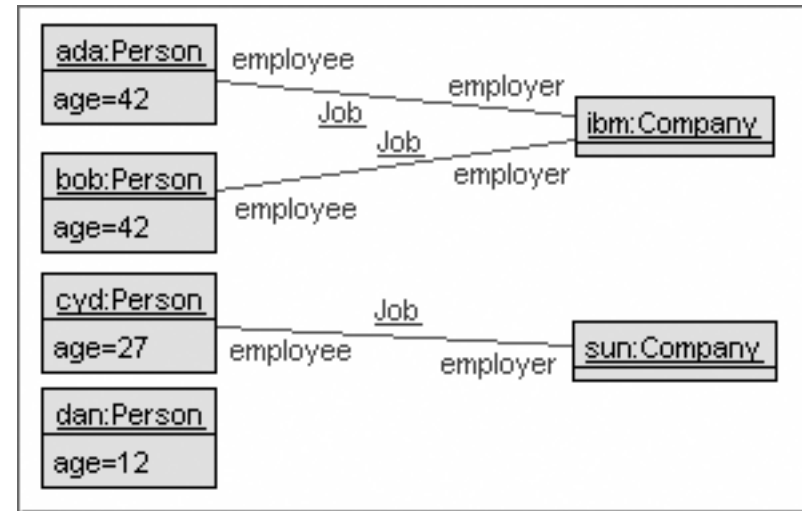

ER-Semantik

UML-Objektdiagramm

$\sigma(\text{att}) : \sigma(E) \rightarrow |\text{DT}|$. $\sigma(R) \subseteq \sigma(E) \times \sigma(F)$. $\sigma(\text{att}) : \sigma(R) \rightarrow |\text{DT}|$.
 $\sigma(R) : \sigma(E) \rightarrow \sigma(F)$ partielle Funktion. $\sigma(E) \subseteq \sigma(F)$ Inklusion.

$\sigma(\text{Person}) = \{\text{ada}, \text{bob}, \text{cyd}, \text{dan}\}$.

$\sigma(\text{Company}) = \{\text{ibm}, \text{sun}\}$.

$\sigma(\text{age}) = \{\text{ada} \rightarrow 42, \text{bob} \rightarrow 42, \text{cyd} \rightarrow 27, \text{dan} \rightarrow 12\}$.

$\sigma(\text{Job}) = \{(\text{ada}, \text{ibm}), (\text{bob}, \text{ibm}), (\text{cyd}, \text{sun})\}$.

$\sigma(\text{Passagier}) = \{\text{eve}, \text{flo}\}$.

$\sigma(\text{Abflug}) = \{\text{LH42_DEZ24}, \text{LH42_DEZ31}, \text{AF43_NOV24}\}$.

$\sigma(\text{Flug}) = \{\text{LH42}, \text{AF43}\}$.

$\sigma(\text{Buchung}) = \{(\text{eve}, \text{LH42_DEZ24}), (\text{eve}, \text{AF43_NOV24}), (\text{flo}, \text{LH42_DEZ24})\}$.

$\sigma(\text{preis}) = \{(\text{eve}, \text{LH42_DEZ24}) \rightarrow 89.99, (\text{eve}, \text{AF43_NOV24}) \rightarrow 89.99, (\text{flo}, \text{LH42_DEZ24}) \rightarrow 79.99\}$.

$\sigma(\text{InstanzVon}) = \{\text{LH42_DEZ24} \rightarrow \text{LH42}, \text{LH42_DEZ31} \rightarrow \text{LH42}, \text{AF43_NOV24} \rightarrow \text{AF43}\}$.

$\sigma(\text{Angestellter}) = \{\text{gil}, \text{hal}, \text{ike}, \text{jan}\}$.

$\sigma(\text{Pilot}) = \{\text{ike}, \text{jan}\}$.

$\sigma(\text{personalNum}) = \{(\text{gil} \rightarrow \text{'GROUND17'}), (\text{hal} \rightarrow \text{'GROUND19'}), (\text{ike} \rightarrow \text{'FLIGHT15'}), (\text{jan} \rightarrow \text{'FLIGHT17'})\}$.

$\sigma(\text{anzFlugSt}) = \{(\text{ike} \rightarrow 250), (\text{jan} \rightarrow 150)\}$.

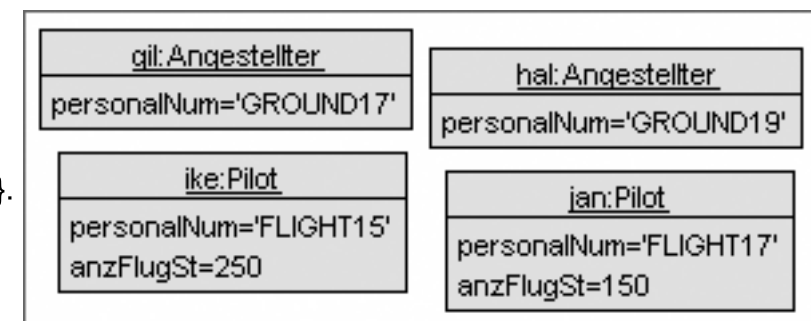
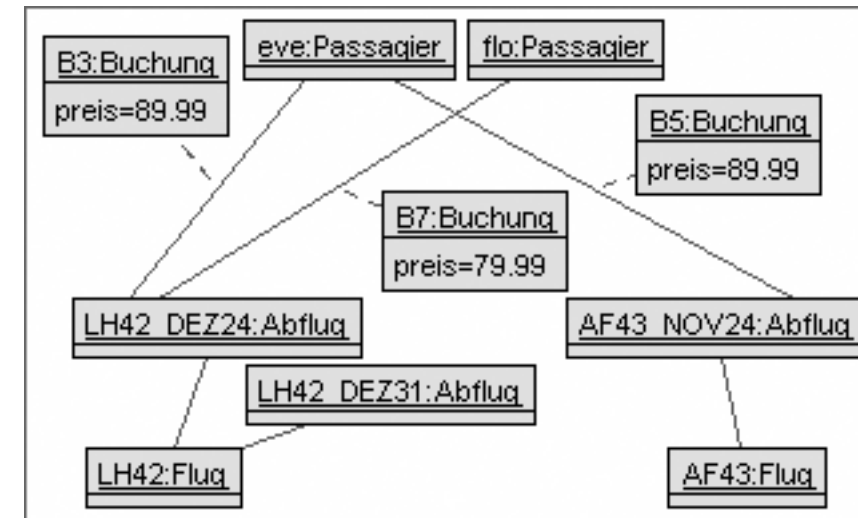
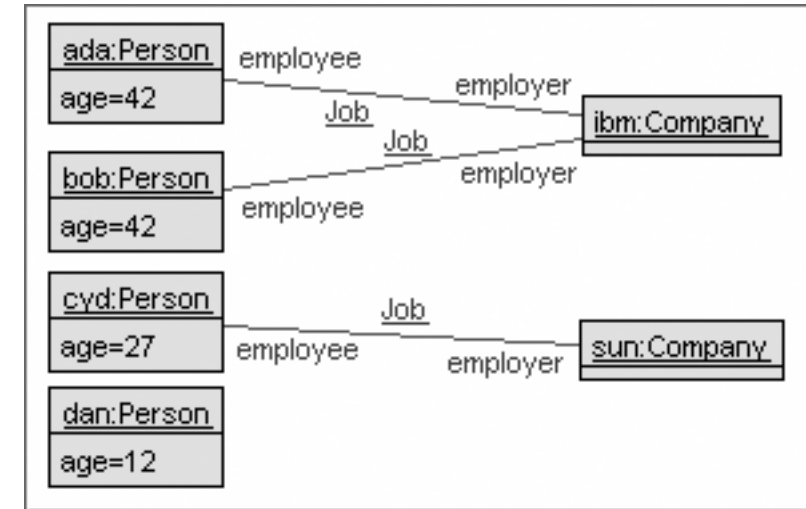

Entity,
Attribut,
Datentyp

Relationship/Beziehung,
Rolle,
Multiplizität (Low, High),
Default: (0,*)

Relationship-Attribut,
Beziehungs-Attribut

(partielle)
funktionale Beziehung

ist-Beziehung,
Generalisierung,
Spezialisierung,
Vererbung

Schlüssel,
Schlüsselattribut,
Nicht-Schlüsselattribut