Operating Instructions

Temperature Control Unit 300L(D)/350L(D)



SWISS MADE



Documentation Temperature Control Unit 300L(D)/350L(D)

This documentation is copyrighted. Unauthorised duplication is prohibited by law. To the best of our knowledge and belief, the information contained in this documentation is true and correct as of the date of publication. The contents, however, do not constitute a binding obligation on the part of Regloplas AG and are subject to change without notice.

© Copyright 2011 Regloplas AG

All rights reserved

Printed in Switzerland

**Regloplas AG
Flurhofstrasse 158
9006 St. Gallen
Switzerland**

Tel.: +41-71-282 58 00

Fax.: +41-71-282 58 40

e-mail: info@regloplas.com

Website: www.regloplas.com







Contents

General Safety Information	1
Safety Symbols	1
Range of Application	2
Intended Use	2
Safety Information	2
General Information	2
Process Monitoring	2
Information for Operators and Personnel	3
Changing the Parameter Settings	3
Residual Risks	3
Using This Documentation	4
Additional Documentation	4
Operating Instructions	5
General	5
Introduction	5
Operating Range	5
Start-up	6
Setting up the Temperature Control Unit	6
Safekeeping of the operating instructions	7
Inspection of Consumers	7
Water Quality	7
Thermal Oil	7
Connecting Lines	8
Electrical Connections	8
Operation of the Temperature Control Unit	9
RT100 Control System	9
Buttons	9
Status LEDs	9
Device Functions	10
Symbols	10
RT100 Operation and Status Displays	10
Setting the Set-point values	10
Parameter Menu	11
RT100 Control System - Functions	11
Switching on the Temperature Control Unit	11
Starting up for the first time / Commissioning	11
Operating Modes	13
Draining the Consumer	13
Operation with Code/Password	13
Operation with Timer	14
Alarm Reset and Alarm History	14
Save/Reset of the Setting Values	14
RT100 Control System - Unlocking Options	14
Switching off the Temperature Control Unit	15
Changing Consumers/Decommissioning	15
Alarm Messages	15
Alarm list	16

Warnings.....	16
Alarms.....	16
System Errors.....	18
Maintenance	18
Periodic Inspections and Maintenance Procedures	18
Cleaning.....	20
Repairs	20
Transport	21
Disposal.....	21
Maintenance	23
Guidelines for Connecting Hoses.....	23
Technical Data 300L(D).....	24
Technical Data 350L(D).....	25
Block Diagram300L(D)/350L(D)	26
Diagram (Pump capacity)	27
Diagram (Cooling capacity)	28
Components/Spare parts 300L(D)/350L(D)	29
Dimension sheet 300L.....	32
Dimension sheet 300LD	33
Dimension sheet 350LD	34
Level Switch.....	35
300L(D).....	35
Dismantling/Replacement.....	35
350L(D).....	36
Dismantling/Replacement.....	36
Solenoid valves	37
Overview.....	37
Safety thermal cut-out	37
Overview and operating principle	37

General Safety Information

Safety Symbols

 DANGER	
	<p>Denotes imminent danger. Failure to heed the information can result in death or grave personal injury (disability)!</p>
 WARNING	
	<p>Denotes a dangerous situation. Failure to heed the information can result in death or grave personal injury (disability)!</p>
 CAUTION	
	<p>Denotes a potentially dangerous situation. Failure to heed the information can result in property damage as well as minor or moderate personal injury!</p>
NOTE	
	<p>Denotes general information, useful advice to users and work recommendations, which, however, do not have any influence on the safety and health of personnel.</p>

Range of Application

This general safety information is generally valid for all temperature controllers and control systems from Regloplas.

Intended Use

The Regloplas temperature control unit is built according to the current state of the art and the generally accepted principles of safety engineering. The temperature control unit is intended solely for the normal use for heating and/or cooling of injection moulds and die casting dies, extruders, calenders, mixers and other consumers in areas where there is no risk of explosion.

Any use beyond this shall be deemed to constitute improper use. The manufacturer is not responsible for damage resulting from improper use; the user is solely responsible for such risks. The temperature control unit may not be used under other operating conditions and/or with other media, in deviation from our specifications, without the prior consent of Regloplas AG.

The intended use also entails compliance with the operating, servicing and maintenance conditions stipulated by the manufacturer. The temperature control unit may only be operated, serviced and maintained by personnel who are familiar with these tasks and have been instructed as to the risks.

Safety Information

General Information

The Regloplas temperature control unit is safe to operate but can cause danger if it is used incorrectly or for a purpose other than its intended use. It should be noted that any such incorrect use or non-compliance with the intended use can cause risks to the life and limb of the user or third parties, adverse effects on the equipment and other material assets belonging to the user, and risks to the efficient operation of the equipment.

Start-up (i.e., commencement of intended use) is prohibited until it has been determined that the temperature control unit has been set up and wired in accordance with the Machinery Directive (2006/42/EC). EN 60204-1 (Safety of Machinery) must also be observed.

These operating instructions must be read carefully before switching on and operating the temperature control unit. The information regarding the intended use and foreseeable misuse must be observed. Local safety regulations must also be obeyed.

If the temperature control unit is used in combination with products made by other manufacturers, the notices and safety regulations of these manufacturers must also be obeyed.

Process Monitoring

In plants in which a malfunction of the temperature control system leads to endangerment of the operating personnel or destruction of the plant,

an independent process monitor that reliably shuts down the plant must be used.

Information for Operators and Personnel

The operator and all persons who are tasked with working on the temperature control unit must obey the fundamental regulations regarding work safety and accident prevention. The operator must ensure that only persons who have read and understood these operating instructions, in particular the chapter on safety, may work on the temperature control unit.

Any working methods that have a negative effect on the technical safety of the temperature control unit must not be used. The operator must ensure that the temperature control unit is operated only in flawless condition. If necessary, the company using the equipment must obligate the operating personnel to wear protective clothing.

For all tasks relating to set-up, start-up, operating, modification of operating conditions and operational methods, maintenance, inspection and repair, any shut-down procedures stated to be necessary in the operating instructions must be followed.

Changing the Parameter Settings

The parameterisation of the control system may only be carried out by personnel trained by Regloplas. In particular, no parameters in the device configuration may be changed without consulting Regloplas.

The relevant accident prevention regulations and the generally accepted principles of safety engineering, occupational medicine and structural engineering must be observed. The national safety regulations must also be obeyed.

Residual Risks

Any unauthorised modifications and changes to the temperature control unit as well as unauthorised changes to the parameterisation of the control system are prohibited for reasons of safety.

If the temperature control unit is damaged, it must not remain in use; the defective part must be replaced or repaired immediately. Only original Regloplas replacement parts may be used. Damage due to use of third-party parts voids any and all warranty claims.



DANGER



The temperature control unit must be disconnected from the electrical power supply before it is opened (unplug the mains plug and, if fitted, press the main switch on the temperature control unit). Danger of electric shock!

Any leaks in the temperature control circuit (device, connecting lines, consumers, etc.) must be repaired immediately.

In the case of temperature control units that use oil as the heat transfer medium, please remember that oil is flammable under certain conditions. For this reason, the temperature control unit must not be located close to heat sources. The thermal insulation in the device must always be kept clean. Insulation that is soaked with thermal oil poses an increased risk of fire.

Burning thermal oil can be extinguished using an AFFF spray foam fire extinguisher, a powder fire extinguisher (to be avoided in the case of dust-sensitive plants, control systems, EDP, etc.) or a CO₂ fire extinguisher. The appropriate fire extinguisher must be provided by the operator, taking into account the equipment located in the room and the mandatory safety regulations.

The temperature control unit may only be operated when all safety systems are completely installed and intact.

The temperature control unit must be protected against sprays and cleaning agents.

Before detaching connecting lines from the temperature control circuit and depending on the outlet temperature, allow the temperature control unit to cool down first and then switch it off. Check that the pump is no longer running.



WARNING



Important - danger of injury in the event of escaping water or oil!

Using This Documentation

This documentation contains important information for safe, economical operation and for proper maintenance of the device.

Compliance with this documentation helps to avoid danger, minimise repair costs and downtime, and increase the dependability and service life of the device/system.

NOTE



The operating instructions should be kept near the corresponding device/system and always be accessible to operating and maintenance personnel.

Additional Documentation

The included documentation is completely correct for the basic versions of devices. Components that do not belong to the basic hardware are noted as extra equipment. The corresponding additional documents are included with special versions of devices. Any additional documents supplement and/or replace the descriptions contained in this documentation, which are then either invalid or only conditionally valid.

Operating Instructions

General

Introduction

These operating instructions contain a detailed description of the Temperature Control Unit 300L(D)/350L(D) as well as important information for safe operation and optimal maintenance.

The operating instructions must be kept near the temperature control unit and always be accessible to operating and maintenance personnel.

Operating Range

The operating range and medium of the Temperature Control Unit 300L(D)/350L(D) are shown in the following table (in this regard, see also the chapter "Technical Data" in the service section).

Temperature Control Unit Type	300L(D)	350L(D)
Temperature range	up to 300 °C	up to 350 °C
Heat transfer medium	Oil	Oil

NOTE



The technical data and information for installation, start-up and maintenance of the temperature control unit can be found in the maintenance section of these operating instructions. The operating instructions should be kept near the device/system and always be accessible to operating and maintenance personnel!

Start-up

Setting up the Temperature Control Unit

The temperature control unit is designed for an ambient temperature range of 10-40 °C. Sufficient ventilation must be ensured during set-up. The distance between the devices and/or between the temperature control unit and a wall must be at least 10 cm. The ventilation slits must not be covered.

- Check the temperature control unit to ensure that it is undamaged and complete
- Do not tip the temperature control unit! Heat transfer medium remaining in the unit from the test run could spill, and there is a risk that the thermal insulation could become soaked with the fluid (medium)
- Position the temperature control unit on a horizontal surface and engage the wheel brake

WARNING



Never start up the temperature control unit without the side panels and housing!
Never use the temperature control unit in potentially explosive environments and protect it against sprays and cleaning agents that contain solvents!
Do not place the temperature control unit close to sources of heat (e.g. furnaces in die-casting plants)!
Any leaks in the temperature control circuit (temperature control unit, connecting lines, consumers, etc.) must be repaired immediately!
The thermal insulation in the temperature control unit must be kept clean at all times (thermal insulation soaked with thermal oil is a fire risk)!
Observe local laws during set-up!

CAUTION



Danger of injury due to release of hot thermal oil!
Before detaching connecting lines in the temperature control circuit, the temperature control unit must first be allowed to cool down. The cooling time will depend on the outlet temperature. The shutdown procedure is initiated by pressing the ON/OFF button. The pump continues to run. The temperature control unit cools down until the temperature of the heat transfer medium has reached the programmed coastdown temperature (factory default 60 °C). The pump and the control system are then switched off!
Check that the pump is no longer running (indicator in the display = OFF)!

NOTE



Burning thermal oil can be extinguished using an AFFF spray foam fire extinguisher, a powder fire extinguisher (to be avoided in the case of dust-sensitive plants, control systems, EDP, etc.) or a CO2 fire extinguisher (danger of reignition, limited suitability).
The appropriate fire extinguisher must be provided by the operator, taking into account the equipment located in the room and the mandatory safety regulations.

Safekeeping of the operating instructions

The operating instructions for the temperature control unit belong in the hands of the personnel responsible for start-up and operation. Please ensure that the operating instructions are read. By doing so, you will avoid unnecessary expense and problems during start-up as well as production downtime.

Inspection of Consumers

Before installing the connecting lines between consumer and temperature control unit, the consumer must be subjected to the following inspections:

- Verify that channels are unobstructed
- Remove residual fluid and fouling with compressed air (foreign objects such as shavings etc. can damage the pump)
- Rust and scale deposits and oil residue must be removed because they greatly interfere with the heat exchange between consumer and heat transfer medium and increase the pressure drop in the consumer. Descaling can be carried out using the Regloplas REG descaling unit (see the "Regloplas Temperature Control Technology" brochure, REG data sheet)
- Oil deposits can be removed with the SR80 system cleaner (see the "Regloplas Temperature Control Technology" brochure, SR80 data sheet)

When converting the consumer from operation with water to thermal oil, all residual water in the consumer and in the connecting lines must be fully removed (danger of accident due to vapour pressure when heating) - see chapter on "Converting the consumer from water to thermal oil"

Water Quality

The water used must meet the following requirements to avoid damage to the cooler of the temperature control unit:

Criterion	Requirement
Appearance	clear/without sediment
Cloud	< 0.5 NTU (very light cloud)
Total hardness	< 10 °dH
pH-value	6.5-8.5
Conductivity	max. 500 µS/cm
Carbonate hardness	< 5 °dH

Addition of RK93 corrosion inhibitor is urgently recommended (see the "Regloplas Temperature Control Technology" brochure, RK93 data sheet).

Thermal Oil

Regloplas recommends the thermal oils Regloplas RO300 or Thermi-nol 66. The film temperature of the thermal oil must be 40 °C above the outlet temperature of the temperature control unit.

Connecting Lines

The connecting lines must consist only of pressure-resistant and temperature-resistant hoses and screw fittings. The cross-section of the connecting lines may not be reduced (see maintenance section).

- Outlet and inlet - use only pressure-resistant and temperature-resistant hoses and screw fittings. The connecting lines must be routed so that they are protected against unintentional contact. Thermal expansion must be taken into account in pipe joints
- Cooling water supply - when connecting to public water mains, the applicable laws and safety regulations must be observed (e.g., connection of the unit via circuit separator). The water mains pressure must be within the range of 2-6 bar Use only pressure-resistant and temperature-resistant hoses and screw fittings
- Cooling water outlet - must be free of back-flow and always open. The hose must be fastened so that any escaping steam at the start of the cooling procedure does not pose a hazard
- Overflow - must always be open



CAUTION



If the cooler is leaky, thermal oil can enter the wastewater!
For reasons of safety, the cooling system must always be connected!

Electrical Connections

The temperature control unit may only be connected by a qualified electrician.

- Compare supply voltage and frequency with the information on the rating plate of the temperature control unit
- Verify the rating of the preliminary fuse according to the information in the electrical diagram, and check that the power consumption conforms to the value on the rating plate of the temperature control unit
- Observe the applicable local laws and safety regulations when connecting to the mains

Operation of the Temperature Control Unit

The temperature control unit must only be switched on after inspecting the consumer, connecting the connecting lines and electrical connections, and opening the outlet/inlet shut-off valves. The vent valves on the consumer and the shut-off valves (if present) must be open.

RT100 Control System

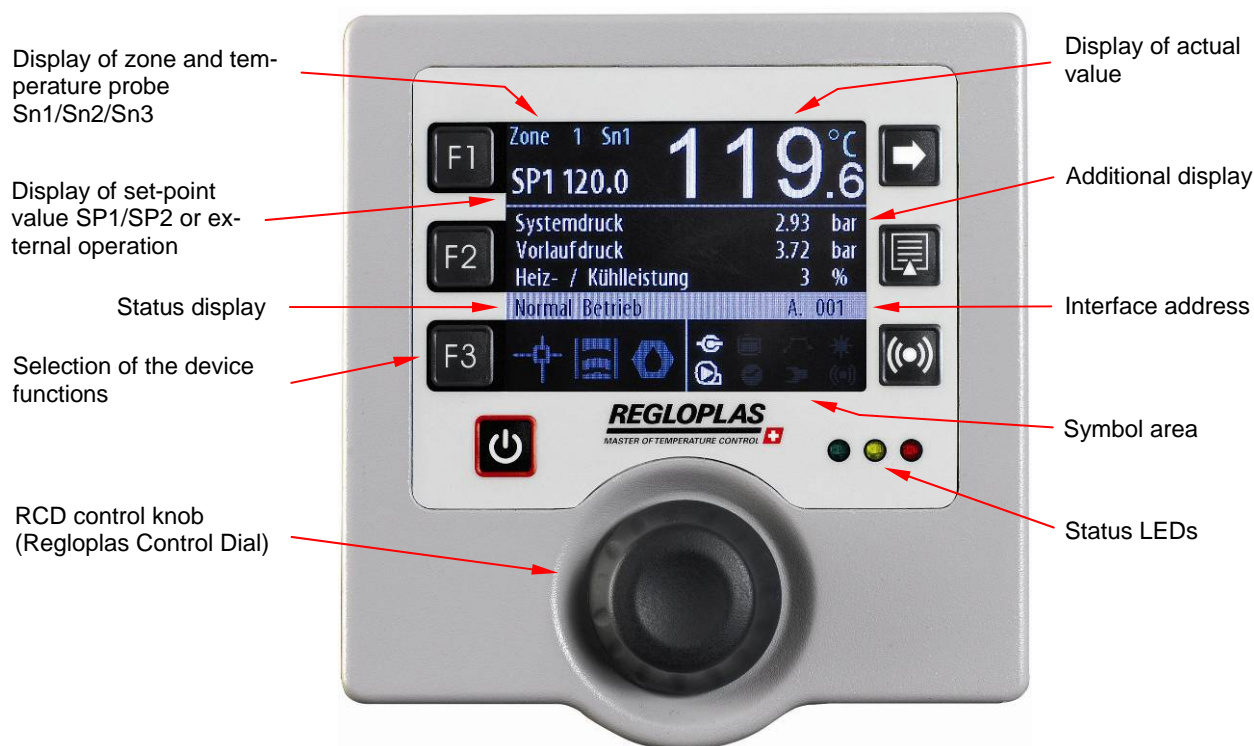

RT100 Control System - front panel



Buttons

	Setting the set-point value		Scrolling through pages
	Setting the additional display		Setting the parameters
	Selection of the device functions (toggling SP1/SP2, drainage by suction, leak-stop)		Alarm reset and alarm history
	Button ON/OFF		











Status LEDs

	Normal mode		Warning		Alarm
--	-------------	--	---------	--	-------

Device Functions

	Set-point value toggling SP1/SP2		Draining (suction or blowing out)
	Leak-stop mode		

Symbols

	Interface operation		Level of the heat transfer medium (filled quantity) LOW
	Level of the heat transfer medium (filled quantity) OK		Heating
	Ramp program activated		Timer activated
	Cooling		Feed pump, counterclockwise rotation
	Feed pump, clockwise rotation		Alarm
	Maintenance due (flashes if maintenance is due)		

RT100 Operation and Status Displays



In the off state of the RT100 control system, the message **OFF** appears in the display area. Upon switching on with the **ON/OFF** button, the additional display is shown. The top left part of the display shows the set-point temperature **SP1** or **SP2** (SP = Set point). The top right part of the display shows the current outlet temperature (actual value of temperature sensor **Sn1**, **Sn2** or **Sn3**).

Sn1 = Outlet temperature

Sn2 = Temperature, external

Sn3 = Inlet temperature



Three other selectable values are shown in the middle part of the display. The additional display can be set by using the **F2** key and by turning/pressing the RCD control knob (turning selects a value, pressing confirms it).

The symbols for set-point value display, suction operation (draining) and leak-stop operation are shown in the lower left part of the display. The various operational and status displays of the temperature control unit are shown in the lower right part of the display.

Setting the Set-point values



The set-point values **SP1** and **SP2** are set by pressing the key **F1**. The set-point value is then coloured light blue and can be set with the RCD control knob. This setting is also possible in the parameter positions. The set-point values can be selected through an external digital signal.



To toggle between set-point values **SP1** and **SP2**, press the **F3** button and select of the set-point toggling function. Set-point toggling is only possible if there is no alarm pending.

Parameter Menu



The parameter menu is activated by pressing the Parameter button. In this menu, all the parameters can be configured by turning/pressing the RCD control knob.

RT100 Control System - Functions

Switching on the Temperature Control Unit



Upon switching on the main switch, the message **OFF** appears in the display. The RT100 control system is now ready for operation and is switched on by pressing the **ON/OFF** button, or by the timer, through a digital input or an interface.

Depending on the programming, the set-point and actual values, as well as information on the operational state of the control system or the temperature control unit are displayed.

Starting up for the first time / Commissioning

Filling with the heat transfer medium

After carrying out the checks on the consumer, connecting the hoses and electrical connections, proceed as follows:

- Switch on the main switch on the temperature control unit
- Open the vent valve on the consumer, and also the shut-off valve (if fitted)
- Using a funnel, pour thermal oil slowly into the filling port, until the red indicator lamp of the level control is switched off. After the pump starts up, top up again with oil until the pressure displayed on the pressure gauge stabilizes at a constant level. This procedure ensures that all lines (both inside and outside the unit) are filled with thermal oil (for the minimum oil level, see the "Technical Data" chapter in the Maintenance section). Regloplas recommends thermal oils Regloplas RO300 or Therminol 66 (see "Accessories for Temperature Control Units" brochure). As a preventive precaution, Regloplas recommends the addition of system cleaner SR80 (see "Regloplas Temperature Control Units" brochure, SR80 data sheet)
- Do not close the vent valve on the consumer until thermal oil is flowing out of the consumer at a regular rate
- Since fresh thermal oil for filling/topping up the system generally contains moisture, action must be taken to remove this moisture as an essential precaution (see chapter on "Procedure in the event of water condensation")
- Check the temperature control circuit for leaks

Operating principle of the two level switches in the 300L(D)

The two level switches in the tank of the 300L(D) each have a specific switching point. The level switch with the blue marking (S1, NC, upper switch-point) controls the level control warning lamp and indicates when the thermal oil must be topped up. The second level switch (S3, NO, lower switch-point) switches off the feed pump if the oil level is too low, in order to prevent the pump running dry (see also the Maintenance section).

When filling with thermal oil, the feed pump starts up at the lower switch-point, and the level control warning lamp is switched off at the upper switch-point.

Rotational field detection / Direction reversal

The rotary field detection of the RT100 control system detects a wrong phase sequence and reports this in the display or corrects the direction of rotation automatically.

Venting the Temperature Control Unit

Each time the unit is filled or refilled with thermal oil, the unit and the temperature control circuit must be vented. To prevent overheating of the heating elements due to incipient air bubbles in the temperature circuit, the inlet pressure in the temperature control unit is monitored by a minimum pressure switch. This switch cuts off the heating if the pressure is too low (0.7 bar) and also activates an alarm. To prevent the heating being switched on by the control system, a set-point value of approximately 10 °C must be set, and the temperature control unit must be vented at this value for about 10 minutes.

Re-starting

- Switch on the main switch on the unit
- Open the vent valve on the consumer, and also the shut-off valve (if fitted)
- Check the temperature control circuit for leaks
- Do not close the vent valve on the consumer until oil is flowing out of the consumer at a regular rate



WARNING



Risk of burns on touching any parts in contact with the thermal oil!

Operating Modes

Normal mode

The heat transfer medium is pumped through the temperature circuit and consumer by pump pressure.

Leak-Stop Mode (Emergency Mode)



Leak-stop mode is activated by pressing button **F3** and selecting the Leak-Stop symbol. The heat transfer medium is drained from the consumer by reversing the direction of rotation of the pump. Leak-stop operation is only possible at temperatures below 250 °C.

CAUTION



During leak-stop operation, if heating is on, the thermal oil is under high thermal stress, because the pump power is reduced!

Draining the Consumer

The heat transfer medium is drained out of the consumer by suction by means of the feed pump. During this process, the maximum expansion volume must be taken into account (see also "Technical Data" chapter).

CAUTION



During drainage by suction, the volume of heat transfer medium in the consumer must be less than the expansion volume in the temperature control unit: otherwise the temperature control unit will overflow!

Drainage by Suction with Pump



The suction program allows the draining of the consumer connected at the temperature control unit and is activated by pressing the **F3** key and selecting the suction symbol. The pump is switched off, and after the pump run-down time has elapsed the pump is switched on again in the opposite direction. The consumer is drained by suction during the defined period (draining time).

Draining is only possible if the temperature of the heat transfer medium is below the programmed coastdown temperature value. If that is not the case, the heat transfer medium is first cooled to this value.



The suction program can be aborted by pressing the **ON/OFF** button. When the **ON/OFF** button is pressed again (wait until the display reads **OFF**), the unit switches back to normal operation.

Operation with Code/Password

In order to prevent the values that have already been set or programmed from being unintentionally reset/adjusted, the use of a code/password is urgently recommended. The code is defined in the parameter **Code**.

The RT100 control system has three password levels that are organised hierarchically:

- User password - Default **0000** (switched off)
- Technician password - Default **0100**
- Service password - only for personnel trained by Regloplas

NOTE



It is strongly recommended that an operator password should be set up when commissioning the temperature control unit.

Operation with Timer

The RT100 control system has an integrated real-time clock. If the **Timer** option is available, the device can be switched on and off with this option.

Alarm Reset and Alarm History

Alarm Reset



If an alarm has been triggered, the signal horn can be switched off by pressing the **Alarm Reset** button. After the malfunction has been remedied, the alarm can be reset by once again pressing the **Alarm Reset** button.

The **Alarm Reset** button also allows manual acknowledgement of the automatic switchover (toggling) from consumer temperature control **Sn2** to outlet temperature control **Sn1** if sensor **Sn2** is defective or removed from the consumer.

Alarm History



If there is no alarm pending, the **Alarm Reset** button can be used to view the alarm history.

Save/Reset of the Setting Values

The RT100 control system provides the facility to load the factory settings or user settings at any time in a simple manner. Two different customer-specific settings can be loaded afresh (user setting 1 and 2).

RT100 Control System - Unlocking Options

The RT100 control system can be equipped with different hardware and software options.

The software options must be activated with a file via USB stick. This requires the serial number of the control system, which is displayed in the parameter **Options** and can be seen on the power section by the barcode.

The serial number consists of 6 letters (e.g. AALASF).

Switching off the Temperature Control Unit



The temperature control unit is switched off by pressing the **ON/OFF** button on the RT100 control system or by the timer, through a digital input or an interface.

Depending on the temperature of the heat transfer medium, the shut-down program runs as follows:

- The pump and the control system are switched off. The RT100 control system will then be in standby mode and the message **OFF** appears on the display.
- The pump continues to run. The unit cools down until the temperature of the heat transfer medium has reached the programmed coastdown temperature. On reaching this temperature, the pump and the control system are effectively switched off. In the case of pressurised water units, the pump then continues running for a further few seconds in the opposite direction (pressure release). The RT100 control system will then be in standby mode and the message **OFF** appears on the display.

Changing Consumers/Decommissioning

Before detaching the connecting lines, it is necessary to verify that the temperature control unit is switched off and that all circuits are depressurized (see the chapter "Switching off the Temperature Control Unit"). The temperature control unit must be drained completely and stored in a dry place at 10-40 °C when not in use. To restart the unit, proceed as instructed in the "Start-up" chapter.

Alarm Messages



The RT100 control system can display various error messages (warnings and alarms). Attention must be paid to these error messages without fail. Otherwise, malfunctions of / damage to the temperature control unit and production downtimes may result.

Pressing the **Alarm Reset** button allows you to acknowledge/reset an alarm (e.g. switching off the horn). Only after the malfunction has been rectified can the alarm display be cleared by once again pressing the **Alarm Reset** button.

The **Alarm Reset** button also allows manual acknowledgement of the automatic switchover (toggling) from consumer temperature control (or cascade control) **Sn2** to outlet temperature control **Sn1** in the event that sensor **Sn2** is defective or removed from the consumer.

Alarm list



Pressing the **Alarm Reset** button opens the alarm list, as long as there is no active alarm. The last ten alarm messages are displayed in this list, complete with date and time.

Warnings

Error message	Remedy
Service is due	Carry out maintenance procedure according to the operating manual. Increment the parameter Next service by 2000 hours
Clean the filter	Clean the corresponding filter or if required, replace it
Current settings lost factory settings loaded	The RT100 control system has lost the parameters and had to load the factory settings
Outlet pressure sensor failure	Replace outlet pressure sensor
Heating contactor 1 failure	The Heating 1 contactor is no longer switching correctly - replace
Heating contactor 2 failure	The Heating 2 contactor is no longer switching correctly - replace
Illegal or broken characteristic curve F1000	Switch the main switch off and on again. If the fault is still present, re-load characteristic curve F1000
Pump power too low	Check/inspect the pump or in the menu F1000 reduce the pump tolerance parameter (default 50%)
Deviation set-point/outlet underrun	Adjust the outlet temperature and acknowledge the fault
Deviation set-point/outlet exceeded	Adjust the outlet temperature and acknowledge the fault
Deviation set-point/external underrun	Adjust the external temperature and acknowledge the fault or error
Deviation set-point/external exceeded	Adjust the external temperature and acknowledge the fault or error
Deviation set-point/inlet underrun	Adjust the inlet temperature and acknowledge the fault
Deviation set-point/inlet exceeded	Adjust the inlet temperature and acknowledge the fault
Deviation outlet/inlet underrun	Adjust the inlet temperature and acknowledge the fault
Deviation outlet/inlet exceeded	Adjust the inlet temperature and acknowledge the fault
Level 2 underrun	Top up heat transfer fluid
Pressure compensation not possible	Check water inflow pipe and water pressure (min. 2 bar)

Alarms



Error message	Remedy
Switch over heat carrier - reboot of the machine required	The device type was changed in the configuration (water/oil as heat transfer medium); the unit must be switched off and then on again using the main switch
External set-point signal disconnected or not available	External set-point signal must be present (if required, check external control system)
Analog option missing or defective	Connect analogue option or switch it off in the Hardware Options parameter

Error message	Remedy
Digital option missing or defective	Connect digital option or switch it off in the Hardware Options parameter
Current monitoring option missing or defective	Connect the current monitoring option or switch it off in the Hardware Options parameter
Rotation reversal option missing or defective	Connect the rotation reversal option or switch it off in the Hardware Options parameter
Profibus option missing or defective	Connect the Profibus option or switch it off in the Hardware Options parameter
CANOpen option missing or defective	Connect the CANOpen option or switch it off in the Hardware Options parameter
A/D converter failure	Replace the base module
Attention - Temperature control cabinet too high	Place the temperature control unit in a place with cooler ambient temperature
Maximal operating time boost pump exceeded	Check the water inflow pipe and hose couplings to the consumer, repair leaks if found
Flow switch act	Check the outlet pressure (min. 0.7 bar must be present)
Min. flow rate underrun	Check the minimum flow rate (the specified minimum flow rate must be present)
Flow rate deviation too high	Large variation in the flow (there may be a leak in the circuit)
Max. temperature exceeded	The maximum temperature of the heat transfer medium must not exceed the maximum temperature of the unit (if required, check the tool temperature)
Heating thermostat triggered	Temperature control unit has become too hot - cool down and search the cause
Current monitoring heating activated	Check the heating element(s) and replace, if necessary
Motor current underrun	Check the pump/pump motor (with ohmmeter) and replace if necessary
Phase sequence failure	Correct the phase sequence (interchange 2 phases)
Phase sequence unidentified	Switch off phase sequence monitoring
Phase missing	Check the mains, power supply line and pump motor
Motor contactor malfunction	Check the motor protection circuit breaker and replace if necessary
Temperature sensor Sn1 failure	Replace temperature sensor Sn1
Temperature sensor Sn2 failure switched to outlet control	Replace temperature sensor Sn2
Temperature sensor Sn3 failure	Replace temperature sensor Sn3
System pressure sensor inactive	Activate system pressure sensor
System pressure sensor failure	Replace system pressure sensor
Level 1 underrun	Top up heat transfer fluid
Motor current exceed	Check the pump/pump motor (with ohmmeter) and replace if necessary
Power failure	Failure of the power supply or temperature control unit not switched off properly
Safety thermostat triggered	Temperature control unit has become too hot - search the cause and do a reset of the thermostat
Temp. monitor cooling act, cooling disabled	Check the cooling and the cooling water flow
Alarm frequency converter	Solve the problem on the frequency converter

System Errors

Error message	Remedy
Memory stick missing	Insert memory stick
Incompatible data on stick	Load current software version
Communication failure	Check the connection between the front panel and the base module
Software version error	Reload software
Data corrupt on memory stick	Insert new memory stick and reload device parameters
Zone 1 missing	Connect Zone 1, check address of Zone 1
Zone 2 missing	Connect Zone 2, check address of Zone 2
Software version option Profibus incompatible	Update the Software
Software version option CANOpen incompatible	Update the Software

Maintenance

 WARNING	
	<p>The temperature control unit must be switched off before carrying out any maintenance work - press the main switch and disconnect from the mains!</p> <p>The temperature control unit may still be pressurized - Danger of injury from escaping hot cooling water or steam!</p> <p>Before disconnecting the feed lines to the temperature control unit/consumer, first allow the temperature control unit to cool down!</p>

Periodic Inspections and Maintenance Procedures

The RT100 control system has a service interval display to simplify the standard maintenance procedures for the temperature control unit. We recommend entering the corresponding maintenance interval (e.g., 2000 hours, see the RT100 control system programming instructions).

Please note that the instructions below are based on a daily operating time of 8 hours. In multi-shift operation, the inspections and maintenance procedures must be carried out at correspondingly shorter intervals. Defective parts must be repaired or replaced immediately.

- Temperature control unit inspections and maintenance procedures must be carried out by an expert
- Maintenance procedures involving electrical equipment may only be carried out by qualified electricians
- The RT100 control system unit may only be replaced when the mains plug is unplugged
- The safety valve should be vented from time to time by brief activation (blow off)



WARNING



Danger of magnetic fields in the case of feed pumps with magnetic drive!

Persons with pacemakers and surgically implanted metal parts must remain at a safe distance or not be required to perform maintenance and repairs on these pumps!

When assembling the magnetic drive, the motor must be securely retained to prevent any possibility of fingers being crushed between components due to the magnetic forces!

All computers, data media, credit cards, electronic watches etc. must be kept at a safe distance!

Daily Inspections/Maintenance Procedures

- Check the entire temperature control circuit (temperature control unit, connecting lines, consumers, etc.) for leakage and repair any leaks immediately
- Check filters and clean if necessary

Monthly Inspections/Maintenance Procedures

- Inspect the cooling air inlet port of the pump motor to ensure that it is free of obstructions. Clean the port by blowing compressed air from inside to outside
- Clean the level switches
- Check filters and clean if necessary



Semi-annual Inspections/Maintenance Procedures

- Inspect the electrical equipment such as grounding wires, secure connection of power supply cord and connecting lines, etc.
- Dismantle solenoid valves (see maintenance section), inspect membranes for lime deposits and damage. Check the core and spring bolt for free movement. Clean or replace parts if necessary
- Descale cooler - exercise caution when tightening the screwed connections on the heat exchanger (max. 170 Nm)!
- Check pump capacity (the flow rate and final pressure must comply with the pump characteristic)

Annual Inspections/Maintenance Procedures

- Replace the heat transfer medium (water and corrosion inhibitor) after approx. 2000 working hours (equivalent to approx. one year in single-shift operation). In the event of poor water quality or multi-shift operation (contamination, etc.), the medium must be replaced correspondingly earlier



Cleaning

 CAUTION	
	<p>Always allow the temperature control unit to cool down!</p> <p>Switch off the temperature control unit: press the main switch and unplug from the mains!</p> <p>When using a solvent for cleaning - do not blow out the tank and the cooler, but flush them instead (explosion hazard)!</p> <p>When using a solvent, the manufacturer's instructions for use must be observed. Solvents are flammable under certain conditions. For this reason, cleaning must never take place near heat sources!</p>

In the event of unfavourable operating conditions, the procedures listed below must be carried out correspondingly earlier.

- 1) Drain the temperature control unit by suction or blowing out
- 2) Clean the filters in the circuit
- 3) Inspect the cooler for scale deposits and clean using the REG Descaling Unit if necessary
- 4) Level control - remove and clean the level switches. Caution - both level switches must be refitted correctly (see Maintenance section)
- 5) Dismantle solenoid valves (see Maintenance section), inspect diaphragms for scale deposits and damage. Check the core and spring bolt for free movement. Clean or replace parts if necessary
- 6) Inspect pump for corrosion and replace if necessary
- 7) It is also advisable to inspect the consumers for contamination. Impurities lead to a sharp reduction in heat exchange between consumer and heat transfer medium. Deposits increase the pressure drop in the consumer, so that, over time, the pump capacity of the temperature control unit is no longer sufficient to handle the necessary heating or cooling load

Repairs



 CAUTION	
	<p>Allow the temperature control unit to cool down and, if necessary, drain it before any repair!</p> <p>Switch off the temperature control unit, press the main switch and unplug from the mains!</p> <p>Disconnect all hose couplings from the temperature control unit!</p>

For fast, error-free supply of spares, we need the following data without fail:



- Device type
- Device number
- Voltage and frequency

This information is given on the rating plate on the temperature control unit.

The item numbers of the components can be found in the corresponding drawings in these operating instructions and the electrical circuit diagrams of the temperature control unit.

 CAUTION	
	<p>Only original Regloplas spare parts may be used! In case of damage from the use of non-original parts, the warranty will be rendered null and void!</p>

Transport

 CAUTION	
	<p>Allow the temperature control unit to cool down; switch off - press the main switch and disconnect from mains (see chapter on "Switching off the temperature control unit")! Disconnect all hose couplings from the temperature control unit!</p>

Before shipping, the temperature control unit must be drained through the discharge port on the delivery pump (see maintenance section). Because of the danger of freezing (bursting of the cooling pipes) at low temperatures, the cooler must be blown out as follows:



- 1) Switch on the temperature control unit - press the main switch and press the **ON/OFF** button

- 2) Set the set-point value on the controller to 0 °C

- 3) Check that the cooler solenoid valve (**Y6**) is open

- 4) Blow out the cooler with compressed air (max. 6 bar)



- 5) Switch off the temperature control unit with the **ON/OFF** button, and then press the main switch and unplug the mains plug

- 6) Do not tip the temperature control unit - heat transfer medium remaining in the unit could spill out

- 7) Use the original packaging and mark the top side clearly



Disposal

The temperature control unit must be drained completely and disposed of in accordance with local regulations.

The temperature control unit can also be returned to Regloplas AG, Switzerland, for disposal.

Maintenance

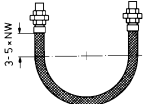
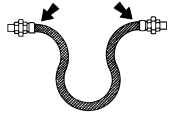
Guidelines for Connecting Hoses

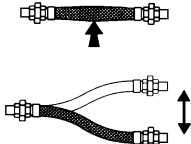
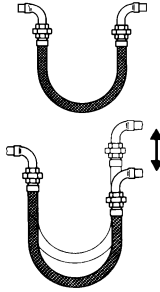
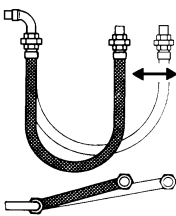
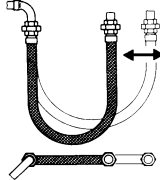
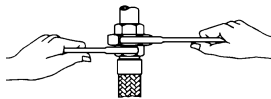
Wrong		Right	
	Hose too short - hose is bent at the connections		Provide sufficiently long neutral hose ends (3-5 x DN)
	Excessive bending load at the connections		Pipe elbows fitted
	Incorrect installation - compression along the longitudinal axis		Pipe elbows fitted
	Torsion - hose axis and direction of movement not in the same plane		The pipe axes must be parallel and in the same plane as the direction of movement
	Important - the hoses may also be twisted during installation!		When attaching/ detaching a hose, always hold it in place with a second wrench

Technical Data 300L(D)

Temperature Control Unit Type	300L	300LD
Max. outlet temperature	300 °C	300 °C
Heat transfer medium	Oil	Oil
Filling capacity	15 litres	24 litres
Max. expansion volume	20 litres	20 litres
Heating capacity at 400 V	20/40 kW	20/40 kW (per circuit)
Heating switch	SSR relay	SSR relay
Cooling capacity	160 kW	160 kW (per circuit)
at outlet temperature	280 °C	280 °C
Pump type	FM65	FM65
Power consumption	2.8 kW	2.8 kW (per circuit)
Max. delivery rate	90 l/min	90 l/min (per circuit)
Max. delivery pressure	10 bar	10 bar (per circuit)
Control System	RT100 Control System	
Measurement type (standard)	Pt100	Pt100
Control voltage	230 V, 50 Hz	230 V, 50 Hz
Input supply voltages	200-600 V 50/60 Hz	200-600 V 50/60 Hz
Input supply voltage (standard)	400 V/50 Hz, 3 PE	400 V/50 Hz, 3 PE
Outlet/inlet connections (standard)	G 3/4" female	G 3/4" female
Cooling water supply connections (standard)	G 3/4"	G 3/4"
Degree of protection	IP54	IP54
Dimensions W/H/D	432/1356/1474 mm	541/1356/1474 mm
Weight	approx. 246 kg	approx. 365 kg
Colour	RAL 9006/7016	RAL 9006/7016
Ambient temperature	max. 40 °C	max. 40 °C
Continuous sound pressure level	< 70 dB(A)	< 70 dB(A)

Technical Data 350L(D)

Temperature Control Unit Type	350L	350LD
Max. outlet temperature	350 °C	350 °C
Heat transfer medium	Oil	Oil
Filling capacity	15 litres	24 litres
Max. expansion volume	20 litres	20 litres
Heating capacity at 400 V	20 kW	20 kW (per circuit)
Heating switch	SSR relay	SSR relay
Cooling capacity at outlet temperature	80 kW	80 kW (per circuit)
	280 °C	280 °C
Pump type	FM65	FM65
Power consumption	2.8 kW	2.8 kW (per circuit)
Max. delivery rate	90 l/min	90 l/min (per circuit)
Max. delivery pressure	10 bar	10 bar (per circuit)
Control System	RT100 Control System	
Measurement type (standard)	Pt100	Pt100
Control voltage	230 V, 50 Hz	230 V, 50 Hz
Input supply voltages	200-600 V 50/60 Hz	200-600 V 50/60 Hz
Input supply voltage (standard)	400 V/50 Hz, 3 PE	400 V/50 Hz, 3 PE
Outlet/inlet connections (standard)	G 3/4" female	G 3/4" female
Cooling water supply connections (standard)	G 3/4"	G 3/4"
Degree of protection	IP54	IP54
Dimensions W/H/D	432/1579/1466 mm	546/1579/1466 mm
Weight	approx. 323 kg	approx. 642 kg
Colour	RAL 9006/7016	RAL 9006/7016
Ambient temperature	max. 40 °C	max. 40 °C
Continuous sound pressure level	< 70 dB(A)	< 70 dB(A)

Block Diagram 300L(D)/350L(D)

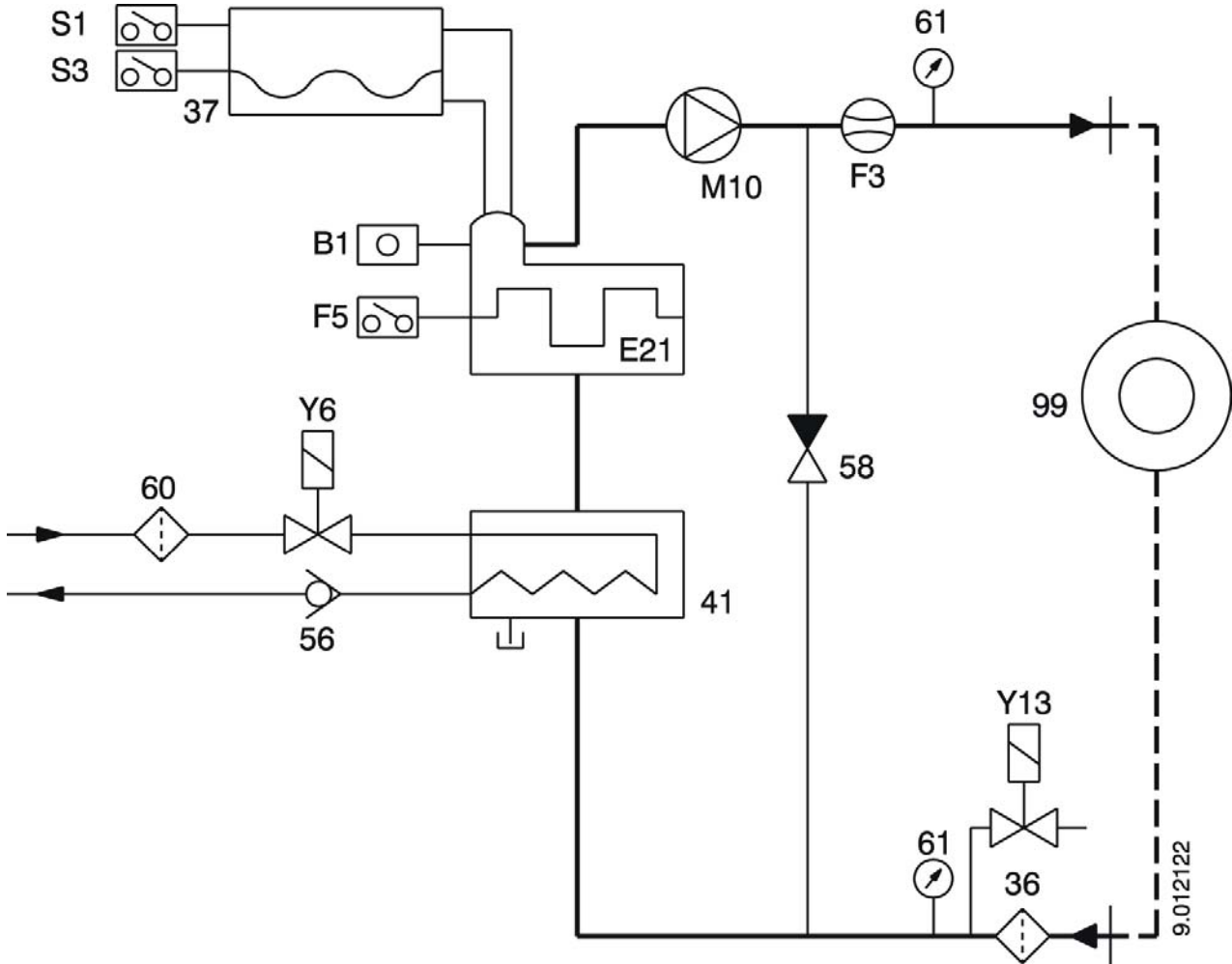

Block Diagram 300L(D)/350L(D)

Item	Designation	Item	Designation
36	Main circuit filter	E21	Heating
37	Expansion tank	F3	Flow monitoring
41	Cooler	F5	Safety thermostat
56	One way check-valve	M10	Pump
58	Bypass	S1	Level control - upper level
60	Cooling circuit filter	S3	Level control - lower level
61	Pressure gauge	Y6	Solenoid valve - cooling
99	Consumer	Y13	Solenoid valve - suction (optional)
B1	Internal temperature probe		

Diagram (Pump capacity)

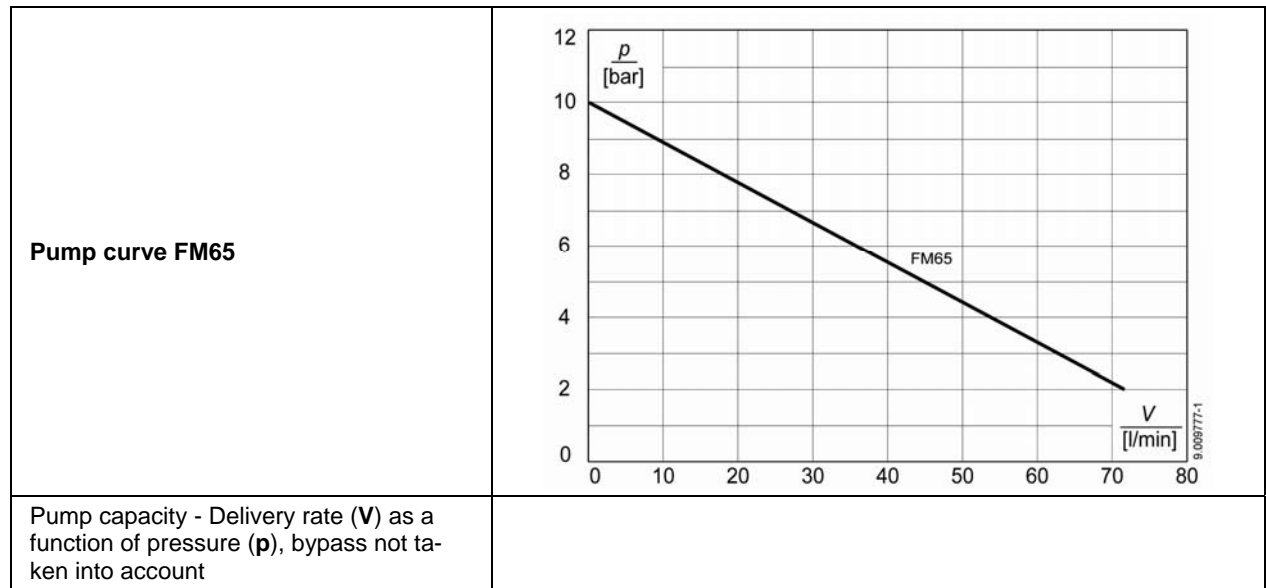
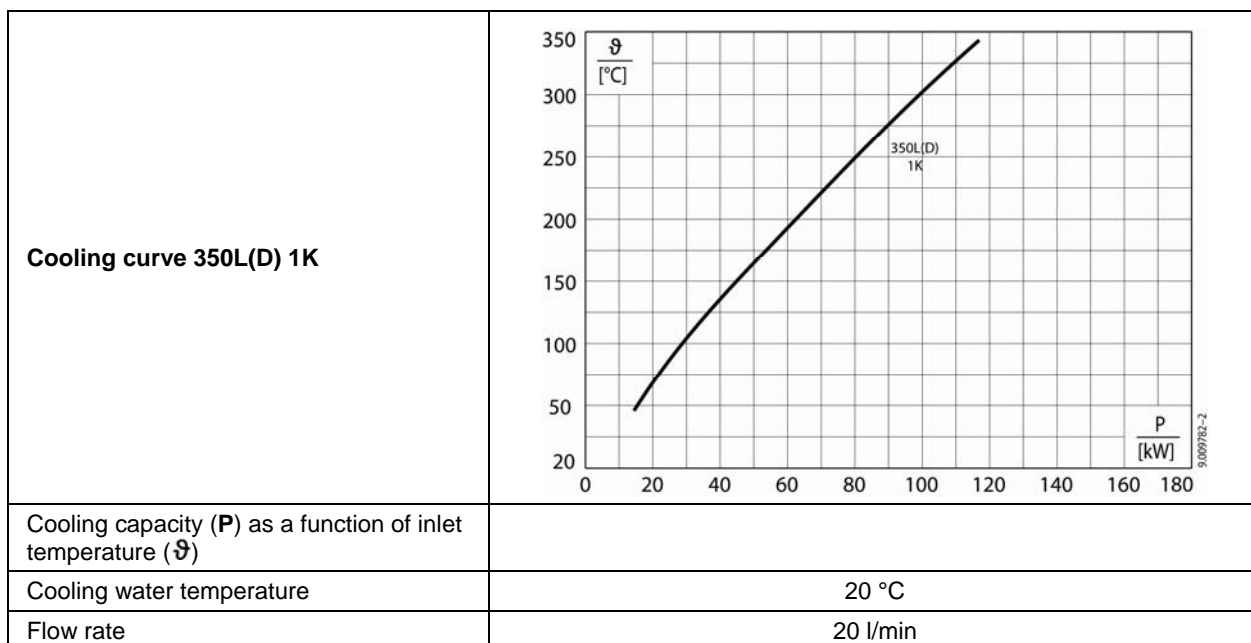
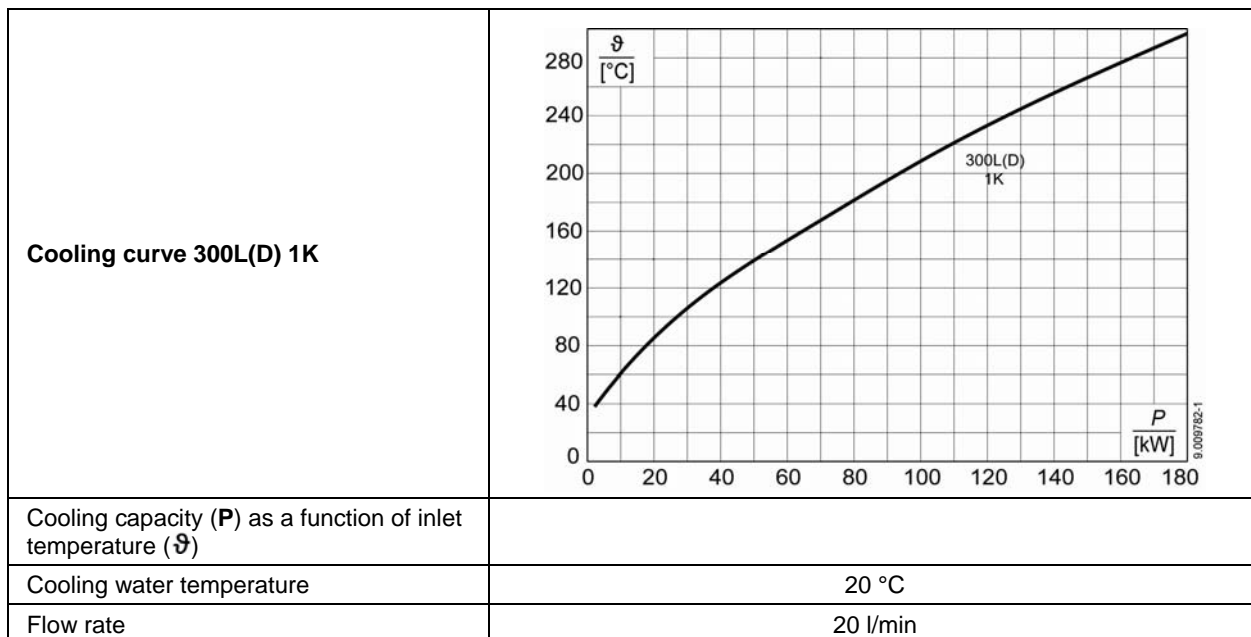
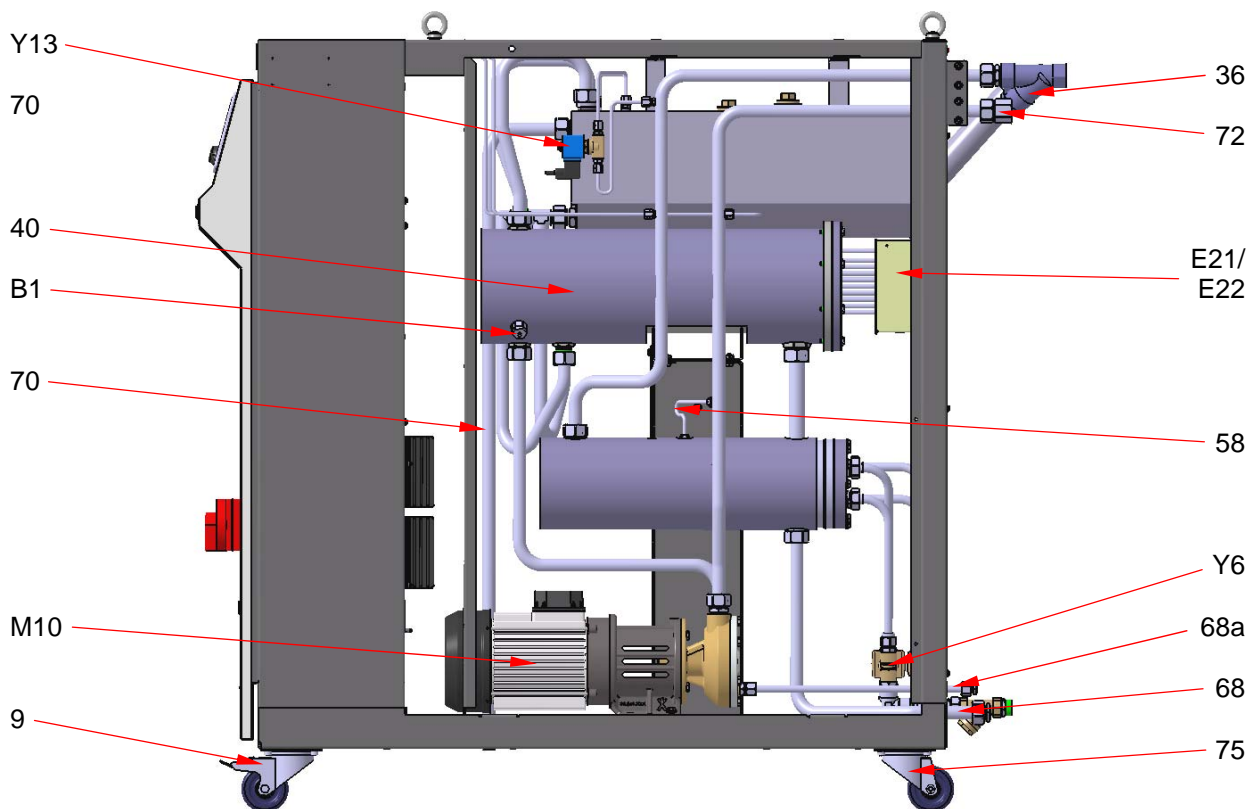
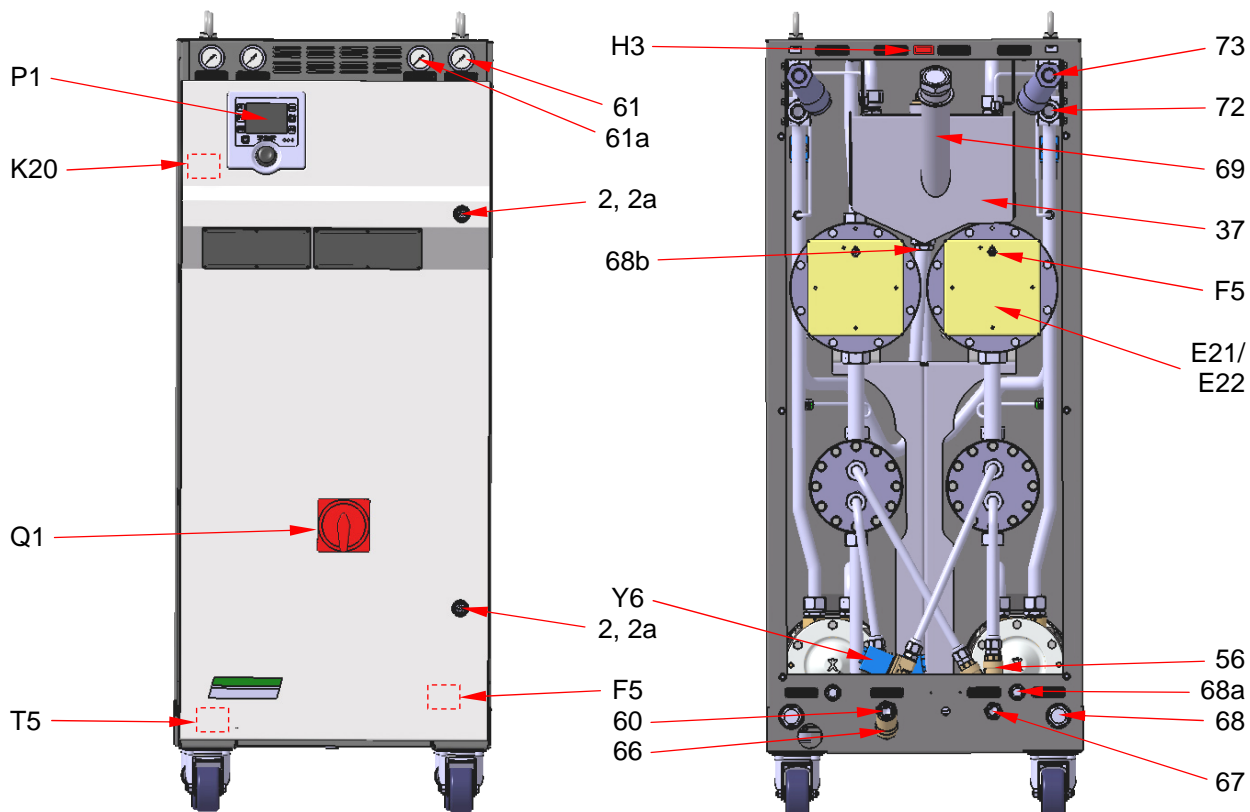
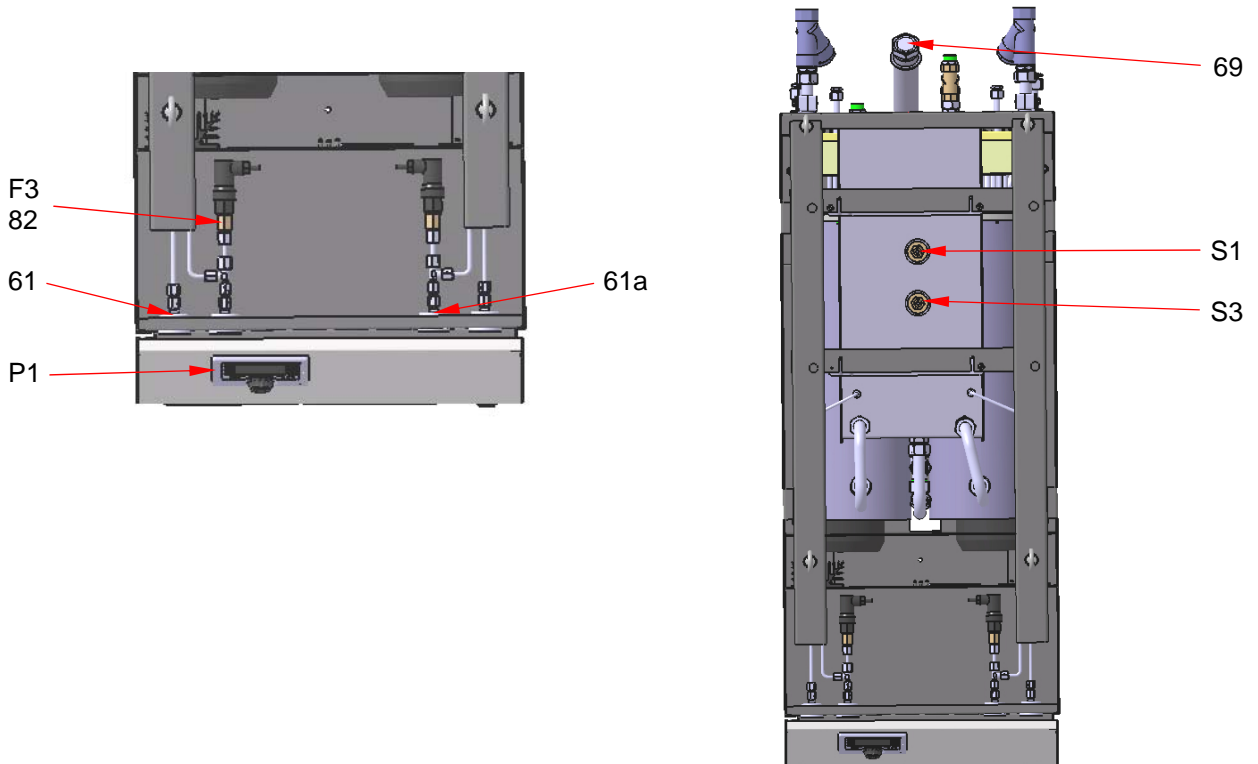
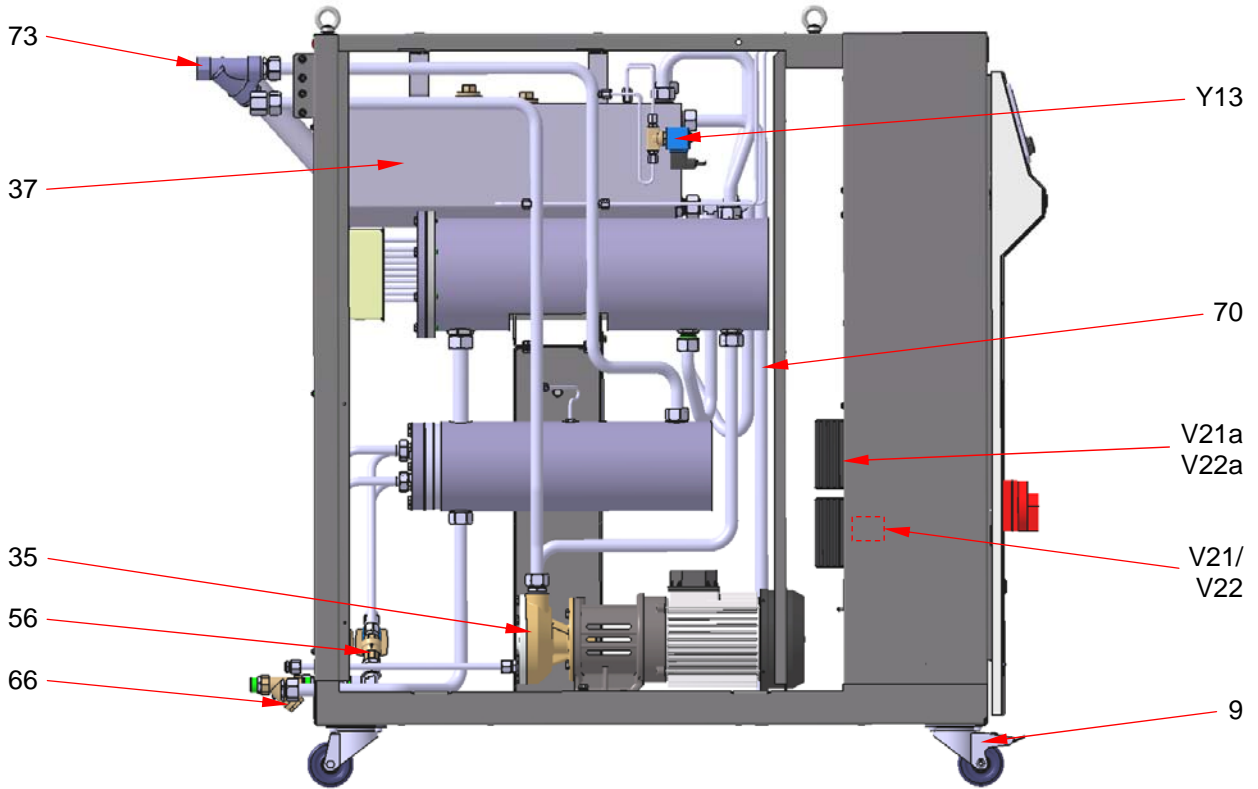

Diagram (Cooling capacity)



Components/Spare parts 300L(D)/350L(D)





Item	Designation	Item	Designation
2	Lock	E21/22	Heating
2a	Locking tongue	F3	Minimum pressure switch/flow monitor
9	Castor with wheel lock	F5	Safety thermostat
30	Power cable	H3	Warning lamp, low level
35	Pump	K20	Main contactor - heating
36	Inlet filter sieve	M10	Pump motor
37	Expansion tank	P1	Control system
40	System with heating and insulation	Q1	Main switch
56	One way check-valve	T5	Control transformer
58	Bypass	V21/22	SSR relay with heat sink
60	Cooling water filter	V21a/V22a	SSR relay seal
61	System pressure gauge (inlet)	S1	Level switch - upper level
61a	System pressure gauge (outlet)	S3	Level switch - lower level
66	Cooling water ON	Y6	Solenoid valve (cooling)
67	Cooling water OFF	Y13	Solenoid valve (suction)
68	Discharge port		
68a	Discharge port (pump)		
69	Filling port		
70	Overflow		
72	Outlet		
73	Inlet		
75	Castor		

NOTE



See electrical wiring diagram of the temperature control unit for additional electrical components!



CAUTION



Only authentic (OEM) Regloplas spare parts may be used. In case of damage from the use of non-OEM parts, the warranty will be rendered null and void!

Dimension sheet 300L

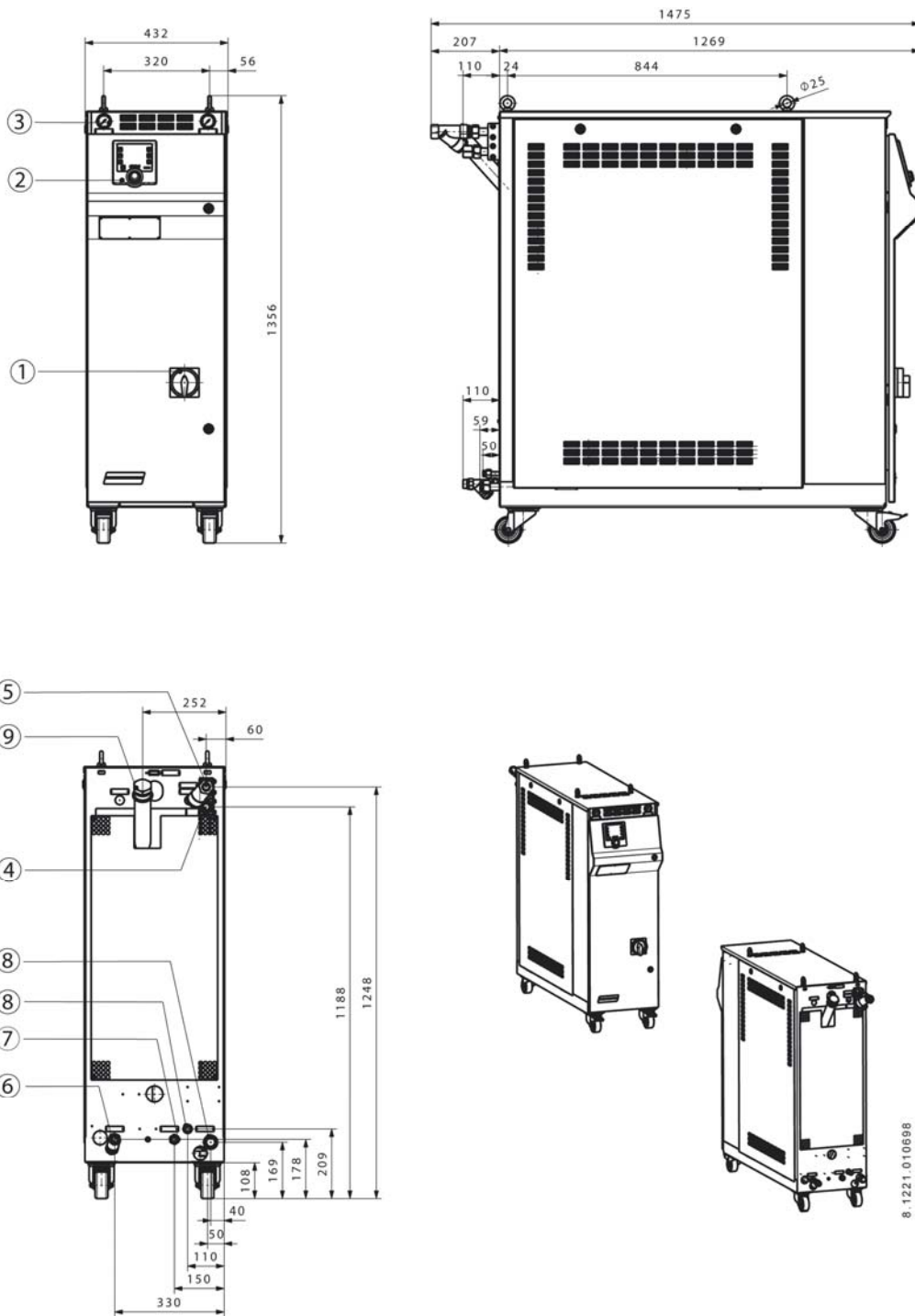

Item	Designation	Item	Designation
1	Main switch	6	Cooling water ON
2	RT100 Control System	7	Cooling water OFF
3	Pressure gauge	8	Discharge port
4	Outlet	9	Filling port
5	Inlet		

Dimension sheet 300LD

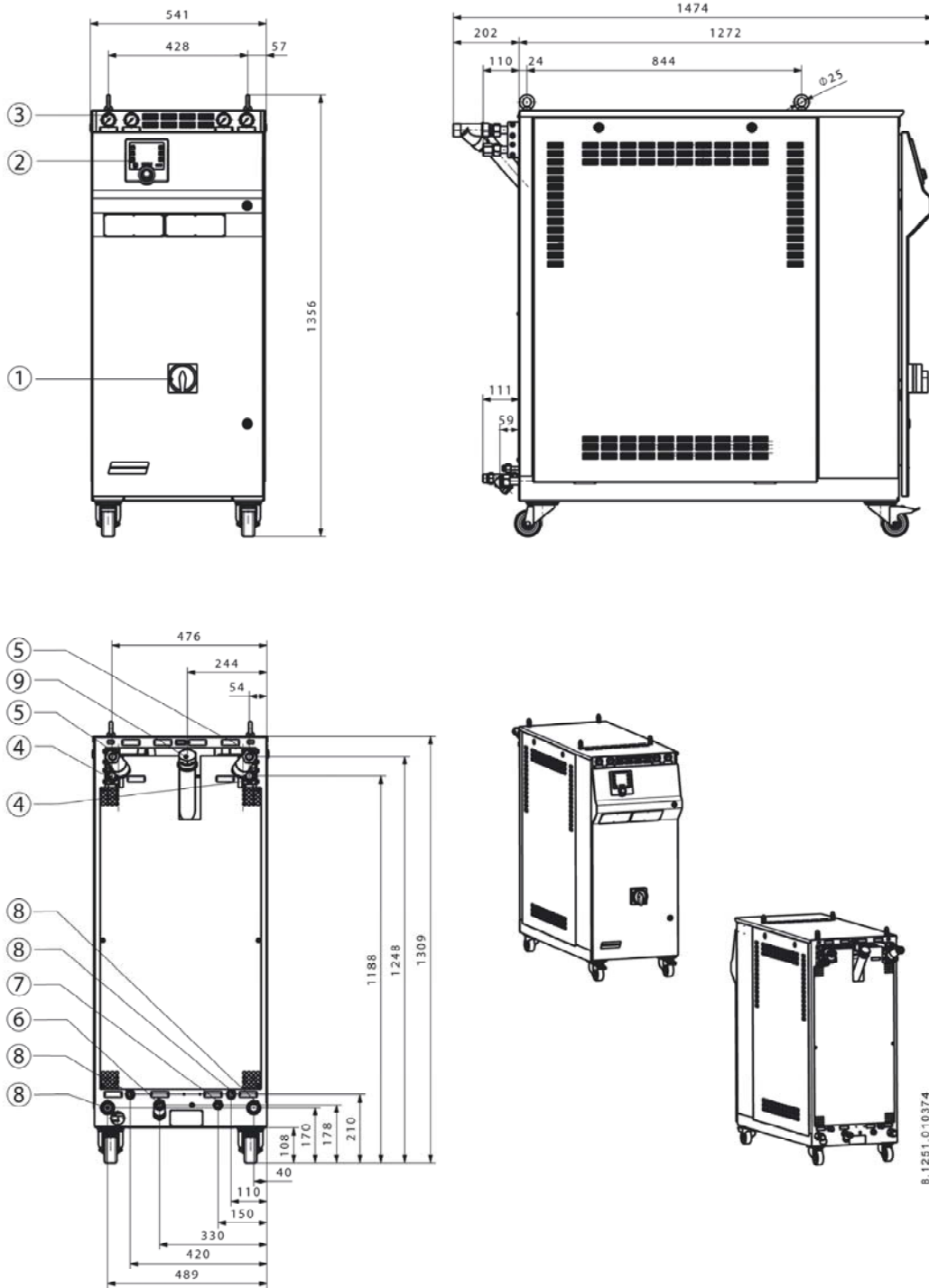

B:1251.010374

Item	Designation	Item	Designation
1	Main switch	6	Cooling water ON
2	RT100 Control System	7	Cooling water OFF
3	Pressure gauge	8	Discharge port
4	Outlet	9	Filling port
5	Inlet		

Dimension sheet 350LD

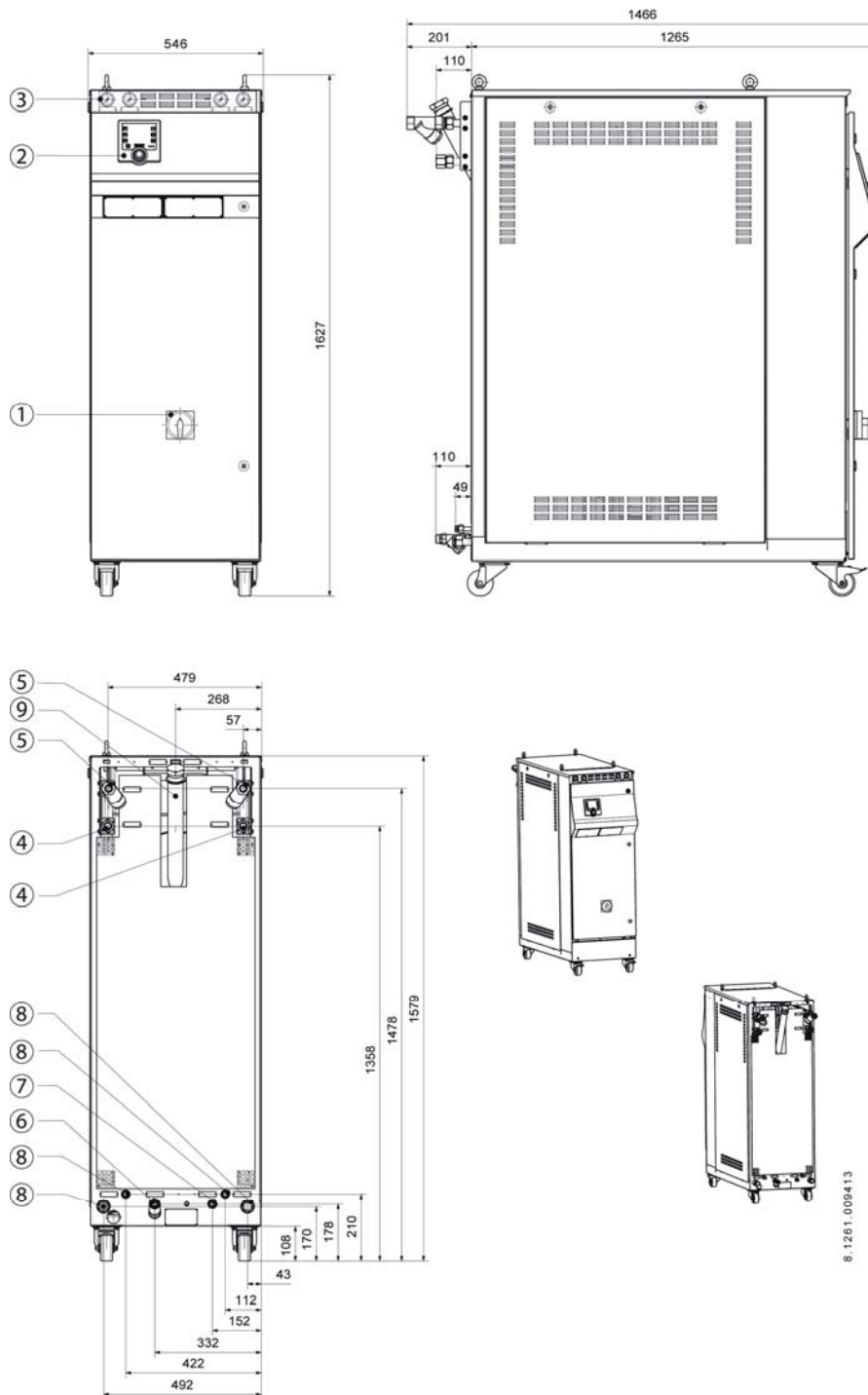

Item	Designation	Item	Designation
1	Main switch	6	Cooling water ON
2	RT100 Control System	7	Cooling water OFF
3	Pressure gauge	8	Discharge port
4	Outlet	9	Filling port
5	Inlet		

Level Switch

300L(D)

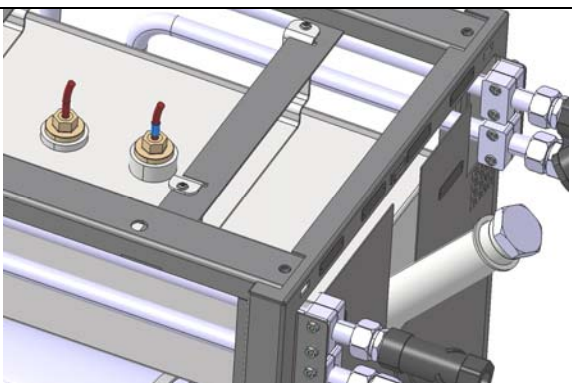
<p>1 level switch for the lower switching point and 1 level switch (with blue marking) for the upper switching point (see section on "Switching on for the first time / Commissioning")</p>	
	<p>Level switch with silicone cable and AMP socket</p>

Dismantling/Replacement

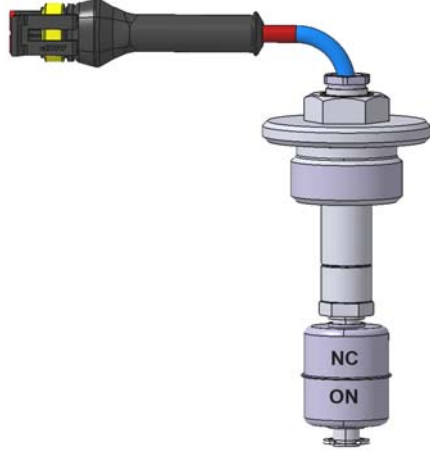
<p>When replacing the level switches after removal, the marking NO or NC on the float must be in the correct position - otherwise, the level control will not work correctly!</p>	
	

350L(D)

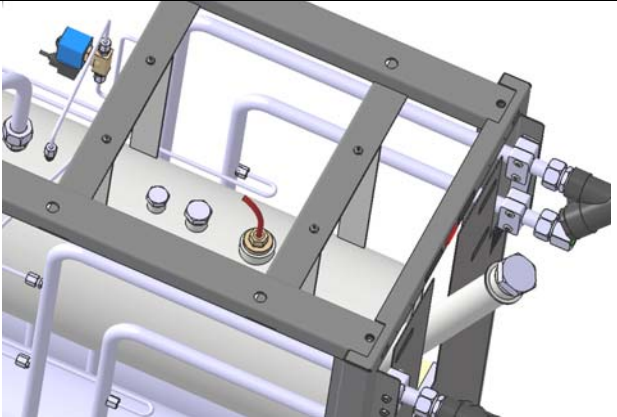
<p>1 level switch for the lower switching point and 1 level switch (with blue marking) for the upper switching point (see section on "Switching on for the first time / Commissioning")</p>	
	<p>Level switch with silicone cable and AMP socket</p>

Dismantling/Replacement

<p>When replacing the level switches after removal, the marking NO or NC on the float must be in the correct position - otherwise, the level control will not work correctly!</p>	
---	---

Solenoid valves

Overview

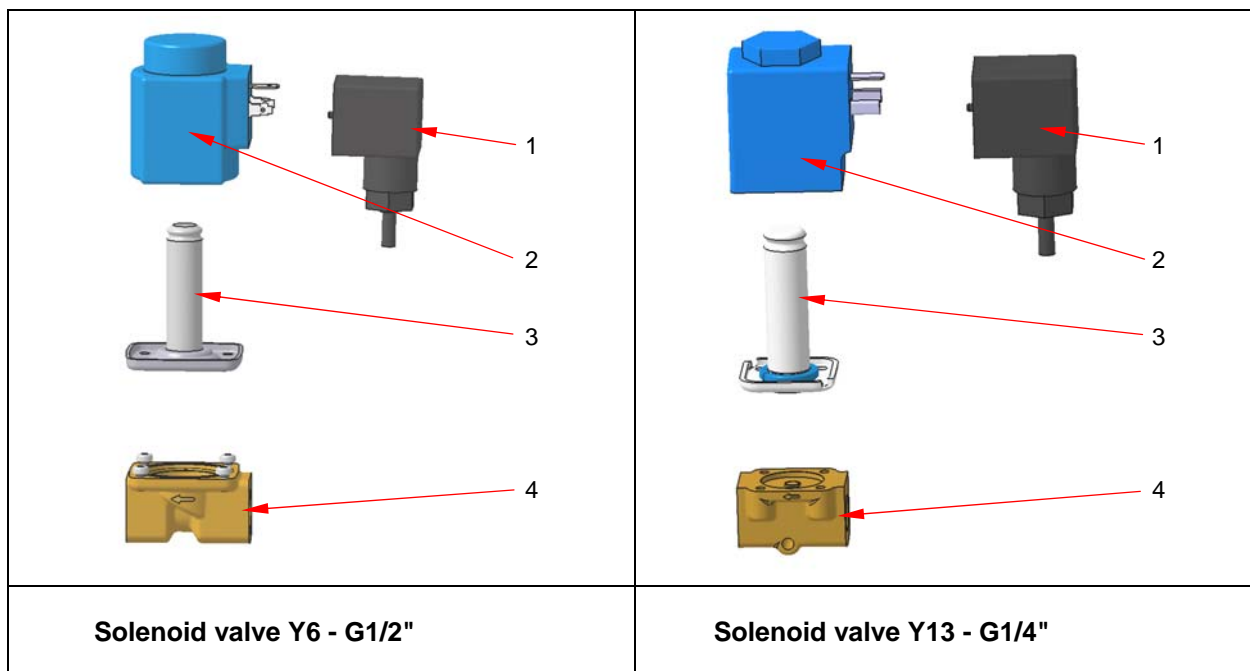

Item	Designation	Item	Designation
1	Female connector	3	Armature guide with armature and spring
2	Coil	4	Housing with membrane and O-ring

Safety thermal cut-out

Overview and operating principle

<p>The safety thermal cut-out (micro switch with break contact, restart interlock and additional signal contact) switches the temperature control unit off when the temperature reaches the preset limit. When the temperature has cooled to roughly 10% below the preset limit, the safety thermal cut-out can be released by pressing the restart button.</p> <p>If the capillary tube is broken or if the device is damaged by temperatures below -10 °C, the safety thermal cut-out must be replaced!</p>	
	<p align="center">Safety thermal cut-out Type EM-50/U</p>