

HYDRAULIC HOSE

January 2016 • Prices are subject to change without notice

Hydraulic Hose	2	Brass Hose Barbs	42
General Purpose Hose	7	Brass Hose Ferrules and Clamps.....	44
Special Application / Truck Hose	10	SAE 100R5 Truck Hose Fittings	46
Thermoplastic Hose	12	Beadlock Air Conditioning Hose Fittings.....	47
Braided Hose Fittings.....	14	Air Brake Hose Fittings.....	48
W Series Hose Fittings	21	SAE 30R7 Fuel Line Hose Barbs.....	49
3 Series Thermoplastic Hose Fittings	28	Hydraulic Quick Disconnects.....	50
T Series PTFE Hose Fittings.....	30	Hydraulic Pumps & Accessories	55
JJ Series Hose Fittings	32	Steel Grease Fittings.....	56
Suction Hose Fittings.....	34	Cam & Groove Hose Fittings	59
Steel Hose Barbs.....	35	Hose Protection	62
SAE 100R1AT Field-Attachable Hose Fittings.....	36	Reelcraft® Hose Reels	64
SAE 100R2AT Field-Attachable Hose Fittings.....	36	Hose Cutting and Cleaning Tools.....	65
SAE 100R5 Field-Attachable Hose Fittings	37	Hydraulic Hose Crimpers.....	66
SAE 100R6 Field-Attachable Hose Fittings	38	Hose Crimpers and Swaging Tools.....	68
SAE 100R7 Field-Attachable Hose Fittings	38	Crimp Specifications.....	70
SAE 100R14A Field-Attachable Hose Fittings.....	39	Fluid Port and Connector Thread Sizes	75
Push-Lock Hose Barbs	40		



DiscountHydraulicHose.com

is brought to you by:

Hydraulax Products Inc.
5606 Tulip Street
PO Box 9580
Philadelphia, PA 19124
USA

Sales/Customer Service

orders@discounthydraulicchase.com
800-535-1302

Technical Support

support@discounthydraulicchase.com
800-535-1302

Outside the USA, call 1-215-744-2828

LIMITED WARRANTY: For ninety days after the date of purchase, Hydraulax Products Inc. warrants the products in this catalog to be free from defect in materials and workmanship when properly installed and maintained. Any claim for defects must be in writing and must be received within 90 days of the receipt of the product. Hydraulax Products Inc. must have a reasonable opportunity thereafter to examine and investigate. The customer's exclusive remedy with respect to any claim of any kind whatsoever shall be refund of the purchase price or replacement of the product at the option of Hydraulax Products Inc. In no event shall Hydraulax Products Inc. be liable for any incidental or consequential damages whatsoever.



Tube: oil-resistant synthetic rubber

Reinforcement: two braids of high-tensile steel wire

Cover: oil and abrasion-resistant synthetic rubber

Temperature range: -40° to +212° F

Recommended hose fittings:

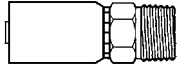

Braided Hose Fittings: page 14

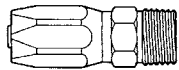

SAE 100R2 AT Field-Attachable Hose Fittings: page 36

R2 | High Pressure, 2-Wire

Meets all requirements of SAE 100R2 AT

Recommended for hydraulic service with petroleum and water-base fluids. No skiving required. Long-lasting cover is well suited for mobile hydraulics.

Item #	Inside Diameter	Outside Diameter	Maximum Operating (PSI)	Minimum Burst (PSI)	Minimum Bend Radius	Reel Length*	Reel Price (per foot)	Cut Price (per foot)
R2-04	1/4"	0.59"	5,800	23,200	4"	500'	\$1.18	\$1.29
R2-06	3/8"	0.75"	4,785	19,140	5"	450'	\$1.41	\$1.55
R2-08	1/2"	0.88"	4,000	16,000	7"	320'	\$1.58	\$1.72
R2-10	5/8"	0.98"	3,625	14,500	8"	520'	\$2.26	\$2.43
R2-12	3/4"	1.16"	3,120	12,480	9½"	400'	\$2.30	\$2.55
R2-16	1"	1.50"	2,395	9,580	12"	200'	\$3.15	\$3.50
R2-20	1¼"	1.87"	1,815	7,260	16½"	131'	\$10.34	\$10.86
R2-24	1½"	2.17"	1,305	5,220	20"	131'	\$12.35	\$12.64
R2-32	2"	2.66"	1,160	4,640	25"	131'	\$15.33	\$16.08

* Reel may not contain one continuous length of hose.



Tube: oil-resistant synthetic rubber

Reinforcement: two braids of high-tensile steel wire

Cover: synthetic rubber with the following key characteristics:

- superior abrasion resistance
- excellent ozone and UV resistance
- weather and salt water resistance
- flame resistance according to MSHA and DSK (LOBA) specs.
- antistatic

Temperature range: -40° to +212° F

Recommended hose fittings:

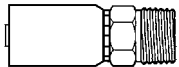

Braided Hose Fittings: page 14 (up to size -12 only)

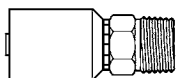

W Series Hose Fittings: page 21

HT | Hydraulax Tough™ 2-Wire

MSHA approved

Hydraulax Tough™ is the ideal hose for high abrasion environments. In addition to its recognised benefits of excellent resistance to ozone, UV radiation, high temperatures and salt water, it meets the special requirements of the underground coal mining industry.

Recommended for hydraulic service with petroleum and water-base fluids. No skiving required. Long-lasting tough cover is ideal for mobile hydraulics in harsh environments.

Item #	Inside Diameter	Outside Diameter	Maximum Operating (PSI)	Minimum Burst (PSI)	Minimum Bend Radius	Reel Length*	Reel Price (per foot)	Cut Price (per foot)
HT-04	1/4"	0.53"	6,525	26,100	1.8"	400'	\$1.76	\$1.94
HT-06	3/8"	0.68"	5,585	22,340	2.8"	525'	\$1.99	\$2.21
HT-08	1/2"	0.81"	5,000	20,000	3.5"	360'	\$2.49	\$2.75
HT-10	5/8"	0.93"	4,205	16,820	5.1"	N/A	N/A	\$3.98
HT-12	3/4"	1.09"	4,060	16,240	6.3"	426'	\$4.13	\$4.57
HT-16	1"	1.40"	2,900	11,600	8.3"	N/A	N/A	\$6.64



Tube: oil-resistant synthetic rubber
Reinforcement: two braids of high-tensile steel wire
Cover: oil and abrasion-resistant synthetic rubber
Temperature range: -40° to +212° F

Recommended hose fittings:

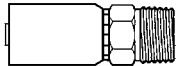

Braided Hose Fittings: page 14

R16 | Compact, High Pressure, 2-Wire

Meets all requirements of SAE 100R16

Recommended for hydraulic service with petroleum and water-base fluids. No skiving required. Half bend radius compared to SAE 100R2.

Item #	Inside Diameter	Outside Diameter	Maximum Operating (PSI)	Minimum Burst (PSI)	Minimum Bend Radius	Reel Length*	Reel Price (per foot)	Cut Price (per foot)
R16-04	1/4"	0.55"	5,800	23,200	2"	500'	\$1.20	\$1.27
R16-06	3/8"	0.67"	4,780	19,120	2½"	450'	\$1.62	\$1.71
R16-08	1/2"	0.81"	3,980	15,920	3½"	320'	\$1.83	\$1.90
R16-10	5/8"	0.93"	3,620	14,480	4"	520'	\$2.65	\$2.79
R16-12	3/4"	1.07"	3,110	12,440	4¾"	400'	\$2.74	\$2.90
R16-16	1"	1.37"	2,390	9,560	6"	200'	\$3.91	\$4.11

* Reel may not contain one continuous length of hose.



Tube: oil-resistant synthetic rubber
Reinforcement: one braid of high-tensile steel wire (R17-04, R17-06); two braids of high-tensile steel wire (all other sizes)
Cover: oil and abrasion-resistant synthetic rubber
Temperature range: -40° to +212° F

Recommended hose fittings:



Braided Hose Fittings: page 14 (up to size -12 only)

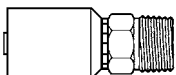

W Series Hose Fittings: page 21

R17 | Compact, Constant Pressure

Meets all requirements of SAE 100R17

Recommended for hydraulic service with petroleum and water-base fluids. No skiving required. Half bend radius compared to SAE 100R2.

Item #	Inside Diameter	Outside Diameter	Maximum Operating (PSI)	Minimum Burst (PSI)	Minimum Bend Radius	Reel Length*	Reel Price (per foot)	Cut Price (per foot)
R17-04	1/4"	0.50"	3,000	12,000	2"	500'	\$1.05	\$1.11
R17-06	3/8"	0.66"	3,000	12,000	2½"	500'	\$1.44	\$1.52
R17-08	1/2"	0.80"	3,000	12,000	3½"	350'	\$1.73	\$1.83
R17-10	5/8"	1.00"	3,000	12,000	4"	520'	\$2.68	\$2.84
R17-12	3/4"	1.12"	3,000	12,000	4¾"	400'	\$2.86	\$3.02
R17-16	1"	1.48"	3,000	12,000	6"	200'	\$4.17	\$4.41

* Reel may not contain one continuous length of hose.



Tube: oil-resistant synthetic rubber

Reinforcement: four spiral layers of high-tensile steel wire

Cover: oil and abrasion-resistant synthetic rubber

Temperature range: -40° to +250° F

Recommended hose fittings:

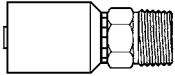

W Series Hose Fittings: page 21

R12 | Very High Pressure, 4-Wire

Meets all requirements of SAE 100R12

Recommended for hydraulic service with petroleum and water-base fluids. No skiving required. Long-lasting cover is well suited for mobile hydraulics.

Item #	Inside Diameter	Outside Diameter	Maximum Operating (PSI)	Minimum Burst (PSI)	Minimum Bend Radius	Price Per Foot (100 feet or more)	Price Per Foot (up to 99 feet)
R12-06	3/8"	0.80"	4,000	16,000	5"	\$4.34	\$4.55
R12-08	1/2"	0.94"	4,000	16,000	7"	\$4.70	\$4.95
R12-12	3/4"	1.21"	4,000	16,000	9½"	\$6.26	\$6.58
R12-16	1"	1.50"	4,000	16,000	12"	\$7.42	\$7.79
R12-20	1¼"	1.85"	3,000	12,000	16½"	\$14.08	\$14.76
R12-24	1½"	2.11"	2,500	10,000	20"	\$16.61	\$17.47
R12-32	2"	2.63"	2,500	10,000	25"	\$25.40	\$26.67



Tube: oil-resistant synthetic rubber

Reinforcement: four spiral layers of high-tensile steel wire

Cover: oil and abrasion-resistant synthetic rubber

Temperature range: -40° to +212° F (max. 248° F intermittent)

Recommended hose fittings:

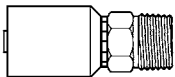

W Series Hose Fittings: page 21 (sizes -12 through -24 only)

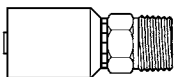

JJ Series Hose Fittings: page 32 (sizes -24 and -32 only)

4SH | Extreme High Pressure, 4-Wire

Meets or exceeds all requirements of DIN 20023 4SH and DIN EN 856 4SH.

Recommended for hydraulic service with petroleum and water-base fluids. No skiving required. Long-lasting cover is well suited for mobile hydraulics.

Item #	Inside Diameter	Outside Diameter	Maximum Operating (PSI)	Minimum Burst (PSI)	Minimum Bend Radius	Coil Length	Coil Price (per foot)	Cut Price (per foot)
4SH-12	3/4"	1.21"	6,095	24,380	9½"	131'	\$8.35	\$8.79
4SH-16	1"	1.50"	5,515	22,060	12"	131'	\$11.47	\$12.06
4SH-20	1¼"	1.85"	5,000	20,000	16½"	131'	\$18.38	\$19.33
4SH-24	1½"	2.11"	4,200	16,800	20"	131'	\$21.95	\$23.10
4SH-32	2"	2.63"	3,625	14,500	25"	131'	\$30.29	\$31.88



Tube: oil-resistant synthetic rubber
Reinforcement: four spiral layers of high-tensile steel wire (R13-12, R13-16); six spiral layers of high-tensile steel wire (R13-20, R13-24, and R13-32)
Cover: oil and abrasion-resistant synthetic rubber
Temperature range: -40° to +250° F

Recommended hose fittings:

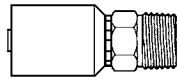

W Series Hose Fittings: page 21
 (sizes -12 and -16 only)

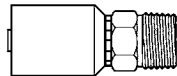

JJ Series Hose Fittings: page 32
 (sizes -20 through -32)

R13 | Extreme High Pressure

Meets all requirements of SAE 100R13

Recommended for hydraulic service with petroleum and water-base fluids. Long-lasting cover is well suited for mobile hydraulics.

Item #	Inside Diameter	Outside Diameter	Maximum Operating (PSI)	Minimum Burst (PSI)	Minimum Bend Radius	Coil Length	Coil Price (per foot)	Cut Price (per foot)
R13-12	3/4"	1.26"	5,000	20,000	9½"	131'	\$11.85	\$12.47
R13-16	1"	1.54"	5,000	20,000	12"	131'	\$17.67	\$18.56
R13-20	1¼"	1.96"	5,000	20,000	16½"	131'	\$25.82	\$27.12
R13-24	1½"	2.26"	5,000	20,000	20"	131'	\$30.53	\$32.07
R13-32	2"	2.8"	5,000	20,000	25"	131'	\$38.98	\$40.93



- Oil-resistant synthetic rubber
- Two braids of high-tensile steel wire reinforcement
- Black oil-resistant and abrasion-resistant synthetic rubber
- Temperature range: -40° to +212° F

Recommended hose fittings:



Braided Hose Fittings: page 14

HJK | 10,000 PSI Jack Hose

Approved for 10,000 psi static jacking applications

Recommended for hydraulic jacking systems with petroleum and water-base fluids. Not intended for impulse applications.

Item #	Inside Diameter	Outside Diameter	Maximum Operating (PSI)	Minimum Burst (PSI)	Minimum Bend Radius	Reel Length*	Reel Price (per foot)	Cut Price (per foot)
HJK-04	1/4"	0.59"	10,000	20,000	4"	500'	\$2.00	\$2.13
HJK-06	3/8"	0.75"	10,000	20,000	7"	450'	\$2.69	\$2.85

* Reel may not contain one continuous length of hose.



Tube: oil-resistant synthetic rubber

Reinforcement: one braid of high-tensile steel wire

Cover: oil and abrasion-resistant synthetic rubber

Temperature range: -40° to +212° F

Recommended hose fittings:

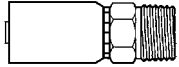

Braided Hose Fittings: page 14

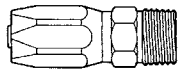

SAE 100R1 AT Field-Attachable Hose Fittings: page 36

R1 | Medium Pressure, 1-Wire

Meets all requirements of SAE 100R1 AT

Recommended for hydraulic service with petroleum and water-base fluids. No skiving required. Long-lasting cover is well suited for mobile hydraulics.

Item #	Inside Diameter	Outside Diameter	Maximum Operating (PSI)	Minimum Burst (PSI)	Minimum Bend Radius	Reel Length*	Reel Price (per foot)	Cut Price (per foot)
R1-04	1/4"	.53"	2,750	11,000	4"	500'	\$1.16	\$1.20
R1-06	3/8"	.69"	2,250	9,000	5"	500'	\$1.23	\$1.28
R1-08	1/2"	.82"	2,000	8,000	7"	350'	\$1.53	\$1.61
R1-10	5/8"	.94"	1,500	6,000	8"	650'	\$2.13	\$2.24
R1-12	3/4"	1.10"	1,250	5,000	9½"	500'	\$2.22	\$2.32
R1-16	1"	1.41"	1,000	4,000	12"	280'	\$3.10	\$3.24

* Reel may not contain one continuous length of hose.



Tube: oil-resistant synthetic rubber

Reinforcement: one helical wire between two braids of textile reinforcement.

Cover: oil and abrasion-resistant synthetic rubber

Temperature range: -40° to +212° F

Recommended hose fittings:

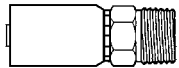

Suction Hose Fittings: page 34

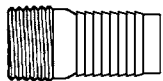

Steel Hose Barbs: page 35

R4 | Suction and Return

Meets all requirements of SAE 100R4

Recommended for suction and transfer applications with petroleum-based hydraulic fluid, fuel, lubricating oils, gasoline and water.

Item #	Inside Diameter	Outside Diameter	Maximum Operating (PSI)	Minimum Burst (PSI)	Rated Suction	Minimum Bend Radius	Coil Length	Coil Price (per foot)	Cut Price (per foot)
R4-12	3/4"	1.18"	300	1,200	25"/hg.	5"	131'	\$5.08	\$5.36
R4-16	1"	1.43"	250	1,000	25"/hg.	6"	131'	\$6.27	\$6.58
R4-20	1¼"	1.74"	200	800	25"/hg.	8"	131'	\$6.55	\$6.90
R4-24	1½"	1.95"	150	600	25"/hg.	10"	131'	\$7.08	\$7.42
R4-32	2"	2.42"	100	400	25"/hg.	12"	131'	\$7.62	\$8.00



Tube: oil-resistant synthetic rubber
Reinforcement: two textile braids
Cover: oil and abrasion-resistant synthetic rubber
Temperature range: 40° to +212° F
Recommended hose fittings:

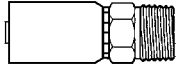

Braided Hose Fittings: page 14

R3 | Low/Medium Pressure, Fiber Braid

Meets all requirements of SAE 100R3

Recommended for hydraulics, fuel, lubricating oils, gasoline, air and water.
 Not approved for air brake applications.

Item #	Inside Diameter	Outside Diameter	Maximum Operating (PSI)	Minimum Burst (PSI)	Minimum Bend Radius	Reel Length*	Reel Price (per foot)	Cut Price (per foot)
R3-04	1/4"	0.57"	1,250	5,000	3"	250'	\$2.57	\$2.71
R3-06	3/8"	0.75"	1,125	4,500	4"	250'	\$2.70	\$2.84
R3-08	1/2"	0.94"	1,000	4,000	5"	250'	\$3.70	\$3.89
R3-12	3/4"	1.25"	750	3,000	6"	250'	\$5.33	\$5.60
R3-16	1"	1.50"	565	2,250	8"	250'	\$6.32	\$6.63



Tube: oil-resistant synthetic rubber
Reinforcement: one textile braid
Cover: oil and abrasion-resistant synthetic rubber
Temperature range: 40° to +212° F
Recommended hose fittings:

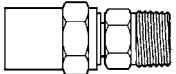

SAE 100R6 Field-Attachable
 Hose Fittings: page 38

R6 | Low Pressure, Fiber Braid

Meets all requirements of SAE 100R6

Recommended for gasoline, fuel, lubricating oils, air and water. Not approved for air brake applications.

Item #	Inside Diameter	Outside Diameter	Maximum Operating (PSI)	Minimum Burst (PSI)	Minimum Bend Radius	Reel Length*	Reel Price (per foot)	Cut Price (per foot)
R6-04	1/4"	.50"	400	1,600	2½"	250'	\$1.34	n/a
R6-05	5/16"	.57"	400	1,600	3"	250'	\$1.44	n/a
R6-06	3/8"	.63"	400	1,600	3"	250'	\$1.63	\$1.72



Tube: water-resistant synthetic rubber
Reinforcement: one braid of high-tensile steel wire
Cover: abrasion-resistant synthetic rubber
Temperature range: -40° to +275° F
Recommended hose fittings:

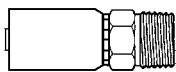

Braided Hose Fittings: page 14

PW/PWB | 4,000 PSI Pressure Wash

Recommended for pressure washer applications.
 Available with black (PW) or non-marking blue (PWB) cover.

Item #	Inside Diameter	Outside Diameter	Maximum Operating (PSI)	Minimum Burst (PSI)	Minimum Bend Radius	Reel Length*	Reel Price (per foot)	Cut Price (per foot)
PW-06	3/8"	.65"	4,000	16,000	3"	500'	\$0.89	\$0.95
PWB-06	3/8"	.65"	4,000	16,000	3"	500'	\$1.06	\$1.11



Tube: EPDM

Reinforcement: multi-fiber spiral

Cover: abrasion-resistant EPDM

Temperature range: 40° to +160° F
(water up to 180° F)

Recommended hose fittings:

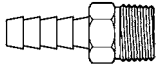

Brass Hose Barbs: page 42

1145 | Heavy-Duty Air

Recommended for air and water applications where petroleum contact is limited. Also recommended for some agricultural solutions. Not recommended for hydraulic fluids.

Item #	Inside Diameter	Outside Diameter	Maximum Operating (PSI)	Minimum Burst (PSI)	Minimum Bend Radius	Length on a Reel*	Reel Price (per foot)	Cut Price (per foot)
1145-04400	1/4"	0.63"	300	1,200	3"	700'	\$0.93	\$1.01
1145-05400	5/16"	0.63"	300	1,200	3 1/4"	700'	\$1.05	\$1.10
1145-06400	3/8"	0.72"	300	1,200	3 1/4"	700'	\$1.16	\$1.24
1145-08400	1/2"	0.88"	300	1,200	4 1/2"	700'	\$1.41	\$1.48
1145-10400	5/8"	1.00"	300	1,200	5 1/4"	700'	\$1.68	\$1.75
1145-12400	3/4"	1.16"	300	1,200	5 3/4"	700'	\$2.12	\$2.21
1145-16300	1"	1.44"	200	800	7 3/4"	700'	\$2.98	\$3.12
1145-20200	1 1/4"	1.78"	200	800	8 3/4"	550'	\$4.22	\$4.44
1145-24200	1 1/2"	2.03"	200	800	10 1/2"	400'	\$5.19	\$5.46
1145-32200	2"	2.50"	200	800	14"	300'	\$7.46	\$7.85

* Reel may not contain one continuous length of hose.



Tube: PVC

Reinforcement: one braid of high-tensile polyester yarn

Cover: PVC

Temperature range: -15° to +150° F

Recommended hose fittings:

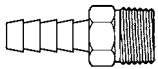

Brass Hose Barbs: page 42

K1134 | PVC Multipurpose Air & Water

Recommended for air, water, and mild water-soluble chemicals. Ideal for in-plant operations requiring color coding of hose supply lines.

Item #	Inside Diameter	Outside Diameter	Maximum Operating (PSI) @ 70° F	Maximum Operating (PSI) @ 122° F	Length on a Reel*	Reel Price (per foot)	Cut Price* (per foot)
K1134-04	1/4"	0.50"	300	180	500'	\$0.54	\$0.56
K1134-05	5/16"	0.63"	300	180	500'	\$0.70	\$0.74
K1134-06	3/8"	0.63"	300	180	500'	\$0.66	\$0.69
K1134-08	1/2"	0.81"	300	180	500'	\$0.82	\$0.87
K1134-10	5/8"	0.91"	300	180	300'	\$1.09	\$1.14
K1134-12	3/4"	1.13"	300	180	300'	\$1.49	\$1.56
K1134-16	1"	1.41"	300	180	300'	\$1.93	\$2.04

* Available in full reel or 100 ft. lengths only.

Please specify color when ordering:

Red (K1134) available in all sizes

Blue (K1136), sizes -04, -06, -08, -12 and -16 only

Gray (K1138), sizes -04, -06, -08, -12 and -16 only

Yellow (K1131), sizes -04, -06, -08, -12 and -16 only



3384 | Push-Lock (No Clamps or Ferrules)

Recommended for gasoline, fuel and lubricating oils, air and water. No clamps or ferrules needed when used with Push-Lock hose barbs.

- Tube:** oil-resistant Nitrile (BTR)
- Reinforcement:** braided fiber
- Cover:** oil and Abrasion-resistant, black Neoprene (CR)
- Temperature range:** -40° to +212° F
Water not to exceed 150° F
Air not to exceed 160° F

Recommended hose fittings:

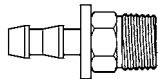

Push-Lock Hose Barbs: page 40

Item #	Inside Diameter	Outside Diameter	Maximum Operating (PSI)	Minimum Burst (PSI)	Minimum Bend Radius	Length on Reel	Reel Price (per foot)	Cut Price (per foot)
3384-04	1/4"	0.50"	250	1,000	3"	250'	\$1.32	\$1.38
3384-06	3/8"	0.62"	250	1,000	3"	250'	\$1.68	\$1.75
3384-08	1/2"	0.75"	250	1,000	5"	250'	\$1.95	\$2.04
3384-10	5/8"	0.91"	250	1,000	6"	250'	\$2.67	\$2.81
3384-12	3/4"	1.03"	250	1,000	7"	250'	\$3.47	\$3.64

Push-Lock Hose is also available in Blue (3385), Gray (3386), Red (3387), and Yellow (3389). Please specify color when ordering.



IBR | Clear Braided PVC Tubing

Recommended for various machine tools and transportation of chemicals.

- Construction:** clear PVC tubing with high tensile polyester yarn reinforcement.
- Temperature range:** +14° to +149° F

Recommended hose fittings:

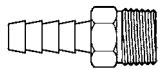

Brass Hose Barbs: page 42

Item #	Inside Diameter	Outside Diameter	Maximum Operating (PSI)	Coil Length	Coil Price	Cost (Per Foot)
IBR0446	1/4"	0.50"	142 psi	300'	\$135.45	\$0.45
IBR0609	3/8"	0.63"	114 psi	300'	\$176.40	\$0.59
IBR0812	1/2"	0.75"	100 psi	300'	\$220.50	\$0.74
IBR1218	3/4"	1.06"	71 psi	300'	\$428.40	\$1.43
IBR1621	1"	1.31"	71 psi	200'	\$367.50	\$1.84

IBR tubing is sold in coil lengths only.



Tube: oil-resistant synthetic rubber

Reinforcement: one braid of high-tensile steel wire

Cover: braided textile

Temperature range: -40° to +212° F

Hydraulic fluids: -40° to +212° F

Air brake: -40° to +200° F

Hot oil: -40° to +302° F (sizes -20 or larger not to exceed 250° F)

Recommended hose fittings:

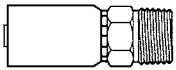

R5 Truck Hose Fittings: page 46

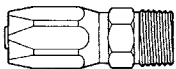

SAE 100R5 Field-Attachable Hose Fittings: page 37

R5 | 1-Wire, Braided Cover

Meets all requirements of SAE 100R5, DOT* and SAE J1402*

Recommended for hydraulics, air, air brake, gasoline, fuel, and lubricating oils. SAE 100R5 is *not* Coast Guard approved for fuel lines on pleasure crafts.

Item #	Inside Diameter	Outside Diameter	Maximum Operating (PSI)	Minimum Burst (PSI)	Minimum Bend Radius	Reel Length*	Reel Price (per foot)	Cut Price (per foot)
R5-04	3/16"	0.51"	3,000	12,000	3"	250'	\$4.51	\$4.74
R5-05	1/4"	0.57"	3,000	12,000	3½"	250'	\$4.62	\$4.84
R5-06	5/16"	0.67"	2,250	9,000	4"	250'	\$5.32	\$5.58
R5-08	13/32"	0.76"	2,000	8,000	4½"	250'	\$5.55	\$5.84
R5-10	1/2"	0.92"	1,750	7,000	5½"	250'	\$6.79	\$7.14
R5-12	5/8"	1.07"	1,500	6,000	6½"	250'	\$8.36	\$8.77
R5-16	7/8"	1.23"	800	3,200	7½"	250'	\$9.46	\$9.93
R5-20	1½"	1.50"	625	2,500	9"	150'	\$12.17	\$12.77
R5-24	1¾"	1.75"	500	2,000	10½"	100'	\$14.16	\$14.86
R5-32	1¾"	2.10"	350	1,400	13¼"	100'	\$17.40	\$18.29

* Sizes -16 and larger are *not* SAE or DOT approved for air brake applications.

** Reel may not contain one continuous length of hose.



Tube: PTFE

Reinforcement and cover: one braid of type 304 stainless steel

Temperature range: -65° to +450° F

Recommended hose fittings:

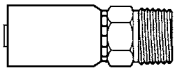

T Series PTFE Hose Fittings: page 30

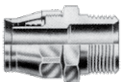

SAE 100R14A Field-Attachable Hose Fittings: page 41

R14 | PTFE Hose

Meets all requirements of SAE 100R14A

Recommended for steam, solvents, fuels, hydraulic fluids, most chemicals and acids. Vibration absorption and high temperature and pressure ranges make PTFE hose extremely versatile.

Item #	Inside Diameter	Outside Diameter	Maximum Operating (PSI)	Minimum Burst (PSI)	Minimum Bend Radius	Coil Length	Coil Price (per foot)	Cut Price (per foot)
R14-04	3/16"	.30"	3,000	12,000	2"	100'	\$2.64	\$2.77
R14-05	1/4"	.38"	3,000	12,000	3"	100'	\$3.08	\$3.24
R14-06	5/16"	.44"	2,500	10,000	4"	100'	\$3.37	\$3.55
R14-07	3/8"	.52"	2,000	8,000	5"	100'	\$4.44	\$4.67
R14-08	13/32"	.54"	2,000	8,000	5"	100'	\$4.45	\$4.68
R14-10	1/2"	.63"	1,500	6,000	6½"	100'	\$5.44	\$5.72
R14-12	5/8"	.76"	1,200	4,800	7½"	100'	\$6.69	\$7.04
R14-14	3/4"	.89"	1,000	4,000	8½"	100'	\$9.43	\$9.92
R14-16	7/8"	1.03"	1,000	4,000	9"	100'	\$9.64	\$10.14
R14-18	1"	1.22"	1,000	4,000	12"	100'	\$15.74	\$16.57



Tube: synthetic rubber
Reinforcement: Spiral multi-fiber
Cover: neoprene
Temperature range: -40° to +200° F

Recommended hose fittings:

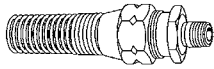

Air Brake Hose Fittings: page 48

4821 | Air Brake

Meets all requirements of SAE J1402A and DOT, Type All

Recommended for air brake applications. Available in 50' coils or 250' and 500' reels. 250' and 500' reels may not contain one continuous length of hose.

Item #	Inside Diameter	Outside Diameter	Maximum Operating (PSI)	Minimum Burst (PSI)	Minimum Bend Radius	Length of Coil/Reel (with cost per foot)	Price
482106451	3/8"	0.75"	225	900	3.5"	50 feet @ \$1.79	\$89.25
482106498	3/8"	0.75"	225	900	3.5"	250 feet @ \$1.69	\$422.63
482106499	3/8"	0.75"	225	900	3.5"	500 feet @ \$1.61	\$803.25
482108451	1/2"	0.88"	225	900	4"	50 feet @ \$2.17	\$108.68
482108498	1/2"	0.88"	225	900	4"	250 feet @ \$2.09	\$522.38
482108500	1/2"	0.88"	225	900	4"	500 feet @ \$1.92	\$960.75



Tube: oil-resistant synthetic rubber
Reinforcement: braided multifiber
Cover: Hypalon
Temperature range: -40° to +257° F

Recommended hose fittings:



Fuel Line Hose Barbs: page 49

30R7 | Fuel Line

Meets all requirements of SAE 30R7

Recommended for low pressure / high temperature fuel for passenger car, light truck and small engine applications. Not intended for fuel injection applications.

Important: 30R7 is not Coast Guard approved for marine applications.

Item #	Inside Diameter	Outside Diameter	Maximum Operating (PSI)	Minimum Burst (PSI)	Minimum Bend Radius	Reel Length*	Reel Price	Cost Per Foot
30R7-03	3/16"	.41"	50	250	2"	700'	\$661.50	\$0.95
30R7-04	1/4"	.50"	50	250	2½"	700'	\$749.70	\$1.07
30R7-05	5/16"	.57"	50	250	2¾"	700'	\$904.05	\$1.29
30R7-06	3/8"	.63"	50	250	3"	700'	\$940.80	\$1.34

* Reel may not contain one continuous length of hose.



Tube: polychloroprene barrier
Reinforcement: braided textile
Cover: abrasion-resistant EPDM
Temperature range: -22° to +257° F

Recommended hose fittings:

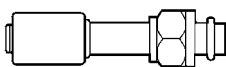

Beadlock A/C Hose Fittings: page 47

BH | A/C, Mobile Refrigeration

Meets all requirements for SAE J2064 Type C Class II

Recommended for R12 and R134A refrigerant application. Ideal for heavy duty truck use as well as industrial and automotive applications.

Sold in 50 foot lengths only.

Item #	Inside Diameter	Outside Diameter	Maximum Operating (PSI)	Minimum Burst (PSI)	Minimum Bend Radius	Coil Length	Coil Price	Cost Per Foot
BH-06-COIL	5/16"	.75"	350	2,000	4"	50'	\$119.18	\$2.38
BH-08-COIL	13/32"	.91"	350	2,000	4¾"	50'	\$137.03	\$2.74
BH-10-COIL	1/2"	1.00"	350	2,000	5½"	50'	\$162.75	\$3.26
BH-12-COIL	5/8"	1.13"	350	1,750	6½"	50'	\$179.03	\$3.58



Tube: oil-resistant synthetic thermoplastic
Reinforcement: textile
Cover: abrasion-resistant polyurethane
Temperature range: -40° to +200° F

Recommended hose fittings:

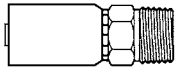

3 Series Hose Fittings: page 28

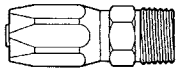

SAE 100R7 Field-Attachable
 Hose Fittings: page 38

R7 | Medium Pressure Thermoplastic

Meets all requirements of SAE 100R7

Recommended for hydraulic lines, lubrication, medium pressure gas, and solvent.
 Available in black (BK) or nonconductive orange (NC).

Item #	Inside Diameter	Outside Diameter	Maximum Operating (PSI)	Minimum Burst (PSI)	Minimum Bend Radius	Length on a Reel*	Reel Price (per foot)	Cut Price (per foot)
R7-02BK**	1/8"	0.32"	2,500	10,000	1/2"	250'	\$1.40	\$1.47
R7-03BK	3/16"	0.41"	3,000	12,000	3/4"	250'	\$1.55	\$1.64
R7-03NC	3/16"	0.41"	3,000	12,000	3/4"	250'	\$1.73	\$1.83
R7-04BK	1/4"	0.49"	2,750	11,000	1 1/4"	250'	\$1.59	\$1.66
R7-04NC	1/4"	0.49"	2,750	11,000	1 1/4"	250'	\$1.79	\$1.87
R7-05BK	5/16"	0.56"	2,500	10,000	1 3/4"	250'	\$2.18	\$2.29
R7-05NC	5/16"	0.56"	2,500	10,000	1 3/4"	250'	\$2.29	\$2.42
R7-06BK	3/8"	0.62"	2,250	9,000	2"	250'	\$2.07	\$2.18
R7-06NC	3/8"	0.62"	2,250	9,000	2"	250'	\$2.17	\$2.28
R7-08BK	1/2"	0.76"	2,000	8,000	3"	250'	\$2.66	\$2.80
R7-08NC	1/2"	0.76"	2,000	8,000	3"	250'	\$2.91	\$3.07

* Reel may not contain one continuous length of hose.

** Size -02 (1/8" ID) is available in black only.



Tube: oil-resistant synthetic thermoplastic
Reinforcement: textile
Cover: abrasion-resistant polyurethane
Temperature range: -40° to +200° F

Recommended hose fittings:

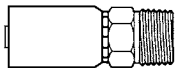

3 Series Hose Fittings: page 28

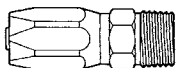

SAE 100R7 Field-Attachable
 Hose Fittings: page 38

R7T | Medium Pressure Thermoplastic Twin Line

Meets all requirements of SAE 100R7

Recommended for hydraulic lines, lubrication, medium pressure gas, and solvent.
 Available in black (BK) or nonconductive orange (NC).

Item #	Inside Diameter	Outside Diameter	Maximum Operating (PSI)	Minimum Burst (PSI)	Minimum Bend Radius	Length on a Reel*	Reel Price (per foot)	Cut Price (per foot)
R7T-04BK	1/4"	0.51"	2,750	11,000	1 1/4"	250'	\$3.93	\$4.14
R7T-04NC	1/4"	0.51"	2,750	11,000	1 1/4"	250'	\$4.19	\$4.41
R7T-06BK	3/8"	0.65"	2,250	9,000	2"	250'	\$5.17	\$5.43
R7T-06NC	3/8"	0.65"	2,250	9,000	2"	250'	\$5.33	\$5.61
R7T-08BK	1/2"	0.81"	2,000	8,000	3"	250'	\$7.09	\$7.47
R7T-08NC	1/2"	0.81"	2,000	8,000	3"	250'	\$7.42	\$7.81

* Reel may not contain one continuous length of hose.



Tube: oil-resistant synthetic thermoplastic

Reinforcement: textile

Cover: abrasion-resistant polyurethane

Temperature range: -40° to +200° F

Recommended hose fittings:

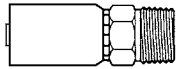

3 Series Hose Fittings: page 28

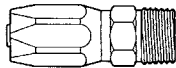

SAE 100R7 Field-Attachable
Hose Fittings: page 38

R8 | High Pressure Thermoplastic

Meets all requirements of SAE 100R8

Reduced OD allows use of standard SAE 100R7 hose fittings.

Recommended for hydraulic lines, lubrication, medium pressure gas, and solvent.

Available in black (BK) or nonconductive orange (NC).

Item #	Inside Diameter	Outside Diameter	Maximum Operating (PSI)	Minimum Burst (PSI)	Minimum Bend Radius	Length on a Reel*	Reel Price (per foot)	Cut Price (per foot)
R8-03BK**	3/16"	0.41"	5,000	20,000	1½"	250'	\$3.39	\$3.57
R8-04BK	1/4"	0.49"	5,000	20,000	2"	250'	\$4.46	\$4.68
R8-04NC	1/4"	0.49"	5,000	20,000	2"	250'	\$5.31	\$5.58
R8-06BK	3/8"	0.62"	4,000	16,000	2½"	250'	\$5.85	\$6.14
R8-06NC	3/8"	0.62"	4,000	16,000	2½"	250'	\$6.41	\$6.71
R8-08BK	1/2"	0.76"	3,500	14,000	4"	250'	\$7.74	\$8.12
R8-08NC	1/2"	0.76"	3,500	14,000	4"	250'	\$9.17	\$9.63

* Reel may not contain one continuous length of hose.

** Size -03 (3/16" ID) is available in black only.

FJX

JIC 37° Female Swivel

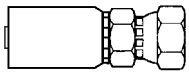

FJX-02-03	\$5.21
FJX-02-04	\$5.48
FJX-03-04	\$5.28
FJX-03-05	\$5.54
FJX-04-03	\$5.81
FJX-04-04	\$2.42
FJX-04-04 <i>Min. 200</i>	\$2.25
FJX-04-05	\$2.47
FJX-04-05 <i>Min. 200</i>	\$2.30
FJX-04-06	\$2.42
FJX-04-06 <i>Min. 200</i>	\$2.32
FJX-04-08	\$9.49
FJX-05-05	\$12.88
FJX-06-04	\$8.13
FJX-06-04 <i>Min. 200</i>	\$7.12
FJX-06-05	\$5.00
FJX-06-06	\$3.03
FJX-06-06 <i>Min. 200</i>	\$2.65
FJX-06-08	\$3.33
FJX-06-08 <i>Min. 200</i>	\$3.10
FJX-06-10	\$4.33
FJX-06-12	\$16.65
FJX-08-06	\$4.15
FJX-08-06 <i>Min. 150</i>	\$3.85
FJX-08-08	\$3.74
FJX-08-08 <i>Min. 150</i>	\$3.48
FJX-08-10	\$4.41
FJX-08-10 <i>Min. 120</i>	\$4.11
FJX-08-12	\$6.45
FJX-08-12 <i>Min. 100</i>	\$6.01
FJX-08-16	\$21.16
FJX-10-08	\$10.45
FJX-10-10	\$6.53
FJX-10-10 <i>Min. 100</i>	\$6.08
FJX-10-12	\$6.89
FJX-12-08	\$11.39
FJX-12-10	\$12.37
FJX-12-12	\$6.17
FJX-12-12 <i>Min. 80</i>	\$5.75
FJX-12-14	\$10.40
FJX-12-16	\$8.46
FJX-16-12	\$16.15
FJX-16-14	\$19.28
FJX-16-16	\$10.84
FJX-16-16 <i>Min. 60</i>	\$8.58
FJX-16-20	\$28.00
FJX-20-16	\$41.93
FJX-20-20	\$26.22

SS-FJX

JIC 37° Female Swivel
Stainless Steel

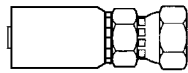

SS-FJX-04-04	\$49.04
SS-FJX-06-06	\$52.55
SS-FJX-06-08	\$80.60
SS-FJX-08-08	\$63.06
SS-FJX-08-10	\$84.09
SS-FJX-10-10	\$92.80
SS-FJX-12-12	\$94.62
SS-FJX-16-16	\$101.62

FJX45

JIC 37° Female Swivel 45°

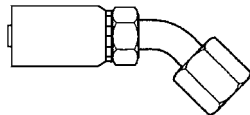

FJX45-04-04	\$6.39
FJX45-04-05	\$7.20
FJX45-04-06	\$7.08
FJX45-06-04	\$7.60
FJX45-06-05	\$12.94
FJX45-06-06	\$6.87
FJX45-06-06 <i>Min. 150</i>	\$6.26
FJX45-06-08	\$7.30
FJX45-08-06	\$8.45
FJX45-08-08	\$7.40
FJX45-08-08 <i>Min. 100</i>	\$6.68
FJX45-08-10	\$11.43
FJX45-10-10	\$12.85
FJX45-10-12	\$13.59
FJX45-12-12	\$14.51
FJX45-12-16	\$22.73
FJX45-16-12	\$54.98
FJX45-16-16	\$25.50
FJX45-20-20	\$47.92

FJX90

JIC 37° Female Swivel 90°

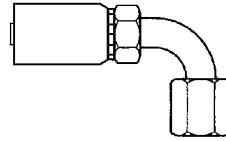

FJX90-04-04	\$6.24
FJX90-04-04 <i>Min. 150</i>	\$5.48
FJX90-04-05	\$7.63
FJX90-04-06	\$6.59
FJX90-04-06 <i>Min. 150</i>	\$5.92
FJX90-06-04	\$7.20
FJX90-06-05	\$10.12
FJX90-06-06	\$6.54
FJX90-06-06 <i>Min. 150</i>	\$5.89
FJX90-06-08	\$7.28
FJX90-06-08 <i>Min. 150</i>	\$6.53
FJX90-08-06	\$8.99
FJX90-08-08	\$8.47
FJX90-08-08 <i>Min. 120</i>	\$7.52
FJX90-08-10	\$15.06
FJX90-08-10 <i>Min. 100</i>	\$13.71
FJX90-08-12	\$14.43
FJX90-10-10	\$11.83
FJX90-10-12	\$16.91
FJX90-12-10	\$16.20
FJX90-12-12	\$14.51
FJX90-12-12 <i>Min. 40</i>	\$13.10
FJX90-12-16	\$23.45
FJX90-16-16	\$22.27
FJX90-16-16 <i>Min. 40</i>	\$20.57
FJX90-20-20	\$69.97

SS-FJX90

JIC 37° Female Swivel 90°
Stainless Steel

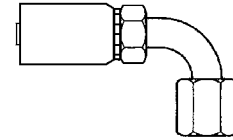

SS-FJX90-04-04	\$90.48
SS-FJX90-06-06	\$94.37
SS-FJX90-06-08	\$107.76
SS-FJX90-08-08	\$100.71
SS-FJX90-08-10	\$123.92
SS-FJX90-12-12	\$175.12
SS-FJX90-16-16	\$201.97

FJX90M

JIC 37° Female Swivel 90°
Medium Drop Elbow

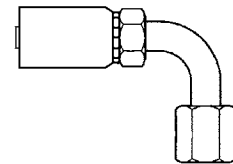

FJX90M-04-04	\$7.07
FJX90M-06-06	\$8.13
FJX90M-08-08	\$9.11
FJX90M-10-10	\$14.83
FJX90M-12-12	\$20.61

FJX90L

JIC 37° Female Swivel 90°
Long Drop Elbow

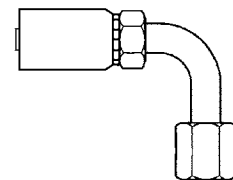

FJX90L-04-04	\$6.80
FJX90L-04-06	\$6.95
FJX90L-06-04	\$9.98
FJX90L-06-06	\$10.56
FJX90L-06-08	\$8.49
FJX90L-08-08	\$11.92
FJX90L-08-10	\$10.11
FJX90L-10-10	\$11.83
FJX90L-12-12	\$17.26
FJX90L-16-16	\$26.80

Braided Hose Fittings are intended for use with most 1-wire and 2-wire hydraulic hoses including R1, R2, R2, R16, R17 KT, and HJK.

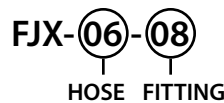

Braided Hose Fittings interchange with Weatherhead U Series, Dayco-Eastman HY Series, Aeroquip FJ Series, Imperial-Eastman HU Series and Dayco SB Series hose fittings.

FJXT

JIC 37° Female Swivel Long

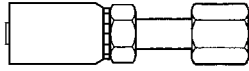

FJXT-04-04	\$7.89
FJXT-04-05	\$15.77
FJXT-06-05	\$15.77
FJXT-06-06	\$7.95
FJXT-06-08	\$14.90
FJXT-08-08	\$10.93
FJXT-08-10	\$14.22

MJ

JIC 37° Male Rigid

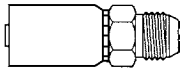

MJ-04-04	\$2.64
MJ-04-05	\$2.70
MJ-04-06	\$2.93
MJ-05-05	\$12.77
MJ-05-06	\$13.10
MJ-06-04	\$5.36
MJ-06-06	\$2.93
MJ-06-08	\$3.00
MJ-06-10	\$6.73
MJ-08-06	\$14.41
MJ-08-08	\$3.49
MJ-08-10	\$4.08
MJ-08-12	\$7.81
MJ-10-10	\$5.37
MJ-10-12	\$5.84
MJ-12-10	\$11.90
MJ-12-12	\$5.18
MJ-12-14	\$7.42
MJ-12-16	\$7.50
MJ-16-16	\$9.67
MJ-20-20	\$16.08

SS-MJ

JIC 37° Male Rigid
Stainless Steel

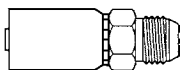

SS-MJ-04-04	\$40.07
SS-MJ-06-06	\$46.04
SS-MJ-08-08	\$53.32
SS-MJ-12-12	\$77.23
SS-MJ-16-16	\$83.11

MP

NPTF Male Pipe Rigid

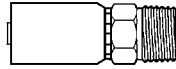

MP-02-02	\$1.93
MP-02-02 <i>Min. 200</i>	\$1.80
MP-03-02	\$3.29
MP-04-02	\$3.30
MP-04-02 <i>Min. 200</i>	\$3.03
MP-04-04	\$2.19
MP-04-04 <i>Min. 200</i>	\$2.05
MP-04-06	\$2.22
MP-04-06 <i>Min. 200</i>	\$2.08
MP-04-08	\$8.06
MP-06-04	\$2.27
MP-06-04 <i>Min. 200</i>	\$2.11
MP-06-06	\$2.45
MP-06-06 <i>Min. 200</i>	\$2.29
MP-06-08	\$2.68
MP-06-08 <i>Min. 160</i>	\$2.50
MP-08-06	\$2.59
MP-08-06 <i>Min. 160</i>	\$2.43
MP-08-08	\$2.68
MP-08-08 <i>Min. 160</i>	\$2.50
MP-08-12	\$4.69
MP-08-12 <i>Min. 100</i>	\$4.39
MP-10-08	\$6.31
MP-10-12	\$8.74
MP-12-08	\$8.22
MP-12-12	\$5.01
MP-12-12 <i>Min. 100</i>	\$4.67
MP-12-16	\$8.61
MP-16-12	\$8.24
MP-16-16	\$7.73
MP-16-16 <i>Min. 60</i>	\$7.23
MP-20-20	\$18.88

SS-MP

NPTF Male Pipe Rigid
Stainless Steel

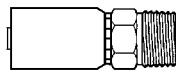

SS-MP-04-04	\$31.51
SS-MP-06-06	\$35.41
SS-MP-08-08	\$45.53
SS-MP-12-12	\$70.08
SS-MP-16-16	\$77.08
SS-MP-16-16	\$77.09

MPX

NPTF Male Pipe Swivel

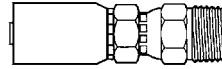

MPX-04-02	\$6.13
MPX-04-04	\$4.54
MPX-04-04 <i>Min. 200</i>	\$4.14
MPX-04-06	\$5.48
MPX-06-04	\$4.76
MPX-06-06	\$4.20
MPX-06-06 <i>Min. 200</i>	\$3.85
MPX-06-08	\$5.20
MPX-06-08 <i>Min. 200</i>	\$3.82
MPX-08-06	\$5.28
MPX-08-08	\$4.57
MPX-08-08 <i>Min. 150</i>	\$4.29
MPX-10-08	\$20.25
MPX-10-12	\$21.49
MPX-12-12	\$7.36
MPX-12-12 <i>Min. 100</i>	\$7.31
MPX-16-16	\$14.06
MPX-16-16 <i>Min. 60</i>	\$13.13

MPX90

NPTF Male Pipe Swivel 90°

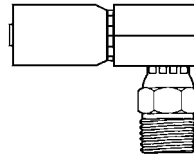

MPX90-04-04	\$8.05
MPX90-04-06	\$8.90
MPX90-06-04	\$10.57
MPX90-06-06	\$8.83
MPX90-06-06 <i>Min. 150</i>	\$8.21
MPX90-06-08	\$10.08
MPX90-08-08	\$9.73
MPX90-08-08 <i>Min. 150</i>	\$8.72
MPX90-12-12	\$16.75
MPX90-16-16	\$33.66

FP

NPTF Female Pipe Rigid



FP-04-02	\$5.13
FP-04-04	\$3.68
FP-04-06	\$15.98
FP-06-04	\$8.69
FP-06-06	\$3.49
FP-06-08	\$7.21
FP-08-08	\$3.93
FP-12-08	\$22.45
FP-12-12	\$9.02
FP-16-16	\$16.59

FPX

NPSM Female Pipe Swivel

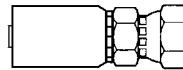

FPX-03-04	\$6.28
FPX-04-02	\$27.57
FPX-04-04	\$4.77
FPX-06-06	\$5.18
FPX-06-08	\$9.92
FPX-08-08	\$6.13
FPX-08-12	\$19.78
FPX-12-12	\$9.84
FPX-16-16	\$13.90
FPX-20-20	\$21.18

PTFE Thread Sealing Compound



Temperature range: -300° to 500° F

LCTS14 (1/4 pint)	\$12.60
LCTS1 (1/2 pint)	\$18.47
LCTS2 (1 pint)	\$28.67

FFX

O-Ring Face Seal (ORFS)
Female Swivel

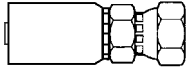

FFX-04-04	\$4.48
FFX-04-06	\$5.26
FFX-05-06	\$18.99
FFX-06-04	\$11.74
FFX-06-06	\$5.16
FFX-06-08	\$5.88
FFX-08-06	\$9.84
FFX-08-08	\$6.24
FFX-08-10	\$9.02
FFX-08-12	\$12.37
FFX-10-08	\$12.78
FFX-10-10	\$10.16
FFX-10-12	\$12.10
FFX-12-10	\$18.32
FFX-12-12	\$11.83
FFX-12-16	\$22.09
FFX-16-16	\$22.18
FFX-16-20	\$24.61
FFX-20-20	\$52.54
FFX-20-24	\$28.63

FFX90

O-Ring Face Seal (ORFS)
Female Swivel 90°

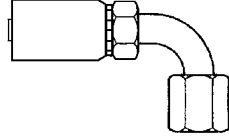

FFX90-04-04	\$8.47
FFX90-04-06	\$9.69
FFX90-05-06	\$15.69
FFX90-06-04	\$18.85
FFX90-06-06	\$8.89
FFX90-06-08	\$11.37
FFX90-08-06	\$12.75
FFX90-08-08	\$10.47
FFX90-08-10	\$12.39
FFX90-08-12	\$35.84
FFX90-10-10	\$14.46
FFX90-10-12	\$19.25
FFX90-12-10	\$20.94
FFX90-12-12	\$22.65
FFX90-12-16	\$52.40
FFX90-16-16	\$26.53
FFX90-16-20	\$61.49
FFX90-20-20	\$64.94

FFX90L

O-Ring Face Seal (ORFS)
Female Swivel 90° Long

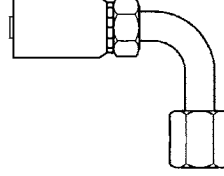

FFX90L-04-04	\$10.12
FFX90L-06-06	\$11.35
FFX90L-06-08	\$14.67
FFX90L-08-08	\$12.02
FFX90L-08-10	\$26.37
FFX90L-10-10	\$22.96
FFX90L-10-12	\$24.92
FFX90L-12-12	\$22.87
FFX90L-16-16	\$32.00

MF

O-Ring Face Seal (ORFS)
Male Rigid

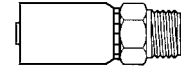

MF-04-04	\$4.01
MF-04-06	\$6.11
MF-06-06	\$5.85
MF-06-08	\$14.32
MF-08-08	\$5.41
MF-08-10	\$12.62
MF-08-12	\$21.53
MF-10-10	\$9.93
MF-10-12	\$19.79
MF-12-12	\$19.85
MF-12-16	\$54.54
MF-16-16	\$26.91

FFXT

O-Ring Face Seal (ORFS)
Female Swivel Long

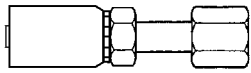

FFXT-04-04	\$4.15
FFXT-04-06	\$6.23
FFXT-06-06	\$5.02
FFXT-06-08	\$6.84
FFXT-08-08	\$5.70
FFXT-10-10	\$8.34
FFXT-10-12	\$17.30
FFXT-12-12	\$11.72
FFXT-16-16	\$20.82

FFX90M

O-Ring Face Seal (ORFS)
Female Swivel 90°
Medium

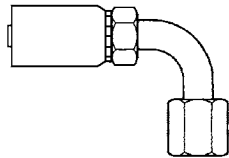

FFX90M-04-04	\$12.45
FFX90M-06-06	\$13.23
FFX90M-08-08	\$14.76
FFX90M-10-10	\$22.96
FFX90M-12-12	\$31.62
FFX90M-16-16	\$28.28

FFX45

O-Ring Face Seal (ORFS)
Female Swivel 45°

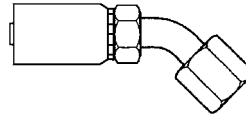

FFX45-04-04	\$8.37
FFX45-04-06	\$10.63
FFX45-06-06	\$9.10
FFX45-06-08	\$11.83
FFX45-08-06	\$12.24
FFX45-08-08	\$11.40
FFX45-08-10	\$14.98
FFX45-08-12	\$24.00
FFX45-10-10	\$15.15
FFX45-10-12	\$18.47
FFX45-12-10	\$24.98
FFX45-12-12	\$23.61
FFX45-12-16	\$29.23
FFX45-16-16	\$27.92
FFX45L-16-16	\$42.03
FFX45LL-16-16	\$46.27
FFX45-16-20	\$40.55
FFX45-20-20	\$62.88
FFX45-16-20	\$40.19
FFX45-20-20	\$62.34

FS4000

Buna O-Ring for Face Seal



FS4000-04	\$0.14
FS4000-06	\$0.17
FS4000-08	\$0.20
FS4000-10	\$0.24
FS4000-12	\$0.36
FS4000-16	\$0.45
FS4000-20	\$0.68
FS4000-24	\$0.35

MB

SAE Straight Thread
O-Ring Boss Male Rigid

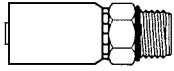

MB-03-04	\$2.91
MB-04-04	\$3.60
MB-04-05	\$5.76
MB-04-06	\$3.58
MB-04-08	\$8.27
MB-06-06	\$3.72
MB-06-08	\$3.36
MB-06-10	\$7.30
MB-08-08	\$3.36
MB-08-10	\$4.60
MB-08-12	\$18.47
MB-10-10	\$9.38
MB-10-12	\$8.05
MB-12-10	\$7.50
MB-12-12	\$9.08
MB-12-14	\$24.84
MB-12-16	\$18.68
MB-16-12	\$18.68
MB-16-16	\$10.30

MBX

SAE Straight Thread
O-Ring Boss Male Swivel

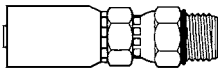

MBX-04-04	\$5.02
MBX-04-05	\$18.79
MBX-04-06	\$5.66
MBX-06-04	\$7.44
MBX-06-06	\$4.48
MBX-06-08	\$5.31
MBX-08-08	\$5.39
MBX-08-10	\$5.57
MBX-12-12	\$11.80
MBX-16-16	\$33.48

MBX90

SAE Straight Thread
O-Ring Boss Male Swivel
90°

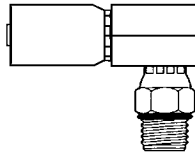

MBX90-04-04	\$7.75
MBX90-04-06	\$7.99
MBX90-06-06	\$9.18
MBX90-06-08	\$9.95
MBX90-06-10	\$12.71
MBX90-08-08	\$10.43
MBX90-08-10	\$11.20
MBX90-08-12	\$31.21
MBX90-10-10	\$64.18
MBX90-12-12	\$23.70

MENDER

Hose Mender

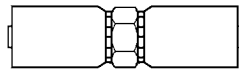

MENDER-04	\$13.46
MENDER-06	\$7.54
MENDER-08	\$8.23
MENDER-12	\$18.95
MENDER-16	\$51.95

SHELL

Crimp collar only

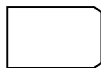

SHELL-04	\$0.98
SHELL-06	\$1.23
SHELL-08	\$1.54
SHELL-10	\$1.68
SHELL-12	\$2.27
SHELL-16	\$2.65

C61

Code 61 Flange

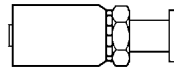

C61-08-08	\$15.57
C61-08-12	\$16.77
C61-12-12	\$16.65
C61-12-16	\$26.41
C61-16-16	\$20.96
C61-16-20	\$22.04
C61-20-20	\$53.07

C6145

Code 61 Flange 45°

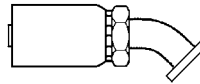

C6145-08-08	\$22.51
C6145-08-12	\$35.03
C6145-12-12	\$28.35
C6145-12-16	\$31.67
C6145-12-20	\$51.21
C6145-16-16	\$35.75
C6145-16-20	\$45.65
C6145-16-24	\$57.25
C6145-20-20	\$45.72

C6190

Code 61 Flange 90°

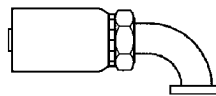

C6190-08-08	\$26.29
C6190-08-12	\$28.41
C6190-12-12	\$28.59
C6190-12-16	\$31.75
C6190-12-20	\$44.68
C6190-16-16	\$37.81
C6190-16-20	\$39.69
C6190-16-24	\$52.95
C6190-20-20	\$45.02

61SF-KIT

Code 61 Split Flange Kit

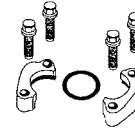

61SF-08-KIT	\$6.92
61SF-12-KIT	\$5.23
61SF-16-KIT	\$5.74
61SF-20-KIT	\$7.01
61SF-24-KIT	\$9.31
61SF-32-KIT	\$10.17
61SF-40-KIT	\$18.59
61SF-48-KIT	\$19.18
61SF-56-KIT	\$125.46
61SF-64-KIT	\$147.47

610

Buna O-Ring for Code 61
and Code 62 Flanges



610-08	\$0.22
610-12	\$0.25
610-16	\$0.29
610-20	\$0.34
610-24	\$0.44
610-32	\$0.51

MT

Flareless Male

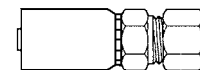

MT-04-04	\$6.07
MT-04-05	\$6.94
MT-04-06	\$16.62
MT-04-08	\$20.36
MT-06-04	\$16.84
MT-06-05	\$6.70
MT-06-06	\$6.58
MT-06-08	\$7.36
MT-08-08	\$8.85
MT-08-10	\$9.58
MT-08-12	\$26.62
MT-12-12	\$14.12
MT-12-16	\$29.78
MT-16-16	\$20.06

LF Flareless Female Swivel

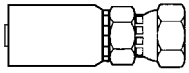

LF-04-04	\$13.63
LF-04-05	\$17.72
LF-04-06	\$14.41
LF-04-08	\$17.46
LF-06-05	\$20.36
LF-06-06	\$14.98
LF-06-08	\$14.58
LF-06-10	\$24.55
LF-08-08	\$15.77
LF-08-10	\$19.04
LF-08-12	\$20.31
LF-12-12	\$19.37

GT Grease Trap Female

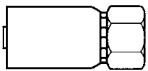

GT-04-08	\$7.47
GT-06-08	\$7.64

KAR Karcher Pressure Wash Female Swivel

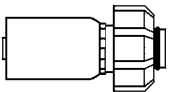

KAR-04-22	\$6.42
KAR-06-22	\$6.27

MIX Inverted Flare Male Swivel

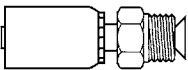

MIX-04-03	\$8.94
MIX-04-04	\$8.53
MIX-04-05	\$8.57
MIX-04-06	\$9.25
MIX-06-04	\$8.61
MIX-06-05	\$9.42
MIX-06-06	\$9.09
MIX-06-07	\$9.94
MIX-06-08	\$9.25
MIX-08-08	\$10.67
MIX-08-10	\$11.52

MIX45 Inverted Flare Male Swivel 45°

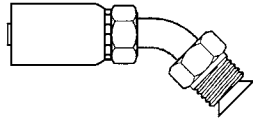

MIX45-04-03	\$9.14
MIX45-04-04	\$8.58
MIX45-04-05	\$9.60
MIX45-04-06	\$9.84
MIX45-06-05	\$7.70
MIX45-06-06	\$9.10
MIX45-06-07	\$9.94
MIX45-06-08	\$11.26
MIX45-08-08	\$9.44
MIX45-08-10	\$20.09

MIX90 Inverted Flare Male Swivel 90°

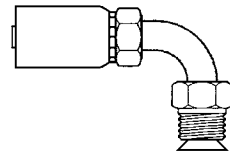

MIX90-03-04	\$8.11
MIX90-04-03	\$9.45
MIX90-04-04	\$8.96
MIX90-04-05	\$7.75
MIX90-04-06	\$7.89
MIX90-06-04	\$11.95
MIX90-06-05	\$7.98
MIX90-06-06	\$10.11
MIX90-06-07	\$12.17
MIX90-06-08	\$12.10
MIX90-08-08	\$12.22
MIX90-08-10	\$21.80

FSX SAE 45° Female Swivel

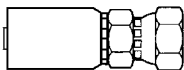

FSX-04-06	\$4.88
FSX-05-06	\$6.17
FSX-06-06	\$3.53
FSX-12-12	\$7.77

FSXT SAE 45° Female Swivel Long

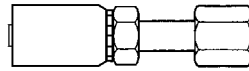

FSXT-04-04	\$7.89
FSXT-04-05	\$15.77
FSXT-06-04	\$12.44
FSXT-06-05	\$15.77
FSXT-06-06	\$7.95
FSXT-06-08	\$14.90
FSXT-08-08	\$10.93
FSXT-08-10	\$14.22

FSX45 SAE 45° Female Swivel 45°

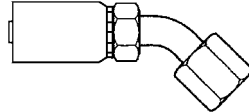

FSX45-04-04	\$10.05
FSX45-04-05	\$12.94
FSX45-06-05	\$14.71
FSX45-06-06	\$8.58
FSX45-08-08	\$11.16
FSX45-08-10	\$15.06
FSX45-10-12	\$20.70
FSX45-12-12	\$12.63

FSX90 SAE 45° Female Swivel 90°

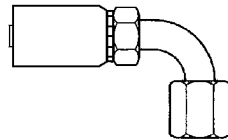

FSX90-04-04	\$8.60
FSX90-04-05	\$12.75
FSX90-05-06	\$15.03
FSX90-06-04	\$11.56
FSX90-06-05	\$13.07
FSX90-06-06	\$9.38
FSX90-06-08	\$10.87
FSX90-08-08	\$11.16
FSX90-08-10	\$15.06
FSX90-10-12	\$22.17
FSX90-12-12	\$13.85

MS SAE 45° Male Rigid

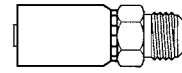

MS-04-04	\$15.08
MS-04-06	\$15.32
MS-05-05	\$17.46
MS-06-06	\$5.70
MS-06-08	\$16.03
MS-08-08	\$15.32
MS-12-12	\$11.55

FW Weld Fitting Female



FW-03-04	\$4.77
FW-04-04	\$3.14
FW-04-05	\$3.89
FW-04-06	\$3.72
FW-06-06	\$3.82
FW-06-08	\$3.58
FW-08-08	\$4.50
FW-08-10	\$5.36
FW-12-12	\$5.96
FW-16-16	\$17.21

MW Stand Tube (North American)

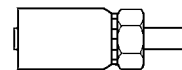

MW-04-04	\$4.65
MW-04-05	\$7.64
MW-04-06	\$5.53
MW-06-06	\$4.57
MW-06-08	\$5.24
MW-08-08	\$5.89
MW-08-10	\$6.57
MW-12-12	\$19.88
MW-16-16	\$19.11

MMSP

Metric Stand Tube

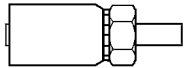

MMSP-04-06	\$9.50
MMSP-04-08	\$8.88
MMSP-04-10	\$8.90
MMSP-05-10	\$9.07
MMSP-05-12	\$9.12
MMSP-06-10	\$10.28
MMSP-06-12	\$10.32
MMSP-06-14	\$10.77
MMSP-08-15	\$10.62
MMSP-08-16	\$10.79
MMSP-08-18	\$10.89
MMSP-10-18	\$12.02
MMSP-10-20	\$12.27
MMSP-12-20	\$12.46
MMSP-12-22	\$12.67
MMSP-12-25	\$12.95
MMSP-16-25	\$16.65
MMSP-16-28	\$16.94
MMSP-16-30	\$17.84

MMSP45

Metric Stand Tube 45°

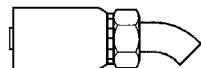

MMSP45-04-06	\$14.98
MMSP45-04-08	\$15.06
MMSP45-04-10	\$16.57
MMSP45-06-10	\$17.37
MMSP45-06-12	\$16.08
MMSP45-06-14	\$16.84
MMSP45-08-15	\$16.49
MMSP45-08-16	\$16.49
MMSP45-08-18	\$17.02
MMSP45-10-18	\$18.08
MMSP45-10-20	\$18.59
MMSP45-12-20	\$18.84
MMSP45-12-22	\$19.11
MMSP45-12-25	\$20.19
MMSP45-16-25	\$24.61
MMSP45-16-28	\$25.76
MMSP45-16-30	\$26.60

MMSP90

Metric Stand Tube 90°

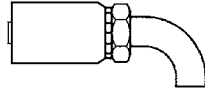

MMSP90-04-06	\$15.03
MMSP90-04-08	\$15.15
MMSP90-04-10	\$16.68
MMSP90-06-10	\$17.47
MMSP90-06-12	\$16.23
MMSP90-06-14	\$17.16
MMSP90-08-15	\$16.79
MMSP90-08-16	\$17.26
MMSP90-08-18	\$17.39
MMSP90-10-18	\$18.40
MMSP90-10-20	\$19.13
MMSP90-12-20	\$19.38
MMSP90-12-22	\$19.76
MMSP90-12-25	\$21.05
MMSP90-16-25	\$25.48
MMSP90-16-28	\$27.20
MMSP90-16-30	\$28.17

FBSPX

British Standard Pipe
Female Swivel

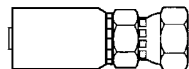

FBSPX-04-02	\$24.26
FBSPX-03-04	\$10.77
FBSPX-04-04	\$5.00
FBSPX-04-06	\$8.52
FBSPX-06-04	\$18.81
FBSPX-06-06	\$4.20
FBSPX-06-08	\$7.78
FBSPX-08-06	\$18.17
FBSPX-08-08	\$6.21
FBSPX-08-10	\$17.47
FBSPX-10-08	\$20.57
FBSPX-10-10	\$10.35
FBSPX-10-12	\$25.37
FBSPX-12-12	\$8.77
FBSPX-12-16	\$29.39
FBSPX-16-16	\$13.01
FBSPX-20-20	\$40.78

FBSPX45

British Standard Pipe
Female Swivel 45°

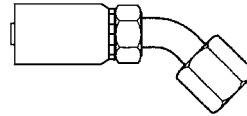

FBSPX45-04-04	\$11.42
FBSPX45-04-06	\$14.15
FBSPX45-06-06	\$12.81
FBSPX45-06-08	\$15.78
FBSPX45-08-08	\$14.76
FBSPX45-10-10	\$24.80
FBSPX45-12-12	\$24.02
FBSPX45-16-16	\$33.97
FBSPX45-20-20	\$113.80

FBSPX90

British Standard Pipe
Female Swivel 90°

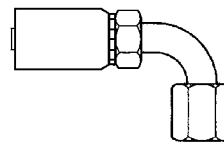

FBSPX90-04-04	\$15.06
FBSPX90-04-06	\$12.33
FBSPX90-06-06	\$13.83
FBSPX90-06-08	\$15.91
FBSPX90-08-08	\$14.58
FBSPX90-08-10	\$38.58
FBSPX90-10-10	\$16.67
FBSPX90-10-12	\$28.70
FBSPX90-12-12	\$36.33
FBSPX90-16-16	\$29.49

MBSPP

British Standard Pipe
Parallel Male Rigid

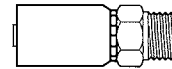

MBSPP-04-04	\$8.15
MBSPP-04-06	\$16.51
MBSPP-06-06	\$4.15
MBSPP-06-08	\$31.00
MBSPP-08-06	\$19.25
MBSPP-08-08	\$6.01
MBSPP-10-10	\$49.95
MBSPP-12-12	\$18.66
MBSPP-16-16	\$35.08

MBSPT

British Pipe Taper
Male Rigid

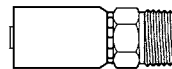

MBSPT-04-02	\$19.37
MBSPT-04-04	\$7.63
MBSPT-04-06	\$11.88
MBSPT-06-06	\$4.54
MBSPT-06-08	\$13.11
MBSPT-08-06	\$13.68
MBSPT-08-08	\$5.16
MBSPT-12-12	\$7.07
MBSPT-16-16	\$10.63

FBFPX

BSP Flat Face (HIAB)
Female Swivel

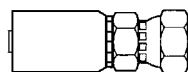

FBFPX-06-06	\$9.94
FBFPX-06-08	\$11.90
FBFPX-08-08	\$17.46
FBFPX-12-12	\$25.78

FJISX

Japanese Industrial Standard (JIS 30°) Female Swivel

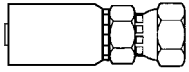

Threads are similar to BSPP.

FJISX-04-04	\$5.64
FJISX-06-06	\$4.66
FJISX-08-08	\$4.92
FJISX-10-10	\$24.47
FJISX-12-12	\$12.45
FJISX-16-16	\$16.66

FKOMX

Komatsu (Metric JIS) Female Swivel

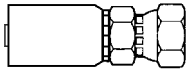

FKOMX-04-14	\$11.26
FKOMX-06-18	\$13.01
FKOMX-08-22	\$13.24
FKOMX-08-24	\$17.02
FKOMX-10-24	\$18.59
FKOMX-12-30	\$18.00
FKOMX-16-33	\$26.10
FKOMX-20-36	\$117.36

FDINLX

DIN Light (Metric) Universal Seat Female Swivel

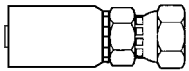

FDINLX-04-12	\$20.31
FDINLX-04-14	\$8.06
FDINLX-04-16	\$8.61
FDINLX-06-16	\$17.97
FDINLX-06-18	\$17.36
FDINLX-08-22	\$5.92
FDINLX-10-26	\$7.70
FDINLX-12-30	\$16.18
FDINLX-16-36	\$23.15

FDINLX45

DIN Light (Metric) Universal Seat Female Swivel 45°

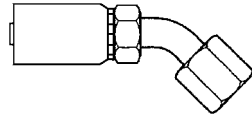

FDINLX45-04-14	\$21.45
FDINLX45-04-16	\$20.57
FDINLX45-06-16	\$27.99
FDINLX45-06-18	\$12.63
FDINLX45-08-22	\$14.58
FDINLX45-10-26	\$22.18
FDINLX45-12-30	\$23.95
FDINLX45-16-36	\$28.28

FDINLX90

DIN Light (Metric) Universal Seat Female Swivel 90°

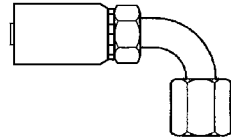

FDINLX90-04-14	\$18.30
FDINLX90-04-16	\$20.27
FDINLX90-06-16	\$27.31
FDINLX90-06-18	\$13.01
FDINLX90-08-22	\$14.71
FDINLX90-10-26	\$22.68
FDINLX90-12-30	\$24.32
FDINLX90-16-36	\$28.34

MDL

DIN Light (Metric) Universal Seat Male

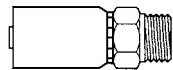

MDL-04-06-12	\$15.63
MDL-04-08-14	\$14.99
MDL-04-10-16	\$10.48
MDL-06-10-16	\$14.13
MDL-06-12-18	\$6.57
MDL-06-15-22	\$16.08
MDL-08-15-22	\$6.30
MDL-10-18-26	\$18.54
MDL-12-22-30	\$13.31
MDL-16-28-36	\$19.76

FDINHX

DIN Heavy (Metric) Universal Seat Female Swivel

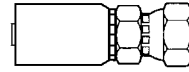

FDINHX-04-16	\$18.54
FDINHX-04-18	\$8.82
FDINHX-06-16	\$51.08
FDINHX-06-20	\$18.47
FDINHX-06-22	\$5.89
FDINHX-08-20	\$20.61
FDINHX-08-24	\$10.11
FDINHX-10-30	\$7.70
FDINHX-12-36	\$11.43
FDINHX-16-42	\$52.21

FDINHX45

DIN Heavy (Metric) Universal Seat Female Swivel 45°

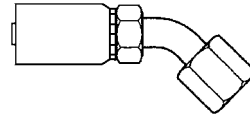

FDINHX45-04-16	\$20.36
FDINHX45-04-18	\$14.12
FDINHX45-06-20	\$24.57
FDINHX45-06-22	\$14.41
FDINHX45-08-24	\$16.85
FDINHX45-10-30	\$20.66
FDINHX45-12-36	\$25.00
FDINHX45-16-42	\$28.74

FDINHX90

DIN Heavy (Metric) Universal Seat Female Swivel 90°

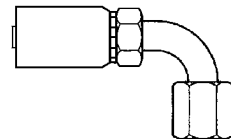

FDINHX90-04-16	\$22.02
FDINHX90-04-18	\$14.23
FDINHX90-06-20	\$21.45
FDINHX90-06-22	\$21.46
FDINHX90-08-24	\$21.91
FDINHX90-10-30	\$20.98
FDINHX90-12-36	\$31.98
FDINHX90-16-42	\$53.43

MDH

DIN Heavy (Metric) Universal Seat Male

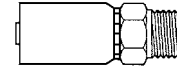

MDH-04-08-16	\$20.72
MDH-04-10-18	\$8.38
MDH-06-10-18	\$15.89
MDH-06-12-20	\$16.08
MDH-06-14-22	\$8.47
MDH-08-16-24	\$8.57
MDH-10-20-30	\$9.18
MDH-12-25-36	\$14.69
MDH-16-30-42	\$21.96

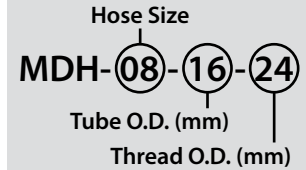

FJX

JIC 37° Female Swivel

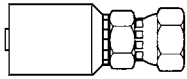

FJX-04-04W	\$4.05
FJX-04-05W	\$4.27
FJX-04-06W	\$4.44
FJX-06-04W	\$10.69
FJX-06-05W	\$12.41
FJX-06-06W	\$6.42
FJX-06-08W	\$5.63
FJX-06-10W	\$7.98
FJX-08-06W	\$8.34
FJX-08-08W	\$8.46
FJX-08-10W	\$9.18
FJX-08-12W	\$9.46
FJX-10-08W	\$15.00
FJX-10-10W	\$8.44
FJX-10-12W	\$10.51
FJX-12-08W	\$16.98
FJX-12-10W	\$9.75
FJX-12-12W	\$8.86
FJX-12-14W	\$16.33
FJX-12-16W	\$17.89
FJX-16-12W	\$23.40
FJX-16-16W	\$17.50
FJX-16-20W	\$25.52
FJX-20-16W	\$41.83
FJX-20-20W	\$32.84
FJX-20-24W	\$73.52
FJX-24-24W	\$38.89
FJX-32-32W	\$86.12

SS-FJX

JIC 37° Female Swivel
Stainless Steel

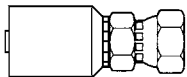

SS-FJX-12-12W	\$122.71
SS-FJX-16-16W	\$161.23
SS-FJX-20-20W	\$304.94
SS-FJX-24-24W	\$340.00
SS-FJX-32-32W	\$567.83

FJX45

JIC 37° Female Swivel 45°

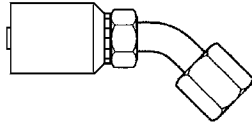

FJX45-04-04W	\$8.24
FJX45-04-06W	\$8.49
FJX45-06-06W	\$17.66
FJX45-06-08W	\$18.56
FJX45-08-08W	\$20.00
FJX45-08-10W	\$21.06
FJX45-10-10W	\$15.18
FJX45-10-12W	\$21.35
FJX45-12-12W	\$29.59
FJX45-12-16W	\$35.71
FJX45-16-16W	\$41.38
FJX45-16-20W	\$44.35
FJX45-20-20W	\$61.50
FJX45-20-24W	\$63.68
FJX45-24-24W	\$71.38
FJX45-32-32W	\$111.49

FJX90

JIC 37° Female Swivel 90°

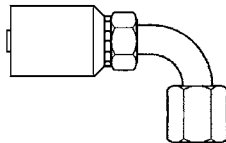

FJX90-04-04W	\$7.36
FJX90-04-05W	\$9.70
FJX90-04-06W	\$9.28
FJX90-06-04W	\$11.45
FJX90-06-06W	\$14.51
FJX90-06-08W	\$10.27
FJX90-08-06W	\$12.00
FJX90-08-08W	\$15.54
FJX90-08-10W	\$20.95
FJX90-08-12W	\$20.22
FJX90-10-10W	\$13.79
FJX90-10-12W	\$19.76
FJX90-12-12W	\$26.88
FJX90-12-16W	\$35.71
FJX90-16-16W	\$37.56
FJX90-16-20W	\$44.35
FJX90-20-20W	\$55.87
FJX90-20-24W	\$65.91
FJX90-24-24W	\$75.53
FJX90-32-32W	\$115.38

W Series Hose Fittings feature a bite-to-the-wire-design, and are intended for use with 4SH (up to size -24), R12, R13 (up to size -16), R1, R2, R16, R17 and KT hydraulic hoses.

FJX-06-08W
HOSE FITTING

FJX90L

JIC 37° Female Swivel 90°
Long

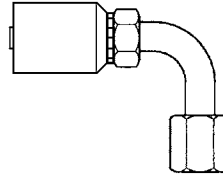

FJX90L-04-04W	\$10.57
FJX90L-06-06W	\$10.35
FJX90L-06-08W	\$13.14
FJX90L-08-08W	\$14.56
FJX90L-08-10W	\$13.10
FJX90L-10-10W	\$19.43
FJX90L-12-12W	\$30.50
FJX90L-16-16W	\$47.42

MJ

JIC 37° Male Rigid

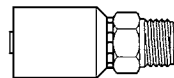

MJ-04-04W	\$3.58
MJ-04-05W	\$7.44
MJ-04-06W	\$4.55
MJ-06-05W	\$9.78
MJ-06-06W	\$5.45
MJ-06-08W	\$7.14
MJ-06-10W	\$10.41
MJ-08-06W	\$12.03
MJ-08-08W	\$6.54
MJ-08-10W	\$9.74
MJ-08-12W	\$10.56
MJ-10-10W	\$8.64
MJ-12-12W	\$12.24
MJ-12-14W	\$12.31
MJ-12-16W	\$12.95
MJ-16-16W	\$20.42
MJ-16-20W	\$23.00
MJ-20-20W	\$23.88
MJ-20-24W	\$55.37
MJ-24-24W	\$37.74
MJ-32-32W	\$86.12

MP

NPTF Male Pipe Rigid

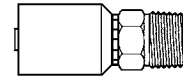

MP-04-02W	\$3.42
MP-04-04W	\$3.18
MP-04-06W	\$5.94
MP-04-08W	\$9.78
MP-06-04W	\$3.38
MP-06-06W	\$4.16
MP-06-08W	\$4.75
MP-08-06W	\$8.22
MP-08-08W	\$5.50
MP-08-12W	\$8.88
MP-10-06W	\$26.82
MP-10-08W	\$6.80
MP-10-12W	\$7.14
MP-12-08W	\$9.92
MP-12-12W	\$7.36
MP-12-16W	\$12.62
MP-16-12W	\$16.00
MP-16-16W	\$11.14
MP-16-20W	\$21.68
MP-20-20W	\$30.10
MP-20-24W	\$29.98
MP-24-24W	\$33.96
MP-32-32W	\$52.80

SS-MP

NPTF Male Pipe Rigid
Stainless Steel

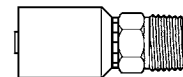

SS-MP-08-08W	\$78.58
SS-MP-12-12W	\$102.95
SS-MP-16-16W	\$124.48
SS-MP-20-20W	\$228.11
SS-MP-24-24W	\$259.74
SS-MP-32-32W	\$438.14

MPX

NPTF Male Pipe Swivel

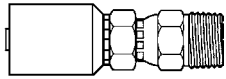

MPX-04-04W	\$5.60
MPX-04-06W	\$6.86
MPX-06-04W	\$6.96
MPX-06-06W	\$5.66
MPX-06-08W	\$7.75
MPX-08-06W	\$8.94
MPX-08-08W	\$6.96
MPX-12-12W	\$11.10
MPX-16-16W	\$16.86

MPX90

NPTF Male Pipe Swivel 90°

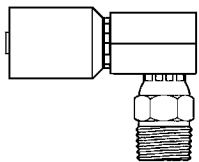

MPX90-04-04W	\$11.30
MPX90-06-06W	\$13.41
MPX90-06-08W	\$14.70
MPX90-08-08W	\$12.71
MPX90-12-12W	\$33.18

FP

NPTF Female Pipe Rigid

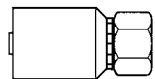

FP-04-02W	\$7.80
FP-04-04W	\$2.98
FP-04-06W	\$6.24
FP-06-04W	\$9.42
FP-06-06W	\$5.93
FP-06-08W	\$9.73
FP-08-08W	\$5.74
FP-12-12W	\$14.67

FPX

NPSM Female Pipe Swivel

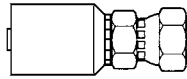

FPX-04-04W	\$3.61
FPX-06-06W	\$4.36
FPX-08-08W	\$5.81
FPX-12-12W	\$12.26
FPX-16-16W	\$19.43

MB

SAE Straight Thread
O-Ring Boss Male Rigid

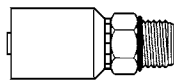

MB-04-04W	\$3.89
MB-04-05W	\$6.50
MB-04-06W	\$4.33
MB-06-06W	\$5.18
MB-06-08W	\$4.65
MB-06-10W	\$7.51
MB-08-06W	\$12.00
MB-08-08W	\$5.18
MB-08-10W	\$5.92
MB-08-12W	\$13.05
MB-10-10W	\$15.66
MB-10-12W	\$17.85
MB-12-12W	\$12.24
MB-16-12W	\$61.99
MB-16-16W	\$15.92
MB-16-20W	\$28.26
MB-20-20W	\$19.59

MBX

SAE Straight Thread
O-Ring Boss Male Swivel

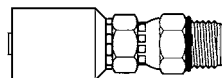

MBX-04-04W	\$8.06
MBX-06-06W	\$7.60
MBX-06-08W	\$7.77
MBX-08-08W	\$8.56
MBX-08-10W	\$8.61
MBX-12-12W	\$12.50

MBX90

SAE Straight Thread
O-Ring Boss Male Swivel
90°

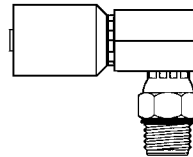

MBX90-06-06W	\$13.66
MBX90-06-08W	\$14.90
MBX90-08-08W	\$15.55
MBX90-08-10W	\$16.75
MBX90-12-12W	\$33.18

FFX

O-Ring Face Seal (ORFS)
Female Swivel

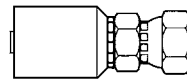

FFX-04-04W	\$3.93
FFX-04-06W	\$8.45
FFX-04-08W	\$16.10
FFX-06-06W	\$8.49
FFX-06-08W	\$10.11
FFX-08-06W	\$17.12
FFX-08-08W	\$8.85
FFX-08-10W	\$9.28
FFX-08-12W	\$17.81
FFX-10-08W	\$21.30
FFX-10-10W	\$11.75
FFX-10-12W	\$18.71
FFX-12-10W	\$15.50
FFX-12-12W	\$13.62
FFX-12-16W	\$20.60
FFX-16-12W	\$27.97
FFX-16-16W	\$17.31
FFX-16-20W	\$42.89
FFX-20-20W	\$42.87
FFX-20-24W	\$84.27
FFX-24-24W	\$62.44

FFX45

O-Ring Face Seal (ORFS)
Female Swivel 45°

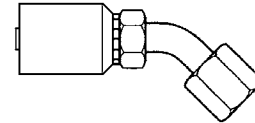

FFX45-04-04W	\$11.71
FFX45-04-06W	\$14.58
FFX45-06-06W	\$17.09
FFX45-06-08W	\$22.79
FFX45-08-08W	\$17.47
FFX45-08-10W	\$18.51
FFX45-08-12W	\$27.27
FFX45-10-10W	\$20.70
FFX45-10-12W	\$40.86
FFX45-12-10W	\$64.97
FFX45-12-12W	\$24.92
FFX45-12-16W	\$29.23
FFX45-16-16W	\$30.28
FFX45-16-20W	\$48.85
FFX45-20-20W	\$44.66
FFX45-20-24W	\$73.34
FFX45-24-24W	\$72.33

FFX90

O-Ring Face Seal (ORFS)
Female Swivel 90°

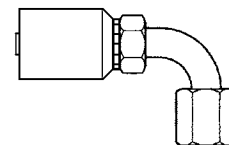

FFX90-04-04W	\$10.77
FFX90-04-06W	\$14.68
FFX90-04-08W	\$16.49
FFX90-06-04W	\$40.56
FFX90-06-06W	\$10.05
FFX90-06-08W	\$14.92
FFX90-08-08W	\$10.48
FFX90-08-10W	\$11.52
FFX90-08-12W	\$27.35
FFX90-10-08W	\$19.74
FFX90-10-10W	\$13.81
FFX90-12-10W	\$28.63
FFX90-12-12W	\$27.28
FFX90-12-16W	\$35.92
FFX90-16-16W	\$32.31
FFX90-16-20W	\$53.97
FFX90-20-20W	\$46.25
FFX90-20-24W	\$78.08
FFX90-24-24W	\$86.91

FFX90M

O-Ring Face Seal (ORFS)
Female Swivel 90°
Medium

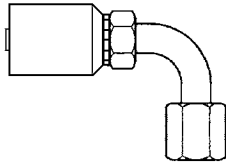

FFX90M-04-04W	\$12.63
FFX90M-06-06W	\$21.75
FFX90M-08-08W	\$15.86
FFX90M-12-12W	\$27.94
FFX90M-16-16W	\$24.53

FFX90L

O-Ring Face Seal (ORFS)
Female Swivel 90° Long

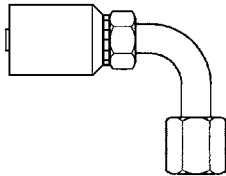

FFX90L-04-04W	\$19.26
FFX90L-06-06W	\$14.71
FFX90L-06-08W	\$25.91
FFX90L-08-08W	\$14.24
FFX90L-08-10W	\$30.48
FFX90L-10-10W	\$26.53
FFX90L-10-12W	\$48.46
FFX90L-12-12W	\$30.46
FFX90L-16-16W	\$54.30
FFX90L-20-20W	\$74.54

MF

O-Ring Face Seal (ORFS)
Male Rigid

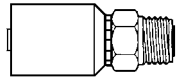

MF-04-04W	\$6.96
MF-04-06W	\$17.21
MF-06-06W	\$7.14
MF-06-08W	\$11.79
MF-08-08W	\$8.56
MF-08-10W	\$9.04
MF-08-12W	\$29.80
MF-10-10W	\$13.82
MF-10-12W	\$14.46
MF-12-12W	\$23.85
MF-12-16W	\$60.17
MF-16-12W	\$63.24
MF-16-16W	\$29.18

C61

Code 61 Flange

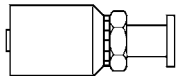

C61-08-08W	\$14.47
C61-08-12W	\$29.07
C61-12-12W	\$16.46
C61-12-16W	\$17.80
C61-16-16W	\$22.98
C61-16-20W	\$23.11
C61-16-24W	\$55.65
C61-20-20W	\$26.43
C61-20-24W	\$31.80
C61-24-24W	\$44.47
C61-24-32W	\$112.26
C61-32-32W	\$64.74

C6122

Code 61 Flange 22°

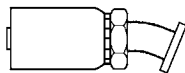

C6122-12-12W	\$26.59
C6122-12-16W	\$27.10
C6122-16-16W	\$33.18
C6122-16-20W	\$28.73
C6122-20-20W	\$45.35
C6122-20-24W	\$42.78
C6122-24-24W	\$61.22
C6122-32-32W	\$91.49

C6130

Code 61 Flange 30°

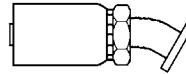

C6130-12-12W	\$22.24
C6130-12-16W	\$22.87
C6130-16-16W	\$28.30
C6130-16-20W	\$28.74
C6130-20-20W	\$42.78
C6130-20-24W	\$42.84
C6130-24-24W	\$57.63
C6130-32-32W	\$79.96

C6145

Code 61 Flange 45°

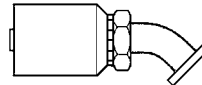

C6145-08-08W	\$21.70
C6145-08-12W	\$24.86
C6145-12-12W	\$23.61
C6145-12-16W	\$23.23
C6145-16-16W	\$30.29
C6145-16-20W	\$28.74
C6145-20-20W	\$40.24
C6145-20-24W	\$42.78
C6145-24-24W	\$51.87
C6145-24-32W	\$77.43
C6145-32-32W	\$86.92
C6145-32-40W	\$157.41

C6160

Code 61 Flange 60°

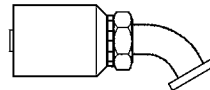

C6160-08-12W	\$37.08
C6160-12-12W	\$22.46
C6160-12-16W	\$24.85
C6160-16-16W	\$33.67
C6160-16-20W	\$34.96
C6160-20-20W	\$39.88
C6160-20-24W	\$40.71
C6160-24-24W	\$50.49
C6160-32-32W	\$80.55

C6190

Code 61 Flange 90°

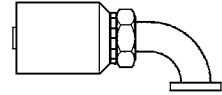

C6190-08-08W	\$23.23
C6190-08-12W	\$31.85
C6190-12-12W	\$23.61
C6190-12-16W	\$27.86
C6190-16-16W	\$30.10
C6190-16-20W	\$29.74
C6190-20-20W	\$41.25
C6190-20-24W	\$43.95
C6190-24-24W	\$53.39
C6190-24-32W	\$99.98
C6190-32-32W	\$88.82

C6190L

Code 61 Flange 90° Long

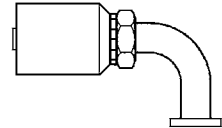

C6190L-08-12W	\$36.84
C6190L-12-12W	\$33.79
C6190L-16-16W	\$43.75
C6190L-16-20W	\$47.22

61SF-KIT

Code 61 Split Flange Kit

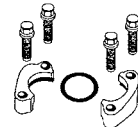

61SF-08-KIT	\$6.92
61SF-12-KIT	\$5.23
61SF-16-KIT	\$5.74
61SF-20-KIT	\$7.01
61SF-24-KIT	\$9.31
61SF-32-KIT	\$10.17
61SF-40-KIT	\$18.59
61SF-48-KIT	\$19.18
61SF-56-KIT	\$125.46
61SF-64-KIT	\$147.47



Hydraulic O-Ring Assortment

A full assortment of O-rings for split flange, face seal, and straight thread (ORB) connectors in a handy steel case.

Kit includes 12 O-rings of each size shown below (also sold separately).

Item #	Description	Price
DRG24	Complete Kit (288 O-Rings)	\$206.46
610-08	Split Flange O-Ring	\$0.23
610-12	Split Flange O-Ring	\$0.25
610-16	Split Flange O-Ring	\$0.30
610-20	Split Flange O-Ring	\$0.38
610-24	Split Flange O-Ring	\$0.47
610-32	Split Flange O-Ring	\$0.58
4000-02	Split Flange O-Ring	\$0.26
4000-03	SAE Straight Thread (ORB) O-Ring	\$0.26
4000-04	SAE Straight Thread (ORB) O-Ring	\$0.25
4000-05	SAE Straight Thread (ORB) O-Ring	\$0.42
4000-06	SAE Straight Thread (ORB) O-Ring	\$0.42
4000-08	SAE Straight Thread (ORB) O-Ring	\$0.42
4000-10	SAE Straight Thread (ORB) O-Ring	\$0.55
4000-12	SAE Straight Thread (ORB) O-Ring	\$0.55
4000-14	SAE Straight Thread (ORB) O-Ring	\$1.14
4000-16	SAE Straight Thread (ORB) O-Ring	\$1.17
4000-20	SAE Straight Thread (ORB) O-Ring	\$1.25
4000-24	SAE Straight Thread (ORB) O-Ring	\$1.35
4000-32	SAE Straight Thread (ORB) O-Ring	\$2.91
FS4000-04	O-Ring Face Seal (ORFS) O-Ring	\$0.14
FS4000-06	O-Ring Face Seal (ORFS) O-Ring	\$0.17
FS4000-08	O-Ring Face Seal (ORFS) O-Ring	\$0.20
FS4000-10	O-Ring Face Seal (ORFS) O-Ring	\$0.24
FS4000-12	O-Ring Face Seal (ORFS) O-Ring	\$0.36
FS4000-16	O-Ring Face Seal (ORFS) O-Ring	\$0.45
FS4000-20	O-Ring Face Seal (ORFS) O-Ring	\$0.68
FS4000-24	O-Ring Face Seal (ORFS) O-Ring	\$0.35

610

Buna O-Ring for Code 61 and Code 62 Flanges



610-08	\$0.21
610-12	\$0.24
610-16	\$0.28
610-20	\$0.32
610-24	\$0.43
610-32	\$0.49

C62

Code 62 Flange

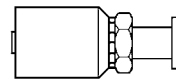

C62-12-08W	\$36.34
C62-12-12W	\$26.16
C62-12-16W	\$45.72
C62-16-16W	\$33.40
C62-16-20W	\$64.33
C62-20-20W	\$43.60
C62-20-24W	\$62.14
C62-24-24W	\$53.17
C62-32-32W	\$76.00

C6222

Code 62 Flange 22°

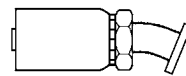

C6222-12-12W	\$41.49
C6222-12-16W	\$38.36
C6222-16-16W	\$34.62
C6222-16-20W	\$40.89
C6222-20-20W	\$57.50
C6222-20-24W	\$58.89
C6222-24-24W	\$70.21

C6230

Code 62 Flange 30°

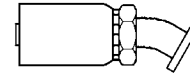

C6230-12-12W	\$38.85
C6230-12-16W	\$38.36
C6230-16-16W	\$35.73
C6230-16-20W	\$46.29
C6230-20-20W	\$61.04
C6230-20-24W	\$67.87
C6230-24-24W	\$71.46

C6245

Code 62 Flange 45°

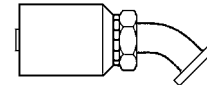

C6245-12-12W	\$32.76
C6245-12-16W	\$35.22
C6245-16-12W	\$46.04
C6245-16-16W	\$39.51
C6245-16-20W	\$42.43
C6245-20-20W	\$59.28
C6245L-20-20W	\$162.20
C6245-20-24W	\$62.87
C6245-24-24W	\$69.31
C6245-32-32W	\$97.35
C6245-32-32W	\$96.48

C6260

Code 62 Flange 60°

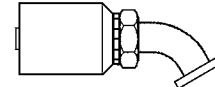

C6260-24-32W	\$133.08
--------------	----------

C6290

Code 62 Flange 90°

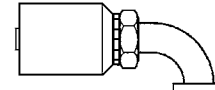

C6290-12-12W	\$34.52
C6290-12-16W	\$34.98
C6290-16-16W	\$41.48
C6290-16-20W	\$45.28
C6290-20-16W	\$95.42
C6290-20-20W	\$60.92
C6290-20-24W	\$64.39
C6290-24-24W	\$79.77
C6290-32-32W	\$100.05

62SF-KIT

Code 62 Split Flange Kit

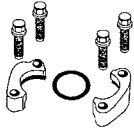

62SF-08-KIT	\$14.02
62SF-12-KIT	\$10.46
62SF-16-KIT	\$13.00
62SF-20-KIT	\$16.98
62SF-24-KIT	\$23.32
62SF-32-KIT	\$40.96

CAT

Caterpillar Flange

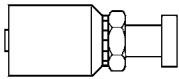

CAT-12-12W	\$25.20
CAT-12-16W	\$29.86
CAT-16-16W	\$30.20
CAT-16-20W	\$36.50
CAT-20-20W	\$49.26
CAT-20-24W	\$59.37
CAT-24-24W	\$68.15

CAT45

Caterpillar Flange 45°

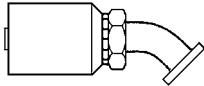

CAT45-12-12W	\$37.13
CAT45-12-16W	\$61.83
CAT45-16-16W	\$50.21
CAT45-16-20W	\$76.30
CAT45-20-20W	\$60.49
CAT45-20-24W	\$84.75
CAT45-24-24W	\$112.19

CAT90

Caterpillar Flange 90°

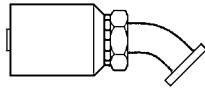

CAT90-12-12W	\$30.93
CAT90-12-16W	\$47.11
CAT90-16-16W	\$38.70
CAT90-16-20W	\$70.01
CAT90-20-20W	\$51.26
CAT90-20-24W	\$85.30
CAT90-24-24W	\$98.79

CAT

Split Flange Half



CAT-12H	\$12.72
CAT-16H	\$13.77
CAT-20H	\$14.98
CAT-24H	\$19.39
CAT-32H	\$25.41

MIX

Inverted Flare Male Swivel

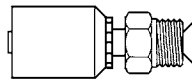

MIX-04-04W	\$8.21
MIX-04-05W	\$9.99
MIX-04-06W	\$11.16
MIX-06-05W	\$11.32
MIX-06-06W	\$9.58
MIX-08-08W	\$11.84
MW-06-06W	\$6.45

MIX45

Inverted Flare Male Swivel 45°

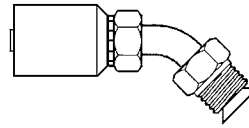

MIX45-04-04W	\$9.04
MIX45-04-05W	\$11.53
MIX45-04-06W	\$23.99
MIX45-06-05W	\$12.17
MIX45-06-06W	\$10.41
MIX45-08-08W	\$11.90

MIX90

Inverted Flare Male Swivel 90°

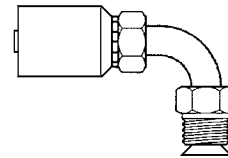

MIX90-04-04W	\$9.68
MIX90-04-05W	\$11.36
MIX90-04-06W	\$11.61
MIX90-06-05W	\$12.38
MIX90-06-06W	\$11.16
MIX90-08-08W	\$13.80

FW

Weld Fitting Female

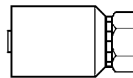

FW-04-04W	\$2.73
FW-06-06W	\$3.57
FW-06-08W	\$3.60
FW-08-08W	\$4.55
FW-12-12W	\$11.95
FW-16-16W	\$20.67

FSX

SAE 45° Female Swivel

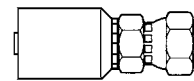

FSX-04-06W	\$9.42
FSX-06-06W	\$9.02
FSX-12-12W	\$12.47

MT

Flareless Compression

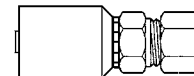

MT-04-04W	\$8.52
MT-04-06W	\$12.13
MT-06-05W	\$10.33
MT-06-06W	\$12.35
MT-06-08W	\$12.44
MT-08-08W	\$12.13
MT-08-10W	\$15.06
MT-12-12W	\$25.14
MT-16-16W	\$26.23

MENDER

Hose Mender

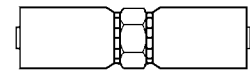

MENDER-04W	\$12.88
MENDER-06W	\$12.29
MENDER-08W	\$13.38

FBSPX

British Standard Pipe
Female Swivel

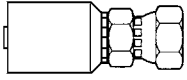

FBSPX-04-04W	\$5.88
FBSPX-04-06W	\$11.30
FBSPX-06-06W	\$4.96
FBSPX-06-08W	\$8.62
FBSPX-08-08W	\$6.30
FBSPX-08-10W	\$16.40
FBSPX-10-10W	\$11.30
FBSPX-12-12W	\$9.50
FBSPX-16-16W	\$12.13
FBSPX-20-20W	\$47.89
FBSPX-24-24W	\$101.60

FBSPX45

British Standard Pipe
Female Swivel 45°

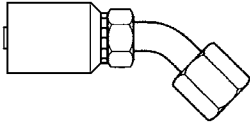

FBSPX45-04-04W	\$12.85
FBSPX45-06-06W	\$11.27
FBSPX45-08-08W	\$12.88
FBSPX45-10-10W	\$11.30
FBSPX45-12-12W	\$20.93
FBSPX45-16-16W	\$25.40

FBSPX90

British Standard Pipe
Female Swivel 90°

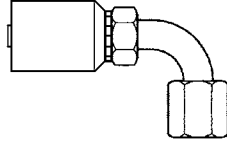

FBSPX90-04-04W	\$13.29
FBSPX90-04-06W	\$13.41
FBSPX90-06-06W	\$32.51
FBSPX90-06-08W	\$15.00
FBSPX90-08-08W	\$28.02
FBSPX90-10-10W	\$21.67
FBSPX90-12-12W	\$41.95
FBSPX90-16-16W	\$62.14

FBSPX90B

British Standard Pipe
Female Swivel 90°
Block Style Elbow

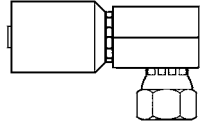

FBSPX90B-06-06W	\$36.28
-----------------	---------

MBSPP

British Standard Pipe
Parallel Male Rigid

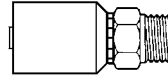

MBSPP-04-04W	\$12.57
MBSPP-04-06W	\$12.65
MBSPP-06-06W	\$11.97
MBSPP-06-08W	\$17.79
MBSPP-08-08W	\$13.61
MBSPP-08-10W	\$19.43
MBSPP-12-12W	\$30.18

FJISX

Japanese Industrial
Standard (JIS 30°) Female
Swivel

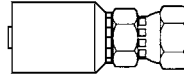

Threads are similar to BSPP.

FJISX-04-04W	\$6.48
FJISX-06-06W	\$6.70
FJISX-08-08W	\$8.55
FJISX-10-10W	\$25.21
FJISX-12-12W	\$19.37
FJISX-16-16W	\$41.09

FKOMX

Komatsu (Metric JIS)
Female Swivel

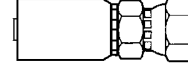

FKOMX-04-14W	\$9.22
FKOMX-06-14W	\$12.38
FKOMX-06-18W	\$7.46
FKOMX-08-22W	\$11.53
FKOMX-08-24W	\$10.71
FKOMX-10-24W	\$15.58
FKOMX-12-30W	\$18.06
FKOMX-16-33W	\$25.56

FDL

DIN Light (Metric)
Universal Seat
Female Swivel

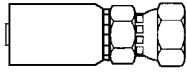

FDL-04-08-14W	\$10.41
FDL-04-10-16W	\$10.87
FDL-06-10-16W	\$11.45
FDL-06-12-18W	\$11.03
FDL-06-15-22W	\$11.75
FDL-08-15-22W	\$12.63
FDL-08-18-26W	\$22.32
FDL-10-18-26W	\$21.96
FDL-12-18-26W	\$24.71
FDL-12-22-30W	\$25.10
FDL-16-28-36W	\$33.73
FDL-20-35-45W	\$73.15

FDL45

DIN Light (Metric)
Universal Seat
Female Swivel 45°

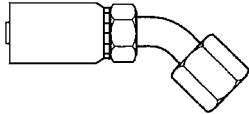

FDL45-04-08-14W	\$17.22
FDL45-04-10-16W	\$16.00
FDL45-06-10-16W	\$17.47
FDL45-06-12-18W	\$17.02
FDL45-08-15-22W	\$18.06
FDL45-10-18-26W	\$30.39
FDL45-12-18-26W	\$33.53
FDL45-12-22-30W	\$40.62
FDL45-16-28-36W	\$51.38
FDL45-20-35-45W	\$83.64

FDL90

DIN Light (Metric)
Universal Seat
Female Swivel 90°

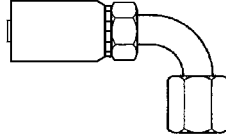

FDL90-04-08-14W	\$17.02
FDL90-04-10-16W	\$16.05
FDL90-06-10-16W	\$17.28
FDL90-06-12-18W	\$17.12
FDL90-08-15-22W	\$19.04
FDL90-08-18-26W	\$23.04
FDL90-10-18-26W	\$30.84
FDL90-12-18-26W	\$33.81
FDL90-12-22-30W	\$37.55
FDL90-16-28-36W	\$49.50
FDL90-20-35-45W	\$85.86

MDL

DIN Light (Metric)
Universal Seat Male

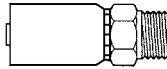

MDL-04-08-14W	\$11.14
MDL-04-10-16W	\$11.16
MDL-06-10-16W	\$13.07
MDL-06-12-18W	\$12.02
MDL-06-15-22W	\$13.82
MDL-08-12-18W	\$14.41
MDL-08-15-22W	\$12.17
MDL-10-18-26W	\$14.20
MDL-12-22-30W	\$15.73
MDL-16-28-36W	\$24.31

FDH

DIN Heavy (Metric)
Universal Seat
Female Swivel

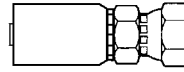

FDH-04-08-16W	\$11.40
FDH-04-10-18W	\$10.89
FDH-06-08-16W	\$19.76
FDH-06-12-20W	\$20.36
FDH-06-14-22W	\$11.12
FDH-08-16-24W	\$16.79
FDH-10-20-30W	\$25.67
FDH-12-20-30W	\$30.03
FDH-12-25-36W	\$26.80
FDH-16-30-42W	\$39.61
FDH-20-30-42W	\$70.35
FDH-20-38-52W	\$144.42
FDH-24-38-52W	\$187.86

FDH45

DIN Heavy (Metric)
Universal Seat
Female Swivel 45°

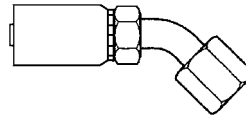

FDH45-04-08-16W	\$19.20
FDH45-04-10-18W	\$15.39
FDH45-06-08-16W	\$24.35
FDH45-06-12-20W	\$20.19
FDH45-06-14-22W	\$18.88
FDH45-08-12-20W	\$25.34
FDH45-08-16-24W	\$23.79
FDH45-10-20-30W	\$39.48
FDH45-12-20-30W	\$39.71
FDH45-12-25-36W	\$40.30
FDH45-16-30-42W	\$45.49
FDH45-20-30-42W	\$80.70
FDH45-20-38-52W	\$84.18

FDH90

DIN Heavy (Metric)
Universal Seat
Female Swivel 90°

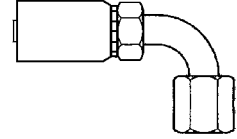

FDH90-04-08-16W	\$19.48
FDH90-04-10-18W	\$15.17
FDH90-06-08-16W	\$22.12
FDH90-06-12-20W	\$19.99
FDH90-06-14-22W	\$18.88
FDH90-08-12-20W	\$25.18
FDH90-08-16-24W	\$23.11
FDH90-10-20-30W	\$40.28
FDH90-12-20-30W	\$39.69
FDH90-12-25-36W	\$39.51
FDH90-16-30-42W	\$49.75
FDH90-20-30-42W	\$82.93
FDH90-20-38-52W	\$86.38

MDH

DIN Heavy (Metric)
Universal Seat Male

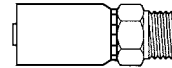

MDH-04-08-16W	\$11.27
MDH-04-10-18W	\$11.67
MDH-06-08-16W	\$13.52
MDH-06-12-20W	\$16.44
MDH-06-14-22W	\$12.09
MDH-08-16-24W	\$12.81
MDH-10-20-30W	\$14.34
MDH-12-25-36W	\$16.05
MDH-16-30-42W	\$37.17

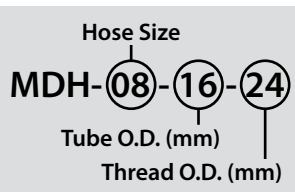

3 Series Thermoplastic Hose Fittings



NPTF Male Pipe

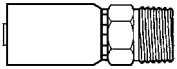

Item #	Hose	NPTF	Die	Pusher	Price
3-02102	1/8"	1/8"	4540-302	4599-MP023	\$3.37
3-03102	3/16"	1/8"	4540-303	4599-MP001	\$3.31
3-03104	3/16"	1/4"	4540-303	4599-MP004	\$3.89
3-04102	1/4"	1/8"	4540-304	4599-MP002	\$3.84
3-04104	1/4"	1/4"	4540-304	4599-MP004	\$3.56
3-04106	1/4"	3/8"	4540-304	4599-MP005	\$3.93
3-05104	5/16"	1/4"	4540-305	4599-MP004	\$4.43
3-05106	5/16"	3/8"	4540-305	4599-MP005	\$4.68
3-06104	3/8"	1/4"	4540-306	4599-MP005	\$4.24
3-06106	3/8"	3/8"	4540-306	4599-MP005	\$4.03
3-06108	3/8"	1/2"	4540-306	4599-MP009	\$5.99
3-08106	1/2"	3/8"	4540-308	4599-MP008	\$4.90
3-08108	1/2"	1/2"	4540-308	4599-MP009	\$4.87
3-12112	3/4"	3/4"	4540-312	4599-MP011	\$7.74
3-16116	1"	1"	4540-316	4599-MP013	\$11.01

NPTF Male Pipe Swivel

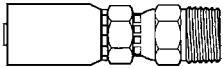

Item #	Hose	NPTF	Die	Pusher	Price
3-03144	3/16"	1/4"	4540-303	4599-MP003	\$6.01
3-04144	1/4"	1/4"	4540-304	4599-MP003	\$5.33
3-06146	3/8"	3/8"	4540-306	4599-MP006	\$6.28
3-08148	1/2"	1/2"	4540-308	4599-MP010	\$7.59

NPSM Female Pipe Swivel

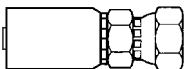

Item #	Hose	NPSM	Die	Pusher	Price
3-03244	3/16"	1/4"	4540-303	4599-FP002	\$4.71
3-04244	1/4"	1/4"	4540-304	4599-FP002	\$4.83
3-05244	5/16"	1/4"	4540-305	4599-FP013	\$6.50
3-06246	3/8"	3/8"	4540-306	4599-FP004	\$5.50
3-08248	1/2"	1/2"	4540-308	4599-FP018	\$6.23

JIC 37° Female Swivel

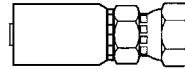

Most sizes (except 3/8" and 3/4") are dual seat, will fit JIC 37° and SAE 45°

Item #	Hose	JIC	Die	Pusher	Price
3-02544	1/8"	1/4"	4540-302	4599-FP010	\$5.76
3-03544	3/16"	1/4"	4540-303	4599-FP011	\$4.00
3-04544	1/4"	1/4"	4540-304	4599-FP012	\$4.03
3-04545	1/4"	5/16"	4540-304	4599-FP013	\$4.29
3-04546	1/4"	3/8"	4540-304	4599-FP013	\$4.41
3-05545	5/16"	5/16"	4540-305	4599-FP013	\$4.87
3-05546	5/16"	3/8"	4540-305	4599-FP013	\$4.71
3-06546	3/8"	3/8"	4540-306	4599-FP015	\$4.53
3-06548	3/8"	1/2"	4540-306	4599-FP005	\$5.25
3-08548	1/2"	1/2"	4540-308	4599-FP016	\$5.95
3-08550	1/2"	5/8"	4540-308	4599-FP006	\$6.54
3-12552	3/4"	3/4"	4540-312	4599-FP008	\$9.84

SAE 45° Swivel

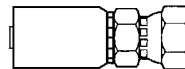

For all other sizes, use JIC 37° Female Swivel

Item #	Hose	SAE	Die	Pusher	Price
3-06A06	3/8"	3/8"	4540-306	4599-FP014	\$5.71

JIC 37° Male

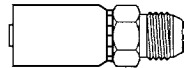

Item #	Hose	JIC	Die	Pusher	Price
3-03504	3/16"	1/4"	4540-303	4599-MP001	\$3.84
3-04504	1/4"	1/4"	4540-304	4599-MP002	\$3.97
3-04505	1/4"	5/16"	4540-304	4599-MP002	\$4.14
3-04506	1/4"	3/8"	4540-304	4599-MP005	\$5.71
3-05506	5/16"	3/8"	4540-305	4599-MP004	\$6.25
3-06506	3/8"	3/8"	4540-306	4599-MP005	\$4.67
3-06508	3/8"	1/2"	4540-306	4599-MP007	\$4.94
3-08508	1/2"	1/2"	4540-308	4599-MP008	\$5.76
3-08510	1/2"	5/8"	4540-308	4599-MP009	\$6.11
3-12512	3/4"	3/4"	4540-312	4599-MP011	\$9.57

3 Series Thermoplastic Hose Fittings are intended for use with SAE 100R7 or reduced O.D. 100R8 Thermoplastic Hose.

- Interchangeable with Synflex 3903 Series Hose Fittings
- Can be attached with a hose crimper or with the DST1 Swaging Tool (page 68).

JIC 37° Female Swivel 45°

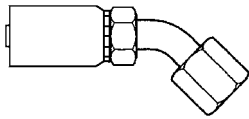

Item #	Hose	JIC	Die	Pusher	Price
3-04605	1/4"	5/16"	4540-304	4599-TP205	\$11.64
3-06606	3/8"	3/8"	4540-306	4599-TP206	\$11.18
3-06608	3/8"	1/2"	4540-306	4599-TP208	\$11.13
3-08608	1/2"	1/2"	4540-308	4599-TP308	\$14.79
3-08610	1/2"	5/8"	4540-308	4599-TP310	\$15.90

JIC 37° Female Swivel 90°

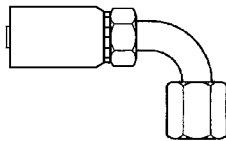

Item #	Hose	JIC	Die	Pusher	Price
3-03644	3/16"	1/4"	4540-303	4599-TP204	\$10.93
3-04644	1/4"	1/4"	4540-304	4599-TP204	\$10.79
3-04645	1/4"	5/16"	4540-304	4599-TP205	\$13.21
3-04646	1/4"	3/8"	4540-304	4599-TP206	\$12.69
3-05646	5/16"	3/8"	4540-305	4599-TP206	\$13.08
3-06646	3/8"	3/8"	4540-306	4599-TP206	\$11.28
3-06648	3/8"	1/2"	4540-306	4599-TP208	\$13.11
3-08648	1/2"	1/2"	4540-308	4599-TP308	\$13.40
3-08650	1/2"	5/8"	4540-308	4599-TP310	\$17.45

JIC 37° Female Swivel 90° Long Drop Elbow

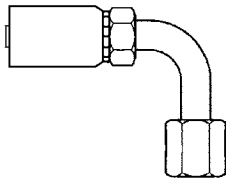

Item #	Hose	JIC	Die	Pusher	Price
3-04845	1/4"	5/16"	4540-304	4599-TP205	\$9.86
3-06846	3/8"	3/8"	4540-306	4599-TP206	\$13.78
3-06848	3/8"	1/2"	4540-306	4599-TP208	\$13.91
3-08850	1/2"	5/8"	4540-308	4599-TP310	\$17.73

O-Ring Face Seal (ORFS) Female Swivel

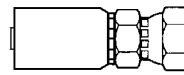

Item #	Hose	ORFS	Die	Pusher	Price
3-04404	1/4"	1/4"	4540-304	4599-MP045	\$9.21
3-05406	5/16"	3/8"	4540-306	4599-MP037	\$10.56
3-06406	3/8"	3/8"	4540-306	4599-MP037	\$10.59
3-08408	1/2"	1/2"	4540-308	4599-MP046	\$12.46

O-Ring Face Seal (ORFS) Female Swivel 45°

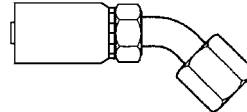

Item #	Hose	ORFS	Die	Pusher	Price
3-04444	1/4"	1/4"	4540-304	4599-TP204	\$10.42
3-06446	3/8"	3/8"	4540-306	4599-TP206	\$11.90
3-08448	1/2"	1/2"	4540-308	4599-TP308	\$13.88

O-Ring Face Seal (ORFS) Female Swivel 90°

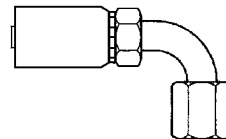

Item #	Hose	ORFS	Die	Pusher	Price
3-04474	1/4"	1/4"	4540-304	4599-TP204	\$11.11
3-05476	5/16"	3/8"	4540-305	4599-TP206	\$13.23
3-06476	3/8"	3/8"	4540-306	4599-TP206	\$11.31
3-08478	1/2"	1/2"	4540-308	4599-TP308	\$13.51

Inverted Flare Male Swivel 45°

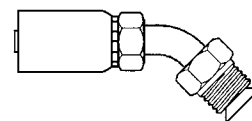

Item #	Hose	Tube	Die	Pusher	Price
3-06C46	3/8"	3/8"	4540-306	4599-TP206	\$10.28

Inverted Flare Male Swivel 90°

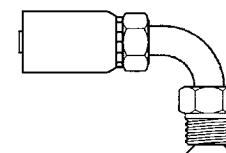

Item #	Hose	Tube	Die	Pusher	Price
3-06C76	3/8"	3/8"	4540-306	4599-TP206	\$10.28

T01 NPTF Male Pipe Rigid

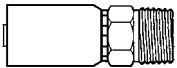

Item #	Hose	NPTF	Price
T01-03-02	3/16"	1/8"	\$3.42
T01-03-04	3/16"	1/4"	\$3.70
T01-04-02	1/4"	1/8"	\$2.76
T01-04-04	1/4"	1/4"	\$3.10
T01-04-06	1/4"	3/8"	\$3.91
T01-05-04	5/16"	1/4"	\$3.42
T01-05-06	5/16"	3/8"	\$3.72
T01-06-04	3/8"	1/4"	\$3.36
T01-06-06	3/8"	3/8"	\$3.60
T01-06-08	3/8"	1/2"	\$4.29
T01-08-06	1/2"	3/8"	\$4.29
T01-08-08	1/2"	1/2"	\$3.91
T01-12-12	3/4"	3/4"	\$6.41
T01-16-16	1"	1"	\$10.31

T04 NPTF Male Pipe Swivel

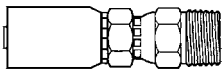

Item #	Hose	NPTF	Price
T04-04-04	1/4"	1/4"	\$5.34
T04-05-04	5/16"	1/4"	\$5.43
T04-06-06	3/8"	3/8"	\$5.64
T04-08-08	1/2"	1/2"	\$6.47

T08 JIC 37° Male Rigid

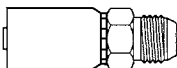

Item #	Hose	JIC	Price
T08-04-04	1/4"	1/4"	\$3.49
T08-04-05	1/4"	5/16"	\$13.02
T08-04-06	1/4"	3/8"	\$3.91
T08-05-05	5/16"	5/16"	\$3.91
T08-06-06	3/8"	3/8"	\$4.13
T08-06-08	3/8"	1/2"	\$4.69
T08-08-08	1/2"	1/2"	\$5.17
T08-08-10	1/2"	5/8"	\$6.02
T08-12-12	3/4"	3/4"	\$8.30
T08-16-16	1"	1"	\$11.20

T09 JIC 37° Female Swivel

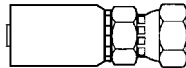

Item #	Hose	JIC	Price
T09-03-04	3/16"	1/4"	\$4.43
T09-04-04	1/4"	1/4"	\$3.74
T09-04-05	1/4"	5/16"	\$4.00
T09-04-06	1/4"	3/8"	\$4.31
T09-05-05	5/16"	5/16"	\$5.21
T09-05-06	5/16"	3/8"	\$4.42
T09-06-06	3/8"	3/8"	\$4.29
T09-06-08	3/8"	1/2"	\$5.27
T09-08-08	1/2"	1/2"	\$5.08
T09-08-10	1/2"	5/8"	\$6.37
T09-12-12	3/4"	3/4"	\$8.77
T09-16-16	1"	1"	\$12.73

T07 SAE 45° Female Swivel

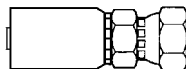

Item #	Hose	SAE	Price
T07-05-06	5/16"	3/8"	\$5.21
T07-06-06	3/8"	3/8"	\$4.45

T23 SAE 45° Female Swivel 90°

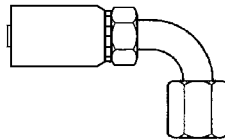

Item #	Hose	SAE	Price
T23-05-06	5/16"	3/8"	\$9.23
T23-06-06	3/8"	3/8"	\$9.08

T10 British Standard Pipe (BSPP) Female Swivel

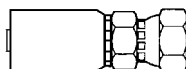

Item #	Hose	BSPP	Price
T10-04-04	1/4"	1/4"	\$10.32
T10-06-06	3/8"	3/8"	\$10.75
T10-08-08	1/2"	1/2"	\$14.76

T25 JIC 37°/SAE 45° Dual Seat Female Swivel 45°

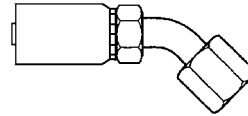

Item #	Hose	JIC	Price
T25-04-04	1/4"	1/4"	\$8.11
T25-05-06*	5/16"	3/8"	\$9.01
T25-06-06*	3/8"	3/8"	\$9.31
T25-08-08	1/2"	1/2"	\$9.89
T25-08-10	1/2"	5/8"	\$11.24
T25-12-12*	3/4"	3/4"	\$15.36
T25-16-16	1"	1"	\$21.27

T26 JIC 37°/SAE 45° Dual Seat Female Swivel 90°

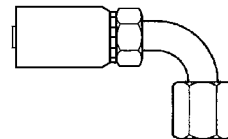

Item #	Hose	JIC	Price
T26-04-04	1/4"	1/4"	\$7.81
T26-04-05	1/4"	5/16"	\$8.24
T26-05-06*	5/16"	3/8"	\$8.73
T26-06-06*	3/8"	3/8"	\$8.90
T26-06-08	3/8"	1/2"	\$9.46
T26-08-08	1/2"	1/2"	\$9.89
T26-08-10	1/2"	5/8"	\$11.85
T26-12-12*	3/4"	3/4"	\$15.56
T26-16-16	1"	1"	\$21.92

T27 JIC 37°/SAE 45° Dual Seat Female Swivel 90° Long

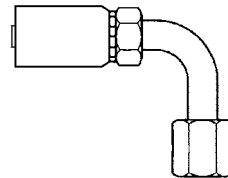

Item #	Hose	JIC	Price
T27-04-04	1/4"	1/4"	\$7.58
T27-06-06*	3/8"	3/8"	\$8.41
T27-08-08	1/2"	1/2"	\$10.75
T27-12-12*	3/4"	3/4"	\$18.43
T27-16-16	1"	1"	\$21.27

* JIC seat and thread only

IMPORTANT: For use only with SAE 100R14A PTFE Hose.

T30

O-Ring Face Seal Female Swivel

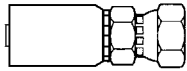

Item #	Hose	ORFS	Price
T30-04-04	1/4"	1/4"	\$5.57
T30-04-06	1/4"	3/8"	\$6.08
T30-05-06	5/16"	3/8"	\$6.21
T30-06-06	3/8"	3/8"	\$6.21
T30-06-08	3/8"	1/2"	\$7.29
T30-08-08	1/2"	1/2"	\$7.47
T30-08-10	1/2"	5/8"	\$9.44
T30-12-12	3/4"	3/4"	\$12.60
T30-16-16	1"	1"	\$18.23

T31

O-Ring Face Seal Female Swivel 45°

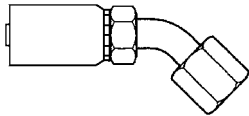

Item #	Hose	ORFS	Price
T31-04-04	1/4"	1/4"	\$9.33
T31-05-06	5/16"	3/8"	\$9.99
T31-06-06	3/8"	3/8"	\$9.99
T31-08-08	1/2"	1/2"	\$11.34
T31-12-12	3/4"	3/4"	\$16.85
T31-16-16	1"	1"	\$21.14

T32

O-Ring Face Seal Female Swivel 90°

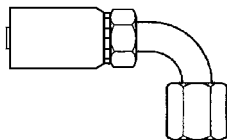

Item #	Hose	ORFS	Price
T32-04-04	1/4"	1/4"	\$8.90
T32-04-06	1/4"	3/8"	\$9.86
T32-05-06	5/16"	3/8"	\$10.42
T32-06-06	3/8"	3/8"	\$9.33
T32-06-08	3/8"	1/2"	\$11.16
T32-08-08	1/2"	1/2"	\$11.29
T32-12-12	3/4"	3/4"	\$18.00
T32-16-16	1"	1"	\$21.14

T33

O-Ring Face Seal Female Swivel 90°
Long

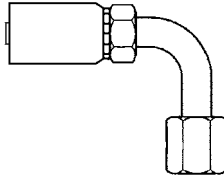

Item #	Hose	ORFS	Price
T33-04-04	1/4"	1/4"	\$9.39
T33-06-06	3/8"	3/8"	\$10.21
T33-08-08	1/2"	1/2"	\$11.58

T18

Inverted Flare Male Swivel

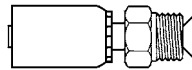

Item #	Hose	Tube	Price
T18-04-04	1/4"	1/4"	\$6.41
T18-04-05	1/4"	5/16"	\$6.52
T18-05-05	5/16"	5/16"	\$8.24
T18-06-06	3/8"	3/8"	\$6.73

T19

Inverted Flare Male Swivel 45°

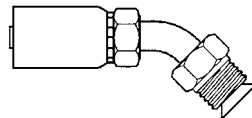

Item #	Hose	Tube	Price
T19-04-04	1/4"	1/4"	\$8.31
T19-06-06	3/8"	3/8"	\$8.34

T20

Inverted Flare Male Swivel 90°

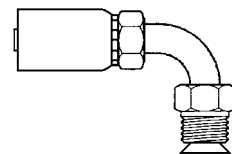

Item #	Hose	Tube	Price
T20-04-04	1/4"	1/4"	\$7.94
T20-06-06	3/8"	3/8"	\$8.34

Weatherhead E Series Interchange

03E-102	T01-03-02	06E-646	T27-06-06
03E-104	T01-03-04	06E-666	T26-06-06
03E-604	T09-03-04	06E-668	T26-06-08
04E-102	T01-04-02	06E-686	T25-06-06
04E-104	T01-04-04	06E-A26	T32-06-06
04E-106	T01-04-06	06E-A28	T32-06-08
04E-354	T10-04-04	06E-A66	T33-06-06
04E-504	T08-04-04	06E-B06	T18-06-06
04E-506	T08-04-06	06E-B46	T19-06-06
04E-604	T09-04-04	06E-B66	T20-06-06
04E-605	T09-04-05	06EJ06	T04-06-06
04E-606	T09-04-06	06E-L66	T31-06-06
04E-644	T27-04-04	06E-S66	T30-06-06
04E-664	T26-04-04	06E-S68	T30-06-08
04E-665	T26-04-05	08E-106	T01-08-06
04E-684	T25-04-04	08E-108	T01-08-08
04E-A24	T32-04-04	08E-358	T10-08-08
04E-A26	T32-04-06	08E-508	T08-08-08
04E-A64	T33-04-04	08E-510	T08-08-10
04E-B04	T18-04-04	08E-608	T09-08-08
04E-B05	T18-04-05	08E-610	T09-08-10
04E-B44	T19-04-04	08E-648	T27-08-08
04E-B64	T20-04-04	08E-668	T26-08-08
04E-J04	T04-04-04	08E-670	T26-08-10
04E-L64	T31-04-04	08E-688	T25-08-08
04E-S64	T30-04-04	08E-690	T25-08-10
04E-S66	T30-04-06	08E-A28	T32-08-08
05E-104	T01-05-04	08E-A68	T33-08-08
05E-106	T01-05-06	08E-J08	T04-08-08
05E-406	T07-05-06	08E-L68	T31-08-08
05E-466	T23-05-06	08E-S68	T30-08-08
05E-505	T08-05-05	08E-S70	T30-08-10
05E-605	T09-05-05	12E-111	T01-12-12
05E-606	T09-05-06	12E-512	T08-12-12
05E-666	T26-05-06	12E-612	T09-12-12
05E-686	T25-05-06	12E-652	T27-12-12
05E-A26	T32-05-06	12E-672	T26-12-12
05E-B05	T18-05-05	12E-692	T25-12-12
05E-J04	T04-05-04	12E-A32	T32-12-12
05E-L66	T31-05-06	12E-L72	T31-12-12
05E-S66	T30-05-06	12E-S72	T30-12-12
06E-104	T01-06-04	16E-115	T01-16-16
06E-106	T01-06-06	16E-516	T08-16-16
06E-108	T01-06-08	16E-616	T09-16-16
06E-356	T10-06-06	16E-656	T27-16-16
06E-406	T07-06-06	16E-676	T26-16-16
06E-466	T23-06-06	16E-696	T25-16-16
06E-506	T08-06-06	16E-A36	T32-16-16
06E-508	T08-06-08	16E-L76	T31-16-16
06E-606	T09-06-06	16E-S76	T30-16-16
06E-608	T09-06-08		

IMPORTANT: For use only with SAE 100R14A PTFE Hose.

FJX
JIC 37° Female Swivel

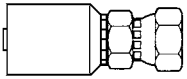

FJX-20-20JJ	\$52.22
FJX-24-24JJ	\$75.23
FJX-32-32JJ	\$121.63

MP
NPTF Male Pipe Rigid

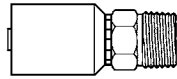

MP-20-20JJ	\$40.77
MP-24-24JJ	\$56.88
MP-24-32JJ	\$86.53
MP-32-32JJ	\$95.85

C61
Code 61 Flange

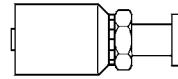

C61-20-20JJ	\$50.63
C61-24-24JJ	\$65.94
C61-24-32JJ	\$76.92
C61-32-32JJ	\$119.93

C6160
Code 61 Flange 60°

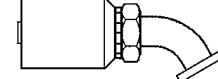

C6160-20-20JJ	\$74.90
C6160-24-24JJ	\$90.85
C6160-24-32JJ	\$94.50
C6160-32-32JJ	\$158.77

FJX45
JIC 37° Female Swivel 45°

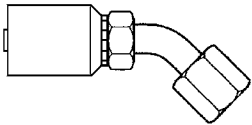

FJX45-20-20JJ	\$78.63
FJX45-24-24JJ	\$98.67
FJX45-32-32JJ	\$208.59

FFX
O-Ring Face Seal (ORFS)
Female Swivel

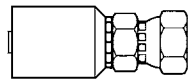

FFX-20-20JJ	\$49.81
FFX-24-24JJ	\$61.55

C6122
Code 61 Flange 22°

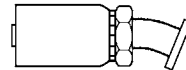

C6122-20-20JJ	\$174.07
C6122-24-24JJ	\$263.43
C6122-24-32JJ	\$116.28
C6122-32-32JJ	\$150.15

C6167
Code 61 Flange 67°

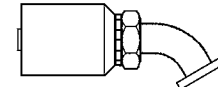

C6167-20-20JJ	\$67.74
C6167-24-24JJ	\$90.88
C6167-24-32JJ	\$94.31
C6167-32-32JJ	\$159.71

FJX90
JIC 37° Female Swivel 90°

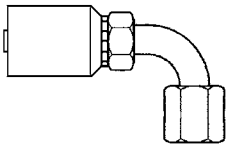

FJX90-20-20JJ	\$73.96
FJX90-24-24JJ	\$119.45
FJX90-32-32JJ	\$202.50

FFX45
O-Ring Face Seal (ORFS)
Female Swivel 45°

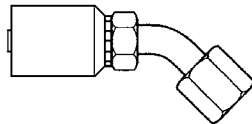

FFX45-20-20JJ	\$90.96
FFX45-24-24JJ	\$99.46

C6130
Code 61 Flange 30°

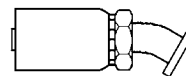

C6130-20-20JJ	\$72.50
C6130-24-24JJ	\$85.75
C6130-24-32JJ	\$96.53
C6130-32-32JJ	\$152.25

C6190
Code 61 Flange 90°

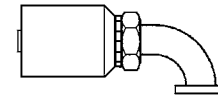

C6190-20-20JJ	\$66.79
C6190-24-24JJ	\$73.09
C6190-24-32JJ	\$116.42
C6190-32-32JJ	\$122.26

MJ
JIC 37° Male Rigid

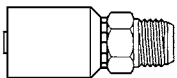

MJ-20-20JJ	\$54.29
MJ-24-24JJ	\$80.01
MJ-32-32JJ	\$136.82

FFX90
O-Ring Face Seal (ORFS)
Female Swivel 90°

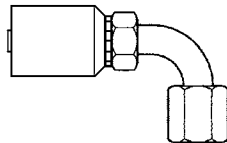

FFX90-20-20JJ	\$73.96
FFX90-24-24JJ	\$102.39

C6145
Code 61 Flange 45°

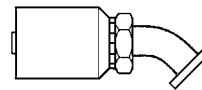

C6145-20-20JJ	\$62.10
C6145-24-24JJ	\$79.63
C6145-24-32JJ	\$93.09
C6145-32-32JJ	\$113.82

C62
Code 62 Flange

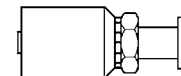

C62-20-20JJ	\$59.86
C62-24-24JJ	\$71.77
C62-24-32JJ	\$92.45
C62-32-32JJ	\$144.61

C6222

Code 62 Flange 22°

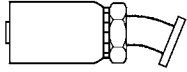

C6222-20-20JJ	\$73.38
C6222-24-24JJ	\$96.43
C6222-24-32JJ	\$152.35
C6222-32-32JJ	\$171.66

C6260

Code 62 Flange 60°

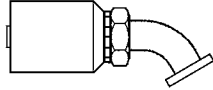

C6260-20-20JJ	\$76.80
C6260-24-24JJ	\$98.65
C6260-24-32JJ	\$161.77
C6260-32-32JJ	\$188.41

CAT

Caterpillar Flange

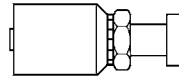

CAT-20-20JJ	\$69.39
CAT-20-24JJ	\$79.63
CAT-24-24JJ	\$62.97
CAT-32-32JJ	\$168.23

FDH

DIN Heavy (Metric)
Universal Seat
Female Swivel

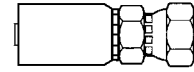

FDH-20-38-52JJ	\$111.23
----------------	----------

C6230

Code 62 Flange 30°

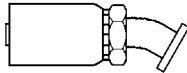

C6230-20-20JJ	\$58.43
C6230-24-24JJ	\$69.57
C6230-32-32JJ	\$176.55

C6267

Code 62 Flange 67°

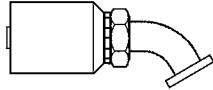

C6267-20-20JJ	\$69.77
C6267-24-24JJ	\$98.65

CAT45

Caterpillar Flange 45°

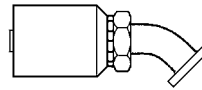

CAT45-20-20JJ	\$76.27
CAT45-20-24JJ	\$91.10
CAT45-24-24JJ	\$91.73
CAT45-32-32JJ	\$162.47

C6245

Code 62 Flange 45°

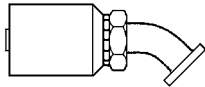

C6245-20-20JJ	\$79.96
C6245-24-24JJ	\$94.07
C6245-24-32JJ	\$162.26
C6245-32-32JJ	\$167.12

C6290

Code 62 Flange 90°

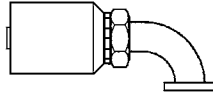

C6290-20-20JJ	\$70.70
C6290-20-24JJ	\$89.91
C6290-24-24JJ	\$96.82
C6290-24-32JJ	\$109.06
C6290-32-32JJ	\$179.53

CAT90

Caterpillar Flange 90°

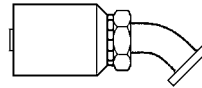

CAT90-20-20JJ	\$67.23
CAT90-20-24JJ	\$87.66
CAT90-24-24JJ	\$85.93
CAT90-32-32JJ	\$163.87

JJ Series Hose Fittings feature a bite-to-the-wire design, and are intended for use with 4SH (sizes -24 and -32) and R13 (sizes -20, -24 and -32) hydraulic hoses.

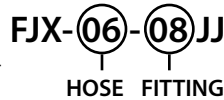

Ferrule



Item #	Hose	Price
112-400	3/4"	\$2.36
116-400	1"	\$2.82
120-400	1 1/4"	\$3.34
124-400	1 1/2"	\$5.32
132-400	2"	\$7.50

NPTF

Male Pipe

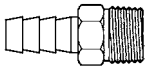

Item #	Hose	NPTF	Price
112-112	3/4"	3/4"	\$3.64
112-116	3/4"	1"	\$6.57
116-116	1"	1"	\$6.16
120-120	1 1/4"	1 1/4"	\$12.27
124-124	1 1/2"	1 1/2"	\$17.91
132-132	2"	2"	\$33.32

ORB

SAE Straight Thread O-Ring Boss - Male

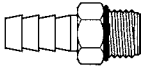

Item #	Hose	ORB	Price
112-712	3/4"	3/4"	\$6.15
116-716	1"	1"	\$10.06
120-720	1 1/4"	1 1/4"	\$16.77

JIC

37° Flare - Female Swivel

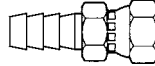

Item #	Hose	JIC	Price
112-612	3/4"	3/4"	\$5.86
112-614	3/4"	7/8"	\$8.94
112-616	3/4"	1"	\$8.94
116-616	1"	1"	\$8.94
120-620	1 1/4"	1 1/4"	\$19.68
124-624	1 1/2"	1 1/2"	\$28.19
132-632	2"	2"	\$66.80

JIC

37° Flare - Male

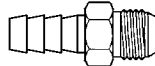

Item #	Hose	JIC	Price
112-512	3/4"	3/4"	\$4.20
112-514	3/4"	7/8"	\$6.71
112-516	3/4"	1"	\$7.28
116-516	1"	1"	\$8.01
120-520	1 1/4"	1 1/4"	\$15.09

Code 61

Flange

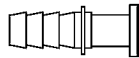

Item #	Hose	Flange	Price
112-G12	3/4"	3/4"	\$20.02
116-G16	1"	1"	\$26.95
120-G20	1 1/4"	1 1/4"	\$45.13
124-G24	1 1/2"	1 1/2"	\$51.98
132-G32	2"	2"	\$69.24

Code 61

Flange 45°

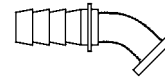

Item #	Hose	Flange	Price
124-G54	1 1/2"	1 1/2"	\$63.36
132-G62	2"	2"	\$91.48
140-G62	2 1/2"	2"	\$131.00

Code 61

Flange 90°



Item #	Hose	Flange	Price
120-G80	1 1/4"	1 1/4"	\$59.16
124-G84	1 1/2"	1 1/2"	\$64.98
124-G92	1 1/2"	2"	\$71.56
132-G92	2"	2"	\$96.08
132-G96	2"	2 1/2"	\$119.02
140-G92	2 1/2"	2"	\$135.96
140-G96	2 1/2"	2 1/2"	\$174.16

IMPORTANT: For use only with SAE 100R4 Suction Hose.

HAS

NPTF Male Pipe

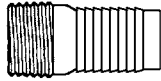

Item #	NPT	Hose	Price
HAS-02	1/2"	1/2"	\$2.18
HAS-03	3/4"	3/4"	\$2.27
HAS-04	1"	1"	\$2.61
HAS-05	1 1/4"	1 1/4"	\$3.35
HAS-06	1 1/2"	1 1/2"	\$3.81
HAS-08	2"	2"	\$4.61
HAS-10	2 1/2"	2 1/2"	\$9.95
HAS-12	3"	3"	\$11.82
HAS-16	4"	4"	\$17.49

HRS

NPTF Male Pipe Reducer

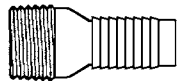

Item #	NPT	Hose	Price
HRS-04x03	1"	3/4"	\$6.45
HRS-05x04	1 1/4"	1"	\$8.07
HRS-06x05	1 1/2"	1 1/4"	\$7.36
HRS-08x06	2"	1 1/2"	\$9.31
HRS-10x08	2 1/2"	2"	\$17.38
HRS-12x10	3"	2 1/2"	\$20.44
HRS-16x12	4"	3"	\$44.89

HES

NPTF Male Pipe Expander

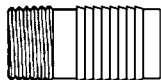

Item #	NPT	Hose	Price
HES-03x04	3/4"	1"	\$4.71
HES-04x05	1"	1 1/4"	\$5.94
HES-05x06	1 1/4"	1 1/2"	\$6.34
HES-06x08	1 1/2"	2"	\$11.50
HES-08x10	2"	2 1/2"	\$18.15
HES-10x12	2 1/2"	3"	\$22.30
HES-12x16	3"	4"	\$44.89

HAPS

Zinc-Plated NPTF Male Pipe

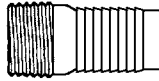

Item #	NPT	Hose	Price
HAPS-02	1/2"	1/2"	\$2.56
HAPS-03	3/4"	3/4"	\$2.65
HAPS-04	1"	1"	\$3.22
HAPS-05	1 1/4"	1 1/4"	\$3.82
HAPS-06	1 1/2"	1 1/2"	\$4.46
HAPS-08	2"	2"	\$5.38
HAPS-10	2 1/2"	2 1/2"	\$11.25
HAPS-12	3"	3"	\$13.68
HAPS-16	4"	4"	\$20.97

HCPS

Zinc-Plated Hose Mender

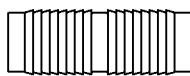

Item #	Hose	Price
HCPS-02	1/2"	\$2.25
HCPS-03	3/4"	\$2.61
HCPS-04	1"	\$2.92
HCPS-05	1 1/4"	\$4.60
HCPS-06	1 1/2"	\$4.56
HCPS-08	2"	\$6.04
HCPS-10	2 1/2"	\$10.73
HCPS-12	3"	\$12.24
HCPS-16	4"	\$20.44

CN-100

NPTF Male Pipe with Clamshell

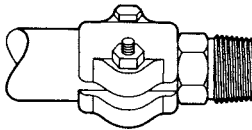

Item #	Hose	NPT	Price
C16N-116	1"	1"	\$18.68
C20N-120	1 1/4"	1 1/4"	\$26.47
C24N-124	1 1/2"	1 1/2"	\$55.86
C32N-132	2"	2"	\$64.07

TBC

T-Bolt Clamp

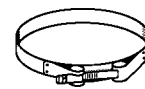

Stainless steel band, carbon steel bolt

Item #	Fits Hose OD	Price
TBC131	1.250" – 1.406"	\$7.07
TBC150	1.344" – 1.562"	\$5.13
TBC175	1.594" – 1.812"	\$5.13
TBC188	1.724" – 1.942"	\$5.13
TBC200	1.844" – 2.062"	\$5.13
TBC225	2.094" – 2.312"	\$5.13
TBC238	2.224" – 2.442"	\$5.13
TBC250	2.344" – 2.562"	\$5.25
TBC256	2.326" – 2.622"	\$5.06
TBC263	2.396" – 2.692"	\$5.06
TBC275	2.516" – 2.812"	\$5.06
TBC288	2.646" – 2.942"	\$5.06
TBC300	2.766" – 3.062"	\$5.09
TBC312	2.886" – 3.182"	\$5.13
TBC325	3.016" – 3.312"	\$5.13
TBC350	3.266" – 3.562"	\$5.41
TBC375	3.516" – 3.812"	\$5.41
TBC382	3.586" – 3.882"	\$5.45
TBC400	3.766" – 4.062"	\$5.45
TBC425	4.016" – 4.312"	\$5.45

Steel hose barbs must be securely affixed with T-Bolt Clamps.

SAE 100R1 Field-Attachable Hose Fittings



JIC 37° Female Swivel



Item #	Hose	JIC	Price
R1-04-604	1/4"	1/4"	\$19.96
R1-04-606	1/4"	3/8"	\$20.96
R1-06-606	3/8"	3/8"	\$12.69
R1-08-608	1/2"	1/2"	\$18.78
R1-08-610	1/2"	5/8"	\$23.97
R1-12-612	3/4"	3/4"	\$41.44
R1-16-616	1"	1"	\$75.51

JIC 37° Male

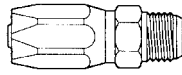

Item #	Hose	JIC	Price
R1-04-504	1/4"	1/4"	\$16.30
R1-06-506	3/8"	3/8"	\$17.48
R1-08-508	1/2"	1/2"	\$19.67
R1-12-512	3/4"	3/4"	\$73.85
R1-16-516	1"	1"	\$83.00

IMPORTANT: For use only with SAE 100R1 AT Hydraulic Hose.

NPTF Male Pipe

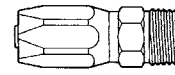

Item #	Hose	NPTF	Price
R1-04-104	1/4"	1/4"	\$14.47
R1-06-104	3/8"	1/4"	\$9.90
R1-06-106	3/8"	3/8"	\$13.71
R1-08-108	1/2"	1/2"	\$17.01
R1-12-112	3/4"	3/4"	\$42.75
R1-16-116	1"	1"	\$58.04

SAE 100R2 Field-Attachable Hose Fittings



NPTF Male Pipe

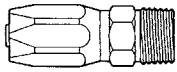

Item #	Hose	NPTF	Price
R2-04-102	1/4"	1/8"	\$29.75
R2-04-104	1/4"	1/4"	\$19.37
R2-06-106	3/8"	3/8"	\$13.60
R2-08-106	1/2"	3/8"	\$23.69
R2-08-108	1/2"	1/2"	\$12.21
R2-08-112	1/2"	3/4"	\$38.92
R2-12-112	3/4"	3/4"	\$37.02
R2-16-116	1"	1"	\$48.06
R2-20-120	1 1/4"	1 1/4"	\$109.84
R2-24-124	1 1/2"	1 1/2"	\$128.93

SS = Stainless Steel

SS-R2-04-104	1/4"	1/4"	\$57.71
SS-R2-06-106	3/8"	3/8"	\$66.94
SS-R2-08-108	1/2"	1/2"	\$79.91
SS-R2-12-112	3/4"	3/4"	\$102.88
SS-R2-16-116	1"	1"	\$176.65

JIC 37° Male

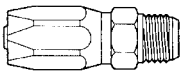

Item #	Hose	JIC	Price
R2-04-504	1/4"	1/4"	\$20.15
R2-04-505	1/4"	5/16"	\$35.72
R2-04-506	1/4"	3/8"	\$31.73
R2-06-506	3/8"	3/8"	\$15.78
R2-06-508	3/8"	1/2"	\$15.79
R2-08-508	1/2"	1/2"	\$15.07
R2-08-510	1/2"	5/8"	\$19.83
R2-12-512	3/4"	3/4"	\$56.33
R2-16-516	1"	1"	\$85.91

JIC 37° Female Swivel



Item #	Hose	JIC	Price
R2-04-604	1/4"	1/4"	\$24.79
R2-04-605	1/4"	5/16"	\$23.09
R2-04-606	1/4"	3/8"	\$21.13
R2-06-606	3/8"	3/8"	\$11.85
R2-06-608	3/8"	1/2"	\$31.13
R2-08-608	1/2"	1/2"	\$15.69
R2-08-610	1/2"	5/8"	\$19.41
R2-12-610	3/4"	5/8"	\$37.92
R2-12-612	3/4"	3/4"	\$25.24
R2-12-614	3/4"	7/8"	\$57.70
R2-16-616	1"	1"	\$37.77
R2-20-620	1 1/4"	1 1/4"	\$104.13
R2-24-624	1 1/2"	1 1/2"	\$160.49

SS = Stainless Steel

SS-R2-04-604	1/4"	1/4"	\$63.57
SS-R2-06-606	3/8"	3/8"	\$74.24
SS-R2-08-608	1/2"	1/2"	\$94.56
SS-R2-12-612	3/4"	3/4"	\$178.13
SS-R2-16-616	1"	1"	\$210.00

JIC 37° Female Swivel 45°

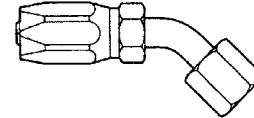

Item #	Hose	JIC	Price
R2-04-684	1/4"	1/4"	\$32.67
R2-06-686	3/8"	3/8"	\$26.74
R2-08-688	1/2"	1/2"	\$31.26
R2-08-690	1/2"	5/8"	\$41.07
R2-12-692	3/4"	3/4"	\$48.44
R2-16-696	1"	1"	\$96.23

JIC 37° Female Swivel 90°

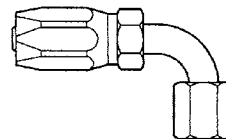

Item #	Hose	JIC	Price
R2-04-664	1/4"	1/4"	\$24.99
R2-06-666	3/8"	3/8"	\$23.76
R2-08-668	1/2"	1/2"	\$25.59
R2-08-670	1/2"	5/8"	\$32.91
R2-12-672	3/4"	3/4"	\$33.83
R2-16-676	1"	1"	\$74.06

IMPORTANT: For use only with SAE 100R2 AT Hydraulic Hose.

JIC 37° Female Swivel



Item #	Hose	JIC	Price
R5-04-604	3/16"	1/4"	\$5.29
R5-05-605	1/4"	5/16"	\$6.73
R5-06-606	5/16"	3/8"	\$7.54
R5-06-608	5/16"	1/2"	\$17.63
R5-08-608	13/32"	1/2"	\$10.10
R5-10-608	1/2"	1/2"	\$24.09
R5-10-610	1/2"	5/8"	\$14.43
R5-12-612	5/8"	3/4"	\$22.45
R5-16-616	7/8"	1"	\$29.56

JIC 37° Female Swivel 45°

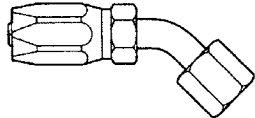

Item #	Hose	JIC	Price
R5-04-684	3/16"	1/4"	\$16.17
R5-05-685	1/4"	5/16"	\$17.62
R5-06-686	5/16"	3/8"	\$17.86
R5-08-688	13/32"	1/2"	\$18.60
R5-10-690	1/2"	5/8"	\$26.40

JIC 37° Female Swivel 90°

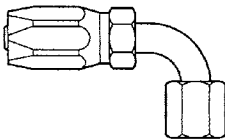

Item #	Hose	JIC	Price
R5-04-664	3/16"	1/4"	\$13.55
R5-05-665	1/4"	5/16"	\$18.05
R5-06-666	5/16"	3/8"	\$19.98
R5-08-668	13/32"	1/2"	\$21.05
R5-10-670	1/2"	5/8"	\$28.39
R5-12-672	5/8"	3/4"	\$39.21
R5-16-676	7/8"	1"	\$59.55

JIC 37° Male

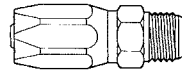

Item #	Hose	JIC	Price
R5-04-504	3/16"	1/4"	\$7.04
R5-05-505	1/4"	5/16"	\$11.96
R5-06-506	5/16"	3/8"	\$7.72
R5-08-508	13/32"	1/2"	\$11.24
R5-10-510	1/2"	5/8"	\$14.62
R5-12-512	5/8"	3/4"	\$25.83

NPTF Male Pipe

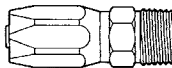

Item #	Hose	NPTF	Price
R5-04-102	3/16"	1/8"	\$3.83
R5-04-104	3/16"	1/4"	\$4.68
R5-05-104	1/4"	1/4"	\$5.07
R5-06-104	5/16"	1/4"	\$5.57
R5-06-106	5/16"	3/8"	\$7.14
R5-08-106	13/32"	3/8"	\$7.78
R5-08-108	13/32"	1/2"	\$8.84
R5-10-108	1/2"	1/2"	\$11.32
R5-10-112	1/2"	3/4"	\$19.72
R5-12-112	5/8"	3/4"	\$18.14

SAE 45° Female Swivel



Item #	Hose	SAE	Price
R5-06-406	5/16"	3/8"	\$7.68
R5-12-412	5/8"	3/4"	\$42.50

SAE 45° Female Swivel 45°

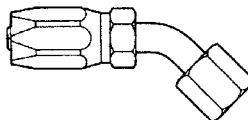

Item #	Hose	SAE	Price
R5-06-486	5/16"	3/8"	\$17.86
R5-12-492	5/8"	3/4"	\$34.36

SAE 45° Female Swivel 90°

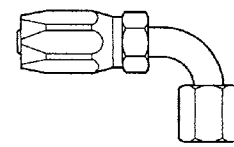

Item #	Hose	SAE	Price
R5-06-466	5/16"	3/8"	\$19.90

SAE 45° Male

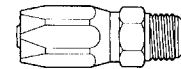

Item #	Hose	SAE	Price
R5-04-304	3/16"	1/4"	\$3.95
R5-06-306	5/16"	3/8"	\$5.61
R5-08-308	13/32"	1/2"	\$7.19
R5-12-312	5/8"	3/4"	\$11.96

Inverted Flare Male Swivel

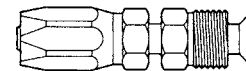

Item #	Hose	MIX	Price
R5-04-B04	3/16"	1/4"	\$10.53
R5-05-B05	1/4"	5/16"	\$12.26
R5-06-B06	5/16"	3/8"	\$12.34
R5-08-B08	13/32"	1/2"	\$14.48

Inverted Flare Male Swivel 90°

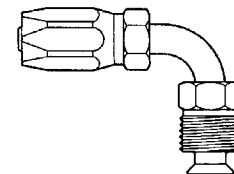

Item #	Hose	MIX	Price
R5-04-E04	3/16"	1/4"	\$17.03
R5-05-E05	1/4"	5/16"	\$25.45
R5-06-E06	5/16"	3/8"	\$21.23

IMPORTANT: For use only with SAE 100R5 General Purpose/Truck Hose.

SAE 100R6 Field-Attachable Hose Fittings

183 NPTF Male Pipe

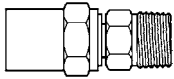

Item #	Hose	Pipe	Price
183-4084K	1/4"	1/4"	\$5.51
183-4086K	1/4"	3/8"	\$7.83
183-5094K	5/16"	1/4"	\$7.72
183-5096K	5/16"	3/8"	\$11.35
183-6104K	3/8"	1/4"	\$6.28
183-6106K	3/8"	3/8"	\$6.74
183-6108K	3/8"	1/2"	\$11.48

185 NPSM Female Pipe Swivel

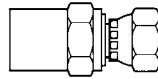

Item #	Hose	Pipe	Price
185-4084K	1/4"	1/4"	\$7.78
185-4086K	1/4"	3/8"	\$9.93
185-5094K	5/16"	1/4"	\$10.00
185-6104K	3/8"	1/4"	\$8.88
185-6106K	3/8"	3/8"	\$10.83

IMPORTANT: For use only with SAE 100R6 General Purpose Hose.

SAE 100R7 Field-Attachable Hose Fittings

JIC 37° Female Swivel



Item #	Hose	JIC	Price
R7-06-606	3/8"	3/8"	\$10.01
R7-08-608	1/2"	1/2"	\$14.34

NPTF Male Pipe

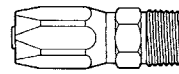

Item #	Hose	Pipe	Price
R7-04-104	1/4"	1/4"	\$7.00
R7-06-106	3/8"	3/8"	\$11.73
R7-08-106	1/2"	3/8"	\$11.68
R7-08-108	1/2"	1/2"	\$11.93

JIC 37° Male

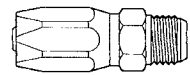

Item #	Hose	JIC	Price
R7-04-504	1/4"	1/4"	\$17.68
R7-06-506	3/8"	3/8"	\$11.98
R7-08-508	1/2"	1/2"	\$14.81

IMPORTANT: For use only with SAE 100R7 Thermoplastic Hose.

63-190600

JIC 37° Female Swivel

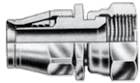

Item #	Tube	Hose	Price
63-190600-04	1/4"	3/16"	\$17.68
63-190600-05	5/16"	1/4"	\$22.62
63-190600-06	3/8"	5/16"	\$22.52
63-190600-08	1/2"	13/32"	\$31.43
63-190600-10	5/8"	1/2"	\$35.11
63-190600-12	3/4"	5/8"	\$45.50
63-190600-16	1"	7/8"	\$60.01

1907772

JIC 37° Female Swivel 90°

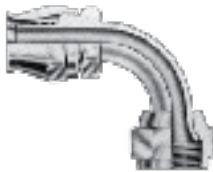

Item #	Tube	Hose	Price
190772-03S	3/16"	1/8"	\$47.99
190772-04S	1/4"	3/16"	\$33.56
190772-05S	5/16"	1/4"	\$35.02
190772-06S	3/8"	5/16"	\$35.35
190772-08S	1/2"	13/32"	\$38.55
190772-10S	5/8"	1/2"	\$52.68
190772-12S	3/4"	5/8"	\$68.99
190772-16S	1"	7/8"	\$96.54

190773

JIC 37° Female Swivel 45°

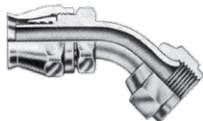

Item #	Tube	Hose	Price
190773-03S	3/16"	1/8"	\$51.79
190773-04S	1/4"	3/16"	\$35.45
190773-06S	3/8"	5/16"	\$40.03
190773-08S	1/2"	13/32"	\$43.59
190773-10S	5/8"	1/2"	\$51.71
190773-12S	3/4"	5/8"	\$58.67
190773-16S	1"	7/8"	\$106.34

38-190627

NPTF Male Pipe

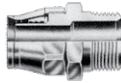

Item #	Pipe	Hose	Price
38-190627-02-04	1/8"	3/16"	\$18.27
38-190627-04-04	1/4"	3/16"	\$17.62
38-190627-04-05	1/4"	1/4"	\$27.01
38-190627-04-06	1/4"	5/16"	\$21.21
38-190627-06-06	3/8"	5/16"	\$24.02
38-190627-06-08	3/8"	13/32"	\$30.04
38-190627-08-10	1/2"	1/2"	\$32.51
38-190627-12-12	3/4"	5/8"	\$36.95
38-190627-16-16	1"	7/8"	\$59.68

63-190990

SAE 45° Female Swivel

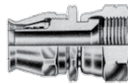

Item #	Tube	Hose	Price
63-190990-04	1/4"	3/16"	\$19.75
63-190990-05	5/16"	1/4"	\$20.53
63-190990-06	3/8"	5/16"	\$21.02
63-190990-08	1/2"	13/32"	\$27.81
63-190990-10	5/8"	1/2"	\$37.18
63-190990-12	3/4"	5/8"	\$44.77

FC9171

SAE 45° Female Swivel 90°

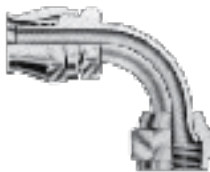

Item #	Tube	Hose	Price
FC9171-0606S	3/8"	5/16"	\$36.06
FC9171-1212S	3/4"	5/8"	\$49.28

900568

Replacement Sleeve

Sleeve is good for only one use. Sleeve must be replaced when the fitting is re-used.

Item #	Hose ID	Price
900568-03B	1/8"	\$3.52
900568-04B	3/16"	\$4.60
900568-05B	1/4"	\$5.61
900568-06B	5/16"	\$4.67
900568-08B	13/32"	\$5.54
900568-10B	1/2"	\$6.70
900568-12B	5/8"	\$7.44
900568-16B	7/8"	\$10.97

IMPORTANT: For use only with SAE 100R14A PTFE Hose.

271 NPTF Male Pipe Swivel

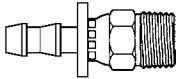

Item #	Hose	Pipe	Price
271-0404C	1/4"	1/4"	\$3.75
271-0604C	3/8"	1/4"	\$3.84
271-0606C	3/8"	3/8"	\$4.29
271-0806C	1/2"	3/8"	\$4.66
271-0808C	1/2"	1/2"	\$5.66
271-1212C	3/4"	3/4"	\$8.38

272 NPTF Male Pipe

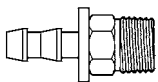

Item #	Hose	Pipe	Price
272-0402C	1/4"	1/8"	\$1.17
272-0404C	1/4"	1/4"	\$1.39
272-0406C	1/4"	3/8"	\$1.18
272-0502C	5/16"	1/8"	\$1.55
272-0504C	5/16"	1/4"	\$1.80
272-0602C	3/8"	1/8"	\$1.48
272-0604C	3/8"	1/4"	\$1.39
272-0606C	3/8"	3/8"	\$1.62
272-0608C	3/8"	1/2"	\$2.55
272-0612C	3/8"	3/4"	\$5.75
272-0804C	1/2"	1/4"	\$2.01
272-0806C	1/2"	3/8"	\$1.87
272-0808C	1/2"	1/2"	\$2.55
272-0812C	1/2"	3/4"	\$4.38
272-1006C	5/8"	3/8"	\$4.29
272-1008C	5/8"	1/2"	\$4.17
272-1012C	5/8"	3/4"	\$5.38
272-1208C	3/4"	1/2"	\$4.38
272-1212C	3/4"	3/4"	\$4.17
272-1612C	1"	3/4"	\$10.71
272-1616C	1"	1"	\$12.56

273 NPTF Male Pipe 90°

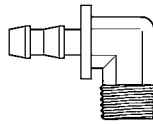

Item #	Hose	Pipe	Price
273-0402C	1/4"	1/8"	\$2.57
273-0404C	1/4"	1/4"	\$3.00
273-0602C	3/8"	1/8"	\$3.94
273-0604C	3/8"	1/4"	\$3.00
273-0606C	3/8"	3/8"	\$3.86
273-0806C	1/2"	3/8"	\$4.88
273-0808C	1/2"	1/2"	\$5.66
273-1208C	3/4"	1/2"	\$14.73
273-1212C	3/4"	3/4"	\$10.51

274 NPTF Female Pipe

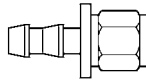

Item #	Hose	Pipe	Price
274-0402C	1/4"	1/8"	\$2.30
274-0404C	1/4"	1/4"	\$1.75
274-0406C	1/4"	3/8"	\$3.95
274-0502C	5/16"	1/8"	\$1.96
274-0504C	5/16"	1/4"	\$2.17
274-0602C	3/8"	1/8"	\$2.03
274-0604C	3/8"	1/4"	\$2.01
274-0606C	3/8"	3/8"	\$2.46
274-0608C	3/8"	1/2"	\$2.72
274-0612C	3/8"	3/4"	\$6.42
274-0804C	1/2"	1/4"	\$3.73
274-0806C	1/2"	3/8"	\$2.79
274-0808C	1/2"	1/2"	\$2.72
274-0812C	1/2"	3/4"	\$7.21
274-1006C	5/8"	3/8"	\$3.39
274-1008C	5/8"	1/2"	\$3.10
274-1208C	3/4"	1/2"	\$4.60
274-1212C	3/4"	3/4"	\$5.66

278 NPSM Female Pipe Swivel Ballseat Type

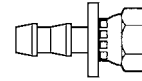

Item #	Hose	Pipe	Price
278-0402C	1/4"	1/8"	\$4.10
278-0404C	1/4"	1/4"	\$2.35
278-0406C	1/4"	3/8"	\$3.72
278-0604C	3/8"	1/4"	\$3.63
278-0606C	3/8"	3/8"	\$4.47
278-0808C	1/2"	1/2"	\$5.21
278-0812C	1/2"	3/4"	\$7.21
278-1212C	3/4"	3/4"	\$10.09

280 NPSM Female Pipe Swivel Gasket Type

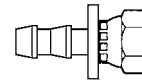

Item #	Hose	Pipe	Price
280-0402C	1/4"	1/8"	\$4.82
280-0404C	1/4"	1/4"	\$3.20
280-0604C	3/8"	1/4"	\$3.80
280-0606C	3/8"	3/8"	\$5.01
280-0608C	3/8"	1/2"	\$6.99
280-0808C	1/2"	1/2"	\$6.34
280-1212C	3/4"	3/4"	\$11.72

282 SAE 45° Male

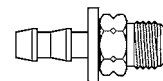

Item #	Hose	Tube	Price
282-0407C	1/4"	1/4"	\$2.50
282-0408C	1/4"	5/16"	\$2.03
282-0610C	3/8"	3/4"	\$3.00
282-0812C	1/2"	1/2"	\$4.96
282-1014C	5/8"	5/8"	\$4.95
282-1217C	3/4"	3/4"	\$9.79

No clamps or ferrules required when used with Push-Lock Low Pressure Hose.

284 SAE 45° Female Swivel

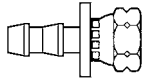

Item #	Hose	Tube	Price
284-0410C	1/4"	3/8"	\$3.02
284-0510C	5/16"	3/8"	\$3.10
284-0610C	3/8"	3/8"	\$2.50
284-1217C	3/4"	3/4"	\$7.29

286 JIC 37° Flare Male

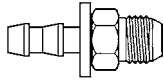

Item #	Hose	Tube	Price
286-0407C	1/4"	1/4"	\$2.37
286-0409C	1/4"	3/4"	\$37.42
286-0609C	3/8"	3/8"	\$3.72
286-0812C	1/2"	1/2"	\$4.50
286-1014C	5/8"	5/8"	\$9.20
286-1217C	3/4"	3/4"	\$9.22

287 Dual Angle Seat (SAE 45° / JIC 37° Flare) Female Swivel

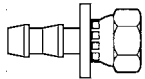

Item #	Hose	Tube	Price
287-0407C	1/4"	1/4"	\$2.37
287-0408C	1/4"	5/16"	\$2.55
287-0612C	3/8"	1/2"	\$4.03
287-0812C	1/2"	1/2"	\$3.20
287-0814C	1/2"	5/8"	\$5.41
287-1014C	5/8"	5/8"	\$5.64

288 JIC 37° Flare Female Swivel

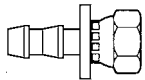

Item #	Hose	Tube	Price
288-0409C	1/4"	3/8"	\$3.00
288-0509C	5/16"	3/8"	\$3.72
288-0609C	3/8"	3/8"	\$2.55
288-1217C	3/4"	3/4"	\$6.64

289 Dual Angle Seat* (SAE 45° / JIC 37° Flare) Female Swivel 90°

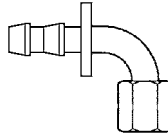

Item #	Hose	Tube	Price
289-0407C	1/4"	1/4"	\$26.11
289-0609C	3/8"	3/8"	\$24.10
289-0610SAE	3/8"	3/8"	\$32.72
289-0812C	1/2"	1/2"	\$29.94
289-1217C	3/4"	3/4"	\$78.80

* 3/8" tube fittings do not have a dual angle seat. Use 289-0609C with JIC 37° flare and 289-0610SAE with SAE 45° flare.

290 Inverted Flare Male Swivel

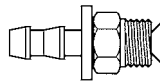

Item #	Hose	Tube	Price
290-0406C	1/4"	3/16"	\$3.45
290-0407C	1/4"	1/4"	\$2.66
290-0408C	1/4"	5/16"	\$2.85
290-0508C	5/16"	5/16"	\$3.58
290-0510C	5/16"	3/8"	\$4.58
290-0608C	3/8"	5/16"	\$3.10
290-0610C	3/8"	3/8"	\$3.26
290-0812C	1/2"	1/2"	\$5.38
290-1014C	5/8"	5/8"	\$7.41

292 Inverted Flare Female

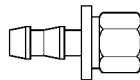

Item #	Hose	Tube	Price
292-0406C	1/4"	3/16"	\$2.75
292-0407C	1/4"	1/4"	\$2.72
292-0408C	1/4"	5/16"	\$2.64
292-0608C	3/8"	5/16"	\$4.13
292-0610C	3/8"	3/8"	\$3.50
292-0812C	1/2"	1/2"	\$5.50

294 Rigid Tube Shank, North American

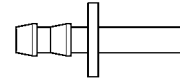

Item #	Hose	Tube	Price
294-0403C	1/4"	3/16"	\$2.22
294-0404C	1/4"	1/4"	\$1.48
294-0405C	1/4"	5/16"	\$1.87
294-0505C	5/16"	5/16"	\$2.09
294-0606C	3/8"	3/8"	\$3.10
294-0808C	1/2"	1/2"	\$5.48
294-1010C	5/8"	5/8"	\$5.38
294-1212C	3/4"	3/4"	\$5.23

294M Rigid Tube Shank, Metric

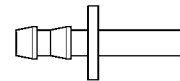

Item #	Hose	Tube	Price
294M-0406M	1/4"	6mm	\$2.30
294M-0408M	1/4"	8mm	\$2.42
294M-0610M	3/8"	10mm	\$2.50
294M-0612M	3/8"	12mm	\$2.50
294M-0815M	1/2"	15mm	\$3.31
294M-1018M	5/8"	18mm	\$3.38
294M-1222M	3/4"	22mm	\$4.82

296 Hose Mender

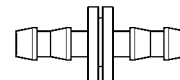

Item #	Hose	Price
296-0404C	1/4"	\$1.75
296-0505C	5/16"	\$1.80
296-0606C	3/8"	\$2.03
296-0808C	1/2"	\$2.66
296-1010C	5/8"	\$4.13
296-1212C	3/4"	\$5.01

No clamps or ferrules required when used with Push-Lock Low Pressure Hose.

102 NPTF Male Pipe

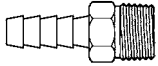

Item #	Hose	NPTF	Price
102-0202C	1/8"	1/8"	\$1.08
102-0204C	1/8"	1/4"	\$1.33
102-0302C	3/16"	1/8"	\$0.87
102-0304C	3/16"	1/4"	\$1.17
102-0402C	1/4"	1/8"	\$1.00
102-0404C	1/4"	1/4"	\$0.87
102-0406C	1/4"	3/8"	\$1.55
102-0408C	1/4"	1/2"	\$2.79
102-0502C	5/16"	1/8"	\$1.08
102-0504C	5/16"	1/4"	\$1.17
102-0506C	5/16"	3/8"	\$1.75
102-0602C	3/8"	1/8"	\$1.39
102-0604C	3/8"	1/4"	\$0.85
102-0606C	3/8"	3/8"	\$1.39
102-0608C	3/8"	1/2"	\$2.33
102-0612C	3/8"	3/4"	\$3.93
102-0804C	1/2"	1/4"	\$1.67
102-0806C	1/2"	3/8"	\$1.45
102-0808C	1/2"	1/2"	\$2.01
102-0812C	1/2"	3/4"	\$3.45
102-1006C	5/8"	3/8"	\$2.01
102-1008C	5/8"	1/2"	\$2.46
102-1012C	5/8"	3/4"	\$3.63
102-1208C	3/4"	1/2"	\$2.72
102-1212C	3/4"	3/4"	\$3.02
102-1612C	1"	3/4"	\$4.13
102-1616C	1"	1"	\$7.21
102-2012C	1-1/4"	3/4"	\$6.89
102-2016C	1-1/4"	1"	\$7.10

103 NPTF Male Pipe Swivel

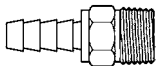

Item #	Hose	NPTF	Price
103-0404C	1/4"	1/4"	\$3.75
103-0604C	3/8"	1/4"	\$3.86
103-0606C	3/8"	3/8"	\$4.21
103-0806C	1/2"	3/8"	\$4.76
103-0808C	1/2"	1/2"	\$6.02
103-1212C	3/4"	3/4"	\$7.80

104 NPTF Female Pipe

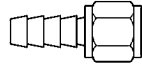

Item #	Hose	NPTF	Price
104-0202C	1/8"	1/8"	\$1.30
104-0204C	1/8"	1/4"	\$2.33
104-0302C	3/16"	1/8"	\$1.20
104-0304C	3/16"	1/4"	\$2.01
104-0402C	1/8"	1/8"	\$1.05
104-0404C	1/4"	1/4"	\$1.39
104-0406C	1/4"	3/8"	\$1.75
104-0502C	1/8"	1/8"	\$1.80
104-0504C	1/4"	1/4"	\$2.01
104-0506C	3/8"	3/8"	\$2.42
104-0602C	3/8"	1/8"	\$1.55
104-0604C	3/8"	1/4"	\$1.41
104-0606C	3/8"	3/8"	\$1.96
104-0608C	3/8"	1/2"	\$3.17
104-0804C	1/2"	1/4"	\$1.67
104-0806C	1/2"	3/8"	\$2.50
104-0808C	1/2"	1/2"	\$3.02
104-1212C	3/4"	3/4"	\$5.48
104-1612C	1"	3/4"	\$4.88
104-1616C	1"	1"	\$9.01

124 NPSM Female Pipe Swivel

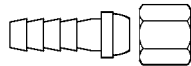

Item #	Hose	NPSM	Price
124-0202K	1/8"	1/8"	\$1.58
124-0302K	3/16"	1/8"	\$1.58
124-0304K	3/16"	1/4"	\$1.80
124-0402K	1/4"	1/8"	\$1.72
124-0404K	1/4"	1/4"	\$1.48
124-0406K	1/4"	3/8"	\$2.03
124-0504K	5/16"	1/4"	\$1.80
124-0506K	5/16"	3/8"	\$2.30
124-0604K	3/8"	1/4"	\$1.62
124-0606K	3/8"	3/8"	\$2.12
124-0608K	3/8"	1/2"	\$3.31
124-0806K	1/2"	3/8"	\$2.37
124-0808K	1/2"	1/2"	\$3.10
124-1212K	3/4"	3/4"	\$4.73

129 NPTF Male Pipe 90°

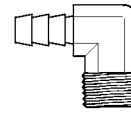

Item #	Hose	NPTF	Price
129-0302C	3/16"	1/8"	\$2.22
129-0402C	1/4"	1/8"	\$2.22
129-0404C	1/4"	1/4"	\$2.55
129-0406C	1/4"	3/8"	\$3.58
129-0502C	5/16"	1/8"	\$2.85
129-0504C	5/16"	1/4"	\$2.75
129-0506C	5/16"	3/8"	\$4.13
129-0602C	3/8"	1/8"	\$2.37
129-0604C	3/8"	1/4"	\$2.46
129-0606C	3/8"	3/8"	\$3.17
129-0608C	3/8"	1/2"	\$3.72
129-0804C	1/2"	1/4"	\$3.17
129-0806C	1/2"	3/8"	\$4.25
129-0808C	1/2"	1/2"	\$5.04
129-1006C	5/8"	3/8"	\$5.95
129-1008C	5/8"	1/2"	\$7.21
129-1208C	3/4"	1/2"	\$9.83
129-1212C	3/4"	3/4"	\$12.14
129-1612C	1"	3/4"	\$13.77
129-1616C	1"	1"	\$16.21

139 NPTF Male Pipe 45°

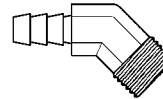

Item #	Hose	NPTF	Price
139-0402C	1/4"	1/8"	\$4.66
139-0404C	1/4"	1/4"	\$4.76
139-0602C	3/8"	1/8"	\$3.58
139-0604C	3/8"	1/4"	\$3.17
139-0606C	3/8"	3/8"	\$4.94
139-0804C	1/2"	1/4"	\$5.95
139-0806C	1/2"	3/8"	\$4.94
139-0808C	1/2"	1/2"	\$6.83

Brass hose barbs must be securely affixed with clamps or ferrules.

142 SAE 45° Male

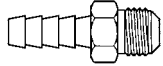

Item #	Hose	Tube	Price
142-0307C	3/16"	1/4"	\$1.87
142-0407C	1/4"	1/4"	\$1.39
142-0410C	1/4"	3/8"	\$1.48
142-0508C	5/16"	5/16"	\$2.37
142-0610C	3/8"	3/8"	\$1.48
142-0612C	3/8"	1/2"	\$2.50
142-0812C	1/2"	1/2"	\$3.02

143 SAE 45° / JIC 37° Dual Angle Seat Female Swivel

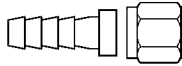

Note: In all sizes except -06 and -12, SAE 45° flare and JIC 37° flare use the same thread. However, the sealing surface angles are not the same.

Item #	Hose	Tube	Price
143-0307K	3/16"	1/4"	\$1.67
143-0407K	1/4"	1/4"	\$1.62
143-0408K	1/4"	5/16"	\$1.96
143-0508K	5/16"	5/16"	\$2.03
143-0612K	3/8"	1/2"	\$2.95
143-0812K	1/2"	1/2"	\$3.13
143-0814K	1/2"	5/8"	\$3.86

144 SAE 45° Female Swivel

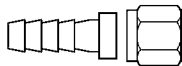

Item #	Hose	Tube	Price
144-0306K	3/16"	3/16"	\$1.72
144-0410K	1/4"	3/8"	\$2.01
144-0510K	5/16"	3/8"	\$2.17
144-0610K	3/8"	3/8"	\$2.17
144-0812K	1/2"	1/2"	\$3.50

145 JIC 37° Female Swivel

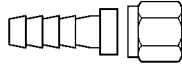

Item #	Hose	Tube	Price
145-0609K	3/8"	3/8"	\$2.01

172 NPSM x NPTF Adapter

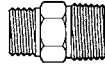

Item #	NPSM	NPTF	Price
172-0202C	1/8"	1/8"	\$1.33
172-0402C	1/4"	1/8"	\$1.26
172-0404C	1/4"	1/4"	\$1.42
172-0604C	3/8"	1/4"	\$1.96
172-0606C	3/8"	3/8"	\$2.07
172-0608C	3/8"	1/2"	\$3.28
172-0806C	1/2"	3/8"	\$2.24
172-0808C	1/2"	1/2"	\$3.06
172-1212C	3/4"	3/4"	\$3.89

176 NPSM x NPSM Union



Item #	NPSM	Price
176-0202C	1/8"	\$1.80
176-0404C	1/4"	\$2.01
176-0606C	3/8"	\$3.13
176-0808C	1/2"	\$4.76

177 Hose Mender Elbow

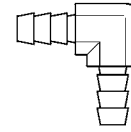

Item #	Hose	Price
177-0404C	1/4"	\$2.33
177-0505C	5/16"	\$2.95
177-0606C	3/8"	\$3.00
177-0808C	1/2"	\$4.21

178 Hose Mender

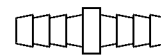

Item #	Hose	Price
178-0202C	1/8"	\$1.20
178-0303C	3/16"	\$1.08
178-0404C	1/4"	\$1.00
178-0505C	5/16"	\$1.26
178-0606C	3/8"	\$1.30
178-0808C	1/2"	\$1.84
178-1010C	5/8"	\$2.50
178-1212C	3/4"	\$2.79
178-1616C	1"	\$4.13

179 Mender Tee

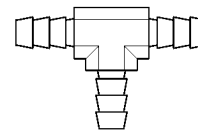

Item #	Hose	Price
179-0303C	3/16"	\$3.17
179-0404C	1/4"	\$3.00
179-0505C	5/16"	\$3.56
179-0606C	3/8"	\$3.58
179-0808C	1/2"	\$5.21
179-1010C	5/8"	\$7.99
179-1212C	3/4"	\$9.96

Brass hose barbs must be securely affixed with clamps or ferrules.

Brass Hose Ferrules and Clamps



BFM Brass Ferrules for Medium Weight Air Hose

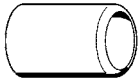

Ferrule I.D.	Ferrule Length	End Hole Size	Metal Gauge	Standard Ind. Part #	Ribbed Die*	Plain Die*	Bag Qty.	Item Number	Price**
0.478"	11/16"	21/64"	0.024"	4750	R41	P41/P42	50	BFM478-BAG	\$16.58
0.500"	1"	11/32"	0.024"	7322	R40	P40	50	BFM500-BAG	\$21.55
0.525"	1"	3/8"	0.024"	7323	R39	P39	50	BFM525-BAG	\$21.55
0.531"	1"	7/16"	0.024"	7324	R39	P39	50	BFM531-BAG	\$22.40
0.562"	1"	7/16"	0.024"	7325	R37	P38	50	BFM562-BAG	\$24.05
0.593"	1"	7/16"	0.024"	7326	R36	P37	50	BFM593-BAG	\$24.86
0.625"	1"	7/16"	0.024"	7327	R35	P25	50	BFM625-BAG	\$25.69
0.656"	1"	7/16"	0.024"	7328	R34	P35	50	BFM656-BAG	\$27.35
0.687"	1"	1/2"	0.024"	7329	R33	P34	50	BFM687-BAG	\$27.35
0.718"	1"	5/8"	0.024"	7330	R31	P32	50	BFM718-BAG	\$29.02
0.718"	1"	1/2"	0.024"	7330B	R31	P32	50	BFM718B-BAG	\$28.18
0.750"	1"	5/8"	0.024"	7331	R30	P31	50	BFM750-BAG	\$29.02
0.750"	1"	1/2"	0.024"	7331B	R30	P31	50	BFM750B-BAG	\$28.18
0.781"	1"	5/8"	0.024"	7332	R29	P30	50	BFM781-BAG	\$30.67
0.781"	1"	1/2"	0.024"	7332B	R29	P30	50	BFM781B-BAG	\$29.85
0.812"	1"	5/8"	0.024"	7333	R28	P29	50	BFM812-BAG	\$31.50

BFL Brass Ferrules for Light Weight Air Hose

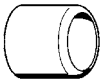

Ferrule I.D.	Ferrule Length	End Hole Size	Metal Gauge	Standard Ind. Part #	Ribbed Die*	Plain Die*	Bag Qty.	Item Number	Price**
0.380"	1/2"	17/64"	.016"	622	R44	P45	50	BFL380-BAG	\$10.77
0.400"	15/32"	17/64"	.020"	619	R44	P44	50	BFL400-BAG	\$11.60
0.410"	1/2"	17/64"	.016"	620	R43	P44	50	BFL410-BAG	\$11.60
0.450"	9/16"	11/32"	.016"	769	R41	P42	50	BFL450-BAG	\$11.60
0.500"	1/2"	11/32"	.016"	624	R40	P41	50	BFL500-BAG	\$11.60
0.525"	1/2"	11/32"	.016"	625	R39	P40	50	BFL525-BAG	\$11.60
0.548"	31/64"	3/8"	.015"	626	R38	P39	50	BFL548-BAG	\$11.60
0.564"	3/4"	3/8"	.019"	3588	R37	P38	50	BFL564-BAG	\$16.58
0.575"	31/64"	15/32"	.019"	KK	R37	P38	50	BFL575-BAG	\$11.60
0.600"	1/2"	1/2"	.019"	JJ	R36	P37	50	BFL600-BAG	\$13.26
0.625"	1/2"	1/2"	.019"	II	R35	P36	50	BFL625-BAG	\$14.08
0.650"	1/2"	1/2"	.019"	HH	R34	P35	50	BFL650-BAG	\$14.92
0.675"	33/64"	1/2"	.019"	GG	R34	P34	50	BFL675-BAG	\$15.74
0.725"	17/32"	1/2"	.019"	EE	R31	P32	50	BFL725-BAG	\$15.74
0.750"	17/32"	1/2"	.019"	DD	R30	P32	50	BFL750-BAG	\$16.58
0.775"	17/32"	1/2"	.016"	CC	R31	P31	50	BFL775-BAG	\$28.18

* Use these dies with the 660T Manual Ferrule Vise or 670T Air-Operated Ferrule Vise (page 69).

** Price per bag. Brass ferrules are not sold individually.

BF/BFW/ BFMW

Brass Ferrules for
Medium Weight
Air or Water Hose



Ferrule I.D.	Ferrule Length	End Hole Size	Metal Gauge	Standard Ind. Part #	Ribbed Die*	Plain Die*	Bag Qty.	Item Number	Price**
0.800"	0.844"	0.688"	.024	---	R28	P29	25	BF800-BAG	\$11.60
0.825"	0.844"	0.688"	.024	---	R27	P28	25	BF825-BAG	\$12.03
0.850"	0.568"	0.688"	.019	Z	R26	P27	25	BF850-BAG	\$10.77
0.875"	0.844"	0.688"	.024	7244A	R25	P26	25	BFW875-BAG	\$13.67
0.900"	0.844"	0.688"	.024	5029A	R24	P25	25	BFW900-BAG	\$13.67
0.925"	0.840"	0.690"	.025	7113	R23	P24	25	BFW925-BAG	\$13.67
0.975"	0.844"	0.688"	.024	5028A	R21	P22	25	BFW975-BAG	\$16.58
1.025"	0.844"	0.688"	.024	7114A	R19	P20	25	BFW1025-BAG	\$17.42
1.175"	0.844"	0.688"	.024	7088A	R13	P14	25	BFW1175-BAG	\$19.47
1.050"	0.625"	0.750"	.025	3605	R18	P19	25	BFMW1050-BAG	\$25.69
1.100"	0.843"	0.812"	.023	5027	R16	P17	25	BFMW1100-BAG	\$19.47
1.150"	0.844"	0.880"	.024	7104A	R15	P15	25	BFMW1150-BAG	\$20.72
1.225"	0.875"	0.875"	.025	875-K	R11	P12	25	BFMW1225-BAG	\$25.69
1.275"	0.875"	1.000"	.025	875-1	R9	P10	25	BFMW1275-BAG	\$55.14
1.400"	0.687"	1.120"	.020	D	R4	P5	25	BFMW1400-BAG	\$55.95
1.500"	0.875"	1.120"	.025	1500	---	P1	25	BFMW1500-BAG	\$33.58

* Use these dies with the 660T Manual Ferrule Vise or 670T Air-Operated Ferrule Vise (page 69).

** Price per bag. Brass ferrules are not sold individually.

Stainless Steel Wormgear Band Clamps



25% OFF
when you buy
100 or more.

Mix and match all sizes

Hose O.D.	Band Width	Item #	Price	Hose O.D.	Band Width	Item #	Price
0.22" – 0.63"	5/16"	M4P	\$0.47	2.06" – 3.00"	1/2"	B40H	\$0.77
0.31" – 0.88"	5/16"	M6P	\$0.51	2.31" – 3.25"	1/2"	B44H	\$0.83
0.38" – 0.88"	1/2"	B6H	\$0.61	2.56" – 3.50"	1/2"	B48H	\$0.83
0.44" – 1.00"	1/2"	B8H	\$0.61	2.81" – 3.75"	1/2"	B52H	\$0.90
0.56" – 1.06"	1/2"	B10H	\$0.61	3.06" – 4.00"	1/2"	B56H	\$0.90
0.56" – 1.25"	1/2"	B12H	\$0.62	3.31" – 4.25"	1/2"	B60H	\$0.95
0.69" – 1.50"	1/2"	B16H	\$0.62	2.50" – 4.50"	1/2"	B64H	\$0.95
0.75" – 1.75"	1/2"	B20H	\$0.63	3.00" – 5.00"	1/2"	B72H	\$1.01
1.06" – 2.00"	1/2"	B24H	\$0.63	3.50" – 5.50"	1/2"	B80H	\$1.07
1.31" – 2.25"	1/2"	B28H	\$0.65	4.00" – 6.00"	1/2"	B88H	\$1.17
1.56" – 2.50"	1/2"	B32H	\$0.65	4.50" – 6.50"	1/2"	B96H	\$1.33
1.81" – 2.75"	1/2"	B36H	\$0.65	5.00" – 7.00"	1/2"	B104H	\$1.33

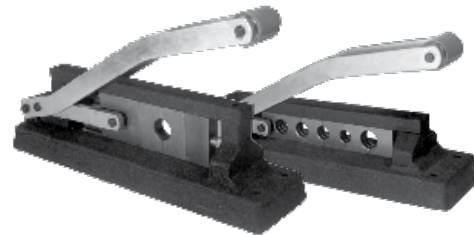
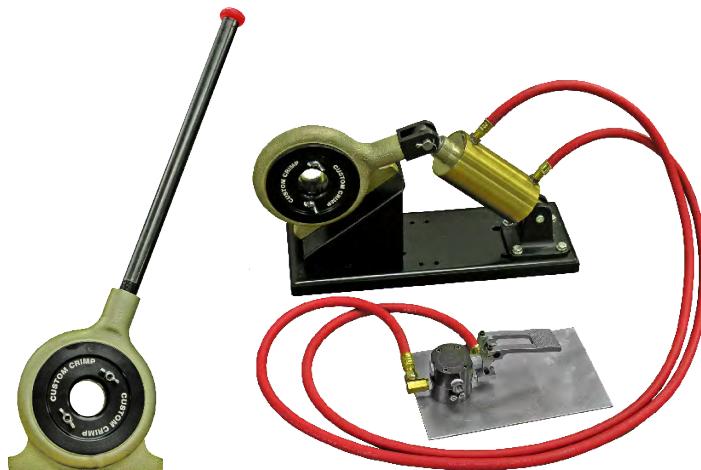

Brass Ferrule Crimping Tools

page 69

MP

NPTF Male Pipe

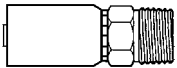

Item Number	Hose	Pipe	Price
MP-03-02-R5	3/16"	1/8"	\$3.28
MP-03-04-R5	3/16"	1/4"	\$4.16
MP-05-04-R5	5/16"	1/4"	\$4.38
MP-05-06-R5	5/16"	3/8"	\$4.16
MP-07-06-R5	13/32"	3/8"	\$8.69
MP-07-08-R5	13/32"	1/2"	\$9.21
MP-10-08-R5	5/8"	1/2"	\$2.64
MP-10-12-R5	5/8"	3/4"	\$2.73
MP-14-12-R5	7/8"	3/4"	\$38.72
MP-14-16-R5	7/8"	1"	\$40.81
MP-18-20-R5	1-1/8"	1-1/4"	\$44.63
MP-22-24-R5	1-3/8"	1-1/2"	\$51.12
MP-29-32-R5	1-13/16"	2"	\$56.64

FJX

JIC 37° Female Swivel

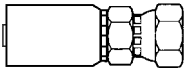

Item Number	Hose	JIC	Price
FJX-03-04-R5	3/16"	1/4"	\$3.83
FJX-03-05-R5	3/16"	5/16"	\$9.35
FJX-05-04-R5	5/16"	1/4"	\$6.39
FJX-05-05-R5	5/16"	5/16"	\$6.39
FJX-05-06-R5	5/16"	3/8"	\$4.68
FJX-07-06-R5	13/32"	3/8"	\$9.27
FJX-07-08-R5	13/32"	1/2"	\$9.88
FJX-10-08-R5	5/8"	1/2"	\$8.37
FJX-10-10-R5	5/8"	5/8"	\$8.24
FJX-10-12-R5	5/8"	3/4"	\$8.24
FJX-14-12-R5	7/8"	3/4"	\$25.89
FJX-14-16-R5	7/8"	1"	\$27.92
FJX-18-20-R5	1-1/8"	1-1/4"	\$32.41
FJX-22-24-R5	1-3/8"	1-1/2"	\$63.82
FJX-29-32-R5	1-13/16"	2"	\$92.81

FJX45

JIC 37° Female Swivel 45°

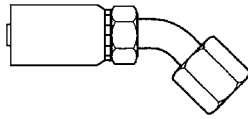

Item Number	Hose	JIC	Price
FJX45-03-04-R5	3/16"	1/4"	\$9.29
FJX45-05-04-R5	5/16"	1/4"	\$7.73
FJX45-05-06-R5	5/16"	3/8"	\$7.73
FJX45-07-06-R5	13/32"	3/8"	\$11.62
FJX45-07-08-R5	13/32"	1/2"	\$11.22
FJX45-10-10-R5	5/8"	5/8"	\$14.98
FJX45-10-12-R5	5/8"	3/4"	\$16.46
FJX45-14-16-R5	7/8"	1"	\$35.93

FJX90

JIC 37° Female Swivel 90°

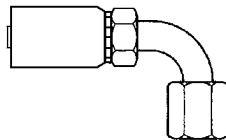

Item Number	Hose	JIC	Price
FJX90-03-04-R5	3/16"	1/4"	\$8.23
FJX90-05-04-R5	5/16"	1/4"	\$24.52
FJX90-05-05-R5	5/16"	5/16"	\$14.40
FJX90-05-06-R5	5/16"	3/8"	\$9.29
FJX90-07-06-R5	5/16"	3/8"	\$13.47
FJX90-07-08-R5	13/32"	3/8"	\$14.56
FJX90-10-10-R5	5/8"	5/8"	\$13.58
FJX90-10-12-R5	5/8"	3/4"	\$16.18
FJX90-14-16-R5	7/8"	1"	\$37.45

MIX

Inverted Flare Male Swivel

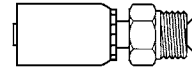

Item Number	Hose	Tube	Price
MIX-05-05-R5	5/16"	5/16"	\$12.46
MIX-05-06-R5	5/16"	3/8"	\$10.72
MIX-07-08-R5	13/32"	1/2"	\$14.14

MIX45

Inverted Flare Male Swivel 45°

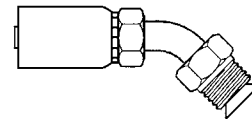

Item Number	Hose	Tube	Price
MIX45-05-05-R5	5/16"	5/16"	\$12.03
MIX45-05-06-R5	5/16"	3/8"	\$10.66
MIX45-07-08-R5	13/32"	1/2"	\$15.04

MIX90

Inverted Flare Male Swivel 90°

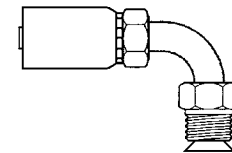

Item Number	Hose	Tube	Price
MIX90-03-04-R5	3/16"	1/4"	\$10.97
MIX90-05-05-R5	5/16"	5/16"	\$12.57
MIX90-05-06-R5	5/16"	3/8"	\$12.63
MIX90-07-08-R5	13/32"	1/2"	\$15.04

When crimping R5-05 (1/4"), R5-10 (1/2") or R5-12 (5/8") hoses, use Braided Hose Fittings (page 16).

IMPORTANT: For use only with SAE 100R5 General Purpose/Truck Hose.

BL-TFS

O-Ring Female Swivel

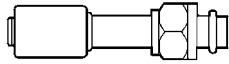

BL06-06TFS	\$3.77
BL08-08TFS	\$4.11
BL10-10TFS	\$4.68
BL12-12TFS	\$6.73

BL-TMS

O-Ring Male Swivel

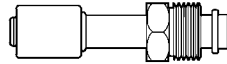

BL06-06TMS	\$4.54
BL08-08TMS	\$4.54
BL10-10TMS	\$5.23
BL12-12TMS	\$7.50

BL-MOR

Insert O-Ring Male

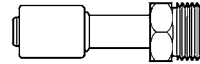

BL06-06MOR	\$5.02
BL08-08MOR	\$5.82
BL10-10MOR	\$6.11
BL12-12MOR	\$7.29

BL-BR

Braze On for Beadlock System

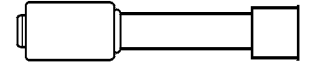

BL06-06BR	\$4.31
BL08-08BR	\$4.97
BL10-10BR	\$5.02
BL12-12BR	\$6.07

BL-TF45

O-Ring Female Swivel 45°

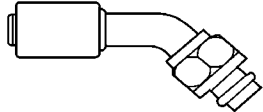

BL06-06TF45T	\$4.00
BL08-08TF45T	\$4.68
BL10-10TF45T	\$5.63
BL12-12TF45T	\$7.86

BL-TM45

O-Ring Male Swivel 45°

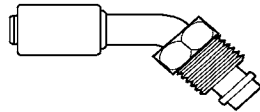

BL06-06TM45T	\$3.72
BL08-08TM45T	\$3.97
BL10-10TM45T	\$4.57
BL12-12TM45T	\$6.78

BL-MOR45

Insert O-Ring Male 45°

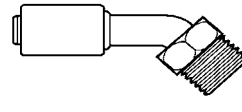

BL06-06MOR45	\$5.73
BL08-08MOR45	\$5.99
BL10-10MOR45	\$6.63
BL12-12MOR45	\$7.81

Braze On Service Ports

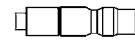

ACP349 (13 mm)	\$1.93
----------------	--------



ACP350 (16 mm)	\$1.93
----------------	--------

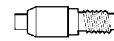

ACP348 (M10x1.5)	\$1.93
------------------	--------

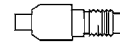

ACPM12A (M12x1.5)	\$2.51
-------------------	--------

BL-TF90

O-Ring Female Swivel 90°

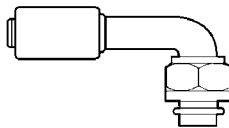

BL06-06TF90T	\$4.54
BL08-08TF90T	\$4.68
BL10-10TF90T	\$5.63
BL12-12TF90T	\$7.86

BL-TM90

O-Ring Male Swivel 90°

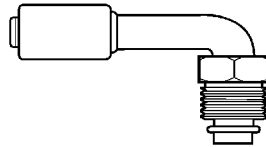

BL06-06TM90T	\$4.36
BL08-08TM90T	\$4.57
BL10-10TM90T	\$5.39
BL12-12TM90T	\$15.44

BL-MOR90

Insert O-Ring Male 90°

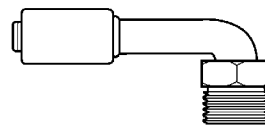

BL06-06MOR90	\$5.73
BL08-08MOR90	\$6.63
BL10-10MOR90	\$7.63
BL12-12MOR90	\$10.13

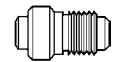

ACP351 (3/8-24)	\$1.93
-----------------	--------

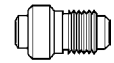

ACP352 (7/16-20)	\$2.51
------------------	--------

BL-RM

Hose Mender/Splicer

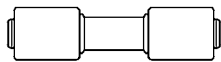

BL06-06RM	\$4.03
BL08-08RM	\$4.48
BL10-10RM	\$4.61
BL12-12RM	\$5.37

BL-MV

Compression Repair Coupling

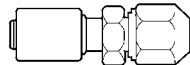

BL06-06MV	\$7.89
BL10-10MV	\$10.69
BL12-12MV	\$13.76

ACF

Beadlock A/C Hose Ferrule



ACF06	\$0.67
ACF06-REDUCED	\$0.67
ACF08	\$0.86
ACF08-REDUCED	\$0.86
ACF10	\$0.91
ACF10-REDUCED	\$0.91
ACF12	\$1.16
ACF12-REDUCED	\$1.16

Aluminum crimp fittings for BH Air Conditioning Hose

Sleeve



Item #	Hose ID	Price
38-300	3/8"	\$1.59
38-301	1/2"	\$2.86

Nut



Item #	Hose ID	Price
38-306	3/8"	\$2.05
38-307	1/2"	\$2.71

Nut

for Spring Guard

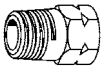

Item #	Hose ID	Price
38-312	3/8"	\$2.09
38-313	1/2"	\$3.43

Nut & Spring Assembly

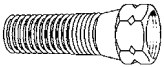

Item #	Hose ID	Price
38-015	3/8"	\$3.44
38-016	1/2"	\$6.03

Male Connector

Body Only

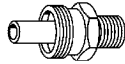

Item #	Hose	Pipe	Price
38-324	3/8"	1/4"	\$2.86
38-325	3/8"	3/8"	\$2.95
38-326	3/8"	1/2"	\$3.19
38-327	1/2"	3/8"	\$10.45
38-328	1/2"	1/2"	\$5.67

Male Connector

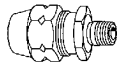

Item #	Hose	Pipe	Price
38-333	3/8"	1/4"	\$8.15
38-334	3/8"	3/8"	\$7.60
38-335	3/8"	1/2"	\$9.37
38-336	1/2"	3/8"	\$11.38
38-337	1/2"	1/2"	\$11.69

Male Connector

with Spring Guard

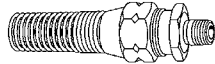

Item #	Hose	MIP	Price
38-342	3/8"	1/4"	\$9.81
38-343	3/8"	3/8"	\$9.64
38-344	3/8"	1/2"	\$10.28
38-345	1/2"	3/8"	\$12.79
38-346	1/2"	1/2"	\$13.09

Spring



Item #	Hose ID	Price
38-351	3/8"	\$1.07
38-352	1/2"	\$2.19

Union

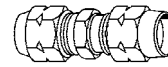

Item #	Hose ID	Price
38-318	3/8"	\$21.28
38-319	1/2"	\$36.77

Female Connector

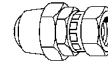

Item #	Hose	ABS	Price
38-357	3/8"	3/4"-20	\$16.18
38-358	1/2"	7/8-20	\$19.35

Female Connector

with Adapter

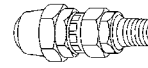

Item #	Hose	Pipe	Price
38-363	3/8"	1/4"	\$16.58
38-364	1/2"	3/8"	\$31.88

Adapter

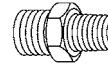

Item #	ABS	Pipe	Price
38-369	3/4-20	1/4"	\$1.98
38-368	3/4-20	3/8"	\$1.82
38-372	3/4-20	1/2"	\$2.71
38-370	7/8-20	3/8"	\$2.35
38-371	7/8-20	1/2"	\$5.09

MP NPTF Male Pipe

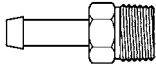

Item #	Hose	Pipe	Price
38-800	3/16"	1/8"	\$1.50
38-802	1/4"	1/8"	\$1.03
32-377	1/4"	1/4"	\$1.32
38-806	5/16"	1/8"	\$0.90
38-808	5/16"	1/4"	\$1.82
38-810	3/8"	1/8"	\$1.49
32-381	3/8"	1/4"	\$1.75
32-382	3/8"	3/8"	\$2.99
32-383	1/2"	3/8"	\$2.17
32-384	1/2"	1/2"	\$3.15
32-182	5/8"	3/8"	\$4.66
32-385	5/8"	1/2"	\$3.23
32-387	3/4"	1/2"	\$3.34
32-388	3/4"	3/4"	\$4.59
32-185	1"	3/4"	\$10.11

MP NPTF Male Pipe 90°

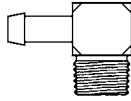

Item #	Hose	Pipe	Price
38-860	1/4"	1/8"	\$2.99
38-862	5/16"	1/8"	\$2.71
38-864	5/16"	1/4"	\$31.88
38-866	3/8"	1/8"	\$3.08
38-868	3/8"	1/4"	\$2.92
32-186	3/8"	3/8"	\$6.96
32-187	1/2"	3/8"	\$9.31
32-191	1/2"	1/2"	\$12.41
32-188	5/8"	3/8"	\$8.57
32-189	5/8"	1/2"	\$10.00
32-190	3/4"	1/2"	\$11.19

MIX Inverted Flare Male Swivel

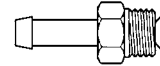

Item #	Hose	Tube	Price
38-828	5/16"	1/4"	\$2.25
38-830	5/16"	5/16"	\$1.48
38-832	5/16"	3/8"	\$2.95
38-834	3/8"	5/16"	\$2.71
38-836	3/8"	3/8"	\$3.86

MIX Inverted Flare Male Swivel 90°

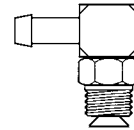

Item #	Hose	Tube	Price
38-873	5/16"	5/16"	\$10.03
38-874	3/8"	3/8"	\$6.39

HT Series

ISO 16028

Flush-Face Interchange Quick Couplers



Flushface valve design minimizes fluid loss for a cleaner, safer work environment.

- Automatic push-to-connect couplings provide high flow with low pressure drop.
- Sleeve lock safety feature reduces the possibility of accidental disconnect.
- Steel construction with zinc plating provides optimum corrosion resistance.

Pressure & Flow Ratings

Body Size	Maximum Working Pressure	Maximum Flow Rate
1/4"	5,000 psi	3.2 gpm
3/8"	5,000 psi	11 gpm
1/2"	5,000 psi	18 gpm
5/8"	5,000 psi	21 gpm
3/4"	5,000 psi	28 gpm
1"	5,000 psi	50 gpm

Interchanges with:

- Parker FEM Series (1/2", 5/8" and 3/4")
- Parker FF Series (3/8" only)
- Faster FF Series
- Holmbury Series A

ISO 16028 Female Couplers



Item #	Body	Thread Size	Price
2HTF2	1/4"	1/4-18 NPTF	\$35.77
3HTF3	3/8"	3/8-18 NPTF	\$42.41
3HTF4	3/8"	1/2-14 NPTF	\$42.41
3HTOF3	3/8"	9/16-18 SAE	\$84.08
3HTOF4	3/8"	3/4-16 SAE	\$88.73
4HTF4	1/2"	1/2-14 NPTF	\$43.66
4HTF6	1/2"	3/4-14 NPTF	\$52.84
4HTOF4	1/2"	3/4-16 SAE	\$90.72
4HTOF5	1/2"	7/8-14 SAE	\$94.56
4HTOF6	1/2"	1 1/16-12 SAE	\$99.55
5HTF6	5/8"	3/4-14 NPTF	\$65.78
5HTOF5	5/8"	7/8-14 SAE	\$130.12
5HTOF6	5/8"	1 1/16-12 SAE	\$130.12
6HTF6	3/4"	3/4-14 NPTF	\$89.93
6HTOF6	3/4"	1 1/16-12 SAE	\$174.89
8HTF8	1"	1-11½ NPTF	\$152.97
8HTOF8	1"	1 5/16-12 SAE	\$293.27

ISO 16028 Male Plug/Nipples



Item #	Body	Thread Size	Price
HT2F2	1/4"	1/4-18 NPTF	\$13.13
HT3F3	3/8"	3/8-18 NPTF	\$15.65
HT3F4	3/8"	1/2-14 NPTF	\$15.65
HT3OF3	3/8"	9/16-18 SAE	\$29.47
HT3OF4	3/8"	3/4-16 SAE	\$29.84
HT4F4	1/2"	1/2-14 NPTF	\$25.69
HT4F6	1/2"	3/4-14 NPTF	\$29.42
HT4OF4	1/2"	3/4-16 SAE	\$56.04
HT4OF5	1/2"	7/8-14 SAE	\$56.04
HT4OF6	1/2"	1 1/16-12 SAE	\$56.36
HT5F6	5/8"	3/4-14 NPTF	\$33.30
HT5OF5	5/8"	7/8-14 SAE	\$69.22
HT5OF6	5/8"	1 1/16-12 SAE	\$69.22
HT6F6	3/4"	3/4-14 NPTF	\$58.20
HT6OF6	3/4"	1 1/16-12 SAE	\$113.83
HT8F8	1"	1-11½ NPTF	\$83.04
HT8OF8	1"	1 5/16-12 SAE	\$168.26

ISO 16028 Matched Sets/Pairs

Includes 1 female and 1 male.



Item #	Thread Size	Price
2HTF2-HT2F2	1/4-18 NPTF	\$46.45
3HTF3-HT3F3	3/8-18 NPTF	\$55.16
4HTF4-HT4F4	1/2-14 NPTF	\$52.45
5HTF6-HT5F6	3/4-14 NPTF	\$90.72
6HTF6-HT6F6	3/4-14 NPTF	\$89.93
8HTF8-HT8F8	1-11½ NPTF	\$152.97

Connect-Under-Pressure Couplers

Flush-face, no-drip couplers connect by hand under pressure without releasing any fluid into the environment. Fully compatible with all standard ISO 16028 couplers.



Male coupler will connect under pressure up to 3571 psi, and female coupler will connect under pressure up to 1595 psi. Mating coupler must be without residual pressure.

Item #	Description	Price
805201005	1/2" Male Plug/Nipple	\$53.19
806801000	1/2" Female Coupler	\$68.85

Elastomer Dust Plugs & Caps

Caps (for female couplers) and plugs (for male plugs/nipples) are compatible with all ISO 16028 quick disconnect couplers.



Item #	Description	Price
3HTDP	3/8" Dust Plug	\$2.50
4HTDP	1/2" Dust Plug	\$3.33
5HTDP	5/8" Dust Plug	\$4.04
6HTDP	3/4" Dust Plug	\$4.20
8HTDP	1" Dust Plug	\$4.80
HT3DC	3/8" Dust Cap	\$2.50
HT4DC	1/2" Dust Cap	\$3.33
HT5DC	5/8" Dust Cap	\$4.04
HT6DC	3/4" Dust Cap	\$4.20
HT8DC	1" Dust Cap	\$4.80

ISO 5675 Female Couplers



Item #	Body	Thread Size	Price
2AGF2	1/4"	1/4-18 NPTF	\$10.22
3AGF3	3/8"	3/8-18 NPTF	\$12.15
4AGF4	1/2"	1/2-14 NPTF	\$12.39
4AGF6	1/2"	3/4-14 NPTF	\$16.58
4AGOF4	1/2"	3/4-16 SAE	\$14.85
4AGOF5	1/2"	7/8-14 SAE	\$14.85
6AGF6	3/4"	3/4-14 NPTF	\$31.13
8AGF8	3/4"	1-11½ NPTF	\$46.86

ISO 5675 Male Plug/Nipples



Item #	Body	Thread Size	Price
AG2F2	1/4"	1/4-18 NPTF	\$5.06
AG3F3	3/8"	3/8-18 NPTF	\$5.49
AG4F4	1/2"	1/2-14 NPTF	\$5.45
AG4F6	1/2"	3/4-14 NPTF	\$7.37
AG4OF4	1/2"	3/4-16 SAE	\$6.74
AG4OF5	1/2"	7/8-14 SAE	\$6.74
AG6F6	3/4"	3/4-14 NPTF	\$16.00
AG8F8	3/4"	1-11½ NPTF	\$21.49

ISO 5675 Matched Sets/Pairs

Buy a set and save. Each pair includes 1 female coupler and 1 male plug/nipple.



Item #	Thread Size	Price
2AGF2-AG2F2	1/4-18 NPTF	\$12.54
3AGF3-AG3F3	3/8-18 NPTF	\$14.45
4AGF4-AG4F4	1/2-14 NPTF	\$16.31
6AGF6-AG6F6	3/4-14 NPTF	\$42.88
8AGF8-AG8F8	1-11½ NPTF	\$62.20

Elastomer Dust Plugs & Caps

Caps (for female couplers) and plugs (for male plugs/nipples) are compatible with all ISO 5675 quick disconnect couplers.



Item #	Description	Price
2AGDP	1/4" Dust Plug	\$3.48
3AGDP	3/8" Dust Plug	\$7.57
4AGDP	1/2" Dust Plug	\$3.85
6AGDP	3/4" Dust Plug	\$9.79
8AGDP	1" Dust Plug	\$13.06
AG2DC	1/4" Dust Cap	\$3.57
AG3DC	3/8" Dust Cap	\$6.74
AG4DC	1/2" Dust Cap	\$3.91
AG6DC	3/4" Dust Cap	\$14.89
AG8DC	1" Dust Cap	\$16.67

AG Series

ISO 5675

Agricultural Hydraulic Quick Couplers



Recommended for use with construction equipment, farm implements, and most other mobile equipment. Features Buna seals, double shut-off, and proven ball-lock mechanism for positive connection.

Pressure & Flow Ratings

Body Size	Maximum Working Pressure	Maximum Flow Rate
1/4"	5,075 psi	3.2 gpm
3/8"	4,350 psi	7 gpm
1/2"	4,350 psi	12 gpm
3/4"	3,625 psi	20 gpm
1"	3,190 psi	40 gpm

Interchanges with:

- Parker 4000 Series
- Safeway Series 'S20'
- Faster 'NS'
- Tomco Series 'PC'
- ISO 7241-1 Series A (1/2" only)

600 Series

ISO 7241-1 Series A Hydraulic Quick Disconnect Couplers



Recommended for general purpose, mobile hydraulics, machine tool, plastic molding and test equipment applications. Features Buna seals, double shut-off, and proven ball-lock mechanism for positive connection.

Pressure & Flow Ratings

Body Size	Maximum Working Pressure	Maximum Flow Rate
1/4"	5,000 psi	3 gpm
3/8"	4,000 psi	6 gpm
1/2"	4,000 psi	12 gpm
3/4"	2,500 psi	28 gpm
1"	2,000 psi	50 gpm

Interchanges with:

- Parker 6600 Series
- Snap-Tite 61 Series'
- Aeroquip 5600 (FD56)
- ISO 5675 (1/2" size only)

ISO 7241-1 Series A Female Couplers



Item #	Body	Thread Size	Price
601-04-04S	1/4"	1/4" NPTF	\$11.88
601-06-06S	3/8"	3/8" NPTF	\$13.01
601-08-08S	1/2"	1/2" NPTF	\$13.04
601-12-12S	3/4"	3/4" NPTF	\$31.91
601-16-16S	1"	1" NPTF	\$42.96

ISO 7241-1 Series A Male Plug/Nipples



Item #	Body	Thread Size	Price
602-04-04S	1/4"	1/4" NPTF	\$5.27
602-06-06S	3/8"	3/8" NPTF	\$7.79
602-08-08S	1/2"	1/2" NPTF	\$8.82
602-12-12S	3/4"	3/4" NPTF	\$14.06
602-16-16S	1"	1" NPTF	\$18.64

ISO 7241-1 Series A Matched Sets/Pairs

Buy a set and save. Each pair includes 1 female coupler and 1 male plug/nipple.



Item #	Body	Thread Size	Price
600-04-04S	1/4"	1/4" NPTF	\$16.31
600-06-06S	3/8"	3/8" NPTF	\$19.78
600-08-08S	1/2"	1/2" NPTF	\$20.77
600-12-12S	3/4"	3/4" NPTF	\$43.67
600-16-16S	1"	1" NPTF	\$58.51

Elastomer Dust Plugs & Caps

Caps (for female couplers) and plugs (for male plugs/nipples) are compatible with all ISO 7241-1 Series A quick disconnect couplers.



Item #	Description	Price
601-04P	1/4" Dust Plug	\$1.25
601-06P	3/8" Dust Plug	\$1.25
601-08P	1/2" Dust Plug	\$1.35
601-12P	3/4" Dust Plug	\$3.31
601-16P	1" Dust Plug	\$3.99
602-04C	1/4" Dust Cap	\$1.25
602-06C	3/8" Dust Cap	\$1.25
602-08C	1/2" Dust Cap	\$1.35
602-12C	3/4" Dust Cap	\$3.31
602-16C	1" Dust Cap	\$3.99

ISO 7241-1 Series B Female Couplers



Steel

Item #	Body	Thread Size	Price
701-04-04S	1/4"	1/4" NPTF	\$9.20
701-06-06S	3/8"	3/8" NPTF	\$13.81
701-08-08S	1/2"	1/2" NPTF	\$15.82
701-12-12S	3/4"	3/4" NPTF	\$25.00
701-16-16S	1"	1" NPTF	\$33.63

Brass

Item #	Body	Thread Size	Price
701-04-04B	1/4"	1/4" NPTF	\$10.87
701-06-06B	3/8"	3/8" NPTF	\$15.70
701-08-08B	1/2"	1/2" NPTF	\$24.55
701-12-12B	3/4"	3/4" NPTF	\$41.06
701-16-16B	1"	1" NPTF	\$56.60

ISO 7241-1 Series B Male Plug/Nipples

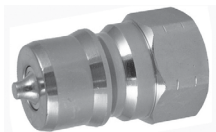

Steel

Item #	Body	Thread Size	Price
702-04-04S	1/4"	1/4" NPTF	\$4.49
702-06-06S	3/8"	3/8" NPTF	\$7.00
702-08-08S	1/2"	1/2" NPTF	\$7.65
702-12-12S	3/4"	3/4" NPTF	\$11.66
702-16-16S	1"	1" NPTF	\$16.34

Brass

Item #	Body	Thread Size	Price
702-04-04B	1/4"	1/4" NPTF	\$5.49
702-06-06B	3/8"	3/8" NPTF	\$7.29
702-08-08B	1/2"	1/2" NPTF	\$9.26
702-12-12B	3/4"	3/4" NPTF	\$15.30
702-16-16B	1"	1" NPTF	\$17.09

ISO 7241-1 Series B Matched Sets/Pairs

Buy a set and save. Each pair includes 1 female coupler and 1 male plug/nipple.



Steel

Item #	Body	Thread Size	Price
700-04-04S	1/4"	1/4" NPTF	\$13.00
700-06-06S	3/8"	3/8" NPTF	\$19.78
700-08-08S	1/2"	1/2" NPTF	\$22.32
700-12-12S	3/4"	3/4" NPTF	\$34.83
700-16-16S	1"	1" NPTF	\$47.48

Brass

Item #	Body	Thread Size	Price
700-04-04B	1/4"	1/4" NPTF	\$15.54
700-06-06B	3/8"	3/8" NPTF	\$21.84
700-08-08B	1/2"	1/2" NPTF	\$32.13
700-12-12B	3/4"	3/4" NPTF	\$53.54
700-16-16B	1"	1" NPTF	\$70.00

Elastomer Dust Plugs & Caps

Caps (for female couplers) and plugs (for male plugs/nipples) are compatible with all ISO 7241-1 Series B quick disconnect couplers.



Item #	Description	Price
701-04P	1/4" Dust Plug	\$1.14
701-06P	3/8" Dust Plug	\$1.14
701-08P	1/2" Dust Plug	\$1.24
701-12P	3/4" Dust Plug	\$3.03
701-16P	1" Dust Plug	\$3.66
702-04C	1/4" Dust Cap	\$1.14
702-06C	3/8" Dust Cap	\$1.14
702-08C	1/2" Dust Cap	\$1.24
702-12C	3/4" Dust Cap	\$3.03
702-16C	1" Dust Cap	\$3.66

700 Series

ISO 7241-1 Series B Hydraulic Quick Disconnect Couplers



Recommended for general purpose, mobile hydraulics, machine tool, plastic molding and test equipment applications. Features Buna seals, double shut-off, and proven ball-lock mechanism for positive connection.

Pressure & Flow Ratings

Body Size	Maximum Working Pressure (Steel)	Maximum Working Pressure (Brass)
1/4"	5,000 psi	1,000 psi
3/8"	4,000 psi	1,000 psi
1/2"	4,000 psi	1,000 psi
3/4"	2,500 psi	1,500 psi
1"	2,000 psi	1,000 psi

Interchanges with:

- Parker 60 Series
- Snap-Tite 72 Series
- Aeroquip FD45 Series

4100 Series Wet Line Coupling



Interchanges with:

- Parker 6100 Series
- Snap-Tite 78 Series
- Aeroquip 5100 Series

Designed for most industrial fluid applications, this coupling is ideal for oil well equipment, sand and salt spreaders, dump and demolition trailers, live bed trailers and other heavy duty applications.

- Connect and disconnect under pressure
- Brass body with steel valving components
- Heavy-duty steel wing nut
- Buna seals

Body Size	Recommended Operating Pressure (psi)	Flow Rate (gpm)
1/4"	3,000	4
3/8"	3,000	7
1/2"	3,000	7
5/8"	3,000	18
3/4"	3,000	18
1"	3,000	40
1 1/4"	2,750*	75
1 1/2"	2,500**	100

* Nipple holds max. 2,500 psi when disconnected

** Nipple holds max. 2,000 psi when disconnected

Female Couplers

Item #	Description	Thread	Material	Price
4100-S5-04B	1/4" Coupler	1/8" NPT (female)	Brass	\$71.72
4100-S5-06B	3/8" Coupler	1/4" NPT (female)	Brass	\$96.92
4100-S5-08B	1/2" Coupler	3/8" NPT (female)	Brass	\$97.46
4100-S5-10B	5/8" Coupler	1/2" NPT (female)	Brass	\$53.46
4100-S5-12B	3/4" Coupler	3/4" NPT (female)	Brass	\$53.46
4100-S5-16B	1" Coupler	1" NPT (female)	Brass	\$63.74
4100-S5-20B	1 1/4" Coupler	1 1/4" NPT (female)	Brass	\$115.42
4100-S5-24B	1 1/2" Coupler	1 1/2" NPT (female)	Brass	\$150.44

Male Nipples

Item #	Description	Thread	Material	Price
4100-S2-04B	1/4" Nipple	1/8" NPT (female)	Brass	\$55.26
4100-S2-06B	3/8" Nipple	1/4" NPT (female)	Brass	\$54.83
4100-S2-08B	1/2" Nipple	3/8" NPT (female)	Brass	\$52.50
4100-S2-10B	5/8" Nipple	1/2" NPT (female)	Brass	\$35.16
4100-S2-12B	3/4" Nipple	3/4" NPT (female)	Brass	\$41.87
4100-S2-16B	1" Nipple	1" NPT (female)	Brass	\$41.60
4100-S2-20B	1 1/4" Nipple	1 1/4" NPT (female)	Brass	\$97.89
4100-S2-24B	1 1/2" Nipple	1 1/2" NPT (female)	Brass	\$146.24

Dust Caps and Plugs

Item #	Description	Price
4100-S5-06P	Dust Plug for 3/8" Coupler	\$11.99
4100-S2-06C	Dust Cap for 3/8" Nipple	\$11.99
4100-S5-08P	Dust Plug for 1/2" Coupler	\$11.99
4100-S2-08C	Dust Cap for 1/2" Nipple	\$11.99
4100-S5-10P	Dust Plug for 5/8" Coupler	\$11.99
4100-S2-10C	Dust Cap for 5/8" Nipple	\$11.99
4100-S5-12P	Dust Plug for 3/4" Coupler	\$12.62
4100-S2-12C	Dust Cap for 3/4" Nipple	\$12.62
4100-S5-16P	Dust Plug for 1" Coupler	\$13.91
4100-S2-16C	Dust Cap for 1" Nipple	\$13.91
4100-S5-20P	Dust Plug for 1 1/4" Coupler	\$18.85
4100-S2-20C	Dust Cap for 1 1/4" Nipple	\$18.85
4100-S5-24P	Dust Plug for 1 1/2" Coupler	\$34.98
4100-S2-24C	Dust Cap for 1 1/2" Nipple	\$34.98



10,000 psi Hydraulic Pumps



Portable hydraulic pumps designed to meet the demanding requirements of industrial, construction and automotive applications. Built with features required for long life and trouble free operation.

- Rugged aluminum construction
- Internal pressure relief valve
- Air exhaust muffler for quiet operation (VAP-10-100 only)
- Filters on both the air and oil inlet (VAP-10-100 only)
- Locking foot pedal release valve and built-in safety valve to protect against overloading (VAP-10-100 only)
- Two-speed operation (VHP-10-25 and VHP-10-43 only)
- Convenient carrying handle and ergonomic handle grip (VHP-10-25 and VHP-10-43 only)

VAP-10-100	10,000 psi Air/Hydraulic	101 in ³ (1650 cc)	\$453.15
VHP-10-25	10,000 psi Two-Speed Manual	25 in ³ (410 cc)	\$259.73
VHP-10-43	10,000 psi Two-Speed Manual	43 in ³ (705 cc)	\$270.78



3/8" Couplers \$30.84 per set

Item number 3TM3-T3F3 includes one male coupler and one female coupler.

T-Series couplers interchange with Enerpac C-604 (3/8" only), Parker 3000 Series, Stucchi IVHP Series, and Holmbury HPA Series.

Screw-Together, High Pressure Quick Disconnects

Threaded sleeve allows connection and disconnection while coupler and/or nipple are under pressure. Urethane seal resists extrusion under high pressure during connection and disconnection.

Item #	Coupler	Thread	Material	Price
2TM2	1/4" Female	1/4" Male NPTF	Steel	\$18.65
3TF3	3/8" Female	3/8" Female NPTF	Steel	\$20.58
3TM3	3/8" Female	3/8" Male NPTF	Steel	\$20.58
3TM3-SS	3/8" Female	3/8" Male NPTF	316 Stainless	\$120.84
T2F2	1/4" Male	1/4" Female NPTF	Steel	\$11.19
T3F3	3/8" Male	3/8" Female NPTF	Steel	\$11.78
T3F3-SS	3/8" Male	3/8" Female NPTF	316 Stainless	\$66.81

Coupler Size	Max. Working Pressure	Maximum Flow Rate
1/4"	10,000 psi	3 gpm
3/8"	10,000 psi	6 gpm

Pipe Thread with Ball Check

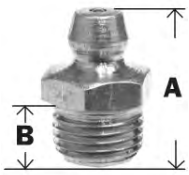

36-110 \$0.62

1/8-27 NPT
Overall length (A): 0.68"
Insert length (B): 0.29"
Hex size: 0.43"

36-111 \$0.84

Thread Forming
Overall length (A): 0.62"
Insert length (B): 0.23"
Hex size: 0.43"

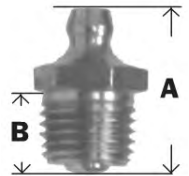

36-130 \$1.08

1/4-18 NPT
Overall length (A): 0.87"
Insert length (B): 0.42"
Hex size: 0.56"

Pipe Thread Long with Ball Check

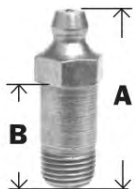

36-112 \$1.75

1/8-27 NPT
Overall length (A): 1.25"
Insert length (B): 0.78"
Hex size: 0.43"

Pipe Thread Extra Long with Ball Check

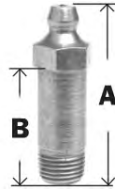

36-113 \$1.92

1/8-27 NPT
Overall length (A): 1.75"
Insert length (B): 1.26"
Hex size: 0.43"

Pipe Thread 30° with Ball Check

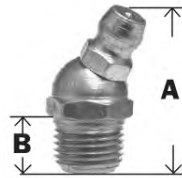

36-114 \$1.03

1/8-27 NPT
Overall length (A): 0.90"
Insert length (B): 0.29"
Hex size: 0.43"

Pipe Thread 45° with Ball Check

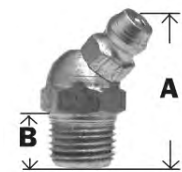

36-116 \$1.12

1/8-27 NPT
Overall length (A): 0.89"
Insert length (B): 0.29"
Hex size: 0.43"

Pipe Thread 65° with Ball Check



36-118 \$1.02

1/8-27 NPT
Overall length (A): 0.84"
Insert length (B): 0.29"
Hex size: 0.43"

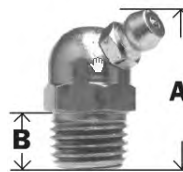

36-132 \$1.55

1/4-18 NPT
Overall length (A): 0.96"
Insert length (B): 0.34"
Hex size: 0.56"

Pipe Thread 90° with Ball Check

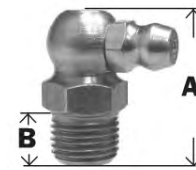

36-120 \$1.00

1/8-27 NPT
Overall length (A): 0.84"
Insert length (B): 0.29"
Hex size: 0.43"

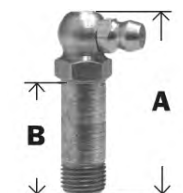

36-121 \$3.19

1/8-27 NPT
Overall length (A): 1.81"
Insert length (B): 1.25"
Hex size: 0.43"

1/4-28 Taper Short with Ball Check

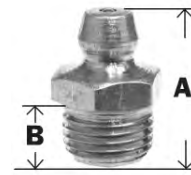

36-140 \$0.36

1/4-28 Taper Thread
Overall length (A): 0.54"
Insert length (B): 0.18"
Hex size: 0.31"

36-141 \$0.38

Thread Forming
Overall length (A): 0.57"
Insert length (B): 0.18"
Hex size: 0.31"

1/4-28 Taper Long with Ball Check



36-142 \$0.45

1/4-28 Taper Thread
Overall length (A): 0.90"
Insert length (B): 0.29"
Hex size: 0.43"

1/4-28 Taper Extra Long with Ball Check

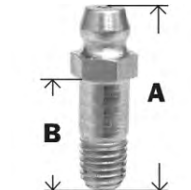

36-144 \$0.68

Thread Forming
Overall length (A): 0.96"
Insert length (B): 0.62"
Hex size: 0.31"

Zinc-plated steel. All fittings meet SAE J-534C specifications.

1/4-28 Taper 45° Short with Ball Check



36-146 \$0.89

1/4-28 Taper Thread
Overall length (A): 0.81"
Insert length (B): 0.20"
Hex size: 0.37"

1/4-28 Taper 65° Short with Ball Check



36-147 \$1.01

1/4-28 Taper Thread
Overall length (A): 0.78"
Insert length (B): 0.20"
Hex size: 0.37"

Drive Type with Ball Check

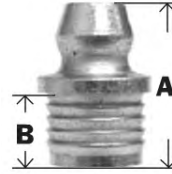

36-160 \$0.50

5/16" Drive
Overall length (A): 0.54"
Insert length (B): 0.25"

Drive Type with Ball Check

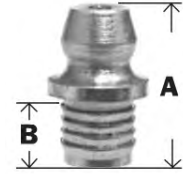

36-166 \$0.42

1/4" Drive
Overall length (A): 0.55"
Insert length (B): 0.23"

1/4-28 Taper 45° Long with Ball Check



36-148 \$1.25

1/4-28 Taper Thread
Overall length (A): 0.90"
Insert length (B): 0.29"
Hex size: 0.37"

1/4-28 Taper 90° with Ball Check

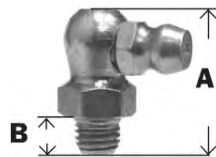

36-150 \$0.76

1/4-28 Taper Thread
Overall length (A): 0.75"
Insert length (B): 0.20"
Hex size: 0.37"

36-152 \$1.44

Thread Forming
Overall length (A): 0.75"
Insert length (B): 0.20"
Hex size: 0.37"

Drive Type with Ball Check

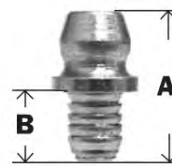

36-164 \$0.50

3/16" Drive
Overall length (A): 0.51"
Insert length (B): 0.25"

Button Head

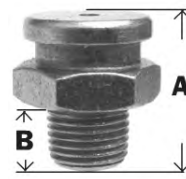

36-200 \$2.47

1/8-27 NPTF thread
Overall length (A): 0.75"
Insert length (B): 0.34"
Hex size: 0.62"

36-205 \$2.63

1/4-18 NPTF thread
Overall length (A): 0.82"
Insert length (B): 0.42"
Hex size: 0.62"

Zinc-plated steel. All fittings meet SAE J-534C specifications.

Rubber Whip Hose



3/16" I.D. hose with 1/8" NPT male pipe fittings

36-210 12" long \$21.88

36-212 18" long \$15.27

36-214 24" long \$18.67

36-216 36" long \$21.36

Grease Gun Coupler

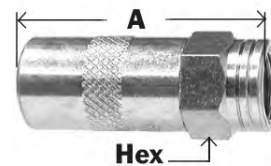

36-220 \$6.95

Overall length (A): 1.50"
Hex size: 0.56"

5/16"-24



36-186 \$0.65

5/16-24 thread
Overall length (A): 0.65"
Insert length (B): 0.25"
Hex size: 0.37"

3/8"-24

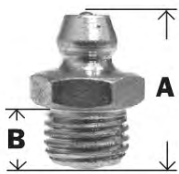

36-188 \$1.10

3/8-24 thread
Overall length (A): 0.65"
Insert length (B): 0.25"
Hex size: 0.43"

Metric

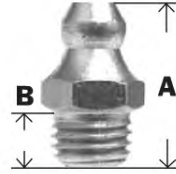

36-168 \$0.65

6 mm x 1 metric thread
Overall length (A): 16 mm
Insert length (B): 6 mm
Hex size: 7 mm

36-174 \$0.56

8 mm x 1 metric thread
Overall length (A): 17 mm
Insert length (B): 6 mm
Hex size: 9 mm

36-180 \$0.83

10 mm x 1 metric thread
Overall length (A): 18 mm
Insert length (B): 6 mm
Hex size: 11 mm

Metric 45°



36-170 \$0.88

6 mm x 1 metric thread
Overall length (A): 21 mm
Insert length (B): 5.5 mm
Hex size: 9 mm

36-176 \$0.92

8 mm x 1 metric thread
Overall length (A): 17 mm
Insert length (B): 5.5 mm
Hex size: 9 mm

36-182 \$1.22

10 mm x 1 metric thread
Overall length (A): 21 mm
Insert length (B): 5.5 mm
Hex size: 11 mm

Metric 90°

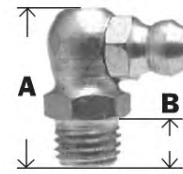

36-172 \$0.92

6 mm x 1 metric thread
Overall length (A): 18 mm
Insert length (B): 5.5 mm
Hex size: 9 mm

36-178 \$0.96

8 mm x 1 metric thread
Overall length (A): 18 mm
Insert length (B): 5.5 mm
Hex size: 9 mm

36-184 \$1.08

10 mm x 1 metric thread
Overall length (A): 18 mm
Insert length (B): 5.5 mm
Hex size: 11 mm

Zinc-plated steel. All fittings meet SAE J-534C specifications.

Specifications

Our aluminium and brass cam and groove fittings are designed to interchange with all product manufactured to Mil-C-27487F.

No standard exists for 1/2" and 8" fittings, and generally these sizes do not interchange with other manufacturers.

Body Size	Max. Working Pressure (Aluminum and Brass)	Max. Working Pressure (Polypropylene)
1/2"	150 psi	125 psi
3/4"	250 psi	125 psi
1"	250 psi	125 psi
1 1/4"	250 psi	100 psi
1 1/2"	250 psi	100 psi
2"	250 psi	100 psi
2 1/2"	150 psi	100 psi
3"	125 psi	70 psi
4"	100 psi	?
5"	75 psi	n/a
6"	75 psi	n/a
8"	?	n/a

Pressure ratings with standard seals at 70° F.

Polypropylene cam and groove should not be used with aluminum fittings.

Aluminum and brass couplings ship with Buna-N gaskets.

Polypropylene couplings ship with EPDM gaskets. Polypropylene is not recommended for use with PTFE gaskets.

Type A Male Adapter x Female NPTF

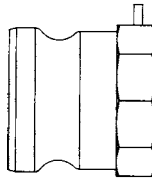

Aluminum

Body	NPT	Item #	Price
1/2"	1/2"	50-A-AL	\$6.44
3/4"	1/2"	7550-A-AL	\$8.18
3/4"	3/4"	75-A-AL	\$6.80
1"	1"	100-A-AL	\$8.07
1 1/4"	1 1/4"	125-A-AL	\$10.42
1 1/2"	1 1/2"	150-A-AL	\$10.47
2"	2"	200-A-AL	\$12.21
2 1/2"	2 1/2"	250-A-AL	\$18.86
3"	3"	300-A-AL	\$21.76
4"	4"	400-A-AL	\$49.29
5"	5"	500-A-AL	\$83.21
6"	6"	600-A-AL	\$98.52
8"	8"	800-A-AL	\$270.83

Brass

Body	NPT	Item #	Price
1/2"	1/2"	50-A-BR	\$12.72
3/4"	1/2"	7550-A-BR	\$21.48
3/4"	3/4"	75-A-BR	\$13.99
1"	1"	100-A-BR	\$15.24
1 1/4"	1 1/4"	125-A-BR	\$26.19
1 1/2"	1 1/2"	150-A-BR	\$27.02
2"	2"	200-A-BR	\$34.61
2 1/2"	2 1/2"	250-A-BR	\$64.14
3"	3"	300-A-BR	\$62.80
4"	4"	400-A-BR	\$137.83
5"	5"	500-A-BR	\$232.69
6"	6"	600-A-BR	\$320.30

Polypropylene

Body	NPT	Item #	Price
3/4"	1/2"	PPA50	\$4.85
3/4"	3/4"	PPA75	\$4.85
1"	1"	PPA100	\$6.02
1 1/2"	1 1/4"	PPA125	\$5.52
1 1/2"	1 1/2"	PPA150	\$6.08
2"	2"	PPA200	\$7.15
3"	3"	PPA300	\$16.09
4"	4"	PPA400	\$26.46

Type B Female Coupler x Male NPTF

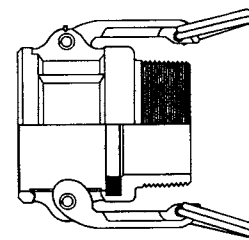

Aluminum

Body	NPT	Item #	Price
1/2"	1/2"	50-B-AL	\$16.96
3/4"	3/4"	75-B-AL	\$16.96
1"	1"	100-B-AL	\$18.19
1 1/2"	1 1/2"	150-B-AL	\$20.84
2"	2"	200-B-AL	\$25.28
3"	3"	300-B-AL	\$41.17
4"	4"	400-B-AL	\$63.03
5"	5"	500-B-AL	\$103.03
6"	6"	600-B-AL	\$145.47
8"	8"	800-B-AL	\$799.50

Brass

Body	NPT	Item #	Price
1/2"	1/2"	50-B-BR	\$30.28
3/4"	3/4"	75-B-BR	\$37.17
1"	1"	100-B-BR	\$40.49
1 1/2"	1 1/2"	150-B-BR	\$55.68
2"	2"	200-B-BR	\$66.68
3"	3"	300-B-BR	\$119.75
4"	4"	400-B-BR	\$175.36

Polypropylene

Body	NPT	Item #	Price
3/4"	1/2"	PPB50	\$12.21
3/4"	3/4"	PPB75	\$12.21
1"	1"	PPB100	\$13.89
1 1/2"	1 1/4"	PPB125	\$16.30
1 1/2"	1 1/2"	PPB150	\$16.09
2"	2"	PPB200	\$19.82
3"	3"	PPB300	\$33.36
4"	4"	PPB400	\$67.01

SAFETY NOTICE: Cam and groove couplings should never be used for compressed air or steam service.

Type C

Female Coupler x Hose Shank

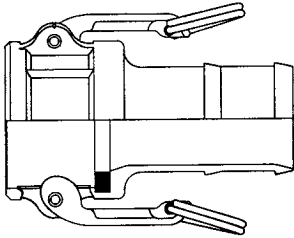

Aluminum

Body	Hose	Item #	Price
1/2"	1/2"	50-C-AL	\$14.30
3/4"	3/4"	75-C-AL	\$16.24
1"	1"	100-C-AL	\$16.86
1 1/2"	1 1/2"	150-C-AL	\$20.90
2"	2"	200-C-AL	\$24.00
3"	3"	300-C-AL	\$38.26
4"	4"	400-C-AL	\$56.95
5"	5"	500-C-AL	\$97.36
6"	6"	600-C-AL	\$143.73
8"	8"	800-C-AL	\$596.19

Brass

Body	Hose	Item #	Price
1/2"	1/2"	50-C-BR	\$35.27
3/4"	3/4"	75-C-BR	\$37.17
1"	1"	100-C-BR	\$41.37
1 1/2"	1 1/2"	150-C-BR	\$56.05
2"	2"	200-C-BR	\$67.46
3"	3"	300-C-BR	\$115.50
4"	4"	400-C-BR	\$176.22
6"	6"	600-C-BR	\$573.14

Polypropylene

Body	Hose	Item #	Price
3/4"	1/2"	PPC50	\$12.21
3/4"	3/4"	PPC75	\$12.21
1"	1"	PPC100	\$13.89
1 1/2"	1 1/4"	PPC125	\$16.30
1 1/2"	1 1/2"	PPC150	\$16.09
2"	2"	PPC200	\$19.82
3"	3"	PPC300	\$33.36
4"	4"	PPC400	\$67.01

Type D

Female Coupler x Female NPTF

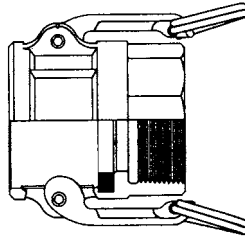

Aluminum

Body	NPT	Item #	Price
1/2"	1/2"	50-D-AL	\$16.61
3/4"	3/4"	75-D-AL	\$17.12
1"	1"	100-D-AL	\$17.31
1 1/2"	1 1/2"	150-D-AL	\$22.43
2"	2"	200-D-AL	\$23.80
3"	3"	300-D-AL	\$39.44
4"	4"	400-D-AL	\$58.55
5"	5"	500-D-AL	\$104.30
6"	6"	600-D-AL	\$137.35
8"	8"	800-D-AL	\$608.36

Brass

Body	NPT	Item #	Price
1/2"	1/2"	50-D-BR	\$34.20
3/4"	3/4"	75-D-BR	\$37.61
1"	1"	100-D-BR	\$41.37
1 1/2"	1 1/2"	150-D-BR	\$55.27
2"	2"	200-D-BR	\$64.56
3"	3"	300-D-BR	\$114.64
4"	4"	400-D-BR	\$186.28
5"	5"	500-D-BR	\$354.00
6"	6"	600-D-BR	\$460.22

Polypropylene

Body	NPT	Item #	Price
3/4"	1/2"	PPD50	\$11.19
3/4"	3/4"	PPD75	\$11.19
1"	1"	PPD100	\$12.75
1 1/2"	1 1/4"	PPD125	\$14.95
1 1/2"	1 1/2"	PPD150	\$14.76
2"	2"	PPD200	\$18.19
3"	3"	PPD300	\$30.60
4"	4"	PPD400	\$61.48

Type E

Male Adapter x Hose Shank

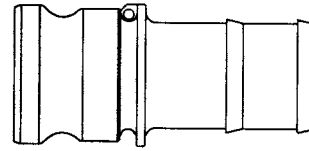

Aluminum

Body	Hose	Item #	Price
1/2"	1/2"	50-E-AL	\$9.05
3/4"	1/2"	7550-E-AL	\$7.93
3/4"	3/4"	75-E-AL	\$9.25
1"	1"	100-E-AL	\$9.30
1 1/4"	1 1/4"	125-E-AL	\$12.10
1 1/2"	1 1/2"	150-E-AL	\$11.50
2"	2"	200-E-AL	\$15.13
2 1/2"	2 1/2"	250-E-AL	\$22.63
3"	3"	300-E-AL	\$26.41
4"	4"	400-E-AL	\$53.38
5"	5"	500-E-AL	\$85.75
6"	6"	600-E-AL	\$104.30
8"	8"	800-E-AL	\$434.54

Brass

Body	Hose	Item #	Price
1/2"	1/2"	50-E-BR	\$22.01
3/4"	3/4"	75-E-BR	\$22.01
1"	1"	100-E-BR	\$27.87
1 1/4"	1 1/4"	125-E-BR	\$38.17
1 1/2"	1 1/2"	150-E-BR	\$38.45
2"	2"	200-E-BR	\$48.80
2 1/2"	2 1/2"	250-E-BR	\$82.65
3"	3"	300-E-BR	\$83.51
4"	4"	400-E-BR	\$160.19
6"	6"	600-E-BR	\$455.16

Polypropylene

Body	Hose	Item #	Price
3/4"	1/2"	PPE50	\$5.37
3/4"	3/4"	PPE75	\$5.37
1"	1"	PPE100	\$6.28
1 1/2"	1 1/4"	PPE125	\$6.28
1 1/2"	1 1/2"	PPE150	\$6.94
2"	2"	PPE200	\$8.12
3"	3"	PPE300	\$20.02
4"	4"	PPE400	\$26.46

SAFETY NOTICE: Cam and groove couplings should never be used for compressed air or steam service.

Type F Male Adapter x Male NPTF

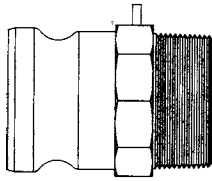

Aluminum

Body	NPT	Item #	Price
1/2"	1/2"	50-F-AL	\$6.69
3/4"	1/2"	7550-F-AL	\$12.21
3/4"	3/4"	75-F-AL	\$8.18
1"	1"	100-F-AL	\$10.37
1 1/4"	1 1/4"	125-F-AL	\$12.57
1 1/2"	1 1/2"	150-F-AL	\$12.66
2"	2"	200-F-AL	\$15.21
2 1/2"	2 1/2"	250-F-AL	\$26.96
3"	3"	300-F-AL	\$29.57
4"	4"	400-F-AL	\$53.94
5"	5"	500-F-AL	\$95.61
6"	6"	600-F-AL	\$119.99
8"	8"	800-F-AL	\$353.42

Brass

Body	NPT	Item #	Price
1/2"	1/2"	50-E-BR	\$22.01
3/4"	1/2"	7550-F-BR	\$21.63
3/4"	3/4"	75-F-BR	\$13.77
1"	1"	100-F-BR	\$18.10
1 1/4"	1 1/4"	125-F-BR	\$27.09
1 1/2"	1 1/2"	150-F-BR	\$26.12
2"	2"	200-F-BR	\$33.38
2 1/2"	2 1/2"	250-F-BR	\$64.11
3"	3"	300-F-BR	\$73.45
4"	4"	400-F-BR	\$116.53
6"	6"	600-F-BR	\$327.14

Polypropylene

Body	NPT	Item #	Price
3/4"	1/2"	PPF50	\$5.37
3/4"	3/4"	PPF75	\$5.37
1"	1"	PPF100	\$6.28
1 1/2"	1 1/4"	PPF125	\$6.28
1 1/2"	1 1/2"	PPF150	\$6.28
2"	2"	PPF200	\$9.09
3"	3"	PPF300	\$20.02
4"	4"	PPF400	\$26.46

Type DC Dust Cap

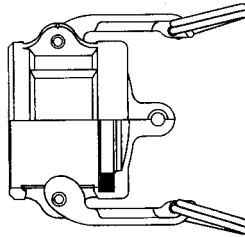

Aluminum

Body	Item #	Price
1/2"	50-DC-AL	\$15.02
3/4"	75-DC-AL	\$16.61
1"	100-DC-AL	\$16.86
1 1/2"	150-DC-AL	\$20.90
2"	200-DC-AL	\$21.30
3"	300-DC-AL	\$28.46
4"	400-DC-AL	\$40.35
5"	500-DC-AL	\$67.27
6"	600-DC-AL	\$101.40
8"	800-DC-AL	\$417.17

Brass

Body	Item #	Price
1/2"	50-DC-BR	\$26.75
3/4"	75-DC-BR	\$31.92
1"	100-DC-BR	\$40.95
1 1/2"	150-DC-BR	\$51.07
2"	200-DC-BR	\$54.40
3"	300-DC-BR	\$78.94
4"	400-DC-BR	\$109.55
5"	500-DC-BR	\$269.72

Polypropylene

Body	Item #	Price
3/4"	PPH75	\$12.21
1"	PPH100	\$13.43
1 1/2"	PPH150	\$16.09
2"	PPH200	\$19.82
3"	PPH300	\$31.51
4"	PPH400	\$48.94

Dust caps and plugs are not to be used in pressure applications for safety and environmental reasons.

Type DP Dust Plug

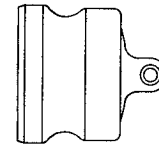

Aluminum

Body	Item #	Price
3/4"	75-DP-AL	\$8.58
1"	100-DP-AL	\$9.54
1 1/4"	125-DP-AL	\$11.34
1 1/2"	150-DP-AL	\$12.17
2"	200-DP-AL	\$12.46
2 1/2"	250-DP-AL	\$17.42
3"	300-DP-AL	\$18.29
4"	400-DP-AL	\$27.84
5"	500-DP-AL	\$51.03
6"	600-DP-AL	\$58.29
8"	800-DP-AL	\$243.35

Brass

Body	Item #	Price
1/2"	50-DP-BR	\$21.08
3/4"	75-DP-BR	\$21.08
1"	100-DP-BR	\$19.45
1 1/4"	125-DP-BR	\$32.58
1 1/2"	150-DP-BR	\$33.77
2"	200-DP-BR	\$36.95
2 1/2"	250-DP-BR	\$50.58
3"	300-DP-BR	\$53.21
4"	400-DP-BR	\$89.39
6"	600-DP-BR	\$379.26

Polypropylene

Body	Item #	Price
3/4"	PPP75	\$4.85
1"	PPP100	\$6.02
1 1/2"	PPP150	\$6.08
2"	PPP200	\$7.85
3"	PPP300	\$16.09
4"	PPP400	\$20.84

Dust caps and plugs are not to be used in pressure applications for safety and environmental reasons.

SAFETY NOTICE: Cam and groove couplings should *never* be used for compressed air or steam service.

Nylon Abrasion Sleeve



Flexible nylon sleeve protects hose from abrasion and allows bundling of hose lines. Allow for the maximum outside diameter of the hose ends if sleeve is installed after hose assembly.

Nylon sleeve is available "by the foot" or in coils (300 feet per coil).

Item #	Sleeve I.D.	Coil Price (per foot)	Cut Price (per foot)
NPS-076	.76"	\$1.07	\$1.19
NPS-105	1.05"	\$1.25	\$1.39
NPS-114	1.14"	\$1.26	\$1.40
NPS-122	1.22"	\$1.38	\$1.53
NPS-153	1.53"	\$1.68	\$1.87
NPS-175	1.75"	\$1.82	\$2.01
NPS-209	2.09"	\$1.97	\$2.19
NPS-260	2.60"	\$2.68	\$2.97
NPS-291	2.91"	\$2.84	\$3.15
NPS-366	3.66"	\$4.08	\$4.54

Spiral Guard Plastic Protective Coil



Chemical and UV ray resistant plastic coil protects hose from abrasion and external damage. Plastic Protective Coil is sold in 66 ft. lengths only (NFSGX110 sold in 33 ft. lengths).

Item #	I.D.	Price
NFSGX16-66FT	.50"	\$58.28
NFSGX20-66FT	.62"	\$80.85
NFSGX25-66FT	.75"	\$111.83
NFSGX32-66FT	.94"	\$160.13
NFSGX40-66FT	1.25"	\$237.83
NFSGX50-66FT	1.50"	\$313.95
NFSGX63-66FT	1.94"	\$427.88
NFSGX75-66FT	2.37"	\$612.68
NFSGX90-66FT	2.62"	\$792.75
NFSGX110-33FT	3.19"	\$471.98

Steel Wire Protective Coil



Rust resistant steel wire protects hose cover from abrasion and accidental damage. Steel Wire Protective Coil is sold in 20-foot lengths only.

Item #	I.D.	Price
SG-1S-20FT	.61"	\$19.39
SG-12S-20FT	.67"	\$21.05
SG-2S-20FT	.75"	\$19.62
SG-14S-20FT	.85"	\$20.11
SG-3S-20FT	.91"	\$20.58
SG-4S-20FT	1.04"	\$29.57
SG-5S-20FT	1.18"	\$48.26
SG-6S-20FT	1.34"	\$39.03
SG-7S-20FT	1.66"	\$46.60
SG-9S-20FT	1.87"	\$56.99
SG-8S-20FT	2.13"	\$54.63
SG-10S-20FT	2.38"	\$85.86
SG-11S-20FT	2.88"	\$162.97

Hose-Bend Restrictors



Reduces bending stress near the hose fitting, preventing damage and extending the life of the hose. No adhesive or clamp needed. Designed to work with a variety of hydraulic and pressure-washer hoses.

Item #	I.D.	Length	Price
HB20	.616"	5.25"	\$3.24
HB40	.668"	5.75"	\$3.42
HB60	.750"	6.50"	\$3.50
HB80	.815"	7.00"	\$3.66
HB100	.871"	7.75"	\$4.61

Hose Armor Steel Protective Coil



Rust resistant steel coil for use where hose lines are subjected to excessive abrasion, kinking, or accidental damage. Hose Armor Steel Protective Coil is sold in 20-foot lengths only.

Item #	Coil I.D.	Price
HA-1S-20FT	.50"	\$39.98
HA-13S-20FT	.57"	\$150.63
HA-2S-20FT	.63"	\$113.02
HA-3S-20FT	.75"	\$115.74
HA-4S-20FT	.88"	\$153.61
HA-5S-20FT	1.03"	\$67.88
HA-14S-20FT	1.13"	\$213.61
HA-6S-20FT	1.22"	\$195.74
HA-7S-20FT	1.47"	\$93.20
HA-9S-20FT	1.69"	\$392.34
HA-8S-20FT	1.91"	\$342.55
HA-15S-20FT	2.00"	\$234.78
HA-10S-20FT	2.13"	\$568.51
HA-11S-20FT	2.56"	\$726.38

Hose Strap

Steel with protective rubber

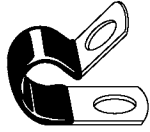

Provides support for long hose lengths, or to insure proper hose routing where abrasion, moving parts or heat may exist.

Item #	Clamp I.D.	Price
COV-0509	0.25"	\$1.95
COV-0709	0.37"	\$1.95
COV-0809	0.44"	\$1.95
COV-0913	0.50"	\$2.02
COV-1013	0.56"	\$2.02
COV-1113	0.63"	\$2.02
COV-1213	0.68"	\$2.02
COV-1313	0.75"	\$2.02
COV-1413	0.81"	\$2.02
COV-1513	0.87"	\$2.13
COV-1613	0.94"	\$2.13
COV-1713	1.00"	\$2.13
COV-1817	1.12"	\$2.18
COV-1917	1.19"	\$2.18
COV-2017	1.18"	\$2.25
COV-2117	1.25"	\$2.25
COV-2317	1.37"	\$2.44
COV-2517	1.50"	\$2.47
COV-2617	1.56"	\$2.49
COV-2917	1.75"	\$2.56
COV-3117	1.81"	\$2.59
COV-3217	1.93"	\$2.67
COV-3317	2.06"	\$2.82
COV-3417	2.15"	\$2.85
COV-3617	2.25"	\$2.94
COV-4517	2.75"	\$3.14
COV-4717	2.88"	\$3.84
COV-5717	3.56"	\$4.45

Fire Jacket

Protective Wrap



Silicone rubber coating over fiberglass (no asbestos) protects hose and tubing from high temperatures or molten splash.

- Iron oxide red color
- Temperature range: -65° to 500° F
- 3" wide

Item #	Length	Price
4055-3	50 feet	\$463.58

Fire Tape



Used to seal the ends of fire jacket sleeve and wrap to prevent fraying.

- Iron oxide red color
- Temperature range: -45° to 380° F
- 1" wide

Item #	Length	Price
FTH100	12 yards	\$49.00

Fire Jacket

Protective Sleeve



Silicone rubber coating over fiberglass (no asbestos) protects hose and tubing from high temperatures or molten splash.

- Iron oxide red color
- Temperature range: -65° to 500° F

Each sleeve is 50' in length

Item #	Sleeve I.D.	Price
0610-04	0.25"	\$176.87
1010-06	0.38"	\$184.41
1310-08	0.50"	\$220.12
1610-10	0.63"	\$248.35
1910-12	0.75"	\$280.34
2210-14	0.88"	\$331.13
2510-16	1.00"	\$378.15
3210-20	1.25"	\$428.40
3810-24	1.50"	\$478.07
4510-28	1.75"	\$577.41
5110-32	2.00"	\$651.91



F7925-OLP

Spring Retractable Fuel Delivery Reels

Reelcraft's spring retractable fuel delivery reels, equipped with Viton® seals, incorporate metal forms to insure the greatest possible strength and are ideal for mobile and permanent-mount applications. These rugged, corrosion-resistant reels are available with or without fuel grade UL330 and ULC approved hose.



FD83075-OLP

Reel with Hose and Bumper	Price	Pressure (psi)	Hose I.D.	Hose O.D.	(M) NPTF Outlet	(F) NPTF Inlet	Hose Length	Without Hose and Bumper	Price	Pressure (psi)
F7925-OLP	\$495.60	50	3/4"	1.188"	3/4"	3/4"	25 feet	F7900-OLP	\$372.75	500
F83050-OLP	\$846.30	50	3/4"	1.188"	3/4"	3/4"	50 feet	F83000-OLP	\$565.95	500
FD83075-OLP	\$1067.85	50	3/4"	1.188"	3/4"	3/4"	75 feet	FD83000-OLP	\$637.35	500



RT650-OLP

Medium Duty Spring Retractable Reels

Reelcraft's Series RT is an economical choice for a medium duty, lighter weight, spring-driven hose reel for applications that are less demanding, yet require a product that can withstand industrial and commercial use. The industrial-grade drive spring is protected from the environment in a polypropylene spool for longer service life. Guide arm adjusts to seven positions.



RT605-OLP

Reel with Hose and Bumper	Price	Pressure (psi)	Hose I.D.	Hose O.D.	(M) NPTF Outlet	(F) NPTF Inlet	Hose Length	Without Hose and Bumper	Price	Pressure (psi)
RT450-OLP	\$194.25	300	1/4"	0.475"	1/4"	1/4"	50 feet	RT405-OLP	\$148.05	300
RT650-OLP	\$235.20	300	3/8"	0.600"	3/8"	3/8"	50 feet	RT605-OLP	\$175.35	300
RT850-OLP	\$317.10	300	1/2"	0.750"	1/2"	1/2"	50 feet	RT805-OLP	\$256.20	300



H18006M

Pressure Wash Reels

Compact design and quality steel construction are incorporated into Reelcraft's newest line of pressure wash reels. The Series H18006 and PW80000 reels are able to carry 100 to 300 feet of tangle-free hose come complete with Super Swivel® for maximum product delivery.



PW81000-OHP

Reel Only (Hose and Bumper not included)	Price	Hose I.D.	Hose Capacity	Pressure (psi)	(F) NPTF Reel Inlet	Length	Width	Height
H18006M	\$212.10	3/8"	100 feet	3,000	1/2"	18 1/4"	20"	19"
CA38106M	\$286.65	3/8"	140 feet	3,000	1/2"	19"	17 3/4"	20 1/4"
CA38112M	\$286.65	3/8"	300 feet	3,000	1/2"	25"	17 3/4"	20 1/4"
PW7600-OHP	\$407.40	3/8"	50 feet	4,500	1/2"	19"	7"	20 1/4"
PW81000-OHP	\$613.20	3/8"	100 feet	4,500	1/2"	24"	10 1/2"	20 1/2"

HS150/HS300/HS500 Hose Cutting Saws

Professional cutting tools with scalloped blade for all hose cutting applications. Hose retaining system is included with HS300 and HS500 Series.

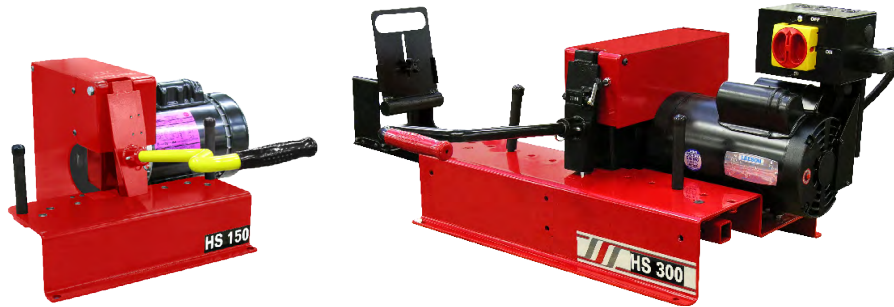

Item	Blade	Motor / Power	Max. Hose Capacity	Price
HS150	10" Scalloped	1 HP / 115V, 3450 RPM	1¼" 4-wire, 1½" 1-wire	\$1154.48
HS300	12" Scalloped	3 HP / 220V Three Phase	1¼" 6-wire, 2" 2-wire	\$1990.80
HS300-1	12" Scalloped	3 HP / 220V Single Phase	1¼" 6-wire, 2" 2-wire	\$2158.80
HS500	12" Scalloped	5 HP / 220V Three Phase	All hoses up to 2"	\$2572.50
HS500-1	12" Scalloped	5 HP / 220V Single Phase	All hoses up to 2"	\$2740.50



Optional 103073 Hose Channel System is available in 5-foot sections with built-in tape measure and adjustable leg. Sold separately for the HS300 and HS500 series only.

Replacement Blades and Accessories

Item # and Description	Price
102210 10" Scalloped Blade	\$314.06
104033 12" Scalloped Blade*	\$379.68
103172 Mister Kit*	\$468.30
103073 Channel Section*	\$110.88

* HS300 and HS500 Series only



Optional 103172 Mister Kit sprays a fine mist of air tool oil, cooling and lubricating the blade as it cuts. Sold separately for the HS300 and HS500 Series only.

JetCleaner JCL-2030 Hose/Tube Cleaning Kit

The JetCleaner pneumatic hose cleaning gun uses compressed air to shoot oversized foam projectiles. As the projectile is propelled forward, it pushes out deposits, leaving the tube, pipe or hose thoroughly cleaned.

- Cleans straight, curved and coiled hoses, with or without fittings
- Simple to operate, minimal training required
- Push button trigger reduces fatigue
- Quick disconnect fittings for no-tools connection
- Power requirements: 90–120 psi compressed air

Item #	Description	Hose	Price
JR-09	100 Projectiles	1/4"	\$43.84
JR-14	100 Projectiles	3/8"	\$50.93
JR-18	100 Projectiles	1/2"	\$59.59
JR-22	100 Projectiles	5/8"	\$77.18
JR-26	50 Projectiles	3/4"	\$43.84
JR-33	50 Projectiles	1"	\$66.68
JR-40	50 Projectiles	1¼"	\$108.68



JCL-2030 JetCleaner Kit \$1761.90
Includes gun, carrying case and nine nozzles (1/4", 3/8", 1/2", 5/8", 3/4" 1", 1¼", 1½", and 2"). Projectiles sold separately.



14" Cut-Off Saw

2 HP single-phase electric motor (3,500 max. RPM) cuts two-, four- and six-wire hydraulic hose up to 4" I.D.. Also cuts metal or masonry.

14" abrasive cutting wheel (sold separately) leaves a straight, smooth edge for easy assembly.

Built-in work vise holds hose securely for cutting.

Item # and Description	Price
CS14 Cut-Off Saw	\$147.00
CS14-5B Pack of 5 blades	\$39.90

D-Series Hydraulic Hose Crimpers accommodate a wide range of hose and fitting types.

Unlike some crimpers that only work with one brand of hose and fittings, our D-Series Hydraulic Hose Crimpers can crimp hose and fittings from virtually any manufacturer.

These fully adjustable crimpers can be set to the precise crimp diameter needed without the use of shims or spacer rings.



D100H Hand-Operated Crimper includes 2-stage manual pump and steel carrying case



D100P Air-Powered Crimper includes pneumatic pump and steel carrying case



D100S Standalone Crimper works with any 10,000 psi hydraulic pump (not included)

Heavy-duty cylinder (D100 Series) delivers up to 35 tons of crimping force

Removable pusher and spring-loaded die sets for easy loading, even with bent tube and special fittings

Lightweight portable models are ideal for emergency repairs in the field

Direct-reading metric micrometer allows for precise adjustment of crimp diameters

Open design provides excellent operator visibility

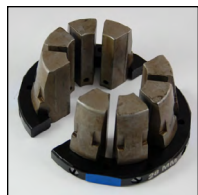

Two-piece die sets allow quick, easy die changes. With an effective crimp range of two to four millimeters, each adjustable die set crimps a variety of hoses and fittings.

Dies are sold separately, so you can buy as many or as few as you need. Recommended die selection is shown with crimp specifications on pages 70–73.

Steel carrying case (D100H and D100P only) has a storage compartment in the lid for dies, tools and operator's manual.



Adjustable Die Set	Effective Crimp Range	Price
D100-07MM	7–8 mm	\$206.33
D100-08MM	8–10 mm	\$206.33
D100-10MM	10–13 mm	\$206.33
D100-12MM	12–15 mm	\$206.33
D100-14MM	14–17 mm	\$206.33
D100-16MM	16–20 mm	\$206.33
D100-19MM	19–23 mm	\$206.33
D100-22MM	22–26 mm	\$206.33
D100-25MM	25–29 mm	\$206.33
D100-28MM	28–32 mm	\$206.33
D100-31MM	31–35 mm	\$206.33
D100-35MM	35–39 mm	\$206.33
D100-39MM ¹	39–43 mm	\$206.33
D100-43MM ¹	43–45 mm	\$206.33

Adjustable Die Set	Effective Crimp Range	Price
D100-47MM ¹	47–51 mm	\$206.33
D100-51MM ¹	51–55 mm	\$206.33
D100DA-37MM ²	37–39 mm	\$412.34
D100DA-39MM ²	39–41 mm	\$412.34
D100DA-41MM ²	41–43 mm	\$412.34
D100DA-43MM ²	43–45 mm	\$412.34
D100DA-46MM ²	46–48 mm	\$412.34
D200-07MM	7–8 mm	\$303.34
D200-08MM	8–10 mm	\$303.34
D200-10MM	10–13 mm	\$303.34
D200-12MM	12–15 mm	\$303.34
D200-14MM	14–17 mm	\$303.34
D200-16MM	16–20 mm	\$303.34
D200-19MM	19–23 mm	\$303.34

Adjustable Die Set	Effective Crimp Range	Price
D200-22MM	22–26 mm	\$303.34
D200-25MM	25–29 mm	\$303.34
D200-28MM	28–32 mm	\$303.34
D200-31MM	31–35 mm	\$303.34
D200-35MM	35–39 mm	\$303.34
D200-39MM	39–43 mm	\$303.34
D200-43MM	43–45 mm	\$303.34
D200-47MM	47–51 mm	\$303.34
D200-51MM	51–55 mm	\$303.34
D200DA-55MM ²	55–57 mm	\$530.46
D200DA-58MM ²	58–60 mm	\$530.46
D200DA-60MM ²	60–62mm	\$530.46
D200DA-72MM ²	72–74 mm	\$530.46
D200DA-74MM ²	74–76 mm	\$530.46

(1) For use with D165 only. (2) DA double-angle dies require additional double-angle tooling (sold separately).

D-Series Crimper Specifications

Dies sold separately. Please see crimp specifications on pages 70–73 for die selection.



	D100S	D100H	D100P	D165	D205
Max. Cylinder Force	35 ton	35 ton	35 ton	60 ton	80 ton
Included Pump	None	2-stage manual	Pneumatic	1 HP Electric	2 HP Electric
Power Requirements	10,000 psi	n/a	80 psi air	110V-15A	220V Single Phase
Dies (sold separately)	D100 Series	D100 Series	D100 Series	D100 Series	D200 Series
Max. 2-wire hose I.D.	1" (1¼")*	1" (1¼")*	1" (1¼")*	1¼"	1½" (2")*
Max. 4-wire hose I.D.	¾" (1")*	¾" (1")*	¾" (1")*	1¼"	1½" (2")*
Max. 6-wire hose I.D.	n/a	n/a	n/a	1"	2" with DA dies*
Crimper Weight	45 pounds	75 pounds	85 pounds	140 pounds	400 pounds
Crimper Depth	14"	16"	16"	22"	29"
Crimper Width	11"	16"	16"	12.5"	37.5"
Crimper Height	23.5"	17"	17"	22.5"	32"
Catalog Price	\$1212.75	\$1863.75	\$2163.00	\$2913.75	\$4677.75

* Requires DA double-angle dies and additional double-angle tooling (sold separately).



D165 Compact Hose Crimper

includes 1 HP 110V-15A electric pump

- Crimps 2-wire and 4-wire hose up to 1¼" I.D.
- Foot pedal keeps both hands free to handle hose.
- Adjustable retraction stop limits ram retractions for quick repetitive crimps.
- Adjustable coupling stop for accurate, repetitive positioning of the assembly inside the dies.



D205 Large Hose Crimper

includes 2 HP 220V electric pump

- Crimps 2-wire, 4-wire and 6-wire hose up to 2" I.D.
- Work light included
- Foot pedal keeps both hands free to handle hose.
- Adjustable retraction stop limits ram retractions for quick repetitive crimps.
- Adjustable coupling stop for accurate, repetitive positioning of the assembly inside the dies.

DST1 Hand Swaging Tool

This hand-operated hose machine produces smooth, uniform coupling surfaces, without raised edge or ridges common in other coupling methods. The DST1 Hand Swaging Tool is designed to mount directly to your workbench or table.

Dies and pushers sold separately. Pusher and die selection chart is shown on page 31.

DST1 Hand Swaging Tool \$424.20
Use only with thermoplastic hose and fittings.



DST1 Swaging Tool Dies

4540-302	\$115.38
4540-303	\$115.38
4540-304	\$115.38
4540-305	\$115.38
4540-306	\$115.38
4540-308	\$115.38
4540-312	\$115.38
4540-316	\$115.38

Female Pushers

4599-FP002	\$54.17
4599-FP004	\$54.17
4599-FP005	\$54.17
4599-FP006	\$54.17
4599-FP008	\$54.17
4599-FP009	\$54.17
4599-FP010	\$54.17
4599-FP011	\$54.17
4599-FP012	\$54.17
4599-FP013	\$54.17
4599-FP014	\$54.17
4599-FP015	\$54.17
4599-FP016	\$54.17
4599-FP018	\$59.22

Male Pushers

4599-MP001	\$43.16
4599-MP002	\$43.16
4599-MP003	\$43.16
4599-MP004	\$43.16
4599-MP005	\$43.16
4599-MP006	\$43.16
4599-MP007	\$43.16
4599-MP008	\$43.16
4599-MP009	\$43.16
4599-MP010	\$43.16
4599-MP011	\$43.16
4599-MP012	\$49.06
4599-MP013	\$57.84
4599-MP023	\$43.16
4599-MP037	\$91.14
4599-MP045	\$91.14
4599-MP046	\$91.14

Bent Tube Pushers

4599-TP204	\$141.96
4599-TP205	\$141.96
4599-TP206	\$141.96
4599-TP208	\$141.96
4599-TP308	\$187.43

Ferrule Vises

Our ferrule vise crimping tools are ideal for light duty repetitive hose crimping. With a wide variety of available dies (sold separately) in either ribbed or straight configuration, these crimpers will consistently produce good looking accurate crimps time after time. Positive over-center action assures a consistent and repeatable crimp diameter with no need for adjustment.

The rugged cast iron frame and base is designed to provide years of dependable service and both the 670T and the 660T models have mounting holes which permit them to be securely mounted to a workbench.

- 660T Manually-Operated Ferrule Vise** \$799.58
- 670T Air-Operated Ferrule Vise** \$2199.75
Requires 80 psi compressed air (not included).
- Dies All Sizes (see pages 44–45)** \$138.60



670T Air-Operated Ferrule Vise

660T Manually-Operated Ferrule Vise

Brass Ferrule Crimper

The 855 Brass Ferrule Crimper provides “big tool” crimping advantages at a fraction of the cost. Rugged, portable and easy to use. Available in two models, each with five dies. Additional dies are available to increase the range of your crimper. *Use with brass ferrules only.*

- 855 Brass Ferrule Crimper (.49" to .71")** \$168.00
Includes 856-1, 856-2, 856-3, 856-4 and 856-5 dies
- 855A Brass Ferrule Crimper (.45" to .67")** \$168.00
Includes 856-1, 856-2, 856-3, 856-4 and 856-7 dies

Hose O.D.	Die #	Price	Hose O.D.	Die #	Price
.38" to .41"	856-10	\$26.20	.64" to .67"	856-1	\$26.20
.45" to .47"	856-7	\$26.20	.69" to .71"	856-5	\$26.20
.49" to .52"	856-4	\$26.20	.76" to .78"	856-8	\$26.20
.54" to .56"	856-3	\$26.20	.82" to .84"	856-9	\$26.20
.59" to .62"	856-2	\$26.20			

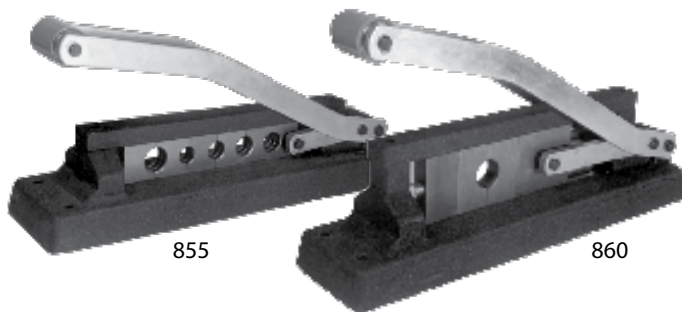

855

860

Large Brass Ferrule Crimper

The 860 Large Brass Ferrule Crimper brings the same economical utility of the 855 and 855A to larger hoses (with outside diameters from 11/16" to 1½"). Dies sold separately. *Use with brass or aluminum ferrules only.*

- 860 Large Brass Ferrule Crimper** \$199.50
Dies are not included.

Hose O.D.	Die #	Price	Hose O.D.	Die #	Price
11/16"	861-22	\$31.45	1"	861-32	\$31.45
23/32"	861-23	\$31.45	1-1/32"	861-33	\$31.45
3/4"	861-24	\$31.45	1-1/16"	861-34	\$31.45
25/32"	861-25	\$31.45	1-1/8"	861-36	\$31.45
13/16"	861-26	\$31.45	1-3/16"	861-38	\$31.45
27/32"	861-27	\$31.45	1-1/4"	861-40	\$31.45
7/8"	861-28	\$31.45	1-5/16"	861-42	\$31.45
29/32"	861-29	\$31.45	1-3/8"	861-44	\$31.45
15/16"	861-30	\$31.45	1-7/16"	861-46	\$31.45
32/32"	861-31	\$31.45	1-1/2"	861-48	\$31.45

CAUTION: the hose assembly tools on this page are not intended for use with high pressure hose assemblies. Please see our hydraulic hose crimpers beginning on page 60.

Crimp Specifications



Hose Fitting	Hose I.D.	Product Code	Crimp Diameter +/- .005" (0.13 mm)	Recommended Die Set Select the die for your crimper below			Micrometer Setting
SAE 100R1AT Hydraulic Hose (R1)				D100	D165	D205	
Braided Hose Fittings crimp to knurl	1/4"	R1-04	0.575" (14.60 mm)	D100-12MM	D100-12MM	D200-12MM	2.60
	3/8"	R1-06	0.725" (18.41 mm)	D100-16MM	D100-16MM	D200-16MM	2.41
	1/2"	R1-08	0.845" (21.46 mm)	D100-19MM	D100-19MM	D200-19MM	2.46
	5/8"	R1-10	0.995" (25.27 mm)	D100-22MM	D100-22MM	D200-22MM	3.27
	3/4"	R1-12	1.100" (27.90 mm)	D100-25MM	D100-25MM	D200-25MM	2.90
	1"	R1-16	1.430" (36.30 mm)	D100-35MM	D100-35MM	D200-35MM	1.30
	1-1/4"	R1-20	1.830" (46.50 mm)	N/A	D100-43MM	D200-43MM	3.50
W Series Bite-To-The Wire Hose Fittings crimp full shell	1/4"	R1-04	0.655" (16.65 mm)	D100-16MM	D100-16MM	D200-16MM	0.65
	3/8"	R1-06	0.790" (20.05 mm)	D100-19MM	D100-19MM	D200-19MM	1.05
	1/2"	R1-08	0.920" (23.36 mm)	D100-22MM	D100-22MM	D200-22MM	1.36
	3/4"	R1-12	1.215" (30.86 mm)	D100-28MM	D100-28MM	D200-28MM	2.86
	1"	R1-16	1.625" (41.30 mm)	D100-39MM	D100-39MM	D200-39MM	2.30
	1-1/4"	R1-20	1.965" (49.91 mm)	N/A	D100-47MM	D200-47MM	2.91
SAE 100R2AT Hydraulic Hose (R2)				D100	D165	D205	
Braided Hose Fittings crimp to knurl	1/4"	R2-04	0.645" (16.38 mm)	D100-16MM	D100-16MM	D200-16MM	0.38
	3/8"	R2-06	0.800" (20.32 mm)	D100-19MM	D100-19MM	D200-19MM	1.32
	1/2"	R2-08	0.910" (23.10 mm)	D100-22MM	D100-22MM	D200-22MM	1.10
	5/8"	R2-10	1.030" (26.16 mm)	D100-25MM	D100-25MM	D200-25MM	1.16
	3/4"	R2-12	1.190" (30.25 mm)	D100-28MM	D100-28MM	D200-28MM	2.25
	1"	R2-16	1.507" (38.27 mm)	D100-35MM	D100-35MM	D200-35MM	3.27
	1-1/4"	R2-20	1.908" (48.46 mm)	N/A	D100-47MM	D200-47MM	1.46
W Series Bite-To-The Wire Hose Fittings crimp full shell	1/4"	R2-04	0.695" (17.65 mm)	D100-16MM	D100-16MM	D200-16MM	1.65
	3/8"	R2-06	0.845" (21.46 mm)	D100-19MM	D100-19MM	D200-19MM	2.48
	1/2"	R2-08	0.970" (24.63 mm)	D100-22MM	D100-22MM	D200-22MM	2.63
	5/8"	R2-10	1.200" (30.48 mm)	D100-28MM	D100-28MM	D200-28MM	2.48
	3/4"	R2-12	1.285" (32.65 mm)	D100-31MM	D100-31MM	D200-31MM	1.65
	1"	R2-16	1.665" (42.30 mm)	D100-41MM	D100-41MM	D200-41MM	1.30
	1-1/4"	R2-20	2.060" (52.32 mm)	N/A	D100-51MM	D200-51MM	1.32
	1-1/2"	R2-24	2.400" (60.95 mm)	N/A	N/A	D200DA-60MM*	0.95
	2"	R2-32	2.870" (72.90 mm)	N/A	N/A	D200DA-72MM*	0.90

* D200DA Double-Angle Die Sets require double-angle tooling (sold separately).



D200 Double Angle Tooling

See pg. 66 of our hydraulic hose catalog for more information.

Hose Fitting	Hose I.D.	Product Code	Crimp Diameter +/- .005" (0.13 mm)	Recommended Die Set Select the die for your crimper below			Micrometer Setting
SAE 100R3 General Purpose/Hydraulic Hose (R3)				D100	D165	D205	
Braided Hose Fittings crimp to knurl	1/4"	R3-04	0.615" (15.60 mm)	D100-14MM	D100-14MM	D200-14MM	1.60
	3/8"	R3-06	0.790" (20.05 mm)	D100-19MM	D100-19MM	D200-19MM	1.05
	1/2"	R3-08	0.950" (24.15 mm)	D100-22MM	D100-22MM	D200-22MM	2.15
	3/4"	R3-12	1.240" (31.50 mm)	D100-31MM	D100-31MM	D200-31MM	0.50
	1"	R3-16	1.520" (36.60 mm)	D100-35MM	D100-35MM	D200-35MM	1.60
SAE 100R4 Suction and Return Hose (R4)				D100	D165	D205	
Braided Hose Fittings crimp to knurl	3/4"	R4-12	1.233" (31.30 mm)	D100-31MM	D100-31MM	D200-31MM	0.30
	1"	R4-16	1.466" (37.25 mm)	D100-35MM	D100-35MM	D200-35MM	2.25
	1-1/4"	R4-20	1.780" (45.20 mm)	N/A	D100-43MM	D200-43MM	2.20
Two-Piece Suction Hose Fittings crimp full shell	3/4"	R4-12	1.280" (32.50 mm)	D100-31MM	D100-31MM	D200-31MM	1.50
	1"	R4-16	1.540" (39.10 mm)	D100-39MM	D100-39MM	D200-39MM	0.10
	1-1/4"	R4-20	1.825" (46.35 mm)	N/A	D100-43MM	D200-43MM	3.35
	1-1/2"	R4-24	2.040" (51.80 mm)	N/A	N/A	D200-51MM	0.80
	2"	R4-32	2.480" (63.00 mm)	N/A	N/A	D200DA-62MM*	1.00
W Series Bite-To-The Wire Hose Fittings crimp full shell	1-1/2"	R4-24	2.360" (59.94 mm)	N/A	N/A	D200DA-58MM*	1.94
	2"	R4-32	2.900" (73.66 mm)	N/A	N/A	D200DA-72MM*	1.66
SAE 100R5 General Purpose/Truck Hose (R5)				D100	D165	D205	
R5 Series Truck Hose Fittings crimp to knurl	3/16"	R5-04	0.535" (13.60 mm)	D100-12MM	D100-12MM	D200-12MM	1.60
	1/4"	R5-05	0.660" (16.75 mm)	D100-16MM	D100-16MM	D200-16MM	0.75
	5/16"	R5-06	0.725" (18.40 mm)	D100-16MM	D100-16MM	D200-16MM	2.40
	13/32"	R5-08	0.830" (21.10 mm)	D100-19MM	D100-19MM	D200-19MM	2.10
	1/2"	R5-10	0.915" (23.30 mm)	D100-22MM	D100-22MM	D200-22MM	1.30
	5/8"	R5-12	1.035" (26.30 mm)	D100-25MM	D100-25MM	D200-25MM	1.30
	7/8"	R5-16	1.240" (31.50 mm)	D100-29MM	D100-29MM	D200-29MM	2.50
	1-1/8"	R5-20	1.535" (38.95 mm)	D100-35MM	D100-35MM	D200-35MM	3.95
	1-3/8"	R5-24	1.730" (43.95 mm)	N/A	D100-43MM	D200-43MM	0.95
1-13/16"	R5-32	2.225" (56.50 mm)	N/A	N/A	D200DA-55MM*	1.50	
SAE 100R7 Thermoplastic Hose (R7BK/R7NC)				D100	D165	D205	
3 Series Thermoplastic Hose Fittings crimp to knurl	1/8"	R7-02	0.358" (09.10 mm)	D100-08MM	D100-08MM	D200-08MM	1.10
	3/16"	R7-03	0.478" (12.14 mm)	D100-10MM	D100-10MM	D200-10MM	2.14
	1/4"	R7-04	0.555" (14.10 mm)	D100-12MM	D100-12MM	D200-12MM	2.10
	5/16"	R7-05	0.630" (16.00 mm)	D100-14MM	D100-14MM	D200-14MM	2.00
	3/8"	R7-06	0.675" (17.15 mm)	D100-16MM	D100-16MM	D200-16MM	1.15
	1/2"	R7-08	0.825" (20.96 mm)	D100-19MM	D100-19MM	D200-19MM	1.96
Braided Hose Fittings crimp to knurl	3/16"	R7-03	0.495" (12.57 mm)	D100-10MM	D100-10MM	D200-10MM	2.57
	1/4"	R7-04	0.580" (14.73 mm)	D100-12MM	D100-12MM	D200-12MM	2.73
	5/16"	R7-05	0.630" (16.00 mm)	D100-14MM	D100-14MM	D200-14MM	2.00
	3/8"	R7-06	0.720" (18.28 mm)	D100-16MM	D100-16MM	D200-16MM	4.28
	1/2"	R7-08	0.850" (21.59 mm)	D100-19MM	D100-19MM	D200-19MM	2.59
	3/4"	R7-12	1.120" (28.44 mm)	D100-28MM	D100-28MM	D200-28MM	0.44
	1"	R7-16	1.400" (35.56 mm)	D100-35MM	D100-35MM	D200-35MM	0.56

Hose Fitting	Hose I.D.	Product Code	Crimp Diameter +/- .005" (0.13 mm)	Recommended Die Set Select the die for your crimper below			Micrometer Setting
SAE 100R8 Thermoplastic Hose (R8BK/R8NC)				D100	D165	D205	
3 Series Thermoplastic Hose Fittings crimp to knurl	3/16"	R8-03	0.358" (12.14 mm)	D100-10MM	D100-10MM	D200-10MM	2.14
	1/4"	R8-04	0.555" (14.10 mm)	D100-12MM	D100-12MM	D200-12MM	2.10
	5/16"	R8-05	0.630" (16.00 mm)	D100-14MM	D100-14MM	D200-14MM	2.00
	3/8"	R8-06	0.675" (17.15 mm)	D100-16MM	D100-16MM	D200-16MM	1.15
	1/2"	R8-08	0.825" (20.96 mm)	D100-19MM	D100-19MM	D200-19MM	1.96
Braided Hose Fittings crimp to knurl	3/16"	R8-03	0.485" (12.32 mm)	D100-12MM	D100-12MM	D200-12MM	0.32
	1/4"	R8-04	0.580" (14.73 mm)	D100-12MM	D100-12MM	D200-12MM	2.73
	3/8"	R8-06	0.725" (18.41 mm)	D100-16MM	D100-16MM	D200-16MM	2.41
	1/2"	R8-08	0.830" (21.08 mm)	D100-19MM	D100-19MM	D200-19MM	2.08
Pressure Washer Hose (PW/PWB)				D100	D165	D205	
Braided Hose Fittings crimp to knurl	1/4"	PW-04 PWB-04	0.560" (14.22 mm)	D100-14MM	D100-14MM	D200-14MM	0.22
	3/8"	PW-04 PWB-04	0.670" (17.02 mm)	D100-16MM	D100-16MM	D200-16MM	1.02

* D200DA Double-Angle Die Sets require double-angle tooling (sold separately).

Braided Vs. W-Series Fittings

Our braided hose fittings are made to interchange with most Weatherhead "U" series fittings, and attach by crimping to the outer rubber jacket of the hose. Our W-Series bite-to-the-wire fittings are designed for superior performance by biting into the steel reinforced wire of the hydraulic hoses.



Finished Braided Crimp



Finished W-Series Crimp



Item: 93293-3VGA

Remember to always measure your crimps!

Hose Fitting	Hose I.D.	Product Code	Crimp Diameter +/- .005" (0.13 mm)	Recommended Die Set Select the die for your crimper below			Micrometer Setting
SAE 100R12 Four-Wire Hydraulic Hose (R12)				D100	D165	D205	
W Series Bite-To-The Wire Hose Fittings crimp full shell	3/8"	R12-06	0.870" (22.10 mm)	D100-22MM	D100-22MM	D200-22MM	0.10
	1/2"	R12-08	1.010" (25.65 mm)	D100-25MM	D100-25MM	D200-25MM	0.65
	3/4"	R12-12	1.320" (33.55 mm)	D100-31MM	D100-31MM	D200-31MM	2.55
	1"	R12-16	1.630" (41.40 mm)	D100-39MM	D100-39MM	D200-39MM	2.40
	1-1/4"	R12-20	2.045" (51.95 mm)	N/A	D100-51MM	D200-51MM	0.95
	1-1/2"	R12-24	2.375" (60.35 mm)	N/A	N/A	D200DA-60MM*	0.35
	2"	R12-32	2.885" (73.30 mm)	N/A	N/A	D200DA-72MM*	1.30
SAE 100R13 Hydraulic Hose (R13)				D100	D165	D205	
W Series Bite-To-The Wire Hose Fittings crimp full shell	3/4"	R13-12	1.335" (33.90 mm)	D100-31MM	D100-31MM	D200-31MM	2.90
	1"	R13-16	1.645" (41.80 mm)	D100-39MM	D100-39MM	D200-39MM	2.80
JJ Series Skived Hose Fittings skive before assembly, crimp full shell	1-1/4"	R13-20	2.050" (52.05 mm)	N/A	D100-51MM	D200-51MM	1.05
	1-1/2"	R13-24	2.320" (58.95 mm)	N/A	N/A	D200DA-58MM*	0.95
	2"	R13-32	2.980" (75.70 mm)	N/A	N/A	D200DA-75MM*	0.70
SAE 100R14A PTFE Hose (R14)				D100	D165	D205	
T Series PTFE Hose Fittings crimp to knurl	3/16"	R14-04	0.395" (10.05 mm)	D100-10MM	D100-10MM	D200-10MM	0.05
	1/4"	R14-05	0.430" (10.90 mm)	D100-10MM	D100-10MM	D200-10MM	0.90
	5/16"	R14-06	0.490" (12.45 mm)	D100-12MM	D100-12MM	D200-12MM	0.45
	3/8"	R14-07	0.565" (14.35 mm)	D100-14MM	D100-14MM	D200-14MM	0.35
	1/2"	R14-10	0.695" (17.65 mm)	D100-16MM	D100-16MM	D200-16MM	1.65
	3/4"	R14-14	0.995" (25.25 mm)	D100-25MM	D100-25MM	D200-25MM	0.25
	1"	R14-18	1.225" (31.10 mm)	D100-31MM	D100-31MM	D200-31MM	0.10
SAE 100R16 Hydraulic Hose (R16)				D100	D165	D205	
Braided Hose Fittings crimp to knurl	1/4"	R16-04	0.615" (15.60 mm)	D100-14MM	D100-14MM	D200-14MM	1.60
	3/8"	R16-06	0.740" (18.79 mm)	D100-16MM	D100-16MM	D200-16MM	2.79
	1/2"	R16-08	0.860" (21.84 mm)	D100-19MM	D100-19MM	D200-19MM	2.84
	5/8"	R16-10	1.000" (25.40 mm)	D100-25MM	D100-25MM	D200-25MM	0.40
	3/4"	R16-12	1.130" (28.70 mm)	D100-28MM	D100-28MM	D200-28MM	0.70
	1"	R16-16	1.425" (36.20 mm)	D100-35MM	D100-35MM	D200-35MM	1.20
W Series Bite-To-The Wire Hose Fittings crimp full shell	1/4"	R16-04	0.670" (17.01 mm)	D100-16MM	D100-16MM	D200-16MM	1.01
	3/8"	R16-06	0.815" (20.70 mm)	D100-19MM	D100-19MM	D200-19MM	1.70
	1/2"	R16-08	0.945" (24.00 mm)	D100-22MM	D100-22MM	D200-22MM	2.00
	5/8"	R16-10	1.178" (29.92 mm)	D100-28MM	D100-28MM	D200-28MM	1.92
	3/4"	R16-12	1.230" (31.25 mm)	D100-31MM	D100-31MM	D200-31MM	0.25
	1"	R16-16	1.555" (39.50 mm)	D100-39MM	D100-39MM	D200-39MM	0.50

* D200DA Double-Angle Die Sets require double-angle tooling (sold separately).

Crimp Specifications

Hose Fitting	Hose I.D.	Product Code	Crimp Diameter +/- .005" (0.13 mm)	Recommended Die Set Select the die for your crimper below			Micrometer Setting
SAE 100R17 Hydraulic Hose (R17)				D100	D165	D205	
Braided Hose Fittings crimp to knurl	1/4"	R17-04	0.565" (14.35 mm)	D100-14MM	D100-14MM	D200-14MM	0.35
	3/8"	R17-06	0.705" (17.90 mm)	D100-16MM	D100-16MM	D200-16MM	1.90
	1/2"	R17-08	0.840" (21.35 mm)	D100-19MM	D100-19MM	D200-19MM	2.35
	5/8"	R17-10	0.995" (25.27 mm)	D100-25MM	D100-25MM	D200-25MM	0.27
	3/4"	R17-12	1.140" (28.95 mm)	D100-28MM	D100-28MM	D200-28MM	0.95
W Series Bite-To-The Wire Hose Fittings crimp full shell	1/4"	R17-04	0.625" (15.90 mm)	D100-14MM	D100-14MM	D200-14MM	1.90
	3/8"	R17-06	0.779" (19.80 mm)	D100-19MM	D100-19MM	D200-19MM	0.80
	1/2"	R17-08	0.950" (24.10 mm)	D100-22MM	D100-22MM	D200-22MM	2.10
	5/8"	R17-10	1.170" (29.70 mm)	D100-28MM	D100-28MM	D200-28MM	1.70
	3/4"	R17-12	1.275" (32.40 mm)	D100-31MM	D100-31MM	D200-31MM	1.40
	1"	R17-16	1.564" (39.75 mm)	D100-35MM	D100-35MM	D200-35MM	4.75
Hydraulax™ TOUGH Hydraulic Hose (HT)				D100	D165	D205	
Braided Hose Fittings crimp to knurl	1/4"	HT-04	0.600" (15.25 mm)	D100-14MM	D100-14MM	D200-14MM	1.25
	3/8"	HT-06	0.750" (19.05 mm)	D100-16MM	D100-16MM	D200-16MM	3.05
	1/2"	HT-08	0.860" (21.85 mm)	D100-19MM	D100-19MM	D200-19MM	2.85
	5/8"	HT-10	0.985" (25.01 mm)	D100-22MM	D100-22MM	D200-22MM	3.01
	3/4"	HT-12	1.151" (29.25 mm)	D100-28MM	D100-28MM	D200-28MM	1.25
W Series Bite-To-The Wire Hose Fittings crimp full shell	1/4"	HT-04	0.660" (16.75 mm)	D100-16MM	D100-16MM	D200-16MM	0.75
	3/8"	HT-06	0.800" (20.30 mm)	D100-19MM	D100-19MM	D200-19MM	1.30
	1/2"	HT-08	0.950" (24.15 mm)	D100-22MM	D100-22MM	D200-22MM	2.15
	5/8"	HT-10	1.170" (29.70 mm)	D100-28MM	D100-28MM	D200-28MM	1.70
	3/4"	HT-12	1.240" (31.50 mm)	D100-31MM	D100-31MM	D200-31MM	0.50
	1"	HT-16	1.545" (39.25 mm)	D100-35MM	D100-35MM	D200-35MM	4.25
10,000 PSI Hydraulic Jack Hose (HJK)				D100	D165	D205	
Braided Hose Fittings crimp to knurl	1/4"	HJK-04	0.634" (16.10 mm)	D100-14MM	D100-14MM	D200-14MM	2.10
	3/8"	HJK-06	0.785" (19.95 mm)	D100-19MM	D100-19MM	D200-19MM	0.95
EN 856 4SH Hydraulic Hose (4SH)				D100	D165	D205	
W Series Bite-To-The Wire Hose Fittings crimp full shell	3/4"	4SH-12	1.320" (33.55 mm)	D100-31MM	D100-31MM	D200-31MM	2.55
	1"	4SH-16	1.630" (41.40 mm)	D100-39MM	D100-39MM	D200-39MM	2.40
	1-1/4"	4SH-20	1.990" (50.55 mm)	N/A	D100-47MM	D200-47MM	3.55
	1-1/2"	4SH-24	2.390" (60.70 mm)	N/A	N/A	D200DA-60MM*	0.70

* D200DA Double-Angle Die Sets require double-angle tooling (sold separately).



Dies can be found on page 66 of our Hydraulic Hose Catalog. Hose Cutting Saws are located on page 65.



NATIONAL PIPE THREADS

There are several variations of pipe threads. Thread forms include the Dryseal American Standard Taper Pipe Thread (NPTF), the National Pipe Straight Threads for Mechanical Joints (NPSM) and the dryseal American Fuel Internal Straight Pipe Thread (NPSF). Each series is normally identified by the abbreviated letter designation.

The NPTF thread is recommended for hydraulic service. This thread series is used on both male and female ends and forms a seal by the interference fit at the root and crest of the mating threads. The NPTF male also has an internal chamfer of 30° which allows it to seal at the seat with female NPSM pipe swivels. The NPSM is a straight pipe thread and sealing is obtained by the mating of the 30° seats of the male and female ends.

FLARED TUBE FITTINGS

SAE 37° Flare (JIC): The seal is obtained by the mating of two beveled metal surfaces. The function of the threads is simply to draw these two surfaces together. This style is used particularly in high pressure systems. As illustrated below, both the bevel on the male and the seat in the female are machined to 37°.

SAE 45° Flare: These flared tube fittings are similar to JIC, however the mating surfaces are machined at 45°. These couplings are usually used for low pressure applications such as refrigerant and fuel lines in conjunction with copper tubing which flares easily to 45°.

O-RING CONNECTIONS

SAE Straight Thread (O-Ring Boss): This fitting is a modification of the male JIC where the beveled 37° nose has been removed and a groove has been machined between the threads and the hex in which an O-ring is seated. The female is a port which has been tapped to the proper straight thread size and chamfered at the port face to provide an O-ring seat. The seal is made when the O-ring is trapped between port chamfer, thread under-cut, and the male fitting.

O-Ring Face Seal (ORFS): Uses an O-ring (SAE J1515) in a groove on the male face side. This is mated to flat face with an O-ring on the female swivel side, forming a seal without metal deformation much the same as an SAE four bolt split flange connection without the bolts. The O-ring face seal connection has been tested to SAE J343 tests and procedures and meets or exceeds SAE J1453 specifications. This connector has proven its superiority in leak resistance, ease of installation, high operating pressure, increased torque tolerance and reusability with its ability to be connected and disconnected frequently.

SAE J518 Four-Bolt Flange: Available in two pressure ratings. Code 61 is referred to as the "standard" series and Code 62 is the "6000 psi" series. The design of both series is the same, but the bolt-hole and flange diameters are different. The female port is unthreaded. The male consists of a flanged head, grooved for an O-ring. The seal is made when the O-ring is compressed between the flange head and the surface surrounding the port.

Nominal Size	Dash Size	National Pipe Thread	SAE 37° Flare (JIC)	SAE 45° Flare	SAE Straight Thread O-Ring Boss (ORB)	O-Ring Face Seal (ORFS)	Code 61 Flange	Code 62 Flange
1/8"	-02	1/8-27	5/16-24	5/16-24	5/16-24			
3/16"	-03		3/8-24	3/8-24	3/8-24			
1/4"	-04	1/4-18	7/16-20	7/16-20	7/16-20	9/16-18		
5/16"	-05		1/2-20	1/2-20	1/2-20			
3/8"	-06	3/8-18	9/16-18	5/8-18	9/16-18	1 1/16-16		
7/16"	-07			1 1/16-16				
1/2"	-08	1/2-14	3/4-16	3/4-16	3/4-16	1 3/16-16	1 3/16"	1 1/4"
5/8"	-10		7/8-14	7/8-14	7/8-14	1-14		
3/4"	-12	3/4-14	1 1/16-12	1 1/16-14	1 1/16-12	1 3/16-12	1 1/2"	1 5/8"
7/8"	-14		1 3/16-12	1 1/4-12	1 3/16-12			
1"	-16	1-11 1/2	1 5/16-12	1 3/8-12	1 5/16-12	1 7/16-12	1 3/4"	1 7/8"
1 1/4"	-20	1 1/4-11 1/2	1 5/8-12		1 5/8-12	1 11/16-12	2"	2 1/8"
1 1/2"	-24	1 1/2-11 1/2	1 7/8-12		1 7/8-12	2-12	2 3/8"	2 1/2"
2"	-32	2-11 1/2	2 1/2-12		2 1/2-12		2 13/16"	3 1/8"

Nominal size usually refers to inside pipe diameter or outside tube diameter. With flanges, nominal size refers to port hole diameter.

