

en

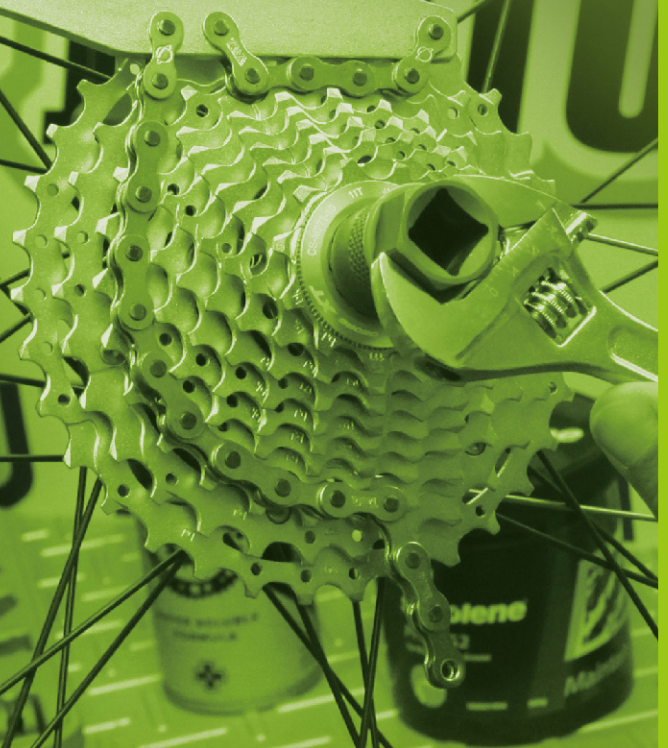

IceToolz[®]

2022~23.v1





CHAMPIONNATS DE FRANCE VALBERG VTT



VALBERG | 15-17 JUILLET 2020



Photo Credit Kéno Derleyn

Third party brand / product names used herein are used to identify such products and are for descriptive purposes only. Such names may be marks and / or registered marks of their respective owners.

IceToolz®

Online Video



Contents

01 What's New	28 Cone Wrenches
02 e-Bike	29 Safety
03 Cable Tools	29 Headset Wrenches
04-05 Tire Service	30-33 Cleaning & Lubrication
06-15 Xpert Series - Tools for Specialists	34 Pedal and Axle Wrenches
16-17 Freewheel & Cassette Tools	34-35 Disc Brake Tools
17-19 Spoke Tools	36 Bottom Bracket Tools
19-20 Crank Tools	37 Tool Kits
20-21 Hex and Star (Torx) Wrenches	38-39 Air Pumps
22-23 Multi Tools	40-41 General Tools
24-25 Display & Storage	42 Frame & Fork Tools
26-27 Chain Tools	43 Accessories

2022 NEW WHAT'S



CLEANING & LUBRICATION >> PAGE 30

E633 >>Page 02
SuperLifter-III Repair Stand



E621 >>Page 09
Franky Repair Stand





E633 SuperLifter-III Repair Stand

- E-bike compatible up to 60kg
- Rotatable rubber clamp for Ø25.4mm ~ Ø55mm
- Adjustable height from 50cm to 180cm (20"~7')
- 1 turn on the handle = 10cm in height
- Integrated wheels for better indoor and outdoor maneuver
- Large base to support the bike firmly to the top
- Includes integrated work tray
- Patented



◀ **E633S**
Spare clamp for
#E139, #E631 &
#E633 SuperLifters

C137



C147



C137 e-Bike Chain Degreaser

- Quickly eliminate built up oil, grease and grime

C147 Chain Lubricant (for e-Bike)

- Engineered specially for e-Bike chains to withstand high temperature and maintains viscosity during usage
- High cooling capacity and electric insulator

E631W Replacement wire fore #E139, #E631 & #E633 SuperLifters



M582 Shimano® Chainring Mounting Tool

- Compatible for Shimano® SM-CR80 (STePS) and FSA Spider
- Use with 1/2" Two-way Ratchet Wrench (#53R4)

M583 Shimano® Chainring Mounting Tool

- Compatible for Shimano® SM-CR60 (STePS)
- Use with 1/2" Two-way Ratchet Wrench (#53R4)

M801 BOSCH® Lockring Tool

- Compatible for Bosch® Active / Performance Line
- Use with 1/2" Two-way Ratchet Wrench (#53R4)

M803 BOSCH® Lockring Tool

- Compatible for Bosch® Gen4
- Use with 1/2" Two-way Ratchet Wrench (#53R4)



C177 e-Bike Grease

- Ideally for the circuit and parts of motors in various electric bike
- Non-conductive
- Protects metal against corrosion, heat, and water
- Highly lubricating even with small amount
- Temperature range: -25°C ~ 200°C



01A1 Cable Plier

- With a thumb lock to hold the cable tight for one hand operation
- Soften coated on handle for comfortable holding
- Suitable for shop, home or professional user



67R1 Internal Routing Tool

- Easy installation for cables, wires and Di2 inside of bike frame
- Plastic coated on wire of stainless steel up to length 250mm with magnet in the end
- Suitable for carbon fiber, titanium and aluminum frames
- One cable with opposite polarity magnet to seek or attach inside frame
- Suitable for hole diameter larger than 6mm



67A5 Pro Shop Cable & Spoke Cutter

- For Shimano® SIS SP
- Contains inner wire (Max. Ø3.5mm) and outer casing (Max. Ø7.0mm) reconitioner
- Patented

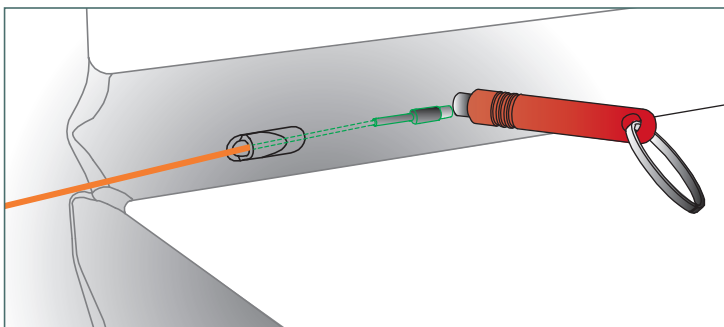

67B4 Cable Cutter

- Cuts cable, housing and wire quickly and easily
- Thumb-lock closure is easy to open and protects cutter when closed



64P3 POM Tire Levers

- Set of 3 pieces
- Unique V shaped design can be easily fixed on the spokes
- Air vent function added on back
- Smart V shaped design on back is a fulcrum on the rim for tire removal
- Patented



1903 Steel Tire Lever Set

- Zinc plated
- Set of 3 pieces



64D3 Screwdriver Type Downhill Tire Lever

- Works for most stubborn bicycle tires
- Metal parts covered by durable nylon to provide extra protection for Alu & Carbon Fiber rims

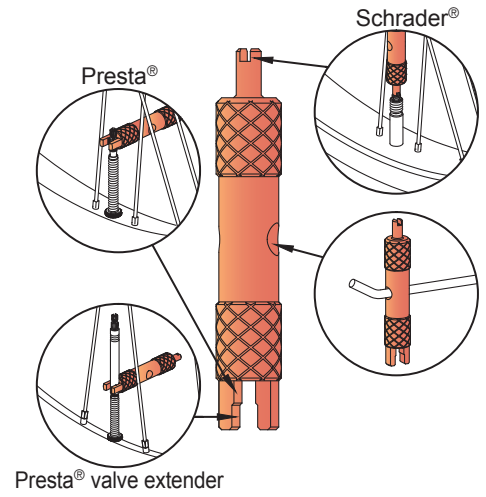

66V1 Valve Core Tool

- For Presta® & Schrader®

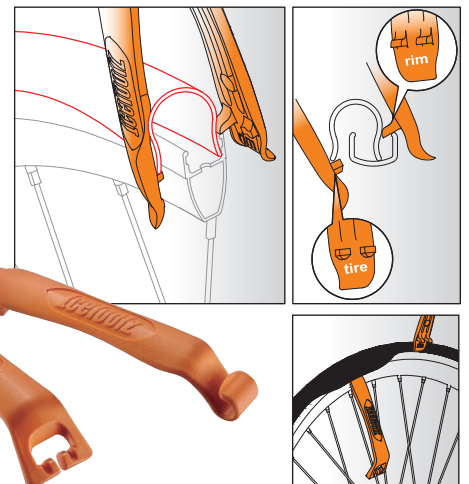
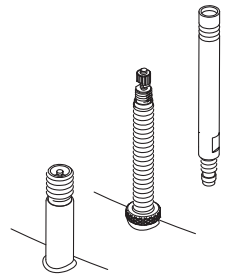

64A2 Clamp-Type, Duo-functional Tire Tool

- Transformable from a traditional tire lever to a new A shaped design for easier tire mounting



64H2 Heavy Duty Steel Tire Lever

- Forged, zinc plated
- 200mmL



65A1 Tire Puncture Repair Kit

- 18 patches
- 3 tire levers
- 10ml adhesive
- 8cm valve hose
- A sandpaper
- Supplied in a tin box



65B1 Tire Puncture Repair Kit

- 125ml adhesive with brush
- 3 sandpapers (85x45mm)
- 30 patches (Ø42mm)



65C1 Puncture Repair Kit for Tubeless Tire



56P6 Glueless Patch Set AirDam

- Six patches per set



66F1 Tire Sealant

- For all inflatable rubber tubes and tubeless tires
- Contains 120ml and one small piece of valve tool for Schrader® and Dunlop® valves
- Applicable for tire pressure under 60 PSI
- Suggest replenishing after half year
- One bottle fills 2 tires



56E6 Glueless Patch Set AirDam

- Six patches per set



56J5 Glueless Patch Set AirDam Set AirDam

- 50 sets #56P6 in jar



66L1 Bead Lubricant

- Bead Lubricant for tubeless tire, 100ml
- Quickens the process of sliding tire into the rim
- Avoids hassle cleaning the tire, the lube dries automatically
- A water base solution prevents damage to the tire



56H1 Glueless Patch Set AirDam

- 10 sets #56E6 per card

56H2 Glueless Patch Set AirDam

- 20 sets #56E6 per card



66G1 10ml Adhesive

- 50 tubes in jar



E129 Truing Stand

- Single-arm design, fits 18"~29" rim
- Increased stability by heavy base design
- #E127T kit for thru-axle hubs

E129T

- #E129 Truing Stand with #E127T Through-Axle Adaptor

E129V ▶

- #E129 Truing Stand with Dial Gauge and Thru-Axle Adaptor

E122 Axle Vise

- Hold a variety of axles
- Prevent turning when making adjustments to the wheel's hub
- Magnets to hold jaws solid in place
- Suitable for Ø5/9/10/12/14/20/25/30/36mm axles



E127T Through-Axle Adaptor

- Use with #E127, #E128, #E129 Truing Stand
- Conical design use with shaft diameter 11mm ~ 20mm
- Suitable for hub width 100 ~ 150mm

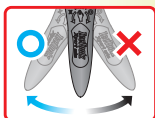

E219 Ocarina Torque Wrench Set

- Operating Range: 3 ~ 10N·m
- Its lightweight and smart design is ideal for all mechanics and riders
- Tightens to the correct torque easily, no need to set up the tool between various torque
- The ergonomic handle holds 3/4/5/6mm hex keys and T-25 in one tool
- Contents: 3/4/5/6mm hex keys and T-25
- Patented



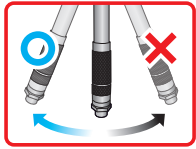

E211 One-way Torque Wrench

- Operating Range: 21 ~ 105N·m
- For 3/8" & 1/2" drive sockets
- Supplied in a case

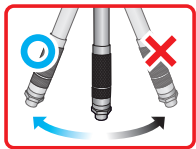

E212 One-way Torque Wrench

- Operating Range: 5 ~ 25N·m
- For 1/4" & 3/8" drive sockets
- Supplied in a case

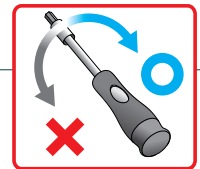

E213 One-way Torque Screwdriver

- Operating Range: 1 ~ 5N·m
- Contains bits of Hex, Pozidriv®, Phillip, Slot, Torx® (totally 32 bits)
- Contains a 1/4" adaptor
- For 1/4" drive sockets
- Supplied in a case

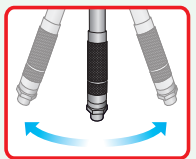

E214 Two-way Torque Wrench

- Operating Range: 20 ~ 100N·m
- For 3/8" & 1/2" drive sockets
- Supplied in a case

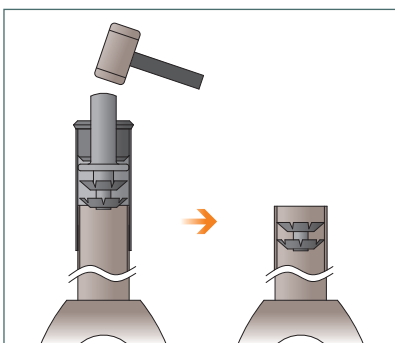

E114 Star Nut Installation Tool

- For 1", 1-1/8", and 1-1/2" fork steerer
- Patented





Tools are optional

Steel base #E132B is optional

E132 Floor Repair Stand

- Single clamp
- Includes tool tray #E132T
- The steel plate #E132B is optional

E132B Steel Plate

- Steel plate for #E132 Floor Repair Stand
- 600 x 600 x 8mm

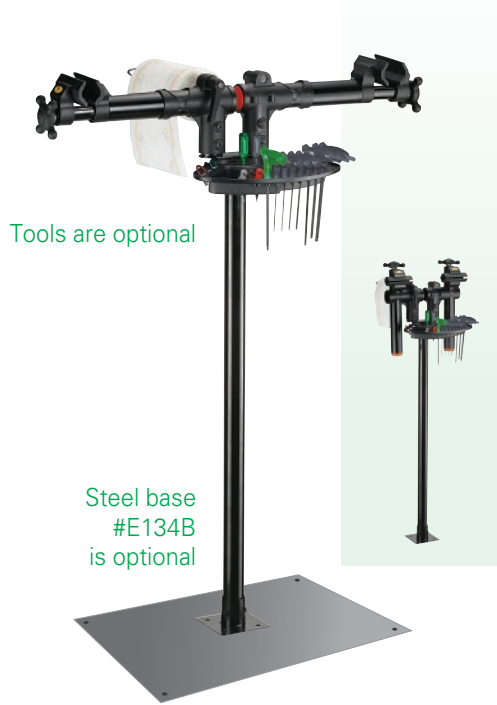

Tools are optional

Steel base #E134B is optional

E134 Floor Repair Stand

- Dual clamp
- Includes tool tray #E132T
- The steel plate #E134B is optional

E134B Steel Plate

- Steel plate for #E134 Floor Repair Stand
- 900 x 600 x 8mm



E136 Floor Repair Stand

- Dual clamp with metallic paw
- Includes tool tray #E132T
- The steel plate #E134B is optional

▶ **E136S Spare clamp for #E132, #E134 & #E136 Floor Repair Stands**



E633 SuperLifter-III Repair Stand

- E-bike compatible up to 60kg
- Rotatable rubber clamp for Ø25.4mm ~ Ø55mm
- Adjustable height from 50cm to 180cm (20"~7')
- 1 turn on the handle = 10cm in height
- Integrated wheels for better indoor and outdoor maneuver
- Large base to support the bike firmly to the top
- Includes integrated work tray
- Patented



◀ **E633S Spare clamp for #E139, #E631 & #E633 SuperLifters**

▶ **E631W Replacement wire fore #E139, #E631 & #E633 SuperLifters**





E137 Professional Repair Stand

- Rotatable clamping mechanism holds Ø25.4 ~ 55mm tubes
- Quick release for easy adjustment
- Fold for better mobility
- 3-leg stands stable and portable
- Contains paper towel holder
- Tool tray (#E132T) and tools are optional



Tool tray and tools are optional



E137C Spare Clamp

- For #E132, #E134, #E136, #E137, #E138, #E139 Repair Stands



E137S Spare Arm Set

- For #E132, #E134, #E137, #E138 Repair Stands

E138 Professional Repair Stand

- Rotatable clamping mechanism holds Ø25.4~55mm tubes
- Quick release for easy adjustment
- Fold for better mobility
- 3-leg stands stable and portable
- Contains paper towel holder
- Contains carry bag
- Tool tray (#E132T) and tools are optional



E614 Rotatable Race Stand

- 360-degree rotatable
- It's quite easy to do bike services and setting or cleaning process
- The crossbar is compatible with all fork and rear dropouts
- Adjustable to match various bikes
- With strap to hold the frame for more safety
- Auto adjustable foot padding to fit uneven floor condition and more stable workstation
- This stand can support 25kgs / 55.12lbs and height 90cm / 3'
- Carry bag included



E621 Franky Repair Stand

- 360-degree rotatable
- It's quite easy to do bike services and setting or cleaning process
- The crossbar is compatible with all fork and rear dropouts
- Adjustable to match various bikes
- With strap to hold the frame for more safety
- Auto adjustable foot padding to fit uneven floor condition and more stable workstation
- This stand can support 20kgs / 44lbs and height 90cm / 3'

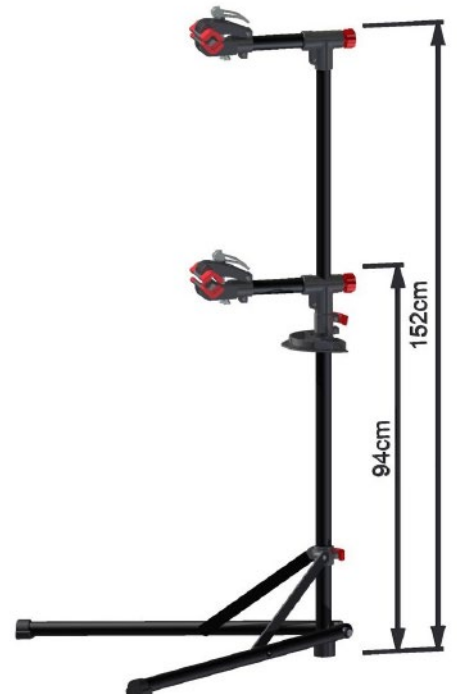



For BB cups



For headset cups

E147 Headset Cup / BB Cup Press Tool

- For 1", 1-1/8", 1-1/4", and 1-1/2"
- For head tube length up to 260mm
- Patented



E152

- Pedal tap, 1/2"x20TPI (left + right)

E154

- Pedal tap, 9/16"x20TPI (left + right)



E158 Complete Tap Set with Handle & Storage Pouch

- #E166: M3x0.5P, dropout alignment screws
- #E167: M5x0.8P, water bottle, fenders
- #E168: M6x1.0P, anti-brakes and large fender bracket
- #E169: M10x1.0P, derailleur hanger
- #E152: 1/2"x20TPI (left + right), pedal taps
- #E154: 9/16"x20TPI (left + right), pedal taps



Facing



Tapping

E175 BB Tapping & Facing Tool, English

- For English (1.37" x 24TPI)
- Patented



E181 Head Tube Reaming & Facing Tool

- For 1" and 1-1/8" conventional headset systems
- #E181A, #E181B, and #E181F are included

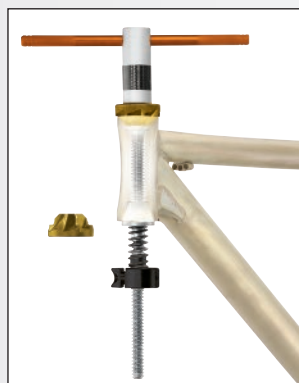

E185 BB Tapping & Head Tube Reaming & Facing Set

- For 1" and 1-1/8" conventional headset systems
- Kit includes: #E171F, #E171L, #E171R, #E171T, #E173L, #E173R, #E173T, #E181A, and #E181B
- Patented

Please refer to the next page for other cutters



A	E173R	Tap	English (1.37" x 24TPI), for right side, Golden
B	E173L	Tap	English (1.37" x 24TPI), for left side, Black
C	E173T	Tap	Italian (1.37" x 24TPI), Green
D	E171N	Bottom Bracket Reaming & Facing Cutter	Ø41mm for BB86/92, PF24, PF41. H.S.S.
E	E171M	Bottom Bracket Reaming & Facing Cutter	Ø46mm for PF30. H.S.S.
F	E171R	BB Screw	English (1.37" x 24TPI), for right side, Golden
G	E171L	BB Screw	English (1.37" x 24TPI), for left side, Black
H	E171T	BB Screw	Italian (1.37" x 24TPI), Silver
I	E181L	Centering Cone	For Head Tube inner ø48~54mm. Usually used in conjunction with E181S
J	E181F	Head Tube Facer	Up to ø45mm
K	E171F	BB & Head Tube Facer	Up to ø55mm
L	E181C	Head Tube Reamer	Ø34mm for 1-1/8" conventional headset systems. Chris King®
M	E181G	Head Tube Reaming & Facing Cutter	Ø41.4mm for Cane Creek®. 1-1/8" ZS compatible low profile headset systems. H.S.S.
N	E181S	Head Tube Reaming & Facing Cutter	Ø49.6mm for 1-1/2" OnePointFive headset systems. H.S.S.
O	E181T	Head Tube Reaming & Facing Cutter	For Campagnolo® Hiddenset compatible integrated headset systems, top. H.S.S.
P	E181P	Head Tube Reaming & Facing Cutter	For Cane Creek®. 1-1/8" IS compatible integrated headset systems, top. H.S.S.
Q	E181U	Head Tube Reaming & Facing Cutter	For Campagnolo® Hiddenset compatible integrated headset systems, bottom. H.S.S.
R	E181R	Head Tube Reaming & Facing Cutter	For Cane Creek®. 1-1/8" IS compatible integrated headset systems, bottom. H.S.S.
S	E181V	Head Tube Reaming & Facing Cutter	For FSA® Integrated #44 series headset systems, 1-1/8", top. H.S.S.
T	E181W	Head Tube Reaming & Facing Cutter	For FSA® Integrated #44 series headset systems, 1-1/4", bottom. H.S.S.



E244 Crown Race Installation Tool

- For 1", 1-1/8", and 1-1/2" fork steerer tubes



E253 Crown Race Remover

- Up to 1-1/2"



E221 Headset Cups Remover

- For 1" and 1-1/8"



E223 Headset Cups Remover

- For 1-1/4" and 1-1/2"





E263 Frame & Fork Adjuster

- For expanding & compressing steel forks, chain stays, and seat stays
- Trapezoid thread provides extra power and longer life time
- With protective rubber where tool meets bike

E263S Spare Rubber Pads for #E263

- Set of 4 pieces



E272 Shuriken Disc Mount Facing Tool

- Unique designed for conventional & 20mm thru-axle frames and forks



E291 Bearing Puller

- For BB30, BB86, BB92, and Campagnolo® Ultra-torque
- For bearing cup of outer Ø40mm ~ 45mm
- Patented

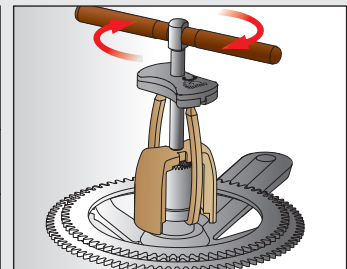
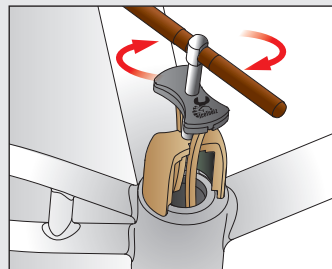

E291S

- Spare Claws for #E291
- Set of 2 pieces



E293 Press-fit Bearing Removal Tool

- For internal Ø24mm ~ 30mm bottom bracket bearings



E294 Press-fit Bearing Removal Tool

- For internal Ø35mm ~ 46mm bottom bracket bearings

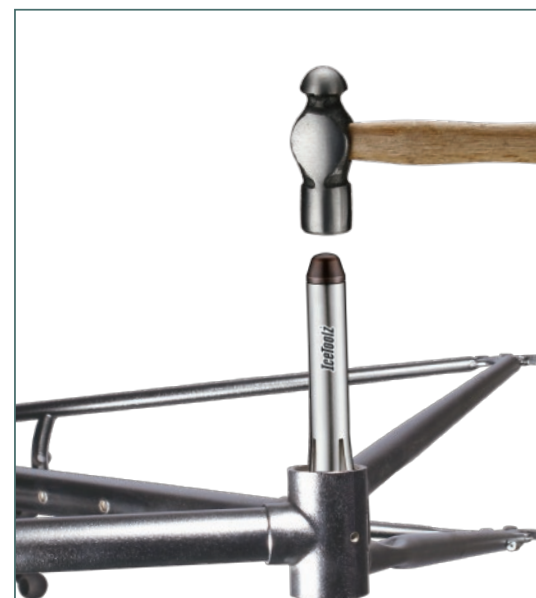



E312 Wheel Centering Gauge

- For rim size 16" ~ 31"



E313 Wheel Centering Gauge with Meter

- For rim size 16" ~ 31"
- Scales to 0.1mm tolerance
- The black tolerance tabs are designed to assign a specific range of acceptable tolerance quickly



E323 Digital Caliper

- 0 ~ 150mm
- Scales to 0.01mm

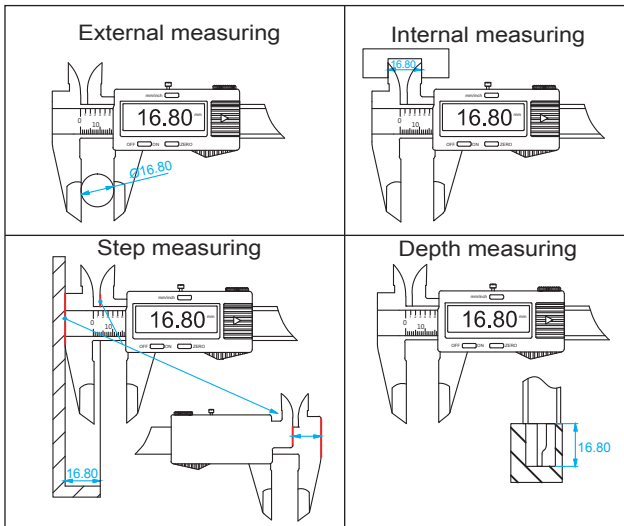

Ø25.4mm~
Ø31.8mm

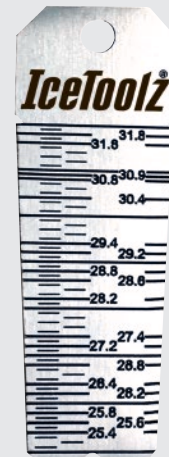

E326 The Wat Seat Tube Gauge

- Takes the hassle out of finding the right seat post
- Measures from Ø25.0 ~ Ø31.8mm



E355 Derailleur Hanger Alignment Tool

- For rim size 18" ~ 30"



E381 Spoke Tension Meter

- For rim size 18" and up
- With Japanese Mitutoyo® analog meter
- Scales to 0.01mm



E383 Digital Spoke Tension Meter

- For rim size 18" and up
- With Japanese Mitutoyo® digital meter
- Scales to 0.01mm



Innovation Award



E521 Stripped Pedal Threads Repair Kit

- Ideal for repairing and saving damaged threads high-end cranks
- Includes one set of tap & five helicoil threads in 9/16" x 20TPI for right crank arms, as the left crank arms
- With one ergonomic handle to use with tap to enlarge the stripped pedal threads on damaged crank arms
- One handle with comfortable rubber grip to install the helicoils threads onto the crank arms
- One brush for cleaning
- One bottle of #C143 cutting fluid (2oz. / 60ml)
- Patented

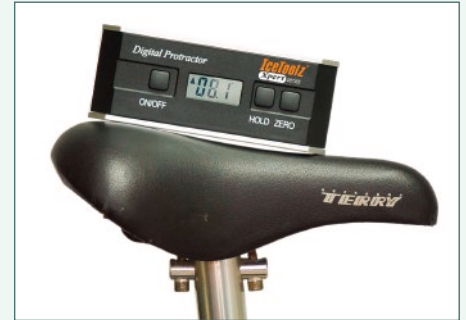

E521H 9/16" Helicoil Threads

- Set of 5 pairs
- Use with the #E521 Stripped Pedal Threads Repair Kit only



E521T Thread Tap Set for #E521

- For use to enlarge the stripped pedal threads on damaged crank arms
- Use with the #E521 Stripped Pedal Threads Repair Kit only

E371 Digital Protractor

- 0° ~ 360° fully measured
- Easy to read the LCD display, automatically switch to the direction



A 0903	Suntour® 2-notch Freewheel Remover	For Suntour® compatible 2-notch freewheel. (#53R4) or 21mm spanner
B 09B3	Freewheel / Cassette Tool	For Shimano® MF compatible freewheels & Campagnolo® cassettes & splined 12-tooth bottom bracket cups found on the square type spindle systems. (#53R4) or 21mm spanner
C 09C1	Cassette Lockring Tool with Guide Pin	For Shimano® CS, SRAM, SunRace, Chris King compatible cassettes and Shimano® Center Lock disc brakes. (#53R4) or 21mm spanner
D 09C2	Cassette Lockring Tool with Guide Pin	For Shimano® CS, SRAM, SunRace, Chris King compatible cassettes and Shimano® Center Lock disc brakes. Guide Pin Ø12mm. (#53R4) or 21mm spanner
E 09C3	Shimano® Cassette Lockring Tool	For Shimano® CS, SRAM, SunRace, Chris King compatible cassettes and Shimano® Center Lock disc brakes. (#53R4) or 21mm spanner
F 09C5	Freewheel / Cassette Lockring Tool	For Shimano® CS, SRAM, SunRace, Chris King compatible cassettes and Shimano® Center Lock disc brakes. Also for Shimano® MF compatible freewheels & Campagnolo® cassettes (all) and Athena. (#35V8)
G 09D1	2-notch Freewheel Remover	For 2-notch freewheels. (#4724)
H 09E1	4-notch Freewheel Remover	For 4-notch freewheels. (#4724)
	Spec.	#53R4 - 1/2" Two-way ratchet wrench #06F2 - 32mm headset wrench (Page 29) #35V8 - 8mm kex key (Page 21) #4724 - 24mm spanner (Page 28)



#53R4 1/2" Two-way Ratchet Wrench

- With quick release function
- Extra long 370mm / 14.5" handle provides a higher force



53A2 Freewheel Turner (Chain Whip, 1/2" x 3/32")

- Compatible for multi-speed
- With chain whip 1/2" x 3/32"



53S3 Freewheel Turner (Chain Whip, 1/2" x 3/32")

- Compatible for multi-speed
- With chain whip 1/2" x 3/32"
- Ergonomic handle with long anti-slip grip

Spoke Tools

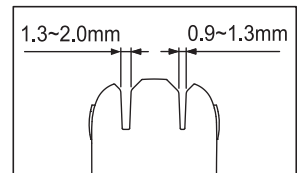

1206 6-groove Spoke Wrench

- For 10 ~ 15 gauge nipples

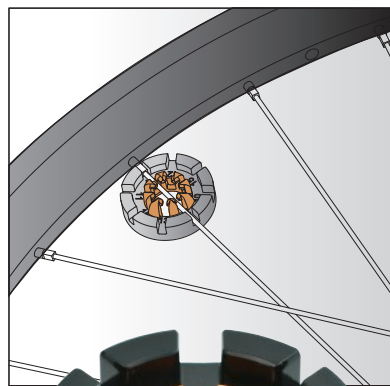

12F8 Forged 8-groove Spoke Wrench

- For 10 ~ 15 gauge nipples
- With spokes holder for more efficient wheel building
- Patented

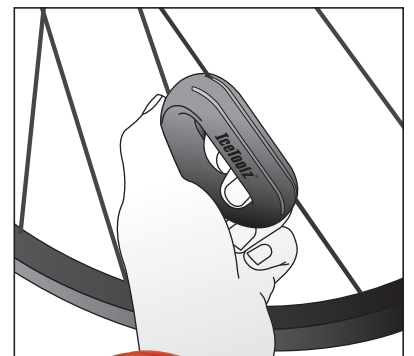

12T4 Bladed Spoke Catcher

- For thickness 0.9 ~ 2.0mm
- Patented





A	08C3	Spoke Tool - For 3.45mm/80 ga./0.136" nipples red vinyl coated
B	08C5	Stainless Steel Spoke Tool - For 3.45mm/80 ga./0.136" nipples
C	12A3	Spoke Tool - 3/16" (Hex) Nipple
D	12A7	Spoke Tool - 3/16" (Hex) Nipple
E	12B3	Spoke Tool - 3.2mm (Square) Nipple
F	12B7	Spoke Tool - 3.2mm (Square) Nipple
G	12C3	Spoke Tool - 5.5mm (Hex) Nipple
H	12C7	Spoke Tool - 5.5mm (Hex) Nipple
I	12D3	Spoke Tool - 3.6mm (Square) Nipple
J	12D7	Spoke Tool - 3.6mm (Square) Nipple
K	12H4	Spoke Tool - For Mavic® wheel systems
L	12K4	Spoke Tool - For 3.45mm/80 ga./0.136" nipples



M	08P1	Spoke Tool - Black vinyl coated
N	08P2	Spoke Tool - Green vinyl coated
O	08P3	Spoke Tool - Red vinyl coated

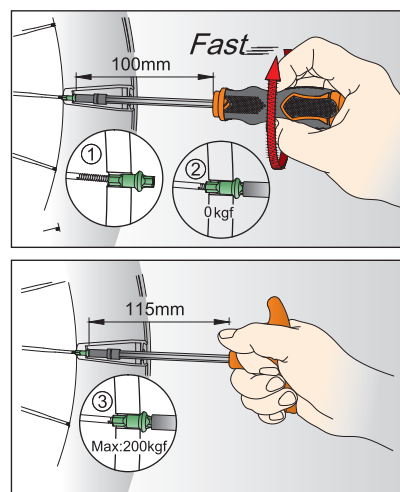

12A5=12A3+12A7
Combo Set of Spoke Tools
For 3/16" (Hex) nipples.

12B5=12B3+12B7
Combo Set of Spoke Tools
For 3.2mm (Square) nipples.

12C5=12C3+12C7
Combo Set of Spoke Tools
For 5.5mm (Hex) nipples.

12D5=12D3+12D7
Combo Set of Spoke Tools
For 3.6mm (Square) nipples.

Turn nipples with screwdriver-handle
RAPIDLY in the beginning stage, and
interchange to T-handle to tighten
FIRMLY at the end.



12S4 Nipple Wrench for Deep Rims

- The V-spring grabs the nipple to screw on deep rims to prevent the nipple from dropping
- With depth control function to release the nipple after 3 ~ 4 mm on the spoke
- Also can use with 1/4" electric screwdriver

12S4S

- Spare V-Spring for #12S4, #12S5
- Set of 2 pieces

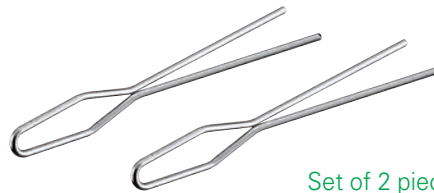

Set of 2 pieces

Crank Tools

A 04C2 Crank Remover

- With interchangeable adaptor fits both square & hollow axles
- Use with 8mm hex key wrench (#35V8)
- Patented

B 04D2 Crank Extractor

- Contains 14x15mm sockets & 8mm hex key for crank bolt and crank arm removal
- Interchangeable adaptor fits both square & hollow axles
- Patented

C 04S1 Crank Tool with Ergonomic Handle

- Contains 14x15mm sockets & 8mm hex key for crank bolt and crank arm removal
- Interchangeable adaptor fits both square & hollow axles
- Patented

D 04T1 Crank Arm/Cap Installation Tool

- For Shimano® Hollowtech II

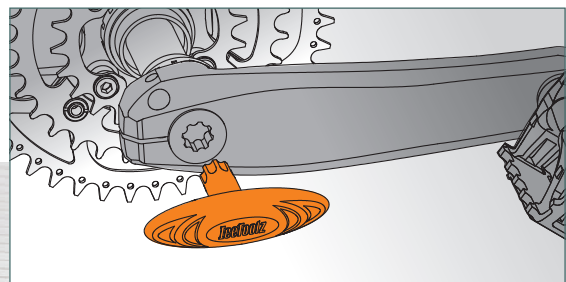



27P5 Chainwheel Nut Tool

- Double-ended design for most slotted-type chainwheel nuts, and crank dust cap
- Securely holds the slotted nut to prevent springing

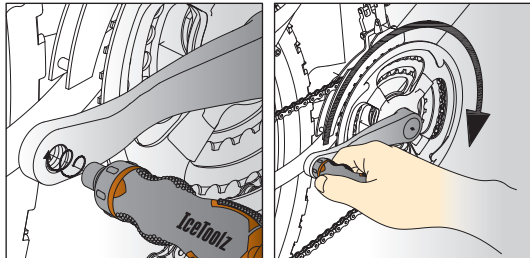

33D1 Dummy Pedal

- Ideal for bike repair and assembly use
- Easy and efficient mount and dismount to rotate the crank

Hex and Star (Torx) Wrenches



74B1 Perfect Tool for In-line Skate

- Bearing pusher
- 4x6mm hex keys
- +/- screwdrivers
- Patented



70TA Y-Wrench 4/5/6mm Hex Key



70J2 3-Way with a Screwdriver

- A new twist on the perfect tool
- 4x5mm hex keys and PH2 screwdriver
- Kraton grip



70Y2 Hex Key Wrench

- 4x5x6mm hex keys
- Kraton grip



70T2 Star Key Wrench

- T25xT30xT40
- Kraton grip



74A1 6-in-1 Wrench

- 3x4+5x6mm hex keys
- +/- screwdrivers
- Patented

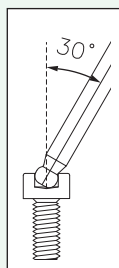

on the wall ①



on the wall ②



7M85 TwinHead Wrench Set

- 2x2.5x3x4x5x6x8mm hex key wrenches (ball-ended)
- T-25 star wrench
- With ball-ended design which can be used effectively at up a 30 degree angle
- Exceed ANSI and DIN standards
- Set also comes with a stand that can easily be mounted to a bench or wall



A 7M20 2mm TwinHead Hex Key Wrench

- 2mm TwinHead hex key wrench with ball-ended

B 7M25 2.5mm TwinHead Hex Key Wrench

- 2.5mm TwinHead hex key wrench with ball-ended

C 7M30 3mm TwinHead Hex Key Wrench

- 3mm TwinHead hex key wrench with ball-ended

D 7M40 4mm TwinHead Hex Key Wrench

- 4mm TwinHead hex key wrench with ball-ended

E 7M50 5mm TwinHead Hex Key Wrench

- 5mm TwinHead hex key wrench with ball-ended

F 7M60 6mm TwinHead Hex Key Wrench

- 6mm TwinHead hex key wrench with ball-ended

G 7M80 8mm TwinHead Hex Key Wrench

- 8mm TwinHead hex key wrench with ball-ended

H 7T20 T-20 TwinHead Star Wrench

I 7T25 T-25 TwinHead Star Wrench

J 7T30 T-30 TwinHead Star Wrench

K 35V8 8mm Hex Key Wrench

- With gray coating

L 35VA 10mm Hex Key Wrench

- With black coating

M 36H1 Quartet Wrench

- 4x5+6x8mm flex-key wrenches

N 36Q1 Hex Key Wrench Set

- 2x2.5x3x4x5x6x8mm
- 4x5x6mm ball-ended

A

91A1 Pocket-17



91.4mm x 47.3mm x 44.5mm

W x H x D



B

91A3 Pocket-22



90mm x 52.2mm x 44.3mm



C

91B4 Urban-7



88mm x 18mm x 45mm



D

91B5 Urban-8



88mm x 18mm x 45mm



E

92A1



96mm x 19mm x 31mm



F

93B1 Release-20



83mm x 28mm x 31mm



G

94H2 Handy-7



71mm x 23.4mm x 33.8mm



H

94H4 Handy-8



71mm x 23.3mm x 33.7mm



I

95A1 Amaze-5



72.3mm x 23.3mm x 30.7mm



J

95A3 Amaze-10



71.2mm x 21.6mm x 37.2mm



K

95A5 Amaze-11



71mm x 21.8mm x 37mm



L

95A7 Amaze-19



73mm x 24.5mm x 37.2mm



M

96B1 Bar-5



87.5mm x 19.2mm x 32mm



N

96B3 Bar-11



88.2mm x 19.5mm x 53mm



O

96T1 Star-8



87mm x 20.8mm x 38.8mm



P

96K2 Blade Man



83mm x 20mm x 34mm



A B C D E F G H I J K L M N O P

	91A1	91A3	91B4	91B5	92A1	93B1	94H2	94H4	95A1	95A3	95A5	95A7	96B1	96B3	96T1	96K2
HEX 1.5mm										•	•	•		•		
HEX 2.0mm					•	•				•	•	•		•		
HEX 2.5mm					•	•				•	•	•		•		
HEX 3.0mm	•	•	•	•	•	•	•	•		•	•	•		•		•
HEX 4.0mm	•	•	•	•	•	•	•	•	•	•	•	•	•	•		•
HEX 5.0mm	•	•	•	•	•	•	•	•	•	•	•	•	•	•		•
HEX 6.0mm	•	•	•	•	•	•	•	•	•	•	•	•	•	•		•
HEX 8.0mm	•	•		•		•		•		•	•	•		•		
PH	•	•	•	•	•	•	•	•	•	•	•	•	•	•		•
SL	•	•	•	•	•	•	•	•	•	•	•	•	•	•		•
T9															•	
T10															•	
T15															•	
T20															•	
T25	•	•	•	•			•	•		•	•	•		•	•	
T27															•	
T30															•	
T40															•	
8mm spanner	•	•				•						•				
9mm spanner	•	•				•						•				
10mm spanner	•	•				•						•				
11mm spanner						•										•
12mm spanner						•										
13mm spanner						•										
14mm spanner						•										
15mm spanner						•						•				
12G spoke wrench		•														
13G spoke wrench		•														
14G spoke wrench		•				•						•				
15G spoke wrench		•				•						•				
15mm pedal wrench	•	•														
0.127" spoke wrench	•	•														
0.130" spoke wrench	•	•														
0.136" spoke wrench	•	•														
tire lever	•	•				•						•				
Chain tool <small>(Shimano® 7-10 sp compatible)</small>		•														
Bottle opener	•	•														
Knife																•
Weight	226g	264g	132g	135g	132g	176g	116g	118g	118g	142g	150g	156g	92g	156g	120g	148g



P413 New Event Stand

- Holds up to 10 bikes by the saddle
- Add the rubber stripe at the top of stand to protect the saddle rail
- With a quick release function, making it easy to assemble or disassemble
- Includes a carry bag and mesh pockets on each side
- Maximum load: 100kg
- Need the extension kit? Please refer to #P411S

P411S Event and Display Stand Extension Kit

- For #P412 and #P413
- Extends 4~6 bikes. Size: 1,470x810x1,215mm



P616 Storage Stand

- For 2 bikes
- Maximum Load: 80kg
- Extra bike holders can be added for up to 4 bikes
- With a stable four legged base, and coating on holder to keep your bicycle scratch free
- Patented

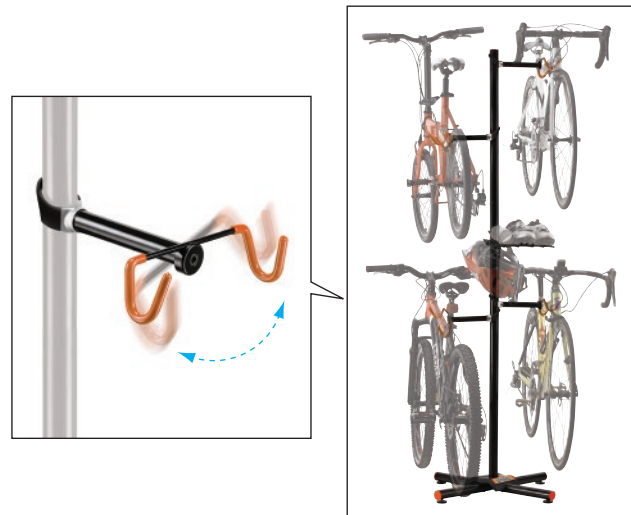

P616S Extra Bike Holder

- Maximum Load: 20kg
- For #P616 to hang more than 2 bikes
- Hook angle adjustable to fit different style of frames
- Patented



P621 Eagle Bicycle Lifter

- Dual pulley system
- Maximum Load: 25kg
- Maximum Height: 3 meters



P678 Hook with Roller

- This is for the fatter tires up to 70mm width



P679 Hook with Roller

- This is for the fatter tires up to 70mm width



P684 Storage Hooks - Wood Thread with Dowels

- Set of 2 pieces
- Black vinyl coated
- Maximum Load: 20kg per hook

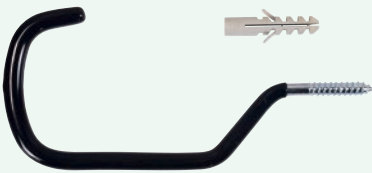

P685 Hook with Dowel

- This is for the fatter tires up to 70mm width
- Maximum Load: 20kg per hook

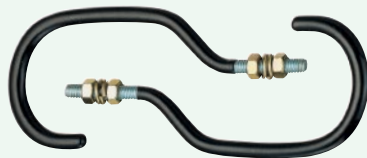

P686 Storage Hooks - Machine Thread with Nuts and Spring Washers

- Set of 2 pieces
- Black vinyl coated
- Maximum Load: 20kg per hook



P688 Hook with Nuts/washers

- This is for the fatter tires up to 70mm width
- Maximum Load: 20kg per hook



P633 Swing-Bull Storage Rack

- Maximum Load: 20kg
- Foldable for out of way storage
- Hook angle adjustable to fit different style of frames
- Patented



P631 Bull Storage Rack

- Foldable for out of way storage
- Maximum Load: 20kg

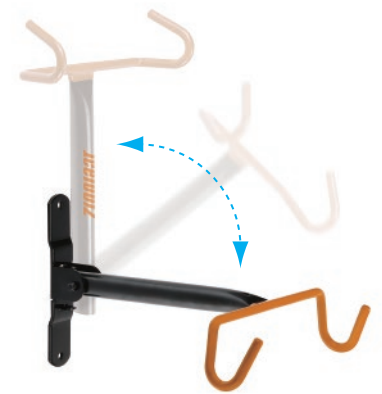

P643 Stand-By-Me

- Bike Stand for display and repair
- The height and angle of chain stay holder adjustable to fit different size and style of frames
- Maximum Load: 25kg



P646 Rear Axle Bike Stand

- Up to 29"
- Maximum Load: 25kg
- Patented



P655 Two-way Storage Hook

- For slat wall or regular wall
- Maximum Load: 20kg
- Patented



A

62B3 Pro Shop Chain Tool for Single Speed

- For 1/2"x3/32", 1/2"x1/8" BMX chains, including YBN® "Offset Link" chains
- The thumb-lid isolates the finger from the greasy chain while locates the chain at the right position
- Connecting rivet pilot pin breaker included
- Patented

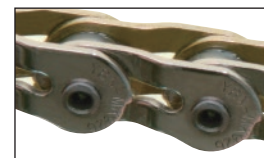

Offset Link Chain

B

62B7 Pro Shop Chain Tool for Electric Bike Chains

- For 1/2"x3/16" chains
- The thumb-lid isolates the finger from the greasy chain while locates the chain at the right position
- Connecting rivet pilot pin breaker included
- Patented



Connecting Pilot Pin Breaker

C

62M1 Pro Shop Chain Tool for Shimano® Chains

- Perfect for 5, 6, 7, 8, 9, 10, 11 and 12-speed chains
- For Shimano® compatible HG/UG/IG chains
- The thumb-lid isolates the finger from the greasy chain while locates the chain at the right position
- Connecting rivet pilot pin breaker included
- Patented

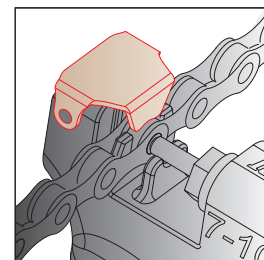

Thumb-lid

D

61M1 Portable Chain Tool

- Perfect for 5, 6, 7, 8, 9, 10, 11 and 12-speed chains
- For Shimano® compatible HG/UG/IG chains
- The thumb-lid isolates the finger from the greasy chain while locates the chain at the right position
- With chain hook to hook the chains when installing the chains
- With chain connectors case
- Flat to put in pocket
- Patented

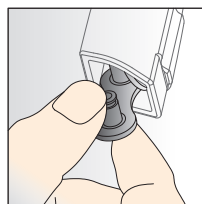

With Chain Connector Case

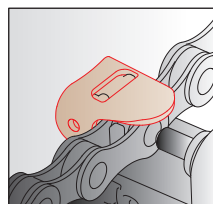

Thumb-lid

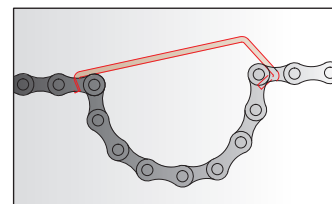

Chain Hook

E

29M2 Shimano® Compatible Chain Tool

- Perfect for 5, 6, 7, 8, 9, 10, 11 and 12-speed chains
- For Shimano® compatible HG/UG/IG chains



61A4S Spare Shaft for #61A4, #61A5, #61M1



29B2S Spare Shaft for #29B2, #29M1



29C2S Spare Shaft for #29C2



61A3S Spare Shaft for #61A3, #61UO

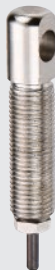

62P3S Spare Shaft for #62xx series

- Spare Shaft for #62B3, #62B7, #62M1, #62P3, #62U3

F

62D1 All-in-1 Master Link Pliers

- Removes and installs the master chain links
- Removes the C-ring
- Patented

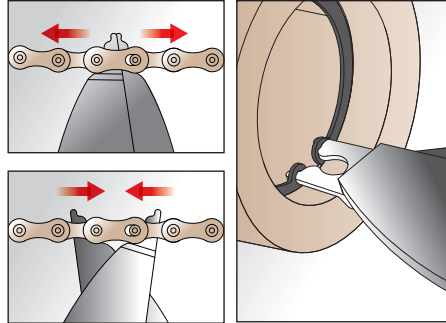

G

62D3 Master Link Pliers

- 2-in-1 tool for Master Link assemble and disassemble

H

62H1 Foldable Chain Hook

- To hook the chains when installing the chains
- Patented



I

62C4 Stainless Steel Go / No-go Chain Checker

- Instantly advises you when it's time to change the chain

J

30C1 ChainMaster

- For rear chain stay, dropout, and derailleur protection when you travel
- Adjustable to fit different length of axles (130, 135, 160, and 165mm)
- Patented

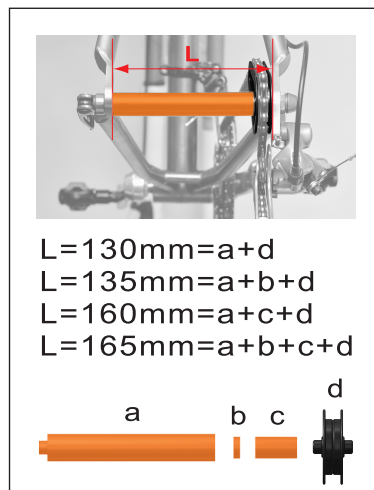

F

G

H

I

J

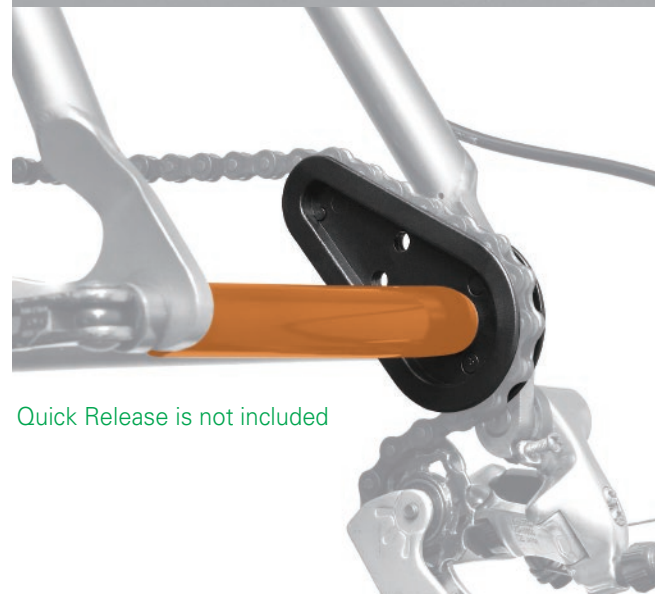

Quick Release is not included

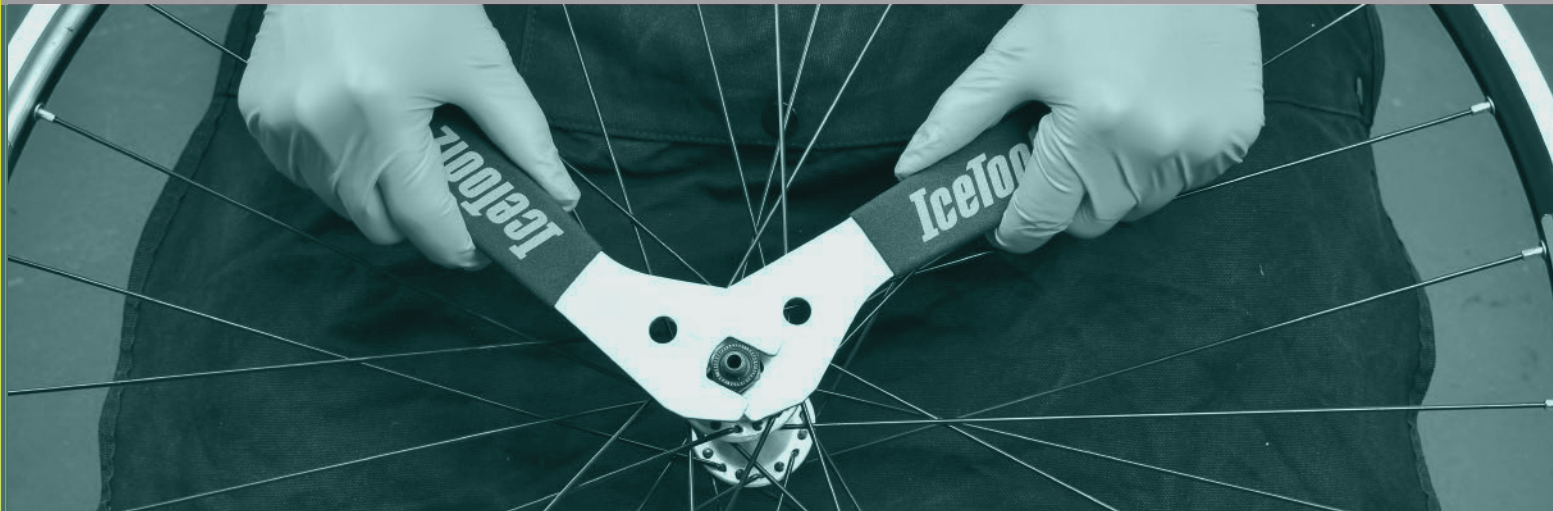

A	4713~4725	Cone Wrench	13mm (#4713) ~ 25mm (#4725)
	47X3	Cone Wrench Set	13+15+17mm, Set of 3 Pieces (#4713 + #4715 + #4717)
	47X7	Cone Wrench Set	13+14+15+16+17+18+19mm, Set of 7 Pieces (#4713 + #4714 + #4715 + #4716 + #4717 + #4718 + #4719)
B	0502	Cone Wrench Set	13x15+14x16mm, Set of 2 pieces
C	37A1	Cone Wrench	13x14mm
D	37B1	Cone Wrench	15x16mm
	37C1	Cone Wrench	17x18mm
E	37X3	Combo Set of Cone Wrenches	37A1+37B1+37C1 (13x14mm + 15x16mm + 17x18mm), Set of 3 pieces
F	37H1	Hub Body Removal Tool	10x10mm
G	37H2	Hub Body Removal Tool	11x12mm
H	37H3	Hub Body Removal Tool	14x15mm

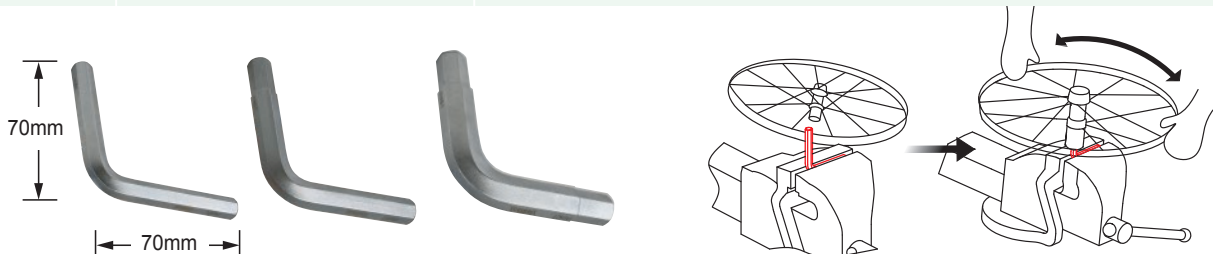



F164 Safety Flag, one-piece, length 60", white fiberglass pole

F174 Safety Flag, one-piece, length 72", white fiberglass pole

F168 Safety Flag, one-piece, length 60", orange fiberglass pole

F178 Safety Flag, one-piece, length 72", orange fiberglass pole

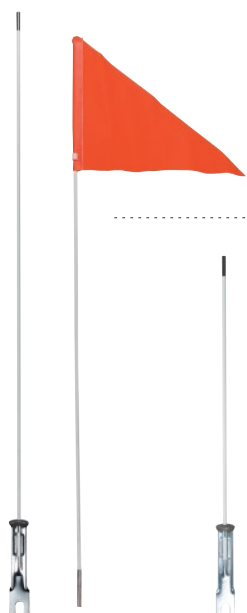

F264 Safety Flag, two-pieces, length 60", white fiberglass pole

F274 Safety Flag, two-pieces, length 72", white fiberglass pole

F268 Safety Flag, two-pieces, length 60", orange fiberglass pole

F278 Safety Flag, two-pieces, length 72", orange fiberglass pole



F368 Safety Flag, three-piece, length 60", orange fiberglass pole

F374 Safety Flag, three-pieces, length 72", white fiberglass pole



21C2 ABS Trousers Clips

- With 3M® Scotchlite reflective sheeting

Headset Wrenches

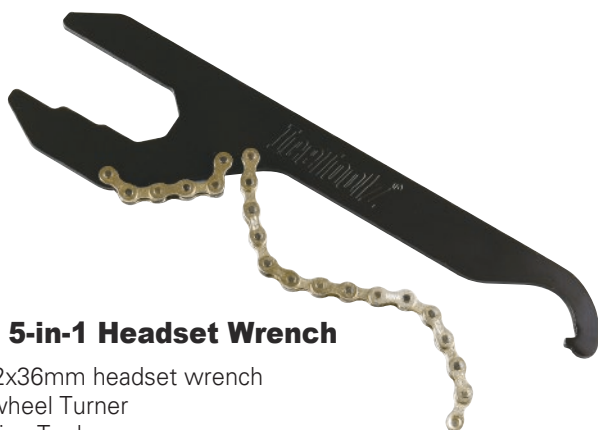

06C3 5-in-1 Headset Wrench

- 30x32x36mm headset wrench
- Freewheel Turner
- Lockring Tool



06F2 32mm Headset Wrench

06F6 36mm Headset Wrench



06H8 4-in-1 Headset Wrench

- 30x32+36x40mm headset wrench



M100 Headset Lock Nut Installation Tool - 30mm

M106 Headset Lock Nut Installation Tool - 36mm

M123 Headset Head Cup Installation Tool - 43mm

M127 Headset Head Cup Installation Tool - 47mm

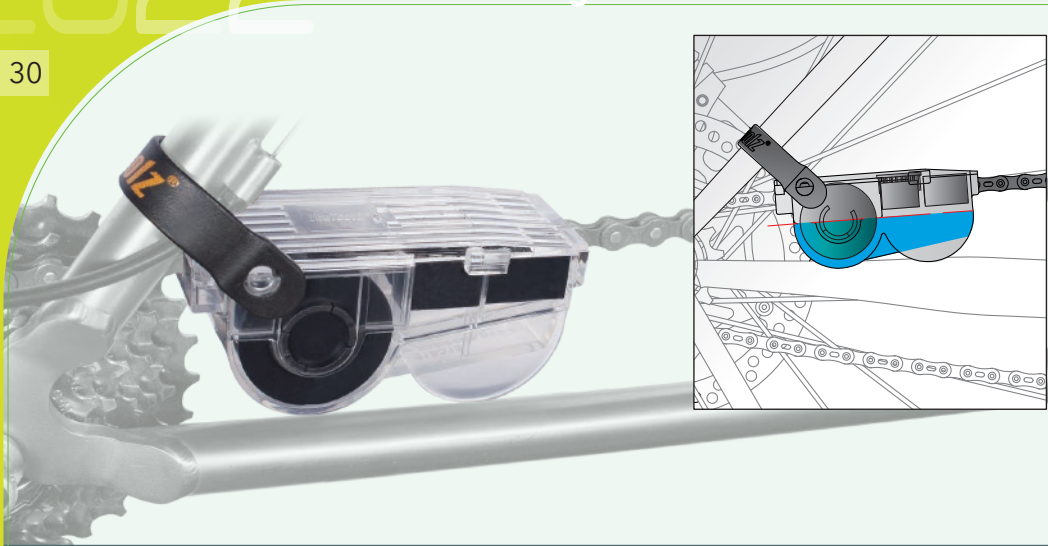

C115 Chain Scrubber

- 20 total brushes with exclusive 4-sided scrubber system clean chain spotlessly
- Rubber band added to allows it to hang on the seat stay by itself, without the need of holding the chain scrubber with your own hand
- This provides more efficiency while cleaning
- Contains one spare sponge
- Patented



C115S Spare Parts for Chain Scrubber

- For chain scrubber #C113 & #C115
- Contains brushes and two sponges



C121 Two-way Brush

- With soft bristles for delicate & stiff bristles for aggressive cleaning



C123 Sprocket Cleaning Brush

- Up to 10-speed
- For cleaning the bike chain, cassette, mechs and chain wheels



C124 Tire Brush Set

- With stiff bristle for aggressive MTB tires & sprockets cleaning
- Set of 2 pieces



C125 Cleaning Sponges

- Easy to grip and hold without offering any difficulty or inconvenience
- Highly absorbent
- Perfect for washing cars, mini vans, bikes as well as other household items
- 235 x 110 x 38mm



C126 Metal Free Rim Brush

- Heavy-duty microfiber cleaning brush compresses for greater flexibility and maneuverability to clean rim safely and effectively
- Cone-shaped head to easily clean hard to reach areas
- 285mmL



C129 Tube Brush

- Stainless steel bar
- Loop handle
- Ø30mm x 300mmL



C145 / C146 Anti-slip Paste

- For assembling parts made of carbon fiber and aluminum alloy
- Keeps parts from moving or loosening and ensures perfect corrosion protection
- Prevents the two components seizing up
- #C145: 5ml, #C146: 17oz. / 500ml



C133 Chain Degreaser

- The environment friendly concentrated degreaser
- With new formula offers a quick and effective way to clean chains and remains new
- Excellent degreasing ability
- Non-corrosive protects your bikes
- It's recommended to use with #C115 Chain Scrubber
- Ratio of bike wash to water 1:3
- 4oz. / 120ml



C134 Jumbo Chain Degreaser

- Water based degreaser is better for the environment and cleaning your chains.
- New formula offers a quick and effective way to clean chains and remains new
- Excellent degreasing ability
- Non-corrosive protects your bikes and skin
- It's recommended to use with #C115 Chain Scrubber
- Ratio of bike wash to water 1:3
- 15oz. / 400ml

C137



C137 e-Bike Chain Degreaser

- Quickly eliminate built up oil, grease and grime
- 4oz. / 120ml

C141



C141 PTFE Lubricant

- Contains PTFE & other additives to keep your chain running smooth
- 4oz. / 120ml



C143 Cutting Fluid

- For cutting, tapping, facing, and reaming
- Extends the lifespan of the tools
- 2oz. / 60ml



C147 Chain Lubricant (for e-Bike)

- Engineered specially for e-Bike chains to withstand high temperature and maintains viscosity during usage
- High cooling capacity and electric insulator
- 4oz. / 120ml



C161 Dry Lubricant

- Well-performed in dust, gravel, and dirt environment
- In dry condition, remains bicycle chains, chain wheels, and derailleur well-functioned in various speed
- It does not stick dust and reduce the wear of parts
- Excellent lubrication can also be maintained at high speeds
- Not recommended for using in wet condition (use #C141 for this application)
- 4oz. / 120ml



C162 Dry Lubricant with PTFE

- Well-performed in dust, gravel, and dirt environment
- In dry condition, remains bicycle chains, chain wheels, and derailleur well-functioned in various speed
- It does not stick dust and reduce the wear of parts
- Excellent lubrication can also be maintained at high speeds
- Not recommended for using in wet condition (use #C141 for this application)
- 4oz. / 120ml



C171 / C172 Anti-wear Copper Grease

- Protects metal against corrosion, heat, and water
- Ideally for hubs, screws, nuts, bolts, bearings, and BBs
- Highly lubricating even with small amount
- Temperature range: -25°C ~ 200°C
- #C171: 17oz. / 500ml, #C172: 4oz. / 120ml



C173 Complex Calcium Sulfonate Grease for Hub

- With high load capacity, resistance against heat, pressure, water and grinding
- Protects against corrosion and oxidation
- Temperature range: -25°C ~ 200°C
- 3ml



C177 e-Bike Grease

- Ideally for the circuit and parts of motors in various electric bike
- Non-conductive
- Protects metal against corrosion, heat, and water
- Highly lubricating even with small amount
- Temperature range: -25°C ~ 200°C
- 4oz. / 120ml

C182



C183



C184



C182 / C183 / C184 Bike Wash

- The environment friendly degreaser offers a quick and effective way to clean bikes
- Excellent degreasing ability
- Non-corrosive protects your bikes
- Concentrated degreaser (#C183 & #C184)
- Ratio of bike wash to water 1:1 (#C183 & #C184)
- #C182: 10oz. / 300ml
- #C183: 2pt. / 1000ml
- #C184: 10.5pt. / 5000ml



C178 Leak-Control Grease Gun

- Ergonomic design for #C172 Copper Grease

C191



C192



C191 Disc Brake Cleaner

- Removing brake dust and oil
- Reduce brake noise
- Restore braking performance
- No any residue
- No CFCs
- 14oz. / 425ml

C192 Grease Remover

- Bubble-based
- 14oz. / 425ml



C193 Suspension Cleaner

- Delete the dirt adhered to the inside of stanchion
- Activate the rubber oil seal and to prolong the life of suspension fork
- Keep the dust off while on bike riding, to ensure the protection on the friction point
- 5oz. / 150ml



C196 Hand Cleaner

- High degreasing
- Antibacterial properties
- Add protective agents and proteins make the product gentle with the hands
- 10.5pt. / 5000ml



C212 Chain Scrubber and Chain Degreaser Combo Set

#C115 Chain Scrubber

- 20 total brushes with exclusive 4-sided scrubber system clean chain spotlessly
- Rubber band added to allows it to hang on the seat stay by itself, without the need of holding the chain scrubber with your own hand
- This provides more efficiency while cleaning
- Contains one spare sponge
- Patented

#C133 Chain Degreaser

- Water based degreaser is better for the environment and cleaning your chains
- New formula offers a quick and effective way to clean chains and remains new
- Excellent degreasing ability
- Non-corrosive protects your bikes and skin
- It's recommended to use with #C115 Chain Scrubber
- Ratio of bike wash to water 1:3
- 4oz. / 120ml



C278 Anti-wear Copper Grease and Grease Gun Combo Set

#C172 Anti-wear Copper Grease

- Protects metal against corrosion, heat, and water
- Ideally for hubs, screws, nuts, bolts, bearings, and BBs
- Highly lubricating even with small amount
- Temperature range : -25°C ~ 200°C

#C178 Leak-Control Grease Gun

- Ergonomic design for #C172 Copper Grease



C311 Bike Polisher

- Helps restoring original shine
- Forms a thin protective layer on your bike
- Non-corrosive, non-toxic, eco-friendly
- Suitable for iron, steel, aluminum, titanium, carbon fiber.
- 14oz. / 425ml



C312 Frame Protection

- Reduce damage from sunlight or rain
- Suitable for both matt and clear coating
- 10oz. / 300ml



A 33S1 15mm Pedal Wrench

- Off-set design
- Ergonomic handle with long anti-slip grip
- 3/8" square hole for use with torque wrench to prevent demaging the parts

B 34S2 Tool for Single Speed Chain Whip, Pedal, Lockring

- Lockring tool
- Freewheel turner (chain whip, 1/2" x 1/8")
- 15mm pedal wrench
- Perfect tool for fixed-gear bikes

34S4 Tool for Multi Speed Chain Whip, Pedal, Lockring

- Lockring tool
- Freewheel turner (chain whip, 1/2" x 3/32")
- 15mm pedal wrench

C 3400 Pedal & Axle Wrench

- 15mm pedal wrench
- 14x15mm sockets for crankarm bolts and axle nuts

D 34B1 Pedal & Axle Wrench

- 15mm pedal wrench
- 14mm socket for crankarm bolts and axle nuts

E 33F5 15mm Pedal Wrench

- Help mounting and removing bike's pedals
- For tighten and loosen pedals and has a comfy, ergonomic grip

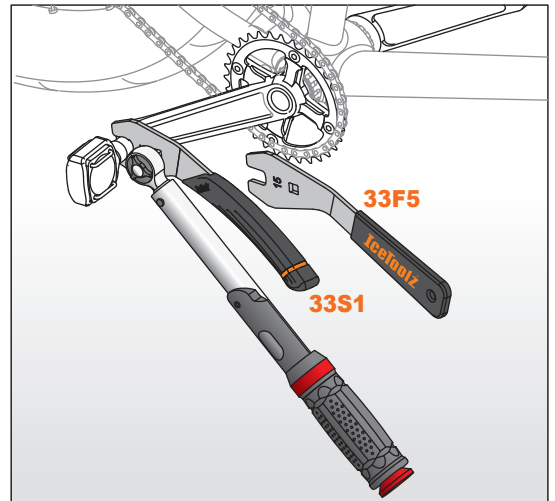

Disc Brake Tools



55A3 Disc Rotor Truing Tool

- Scales to 2.5mm
- Adjust disc up to 45mm / 1.75"



55B3 Disc Brake Caliper Alignment Tool

- Very simple and very easy to align the disc brake
- SUS304 stainless steel



A 54R3 Bleed Kit

- Universal design for all hydraulic disc brake systems
- Compatible with AVID®, FORMULA®, HAYES®, HOPE®, MAGURA®, and Shimano®
- Suitable to use with Mineral and DOT oil
- With one pair of NBR Gloves (#17G3)
- New syringes with adaptor to fix on the syringe & PU tubes tightly
- With a releasable cable tie which can fix the PU tubes onto the calipers
- With tubing clips to on/off the flow of syringes

B 54B1 Disc Brake Piston and Pad Alignment Tool

- Reposition pistons or help align disc pads
- With ergonomically designed handle for comfortable grip
- Easy to use

C 54A1 Hydraulic Hose Cutter

- Flawlessly cuts hose and prevents inner tube from deforming
- Contains one spare blade #54A1S



54A1S Spare Blade for #54A1



M082 Shimano® Disc Brake Locking Tool

- Compatible for Shimano® Disc Brake Lockring - Externally serrated type
- Deepness: 34mm, for both QR-type and Nut-type hubs
- Use with 1/2" Torque Wrench (#E211 / #E214)

D 54P5 Lipstick Needle Driver

- The needle driver is designed for inserting hydraulic needle joints into hose with perfect alignment
- This tool prevents damages when insert the soft brass fittings into a hydrau cable
- It is a handy tool when installing or mending the workings of your bike brakes and hydraulic hoses

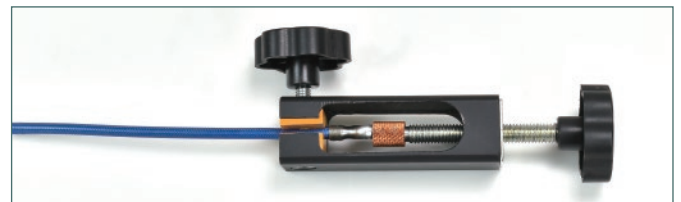

E 55B1 Croco Brake Shoe Tuner

- Align rim brake pads easier and faster
- Adjustable to various rim width 15mm ~ 40mm and the rim max depth at 60mm
- Patented

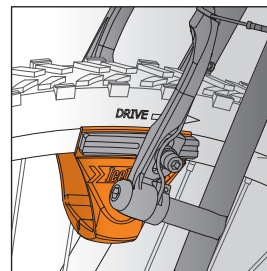

54H1 8x9mm Hose Wrench

- Maintains the disc brake



Parts Specifications	Parts Number for Reference	SHIMANO® TL	IceToolz	Driver
Campagnolo® splined 12-Tooth			09B3	1/2" Driver
Adjustable BB cup pegs/pins tool			11A0	
Cartridge / OCTALINK®	SM-FC4500, FC5600, FC6600, FC6601 & FC7800	TL-UN74-S	11B1	1/2" Driver
	BB-5500, 6500 & ES25 BB-UN26		11B3	32mm wrench
8-Notch 44mm O.D. cups		TL-UN96	11D3	32mm wrench
BB and headset locking tool			11H1	
22/24/30mm I.D. bearings	Press-Fit system		11R3	
4-Notch 46mm O.D. locking			M074	1/2" Driver
3-Notch 46mm O.D. locking			M083	1/2" Driver
16-Notch 44mm O.D. cups	FC-4500, 5600, 5603, 6600, 6750 & 7800	TL-FC32/33/36	11C1	
	FC-M532, M533, M580, M581, M582, M583, M590, M591, M600, M601, M640, M645, M660, M665, M670, M672, M675, M760, M761, M770, M771, M780, M782, M785, M800, M805, M810, M815, M820, M825, M960, M970, M980 & M985		11F3	8mm hex key
	FC-MX71 FC-T661, T671, T780 & T781 BB-RS500 SM-BB4600, BB51, BB52, BB5700, BB6700, BB70, BB7900 & BB80		M091	1/2" Driver
16-Notch 41mm O.D. cups	BB-MT800 & BBR60	TL-FC25/37	11C3 M093	1/2" Driver
16-Notch 39mm O.D. cups	BB-R9100 SM-BB9000 & BB93	TL-FC24/34	11C5	1/2" Driver
12-Notch 46mm O.D. cups	SRAM® DUB™ Race Face® Cinch™ Rotor® BSA30 Zipp® Vuma™ Hawk Racing™ BB3086™		11C7	
			M097	1/2" Driver
12-Notch 50.4mm O.D. cups	T47		M098	1/2" Driver
16-Notch 52.2mm O.D. cups	T47		M099	1/2" Driver

82A8 Ultimate Tool Kit



- #04C2: Crank Remover
- #09C5: Freewheel / Cassette Locking Tool
- #33S1: 15mm Pedal Wrench
- #35V8: 8mm Hex Key Wrench
- #25H6: 6" Adjustable Forged Wrench
- #28P1: #1 Phillips Screwdriver
- #28S3: 3mm Flat Blade Screwdriver
- #53S3: Freewheel Turner (Chain Whip, 1/2" x 3/32")
- #29M1: Shimano® Compatible Chain Tool (5x6x7x8x9x10x11x12-speed)
- #56E6: Glueless Patch Set AirDam, 6 Pieces
- #97T1: T-9x10x15x20x25x27x30x40 Star Key Wrenches
- #12F8: 10-15G Forged 8-groove Spoke Tool
- #11F3: Shimano® Hollowtech II Compatible BB Tool
- #64P3: Tire Lever Set, Set of 3 Pieces
- #39H4: 9x10mm Open-ended Spanner
- #97Y1: 2x2.5x3x4x5x6mm Hex Key Wrenches
- Product Dimensions: 30.5 x 21 x 6.5cm
- Weight: 2.16kg
- Color: Grey

82F4 Essence Tool Kit



- #04C2: Crank Remover
- #64P3: Tire Lever Set, Set of 3 Pieces
- #25H6: 6" Forged Adjustable Wrench
- #39H4: 9x10mm Open-ended Wrench
- #35V8: 8mm Hex Key Wrench
- #29M1: Shimano® Compatible Chain Tool (5x6x7x8x9x10x11x12-speed)
- #D8D4: Connecting Tool (from 8mm changing to 1/2")
- #09C1: Cassette Locking Tool with Guide Pin
- #36Q1: 2/2.5/3/4/5/6 Hex Key Wrench, 4x5x6mm Ball-end
- #28P1: #1 Phillips Screwdriver
- #28S6: 6mm Flat Blade Screwdriver
- #34S4: Locking Tool, Freewheel Turner, and 15mm Pedal Wrench
- #11F3: Shimano® Hollowtech II Compatible BB Tool
- #12F8: 10-15G Forged 8-groove Spoke Tool
- #35T25: T-25 Torx Wrench, 20x100mmL
- #11B1: Shimano® / ISIS Drive BB Tool
- Product Dimensions: 30.5 x 21 x 6.5cm
- Weight: 1.8kg
- Color: Black

84S2 Starter Tool-Roll



- Keep your cycling accessories organized and accommodate in the Starter Tool-roll
- The simple, versatile design allows you to stow all sorts of tools
- Durable polyester storage roll
- Simple roll-up design carries essential ride necessities
- Contains:
 - #28S6: 6mm flat blade screwdriver with magnetic tip
 - #28P1: #1 Phillips screwdriver with magnetic tip
 - #29M1: Shimano® compatible chain tool (5x6x7x8x9x10x11x12-speed)
 - #36Q1: 2/2.5/3/4/5/6 hex key wrench, 4x5x6mm ball-ended
 - #65A1: Tire puncture repair kit (18 patches, 3 tire levers, 10ml adhesive, 8cm valve hose, A sandpaper)
 - #C123: Sprocket cleaning brush (up to 10-speed for aggressive cleaning)

83A1 Storage Bottle



- Keeps your tools and spares secure and protected, in a safe spot when you need them the most
- PE material bottle case, strong and durable for holding tools
- Bottle shaped case, portable and convenient for outdoor use



Product includes tire lever x3, glue, patch x18

Image contains for reference only

85A5 Advanced Mechanic Tool Kit



- Carry Case
- WD-40 (1.5oz / 51ml)
- #11B1: Shimano® / ISIS Drive BB Tool
- #09C1: Cassette Locking Tool with Guide Pin
- #M091: BB Installation Tool for Shimano® Hollowtech II
- #C121: Two-way Brush
- #12F8: 10-15G Forged 8-groove Spoke Tool
- #17M4: Tape Measure, Up to 3M / 10FT
- #04C2: Crank Remover
- #3TA1: Star Key Wrench (T-10x15x20x25x27x30x40x45x50)
- #36Q9: Hex Key Wrench Set w/Ball-ended (1.5x2x2.5x3x4x5x6x8x10mm)
- #67B4: Cable Cutter
- #25H6: 6" Forged Adjustable Wrench
- #47X7: 13x14x15x16x17x18x19mm Cone Wrench Set
- #33F5: 15mm Pedal Wrench
- #62M1: Pro Shop Chain Tool (for 5x6x7x8x9x10x11x12-speed)
- #28P1: #1 Phillips Screwdriver

801A



- #1100: 15mm wrench & locking tool
- #1206: 10-15G Forged 6-groove Spoke Tool
- #25H6: 6" Adjustable Forged Wrench
- #60A2: 8x9x10 Y box wrench
- #60D2: 12x13x14 Y box wrench
- #64P3: Tire Lever Set, Set of 3 Pieces
- 4x5x6x8 Hex key
- 4x6mm flat blade screwdriver
- #1x#2 Phillips screwdriver

- #28S6: 6mm Flat Blade Screwdriver
- #64P3: Tire Lever Set, Set of 3 Pieces
- #53A2: Multi-speed Freewheel Turner (Chain Whip, 1/2" x 3/32")
- #53R4: 1/2" Two-way Ratchet Wrench
- Product Dimensions: 37.8 x 16.8 x 14.5cm
- Weight: 5.4kg
- Color: Black

85A7 Pro Shop Mechanic Tool Kit



- Carry Case
- WD-40 (1.5oz / 51ml)
- #C153: Pro Shop Apron
- #53R4: 1/2" Two-way Ratchet Wrench
- #33S1: 15mm Pedal Wrench
- #53S3: Multi-speed Freewheel Turner (Chain Whip, 1/2" x 3/32")
- #C121: Two-way Brush
- #0502: 13x15+14x16mm Cone Wrench Set, 2 Pieces
- #62M1: Pro Shop Chain Tool (for 5x6x7x8x9x10x11x12-speed)
- #04C2: Crank Remover
- #09C1: Cassette Locking Tool with Guide Pin
- #12F8: 10-15G Forged 8-groove Spoke Tool
- #56E6: Glueless Patch Set AirDam, 6 Pieces
- #M091: BB Installation Tool for Shimano® Hollowtech II

- #30C1: ChainMaster
- #67B4: Cable Cutter
- #97T1: "Star-8" T-9x10x15x20x25x27x30x40 Star Keys
- #97A3: "Mighty-9" 1.5x2x2.5x3x4x5x6mm Hex Keys, +/- Screwdrivers
- #25H6: 6" Forged Adjustable Wrench
- #35V8: 8mm Hex Key Wrench
- #64P3: POM Tyre Levers, Set of 3 Pieces
- #28P1: #1 Phillips Screwdriver
- #28S6: 6mm Flat Blade Screwdriver
- #27P5: Chainwheel Nut Tool
- Product Dimensions: 37.8 x 16.8 x 14.5cm
- Weight: 4.9kg
- Color: Black



A251 VeloAgile High Pressure Alu Mini Pump



A351 VeloClub High Pressure Alu Mini Floor Pump



A451 Sport Steel Floor Pump



A551 Comp Steel Floor Pump

		material	valve lock	Length	air pressure
A251	VeloAgile High Pressure Alu Mini Pump	alu	alu thumblock lever	272mm	120 psi 8.2 bar
A351	VeloClub High Pressure Alu Mini Floor Pump	alu	alu thumblock lever	343mm	140 psi 9.6 bar
A451	Sport Steel Floor Pump	steel	twin-valve with thumblock lever	625mm	160 psi 11.0 bar
A551	Comp Steel Pump	steel	twin-valve with thumblock lever	678mm	160 psi 11.0 bar
A652	Extreme High Pressure Floor Pump	alu	alu thumblock lever	658mm	260 psi 18.0 bar
A653	High Pressure Air Tank for Tubeless System	alu	plastic thumblock lever	605mm	160 psi 11.0 bar



A652 Extreme High Pressure Floor Pump



A653 Cannon Air Compressor

- For Tubeless System
- Up to 160psi
- A new innovative valve that manages schrader / Presta / Dunlop



Technical Information



A911

A912



A91A

A91B



A91C

A91E

A911 Dual Valve Pump Head, 1/4" BSP Inner Wire Type

A912 Dual Valve Pump Head, ID-8mm Hose Barb Type

A91A Dual Valve Pump Head, Quick Coupling ARO 210 Type

A91B Dual Valve Pump Head, Quick Coupling ISO 6150 B Type

A91C Dual Valve Pump Head, Quick Coupling C Type

A91E Dual Valve Pump Head, Quick Coupling Euro Type

	valve type	weight	capacity		
A251	Presta®/Schrader®/Dunlop®	112 gram	56 cm ³	Road bike	inflating on both ways
A351	Presta®/Schrader®/Dunlop®	260 gram	90 cm ³	home usage	with gauge
A451	Presta®/Schrader®/Dunlop®	1,100 gram	280 cm ³	home usage	with gauge (2.5")
A551	Presta®/Schrader®/Dunlop®	1,280 gram	300 cm ³	both home/store usage	with gauge (2.5")
A652	Presta®/Schrader®/Dunlop®	1,320 gram	300 cm ³	both home/store usage	with gauge (up to 3")
A653	Presta®/Schrader®/Dunlop®	1,760 gram	880 cm ³	home usage	with safety valve



17M4 Tape Measure

- Measures up to 3 meters / 10 feet in centimeters & inches

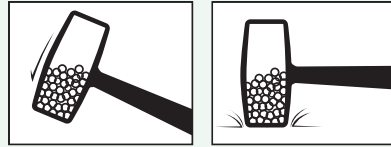

17N1 Rubber Mallet

- When a little force is needed
- Coated to prevent marring and marking 2.5lb / 1.13kg



60A2 8x9x10mm Y Box Wrench

- With comfortable Kraton grip, Red

60D2 12x13x14mm Y Box Wrench

- With comfortable Kraton grip, Black



28C2 7" Combination Pliers

- 2-tone handle for comfort grip
- Heat treated CR-V for longer lifespan
- Compact 180mm
- Self-opening jaw

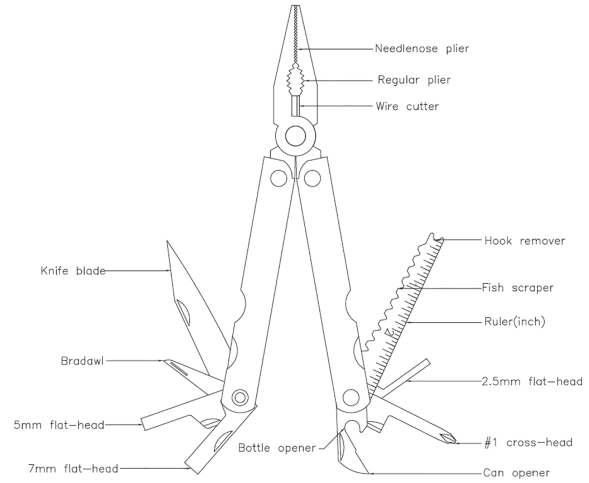

40B1 LifeGuard 15-Function Multi-Plier

- The foldable multi tool contains plier, needle-nose plier, wire cutter, blade knives, three slotted screwdrivers, bradawl, bottle opener, can opener, Phillips screwdriver, fish scaler, hook remover, carpenter's saw and meters
- Stainless Steel



28D2 7" Diagonal Cutting Pliers

- 2-tone handle for comfort grip
- Heat treated CR-V for longer lifespan
- Compact 180mm
- Self-opening jaw



28P0 #0 Crosshead (Phillips) Screwdriver with Magnetic Tip

- Ergonomically designed handle for comfortable grip
- 100mm length

28P1 #1 Crosshead (Phillips) Screwdriver with Magnetic Tip

- Ergonomically designed handle for comfortable grip
- 100mm length

28P2 #2 Crosshead (Phillips) Screwdriver with Magnetic Tip

- Ergonomically designed handle for comfortable grip
- 100mm length



28L2 6" Needle Nose Pliers

- 2-tone handle for comfort grip
- Heat treated CR-V for longer lifespan
- Compact 150mm
- Self-opening jaw



28S3 3mm Flat Blade Screwdriver with Magnetic Tip

- Ergonomically designed handle for comfortable grip
- 100mm length

28S6 6mm Flat Blade Screwdriver with Magnetic Tip

- Ergonomically designed handle for comfortable grip
- 100mm length

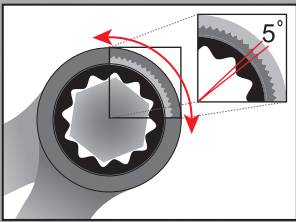

4108-4115 Combination Ratchet Wrench

• 8mm (#4108) ~ 15mm (#4115), 5-degree ratcheting

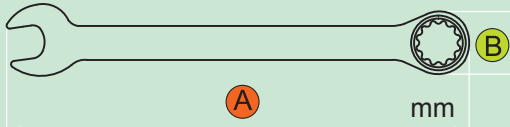

	4108	4109	4110	4111	4112	4113	4114	4115
A	135	158	158	165	166	176	189	196
B	17.85	20.8	20.85	23.3	23.65	25.6	27.95	29.05



3908-3915 Dual Wrench

- #3908: 8mm
- #3909: 9mm
- #3910: 10mm
- #3911: 11mm
- #3912: 12mm
- #3913: 13mm
- #3914: 14mm
- #3915: 15mm

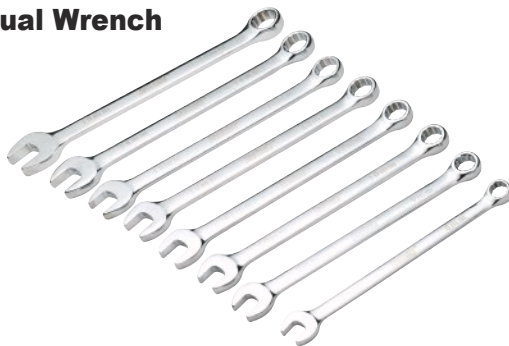

41B8 8~15mm Combination Ratchet Wrench Set

- With a storage pouch, the pouch includes two holes to hang during use of wrenches
- Contains 8pcs Combination Ratchet Wrenches, 8mm (#4108) ~ 15mm (#4115)

25H6 6" Adjustable Forged Wrench

- With scales to 1mm



◀53R4 1/2" Two-way Ratchet Wrench

- With quick release function
- Extra long 370mm / 14.5" handle provides a higher force





16A5 H.S.S. Blade Tube Cutter

- Ideal for Ti/AL/Cr-Mo/Steel
- Not recommended for carbon fiber or threaded tubes (see #16G1 and #16H3 for these applications)
- Up to 1-5/8" (42mm) tube diameter



16A2S Spare H.S.S. Blade

- For #16A2, #16A4, & #16A5 tube cutters



16H3 Professional Hack Saw

- Contains carbide grit blade, especially for carbon fiber tubes
- It's also adjustable to 45 degree



16H3S Carbide Grit Blades

- Carbide Grit Blades for #16H3
- Set of 2 pieces



16H1S Spare H.S.S. Bi-metal Saw

- For #16H1 mini hack saw

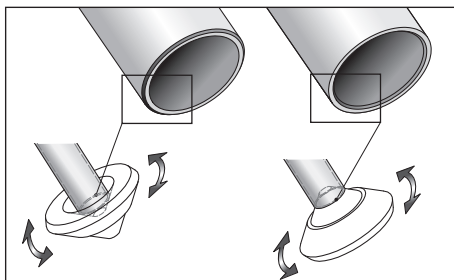

16B1 Tube-end Chamfering Tool

- For easy deburring sawed-off tubes
- Suitable for any bicycle tube diameters
- With the tool you can deburr both, inside diameter and outside diameter
- Patented

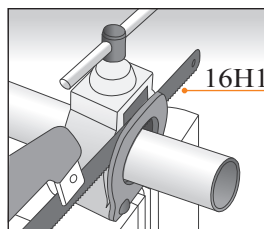
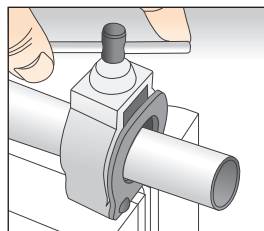
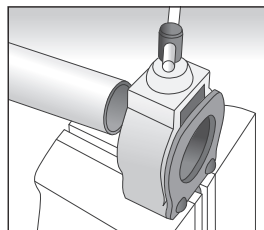

16G1 Saw Guide

- 90-degree no swing design
- For up to 1-1/4" (32mm) tubes
- Patented



17G1-17G3-17G5 NBR Gloves

- Keep your hands clean of oils, acids and dirt while keeping the natural feel. 100 PCS / BOX

- Powder-Free
- Protein-Free
- High Flexibility
- Textured
- Non Sterile
- Ambidextrous
- Anti-Oil
- Acid Resistant
- Alkali Resistant

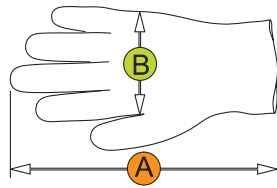

Item	17G1	17G3	17G5
Size	M	L	XL
A	26cm	26cm	26cm
B	9.5cm	10.5cm	11.5cm

± 0.5cm



C155 Pro Shop Apron

- Double zip center pockets, dual open side pockets, and single zip chest pocket
- Tough enough for a pro shop & comfortable enough for home use



17H5 IceToolz® Flat Top Cap

- One size for all

17H6 IceToolz® Cool Cap

- One size for all



Item	17V1	17V2	17V3	17V4	17V5	17V6	17V7	17V8
Size	2XS	XS	S	M	L	XL	2XL	3XL
Width	43cm	45.5cm	48cm	50.5cm	53cm	55.5cm	58cm	60.5cm

17V1-17V8 IceToolz® Moisture Wicking Shirt

- Material: 100% Polyester

Item	17U1	17U2	17U3	17U4	17U5
Size	S	M	L	XL	XXL
Width	50.5cm	53cm	55.5cm	58cm	61cm

17U1-17U5 IceToolz® T-shirt

- Material: 100% Cotton



18G1 Protective Glasses

- Comply with EN 166 and ANSI Z87.1
- Reinforced glasses with antistatic coating
- Carry pouch included



www.icetoolz.com
contact@icetoolz.com

credit Sven Martin / @svenmartinphoto



Lifu Bicycle Co., Ltd.

No. 4, Lane 11, Ziqiang Street, Tucheng District
New Taipei City 23678, Taiwan
Tel: +886 2.2268-7367
Fax: +886 2.2268-1947