

Coral Reef Restoration Toolkit

A Field-Oriented Guide Developed in the
Seychelles Islands

EDITED BY SARAH FRIAS-TORRES, PHANOR H MONTOYA-MAYA, AND NIRMAL SHAH



A. DUNAND



USAID
FROM THE AMERICAN PEOPLE



Coral Reef Restoration Toolkit

A Field-Oriented Guide Developed in the Seychelles Islands

Editors

Sarah Frias-Torres ^{1,2,3}, Phanor H Montoya-Maya ^{1,4}, Nirmal Shah ¹

¹ Nature Seychelles, The Centre for Environment & Education, Roche Caiman, Mahe, Republic of Seychelles

² Smithsonian Marine Station, 701 Seaway Drive, Fort Pierce, FL 34949 USA

³ Vulcan Inc., 505 5th Avenue South, Seattle WA 98104 USA

⁴ Corales de Paz, Calle 4 No. 35A-51, Cali, Colombia

Contributors

Paul Anstey, Nature Seychelles, Republic of Seychelles

Gilles-David Derand, BirdLife International, La Reunion (France)

Calum Ferguson, Republic of Seychelles

Sarah Frias-Torres, Nature Seychelles, Republic of Seychelles

Joseph Marlow, Victoria University, Wellington, New Zealand

Paul McCann, Trojan Diving Services, Australia

Phanor H Montoya-Maya, Nature Seychelles, Republic of Seychelles / Corales de Paz, Colombia

Claude Reveret, CREOCEAN, France

Katherine Rowe, King Abdullah University of Science and Technology, Saudi Arabia

Chloe Shute, Nature Seychelles, Republic of Seychelles

Derek Soto, University of Puerto Rico, Mayaguez, Puerto Rico

Acknowledgements

Expert advice from several colleagues has aided the development of the Toolkit. We particularly thank Kaylee Smit and Sofie Klaus-Caan for their helpful and constructive reviews. This Toolkit was tested on a live audience attending the first Reef Rescuers Training Program in Coral Reef Restoration at Nature Seychelles, Praslin, Republic of Seychelles in June-August 2015. The authors would like to acknowledge the participants for their contributions to early drafts of this Toolkit: Danielle M Becker, Tamsen T Byfield, Austin Laing-Herbert, Louise Malaise, Ron Kirby Bugay Manit, Tess Moriarty. Production of this Toolkit was funded by the United States Agency for International Development (USAID) through the Nature Seychelles' Reef Rescuers Project 674-A-00-10-00123-00. Kerstin Henri, Director Strategic Operations of Nature Seychelles, is also thanked for managing the project in which this Toolkit was produced. The statements, findings, conclusions and recommendations are those of the authors and do not necessarily reflect the views of USAID and Nature Seychelles.

Published By Nature Seychelles

Copyright © 2018, Nature Seychelles.

This publication may be reproduced for educational or non-profit purposes without special permission from the copyright holders, provided acknowledgement of the source is made. Nature Seychelles would appreciate receiving a copy of any publications that use this document as a source.

About Nature Seychelles

Nature Seychelles is a leading environmental non-government organization (NGO) in the Western Indian Ocean. Based in Victoria, Mahe, Seychelles, with facilities in Praslin and Cousin islands, the primary objective of Nature Seychelles, according to its statutes, is to improve the conservation of biodiversity through scientific, management, educational and training programs.

Nature Seychelles was founded in 1998 as BirdLife Seychelles and legally changed its name in 2002. It is registered as an Association under the laws of Seychelles. To achieve the above primary objective Nature Seychelles aims to:

- study, research and assess the status of biodiversity
- manage areas important for conservation
- seek ways and means to assist official efforts for management and conservation of biodiversity
- increase and propagate scientific knowledge of biodiversity and educate the public
- implement relevant training programs
- fund-raise for conservation programs
- promote partnership / cooperation between like-minded individuals and organizations

For further information, please contact:

Nature Seychelles
The Centre for Environment & Education
Roche Caiman,
P.O. Box 1310
Mahe, Republic of Seychelles

Tel: + 248 460 1100

Email: nature@seychelles.net

www.natureseychelles.org

Citation:

Frias-Torres, S., P.H. Montoya-Maya, N. Shah (Eds). 2018. Coral Reef Restoration Toolkit: A Field-Oriented Guide Developed in the Seychelles Islands. Nature Seychelles, Mahe, Republic of Seychelles.

Disclaimer:

The activities presented in this Toolkit involved the use of SCUBA diving techniques and science-based ecological restoration. For safety reasons, only certified SCUBA divers with training in scientific diving should attempt the techniques shown here. We do not recommend initiating a coral reef restoration project unless it follows a solid scientific foundation and implementation.

ISBN: 978-999-972-0-1

Going from this...



...to this!



Table of Contents

Foreword.....	5
Preface.....	6
1. Introduction.....	7
Purpose of the coral reef restoration toolkit.....	7
Who is the Toolkit for?.....	8
Do you need a reef restoration project?	9
How to use this toolkit.....	10
2. Planning the work.....	11
Team selection.....	12
Planning the project's activities.....	12
Gathering the resources.....	15
Land resources.....	15
Field resources.....	15
Diving equipment.....	15
Boat equipment.....	15
Some considerations for equipment maintenance.....	17
Selecting donor sites, species and colonies	17
Donor sites.....	17
Coral species.....	17
Coral colonies.....	18
Nursery site selection.....	20
Transplantation site selection	21
3. Coral Gardening.....	22
Nursery construction.....	23
Constructing a rope nursery	23
Constructing a net nursery	26
Donor fragment collection.....	29
Nursery stocking.....	30
Rope nursery stocking.....	30
Net nursery stocking.....	33
Nursery maintenance.....	33
Checking, repairing and cleaning nursery	33
Structural maintenance and repairs	35
Seasonal rope nursery transfer	36
Fragment replacement.....	38
Data recording.....	38
Debriefing.....	38
Data entry.....	38
4. Coral Reef Transplantation.....	39
Transporting whole coral ropes to the transplantation site.....	40
Transportation of corals using baskets	41
Transplantation by cementing individual colonies	42
Preparing cement	42
Transplantation density and species arrangement	44
Selection of suitable areas for colony stability and self-attachment	44
Cementing process	44
Transplantation by nailing ropes	46
Rescue cementing	46
Data recording	48
Debriefing	48
Data entry	48
5. Monitoring	49
The rationale for monitoring	50
Preparing for monitoring	50
Making marker buoys for multi-purpose monitoring	50
Making tags for monitoring coral colonies	51
Attaching buoys and tags underwater	52
Monitoring donor and control colonies	52

Datasheet recommendation	53
Monitoring nursery colonies	53
Survivorship	53
Datasheet recommendation	53
Monitoring transplanted colonies	54
Growth Rate	54
Datasheet recommendation	54
Survivorship	55
Growth rate	55
Datasheet recommendation	55
Protocol for digital monitoring of coral growth	55
Monitoring for reef recovery and resilience	56
Debriefing	56
Data entry	56
6. Project Management and Evaluation	57
Identification and preparation	58
Presentation	58
Implementation	58
Field operations	58
Tasks for diving operations	58
Monitoring and evaluation	60
7. Research Projects in Coral Reef Restoration	61
Project: Assessment of coral recruitment	62
Background	62
Objective	62
Research hypothesis	62
Methods	62
Coral Recruitment	63
Reef Rescuers papers published to date	64
Literature cited	65
Resources	67

Foreword

Hacking the coral reef

In Madagascar a person might describe a half hour “as the time of a rice cooking,” says social psychologist Robert Levine in his book *A Geography of Time*. In terms of climate change how would we describe the next 10 years? The time it takes to cook our coral reefs? Or the time it would take to inundate our coastal zones? Or the time it would take to try to “un-cook” coral reefs?

Restoration of coral reefs is not a new notion but efforts underpinned by science are relatively recent. My own “Aha! moment” in this respect came over 10 years ago at a Scientific Symposium organized by the Western Indian Ocean Marine Science Association (WIOMSA) of which I was President at the time. An eminent coral reef scientist was presenting a comprehensive study of coral bleaching. In that particular Symposium coral bleaching had been a prominent feature in the presentations. But no one had been talking about restoration. When I proposed it there was polite resistance and even some incredulity at my foolishness. It reminded me of the time when I led large multi-stakeholder projects to restore terrestrial ecosystems and save Critically Endangered birds. A biologist even wrote a couple of papers showing that it was impossible to save these birds.

With our successes in creating novel ecosystems on islands and arresting the extinction events of birds in mind, I embarked on a quest to find donors to help us save reefs. After 2 years of unsuccessful hawking, I finally managed, with the scientific knowledge of Professor Buki Rinkevich, to develop a proposal that got the United States Agency for International Development (USAID) interested in a substantive project, which I named the Reef Rescuers, 8 years ago. My co-conspirator at Nature Seychelles, Kerstin Henri, and I then managed to attract more donors to the table over the years. To date we have leveraged over USD 1.7 million in all, with the majority of funds coming from the USAID who have continued to be a supportive development partner. This has enabled us to bring in many practitioners and specialists from all over the world to work with us.

Over the last 8 years we have hired 23 staff including 6 Technical Coordinators and Managers to help us deliver the project. In addition, we have had some 43 volunteer scientific divers to assist in the field. Many core Nature Seychelles staff have also been involved in the logistics and management required to keep such a large project going in Seychelles, a small and remote country. This compilation of tools is the result of the efforts of all these people. The toolkit was tested during our first restoration training program and participants also contributed suggestions.

Today, in less than a decade, coral reef restoration is now widely accepted. In our case we want to restore coral reef ecosystem services. Turning back the clock and trying to restore coral reefs as they were pre-bleaching is impossible in our view. The large “designer reef” we have implanted in the no-take Cousin Island Special Reserve marine area is such a reef – it is not a replication of what was there before, but a novel ecosystem. As a result, this toolkit is not an attempt to produce what we can call “coral reef mechanics” but rather “coral reef engineers.” We must understand that coral reef is one of the most complex ecosystems on earth. Amateurish tinkering with it is not an option especially in the time of climate change. We recommend that users of this toolkit have at the very least a first degree in coral reef biology or more advanced degrees in marine sciences.

In closing, we need to explain why we have named this a “toolkit” rather than a “best practice.” Use and experience mean that modifications and additions may be necessary. The toolkit should remain an adaptive management instrument and we invite you the user to provide insights and comments which could lead to better and more effective efforts in coral reef restoration.

Dr. Nirmal Jivan Shah,
Chief Executive,
Nature Seychelles

Preface

Coral reef restoration is a subfield within the larger scientific discipline of ecological restoration (also known as restoration ecology). Ecological restoration is the process of assisting the recovery of an ecosystem that has been degraded, damaged, or destroyed (SER, 2018).

Coral reef restoration must follow the four basic principles of planning and implementation of ecological restoration in order to increase sustainable and valuable outcomes (Suding et al. 2015):

1. Restoration increases ecological integrity. Restoration initiates or accelerates recovery of degraded areas by prioritizing the complexity of biological assemblages, including species composition and representation of all functional groups, as well as the features and processes needed to sustain these biota and to support ecosystem function;

2. Restoration is sustainable in the long term. Restoration aims to establish systems that are self-sustaining and resilient; thus, they must be consistent with their environmental context and landscape setting. Once a restoration project is complete, the goal should be to minimize human intervention over the long term. When intervention is required, it should be to simulate natural processes that the landscape no longer provides or to support traditional practices of local communities;

3. Restoration is informed by the past and future. Historical knowledge, in its many forms, can indicate how ecosystems functioned in the past and can provide references for identifying potential future trajectories and measuring functional and compositional success of projects. However, the unprecedented pace and spatial extent of anthropogenic changes in the present era can create conditions that depart strongly from historical trends. Often, then, history serves less as a template and more as a guide for determining appropriate restoration goals.

4. Restoration benefits and engages society. Restoration focuses on recovering biodiversity and supporting the intrinsic value of nature. It also provides a suite of ecosystem services (e.g., improved water quality, fertile and stable soils, drought and flood buffering, genetic diversity, and carbon sequestration) that enhance human quality of life (e.g., clean water, food security, enhanced health, and effective governance). Restoration engages people through direct participation and, thus, increases understanding of ecosystems and their benefits and strengthens human communities.

We followed the four basic principles of ecological restoration when implementing our coral reef restoration project. These principles are summarized in a practical decision tool in the next section (Figure 1).

We encourage readers of our Coral Reef Restoration Toolkit to follow the basic principles of ecological restoration in their own projects. As coral reef restoration scientists and practitioners, we were rewarded with the experience of bringing back life to a dead coral reef. We hope newcomers to the field of coral reef restoration and those already with some experience will benefit from reading and implementing our Toolkit, so they are also rewarded with successful outcomes.

The Reef Rescuers Team
Nature Seychelles, Mahe, Republic of Seychelles
August 2018

1. Introduction

Purpose of the coral reef restoration toolkit

The purpose of this Toolkit is to describe how to complete a coral reef restoration project, using the 'coral gardening' concept. Coral gardening incorporates a two-step protocol. First, coral 'seedlings' (from fragments, nubbins or settled larvae) are raised in underwater nurseries. Second, the nursery-reared corals are harvested and transplanted onto damaged

reef areas (Rinkevich 2006). We provide guidance on appropriate design, logistics, and execution of the project based on our own experience using field-tested methods (developed by us or others) in the Republic of Seychelles, Western Indian Ocean (WIO).



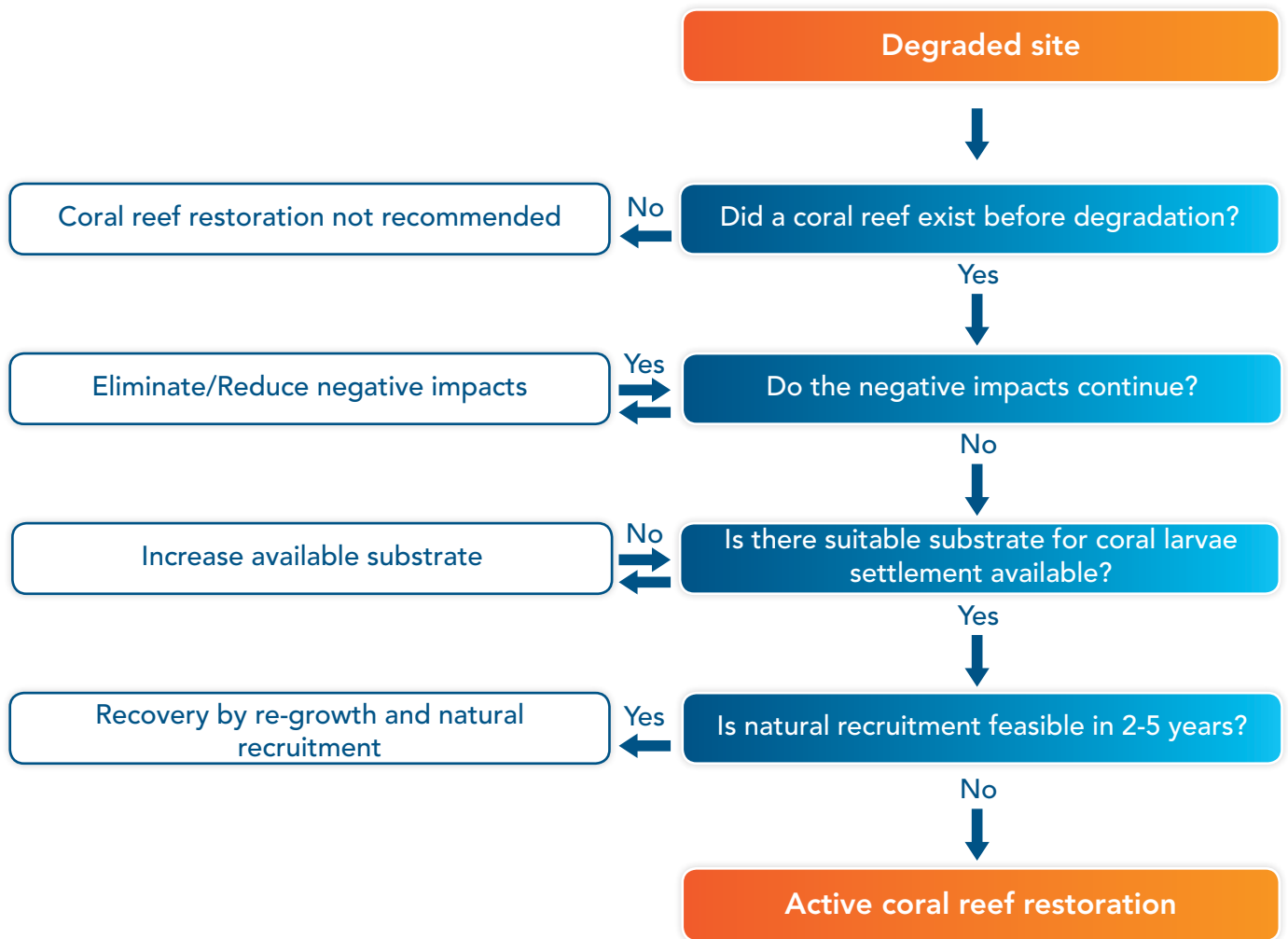

Figure 1 Do you need a coral reef restoration project? This flowchart shows the basic steps to take before consensus on an active coral reef restoration effort occurs.

Who is the Toolkit for?

This toolkit aims to be a companion for scientists, managers, practitioners and local communities who are facing a coral reef restoration challenge and require guidance using low cost, field-tested methods. We explain the methods used in our coral reef restoration project and how we solved the problems encountered, using low cost solutions with the limited resources found in a developing nation.

This toolkit is not a comprehensive treatise in coral reef restoration. Instead, we aim to fill a void in the practical know-how of coral reef restoration. For a more in-depth analysis we suggest Precht (2006), Edwards & Gomez (2007), Johnson et al (2011).

Do you need a reef restoration project?

The marine environment is increasingly under severe threat from various impacts such as pollution and over exploitation of resources. Furthermore, climate change has been identified as the single most palpable threat to global marine ecosystems, with particular emphasis on coral reefs. Described as the 'rain forests of the sea', coral reefs have recently been devastated by several large-scale warming events, commonly known as El Niño. Coral bleaching, caused by warmer than average sea temperatures, has emerged as a persistent and long-term threat to coral reefs and their related communities. This is a new challenge for coral reef management as traditional conservation practices are becoming undermined.

The restoration of coral reefs (using the coral reef gardening concept, or similar), has emerged as a supplement to more traditional coral reef conservation practices. To some, this conservation tool can be used to enhance reef recovery whilst contributing to overall resilience, as coral reproductive success is increased (Soong & Chen 2003; Grimsditch & Salm 2006). Restoration is also considered to promote the spread of stress-resistant genotypes (Mascarelli 2014) and as it generates both employment opportunities and wider ecosystem services, coral reef restoration provides socio-economic benefits to marine resource management. In addition, there are already

conservation initiatives available, involving the use of gene-banks to store reproductive material from colonies resistant to bleaching, making it available for subsequent transplantation (Mascarelli 2014).

Some scientists also argue that, if the initial causes of deterioration are not eliminated, coral reef restoration is a waste of the already limited funds available for conservation, while diverting the attention from the real solutions to coral degradation (Adger et al 2005, Edwards 2010). According to Baums (2008), "the money invested in restoration may become lost because transplanted colonies may be poorly adapted to their new environment, sexual reproduction of the restored areas may be compromised due to genetic incompatibility of the colonies, and the diversity of associated fauna may be reduced due to the low genetic diversity of the restored areas". However, Edwards (2010) recommends considering transplantation only as the first step in a long path to improve the structure and function of a coral reef. Therefore, before you embark on a coral reef restoration project, we recommend you to see the flowchart depicted in Figure 1. The flowchart is the first tool of our toolkit: it was created as the first step in planning a reef restoration project and it provides a suite of actions that can be taken as an alternative to active reef restoration. If you follow the diagram and answer each and every question in an objective way, we are confident your well-intentioned coral reef conservation efforts will be maximized.

Coral reef restoration in the Seychelles

In 1998 an El-Niño event coupled with the Indian Ocean Dipole (a similar phenomenon to El Niño but which occurs ahead of El Niño events (Graham et al., 2006), resulted in both the highest seawater temperature anomaly recorded in 50 years and widespread coral mortality worldwide; affecting most severely the reefs of the Indian Ocean (Sheppard et al., 2005). At a regional level, mortality was recorded at 30% (Obura, 2005), with a reduction of live coral cover as much as 80-95% at the most heavily impacted reefs, of which those were amongst the Seychelles (Spencer et al., 2000; Spalding and Jarvis, 2002). Within the inner granitic islands of Seychelles, the 1998 bleaching catastrophe decreased the coral cover to less than 3% in some areas, leaving no depth refuge from coral mortality (Graham et al., 2006, 2007). Shortly thereafter, a rapid algal-colonization was observed (Spalding and Jarvis, 2002), along with a gradual transformation of the impacted reefs into rubble and algal-dominated communities, accompanied by a collapse in the structural complexity (Baker et al., 2008). During the following decade, recovery has been extremely slow in the inner granitic islands of Seychelles (Graham et al., 2006, 2007; Mumby and Steneck, 2008). Live scleractinian coral cover still remains very low with less than 1% of the benthos composed by fast growing habitat forming branching species (Harris et al., 2014). Recovery within the Seychelles has been somewhat patchy, showing significant spatial heterogeneity. In 2011, of the 21 reef sites surveyed between Mahe and Praslin, 12 sites were showing signs of recovery with mean live coral cover 23% and macro-algal cover of less than 1%. However, 9 of the sites had shifted towards macro-algal dominated reefs, with an average of less than 3% live coral cover and average macro-algal cover of 42% (Graham et al., 2015).

Coral reef degradation and limited recovery threatens the economy of Seychelles. To a large extent, the population of Seychelles depends on fish for its protein requirement and is the third largest consumer of fish per capita in the world, an important part of this being sourced from reef and coral associated areas. The Seychelles depend almost exclusively on tourism and fisheries for foreign revenue (Jennings et al., 1996; Shareef and McAleer, 2008). Beside the direct contribution of tourism to revenues, it also stimulates other commercial sectors that support tourism industry (Cesar and van Beukering, 2004), playing an important role in the financing of protected areas (Gössling et al., 2002).

Coral reef restoration in the Seychelles (Cont)

The loss of reef structure caused by bleaching-induced mortality also impedes the ability of reefs to provide coastal protection and sustain white sandy beaches (Sheppard et al., 2005). The loss of corals is expected to have future repercussions on Seychelles beaches, classified among the most attractive in the world and of crucial importance for the local economy (Sheppard et al., 2005). Thus, in the long run, recent bleaching events causing mass coral mortality and the subsequent marine environmental deterioration in the Seychelles, can substantially influence tourist arrival (Cesar and van Beukering, 2004). Furthermore, the predicted increase in both frequency and severity of coral bleaching events, will further worsen these problems.

In order to ensure that coral reefs continue to provide local populations with all the vital biological, ecological and socio-economic goods and services and to maintain resilience capacities, the United States Agency for International Development (USAID) Development Grant Program (DGP) funded Reef Rescuers, a project awarded to Nature Seychelles (2011-2014) to: 1) undertake vulnerability assessments and stakeholder consultations on coral reef restoration, 2) generate a stock of coral colonies for the purpose of reef restoration, 3) initiate seascape restoration of selected coral reef habitats as a model for the Seychelles and the Region, 4) build stakeholder capacity in Seychelles and the Region and generate a pool of skilled persons for sustained coral reef restoration and, 5) produce a Green Business Plan to ensure financing and long term sustainability.

In 2014, Reef Rescuers completed coral reef restoration at a degraded reef site within the marine protected area of Cousin Island Special Reserve. The project used the 'coral gardening' concept. First, we generated a pool of farmed colonies in underwater nurseries until they reached a threshold transplantation size. Second, we transplanted the nursery colonies onto degraded reefs. The project built and cultivated 12 midwater nurseries (9 rope nurseries and 3 net nurseries), filled initially with up to 40,000 coral fragments or nubbins (from donor corals and corals of opportunity) of 34 coral species (branching, massive and encrusting). A total of 24,431 corals were transplanted in an area of 5,225 m² within the no-take marine reserve of Cousin Island Special Reserve. Additional support from the United Nations Development Program (UNDP) and Global Environmental Fund (GEF) Tourism Partnership Programme resulted in the transplantation of 2,015 corals in an area of 1,636 m² at a small bay (Petite Anse Kerlan) within the Constance Lemuria 5-star resort in Praslin. This toolkit summarizes our experience.

How to use this toolkit

This toolkit is a preparation and methodology guide for use in the field and lab during the planning and completion of a coral reef restoration project using the coral gardening concept.

The section on transplantation and monitoring can be used as a stand-alone guide, when corals of opportunity (instead of gardening) are being used for transplantation. Throughout the text, you will find boxes, biology tips and troubleshooting guidelines.

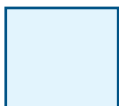

Boxes are short summaries of a specific section for quick reference.



Biology tips are indicated by this brain coral symbol and explain the application of a coral reef biology concept to coral reef restoration (biomimicry)



Troubleshooting tips are indicated by this tool symbol and explain recommended tips; also, they refer to problems we found in the field and how we fixed them

The last section of the toolkit contains a summary of protocols we used in our coral reef restoration project.

Some protocol videos can be found at the **Nature Seychelles YouTube channel**. The link is: <http://www.youtube.com/user/NatureSeychelles>

For any enquiries regarding this toolkit, contact us at

Nature Seychelles,
The Centre for Environment & Education
Roche Caiman,
P.O. Box 1310
Mahe, Republic of Seychelles

Tel: + 248 4 60 11 00
Email: nature@seychelles.net

2. Planning the work

Every project must have a solid start. Only then can the objectives be achieved on time and within allocated resources. Thus, this chapter is about planning your coral reef restoration project. Here you can learn about the kind of team you should consider recruiting; the equipment and tools that can facilitate your work; and the considerations to have in mind when selecting your donor, nursery and transplantations sites. This chapter is designed to help you have that solid start!

The Reef Rescuers project was planned to run for three years. Therefore, all recommendations in this chapter are framed within a similar 3-year time line. Although we found this to be a good time frame to accomplish our objectives, you should adjust the time frame to your needs.



Team selection

A project is only as good as the people working on it. A coral reef restoration project requires a good balance of academic and technical skills. We found that the best people for our project were those well-rounded individuals, with a sound academic background, that were proactive and did not mind getting their hands dirty. People who understand the importance of collecting good quality scientific data, are aware of the limited resources found in remote locations and are keen to experience challenging situations, are most suited for a coral reef restoration project in a developing country. As people of this kind are not easy to come by, any time invested in identifying and selecting the right team with the right skills and attitude is time well spent. We indeed see team selection as paramount to achieve the project's objectives.

The Reef Rescuers team consisted of 4 staff members and 4 to 6 volunteers throughout the project. The staff included: Chief Scientist/Project Coordinator, Technical/Scientific Officer, Dive Leader and Boatman/Maintenance Technician. The volunteers were qualified SCUBA divers who assisted as scientific divers and rotated every three months for the duration of the project. This last system of hosting a new team of divers every three months fulfilled two of the main objectives

of the Reef Rescuers project, namely: 1) build stakeholder capacity, and 2) generate a pool of skilled persons for sustained coral reef restoration. The skills, qualifications, and work specifications recommended for every team member are listed in Table 1.

Planning the project's activities

Every coral reef restoration project is different due to the nature of the location and the type of reef to be restored. However, a science-based coral reef restoration project should operate around five main objectives (Fig. 2):

1. **A vulnerability assessment and stakeholder involvement plan.** This objective is a precursor to action and will enable the stakeholders and their concerns to be identified correctly.
2. **Generation of a stock of coral colonies for the purpose of reef restoration.** An assessment of feasible donor and nursery sites is conducted as well as the identification of candidate coral species; then underwater nurseries are established to enable easy natural growth of corals.
3. **Seascape restoration of selected coral reef habitats.** An assessment of feasible transplantation sites is conducted following the stakeholder involvement plan.

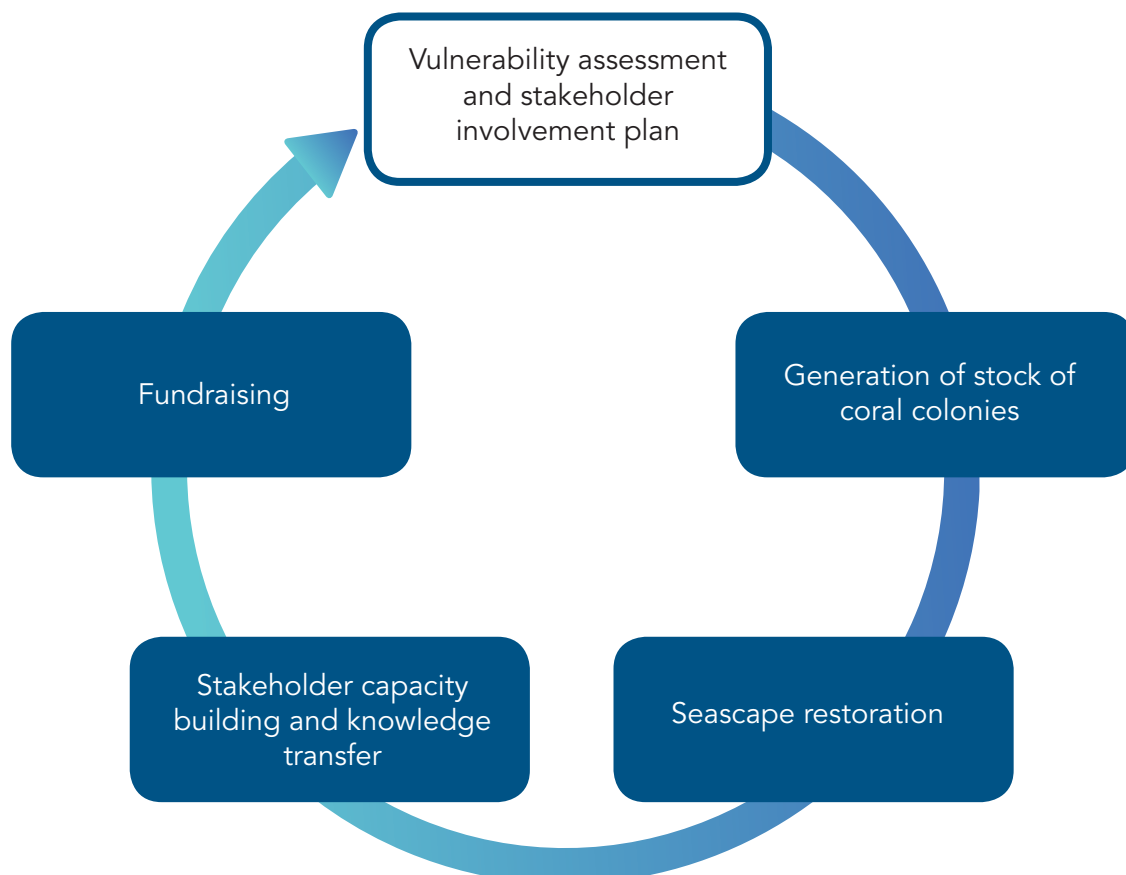

Figure 2 Overarching objectives of a coral reef restoration project, presented in a sequence

Table 1 Recommended human resources for the duration of a coral reef restoration project. Number in brackets corresponds to the amount of people per job title.

Job Title	Skills & Qualifications	Work Specifications
Project Coordinator – PC (1)	Solid conservation-oriented coral reef restoration experience; PhD in marine science, expert diver; capacity for developing and coordinating work plans, budgets, stakeholder involvement, managing field staff, and project monitoring and reporting. Strong analytic and scientific writing skills for scientific field experiments and publishing in peer-reviewed scientific journals.	Coordinate and manage all aspects of the project, notably liaising with the TSO to supervise the implementation of the project activities. Participate in designing, executing, monitoring, analysing experiments and writing scientific publications. Liaise with other institutional staff to manage project administration and logistics, performance & reporting, stakeholder involvement, communication, and serve as focal point for the scientific committee.
Technical and Scientific Officer - TSO (1)	Coral reef restoration expert with significant coral nursery construction, coral transplantation and management experience; MSc/PhD level in marine science, expert diver with superior technical skills, strong analytic and scientific writing skills, strong physical abilities; boat license and boat driving experience, diving and boat equipment maintenance.	Lead the implementation of all technical aspects of the project namely: building, stocking and maintaining the nurseries and performing transplantation efforts; designing, executing, monitoring and analyzing experiments, and assisting the PC in any other project aspects which demand his intervention, leading scientific reporting and publication
From the start of diving operations to the end of the project		
Scientific Dive Leader – SDL (1)	Divemaster with high physical fitness; BSc/ MSc degree in marine science and/or conservation; working experience in coral reef management or research, preferably in donor-funded projects and in coral reef restoration; proven leadership capabilities and experience leading staff in the field; boat license and boat driving experience; diving and boat equipment maintenance; strong physical abilities. Emergency First Responder (or equivalent) and Oxygen Provider – First aid instructor, desirable.	Lead the scientific diver/volunteers team whenever required, to help to implement all technical aspects of the project, notably building, stocking, maintaining underwater coral nurseries, performing transplantation of nursery-grown coral colonies and monitoring of transplantation “success”. Develop an Emergency Action Plan and ensure all dives follow appropriate safety protocols. Ensure all staff are aware of emergency protocols. Design, execute, monitor and analyse experiments in relation to the already established scientific framework. Assist the PC and TSO in any other aspects of the project which demand his/her intervention, particularly project planning, monitoring, reporting, management of project equipment, etc.
Boatman and maintenance technician (1)	Skipper licence, basic knowledge in mechanics and experience with handling boat engines; acquaintance with local reefs and navigation hazards around working area.	Responsible for driving the project boat, and maintaining the boat and the engine. When not undertaking one of these tasks he will be an integral part of the crew and assist in land and boat-based activities (e.g. preparing nursery frames on land, securing nursery hardware, helping to fill coral nursery on the boat, etc).
Scientific divers/field assistants (4 -6)	Competent and certified diver (as a minimum PADI Advanced diver, or equivalent), high physical fitness; BSc/ MSc degree in marine science and/or conservation, experience in monitoring and analysis of scientific data (coral and fish monitoring is desirable), underwater photography.	In addition to the routine work of constructing, filling and maintaining the nurseries and coral collection, the scientific divers will be involved in monitoring the nurseries, perform any ongoing field experiments and help in analysis of collected data. For the transplantation phase, scientific divers are also required to transplant coral colonies and monitor both baseline and post-transplantation conditions in transplanted plots. Responsible for filling the scuba tanks.

4. Stakeholder capacity building and training of skilled people for sustained coral reef restoration.

Transfer of knowledge and skills for coral reef restoration is paramount to achieve both sustainable and efficient, long-term reef conservation programs. Similarly, as in this toolkit, gained knowledge on coral culture and transplantation should be integrated and processed towards the delivery of clear protocols for best practice that will also allow evaluation over time.

5. Generating new funding opportunities to ensure financing and long-term sustainability. Coral reef restoration projects deliver physical structures,

knowledge and practical skills that are marketable. Many hotels and island resorts, dive operators and so forth have seen their marine sites degraded by coral bleaching and are potential clients for restoration. Therefore, business ideas need to be investigated to allow the commercialisation of these deliverables through local, indigenous business ventures and using the persons trained under the project.

In order to accomplish these objectives a set of timed activities are required. We have listed the minimum set of activities required in Table 2.

Objectives and activities	Timeline
Vulnerability assessment and stakeholder involvement plan	
Produce vulnerability assessment and stakeholder involvement plan	1st Year
Launch stakeholder meeting	1st Year
Involve relevant stakeholders	1st Year
Communication and public awareness	1st to 3rd Year
Generate stock of coral colonies for reef restoration	
Build dive shed to support underwater activities	1st Year
Purchase materials required for nursery building	1st Year
Produce site selection protocol and research plan	1st Year
Build nurseries	1st Year
Collect coral fragments, prepare nubbins and start culture	1st to 2nd Year
Conduct nursery related-experiments	1st to 3rd Year
Initiate nursery monitoring and maintenance program	1st to 3rd Year
Continue communication and public awareness	1st to 3rd Year
Seascape restoration of nursery-grown corals	
Select sites for transplantation	1st Year
Baseline monitoring	2nd Year
Transplant nursery-grown colonies onto selected sites	2nd to 3rd Year
Conduct transplantation-related experiments	2nd to 3rd Year
Monitoring of transplanted colonies and related experiments	2nd to 3rd Year
Continue communication and public awareness	2nd to 3rd Year
Stakeholder capacity building and knowledge transfer	
Develop protocols and methods for reef restoration	2nd to 3rd Year
Provide onsite training to local and regional stakeholders	2nd to 3rd Year
Continue communication and public awareness	2nd to 3rd Year
Publish and disseminate experiment results	2nd to 3rd Year
Generating new funding opportunities	
Hire marketing and financial consultant	3rd Year
Investigate funding opportunities	3rd Year
Discuss options with stakeholders and adopt relevant options	3rd Year

Gathering the resources

The equipment, materials and tools needed in a coral reef restoration project are very diverse (Table 3). They can be separated into land and field resources. Land resources will facilitate the planning, training, diving and reporting sections of the project. The field resources can be further subdivided into surface and underwater gear. Their use will vary depending on the task or phase of the project (e.g. baseline monitoring, nursery construction, transplantation, report writing, etc). Details and quantities of each item will be described in the next chapters.

Land resources

Land resources are all those items that will facilitate the day-to-day work in a reef restoration project. They include: office facilities, storage facilities and diving operations.

The team working for the project will require office space to manage, discuss, plan and report activities. Therefore, standard office equipment and services will be required. These shall include computers, desks, meeting table, chairs, bookshelves, printers, projector, and internet services.

A happy team is a productive team. Therefore, good toilets/lavatories and a coffee-stocked kitchenette are recommended to keep your team always in a good mood. Air conditioning and electric fans in the office, or at least well-ventilated office space, can also guarantee a motivated team particularly in the hot and humid places where coral reefs are found.

Coral reef restoration requires equipment and materials that can be very expensive. For security and protection, it is recommended to have storage facilities. One lockup store room where all materials (e.g. cement, rope, gasoline, oil, etc) and tools (e.g. spare parts, hammers, dust mask, GPS, etc) are kept safe is recommended.

Correspondingly, a separated diving shed to store all diving gear, compressor and wet tools is recommended; this building should have an electric connection suitable to the needs of the compressor (i.e. Tri-phase or 220V) and a fresh water tub to rinse the gear after diving. For the latter, consider rainwater harvesting; it will significantly reduce water bills.

Field resources

Diving equipment

Equipment divers should carry on each dive

Along with the standard SCUBA dive equipment of cylinder, BCD, regulators, mask, fins, wetsuit, gloves, some extra tools are advised.

- A dive knife is required for working with and around ropes and nets, as safety equipment in case of entanglement.
- A Surface Marker Buoy (SMB) is essential especially in the initial project phases, when exploratory dives are being conducted to find suitable sites for nurseries, donor sites and transplantation sites.
- A toothbrush in the BCD pocket is useful to clean coral nurseries, or clean a stubborn knot.
- Several extra lengths of rope are useful in many situations such as attaching a slate to the BCD when monitoring, or fixing a stretch of fraying rope.
- Cable ties can be one of the most useful tools to have underwater because they are used to attach ropes to pipes which often break and need replacement. Cable ties can also be used as a temporary fix before coming back the next day with a more permanent repair.

Boat equipment

By having a diving boat, you'll be able to gain unlimited access to the 3 key areas of your project: donor, nursery and transplantation sites. The type of boat and engine to have in a coral reef restoration project will depend on the scope of the project. The selection can be narrowed by answering the following questions:

- How far are the working sites (i.e. donor, nursery and transplantation) from the office/marine laboratory?
- How many people will be working at any given time?
- What specific skills will be required to drive the boat?
- What is the equipment budget in your restoration project?

Table 3 Here we provide a checklist of the minimum equipment and items that should be available for the project and the tasks were the item will be mostly likely used.

Item	Nursery construction & Maintenance		Coral Fragmentation	Transplantation	Monitoring
	Rope	Net			
Angle bars	X	X			
Mooring line	X	X	X	X	X
Assorted cable ties	X	X	X	X	X
Assorted plastic crates	X	X	X	X	
Assorted baskets			X	X	
Assorted water containers	X	X	X	X	
Cement (dry)				X	X
Chisel			X		
>5m Diving Boat + >40HP Engine	X	X	X	X	X
Diving Compass	X	X			X
Diving Compressor	X	X	X	X	X
Diving knife	X	X	X		X
Diving gloves	X	X	X	X	X
Dust mask				X	
Elbows to connect PVC pipes		X			
Fine mesh net		X			
On-board fresh water				X	
Full diving equipment	X	X	X	X	X
GPS in waterproof bag	X	X	X		X
Hammer	X	X	X		X
Iron bars (100cm long)					X
>6cm Ø PVC pipes with end caps	X	X			
Heavy duty gloves				X	
Measuring tape (25-50m)	X	X			X
Underwater bags for cement				X	
Quadrats (1m ²)		X			X
Rope of different diameters	X	X	X	X	
Scrubbing brushes				X	
Toothbrushes	X	X			
Side cutters			X		
Sikacrete (dry)				X	
Slates and pencils	X	X	X	X	X
Sledgehammers	X	X			
Stainless Steel Carabiners	X	X	X		X
Underwater camera	X	X	X	X	X
Underwater buoys	X	X	X	X	X
Water containers			X		
Office computer	X	X	X	X	X
Jerry cans or buoyant devices	X	X	X	X	

The answers to these questions will give you an idea on the size of the boat, the required engine power, the minimum safety equipment to have on-board and the staff requirements to drive the boat. Regardless of the above, you should take the following information into consideration when selecting the boat and engine to have in your reef restoration project:

- Open rigid hulled boats are light, durable and economical. A ladder (or other type of boarding aid) which hook over the sides or the transom will make boarding easier for all divers.
- Independent of the boat size, a large working area should be available. You will need space to hold baskets with corals, to prepare cement, to carry people and diving gear, etc. Thus, a cockpit is not recommended. Benches that can be removed for increasing working area are ideal.
- You will be working many hours under the sun. Thus, a foldable/detachable canopy over 80% of the boat is highly recommended.
- A large portion of the fieldwork will require carrying or towing heavy load (e.g. rope nurseries or full nurseries). Thus, a midrange outboard four-stroke engine (e.g. 50HP – 60HP) should offer good performance and efficiency in an average size boat (3- 5 meters/ 10-15ft).
- The boat should carry basic safety and emergency equipment (e.g. life jackets, flares, fire extinguishers) according to the size and operating range of the boat; oxygen first aid kit, diving shot, and a signal flag to indicate that divers are in the water. It is recommended to check the local boating agency for the minimum safety and equipment requirements for the appropriate type of boat in use.

Some considerations for equipment maintenance

As the conditions on the water can be very tough for the equipment and tools, great care must be taken to ensure their longevity.

- All metallic tools that are used in the field that get covered in salt and sand, must be rinsed in fresh water and then sprayed with a moisture repellent (e.g. WD-40 or equivalent) after every use to stop rust from forming.
- The Oxygen kit should be checked and cleaned each week to ensure the O-ring is not covered in sand/salt and the cylinder is in good condition. The pressure of the cylinder should also be checked on a regular basis.
- All dive equipment should be thoroughly washed in fresh water after every use, to be kept free of sand, salt and shrimp that will congregate on you as you clean the coral nurseries.
- An inventory of all tools and equipment, to ensure proper equipment replacement and servicing, is required
- A small on-board toolkit for dive gear and engine

problems is essential. The toolkit should contain spanners, O-rings, O-ring pick, and Allen keys. Store the toolkit in a sealed dry-bag and remove and check the tools after each day, to combat the build-up of rust.

- If a camera is being used on the project, ensure the O-ring on the housing is removed, cleaned and re-greased using the correct silicone grease every couple of dives so it will last. When not being used, it is a good idea to keep the housing closed to prevent dust entering and stop insects for example eating the O-ring. Extendable camera clips are recommended, to attach to the divers BCD.

Selecting donor sites, species and colonies

Donor sites

The criteria to choose a donor site include:

- a. Distance from nursery site
- b. Health state of the site and availability of live coral
- c. Identifying abundance and diversity of coral species
- d. Environmental conditions of site (e.g., benthic composition, exposure, sedimentation, current strength)

When locating potential donor sites, we recommend:

- a. Conduct verbal surveys with potential stakeholders (e.g., fishermen, dive shops, conservation managers/organizations, hotels).
- b. Conduct a preliminary qualitative diving survey at the suggested potential collection sites using the aforementioned criteria. After eliminating sites that were found unsuitable, a more thorough quantitative survey could be done by estimating diversity and abundance of coral species in small areas and extrapolating to the whole area.

Coral species

When choosing coral species (Fig. 3) consider:

- a. The diversity and abundance of species in your area.
- b. The available information on relative survival and growth rates of the species in your area.
- c. Selecting a mix of species which offer reasonable growth and good survival with different characteristics to ensure a resilient transplanted community.
- d. Coral species that survived previous local degradation events (e.g. bleaching)
- e. Coral species with high-CHAR (per cent contribution of heterotrophically acquired carbon to daily animal respiration) capability during bleaching and recovery.
- f. Starting with branching species with rapid growth rates for their immediate positive impacts on the ecosystem. Branching species act as "ecological

engineers” by changing the physical, chemical, and biological attributes of the habitat.

Coral colonies

Once you have selected donor species and quantified their abundance, you proceed to select the colonies from which fragments can be harvested. When doing so, we recommend to:

- a. Select donor colonies where no more than 10% of the colony will be pruned, in order to eliminate the chance of causing irreversible damage to donor colonies/site. In the case of species of encrusting or massive morphologies which are regularly small and hard to fragment, pruning 10% yields only a few fragments yet causes a substantial damage to the donor colony: in this case the whole colony will be harvested and fragmented and later during the transplantation procedure, colonies will be re-transplanted to the donor site to compensate for the loss.
- b. Quantify the number of colonies available for harvest by counting the number of colonies in an area (e.g. 4 m²) and then extrapolate to the whole site.
- c. Estimating the average amount of material that can be taken from a colony of an average size (i.e. surface area or number of branches) and multiplying 10% of this amount by the estimated number of colonies



Different corals, different traits. Although some coral species (e.g., branching Acroporids and Pocilloporids) grow fast and have thus been favored by those undertaking reef restoration (Lindahl 2003; Shafir and Rinkevich 2008), surveys conducted over a broad range of habitats, bio-geographic regions, and different ocean warming events have demonstrated that scleractinian corals with branching morphologies generally suffer higher rates of mortality when compared to species with massive and encrusting morphologies (Glynn 1983). Given the predicted increase in the frequency and severity of bleaching events (Kleypas et al. 2008), coral bleaching is becoming a pantropical phenomenon, with consequences for coral populations (McClanahan et al. 2007) and their ecology and biodiversity (Aronson et al. 2002). Coral species with high-CHAR (per cent contribution of heterotrophically acquired carbon to daily animal respiration) capability during bleaching and recovery, irrespective of morphology (e.g. *Porites compressa* (branching)), will be more resilient to bleaching events over the long term, and therefore could become the dominant coral species on reefs, and may help to safeguard affected reefs from potential local and global extinction (Grottoli et al. 2006).

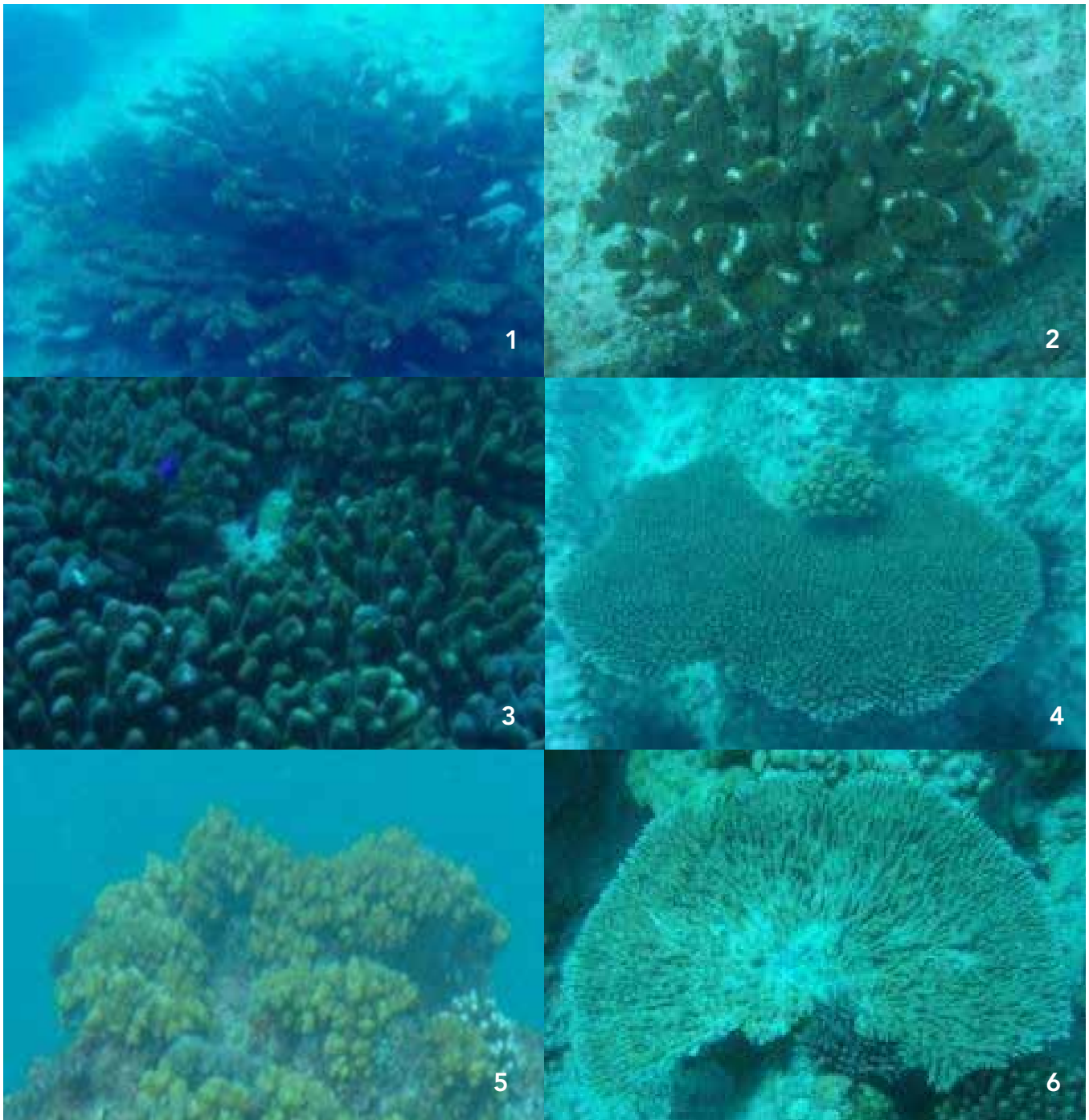

Figure 3 Six different types of corals from the Indian Ocean that are commonly found on healthy reefs and that do well in underwater nurseries: 1) *Acropora irregularis*, 2) *Pocillopora grandis*, 3) *Pocillopora verrucosa*, 4) *Acropora hyacinthus*, 5) *Pocillopora damicornis*, 6) *Acropora cytherea*.



Suggested protocols to estimate the abundance of coral fragments to be harvested

Protocol 1: Applied to species with colonies scattered irregularly around the site with no evident dispersal pattern:

1. Look at the different sizes of colonies and try to get an idea of what a 'small' colony looks like as compared to a 'medium' or 'large' colony,
2. Evaluate the number of fragments of your

selected size (see section on fragment collection/nursery stocking) that can be collected from each coral size category,

3. Swim in a certain direction (using a compass, or land marks) and count all colonies under each size category,
4. Survey as much of the site as possible to get a figure as accurate as possible of a) the total number of colonies of each size category and b) the total number of fragments that could be available from the whole site, and
5. Do not take more than 10% of the total number

of fragments that could be available from either a single colony and/or the whole site. In the case of encrusting species where the colonies are small (e.g. *Acanthastrea brevis*) taking only 10% means that only a few fragments are collected and the relative damage to the colony is vast, the whole colony will be harvested and later during the transplantation phase colonies of these species could be returned to the donor site.

Protocol 2: Applied to species where colonies are very abundant and homogeneously distributed throughout the site, but where the size of the colonies varies:

1. Estimate the average amount of fragments that can be harvested from a 'small', 'medium' and 'large' colony
2. Count the number of colonies per square meter using 10 repetitive 1m² quadrats and make an average for the different colony size categories within each quadrat
3. Extrapolate to the total number of fragments that could be available from the whole site
4. Do not take more than 10% of the total number of fragments that could be available from either a single colony and/or the whole site.

Protocol 3: Applied to species where colonies distribution is patchy (aggregating in small areas in different densities in a very irregular manner - small areas with high number of colonies and no colonies all around):

1. Estimate the density of colonies in a specific area
2. Categorize the density into 'sparse', 'medium' and 'dense'
3. Define the number of colonies within each density category, making an average of at least 5 repetitive quadrats, per density category
4. Across the whole site, count all areas of different density categories and define their size (in square meters)
5. Compute the total number of colonies that could be available within the whole site, using the average number of colonies per density category, multiplied by the sum of each density category
6. Compute the total number of fragments available within the whole site, by multiplying the total number of colonies by the average number of fragments per colony
7. Do not take more than 10% of the total number of fragments that could be available from either a single colony and/or the whole site

Nursery site selection

When choosing a site to establish the nursery, it is important to consider the following points: water quality, depth, shelter, and accessibility. Above all the nursery site should be appropriate for rearing corals that will survive at the transplantation site; thus, conditions at the nursery site should be reasonably similar to the transplantation site

Recommended reading:

Epstein N, Bak RPM, Rinkevich B (2001) Strategies for gardening denuded coral reef areas: The applicability of using different types of coral material for reef restoration. *Restoration Ecology* 9:432–442.

Forsman ZH, Rinkevich B, Hunter CL (2006) Investigating fragment size for culturing reef-building corals (*Porites lobata* and *P. compressa*) in ex situ nurseries. *Aquaculture* 261(1):89–97

Levy G, Shaish L, Haim A, Rinkevich B (2010) Mid-water rope nursery-Testing design and performance of a novel reef restoration instrument. *Ecological Engineering* 36:560–569.

Shafir S, Van Rijn J, Rinkevich B (2006) Steps in the construction of underwater coral nursery, an essential component in reef restoration acts. *Marine Biology* 149:679–687.

Soong K, Chen T (2003). Coral Transplantation: Regeneration and Growth of *Acropora* Fragments in a Nursery. *Restoration Ecology* 11(1): 62–71.

The following criteria are recommended for selecting potential nursery sites:

- Protected from waves, current and wind action (e.g. monsoon winds)
- Deep enough for having a range of depths suitable for a variety of species (10–20 m), enabling the lowering of the nursery in the water column during bleaching events
- Areas with sandy bottom, low turbidity and sedimentation, high water flux and adequate distance from other reefs, so as to avoid predation by corallivores but promote turf algal cleaning by herbivorous fishes
- Close to collection and transplantation sites
- Close enough to office and land facilities for routine maintenance
- Protected from anthropogenic harmful impacts such as fishermen, pollution or recreational activities: location inside marine protected areas (MPA) or managed areas.



The following protocol, implemented around Cousin Island, is recommended to select nursery sites:

1. Locate areas protected from the winds. In our case, the SE and NW monsoons (the site of the nursery had to change according to the monsoon season),
2. Conduct a diving survey to determine the depth and substrate composition suitable for nursery anchoring and construction,
3. Quantify the environmental conditions of the site: water clarity, water flux, distance from nearby reefs,
4. Assess the relative proximity to the collection and transplantation sites,
5. Estimate the advantages and disadvantages in terms of natural and anthropogenic impacts of the site.

Transplantation site selection

Transplantation sites may be chosen for different purposes. Two different goals could be the enhancement of biodiversity and recovery of the natural reef habitat of a protected area (e.g. our goal around Cousin Island Special Marine Reserve) or to increase coral cover in targeted recreational areas (i.e., dive sites, hotel beachfronts). Transplantation sites for both goals may differ slightly in substrate composition and physicochemical properties. Self-attachment (i.e. growth of coral tissue onto the substrate) provides a more secure and lasting bond, therefore transplantation sites as well as coral species and morphologies should be chosen appropriately to facilitate this process (Guest et al. 2009).

A hierarchy of criteria for site selection includes the following:

- Presence of or location within a legislated protected area (e.g. Marine Protected Area, No-take Area or Special Reserve) or actively managed reef,
- Dominance of calcium carbonate (i.e. presence of consolidated bare substratum) substrate with intermediate patches of rubble and sand,
- Evidence of past reef existence with minimal recovery,
- Depth gradient which should start at 5-7m and reach a maximum depth between 10-15m,
- Low hydrodynamic condition, low turbidity and sedimentation,
- Size of area to be restored, and target density of coral transplants, which will determine how many nursery-grown corals are needed for transplantation.

Diving surveys should be conducted at all 'potential' transplantation sites (i.e. sites fulfilling as much as possible the above listed criteria) specified by the stakeholders involved with the project. At each potential

site, a quantitative and qualitative evaluation must be performed. This will help establish the condition of the reef before transplantation effort starts. Later, it will assist in the assessment of the effectiveness of transplantation in reef recovery.

The following protocol, implemented around Cousin Island, is recommended to select transplantation sites:

1. Quantify benthic cover within random line intercept transects (e.g. 3 x 10m) classifying cover by functional groups,
2. Estimate fish abundance and diversity within random stationary point counts (e.g. 3 x 7m radius), classifying fish by family. Try to size the fish by placing them into 10cm size-class bins,
3. Quantify macro-algal density within randomly placed 1m² quadrats, at 5 independent locations.
4. Conduct all methods twice, once at a depth of 5-10m and once at a depth of 10-15m.
5. Following this quantitative survey, a separate qualitative survey should be conducted for approximately 10 min. Divers should take photographs and notes with the 'site selection criteria' in mind.
6. Discuss and record all observations following each dive.

3. Coral Gardening

Once you have selected your donor sites, the species you will be working on and identified your nursery site, it is time to build your nurseries, collect your coral fragments and stock the nursery. Regular maintenance to the corals and nurseries will also be required to ensure the corals grow well and stay healthy.

In this chapter, you will learn how to build two different types of nurseries, using nets and ropes. Both of

which, were implemented in the Reef Rescuers Project. These nurseries are low cost and easy to construct with materials you will find in your local hardware store or landfill! We will also advise you on how to collect the fragments and stock up your nurseries. Finally, we will show you the tasks required to keep the nursery corals growing healthy and to avoid the potentially damaging impacts of the ocean, on the nursery itself.



Nursery construction

The Reef Rescuers Project used two types of nurseries to grow corals. The main nursery type was the rope nursery which is suited for branching corals. The second nursery type was a net nursery which is better suited for encrusting and massive species. There are many more types of nurseries you can construct to grow coral fragments for transplantation (see Edwards, A.J. (2010) and references below). We used nurseries previously developed at an experimental size by the Israeli group at the Haifa Oceanographic Institute (See references below), which were scaled up to comply with the large-scale scope of our project. We found both rope and net nurseries are cheap and fast to work with in a remote and developing country like the Seychelles.

Recommended reading:

Levy G, Shaish L, Haim A, Rinkevich B (2010) Mid-water rope nursery-Testing design and performance of a novel reef restoration instrument. *Ecol Eng* 36:560–569.

Nedimyer K, Gaines K, Roach S (2011) Coral Tree Nursery ©: An innovative approach to growing corals in an ocean-based field nursery. *AACL Bioflux* 4:442–446.

Shafir S, Rinkevich B (2010) Integrated long-term mid-water coral nurseries: A management instrument evolving into a floating ecosystem. *Univ Mauritius Res J* 16:365–386.

Shafir S, Van Rijn J, Rinkevich B (2006) Steps in the construction of underwater coral nursery, an essential component in reef restoration acts. *Mar Biol* 149:679–687.



When constructing a nursery, consider this:

- Nursery building requires acceptable sea conditions and should not be attempted in the case of strong current and/or bad visibility, given the risk of misplacing nursery foundations and also for safety reasons
- Nursery foundations should be built for one nursery at a time, and not for several nurseries in advance, given the time required for nursery filling and potential changes to the work plan/staff that may occur in between
- It is advisable to group all nurseries in the same area, to facilitate nursery maintenance and monitoring
- Nurseries established in the vicinity of nearby reefs benefited from cleaning by herbivorous fish, as they consumed turf algae.

- Mooring lines should be set up adequately so that all nurseries are accessible without throwing the anchor and no matter the current direction
- GPS coordinates for moorings and nurseries should be communicated to boat and tour operators, both for nursery protection and diver security.

Constructing a rope nursery

Nursery construction underwater should be completed in ideal sea conditions with limited current. Dive planning is essential.

A 6m x 20 m rope nursery requires a 16m x 30m bottom area free of major rocks. To construct a nursery of this size, anchored at a bottom depth of 18m and floating 8 m below the sea surface, you will need the following:

- 15 x angle bars (iron L-bars cut to 1.6 m length) anchored in the sandy bottom
- 5 x 6-m pipes (64 mm diameter, high pressure, 6m long)
- 10 x caps (water proof fitting for the high pressure pipes)
- 15 x vertical ropes (12 m long, 10 mm diameter, can be woven or coiled), linking the angle bars to the 5 pipes. The length of rope will also depended on individual location.
- 4 x stretching ropes (25 m long, 4 mm diameter, preferably white, coiled or woven)
- 4 x rebar (1.2 m long, 10 mm diameter)
- 40 x ropes containing coral fragments (22m long, 4mm diameter, preferably white, coiled, model 'Sea King' very suitable for inserting fragments)
- 2 x sledgehammers
- 3 x 50m measuring tape
- Quadrat (1m²)
- Compass for every diver
- Extra weights for the hammering diver
- Hang tank
- 10 x recycled jerry cans or any other buoyant device

The basic rope nursery structure will look like the structure in Figure 4. The total rope length needed for 1 nursery is: 880m of 4mm diameter rope and 280m of 10mm diameter rope. To build the foundations, screw-anchors work well in muddy substrate whereas angle bars work better in sandy substrate.

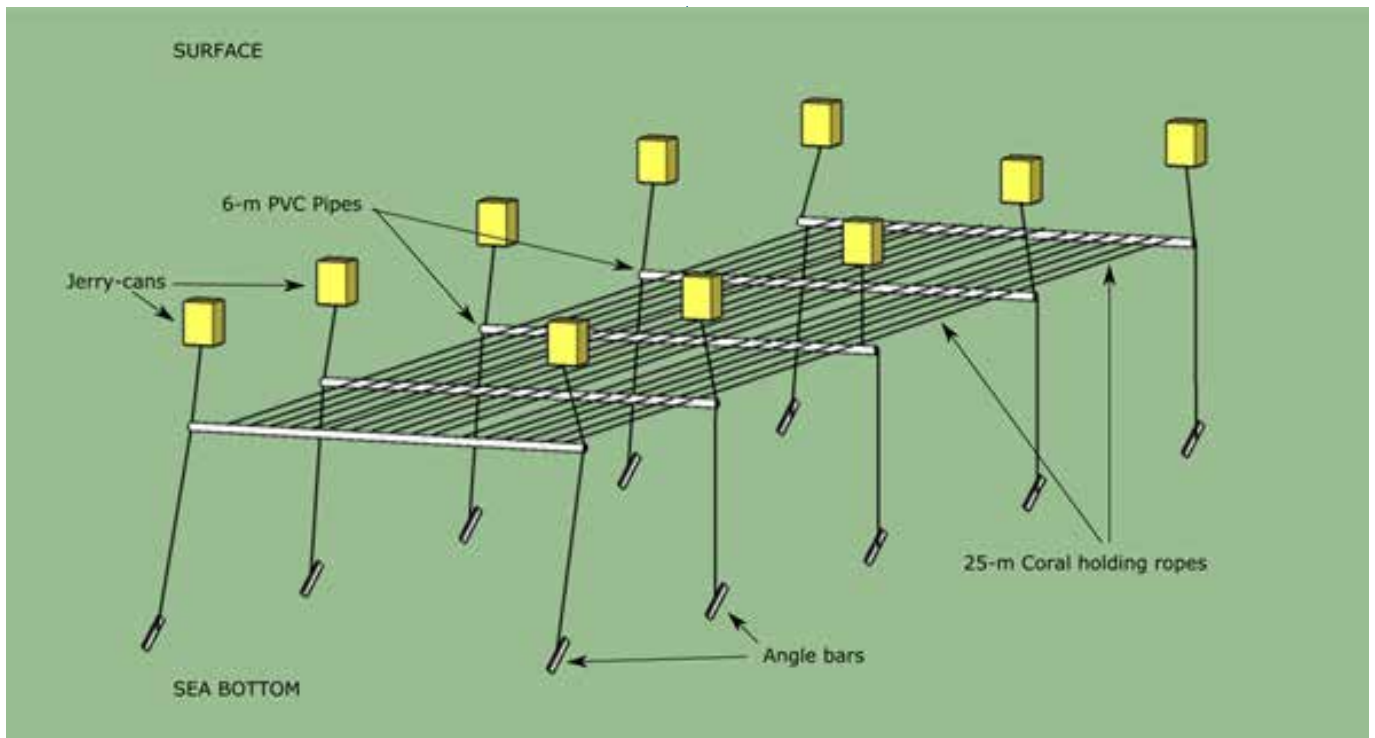

Figure 4 Schematic drawing of the rope nursery

To build the rope nursery we suggest the following procedure:

1. Two divers position the 15 angle bars for anchoring the 6m x 20m rope nursery, starting at one corner of the nursery, using three 50m tape measures (two for the nursery outline, one for the middle angle bars).
2. For each of the five 6m pipes making the nursery framework, 3 angle bars are positioned in a straight line at 3 m intervals, and each pipe is 5m away from its neighbouring pipe.
3. First, place the angle bars into the correct locations; second, once you are confident in their position, secure them in place by hammering them into the substrate, a few centimetres only.
4. Compass bearings or a 1m² quadrat may be used to make sure the angle bars are at a right angle to each nursery corner and the middle angle bars are positioned in a straight line with the two corner ones.
5. When all 15 angle bars are well positioned, hammer them into the substrate, to a depth of at least 1m and with an angle of 45° (Fig. 5). This should require two divers working with one sledge hammer, on a rotational basis.



Figure 5 Anchoring a nursery. Top: Installing an angle bar with a sledge hammer to support the net nursery above the sandy sediment. Bottom: Tying rope to angle bar before anchoring the rope nursery.

6. Note that when hammering, you may empty your tank in about 30 minutes! Thus, check your gauge regularly and do not push the limits!
7. Do not worry too much if you encounter a rock while trying to secure the anchor. If this happens just move that anchor slightly outwards from the centre and try again. If you keep encountering the same problem then you may have to find a new nursery position.
8. When all 15 angle bars are well secured, 2-3 divers attach the vertical ropes to each of the 15 angle bars, close to the substrate using an anti-slip knot (Fig. 5).
9. The length of the vertical ropes depends on your substrate depth and the desired levelling depth for the nursery. For a bottom depth of 18m and a nursery depth of 8m, you will need 10m of rope plus a meter either end for tying, making a total of 12 m. It is normally a good idea to put an extra meter in case of miscalculation in measurement or strong tides.
10. Once the vertical ropes are all attached to each angle bar, in groups of 3, tie together the ends of each middle and two outer ropes. A small buoy can be attached to send all ropes up to the levelling depth, together. This will avoid divers going up and down and unsafe dive profiles in their dive computers.
11. At the surface, tie the empty jerry cans to the ends of each 6m pipe using the same anti-slip knot. Keep the caps of the jerry cans with you as you will use them when leveling the nursery.
12. To bring each 6m pipe (fitted with waterproof caps) down to a depth of 8m, a sledge hammer can be tied to one end of the pipe to reduce its buoyancy.
13. Then, two divers will bring the pipe to a depth of 8m by strongly holding each end of the pipe, one forcing down and the other pushing and guiding from the surface.
14. A third diver, after detaching the small buoy holding the three vertical ropes together at 8m depth, will be ready to receive the pipe and attach one of the edge ropes, using the anti-slip knot.
15. In case of strong current, the third diver should not wait for the pipe to come down at 8m depth, but actually bring up the rope as much as possible to the other divers coming down, in order to facilitate the connection process.
16. When the first vertical rope has been connected to the pipe, the two others can be easily attached in the same way.
17. When all 15 vertical ropes are connected to the 5 pipes, one diver using the same dive computer will check the nursery depth and level it between 7-8m depth, by filling jerry cans with air (Fig. 6)



Figure 6 Filling a jerry can with air to ensure nursery floats at the desired depth.

18. After the nursery has been filled with a few ropes of corals, stretching ropes will be set up at each nursery corner. This will reduce side-movement of the nursery in surge and strong current conditions. Using the anti-slip knot, 25m x 4mm rope will be attached to nursery corner, stretched down and away from the nursery (with a 45° angle) and attached to a rebar anchored to the substrate.

Constructing a net nursery

Net nurseries are constructed in three steps. The first step is to build the nursery framework on land; the second step is building the foundations at sea; and, the third step is to transport and secure the net nursery at its final destination. To construct a 6m x 6 m net nursery anchored at a bottom depth of 18m and floating 8m below the sea surface, you will need the following:

- 4 x 6m pipes
- 4 x waterproof elbows to connect pipes in a square
- 6m x 6 m piece of fine net (can also tie several smaller pieces together using 4mm rope).
- 4 mm rope to tie the net to the pipe framework.
- 5 x angle bars (approx. 2m length).
- 5 x 12m ropes, each with a small buoy attached. The length of rope will depend on individual location and depth.
- 4 – 6 jerry cans or any other buoyant device.
- 2 x sledgehammers
- Measuring tape (50m)
- Quadrat (1m²)
- Compass for every diver
- Extra weights for the hammering diver
- Hang tank

Step 1: Building the frame of the nursery

1. To build the frame of the nursery you will need 4 x 6m high pressure pipes and 4 water tight elbows to fit the pipes. Fit these together making a basic square frame. Make sure the elbows are on tight and the O-rings are secure inside.



Figure 7 Building the 6 m x 6 m net nursery on the beach.

2. Using a 10m x 4mm rope, attach one end to one of the elbows and line up a stretch of net, parallel to the pipe (Fig. 7). Any longer and the rope starts to become hard to manage and any shorter, it will not reach the end of the pipe. If a rope does not reach the end then just tie another piece on. Start attaching the net to the frame by using a 'half-hitch' knot, every three squares of net (approx. 15-30cm). To tie a 'half hitch' knot, wrap the rope around the net and frame, then tuck it under it-self, before moving on three squares and repeat (See Resources). Continue this process until the net reaches the other end of the pipe. Depending on the size of net used you may have to attach two or more pieces together. This is done in the same way as you attach it to the pipe by using a half hitch. The only difference is that you must make a knot every square of the net to make sure you don't end up with big holes in your net (Fig. 8).



Figure 8 Detail of knot tying during net nursery building.

3. Be sure to stretch the net along the pipe by sliding the knots along the pipe and taking in the excess slack. Tie the rope to the elbow tightly, to hold the net stretched. The pipe will bend slightly but this should be counteracted by the stretch ropes when in the water so it will not be a problem. Continue this process for all 4 sides. Now you will have a 6m x 6 m tight net attached to your frame.
4. Once the net is attached to the frame, you can start attaching the jerry cans or any other type of buoyant device onto the frame (Fig. 9). This will help with the flotation of the net nursery. One jerry can at each corner is required, with an additional middle jerry can on pipes located at opposite sides of the square frame.



Figure 9 Attaching jerry cans to the net nursery to allow flotation

Step 2: Building the foundations

A 6m x 6m net nursery requires a 13m x 13m bottom area, free of major rocks. To build the foundations, the type of anchorage may depend on the substrate. Screw-anchors work well in muddy substrate whereas angle bars work better in sandy substrate.

To build the foundations of the net nursery we suggest the following procedure:

1. Find an open area free of major rocks of approximately 13m x 13m.
2. In the centre of this square you must place your first angle bar/screw-anchor for anchorage. Do not hammer/secure anchors until you have placed them all into position and are confident they are in the correct place.
3. From this central point, you can place four other anchors, 3m away, at a 90° angle (Fig. 10).

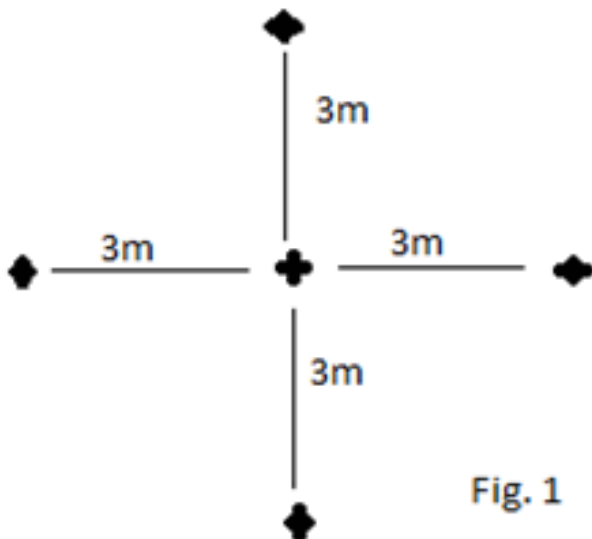

Figure 10 Initial placements of anchors during construction of net nursery.

4. After this, use two tape measures and a quadrat to place the corner anchors; measuring 3m from two concurrent angle bars and ensuring the tapes meet at a right angle (Fig. 11). As an extra check, you can measure a straight line from the central anchor and it should be 4.24m away. Continue until you have completed all 4 corners and so have 9 anchors in place. Hovering just above the foundations will also give a good indication if something has gone wrong in the measurements.

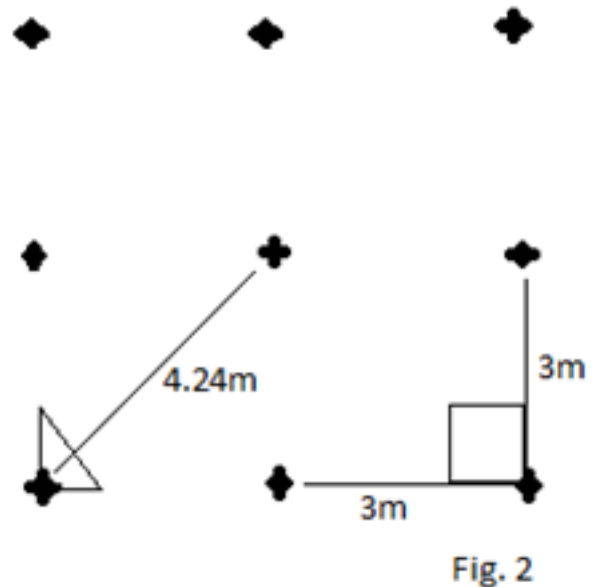

Figure 11 Final placement of anchors during construction of net nursery.

5. After you are confident in your placement you can hammer/secure these 9 anchors. Do not worry too much if you encounter a rock while trying to secure the anchor. If this happens just move that anchor slightly outwards from the centre and try again. If you keep encountering the same problem then you may have to find a new position.
6. After all the anchors are in place, attach a 10-mm rope to each anchor using the basic anti-slip knot. The length of each of these ropes depends on substrate depth and the depth you want to place your nursery. For a depth of 18m and a nursery depth of 8m you will need 10m of rope plus a meter on either end for tying, making a total of 12 m. It is normally a good idea to put an extra meter in case of miscalculation in measurement or tides.

Step 3: Transporting and placing the net nursery

1. To get it to the nursery area, the best way we have found is to tow it using a boat (Fig. 12). The distance from the net to the boat should be approximately 30m or more, depending on sea conditions. To ensure towing does not create too much drag or pull the boat to one side, it is best to attach the rope to both the nursery and the boat, in two places.



Figure 12 Towing net nurseries to final location.

2. The best way to attach the nursery to the boat is to use 3 ropes in total. The first rope is attached to two places on the net using bowlines (Fig. 13); the second rope is attached to two back cleats on the boat (creating a large 'U'-shape behind the engine), using standard cleat knots; and the third rope is attached to the middle of both the first and second ropes, using bowlines to centre the ropes and tow in a straight line.

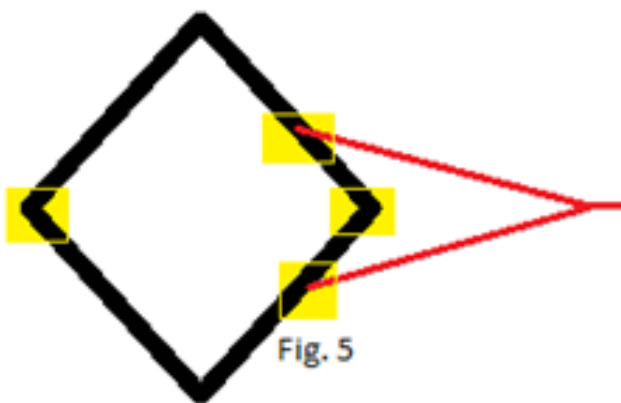

Figure 13 Schematic showing placements of jerry cans on nursery during towing.

3. It is also a good idea to make sure the front of the nursery does not dive. Attach some buoys or empty jerry cans and place under the net in certain places. They should be placed on the front point, where the tow rope is attached, and at the back point, just

in case water gets into the pipes.

4. To sink the nursery into place, tow the nursery into place using the boat then release the tow rope from the boat. A pair of divers swim the end of the tow rope down to one of the corner anchors. Make a loop in the rope attached to the anchor (using a "figure of 8" knot) and place the end of the tow rope through one of the loops (Fig. 14).
5. Pull the tow rope through this knot, without trying to pull the nursery under the water. At this point, tie a water filled jerry can to the end of the tow rope (Fig. 14).

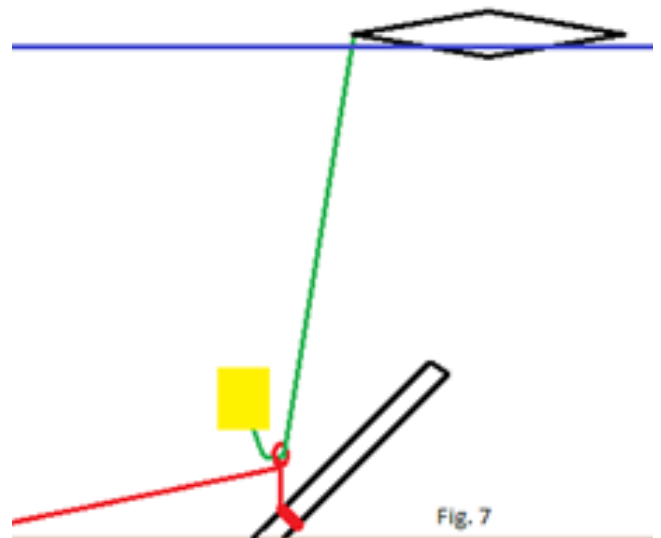

Figure 14 Schematic showing placements of ropes and jerry can during sinking of the nursery.

6. Using the jerry can as a counter weight, fill it with air from you alternate air source as you would do a lift bag. While you are filling it, have someone hold it down slightly by holding the anchor and the jerry can together, so you are not ascending with it, as it fills. When you feel it is positively buoyant release the jerry can and it should start rising up, while in turn pulling the corner of the net nursery down. If it does not completely work, either add another jerry can or stand at the bottom, pulling the ropes to bring the nursery down a few metres above the substrate, so you can tie the 3 remaining corners to the anchors, without yo-yo diving. Next, tie the anchor rope to the corner of the nursery, using an anti-slip knot. Empty the jerry can of water by tipping it to the side and let air out from your alternate air source into the jerry can; fill with air half way at first. The jerry cans will be filled completely with air once the nursery is level on the horizontal plane, allowing for a fine adjustment of the desired depth. Untie from the rope. The tow rope can then be removed from the "figure of 8" knot from the 1st anchor and from the corner of the nursery. This rope can then be attached to one of the adjacent corners of the nursery and the whole process repeated to bring the nursery down in the water to a horizontal position. Repeat this process of using the counterweight for all 4 corners until the

nursery is secured at all 4 corners using the anchors and is horizontal. The remaining 5 ropes can now be attached and the whole nursery levelled to the desired depth.

7. Stretch ropes can now be added to the middle of each pipe, to counter the natural bend that was encountered during the stretching of the net. For the stretch ropes, you will need 4 x 25m ropes, 4 re-bars (approximately 80cm – 1m length) and a sledgehammer. Attach one end of each rope to the middle of each of the four sides of the nursery (using an anti-slip knot). With the other end, swim away from the nursery at a 90° angle, remaining near the substrate. When you reach the end of the rope go an extra 2m and this is where you have to hammer in the rebar. Hammer until the rebar is completely secure in the substrate then pull the rope towards the rebar and using an anti-slip knot attach the rope to the rebar. This should hold the pipes straight on the nursery and stop the nursery from swaying in surge/current. A jerry can should be attached to the pipe in the same place as the stretch rope to counteract the downward pull of the stretch rope and also, to hold the nursery up. As corals are added and start growing, the net becomes heavier (Fig. 15).

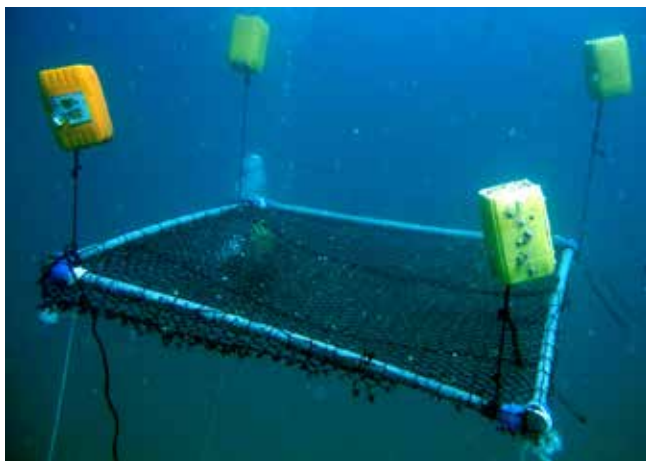

Figure 15 Overview of a net nursery moored at the nursery site, with a bottom depth of 18m and nursery depth of 8m. Top: view from sea surface to seabed. Bottom: view from seabed to sea surface

Donor fragment collection

Consider this before collecting coral fragments:



Coral gardening relies on causing minimal damage to donor colonies and sites. Therefore, it is important to follow the recovery of donor colonies to evaluate the optimal amount that can be harvested from a specific morphology and species, without causing irreversible damage. Recovery may be species and/or site specific, therefore establishing baseline data for future projects is vital. Recommended protocols to monitor donor colonies are discussed later.

Coral collection from laminar or table-like corals (e.g. *Acropora hyacinthus* and *Acropora cytherea*) can be carried out using side cutter pliers or directly breaking the colony with hands (while wearing gloves). Although the later technique involves a high level of practice and confidence, given the risk of breaking off an entire colony. For more robust species (e.g. *Pocillopora verrucosa* and *Pocillopora grandis*), collection can be carried out using a hammer and chisel, to detach selected branches. For less robust species (*Acropora irregularis* and *Pocillopora damicornis*) only a chisel is required.

For simplicity, it is recommended that all divers are familiar with the proposed species to be collected. Only healthy corals are to be used as donors, where a maximum of 10% is to be collected from any individual colony. In addition, be careful not to leave a large scar as the donor colony may struggle to recover.

Various methods are employed to collect coral fragments from donor colonies. Such methods are primarily dependent upon the species being collected.

A summary of these follows:

- **Laminar or table-like corals:** Select an area of coral at the edge of the colony (approx. 10cm in diameter), placing one hand above and one below. Carefully exert a small downward force to separate the selected area, ensuring that the holdfast of the donor colony is not being compromised.
- **Branching or digitate corals:** A hammer and chisel is used to separate a section of the donor colony (Fig. 16). Ideally, a well-defined branch or digit positioned away from other branches should be selected for collection. On thinner branching coral species, clippers may be used instead (Fig. 17).
- **Encrusting corals:** If possible, locate an area of an encrusting colony that overhangs from the substrate. Carefully position the chisel underneath the coral, with an upwards angle. Use the hammer and chisel to separate a section of the colony.



Fig. 16 Harvesting coral fragments with a hammer and chisel

- Massive / Sub-massive corals: Select an area of the colony which is easily accessible (perhaps protruding from the side). Carefully use the hammer and chisel to remove a small section.



Fig. 17 Harvesting a thinly branching coral, using clippers.

- Corals of opportunity: Various coral colonies and/or fragments may have been detached due to either anthropogenic or natural environmental damage. Often, the entire coral colony cannot be fixed to its original location, therefore fragmenting the entire coral colony provides an additional source of nubbins for the coral nurseries.

Recommended reading:

Forsman ZH, Rinkevich B, Hunter CL (2006) Investigating fragment size for culturing reef-building corals (*Porites lobata* and *P. compressa*) in ex situ nurseries. *Aquaculture* 261(1):89–97

Forsman ZH, Page CA, Toonen RJ, Vaughan D (2015) Growing coral larger and faster: micro-colony-fusion as a strategy for accelerating coral cover. *PeerJ*, 3(January 2016), e1313

Soong K, Chen T (2003). *Coral Transplantation: Regeneration and Growth of Acropora Fragments in a Nursery*. *Rest Ecol* 11(1): 62–71

Place collected fragments carefully within a basket/ crate/box/bucket and continue until full or enough has been collected.



Coral fragmentation is a natural process, when coral pieces are broken from a colony as a result of wave action, storms or animal activities. Under favourable conditions, these fragments can attach and develop into new colonies. As this is a form of asexual reproduction in corals, only loose fragments should be harvested. Coral gardening using coral fragments (nubbins) attached to underwater nurseries, relies on the coral's ability to grow into a full colony from a fragment, through the process of budding (division of coral polyps into clones).

Nursery stocking

In terms of nursery filling, nets are 10 times less “productive” (500 fragments were placed on a 6 m x 6 m net in 5 days with 5 divers, compared to about 5,000 fragments placed on 20 m x 6 m rope nursery).

Rope nursery stocking

You will need:

- Clippers
- 40 x 23 m ropes
- 40 x 3 = 120 cable ties
- Basket/crates/tubs/boxes to hold the fragments
- Chisel and hammer
- Gloves

Divers and timeline:

- Two teams of two; One team clips nubbins from coral fragments, and; the other inserts the nubbins into the rope (as it hangs over the boat). Once the ropes are full, divers install onto the nursery.
- Under normal working conditions, one can expect that 6 divers would spend three days collecting enough fragments to produce 4000-5000 nubbins, required to fill a rope nursery.

Once the coral fragments have been collected from the donor site and the divers have surfaced, the collected fragments need to be transferred into large tubs, filled with enough seawater for the fragments to be completely submerged.

The collected fragments are generally 10% of the donor colony so their size is too large to be immediately transferred onto the rope nurseries. Therefore, the individual pieces need to be fragmented into multiple smaller pieces, called nubbins. The ideal size for a nubbin varies on the species however the general rule of thumb is about 8cm long.



The area in which the nubbin is cut from the rest of the fragment will result in a scar. The surface area of this scar needs to be minimised for survival and optimal growth of the nubbin. Large surface areas of scarring increase the chance of algae settling onto this exposed area. In addition, coral fragments should not be exposed to the air for longer than 20-60 minutes and seawater should be changed regularly, to maintain an ideal water temperature and minimise stress.

The most successful method for fragmenting the collected coral into nubbins, is by using clippers or chisels (Fig. 18). Remove a large coral fragment from the tub and fragment the coral into 8 cm pieces, using the clippers or chisels. Depending on the species, methods of fragmentation varies. For example, tabular species should be cut at the base of branchlets. This is generally done by one person.



There is a trade-off between nubbin size and growth and survival rates in the nursery. To maximize the amount of nursery material obtained as fragments from donor colonies or corals of opportunity, you may want to re-fragment the material into the smallest nubbin possible. However, the smaller the nubbin is at first insertion in the nursery, the lower the survival and growth rates are. Through a series of experimental trials, we discovered that the smallest nubbin we could insert in the midwater ocean nurseries with the highest rates of growth and survival was about 8 cm long. Ultimately, the ideal nubbin size depends on species and colony growth form.



Once a new nubbin has been created, immerse it back into a new tub of seawater (Fig. 19). Meanwhile a team of two people will sit on the edge of the boat, each with 23 m of rope (Fig. 20). Starting at one end, leave approximately 1.5 m space to secure the rope to the nursery, once the rope is filled.



Figure 18 Breaking coral fragments into nubbins using a hammer, chisel and clippers on the boat. Top: Above view. Next page: Closer detail



Figure 19 Coral fragments in buckets full of water.



Figure 20 Donor coral fragments are fixed to nursery ropes by splicing the rope and inserting them.

Beginning at 1.5 m, one person will splice the rope open by twisting the rope in the opposite direction to its natural coil, creating a hole in the rope large enough to place a coral nubbin through to secure it. Meanwhile, the other person wearing gloves, will take a coral nubbin out of the tub and secure it through the spliced rope (Fig. 21). Once the coral is inserted into the spliced rope, the person holding the rope open will release and the rope should automatically return back together.



Figure 21 Detail of coral nubbin on rope nursery. The coenosarc has grown over the spliced rope after 1 month of insertion in the

Continue this process leaving a predetermined space (10 cm for slow growing corals and 20 cm for faster growing corals), until 1.5 m of rope is remaining at the other end. As nubbins are attached to the rope, hang

the filled section over the side of the boat into the water so that nubbins are not exposed to the air.



Twisted (4 mm) white rope is used due to ease of splicing and to limit the process of algae colonizing the rope and competing against corals.



In corals, there is a continuum of living tissue on the surface of the coral colony (coenosarc) connecting individual polyps (each one hosted in their own corallite skeleton) with spaces between polyps. The existence of this living surface layer is critical in low-cost coral nurseries. Coral colonies will "grow-over" the spliced rope within 1 month of insertion. This biological process increases coral fragment (nubbin) stability and reduces project costs, because no extra connectors are needed to attach the nubbin to the nursery rope. In our project, we reported such new growth as successful self-attachment.

Once all necessary ropes are filled with corals, you can proceed to bring the ropes down to the nursery, using SCUBA. You can attach jerry cans to the start, middle and end part of the rope to make them float while you get ready. To sink the ropes, just slowly vent air out of the jerry cans while you position the ropes onto the rope nursery, where they will finally be attached. You can attach both ends of the rope to the outer pipes of the nursery using an anti-slip know (Fig. 22-23).



Figure 22 Attachment of ropes to nursery.

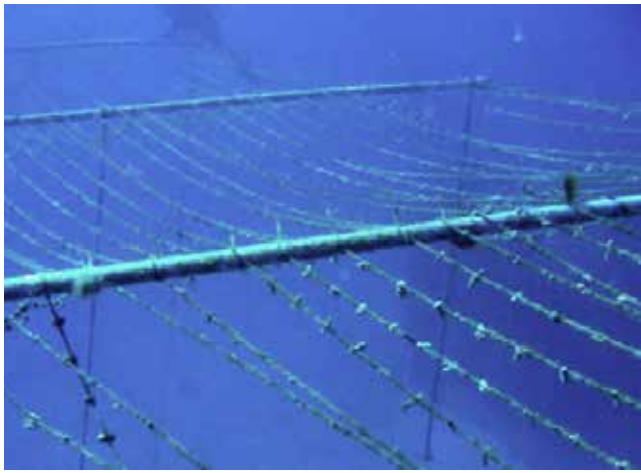

Figure 23 A newly stocked rope nursery.

Net nursery stocking

Old nylon fishing lines are the best to attach/hold coral fragments to the net (Fig. 24). After a while, fragments from different species and many different growth-forms self-attached onto the net. Also, this nylon is thin enough to reduce the contact area with the coral. Ask fishermen if they have any old lines too.



Figure 24 Detail of encrusting coral attached to net nursery using wire (top) and of net nursery stocked with corals (bottom).



Micro-fragmentation for speeding the growth of corals

Massive corals, including boulder, star, and brain corals have been overlooked as candidates for restoration, due to their slow growth and thick skeleton. However, recent success in cultivation of massive corals now allows for rapid production of clones using a method termed “micro-fragmentation”. When small (~1–3 cm²) fragments cut from the same colony are spaced regularly over ceramic tiles they have shown to spread at rapid rates (e.g., tens of square centimeters per month) followed by tissue fusion. Using this strategy, one can now grow a 25-year old massive coral colony from a 6-year old initial colony. Although this technique is still under development it has shown promising results with several massive and branching species. To learn more about this technique we recommend reading: Forsman ZH, Page CA, Toonen RJ, Vaughan D (2015) Growing coral larger and faster: micro-colony-fusion as a strategy for accelerating coral cover. PeerJ 3, e1313.

Nursery maintenance

Checking, repairing and cleaning nursery

All nurseries should be checked, repaired and maintained on a regular basis to provide corals the best conditions for growth and survival. The ropes of the nurseries attract other settlers (biofouling) that can be in direct competition with the growing coral fragments and are quickly covered with turf algae after deployment in the nursery site (Fig. 25). They should be cleaned when the algae start to grow to a size similar to the size of the fragments in that rope nursery. Rope nursery cleaning is carried out using toothbrushes and a table knife. Carefully remove turf algae and sponge between each coral fragment, avoiding any damage to newly formed coral tissue. Use the side of the toothbrush (or a table knife) to remove turf algae growing in between the fragments, to reduce the damage to the bristles of the toothbrush and reduce waste. Toothbrushes with bristles that were worn out or sticking out to the side, instead to the original straightforward angle, were discarded.

Cleaning of net nurseries is done using wire-brushes, dive knives and toothbrushes. Nets attract more barnacles and invertebrates, compared to ropes. Therefore, wire-brushes and dive knife are used to clean the mesh.

Planning a cleaning schedule will be helpful to organize the cleaning work. Midwater coral nurseries often require weekly to monthly cleaning during the first six months after filling with corals, and monthly cleaning thereafter (Shafir et al. 2010; Johnson et al. 2011; Hyde et al. 2013). On average, we spent 6 months every year cleaning nurseries. However, the

presence of fish assemblages, and their predatory effect on biofouling, reduced the amount of effort to clean the net nurseries up to 50 % over our planned cleaning schedule (See Frias-Torres et al. 2015 in "Reef Rescuers papers published to date").



Figure 25 A dirty net nursery.

Below is a basic checklist for nursery maintenance:

Structural maintenance:

- Check nursery buoyancy and vertical ropes (connecting angle bars to the pipe framework) for fraying or winding at angle bar
- Check rebar (anchoring stretching ropes to the sandy bottom) for movement from original position

Coral fragment maintenance:

- Check pipes for settlement of other sessile filter feeders (e.g. barnacles). Remove with knife, scraper or hammer
- Check ropes containing fragments for algal and sponge growth and remove with a toothbrush/ table knife (turf algae) or manually (macro-algae, such as Sargassum sp.)
- On the nets, removal of turf algae and filter feeders in competition with the growing fragments (barnacles, sponges, oysters) can be done with wire-brushes and/or dive knives.

Cleaning

Equipment:

- Toothbrush (rope), wire-brushes (net)
- Table knife (rope), dive knife (net)
- Hammer

A toothbrush is used to remove algae from the nursery by gently brushing around coral fragments (Fig. 26). While brushing, do not hold the coral; instead, hold the rope beneath the coral and rest the base of the coral in an open hand. It is common for acorn and goose (stalked) barnacles to attach to the holdfast of a coral on a rope nursery. These barnacles can be removed using a knife and by hand.

Cleaning sponge which has enveloped parts of a coral is done by hand. A knife can be used to lift the edge of the sponge so as to create a flap to peel. Brushing sponge off a coral is ineffective.

For the rope spaces between coral fragments, the blunt side of a table knife is used to scrape algae off the rope. A hammer is used to break barnacles off buoys and pipes.



Figure 26 Cleaning rope nursery. Top: using a knife and toothbrush to clean the ropes between corals. Bottom: using a hammer to keep rope-pipe attachments clean.



Corals growing in midwater ocean nurseries may experience disease outbreaks due to virus or bacteria. To minimise the spread of disease, it is recommended to sterilize all cleaning equipment in a mixture of boiling water and Dettol (or other safe disinfectant), after each dive. Similarly, handling diseased corals and then handling healthy corals without prior sterilization of dive gloves and dive equipment is not recommended, as divers may inadvertently become disease vectors. If disease is observed on the nursery we recommend removing colonies immediately, because the rate of transfer between colonies can be rapid and diffuse. It may also be necessary to remove additional colonies near the diseased ones, to build a buffer zone that will act as a barrier to the spread of disease.

Structural maintenance and repairs

Equipment:

- Hammer
- Knife
- Cable ties
- Rope
- Scraper

All rope nurseries need to be checked, repaired and maintained on a regular basis to provide the best conditions for growth and survival. The structural maintenance issues encountered on nurseries will be variable and we are unable to list all problems that may be encountered. Most issues will need to be assessed on an individual basis and the most appropriate solution will be based on the specific problem. Below are some of the more common issues that we have encountered during our project.

Nursery positioning

Problems may be encountered where jerry cans, used to control the buoyancy of the nursery, have lost air, causing the partial or total sinking of that section of the nursery (Fig. 27). This problem is commonly encountered when jerry cans do not have caps, so the air leaks out. Therefore, always ensure there is a cap sealing the jerry can. Looking at the placement of the nursery in the water should be a good indication of any buoyancy issues. As corals grow, the nurseries get heavier. Heavy nurseries may need to be stabilised with more jerry cans, at mid sections of the PVC pipes. Removal of barnacles may be useful in increasing the buoyancy of the jerry cans (Fig. 27). Rough weather conditions may call for nurseries to be reinforced with additional stretch ropes. If the anchoring ropes are loose, jerry cans need to be filled so that the rope becomes tight. Regularly check the placement of angle bars and rebars to ensure they have not fallen over.



Figure 27 Above A diver using a hammer to remove the barnacles from a nursery jerry can. Previous page: A diver using his alternate air source to refill a jerry can and level a tilted nursery.

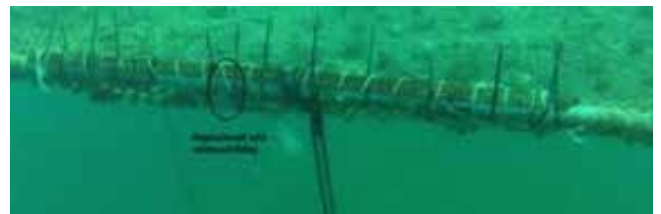

Figure 28 Above: Detail of broken net nursery. Below: Original break with reinforced fitting.

Tangled ropes

Sometimes a large tangle may occur in one section of the rope nursery. This may involve two or three ropes, or as many as 20 ropes. This can occur for a number of reasons including: strong currents, inappropriate buoyancy of that section of the nursery and, weight of individual ropes. Ropes will need to be gently untangled by hand, using gloves. Sometimes, jerry cans will need to be emptied to some degree to release tension.

PVC pipe broken

One problem potentially encountered, is a PVC pipe snapping due to too much tension. This is generally

related to buoyancy and weight of the nursery. If the PVC pipe has snapped at the mid-section, a two-way pipe connector can be used to reattach both sections together. Jerry cans will need to be emptied to some degree to release tension as the PVC pipes will be angled downwards. Releasing air from jerry cans will enable divers to align the PVC pipes. PVC pipes can be reconnected using an appropriate fitting. This fix is then reinforced using an angle bar, rope and cable ties, as shown in Figure 28. However, if spare PVC pipes are available, change the entire section.

Ropes fraying

There are many ropes present on the nursery, i.e. stretch ropes for anchoring the nursery to the sea floor, anchor ropes connecting the angle bars to the PVC pipe framework etc. These ropes are connected using anti-slip knots and when barnacles begin to cover the angle bars, rebars and PVC piping, these anti-slip knots and the leading ropes, begin to fray against them. Therefore, regularly checking and cleaning barnacles is essential for the integrity of the ropes.

Ropes breaking

Sometimes ropes may be heavily weighted, for example large *Pocillopora* colonies on a rope. Occasionally, ropes will snap and will need to be reattached using extra sections of rope.

Cable ties

Where ropes make contact with the PVC pipes, it is always useful to cable tie them to the pipe and thus, reducing movement of the ropes.

Seasonal rope nursery transfer



Due to the prevailing weather around the granitic islands of the Seychelles (including Cousin Island) and the bi-annual change in wind regime and subsequent sea conditions (NW monsoon from November to April, SE monsoon from May to October), there was a need to move the nurseries to more sheltered areas, every six months. Notably, when nursery filling and/or monitoring was still underway. When the nursery-grown fragments reached suitable size for transplantation, usually after seven months to one year, there was also a need to move the nursery from the SE or NW nursery sites to the transplantation site. However, during the last year of transplantation, weather conditions did not require relocating entire nurseries, and we only extracted 1 or 2 ropes at a time for daily transplantation. The recommended operational procedure for relocating a nursery is described in the following section.

Moving a nursery is a three-step procedure, including: nursery and reception site preparation, nursery towing and, nursery set up at the reception site. The recommended operational procedure for each of these three steps is described below.



Figure 29 Divers preparing a rope nursery for relocation.

Reception site and nursery preparation

1. Prepare a nursery base with angle bars and ropes just as described previously in how to build a rope nursery, at the new chosen location for the nursery.
2. Put a "figure of 8" knot on the bottom of the corner angle bars, to aid bringing the nursery down.
3. Ensure there is a mooring buoy up-current of the nursery base, far enough away for the boat to moor onto and the towed nursery to be directly above the desired underwater location.
4. Proceed to the old nursery site, to collect nursery.
5. Anchor the boat securely up current from the nursery.
6. Undo middle anchor ropes of nursery (if any)
7. Tie angle bars (or other stiff bar to stop pipes bending under the pressure of being dragged) to the underside of each pipe.
8. Set a rope connecting all pipes to ensure there will be minimal movement of pipes (if cable ties fail etc).
9. Add buoyancy to the nursery to ensure it will rise to the surface easily.
10. Attach tow ropes from boat, to the nursery
11. It will take 2 ropes of at least 25 m and 1 of 10 m to tow effectively.
12. First, attach the ends of one of the long ropes to either end of the 1st nursery pipe, creating a loop.
13. Use the other long rope (25 m) to do the same on the back of the boat
14. Tie a bowline at each end of the shorter rope (10 m) and attach double-ended clips to each.
15. Attach double-ended clips to the ropes on both the 1st nursery pipe and the back of the boat, respectively (See Figure 30).

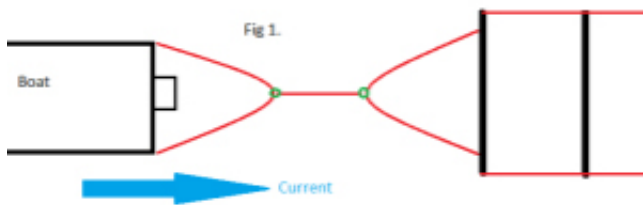

Figure 30 Attachment of ropes for transfer of a nursery. New ropes added in red and double-ended clips are represented by green circles

Nursery towing

1. Remove all anchor ropes but leave stretch ropes intact.
2. All divers except for two, exit the water and get back on the boat.
3. Once the boat engine is on and everyone is ready, the two divers in the water cut the stretch ropes furthest away from the boat.
4. The two divers swim to the front of the nursery and cut the near stretch ropes and then swim to the boat.
5. Quickly pull in the anchor or free the boat from mooring, otherwise the nursery might collapse on itself and tangle the ropes.
6. The boat will have to move slowly and be very careful of objects in the distance as the turning circle while towing a nursery is large (Fig. 31).
7. The boat will need to approach the new nursery site from up current so make sure if the boat needs to turn, it has plenty of time and space to do so.
8. While the boat is in motion use this time to prepare two 25 m ropes, each with a "figure of 8" knot and bowline. From one end of the rope, leave 1 m open, then make one bowline and attach a carabineer. Another 30 cm further on from the bowline, make a "figure of 8" knot to create another loop in the rope.



Figure 31 Towing a nursery with a boat.

9. As the boat approaches and starts to slow down, it is a good idea for a couple of people to get into the water and hold the back of the nursery so that it does not collapse on itself as it comes to a halt.

Nursery set up at the reception site

1. When the boat is moored and the nursery is approximately above the desired location, have two divers attach the long loose end of the prepared rope, to the 1st pipe of the nursery.
2. The two divers, dive down to the first set of angle bars and attach the carabineer to the "figure of 8" knot that is in the anchor rope, to ensure the nursery will not float away in current/waves.
3. Remove the tow ropes from the nursery and pull them into the boat.
4. The situation should then look like Figure 32.

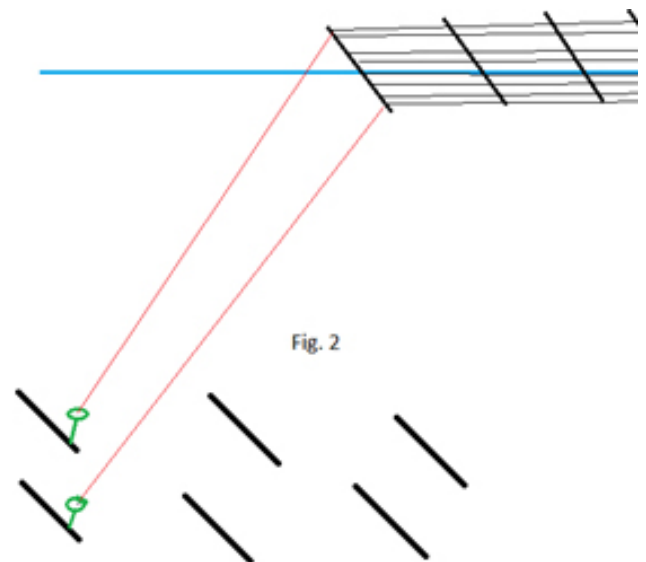

Figure 32 At reception site, nursery still on the surface and already attached to the first angle bars.

5. Ensure the loose end of the rope is passed through the carabineer and wrapped around the angle bar (but not tied).
6. Bring down two (or more if needed) jerry cans and pass the rope attached to the jerry can through the carabineer and tie onto the "figure of 8" knot in the rope attached to the nursery (Fig. 33).

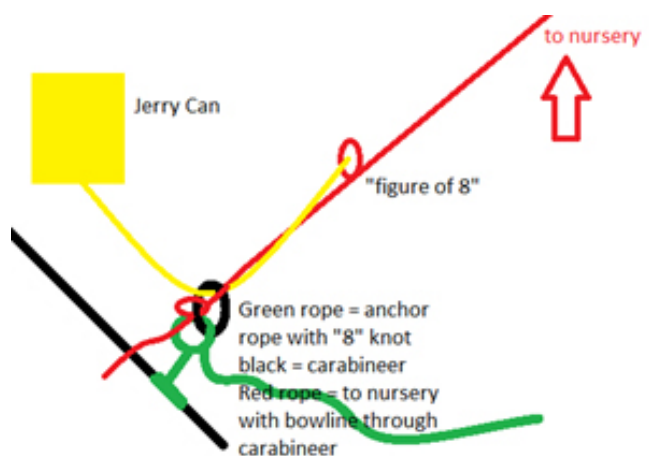

Figure 33 Counter-weight system set up to bring down the nursery at the reception site.

From here there are two different methods depending if the nursery being towed is positively or negatively buoyant, without any buoys on it.

If the nursery is negatively buoyant

1. Make sure the loose end of rope is wrapped around the angle bar a couple of times, and is being held by a buddy. Partially fill the jerry can, so it starts to rise.
2. As the jerry can pulls the "figure of 8" knot towards the carabineer, it creates slack on the bowline. When there is enough slack, open the carabineer and remove the bowline from it to create just one long rope going through the carabineer but nothing attached to it.
3. Completely fill the jerry can with air.
4. When this has been done on both corner angle bars and both divers are ready, signal to let the loose end of the rope go and it should unravel from the angle bar, sending the jerry can towards the surface and pulling the nursery towards the angle bar.
5. It may not bring the nursery under the surface depending how much buoyancy is on the nursery but that is OK, as one diver can be at the surface removing one buoy (or emptying one jerry can) at a time from the first pipe until the nursery starts to sink. As soon as it starts to sink then do not release more air.
6. Do the same on the second pipe to allow the first pipe to be deep enough to be tied off at the end of the anchor ropes and the angle bar supporting the pipe to be removed.
7. As soon as the pipe is tied off, add buoyancy to it, to ensure it does not sink anymore and end up on the substrate.
8. At this point the diver on the surface can release the air from the jerry cans that were used to counterweight the nursery and the ropes can be removed.
9. Do the same with each pipe until all pipes are tied off at the end of the anchor ropes and the nursery is positively buoyant.

If the nursery is positively buoyant

1. Start the same way as if it was negative but ensure there is no extra buoyancy on the pipes apart from the pipes themselves.
2. A second jerry can may also be needed on the bottom to ensure enough buoyancy on the counterweight, to bring the nursery down.
3. When both jerry cans are released from the angle bar (step 4 of previous explanation), the nursery should then be pulled underwater.
4. Tie off the 1st pipe as soon as it is low enough in the water to be reached by the anchor rope.
5. Empty the jerry cans used as a counterweight and remove the rope from the 1st pipe.
6. Repeat the process with pipes 2-5 using the counterweight to bring down the nursery but this

time there is no need for the bowline or figure of 8 knot as the anchor rope is not holding the weight of the nursery at this time.

7. The other way of doing this (if the nursery is only slightly positive), is to attach a weight (sledgehammer) to the end of each pipe in turn, to bring it low enough to tie them off.
8. All that is left to do is add the stretch ropes and level the nursery off at the required depth.

Fragment replacement

Fragment replacement can be initiated when the pooled sum of '>50% Dead' and 'Dead' survivorship categories is more than 60% of the total number of fragments on a rope. These ropes are brought up to the boat and the dead fragments are removed and replaced with new fragments.

Data recording

At least one slate per buddy pair should be used to monitor the total number of fragments and number of fragments per species, that are put into the nurseries. Additional data can be recorded to gain information on cost per unit effort for nursery cleaning: number of cleaning dives, start and end of cleaning time, number of divers cleaning per dive and, number of fragments, ropes and nurseries cleaned.

Debriefing

The dive leader should provide team members with an opportunity to debrief at a convenient time, before operations are concluded for the day. During this time, each team can present and log their data and any procedural improvements or safety notes for general discussion can also be mentioned and referred to, for further description during the weekly meeting.

Data entry

- All data entry should be completed on the day that data was collected.
- All updated spreadsheets should be backed up on a portable storage device once data entry for the day is completed.
- Slates should be cleaned following the successful back up of date and made ready for subsequent use.

4. Coral Reef Transplantation

There are several ways to transplant corals onto a degraded reef. Coral fragments can be placed onto artificial structures or placed directly onto the reef substrate. We have found that the latter is more cost-effective, results in a higher survival rate of coral fragments and improves the positive effect of coral transplants on natural recruitment.

In the Reef Rescuers project, we used two types of coral transplantation procedures namely, rope nailing and coral cementing. These two procedures are described in this chapter. For other methods of transplanting corals onto a degraded reef see Edwards (2010). In addition, we describe other procedures we found helpful to ensure the survival of coral fragments onto the reef.



Transporting whole coral ropes to the transplantation site

You will need:

- Gloves
- Rope cutters/Scissors/Dive knives
- Lift buoys with rope
- Tow rope

The presence of current is the critical factor when transporting nursery ropes to the transplantation site. The three types of current conditions are: no current, medium current (a diver can still progress forward when swimming against the current), and strong current (a diver can only maintain a stationary position when swimming against the current). Surge will reduce efficiency but should not stop completion of this activity.

If divers are moving ropes independently (where the nursery and transplantation site are in close proximity), a surface snorkeler is advisable for safety. Ropes should be transported from nursery to transplantation site underwater (i.e. correctly inflate lift bags or jerry cans to achieve neutral buoyancy of the coral rope at 7-8 m depth; Fig. 34). If a diver is unfamiliar with the correct use of buoyancy lifting devices they should not attempt to undertake this task alone. Ropes of large, heavy coral colonies such as *Pocillopora grandis* and *P. verrucosa* create more drag and this should be considered with regards to the prevailing environmental conditions before undertaking the task. In extreme current conditions the boat may be required to effectively transport coral ropes to the transplantation site.

On arrival to the transplantation site, handle ropes containing colonies from the nursery with care. Avoid unnecessary handling that can damage delicate coral tissue, or leaving colonies for extended periods of time in areas affected by scour or high density of sand.



Figure 34 Transporting nursery ropes with corals. Top: Diver towing a full nursery rope to the transplantation site with the aid of jerry cans. Bottom: Boat towing a full nursery rope to the transplantation site. Jerry cans keeping the rope afloat are shown on sea surface.

Condition: No current

When there is little to no current and the transplantation site is a few tens of meters away a single diver can transport a 20-m rope to the transplantation site without too much difficulty. The diver will take 2 or more lift buoys to the rope awaiting transport, where the first buoy is attached to the end of the 20-m rope located down-current. The diver then proceeds to add enough air to the lift buoy in order to stop it from bouncing around and remove some of the tension on the knot that is holding the 20-m rope to the nursery. The diver then releases the knot, (this is an anti-slipknot with several half hitches), to enable the 20-m rope to detach from the pipe. Extra air is then added to the lift buoy so that it ascends to the surface. If the knot is too difficult to open, the diver can cut the rope to release it from the nursery.

The next step is to release the rope from the second pipe which is attached with a cable tie. This can be done by giving it a strong pull or cutting the cable tie. The second lift buoy is attached halfway along the 20-m rope (3rd pipe) using a clove hitch followed by a half hitch. Air is added to the second lift buoy and the rope is unattached from the pipe by pulling force or cutting the cable tie.

Afterwards the diver continues to the end of the nursery (5th pipe), skipping the 4th pipe. On the 5th pipe the diver will release the knot from the nursery using the same procedure as for the first knot. When the knot is released the diver ties the rope back onto the 5th pipe with an easy to release knot, such as a clove hitch. Add an additional jerry can and fill to neutral buoyancy.

The rope is now ready to be released and both lift

buoys should be well above the nursery and not entangled in other ropes, or other buoys. The diver swims to the 4th pipe to cut/break the last cable tie. The diver then swims back to the 5th pipe to release the easy to release knot and further inflate the jerry can to counter the extra weight of the rope with corals. Now that the rope is completely free from the nursery the diver can slowly ascend to the surface where the jerry will now be fully inflated and the diver can now swim the rope on the surface to the transplantation site either by back paddling or snorkeling. The diver should take care to ascend at the correct safe rate – if ascending too quickly, let go of the rope.

Condition: Medium current

Two divers will dive with a single lift buoy. The buoy is attached to the middle of the 20 m rope and air is added to raise the buoy to the surface as the cable tie on the 3rd pipe is cut or broken. Care should be taken that the rope being lifted is not entangled with other buoys or other ropes. Keep in mind that the buoy will directly drift with the current thus try to prevent problems by anticipating the trajectory and results of this ascent. The divers then each move to opposite ends of the 20 m rope and untie the knot. If the knot cannot be untied the diver moves to the next pipe and waits for the buddy diver to finish untying their end and to move to the next pipe (either number 2 or 4 depending on the side the diver was on). If the knot can be untied the diver then proceeds by tying the rope back to the pipe with an easy to release knot, and swims to the next pipe to wait for the buddy diver.

When both divers are at their respective pipes (2 and 4) they give each other the OKAY signal before proceeding to cut/break the cable tie at that end. Once the cable ties are broken the divers then return to their end of the rope to either cut the knot or use the quick release to release the rope from the pipe. After this both divers should inflate their BCD's to counter the extra weight of the coral rope and start swimming towards the transplantation site while slowly ascending.

Once at the surface both divers can fully inflate their BCD's and either back paddle or snorkel towards the site.

A note of caution: If there are mooring buoys around they can snag the 20 m rope due to the current. Watch out for these lines when transporting the 20-m coral ropes and anticipate where the current is taking you to avoid potential problems.

Condition: Strong current

With strong current transplantation is not an option and far too risky to proceed. If a diver is at risk of drifting too far from the transplantation site, then towing from a boat should be used for transporting nursery ropes with corals.

The diver(s) will signal to the boat to come and get them or, if too far away, inflate their SMB to indicate the requirement of boat assistance. The diver is responsible for tying the towing line to the 20 m rope. Using an additional carabineer on the tow line allows the 20 m rope to move freely during the tow, reducing tension and risk of snapping. Preferably a bowline knot is used to tie the two ropes together. Should there not be enough rope for a bowline then proceed with either a clove hitch followed by 1-2 half hitches on the rope between two corals. The diver and the rope are towed to the site. The diver will stay in the water with the rope to make sure that the knot for towing holds and to indicate to the skipper where is a good place to drop him off to transplant the corals. Keep in mind that releasing can take several seconds and it is possible to drift off again.

Therefore, it is suggested you overshoot the area aimed for transplanting and utilize the current to arrive at the correct place.

Transportation of corals using baskets

Recycled supermarket baskets are useful for carrying and moving large quantities of coral underwater (Fig. 35). It is important that the corals collected in baskets are transplanted first as you do not want to run out of time and leave the corals unattached underwater.

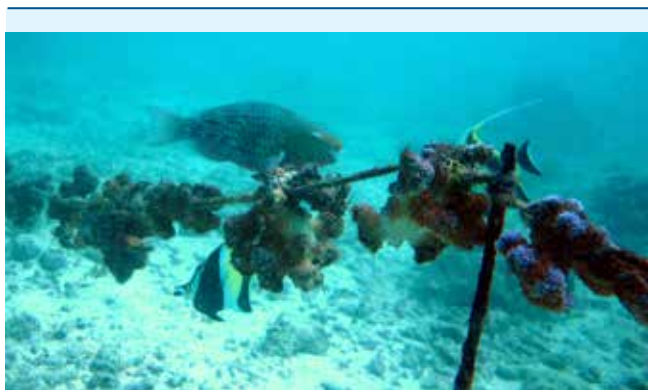

Figure 35 A diver using a basket to transport corals to be transplanted.

Coral baskets are filled in two buddy teams. Each diver will descend with a weighted basket (negatively buoyant), a lift bag and a knife. Hang the basket on the nursery and add the corals into the basket ensuring the weight is evenly distributed. Repeat with the second basket. Attach the lift bag to each respective basket and proceed to add air slowly until neutral buoyancy is achieved. Proceed to make a safe ascent, releasing air from the lift bag as necessary. If the lift bag begins to ascend too quickly, release it, and recover it at the surface. Tow the basket to the boat.

On the boat, proceed to remove any remaining rope from the corals. Ensure that the rope is entirely removed from the colony by cutting at the edge of coral growth. This will reduce turf algae competition

and avoid over-growth of the colony in the first stages of self-attachment to the substrate. Only sharp scissors or shears are effective for this task and this should be taken into account when selecting (or preparing) equipment for the operation. One diver holds the end of the rope taut while the other diver cuts the rope, thus freeing the nursery coral. Once all corals have been separated, count them and carefully place them back into the basket (covered from direct sunlight). If a delay is foreseen at the transplantation site, submerge the basket hanging off the boat, in order to minimize the amount of stress applied to the corals.



Cleaning Station

A cleaning station is a series of rebars placed near the mooring line on the transplantation site at 5m intervals. The purpose of which is to allow grazing fish to clean the corals of any mobile invertebrates living on the corals, or sessile biofouling attached to the rope. This step is important because corals transplanted with mobile invertebrates living on them can be knocked over by fish (mainly wrasses and triggerfish) attempting to feed, therefore not giving the cement a chance to set. See Frias-Torres & van de Geer (2015) in the Resources section.

To transfer a floating coral rope from the mooring line to the cleaning station, attach both ropes together using a carabineer. One diver will unscrew the cap on the distal jerry can and let it fill with water. The distal end of the line will sink and that diver will submerge with it and lay out the distal end parallel to the cleaning station. The diver at the surface will then repeat the same process with the proximal jerry can while sliding the attached carabineer down the mooring line. Once at the bottom, remove both jerry cans from the coral rope and secure them to the mooring line for retrieval at the end of the dive. Attach the coral rope to the rebar closest to the mooring line (using cable ties) then stretch it out to the next rebar and attach again. Repeat this process until the whole line is attached to the cleaning station and safely off the substrate. Lines are typically left at the cleaning station for 1-2 days.

Once the corals have been grazed clean, the corals are cut from the rope, counted and then transferred to the basket for transplantation.

Transplantation by cementing individual colonies

Equipment

- Mixing bowl or container
- Marine cement
- 'Sikacrete' (a stabilizing powder, to increase cohesion and reduce washout when cement is applied underwater)
- Fresh water
- Rubber gloves
- Cement piping bags or pastry bags

Preparing cement

Preparing a good cement mixture is essential for obtaining good consistency underwater. A mixture with too much water will mostly dissolve underwater and not set properly, while a mixture with not enough water will be hard and difficult to squeeze out of the pastry bag.

For practical reasons and to ensure the mixture contained consistent proportions of each ingredient, fixed measuring containers were used. To provide one measure of mixed cement, the following sized containers were used:

- Marine cement measuring cup = 460g
- Sikacrete measuring cup = 43g
- Fresh water bottle = 1L

A single dry mixture of both cement and Sikacrete consists of a ratio 460g:5.6g respectively, where two mixed measures 920g:11.2g are enough to fill a single 40 cm pastry bag. During a single dive, a pair of divers will typically use 2 pastry bags, per dive. This ratio can be scaled up based on the number of divers cementing corals.

Before you begin, lay out some plastic lining to protect the boat from any cement spills and wear gloves and eye protection for health and safety. Measure the required amount of cement, carefully place into the mixing container and level it. Spread the Sikacrete evenly over the cement and mix thoroughly, using dry gloves. After mixing, have an assistant carefully sprinkle enough water on the mixture to wet the surface layer. Mix the cement by first covering the wet areas with dry cement from the sides, soaking up excess water. Pay special attention to breaking up any clumps which may form (Fig. 36), as these may clog up the pastry bags. A good method for this, is to rub the clumpy mixture between your palms. Continue to add water sparingly while mixing, so not to over saturate the mixture. At this point, punching and folding the mixture helps to evenly distribute the water, until the cement achieves a consistency resembling a sticky, soft bread dough. This cement is now ready to be transferred into the pastry bag (Fig. 37).



Figure 36. Mixing the cement on the boat.



Figure 37. Filling the pastry bags with cement.

While the cement is being prepared, another assistant can begin preparing the pastry bags. A 10 cm flap on the wide end is folded over to open the bag for filling whilst the narrow end is folded over by 2 cm and a peg is attached to close (Fig. 38). This makes it easier to fill the bag and prevents the cement mixture leaking out the other end. Fill the pastry bag up to 2/3 full and remove the excess air. Unfold the flap at the top and tie the bag in a knot as close to the top of the cement as possible. Use a length of rope and tie a knot to secure this end and verify that the peg is still attached to the narrow end. It is essential to keep the pastry bags in the shade if not being used immediately. **However, cement should not be prepared more than 30 minutes before a dive.**



Figure 38 Tying the wide end of the pastry bags shut. The narrow end is folded and clipped with a peg.

There are 3 key factors that should be considered when transplanting individual coral colonies using cement: 1) transplantation density and species arrangement, 2) selection of suitable areas for colony stability and self-attachment and, 3) the cementing process.



The Sikacrete-to-marine cement ratio used was proportional to the expected wave energy at the transplantation site. At Cousin Island, where the 12 m deep transplantation site had some swell, we used a cement mix with 3 % Sikacrete. At Petite Anse Kerlan, Praslin, where the 3 m deep transplantation site was highly influenced by wave energy, we used a cement mix with 10 % Sikacrete.

Transplantation density and species arrangement

A density of about 4-8 colonies per square meter should be considered as a guideline (Fig. 39). Where possible, depending on the colonies available in the nurseries, transplant a selection of variable species and growth forms (branching, digitate, tabular etc.) to avoid the creation of uniform patches.



Figure 39 Coral transplantation area showing approximate density of coral colonies (4-8 colonies per square meter) and suitable hard substrate for attachment.

Selection of suitable areas for colony stability and self-attachment

The primary objective of coral transplantation using cement is to securely position the coral using as little cement and effort (dive time) as possible. Marine cement is a valuable resource that is energy intensive to create and subject to a rapid rate of degradation shortly after being mixed. Any coral colonies that fall off after an unsuccessful first attempt at transplantation require significant effort to re-locate and re-attach.



In corals, there is a continuum of living tissue on the surface of the colony (coenosarc) connecting individual polyps (each one hosted in their own corallite skeleton) with the spaces between polyps. The existence of this living surface layer is critical in coral transplantation. Coral colonies will "grow-over" their cemented attachment point within 1 month of transplantation, increasing their stability. In our project we reported such new growth as successful self-attachment.



To maximize successful transplantation in the first instance, consider this when selecting a suitable area to cement the colony:

- **Stable substratum** (i.e. hard substrate with no loose rubble or boring sponges)
- **Surface area represents a 'good fit'** with the shape of the transplanted colony (i.e. colony will not move or dislodge during the time required for cement to harden)
- **Substrate free of algae, sponges, tunicates, sediment** (i.e. the point of coral-substrate contact in the transplantation area has been scrubbed thoroughly to maximize self-attachment potential and survivorship of the transplanted colony. (Fig. 40).



Figure 40 Ensuring areas of suitable hard substrate are adequately cleaned prior to transplanting with cement.

Cementing process

The coral transplantation methodology with cement operates most efficiently and safely by using buddy teams consisting of one diver that places the colonies on suitable areas, and another following to apply cement. First, use the natural contour of the substrate to locate pockets, ridges or depressions in which a coral colony may sit, with as little movement as possible. Then, using a brush, scrub the substrate to remove any sand or sediment that may impede adhesion of cement to the substrate. Place the colony in position and apply cement to specific areas of the colony that are in direct contact with the substrate (contact patches). The precise technique used to deliver the adhesive is dependent on the growth form, size and species of the transplanted colony in question (Fig. 41).

For light weight branching colonies like *A. hyacinthus* and *A. cytherea*, a single line, or series of small cement lumps, is usually adequate to hold the colony in position until the cement cures (hardening time is roughly 4-6 hours) (Fig. 41).



Figure 41 Transplantation of tabular *Acropora* is often faster and more straightforward than 3-D sub-massive *Pocillopora*.

For large and irregularly shaped *Pocillopora* colonies, which are often heavy and prone to 'rocking' in conditions of surge, additional measures may be used to increase stability and lower the chance of dislodgement. For example, in rugose areas a small portion of the colony may be 'anchored' in cracks or crevices of the substrate (Fig. 42). This technique can stabilize the colony under heavy surge or high current and has the dual benefit of requiring less cement.



Figure 42 Effective transplantation of sub-massive *Pocillopora* requires attention to both the substrate topography as well as the prevailing environmental conditions for best results.

In more exposed transplantation sites, a small piece of rubble or rock can be placed around the colony to prevent rocking. This temporary addition can stabilize the colony while the cement hardens, and further reduce the likelihood of dislodgment caused by swell and adhesion failure.



The best way to manage the pastry bag is to keep the peg on until immediately before cementing. Twist and tighten the wide end of the bag, until it is firm enough to squeeze; keep a hold on the twisted end while cement remain, as this prevents water from entering the pastry bag. Effective cementing requires maintaining good buoyancy. Since holding the pastry bag requires both hands, a free hand will not be available for the diver to stabilize under strong currents or surge. Additionally, good buoyancy will ensure that the cementing diver does not accidentally knock over any recently cemented corals.

All cement bags, mixing buckets and ropes should be thoroughly cleaned after use, to prevent cement from hardening and rendering items unusable in the future. Salt water can be used for this on boat and fresh water in the dive shed.

All diving equipment should be thoroughly rinsed to clean any unwanted cement from regulators and BCDs.

The cement storage container should be stirred to prevent packing of dry cement and checked to ensure that water has not entered. This container should then be refilled with the required quantity of dry cement (Sikacrete contained separately) for subsequent use the following day. If an extended layover between cementing operations is likely, avoid premature hardening of cement by keeping container empty. Storing cement bags in an air-conditioned room will prevent any moisture spoiling the powder.

Rescue cementing

Rescue cementing, refers to seeking out loose and/or unattached corals on the transplantation site and reattaching them using the cementing process previously described.

Rescue cementing is usually undertaken when a team of divers goes through all available corals and still has cement and air available. Unattached corals are sought out and returned to the basket; these will be strewn down-current from where they were originally transplanted. If in doubt, a light touch will quickly determine if a coral is loose or in the process of becoming unattached. If a colony is only partially loose, it may be possible to simply add some more cement to it.

Rescue cementing corals is normal and is an important part of any restoration project. If, however, rescue cementing is consuming an exaggerated amount of time, consider the following factors:

Problem	Possible Cause	Solution
<i>Corals become unattached with dry cement still adhered to coral</i>	<i>Poor brushing, Planting on heavy sediment area</i>	<i>Remove all sediment from contact point. Plant on rocky substrates.</i>
<i>Fish are knocking corals over.</i>	<i>Corals still have mobile invertebrates on them.</i>	<i>Leave corals on the cleaning station for longer.</i>
<i>Corals become unattached before cement dries.</i>	<i>Poor cement, Strong currents, Planting on exposed surfaces, Rogue diver, Corallivorous fish feeding (Parrotfish)</i>	<i>Check cement consistency, Plant in shielded locations, Verify corals lay flat, Check diver buoyancy, Keep fins and hoses off the ground, Leave corals on cleaning station for longer.</i>



Currently there are no procedures for transplanting thresholds pertaining to levels of partial mortality (PM). Colonies that are 100% dead are not transplanted; however the following could serve as guidelines for the transplantation of corals:

- >75% PM (advised to position without cement using substrate contours only)
- > 50% but <75% PM (advised to position dead side down)
- >25% but < 50% PM (advised to position dead side down)
- <25% PM (transplant as normal)

At the beginning of the Reef Rescuers Project, coral fragments were transplanted by nailing ropes to the substrate. However, we found that the high wave energy and wave swells characteristic of the transplantation site did not allow corals to remain still long enough to ensure self-attachment. Therefore, we changed our strategy to transplantation by cementing the corals directly onto the substrate, which ensured proper stability and self-attachment.

Transplantation by nailing ropes

Transplantation has three phases: Preparing the 20 m rope, finding a suitable location, and fixing the rope onto the reef.

Equipment:

- Gloves
- Prussic (small rope loops)
- Nails
- Hammers

Preparing the 20-meter rope

Upon arrival with the 20 m rope the diver(s) proceed by deflating the lift buoys (either by filling with water at the surface or pulling the buoy using strength down to your position in the water column, making sure to counteract your own flotation by deflating your BCD). The diver must then lay out the rope on the reef being careful to avoid the rope becoming entangled with other corals and ropes that are already on the site. If there is a medium current the rope can initially be attached to one of the re-bars that are on the reef to prevent the rope from continuing to drift with the current, if there is no current the diver has to manually layout the line whilst deflating the lift buoys.

Once the rope is flat on the reef the 20 m rope is cut into 1-m, 2-m or 5-m long rope sections. These pieces can then be fitted with simple prussic in preparation for its attachment to the substrate (Fig. 43). However, this can also be done once the suitable location has been found.

Prussic: A small loop of rope is tied to the rope with the corals using the Prussic knot (see Figure 43). This knot is applied every 3-5 corals depending on rope availability. The loop is made of three strand rope. This rope can be opened to push a 2-inch concrete nail through. The nail must always go through the rope of the prussic to secure the rope with corals properly onto the reef flat.



Figure 43 Corals secured using prussic knots.

Finding a suitable location

The location should be large enough to be able to hold the 1-m, 2-m or 5-m long rope sections. Substrate such as sand, rubble or granite will not hold the nails used to fix the rope to the substrate. The only good substrate to transplant on with this technique is hard carbonate reef. Make sure that the substrate is solid and does not move before starting to hammer the nails in the substrate.

Once a suitable substrate is found the diver will layout the rope approximately as it should be transplanted, taking full advantage of the solid carbonate reef available.

Fixing the rope onto the reef

If no prussics were added at the start they should be added as the rope is fixed onto the substrate. The only exceptions are the first and the last coral on the 5-meter line. The first and the last piece of the 5-meter rope are anchored in using a singular piece of rope with knots at the end, and the coral pieces are put through the rope, by untwisting the finer strands, and tightening the strands again. To get the best tension on the rope the diver will skip every second prussic when first hammering in the line. The diver returns to these prussic to add tension to the 5-meter rope. This will cause a zigzag pattern. Nails should always be hammered in either vertically or slightly leaning away from the rope (Fig. 44-45). The nails should never be leaning towards the rope. Nails leaning towards the rope have a much higher chance of dislodging. See nail positioning if this is unclear.



Figure 44 Securing a rope with nails.



Figure 45 Detail of secured coral head.

It is imperative that corals are touching the substrate and not hovering in the water. Also, any slack on the line will cause the corals to shift in surge or current. This will cause constant abrasion of the skeletal tissue of the coral and will eventually lead to infection and then death. Also remember the fixation will need to hold in strong current and large surge; make sure the nails that are hammered in are not going to come out when the 5-meter line is pulled horizontally. The diver can cut the 5-meter rope again if it becomes apparent there is not sufficient hard substrate for the whole piece: Quality of fixation is more important than quantity (Fig. 46).



Figure 46 Coral rope fixed with nails at transplantation site.



Nailing ropes is only successful when the corals make direct and constant contact with the substrate. This situation allows the coenosarc, the living tissue overlying the stony skeletal material of the coral, to make contact with the substrate, grow over it and result in a self-attached coral within one month. However, if the area is affected regularly by swells, big or small, the nailed ropes will not guarantee the stable conditions needed for coral self-attachment. In the Seychelles restoration project, we first attempted nailing ropes to the substrate, but the recurrent swell prevented self-attachment. For this reason we developed the cementing technique explained here.

Data recording

At least one slate per buddy pair should be used to monitor the total number of colonies and number of colonies per species that are transplanted per dive (plus dive time in minutes). Additional data that can be recorded to gain information on cost per unit effort for coral transplantation include: the number of colonies (incl. sp.) re-attached per dive and the number of transplanted colonies (incl. the location if using grids) observed with 100% mortality.

The number of divers, ropes cut and transplanted, pastry bags of cement and number of nails used should be recorded on a daily basis (Cf. "daily log transplanting"). During a typical transplantation day, about 3 ropes with 130 colonies per ropes were cut and transplanted with a team of 6 divers.

Debriefing

The dive leader should provide team members with an opportunity to debrief at a convenient time before operations are concluded for the day. During this time each team can present and log their data and mention any procedural improvements or safety notes for general discussion which can be referred for further description during the weekly meeting.

Data entry

- All data entry should be completed on the day that data was collected.
- All updated spreadsheets should be backed up on a portable storage device once data entry for the day is completed.
- Slates should be cleaned following the successful back up of data and made ready for subsequent use.

5. Monitoring

Monitoring the activities and effects of the coral reef restoration project is paramount in assessing the effectiveness of this active conservation strategy. Monitoring the survival of donor colonies and of fragments in the nursery can help estimate the effects of reef restoration on natural reefs and the fitness of the selected colonies. Similarly, estimating the number of hours spent cleaning the nurseries and the number of corals transplanted per hour dive may

assist with ensuring the good use of project resources. Monitoring should be done periodically the specific frequency being dependent on available resources. However, at least once a year monitoring of fragments and transplanted colonies should take place. In this chapter, we present some of the monitoring activities that were undertaken in the Reef Rescuers Project to evaluate project success.

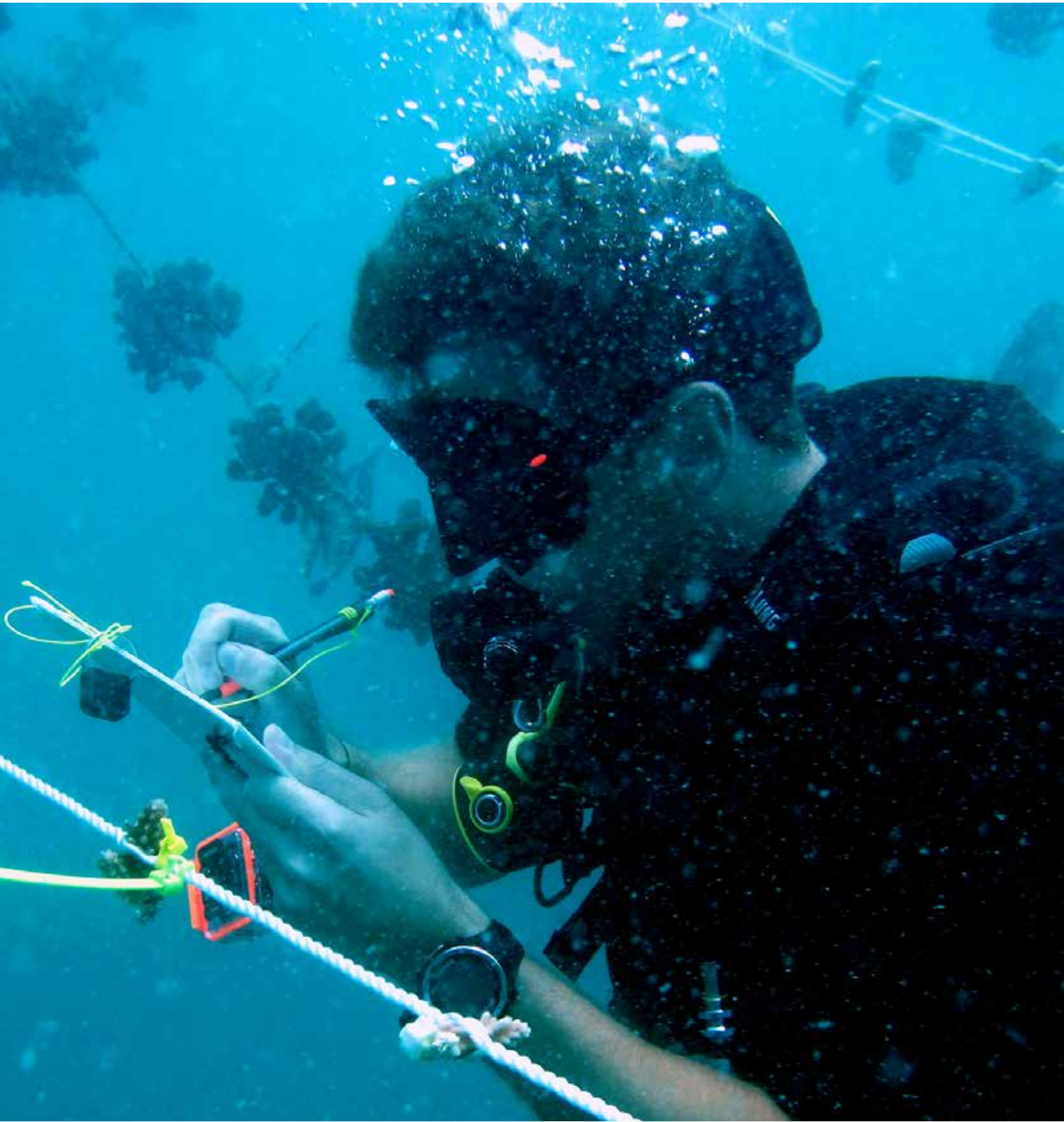

The rationale for monitoring

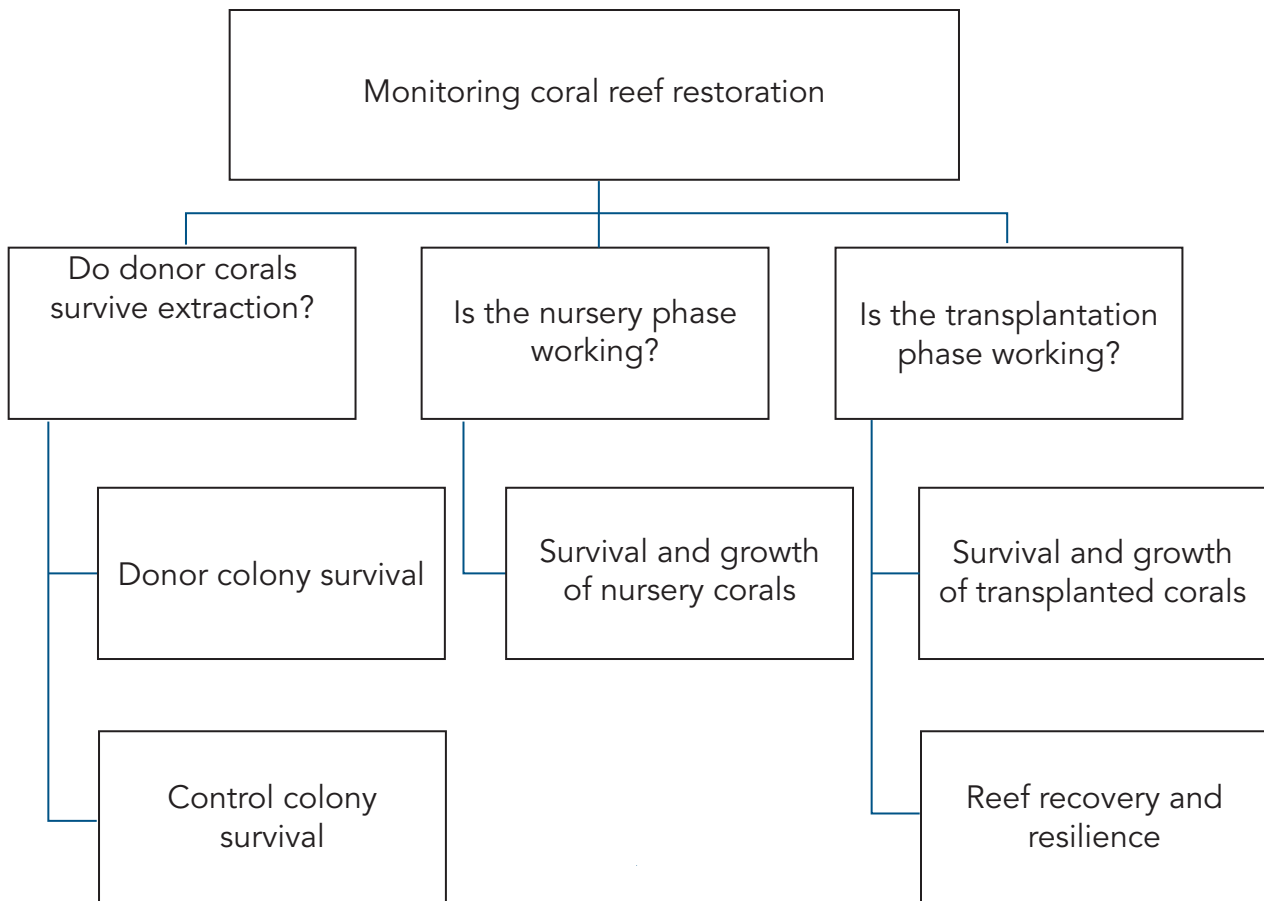

Preparing for monitoring

Before monitoring can start, tags and buoys must be prepared. Tags and buoys are used to identify individual colonies and plots to be monitored. Buoys can also be used to demarcate monitoring plots in the transplantation site.

Many items can be used to prepare tags and buoys. It is recommended to visit your local landfill and look for old PVC pipes, jerry cans and fishing buoys that can be recycled for this purpose. Here we show you how to make tags and buoys from such recycled items.

Making marker buoys for multi-purpose monitoring

To make small buoys for monitoring (nets, plots, fixed transects etc.) use one big white or yellow buoy and cut into small pieces with a saw.

- Cut a slice approximately 1.5 -2 inches wide.
- Cut the slice into eighths (quarters and half again).
- For each of the eighths, cut the narrow end off and cut the wide end in half (Fig. 47)



Figure 47 Slicing up a buoy to make markers.

From each slice you will be left with 24 small pieces of buoy. To attach these to the net (or whatever is being monitored) use a rope of small diameter (e.g. 4 mm).

- Cut the rope to approximately 1.5 m in length, so buoy is at least 1 m from substrate
- Using a drill or a sharp pointed instrument (such as o-ring pick/ metal rod etc.) put a hole in the middle of the buoy.
- Put one end of the rope through the hole and wrap around the buoy until you can wind it back around itself and tie a bowline knot (Fig. 48).



Figure 48 Marker buoys.

Making tags for monitoring coral colonies

Plastic PVC pipe works well for making the tags. Make sure the pipe has a large enough diameter so the tags are not too curved.

- a. Cut the pipe into rings of approximately 8cm in length (Fig. 49). This can be done using a hack saw.



Figure 49 Cutting a pipe to make tags.

- b. Cut each ring into strips approximately 2-3 cm wide, adjust as needed (Fig. 50).

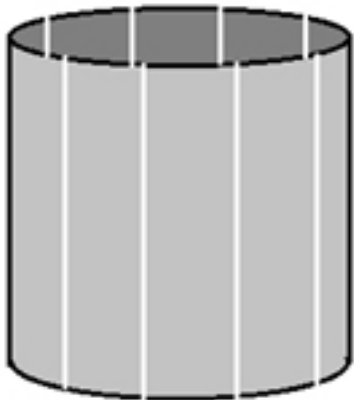

Figure 50 Cutting a pipe to make tags.



Figure 51 A partially completed tag.

- c. Drill a hole in one end (Fig. 51).
- d. Put string through the hole and wind back on itself, tie a bowline
- e. Using a soldering iron, mark each tag with the code needed to identify each individual coral (eg. PL1 for *Porites lobata* number 1). For donor colonies use a "D" for donor and "C" for control. A soldering iron is preferred to an imprinting kit as soldering results in a deeper imprint of the code, thus the tag can be read easily even after biofouling. Note: The soldering iron works best when it is very hot and held towards the tip using pliers (Fig. 52). Always wear protective clothing.
- f. Jerry cans can also be used to make tags, see example in Fig. 54.
- g. The other end of the string can then be fixed onto buoys for either net nurseries or donor colony monitoring depending on the size of the buoy used.



Figure 52 Above: Using a soldering iron to inscribe tags. Below: A finished tag.

Attaching buoys and tags underwater

When a colony is identified for monitoring:

- Find a section of substrate with two holes, close to the colony that you can thread the piece of rope through and tie a bowline, so the buoy sits about 60-100 cm above the substrate (Fig. 53).



Figure 53 Example of how to attach a buoy and tag to the substrate for marking a monitored colony.

- Put a small cable-tie (200 mm x 1 mm) or a thin rope (which stays longer) through the hole in the tag and attach securely to the rope with the buoy (Fig. 53). This method should be resistant for long term monitoring.
- Plastic tags can also be fixed to the substrate with stainless steel nails (Fig. 54) or with cable ties.



Figure 54 A plastic tag (made from a jerry can) can also be attached to the substrate next to the monitored colony with stainless steel nails.

- Indicate to a team member on the surface to GPS the location so that you can find tagged colonies easily at a later date.
- In the net nurseries tags can be placed right next to the monitored colonies.

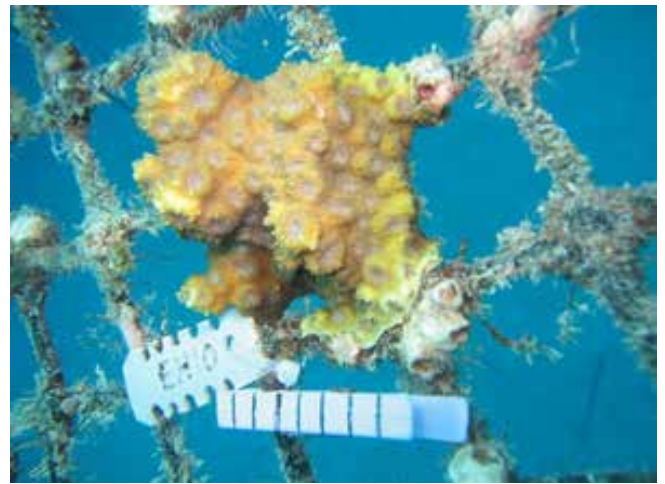

Figure 55 Tag placed next to a monitored colony in a net nursery.



Tags, buoys and ropes can quickly get covered by algae and encrusting animals. This will make reading the tags difficult and can weaken the rope. Thus, it is recommended to periodically clean the tags, buoys and ropes with a brush to remove all biofouling.

Monitoring donor and control colonies

A vital part of the project is to monitor the donor colonies from which coral fragments are removed. This is done through the examination of photographs, especially of the scar tissue from where the cuttings are taken.

Monitoring includes 'control' and 'donor' colonies for each harvested species and a minimum sample size of 8 colonies per species per treatment. For example, for species A, monitoring should include a minimum sample size of 8 'control' colonies and 8 'donor' colonies. In order to facilitate the relocation of monitored colonies, all donor and control colonies belonging to the same species should be selected in the same area of the donor site and GPS coordinates of the specific area(s) for each species should be recorded.

Once a donor colony is selected it must be tagged. Individual colonies can be tagged with a double-system: a small white buoy and an imprinted plastic tag. If buoys are used, donor and control colonies can be differentiated by using buoys with different colors and sizes. We used white and yellow buoys. For instance, a slice of buoy can indicate the tagged colony is a donor colony whereas a half buoy can indicate it is a control colony (Fig. 56).



Figure 56 A half buoy and a slice buoy.

Imprinted plastic tags can also be used to identify colonies for monitoring. Small pieces (8 x 3 cm) of plastic jerry cans or PVC pipes can be used for this purpose. The tags can be imprinted with a code that includes the initials of the species' scientific name (e.g. AA for *Acropora appressa*), followed by a letter identifying whether the colony is a donor (D) or a control (C) colony, and then by the colony number. For instance, the code AAC5 identifies control colony number 5 of *A. appressa*. The imprinted tag can be attached to the rope holding the buoy with a small cable-tie.

The monitoring consists of taking pictures of each monitored donor colony before the fragment is taken and right after the fragment has been taken. The photos should be large top views of the colonies, ensuring the whole colony fits within the frame. Photos are taken periodically in the same manner for both donor and control colonies (to be able to match the colony outline with previous pictures in case the tagging system disappear before the end of the monitoring). Additional photos are taking of the scar that is created by harvesting (to follow the healing process and make sure the colony recovers). The health status of the donor or control colony should be recorded on a slate (see table below). Monitoring frequency (once every two weeks, once a month, once every 3 months) depends on resources available.

Datasheet recommendation

A datasheet with location, date, colony code/tag number, photo number and health status (e.g. dead, alive, bleached; see table below) is needed. The datasheet should have space for additional notes on the healing process of the donor colonies.

Monitoring nursery colonies

Two variables are monitored at the nursery site: the survivorship of the colonies and their growth. Survivorship will tell us how well a nursery is doing and if it requires re-stocking. Monitoring growth in nurseries, from initial nubbin (fragment) towards a larger colony

will provide information that can be used for planning the timing of the transplantation phase (See box on "Monitoring growth in nursery corals"). Depending on the size of the team, the two variables (survivorship and growth) can be monitored simultaneously or on alternate days.

Survivorship

Survivorship monitoring should be done for each individual colony and each nursery every month if possible. The colonies are noted for their current state of health (healthy, less than 50 % dead, more than 50 % dead, dead and bleached).

- Mark a slate with the following health status categories for survivorship monitoring in the nurseries:

Denotation	Description
Healthy	living tissue on the fragment 100%
Dead % 50>	More than 50 % living tissue left on the fragment
Dead % 50<	Less than 50 % living tissue left on the fragment
Dead	No living tissue present on the fragment
Pale	Discoloration of the tissue towards pale
Bleached	Polyps still alive and fragment 'looking' fluorescent white

- Also include a column for the total number of individuals on the rope.
- Leave a buoy on the leading end of the nursery either on the left or right and then mark each individual rope number, from 1-40 on the PVC pipe using a pencil. The buoy remains in place so that each month you return you know at which side and end of the nursery you should start the monitoring.
- With a team of divers decide who is going to collect data from each rope (i.e. one diver does 1-6, the next 7-13 etc).
- With the slate and pencil note the state of health of each colony on the rope using the categories provided.
- At the end of the rope turn around and count up the total number of individuals on the rope and then repeat this process until the whole nursery is completed.

Datasheet recommendation

A datasheet with date, nursery number, rope number, coral species, health status category in columns (see table above), and total number of colonies per rope is needed. The datasheet should have space for additional notes on the survival condition of the colonies (e.g. fouling organism).

Growth Rate

Randomly selected coral fragments (> 30) can be used to measure growth rates per nursery. In each nursery, randomly select three to four individual ropes. Then randomly select five to six colonies on each rope and tag them by securing a small cable-tie around the rope. The goal is to select 3 % to 5 % of the total number of fragments per rope nursery for monitoring. Carry out the same selection and tagging process when monitoring coral fragments in the net nursery, with the same percentage of fragments (3 % - 5 %). Then proceed to monitor growth rate using the following procedure:

1. Leave a buoy on the leading end of the nursery either on the left or right and then mark each individual rope number, from 1-40 on the PVC pipe using a pencil. The buoy remains there so that each month you return you know which side and end of the nursery to begin with.
2. Randomly select at least five individual ropes and on each rope select five to six individual colonies to monitor, giving you a sample size of 3 % of the total number of fragments per nursery.
3. Fragments are then marked using a cable tie secured around the rope before the selected colony (i.e. closer to the leading end, marked with a buoy).
4. With a team of divers decide who is going to collect data from each rope (i.e. one diver does 1-6, the next 7-13 etc.).
5. Always starting from the same side of the nursery (i.e. leading end), swim over the rope and identify the first tagged colony of that rope (marked with a cable tie). This will be monitored colony number 1.
6. Note three measurements for the tagged coral fragment on a slate. Measure the length (first longest dimension), width (second longest dimension) and height (third longest dimension) perpendicularly to each other. Measure tagged fragments using a caliper to the nearest millimeter.
7. Once the fragment is measured, swim along the rope looking for the next tagged coral fragment. This will be monitored colony number 2.
8. Repeat Step 5 through 7 until all tagged fragments in that rope are measured. It is important to do it in sequence so that the same fragments and measurements correspond in subsequent monitoring.
9. Pictures of each measured fragment can be taken (top, bottom and side views) to create a visual timeline of the growing fragments, as well as to identify possible discrepancies, making it possible to back-track the fragment if the data deviates from what is expected.

Datasheet recommendation

A datasheet with date, nursery number, rope number, colony number, height, length, width, and estimated ecological volume (see Box below) is needed. The

datasheet should have space for additional notes on the survival condition of the colonies (e.g. fouling organism).

Monitoring growth in nursery corals.

Growth is determined by calculating an ecological volume index (EVI), which most accurately expresses the total volume taken by a fragment/colony and the water volume between and below the branches. The EVI is calculated using the following formula as per Shafir et al. (2006):

$$EVI = h\pi r^2, \text{ where } r = \frac{w+l}{4}$$

EVI= ecological Volume Index, h = height, r = radius, w = width, l = length.

Recommended reading:

Shaish L, Levy G, Katzir G, Rinkevich B (2010) Employing a highly fragmented, weedy coral species in reef restoration. *Ecological Engineering*, 36(10), 1424–1432.

Villanueva RD, Baria MVB, de la Cruz DW (2012) Growth and survivorship of juvenile corals outplanted to degraded reef areas in Bolinao-Anda Reef Complex, Philippines. *Marine Biology Research*, 8(9), 877–884.

Monitoring transplanted colonies

Once transplantation starts, permanent plots should be marked out and monitored periodically. Colonies within the plots will be monitored for survivorship and growth rate.

1. Select three or more representative areas (e.g. multiple 5 m x 5 m plots in different areas based on the distribution of coral species) of the transplantation site for monitoring. Particularly, select areas where a similar number of colonies of each transplanted species is found.
2. Demarcate the selected plots using rope and iron bars.
3. Proceed to identify both the total number of transplanted colonies and the total number of each species within each plot. It is important to show an appropriate representation (3%-5%) of the whole population, depending on how many colonies have been transplanted.
4. Transplanted fragments are then marked for future monitoring. Imprinted plastic tags nailed to the substrate can be used for marking the selected colony (Fig. 57).

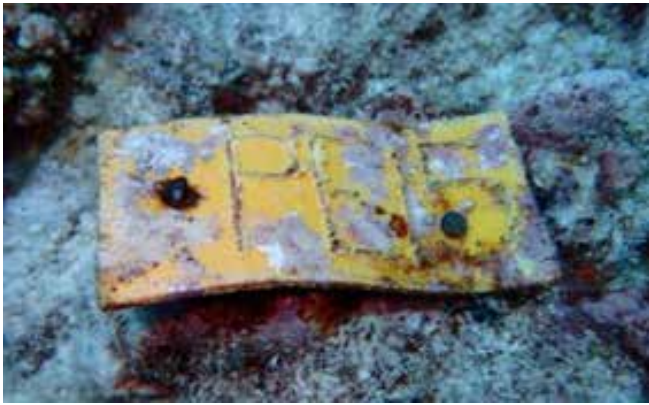

Figure 57 An Imprinted plastic tag, nailed to the substrate can be used to mark transplanted colonies for continued monitoring.

Survivorship

5. Identify the plot that is being monitored and your first colony. Note the plot number and colony code on your slate. It might be necessary to clean the tag in order to see code or identifier for the colony; use a brush and knife to remove any biofouling.
6. Noted the current state of health (healthy, less than 50 % dead, more than 50 % dead, dead and bleached) for each colony following the health status categories for survivorship monitoring in the nurseries (Above).
7. Also include a column for the total number of individuals in the plot.

Growth rate

8. Note three measurements for the tagged coral fragment on a slate. Measure the length (first longest dimension), width (second longest dimension) and height (third longest dimension) perpendicularly to each other. Measure transplanted fragments using a caliper to the nearest millimeter.
9. Once the fragment is measured, swim over the plot looking to the next coral fragment. Looking for plastic tags also speeds up finding the monitored fragments.
10. Repeat Step 8 and 9 till all tagged fragments in that plot are measured. It is important to record the colony code or identifier so that the same fragments and measurements correspond in subsequent monitoring.
11. Pictures of each measured fragment can be taken (top, bottom and side views) to create a visual timeline of the growing fragments, as well as to identify possible discrepancies, making it possible to back-track the fragment if the data deviates from what is expected.

Datasheet recommendation

A datasheet with date, location, plot number, colony code/tag number, coral species, health status category height, length, width and estimated ecological volume

(see Box above) is needed. The datasheet should have space for additional notes on the survival condition of the colonies (e.g. fouling organism).

Protocol for digital monitoring of coral growth

Today, digital photographs of coral colonies can be used to monitor coral growth using image software such as ImageJ (<http://imagej.nih.gov/ij/>). To accomplish this, digital top down photographs are taken periodically from a fixed photo frame with a scale, and top down area covered by live coral tissue. Live coral tissue area is measured with ImageJ v 1.0. For each image taken:

1. Measure how many pixels is the square side, so $X \text{ pixels} = 10 \text{ cm}$
2. Analyze tool > set scale > input distance in pixels and known distance in cm (10 cm), unit cm
3. For surface area, use irregular shape tool (looks like a heart)
4. Shape tool > click on the image and drag all around the outline of the coral, try to be as close to real specimen outline as possible, don't go too fast. Join the start and end outline drag.
5. Analyze tool > measure > window pops up with area.
6. Take area value, input on results table.

Note: remember to set the scale (square in image) every time you attempt to measure a new image.



An example of a photograph used for digital monitoring of coral growth for later processing in Image J

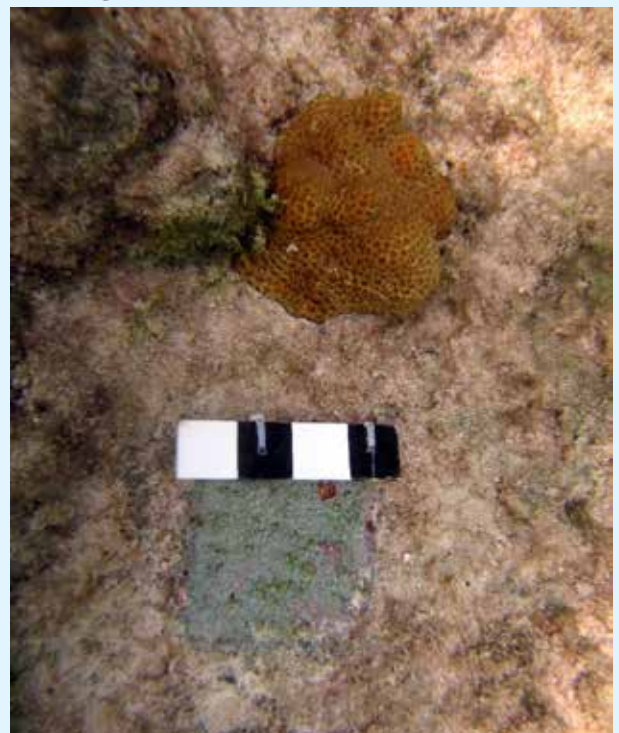

Recommended reading:

Recommended reading and further instructions:

- Watch this video for a quick introduction:

Using Image J to Measure surface area <https://www.youtube.com/watch?v=Qsxvnby7aCM>

- Read this paper to see Image J used in corals
Cummings et al 2015. Coral growth assessment on an established artificial reef in Antigua. *Ecological Restoration* 33 (1): 90-95

Monitoring for reef recovery and resilience

The restoration of damaged reefs via coral transplantation can particularly improve reef resilience by increasing coral cover, species diversity, coral reproduction capacity and local recruitment. When donor coral colonies are the survivors of previous bleaching events, coral gardening is considered as a strategy to increase the "spread" of bleaching resistance genotypes. The effectiveness of reef restoration efforts at increasing reef resilience or resistance to bleaching can only be assessed if the community structure of the transplanted site is periodically monitored.

There are many coral reef monitoring protocols available in the literature that can be used for assessing the effectiveness of a coral reef restoration project. The most appropriate protocol needs to be selected based on the logistics of the project, the expertise of the staff and the available resources. Notwithstanding the above, the protocol for resilience assessment of coral reefs outlined in Obura and Grimdstich (2009) is highly recommended (see Resources' chapter). This rapid assessment protocol focuses on climate change related impacts on coral reefs (e.g. coral bleaching and thermal stress) and includes a holistic approach to assessing reef resilience.

Debriefing

The dive leader should provide team members with an opportunity to debrief at a convenient time before operations are concluded for the day. During this time, each team can present and log their data and mention any procedural improvements or safety notes for general discussion which can be referred for further description during the weekly meeting.

Data entry

- All data entry should be completed on the day that the data was collected.
- All updated spreadsheets should be backed up on a portable storage device once data entry for the day is completed.
- Slates should be cleaned following the successful back up of data and made ready for subsequent use

6. Project Management and Evaluation

A coral reef restoration project is a complex endeavor. Thus, project management and evaluation are essential and should be incorporated regularly. We have found that conducting project management activities on a weekly basis is enough for running the project smoothly and without interference with field operations. Project

management can be used to assess and evaluate the project's performance as well as its lasting impact. This chapter provides some tasks that can be undertaken to manage and evaluate the restoration project. It roughly follows the entire project cycle.



Identification and preparation

Recommendations to motivate and structure your reef restoration project can be found in Chapter 1 and 2 of this Toolkit. In summary, we recommend that you consider the following when developing a coral reef restoration project:

- Ask yourself and your team: Is there a need for a reef restoration project? See Chapter 1 Figure 1.
- If your answer is yes, study all coral reef restoration techniques and evaluate which would be more suitable for your area. This Toolkit covers only methods related to the coral gardening concept. Other methods can be found in Precht (2006), Edwards & Gomez (2007), Johnson et al (2011), and other references included in the Resources section of this Toolkit.
- If you decide to follow the coral gardening concept, use chapters 2 and 3 of this Toolkit to prepare a project plan.

Presentation

The presentation phase of the project cycle refers to the time when you take your developed idea to government agencies, local communities and funders seeking permits, endorsements or resources to implement your project. It is recommended to subscribe to coral reef related mailing lists and newsletters to receive information on potential grant applications and other sources of funding and collaboration.

The format of the presentation (written application or oral presentation) will vary depending on who you are approaching. Regardless of who you approach and what format you use, keep the following in mind:

- **Research your target audience.** Make sure you know the person and the institution you are approaching. Think about what you can give to them (e.g. expertise) and what they can give to you (e.g. network of collaborators), besides the money.
- **A good idea is important, but a capable team is essential.** Make sure you reflect on the competence of your team as well as the necessity of the project.
- **Follow all detailed guidelines** for applying to calls for proposals or other sources of funding where written applications are requested.

Implementation

Once you have secured funding and your project is ready to start, long- and short-term planning of activities is very important. For long-term planning refer to Table 2 in Chapter 2. There you will find a list of activities and the time-frame to implement them. Short-term planning refers to daily and weekly tasks; these will include diving and non-diving activities. As the coral reef restoration project evolves, the importance and intensity of each task will shift. For example, at the start of a project short-term activities

will be focused on building the nursery mainframe, obtaining donor fragments and seeding the nurseries, whereas towards the end of a project, the focus will shift to monitoring transplantation success.

Regardless of the phase of the project, it is recommended to have a 30-minute team briefing on the tasks planned for the week at the start of each week (e.g. Monday morning). Keep in mind that most of the project field activities will be weather dependent. Thus, always be flexible and have an alternate plan. After returning from the sea, the day ends with the second part of the weekly meeting. In this part, activities completed the previous week, planned activities for the ongoing week and comparisons between work completed and pending are discussed in more detail. An example of a Reef Rescuers weekly work program, showing tasks planned for each day, can be seen in

Table 4. When planning weekly activities, it is helpful to:

- Check the weather forecasts for the week ahead.
- Divide the team into two or more teams and assign different tasks to each team.
- Rotate team members and tasks so that each team member has a chance to perform all tasks.

Field operations

During fieldwork at sea and at the laboratory it is helpful to refer frequently to a few key maps:

- Location of coral nursery site, and coral transplantation site
- Location of coral nurseries at nursery site
- Location of transplantation plots at transplantation site

Exposure to these maps helps the team to retain a mental image of each key location, a useful tool when completing work underwater. It is possible to print copies of the maps on waterproof paper and add them to the diver's equipment. However, we have found it is useful to minimize the number of accessories divers carry around particularly when experiencing strong currents. Therefore, repetitive exposure to the maps can be useful in lieu of carrying a set of underwater maps.

Tasks for diving operations

Assign and rotate different tasks for each team member. Daily tasks include (assign 1 or 2 people for each task):

- Filling tanks and compressor checking
- Setting team gear up before dive: SCUBA gear and other tools required
- Cleaning team gear after the dive day
- Capturing progress data (e.g. number and species of coral colonies transplanted, corals seeded into nursery, repaired nurseries)
- Capturing monitoring data (e.g. survivorship and growth data)

Table 4 Example of the Reef Rescuers weekly work program, showing tasks planned for each day. Letters in team rows correspond to name initials. N= nursery; M= Monitoring plot. Divers are indicated by their initials.

Day	Team
Monday	5 divers: PMO/SBE/SCL/KRO/NTA CRE Office / Mike boatman 1st Team: PMO/SBE/SCL; 2nd Team: KRO/NTA
Weekly meeting Part 1	
1st dive: 1st team: remove rope #9 to #13 from N12	
2nd dive: 1st team: transplantation in new plot 2nd team: rescue transplantation	
3rd dive: 1st team: transplantation in new plot 2nd team: rescue transplantation	
End of weekly meeting	
Tuesday	6 divers: PMO/SBE/SCL/KRO/CRE/NTA Mike boatman 1st Team: PMO/SBE/NTA; 2nd Team: KRO/CRE/SCL
1st dive: 1st team: checking all nurseries; remove rope #24 A. lamarcki from N12 2nd team: cleaning N8	
2nd dive: 1st team: transplantation in new plot 2nd team: monitoring transplantation success M1 & M2	
Wednesday	6 divers: PMO/SBE/SCL/KRO/CRE/NTA Mike boatman 1st Team: PMO/KRO/NTA; 2nd Team: CRE/SCL/SBE
1st dive: 1st team: remove rope #14 to #16, #18 and #19 A. formosa from N12	
2nd dive: 1st team: transplantation in new plot 2nd team: monitoring transplantation success M3 & M4	
3rd dive: 1st team: transplantation in new plot 2nd team: monitoring transplantation success M5 & M6	
Thursday	6 divers: PMO/SBE/SCL/KRO/CRE/NTA Mike boatman 1st Team: PMO/CRE/NTA; 2nd Team: KRO/SCL/SBE
1st dive: 1st team: remove rope #8 and #9 P. eydouxi from N11	
2nd dive: 1st team: transplantation in new plot 2nd team: growth rate and survivorship monitoring M1	
3rd dive: 1st team: transplantation in new plot 2nd team: growth rate and survivorship monitoring M2	
Friday	6 divers: PMO/SBE/SCL/KRO/CRE/NTA Mike boatman 1st Team: PMO/CRE/NTA; 2nd Team: KRO/SCL/SBE
6 divers: PMO/SBE/SCL/KRO/CRE/NTA Mike boatman 1st Team: PMO/CRE/NTA; 2nd Team: KRO/SCL/SBE	
2nd dive: 1st team: transplantation in new plot 2nd team: growth rate and survivorship monitoring M3	
3rd dive: 1st team: transplantation in new plot 2nd team: growth rate and survivorship monitoring M4	

Monitoring and evaluation

For project monitoring and evaluation, we recommend creating the following electronic files and updating them periodically:

- File 1: Daily achievements: It shows work completed, week by week, with itemized tasks (Table 5). Updated daily.
- File 2: Weekly work summary: Summary of work achieved to date, with pending work in the week ahead; it shows important deadlines to keep in mind. Updated once a week.
- File 3: Quarterly report: Document describing project progress over a three-month period. It is prepared pooling information from the two previous files, complies with funder/s requirements and quantifies progress of all project activities.

When preparing these three files, remember to include the following information:

- Nursery building/foundations reinforcement; checking, fixing and leveling; repairing, dismantling.
- Coral collection, fragmentation and nursery filling; algae cleaning; replacing dead fragments; preparing for nursery transfer; transferring nursery or rope.
- Transplantation site checking; transplanting; cementing.
- Donor and control colonies monitored at sites, coral survival and growth at nurseries; self-attachment of transplanted colonies; transplantation site success.

Table 5 Snapshot of Reef Rescuers 'Daily Achievements' file. Numbers in cells indicate the nursery number. Note that not all recommended activities are shown.

ACTIVITY	February									
	17	18	19	20	21	24	25	26	27	28
Monitoring of donor/control colonies	X									
Nursery checking, fixing & leveling		7/8				8/9	10/11			5
Collection, fragmentation & nursery filling										5
Survival monitoring in nursery										
Growth rate monitoring in nursery			11	9						
Transplanting	X	X	X	X	X	X	X	X	X	
Monitoring colonies self-attachment										
Coral Spawning or coral recruitment experiment	X		X		X					

7. Research Projects in Coral Reef Restoration

Coral reef restoration projects are great opportunities to conduct scientific research. The whole project can be considered an underwater laboratory where research questions on coral reproduction, coral growth, animal behavior and reef resilience can be addressed. In this section, we briefly describe one research project conducted during the Reef Rescuers project. This example and other research projects were added as

the restoration work developed. However, they can be incorporated as part of the planning or implementation phases of the project. Additional research projects can be found in the manuscripts produced during the Reef Rescuers project and published in peer-reviewed scientific journals (abstracts and links below).



Project: Assessment of coral recruitment

Background

The restoration of damaged reefs via transplantation of whole coral colonies or coral fragments can increase coral cover, species diversity, coral reproduction capacity and local recruitment. When donor coral colonies are the survivors of previous bleaching events, coral transplantation is considered as a strategy to increase the “spread” of bleaching resistance genotypes. Whether to improve reef resilience or resistance to bleaching, the long-term sustainability of active reef restoration can only be ensured if coral recruitment is enhanced. Either by the transplants becoming an additional source of recruits (Fig. 58) or by the attraction of recruits from elsewhere through settlement cues associated with the presence of coral transplants. Thus, quantification of coral recruitment on intervened sites could be used to assess the success of coral restoration projects.



Figure 58 A *Pocillopora* spat that settled onto a ceramic tile.

Objective

To investigate the effects of a coral transplantation project on scleractinian settlement and recruitment.

Information obtained

- Diversity of coral recruits
- Coral settlement (<1 cm; <6 months after spawning) and recruitment (<5 cm in diameter, >12 months) rates

Research hypothesis

Scleractinian coral settlement and recruitment rates will be highest at a healthy site and lowest at a degraded site, with a transplanted site showing settlement and recruitment rates higher than the degraded site but lower than the healthy site.

Methods

Study sites

Quantification of scleractinian settlement (spats <1 cm) and recruitment (colonies 1-5 cm) should be conducted at a transplanted, a degraded control and a healthy control site. The healthy control site is included to quantify differences in coral settlement and recruitment rates between the degraded and the transplanted sites in comparison to a healthy coral reef.

Coral Settlement

Start by monitoring coral reproduction in the study area to ensure that coral settlement rates are estimated at peak times. Field observations of gravid coral colonies can be conducted on the most ubiquitous coral species. Look for macroscopic signs of their reproductive stage (i.e. presence of unpigmented and pigmented eggs in coral fragments) (Fig. 59). Following these observations, deployment of settlement structures (e.g. tiles, described below) onto the reef can be planned for 1 to 3 months before the expected spawning season in the area. This deployment schedule should allow for the biological conditioning of the settlement structures.



Figure 59 Pink or red tissue (eggs) seen in fragments broken from corals are an indication of gravid colonies that are ready to spawn, normally within two weeks.

Coral settlement can be assessed using settlement tiles. Ceramic tiles can be independently placed either directly on the reef, on concrete blocks (Fig. 60) or on customized holding structures. It is recommended to use settlement structures of differing texture and orientation (Petersen et al. 2005) to meet the diverse settlement preferences of coral larvae. Deploy settlement surfaces or structures systematically onto the reef at different sites representing your entire area of influence. Make sure to deploy settlement structures within the same depth range across sites. The time that the tiles will be left underwater will depend on your restoration project and specific objective; however, it is recommended to leave the tiles at least three months after deployment to allow coral larvae to settle and grow. Once retrieved, tiles can be left to dry in the sun

for 24 hours and then rinsed with freshwater to remove any sediment. If available, bleach the tiles by soaking them in water containing 5 % bleach for 24 hours; this will make it easier to spot the spat/settlers. Visually examine each tile under a dissecting microscope to count and identify coral skeletons to family level, noting the position of settlement (e.g. underside, borders, etc.). Families of newly settled corals can be identified following Babcock et al. (2003).

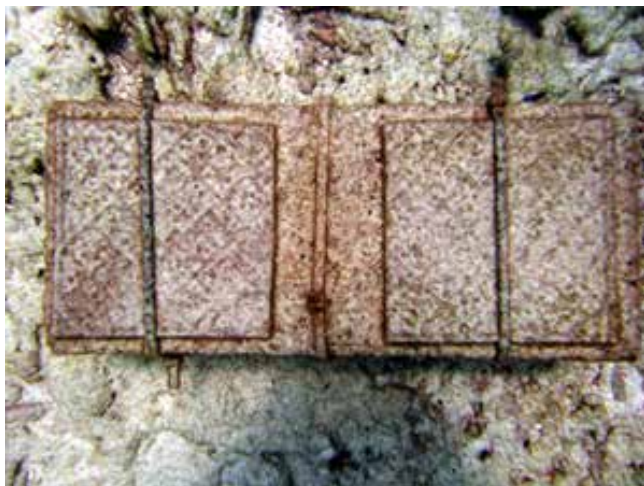

Figure 60 Example of a simple settlement structure. Concrete blocks can be deployed onto the substrate and ceramic tiles can be affixed to them with cable ties. The ceramic tiles will provide a settlement surface for the coral larvae.

Coral Recruitment

Coral recruitment sampling should be conducted several times during the transplantation stage (e.g. every six months) and continue, if possible, after transplantation is complete. Abundance and diversity of coral recruits at genus level can be quantified by counting the number of juvenile scleractinian corals (<5 cm in diameter; approximately 2 years old) within 1 m² quadrats. Lay six or more independent 10 m transects per site. Within each transect randomly place 3 quadrats for surveying coral recruit abundance (i.e. 3 study sites x 6 transects x 3 quadrats = 54 quadrats). The substratum of each quadrat is carefully examined for non-fragmented small colonies; any obstructive macro-algae is parted where necessary.

Materials

- Settlement structures (e.g. ceramic tiles)
- 1 m² PVC quadrat, split into smaller sections with rope
- Transect line/tape measure
- Dissecting microscope or other magnifying equipment for visual examination of settlement structures

Observer skills

Two observers that are familiar with adult coral identification to genus level (at least) are required. Should be able to distinguish known from unknown genus and to identify coral families down to small sizes of <5 cm.

Add-ons

- Measure the size of settlers and recruits using calipers. This information can be used to obtain size class distributions and population structure.
- Use an underwater camera and a smaller quadrat size to obtain photos of the substrate (i.e. photo-quadrats) for analysis in the lab. However, increase the number of smaller photo-quadrats in order to cover the entire 1 m² quadrats that would have been completed with in-water observers without the camera (see above). The photo-quadrat approach can save time in the field but will demand a higher amount of computer time for image processing.
- Collect small tissue samples from settlers and recruits and follow a molecular biology approach to identify the sources of coral larvae.

Reef Rescuers papers published to date

At the time of writing this Toolkit, 4 Reef Rescuers papers have been published in peer-reviewed scientific journals.

Frias-Torres S, Goehlich H, Reveret C, Montoya-Maya PH. (2015). Reef fishes recruited at midwater coral nurseries consume biofouling and reduce cleaning time in Seychelles, Indian Ocean. *African Journal of Marine Science* 37 (3): 421- 426 doi: 10.2989/1814232X.2015.1078259.

Journal: <http://www.tandfonline.com/doi/abs/10.2989/1814232X.2015.1078259>

Frias-Torres S, van de Geer C. (2015). Testing animal-assisted cleaning prior to transplantation in coral reef restoration. *PeerJ* 3:e1287.

Open Access: <https://peerj.com/articles/1287>

Montoya-Maya PH, Smit KP, Burt AJ, Frias-Torres S. (2016). Large-scale coral reef restoration could assist natural recovery in Seychelles, Indian Ocean. *Nature Conservation* 16: 1-17.

Open Access: <http://natureconservation.pensoft.net/articles.php?id=8604>

Frias-Torres S. (2017). Captive bred, adult giant clams survive restoration in the wild in Seychelles, Indian Ocean. *Frontiers in Marine Science* 4:97. doi:10.3389/fmars.2017.00097

Open Access: <http://journal.frontiersin.org/article/10.3389/fmars.2017.00097/abstract>

Literature cited

- Adger WN, Hughes TP, Folke C, Carpenter SR, Rockstrom J (2005) Social-ecological resilience to coastal disasters, *Science* 309: 1036 – 1039.
- Aronson RB, Precht WF, Toscano MA, Koltés KH (2002) The 1998 bleaching event and its aftermath on a coral reef in Belize. *Marine Biology* 141: 435–447.
- Baker AC, Glynn PW, Riegl B (2008) Climate change and coral reef bleaching: An ecological assessment of long-term impacts, recovery trends and future outlook. *Estuarine, Coastal and Shelf Science* 80: 435-471.
- Baums I (2008) A restoration genetics guide for coral reef conservation. *Molecular Ecology* 17: 2796–2811.
- Cesar HSJ, van Beukering PJH (2004) Economic Valuation of the Coral Reefs of Hawai'i. *Pacific Science* 58: 231-242.
- Edwards, A.J. (ed.) (2010). Reef Rehabilitation Manual. Coral Reef Targeted Research & Capacity Building for Management Program: St Lucia, Australia. ii + 166 pp.
- Edwards, A.J., Gomez, A.D. 2007. Reef restoration concepts and guidelines: Making sensible management choices in the face of uncertainty. Coral Reef Targeted Research & Capacity building for Management Programme, St. Lucia, Australia, 38 pp (www.gefcoral.org).
- Glynn PW (1983) Extensive 'Bleaching' and Death of Reef Corals on the Pacific Coast of Panamá. *Environmental Conservation* 10: 149-154.
- Graham NAJ, Jennings S, MacNeil MA, Mouillot D, Wilson SK (2015) Predicting climate-driven regime shifts versus rebound potential in coral reefs. *Nature* 518: 94–97.
- Graham NAJ, Wilson SK, Jennings S, Polunin NVC, Bijoux JP, Robinson J (2006) Dynamic fragility of oceanic coral reef ecosystems. *Proceedings of the National Academy of Sciences of the United States of America* 103(22): 8425–8429.
- Graham NAJ, Wilson SK, Jennings S, Polunin NVC, Robinson J, et al. (2007) Lag effects in the impacts of mass coral bleaching on coral reef fish, fisheries, and ecosystems. *Conservation Biology* 21: 1291–1300
- Gössling S. 2002. Global environmental consequences of tourism. *Global Environmental Change* 12: 283-302.
- Grimsditch GD, Salm RV (2006). Coral Reef Resilience and Resistance to Bleaching. IUCN, Gland, Switzerland. 52pp.
- Grottoli AG, Rodrigues L J, Palardy JE (2006) Heterotrophic plasticity and resilience in bleached corals. *Nature* 440: 1186-1189.
- Harris A, Wilson S, Graham NAJ, Sheppard C (2014) Scleractinian coral communities of the inner Seychelles 10 Years after the 1998 Mortality Event. *Aquatic Conservation* 24: 667–679.
- Hyde J, Chelliah AJ, Chen SY. 2013. Reef rehabilitation experiments: a review of results and lessons learned. Reef Check Malaysia, Jalan Ampang, Malaysia.
- Jennings S, Marshall SS, Polunin NVC (1996) Seychelles' marine protected areas: comparative structure and status of reef fish communities. *Biological Conservation* 75: 201-209.
- Johnson ME, Lustic C, Bartels E, Baums IB, Gilliam DS, Larson L, Lirman D, Miller MW, Nedimyer K, Schopmeyer S. 2011. Caribbean Acropora Restoration Guide: Best Practices for Propagation and Population Enhancement. The Nature Conservancy, Arlington, VA, 54 p.
- Kleypas J A, Danabasoglu G, Lough JM (2008) Potential role of the ocean thermostat in determining regional differences in coral reef bleaching events. *Geophysical Research Letters* 35, L03613.
- Lindahl U (2003) Coral reef rehabilitation through transplantation of staghorn corals: effects of artificial stabilization and mechanical damages. *Coral Reefs* 22: 217-223.
- Mascarelli A (2014) Climate-change adaptation: Designer reefs. *Nature* 508, 444–446.

McClanahan TR, Ateweberhan M, Graham NAJ, Wilson SK, Ruiz Sebastián C, Guillaume MMM, Bruggemann JH (2007). Western Indian Ocean coral communities: bleaching responses and susceptibility to extinction. *Marine Ecology Progress Series* 337: 1-13.

Mumby PJ, Steneck RS (2008) Coral reef management and conservation in light of rapidly evolving ecological paradigms. *Trends in Ecology and Evolution* 23: 555-563.

Obura D (2005) Resilience and climate change: lessons from coral reefs and bleaching in Western Indian Ocean. *Estuarine, Coastal and Shelf Science* 63: 353–372.

Precht WF. (Ed) (2006). *Coral Reef Restoration Handbook*. CRC Press, Boca Raton, FL. 384 pp.

Rinkevich B. (2006). The coral gardening concept and the use of underwater nurseries; lesson learned from silvics and silviculture. In: Precht WF (ed.), *Coral reef restoration handbook*. Boca Raton, Florida: CRC Press. pp 291–302.

SER (2018). Society for Ecological Restoration. Accessed 16 July 2018 <https://www.ser.org/>

Shafir S, Rinkevich B (2008) The underwater silviculture approach for reef restoration: an emergent aquaculture theme. In *Aquaculture Research Trends* (SH Schwartz, ed.), pp. 279-295, Nova Science Publishers, New York.

Shafir S, Van Run J, Rinkevich B (2006) Steps in the construction of underwater coral nursery, an essential component in reef restoration acts. *Marine Biology* 149: 679-687.

Shafir S, Edwards A, Rinkevich B, Bongiorni L, Levy G, Shaish L. 2010. Constructing and managing nurseries for asexual rearing of corals. In: Edwards AJ (ed.), *Reef rehabilitation manual*. St Lucia, Australia: Coral Reef Targeted Research and Capacity Building for Management Program. pp 49–72

Shareef R, McAleer M (2008) Modelling international tourism demand and uncertainty in Maldives and Seychelles: A portfolio approach. *Mathematics and Computers Simulation* 78: 459-468.

Sheppard C, Dixon DJ, Gourlay M, Sheppard A, Payet R (2005) Coral mortality increases wave energy reaching shoresprotected by reef flats: Examples from the Seychelles. *Estuarine, Coastal and Shelf Science* 64: 223-234

Soong K, Chen TA (2003) Coral transplantation: Regeneration and growth of *Acropora* fragments in a nursery. *Restoration Ecology* 11, 62-71.

Spalding MD, Jarvis GE (2002) The impact of the 1998 coral mortality on reef fish communities in the Seychelles. *Marine Pollution Bulletin* 44: 309–321.

Spencer T, Teleki KA, Bradshaw C, Spalding MD (2000) Coral bleaching in the southern Seychelles during the 1997–1998 Indian Ocean warm event. *Marine Pollution Bulletin* 40(7): 569–586.

Suding K. and 12 authors (2015). Committing to ecological restoration. *Science* 348: 638-640

Resources

In this last section, you will find several resources (e.g. literature, data forms, tasks outlines) that can be useful for your restoration project.

1. Literature

Status of the world and the basis for Restoration Ecology

Arnold SN, Steneck RS (2011) Settling into an increasingly hostile world: the rapidly closing "recruitment window" for corals. *Plos One* 6: e28681.

Baker AC (2003) Flexibility and Specificity in Coral-Algal Symbiosis: Diversity, Ecology, and Biogeography of Symbiodinium. *Annual Review of Ecology, Evolution and Systematics* 34: 661–689.

Baker AC (2004) Corals' adaptive response to climate change. *Nature* 430: 741.

Epstein N, Bak RPM, Rinkevich B (2003) Applying forest restoration principles to coral reef rehabilitation. *Aquatic Conservation: Marine and Freshwater Ecosystems* 13: 387–395.

Goreau T, McClanahan T (2000) Conservation of coral reefs after the 1998 global bleaching event. *Conservation Biology* 14: 5–15.

Hughes TP et al. (2003) Climate change, human impacts, and the resilience of coral reefs. *Science* 301: 929–933.

Hughes TP et al. (2005) New paradigms for supporting the resilience of marine ecosystems. *Trends in Ecology and Evolution* 20: 380–386.

Mumby PJ, Steneck RS (2008) Coral reef management and conservation in light of rapidly evolving ecological paradigms. *Trends in Ecology and Evolution* 23: 555–563.

Rinkevich B (2005) Conservation of coral reefs through active restoration measures: Recent approaches and last decade progress. *Environmental Science and Technology* 39: 4333–4342.

Rinkevich B (2008) Management of coral reefs: We have gone wrong when neglecting active reef restoration. *Marine Pollution Bulletin* 56: 1821–1824.

Rinkevich B (2014) Rebuilding coral reefs: Does active reef restoration lead to sustainable reefs? *Current Opinion in Environmental Sustainability* 7: 28–36.

Shackelford N et al. (2013) Primed for change: Developing ecological restoration for the 21st century. *Restoration Ecology* 21: 297–304.

Shearer TL, Porto I, Zubillaga A L (2009) Restoration of coral populations in light of genetic diversity estimates. *Coral Reefs* 28: 727–733.

Shokry M, Ammar A. (2009) Coral Reef Restoration and Artificial Reef Management, Future and Economic. *The Open Environmental Engineering Journal* 2: 37–49.

Suding K. et al. (2015) Committing to ecological restoration. *Science* 348: 638–640.

Thomas CD et al. (2004) Extinction risk from climate change. *Nature* 427: 145–148.

Science-based coral reef restoration used by Reef Rescuers at Nature Seychelles

Guest JR et al. (2011) How quickly do fragments of coral "self-attach" after transplantation?. *Restoration Ecology* 19: 234–242.

Levy G et al. (2010) Mid-water rope nursery—Testing design and performance of a novel reef restoration instrument. *Ecological Engineering* 36: 560–569.

Lirman D, Miller M (2003) Modeling and Monitoring Tools to Assess Recovery Status and Convergence Rates between Restored and Undisturbed Coral Reef Habitats. *Restoration Ecology* 11: 448–456.

Lirman et al. (2010) Propagation of the threatened staghorn coral *Acropora cervicornis*: methods to minimize the impacts of fragment collection and maximize production. *Coral Reefs* 29: 729–735.

Shafir S, Rinkevich B (2010) Integrated long-term mid-water coral nurseries: A management instrument evolving into a floating ecosystem. *University of Mauritius Research Journal* 16: 365–386.

Shafir S, Van Rijn J, Rinkevich B (2006) Steps in the construction of underwater coral nursery, an essential component in reef restoration acts. *Marine Biology* 149: 679–687.

Shaish L et al. (2008) Fixed and suspended coral nurseries in the Philippines: Establishing the first step in the "gardening concept" of reef restoration. *Journal of Experimental Marine Biology and Ecology* 358: 86–97.

Reef restoration case studies

Ammar MSA, Amin E M, Gundacker D, Mueller WEG (2000) One Rational Strategy for Restoration of Coral Reefs : Application of Molecular Biological Tools to Select Sites for Rehabilitation by Asexual Recruits. *Marine Pollution Bulletin* 40: 618–627.

Baums I B (2008) A restoration genetics guide for coral reef conservation. *Molecular Ecology* 17: 2796–2811.

Biggs BC (2013). *Harnessing Natural Recovery*

Processes to Improve Restoration Outcomes: An Experimental Assessment of Sponge-Mediated Coral Reef Restoration. *PLoS ONE*, 8(6) e64945.

Boch CA, Morse ANC (2012) Testing the effectiveness of direct propagation techniques for coral restoration of *Acropora* spp. *Ecological Engineering* 40: 11–17.

Clark S, Edwards A J (1995) Coral transplantation as an aid to reef rehabilitation: evaluation of a case study in the Maldives. *Coral Reefs* 14: 201–213.

Edwards A J (Ed.) (2010) Reef Rehabilitation Manual. Coral Reef Targeted Research & Capacity Building for Management Program. St Lucia, Australia. p. ii + 166 p.

Edwards AJ, Gomez ED (2007) Reef restoration concepts and guidelines: making sensible management choices in the face of uncertainty. St Lucia, Australia: Coral Reef Targeted Research & Capacity Building for Management Programme. p. iv + 38 p.

Epstein N, Bak RPM, Rinkevich B (2001) Strategies for gardening denuded coral reef areas: The applicability of using different types of coral material for reef restoration. *Restoration Ecology* 9: 432–442.

Ferse SCA, Nugues MM, Romatzki SBC, Kunzmann A (2013) Examining the use of mass transplantation of brooding and spawning corals to support natural coral recruitment in Sulawesi/Indonesia. *Restoration Ecology* 21: 745–754.

Forrester GE et al. (2011). Evaluating methods for transplanting endangered elkhorn corals in the Virgin Islands. *Restoration Ecology* 19: 299–306.

Garrison V, Ward G (2008) Storm-generated coral fragments – A viable source of transplants for reef rehabilitation. *Biological Conservation*, 141: 3089–3100.

Gomez E D, Cabaitan PC, Yap HT, Dizon RM (2014). Can coral cover be restored in the absence of natural recruitment and reef recovery? *Restoration Ecology*, 22: 142–150.

Guest JR, Baria MV, Gomez ED, Heyward AJ, Edwards AJ (2014). Closing the circle: Is it feasible to rehabilitate reefs with sexually propagated corals? *Coral Reefs* 33: 45–55.

Heenan A, Simpson SD, Meekan MG, Healy SD, Braithwaite VA (2009). Restoring depleted coral-reef fish populations through recruitment enhancement: A proof of concept. *Journal of Fish Biology* 75: 1857–1867.

Herler J, Dirnwöber M (2011) A simple technique for measuring buoyant weight increment of entire, transplanted coral colonies in the field. *Journal of*

Experimental Marine Biology and Ecology 407: 250–255.

Horoszowski-Fridman YB, Izhaki, I, Rinkevich, B (2011) Engineering of coral reef larval supply through transplantation of nursery-farmed gravid colonies. *Journal of Experimental Marine Biology and Ecology* 399: 162–166.

Hyde J, Chelliah AJ, Yee CS (2013) Reef Rehabilitation Experiments: A Review of Results & Lessons Learned. Reef Check Malaysia. 26 p.

Johnson ME, Lustic C, Bartels E, Baums IB, Gilliam DS, Larson L, Lirman D, Miller MW, Nedimyer K, Schopmeyer S (2011) Caribbean *Acropora* Restoration Guide: Best Practices for Propagation and Population Enhancement. The Nature Conservancy, Arlington, VA, 54 p.

Lindahl U (2003) Coral reef rehabilitation through transplantation of staghorn corals: Effects of artificial stabilization and mechanical damages. *Coral Reefs* 22(3): 217–223.

McMurray SE, Pawlik JR (2009) A novel technique for the reattachment of large coral reef sponges. *Restoration Ecology* 17: 192–195.

Miller MW, Valdivia A, Kramer KL, Mason B, Williams DE, Johnston L (2009) Alternate benthic assemblages on reef restoration structures and cascading effects on coral settlement. *Marine Ecology Progress Series* 387: 147–156.

Moon KS, Tal A, Ronen B, Yariv S (2010) Gardening Coral Reefs: Development of New Methodologies for Coral Reef Restoration. The School of Marine Sciences, Mikhmoret, Ruppin Academic Center. August 2010.

Muko S, Iwasa Y (2011) Long-term effect of coral transplantation: restoration goals and the choice of species. *Journal of Theoretical Biology* 280: 127–38.

Okubo N, Motokawa T, Omori M (2007). When fragmented coral spawn? Effect of size and timing on survivorship and fecundity of fragmentation in *Acropora formosa*. *Marine Biology* 151: 353–363.

Okubo N, Taniguchi H, Omori M (2009) Sexual Reproduction in Transplanted Coral Fragments of. *Zoological Studies* 48: 442–447.

Petersen D, Hatta M, Laterveer M, Van Bergen D (2005) Ex situ transportation of coral larvae for research, conservation, and aquaculture. *Coral Reefs* 24: 510–513.

Precht WF (ed.) (2006) Coral Reef Restoration Handbook. CRC Press, Boca Raton. 363 p

Rinkevich B (2000). Steps towards the evaluation of

coral reef restoration by using small branch fragments. *Marine Biology* 136: 807–812.

Tortolero-Langarica JJA, Cupul-Magaña AL, Rodríguez-Troncoso AP (2014) Restoration of a degraded coral reef using a natural remediation process: A case study from a Central Mexican Pacific National Park. *Ocean & Coastal Management* 96: 12–19.

Reef monitoring

Green AL, Bellwood DR (2009) Monitoring Functional Groups of Herbivorous Reef Fishes as Indicators of Coral Reef Resilience A practical guide for coral reef managers in the Asia Pacific Region. IUCN working group on Climate Change and Coral Reefs. IUCN, Gland, Switzerland. 70p.

Obura D, Grimsditch G (2009) Resilience Assessment of Coral Reefs bleaching and thermal stress. IUCN working group on Climate Change and Coral Reefs. IUCN, Gland, Switzerland. 70p.

Wilkinson C, Green A, Almany J, Dionne S (2003) Monitoring coral reef marine protected areas: A practical guide on how monitoring can support effective management of MPAs (p. 68). Australian Institute of Marine Science and the IUCN Marine Program. 117p.

2. Web resources

The Global Restoration Network (GRN) a project of the Society for Ecological Restoration (SER) <http://www.globalrestorationnetwork.org/>

3. Field techniques

a. Knots

Anti-slip knot

This is the most commonly used knot on the project. It is used to: attach the ropes between the pipes and anchors; attach both the coral ropes and stretch ropes; and is generally a very useful knot to be able to bring out. For a 63mm Ø pipe, approximately a meter of rope is used to tie this knot properly.

- First, wrap the rope round the pipe 3 times (Figure 1), before wrapping the rope over itself (Figure 2).
- Second, the rope is brought under the pipe and through the newly created loop (Figure 3) and tightened to secure.

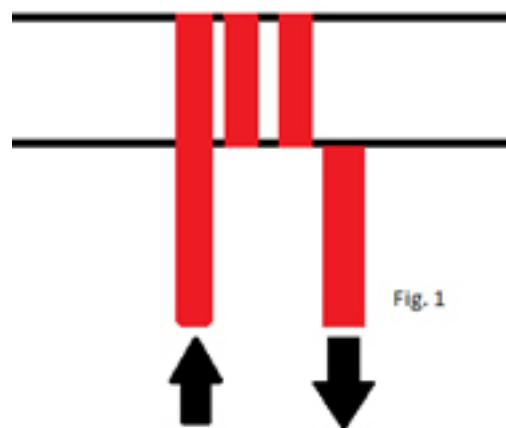

Figure 1 Anti-slip knot

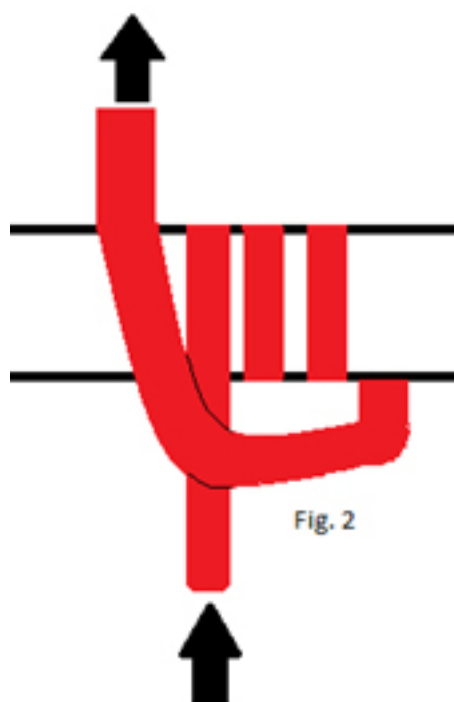

Figure 2 Anti-slip knot



Figure 3 Anti-slip knot

Cleat hitch

This is an essential knot for anyone working on or around boats. It is used whenever a boat moors, anchors, trawls, or when hanging something from the boat.

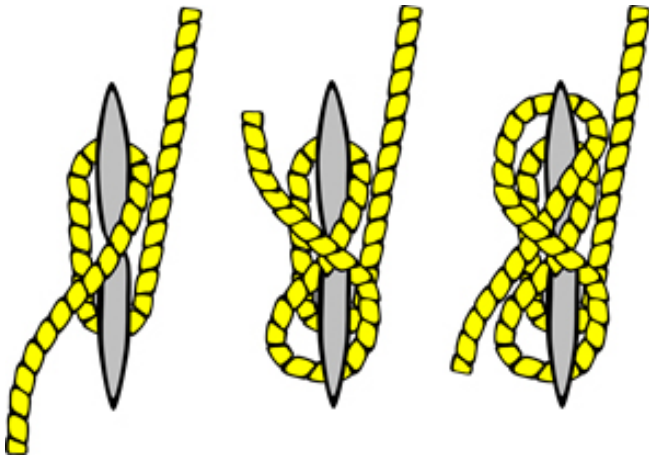

Figure 4 Cleat hitch

“Figure of 8” knot

This knot is mainly used when using any type of lift bag, or making a loop in the middle of a rope to hold any equipment being used, or using a pulley system to bring buoyant frames underwater (see building 6 m x 6 m net nurseries).

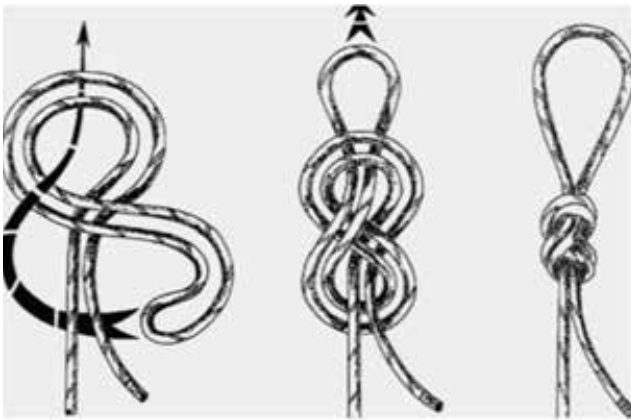

Figure 5 Figure of Eight Knot

Bowline

This is a very useful knot for many things. It creates a loop that will not slip and is very easy to undo. Therefore, the bowline is very useful for tying onto moorings or a temporary knot to hold something in place. This is a common knot that is taught to young people with a rhyme to help remember it, which may be similar to: “The rabbit comes up the hole, around the tree and back down the hole”. This diagram also shows a safety knot in ‘part c’ which is a good idea if the knot will be in place for a long time, but is not necessary.

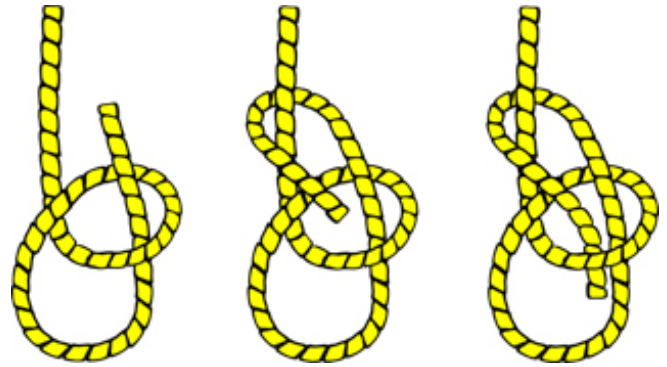

Figure 6 Bowline

Two Half Hitches

This knot is a ‘slip knot’ and so, will tighten around whatever you are tying, making it secure. It is therefore, very useful for hanging deco tanks as the knot will tighten around the cylinder valve making it secure.

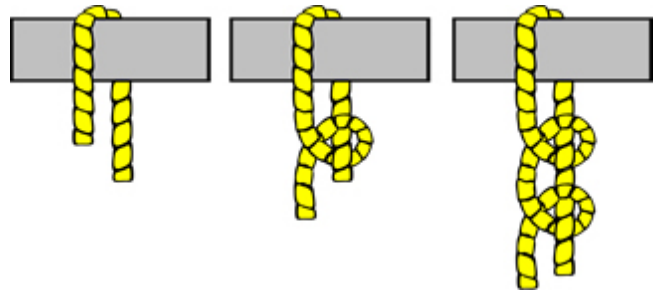

Figure 7 Half-Hitch knot

4. Funding sources

Sourcing funds for a reef restoration project is not an easy task. Potential funders will depend on the nature of the cause for degradation, natural or anthropogenic. On the one hand, initiatives seeking to restore degraded reefs due to coral bleaching can be funded by local and international organisations, focused on marine conservation and adaptation to climate change. Governments can also be approached to fund the restoration projects as they will assist governments in ensuring the livelihoods of their people. On the other hand, the restoration of reefs damaged by ship groundings, oil spills, or development projects can be conducted with funds from the companies causing the damage if an appropriate legal framework exists. However, intervening with such damaged reefs cannot be considered as ‘true ecological restoration’ and rather, it will become a mitigation measure or rehabilitation action.

When no external funding can be secured or there is not enough to conduct a restoration project, additional funding can be brought into the project by means of developing and commercialising project-related products. For instance, consider this:

- Showcase your project online and ask for donations through a web portal.

- Create an 'Adopt-a-coral' campaign and offer people the opportunity to follow the colony or colonies they adopt through the whole process, from collection, growing, transplantation and monitoring.
- Develop diving opportunities where by individual divers can pay to see your work.
- Offer interested people the opportunity to gain experience on reef restoration by volunteering in your project; you can ask for some form of financial contribution.
- Develop educational programs whereby people will pay to get trained and certified in the type of reef restoration you do.

These are just some ways to seek additional funding. We recommend you to enrol an economist, marketing specialist and entrepreneur and brainstorm other funding alternatives. The sky is the limit!

Coral Reef Restoration Toolkit

A Field-Oriented Guide Developed in the Seychelles Islands

Edited By Sarah Frias-Torres, Phanor H Montoya-Maya, and Nirmal Shah

Published by: Nature Seychelles | The Centre for Environment & Education, Roche Caiman, P.O. Box 1310

Mahe, Republic of Seychelles | Email: nature@seychelles.net | www.natureseychelles.org

ISBN: 978-999-972-0-1

