

NOVAplus biogas

USER MANUAL



Producer:



**MRU · Messgeräte für Rauchgase
und Umweltschutz GmbH**

Fuchshalde 8 + 12

74172 Neckarsulm-Obereisesheim

Fon 07132 99620 · Fax 07132 996220

info@mru.de · www.mru.eu

Legal notices / Intellectual property rights comments

Original user manual

© 2023 by MRU

No part of this manual may be published in any form (print, photocopy, electronic media or any other publication form) without a written approval by the publisher.

All user trade marks and name mark descriptions, even those which are not marked as such, are properties of the respective owners.

Edition: 2023-03-10-V1.21.EN

Table of content

1	Information for product and safety	6
1.1.	Safety manual	6
1.2.	Safety precautions.....	6
1.3.	Ensure safety	7
1.4.	Important general information.....	9
1.5.	User guideline for rechargeable batteries.....	10
2	Introduction	11
2.1.	Intended use	11
2.2.	About us	13
2.3.	Packaging	14
2.4.	Return of hazardous materials	14
2.5.	Return of electronic equipment.....	14
3	Description	15
3.1.	Gas flow diagram.....	15
3.2.	Remote control unit (RCU).....	16
3.3.	Base unit	17
	Connectors depending on the options (gas cooler)	18
3.4.	Gas sampling probes	19
4	Operating	20
4.1.	Display.....	20
4.2.	Keypad.....	21
4.3.	Connection Remote control unit (RCU) to base unit.....	22
	Declaration of symbols.....	22
4.4.	Reset and Blink codes.....	24
4.5.	Menu structure.....	24
5	First usage	26
5.1.	Preparatory steps	26
5.2.	Analyzer settings	26
5.3.	Measurement settings.....	27
5.4.	Switch-On protection.....	28
5.5.	Print-out settings.....	28
5.6.	Bluetooth settings.....	29
5.7.	Setting date and time	29
5.8.	Configuring Measurement Programs	30
5.9.	Setting CO limit value	30
5.10.	Select fuel types and O ₂ reference.....	31
	Adding fuels to Fuel type selection.....	31
	Setting O ₂ reference.....	31

5.11. Defining user fuels type	32
5.12. Defining measurement windows	33
5.13. Configuring zoom window.....	33
5.14. Changing measurement program names.....	34
6 Preparing measurement	35
6.1. Ensure power supply	35
6.2. Automatic Auto off function.....	35
6.3. Measuring with grid power supply / Battery charging	35
6.4. Battery charge condition	35
6.5. Operating temperature	36
6.6. Connections and tightness	36
6.7. Automatic zero-point setting.....	37
6.8. Repeating the zeroing	37
7 Performing measurement	38
7.1. Select measuring program.....	38
7.2. Performing Biogas measurement.....	39
7.3. Flue gas measurement.....	40
7.4. Setting CO-limit (only with optional flue gas measurement)....	41
7.5. Storing measured values	41
7.6. Terminate measurement.....	41
7.7. Printing measurement results.....	41
7.8. Last measurement values	42
7.9. Pressure measurement	43
7.10. Differential temperature measurement.....	44
7.11. Performing measurements on CHP units (option)	45
7.12. Performing Auto-measurement (Option)	46
Auto-measurement incl. data logger	46
Semi-continuous Auto-measurement incl. data logger.....	48
Selecting sites	48
8 Data Storage	49
8.1. Organizing data storage	49
8.2. Calling up information about data storage	49
8.3. Site administration	50
Create new site	50
View sites.....	51
Searching site.....	51
Changing sites	52
Deleting sites	53
Data transfer using SD card (option).....	54
Importing sites	54
Exporting sites	56
Exporting combustion measurements.....	56
Exporting differential pressure measurements.....	57

8.4.	Measurements in Data storage	57
	Viewing Measurements.....	57
	Deleting Measurements.....	58
	Transferring measurements to SD-Card (Option)	59
9	Extras / Adjustments.....	60
9.1.	User definable Logo print out.....	60
9.2.	Service calibration menu	62
9.3.	Default settings	63
9.4.	Service values RCU / Service values Base unit	64
9.5.	Performing leak test	65
9.6.	Contents SD card.....	66
9.7.	Contents Analyzer info	67
	Options list remote control	67
	Options list base unit.....	67
9.8.	Self diagnostics	68
10	Maintenance and care	69
10.1.	Cleaning.....	69
10.2.	Maintenance.....	69
10.3.	Service messages.....	69
10.4.	Check/replace optional water stop filter	70
11	Appendix.....	71
11.1.	Technical data.....	71
	General Data	71
	Gas conditioning and sampling	73
	Measured values.....	73
	Calculated values.....	76
	Data communication.....	77
11.2.	Analysis and calculations	78
11.3.	Text input	79
11.4.	Asking user for decision.....	79
11.5.	Firmware update.....	80
11.6.	Troubleshooting	82
	Troubleshooting the analyzer.....	82

1 Information for product and safety

1.1. Safety manual

All general information and safety precautions of MRU products are listed in the supplied separate safety manual.

Therefore, this manual must be read and observed before the first use of the instrument.

Instrument-specific safety and warning requirements in this manual are prefixed before dangerous actions.

1.2. Safety precautions

The used categories of safety precautions are here explained once more



⚠ DANGER

Identifies an immediate, impending hazard that, if ignored, will result in severe bodily injuries or death.



⚠ WARNING

Identifies an immediate, impending hazard that, if ignored, may result in severe bodily injuries, material damage or death.



⚠ CAUTION

Identifies a possibly dangerous situation that, if ignored, may result in minor injuries.



ATTENTION

Identifies a possibly harmful situation that, if ignored, may result in damages to the device or its surroundings.



NOTE

Identifies user tips and other especially important information.

The explanation of safety notices:



⚠ CAUTION

HOT – danger of burns and fire hazards from gas extraction probe.

Physical harm and property damage can be caused.

► Cool down the probe tube.

1.3. Ensure safety

- ▶ Please read the user manual completely before the first use.
- ▶ Only use the analyzer for the intended use and within the parameters specified in the technical data.
- ▶ Do not use any violence.
- ▶ Avoid falls.
- ▶ Do not put the analyzer into use, if the housing, power supply unit or supply leads are damaged.
- ▶ Do not store the analyzer together with solvents. Do not use desiccants.
- ▶ Only carry out maintenance and service work on this analyzer as described in the User Manual. Observe the prescribed action steps.
- ▶ Operate the analyzer only in closed, dry rooms and protect it from rain and moisture.
- ▶ When operating the analyzer on mains power, operate it only with the mains adapter supplied
- ▶ The analyzer must not be located in the immediate vicinity of open fire or great heat.
- ▶ Do not use the metal tube of the gas sampling probe or other metallic parts / accessories as electrical conductors.
- ▶ Do not use the analyzer in or under water.
- ▶ The specified temperature range of the gas sampling probe must not be exceeded, otherwise the probe tube and temperature sensor will be destroyed.
- ▶ Moisture, being pumped out of the condensates trap can be slightly acidic. In case of skin contact IMMEDIATELY: clean affected parts of the body. Avoid getting liquid in eyes. Please carefully clean all parts that come into contact with the condensates.
- ▶ After measurement, vent the analyzer with ambient air and allow the probe to cool. A hot probe could cause burns or ignite flammable material.
- ▶ Electrochemical sensors are by their operating principle not only sensitive to the gas they are intended for, but for other gases as well. This cross sensitivity is compensated by MRU for the typical application of flue gas analysis. However, unusual high concentration levels of single gas components might lead to a reduced measurement accuracy of other gas components and to a temporary change of the sensitivity of sensors, which may require several hours recovery time. Especially concentration levels as high as several % for single gas components may affect the measurement of other gas components at ppm level. Those applications need to be discussed with MRU in detail

Biogas or other similar gases (landfill gas, bio-methane, coal seam gas etc) is containing flammable component CH₄ and toxic component as well (H₂S and CO₂).

Analyzers sample a certain volume of the biogas, and vent it to the ambient air.

For this reason, there are two aspects which must be considered:

- 1.) toxicity danger of sample gas
- 2.) flammable (explosion) danger of sample gas

1) Inhaling toxic gases is harmful to health and can even cause death in some cases.

- It is the responsibility of analyzer user to ensure that person is skilled and trained in safety aspects of gases being analyzed and procedures to follow while using this instrument.
- Local regulations for possible exposition to toxic gases have to be known by the user and obeyed by the user of the analyzer
- Using a personal gas detector inside the biogas plant is highly recommended since H₂S in higher (very dangerous concentration) cannot be detected by human nose. Only small concentrations around few ppm can be detected by human nose
- CO₂ gas is heavier than air and therefore operator shall avoid using portable biogas analyzer at underground levels. Beside of that CO₂ is also odourless!
- It is not allowed using the portable biogas analyzer in confined space or rooms without sufficient ventilation.
- Sample gas exiting the analyzer will flow in the ambient air and only outdoor use or forced ventilation rooms are suitable for using the portable biogas analyzer

2) Regarding flammable gases (e.g. CH₄ methane) and hazardous area of operating the instruments, user must also be able to recognize the area classification and be aware of using the instrument there. This area classification is country specific, please observe and notice it.

- MRU instruments may be operated in hazardous areas zone 2 by skilled users obeying local guidelines e.g. by using LEL gas detectors.

1.4. Important general information

This analyzer is not designed to be used for continuous measurements. Before using the analyzer verify the condition of the various parts of the analyzer, such as the probe, the ambient air conditions, the condensate separator, star filter and the connectors for damage and/or blockages. Depending on the state of the electrochemical sensors, the time taken to reach the operating status after switching on is 1 to 3 minutes (zeroing) or 4 to 9 minutes with an installed 2-gas cuvette

When starting up the analyzer it will take between 1 – 3 minutes to set to zero depending on the condition of the sensors and of ambient.

The minimum zeroing time of the analyzer to achieve correct measurement values can be expected by 1.5 minutes!

Caution: Exposure to acids; aggressive gases such as sulphur; vapours such as thinners, gasoline, alcohol and paint, etc. can damage, reduce the life of, or destroy the sensors.

The life of the sensors depends on how they are used, maintained and treated. Typical average life expectations are: O₂ - 2 years; CO - 2 - 3 years and NO - 3 years.

The use of the analyzer for regulatory purposes is subject to special regulations (for example a periodical examination of the analyzer). Please obtain the appropriate regulations from your local responsible authority.

1.5. User guideline for rechargeable batteries

NOTE



The rechargeable batterie is installed inside the analyzer and is not accessible to the end customer. However, the following instructions must generally be observed when handling lithium-ion rechargeable batteries.

- This rechargeable battery can only be used in this analyzer.
- Do not throw the rechargeable battery into a fire, charge it at high temperatures and store it in a hot environment.
- Do not deform, short-circuit or modify the rechargeable battery.
- The rechargeable battery must not be used in or under water.
- Do not expose the rechargeable battery to strong mechanical forces and do not throw it.
- Do not cut or squeeze the connecting cables of the rechargeable battery.
- Do not connect the (+) contact to the (-) contact or metal.
- Non-observance of the above guidelines can cause heat, fire and explosions

2 Introduction

- This manual enables you to understand and safely operate this MRU Analyzer.
- Please read this manual with great vigilance and get familiar with the product before using it.
- This analyzer may only be operated by competent personnel and for its intended use.
- Please pay special attention to all safety directions and warnings to prevent personal injuries and damaging of the product.
- We can't be held responsible for any injuries and/or damages that occur by not following the instructions in this manual.
- Always keep the manual near you when working with the analyzer, to be able to read instructions as needed. Please ensure to hand over all documents to when handing the analyzer over to others.

2.1. Intended use

The analyzer is used for:

- for BIOGAS simultaneous measurements of O₂, CH₄, CO₂, H₂S and optional the BIOGAS pressure
- optional for combustion measurements of the engine: O₂, CO, NO, NO₂ and CO₂ (NDIR) including the calculation of: mg/m³, NO_x as mg/m³ NO₂, true NO_x-measurement $NO_x = NO + NO_2$, referencing (normalisation) to user settable value

It can also be used (when optionals are activated or external equipment is used) for a number of measurement tasks, such as:

- Flow velocity measurement
- Differential measurement of pressure and temperature
- Combustibles detection with external HC sensor
- Automatic measurement with data logging

You will find a list of all options for this analyzer on our web page or you can contact MRU or our local representative. The NOVApplus BIOGAS Analyzer is available in different versions. This manual will describe all versions indicating optionals and features not always available on all versions.

The analyzer is specifically not intended as a safety device or personal protective equipment.

The analyzer should not be used as a warning device to warn people against the presence of harmful gases.

The analyzer must be used according to instructions for the intended use.

Our analyzers are checked according to the following regulations:

VDE 0411 (EN61010) and **DIN VDE 0701** before they leave the MRU GmbH factory.

MRU technical products are designed and manufactured according to **DIN 31000/ VDE 1000** and **UVV = VBG 4** of the professional guilds for fine mechanics and electrical engineering.

MRU GmbH assures that the analyzer complies to the essential requirements of the legal regulations of the member states of the electro-magnetic compatibility **(2014/30/EU)**

▲ WARNING



Risk from manipulations to the measuring device

Operational safety hazard

- ▶ Modifications or changes to the measuring device are not allowed.
-

2.2. About us

The analyzer is produced by the MRU GmbH in Neckarsulm, Germany (Founded in 1984), a medium sized company that specializes in developing, producing and marketing high quality emission monitoring analyzers. MRU GmbH produces a wide range of instruments, from standard analyzers up to tailor made industrial analyzers.



Plant 1: Sales, Service, R&D



Plant 2 (Production)

Fuchshalde 8 + 12

74172 Neckarsulm - Obereisesheim

GERMANY

Tel +49 71 32 99 62 0 (Front office)

Tel +49 71 32 99 62 61 (Service)

Fax +49 71 32 99 62 20

Email: info@mru.de

Site: www.mru.eu

2.3. Packaging

Save the original carton and packing materials to prevent damage in transit in case you need to return the unit to the factory.

2.4. Return of hazardous materials

Waste Disposal>Returns/Warranty - MRU GmbH is required to accept the return of hazardous waste such as electro-chemical sensors that cannot be disposed of locally.

Hazardous waste must be returned to MRU prepaid.

2.5. Return of electronic equipment

MRU GmbH is required to accept the return, for proper disposal, of all analyzers delivered after 13th of August 2005. Analyzers must be returned to MRU prepaid.

3 Description

3.1. Gas flow diagram

A partial volume of the biogas is sucked and analyzed using NDIR and electro-chemical sensors on its ingredients.

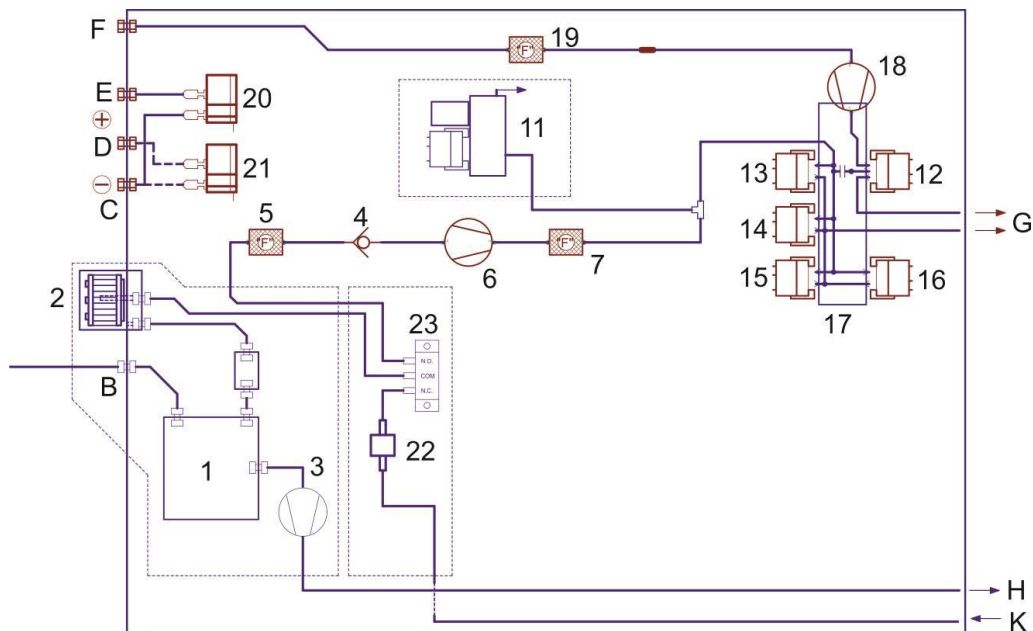

Position	Description	Position	Description
B	Gas inlet	7	Filter
C	Differential pressure -	11	NDIR bench
D	Differential pressure +	12	O2 sensor
E	Draft	13	CO sensor
F	Fresh air inlet	14	NO sensor
G	Gas outlet	15	NO2 sensor
H	Condensate outlet	16	SO2 sensor
K	Fresh air inlet for zeroing	17	Sensor chamber
1	Gas cooler	18	Purge pump
2	Star filter unit	19	Filter
3	Hose pump	20	Pressure sensor
4	Non return valve	21	Pressure sensor
5	Filter	22	Air filter
6	Gas pump	23	Valve for zeroing

3.2. Remote control unit (RCU)

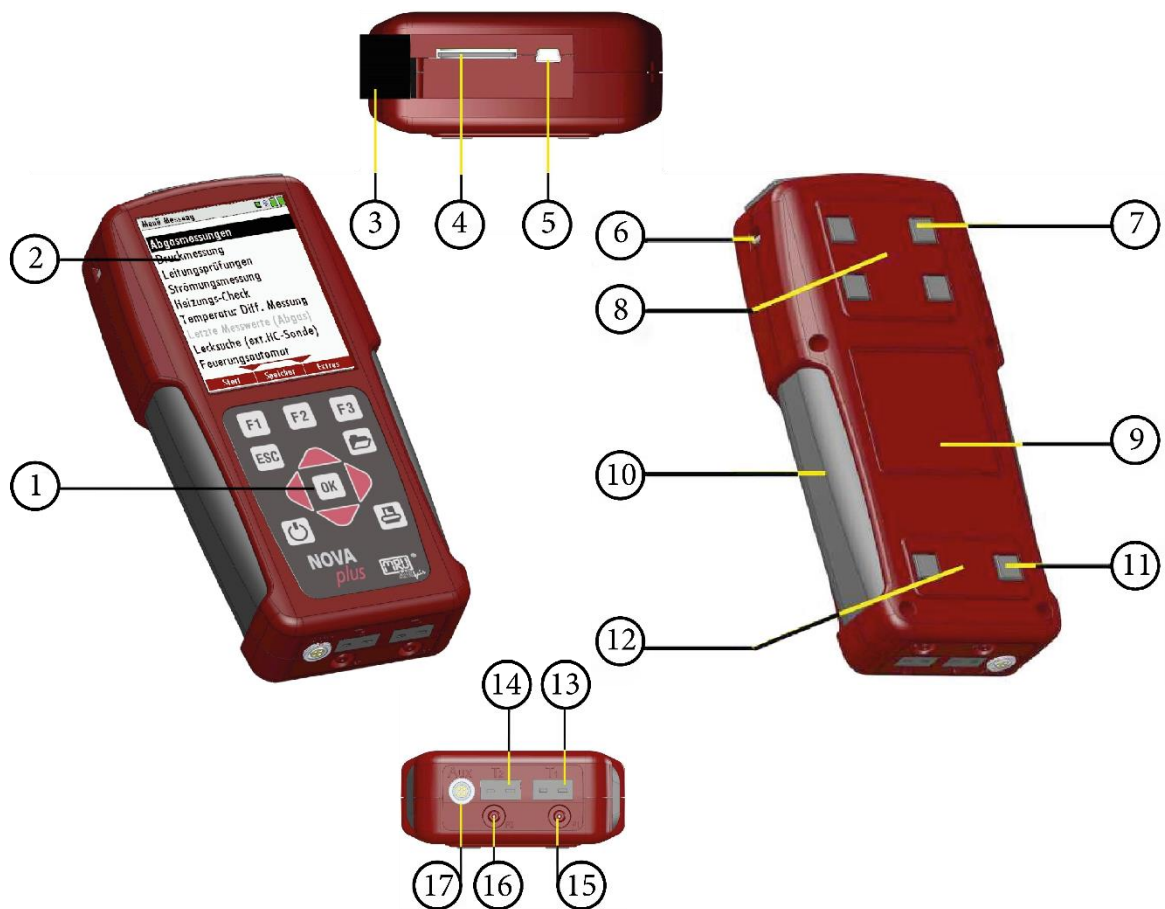

Position	Description	Position	Description
1	Keypad	2	Display
3	Cover	4	SD-card reader (only by using a MRU-SD-CARD we can assure the compatibility of all analyzer functions)
5	USB port	6	Eyes for shoulder strap
7	Analyzer feet	8	Fixing magnets
9	Contactless battery charging	10	Handle strip
11	Analyzer feet	12	Fixing magnets
13	Temperature connection 1	14	Temperature connection 2
15	Pressure connection 1	16	Pressure connection 2 (Diff. pressure)
17	AUX connector		

3.3. Base unit

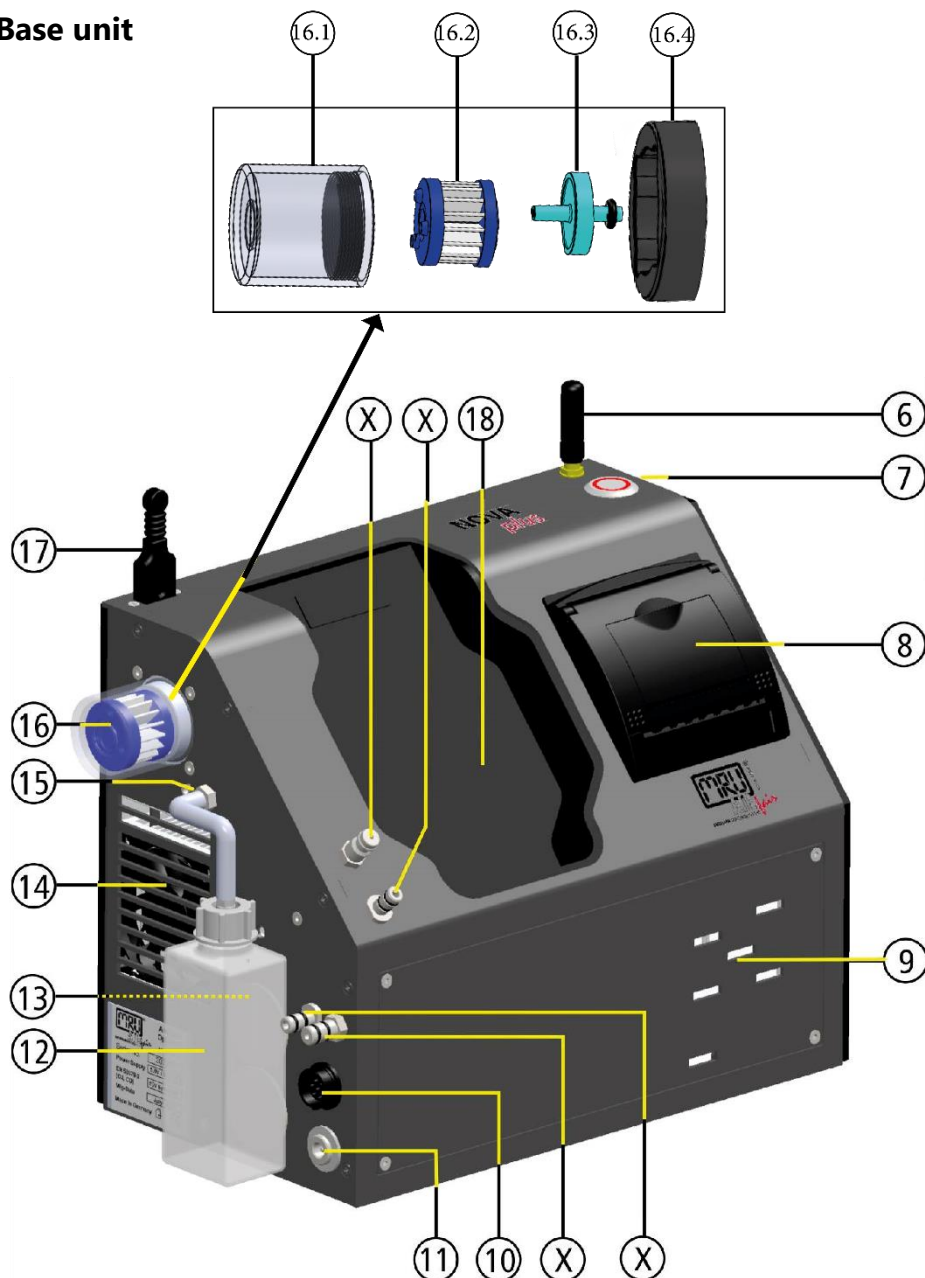

Position	Description	Position	Description
6	Aerial	16	Filter unit for gas cooler
7	ON-/OFF key button	16.1	Filter vessel
8	Built-in speed printer	16.2	Star filter
9	Gas outlet	16.3	Water stop filter (optional)
10	Connector T-gas	16.4	Filter holder on basic unit*
11	Charging socket	17	Connector T-Ambient air (combustion air)
12	Condensate container	18	Charging frame for Remote control unit
13	LED condensate container	X	Connectors see chapter Connectors depending on the options (gas cooler), Page 18.
14	Fan gas cooler		
15	Outlet for condensate		

NOTE

* Note on filter holder
Please note that the filter holder differs without option-ally installed water stop filter differs

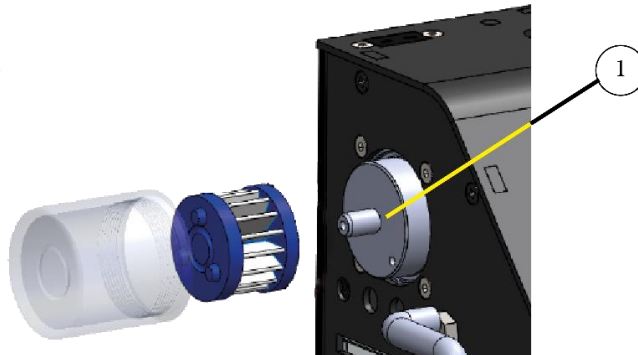

1	Filter holder without water stop
---	----------------------------------

Connectors depending on the options (gas cooler)

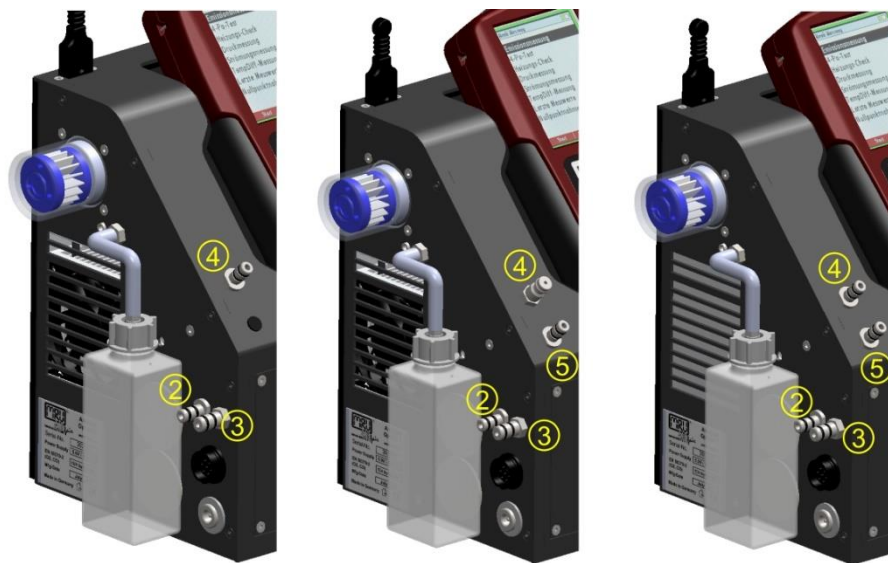

Connector	2	3	4	5
Models				
1 pressure sensor standard	draft / pressure -	gas inlet	pressure +	
TRGI Option pipe tests according TRGI	draft / pressure -	gas inlet	TRGI	pressure +
2 pressure sensors Option Diff. Pressure measurement with 2nd internal pressure sensor	draft	gas inlet	pressure -	pressure +

3.4. Gas sampling probes

The Analyzer is available with different probes, both with fixed and exchangeable probe tubes.

A complete list of available probes can be found in the current price list of this analyzer.

Below are two different probe types

Probe
with 300 mm probe pipe
(fixed) and 2,7m sampling line

Probe
with 300 mm exchangeable
probe pipe and 2,7 m sampling line

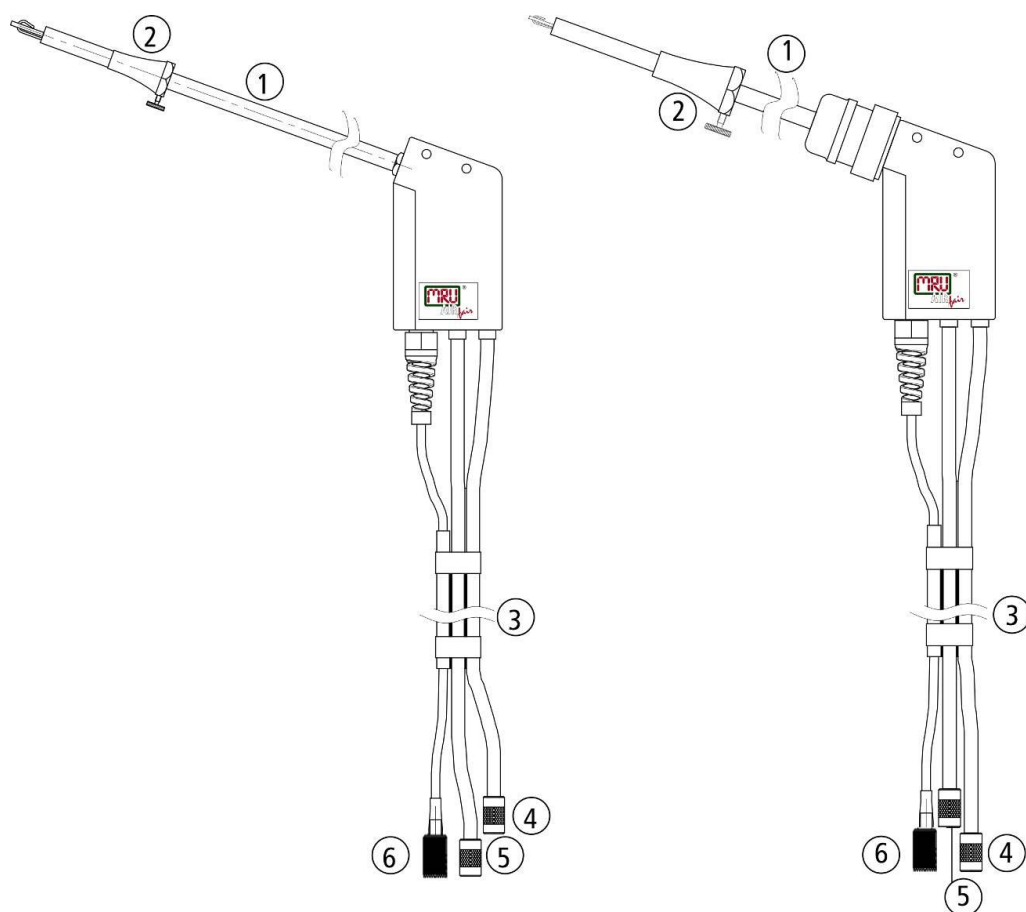

1	Probe tube
2	Probe cone (high grade steel)
3	Hose
4	Connector for sample gas measurement
5	Connector for draft measurement
6	Connector for temperature measurement

4 Operating

All information required to operate the analyzer is displayed as shown below.



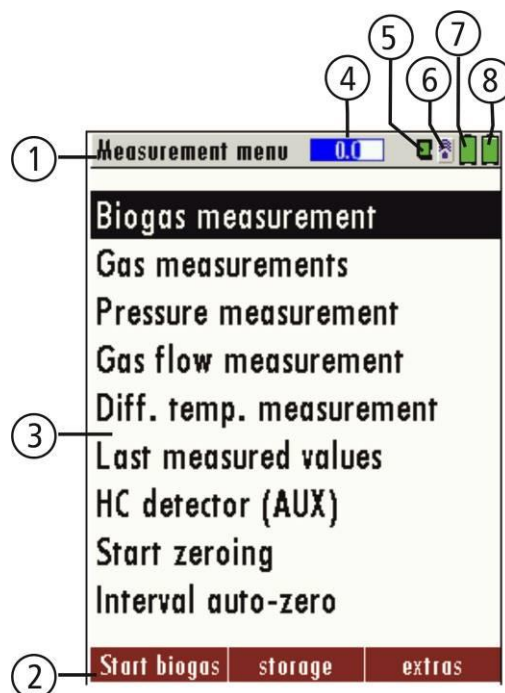



4.1. Display



1	Menu bar
2	Function key bar
3	Display panel Menu Measurement value,
4	Zeroing active
5	SD-Card in the slot Indication green Read- and write access Indication yellow only Read access (SD-Card write protected) Indication red SD-Card is damaged SD-Card is damaged
6	Blue: Bluetooth connection base unit to RCU Red: No Bluetooth connection base unit to RCU Yellow: Base unit is in the update mode (Press ON-key at the base unit for changing to the measurement mode)
7	Battery charge condition base unit
8	Battery charge condition RCU



4.2. Keypad

Description and function of the keys:

ON / OFF		<p>By pressing the ON/OFF button the RCU will start up without delay.</p> <p>By pressing the ON/OFF button the base unit and the RCU (if RCU is placed in the charging doc) will start up.</p> <p>The powering down of the unit is timely delayed to protect the sensors if there is no fresh air inside the system. If there is no fresh air inside the system the analyzer will recommend a purging of the sensors.</p>
Function Keys		Activates the functions seen on the display (2 function key bar).
Menu Key		Will show all available functions in the window that is currently in use – also those which have an individual key on the key pad like the printer and the three function keys.
ESC		Abort or return to the menu above
Arrow Keys		Jump in between lines, change values
OK		Confirmation key, select a marked menu point
Printer Key		Activates the print out of the measuring results in the measuring screen in a pre-defined format. Linefeed when there is no printable display condition:

4.3. Connection Remote control unit (RCU) to base unit

Declaration of symbols

Symbol	Description
	No Bluetooth connection base unit to RCU
	Base unit is in the update mode (Press ON-key at the base unit for changing to the measurement mode)
	Bluetooth connection base unit to RCU

If the connection breaks off base unit to RCU during a measurement, e.g., because of the distance, the symbol changes the colour from blue to red at the display of the RCU. The measurement in the base unit is not thereby broken off. As soon as the distance base unit to RCU decreases again the connection is rebuilt and the topical measuring values are indicated.

Connecting base unit to RCU

For connecting the RCU with the base unit select the menu settings/device info base



- ▶ Press F3.
- ▶ The menu Connection to base appears.
- ▶ Select an analyzer from the list or search (F3) for basic devices in the immediate vicinity



NOTE

Connection menu (the connection remote control <-> base unit is preconfigured)

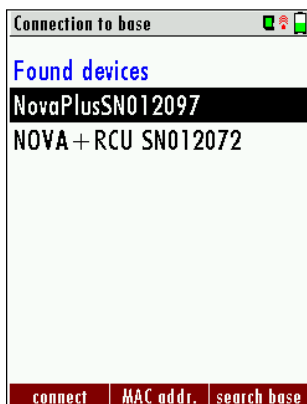

► Press F1, to connect to the base unit with the RCU.



NOTE

The name consists of NOVApplus and the serial number of the base unit.



MAC Addr.: display the Bluetooth address.

Search: All switched ON base units in the near environment will be displayed.

Delete list: Connection list will be deleted.

Disconnect: Existing connection will be disconnected with the F1

4.4. Reset and Blink codes

Reset of the RCU	press ESC and ON/OFF- button at the same time for a couple of seconds
Reset of the base unit	press ON/OFF- button for about ten seconds (LED switches off)
LED in ON/OFF- button in the base unit	
Illuminated constantly red	operating mode display
Flashes every five seconds	no connection with the RCU
Flashes every second	Software update active: Abort by using the ON/OFF- button

4.5. Menu structure

The analyzer organizes all available actions in three main Menus:

- **Menu Measurement**

All available measurement options will be displayed and can be selected here

- **Menu Storage**

All available storage options will be displayed and can be selected here

- **Menu Extra**

All other actions are available here to manage and customize the device.

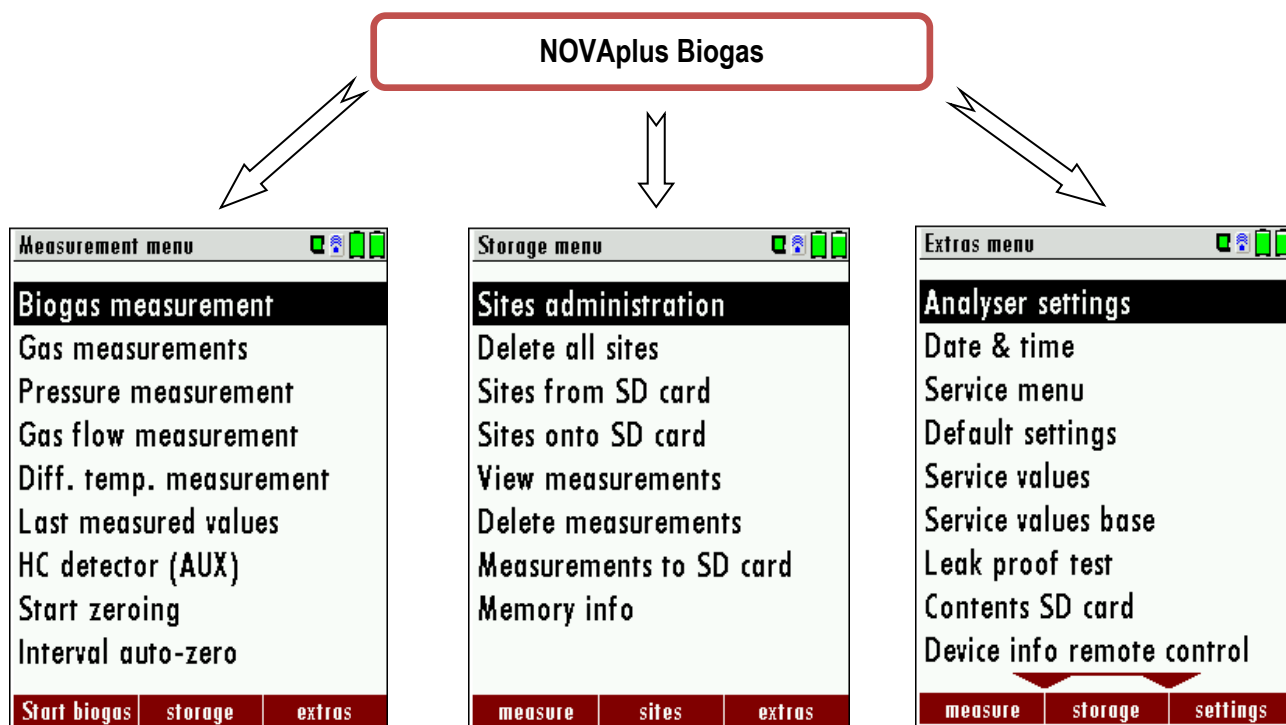

The topic „Biogas measurement“ is a standard feature in every analyzer and is explained in chapter 7.2 Performing Biogas measurement 39. Other menu points are optional and will be explained either in this manual or in an additional manual or flyer.

The Storage menu is explained in chapter 8 Data Storage, Page 49.

The Extras menu is explained in chapter 9 Extras / Adjustments, Page 60.

You can jump in between the 3 main menus with the 3 function keys (according to the displayed name on the screen).

5 First usage

After the analyzer has been inspected and is ready for start-up it can be switched on and personalized settings can be entered. These settings can be changed at any time.

5.1. Preparatory steps

- ▶ Unpack the analyzer.
- ▶ Read the User Manual completely.
- ▶ The analyzer leaves the factory assembled and ready for use. Nevertheless, check the device for completeness and integrity.
- ▶ Charge the battery of the analyzer for about 8 hours.
- ▶ Check date and time. Modify it needed.

5.2. Analyzer settings

The “Settings” menu allows configuring some instrument specific parameters.

In the main menu EXTRAS = F3 key - scroll down to Settings then press the OK key. By selecting a line, the parameter value can be changed by the arrow keys.

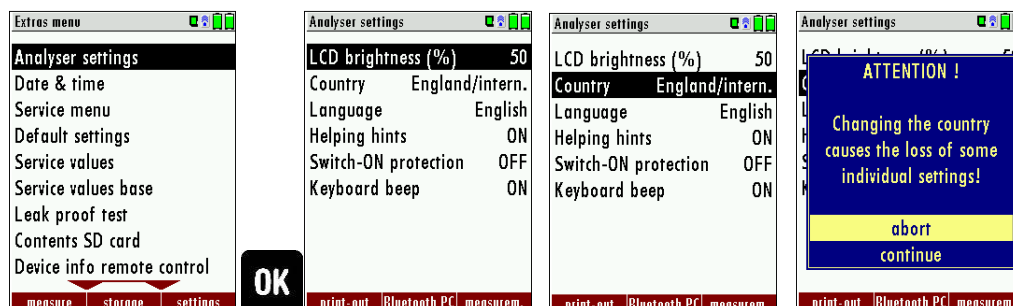

LCD brightness	5 – 100 %	Display-brightness, depending on the personal judgement of the user, at 20°C a value of ca. 50% is normal
Country	DE/GB/IT/FR/CZ/RO /TR/ ES/NO/HU/NL/PL/SI /RU/ LV/HR/JAP/	Enables some country specific parameters like fuel types, calculated values etc.
Language	DE/USA/GB/IT/AT/R O/ES/CZ/NO/TR/PL /HU/NL/FR/ SI/RU/CH	Select device languages
Helping hints	ON / OFF	Helpful hints activated or deactivated (explanation below)
Switch ON protection	ON / OFF	If activated and if ON key is pressed (possibly inadvertently), then the message „3 seconds OK key press displays
Keyboard beep	ON / OFF	Keyboard beeper activated or deactivated

5.3. Measurement settings

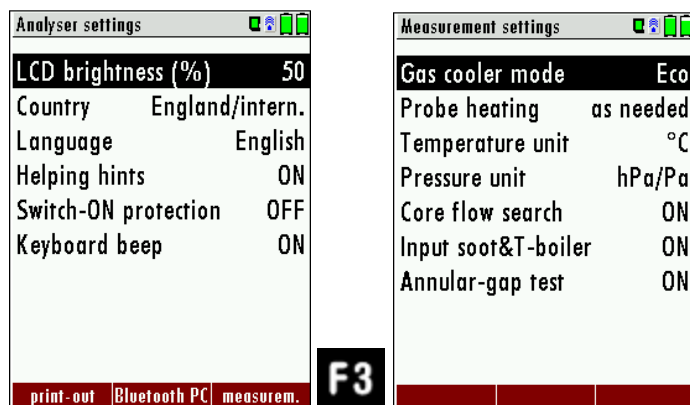

Gas cooler mode	Full / Eco	full: cooling up to approx. + 5 °C eco: cooling up to approx. 10 °C below ambient temperature (not under +5 °C!)
Probe heating	as needed / with mains	Probe heating is always switched on with mains, if the NOVApplus is connected to mains and is switched ON.
Temperature unit	°C or °F	Change the unit for temperature in all screens
Pressure unit	hPa/PA, hPa, kPa/Pa, kPa, mbar, mmH2O, cmH2O, inchH2O, mmHG, inchHG, PSI, Pa	Change the unit for pressure in all screens. The meaning of hPa/PA and kPa/Pa is that the instrument performs a dynamic change of unit depending on the absolute value of pressure.
Core flow search	ON / OFF	Core flow search before start of each flue gas measurement: activated or deactivated
Input soot & T-Boiler	ON / OFF	Input soot and T-boiler values for print-outs and/or storage: activated or deactivated
Annular-gap test	ON / OFF	Annular-gap measurement: activated or deactivated

Explanation for "Helping hints":

Some helpful hints which are very useful for an inexperienced user but are not needed by experienced users, can be activated or deactivated.

The following hints will be affected:

"Zeroing finished, Sensors are ready. Analyzer ready for measurement."

"Reminder! Charge batteries at regular intervals!"

"Measurement stopped/started."

5.4. Switch-On protection

If activated and if ON key is pressed (possibly inadvertently), then the message: „3 seconds OK key press “displays.

5.5. Print-out settings

The printout can be set in the Extra menu under the menu item analyzer settings.

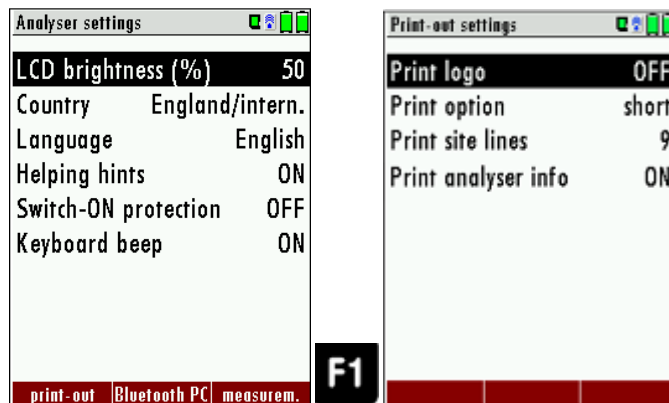

You can make the following adjustments in the menu Print-out settings:

Print logo ON/OFF	Print logo ☞ See also Chapter 9.1 User definable Logo print out, Page 60.
Print option short/long	Print-out without area for signature and site information
Print site lines 0...9	Line 1 (Site no.) is necessary, further lines (free text) printable if necessary.
Print analyzer info	To measuring print out can be shorter designed, while the device info will be left out. In some print outs (adjustment, service ...) the info will be printed forever

5.6. Bluetooth settings

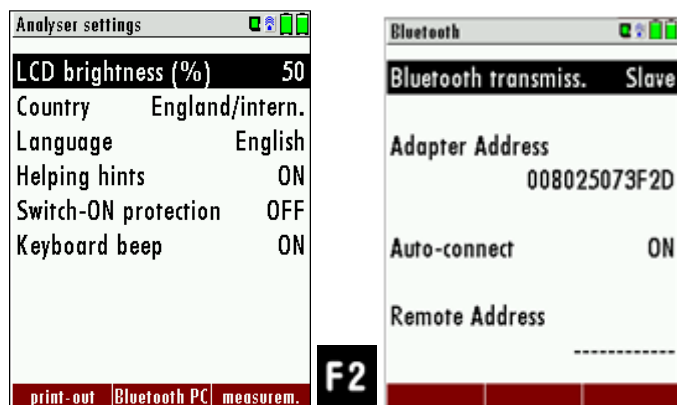

If RemoteData, OnlineView or MRUConnect (PDA) with Bluetooth is used, the SLAVE mode must be selected. The auto connect mode must be switched OUT.

5.7. Setting date and time

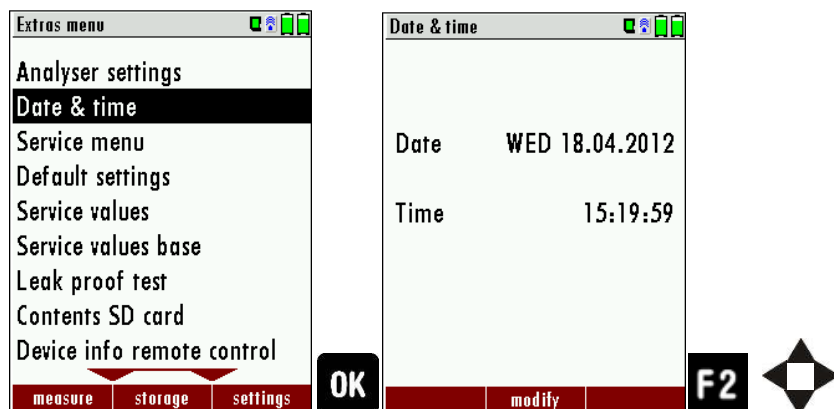

- ▶ Go to the Extras menu.
- ▶ Select Date and time.
- ▶ Press Ok.
 - ⇒ The Menu Date & time appears.
- ▶ Press F2.
- ▶ Set the desired date.
- ▶ Set the desired time.
- ▶ Press F2.
 - ⇒ The changes are stored.

5.8. Configuring Measurement Programs

Select one of the 6 configurable measurement programs.

For each of the programs the following parameters can be configured:

- CO ppm limit: adjustable value for the CO sensor protection. If the CO value in the flue gas is higher than the adjusted value in the analyzer, the purge pump will be activated and the sensor will be protected against high CO concentrations. (Optional)
- Selectable fuel types: choose and select from the available fuel type list
- Measurement windows: configuration of what and where will be displayed in the 3 measurement value windows.
- Zoom – window: select what will be displayed in the zoom - window
- Program name

The following programs have a pre-configured:

- „Flue gas measurement“ with CO – limit of 2000 ppm
- „CO measurement“ with CO limit of 2000 ppm
- „Annular-gap test“ for pure O2 and CO – display
- „Test program“ indented for use at instrument maintenance and calibration, without fuel selection

5.9. Setting CO limit value

The CO ppm limit can be adjusted in the window „Measuring program selection“. Select one of the available programs (arrow up/down) then press the F1 key.

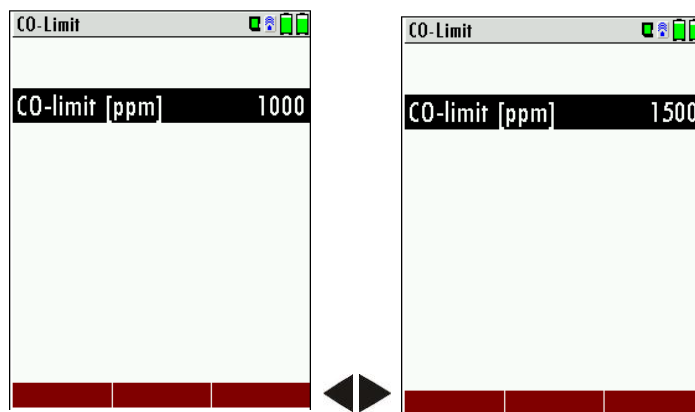

	The CO-ppm limit value can be adjusted in 100 ppm steps between 300 ppm and 4.000 ppm / 10.000 ppm
OK or ESC	Return to the measurement window

5.10. Select fuel types and O2 reference

Whenever a measuring program for flue gas measurements is called, a fuel can be selected from a list. Which fuel is available can be selected from a maximum fuel type list.

Adding fuels to Fuel type selection

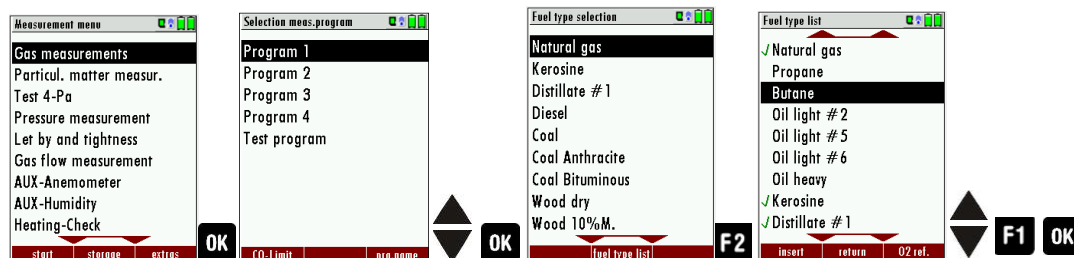

- ▶ Select Gas measurements.
- ▶ Press OK
 - ⇒ The menu Selection meas. Program appears.
- ▶ Select the desired Measuring program.
- ▶ Press OK.
 - ⇒ The menu fuel type selection appears.
- ▶ Press OK.
 - ⇒ The menu Fuel type list appears.
- ▶ Select the fuel which should be added to the menu Fuel type selection.
- ▶ Press F1.
 - ⇒ The selected fuel is marked with a check mark.
- ▶ Select other fuels if necessary.
- ▶ Press OK.
 - ⇒ The selected fuel is displayed in the menu Fuel type selection.

Setting O₂ reference

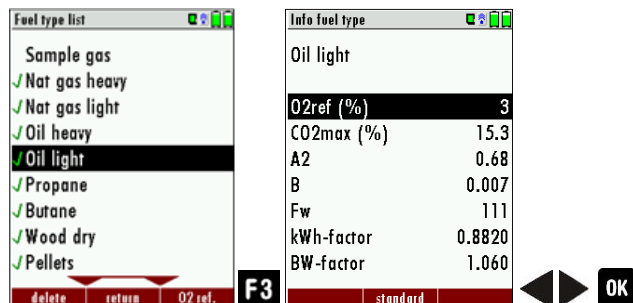

- ▶ Go to the Menu Fuel type list.
 - ☞ See also Chapter Adding fuels to Fuel type selection, S. 31.

- ▶ Select the desired fuel.
- ▶ Press F3
 - ⇒ The menu Info fuel type appears.
- ▶ Set the desired O2 reference.
- ▶ Press OK.
 - ⇒ The set O2 reference is saved.

5.11. Defining user fuels type

You can define four fuels to your individual needs. You can define the name and the fuel parameters. Like the other fuels, you can add user fuels to the menu Fuel type selection.

NOTE



The last 4 fuels in the menu Fuel type list are the user fuels. The user fuels are indicated in the menu Fuel Type list in green colour.

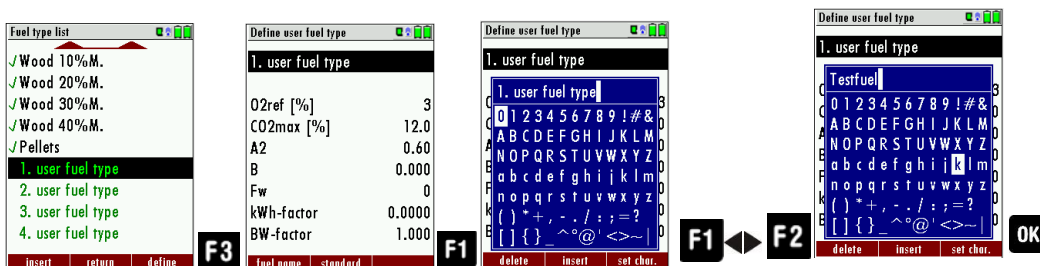

- ▶ Go to the menu Fuel type list.
 - ☞ See also Chapter Adding fuels to Fuel type selection, Page 31.
- ▶ Select the user fuel you want to define.
- ▶ Press F3
 - ⇒ The menu Define user fuel type appears.
- ▶ Press F1.
 - ⇒ A window appears.
- ▶ Change the name of the user fuel to your needs
- ▶ Press OK
 - ⇒ The changed name is displayed in the menu Define user fuel type.
 - ⇒ After you have changed the name of the user fuel, you can define the fuel parameters.
- ▶ Select the desired fuel parameter.
- ▶ Change the desired fuel parameter.
- ▶ Press OK.
 - ⇒ The defined user fuel appears in the menu Fuel type list
 - ⇒ You can add the defined user fuel to the menu Fuel type selection.
 - ⇒ See also Chapter Adding fuels to Fuel type selection, Page 31.

5.12. Defining measurement windows

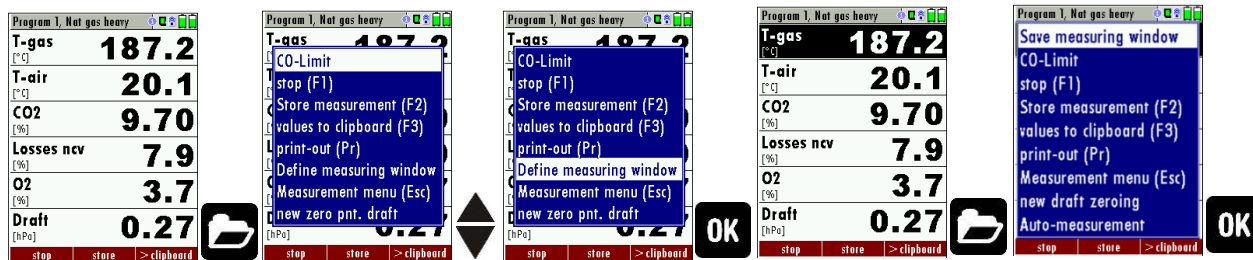

- ▶ Start a measuring program.
In this example Program 1, Nat gas heavy.
- ▶ Select one of three measurement windows
- ▶ Press the Menu Key
 - ⇒ A selection list appears.
- ▶ Select Define measuring window.
- ▶ Press OK.
 - ⇒ The measurement window appears.
- ▶ Select the desired measured value that you want to change.
- ▶ Press the Menu Key
 - ⇒ A selection list appears.
- ▶ Select Save measuring window.
- ▶ Press OK.
 - ⇒ The change is saved.

5.13. Configuring zoom window

Three zoom windows are available in each measuring program for the zoomed display of 2 measured values each. Which values are displayed zoomed is configurable.

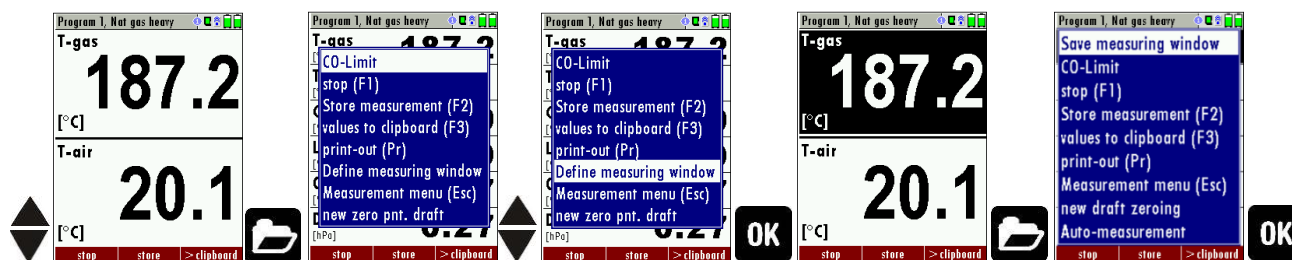

- ▶ Start a measuring program.
In this example Program 1, Nat gas heavy.
- ▶ Select the zoom function using the up / down arrow keys.
- ▶ Select one of three measurement windows.
- ▶ Press the menu key.
 - ⇒ A selection list appears.
- ▶ Select Define measuring window.
- ▶ Press OK.
- ▶ Select the desired measured value that you want to change.

- ▶ Press the Menu Key.
 - ⇒ A selection list appears.
- ▶ Select Save measuring window.
- ▶ Press OK.
 - ⇒ The change is saved.

5.14. Changing measurement program names

In the menu Selection meas. program, the name of the measurement program can be changed.

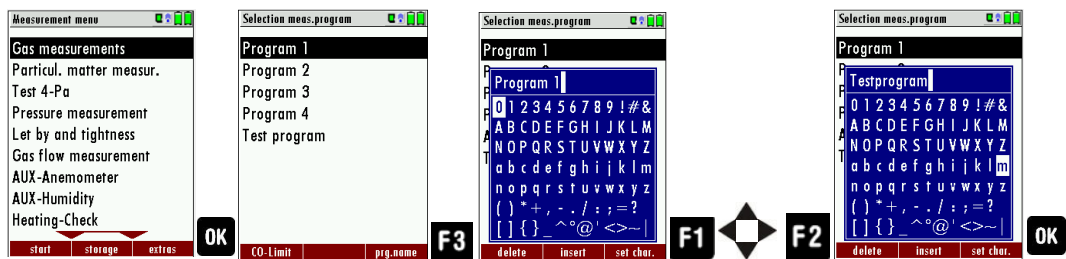

- ▶ Press OK
 - ⇒ The menu Selection meas. Program appears
- ▶ Press F3.
 - ⇒ A window appears.
- ▶ Change the name of the measurement program to your needs
- ▶ Press OK.
 - ⇒ The changed name is displayed in the menu Selection meas. program.

6 Preparing measurement

6.1. Ensure power supply

The analyzer can be used with:

1. with the internal MRU battery (provided)
2. with the MRU battery charger (provided)

External equipment may only be connected while the analyzer is switched off!

6.2. Automatic Auto off function

The instrument is automatically switched off after 60 minutes. During a measurement or a battery charging cycle the auto off is deactivated.



6.3. Measuring with grid power supply / Battery charging

Whenever you connect the base unit with external power supply (100 - 240 V / 50/ 60Hz) the battery of the base unit will be charged.

The battery of the Remote Control Unit (RCU) will be charged, if the RCU is in the charging frame of the mains connected base unit. The battery status screen will appear when the base unit is connected to the battery charger and the RCU is in its charging doc. This screen can also be manually opened with the menu button.

At the moment, if the battery is fully charged and the trickle charge mode begins an acoustic feedback will be played.

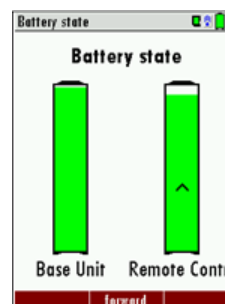

6.4. Battery charge condition

The battery symbols in the top right corner displays the current battery charge condition.

Approximately 15 minutes (depending on the analyzer configuration) before the battery is drained, the battery symbol (base unit or RCU) will start to blink red (about once per second).

If the battery is almost drained and the analyzer is not connected to the battery charger within one minute, then the analyzer will switch off automatically to prevent deep discharge of the battery.

6.5. Operating temperature

If the analyzer has been stored at low temperatures, it will require some time to equilibrate to the ambient temperature before being switched on. If it does not equilibrate, condensation will occur inside the analyzer! If the temperature is out of its operation range you will see the following messages on the display.

☞ See also Chapter 11.1 Technical data, Page 71.



ATTENTION

Once one of these messages appears you will not be able to use the analyzer, the zeroing doesn't start until it has reached the specified operation temperature.

6.6. Connections and tightness

Check all plug connections for correct fitting.

Check all hoses, hose connections, condensate containers (from the probe tip to the gas connection on the analyzer) for tightness.

The analyzer has a built-in automatic test to check the tightness of the gas paths.

☞ See also chapter 9.5 Performing leak test, Page 65.

6.7. Automatic zero-point setting



NOTE

The probe must not be in the exhaust gas during the zeroing

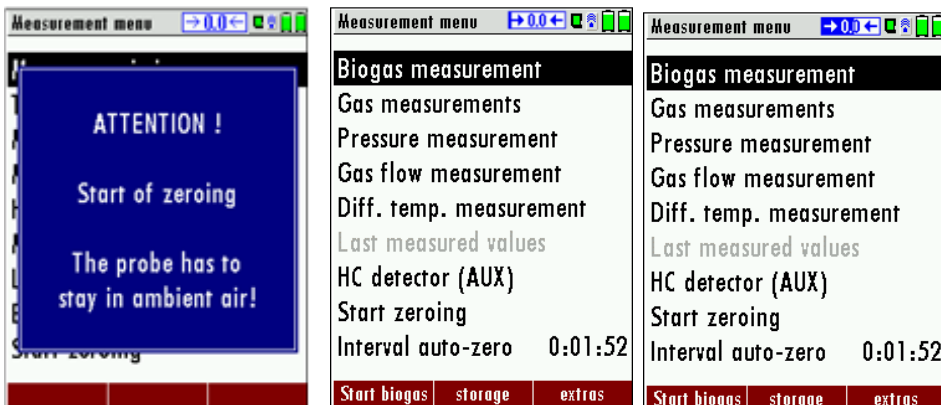

- ▶ Press the power button on the base unit.
 - ⇒ The analyzer performs a zero point measurement automatically.
 - ⇒ During zero point measurement, the -> 0.0 <- symbol flashes in the upper right corner of the display.
 - ⇒ After zeroing is completed, the self diagnostics follows (Leak proof test, sensor test, flow control and battery status).

The unit will display any error (for example defect sensor) that is detected during the self-test. With the ESC button you can delete any displayed error messages and then reach the measuring

6.8. Repeating the zeroing

The zeroing can be repeated at any time as long as the probe is not inside the stack. In the main menu you select "Zeroing", and after the displayed message press the OK key.

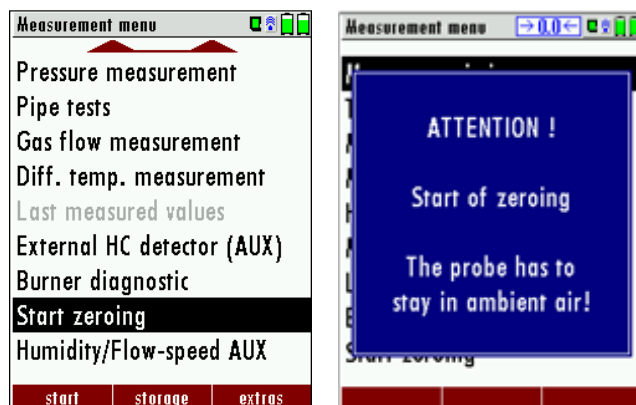

7 Performing measurement

Every NOVApplus BIOGAS is capable of making a complete BIOGAS measurement. How to perform this is described below.

7.1. Select measuring program

⚠ DANGER



Rick due to toxic gases

There is a risk of poisoning.
Noxious gases are sucked in by the measuring device and released into the ambient air.

- ▶ Only use the measuring device in well ventilated spaces.

NOTE



Wrong measuring results

The extracted flue gas must be able to evacuate the analyzer without obstruction.

- ▶ The exhaust outlet at the rear of the analyzer may never be covered during a measurement, never operate the analyzer in a transport case.

- ▶ Go the Measurement menu.
- ▶ Select the desired measurement program
- ▶ Press OK.
 - ⇒ The selected measuring program is started.

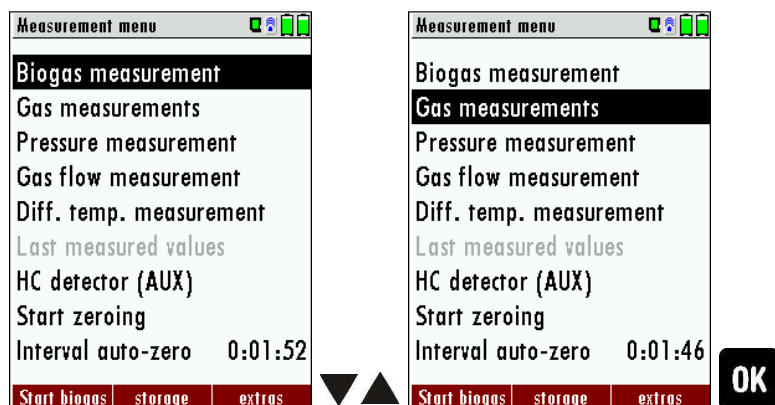

NOTE

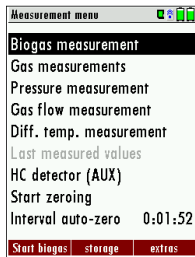

You can start a measurement with the previously set measurement parameters directly from the Measurement menu.

- ▶ Press F1.
- ⇒ The measurement is started.

7.2. Performing Biogas measurement

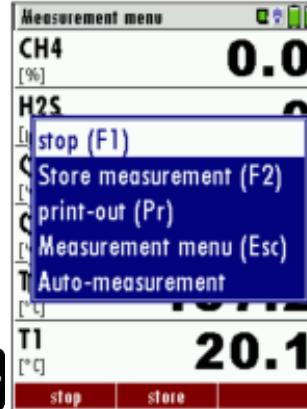
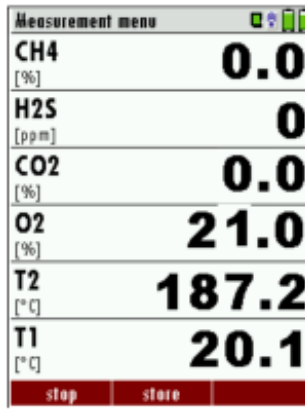
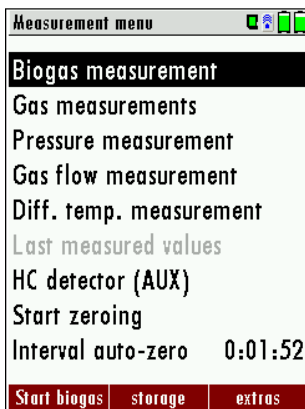

- ▶ Go to the Measurement menu
- ▶ Select Biogas measurement.
- ▶ Press OK.
 - ⇒ The Biogas measurement is started.
 - ⇒ If necessary, press the Menu key to stop the measurement, store it, make a printout, return to the Measurement menu or activate the Auto-measurement.

NOTE



Please refer also to the separate User manual of the Auto-measurement.

	Measurement: start / stop
	Menu key
	Store measurement
	Print display content
	Back to measurement menu

7.3. Flue gas measurement

Measurement values can be organized on three pages, each page displaying 6 measurement values.

The order of the display is operator settable.



There are direct measured values available such as Oxygen and Temperature as well as calculated values such as dew point, efficiency and CO₂. You will also find the same measurement value in different calculated values such as CO in ppm or CO in mg/kWh.

Values that cannot be displayed are indicated with dashes. Possible reasons for value not being displayed are:

- Electro chemical sensor was detected as defective during zeroing.
- External temperature sensors are not connected.

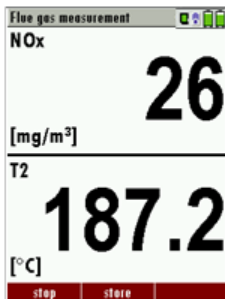

The measurement value T-Gas is usually read at the connector "T-Gas/AUX" (depending on configuration) or if not available from the connector "T1". (see chapter 6)

There are three measurement windows available, with the arrow keys left and right moving between them.

Zoom function, each with two values, is activated by moving the arrow keys up and down. Moving arrow keys left and right pages between the two zoom windows.

7.4. Setting CO-limit (only with optional flue gas measurement)

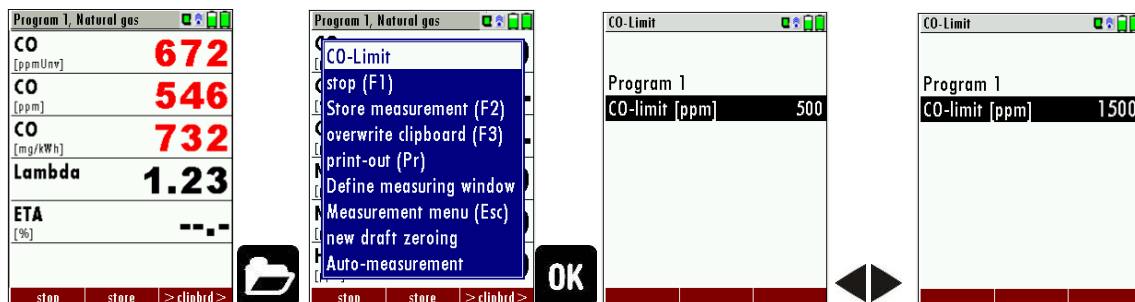

If the CO limit value is exceeded, the colour of the measured CO values changes (red).

7.5. Storing measured values

If in the function key bar "store" is indicated, you can store with the accompanying function key F2 or F3 the measurement in the data memory.

☞ See also Chapter 8 Data Storage, Page 49.

7.6. Terminate measurement

A current emission measurement can be stopped at any time with the F1 key. The display will change its colour and the measurement will be frozen. At the time you stop the measurement all measured values are still available and can be viewed at a later time.

Return to the measurement menu by pressing the ESC key.

☞ See also chapter 7.8 Last measurement values, Page 42.

7.7. Printing measurement results

Measurement results can be printed using the printer button. Printer line feed is activated when pressing the printer button outside of a measuring screen. All measurement values which are activated in the measurement screen will be printed (values which are selected more than once will only be printed once).



To change the printer paper, you pull out the little plastic recessed grip (2) which is mounted on the transparent printer cover (1). Insert the new printer roll and let the end of the paper stick out of the printer (+/- half inch). Close the printer cover (marking 3) using only with light pressure. Paper feed is activated using the printer button (when not in measuring window).

7.8. Last measurement values

The analyzer offers the possibility to continue working with the last measured values after the end of a measurement.

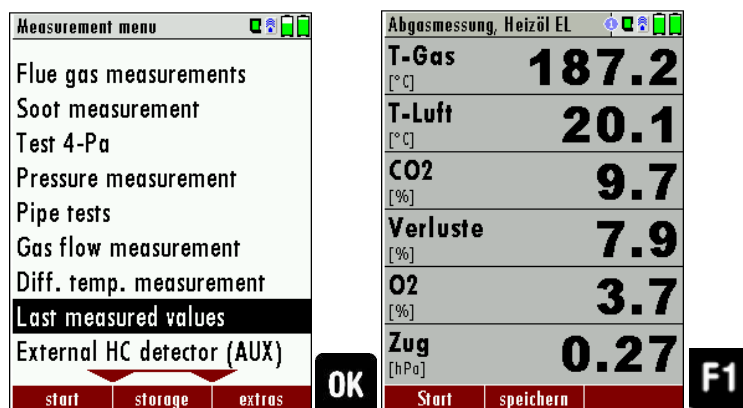

- ▶ Go to the Measurement menu.
- ▶ Select Last measured values.
- ▶ Press OK.
 - ⇒ The measured value window with the last measured values appears.
- ▶ Press F1.
 - ⇒ The measurement is continued.

7.9. Pressure measurement

Pressure (4 values) is measured and saved to the selected measurement name. The actual measured value is displayed in the middle of the display. The 4 measurement names can be changed as desired.

Rearrangement of the differential pressure sensors:

To be able to use the pressure sensors in the RCU (only Comfort Model) as well as the pressure sensors in the base unit a selection will take place using the arrow keys:

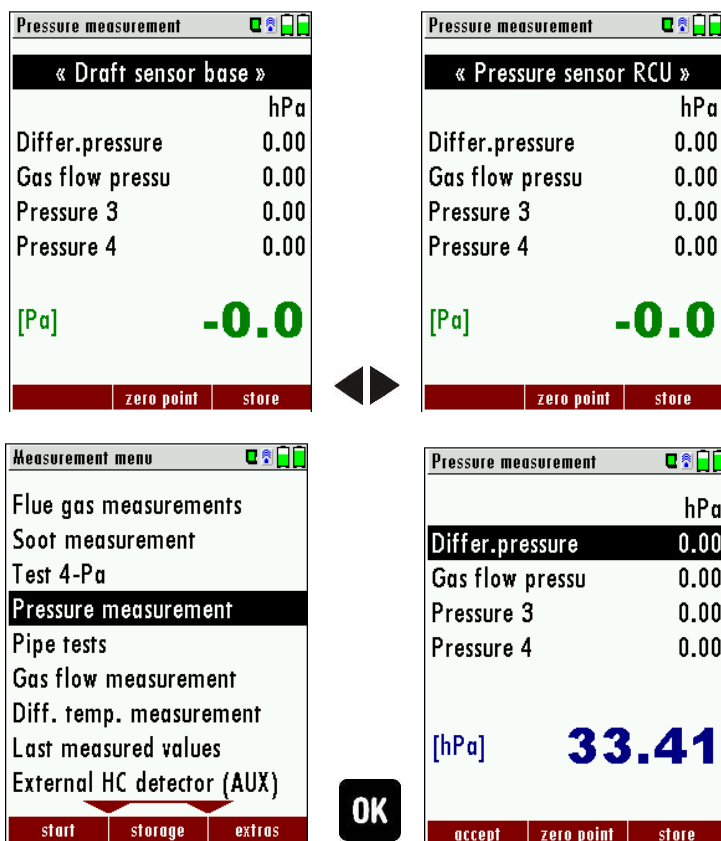

▲▼	Select the measurement name 1-4
F1	Save the measured value to one of the measurement name
F2	Zeroing the pressure sensor
F3	Change the name of the measurement category
ESC	Return to the measurement menu



NOTE

The pressure of the remote control (RCU) can also be displayed in the flue gas measurement.

7.10. Differential temperature measurement

The RCU (only comfort version) can display two temperature values in the menu Differential Temperature if two temperature sensors are connected to T1 and T2. The RCU will also calculate and display the differential temperature.

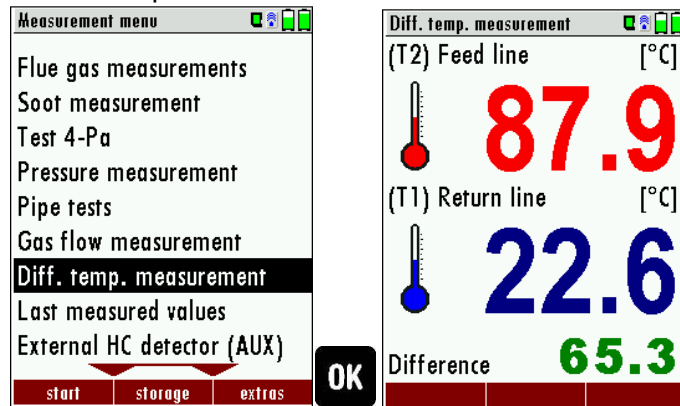

- ▶ Go to the Measurement menu.
- ▶ Select Diff. Temp. measurement.
- ▶ Press OK.
 - ⇒ The menu Diff. temp. measurement appears.
 - ⇒ The temperatures T1, T2 and the difference are displayed.



NOTE

The accuracy of the difference temperature measurement is guaranteed only on use of the MRU temperature sensors.

7.11. Performing measurements on CHP units (option)

With the option BHKW you can perform flue gas measurements on CHP (Combined heat and power) plants. If this option is installed in the analyzer there is an accessible Purafil-filter on the front of the analyzer. Due to high NO_x values in CHP measurements, an additional Purafil-filter is necessary to protect the analyzer.

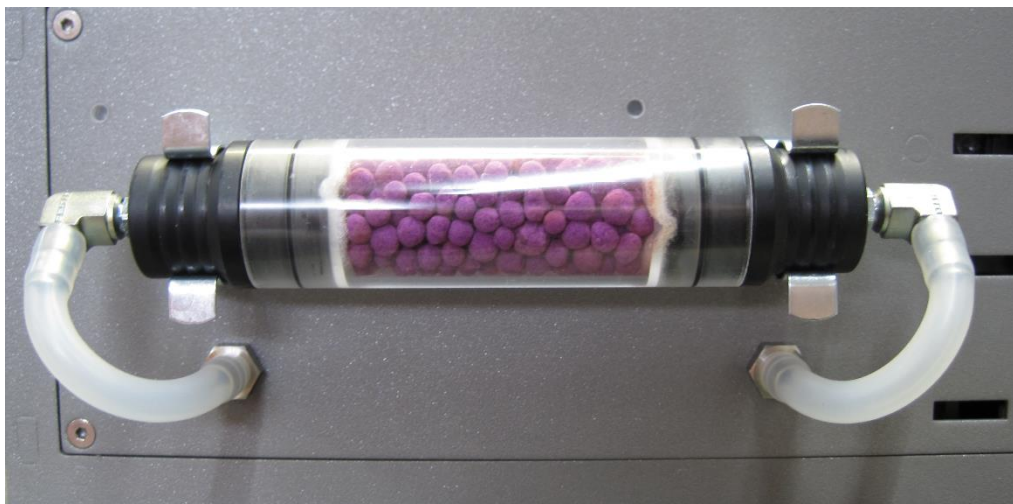

ATTENTION

Check the Purafil filter by performing a visual control before each measurement. Replace the Purafil filter if necessary, to protect the analyzer from high NO_x levels.



NOTE

► Note that depending on the installed options certain representations of menu items / measurements in this manual and the actual representation on your measuring device may differ

☞ See also Chapter 7.1 Select measuring program, Page 38.

7.12. Performing Auto-measurement (Option)

NOTE



We recommend a regular zeroing of the sensors. During long-term measurements the sensors may drift, resulting in a lower measuring accuracy until the next zero point is taken. How long can be measured without drift depends on the ambient conditions and the gas concentrations. Ensure that the filters do not clog during long-term measurements

Auto-measurement incl. data logger

With the option Auto-measurement, the analyzer can automatically log long-term measurements. You can customize the Auto-measurement settings to your individual needs. The data is saved in the internal data memory and can then be transferred to the SD card.

The size of the internal data memory is limited. Therefore, the ratio between total duration and interval is subject to limits if the automatic measuring system is to store values in the internal memory. If the memory requirement is too large, please reduce the measurement duration or increase the interval to minimize the memory requirement. If there is not enough free memory, please delete the internal data memory. When starting a measurement, the Auto-measurement is generally switched off. The Auto-measurement must be activated by the operator in the measuring window via the menu key. Please select Auto-measurement.

The total measuring time of the Auto-measurement is between 1 minute - 24 hours.

With the Auto-measurement function, the measurements can be both saved and printed out.

The following tables show how the memory and printing functions can be set.

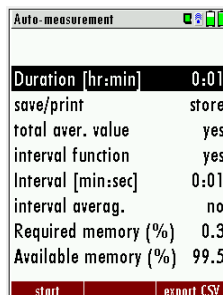
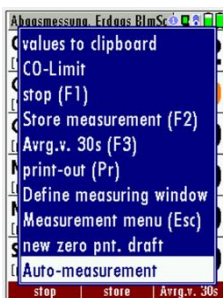

Printout Settings			
Total average value	Interval function	Interval average	Comment
Yes	Yes	Yes	the printout contains the mean values over interval and the Total average value
Yes	Yes	No	the printout contains the last measured values of the interval and the total average value
Yes	No	Yes/No	the printout contains the Total average value
No	Yes	Yes	the printout contains the mean value over interval
No	Yes	No	the printout contains the last measured values over interval
No	Yes	Yes/No	the printout contains the last measured values

Storage Settings			
Total average value	Interval function	Interval average	Comment
Yes	Yes	Yes	the mean values over interval and the Total average value are saved
Yes	Yes	No	the last measured values of the interval and the Total average value are saved
Yes	No	Yes/No	the Total average value is saved
No	Yes	No	only the mean values over interval are saved
No	Yes	No	the last measured values over interval are saved
No	No	Yes/No	the last measured values are saved

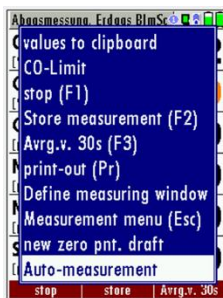

Semi-continuous Auto-measurement incl. data logger

A precondition for semi-continuous Auto-measurement is the option: Automatic zeroing and calibration of the analyzer art. no. 64198. The Auto-measurement must be activated by the operator in the measuring window via the menu key. Please select Auto-measurement. In semi-continuous mode, the minimum interval is 10 minutes. Average values are not possible. When the semi-continuous Auto-measurement is started, the following procedure is started:

purging / waiting/ sucking in gas / measuring

The "purging" phase takes 2 minutes each time.
The "sucking in gas" phase has a duration of at least 3 minutes
The "waiting" phase depends on the duration of the zeroing.

At the first start, the duration of the zeroing process is assumed to be 2 minutes. With the 2nd zeroing the time is measured how long the zeroing runs.

This will be considered in the next "waiting" phase.
In order to protect the electrochemical sensors, the valve is only switched to "gas" during "gas suction/measurement".

Selecting sites

The storage location in the internal data memory is the currently selected site. Select the desired site before you start the Auto-measurement. The site can be selected in the Storage menu under Sites administration. Use the RIGHT/LEFT keys to switch to the next or previous site.

- ☞ For details on the Data Storage refer to the User manual, chapter 8 Data Storage, Page 49.

8 Data Storage

8.1. Organizing data storage

Basis of the data memory of the analyzer is a set of sites stored in the device. Every site exists of a unique site number and 8 freely usable text lines which can have, e.g., the address, customer name etc.

The device can store up to 4000 different sites.

Sites can be created in the device and be changed, or could be imported from a PC program. Attention: sites created in the device and site data changed in the device will not be updated towards the PC. The device does only transmit to the PC the measurement values, but no information about site data.

Measurements are stored by assigning them to a site. Measurements can be, on this occasion, singles flue gas measurements or other measuring programmes available in the device.

8.2. Calling up information about data storage

In the menu item "storage" you select „memory info“ get information about the actual memory volume. The part of free memory, the total number of the stored sites and the number of the measurements stored all together, split in the kind of the measurement is listed.

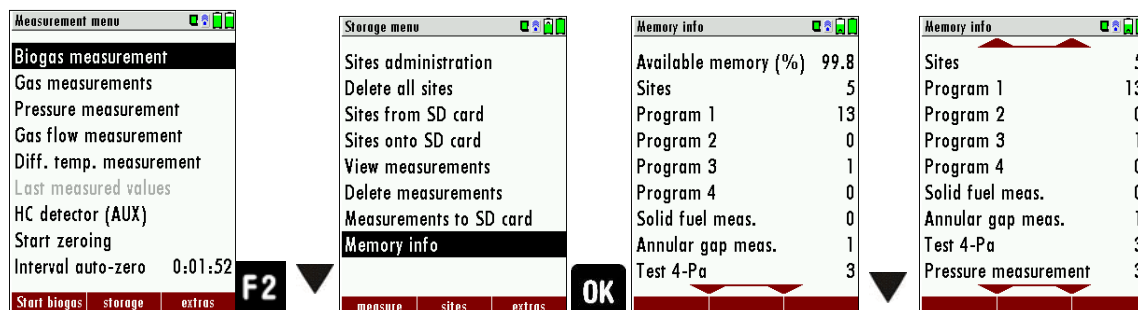

- ▶ Press F2
 - ⇒ The Storage menu appears.
- ▶ Select Memory info.
 - ⇒ The menu Memory info appears.
 - ⇒ Information about the data storage is listed.



8.3. Site administration

In the menu item "Sites administration" you are able

- view all data of the stored sites
- create new sites
- change date of existing sites
- delete sites

In the device new created sites and changes in the data of a site will not transmit to the PC back.

Create new site



- ▶ Go to the Storage menu.
- ▶ Press F2.
 - ⇒ The menu Sites administration appears.
- ▶ Press F1.
 - ⇒ The menu Modify site appears.
- ▶ Press F1 to assign manually a site number to the site.
- ▶ Press F2 to assign automatically a site number to the site.
 - ⇒ The site is assigned a site number.
- ▶ Select the free text lines that you want to edit.
- ▶ Press F1.
 - ⇒ A window appears.
- ▶ Enter the desired content.
- ▶ If necessary, select further free text lines and fill them with content.
- ▶ Press F3.
 - ⇒ The site is stored.

View sites

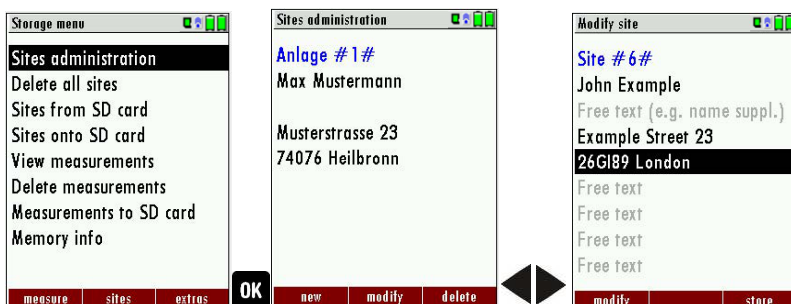

- ▶ Go to the Storage menu.
- ▶ Select Site administration.
 - ⇒ The menu Sites administration appears.
 - ⇒ Each stored site is displayed on a page with the coloured site number and eight additional free text lines.
- ▶ If necessary, scroll through the sites until you have found the desired site.

NOTE



You also have the possibility to search for sites by setting a search mask.

☞ See also chapter Searching site, Page 51.

Searching site

You have the possibility to enter certain parameters in order to search for particular sites. In the following example we will search for the site that is assigned to John Example.

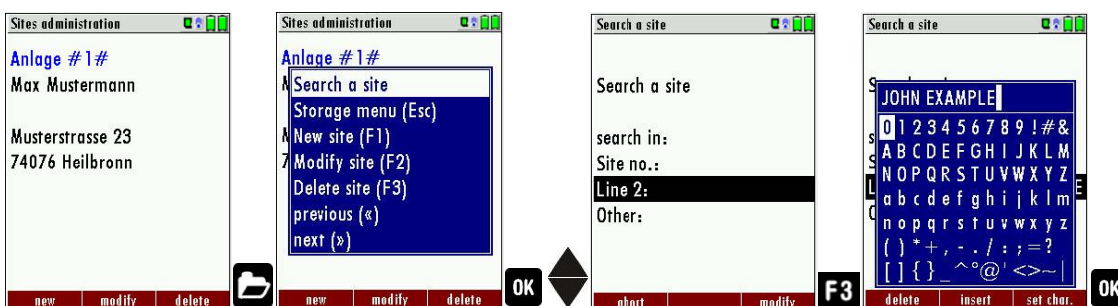

- ▶ Go to the Storage menu.
- ▶ Press the Menu Key.
 - ⇒ A selection list appears.
- ▶ Select search a site.
- ▶ Press OK.
 - ⇒ The menu Search a site appears.
 - ⇒ You can choose to filter by Site number, by content in Line 2 or for the rest of the other text lines.

- ▶ Select a line in which you want to search for content.
In this example, the search is performed in line 2.
- ▶ Press F3.
 - ⇒ A window appears.
- ▶ Enter the desired search term
In this example the search term is John Example.
- ▶ Press OK.
 - ⇒ The menu Search a site appears.
 - ⇒ The search term appears in the selected line.

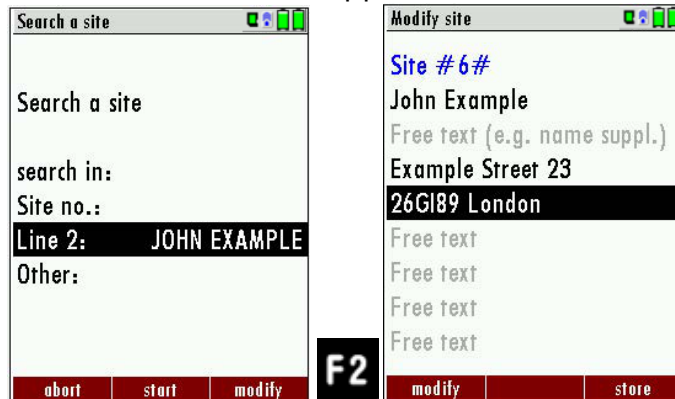

- ▶ Press F2.
 - ⇒ The site that is assigned to John Example is displayed. If several sites were found, the total number is displayed in the header and you can scroll through these found sites.

Changing sites



- ▶ Go to the Storage menu.
- ▶ Select Sites administration
- ▶ Press F2.
 - ⇒ The menu Sites administration appears.
- ▶ Select the site that you want to change
- ▶ Press F2.
 - ⇒ A bar appears.
- ▶ Select the free text lines that you want to change.
- ▶ Press F1.
 - ⇒ A window appears.
- ▶ Enter the desired changes.
- ▶ If necessary, select further free text lines and change the corresponding free text lines
- ▶ Press F3.
 - ⇒ The changes are stored.

Deleting sites

You can delete sites individually or delete all sites simultaneously

Deleting sites individually

You can delete sites individually or delete all sites simultaneously



- ▶ Go to the Storage menu.
- ▶ Select Sites administration.
- ▶ Press F2.
 - ⇒ The menu Sites administration appears.
- ▶ Select the site you want to delete.
- ▶ Press F3.
 - ⇒ A message appears.
- ▶ Select continue to delete the site
- ▶ Select abort to retain the site.
- ▶ Press OK.
 - ⇒ Depending on the selection, the site is deleted or retained

Deleting all sites

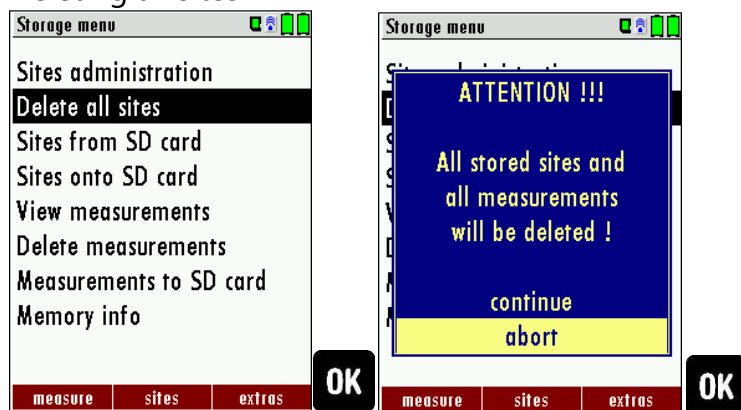

- ▶ Go to the Storage menu
- ▶ Select Delete all sites.
- ▶ Press OK.
 - ⇒ A message appears.
- ▶ Select continue to delete all sites.
- ▶ Select abort to retain all sites.
- ▶ Press OK.
 - ⇒ Depending on the selection, the site is deleted or retained

Data transfer using SD card (option)

The data exchange format is CSV. A character-separated values (CSV) file is a simple text format for a database table. Each record in the table is one line of the text file. Each field value of a record is separated from the next by a character. NOVApplus Combustion Analyzer uses a semi-colon ‘;’ as value separator (other implementations use sometimes a comma). Implementations of CSV can often handle field values with embedded line breaks or separator characters by using quotation marks or escape sequences. CSV is a simple file format that is widely supported, so it is often used to move tabular data between different computer programs, for example Microsoft Excel™ or Access™, that support the format. Also, other computer programs offer this type of interface because it is widely spread and easy to use.

The following functions are available from Software Version 1.11 and higher:

- 1.Importing sites
- 2.Exporting sites
- 3.Exporting combustion measurements
- 4.Exporting differential pressure measurements

Importing sites

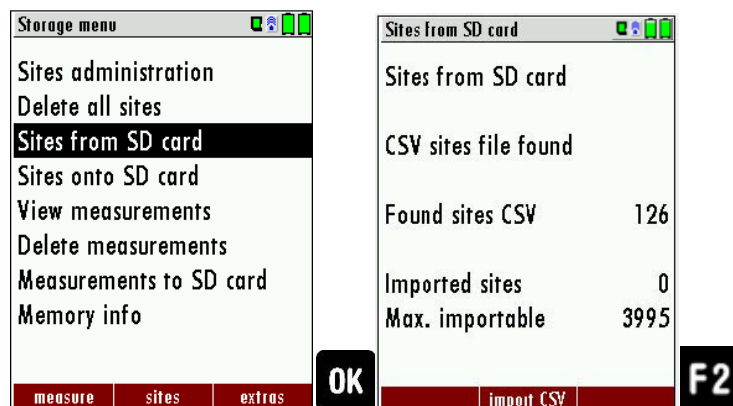

- ▶ Go to the Storage menu.
- ▶ Select Sites from SD card.
 - ⇒ The Menu sites from SD card appears.
- ▶ Press F2, to select Import CSV.

With this function you can Import Sites which have been created on a computer or another Analyzer.

The File name must have the name "anlagen.csv" (anlagen = German for sites) . The file has no column heading that means that the first line already has user data. Each line has a minimum of 9 columns (with 8 semi-colons) and the first field in the line will be the site number. All data will be imported as long a site number is available. Per field a maximum of 24 characters will be imported, too long words will be cut off.

Example file with 8 valid sites (4 with 9 lines and 4 with less lines):

```
A1-Z1;A1-Z2;A1-Z3;A1-Z4;A1-Z5;A1-Z6;A1-Z7;A1-Z8;A1-Z9
A2-Z1;A2-Z2;A2-Z3;A2-Z4;A2-Z5;A2-Z6;A2-Z7;A2-Z8;A2-Z9
A3-Z1;A3-Z2;A3-Z3;A3-Z4;A3-Z5;A3-Z6;A3-Z7;A3-Z8;A3-Z9
A4-Z1;A4-Z2;A4-Z3;A4-Z4;A4-Z5;A4-Z6;A4-Z7;A4-Z8;A4-Z9
A5-Z1;A5-Z2;A5-Z3;A5-Z4;;;;;
A6-Z1;A6-Z2;;A6-Z4;;;;;
A7-Z1;;;A7-Z4;;;;;
A8-Z1;;;;;;;;;
```

Example file with 2 invalid sites (1 with not enough fields and 1 with missing site number):

```
A1-Z1;A1-Z2
;A1-Z2;A1-Z3;A1-Z4;A1-Z5;A1-Z6;A1-Z7;A1-Z8;A1-Z9
```

NOTE



While importing data from the SD Card to the analyzer there is no check for double site numbers (Line 1), neither inside of the file that is imported nor between the file and the sites already inside the analyzer. The analyzer can easily handle double site numbers but you could face problems with double site numbers when exporting them again to a computer program (see also Export of Measurements).

However, the analyzer marks the files that have been imported successfully. If you try to import a file with the same analyzer that is already in the analyzer you will get a red information screen.

Exporting sites

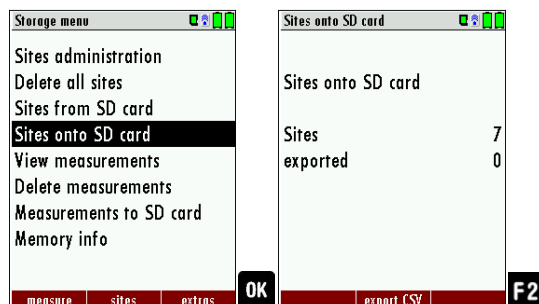

- ▶ Go to the Storage menu.
- ▶ Select Sites onto SD card.
- ▶ Press OK.
 - ⇒ The menu Sites onto SD card appears.
- ▶ Press F2.
 - ⇒ The sites are exported.

This function can be used for an analyzer back up or if you wish to supply the analyzer information to a computer program or another analyzer. This is very handy if you have made some modifications inside the analyzer (site) for example if you have modified the phone number of a customer and this modification needs to be updated in the computer software, or if a second analyzer needs to have the same site information.

The File format is the same as described above „Import of Sites“. Only the file name is different, the file name will be ‚ANLxxxx.csv‘, in which the xxxx are continuing 5-digit numbers with leading zeros. If the file must be imported into another analyzer, the file must first be renamed into „anlagen.csv“.

Exporting combustion measurements

This function is used to export the measurements from the analyzer to a computer program



NOTE

This function is not suitable for back up or for the transfer to another analyzer because the exported file can't be imported again!

The created file has the name ‚EMIxxxx.csv‘, in which the xxxx are continuing 5-digit numbers with leading zeros.

The created file has a column header with the following information: Site number, Date/Time, Measuring program name, Fuel type, CO2max, O2reference, and all measured values that the analyzer can measure as well as the soot numbers, Derivate and T-Boiler.

Example:

	A	B	C	D	E	F	G	H	I	J	K
1	Site no.	Date & time	meas.progra	fuel type	CO2max [%]	O2ref [%]	T-gas [°F]	T-air [°F]	Dewpoint [°F]	O2 [%]	CO2 [%]
2	BOILER	THU 30.09.2012	Program 1	Natural gas	11.7	3.0	--	73.5	--	21.0	--
3	BOILER	THU 30.09.2012	Program 1	Natural gas	11.7	3.0	--	73.0	--	21.0	--
4	BOILER	THU 30.09.2012	Program 1	Natural gas	11.7	3.0	--	73.0	--	21.0	--
5	BOILER	THU 30.09.2012	Program 1	Natural gas	11.7	3.0	--	72.5	--	21.0	--
6	BOILER	FRI 01.10.2012	Program 1	Natural gas	11.7	3.0	--	72.5	--	21.0	--
7	A FURNACE	TUE 05.10.2012	Program 1	Natural gas	11.7	3.0	81.0	--	113.0	11.7	5.2
8	A FURNACE	TUE 05.10.2012	Program 1	Natural gas	11.7	3.0	81.0	--	113.0	11.7	5.2
9	A FURNACE	TUE 05.10.2012	Program 1	Natural gas	11.7	3.0	82.5	--	112.5	11.7	5.1
10	A FURNACE	TUE 12.10.2012	Program 1	Natural gas	11.7	3.0	84.5	--	132.5	2.7	10.2

Exporting differential pressure measurements

The same function as Export of combustion tests only the file name is different. The created file has the file name "DDMxxxxx.csv", in which the xxxxx are continuing 5-digit numbers with leading zeros.

The created file has a column header with the following information: Site number, Date/Time, as well as 4 saved pressure measurements.

8.4. Measurements in Data storage

Viewing Measurements

In the menu item „View measurements“ you can inspect the stored measurements. After selection of this item you receive first an overview of the number of the stored measurements according to measuring type.

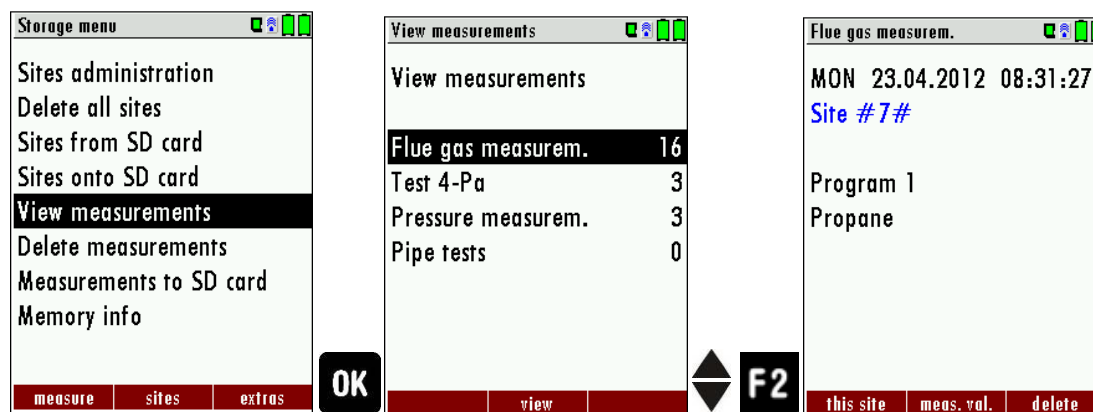

- ▶ Go to the Storage menu.
- ▶ Select View measurements.
- ▶ Press OK
 - ⇒ The menu View measurements appears.
 - ⇒ An overview of the number of stored measurements according to the measurement type appears.
- ▶ Select the desired measurement type.
- ▶ Press F2.

- ⇒ Then you receive first a page with context information to the stored measurement. Scroll with the arrow keys by the context information of the stored measurements.
- ▶ With F2 = "measured value" are displayed the measured data of the stored measurement in detail, available in 3 measuring value pages, as they are defined in the measuring value window.
- ▶ With ESC you return to the context information of the measurement. You have the possibility to display only those data that are assigned to a single site:
 - either F1 = „this site“ , while a measurement of the desired site is displayed. With F1 = „all sites“ you cancel this filter again.
 - or while you select with the menu key the function "search a site" and execute, as described in the chapter site administration.

Deleting Measurements

You are able to

- delete single measurements, while they are displayed – press the key F3 = "delete" .
- or delete all measurements of a measuring type.

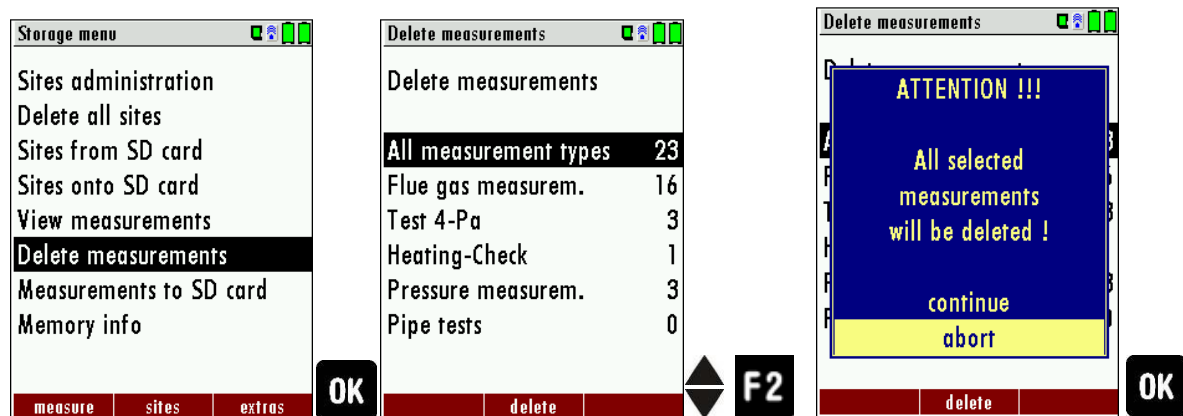

- ▶ Go to the Storage menu.
- ▶ Select Delete measurements.
 - ⇒ The menu Delete measurements appears.
- ▶ Select which measurement type you want to delete.
- ▶ Press F2.
 - ⇒ A message appears.
 - ⇒ Select continue to delete all measurements.
 - ⇒ Select abort to retain all measurements.
- ▶ Press OK.
 - ⇒ Depending on the selection, the measurement data are deleted or retained.

Transferring measurements to SD-Card (Option)

The analyzer offers the possibility to export all stored measurements to a SD card

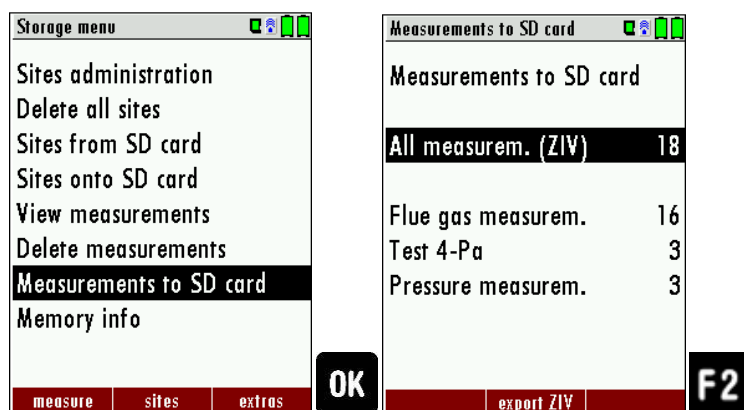

- ▶ Go to the Storage menu.
- ▶ Select Measurements to SD card.
- ▶ Press OK.
- ▶ Select the desired measurement type.
- ▶ Press F2.
 - ⇒ The selected measurement type is transferred to the SD card.

By confirming with the F2 key the data transmission / export on the SD card is started.

During the data export the display reads „please wait“. A write error to SD card is reported by the instrument. Make sure that the SD card is not write protected.

The data are stored as a csv-file (e.g., EMI01032.csv) on the SD card. The filename exists of a sequential number which fixes the device.

This file is editable on your Notebook/PC with a program like e.g. Microsoft® EXCEL or OpenOffice® Calc.

With possible problems with the using of your computer programs please read your software documentations or ask your software dealer.

9 Extras / Adjustments

The analyzer is delivered in a standard software configuration which should cover most needs. However, there are many ways to tailor the settings to your individual needs if required. The possibilities are highly flexible and individual adaptable.

Use the variable possibilities to adapt your analyzer to your own needs and customize the measurement menu, the measurement window, the printer output and many other features. Usually this is something you will do once you receive the analyzer, once you have adapted your analyzer you will most probably don't make much changes in future, but you can whenever you need and want to do so.

After you have made any changes in the configuration, you should switch off the analyzer to save all the changes that have been made. Next time that you start up the analyzer, all changes will have been made.

9.1. User definable Logo print out

Overview:

The Logo file can be created out of a Bitmap using the program "NOVAPplusPrnLogoCreator.exe" which comes with the analyzer CD. The generated file will be transferred from your computer to the analyzer using the SD card (only once). Once transferred the Logo can either be printed above or below the customer address or you can choose not to print the logo at all

Converting a Bitmap into a Logo file:



Use the enclosed Windows-Program "NOVAPplusPrnLogoCreator.exe" (MRU Product CD / Software / NOVAPplusPrnLogoCreator).

The Bitmap can have any colour depth bit ideal is a colour depth of 1-bit black-white. The horizontal resolution must have 384 pixels. If necessary the Bitmap can be adjusted using a picture editing program (not included on the CD).

The vertical resolution of the Bitmap must be a multiple of 24, where 24 is the minimum and the maximum is 480 pixels. If necessary the Bitmap can be adjusted using a picture editing program (not included on the CD).

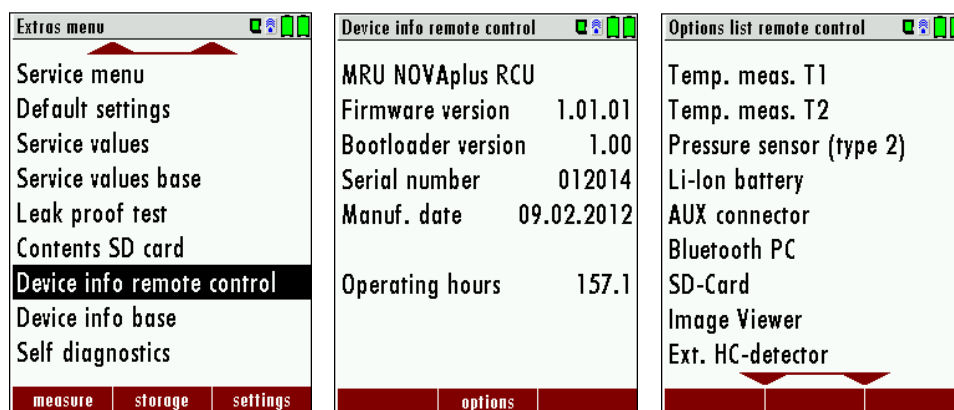

Transferring the Logo file per SD card to the analyzer:

Copy the created file "lg_print.mru" onto the SD card (root).

Switch on the analyzer then navigate to – Extras (F3) Analyzer info RCU / options. Now insert the SD card into the SD card slot, the unit will conform the upload with a short beep and on the screen, you will see a short message – Logo installed.

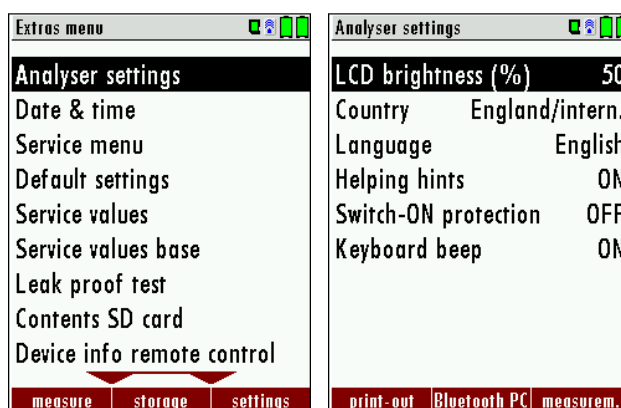

Printer Logo setting:

As soon as the Logo has been installed and the printer type is set on MRU, the Logo print will be available in the menu "extras / settings (print Logo).

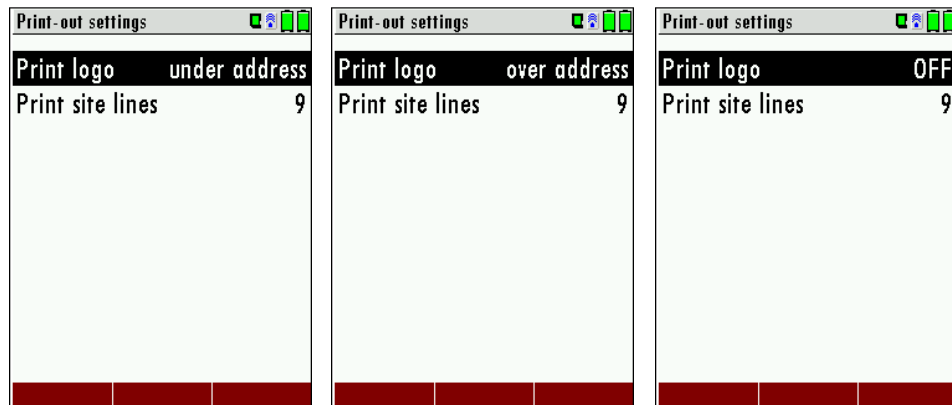

9.2. Service calibration menu

Das Abgleich-Menü ist durch einen PIN-Code vor Eingriffen von nicht autorisierten Personen geschützt.

Für den PIN Code setzen Sie sich mit einer MRU-Servicestelle (www.mru.eu) in Verbindung. Sollten Sie versehentlich die PIN-Code-Abfrage gestartet haben, dann drücken Sie die ESC Taste. Sie gelangen zurück in das Menü Extras.

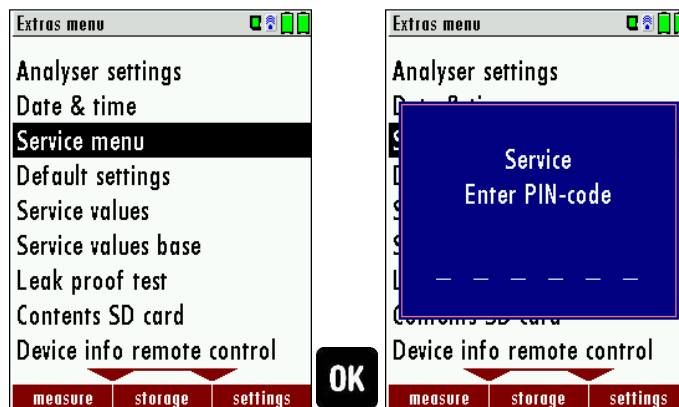

- ▶ Go to the Extras menu.
- ▶ Select Service menu.
- ▶ Press OK.
 - ⇒ A window for entering the PIN-code appears.
- ▶ Enter the PIN-Code.
 - ⇒ If you enter the PIN-code correctly, you will have access to the service menu
 - ⇒ If the PIN-code is entered incorrectly, you will be returned to the Extras menu.

9.3. Default settings

The analyzer will be reset to original delivery settings.



NOTE

With the default setting, all individual settings are lost.

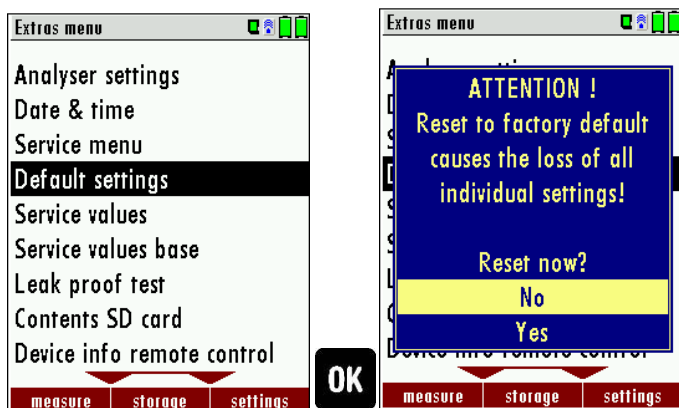

- ▶ Go to the Extras menu.
- ▶ Select Default settings.
- ▶ Press OK.
 - ⇒ A window appears.
- ▶ Select "No" to not reset the default settings.
- ▶ Select "Yes" to reset the analyzer to default settings.
- ▶ Press OK.
 - ⇒ Depending on the selection, the analyzer is reset to the default settings or not.

Be aware that your configurations will be deleted, such as:

- CO-ppm limits
- Fuel type list activation
- Measurement window selection
- and others.

9.4. Service values RCU / Service values Base unit

Should your analyzer display an error message after zeroing (for example: „O2-Sensor not OK"), then you can use the Service value menu to get detailed information about possible defects. In this menu you will see all service values of the sensors and also other parameters.

In case of a defect contact the MRU service department. The MRU service technician will ask you about these values or he will ask you to send them by fax or email.

Service values RCU:

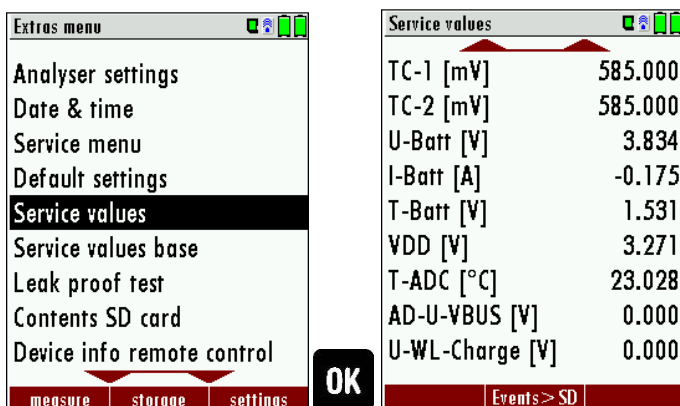

▲, ▼	Jump between the lines
F2	Export of service values to SD card
ESC	return

Service values base unit:

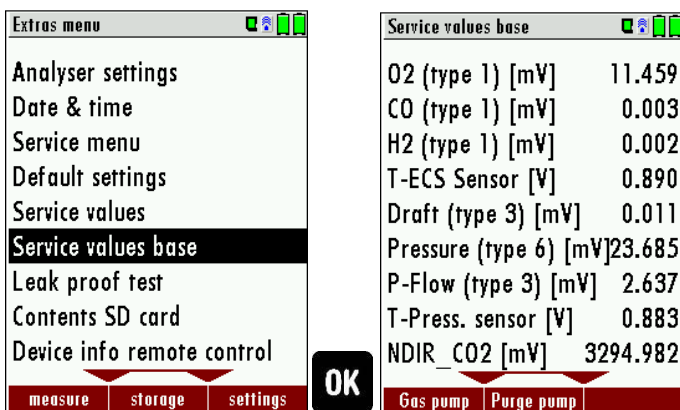

▲, ▼	Jump between the lines
F1	Function test gas pump (on / off -> only with service PIN code!)
F2	Function test purge pump (on / off -> only with service PIN code!)
ESC	return

9.5. Performing leak test

With the leak proof test, the system is checked by the device (incl. the condensate separator) up to the probe spike on undensity. The internal gas pump generates in addition a sub pressure which is measured over the built-in draft sensor and is observed for a period of 10 seconds. Based on the decrease of pressure the leakiness of the system will be determined.

Operation:

- ▶ Connect the hose to the analyzer as shown in the figure below.



- ▶ Go to the Extras menu.
- ▶ Select Leak proof test.
- ▶ Press OK.
 - ⇒ The menu Leak proof test appears.
- ▶ Ensure that the hose is installed.
 - ⇒ Pressure is established.
 - ⇒ A message appears if the leak test was passed or not.
- ▶ Remove the hose.

If the leak proof test is not passed the probe must be checked including the hosing as well as the condensate separator.

If no undensity is ascertained in these external parts the analyzer has to be checked in a service department (worldwide service departments see www.mru.eu).

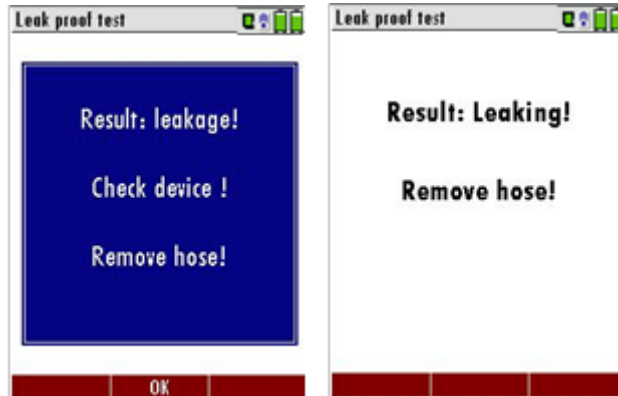

9.6. Contents SD card

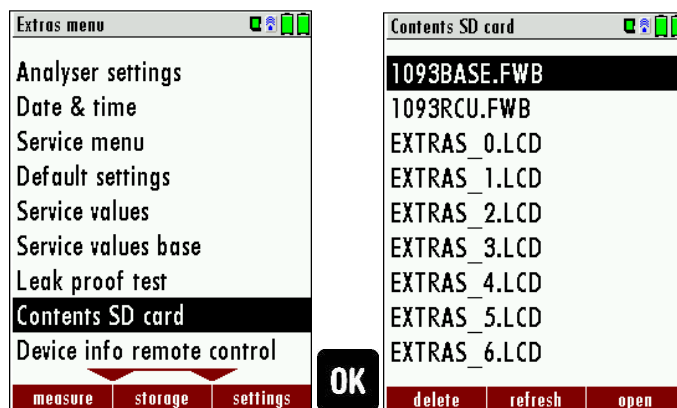

- ▶ Go to the Extras menu.
- ▶ Select Contents SD card.
- ▶ Press OK.
 - ⇒ The menu Contents SD card appears.
 - ⇒ The files stored on the SD card are displayed.
- ▶ Select a file.
- ▶ If necessary, press F1 to delete the file.
- ▶ If necessary, press F2 to refresh the file.
- ▶ If necessary, press F3 to open the file.

9.7. Contents Analyzer info

Here you will find information about the analyzer and the installed options.

Options list remote control



- ▶ Go to the Extras menu.
- ▶ Select Device info remote control.
 - ⇒ The menu Device info remote control appears.
- ▶ Press F2.
 - ⇒ The menu Options list remote control appears.

Options list base unit



- ▶ Go to the Extras menu.
- ▶ Select Device info base.
 - ⇒ The menu Device info base appears.
- ▶ Press F2.
 - ⇒ Das menu Options list base appears.
- ▶ Press F3.
 - ⇒ The name respectively the MAC address of the connected base unit appears.

9.8. Self diagnostics

The analyzer performs a self-diagnosis. The self-diagnosis provides a quick overview of the condition of the batteries and sensors. If the option "Flow control" is installed, the current flow rate [l/min] can be displayed.



Top left: Leak proof test
 Top right: sensor test
 Bottom left: flow control
 Bottom right: Battery status

- ▶ Go to the Extras menu.
- ▶ Select Self diagnostics.
- ▶ Press OK.
 - ⇒ The menu Self diagnostics appears.
- ▶ Press F2.
- ▶ Follow the instructions on the display.

10 Maintenance and care

10.1. Cleaning

The analyzer requires very little maintenance to maintain its value over a long period

- occasionally: cleaning the probe and the probe hose.
- after each measurement: Pull off the gas sampling hose on the analyzer, so that the hose can dry.
- If not used for a longer period of time, charge the battery first.

10.2. Maintenance

An annual service check and if necessary, adjustment of the sensors at an MRU service department (www.mru.eu) are recommended for the preservation of value.

With optional gas detector: In the case of a use to the pure leakage detection (maximum value search) a function check of the equipment is enough e.g. over an impact from a search gas bottle. A long-term continuous detector accuracy is guaranteed

NOTE



Please note that correct operation of the analyzer is only ensured if the sensors are adjusted regularly.

- ▶ Depending on the intensity of use, the sensors have to be adjusted / calibrated 1-2 times a year.

10.3. Service messages

A check of the analyzer at our Service Department is necessary: after 1000 working hours or if it has been more than 11 months since the last check.

When next powered on, you will be reminded to the execution of the annual customer service.

A complete service at an MRU service station (for MRU services station please see: www.mru.eu)

contains the function control and calibration and/or cleaning of the following components:

Sensors, pumps, internal/external hose lines, battery, draft sensor, electronics, time and date, temperature sensors, gas sampling probes, condensate separator



10.4. Check/replace optional water stop filter

The water stop filter protects the analyzer from moisture.

The water stop filter closes as soon as there is a risk that condensate is sucked into the analyzer.

A closed water stop filter can be indicated, for example, by the fact that the flow rate is too low.

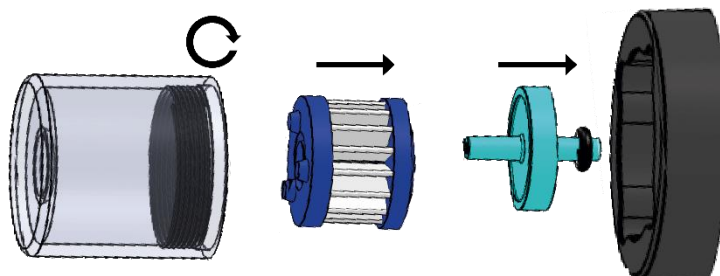

- ▶ Unscrew the filter vessel from the filter holder.

☞ See also chapter 3.3 Base unit, page 17

- ▶ Remove the star filter and the water stop.
- ▶ Check the water stop.
- ▶ Replace the water stop if necessary.
- ▶ Plug the water stop into the filter holder.
- ▶ Plug the star filter onto the water stop.
- ▶ Screw the filter vessel onto the filter holder.

Observe the direction when installing the water stop filter

The side with the sealing ring must be inserted into the filter holder.

Due to the arrangement of the membrane in the filter, the water stop filter will quickly become defective if inserted in the wrong direction due to excessive pressure.

The water stop filter should be replaced annually

11 Appendix

11.1. Technical data

General Data

Deutsch	Angabe	English
Betriebstemperatur	+5°C ... +45 °C / 41 °F ... 113 °F	Operating temperature
Rel. Luftfeuchtigkeit bei Betrieb, nicht-kondensierend	95%	Rel. Humidity, non-condensing
Lagertemperatur	-20°C ... +50°C / -4°F ... 122°F	Storage Temperature
Fernbedieneinheit: Akku intern, Betriebszeit	Li-Ion: 25h	Remote Control Unit: Internal Battery Pack, operating hours
Grundgerät: Akku intern, Betriebszeit (ohne Gaskühler und Rußsonde)	Li-Ion, 10h	Base unit: internal Battery Pack, operating hours (w/o gas cooler and soot probe)
Stromversorgung Grundgerät	100 - 240 V / 1,4A 12V DC / 5A	Power supply base unit
Stromversorgung Fernbedieneinheit: - kontaktlos in der Ladeschale - oder ext. USB Netzteil	• USB 5V 1A	Power Supply Remote Control Unit RCU - wireless charging via base unit, - or USB power supply externally
Gewicht mit 2 Sensoren, Koffer, Sonde, Netzteil	7,4 kg	Weight w/ 2 sensors, case, probe, power supply
Maße inkl. Koffer (BxHxT)	470 x 314 x 235 mm ³	Size incl Case (WxHxD)
Gehäusematerial Fernbedienung	PA6 GF 30	Housing Material RCU
Schutzart Fernbedienung	IP30	IP degree of protection of remote control
Gehäusematerial Grundgerät	Aluminium	Housing Material Base Unit
Schutzart Grundgerät	IP30	IP degree of protection of Base Unit
Schutzart (Grundgerät geöffnet)	IP20	IP degree of protection (Base Unit open)

Bluetooth Frequenzbereich und Ausgangsleistung		Bluetooth frequency range and output power
Fernbedienung (RCU)	BlueMod+SR Bluetooth Dualmode	Remote control (RCU
	EDR Power @2.402 GHz: 5.5* dBm)
	EDR Power @2.441 GHz: 7.5* dBm	
	EDR Power @2.480 GHz: 8.5* dBm	
	BLE power @2.402 GHz: 5.5* dBm	
	BLE power @2.440 GHz: 7.5* dBm	
	BLE power @2.480 GHz: 8.5* dBm	
	*Typische Werte/ typical values	
Fernbedienung (RCU) <-> Grundgerät (Basis)	RN41 Bluetooth Classic	Remote contol (RCU) <-> Base unit
	2.402 GHz to 2.480 GHz	
	RF power @ 2.402 GHz: 16.3* dBm	
	RF power @ 2.441 GHz: 17.0* dBm	
	RF power @ 2.480 GHz: 18.4* dBm	
	*Typische Werte / typical values	
Fernbedienung (RCU) <-> Grundgerät (Basis)	RN41N Bluetooth Classic	Remote contol (RCU) <-> Base unit
	2.402 GHz to 2.480 GHz	
	2.402 GHz: 11.9* dBm	
	2.441 GHz: 10.9* dBm	
	2.480 GHz: 9.9* dBm	
	Typische Werte/ typical values	

Gas conditioning and sampling

Deutsch	Angabe	English
max. Unterdruckbereich der Gaspumpe	650 hPa	Max suction range gas pump
typischer Gasdurchfluss	90 l/h	gas flow typ.
Kondenstafalle (nicht-gekühlt)	Standard	Condensate trap (non-cooled)
Gaskühler	Option	Gas cooler
Temperatur Peltierkühler (an Netz und Akku)	5 °C	Temperature Peltier cooler (during grid and battery operation)
Akkubetriebszeit mit Gaskühler	2,5h (5°C) / 6h (ECO T-Gerät - 10°C)	Batt operating hours with gas cooler
Kondensatentsorgung aus dem Gaskühler	•	Condensate removal from gas cooler
Interne Durchflussmessung	•	internal gas flow measurement

Measured values

Deutsch	Angaben	English
Elektrochemischer Sensor	O2 Long Life	Electrochemical Sensor
Messbereich	0 - 21 Vol%	Measuring Range
Auflösung		Resolution
Genauigkeit abs.	± 0,2 Vol%	Abs. Accuracy
Ansprechzeit T90	< 20s	Response Time T90
Jahre erwartete Lebensdauer an Luft	5	Years expected lifetime (@air)
Elektrochemischer Sensor	CO	Electrochemical Sensor
H2 - kompensiert		H2 compensated
Nominaler Messbereich	0 - 10000 ppm	Nom. Measuring Range
Überlastbereich	20000 ppm	Overload Range
Auflösung	1 ppm	Resolution
Genauigkeit absolut / vom Messwert	± 10 ppm/ 5% (0 .. 4000 ppm) 10% (> 4000 ppm)	Accuracy abs. / reading
Ansprechzeit T90	< 40s	Response Time T90

Elektrochemischer Sensor	NO	Electrochemical Sensor
Nominaler Messbereich	0 - 1000 ppm	Nom. Measuring Range
Überlastbereich	< 5000 ppm	Overload Range
Auflösung		Resolution
Genauigkeit abs. /vom Messwert	± 5ppm / 5% (0 ... 1000 ppm) 10% (> 1000 ppm)	Accuracy abs./reading
Ansprechzeit T90	< 30s	Response Time T90
Elektrochemischer Sensor	NO₂	Electrochemical Sensor
Nominaler Messbereich	0 - 200 ppm	Nom. Measuring Range
Überlastbereich	< 1000 ppm	Overload Range
Auflösung		Resolution
Genauigkeit abs. /vom Messwert	± 5ppm / 5% (0 ... 200 ppm) 10% (> 200 ppm)	Accuracy abs./reading
Ansprechzeit T90	< 40s	Response Time T90
Elektrochemischer Sensor	SO₂	Electrochemical Sensor
Nominaler Messbereich	0 - 2000 ppm	Nom. Measuring Range
Überlastbereich	< 5000 ppm	Overload Range
Auflösung		Resolution
Genauigkeit abs. /vom Messwert	± 10ppm / 5% (0 ... 2000 ppm) 10% (> 2000 ppm)	Accuracy abs./reading
Ansprechzeit T90	< 40s	Response Time T90
Elektrochemischer Sensor	H₂S	Electrochemical Sensor
Nominaler Messbereich	0 - 500 ppm	Nom. Measuring Range
Überlastbereich	< 2000 ppm	Overload Range
Auflösung		Resolution
Genauigkeit abs. /vom Messwert	± 5 ppm / 5% (0 ... 500 ppm) 10% (> 500 ppm)	Accuracy abs./reading
Ansprechzeit T90	< 40s	Response Time T90

Nicht-dispersive Infrarotmessung (NDIR)	CO₂	Non-dispersive Infrared Measurement (NDIR)
Nominaler Messbereich	0 - 100 Vol%	Nom. Measuring Range
Auflösung		Resolution
Genauigkeit abs. /vom Messwert	± 0,3 Vol% / 3%	Accuracy abs./reading
Ansprechzeit T90	< 35 s	Response Time T90
Nicht-dispersive Infrarotmessung (NDIR)	CH₄	Non-dispersive Infrared Measurement (NDIR)
Nominaler Messbereich	0 - 100 Vol%	Nom. Measuring Range
Auflösung		Resolution
Genauigkeit abs. /vom Messwert	± 0,3 Vol% / 3%	Accuracy abs./reading
Ansprechzeit T90	< 35 s	Response Time T90
Abgastemperatur	T_A	Flue gas temperature
Messbereich mit Gasentnahmerohr aus Edelstahl	0 - 650°C	Measuring Range with high grade steel probe pipe
Messbereich mit Gasentnahmerohr aus Inconel	0 - 1100°C	Measuring range with Inconel probe pipe
Genauigkeit abs. / vom Messwert	±2°C / 1%	Accuracy abs. / reading
Anschluss am Basisgerät		To be connected to base unit
Verbrennungslufttemperatur	T_i	Air temperature
Messbereich	0 - 100°C	Measuring Range
Genauigkeit abs.	1°C	Accuracy
Anschluss an Grundgerät oder optional an Fernbedieneinheit		To be connected to base unit or optional to remote control unit
Differenzdruck Basis		Differential Pressure Base Unit
Messbereich	± 300 hPa	Measuring Range
Genauigkeit abs. / vom Messwert	0,1 hPa / 1%	Accuracy abs. / reading
Anschluss an Grundgerät		To be connected to base unit
Differenzdruck RCU		Differential Pressure RCU
Messbereich	± 120 hPa	Measuring Range
Genauigkeit abs. / vom Messwert	0,02 hPa / 1%	Accuracy abs. / reading
Anschluss an Fernbedieneinheit		To be connected to Remote Control Unit

Temperaturmessung RCU		Temperature Measurement RCU
Messbereich	-50 ... 1100 °C	Measuring Range
Thermoelement	Typ K Mini	Thermocouple
Barometrischer Druck	P _{abs}	Barometric Pressure
Messbereich	300 1200 hPa	Measuring Range
Genauigkeit	± 3 hPa	Accuracy

Calculated values

Deutsch	Angabe	English
	CO₂	
Messbereich (brennstoffabhängig)	0 - CO ₂ max	Measuring range (fuel type dependant)
Genauigkeit abs.	± 0,3 Vol%	Accuracy abs.
Taupunkt	°C	Dew point
Abgasverlust qA	0 - 99,9%	Losses qA
Wirkungsgrad	0 - 120%	Efficiency
Messwerte darstellbar als	mg/Nm ³ O ₂ Ref mg/kWh NOx: mg/Nm ₃ NO ₂	Measurement values available as
Strömungsgeschwindigkeit	v	Velocity
<i>basierend auf Differenzdruckmessung mit Prandtlrohr</i>		<i>based on differential pressure measurement with Pitot tube</i>
Messbereich typisch	3 m/s ... 100 m/s	typical measuring range
Genauigkeit bei 3 m/s	1 m/s	accuracy at 3m/s.
Genauigkeit > 12 m/s (vom Messwert)	± 1%	accuracy > 12 m/s (reading)
Auflösung	0,1 m/s	resolution
Absolutdruckmessung	•	absolute pressure measurement
<i>basierend auf Flügelradmessung</i>		<i>based on vane anemometer</i>
Messbereich (abhängig von Flügelrad-Typ)	0,25 - 35 m/s	measuring range (depending on actual vane type)

Externe Drucksensoren		External pressure sensor
	#63684	
Messbereich	5 bar	Range
Auflösung	1 mbar	Resolution
Genauigkeit abs. / vom Messwert	10 mbar / 1%	Accuracy abs. / reading
	#63685	
Messbereich	25 bar	Range
Auflösung	1 mbar	Resolution
Genauigkeit abs./ vom Messwert	50 mbar / 1%	Accuracy abs. / reading
	#63686	
Messbereich	40 bar	Range
Auflösung	1 mbar	Resolution
Genauigkeit abs./ vom Messwert	100 mbar / 1%	Accuracy abs. / reading
Feuchte- & Temperatursonde	RH	Humidity & Temperature Probe
Messbereich Feuchte	3 - 98 %	Measuring Range Humidity
Genauigkeit Feuchtemessung abs.	± 3% RH	Accuracy Humidity Measurement
Messbereich Umgebungstemperatur	-20 °C ... +80°C	Measuring Range Ambient Temperature
Genauigkeit Umgebungstemperaturmessung	± 1°C	Accuracy Ambient Temperature Measurement

Data communication

Deutsch	Angabe	English
USB Anschluss	via RCU	USB interface
SD Karte für SW update, Datenaustausch, erweiterter Datenspeicher	>= 2GB, via RCU	SD card for SW update, data exchange or extended data memory
Reichweite Funkverbindung RCU - Grundgerät freie Sicht typisch in Gebäuden (situationsabhängig)	100 m 20 m	Range of link RCU to base unit free air typical inside buildings (depending on actual situation)

11.2. Analysis and calculations

Measured values	Unit
O ₂	[%]
Temp. Ambient air (Thermo-Element)	[°C]
Temp. Flue gas (Thermo-Element)	[°C]
CO	[ppm]
Draft	[hPa]

Available conversions of CO	CO
[ppm] related to. on 0% rest O ₂ (undiluted)	X
[ppm] related to. on fuel type dependent O ₂ reference value	X
[mg/m ³]	X
[mg/kWh]	X
[mg/MJ]	X
[mg/m ³] on fuel type dependent O ₂ reference value	X

Continuously caculated values	Unit
CO ₂	[%]
Efficiency ETA	[%]
Efficiency condensed	[%]
Losses	[%]
Losses condensed	[%]
Lambda	-
Dew point	[°C]

Losses and efficiency are calculated by means of net calorific value. These values are than referenced for the gross calorific value for condensing boilers only. (efficiency > 100)
The calculations of efficiency and exhaust losses are performed using Siegert's formula.

For further information please contact MRU GmbH. (www.mru.eu)

11.3. Text input

A number of texts and names can be changed to your own needs.
(for example: the names of the user defined fuel types, site names, the names of the measurement programs)

When you select the text input, the following window will pop up:

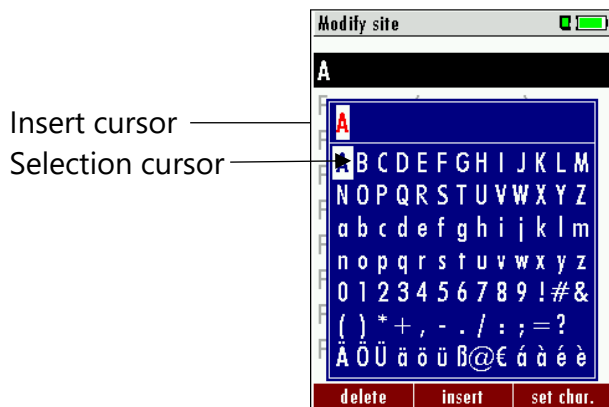

▲, ▼, ◀, ▶	Select a letter, number or sign
F1 – delete	The letter left of the cursor will be deleted
F2 – insert	Selected letter or number will be inserted
F3 – over write	Selected letter or number will over write the current letter or number
ESC	Abort the window, changes will NOT be saved

11.4. Asking user for decision

The analyzer requires confirmation of the user decision for various Functions.

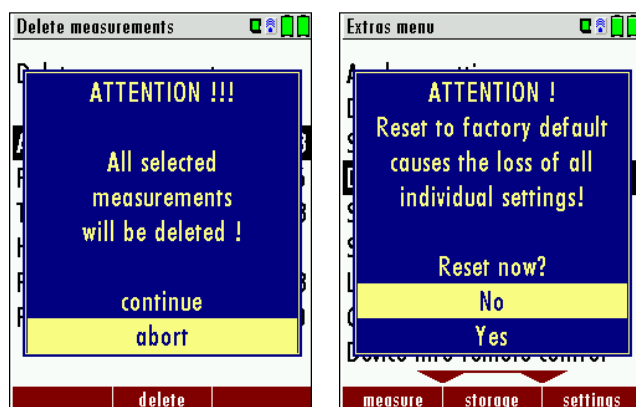

▲, ▼	Select a line
OK	Confirm the action
ESC	Abort the window, changes will NOT be saved

11.5. Firmware update

NOTE



During the Firmware update the LED of the ON-OFF switch (Base unit) is flashing and the Bluetooth connection symbol changes the colour from blue to yellow.

Don't press during the update any key and remove the SD card first after a restart of the base unit from the device!

- ▶ Switch OFF the device.
- ▶ Select F3 settings/Device info remote control

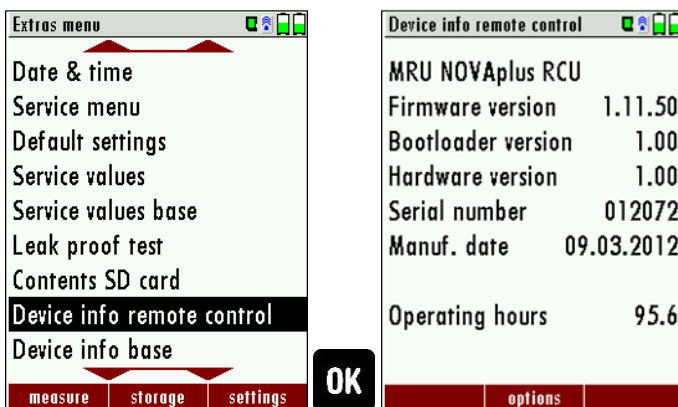

The first line shows e.g.: Firmware-Version 1.11.50

Following select Device info base

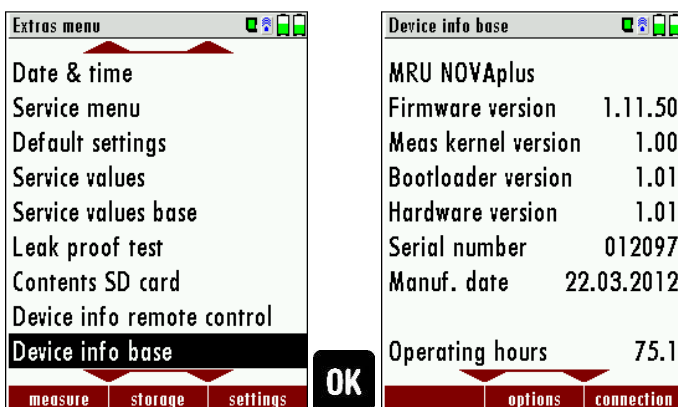

For the case that there should be problems by the update we need some information of you.

RCU:

Please write down your Firmware-Version

(e.g. 1.11.50) _____

Please write down your serial number

(e.g. 012072) _____

Base unit:

Please write down your Firmware-Version

(e.g. 1.09.01) _____

Please write down your serial number

(e.g. 012039) _____

Do the following steps in order to update the firmware:

- ▶ copy the files '1093Base.fwb' and '1093RCU.fwb' to a SD card in the root directory (that means in no directory), in case you received the files in a zip archive you'll have to decompress it first
- ▶ switch on the analyzer (Base and remote control) and verify whether the connection is OK (blue symbol)
- ▶ insert the SD card into the remote control
- ▶ you will be asked: 'Firmware for base found. Install now?'
- ▶ acknowledge with 'install'
- ▶ the base update will be started and will take about 1 minute, while you will hear several beeps
- ▶ then you will be asked: 'Firmware for remote control found. Install now?'
- ▶ acknowledge again with 'install'
- ▶ the remote control update will be started and will take about half a minute, while the display remains empty
- ▶ finished

How do I identify if the update was successful?

- ▶ Switch on the analyzer.
- ▶ Go to the Extras menu
- ▶ Select Device info.
 - ⇒ In the first line the new firmware version must be displayed

11.6. Troubleshooting

Troubleshooting the analyzer

1. Effect	2. Error indication	3. Cause	4. Solution
Device cannot be switched off by pressing the OFF key.	LED behind the condensate separator is on and the LCD display is dark	Device does not react on any key.	Press ESC and ON simultaneously! EMERGENCY OFF After this, the date and time have to set new.
Inside of the device is too cold, device not ready for operation.	Display indication: "Device too cold" or audible sound every 5 sec..	e.g. device was stored in a cold place during winter.	Put the device to a warm room and wait
Measuring values are not correct		Sensors already get in touch with the gas during calibration.	Vent device with fresh air and re-start!
No measurement possible		Device cannot be switched on or does not react after being switched on. Battery discharge	Connect the device to the line power in order to charge the battery.
Measurement without exact temperature values.	Temperature indication: - - - , - °C	Thermo element defective, balancing network interrupted or not connected.	Call our after-sales service. Remove probe from the gas duct and condensate from the probe tube.
Wrong measuring values	Measuring range exceeded: Value O ₂ too high Values CO and CO ₂ to low	Connection probe – device not correct. Leakage at probe / tube / condensate separator, pump does not suck correctly	Effect tightness test! By visual control of probes, tubes condensate separator, leaking parts could be found.
Wrong measuring values	Gas temperature is too hot or alternates	Probe is not plugged in correctly, defective cable in the probe line, formation of condensate at the probe tip.	Check probe plug respectively probe line regarding damages (loose connection), remove condensate from the probe tip.



**MRU · Messgeräte für Rauchgase
und Umweltschutz GmbH**

Fuchshalde 8 + 12

74172 Neckarsulm-Oberreisesheim

Fon 07132 99620 · Fax 07132 996220

info@mru.de · www.mru.eu