

ELECTRICAL CONTACTS

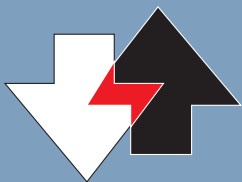

REPCO

INTRODUCTION

Repco is the industry-leading source for replacement electrical contacts for industrial motor controls. For more than 30 years Repco has built a solid reputation for quality products and customer service. We supply a lower-cost alternative guaranteed to be equivalent in fit, form and function. The company product offering spans 25 control manufacturers representing over 90 series. Over 4000 different catalog items are stocked at our Marlton, NJ warehouse for industrial applications.

This catalog contains over 800 of the most popular contacts and contact sets in the industrial replacement marketplace. Items are either current or may have been obsoleted by the manufacturer. All items pictured in this catalog are normal stock. All stock items ordered before 3:00 PM EST are shipped the same day.

The main body of the catalog is arranged by control manufacturer. Once you've identified the manufacturer and series, from the nameplate or other record, simply locate it in the Table of Contents on the opposite page and turn to the section given. Contact sets are listed in order of size and/or amperage.

All contact photos in this catalog are actual size. If you do not have nameplate data, but know the control manufacturer, turn to that OEM section and search the photos, within each series, for a physical match. When you find one, simply lay your sample over the photo to verify.

If you do not see what you need in this catalog please call toll-free 800-822-9190 for identification assistance. Our cross-reference file contains over 8500 numbers. Our knowledgeable and experienced staff is able to identify and supply any industrial motor starter contact. In rare instances, a sample may be needed for identification.

Contact re-tipping services are available for larger-sized, silver-tipped contacts. Two common reasons for re-tipping are expense and obsolescence. The cost of this procedure is significantly less than a new contact or set for NEMA size 4 and above. For more information, please go to www.repcoinc.com and choose the Services tab at the top of the page.

Please turn to the inside back cover for information about our Repalloy® product.

TABLE OF CONTENTS

AEG	3	HUBBELL / EUCLID	73
ALLEN-BRADLEY		KLOCKNER-MOELLER	74
BULLETIN 646	6	MITSUBISHI	75
SERIES A	7	P & H	76
500-LINE	8	RELIANCE	78
SERIES K	9	ROWAN ITE	80
100-LINE	12	S & S (SPRECHER & SCHUH)	
100C-LINE	14	CA1 SERIES	81
AROMAT	15	CA3-CA6 SERIES	83
ARROW HART	16	CA7 SERIES	83
ASEA BROWN BOVERI		SIEMENS	
TYPE EG	17	VALUE-LINE	84
TYPE EFLG	18	3TA SERIES	85
TYPE EH	19	3TB SERIES	87
TYPE EHDB	21	3TF SERIES	89
TYPE B	22	3RT SERIES	92
TYPE A/AF/AE	23	MISCELLANEOUS	93
CLARK/CHALLENGER/JOSLYN		DC CONTACTORS	94
OLD STYLE AUXILIARIES	24	SQUARE D	
TYPE CY	25	CURRENT DEVICES	95
TYPE TM	26	DPR, DP, DPA, SYD SERIES	96
TYPE KD, KS	27	ISO-FLEX	97
TYPE 7400 RS, RD, DC	28	OLD STYLE	98
MISCELLANEOUS	29	CLASS 7004, TYPE H	100
CUTLER-HAMMER		CLASS 7004, TYPE M	101
SERIES A1	30	MISCELLANEOUS	101
SERIES B1	32	STARKSTROM	105
FREEDOM SERIES	33	STROMBERG	108
OLD STYLES	35	STRUTHERS-DUNN	110
XT SERIES	38	TELEMECANIQUE	
DC CONTACTORS & AUX	39	OLD ITE-GOULD STYLE	111
HIGH AMPERAGE	41	CN1 SERIES	112
9141 COMPENSATORS	42	CN2 SERIES	113
MISCELLANEOUS	44	LC1 SERIES	114
FUJI	45	PN1 SERIES	116
FURNAS		PA2 SERIES	117
OLD STYLES	47	WARD LEONARD	
VERTICAL LIFT	48	5000/5000DP SERIES	118
INNOVA 45	48	NAVY CONTROL	119
INNOVA PLUS	48	WESTINGHOUSE	
IEC	48	A200 LINE	120
GENERAL ELECTRIC		TYPE NF	123
VARIOUS TIPS AND FINGERS	52	TYPE N, LIFELINE	124
100, 200, 300-LINE	53	TYPE DPCK	125
CR7006 SERIES	55	TYPE MD, MME	126
CR2810, CR2811 SERIES	56	JF AUTOSTARTERS	128
CR134, CR1034 COMPENSATORS	58	AMPGUARD	130
CR2800, IC2800 SERIES	60	DRUM SWITCHES	130
CR2810 SERIES	65	MISCELLANEOUS	131
DRUM SWITCHES	66	ADVANTAGE-LINE	133
MISCELLANEOUS	67	TYPE DPM	134
IC2956 AUXILIARY BLOCKS	68	SERIES 500	134
MEDIUM VOLTAGE	69	NUMERICAL LISTING	135
CR7 IEC SPECTRA 700 SERIES	69		
DS303 SERIES	70		
C2000 SERIES	71		
IC5181 NAVY CONTACTORS	72		

**ALL PICTURES IN THIS
CATALOG ARE FULL SIZE**

AEG

TYPE LS

<u>SIZE</u>	<u>DEVICE#</u>	<u>REF.</u>	<u>OEM#</u>	<u>OUR#</u>																													
1 3/4	LS37	A	910-392-257	9103CE																													
2+	LS47	B	910-392-266	9113CE																													
2 1/2	LS57	C	9123CE	3	LS77	D	910-392-268	9133CE	3 1/2 - 4	LS97/107	E	910-392-263	9143CE	4 1/2	LS167/177	F	910-392-264	9153CE	5	LS247	G	910-392-265	9163CE	5 1/2	LS297 (200)	H	910-392-270	9173CE	6	LS300/330	J	910-392-326	9183CE
3	LS77	D	910-392-268	9133CE																													
3 1/2 - 4	LS97/107	E	910-392-263	9143CE																													
4 1/2	LS167/177	F	910-392-264	9153CE																													
5	LS247	G	910-392-265	9163CE																													
5 1/2	LS297 (200)	H	910-392-270	9173CE																													
6	LS300/330	J	910-392-326	9183CE																													

3-POLE SETS

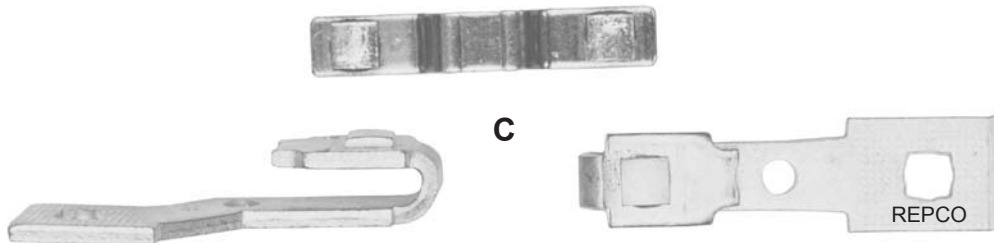
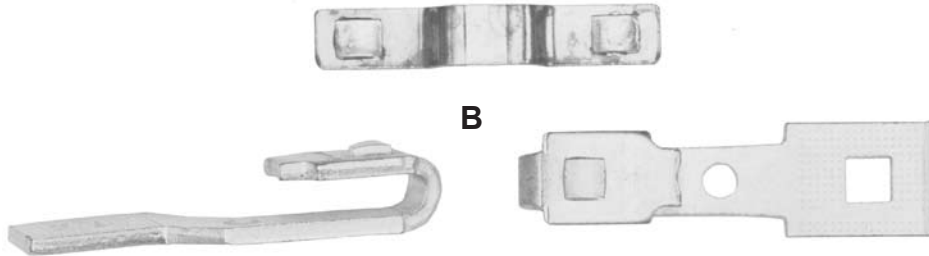
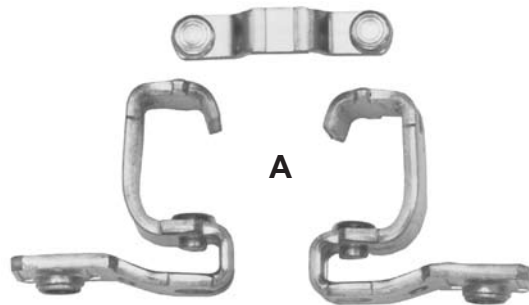

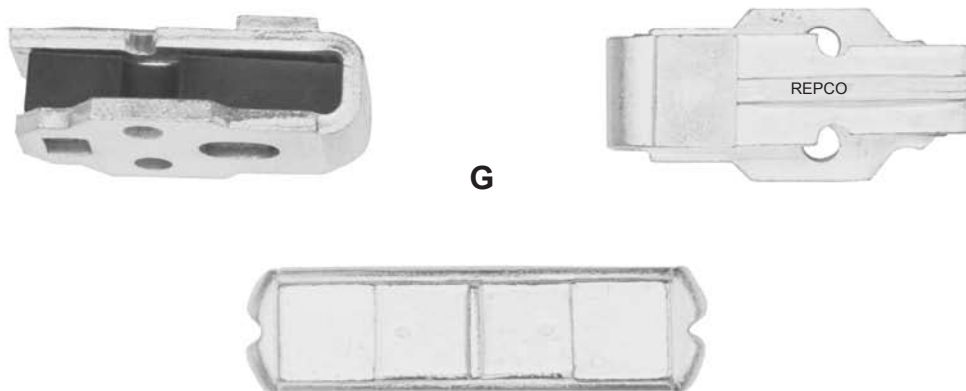
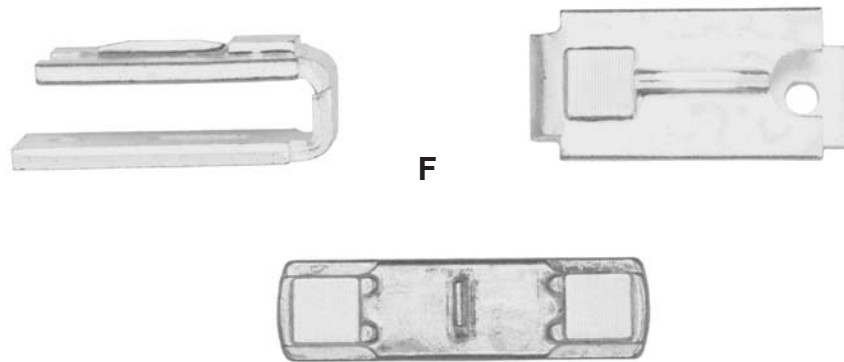
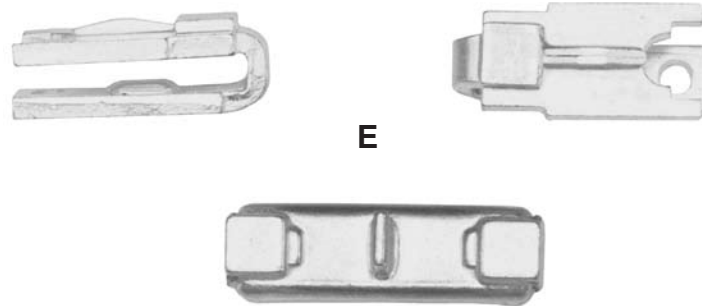
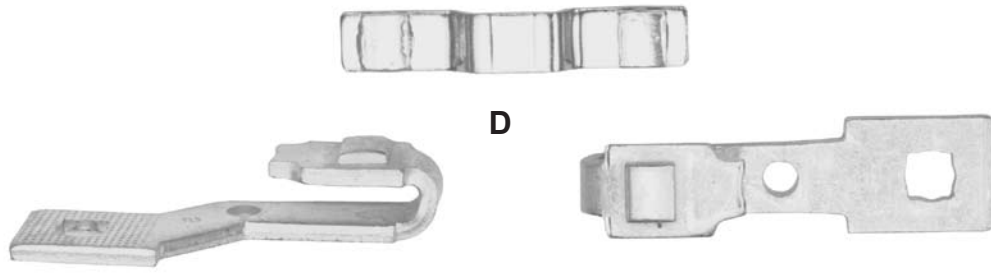

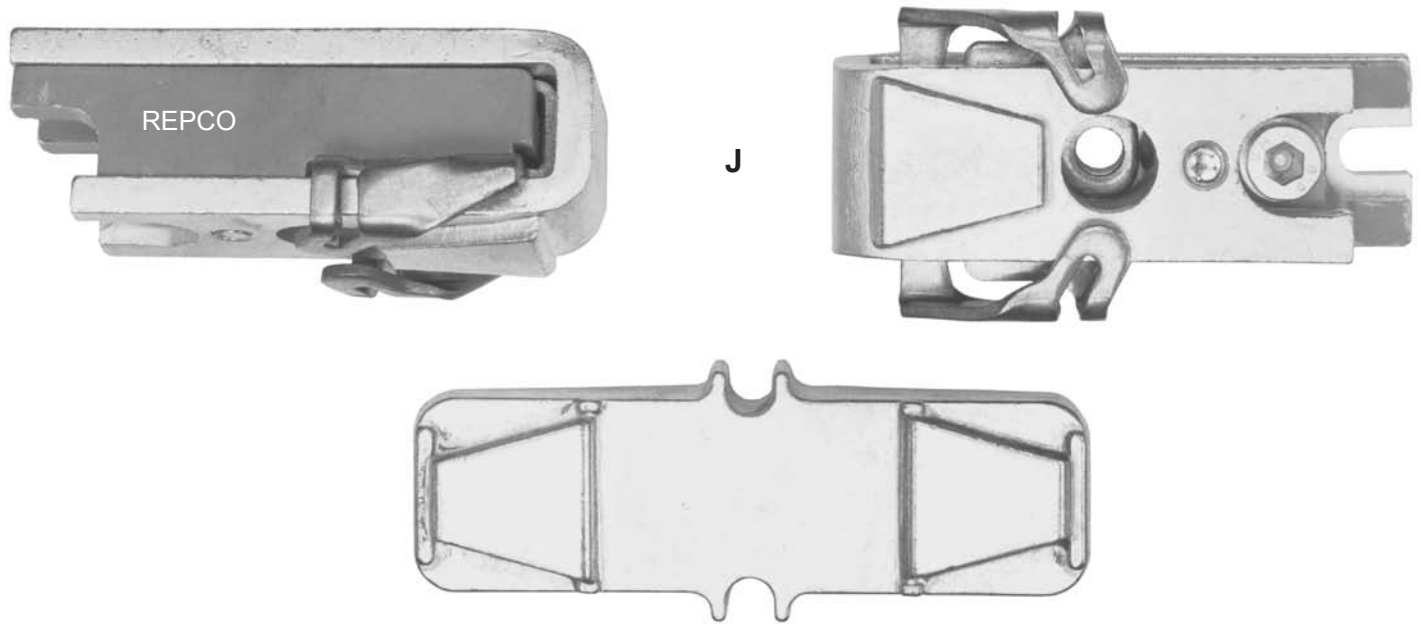
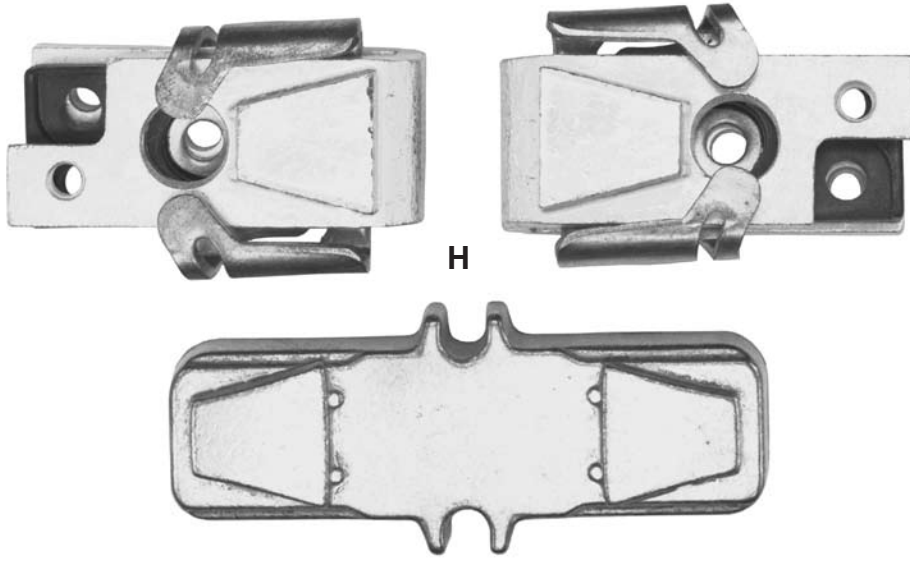

For more information on
REPALLOY®, please visit
our website at www.repcoinc.com

ALLEN-BRADLEY

BULLETIN 646 STARTERS

<u>SIZE</u>	<u>REF.</u>	<u>DESCRIPTION</u>	<u>OUR#</u>
B	E	MOVABLE	1003CA
B	F	STA., LONG	4003CA
B	G	STA., SHORT	4004CA
C	H	MOVABLE	1002CA
C	J	STA., LONG	4002CA
C	K	STA., SHORT	4001CA
D	L	MOVABLE	1000CA
D	M	STATIONARY	4000CA

COMPLETE SET FOR SIZE B AND C
USUALLY CONSISTS OF:
5 MOVABLE, 10 SHORT STA., AND
5 LONG STATIONARY CONTACTS.
SIZE D USUALLY CONSISTS OF:
5 MOVABLE AND 15 STA. CONTACTS.

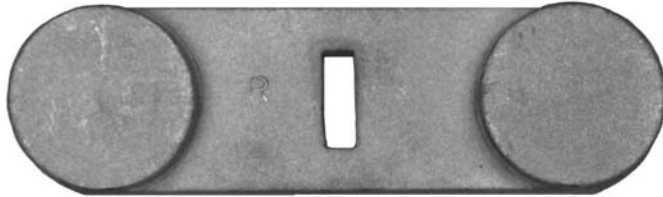

E

SIZES B AND C ARE REPALLOY®.
THEY ARE APPLICABLE TO
BOTH AIR AND OIL STARTERS.

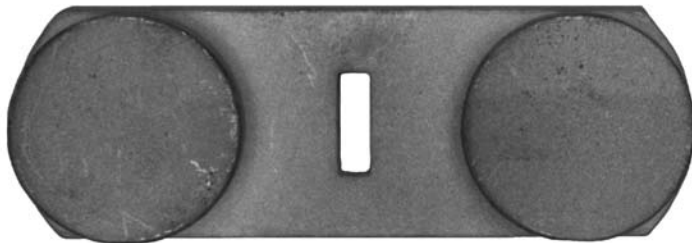

H

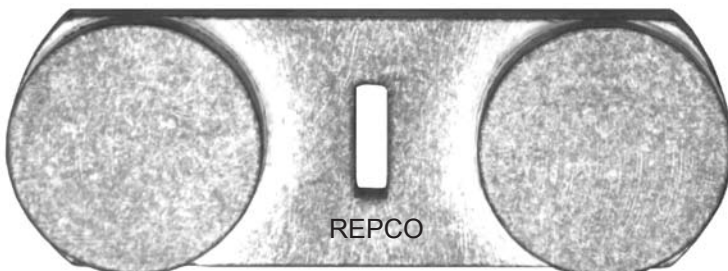

L

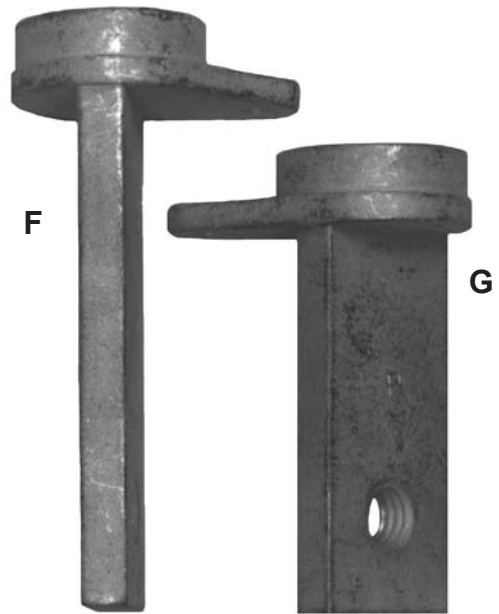

F

G

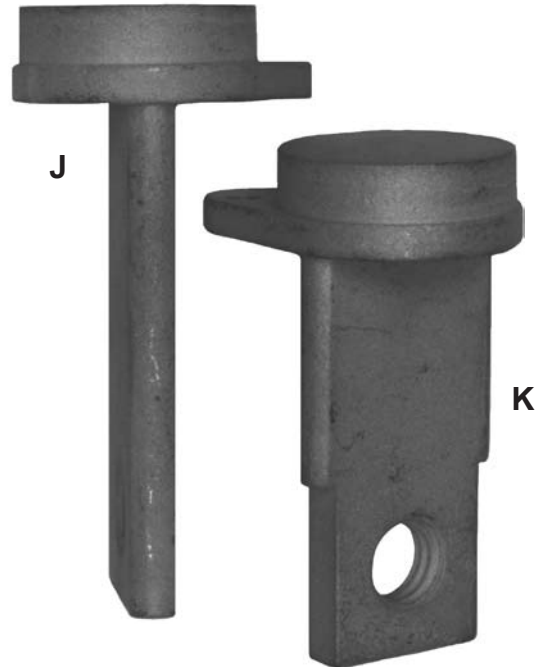

J

K

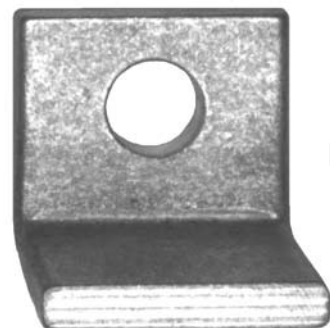

M

ALLEN-BRADLEY SERIES A (OLD STYLE)

STATIONARY				MOVABLE			3-POLE SETS
SIZE	OEM#	OUR#	REF.	OEM#	OUR#	REF.	OUR#
0	X-33977	6802CA	L	X-33553	1010CA	A	9513CA
0	X-35162	6801CA	K				
1	X-33519	6804CA	J	X-33552	1011CA	B	
1	X-35163	6803CA	I				
2	X-36702	6805CA	H	X-36670	1012CA	C	
3	X-36703	6806CA	G	X-36671	1013CA	D	9523CA
4	X-67541	6807CA	F	X-119624	1014CA	E	9533CA
5	X-98909	6808CA	--	X-104555	1015CA	--	

NORMALLY SOLD AS SINGLE CONTACTS



ALLEN-BRADLEY

500-LINE

SIZE	REF.	OEM#	OUR#
00	A	Z21103**	9194CA
0	B	40410-331-51	9201CA
1	C	40410-331-52	9211CA
2	D	40420-322-51	9221CA
3	E	40430-300-51	9231CA
4	F	40440-300-51	9241CA
5	G	42450-805-01*	9251CA
6	--	40783-802-02	9691CA

*SERIES L

**4 POLES, MOVABLES ONLY

(One pole sets unless noted)

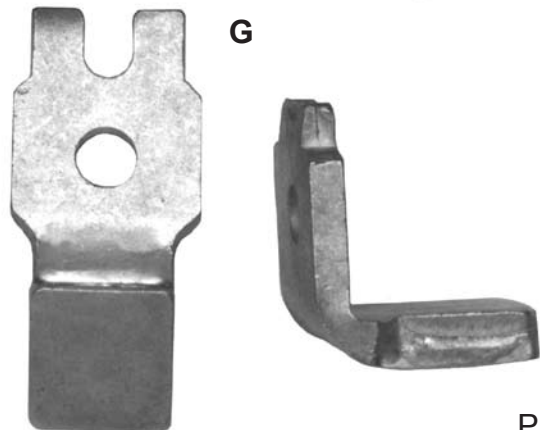
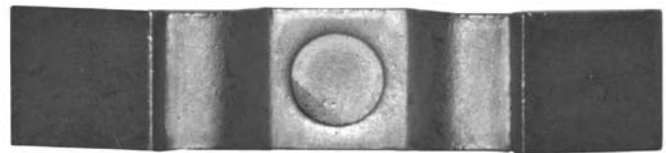
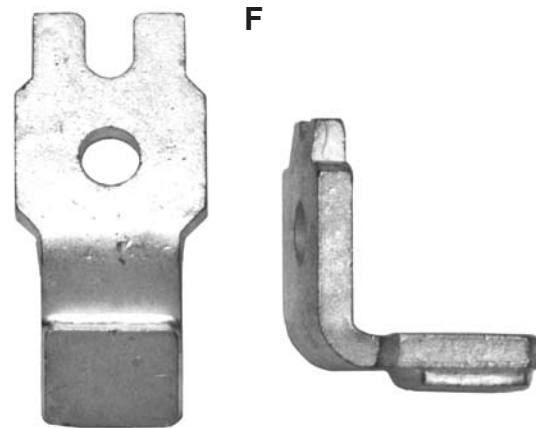
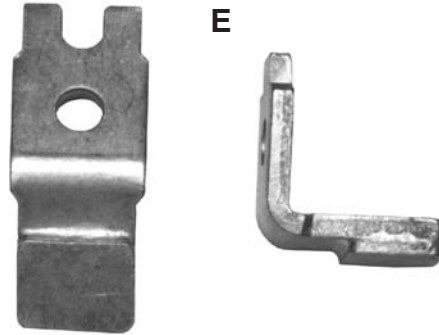
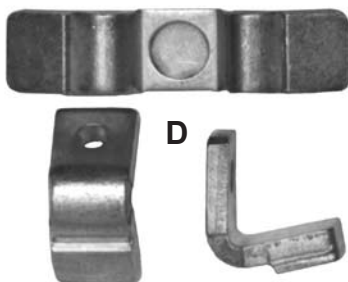
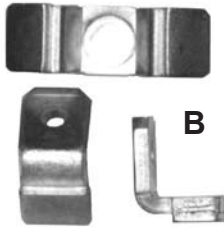

ALLEN-BRADLEY

SERIES K

<u>SIZE</u>	<u>REF.</u>	<u>OEM#</u>	<u>OUR#</u>
0	A	Z34037	9101CA
1	B	Z34038	9111CA
2	C	Z34039	9121CA
3	D	Z34040	9131CA
4	E	Z34041	9141CA
5	F	Z34042	9151CA
5	G	Z34043	9351CA
6	H	X-343110	1016CA*
6	I	X-307644	4005CA*
6	J	X-307636	4006CA*

(One-pole sets unless noted)
*SINGLE CONTACTS

NOTE

9151CA does not accommodate terminal mounted current transformers.

9351CA does accommodate terminal mounted current transformers.

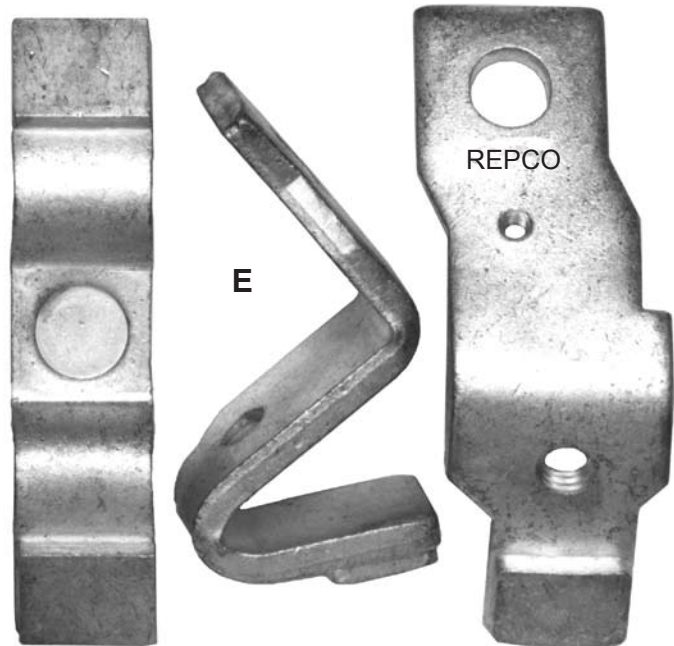
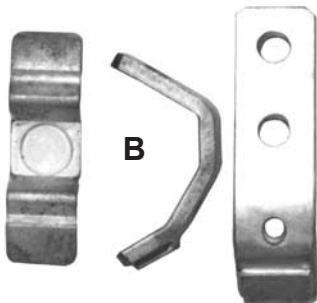
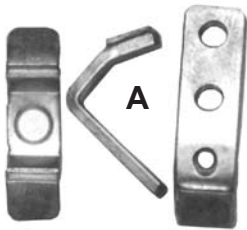
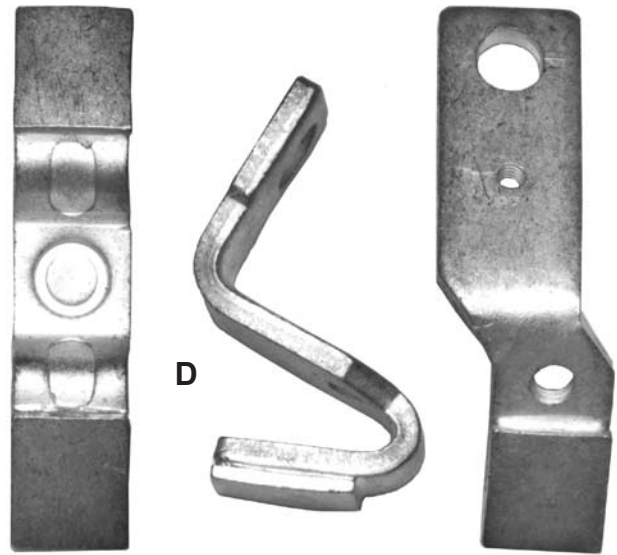
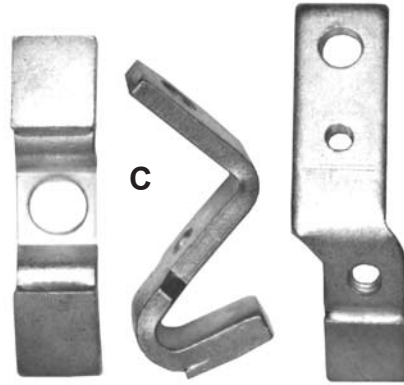

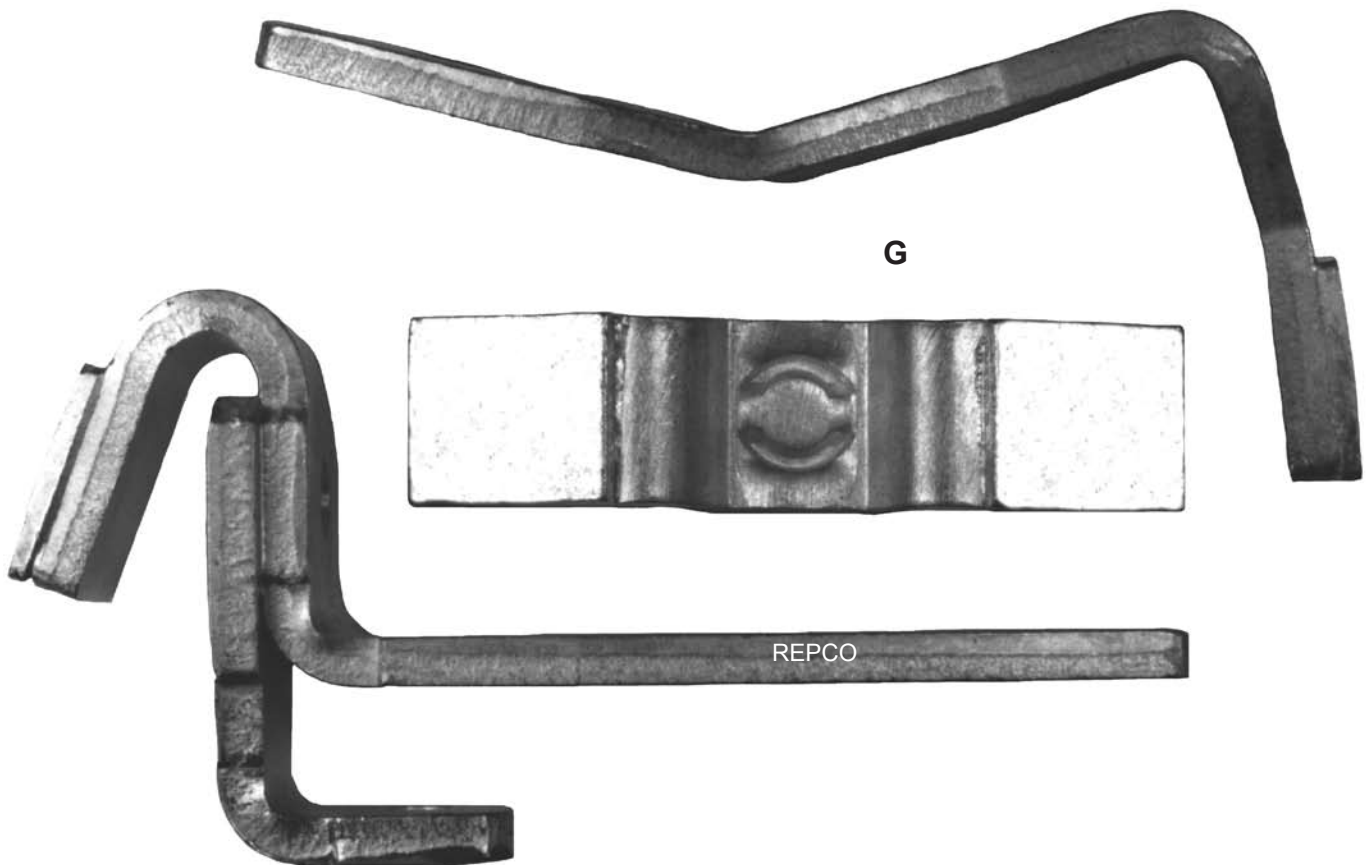
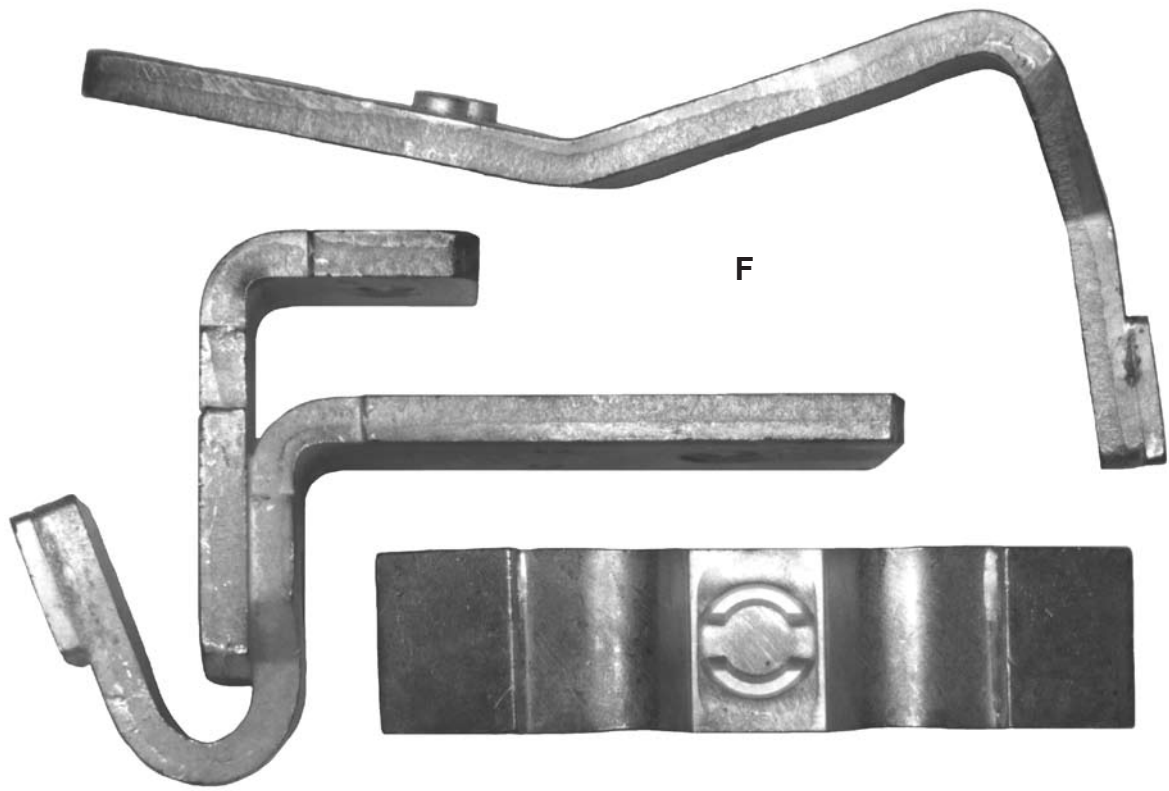

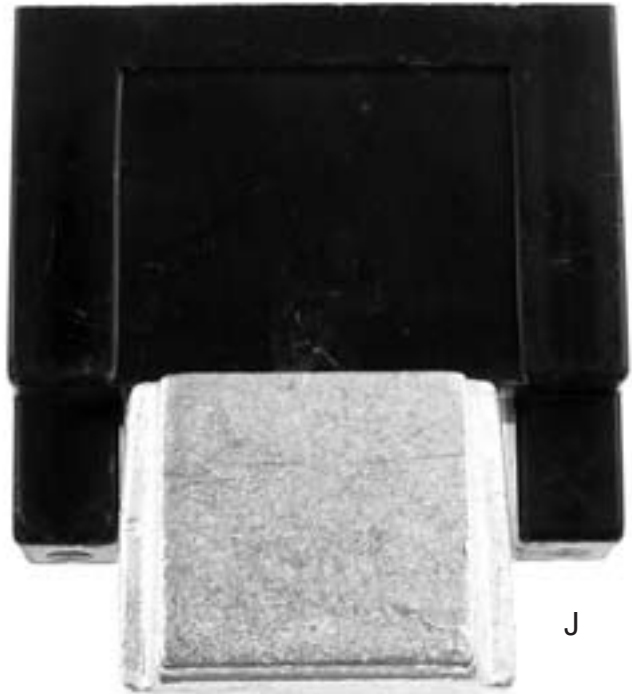
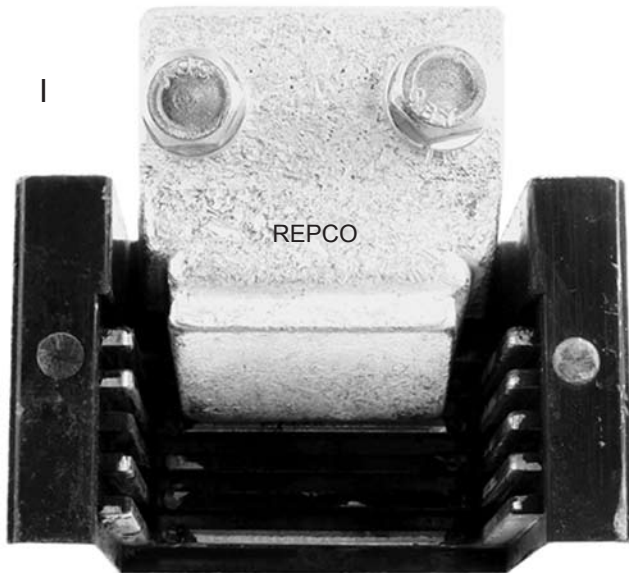
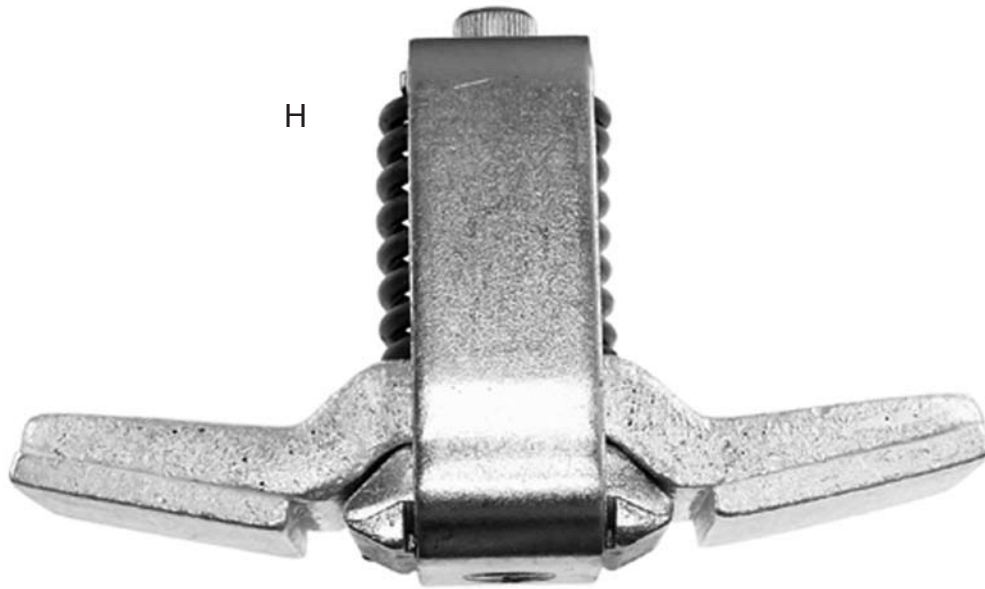

**REPCO CAN ALSO OFFER THE FOLLOWING
SERIES K CONTACT SET REPLACEMENTS:**

**X-247278
X-247282
X-247284
X-247285
X-247286
X-247287
X-247288
X-247290**

**X-247291
X-247294
X-247295
X-247297
X-247298
X-247299
X-247300**

ALLEN-BRADLEY

IEC 100-LINE

<u>DEVICE#</u>	<u>OEM#</u>	<u>OUR#</u>	<u>REF.</u>
100-A38	40768-801-01	9613CA	A
100-A45	40768-802-01	9623CA	B
100-A60	40769-800-01	9633CA	C
100-A75	40769-801-01	9643CA	D
100-B110	40780-800-01	9653CA	E
100-B180	40781-800-01	9663CA	F
100-B250	40782-800-01	9673CA	G
100-B300	40782-801-01	9683CA	H
100-B400	40783-801-01	9603CA	I
100-B600	40783-802-01	9693CA	J

3-POLE SETS

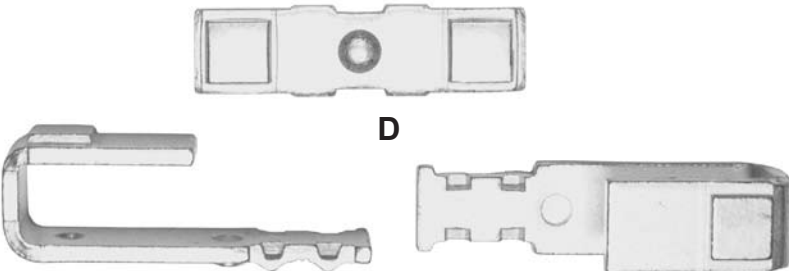
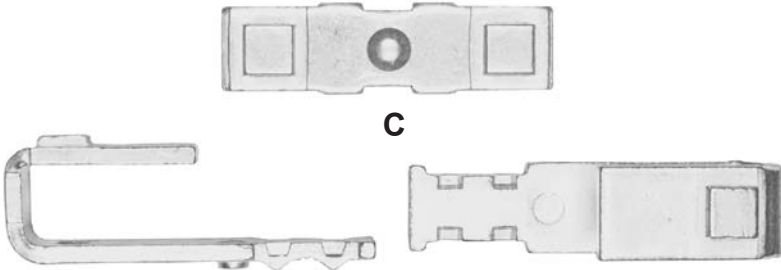
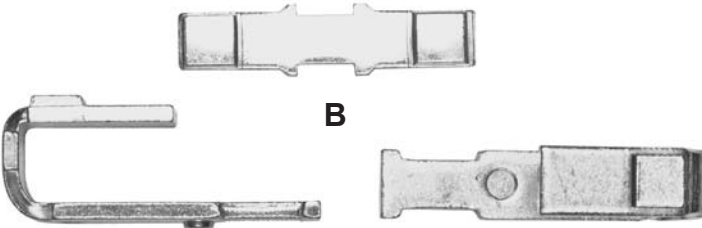
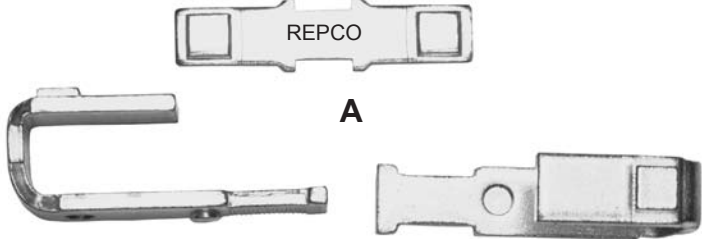



E

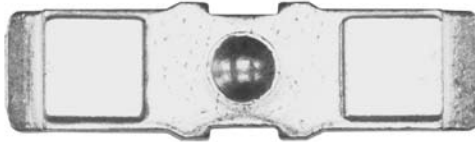
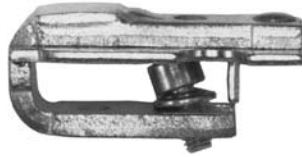

F

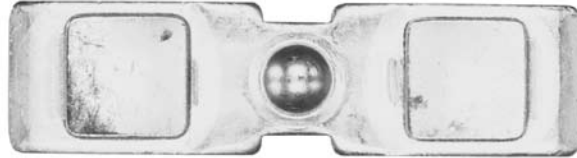
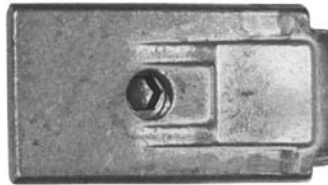
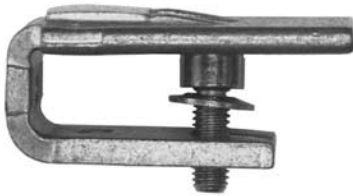

G

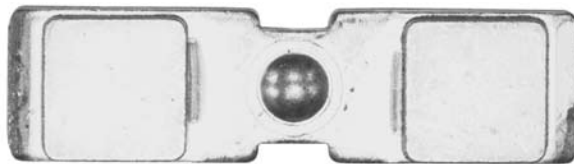
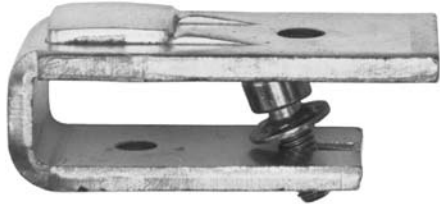

H

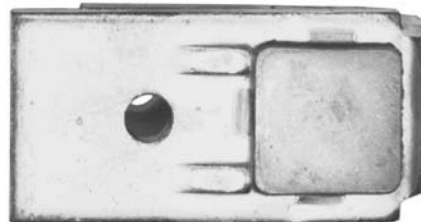
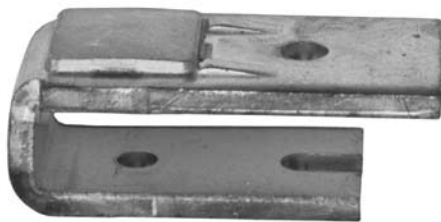

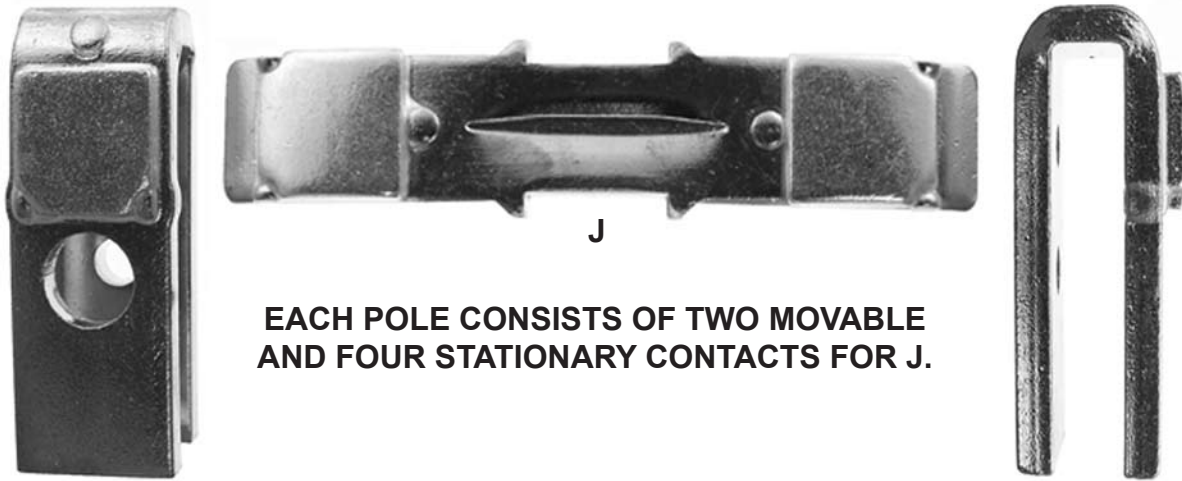

EACH POLE CONSISTS OF TWO MOVABLE
AND FOUR STATIONARY CONTACTS FOR J.

ALLEN-BRADLEY

100-C CONTACTORS

DEVICE#	REF.	OUR#
100-C30 THRU C43	A	9543CR
100-C60 THRU C72	B	9553CR
100-C85	C	9563CR

3-POLE SETS

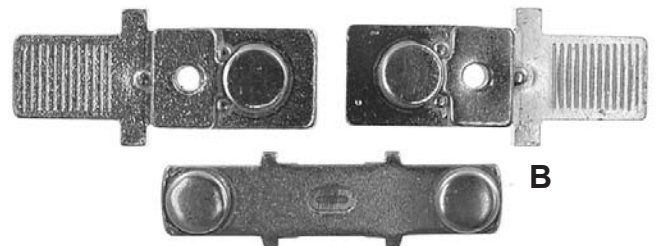

AROMAT

GREEN POWER CONTACTORS

TYPES F/ FC/ FCR/ FCRM

<u>DEVICE#</u>	<u>OEM#</u>	<u>SIZE</u>	<u>OUR#</u>	<u>REF.</u>
F/FC/FCR/FCRM35	BM6-35-901	1++	9823CLX	A
F/FC/FCR/FCRM50	BM6-50-901	2+	9823CLX	A
F/FC/FCR/FCRM65	BM6-65-901	2++	9853CLX	B
F/FC/FCR/FCRM80	BM6-80-901	3	9853CLX	B
F/FC/FCR/FCRM85	BM6-85-901	3+	9853CLX	B
F/FC/FCR/FCRM125	BM6-125-901	3++	9863CLX	C
F/FC/FCR/FCRM160	BM6-160-901	4+	9883CLX	D
F/FC/FCR/FCRM190	BM6-190-901	4++	9883CLX	D

3-POLE SETS

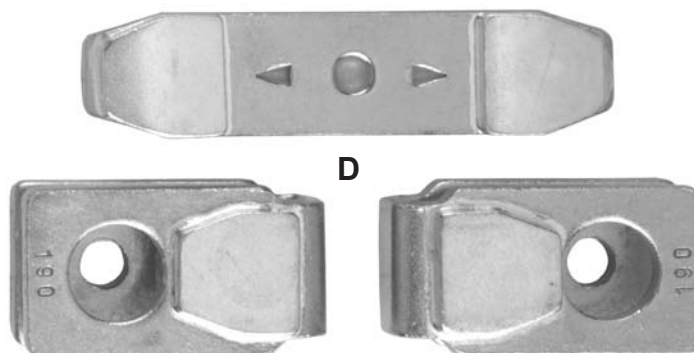
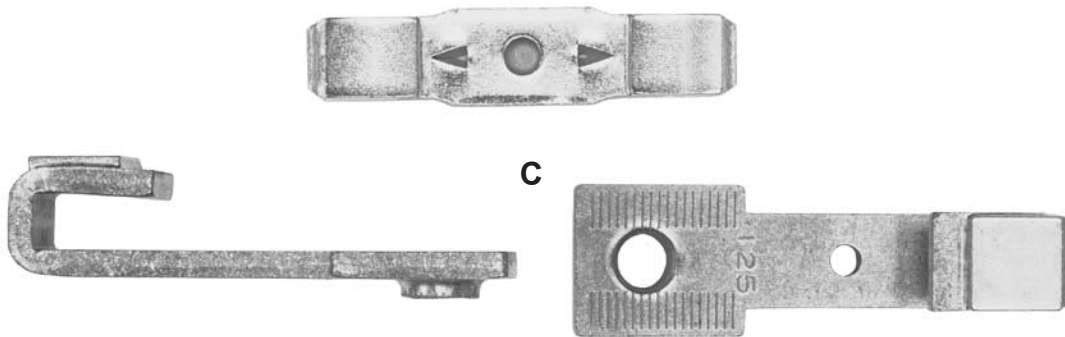
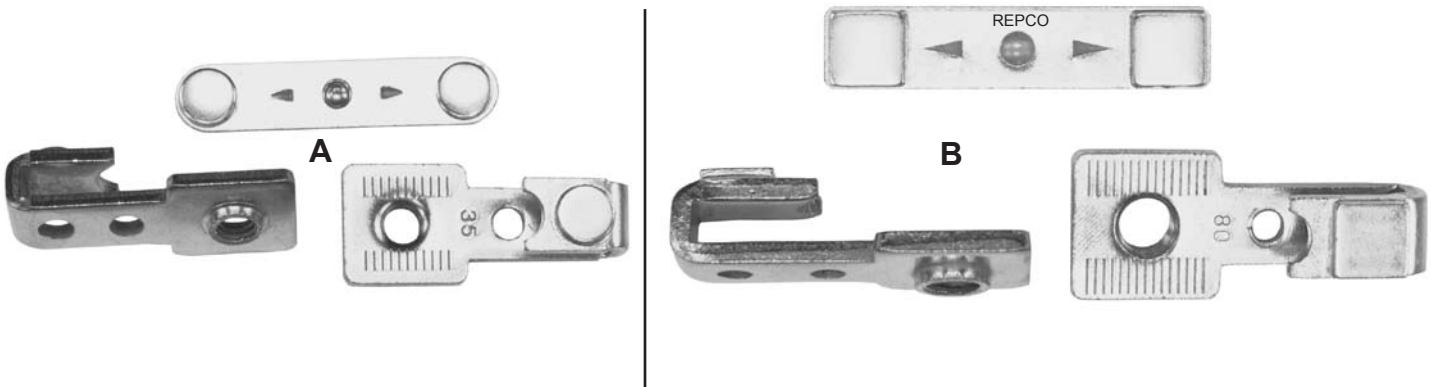

ARROW HART

TYPE RA (OLD STYLE)

OEM#	SIZE	REF.	OUR#
37640-301	2	A	9521CM
38640-301	3	B	9531CM
40500-301	4	C	9551CM

ALL SETS ON THIS PAGE ARE ONE-POLE SETS



A

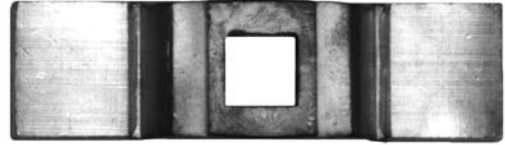

B

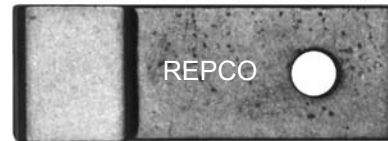

C

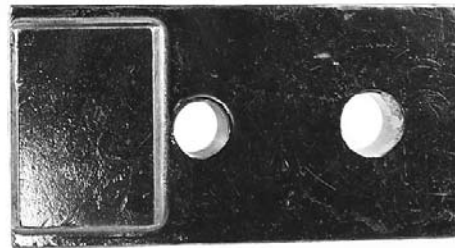
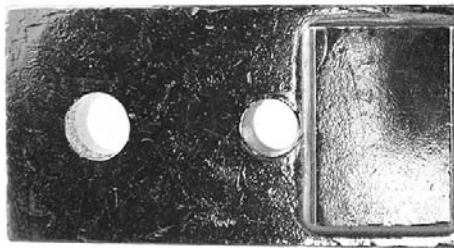

TYPES ACC, ACS, ACV

OEM#	AMPS	REF.	OUR#
34300-301	30-40	D	9431CM
34600-301	50-75	E	9441CM



D

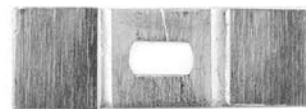

E



ASEA BROWN BOVERI

GENERAL PURPOSE CONTACTORS - TYPE EG

<u>OEM#</u>	<u>TYPE</u>	<u>SIZE</u>	<u>REF.</u>	<u>OUR#</u>
EG401CK	EG30, 40	2	A	9223CB
EG801CK	EG80	3	B	9233CB
EG1601CK	EG160	4	C	9243CB
EG3151CK	EG315	5	D	9253CB
EG6302CK	EG630	6	D	9263CB
EG900CK	EG900	7	D	9273CB

3-POLE SETS



A

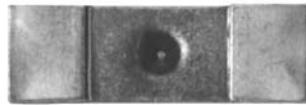

B

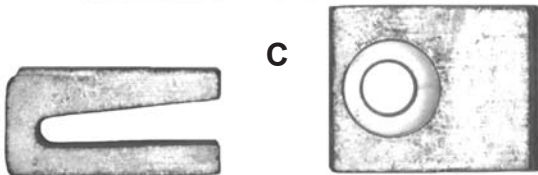

C



D

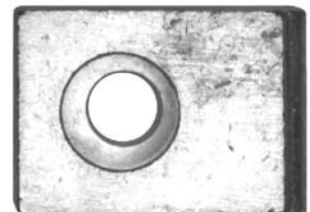
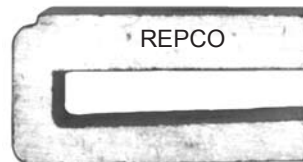

ASEA BROWN BOVERI

DRIVE CONTACTORS - TYPE EFLG

<u>OEM#</u>	<u>TYPE</u>	<u>AMPS</u>	<u>REF.</u>	<u>OUR#</u>
EFLG80CK	EFLG80	110	A	9333CB
EFLG160CK	EFLG160	180	B	9343CB
EFLG280CK	EFLG280	280	C	9353CB
EFLG315CK	EFLG315	360	C	9363CB
EFLG630CK	EFLG630	535	C	9373CB

3-POLE SETS

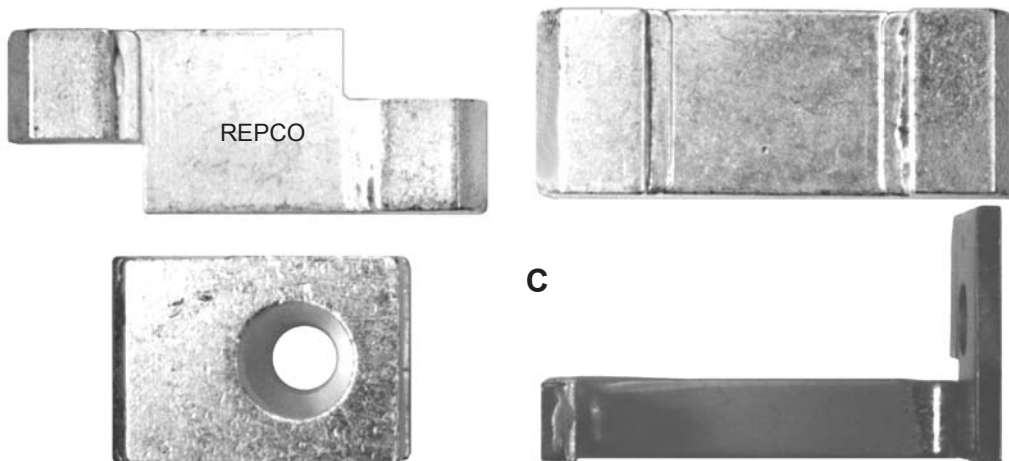
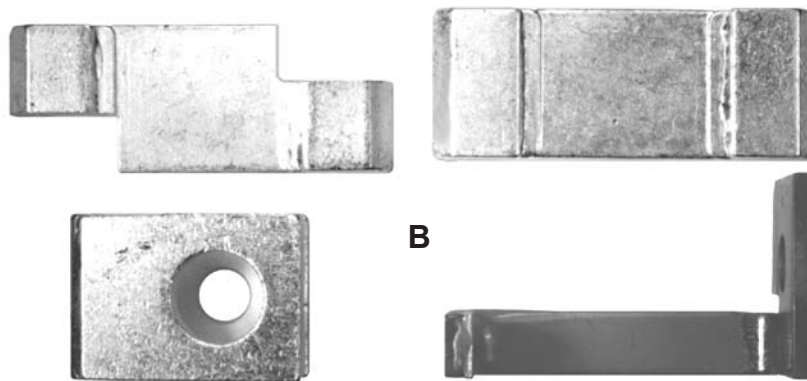
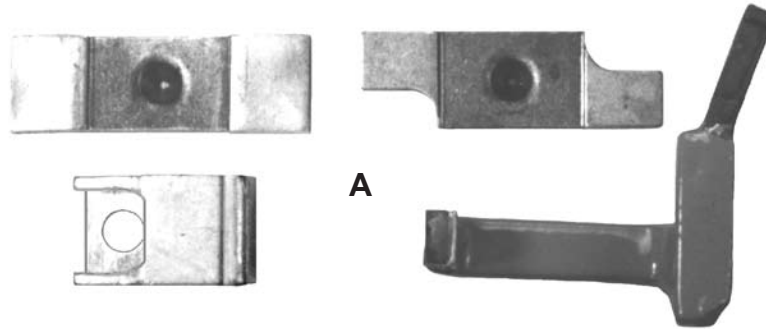

ASEA BROWN BOVERI

TYPE EH

<u>SIZE</u>	<u>DEVICE#</u>	<u>OEM#</u>	<u>OUR#</u>	<u>REF.</u>
2	EH50	EHCK50-3	9513CB	A
2	EH65	EHCK65-3	9513CB	A
2	EH75	EHCK75-3	9513CB	A
3	EH80	EHCK80-3	9523CB	B
3	EH90	EHCK90-3	9523CB	B
4	EH100	EHCK100-3	9533CB	C
4	EH145	EHCK145-3	9533CB	C
4+	EH150	EHCK150-3	9543CB	D
4+	EH160	EHCK160-3	9543CB	D
4+	EH170	EHCK170-3	9543CB	D
4+	EH175	EHCK175-3	9543CB	D
4+	EH210	EHCK210-3	9543CB	D
5	EH250	EHCK250-3	9553CB	E
5	EH260	EHCK260-3	9553CB	E
5	EH270	EHCK270-3	9553CB	E
5	EH280	EHCK280-3	9553CB	E
5	EH300	EHCK300-3	9553CB	E
6	EH370	EHCK370-3	9573CB	F
6	EH450	EHCK450-3	9573CB	F
6	EH550	EHCK550-3	9573CB	F
7	EH700	EHCK700-3	9583CB	G
8	EH800	EHCK800-3	9583CB	G

3-POLE SETS

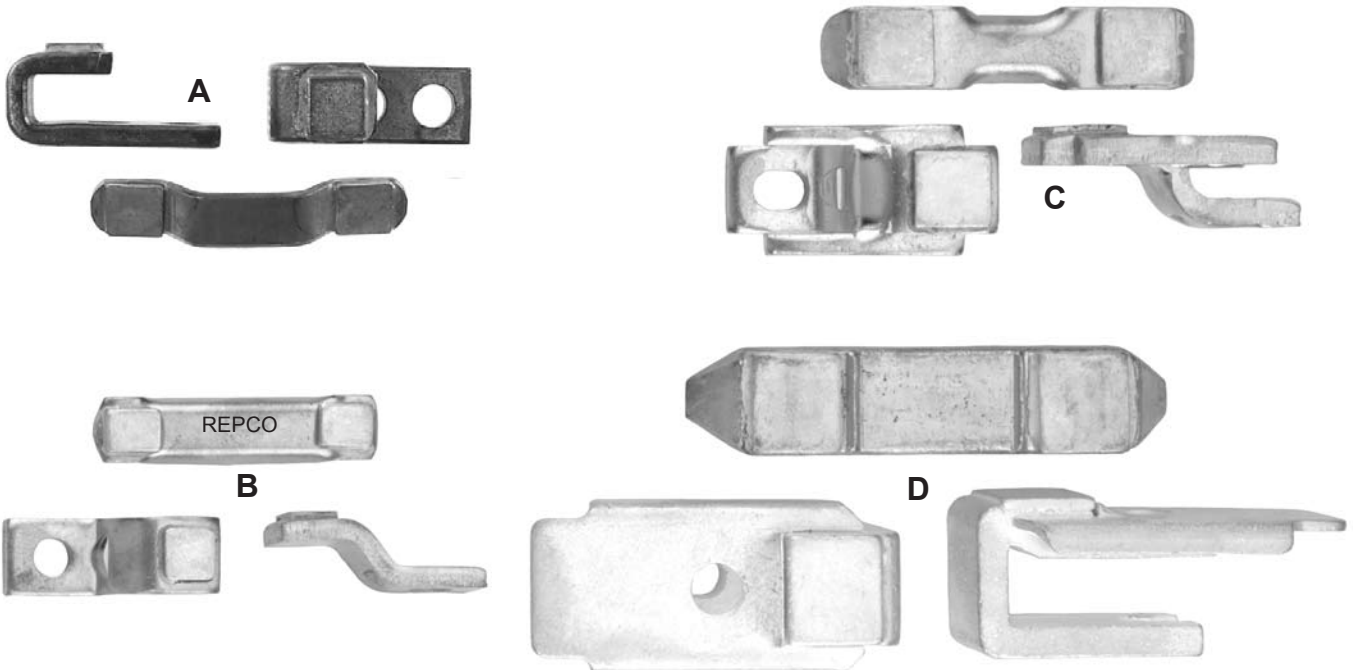

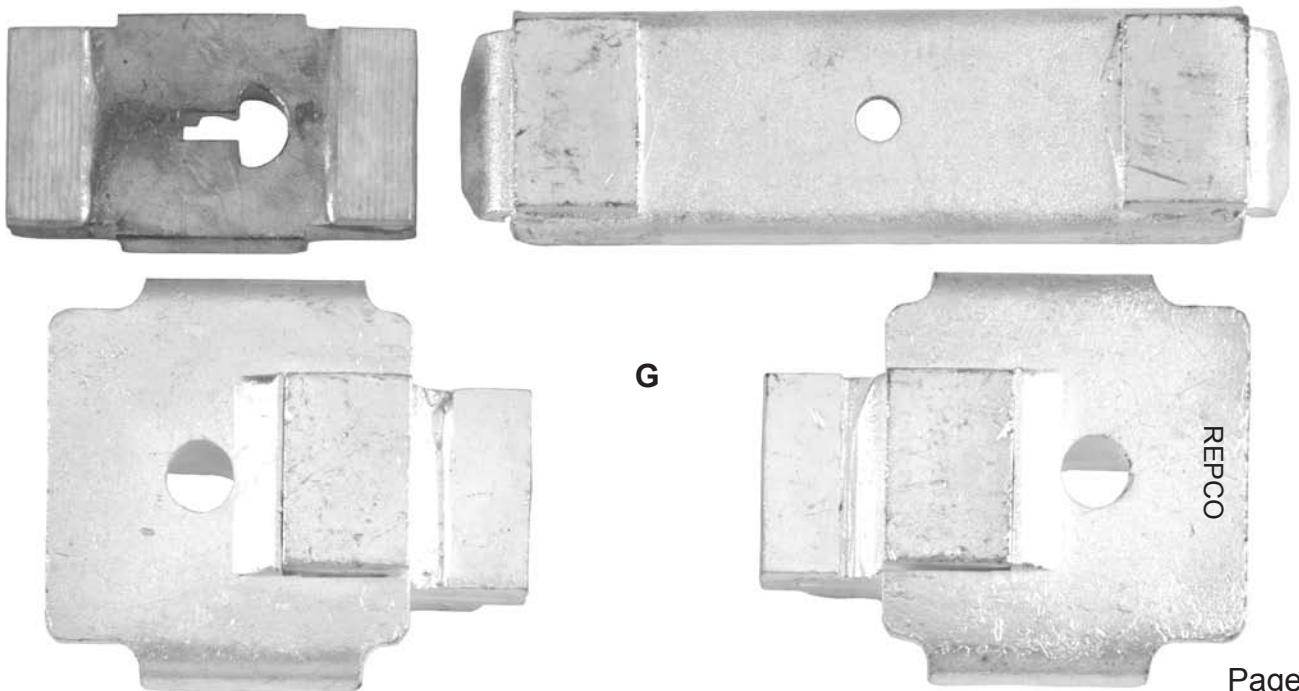
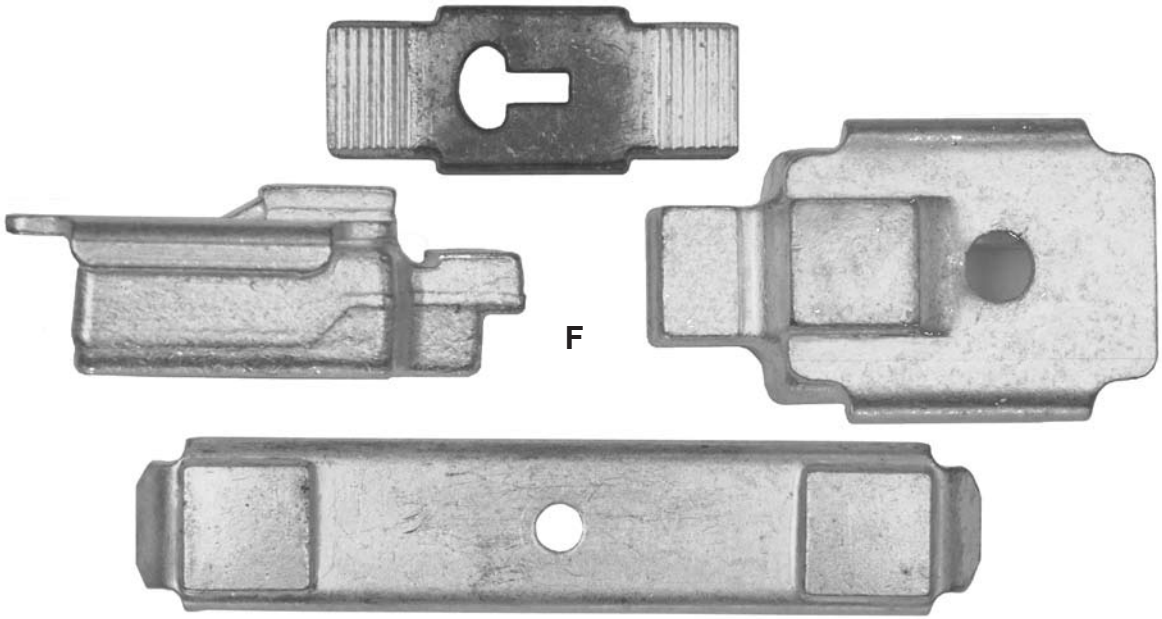
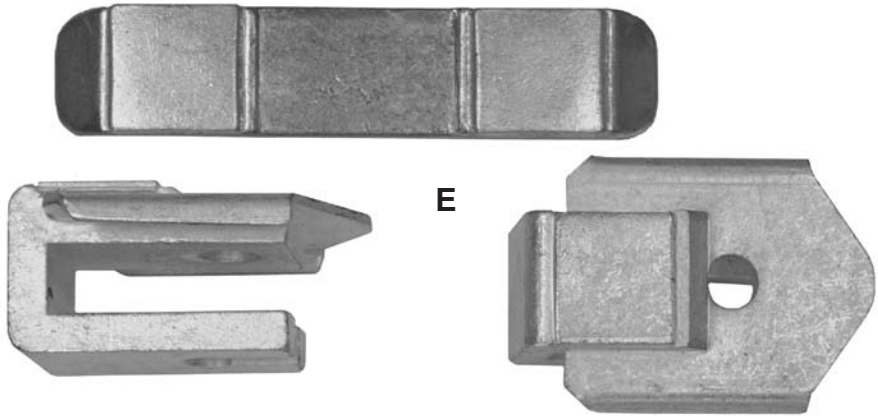

TYPE EHDB DRIVE CONTACTORS

NORMALLY CLOSED 1 POLE KITS

<u>TYPE</u>	<u>OEM#</u>	<u>OUR#</u>	<u>REF.</u>
EHDB75	EHDBCK075-NC	9601CB	A
EHDB110	EHDBCK110-NC	9601CB	A
EHDB130	EHDBCK130-NC	9611CB	B
EHDB220	EHDBCK220-NC	9621CB	C
EHDB280	EHDBCK280-NC	9631CB	C
EHDB360	EHDBCK360-NC	9641CB	D
EHDB520	EHDBCK520-NC	9651CB	E
EHDB650	EHDBCK650-NC	9661CB	E
EHDB800	EHDBCK800-NC	9671CB	F
EHDB960	EHDBCK960-NC	9681CB	F

NORMALLY OPEN 2 POLE KITS

<u>OEM#</u>	<u>OUR#</u>
EHDBCK075-2	9522CB
EHDBCK110-2	9522CB
EHDBCK130-2	9532CB
EHDBCK220-2	9542CB
EHDBCK280-2	9542CB
EHDBCK360-2	9552CB
EHDBCK520-2	9572CB
EHDBCK650-2	9572CB
EHDBCK800-2	9582CB

(Items not pictured)

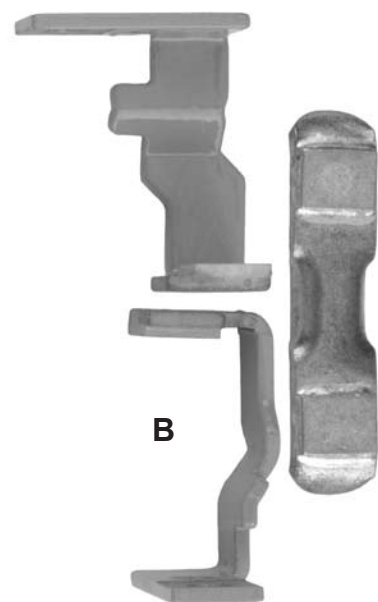
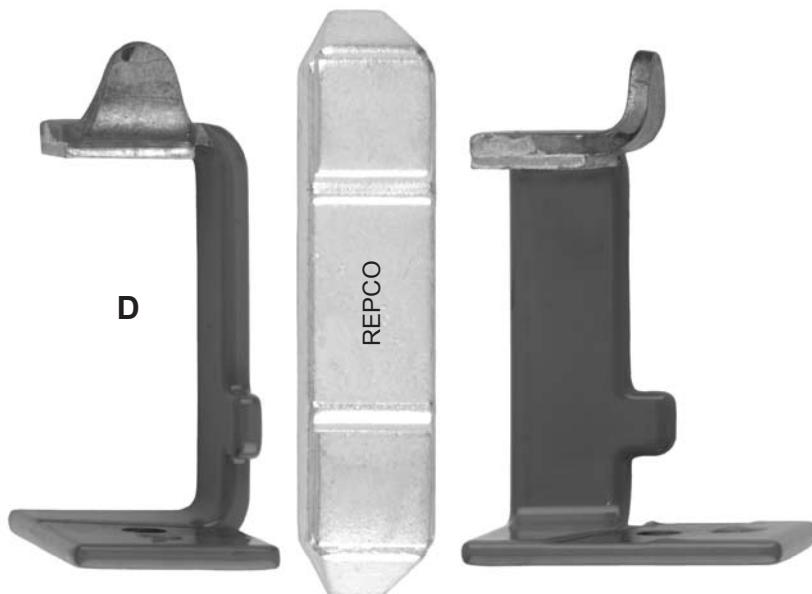
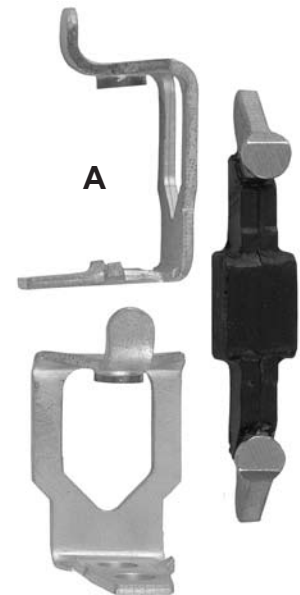
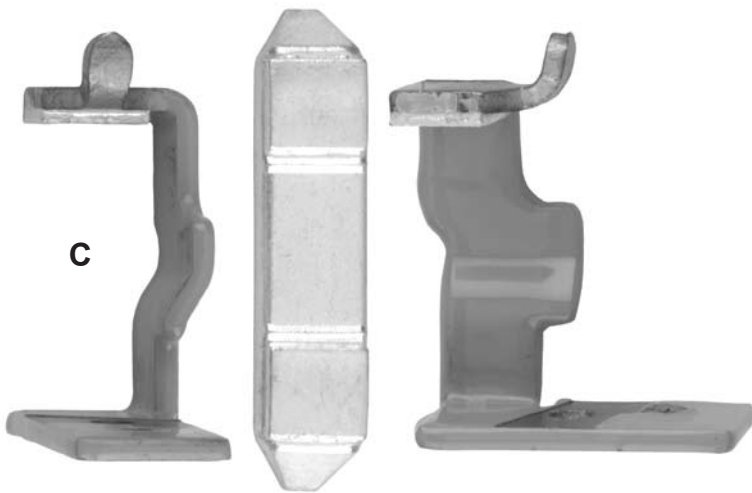

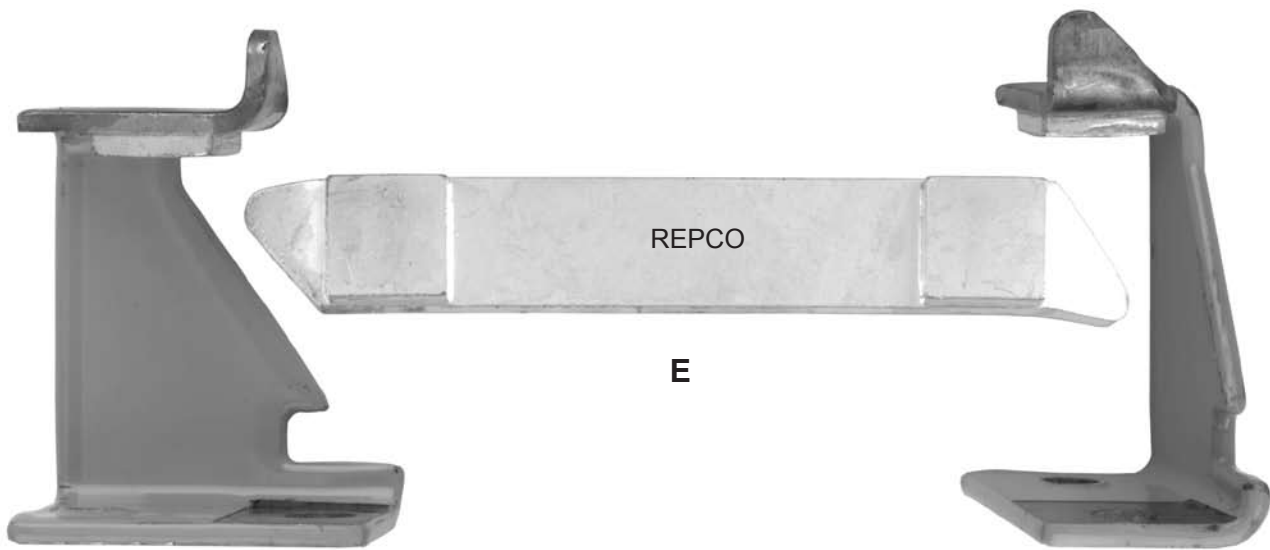

E

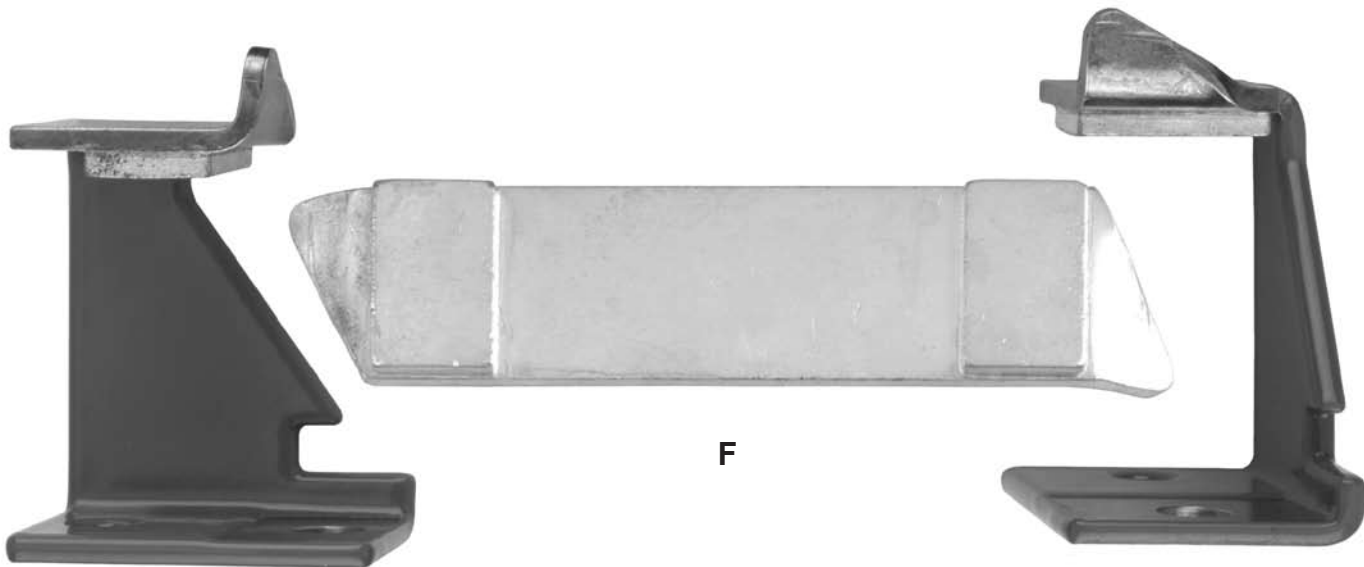

F

TYPE B CONTACTORS

<u>TYPE</u>	<u>OEM#</u>	<u>OUR#</u>	<u>REF.</u>
B30, BC30	KL30	9713CB	G
B40, B50, BE40, BE50	KL40, KL50	9743CB	H
B63, BE63	KL63	9743CB	H
B75, BE75	KL75	9743CB	H

3-POLE SETS

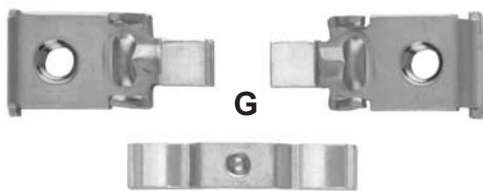

G

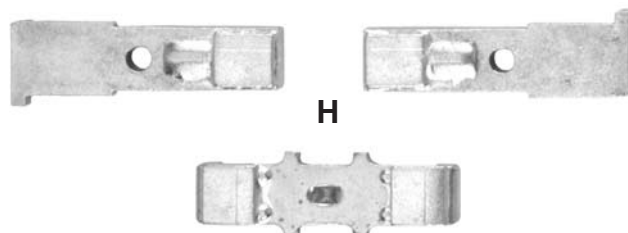

H

ASEA BROWN BOVERI

TYPE A/AF/AE/TAE

OEM#	OUR#	REF.	DEVICE#
ZL50, 63, 75	9823CB	A	A/AF/AE/TAE50, 63, 75
ZL95, 110	9843CB	B	A/AF/AE/TAE95, 110
ZL145, 185	9863CB	C	A/AF145, 185
ZL210, 260, 300	9873CB	D	A/AF210, 260, 300
ZL400, 460	9883CB	E	A/AF400, 460
ZL580, 750	9893CB	--	A/AF580, 750

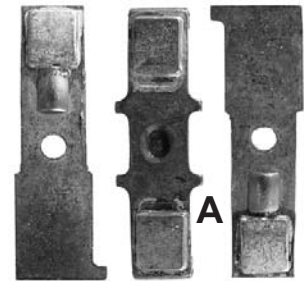

3-POLE SETS

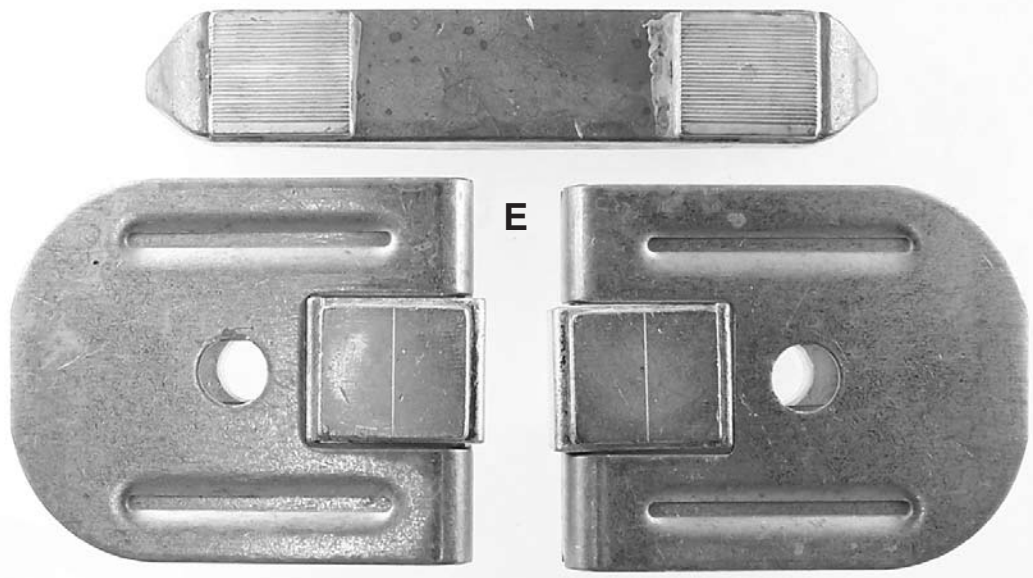
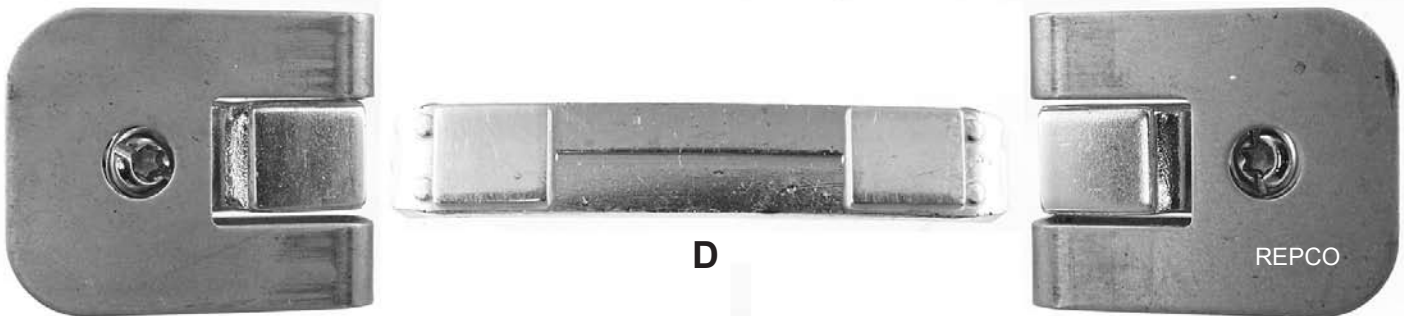
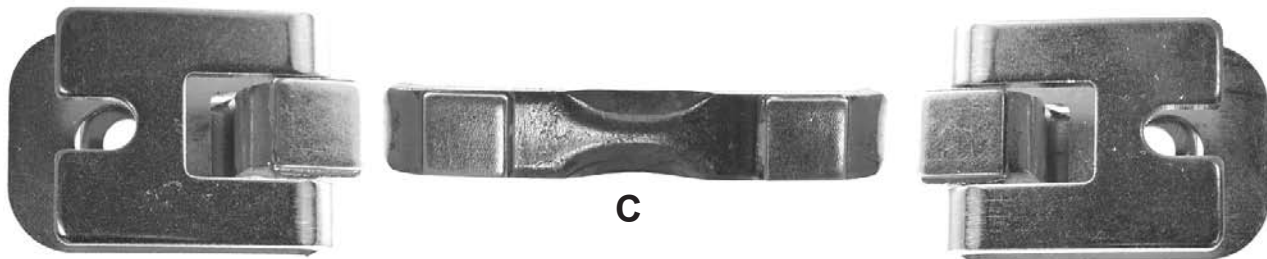
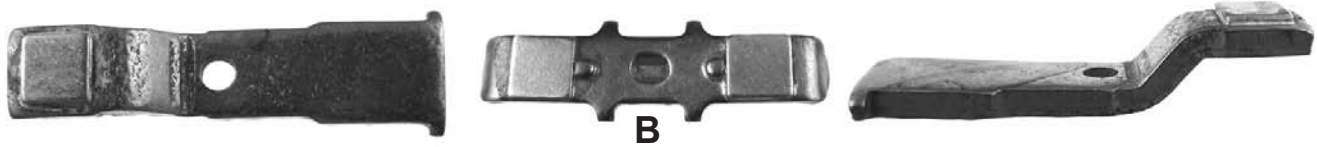

CLARK

AUXILIARY CONTACTS

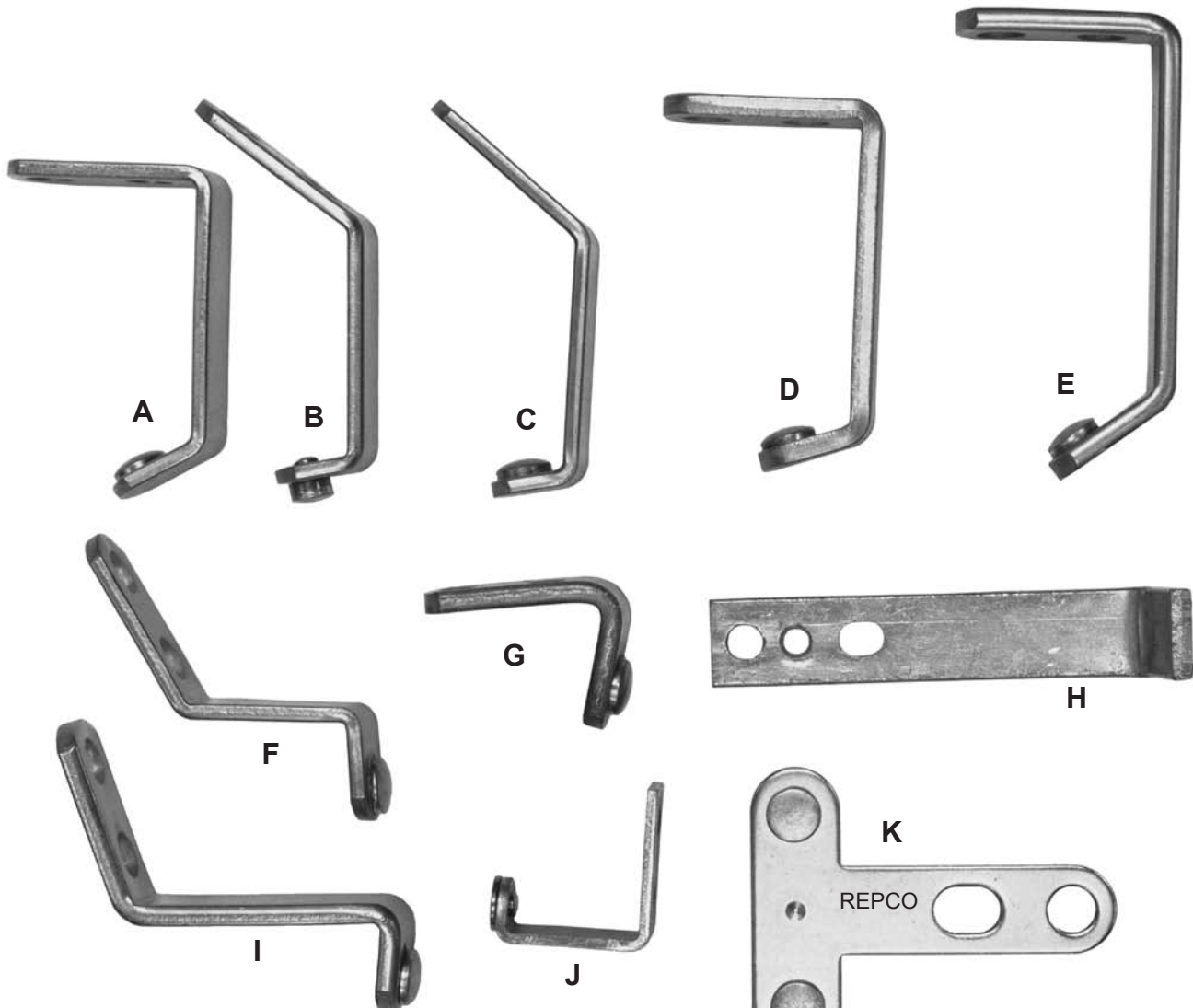

<u>REF.</u>	<u>OUR#</u>
A	4029CD
B	4031CD
C	4032CD
D	4033CD
E	4034CD
F	4035CD
G	4036CD
H	4027CD
I	4037CD
J	4038CD
K	4028CD
L	4039CD
M	4024CD
N	4042CD
P	4025CDB

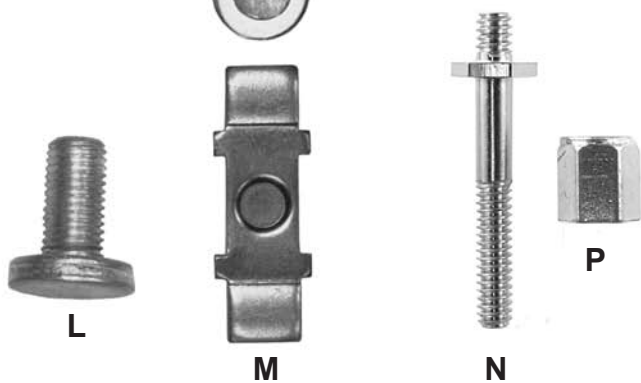

REFERENCES A, B, C, D, E, F, G, AND I
ARE 1/2" WIDE
REFERENCE J IS 3/8" WIDE

CLARK • SYLVANIA • JOSLYN

TYPE CY

<u>SIZE</u>	<u>OEM#</u>	<u>REF.</u>	<u>OUR#</u>
1	CY31-1	A	9413CD
2	CY32-1	B	9423CD
3	CY33-1	C	9433CD
4	CY34-1	D	9443CD

3-POLE SETS

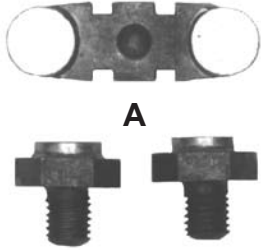

A



B

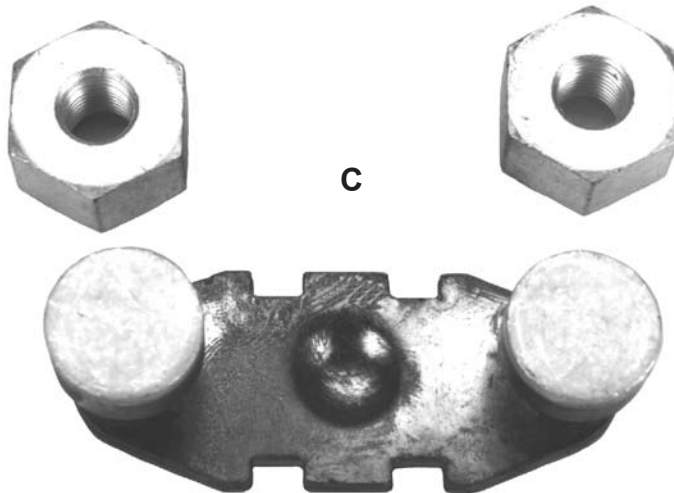

C

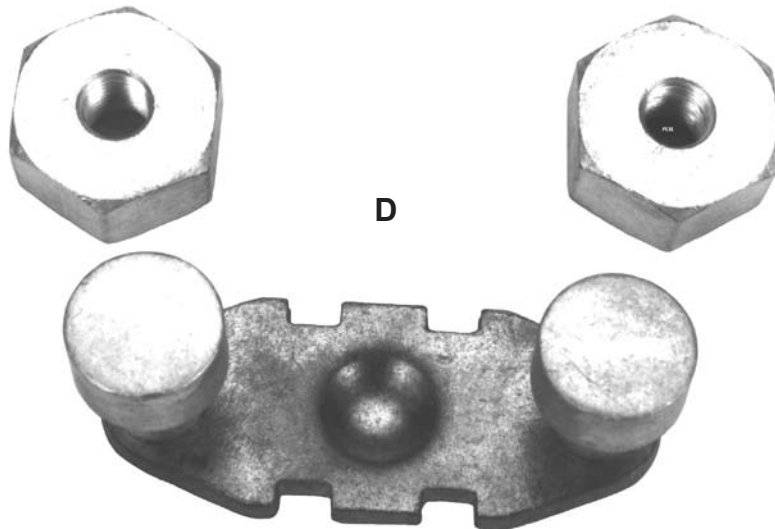

D

CLARK • SYLVANIA • JOSLYN

TYPE TM

<u>SIZE</u>	<u>OEM#</u>	<u>REF.</u>	<u>OUR#</u>
1	KTM31-1	A	9583CD
2	KTM32-1	B	9523CD
3	KTM33-1	C	9533CD
4	KTM34-1	D	9543CD
5	KTM35-1	E	9553CD

3-POLE SETS

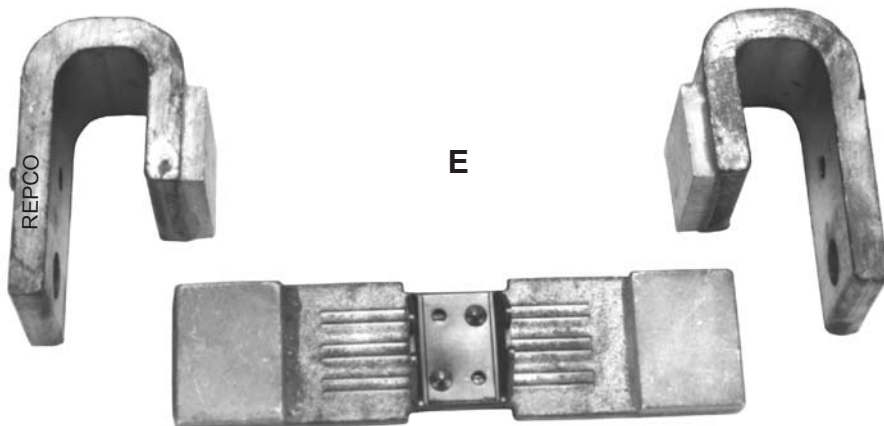
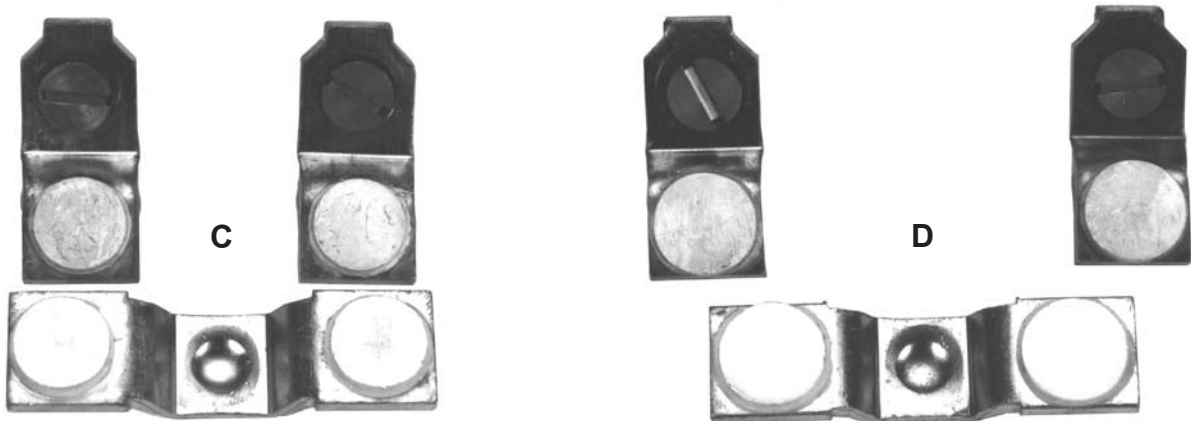

CLARK • CHALLENGER

50 AMP TO 300 AMP DC CONTACTORS
BULLETIN 7400, TYPE KD AND KS

<u>UNIT#</u>	<u>AMPS</u>	<u>OEM#</u>	<u>OUR#</u>	<u>REF.</u>
74U12	50	KKD-050	9611CD	A
74U13	100	KKD-100	9621CD	B
74U14	150	KKD-150	9631CD	C
74U15	300	KKD-300	D	

ONE-POLE SETS



A

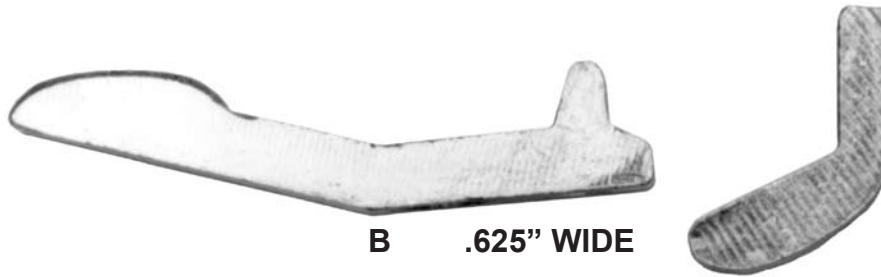

B .625" WIDE

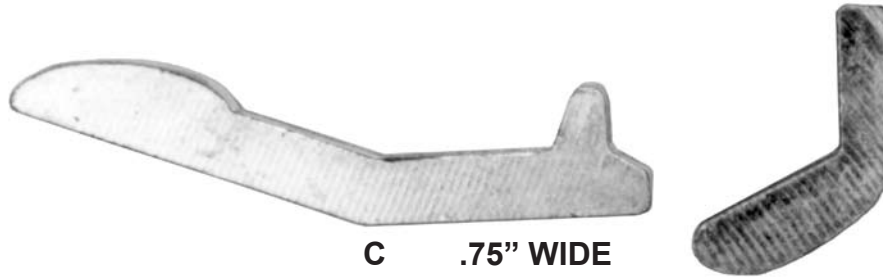

C .75" WIDE

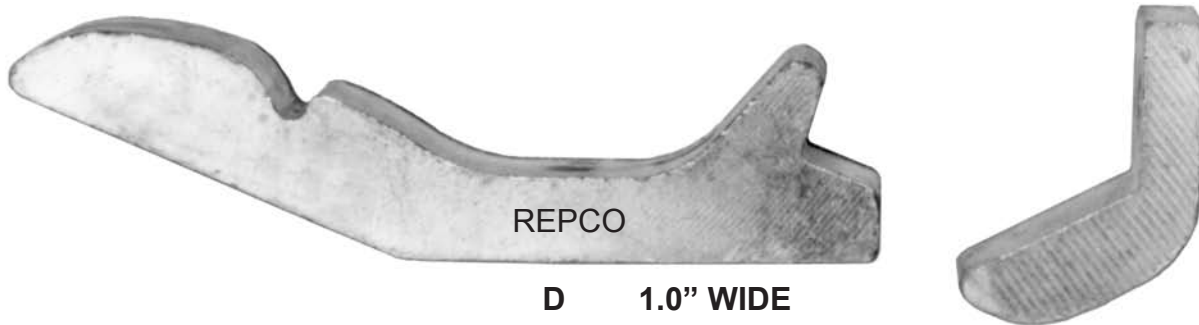

REPCO

D 1.0" WIDE

CLARK • CHALLENGER • SYLVANIA

100 AMP TO 900 AMP DC CONTACTORS
 BULLETIN 7400, RS AND RD

<u>UNIT#</u>	<u>AMPS</u>	<u>OUR#</u>	<u>REF.</u>
100-4RD	100	4301CD	A
150-4RD	150	4001CD	B
300-4RD	300	4002CD	C
400-4RD	400	4003CD	D
600-4RD	600	4302CD	E
900-4RD	900	4303CD	F

SINGLE CONTACTS

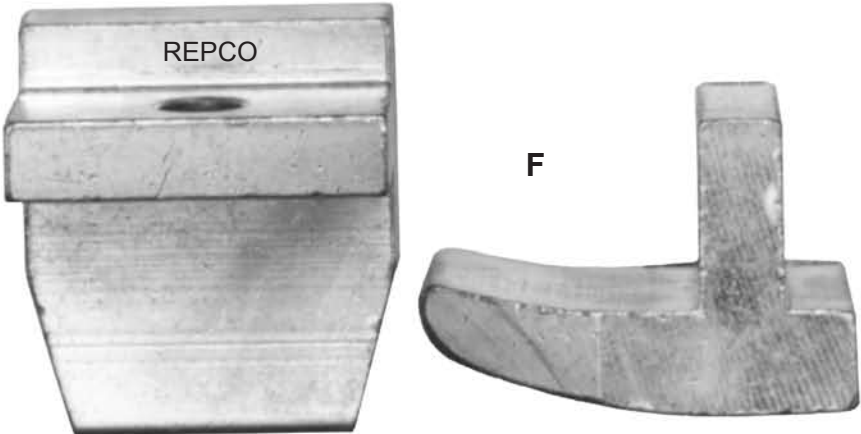
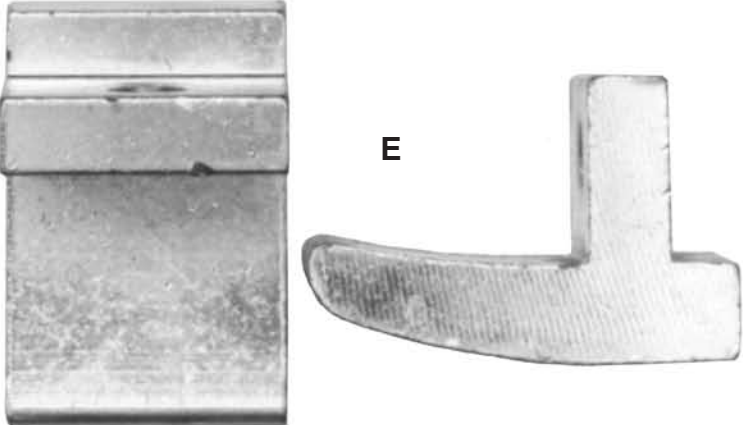
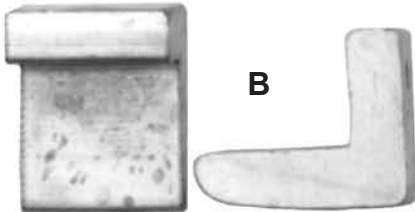
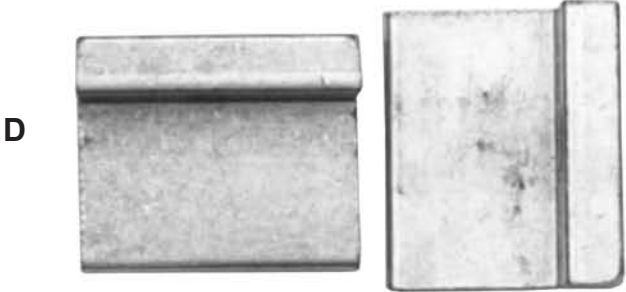
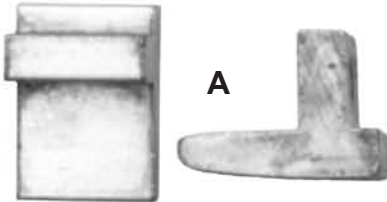
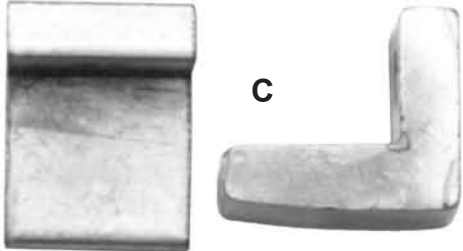

CLARK • SYLVANIA • CHALLENGER

MISCELLANEOUS CONTACTS

<u>REF.</u>	<u>WIDTH</u>	<u>OUR COPPER#</u>	<u>OUR SILVER#*</u>
A	1/2"	4022CD	4022CDR
A	3/4"	1024CD	1024CDR
B	1 1/2"	1026CD	1026CDR
B	2"	1027CD	1027CDR
C	3/4"	4011CD	4011CDR
D	1"	4010CD	4010CDR

*SILVER REPLACED WITH REPALLOY®

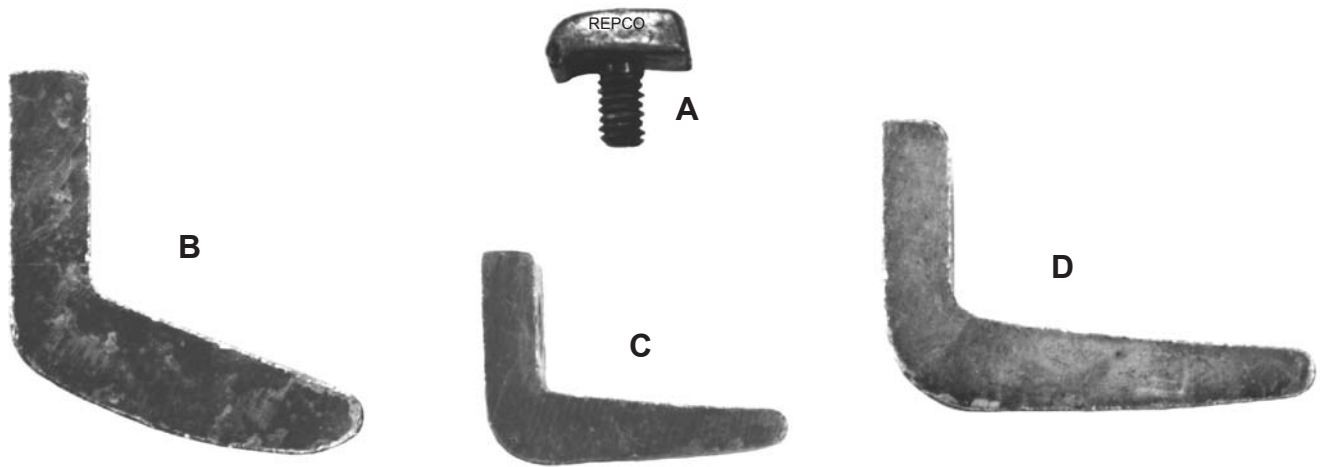

KKD AUXILIARY CONTACTS

<u>OEM#</u>	<u>TYPE</u>	<u>OUR#</u>
KKD-1	1NO, 1NC	4045CD
KKD-2	2NO	4046CD
KKD-3	2NC	4047CD
KKD-7	1NO	4048CD
KKD-8	1NC	4049CD

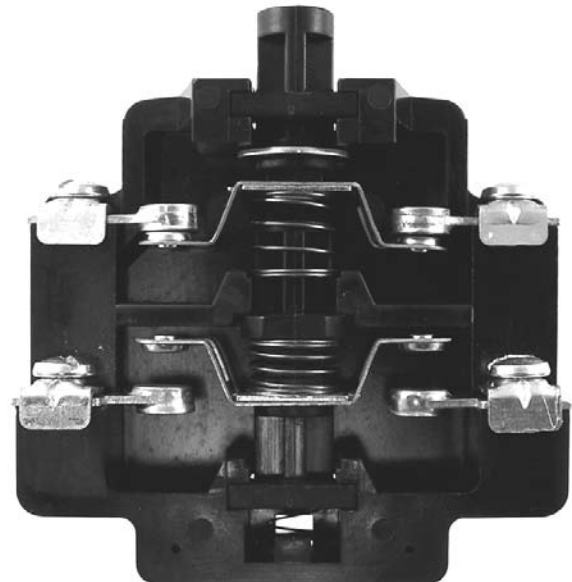

WE ALSO CARRY SHUNTS, ARC GUARDS,
AND OTHER DC COMPONENTS IN STOCK

CUTLER-HAMMER

CITATION LINE, SERIES A1

<u>SIZE</u>	<u>OEM#</u>	<u>REF.</u>	<u>OUR#</u>
0	6-22-2	A	9103CC
1	6-23-2	B	9113CC
2	6-24-2	C	9123CC
3	6-25-2	D	9133CC
4	6-26-2	E	9143CC
5	6-27-2	F	9153CC
6 & 7	6-28-2	G	9163CC
6 & 7	6-570	H	9263CC
8	6-29-2	--	9283CC

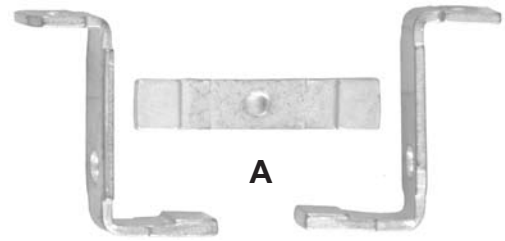

A

3-POLE SETS

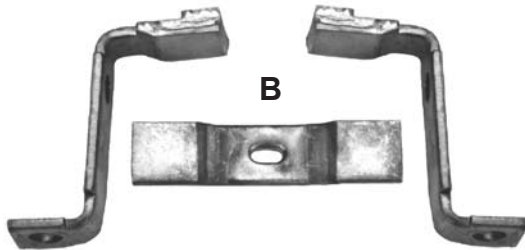

B

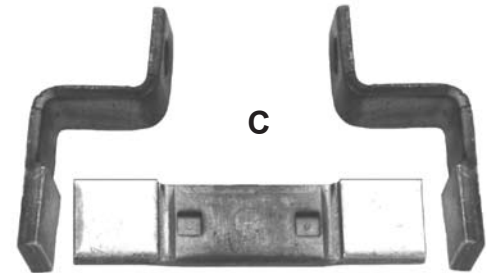

C

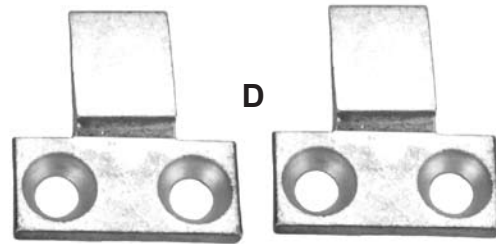

D



REPCO

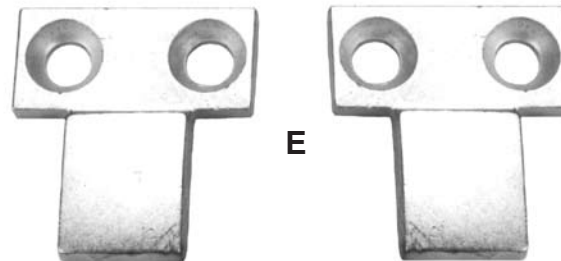

E

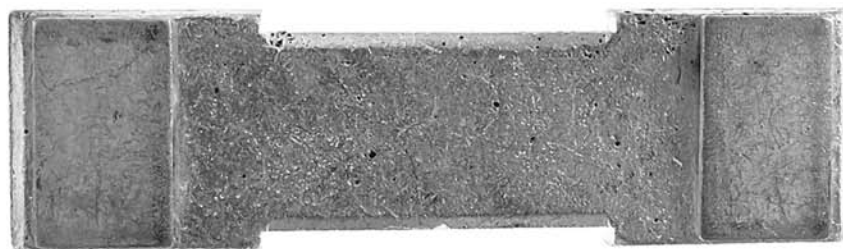
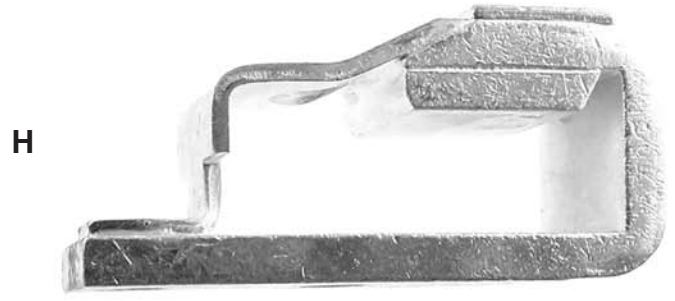
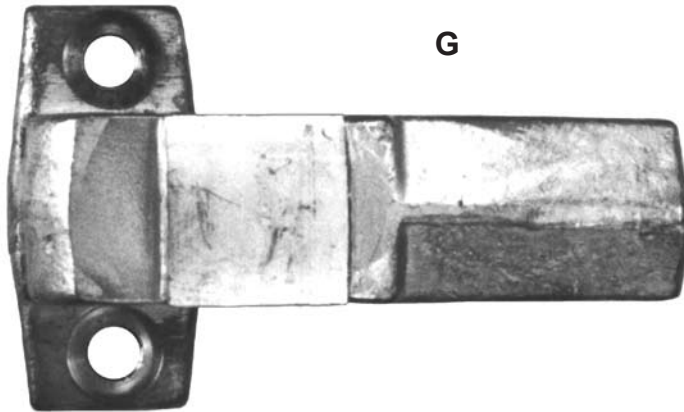
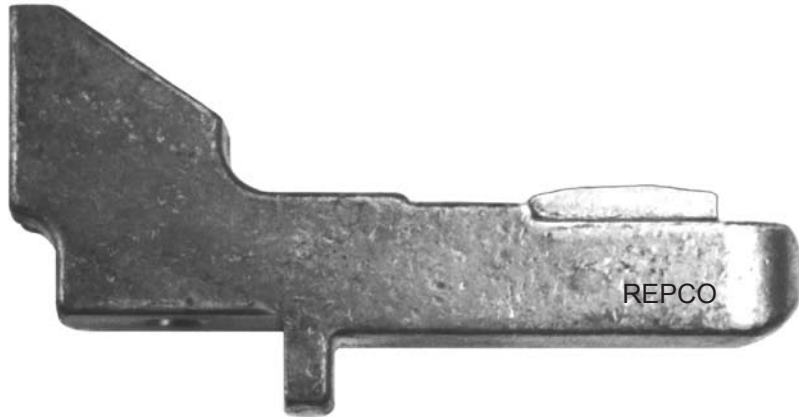
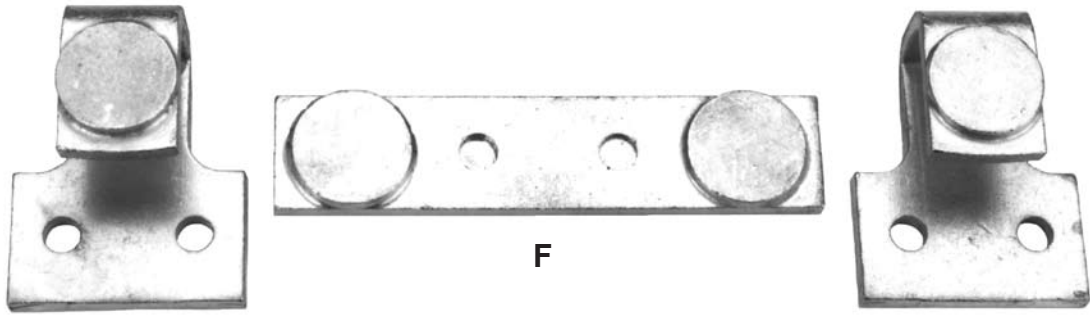

CUTLER-HAMMER

SERIES B1

<u>SIZE</u>	<u>OEM#</u>	<u>REF.</u>	<u>OUR#</u>
2	6-34-2	A	9223CC
3	6-35-2	B	9233CC
4	6-36-2	C	9243CC

3-POLE SETS

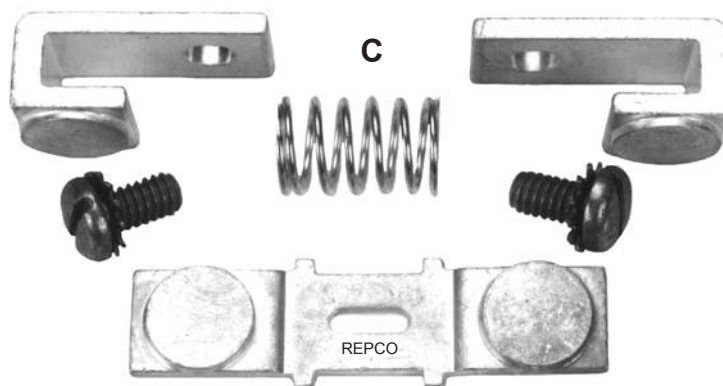
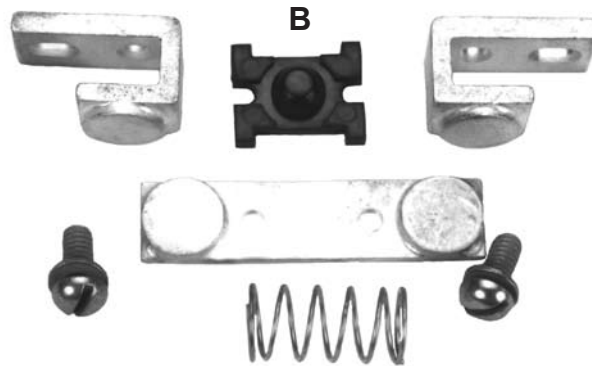
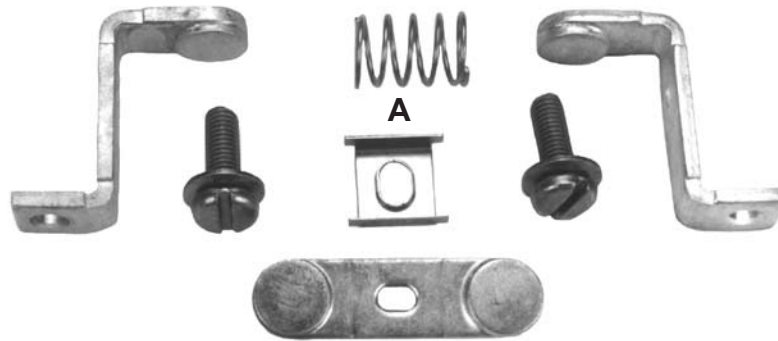

CUTLER-HAMMER

FREEDOM SERIES

<u>SIZE</u>	<u>REF.</u>	<u>OEM#</u>	<u>OUR#</u>
1	A	6-65-2	9813CC
G	A	6-65-4	9823CC
1 3/4, H	A	6-65-6	9893CC
2, J	A	6-65-8	9823CC
K	A	6-65-17	9823CC
L	B	6-43-4	9833CC
3, M	B	6-43-2	9833CC
N	B	6-43-6	9733CC
4	C	6-44-2	9843CC
P	D	6-294	9143CC
R	D	6-288	9143CC
S	D	6-286	9143CC
T	E	6-621	9753CC
U	E	6-622	9753CC
5	F	6-45-2	9853CC
6, V	G	6-601	9863CC
7, W, X	H	6-613	9763CC

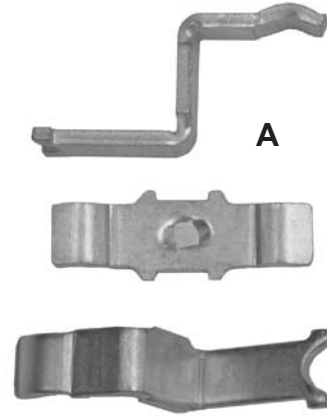

3-POLE SETS

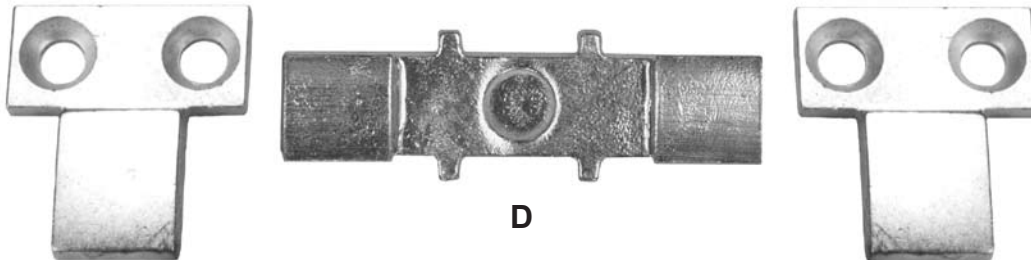
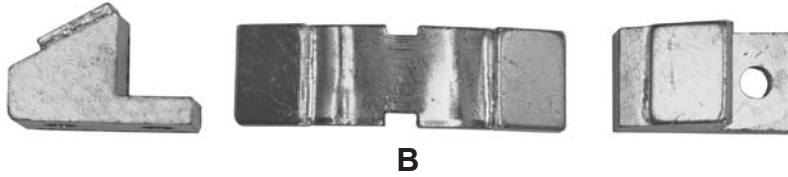

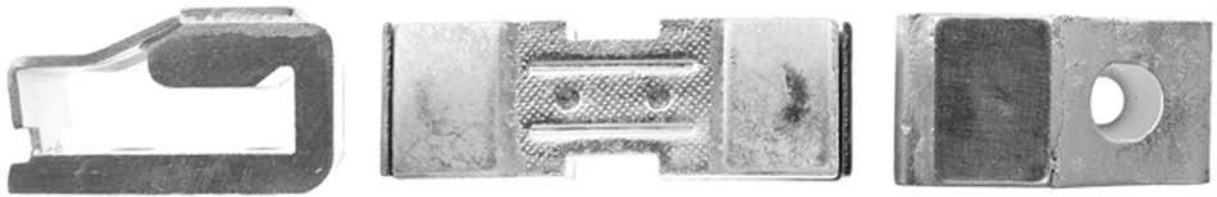

E



F



G

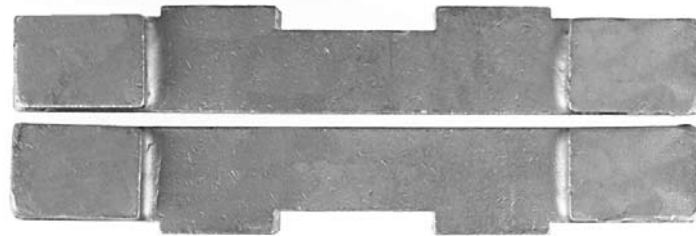

H

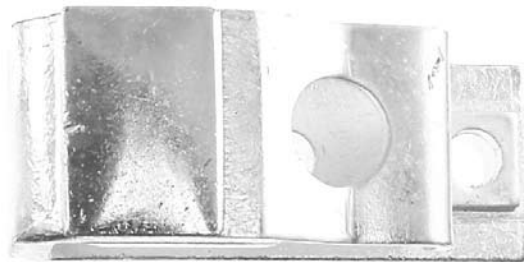

CUTLER-HAMMER

OLD STYLES

<u>SIZE</u>	<u>OEM#</u>	<u>OUR#</u>	<u>REF.</u>
00	6-2-3	9693CC	A
1	6-106	9001CC	B
1	6-3-3	9613CC	C
2	6-113	9000CC	D
2	6-10-2	9623CC	E
3	6-12-2	9633CC	F
3	6-16-2	9633CC	F
4	6-14-2	9643CC	G
5	6-186-2	9653CC	H
5	6-186-5	9650CC	H

3-POLE SETS

9653CC consists of 3 each x, y, and z.

9650CC consists of 3 each z, 2 each of w, y,
and 1 each v and x.

Other 6-186- configurations are available.

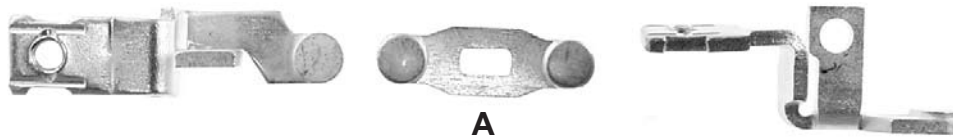

A

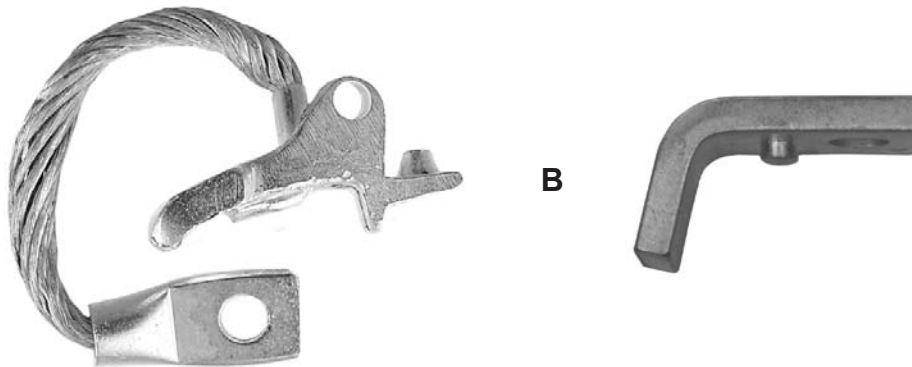

B



C



D

(REF. E ON PAGE 37)



F

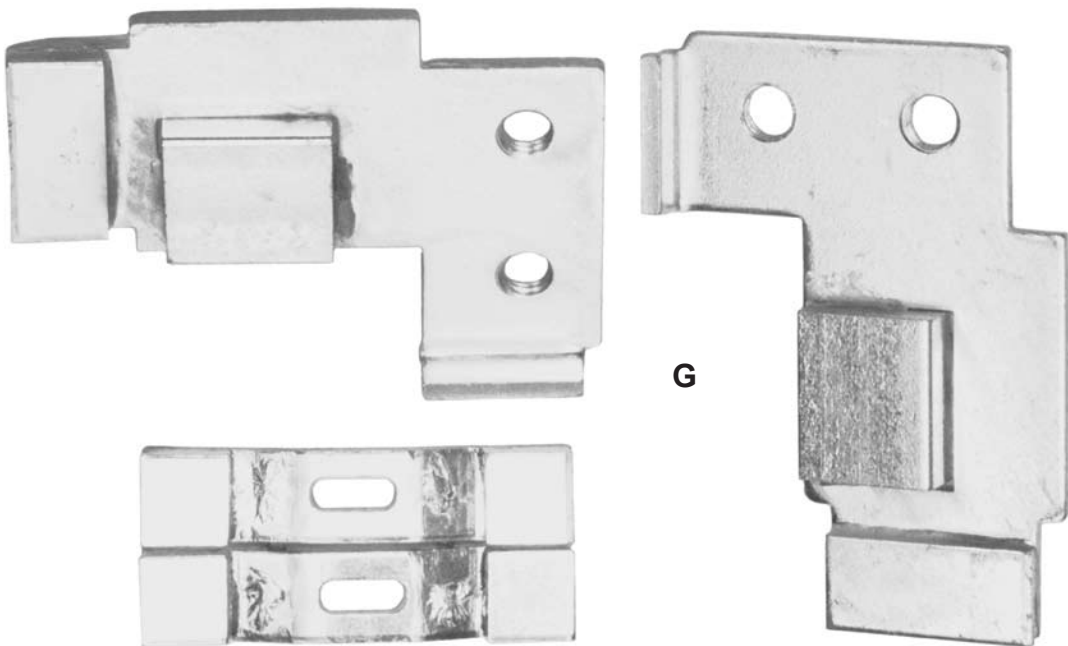

G



E

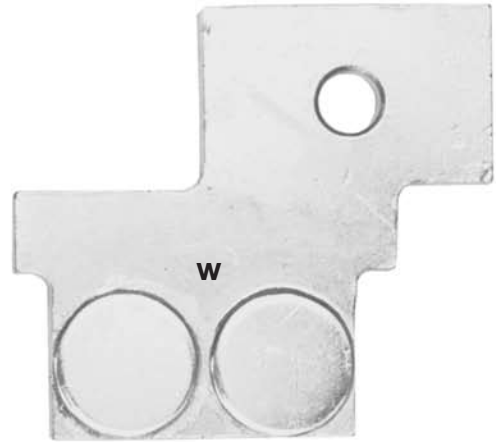
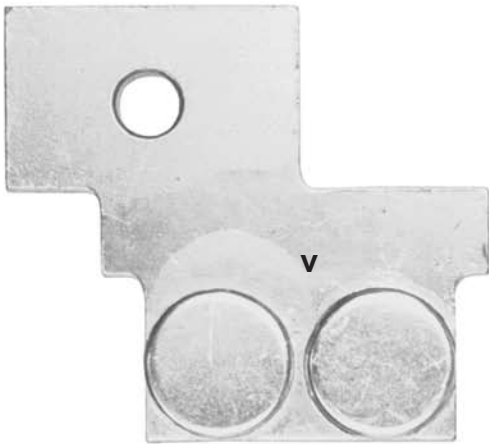

H

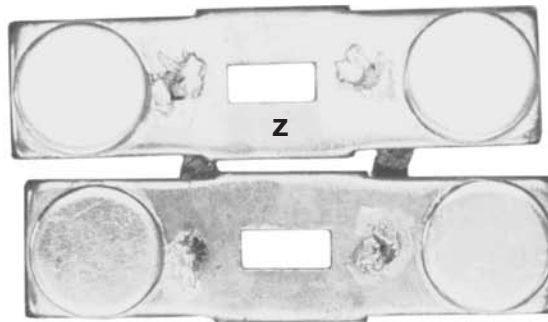
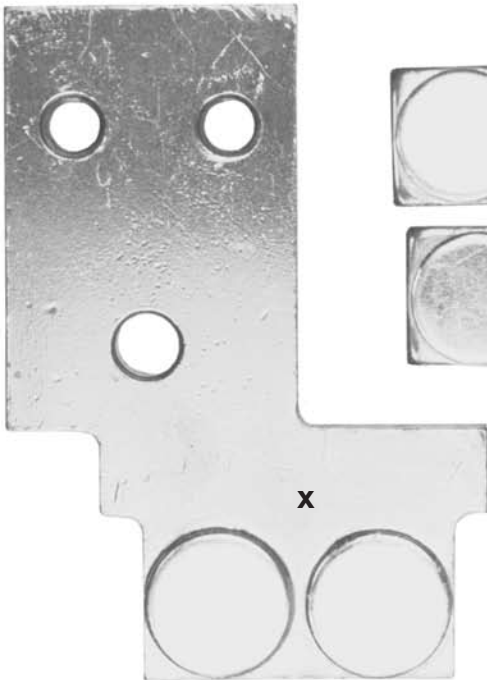

z

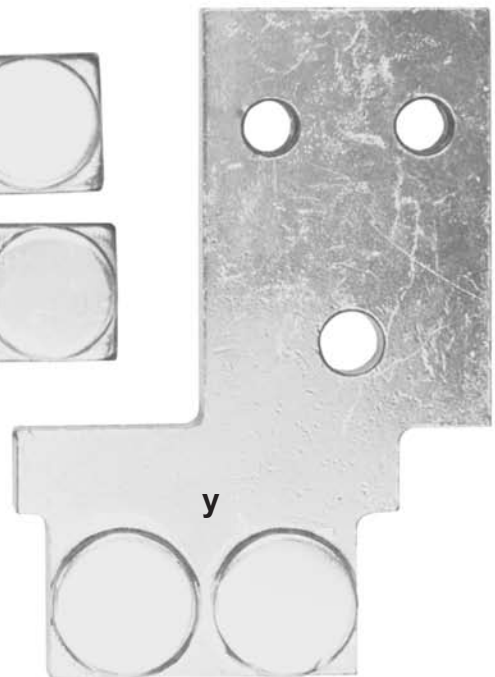

y

CUTLER-HAMMER

XT SERIES

<u>DEVICE#</u>	<u>FRAME</u>	<u>OEM#</u>	<u>REF.</u>	<u>OUR#</u>
XTCE040D-065D	D	XTCERENCONTACTD	A	9906CC
XTCE085F-095F	F	XTCERENCONTACTF	B	9907CC
XTCE115G-150G	G	XTCERENCONTACTG	B	9907CC
XTCE185L-200L	L	XTCERENCONTACTL	C	9908CC
XTCE300M-570M	M	XTCERENCONTACTM	D	9909CC

3-POLE SETS

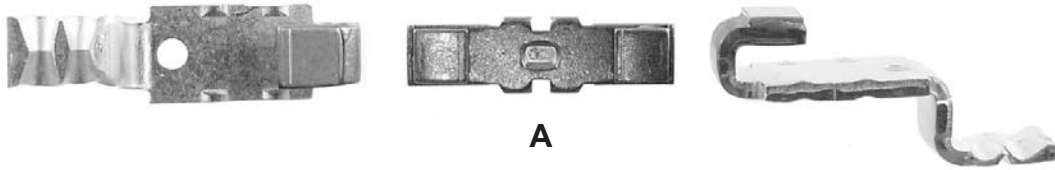

A

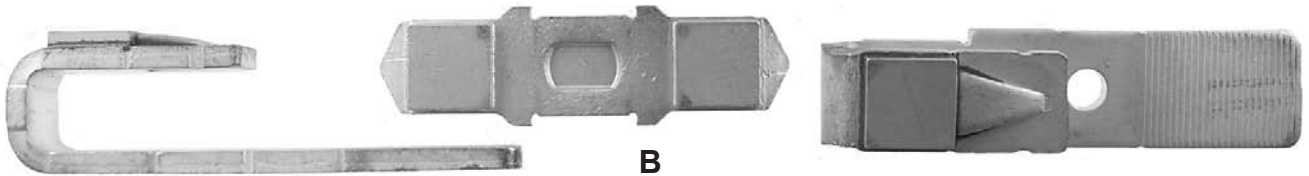

B

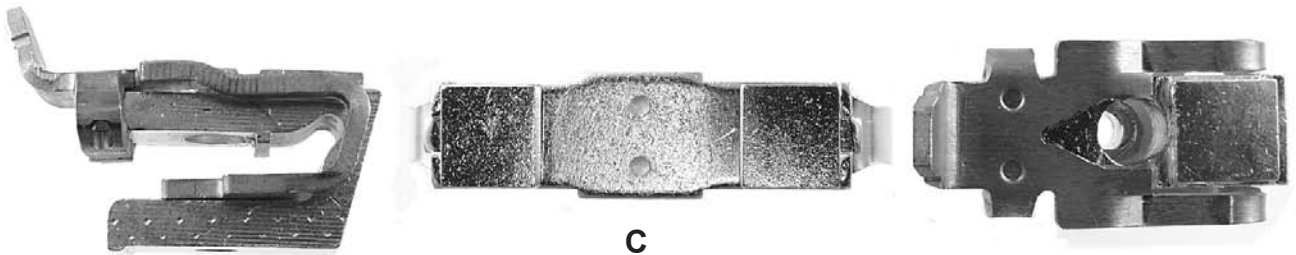

C

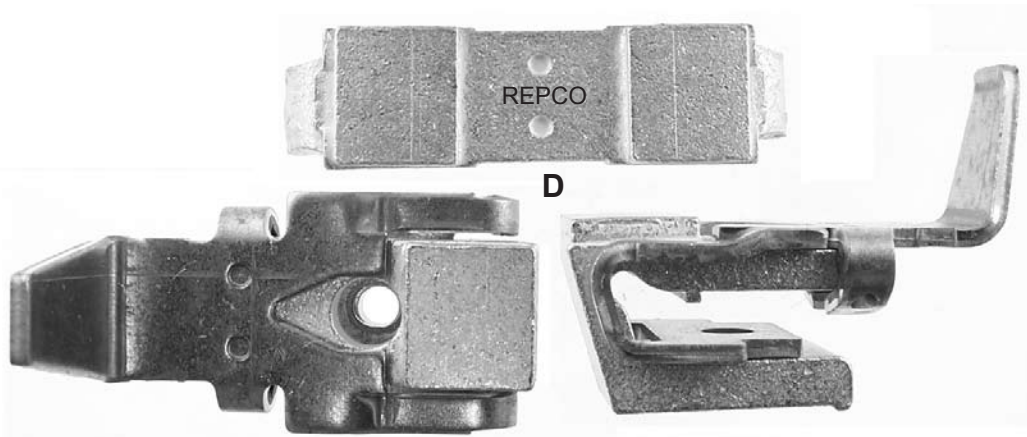

D

CUTLER-HAMMER

DC CONTACTORS (C80, 6002)

COPPER CONTACTS

<u>AMPS</u>	<u>OEM#</u>	<u>REF.</u>	<u>OUR#</u>	<u>DEVICE#</u>
25 / 50	6-169-3	A	9411CC	912, 932, 952, 972
100	6-189	B	9421CC	913, 923, 933
150	6-189-2	C	9431CC	914, 924, 934
300	6-189-3	D	9441CC	915, 925, 935
600 / 810	6-189-4	E	9451CC	916, 926, 936
1350	6-215	--	9471CC	988, 1000

ALL SETS INCLUDE TWO CONTACTS
AND ONE SPRING

REPALLOY® (REPLACES SILVER-TIPPED)

<u>AMPS</u>	<u>OEM#</u>	<u>REF.</u>	<u>OUR#</u>	<u>DEVICE#</u>
25 / 50	----	A	9511CC	912, 932, 952, 972
100	6-189-5	B	9521CC	913, 923, 933
150	6-189-6	C	9531CC	914, 924, 934
300	6-189-7	D	9541CC	915, 925, 935
600 / 810	6-189-8	E	9551CC	916, 926, 936
1350	6-215-2	--	9472CC	988, 1000

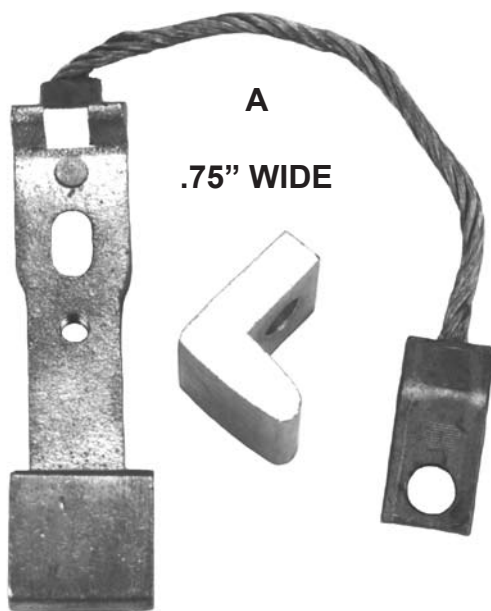
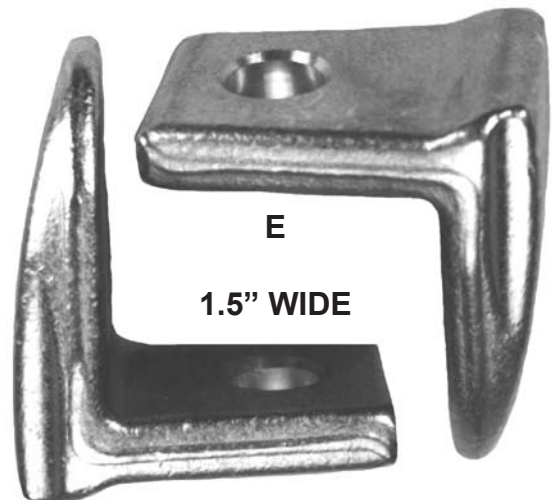
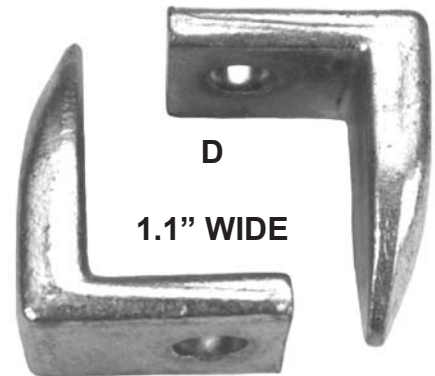
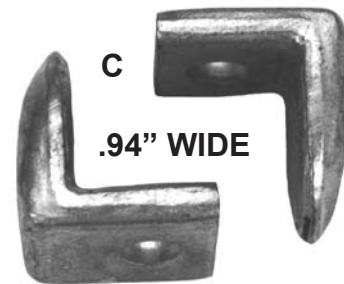
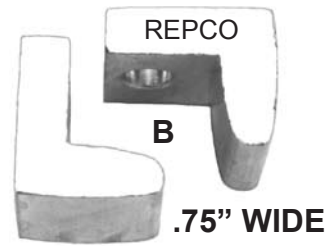

CUTLER-HAMMER

DC AUXILIARY CONTACTS

<u>OEM#</u>	<u>CONFIG.</u>	<u>REF.</u>	<u>OUR#</u>
10923H1	1NO	A	8000CC
10923H2	2NO	A	8001CC
10923H3	1NO, 1NC	A	8002CC
10923H4	1NC	A	8003CC
10923H5	2NC	A	8004CC
10923H6	1NO	B	8005CC
10923H7	2NO	B	8006CC
10923H8	1NO, 1NC	B	8007CC
10923H9	1NC	B	8008CC

SOME MOUNTING HARDWARE IS ALSO AVAILABLE.

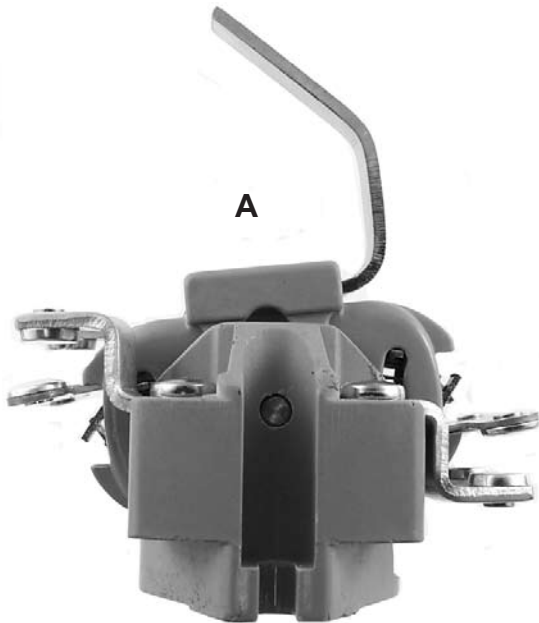

FOR TYPE "F" MASTER SWITCH

<u>OEM#</u>	<u>OUR#</u>	<u>REF.</u>
86-2601	8009CC	C
6-202	9901CC	D

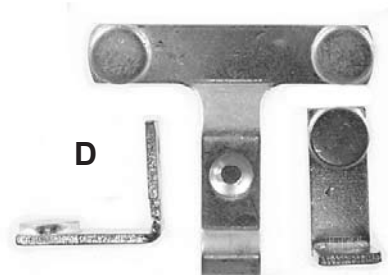

CUTLER-HAMMER

HIGH AMPERAGE

<u>DEVICE TYPE</u>	<u>OEM#</u>	<u>AMPS</u>	<u>REF.</u>	<u>OUR#</u>
REVERSING/ASSIGNMENT	6-602	1100	A	9690CC
REVERSING/ASSIGNMENT	OLD STYLE	1100	B	9691CC
AVD CONTACTOR	23-7253	1400	C	1055CC
AVD CONTACTOR	23-7255	1400	D	1056CC
SIZE D	6-497	1800 MAIN	--	9390CC
SIZE D	23-5449	1800 ARCING	--	9392CC
SIZE D	6-496	3000 MAIN	--	9391CC
SIZE D	23-5448	3000 ARCING	--	9393CC

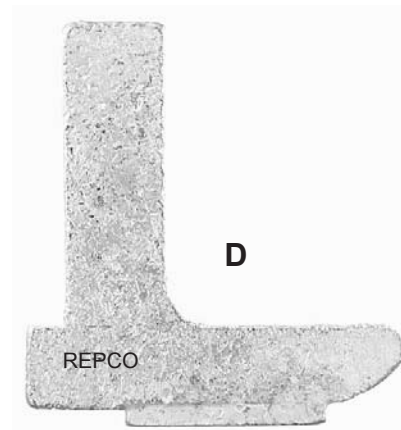
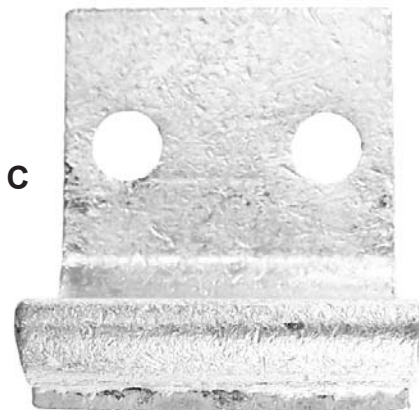
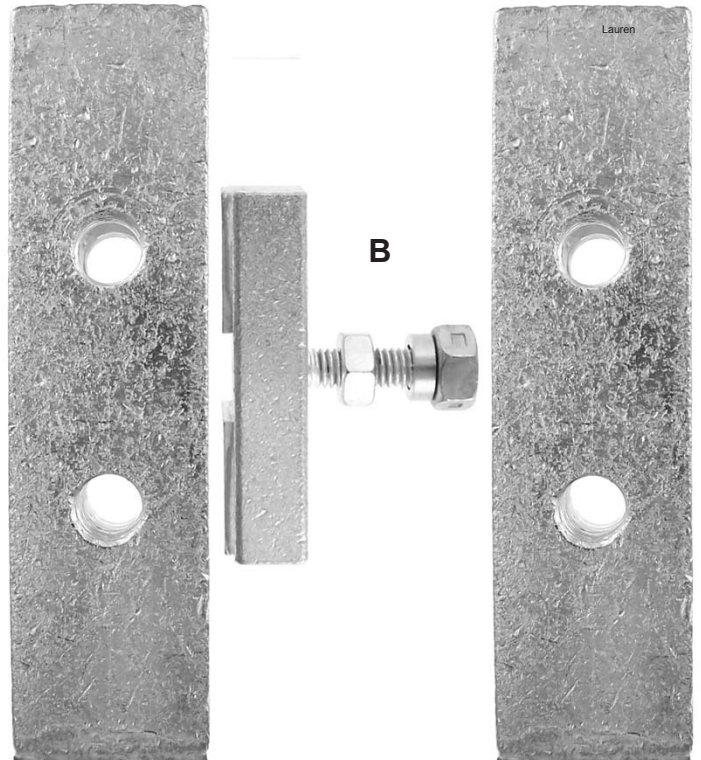
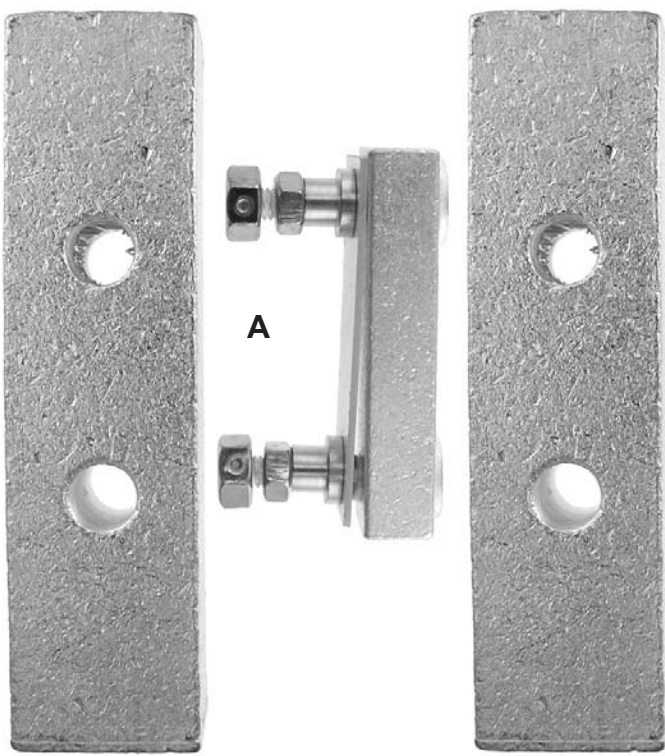

CUTLER-HAMMER

FOR 9141 COMPENSATORS

SIZE 4

POLES	OUR#	REF.
3	9345CC	A

**TIP - 1" WIDE
BAR - 1" WIDE X 4.875" LONG**

**SET CONSISTS OF:
5 BARS, 18 TIPS AND
HARDWARE**

SIZE 5

POLES	OUR#	REF.
3	9355CC	B

**TIP - 1" WIDE
BARS - 4 EACH 1" WIDE X 6.9" LONG
1 EACH 1" WIDE X 6.7" LONG**

**SET CONSISTS OF:
5 BARS, 18 TIPS AND
HARDWARE**

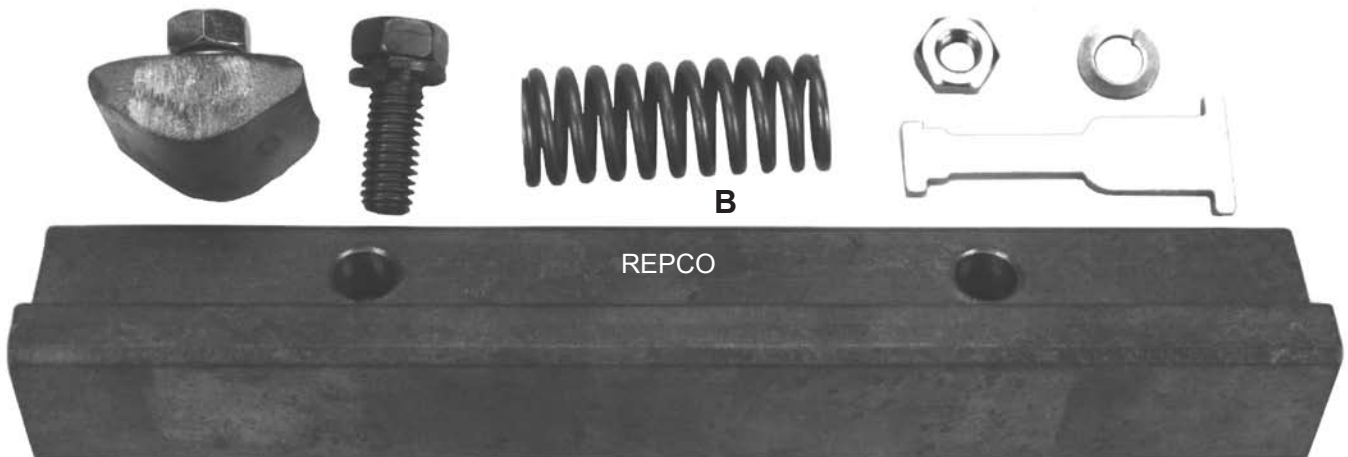
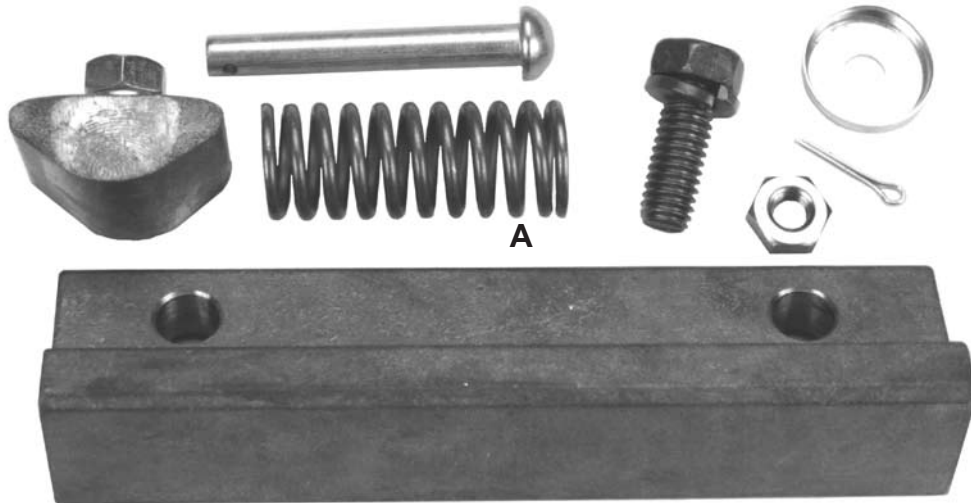

CUTLER-HAMMER FOR 9141 COMPENSATORS



6301CC
.75" WIDE

6302CC
1.0" WIDE



1023CC
2.25" LONG



1027CC
2.88" LONG



1006CC
3.0" LONG

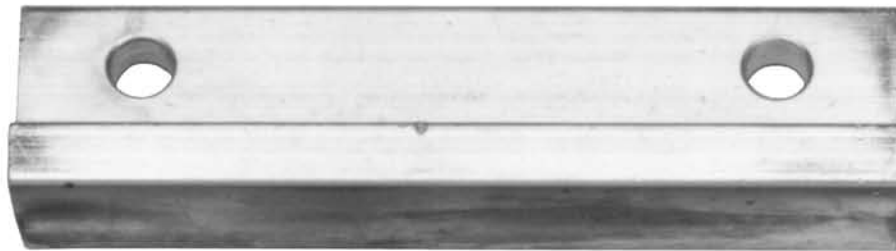

1021CC

4.75" LONG X 1.0" WIDE

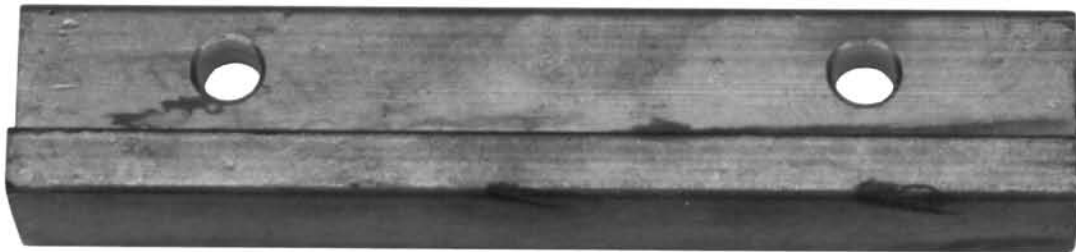

1020CC

5.3" LONG X 1.0" WIDE



1007CC

6.9" LONG X 1.0" WIDE

CUTLER-HAMMER MISCELLANEOUS

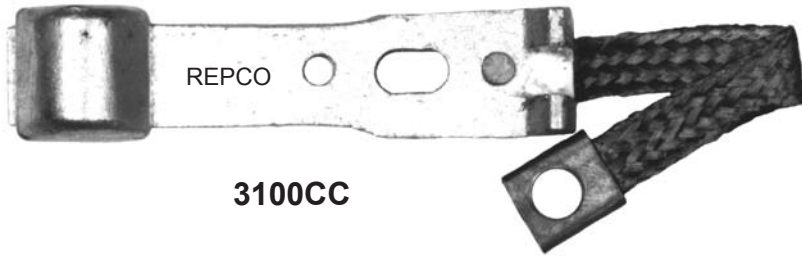

3100CC



1036CC



3500CC



**4303CC - COPPER
4303CCR - SILVER (REPALLOY®)**

1.88" WIDE



**1019EVC
.75" WIDE**



**1043CC
1" WIDE**

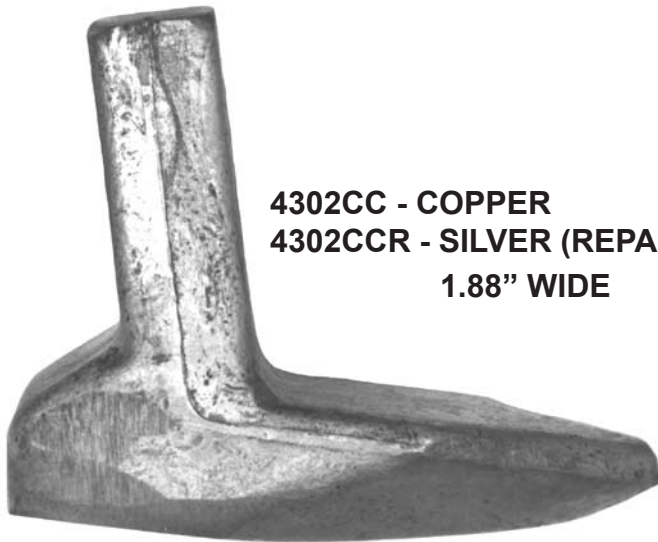

**4302CC - COPPER
4302CCR - SILVER (REPALLOY®)**

1.88" WIDE



**1022CC
1.3" WIDE**



**1003CC
.5" WIDE**



1051CC

FUJI

<u>OEM#</u>	<u>SIZE</u>	<u>AMPS</u>	<u>DEVICE#</u>	<u>OUR#</u>	<u>REF.</u>
4NC0A-CK	00+	11	4NC0A0 / SC-03	9193CO	A
4NC0G-CK	0	13	4NC0G0 / SC-05	9103CO	B
4NC0Q-CK	0	20	4NC0Q0 / SC-4-0	9203CO	C
4NC0H-CK	0+	20	4NC0H0 / SC-5-1	9303CO	D
2NC0T-CK	0+	26	2NC0T0 / SC-1N	9403CO	E
2NC1Q-CK	1+	35	2NC1Q0 / SC-2N	9113CO	F
2NC2F-CK	2	50	2NC2F0 / SC-2SN	9123CO	G
2NC2H-CK	2+	70	2NC2H0 / SC-3N	9223CO	H
2NC2T-CK	2+	90	2NC2T0 / SC-4N	9323CO	I
2NC3F-CK	3	100	2NC3F0 / SC-5N	9133CO	J
2NC3H-CK	3+	125	2NC3H0 / SC-6N	9233CO	K

3-POLE SETS

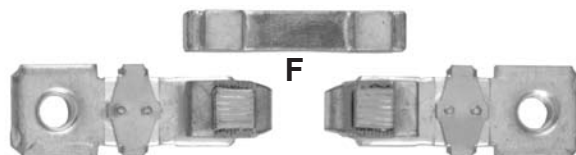
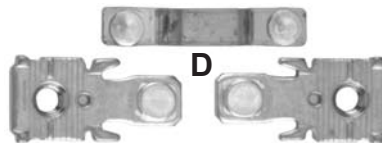
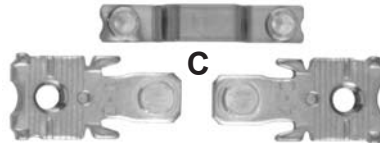
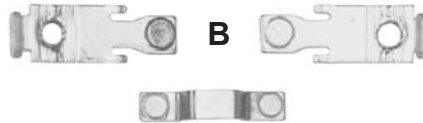
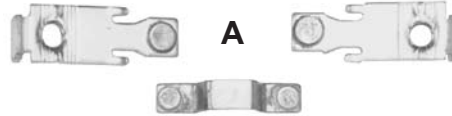

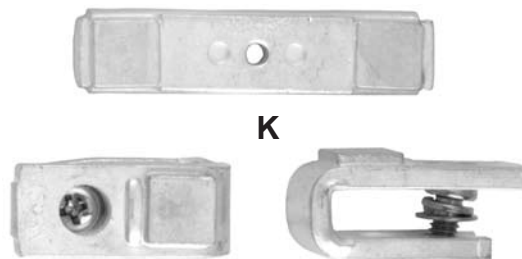
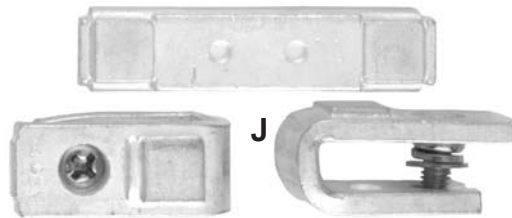
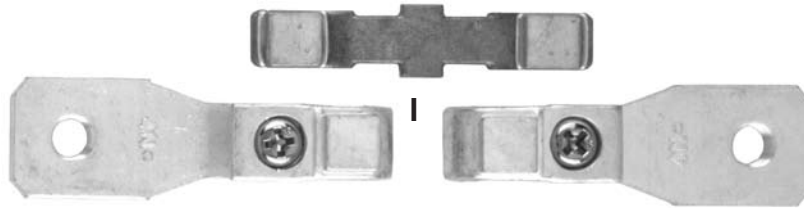
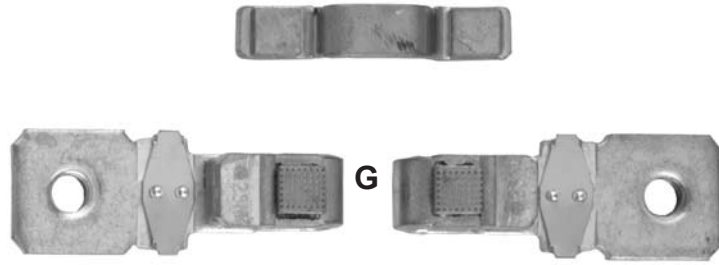

FURNAS

OLD STYLE DEFINITE PURPOSE

<u>OEM#</u>	<u>AMPS</u>	<u>OUR#</u>	<u>REF.</u>
75NB41	25	9300CF	A
75BE42	30	9400CF	B
75CE42	40	9405CF	C
75DE42	50	9410CF	D
75EE42	60	9415CF	E
75FE42	75	9420CF	F
75GE42	90	9425CF	G

ONE-POLE SETS

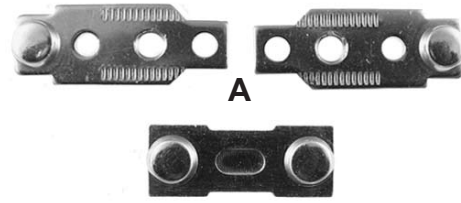

A

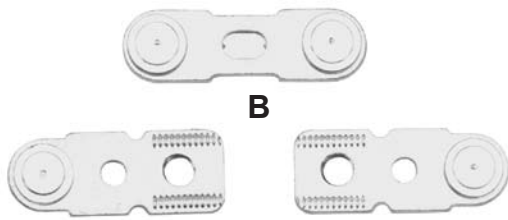

B

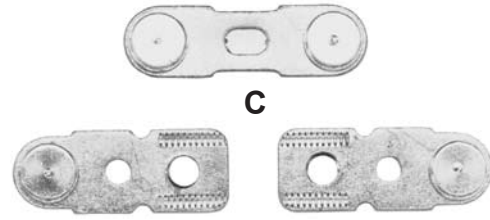

C

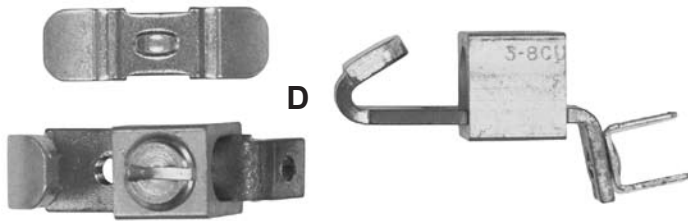

D

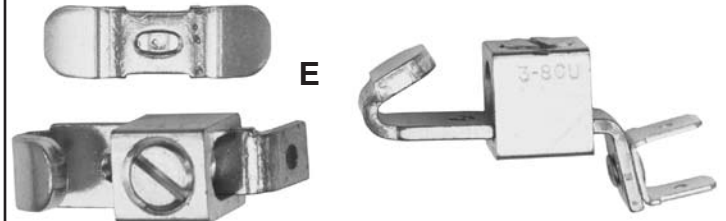

E

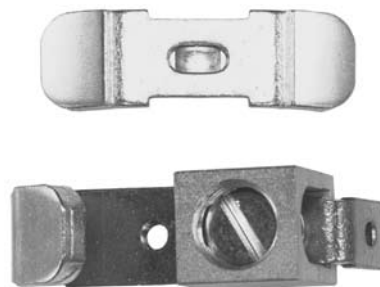

F

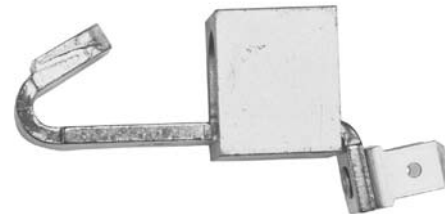

G

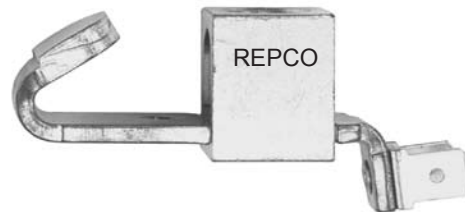
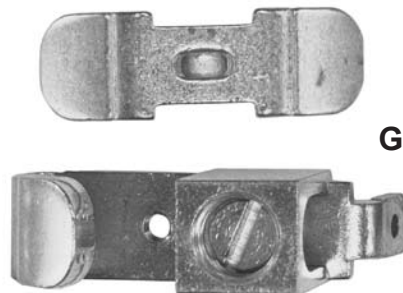

FURNAS

VERTICAL LIFT CONTACTORS

<u>SIZE</u>	<u>REF.</u>	<u>STARTER#</u>	<u>OEM#</u>	<u>OUR#</u>
0	A	14, 40CA	75CA14	9411CF
1, 1 1/2	A	14, 40DA	75DA14	9411CF
1 3/4	B	14, 40EA	75EA14	9412CF
2	C	14, 40, 22FB	75FB14A	9120CF
2 1/2	C	14, 40, 22GB	75GB14	9125CF
3	D	14, 40, 22HB	75HB14	9130CF
3 1/2	E	14, 40, 22IB	75IB14	9135CF
4	E	14, 40, 22JB	75JB14	9140CF
4 1/2	F	14, 40, 22RB, RF, RS	75RB14	9145CF
5	G	14, 40, 22KB, KF, KS	75KB14	9150CF
6	--	14, 40, 22MB, MF	75MB14	9160CF
<u>INNOVA 45 SERIES</u>				
00	H	14, 40, 22BF	75BF14	9205CF
0	H	14, 40, 22CF, CP, CS	75CF14	9205CF
1	I	14, 40, 22DF, DP, DS	75DF14	9210CF
1P, 1 3/4	J	14, 40, 22EF, EP, ES	75EF14	9215CF
2	K	14, 40, 22FF	75FF14	9220CF
2 1/2	L	14, 40, 22GF	75GF14	9225CF
3	M	14, 40, 22HF, HP, HS	75HF14	9230CF
3 1/2	N	14, 40, 22IF, IP, IS	75IF14	9235CF
4	O	14, 40, 22JT, JG	75JG14	9525CF
<u>INNOVA PLUS SERIES</u>				
2	P	14, 40, 22FP, FS	75FP14	9320CF
2	Q	DOVER SPECIAL	75FP109153	9315CF
2 1/2	R	14, 40, 22GP, GS	75GP14	9325CF
<u>IEC</u>				
F	S	15, 21FF	75FF15	9625CF
G	S	15, 21GF	75GF15	9625CF
H	T	15, 21HF	75HF15	9630CF

ALL SETS ABOVE ARE ONE-POLE.

AVAILABLE 3-POLE CONTACT SETS (NOT PICTURED):

75CK210	75CK550
75CK280	75CK700
75CK300	75CK750
75CK400	

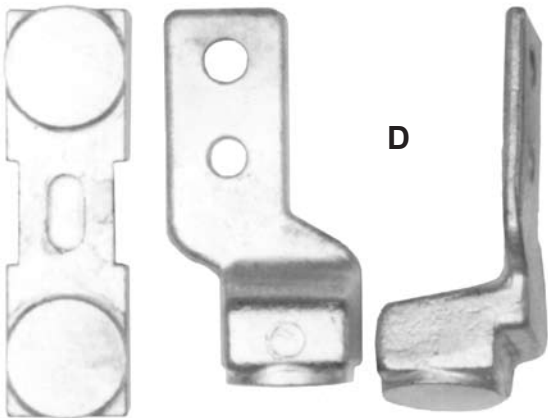
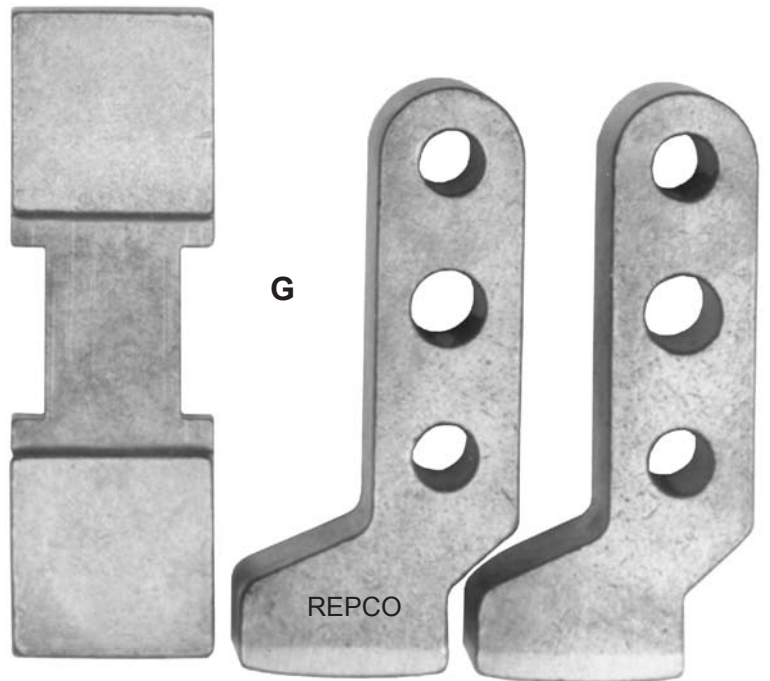
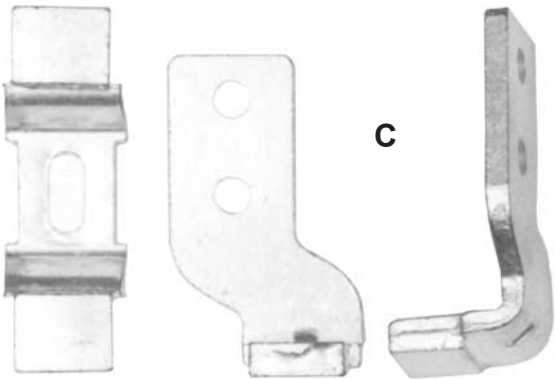
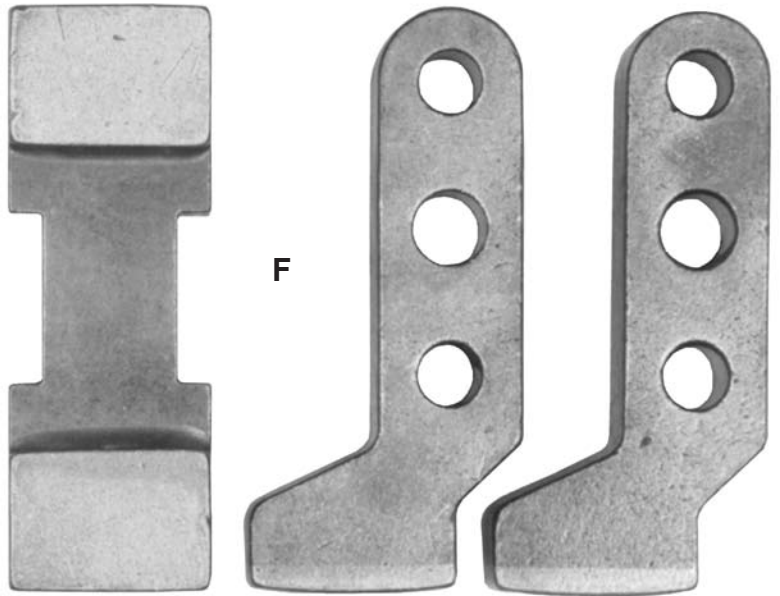
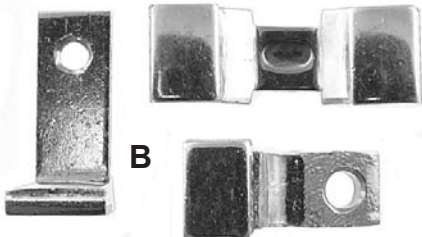
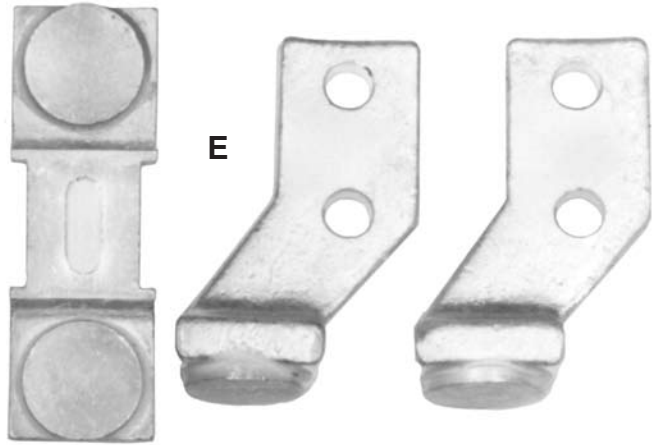
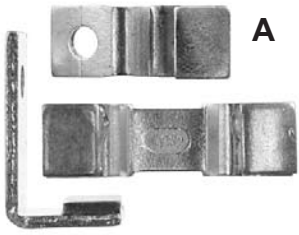

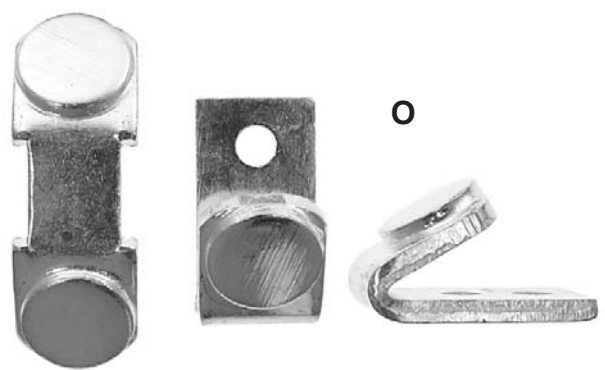
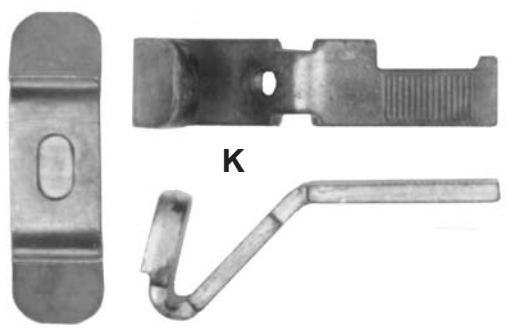
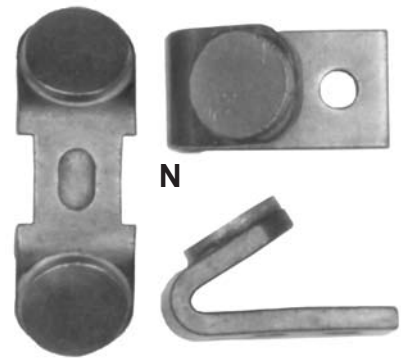
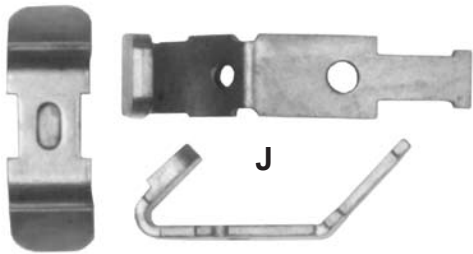
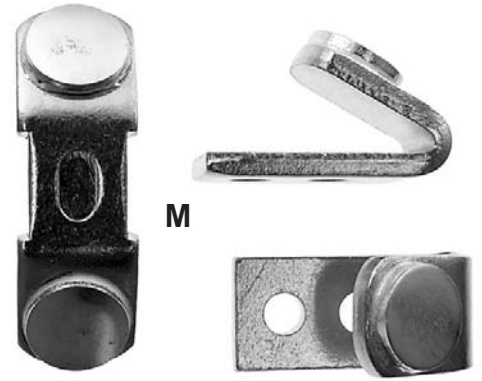
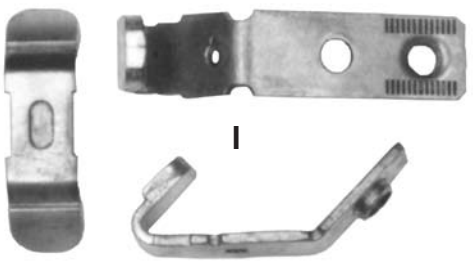
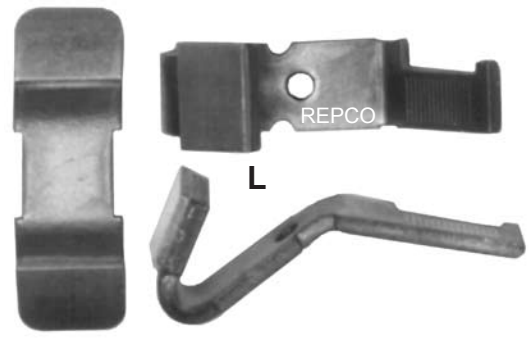
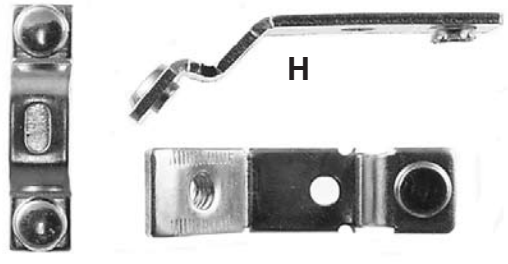

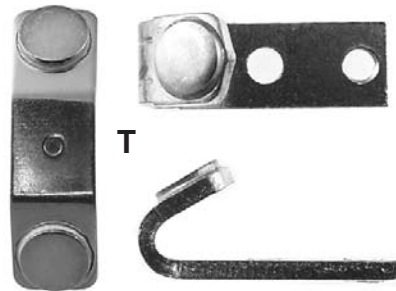
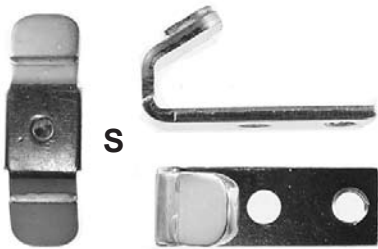
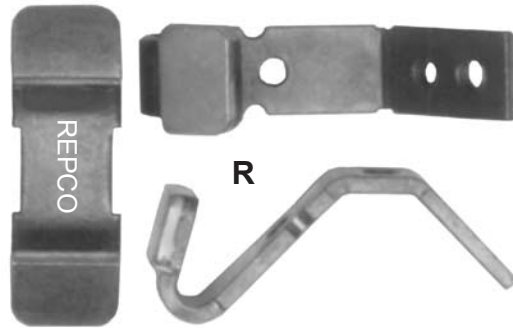
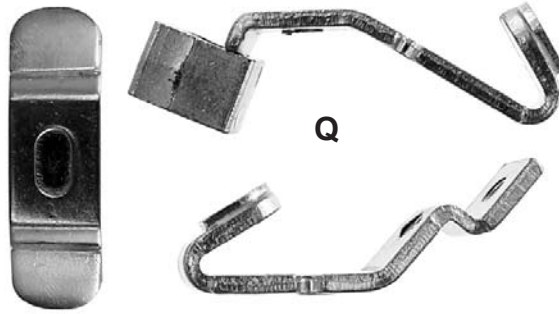
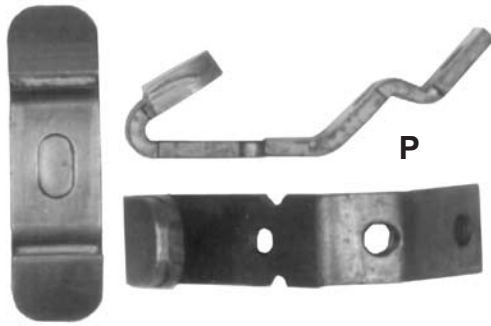

GENERAL ELECTRIC

VARIOUS TIPS AND FINGERS



2305EVG

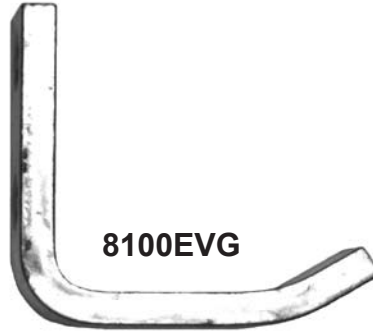

8100EVG



6802CG



2303EVG



6801CG



2304EVG



8101EVG



6310CG



2308EVG



3504CG



6309CG



6803CG

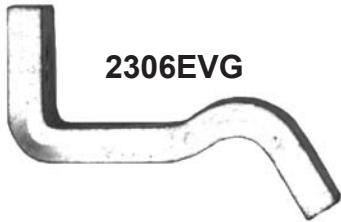

2306EVG



6303CG



6302CG



4017EVG .75" WIDE
4021EVG 1.25" WIDE

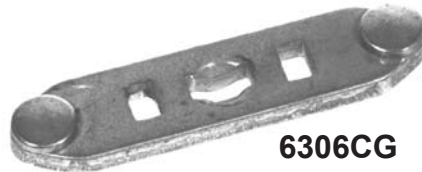

6306CG



6307CG



1601CG



4306EVG

GENERAL ELECTRIC

100, 200, 300-LINE

OEM#	SIZE	OUR#	REF.
546A300G2	0	9704CG	A
546A301G2/G53	1	9714CG	B
546A780G2/G51	2	9723CG	C
55-153677G2	3	9733CG	D
55-153678G2	4	9743CG	E
55-154607G2/G41	5	9753CG	F
232A6724G5	5	9253CG	--
55-186556G4	6	9753CGA	F
232A6724G6/G9	6	9763CG	G
232A6724G10*	7	9773CG	H

*200 AND 300-LINE ONLY
 SIZES 0 AND 1 ARE 4-POLE
 ALL OTHERS ARE 3-POLE

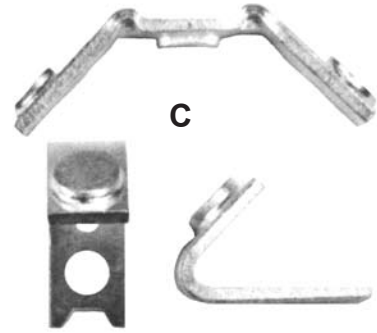

C



D



E

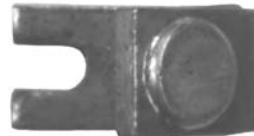

F

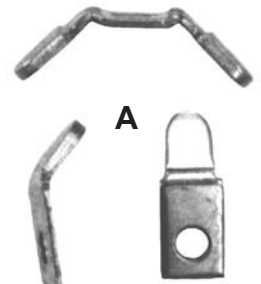
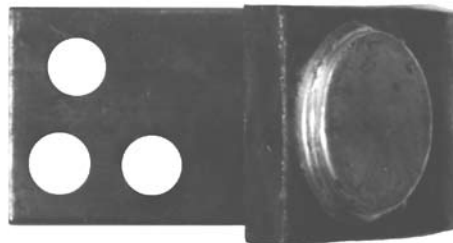

A

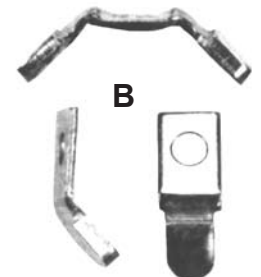

B

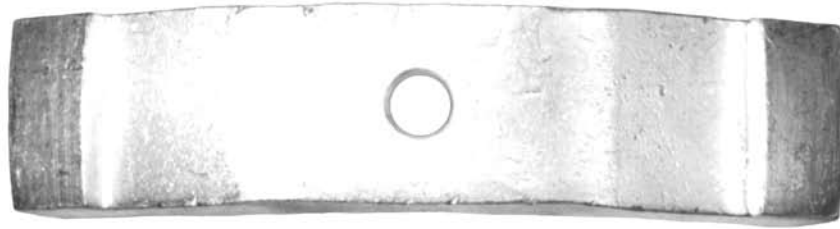

G

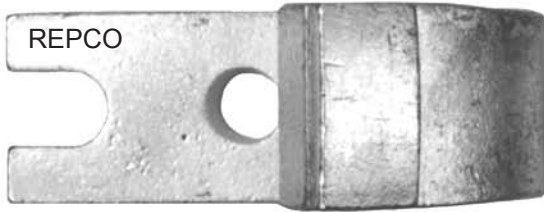

H

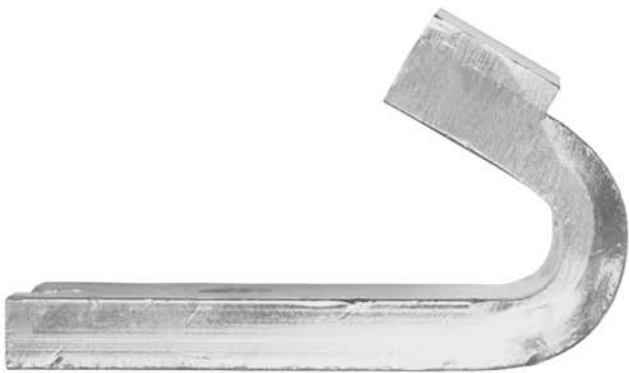

GENERAL ELECTRIC

CR7006 SERIES

SIZE	OEM#	OUR#	REF.
00	101X100	9694CG	A
0	101X110	9604CG	B
1	101X111	9613CG	C
2	101X112	9623CG	D
3	101X113	9633CG	E
4	6960067G1	9643CG	F
5	6960049G1	9653CG	G

SIZES 00, 0, AND 1 ARE 4-POLE
ALL OTHERS ARE 3-POLE

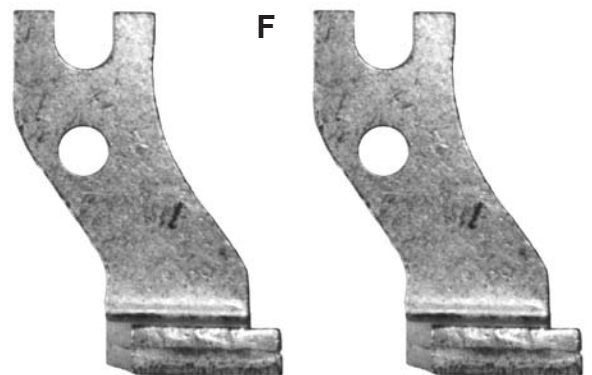
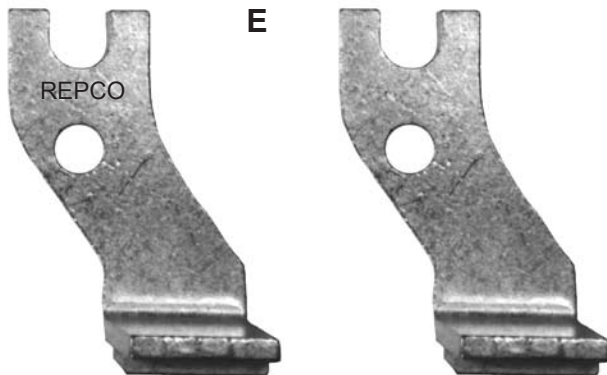
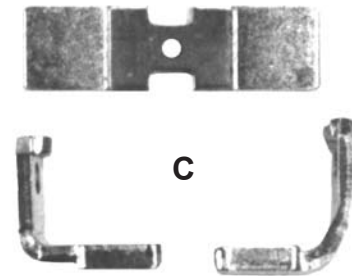
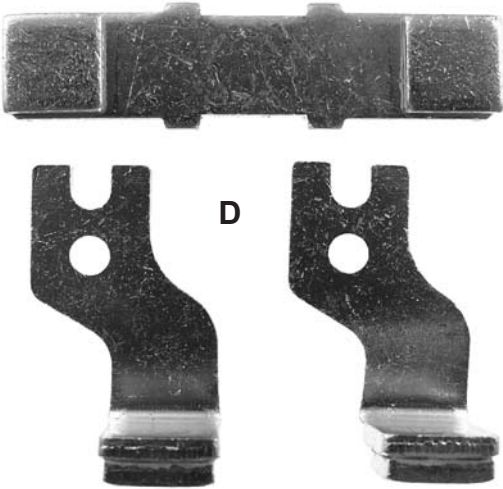
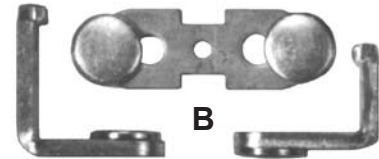
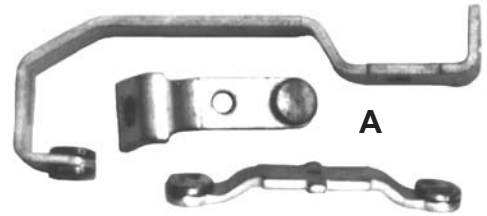

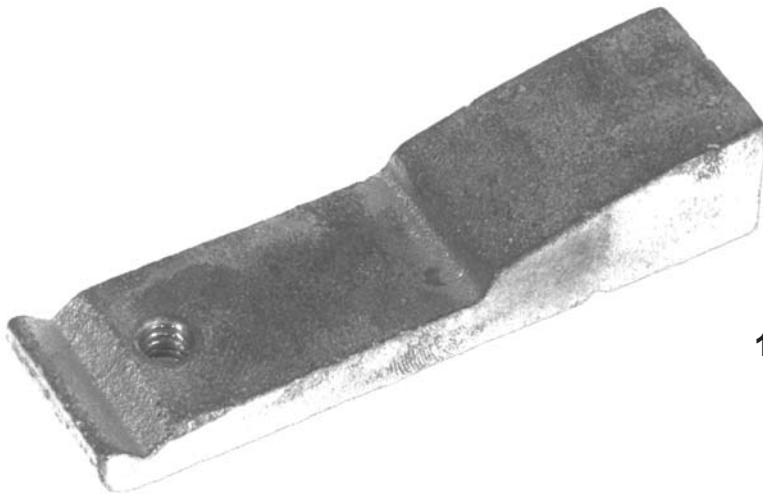

G
1" WIDE



VARIOUS SETS FOR CR2810, CR2811, CR7006, ETC.



<u>POLES</u>	<u>OUR#</u>
1	9113CG
3	9052CG
4	9000CG
6	9009CG

.5" WIDE



<u>POLES</u>	<u>OUR#</u>
2	9002CG
3	9001CG
6	9008CG

.5" WIDE

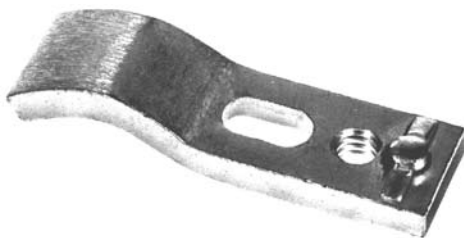

<u>POLES</u>	<u>OUR#</u>
1	9110CG
3	9012CG
4	9005CG
6	9006CG

.625" WIDE

GENERAL ELECTRIC

VARIOUS SETS CONTINUED



<u>POLES</u>	<u>OUR#</u>
1	9120CG
3	9014CG
6	9007CG

MOV. - .625" WIDE, STA. - .75" WIDE



<u>POLES</u>	<u>OUR#</u>
1	9111CG
3	9051CG
4	9054CG
6	9050CG

.625" WIDE

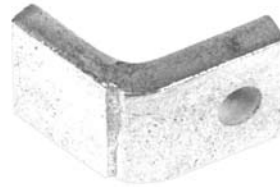

<u>POLES</u>	<u>OUR#</u>
1	9121CG
3	9053CG

.625" WIDE

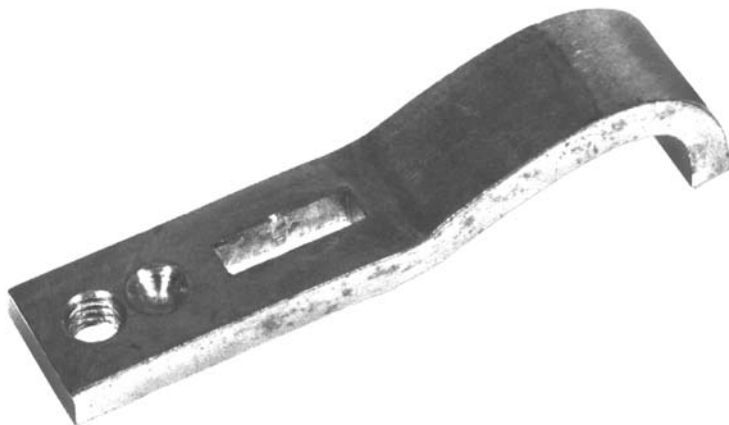

<u>POLES</u>	<u>OUR#</u>
1	9133CG
3	9011CG
6	9010CG

.75" WIDE

GENERAL ELECTRIC

CR134 AND CR1034 COMPENSATORS

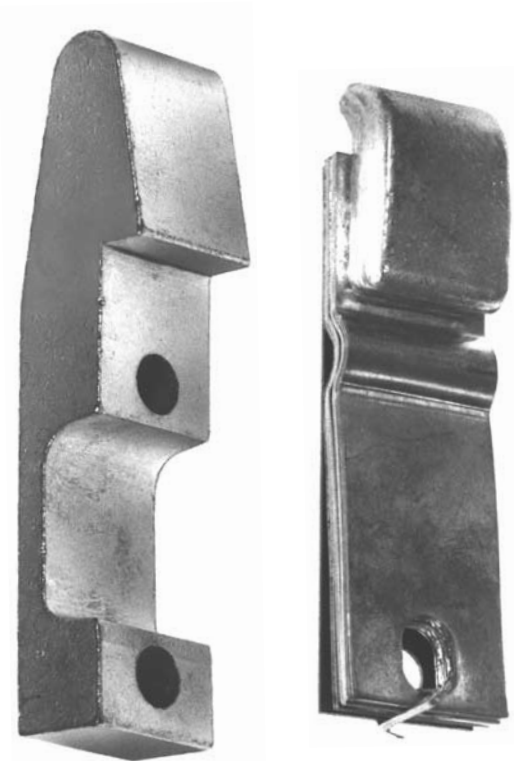

<u>POLES</u>	<u>OUR#</u>	
1	9155CG	
9	9083CG	.85" WIDE
10	9080CG	

1 POLE = 2 FINGERS AND 1 WEDGE

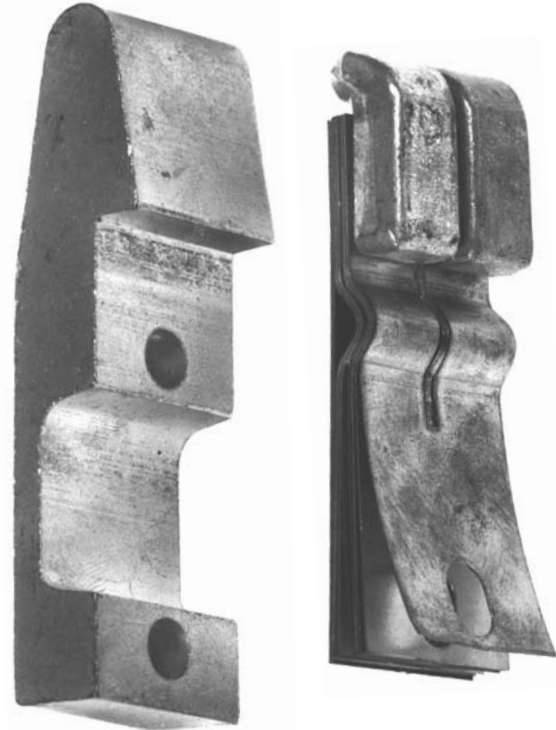

<u>POLES</u>	<u>OUR#</u>	
1	9156CG	
9	9084CG	1.06" WIDE
10	9081CG	

1 POLE = 2 FINGERS AND 1 WEDGE

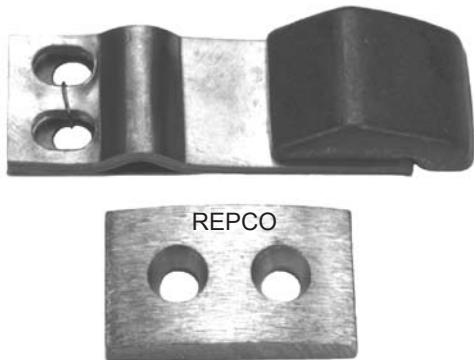

<u>POLES</u>	<u>OUR#</u>	
5	9076CG	.75" WIDE

1 SET = 10 FINGERS AND 6 SEGMENTS

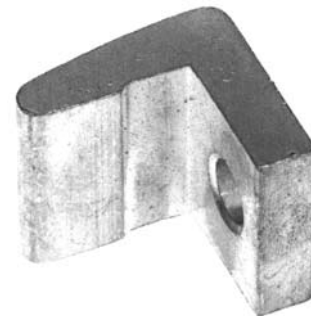

<u>POLES</u>	<u>OUR#</u>	
1*	9158CG	
8	9103CG	1" WIDE
8*	9102CG	
9*	9101CG	

1 POLE = 2 TIPS
***INCLUDES SPRINGS**

GENERAL ELECTRIC

CR134 AND CR1034 COMPENSATORS



<u>POLES</u>	<u>OUR#</u>	
1	9157CG	.75" WIDE
6	9075CG	
1 POLE = 2 FINGERS AND 1 WEDGE		

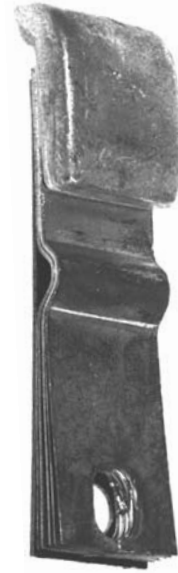

<u>POLES</u>	<u>OUR#</u>	
5	9079CG	.75" WIDE
1 SET = 10 FINGERS AND 6 TIPS		

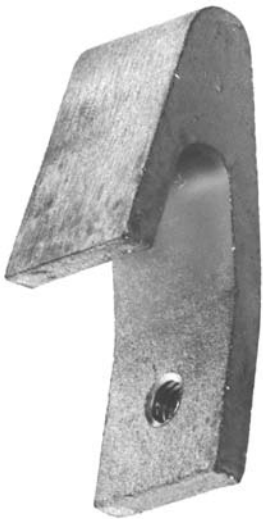

<u>POLES</u>	<u>OUR#</u>	
10	9077CG	.875" WIDE

1 POLE = 2 FINGERS AND 1 WEDGE

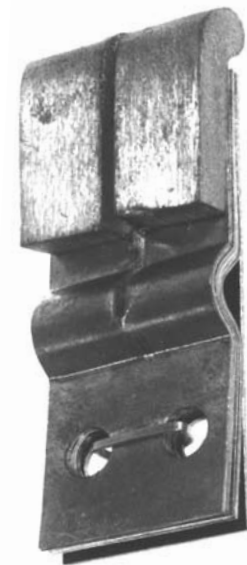

<u>POLES</u>	<u>OUR#</u>	
10	9078CG	1" WIDE

1 POLE = 2 FINGERS AND 1 WEDGE

GENERAL ELECTRIC

IC2800 CONTACTORS



POLES
1

OUR#
9900CG

CR2800-
1607 THRU 1609

STA. - .5", MOV. - .375" WIDE



POLES
1

OUR#
9901CG

CR2800-
1612 THRU 1619

.5" WIDE

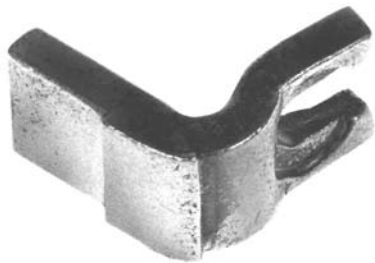

POLES
1

OUR#
9902CG

CR2800-
1620 THRU 1625

.75" WIDE



POLES
1

OUR#
9910CG

CR2800-
Y100, 1170

.75" WIDE

GENERAL ELECTRIC CR2800 CONTACTORS

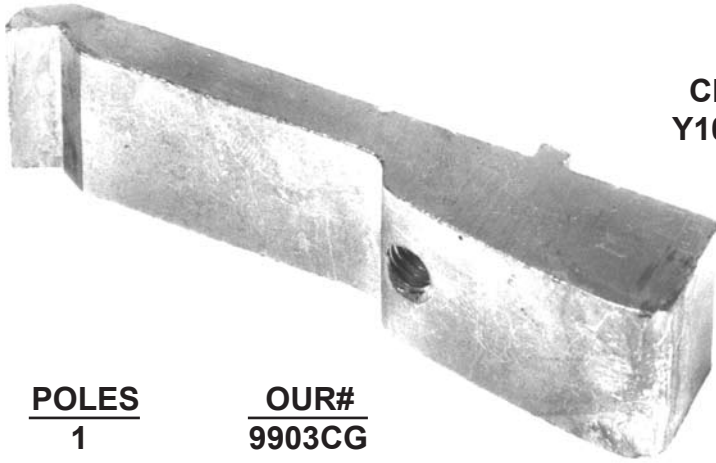

CR2800-
Y106, 1175

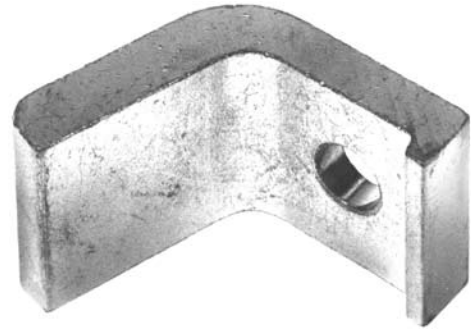

POLES
1

OUR#
9903CG

STA. 1.2", MOV. 1.0" WIDE

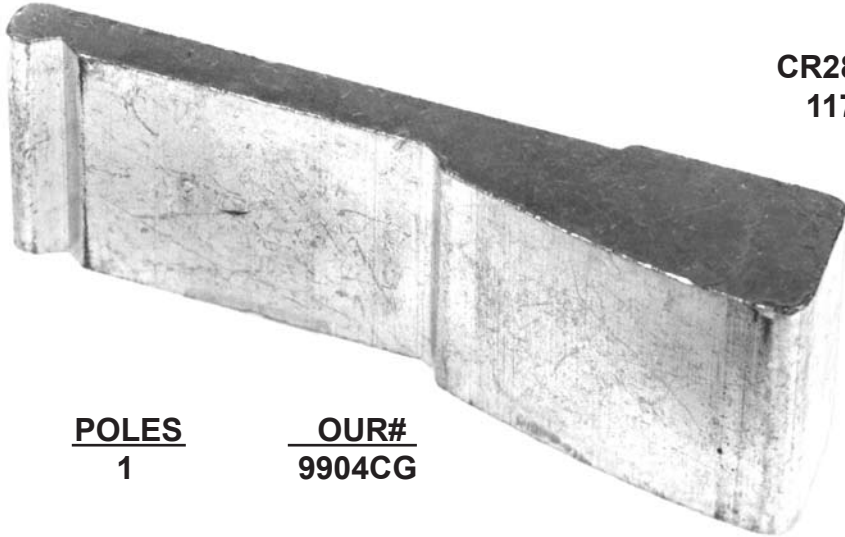

CR2800-
1176



POLES
1

OUR#
9904CG

1.5" WIDE

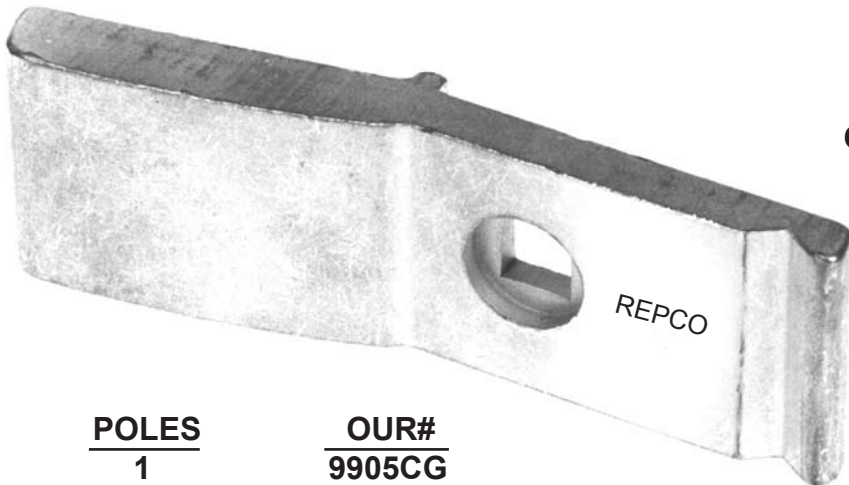

CR2800-
Y103

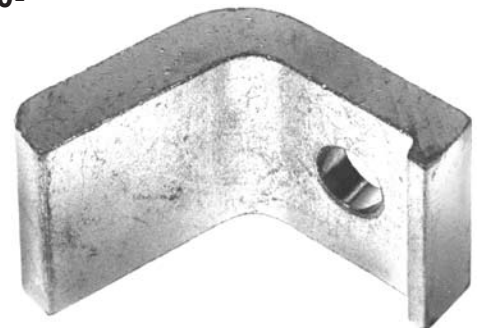

POLES
1

OUR#
9905CG

STA. 1.2", MOV. 1.5" WIDE

GENERAL ELECTRIC

CR2800 CONTACTORS

CR2800-
Y103, Y104
1176, 1177

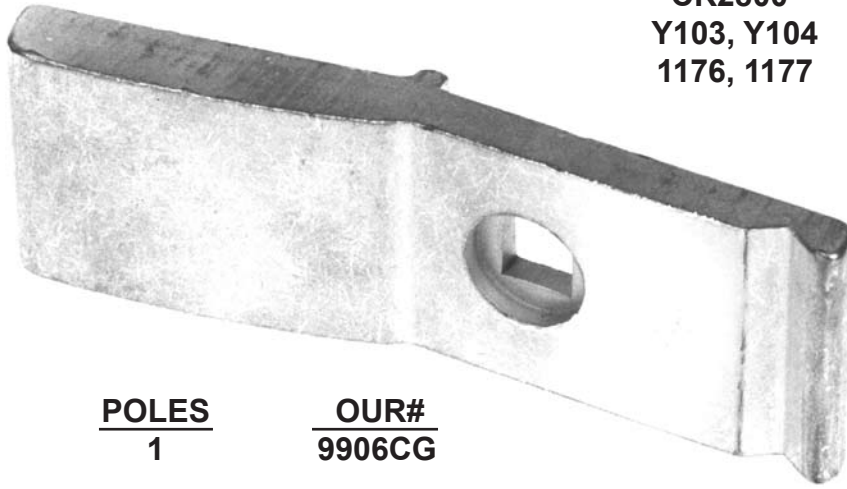

POLES
1

OUR#
9906CG

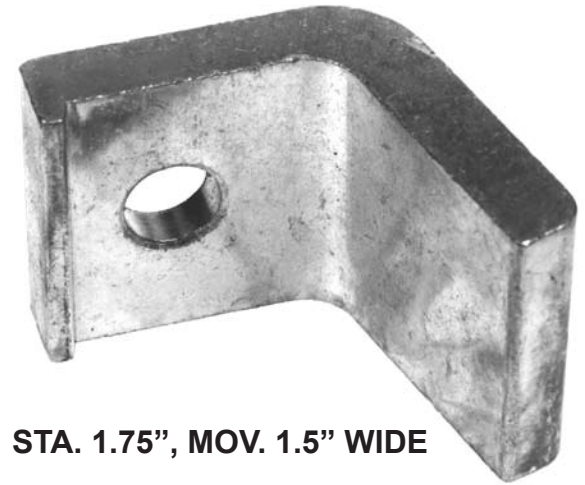

STA. 1.75", MOV. 1.5" WIDE

CR2800-
1174, 1175

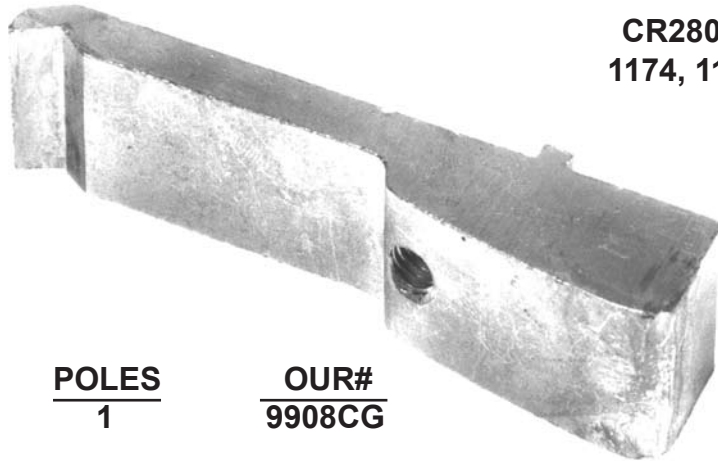

POLES
1

OUR#
9908CG



1.0" WIDE

CR2800-
Y102, 1174



POLES
1

OUR#
9911CG

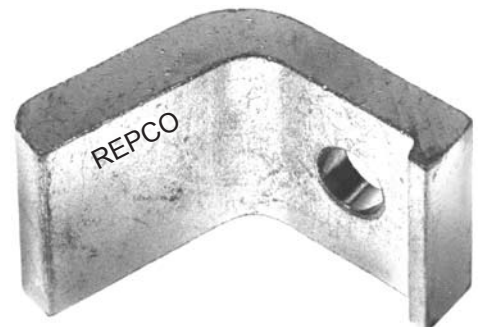

STA. 1.2", MOV. 1.0" WIDE

GENERAL ELECTRIC CR2800 CONTACTORS



CR2800-
Y101, Y105
1172, 1173



POLES
1

OUR#
9909CG

.75" WIDE

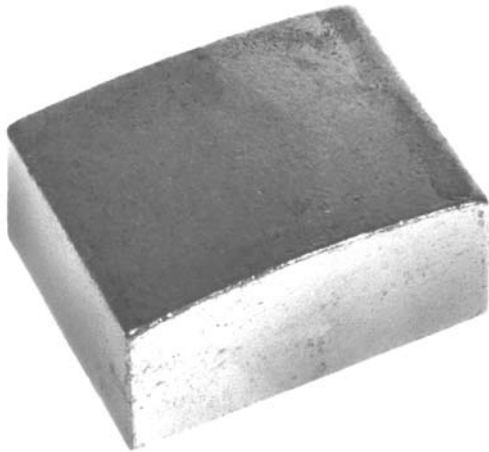

CR2800-
1178



POLES
1

OUR#
9912CG

1.5" WIDE

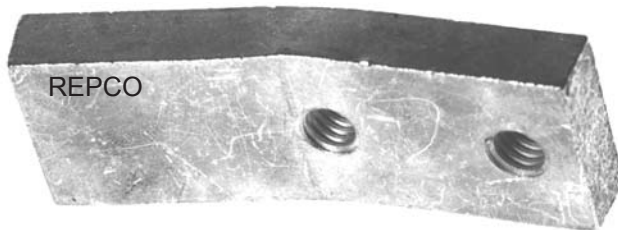

CR2800-, CR2810-
VARIOUS

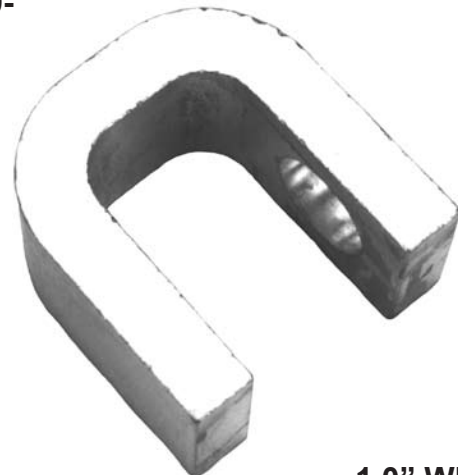

POLES
1

OUR#
9915CG

1.0" WIDE

GENERAL ELECTRIC
FOR IC2800-1178, 1180, Y107, Y108 CONTACTORS
SIZE 8 AND 9



3503CG

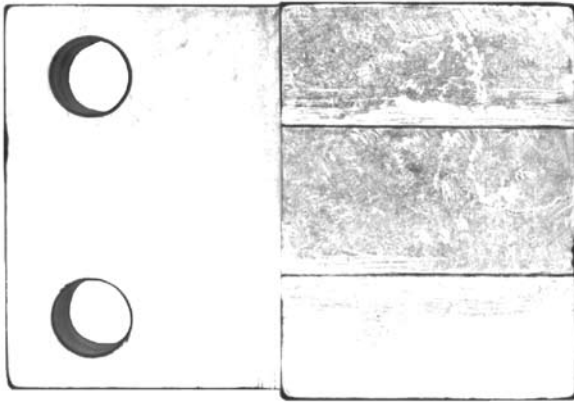

3501CG

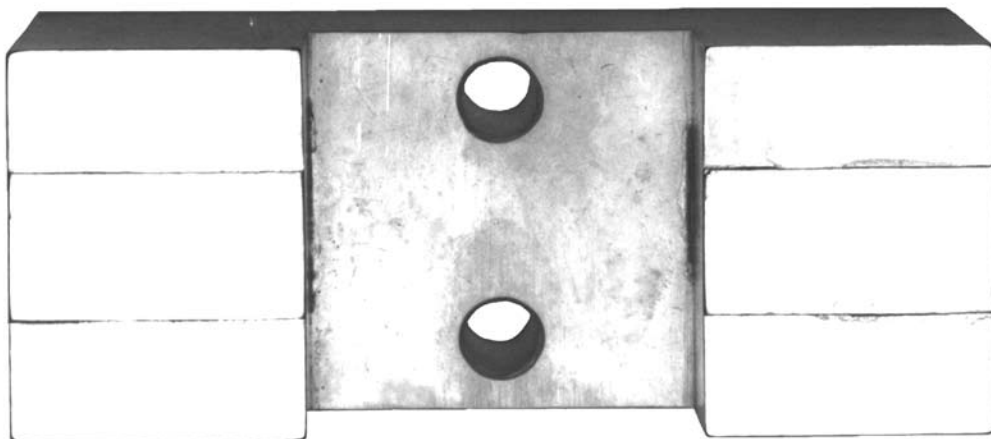

3502CG

GENERAL ELECTRIC CR2810 CONTACTORS

CR2810-
1572 THRU 1575

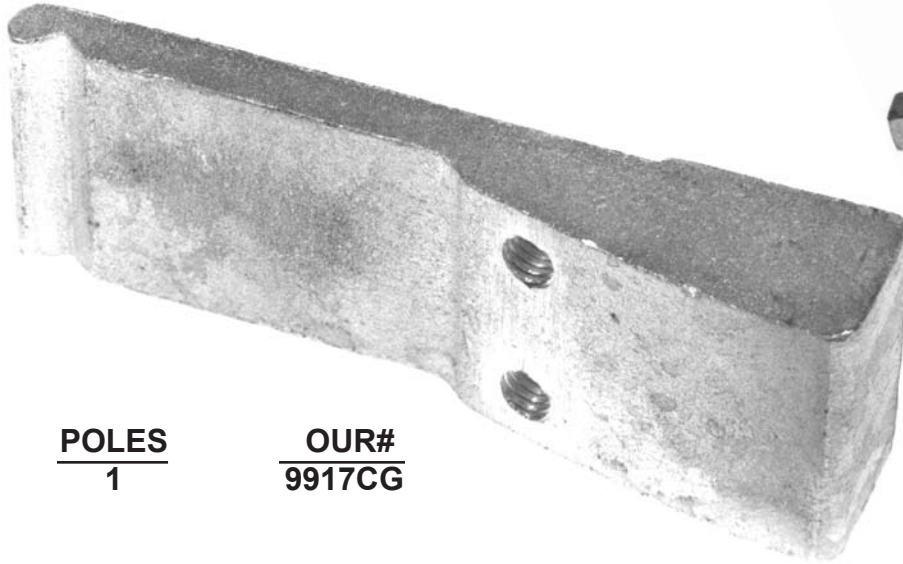
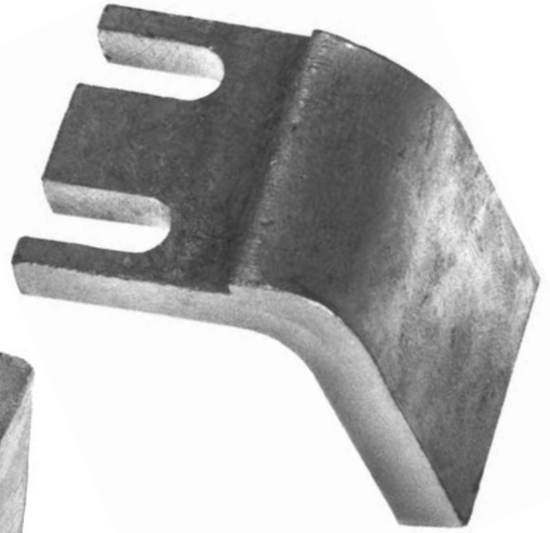

POLES
1

OUR#
9917CG

1.5" WIDE

CR2810-
1852 THRU 1865

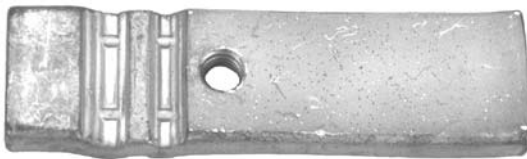

POLES
1
3

OUR#
9181CG
9015CG

.75" WIDE

CR2810-
1823 THRU 1825



POLES
1

OUR#
9115CG

.5" WIDE

GENERAL ELECTRIC
DRUM SWITCH FINGERS AND TIPS
SINGLE CONTACTS



3301EVG



3302EVG



3300EVG

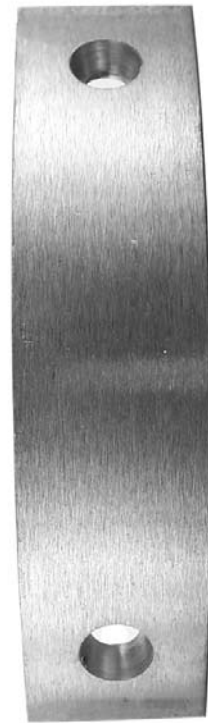

SEGMENTS*



2653EVG



2652EVG



2651EVG



2053EVG 1" WIDE



2051EVG 3/4" WIDE



2050EVG 1/2" WIDE

***FOR SEGMENTS, PLEASE FURNISH EXACT
 CATALOG NUMBER OR DRUM SWITCH NUMBER.**

GENERAL ELECTRIC MISCELLANEOUS

CR7006 • CR7008

POLES
1

OUR#
9916CG

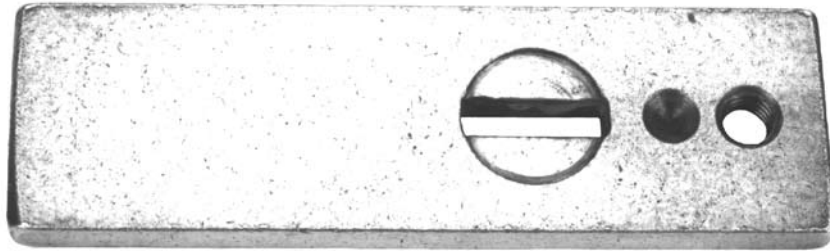

1.25" WIDE

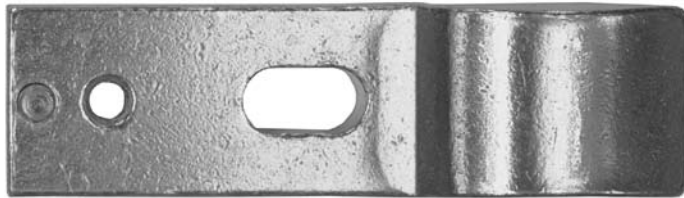

2309CG

FOR CR2810-1392, 1397
AND CR1034-K21 CONTACTORS

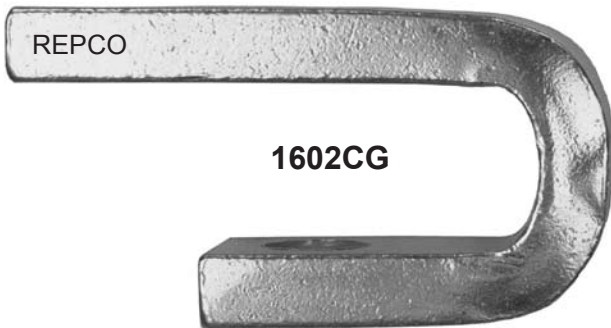

1602CG

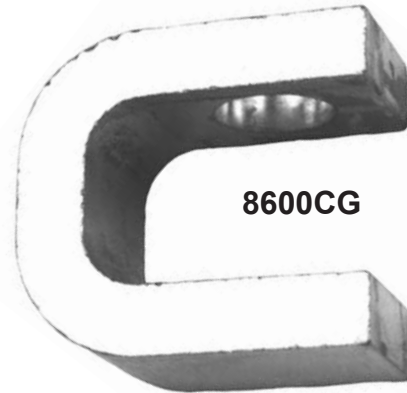

8600CG



4041CG

FOR CR2800-M16
CONTACTORS

GENERAL ELECTRIC

MISCELLANEOUS

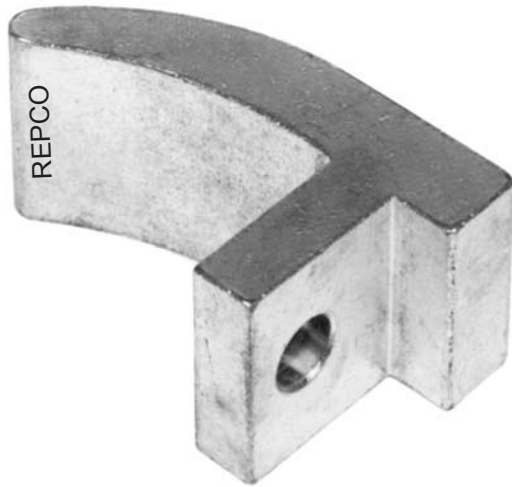

1.25" W 4301EVG
2.50"W 4304EVG



4045CG



4046CG



6315CG



6316CG

For AK Breakers

IC2956 DC AUXILIARY BLOCKS

<u>OEM#</u>	<u>CONFIG.</u>	<u>OUR#</u>
IC2956A200A	2NO	3506CG
IC2956A200B	2NC	3507CG
IC2956A200C	1NO-1NC	3508CG

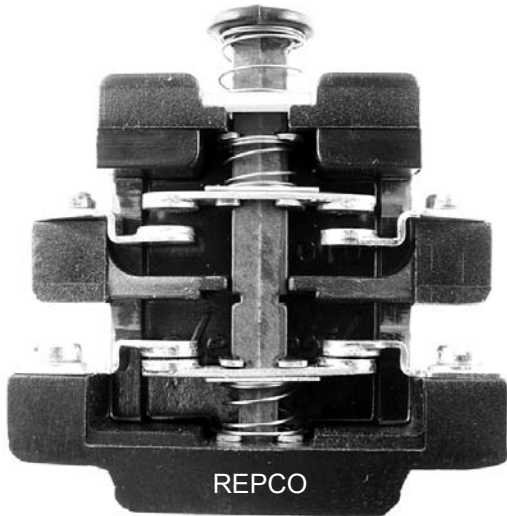

CONTACT KIT FOR THE ABOVE BLOCKS
(OEM# 6960053G3) OUR# 9907CG
2-POLE SET

SBM SWITCHES



SG1



SG2



SG3

GENERAL ELECTRIC

MEDIUM VOLTAGE 5KV SERIES

<u>OEM#</u>	<u>REF.</u>	<u>AMPS</u>	<u>OUR#</u>
138A1125G1	B	400	4020CG
167A8898G1	D	200 / 400	4026CG
167A9956G1	C	400	4025CG
245A1229G1	A	700	4022CG

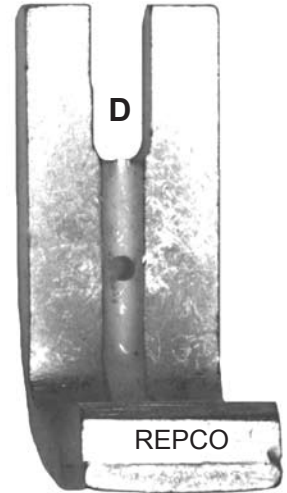
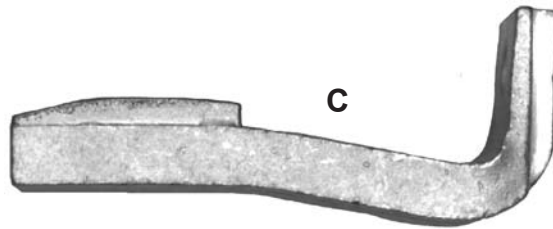
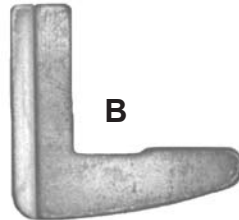
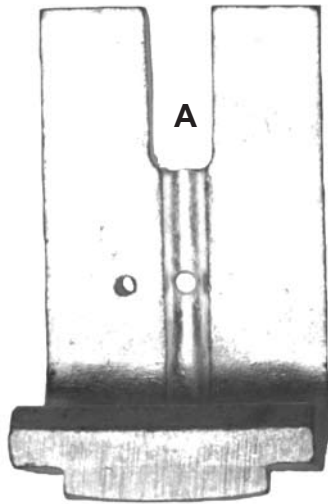

GENERAL ELECTRIC IEC SPECTRA 700 SERIES

<u>DEVICE#</u>	<u>OEM#</u>	<u>AMPS</u>	<u>OUR#</u>	<u>REF.</u>
CR7CG	CR7XDG	37	9313CG	A
CR7CH	CR7XDH	45	9313CG	A
CR7CJ	CR7XDJ	56	9323CG	B
CR7CK	CR7XDK	73	9323CG	B
CA5F2	CA5F2CPR1	105	9333CG	C
CA5F3	CA5F3CPR1	140	9343CG	C

3-POLE SETS

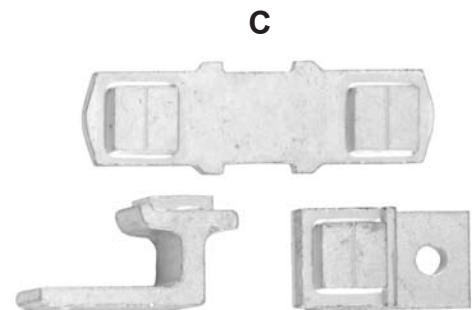
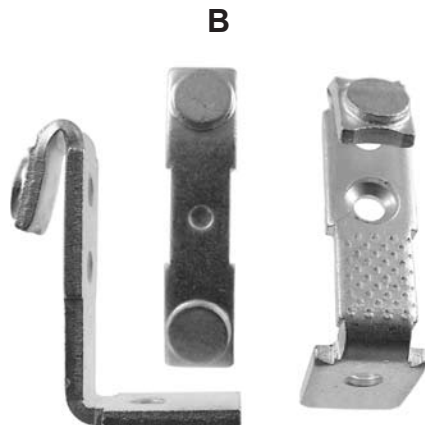
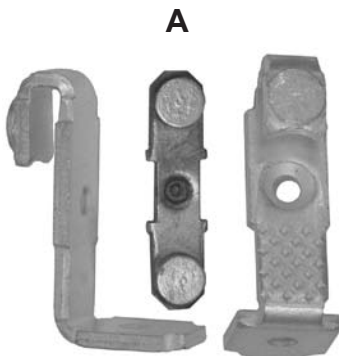

GENERAL ELECTRIC

DS303 DC CONTACTORS

<u>DEVICE#</u>	<u>SIZE</u>	<u>OUR#</u>	<u>REF.</u>
DS303A1, A2	1, 2	1006CG	A
DS303A1, A2	1, 2	4023CG	B
DS303A3	3	1007CG	C
DS303A3	3	4033CG	D
DS303A4, A5	4, 5	1011CG	E
DS303A4, A5	4, 5	4032CG	F
DS303A6, A7	6, 7	2859CG	G
DS303A6, A7	6,7	4044CG	H

SINGLE CONTACTS



A



B



C



D



E



F

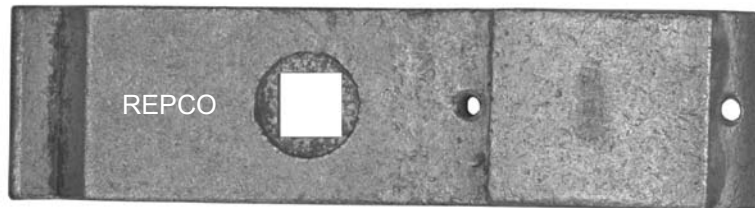

G

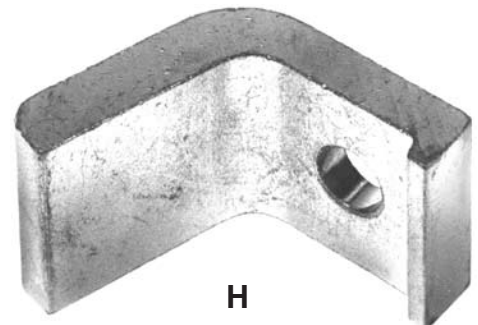

H

GENERAL ELECTRIC

C2000 SERIES

<u>DEVICE#</u>	<u>OEM#</u>	<u>POLES</u>	<u>OUR#</u>	<u>REF.</u>
CL05	VB1205B	4	8144CG	A
CL06	V31206B	3	8143CG	A
CL07	V31207B	3	8143CG	A
CL07	VB1207B	4	8144CG	A
CL08	V31208B	3	8143CG	A
CL08	VB1208B	4	8144CG	A
CL09	V31209B	3	8153CG	B
CL10	V31210B	3	8163CG	C
CK75	V31175CA	3	8173CG	D
CK08C	V31108CA	3	8183CG	E
CK09B, 08B	V31109BA	3	8203CG	F
CK95B	V31195BA	3	8203CG	F
CK10C	V31110CA	3	8213CG	G

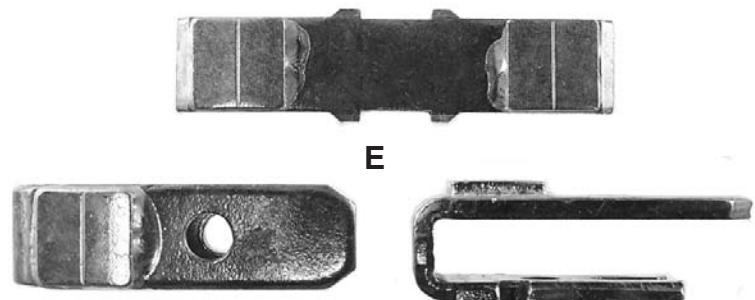
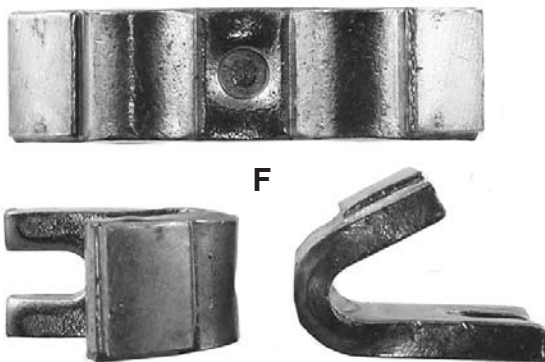
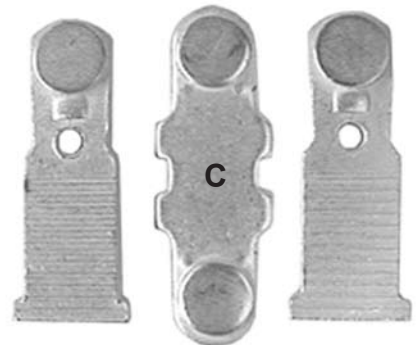
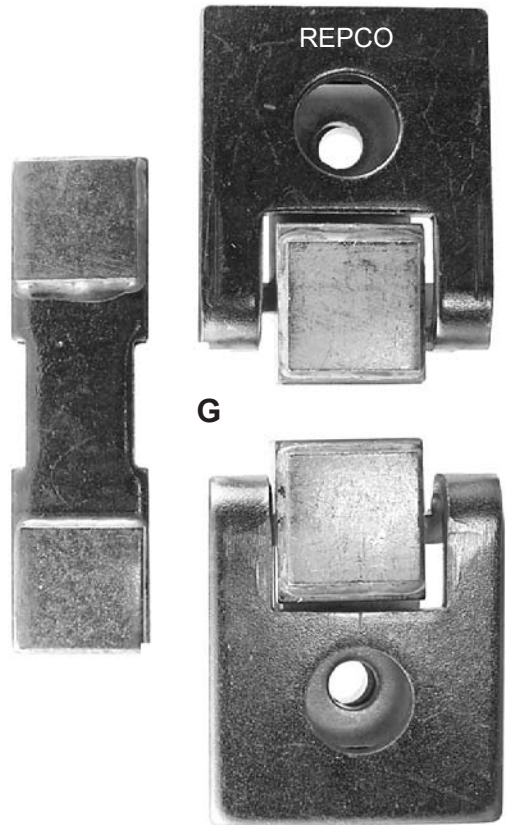
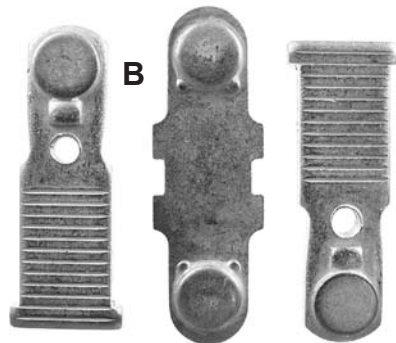
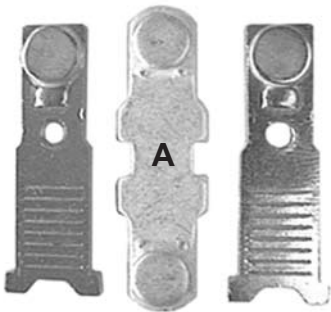

GENERAL ELECTRIC

NAVY CONTROL IC5181

<u>SIZE</u>	<u>DEVICE#</u>	<u>OEM MOV#</u>	<u>REF.</u>	<u>OUR#</u>	<u>OEM STA#</u>	<u>OUR#</u>	<u>REF.</u>
0	IC5181C100	174A7609G1	A	1501CG	174A7610G1	4052CG	B
1	IC5181C101	174A7611G1	C	1502CG	174A7613G1	4053CG	D
2	IC5181C102	174A7153G1	E	1503CG	174A7154G1	4054CG	F
3	IC5181C103	174A7636G1	G	1504CG	174A7638G1	4055CG	H
4	IC5181C104	174A5315G1	I	1505CG	174A5316G1	4056CG	J
5	IC5181C105	188A4581G1	K	1506CG	188A4583G1	8104CG	L
6	IC5181C106	206A2725G1	--	1507CG	157B9712G1	8105CG	--



A

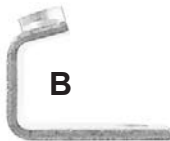

B



C

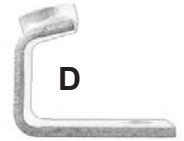

D



E

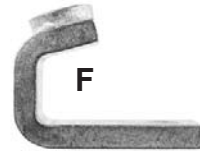

F



G



H



I

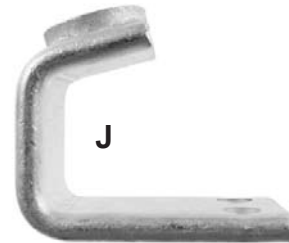

J



K



L

HUBBELL / EUCLID

SIZE	TYPE	REF.	WIDTH	OUR#	SIZE	TYPE	REF.	WIDTH	OUR#
0, 1	MOV	B	1/2"	1000CH	5	STA	D	1"	1050CH
0, 1	STA	A	9/16"	1011CH	6	MOV	F	1 1/2"	1063CH
2	MOV	B	5/8"	1020CH	6	STA	G	1 3/4"	1060CH
2	STA	A	11/16"	1021CH	6	M & S	H	1 1/2"	1061CH
3	M & S	C	3/4"	4001CH	7	M & S	H	1 3/4"	1064CH
4	M & S	C	7/8"	1040CH	8	M & S	H	2 1/8"	1062CH
5	MOV	E	1"	1051CH					

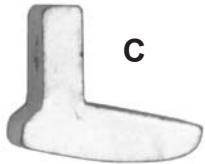

C

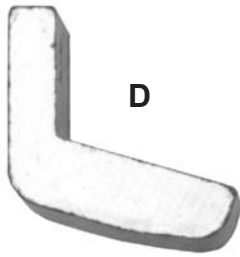

D



B

REPCO

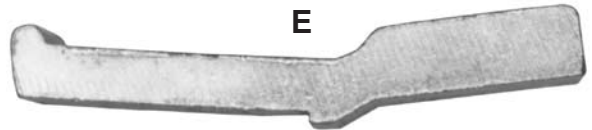

E



A

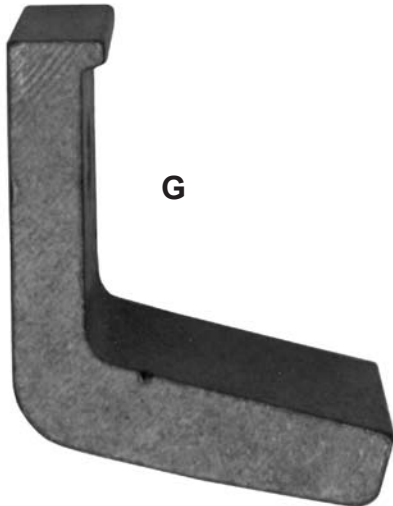

G

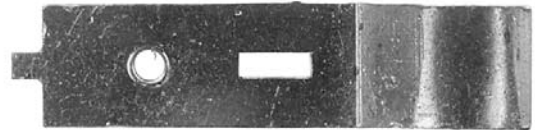

1010CH

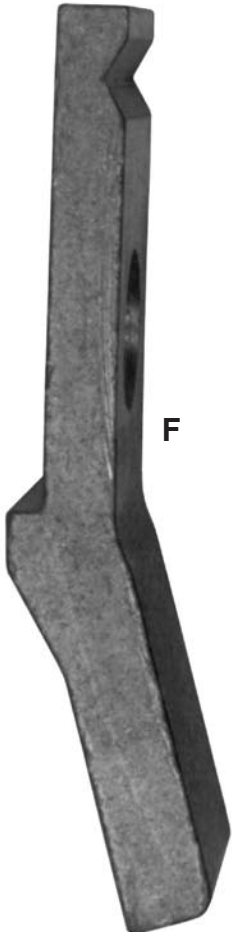

F

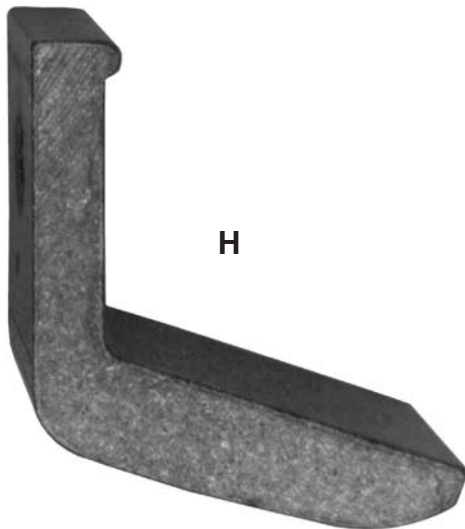

H

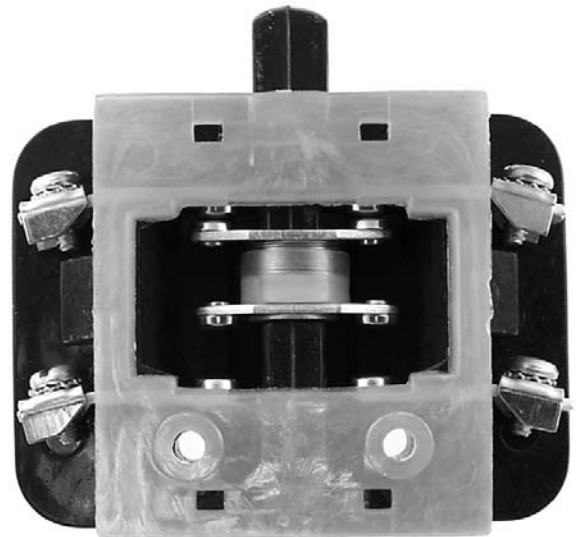

AUXILIARY BLOCK

OEM# 68011-003

OUR# 9000CH

**WE ALSO CARRY THE MOST
COMMON SHUNTS
FROM SIZE 1 THROUGH
SIZE 8.**

KLOCKNER-MOELLER

UNIVERSAL AND CURRENT SERIES

<u>OEM#</u>	<u>OUR#</u>	<u>REF.</u>
DIL2-22	9123CK	A
DIL3-22	9133CK	B
DIL4-22	9143CK	C
DIL6-22	9153CK	D
DIL6-M	9753CK	--
DIL6-AM	9853CK	--
DIL8-M	9763CK	--
DIL8-AM	9863CK	--
DIL10-M	9773CK	--
DIL10-AM	9873CK	--

**DILM KITS ALSO
AVAILABLE**

3-POLE SETS

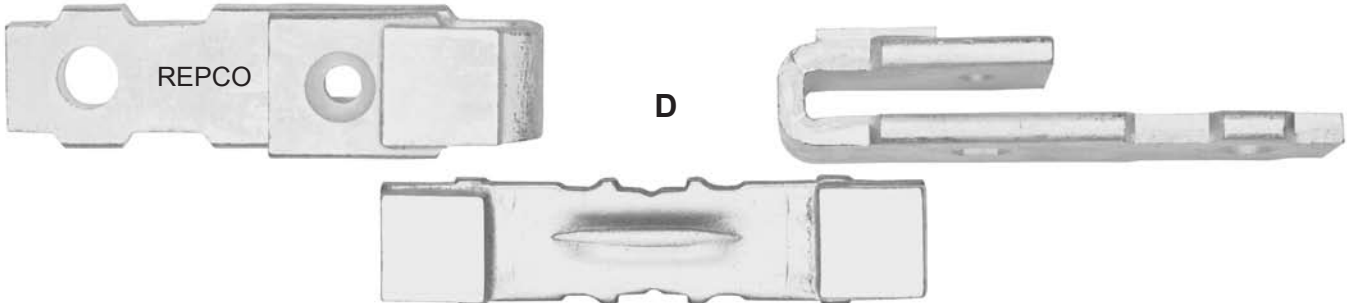
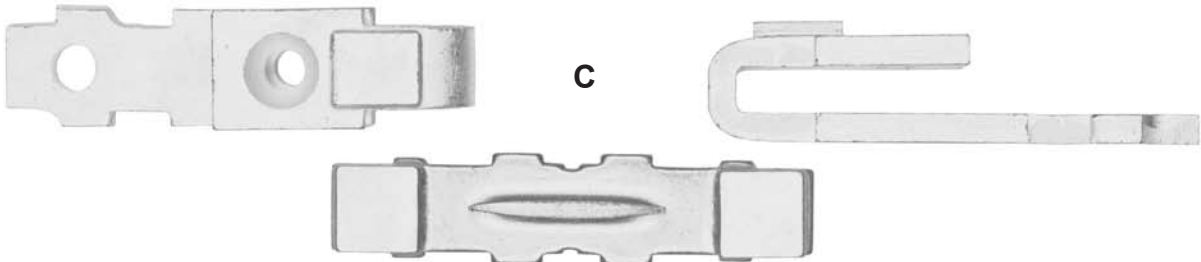
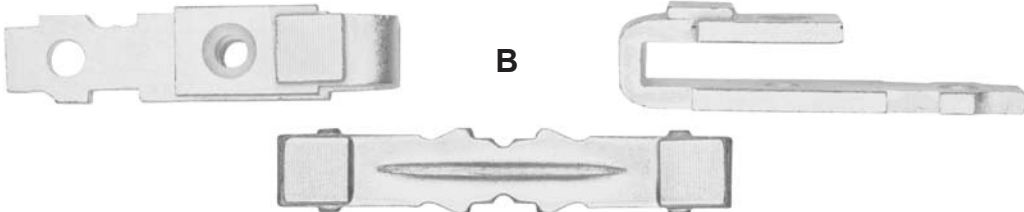
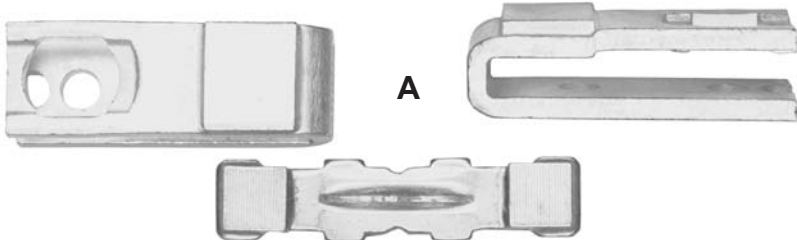

MITSUBISHI

<u>DEVICE#</u>	<u>OEM#</u>	<u>OUR#</u>	<u>REF.</u>
S-K18, 19	BH529N301	9103CX	A
S(D)-K21	BH539N300	9203CX	B
S-K25	BH549N300	9113CX	C
S(D)-K35	BH549N301	9213CX	D
S-K38	BH559N306	9123CX	E
S-K48	BH559N307	9223CX	F
S-K50	BH559N300	9133CX	G
SD-K50	BH559N302	9233CX	--
S-K65	BH559N301	9143CX	G
SD-K65	BH559N303	9243CX	--
S-K80	BH569N300	9153CX	H
SD-K80	BH569N302	9253CX	--
S-K95	BH569N301	9163CX	H
SD-K95	BH569N303	9263CX	--
S-K125	BH579N301	9173CX	I

3-POLE SETS

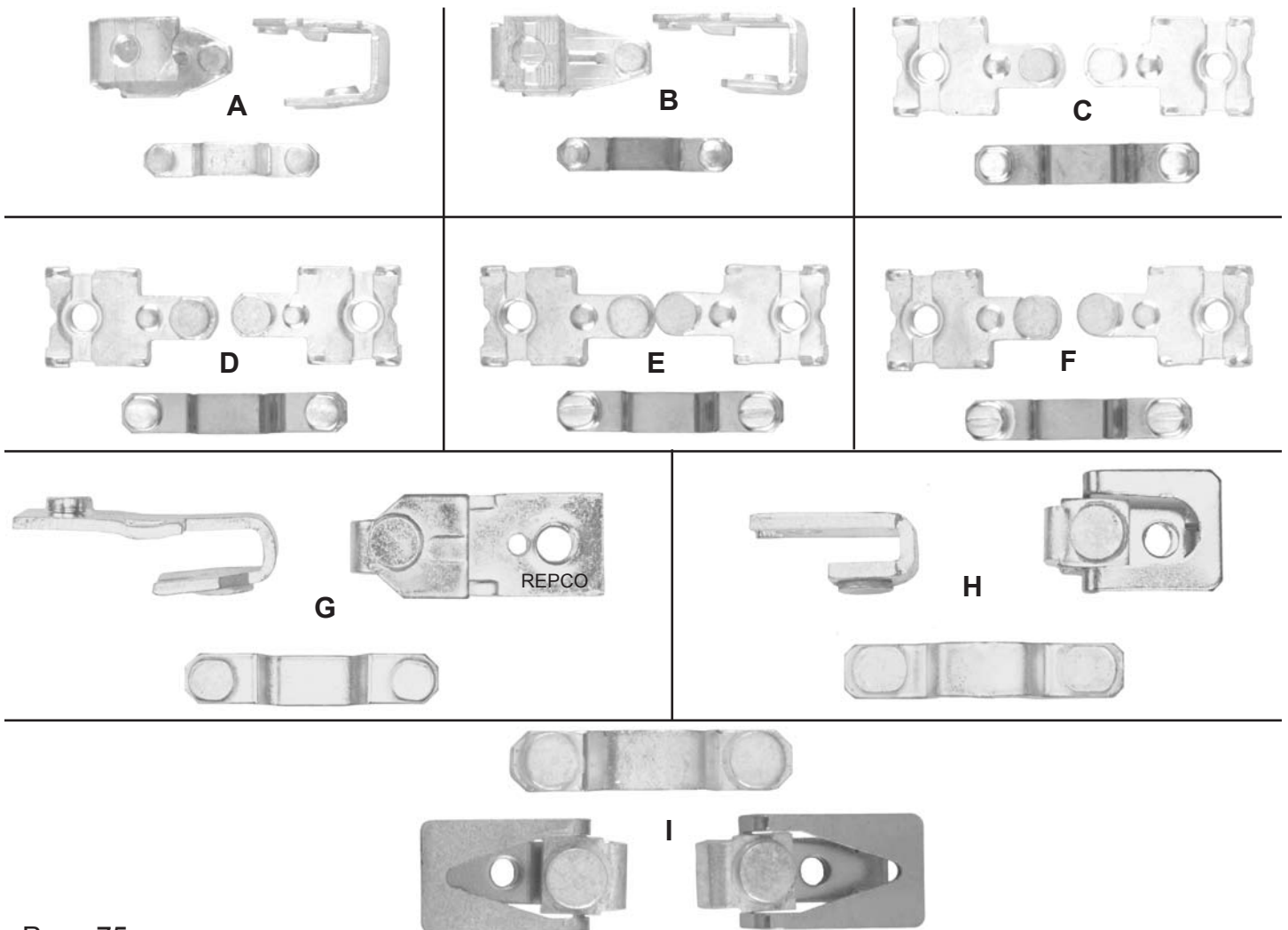

P & H

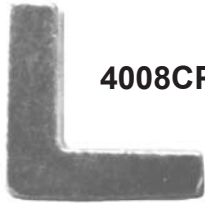

4008CP 3/4" WIDE

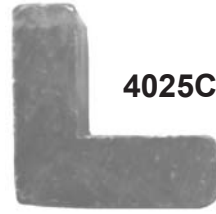

4025CP 1 1/2" WIDE

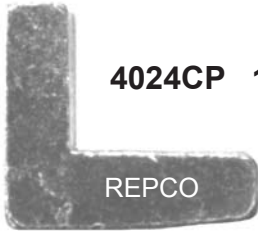

4024CP 1" WIDE

REPCO



4002CP 11/16" WIDE
4023CP 5/8" WIDE



4003CP 3/4" WIDE



4028CP 11/16" WIDE
SILVER-TIPPED
(REPALLOY)



4004CP 1" WIDE

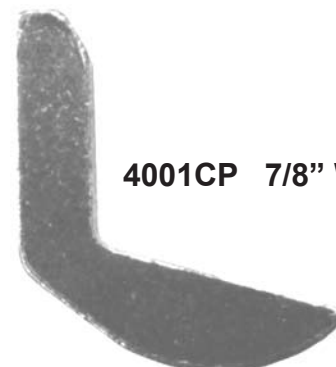

4001CP 7/8" WIDE

P & H



4022CP 1" WIDE
4029CP 3/4" WIDE



2100CP 3/4" WIDE



4030CP 1" WIDE



2300CP
ADAPTER FOR
3/4" AND 1" TIPS

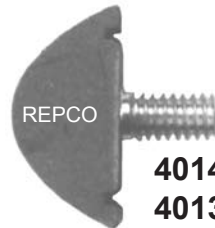

4014CP 3/4" WIDE
4013CP 1" WIDE

**IF YOU CANNOT FIND YOUR CONTACTS IN THIS SECTION,
PLEASE CHECK IN THE FURNAS SECTION.**

RELIANCE

<u>OEM#</u>	<u>OUR#</u>	<u>REF.</u>
K200	9123CJ	A
K201	9133CJ	A
K500	9233CJ	B
K250	9143CJ	C
K502	9243CJ	C
K300	9153CJ	D
K352	9163CJ	E
K353	9173CJ	F
K354	9183CJ	G

KITS ALSO AVAILABLE FOR:

K256	K263	78095-60AP
K257	K268	78095-61AP
K258	K269	78096-60AP
K259	78093-60AP	78096-61AP
K260	78094-60AP	78097-60AP
K261	78094-61AP	78097-61AP

(NOT SHOWN)

ONE-POLE SETS

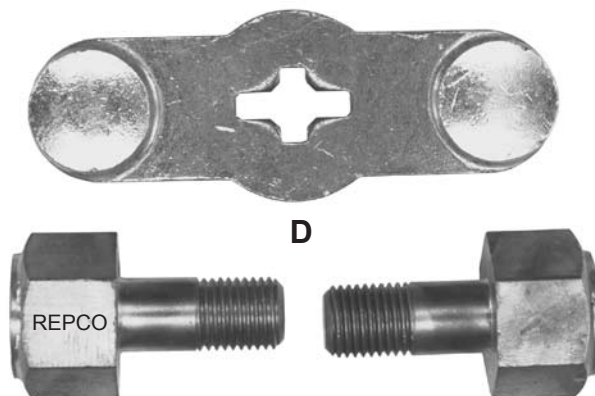
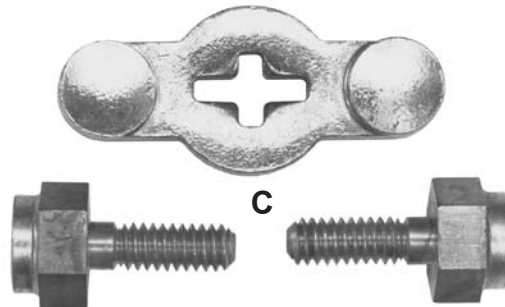
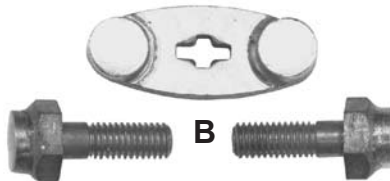
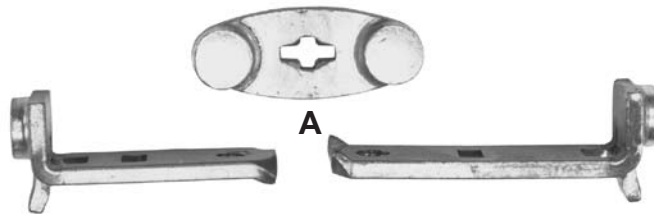

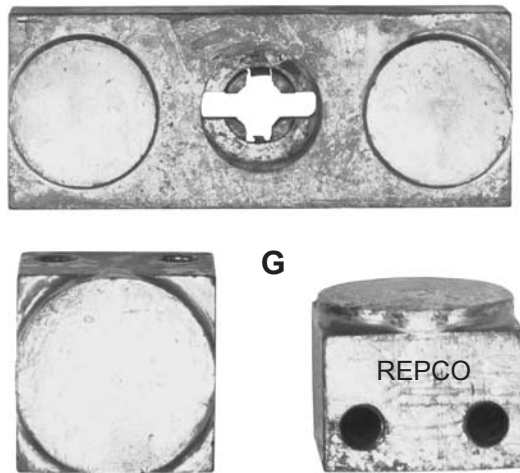
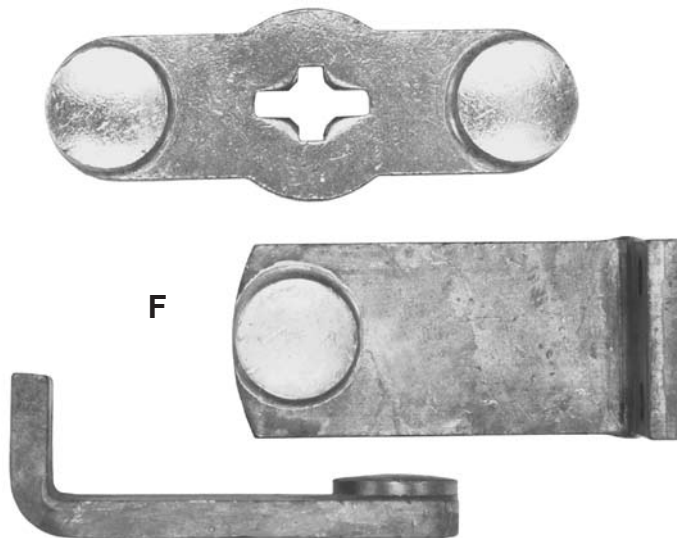
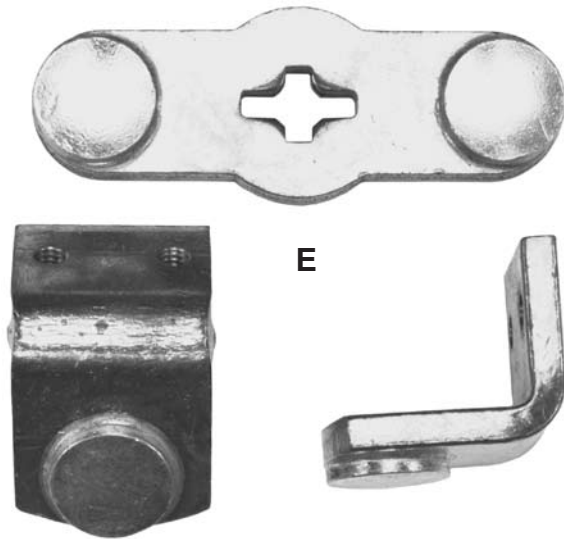

ROWAN ITE

<u>OEM#</u>	<u>REF.</u>	<u>OUR#</u>	<u>SIZE</u>	<u>FRAME</u>
3833G1	A	4203CZ	1	50
3120G1	B	4202CZ	3	150
3121G1	C	4201CZ	4, 5	300, 600
5377	D	3501CZ	4, 5	300, 600
5375	E	3500CZ	3	150

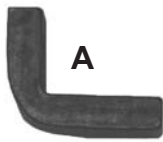

A

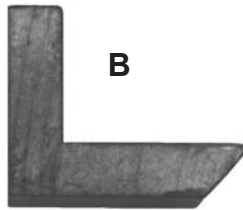

B

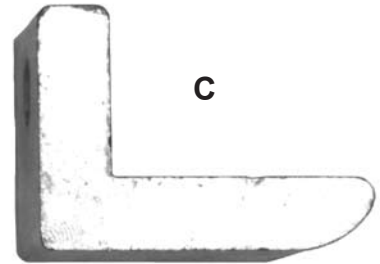

C

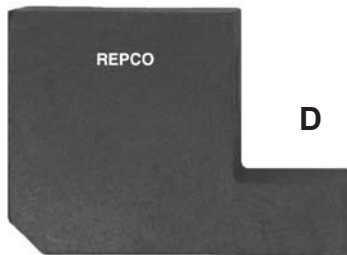

REPCO

D



E

FOR 5 KV H3 CONTACTOR



8007CZ



8008CZ

S & S (SPRECHER & SCHUH)

CA1 CONTACTORS

<u>OEM#</u>	<u>DEVICE#</u>	<u>SIZE</u>	<u>REF.</u>	<u>OUR#</u>
22.109.212-02	CA1-14/16	1, 1 3/4	--	9113CR
22.110.212-02	CA1-25	2	A	9123CR
22.114.212-02	CA1-40	2 1/2	B	9223CR
22.104.212-04	CA1-55/60	3, 3 1/2	C	9133CR
22.104.212-06	CA1-100	4	D	9143CR
22.105.212-03	CA1-150	4 1/2	E	9243CR
22.106.212-02	CA1-250	5	F	9153CR
22.107.212-02	CA1-480	5 1/2	G	9253CR

3-POLE SETS

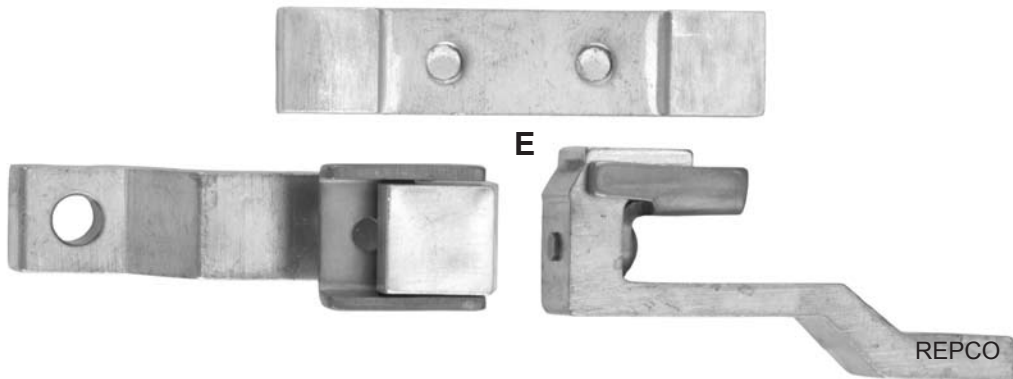
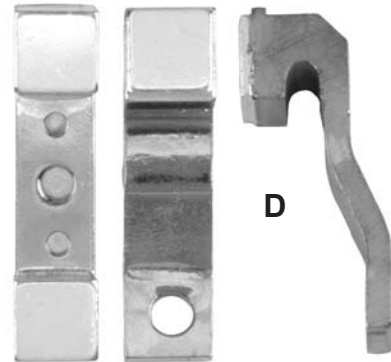
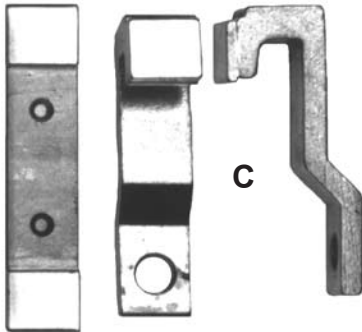
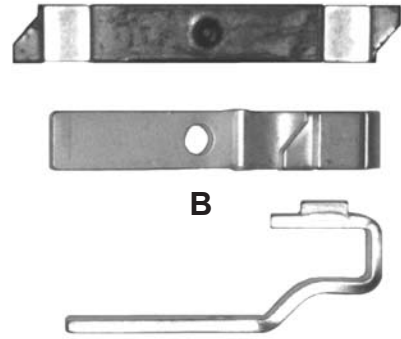
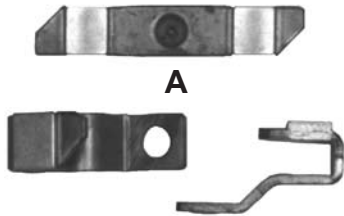

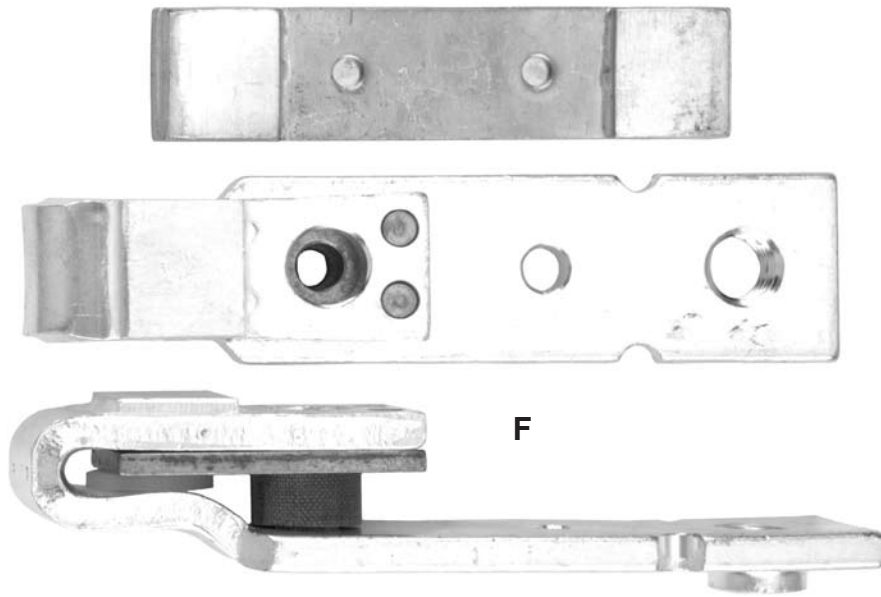

F

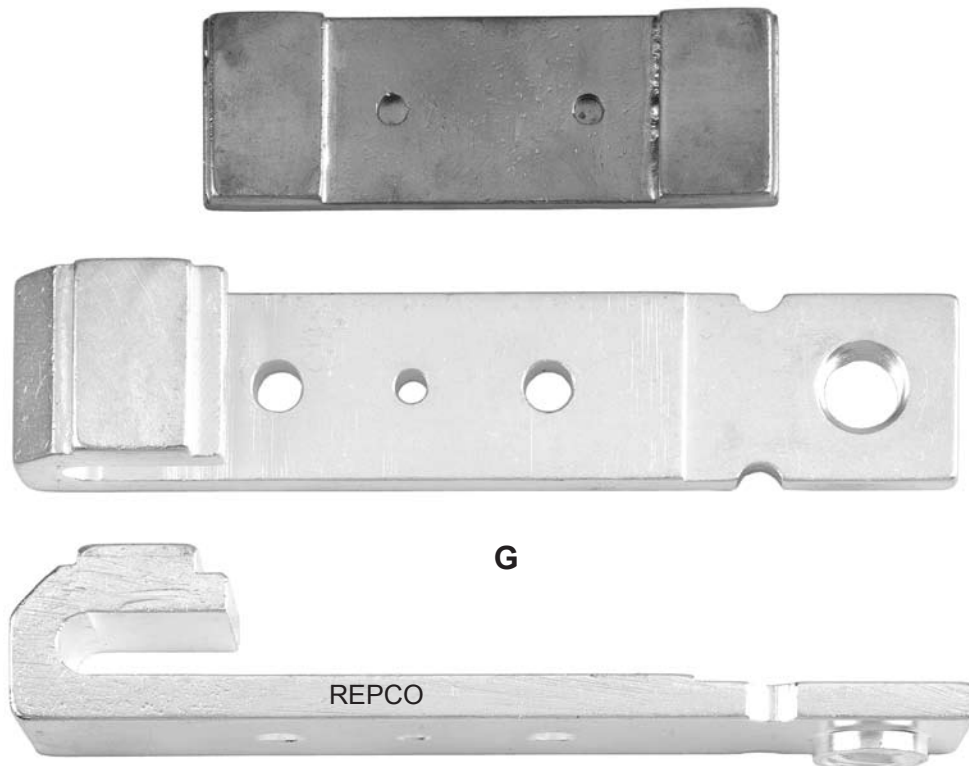

G

CA5 CONTACTS ARE ALSO AVAILABLE

S & S (SPRECHER & SCHUH)

CA3-CA6 CONTACTORS

<u>OEM#</u>	<u>SIZE</u>	<u>DEVICE#</u>	<u>OUR#</u>	<u>REF.</u>
22.701.214-01	1	CA3-37	9433CR	A
22.701.215-01	2	CA3-43	9433CR	A
22.701.216-01	2	CA3-60	9433CR	A
22.701.217-01	2.5	CA3-72	9433CR	A
22.801.200-01	3	CA6-85	9453CR	B
22.801.201-01	3.5	CA6-105-E(1)	9453CR	B
22.802.200-01	4	CA6-140-E(1)	9473CR	B
22.802.201-01	4	CA6-170-E(1)	9473CR	B

3-POLE SETS

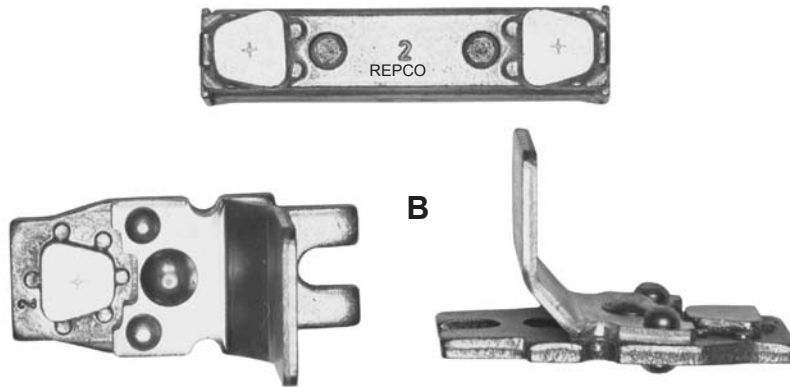
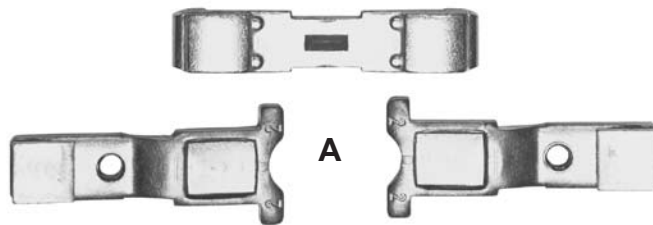

CA7 CONTACTORS

<u>DEVICE#</u>	<u>REF.</u>	<u>OUR#</u>
CA7-30 THRU 43	A	9543CR
CA7-60 THRU 72	B	9553CR
CA7-85	C	9563CR

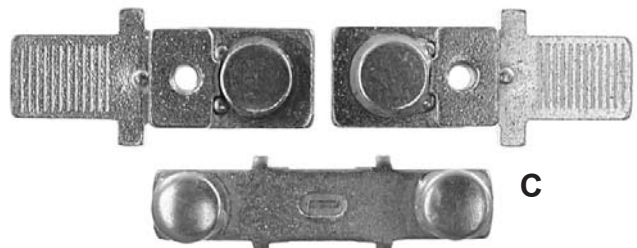
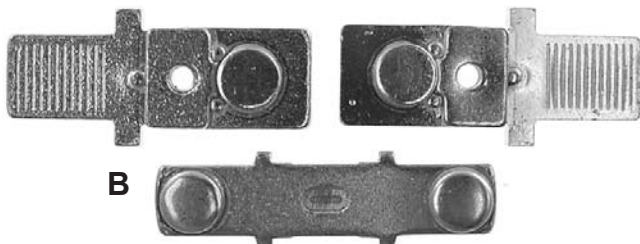
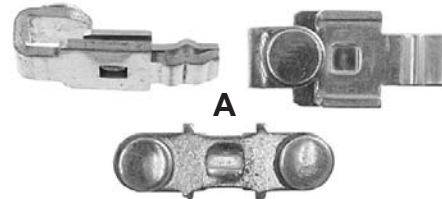

SIEMENS-ALLIS

VALUE-LINE

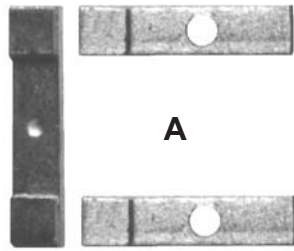

A

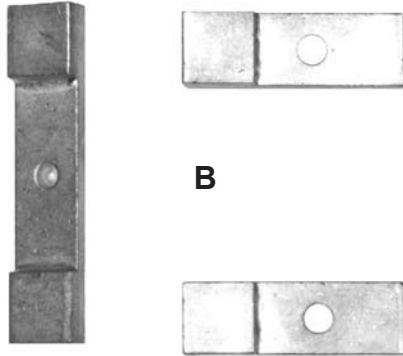

B

OEM#	SIZE	POLES	OUR#	REF.
25-106-921-812 (K-C1)	1	4	9114CV	A
25-106-922-812 (K-C2)	2	3	9123CV	B
25-106-923-812 (K-C3)	3	3	9133CV	C
25-106-924-812 (K-C4)	4	3	9143CV	D

VALUE-LINE HEAVY-DUTY

14-134-047-801	4	3	9243CV	E
14-134-875-801	5	3	9253CV	F
14-134-893-801	6	3	9263CV	G

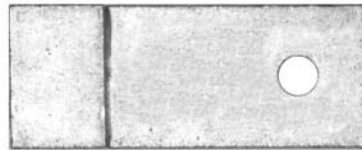
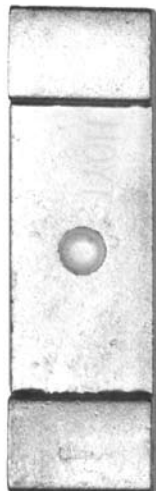

C

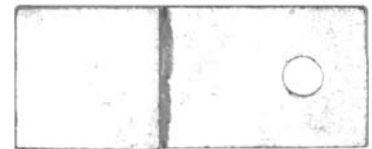
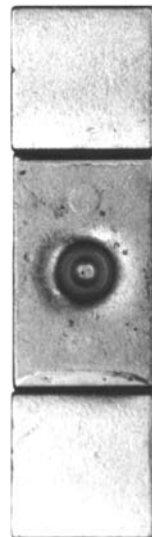

D

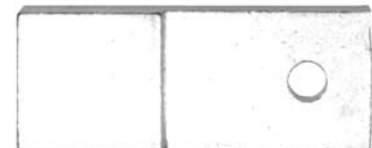

E

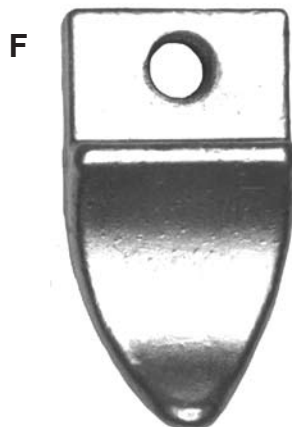

F

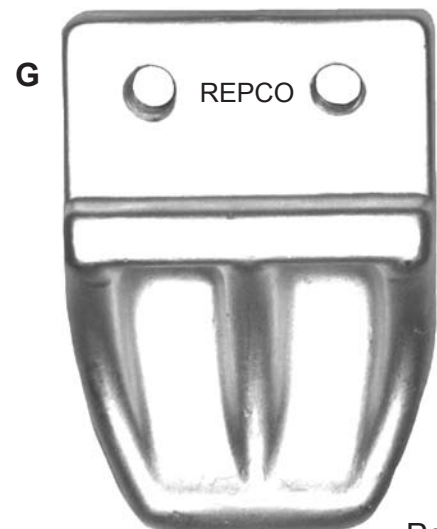

G

SIEMENS

3TA SERIES

<u>DEVICE#</u>	<u>OEM#</u>	<u>OUR#</u>	<u>REF.</u>
3TA21	3TY1210-OA	9413CV	A
3TA22	3TY1220-OA	9423CV	B
3TA23	3TY1230-OA	9433CV	C
3TA24	3TY1240-OA	9443CV	D
3TA26	3TY1260-OA	9453CV	E
3TA28	3TY1280-OA	9463CV	F
3TA30	3TY1300-OA	9473CV	G
3TA32	3TY1320-OA	9483CV	H

3-POLE SETS



A



B



C



D



E

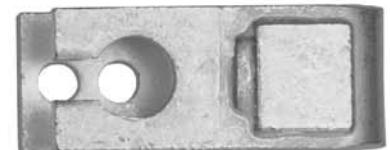

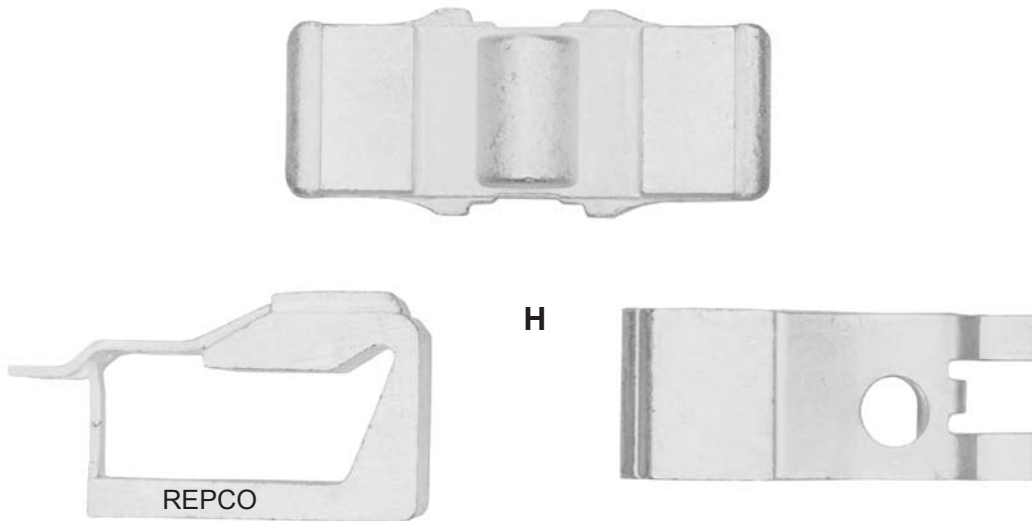
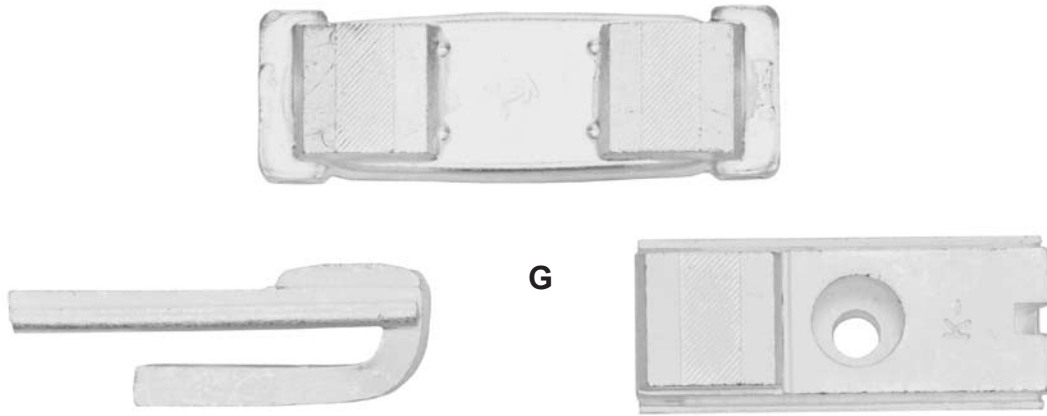
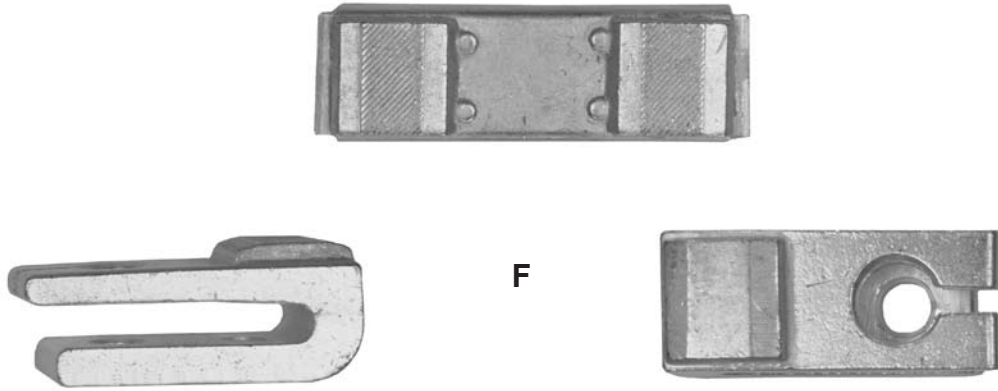

SIEMENS

WORLD SERIES FOR 3TB SERIES

<u>DEVICE#</u>	<u>OEM#</u>	<u>REF.</u>	<u>OUR#</u>
3TB44	3TY6440-OA	A	9503CV
3TB46	3TY6460-OA	B	9513CV
3TB47	3TY6470-OA	C	9523CV
3TB48	3TY6480-OA	D	9533CV
3TB50	3TY6500-OA	E	9543CV
3TB52	3TY6520-OA	F	9553CV
3TB54	3TY6540-OA	G	9563CV
3TB56	3TY6560-OA	H	9573CV
3TB58	3TY6580-OA	--	9583CV

3-POLE SETS

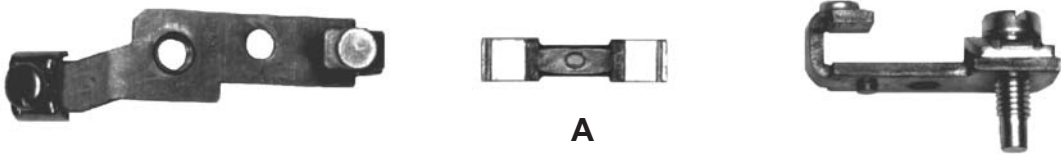

A

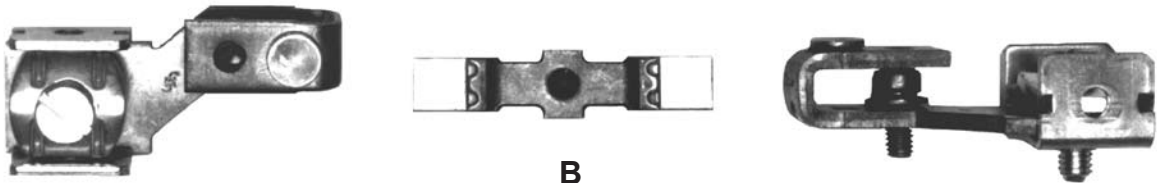

B



C



D

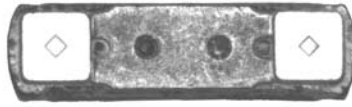
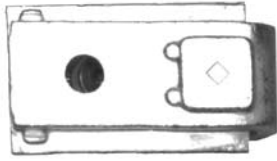

E

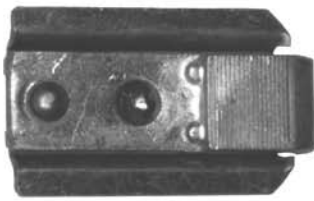

F

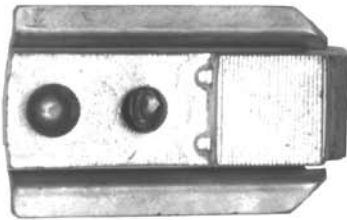

G

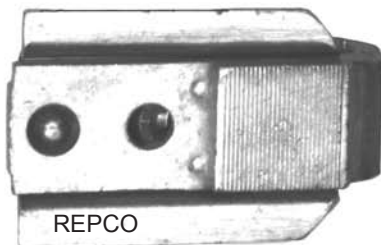
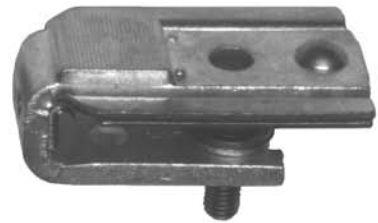

REPCO

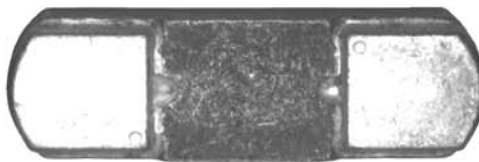

H



SIEMENS

CONTACTS FOR 3TF CONTACTORS

<u>DEVICE#</u>	<u>OEM#</u>	<u>OUR#</u>	<u>REF.</u>
3TF44	3TY7440-OA	9703CV	A
3TF45	3TY7450-OA	9803CV	B
3TF46	3TY7460-OA	9713CV	C
3TF47	3TY7470-OA	9723CV	D
3TF48	3TY7480-OA	9733CV	E
3TF49	3TY7490-OA	9833CV	F
3TF50	3TY7500-OA	9743CV	G
3TF51	3TY7510-OA	9843CV	H
3TF52	3TY7520-OA	9753CV	I
3TF53	3TY7530-OA	9853CV	J
3TF54	3TY7540-OA	9763CV	K
3TF55	3TY7550-OA	9863CV	L
3TF56	3TY7560-OA	9773CV	M
3TF57	3TY7570-OA	9873CV	N
3TF58	3TY7580-OA	9883CV	--

3-POLE SETS

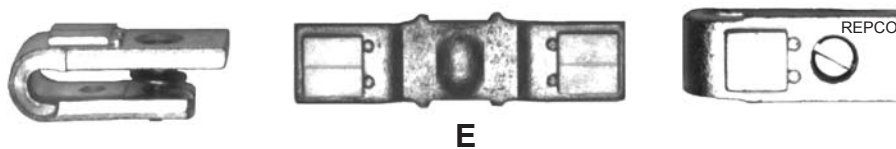
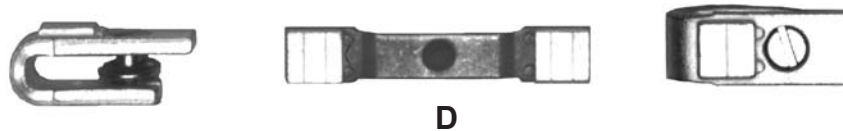
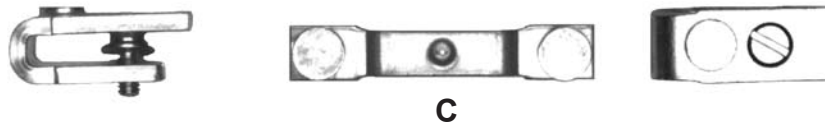
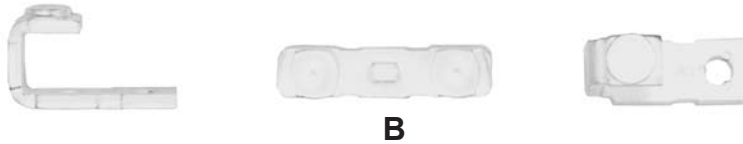
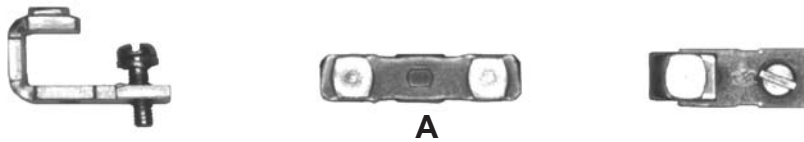

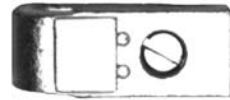
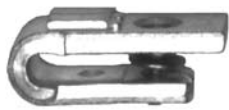

F

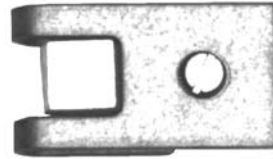
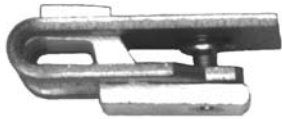

G

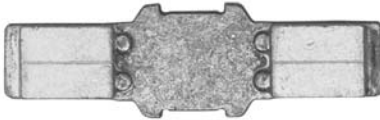

H

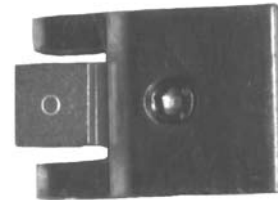
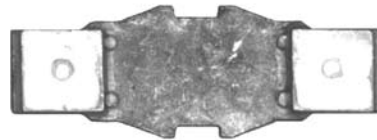
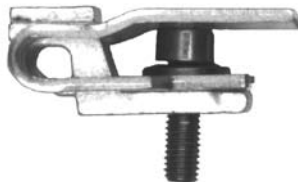

I

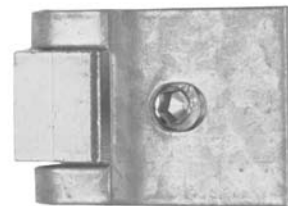

J

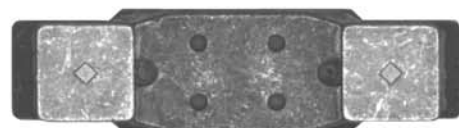
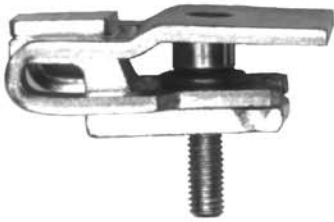

K

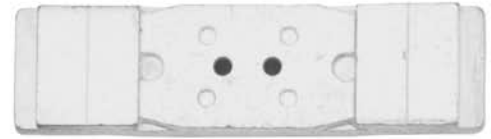

L

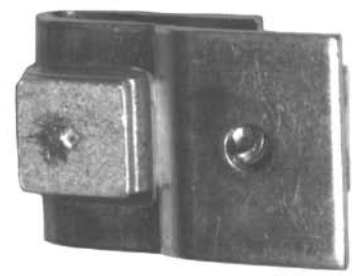
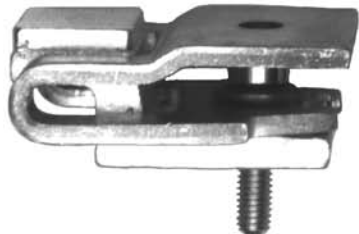

M

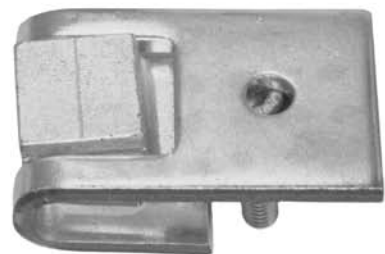
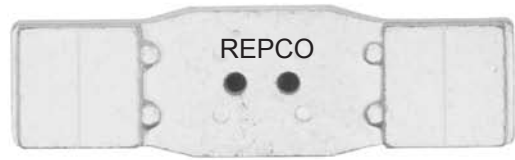

N

SIEMENS

FOR 3RT SIRIUS CONTACTORS

<u>DEVICE#</u>	<u>OEM#</u>	<u>REF.</u>	<u>OUR#</u>
3RT1033	3RT1934-6A	A	9313CV
3RT1034	3RT1934-6A	A	9313CV
3RT1035	3RT1935-6A	A	9333CV
3RT1036	3RT1936-6A	A	9333CV
3RT1044	3RT1944-6A	B	9343CV
3RT1045	3RT1945-6A	C	9363CV
3RT1046	3RT1946-6A	C	9363CV
3RT1054	3RT1954-6A	D	9354CV
3RT1055	3RT1955-6A	E	9356CV
3RT1056	3RT1956-6A	E	9356CV
3RT1064	3RT1964-6A	F	9366CV
3RT1065	3RT1965-6A	F	9366CV
3RT1066	3RT1966-6A	F	9366CV
3RT1075	3RT1975-6A	G	9376CV
3RT1076	3RT1976-6A	G	9376CV

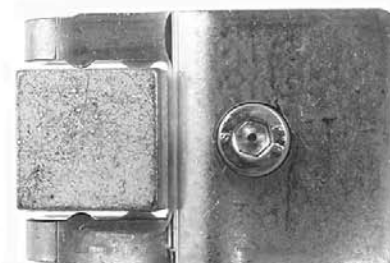
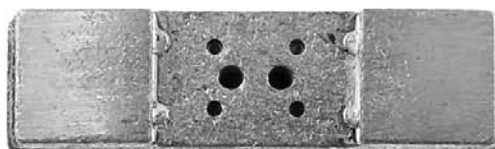
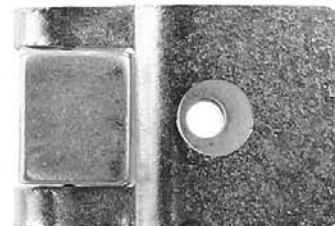
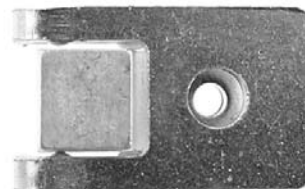
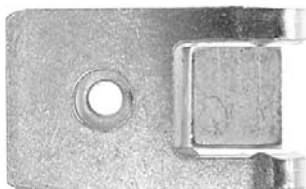
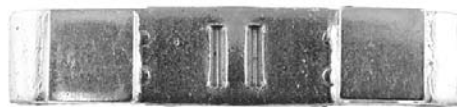
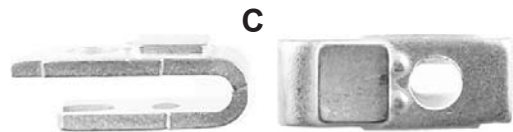
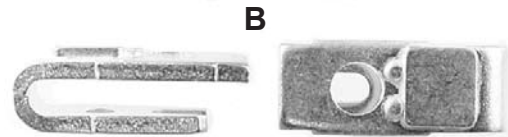
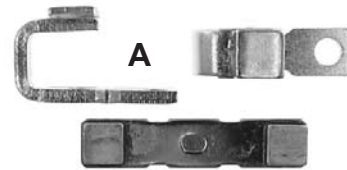

SIEMENS MISCELLANEOUS

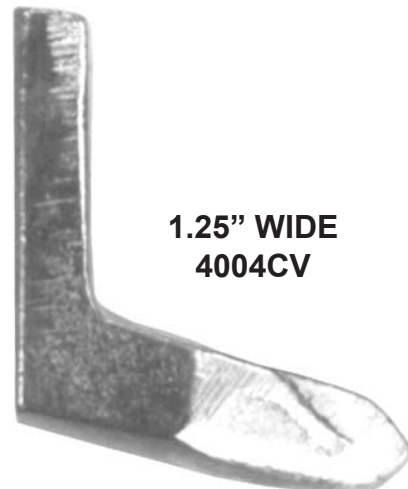
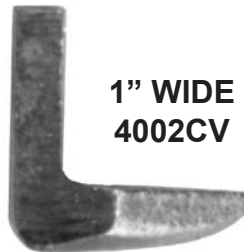

SIEMENS

SPECIAL PURPOSE DC CONTACTORS

<u>TYPE</u>	<u>AMPS</u>	<u>OEM#</u>	<u>CONFIG.</u>	<u>OUR#</u>	<u>REF.</u>
		14-187-872-801	SPNO	9623CV	A
720	200	14-192-887-803	REV	9643CV	B
264	400	14-189-790-511	SPNO	9633CV	C



A



C

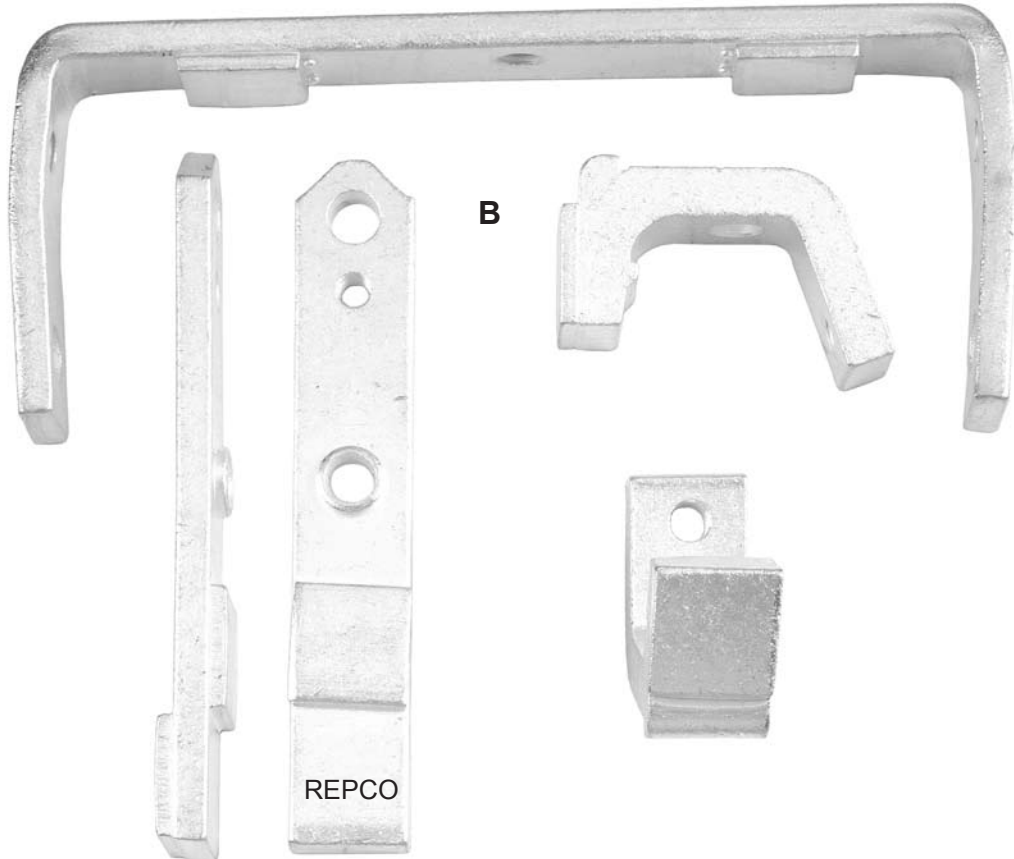

B

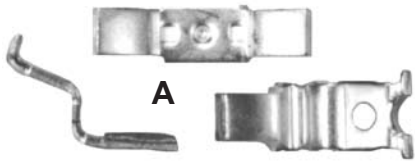

A

SQUARE D CURRENT STYLE DEVICES

OEM#	SIZE	OUR#	REF.
SL-2	0	9703CS	A
SL-3	1	9713CS	B
SL-4	2	9723CS	C
SL-7	3	9733CS	D
SL-9	4	9743CS	E
SL-11	5	9753CS	F
SL-26	6	9763CS	G

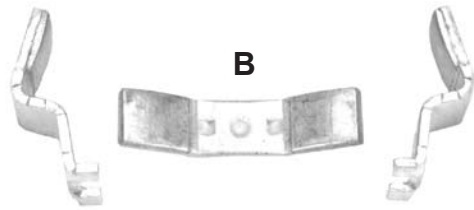

B

3-POLE SETS

SPRINGS ARE AVAILABLE
FOR SIZE 3 AND 4 CONTACTORS.

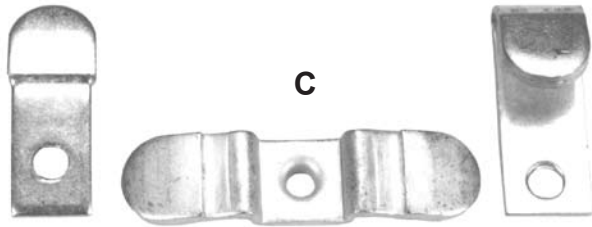

C

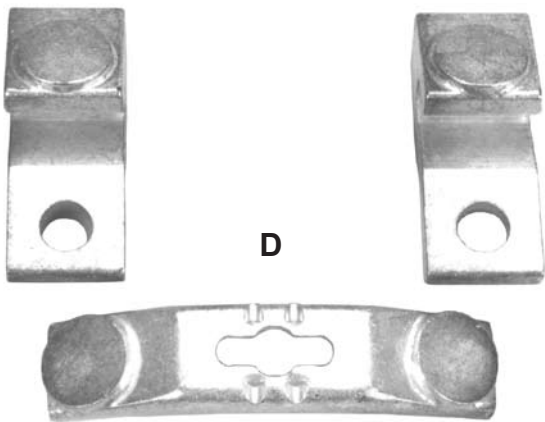

D

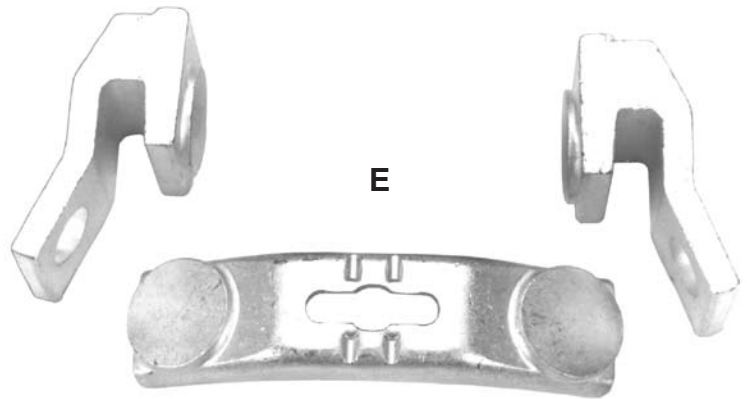

E

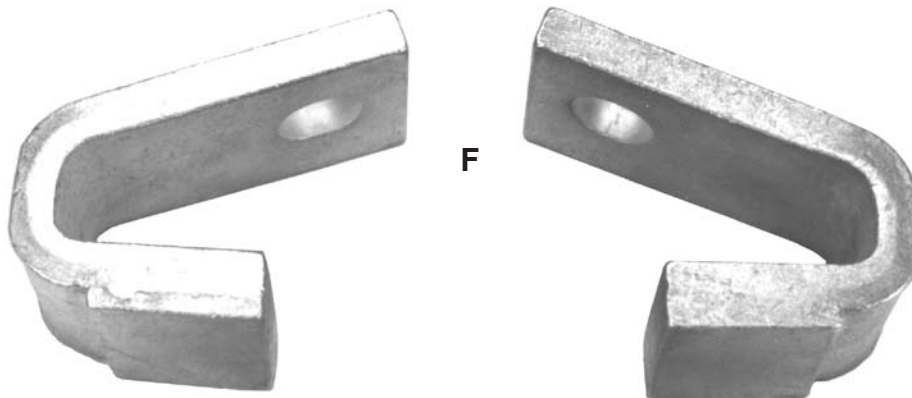

F



REPCO

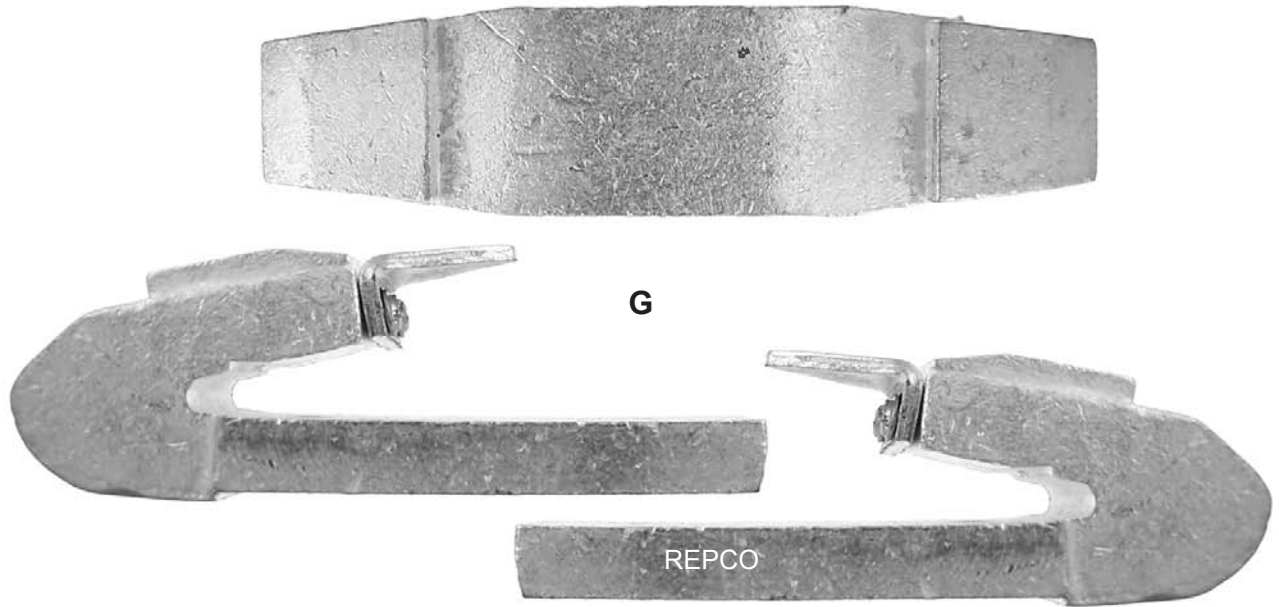

DEFINITE PURPOSE CONTACTORS
CLASS 8910, 8965 TYPES DPR, DP, DPA, SYD

<u>DEVICE#</u>	<u>POLES</u>	<u>OEM#</u>	<u>AMPS</u>	<u>REF.</u>	<u>OUR#</u>
DPA33	1	DRC3	30	A	8131CS
DPA43	1	DRC4	40	B	8141CS
DPA53	1	DRC5	50	C	8151CS
DPA63	1	DRC6	60	D	8161CS
DPA73	1	DRC7	75	E	8191CS
DPA93	1	DRC9	90	E	8191CS
DPA123	1	DRC12	120	--	8731CS
SYD138	3	SL-27	132	--	8733CS
SYD230	3	SL-28	220	--	8743CS
SYD368	3	SL-29	352	--	8753CS

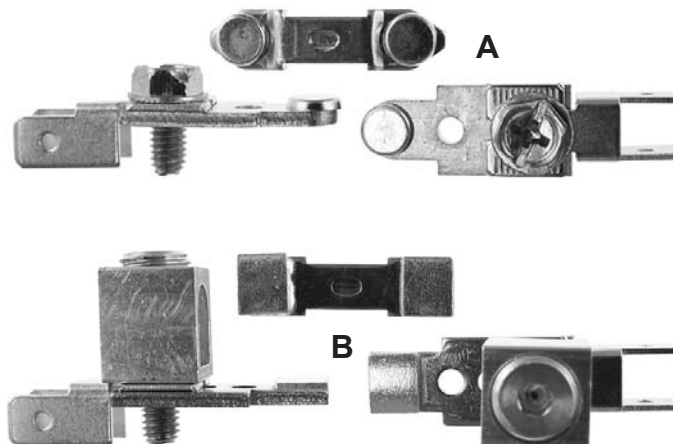

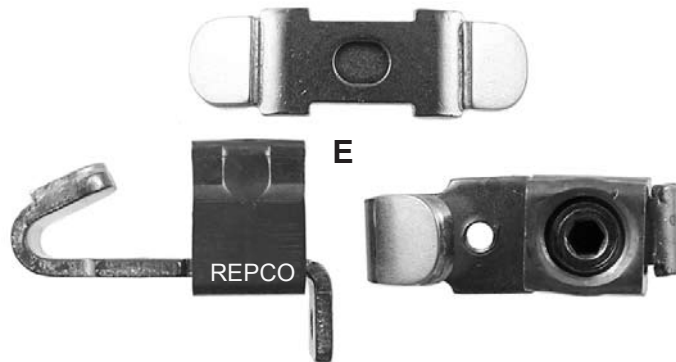
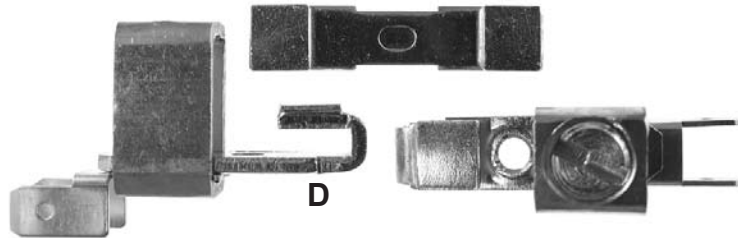
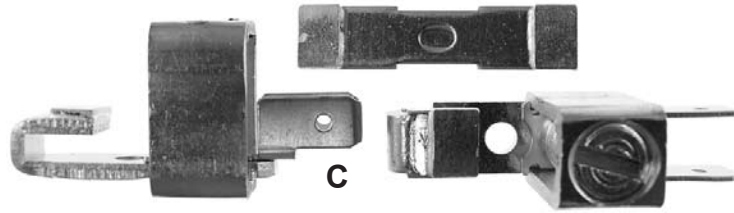

CLASS 8198 ISO-FLEX



1.25" WIDE

9103CS
OEM# 9998 LA-2
(Set includes 6 contacts)

SQUARE D

"OLD STYLE"

<u>SIZE</u>	<u>REF.</u>	<u>OEM#</u>	<u>SERIES</u>	<u>OUR#</u>
0	A	BA-81	A	9603CS
0	B	RA-81	PRE-A	9503CS
1	C	SA-81	PRE-A	9513CS
1	D	CA-81	A, B	9613CS
2	E	TA-81		9623CS
3	F	UA-81		9633CS
4	G	FA-81	A, B	9543CS
4	H	FA-82	C	9643CS
5	I	GA-81	B, C	9653CS
6	--	HA-81	A	9563CS
6	--	HA-82	B, C	9663CS
7	--	JA-81	A	9673CS
8	--	KA-81		9683CS

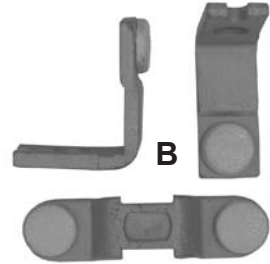
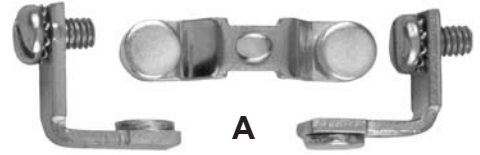

3-POLE SETS

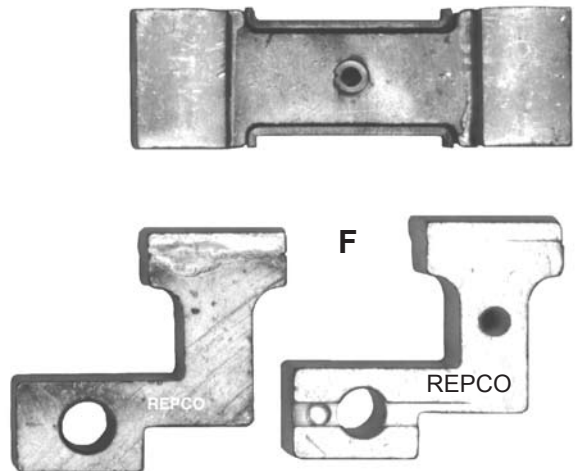
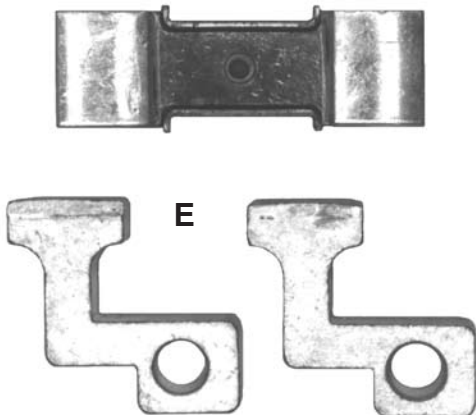
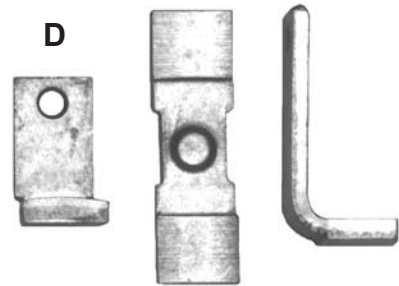
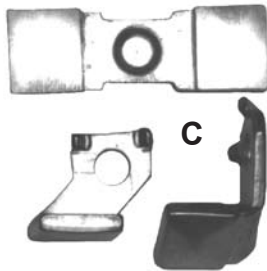

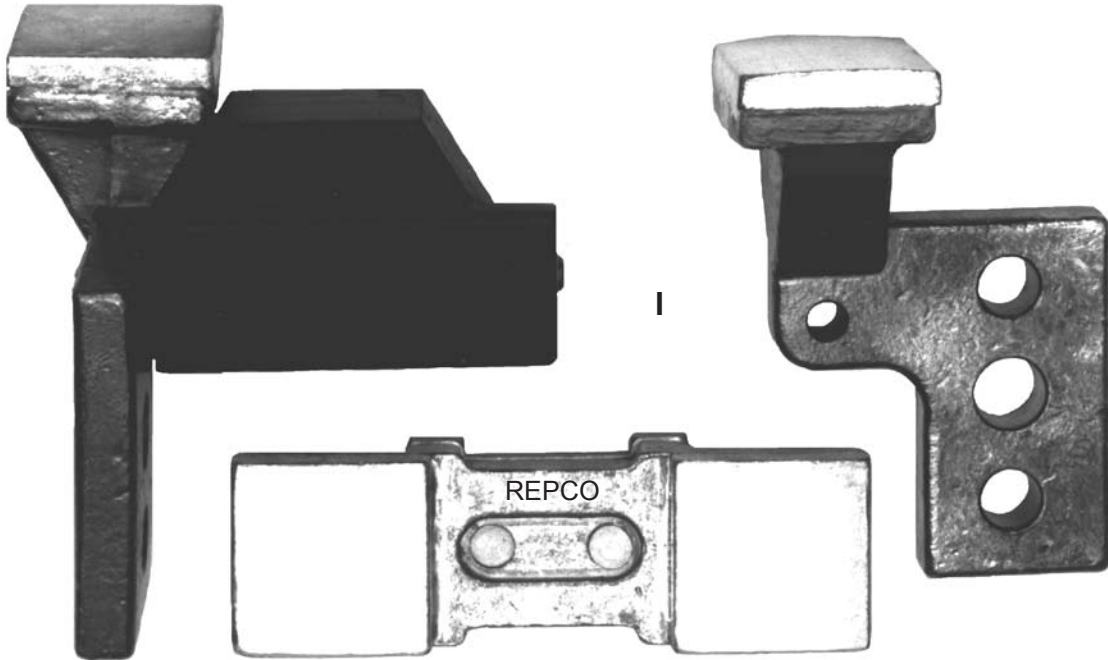
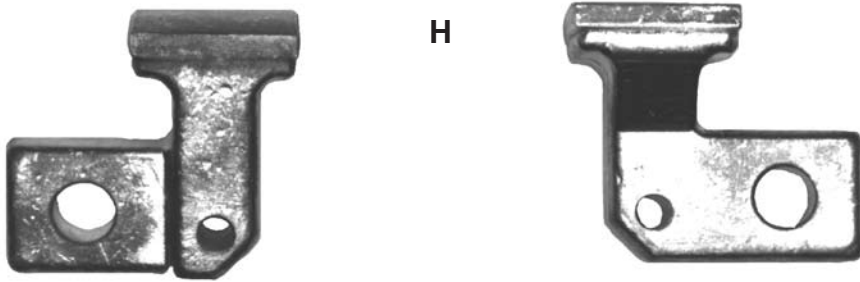
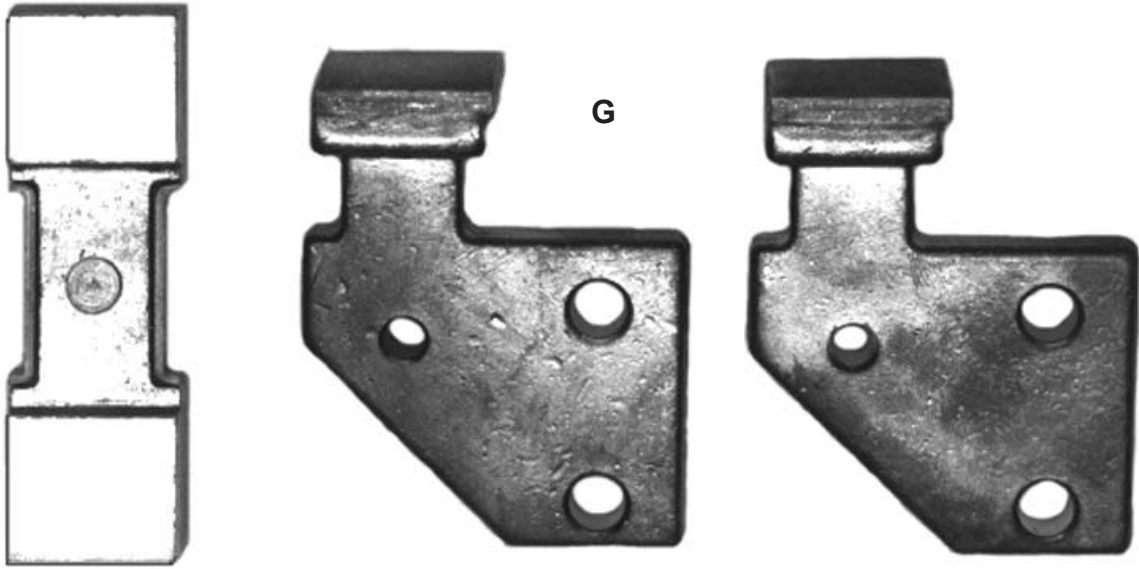

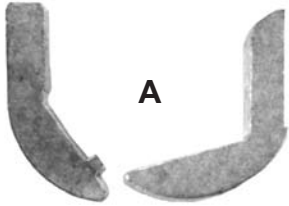

A

SQUARE D

CLASS 7004, TYPE H

<u>OEM#</u>	<u>POLES</u>	<u>SIZE</u>	<u>WIDTH</u>	<u>OUR#</u>	<u>REF.</u>
HC-1	2	1	.40"	9948CS	A
HD-1	2	2	.50"	9941CS	A
HE-1	2	3	.56"	9951CS	B
HF-1	2	4	.75"	9952CS	C
HG-1	2	5	1.0"	9953CS	D
HH-1	1	6	1.38"	9954CS	E

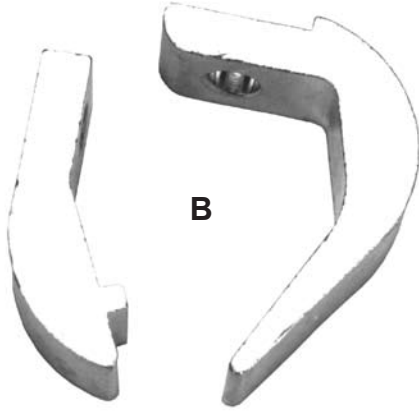

B

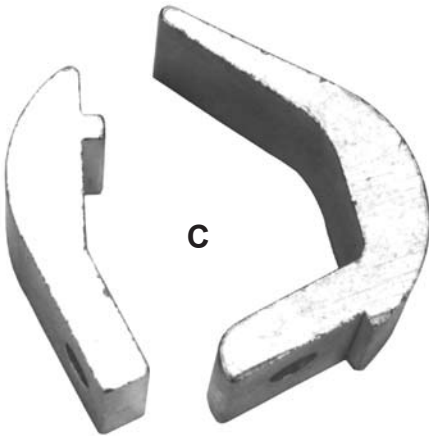

C

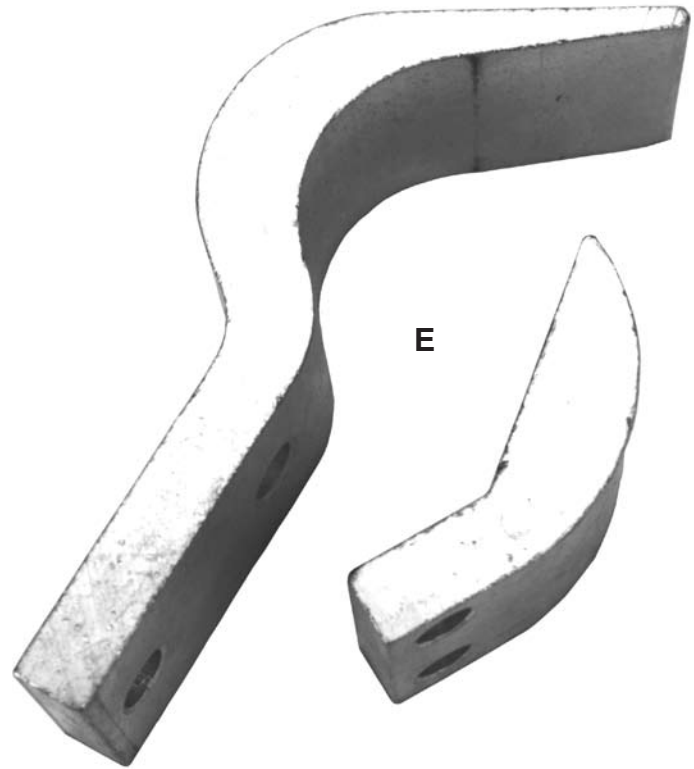

E

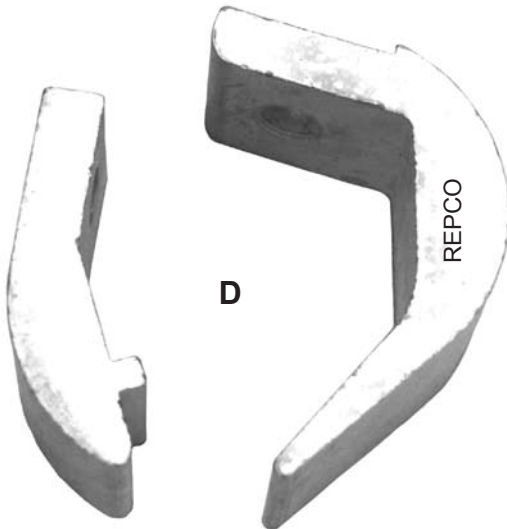

D

TYPE 2205, 2605 COMPENSATORS

POLES

1

OUR#

9950CS



SQUARE D

TYPE M LINE-ARC, CLASS 8503, AND 7004 CONTACTORS

OEM#	POLES	SIZE	OUR#
MX-1	2	1, 2	9522CS
ME-1	2	3	9532CS
MF-1	2	4	9542CS
MG-1	2	5	9552CS
MH-1	2	6	9562CS
MJK-1	2	7, 8	9572CS

ALLOY TIPS ARE
ALSO AVAILABLE.

MISCELLANEOUS SINGLE CONTACTS

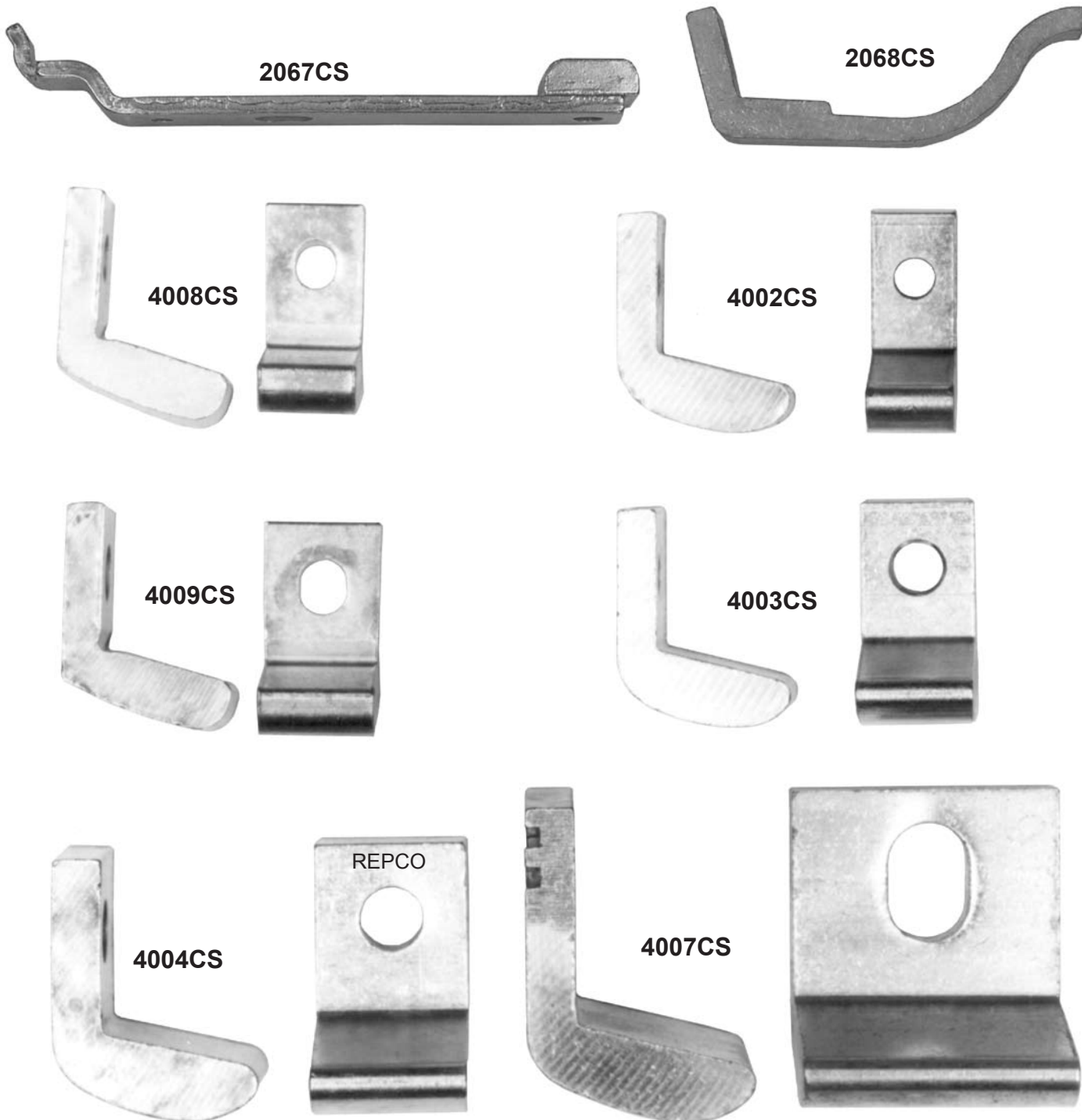

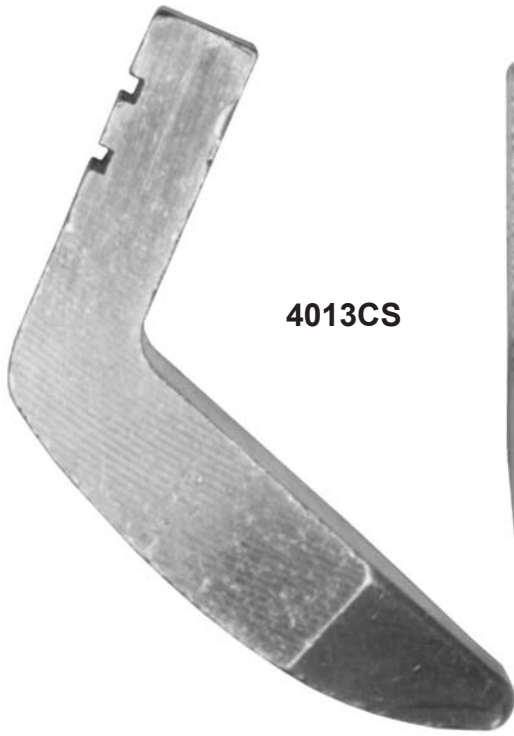

4013CS



4012CS

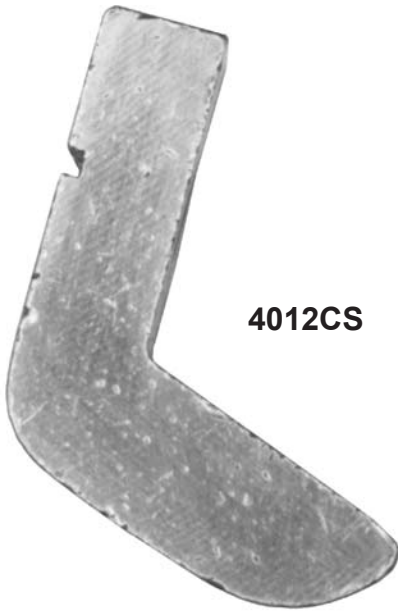

4005CS



REPCO



4006CS



4000CS



4001CS

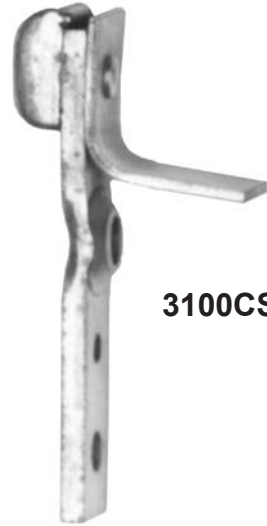

3100CS



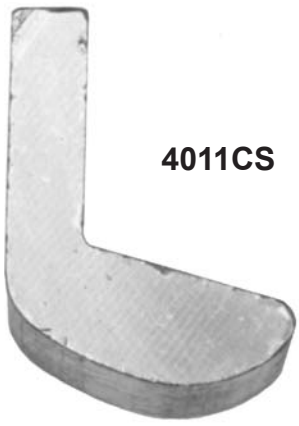

4011CS

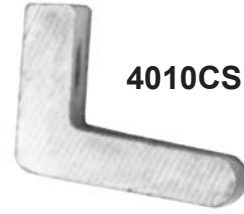
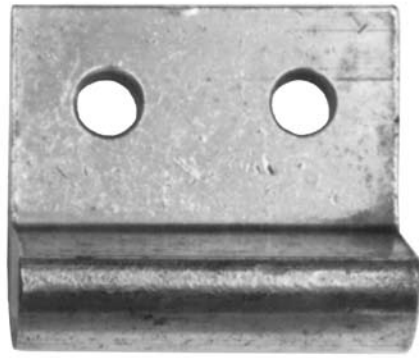

4010CS



4014CS

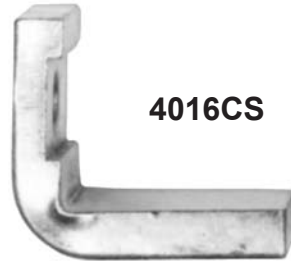
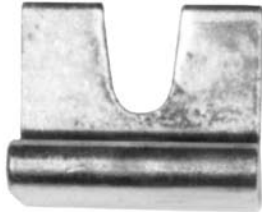

4016CS

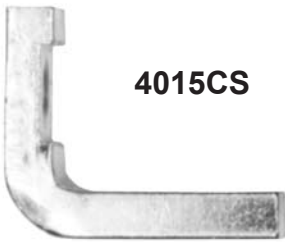

4015CS



4017CS

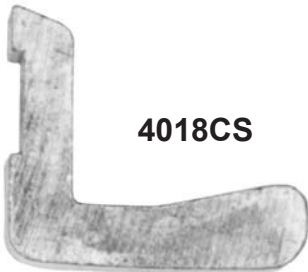
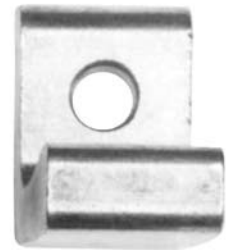

4018CS

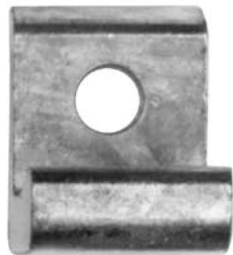

4019CS

REPCO





4020CS

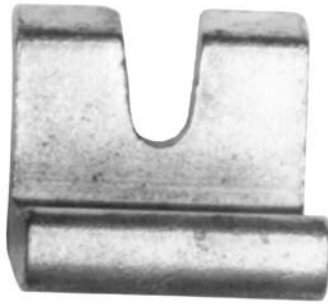

2057CS 1.25" WIDE
2052CS 1.75" WIDE

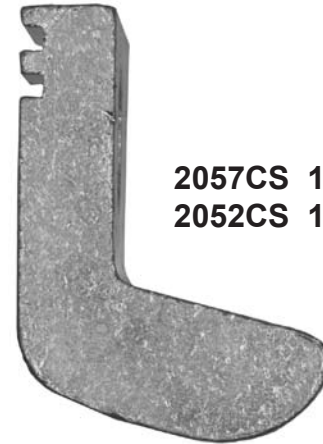

8005CZ



8006CZ



2053CS



2030CS



4013CST
SILVER-TUNGSTEN
TIP



2055CS
(2 TIPS)



2056CS
(2 TIPS)

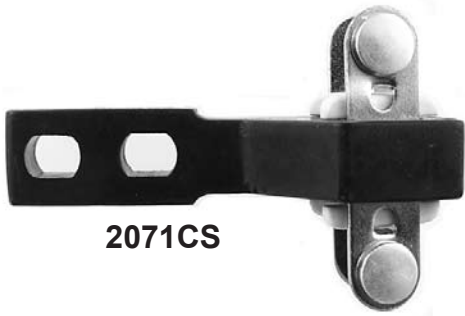

2071CS



2070CS



2050CS



9216CS
RA-88



9226CS
JA-2

STARKSTROM

<u>OEM#</u>	<u>REF.</u>	<u>OUR#</u>
DLS10	A	9205CS
DLS18/25	B	9210CS
DLS30	C	9215CS
DLS40	D	9220CS
DLS46	E	9225CS
DLS60	F	9230CS
DLS100	G	9235CS
DLS101	H	9240CS
DLS120	I	9245CS
DLS151	J	9250CS
DLS200	K	9255CS

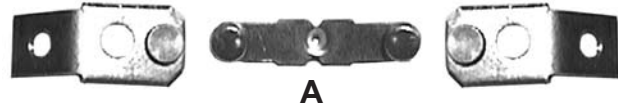

3-POLE SETS

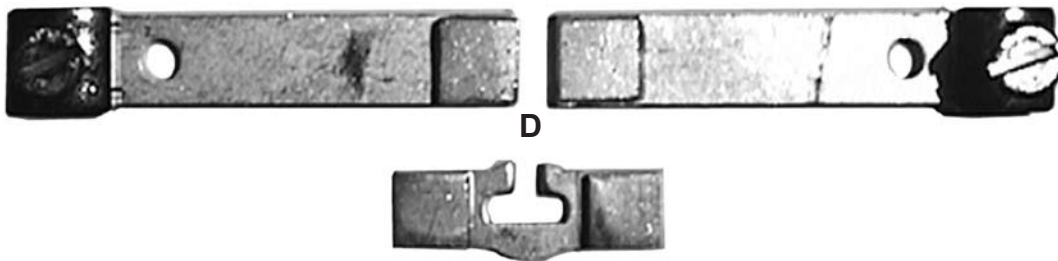
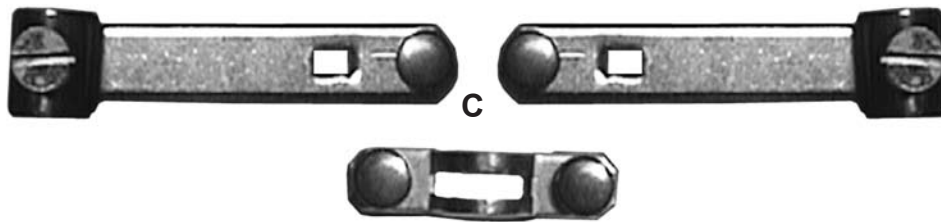
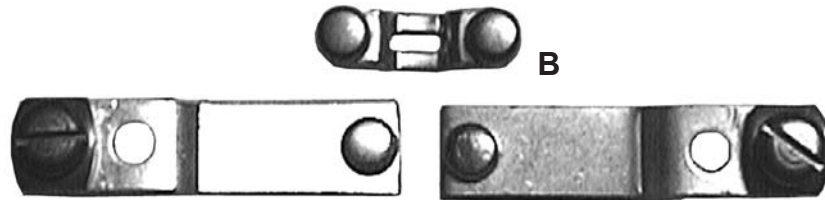

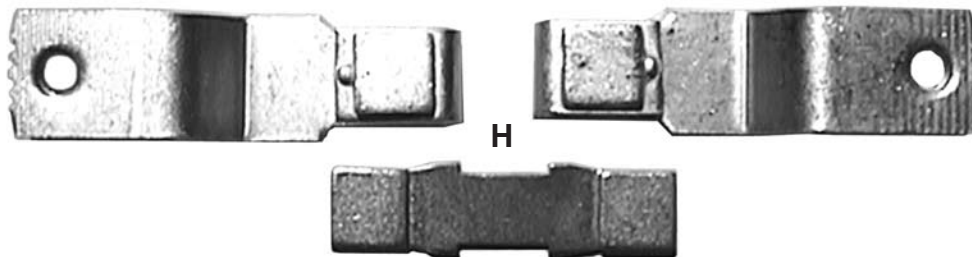
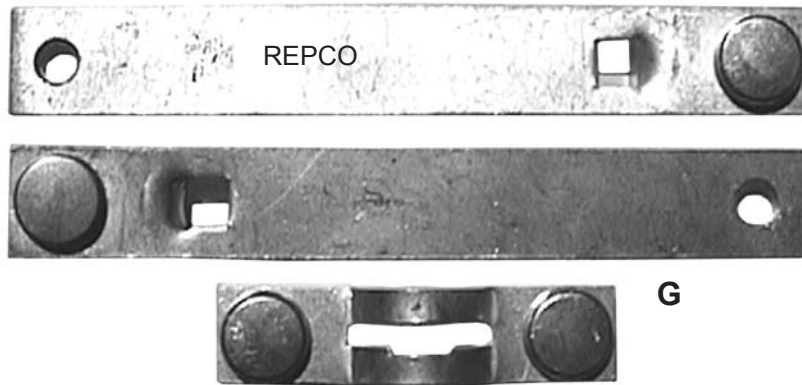
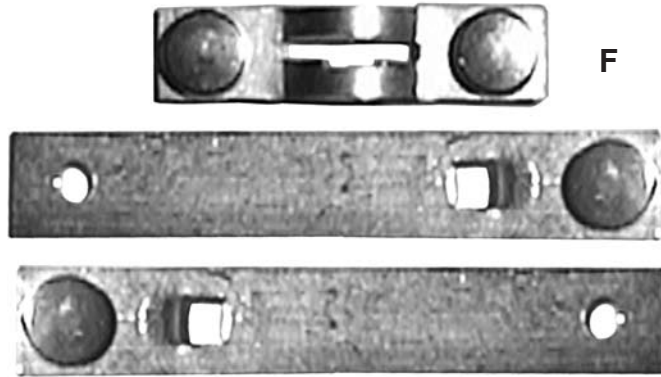

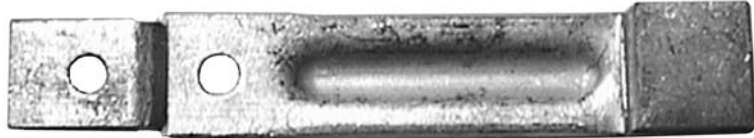
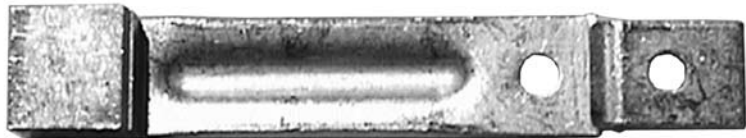

I

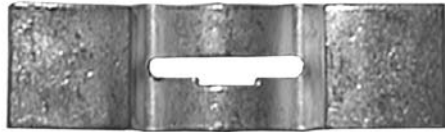

J

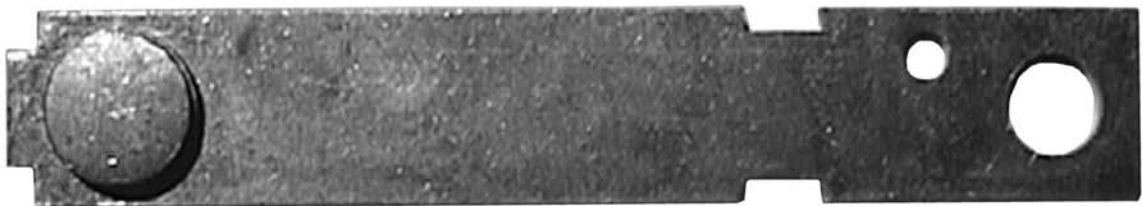
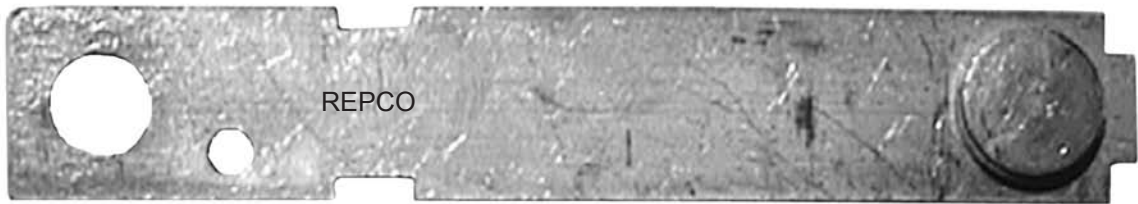

K

STROMBERG

<u>DEVICE#</u>	<u>SIZE</u>	<u>OEM#</u>	<u>REF.</u>	<u>OUR#</u>
OK2, OKYM-2	2	OKYZX-31	A	9023CB
OK3, OKYM-3	3	OKYZX-32	B	9033CB
OK4, OKYM-4	4	OKYZX-20	C	9043CB
OK5, OKYM-5	5	OKYZX-22	D	9053CB
OK05	5	OKYZX-42	--	9653CB
OK6, OKYM-6	6	OKYZX-24	E	9063CB
OK7, OKYM-7	7	OKYZX-33	F	9073CB*

3-POLE SETS

*CONSISTS OF 2 MOVABLE AND 4 STATIONARY CONTACTS PER POLE.

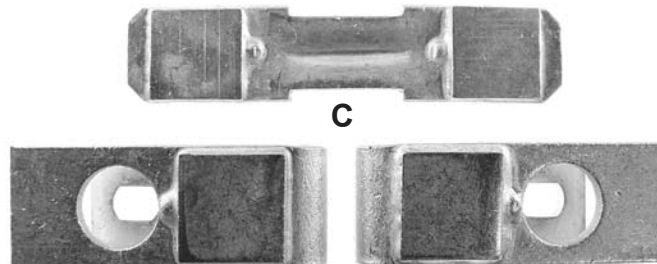
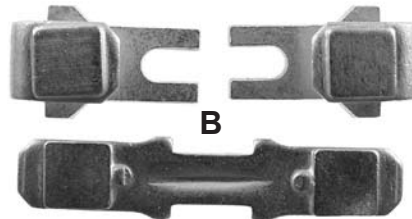
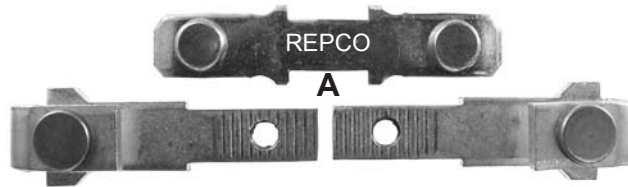

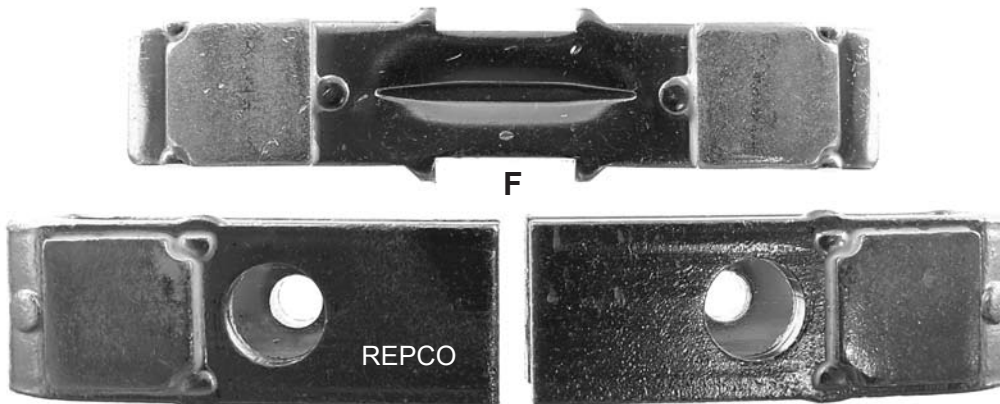
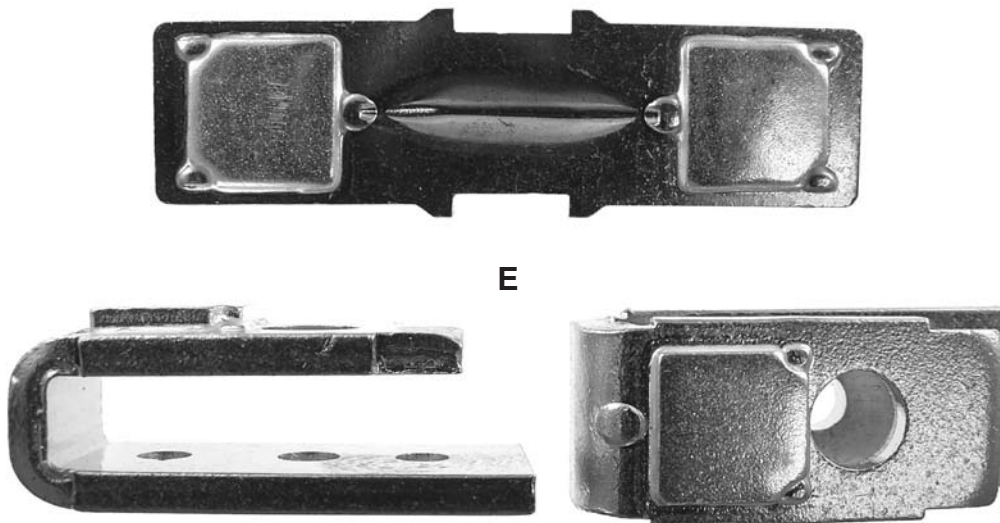
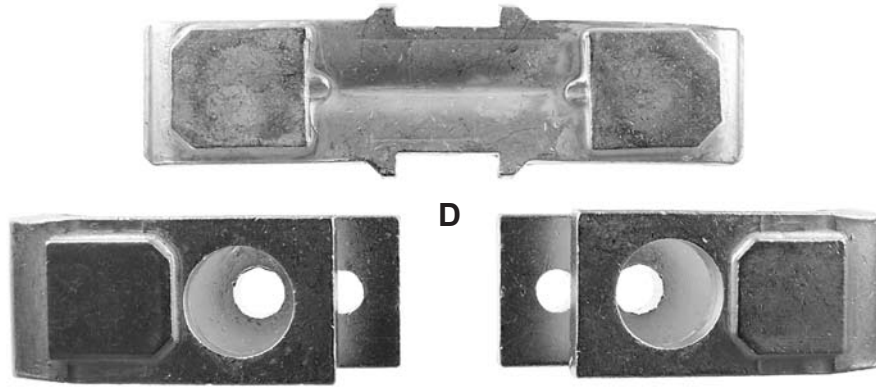

STRUTHERS-DUNN

FOR DOVER #14 AND #15 SWITCHES

<u>OEM#</u>	<u>OUR#</u>	<u>REF.</u>
35900	2002CX	A
35890	2001CX	B
35909	2003CX	C

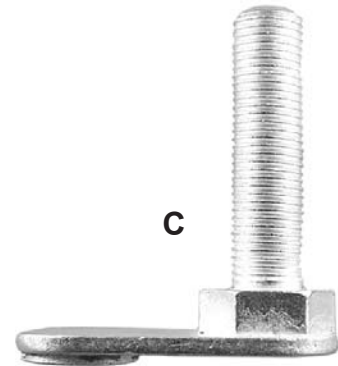
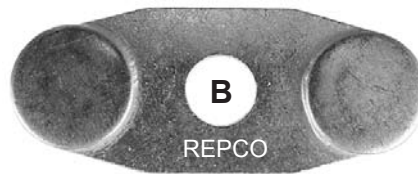
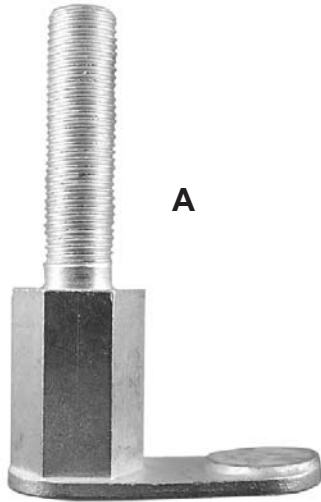

SERIES A575

<u>OEM#</u>	<u>TYPE</u>	<u>OUR#</u>	<u>REF.</u>
15882	MOV	2004CX	D
12314	STA	2005CX	E

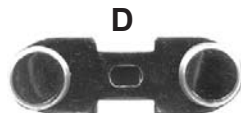

TELEMECANIQUE

OLD STYLE GOULD, ITE

<u>SIZE</u>	<u>REF.</u>	<u>OEM#</u>	<u>OUR#</u>
1	A	G203C	9813CT
2	B	G203D	9823CT
3	C	G203E	9833CT
4	D	G203F	9843CT
5	E	G203G	9853CT

3-POLE SETS

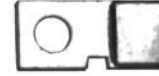

A



D



B



E



C



TELEMECANIQUE

CN1 SERIES

<u>TYPE</u>	<u>OEM#</u>	<u>OUR#</u>	<u>REF.</u>
FC	CN1-FC803	9613CN	A
GC	CN1-GC803	9623CN	B
HC	CN1-HC803	9633CN	C
JC	CN1-JC803	9643CN	D

3-POLE SETS

A



B



C



D



TELEMECANIQUE

CN2 SERIES

<u>TYPE</u>	<u>OEM#</u>	<u>OUR#</u>	<u>REF.</u>
FC	CN2-FC803	9513CN	A
GC	CN2-GC803	9523CN	B
HC	CN2-HC803	9533CN	C

3-POLE SETS

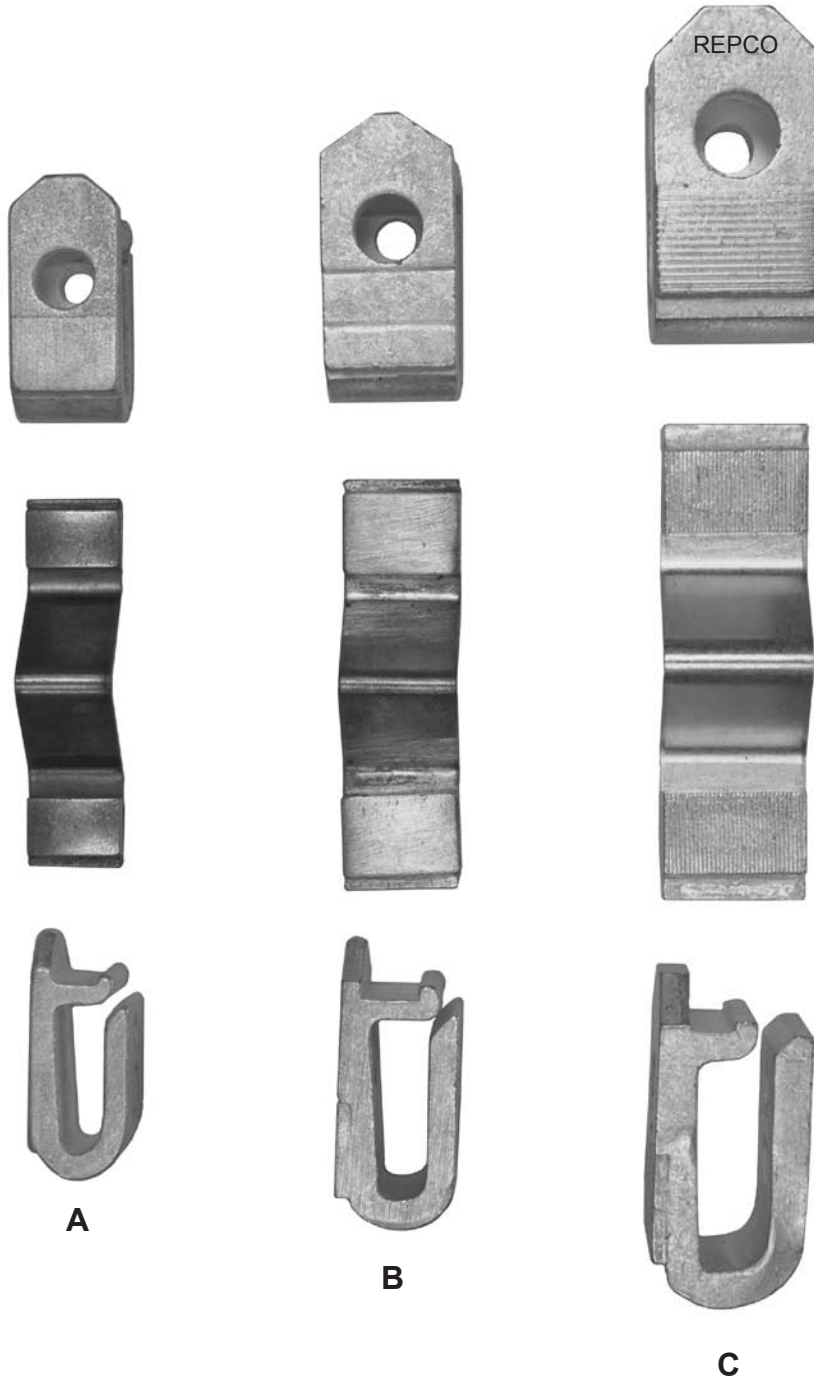

TELEMECANIQUE

LC1 SERIES

<u>DEVICE#</u>	<u>OEM#</u>	<u>OUR#</u>	<u>REF.</u>
LC1FF43, F115, F150	LA5-FF431	9413CN	A
LC1FG43, F185	LA5-FG431	9423CN	B
LC1FH43, F265	LA5-FH431	9433CN	C
LC1FJ43	LA5-FJ431	9453CN	D
LC1FK43	LA5-FK431	9463CN	E
LC1FL43	LA5-FL431	9473CN	F
LC1F330, F400	LA5-F400803	9453CN	D
LC1F500	LA5-F500803	9463CN	E
LC1F630	LA5-F630803	9473CN	F

3-POLE SETS

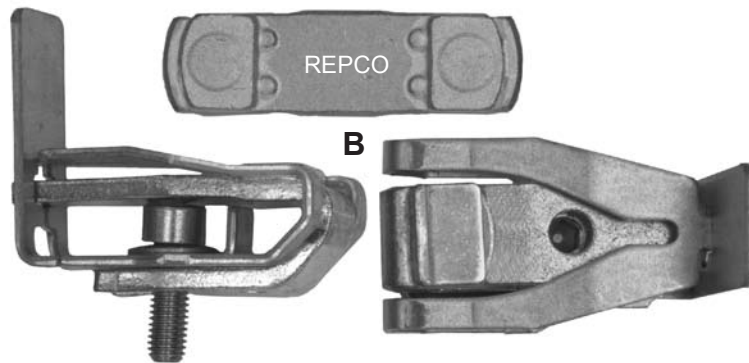
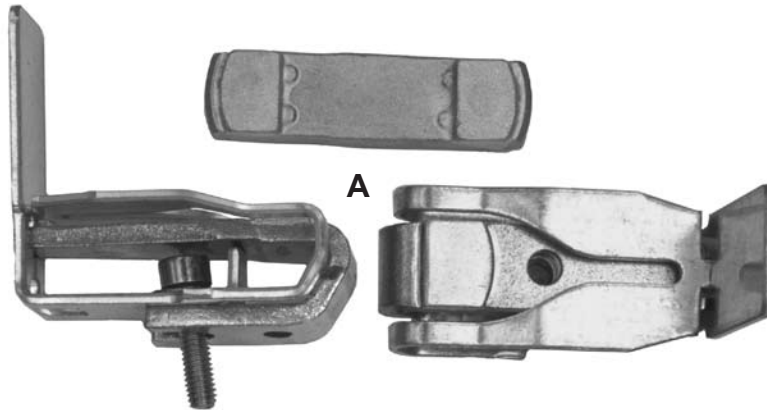

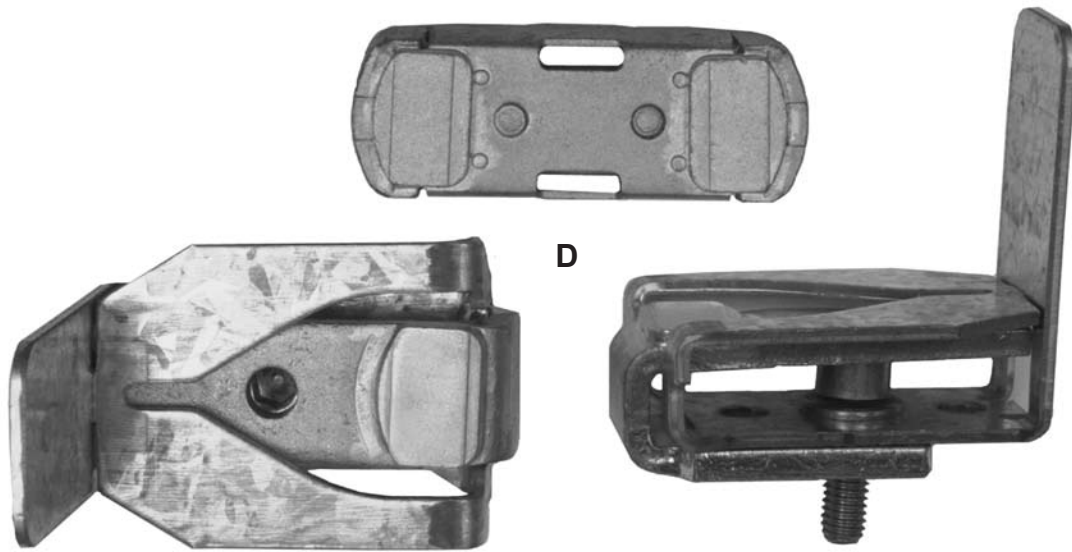
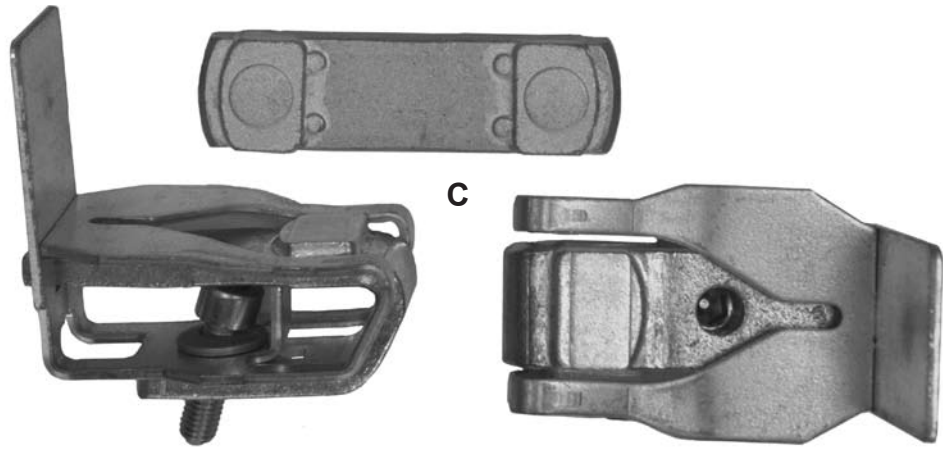



TELEMECANIQUE
PN1 SERIES

<u>TYPE</u>	<u>OEM#</u>	<u>OUR#</u>	<u>REF.</u>
EA	PN1-EA80	9201CN	A
FB	PN1-FB80	9202CN	B
GB	PN1-GB80	9203CN	C
HB	PN1-HB80	9204CN	D
JB	PN1-JB80	9205CN	E
KB	PN1-KB80	9206CN	F

ONE-POLE SETS

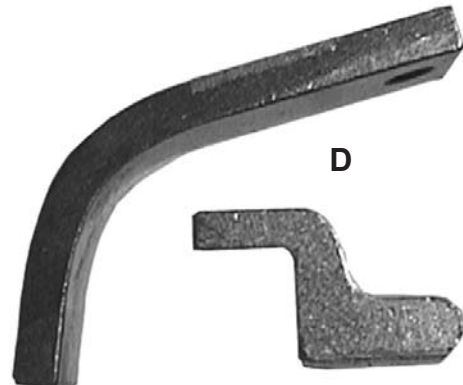
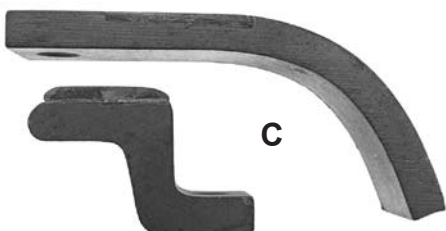
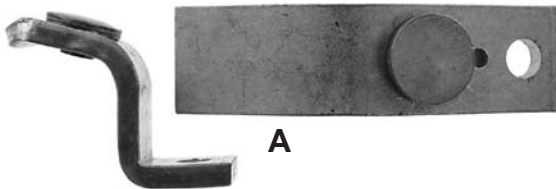

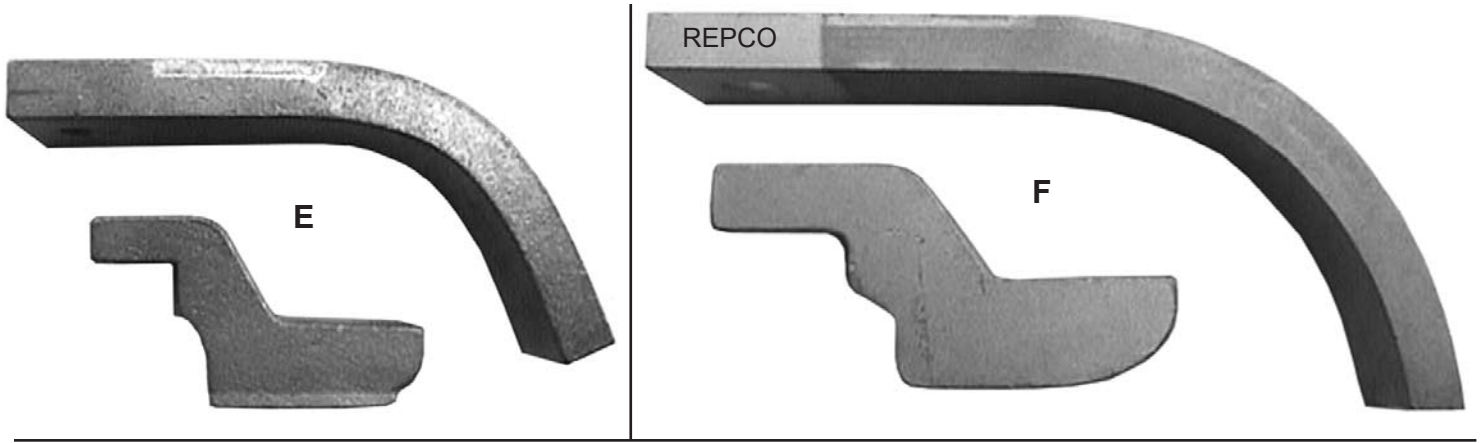

TELEMECANIQUE

PA2 SERIES

<u>TYPE</u>	<u>OEM#</u>	<u>OUR#</u>	<u>REF.</u>
FB	PA2-FB80	9207CN	A
GB	PA2-GB80	9208CN	B
HB	PA2-HB80	9209CN	C

ONE-POLE SETS

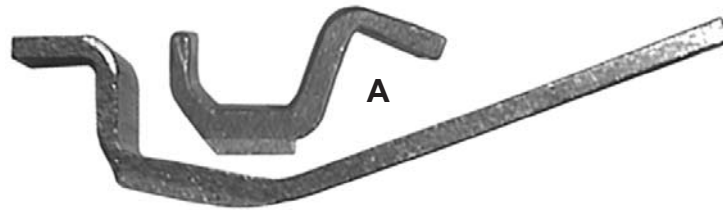

WARD LEONARD

5000 / 5000DP SERIES



B



OEM#	SIZE	AMPS	TYPE	OUR#	REF.
5M49	3, 4	110, 180, 260	NC	9134CY	A
5M52	2	56	NO	9120CY	B
5M53	3	110	NO	9130CY	C
5M54	4	180	NO	9130CY	C
5M56	4 1/2	260	NO	9145CY	D
5M45	5	360	NO	9150CY	E
5999-2371	--	535	NO	9155CY	F

ONE-POLE SETS

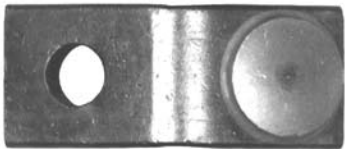
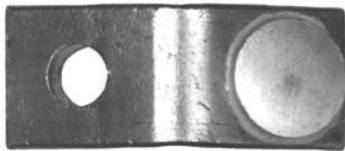

C

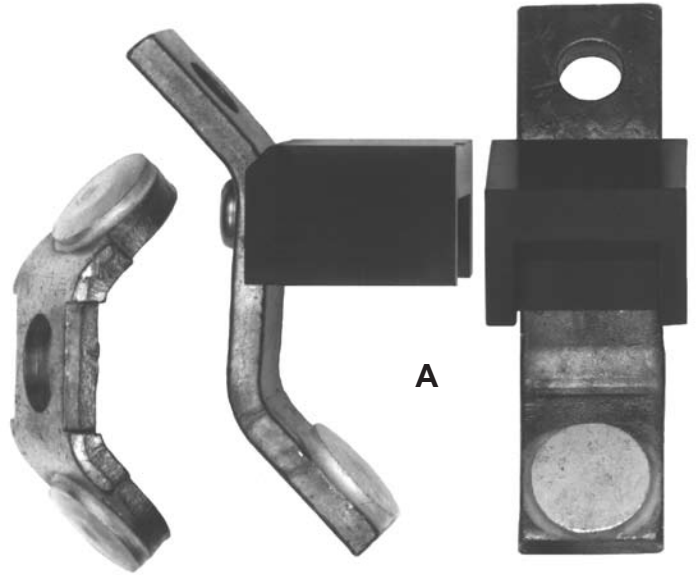

A

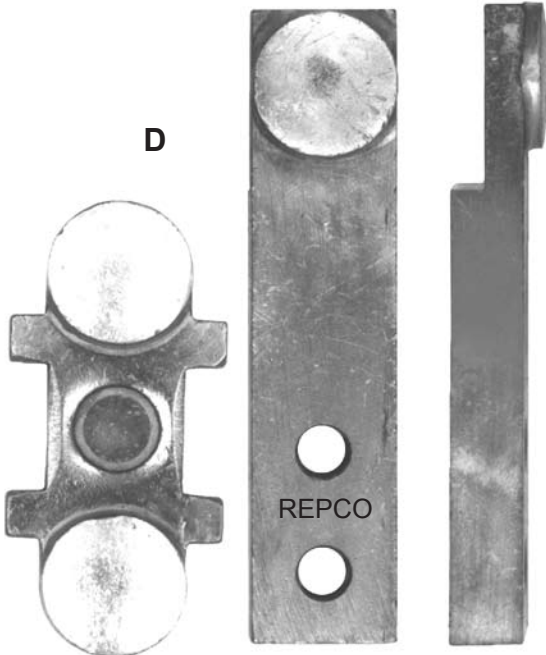

D

REPCO

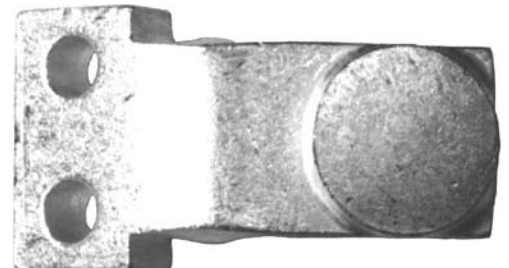
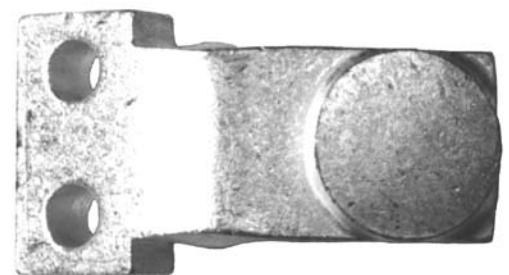
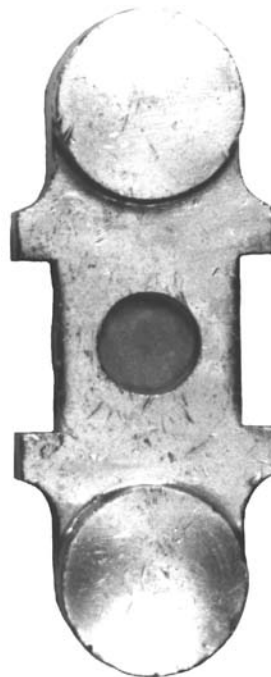

E

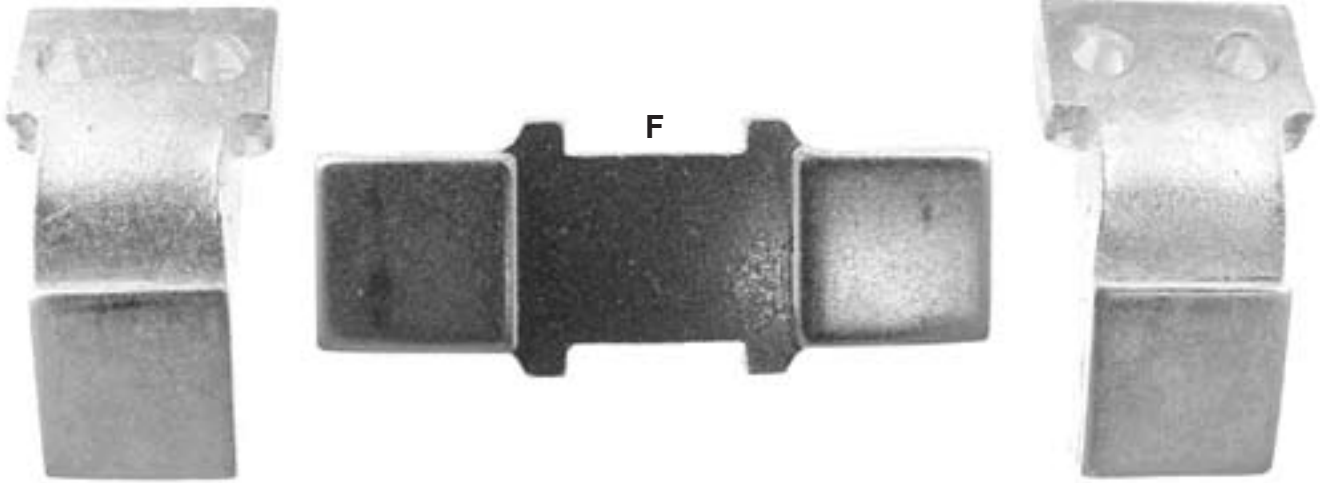

WARD LEONARD
NAVY CONTROL

<u>DEVICE#</u>	<u>OEM#</u>	<u>REF.</u>	<u>SIZE</u>	<u>OUR#</u>
N161	4999-2113	A	1	9213CY
N162	4999-2123	B	2	9223CY
N163	4999-2133	C	3	9233CY
N164	4999-2143	C	4	9243CY

3-POLE SETS

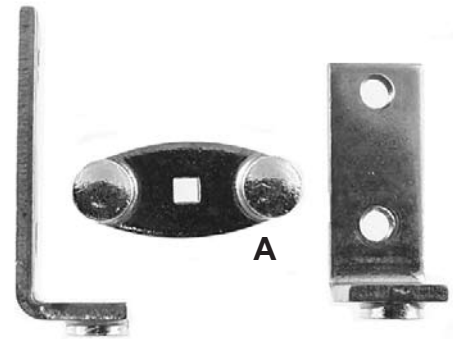

A

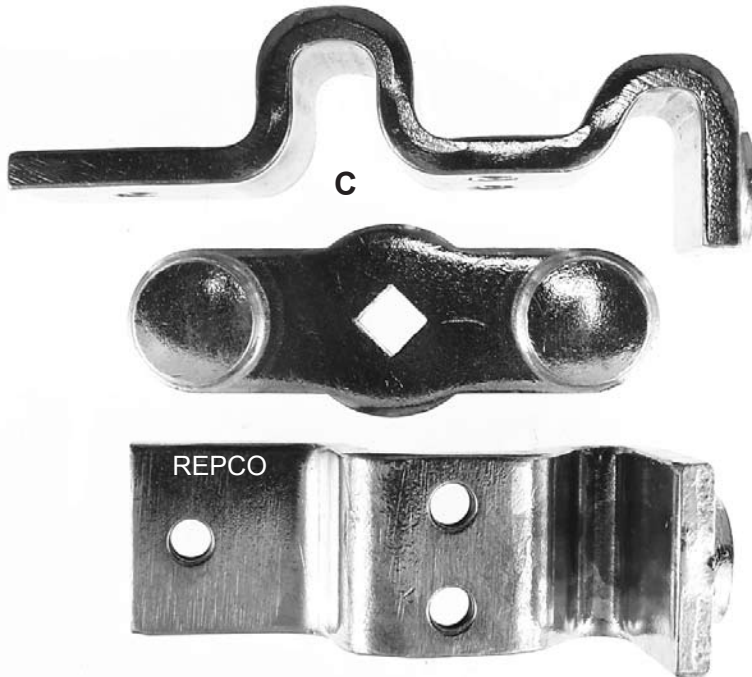

C

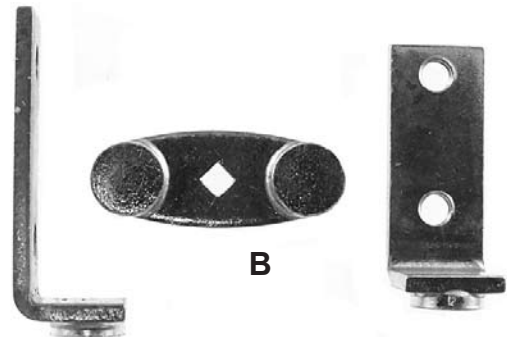

B

WESTINGHOUSE

A200 SERIES



<u>POLES</u>	<u>SIZE 00</u> <u>OEM#</u>	<u>OUR#</u>
4	373B331G18	9294CW

(2 poles shown)

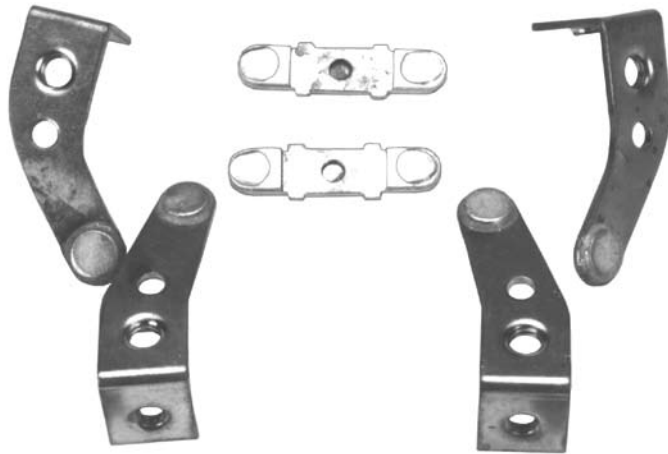

<u>POLES</u>	<u>SIZE 0</u> <u>OEM#</u>	<u>OUR#</u>
4	373B331G04	9204CW

(2 poles shown)

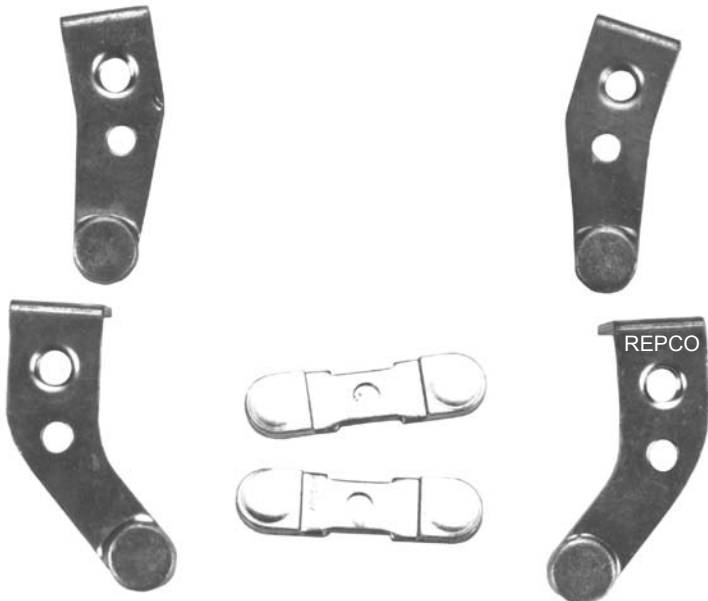

<u>POLES</u>	<u>SIZE 1</u> <u>OEM#</u>	<u>OUR#</u>
2	373B331G07	9212CW
4	373B331G09	9214CW
5	373B331G10	9215CW

(2 poles shown)

WESTINGHOUSE

A200 SERIES

SIZE 2

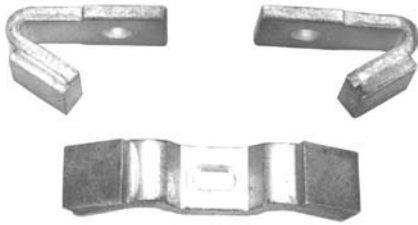

<u>POLES</u>	<u>OEM#</u>	<u>OUR#</u>
2	373B331G11	9222CW
3	373B331G12	9223CW
4	373B331G13	9224CW
5	373B331G14	9225CW

SIZE 3



<u>POLES</u>	<u>OEM#</u>	<u>OUR#</u>
2	626B187G12	9232CW
3	626B187G13	9233CW
4	626B187G14	9234CW
5	626B187G15	9235CW

SIZE 4, MODEL J



<u>POLES</u>	<u>OEM#</u>	<u>OUR#</u>
2	626B187G16	9242CW
3	626B187G17	9243CW
4	626B187G18	9244CW
5	626B187G19	9245CW

SIZE 4, MODEL K

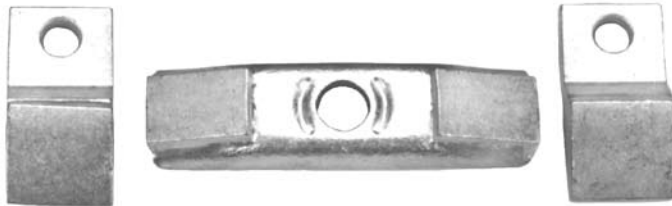

<u>POLES</u>	<u>OEM#</u>	<u>OUR#</u>
3	5250C81G17	9943CW

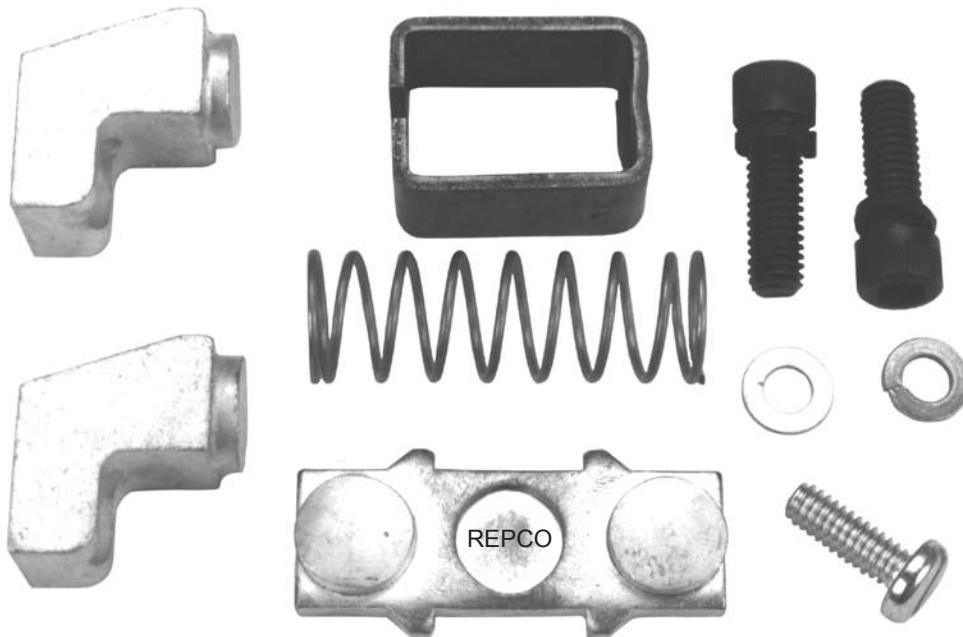

SIZE 5

<u>POLES</u>	<u>OUR#</u>
1	9251CW

OEM#
477B477G05

WESTINGHOUSE SIZE 6

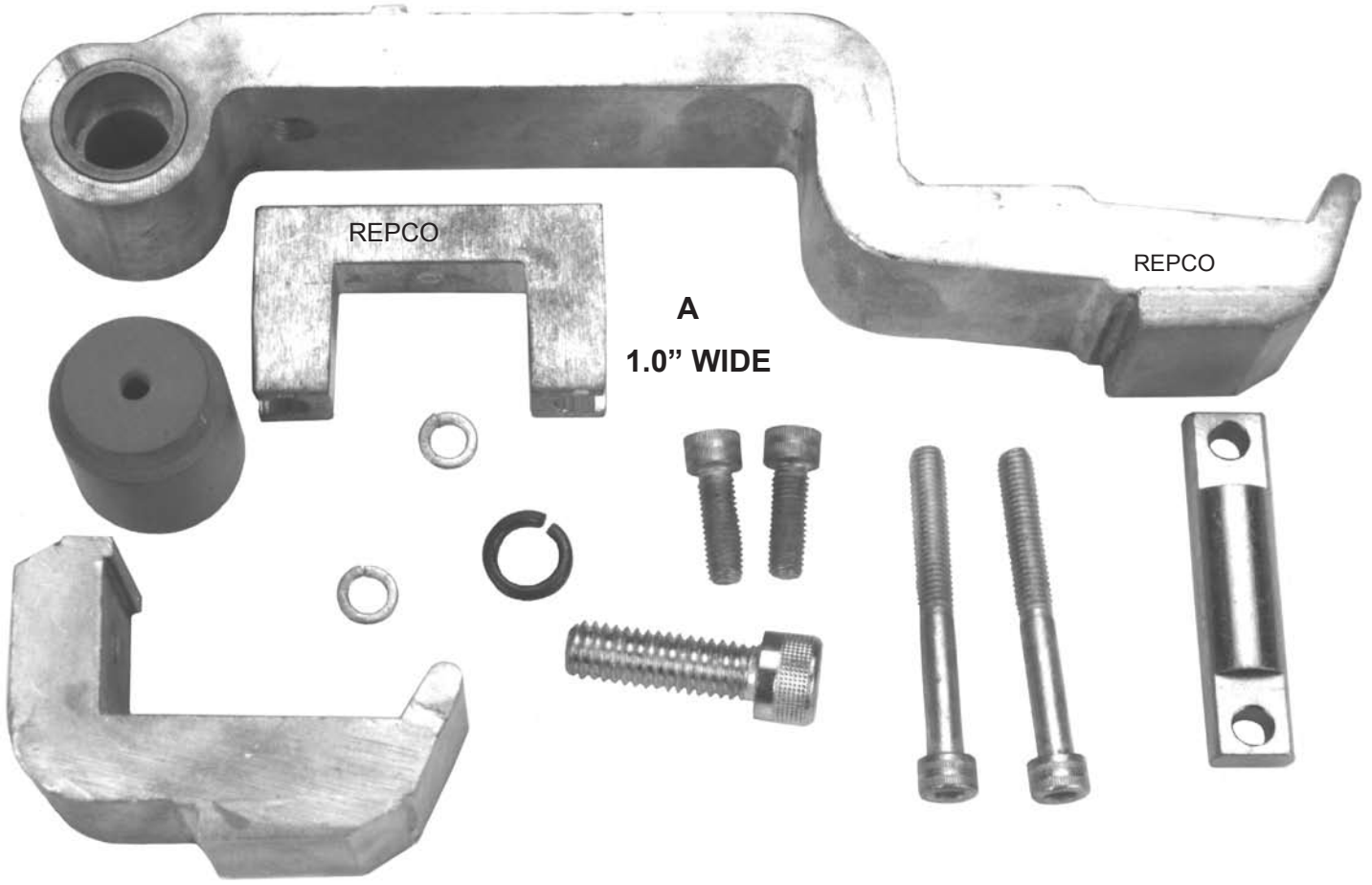

<u>OEM#</u>	<u>TYPE</u>	<u>POLES</u>	<u>OUR#</u>	<u>REF.</u>
2066A10G11	GCA	1	9261CW	A
217A700G15	GPD	1	9761CW	B

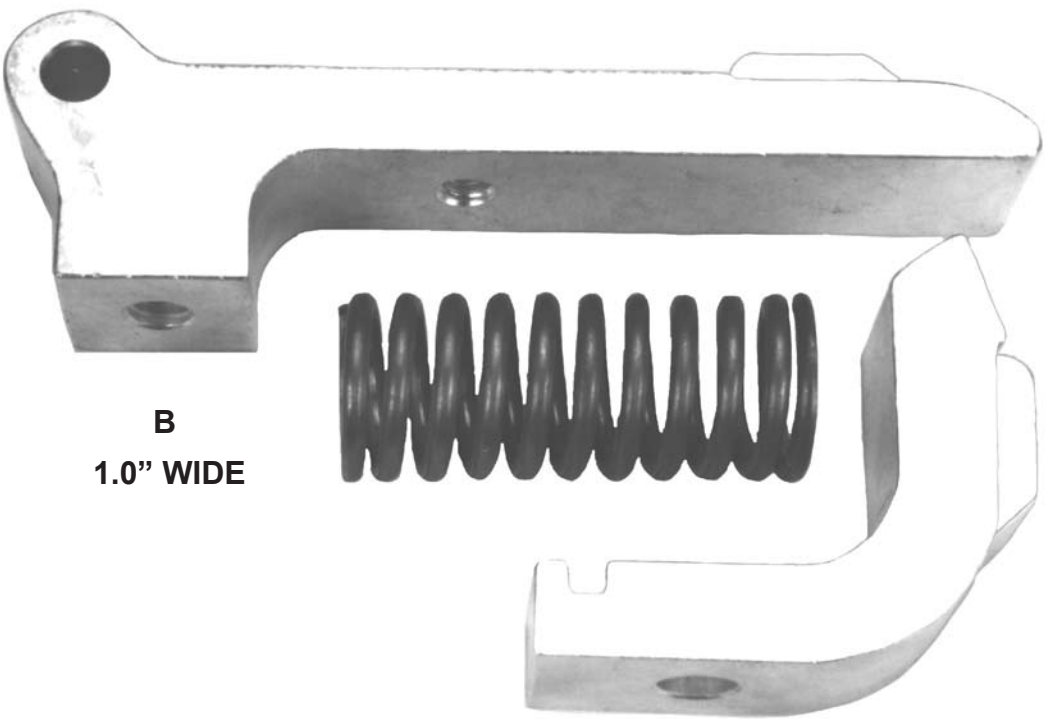

WESTINGHOUSE

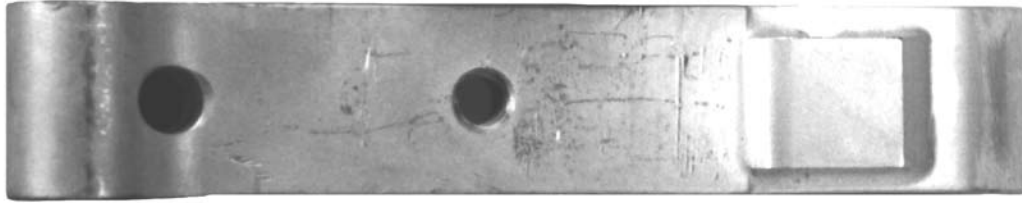

TYPE GPD
SIZE 7 AND 8

<u>OEM#</u>	<u>POLES</u>	<u>SIZE</u>	<u>OUR#</u>
461A757G17*	1	7	9271CW
646C829G05**	1	8	9281CW

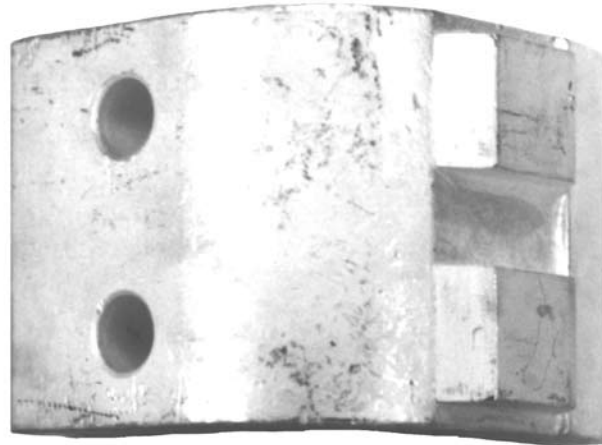

*SET CONSISTS OF
2 MOVABLES AND
1 STATIONARY
**SET CONSISTS OF
3 MOVABLES AND 1
LARGER STATIONARY
(NOT PICTURED)

TYPE NF • SIZE 5



MOVABLE - 1" WIDE X 5 1/2" LONG
STATIONARY - 1' WIDE

<u>POLES</u>	<u>OEM#</u>	<u>OUR#</u>
2	1620145	9152CW
3	1620146	9153CW



WESTINGHOUSE
TYPE N • LIFELINE SERIES
3-POLE SETS



SIZE 1

OEM#
1605212

OUR#
9113CW

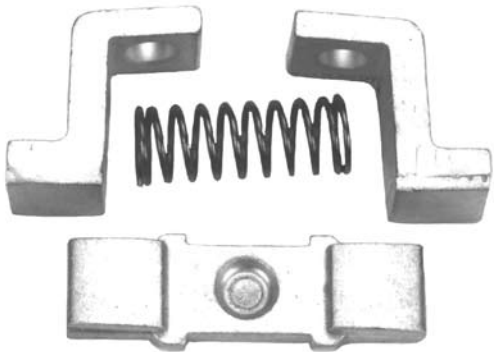

SIZE 2

OEM#
1605202

OUR#
9123CW

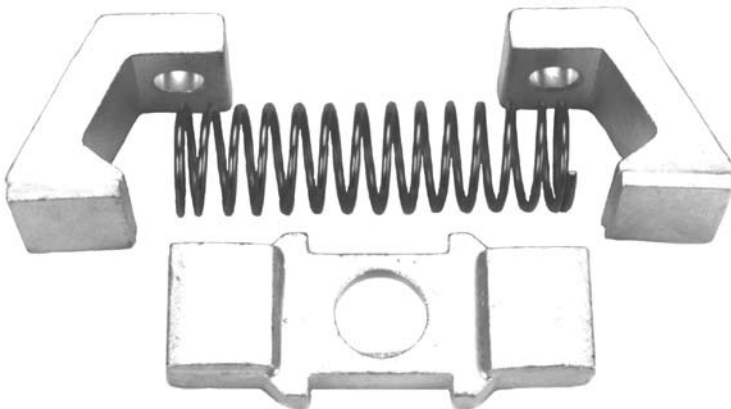

SIZE 3

OEM#
1625563

OUR#
9133CW

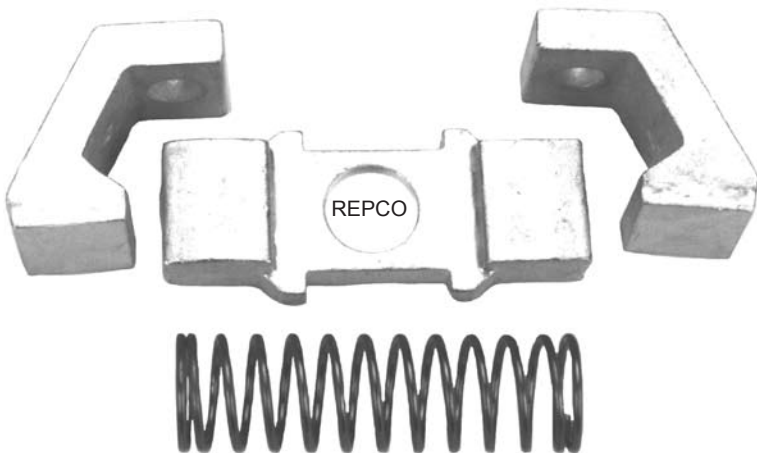

SIZE 4

OEM#
1625564

OUR#
9143CW

WESTINGHOUSE

DPCK CONTACTORS

<u>OEM#</u>	<u>AMPS</u>	<u>OUR#</u>	<u>REF.</u>	
180C180G02	35	9503CW	A	3-POLE SETS
180C180G06	100	9513CW	B	
672B839G02	250 MODEL A	9707CW	C	
672B839G22	250 MODEL B	9709CW	D	

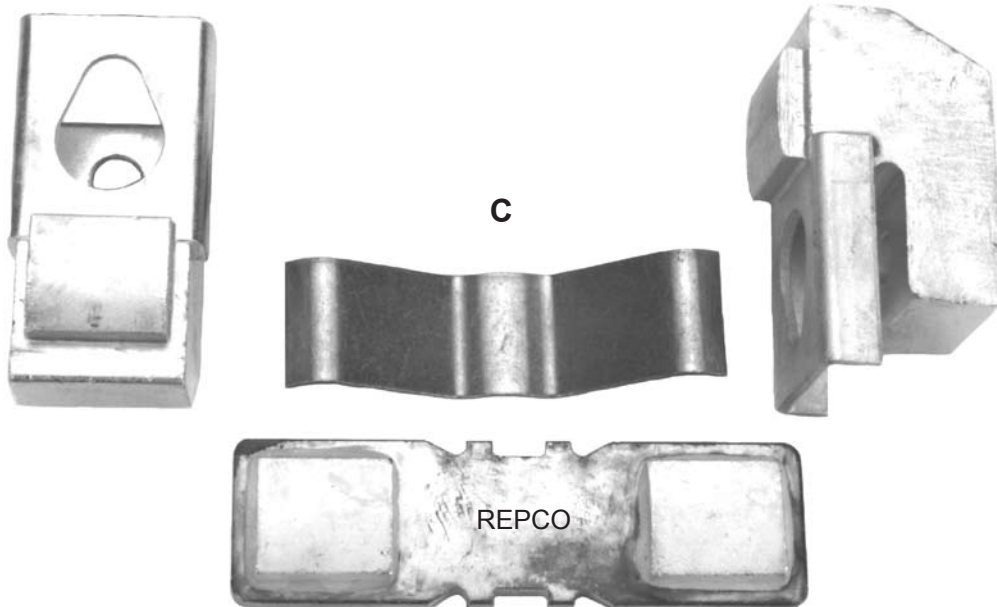
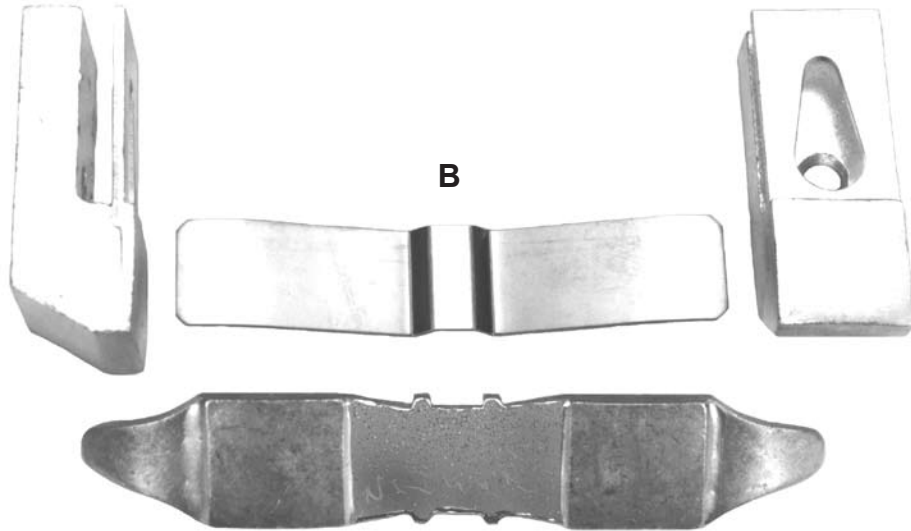
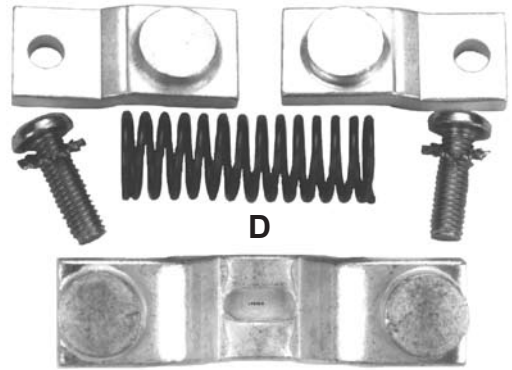
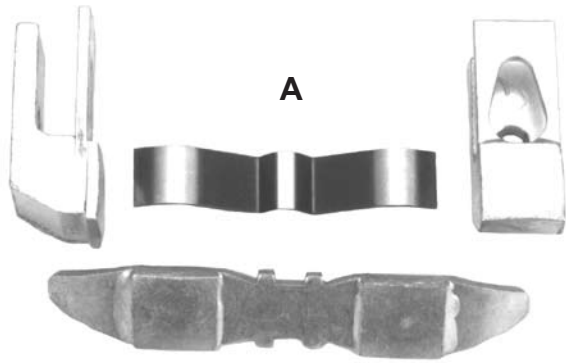

WESTINGHOUSE

MD SERIES DC CONTACTORS

<u>DEVICE#</u>	<u>OEM SET#</u>	<u>AMPS</u>	<u>OUR 1-POLE SET#</u>	<u>SINGLE CONTACT#</u>	<u>REF.</u>
MD301, 401	26D2610G21	100 / 150	9451CW	4005CW	A
MD310, 410	26D2610G14	100 / 150	9401CW	4005CW	A
MD501, 501R	26D2610G22	300	9461CW	4006CW	B
MD510	26D2610G15	300	9411CW	4006CW	B
MD601	26D2610G23	900	9471CW	4007CW	C
MD610	26D2610G16	900	9421CW	4007CW	C
MD701, 710	26D2610G24	900	9771CW	4007CW	C
MD810	26D2610G18	1350	9431CW	4013CW	D
MD810R	26D2610G19	1350	9481CW	4013CW	D

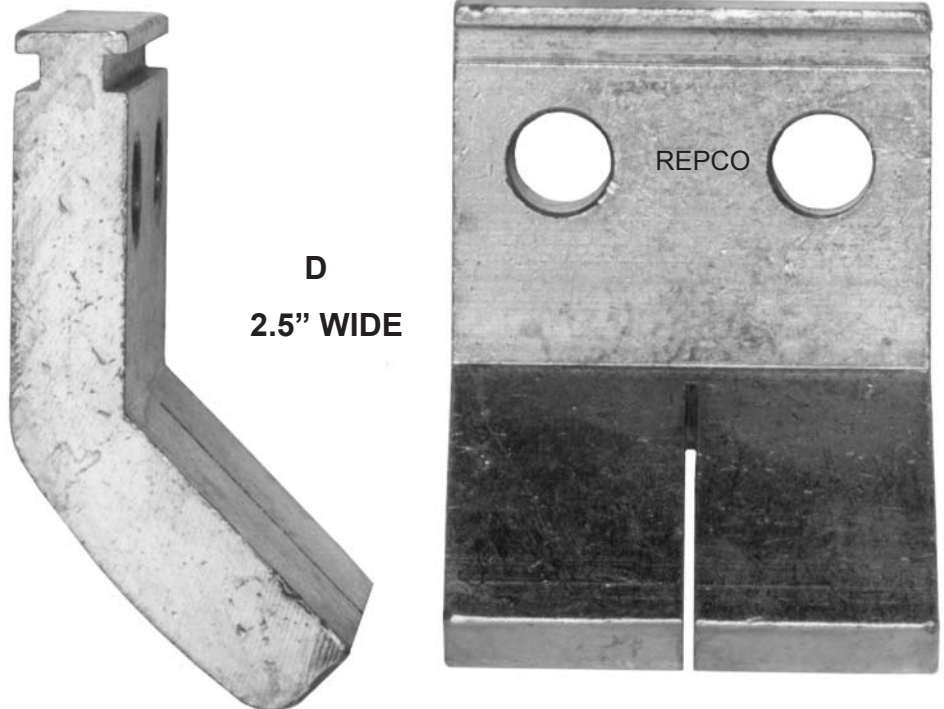
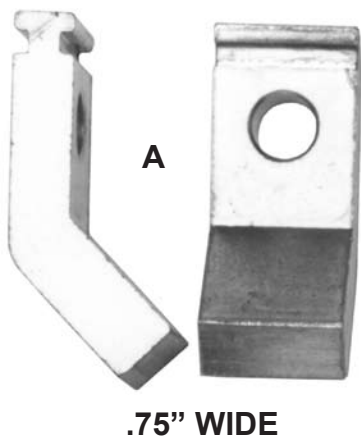
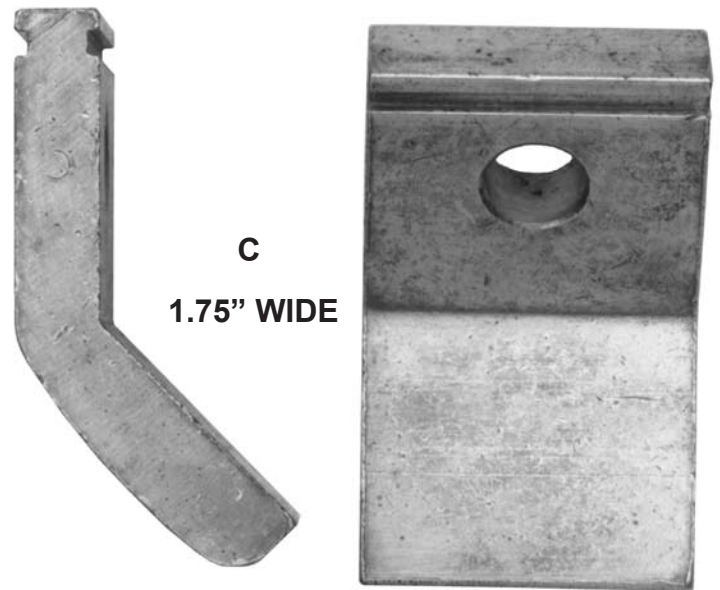
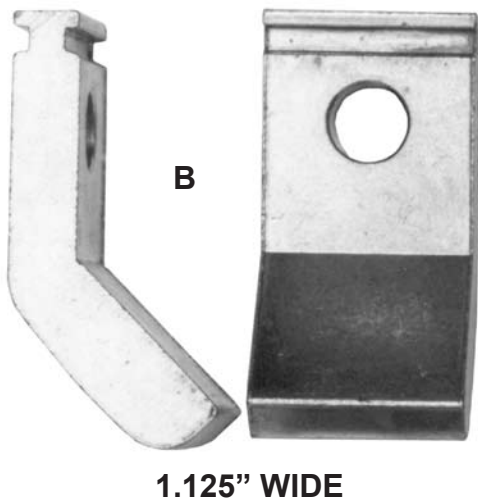

WESTINGHOUSE

J F AUTOSTARTERS

<u>OEM#</u>	<u>SIZE</u>	<u>TYPE</u>	<u>OUR#</u>	<u>SET CONSISTS OF:</u>
38A7018G12	2, 3	START	9011CW	REF. A - 6 EACH, REF. B - 12 EACH
38A7018G13	2, 3	RUN	9012CW	REF. C - 12 EACH, REF. D - 6 EACH
550D409G18	4, 5, 5L	START	9021CW	REF. E, F, AND G - 6 OF EACH
550D409G19	4, 5, 5L	RUN	9022CW	REF. H - 12 EACH, REF. J - 6 EACH
3354D90G08	5M, 5MM, 5A, 6	START	9031CW	REF. K - 6 EACH, REF. L - 12 EACH
3354D90G09	5M, 5MM, 5A, 6	RUN	9032CW	REF. M - 12 EACH, REF. N - 6 EACH

(SOLD IN COMPLETE SETS ONLY)

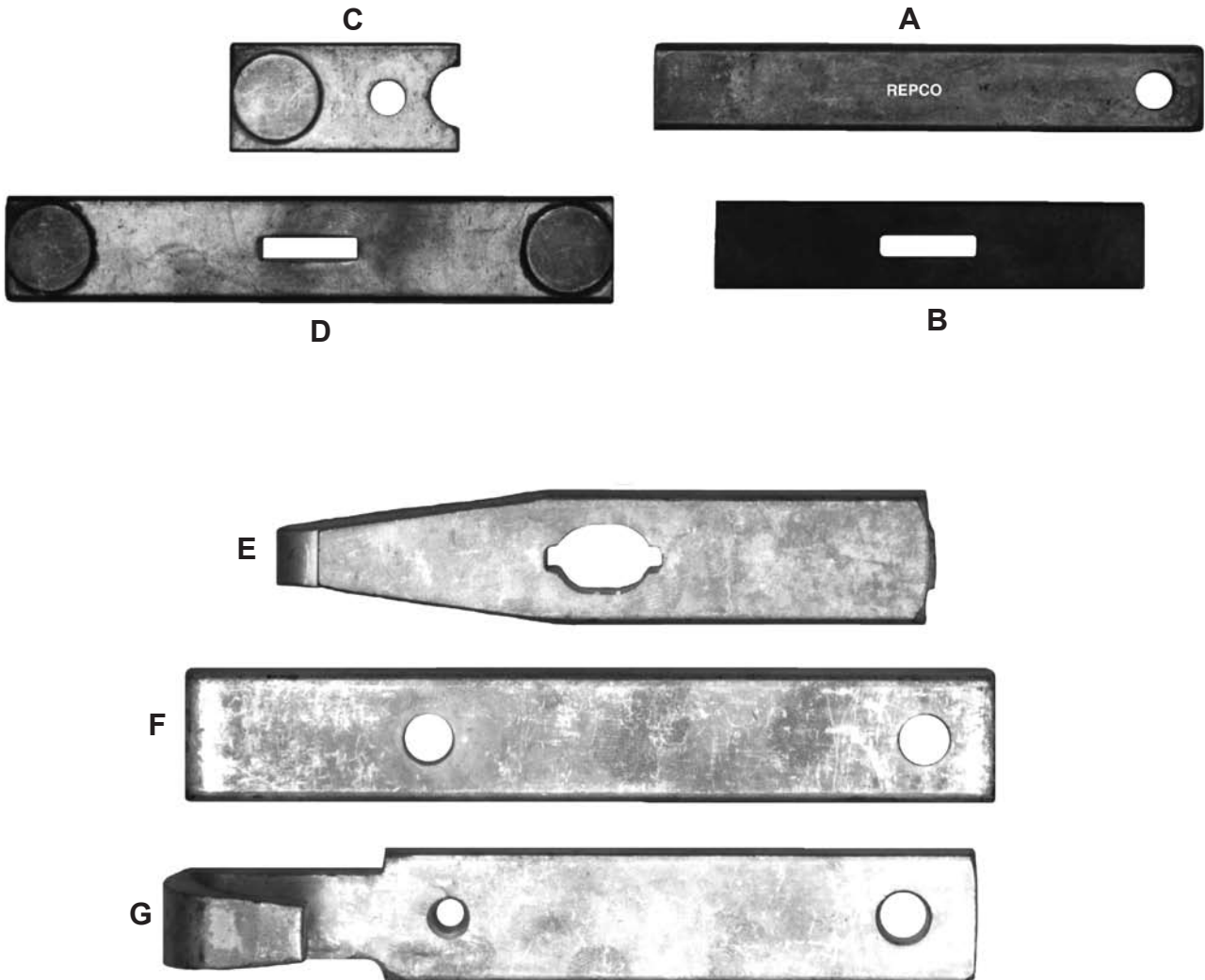



J

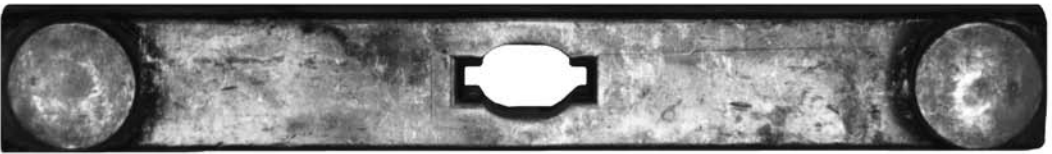
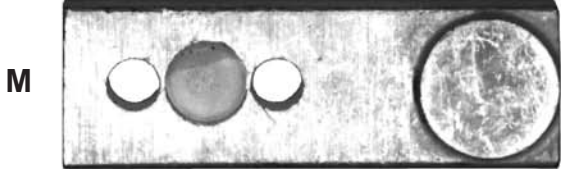
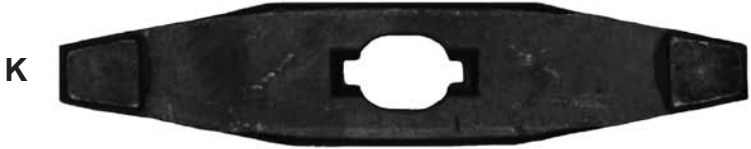

N

WESTINGHOUSE

AMPGUARD - LF, GF SERIES

<u>OEM#</u>	<u>AMPS</u>	<u>TYPE</u>	<u>POLES</u>	<u>WIDTH*</u>	<u>OUR#</u>
2147A22G01	200	LF	3	3/4"	9643CW
2147A42G01	400	LF	3	1"	9663CW
2147A72G01	700	LF	3	1"	9673CW
2147A72G02	700 HD	LF	3	1"	9673CW
490A898G28	1000	GF	1	5/8", 2 7/8"	9693CW
490A898G29	1000+	GF	1	5/8", 2 7/8"	9694CW

*CONTACT PAD SIZE INCREASES WITH AMPERAGE



DRUM SWITCH CONTACTS



1/2" WIDE 4115CW



<u>WIDTH</u>	<u>OUR#</u>
1/2"	1011CW
3/4"	4112CW
1	4111CW

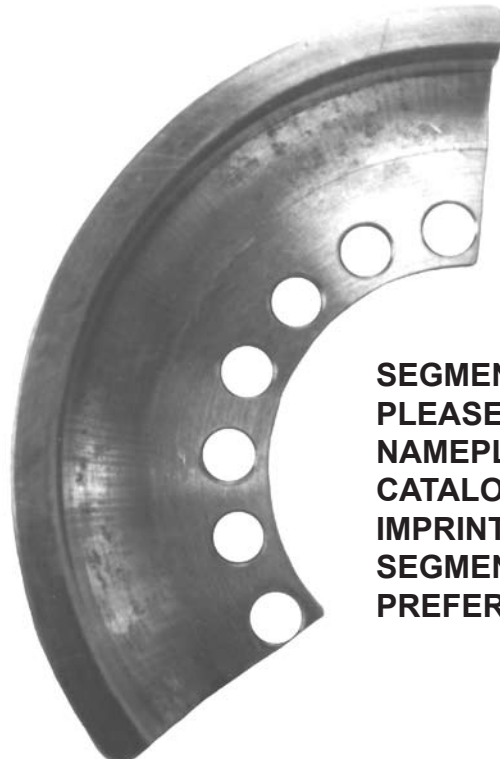

**SEGMENTS -
PLEASE PROVIDE ALL
NAMEPLATE DATA OR
CATALOG NUMBER
IMPRINTED ON THE
SEGMENT, SAMPLES
PREFERRED**

WESTINGHOUSE
MISCELLANEOUS



4002CW



4010CW



4004CW



4011CW



4012CW



4000CW



4003CW

WESTINGHOUSE

TYPE A LIMIT AND SM MASTER SWITCHES



4113CW



4105CW

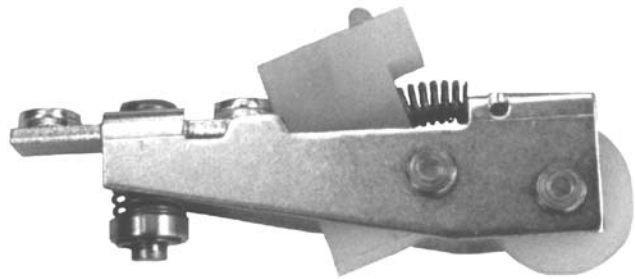

4114CW

MISCELLANEOUS



4101CW
5/8" WIDE



4100CW
5/8" WIDE



4103CW
1" WIDE



4102CW
1" WIDE



4018CW
7/16" WIDE

4009CW
1" WIDE



4200CW
1" WIDE



POLES
3

OEM#
672B788G09

OUR#
9703CW

SIZE 2 1/2

WESTINGHOUSE

ADVANTAGE SERIES

<u>SIZE</u>	<u>OEM#</u>	<u>POLES</u>	<u>OUR#*</u>	<u>REF.</u>
1	WCK13	3	9313CW	A
2	WCK23	3	9323CW	B
3	WCK33	3	9333CW	C
4	WCK43	3	9343CW	D
5	WCK53	3	9353CW	E
6	WCK63	3	9363CW	F

***CONTACT SETS INCLUDE CONTACTS, SPRINGS, AND SCREWS ONLY.**

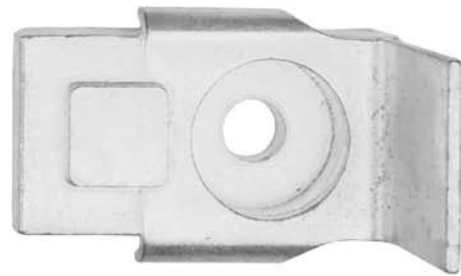
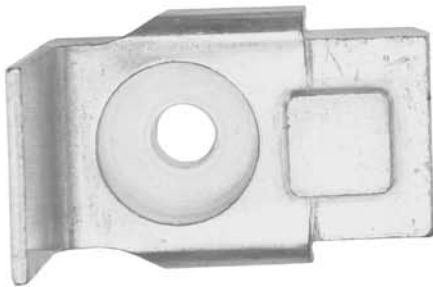
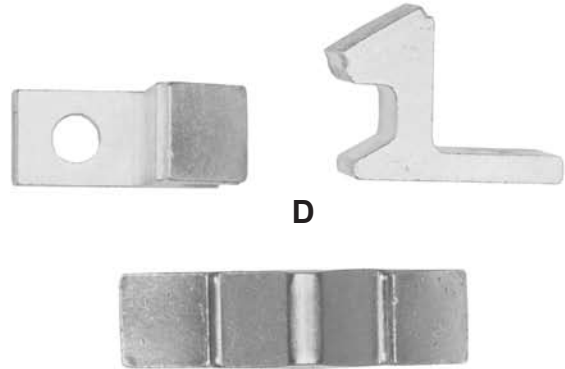
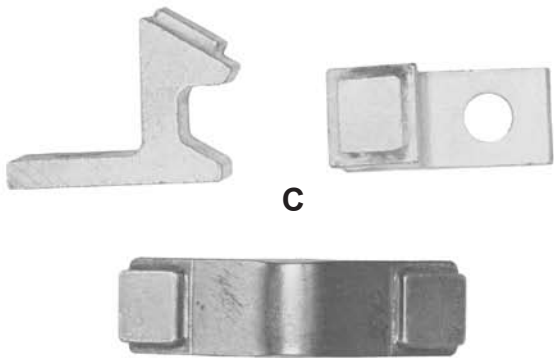
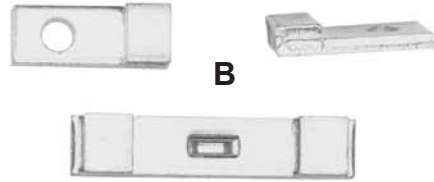
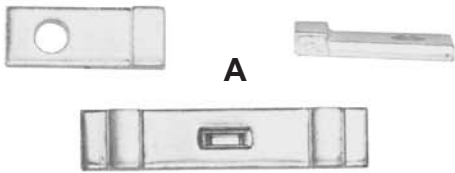

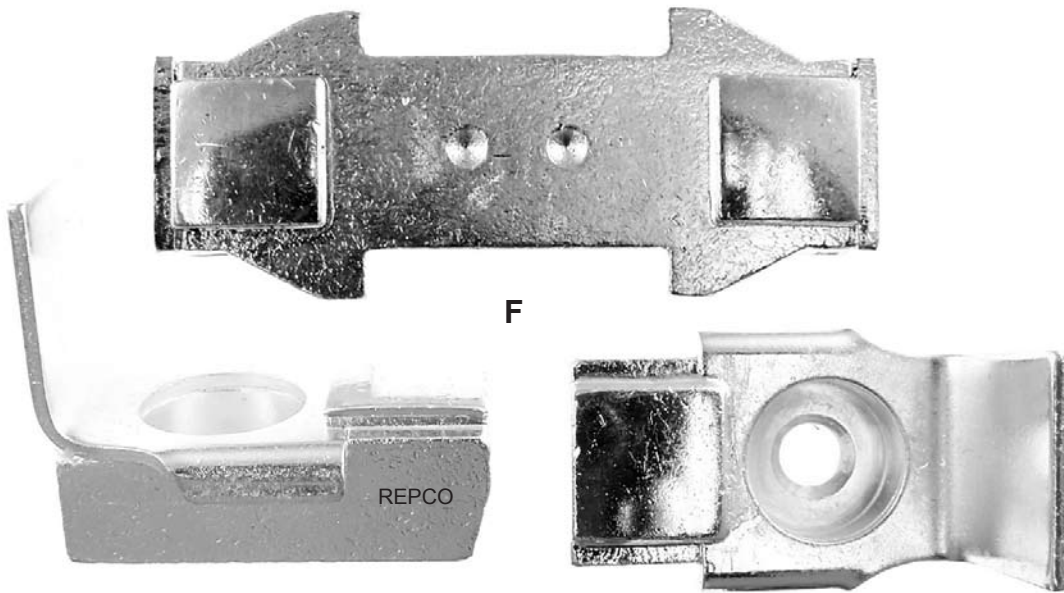

F

DPM 1000 VDC DEFINITE PURPOSE CONTACTOR



OEM#
2131A94G10

OUR#
9581CW

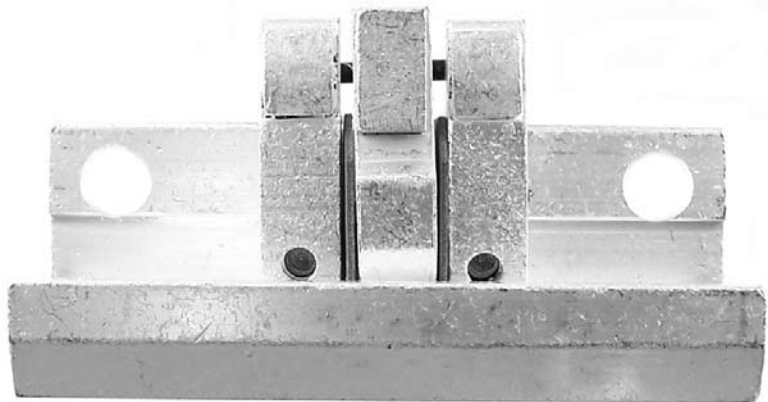

SERIES 500, SIZE 5 (FORMERLY FEDERAL NOARK)

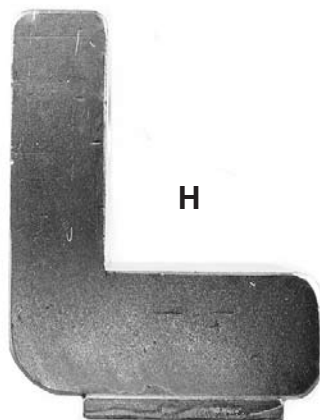

H

<u>OEM#</u>	<u>REF.</u>	<u>OUR#</u>
1013W	G	2044CW
1462W	H	2043CW

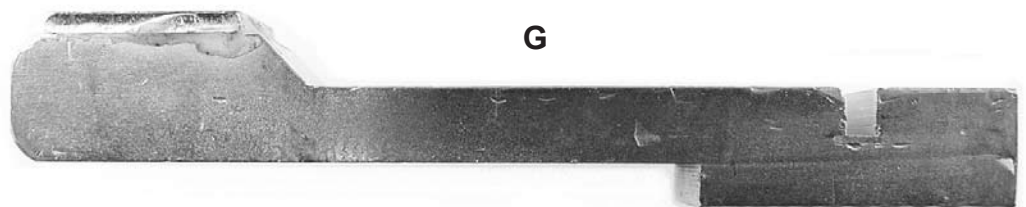

G

NUMERICAL LISTING

AEG	X247294	5326	72-211-653-008	EB260/260-1
910-392-257	X-307636	5327	8060	EF200/400
910-392-263	X-307644	5328A	8061	EFLG160CK
910-392-264	X-33519	5332	8066	EFLG160CK2P
910-392-265	X-33552	5333	8069	EFLG280CK
910-392-266	X-33553	5334	8069A	EFLG280CK2P
910-392-267	X-33977	5352	8070	EFLG315CK
910-392-268	X-343110	5353	8072	EFLG315CK2P
910-392-270	X-35162	5356	8074	EFLG630CK
910-392-326	X-35163	5358	8074A	EFLG630CK2P
910-392-500	X36670	5358B	8076	EFLG80CK
	X-36670	5358B	8077	EG1601CK
Allen-Bradley	X-36671	5359	8079	EG30
100-C30KIT	X-36702	5360B	8080	EG301CK
100-C37KIT	X-36703	5360B	8081	EG30-1CK
100-C43KIT	X-67541	5364		EG315
100-C72KIT	X-68996	5364	Aromat	EG3151CK
100-C85KIT	X-98909	6060	BM6-125-901	EG40
100-DCE-140	Z21103	6061	BM6-160-901	EG401CK
100-DCE-170	Z34037	6066	BM6-190-901	EG40-1CK
100-DCE-180	Z34038	6069	BM6-35-901	EG630
40410-331-51	Z34039	6070	BM6-50-901	EG6302CK
40410-331-52	Z34040	6072	BM6-65-901	EG801CK
40410-331-53	Z34041	6077	BM6-80-901	EG900CK
40410-331-54	Z34042	6079	BM6-85-901	EHCK100-3
40420-322-51	Z34043	6080		EHCK145-3
40420-322-52		6081	Arrow Hart	EHCK150-3
40430-300-51		7059	34300-301	EHCK160-3
40430-300-52	Allis Chalmers	7060	34600-301	EHCK170-3
40430-300-53	01-117-170-801	7061	37640-301	EHCK175-3
40440-300-51	01-117-181-806	7066	38640-301	EHCK210-3
40440-325-52	114542	7069	40500-301	EHCK250-3
40440-325-53	21-100-511-601	7069A	41500-301	EHCK260-3
40768-801-01	3005	7070		EHCK270-3
40768-802-01	3007	7072	Asea	EHCK280-3
40769-800-01	3008	7074	1SBN163503R1000	EHCK300-3
40769-801-01	3010	7077	1SBN163703R1000	EHCK370-3
40780-800-01	3013	7079	1SBN164103R1000	EHCK450-3
40781-800-01	3014	7080	1SFN164303R1000	EHCK50-3
40782-800-01	3021	7081	1SFN164503R1000	EHCK550-3
40782-801-01	3022	71-106-460-004	1SFN164703R1000	EHCK60-3
40783-801-01	3023	71-108-311-501	1SFN164903R1000	EHCK700-3
40783-802-01	3024	71-111-592-501	1SFN165103R1000	EHCK75-3
40783-802-02	4712A	71-112-913-501	1SFN165303R1000	EHCK800-3
42450-805-01	4712B	71-115-192-001		EHCK80-3
42450-805-02	4712C	71-116-285-09	5309138-B	EHCK90-3
G-7593	4713	71-201-458-502	5309139-A	EHDBCK075-2
X-104555	4714	71-204-124-501	5309176-C	EHDBCK075-NC
X-119624	4714A	71-209-754-504	5309558-A	EHDBCK110-2
X-130535	4716	71-921-052-501	5309559-A	EHDBCK110-NC
X-147299	4716A	72-111-898-002	5309560-A	EHDBCK130-2
X-147300	4716A	72-111-898-003	5309561-A	EHDBCK130-NC
X-147520	4726	72-111-997-501	5309608-A	EHDBCK220-2
X-160999	5321	72-116-530-06	5309DEB60G	EHDBCK220-NC
X247284	5322	72-210-492-502	ABBSK5309561-A	EHDBCK280-2
X-247284	5323	72-211-472-001	ABBSK822200-A	EHDBCK280-NC
X247286	5324	72-211-653-004	DEB60G	EHDBCK360-2
	5325		EA310/335	

EHDBCK360-NC	KZD130NC	A102-237821	A73-32460A	Cutler-Hammer
EHDBCK520-2	KZD130NO	A102-237821A	A74-190300	
EHDBCK520-NC	KZD220NC	A102-237821ASP	A74-207723A	
EHDBCK650-2	KZD220NO	A102-28965A	A74-244356	
EHDBCK650-NC	KZD280NC	A102-41257A	A74-244363	
EHDBCK75-NC	KZD280NO	A11-456	A74-250814	
EHDBCK800-2	KZD360NC	A11-486	A74-253067-0001	
EHDBCK800-NC	KZD360NO	A13-112966A	A74-253068-001	
EHDBCK960-NC	KZD520NC	A13-37261	A74-253069-0001	
KL30	KZD520NO	A13-41356A	A74-266268	
KL40	KZD650NC	A13-930	A74-266268A	
KL50	KZD650NO	A16-10264	A74-266269	
KL63	KZD800NC	A16-11338	A74-266269A	
KL75	KZD800NO	A16-11544	A74-281986	
KZ100	SK822200-A	A16-12138	A77-175957	
KZ-100	SK823220-B	A16-12674	A77-175975	
KZ145	SK824200-A	A16-15733	A77-175978	
KZ-145	SK824200-B	A16-18681A	A77-193027A	
KZ150	SK824202-A	A16-18684A	A77-193996A	
KZ-150	SK824203-A	A16-1936	A77-207701A	
KZ160	SK825200-A	A16-20982A	A77-207705A	
KZ-160	SK825200-B	A16-24811	A77-207707A	
KZ170	SK825202-A	A16-37787A	A77-207709A	
KZ-170	SK825202-B	A16-37908A	A77-207711A	
KZ175	SK825203-A	A16-51767A	A77-207713A	
KZ-175	SK825203-B	A16-6957	A77-207715A	
KZ210	SK826200-A	A16-7980	A77-207719A	
KZ-210	SK826200-X	A16-82220A	A77-207721A	
KZ250	SK826202-A	A18-10029	A77-94950	
KZ-250	SK826203-A	A18-13823	A91-263212A	
KZ260	SK827200-C	A18-2510	B74-243831	
KZ-260	SK827200-D	A18-31750A	B74-244363	
KZ270	SK827202-A	A18-3504	B74-250831	
KZ-270	SK827202-B	A18-3516	CY31-1	
KZ280	SK827203-A	A18-41304A	CY32-1	
KZ-280	SK827203-B	A18-41308A	CY33-1	
KZ300	SK828200-C	A18-5581	CY34-1	
KZ-300	SK828202-A	A18-80356	CY43-1	
KZ370	SK828203-A	A18-8863A	CY44-1	
KZ-370	ZL110	A18-9060A	E11733-1	
KZ450	ZL145	A18-9091	E12712-1	
KZ-450	ZL185	A18-9098	E14247	
KZ50	ZL210	A18-9099	E14248	
KZ-50	ZL260	A18-9109	E6154	
KZ500	ZL50	A18-9109A	KKD-050	
KZ550	ZL63	A18-9110	KKD-054	
KZ-550	ZL75	A18-9356A	KKD-1	
KZ65	ZL-75	A18-9464	KKD-100	
KZ-65	ZL95	A18-9464A	KKD-104	
KZ700		A18-9465	KKD-150	
KZ-700		A18-9465A	KKD-154	
KZ75		A18-9466	KKD-2	
KZ-75	A074-253067-0001	A18-9466A	KKD-300	
KZ80	A074-253068-001	A29-2691A	KKD-304	
KZ-80	A074-253069-0001	A29-4412A	KKD-50	
KZ800	A074-281986	A29-81955A	SA-660	
KZ-800	A101-28965A	A59-12650	SA-661	
KZ90	A101-28966A	A73-24295		
KZ-90	A101-34104A	A73-24295A		
	A102-237820			

Clark

1321-1704	1321-495	21-136	23-1316	6-168-35
1321-1705	1321-529	21-138	23-1341	6-168-6
1321-1706	1321-533	21-139	23-1396	6-169-3
1321-1708	1321-585	21-16	23-1405	6-186
1321-1709	1321-61	21-17	23-2103	6-186-10
1321-1711	1321-64	21-18	23-2103-2	6-186-2
1321-1712	1321-68	21-194	23-2103-3	6-186-5
1321-1713	1321-69	21-20	23-2103-5	6-186-7
1321-1714	1321-731	21-219	23-2845-2	6-189
1321-1716	1321-738	21-22	23-2942	6-189-2
1321-1717	1321-806	21-23	23-2961	6-189-3
1321-1718	1321-807	21-24	23-2961-2	6-189-4
1321-1721	1321-808	21-253	23-2962	6-189-5
1321-1724	1321-820	21-28	23-2962-2	6-189-6
1321-1725	1321-826	21-30	23-3286	6-189-7
1321-1726	1321-829	21-31	23-3344	6-189-8
1321-1727	1321-841	21-32	23-3387	6-202
1321-1731	1321-847	21-368	23-3439	6-20-2
1321-1733	1321-848	21-37	23-3449	6-203-2
1321-182	1321-849	21-373	23-3466	6-203-3
1321-234	1321-852	21-374	23-3514	6-20-4
1321-24	1321-856	21-38	23-3552	6-20-6
1321-245	1321-99	21-4	23-3553	621-149
1321-258	1323-1484	21-40	23-3926	621-164
1321-259	1323-15	21-41	23-4026	621-165
1321-297	1323-1604	21-435	23-4079	621-218
1321-342	1323-1721	21-436	23-408	621-49
1321-343	1323-1723	21-437	23-4080	6-215
1321-344	1323-1724	21-438	23-411	6-215-2
1321-385	1323-2001F	21-440	23-435	6-22-2
1321-386	1323-2044-F1	21-441	23-435-2	6-23
1321-388	1323-2046-F1	21-443	23-4595	6-2-3
1321-390	1323-2202	21-45	23-4596	6-23-2
1321-391	1323-2405-F1	21-468	23-5448	6-23-3
1321-394	1325-514	21-481	23-5449	6-23-4
1321-395	1325-74	21-482	23-6378	6-24
1321-397	1326-1651	21-483	23-6380	6-24-2
1321-401	1327-1615-A	21-484	23-662	6-25
1321-402	1340-2365	21-485	23-713	6-25-2
1321-407	21-103	21-487	23-717	6-26
1321-408	21-1097	21-488	23-7253	6-26-2
1321-415	21-1097-2	21-489	23-7255	6-27
1321-417	21-1097-3	21-490	23-812	6-27-2
1321-423	21-115	21-620	23-813	6-28-2
1321-425	21-116	21-620-2	25-245	6-286
1321-428	21-117	21-670	40-290	6-288
1321-429	21-118	21-671	40-45	6-29-2
1321-434	21-119	21-672	40-522	6-294
1321-436	21-120	21-688	40-522-4	6-3-3
1321-442	21-122	21-915	4221-4	6-34
1321-450	21-123	21-917	46-214	6-34-2
1321-455	21-124	21-962	6-10-2	6-34-3
1321-456	21-125	23-1017	6-106	6-34-4
1321-461	21-126	23-1042-2	6-113	6-35
1321-471	21-127	23-1191	6-12-2	6-35-2
1321-472	21-128	23-1192	6-1-3	6-36
1321-491	21-129	23-1225	6-14-2	6-36-2
1321-492	21-13	23-1258	6-16-2	6-36-4
1321-493	21-130	23-1288	6-168-21	640-126

640-242	9755792	8436624	EZ-1549A	75CA14
640-29	9755810	8441833	FA000201700A	75CE42
640-62	9755822	8441835	FA-2172C	75CF14
6-43-2	9755834	8446413	FA-2172-C	75CK210
6-43-4	9758902	8446420	RHE-78-138	75CK280
6-43-6	9759001	8446421	W512108199A	75CK300
6-44-2	9759098	8451522	W-5121-0-8199A	75CK400
6-45-2	9788748	8451655	W-5121-0-827A	75CK550
6-496	9788785	8451656	W512110169B	75CK700
6-497		8468987	W-5121-10169B	75CK750
6-569-2	EMD	8468991	W5121A0434	75DA14
6-570	8040662	8471755	W-5121-A-0434	75DE42
6-601	8102357	8488949	W5121A0441	75DF14
6-601-2	8102509	8488951	W-5121-A-0441	75EA14
6-602	8102509	8492373	W5121A0443	75EE42
6-611-2	8102510	8492374	W-5121-A-0443	75EF14
6-621	8102510	9536539	W5121A0446	75FB14A
6-622	8106599	9536540	W-5121-A-0446	75FE42
6-65-17	8193990	9567214	W5121A0451	75FF14
6-65-19	8193993	9570140	W-5121-A-0451	75FF15
6-65-2	8196595	9570140	W5121A0496	75FP109153
6-65-4	8200375	9570141	W-5121-A-0496	75FP14
6-65-6	8208931	9571059	W5121A700	75GB14
6-65-8	8209354	9577750	W-5121-A-700	75GE42
740-22	8209964	9577755	W5121B0452	75GF14
740-964	8209971	9577761	W-5121-B-0452	75GF15
840-1123	8218564		W5121B0528-1	75GP14
911-7881-Z	8218567	Federal Pacific	W-5121-B-0528-1	75HB14
940-1121AZ	8219479	1551A3334	W5121B0528-2	75HF14
940-1121-AZ	8219480	5480CR23	W-5121-B-0528-2	75HF15
940-1121-AZ3	8247051	5480CR24	W5121O827A	75IB14
940-1121-AZ5	8251206	5480CR25	W5121P0809	75IF14
940-1121-AZ8	8251207	5480CR26	W-5121-P-0809	75JB14
940-1122-AZ	8260102	5480CR26K	W5121P0811	75JG14
940-961-AZ2	8260104	5480CR33	W-5121-P-0811	75KB14
940-961-AZ3	8260105	5480CR35	W5121P0817	75KF14
940-963-AZ1	8260106	5480CR36	W-5121-P-0817	75MB14
940-963-AZ6	8261142	5480CR37	W5121P0818	75RB14
940-963-AZ7	8261218	5480CR38	W-5121-P-0818	75RF14
CA105	8262194	5480CR39	W5121P0819	
CA110	8262232	5480CR39A	W-5121-P-0819	General Electric
CA115	8330350	5480CR50	W5121P0820	005509087G11
Delta	8337579	5480CR50A	W-5121-P-0820	00631833P2
CK400-3	8337802	5480CR51		006440364P1
CK400-4	8339355	5480CR52	Firetrol	006509085G011
	8339361	5480CR53	FTA305	006509087G011
	8339390	5480CR54		006509089G011
Dover	8339440	5480CR62	Fuji	0103A118G003
112194	8339441	5480CR63	2NC0T-CK	0103A3849G003
35579	8399152	5480CR64	2NC1Q-CK	0103A3850G001
35581	8407131	E10301B	2NC2F-CK	0103A3850G002
35582	8407132	E10301J	2NC2H-CK	0103A6272P9
35583	8409388	E15048A	2NC2T-CK	0104D5801G002
75533	8409389	E20538	2NC3F-CK	0104D5801G003
75551	8424739	E-20538	2NC3H-CK	0153B5254P001
75553	8424740	E20539		0153B6737G001
75561	8424740	E-20539	Furnas	0158A776P001
975543	8436607	EZ00104210BB	75BE42	0158A776P002
9755536	8436622	EZ1549A	75BF14	0158A777P002

0195X0154702G1	1107918P1	129553	1407284	14692
0195X0154703G2	111077	129556	1407522	1469207
0203A1775G003	111079	129566	1407526	14693
0203A1776G001	111080	129568	1407527	1475419P1
0214X0109G004	111081	129570	1416332P1	1475423
0214X0775G002	111099	129572	142825	1475499
0269A2219711	11136	129575	142826	1476440P1
0269A2219713	11137	129577	14355P1	1476698
0269A2219714	11138	12B108197P3	143846	1476900P1
0269A2229701	111548	1304270	143940	1476935
0269A2229702	111719	1304271	1441758	1476936
0809130326G1	111720	1348653	1442248	1476937
0842C0550701	111741	1348654	1443051P1	1476999
0958D0933G2	11190	1348655	1443121	1477185
101X100	11191	134890	1443249	1477513P1
101X110	11192	134891	1443249P1	1477525
101X111	11193	134892	1444352	1477573
101X112	112039	134893	1444353	1477573P1
101X113	112040	134894	1445169	1477925P1
103A118G3	112041	134941	1445307P1	1477942
103A3849G3	112042	134957	1445428	1477943
103A3850G1	112043	134A7285G1	1447011	1477967
103A3850G2	112044	1350000	144929	1478604
103A6272P9	112045	1350001	144930	1479663P1
103A6953G001	112046	135887	144931	1479797
103A6953G002	112047	135888	1451541	1486046
104B9949P6	11217	135889	1452601	1486046P1
104B9949P7	11218	135890	1452603	148931
104D5801G2	1158696P5	135891	1453258	1490967
104D5801G3	1158696P8	135892	1453260P1	1491133
10539	1158696P9	135893	1454024	1491136
105676	118B5324G1	135894	1455932	1491153
105677	118B5324G2	135895	1456875	1492168
105678	119B318G1	135896	1458240	1492678
105679	119B318G2	135897	1460031P1	1492678G1
105681	119B318G3	136101	1460935P1	1493402P1
105682	119B318G4	137A9164P3	14629	1493414
105689	121442	138A1125G1	1464166	1493584
105693	121562	139B8097G1	1464827	1493589
105694	121563	139B8097G3	1464847	1494525
105695	121564	139B8098G1	1464861P1	1494537
105696	121566	139B8098G2	1466032	1494542
105697	121567	139B8099G1	1466032G1	1494543
105698	121568	139B8099G2	1466387P1	1494544
105701	122A2468G1	13D324G1	1466387P2	1494545
106166	122A2468G2	1400457	1467727P1	1494546
107968	122A2468G5	1401393G1	1467728	1494547
107969	125A4268P1	1401985	1467786	1494548
107970	125A6098G1	1402284	1467801	1494550
107971	126161	1404009	1467811	1494552
107972	126162	1404076	1467840	1494553
107973	126163	1404078	1467860	1494556
107974	126164	1404940	1467860P1	1495214
10967	1265168	1404949	14681	1495227
10969	126932	1404950	1468311	1495256
10971	127A6749G1	1404969	1468331	1495257
10974	127A6751G1	1405080	1468386	1495259
10975	127A6770G1	1406315	14687	1495261
110046	129520	1406655	1468908P1	1495262

1495263	1496910	1498744	154295	167A9956G1
1495264	1496944	1498747	154296	1689507P3
1495265	1496945	1498773	154297	168A2665G1
1495266	1496946	1498774	154298	169A8547G1
1495267	1496947	1498775	155399	170X1004
1495268	1496949	1498776	157768	170X1035
1495269	1496950	1498777	157769	170X1036
1495270	1496951	1498778	157770	170X1037
1495271	1496952	1498780	157771	170X1038
1495272	1496953	1498782	157772	170X1039
1495273	1496954	1498783	157774	170X1040
1495277	1496955	1498784	157775	170X1041
1495278	1497640	1498786	157776	170X1042
1495279	1497905	1498787	157777	170X1043
1495280	1497909	1498788	157778	170X1044
1495281	1497910	1499030	15778	170X1045
1495287	1497911	1499088	157781	170X1046
1495288	1497914	1499089	158A776P2	170X1078
1495289	1497915	1499409	158A777P2	170X1079
1495291	1497947	1499410	158A8776P1	170X1080
1495293	1497948	1499412	159066	170X1082
1495294	1497951	1499413	159384	170X1083
1495296	1497952	1499415	159393	170X1084
1495297	1497953	1499416	159397	170X1085
1495298	1497954	1499417	1608293P5	170X1086
1495299	1497955	1499420	162V945	170X1087
1495305P1	1497956	1499421	1642003G1	170X1088
1495306P1	1497957	1499422	1642206G4	170X1089
1495603	1497958	1499423	164234	170X1090
1495604	1497959	1499429	164235	170X1091
1495605	1497960	1499431	164510	170X1092
1495606	1497964	1499432	164511	170X1093
1495607	1497966	1499433	164512	170X1094
1495610	1497970	1499434	164513	170X1095
1495612	1497971	1499435	164514	170X1096
1495613	1497972	1499436	164515	170X1097
1495614	1497973	1499444	164516	170X1098
1495615	1497974	1499455	164517	170X1099
1495632	1497975	1499586	164518	170X1100
1495649	1498374	1499587	164519	170X1101
1495657	1498375	1499588	164520	170X1204
1495660	1498386	1499596	164521	170X1258
1495661	1498450	1499724	164522	170X1260
1495662	1498492G1	1499725	164735	170X1261
1495663	149850	1499768	164736	170X1262
1495664	1498723	149B9116P22	164737	170X1263
1495665	1498724	149B9116P32	164738	170X1264
1495666	1498725	151304	164739	170X1265
1495670	1498730	151468	164740	171226
1495672	1498731	151660	164741	171595
1495673	1498732	151667	164742	171782
1495674	1498733	151668	164762	173817
1495675	1498734	151669	165178	174A4428P1
1495676	1498735	151A4432P1	166391	174A5315G1
1495677	1498736	152A6942G1	166V880	174A5316G1
1495686	1498737	152A6942G2	167540	174A7153G1
1496152	1498738	15321	167541	174A7154G1
1496154	1498739	153B5254P1	167542	174A7609G1
1496901	1498742	153B6737G1	167A8898G1	174A7610G1

174A7611G1	197962	2230287	23928	2458811P1
174A7613G1	197963	2236372P1	23929	2458898P1
174A7636G1	197964	2236930P1	23930	2459875P1
174A7638G1	197965	2238066P10	23931	2459875P3
1752900P1	197966	2238066P11	23932	245A1229G1
17617	197992	2238066P16	23933	2460961P1
17618	198267	2238066P6	23934	2473010
17619	198562	2238070P1	23935	247B663P23
17620	198563	223821	23936	2482988P1
17621	198566	2242320P2	23937	2483877P1
17622	198567	2242621G17	23979	2488727
17623	198603	2242621G18	23980	2492908
17624	199086	2242621G19	23981	2492908P1
17636	201343	2242621G20	2407535	24986
17667	201800	2242621G29	24175	251302
176781	203A1775G3	2242621G30	24176	25499
176983	203A1776G1	2242621G31	24348	25721
177069	205068	2242621G32	24349	259221
177070	205A4039G1	2242621G35	24350	259A1557G1
177071	205A4708P1	2242621G36	24351	259A5562G1
177072	206A2725G1	2242621G40	24352	259A5614G1
177073	207019	2242621G52	24353	259A5615G1
177729	207023	2242621G61	24354	259A5637G1
177789	208714	2242621G73	24355	259A5640G1
17794	208715	2242621G80	24356	259A5658G1
178651	208716	2242621G87	24357	259A5663G1
179913	208717	2242621G99	2437279P1	259A5673P1
180223	210982	2247570G1	2440216	259A8114G1
18040	21448	225311	2440217	259A8124G1
180471	21449	226455	2440218	259A8126G1
1805116	21450	2280620G13	2440219	2601241P1
1824774P10	214X0109G4	2280620G9	2440222	2601241P2
187822	214X0775G2	2282859G14	2440223	2601242P2
187V471	216694	2282859G15	2440376	2605601P3
188A4581G1	216696	2282859G16	2440952	2605601P4
188A4583G1	216719	2282859G19	2440977	2605602P6
189267	216837	2282862G6	2440990	2605607P1
1893	2182133P1	2282864G1	2441451	2605614P2
189896	2182133P2	2282864G2	2441480	2605619P3
189900	218377	22847	2443842P1	2605620P1
1933901P2	218381	22996	2447762	2605620P10
1933901P3	218861	231017	2449720P1	2605620P12
1933901P4	219868	2311169G1	2449779P1	2605620P15
1933901P5	220132	23114	2451575P1	2605620P17
1933901P6	2204790	23119	2451595P1	2605620P18
1933901P7	2210062G6	231A6212P21	2451757P1	2605620P2
1939907P2	2210095G1	232A6724G012	2452207	2605620P3
194997	2210095G2	232A6724G10	2453510	2605620P6
194A9348P21	2210095G7	232A6724G5	2453510P1	2605620P7
194A9435G1	2210800G11	232A6724G6	2455288P1	2605620P8
194A9435G24	2210800G4	232A6724G9	2455923	2605623P10
195X0154702G1	2210800G5	234394	2455923P001	2605623P4
195X0154703G2	2213266P1	234395	2456830	2605623P9
196367	2213266P2	234399	2456830P1	2605624P1
19681	2213266P6	235713	2457337P1	2605624P2
19683	2213266P7	236C790G9	2457351P1	2605624P3
19715	2215635P1	23924	2458292P1	2605624P5
1977637P1	2215731	23926	2458488P1	2605624P6
1977637P14	2220358P1	23927	2458490P1	2605624P7

2605628P1	2605671P7	27652	29376	3614137G1
2605628P10	2605671P8	27653	29377	3614137G3
2605628P19	2605671P9	27654	29378	3614137G7
2605628P2	2605675P4	27655	296B0387G1	365441
2605628P3	2605696P1	27656	30358	365445
2605628P36	2605696P2	27657	30434	365448
2605628P4	2605696P3	278714	30683	3667572G1
2605628P5	2605697P1	27925	311V218P1	3667572G2
2605628P6	2605697P2	279A504G1	311V219P1	36773
2605628P7	2605698P1	280055	318382	36964
2605628P8	2605698P10	2801699G1	325A245P25	37579
2605629P4	2605698P11	2809031P2	332B313G1	37683
2605629P5	2605698P13	2810405G1	335V517P1	37749
2605629P6	2605698P2	2810484G1	33602	37770
2605629P7	2605698P5	2810484G2	336B737G1	37772
2605631P28	2605698P7	2810492G1	33789	37900
2605631P29	2605698P8	2810492G2	33802	37902
2605634P1	263A3723P27	2811100P1	33837	37904
2605634P2	263X340G1	2811100P6	33838	37905
2605634P3	2646132G1	2811102P1	33839	37906
2605636P1	264613G1	2811103P1	33840	37911
2605636P10	2649308G2	2811103P2	33841	37913
2605636P11	2649326P2	2840219G1	33842	37918
2605636P12	2649326P4	2840219G2	33843	37922
2605636P13	2649326P6	2840224G1	33844	37924
2605636P14	266109	2840261G1	33845	37929
2605636P15	267C907G2	2840261G2	33846	37930
2605636P16	269570	2840261G7	341581	37939
2605636P17	269572	2840276G1	34211	37946
2605636P18	269573	2840276G5	34212	37947
2605636P19	269574	284A956P1	34213	37949
2605636P2	269A2219711	284A969P1	34214	37954
2605636P25	269A2219713	284A994G2	34215	37973
2605636P3	269A2219714	284B425G2	34216	37976
2605636P35	269A2229701	286466	34217	37980
2605636P36	269A2229702	286467	34218	37989
2605636P37	269C257G1	286626	34219	37994
2605636P38	269C257G15	286A118G1	34220	379C615G1
2605636P4	269C257G2	28700	34221	379C616G1
2605636P5	270049	287A160G1	34222	380109
2605636P6	2705831G1	287A160G2	34223	3803265G1
2605636P7	27067	287A162P1	34224	3805658G3
2605636P8	2710032G1	287A162P3	34401	382332
2605636P87	2710083	287A960G1	346A4106G1	3841733G1
2605636P88	2710260	287A960G2	348997	3841733G3
2605636P9	2710261	287A977G1	348998	3845760G1
2605651P2	2710262	287A977G2	348999	38582
2605659P1	2711511P1	28847	349A143G1	38583
2605659P2	2716434	288A389G1	349A143P21	38584
2605659P3	2718146	288A389G2	349A145G1	3860990G1
2605664P1	2728673G3	288A389G3	349A145G2	3860990G2
2605664P2	273A2425G1	2890181G1	358A866P22	3866756G2
2605664P3	273A2425P1	2890181G2	358A886P21	387A0331G002
2605671P1	27633	2890192G4	359A139G1	387A0331G1
2605671P2	27647	290839	359A139G4	3901A373AB27
2605671P22	27648	290840	359A139P31	3901A373AB28
2605671P3	27649	29362	359A422G1	3906B444G1
2605671P5	27650	29363	359A422G2	3916B561P21
2605671P6	27651	29375	359A613P23	3916B561P22

3923A412AAG16	41A259648G1	41C655170G2	47178	488B756P24
3929A548P22	41A259862P1	41C655170G3	47188	489B855P21
392A201G1	41A259958G1	41C665203P1	472027	489B880G1
392A201G1	41A260370G2	42548	472092	489B880G2
394A143P21	41A261394P1	428A926G1	472094	489B880P24
395057	41A262089G1	4311097G1	472176	489B885P22
395059	41A263565G1	4311097G2	472180	4907067G1
395063	41A263565G2	431147	472194	4907067G2
395110	41A264410G1	4319409G2	472406	4907950P1
395111	41A264589G1	4319409G3	472466	4907957P1
395112	41A265467P1	4338327G1	472507	49092
395113	41A265467P10	4371412G1	47294	49093
395115	41A265467P13	4371412G2	47312	49094
3963X110G1	41A265467P14	4379461G2	4734382G1	491344
398A752G1	41A265467P2	438378	4734382G2	492637
398A752G2	41A265467P4	43928	4734881G1	492A199G1
39922	41A265467P6	43929	4735054G1	492A201G1
3995X542G1	41A265467P8	439730	4735054G2	492A394G1
3X6244	41A265467P9	439731	4735054G5	492A596G1
3X6659	41A265986G1	460466	4737646G2	49326
3X6659	41A268819G1	461756	4737646G3	49327
3X6660	41A272462G1	461757	473929	49328
3X6660	41A273070G1	461758	473930	49329
3X6672	41A278788P1	461762	473936	4953034G1
3X6673	41A288025G1	461764	4748599G1	4953681G2
3X7084	41A288026G1	461808	4748599G2	4953681G4
40001024	41A288026G2	461888	4748599G3	4953681G5
400037	41A288538G10	461889	4750260	4953681G6
40009951	41A288538G12	46245	4760521	4959854G1
40015677	41A288538G13	465525	4760521P1	4959854G2
40481	41A288538G14	469040P1	4760559G3	496A427G1
40482	41A288538G15	469252	4767443G1	496A428G1
40483	41A288538G9	469252	4767491P1	496A428G2
413577	41A323945P2	4702517	4767492P1	496A899G1
414495	41A323947P1	4702576	4768954P1	496A899G3
416682	41A324557G1	4703911	478B389G2	496A923G1
416687	41B53217G1	4704439	480385	498A745G1
4167739	41B53217G2	4704594G1	482A768G1	498A755G1
41A237226P1	41B538814P1	4704700P1	482A946G1	498A757G1
41A251478P1	41B550098G1	4708341	482A946G2	498A762G1
41A251500P1	41B551687P1	4709042	482A946G2	498A888G1
41A252140P1	41B551721P4	4709938G1	486B181G1	51426
41A254311P1	41B551952G1	4710010P1	486B181P21	51445
41A254419G1	41B551996G1	4710497P1	487A228G1	51449
41A255337G1	41B551996G2	4711041	487A228G1	51450
41A255848G1	41B552286P1	4711041G1	487A563G1	51451
41A255849G1	41B553453G1	4711042	487A564G2	51452
41A255850G1	41B554544G1	4711182G1	487A580G1	51453
41A256426G1	41B555154G1	4711634G1	487A587G1	51454
41A256913G1	41B564155G1	4712065G1	487A605G1	51455
41A257187G1	41B564155G2	4712138	487A664P1	51456
41A257595G2	41B566942AAP1	4712139	487A729G1	51457
41A258090G1	41B569867G1	4712567	487B531G1	51458
41A258094G1	41C32545P4	4712980P1	487B686G3	5151779P1
41A258094G2	41C59301P2	4712999	488A625G1	5189047G1
41A258096G1	41C652970G1	4715358P1	488A822G2	5189047G2
41A258443G1	41C652971G1	4715623P1	488B756P21	5189048G3
41A258949G1	41C653395G1	4715959P1	488B756P22	5300313P1
41A259642G1	41C653395G2	4715961G1	488B756P23	5300830G1

5300851G1	55-151670G12	5721042G4	6509085G011	6714207P1
5303515G1	55-151670G2	5759047G1	6509087G11	6714294
5303568G1	55-151670G3	5759047G2	6509089G11	6714756G1
5304778G1	55-151670G4	577A603G1	6509266G11	67459
5306170G1	55-151670G5	578A994G1	66720	67460
5306170G2	55-151670G6	5904068G1	66721	68255
5306170G3	55-151670G9	5908318G1	66899	688A528
5306170G4	55-151939G1	5908357G2	66900	688A529
5306170G6	55-151939G11	6017812P2	66901	6904048
5306170G7	55-151939G4	6017812P4	66902	6908543
5306829G1	55-151939G7	6024044G2	66903	6914856G1
5346578G1	55-151940G3	6047538P001	66904	6916929G1
5346578G2	55-151940G4	6078420	66905	6960043G25
5350495P1	55-151940G5	6127068G2	6700056G1	6960043G26
5351643P1	55-151941G2	6150581G1	6700277	6960045G11
5352149P1	55-152012G1	6178377	6700284G1	6960045G36
5352168P1	55-152012G2	61844	6700289G1	6960045G51
5352177P1	55-152012G3	61845	6700314G1	6960045G76
5354901G2	55-152012G4	61907	6700316G1	6960045G77
5377842G1	55-152313G09	61908	6700391G2	6960047G26
5384962	55-152313G138A	6315903FAG15	6700392G1	6960049G1
5384962P1	55-152313G139	6318113G1	6700393G1	6960049G16
5384963	55-152313G140	63182553G1	6700393G2	6960051G12
5386047	55-152313G141	631833P2	6700398G1	6960051G13
541A900P1	55-152313G142	64049	6700531P1	6960051G14
542A964G4	55-152313G165	64050	6700549G1	6960051G15
543A408P1	55-152313G173	64051	6700549G2	6960051G17
543A800G1	55-152313G94	64052	6700790G1	6960051G20
543A900G1	55-152313G95	64053	6700890G1	6960051G22
543A980G1	55-152313G98A	64054	6701902G1	6960051G25
544A881G1	55-152313G98B	64055	6701973P1	6960051G26
544A968G1	55-152489G1	64056	6702386G1	6960051G27
545A210P1	55-153677G02	64057	6702600G1	6960051G28
545A398P1	55-153677G1	64058	6702667G1	6960051G30
545A507P1	55-153677G2	64059	6703676P1	6960051G31
546A300G010	55-153678G034	64060	6703682P1	6960051G34
546A300G1	55-153678G1	64061	6703912P1	6960051G35
546A300G2	55-153678G2	64065	6703943G1	6960051G36
546A301G1	55-154607G041	64066	6703947G1	6960051G41
546A301G2	55-154607G1	64067	6706024G1	6960051G43
546A301G53	55-154607G2	64068	6706065G1	6960051G44
546A780G060	55-176451G032	64069	6706067G1	6960051G45
546A780G2	55-186556G04	64070	6706210G1	6960051G46
546A780G20	56644	64071	6706357G1	6960051G48
546A780G35	56645	64072	6710098G1	6960051G51
546A780G36	56646	64073	6710524G1	6960051G52
546A780G51	56647	64074	6710610G1	6960051G54
548A790G1	56648	64075	6711318G1	6960051G57
548A791G1	56649	64076	6711338G1	6960051G63
550866	56650	64078	6711338G2	6960053G3
5509087G11	56651	64079	6711352G1	6960067G1
55-150161G1	56652	64080	6711352G2	6960067G2
55-150161G2	56653	64081	6711440P1	6960067G3
55-150161G3	56654	64082	6712788P1	6960067G4
55-150161G4	56662	6414374G1	6712788P1	6960076G1
55-150161G8	56663	6440364P1	6713304	6960076G5
55-151670G1	56771	6496488P3	6713304P1	6960076G51
55-151670G10	56831	6508227P2	6713719P1	6965160G1
55-151670G11	5721042G3	6508298G1	6713749	6965160G2

6969508G1	8803222G1	9723633	W8000CPP2	K134
6973075G1	8803229G1	9723633G2	W8000GLP1	K136
6974682G1	8803895G1	9723633G4	W8007ACP22	K145
6974718G2	8803897G1	9723633G6	W8007ACP23	K147
6974772G1	880657G1	9752218G1		K148
718530	8807882G1	9756574G1	Hoyt	K149
719889	8807883G1	9756574G2	K001	K151
719890	8810390G1	9837930G1	K006	K152
719891	8810879	9948325G1	K011	K153
726984	8813367G1	9960190G1	K019	K154
76439	8814584G1	9960190G2	K021	K155
764961	8814658G1	9960190G3	K023	K156
793C797P21	8814659G1	9960190G5	K025	K157
793C797P22	8815354G1	9960190G7	K026	K158
8007ABP22	8815480P1	9960266G1	K028	K159
8007ABP23	8817548P1	9960282G1	K032	K160
805B910G1	8827648G1	9960283G1	K033	K161
805B910G2	8831049G1	9960410G1	K036	K162
8067063G1	8831734G2	9960690G1	K038	K163
8067076G1	8839678G1	9963468G1	K046	K164
8067076G2	8839678G3	9963477G1	K048	K165
8067076G4	8860205G1	9963477G11	K050	K166
8090348	8860749G1	9963477G12	K051	K167
809130326G1	8863788G1	9963477G19	K052	K168
8353158P22	8865555G2	9963477G3	K053	K172
8353158P23	8865611G1	9963477G9	K056	K175
8369262G1	8867084G1	9963521G2	K066	K176
8375382G1	8867205G1	9963542G1	K071	K177
8375382G2	8867977P1	9963819G1	K075	K178
8380576P21	8867977P2	9963857G1	K077	K179
8380576P21	9034003G1	9963871G2	K079	K180
842C0550701	9034003G2	9964895G1	K081	K181
84A206537P8	9034175P1	CA5F2CPR1	K086	K182
84A206537P9	9034269P1	CA5F3CPR1	K096	K183
84B510321G2	9034270G1	CR4XDG	K101	K184
851021	9034293G1	CR4XDH	K102	K185
8617100P1	9034293G2	CR4XDJ	K103	K186
8617333P1	9034388G1	CR4XDK	K104	K187
8626928P1	9034388G2	CR7XDG	K105	K188
8628928P2	9034639G1	CR7XDH	K106	K189
8650777P7	9043178G1	CR7XDJ	K107	K190
8650869G1	9043584G1	CR7XDK	K108	K191
8690980P1	9094175P2	CV-175290001	K109	K197
8690992G1	9265613G1	IC2956A200A	K110	K204
8800167G1	9265613P21	IC2956A200B	K111	K210
8800168	9289843	IC2956A200C	K112	K215
8800657G1	9289877G1	R2028	K113	K220
8800740	9289877G2	V31175CA	K114	K230
8801407G1	9291849P21	V31206B	K116	K232
8801552G1	9291849P22	V31207B	K120	K235
8801705G1	9516986P21	V31208B	K121	K237
8801839G1	9520729G1	V31209B	K124	K239
8801846G1	9520729G2	V31210B	K125	K251
8801973	958D0933G2	VB1205B	K126	K280
8802039G1	9645809	VB1207B	K127	K290
8802270	9707362G1	VB1208B	K128	K291
8802880	9709362G1	W8000CMP1	K129	K293
8802954	9723629G1	W8000CMP2	K130	K294
8803142G1	9723629G2	W8000CPP1	K131	K351

K355	K665	K825	1036	3595
K360	K670	K826	1037	4026
K365	K673	K827	1038	4035
K370	K675	K829	1039	4038
K395	K676	K830	1067	4062
K400	K677	K831	1068	4091
K405	K678	K835	1111	4092
K410	K679	K840	1113	4116
K415	K680	K841	1117	4156
K420	K681	K845	1118	4157
K425	K682	K850	1119	41702
K430	K683	K855	16924	41702-000
K500	K685	K860	16924-000	41702-001
K502	K686	K865	16924-001	41703
K505	K690	K870	16965-000	41703-000
K510	K691	K875	17279	41703-001
K511	K704	K880	17279-000	41719
K512	K705	K885	17279-001	41719-000
K515	K706	K905	17280	41719-001
K520	K707	K910	17813-000	4173
K522	K708	K915	18402	48578-001
K525	K710	K920	18402-000	48579-001
K530	K711	K925	18402-001	4870-001
K535	K712	K930	19784-000	4873-000
K536	K713	K933	19785-000	5721
K540	K714	K942	2315	5721-000
K541	K715	K943	2315-000	5721-001
K542	K717	K952	2315-001	5722
K545	K720	K953	2317	5722-000
K550	K721	K962	2317-000	5722-001
K551	K722	K963	2317-001	5738
K553	K723	K972	24344	5738-000
K555	K725	K973	24344-000	59596-306
K557	K729	KR200	2852	59596-307
K558	K730	KR201	2860	59596-308
K568	K731	KR250	2869	59596-406
K569	K732	KR300	2870	59596-407
K585	K733	KR352	2874	59596-408
K590	K735	KR353	3028	59596-601
K605	K736	KR354	3036	59596-701
K610	K737	KR500	3526	59596-801
K615	K740	KR502	3527	59605-611
K616	K742	M019	3532	59605-711
K617	K745	M019AG	3535	59605-811
K624	K747	M020	3537	59644-600
K625	K751	M020AG	3540	59644-700
K626	K757	M021	3541	59644-800
K627	K759	M021AG	3542	68000-001
K628	K760	M034	3543	68000-002
K629	K765	M034AG	3544	68027-001
K633	K770	Z321	3545	68027-002
K643	K775	Z321AG	3547	7491
K650	K780	Z322	3549	7493
K652	K785	Z322AG	3587	7510
K653	K800		3587	7517
K654	K805	Hubbell	3590	7527
K655	K810	04870-001	3590	7528
K660	K815	04873-000	3592	7529
K663	K820	1035	3594	7530

7535	DIL10-M	KA105DVI	22465-14	1079Z2838
7536	DIL-10-M	KA11W1	22465-24	1079Z2839
823028	DIL2-22	KA16VLR	22466-14	1079Z2840
9858	DIL-2-22	KA258R	22466-24	1079Z2844
9859	DIL3-22	KA32L	22467	1079Z2864
Ingersol Rand	DIL-3-22	KA538R1	26195-00	1079Z32
39109236	DIL4-22		26196	1079Z3296
39114541	DIL-4-22	Mitsubishi	26805-14	1079Z33
39114558	DIL6-22	BH509N301	26807-00	1079Z34
39114566	DIL-6-22	BH509N304	26831-00	1079Z4496
ITE	DIL6AM	BH509N313	27093-00	1079Z4511
269A069-01	DIL6-AM	BH519N301	2A3211	1079Z4512
296A005-01	DIL6M	BH519N304	2A3212	1079Z4513
296A014-01	DIL6-M	BH529N301	42055-00	1079Z4514
296A051-01	DIL-6-M	BH539N300	43930-00	1079Z4521
296A053-01	DIL8AM	BH549N300	44683-00	1079Z4522
296A059-01	DIL8-AM	BH549N301	47147-00	1079Z4524
296A061-01	DIL8-AM	BH559N300	47157-00	1079Z542
296A070-01	DIL8M	BH559N301	47160-00	1079Z57
296A167-01	DIL8-M	BH559N302	47161-00	1079Z72
296A167-01	DIL-8-M	BH559N303	47162-00	1079Z73
296A501-01	DILM150-XCT	BH559N306	47163-00	10K45160
296B016-02	DILM250-XCT	BH559N307	47600-00	10K45161
296B317-01	DILM500-XCT	BH569N300	47660-00	10K45242
296B324-01	DILM65-XCT	BH569N301	47661-00	1171
41-10612-1021	McGraw	BH569N302	47667-00	1172
856B150-01	A-218849	BH569N303	47668-00	11K45160
Joslyn Clark	A-30891	BH579N301	47699-00	11K45242
KTM25-1	AZ0065804	BH579N304	47715-00	12K45160
KTM-25-1	AZO-18271700B	BH719N300	47716-00	12K45161
KTM31-1	AZO-218846	BH729N300	47717-00	12K45242
KTM31-1	AZO-218849	BH739N300	8487	13K45160
KTM32-1	AZO-219052	BH749N300	8488	13K45161
KTM-32-1	AZO-219161	BH749N301	8489	13K45242
KTM33-1	AZO-308551	BH749N302	8490	14K45160
KTM33-1	B121691	BH749N303	8491	14K45242
KTM34-1	BZO-183206	Moloney	8511A	15K45160
KTM-34-1	BZO-218208	08511-01	8512A	15K45160
KTM34-1	BZO-218216	10137	8686A	15K45161
KTM35-1	BZO-218216	10140-00	8687A	15K45242
KTM35-1	BZO-218223	10159-00	9095	16K45160
KTM-35-1	BZO-292464	10161-00	T1-11664-00	16K45161
Joy	BZO-292844	10565-00	P & H	17K45161
601548-12	BZO-292857	11654-00	1079Z115	17K45161
601548-13	BZO-308149	11664	1079Z2159	18K45161
601548-14	BZO-308554	11672-00	1079Z2160	19K45161
601548-15	BZO-308557	11672-00	1079Z2161	1K45160
601548-84	BZO-308560	11681-00	1079Z2162	1K45161
601548-86	BZO-308663	11685	1079Z2163	1K45242
601821-31	BZO-308681	12183	1079Z2163	2K45160
601823-0013	BZO-353193	12184-00	1079Z22	2K45160
Klockner-Moeller	BZO-353248	12184-00	1079Z23	2K45161
DIL10AM	C-308680	12195	1079Z24	2K45242
DIL10-AM	CZO-064499	12196	1079Z2435	2K45242
DIL-10-AM	CZO-06606	12197	1079Z2436	3K45160
DIL10M	CZO-066185	14516	1079Z25	3K45161
	CZO-308555	15068-14	1079Z27	3K45242
	CZO-308680	150995	1079Z28	4079Z110
			1079Z2812	4079Z126

4079Z127	80F374D7	L42301	CO-2	25-106-933-812
4079Z150	80F385D1	L42439	CO-20	25-112-000-501
4079Z151	80F385D11	L-42439	CO-21	25-113-000-501
4079Z152	80F385D2	RAD-1	CO-3	25-114-000-501
4079Z178	80F385D4	RPH-16	CO-34	29-101-400-001
4079Z195	80F385D8	RPH-26	CO-35-5	29-101-401-001
4079Z196	80F386D1	RPH-28	CO-36	3RT1934-6A
4079Z22	80F386D10	RPH-6	CO-37	3RT1935-6A
4079Z23	80F386D11	TEI-1	CO-38	3RT1936-6A
4079Z27	80F386D12	TEI-2	CO-39-1	3RT1944-6A
4079Z35	80F386D13	TEI-3	CO-4	3RT1945-6A
4079Z45	80F386D14	TEI-4	CO-5	3RT1946-6A
4079Z74	80F386D2	TEI-5	CO-6	3RT19546A
4079Z75	80F386D3	TEI-6	CO-6-2	3RT1954-6A
4079Z94	80F386D4	TEI-7	CO-7	3RT1955-6A
4K45160	80F386D5		CO-8	3RT1956-6A
4K45161	80F386D6	Penn	CO-82	3RT1964-6A
4K45242	80F386D7	A64438		3RT1965-6A
5K45160	80F386D8	A64439	Rowan ITE	3RT1966-6A
5K45161	80F386D9	C64462B	3120G1	3RT1975-6A
5K45242	80F387D11	C97339C	3121G1	3RT1976-6A
6K45160	80F387D11	C97339D	3833G1	3TY1210-OA
6K45161	80F387D12	FA-10373	5375	3TY1220-OA
6K45242	80F387D13	FA-10374	5377	3TY1230-OA
78F463C1F1	80F387D14	FB-5932A		3TY1240-OA
79F305C1F1	80F387D15	SCA01146A00A	Siemens	3TY1260-OA
79H1107	80F387D16	SCA01437A00A	14-124-454-001	3TY1280-OA
79H1348	80F387D2	SCB00374A00A	14-125-864-001	3TY1300-OA
79H1359	80F387D3	SCB00384A001	14-126-260-001	3TY1320-OA
79H1561	80F387D4		14-127-814-503	3TY2440-OA
79H1562	80F387D5	Reliance	14-127-817-501	3TY2480-OA
79H1563	80F387D6	78093-60AP	14-131-453-001	3TY2520-OA
79H1564	80F387D9	78094-60AP	14-132-171-001	3TY2560-OA
79H1565	80F418D1	78094-61AP	14-133-172-001	3TY6440-OA
79H1683	80F418D10	78095-60AP	14-134-047	3TY6460-OA
79H1684	80F418D12	78095-61AP	14-134-047-801	3TY6470-OA
79H2115	80F418D4	78096-60AP	14-134-875-801	3TY6480-OA
79H2171	80F418D6	78096-61AP	14-134-875-801S	3TY6500-OA
79H2181	80F418D8	78097-60AP	14-134-893-801	3TY6520-OA
79H3145	80H389	78097-61AP	14-187-872-801	3TY6540-OA
79H378	80H390	78464AB	14-188-597-504	3TY6560-OA
79H393	80H782D1	78464AE	14-189-790-511	3TY6580-OA
79H425	80H782D2	K200	14-192-887-803	3TY7440-OA
79H442	80H783	K201	14-193-100-229	3TY7450-OA
79H443	80H784	K250	14-193-100-241	3TY7460-OA
79H549	80H807	K256	14-193-100-244	3TY7470-OA
79H550	80H809F1	K257	14-193-100-278	3TY7480-OA
79H583	80H812	K258	14-223-526-00	3TY7490-OA
79H708C1	80H835	K259	14-969-101-09-026	3TY7500-OA
79H734	80H838	K260	25-104-592-502	3TY7510-OA
79Z761	80H840	K261	25-104-594-501	3TY7520-OA
7K45160	80H841	K300	25-104-595-501	3TY7530-OA
7K45161	80H843	K350	25-105-147-501	3TY7540-OA
80F374D1	80H877D1	K352	25-105-196-501	3TY7550-OA
80F374D10	8K45160	K353	25-105-197-501	3TY7560-OA
80F374D17	8K45161	K354	25-106-921-812	3TY7570-OA
80F374D19	9K45160		25-106-922-812	3TY7580-OA
80F374D2	9K45161	Ringsdorf	25-106-923-812	CLMGCK02
80F374D4	9K45242	CO-1-2	25-106-924-812	KC1

NT-103	NT-717	U-205	Stromberg ABB	LA5F630804
NT-104	NT-718	U-211		LA5-F630804
NT-105	NT-78	U-211B	OKYM6W	LA5F780803
NT-106	NT-983	U-212	OKYZX109	LA5-F780803
NT-107	NT-984	U-212B	OKYZX-109	LA5FF431
NT-108	NX-58	UA-81	OKYZX20	LA5-FF431
NT-109	NX-59	UA-82	OKYZX-20	LA5FF441
NT-110	NX-60	V-1015	OKYZX22	LA5-FF441
NT-111	NX-61	V-1094	OKYZX-22	LA5FG431
NT-112	NX-62	V-1095	OKYZX24	LA5-FG431
NT-1158	NX-63	V-1096	OKYZX-24	LA5FG441
NT-1185	PD-1-1	V-1149	OKYZX31	LA5-FG441
NT-119	PD-1-2	V-116	OKYZX-31	LA5FH431
NT-120	RA-81	V-1256	OKYZX32	LA5-FH431
NT-1353	RA-82	V-1264	OKYZX-32	LA5FH441
NT-1530	RA88	V-145	OKYZX33	LA5-FH441
NT-18A	RA-88	V-146	OKYZX-33	LA5FJ431
NT-256	SA705	V-147A	OKYZX-42	LA5-FJ431
NT-29	SA-705	V-2141		LA5FJ441
NT-30	SA-81	V-216	Struthers-Dunn	LA5-FJ441
NT-31	SA-82	V-298	12314	LA5-FJ441
NT-32	SI-132-A	V-3003	15882	LA5FK431
NT-33	SI-86A	V-321	35890	LA5-FK431
NT-34	SL-10	V-322	35900	LA5FK441
NT-349	SL-11	V-323A	35909	LA5-FK441
NT-35	SL-13	V-359		LA5FL431
NT-350	SL-14	Z-028	Telemecanique	LA5-FL431
NT-351	SL-2	Z-1109	CN1 FC803	LA5FL441
NT-354	SL-26	ZC-1078	CN1 GC803	LA5-FL441
NT-36	SL-27	ZC-160	CN1 HC803	PA2 FB80
NT-37	SL-28	ZC-2078	CN1 JC803	PA2 GB80
NT-38	SL-29	ZC260	CN1FC803	PA2 HB80
NT-39	SL-3	ZC-260	CN1-FC803	PA2FB80
NT-392	SL-4	ZC-3106	CN1GC803	PA2-FB80
NT-40	SL-6	ZCX-60	CN1-GC803	PA2GB80
NT-41	SL-7	ZCX-60S	CN1HC803	PA2-GB80
NT-42	SL-8	ZO-1109	CN1-HC803	PA2HB80
NT-43	SL-9		CN1JC803	PA2-HB80
NT-435	SS-0751	Starkstrom	CN1-JC803	PN1 EA80
NT-44	SS-0751S	DLS10	CN2-FC803	PN1 FB80
NT-45	SS-0755-A	DLS100	CN2-GC803	PN1 GB80
NT-46	SS-0755-AS	DLS101	CN2-HC803	PN1 HB80
NT-47	SS-0834	DLS120	G203C	PN1 JB80
NT-470	SS126	DLS151	G203D	PN1 KB80
NT-48	SS-1621A	DLS18	G203E	PN1EA80
NT-49	SS-1642	DLS18/25	G203F	PN1-EA80
NT-50	SS-1687A	DLS200	G203G	PN1FB80
NT-53	SS226	DLS25	G203HA	PN1-FB80
NT-54	SS-226	DLS30	LA5-630804	PN1GB80
NT-57	SS-228	DLS31	LA5F400803	PN1-GB80
NT-58	SS-2332A	DLS40	LA5-F400803	PN1HB80
NT-59	SS-2333A	DLS46	LA5F400804	PN1-HB80
NT-60	SS-2635	DLS60	LA5F400804	PN1JB80
NT-61	SS-2642		LA5F500803	PN1-JB80
NT-62	SS-326	Stone	LA5-F500803	PN1KB80
NT-64	SS-365	S6795-25	LA5F500804	PN1-KB80
NT-679	SS-426	S6795-31	LA5-F500804	
NT-715	SSX-15	S7083-31	LA5F630803	Trane
NT-716	TA-81		LA5-F630803	1233
				1234

1235	133767	1717261	259B699G02	373B331G11
1236	133768	1735553	25D6375G02	373B331G12
1237	133770	1745051	25D6380G01	373B331G13
K292	133771	1745052	261D038H02	373B331G14
Wabco	133772	1745053	261D134G01	373B331G15
VM0259	1358145	1745054	261D134G02	373B331G18
VM0260	135898	1745056	261D146G01	373B331G20
VS9285	1399206	1745058	261D146H03	373B331G21
VS9286	1400987	1745060	261D146H05	373B331G22
	1405080	1765874	261D146H08	373B331G23
Wagner	1486802	176A147A01	261D146H09	373B331G24
64-25702	1486803	176A561H01	266C673G01	373B331G25
64-25708	1486804	176A688H01	266D198H18	373B331G26
64-25714	1486805	177070	26D2610G14	373B331G27
65-08524-000	1491412	177A119H01	26D2610G15	375532
65-9009-002	1491414	178623	26D2610G16	375538
TE-9010	1491421	178791	26D2610G18	378241
	1494552	179543	26D2610G19	37906
Ward Leonard	1494553	1801648	26D2610G20	380395
22796.11-1	15121604-64	1804096	26D2610G21	380399
22796.12-1	1527304	180C180G01	26D2610G22	424D549G04
22996.25-1	1528363	180C180G02	26D2610G23	424D955G06
5999-2371	1529200	180C180G05	26D2610G24	431C012G01
5M45	1529345	180C180G06	280394	431C013G01
5M49	153072	184665	281938	4405A32G01
5M52	1530722	1875399FTR	281940	4405A32G02
5M53	1530723	196246	281941	4405A32G03
5M54	154736	201279	282812	4421A39H01
5M56	154895	201280	28D1729G01	4421A39H01
	1572694	201281	28D5291G01	448605
Westinghouse	1572799	2018A14G18	28D5296G02	452C33H07
0660133R0004	1572800	2050A16G11	293590	457197
0665109R0001	1576764	2050A16G13	295B408G3	458C149G07
0765500R0002	1579035	2066A10G11	298437	461A700G3
1016505	158057	2066C75G02	298442	461A757G17
1023028	1581766	20B5355G07	302C596	462C302GR3
1070215B	1584472	20C0163G03	305C659G02	466792
1070216B	1584473	20D1229G01	305C661G02	471C167GR1
1070218B	1589490	2126A44G01	30B9355G07	471C339H07
1073593	1605202	2131A94G10	310020	472267
1086852	1605212	2147A22G01	316B948G01	472267
1089375	1611768	2147A42G01	316B948G02	475C858G01
110046	1617987	2147A72G01	317724	477B477G01
1116990	1617988	2147A72G02	318949	477B477G03
114C5382P2	1620041	216291	322325	477B477G05
1170687	1620042	216292	324CWE041561	477B477G06
1175822	1620043	217A700G15	328B881GR1	480385
11C2098G01	1620145	2184A10G14	332P234GR1	480390
1224773	1620146	220489	3354D90G08	482B593G03
1224774	1625563	220490	3354D90G09	490A898G28
1226587	1625564	225C831G03	349B518G02	492759
1251187	1625797	225C831H01	358721	516B470G01
1265168	162A576H05	231C471G02	358730	516B470G02
1265912	1633962	250D307G2	358731	517B624G01
126932	170C184G01	254755	373B331G04	517B624G02
1302655	171218	256922	373B331G07	518B305G1
1310486-F	171218A	256956	373B331G08	5250C81G01
1332863	171532	256956S	373B331G09	5250C81G02
	171533	256A167G03	373B331G10	5250C81G16

5250C81G17	702C767G01
5250C81G18	73C0971A01
5346D19GR1	74883
5346D21G01	756B077G2
5346D21G02	757451
540269	764207
542290	764222
54C3136G01	764455
550866	770B440G01
550D409G18	770B443G01
550D409G19	770B444G01
557317	771C112G01
557968	776560
557969	780298
557970	785C156H04
557972	785C156H06
559141	7D5244G01
559142	7D5264G01
559144	811C985H06
55D8553H01	814A601G1
5613D69G01	816117
562447	816A837H01
5708D56H01	8207C65G02
593A892G01	847734
594324	849379
5A4579	850334
617D082GR2	850337
626B187G12	850703
626B187G13	850787
626B187G14	859231
626B187G15	884595
626B187G16	884596
626B187G17	891D325G02
626B187G18	895117
626B187G19	919375
626C829G05	919376
646C829G05	919939
646C834G03	919940
660C215G04	93641D55G01
660C215G05	94401
661030	969137
661C462H35	969138
661C462H36	969919
661C462H37	RCK-45
661C463H69	RCK-56
661C463H76	SCK-3
661C464H37	SCK-45
661C466H28	SCK-56
661C466H70	WCK13
661C466H71	WCK-13
672B788G03	WCK23
672B788G09	WCK-23
672B839G01	WCK33
672B839G02	WCK-33
672B839G21	WCK43
672B839G22	WCK-43
680042	WCK53
701C420G06	WCK-53
701C618G01	WCK63

WCK-63

**NOT ALL OF THE NUMBERS
IN THE NUMERICAL INDEX
ARE CONTAINED IN THE
CATALOG, BUT THEY ARE
AVAILABLE.**

REPALLOY®



Repcos developed the Repalloy® process in 1996. This innovative technology is designed to extend contact life and improve performance. Whether the contact material is copper, copper alloy, silver or silver alloy, it can be Repalloy® treated. Laboratory and field tests show a life that's more than double the normal expectancy for silver-tipped contacts.

In an independent laboratory test, Repalloy® treated contacts outlasted the original OEM product 2.68 times. The test was performed and certified by Environ Labs of Minneapolis, MN. Two 25-amp DC contactors were subjected to 54 amps. The untreated OEM contacts lasted 257,748 cycles. The Repalloy® treated contacts lasted 691,548 cycles.

Whether the motor and control system is used to move material or air, or to pump liquids, Repalloy® treated contacts are guaranteed to last twice the life of any other contact being used. If not completely satisfied, your money will be refunded. Repalloy® treated contacts help keep costs down and provide true operational savings.

FREE CATALOG

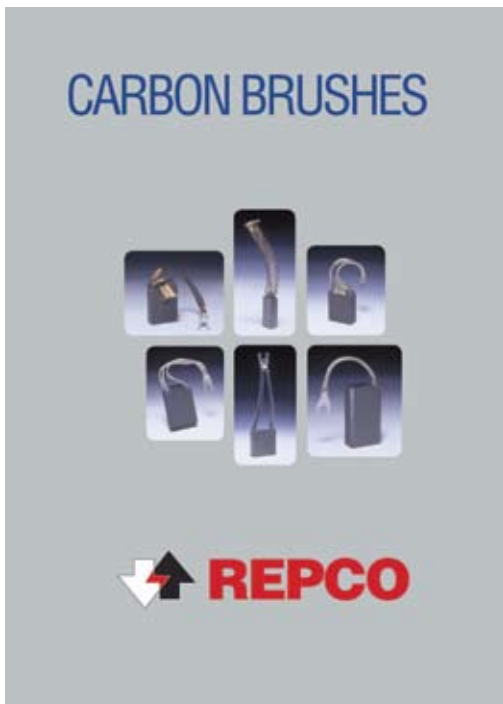

This catalog features 300 replacement carbon brushes for industrial motors and generators. Repco supplies either the OEM or its equivalent brush. Repco brand brushes provide a fully guaranteed, quality and lower-cost alternative to OEM items. Over 1500 different catalog items are stocked at our Marlton, NJ warehouse.

This publication features Repco brushes for 30 motor and generator manufacturers including:

- ABB
- Alstom
- Baldor
- Century
- Eaton-Dynamatic
- Electric Machinery
- Emerson
- GE
- Gettys
- Imperial
- Indiana General
- Leeson
- Leroy-Somer
- Lincoln
- Louis-Allis
- Northwest
- P & H
- Pacific Scientific
- Reliance
- Siemens
- Warner Brake
- Westinghouse

Call 800-822-9190 and ask for your copy of the Carbon Brush catalog.



6 Eves Drive • Marlton, NJ 08053

TOLL FREE: (800) 822-9190 • FAX FREE: (800) 424-9224

www.repcoinc.com • sales@repcoinc.com