

GAUGE BOARDS



10 year old D53



D50

A range of water depth gauge boards produced to BS EN ISO 4373:2008, docks & harbours design & Traffic Regulation Standard designs.

This leaflet introduces the standard design boards, normally held in stock. In addition to the British Standard design boards bespoke, special designs are available - size, colour and digit size can all be amended. Please contact us if you require more details about these options.

Gauge boards are produced in our exceptionally robust Encapsulated Glass Reinforced Plastic (GRP) process – this board has been in Pwelli Marina for over 10 years and is a testament to the durability of the material in both fresh water and sea water environments

Gauge boards are suitable for use in rivers, reservoirs, marinas, dock, harbours, canals and water courses. A brief explanation of the standard designs is given overleaf.

Standard Gauge Board Designs

Inland Design Boards



D50 Style Gauge Boards

The D50 gauge board is an inland style board, produced at a width of 145mm, in 1m long sections which are butted together for greater depths. The D50 reads above datum, the D50R is a reverse board for reading below datum. The D50(Z) reads above and below a datum, usually zero. The D50 is the most popular style of inland board.

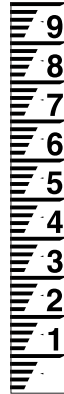

D50

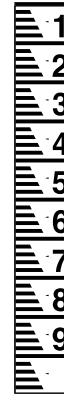

D50 (R)



D50 (Z)



D50 Red



D50 Photoluminescent



D50 Retroreflective

D64 Style Gauge Boards

The D64 works to the same principles as the D50 but at 100mm wide is a narrower board and is used where space is more restricted.



D64



D64 (R)



D64 (Z)



D64 Red



D64 Photoluminescent



D64 Retroreflective

Imperial Boards

The standard design is 3' high x 6" wide.



Imperial



Combined Imperial & Metric

SEPA Boards

A special design board at 1000 x 70mm.



SEPA

Numeral Plates

Red datum numeral plates are used to show datum or metre graduations. They can be printed as a main part of the board or supplied as separate numerals. Please specify the digit required.

Plate sizes:

D50 55 x 75mm

D64 35 x 70 mm

Full size top digit 145 or 100 x 75mm

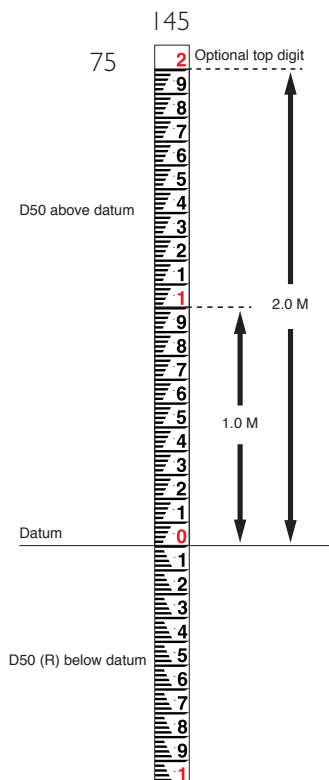

Using Inland Boards

Boards are 1m long with the top of each board reading the full metre. Red datum numerals are used to indicate the metre depths while a separate digit can be supplied for the top reading.

V Notch Plates

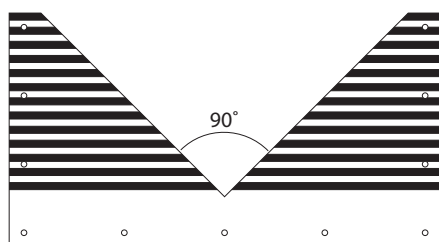

V notch plate standard sizes

Angle	Width	Length
28° 4'	132 mm	178 mm
53° 8'	240 mm	240 mm
90°	610 mm	330 mm

Incline Gauge Boards

Gauge boards are often fitted at an angle to a bank or wall. The standard design is adapted to allow for the incline. We have standard artwork for 30 degree and 45 degree but most locations require artwork to be created.

To quote or create the artwork for incline gauge boards we require at least 2 of the following dimensions

- Vertical fall to be measured
- Overall face length of gauge board
- Angle of incline

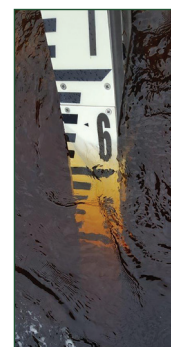
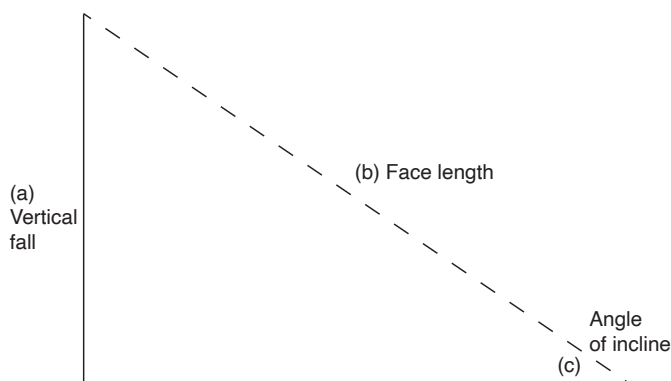

Incline gauge board

Fords & Floods

The Traffic Signs Regulations provide standard design gauge boards for use at fords or locations where flooding is a persistent problem. The zero level is the lowest part of the carriage way. Gauges should be sited so the depth of the water can be seen by road users on both approaches.

To comply with traffic regulations the imperial design (Ref 826) or combined imperial / metric (Ref 826.1) may be used but metric units must not be used alone.

The imperial board has a standard size of 225 x 2150mm, the combined board a standard size of 615 x 2175mm.

Ref 826 V is a narrower version of the combined gauge board at 230mm wide.



Ref 826

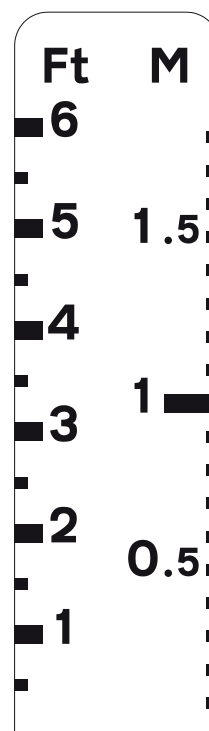

Ref 826.1

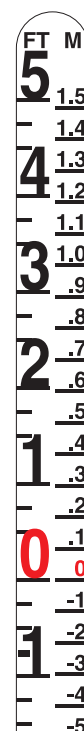

Ref 826 V

Tidal Design Boards

The D53 gauge board is a tidal design board, produced at a width of 300mm, in 1m long sections which are butted together for greater depths. The D53 reads above datum, the D53R is reverse board should you wish to read below a datum point.



D53



D53 (R)



D53 White on black

Using Tidal Boards

The bottom of each graduation on a tidal board gives the appropriate depth. Position the bottom tidal board 200mm above datum to allow for this.

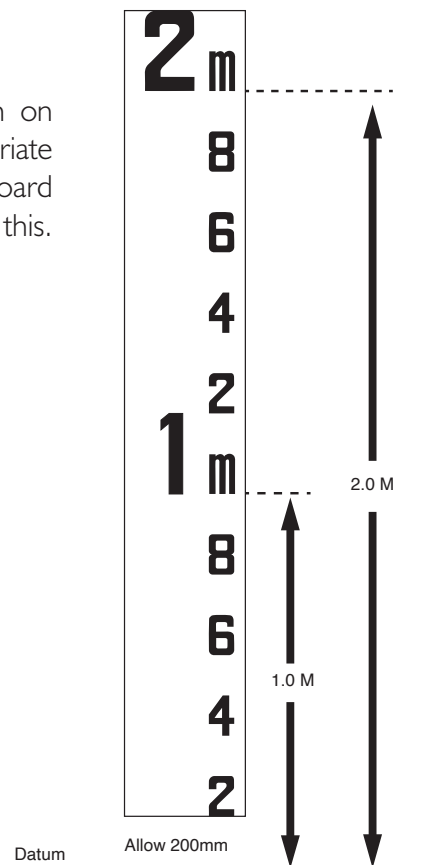

High Contrast Digits

If you plan using boards with infra red or cameras these high contrast digits enhance legibility. These digits can be used on all boards including the standard GRP finish, retroflective and photoluminescent finishes.

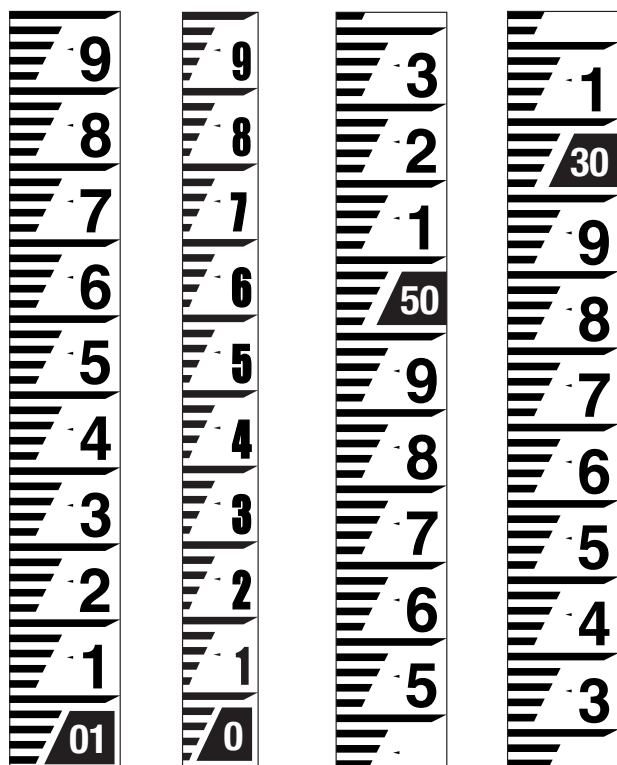

Air Draught Boards

Draught boards are designed to measure clearance heights under bridges and structures. They are normally produced as 300mm wide boards, reading in reverse. To ensure they are distinctive black text on a yellow background is a common colour combination.

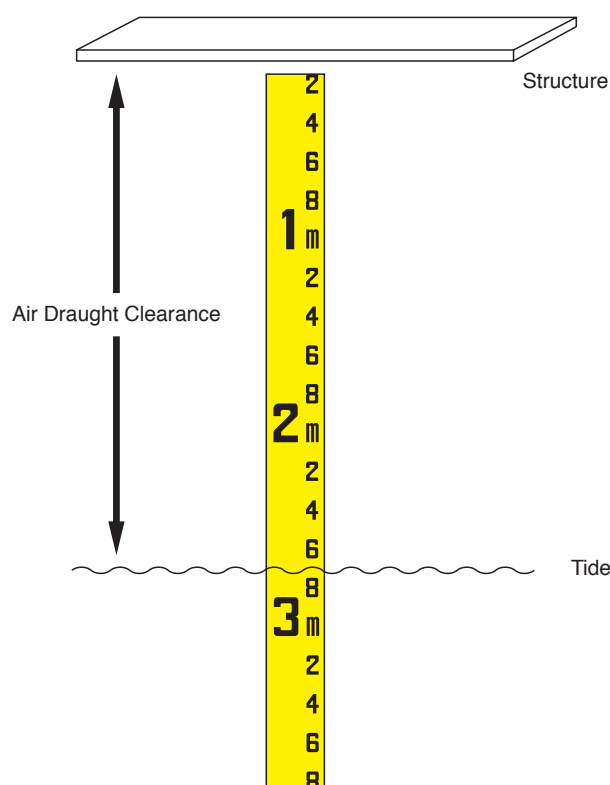

Non Standard: We design & produce non-standard gauge boards with a few examples shown in this section. Prices for bespoke boards are available on request.

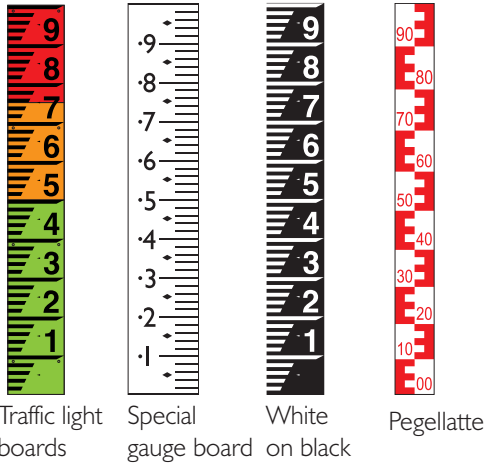

Traffic light boards Special gauge board White on black Pegellatte

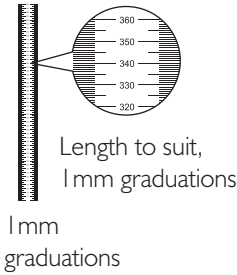

1mm graduations

Other Gauge Board Examples

Reflective Boards:

All gauge boards can be produced either a) with a Retroreflective finish that shows up clearly in the dark under a direct light, or, b) with a glow in the dark, Photoluminescent finish.

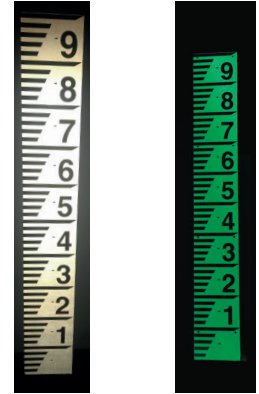

Retroreflective gauge board Photoluminescent gauge board

Posts & Brackets

We can quote to supply galvanised steel, recycled plastic or hardwood posts on request. Gauge boards have also been supplied with aluminium frames & ladder structures that can be bolted together on site. Please ask for details.



Galvanised steel post Recycled plastic post

Backing Boards

Boards can be supplied with 19mm thick PVC backing boards. These are not self-supporting but are intended to provide a smooth surface if you are fitting to an uneven wall and allow up to 3m of board to be fitted to one structure.

Fixing systems

Simple steel T section for setting off a wall at 90° or angle to suit. Single or double-sided.

Ladder system with fixing bracket at the top and sections that bolt together. Suitable for tanks or difficult access.

Sub-frame and brackets for fixing direct to wall or structure.

Standard Gauge Board Fixing

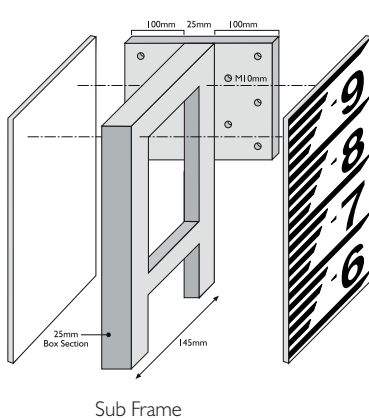

GRP Gauge Board pop rivet to H frame

Aluminium D50 Gauge Board Support Ladder

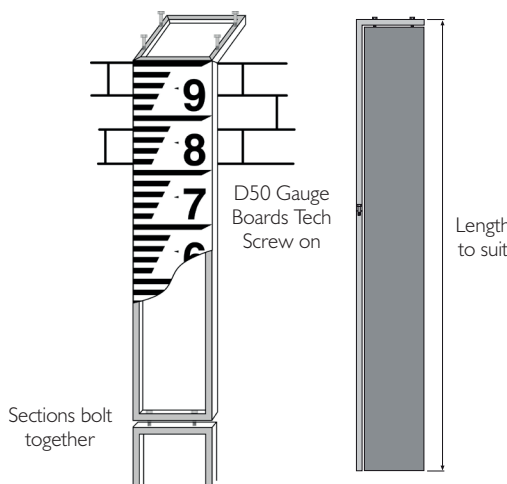

Sections bolt together

25mm Sq Aluminium Box Section

D50 Gauge Boards Tech Screw on

Aluminium D50 Gauge Board Support Ladder

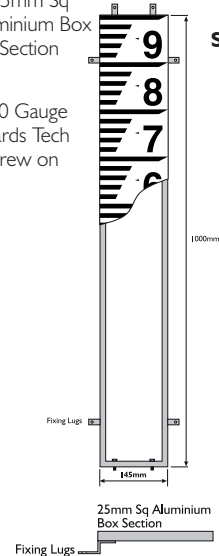

How To Order

For most clients we prepare a formal quotation to match your needs. This page provides an introduction to gauge boards but please either email your particular specification or call to chat through the options. We can accept instructions to proceed by email and normally raise an invoice when the boards have been despatched.