

# CATALOGUE CONDENSING UNITS

EUROPEAN RANGE 50Hz



COOLING FOR A BETTER TOMORROW™



*Tecumseh*



# A WORD FROM THE DIRECTOR

Tecumseh Europe has been established for more than 85 years as a major player in commercial refrigeration, combining product expertise and commitment to its customers.

Our reputation as a key player in the market is based on the simple principles driving our business: understanding our customers' issues and meeting their needs. It is thanks to the trust placed in us by each of our customers that we can continue to innovate and offer appropriate solutions.

Rising to the challenges currently facing our industry, combining professional expertise and passion, the Tecumseh teams are fully mobilised and at your side.

**François Bouillot**  
**Managing Director**



# TABLE OF CONTENTS

## INTRODUCTION

## TRADITIONAL CONDENSING UNITS

## WINTSYS®

## SILENSYS®

## SILENSYS® INVERTER

## RACK TRIO QUATTRO INFINEE®

## TOOLS

Tecumseh, at its customers' side .....	<b>08</b>
The Tecumseh laboratories, guaranteeing performance .....	<b>12</b>
The environmental transition .....	<b>14</b>
Focus on liquid refrigerants with glide .....	<b>15</b>
The widest range of products on the market .....	<b>16</b>
Nomenclature .....	<b>18</b>

**07**

LBP (Low Back Pressure) .....	<b>22</b>
MHBP (Medium High Back Pressure) .....	<b>26</b>
Dimensions .....	<b>34</b>
Application windows .....	<b>36</b>

**21**

LBP (Low Back Pressure) .....	<b>40</b>
MHBP (Medium High Back Pressure) .....	<b>41</b>
Dimensions .....	<b>43</b>
Application windows .....	<b>44</b>

**39**

LBP (Low Back Pressure) .....	<b>48</b>
MHBP (Medium High Back Pressure) .....	<b>50</b>
Dimensions .....	<b>53</b>
Application windows .....	<b>54</b>

**47**

MHBP (Medium High Back Pressure) .....	<b>58</b>
Dimensions .....	<b>60</b>
Application windows .....	<b>61</b>

**57**

Rack Trio Quattro .....	<b>64</b>
Infinee® .....	<b>66</b>

**63**

Tools .....	<b>70</b>
-------------	-----------

**69**

**TECUMSEH, AT ITS CUSTOMERS' SIDE .....08**

- ▶ An international player
- ▶ A local presence
- ▶ Over 80 years of expertise
- ▶ Integrity – Excellence – Passion – Team Spirit – Respect

**THE TECUMSEH LABORATORIES, GUARANTEEING PERFORMANCE ...12**

- ▶ The Tecumseh laboratories
- ▶ Certified products

**THE ENVIRONMENTAL TRANSITION .....14**

**FOCUS ON LIQUID REFRIGERANTS WITH GLIDE .....15**

**THE WIDEST RANGE OF PRODUCTS ON THE MARKET .....16**

- ▶ From the simplest to the most extensively equipped

**NOMENCLATURE .....18**

- ▶ Explanation of the designation of the model names
- ▶ Explanation of the codes and voltage ranges
- ▶ The serial label





# INTRODUCTION

# AN INTERNATIONAL PLAYER

The **mission** of Tecumseh Europe, subsidiary of American Group Tecumseh Products Company, is to make life better through cooling. Tecumseh improves everyday life by offering a full range of compressors and condensing units. These products are intended for customers' food preservation and thermal comfort applications.

Tecumseh **aims** to become the expert in innovative, sustainable and safe cooling solutions for commercial use.

Aiming for global success and exceeding its results, Tecumseh is committed to participating in the success of its customers by offering innovative, certified and environmentally-friendly products.

## TECUMSEH AROUND THE WORLD

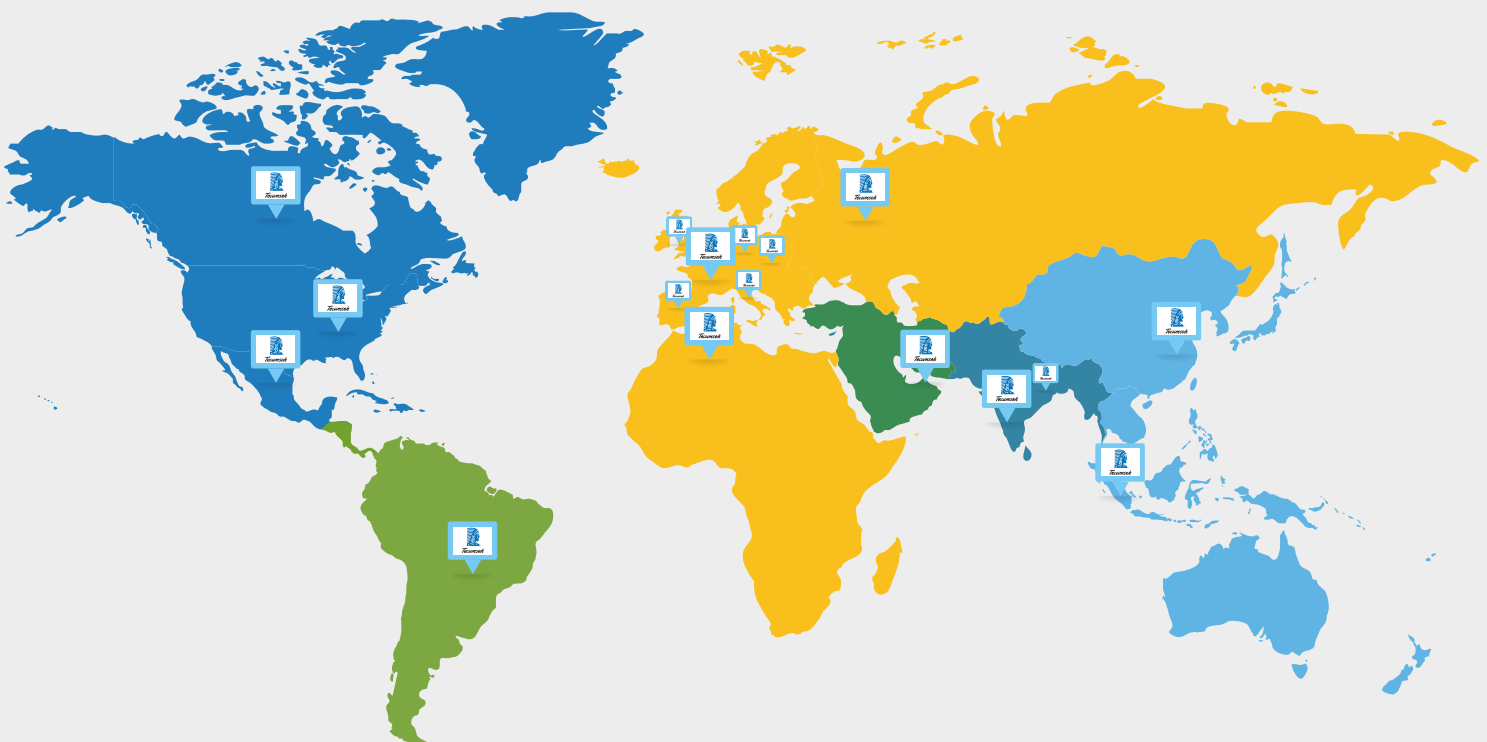
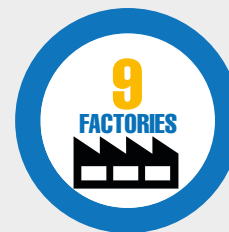



# A LOCAL PRESENCE

Tecumseh's largest geographic area, Tecumseh Europe, covers the whole of Europe and Africa. The headquarters of this subsidiary is located in the Auvergne-Rhône-Alpes region of France, in the heart of Europe. In order to be as close as possible to its customers, the company has a reinforced commercial presence across the entire area, with offices in Germany, Spain, Italy, Poland, the United Kingdom and Morocco, and European coverage extending as far as Russia.

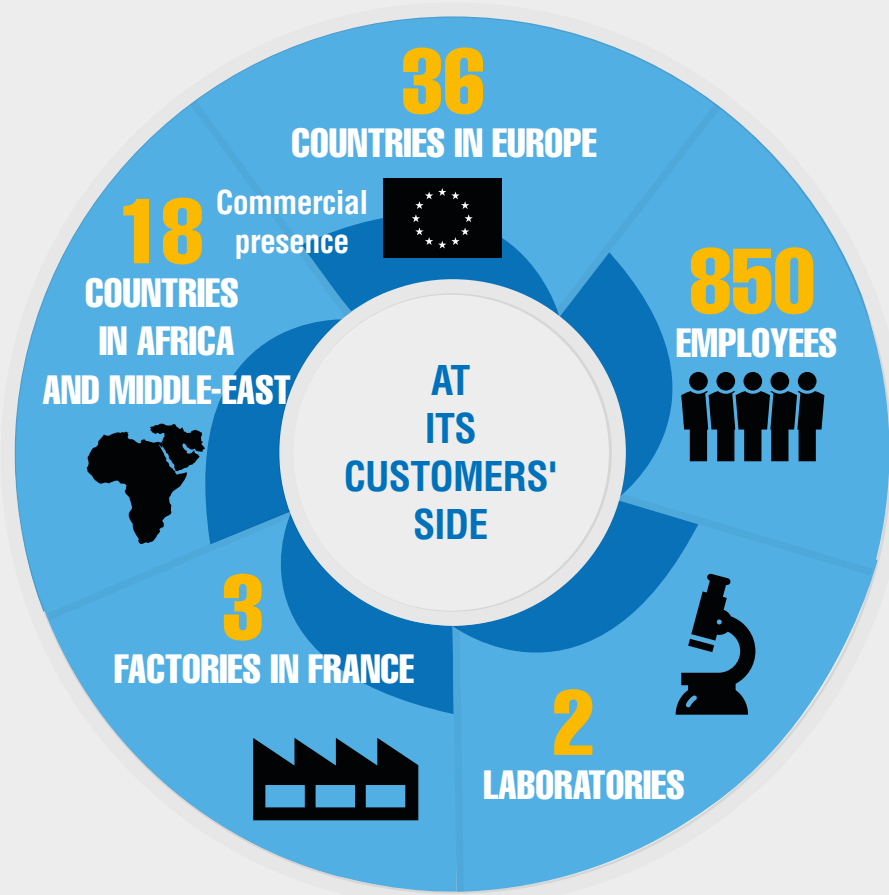

## OUR PLANTS IN FRANCE





# INTEGRITY - EXCELLENCE

# PASSION - TEAM SPIRIT - RESPECT

Listed in the Tecumseh Products Company's DNA, our values are expressed in the daily lives of all teams around the world by guiding our actions and behaviors.



**Integrity** is a value based on the principle of consistency. We carry ourselves in a way where integrity is visible through our actions, words, decisions, methods and outcomes. We lead with honesty and authenticity and move forward with intentionality and thought. We are who we are always, regardless of the situation or the environment we are in. We recognize our impact on the world and those around us and are actively focused on the development of character. Most importantly, we lead by example and draw those around us to be on the same journey.



**Excellence** is also a founding value. By engaging with our customers, suppliers and partners, we always looking for perfection. The highest degree of quality applies everywhere: design of compressors and condensing units, search for safety, understanding customer needs. We share this desire to go beyond ourselves to offer the best to our customers.



If for 85 years, we have been dedicated to a single profession, commercial refrigeration is primarily for **passion**. Passion for what refrigeration brings to individuals: serenity, pleasure. Passion also for a profession concerning a precision industry, with the desire to design new solutions and deploy the enthusiasm to create them. Passion drives each of our 5,000 employees every day.



**Teamwork** is a value that has always been rooted in our practices and the involvement of our employees. It is the union of all our talents that shapes this spirit: the skills of one team with the expertise of others and thus contribute to our success. This team spirit gives full meaning to the relationship we build with our customers, partners and suppliers.



Finally, **respect** is embedded in our culture, animated since its inception by deep human values. Diversity and complementarity are considered as a wealth, a source of dynamism and creativity. Beyond an attitude of listening, respect is about fulfilling commitments in the long term. Respect is an integration of internal social responsibility as well as environmental responsibility.

# THE TECUMSEH LABORATORIES

**Reliability and efficiency** are the key words for all Tecumseh products.

Our laboratories are unique tools, carrying out a range of R&D tests, certifications and measurements specific to the condensing units and compressors. In this way, Tecumseh guarantees customers the optimum operation and service life for its products.

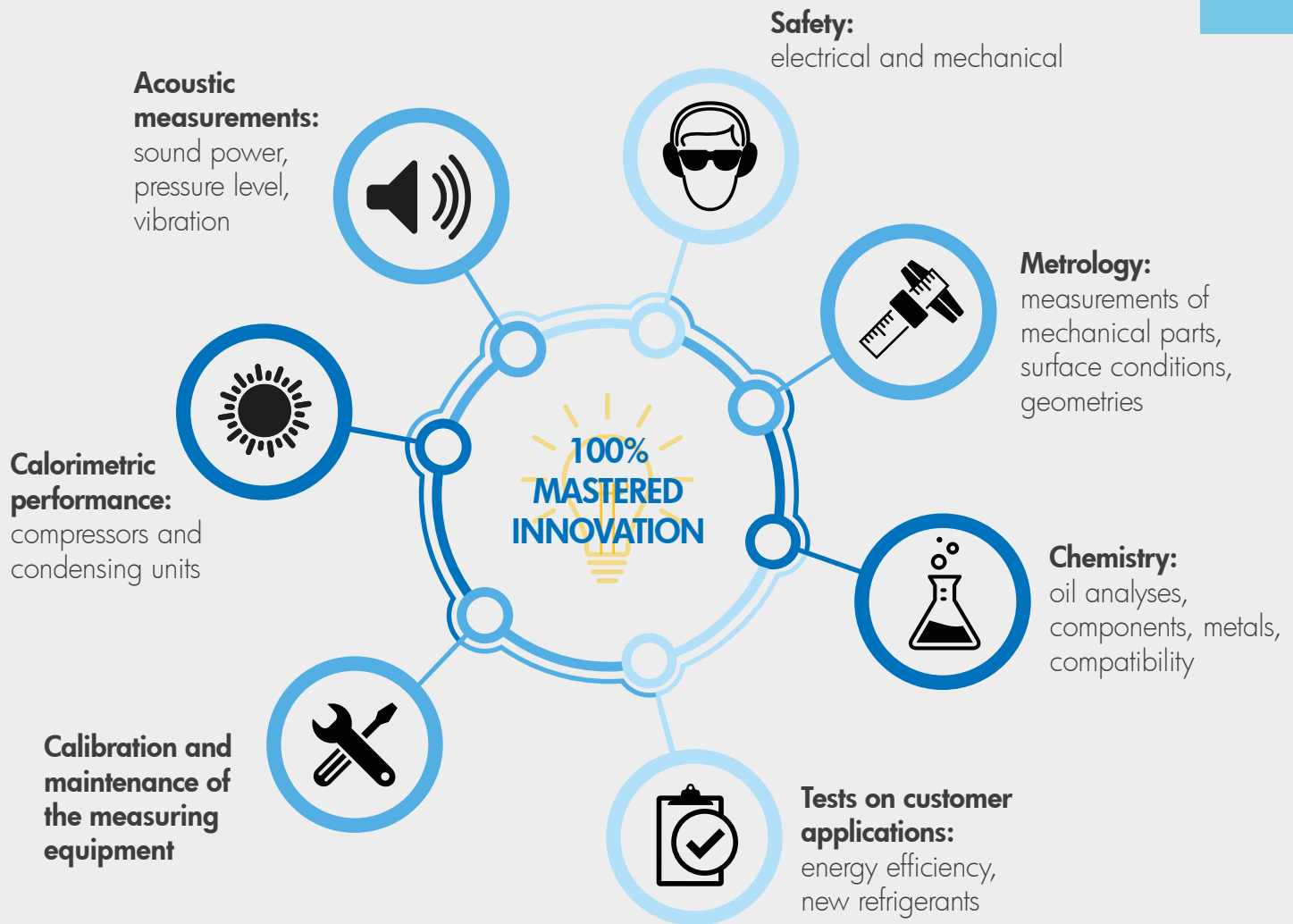



## 29 TEST CHAMBERS AND 4 MOTOR TEST BENCHES



**17** calorimeters



**3** endurance rooms



**2** acoustic rooms



**7** climatic rooms



**50** engineers and technicians



**800** test reports per year



**1200** measuring sensors



**2500** products tested by year

## CERTIFIED PRODUCTS

Tecumseh wishes to provide its customers with innovative products and services of excellent quality and high added value. So, it favours product certification.

### QUALITY AND ENVIRONMENT

The two Management systems run by Tecumseh testify to its day-to-day commitment and its ability to maintain and advance its certifications.

#### ASERCOM

An active member of ASERCOM for more than 20 years, Tecumseh Europe submits all its products to the association certification procedures.



The performance and quality of Tecumseh products are measured in the laboratory in accordance with the procedures and conditions defined by standards EN 13771-1 and -2 and declared in accordance with EN 13215 and EN 12900. They are also compared to the competing products certified by ASERCOM.

#### ISO 17025 by the COFRAC

Audited every year, the laboratory is accredited for 2 test programmes:

- ▶ Refrigerating performance of compressors and condensing units
- ▶ Electrical and mechanical safety

The laboratory guarantees the accuracy of the measurements provided and the conformity of the products to installers, specifiers and users.

Accreditation n° 1-6818.  
Scope available on  
[www.cofrac.fr](http://www.cofrac.fr)



#### ISO 9001, version 2015: Quality Management System

This certification fulfils the needs and expectations of our customers by offering products that meet the requirements of the European regulation.



#### ISO 14001, version 2015: Environmental Management System

The Cessieu plant has received ISO 14001 certification. This certification attests to Tecumseh's commitment to environmental aspects.



# THE ENVIRONMENTAL TRANSITION

The condensing units offered by Tecumseh meet the requirements of the European directives:

- ▶ The requirements of the European **Ecodesign directive 2009/125/EC** relating to electrical devices affecting the level of energy efficiency of the condensing units through EU Regulation 2015/1095-Lot 1.
- ▶ The application of the European **F-Gas directive 517/2014** is gradually restricting the use of Hydrofluorocarbon (HFC) liquid refrigerants over time, with a high level of reduction of the marketing of new products imposed in 2018 and 2021.

## THE ADVANTAGES OF THE TECUMSEH RANGE, YOUR PARTNER OF CHOICE:

- ▶ Condensing units with low power consumption
- ▶ An approved range with liquid refrigerants A1, A2L and A3
- ▶ A wide and varied range

## A CHOICE OF LOW GWP FLUIDS

Since January 2018, there is a range of hermetic condensing units compatible with fluids having a GWP (Global Warming Potential) which are 50 to 60% lower than the fluids that they replace, those available are:

- ▶ **R452A/R404A** for low pressure and medium high pressure
- ▶ **R134a/R513A** for medium high pressure

## THE LIQUID REFRIGERANT ROADMAP

By 2030, the F-Gas directive will limit the availability of HFCs, all fluids and all applications combined to 21%.

**Between 2020 and 2022**, additional measures will prohibit the use of HFCs with high GWP for certain applications such as fixed refrigeration equipment or mobile air conditioning.

**Eventually**, in order to limit the proliferation of alternatives, the choices of liquid refrigerants for commercial refrigeration will be made according to market requirements, which tend to synthetic fluids or natural fluids with GWP lower than 150.

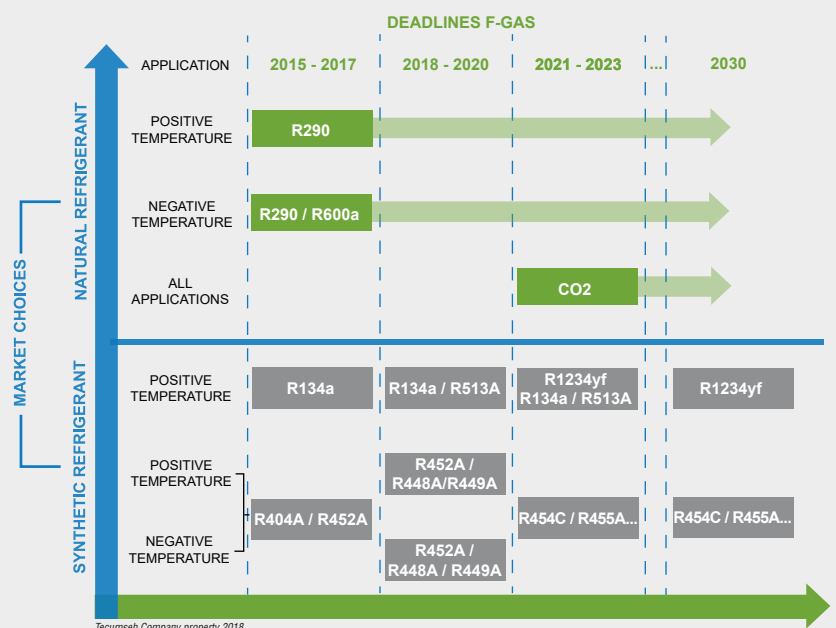

ROADMAP OF PRODUCT LAUNCHES IN LINE WITH THE F-GAS CUT-OFF DATES



# FROM THE SIMPLEST...

## TRADITIONAL CONDENSING UNITS



**W** **COOLING CAPACITY**  
ACCORDING TO EN13215 and SH 10 K

**-30°C evap.:** from 0.2 to 5.9 kW  
**-10°C evap.:** from 0.1 to 17 kW

- ▶ A stretch of cooling capacity to suit all requirements with high efficiency
- ▶ Compactness for ease of integration within applications
- ▶ Recognised reliability

**OPTION:**

- ▶ Liquid line with full pre-equipped units

## WINTSYS®

PRE-EQUIPPED AND EASY TO INSTALL



**W** **COOLING CAPACITY**  
ACCORDING TO EN13215 and SH 10 K

**-30°C evap.:** from 0.4 to 1.6 kW  
**-10°C evap.:** from 0.7 to 4.4 kW

- ▶ A competitive plug & play unit for demanding outdoor solutions
- ▶ Easy to install

## APPLICATIONS

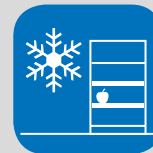



# ... TO THE MOST EXTENSIVELY EQUIPPED

## SILENSYS®

THE ACOUSTIC REFERENCE ON THE MARKET

**W**

### COOLING CAPACITY

ACCORDING TO EN13215 and SH 10 K

-30°C evap.: from 0.5 to 6.1 kW  
 -10°C evap.: from 0.7 to 17 kW

- ▶ An acoustic solution for urban environments
- ▶ High energy efficiency without compromise on the components
- ▶ Enhanced electrical safety and complete electrical equipment

## SILENSYS® INVERTER

PLUG & PLAY CAPACITY VARIATION

**W**

### COOLING CAPACITY

ACCORDING TO EN13215 and SH 10 K

-10°C evap.: from 0.7 to 17.3 kW

- ▶ Continuity of cooling the system assured by its dual control
- ▶ Variable capacity to suit the following types of installation:
  - multi-station
  - with extensive variation of heat load
- ▶ Advantages:
  - complete wiring
  - factory configuration
  - Tecumseh standard compressor



# EXPLANATION OF THE MODEL NAMES DESCRIPTION

**T A J N T 4 5 19 Z H R**

## Connection

**Letter absence** = with valve or to be soldered  
**R** = with liquid reservoir

**H** = High suction pressure (-15°C to + 15°C)

**B** = Low pressure (-40°C to -10°C)

**M** = Medium and high suction pressure (-25°C to +15°C)

**U** = Refrigerant R290

**Y** = Refrigerant R513A – R134a

**Z** = Refrigerant R452A – R404A

Corresponds to the first digits of the cooling capacity expressed in BTU/h at 60 Hz in accordance with the given rating point conditions.  
 Example: 19 preceded by the digit 5 means: 19,000 BTU/h.

Number of figures making up the cooling capacity.  
 Example: 19,000 BTU/h.

## Applications

**2** = Low back pressure. Motor with high starting torque.

**3** = High back pressure. Motor with high normal starting torque.

**4** = High back pressure. Motor with high starting torque.

**9** = Medium and high back pressure. Motor with high starting torque.

## Condensing units

**T** = HAT (High Ambient Temperature)

## Condensing units

**N** = New model AJ

## Compressors

The letter **D** designates compressors or units mounted as a "duo".

The letter **TR** designates compressors mounted as a "trio".

**Families: THB-AE-AJ-FH-AW-AG-HGA-RGA-SH.**

**Without letter** = single-phase low torque

**C** = single-phase high torque

**T** = three-phase

COMPRESSOR DESIGNATION

CONDENSING UNIT DESIGNATION

# EXPLANATION OF THE CODES AND VOLTAGE RANGES

CODE	FZ	XC	KZ	TZ - XG
PHASE	1~	1~	3~	3~
NOMINAL 50 Hz	220-240 V	220-240 V	220 V	400 V
VOLTAGE RANGE 50 Hz	198-253 V	198-264 V	180-253 V	340-440 V

## SERIAL LABEL

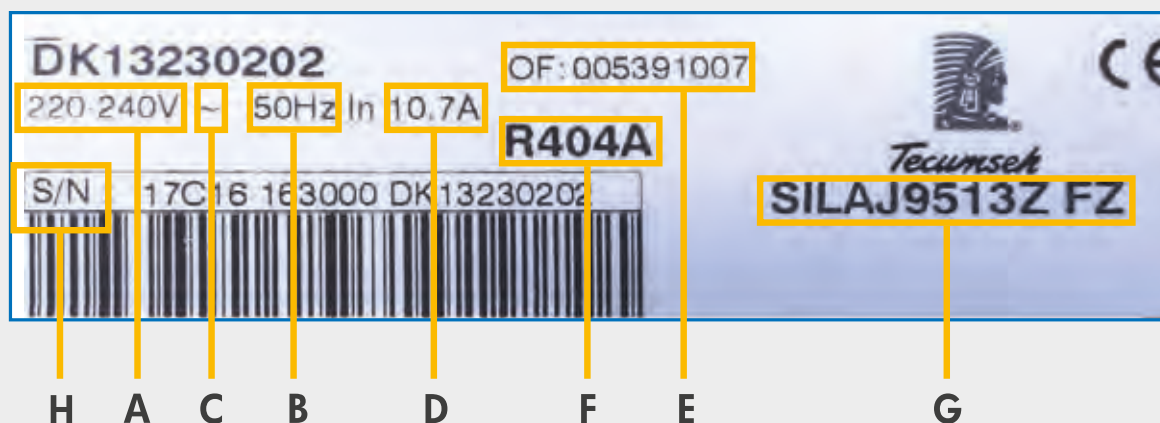

REFERENCE	DESIGNATION
A	Voltage
B	Frequency
C	Number of phases
D	Nominal current
E	Production order number
F	Liquid refrigerant
G	Designation of the unit
H	Serial number

## TRADITIONAL CONDENSING UNITS

### EQUIPMENT

#### ELECTRICAL COMPONENTS

- ▶ AC fans (AJ platform: EC fans), compatible with variable speed
- ▶ IP 44 electrical box
- ▶ Casing heater (AW, FH, AG)
- ▶ Compressor electrical protection

#### CIRCUIT

- ▶ Adjustable HP/LP pressure switch with automatic resetting on AW, FH and AG
- ▶ Condenser up to 46°C
- ▶ Liquid reservoir

#### INSTALLATION/MAINTENANCE

- ▶ Isolation valves, charge points and vacuum drawing

### PRE-EQUIPPED TRADITIONAL CONDENSING UNITS

- ▶ Reduction in installation time recognised by installers (between half an hour and one hour)
- ▶ Increased safety with all components checked



sight glass



dryer filter



HP/LP pressure switch  
with manual  
or automatic  
resetting



fittings  
to be soldered  
(CAJN/TAJN units)

**ACCESSORY:** fan speed control kit







# TRADITIONAL CONDENSING UNITS



Special condensing units\*

MODEL NUMBER	REFRIGERATION OUTPUT 43 ° amb., 10K superheating, 3K subcooling, Mid/Mid						REFRIG. OUTPUT EN13215 Evap. T -35°C		Aco. P db(A)	Air flow m3/h	Liq. Rec. Vol.	Diam. for tubing O.D.		Net/ Gross weight kg	No. Dim	Maximum current according to voltage code	
	Evaporation temperature (°C):						Perf. (W)	COP (W/W)				Suc.	Liqu. Line			FZ	TZ
	-35°	-30°	-25°	-20°	-15°	-10°											
CAJT2432ZBR	243	359	497	656	839	1046	397	0.83	39	1130	1.50	1/2"	1/4"	34/36	M300	6.5	na
CAJT/TAJT2446ZBR	384	538	711	901	1110	1343	625	0.96	40	1130	1.50	1/2"	3/8"	36/38	M300	8.8	3.3
CAJT/TAJT2464ZBR	545	745	980	1255	1571	1931	844	0.93	45	2464	1.50	5/8"	3/8"	47/51	M350	10.7	3.8

na: not applicable

\* Special: Tropical units formerly called HTA.



Traditional condensing units

MODEL NUMBER	REFRIGERATION OUTPUT 32 ° amb., 10K superheating, 3K subcooling, Mid/Mid						REFRIG. OUTPUT EN13215 Evap. T -35°C		Aco. P db(A)	Air flow m3/h	Liq. Rec. Vol.	Diam. for tubing O.D.		Net/ Gross weight kg	No. Dim	Maximum current according to voltage code	
	Evaporation temperature (°C):						Perf. (W)	COP (W/W)				Suc.	Liqu. Line			FZ	TZ
	-35°	-30°	-25°	-20°	-15°	-10°											
AET2415ZBR	159	209	267	331	402	479	184	0.80	28	340	0.75	3/8"	1/4"	20/21	M200	3.2	na
AET2420ZBR	201	268	345	434	533	643	232	0.88	27	410	0.75	3/8"	1/4"	20/21	M200	4.6	na
CAJ/TAJN2428ZBR	245	334	440	562	703	863	283	0.80	26	550	1.50	1/2"	1/4"	30/32	M250	5.3	2.2
AET2425ZBR	266	354	454	568	695	836	309	0.86	34	500	0.75	3/8"	1/4"	26/27	M250	4.6	na
CAJN2432ZBR	295	401	523	664	823	1003	342	0.86	28	550	1.50	1/2"	1/4"	30/32	M250	6.0	na
CAJN2440ZBR	416	573	758	970	1213	1489	473	0.98	27	900	1.50	1/2"	3/8"	32/34	M300	5.8	na
CAJ/TAJN2446ZBR	521	698	901	1129	1382	1659	600	1.04	31	900	2.35	1/2"	3/8"	33/35	M300	8.4	3.2
CAJ/TAJN2464ZBR	662	868	1103	1366	1657	1978	771	0.95	33	900	2.35	5/8"	3/8"	34/36	M300	10.2	4.0
FH/TFHT2480ZBR	1024	1375	1773	2219	2717	3273	1164	1.03	43	1750	1.50	5/8"	3/8"	57/61	M350	16.5	6.9
FH/TFHT2511ZBR	1279	1718	2217	2780	3423	4169	1465	1.06	46	1750	1.50	5/8"	3/8"	57/61	M350	24.6	7.8
TAGT2513ZBR	1472	2162	2959	3858	4856	5957	1631	0.95	51	3900	2.35	7/8"	3/8"	73/87	M420	na	9.3
TAGT2516ZBR	1773	2543	3434	4446	5586	6870	1992	1.09	50	3300	2.35	7/8"	3/8"	79/93	M420	na	10.2
TAGT2519ZBR	2066	2945	3968	5137	6464	7968	2317	1.60*	51	2500	3.90	7/8"	3/8"	85/105	M450	na	11.7
TAGT2522ZBR	2345	3271	4346	5573	6964	8540	2650	1.62*	51	2500	3.90	1"1/8	3/8"	86/100	M450	na	14.2
TAGT2525ZBR	2598	3597	4728	5993	7401	8974	2940	1.60*	54	2500	3.90	1"1/8	1/2"	87/101	M450	na	14.1
TAGDT2532ZBR	3586	5136	6909	8897	11100	13547	4020	1.63*	53	7000	6.00	1"1/8	1/2"	154/184	B420	na	21.3
TAGDT2538ZBR	4111	5738	7598	9687	12012	14612	4656	1.65*	53	7000	6.00	1"1/8	1/2"	154/184	B420	na	21.3
TAGDT2544ZBR	5010	6864	8918	11268	13932	16974	5707	1.65*	54	7000	6.00	1"1/8	1/2"	161/191	B420	na	29.0
TAGDT2550ZBR	5069	6982	9290	11913	14792	17834	5811	1.69*	57	7000	6.00	1"1/8	1/2"	161/191	B420	na	29.0
SHT2529ZBR-YZ	3603	4772	6063	7471	8997	10654	3729	1.92*	na	7600	3.90	1"1/8	1/2"	132/162	B420	na	14.0 <sup>c</sup>
SHT2534ZBR-YZ	4479	5849	7376	9053	10872	12834	4667	1.88*	na	7000	3.90	1"3/8	5/8"	134/164	B420	na	16.3 <sup>c</sup>
SHT2542ZBR-YZ	5332	6789	8422	10230	12210	14361	5637	1.86*	na	7000	6.00	1"3/8	5/8"	134/164	B420	na	16.7 <sup>c</sup>
SHT2552ZBR-YZ	6694	8584	10715	13089	15703	18555	7002	2.04*	na	8270	6.00	1"3/8	5/8"	151/181	B420	na	21.7 <sup>c</sup>
SHT2568ZBR-MZ	8666	10913	13349	16005	18901	22058	9207	1.99*	na	7600	9.50	1"3/8	5/8"	199/229	B500	na	27.2 <sup>d</sup>
SHT2575ZBR-MZ	10142	13099	16380	20026	24065	28513	10551	2.13*	na	14600	9.50	1"5/8	5/8"	221/251	B500	na	33.2 <sup>d</sup>

Statement of the seasonal COP / na: not applicable/ <sup>a</sup> voltage code XC, <sup>b</sup> voltage code XG, <sup>c</sup> voltage code YZ, <sup>d</sup> voltage code MZ

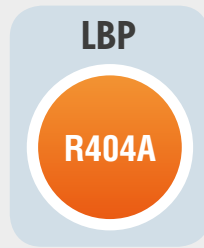

## Special condensing units\*

MODEL NUMBER	REFRIGERATION OUTPUT 43 ° amb., 10K superheating, 3K subcooling						REFRIG. OUTPUT EN13215 Evap. T -35°C		Aco. P db(A)	Air flow m3/h	Liq. Rec. Vol.	Diam. for tubing O.D.		Net/ Gross weight kg	No. Dim	Maximum current according to voltage code	
	Evaporation temperature (°C):						Perf. (W)	COP (W/W)				Suc.	Liqu. Line			FZ	TZ
	-35°	-30°	-25°	-20°	-15°	-10°											
CAJT2432ZBR	268	381	514	668	843	1039	465	0.95	38	1130	1.50	1/2"	1/4"	34/36	M300	6.5	na
CAJ/TAJT2446ZBR	396	543	708	890	1087	1298	701	1.01	40	1130	1.50	1/2"	3/8"	36/38	M300	8.8	3.3
CAJ/TAJT2464ZBR	557	755	985	1250	1548	1882	933	0.96	45	2464	1.50	5/8"	3/8"	47/51	M350	10.7	3.8

na: not applicable

For information, the cooling capacity of fluids R449A and R448A: at the evaporation point  $T_o = -30^\circ\text{C}$ , SH10K, apply the multiplier ratio 0.94 to the cooling capacities read with R404A.

\* Special: Tropical units formerly called HTA.



## Traditional condensing units

MODEL NUMBER	REFRIGERATION OUTPUT 32 ° amb., 10K superheating, 3K subcooling						REFRIG. OUTPUT EN13215 Evap. T -35°C		Aco. P db(A)	Air flow m3/h	Liq. Rec. Vol.	Diam. for tubing O.D.		Net/ Gross weight kg	No. Dim	Maximum current according to voltage code	
	Evaporation temperature (°C):						Perf. (W)	COP (W/W)				Suc.	Liqu. Line			FZ	TZ
	-35°	-30°	-25°	-20°	-15°	-10°											
AET2415ZBR	160	208	263	323	389	459	202	0.83	28	340	0.75	3/8"	1/4"	20/21	M200	3.2	na
AET2420ZBR	206	271	347	432	526	628	259	0.92	27	410	0.75	3/8"	1/4"	20/21	M200	4.6	na
CAJ/TAJN2428ZBR	250	339	442	561	694	844	315	0.82	26	550	1.50	1/2"	1/4"	30/31	M250	5.3	2.2
AET2425ZBR	273	359	456	565	685	817	344	0.90	34	500	0.75	3/8"	1/4"	26/27	M250	4.6	na
HGA2426ZBR	299	385	482	597	729	880	375	1.07	37	1000	0.75	3/8"	1/4"	21/28	B200	3.8	na
CAJN2432ZBR	309	415	536	673	824	991	392	0.95	28	550	1.50	1/2"	1/4"	30/31	M250	6.0	na
HGA2432ZBR	367	467	578	705	848	1011	462	1.09	35	1000	0.75	3/8"	1/4"	21/28	B200	4.6	na
HGA2436ZBR	384	492	613	750	905	1080	484	1.08	39	1000	0.75	1/2"	1/4"	22/29	B200	5.4	na
CAJN2440ZBR	425	577	756	962	1194	1453	529	1.01	27	900	1.50	1/2"	3/8"	32/33	M300	5.8	na
HGA2446ZBR	494	636	794	974	1178	1409	623	1.11	38	1000	0.75	1/2"	3/8"	26/33	B200	5.8	na
CAJ/TAJN2446ZBR	530	707	907	1129	1370	1629	665	1.04	31	900	2.35	1/2"	3/8"	33/35	M300	8.4	3.2
CAJ/TAJN2464ZBR	678	881	1109	1361	1634	1924	856	0.98	33	900	2.35	5/8"	3/8"	34/36	M300	10.2	4.0
FH/TFHT2480ZBR	1068	1424	1822	2262	2743	3267	1323	1.08	43	1750	1.50	5/8"	3/8"	57/61	M350	16.5	6.9
FH/TFHT2511ZBR	1302	1743	2236	2782	3389	4073	1629	1.09	46	1750	1.50	5/8"	3/8"	57/61	M350	24.6	7.8
TAGT2513ZBR	1482	2092	2810	3632	4550	5553	1840	0.99	51	3900	2.35	7/8"	3/8"	73/87	M420	na	9.3
TAGT2516ZBR	1906	2681	3582	4605	5746	7005	2361	1.61*	50	3900	2.35	7/8"	3/8"	79/93	M420	na	10.2
TAGT2519ZBR	2117	2978	3977	5110	6377	7784	2629	1.70*	50	2500	3.90	7/8"	3/8"	85/105	M450	na	11.7
TAGT2522ZBR	2403	3306	4353	5542	6872	8343	2990	1.70*	51	2500	3.90	1 1/8"	3/8"	86/100	M450	na	14.2
TAGT2525ZBR	2631	3589	4676	5888	7220	8671	3280	1.67*	54	2500	3.90	1 1/8"	1/2"	87/101	M450	na	14.1
SHT2529ZBR	3378	4452	5661	7002	8473	10075	3813	1.69*	na	7600	3.90	1 1/8"	1/2"	132/162	B420	na	14.0 <sup>c</sup>
SHT2534ZBR	4197	5481	6926	8527	10275	12169	4753	1.69*	na	7000	3.90	1 3/8"	5/8"	134/164	B420	na	16.3 <sup>c</sup>
TAGDT2532ZBR	3713	5198	6906	8825	10941	13250	4612	1.73*	53	7000	6.00	1 1/8"	1/2"	154/184	B420	na	21.3
TAGDT2538ZBR	4240	5803	7599	9613	11836	14268	5283	1.74*	53	7000	6.00	1 1/8"	1/2"	154/184	B420	na	21.3
TAGDT2544ZBR	4755	6390	8264	10364	12687	15241	5944	1.75*	54	7000	6.00	1 1/8"	1/2"	161/191	B420	na	29.0
SHT2542ZBR	5042	6424	7978	9703	11599	13666	5741	1.70*	na	7000	6.00	1 3/8"	5/8"	134/164	B420	na	16.7 <sup>c</sup>
TAGDT2550ZBR	5174	6903	8839	10971	13297	15835	6485	1.63*	57	7000	6.00	1 1/8"	1/2"	161/191	B420	na	29
SHT2552ZBR	6387	8176	10219	12520	15076	17881	7206	1.89*	na	8270	6.00	1 3/8"	5/8"	151/181	B420	na	21.7 <sup>c</sup>
SHT2568ZBR	8076	10176	12451	14929	17629	20579	9252	1.83*	na	7600	9.50	1 3/8"	5/8"	199/229	B500	na	27.2 <sup>d</sup>
SHT2575ZBR	9525	12247	15300	18727	22557	26810	10749	1.77*	na	14600	9.50	1 5/8"	5/8"	221/251	B500	na	33.2 <sup>d</sup>

Statement of the seasonal COP / na: not applicable / <sup>a</sup> voltage code XC, <sup>b</sup> voltage code XG, <sup>c</sup> voltage code YZ, <sup>d</sup> voltage code MZ



LBP

R290

## Traditional condensing units

MODEL NUMBER	REFRIGERATION OUTPUT 32 ° amb., 10K superheating, 3K subcooling Evaporation temperature (°C):						REFRIG. OUTPUT EN13215 Evap. T -35°C		Aco. P db(A)	Air flow m3/h	Liq. Rec. Vol.	Diam. for tubing O.D.		Net/ Gross weight kg	No. Dim	Maximum current according to voltage code
	-35°	-30°	-25°	-20°	-15°	-10°	Perf. (W)	COP (W/W)				Suc.	Liqu. Line			FZ
AE2410UB	105	146	194	250	314	387	123	0.72	29	340	na	1/4"	1/4"	17/19	M200	2.5
AE2415UB	162	221	287	361	441	530	191	0.85	29	340	na	3/8"	1/4"	17/19	M200	3.1
AE2420UB	240	310	390	480	581	693	283	0.97	29	410	na	3/8"	1/4"	17/19	M200	3.9

na: not applicable







MHBP

R452A

## Special condensing units\*

MODEL NUMBER	REFRIGERATION OUTPUT 43° amb., 10K superheating, 3K subcooling, Mid/Mid							REFRIG. OUTPUT EN13215 Evap. T -10°C		Aco. P db(A)	Air flow m3/h	Liq. Rec. Vol.	Diam. for tubing O.D.		Net/ Gross weight kg	No. Dim	Maximum current according to voltage code	
	Evaporation temperature (°C):							Perf. (W)	COP (W/W)				Suc.	Liqu. Line			FZ	TZ
	-25°	-15°	-10°	-5°	0°	5°	15°											
CAJ/TAJT9480ZMHR	430	754	948	1169	1422	1708	2393	1227	1.67	38	1130	1.50	1/2"	3/8"	37/39	M300	7.3	3.4
CAJ/TAJT9510ZMHR	550	948	1186	1458	1769	2122	2965	1538	1.72	40	1180	1.50	5/8"	3/8"	42/46	M320	9.2	3.4
CAJ/TAJT9513ZMHR	623	1156	1480	1849	2268	2743	3872	1966	1.89	45	2250	1.50	5/8"	3/8"	45/49	M350	12.0	4.3
CAJ/TAJT4517ZHR	712	1318	1648	2022	2449	2934	4103	2167	1.85	45	2250	2.35	5/8"	3/8"	48/52	M350	13.4	4.4
CAJ/TAJT4519ZHR	881	1632	2070	2566	3123	3742	5239	2752	1.73	40	1650	2.35	5/8"	3/8"	48/52	M350	15.6	6.6

\* Special: Tropical units formerly called HTA.



## Traditional condensing units

MODEL NUMBER	REFRIGERATION OUTPUT 32° amb., 10K superheating, 3K subcooling, Mid/Mid							REFRIG. OUTPUT EN13215 Evap. T -10°C		Aco. P db(A)	Air flow m3/h	Liq. Rec. Vol.	Diam. for tubing O.D.		Net/ Gross weight kg	No. Dim	Maximum current according to voltage code	
	Evaporation temperature (°C):							Perf. (W)	COP (W/W)				Suc.	Liqu. Line			FZ	TZ
	-25°	-15°	-10°	-5°	0°	5°	15°											
AET4425ZHR	154	262	329	408	499	604	857	340	1.44	31	410	0.75	3/8"	1/4"	19/21	M200	3.0	na
AET4430ZHR	189	320	398	489	592	709	981	414	1.49	29	410	0.75	3/8"	1/4"	20/21	M200	3.1	na
AET4440ZHR	259	437	544	667	808	969	1359	565	1.49	35	500	0.75	3/8"	1/4"	24/26	M250	4.1	na
AET4450ZHR	---	550	675	816	974	1151	1563	708	1.46	39	500	0.75	3/8"	1/4"	25/27	M250	5.5	na
AET4460ZHR	457	728	890	1079	1296	1543	2138	924	1.61	39	1130	0.75	3/8"	1/4"	25/27	M300	6.5	na
AET4470ZHR	523	847	1034	1248	1490	1766	2446	1077	1.61	39	1130	0.75	3/8"	1/4"	28/30	M300	5.9	na
HGA4467ZHR	511	772	928	1103	1297	1510	1997	974	2.10	38	1000	0.75	3/8"	1/4"	22/29	B200	4.0	na
HGA4480ZHR	614	932	1121	1332	1565	1820	2389	1176	2.16	35	1000	0.75	3/8"	3/8"	25/32	B200	5.7	na
HGA4492ZHR	711	1055	1259	1487	1739	2017	2655	1326	2.18	38	1000	0.75	1/2"	3/8"	26/33	B200	5.5	na
HGA4512ZHR	834	1238	1470	1721	1990	2274	2874	1562	1.98	39	1000	0.75	1/2"	3/8"	26/33	B200	7.1	na
CAJ/TAJN9480ZMHR	529	887	1098	1341	1616	1925	2648	1148	1.66	33	900	1.50	1/2"	3/8"	33/35	M300	6.9	3.2
CAJ/TAJN9510ZMHR	653	1068	1310	1586	1897	2246	3063	1380	1.64	34	900	1.50	5/8"	3/8"	33/35	M300	8.6	3.2
CAJ/TAJN9513ZMHR	768	1287	1585	1916	2278	2673	na	1675	1.70	34	900	1.50	5/8"	3/8"	34/36	M300	11.5	4.1
CAJ/TAJN4517ZHR	1000	1644	2023	2460	2955	3514	4845	2109	1.84	40	1700	2.35	5/8"	3/8"	44/48	M350	13.5	4.4
CAJ/TAJN4519ZHR	1212	2044	2520	3055	3649	4307	5835	2641	1.64	40	1700	2.35	5/8"	3/8"	44/48	M350	16.0	5.6
FH/TFHT4522ZHR	1122	2103	2692	3361	4097	4888	6526	2772	1.80	43	1650	2.35	5/8"	3/8"	55/59	M350	17.1	6.5
FH/TFHT4524ZHR	1325	2429	3088	3834	4660	5561	7558	3187	1.72	49	3900	2.35	5/8"	3/8"	63/77	M420	20.7	8.8
FH/TFHT4531ZHR	1747	3113	3895	4775	5754	6840	9353	4048	1.80	50	3670	3.90	7/8"	1/2"	69/83	M420	23.5	9.3
AWT4538ZHR	2218	3929	4905	5984	7162	8456	11556	5095	2.80*	50	3300	3.90	7/8"	1/2"	67/81	M420	27.0 <sup>a</sup>	9.7 <sup>b-c</sup>
TAGT4546ZHR	2349	4702	6146	7949	9572	11560	16229	6271	2.59*	55	7000	6.00	7/8"	1/2"	100/120	B420	na	15.6
TAGT4553ZHR	2714	5321	6891	8838	10558	12660	17569	7055	2.59*	54	7000	6.00	7/8"	5/8"	101/121	B420	na	16.3
TAGT4561ZHR	3219	6083	7779	9873	11698	13939	19232	7988	2.61*	55	7000	6.00	1 1/8"	5/8"	101/121	B420	na	17.6
TAGT4568ZHR	3902	6953	8755	11000	12953	15391	21354	9065	2.60*	54	7000	6.00	1 1/8"	5/8"	102/122	B420	na	20.1
TAGT4573ZHR	4411	7857	9877	12379	14531	17209	23545	10182	2.58*	54	6000	6.00	1 1/8"	5/8"	107/127	B420	na	21.3

Statement of the seasonal COP / na: not applicable / <sup>a</sup> voltage code XC, <sup>b</sup> voltage code XG, <sup>c</sup> voltage code YZ, <sup>d</sup> voltage code MZ





## Traditional condensing units

MODEL NUMBER	REFRIGERATION OUTPUT 32° amb., 10K superheating, 3K subcooling, Mid/Mid							REFRIG. OUTPUT EN13215 Evap. T -10°C		Aco. P db(A)	Air flow m3/h	Liq. Rec. Vol.	Diam. for tubing O.D.		Net/ Gross weight kg	No. Dim	Maximum current according to voltage code	
	Evaporation temperature (°C):							Perf. (W)	COP (W/W)				Suc.	Liqu. Line			FZ	TZ
	-25°	-15°	-10°	-5°	0°	5°	15°											
SHT4576ZHR	5285	8488	10285	12296	14470	16803	21972	10245	2.80*	na	6000	6.00	1"1/8	5/8"	138/158	B420	na	13.9 <sup>c</sup>
TAGT4581ZHR	4772	8216	10228	12719	14829	17435	23592	10636	2.55*	55	6000	6.00	1"1/8	5/8"	107/127	B420	na	23.1
TAGDT4590ZHR	4639	8809	11412	14692	17644	21257	29481	11739	2.85*	57	8270	9.50	1"1/8	5/8"	175/205	B420	na	28.9
SHT4591ZHR	6567	10391	12639	15225	18088	21217	na	12518	3.05*	na	8270	6.00	1"1/8	5/8"	151/181	B420	na	15.0 <sup>c</sup>
TAGDT4610ZHR	5464	10107	12953	16518	19671	23520	32271	13359	2.85*	56	8270	9.50	1"1/8	5/8"	179/209	B420	na	30.3
SHT4610ZHR	7660	12292	14860	17726	20871	24379	na	14733	2.65*	na	14600	9.50	1"3/8	5/8"	180/210	B500	na	20.3 <sup>c</sup>
TAGDT4612ZHR	6516	11815	15088	19210	22856	27288	37121	15532	2.65*	60	14600	9.50	1"1/8	5/8"	205/239	B500	na	33.3
SHT4612ZHR	8827	14158	16956	19977	23227	26885	na	16877	2.63*	na	14600	9.50	1"3/8	5/8"	180/210	B500	na	22.7 <sup>d</sup>
TAGDT4614ZHR	7964	13744	17360	21957	26019	30986	42198	17962	2.72*	59	14600	12.00	1"3/8	7/8"	209/239	B500	na	38.3
TAGDT4615ZHR	8851	15470	19279	23955	27903	32842	45160	19970	2.72*	59	13000	12.00	1"3/8	7/8"	217/247	B500	na	40.7
SHT4615ZHR	10427	16310	19810	23806	28129	32666	na	19751	2.72*	na	14100	12.00	1"3/8	7/8"	227/257	B500	na	25.7 <sup>d</sup>
TAGDT4616ZHR	9960	17486	21721	26889	31214	36654	50433	22554	2.69*	60	13000	12.00	1"3/8	7/8"	216/246	B500	na	44.3
SHT4620ZHR	14684	22333	26401	30937	35957	41690	na	26511	2.78*	na	13000	12.00	1"5/8	7/8"	234/264	B500	na	35.7 <sup>d</sup>

Statement of the seasonal COP / na: not applicable / <sup>a</sup> voltage code XC, <sup>b</sup> voltage code XG, <sup>c</sup> voltage code YZ, <sup>d</sup> voltage code MZ

For information, the cooling capacity of fluids R449A and R448A: at the evaporation point  $T_o = -30^\circ\text{C}$ , SH10K, apply the multiplier ratio 0.94 to the cooling capacities read with R404A.





Special condensing units\*

MODEL NUMBER	REFRIGERATION OUTPUT 43° amb., 10K superheating, 3K subcooling							REFRIG. OUTPUT EN13215 Evap. T -10°C		Aco. P db(A)	Air flow m3/h	Liq. Rec. Vol.	Diam. for tubing O.D.		Net/ Gross weight kg	No. Dim	Maximum current according to voltage code	
	Evaporation temperature (°C):							Perf. (W)	COP (W/W)				Suc.	Liqu. Line			FZ	TZ
	-25°	-15°	-10°	-5°	0°	5°	15°											
CAJ/TAJT9480ZMHR	429	746	934	1143	1376	1634	2245	1299	1.69	38	1130	1.50	1/2"	3/8"	37/40	M300	7.3	3.4
CAJ/TAJT9510ZMHR	548	937	1168	1426	1711	2028	2781	1627	1.74	39	1180	1.50	5/8"	3/8"	42/41	M320	9.2	3.4
CAJ/TAJT9513ZMHR	616	1140	1454	1805	2193	2622	3633	2083	1.91	45	2250	1.50	5/8"	3/8"	45/47	M350	12.0	4.3
CAJ/TAJT4517ZHR	726	1305	1625	1979	2370	2804	3843	2292	1.87	46	2250	2.35	5/8"	3/8"	48/52	M350	13.4	4.4
CAJ/TAJT4519ZHR	938	1687	2119	2594	3112	3674	4937	3007	2	41	1350	2.35	5/8"	3/8"	48/52	M350	15.6	6.6

\* Special: Tropical units formerly called HTA.



Traditional condensing units

MODEL NUMBER	REFRIGERATION OUTPUT 32° amb., 10K superheating, 3K subcooling							REFRIG. OUTPUT EN13215 Evap. T -10°C		Aco. P db(A)	Air flow m3/h	Liq. Rec. Vol.	Diam. for tubing O.D.		Net/ Gross weight kg	No. Dim	Maximum current according to voltage code	
	Evaporation temperature (°C):							Perf. (W)	COP (W/W)				Suc.	Liqu. Line			FZ	TZ
	-25°	-15°	-10°	-5°	0°	5°	15°											
AET4425ZHR	154	258	323	398	484	581	811	359	1.46	31	410	0.75	3/8"	1/4"	19/20	M200	3.0	na
AET4430ZHR	190	315	392	479	575	682	929	437	1.50	29	410	0.75	3/8"	1/4"	19/21	M200	3.1	na
AET4440ZHR	263	432	535	652	784	930	1273	596	1.51	35	500	0.75	3/8"	1/4"	24/25	M250	4.1	na
AET4450ZHR	339	545	666	799	944	1101	1458	746	1.47	39	500	0.75	3/8"	1/4"	25/26	M250	5.5	na
AET4460ZHR	463	721	880	1059	1261	1488	2029	976	1.63	39	1130	0.75	3/8"	1/4"	25/27	M300	6.5	na
AET4470ZHR	535	840	1020	1222	1448	1700	2304	1134	1.62	39	1130	0.75	3/8"	1/4"	28/30	M300	5.9	na
HGA4467ZHR	472	723	873	1040	1228	1440	1952	973	1.92	38	1000	0.75	3/8"	1/4"	22/28	B200	4.0	na
HGA4480ZHR	568	877	1057	1257	1480	1728	2324	1178	2.01	35	1000	0.75	3/8"	3/8"	25/31	B200	5.7	na
HGA4492ZHR	663	992	1185	1400	1639	1908	2559	1323	2.04	38	1000	0.75	1/2"	3/8"	26/32	B200	5.5	na
HGA4512ZHR	766	1170	1389	1621	1870	2138	2768	1561	1.83	39	1000	0.75	1/2"	3/8"	26/33	B200	7.1	na
CAJ/TAJN9480ZMH	533	877	1084	1315	1571	1852	2503	1212	1.66	33	900	1.50	1/2"	3/8"	33/35	M300	6.9	3.2
CAJ/TAJN9510ZMH	659	1058	1295	1557	1845	2159	2886	1455	1.63	34	900	1.50	5/8"	3/8"	33/35	M300	8.6	3.2
CAJ/TAJN9513ZMHR	774	1277	1569	1884	2219	2572	3351	1768	1.69	34	900	1.50	5/8"	3/8"	34/38	M300	11.5	4.1
CAJ/TAJN4517ZHR	1012	1629	2000	2415	2876	3386	4584	2229	1.85	40	1700	2.35	5/8"	3/8"	44/48	M350	13.5	4.4
CAJ/TAJN4519ZHR	1212	2023	2491	3002	3553	4148	5505	2788	1.65	40	1700	2.35	5/8"	3/8"	44/48	M350	16.0	5.6
FH/FTHT4522ZHR	1121	2068	2647	3290	3987	4720	6212	2942	1.82	43	1650	2.35	5/8"	3/8"	55/59	M350	17.1	6.5
FH/FTHT4524ZHR	1323	2390	3037	3751	4528	5359	7169	3377	1.73	49	3900	2.35	5/8"	3/8"	63/67	M420	20.7	8.8
FH/FTHT4531ZHR	1749	3075	3843	4684	5597	6586	8841	4285	1.81	50	3670	3.90	7/8"	1/2"	69/73	M420	23.5	9.3
AWT4538ZHR	2270	3871	4814	5852	6985	8219	11080	5352	2.81*	50	3300	3.90	7/8"	1/2"	67/81	M420	27	9.7 <sup>b</sup>
TAGT4546ZHR	2423	4579	5924	7448	9147	11020	15330	6553	2.61*	55	7000	6.00	7/8"	1/2"	100/120	B420	na	15.6
TAGT4553ZHR	2751	5127	6580	8208	10007	11974	16475	7292	2.58*	54	7000	6.00	7/8"	5/8"	101/121	B420	na	16.3
TAGT4561ZHR	3326	5870	7419	9151	11061	13148	17911	8221	2.59*	55	7000	6.00	1 1/8"	5/8"	101/121	B420	na	17.6
TAGT4568ZHR	3925	6682	8346	10204	12256	14509	19787	9286	2.58*	54	7000	6.00	1 1/8"	5/8"	102/122	B420	na	20.1
TAGT4573ZHR	4447	7596	9448	11482	13703	16135	21976	10468	2.55*	54	6000	6.00	1 1/8"	5/8"	107/127	B420	na	21.3

Statement of the seasonal COP / na: not applicable / <sup>a</sup> voltage code XC, <sup>b</sup> voltage code XG, <sup>c</sup> voltage code YZ, <sup>d</sup> voltage code MZ



## Traditional condensing units

MODEL NUMBER	REFRIGERATION OUTPUT 32° amb., 10K superheating, 3K subcooling							REFRIG. OUTPUT EN13215 Evap. T -10°C		Aco. P db(A)	Air flow m <sup>3</sup> /h	Liq. Rec. Vol.	Diam. for tubing O.D.		Net/ Gross weight kg	No. Dim	Maximum current according to voltage code	
	Evaporation temperature (°C):							Perf. (W)	COP (W/W)				Suc.	Liqu. Line			FZ	TZ
	-25°	-15°	-10°	-5°	0°	5°	15°											
SHT4576ZHR	5271	8392	10169	12070	14084	16199	20811	10780	2.86*	na	6000	6.00	1"1/8	5/8"	138/168	B420	na	13.9 <sup>d</sup>
TAGT4581ZHR	5076	8324	10242	12350	14642	17118	22763	11386	2.56*	55	6000	6.00	1"1/8	5/8"	107/127	B420	na	23.1
TAGDT4590ZHR	4578	8623	11136	13971	17114	20550	28319	12367	2.88*	57	8270	9.50	1"1/8	5/8"	175/205	B420	na	28.9
SHT4591ZHR	6580	10265	12471	14911	17571	20434	na	13177	3.12*	na	8270	9.50	1"1/8	5/8"	151/181	B420	na	15.0 <sup>c</sup>
TAGDT4610ZHR	5409	9916	12668	15742	19122	22791	31048	14067	2.89*	56	8270	9.50	1"1/8	5/8"	179/209	B420	na	30.3
SHT4610ZHR	7621	12144	14686	17399	20301	23457	na	15504	2.72*	na	14600	9.50	1"3/8	5/8"	180/210	B500	na	20.3 <sup>c</sup>
TAGDT4612ZHR	6460	11583	14737	18282	22194	26434	35775	16334	2.69*	60	14600	9.50	1"1/8	5/8"	205/235	B500	na	33.3
SHT4612ZHR	8753	14010	16804	19670	22646	25873	na	17755	2.69*	na	14600	9.50	1"3/8	5/8"	180/210	B500	na	22.7 <sup>c</sup>
TAGDT4614ZHR	7961	13516	16982	20902	25248	29971	40468	18860	2.75*	59	14600	12.00	1"3/8	7/8"	209/235	B500	na	38.3
TAGDT4615ZHR	8748	15218	18919	22914	27208	31871	43225	20964	2.75*	59	13000	12.00	1"3/8	7/8"	217/247	B500	na	40.7
TAGDT4616ZHR	10065	17093	21021	25217	29706	34596	46777	23265	2.68*	60	13000	12.00	1"3/8	7/8"	216/246	B500	na	44.3
SHT4615ZHR	10456	16126	19556	23313	27299	31394	na	20766	2.78*	na	14100	12.00	1"3/8	7/8"	227/257	B500	na	25.1 <sup>d</sup>
SHT4620ZHR	14694	22161	26185	30419	34941	39949	na	27812	2.83*	na	13000	12.00	1"3/8	7/8"	234/264	B500	na	35.1 <sup>d</sup>

Statement of the seasonal COP/na: not applicable;<sup>a</sup> voltage code XC, <sup>b</sup> voltage code XG, <sup>c</sup> voltage code YZ, <sup>d</sup> voltage code MZ

For information, the cooling capacity of fluids R449A and R448A: at the evaporation point  $T_o = -30^\circ\text{C}$ , SH10K, apply the multiplier ratio 0.94 to the cooling capacities read with R404A.







**Special condensing units\***

MODEL NUMBER	REFRIGERATION OUTPUT 43° amb., 10K superheating, 3K subcooling							REFRIG. OUTPUT EN13215 Evap. T -10°C		Aco. P db(A)	Air flow m3/h	Liq. Rec. Vol.	Diam. for tubing O.D.		Net/ Gross weight kg	No. Dim	Maximum current according to voltage code	
	Evaporation temperature (°C):							Perf. (W)	COP (W/W)				Suc.	Liqu. Line			FZ	TZ
	-15°	-10°	-5°	0°	5°	10°	15°											
AET4425YHR	194	259	330	408	491	579	674	346	1.48	28	410	0.75	3/8"	1/4"	19/20	M200	2.6	na
AET4430YHR	268	342	427	522	629	747	877	445	1.44	34	500	0.75	3/8"	1/4"	22/23	M250	3.5	na
AET4440YHR	359	446	546	658	783	923	/	585	1.54	38	500	0.75	3/8"	1/4"	24/26	M250	4.1	na
AET4450YHR	466	584	718	866	1032	1215	1417	767	1.62	38	800	0.75	3/8"	1/4"	27/28	M300	5.2	na
AET4456YHR	538	673	826	997	1187	1398	1631	877	1.67	38	1130	0.75	3/8"	1/4"	26/28	M300	8.6	na
AET4460YHR	551	693	853	1033	1233	1457	1709	907	1.81	37	1130	0.75	3/8"	1/4"	26/28	M300	5.3	na
CAJT4452YHR	416	552	705	877	1068	1279	1509	759	1.49	38	1130	1.50	1/2"	1/4"	33/37	M300	6.1	na
CAJ/TAJT4461YHR	539	691	867	1067	1292	1541	1813	923	1.59	37	1130	1.50	1/2"	1/4"	33/37	M300	6.5	2.6
CAJT4476YHR	579	773	993	1241	1519	1826	2161	1066	1.57	37	1130	1.50	1/2"	3/8"	36/40	M300	7.5	na
CAJ/TAJT4492YHR	783	1038	1326	1650	2013	2416	2862	1387	1.73	44	2250	2.35	1/2"	3/8"	45/49	M350	9.6	3.2
CAJ/TAJT4511YHR	1066	1373	1716	2097	2517	2978	3480	1810	1.96	45	2250	2.35	5/8"	3/8"	47/51	M350	9.3	3.7

Statement of the seasonal COP / na: not applicable

\* Special: Tropical units formerly called HTA.





## Traditional condensing units

MODEL NUMBER	REFRIGERATION OUTPUT 32° amb., 10K superheating, 3K subcooling							REFRIG. OUTPUT EN13215 Evap. T -10°C		Acc. P db(A)	Air flow m3/h	Liq. Rec. Vol.	Diam. for tubing O.D.		Net/ Gross weight kg	No. Dim	Maximum current according to voltage code	
	Evaporation temperature (°C):							Perf. (W)	COP (W/W)				Suc.	Liqu. Line			FZ	TZ
	-15°	-10°	-5°	0°	5°	10°	15°											
THB4410YH	111	142	178	220	272	330	397	153	1.33	26	340	/	1/4"	1/4"	14/15	M200	1.1	na
THB4413YH	129	165	206	255	311	375	447	179	1.24	27	340	/	1/4"	1/4"	14/15	M200	1.8	na
THB4415YHR	161	204	254	312	374	445	520	221	1.42	26	340	0.75	1/4"	1/4"	14/15	M200	1.5	na
THB4419YHR	188	235	290	354	425	505	595	255	1.42	26	340	0.75	3/8"	1/4"	14/15	M200	1.8	na
THB4422YHR	228	283	346	416	494	579	671	306	1.42	26	340	0.75	3/8"	1/4"	12/14	M200	2.5	na
AE4430YHR	320	403	499	610	734	871	1021	439	1.59	28	410	0.75	3/8"	1/4"	15/17	M200	3.3	na
AE4440YHR	415	509	616	737	871	1020	1182	556	1.59	28	410	0.75	3/8"	1/4"	19/21	M200	3.9	na
AE4450YHR	553	681	823	984	1164	1362	1578	741	1.62	38	500	0.75	3/8"	1/4"	19/21	M250	5.0	na
AE4456YHR	614	755	914	1094	1294	1519	1764	821	1.60	38	500	0.75	3/8"	1/4"	25/26	M250	6.2	na
AE4460YHR	633	781	948	1134	1342	1573	1826	850	1.70	39	500	0.75	3/8"	1/4"	25/27	M250	5.1	na
CAJN4452YHR	481	610	752	906	1070	1241	1416	666	1.50	27	550	1.50	1/2"	1/4"	29/30	M250	5.6	na
CAJ/TAJN4461YHR	585	723	876	1042	1220	1405	---	793	1.50	27	550	1.50	1/2"	1/4"	29/30	M250	6.0	2.4
CAJN4476YHR	751	964	1207	1483	1795	2144	2531	1047	1.67	31	900	1.50	1/2"	3/8"	29/31	M300	7.1	na
CAJ/TAJN4492YHR	939	1192	1473	1782	2117	2471	2841	1297	1.79	32	900	2.35	1/2"	3/8"	30/32	M300	9.1	3
CAJ/TAJN4511YHR	1195	1478	1784	2110	2452	2803	---	1616	1.89	33	900	2.35	5/8"	3/8"	31/33	M300	8.8	3.5
CAJN4513YHR	1397	1767	2195	2686	3245	3877	4583	1914	1.98	39	1700	2.35	5/8"	3/8"	39/43	M350	10.5	na
FH/TFHT4518YHR	1703	2267	2921	3666	4497	5404	6365	2459	1.87	40	1650	1.50	5/8"	3/8"	52/56	M350	11.8	4.8
FH/TFHT4525YHR	2396	3069	3842	4711	5665	6681	7726	3343	1.99	43	1650	1.50	5/8"	3/8"	53/56	M350	15.8	7.3
TAGT4528YHR	2853	3653	4546	5532	6615	7798	9092	3968	2.27	50	3900	2.35	7/8"	3/8"	72/76	M420	na	11.1
TAGT4534YHR	2931	3885	5007	6268	7652	9142	10721	4223	1.94	52	3670	2.35	7/8"	3/8"	75/89	M420	na	11.5
TAGT4537YHR	3343	4307	5380	6566	7875	9323	10933	4694	2.04	49	3670	2.35	7/8"	3/8"	74/89	M420	na	11.1
TAGT4543YHR	3785	4900	6135	7498	8999	10660	12516	5331	2.75*	50	3300	2.35	7/8"	3/8"	76/89	M420	na	11.1
TAGT4547YHR	3995	5158	6465	7925	9542	11321	13268	5621	2.35*	54	na	3.90	1 1/8"	1/2"	87/90	M450	na	11.6
TAGDT4556YHR	4303	6286	8679	11457	14622	18181	22141	6803	3.09*	53	7000	3.90	1 1/8"	1/2"	153/183	B420	na	22.3
TAGDT4568YHR	5910	7926	10312	13013	15992	19210	22618	8577	2.79*	53	6000	3.90	1 1/8"	1/2"	158/188	B420	na	21.9
TAGDT4574YHR	7161	9368	11894	14760	17982	21575	25554	10156	3.07*	53	8270	6.00	1 1/8"	5/8"	171/201	B420	na	23.3
TAGDT4586YHR	7742	10058	12640	15495	18629	22055	25800	10924	3.11*	53	7600	6.00	1 1/8"	5/8"	175/205	B420	na	22.3

Statement of the seasonal COP / na: not applicable

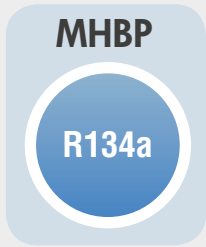

Special condensing units\*

MODEL NUMBER	REFRIGERATION OUTPUT 43° amb., 10K superheating, 3K subcooling							REFRIG. OUTPUT EN13215 Evap. T -10°C		Aco. P db(A)	Air flow m3/h	Liq. Rec. Vol.	Diam. for tubing O. D.		Net/ Gross weight kg	No. Dim	Maximum current according to voltage code	
	Evaporation temperature (°C):							Perf. (W)	COP (W/W)				Suc.	Liqu. Line			FZ	TZ
	-15°	-10°	-5°	0°	5°	10°	15°											
AET4425YHR	181	246	319	400	488	584	687	320	1.45	28	410	0.75	3/8"	1/4"	19/20	M200	2.6	na
AET4430YHR	250	325	412	512	625	752	894	412	1.41	34	500	0.75	3/8"	1/4"	22/23	M250	3.5	na
AET4440YHR	335	424	527	645	778	929	---	541	1.51	38	500	0.75	3/8"	1/4"	24/26	M250	4.1	na
AET4450YHR	435	555	693	849	1025	1223	1445	709	1.59	38	800	0.75	3/8"	1/4"	27/28	M300	5.2	na
AET4456YHR	502	640	798	977	1179	1407	1663	811	1.64	38	1130	0.75	3/8"	1/4"	26/28	M300	8.6	na
AET4460YHR	514	659	824	1012	1225	1467	1743	839	1.77	37	1130	0.75	3/8"	1/4"	26/28	M300	5.3	na
CAJT4452YHR	387	524	681	859	1061	1287	1539	702	1.46	38	1130	1.50	1/2"	1/4"	33/37	M300	6.1	na
CAJ/TAJT4461YHR	502	657	838	1047	1285	1553	1853	853	1.56	37	1130	1.50	1/2"	1/4"	33/37	M300	6.5	2.6
CAJT4476YHR	549	747	971	1222	1500	1804	2135	999	1.56	37	1130	1.50	1/2"	3/8"	36/40	M300	7.5	na
CAJ/TAJT4492YHR	729	984	1277	1613	1994	2426	2910	1281	1.69	44	2250	2.35	1/2"	3/8"	45/49	M350	9.6	3.2
CAJ/TAJT4511YHR	995	1305	1657	2055	2501	2998	3549	1674	1.92	45	2250	2.35	5/8"	3/8"	47/51	M350	9.3	3.7

na: not applicable \* Special: Tropical units formerly called HTA.

Traditional condensing units

MODEL NUMBER	REFRIGERATION OUTPUT 32° amb., 10K superheating, 3K subcooling							REFRIG. OUTPUT EN13215 Evap. T -10°C		Aco. P db(A)	Air flow m3/h	Liq. Rec. Vol.	Diam. for tubing O. D.		Net/ Gross weight kg	No. Dim	Maximum current according to voltage code	
	Evaporation temperature (°C):							Perf. (W)	COP (W/W)				Suc.	Liqu. Line			FZ	TZ
	-15°	-10°	-5°	0°	5°	10°	15°											
THB4410YH	103	134	170	213	264	322	388	143	1.32	26	340	na	1/4"	1/4"	14/15	M200	1.1	na
THB4413YH	120	156	197	246	302	366	437	167	1.23	27	340	na	1/4"	1/4"	14/15	M200	1.8	na
THB4415YHR	149	193	243	301	364	434	508	206	1.41	26	340	0.75	1/4"	1/4"	14/15	M200	1.5	na
THB4419YHR	174	222	278	342	413	493	582	238	1.41	26	340	0.75	3/8"	1/4"	14/15	M200	1.8	na
THB4422YHR	211	267	331	402	480	565	656	286	1.41	26	340	0.75	3/8"	1/4"	13/14	M200	2.5	na
AE4430YHR	297	381	478	589	713	849	998	410	1.58	28	410	0.75	3/8"	1/4"	16/17	M200	3.3	na
AE4440YHR	385	481	590	712	847	995	1155	519	1.58	28	410	0.75	3/8"	1/4"	20/21	M200	3.9	na
CAJN4452YHR	444	575	723	885	1061	1250	1449	620	1.48	27	550	1.50	1/2"	1/4"	29/31	M250	5.6	na
AE4450YHR	513	643	788	951	1131	1328	1542	692	1.61	38	500	0.75	3/8"	1/4"	20/21	M250	5.0	na
CAJ/TAJN4461YHR	541	685	846	1024	1218	1425	na	740	1.49	27	550	1.50	1/2"	1/4"	29/30	M250	6.0	2.4
AE4456YHR	569	713	875	1057	1258	1481	1724	767	1.59	38	500	0.75	3/8"	1/4"	25/27	M250	6.2	na
AE4460YHR	587	738	907	1096	1304	1534	1785	794	1.69	39	500	0.75	3/8"	1/4"	26/27	M250	5.1	na
CAJN4476YHR	700	915	1162	1442	1756	2104	2488	982	1.67	31	900	1.50	1/2"	3/8"	29/31	M300	7.1	na
CAJ/TAJN4492YHR	864	1120	1410	1733	2088	2474	2887	1203	1.77	32	900	2.35	1/2"	3/8"	30/32	M300	9.1	3.0
CAJ/TAJN4511YHR	1104	1396	1718	2067	2439	2831	na	1506	1.87	33	900	2.35	5/8"	3/8"	31/33	M300	8.8	3.5
CAJN4513YHR	1295	1669	2101	2595	3154	3781	4479	1787	1.97	39	1700	2.35	5/8"	3/8"	43/45	M350	10.5	na
FH/TFHT4518YHR	1564	2124	2783	3545	4408	5368	6414	2276	1.85	40	1650	1.50	5/8"	3/8"	52/56	M350	11.8	4.8
TAGT4528YHR	1979	2846	3866	5010	6253	7572	8948	3053	1.75	50	3900	2.35	7/8"	3/8"	72/76	M420	na	11.1
FH/TFHT4525YHR	2208	2888	3680	4583	5590	6689	7861	3106	1.97	43	1650	1.50	5/8"	3/8"	53/57	M350	15.8	7.3
TAGT4534YHR	2718	3670	4792	6056	7438	8916	10479	3943	1.93	52	3670	2.35	7/8"	3/8"	75/89	M420	na	11.5
TAGT4537YHR	3116	4131	5331	6684	8164	9749	11431	4444	1.94	49	3670	2.35	7/8"	3/8"	74/89	M420	na	11.1
TAGT4543YHR	3342	4407	5731	7271	8990	10861	12870	4734	1.95	50	3300	2.35	7/8"	3/8"	76/91	M420	na	11.1
TAGT4547YHR	3930	5153	6538	8084	9788	11652	13679	5526	2.56*	54	2500	3.90	1 1/8"	1/2"	87/90	M450	na	11.6
TAGDT4556YHR	3990	5939	8307	11069	14212	17732	21641	6352	2.74*	53	7000	3.90	1 1/8"	1/2"	153/183	B420	na	22.3
TAGDT4568YHR	5480	7488	9870	12573	15544	18735	22107	8009	2.77*	53	6000	3.90	1 1/8"	1/2"	158/188	B420	na	21.9
TAGDT4574YHR	6362	8645	11395	14560	18086	21916	25995	9244	2.90*	53	8270	6.00	1 1/8"	5/8"	171/201	B420	na	23.3
TAGDT4586YHR	6568	8766	11507	14703	18264	22108	26163	9388	2.78*	53	7600	6.00	1 1/8"	5/8"	175/205	B420	na	22.3

Statement of the seasonal COP / na: not applicable



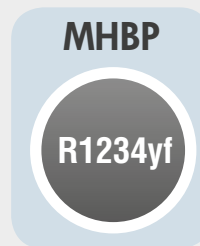

### Traditional condensing units

MODEL NUMBER	REFRIGERATION OUTPUT 32° amb., 10K superheating, 3K subcooling							REFRIG. OUTPUT EN13215 Evap. T -10°C		Aco. P db(A)	Air flow m3/h	Liq. Rec. Vol.	Diam. for tubing O.D.		Net/ Gross weight kg	No. Dim	Maximum current according to voltage code	
	Evaporation temperature (°C):							Perf. (W)	COP (W/W)				Suc.	Liqu. Line			FZ	TZ
	-15°	-10°	-5°	0°	5°	10	15°											
AE4430NH	305	386	480	587	708	845	1000	430	1.56	28	410	na	3/8"	1/4"	15/16	M200	3.3	na
AE4440NH	382	479	589	713	853	1013	1196	535	1.52	28	410	na	3/8"	1/4"	15/17	M200	3.9	na
CAJ/TAJN4492NH	890	1145	1434	1758	2115	2496	2893	1276	1.75	32	900	na	1/2"	5/16"	30/32	M300	9.1	3.7
CAJ/TAJN4511NH	1116	1403	1723	2077	2466	2894	3368	1570	1.89	33	900	na	1/2"	5/16"	30/32	M300	8.8	4.4
CAJN4513NH	1232	1565	1946	2376	2860	3401	4006	1738	1.88	39	1700	na	1/2"	3/8"	39/43	M350	10.5	na

na: not applicable

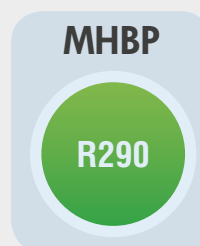

### Traditional condensing units

MODEL NUMBER	REFRIGERATION OUTPUT 32° amb., 10K superheating, 3K subcooling							REFRIG. OUTPUT EN13215 Evap. T -10°C		Aco. P db(A)	Air flow m3/h	Liq. Rec. Vol.	Diam. for tubing O.D.		Net/ Gross weight kg	No. Dim	Maximum current according to voltage code
	Evaporation temperature (°C):							Perf. (W)	COP (W/W)				Suc.	Liqu. Line			FZ
	-25°	-15°	-10°	-5°	0°	5°	15°										
AE4425UH	162	269	332	399	483	572	783	359	1.54	30	340	na	3/8"	1/4"	17/19	M200	2.4
AE4430UH	198	331	414	504	617	734	984	447	1.70	29	410	na	3/8"	1/4"	18/19	M200	2.8
AE4440UH	277	440	537	636	762	891	1190	580	1.47	38	800	na	3/8"	1/4"	19/21	M250	3.9
AE4450UH	372	570	686	805	957	1115	1495	744	1.48	38	980	na	3/8"	1/4"	20/21	M250	5.0
AE4460UH	359	592	727	864	1036	1215	1655	789	1.38	40	980	na	3/8"	1/4"	20/21	M250	5.7

na: not applicable

# DIMENSIONS

## CONDENSING UNITS SPECIAL & TRADITIONAL

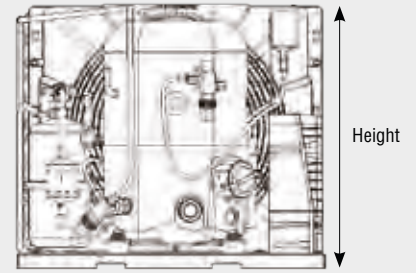
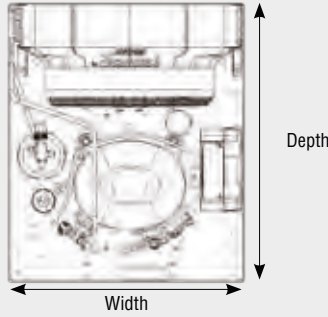

	HGA	THB	AE <sup>2</sup>	AJ <sup>2</sup>	FH/AW	TAG	TAGD	SH
M200 or B200								
M250								
M300								
M320 or M350								
M420 or M450								
B420								
B500								

M = Single fan / B = Dual fan / The 3 digits following the letter indicate the fan diameter in mm.

### LBP R290

MODEL NUMBER	Width	Height	Depth	Base
AE2410UB	300	227	374	M200
AE2415UB	300	227	374	M200
AE2420UB	322	257	404	M200

### LBP R452A R404

MODEL NUMBER	Width	Height	Depth	Base
AET2415ZBR	312	237	398	M200
AET2420ZBR	322	257	404	M200
CAJ/TAJN2428ZBR	345	304	511	M250
AET2425ZBR	346	303	501	M250
CAJN2432ZBR	345	304	511	M250
CAJN2440ZBR	432	340	488	M300
CAJ/TAJN2446ZBR	432	340	488	M300
CAJ/TAJN2464ZBR	432	340	488	M300
HGA2426ZBR	500	219	450	B200
HGA2432ZBR	500	219	450	B200
HGA2436ZBR	500	219	450	B200
HGA2446ZBR	700	219	450	B200
TFHT2480ZBR	512	436	607	M350
TFHT2511ZBR	512	436	607	M350
TAGT2513ZBR	591	540	685	M420
TAGT2516ZBR	710	540	685	M420
TAGT2519ZBR	760	608	642	M450
TAGT2522ZBR	760	608	642	M450
TAGT2525ZBR	755	608	685	M450
TAGDT2532ZBR	1060	589	703	B420
TAGDT2538ZBR	1060	589	703	B420
TAGDT2544ZBR	1060	589	703	B420
TAGDT2550ZBR	1060	589	703	B420
SHT2529ZBR	601	556	1060	B420
SHT2534ZBR	601	556	1060	B420
SHT2542ZBR	1417	665	720	B420
SHT2552ZBR	1417	665	720	B420
SHT2568ZBR	1417	860	720	B500
SHT2575ZBR	1417	860	720	B500

### LBP SPE. R452A R404

MODEL NUMBER	Width	Height	Depth	Base
CAJT2432ZBR	430	340	490	M300
CAJ/TAJT2446ZBR	430	340	490	M300
CAJ/TAJT2464ZBR	512	445	607	M350

### MHBP R290

MODEL NUMBER	Width	Height	Depth	Base
AE4425UH	300	227	374	M200
AE4430UH	322	257	404	M200
AE4440UH	334	300	485	M250
AE4450UH	334	300	485	M250
AE4460UH	334	300	485	M250

### MHBP SPE. R452A R404

MODEL NUMBER	Width	Height	Depth	Base
CAJ/TAJT9480ZMHR	430	340	490	M300
CAJ/TAJT9510ZMHR	512	445	607	M320
CAJ/TAJT9513ZMHR	512	445	607	M350
CAJ/TAJT4517ZHR	512	445	607	M350
CAJ/TAJT4519ZHR	513	436	608	M350

### MHBP R452A R404

MODEL NUMBER	Width	Height	Depth	Base
AET4425ZHR	322	257	404	M200
AET4430ZHR	322	257	404	M200
AET4440ZHR	346	303	501	M250
AET4450ZHR	346	303	501	M250
AET4460ZHR	433	338	496	M300
AET4470ZHR	433	338	496	M300
HGA4467ZHR	500	219	450	B200
HGA4480ZHR	700	219	450	B200
HGA4492ZHR	700	219	450	B200
HGA4512ZHR	700	219	450	B200
CAJ/TAJN9480ZMH	432	340	488	M300
CAJ/TAJN9510ZMH	432	340	488	M300
CAJ/TAJN9513ZMHR	432	340	488	M300
CAJ/TAJN4517ZHR	513	437	608	M350
CAJ/TAJN4519ZHR	513	437	608	M350
FH/TFHT4522ZHR	512	436	607	M350
FH/TFHT4524ZHR	591	540	625	M420
FH/TFHT4531ZHR	591	540	625	M420
AWT4538ZHR	592	540	647	M420
TAGT4546ZHR	1060	555	615	B420
TAGT4553ZHR	1060	555	615	B420
TAGT4561ZHR	1060	555	615	B420
TAGT4568ZHR	1060	555	615	B420
TAGT4573ZHR	1060	555	615	B420
SHT4576ZHR	1060	555	601	B420
TAGT4581ZHR	1060	555	615	B420
TAGDT4590ZHR	1417	868	720	B420
SHT4591ZHR	1417	660	720	B420
TAGDT4610ZHR	1417	868	720	B420
SHT4610ZHR	1417	860	720	B420
TAGDT4612ZHR	1417	868	720	B500
SHT4612ZHR	1417	860	720	B500
TAGDT4614ZHR	1417	868	720	B500
TAGDT4615ZHR	1417	868	720	B500
TAGDT4616ZHR	1417	868	720	B500
SHT4615ZHR	1417	860	720	B500
SHT4620ZHR	1417	860	720	B500

### MHBP R1234yf

MODEL NUMBER	Width	Height	Depth	Base
AE4430NH	322	257	378	M200
AE4440NH	322	257	378	M200
CAJ/TAJN4492NH	432	340	488	M300
CAJ/TAJN4511NH	432	340	488	M300
CAJN4513NH	512	437	607	M350

### MHBP R134a R513A

MODEL NUMBER	Width	Height	Depth	Base
THB4410YH	309	227	398	M200
THB4413YH	309	227	398	M200
THB4415YHR	309	227	398	M200
THB4419YHR	309	227	398	M200
THB4422YHR	309	227	398	M200
AE4430YHR	322	257	404	M200
AE4440YHR	322	257	404	M200
CAJN4452YHR	345	304	511	M250
AE4450YHR	346	303	501	M250
CAJ/TAJN4461YHR	345	304	511	M250
AE4456YHR	346	303	501	M250
AE4460YHR	346	303	501	M250
HGA4445YHR	500	218	450	B200
HGA4450YHR	500	218	450	B200
HGA4460YHR	500	218	450	B200
HGA4476YHR	700	218	450	B200
CAJN4476YHR	432	340	488	M300
CAJ/TAJN4492YHR	432	340	488	M300
CAJ/TAJN4511YHR	432	340	488	M300
CAJN4513YHR	513	437	608	M350
FH/TFHT4518YHR	512	436	607	M350
TAGT4528YHR	597	540	629	M420
FH/TFHT4525YHR	512	436	607	M350
TAGT4534YHR	597	540	629	M420
TAGT4537YHR	597	540	629	M420
TAGT4543YHR	597	540	629	M420
TAGT4547YHR	597	540	629	M450
TAGDT4556YHR	1060	589	703	B420
TAGDT4568YHR	1060	589	703	B420
TAGDT4574YHR	1417	868	720	B420
TAGDT4586YHR	1417	868	720	B420

### MHBP SPE. R134a R513A

MODÈLE	Width	Height	Depth	Base
AET4425YHR	322	257	404	M200
AET4430YHR	336	298	486	M250
AET4440YHR	346	303	501	M250
AET4450YHR	433	338	496	M300
AET4456YHR	346	303	501	M300
AET4460YHR	346	303	501	M300
CAJT4452YHR	430	340	490	M300
CAJ/TAJT4461YHR	430	340	490	M300
CAJT4476YHR	430	340	490	M350
CAJ/TAJT4492YHR	512	445	607	M350
CAJ/TAJT4511YHR	512	445	607	M350

# APPLICATION WINDOWS

## LBP R452A R404A

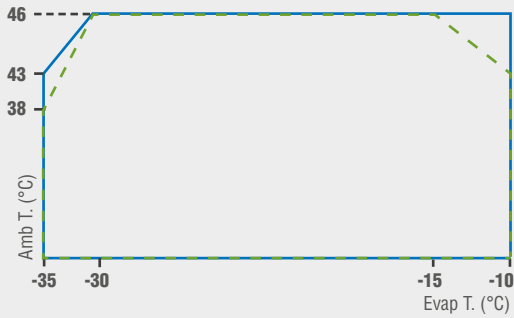

MODEL NUMBER
T/CAJN 2428 ZBR
T/CAJN 2440 ZBR
T/CAJN 2446 ZBR
CAJT 2432 ZBR
T/CAJT 2446 ZBR
T/CAJT 2464 ZBR
T/FHT 2480 ZBR
TAGT 2513 ZBR
TAGT 2516 ZBR
TAGT 2519 ZBR
TAGT 2522 ZBR
TAGT 2525 ZBR
SHT 2529 ZBR
SHT 2534 ZBR

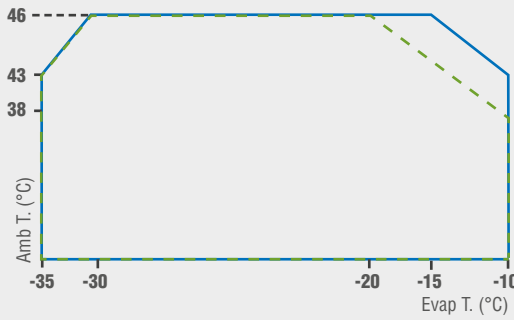

MODEL NUMBER
T/CAJN 2432 ZBR
T/CAJT 2464 ZBR
SHT 2534 ZBR

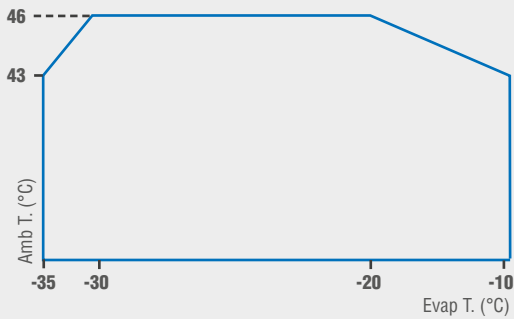

MODEL NUMBER
SHT 2542 ZBR

## LBP R290

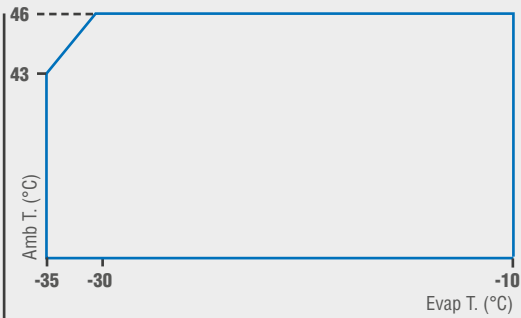

MODEL NUMBER
AE 2410 UB

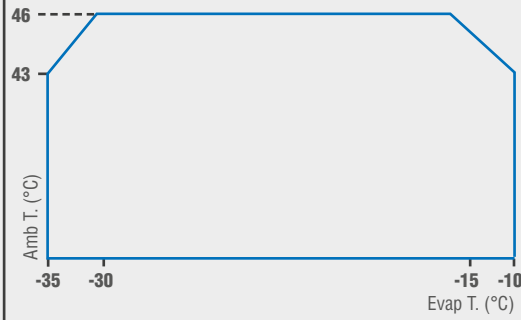

MODEL NUMBER
AE 2415 UB
AE 2420 UB

## MHBP R290

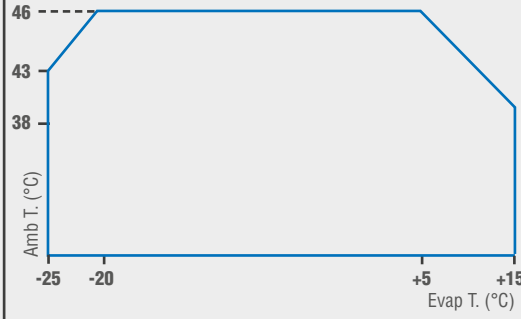

MODEL NUMBER
AE 4425 UH
AE 4430 UH
AE 4440 UH

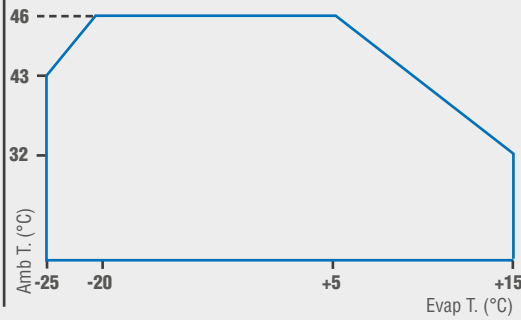

MODEL NUMBER
AE 4450 UH
AE 4460 UH

# MHBP R452A R404A

# MHBP R134a R513A R1234yf

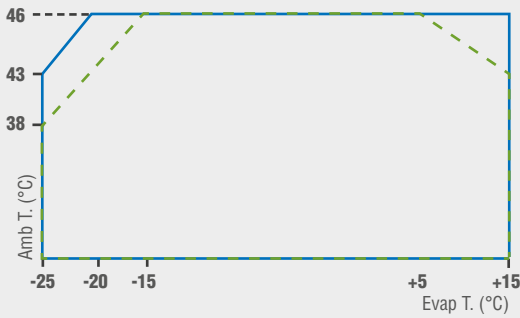

MODEL NUMBER
T/CAJN 4517 ZHR
AET 4460 ZHR
AET 4470 ZHR
T/CAJT 9480 ZMHR
T/CAJT 9513 ZMHR
TAGT 4546 ZHR
TAGT 4553 ZHR
TAGT 4561 ZHR
TAGT 4573 ZHR
TAGDT 4612 ZHR
TAGDT 4614 ZHR
TAGDT 4616 ZHR

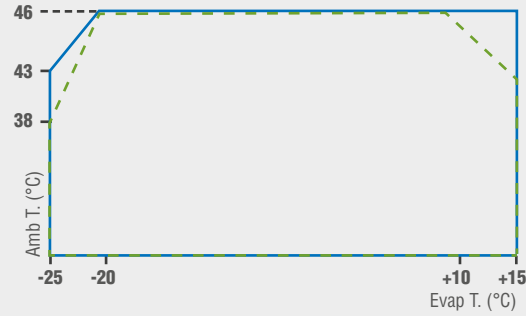

MODEL NUMBER
THB 4419 YHR
THB 4410 YH
THB 4413 YH
T/CAJT 4492 YHR

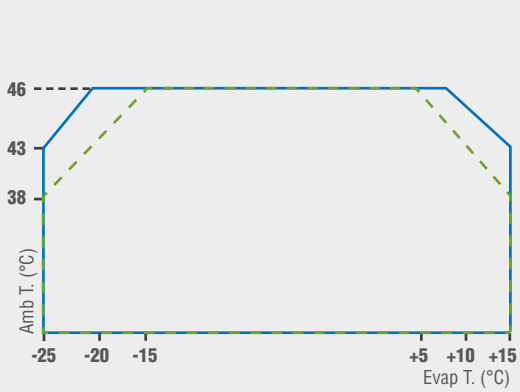

MODEL NUMBER
T/CAJN 9480 ZMHR
T/CAJN 4517 ZHR
AET 4425 ZHR
AET 4430 ZHR
AET 4440 ZHR
T/CAJT 9510 ZMHR
T/CAJT 4517 ZHR
T/CAJT 4519 ZHR
T/FHT 4522 ZHR
T/FHT 4524 ZHR
AWT 4538 ZHR
TAGT 4568 ZHR
TAGT 4581 ZHR
TAGDT 4590 ZHR
TAGDT 4610 ZHR
TAGDT 4615 ZHR

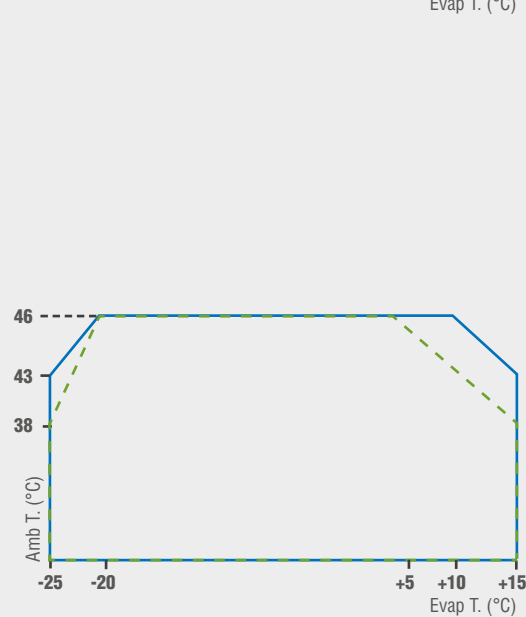

MODEL NUMBER
AE 4456 YHR
THB 4422 YHR
T/CAJN 4476 YHR
AET 4450 YHR
AET 4456 YHR
AET 4460 YHR
T/CAJT 4461 YHR
T/CAJT 4476 YHR
T/CAJT 4511 YHR
TAGDT 4556 YHR
TAGDT 4568 YHR
TAGDT 4574 YHR
CAJN 4513 YHR
AE 4430 NH
T/CAJN 4492NH
CAJN 4513 NH

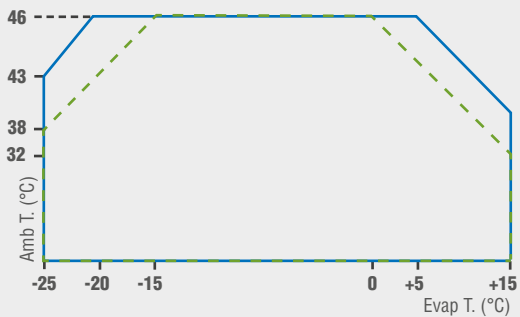

MODEL NUMBER
T/CAJN 9510 ZMHR
AET 4450 ZHR
T/FHT 4531 ZHR

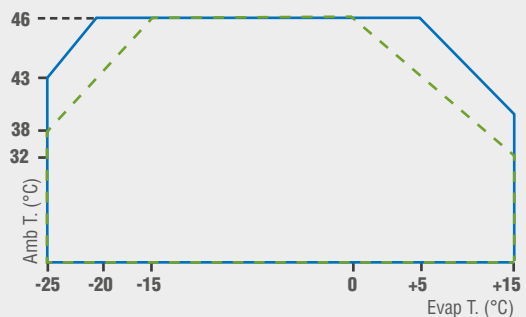

MODEL NUMBER
AE 4430 YHR
AE 4440 YHR
AE 4450 YHR
AE 4456 YHR
AE 4460 YHR
CAJN 4452 YHR
T/CAJN 4492 YHR
AET 4425 YHR
AET 4430 YHR
T/FHT 4525 YHR
TAGT 4528 YHR
TAGT 4534 YHR
TAGT 4547 YHR
TAGT 4586 YHR
AE 4440 NH

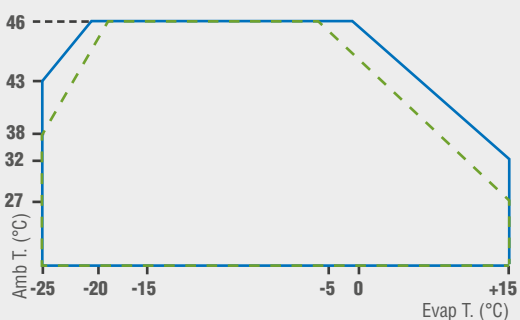

MODEL NUMBER
T/CAJN 9513 ZMHR
SHT 4576 ZHR
SHT 4591 ZHR
SHT 4610 ZHR
SHT 4612 ZHR
SHT 4615 ZHR
SHT 4620 ZHR

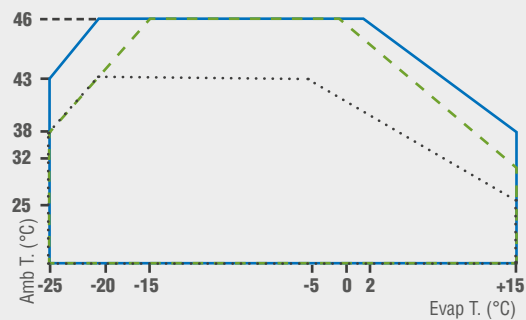

MODEL NUMBER
AE 4450 YHR
AE 4460 YHR
T/CAJN 4511 YHR
T/CAJN4511 NH
AE 4460 YHR
TAGT 4537 YHR
TAGT 4543 YHR
CAJN 4461 YHR



## Solution for demanding outdoor conditions

*High energy efficiency  
Meticulous assembly and aesthetics  
Recognised reliable product*



### EQUIPMENT ELECTRICAL COMPONENTS

- ▶ Isolator switch
- ▶ Contactor
- ▶ Din Rail adapter with free length



### CIRCUIT

- ▶ Dryer filter
- ▶ Liquid indicator

### INSTALLATION/MAINTENANCE

- ▶ Polypropylene shock-proof and anti-UV fairing
- ▶ Corrosion resistance in accordance with standard NF EN ISO 9227 – 500-hour neutral salt spray test
- ▶ Ground fixing

### CONTROL

- ▶ Thermostatic or pressure control of the compressor without additional wiring
- ▶ Pressure switch fault reporting terminals

### FIXING



Direct access to the feet



WINTSYS

**WINTSYS<sup>®</sup>**



Wintsys®

**LBP**

**R452A**

MODEL NUMBER	REFRIGERATION OUTPUT 32° amb., 10K superheating, 3K subcooling, Mid/Mid						REFRIG. OUTPUT EN13215 Evap. T -35°C		Acc. P db(A)	Air flow m3/h	Liq. Rec. Vol.	Diam. for tubing O.D.		Net/ Gross weight kg	No. Dim	Maximum current according to voltage code	
	Evaporation temperature (°C):						Perf. (W)	COP (W/W)				Suc.	Liqu. Line			FZ	TZ
	-35°	-30°	-25°	-20°	-15°	-10°											
WINAE2425Z	302	411	542	699	884	1100	340	0.94	26	1650	0.75	3/8"	1/4"	53/71	S	4.5	na
WINAJ2440Z	429	601	806	1048	1331	1662	484	0.95	27	1650	1.50	1/2"	1/4"	61/79	S	6.2	na
WINAJ2446Z	565	763	999	1280	1612	2003	643	1.03	27	1650	1.50	1/2"	3/8"	63/81	S	8.7	3.4
WINAJ2464Z	765	1026	1337	1699	2116	2589	867	1.02	28	1650	1.50	5/8"	3/8"	65/83	S	10.5	3.9
WINFH2480Z	1012	1407	1852	2351	2912	3543	1142	1.05	39	1650	2.35	5/8"	1/2"	74/95	M	16.7	7.0
WINFH2511Z	1353	1871	2488	3211	4049	5009	1531	1.08	42	2750	2.35	5/8"	1/2"	82/103	M	24.7	7.9

na : not applicable



Wintsys®

**LBP**

**R404A**

MODEL NUMBER	REFRIGERATION OUTPUT 32° amb., 10K superheating, 3K subcooling, Mid/Mid						REFRIG. OUTPUT EN13215 Evap. T -35°C		Acc. P db(A)	Air flow m3/h	Liq. Rec. Vol.	Diam. for tubing O.D.		Net/ Gross weight kg	No. Dim	Maximum current according to voltage code	
	Evaporation temperature (°C):						Perf. (W)	COP (W/W)				Suc.	Liqu. Line			FZ	TZ
	-35°	-30°	-25°	-20°	-15°	-10°											
WINAE2425Z	306	412	540	690	867	1071	378	0.99	26	1650	0.75	3/8"	1/4"	53/71	S	4.5	na
WINAJ2440Z	436	595	787	1013	1277	1582	542	0.97	27	1650	1.50	1/2"	1/4"	61/79	S	6.2	na
WINAJ2446Z	573	768	999	1270	1586	1951	712	1.06	27	1650	1.50	1/2"	3/8"	63/81	S	8.7	3.4
WINAJ2464Z	774	1033	1337	1688	2087	2532	957	1.05	28	1650	1.50	5/8"	3/8"	65/83	S	10.5	3.9
WINFH2480Z	1056	1429	1851	2324	2853	3441	1311	1.11	39	1600	2.35	5/8"	1/2"	74/95	M	16.7	7.0
WINFH2511Z	1366	1882	2489	3190	3989	4889	1700	1.11	42	2750	2.35	5/8"	1/2"	82/103	M	24.7	7.9

na : not applicable

For information, the cooling capacity of fluids R449A and R448A: at the evaporation point  $T_o = -30^\circ\text{C}$ , SH10K, apply the multiplier ratio 0.94 to the cooling capacities read with R404A.

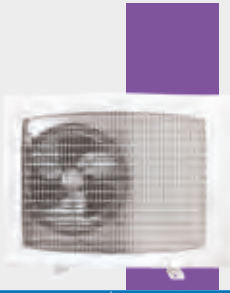

**MHBP**
**R452A**

**Wintsys®**

MODEL NUMBER	REFRIGERATION OUTPUT 32° amb., 10K superheating, 3K subcooling, Mid/Mid							REFRIG. OUTPUT EN13215 Evap. T -10°C		Acc. P db(A)	Air flow m3/h	Liq. Rec. Vol.	Diam. for tubing O.D.		Net/ Gross weight kg	No. Dim	Maximum current according to voltage code	
	Evaporation temperature (°C):							Perf. (W)	COP (W/W)				Suc.	Liqu. Line			FZ	TZ
	-25°	-15°	-10°	-5°	0°	5°	15°											
WINAE4450Z	368	638	805	1004	1237	1506	2167	820	1.78	27	1650	0.75	3/8"	1/4"	53/71	S	5.6	na
WINAE4460Z	470	771	957	1178	1436	1735	2470	981	1.84	28	1650	0.75	3/8"	1/4"	53/71	S	6.4	na
WINAE4470Z	474	833	1056	1324	1641	2019	3004	1081	1.66	29	1650	0.75	3/8"	1/4"	53/71	S	7.6	na
WINAJ9480Z	607	1027	1286	1590	1943	2348	3329	1316	1.90	30	1650	1.50	1/2"	3/8"	62/80	S	7.3	3.7
WINAJ9510Z	758	1263	1571	1934	2352	2830	3988	1614	1.93	30	1650	1.50	5/8"	3/8"	63/81	S	8.9	4.1
WINAJ9513Z	914	1568	1968	2432	2963	3566	5005	2021	2.08	30	1650	1.50	5/8"	3/8"	65/83	S	11.8	4.9
WINAJ4517Z	1008	1689	2094	2562	3097	3711	5216	2171	1.96	30	1650	2.35	5/8"	3/8"	65/83	S	13.2	4.7
WINAJ4519Z	1130	2093	2596	3171	3828	4587	6519	2708	1.72	32	1650	2.35	5/8"	3/8"	65/83	S	15.5	6.7
WINFH4524Z	1319	2439	3122	3911	4807	5821	8236	3213	1.83	39	2750	2.35	5/8"	1/2"	79/100	M	20.3	8.4
WINFH4531Z	1797	3150	3947	4868	5922	7129	10089	4092	1.90	41	2750	3.90	7/8"	1/2"	83/104	M	23.1	9.7
WINAW4538Z	2174	3851	4814	5877	7027	8267	11132	5008	2.98*	47	2750	3.90	7/8"	1/2"	79/100	M	27.0 <sup>a</sup>	9.7 <sup>b</sup>

Statement of the seasonal COP / na: not applicable / <sup>a</sup> voltage code XC, <sup>b</sup> voltage code XG, <sup>c</sup> voltage code YZ, <sup>d</sup> voltage code MZ

**MHBP**
**R404A**

**Wintsys®**

MODEL NUMBER	REFRIGERATION OUTPUT 32° amb., 10K superheating, 3K subcooling							REFRIG. OUTPUT EN13215 Evap. T -10°C		Acc. P db(A)	Air flow m3/h	Liq. Rec. Vol.	Diam. for tubing O.D.		Net/ Gross weight kg	No. Dim	Maximum current according to voltage code	
	Evaporation temperature (°C):							Perf. (W)	COP (W/W)				Suc.	Liqu. Line			FZ	TZ
	-25°	-15°	-10°	-5°	0°	5°	15°											
WINAE4450Z	370	627	790	980	1199	1450	2065	870	1.81	27	1650	0.75	3/8"	1/4"	53/70	S	5.6	na
WINAE4460Z	476	762	942	1152	1394	1673	2354	1039	1.87	28	1650	0.75	3/8"	1/4"	53/70	S	6.4	na
WINAE4470Z	547	888	1096	1334	1605	1912	2648	1209	1.87	29	1650	0.75	3/8"	1/4"	53/70	S	7.6	na
WINAJ9480Z	614	1014	1266	1556	1888	2265	3172	1396	1.92	30	1650	2.35	1/2"	3/8"	62/79	S	7.3	3.7
WINAJ9510Z	768	1248	1549	1894	2286	2730	3793	1710	1.95	30	1650	2.35	5/8"	3/8"	63/80	S	8.9	4.1
WINAJ9513Z	924	1548	1938	2382	2881	3440	4759	2143	2.10	30	1650	2.35	5/8"	3/8"	65/82	S	11.8	4.9
WINAJ4517Z	1016	1671	2066	2512	3012	3575	4941	2296	1.97	30	1650	2.35	5/8"	3/8"	65/82	S	13.2	4.7
WINAJ4519Z	1223	2068	2562	3108	3719	4408	6141	2860	1.73	32	1650	2.35	5/8"	3/8"	65/82	S	15.5	6.7
WINFH4524Z	1316	2397	3064	3817	4658	5593	7793	3405	1.84	39	2750	3.90	5/8"	1/2"	79/100	M	20.3	8.4
WINFH4531Z	1809	3112	3892	4767	5747	6847	9517	4333	1.91	41	2750	3.90	7/8"	1/2"	83/104	M	23.1	9.7
WINAW4538Z	2203	3774	4704	5724	6828	8007	10621	5239	2.97*	47	2970	3.90	7/8"	1/2"	79/100	M	27.0 <sup>a</sup>	9.7 <sup>b</sup>

Statement of the seasonal COP / na: not applicable / <sup>a</sup> voltage code XC, <sup>b</sup> voltage code XG, <sup>c</sup> voltage code YZ, <sup>d</sup> voltage code MZ

For information, the cooling capacity of fluids R449A and R448A: at the evaporation point To = -30°C, SH10K, apply the multiplier ratio 0.94 to the cooling capacities read with R404A.





MHBP

R513A

Wintsys®

MODEL NUMBER	REFRIGERATION OUTPUT 32° amb., 10K superheating, 3K subcooling							REFRIG. OUTPUT EN13215 Evap. T -10°C		Aco. P db(A)	Air flow m3/h	Liq. Rec. Vol.	Diam. for tubing O.D.		Net/ Gross weight kg	No. Dim	Maximum current according to voltage code	
	Evaporation temperature (°C):							Perf. (W)	COP (W/W)				Suc.	Liqu. Line			FZ	TZ
	-15°	-10°	-5°	0°	5°	10°	15°											
WINAE4450Y	616	773	959	1178	1435	1734	2079	835	1.66	28	1650	0.75	3/8"	1/4"	53/71	S	5.1	na
WINAE4460Y	692	871	1081	1328	1614	1944	2318	941	1.96	28	1650	0.75	3/8"	1/4"	53/71	S	5.0	na
WINAJ4476Y	798	1032	1306	1626	1999	2429	2922	1117	1.72	28	1650	1.50	1/2"	3/8"	62/80	S	8.3	na
WINAJ4492Y	1035	1323	1656	2036	2466	2947	3480	1430	1.94	27	1650	1.50	1/2"	3/8"	62/80	S	9.4	3.8
WINAJ4511Y	1329	1675	2065	2503	2987	3516	4089	1815	2.10	29	1650	1.50	5/8"	3/8"	63/81	S	9.1	4.1
WINAJ4513Y	1425	1809	2248	2748	3313	3945	4650	1958	2.10	28	1650	1.50	5/8"	3/8"	63/81	S	10.4	na
WINFH4518Y	1685	2231	2863	3590	4416	5347	6387	2421	1.79	36	2750	2.35	5/8"	3/8"	75/96	M	11.9	4.9
WINFH4525Y	2377	3026	3776	4634	5606	6699	7919	3297	1.92	40	2750	2.35	5/8"	3/8"	77/98	M	15.9	7.4

na : not applicable



MHBP

R134a

Wintsys®

MODEL NUMBER	REFRIGERATION OUTPUT 32° amb., 10K superheating, 3K subcooling							REFRIG. OUTPUT EN13215 Evap. T -10°C		Aco. P db(A)	Air flow m3/h	Liq. Rec. Vol.	Diam. for tubing O.D.		Net/ Gross weight kg	No. Dim	Maximum current according to voltage code	
	Evaporation temperature (°C):							Perf. (W)	COP (W/W)				Suc.	Liqu. Line			FZ	TZ
	-15°	-10°	-5°	0°	5°	10°	15°											
WINAE4450Y	571	730	918	1138	1395	1691	2032	780	1.65	28	1650	0.75	3/8"	1/4"	53/73	S	5.1	na
WINAE4460Y	642	823	1035	1283	1569	1896	2266	879	1.95	28	1650	0.75	3/8"	1/4"	53/73	S	5.0	na
WINAJ4476Y	740	975	1250	1571	1943	2369	2856	1043	1.71	28	1650	1.50	1/2"	3/8"	62/81	S	8.3	na
WINAJ4492Y	947	1235	1571	1960	2404	2908	3474	1319	1.91	27	1650	1.50	1/2"	3/8"	62/82	S	9.4	3.8
WINAJ4511Y	1220	1568	1967	2418	2924	3486	4105	1679	2.07	29	1650	1.50	5/8"	3/8"	63/83	S	9.1	4.1
WINAJ4513Y	1307	1691	2136	2648	3231	3893	4641	1809	2.07	28	1650	1.50	5/8"	3/8"	63/83	S	10.4	na
WINFH4518Y	1548	2091	2730	3473	4330	5308	6421	2242	1.76	36	2750	2.35	5/8"	3/8"	75/101	M	11.9	4.9
WINFH4525Y	2190	2848	3616	4504	5523	6686	8012	3062	1.89	40	2750	2.35	5/8"	3/8"	77/104	M	15.9	7.4

na : not applicable



# DIMENSIONS

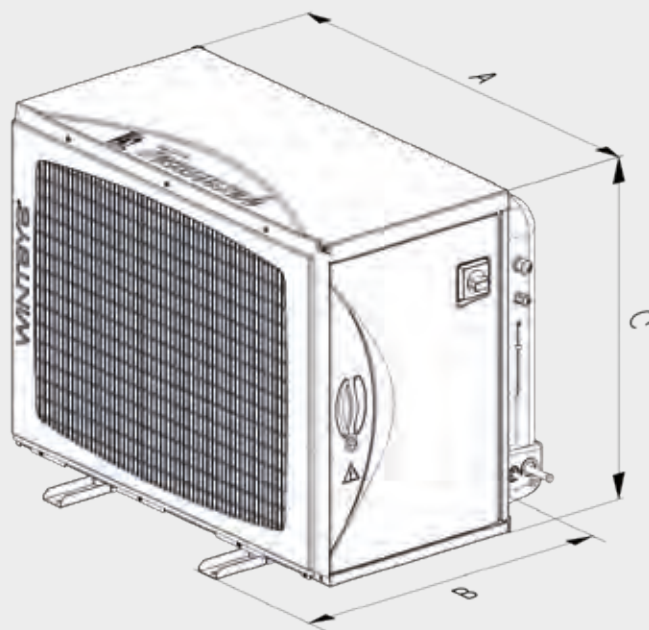

Wintsys®

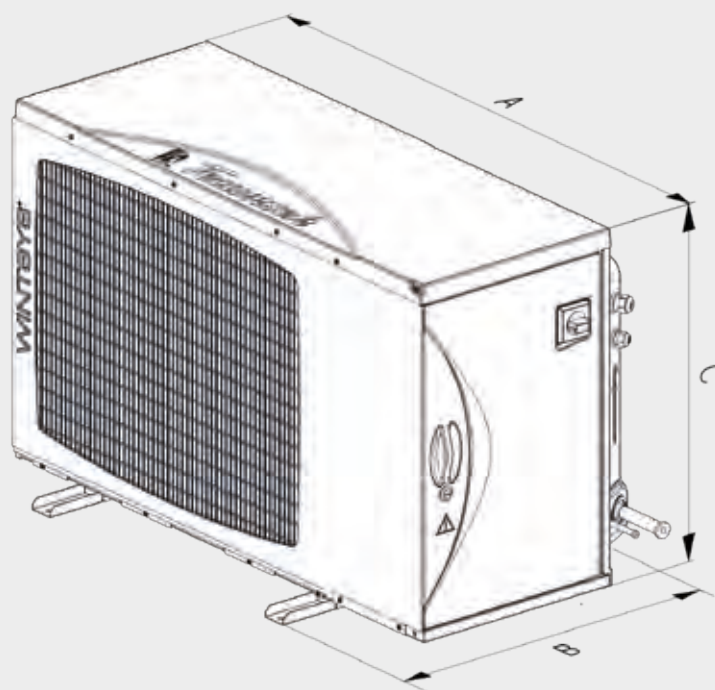

SIZE S



SIZE M

		A	B	C
	S	942	654	710
	M	1174	654	710

# APPLICATION WINDOWS

## LBP R452A R404A

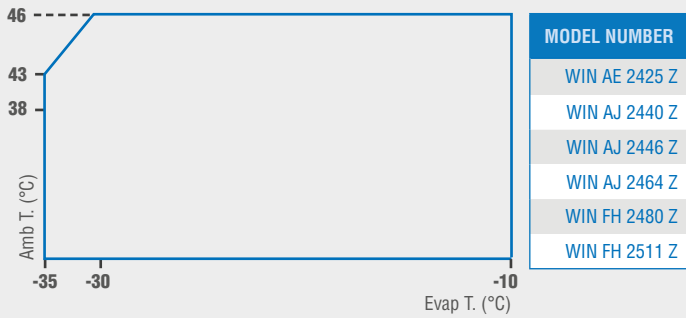

## MHBP R452A R404A

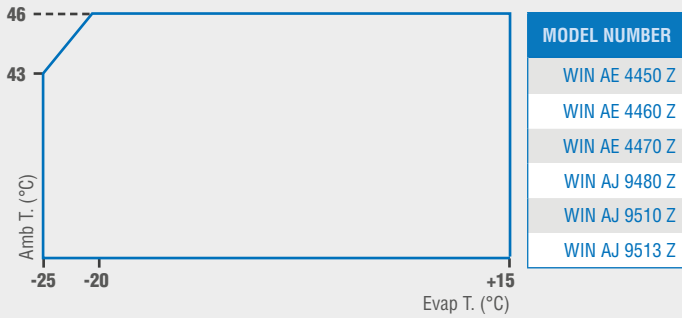

## MHBP R134a R513A

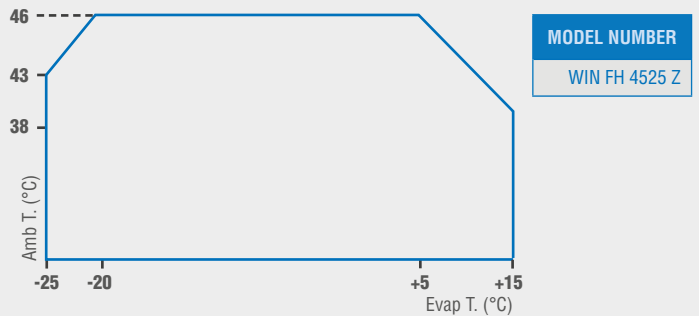
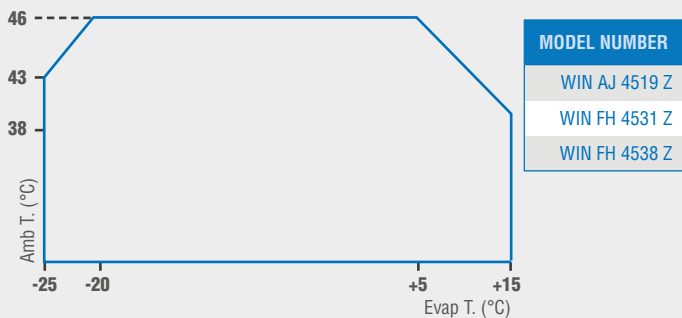
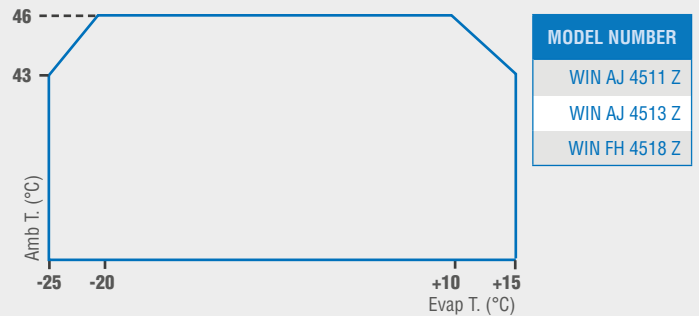
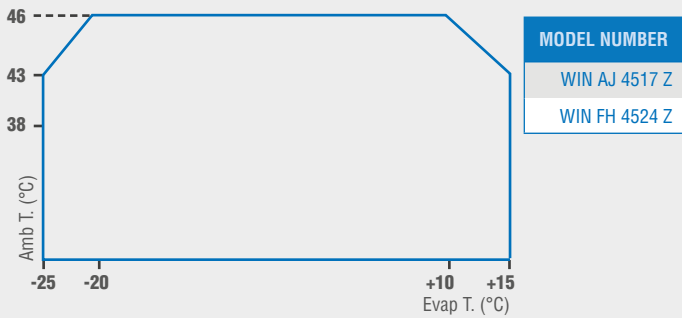
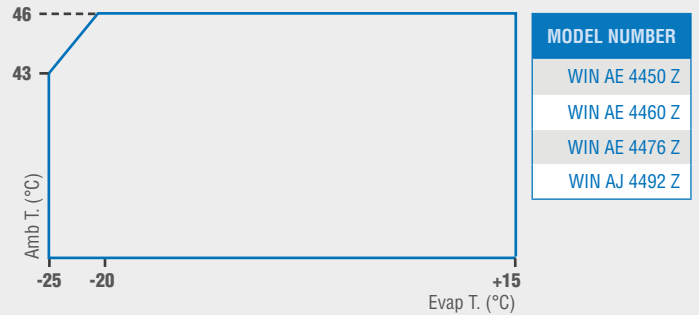







## Acoustic and aesthetic solution for urban areas

*Acoustic benchmark*  
*Robustness and reliability*  
*Enhanced safety*



### EQUIPMENT

#### **ELECTRICAL COMPONENTS = ENHANCED SAFETY**

- ▶ Magneto-thermal circuit breaker on the compressor
- ▶ Fan circuit breaker
- ▶ Pressure switch fault referral terminals
- ▶ Din Rail adapter accessible and with free length



### CIRCUIT

- ▶ Isolation of the suction line
- ▶ Service valves on the reservoir bottle



### FIXING

- ▶ Ensures the minimum distance between the condenser and the wall
- ▶ Direct access to the mounting feet
- ▶ Fixing on the ground and the wall with the original feet



### ACOUSTICS

- ▶ Compressor isolated in a separate compartment
- ▶ Fan speed variation
- ▶ Muffler on the discharge
- ▶ Reduction of radiated noise by means of an insulated door
- ▶ Absorption of vibration through special bends on the copper tubes

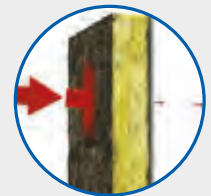



**SILENSYS®**





Silensys®



MODEL NUMBER	REFRIGERATION OUTPUT 32° amb., 10K superheating, 3K subcooling, Mid/Mid						REFRIG. OUTPUT EN13215 Evap. T -35°C		Aco. P db(A)	Air flow m3/h	Liq. Rec. Vol.	Diam. for tubing O.D.		Net/ Gross weight kg	No. Dim	Maximum current according to voltage code		
	Evaporation temperature (°C):						Perf. (W)	COP (W/W)				Suc.	Liqu. Line			FZ	KZ	TZ
	-35°	-30°	-25°	-20°	-15°	-10°												
SILRG2426Z	315	412	530	671	836	1028	356	1.03	26	1650	0.75	3/8"	1/4"	61/78	S	3.7	na	na
SILRG2432Z	387	504	642	805	994	1211	439	1.08	27	1650	0.75	3/8"	1/4"	61/78	S	4.5	na	na
SILAJ2432Z	350	506	697	927	1198	1511	392	0.88	26	1650	1.50	1/2"	1/4"	71/88	S	6.2	na	na
SILAJ2440Z	429	601	806	1048	1331	1662	484	0.95	26	1650	1.50	1/2"	1/4"	70/87	S	6.0	na	na
SILRG2446Z	523	682	874	1101	1367	1674	594	1.12	27	1650	1.50	3/8"	1/4"	63/80	S	5.7	na	na
SILAJ2446Z	564	761	996	1276	1607	1996	643	1.03	26	1650	1.50	1/2"	3/8"	72/89	S	8.5	na	3.2
SILAJ2464Z	765	1026	1337	1699	2116	2589	867	1.02	27	1650	1.50	1/2"	3/8"	74/91	S	10.3	na	4.1
SILFH2480Z	1012	1403	1847	2345	2904	3532	1142	1.05	39	1650	2.35	5/8"	1/2"	74/95	M	17.3	11.7	6.6
SILFH2511Z	1350	1866	2481	3202	4037	4994	1415	0.98	44	2700	2.35	5/8"	1/2"	71/92	M	26.0	14.4	8.3
SILAG2513Z	1351	1962	2665	3464	4365	5387	1518	0.97	40	2970	3.90	7/8"	1/2"	103/119	M	na	20.4	9.3
SILAG2516Z	1756	2530	3424	4436	5566	6821	1970	1.16	38	2970	3.90	7/8"	1/2"	128/144	M	na	25.3	10.3
SILAG2519Z	2055	2891	3855	4945	6158	7505	2321	1.61*	na	2970	3.90	7/8"	1/2"	108/129	M	na	na	11.2
SILAG2522Z	2349	3250	4295	5486	6835	8366	2669	1.62*	40	2700	3.90	7/8"	1/2"	112/128	M	na	30.2	14.2
SILAG2525Z	2614	3591	4695	5930	7306	8850	2971	1.60*	44	2700	3.90	7/8"	1/2"	112/128	M	na	26.7	14.1
SILAGD2532Z	3488	5112	7061	9332	11903	14726	3900	1.65*	43	6600	9.50	1 1/8"	5/8"	236/257	XL	na	na	22.0
SILAGD2538Z	3972	5678	7728	10115	12803	15727	4491	1.66*	na	6600	9.50	1 1/8"	5/8"	236/257	XL	na	na	22.0
SILSH2534Z	4315	5849	7647	9729	12110	14812	4425	1.71*	44	5000	12.00	1 3/8"	5/8"	244/265	XL	na	na	16.2°
SILAGD2544Z	5002	6883	9147	11793	14795	18097	5725	1.72*	43	6600	9.50	1 1/8"	5/8"	252/273	XL	na	na	28.0

Statement of the seasonal COP / na: not applicable / <sup>a</sup> voltage code XC, <sup>b</sup> voltage code XG, <sup>c</sup> voltage code YZ, <sup>d</sup> voltage code MZ





**Silensys®**

**LBP**

**R404A**

MODEL NUMBER	REFRIGERATION OUTPUT 32° amb., 10K superheating, 3K subcooling						REFRIG. OUTPUT EN13215 Evap. T -35°C		Aco. P db(A)	Air flow m3/h	Liq. Rec. Vol.	Diam. for tubing O. D.		Net/ Gross weight kg	No. Dim	Maximum current according to voltage code		
	Evaporation temperature (°C):						Perf. (W)	COP (W/W)				Suc.	Liqu. Line			FZ	KZ	TZ
	-35°	-30°	-25°	-20°	-15°	-10°												
SILRG2426Z	268	359	470	601	754	930	331	0.89	26	1650	0.75	3/8"	1/4"	61/78	S	3.7	na	na
SILRG2432Z	351	457	586	739	916	1116	435	0.98	27	1650	0.75	3/8"	1/4"	61/88	S	4.5	na	na
SILAJ2432Z	380	531	714	931	1184	1476	469	1.03	26	1650	1.50	1/2"	1/4"	71/87	S	6.2	na	na
SILAJ2440Z	449	611	807	1037	1306	1618	555	1.01	26	1650	1.50	1/2"	1/4"	70/80	S	6.0	na	na
SILRG2446Z	467	612	786	992	1231	1506	579	1.02	27	1650	1.50	3/8"	1/4"	63/92	S	5.7	na	na
SILAJ2446Z	573	768	999	1270	1586	1951	712	1.07	26	1650	1.50	1/2"	3/8"	72/91	S	8.5	na	3.2
SILAJ2464Z	774	1033	1337	1688	2087	2532	957	1.09	27	1650	1.50	1/2"	3/8"	74/91	S	10.3	na	4.1
SILFH2480Z	1056	1429	1851	2324	2853	3441	1311	1.11	39	1650	2.35	5/8"	1/2"	74/91	M	17.3	11.7	6.6
SILFH2511Z	1357	1867	2472	3177	3988	4912	1688	1.13	44	2700	2.35	5/8"	1/2"	71/124	M	26.0	14.4	8.3
SILAG2513Z	1380	1974	2657	3427	4285	5238	1726	1.01	40	2970	3.90	7/8"	1/2"	103/144	M	na	20.4	9.3
SILAG2516Z	1786	2535	3409	4400	5498	6690	2225	1.67*	38	2970	3.90	7/8"	1/2"	128/124	M	na	25.3	10.3
SILAG2519Z	2030	2816	3731	4768	5913	7153	2540	1.67*	na	2970	3.90	7/8"	1/2"	108/133	M	na	na	11.2
SILAG2522Z	2396	3275	4295	5454	6749	8180	2991	1.70*	40	2700	3.90	7/8"	1/2"	112/128	M	na	30.2	14.2
SILAG2525Z	2619	3554	4614	5794	7092	8510	3276	1.66*	44	2700	3.90	7/8"	1/2"	112/252	M	na	26.7	14.1
SILAGD2532Z	3508	5096	7003	9220	11715	14422	4378	1.73*	43	6600	9.50	1*1/8"	5/8"	236/257	XL	na	na	22.0
SILSH2534Z-YZ	4406	5880	7583	9525	11716	14173	4950	1.86*	44	5000	12.00	1*3/8"	5/8"	244/265	XL	na	na	16.2 <sup>b</sup>
SILAGD2538Z	3999	5676	7686	10014	12613	15397	5009	1.74*	na	6600	9.50	1*1/8"	5/8"	236/272	XL	na	na	22.0
SILAGD2544Z	4551	6328	8453	10905	13620	16485	5710	1.76*	43	6600	9.50	1*1/8"	5/8"	252/286	XL	na	na	28.0

Statement of the seasonal COP / na: not applicable / <sup>a</sup> voltage code XC, <sup>b</sup> voltage code XG, <sup>c</sup> voltage code YZ, <sup>d</sup> voltage code MZ

For information, the cooling capacity of fluids R449A and R448A: at the evaporation point To = -30°C, SH10K, apply the multiplier ratio 0.94 to the cooling capacities read with R404A.







Silensys®

MHBP

R452A

MODEL NUMBER	REFRIGERATION OUTPUT 32° amb., 10K superheating, 3K subcooling, Mid/Mid							REFRIG. OUTPUT EN13215 Evap. T -10°C		Aco. P db(A)	Air flow m3/h	Liq. Rec. Vol.	Diam. for tubing O.D.		Net/ Gross weight kg	No. Dim	Maximum current according to voltage code		
	Evaporation temperature (°C):							Perf. (W)	COP (W/W)				Suc.	Liqu. Line			FZ	KZ	TZ
	-25°	-15°	-10°	-5°	0°	5°	15°												
SILAE4450Z	368	638	805	1004	1237	1506	2167	820	1.78	27	1620	0.75	3/8"	1/4"	73/87	S	5.4	na	na
SILAE4460Z	470	771	957	1178	1436	1735	2470	981	1.84	27	1620	0.75	3/8"	1/4"	72/86	S	6.2	na	na
SILRG4467Z	498	800	986	1206	1462	1757	2478	1013	2.16	26	1650	0.75	3/8"	1/4"	62/79	S	4.8	na	na
SILRG4480Z	595	951	1170	1429	1730	2079	2941	1203	2.20	26	1650	1.50	3/8"	3/8"	62/79	S	5.6	na	na
SILAJ9480Z	607	1027	1286	1590	1943	2348	3329	1316	1.90	28	1650	1.50	1/2"	3/8"	70/87	S	7.0	na	3.7
SILRG4492Z	669	1066	1307	1591	1918	2294	3204	1350	2.21	26	1650	1.50	1/2"	3/8"	63/80	S	6.2	na	na
SILAJ9510Z	758	1252	1554	1908	2318	2789	3942	1600	1.86	26	1650	1.50	5/8"	3/8"	72/89	S	8.7	na	4.1
SILRG4512Z	836	1329	1628	1977	2378	2836	3934	1681	2.20	26	1650	1.50	1/2"	3/8"	65/82	S	7.0	na	na
SILAJ9513Z	914	1568	1968	2432	2963	3566	5005	2021	2.08	26	1650	1.50	5/8"	3/8"	74/91	S	11.6	na	4.7
SILAJ4517Z	1008	1689	2094	2562	3097	3711	5216	2171	1.96	27	1650	2.35	5/8"	3/8"	73/92	S	13.0	6.3	4.7
SILAJ4519Z	1226	2093	2596	3171	3828	4587	6519	2708	1.72	28	1650	2.35	5/8"	3/8"	74/91	S	15.5	11.2	6.5
SILFH4524Z	1319	2439	3122	3911	4807	5821	8236	3213	1.82	35	2700	2.35	5/8"	1/2"	69/90	M	20.8	11.1	8.9
SILFH4531Z	1797	3150	3947	4868	5922	7129	10089	4092	1.90	45	2700	3.90	7/8"	1/2"	72/93	M	24.0	14.6	9.4
SILAW4538Z	2174	3851	4814	5877	7027	8267	11132	5008	2.98*	38	2700	3.90	7/8"	1/2"	80/111	M	27.0 <sup>a</sup>	na	9.7 <sup>b</sup>
SILAG4546Z	2306	4485	5791	7249	8873	10703	15357	5957	2.66*	46	5940	6.00	7/8"	1/2"	128/143	L	na	23.7	14.9
SILAG4553Z	2712	5259	6774	8458	10326	12418	17663	6956	2.72*	48	5940	6.00	7/8"	5/8"	133/149	L	na	27.8	15.6
SILAG4561Z	3123	5763	7276	8933	10765	12843	18374	7550	2.60*	47	5940	6.00	1 1/8"	5/8"	134/149	L	na	30.0	16.9
SILAG4568Z	3900	6941	8738	10745	12998	15766	22218	9047	2.75*	43	5940	6.00	1 1/8"	5/8"	138/153	L	na	36.0	19.4
SILAG4573Z	4297	7392	9228	11267	13534	16083	22551	9595	2.59*	42	5940	6.00	1 1/8"	5/8"	139/154	L	na	33.0	20.6
SILAG4581Z	4728	8333	10448	12783	15345	18157	24773	10813	2.59*	42	5400	6.00	1 1/8"	5/8"	145/154	L	na	39.0	22.0
SILAGD4590Z	4621	8988	11750	14884	18351	22082	30018	12034	3.06*	47	6600	9.50	1 1/8"	5/8"	246/267	XL	na	na	25.0
SILAGD4610Z	5252	10038	13002	16321	19936	23756	31589	13381	3.00*	47	6600	9.50	1 1/8"	7/8"	249/270	XL	na	na	29.0
SILSH4591Z	6469	10317	13317	15411	18461	21862	na	13192	3.29*	na	6600	12	1 3/8"	5/8"	244/264	XL	na	na	15.1 <sup>c</sup>
SILAGD4612Z	6111	12232	14352	17852	21514	25375	33102	14858	2.92*	48	6600	12	1 3/8"	7/8"	253/274	XL	na	na	32.0
SILAGD4614Z	7381	12937	16356	20135	24158	28253	36338	17045	2.94*	45	6600	12	1 3/8"	7/8"	256/277	XL	na	na	37.0
SILAGD4615Z	8081	13829	17286	21048	24986	28917	36431	18100	2.76*	45	6600	12	1 3/8"	7/8"	257/278	XL	na	na	39.0

Statement of the seasonal COP / na: not applicable<sup>a</sup> voltage code XC, <sup>b</sup> voltage code XG, <sup>c</sup> voltage code YZ, <sup>d</sup> voltage code MZ



**Silensys®**
**MHBP**
**R404A**

MODEL NUMBER	REFRIGERATION OUTPUT 32° amb., 10K superheating, 3K subcooling							REFRIG. OUTPUT EN13215 Evap. T -10°C		Aco. P db(A)	Air flow m3/h	Liq. Rec. Vol.	Diam. for tubing O.D.		Net/ Gross weight kg	No. Dim	Maximum current according to voltage code		
	Evaporation temperature (°C):							Perf. (W)	COP (W/W)				Suc.	Liqu. Line			FZ	KZ	TZ
	-25°	-15°	-10°	-5°	0°	5°	15°												
SILAE4450Z	370	627	790	980	1199	1450	2065	870	1.81	27	1620	0.75	3/8"	1/4"	73/90	S	5.4	na	na
SILRG4467Z	456	729	906	1114	1353	1628	2299	999	2.07	26	1650	0.75	3/8"	1/4"	62/79	S	4.8	na	na
SILAE4460Z	476	762	942	1152	1394	1673	2354	1039	1.87	27	1620	0.75	3/8"	1/4"	72/89	S	6.2	na	na
SILRG4480Z	559	888	1101	1349	1635	1963	2763	1214	2.09	26	1650	1.50	3/8"	3/8"	62/79	S	5.6	na	na
SILRG4492Z	625	988	1220	1488	1797	2149	3010	1349	2.15	26	1650	1.50	1/2"	3/8"	63/80	S	6.2	na	na
SILAJ9480Z	614	1014	1266	1556	1888	2265	3172	1396	1.93	28	1650	2.35	1/2"	3/8"	70/87	S	7.0	na	3.7
SILAJ9510Z	768	1248	1549	1894	2286	2730	3793	1710	1.95	26	1650	2.35	5/8"	3/8"	72/89	S	8.7	na	4.1
SILRG4512Z	811	1279	1570	1901	2277	2703	3730	1736	2.19	26	1650	1.50	1/2"	3/8"	65/82	S	7.0	na	na
SILAJ9513Z	886	1518	1894	2313	2780	3298	4515	2094	2.05	26	1650	2.35	5/8"	3/8"	74/91	S	11.6	na	4.7
SILAJ4517Z	1016	1671	2066	2512	3012	3575	4941	2296	1.97	27	1650	2.35	5/8"	3/8"	73/90	S	13.0	6.3	4.7
SILAJ4519Z	1223	2068	2562	3108	3719	4408	6141	2860	1.73	28	1650	2.35	5/8"	3/8"	74/91	S	15.5	11.2	6.5
SILFH4524Z	1316	2397	3064	3817	4658	5593	7793	3405	1.85	35	2970	2.35	5/8"	1/2"	69/90	M	20.8	11.1	8.9
SILFH4531Z	1809	3112	3892	4767	5747	6847	9517	4333	1.93	45	2970	3.90	7/8"	1/2"	72/93	M	24.0	14.6	9.4
SILAW4538Z	2203	3774	4704	5724	6828	8007	10621	5239	2.97*	38	2970	3.90	7/8"	1/2"	80/101	M	27.0 <sup>a</sup>	na	9.7 <sup>b</sup>
SILAG4546Z	2348	4317	5543	6931	8485	10212	14292	6158	2.65*	46	5940	6.00	7/8"	5/8"	128/144	L	na	23.7	14.9
SILAG4553Z	2838	5097	6499	8087	9866	11845	16509	7206	2.70*	48	5940	6.00	7/8"	5/8"	133/149	L	na	27.8	15.6
SILAG4561Z	3227	5562	6976	8562	10327	12288	16972	7773	2.58*	47	5940	6.00	1*1/8"	5/8"	134/150	L	na	30.0	16.9
SILAG4568Z	3993	6733	8412	10313	12450	14851	20688	9352	2.73*	43	5940	6.00	1*1/8"	5/8"	138/154	L	na	36.0	19.4
SILAG4573Z	4347	7177	8900	10831	12980	15363	21042	9912	2.57*	42	5940	6.00	1*1/8"	5/8"	139/155	L	na	33.0	20.6
SILAG4581Z	4738	8103	10097	12304	14722	17353	23332	11208	2.58*	42	5400	6.00	1*1/8"	5/8"	145/161	L	na	39.0	22.0
SILAGD4590Z	4545	8769	11430	14447	17779	21364	28970	12674	3.10*	47	6600	9.50	1*1/8"	5/8"	246/267	XL	na	na	25.0
SILSH4591Z	6462	10228	12510	15065	17899	21016	na	13215	3.15*	na	6600	9.50	1*3/8"	5/8"	244/264	XL	na	na	15.1 <sup>c</sup>
SILAGD4610Z	5181	9819	12683	15885	19372	23056	30582	14087	3.04*	47	6600	9.50	1*1/8"	7/8"	249/270	XL	na	na	29.0
SILAGD4612Z	6064	11025	14037	17368	20949	24673	32059	15622	2.95*	48	6600	12.00	1*3/8"	7/8"	253/274	XL	na	na	32.0
SILAGD4614Z	7385	12735	16024	19658	23529	27468	34966	17893	2.96*	45	6600	12.00	1*3/8"	7/8"	256/277	XL	na	na	37.0
SILAGD4615Z	8093	13654	16995	20631	24439	28238	35112	19007	2.78*	45	6600	12.00	1*3/8"	7/8"	257/278	XL	na	na	39.0

Statement of the seasonal COP / na : not applicable

For information, the cooling capacity of fluids R449A and R448A: at the evaporation point  $T_o = -30^\circ\text{C}$ , SH10K, apply the multiplier ratio 0.94 to the cooling capacities read with R404A.





Silensys®

MHBP

R513A

MODEL NUMBER	REFRIGERATION OUTPUT 32° amb., 10K superheating, 3K subcooling							REFRIG. OUTPUT EN13215 Evap. T -10°C		Aco. P db(A)	Air flow m3/h	Liq. Rec. Vol.	Diam. for tubing O.D.		Net/ Gross weight kg	No. Dim	Maximum current according to voltage code		
	Evaporation temperature (°C)							Perf. (W)	COP (W/W)				Suc.	Liqu. Line			FZ	KZ	TZ
	-15°	-10°	-5°	0°	5°	10	15°												
SILAE4450Y	616	773	959	1178	1435	1734	2079	835	1.66	28	1650	0.75	3/8"	1/4"	73/87	S	4.9	na	na
SILAJ4461Y	691	885	1117	1391	1712	2083	2507	957	1.74	26	1650	1.50	1/2"	1/4"	68/85	S	6.1	na	2.5
SILAJ4476Y	798	1032	1306	1626	1999	2429	2922	1117	1.98	26	1650	1.50	1/2"	3/8"	70/79	S	7.2	na	na
SILAJ4492Y	1035	1323	1656	2036	2466	2947	3480	1430	1.94	26	1650	1.50	1/2"	3/8"	70/87	S	9.2	na	3.1
SILAJ4511Y	1329	1675	2065	2503	2987	3516	4089	1815	2.10	27	1650	1.50	5/8"	3/8"	72/89	S	8.9	na	3.9
SILFH4518Y	1685	2231	2863	3590	4416	5347	6387	2421	1.79	33	2970	2.35	5/8"	3/8"	85/106	M	12.4	8.1	5.4
SILFH4525Y	2377	3026	3776	4634	5606	6699	7919	3297	1.92	40	2970	2.35	5/8"	3/8"	87/108	M	16.4	13.1	7.9
SILAG4528Y	2958	3788	4716	5749	6897	8179	9620	4106	2.54	39	2970	3.90	7/8"	1/2"	102/123	M	na	24.8	10.8
SILAG4534Y	3173	4135	5226	6453	7820	9331	10992	4486	2.33	37	2970	3.90	7/8"	1/2"	104/126	M	na	24.8	10.6
SILAG4537Y	3608	4698	5936	7330	8893	10636	12584	5092	2.36	37	2970	3.90	7/8"	1/2"	104/125	M	na	24.8	10.2
SILAG4543Y	3968	5168	6515	8018	9687	11538	13596	5603	3.02*	38	2970	3.90	7/8"	1/2"	107/128	M	na	24.8	11.5
SILAG4547Y	4325	5606	7062	8700	10523	12531	14723	6078	2.63*	37	2970	3.90	7/8"	1/2"	107/128	M	na	24.8	11.3
SILAGD4556Y	5950	7738	9763	12036	14576	17406	20570	8364	3.32*	43	6600	9.50	1 1/8"	5/8"	234/255	XL	na	na	22.3
SILAGD4568Y	6371	8425	10801	13507	16528	19824	23329	9127	3.14*	42	6600	9.50	1 1/8"	5/8"	236/257	XL	na	na	21.9
SILAGD4574Y	6992	9163	11652	14478	17651	21176	25051	9935	2.96*	42	6600	9.50	1 1/8"	5/8"	246/267	XL	na	na	23.0
SILAGD4586Y	7852	10358	12232	16489	20124	24119	28436	11232	3.31*	42	6600	9.50	1 1/8"	5/8"	246/267	XL	na	na	24.0

Statement of the seasonal COP / na: not applicable

MHBP

R134a

Silensys®

MODEL NUMBER	REFRIGERATION OUTPUT 32° amb., 10K superheating, 3K subcooling, Mid/Mid							REFRIG. OUTPUT EN13215 Evap. T -10°C		Aco. P db(A)	Air flow m3/h	Liq. Rec. Vol.	Diam. for tubing O.D.		Net/ Gross weight kg	No. Dim	Maximum current according to voltage code		
	Evaporation temperature (°C):							Perf. (W)	COP (W/W)				Suc.	Liqu. Line			FZ	KZ	TZ
	-15°	-10°	-5°	0°	5°	10	15°												
SILRG4445Y	414	530	674	846	1048	1283	1550	566	1.79	26	1650	0.75	3/8"	1/4"	61/78	S	3.9	na	na
SILRG4450Y	504	644	815	1020	1262	1544	1868	688	1.76	26	1650	0.75	3/8"	1/4"	61/78	S	4.2	na	na
SILRG4460Y	560	713	902	1133	1409	1736	2119	762	1.84	26	1650	0.75	1/2"	1/4"	62/79	S	4.6	na	na
SILAE4450Y	571	730	918	1138	1395	1691	2032	780	1.90	27	1620	0.75	3/8"	1/4"	73/87	S	4.9	na	na
SILAJ4461Y	633	827	1060	1338	1666	2049	2493	883	1.71	26	1650	1.50	1/2"	1/4"	68/85	S	6.1	na	2.5
SILRG4476Y	734	932	1169	1447	1768	2136	2553	996	1.96	26	1650	1.50	1/2"	3/8"	62/79	S	5.8	na	na
SILAJ4476Y	740	975	1250	1571	1943	2369	2856	1043	1.71	26	1650	1.50	1/2"	3/8"	70/87	S	7.2	na	na
SILAJ4492Y	947	1235	1571	1960	2404	2908	3474	1319	1.91	26	1650	1.50	1/2"	3/8"	70/87	S	9.2	na	3.1
SILAJ4511Y	1220	1568	1967	2418	2924	3486	4105	1679	2.08	27	1650	1.50	5/8"	3/8"	72/89	S	8.9	na	3.9
SILFH4518Y	1548	2091	2730	3473	4330	5308	6421	2242	1.76	33	2700	2.35	5/8"	3/8"	85/106	M	12.4	8.1	5.4
SILFH4525Y	2190	2848	3616	4504	5523	6686	8012	3062	1.89	40	2700	2.35	5/8"	3/8"	87/108	M	16.4	13.1	7.9
SILAG4528Y	1956	2851	3904	5093	6397	7805	9313	3048	2.01	39	2700	3.90	7/8"	1/2"	102/123	M	na	24.8	10.8
SILAG4534Y	2693	3705	4910	6282	7792	9413	11117	3964	2.20	37	2700	3.90	7/8"	1/2"	104/126	M	na	24.8	10.6
SILAG4537Y	3203	4332	5685	7235	8955	10823	12819	4632	2.29	37	2700	3.90	7/8"	1/2"	104/125	M	na	24.8	10.2
SILAG4543Y	3353	4489	5910	7578	9455	11509	13716	4801	2.24	38	2700	3.90	7/8"	1/2"	107/128	M	na	24.8	11.5
SILAG4547Y	3968	5249	6727	8412	10313	12440	14808	5623	2.61	37	2700	3.90	7/8"	1/2"	107/128	M	na	na	11.3
SILAGD4556Y	3935	5809	8048	10602	13424	16474	19725	6197	2.56	43	6600	9.50	1 1/8"	5/8"	234/255	XL	na	na	21.0
SILAGD4568Y	5404	7530	10108	13078	16362	19858	23438	8048	2.88	42	6600	9.50	1 1/8"	5/8"	236/256	XL	na	na	23.0
SILAGD4574Y	6242	8474	11180	14302	17775	21528	25479	9063	2.81	42	6600	9.50	1 1/8"	5/8"	246/266	XL	na	na	21.0
SILAGD4586Y	6645	8995	11983	15536	19561	23948	28574	9621	2.96	42	6600	9.50	1 1/8"	5/8"	246/267	XL	na	na	24.0

na: not applicable

# DIMENSIONS

## Silensys®

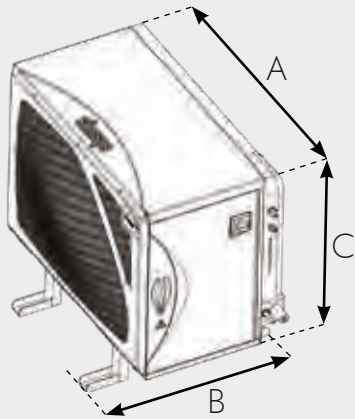

**SIZE S**

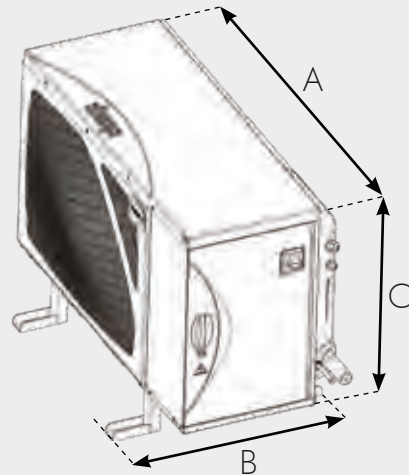



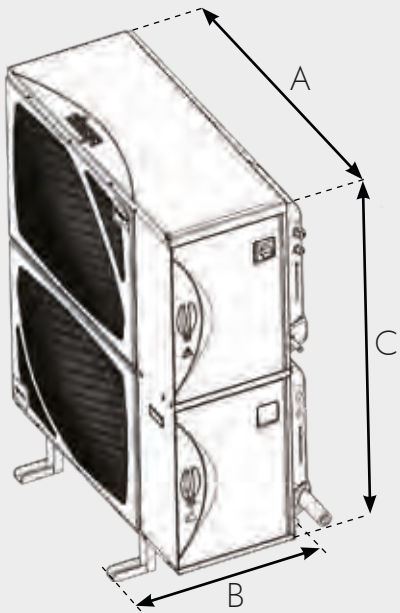

**SIZE M**

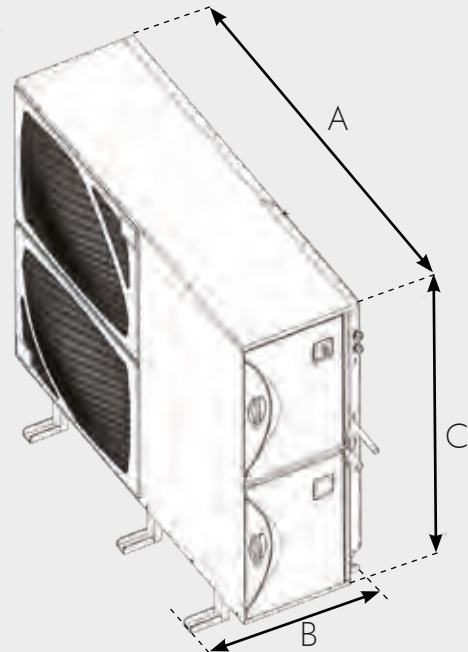

**SIZE L**



**SIZE XL**

		A	B	C
	S	942	654	837
	M	1174	654	837
	L	1209	654	1465
	XL	1666	654	1457

# APPLICATION WINDOWS

## LBP R452A R404A

## MHBP R452A R404A

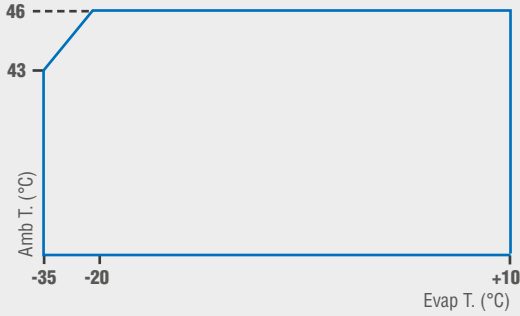

MODEL NUMBER
SIL RG 2426 Z
SIL RG 2432 Z
SIL RG 2446 Z
SIL AJ 2432 Z
SIL AJ 2440 Z
SIL AJ 2446 Z
SIL AJ 2464 Z
SIL FH 2480 Z
SIL FH 2511 Z
SIL AG 2513 Z
SIL AG 2516 Z
SIL AG 2519 Z
SIL AG 2522 Z
SIL AG 2525 Z
SIL AGD 2532 Z
SIL AGD 2538 Z
SIL AGD 2544 Z
SIL SH 2534 Z

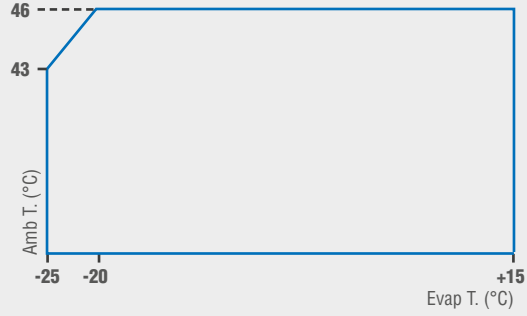

MODEL NUMBER
SIL AE 4450 Z
SIL AE 4460 Z
SIL RG 4467 Z
SIL RG 4480 Z
SIL RG 4492 Z
SIL RG 4512 Z
SIL AJ 9480 Z
SIL AJ 9510 Z
SIL AJ 9513 Z

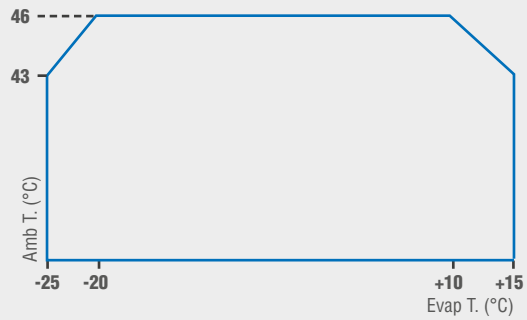

MODEL NUMBER
SIL AJ 4517 Z
SIL FH 4524 Z
SIL AG 4553 Z
SIL AG 4581 Z
SIL AGD 4590 Z

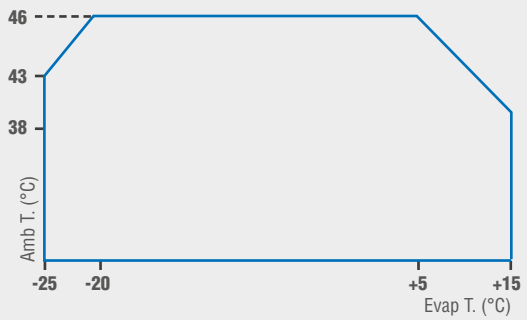

MODEL NUMBER
SIL AJ 4519 Z
SIL FH 4531 Z
SIL AW 4538 Z
SIL AG 4546 Z
SIL AG 4561 Z
SIL AG 4568 Z
SIL AG 4573 Z
SIL AGD 4610 Z
SIL AGD 4612 Z

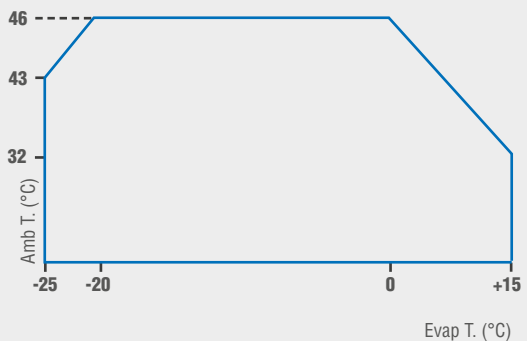

MODEL NUMBER
SIL AGD 4614 Z
SIL AGD 4615 Z
SIL SH 4591 Z



# MHBP R513A R134a

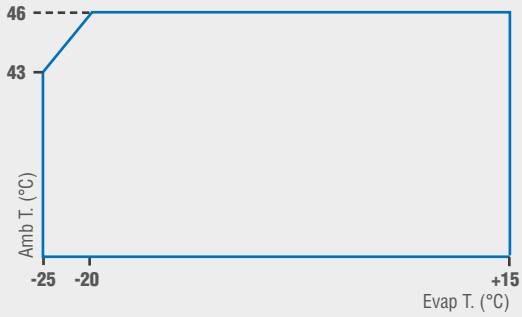

MODEL NUMBER
SIL RG 4445 Y
SIL RG 4450 Y
SIL RG 4460 Y
SIL RG 4476 Y
SIL AE 4450 Y
SIL AJ 4461 Y
SIL AJ 4476 Y
SIL AJ 4492 Y
SIL AGD 4556 Y
SIL AGD 4568 Y
SIL AGD 4574 Y

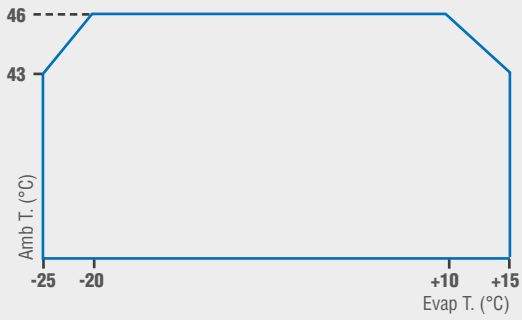

MODEL NUMBER
SIL AJ 4511 Y
SIL FH 4518 Y
SIL AG 4528 Y
SIL AG 4534 Y
SIL AG 4537 Y
SIL AG 4543 Y
SIL AG 4547 Y
SIL AGD 4586 Y

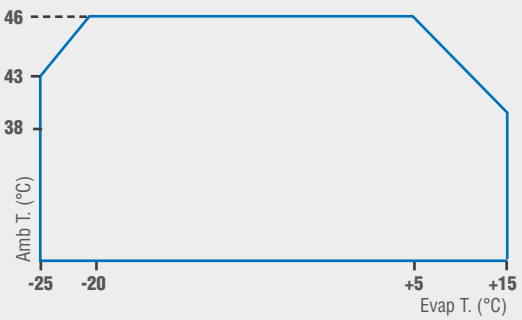

MODEL NUMBER
SIL FH 4525 Y





**Plug & Play power variation**

*Acoustic level of the SILENSYS®*

**REGULATION OF THE REFRIGERATING SYSTEM:**

- ▶ Dual control, inverter/pressure-actuated mode, ensuring continuity of the cold without additional wiring
- ▶ Variation of capacity thanks to a frequency variator
- ▶ Supply of 2 or 3 evaporators
- ▶ Energy efficiency: the capacity variation permits balanced energy and optimum efficiency: reduction of power consumption by up to 25%
- ▶ Precise regulation ensuring better temperature and humidity control

*Controller and other electrical components grouped together on the door*

*Cabled transducer*

*Fan speed controller*

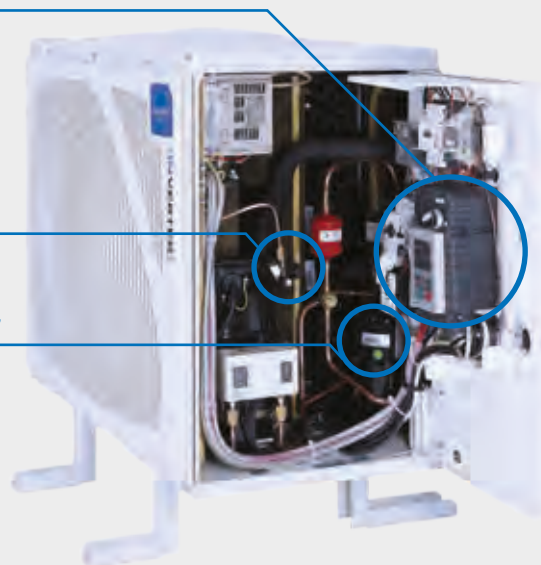



# SILENSYS<sup>®</sup> INVERTER



MHBP

R452A

## Silensys® Inverter

MODEL NUMBER	Freq.	REFRIGERATION OUTPUT 32° amb., 10K superheating, 3K subcooling, Mid/Mid Evaporation temperature (°C):							REFRIG. OUTPUT EN13215 Evap. T -35°C		Acc. P db(A)	Air flow m3/h	Liq. Rec. Vol.	Diam. for tubing O.D.		Net/ Gross weight kg	No. Dim	Max. current according to voltage code
		-25°	-15°	-10°	-5°	0°	5°	15°	Perf. (W)	COP (W/W)				Suc.	Liqu. Line			
		SILAJV9513Z	60 30	986 514	1724 899	2176 1135	2688 1402	3261 1702	3901 2035	5308 2818				2429	2.00			26
SILAJV4517Z	60 30	1061 583	1871 1049	2336 1326	2848 1636	3413 1982	4042 2370	5697 3294	2459	1.86	27	1650	2.35	5/8"	3/8"	92/110	S	5.1
SILFHV4524Z	60 30	1457 800	2717 1524	3458 1968	4280 2468	5191 3025	6199 3639	8808 5060	3624	1.80	35	2700	2.35	5/8"	1/2"	74/95	M	9.1
SILFHV4531Z	60 30	1982 1097	3499 1985	4353 2512	5294 3100	6342 3755	7521 4485	10701 6214	4599	1.82	45	2700	3.90	7/8"	1/2"	78/93	M	10.4
SILFHV4540Z	60 30	2680 1489	4573 2612	5627 3265	6752 3985	7951 4776	9230 5646	12442 7675	5964	1.75*	40	2700	6.00	7/8"	1/2"	101/116	M	14.1
SILAGV4546Z	60 30	2568 1412	4798 2708	6112 3508	7558 4412	9142 5426	10872 6555	15284 9213	6403	1.83*	46	5940	6.00	7/8"	1/2"	133/148	L	14.6
SILAGV4553Z	60 30	3098 1706	5698 3219	7212 4142	8875 5182	10694 6343	12684 7635	17773 10665	7544	1.90*	47	5940	6.00	7/8"	5/8"	150/166	L	16.4
SILAGV4568Z	60 30	4407 2447	7529 4294	9328 5416	11302 6678	13470 8093	15858 9673	22079 13424	9842	2.01*	43	5940	6.00	1*1/8	5/8"	133/148	L	20.2
SILSHV4610V	60 30	8936 4964	13816 7676	16615 9231	19747 10970	23866 13259	25428 14126	na	18252	2.45*	na	5000	12.00	1*3/8	7/8"	260/280	XL	20.0

Statement of the seasonal COP / na: not applicable

For information, the cooling capacity of fluids R449A and R448A: at the evaporation point To = -30°C, SH10K, apply the multiplier ratio 0.94 to the cooling capacities read with R404A.

MHBP

R404A

## Silensys® Inverter

MODEL NUMBER	Freq.	REFRIGERATION OUTPUT 32° amb., 10K superheating, 3K subcooling Evaporation temperature (°C):							REFRIG. OUTPUT EN13215 Evap. T -10°C		Acc. P db(A)	Air flow m3/h	Liq. Rec. Vol.	Diam. for tubing O.D.		Net/ Gross weight kg	No. Dim	Max. current according to voltage code
		-25°	-15°	-10°	-5°	0°	5°	15°	Perf. (W)	COP (W/W)				Suc.	Liqu. Line			
		SILAJV9513Z	60 30	959 524	1676 931	2107 1184	2591 1472	3129 1797	3728 2162	5141 2973				2312	1.77			26
SILAJV4517Z	60 30	1146 629	1940 1083	2405 1358	2924 1668	3504 2016	4156 2404	5728 3264	2648	1.61	27	1650	2.35	5/8"	3/8"	92/110	S	5.1
SILFHV4524Z	60 30	1485 815	2705 1511	3427 1943	4233 2431	5127 2975	6122 3578	8474 4883	3787	1.59	35	2700	2.35	5/8"	1/2"	74/95	M	9.1
SILFHV4531Z	60 30	2031 1126	3493 1975	4326 2487	5246 3059	6271 3697	7424 4406	10236 5961	4795	1.61	45	2700	3.90	7/8"	1/2"	78/93	M	10.3
SILFHV4540Z	60 30	2717 1506	4539 2582	5574 3220	6684 3925	7868 4698	9126 5541	11915 7329	6182	1.72	40	2700	3.90	7/8"	1/2"	95/116	M	10.4
SILAGV4546Z	60 30	2654 1458	4846 2723	6159 3518	7607 4417	9187 5421	10899 6529	14774 8916	6804	2.46*	46	5940	6.00	7/8"	1/2"	133/148	L	14.6
SILAGV4553Z	60 30	3203 1762	5731 3223	7239 4138	8907 5174	10735 6331	12732 7613	17309 10390	7981	2.57*	47	5940	6.00	7/8"	5/8"	150/166	L	16.4
SILAGV4568Z	60 30	4768 2657	7516 4278	9229 5347	11152 6573	13274 7947	15590 9462	20845 12671	10214	2.77*	43	5940	6.00	1*1/8	5/8"	133/148	L	20.2
SILSHV4610Z	60 30	9469 5214	14769 8409	17352 10342	19899 12510	22425 14919	24953 17580	na	18303	3.63*	na	5000	12.00	1*3/8	7/8"	260/281	XL	20.0

Statement of the seasonal COP / na: not applicable



### Silensys® Inverter

MODEL NUMBER	Freq.	REFRIGERATION OUTPUT 32° amb., 10K superheating, 3K subcooling							REFRIG. OUTPUT EN13215 Evap. T -10°C		Aco. P db(A)	Air flow m3/h	Liq. Rec. Vol.	Diam. for tubing O.D.		Net/ Gross weight kg	No. Dim	Max. current according to voltage code
		Evaporation temperature (°C):							Perf. (W)	COP (W/W)				Suc.	Liqu. Line			TZ
		-15°	-10°	-5°	0°	5°	10°	15°										
SILAJV4492Y	60	1095	1438	1825	2258	2743	3285	3886	1557	1.92	26	1650	1.50	1/2"	3/8"	90/107	S	3.1
	30	592	781	999	1246	1529	1850	2213	844	2.12								
SILAJV4511Y	60	1435	1819	2252	2734	3273	3870	4527	1974	1.74	27	1650	1.50	5/8"	3/8"	91/108	S	4.2
	30	784	1002	1253	1536	1856	2218	2621	1084	1.99								
SILFHV4518Y	60	2063	2641	3321	4113	5030	6088	7299	2867	1.77	33	2700	2.35	5/8"	3/8"	85/106	M	5.8
	30	1127	1458	1850	2311	2849	3470	4180	1575	1.98								
SILFHV4525Y	60	2822	3530	4329	5227	6241	7386	8678	3846	2.11	40	2700	2.35	5/8"	3/8"	71/92	M	8.5
	30	1559	1972	2446	2986	3603	4304	5099	2137	2.41								
SILAGV4534Y	60	3236	4364	5691	7178	8792	10502	12263	4738	2.01	40	2970	3.90	7/8"	1/2"	82/103	M	11.1
	30	1757	2393	3154	4023	4988	6031	7134	2588	2.36								
SILAGV4543Y	60	4030	5279	6829	8626	10630	12795	15068	5729	3.13*	40	2700	3.90	7/8"	1/2"	85/106	M	11.3
	30	2191	2897	3788	4842	6041	7366	8792	3133									

Statement of the seasonal COP

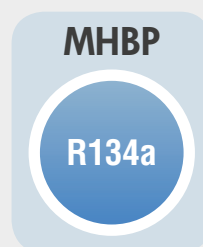

### Silensys® Inverter

MODEL NUMBER	Freq.	PRODUCTION FRIGORIFIQUE 32° amb., 10K surchauffe, 3K sous-ref.							REFRIG. OUTPUT EN13215 Evap. T -10°C		Aco. P db(A)	Air flow m3/h	Liq. Rec. Vol.	Diam. for tubing O.D.		Net/ Gross weight kg	No. Dim	Max. current according to voltage code
		Température d'évaporation (°C) :							Perf. (W)	COP (W/W)				Suc.	Liqu. Line			TZ
		-15°	-10°	-5°	0°	5°	10°	15°										
SILAJV4492Y	60	1015	1359	1747	2182	2666	3204	3798	1454	1.91	26	1650	1.50	1/2"	3/8"	90/107	S	3.1
	30	549	738	956	1204	1486	1804	2163	788	2.11								
SILAJV4511Y	60	1331	1719	2155	2642	3181	3774	4425	1843	1.73	27	1650	1.50	5/8"	3/8"	91/108	S	4.2
	30	727	947	1199	1484	1804	2163	2562	1012	1.98								
SILFHV4518Y	60	1913	2495	3179	3974	4889	5938	7134	2677	1.76	33	2700	2.35	5/8"	3/8"	85/106	M	5.8
	30	1045	1377	1771	2233	2769	3384	4086	1471	1.97								
SILFHV4525Y	60	2617	3335	4143	5050	6066	7204	8482	3591	2.10	40	2700	2.35	5/8"	3/8"	71/92	M	8.5
	30	1446	1863	2341	2885	3502	4198	4984	1995	2.40								
SILAGV4534Y	60	3001	4123	5447	6935	8546	10243	11986	4424	2.00	40	2970	3.90	7/8"	1/2"	82/103	M	11.1
	30	1629	2261	3019	3887	4848	5882	6973	2417	2.35								
SILAGV4543Y	60	3737	4987	6536	8334	10332	12479	14728	5349		40	2700	3.90	7/8"	1/2"	85/106	M	11.3
	30	2032	2737	3626	4678	5872	7184	8593	2925	3.11								



# DIMENSIONS

## Silensys® Inverter

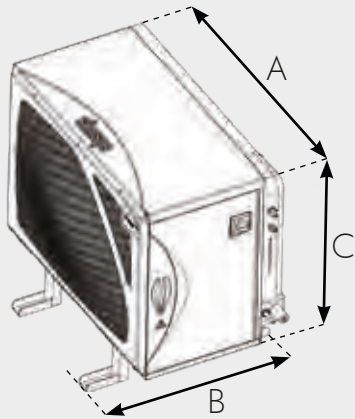

**SIZE S**

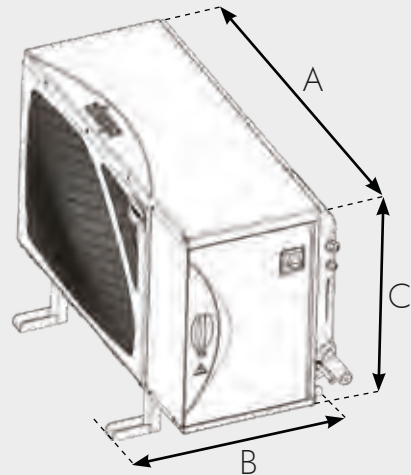



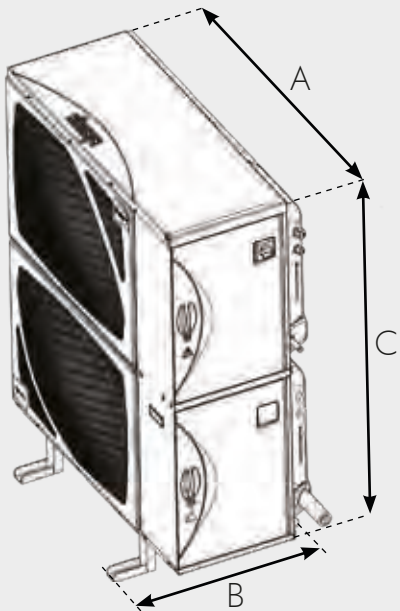

**SIZE M**

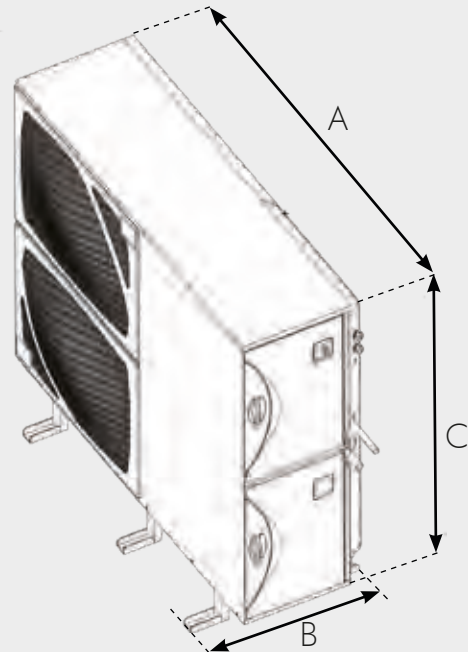

**SIZE L**



**SIZE XL**

		A	B	C
	S	942	654	837
	M	1174	654	837
	L	1209	654	1465
	XL	1666	654	1457

# APPLICATION WINDOWS

## MHBP R452A R404A

## MHBP R134a R513A

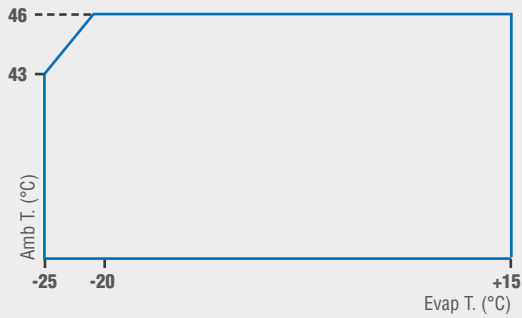

**MODEL NUMBER**  
SIL AJV 4517 Z

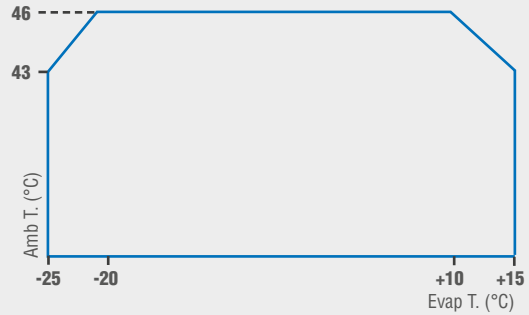

**MODEL NUMBER**  
SIL AJV 4492 Y  
SIL AGV 4543 Y

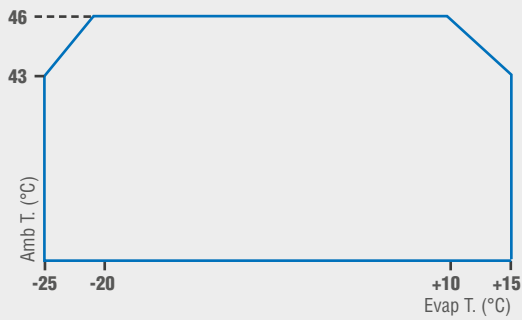

**MODEL NUMBER**  
SIL AJV 9513 Z  
SIL AGV 4553 Z

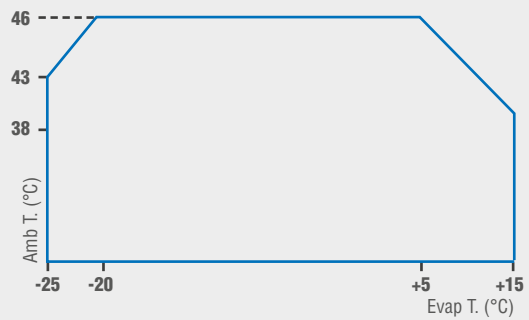

**MODEL NUMBER**  
SIL AJV 4511 Y  
SIL FHV 4518 Y  
SIL AGV 4534 Y

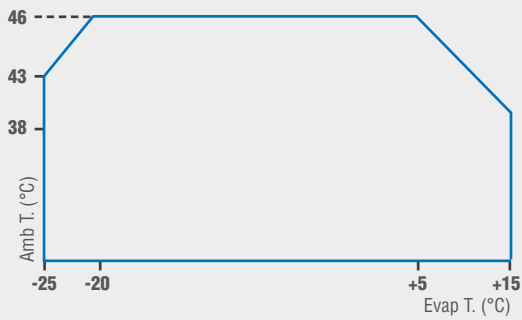

**MODEL NUMBER**  
SIL FHV 4524 Z  
SIL FHV 4531 Z  
SIL AGV 4546 Z  
SIL AGV 4568 Z

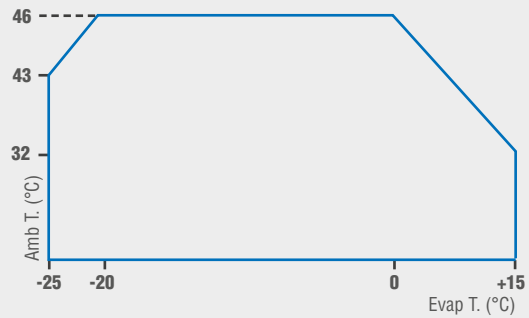

**MODEL NUMBER**  
SIL FHV 4525 Y

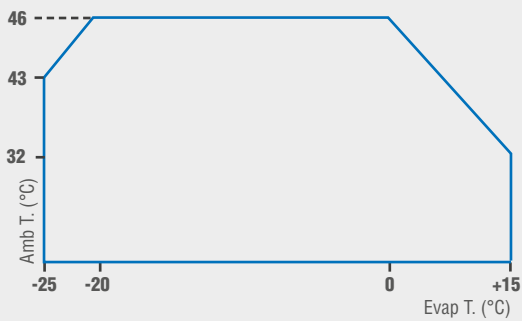

**MODEL NUMBER**  
SIL FHV 4540 Z

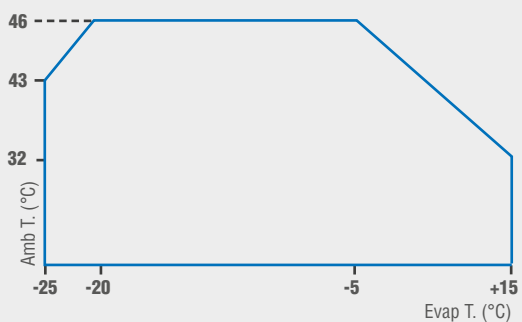

**MODÈLE**  
SIL SHV 4610 Z

<b>RACK TRIO-QUATTRO .....</b>	<b>64</b>
<b>INFINEE® .....</b>	<b>66</b>





# RACK TRIO QUATTRO AND INFINEE<sup>®</sup>

**POSITIVE  
REFRIGERATION  
from 3.4  
to 15.9 kW**

## RACK TRIO QUATTRO

### Power modulation system

*The Rack Trio-Quattro range is a new generation of refrigeration plant.*

*This Rack range can supply several evaporation units and has stand-alone regulation.*

#### IN SHORT...

- ▶ R134a/R513A or R452A/R449A/R448A/R404A refrigerants
- ▶ 3 or 4 compressor stages
- ▶ Version available with air condenser or without condenser
- ▶ Integrated regulation

### CHARACTERISTICS

#### REFRIGERATION

- ▶ AJ<sup>2</sup> or FH compressors with identical power
- ▶ Oil balancing
- ▶ Oil separator coalescing

#### CONDENSING

##### **Version with condenser (Type A) including:**

- ▶ Aluminium micro-channel exchanger
- ▶ Variable speed fans
- ▶ Receiver which can be isolated
- ▶ Housing as an accessory

##### **Version without condenser (Type B):**

- ▶ More compact (629 mm deep)

#### ELECTRICAL CABINET

- ▶ Regulation  $\mu$ Rack:
  - Manages the capacity staging
  - Ensures operating safety
- ▶ High pressure regulation sensor
- ▶ Contactors and circuit breakers provided





## APPLICATIONS

Installation with several indoor units:



## CUSTOMER BENEFITS

- ▶ **Multiple evaporation units:** capacity modulation
- ▶ **Reliability:** oil recovery and integrated regulation
- ▶ **Adaptability:** with or without condenser

## INFINEE®

### Water chiller for refrigeration, environmentally-friendly

*Capacity variation: from 7.4 to 20.5 kW*

Ambient temperature 35°C water condition -4°C/-8°C 35% Glycol

#### IN SHORT...

- ▶ R290 refrigerant sustainable (GWP\* = 3) and very efficient solution
- ▶ Optimized for negative operation: water outlet temperature down to -10°C
- ▶ 100% inverter: compressor, pump and ventilation
- ▶ Plug and Play

#### CHARACTERISTICS REFRIGERATION

- ▶ Semi-hermetic compressor
- ▶ Compressor inverter frequency of 25 to 85 Hz i.e. 7.4 to 20.5 kW
- ▶ Electronic temperature and pressure sensor
- ▶ Electronic pressure relief valve
- ▶ Ventilation with electronic commutation

#### HYDRAULICS

- ▶ Pump on inverter to maintain a constant delta T
- ▶ Electronic pressure and temperature sensor
- ▶ Strainer which can be isolated by valves
- ▶ Expansion tank

#### ELECTRONICS

- ▶ Full and communicating regulation (Tecumseh software)
- ▶ Class B residential CEM emissions filter (EN 61000-6-3)

\* Global Warming Potential

**NEW**

## APPLICATIONS

Negative temperature water for small shops such as bakeries, service stations, groceries...  
 Positive temperature water for water-cooled condensing units, Transcritical CO2 units...



## CUSTOMER BENEFITS

- ▶ Chilled water **easy to handle**
- ▶ Efficiency of **R290 and the 100% Inverter design**: especially with partial loads
- ▶ **Reliability**: redundancy possible with chillers in parallel
- ▶ **Sustainability**: water and propane have a guaranteed future

## COOLING CAPACITY

Freq. comp. (Hertz)	Cold power (kW)	Refrigeration COP	Flow of water + Glycol (m³/h)	Machine COP
25	7.42	2.64	1.71	1.92
30	8.69	2.60	2.01	1.98
35	9.94	2.55	2.29	2.01
40	11.1	2.50	2.57	2.02
45	12.3	2.44	2.84	2.02
50	13.5	2.39	3.11	2.01
55	14.6	2.33	3.36	1.99
60	15.6	2.27	3.61	1.97
65	16.7	2.22	3.85	1.94
70	17.7	2.16	4.08	1.91
75	18.6	2.10	4.30	1.88
80	19.6	2.05	4.52	1.85
85	20.5	2.00	4.72	1.81

Ambient T° 35°C/Output T° -8°C







# TOOLS

# TOOLS

## COMPLETE AND EFFECTIVE SELECTION SOFTWARE

- ▶ **Selection of the compressor and/or condensing unit** according to several parameters: cooling capacity, voltage, refrigerant, compressor technology, and according to different modes governed by standards: EN, ARI, CECOMAF etc. or customised conditions (operating pressure, gas return, useful superheating, subcooling, etc.)
- ▶ **Performance data and polynomials** for refrigerants R452A, R448A/R449A, R513A, R1234yf and R290
- ▶ Selection of the designation of the model according to the **dew point temperature or mean temperature**
- ▶ Notification of **new models**
- ▶ **Obsolete models** identified in a specific tab
- ▶ Access to the **documentation** available: technical sheets, acoustic spectrum, electrical drawings, layout, installation instructions, photo, 3D model
- ▶ Use of the data made easier by **export to Excel and Open Office**
- ▶ **Automatic update**
- ▶ Available in **7 languages**
- ▶ **Network installation** possible



**VERSION 4.5 - January 2019**

Download the selection software now, available on the website: [www.tecumseh.com](http://www.tecumseh.com)

## SELECT

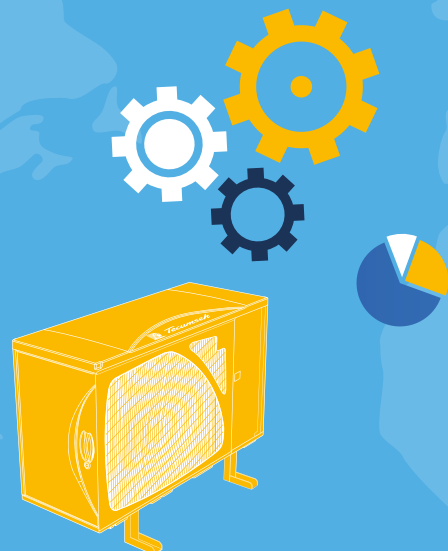

## THE CROSS REF SOFTWARE

An ergonomic and functional tool allowing you to **determine the equivalent Tecumseh compressor from a competing model.**

An obsolete refrigerant? A Tecumseh model to replace that of a competitor? The Cross Ref software is here to help.

## FOLLOW US



REPLACE

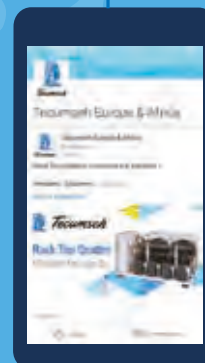
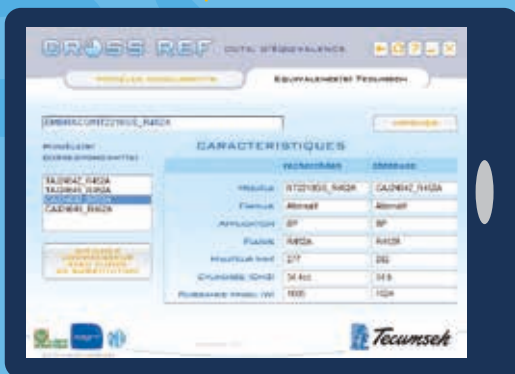

<https://www.tecumseh.com/fr/Europe/Cross-Reference-Tool>

WWW.TECUMSEH.COM

## TECUMSEH EUROPE

2, avenue Blaise Pascal, 38080 Vaulx-Milieu, France.

PHONE : +33 (0)4 74 82 24 00

EMAIL : sales.eu@tecumseh.com



© 2019 Tecumseh Products Company. All rights reserved. Note: in a constant effort to improve, Tecumseh Europe reserves the right to change the data contained in this document without prior notice.

