



U.S. Department of Health and Human Services  
U.S. Department of Housing and Urban Development

# Healthy Housing Reference Manual



Suggested citation: Centers for Disease Control and Prevention and U.S. Department of Housing and Urban Development. Healthy housing reference manual. Atlanta: US Department of Health and Human Services; 2006.

Use of trade names is for identification only and does not imply endorsement by the Centers for Disease Control and Prevention, the Public Health Service, the U.S. Department of Health and Human Services, or the U.S. Department of Housing and Urban Development.

Cover: Large photo by Teresa M. Sims; small photo by Don W. Johnson.

**Additional copies of this manual can be downloaded from  
[www.cdc.gov/healthyhomes/publications.html](http://www.cdc.gov/healthyhomes/publications.html)**

Preface.....	1
Acknowledgments .....	3
Abbreviations and Acronyms.....	5
Definitions .....	7
Standards and Organizations.....	11
Executive Summary.....	15
<b>Chapter 1: Housing History and Purpose.....</b>	<b>1-1</b>
Introduction.....	1-1
Preurban Housing .....	1-1
Ephemeral Dwellings .....	1-1
Episodic Dwellings.....	1-1
Periodic Dwellings.....	1-1
Seasonal Dwellings.....	1-2
Semipermanent Dwellings.....	1-2
Permanent Dwellings .....	1-2
Urbanization .....	1-2
Trends in Housing.....	1-3
References .....	1-7
Additional Sources of Information .....	1-7
<b>Chapter 2: Basic Principles of Healthy Housing .....</b>	<b>2-1</b>
Introduction.....	2-1
Fundamental Physiologic Needs .....	2-1
Fundamental Psychologic Needs.....	2-3
Protection Against Disease .....	2-3
Protection Against Injury .....	2-5
Protection Against Fire .....	2-6
Fire Extinguishers.....	2-8
Protection Against Toxic Gases.....	2-9
References .....	2-9
Additional Sources of Information .....	2-10
<b>Chapter 3: Housing Regulations.....</b>	<b>3-1</b>
Introduction.....	3-1
History .....	3-1
Zoning, Housing Codes, and Building Codes .....	3-2
Zoning and Zoning Ordinances .....	3-3
Exceptions to the Zoning Code.....	3-5
Housing Codes.....	3-6
Building Codes.....	3-11
References .....	3-12
Additional Sources of Information .....	3-12

<b>Chapter 4: Disease Vectors and Pests.....</b>	<b>4-1</b>
Introduction.....	4-1
Disease Vectors and Pests .....	4-1
Rodents.....	4-1
Cockroaches .....	4-4
Fleas.....	4-6
Flies.....	4-7
Termites .....	4-8
Fire Ants.....	4-12
Mosquitoes .....	4-15
References .....	4-17
<b>Chapter 5: Indoor Air Pollutants and Toxic Materials.....</b>	<b>5-1</b>
Introduction.....	5-1
Indoor Air Pollution.....	5-1
Biologic Pollutants .....	5-1
Chemical Pollutants .....	5-6
Toxic Materials.....	5-13
Asbestos .....	5-13
Lead.....	5-14
Arsenic.....	5-18
References .....	5-19
<b>Chapter 6: Housing Structure.....</b>	<b>6-1</b>
Introduction.....	6-1
Foundation .....	6-7
Vapor Barriers .....	6-9
Crawl Space Vapor Barriers .....	6-9
Vapor Barriers for Concrete Slab Homes .....	6-9
Wall and Ceiling Vapor Barriers .....	6-9
House Framing.....	6-10
Foundation Sills .....	6-10
Flooring Systems .....	6-10
Studs.....	6-10
Interior Walls .....	6-10
Stairways .....	6-11
Windows.....	6-11
Doors.....	6-13
Roof Framing.....	6-14
Rafters.....	6-14
Collar Beam .....	6-14
Purlin.....	6-14
Ridge Board .....	6-15
Hip .....	6-15

Roof Sheathing.....	6-15
Dormer .....	6-15
Roofs.....	6-15
Asphalt Shingle .....	6-15
EPDM .....	6-15
Asphalt Built-up Roofs.....	6-15
Coal Tar Pitch Built-up Roofs .....	6-15
Slate Roofs .....	6-15
Tile Roofs.....	6-15
Copper Roofs.....	6-15
Galvanized Iron Roofs.....	6-15
Wood Shingle Roofs.....	6-15
Roof Flashing.....	6-15
Gutters and Leaders .....	6-16
Exterior Walls and Trim.....	6-16
Putting It All Together.....	6-16
References .....	6-21
Additional Sources of Information .....	6-21

## **Chapter 7: Environmental Barriers..... 7-1**

Introduction.....	7-1
Roof.....	7-2
Insulation.....	7-2
Siding.....	7-3
Fiber Cement .....	7-4
Brick .....	7-4
Stucco .....	7-4
Vinyl .....	7-4
Asbestos .....	7-5
Metal.....	7-5
References .....	7-5

## **Chapter 8: Rural Water Supplies and Water-quality Issues..... 8-1**

Introduction.....	8-1
Water Sources.....	8-1
Source Location .....	8-2
Well Construction.....	8-3
Sanitary Design and Construction .....	8-4
Pump Selection .....	8-4
Dug and Drilled Wells.....	8-4
Springs .....	8-6
Cisterns.....	8-6
Disinfection of Water Supplies .....	8-7
Chlorine Carrier Solutions .....	8-9
Routine Water Chlorination (Simple) .....	8-9

Well Water Shock Chlorination.....	8-9
Backflow, Back-siphonage, and Other Water Quality Problems.....	8-9
Backflow .....	8-9
Back-Siphonage.....	8-10
Other Water Quality Problems.....	8-10
Protecting the Groundwater Supply .....	8-10
References .....	8-10
Additional Sources of Information .....	8-12
<b>Chapter 9: Plumbing .....</b>	<b>9-1</b>
Introduction.....	9-1
Elements of a Plumbing System .....	9-1
Water Service .....	9-1
Hot and Cold Water Main Lines.....	9-4
Water Heaters.....	9-7
Drainage System .....	9-8
Corrosion Control.....	9-12
Water Conservation.....	9-13
Putting It All Together.....	9-14
References .....	9-15
Additional Sources of Information .....	9-16
<b>Chapter 10: On-site Wastewater Treatment .....</b>	<b>10-1</b>
Introduction.....	10-1
Treatment of Human Waste .....	10-1
On-site Wastewater Treatment Systems .....	10-3
Septic Tank Systems .....	10-3
Alternative Septic Tank Systems .....	10-6
Maintaining On-site Wastewater Treatment Systems .....	10-8
Symptoms of Septic System Problems .....	10-9
Septic Tank Inspection .....	10-9
References .....	10-11
Additional Sources of Information .....	10-11
<b>Chapter 11: Electricity .....</b>	<b>11-1</b>
Introduction.....	11-1
Flow of Electric Current.....	11-2
Electric Service Entrance .....	11-3
Service Drop .....	11-3
Underground Service.....	11-4
Electric Meter.....	11-4
Grounding .....	11-4
Two- or Three-wire Electric Services.....	11-6
Residential Wiring Adequacy .....	11-6
Wire Sizes and Types.....	11-6

Reducing Risk.....	11-7
Wire Sizes.....	11-7
Wire Types .....	11-8
Types of Cable.....	11-8
Flexible Cords .....	11-8
The Problem.....	11-9
The Standards.....	11-9
Safety Suggestions .....	11-9
Wiring .....	11-10
Open Wiring.....	11-10
Concealed Knob and Tube Wiring .....	11-10
Electric Service Panel.....	11-10
Over-current Devices .....	11-10
Circuit Breakers (Fuseless Service Panels) .....	11-11
Ground Fault Circuit Interrupters .....	11-11
Arc-fault Circuit Interrupters .....	11-11
Fused Ampere Service Panel (Fuse Box).....	11-12
Electric Circuits.....	11-13
Outlet Switches and Junction Boxes .....	11-13
Grounding Outlets.....	11-13
Polarized Plugs and Connectors.....	11-14
Common Electrical Violations .....	11-14
Excessive or Faulty Fusing .....	11-15
Cords Run Through Walls or Doorways and Hanging Cords or Wires.....	11-15
Temporary Wiring.....	11-15
Excessively Long Extension Cords .....	11-15
Dead or Dummy Outlets .....	11-15
Aluminum Wiring Inside the Home .....	11-15
Inspection Steps .....	11-15
References .....	11-16
Additional Sources of Information .....	11-16
<b>Chapter 12: Heating, Air Conditioning, and Ventilating.....</b>	<b>12-1</b>
Introduction.....	12-1
Heating.....	12-4
Standard Fuels.....	12-4
Central Heating Units.....	12-7
Space Heaters .....	12-12
Hydronic Systems .....	12-14
Direct Vent Wall Furnaces.....	12-14
Cooling.....	12-14
Air Conditioning.....	12-14
Circulation Fans.....	12-16
Evaporation Coolers.....	12-16

Safety .....	12-16
Chimneys .....	12-17
Fireplaces.....	12-17
References .....	12-18
Additional Sources of Information .....	12-19

## **Chapter 13: Energy Efficiency ..... 13-1**

Introduction.....	13-1
Energy Systems .....	13-1
R-values .....	13-1
Roofs.....	13-2
Ridge Vents .....	13-2
Fan-powered Attic Ventilation.....	13-3
White Roof Surface.....	13-3
Insulation.....	13-3
Wall Insulation.....	13-4
Floor Insulation.....	13-4
Doors .....	13-5
Hot Water Systems.....	13-6
Windows.....	13-7
Caulking and Weather-Stripping .....	13-7
Replacing Window Frames .....	13-7
Tinted Windows .....	13-7
Reducing Heat Loss and Condensation .....	13-7
Glazing.....	13-8
Layering.....	13-8
Other Options .....	13-9
Solar Energy.....	13-9
Active Solar Systems.....	13-9
Passive Solar Systems.....	13-9
Conducting an Energy Audit.....	13-10
References .....	13-10
Additional Sources of Information .....	13-11

## **Chapter 14: Residential Swimming Pools and Spas ..... 14-1**

Introduction .....	14-1
Childproofing .....	14-1
Hazards .....	14-2
Public Health Issues .....	14-2
Diseases.....	14-3
Injuries.....	14-3
Water Testing Equipment.....	14-3



Disinfection .....	14-4
Content Turnover Rate.....	14-4
Filters .....	14-4
High-rate Sand Filters .....	14-4
Cartridge Filters .....	14-5
Diatomaceous Earth .....	14-5
Filter Loading Rates .....	14-5
Disinfectants .....	14-5
Effect of pH .....	14-6
Pool Water Hardness and Alkalinity .....	14-8
Liquid Chemical Feeders .....	14-8
Positive Displacement Pump .....	14-8
Erosion and Flow-through Disinfectant Feeders .....	14-8
Spas and Hot Tubs .....	14-9
References .....	14-10
Additional Sources of Information .....	14-11

<b>Chapter 1: Housing History and Purpose.....</b>	<b>1-1</b>
Figure 1.1. Conditions in the Tenements.....	1-3
Figure 1.2. Levittown, New York.....	1-6
<b>Chapter 2: Basic Principles of Healthy Housing.....</b>	<b>2-1</b>
Figure 2.1. Circa 1890 Icebox .....	2-5
Figure 2.2. Smoke Alarm Testing.....	2-8
<b>Chapter 3: Housing Regulations.....</b>	<b>3-1</b>
Figure 3.1. Example of a Floor Area .....	3-5
Figure 3.2. Example of an Angle of Light Obstruction .....	3-5
<b>Chapter 4: Disease Vectors and Pests.....</b>	<b>4-1</b>
Figure 4.1. Field Identification of Domestic Rodents .....	4-2
Figure 4.2. Norway Rat.....	4-2
Figure 4.3. Roof Rat.....	4-2
Figure 4.4. Signs of Rodent Infestation.....	4-3
Figure 4.5. Rodent Prevention.....	4-4
Figure 4.6. Live Traps for Rats.....	4-4
Figure 4.7. Kill Traps for Rats.....	4-4
Figure 4.8. American, Oriental, German, and Brown-banded Cockroaches.....	4-5
Figure 4.9. American Cockroaches, Various Stages and Ages .....	4-5
Figure 4.10. Oriental Cockroaches, Various Stages and Ages .....	4-5
Figure 4.11. German Cockroaches, Various Stages and Ages.....	4-5
Figure 4.12. Brown-banded Cockroaches, Various Stages and Ages .....	4-5
Figure 4.13. Wood Cockroach, Adult Male .....	4-5
Figure 4.14. Reported Human Plague Cases (1970–1997) .....	4-6
Figure 4.15. Flea Life Cycle.....	4-6
Figure 4.16. Housefly [ <i>Musca domestica</i> ] .....	4-7
Figure 4.17. Life Cycle of the Fly .....	4-8
Figure 4.18. Termite Tube Extending from Ground to Wall .....	4-9
Figure 4.19. Termite Mud Shelter Tube Constructed Over a Brick Foundation.....	4-9
Figure 4.20a. Ant (Elbowed Antennae: Fore Wings Larger Than Hind; Constricted Waist).....	4-9
Figure 4.20b. Termite (Beaded Antennae; All Wings Equal).....	4-9
Figure 4.21. Life Cycle of the Subterranean Termite.....	4-10
Figure 4.22. Subterranean Termite Risk in the United States.....	4-11
Figure 4.23. Typical Points of Attack by Termites in the Home .....	4-12
Figure 4.24. Construction Techniques That Discourage Termite Attacks.....	4-14
Figure 4.25. Fire Ants.....	4-14
Figure 4.26. Range Expansion of Red Imported Fire Ants [RIFAs] in the United States, 1918–1998.....	4-15
Figure 4.27. Fire Ant Mound .....	4-15

<b>Chapter 5: Indoor Air Pollutants and Toxic Materials.....</b>	<b>5-1</b>
Figure 5.1. Mold Growth in the Home .....	5-6
Figure 5.2. Home Carbon Monoxide Monitor .....	5-7
Figure 5.3. Environmental Tobacco Smoke and Children’s Exposure .....	5-8
Figure 5.4. Wood Products Label .....	5-9
Figure 5.5. EPA Map of Radon Zones .....	5-10
Figure 5.6. Radon Entry .....	5-10
Figure 5.7. Home Radon Detectors .....	5-11
Figure 5.8. Radon-resistant Construction .....	5-11
Figure 5.9. Arsenic Label .....	5-19
<b>Chapter 6: Housing Structure.....</b>	<b>6-1</b>
Figure 6.1. Housing Structure Terminology, Typical House Being Built Today .....	6-1
Figure 6.2. Housing Structure and Terminology, Typical House Built Between 1950 and 1980 .....	6-5
Figure 6.3. Foundation .....	6-8
Figure 6.4. Foundation Cracks .....	6-8
Figure 6.5. Interior Stairway .....	6-11
Figure 6.6. Classifications of Windows .....	6-12
Figure 6.7. Three Dimensional View of a Window .....	6-12
Figure 6.8. Window Details .....	6-12
Figure 6.9. Wall Framing .....	6-16
<b>Chapter 7: Environmental Barriers.....</b>	<b>7-1</b>
Figure 7.1. Sources of Moisture and Air Pollutants .....	7-1
Figure 7.2. Blown Attic Insultation .....	7-3
Figure 7.3. Depth of Attic Insulation .....	7-3
Figure 7.4. Attic ventilation .....	7-3
Figure 7.5. Brick Structural Defect.....	7-4
Figure 7.6. Corrosion in Piping Resulting From Galvanic Response.....	7-5
<b>Chapter 8: Rural Water Supplies and Water-quality Issues.....</b>	<b>8-1</b>
Figure 8.1. U.S. Water Supply by Source .....	8-1
Figure 8.2. Cross Section of a Driven Well .....	8-3
Figure 8.3. Well Seal.....	8-4
Figure 8.4. Converted Dug Well .....	8-4
Figure 8.5. Recapped and Sealed Dug Well .....	8-5
Figure 8.6. Drilled Well .....	8-5
Figure 8.7. Typical Dug Well .....	8-5
Figure 8.8. Sewage in Drainage Ditch .....	8-6
Figure 8.9. Drilled Well .....	8-6
Figure 8.10. Spring Box .....	8-6
<b>Chapter 9: Plumbing.....</b>	<b>9-1</b>
Figure 9.1. Typical Home Water System .....	9-1
Figure 9.2. House Service Installation .....	9-2
Figure 9.3. Gas Water Heater .....	9-7

Figure 9.4. Temperature-Pressure Valve .....	9-8
Figure 9.5. Branch Connections .....	9-10
Figure 9.6. P-trap .....	9-10
Figure 9.7. Types of S-traps .....	9-10
Figure 9.8. Trap Seal .....	9-10
Figure 9.9. Loss of Trap Seal in Lavatory Sink .....	9-11
Figure 9.10. Back-to-back Venting [Toilet].....	9-11
Figure 9.11. Back-to-back Venting [Sink].....	9-11
Figure 9.12. Wall-hung Fixtures .....	9-12
Figure 9.13. Unit Vent Used in Bathtub Installation.....	9-12
Figure 9.14. Toilet Venting.....	9-12
Figure 9.15. Janitor’s Sink .....	9-13
Figure 9.16. Common Y-trap .....	9-13
Figure 9.17. Hose Bib With Vacuum Breaker.....	9-13

## **Chapter 10: On-site Wastewater Treatment ..... 10-1**

Figure 10.1. Conventional On-site Septic System .....	10-1
Figure 10.2. Straight Pipe Discharge.....	10-2
Figure 10.3. Clear Creek Water Contaminated With Sewage.....	10-2
Figure 10.4. Septic Tank System .....	10-3
Figure 10.5. Septic Tank .....	10-4
Figure 10.6. On-site Sewage Disposal System Site Evaluation Form .....	10-5
Figure 10.7. Cross-section of an Absorption Field .....	10-5
Figure 10.8. Mound System Cutaway .....	10-7
Figure 10.9. Low Pressure On-site System .....	10-7
Figure 10.10. Plant-rock Filter system .....	10-8
Figure 10.11. Sludge and Scum in Multicompartment Septic Tank .....	10-10

## **Chapter 11: Electricity ..... 11-1**

Figure 11.1. Utility Overview .....	11-3
Figure 11.2. Entrance Head .....	11-3
Figure 11.3. Armored Cable Service Entrance .....	11-4
Figure 11.4. Breakers .....	11-4
Figure 11.5. Thin-wall Conduit .....	11-4
Figure 11.6. Electric Meter.....	11-5
Figure 11.7. Typical Service Entrance .....	11-5
Figure 11.8. Grounding Scheme .....	11-6
Figure 11.9. Grounding .....	11-6
Figure 11.10. Three-wire Service .....	11-7
Figure 11.11. Two-wire Service .....	11-7
Figure 11.12. Wire Markings .....	11-8
Figure 11.13. Armored Cable .....	11-9
Figure 11.14. 200-Amp Service Box .....	11-10
Figure 11.15. External Power Shutoff and Meter .....	11-10

Figure 11.16. GFCI .....	11-11
Figure 11.17. Arc Interrupter .....	11-12
Figure 11.18. Types of Fuses .....	11-12
Figure 11.19. Appliance Ground and Grounded Plug .....	11-14

## **Chapter 12: Heating, Air Conditioning, and Ventilating..... 12-1**

Figure 12.1. Heat Pump in Cooling Mode .....	12-5
Figure 12.2. Piping Hookup for Inside Tank Installation .....	12-6
Figure 12.3. Piping Hookup for Buried Outside Tank .....	12-6
Figure 12.4. Minimum Clearance for Pipeless Hot Air and Gravity Warm Air Furnace .....	12-7
Figure 12.5. Minimum Clearance for Steam or Hot Water Boiler and Mechanical Warm-air Furnace .....	12-7
Figure 12.6. Heating Ducts Covered With Asbestos Insulation .....	12-7
Figure 12.7. Typical Underfeed Coal Stoker Installation in Small Boilers .....	12-8
Figure 12.8. Cutaway View of Typical High-pressure Gun Burner .....	12-9
Figure 12.9. Gas-fired Boiler .....	12-9
Figure 12.10. Typical Gravity One-pipe Heating System .....	12-10
Figure 12.11. One-pipe Gravity Water Heating System .....	12-11
Figure 12.12. Two-pipe Gravity Water Heating System .....	12-11
Figure 12.13. Warm-air Convection Furnace .....	12-11
Figure 12.14. Cross-sectional View of Building Showing Forced Warm-air Heating System .....	12-12
Figure 12.15. Perforated-sleeve Burner .....	12-13
Figure 12.16. Condition of Burner Flame with Different Rates of Fuel Flow .....	12-13
Figure 12.17. Wall and Ceiling Clearance Reduction .....	12-14
Figure 12.18. Draft Relation to Height of Chimney .....	12-14
Figure 12.19. Location and Operation of Typical Backdraft Diverter .....	12-15
Figure 12.20. Split-system Air Conditioner .....	12-16
Figure 12.21. External Air-conditioning Condenser Unit .....	12-16
Figure 12.22. Chimney Plan .....	12-17
Figure 12.23. Fireplace Construction .....	12-18

## **Chapter 13: Energy Efficiency ..... 13-1**

Figure 13.1. Roof Components .....	13-3
Figure 13.2. Potential Effects of Radiant Barriers .....	13-4
Figure 13.3. Common Floor Insulation Flaws .....	13-5
Figure 13.4a. Insulation Cavity Fill, Lath .....	13-6
Figure 13.4c. Insulation Cavity Fill, Metal Rods .....	13-6
Figure 13.4b. Insulation Cavity Fill, Mesh .....	13-6
Figure 13.4d. Insulation Cavity Fill, Polypropylene Twine .....	13-6
Figure 13.5. Solar Panels .....	13-9

## **Chapter 14: Residential Swimming Pools and Spas ..... 14-1**

Figure 14.1. Pool Cover.....	14-2
Figure 14.2. Typical Home Pool Equipment System.....	14-5

Table 8.1.	Recommended Minimum Distance Between Well and Pollution Sources (Horizontal Distance).....	8-2
Table 8.2.	Types of Wells for Accessing Groundwater, Well Depths, and Diameters.....	8-3
Table 8.3.	Disinfection Methods.....	8-7
Table 8.4.	Chlorination Guide for Specific Water Conditions.....	8-8
Table 8.5.	Preparing a 200-ppm Chlorine Solution.....	8-9
Table 8.6.	Analyzing and Correction Water Quality Problems .....	8-11
Table 9.1.	Fixture Unit Values.....	9-9
Table 9.2.	Sanitary House Drain Sizes .....	9-9
Table 9.3.	Minimum Fixture Service Pipe Diameters.....	9-12
Table 10.1.	Mound System Advantages and Disadvantages.....	10-6
Table 10.2.	Low-pressure Pipe Systems Advantages and Disadvantages.....	10-7
Table 10.3.	Plant-rock Filter Systems Advantages and Disadvantages.....	10-8
Table 10.4.	Septic Tank System Troubleshooting .....	10-10
Table 13.1.	Cost-effective Insulation R-values for Existing homes.....	13-2
Table 13.2.	Potential Effects of Radiant Barriers .....	13-3
Table 13.3.	Floor Insulation.....	13-5
Table 14.1.	Pool Water Quality Problem Solving.....	14-7
Table 14.2.	pH Effect on Chlorine Disinfection .....	14-8
Table 14.3.	Chlorine Use in Swimming Pools.....	14-8
Table 14.4.	Swimming Pool Operating Parameters .....	14-9
Table 14.5.	Spa and Hot Tub Operating Parameters .....	14-10

**H**ousing quality is key to the public's health. Translating that simple axiom into action is the topic of this book. In the 30 years since the first edition was published, the nation's understanding of how specific housing conditions are related to disease and injury has matured and deepened. This new edition will enable public health and housing professionals to grasp our shared responsibility to ensure that our housing stock is safe, decent, affordable, and healthy for our citizens, especially those who are particularly vulnerable and who spend more time in the home, such as children and the elderly.

The Centers for Disease Control and Prevention and the U.S. Department of Housing and Urban Development (HUD) have worked together with many others to discover the ways to eliminate substandard housing conditions that harm health. For example, the advances in combating water borne diseases was possible, in part, through standardization of indoor plumbing and sewage, and the institution of federal, state and local regulations and codes. Childhood lead poisoning has been dramatically reduced, in part, through the elimination of residential lead-based paint hazards. Other advances have been made to protect people from carbon monoxide poisoning, falls, safety hazards, electrocution, and many other risks.

However, more must be done to control existing conditions and to understand emerging threats that remain poorly understood. For example, nearly 18 million Americans live with the health threat of contaminated drinking water supplies, especially in rural areas where on-site wastewater systems are prevalent. Despite progress, thousands of children still face the threat of lead poisoning from residential lead paint hazards. The increase in asthma in recent decades and its relationship to housing conditions such as excess moisture, mold, settled dust allergens and ventilation remains the subject of intense research. The impact of energy conservation measures on the home environment is still unfolding. Simple affordable construction techniques and materials that minimize moisture problems and indoor air pollution, improve ventilation, and promote durability and efficiency continue to be uncovered.

A properly constructed and maintained home is nearly timeless in its usefulness. A home is often the biggest single investment people make. This manual will help to ensure that the investment is a sound one that promotes healthy and safe living.

Home rehabilitation has increased significantly in the last few years and HUD has prepared a nine-part series, The Rehab Guide, that can assist both residents and contractors in the rehabilitation process. For additional information, go to <http://www.huduser.org/publications/destech/rehabgui.html>.





We acknowledge the suggestions, assistance, and review of numerous individuals and organizations that went into the original and current versions of this manual. The revisions to this manual were made by a team of environmental health, housing, and public health professionals led by Professor Joe Beck, Dr. Darryl Barnett, Dr. Gary Brown, Dr. Carolyn Harvey, Professor Worley Johnson, Dr. Steve Konkell, and Professor Charles Treser.

Individuals from the following organizations were involved in the various drafts of this manual:

- Department of Housing and Urban Development (HUD), Office of Healthy Homes and Lead Hazard Control;
- U.S. Department of Health and Human Services (HHS), Centers for Disease Control and Prevention (CDC), National Center for Environmental Health (NCEH);
- National Healthy Homes Training Center and Network;
- National Association of Housing and Redevelopment Officials;
- Department of Building, Housing and Zoning (Allentown, Pennsylvania);
- Code Enforcement Associates (East Orange, New Jersey);
- Eastern Kentucky University (Richmond, Kentucky);
- University of Washington; Seattle (Washington); and
- Battelle Memorial Institute (Columbus, Ohio).
- Specifically, our gratitude goes to the following reviewers:
- Dr. David Jacobs, Martin Nee, and Dr. Peter Ashley, HUD;
- Pat Bohan, East Central University;
- James Larue, The House Mender Inc.;
- Ellen Tohn, ERT Associates;
- Dr. Stephen Margolis, Emory University; and
- Joseph Ponessa and Rebecca Morley, Healthy Homes Training Center.

A special thank-you for assistance from Carolyn Case-Compton, Habitat for Humanity, 123 East Main Street, Morehead, Kentucky. Pictures of a home under construction are courtesy of Habitat for Humanity and John King, home builder and instructor, Rowan County Technical College, Morehead, Kentucky; and Don W. Johnson, building photographer of Habitat for Humanity.

In addition, a special thank you to CAPT Craig Shepherd and CAPT Michael Herring, Commissioned Corps, U.S. Public Health Service, CDC/NCEH/Environmental Health Services Branch for their research and review during the editing of this manual. Special thanks to Pamela S. Wigington and Joey L. Johnson for their hard work preparing this manual for publication and to Teresa M. Sims for Web publication.



# Abbreviations and Acronyms

---

<b>ABS</b>	acrylonitrile-butadiene-styrene
<b>ADA</b>	Americans with Disabilities Act
<b>AGA</b>	American Gas Association
<b>ALA</b>	American Lung Association
<b>ANSI</b>	American National Standards Institute
<b>APHA</b>	American Public Health Association
<b>ASME</b>	American Society of Mechanical Engineers
<b>ASSE</b>	American Society of Structural Engineers
<b>ASTM</b>	American Society for Testing Materials
<b>ATSDR</b>	Agency for Toxic Substances and Disease Registry
<b>AWG</b>	American Wire Gauge
<b>AWWA</b>	American Waters Works Association
<b>BTU</b>	British thermal unit
<b>CDC</b>	Centers for Disease Control and Prevention
<b>CFR</b>	Code of Federal Regulations
<b>CGA</b>	Canadian Gas Association
<b>CO</b>	carbon monoxide
<b>CPR</b>	cardiopulmonary resuscitation
<b>CPSC</b>	Consumer Product Safety Commission
<b>CSIA</b>	Chimney Safety Institute of America
<b>DDT</b>	dichlorodiphenyltrichlorethane
<b>DE</b>	diatomaceous earth
<b>DPD</b>	N,N-diethyl-p-phenylene diamine
<b>DWV</b>	drain, waste, and vent
<b>EIFS</b>	exterior insulation and finish system
<b>EPA</b>	U.S. Environmental Protection Agency
<b>EPDM</b>	ethylene propylene diene terpolymer
<b>ETS</b>	environmental tobacco smoke
<b>FHA</b>	Federal Housing Administration
<b>FM</b>	Factory Mutual
<b>GFCI</b>	ground fault circuit interrupter
<b>HEPA</b>	high-efficiency particulate air
<b>HHS</b>	Health and Human Services, U.S. Department of
<b>HSC</b>	Home Safety Council
<b>HUD</b>	Housing and Urban Development, U.S. Department of
<b>HVAC</b>	heating, ventilating and air conditioning
<b>IAPMO</b>	International Association of Plumbing and Mechanical Officials

<b>ICC</b>	International Code Council
<b>IPM</b>	integrated pest management
<b>ISO</b>	International Standard Organization
<b>kg</b>	kilogram
<b>LPP</b>	low-pressure pipe
<b>MPMH</b>	<i>Military Pest Management Handbook</i>
<b>MSS</b>	Mechanical Standardization Society of the Valve and Fitting Industry
<b>NCEH</b>	National Center for Environmental Health
<b>NCI</b>	National Cancer Institute
<b>NIA</b>	National Institute on Aging
<b>NSF</b>	National Science Foundation
<b>NTU</b>	nephelometric turbidity unit
<b>ODTS</b>	organic dust toxic syndrome
<b>OSHA</b>	Occupational Safety and Health Administration
<b>PEX</b>	cross-formulated polyethylene
<b>POTW</b>	publicly owned treatment works
<b>ppm</b>	parts per million
<b>psi</b>	pound per square inch
<b>PVC</b>	polyvinyl chloride
<b>PW</b>	potable water
<b>RIFA</b>	red imported fire ant
<b>SDWA</b>	Safe Drinking Water Act
<b>SEER</b>	seasonal energy efficiency ratio
<b>T&amp;P</b>	temperature-pressure
<b>TSP</b>	trisodium phosphate
<b>UF</b>	urea-formaldehyde
<b>UL</b>	Underwriters Laboratories
<b>USCB</b>	U.S. Census Bureau
<b>USDA</b>	U.S. Department of Agriculture
<b>USFA</b>	U.S. Fire Administration
<b>USGS</b>	U.S. Geological Survey
<b>USHA</b>	United States Housing Authority
<b>VA</b>	Veteran's Administration
<b>VOC</b>	volatile organic compound
<b>XRF</b>	X-ray fluorescence

**Accessory building or structure:** a detached building or structure in a secondary or subordinate capacity from the main or principal building or structure on the same premises.

**Appropriate authority/Authority having jurisdiction (AHJ):** a person within the governmental structure of the corporate unit who is charged with the administration of the appropriate code.

**Ashes:** the residue from burning combustible materials.

**Attic:** any story or floor of a building situated wholly or partly within the roof, and so designed, arranged, or built to be used for business, storage, or habitation.

**Basement:** the lowest story of a building, below the main floor and wholly or partially lower than the surface of the ground.

**Building:** a fixed construction with walls, foundation, and roof, such as a house, factory, or garage.

**Bulk container:** any metal garbage, rubbish, or refuse container having a capacity of 2 cubic yards or greater and which is equipped with fittings for hydraulic or mechanical emptying, unloading, or removal.

**Central heating system:** a single system supplying heat to one or more dwelling unit(s) or more than one rooming unit.

**Chimney:** a vertical masonry shaft of reinforced concrete, or other approved noncombustible, heat-resisting material enclosing one or more flues, for the purpose of removing products of combustion from solid, liquid, or gaseous fuel.

**Dilapidated:** in a state of disrepair or ruin and no longer adequate for the purpose or use for which it was originally intended.

**Dormitory:** a building or a group of rooms in a building used for institutional living and sleeping purposes by four or more persons.

**Dwelling:** any enclosed space wholly or partly used or intended to be used for living, sleeping, cooking, and eating. (*Temporary housing*, as hereinafter defined, shall not be classified as a dwelling.) Industrialized housing and modular construction that conform to nationally accepted industry standards and are used or intended for use for living, sleeping, cooking, and eating purposes shall be classified as dwellings.

**Dwelling unit:** a room or group of rooms located within a dwelling forming a single habitable unit with facilities used or intended to be used by a single family for living, sleeping, cooking, and eating.

**Egress:** arrangements and openings to assure a safe means of exit from buildings.

**Extermination:** the control and elimination of insects, rodents, or other pests by eliminating their harborage places; by removing or making inaccessible materials that may serve as their food; by poisoning, spraying, fumigating, trapping, or any other recognized and legal pest elimination methods approved by the local or state authority having such administrative authority. Extermination is one of the components of integrated pest management.

**Fair market value:** a price at which both buyers and sellers will do business.

**Family:** one or more individuals living together and sharing common living, sleeping, cooking, and eating facilities (See also *Household*).

**Flush toilet:** a toilet bowl that can be flushed with water supplied under pressure and that is equipped with a water-sealed trap above the floor level.

**Garbage:** animal and vegetable waste resulting from handling, preparation, cooking, serving, and nonconsumption of food.

**Grade:** the finished ground level adjacent to a required window.

**Guest:** an individual who shares a dwelling unit in a nonpermanent status for not more than 30 days.

**Habitable room:** a room or enclosed floor space used or intended to be used for living, sleeping, cooking or eating purposes, excluding bathrooms, laundries, furnace rooms, pantries, kitchenettes and utility rooms of less than 50 square feet of floor space, foyers, or communicating corridors, stairways, closets, storage spaces, workshops, and hobby and recreation areas.

**Health officer:** the legally designated health authority of the jurisdiction or that person's authorized representative.

**Heated water:** water heated to a temperature of not less than 120°F–130°F (49°C–54°C) at the outlet.

**Heating device:** all furnaces, unit heaters, domestic incinerators, cooking and heating stoves and ranges, and other similar devices.

**Household:** one or more individuals living together in a single dwelling unit and sharing common living, sleeping, cooking, and eating facilities (see also *Family*).

**Infestation:** the presence within or around a dwelling of any insects, rodents, or other pests.

**Integrated pest management:** a coordinated approach to managing roaches, rodents, mosquitoes, and other pests that combines inspection, monitoring, treatment, and evaluation, with special emphasis on the decreased use of toxic agents.

**Kitchen:** any room used for the storage and preparation of foods and containing the following equipment: sink or other device for dishwashing, stove or other device for cooking, refrigerator or other device for cold storage of food, cabinets or shelves for storage of equipment and utensils, and counter or table for food preparation.

**Kitchenette:** a small kitchen or an alcove containing cooking facilities.

**Lead-based paint:** any paint or coating with lead content equal to or greater than 1 milligram per square centimeter, or 0.5% by weight.

**Multiple dwelling:** any dwelling containing more than two dwelling units.

**Occupant:** any individual, over 1 year of age, living, sleeping, cooking, or eating in or having possession of a dwelling unit or a rooming unit; except that in dwelling units a guest shall not be considered an occupant.

**Operator:** any person who has charge, care, control or management of a building, or part thereof, in which dwelling units or rooming units are let.

**Ordinary summer conditions:** a temperature 10°F (-12°C) below the highest recorded temperature in the locality for the prior 10-year period.

**Ordinary winter conditions:** mean a temperature 15°F (-9.4°C) above the lowest recorded temperature in the locality for the prior 10-year period.

**Owner:** any person who alone, jointly, or severally with others (a) shall have legal title to any premises, dwelling, or dwelling unit, with or without accompanying actual possession thereof, or (b) shall have charge, care or control of any premises, dwelling, or dwelling unit, as owner or agent of the owner, or as executor, administrator, trustee, or guardian of the estate of the owner.

**Permissible occupancy:** the maximum number of individuals permitted to reside in a dwelling unit, rooming unit, or dormitory.

**Person:** any individual, firm, corporation, association, partnership, cooperative, or government agency.

**Plumbing:** all of the following supplied facilities and equipment: gas pipes, gas burning equipment, water pipes, garbage disposal units, waste pipes, toilets, sinks, installed dishwashers, bathtubs, shower baths, installed clothes washing machines, catch basins, drains, vents, and similarly supplied fixtures, and the installation thereof, together with all connections to water, sewer, or gas lines.

**Privacy:** the existence of conditions which will permit an individual or individuals to carry out an activity commenced without interruption or interference, either by sight or sound by unwanted individuals.

**Rat harborage:** any conditions or place where rats can live, nest or seek shelter.

**Ratproofing:** a form of construction that will prevent the entry or exit of rats to or from a given space or building, or from gaining access to food, water, or harborage. It consists of the closing and keeping closed of every opening in foundations, basements, cellars, exterior and interior walls, ground or first floors, roofs, sidewalk gratings, sidewalk openings, and other places that may be reached and entered by rats by climbing, burrowing, or other methods, by the use of materials impervious to rat gnawing and other methods approved by the appropriate authority.

**Refuse:** leftover and discarded organic and nonorganic solids (except body wastes), including garbage, rubbish, ashes, and dead animals.

**Refuse container:** a watertight container that is constructed of metal, or other durable material impervious to rodents, that is capable of being serviced without creating unsanitary conditions, or such other containers as have been approved by the appropriate authority (see also *Appropriate Authority*). Openings into the container, such as covers and doors, shall be tight fitting.

**Rooming house:** any dwelling other than a hotel or motel or that part of any dwelling containing one or more rooming units, or one or more dormitory rooms, and in which persons either individually or as families are housed with or without meals being provided.

**Rooming unit:** any room or group of rooms forming a single habitable unit used or intended to be used for living and sleeping, but not for cooking purposes.

**Rubbish:** nonputrescible solid wastes (excluding ashes) consisting of either: (a) combustible wastes such as paper, cardboard, plastic containers, yard clippings and wood; or (b) noncombustible wastes such as cans, glass, and crockery.

**Safety:** the condition of being reasonably free from danger and hazards that may cause accidents or disease.

**Space heater:** a self-contained heating appliance of either the convection type or the radiant type and intended primarily to heat only a limited space or area such as one room or two adjoining rooms.

**Supplied:** paid for, furnished by, provided by, or under the control of the owner, operator or agent.

**System:** the dynamic interrelationship of components designed to enact a vision.

**Systems theory:** The concept proposed to promote the dynamic interrelationship of activities designed to accomplish a unified system.

**Temporary housing:** any tent, trailer, mobile home, or other structure used for human shelter that is designed to be transportable and which is not attached to the ground, to another structure, or to any utility system on the same premises for more than 30 consecutive days.

**Toxic substance:** any chemical product applied on the surface of or incorporated into any structural or decorative material, or any other chemical, biologic, or physical agent in the home environment or its immediate surroundings, which constitutes a potential hazard to human health at acute or chronic exposure levels.

**Variance:** a difference between that which is required or specified and that which is permitted.





# Standards and Organizations

In addition to the standards and organizations listed in this section, the U.S. Justice Department enforces the requirements of the Americans with Disabilities Act (ADA) (<http://www.ada.gov>) and assures that products fully comply with the provisions of the act to ensure equal access for physically challenged users.

- ABPA** The American Backflow Prevention Association, <http://abpa.org>  
Develops cross-connections; ABPA is an organization whose members have a common interest in protecting drinking water from contamination.
- ACI** American Concrete Institute, <http://www.concrete.org/general/home.asp>  
Has produced more than 400 technical documents, reports, guides, specifications, and codes for the best use of concrete. ACI conducts more than 125 educational seminars each year and has 13 certification programs for concrete practitioners, as well as a scholarship program to promote careers in the industry.
- AGA** American Gas Association, <http://www.aga.org>  
Develops standards, tests, and qualifies products used in gas lines and gas appliance installations.
- AGC** Associated General Contractors of America, <http://www.agc.org>  
Is dedicated to improving the construction industry by educating the industry to employ the finest skills, promoting use of the latest technology and advocating building the best quality projects for owners—public and private.
- AMSA** Association of Metropolitan Sewerage Agencies, <http://www.amsa-cleanwater.org>  
Represents the interests of the country's wastewater treatment agencies.
- ANSI** American National Standards Institute, <http://www.ansi.org>  
Coordinates work among U.S. standards writing groups. Works in conjunction with other groups such as ISO, ASME, and ASTM.
- ARI** Air-Conditioning and Refrigeration Institute, <http://www.ari.org>  
Provides information about the 21st Century Research (21-CR) initiative, a private-public sector research collaboration of the heating, ventilation, air-conditioning, and refrigeration industry, with a focus on energy conservation, indoor environmental quality, and environmental protection.
- ASCE** American Society of Civil Engineers, <http://www.asce.org>  
Provides essential value to its members, careers, partners, and the public by developing leadership, advancing technology, advocating lifelong learning, and promoting the profession.
- ASHI** The American Society of Home Inspectors, <http://www.ashi.org>  
Is a source of information about the home inspection profession.
- ASHRAE** American Society of Heating, Refrigerating and Air-Conditioning Engineers, <http://www.ashrae.org>  
Writes standards and guidelines that include uniform methods of testing for rating purposes, describe recommended practices in designing and installing equipment and provide other information to guide the industry. ASHRAE has more than 80 active standards and guideline project committees, addressing such broad areas as indoor air quality, thermal comfort, energy conservation in buildings, reducing refrigerant emissions, and the designation and safety classification of refrigerants.
- ASME** The American Society of Mechanical Engineers, <http://www.asme.org>  
Develops standards for materials and testing as well as finished products.
- ASSE** American Society of Sanitary Engineering, <http://www.asse.org>  
Develops standards and qualifies products for plumbing and sanitary installations.
- ASTM** American Society for Testing and Materials, <http://www.astm.org>  
Is one of the largest voluntary standards development organizations in the world—a trusted source for technical standards for materials, products, systems, and services.

- AWWA** American Water Works Association, <http://www.awwa.org>  
Promotes public health through improvement of the quality of water and develops standards for valves, fittings, and other equipment.
- CGA** Canadian Gas Association, <http://www.cga.ca>  
Develops standards, tests, and qualifies products used in gas lines and gas appliance installations.
- CPSC** U.S. Consumer Product Safety Commission, <http://www.cpsc.gov>  
Protects the public from unreasonable risks for serious injury or death from more than 15,000 types of consumer products. CPSC is committed to protecting consumers and families from products that pose a fire, electrical, chemical, or mechanical hazard or can injure children.
- CRBT** Center for Resourceful Building Technology, <http://www.crbt.org>  
Contains the online *Guide to Resource-Efficient Building Elements*, which provides information about environmentally efficient construction materials, including foundations, wall systems, panels, insulation, siding, roofing, doors, windows, interior finishing, and floor coverings.
- EPA** U.S. Environmental Protection Agency, <http://www.epa.gov>  
Protects human health and the environment.
- FM** Factory Mutual, <http://fmglobal.com>  
Develops standards and qualifies products for use by the general public and develops standards for materials, products, systems, and services.
- HFHI** Habitat for Humanity International, <http://www.habitat.org>  
Is a nonprofit, ecumenical Christian housing ministry. HFHI seeks to eliminate poverty housing and homelessness from the world, and to make decent shelter a matter of conscience and action.
- HUD** U.S. Department of Housing and Urban Development, <http://www.hud.gov>  
As part of the HUD efforts toward eliminating childhood lead poisoning, the Office of Healthy Homes and Lead Hazard Control is sharing local lead ordinances and regulations that have proven effective in helping communities deal with lead-based paint hazards. Also, the design and construction of manufactured housing are regulated by the federal government and must comply with HUD's Manufactured Home Construction and Safety Standards. Modular and panelized construction must comply with model or local building codes.
- IAPMO** International Association of Plumbing and Mechanical Officials, <http://www.iapmo.org>  
Developed and maintains the Uniform Plumbing Code and the Uniform Mechanical Code.
- ICBO** The Uniform Building Code (UBC)/International Conference of Building Officials, <http://www.iccsafe.org>  
Is the most widely adopted model building code in the world and is a proven document meeting the needs of government units charged with enforcement of building regulation. Published triennially, the UBC provides complete regulations covering all major aspects of building design and construction relating to fire and life safety and structural safety. The requirements reflect the latest technologic advances available in the building and fire- and life-safety industry.
- ICC** International Code Council, <http://www.iccsafe.org>  
Produces the most widely adopted and enforced building safety codes in the United States (I-Codes). International Residential Code (IRC) 2003 has been adopted by many states, jurisdictions, and localities. IRC also references several industry standards such as ACI 318, ASCE 7, ASTM, and ANSI standards that cover specific load, load combinations, design methods, and material specifications.
- ISO** International Standard Organization, <http://www.iso.org>  
Provides internationally recognized certification for manufacturers that comply with high standards of quality control, developed standards ISO-9000 through ISO-9004, and qualifies and lists products suitable for use in plumbing installations.

<b>MSS</b>	Manufacturers Standardization Society of the Valve and Fittings Industry, Inc., <a href="http://www.mss-hq.com">http://www.mss-hq.com</a> Develops technical codes and standards for the valve and fitting industry.
<b>NACHI</b>	The National Association of Certified Home Inspectors, <a href="http://www.nachi.org/index.htm">http://www.nachi.org/index.htm</a> Is the world's largest, most elite nonprofit inspection association.
<b>NAHB</b>	National Association of Home Builders, <a href="http://www.nahb.org">http://www.nahb.org</a> Is a trade association representing more than 220,000 residential home building and remodeling industry members. NAHB is affiliated with more than 800 state and local home builders associations around the country. NAHB urges codes and standards development and application that protects public health and safety without cost impacts that decrease affordability and consequently prevent people from moving into new, healthier, safer homes.
<b>NEC</b>	National Electrical Code, <a href="http://www.nfpa.org">http://www.nfpa.org</a> Protects public safety by establishing requirements for electrical wiring and equipment in virtually all buildings.
<b>NESC</b>	National Environmental Services Center, <a href="http://www.nesc.wvu.edu/nesc/nesc_about.htm">http://www.nesc.wvu.edu/nesc/nesc_about.htm</a> Is a repository for water, wastewater, solid waste, and environmental training research.
<b>NFPA</b>	National Fire Protection Association, <a href="http://www.nfpa.org/index.asp">http://www.nfpa.org/index.asp</a> Develops, publishes, and disseminates more than 300 consensus codes and standards intended to minimize the possibility and effects of fire and other risks.
<b>NOWRA</b>	National Onsite Wastewater Recycling Association, <a href="http://www.nowra.org">http://www.nowra.org</a> Provides leadership and promotes the onsite wastewater treatment and recycling industry through education, training, communication, and quality tools to support excellence in performance.
<b>NSF</b>	National Sanitation Foundation, <a href="http://www.nsf.org">http://www.nsf.org</a> Develops standards for equipment, products and services; a nonprofit organization now known as International.
<b>UL</b>	Underwriters Laboratory, <a href="http://www.ul.com">http://www.ul.com</a> Has developed more than 800 Standards for Safety. Millions of products and their components are tested to UL's rigorous safety standards.
<b>WEF</b>	Water Environment Federation, <a href="http://www.wef.org">http://www.wef.org</a> Is a not-for-profit technical and educational organization with members from varied disciplines who work toward the WEF vision of preservation and enhancement of the global water environment. The WEF network includes water quality professionals from 76 member associations in 30 countries.



The original *Basic Housing Inspection* manual was published in 1976 by the Center for Disease Control (now known as the Centers for Disease Control and Prevention). Its Foreword stated:

*“The growing numbers of new families and the increasing population in the United States have created a pressing demand for additional housing that is conducive to healthful living. These demands are increased by the continuing loss of existing housing through deterioration resulting from age and poor maintenance. Large numbers of communities in the past few years have adopted housing codes and initiated code enforcement programs to prevent further deterioration of existing housing units. This growth in housing activities has caused a serious problem for communities in obtaining qualified personnel to provide the array of housing service needed, such as information, counseling, technical advice, inspections, and enforcement. As a result many agencies throughout the country are conducting comprehensive housing inspection training courses. This publication has been designed to be an integral part of these training sessions.”*

The original *Basic Housing Inspection* manual has been successfully used for several decades by public health and housing personnel across the United States. Although much has changed in the field of housing construction and maintenance, and health and safety issues have expanded, the manual continues to have value, especially as it relates to older housing.

Many housing deficiencies impact on health and safety. For example, lead-based paint and dust may contribute to lead poisoning in children; water leakage and mold may contribute to asthma episodes; improper use and storage of pesticides may result in unintentional poisoning; and lack of working smoke, ionization, and carbon monoxide alarms may cause serious injury and death.

Government agencies have been very responsive to “healthy homes” issues. The U.S. Department of Housing and Urban Development (HUD) created an office with an exclusive focus on healthy homes. In 2003, CDC joined HUD in the effort to improve housing conditions through the training of environmental health practitioners, public health nurses, housing specialists, and others who have interest and responsibility for creating healthy homes.

The revised *Basic Housing Inspection* manual, renamed the *Healthy Housing Reference Manual*, responds to the enormous changes that have occurred in housing construction methods and materials and to new knowledge related to the impact of housing on health and safety. New chapters have been added, making the manual more comprehensive. For example, an entire chapter is devoted to rural water supplies and on-site wastewater treatment. A new chapter was added that discusses issues related to residential swimming pools and spas. At over 200 pages, the comprehensive revised manual is designed primarily as a reference document for public health and housing professionals who work in government and industry.

The *Healthy Housing Reference Manual* contains 14 chapters, each with a specific focus. All chapters contain annotated references and a listing of sources for additional topic information. A summary of the content of each chapter follows:

**Chapter One, Housing History and Purpose**, describes the history of dwellings and urbanization and housing trends during the last century.

**Chapter Two, Basic Principles of Healthy Housing**, describes the basic principles of healthy housing and safety—physiologic needs, psychologic needs, protection against injury and disease—and lays the groundwork for following chapters.

**Chapter Three, Housing Regulations**, reviews the history of housing regulations, followed by a discussion of zoning, housing, and building codes.

**Chapter Four, Disease Vectors and Pests**, provides a detailed analysis of disease vectors that have an impact on residences. It includes information on the management of mice, rats, cockroaches, fleas, flies, termites, and fire ants.

**Chapter Five, Indoor Air Pollution and Toxic Materials**, provides information on indoor air pollution, both biologic and chemical, and to toxic materials in the home, including methods for controlling these hazards. The impact of cockroaches, dust mites, pets, and mold are discussed. Also included is information about the impact of carbon monoxide, ozone, tobacco smoke, volatile organic compounds, radon, and pesticides.

**Chapter Six, Housing Structure**, contains information about “older” housing construction and new construction materials and methods. The chapter also introduces new terminologies and includes information about foundations, vapor barriers, house framing, roof framing, exterior walls, and roofs.

**Chapter Seven, Environmental Barriers**, provides information on roofing, insulation, and siding materials.

**Chapter Eight, Rural Water Supplies and Water-quality Issues**, covers issues related to the drilling and proper maintenance of wells. Research information is provided that indicates that many wells are not properly sealed, allowing for the leakage of contaminated water into wells during hurricanes and periods of significant flooding.

**Chapter Nine, Plumbing**, provides information on plumbing standards and how they can be accessed, followed by a review of the elements of a residential water delivery system, the types of available hot-water heaters, drainage systems, and methods for water conservation. It also includes a visual synthesis of water system components during new residential construction.

**Chapter Ten, On-site Wastewater Treatment**, complements chapter seven by providing information on proper on-site methods for the treatment of human waste.

**Chapter Eleven, Electricity**, expands on information contained in the original manual covering such topics as breaker systems and polarized plugs and connectors. It also provides a format for the inspection of residential electrical systems.

**Chapter Twelve, Heating, Air Conditioning, and Ventilation**, provides information about types of residential fuels and heating systems, including solar heating and minor sources of heating (e.g., coal-fired, oil-fired, gas-fired, and electrical space heaters). Chimney and fireplace safety and the variety of cooling systems are also discussed.

**Chapter Thirteen, Energy Efficiency**, discusses energy efficiency, including “R” values and their interpretation, roof ventilation, wall and floor insulation, and door and window energy efficiency systems. It also discusses active and passive solar systems and provides a methodology for conducting a residential energy audit.

**Chapter Fourteen, Residential Swimming Pools and Spas**, provides information about child safety, pool and spa hazards, and diseases. It also provides information on methods for testing and ensuring a safe water system and on methods for spa and pool disinfection. Further, it covers concerns related to unregulated individual residential pools and spas.

The quality of housing plays a decisive role in the health status of its occupants. Substandard housing conditions have been linked to adverse health effects such as childhood lead poisoning, asthma and other respiratory conditions, and unintentional injuries. This new and revised *Healthy Housing Reference Manual* is an important reference for anyone with responsibility and interest in creating and maintaining healthy housing.

The housing design and construction industry has made great progress in recent years through the development of new innovative techniques, materials technologies, and products. The HUD *Rehab Guide* series was developed to inform the design and construction industry about state-of-the-art materials and innovative practices in housing rehabilitation. The series focuses on building technologies, materials, components, and techniques rather than on projects such as adding a new room. The nine volumes each cover a distinct element of housing rehabilitation and feature breakthrough materials, labor-saving tools, and cost-cutting practices. The nine volumes address foundations; exterior walls; roofs; windows and doors; partitions, ceilings, floors, and stairs; kitchen and baths; electrical/electronics; heating, air conditioning, and ventilation; plumbing; and site work.

Additional information about the series can be found at <http://www.huduser.org/publications/destech/rehabgui.html> and <http://www.pathnet.org/sp.asp?id=997>. This series is an excellent adjunct to the *Healthy Housing Reference Manual*.

# Chapter 1: Housing History and Purpose

*“Safe, affordable housing is a basic necessity for every family. Without a decent place to live, people cannot be productive members of society, children cannot learn and families cannot thrive.”*

Tracy Kaufman, Research Associate  
National Low Income Housing Coalition/  
Low Income Housing Information Service  
<http://www.habitat.org/how/poverty.html>; 2003

## Introduction

The term “shelter,” which is often used to define housing, has a strong connection to the ultimate purpose of housing throughout the world. The mental image of a shelter is of a safe, secure place that provides both privacy and protection from the elements and the temperature extremes of the outside world.

This vision of shelter, however, is complex. The earthquake in Bam, Iran, before dawn on December 26, 2003, killed in excess of 30,000 people, most of whom were sleeping in their homes. Although the homes were made of the most simple construction materials, many were well over a thousand years old. Living in a home where generation after generation had been raised should provide an enormous sense of security. Nevertheless, the world press has repeatedly implied that the construction of these homes destined this disaster. The homes in Iran were constructed of sun-dried mud-brick and mud.

We should think of our homes as a legacy to future generations and consider the negative environmental effects of building them to serve only one or two generations before razing or reconstructing them. Homes should be built for sustainability and for ease in future modification. We need to learn the lessons of the earthquake in Iran, as well as the 2003 heat wave in France that killed in excess of 15,000 people because of the lack of climate control systems in their homes. We must use our experience, history, and knowledge of both engineering and human health needs to construct housing that meets the need for privacy, comfort, recreation, and health maintenance.

Health, home construction, and home maintenance are inseparable because of their overlapping goals. Many highly trained individuals must work together to achieve quality, safe, and healthy housing. Contractors, builders, code inspectors, housing inspectors, environmental health officers, injury control specialists, and epidemiologists all

are indispensable to achieving the goal of the best housing in the world for U.S. citizens. This goal is the basis for the collaboration of the U.S. Department of Housing and Urban Development (HUD) and the Centers for Disease and Control and Prevention (CDC).

## Preurban Housing

inhabitants. The housing similarities among civilizations separated by vast distances may have been a result of a shared heritage, common influences, or chance.

Caves were accepted as dwellings, perhaps because they were ready made and required little or no construction. However, in areas with no caves, simple shelters were constructed and adapted to the availability of resources and the needs of the population. Classification systems have been developed to demonstrate how dwelling types evolved in preurban indigenous settings [1].

## Ephemeral Dwellings

Ephemeral dwellings, also known as transient dwellings, were typical of nomadic peoples. The African bushmen and Australia’s aborigines are examples of societies whose existence depends on an economy of hunting and food gathering in its simple form. Habitation of an ephemeral dwelling is generally a matter of days.

## Episodic Dwellings

Episodic housing is exemplified by the Inuit igloo, the tents of the Tungus of eastern Siberia, and the very similar tents of the Lapps of northern Europe. These groups are more sophisticated than those living in ephemeral dwellings, tend to be more skilled in hunting or fishing, inhabit a dwelling for a period of weeks, and have a greater effect on the environment. These groups also construct communal housing and often practice slash-and-burn cultivation, which is the least productive use of cropland and has a greater environmental impact than the hunting and gathering of ephemeral dwellers.

## Periodic Dwellings

Periodic dwellings are also defined as regular temporary dwellings used by nomadic tribal societies living in a pastoral economy. This type of housing is reflected in the yurt used by the Mongolian and Kirgizian groups and the Bedouins of North Africa and western Asia. These groups’ dwellings essentially demonstrate the next step in the evolution of housing, which is linked to societal develop-

ment. Pastoral nomads are distinguished from people living in episodic dwellings by their homogenous cultures and the beginnings of political organization. Their environmental impact increases with their increased dependence on agriculture rather than livestock.

### Seasonal Dwellings

Schoenauer [1] describes seasonal dwellings as reflective of societies that are tribal in nature, seminomadic, and based on agricultural pursuits that are both pastoral and marginal. Housing used by seminomads for several months or for a season can be considered semisedentary and reflective of the advancement of the concept of property, which is lacking in the preceding societies. This concept of property is primarily of communal property, as opposed to individual or personal property. This type of housing is found in diverse environmental conditions and is demonstrated in North America by the hogans and armadas of the Navajo Indians. Similar housing can be found in Tanzania (Barabaig) and in Kenya and Tanzania (Masai).

### Semipermanent Dwellings

According to Schoenauer [1], sedentary folk societies or hoe peasants practicing subsistence agriculture by cultivating staple crops use semipermanent dwellings. These groups tend to live in their dwellings various amounts of time, usually years, as defined by their crop yields. When land needs to lie fallow, they move to more fertile areas. Groups in the Americas that used semipermanent dwellings included the Mayans with their oval houses and the Hopi, Zuni, and Acoma Indians in the southwestern United States with their pueblos.

### Permanent Dwellings

The homes of sedentary agricultural societies, whose political and social organizations are defined as nations and who possess surplus agricultural products, exemplify this type of dwelling. Surplus agricultural products allowed the division of labor and the introduction of other pursuits aside from food production; however, agriculture is still the primary occupation for a significant portion of the population. Although they occurred at different points in time, examples of early sedentary agricultural housing can be found in English cottages, such as the Suffolk, Cornwall, and Kent cottages [1].

### Urbanization

Permanent dwellings went beyond simply providing shelter and protection and moved to the consideration of comfort. These structures began to find their way into what is now known as the urban setting. The earliest

available evidence suggests that towns came into existence around 4000 BC. Thus began the social and public health problems that would increase as the population of cities increased in number and in sophistication. In preurban housing, the sparse concentration of people allowed for movement away from human pollution or allowed the dilution of pollution at its location. The movement of populations into urban settings placed individuals in close proximity, without the benefit of previous linkages and without the ability to relocate away from pollution or other people.

Urbanization was relatively slow to begin, but once started, it accelerated rapidly. In the 1800s, only about 3% of the population of the world could be found in urban settings in excess of 5,000 people. This was soon to change. The year 1900 saw the percentage increase to 13.6% and subsequently to 29.8% in 1950. The world's urban population has grown since that time. By 1975, more than one in three of the world's population lived in an urban setting, with almost one out of every two living in urban areas by 1997. Industrialized countries currently find approximately 75% of their population in an urban setting. The United Nations projects that in 2015 the world's urban population will rise to approximately 55% and that in industrialized nations it will rise to just over 80%.

In the Western world, one of the primary forces driving urbanization was the Industrial Revolution. The basic source of energy in the earliest phase of the Industrial Revolution was water provided by flowing rivers. Therefore, towns and cities grew next to the great waterways. Factory buildings were of wood and stone and matched the houses in which the workers lived, both in construction and in location. Workers' homes were little different in the urban setting than the agricultural homes from whence they came. However, living close to the workplace was a definite advantage for the worker of the time. When the power source for factories changed from water to coal, steam became the driver and the construction materials became brick and cast iron, which later evolved into steel. Increasing populations in cities and towns increased social problems in overcrowded slums. The lack of inexpensive, rapid public transportation forced many workers to live close to their work. These factory areas were not the pastoral areas with which many were familiar, but were bleak with smoke and other pollutants.

The inhabitants of rural areas migrated to ever-expanding cities looking for work. Between 1861 and 1911 the population of England grew by 80%. The cities and towns of England were woefully unprepared to cope with the



resulting environmental problems, such as the lack of potable water and insufficient sewerage.

In this atmosphere, cholera was rampant; and death rates resembled those of Third World countries today. Children had a one in six chance of dying before the age of 1 year. Because of urban housing problems, social reformers such as Edwin Chadwick began to appear. Chadwick's *Report on an Enquiry into the Sanitary Condition of the Labouring Population of Great Britain and on the Means of its Improvement* [2] sought many reforms, some of which concerned building ventilation and open spaces around the buildings. However, Chadwick's primary contention was that the health of the working classes could be improved by proper street cleaning, drainage, sewage, ventilation, and water supplies. In the United States, Shattuck et al. [3] wrote the *Report of the Sanitary Commission of Massachusetts*, which was printed in 1850. In the report, 50 recommendations were made. Among those related to housing and building issues were recommendations for protecting school children by ventilation and sanitation of school buildings, emphasizing town planning and controlling overcrowded tenements and cellar dwellings. Figure 1.1 demonstrates the conditions common in the tenements.

In 1845, Dr. John H. Griscom, the City Inspector of New York, published *The Sanitary Condition of the Laboring Population of New York* [4]. His document expressed once again the argument for housing reform and sanitation. Griscom is credited with being the first to use the phrase "how the other half lives." During this time, the poor were not only subjected to the physical problems of poor housing, but also were victimized by corrupt landlords and builders.

## Trends in Housing

The term "tenement house" was first used in America and dates from the mid-nineteenth century. It was often intertwined with the term "slum." Wright [5] notes that in English, tenement meant "an abode for a person or for the soul, when someone else owned the property." Slum, on the other hand, initially was used at the beginning of the 19th century as a slang term for a room. By the middle of the century, slum had evolved into a term for a back dwelling occupied by the lowest members of society. Von Hoffman [6] states that this term had, by the end of the century, begun to be used interchangeably with tenement. The author noted that in the larger cities of the United States, the apartment house emerged in the 1830s as a housing unit of two to five stories, with each story containing apartments of two to four rooms. It was origi-

nally built for the upper group of the working class. The tenement house emerged in the 1830s when landlords converted warehouses into inexpensive housing designed to accommodate Irish and black workers. Additionally, existing large homes were subdivided and new structures were added, creating rear houses and, in the process, eliminating the traditional gardens and yards behind them. These rear houses, although new, were no healthier than the front house, often housing up to 10 families. When this strategy became inadequate to satisfy demand, the epoch period of the tenements began.



Figure 1.1. Conditions in the Tenements

Although unpopular, the tenement house grew in numbers, and, by 1850 in New York and Boston, each tenement housed an average of 65 people. During the 1850s, the railroad house or railroad tenement was introduced. This structure was a solid, rectangular block with a narrow alley in the back. The structure was typically 90 feet long and had 12 to 16 rooms, each about 6 feet by 6 feet and holding around four people. The facility allowed no direct light or air into rooms except those facing the street or alley. Further complicating this structure was the lack of privacy for the tenants. A lack of hallways eliminated

## History of the Department of Housing and Urban Development

1934	Housing Act establishes Federal Housing Administration to insure mortgages and make loans to low-income families; Fannie Mae created.
1937	Housing Act establishes public housing.
1944	Serviceman's Readjustment Act creates Veteran Administration mortgages; trend toward suburbia begins.
Late 1950s	Urban renewal begins; slum clearance developed to promote construction of affordable housing.
1965	Department of Housing and Urban Development created.
1968	Model Cities program launched; fair housing launched through the Civil Rights Act.
1971	Lead-Based Paint Poisoning Prevention Act passed.
1974	Section 8 rental subsidy program begins; Community Development Block Grant program begins.
1977	Urban Development Action Grants begin.
1986	Low-income housing tax credit created.
1987	McKinney Homeless Assistance Act passed; creation of low-income housing tax credit.
1991–1994	Public housing inspection for lead paint.
1992	Residential Lead Hazard Reduction Act passed (Title X of the 1992 Housing and Community Development Act).
1993	Hope VI program begins to redevelop old public housing.
1996	Lead-based paint disclosure becomes law.
1999	HUD and CDC launch the Healthy Homes Initiative.
2000	HUD publishes new lead paint regulations for federally funded assisted housing; President's Task Force releases federal interagency plan to eliminate childhood lead paint poisoning by 2010.
2001	EPA publishes final standards for lead in paint, dust, and soil in housing.

any semblance of privacy. Open sewers, a single privy in the back of the building, and uncollected garbage resulted in an objectionable and unhygienic place to live. Additionally, the wood construction common at the time, coupled with coal and wood heating, made fire an ever-present danger. As a result of a series of tenement fires in 1860 in New York, such terms as death-trap and fire-trap were coined to describe the poorly constructed living facilities [6].

The two last decades of the 19th century saw the introduction and development of dumbbell tenements, a front and rear tenement connected by a long hall. These tenements were typically five stories, with a basement and no elevator (elevators were not required for any building of less than six stories). Dumbbell tenements, like other tenements, resulted in unaesthetic and unhealthy places to live. Garbage was often thrown down the airshafts, natu-

ral light was confined to the first floor hallway, and the public hallways only contained one or two toilets and a sink. This apparent lack of sanitary facilities was compounded by the fact that many families took in boarders to help with expenses. In fact, 44,000 families rented space to boarders in New York in 1890, with this increasing to 164,000 families in 1910. In the early 1890s, New York had a population of more than 1 million, of which 70% were residents of multifamily dwellings. Of this group, 80% lived in tenements consisting mostly of dumbbell tenements.

The passage of the New York Tenement House Act of 1901 spelled the end of the dumbbells and acceptance of a new tenement type developed in the 1890s—the park or central court tenement, which was distinguished by a park or open space in the middle of a group of buildings. This design was implemented to reduce the activity on

the front street and to enhance the opportunity for fresh air and recreation in the courtyard. The design often included roof playgrounds, kindergartens, communal laundries, and stairways on the courtyard side.

Although the tenements did not go away, reform groups supported ideas such as suburban cottages to be developed for the working class. These cottages were two-story brick and timber, with a porch and a gabled roof.

According to Wright [5], a Brooklyn project called Homewood consisted of 53 acres of homes in a planned neighborhood from which multifamily dwellings, saloons, and factories were banned.

Although there were many large homes for the well-to-do, single homes for the not-so-wealthy were not abundant. The first small house designed for the individual of modest means was the bungalow. According to Schoenauer [1], bungalows originated in India. The bungalow was introduced into the United States in 1880 with the construction of a home in Cape Cod. The bungalow, derived for use in tropical climates, was especially popular in California.

Company towns were another trend in housing in the 19th century. George Pullman, who built railway cars in the 1880s, and John H. Patterson, of the National Cash Register Company, developed notable company towns. Wright [5] notes that in 1917 the U.S. Bureau of Labor Standards estimated that at least 1,000 industrial firms were providing housing for their employees. The provision of housing was not necessarily altruistic. The motivation for providing housing varied from company to company. Such motivations included the use of housing as a recruitment incentive for skilled workers, a method of linking the individual to the company, and a belief that a better home life would make the employees happier and more productive in their jobs. Some companies, such as Firestone and Goodyear, went beyond the company town and allowed their employees to obtain loans for homes from company-established banks. A prime motivator of company town planning was sanitation, because maintaining the worker's health could potentially lead to fewer workdays lost due to illness. Thus, in the development of the town, significant consideration was given to sanitary issues such as window screens, sewage treatment, drainage, and water supplies.

Before World War I there was a shortage of adequate dwellings. Even after World War I, insufficient funding, a shortage of skilled labor, and a dearth of building materials compounded the problem. However, the design of homes after the war was driven in part by health consid-

erations, such as providing good ventilation, sun orientation and exposure, potable pressurized water, and at least one private toilet. Schoenauer [1] notes that, during the postwar years, the improved mobility of the public led to an increase in the growth of suburban areas, exemplified by the detached and sumptuous communities outside New York, such as Oyster Bay. In the meantime, the conditions of working populations consisting of many immigrants began to improve with the improving economy of the 1920s. The garden apartment became popular. These units were well lighted and ventilated and had a courtyard, which was open to all and well maintained.

Immediately after World War I and during the 1920s, city population growth was outpaced by population growth in the suburbs by a factor of two. The focus at the time was on the single-family suburban dwelling. The 1920s were a time of growth, but the decade following the Great Depression, beginning in 1929, was one of deflation, cessation of building, loss of mortgage financing, and the plunge into unemployment of large numbers of building trade workers. Additionally, 1.5 million home loans were foreclosed during this period. In 1936, the housing market began to make a comeback; however, the 1930s would come to be known as the beginning of public housing, with increased public involvement in housing construction, as demonstrated by the many laws passed during the era [5]. The National Housing Act was passed by Congress in 1934 and set up the Federal Housing Administration. This agency encouraged banks, building and loan associations, and others to make loans for building homes, small business establishments, and farm buildings. If the Federal Housing Administration approved the plans, it would insure the loan. In 1937, Congress passed another National Housing Act that enabled the Federal Housing Administration to take control of slum clearance. It made 60-year loans at low interest to local governments to help them build apartment blocks. Rents in these homes were fixed and were only available to low-income families. By 1941, the agency had assisted in the construction of more than 120,000 family units.

During World War II, the focus of home building was on housing for workers who were involved in the war effort. Homes were being built through federal agencies such as the newly formed Federal Housing Administration, formed in 1934 and transferred to HUD in 1965. According to the U.S. Census Bureau (USCB) [7], in the years since World War II, the types of homes Americans live in have changed dramatically. In 1940, most homes were considered attached houses (row houses, townhouses, and duplexes). Small apartment houses with two

to four apartments had their zenith in the 1950s. In the 1960 census, two-thirds of the housing inventory was made up of one-family detached houses, which declined to less than 60% in the 1990 census.

The postwar years saw the expansion of suburban housing led by William J. Levitt's Levittown, on Long Island, which had a strong influence on postwar building and initiated the subdivisions and tract houses of the following decades (Figure 1.2). The 1950s and 1960s saw continued suburban development, with the growing ease of transportation marked by the expansion of the interstate highway system. As the cost of housing began to increase as a result of increased demand, a grassroots movement to provide adequate housing for the poor began to emerge. According to Wright [5], in the 1970s only about 25% of the population could afford a \$35,000 home. According to Gaillard [8], Koinonia Partners, a religious organization founded in 1942 by Clarence Jordan near Albany, Georgia, was the seed for Habitat for Humanity. Habitat for Humanity, founded in 1976 by Millard Fuller, is known for its international efforts and has constructed more than 150,000 houses in 80 countries; 50,000 of these houses are in the United States. The homes are energy-efficient and environmentally friendly to conserve resources and reduce long-term costs to the homeowners.

Builders also began promoting one-floor minihomes and no-frills homes of approximately 900 to 1,200 square feet. Manufactured housing began to increase in popularity, with mobile home manufacturers becoming some of the most profitable corporations in the United States in the early 1970s. In the 1940 census, manufactured housing were lumped into the "other" category with boats and



Figure 1.2. Levittown, New York

tourist cabins: by the 1990 census, manufactured housing made up 7% of the total housing inventory. Many communities ban manufactured housing from residential neighborhoods.

According to Hart et al. [9], nearly 30% of all home sales nationwide are of manufactured housing, and more than 90% of those homes are never moved once they are anchored. According to a 2001 industry report, the demand for prefabricated housing is expected to increase in excess of 3% annually to \$20 billion in 2005, with most units being manufactured homes. The largest market is expected to continue in the southern part of the United States, with the most rapid growth occurring in the western part of the country. As of 2000, five manufactured-home producers, representing 35% of the market, dominated the industry. This industry, over the past 20 to 25 years, has been affected by two pieces of federal legislation. The first, the Mobile Home Construction and Safety Standards Act, adopted by HUD in 1974, was passed to aid consumers through regulation and enforcement of HUD design and construction standards for manufactured homes. The second, the 1980 Housing Act, required the federal government to change the term "mobile home" to "manufactured housing" in all federal laws and literature. One of the prime reasons for this change was that these homes were in reality no longer mobile in the true sense.

The energy crisis in the United States between 1973 and 1974 had a major effect on the way Americans lived, drove, and built their homes. The high cost of both heating and cooling homes required action, and some of the action taken was ill advised or failed to consider healthy housing concerns. Sealing homes and using untried insulation materials and other energy conservation actions often resulted in major and sometimes dangerous buildups of indoor air pollutants. These buildups of toxins occurred both in homes and offices. Sealing buildings for energy efficiency and using off-gassing building materials containing urea-formaldehyde, vinyl, and other new plastic surfaces, new glues, and even wallpapers created toxic environments. These newly sealed environments were not refreshed with makeup air and resulted in the accumulation of both chemical and biologic pollutants and moisture leading to mold growth, representing new threats to both short-term and long-term health. The results of these actions are still being dealt with today.

## References

1. Schoenauer N. 6,000 years of housing. New York/London: W.W. Norton & Company, Inc.; 2000.
  2. Chadwick E. Report on an enquiry into the sanitary condition of the labouring population of Great Britain and on the means of its improvements. London: Clowes and Sons; 1842.
  3. Shattuck L, Banks N Jr, Abbot J. Report of the Sanitary Commission of Massachusetts, 1850. Boston: Dutton and Wentworth; 1850. Available from URL: <http://www.deltaomega.org/shattuck.pdf>.
  4. Griscom JH. The sanitary condition of the labouring population of New York. New York: Harper; 1845.
  5. Wright G. Building the dream—a social history of housing in America. Cambridge, MA/London: The MIT Press; 1998.
  6. Von Hoffman A. The origins of American housing reform. Cambridge, MA: Joint Center for Housing Studies—Harvard University; August 1998. p. W98-2.
  7. US Census Bureau. Historical census of housing tables—units in structure; 2002. Washington, DC: US Census Bureau; 2002. Available from URL: <http://www.census.gov/hhes/www/housing/census/historic/units.html>.
  8. Gaillard F. If I were a carpenter, twenty years of Habitat for Humanity. Winston-Salem, NC: John E. Blair; 1996.
  9. Hart JF, Rhodes MJ, Morgan JT, Lindberg MB. The unknown world of the mobile home. Baltimore, MD: Johns Hopkins University Press; 2002.
- Lang RE, Sohmer RR. Editors' introduction, legacy of the Housing Act of 1949: the past, present, and future of federal housing and urban policy. *Housing Policy Debate* 2000; 11(2) 291–8. Available from URL: <http://www.fanniemaefoundation.org/programs/hpd/v11i2-edintro.shtml>.
- Mason JB. *History of housing in the US. 1930–1980*. Houston, TX: Gulf Publishing Company; 1982.
- Passic F. Urban renewal. *Morning Star* [Albion, Michigan]. 1997 Feb 13; 6. Available from URL: [http://www.albionmich.com/history/histor\\_note-book/940213.shtml](http://www.albionmich.com/history/histor_note-book/940213.shtml).
- Red-lining [definition of], 535A.1 Definitions, Iowa Code 2001: Section 535A.1. Des Moines, IA: The Iowa Legislature. Available from URL: <http://www.legis.state.ia.us/IACODE/2001/535A/1.html>.
- Rental Housing On Line. Federal housing acts. Port Huron, MI: Rental Housing On Line; no date. Available from URL: <http://www.rhol.org/rental/fedact.htm>.
- Rental Housing On Line. Government's role in low income housing. Port Huron, MI: Rental Housing On Line; no date. Available from URL: <http://www.rhol.org/rental/housing.htm>.
- Texas Low Income Housing Information Service. The past: special interests, race, and local control; Housing Act of 1949: bipartisan support for public housing. Austin, TX: Texas Low Income Housing Information Service; no date. Available from URL: <http://www.texas-housing.org/txlihis/phdebate/past12.html>.

## Additional Sources of Information

Dolkart A. The 1901 Tenement House Act: chapter 6, cleaning up the toilets. New York: Lower East Side Tenement Museum; no date. Available from URL: [http://www.tenement.org/features\\_dolkart7.html](http://www.tenement.org/features_dolkart7.html).

Hale EE. *Workingmen's homes, essays and stories, on the homes of men who work in large towns*. Boston: James R. Osgood and Company; 1874.

History of plumbing in America. *Plumbing and Mechanical Magazine*. 1987 Jul. Available from URL: <http://www.plumbingsupply.com/pmamerica.html>.

Housing Act of 1949, The US Committee on Agriculture Glossary.

US Department of Housing and Urban Development. Fair housing laws and presidential Executive Orders. Washington, DC: US Department of Housing and Urban Development; no date. Available from URL: <http://www.hud.gov/offices/fheo/FHLaws/index.cfm>.

US Department of Housing and Urban Development. *Homes and communities*. Washington, DC: US Department of Housing and Urban Development; no date. Available from URL: <http://www.hud.gov>.

Warth G. Research project looking at red-lining. *North County [California] Times* 2002 May 5. Available from URL: <http://www.nctimes.com/articles/2002/05/05/export8963.txt>.



# Chapter 2: Basic Principles of Healthy Housing

*“The connection between health and dwelling is one of the most important that exists.”*

Florence Nightingale

## Introduction

It seems obvious that health is related to where people live. People spend 50% or more of every day inside their homes. Consequently, it makes sense that the housing environment constitutes one of the major influences on health and well-being. Many of the basic principles of the link between housing and health were elucidated more than 60 years ago by the American Public Health Association (APHA) Committee on the Hygiene of Housing. After World War II, political scientists, sociologists, and others became interested in the relation between housing and health, mostly as an outgrowth of a concern over poor housing conditions resulting from the massive influx into American cities of veterans looking for jobs. Now, at the beginning of the 21st century, there is a growing awareness that health is linked not only to the physical structure of a housing unit, but also to the neighborhood and community in which the house is located.

According to Ehlers and Steel [1], in 1938, a Committee on the Hygiene of Housing, appointed by APHA, created the Basic Principles of Healthful Housing, which provided guidance regarding the fundamental needs of humans as they relate to housing. These fundamental needs include physiologic and psychologic needs, protection against disease, protection against injury, protection against fire and electrical shock, and protection against toxic and explosive gases.

## Fundamental Physiologic Needs

Housing should provide for the following physiologic needs:

1. protection from the elements,
2. a thermal environment that will avoid undue heat loss,
3. a thermal environment that will permit adequate heat loss from the body,
4. an atmosphere of reasonable chemical purity,
5. adequate daylight illumination and avoidance of undue daylight glare,

6. direct sunlight,
7. adequate artificial illumination and avoidance of glare,
8. protection from excessive noise, and
9. adequate space for exercise and for children to play.

The first three physiologic needs reflect the requirement for adequate protection from the elements. The lack of adequate heating and cooling systems in homes can contribute to respiratory illnesses or even lead to death from extreme temperatures. According to the National Weather Service, 98 people died from extreme temperatures in 1996; 62 of these were due to extreme cold. Hypothermia occurs when the body temperature drops below 96°F (46°C). It can occur in any person exposed to severe cold without enough protection. Older people are particularly susceptible because they may not notice the cold as easily and can develop hypothermia even after exposure to mild cold. Susceptibility to the cold can be exacerbated by certain medications, medical conditions, or the consumption of alcohol. Hyperthermia is the name given to a variety of heat-related illnesses. The two most common forms of hyperthermia are heat exhaustion and heat stroke. Of the two, heat stroke is especially dangerous and requires immediate medical attention.

According to the National Institute on Aging (NIA) [2], lifestyle factors can increase the risk for hyperthermia:

**Unbearably hot living quarters.** This would include people who live in homes without fans or air conditioners. To help avert the problem, residents should open windows at night; create cross-ventilation by opening windows on two sides of the building; cover windows when they are exposed to direct sunlight and keep curtains, shades, or blinds drawn during the hottest part of the day.

**Lack of transportation.** People without fans or air conditioners often are unable to go to shopping malls, movie theaters, and libraries to cool off because of illness or the lack of transportation.

**Inadequate or inoperable windows.** Society has become so reliant on climate control systems that when they fail, windows cannot be opened. As was the case in the 2003 heat wave in France, many homes worldwide do not even have fans for cooling.

**Overdressing.** Older people, because they may not feel the heat, may not dress appropriately in hot weather.

**Visiting overcrowded places.** Trips should be scheduled during nonrush-hour times and participation in special events should be carefully planned to avoid disease transmission.

**Not checking weather conditions.** Older people, particularly those at special risk, should stay indoors on especially hot and humid days, particularly when an air pollution alert is in effect.

USCB [3] reported that about 75% of homes in the United States used either utility gas or electricity for heating purposes, with utility gas accounting for about 50%. This, of course, varies with the region of the country, depending on the availability of hydroelectric power. This compares with the 1940 census, which found that three-quarters of all households heated with coal or wood. Electric heat was so rare that it was not even an option on the census form of 1940. Today, coal has virtually disappeared as a household fuel. Wood all but disappeared as a heating fuel in 1970, but made a modest comeback at 4% nationally by 1990. This move over time to more flexible fuels allows a majority of today's homes to maintain healthy temperatures, although many houses still lack adequate insulation.

The fifth through the seventh physiologic concerns address adequate illumination, both natural and artificial. Research has revealed a strong relationship between light and human physiology. The effects of light on both the human eye and human skin are notable. According to Zilber [4], one of the physiologic responses of the skin to sunlight is the production of vitamin D. Light allows us to see. It also affects body rhythms and psychologic health. Average individuals are affected daily by both natural and artificial lighting levels in their homes. Adequate lighting is important in allowing people to see unsanitary conditions and to prevent injury, thus contributing to a healthier and safer environment. Improper indoor lighting can also contribute to eyestrain from inadequate illumination, glare, and flicker.

Avoiding excessive noise (eighth physiologic concern) is important in the 21st century. However, the concept of noise pollution is not new. Two thousand years ago, Julius Caesar banned chariots from traveling the streets of Rome late at night. In the 19th century, numerous towns and cities prohibited ringing church bells. In the early 20th century, London prohibited church bells from ringing between 9:00 PM and 9:00 AM. In 1929, New York City formed a Noise Abatement Commission that was charged with evaluating noise issues and suggesting solutions. At

that time, it was concluded that loud noise affected health and productivity. In 1930, this same commission determined that constant exposure to loud noises could affect worker efficiency and long-term hearing levels. In 1974, the U.S. Environmental Protection Agency (EPA) produced a document titled *Information on Levels of Environmental Noise Requisite to Protect Public Health and Welfare With an Adequate Margin of Safety* [5]. This document identified maximum levels of 55 decibels outdoors and 45 decibels indoors to prevent interference with activities and 70 decibels for all areas to prevent hearing loss. In 1990, the United Kingdom implemented The Household Appliances (Noise Emission) Regulations [6] to help control indoor noise from modern appliances. Noise has physiologic impacts aside from the potential to reduce hearing ability. According to the American Speech-Language-Hearing Association [7], these effects include elevated blood pressure; negative cardiovascular effects; increased breathing rates, digestion, and stomach disturbances; ulcers; negative effects on developing fetuses; difficulty sleeping after the noise stops; plus the intensification of the effects of drugs, alcohol, aging, and carbon monoxide. In addition, noise can reduce attention to tasks and impede speech communication. Finally, noise can hamper performance of daily tasks, increase fatigue, and cause irritability.

Household noise can be controlled in various ways. Approaching the problem during initial construction is the simplest, but has not become popular. For example, in early 2003, only about 30% of homebuilders offered sound-attenuating blankets for interior walls. A sound-attenuating blanket is a lining of noise abatement products (the thickness depends on the material being used). Spray-in-place soft foam insulation can also be used as a sound dampener, as can special walking mats for floors. Actions that can help reduce household noise include installing new, quieter appliances and isolating washing machines to reduce noise and water passing through pipes.

The ninth and final physiologic need is for adequate space for exercise and play. Before industrialization in the United States and England, a preponderance of the population lived and worked in more rural areas with very adequate areas for exercise and play. As industrialization impacted demographics, more people were in cities without ample space for play and exercise. In the 19th century, society responded with the development of playgrounds and public parks. Healthful housing should include the provision of safe play and exercise areas.



Many American neighborhoods are severely deficient, with no area for children to safely play. New residential areas often do not have sidewalks or street lighting, nor are essential services available by foot because of highway and road configurations.

## Fundamental Psychologic Needs

Seven fundamental psychologic needs for healthy housing include the following:

1. adequate privacy for the individual,
2. opportunities for normal family life,
3. opportunities for normal community life,
4. facilities that make possible the performance of household tasks without undue physical and mental fatigue,
5. facilities for maintenance of cleanliness of the dwelling and of the person,
6. possibilities for aesthetic satisfaction in the home and its surroundings, and
7. concordance with prevailing social standards of the local community.

Privacy is a necessity to most people, to some degree and during some periods. The increase in house size and the diminishing family size have, in many instances, increased the availability of privacy. Ideally, everyone would have their own rooms, or, if that were not possible, would share a bedroom with only one person of the same sex, excepting married couples and small children.

Psychiatrists consider it important for children older than 2 years to have bedrooms separate from their parents. In addition, bedrooms and bathrooms should be accessible directly from halls or living rooms and not through other bedrooms. In addition to the psychologic value of privacy, repeated studies have shown that lack of space and quiet due to crowding can lead to poor school performance in children.

Coupled with a natural desire for privacy is the social desire for normal family and community life. A wholesome atmosphere requires adequate living room space and adequate space for withdrawal elsewhere during periods of entertainment. This accessibility expands beyond the walls of the home and includes easy communication with centers of culture and business, such as schools, churches, entertainment, shopping, libraries, and medical services.

## Protection Against Disease

Eight ways to protect against contaminants include the following:

1. provide a safe and sanitary water supply;
2. protect the water supply system against pollution;
3. provide toilet facilities that minimize the danger of transmitting disease;
4. protect against sewage contamination of the interior surfaces of the dwelling;
5. avoid unsanitary conditions near the dwelling;
6. exclude vermin from the dwelling, which may play a part in transmitting disease;
7. provide facilities for keeping milk and food fresh; and
8. allow sufficient space in sleeping rooms to minimize the danger of contact infection.

According to the U.S. EPA [8], there are approximately 160,000 public or community drinking water systems in the United States. The current estimate is that 42 million Americans (mostly in rural America) get their water from private wells or other small, unregulated water systems. The presence of adequate water, sewer, and plumbing facilities is central to the prevention, reduction, and possible elimination of water-related diseases. According to the Population Information Program [9], water-related diseases can be organized into four categories:

- waterborne diseases, including those caused by both fecal-oral organisms and those caused by toxic substances;
- water-based diseases;
- water-related vector diseases; and
- water-scarce diseases.

Numerous studies link improvements in sanitation and the provision of potable water with significant reductions in morbidity and mortality from water-related diseases. Clean water and sanitation facilities have proven to reduce infant and child mortality by as much as 55% in Third World countries according to studies from the 1980s. Waterborne diseases are often referred to as “dirty-water” diseases and are the result of contamination from chemical, human, and animal wastes. Specific diseases in this group include cholera, typhoid, shigella, polio, meningitis, and hepatitis A and E. Water-based diseases are caused by aquatic organisms that spend part of their life cycle in the water and another part as parasites of animals.

Although rare in the United States, these diseases include dracunculiasis, paragonimiasis, clonorchiasis, and schistosomiasis. The reduction in these diseases in many countries has not only led to decreased rates of illness and death, but has also increased productivity through a reduction in days lost from work.

Water-related diseases are linked to vectors that breed and live in or near polluted and unpolluted water. These vectors are primarily mosquitoes that infect people with the disease agents for malaria, yellow fever, dengue fever, and filariasis. While the control of vectorborne diseases is a complex matter, in the United States, most of the control focus has been on controlling habitat and breeding areas for the vectors and reducing and controlling human cases of the disease that can serve as hosts for the vector.

Vectorborne diseases have recently become a more of a concern to the United States with the importation of the West Nile virus. The transmission of West Nile virus occurs when a mosquito vector takes a blood meal from a bird or incidental hosts, such as a dog, cat, horse, or other vertebrate. The human cases of West Nile virus in 2003 numbered 9,862, with 264 deaths. Finally, water-scarce diseases are diseases that flourish where sanitation is poor due to a scarcity of fresh water. Diseases included in this category are diphtheria, leprosy, whooping cough, tetanus, tuberculosis, and trachoma. These diseases are often transmitted when the supply of fresh water is inadequate for hand washing and basic hygiene. These conditions are still rampant in much of the world, but are essentially absent from the United States due to the extensive availability of potable drinking water.

In 2000, USCB [10] reported that 1.4% of U.S. homes lacked plumbing facilities. This differs greatly from the 1940 census, when nearly one-half of U.S. homes lacked complete plumbing. The proportion has continually dropped, falling to about one-third in 1950 and then to one-sixth in 1960. Complete plumbing facilities are defined as hot and cold piped water, a bathtub or shower, and a flush toilet. The containment of household sewage is instrumental in protecting the public from waterborne and vectorborne diseases. The 1940 census revealed that more than a third of U.S. homes had no flush toilet, with 70% of the homes in some states without a flush toilet. Of the 13 million housing units at the time without flush toilets, 11.8 million (90.7%) had an outside toilet or privy, another 1 million (7.6%) had no toilet or privy, and the remainder had a nonflush toilet in the structure.

In contrast to these figures, the 2000 census data demonstrate the great progress that has been made in providing sanitary sewer facilities. Nationally, 74.8% of homes are

served by a public sewer, with 24.1% served by a septic tank or cesspool, and the remaining 1.1% using other means.

Vermin, such as rodents, have long been linked to property destruction and disease. Integrated pest management, along with proper housing construction, has played a significant role in reducing vermin around the modern home. Proper food storage, rat-proofing construction, and ensuring good sanitation outside the home have served to eliminate or reduce rodent problems in the 21st century home.

Facilities to properly store milk and food have not only been instrumental in reducing the incidence of some foodborne diseases, but have also significantly changed the diet in developed countries. Refrigeration can be traced to the ancient Chinese, Hebrews, Greeks, and Romans. In the last 150 years, great strides have been made in using refrigeration to preserve and cool food. Vapor compression using air and, subsequently, ammonia as a coolant was first developed in the 1850s. In the early 1800s, natural ice was extracted for use as a coolant and preserver of food. By the late 1870s, there were 35 commercial ice plants in the United States and, by 1909, there were 2,000. However, as early as the 1890s, sources of natural ice began to be a problem as a result of pollution and sewage dumped into bodies of water. Thus, the use of natural ice as a refrigerant began to present a health problem. Mechanical manufacture of ice provided a temporary solution, which eventually resulted in providing mechanical refrigeration.

Refrigeration was first used by the brewing and meat-packing industries; but most households had iceboxes (Figure 2.1), which made the ice wagon a popular icon of the late 1800s and early 1900s. In 1915, the first refrigerator, the Guardian, was introduced. This unit was the predecessor of the Frigidaire. The refrigerator became as necessary to the household as a stove or sewing machine. By 1937, nearly 6 million refrigerators were manufactured in the United States. By 1950, in excess of 80% of American farms and more than 90% of urban homes had a refrigerator.

Adequate living and sleeping space are also important in protecting against contagion. It is an issue not only of privacy but of adequate room to reduce the potential for the transmission of contagion. Much improvement has been made in the adequacy of living space for the U.S. family over the last 30 years. According to USCB [11], the average size of new single homes has increased from a 1970 average of 1,500 square feet to a 2000 average of



**Figure 2.1.** Circa 1890 Icebox

Source: Robert R. McCormick Museum, Wheaton, Illinois

2,266 square feet. USCB [11] says that slightly less than 5% of U.S. homes were considered crowded in 1990; that is, they had more than one person per room. However, this is an increase since the 1980 census, when the figure was 4.5%. This is the only time there has been an increase since the first housing census was initiated in 1940, when one in five homes was crowded. During the 1940 census, most crowded homes were found in southern states, primarily in the rural south. Crowding has become common in a few large urban areas, with more than one-fourth of all crowded units located in four metropolitan areas: Houston, Los Angeles, Miami, and New York. The rate for California has not changed significantly between 1940 (13%) and 1990 (12%). Excessive crowding in homes has the potential to increase not only communicable disease transmission, but also the stress level of occupants because modern urban individuals spend considerably more time indoors than did their 1940s counterparts.

## Protection Against Injury

A major provision for safe housing construction is developing and implementing building codes. According to the International Code Council one- and two-family dwelling code, the purpose of building codes is to provide minimum standards for the protection of life, limb, property, environment, and for the safety and welfare of

the consumer, general public, and the owners and occupants of residential buildings regulated by this code [12].

However, as with all types of codes, the development of innovative processes and products must be allowed to take a place in improving construction technology. Thus, according to the International Code Council one- and two-family dwelling code, building codes are not intended to limit the appropriate use of materials, appliances, equipment, or methods by design or construction that are not specifically prescribed by the code if the building official determines that the proposed alternate materials, appliances, equipment or methods of design or construction are at least equivalent of that prescribed in this code. While the details of what a code should include are beyond the scope of this section, additional information can be found at <http://www.iccsafe.org/>, the Web site of the International Code Council (ICC). ICC is an organization formed by the consolidation of the Building Officials and Code Administrators International, Southern Building Code Congress International, Inc., and the International Conference of Building Officials [12].

According to the Home Safety Council (HSC) [13], the leading causes of home injury deaths in 1998 were falls and poisonings, which accounted for 6,756 and 5,758 deaths, respectively. As expected, the rates and national estimates of the number of fall deaths were highest among those older than 64 years, and stairs or steps were associated with 17% of fall deaths. Overall, falls were the leading cause of nonfatal, unintentional injuries occurring at home and accounted for 5.6 million injuries. Similar to the mortality statistics, consumer products most often associated with emergency department visits included stairs and steps, accounting for 854,631 visits, and floors, accounting for 556,800 visits. A national survey by HSC found that one-third of all households with stairs did not have banisters or handrails on at least one set of stairs. Related to this, homes with older persons were more likely to have banisters or handrails than were those where young children live or visit. The survey also revealed that 48% of households have windows on the second floor or above, but only 25% have window locks or bars to prevent children from falling out. Bathtub mats or nonskid strips to reduce bathtub falls were used in 63% of American households. However, in senior households (age 70 years and older), 79% used mats or nonskid strips. Nineteen percent of the total number of homes surveyed had grab bars to supplement the mats and strips. Significantly, only 39% of the group most susceptible to falls (people aged 70 years and older) used both nonskid surfaces and grab bars.

## Protection Against Fire

An important component of safe housing is to control conditions that promote the initiation and spread of fire. Between 1992 and 2001, an average of 4,266 Americans died annually in fires and nearly 25,000 were injured. This fact and the following information from the United States Fire Administration (USFA) [14] demonstrate the impact that fire safety and the lack of it have in the United States. The United States has one of the highest fire death rates in the industrialized world, with 13.4 deaths per million people. At least 80% of all fire deaths occur in residences. Residential fires account for 23% of all fires and 76% of structure fires. In one- and two-family dwellings, fires start in the kitchen 25.5% of the time and originate in the bedroom 13.7% of the time. Apartment fires most often start in the kitchen, but at almost twice the rate (48.5%), with bedrooms again being the second most common place at 13.4%.

These USFA statistics also disclose that cooking is the leading cause of home fires, usually a result of unattended cooking and human error rather than mechanical failure of the cooking units. The leading cause of fire deaths in homes is careless smoking, which can be significantly deterred by smoke alarms and smolder-resistant bedding and upholstered furniture. Heating system fires tend to be a larger problem in single-family homes than in apartments because the heating systems in family homes frequently are not professionally maintained.

A number of conditions in the household can contribute to the creation or spread of fire. The USFA data indicate that more than one-third of rural Americans use fireplaces, wood stoves, and other fuel-fired appliances as primary sources of heat. These same systems account for 36% of rural residential fires. Many of these fires are the result of creosote buildup in chimneys and stovepipes. These fires could be avoided by

- inspecting and cleaning by a certified chimney specialist;
- clearing the area around the hearth of debris, decorations, and flammable materials;
- using a metal mesh screen with fireplaces and leaving glass doors open while burning a fire;
- installing stovepipe thermometers to monitor flue temperatures;
- leaving air inlets on wood stoves open and never restricting air supply to the fireplaces, thus helping to reduce creosote buildup;

- using fire-resistant materials on walls around wood stoves;
- never using flammable liquids to start a fire;
- using only seasoned hardwood rather than soft, moist wood, which accelerates creosote buildup;
- building small fires that burn completely and produce less smoke;
- never burning trash, debris, or pasteboard in a fireplace;
- placing logs in the rear of the fireplace on an adequate supporting grate;
- never leaving a fire in the fireplace unattended;
- keeping the roof clear of leaves, pine needles, and other debris;
- covering the chimney with a mesh screen spark arrester; and
- removing branches hanging above the chimney, flues, or vents.

USFA [14] also notes that manufactured homes can be susceptible to fires. More than one-fifth of residential fires in these facilities are related to the use of supplemental room heaters, such as wood- and coal-burning stoves, kerosene heaters, gas space-heaters, and electrical heaters. Most fires related to supplemental heating equipment result from improper installation, maintenance, or use of the appliance. USFA recommendations to reduce the chance of fire with these types of appliances include the following:

- placing wood stoves on noncombustible surfaces or a code-specified or listed floor surface;
- placing noncombustible materials around the opening and hearth of fireplaces;
- placing space heaters on firm, out-of-the-way surfaces to reduce tipping over and subsequent spillage of fuel and providing at least 3 feet of air space between the heating device and walls, chairs, firewood, and curtains;
- placing vents and chimneys to allow 18 inches of air space between single-wall connector pipes and combustibles and 2 inches between insulated chimneys and combustibles; and
- using only the fuel designated by the manufacturer for the appliance.

The ability to escape from a building when fire has been discovered or detected is of extreme importance. In the

modern home, three key elements can contribute to a safe exit from a home during the threat of fire. The first of these is a working smoke alarm system. The average homeowner in the 1960s had never heard of a smoke alarm, but by the mid-1980s, laws in 38 states and in thousands of municipalities required smoke alarms in all new and existing residences. By 1995, 93% of all single-family and multifamily homes, apartments, nursing homes, and dormitories were equipped with alarms. The cost decreased from \$1,000 for a professionally installed unit for a three-bedroom home in the 1970s to an owner-installed \$10 unit. According to the EPA [15], ionization chamber and photoelectric are the two most common smoke detectors available commercially. Helmenstein [16] states that a smoke alarm uses one or both methods, and occasionally uses a heat detector, to warn of a fire. These units can be powered by a 9-volt battery, a lithium battery, or 120-volt house wiring. Ionization detectors function using an ionization chamber and a minute source of ionizing radiation. The radiation source is americium-241 (perhaps 1/5,000th of a gram), while the ionization chamber consists of two plates separated by about a centimeter. The power source (battery or house current) applies voltage to the plates, resulting in one plate being charged positively while the other plate is charged negatively. The americium constantly releases alpha particles that knock electrons off the atoms in the air, ionizing the oxygen and nitrogen atoms in the chamber. The negative plate attracts the positively charged oxygen and nitrogen atoms, while the electrons are attracted to the positive plate, generating a small, continuous electric current. If smoke enters the ionization chamber, the smoke particles attach to the ions and neutralize them, so they do not reach the plate. The alarm is then triggered by the drop in current between the plates [16].

Photoelectric devices function in one of two ways. First, smoke blocks a light beam, reducing the light reaching the photocell, which sets off the alarm. In the second and more common type of photoelectric unit, smoke particles scatter the light onto a photocell, initiating an alarm. Both detector types are effective smoke sensors and both must pass the same test to be certified as Underwriters Laboratories (UL) smoke detectors. Ionization detectors respond more quickly to flaming fires with smaller combustion particles, while photoelectric detectors respond more quickly to smoldering fires. Detectors can be damaged by steam or high temperatures. Photoelectric detectors are more expensive than ionization detectors and are more sensitive to minute smoke particles. However, ionization detectors have a degree of built-in security not

inherent to photoelectric detectors. When the battery starts to fail in an ionization detector, the ion current falls and the alarm sounds, warning that it is time to change the battery before the detector becomes ineffective. Backup batteries may be used for photoelectric detectors that are operated using the home's electrical system.

According to USFA [14], a properly functioning smoke alarm diminishes the risk for dying in a fire by approximately 50% and is considered the single most important means of preventing house and apartment fire fatalities. Proper installation and maintenance, however, are key to their usefulness. Figure 2.2 shows a typical smoke alarm being tested.

Following are key issues regarding installation and maintenance of smoke alarms. (Smoke alarms should be installed on every level of the home including the basement, both inside and outside the sleeping area.)

- Smoke alarms should be installed on the ceiling or 6–8 inches below the ceiling on side walls.
- Battery replacement is imperative to ensuring proper operation. Typically, batteries should be replaced at least once a year, although some units are manufactured with a 10-year battery. A “chirping” noise from the unit indicates the need for battery replacement. A battery-operated smoke alarm has a life expectancy of 8 to 10 years.
- Battery replacement is not necessary in units that are connected to the household electrical system.
- Regardless of the type, it is crucial to test every smoke alarm monthly. Data from HSC [13] revealed that only 83% of individuals with fire alarms test them at least once a year; while only 19% of households with at least one smoke alarm test them quarterly.

A second element impacting escape from a building is a properly installed fire-suppression system. According to USFA [14], sprinkler systems began to be used over 100 years ago in New England textile mills. Currently, few homes are protected by residential sprinkler systems. However, UL-listed home systems are available and are designed to protect homes much faster than standard commercial or industrial sprinklers. Based on approximately 1% of the total building price in new construction, sprinkler systems can be installed for a reasonable price. These systems can be retrofitted to existing construction and are smaller than commercial systems. In addition, homeowner insurance discounts for such systems range between 5% and 15% and are increasing in availability.

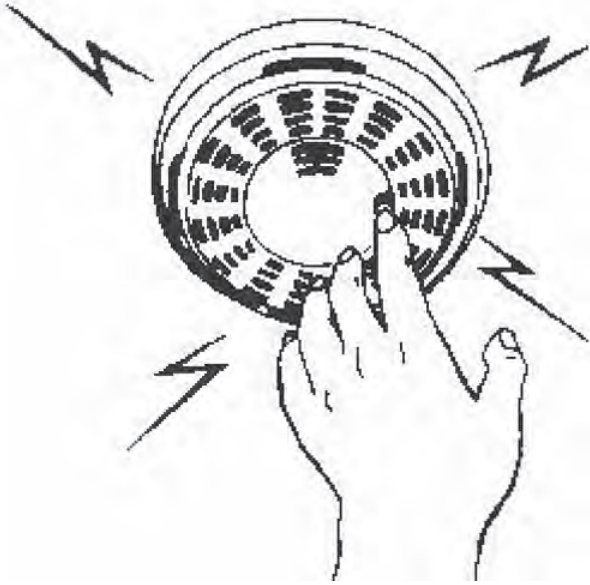

**Figure 2.2.** Smoke Alarm Testing  
Source: Federal Emergency Management Agency

The final element in escaping from a residential fire is having a fire plan. A 1999 survey conducted by USFA [14] found that 60% of Americans have an escape plan, with 42% of these individuals having practiced the plan. Surprisingly, 26% of Americans stated they had never thought about practicing an escape plan, and 3% believed escape planning to be unnecessary. In addition, of the people who had a smoke alarm sound an alert over the past year before the study, only 8% believed it to be a fire and thought they should evacuate the building.

Protection from electrical shocks and burns is also a vital element in the overall safety of the home. According to the National Fire Protection Association (NFPA) [17], electrical distribution equipment was the third-leading cause of home fires and the second-leading cause of fire deaths in the United States between 1994 and 1998. Specifically, NFPA reported that 38,300 home electrical fires occurred in 1998, which resulted in 284 deaths, 1,184 injuries, and approximately \$670 million in direct property damage. The same report indicated that the leading cause of electrical distribution fires was ground fault or short-circuit problems. A third of the home electrical distribution fires were a result of problems with fixed wiring, while cords and plugs were responsible for 17% of these fires and 28% of the deaths.

Additional investigation of these statistics reveals that electrical fires are one of the leading types of home fires in manufactured homes. USFA [14] data demonstrate that many electrical fires in homes are associated with improper installation of electrical devices by do-it-your-

selfers. Errors attributed to this amateur electrical work include use of improperly rated devices such as switches or receptacles and loose connections leading to overheating and arcing, resulting in fires. Recommendations to reduce the risk of electrical fires and electrocution include the following:

1. Use only the correct fuse size and do not use pennies behind a fuse.
2. Install ground fault circuit interrupters (GFCI) on all outlets in kitchens, bathrooms, and anywhere else near water. This can also be accomplished by installing a GFCI in the breaker box, thus protecting an entire circuit.
3. Never place combustible materials near light fixtures, especially halogen bulbs that get very hot.
4. Use only the correct bulb size in a light fixture.
5. Use only properly rated extension cords for the job needed.
6. Never use extension cords as a long-term solution to the need for an additional outlet. Size the extension cord to the wattage to be used.
7. Never run extension cords inside walls or under rugs because they generate heat that must be able to dissipate.

### Fire Extinguishers

A fire extinguisher should be listed and labeled by an independent testing laboratory such as FM (Factory Mutual) or UL. Fire extinguishers are labeled according to the type of fire on which they may be used. Fires involving wood or cloth, flammable liquids, electrical, or metal sources react differently to extinguishers. Using the wrong type of extinguisher on a fire could be dangerous and could worsen the fire. Traditionally, the labels A, B, C, and D have been used to indicate the type of fire on which an extinguisher is to be used.

**Type A**—Used for ordinary combustibles such as cloth, wood, rubber, and many plastics. These types of fire usually leave ashes after they burn: Type A extinguishers for ashes. The Type A label is in a triangle on the extinguisher.

**Type B**—Used for flammable liquid fires such as oil, gasoline, paints, lacquers, grease, and solvents. These substances often come in barrels: Type B extinguishers for barrels. The Type B label is in a square on the extinguisher.

**Type C**—Used for electrical fires such as in wiring, fuse boxes, energized electrical equipment, and other electrical

sources. Electricity travels in currents; Type C extinguishers for currents. The Type C label is in a circle on the extinguisher.

**Type D**—Used for metal fires such as magnesium, titanium, and sodium. These types of fires are very dangerous and seldom handled by the general public; Type D means don't get involved. The Type D label is in a star on the extinguisher.

The higher the rating number on an A or B fire extinguisher, the more fire it can put out, but high-rated units are often the heavier models. Extinguishers need care and must be recharged after every use—a partially used unit might as well be empty. An extinguisher should be placed in the kitchen and in the garage or workshop. Each extinguisher should be installed in plain view near an escape route and away from potential fire hazards such as heating appliances.

Recently, pictograms have come into use on fire extinguishers. These picture the type of fire on which an extinguisher is to be used. For instance, a Type A extinguisher has a pictogram showing burning wood. A Type C extinguisher has a pictogram showing an electrical cord and outlet. These pictograms are also used to show what not to use. For example, a Type A extinguisher also show a pictogram of an electrical cord and outlet with a slash through it (do not use it on an electrical fire).

Fire extinguishers also have a number rating. For Type A fires, 1 means 1¼ gallons of water; 2 means 2½ gallons of water, 3 means 3¾ gallons of water, etc. For Type B and Type C fires, the number represents square feet. For example, 2 equals 2 square feet, 5 equals 5 square feet, etc.

Fire extinguishers can also be made to extinguish more than one type of fire. For example, you might have an extinguisher with a label that reads 2A5B. This would mean this extinguisher is good for Type A fires with a 2½-gallon equivalence and it is also good for Type B fires with a 5-square-foot equivalency. A good extinguisher to have in each residential kitchen is a 2A10BC fire extinguisher. You might also get a Type A for the living room and bedrooms and an ABC for the basement and garage.

PASS is a simple acronym to remind you how to operate most fire extinguishers—pull, aim, squeeze, and sweep. Pull the pin at the top of the cylinder. Some units require the releasing of a lock latch or pressing a puncture lever. Aim the nozzle at the base of the fire. Squeeze or press the handle. Sweep the contents from side to side at the base of the fire until it goes out. Shut off the extinguisher and then watch carefully for any rekindling of the fire.

## Protection Against Toxic Gases

Protection against gas poisoning has been a problem since the use of fossil fuels was combined with relatively tight housing construction. NFPA [17] notes that National Safety Council statistics reflect unintentional poisonings by gas or vapors, chiefly carbon monoxide (CO), numbering about 600 in 1998. One-fourth of these involved heating or cooking equipment in the home. The U.S. Consumer Product Safety Commission [18] states that in 2001 an estimated 130 deaths occurred as a result of CO poisoning from residential sources; this decrease in deaths is related to the increased use of CO detectors. In addition, approximately 10,000 cases of CO-related injuries occur each year. NFPA [17] also notes that, similar to fire deaths, unintentional CO deaths are highest for ages 4 years and under and ages 75 years and older. Additional information about home CO monitoring can be found in Chapter 5.

## References

1. Ehlers VE, Steel EW. Municipal and rural sanitation. Sixth edition. New York: McGraw-Hill Book Company; 1965. p. 462–4.
2. National Institute on Aging. Hyperthermia—too hot for your health, fact sheet health information. Bethesda, MD: US Department of Health and Human Services; no date. Available from URL: <http://www.niapublications.org/engagepages/hyperther.asp>.
3. US Census Bureau. Historical census of housing tables—house heating fuel. Washington, DC: US Census Bureau; 2002. Available from URL: <http://www.census.gov/hhes/www/housing/census/historic/fuels.html>.
4. Zilber SA. Review of health effects of indoor lighting. *Architronic* 1993;2(3). Available from URL: <http://architronic.saed.kent.edu/v2n3/v2n3.06.html>.
5. US Environmental Protection Agency. Information on levels of environmental noise requisite to protect public health and welfare with an adequate margin of safety. Washington, DC: US Environmental Protection Agency; 1974.
6. Public Health, England and Wales. The Household Appliances (Noise Emission) Regulations 1990. London: Her Majesty's Stationery Office; 1990.
7. American Speech-Language-Hearing-Association. Noise: noise is difficult to define. Rockville, MD: American Speech-Language-Hearing-Association; 2003. Available from URL: <http://www.asha.org/public/hearing/disorders/noise.htm>.

8. US Environmental Protection Agency. Factoids: drinking water and ground water statistics for 2002. Washington, DC: US Environmental Protection Agency, Office of Ground Water and Drinking Water; January 2003. Available from URL: <http://www.epa.gov/safewater>.
9. Hinrichsen D, Robey B, Upadhyay UD. The health dimension. In: Solutions for a water-short world. Population Report, Series M, No. 14. Baltimore, MD: Johns Hopkins School of Public Health, Population Information Program; 1998. Available from URL: <http://www.infoforhealth.org/pr/m14/m14chap5.shtml>
10. US Census Bureau. Historical census of housing tables—plumbing facilities, 2002. Washington, DC: US Census Bureau; 2003. Available from URL: <http://www.census.gov/hhes/www/housing/census/historic/plumbing.html>.
11. US Census Bureau. Historical census of housing tables—crowded and severely crowded housing units, 2002. Washington, DC: US Census Bureau; 2003. Available from URL: <http://www.census.gov/hhes/www/housing/census/historic/crowding.html>.
12. International Code Council. Fact sheet. Falls Church, VA: International Code Council; no date. Available from URL: <http://www.iccsafe.org/news/pdf/factssheet.pdf>.
13. Home Safety Council. The state of home safety in America—executive summary. Washington, DC: The Home Safety Council; 2002.
14. US Fire Administration. Welcome to the U.S. Fire Administration (USFA) Web site. Washington, DC: Federal Emergency Management Agency, Department of Homeland Security; 2003. Available from URL: <http://www.usfa.fema.gov/>.
15. US Environmental Protection Agency. Smoke detectors and radiation. Washington, DC: US Environmental Protection Agency; 2003. Available from URL: [http://www.epa.gov/radiation/sources/smoke\\_alarm.htm](http://www.epa.gov/radiation/sources/smoke_alarm.htm).
16. Helmenstein AM. How do smoke detectors work? Photoelectric & ionization smoke detectors, what you need to know about chemistry. New York: About, Inc.; 2003. Available from URL: <http://chemistry.about.com/library/weekly/aa071401a.htm>.
17. National Fire Protection Association. NFPA fact sheets—electrical safety. Quincy, MA: National Fire Protection Association; 2003. Available from URL: <http://www.nfpa.org/Research/NFPAFactSheets/Electrical/electrical.asp>.
18. US Consumer Product Safety Commission. Nonfire carbon monoxide deaths: 2001 annual estimate. Washington, DC: US Consumer Product Safety Commission; 2004. Available from URL: <http://www.cpsc.gov/LIBRARY/co04.pdf>.

## Additional Sources of Information

Barbalace RC. Environmental justice and the NIMBY principle. Environmental Chemistry.com: Environmental, Chemistry, and Hazardous Materials Information and Resources. Portland, ME; no date. Available from URL: <http://environmentalchemistry.com/yogi/hazmat/articles/nimby.html>.

Bryant B. The role of SNRE in the environmental justice movement. Ann Arbor, MI: University of Michigan; 1997. Available from URL: <http://www.umich.edu/~snre492/history.html>.

Bullard RD. Waste and racism: a stacked deck? Forum Appl Res Public Pol spring 1993.

National Institute on Aging. Hypothermia: a cold weather hazard, fact sheet health information. Bethesda, MD: US Department of Health and Human Services; 2001. Available from URL: <http://www.niapublications.org/engagepages/hypother.asp>.

National Weather Service. Natural hazard statistics; no date. Silver Spring, MD: National Weather Service. Available from URL: <http://www.nws.noaa.gov/om/haz-stats.shtml>.

US Census Bureau. New residential construction (building permits, housing starts, and housing completions). Washington, DC: US Census Bureau; no date. Available from URL: <http://www.census.gov/newresconst>.



*“The poorest man may in his cottage bid defiance to all the force of the Crown. It may be frail—its roof may shake—the wind may blow through it—the storm may enter, the rain may enter—but the King of England cannot enter—all his force dares not cross the threshold of the ruined tenement!”*

William Pitt, March 1763

## Introduction

William Pitt, arguing before the British Parliament against excise officers entering private homes to levy the Cyder Tax, eloquently articulated this long-held and cherished notion of the sanctity of private property. However, a person’s right to privacy is not absolute. There has always been a tension between the rights of property owners to do whatever they desire with their property and the ability of the government to regulate uses to protect the safety, health, and welfare of the community. Few, however, would argue with the right and duty of a city government to prohibit the operation of a munitions factory or a chemical plant in the middle of a crowded residential neighborhood.

## History

The first known housing laws are in the Code of Laws of Hammurabi [1], who was the King of Babylonia, circa 1792–1750 BC. These laws addressed the responsibility of the home builder to construct a quality home and outlined the implications to the builder if injury or harm came to the owner as a result of the failure to do so. During the Puritan period (about 1620–1690), housing laws essentially governed the behavior of the members of the society. For example, no one was allowed to live alone, so bachelors, widows, and widowers were placed with other families as servants or boarders. In 1652, Boston prohibited building privies within 12 feet of the street. Around the turn of the 18th century, some New England communities implemented local ordinances that specified the size of houses. During the 17th century, additional public policies on housing were established. Because the English tradition of using wooden chimneys and thatched roofs led to fires in many dwellings, several colonies passed regulations prohibiting them.

After the early 17th century came an era of very rapid metropolitan growth along the East Coast. This growth was due largely to immigration from Europe and was spurred by the Industrial Revolution. The most serious

housing problems began in New York about 1840 when the first tenements were built. In 1867, a report by the New York Metropolitan Board of Health on living conditions in tenements convinced the New York State legislature to pass the Tenement Housing Act of 1867 [2]. The principal requirements of the act included the following:

- Every room occupied for sleeping, if it does not communicate directly with the external air, must have a ventilating or transom window of at least 3 square feet to the neighboring room or hall.
- A proper fire escape is necessary on every tenement or lodging house.
- The roof is to be kept in repair and the stairs are to have banisters.
- At least one toilet is required for every 20 occupants for all such houses, and those toilets must be connected to approved disposal systems.
- Cleansing of every lodging house is to be to the satisfaction of the Board of Health, which is to have access at any time.
- All cases of infectious disease are to be reported to the Board by the owner or his agent; buildings are to be inspected and, if necessary, disinfected or vacated if found to be out of repair.

There were also regulations governing distances between buildings, heights of rooms, and dimensions of windows. Although this act had some beneficial influences on overcrowding, sewage disposal, lighting, and ventilation, perhaps its greatest contribution was in laying a foundation for more stringent future legislation.

Jacob A. Riis, a Danish immigrant and a police reporter on New York’s Lower East Side, published a book titled *How the Other Half Lives—Studies Among the Tenements of New York* [3], which swayed public opinion in the direction of housing reform and resulted in the Tenement House Act of 1901. The basic principles established in the Tenement House Act of 1901 still underlie much of the housing efforts in New York City today [4]. Since 1909, with the establishment of the Philadelphia Housing Association, that city has had almost continual inspection and improvement. Chicago enacted housing legislation as early as 1889 and health legislation as early as 1881. Regulations on ventilation, light, drainage, and plumbing were put into effect in 1896.

Before 1892, all government involvement in housing was at a local level. In 1892, however, the federal government passed a resolution authorizing investigation of slum conditions in cities with 200,000 or more inhabitants.

Congress appropriated only \$20,000 (roughly equal to \$390,000 in 2003) to cover the expenses of this project, which limited the number of investigations.

No significant housing legislation was passed in the 20th century until 1929 [5], when the New York State legislature passed its Multiple Dwelling Law. Other cities and states followed New York's example and permitted less strict requirements in their codes. This decreased what little emphasis there was on enforcement. Conditions declined until, by the 1930s, President Franklin D.

Roosevelt's shocking report to the people was "that one-third of the nation is ill-fed, ill-housed, and ill-clothed." In response to the overwhelming loss of homes during the Great Depression, Congress passed the United States Housing Act of 1937, which created the United States Housing Authority (USHA). This act subsidized construction of new public housing units and required the elimination of at least an equivalent number of units from the local housing supply that were determined to be inferior. In 1942, the USHA was renamed the Federal Public Housing Administration and, in 1947, was renamed the Public Housing Administration.

The federal government not only encouraged the construction of public housing, but took on the role of financing private housing. In 1938, the Federal National Mortgage Association was created. (Fannie Mae became a private organization in 1968 [6].) Its purpose was to provide a secondary market for the FHA, created in 1934, and Veterans Administration (VA) mortgage loans. The Servicemen's Readjustment Act of 1944, also known as the GI Bill of Rights, created a VA loan program guaranteeing home mortgage loans for veterans. This legislation, in conjunction with the FHA loan program, was the impetus for initiating the huge program of home construction and subsequent suburban growth following World War II. In 1946, the Farmers Home Administration, housed in the United States Department of Agriculture (USDA), was created to make loans and grants for constructing and repairing farm homes and assisting rural self-help housing groups.

The Housing Act of 1949 allowed "primarily residential" and "blighted" urban areas to be condemned, cleared of buildings, and sold for private development. In addition to assisting in slum clearance, this act also provided for additional public housing and authorized the USDA to

provide farmers with loans to construct, improve, repair or replace dwellings to provide decent, safe, and sanitary living conditions for themselves, their tenants, lessees, sharecroppers, and laborers.

Because the many housing responsibilities administered by various agencies within the federal government proved unwieldy, the Housing and Urban Development Act was passed in 1965. The U.S. Department of Housing and Urban Development (HUD) was created to centralize the responsibilities of the Housing and Home Finance Agency and incorporated the FHA, the Federal National Mortgage Association, the Public Housing Administration, Urban Development Administration, and the Community Facilities Administration.

## Zoning, Housing Codes, and Building Codes

Housing is inextricably linked to the land on which it is located. Changes in the patterns of land use in the United States, shifting demographics, an awareness of the need for environmental stewardship, and competing uses for increasingly scarce (desirable) land have all placed added stress on the traditional relationship between the property owner and the community. This is certainly not a new development.

In the early settlement of this country, following the precedent set by their forefathers from Great Britain, gunpowder mills and storehouses were prohibited from the heavily populated portions of towns, owing to the frequent fires and explosions. Later, zoning took the form of fire districts and, under implied legislative powers, wooden buildings were prohibited from certain sections of a municipality. Massachusetts passed one of the first zoning laws in 1692. This law authorized Boston, Salem, Charlestown, and certain other market towns in the province to restrict the establishment of slaughterhouses and stillhouses for currying leather to certain locations in each town.

Few people objected to such restrictions. Still, the tension remained between the right to use one's land and the community's right to protect its citizens. In 1926, the United States Supreme Court took up the issue in *Village of Euclid, Ohio, v. Ambler Realty* [7]. In this decision, the Court noted,

*"Until recent years, urban life was comparatively simple; but with great increase and concentration of population, problems have developed which require additional restrictions in respect of the use and occupation of private lands in urban communities."*

In explaining its reasoning, the Court said,

*“the law of nuisances may be consulted not for the purpose of controlling, but for the helpful aid of its analogies in the process of ascertaining the scope of the police power. Thus the question of whether the power exists to forbid the erection of a building of a particular kind or a particular use is to be determined, not by an abstract consideration of the building or other thing considered apart, but by considering it in connection with the circumstances and the locality... A nuisance may be merely the right thing in the wrong place—like a pig in the parlor instead of the barnyard.”*

Zoning, housing, and building codes were adopted to improve the health and safety of people living in communities. And, to some extent, they have performed this function. Certainly, housing and building codes, when enforced, have resulted in better constructed and maintained buildings. Zoning codes have been effective in segregating noxious and dangerous enterprises from residential areas. However, as the U.S. population has grown and changed from a rural to an urban then to a suburban society, land use and building regulations developed for the 19th and early 20th centuries are creating new health and safety problems not envisioned in earlier times.

### Zoning and Zoning Ordinances

Zoning is essentially a means of ensuring that a community's land uses are compatible with the health, safety, and general welfare of the community. Experience has shown that some types of controls are needed to provide orderly growth in relation to the community plan for development. Just as a capital improvement program governs public improvements such as streets, parks and other recreational facilities, schools, and public buildings, so zoning governs the planning program with respect to the use of public and private property.

It is very important that housing inspectors know the general nature of zoning regulations because properties in violation of both the housing code and the zoning ordinance must be brought into full compliance with the zoning ordinance before the housing code can be enforced. In many cases, the housing inspector may be able to eliminate violations or properties in violation of housing codes through enforcement of the zoning ordinance.

### Zoning Objectives

As stated earlier, the purpose of a zoning ordinance is to ensure that the land uses within a community are regulated not only for the health, safety, and welfare of the community, but also are in keeping with the comprehensive plan for community development. The provisions in a zoning ordinance that help to achieve development that provides for health, safety, and welfare are designed to do the following:

- Regulate height, bulk, and area of structure. To provide established standards for healthful housing within the community, regulations dealing with building heights, lot coverage, and floor areas must be established. These regulations then ensure that adequate natural lighting, ventilation, privacy, and recreational areas for children will be realized. These are all fundamental physiologic needs necessary for a healthful environment. Safety from fires is enhanced by separating buildings to meet yard and open-space requirements. Through requiring a minimum lot area per dwelling unit, population density controls are established.
- Avoid undue levels of noise, vibration, glare, air pollution, and odor. By providing land-use category districts, these environmental stresses upon the individual can be reduced.
- Lessen street congestion by requiring off-street parking and off-street loading.
- Facilitate adequate provision of water, sewerage, schools, parks, and playgrounds.
- Provide safety from flooding.
- Conserve property values. Through careful enforcement of the zoning ordinance provisions, property values can be stabilized and conserved.

To understand more fully the difference between zoning and subdivision regulations, building codes, and housing ordinances, the housing inspector must know what cannot be accomplished by a zoning ordinance. Items that cannot be accomplished by a zoning ordinance include the following:

- Overcrowding or substandard housing. Zoning is not retroactive and cannot correct existing conditions. These are corrected through enforcement of a minimum standards housing code.
- Materials and methods of construction. Materials and methods of construction are enforced through building codes rather than through zoning.

- Cost of construction. Quality of construction, and hence construction costs, are often regulated through deed restrictions or covenants. Zoning does, however, stabilize property values in an area by prohibiting incompatible development, such as heavy industry in the midst of a well-established subdivision.
- Subdivision design and layout. Design and layout of subdivisions, as well as provisions for parks and streets, are controlled through subdivision regulations.

### *Content of the Zoning Ordinance*

Zoning ordinances establish districts of whatever size, shape, and number the municipality deems best for carrying out the purposes of the zoning ordinance. Most cities use three major districts: residential (R), commercial (C), and industrial (I). These three may then be subdivided into many subdistricts, depending on local conditions; e.g., R-1 (single-unit dwellings), R-2 (duplexes), R-3 (low-rise apartment buildings), and so on. These districts specify the principal and accessory uses, exceptions, and prohibitions [8].

In general, permitted land uses are based on the intensity of land use—a less intense land use being permitted in a more intense district, but not vice versa. For example, a single-unit residence is a less intense land use than a multiunit dwelling (defined by HUD as more than four living units) and hence would be permitted in a residential district zoned for more intense land use (e.g., R-3). A multiunit dwelling would not, however, be permitted in an R-1 district. While intended to promote the health, safety, and general welfare of the community, housing trends in the last half of the 20th century have led a number of public health and planning officials to question the blind enforcement of zoning districts. These individuals, citing such problems as urban sprawl, have stated that municipalities need to adopt a more flexible approach to land use regulation—one that encourages creating mixed-use spaces, increasing population densities, and reducing reliance on the automobile.

These initiatives are often called smart growth programs. It is imperative, if this approach is taken, that both governmental officials and citizens be involved in the planning stage. Without this involvement, the community may end up with major problems, such as overloaded infrastructure, structures of inappropriate construction crowded together, and fire and security issues for residents. Increased density could strain the existing water, sewer and waste collection systems, as well as fire and police services, unless proper planning is implemented.

In recent years, some ordinances have been partially based on performance standards rather than solely on land-use intensity. For example, some types of industrial developments may be permitted in a less intense use district provided that the proposed land use creates no noise, glare, smoke, dust, vibration, or other environmental stress exceeding acceptable standards and provided further that adequate off-street parking, screening, landscaping, and similar measures are taken.

**Bulk and Height Requirements.** Most early zoning ordinances stated that, within a particular district, the height and bulk of any structure could not exceed certain dimensions and specified dimensions for front, side, and rear yards. Another approach was to use floor-area ratios for regulation. A floor-area ratio is the relation between the floor space of the structure and the size of the lot on which it is located. For example, a floor-area ratio of 1 would permit either a two-story building covering 50% of the lot, or a one-story building covering 100% of the lot, as demonstrated in Figure 3.1. Other zoning ordinances specify the maximum amount of the lot that can be covered or merely require that a certain amount of open space must be provided for each structure, and leave the builder the flexibility to determine the location of the structure. Still other ordinances, rather than specify a particular height for the structure, specify the angle of light obstruction that will assure adequate air and light to the surrounding structures, as demonstrated in Figure 3.2.

**Yard Requirements.** Zoning ordinances also contain minimum requirements for front, rear, and side yards. These requirements, in addition to stating the lot dimensions, usually designate the amount of setback required. Most ordinances permit the erection of auxiliary buildings in rear yards provided that they are located at stated distances from all lot lines and provided sufficient open space is maintained. If the property is a corner lot, additional requirements are established to allow visibility for motorists.

**Off-street Parking.** Space for off-street parking and off-street loading, especially for commercial buildings, is also contained in zoning ordinances. These requirements are based on the relationship of floor space or seating capacity to land use. For example, a furniture store would require fewer off-street parking spaces in relation to the floor area than would a movie theater.

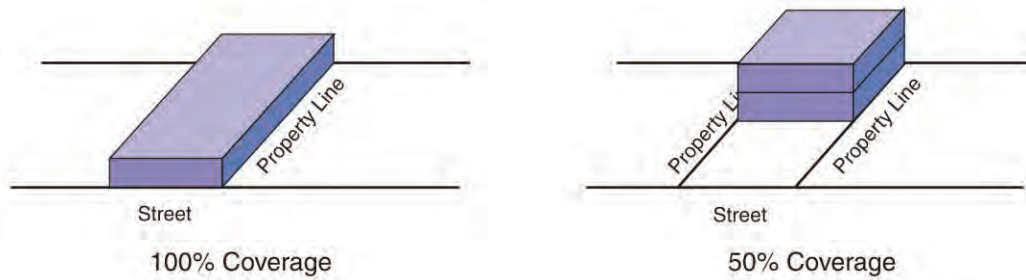

**Figure 3.1.** Example of a Floor Area

## Exceptions to the Zoning Code

### *Nonconforming Uses*

Because zoning is not retroactive, all zoning ordinances contain a provision for nonconforming uses. If a use has already been established within a particular district before the adoption of the ordinance, it must be permitted to continue, unless it can be shown to be a public nuisance.

Provisions are, however, put into the ordinance to aid in eliminating nonconforming uses over time. These provisions generally prohibit a) an enlargement or expansion of the nonconforming use, b) reconstruction of the nonconforming use if more than a certain portion of the building should be destroyed, c) resumption of the use after it has been abandoned for a period of specified time, and d) changing the use to a higher classification or to another nonconforming use. Some zoning ordinances further provide a period of amortization during which nonconforming land use must be phased out.

### *Variations*

Zoning ordinances contain provisions for permitting variances and providing a method for granting these

variances, subject to certain specified provisions. A variance may be granted when, owing to the specific conditions or use of a particular lot, an undue hardship would be imposed on the owner if the exact content of the ordinance is enforced. A variance may be granted due to the shape, topography, or other characteristic of the lot. For example, suppose an irregularly shaped lot is located in a district having a side yard requirement of 20 feet on a side and a total lot size requirement of 10,000 square feet. Further suppose that this lot contains 10,200 square feet (and thus meets the total size requirement); however, due to the irregular shape of the lot, there would be sufficient space for only a 15-foot side yard. Because a hardship would be imposed on the owner if the exact letter of the law is applied, the owner of the property could apply to the zoning adjustment board for a variance. Because the total area of the lot is sufficient and a lessening of the ordinance requirements would not be detrimental to the surrounding property, nor would it interfere with neighboring properties, a variance would probably be granted. Note that a variance is granted to the owner under specific conditions. Should use of the property change, the variance would be voided.

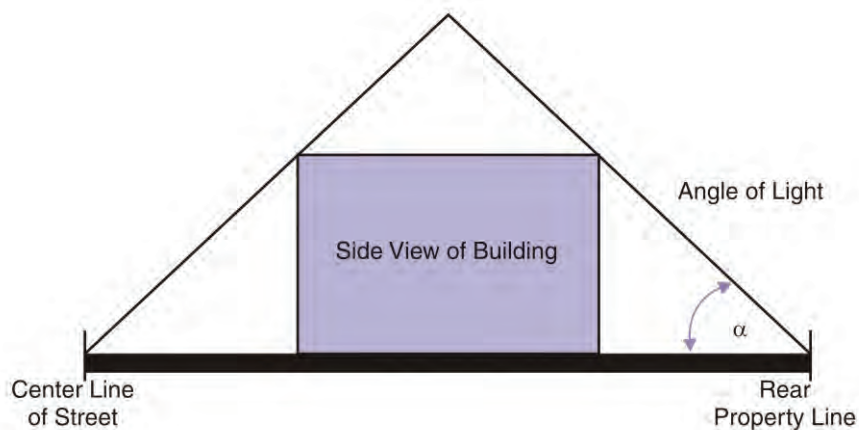

**Figure 3.2.** Example of an Angle of Light Obstruction

### *Exceptions*

An exception is often confused with a variance. In every city there are some necessary uses that do not correspond to the permitted land uses within the district. The zoning code recognizes, however, that if proper safeguards are provided, these uses would not have a detrimental effect on the district. An example would be a fire station that could be permitted in a residential area, provided the station house is designed and the property is properly landscaped to resemble or fit in with the characteristics of the neighborhood in which it is located.

### *Administration*

Zoning inspectors are essential to the zoning process because they have firsthand knowledge of a case. Often, the zoning inspector may also be the building inspector or housing inspector. Because the building inspector or housing inspector is already in the field making inspections, it is relatively easy for that individual to check compliance with the zoning ordinances. Compliance is determined by comparing the actual land use with that allowed for the area and shown on the zoning map.

Each zoning ordinance has a map detailing the permitted usage for each block. Using a copy of this map, the inspector can make a preliminary check of the land use in the field. If the use does not conform, the inspector must then contact the Zoning Board to see whether the property in question was a nonconforming use at the time of the passage of the ordinance and whether an exception or variance has been granted. In cities where up-to-date records are maintained, the inspector can check the use in the field.

When a violation is observed, and the property owners are duly notified of the violation, they have the right to request a hearing before the Zoning Board of Adjustment (also called the Zoning Board of Appeals in some cities). The board may uphold the zoning enforcement officer or may rule in favor of the property owner. If the action of the zoning officer is upheld, the property owner may, if desired, seek relief by appealing the decision to the courts; otherwise, the violation must be corrected to conform to the zoning code.

It is critical for the housing or building inspector and the zoning inspector to work closely in municipalities where these positions and responsibilities are separate. Experience has shown that illegally converted properties are often among the most substandard encountered in the municipality and often contain especially dangerous housing code violations.

In communities where the zoning code is enforced effectively, the resulting zoning compliance helps to advance, as well as sustain, many of the minimum standards of the housing code such as occupancy, ventilation, light, and unimpeded egress. By the same token, building or housing inspectors can often aid the zoning inspector by helping eliminate some nonconforming uses through code enforcement.

### *Housing Codes*

A housing code, regardless of who promulgates it, is basically an environmental health protection code. Housing codes are distinguished from building codes in that they cover houses, not buildings in general. For example, the housing code requires that walls support the weight of the roof, any floors above, and the furnishings, occupants, etc., within a building.

Early housing codes primarily protected only physical health; hence, they were enforced only in slum areas. In the 1970s, it was realized that, if urban blight and its associated human suffering were to be controlled, housing codes must consider both physical and mental health and must be administered uniformly throughout the community.

In preparing or revising housing codes, local officials must maintain a level of standards that will not merely be minimal. Standards should maintain a living environment that contributes positively to healthful individual and family living. The fact that a small portion of housing fails to meet a desirable standard is not a legitimate reason for retrogressive modification or abolition of a standard. The adoption of a housing ordinance that establishes low standards for existing housing serves only to legalize and perpetuate an unhealthy living environment. Wherever local conditions are such that immediate enforcement of some standards within the code would cause undue hardship for some individuals, it is better to allow some time for compliance than to eliminate an otherwise satisfactory standard. When immediate health or safety hazards are not involved, it is often wise to attempt to create a reasonable timetable for accomplishing necessary code modifications.

### *History*

To assist municipalities with developing legislation necessary to regulate the quality of housing, the American Public Health Association (APHA) Committee on the Hygiene of Housing prepared and published in 1952 a proposed housing ordinance. This provided a prototype on which such legislation might be based and has served

as the basis for countless housing codes enacted in the United States since that time. Some municipalities enacted it without change. Others made revisions by omitting some portions, modifying others, and sometimes adding new provisions [9].

The APHA ordinance was revised in 1969 and 1971. In 1975, APHA and the CDC jointly undertook the job of rewriting and updating this model ordinance. The new ordinance was entitled the *APHA-CDC Recommended Housing Maintenance and Occupancy Ordinance* [10]. The most recent model ordinance was published by APHA in 1986 as *Housing and Health: APHA-CDC Recommended Minimum Housing Standards* [11]. This new ordinance is one of several model ordinances available to communities when they are interested in adopting a housing code.

A community should read and consider each element within the model code to determine its applicability to their community. A housing code is merely a means to an end. The end is the eventual elimination of all substandard conditions within the home and the neighborhood. This end cannot be achieved if the community adopts an inadequate housing code.

### **Objectives**

The Housing Act of 1949 [12] gave new impetus to existing local, state, and federal housing programs directed toward eliminating poor housing. In passing this legislation, Congress defined a new national objective by declaring that “the general welfare and security of the nation and the health and living standards of its people... require a decent home and a suitable living environment for every American family.” This mandate generated an awareness that the quality of housing and residential environment has an enormous influence upon the physical and mental health and the social well-being of each individual and, in turn, on the economic, political, and social conditions in every community. Consequently, public agencies, units of government, professional organizations and others sought ways to ensure that the quality of housing and the residential environment did not deteriorate.

It soon became apparent that ordinances regulating the supplied utilities and the maintenance and occupancy of dwellings were needed. Commonly called housing codes, these ordinances establish minimum standards to make dwellings safe, sanitary, and fit for human habitation by governing their condition and maintenance, their supplied utilities and facilities, and their occupancy. The 2003 International Code Council (ICC) [13,14]

International Residential Code-One- and Two-Family Dwellings (R101.3) states

*“the purpose of this code is to provide minimum requirements to safeguard the public safety, health and general welfare, through affordability, structural strength, means of egress, facilities, stability, sanitation, light and ventilation, energy conservation, safety to fire and property from fire and other hazards attributed to the built environment.”*

### **Critical Requirements of an Effective Housing Program**

A housing code is limited in its effectiveness by several factors. First, if the housing code does not contain standards that adequately protect the health and well-being of the individuals, it cannot be effective. The best-trained housing inspector, if not armed with an adequate housing code, can accomplish little good in the battle against urban blight.

A second issue in establishing an effective housing code is the need to establish a baseline of current housing conditions. A systems approach requires that you establish where you are, where you are going, and how you plan to achieve your goals. In using a systems approach, it is essential to know where the program started so that the success or failure of various initiatives can be established. Without this information, success cannot be replicated, because you cannot identify the obstacles navigated nor the elements of success. Many initiatives fail because program administrators are without the necessary proof of success when facing funding shortfalls and budget cuts.

A third factor affecting the quality of housing codes is budget. Without adequate funds and personnel, the community can expect to lose the battle against urban blight. It is only through a systematic enforcement effort by an adequately sized staff of properly trained inspectors that the battle can be won.

A fourth factor is the attitude of the political bodies within the area. A properly administered housing program will require upgrading substandard housing throughout the community. Frequently, this results in political pressures being exerted to prevent the enforcement of the code in certain areas of the city. If the housing effort is backed properly by all political elements, blight can be controlled and eventually eliminated within the community. If, however, the housing program is not permitted to choke out the spreading influence of substandard conditions, urban blight will spread like a cancer, engulfing greater and greater portions of the city. Similarly, an effort directed at only the most seriously

blighted blocks in the city will upgrade merely those blocks, while the blight spreads elsewhere. If urban blight is to be controlled, it must be cut out in its entirety.

A fifth element that limits housing programs is whether they are supported fully by the other departments within the city. Regardless of which city agency administers the housing program, other city agencies must support the activities of the housing program. In addition, great effort should be expended to obtain the support and cooperation of the community. This can be accomplished through public awareness and public information programs, which can result in considerable support or considerable resistance to the efforts of the program.

A sixth limitation is an inadequately or improperly trained inspection staff. Inspectors should be capable of evaluating whether a serious or a minor problem exists in matters ranging from the structural stability of a building to the health and sanitary aspects of the structure. If they do not have the authority or expertise, they should develop that expertise or establish effective and efficient agreements with overlapping agencies to ensure timely and appropriate response.

A seventh item that frequently restricts the effectiveness of a housing program is the fact that many housing groups fail to do a complete job of evaluating housing problems. The deterioration of an area may be due to factors such as housing affordability, tax rates, or issues related to investment cost and return. In many cases, the inspection effort is restricted to merely evaluating the conditions that exist, with little or no thought given to why these conditions exist. If a housing effort is to be successful, as part of a systems approach, the question of why the homes deteriorated must be considered. Was it because of environmental stresses within the neighborhood that need to be eliminated or was it because of apathy on the part of the occupants? In either case, if the causative agent is not removed, then the inspector faces an annual problem of maintaining the quality of that residence. It is only by eliminating the causes of deterioration that the quality of the neighborhood can be maintained. Often the regulatory authority does not have adequate authority within the enabling legislation of the code needed to resolve the problem or there are gaps in jurisdiction.

### *Content of a Housing Code*

Although all comprehensive housing codes or ordinances contain a number of common elements, the provisions of communities will usually vary. These variations stem from

differences in local policies, preferences, and, to a lesser extent, needs. They are also influenced by the standards set by the related provisions of the diverse building, electrical, and plumbing codes in use in the municipality.

Within any housing code there are generally five features:

1. Definitions of terms used in the code.
2. Administrative provisions showing who is authorized to administer the code and the basic methods and procedures that must be followed in implementing and enforcing the sections of the code. Administrative provisions deal with items such as reasonable hours of inspections, whether serving violation notices is required, how to notify absentee owners or resident-owners or tenants, how to process and conduct hearings, what rules to follow in processing dwellings alleged to be unfit for human habitation, and how to occupy or use dwellings finally declared fit.
3. Substantive provisions specifying the various types of health, building, electrical, heating, plumbing, maintenance, occupancy, and use conditions that constitute violations of the housing code. These provisions can be and often are grouped into three categories: minimum facilities and equipment for dwelling units; adequate maintenance of dwellings and dwelling units, as well as their facilities and equipment; and occupancy conditions of dwellings and dwelling units.
4. Court and penalty sections outlining the basis for court action and the penalty or penalties to which the alleged violator will be subjected if proved guilty of violating one or more provisions of the code.
5. Enabling, conflict, and unconstitutionality clauses providing the date a new or amended code will take effect, prevalence of more stringent provision when there is a conflict of two codes, severability of any part of the ordinance that might be found unconstitutional, and retention of all other parts in full course and effect. In any city following the format of the *APHA-CDC Recommended Housing Maintenance and Occupancy Ordinance* [10] the housing officer or other supervisor in charge of housing inspections will also adopt appropriate housing rules and regulations from time to time to clarify or further refine the provisions of the ordinance. When rules and regulations are used, care should be taken that the department is not overburdened with a number of minor rules and regulations. Similarly, a housing ordinance that encompasses all rules and regulations might have difficulty because any amendments to it will require action by the political element of the community. Some



housing groups, in attempting to obtain amendments to an ordinance, have had the entire ordinance thrown out by the political bodies.

### *Administrative Provisions of a Housing Code*

The administrative procedures and powers of the housing inspection agency, its supervisors, and its staff are similar to other provisions in that all are based on the police power of the state to legislate for public health and safety. In addition, the administrative provisions, and to a lesser extent, the court and penalty provisions, outline how the police power is to be exercised in administering and enforcing the code.

Generally, the administrative elements deal with procedures for ensuring that the constitutional doctrines of reasonableness, equal protection under the law and due process of law are observed. They also must guard against violation of prohibitions against unlawful search and seizure, impairment of obligations of contract, and unlawful delegation of authority. These factors encompass items of great importance to housing inspection supervisors such as the inspector's right of entry, reasonable hours of inspection, proper service, and the validity of the provisions of the housing codes they administer.

**Owner of Record.** It is essential to file legal actions against the true owners of properties in violation of housing codes. With the advent of the computer, this is often much easier than in the past. Databases that provide this information are readily available from many offices of local government such as the tax assessment office. The method of obtaining the name and address of the legal owner of a property in violation varies from place to place. Ordinarily, a check of the city tax records will suffice unless there is reason to believe these are not up to date. In this case, a further check of county or parish records will turn up the legal owner if state law requires deed registration there. If it does not, the advice of the municipal law department should be sought about the next steps to follow.

**Due Process Requirements.** Every notice, complaint, summons, or other type of legal paper concerning alleged housing code violations in a given dwelling or dwelling unit must be legally served on the proper party to be valid and to prevent harassment of innocent parties. This might be the owner, agent, or tenant, as required by the code. It is customary to require that the notice to correct existing violations and any subsequent notices or letters be served by certified or registered mail with return receipt requested. The receipt serves as proof of service if the case has to be taken to court.

Due process requirements also call for clarity and specificity with respect to the alleged violations, both in the violation notices and the court complaint-summons. For this reason, special care must be taken to be complete and accurate in listing the violations and charges. To illustrate, rather than direct the violator to repair all windows where needed, the violator should be told exactly which windows and what repairs are involved.

The chief limitation on the due process requirement, with respect to service of notices, lies in cases involving immediate threats to health and safety. In these instances, the inspection agency or its representative may, without notice or hearing, issue an order citing the existence of the emergency and requiring that action deemed necessary to meet the emergency be taken.

In some areas housing courts on the municipal level have advocates that assist both plaintiffs and defendants prepare for the court process or to resolve the issue to avoid court.

**Hearings and Condemnation Power.** The purpose of a hearing is to give the alleged violator an opportunity to be heard before further action is taken by the housing inspection agency. These hearings may be very informal, involving meetings between a representative of the agency and the person ordered to take corrective action. They also may be formal hearings at which the agency head presides and at which the city and the defendant both are entitled to be represented by counsel and expert witnesses.

*Informal Hearings.* A violator may have questions about a violation notice or the notice may be served at a time when personal hardship or other factors prevent a violator from meeting the terms of the notice. Therefore, many housing codes provide the opportunity for a hearing at which the violator may discuss questions or problems and seek additional time or some modification of the order. Administered in a firm but understanding manner, these hearings can serve as invaluable aids in relieving needless fears of those involved, in showing how the inspection program is designed to help them and in winning their voluntary compliance.

*Formal Hearings.* Formal hearings are often quasijudicial hearings (even though the prevailing court rules of evidence do not always apply) from which an appeal may be taken to court. All witnesses must therefore be sworn in, and a record of the proceedings must be made. The formal hearing is used chiefly as the basis for determining whether a dwelling is fit for human habitation, occupancy, or use. In the event it is proved unfit, the building is condemned and the owner is given a designated

amount of time either to rehabilitate it completely or to demolish it. Where local funds are available, a municipality may demolish the building and place a lien against the property to cover demolition costs if the owner fails to obey the order within the time specified. This type of condemnation hearing is a very effective means of stimulating prompt and appropriate corrective action when it is administered fairly and firmly.

**Procedures for Coping With Common Problems.** Several states and local communities have developed innovative ways to resolve code violation issues.

*Limitation of Occupancy Notification.* This technique was pioneered in Wilmington, Delaware. It makes it mandatory for property owners in the community to obtain a legal notice from the housing inspection agency specifying the maximum number of persons that may occupy each of their properties. It also requires these owners to have a residence, place of business, or an agent for their properties within the community. The agent should be empowered to take remedial action on any of the properties found in violation. In addition, if the property is sold, the new owner must obtain a new Limitation of Occupancy Notification.

*Request for Inspections.* Several states permit their municipalities to offer a request for inspection service. For a fee, the housing inspector will inspect a property for violations of the housing code before its sale so that the buyer can learn its condition in advance. Many states and localities now require owners to notify prospective purchasers of any outstanding notice of health risk or violations they have against their property before the sale. If they fail to do so, some codes will hold the owner liable to the purchaser and the inspection agency for violations.

*Tickets for Minor Offenses.* Denver, Colorado, has used minimal financial fines to prod minor violators and first offenders into correcting violations without the city resorting to court action. There are mixed views about this technique because it is akin to formal police action. Nevertheless, the action may stimulate compliance and reduce the amount of court action needed to achieve it.

**Forms and Form Letters.** A fairly typical set of forms and form letters are described below. It should be stressed that inspection forms to be used for legal notices must satisfy legal standards of the code, be meaningful to the owner and sufficiently explicit about the extent and location of particular defects, be adaptable to statistical compilation for the governing body reports, and be written in a manner that will facilitate clerical and other administrative usage.

*The Daily Report Form.* This form gives the inspection agency an accurate basis for reporting, evaluating, and, if necessary, improving the productivity and performance of its inspectors.

*Complaint Form.* This form helps obtain full information from the complainant and thus makes the relative seriousness of the problem clear and reduces the number of crank complaints.

*No-entry Notice.* This notice advises occupants or owners that an inspector was there and that they must return a call to the inspector.

*Inspection Report Form.* This is the most important form in an agency. It comes in countless varieties, but if designed properly, it will ensure more productivity and more thoroughness by the inspectors, reduce the time spent in writing reports, locate all violations correctly, and reduce the time required for typing violation notices. Forms may vary widely in sophistication from a very simple form to one whose components are identified by number for use in processing the case by automation. Some forms are a combined inspection report and notice form in triplicate so that the first page can be used as the notice of violation, the second as the office record, and the third as the guide for reinspection. A covering form letter notifies the violator of the time allowed to correct the conditions listed in the report form.

*Violation Notice.* This is the legal notice that housing code violations exist and must be corrected within the indicated amount of time. The notice may be in the form of a letter that includes the alleged violations or has a copy of these attached. It may be a standard notice form, or it may be a combined report-notice. Regardless of the type of notice used, it should make the location and nature of all violations clear and specify the exact section of the code that covers each one. The notice must advise violators of their right to a hearing. It should also indicate that the violator has a right to be represented by counsel and that failure to obtain counsel will not be accepted as grounds for postponing a hearing or court case.

*Hearing Forms.* These should include a form letter notifying the violator of the date and time set for the hearing, a standard summary sheet on which the supervisor can record the facts presented at an informal hearing, and a hearing-decision letter for notifying all concerned of the hearing results. The latter should include the names of the violator, inspector, law department, and any other city official or agency that may be involved in the case.

*Reinspection Form Letters or Notices.* These have the same characteristics as violation notices except that they cover the follow-up orders given to the violator who has failed to comply with the original notice within the time specified. Some agencies may use two or three types of these form letters to accommodate different degrees of response by the violator. Whether one or several are used, standardization of these letters or notices will expedite the processing of cases.

*Court Complaint and Summons Forms.* These forms advise alleged violators of the charges against them and summon them to appear in court at the specified time and place. It is essential that the housing inspection agency work closely with the municipal law department in preparing these forms so that each is done in exact accord with the rules of court procedure in the relevant state and community.

*Court Action Record Form.* This form provides an accurate running record of the inspection agency's court actions and their results.

### *Substantive Provisions of a Housing Code*

A housing code is the primary tool of the housing inspector. The code spells out what the inspector may or may not do. An effort to improve housing conditions can be no better than the code allows. The substantive provisions of the code specify the minimal housing conditions acceptable to the community that developed them.

Dwelling units should have provisions for preparing at least one regularly cooked meal per day. Minimum equipment should include a kitchen sink in good working condition and properly connected to the water supply system approved by the appropriate authority. It should provide, at all times, an adequate amount of heated and unheated running water under pressure and should be connected to a sewer system approved by the appropriate authority. Cabinets or shelves, or both, for storing eating, drinking, and cooking utensils and food should be provided. These surfaces should be of sound construction and made of material that is easy to clean and that will not have a toxic or deleterious effect on food.

In addition, a stove and refrigerator should be provided. Within every dwelling there should be a room that affords privacy and is equipped with a flush toilet in good working condition.

Within the vicinity of the flush toilet, a sink should be provided. In no case should a kitchen sink substitute as a lavatory sink. In addition, within each dwelling unit there

should be, within a room that affords privacy, either a bathtub or shower or both, in good working condition. Both the lavatory sink and the bathtub or shower or both should be equipped with an adequate amount of heated and unheated water under pressure. Each should be connected to an approved sewer system.

Within each dwelling unit two or more means of egress should be provided to safe and open space at ground level. Provisions should be incorporated within the housing code to meet the safety requirements of the state and community involved. The housing code should spell out minimum standards for lighting and ventilation within each room in the structure. In addition, minimum thermal standards should be provided. Although most codes merely provide the requirement of a given temperature at a given height above floor level, the community should give consideration to the use of effective temperatures. The effective temperature is a means of incorporating not only absolute temperature in degrees, but also humidity and air movement, giving a better indication of the comfort index of a room.

The code should provide that no person shall occupy or let for occupancy any dwelling or dwelling units that do not comply with stated requirements. Generally, these requirements specify that the foundation, roof, exterior walls, doors, window space and windows of the structure be sound and in good repair; that it be moisture-free, watertight and reasonably weather tight and that all structural surfaces be sound and in good repair.

HUD defines a multifamily dwelling unit as one that contains four or more dwelling units in a single structure. A dwelling unit is further defined as a single unit of residence for a family of one or more persons in which sleeping accommodations are provided but toileting or cooking facilities are shared by the occupants.

### **Building Codes**

Building codes define what materials and methods are to be used in the construction of various buildings. Model building codes have been published by various trade organizations such as the Southern Building Code Congress International (SBCCI), Building Officials and Code Administrators (BOCA), and the International Conference of Building Officials (ICBO). Each of these groups published a model building code that was widely used or adapted regionally in the United States. BOCA national codes were used mostly in eastern and Great Lakes states, ICBO uniform codes in western and Midwest states, and SBCCI standard codes in southern states. As a result, the construction industry often faced

the challenge, and cost, of building to different codes in different areas of the country.

In 1994, BOCA, ICBO, and SBCCI created the International Code Council (ICC) to develop a single set of comprehensive, coordinated model construction codes that could be used throughout the United States and around the world. The first I-Code published was the International Plumbing Code in 1995. By 2000, a complete family of I-Codes was available, including the International Building Code. The ICC Performance Code for Buildings and Facilities joined the I-Code family in 2001.

On February 1, 2003, the three organizations (BOCA, SBCCI, and ICBO) were consolidated into the ICC [13,14]. According to ICC Board president, Paul E. Myers,

*“The ICC International Codes (I Codes) combine the strengths of the regional codes without regional limitations. The ICC is a nonprofit organization dedicated to developing a single set of comprehensive and coordinated national codes to make compliance easier and more cost-effective. I Codes respond to the needs of the construction industry and public safety. A single set of codes has strong support from government, code enforcement officials, fire officials, architects, engineers, builders, developers, and building owners and managers.”*

## References

1. Hammurabi's Code of Laws. Translated by L.W. King. Available from URL: <http://eawc.evansville.edu/anthology/hammurabi.htm>.
2. Claghorn KH. The foreign immigrant in New York City. Reports of the Industrial Commission, Volume XV. Washington, DC: US Government Printing Office; 1901.p. 465-92. Available from URL: <http://tenant.net/Community/LES/clag2.html>.
3. Riis J. How the other half lives—studies among the tenements of New York. New York: Charles Scriber's Sons; 1890. Available from URL: <http://www.bartleby.com/208/>.
4. New York City Department of City Planning. New York City zoning: zoning history. New York City: New York City Department of City Planning; no date. Available from URL: <http://www.nyc.gov/html/dcp/html/zone/zonehis.html>.
5. New York State Multiple Dwelling Law: chapter 713 of the Laws of 1929, as amended. Available from URL: [http://tenant.net/Other\\_Laws/MDL/mdltoc.html](http://tenant.net/Other_Laws/MDL/mdltoc.html).
6. Understanding Fannie Mae: our history. Washington, DC: Fannie Mae; 2005. Available from URL: <http://www.fanniemae.com/aboutfm/understanding/history:jhtml?p=About+Fannie+Mae&s=Understanding+Fannie+Mae&t=Our+History>.
7. Paulson PB. Protecting zoning laws. Atlanta: North Buckhead Civic Association; 2000 18 Mar. Available from URL: [http://www.nbca.org/TAP\\_AJC\\_3-18.htm](http://www.nbca.org/TAP_AJC_3-18.htm).
8. Municipal Code Corporation. Municipal building codes (online library). Tallahassee, FL: Municipal Code Corporation. Available from URL: [http://www.municode.com/resources/online\\_codes.asp](http://www.municode.com/resources/online_codes.asp).
9. American Public Health Association. Housing ordinance. Am J Public Health 1952 Jan;42(1):76–7.
10. US Public Health Service. APHA-CDC recommended housing maintenance and occupancy ordinance. Atlanta: US Department of Health and Human Services; 1975.
11. American Public Health Association. Housing and health: APHA-CDC recommended minimum housing standards. Washington, DC: American Public Health Association; 1986.
12. Lang RE, Sohmer RR, editors. Legacy of the Housing Act of 1949: The past, present, and future of federal housing and urban policy. Housing Policy Debate 2000;11(2): 291–7. Available from URL: [http://www.fanniemae.foundation.org/programs/hpd/pdf/hpd\\_1102\\_edintro.pdf](http://www.fanniemae.foundation.org/programs/hpd/pdf/hpd_1102_edintro.pdf).
13. International Code Council. International residential code 2003. Country Club Hills, IL: ICC; 2003.
14. International Code Council. International building code 2003. Country Club Hills, IL: ICC; 2003.

## Additional Sources of Information

- American Planning Association. Available from URL: <http://www.planning.org/>.
- Arendt R. “Open Space” zoning: what it is and why it works. Planners Commission Journal 1992. Available from URL: <http://www.plannersweb.com/articles/are015.html>.
- Bookmark, Inc. Available from URL: <http://www.bookmarki.com>.

International Code Council. Available from URL:  
<http://www.iccsafe.org>.

Rosenberg M. Zoning: residential, commercial, or industrial? New York: About, Inc.; no date. Available from URL: [http://geography.about.com/library/weekly/aa072801a.htm?iam=sherlock\\_abc/](http://geography.about.com/library/weekly/aa072801a.htm?iam=sherlock_abc/).

US Department of Energy, Land Use Planning. Smart Communities Network. Washington, DC: US Department of Energy; no date. Available from URL: <http://www.smartcommunities.ncat.org/landuse/luintro.shtml>.

US Department of Housing and Urban Development. Available from URL: <http://www.hud.gov/>.

US Department of Housing and Urban Development. Final report of HUD review of model building codes. Washington, DC: US Department of Housing and Urban Development; no date. Available from URL: <http://www.hud.gov/offices/fheo/disabilities/modelcodes/chapter5.html>.



*“Sometimes poor housing is a shorthand way of describing living conditions of poor people. The poor include the aged, deprived, ethnic minority groups, the infirmed, and families headed by unemployed women. In other words, the people most at risk for illness often live in inferior housing. Therefore, it is a matter of conjecture whether many people live in poor housing because they are sick or are sick because they live in poor housing.”*

Carter L. Marshall, M.D.  
*Dynamics of Health and Disease*  
Appleton, Century Crofts 1972

## Introduction

The most immediate and obvious link between housing and health involves exposure to biologic, chemical, and physical agents that can affect the health and safety of the occupants of the home. Conditions such as childhood lead poisoning and respiratory illnesses caused by exposure to radon, asbestos, tobacco smoke, and other pollutants are increasingly well understood and documented. However, even 50 years ago, public health officials understood that housing conditions were linked to a broader pattern of community health. For example, in 1949, the Surgeon General released a report comparing several health status indicators among six cities having slums. The publication reported that:

- the rate of deaths from communicable disease in these areas was the same as it was for the rest of the country 50 years ago (i.e., around 1900);
- most of the tuberculosis cases came from 25% of the population of these cities; and
- the infant mortality rate was five times higher than in the rest of the country, approximately equal to what it was 50 years ago.

Housing-related health concerns include asthma episodes triggered by exposure to dust mites, cockroaches, pets, and rodents. The existence of cockroaches, rats, and mice mean that they can also be vectors for significant problems that affect health and well-being. They are capable of transmitting diseases to humans. According to a 1997 American Housing Survey, rats and mice infested 2.7 million of 97 million housing units. A CDC-sponsored survey of two major American cities documented that nearly 50% of the premises were infected with rats and mice.

This chapter deals with disease vectors and pests as factors related to the health of households.

## Disease Vectors and Pests

Integrated pest management (IPM) techniques are necessary to reduce the number of pests that threaten human health and property. This systems approach to the problem relies on more than one technique to reduce or eliminate pests. It can be visualized best as concentric rings of protection that reduce the need for the most risky and dangerous options of control and the potential for pests to evolve and develop. It typically involves using some or all of the following steps:

- monitoring, identifying, and determining the level of threat from pests;
- making the environment hostile to pests;
- building the pests out by using pest-proof building materials;
- eliminating food sources, hiding areas, and other pest attractants;
- using traps and other physical elimination devices; and
- when necessary, selecting appropriate poisons for identified pests.

The above actions are discussed in more detail in the following section on the four basic strategies for controlling rodents.

Most homeowners have encountered a problem with rodents, cockroaches, fleas, flies, termites, or fire ants. These pests destroy property or carry disease, or both, and can be a problem for rich and poor alike.

## Rodents

Rodents destroy property, spread disease, compete for human food sources, and are aesthetically displeasing. Rodent-associated diseases affecting humans include plague, murine typhus, leptospirosis, rickettsialpox, and rat-bite fever. The three primary rodents of concern to the homeowner are the Norway rat (*Rattus norvegicus*), roof rat (*Rattus rattus*), and the house mouse (*Mus musculus*). The term “commensal” is applied to these rodents, meaning they live at people’s expense. The physical traits of each are demonstrated in Figure 4.1.

## FIELD IDENTIFICATION OF DOMESTIC RODENTS

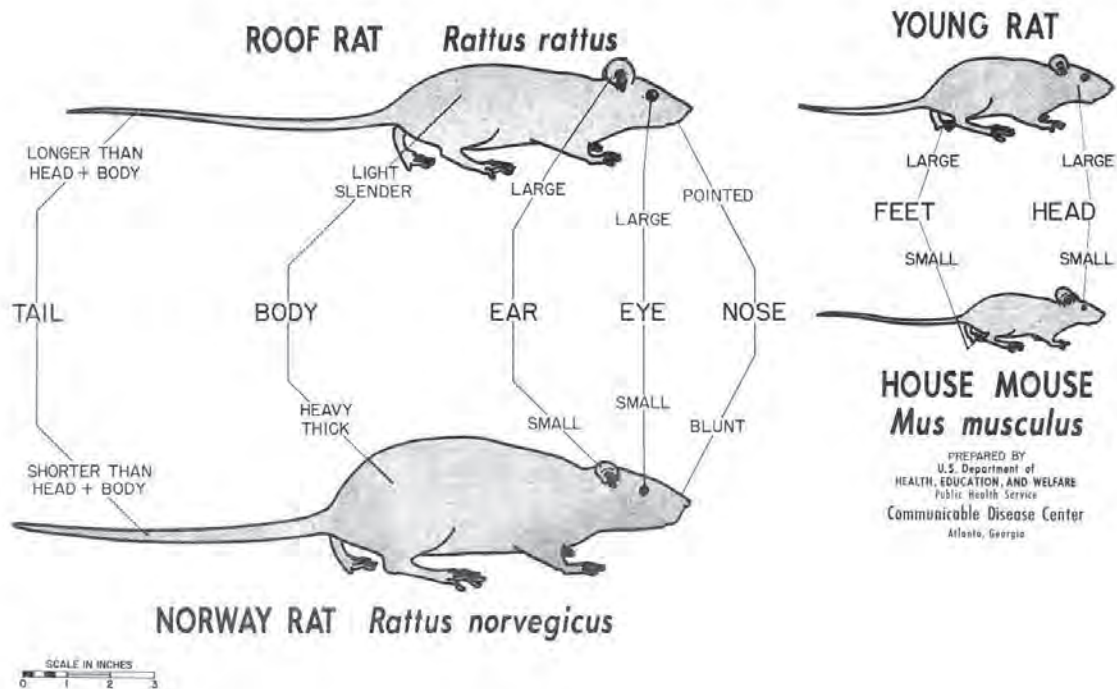

Figure 4.1. Field Identification of Domestic Rodents [2]

Barnett [1] notes that the house mouse is abundant throughout the United States. The Norway rat (Figure 4.2) is found throughout the temperate regions of the world, including the United States. The roof rat is found mainly in the South, across the entire nation to the Pacific coast. As a group, rodents have certain behavioral characteristics that are helpful in understanding them. They are perceptive to touch, with sensitive whiskers and guard hairs on their bodies. Thus, they favor running along walls and between objects that allow them constant contact with vertical surfaces.



Figure 4.2. Norway Rat [3]

They are known to have poor eyesight and are alleged to be colorblind. Contrastingly, they have an extremely sharp sense of smell and a keen sense of taste. The word rodent is derived from the Latin verb *rodere*, meaning “to gnaw.”

The gnawing tendency leads to structural damage to buildings and initiates fires when insulation is chewed from electrical wires. Rodents will gnaw to gain entrance and to obtain food.

from electrical wires. Rodents will gnaw to gain entrance and to obtain food.

The roof rat (Figure 4.3) is a slender, graceful, and very agile climber. The roof rat prefers to live aboveground: indoors in attics, between floors, in walls, or in enclosed spaces; and outdoors in trees and dense vine growth.



Figure 4.3. Roof Rat [4]

Contrasted with the roof rat, the Norway rat is at home below the ground, living in a burrow. The house mouse commonly is found living in human quarters, as suggested by its name. Signs indicative of the presence of rodents—aside from seeing live or dead rats and hearing rats—are rodent droppings, runways, and tracks (Figure 4.4). Other signs include nests, gnawings, food scraps, rat hair, urine spots, and rat body odors. Note that waste droppings from rodents are often confused with cockroach egg packets, which are smooth, segmented, and considerably smaller than a mouse dropping.

According to the *Military Pest Management Handbook (MPMH)* [2], rats and mice are very suspicious of any new objects or food found in their surroundings. This characteristic is one reason rodents can survive in dangerous environments. This avoidance reaction accounts for



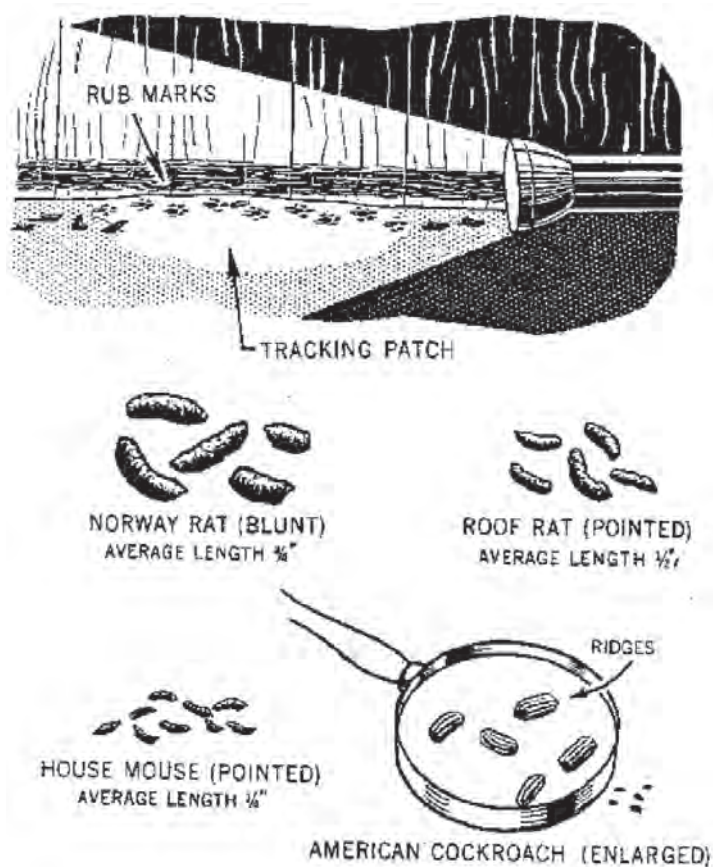

Figure 4.4. Signs of Rodent Infestation [2]

prebaiting (baiting without poisoning) in control programs. Initially, rats or mice begin by taking only small amounts of food. If the animal becomes ill from a sub-lethal dose of poison, its avoidance reaction is strengthened, and a poisoning program becomes extremely difficult to complete. If rodents are hungry or exposed to an environment where new objects and food are commonly found, such as a dump, their avoidance reaction may not be as strong; in extreme cases of hunger, it may even be absent.

The first of four basic strategies for controlling rodents is to **eliminate food sources**. To accomplish this, it is imperative for the homeowner or occupant to do a good job of solid waste management. This requires proper storing, collecting, and disposing of refuse.

The second strategy is to **eliminate breeding and nesting places**. This is accomplished by removing rubbish from near the home, including excess lumber, firewood, and similar materials. These items should be stored above ground with 18 inches of clearance below them. This height does not provide a habitat for rats, which have a propensity for dark, moist places in which to burrow. Wood should not be stored directly on the ground, and trash and similar rubbish should be eliminated.

The third strategy is to **construct buildings and other structures using rat-proofing methods**. *MPMH* notes that it is much easier to manage rodents if a structure is built or modified in a way that prevents easy access by rodents. Tactics for rodent exclusion include building or covering doors and windows with metal. Rats can gnaw through wooden doors and windows in a very short time to gain entrance. All holes in a building's exterior should be sealed. Rats are capable of enlarging openings in masonry, especially if the mortar or brick is of poor quality. All openings more than  $\frac{3}{4}$ -inch wide should be closed, especially around pipes and conduits. Cracks around doors, gratings, windows, and other such openings should be covered if they are less than 4 feet above the ground or accessible from ledges, pipes, or wires (Figure 4.5).

Additional tactics include using proper materials for rat proofing. For example, sheet metal of at least 26-gauge,  $\frac{1}{4}$ -inch or  $\frac{1}{2}$ -inch hardware cloth, and cement are all suitable rat-resistant materials. However,  $\frac{1}{2}$ -inch hardware cloth has little value against house mice. Tight fittings and self-closing doors should be constructed. Rodent runways can be behind double walls; therefore, spaces between walls and floor-supporting beams should be blocked with fire stops. A proper rodent-proofing strategy must bear in mind that rats can routinely jump 2 feet vertically, dig 4 feet or more to get under a foundation, climb rough walls or smooth pipes up to 3 inches in diameter, and routinely travel on electric or telephone wires.

The first three strategies—good sanitation techniques, habitat denial, and rat proofing—should be used initially in any rodent management program. Should they fail, the fourth strategy is a **killing program**, which can vary from a family cat to the professional application of rodenticides. Cats can be effective against mice, but typically are not useful against a rat infestation. Over-the-counter rodenticides can be purchased and used by the homeowner or occupant. These typically are in the red squill or warfarin groups.

A more effective alternative is trapping. There are a variety of devices to choose from when trapping rats or mice. The two main groups of rat and mouse traps are live traps (Figure 4.6) and kill traps (Figure 4.7). Traps usually are placed along walls, near runways and burrows, and in other areas. Bait is often used to attract the rodents to the trap. To be effective, traps must be monitored and emptied or removed quickly. If a rat caught in a trap is left there, other rats may avoid the traps. A trapping strategy also may include using live traps to remove these vermin.

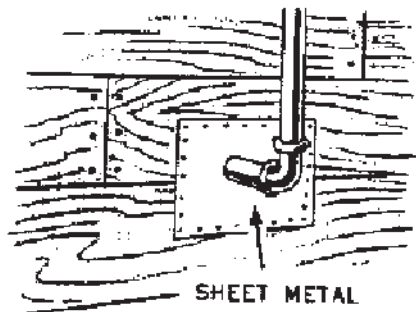
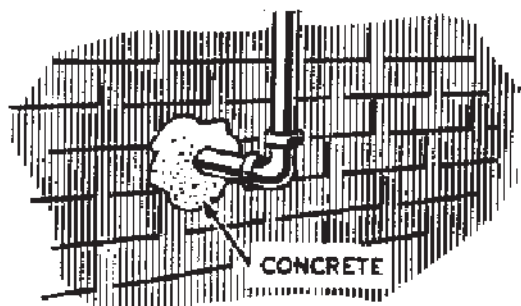
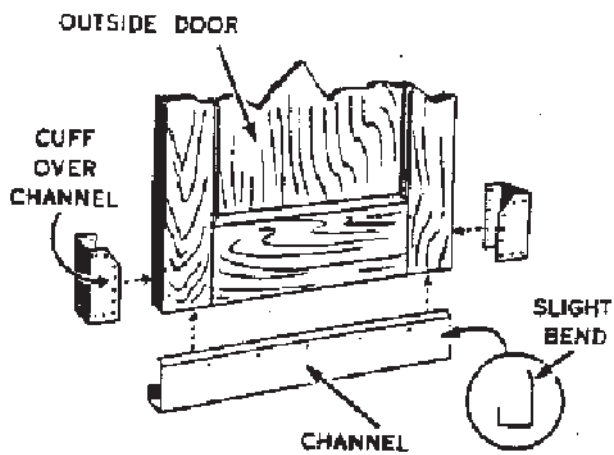

Figure 4.5. Rodent Prevention [2]

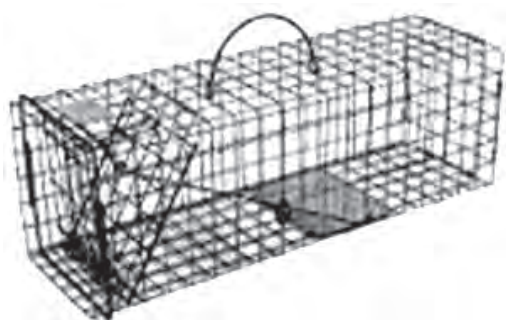

Figure 4.6. Live Traps for Rats [5]

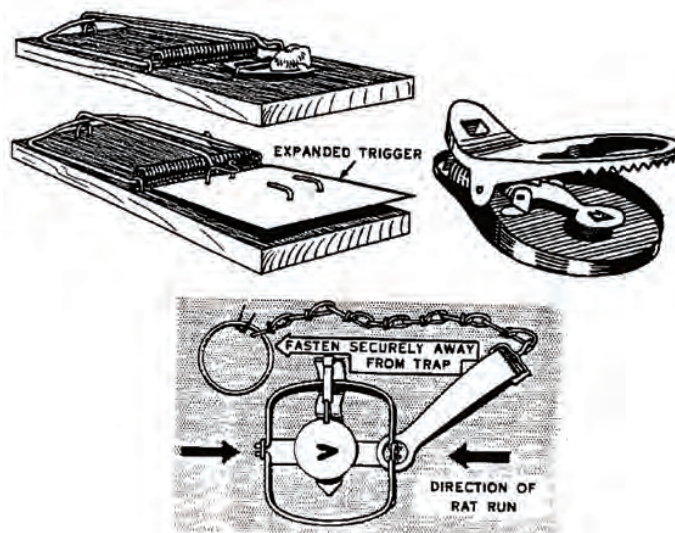

Figure 4.7. Kill Traps for Rats [2]

### Cockroaches

Cockroaches have become well adapted to living with and near humans, and their hardiness is legendary. In light of these facts, cockroach control may become a homeowner's most difficult task because of the time and special knowledge it often involves. The cockroach is considered an allergen source and an asthma trigger for residents. Although little evidence exists to link the cockroach to specific disease outbreaks, it has been demonstrated to carry *Salmonella typhimurium*, *Entamoeba histolytica*, and the poliomyelitis virus. In addition, Kamble and Keith [6] note that most cockroaches produce a repulsive odor that can be detected in infested areas. The sight of cockroaches can cause considerable psychological or emotional distress in some individuals. They do not bite, but they do have heavy leg spines that may scratch.

According to MPMH [2], there are 55 species of cockroaches in the United States. As a group, they tend to prefer a moist, warm habitat because most are tropical in origin. Although some tropical cockroaches feed only on vegetation, cockroaches of public health interest tend to live in structures and are customarily scavengers. Cockroaches will eat a great variety of materials, including cheese and bakery products, but they are especially fond of starchy materials, sweet substances, and meat products.

Cockroaches are primarily nocturnal. Daytime sightings may indicate potentially heavy infestations. They tend to hide in cracks and crevices and can move freely from room to room or adjoining housing units via wall spaces, plumbing, and other utility installations. Entry into homes is often accomplished through food and beverage

boxes, grocery sacks, animal food, and household goods carried into the home. The species of public health interest that commonly inhabit human dwellings (Figures 4.8–4.13) include the following: German cockroach (*Blattella germanica*); American cockroach (*Periplaneta americana*); Oriental cockroach (*Blatta orientalis*); brown-banded cockroach (*Supella longipalpa*); Australian cockroach (*Periplaneta australasiae*); smoky-brown cockroach (*Periplaneta fuliginosa*); and brown cockroach (*Periplaneta brunnea*).

Four management strategies exist for controlling cockroaches. The first is **prevention**. This strategy includes inspecting items being carried into the home and sealing cracks and crevices in kitchens, bathrooms, exterior doors, and windows. Structural modifications would include weather stripping and pipe collars. The second strategy is **sanitation**. This denies cockroaches food, water, and shelter. These efforts include quickly cleaning food particles from shelving and floors; timely washing of dinnerware; and routine cleaning under refrigerators, stoves, furniture, and similar areas. If pets are fed indoors, pet food should be stored in tight containers and not left in bowls overnight. Litter boxes should be cleaned routinely. Access should be denied to water sources by fixing



Figure 4.10. Oriental Cockroaches, Various Stages and Ages [7]



Figure 4.11. German Cockroaches, Various Stages and Ages [7]

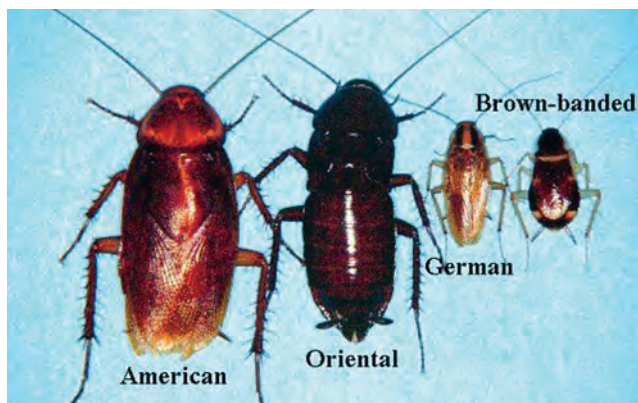

Figure 4.8. American, Oriental, German, and Brown-banded Cockroaches [7]



Figure 4.12. Brown-banded Cockroaches, Various Stages and Ages [7]

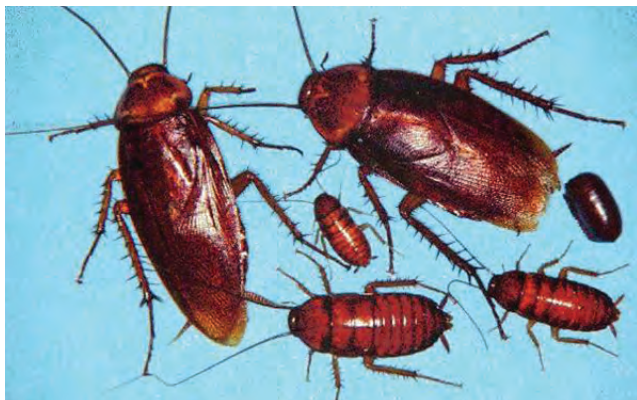

Figure 4.9. American Cockroaches, Various Stages and Ages [7]

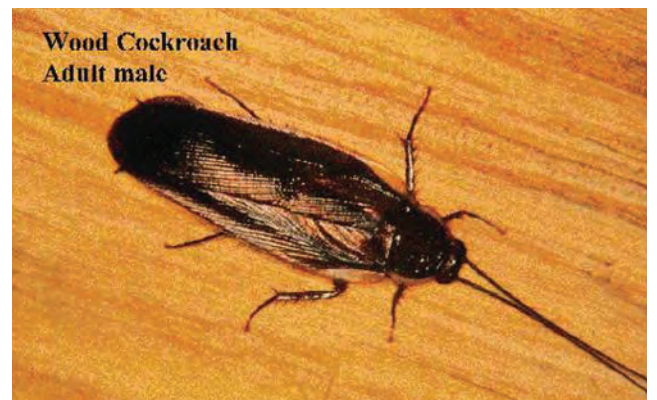

Figure 4.13. Wood Cockroach, Adult Male [7]

leaking plumbing, drains, sink traps, and purging clutter, such as papers and soiled clothing and rags. The third strategy is **trapping**. Commercially available cockroach traps can be used to capture roaches and serve as a monitoring device. The most effective trap placement is against vertical surfaces, primarily corners, and under sinks, in cabinets, basements, and floor drains. The fourth strategy is **chemical control**. The use of chemicals typically indicates that the other three strategies have been applied incorrectly. Numerous insecticides are available and appropriate information is obtainable from EPA.

### Fleas

The most important fleas as disease vectors are those that carry murine typhus and bubonic plague. In addition, fleas serve as intermediate hosts for some species of dog and rodent tapeworms that occasionally infest people. They also may act as intermediate hosts of filarial worms (heartworms) in dogs. In the United States, the most important disease related to fleas is the bubonic plague. This is primarily a concern of residents in the southwestern and western parts of the country (Figure 4.14).

Of approximately 2,000 species of flea, the most common flea infesting both dogs and cats is the cat flea *Ctenocephalides felis*. Although numerous animals, both wild and domestic, can have flea infestations, it is from the exposure of domestic dogs and cats that most homeowners inherit flea infestation problems. According to *MPMH* [2], fleas are wingless insects varying from 1 to 8½ millimeters (mm) long, averaging 2 to 4 mm, and feed through a siphon or tube. They are narrow and compressed laterally with backwardly directed spines, which adapt them for moving between the hairs and feathers of mammals and birds. They have long, powerful legs adapted for jumping. Both sexes feed on blood, and the female requires a blood meal before she can produce viable eggs. Fleas tend to be host-specific, thus feeding on only one type of host. However, they will infest other species in the absence of the favored host. They are found in relative abundance on animals that live in burrows and sheltered nests, while mammals and birds with no permanent nests or that are exposed to the elements tend to have light infestations.

*MPMH* [2] notes that fleas undergo complete metamorphosis (egg, larva, pupa, and adult). The time it takes to complete the life cycle from egg to adult varies according to the species, temperature, humidity, and food availability. Under favorable conditions, some species can complete a generation in as little as 2 or 3 weeks. Figure 4.15 shows the life cycle of the flea.

### Reported Human Plague Cases by County: U.S., 1970-1997

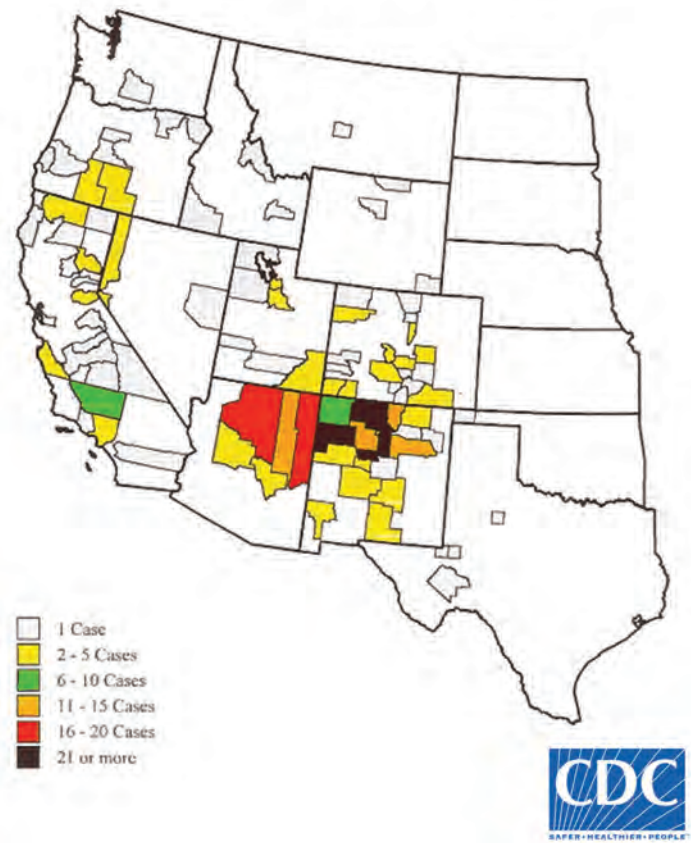

Figure 4.14. Reported Human Plague Cases (1970–1997) [8]

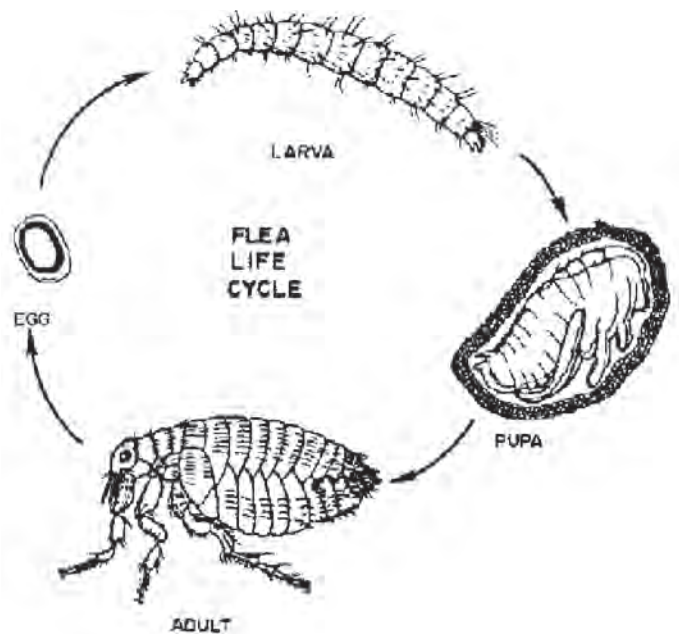

Figure 4.15. Flea Life Cycle [2]

Flea eggs usually are laid singly or in small groups among the feathers or hairs of the host or in a nest. They are often laid in carpets of living quarters if the primary host is a household pet. Eggs are smooth, spherical to oval, light colored, and large enough to be seen with the naked eye. An adult female flea can produce up to 2,000 eggs in a lifetime. Flea larvae are small (2 to 5 mm), white, and wormlike with a darker head and a body that will appear brown if they have fed on flea feces. This stage is mobile and will move away from light, thus they typically will be found in shaded areas or under furniture. In 5 to 12 days, they complete the three larval stages; however, this may take several months depending on environmental conditions. The larvae, after completing development, spin a cocoon of silk encrusted with granules of sand or various types of debris to form the pupal stage. The pupal stage can be dormant for 140 to 170 days. In some areas of the country, fleas can survive through the winter. The pupae, after development, are stimulated to emerge as adults by movement, pressure, or heat. The pupal form of the flea is resistant to insecticides. An initial treatment, while killing egg, larvae, and adult forms, will not kill the pupae. Therefore, a reapplication will often be necessary. The adult forms are usually ready to feed about 24 hours after they emerge from the cocoon and will begin to feed within 10 seconds of landing on a host. Mating usually follows the initial blood meal, and egg production is initiated 24 to 48 hours after consuming a blood meal. The adult flea lives approximately 100 days, depending on environmental conditions.

Following are some guidelines for controlling fleas:

- The most important principle in a total flea control program is simultaneously treating all pets and their environments (indoor and outdoor).
- Before using insecticides, thoroughly clean the environment, removing as many fleas as possible, regardless of the form. This would include indoor vacuuming and carpet steam cleaning. Special attention should be paid to source points where pets spend most of their time.
- Outdoor cleanup should include mowing, yard raking, and removing organic debris from flowerbeds and under bushes.
- Insecticide should be applied to the indoor and outdoor environments and to the pet.
- Reapplication to heavily infested source points in the home and the yard may be needed to eliminate pre-emerged adults.

## Flies

The historical attitude of Western society toward flies has been one of aesthetic disdain. The public health view is to classify flies as biting or nonbiting. Biting flies include sand flies, horseflies, and deerflies. Nonbiting flies include houseflies, bottleflies, and screwworm flies. The latter group is often referred to as synanthropic because of their close association with humans. In general, the presence of flies is a sign of poor sanitation. The primary concern of most homeowners is nonbiting flies.

According to *MPMH* [2], the housefly (*Musca domestica*) (Figure 4.16) is one of the most widely distributed insects, occurring throughout the United States, and is usually the predominant fly species in homes and restaurants. *M. domestica* is also the most prominent human-associated (synanthropic) fly in the southern United States.

Because of its close association with people, its abundance, and its ability to transmit disease, it is considered a greater threat to human welfare than any other species of nonbiting fly. Each housefly



Figure 4.16. Housefly [*Musca domestica*][9]

can easily carry more than 1 million bacteria on its body. Some of the disease-causing agents transmitted by houseflies to humans are *Shigella spp.* (dysentery and diarrhea = shigellosis), *Salmonella spp.* (typhoid fever), *Escherichia coli*, (traveler's diarrhea), and *Vibrio cholera* (cholera). Sometimes these organisms are carried on the fly's tarsi or body hairs, and frequently they are regurgitated onto food when the fly attempts to liquefy it for ingestion.

The fly life cycle is similar across the synanthropic group. *MPMH* [2] notes that the egg and larval stages develop in animal and vegetable refuse. Favorite breeding sites include garbage, animal manure, spilled animal feed, and soil contaminated with organic matter. Favorable environmental conditions will result in the eggs hatching in 24 hours or less. Normally, a female fly will produce 500 to 600 eggs during her lifetime.

The creamy, white larvae (maggots) are about ½-inch long when mature and move within the breeding material to maintain optimum temperature and moisture conditions. This stage lasts an average of 4 to 7 days in warm weather. The larvae move to dry parts of the breeding medium or move out of it onto the soil or sheltered

places under debris to pupate, with this stage usually lasting 4 to 5 days. When the pupal stage is accomplished, the adult fly exits the puparium, dries, hardens, and flies away to feed, with mating occurring soon after emergence. Figure 4.17 demonstrates the typical fly life cycle.

The control of the housefly is hinged on good sanitation (denying food sources and breeding sites to the fly). This includes the proper disposal of food wastes by placing garbage in cans with close-fitting lids. Cans need to be periodically washed and cleaned to remove food debris. The disposal of garbage in properly operated sanitary landfills is paramount to fly control.

The presence of adult flies can be addressed in various ways. Outside methods include limited placement of common mercury vapor lamps that tend to attract flies. Less-attractive sodium vapor lamps should be used near the home. Self-closing doors in the home will deny entrance, as will the use of proper-fitting and well-maintained screening on doors and windows.

Larger flies use homes for shelter from the cold, but do not reproduce inside the home. Caulking entry points and using fly swatters is effective and much safer than the use of most pesticides. Insecticide “bombs” can be used in attics and other rooms that can be isolated from the rest of the house. However, these should be applied to areas away from food, where flies rest.

The blowfly is a fairly large, metallic green, gray, blue, bronze, or black fly. They may spend the winter in homes or other protected sites, but will not reproduce during this time. Blowflies breed most commonly on decayed carcasses (e.g., dead squirrels, rodents, birds) and in droppings of dogs or other pets during the summer; thus, removal of these sources is imperative. Small animals, on occasion, may die inside walls or under the crawl space of a house. A week or two later, blowflies or maggots may appear. The adult blowfly is also attracted to gas leaks.

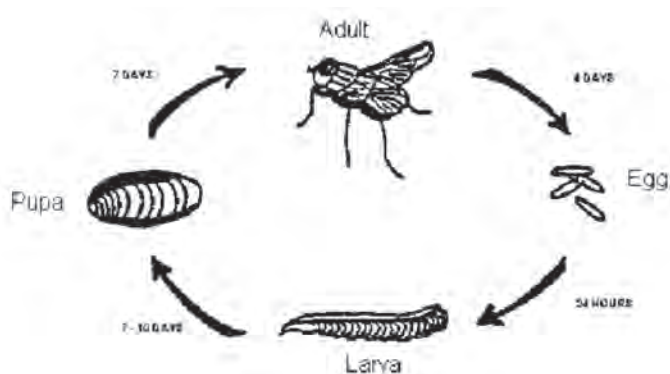

Figure 4.17. Life Cycle of the Fly [10]

## Termites

According to Gold et al. [11], subterranean termites are the most destructive insect pests of wood in the United States, causing more than \$2 billion in damage each year. Annually, this is more property damage than that caused by fire and windstorms combined. In the natural world, these insects are beneficial because they break down dead trees and other wood materials that would otherwise accumulate. This biomass breakdown is recycled to the soil as humus. *MPMH* [2], on the other hand, notes that these insects can damage a building so severely it may have to be replaced. Termites consume wood and other cellulose products, such as paper, cardboard, and fiberboard. They will also destroy structural timbers, pallets, crates, furniture, and other wood products. In addition, they will damage many materials they do not normally eat as they search for food. The tunneling efforts of subterranean termites can penetrate lead- and plastic-covered electric cable and cause electrical system failure. In nature, termites may live for years in tree stumps or lumber beneath concrete buildings before they penetrate hairline cracks in floors and walls, as well as expansion joints, to search for food in areas such as interior door frames and immobile furniture. Termite management costs to homeowners are exceeded only by cockroach control costs.

Lyon [12] notes that termites are frequently mistaken by the homeowner as ants and often are referred to erroneously as white ants. Typical signs of termite infestations occur in March through June and in September and October. Swarming is an event where a group of adult males and female reproductives leave the nest to establish a new colony. If the emergence happens inside a building, flying termites may constitute a considerable nuisance. These pests can be collected with a vacuum cleaner or otherwise disposed of without using pesticides. Each homeowner should be aware of the following signs of termite infestation:

- Pencil-thin mud tubes extending over the inside and outside surfaces of foundation walls, piers, sills, joists, and similar areas (Figures 4.18 and 4.19).
- Presence of winged termites or their shed wings on windowsills and along the edges of floors.
- Damaged wood hollowed out along the grain and lined with bits of mud or soil. According to Oi et al. [15], termite tubes and nests are made of mud and carton. Carton is composed of partially chewed wood, feces, and soil packed together. Tubes maintain the

high humidity required for survival, protect termites from predators, and allow termites to move from one spot to another.

Differentiating the ant from the dark brown or black termite reproductives can be accomplished by noting the respective wings and body shape. *MPMH* [2] states that a termite has four wings of about equal length and that the wings are nearly twice as long as the body. By comparison, ant wings that are only a little longer than the body and the hind pair is much shorter than the front. Additionally, ants typically have a narrow waist, with the abdomen connected to the thorax by a thin petiole. Termites do not have a narrow or pinched waist. Figure 4.20a and b demonstrates the differences between the ant and termite. Entomologists refer to winged ants and termites as alates.

Figure 4.21 shows the life cycle of the termite. In each colony, there are three castes or forms of individuals known as reproductives, workers, and soldiers. According

to Lyon [12], the reproductives can be winged or wingless, with the latter found in colonies to serve as replacements for the primary reproductives. The primary reproductives (alates) vary in color from pale yellow-brown to coal black, are ½-inch to ¾-inch in length, are flattened dorsa-ventrally, and have pale or smoke-gray to brown wings. The secondary reproductives have short wing buds and are white to cream colored. The workers are the same size as the primary reproductives and are white to grayish-white, with a yellow-brown head, and are wingless. In addition, the soldiers resemble workers, in that they are wingless, but soldiers have large, rectangular, yellowish, and brown heads with large jaws.

*MPMH* [2] states there are five families of termites found in the world, with four of them occurring in the United States. The families in the United States are *Hodotermitidae* (rotten-wood termites), *Kalotermitidae* (dry-wood termites), *Rhinotermitidae* (subterranean termites) and *Termitidae* (desert termites). Subterranean

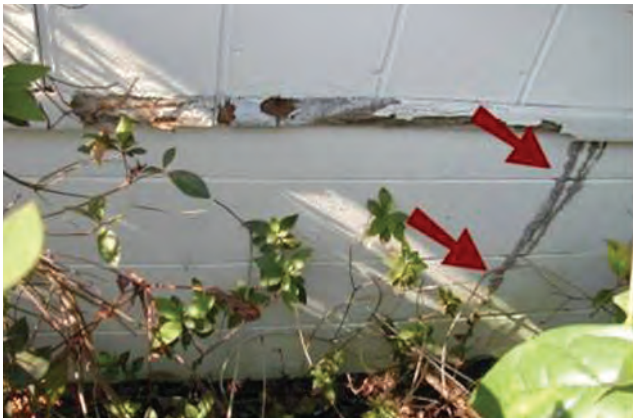

**Figure 4.18.** Termite Tube Extending from Ground to Wall [Red Arrows] [13]



**Figure 4.19.** Termite Mud Shelter Tube Constructed Over a Brick Foundation [14]

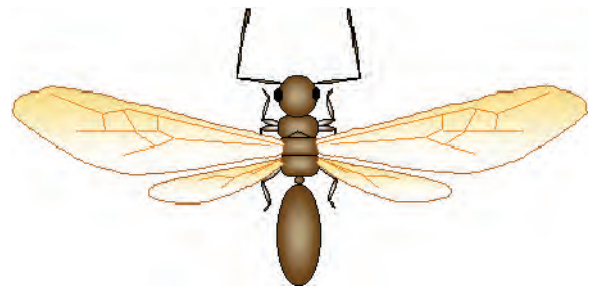

**Figure 4.20a.** Ant (Elbowed Antennae; Fore Wings Larger Than Hind; Constricted Waist) [16]



**Figure 4.20b.** Termite (Beaded Antennae; All Wings Equal) [16]

termites typically work in wood aboveground, but must have direct contact with the ground to obtain moisture. Nonsubterranean termites colonize above the ground and feed on cellulose; however, their life cycles and methods of attack, and consequently methods of control, are quite different. Nonsubterranean termites in the United States are commonly called drywood termites.

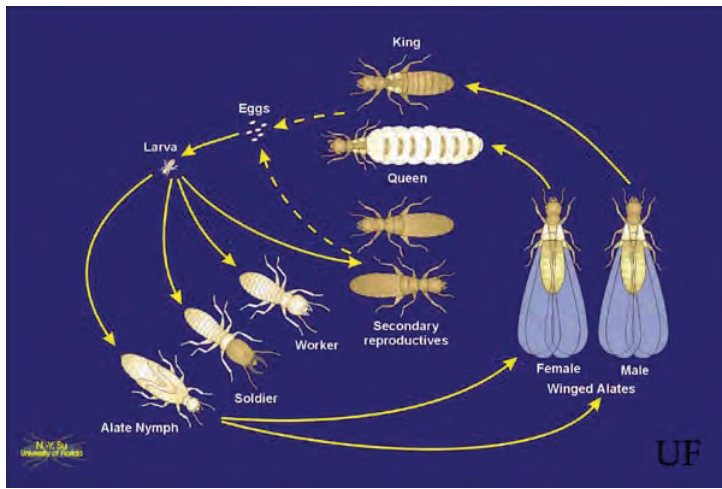

Figure 4.21. Life Cycle of the Subterranean Termite [17]

In the United States, according to *MPMH* [2], native subterranean termites are the most important and the most common. These termites include the genus *Reticulitermes*, occurring primarily in the continental United States, and the genus *Heterotermes*, occurring in the Virgin Islands, Puerto Rico, and the deserts of California and Arizona. The appearance, habits, and type of damage they cause are similar. The Formosan termite (*Coptotermes formosanus*) is the newest species to become established in the United States. It is a native of the Pacific Islands and spread from Hawaii and Asia to the United States during the 1960s. It is now found along the Gulf Coast, in California, and in South Carolina, and is expected to spread to other areas as well. Formosan termites cause greater damage than do native species because of their more vigorous and aggressive behavior and their ability to rapidly reproduce, build tubes and tunnels, and seek out new items to infest. They have also shown more resistance to some soil pesticides than native species. Reproductives (swarmers) are larger than native species, reaching up to 5/8-inch in length, and are yellow to brown in color. Swarmers have hairy-looking wings and swarm after dusk, unlike native species, which swarm in the daytime. Formosan soldiers have more oval-shaped heads than do native species. On top of the head is an opening that emits a sticky, whitish substance.

Dry-wood termites (*Cryptotermes spp.*) live entirely in moderately to extremely dry wood. They require contact with neither the soil nor any other moisture source and may invade isolated pieces of furniture, fence posts, utility poles, firewood, and structures. Dry-wood termite colonies are not as large as other species in the United States, so they can occupy small wooden articles, which are one way these insects spread to different locations. They are of major economic importance in southern California,

Arizona, and along the Gulf Coast. The West Indian dry-wood termite is a problem in Puerto Rico, the U.S. Virgin Islands, Hawaii, parts of Florida and Louisiana, and a number of U.S. Pacific Island territories. Dry-wood termites are slightly larger than most other species, ranging from 1/2 inch to 5/8 inch long, and are generally lighter in color.

Damp-wood termites do not need contact with damp ground like subterranean termites do, but they do require higher moisture content in wood. However, once established, these termites may extend into slightly drier wood.

Termites of minor importance are the tree-nesting groups. The nests of these termites are found in trees, posts, and, occasionally, buildings. Their aboveground nests are connected to soil by tubes. Tree-nesting termites may be a problem in Puerto Rico and the U.S. Virgin Islands.

The risk for encountering subterranean termites in the United States is greater in the southeastern states and in southwestern California. In the United States, the risk for termite infestations tends to decrease as the latitude increases northward.

Figure 4.22 portrays the geographic risk of subterranean termites in the United States. Subterranean termites are found in all states except Alaska and are most abundant in the south and southeastern United States [18].

According to Potter [19], homeowners can reduce the risk for termite attack by adhering to the following suggestions:

- **Eliminate wood contact with the ground.** Earth-to-wood contact provides termites with simultaneous access to food, moisture, and shelter in conjunction with direct, hidden entry into the structure. In addition, the homeowner or occupant should be aware that pressure-treated wood is not immune to termite attack because termites can enter through the cut ends and build tunnels over the surfaces.
- **Do not allow moisture to accumulate near the home's foundation.** Proper drainage, repair of plumbing, and proper grading will help to reduce the presence of moisture, which attracts termites.
- **Reduce humidity in crawl spaces.** Most building codes state that crawl space area should be vented at a rate of 1 square foot per 150 square feet of crawl space area. This rate can be reduced for crawl spaces equipped with a polyethylene or equivalent vapor barrier to one square foot per 300 to 500 square feet of crawl space area. Vent placement design includes positioning one vent within 3 feet of each building



corner. Trimming and controlling shrubs so that they do not obstruct the vents is imperative. Installing a 4- to 6-mil polyethylene sheeting over a minimum of 75% of the crawl space will reduce the crawl-space moisture. Covering the entire floor of the crawl space with such material can reduce two potential home problems at one time: excess moisture and radon (Chapter 5). The barrier will reduce the absorption of moisture from the air and the release of moisture into the air in the crawl space from the underlying soil.

- **Never store firewood, lumber, or other wood debris against the foundation or inside the crawl space.**

Termites are both attracted to and fed by this type of storage. Wood stacked in contact with a dwelling and vines, trellises, and dense plant material provide a pathway for termites to bypass soil barrier treatment.

- **Use decorative wood chips and mulch sparingly.**

Cellulose-containing products attract termites, especially materials that have moisture-holding properties, such as mulch. The homeowner should never allow these products to contact wood components of the home. The use of crushed stone or pea gravel is recommended as being less attractive to termites and helpful in diminishing other pest problems.

- **Have the structure treated by a professional pest control treatment.** The final, and most effective, strategy to prevent infestation is to treat the soil around and beneath the building with termiticide. The treated ground is then both a repellent and toxic to termites.

Figure 4.23 demonstrates some typical points of attack by subterranean termites and some faulty construction practices that can contribute to subterranean termite infestations.

Lyon [12] notes the following alternative termite control measures:

- **Nematodes.** Certain species of parasitic round worms (nematodes) will infest and kill termites and other soil insects. Varying success has been experienced with this method because it is dependent on several variables, such as soil moisture and soil type.
- **Sand as a physical barrier.** This would require preconstruction planning and would depend on termites being unable to manipulate the sand to create tunnels. Some research in California and Hawaii has indicated early success.

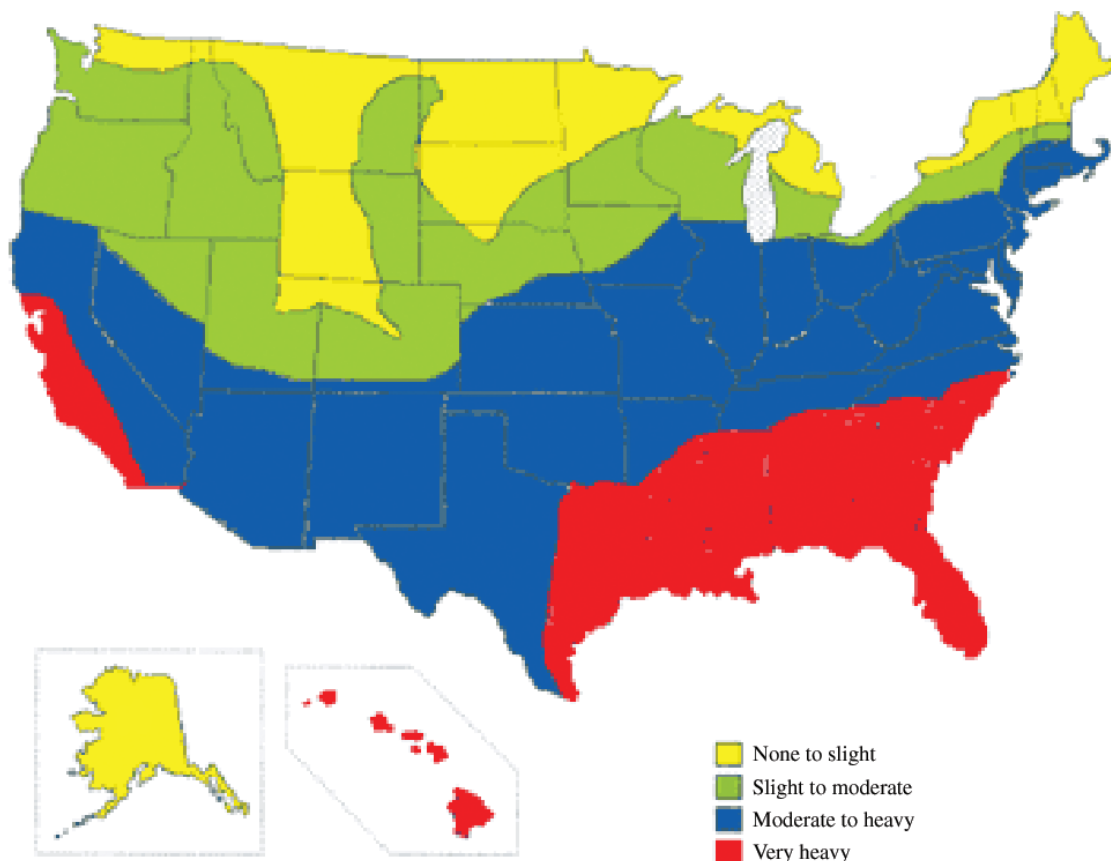

Figure 4.22. Subterranean Termite Risk in the United States [18]

- **Chemical baits.** This method uses wood or laminated texture-flavored cellulose impregnated with a toxicant and/or insect growth regulator. The worker termite feeds on the substance and carries it back to the nest, reducing or eliminating the entire colony. According to HomeReports.com [20], an additional system is to strategically place a series of baits around the house. The intention is for termite colonies to encounter one or more of the baits before approaching the house. Once termite activity is observed, the bait wood is replaced with a poison. The termites bring the poison back to the colony and the colony is either eliminated or substantially reduced. This system is relatively new to the market. Its success depends heavily on the termites finding the bait before finding and damaging the house.

Additional measures include construction techniques that discourage termite attacks, as demonstrated in Figure 4.24. Termites often invade homes by way of the foundation, either by crawling up the exterior surface where their activity is usually obvious or by traveling inside hollow block masonry. One way to deter their activity is to block their access points on or through the foundation. Metal termite shields have been used for decades to deter termite movement along foundation walls and piers on up to the wooden structure. Metal termite shields should extend 2 inches from the foundation and 2 inches down.

Improperly installed (i.e., not soldered/sealed properly), damaged, or deteriorated termite shields may allow termites to reach parts of the wooden floor system. Shields should be made of noncorroding metal and have no cracks or gaps along the seams. If a house is being built with metal termite shielding, the shielding should extend at least 2 inches out and 2 inches down at a 45° angle from the foundation wall. An alternative to using termite shields on a hollow-block foundation is to fill the block with concrete or put in a few courses of solid or concrete-filled brick (which is often done anyway to level foundations). These are referred to as masonry caps. The same approach can be used with support piers in the crawl space. Solid caps (i.e., a continuously poured concrete cap) are best at stopping termites, but are not commonly used. Concrete-filled brick caps should deter termite movement or force them through small gaps, thus allowing them to be spotted during an inspection [21].

### Fire Ants

According to *MPMH* [2], ants are one of the most numerous species on earth. Ants are in the same order as wasps and bees and, because of their geographic distribution, they are universally recognized (Figure 4.25).

The life cycle of the fire ant begins with the mating of the winged forms (alates) some 300 to 800 feet in the air, typically occurring in the late spring or early summer.

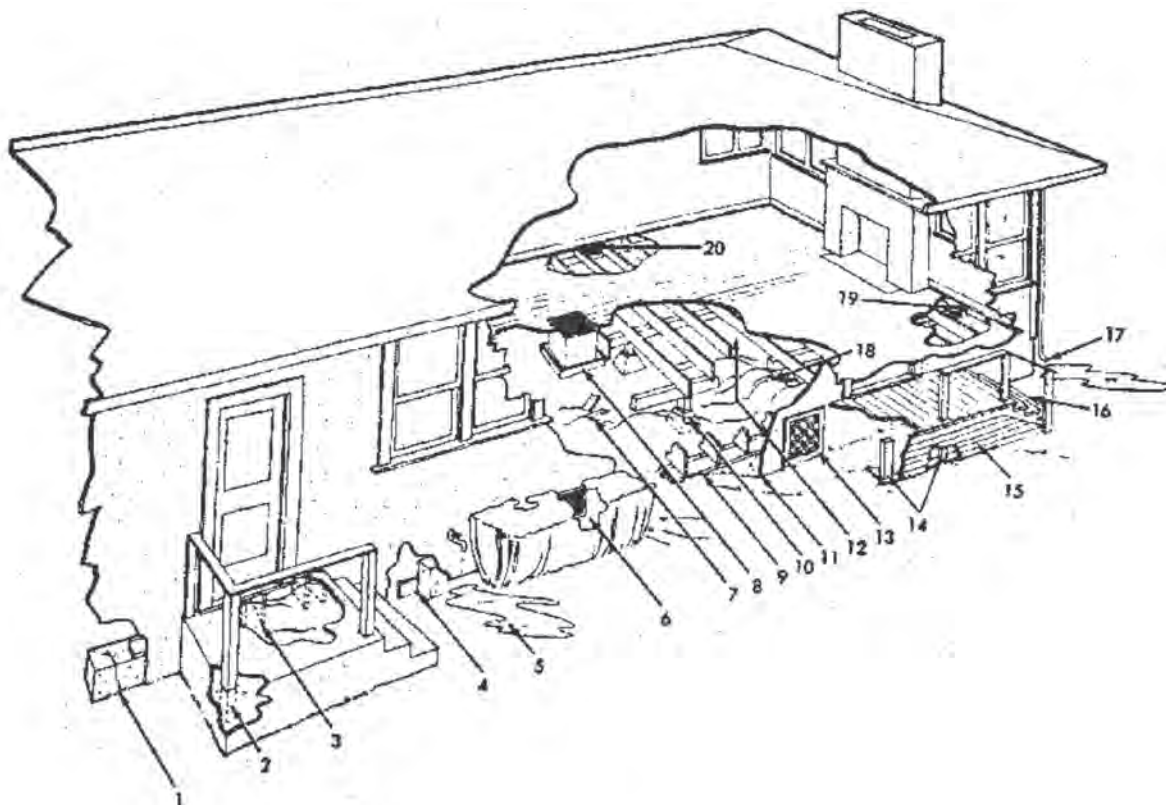

**Figure 4.23.** Typical Points of Attack by Termites in the Home [2]

The male dies after the mating; and the newly mated queen finds a suitable moist site, drops her wings, and burrows in the soil, sealing the opening behind her. Ants undergo complete metamorphosis and, therefore, have egg, larval, pupal and adult stages. The new queen will begin laying eggs within 24 hours. Once fully developed, she will produce approximately 1,600 eggs per day over a maximum life span of 7 years. Soft, whitish, legless larvae are produced from the hatching. These larvae are fed by the worker ants. Pupae resemble adults in form, but are soft, nonpigmented, and lack mobility. There are at least three distinct castes of ants: workers, queens, and males. Typically, the males have wings, which they retain until death. Queens, the largest of the three castes, normally have wings, but lose them after mating. The worker, which is also a female, is never winged, except as a rare abnormality. Within this hierarchy, mature colonies contain males and females that are capable of flight and reproduction. These are known as reproductives, and an average colony may produce approximately 4,500 of these per year. A healthy nest usually produces two nuptial flights of reproductives each year and a healthy, mature colony may contain more than 250,000 ants. Though uncommon among ants, multiple queen colonies (10 to

100) occur somewhat frequently in fire ants, resulting in more numerous mounds per acre.

There are many species of fire ants in the United States. The most important are four species in the genus *Solenopsis*. Of these, the number one fire ant pest is the red imported fire ant (RIFA) *Solenopsis invicta* (Figure 4.25). This ant was imported inadvertently from South America in the 1930s through the port of Mobile, Alabama. RIFAs are now found in more than 275 million acres in 11 southern states and Puerto Rico. The second most important species is the black imported fire ant, *S. richteri*, which was introduced into the United States in the 1920s from Argentina or Uruguay. It is currently limited in distribution to a small area of northern Mississippi and Alabama. There are two native species of fire ants: the tropical or native fire ant, *S. geminata*, ranging from South Carolina to Florida and west to Texas; and the Southern fire ant, *S. xyloni*, which occurs from North Carolina south to northern Florida, along the Gulf Coast, and west to California. The most important extension of the RIFA range is thought to have occurred during the 1950s housing boom as a result of the transportation of sod and nursery plants (Figure 4.26).

## Key to Figure 4.23

1. Cracks in foundation permit hidden points of entry from soil to sill.
2. Posts through concrete in contact with substructural soil. Watch door frames and intermediate supporting posts.
3. Wood-framing members in contact with earthfill under concrete slab.
4. Form boards left in place contribute to termite food supply.
5. Leaking pipes and dripping faucets sustain soil moisture. Excess irrigation has same effect.
6. Shrubbery blocking air flow through vents.
7. Debris supports termite colony until large population attacks superstructure.
8. Heating unit accelerates termite development by maintaining warmth of colony on a year-round basis.
9. Foundation wall too low permits wood to contact soil. Adding topsoil often builds exterior grade up to sill level.
10. Footing too low or soil thrown against it causes wood-soil contact. There should be 8 inches of clean concrete between soil and pier block.
11. Stucco carried down over concrete foundation permits hidden entrance between stucco and foundation if bond fails.
12. Insufficient clearance for inspection also permits easy construction of termite shelter tubes from soil to wood.
13. Wood framing of crawl hole forming wood-soil contact.
14. Mud sill and/or posts in contact with soil.
15. Wood siding and skirting form soil contact. There should be a minimum of 3 inches clearance between skirting and soil.
16. Porch steps in contact with soil. Also watch for ladders and other wooden materials.
17. Downspouts should carry water away from the building.
18. Improper maintenance of soil piled against pier footing. Also makes careful inspection impossible.
19. Wall girder entering recess and foundation wall. Should have a 1-inch free air space on both sides and end and be protected with a moisture-impervious seal.
20. Vents placed between joists tunnel air through space without providing good substructural aeration. Vents placed in foundation wall give better air circulation.

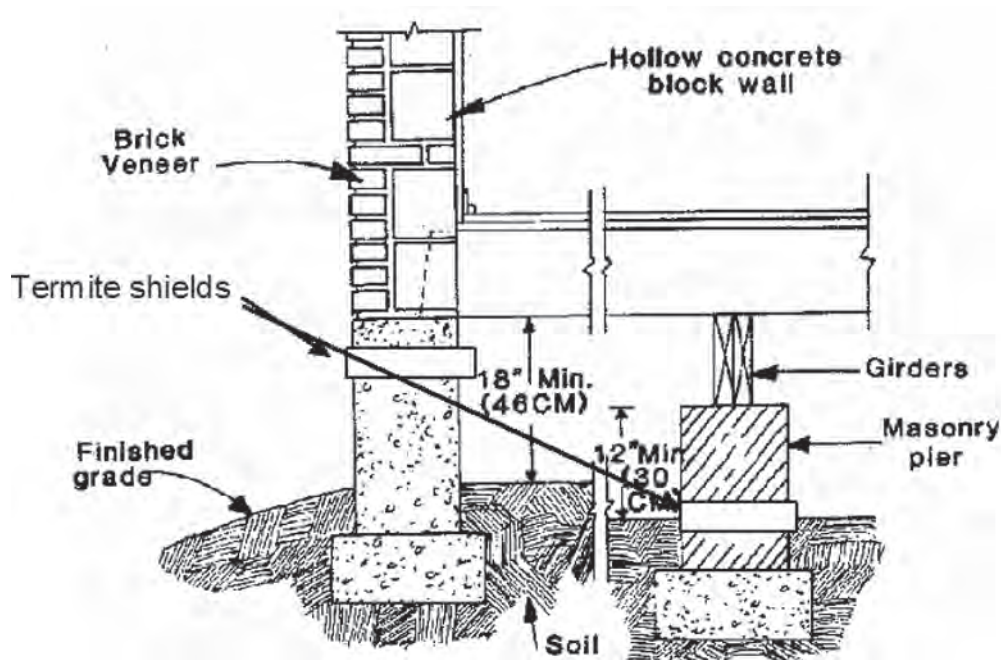

**Figure 4.24.** Construction Techniques That Discourage Termite Attacks: Thin Metal Termite Shield Should Extend 2 Inches Beyond Foundation and 2 Inches Down [2]



**Figure 4.25.** Fire Ants [22]

RIFAs prefer open and sun-exposed areas. They are found in cultivated fields, cemeteries, parks, and yards, and even inside cars, trucks, and recreational vehicles. RIFAs are attracted to electrical currents and are known to nest in and around heat pumps, junction boxes, and similar areas. They are omnivorous; thus they will attack most things, living or dead. Their economic effects are felt by their destruction of the seeds, fruit, shoots, and seedlings of numerous native plant species. Fire ants are known to tend pests, such as scale insects, mealy bugs, and aphids, for feeding on their sweet waste excretion (honeydew).

RIFAs transport these insects to new feeding sites and protect them from predators. The positive side of RIFA infestation is that the fire ant is a predator of ticks and controls the ground stage of horn flies.

The urban dweller with a RIFA infestation may find significant damage to landscape plants, with reductions in the number of wild birds and mammals. RIFAs can discourage outdoor activities and be a threat to young animals or small confined pets. RIFA nests typically are not found indoors, but around homes, roadways, and structures, as well as under sidewalks. Shifting of soil after RIFAs abandon sites has resulted in collapsing structures. Figure 4.27 shows a fire ant mound with fire ants and a measure of their relative size.

The medical complications of fire ant stings have been noted in the literature since 1957. People with disabilities, reduced feeling in their feet and legs, young children, and those with mobility issues are at risk for sustaining numerous stings before escaping or receiving assistance. Fatalities have resulted from attacks on the elderly and on infants. Control of the fire ant is primarily focused on the mound by using attractant bait consisting of soybean oil, corn grits, or chemical agents. The bait is picked up by the worker ants and taken deep into the mound to the queen. These products typically require weeks to work.

Individual mound treatment is usually most effective in the spring. The key is to locate and treat all mounds in

## Range Expansion of RIFA in the U.S. From 1918-1998

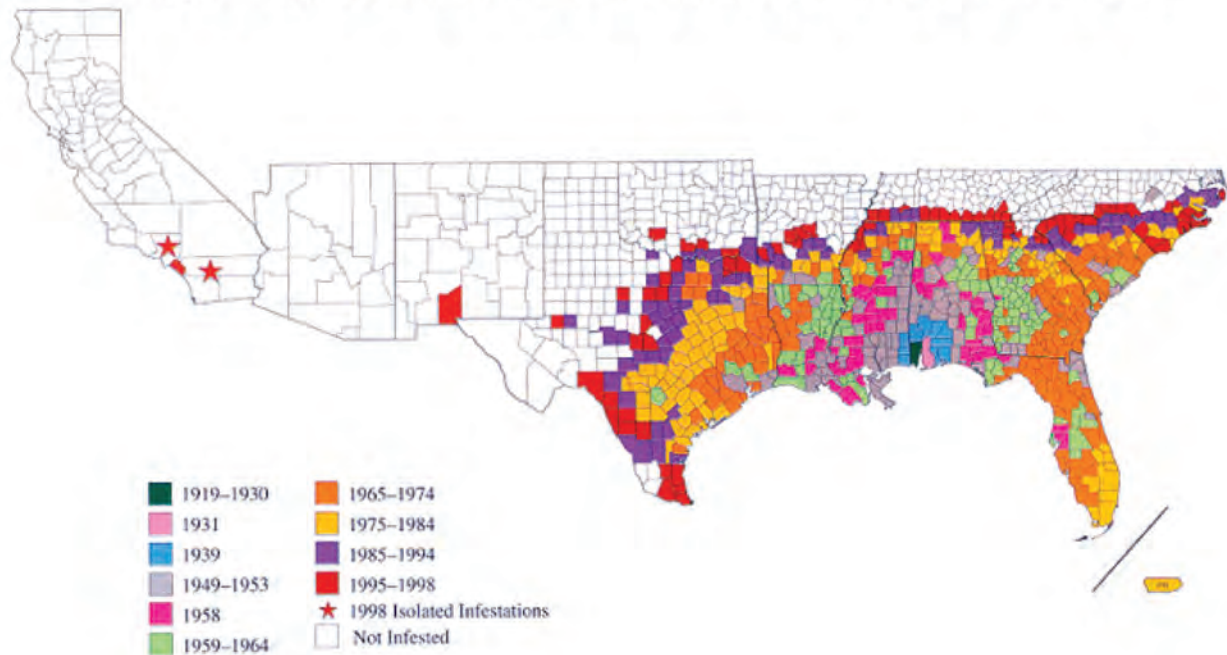

**Figure 4.26.** Range Expansion of Red Imported Fire Ants [RIFAs] in the United States, 1918–1998 [23]

the area to be protected. If young mounds are missed, the area can become reinfested in less than a year.

### Mosquitoes

All mosquitoes have four stages of development—egg, larva, pupa, and adult—and spend their larval and pupal stages in water. The females of some mosquito species deposit eggs on moist surfaces, such as mud or fallen leaves, that may be near water but dry. Later, rain or high tides relood these surfaces and stimulate the eggs to hatch into larvae. The females of other species deposit their eggs directly on the surface of still water in such places as ditches, street catch basins, tire tracks, streams that are drying up, and fields or excavations that hold water for some time. This water is often stagnant and close to the home in discarded tires, ornamental pools, unused wading and swimming pools, tin cans, bird baths, plant saucers, and even gutters and flat roofs. The eggs soon hatch into larvae. In the hot summer months, larvae grow rapidly, become pupae, and emerge 1 week later as flying adult mosquitoes. A few important spring species have only one generation per year. However, most species have many generations per year, and their rapid increase in numbers becomes a problem.

When adult mosquitoes emerge from the aquatic stages, they mate, and the female seeks a blood meal to obtain

the protein necessary for the development of her eggs. The females of a few species may produce a first batch of eggs without this first blood meal. After a blood meal is digested and the eggs are laid, the female mosquito again seeks a blood meal to produce a second batch of eggs. Depending on her stamina and the weather, she may repeat this process many times without mating again. The male mosquito does not take a blood meal, but may feed on plant nectar. He lives for only a short time after mating. Most mosquito species survive the winter, or overwinter, in the egg stage, awaiting the spring thaw, when



**Figure 4.27.** Fire Ant Mound

Source: CAPT Craig Shepherd, U.S. PHS; used with permission.

waters warm and the eggs hatch. A few important species spend the winter as adult, mated females, resting in protected, cool locations, such as cellars, sewers, crawl spaces, and well pits. With warm spring days, these females seek a blood meal and begin the cycle again. Only a few species can overwinter as larvae.

Mosquitoborne diseases, such as malaria and yellow fever, have plagued civilization for thousands of years. Newer threats include Lyme disease and West Nile virus. Organized mosquito control in the United States has greatly reduced the incidence of these diseases. However, mosquitoes can still transmit a few diseases, including eastern equine encephalitis and St. Louis encephalitis. The frequency and extent of these diseases depend on a complex series of factors.

Mosquito control agencies and health departments cooperate in being aware of these factors and reducing the chance for disease. It is important to recognize that young adult female mosquitoes taking their first blood meal do not transmit diseases. It is instead the older females, who, if they have picked up a disease organism in their first blood meals, can then transmit the disease during the second blood meal.

The proper method to manage the mosquito problem in a community is through an organized integrated pest management system that includes all approaches that safely manage the problem. The spraying of toxic agents is but one of many approaches.

When mosquitoes are numerous and interfere with living, recreation, and work, you can use the various measures described in the following paragraphs to reduce their annoyance, depending on location and conditions.

#### *How to Reduce the Mosquito Population*

The most efficient method of controlling mosquitoes is by reducing the availability of water suitable for larval and pupal growth. Large lakes, ponds, and streams that have waves, contain mosquito-eating fish, and lack aquatic vegetation around their edges do not contain mosquitoes; mosquitoes thrive in smaller bodies of water in protected places. Examine your home and neighborhood and take the following precautions recommended by the New Jersey Agricultural Experiment Station [24]:

- dispose of unwanted tin cans and tires;
- clean clogged roof gutters and drain flat roofs;
- turn over unused wading pools and other containers that tend to collect rainwater;
- change water in birdbaths, fountains, and troughs twice a week;

- clean and chlorinate swimming pools;
- cover containers tightly with window screen or plastic when storing rainwater for garden use during drought periods;
- flush sump-pump pits weekly; and
- stock ornamental pools with fish.

If mosquito breeding is extensive in areas such as woodland pools or roadside ditches, the problem may be too great for individual residents. In such cases, call the organized mosquito control agency in your area. These agencies have highly trained personnel who can deal with the problem effectively.

Several commercially available insecticides can be effective in controlling larval and adult mosquitoes. These chemicals are considered sufficiently safe for use by the public. Select a product whose label states that the material is effective against mosquito larvae or adults. For safe and effective use, read the label and follow the instructions for applying the material. The label lists those insects that the EPA agrees are effectively controlled by the product.

For use against adult mosquitoes, some liquid insecticides can be mixed according to direction and sprayed lightly on building foundations, hedges, low shrubbery, ground covers, and grasses. Do not overapply liquid insecticides—excess spray drips from the sprayed surfaces to the ground, where it is ineffective. The purpose of such sprays is to leave a fine deposit of insecticide on surfaces where mosquitoes rest. Such sprays are not effective for more than 1 or 2 days.

Some insecticides are available as premixed products or aerosol cans. These devices spray the insecticide as very small aerosol droplets that remain floating in the air and hit the flying mosquitoes. Apply the sprays upwind, so the droplets drift through the area where mosquito control is desired. Rather than applying too much of these aerosols initially, it is more practical to apply them briefly but periodically, thereby eliminating those mosquitoes that recently flew into the area.

Various commercially available repellents can be purchased as a cream or lotion or in pressurized cans, then applied to the skin and clothing. Some manufacturers also offer clothing impregnated with repellents; coarse, repellent-bearing particles to be scattered on the ground; and candles whose wicks can be lit to release a repellent chemical. The effectiveness of all repellents varies from location to location, from person to person, and from mosquito to mosquito. Repellents can be especially effective in recreation areas, where mosquito control may not be con-

ducted. All repellents should be used according to the manufacturers' instructions. Mosquitoes are attracted by perspiration, warmth, body odor, carbon dioxide, and light. Mosquito control agencies use some of these attractants to help determine the relative number of adult mosquitoes in an area. Several devices are sold that are supposed to attract, trap, and destroy mosquitoes and other flying insects. However, if these devices are attractive to mosquitoes, they probably attract more mosquitoes into the area and may, therefore, increase rather than decrease mosquito annoyance.

## References

1. Barnett DB. Vectors and their control. In: Morgan MT, editor. Environmental health. 3rd ed. Englewood, CO: Wadsworth Publishing Co.; 2002. p. 137–50.
2. Armed Forces Pest Management Board. Military pest management handbook. Washington, DC: Armed Forces Pest Management Board; no date. Available from URL: <http://www.afpmb.org/MPMH/toc.htm>.
3. Indiana Department of Natural Resources. Rodent pictures. Lafayette, IN: Indiana Department of Natural Resources; no date. Available from URL: [http://www.entm.purdue.edu/wildlife/rat\\_pictures.htm](http://www.entm.purdue.edu/wildlife/rat_pictures.htm).
4. Arrow Services, Inc. Rats: roof rats. Plymouth, IN: Arrow Services, Inc.; no date. Available from URL: <http://www.arrowpestcontrol.com/pages/rod/roofpic.html>.
5. Cobb County Extension Service. Fact sheet on rodents: rats and mice. Marietta, GA: Cobb County Extension Service; 2003. Available from URL: <http://www.griffin.peachnet.edu/ga/cobb/Horticulture/Factsheets/peskycritters/ratsmice.htm>.
6. Kamble ST, Keith DL. Cockroaches and their control. Lincoln, NE: University of Nebraska Cooperative Extension; 1995.
7. University of Nebraska-Lincoln. Cockroach picture gallery. Lincoln, NE: University of Nebraska-Lincoln; no date. Available from URL: <http://pested.unl.edu/roachind.htm>.
8. Centers for Disease Control and Prevention. Reported human plague cases by county: United States, 1970–1997. Atlanta: US Department of Health and Human Services; no date. Available from URL: <http://www.cdc.gov/ncidod/dvbid/plague/plagwest.htm>.
9. Leslie M, editor. Netwatch: flies in the Web. Science 2004;306:1269. Available from URL: <http://www.sel.barc.usda.gov/diptera/names/images/science1104.pdf>.
10. Oderkirk A. Fly control in poultry barns: poultry fact sheet. Truro, Nova Scotia, Canada: Nova Scotia Department of Agriculture and Marketing; 2001.
11. Gold RE, Howell HN Jr, Glenn GJ. Subterranean termites. College Station, TX: Texas Agricultural Extension Service; 1999. Available from URL: <http://insects.tamu.edu/extension/bulletins/b6080.html>.
12. Lyon WF. Termite control: HYG-2092-03. Columbus, OH: The Ohio State University Extension; 2003. Available from URL: <http://ohioline.osu.edu/hyg-fact/2000/2092.html>.
13. Austin AR. Sample photos of structural foundation defects and deficiencies. Houston: Diligent Home Inspections; no date.
14. Fumapest Group. Western subterranean termites. Revesby, New South Wales, Australia: Fumapest Group Pty.; no date. Available from URL: <http://www.termite.com/termites/western-subterranean-termite.html>.
15. Oi FM, Castner JL, Koehler PG. The Eastern subterranean termite. Gainesville, FL: University of Florida Cooperative Extension Service; 1997. Available from URL: [http://edis.ifas.ufl.edu/BODY\\_IN031](http://edis.ifas.ufl.edu/BODY_IN031).
16. Ferster B, Deyrup M, Scheffrahn RH. How to tell the difference between ant and termite alates. Fort Lauderdale, FL: University of Florida; no date. Available from URL: <http://flrec.ifas.ufl.edu/entomo/ants/Ant%20vs%20Termite.htm>.
17. Su N-Y. Life cycle of the Formosan subterranean termite, *Coptotermes formosanus* Shiraki. Gainesville, FL: University of Florida; no date. Available from URL: <http://creatures.ifas.ufl.edu/urban/termites/fst10.htm>.
18. Suiter DR, Jones SC, Forschler BT. Biology of subterranean termites in the Eastern United States. Bulletin 1209. Columbus, OH: The Ohio State University Extension; no date. Available from URL: <http://ohioline.osu.edu/b1209/>.
19. Potter MF. Protecting your home against termites. Lexington, KY: University of Kentucky Department of Entomology; 2004. Available from URL: <http://www.uky.edu/Agriculture/Entomology/entfacts/struct/ef605.htm>.
20. HomeReports.com. Pest and termite control companies. Atlanta: HomeReports.com; no date. Available from URL: <http://www.homereports.com/ge/PestControl.htm>.
21. North Carolina Cooperative Extension Service. Termite prevention: approaches for new construction. Raleigh,

NC: North Carolina Cooperative Extension Service; no date. Available from URL: <http://www.ces.ncsu.edu/depts/ent/notes/Urban/termites/pre-con.htm>.

22. Core J. Update: hot on the trail of fire ants. *Agric Res* 2003; 51:20-23. Available from URL: <http://ars.usda.gov/is/AR/archive/Feb03/ants0203.htm>.
23. California Department of Food and Agriculture. First reported occurrence of red imported fire ant; *Solenopsis invicta*. Sacramento, CA: California Department of Food and Agriculture; no date. Available from URL: [www.cdfa.ca.gov/phpps/pdep/rifa/html/english/facts/rifaTIME.htm](http://www.cdfa.ca.gov/phpps/pdep/rifa/html/english/facts/rifaTIME.htm).
24. Sutherland DJ, Crans WJ. Mosquitoes in your life. New Jersey Agricultural Experiment Station Publication SA220-5M-86. New Brunswick, NJ: New Jersey Agricultural Experiment Station, Cook College, Rutgers, The State University of New Jersey; no date. Available at URL: <http://www.rci.rutgers.edu/~insects/moslife.htm>.



# Chapter 5: Indoor Air Pollutants and Toxic Materials

*“Walking into a modern building can sometimes be compared to placing your head inside a plastic bag that is filled with toxic fumes.”*

John Bower

Founder, *Healthy House Institute*

## Introduction

We all face a variety of risks to our health as we go about our day-to-day lives. Driving in cars, flying in airplanes, engaging in recreational activities, and being exposed to environmental pollutants all pose varying degrees of risk. Some risks are simply unavoidable. Some we choose to accept because to do otherwise would restrict our ability to lead our lives the way we want. Some are risks we might decide to avoid if we had the opportunity to make informed choices. Indoor air pollution and exposure to hazardous substances in the home are risks we can do something about.

In the last several years, a growing body of scientific evidence has indicated that the air within homes and other buildings can be more seriously polluted than the outdoor air in even the largest and most industrialized cities. Other research indicates that people spend approximately 90% of their time indoors. Thus, for many people, the risks to health from exposure to indoor air pollution may be greater than risks from outdoor pollution.

In addition, people exposed to indoor air pollutants for the longest periods are often those most susceptible to their effects. Such groups include the young, the elderly, and the chronically ill, especially those suffering from respiratory or cardiovascular disease [1].

## Indoor Air Pollution

Numerous forms of indoor air pollution are possible in the modern home. Air pollutant levels in the home increase if not enough outdoor air is brought in to dilute emissions from indoor sources and to carry indoor air pollutants out of the home. In addition, high temperature and humidity levels can increase the concentration of some pollutants. Indoor pollutants can be placed into two groups, biologic and chemical.

### Biologic Pollutants

Biologic pollutants include bacteria, molds, viruses, animal dander, cat saliva, dust mites, cockroaches, and pollen. These biologic pollutants can be related to some

serious health effects. Some biologic pollutants, such as measles, chickenpox, and influenza are transmitted through the air. However, the first two are now preventable with vaccines. Influenza virus transmission, although vaccines have been developed, still remains of concern in crowded indoor conditions and can be affected by ventilation levels in the home.

Common pollutants, such as pollen, originate from plants and can elicit symptoms such as sneezing, watery eyes, coughing, shortness of breath, dizziness, lethargy, fever, and digestive problems. Allergic reactions are the result of repeated exposure and immunologic sensitization to particular biologic allergens.

Although pollen allergies can be bothersome, asthmatic responses to pollutants can be life threatening. Asthma is a chronic disease of the airways that causes recurrent and distressing episodes of wheezing, breathlessness, chest tightness, and coughing [2]. Asthma can be broken down into two groups based on the causes of an attack: extrinsic (allergic) and intrinsic (nonallergic). Most people with asthma do not fall neatly into either type, but somewhere in between, displaying characteristics of both classifications. Extrinsic asthma has a known cause, such as allergies to dust mites, various pollens, grass or weeds, or pet danders. Individuals with extrinsic asthma produce an excess amount of antibodies when exposed to triggers. Intrinsic asthma has a known cause, but the connection between the cause and the symptoms is not clearly understood. There is no antibody hypersensitivity in intrinsic asthma. Intrinsic asthma usually starts in adulthood without a strong family history of asthma. Some of the known triggers of intrinsic asthma are infections, such as cold and flu viruses, exercise and cold air, industrial and occupational pollutants, food additives and preservatives, drugs such as aspirin, and emotional stress. Asthma is more common in children than in adults, with nearly 1 of every 13 school-age children having asthma [3]. Low-income African-Americans and certain Hispanic populations suffer disproportionately, with urban inner cities having particularly severe problems. The impact on neighborhoods, school systems, and health care facilities from asthma is severe because one-third of all pediatric emergency room visits are due to asthma, and it is the fourth most prominent cause of physician office visits. Additionally, it is the leading cause of school absenteeism—14 million school days lost each year—from chronic illness [4]. The U.S. population, on the average,

spends as much as 90% of its time indoors. Consequently, allergens and irritants from the indoor environment may play a significant role in triggering asthma episodes. A number of indoor environmental asthma triggers are biologic pollutants. These can include rodents (discussed in Chapter 4), cockroaches, mites, and mold.

### *Cockroaches*

The droppings, body parts, and saliva of cockroaches can be asthma triggers. Cockroaches are commonly found in crowded cities and in the southern United States. Allergens contained in the feces and saliva of cockroaches can cause allergic reactions or trigger asthma symptoms. A national study by Crain et al. [5] of 994 inner-city allergic children from seven U.S. cities revealed that cockroaches were reported in 58% of the homes. The Community Environmental Health Resource Center reports that cockroach debris, such as body parts and old shells, trigger asthma attacks in individuals who are sensitized to cockroach allergen [6]. Special attention to cleaning must be a priority after eliminating the presence of cockroaches to get rid of the presence of any allergens left that can be asthma triggers.

### *House Dust Mites*

Another group of arthropods linked to asthma is house dust mites. In 1921, a link was suggested between asthmatic symptoms and house dust, but it was not until 1964 that investigators suggested that a mite could be responsible. Further investigation linked a number of mite species to the allergen response and revealed that humid homes have more mites and, subsequently, more allergens. In addition, researchers established that fecal pellets deposited by the mites accumulated in home fabrics and could become airborne via domestic activities such as vacuuming and dusting, resulting in inhalation by the inhabitants of the home. House dust mites are distributed worldwide, with a minimum of 13 species identified from house dust. The two most common in the United States are the North American house dust mite (*Dermatophagoides farinae*) and the European house dust mite (*D. pteronyssinus*). According to Lyon [7], house dust mites thrive in homes that provide a source of food and shelter and adequate humidity. Mites prefer relative humidity levels of 70% to 80% and temperatures of 75°F to 80°F (24°C to 27°C). Most mites are found in bedrooms in bedding, where they spend up to a third of their lives. A typical used mattress may have from 100,000 to 10 million mites in it. In addition, carpeted floors, especially long, loose pile carpet, provide a microhabitat for the accumulation of food and moisture

for the mite, and also provide protection from removal by vacuuming. The house dust mite's favorite food is human dander (skin flakes), which are shed at a rate of approximately 0.20 ounces per week.

A good microscope and a trained observer are imperative in detecting mites. House dust mites also can be detected using diagnostic tests that measure the presence and infestation level of mites by combining dust samples collected from various places inside the home with indicator reagents [7]. Assuming the presence of mites, the precautions listed below should be taken if people with asthma are present in the home:

- Use synthetic rather than feather and down pillows.
- Use an approved allergen barrier cover to enclose the top and sides of mattresses and pillows and the base of the bed.
- Use a damp cloth to dust the plastic mattress cover daily.
- Change bedding and vacuum the bed base and mattress weekly.
- Use nylon or cotton cellulose blankets rather than wool blankets.
- Use hot (120°F–130°F [49°C–54°C]) water to wash all bedding, as well as room curtains.
- Eliminate or reduce fabric wall hangings, curtains, and drapes.
- Use wood, tile, linoleum, or vinyl floor covering rather than carpet. If carpet is present, vacuum regularly with a high-efficiency particulate air (HEPA) vacuum or a household vacuum with a microfiltration bag.
- Purchase stuffed toys that are machine washable.
- Use fitted sheets to help reduce the accumulation of human skin on the mattress surface.

HEPA vacuums are now widely available and have also been shown to be effective [8]. A conventional vacuum tends to be inefficient as a control measure and results in a significant increase in airborne dust concentrations, but can be used with multilayer microfiltration collection bags. Another approach to mite control is reducing indoor humidity to below 50% and installing central air conditioning.

Two products are available to treat house dust mites and their allergens. These products contain the active ingredients benzyl benzoate and tannic acid.

## Pets

According to the U.S. Environmental Protection Agency (EPA) [9], pets can be significant asthma triggers because of dead skin flakes, urine, feces, saliva, and hair. Proteins in the dander, urine, or saliva of warm-blooded animals can sensitize individuals and lead to allergic reactions or trigger asthmatic episodes. Warm-blooded animals include dogs, cats, birds, and rodents (hamsters, guinea pigs, gerbils, rats, and mice). Numerous strategies, such as the following, can diminish or eliminate animal allergens in the home:

- Eliminate animals from the home.
- Thoroughly clean the home (including floors and walls) after animal removal.
- If pets must remain in the home, reduce pet exposure in sleeping areas. Keep pets away from upholstered furniture, carpeted areas, and stuffed toys, and keep the pets outdoors as much as possible.

However, there is some evidence that pets introduced early into the home may prevent asthma. Several studies have shown that exposure to dogs and cats in the first year of life decreases a child's chances of developing allergies [10] and that exposure to cats significantly decreases sensitivity to cats in adulthood [11]. Many other studies have shown a decrease in allergies and asthma among children who grew up on a farm and were around many animals [12].

## Mold

People are routinely exposed to more than 200 species of fungi indoors and outdoors [13]. These include moldlike fungi, as well as other fungi such as yeasts and mushrooms. The terms “mold” and “mildew” are nontechnical names commonly used to refer to any fungus that is growing in the indoor environment. Mold colonies may appear cottony, velvety, granular, or leathery, and may be white, gray, black, brown, yellow, greenish, or other colors. Many reproduce via the production and dispersion of spores. They usually feed on dead organic matter and, provided with sufficient moisture, can live off of many materials found in homes, such as wood, cellulose in the paper backing on drywall, insulation, wallpaper, glues used to bond carpet to its backing, and everyday dust and dirt.

Certain molds can cause a variety of adverse human health effects, including allergic reactions and immune responses (e.g., asthma), infectious disease (e.g., histoplasmosis), and toxic effects (e.g., aflatoxin-induced liver cancer from exposure to this mold-produced toxin in food) [14]. A recent Institute of Medicine (IOM) review of the scientific literature found sufficient evidence for an associ-

ation between exposure to mold or other agents in damp indoor environments and the following conditions: upper respiratory tract symptoms, cough, wheeze, hypersensitivity pneumonitis in susceptible persons, and asthma symptoms in sensitized persons [15]. A previous scientific review was more specific in concluding that sufficient evidence exists to support associations between fungal allergen exposure and asthma exacerbation and upper respiratory disease [13]. Finally, mold toxins can cause direct lung damage leading to pulmonary diseases other than asthma [13].

The topic of residential mold has received increasing public and media attention over the past decade. Many news stories have focused on problems associated with “toxic mold” or “black mold,” which is often a reference to the toxin-producing mold, *Stachybotrys chartarum*. This might give the impression that mold problems in homes are more frequent now than in past years; however, no good evidence supports this. Reasons for the increasing attention to this issue include high-visibility lawsuits brought by property owners against builders and developers, scientific controversies regarding the degree to which specific illness outbreaks are mold-induced, and an increase in the cost of homeowner insurance policies due to the increasing number of mold-related claims. Modern construction might be more vulnerable to mold problems because tighter construction makes it more difficult for internally generated water vapor to escape, as well as the widespread use of paper-backed drywall in construction (paper is an excellent medium for mold growth when wet), and the widespread use of carpeting.

**Allergic Health Effects.** Many molds produce numerous protein or glycoprotein allergens capable of causing allergic reactions in people. These allergens have been measured in spores as well as in other fungal fragments. An estimated 6%–10% of the general population and 15%–50% of those who are genetically susceptible are sensitized to mold allergens [13]. Fifty percent of the 937 children tested in a large multicity asthma study sponsored by the National Institutes of Health showed sensitivity to mold, indicating the importance of mold as an asthma trigger among these children [16]. Molds are thought to play a role in asthma in several ways. Molds produce many potentially allergenic compounds, and molds may play a role in asthma via release of irritants that increase potential for sensitization or release of toxins (mycotoxins) that affect immune response [13].

**Toxics and Irritants.** Many molds also produce mycotoxins that can be a health hazard on ingestion, dermal contact, or inhalation [14]. Although common outdoor

molds present in ambient air, such as *Cladosporium clado-sporioides* and *Alternaria alternata*, do not usually produce toxins, many other different mold species do [17].

Genera-producing fungi associated with wet buildings, such as *Aspergillus versicolor*, *Fusarium verticillioides*, *Penicillium aiurantiorisen*, and *S. chartarum*, can produce potent toxins [17]. A single mold species may produce several different toxins, and a given mycotoxin may be produced by more than one species of fungi.

Furthermore, toxin-producing fungi do not necessarily produce mycotoxins under all growth conditions, with production being dependent on the substrate it is metabolizing, temperature, water content, and humidity [17]. Because species of toxin-producing molds generally have a higher water requirement than do common household molds, they tend to thrive only under conditions of chronic and severe water damage [18]. For example, *Stachybotrys* typically only grows under continuously wet conditions [19]. It has been suggested that very young children may be especially vulnerable to certain mycotoxins [19,20]. For example, associations have been reported for pulmonary hemorrhage (bleeding lung) deaths in infants and the presence of *S. chartarum* [21–24].

**Causes of Mold.** Mold growth can be caused by any condition resulting in excess moisture. Common moisture sources include rain leaks (e.g., on roofs and wall joints); surface and groundwater leaks (e.g., poorly designed or clogged rain gutters and footing drains, basement leaks); plumbing leaks; and stagnant water in appliances (e.g., dehumidifiers, dishwashers, refrigerator drip pans, and condensing coils and drip pans in HVAC systems). Moisture problems can also be due to water vapor migration and condensation problems, including uneven indoor temperatures, poor air circulation, soil air entry into basements, contact of humid unconditioned air with cooled interior surfaces, and poor insulation on indoor chilled surfaces (e.g., chilled water lines). Problems can also be caused by the production of excess moisture within homes from humidifiers, unvented clothes dryers, overcrowding, etc. Finished basements are particularly susceptible to mold problems caused by the combination of poorly controlled moisture and mold-supporting materials (e.g., carpet, paper-backed sheetrock) [15]. There is also some evidence that mold spores from damp or wet crawl spaces can be transported through air currents into the upper living quarters. Older, substandard housing low income families can be particularly prone to mold problems because of inadequate maintenance (e.g., inoperable gutters, basement and roof leaks), overcrowding, inadequate insulation, lack of air conditioning, and poor heating. Low interior temperatures (e.g., when one or two

rooms are left unheated) result in an increase in the relative humidity, increasing the potential for water to condense on cold surfaces.

**Mold Assessment Methods.** Mold growth or the potential for mold growth can be detected by visual inspection for active or past microbial growth, detection of musty odors, and inspection for water staining or damage. If it is not possible or practical to inspect a residence, this information can be obtained using occupant questionnaires. Visual observation of mold growth, however, is limited by the fact that fungal elements such as spores are microscopic, and that their presence is often not apparent until growth is extensive and the fact that growth can occur in hidden spaces (e.g., wall cavities, air ducts).

Portable, hand-held moisture meters, for the direct measurement of moisture levels in materials, may also be useful in qualitative home assessments to aid in pinpointing areas of potential biologic growth that may not otherwise be obvious during a visual inspection [14].

For routine assessments in which the goal is to identify possible mold contamination problems before remediation, it is usually unnecessary to collect and analyze air or settled dust samples for mold analysis because decisions about appropriate intervention strategies can typically be made on the basis of a visual inspection [25]. Also, sampling and analysis costs can be relatively high and the interpretation of results is not straightforward. Air and dust monitoring may, however, be necessary in certain situations, including 1) if an individual has been diagnosed with a disease associated with fungal exposure through inhalation, 2) if it is suspected that the ventilation systems are contaminated, or 3) if the presence of mold is suspected but cannot be identified by a visual inspection or bulk sampling [26]. Generally, indoor environments contain large reservoirs of mold spores in settled dust and contaminated building materials, of which only a relatively small amount is airborne at a given time.

Common methods for sampling for mold growth include bulk sampling techniques, air sampling, and collection of settled dust samples. In bulk sampling, portions of materials with visual or suspected mold growth (e.g., sections of wallboard, pieces of duct lining, carpet segments, or return air filters) are collected and directly examined to determine if mold is growing and to identify the mold species or groups that are present. Surface sampling in mold contamination investigations may also be used when a less destructive technique than bulk sampling is desired. For example, nondestructive samples of mold may be collected using a simple swab or adhesive tape [14].

Air can also be sampled for mold using pumps that pull air across a filter medium, which traps airborne mold spores and fragments. It is generally recommended that outdoor air samples are collected concurrent with indoor samples for comparison purposes for measurement of baseline ambient air conditions. Indoor contamination can be indicated by indoor mold distributions (both species and concentrations) that differ significantly from the distributions in outdoor samples [14]. Captured mold spores can be examined under a microscope to identify the mold species/groups and determine concentrations or they can be cultured on growth media and the resulting colonies counted and identified. Both techniques require considerable expertise.

Dust sampling involves the collection of settled dust samples (e.g., floor dust) using a vacuum method in which the dust is collected onto a porous filter medium or into a container. The dust is then processed in the laboratory and the mold identified by culturing viable spores.

**Mold Standards.** No standard numeric guidelines exist for assessing whether mold contamination exists in an area. In the United States, no EPA regulations or standards exist for airborne mold contaminants [26]. Various governmental and private organizations have, however, proposed guidance on the interpretation of fungal measures of environmental media in indoor environments (quantitative limits for fungal concentrations).

Given evidence that young children may be especially vulnerable to certain mycotoxins [18] and in view of the potential severity of diseases associated with mycotoxin exposure, some organizations support a precautionary approach to limiting mold exposure [19]. For example, the American Academy of Pediatrics recommends that infants under 1 year of age are not exposed at all to chronically moldy, water-damaged environments [18].

**Mold Mitigation.** Common intervention methods for addressing mold problems include the following:

- maintaining heating, ventilating, and air conditioning (HVAC) systems;
- changing HVAC filters frequently, as recommended by manufacturer;
- keeping gutters and downspouts in working order and ensuring that they drain water away from the foundation;
- routinely checking, cleaning, and drying drip pans in air conditioners, refrigerators, and dehumidifiers;

- increasing ventilation (e.g., using exhaust fans or open windows to remove humidity when cooking, showering, or using the dishwasher);
- venting clothes dryers to the outside; and
- maintaining an ideal relative humidity level in the home of 40% to 60%.
- locating and removing sources of moisture (controlling dampness and humidity and repairing water leakage problems);
- cleaning or removing mold-contaminated materials;
- removing materials with severe mold growth; and
- using high-efficiency air filters.

**Moisture Control.** Because one of the most important factors affecting mold growth in homes is moisture level, controlling this factor is crucial in mold abatement strategies. Many simple measures can significantly control moisture, for example maintaining indoor relative humidity at no greater than 40%–60% through the use of dehumidifiers, fixing water leakage problems, increasing ventilation in kitchens and bathrooms by using exhaust fans, venting clothes dryers to the outside, reducing the number of indoor plants, using air conditioning at times of high outdoor humidity, heating all rooms in the winter and adding heating to outside wall closets, sloping surrounding soil away from building foundations, fixing gutters and downspouts, and using a sump pump in basements prone to flooding [27]. Vapor barriers, sump pumps, and aboveground vents can also be installed in crawlspaces to prevent moisture problems [28].

**Removal and Cleaning of Mold-contaminated Materials.** Nonporous (e.g., metals, glass, and hard plastics) and semiporous (e.g., wood and concrete) materials contaminated with mold and that are still structurally sound can often be cleaned with bleach-and-water solutions. However, in some cases, the material may not be easily cleaned or may be so severely contaminated that it may have to be removed. It is recommended that porous materials (e.g., ceiling tiles, wallboards, and fabrics) that cannot be cleaned be removed and discarded [29]. In severe cases, clean-up and repair of mold-contaminated buildings may be conducted using methods similar to those used for abatement of other hazardous substances such as asbestos [30]. For example, in situations of extensive colonization (large surface areas greater than 100 square feet or where the material is severely degraded), extreme precautions may be required, including full containment (complete isolation of work area) with critical barriers (airlock and decontami-

nation room) and negative pressurization, personnel trained to handle hazardous wastes, and the use of full-face respirators with HEPA filters, eye protection, and disposable full-body covering [26].

### Worker Protection When Conducting Mold

**Assessment and Mitigation Projects.** Activities such as cleaning or removal of mold-contaminated materials in homes, as well as investigations of mold contamination extent, have the potential to disturb areas of mold growth and release fungal spores and fragments into the air. Recommended measures to protect workers during mold remediation efforts depend on the severity and nature of the mold contamination being addressed, but include the use of well fitted particulate masks or respirators that retain particles as small as 1 micrometer or less, disposable gloves and coveralls, and protective eyewear [31].

Following are examples of guidance documents for remediation of mold contamination:

- New York City Department of Health and Mental Hygiene. Guidelines on Assessment and Remediation of Fungi in Indoor Environments (available from URL: <http://www.nyc.gov/html/doh/html/epi/moldrpt1.shtml>).
- American Conference of Governmental Industrial Hygienists (ACGIH) 1999 document, Biosaerosols: Assessment and Control (can be ordered at URL <http://www.acgih.org/home.htm>).
- American Industrial Hygiene Association (AIHA) 2004 document, Assessment, Remediation, and Post-Remediation Verification of Mold in Buildings (can be ordered at URL <http://www.aiha.org>)
- Environmental Protection Agency guidance, Mold Remediation in Schools and Commercial Buildings (includes many general principles also applicable to residential mold mitigation efforts; available at URL: [http://www.epa.gov/iaq/molds/mold\\_remediation.html](http://www.epa.gov/iaq/molds/mold_remediation.html))
- Environmental Protection Agency guidance, A Brief Guide to Mold, Moisture, and Your Home (for homeowners and renters on how to clean up residential mold problems and how to prevent mold growth; available at URL: <http://www.epa.gov/iaq/molds/images/moldguide.pdf>)
- Canada Mortgage and Housing Corporation, Clean-up Procedures for Mold in Houses, (provides qualitative guidance for mold mitigation; can be ordered at URL: <https://www.cmhc-schl.gc.ca:50104/b2c/b2c/init.do?language=en>).

Figure 5.1 shows mold growth in the home.



Figure 5.1. Mold Growth in the Home

## Chemical Pollutants

### Carbon Monoxide

Carbon monoxide (CO) is a significant combustion pollutant in the United States. CO is a leading cause of poisoning deaths [32]. According to the National Fire Protection Association (NFPA), CO-related nonfire deaths are often attributed to heating and cooking equipment. The leading specific types of equipment blamed for CO-related deaths include gas-fueled space heaters, gas-fueled furnaces, charcoal grills, gas-fueled ranges, portable kerosene heaters, and wood stoves.

As with fire deaths, the risk for unintentional CO death is highest for the very young (ages 4 years and younger) and the very old (ages 75 years and older). CO is an odorless, colorless gas that can cause sudden illness and death. It is a result of the incomplete combustion of carbon. Headache, dizziness, weakness, nausea, vomiting, chest pain, and confusion are the most frequent symptoms of CO poisoning. According to the American Lung Association (ALA) [33], breathing low levels of CO can cause fatigue and increase chest pain in people with chronic heart disease. Higher levels of CO can cause flulike symptoms in healthy people. In addition, extremely high levels of CO cause loss of consciousness and death. In the home, any fuel-burning appliance that is not adequately vented and maintained can be a potential source of CO. The following steps should be followed to reduce CO (as well as sulfur dioxide and oxides of nitrogen) levels:

- Never use gas-powered equipment, charcoal grills, hibachis, lanterns, or portable camping stoves in enclosed areas or indoors.

- Install a CO monitor (Figure 5.2) in appropriate areas of the home. These monitors are designed to provide a warning before potentially life-threatening levels of CO are reached.
- Choose vented appliances when possible and keep gas appliances properly adjusted to decrease the combustion to CO. (Note: Vented appliances are always preferable for several reasons: oxygen levels, carbon dioxide buildup, and humidity management).
- Only buy certified and tested combustion appliances that meet current safety standards, as certified by Underwriter’s Laboratories (UL), American Gas Association (AGA) Laboratories, or equivalent.
- Assure that all gas heaters possess safety devices that shut off an improperly vented gas heater. Heaters made after 1982 use a pilot light safety system known as an oxygen depletion sensor. When inadequate fresh air exists, this system shuts off the heater before large amounts of CO can be produced.
- Use appliances that have electronic ignitions instead of pilot lights. These appliances are typically more energy efficient and eliminate the continuous low-level pollutants from pilot lights.
- Use the proper fuel in kerosene appliances.
- Install and use an exhaust fan vented to the outdoors over gas stoves.
- Have a trained professional annually inspect, clean, and tune up central heating systems (furnaces, flues, and chimneys) and repair them as needed.
- Do not idle a car inside a garage.

The U.S. Consumer Product Safety Commission (CPSC) recommends installing at least one CO alarm per household near the sleeping area. For an extra measure of safety, another alarm should be placed near the home’s heating source. ALA recommends weighing the benefits of using models powered by electrical outlets versus models powered by batteries that run out of power and need replacing. Battery-powered CO detectors provide continuous protection and do not require recalibration in the event of a power outage. Electric-powered systems do not provide protection during a loss of power and can take up to 2 days to recalibrate. A device that can be easily self-tested and reset to ensure proper functioning should be chosen. The product should meet Underwriters Laboratories Standard UL 2034.

## Ozone

Inhaling ozone can damage the lungs. Inhaling small amounts of ozone can result in chest pain, coughing, shortness of breath, and throat irritation. Ozone can also exacerbate chronic respiratory diseases such as asthma. Susceptibility to the effects of ozone varies from person to person, but even healthy people can experience respiratory difficulties from exposure.

According to the North Carolina Department of Health and Human Services [34], the major source of indoor ozone is outdoor ozone. Indoor levels can vary from 10% of the outdoor air to levels as high as 80% of the outdoor air. The Food and Drug Administration has set a limit of 0.05 ppm of ozone in indoor air. In recent years, there have been numerous advertisements for ion generators that destroy harmful indoor air pollutants. These devices create ozone or elemental oxygen that reacts with pollutants. EPA has reviewed the evidence on ozone generators and states: “available scientific evidence shows that at concentrations that do not exceed public health standards, ozone has little potential to remove indoor air contaminants,” and “there is evidence to show that at concentrations that do not exceed public health standards, ozone is not effective at removing many odor causing chemicals” [35].

Ozone is also created by the exposure of polluted air to sunlight or ultraviolet light emitters. This ozone produced outside of the home can infiltrate the house and react with indoor surfaces, creating additional pollutants.

## Environmental Tobacco Smoke or Secondhand Smoke

Like CO, environmental tobacco smoke (ETS; also known as secondhand smoke), is a product of combustion. The National Cancer Institute (NCI) [36], states that ETS is the combination of two forms of smoke from burning tobacco products:

- Sidestream smoke, or smoke that is emitted between the puffs of a burning cigarette, pipe, or cigar; and
- Mainstream smoke, or the smoke that is exhaled by the smoker.



**Figure 5.2.** Home Carbon Monoxide Monitor  
Source: U.S. Navy

The physiologic effects of ETS are numerous. ETS can trigger asthma; irritate the eyes, nose, and throat; and cause ear infections in children, respiratory illnesses, and lung cancer. ETS is believed to cause asthma by irritating chronically inflamed bronchial passages. According to the EPA [37], ETS is a Group A carcinogen; thus, it is a known cause of cancer in humans. Laboratory analysis has revealed that ETS contains in excess of 4,000 substances, more than 60 of which cause cancer in humans or animals. The EPA also estimates that approximately 3,000 lung cancer deaths occur each year in nonsmokers due to ETS. Additionally, passive smoking can lead to coughing, excess phlegm, and chest discomfort. NCI also notes that spontaneous abortion (miscarriage), cervical cancer, sudden infant death syndrome, low birth weight, nasal sinus cancer, decreased lung function, exacerbation of cystic fibrosis, and negative cognitive and behavioral effects in children have been linked to ETS [36].

The EPA [37] states that, because of their relative body size and respiratory rates, children are affected by ETS more than adults are. It is estimated that an additional 7,500 to 15,000 hospitalizations resulting from increased respiratory infections occur in children younger than 18 months of age due to ETS exposure. Figure 5.3 shows the ETS exposure levels in homes with children under age 7 years. The following actions are recommended in the home to protect children from ETS:

- if individuals insist on smoking, increase ventilation in the smoking area by opening windows or using exhaust fans; and
- refrain from smoking in the presence of children and do not allow babysitters or others who work in the home to smoke in the home or near children.

### *Volatile Organic Compounds*

In the modern home, many organic chemicals are used as ingredients in household products. Organic chemicals that vaporize and become gases at normal room temperature are collectively known as VOCs.

Examples of common items that can release VOCs include paints, varnishes, and wax, as well as in many cleaning, disinfecting, cosmetic, degreasing, and hobby products. Levels of approximately a dozen common VOCs can be two to five times higher inside the home, as opposed to outside, whether in highly industrialized areas or rural areas. VOCs that frequently pollute indoor air include toluene, styrene, xylenes, and trichloroethylene. Some of these chemicals may be emitted from aerosol products, dry-cleaned clothing, paints, varnishes, glues,

art supplies, cleaners, spot removers, floor waxes, polishes, and air fresheners. The health effects of these chemicals are varied. Trichloroethylene has been linked to childhood leukemia. Exposure to toluene can put pregnant women at risk for having babies with neurologic problems, retarded growth, and developmental problems. Xylenes have been linked to birth defects. Styrene is a suspected endocrine disruptor, a chemical that can block or mimic hormones in humans or animals. EPA data reveal that methylene chloride, a common component of some paint strippers, adhesive removers, and specialized aerosol spray paints, causes cancer in animals [38]. Methylene chloride is also converted to CO in the body and can cause symptoms associated with CO exposure. Benzene, a known human carcinogen, is contained in tobacco smoke, stored fuels, and paint supplies. Perchloroethylene, a product uncommonly found in homes, but common to dry cleaners, can be a pollution source by off-gassing from newly cleaned clothing. Environmental Media Services [39] also notes that xylene, ketones, and aldehydes are used in aerosol products and air fresheners.

To lower levels of VOCs in the home, follow these steps:

- use all household products according to directions;
- provide good ventilation when using these products;
- properly dispose of partially full containers of old or unneeded chemicals;
- purchase limited quantities of products; and
- minimize exposure to emissions from products containing methylene chloride, benzene, and perchlorethylene.

A prominent VOC found in household products and construction products is formaldehyde. According to CPSC [40], these products include the glue or adhesive used in pressed wood products; preservatives in paints, coating, and cosmetics; coatings used for permanent-press quality in fabrics and draperies; and the finish on paper products and certain insulation materials. Formaldehyde

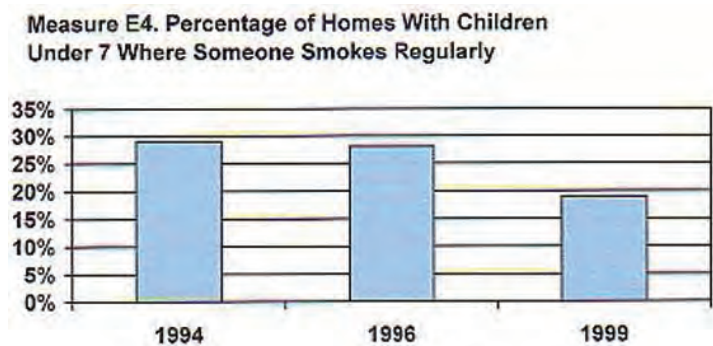

**Figure 5.3.** Environmental Tobacco Smoke and Children’s Exposure [37]



is contained in urea-formaldehyde (UF) foam insulation installed in the wall cavities of homes as an energy conservation measure. Levels of formaldehyde increase soon after installation of this product, but these levels decline with time. In 1982, CPSC voted to ban UF foam insulation. The courts overturned the ban; however, the publicity has decreased the use of this product.

More recently, the most significant source of formaldehyde in homes has been pressed wood products made using adhesives that contain UF resins [41]. The most significant of these is medium-density fiberboard, which contains a higher resin-to-wood ratio than any other UF pressed wood product. This product is generally recognized as being the highest formaldehyde-emitting pressed wood product. Additional pressed wood products are produced using phenol-formaldehyde resin. The latter type of resin generally emits formaldehyde at a considerably slower rate than those containing UF resin. The emission rate for both resins will change over time and will be influenced by high indoor temperatures and humidity. Since 1985, U.S. Department of Housing and Urban Development (HUD) regulations (24 CFR 3280.308, 3280.309, and 3280.406) have permitted only the use of plywood and particleboard that conform to specified formaldehyde emission limits in the construction of prefabricated and manufactured homes [42]. This limit was to ensure that indoor formaldehyde levels are below 0.4 ppm.

CPSC [40] notes that formaldehyde is a colorless, strong-smelling gas. At an air level above 0.1 ppm, it can cause watery eyes; burning sensations in the eyes, nose, and throat; nausea; coughing; chest tightness; wheezing; skin rashes; and allergic reactions. Laboratory animal studies have revealed that formaldehyde can cause cancer in animals and may cause cancer in humans. Formaldehyde is usually present at levels less than 0.03 ppm indoors and outdoors, with rural areas generally experiencing lower concentrations than urban areas. Indoor areas that contain products that release formaldehyde can have levels greater than 0.03 ppm. CPSC also recommends the following actions to avoid high levels of exposure to formaldehyde:

- Purchase pressed wood products that are labeled or stamped to be in conformance with American National Standards Institute criteria ANSI A208.1-1993. Use particleboard flooring marked with ANSI grades PBU, D2, or D3. Medium-density fiberboard should be in conformance with ANSI A208.2-1994 and hardwood plywood with ANSI/HPVA HP-1-1994 (Figure 5.4).

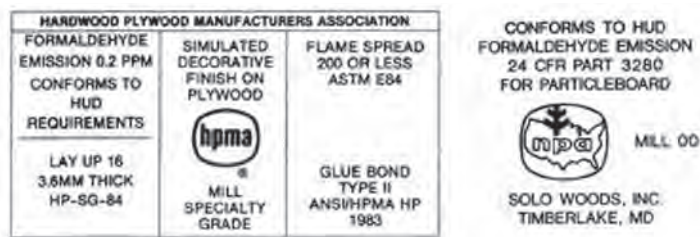

Figure 5.4. Wood Products Label [42]

- Purchase furniture or cabinets that contain a high percentage of panel surface and edges that are laminated or coated. Unlaminated or uncoated (raw) panels of pressed wood panel products will generally emit more formaldehyde than those that are laminated or coated.
- Use alternative products, such as wood panel products not made with UF glues, lumber, or metal.
- Avoid the use of foamed-in-place insulation containing formaldehyde, especially UF foam insulation.
- Wash durable-press fabrics before use.

CPSC also recommends the following actions to reduce existing levels of indoor formaldehyde:

- Ventilate the home well by opening doors and windows and installing an exhaust fan(s).
- Seal the surfaces of formaldehyde-containing products that are not laminated or coated with paint, varnish, or a layer of vinyl or polyurethane-like materials.
- Remove products that release formaldehyde in the indoor air from the home.

### Radon

According to the EPA [43], radon is a colorless, odorless gas that occurs naturally in soil and rock and is a decay product of uranium. The U.S. Geological Survey (USGS) [44] notes that the typical uranium content of rock and the surrounding soil is between 1 and 3 ppm. Higher levels of uranium are often contained in rock such as light-colored volcanic rock, granite, dark shale, and sedimentary rock containing phosphate. Uranium levels as high as 100 ppm may be present in various areas of the United States because of these rocks. The main source of high-level radon pollution in buildings is surrounding uranium-containing soil. Thus, the greater the level of uranium nearby, the greater the chances are that buildings in the area will have high levels of indoor radon. Figure 5.5 demonstrates the geographic variation in radon levels in the United States. Maps of the individual states and areas that have proven high for radon are available at

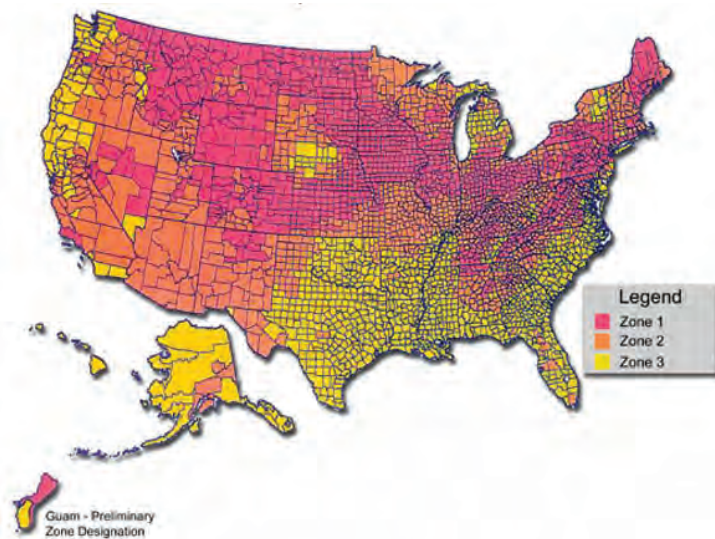

**Figure 5.5.** EPA Map of Radon Zones [43]

**Zone 1:** predicted average indoor radon screening level greater than 4 pCi/L [picocuries per liter]

**Zone 2:** predicted average indoor radon screening level between 2 and 4 pCi/L

**Zone 3:** predicted average indoor radon screening level less than 2 pCi/L

**Important:** Consult the EPA Map of Radon Zones document [EPA-402-R-93-071] before using this map. This document contains information on radon potential variations within counties.

EPA also recommends that this map be supplemented with any available local data to further understand and predict the radon potential of a specific area.

<http://www.epa.gov/iaq/radon/zonemap.html>. A free video is available from the U.S. EPA: call 1-800-438-4318 and ask for EPA 402-V-02-003 (TRT 13.10).

Radon, according to the California Geological Survey [45], is one of the intermediate radioactive elements formed during the radioactive decay of uranium-238, uranium-235, or thorium-232. Radon-222 is the radon isotope of most concern to public health because of its longer half-life (3.8 days). The mobility of radon gas is much greater than are uranium and radium, which are solids at room temperature. Thus, radon can leave rocks and soil, move through fractures and pore spaces, and ultimately enter a building to collect in high concentrations. When in water, radon moves less than 1 inch before it decays, compared to 6 feet or more in dry rocks or soil. USGS [44] notes that radon near the surface of soil typically escapes into the atmosphere. However, where a house is present, soil air often flows toward the house foundation because of

- differences in air pressure between the soil and the house, with soil pressure often being higher;
- presence of openings in the house's foundation; and
- increases in permeability around the basement (if present).

Houses are often constructed with loose fill under a basement slab and between the walls and exterior ground. This fill is more permeable than the original ground. Houses typically draw less than 1% of their indoor air from the soil. However, houses with low indoor air pressures, poorly sealed foundations, and several entry points for soil air may draw up to 20% of their indoor air from the soil.

USGS [44] states that radon may also enter the home through the water systems. Surface water sources typically contain little radon because it escapes into the air. In larger cities, radon is released to the air by municipal processing systems that aerate the water. However, in areas where groundwater is the main water supply for communities, small public systems and private wells are typically closed systems that do not allow radon to escape. Radon then enters the indoor air from showers, clothes washing, dishwashing, and other uses of water. Figure 5.6 shows typical entry points of radon.

Health risks of radon stem from its breakdown into “radon daughters,” which emit high-energy alpha particles. These progeny enter the lungs, attach themselves, and may eventually lead to lung cancer. This exposure to radon is believed to contribute to between 15,000 and 21,000 excess lung cancer deaths in the United States each year. The EPA has identified levels greater than 4 picocuries per liter as levels at which remedial action should be taken. Approximately 1 in 15 homes nationwide have radon above this level, according to the U.S. Surgeon General's recent advisory [46]. Smokers are at significantly higher risk for radon-related lung cancer.

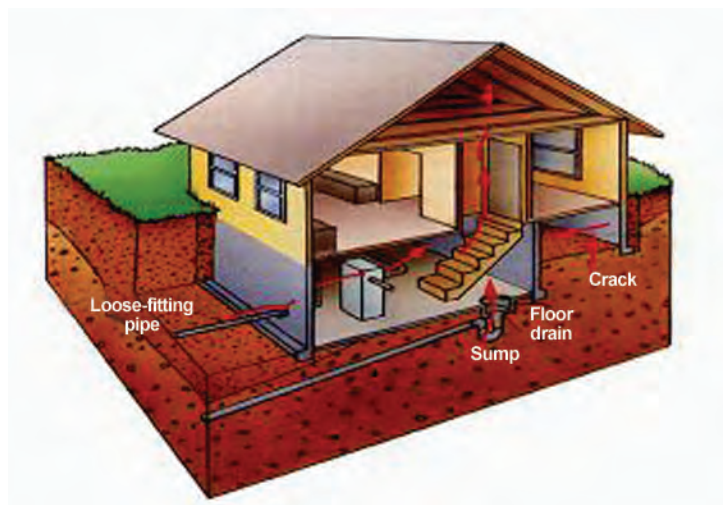

**Figure 5.6.** Radon Entry [30]

Radon in the home can be measured either by the occupant or by a professional. Because radon has no odor or color, special devices are used to measure its presence. Radon levels vary from day to day and season to season. Short-term tests (2 to 90 days) are best if quick results are needed, but long-term tests (more than 3 months) yield better information on average year-round exposure.

Measurement devices are routinely placed in the lowest occupied level of the home. The devices either measure the radon gas directly or the daughter products. The simplest devices are passive, require no electricity, and include a charcoal canister, charcoal liquid scintillation device, alpha track detector, and electret ion detectors [47].

All of these devices, with the exception of the ion detector, can be purchased in hardware stores or by mail. The ion detector generally is only available through laboratories. These devices are inexpensive, primarily used for short-term testing, and require little to no training. Active devices, however, need electrical power and include continuous monitoring devices. They are customarily more expensive and require professionally trained testers for their operation. Figure 5.7 shows examples of the charcoal tester (a; left) and the alpha track detector (b; right).

After testing and evaluation by a professional, it may be necessary to lower the radon levels in the structure. The Pennsylvania Department of Environmental Protection [48] states that in most cases, a system with pipes and a fan is used to reduce radon. This system, known as a sub-slab depressurization system, requires no major changes to the home. The cost typically ranges from \$500 to \$2,500 and averages approximately \$1,000, varying with geographic region. The typical mitigation system usually has only one pipe penetrating through the basement floor; the pipe also may be installed outside the house. The Connecticut Department of Public Health [49] notes that it is more cost effective to include radon-resistant techniques while constructing a building than to install a

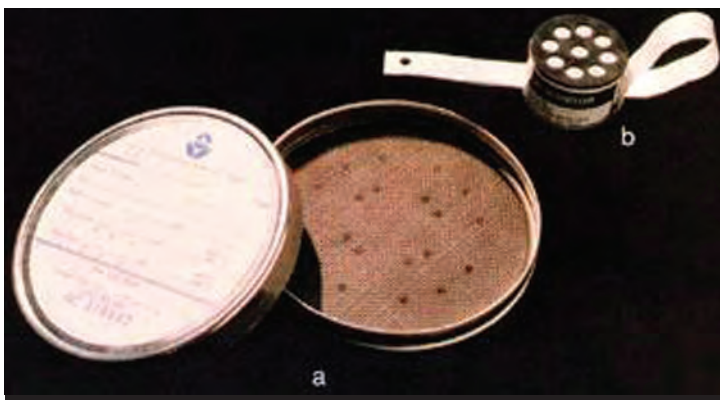

Figure 5.7. Home Radon Detectors [31]

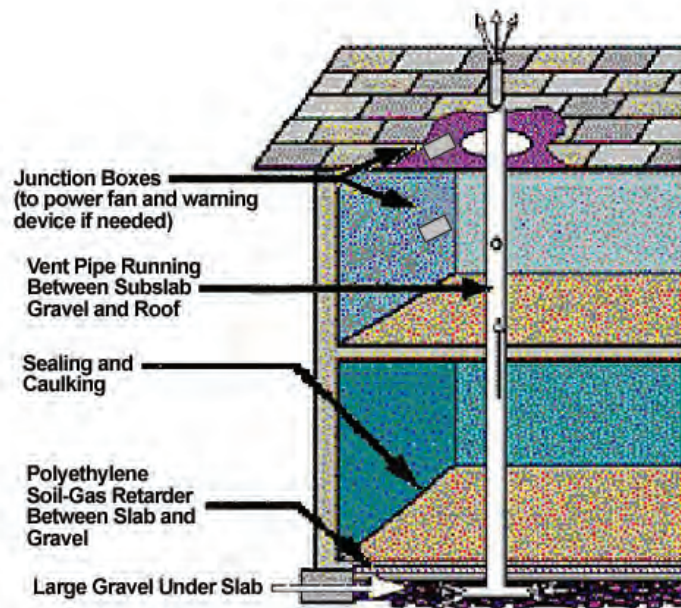

Figure 5.8. Radon-resistant Construction [50]

reduction system in an existing home. Inclusion of radon-resistant techniques in initial construction costs approximately \$350 to \$500 [50]. Figure 5.8 shows examples of radon-resistant construction techniques.

A passive radon-resistant system has five major parts:

1. A layer of gas-permeable material under the foundation.
2. The foundation (usually 4 inches of gravel).
3. Plastic sheeting over the foundation, with all openings in the concrete foundation floor sealed and caulked.
4. A gas-tight, 3- or 4-inch vent pipe running from under the foundation through the house to the roof.
5. A roughed-in electrical junction box for the future installation of a fan, if needed.

These features create a physical barrier to radon entry. The vent pipe redirects the flow of air under the foundation, preventing radon from seeping into the house.

### Pesticides

Much pesticide use could be reduced if integrated pest management (IPM) practices were used in the home. IPM is a coordinated approach to managing roaches, rodents, mosquitoes, and other pests that integrates inspection, monitoring, treatment, and evaluation, with special emphasis on the decreased use of toxic agents. However, all pest management options, including natural, biologic, cultural, and chemical methods, should be considered. Those that have the least impact on health and the environment should be selected. Most household

pests can be controlled by eliminating the habitat for the pest both inside and outside, building or screening them out, eliminating food and harborage areas, and safely using appropriate pesticides if necessary.

EPA [51] states that 75% of U.S. households used at least one pesticide indoors during the past year and that 80% of most people's exposure to pesticides occurs indoors. Measurable levels of up to a dozen pesticides have been found in the air inside homes. Pesticides used in and around the home include products to control insects (insecticides), termites (termiticides), rodents (rodenticides), fungi (fungicides), and microbes (disinfectants). These products are found in sprays, sticks, powders, crystals, balls, and foggers.

Delaplane [52] notes that the ancient Romans killed insect pests by burning sulfur and controlled weeds with salt. In the 1600s, ants were controlled with mixtures of honey and arsenic. U.S. farmers in the late 19th century used copper actoarsenite (Paris green), calcium arsenate, nicotine sulfate, and sulfur to control insect pests in field crops. By World War II and afterward, numerous pesticides had been introduced, including DDT, BHC, aldrin, dieldrin, endrin, and 2,4-D. A significant factor with regard to these pesticides used in and around the home is their impact on children. According to a 2003 EPA survey, 47% of all households with children under the age of 5 years had at least one pesticide stored in an unlocked cabinet less than 4 feet off the ground. This is within easy reach of children. Similarly, 74% of households without children under the age of 5 also stored pesticides in an unlocked cabinet less than 4 feet off the ground. This issue is significant because 13% of all pesticide poisoning incidents occur in homes other than the child's home. The EPA [53] notes a report by the American Association of Poison Control Centers indicating that approximately 79,000 children were involved in common household pesticide poisonings or exposures.

The health effects of pesticides vary with the product. However, local effects from most of the products will be on eyes, noses, and throats; more severe consequences, such as on the central nervous system and kidneys and on cancer risks, are possible. The active and inert ingredients of pesticides can be organic compounds, which can contribute to the level of organic compounds in indoor air. More significantly, products containing cyclodiene pesticides have been commonly associated with misapplication. Individuals inadvertently exposed during this misapplication had numerous symptoms, including headaches, dizziness, muscle twitching, weakness, tin-

gling sensations, and nausea. In addition, there is concern that these pesticides may cause long-term damage to the liver and the central nervous system, as well as an increased cancer risk. Cyclodiene pesticides were developed for use as insecticides in the 1940s and 1950s. The four main cyclodiene pesticides—aldrin, dieldrin, chlordane, and heptachlor—were used to guard soil and seed against insect infestation and to control insect pests in crops. Outside of agriculture they were used for ant control; farm, industrial, and domestic control of fleas, flies, lice, and mites; locust control; termite control in buildings, fences, and power poles; and pest control in home gardens. No other commercial use is permitted for cyclodiene or related products. The only exception is the use of heptachlor by utility companies to control fire ants in underground cable boxes.

An EPA survey [53] revealed that bathrooms and kitchens are areas in the home most likely to have improperly stored pesticides. In the United States, EPA regulates pesticides under the pesticide law known as the Federal Insecticide, Fungicide, and Rodenticide Act. Since 1981, this law has required most residential-use pesticides to bear a signal word such as "danger" or "warning" and to be contained in child-resistant packaging. This type of packaging is designed to prevent or delay access by most children under the age of 5 years. EPA offers the following recommendations for preventing accidental poisoning:

- store pesticides away from the reach of children in a locked cabinet, garden shed, or similar location;
- read the product label and follow all directions exactly, especially precautions and restrictions;
- remove children, pets, and toys from areas before applying pesticides;
- if interrupted while applying a pesticide, properly close the package and assure that the container is not within reach of children;
- do not transfer pesticides to other containers that children may associate with food or drink;
- do not place rodent or insect baits where small children have access to them;
- use child-resistant packaging properly by closing the container tightly after use;
- assure that other caregivers for children are aware of the potential hazards of pesticides;

- teach children that pesticides are poisons and should not be handled; and
- keep the local Poison Control Center telephone number available.

## Toxic Materials

### Asbestos

Asbestos, from the Greek word meaning “inextinguishable,” refers to a group of six naturally occurring mineral fibers. Asbestos is a mineral fiber of which there are several types: amosite, crocidolite, tremolite, actinolite, anthrophyllite, and chrysotile. Chrysotile asbestos, also known as white asbestos, is the predominant commercial form of asbestos. Asbestos is strong, flexible, resistant to heat and chemical corrosion, and insulates well. These features led to the use of asbestos in up to 3,000 consumer products before government agencies began to phase it out in the 1970s because of its health hazards. Asbestos has been used in insulation, roofing, siding, vinyl floor tiles, fireproofing materials, texturized paint and soundproofing materials, heating appliances (such as clothes dryers and ovens), fireproof gloves, and ironing boards. Asbestos continues to be used in some products, such as brake pads. Other mineral products, such as talc and vermiculite, can be contaminated with asbestos.

The health effects of asbestos exposure are numerous and varied. Industrial studies of workers exposed to asbestos in factories and shipyards have revealed three primary health risk concerns from breathing high levels of asbestos fibers: lung cancer, mesothelioma (a cancer of the lining of the chest and the abdominal cavity), and asbestosis (a condition in which the lungs become scarred with fibrous tissue).

The risk for all of these conditions is amplified as the number of fibers inhaled increases. Smoking also enhances the risk for lung cancer from inhaling asbestos fibers by acting synergistically. The incubation period (from time of exposure to appearance of symptoms) of these diseases is usually about 20 to 30 years. Individuals who develop asbestosis have typically been exposed to high levels of asbestos for a long time. Exposure levels to asbestos are measured in fibers per cubic centimeter of air. Most individuals are exposed to small amounts of asbestos in daily living activities; however, a preponderance of them do not develop health problems. According to the Agency for Toxic Substances and Disease Registry (ATSDR), if an individual is exposed, several factors determine whether the individual will be harmed [54]. These factors include the dose (how much), the duration

(how long), and the fiber type (mineral form and distribution). ATSDR also states that children may be more adversely affected than adults [54]. Children breathe differently and have different lung structures than adults; however, it has not been determined whether these differences cause a greater amount of asbestos fibers to stay in the lungs of a child than in the lungs of an adult. In addition, children drink more fluids per kilogram of body weight than do adults and they can be exposed through asbestos-contaminated drinking water. Eating asbestos-contaminated soil and dust is another source of exposure for children. Certain children intentionally eat soil and children’s hand-to-mouth activities mean that all young children eat more soil than do adults. Family members also have been exposed to asbestos that was carried home on the clothing of other family members who worked in asbestos mines or mills. Breathing asbestos fibers may result in difficulty in breathing. Diseases usually appear many years after the first exposure to asbestos and are therefore not likely to be seen in children. But people who have been exposed to asbestos at a young age may be more likely to contract diseases than those who are first exposed later in life. In the small number of studies that have specifically looked at asbestos exposure in children, there is no indication that younger people might develop asbestos-related diseases more quickly than older people. Developing fetuses and infants are not likely to be exposed to asbestos through the placenta or breast milk of the mother. Results of animal studies do not indicate that exposure to asbestos is likely to result in birth defects.

A joint document issued by CPSC, EPA, and ALA, notes that most products in today’s homes do not contain asbestos. However, asbestos can still be found in products and areas of the home. These products contain asbestos that could be inhaled and are required to be labeled as such. Until the 1970s, many types of building products and insulation materials used in homes routinely contained asbestos. A potential asbestos problem both inside and outside the home is that of vermiculite. According to the USGS [55], vermiculite is a claylike material that expands when heated to form wormlike particles. It is used in concrete aggregate, fertilizer carriers, insulation, potting soil, and soil conditioners. This product ceased being mined in 1992, but old stocks may still be available. Common products that contained asbestos in the past and conditions that may release fibers include the following:

- Steam pipes, boilers, and furnace ducts insulated with an asbestos blanket or asbestos paper tape. These materials may release asbestos fibers if damaged, repaired, or removed improperly.

- Resilient floor tiles (vinyl asbestos, asphalt, and rubber), the backing on vinyl sheet flooring, and adhesives used for installing floor tile. Sanding tiles can release fibers, as may scraping or sanding the backing of sheet flooring during removal.
- Cement sheet, millboard, and paper used as insulation around furnaces and wood-burning stoves. Repairing or removing appliances may release asbestos fibers, as may cutting, tearing, sanding, drilling, or sawing insulation.
- Door gaskets in furnaces, wood stoves, and coal stoves. Worn seals can release asbestos fibers during use.
- Soundproofing or decorative material sprayed on walls and ceilings. Loose, crumbly, or water-damaged material may release fibers, as will sanding, drilling, or scraping the material.
- Patching and joint compounds for walls, ceilings, and textured paints. Sanding, scraping, or drilling these surfaces may release asbestos.
- Asbestos cement roofing, shingles, and siding. These products are not likely to release asbestos fibers unless sawed, drilled, or cut.
- Artificial ashes and embers sold for use in gas-fired fireplaces in addition to other older household products such as fireproof gloves, stove-top pads, ironing board covers, and certain hair dryers.
- Automobile brake pads and linings, clutch facings, and gaskets.

Homeowners who believe material in their home may be asbestos should not disturb the material. Generally, material in good condition will not release asbestos fibers, and there is little danger unless the fibers are released and inhaled into the lungs. However, if disturbed, asbestos material may release asbestos fibers, which can be inhaled into the lungs. The fibers can remain in the lungs for a long time, increasing the risk for disease. Suspected asbestos-containing material should be checked regularly for damage from abrasions, tears, or water. If possible, access to the area should be limited. Asbestos-containing products such as asbestos gloves, stove-top pads, and ironing board covers should be discarded if damaged or worn. Permission and proper disposal methods should be obtainable from local health, environmental, or other appropriate officials. If asbestos material is more than slightly damaged, or if planned changes in the home might disturb it, repair or removal by a professional is needed. Before remodeling, determine whether asbestos materials are present.

Only a trained professional can confirm suspected asbestos materials that are part of a home's construction. This individual will take samples for analysis and submit them to an EPA-approved laboratory.

If the asbestos material is in good shape and will not be disturbed, the best approach is to take no action and continue to monitor the material. If the material needs action to address potential exposure problems, there are two approaches to correcting the problem: repair and removal.

Repair involves sealing or covering the asbestos material. Sealing or encapsulation involves treating the material with a sealant that either binds the asbestos fibers together or coats the material so fibers are not released. This is an approach often used for pipe, furnace, and boiler insulation; however, this work should be done only by a professional who is trained to handle asbestos safely. Covering (enclosing) involves placing something over or around the material that contains asbestos to prevent release of fibers. Exposed insulated piping may be covered with a protective wrap or jacket. In the repair process, the approach is for the material to remain in position undisturbed. Repair is a less expensive process than is removal.

With any type of repair, the asbestos remains in place. Repair may make later removal of asbestos, if necessary, more difficult and costly. Repairs can be major or minor. Both major and minor repairs must be done only by a professional trained in methods for safely handling asbestos.

Removal is usually the most expensive and, unless required by state or local regulations, should be the last option considered in most situations. This is because removal poses the greatest risk for fiber release. However, removal may be required when remodeling or making major changes to the home that will disturb asbestos material. In addition, removal may be called for if asbestos material is damaged extensively and cannot be otherwise repaired. Removal is complex and must be done only by a contractor with special training. Improper removal of asbestos material may create more of a problem than simply leaving it alone.

### Lead

Many individuals recognize lead in the form often seen in tire weights and fishing equipment, but few recognize its various forms in and around the home. The Merriam-Webster Dictionary [56] defines lead as “a heavy soft malleable ductile plastic but inelastic bluish white metallic element found mostly in combination and used especially in pipes, cable sheaths, batteries, solder, and shields

against radioactivity.” Lead is a metal with many uses. It melts easily and quickly. It can be molded or shaped into thin sheets and can be drawn out into wire or threads. Lead also is very resistant to weather conditions. Lead and lead compounds are toxic and can present a severe hazard to those who are overexposed to them. Whether ingested or inhaled, lead is readily absorbed and distributed throughout the body.

Until 1978, lead compounds were an important component of many paints. Lead was added to paint to promote adhesion, corrosion control, drying, and covering. White lead (lead carbonate), linseed oil, and inorganic pigments were the basic components for paint in the 18th and 19th centuries, and continued until the middle of the 20th century. Lead was banned by CPSC in 1978. Lead-based paint was used extensively on exteriors and interior trim-work, window sills, sashes, window frames, baseboards, wainscoting, doors, frames, and high-gloss wall surfaces, such as those found in kitchens and bathrooms. The only way to determine which building components are coated with lead paint is through an inspection for lead-based paint. Almost all painted metals were primed with red lead or painted with lead-based paints. Even milk (casein) and water-based paints (distemper and calcimines) could contain some lead, usually in the form of hiding agents or pigments. Varnishes sometimes contained lead. Lead compounds also were used as driers in paint and window-glazing putty.

Lead is widespread in the environment. People absorb lead from a variety of sources every day. Although lead has been used in numerous consumer products, the most important sources of lead exposure to children and others today are the following:

- contaminated house dust that has settled on horizontal surfaces,
- deteriorated lead-based paint,
- contaminated bare soil,
- food (which can be contaminated by lead in the air or in food containers, particularly lead-soldered food containers),
- drinking water (from corrosion of plumbing systems), and
- occupational exposure or hobbies.

Federal controls on lead in gasoline, new paint, food canning, and drinking water, as well as lead from industrial air emissions, have significantly reduced total human exposure to lead. The number of children with

blood lead levels above 10 micrograms per deciliter ( $\mu\text{g}/\text{dL}$ ), a level designated as showing no physiologic toxicity, has declined from 1.7 million in the late 1980s to 310,000 in 1999–2002. This demonstrates that the controls have been effective, but that many children are still at risk. CDC data show that deteriorated lead-based paint and the contaminated dust and soil it generates are the most common sources of exposure to children today. HUD data show that the number of houses with lead paint declined from 64 million in 1990 to 38 million in 2000 [57].

Children are more vulnerable to lead poisoning than are adults. Infants can be exposed to lead in the womb if their mothers have lead in their bodies. Infants and children can swallow and breathe lead in dirt, dust, or sand through normal hand-to-mouth contact while they play on the floor or ground. These activities make it easier for children to be exposed to lead. Other sources of exposure have included imported vinyl miniblinds, crayons, children’s jewelry, and candy. In 2004, increases in lead in water service pipes were observed in Washington, D.C., accompanied by increases in blood lead levels in children under the age of 6 years who were served by the water system [58].

In some cases, children swallow nonfood items such as paint chips. These may contain very large amounts of lead, particularly in and around older houses that were painted with lead-based paint. Many studies have verified the effect of lead exposure on IQ scores in the United States. The effects of lead exposure have been reviewed by the National Academy of Sciences [59].

Generally, the tests for blood lead levels are from drawn blood, not from a finger-stick test, which can be unreliable if performed improperly. Units are measured in micrograms per deciliter and reflect the 1991 guidance from the Centers of Disease Control [60]:

- Children: 10  $\mu\text{g}/\text{dL}$  (level of concern)—find source of lead;
- Children: 15  $\mu\text{g}/\text{dL}$  and above—environmental intervention, counseling, medical monitoring;
- Children: 20  $\mu\text{g}/\text{dL}$  and above—medical treatment;
- Adults: 25  $\mu\text{g}/\text{dL}$  (level of concern)—find source of lead; and
- Adults: 50  $\mu\text{g}/\text{dL}$ —Occupational Safety and Health Administration (OSHA) standard for medical removal from the worksite.

Adults are usually exposed to lead from occupational sources (e.g., battery construction, paint removal) or at home (e.g., paint removal, home renovations).

In 1978, CPSC banned the use of lead-based paint in residential housing. Because houses are periodically repainted, the most recent layer of paint will most likely not contain lead, but the older layers underneath probably will. Therefore, the only way to accurately determine the amount of lead present in older paint is to have it analyzed.

It is important that owners of homes built before 1978 be aware that layers of older paint can contain a great deal of lead. Guidelines on identifying and controlling lead-based paint hazards in housing have been published by HUD [61].

### *Controlling Lead Hazards*

The purpose of a home risk assessment is to determine, through testing and evaluation, where hazards from lead warrant remedial action. A certified inspector or risk assessor can test paint, soil, or lead dust either on-site or in a laboratory using methods such as x-ray fluorescence (XRF) analyzers, chemicals, dust wipe tests, and atomic absorption spectroscopy. Lists of service providers are available by calling 1-800-424-LEAD. Do-it-yourself test kits are commercially available; however, these kits do not tell you how much lead is present, and their reliability at detecting low levels of lead has not been determined. Professional testing for lead in paint is recommended. The recommended sampling method for dust is the surface wet wipe. Dust samples are collected from different surfaces, such as bare floors, window sills, and window wells. Each sample is collected from a measured surface area using a wet wipe, which is sent to a

laboratory for testing. Risk assessments can be fairly low-cost investigations of the location, condition, and severity of lead hazards found in house dust, soil, water, and deteriorating paint. Risk assessments also will address other sources of lead from hobbies, crockery, water, and work environments. These services are critical when owners are seeking to implement measures to reduce suspected lead hazards in housing and day-care centers or when extensive rehabilitation is planned.

HUD has published detailed protocols for risk assessments and inspections [61].

It is important from a health standpoint that future tenants, painters, and construction workers know that lead-based paint is present, even under treated surfaces, so they can take precautions when working in areas that will generate lead dust. Whenever mitigation work is completed, it is important to have a clearance test using the dust wipe method to ensure that lead-laden dust generated during the work does not remain at levels above those established by the EPA and HUD. Such testing is required for owners of most housing that is receiving federal financial assistance, such as Section 8 rental housing. A building or housing file should be maintained and updated whenever any additional lead hazard control work is completed. Owners are required by law to disclose information about lead-based paint or lead-based paint hazards to buyers or tenants before completing a sales or lease contract [62].

All hazards should be controlled as identified in a risk assessment.

Whenever extensive amounts of lead must be removed

## Action Levels for Lead

**Lead in paint.** Differing methods report results in differing units. Lead is considered a potential hazard if above the following levels, but can be a hazard at lower levels if improperly handled. Below are the current action levels identified by HUD [62] and EPA (40 CFR Part 745):

### **Lab analysis of samples:**

5,000 milligram per kilogram (mg/kg) or 5,000 parts per million (ppm) 0.5% lead by weight.

### **X-ray fluorescence:**

1 milligram per square centimeter (mg/cm<sup>2</sup>)

### **Lead in dust:**

Floors, 40 micrograms per square foot (µg/ft<sup>2</sup>)

Window sills, 250 µg/ft<sup>2</sup> Window troughs, 400 µg/ft<sup>2</sup> (clearance only)

### **Lead in soil:**

High-contact bare play areas: 400 ppm

Other yard areas: 1,200 ppm



from a property, or when methods of removing toxic substances will affect the environment, it is extremely important that the owner be aware of the issues surrounding worker safety, environmental controls, and proper disposal. Appropriate architectural, engineering, and environmental professionals should be consulted when lead hazard projects are complex.

Following are brief explanations of the two approaches for controlling lead hazard risks. These controls are recommended by HUD in HUD *Guidelines for the Evaluation and Control of Lead-Based Paint Hazards in Housing* [61], and are summarized here to focus on special considerations for historic housing:

**Interim Controls.** Short-term solutions include thorough dust removal and thorough washdown and cleanup, paint film stabilization and repainting, covering of lead-contaminated soil, and informing tenants about lead hazards. Interim controls require ongoing maintenance and evaluation.

**Hazard Abatement.** Long-term solutions are defined as having an expected life of 20 years or more and involve permanent removal of hazardous paint through chemicals, heat guns, or controlled sanding or abrasive methods; permanent removal of deteriorated painted features through replacement; removal or permanent covering of contaminated soil; and the use of enclosures (such as drywall) to isolate painted surfaces. The use of specialized encapsulant products can be considered as permanent abatement of lead.

Reducing and controlling lead hazards can be successfully accomplished without destroying the character-defining features and finishes of historic buildings. Federal and state laws generally support the reasonable control of lead-based paint hazards through a variety of treatments, ranging from modified maintenance to selective substrate removal. The key to protecting children, workers, and the environment is to be informed about the hazards of lead, to control exposure to lead dust and lead in soil and lead paint chips, and to follow existing regulations.

The following summarizes several important regulations that affect lead-hazard reduction projects. Owners should be aware that regulations change, and they have a responsibility to check state and local ordinances as well. Care must be taken to ensure that any procedures used to release lead from the home protect both the residents and workers from lead dust exposure.

**Residential Lead-Based Paint Hazard Reduction Act of 1992, Title X [62].** Part of the Housing and Community Development Act of 1992 (Public Law 102-550) [63]. It established that HUD issue *Guidelines for the Evaluation and Control of Lead-Based Paint Hazards in Housing* [61] to outline risk assessments, interim controls, and abatement of lead-based paint hazards in housing. Title X calls for the reduction of lead in federally supported housing. It outlines the federal responsibility toward its own residential units and the need for disclosure of lead in residences, even private residences, before a sale. Title X also required HUD to establish regulations for federally assisted housing (24 CFR Part 35) and EPA to establish

## Definitions Related to Lead

**Deteriorated lead-based paint:** Paint known to contain lead above the regulated level that shows signs of peeling, chipping, chalking, blistering, alligating, or otherwise separating from its substrate.

**Dust removal:** The process of removing dust to avoid creating a greater problem of spreading lead particles; usually through wet or damp collection and use of HEPA vacuums.

**Hazard abatement:** Long-term measures to remove the hazards of lead-based paint through replacement of building components, enclosure, encapsulation, or paint removal.

**Interim control:** Short-term methods to remove lead dust, stabilize deteriorating painted surfaces, treat friction and impact surfaces that generate lead dust, and repaint surfaces. Maintenance can ensure that housing remains lead-safe.

**Lead-based paint:** Any existing paint, varnish, shellac, or other coating that is equal to or greater than 1.0 milligrams per square centimeter (mg/cm<sup>2</sup>) or greater than 0.5% by weight (5,000 ppm, 5,000 micrograms per gram [µg/g], or 5,000 milligrams per kilogram [mg/kg]). For new paint, CPSC has established 0.06% as the maximum amount of lead allowed in new paint. Lead in paint can be measured by x-ray fluorescence analyzers or laboratory analysis by certified personnel and approved laboratories.

**Risk assessment:** An on-site investigation to determine the presence and condition of lead-based paint, including limited test samples and an evaluation of the age, condition, housekeeping practices, and uses of a residence.

standards for lead in paint, dust, and soil, as well as standards for laboratory accreditation (40 CFR Part 745). EPA's residential lead hazard standards are available at <http://www.epa.gov/lead/leadhaz.htm>.

**Interim Final Rule on Lead in Construction (29 Code of Federal Regulations [CFR] 1926.62) [64].** Issued by OSHA, these regulations address worker safety, training, and protective measures. The regulations are based in part on personal-air sampling to determine the amount of lead dust exposure to workers.

**State Laws.** States generally have the authority to regulate the removal and transportation of lead-based paint and the generated waste through the appropriate state environmental and public health agencies. Most requirements are for mitigation in the case of a lead-poisoned child, for protection of children, or for oversight to ensure the safe handling and disposal of lead waste. When undertaking a lead-based paint reduction program, it is important to determine which laws are in place that may affect the project.

**Local Ordinances.** Check with local health departments, poison control centers, and offices of housing and community development to determine whether any laws require compliance by building owners. Determine whether projects are considered abatements and will require special contractors and permits.

**Owner's Responsibility.** Owners are ultimately responsible for ensuring that hazardous waste is properly disposed of when it is generated on their own sites. Owners should check with their state government to determine whether an abatement project requires a certified contractor. Owners should establish that the contractor is responsible for the safety of the crew, to ensure that all applicable laws are followed, and that transporters and disposers of hazardous waste have liability insurance as a protection for the owner. The owner should notify the contractor that lead-based paint may be present and that it is the contractor's responsibility to follow appropriate work practices to protect workers and to complete a thorough cleanup to ensure that lead-laden dust is not present after the work is completed. Renovation contractors are required by EPA to distribute an informative educational pamphlet (Protect Your Family from Lead in Your Home) to occupants before starting work that could disturb lead-based paint (<http://www.epa.gov/lead/leadinfo.htm#remodeling>).

## Arsenic

Lead arsenate was used legally up to 1988 in most of the orchards in the United States. Often 50 applications or more of this pesticide were applied each year. This toxic heavy metal compound has accumulated in the soil around houses and under the numerous orchards in the country, contaminating both wells and land. These orchards are often turned into subdivisions as cities expand and sprawl occurs. Residues from the pesticide lead arsenate, once used heavily on apple, pear, and other orchards, contaminate an estimated 70,000 to 120,000 acres in the state of Washington alone, some of it in areas where agriculture has been replaced with housing, according to state ecology department officials and others.

Lead arsenate, which was not banned for use on food crops until 1988, nevertheless was mostly replaced by the pesticide dichlorodiphenyltrichloroethane (DDT) and its derivatives in the late 1940s. DDT was banned in the United States in 1972, but is used elsewhere in the world.

For more than 20 years, the wood industry has infused green wood with heavy doses of arsenic to kill bugs and prevent rot. Numerous studies show that arsenic sticks to children's hands when they play on treated wood, and it is absorbed through the skin and ingested when they put their hands in their mouths. Although most uses of arsenic wood treatments were phased out by 2004, an estimated 90% of existing outdoor structures are made of arsenic-treated wood [65].

In a study conducted by the University of North Carolina Environmental Quality Institute in Asheville, wood samples were analyzed and showed that

- Older decks and play sets (7 to 15 years old) that were preserved with chromated copper arsenic expose people to just as much arsenic on the wood surface as do newer structures (less than 1 year old). The amount of arsenic that testers wiped off a small area of wood about the size of a 4-year-old's handprint typically far exceeds what EPA allows in a glass of water under the Safe Drinking Water Act standard. Figure 5.9 shows a safety warning label placed on wood products.
- Arsenic in the soil from two of every five backyards or parks tested exceeded EPA's Superfund cleanup level of 20 ppm.

Arsenic is not just poisonous in the short term, it causes cancer in the long term. Arsenic is on EPA's short list of chemicals known to cause cancer in humans. According to the National Academy of Sciences, exposure to arsenic

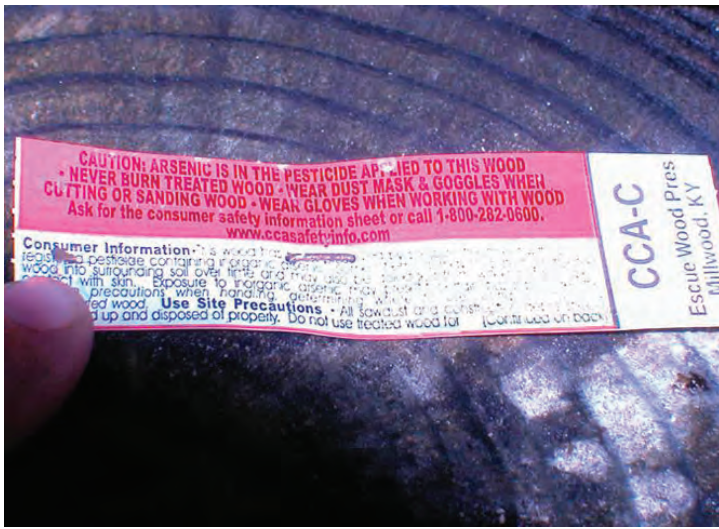

**Figure 5.9.** Arsenic Label

causes lung, bladder, and skin cancer in humans, and is suspected as a cause of kidney, prostate, and nasal passage cancer.

## References

1. US Environmental Protection Agency and the US Consumer Product Safety Commission. The inside story: a guide to indoor air quality. Washington, DC: US Environmental Protection Agency and the US Consumer Product Safety Commission, Office of Radiation and Indoor Air; 1995. Document #402-K-93-007. Available from URL: <http://www.epa.gov/iaq/pubs/insidest.html>.
2. Centers for Disease Control and Prevention. Asthma: speaker's kit for health care professionals; preface. Atlanta: US Department of Health and Human Services; no date. Available from URL: <http://www.cdc.gov/asthma/speakit/intro.htm>.
3. US Environmental Protection Agency. Washington, DC: US Environmental Protection Agency; 2004. Asthma facts. EPA #402-F-04-019. Available from URL: [http://www.epa.gov/asthma/pdfs/asthma\\_fact\\_sheet\\_en.pdf](http://www.epa.gov/asthma/pdfs/asthma_fact_sheet_en.pdf).
4. Centers for Disease Control and Prevention. Asthma: speaker's kit for health care professionals; epidemiology. Atlanta: US Department of Health and Human Services; no date. Available from URL: <http://www.cdc.gov/asthma/speakit/epi.htm>.
5. Crain EF, Walter M, O'Connor GT, Mitchell H, Gruchalla RS, Kattan M, et al. Home and allergic characteristics of children with asthma in seven U.S. urban communities and design of an environmental intervention: The Inner-City Asthma Study. *Environ Health Perspect* 2002;119:939–45.
6. Community Environmental Health Resource Center. Cockroaches: tools for detecting hazards. Washington, DC: Community Environmental Health Resource Center; no date. Available from URL: <http://www.cehrc.org/tools/cockroaches/index.cfm>.
7. Lyon WF. Entomology, House Dust Mites HYG 2157-97. Columbus, OH: The Ohio State University Extension; 1997. Available from URL: <http://ohioline.osu.edu/hyg-fact/2000/2157.html>.
8. Morgan WJ, Crain EF, Gruchalla RS, O'Connor GT, Kattan M, et al. Results of a home-based environmental intervention among urban children with asthma. *N Engl J Med* 2004;351:1068–80.
9. US Environmental Protection Agency. Sources of indoor air pollution—biological pollutants. Washington, DC: US Environmental Protection Agency; no date. Available from URL: <http://www.epa.gov/iaq/biologic.html>.
10. Ownby DR. Exposure to dogs and cats in the first year of life and risk of allergic sensitization at 6 to 7 years of age. *JAMA* 2002;288(8):963–72.
11. Roost HP. Role of current and childhood exposure to cat and atopic sensitization. *J Allergy Clin Immunol* 1999;104(5):94.
12. Downs SH. Having lived on a farm and protection against allergic diseases in Australia. *Clin Exp Allergy* 2001;31(4):570–5.
13. Institute of Medicine. Clearing the air: asthma and indoor air exposures. Washington, DC: National Academies Press; 2000.
14. American Conference of Governmental and Industrial Hygienists. Macher J, editor. Bioaerosols: assessment and control. Cincinnati, OH: American Conference of Governmental and Industrial Hygienists; 1999.
15. Institute of Medicine. Damp indoor spaces and health. Washington, DC: National Academies Press; 2004.
16. Morgan WJ, Crain EF, Gruchalla RS, O'Connor GT, Kattan M, Evans R 3rd, et al. Results of home-based environmental intervention among urban children with asthma. *N Engl J Med* 2004;351:1068–80.
17. Burge HA, Ammann HA. Fungal toxins and  $\beta$  (1→3)-D-glucans. In: Macher J, editor. Bioaerosols: assessment and control. Cincinnati, OH: American Conference of Governmental and Industrial Hygienists; 1999.
18. American Academy of Pediatrics, Committee on Environmental Health. Toxic effects of indoor molds. *Pediatrics* 1998;101:712–14.

19. Burge HA, Otten JA. 1999. Fungi. In: Macher J, editor. *Bioaerosols: assessment and control*. Cincinnati, OH: American Conference of Governmental and Industrial Hygienists; 1999.
20. Etzel RA. The “fatal four” indoor air pollutants. *Pediatr Ann* 2000;29(6):344–50.
21. Dearborn DG, Smith PG, Dahms BB, Allan TM, Sorenson WG, Montana E, et al. Clinical profile of thirty infants with acute pulmonary hemorrhage in Cleveland. *Pediatrics* 2002;110:627–37.
22. Etzel RA, Montana E, Sorenson WG, Kullman GJ, Allan TM, Dearborn DG. Acute pulmonary hemorrhage in infants associated with exposure to *Stachybotrys atra* and other fungi. *Arch Pediatr Adolesc Med* 1998;152:757–62.
23. Flappan SM, Portnoy J, Jones P, Barnes C. Infant pulmonary hemorrhage in a suburban home with water damage and mold (*Stachybotrys atra*). *Environ Health Perspect* 1999;107:927–30.
24. Vesper S, Dearborn DG, Yike I, Allan T, Sobolewski J, Hinkley SE, et al. Evaluation of *Stachybotrys chartarum* in the house of an infant with pulmonary hemorrhage: quantitative assessment before, during, and after remediation. *J Urban Health Bull N Y Acad Med* 2000;77(1):68–85.
25. US Environmental Protection Agency. A brief guide to mold, moisture, and your home (EPA 402-K-02-003). Washington, DC: US Environmental Protection Agency; 2002. Available from URL: <http://www.epa.gov/iaq/molds/images/moldguide.pdf>.
26. NYC. 2000. Guidelines on assessment and remediation of fungi in indoor environments. New York City Department of Health, Bureau of Environmental & Occupational Disease Epidemiology. Available from URL: <http://www.ci.nyc.ny.us/html/doh/html/epi/moldrpt1.shtml>.
27. Bush RK, Portnoy JM. The role and abatement of fungal allergens in allergic diseases. *J Allerg Clin Immunol Suppl* 2001;107(3 pt 2):430.
28. Department of Housing and Urban Development, Office of Native American Programs. Mold detection and prevention: a guide for housing authorities in Indian Country. Washington, DC: Department of Housing and Urban Development; 2001. Available from URL: <http://www2.ih.gov/IEH/documents/HUD%20Mold%20Detection.pdf>.
29. US Environmental Protection Agency. Mold remediation in schools and commercial buildings (EPA 402-K-01-001). Washington, DC: US Environmental Protection Agency; 2001.
30. Shaughnessy RJ, Morey PR. Remediation of microbial contamination. In: Macher J, editor. *Bioaerosols: assessment and control*. Cincinnati, OH: American Conference of Governmental and Industrial Hygienists; 1999.
31. National Institute of Environmental Health Sciences. Interim final guidelines for the protection and training of workers engaged in maintenance and remediation work associated with mold. Report of a national technical workshop, National Institute of Environmental Health Sciences, New York City, 2004 Jan 27–28.
32. Mott JA, Wolfe MI, Alverson CJ, Macdonald SC, Bailey CR, Ball LB, et al. National vehicle emissions policies and practices and declining US carbon monoxide mortality. *JAMA* 2002;288:988–95.
33. American Lung Association. Carbon monoxide fact sheet. New York: American Lung Association; 2004. Available from URL: <http://www.lungusa.org/site/pp.asp?c=dvLUK9O0E&b=35375>.
34. North Carolina Department of Health and Human Services. Indoor ozone. Raleigh, NC: North Carolina Department of Health and Human Services; 2003. Available from URL: <http://www.epi.state.nc.us/epi/oe/ozone/indoor.html>.
35. US Environmental Protection Agency. Ozone generators that are sold as air cleaners: an assessment of effectiveness and health consequences. Washington, DC: US Environmental Protection Agency; no date. Available from URL: <http://www.epa.gov/iaq/pubs/ozonegen.html>.
36. National Cancer Institute. Secondhand smoke: questions and answers. Bethesda, MD: National Cancer Institute; no date. Available from URL: <http://www.cancer.gov/cancertopics/factsheet/Tobacco/ETS>.
37. US Environmental Protection Agency. What you can do about secondhand smoke as parents, decision-makers, and building occupants. Washington, DC: US Environmental Protection Agency; 1993. Available from URL: <http://www.epa.gov/smokefree/pubs/etsbro.html>.
38. US Environmental Protection Agency. Methylene chloride (dichloromethane). Washington, DC: US Environmental Protection Agency; 1992. Available from URL: <http://www.epa.gov/ttnatw01/hlthef/methylen.html>.

39. Environmental Media Services. Four to avoid. Washington, DC: Environmental Media Services; 2002.
40. US Consumer Product Safety Commission. An update on formaldehyde: 1997 revision. Washington, DC: Consumer Product Safety Commission; 1997. CPSC Document 725. Available from URL: <http://www.cpsc.gov/cpsc/pub/pubs/725.html>.
41. US Environmental Protection Agency. Sources of indoor air pollution—formaldehyde. Washington, DC: US Environmental Protection Agency. Available from URL: <http://www.epa.gov/iaq/formalde.html>.
42. US Department of Housing and Urban Development. Formaldehyde emission controls for certain wood products. 24 CFR3280.308. Washington, DC: US Department of Housing and Urban Development; 2001. Available from URL: <http://www.hudclips.org/cgi/index.cgi>.
43. US Environmental Protection Agency. Assessment of risks from radon in homes. Washington, DC: US Environmental Protection Agency; 2003. Available from URL: [http://www.epa.gov/radon/risk\\_assessment.html](http://www.epa.gov/radon/risk_assessment.html).
44. US Geological Survey. The geology of radon. Reston, VA: US Geological Survey; 1995. Available from URL: <http://energy.cr.usgs.gov/radon/georadon/3.html>.
45. California Geological Survey. Radon. Sacramento, CA: California Geological Survey; no date. Available from URL: [http://www.consrv.ca.gov/cgs/minerals/hazardous\\_minerals/radon/](http://www.consrv.ca.gov/cgs/minerals/hazardous_minerals/radon/).
46. US Department of Health and Human Services. Surgeon General releases national health advisory on radon. Washington, DC: US Department of Health and Human Services; 2005. Available from URL: <http://www.hhs.gov/surgeongeneral/pressreleases/sg01132005.html>.
47. Brain M, Freudenrich C. How radon works. Atlanta: How Stuff Works; no date. Available from URL: <http://home.howstuffworks.com/radon.htm>.
48. Pennsylvania Department of Environmental Protection. Mitigating your home or office. Harrisburg, PA: Pennsylvania Department of Environmental Protection; no date. Available from URL: [http://www.dep.state.pa.us/dep/deputate/airwaste/rp/radon\\_division/Mitigation\\_Info.htm](http://www.dep.state.pa.us/dep/deputate/airwaste/rp/radon_division/Mitigation_Info.htm).
49. Connecticut Department of Public Health. Why should you build homes with radon-resistant techniques? Hartford, CT: Connecticut Department of Public Health Radon Program; no date. Available from URL: [http://www.dph.state.ct.us/BRS/radon/radon\\_techniques.htm](http://www.dph.state.ct.us/BRS/radon/radon_techniques.htm).
50. US Environmental Protection Agency. Radon-resistant new construction. Washington, DC: US Environmental Protection Agency; no date. Available from URL: <http://www.epa.gov/radon/construc.html>.
51. US Environmental Protection Agency. Pesticides and child safety. Washington, DC: US Environmental Protection Agency; no date. Available from URL: <http://www.epa.gov/pesticides/factsheets/childsaf.htm>.
52. Delaplane KS. Pesticide usage in the United States: history, benefits, risks, and trends. Athens, GA: Cooperative Extension Service, The University of Georgia College of Agriculture and Environmental Sciences; no date. Available from URL: <http://pubs.caes.uga.edu/caespubs/pubcd/B1121.htm>.
53. US Environmental Protection Agency. Sources of indoor air pollution—pesticides. Washington, DC: US Environmental Protection Agency; no date. Available from URL: <http://www.epa.gov/iaq/pesticid.html>.
54. Agency for Toxic Substances and Disease Registry. Public health statement for asbestos. Atlanta: US Department of Health and Human Services; 2001. Available from URL: <http://www.atsdr.cdc.gov/toxprofiles/phs61.html>.
55. US Geological Survey. Some facts about asbestos. USGS fact sheet FS-012-01, online version 1.1. Reston, VA: US Geological Survey; March 2001. Available from URL: <http://pubs.usgs.gov/fs/fs012-01/>.
56. Merriam-Webster, Inc. Merriam-Webster dictionary. Springfield, MA: Merriam-Webster, Inc.; no date. Available from URL: <http://www.m-w.com/home.htm>.
57. Jacobs DE, Clickner RP, Zhou JY, Viet SM, Marker DA, Rogers JW, et al. The prevalence of lead-based paint hazards in U.S. housing. *Environ Health Perspect* 2002;100:A599–606.
58. Centers for Disease Control and Prevention. Blood lead levels in residents of homes with elevated lead in tap water—District of Columbia, 2004. *MMWR* 2004; 53(12):268–70. Available from URL: <http://www.cdc.gov/mmwr/preview/mmwrhtml/mm5312a6.htm>.

59. National Research Council. Measuring lead exposure in infants, children and other sensitive populations. Washington, DC: National Academy Press; 1993.
60. Centers for Disease Control. Preventing lead poisoning in young children. Report No. 99-2230. Atlanta: US Department of Health and Human Services; 1991.
61. US Department of Housing and Urban Development. HUD technical guidelines for the evaluation and control of lead-based paint hazards in housing. Washington, DC: US Department of Housing and Urban Development; 1995. Available from URL: <http://www.hud.gov/offices/lead/guidelines/hudguidelines/index.cfm>.
62. US Department of Housing and Urban Development. The lead-based paint disclosure rule (Section 1018 of the Residential Lead-Based Paint Hazard Reduction Act of 1992). Washington, DC: US Department of Housing and Urban Development; no date. Available from URL: <http://www.hud.gov/offices/lead/disclosurerule/index.cfm>.
63. Residential Lead-Based Paint Hazard Reduction Act of 1992, Title X of the Housing and Community Development Act of 1992, Pub. L. No. 102-550 (Oct 28, 1992).
64. Occupational Safety and Health Administration. Lead exposure in construction: interim final rule. Fed Reg 1993;58:26590–649.
65. Environmental Working Group. Nationwide consumer testing of backyard decks and play sets shows high levels of arsenic on old wood. Washington, DC: Environmental Working Group; 2002. Available from URL: <http://www.ewg.org/reports/allhandsondeck/>.

# Chapter 6: Housing Structure

*“The Palace of Fine Arts in Mexico City has sunk more than 10 feet into the ground since it was built 60 years ago and the most noticeable effect is that the grand stone stairway has disappeared and the entrance is now at street level.”*

C.B. Crawford,  
*Canadian Building Digest*

## Introduction

The principal function of a house is to provide protection from the elements. Our present society, however, requires that a home provide not only shelter, but also privacy, safety, and reasonable protection of our physical and mental health. A living facility that fails to offer these essentials through adequately designed and properly maintained interiors and exteriors cannot be termed “healthful housing.”

In this chapter, the home is considered in terms of the parts that have a bearing on its soundness, state of repair, and safety. These are some of the elements that the housing inspector must examine when making a thorough housing inspection.

Figure 6.1 shows a typical house being built and inspected today and includes a terminology key. Both the

figure and the key are available in an interactive format in the glossary on the U.S. Inspect Web site [1].

Figure 6.2 shows a typical house built between 1950 and 1980 and also includes a terminology key. The figures show the complexity and the numerous components of a home. These components form the vocabulary that is necessary to discuss housing structure inspection issues.

## Key to Figure 6.1 (New Housing Terminology)

1. **Ash dump** (see 35)—A door or opening in the firebox that leads directly to the ash pit, through which the ashes are swept after the fire is burned out. All fireboxes are not equipped with an ash dump.
2. **Attic space**—The open space within the attic area.
3. **Backfill**—The material used to refill an excavation around the outside of a foundation wall or pipe trench.
4. **Baluster**—One of a series of small pillars that is attached to and runs between the stairs and the handrails. The spacing between the balusters should be less than 4 inches to prevent small children from getting stuck between the balusters. Balusters are considered a safety item and provide an additional barrier.

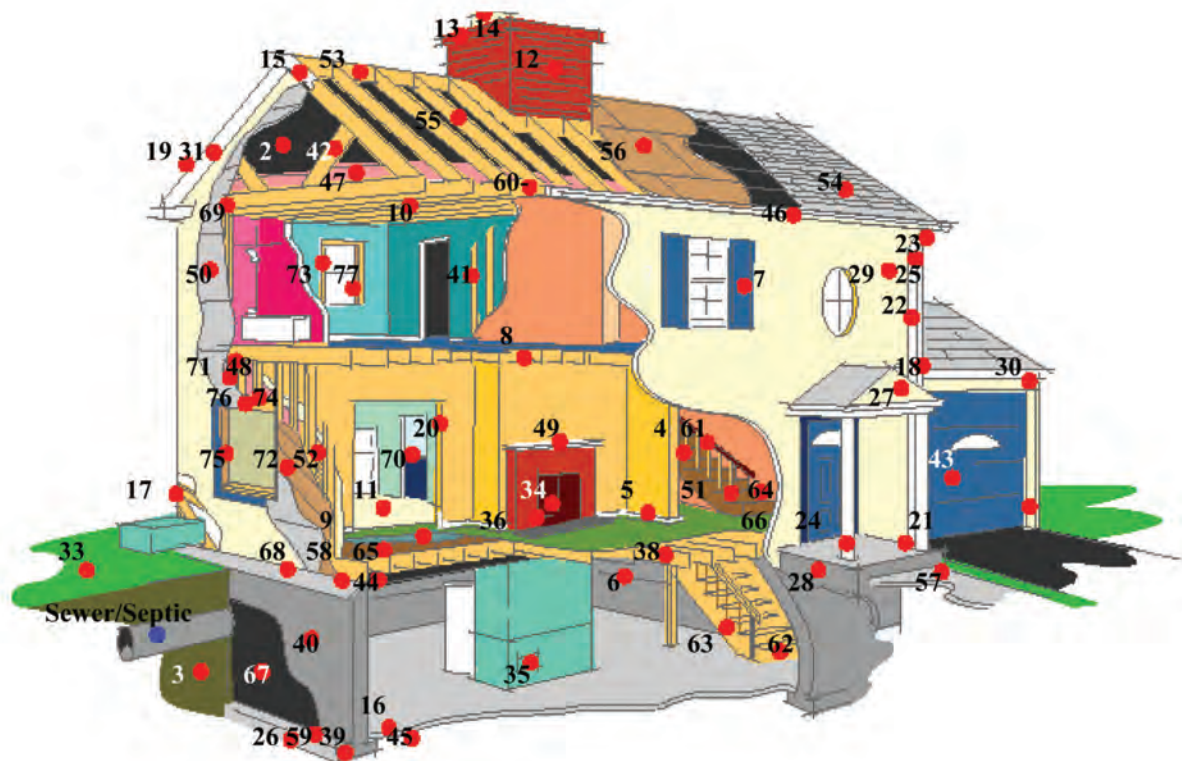

**Figure 6.1.** Housing Structure Terminology, Typical House Being Built Today [1]

5. **Baseboard trim**—Typically a wood trim board that is placed against the wall around the perimeter of a room next to the floor. The intent is to conceal the joint between the floor and wall finish.
6. **Basement window**—A window opening installed in the basement wall. Basement windows are occasionally below the finish grade level and will be surrounded on the exterior by a window well.
7. **Blind or shutter**—A lightweight frame in the form of a door located on each side of a window. They are most commonly constructed of wood (solid or louvered panels) or plastic. Originally they were designed to close and secure over the windows for security and foul weather. Most shutters now are more likely decorative pieces that are secured to the house beside the windows.
8. **Bridging**—Small pieces of wood or metal strapping placed in an X-pattern between the floor joists at midspan to prevent the joists from twisting and squeaking and to provide reinforcement and distribution of stress.
9. **Building paper/underlayment**—Building material, usually a felt paper that is used as a protective barrier against air and moisture passage from the area beneath the flooring as well as providing a movement/noise isolator in hardwood flooring.
10. **Ceiling joist**—A horizontally placed framing members at the ceiling of the top-most living space of a house that provides a platform to which the finished ceiling material can be attached.
11. **Chair rail (not shown)**—Decorative trim applied around the perimeter of a room such as a formal dining room or kitchen/breakfast nook at the approximate same height as the back of a chair. It is sometimes used as a cap trim for wainscoting (see wainscoting).
12. **Chimney**—A masonry or in more modern construction wood framed enclosure that surrounds and contains one or more flues and extends above the roofline.
13. **Chimney cap**—The metal or masonry protective covering at the top of the chimney that seals the chimney shaft from water entry between the chimney enclosure and the flue tiles.
14. **Chimney flues**—The space or channel in a chimney that carries off the smoke and other combustion gases to the outside air. Most homes will have a terra cotta tile flue or a metal flue.
15. **Collar beam/tie**—A horizontal piece of framing lumber that provides intermediate support for opposite rafters. They are usually located in the middle to upper third portion of the rafters. It is also known as a collar beam or collar brace.
16. **Concrete slab floor**—Typically approximately 4 inches thick, the concrete slab floor provides a number of uses. It creates a solid level surface to walk and work on. It provides a separation between the grade/soil and a potentially livable area. It also provides lateral compression resistance for the foundation walls, preventing soil pressure from outside the foundation from pushing the foundation walls and footings inward.
17. **Corner brace**—Diagonal braces placed at the corners of framed walls to stiffen them and provide extra strength.
18. **Cornice**—An overhang of a pitched roof at the eave line that usually consists of a fascia board, a soffit, and any appropriate moldings or vents.
19. **Cornice molding**—The individual pieces of wood trim that are applied to the cornice area at the eaves.
20. **Door casing/trim**—The finish trim details around the perimeter of the door on the interior finished wall.
21. **Door frame/jamb**—The top and sides of the door to include the wall framing as well as the actual door frame and trim.
22. **Downspout**—A pipe, usually of metal or vinyl, that is connected to the gutters and is used to carry the roof-water runoff down and away from the house.
23. **Downspout gooseneck**—Segmented section of downspout that is bent at a radius to allow the downspout to be attached to the house and to follow the bends and curves of the eaves and ground.
24. **Downspout shoe**—The bottom downspout gooseneck that directs the water from the downspout to the extension or splash block at the grade.
25. **Downspout strap**—Strap used to secure the downspout to the side of the house.
26. **Drain tile**—A tube or cylinder that is normally installed around the exterior perimeter of the foundation footings that collects and directs ground water away from the foundation of the house. The tile can be individual sections of clay or asphalt tubing or, in more recent construction, a perforated-plastic drain tile that is approximately 4 inches in diameter. The drain tile leads either towards a sump or to an exterior discharge away from the house.



27. **Entrance canopy**—A small overhanging roof that shelters the front entrance.
28. **Entrance stoop**—An elevated platform constructed of wood framing or masonry at the front entry that allows visitors to stand above or out of the elements. The platform should be wide enough to allow someone to stand on the platform while opening an outward swinging door such as a storm door even if one is not present.
29. **Exterior siding**—The decorative exterior finish on a house. Its primary function is to protect the shell of the house from the elements. The choice of siding materials varies widely to include wood, brick, metal, vinyl, concrete, stucco, and a variety of manufactured compositions such as compressed wood, compressed cellulose (paper), fiber-reinforced cement, and synthetic stucco.
30. **Fascia**—The visible flat front board that caps the rafter tail ends and encloses the overhang under the eave that runs along the roof edge. The gutter is usually attached at this location.
31. **Fascia/rake board**—The visible flat front board that caps the rafter tail ends and encloses the overhang under the eave that runs along the roof edge and at the edge of the roofing at the gables. The gutter is usually attached to this board at the eaves.
32. **Finish flooring (not shown)**—The final floor covering inside the living space of a house. The most common types of finishes are carpeting; hardwood flooring; ceramic, composite, or laminate stone tile; parquet panels; or vinyl sheet flooring.
33. **Finished grade line**—A predetermined line indicating the proposed elevation of the ground surface around a building.
34. **Firebox**—The cavity in the open face of the fireplace in which the fire is maintained. The firebox leads directly to the fireplace flue. The firebox is constructed of fire or refractory brick set in fireclay or reinforced mortar in traditional masonry fireplaces. The firebox may also be constructed of metal or ceramic-coated metal panels in more modern prefabricated fireplaces. The walls of the firebox are usually slanted toward the living space both to direct smoke up toward the flue and to reflect heat into the room.
35. **Fireplace cleanout door**—The access door to the ash pit beneath the fireplace. On a fireplace that is located inside the house, the cleanout door is usually located in the lowest accessible level of the house such as the basement or crawl space. On a fireplace that is located at the outside of the house, the cleanout door will be located at the exterior of the chimney. Not all fireplaces are equipped with a cleanout door.
36. **Fireplace hearth**—The inner or outer floor of a fireplace, usually made of brick, tile, or stone.
37. **Flashing (not shown)**—The building component used to connect and cover portions of a deck, roof, or siding material to another surface such as a wall, a chimney, a vent pipe, or anywhere that runoff is heavy or where two dissimilar materials meet. The flashing is mainly intended to prevent water entry and is usually made of rubber, tar, asphalt, or various metals.
38. **Floor joists**—The main subfloor framing members that support the floor span. Joists are usually made of engineered wood I-beams or 2×8 or larger lumber.
39. **Foundation footing**—The base on which the foundation walls rests. The foundation is wider than the foundation wall to spread out the load it is bearing and to help prevent settling.
40. **Foundation wall**—The concrete block, concrete slab or other nonwood material that extends below or partly below grade, which provides support for exterior walls and other structural parts of the building.
41. **Framing studs**—A 2×4 or 2×6 vertical framing member used to construct walls and partitions, usually spaced 12 to 24 inches apart.
42. **Gable framing**—The vertical and horizontal framing members that make up and support the end of a building as distinguished from the front or rear side. A gable is the triangular end of an exterior wall above the eaves.
43. **Garage door**—The door for the vehicle passage into the garage area. Typical garage doors consist of multiple jointed panels of wood, metal, or fiberglass.
44. **Girder**—A large beam supporting floor joists at the same level as the sills. A larger or principal beam used to support concentrated loads at isolated points along its length.
45. **Gravel fill**—A bed of coarse rock fragments or pebbles that is laid atop the existing soil before pouring the concrete slab. The gravel serves a dual purpose of breaking surface tension on the concrete slab and providing a layer that interrupts capillary action of subsurface moisture from reaching the concrete slab. Typically, a polyethylene sheeting will be installed between the gravel fill and the concrete slab for further moisture proofing.

46. **Gutter**—A channel used for carrying water run-off. Usually located at the eaves of a house and connected to a downspout. The primary purpose of the gutters and downspouts is to carry roof water run-off as far away from the house as possible.
47. **Insulation**—A manufactured or natural material that resists heat flow that is installed in a house's shell to keep the heat in a house in the winter and the coolness in the house in the summer. The most common form of insulation is fiberglass, whether in batts or blown-in material, along with cellulose, rigid foam boards, sprayed-in foam, and rock wool.
48. **Jack/king stud**—The framing stud, sometimes called the trimmer, that supports the header above a window, door, or other opening within a bearing wall. Depending on the size of the opening, there may be several jack studs on either side of the opening.
49. **Mantel**—The ornamental or decorative facing around a fireplace including a shelf that is attached to the breast or backing wall above the fireplace.
50. **Moisture/vapor barrier**—A nonporous material, such as plastic or polyethylene sheeting, that is used to retard the movement of water vapor into walls and attics and prevent condensation in them. A vapor barrier is also installed in crawl space areas to prevent moisture vapor from entering up through the ground.
51. **Newel post**—The post at the top and bottom of the handrails and anywhere along the stair run that creates a directional change in the handrails is called the newel post. The newel post is securely anchored into the underlying floor framing or the stair stringer to provide stability to the handrails.
52. **Reinforcing lath**—A strip of wood or metal attached to studs and used as a foundation for plastering, slating or tiling. Lath has been replaced by gypsum board in most modern construction.
53. **Ridge board/beam**—The board placed on edge at the top-most point of the roof framing, into which the upper ends of the rafters are joined or attached.
54. **Roofing**—The finished surface at the top of the house that must be able to withstand the effects of the elements (i.e., wind, rain, snow, hail, etc.). A wide variety of materials are available, including asphalt shingles, wood shakes, metal roofing, ceramic and concrete tiles, and slate, with asphalt shingles making up the bulk of the material used.
55. **Roof rafters**—Inclined structural framing members that support the roof, running from the exterior wall to the ridge beam. Rafters directly support the roof sheathing and create the angle or slope of the roof.
56. **Roof sheathing**—The material used to cover the outside surface of the roof framing to provide lateral and rack support to the roof, as well as to provide a nailing surface for the roofing material. This material most commonly consists of plywood OSB or horizontally laid wood boards.
57. **Sidewalk**—A walkway that provides a direct, all-weather approach to an entry. The sidewalk can be constructed of poured concrete, laid stone, concrete pavers, or gravel contained between borders or curbs.
58. **Sill plate**—The horizontal wood member that is anchored to the foundation masonry to provide a nailing surface for floors or walls built above.
59. **Silt fabric**—A porous fabric that acts as a barrier between the backfilled soil (see backfill) and the gravel surrounding the drain tile. This barrier prevents soil particles from blocking the movement of groundwater to the drain tile.
60. **Soffit/lookout block**—Rake cross-bracing between the fly rafters and end gable rafters that the soffit is nailed to.
61. **Stair rail**—A sturdy handhold and barrier that follows the outside, and sometimes inside, perimeter of the stairs. The stair rail is used to prevent falls and to provide a means of additional support when walking up or down the stairs.
62. **Stair riser**—The vertical boards that close the space between each stair tread on a set of stairs (see *stair stringer* and *stair tread*).
63. **Stair stringer**—The supporting members in a set of stairs that are cut or notched to accept the individual treads and risers (see *stair riser* and *stair tread*).
64. **Stair tread**—The horizontal board in a stairway that is walked upon (see *stair riser* and *stair stringer*).
65. **Subfloor**—Boards or plywood, installed over joists, on which the finish floor rests.
66. **Support post**—A vertical framing member usually designed to carry or support a beam or girder. In newer construction a metal lally (pronounced “lolly”) column is commonly used, as well as 4×4- or 6×6-inch wood posts.
67. **Tar**—Otherwise known as asphalt, tar is a very thick, dark brown/black substance that is used as a sealant or waterproofing agent. It is usually produced naturally by the breakdown of animal and vegetable matter that has

been buried and compressed deep underground. Tar is also manufactured—a hydrocarbon by-product or residue that is left over after the distillation of petroleum. It is commonly used as a sealant or patch for roof penetrations, such as plumbing vents and chimney flashing. Tar is also used as a sealer on concrete and masonry foundation walls before they have been backfilled.

68. **Termite shield**—A metal flashing that is installed below the sill plate that acts as a deterrent to keep termites from reaching the sill plate.
69. **Top plate**—The topmost horizontal framing members of a framed wall. Most construction practices require the top plate to be doubled in thickness.
70. **Wainscoting**—The wooden paneling of the lower part of an interior wall up to approximately waist-height or between 36 and 48 inches from the floor.
71. **Wall insulation**—A manufactured or natural material that resists heat flow that is installed in a house's shell to keep the heat in a house in the winter and the coolness in the house in the summer. Fiberglass batts are the most common form of wall insulation.
72. **Wall sheathing**—The material used to cover the outside surface of the wall framing that provides lateral and shear support to the wall as well as a nailing surface for the exterior siding.
73. **Window casing/trim**—The finish trim details around the perimeter of the window on the interior finished wall.
74. **Window cripple**—Short studs placed between the header and a top plate or between a sill and sole plate.
75. **Window frame/jamb**—The top and sides of the window, to include the wall framing and the actual window frame and trim.
76. **Window header**—A beam placed perpendicular to wall studs above doors, windows, or other openings to carry the weight of structural loads above the window or door.
77. **Window sash**—The framework that holds the glass in a door or window.
78. **Window well (not shown)**—An excavation around a basement window that prevents the surrounding soils from collapsing into the window. The window well surround is normally constructed of formed corrugated galvanized metal, built-up masonry, or pressure-treated wood.

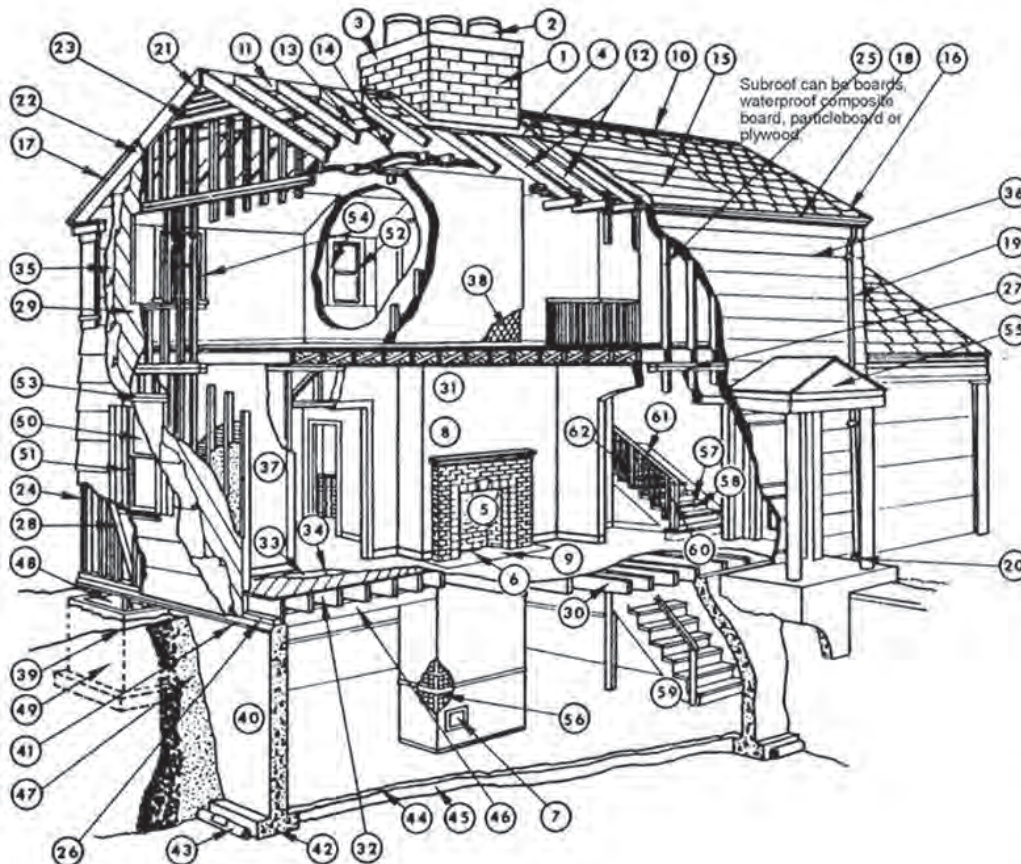

Figure 6.2. Housing Structure and Terminology, Typical House Built Between 1950 and 1980 [2]

## Key to Figure 6.2 (Old Housing Terminology)

### Fireplace

1. **Chimney**—A vertical masonry shaft of reinforced concrete or other approved noncombustible, heat resisting material enclosing one or more flues. It removes the products of combustion from solid, liquid or gaseous fuel.
2. **Flue liner**—The flue is the hole in the chimney. The liner, made of terra cotta or metal, protects the brick from harmful smoke gases.
3. **Chimney cap**—This top is generally of concrete. It protects the brick from weather.
4. **Chimney flashing**—Sheet metal flashing provides a tight joint between chimney and roof.
5. **Firebrick**—An ordinary brick cannot withstand the heat of direct fire, and so special firebrick is used to line the fireplace. In newer construction, fireplaces are constructed of prefabricated metal inserts.
6. **Ash dump**—A trap door to let the ashes drop to a pit below, where they may be easily removed.
7. **Cleanout door**—The door to the ash pit or the bottom of a chimney through which the chimney can be cleaned.
8. **Chimney breast**—The inside face or front of a fireplace chimney.
9. **Hearth**—The floor of a fireplace that extends into the room for safety purposes.

### Roof

10. **Ridge**—The top intersection of two opposite adjoining roof surfaces.
11. **Ridge board**—The board that follows along under the ridge.
12. **Roof rafters**—The structural members that support the roof.
13. **Collar beam**—Not a beam at all; this tie keeps the roof from spreading and connects similar rafters on opposite sides of the roof.
14. **Roof insulation**—An insulating material (usually rock wool or fiberglass) in a blanket form placed between the roof rafters to keep a house warm in the winter and cool in the summer.
15. **Roof sheathing**—The boards that provide the base for the finished roof. In newer construction, roof sheathing is composed of sheets of plywood, or oriented strand board (OSB).

16. **Roofing**—The wood, asphalt or asbestos shingles—or tile, slate, or metal—that form the outer protection against the weather.
17. **Cornice**—A decorative element made of molded members, usually placed at or near the top of an exterior or interior wall.
18. **Gutter**—The trough that gathers rainwater from a roof.
19. **Downspout**—The pipe that leads the water down from the gutter.
20. **Storm sewer tile**—The underground pipe that receives the water from the downspouts and carries it to the sewer. In newer construction, plastic-type material have replaced tile.
21. **Gable**—The triangular end of a building with a sloping roof.
22. **Barage board**—The fascia or board at the gable just under the edge of the roof.
23. **Louvers**—A series of slanted slots arranged to keep out rain, yet allow ventilation.

### Walls and Floors

24. **Corner post**—The vertical member at the corner of the frame, made up to receive inner and outer covering materials.
25. **Studs**—The vertical wood members of the house, usually 2×4s at minimum and spaced every 16 inches.
26. **Sill**—The board that is laid first on the foundation, and on which the frame rests.
27. **Plate**—The board laid across the top ends of the studs to hold them even and tight.
28. **Corner bracing**—Diagonal strips to keep the frame square and plumb.
29. **Sheathing**—The first layer of outer wall covering nailed to the studs.
30. **Joist**—The structural members or beams that hold up the floor or ceiling, usually 2×10s or 2×12s spaced 16 inches apart.
31. **Bridging**—Cross-bridging or solid. Members at the middle or third points of joist spans to brace one to the next and to prevent them from twisting.
32. **Subflooring**—Typically plywood or particle wood that is laid over the joists.
33. **Flooring paper**—A felt paper laid on the rough floor to stop air infiltration and, to some extent, noise.

34. **Finish flooring**—Hardwood, of tongued and grooved strips, carpet, or vinyl products (tile, linoleum).
35. **Building paper or sheathing**—Paper or plasticized material placed outside the sheathing, not as a vapor barrier, but to prevent water and air from leaking in. Building paper is also used as a tarred felt under shingles or siding to keep out moisture or wind.
36. **Beveled siding**—Sometimes called clapboards, with a thick butt and a thin upper edge lapped to shed water. In newer construction, vinyl, aluminum, or fiber cement siding and stucco are more prevalent.
37. **Wall insulation**—A blanket of wool or reflective foil placed inside the walls.
38. **Metal lath**—A mesh made from sheet metal onto which plaster or other composite surfacing materials can be applied. In newer construction, plaster sheetrock 4- $\times$ 8-foot sheets have replaced lath.

### *Foundation and Basement*

39. **Finished grade line**—The top of the ground at the foundation.
40. **Foundation wall**—The wall of poured concrete (shown) or concrete blocks that rests on the footing and supports the remainder of the house.
41. **Termite shield**—A metal baffle to prevent termites from entering the frame.
42. **Footing**—The concrete pad that carries the entire weight of the house upon the earth.
43. **Footing drain tile**—A pipe with cracks at the joints, or perforated plastic pipe to allow underground water to drain away before it gets into the basement.
44. **Basement floor slab**—The 4- or 5-inch layer of concrete that forms the basement floor.
45. **Gravel fill**—Placed under the slab to allow drainage and to guard against a damp floor.
46. **Girder**—A main beam upon which floor joists rest. Usually of steel, but also of wood.
47. **Backfill**—Earth, once dug out, that has been replaced and tamped down around the foundation.
48. **Areaway**—An open space to allow light and air to a window. Also called a light well.
49. **Area wall**—The wall, of metal or concrete, that forms the open area.

### *Windows and Doors*

50. **Window**—An opening in a building for admitting light and air. It usually has a pane or panes of glass and is set in a frame or sash that is generally movable for opening and shutting.
51. **Window frame**—The lining of the window opening.
52. **Window sash**—The inner frame, usually movable, that holds the glass.
53. **Lintel**—The structural beam over a window or door opening.
54. **Window casing**—The decorative strips surrounding a window opening on the inside.

### *Stairs and Entry*

55. **Entrance canopy**—A roof extending over the entrance door.
56. **Furring**—Falsework or framework necessary to bring the outer surface level to the inner surface.
57. **Stair tread**—The horizontal part of a step that the foot hits when climbing up or down the stairs.
58. **Stair riser**—The vertical board connecting one tread to the next.
59. **Stair stringer**—The sloping board that supports the ends of the steps.
60. **Newel**—The post that terminates the railing.
61. **Stair rail**—The bar used for a handhold when using the stairs.
62. **Balusters**—Vertical rods or spindles supporting a rail.

### *Foundation*

The word “foundation” is used to mean

- construction below grade, such as footings, cellar, or basement;
- the composition of the earth on which the building rests; and
- special construction, such as pilings and piers used to support the building.

The foundation bed may be composed of solid rock, sand, gravel, or unconsolidated sand or clay. Rock, sand, or gravel are the most reliable foundation materials. Figure 6.3 shows the three most common foundations for homes. Unconsolidated sand and clay, though found in many sections of the country, are not as desirable for foundations

because they are subject to sliding and settling [1]. Capillary breaks have been identified as a key way of reducing moisture incursion in new construction [3].

The footing distributes the weight of the building over a sufficient area of ground to ensure that the foundation walls will stand properly. Footings are usually concrete; however, in the past, wood and stone have been used. Some older houses were constructed without footings.

Although it is usually difficult to determine the condition of a footing without excavating the foundation, a footing in a state of disrepair or lack of a footing will usually be indicated either by large cracks or by settlement in the foundation walls. This type of crack is called a “Z” crack.

Foundation wall cracks are usually diagonal, starting from the top, the bottom, or the end of the wall (Figure 6.4).

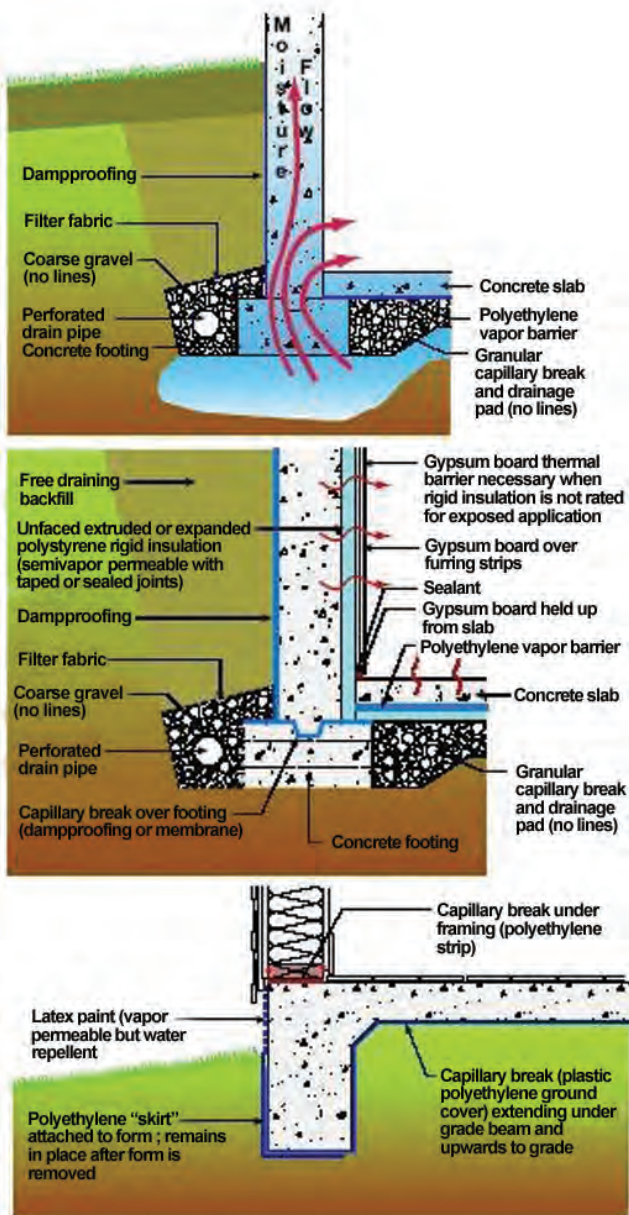

Figure 6.3. Foundation [3]

Cracks that do not extend to at least one edge of the wall may not be caused by foundation problems. Such wall cracks may be due to other structural problems and should also be reported.

The foundation walls support the weight of the structure and transfer this weight to the footings. The foundation walls may be made of stone, brick, concrete, or concrete blocks. The exterior should be moisture proofed with either a membrane of waterproof material or a coating of portland cement mortar. The membrane may consist of plastic sheeting or a sandwich of standard roofing felt joined and covered with tar or asphalt. The purpose of waterproofing the foundation and walls is to prevent water from penetrating the wall material and leaving the basement or cellar walls damp.

Holes in the foundation walls are common in many old houses. These holes may be caused by missing bricks or blocks. Holes and cracks in a foundation wall are undesirable because they make a convenient entry for rats and other rodents and also indicate the possibility of further structural deterioration. Basement problems are a major complaint of homeowners [4–9].

Concrete is naturally porous (12%–18% air). When it cures, surplus water creates a network of interconnected capillaries. These pores let in liquid water, water vapor, and radon gas. Like a sponge, concrete draws water from several feet away. As concrete ages, the pores get bigger as a result of freezing, thawing, and erosion.

Concrete paints, waterproofing sealers, or cement coatings are a temporary fix. They crack or peel and cannot stop gases such as water vapor and radon.

Damp basement air spreads mold and radon through the house. Efflorescence (white powder stains) and musty odors are telltale signs of moisture problems.

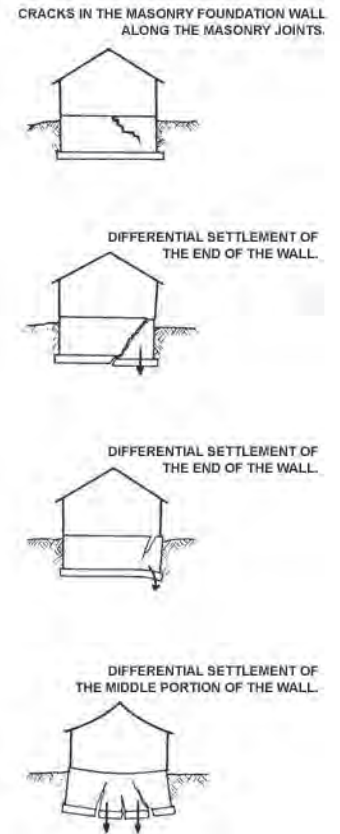

Figure 6.4. Foundation Cracks [4]

Basement remodeling traps invisible water vapor, causing mold and mildew. Most basements start leaking within 10 to 15 years. The basement walls and floors should be sealed and preserved before they deteriorate. The basement floor should be concrete placed on at least 6 inches of gravel. The gravel distributes groundwater movement under the concrete floor, reducing the possibility of the water penetrating the floor. A waterproof membrane, such as plastic sheeting, should be laid before the concrete is placed for additional protection against flooding and the infiltration of radon and other gases.

The basement floor should be gradually, but uniformly, sloped from all directions toward a drain or a series of drains. These drains permit the basement or cellar to drain if it becomes flooded.

Water or moisture marks on the floor and walls are signs of ineffective waterproofing or moisture proofing. Cellar doors, hatchways, and basement windows should be weather-tight and rodent-proof. A hatchway can be inspected by standing at the lower portion with the doors closed; if daylight can be seen, the door needs to be sealed or repaired.

## Vapor Barriers

### Crawl Space Vapor Barriers

Throughout the United States, even in desert areas, there is moisture in the ground from groundwater being absorbed. Even in an apparently dry crawl space, a large amount of water is entering. The moisture is drying out as fast as it is entering, which causes high moisture levels in the crawl space and elsewhere in the house. A solid vapor barrier is recommended in all crawl spaces and should be required if moisture problems exist [10]. This vapor barrier, if properly installed, also reduces the infiltration of radon gas. Of course, if the moisture is coming from above ground, a vapor barrier will collect and hold the moisture. Therefore, any source of moisture must be found and eliminated. The source may be as obvious as sweating pipes, or may be more difficult to spot, such as condensation on surfaces. The solution can be as simple as applying insulation to exposed sections of the piping or complex enough to require power exhaust fans and the addition of insulation and vapor barriers.

The more common causes of moisture problems in a new home are moisture trapped within the structure during construction and a continuing source of excess moisture from the basement, crawl space, or slab. To resolve this

potential problem, 6-mil plastic sheets should be laid as vapor barriers over the entire crawl space floor. The sheets should overlap each other by at least 6 inches and should be taped in place. The plastic should extend up the perimeter walls by about 6 inches. The plastic sheets should be attached to the interior walls of the crawl space with mastic or batten strips. All of the perimeter walls should be insulated, and insulation should be between the joists at the top of the walls. Vents, which may need to be opened in the late spring and closed in the fall, should not be blocked. If not properly managed, moisture originating in the crawl space can cause problems with wood flooring and create many biologic threats to health and property. A properly placed vapor barrier can prevent or reduce problem moisture from entering the home.

### Vapor Barriers for Concrete Slab Homes

Strip flooring and related products should be protected from moisture migration by a slab. Proper on-grade or above-grade construction requires that a vapor barrier be placed beneath the slab. Moisture tests should be done to determine the suitability of the slab before installing wood products. A vapor barrier equivalent to 4- or 6-mil polyethylene should be installed on top of the slab to further protect the wood products and the residents of the home.

### Wall and Ceiling Vapor Barriers

Wall and ceiling vapor barriers should go on the heated side of the insulation and are necessary in cold climates. Water vapor flows from areas of high pressure (indoors in winter) through the wall to an area of low pressure (outdoors in winter). People and their pets produce amazing quantities of water vapor by breathing. Additional moisture in considerable quantities is created in the home from everyday activities such as washing clothes, cooking, and personal hygiene. The purpose of the vapor barrier is to prevent this moisture from entering the wall and freezing, then draining, causing damage. In addition, wet insulation has very little insulating value. Insulation with the vapor barrier misplaced will allow the vapor to condense in the insulation and then freeze. In cold climates, this ice can actually build up all winter and run out on the floor in the spring. Such moisture buildup blisters paint, rots sheathing, and destroys the insulating value of insulation.

## House Framing

Many types of house-framing systems are found in various sections of the country; however, most framing systems include the elements described in this section.

### Foundation Sills

The purpose of the sill is to provide support or a bearing surface for the outside walls of the building. The sill is the first part of the frame to be placed and rests directly on the foundation wall. It is often bolted to the foundation wall by sill anchors. In many homes, metal straps are cemented into the foundation wall that are bent around and secured to the sill. It is good practice to protect the sill against termites by extending the foundation wall to at least 18 inches above the ground and using a noncorroding metal shield continuously around the outside top of the foundation wall.

### Flooring Systems

The flooring system is composed of a combination of girders, joists, subflooring, and finished flooring that may be made up of concrete, steel, or wood. Joists are laid perpendicular to the girders, at about 16 inches on center, and the subflooring is attached to them. If the subfloor is wood, it may be nailed, glued, or screwed at either right angles or diagonally to the joists. Many homes are built with wood I-joists or trusses rather than solid wood joists.

In certain framing systems, a girder supports the joists and is usually a larger section than the joists it supports. Girders are found in framing systems where there are no interior bearing walls or where the span between bearing walls is too great for the joists. The most common application of a girder is to support the first floor. Often a board known as a ledger is applied to the side of a wood girder or beam to form a ledge for the joists to rest upon. The girder, in turn, is supported by wood posts or steel “lally columns” that extend from the cellar or basement floor to the girder.

### Studs

For years, wall studs were composed of wood and were 2×4 inches; but, with the demand for greater energy efficiency in homes, that standard no longer holds true. Frame studs up to 6 inches wide are used to increase the area available for placing insulation material. The increased size in the studs allow for larger spaces between joists.

There are now alternatives to conventional wood studs, specifically, insulated concrete forms, structural insulated

panels, light-gauge steel, and combined steel and wood [11–13]. The advantages of light-gauge steel include the following:

- weighs 60% less than equivalent wood units and has greater strength and durability;
- is impervious to termites and other damage-causing pests;
- stays true and does not warp;
- is noncombustible; and
- is recyclable.

The disadvantages of steel include these:

- steel is an excellent thermal conductor and requires additional external insulation;
- as a new product, it is unfamiliar to craftsmen, engineers, and code officials; and
- a different type of construction tools are required.

The combined steel and wood framing system includes light-gauge steel studs with 6-inch wooden stud pieces attached to the top and bottom to allow easy attachment to traditional wood frame materials.

There are two types of walls or partitions: bearing and nonbearing. A bearing wall is constructed at right angles to support the joists. A nonbearing wall, or partition, acts as a screen or enclosure; hence, the headers in it are often parallel to the joists of the floor above.

In general, studs, like joists, are spaced 16 inches on center. In light construction, such as garages and summer cottages, wider spacing on studs is common.

Openings for windows or doors must be framed in studs. This framing consists of horizontal members (headers) and vertical members (trimmers or jack studs).

Because the vertical spaces between studs can act as flues to transmit flames in the event of a fire, fire stops are important in preventing or retarding fire from spreading through a building by way of air passages in walls, floors, and partitions. Fire stops are wood obstructions placed between studs or floor joists to block fire from spreading in these natural flue spaces.

### Interior Walls

Many types of materials are used for covering interior walls and ceilings, but the principal type is drywall. The generic term “drywall” is typically used when talking about gypsum board. It is also called wallboard or referred



to by the brand name Sheetrock. Gypsum board is a sheet material composed of a gypsum filler faced with paper. In drywall construction, gypsum boards are fastened to the studs either vertically or horizontally and then painted. The edges along the length of the sheet are slightly recessed to receive joint cement and tape.

Drywall finish, composed of gypsum board, is a material that requires little, if any, wait for application. Other drywall finishes include plywood, fiberboard, or wood in various sizes and forms. Plaster was once quite popular for interior walls. Plaster is a mixture (usually of lime, sand, and water) applied in two or three coats to lath to form a hard-wall surface. A plaster finish requires a base on which plaster can be spread. Wood lath at one time was the plaster base most commonly used, but today gypsum-board lath is more popular. Gypsum lath may be perforated to improve the bond and thus lengthen the time the plaster can remain intact when exposed to fire. Building codes in some cities require that gypsum lath be perforated. Expanded-metal lath also may be used as a plaster base. Expanded-metal lath consists of sheet metal slit and expanded to form openings to hold the plaster. Plaster is applied over the base to a minimum thickness of ½ inch. Because wood-framing members may dry after the house is completed, some shrinkage can be expected, which, in turn, may cause plaster cracks to develop around openings and in corners. Strips of lath embedded in the plaster at these locations prevent cracks. Bathrooms have unique moisture exposure problems and local code approved cement board should be used around bath and shower enclosures.

### Stairways

The purpose of stairway dimension standards is to ensure adequate headroom and uniformity in riser and tread size.

Interior stairways (Figure 6.5) should be no less than 44 inches wide. The width of a stairway may be reduced to 36 inches when permitted by local or state code in one- and two-family dwellings. Stairs with closed risers should have maximum risers of 8¼ inches and minimum treads of 9 inches plus 1 inch nosing. Basement stairs are often constructed with open risers. These stairs should have maximum risers of 8¼ inches and minimum treads of 9 inches plus 1-inch nosing. The headroom in all parts of the stair enclosure should be no less than 80 inches. Dimensions of exterior stairways should be the same as those of interior stairways, except that the headroom requirement does not apply.

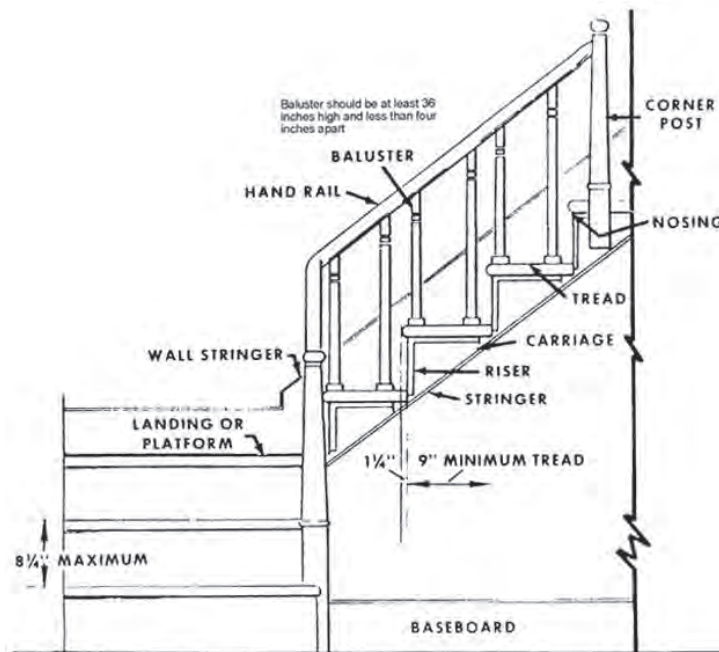

Figure 6.5. Interior Stairway [4]

Staircases should have handrails that are between 1¼ and 2⅝ inches wide, particularly if the staircases have more than four steps. Handrails should be shaped so they can be readily grasped for safety and placed so they are easily accessible. Handrails should be 4⅞ inches from the wall and be 34 to 38 inches above the leading edge of the stairway treads. Handrails should not end in any manner or have projections that can snag clothing.

### Windows

The six general classifications of windows (Figure 6.6) are as follows [1]:

- *Double-hung* sash windows that move up or down, balanced by weights hung on chains, ropes, or springs on each side;
- *Casement* sash windows that are hinged at the side and can be hung so they will swing out or in;
- *Awning* windows that usually have two or more glass panes that are hinged at the top and swing out horizontally;
- *Sliding* windows that usually have two or more glass panes that slide past one another on a horizontal track;
- *Fixed* windows that are generally for increased light entry and decorative effect; and
- *Skylight* windows for increased room illumination and decoration that can be built to open.

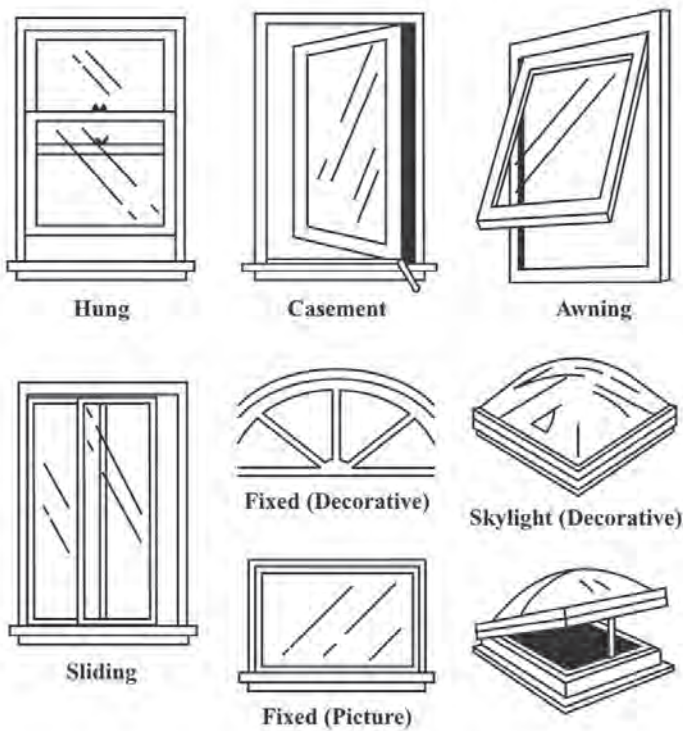

Figure 6.6. Classifications of Windows [1]

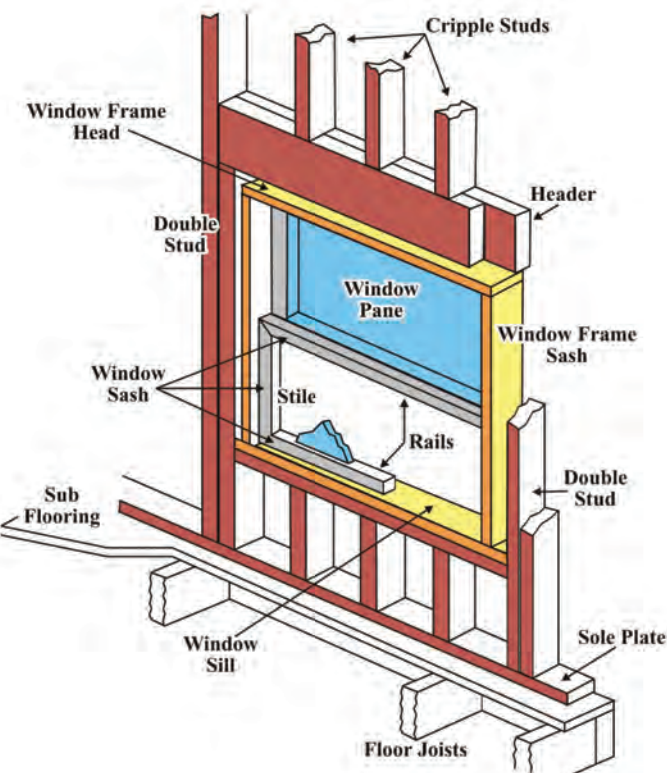

Figure 6.7. Three Dimensional View of a Window [1]

The principal parts of a window, shown in three-dimensional view in Figure 6.7 and face-on and side view in Figure 6.8, are the following:

**Drip cap**—A separate piece of wood projecting over the top of the window; a component of the window casing. The drip cap protects against moisture.

**Window trough**—The cut or groove in which the sash of the window slides or rests.

**Window sill**—The shelf on the bottom edge of a window, either a projecting part of the window frame or the bottom of the wall recess that the window fits into. The sill contains the trough and protects against moisture.

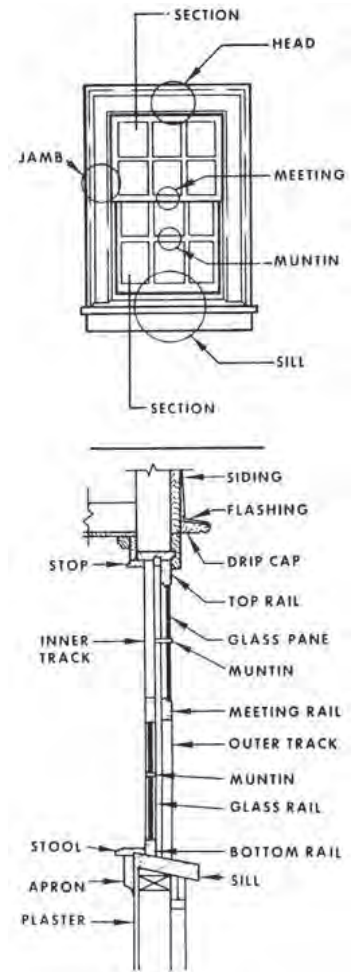

Figure 6.8. Window Details [3]

**Recent technological advancements**—new materials, coatings, design, and construction features—make it possible to choose windows that allow you to balance winter heating and summer cooling needs without sacrificing versatility or style. To ensure that windows, doors, or skylights selected are appropriate for the region in which they are to be installed, Energy Star Certification labels include a climate region map.

Some window glass is made of tempered glass to resist breakage. Some windows are made of laminated glass, which resists breakage, but if broken produces glass shards too small to cause injury [14]. The glazing, or glass, can be a solid glass sheet (single glazed) or have two layers of glass (double glazed) separated by a spacer. Air trapped between the glass layers provides some insulation value. Triple-glazed windows have three pieces of glass, or two layers of glass with a low emissivity film suspended between them. Triple-glazed windows have advantages where extremes in weather and temperature are the norm. They also can reduce sound transmission to a greater degree than can single- or double-glazed windows.

## Doors

There are many styles of doors both for exterior and interior use. Exterior doors must, in addition to offering privacy, protect the interior of the structure from the elements. Various parts of a door are the same as the corresponding parts of a window. A door's function is best determined by the material from which it is made, how it looks, and how it operates. When doors are used for security, they are typically made from heavy materials and have durable, effective locks and hinges. A door that lets in light or allows people to look out onto the yard, such as a sliding glass door or a french door, will have multiple panes (also called lights) or be made almost completely of glass.

Houses have many exterior and interior door options. Exterior doors are typically far sturdier than interior doors and need to be weather tight and ensure security for the home. Exterior doors are also more decorative than most interior doors and may cost a considerable amount. Typical exterior doors include front entry doors, back doors, french doors, dutch doors, sliding glass doors, patio doors, and garage doors.

French doors and sliding doors are examples of the two primary ways doors open. French doors swing on hinges; sliding doors glide along a track. Some doors, such as dutch doors, have tops and bottoms that swing open independently.

Most doors are made of wood or materials made to look like wood. Fiberglass composite and steel doors often have polymer or vinyl coatings embossed with wood grain; some even have cellulose-based coatings that can be stained like wood doors. Wood doors are made from every kind of wood imaginable, hardwoods being the most durable and elegant. Wood doors insulate better than glass; composite and steel doors provide even more insulation and durability, as well as better security than does wood.

### *Garage Doors*

Garage doors open in almost any configuration needed for the design of the home. Installing most garage doors is complex and dangerous enough that only a building professional should attempt it. Garage doors often include very strong springs that can come loose and severely injure the unsuspecting installer. Garage door springs are under extreme tension because of the heavy loads they must lift, which makes them dangerous to adjust. A garage door may suffer from any of several problems. The most common problem is that the door

becomes difficult to lift and lower. This may be something that can be resolved with simple adjustments, or it may be more serious. If the door is connected to an electric opener, the opener mechanism can be disconnected from the door by pulling the release cord or lever. If the door then works manually, the problem is with the electric opener. A door that seems unusually hard to lift may have a problem with spring tension. Wood doors should be properly painted or stained both outside and inside. If only the outside of a garage door is finished, the door may warp and moisture may cause the paint to peel.

Rules issued by the Consumer Product Safety Commission on December 3, 1992, specify entrapment protection requirements for garage doors [15].

The rules require that residential garage door openers contain one of the following:

- An external entrapment protection device, such as an electric eye that sees an object obstructing the door without having actual contact with the object. A door-edge sensor is a similar device. The door-edge sensor acts much like the door-edge sensors on elevator doors.
- A constant contact control button, which is a wall-mounted button requiring a person to hold in the control button continuously for the door to close completely. If the button is released before the door closes, the door reverses and opens to the highest position.
- A sticker on all newly manufactured garage door openers warning consumers of the potential entrapment hazard. The sticker is to be placed near the wall-mounted control button.

The variety of exterior door systems has increased significantly over the past 5 to 10 years. Many combine several different materials to make a realistic, if not actual wood, door that provides both beauty and enhanced security.

### *Exterior House Doors*

Exterior door frames are ordinarily of softwood plank, with the side rabbitted to receive the door in the same way as casement windows. At the foot is a sill, made of hardwood or other material, such as aluminum, to withstand the wear of traffic and sloped down and out to shed water. Doors often come equipped with door sweeps to conserve energy.

The four primary categories of modern exterior doors are steel, fiberglass, composites, and wood.

**Steel**—The most common exterior door sold today is steel. Humidity will not cause a steel door to warp or twist. Steel doors often have synthetic wood-grain embossed finishes that accept stain. Just about every steel exterior door is filled with some type of foam. This foam allows the doors to achieve R-values almost five times that of an ordinary wood door. Metal is often used as a veneer frame. In general, the horizontal members are called rails and the vertical members are called stiles. Every door has a top and bottom rail, and some may have intermediate rails. There are always at least two stiles, one on each side of the door.

**Fiberglass**—The second most frequently selected exterior door is fiberglass. Fiberglass doors are similar to steel doors, but tend to be much more resistant to denting. (Steel doors can be dented quite easily.) Fiberglass doors also are stainable and have rich, realistic wood graining. Fiberglass doors are insulated with foam and have high R-values.

**Composite materials**—The third most common exterior door is made of composite materials. These doors often are of two materials blended together. Their composite fiber-reinforced core can be twice as strong as wood. This composite core will not rot, warp, or twist when subjected to high levels of humidity.

**Wood**—The last major category of doors is wood. Solid wood doors range from inexpensive to true works of art. Their downside is that they can warp and bow if not sealed properly from humidity and will then fit poorly in their frames.

Other types of wooden doors are described below.

- **Batten doors** are often found on older homes. They are made of boards nailed together in various ways. The simplest is two layers nailed to each other at right angles, usually with each layer at 45° to the vertical. Another type of batten door consists of vertical boards nailed at right angles to several (two to four) cross strips called ledgers, with diagonal bracing members nailed between the ledgers. If vertical members corresponding to ledgers are added at the sides, the verticals are called frames. Batten doors are often found in cellars and other places where appearance is not a factor and economy is desired.
- **Solid flush doors** are perfectly flat, usually on both sides, although occasionally they are made flush on one side and are paneled on the other. Flush doors sometimes are solid planking, but they are commonly

veneered and possess a core of small pieces of white pine or other wood. These pieces are glued together with staggered end joints. Along the sides, top, and bottom are glued  $\frac{3}{4}$  inch edge strips of the same wood, used to create a smooth surface that can be cut or planed. The front and back faces are then covered with a  $\frac{1}{8}$ -inch to  $\frac{1}{4}$ -inch layer of veneer. Solid flush doors may be used on both the interior and exterior.

- **Hollow-core doors**, like solid flush doors, are perfectly flat; but, unlike solid doors, the core consists mainly of a grid of crossed wooden slats or some other type of grid construction. Faces are three-ply plywood instead of one or two plies of veneer, and the surface veneer may be any species of wood, usually hardwood. The edges of the core are solid wood and are made wide enough at the appropriate places to accommodate locks and butts. Doors of this kind are considerably lighter than solid flush doors. Hollow-core doors are usually used as interior doors.

Many doors are paneled, with most panels consisting of solid wood or plywood, either raised or flat, although exterior doors frequently have one or more panels of glass. One or more panels may be used, although some have as many as nine panels. Paneled doors may be used both on the interior or exterior.

The frame of a doorway is the portion to which the door is hinged. It consists of two side jambs and a head jamb, with an integral or attached stop against which the door closes.

## Roof Framing

### Rafters

One of a series of structural roof members spanning from an exterior beam or a ridge board. Rafters serve the same purpose for the roof as joists do for floors, that is, providing support for sheathing and roofing material. They are typically placed on 16-inch centers.

### Collar Beam

Collar beams are ties between rafters on opposite sides of the roof. If the attic is to be used for rooms, the collar beam may double as the ceiling joist.

### Purlin

A purlin is the horizontal member that forms the support for the rafters at the intersection of the two slopes of a gambrel roof.

## Ridge Board

A ridge board is a horizontal member that forms a lateral tie to make rafters secure.

## Hip

A hip is like a ridge, except that it slopes. It is the intersection of two adjacent, rather than two opposite, roof planes.

## Roof Sheathing

The manner in which roof sheathing is applied depends upon the type of roofing material. Roof boards may vary from tongue-and-groove lumber to plywood panels.

## Dormer

The term “dormer window” is applied to all windows in the roof of a building, whatever their size or shape.

## Roofs

### Asphalt Shingle

The principal damage to asphalt shingle roofs is caused by strong winds on shingles nailed close to the ridge line of the roof. Usually the shingles affected by winds are those in the four or five courses nearest the ridge and in the area extending about 5 feet down from the edge or rake of the roof.

### EPDM

Ethylene propylene diene monomer (EPDM) is a single-ply roofing system. EPDM allows extreme structural movement without splitting or cracking and retains its pliability in a wide range of temperatures.

### Asphalt Built-up Roofs

Asphalt roofs may be unsurfaced (a coating of bitumen being exposed directly to the weather) or surfaced (with slag or gravel embedded in the bituminous coating). Using surfacing material is desirable as a protection against wind damage and the elements. This type of roof should have enough pitch to drain water readily.

### Coal Tar Pitch Built-up Roofs

This type of roof must be surfaced with slag or gravel. A coal tar pitch built-up roof should always be used on a deck pitched less than ½ inch per foot; that is, where water may collect and stand. This type of roof should be inspected on completion, 6 months later, and then at least once a year, preferably in the fall. When the top coating of bitumen shows damage or has become badly weathered, it should be renewed.

## Slate Roofs

The most common problem with slate roofs is the replacement of broken slates. Otherwise, slate roofs normally render long service with little or no repair.

## Tile Roofs

Replacement of broken shingle tiles is the main maintenance problem with tile roofs. This is one of the most expensive roofing materials. It requires very little maintenance and gives long service.

## Copper Roofs

Usually made of 16-ounce copper sheeting and applied to permanent structures, copper roofs require practically no maintenance or repair when properly installed. Proper installation allows for expansion and contraction with changes in temperature.

## Galvanized Iron Roofs

The principal maintenance for galvanized iron roofs involves removing rust and keeping the roof well painted. Leaks can be corrected by re-nailing, caulking, or replacing all or part of the sheet or sheets in disrepair.

## Wood Shingle Roofs

The most important factors of wood shingle roofs are their high pitch and exposure, the character of wood, the kind of nails used and the preservative treatment given the shingles. At one time these roofs were treated with creosote and coal tar preservatives. Because they are made from a flammable material, insurance companies frequently have higher rates for wood shingle roofs.

## Roof Flashing

Valleys in roofs (such as gambrel roofs, which have two pitches designed to provide more space on upper floors and are steeper on their lower slope and flatter toward the ridge) that are formed by the junction of two downward slopes may be open or closed. In a closed valley, the slates, tiles, or shingles of one side meet those of the other, and the flashing below them may be comparatively narrow. In an open valley, the flashing, which may be made of zinc, copper, or aluminum, is laid in a continuous strip, extending 12 to 18 inches on each side of the valley, while the tiles or slates do not come within 4 to 6 inches of it. The ridges built up on a sloping roof where it runs down against a vertical projection, like a chimney or a skylight, should be weatherproofed with flashing. Failure of roof flashing is usually due to exposed nails that have come loose. The loose nails allow the flashing

to lift, resulting in leakage. Flashings made of lead or coated with lead should not be used.

The use of a thin, self-sticking rubber ice and water shield under flashings and on the edge of roofs is now common practice. The shield helps reduce leakage and ice backup in cold climates, preventing serious damage to this part of the home.

### Gutters and Leaders

Gutters and leaders should be of noncombustible materials and should not be made of lead, lead-coated copper, or any other formulation containing lead. They should be securely fastened to the structure and spill into a storm sewer, not a sanitary sewer, if the neighborhood has one. When there is no storm sewer, a concrete or stone block placed on the ground beneath the leader prevents water from eroding the lawn. This stone block is called a splash block. Gutters should be checked every spring and fall and cleaned when necessary. Gutters must be placed or installed to ensure that water drainage is taken away from the foundation of the house. Soil around the home should be graded in a manner that also drains the water away from the foundation of the home.

In frame construction, the base material of the exterior walls is called sheathing. The sheathing material may be square-edge, shiplap, tongue-and-groove boards, or plywood or oriented strand board (OSB). Sheathing, in addition to serving as a base for the finished siding material, stiffens the frame to resist sway caused by wind. It is for this reason that sheathing is applied diagonally on frame buildings. Its role is to brace the walls effectively to keep them from racking.

Many types of sidings, shingles, and other exterior coverings are applied over the sheathing. Vinyl siding; wood siding; brick, cedar, and other wood shingles or shakes; asphalt; concrete; clapboard; common siding (called bevel siding); composition siding; cement shingles; fiber cement (e.g., Hardiplank); and aluminum siding are commonly used for exterior coverings. In older homes, asbestos-cement siding shingles can still be found as an exterior application or underneath various types of aluminum or vinyl siding.

Clapboard and common siding differ only in the length of the pieces. Composition siding is made of felt, grit, and asphalt, which are often shaped to look like brick. Asbestos and cement shingles, which were used until the early 1970s, are rigid and produce a siding that is fire-resistant, but also a health hazard. Cedar wood shingles and aluminum are manufactured with a backer board that gives insulation and fire-resistant qualities. Vinyl siding is manufactured from polyvinyl chloride (PVC), a building material that has replaced metal as the prime material for many industrial, commercial, and consumer products. PVC has many years of performance as a construction material, providing impact-resistance, rigidity, and strength. The use of vinyl siding is not without controversy, because PVC is known to cause cancer in humans. Accidental fires in vinyl-sided buildings are more dangerous because vinyl produces toxic vapors when heated.

### Putting It All Together

The next section shows a home being built by Habitat for Humanity.

This small, one-family home represents all of the processes that would also be used for a far more expensive and elaborate dwelling. The homebuilding demonstrated by the following pictures was by an industrial arts class to educate and train a new generation of construction specialists and homebuilders.

### Exterior Walls and Trim

Exterior walls are enclosure walls whose purpose is not only to make the building weather tight, but to also allow the building to dry out. In most one- to three-story buildings they also serve as bearing walls. These walls may be made of many different materials (Figure 6.9).

Brick is often used to cover framed exterior walls. In this situation, the brick is only one course thick and is called a brick veneer. It supports nothing but itself and is kept from toppling by ties connected to the frame wall.

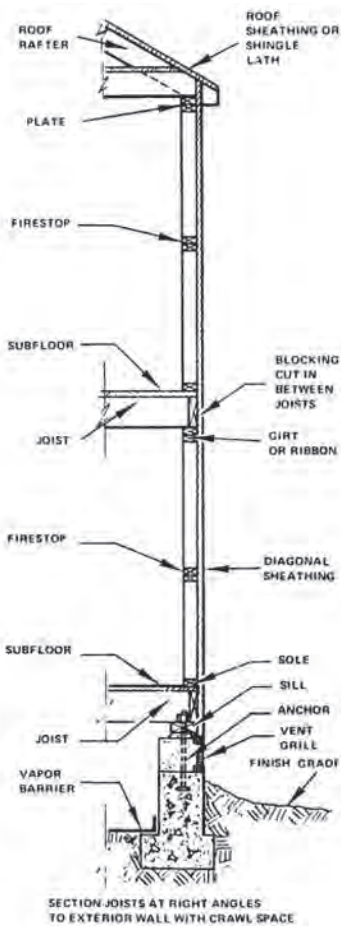

Figure 6.9. Wall Framing [4]



**A.**

The foundation trench for a new home has horizontal metal rods, also called reinforcement rods or rebar, to increase the strength of the concrete. After the concrete hardens, a perforated pipe 4 to 6 inches in diameter is placed beside it to collect water and allow it to drain away from the foundation. This pipe is the footing drain, and the poured concrete beside it is the footer. The footing drain is important in removing water from the base of the home. It also serves the secondary purpose of moisture control in the home and provides a venting route for radon gas. The holes dug near the legs of the workers will be filled with concrete and form the footer that will hold up the porch of the home.

To assist in preventing capillary action from wicking water from the foundation to the wooden structure, a polyethylene sheet is placed over the footer before pouring the concrete foundation, or building a cinderblock foundation.



**B.**

The concrete on top of the footer is leveled to establish a surface for the foundation of the home. Once the footer has hardened, the perforated drainage pipe will be laid on the outside of the poured foundation wall. The reinforcing rods were positioned in the trench before pouring the concrete.



**C.**

Concrete will be poured into this form on top of the footer to create the foundation of the home. Again, reinforcing rods are added to ensure that the concrete has both lateral strength, as well as the strength to support the home. Once the concrete has hardened and becomes seasoned, the forms will be removed to reveal the finished poured concrete foundation over the perforated drainage pipe. Not shown is a newer technique of using insulating polystyrene forms and ties in a building foundation.



#### D.

Foundations are not always poured concrete, but are often cinderblock or similar materials that are cemented in place to form the load-bearing wall. The arrow shows the concrete chute delivering concrete into the form. Long poles are pushed into the freshly poured concrete to remove air pockets that would weaken the foundation.

Care must be taken to ensure that the forms are appropriately supported before pouring the concrete. Often tar, plastic, or other waterproof materials are placed on the outside of the foundation to the ground level to further divert moisture from the house to the footing drains.



#### E.

Gravel fill is placed outside the finished poured concrete foundation. This ensures that moisture does not stand around the foundation for any time. The moisture is routed to the footing drain for fast dispersal.



#### F.

A termite shield is established on top of the concrete wall (foundation) just below the sill of the home. The sill is typically made of pressure- and insecticide-treated wood to ensure stability and long life.

A cinderblock foundation will be used to support the storage shed attached to the house. Note the potential for inadvertent sabotage of the termite shield if a shield is not installed on the top of the cinder block foundation.



#### G.

OSB subfloor, the joist supporting the floor, and the metal bridging that is used to keep the joist from twisting can be seen from the crawl space under the home.

If the material used for the flooring or external sheathing of the home is made of plywood or a composition that is not waterproof, the material must be protected from rain to prevent deterioration and germination of mold spores. Some glues or resins release toxic vapors for years if deterioration is allowed to begin.





#### H.

The flooring material of the first floor of the home is OSB applied to the subfloor with both glue and wood screws. Where possible, the screws should extend into the subfloor and the joist below the subfloor to prevent squeaking.



#### I.

The interior wall framing is composed of studs traditionally referred to as 2×4s. The horizontal member at the top of the studs is called a girder or a ribbon. In this case the builders have used two 2×4s, placing one on top of the other. Because the outside walls have used studs that are 2×6-inch boards, the girts or ribbons on top of these are also double 2×6-inch boards.



#### J.

The exterior wall framing is composed of studs that are 2×6-inch boards. The horizontal member extending from one exterior wall to the other is called a girder and is a prime support for the second floor of the home. The larger studs in the exterior wall are used both for greater strength and to provide greater energy efficiency for the home.

The lintels above the windows and doors distribute the weight of the second floor and roof across the studs that are located on each side of the openings in the frame.

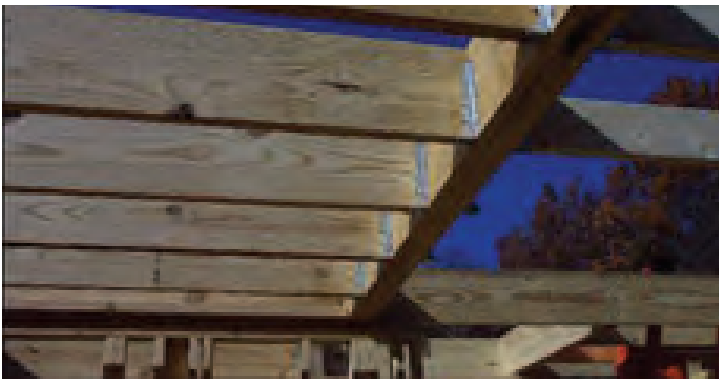

#### K.

The joists above the first floor are connected to the central girder of the home by steel brackets. These brackets provide a far more effective alternative than does toenailing nails to hold the joists in place or to notching the girder to hold them.



#### L.

The subroof or roof sheathing is applied from the bottom up with temporary traction boards nailed to the subroof to allow safe installation of the material.

The subroof is placed on the rafters up to the ridge board of the roof. A waterproof material will be added to the subroof before installing the final roofing material.



#### M.

An interior wall is installed to create second-floor rooms.

The subroof has been installed.

The exterior wood of the home has been covered with plastic sheathing or a housewrap to protect it from moisture.



#### N.

Flashing material, such as sheet metal, is installed at critical locations to make sure that water does not enter the home where the joints and angles of a roof meet: where the dormer roof meets the roof and the walls of the dormer meet the roof, where windows penetrate the walls, where the vent stack penetrates the roof, where the porch roof meets the front wall, skylights, and eaves of the house.



#### O.

A safety scaffold is standing at the rear of the home, and the final roofing material has been applied, in addition to the exterior vinyl siding.



## P.

The front porch of the home is constructed of pressure-treated, insect-resistant lumber. The use of such lumber should be carefully evaluated with respect to what chemicals have been used and the potential for human exposure to the treated wood. Composite wood products and plastic decking materials, collectively called Trex, are available as an alternative to pressure-treated wood. A proper hand railing and balusters will be installed.

## References

1. US Inspect. Glossary of terms. Chantilly, VA: US Inspect; no date. Available from URL: <http://www.usinspect.com/Glossary/glossary.asp>.
2. Center for Disease Control. Housing construction terminology. In: Basic housing inspection. Atlanta: US Department of Health and Human Services; 1976.
3. Building Science Corporation. Read this before you design, build, or renovate. Westford, MA: Building Science Corporation; 2004.
4. Center for Disease Control. Basic housing inspection. Atlanta: US Department of Health and Human Services; 1976.
5. Wagner JD. Drying out a wet basement. New York: This Old House Ventures, Inc.; no date. Available from URL: <http://www.thisoldhouse.com/toh/knowhow/interiors/article/0,16417,220912,00.html>.
6. Friedman D. Inspecting foundations for structural defects. Poughkeepsie, NY: Daniel Friedman; 2001. Available from URL: <http://www.inspect-ny.com/structure/foundation.htm>.
7. Association of Bay Area Governments. Foundations: section 5. Oakland, CA: Association of Bay Area Governments; 1998. Available from URL: <http://www.abag.ca.gov/bayarea/eqmaps/fixit/ch5>.
8. Crawford CB. CBD-148: foundation measurements. Ottawa, Ontario, Canada: National Research Council; 1972. Available from URL: <http://irc.nrc-cnrc.gc.ca/cbd/cbd148e.html>.
9. Hamilton JJ. CBD-184: foundations on swelling or shrinking subsoils. Ottawa, Ontario, Canada: National Research Council; 1977. Available from URL: [http://irc.nrc-cnrc.gc.ca/pubs/cbd/cbd184\\_e.html](http://irc.nrc-cnrc.gc.ca/pubs/cbd/cbd184_e.html).
10. US Department of Housing and Urban Development. Basements and crawl spaces. Washington, DC: US Department of Housing and Urban Development; 2000. Available from URL: <http://www.hud.gov/offices/hsg/sfh/ref/sfhp1-25.cfm>.
11. Bateman BW. Light-gauge steel verses conventional wood framing in residential construction. J Construction Educ 1997;2(2):99–108.
12. National Association of Home Builders Research Center. Integrated steel/wood combination framing. Upper Marlboro, MD: National Association of Home Builders; no date. Available from URL: <http://www.toolbase.org/tertiaryT.asp?DocumentID=4249&CategoryID=1142>.
13. Steel Wood Studs. Why use steel wood studs? Reno, NV: Steel Wood Studs; 2001.
14. Canadian Mortgage and Housing Corporation. Understanding window terminology. Ottawa, Ontario, Canada: Canadian Mortgage and Housing Corporation; no date. Available from URL: [http://www.cmhc-schl.gc.ca/en/burema/gesein/abhose/abhose\\_061.cfm](http://www.cmhc-schl.gc.ca/en/burema/gesein/abhose/abhose_061.cfm).
15. US Consumer Product Safety Commission. Safety commission publishes Final Rules for automatic garage door openers. Washington, DC: US Consumer Product Safety Commission; 1992. Available from URL: <http://www.cpsc.gov/cpsc/pub/prerel/prhtml93/93024.html>.

## Additional Sources of Information

Carmody J, Christian J, Labs K, editors. Builder's foundation handbook. Oak Ridge, TN: Oak Ridge National Laboratory; 1991.

US Department of Housing and Urban Development. Basements and crawl spaces. Washington, DC: US Department of Housing and Urban Development; 2000. Available from URL: <http://www.hud.gov/offices/hsg/sfh/ref/sfhp1-25.cfm>.



*“The physician can bury his mistakes, but the architect can only advise his client to plant vines—so they should go as far as possible from home to build their first buildings.”*

Frank Lloyd Wright  
*New York Times*, October 4, 1953

## Introduction

Damaging moisture originates not only from outside a home; it is created inside the home as well. Moisture is produced by smoking; breathing; burning candles; washing and drying clothes; and using fireplaces, gas stoves, furnaces, humidifiers, and air conditioning. Leaks from plumbing, unvented bathrooms, dishwashers, sinks, toilets, and garbage disposal units also create moisture problems because they are not always found before water damage or mold growth occurs. Figure 7.1 provides an overview of the sources of moisture and types of air pollutants that can enter a home.

Solving moisture problems is often expensive and time-consuming. The first step is to do a moisture inventory to eliminate problems in their order of severity. Problems that are easiest and least expensive to resolve should be addressed first. For example, many basement leaks have been eliminated by making sure sump pumps and downspouts drain away from the house. On the other hand, moisture seeping through basement or foundation walls often is very expensive to repair. Eliminating such mois-

ture is seldom as simple as coating the interior wall, but often requires expert consultation and excavating around the perimeter of the house to install or clean clogged footing drains. Sealing the outside of the basement walls and coating the exterior foundation wall with tar or other waterproofing compounds are often the only solutions to eliminate moisture.

Moisture condensation occurs in both winter and summer. The following factors increase the probability of condensation:

- Homes that are ineffectively insulated and are not sealed against air infiltration in cold climates can result in major moisture problems.
- Cool interior surfaces such as pipes, windows, tile floors, and metal appliances; air conditioner coils with poor outside drainage; masonry or concrete surfaces; toilet tanks; and, in the winter, outside walls and ceilings can result in moisture buildup from condensation. If the temperature of an interior surface is low enough to reach the dew point, moisture in the air will condense on it and enhance the growth of mold.
- Dehumidifiers used in regions where outside humidity levels are normally 80% or higher have a moisture-collecting tank that should be cleaned and disinfected regularly to prevent the growth of mold and bacteria.

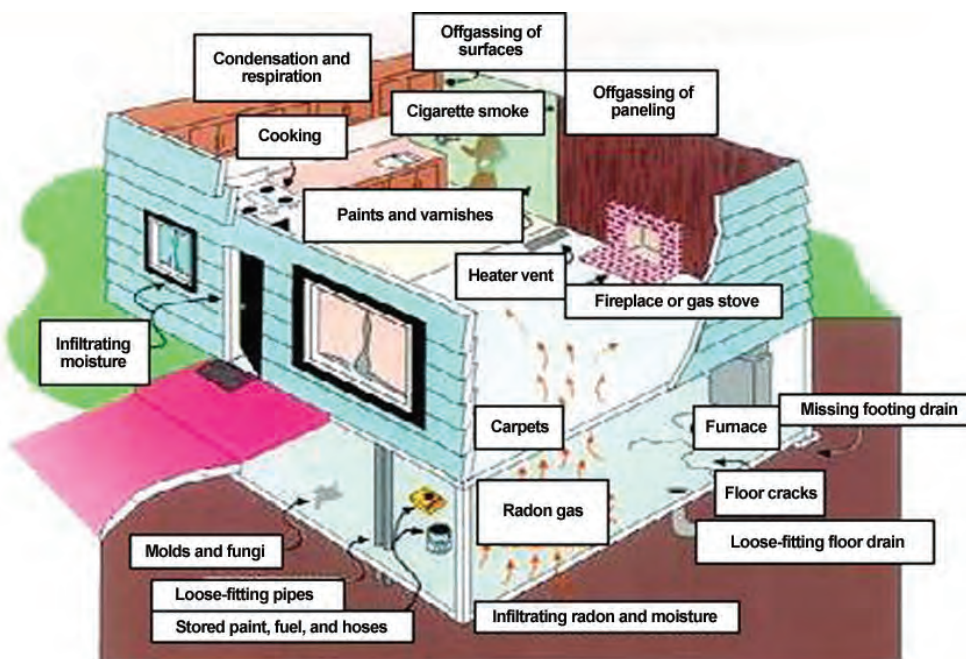

Figure 7.1. Sources of Moisture and Air Pollutants [1]

It is best if dehumidifiers have a drain line continuously discharging directly to the outside or into a properly plumbed trap. This is also true in climates where air conditioning units are used on a full-time or seasonal basis. Their cooling pans provide an excellent environment for the growth of allergenic or pathogenic organisms.

- Moisture removed from clothing by clothes driers ends up in the dryer vent if it is clogged by lint or improperly configured. Moisture buildup in this vent can result in mold growth and, if leakage occurs, damage to the structure of the home. The vent over the cooking area of the kitchen also should be checked routinely for moisture or grease buildup.

## Roof

The control of moisture in a home is of paramount importance. It is no surprise that moisture control begins with the design and integrity of the roof. Many types of surfacing materials are used for roofs—stone, composition asphalt, plastic, or metal, for example. Some have relatively short lives and some, such as slate and tile, have extraordinarily long lives. As in nearly all construction materials, tradeoffs must be made in terms of cost, thermal efficiency, and longevity. However, all roofs have two things in common: the need to shed moisture and protect the interior from the environment.

When evaluating the roof of a home, the first thing to observe is the roofline against the sky to see if the roof's ridge board is straight and level. If the roofline is not straight, it could mean that serious deterioration has taken place in the structure of the home as a result of

improper construction, weight buildup, a deteriorated or broken ridge beam, or rotting rafters. Whatever the cause, the focus of an inspection must be to locate the extent of the damage.

The next area to inspect is around the flashing on the roof. Flashing is used around any structure that penetrates the surface of a roof or where the roofline takes another direction. These areas include chimneys, gas vents, attic vents, dormers, and raised and lowered roof surfaces. One of the best ways to locate a leak around flashing is to go into the attic and look carefully. Leaks often are discovered when it rains; but if it is not raining, the underside of the roof can be examined with the attic lights off for pinpoint points of daylight.

Roofing material should lay relatively flat and should not wave or ripple. The roof should be checked for missing or damaged shingles, areas where flashing should be installed, elevation changes in roof surfaces, and evidence of decomposing or displaced surfaces around the edge of the roof [1–3].

## Insulation

A house must be able to breathe; therefore, air must not be trapped inside, but must be allowed to exit the home with its moisture. Moisture buildup in the home will lead to both mold and bacteria growth. Figure 7.2 demonstrates insulation blown into an attic, to a depth of approximately 12 inches (Figure 7.3). Figure 7.4 shows the area extending from a house under the roof, known as the soffit. The soffit is perforated so that air can flow into the attic and up through the ridge vents to ventilate the attic.

## Roof Inspection

1. Is the roofline of the house straight?
2. Are there ripples or waves in the roof?
3. What is the condition of the gutters and downspouts?
4. What is the condition of the boards the gutters are attached to?
5. Does the flashing appear to be separated or damaged?
6. Is there any apparent damage in the attic or can sunlight be seen through the roof?
7. Is there mold or discoloration on the rafters or roof sheathing?
8. Is there evidence of corrosion between the gutter and downspouts and any metal roofing or aluminum siding?
9. Do the downspouts route the water away from the base or foundation of the home?
10. Are the gutters covered or free of leaves? Are they sagging or separating from the fascia?
11. Does the gutter provide a mosquito-breeding area by holding water?



Figure 7.2. Blown Attic Insulation



Figure 7.3. Depth of Attic Insulation

If insulation is too thick or installed improperly, it restricts proper air turnover in the attic and moisture or extreme temperatures could result in mold or bacteria growth, as well as delamination of the plywood and particleboards and premature aging of the roof's subsurface and shingles.

Care also must be taken in cold climates to ensure that the insulation has a vapor barrier and that it is installed face down. When insulation is placed in the walls of a home, a thin plastic vapor barrier should be placed over the insulation facing the inside of the home. The purpose of this vapor barrier is to keep moisture produced inside the house from compromising the insulation. If the barrier is not installed, warm, moist air will move through the drywall and into the insulated wall cavity. When the air cools, moisture will condense on the fibers of the insulation making it wet; and, if it is cellulose insulation, it will absorb and hold the moisture. Wetness reduces the effectiveness of the insulation and provides a favorable environment for the growth of bacteria and mold [4,5].

## Siding

Good siding should be attractive, durable, insect- and vermin-resistant, waterproof, and capable of holding a weather-resistant coating. Fire-resistant siding and roofing are important in many areas where wildfires are common and are required by many local building codes.

All exterior surfaces will eventually deteriorate, regardless of manufacturer warranties or claims. Leaks in the home from the outside occur in many predictable locations. The exterior siding or brick should be checked for cracks or gaps in protective surfaces. Where plumbing, air vents, electrical outlets, or communication lines extend through an exterior wall, they should be carefully checked to

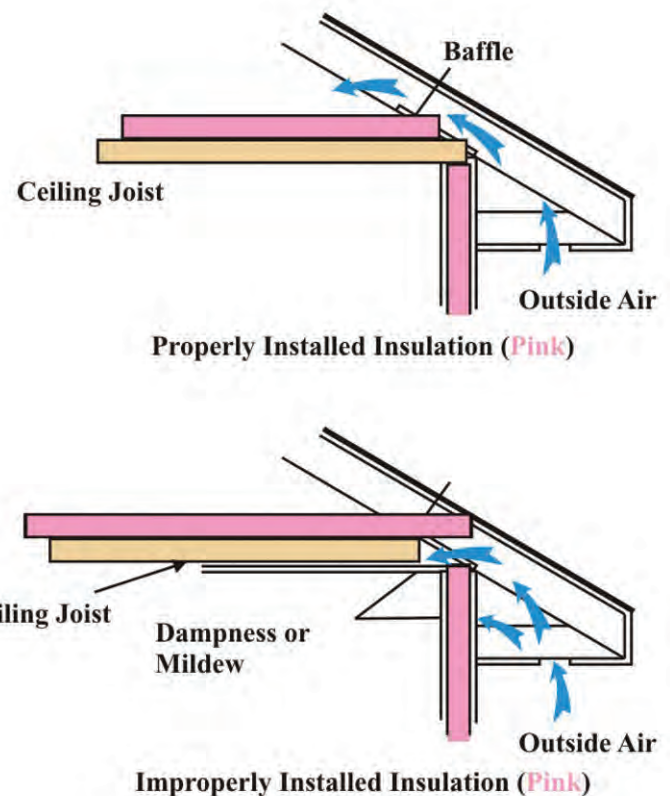

Figure 7.4. Attic ventilation

ensure an airtight seal around those openings. The exterior surface of the home has doors, windows, and other openings. These openings should be caulked routinely, and the drainage gutters along the top should be checked to ensure that they drain properly.

Exterior surface materials include stucco, vinyl, asbestos shingles, brick, metal (aluminum), fiber cement, exterior plywood, hardwood, painted or coated wood, glass, and tile, some of which are discussed in this chapter [6,7].

## Fiber Cement

Fiber cement siding is engineered composite-material products that are extremely stable and durable. Fiber cement siding is made from a combination of cellulose fiber material, cement and silica sand, water, and other additives. Fiber cement siding is fire resistant and useful in high-moisture areas.

The fiber cement mixture is formed into siding or individual boards, then dried and cured using superheated steam under pressure. The drying and curing process assures that the fiber cement siding has very low moisture content, which makes the product is stable—no warping or excessive movement—and its surface good for painting.

Weight is a minor concern with fiber cement products: they weigh about 1½ times what comparably sized composite wood products do. Other concerns relate to cutting fiber cement: cutting produces a fine dust with microscopic silica fibers, so personal protective equipment (respirator and goggles) are necessary. In addition, special tools are needed for cutting.

## Brick

Brick homes may seem on the surface to be nearly maintenance free. This is true in some cases, but, like all surfaces, brick also degrades. Although this degradation takes longer in brick than in other materials, repairing brick is complex and quite expensive. There are two basic types of brick homes. One is brick veneer, which is a thin brick set to the outside of a wooden stud wall. The brick is not actually the supporting wall. Brick veneer typically has the same pattern of bricks around the doors and windows; a true brick wall will have brick arches or heavy steel plates above the doors and other openings of the building. Some brick walls have wooden studs behind the brick to provide an area for insulation, plumbing, vents, and wiring. It is important that weep holes and flashing be installed in brick homes to control moisture.

Improperly constructed building footers can result in major damage to the exterior brick surface of a home by allowing moisture, insects, and vermin to enter. A crack, such as the one in Figure 7.5, is an example of such a failure. This type of damage will require much more than just a mortar patch. Buildings constructed of concrete



**Figure 7.5.** Brick Structural Defect

block also experience footer failure. The damage is reason to not skimp when installing and inspecting the footing and reinforces the need for appropriate concrete mix, rebar, and footing drains.

## Stucco

Synthetic stucco (exterior insulation and finish system; EIFS) is a multilayered exterior finish that has been used in Europe since shortly after World War II, when contractors found it to be a good repair choice for buildings damaged during the war. North American builders began using EIFS in the 1980s, first in commercial buildings, then as an exterior finish to wood frame houses.

EIFS has three layers:

- **Inner layer**—foam insulation board secured to the exterior wall surface, often with adhesive;
- **Middle layer**—a polymer and cement base coat applied to the top of the insulation, then reinforced with glass fiber mesh; and
- **Exterior layer**—a textured finish coat.

EIFS layers bond to form a covering that does not breathe. If moisture seeps in, it can become trapped behind the layers. With no place to go, constant exposure to moisture can lead to rot in wood and other vulnerable materials within the home. Ripples in the stucco could be a sign of a problem. On the surface it may look like nothing is wrong, but beneath the surface, the stucco may have cracked from settling of the house. With a properly installed moisture barrier, no moisture should be able to seep behind the EIFS, including moisture originating inside the home. Drains in the foundation can be designed to enable moisture that does seep in to escape.

Other signs of problems are mold or mildew on the interior or exterior of the home, swollen wood around door and window frames, blistered or peeling paint; and cracked EIFS or cracked sealant.

## Vinyl

Standard vinyl siding is made from thin, flexible sheets of plastic about 2 mm thick, precolored and bent into shape during manufacturing. The sheets interlock as they are placed above one another. Because temperature and sunlight cause vinyl to expand and contract, it fits into deep channels at the corners and around windows and doors. The channels are deep enough that as the siding contracts, it remains within the channel.

Siding composed of either vinyl or aluminum will expand and contract in response to temperature change. This requires careful attention to the manufacturer's specifications during application. Cutting the siding too short causes exposed surfaces when the siding contracts, resulting in moisture damage and eventual leakage. Even small cracks exposing the undersurface can create major damage.



## Metal Corrosion Prevention

Use like metals when possible

Use metals with similar electronegativity levels

Use dielectric unions for plumbing

Use anodes that are inexpensive to replace

Remember: Use metals with less susceptibility to protect metals that are more susceptible to corrosion.

Vinyl has some environmental and health concerns, as do most exterior treatments. Vinyl chloride monomer, of which polyvinyl chloride siding is made, is a strong carcinogen and, when heated, releases toxic gases and vapors. Under normal conditions, significant exposures to vinyl chloride monomer are unlikely.

### Asbestos

Older homes were often sided with composites containing asbestos. This type of siding was very popular in the early 1940s. It was heavily used through the 1950s and decreasingly used up until the early 1960s. The siding is typically white, although it may be painted. It is often about ¼-inch thick and very brittle and was sold in sections of about 12×18 inches. The composite is quite heavy and very slate-like in difficulty of application. As it ages, it becomes even more brittle, and the surface erodes and becomes powdery. This siding, when removed, must be disposed of in accordance with local, state, and federal laws regulating the disposal of asbestos materials. The workers and the site must be carefully managed and protected from contamination. The composite had several virtues as siding. It was quite resistant to fire, was not attractive to insects or vermin, provided very good insulation, and did not grow mold readily. Because of its very brittle nature, it could be damaged by children playing and, as a result, often was covered later with aluminum siding.

### Metal

If metal siding is used, the mounting fasteners (nails or screws) must be compatible with the metal composition of the siding, or the siding or fasteners will corrode. This corrosion is due to galvanic response.

Galvanic response (corrosion) can produce devastating results that often are only noticed when it is too late. It should always be considered in inspections and is preventable in nearly all cases.

When two dissimilar metals, such as aluminum and steel, are coupled and subjected to a corrosive environment (such as air, water, salt spray, or cleaning solutions), the more active metal (aluminum) becomes an anode and corrodes through exfoliation or pitting. This can happen with plumbing, roofing, siding, gutters, metal venting, and heating and air conditioning systems.

When two metals are electrically connected to each other in a conductive environment, electrons flow from the more active metal to the less active because of the difference in the electrical potential, the so-called “driving force.” When the most active metal (anode) supplies cur-

rent, it will gradually dissolve into ions in the electrolyte and, at the same time, produce electrons, which the least active (cathode) will receive through the metallic connection with the anode. The result is that the cathode will be negatively polarized and hence be protected against corrosion.

Thus, less noble metals are more susceptible to corrosion. An example of protecting an appliance such as an iron-bodied water heater would be to ensure that piping connections are of similar material when possible and follow the manufacturer’s good practice and instructions on using dielectric (not conductors of electricity) unions [8].

Figure 7.6 shows examples of electrochemical kinetics in pipes that were connected to dissimilar metals.



Figure 7.6. Corrosion in Piping Resulting From Galvanic Response

## References

1. Lawrence Berkeley National Laboratory. Cool roofing materials database. Berkeley, CA: Lawrence Berkeley National Laboratory, Environmental Energy Technologies Division; 2000. Available from URL: <http://eetd.lbl.gov/coolroof/>.
2. California Energy Commission. Roofing. Sacramento: California Energy Commission; no date. Available from URL: <http://www.consumerenergycenter.org/homeandwork/homes/construction/roofing.html>.

3. Cazayoux EJ, Bilello RA. Roof materials. Baton Rouge, LA: Louisiana State University; no date. Available from URL: <http://www.leeric.lsu.edu/bgbb/7/ecep/carpntry/i/i.htm>.
4. Department of Energy. Insulation fact sheet. Washington, DC: Department of Energy; 2002. Available from URL: [http://www.ornl.gov/sci/roofs+walls/insulation/ins\\_01.htm](http://www.ornl.gov/sci/roofs+walls/insulation/ins_01.htm).
5. The Old House Web. Insulation: stories and more from the Old House Web. Gardiner, ME: The Old House Web; no date. Available from URL: [http://www.oldhouseweb.com/stories/HowTo/HVAC\\_and\\_Insulation/Insulation/](http://www.oldhouseweb.com/stories/HowTo/HVAC_and_Insulation/Insulation/).
6. The Old House Web. Siding: stories and more from the Old House Web. Gardiner, ME: The Old House Web; no date. Available from URL: <http://www.oldhouseweb.com/stories/How-To/Siding/>.
7. Vandervort D. House siding and architectural details. Glendale, CA: Hometips.com; no date. Available from URL: [http://www.hometips.com/home\\_improvement/siding.html](http://www.hometips.com/home_improvement/siding.html).
8. University of Wisconsin-Stevens Point. Corrosion, lead, copper: in-home water supplies—are you at risk? Stevens Point, WI: University of Wisconsin-Stevens Point; no date. Available from URL: <https://www.uwsp.edu/cnr/etf/corros.htm>.

# Chapter 8: Rural Water Supplies and Water-quality Issues

*"We never know the worth of water till the well is dry."*

Thomas Fuller  
*Gnomologia*, 1732

## Introduction

One of the primary differences between rural and urban housing is that much infrastructure that is often taken for granted by the urban resident does not exist in the rural environment. Examples range from fire and police protection to drinking water and sewage disposal. This chapter is intended to provide basic knowledge about the sources of drinking water typically used for homes in the rural environment. It is estimated that at least 15% of the population of the United States is not served by approved public water systems. Instead, they use individual wells and very small drinking water systems not covered by the Safe Water Drinking Act (SDWA); these wells and systems are often untested and contaminated [1]. Many of these wells are dug rather than drilled. Such shallow sources frequently are contaminated with both chemicals and bacteria. Figure 8.1 shows the change in water supply source in the United States from 1970 to 1990.

According to the 2003 American Housing Survey, of the 105,843,000 homes in the United States, water is provided to 92,324,000 (87.2%) by a public or private business; 13,097,000 (12.4%) have a well (11,276,000 drilled, 919,000 dug, and 902,000 not reported) [3].

## Water Sources

The primary sources of drinking water are groundwater and surface water. In addition, precipitation (rain and snow) can be collected and contained. The initial quality

of the water depends on the source. Surface water (lakes, reservoirs, streams, and rivers), the drinking water source for approximately 50% of our population, is generally of poor quality and requires extensive treatment.

Groundwater, the source for the other approximately 50% of our population, is of better quality. However, it still may be contaminated by agricultural runoff or surface and subsurface disposal of liquid waste, including leachate from solid waste landfills. Other sources, such as spring water and rain water, are of varying levels of quality, but each can be developed and treated to render it potable.

Most water systems consist of a water source (such as a well, spring, or lake), some type of tank for storage, and a system of pipes for distribution. Means to treat the water to remove harmful bacteria or chemicals may also be required. The system can be as simple as a well, a pump, and a pressure tank to serve a single home. It may be a complex system, with elaborate treatment processes, multiple storage tanks, and a large distribution system serving thousands of homes. Regardless of system size, the basic principles to assure the safety and potability of water are common to all systems. Large-scale water supply systems tend to rely on surface water resources, and smaller water systems tend to use groundwater.

Groundwater is pumped from wells drilled into aquifers. Aquifers are geologic formations where water pools, often deep in the ground. Some aquifers are actually higher than the surrounding ground surface, which can result in flowing springs or artesian wells. Artesian wells are often drilled; once the aquifer is penetrated, the water flows onto the surface of the ground because of the hydrologic pressure from the aquifer.

**Water Supply by Decennial Census**

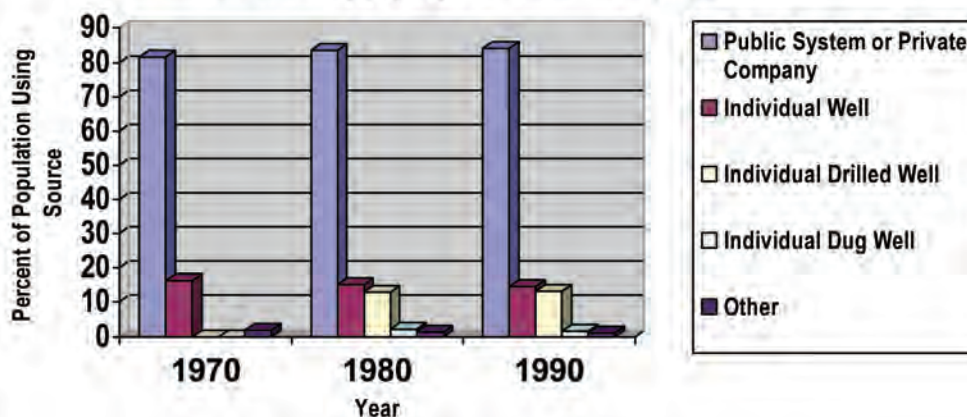

Figure 8.1. U.S. Water Supply by Source [2]

SDWA defines a public water system as one that provides piped water to at least 25 persons or 15 service connections for at least 60 days per year. Such systems may be owned by homeowner associations, investor-owned water companies, local governments, and others. Water not from a public water supply, and which serves one or only a few homes, is called a private supply. Private water supplies are, for the most part, unregulated. Community water systems are public systems that serve people year-round in their homes. The U.S. Environmental Protection Agency (EPA) also regulates other kinds of public water systems—such as those at schools, factories, campgrounds, or restaurants—that have their own water supply.

The quantity of water in an aquifer and the water produced by a well depend on the nature of the rock, sand, or soil in the aquifer where the well withdraws water. Drinking water wells may be shallow (50 feet or less) or deep (more than 1,000 feet).

On average, our society uses almost 100 gallons of drinking water per person per day. Traditionally, water use rates are described in units of gallons per capita per day (gallons used by one person in 1 day). Of the drinking water supplied by public water systems, only a small portion is actually used for drinking. Residential water consumers use most drinking water for other purposes, such as toilet flushing, bathing, cooking, cleaning, and lawn watering.

The amount of water we use in our homes varies during the day:

- **Lowest rate of use**—11:30 pm to 5:00 am,
- **Sharp rise/high use**—5:00 am to noon (peak hourly use from 7:00 am to 8:00 am),
- **Moderate use**—noon to 5:00 pm (lull around 3:00 pm), and
- **Increasing evening use**—5:00 pm to 11:00 pm (second minor peak, 6:00 pm to 8:00 pm).

## Source Location

The location of any source of water under consideration as a potable supply, whether individual or community, should be carefully evaluated for potential sources of contamination. As a general practice, the maximum distance that economics, land ownership, geology, and topography will allow should separate a water source from potential contamination sources. Table 8.1 details some of the sources of contamination and gives minimum distances recommended by EPA to separate pollution sources from the water source.

Water withdrawn directly from rivers, lakes, or reservoirs cannot be assumed to be clean enough for human consumption unless it receives treatment. Water pumped from underground aquifers will require some level of treatment. Believing surface water or soil-filtered water has purified itself is dangerous and unjustified. Clear water is not necessarily safe water. To assess the level of treatment a water source requires, follow these steps:

- Determine the quality needed for the intended purpose (drinking water quality needs to be evaluated under the SDWA).
- For wells and springs, test the water for bacteriologic quality. This should be done with several samples taken over a period of time to establish a history on the source. With few exceptions, surface water and groundwater sources are always presumed to be bacteriologically unsafe and, as a minimum, must be disinfected.
- Analyze for chemical quality, including both legal (primary drinking water) standards and aesthetic (secondary) standards.
- Determine the economical and technical restraints (e.g., cost of equipment, operation and maintenance costs, cost of alternative sources, availability of power).
- Treat if necessary and feasible.

Pollution Source	Minimum Surface Distance From Well
Septic tank	50 feet
Livestock yard silos Septic leach fields	50 feet
Petroleum tanks Liquid-tight manure storage Pesticide and fertilizer storage and handling	100 feet
Manure stacks	250 feet

**Table 8.1.** Recommended Minimum Distance Between Well and Pollution Sources (Horizontal Distance) [1]

Type of Well	Depth, in Feet	Diameter	Suitable Geologic Formations
Dug	0–50 typically less than 25	3 to 20 feet	Suitable in clay, silt, sand, gravel, and soft fractured limestone
Bored	0–100	2 to 30 inches	Clay, silt, sand, gravel, boulders less than well diameter, soft sandstone, and fractured limestone
Driven	0–50	1.25 to 2 inches	Clay, sand, silt, fine gravel, and thin layers of sandstone
Drilled (rotary type)	0–1,000	4 to 24 inches	Same as above with percussion type drilling

**Table 8.2.** Types of Wells for Accessing Groundwater, Well Depths, and Diameters

## Well Construction

Many smaller communities obtain drinking water solely from underground aquifers. In addition, according to the last census with data on water supply systems, 15% of people in the United States are on individual water supply systems. In some sections of the country, there may be a choice of individual water supply sources that will supply water throughout the year. Some areas of the country may be limited to one source. The various sources of water include drilled wells, driven wells, jetted wells, dug wells, bored wells, springs, and cisterns. Table 8.2 provides a more detailed description of some of these wells.

Regardless of the choice for a water supply source, special safety precautions must be taken to assure the potability of the water. Drainage should be away from a well. The casings of the well should be sealed with grout or some other mastic material to ensure that surface water does not seep along the well casing to the water source. In Figure 8.2, the concrete grout has been reinforced with steel and a drain away from the casing has been provided to assist in protecting this water source. Additionally, research suggests that a minimum of 10 feet of soil is essential to filter unwanted biologic organisms from the water source.

However, if the area of well construction has any sources of chemical contamination nearby, the local public health authority should be contacted. In areas with karst topography (areas characterized by a limestone landscape with caves, fissures, and underground streams), wells of any type are a health risk because of the long distances that both chemical and biologic contaminants can travel.

When determining where a water well is to be located, several factors should be considered:

- the groundwater aquifer to be developed,
- depth of the water-bearing formations,

- the type of rock formations that will be encountered,
- freedom from flooding, and
- relation to existing or potential sources of contamination.

The overriding concern is to protect any kind of well from pollution, primarily bacterial contamination. Groundwater found in sand, clay, and gravel formations is more likely to be safer than groundwater extracted from limestone and other fractured rock formations. Whatever the strata, wells should be protected from

- surface water entering directly into the top of the well,
- groundwater entering below ground level without filtering through at least 10 feet of earth, and
- surface water entering the space between the well casing and surrounding soil.

Also, a well should be located in such a way that it is accessible for maintenance, inspection, and pump or pipe replacement when necessary. Driven wells (Figure 8.2) are typically installed in sand or soil and do not penetrate base rock. They are, as a result, hammered into the

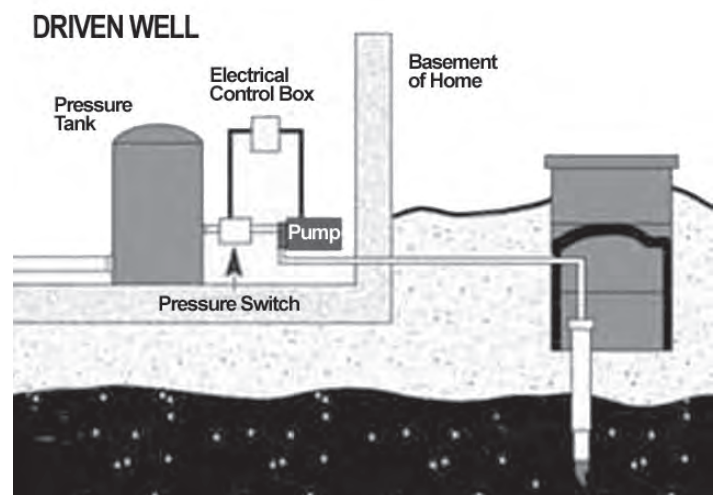

**Figure 8.2.** Cross Section of a Driven Well

ground and are quite shallow, resulting in frequent contamination by both chemical and bacterial sources.

### Sanitary Design and Construction

Whenever a water-bearing formation is penetrated (as in well construction), a direct route of possible water contamination exists unless satisfactory precautions are taken. Wells should be provided with casing or pipe to an adequate depth to prevent caving and to permit sealing of the earth formation to the casing with watertight cement grout or bentonite clay, from a point just below the surface to as deep as necessary to prevent entry of contaminated water.

Once construction of the well is completed, the top of the well casing should be covered with a sanitary seal, an approved well cap, or a pump mounting that completely covers the well opening (Figure 8.3). If pumping at the design rate causes drawdown in the well, a vent through a tapped opening should be provided. The upper end of the vent pipe should be turned downward and suitably screened to prevent the entry of insects and foreign matter.

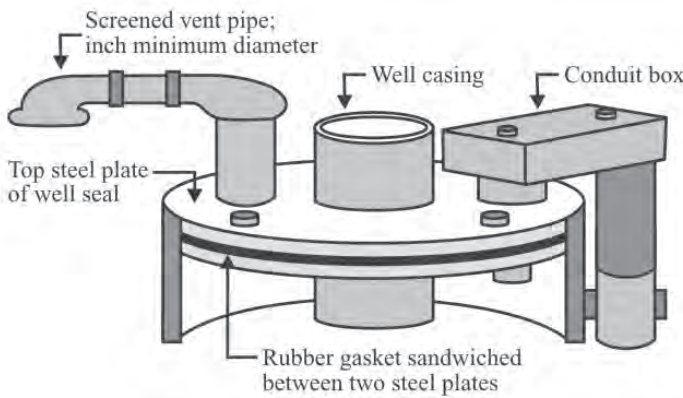

Figure 8.3. Well Seal

### Pump Selection

A variety of pump types and sizes exist to meet the needs of individual or community water systems. Some of the factors to be considered in selecting a pump for a specific application are well depth, system design pressure, demand rate in gallons per minute, availability of power, and economics.

### Dug and Drilled Wells

Dug wells (Figures 8.4 and 8.5) were one of the most common types of wells for individual water supply in the United States before the 1950s. They were often constructed with one person digging the hole with a shovel

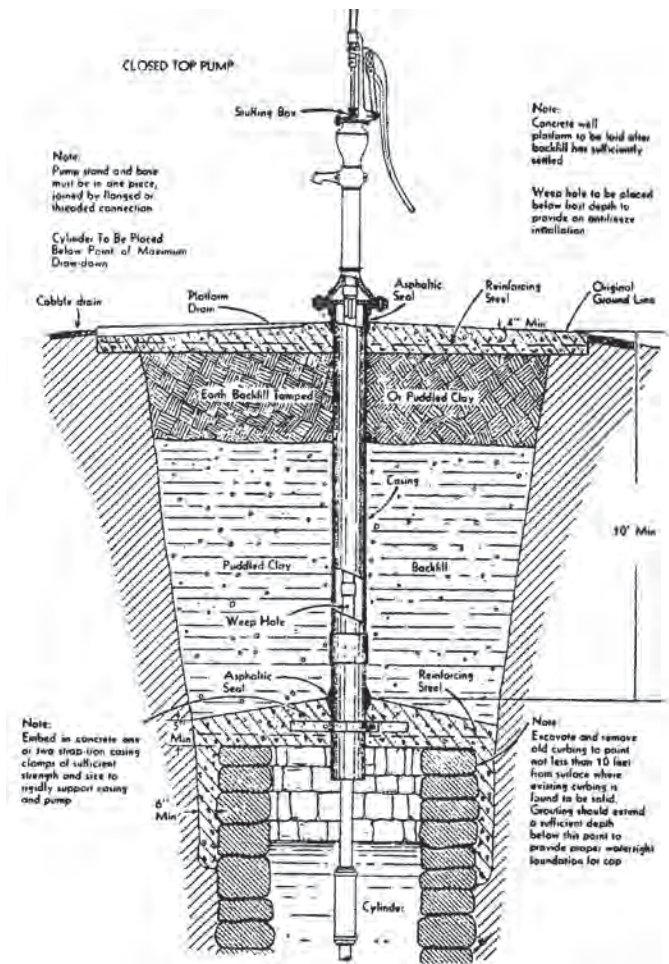

Figure 8.4. Converted Dug Well [1]

and another pulling the dirt from the hole with a rope, pulley, and bucket. Of course, this required a hole of rather large circumference, with the size increasing the potential for leakage from the surface. The dug well also was traditionally quite shallow, often less than 25 feet, which often resulted in the water source being contaminated by surface water as it ran through cracks and crevices in the ground to the aquifer. Dug wells provide potable water only if they are properly located and the water source is free of biologic and chemical contamination. The general rule is, the deeper the well, the more likely the aquifer is to be free of contaminants, as long as surface water does not leak into the well without sufficient soil filtration.

Two basic processes are used to remediate dug wells. One is to dig around the well to a depth of 10 feet and install a solid slab with a hole in it to accommodate a well casing and an appropriate seal (Figures 8.4 and 8.5). The dirt is then backfilled over the slab to the surface, and the casing is equipped with a vent and second seal, similar to a drilled well, as shown in Figure 8.6. This results in a considerable reduction in the area of the casing that needs

to be protected. Experience has shown that the disturbed dirt used for backfilling over the buried slab will continue to release bacteria into the well for a short time after modification. Most experts in well modification suggest installing a chlorination system on all dug wells to disinfect the water because of their shallow depth and possible biologic impurity during changing drainage and weather conditions above ground. Figure 8.7 shows a dug well near the front porch of a house and within 5 feet of a drainage ditch and 6 feet of a rural road. This well is likely to be contaminated with the pesticide used to termite-proof the home and from whatever runs off the nearby road and drainage ditch. The well shown is about 15 feet deep. The brick structure around the well holds the centrifugal pump and a heater to keep the water from freezing. Although dangerous to drink from, this well is typical of dug wells used in rural areas of the United States for drinking water.

Samples should not be taken from such wells because they instill a false sense of security if they are negative for both chemicals and biologic organisms. The quality of the water in such wells can change in just a few hours through infiltration of drainage water. Figure 8.8 shows the septic tank discharge in the drainage ditch 5 feet upstream of the dug well in Figure 8.7. This potential combination of drinking water and waste disposal presents an extreme risk to the people serviced by the dug well. Sampling is not the answer; the water source should be changed under the supervision of qualified environmental health professionals.

Note:  
Pump screen to be placed below point of maximum draw-down

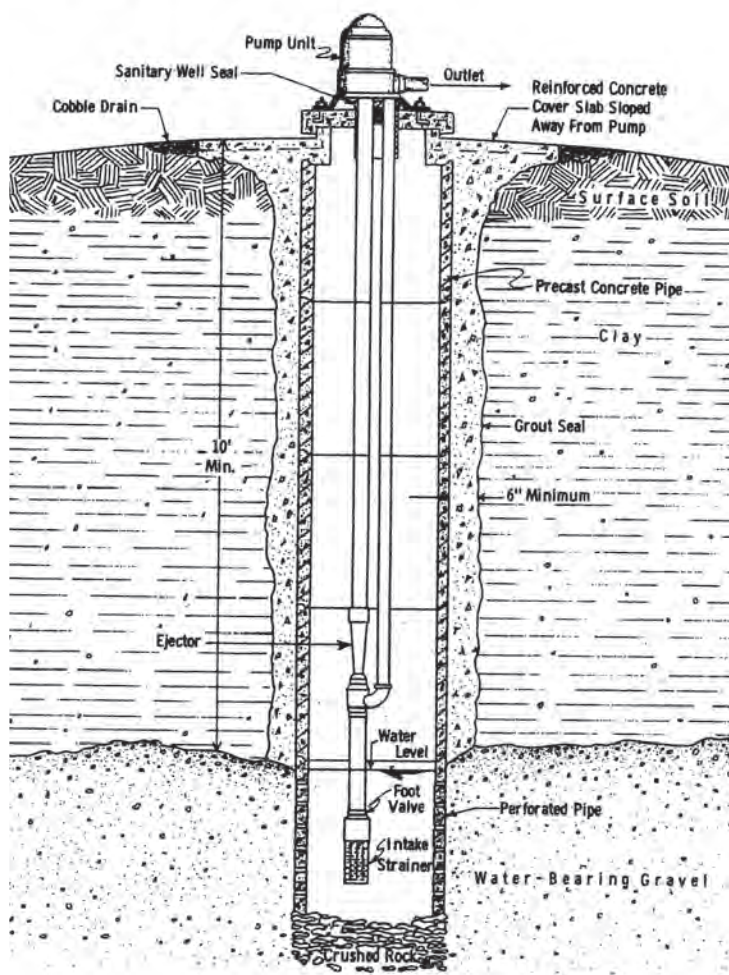

Figure 8.5. Recapped and Sealed Dug Well [1]

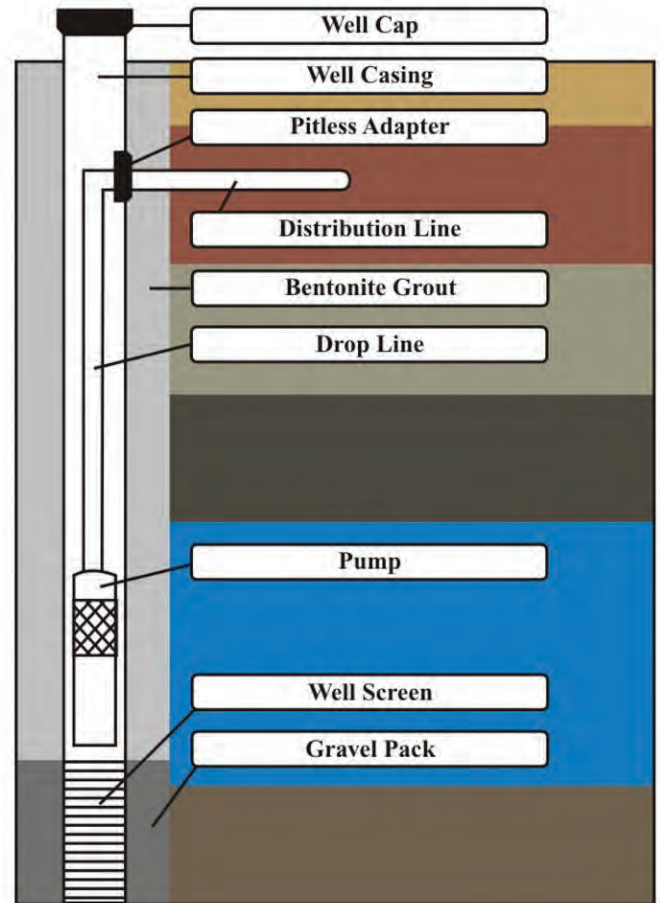

Figure 8.6. Drilled Well [4]



Figure 8.7. Typical Dug Well

Figure 8.9 shows a drilled well. On the left side of the picture is the corner of the porch of the home. The well appears not to have a sanitary well seal and is likely open to the air and will accept contaminants into the casing. Because the well is so close to the house, the casing is open, and the land slopes toward the well, it is a major candidate for contamination and not a safe water source.

### Springs

Another source of water for individual water supply is natural springs. A spring is groundwater that reaches the surface because of the natural contours of the land.

Springs are common in rolling hillside and mountain areas. Some provide an ample supply of water, but most provide water only seasonally. Without proper precautions, the water may be biologically or chemically contaminated and not considered potable.



Figure 8.8. Sewage in Drainage Ditch



Figure 8.9. Drilled Well

To obtain satisfactory (potable) water from a spring, it is necessary to

- find the source,
- properly develop the spring,
- eliminate surface water outcroppings above the spring to its source,
- prevent animals from accessing the spring area, and
- provide continuous chlorination.

Figure 8.10 illustrates a properly developed spring. Note that the line supplying the water is well underground, the spring box is watertight, and surface water runoff is diverted away from the area. Also be aware that the water quality of a spring can change rapidly.

### Cisterns

A cistern is a watertight, traditionally underground reservoir that is filled with rainwater draining from the roof of a building. Cisterns will not provide an ample supply of water for any extended period of time, unless the amount of water used is severely restricted. Because the water is coming off the roof, a pipe is generally installed to allow redirection of the first few minutes of rainwater until the water flows clear. Disinfection is, nevertheless, of utmost importance. Diverting the first flow of water does not assure safe, non-polluted water because chemicals and biologic waste from birds and other animals can migrate from catchment surfaces and from windblown sources. In addition, rainwater has a low pH, which can corrode plumbing pipes and fixtures if not treated.

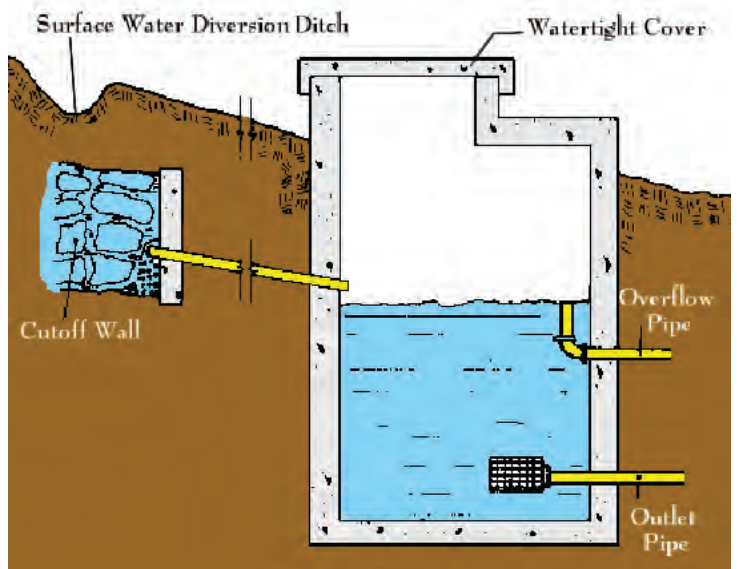

Figure 8.10. Spring Box [5]



## Disinfection of Water Supplies

Water supplies can be disinfected by a variety of methods including chlorination, ozonation, ultraviolet radiation, heat, and iodination. The advantages and disadvantages of each method are noted in Table 8.3.

The understanding of certain terms (blue box, next page) is necessary in talking about chlorination.

Table 8.4 is a chlorination guide for specific water conditions.

Chlorine is the most commonly used water disinfectant. It is available in liquid, powder, gas, and tablet form. Chlorine gas is often used for municipal water disinfection, but can be hazardous if mishandled. Recommended liquid, powder, and tablet forms of chlorine include the following:

- **Liquid**—Chlorine laundry bleach (about 5% chlorine). Swimming pool disinfectant or concentrated chlorine bleach (12%–17% chlorine).

- **Powder**—Chlorinated lime (25% chlorine), dairy sanitizer (30% chlorine), and high-test calcium hypochlorite (65%–75% chlorine).
- **Tablets**—High-test calcium hypochlorite (65%–75% chlorine).
- **Gas**—Gas chlorine is an economical and convenient way to use large amounts of chlorine. It is stored in steel cylinders ranging in size from 100 to 2,000 pounds. The packager fills these cylinders with liquid chlorine to approximately 85% of their total volume; the remaining 15% is occupied by chlorine gas. These ratios are required to prevent tank rupture at high temperatures. It is important that direct sunlight never reaches gas cylinders. It is also important that the user of chlorine knows the maximum withdrawal rate of gas per day per cylinder. For example, the maximum withdrawal rate from a 150-pound cylinder is approximately 40 pounds per day at room temperature discharging to atmospheric pressure.

Disinfection Method	Advantages	Disadvantages
Boiling	Readily accessible Well suited for emergencies Removes volatile organic compounds from water Effective even on <i>Giardia</i> and <i>Cryptosporidium</i>	Requires a great deal of heat Takes time to boil and cool Water tastes stale Typically limited capacity
Chlorine	Provides residual treatment Residual easy to test and measure Readily available; reasonable cost Low electrical requirement Useful for multiple water problems Can treat large volumes of water	Requires contact time of 30 minutes Turbidity reduces effectiveness Gives water a chlorine taste May form disinfection by-products Does not kill <i>Giardia</i> or <i>Cryptosporidium</i> Requires careful handling and storage
Ultraviolet light	Does not change taste of water Leaves no discernable odor Kills bacteria almost immediately Compact and easy to use	High electrical requirement Provides no residual treatment Requires pretreatment if turbid Requires new lamp annually
Iodine	Does not require electricity Requires little maintenance Provides residual treatment Residual easy to measure	Health side effects undetermined Affected by water temperature Gives water an iodine taste
Ozone	Is a more powerful disinfectant than chlorine Does not change taste of water Leaves no discernable odor	Ozone gas is unstable and must be generated at point of use

**Table 8.3.** Disinfection Methods

Chlorination Treatment for	Typical Dosage Rates
Algae	3 to 5 ppm
Bacteria	3 to 5 ppm
Biologic oxygen demand reduction	10 parts per million
Color (removal)	Dosage depends on type and extent of color removal desired; may vary from 1 to 500 ppm dosage rate
Cyanide	
Reduction to cyanate	2 times cyanide content
Complete destruction	8.5 times cyanide content
Hydrogen sulfide	
Taste and odor control	2 times hydrogen sulfide content
Destruction	8.4 times hydrogen sulfide content
Iron bacteria	1 to 10 ppm, varying with amount of bacteria to control
Iron precipitation	64 times iron content
Manganese precipitation	1 to 3 times manganese content
Odor	1 to 3 ppm
Taste	1 to 3 ppm
ppm: parts per million	

**Table 8.4.** Chlorination Guide for Specific Water Conditions

## Definitions of Terms Related to Chlorination

**Breakpoint chlorination**—A process sometimes used to ensure the presence of free chlorine in public water supplies by adding enough chlorine to the water to satisfy the chlorine demand and to react with all dissolved ammonia that might be present. The concentrations of chlorine needed to treat a variety of water conditions are listed in Table 8.4.

**Chlorine concentration**—The concentration (amount) of chlorine in a volume of water is measured in parts per million (ppm). In 1 million gallons of water, a chlorine concentration of 1 ppm would require 8.34 pounds of 100% chlorine.

**Contact time**—The time, after chlorine addition and before use, given for disinfection to occur. For groundwater systems, contact time is minimal. However, in surface water systems, a contact time of 20 to 30 minutes is common.

**Dosage**—The total amount of chlorine added to water. Given in parts per million (ppm) or milligrams per liter (mg/L).

**Demand**—Chlorine solution used by reacting with particles of organic matter such as slimes or other chemicals and minerals that may be present. The difference between the amount of chlorine applied to water and total available chlorine remaining at the end of a specified contact period.

**Parts per million**—A weight-to-weight comparison; 1 ppm equals 1 pound per million pounds. Because water weighs 8.34 pounds per gallon, it takes 8.34 pounds of any substance per million gallons to equal 1 ppm. In water chemistry, 1 ppm equals 1 mg/L.

**Residual**—The amount of chlorine left after the demand is met; available (free) chlorine. This portion provides a ready reserve for bactericidal action. Both combined and free chlorine make up chlorine residual and are involved in disinfection. Total available chlorine = free chlorine + combined chlorine.

## Chlorine Carrier Solutions

On small systems or individual wells, a high-chlorine carrier solution is mixed in a tank in the pump house and pumped by the chlorinator into the system. Table 8.5 shows how to make a 200-ppm carrier solution. By using 200 ppm, only small quantities of this carrier have to be added. Depending on the system, other stock solutions may be needed to better use existing chemical feed equipment.

Carrier Solution	Amount of Chlorine per 100 Gallons of Water
5% chlorine bleach	3 pints
12%–17% chlorine solution	1 pint
25%–30% chlorine powder	2/3 pound
65%–75% chlorine powder	1/4 pound

**Table 8.5.** Preparing a 200-ppm Chlorine Solution

## Routine Water Chlorination (Simple)

Most chlorinated public water supplies use routine water chlorination. Enough chlorine is added to the water to meet the chlorine demand, plus enough extra to supply 0.2 to 0.5 ppm of free chlorine when checked after 20 minutes.

Simple chlorination may not be enough to kill certain viruses. Chlorine as a disinfectant increases in effectiveness as the chlorine residual is increased and as the contact time is increased.

Chlorine solutions should be mixed and chlorinators adjusted according to the manufacturer's instructions. Chlorine solutions deteriorate gradually when standing. Fresh solutions must be prepared as necessary to maintain the required chlorine residual. Chlorine residual should be tested at least once a week to assure effective equipment operation and solution strengths.

A dated record should be kept of solution preparation, type, proportion of chlorine used, and residual-test results. Sensing devices are available that will automatically shut off the pump and activate a warning bell or light when the chlorinator needs servicing.

## Well Water Shock Chlorination

Shock chlorination is used to control iron and sulfate-reducing bacteria and to eliminate fecal coliform bacteria in a water system. To be effective, shock chlorination must disinfect the following: the entire well depth, the formation around the bottom of the well, the pressure system, water treatment equipment, and the distribution

system. To accomplish this, a large volume of super-chlorinated water is siphoned down the well to displace the water in the well and some of the water in the formation around the well. Check specifications on the water treatment equipment to ensure appropriate protection of the equipment.

With shock chlorination, the entire system—from the water-bearing formation through the well-bore and the distribution system—is exposed to water that has a concentration of chlorine strong enough to kill iron and sulfate-reducing bacteria. The shock chlorination process is complex and tedious. Exact procedures and concentrations of chlorine for effective shock treatment are available [6,7].

## Backflow, Back-siphonage, and Other Water Quality Problems

In addition to contamination at its source, water can become contaminated with biologic materials and toxic construction or unsuitable joint materials as it flows through the water distribution system in the home. Water flowing backwards (backflow) in the pipes sucks materials back (back-siphonage) into the water distribution system, creating equally hazardous conditions. Other water quality problems relate to hardness, dissolved iron and iron bacteria, acidity, turbidity, color, odor, and taste.

### Backflow

Backflow is any unwanted flow of nonpotable water into a potable water system. The direction of flow is the reverse of that intended for the system. Backflow may be caused by numerous factors and conditions. For example, the reverse pressure gradient may be a result of either a loss of pressure in the supply main (back-siphonage) or the flow from a pressurized system through an unprotected cross-connection (back-pressure). A reverse flow in a distribution main or in a customer's system can be created by a change of system pressure wherein the pressure at the supply point becomes lower than the pressure at the point of use. When this happens, the water at the point of use will be siphoned back into the system, potentially polluting or contaminating it. It is also possible that contaminated or polluted water could continue to backflow into the public distribution system. The point at which nonpotable water comes in contact with potable water is called a cross-connection.

Examples of backflow causes include supplemental supplies, such as a standby fire protection tank; fire pumps; chemical feed pumps that overpower the potable water system pressure; and sprinkler systems.

## Back-Siphonage

Back-siphonage is a siphon action in an undesirable or reverse direction. When there is a direct or indirect connection between a potable water supply and water of questionable quality due to poor plumbing design or installation, there is always a possibility that the public water supply may become contaminated. Some examples of common plumbing defects are

- washbasins, sterilizers, and sinks with submerged inlets or threaded hose bibs and hose;
- oversized booster pumps that overtax the supply capability of the main and thus develop negative pressure;
- submerged inlets and fire pumps (if the fire pumps are directly connected into the water main, a negative pressure will develop); and
- a threaded hose bib in a health-care facility (which is technically a cross-connection).

There are many techniques and devices for preventing back-flow and back-siphonage. Some examples are

- Vacuum breakers (nonpressure and pressure);
- Back-flow preventers (reduced pressure principle, double gate-double check valves, swing-connection, and air gap-double diameter separation);
- Surge tanks (booster pumps for tanks, fire system make-up tank, and covering potable tanks); and
- Color coding in all buildings where there is any possibility of connecting two separate systems or taking water from the wrong source (blue-potable, yellow-nonpotable, and other-chemical and gases).

An air gap is a physical separation between the incoming water line and maximum level in a container of at least twice the diameter of the incoming water line. If an air gap cannot be installed, then a vacuum breaker should be installed. Vacuum breakers, unlike air gaps, must be installed carefully and maintained regularly. Vacuum breakers are not completely failsafe.

## Other Water Quality Problems

Water not only has to be safe to drink; it should also be aesthetically pleasing. Various water conditions affect water quality. Table 8.6 describes symptoms, causes, measurements, and how to correct these problems.

## Protecting the Groundwater Supply

Follow these tips to help protect the quality of groundwater supplies:

- Periodically inspect exposed parts of wells for cracked, corroded, or damaged well casings; broken or missing well caps; and settling and cracking of surface seals.
- Slope the area around wells to drain surface runoff away from the well.
- Install a well cap or sanitary seal to prevent unauthorized use of, or entry into, a well.
- Disinfect wells at least once a year with bleach or hypochlorite granules, according to the manufacturer's directions.
- Have wells tested once a year for coliform bacteria, nitrates, and other constituents of concern.
- Keep accurate records of any well maintenance, such as disinfection or sediment removal, that require the use of chemicals in the well.
- Hire a certified well driller for new well construction, modification, or abandonment and closure.
- Avoid mixing or using pesticides, fertilizers, herbicides, degreasers, fuels, and other pollutants near wells.
- Do not dispose of waste in dry or abandoned wells.
- Do not cut off well casings below the land surface.
- Pump and inspect septic systems as often as recommended by local health departments.
- Never dispose of hazardous materials (e.g., paint, paint stripper, floor stripper compounds) in a septic system.

## References

1. Rhode Island Department of Health and University of Rhode Island Cooperative Extension Water Quality Program. Healthy drinking waters for Rhode Islanders. Kingston, RI: Rhode Island Department of Health and University of Rhode Island Cooperative Extension Water Quality Program; 2003. Available from URL: <http://www.uri.edu/ce/wq/has/html/Drinking.pdf>.
2. US Census Bureau. Historical census of housing graphs: water supply. Washington, DC: US Census Bureau; no date. Available from URL: <http://www.census.gov/hhes/www/housing/census/historic/swgraph.html>.

Symptoms	Probable Cause	Measurement	Corrective Action
<p>Hardness</p> <ul style="list-style-type: none"> <li>– Sticky curd forms when soap is added to water</li> <li>– Causes bathtub ring</li> <li>– Requires more soap</li> <li>– Glassware appears streaked, scale forms in pipes</li> </ul>	<p>Calcium and magnesium in the water, compounded with bicarbonates, sulfates, or chlorides.</p>	<p>Hardness test kits, which measure in grains per gallon (gpg) or parts per million (ppm). 1 gpg = 17.1 ppm</p> <p>50 ppm is soft water; 50 to 100 ppm is moderately hard water; 100 to 200 ppm is hard water; 200 to 300 ppm is very hard; over 300 ppm is extremely hard</p>	<p>If hardness creates problems, a sodium zeolite ion exchange water softener or a reverse osmosis unit can be used.</p>
<p>Dissolved iron</p> <ul style="list-style-type: none"> <li>– Red stains (red water) on clothes and plumbing fixtures</li> <li>– Corrosion of steel pipes</li> <li>– Metallic taste</li> <li>– Clear water just drawn begins to form red particles that settle to the bottom</li> </ul>	<p>Iron, from geologic formations that ground-water passes through. Water, an excellent solvent, ionizes iron and holds it in solution.</p> <p>Iron is common in soft water and when water hardness is above 175 ppm.</p>	<p>Atomic absorption (AA) units or numerous colorimetric test kits measure iron in ppm.</p> <p>Any measurement above 0.3 ppm will cause problems.</p>	<p>To treat soft water that contains no iron but picks it up in distribution lines, add calcium to the water with calcite (limestone) units.</p> <p>To treat hard water containing iron ions, install a sodium zeolite ion exchange unit.</p> <p>To treat soft water containing iron, carbon dioxide must be neutralized, followed by a manganese zeolite unit.</p>
<p>Iron bacteria (red slime appears in toilet)</p>	<p>Caused by bacteria that act in the presence of iron.</p>	<p>Check under toilet tank cover for slippery jelly-like coating.</p>	<p>Kill bacteria by super-chlorinating pump and piping system.</p>
<p>Brownish-black water</p> <ul style="list-style-type: none"> <li>– Fixture stains black</li> <li>– Fabric stains black</li> <li>– Bitter coffee and tea</li> </ul>	<p>Manganese is present usually along with iron.</p>	<p>Colorimetric tests for manganese (concentrations above 0.05 mg/L cause problems).</p>	<p>Same methods as for iron.</p>
<p>Acidity (corrosion of copper and steel in pumps, fixtures, piping and tanks)</p>	<p>Carbon dioxide forms carbonic acid. Water may contain H<sub>2</sub>SO<sub>4</sub>, HCl, or nitric acid, but unlikely.</p>	<p>Colorimetric field titrametric tests for acidity, pH, and carbon dioxide (pH is determined at the titration end point). A pH below 6.5 causes corrosion. Carbon dioxide should be less than 10 mg/L or less than 5 mg/L if alkalinity is less than 100 ppm.</p>	<p>Soda ash solution is fed into the well or suction line of a pump. May be fed along with chlorine solution.</p> <p>Limestone chips (calcite) neutralize the water by increasing its alkalinity and hardness.</p>
<p>Odors and tastes</p> <ul style="list-style-type: none"> <li>– Bitter taste</li> <li>– Rotten egg odor</li> <li>– Salty taste</li> <li>– Flat, soda taste</li> <li>– Salty taste</li> <li>– Chlorine odor/taste</li> </ul>	<p>Very high mineral content</p> <p>Sulfate-reducing bacteria, hydrogen sulfide</p> <p>High chloride levels</p> <p>Bicarbonates</p> <p>High total dissolved solids (TDS)</p> <p>High levels of di- or trichloramines in water</p>	<p>Excess iron, manganese, sulfate</p> <p>Sulfate levels above 250 mg/L or any trace of hydrogen sulfide cause problems</p> <p>Problems at levels &gt;250 mg/L</p> <p>Carbonate hardness test</p> <p>TDS levels above 500 mg/L may cause problems</p> <p>Check pH</p>	<p>Methods mentioned above</p> <p>Chlorinator and filter</p> <p>Reverse osmosis unit</p> <p>Aeration unit</p> <p>Sand filter</p> <p>Activated charcoal filter</p>

**Table 8.6.** Analyzing and Correcting Water Quality Problems (*continues on next page*)

Symptoms	Probable Cause	Measurement	Corrective Action
Turbidity (cloudy water)	Silt, sediment, large number of microorganisms or organic material	Nephelometric turbidity units (NTUs) using laboratory spectrophotometers. (Less than 5 NTUs is best, >10 not acceptable.)	Fine filtering with sand filter or diatomaceous earth filter. For ponds, coagulation and sedimentation are needed.
Blue stain on porcelain fixtures	Corrosion of copper pipes and fixtures due to low pH, hardness, and alkalinity	Langelier index determines proper balance of pH, hardness, and alkalinity.	Methods mentioned above to adjust pH, hardness, and alkalinity.
Lead contamination	Leaching from lead service lines, solder, or brass or lead fittings	15 parts per billion	Adjust pH Filtration Chemical treatment

**Table 8.6.** Analyzing and Correcting Water Quality Problems (*continued*)

3. US Census Bureau. American housing survey. Washington, DC: US Census Bureau; 2003. Available from URL: <http://www.census.gov/hhes/www/housing/ahs/nationaldata.html>.
4. National Ground Water Association. Well system material. Westerville, OH: National Ground Water Association; 2003. Available from URL: <http://www.ngwa.org/pdf/wellsystemmaterials.pdf>.
5. US Environmental Protection Agency. Spring development. Chicago: US Environmental Protection Agency; 2001.
6. Government of Alberta. Shock chlorination—well maintenance. Edmonton, Alberta, Canada: Alberta Agriculture, Food & Rural Development; 2001. Available from URL: [http://www1.agric.gov.ab.ca/\\$department/deptdocs.nsf/all/wwg411](http://www1.agric.gov.ab.ca/$department/deptdocs.nsf/all/wwg411).
7. Boulder GNS Water Well Service and Supply. Chlorination of water systems. Boulder, CO: Boulder GNS Water Well Service and Supply; 2002. Available from URL: <http://www.waterwell.cc/CHLORIN.HTM>.
8. Iowa State University Diagnosing and solving common water-quality problems. Ames, IA: Iowa State University; 1994. Available from URL: <http://www.abe.iastate.edu/HTMDOCS/aen152.pdf>.

### Additional Sources of Information

American Water Works Association. Available from URL: <http://www.awwa.org>.

Drexel University: Drinking water outbreaks. Available from URL: <http://water.sesep.drexel.edu/outbreaks/>.

US Environmental Protection Agency: Ground water and drinking water. Available from URL: <http://www.epa.gov/safewater>.

*“The society which scorns excellence in plumbing as a humble activity and tolerates shoddiness in philosophy because it is an philosophy: neither its pipes nor its theories will hold water.”*

John W. Gardner, Secretary,  
Department of Health, Education, and Welfare, 1965

## Introduction

Plumbing may be defined as the practice, materials, and fixtures used in installing, maintaining, and altering piping, fixtures, appliances, and appurtenances in connection with sanitary or storm drainage facilities, a venting system, and public or private water supply systems.

Plumbing does not include drilling water wells; installing water softening equipment; or manufacturing or selling plumbing fixtures, appliances, equipment, or hardware. A plumbing system consists of three parts: an adequate potable water supply system; a safe, adequate drainage system; and ample fixtures and equipment.

The housing inspector’s prime concern while inspecting plumbing is to ensure the provision of a safe water supply system, an adequate drainage system, and ample and proper fixtures and equipment that do not contaminate water. The inspector must make sure that the system moves waste safely from the home and protects the occupants from backup of waste and dangerous gases. This chapter covers the major features of a residential plumbing system and the basic plumbing terms and principles the inspector must know and understand to identify housing code violations that involve plumbing. It will also assist in identifying the more complicated defects that the inspector should refer to the appropriate agencies. This chapter is not a plumbing code, but should provide a base of knowledge sufficient to evaluate household systems.

## Elements of a Plumbing System

The primary purposes of a plumbing system are

- To bring an adequate and potable supply of hot and cold water to the inhabitants of a house, and
- To drain all wastewater and sewage discharge from fixtures into the public sewer or a private disposal system.

It is, therefore, very important that the housing inspector be completely familiar with all elements of these systems so that inadequacies of the structure’s plumbing and other

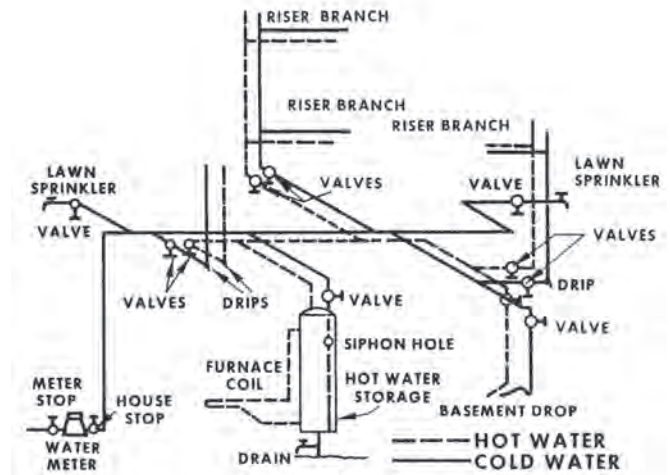

Figure 9.1. Typical Home Water System [1]

code violations will be recognized. To aid the inspector in understanding the plumbing system, a schematic of a home plumbing system is shown in Figure 9.1.

## Water Service

The piping of a house service line should be as short as possible. Elbows and bends should be kept to a minimum because they reduce water pressure and, therefore, the supply of water to fixtures in the house. The house service line also should be protected from freezing. Four feet of soil is a commonly accepted depth to bury the line to prevent freezing. This depth varies, however, across the country from north to south. The local or state plumbing code should be consulted for recommended depths. The minimum service line size should be  $\frac{3}{4}$  inch. The minimum water supply pressure should be 40 pounds per square inch (psi), no cement or concrete joints should be allowed, no glue joints between different types of plastic should be allowed, and no female threaded PVC fittings should be used.

The materials used for a house service may be approved plastic, copper, cast iron, steel, or wrought iron. The connections used should be compatible with the type of pipe used. A typical house service installation is pictured in Figure 9.2. The elements of the service installation are described below.

**Corporation stop**—The corporation stop is connected to the water main. This connection is usually made of brass and can be connected to the main with a special tool without shutting off the municipal supply. The valve

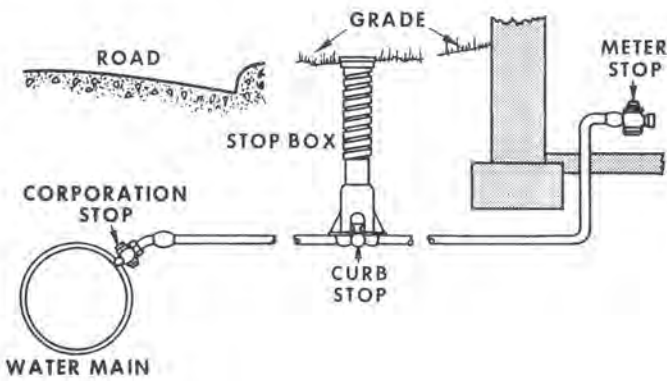

Figure 9.2. House Service Installation [1]

incorporated in the corporation stop permits the pressure to be maintained in the main while the service to the building is completed.

**Curb stop**—The curb stop is a similar valve used to isolate the building from the main for repairs, nonpayment, of water bills or flooded basements. Because the corporation stop is usually under the street and it is necessary to break the pavement to reach the valve, the curb stop is used as the isolation valve.

**Curb stop box**—The curb stop box is an access box to the curb stop for opening and closing the valve. A long-handled wrench is used to reach the valve.

## Definitions of Terms Related to Home Water Systems

**Air chambers**—Pressure-absorbing devices that eliminate water hammer. Air chambers should be installed as close as possible to the valves or faucet and at the end of long runs of pipe.

**Air gap (drainage system)**—The unobstructed vertical distance through the free atmosphere between the outlet of a water pipe and the flood level rim of the receptacle into which it is discharging.

**Air gap (water distribution system)**—The unobstructed vertical distance through the free atmosphere between the lowest opening from any pipe or faucet supplying water to a tank, plumbing fixture, or other device and the flood level rim of the receptacle.

**Backflow**—The flow of water or other liquids, mixtures, or substances into the distributing pipes of a potable water supply from any source or sources other than the intended source. Back siphonage is one type of backflow.

**Back siphonage**—The flowing back of used, contaminated, or polluted water from a plumbing fixture or vessel into a potable water supply because of negative pressure in the pipe.

**Branch**—Any part of the piping system other than the main, riser, or stack.

**Branch vent**—A vent connecting one or more individual vents with a vent stack.

**Building drain**—Part of the lowest piping of a drainage system that receives the discharge from soil, waste, or other drainage pipes inside the walls of the building (house) and conveys it to the building sewer beginning 3 feet outside the building wall.

**Cross connection**—Any physical connection or arrangement between two otherwise separate piping systems (one of which contains potable water and the other which contains either water of unknown or questionable safety or steam, gas, or chemical) whereby there may be a flow from one system to the other, the direction of flow depending on the pressure differential between the two systems. (See *Backflow* and *Back siphonage*.)

**Disposal field**—An area containing a series of one or more trenches lined with coarse aggregate and conveying the effluent from a septic tank through vitrified clay pipe or perforated, nonmetallic pipe, laid in such a manner that the flow will be distributed with reasonable uniformity into natural soil.

**Drain**—Any pipe that carries wastewater or waterborne waste in a building (house) drainage system.

**Flood level rim**—The top edge of a receptacle from which water overflows.

**Flushometer valve**—A device that discharges a predetermined quantity of water to fixtures for flushing purposes and is closed by direct water pressures.

**Flushometer toilet**—a toilet using a flushometer valve that uses pressure from the water supply system rather than the force of gravity to discharge water into the bowl, designed to use less water than conventional flush toilets.

**Flush valve**—A device located at the bottom of the tank for flushing toilets and similar fixtures.



**Meter stop**—The meter stop is a valve placed on the street side of the water meter to isolate it for installation or maintenance. Many codes require a gate valve on the house side of the meter to shut off water for plumbing repairs. The curb and meter stops can be ruined in a short time if used very frequently.

The water meter is a device used to measure the amount of water used in the house. It is usually the property of the water provider and is a very delicate instrument that should not be abused. In cold climates, the water meter is often inside the home to keep it from freezing. When the

meter is located inside the home, the company providing the water must make appointments to read the meter, which often results in higher water costs unless the meter is equipped with a signal that can be observed from the outside. The water meter is not shown in Figure 9.2 because of regional differences in location of the unit.

Because the electric system is sometimes grounded to an older home's water line, a grounding loop device should be installed around the meter. Many meters come with a yoke that maintains electrical continuity even though the meter is removed.

## Definitions of Terms Related to Home Water Systems

**Grease trap**—See *Interceptor*.

**Hot water**—Potable water heated to at least 120°F–130°F (49°C–54°C) and used for cooking, cleaning, washing dishes, and bathing.

**Insanitary**—Unclean enough to endanger health.

**Interceptor**—A device to separate and retain deleterious, hazardous, or undesirable matter from normal waste and permit normal sewage or liquid waste to discharge into the drainage system by gravity.

**Main vent**—The principal artery of the venting system, to which vent branches may be connected.

**Leader**—An exterior drainage pipe for conveying storm water from roof or gutter drains to the building storm drain, combined building sewer, or other means of disposal.

**Main sewer**—See *Public sewer*.

**Pneumatic**—Pertaining to devices making use of compressed air as in pressure tanks boosted by pumps.

**Potable water**—Water having no impurities present in amounts sufficient to cause disease or harmful physiologic effects and conforming in its bacteriologic and chemical quality to the requirements of the U.S. Environmental Protection Agency's Safe Drinking Water Act or meeting the regulations of other agencies having jurisdiction.

**P & T (pressure and temperature) relief valve**—A safety valve installed on a hot water storage tank to limit temperature and pressure of the water.

**P-trap**—A trap with a vertical inlet and a horizontal outlet.

**Public sewer**—A common sewer directly controlled by public authority.

**Relief vent**—An auxiliary vent that permits additional circulation of air in or between drainage and systems.

**Septic tank**—A watertight receptacle that receives the discharge of a building's sanitary drain system or part thereof and is designed and constructed to separate solid from liquid, digest organic matter through a period of detention, and allow the liquids to discharge into the soil outside of the tank through a system of open-joint or perforated piping or through a seepage pit.

**Sewerage system**—A system comprising all piping, appurtenances, and treatment facilities used for the collection and disposal of sewage, except plumbing inside and in connection with buildings served, and the building drain.

**Soil pipe**—The pipe that directs the sewage of a house to the receiving sewer, building drain or building sewer.

**Soil stack**—The vertical piping that terminates in a roof vent and carries off the vapors of a plumbing system.

**Stack vent**—An extension of a solid or waste stack above the highest horizontal drain connected to the stack, sometimes called a waste vent or a soil vent.

## Hot and Cold Water Main Lines

The hot and cold water main lines are usually hung from the basement ceiling or in the crawl space of the home and are attached to the water meter and hot water tank on one side and the fixture supply risers on the other. These pipes should be installed neatly and should be supported by pipe hangers or straps of sufficient strength and number to prevent sagging. Older homes that have copper pipe with soldered pipes can pose a lead poisoning risk, particularly to children. In 1986, Congress banned lead solder containing greater than 0.2% lead and restricted the lead content of faucets, pipes, and other plumbing materials to no more than 8%. The water should be tested to determine the presence or level of lead in the water. Until such tests can be conducted, the water should be run for about 2 minutes in the morning to flush any such material from the line. Hot and cold water lines should be approximately 6 inches apart unless the hot water line is insulated. This is to ensure that the cold water line does not pick up heat from the hot water line [2].

The supply mains should have a drain valve stop and waste valve to remove water from the system for repairs. These valves should be on the low end of the line or on the end of each fixture riser.

The fixture risers start at the basement main and rise vertically to the fixtures on the upper floors. In a one-family dwelling, riser branches will usually proceed from the main riser to each fixture grouping. In any event, the fixture risers should not depend on the branch risers for support, but should be supported with a pipe bracket.

The size of basement mains and risers depends on the number of fixtures supplied. However, a ¾-inch pipe is usually the minimum size used. This allows for deposits on the pipe due to hardness in the water and will usually give satisfactory volume and pressure.

In homes without basements, the water lines are preferably located in the crawl space or under the slab. The water lines are sometimes placed in the attic; however, because of freezing, condensation, or leaks, this placement can result in major water damage to the home. In two-story or multistory homes, the water line placement for the second floor is typically between the studs and, then, for the shortest distance to the fixture, between the joists of the upper floors.

## Hot and Cold Water Piping Materials

Care must be taken when choosing the piping materials. Some state and local plumbing codes prohibit using some of the materials listed below in water distribution systems.

**Polyvinyl Chloride (PVC).** PVC is used to make plastic pipe. PVC piping has several applications in and around homes such as in underground sprinkler systems, piping for swimming pool pumping systems, and low-pressure drain systems. PVC piping is also used for water service between the meter and building [3]. PVC, or polyvinyl chloride, is one of the most commonly used materials in the marketplace. It is in packaging, construction and automotive material, toys, and medical equipment.

## Definitions of Terms Related to Home Water Systems

**Storm sewer**—A sewer used for conveying rain water, surface water, condensate, cooling water, or similar liquid waste.

**Trap**—A fitting or device that provides a liquid seal to prevent the emission of sewer gases without materially affecting the flow of sewage or wastewater through it.

**Vacuum breaker**—A device to prevent backflow (back siphonage) by means of an opening through which air may be drawn to relieve negative pressure (vacuum).

**Vapor lock**—A bubble of air that restricts the flow of water in a pipe.

**Vent stack**—The vertical vent pipe installed to provide air circulation to and from the drainage system and that extends through one or more stories.

**Water hammer**—The loud thump of water in a pipe when a valve or faucet is suddenly closed.

**Water service pipe**—The pipe from the water main or other sources of potable water supply to the water-distributing system of the building served.

**Water supply system**—Consists of the water service pipe, the water-distributing pipes, the necessary connecting pipes, fittings, control valves, and all appurtenances in or adjacent to the building or premises.

**Wet vent**—A vent that receives the discharge of waste other than from water closets.

**Yoke vent**—A pipe connecting upward from a soil or waste stack to a vent stack to prevent pressure changes in the stacks.

**Chlorinated PVC (CPVC).** CPVC is a slightly yellow plastic pipe used inside homes. It has a long service life, but is not quite as tough as copper. Some areas with corrosive water will benefit by using chlorinated PVC piping. CPVC piping is designed and recommended for use in hot and cold potable water distribution systems [4].

**Copper.** Copper comes in three grades:

- M for thin wall pipe (used mainly inside homes);
- L for thicker wall pipe (used mainly outside for water services); and
- K, the thickest (used mainly between water mains and the water meter).

Copper lasts a long time, is durable, and connects well to valves. It should not be installed if the water has a pH of 6.5 or less. Most public utilities supply water at a pH between 7.2 and 8.0. Many utilities that have source water with a pH below 6.5 treat the water to raise the pH. Private well water systems often have a pH below 6.5. When this is the case, installing a treatment system to make the water less acidic is a good idea [5].

**Galvanized Steel.** Galvanized pipe corrodes rather easily. The typical life of this piping is about 40 years. One of the primary problems with galvanized steel is that, in saturated water, the pipe will become severely restricted by corrosion that eventually fills the pipe completely. Another problem is that the mismatch of metals between the brass valves and the steel results in corrosion. Whenever steel pipe meets copper or brass, the steel pipe will rapidly corrode. Dielectric unions can be used between copper and steel pipes; however, these unions will close off flow in a short time. The problem with dielectric unions is that they break the grounding effect if a live electrical wire comes in contact with a pipe. Some cities require the two pipes to be bonded electrically to maintain the safety of grounded pipes.

**PEX.** PEX is an acronym for a cross-formulated polyethylene. “PE” refers to the raw material used to make PEX (polyethylene), and “X” refers to the cross-linking of the polyethylene across its molecular chains. The molecular chains are linked into a three-dimensional network that makes PEX remarkably durable within a wide range of temperatures, pressures, and chemicals [6].

PEX is flexible and can be installed with fewer fittings than rigid plumbing systems. It is a good choice for repiping and for new homes and works well for corrosive water conditions. PEX stretches to accommodate the expansion of freezing water and then returns to its original size when water thaws. Although it is highly freeze-resistant, no material is freeze-proof.

**Kitec.** Kitec is a multipurpose pressure pipe that uniquely unites the advantages of both metal and plastic. It is made of an aluminum tube laminated to interior and exterior layers of plastic. Kitec provides a composite piping system for a wide range of applications, often beyond the scope of metal or plastic alone. Unlike copper and steel materials, Kitec is noncorroding and resists most acids, salt solutions, alkalis, fats, and oils.

**Poly.** Poly pipe is a soft plastic pipe that comes in coils and is used for cold water. It can crack with age or wear through from rocks. Other weak points can be the stainless steel clamps or galvanized couplings.

**Polybutylene [Discontinued].** Polybutylene pipe is a soft plastic pipe. This material is no longer recommended because of early chemical breakdown. Individuals with a house, mobile home, or other structure that has polybutylene piping with acetal plastic fittings may be eligible for financial relief if they have replaced that plumbing system. For claims information, call 1-800-392-7591 or go to [www.pbpipe.com](http://www.pbpipe.com).

### *Hot Water Safety*

In the United States, more than 112,000 people enter a hospital emergency room each year with scald burns. Of these, 6,700 (6%), have to be hospitalized. Almost 3,000 of these scald burns come from tap water in the home. The three high risk groups are children under the age of 5 years, the handicapped, and adults over the age of 65 years. It only takes 1 second to get a serious third-degree burn from water that is 156°F (69°C). Tap water is too hot if instant coffee granules melt in it.

Young children, some handicapped individuals, and elderly people are particularly vulnerable to tap water burns. Children cannot always tell the hot water faucets from the cold water faucets. Children have delicate skin and often cannot get out of hot water quickly, so they suffer hot water burns most frequently. Elderly and handicapped persons are less agile and more prone to falls in the bath tub. They also may have diseases, such as diabetes, that make them unable to feel heat in some regions of the body, such as the hands and feet. Third-degree burns can occur quickly—in 1 second at 156°F (69°C), in 2 seconds at 149°F (65°C), in 5 seconds at 140°F (60°C), and in 15 seconds at 133°F (56°C).

A tap-water temperature of 120°F–130°F (49°C–54°C) is hot enough for washing clothes, bedding, and dishes. Even at 130°F (54°C), water takes only a few minutes of constant contact to produce a third-degree burn. Few people bathe at temperatures above 110°F (43°C), nor

should they. Water heater thermostats should be set at about 120°F (49°C) for safety and to save 18% of the energy used at 140°F (60°C). Antiscald devices for faucets and showerheads to regulate water temperature can help prevent burns. A plumber should install and calibrate these devices. Most hot water tank installations now require an expansion tank to reduce pressure fluctuations and a heat trap to keep hot water from escaping up pipes.

### *Types of Water Flow Controls*

It is essential that valves be used in a water system to allow the system to be controlled in a safe and efficient manner. The number, type, and size of valves required will depend on the size and complexity of the system. Most valves can be purchased in sizes and types to match the pipe sizes used in water system installations. Listed below are some of the more commonly encountered valves with a description of their basic functions.

**Shutoff Valves.** Shutoff valves should be installed between the pump and the pressure tank and between the pressure tank and service entry to a building. Globe, gate, and ball valves are common shutoff valves. Gate and ball valves cause less friction loss than do globe valves; ball valves last longer and leak less than do gate valves. Shutoff valves allow servicing of parts of the system without draining the entire system.

**Flow-control Valves.** Flow-control valves provide uniform flow at varying pressures. They are sometimes needed to regulate or limit the use of water because of limited water flow from low-yielding wells or an inadequate pumping system. They also may be needed with some treatment equipment. These valves are often used to limit flow to a fixture. Orifices, mechanical valves, or diaphragm valves are used to restrict the flow to any one service line or complete system and to assure a minimum flow rate to all outlets.

**Relief Valves.** Relief valves permit water or air to escape from the system to relieve excess pressure. They are spring-controlled and are usually adjustable to relieve varying pressures, generally above 60 psi. Relief valves should be installed in systems that may develop pressures exceeding the rated limits of the pressure tank or distribution system. Positive displacement and submersible pumps and water heaters can develop these excessive pressures. The relief valve should be installed between the pump and the first shutoff valve and must be capable of discharging the flow rate of the pump. A combined pressure and temperature relief valve is needed on all water heaters. Combination pressure and vacuum relief valves

also should be installed to prevent vacuum damage to the system.

**Pressure-reducing Valves.** A pressure-reducing valve is used to reduce line pressure. On main lines, this allows the use of thinner walled pipe and protects house plumbing. Sometimes these valves are installed on individual services to protect plumbing.

**Altitude Valves.** Often an altitude valve is installed at the base of a hot water tank to prevent it from overflowing. Altitude valves sense the tank level through a pressure line to the tank. An adjustable spring allows setting the level so that the valve closes and prevents more inflow when the tank becomes full.

**Foot Valves.** A foot valve is a special type of check valve installed at the end of a suction pipe or below the jet in a well to prevent backflow and loss of prime. The valve should be of good quality and cause little friction loss.

**Check Valves.** Check valves have a function similar to foot valves. They permit water flow in only one direction through a pipe. A submersible pump may use several check valves. One is located at the top of the pump to prevent backflow from causing back spin of the impellers. Some systems use another check valve and a snifter valve. They will be in the drop pipe or pitless unit in the well casing and allow a weep hole located between the two valves to drain part of the pipe. When the pump is started, it will force the air from the drained part of the pipe into the pressure tank, thus recharging the pressure tank.

**Frost-proof Faucets.** Frost-proof faucets are installed outside a house with the shutoff valve extending into the heated house to prevent freezing. After each use, the water between the valve and outlet drains, provided the hose is disconnected, so water is not left to freeze.

**Frost-proof Hydrants.** Frost-proof hydrants make outdoor water service possible during cold weather without the danger of freezing. The shutoff valve is buried below the frost line. To avoid submerging it, which might result in contamination and back siphoning, the stop-and-waste valve must drain freely into a rock bed. These hydrants are sometimes prohibited by local or state health authorities.

**Float Valves.** Float valves respond to a high water level to close an inlet pipe, as in a tank-type toilet.

**Miscellaneous Switches.** Float switches respond to a high and/or low water level as with an intermediate storage tank. Pressure switches with a low-pressure cutoff stop the pump motor if the line pressure drops to the

cutoff point. Low-flow cutoff switches are used with submersible pumps to stop the pump if the water discharge falls below a predetermined minimum operating pressure. High-pressure cut-off switches are used to stop pumps if the system pressure rises above a predetermined maximum. Paddle-type flow switches detect flow by means of a paddle placed in the pipe that operates a mechanical switch when flow in the pipe pushes the paddle.

The inadvertent contamination of a public water supply as a result of incorrectly installing plumbing fixtures is a potential public health problem in all communities. Continuous surveillance by environmental health personnel is necessary to know whether such public health hazards have developed as a result of additions or alterations to an approved system. All environmental health specialists should learn to recognize the three general types of defects found in potable water supply systems: back flow, back siphonage, and overhead leakage into open potable water containers. If identified, these conditions should be corrected immediately to prevent the spread of disease or poisoning from high concentrations of organic or inorganic chemicals in the water.

### Water Heaters

Water heaters (Figure 9.3) are usually powered by electricity, fuel oil, gas, or, in rare cases, coal or wood. They consist of a space for heating the water and a storage tank for providing hot water over a limited period of time. All water heaters should be fitted with a temperature-pressure (T&P) relief valve no matter what fuel is used. The installation port for these valves may be found on the top or on the side of the tank near the top. T&P valves should not be placed close to a wall or door jamb, where they would be inaccessible for inspection and use. Hot water tanks sometimes are sold without the T&P valve, and it must be purchased separately. This fact alone should encourage individual permitting and inspection by counties and municipalities to ensure that they are installed. The T&P valve should be inspected at a minimum of once per year.

A properly installed T&P valve will operate when either the temperature or the pressure becomes too high due to an interruption of the water supply or a faulty thermostat. Figure 9.3 shows the correct installation of a gas water heater. Particular care should be paid to the exhaust port of the T&P valve. Figure 9.4 shows the placement of the T&P valve. This vent should be directed to within 6 inches of the floor, and care must be taken to avoid reducing the diameter of the vent and creating any unnecessary bends in the discharge pipe. Most codes will

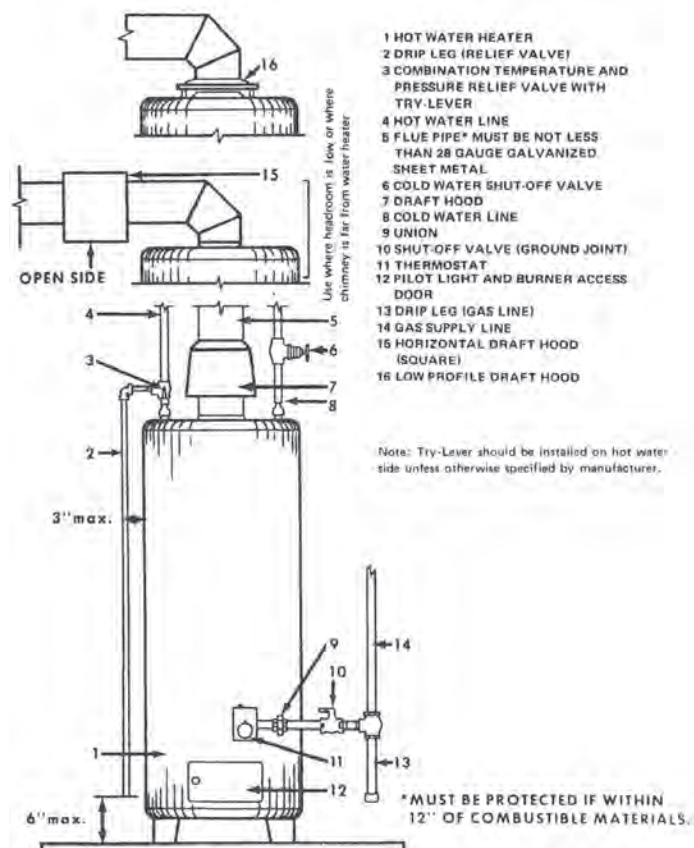

Figure 9.3. Gas Water Heater [1]

allow only one 90° bend in the vent. The point is to avoid any constrictions that could slow down the steam release from the tank to avoid explosive pressure buildup.

Water heaters that are installed on wooden floors should have water collection pans with a drainage tube that drains to a proper drain. The pan should be checked on a regular basis.

### Tankless Water Heaters

A tankless unit has a heating device that is activated by the flow of water when a hot water valve is opened. Once activated, the heater delivers a constant supply of hot water. The output of the heater, however, limits the rate of the heated water flow. Demand water heaters are available in propane (LP), natural gas, or electric models. They come in a variety of sizes for different applications, such as a whole-house water heater, a hot water source for a remote bathroom or hot tub, or as a boiler to provide hot water for a home heating system. They can also be used as a booster for dishwashers, washing machines, and a solar or wood-fired domestic hot water system [7].

The appeal of demand water heaters is not only the elimination of the tank standby losses and the resulting lower operating costs, but also the fact that the heater delivers hot water continuously. Most tankless models have a life

expectancy of more than 20 years. In contrast, storage tank water heaters last 10 to 15 years. Most tankless models have easily replaceable parts that can extend their life by many years more.

## Drainage System

Water is brought into a house, used, and discharged through the drainage system. This system is a sanitary drainage system carrying just interior wastewater.

### Sanitary Drainage System

The proper sizing of the sanitary drain or house drain depends on the number of fixtures it serves. The usual minimum size is 4 inches in diameter. The materials used are usually cast iron, vitrified clay, plastic, and, in rare cases, lead. The top two pipe choices for drain, waste, and vent (DWV) systems are PVC or ABS. For proper flow in the drain, the pipe should be sized and angled so that the pipe is approximately half full. This ensures proper scouring action so that the solids contained in the waste will not be deposited in the pipe.

Using PVC in DWV pipe is a two-step process needing a primer and then cement. ABS uses cement only. In most cases the decision will be made on the basis of which material is sold in an area. Few areas stock both materials because local contractors usually favor one or the other.



Figure 9.4. Temperature-Pressure Valve

ABS costs more than PVC in many areas, but Schedule 40 PVC DWV solid core pipe is stronger than ABS. Their durability is similar.

**Size of House Drain.** The Uniform Plumbing Code Committee has developed a method of sizing house drains in terms of fixture units. One fixture unit equals approximately 7½ gallons of water per minute. This is the surge flow rate of water discharged from a wash basin in one minute.

All other fixtures have been related to this unit. Fixture unit values are shown in Table 9.1.

**Grade of House Drain.** A house drain should be sloped toward the sewer to ensure scouring of the drain. The usual pitch of a house or building sewer is a ¼-inch drop in 1 foot of length. The size of the drain is based on the fixture units flowing into the pipe and the slope of the drain. Table 9.2 shows the required pipe size for the system.

**House Drain Installation.** Typical branch connections to the main are shown in Figure 9.5.

**Fixture and Branch Drains.** A branch drain is a waste pipe that collects the waste from two or more fixtures and conveys it to the sewer. It is sized in the same way as the sewer, taking into account that all toilets must have a minimum 3-inch diameter drain, and only two toilets may connect into one 3-inch drain. All branch drains must join the house drain with a Y-fitting as shown in Figure 9.5. The same is true for fixture drains joining branch drains. The Y-fitting is used to eliminate, as much as possible, the deposit of solids in or near the connection. A buildup of these solids will block the drain. Recommended minimum sizes of fixture drains are shown in Table 9.2.

### Traps

A plumbing trap is a device used in a waste system to prevent the passage of sewer gas into the structure and yet not hinder the fixture's discharge to any great extent. All fixtures connected to a household plumbing system should have a trap installed in the line. The effects of sewer gases on the human body are well known; many of the gases are extremely harmful. In addition, certain sewer gases are explosive.

**P-trap.** The most commonly used trap is the P-trap (Figure 9.6). The depth of the seal in a trap is usually 2 inches. A deep seal trap has a 4-inch seal.

As mentioned earlier, the purpose of a trap is to seal out sewer gases from the structure. Because a plumbing system is subject to wide variations in flow, and this flow originates in many different sections of the system, pressures vary widely in the waste lines. These pressure differences tend to remove the water seal in the trap. The waste system must be properly vented to prevent the traps from siphoning dry, thus losing their water seal and allowing gas from the sewer into the building.

**Objectionable Traps.** The S-trap and the  $\frac{3}{4}$  S-trap (Figure 9.7) should not be used in plumbing installations. They are almost impossible to ventilate properly, and the  $\frac{3}{4}$  S-trap forms a perfect siphon. Mechanical traps were introduced to counteract this problem. It has been found, however, that the corrosive liquids flowing in the system corrode or jam these mechanical traps. For this reason, most plumbing codes prohibit mechanical traps.

The bag trap, an extreme form of S-trap, is seldom found. Figure 9.7 also shows this type of S-trap.

Traps are used only to prevent the escape of sewer gas into the structure. They do not compensate for pressure variations. Only proper venting will eliminate pressure problems.

### Ventilation

A plumbing system is ventilated to prevent trap seal loss, material deterioration, and flow retardation.

**Trap Seal Loss.** The seal in a plumbing trap may be lost due to siphonage (direct and indirect or momentum), back pressure, evaporation, capillary attraction, or wind

effect. The first two are probably the most common causes of loss. Figure 9.8 depicts this siphonage process; Figure 9.9 depicts loss of trap seal.

If a waste pipe is placed vertically after the fixture trap, as in an S-trap, the wastewater continues to flow after the fixture is emptied and clears the trap. This is caused by the pressure of air on the water of the fixture being greater than the pressure of air in the waste pipe. The action of the water discharging into the waste pipe removes the air from that pipe and thereby causes a negative pressure in the waste line.

Fixture	Units
Lavatory/washbasin	1
Kitchen sink	2
Bathtub	2
Laundry tub	2
Combination fixture	3
Urinal	5
Shower bath	2
Floor drain	1
Slop sink	3
Toilet	6 or 3 (based on type)
One bathroom group	8
180 square feet of roof	1

**Table 9.1.** Fixture Unit Values

Diameter of Pipe, Inches	Maximum Number of Fixtures per Listed Drain Slope†		
	$\frac{1}{8}$ inch per foot	$\frac{1}{4}$ inch per foot	$\frac{1}{2}$ inch per foot
1 $\frac{1}{4}$	1	1	1
1 $\frac{1}{2}$	2	2	3
2	5	6	8
3	15	18	21
4	84	96	114
6	300	450	600
8	990	1,392	2,220
12	3,084	4,320	6,912

† Number of fixture units.

**Table 9.2.** Sanitary House Drain Sizes

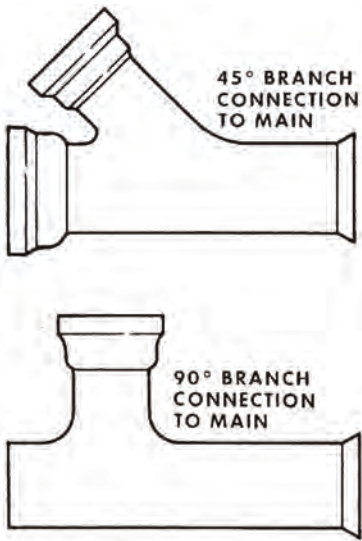

Figure 9.5. Branch Connections

In the case of indirect or momentum siphonage, the flow of water past the entrance to a fixture drain in the waste pipe removes air from the fixture drain. This reduces the air pressure in the fixture drain, and the entire assembly acts as an aspirator. (Figures 9.10 and 9.11 show plumbing configurations that would allow this type of siphonage to occur.)

**Back Pressure.** The flow of water in a soil pipe varies according to the fixtures being used. Small flows tend to cling to the sides of the pipe, but large ones form a slug of waste as they drop. As this slug of water falls down the pipe, the air in front of it becomes pressurized. As the pressure builds, it seeks an escape point. This point is either a vent or a fixture outlet. If the vent is plugged or there is no vent, the only escape for this air is the fixture outlet.

The air pressure forces the trap seal up the pipe into the fixture. If the pressure is great enough, the seal is blown out of the fixture entirely. Figures 9.8 and 9.9 illustrate the potential for this type of problem. Large water flow past the vent can aspirate the water from the trap, while water flow approaching the trap can blow the water out of the trap.

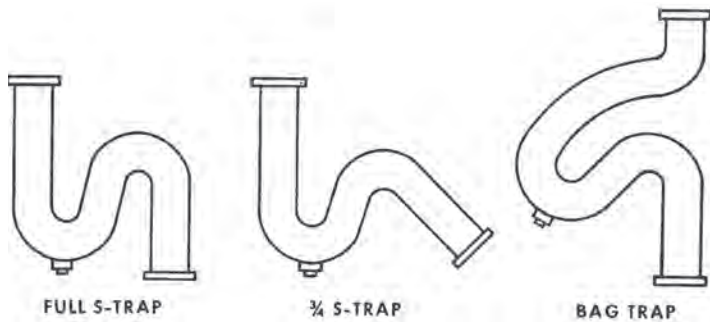

Figure 9.7. Types of S-traps

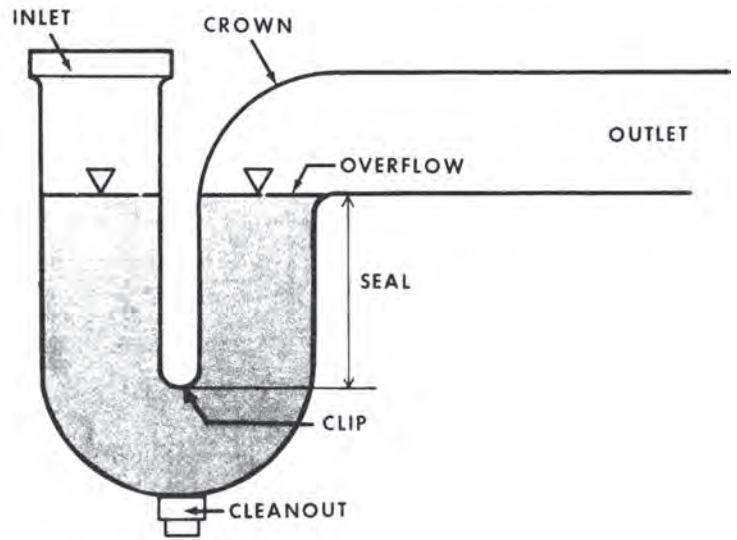

Figure 9.6. P-trap [1]

**Vent Sizing.** Vent pipe installation is similar to that of soil and waste pipe. The same fixture unit criteria are used. Table 9.3 shows minimum vent pipe sizes.

Vent pipes of less than 1¼ inches in diameter should not be used. Vents smaller than this diameter tend to clog and do not perform their function.

**Individual Fixture Ventilation.** Figure 9.12 shows a typical installation of a wall-hung plumbing unit. This type of ventilation is generally used for sinks, drinking fountains, and so forth. Air admittance valves are often used for individual fixtures. Figure 9.13 shows a typical installation of a bathtub or shower ventilation system. Figure 9.14 shows the proper vent connection for toilet fixtures and Figure 9.15 shows a janitor's sink or slop sink that has the proper P-trap. For the plumbing fixture to work properly, it must be vented as in Figures 9.13 and 9.14.

**Unit Venting.** Figures 9.10 and 9.11 show a back-to-back shared ventilation system for various plumbing fixtures. The unit vent-

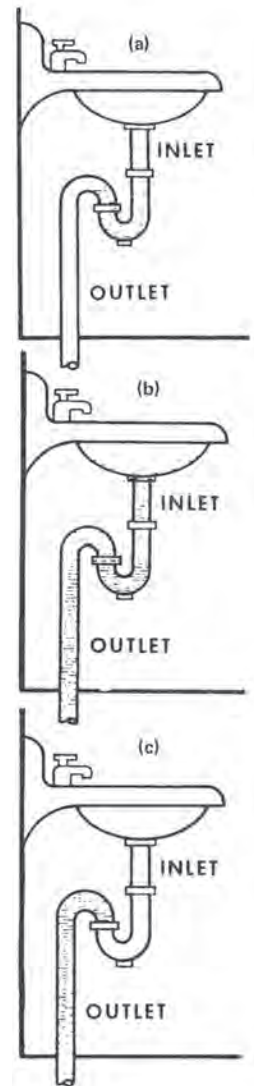
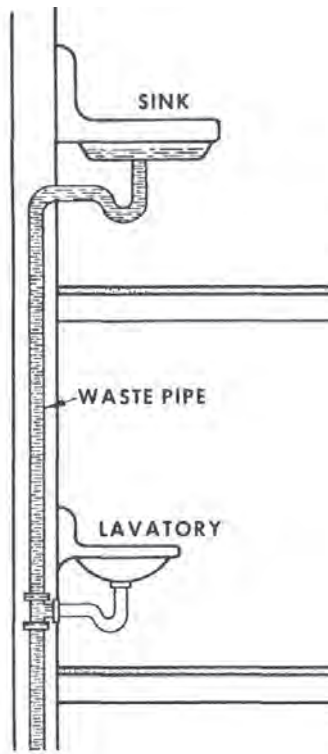

Figure 9.8. Trap Seal: [a] Seal Intact; [b] Fixture Draining; [c] Loss of Gas Seal [1]





**Figure 9.9.** Loss of Trap Seal in Lavatory Sink [1]

ing system is commonly used in apartment buildings. This type of system saves a great deal of money and space when fixtures are placed back-to-back in separate apartments. It does, however, pose a problem if the vents are undersized because they will aspirate the water from the other trap. Figure 9.16 shows a double combination Y-trap used for joining the fixtures to the common soil pipe fixture on the other side of the wall.

**Wet Venting.** Bathroom fixture groupings are commonly wet vented; that is, the vent pipe also is used as a waste line.

### Total Drainage System

The drain, soil waste, and vent systems are all connected, and the inspector should remember the following fundamentals:

Working vents must provide air to all fixtures to ensure the movement of waste into the sewer. Improperly vented fixtures will drain slowly and clog often. They also present a health risk if highly toxic and explosive sewer gases enter the home. Correct venting is shown in Figures 9.10–9.15; incorrect venting is shown in Figures 9.8 and 9.9. A wet vent can result in one of the traps siphoning the other dry when large volumes of water are poured down the drain. Wet vents are not permitted by many state plumbing codes because of the potential for self-siphoning.

Backup of sewage into sinks, dishwashers, and other appliances is always a possibility unless the system is equipped with air gaps or vacuum breakers. All connections to the potable water system must be a minimum of two pipe diameters above the overflow of the appliance and, in some cases, where flat surfaces are near, two and one-half pipe diameters above the overflow of the appliance.

A simple demonstration of how easily siphoning can occur is to hold a glass of water with food coloring in it with the tip of a faucet in the colored water. If the sink's

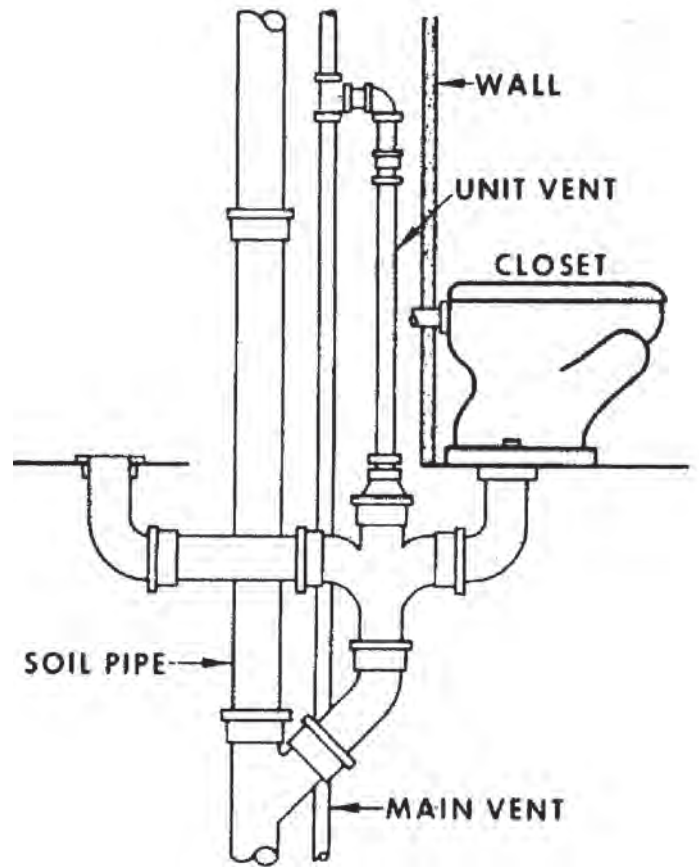

**Figure 9.10.** Back-to-back Venting [Toilet]

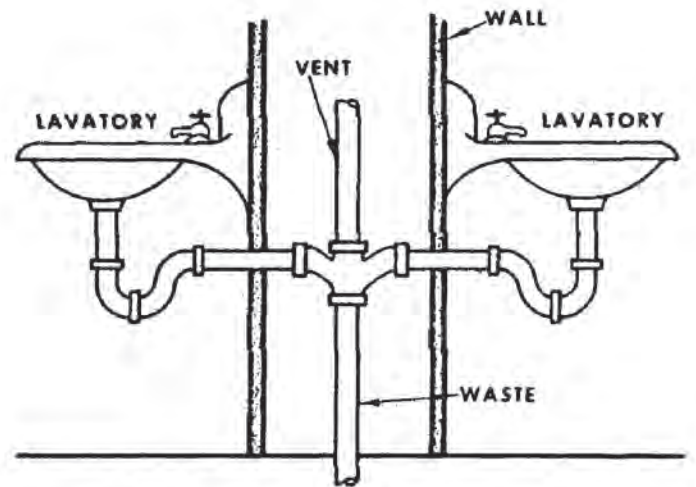
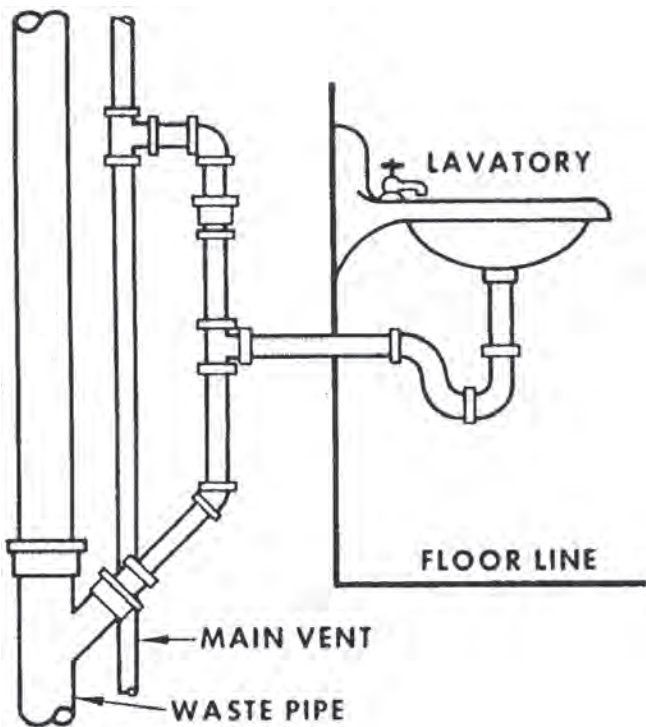

**Figure 9.11.** Back-to-back Venting [Sink]

vegetable sprayer is directed to a second glass and sprayed, in most cases, the colored water will be aspirated into the faucet and then out of the sprayer into the second glass. Weed or pest killer attachments that hook to garden hoses work on the same principle. Figure 9.17 shows an outside hose bib equipped with a vacuum breaker. In the areas of the United States that freeze, these vacuum breakers must be removed because they trap water in the area of the line that can freeze and burst. Many vacuum breakers sold today automatically drain to prevent freeze damage.

Fixture	Supply Line, Inches	Vent Line, Inches	Drain Line, Inches
Bathtub	1/2	1 1/2	1 1/2
Kitchen sink	1/2	1 1/2	1 1/2
Lavatory	3/8	1 1/4	1 1/4
Laundry sink	1/2	1 1/2	1 1/2
Shower	1/2	2	2
Toilet tank	3/8	3	3

**Table 9.3.** Minimum Fixture Service Pipe Diameters



**Figure 9.12.** Wall-hung Fixtures

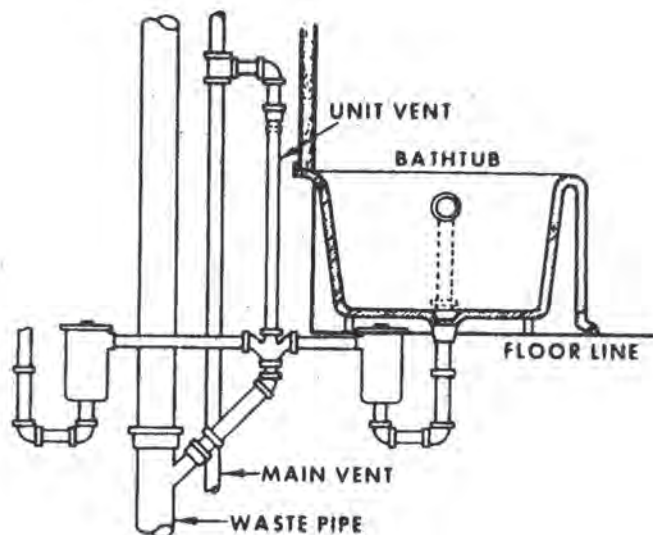

**Figure 9.13.** Unit Vent Used in Bathtub Installation

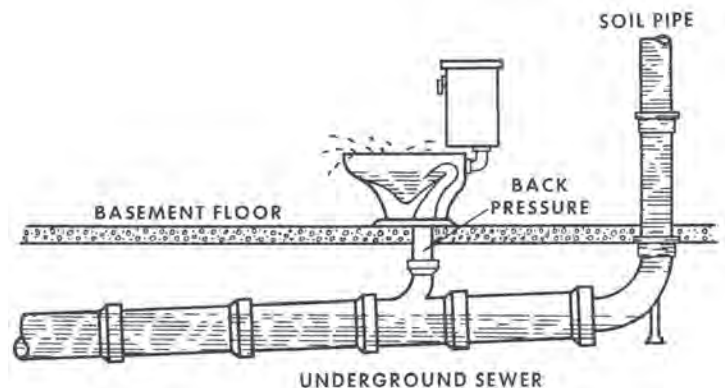

**Figure 9.14.** Toilet Venting

Devices that pull water from a utility may create negative pressures that can damage water piping and pull dangerous substances into the line at the same time. These devices include power sprayers that hook to the home hose bib (outside faucets) and pressurize the spray by creating a vacuum on the supply side.

### Corrosion Control

To understand the proper maintenance procedures for the prevention and elimination of water quality problems in plumbing systems, it is necessary to understand the process used to determine the chemical aggressiveness of water. The process is used to determine when additional treatment is needed. Water that is out of balance can result in many negative outcomes, from toxic water to damaged and ruined equipment.

Water dissolves and carries materials when it is not saturated. An equilibrium among pH, temperature, alkalinity, and hardness controls water's ability to create scale or to dissolve material. If water is saturated with harmless or beneficial substances, such as calcium, then the threat of damage can be mitigated. The Langelier method, developed in the early 1930s, is a process used in boiler management, municipal water treatment, and swimming pools to provide this balance. In the Langelier index, saturation over 0.3 is scale forming, and a saturation below 0.3 is corrosive.

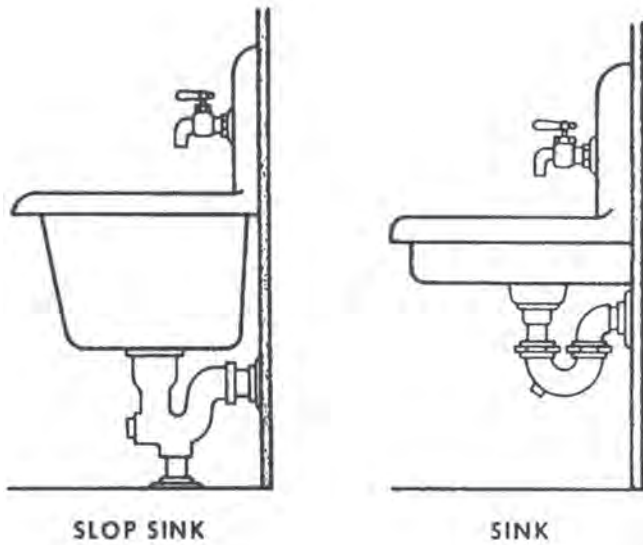

Figure 9.15. Janitor's Sink

The susceptibility of metal to corrosion is as follows (most susceptible to least susceptible): magnesium, zinc, aluminum, cadmium, mild steel, cast iron, stainless steel (active), lead-tin solder, lead, tin, brass, gun metal, aluminum bronze, copper, copper-nickel alloy, Monel, titanium, stainless steel (passive), silver, gold, and platinum.

## Water Conservation

How much attention should be paid to fixtures that just drip a little bit of water or that just will not quite shut off? At 30 drops per minute, you will lose and pay for 54 gallons per month. At 60 drops per minute, you will lose and pay for 113 gallons per month. At 120 drops per minute, you will lose and pay for 237 gallons per month.

This is only a small loss of water considering the 5 to 7 gallons per flush used by a properly functioning toilet. If the toilet is not properly maintained, the loss of water and its effect on the monthly water bill can be incredible. Lower flow toilets have been mandated to save precious and limited resources. Most pre-1992 toilets used up to 7 gallons per flush. Toilets have since evolved to use 5.5, then 3.5, and now 1.6 gallons per flush.

With the changes in the water usage laws in 1992, there were many customer complaints, and plumbers were in the bad position of installing products that nobody wanted to use. New and updated products now work better than the old water wasters.

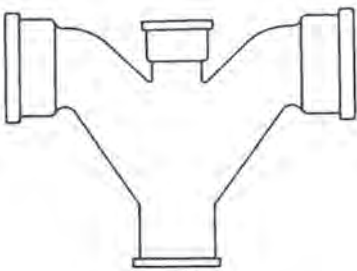

Figure 9.16. Common Y-trap



Figure 9.17. Hose Bib With Vacuum Breaker

According to the EPA, in 2000, a typical U.S. family of four spent approximately \$820 every year on water and sewer fees, plus another \$230 in energy for heating

water. In many cities, according to the U.S. EPA, water and sewer costs can be more than twice those amounts. Many people do not realize how much money they can save by taking simple steps to save water, and they do not know the cumulative effects small changes can have on water resources and environmental quality. Fixing a leaky faucet, toilet, or lawn-watering system can reduce water consumption. Changing to water-efficient plumbing fixtures and appliances can result in major water and energy savings [9,10].

Summer droughts remind many of the need to appreciate clean water as an invaluable resource. As the U.S. population increases, the need for clean water supplies continues to grow dramatically and puts additional stress on our limited water resources. We can all take steps to save and conserve this valuable resource.

The EPA [11] suggests the following steps homeowners should take right away to save water and money:

- **Stop leaks!**—Check indoor water-using appliances and devices for leaks. Pay particular attention to toilets that leak.
- **Take showers**—Showers use considerably less water than do baths.
- **Replace shower heads**—Replacement shower heads are available that reduce water use.
- **Turn the water off when not needed**—While brushing your teeth, turn the water off until you need to rinse.
- **Replace your old toilet**—The largest water user inside the home is the toilet. If a home was built before 1992 and the toilet has never been replaced, it is very likely that it is not a water-efficient, 1.6 gallons-per-flush toilet. Choose a replacement toilet carefully to ensure that what you make up per individual flush, you do not lose because you must flush more often.
- **Replace your clothes washer**—The second largest water user in the home is the washing machine. Energy Star-rated washers that also have a water factor at or

lower than 9.5 use 35%–50% less water and 50% less energy per load. This saves money on both water and energy bills.

- **Plant the right plants with proper landscape design and irrigation**—Select plants that are appropriate for the local climate. Having a 100% turf lawn in a dry desert climate uses a significant amount of water. Also, home owners should consider the benefits of a more natural landscape or wildscape.
- **Water plants only as needed**—Most water wasted in the garden is by watering when plants do not need it

or by not maintaining the irrigation system. If manually watering, set a timer and move the hose promptly. Make sure the irrigation controller has a rain shutoff device and that it is appropriately scheduled. Drip irrigation should be considered where practical. Newer irrigation systems have sensors to prevent watering while it is raining.

## Putting It All Together

These photographs, taken during construction of a home by Habitat for Humanity, show various plumbing elements discussed in this chapter.



### A.

Hot and cold copper water lines and drain, p-trap and vent, and vent for the washer drain shown. When a house is vacant for awhile, the P-trap should be filled with water to prevent sewer gas from entering the home. Mineral oil added to the water can slow the loss of fluid in the trap.



### B.

Hot and cold water pipes, soil pipe, and vent shown.



### C.

Vent for the sink and toilet, soil pipe, and cap for toilet connection shown. A wax or plastic seal shaped like a donut will be placed on the cap before bolting down the toilet.



#### D.

Mixing and antiscald water flow control, vent for fixture, hot and cold water lines, and bathtub overflow shown. At this point in construction, insulation might be considered for the hot water lines. Water service and waste water line.



#### E.

Polyethylene water service pipe entering the home through the concrete basement wall shown. White plastic adapter shown between polyethylene water service pipe and  $\frac{3}{4}$  inch copper water line. A short distance above the adapter is a pressure reducing valve. To the right of water line is the 4-inch PVC pipe waste water line.

## References

1. US Environmental Protection Agency. United States Environmental Protection Agency guidance from hotline compendium: lead ban. Washington, DC: US Environmental Protection Agency; 1988. Available from URL: [http://www.epa.gov/safewater/wsg/wsg\\_H19.pdf](http://www.epa.gov/safewater/wsg/wsg_H19.pdf).
2. Uni-Bell PVC Pipe Association. Handbook of PVC pipe design and construction. Dallas: Uni-Bell PVC Pipe Association; 2001. Available from URL: <http://www.uni-bell.org/pubs/handbook.pdf>.
3. Occupational Safety and Health Administration. Safety hazard information bulletin on the use of polyvinyl chloride (PVC) pipe in above ground installations. Washington, DC: Occupational Safety and Health Administration; 1988. [http://www.osha.gov/dts/hib/hib\\_data/hib19880520.html](http://www.osha.gov/dts/hib/hib_data/hib19880520.html).
4. Copper Development Association. Copper in your home: plumbing, heating, cooling. New York: Copper Development Association; no date. Available from URL: [http://www.copper.org/copperhome/PHC/phc\\_home.html](http://www.copper.org/copperhome/PHC/phc_home.html).
5. Plastic Pipe and Fittings Association. Cross-linked polyethylene. Glen Ellyn, IL: Plastic Pipe and Fittings Association; no date. Available from URL: <http://www.ppfahome.org/pex/historypex.html>.
6. NAMCO. Determine the total fixture unit load. Dallas: NAMCO; no date. Available from URL: <http://www.namco-div.com/booster/sel%20criteria/fixtureload.htm>.
7. Energy Efficiency and Renewable Energy Clearinghouse. Demand (tankless or instantaneous) water heaters. Merrifield, VA: Energy Efficiency and Renewable Energy Clearinghouse; no date. Available from URL: <http://www.toolbase.org/tertiaryT.asp?DocumentID=3206&&&CategoryID=0>.

8. Public Health-Seattle and King County. Public health plumbing program: water supply fixture units (WSFU) and minimum fixture branch pipe sizes. Seattle, WA: Public Health-Seattle and King County; no date. Available from URL: <http://www.metrokc.gov/health/plumbing/wsfu.htm>.
9. US Environmental Protection Agency. Developing water system financial capacity. Washington, DC: US Environmental Protection Agency; 2002. Available from URL: <http://www.epa.gov/safewater/dwa/electronic/presentations/pwsoper/fincapacity.pdf>.
10. US Environmental Protection Agency. Water and wastewater pricing. Washington, DC: US Environmental Protection Agency; no date. Available from URL: <http://www.epa.gov/water/infrastructure/pricing/>.
11. US Environmental Protection Agency. Using water wisely in the home. Washington, DC: US Environmental Protection Agency; 2002. Available from URL: [http://www.epa.gov/owm/water-efficiency/waterconservation\\_final.pdf](http://www.epa.gov/owm/water-efficiency/waterconservation_final.pdf).

## Additional Sources of Information

American Backflow Prevention Association. Available from URL: <http://www.abpa.org>.

American Society of Plumbing Engineers. Available from URL: <http://aspe.org>.

American Society of Sanitary Engineering. Available from URL: <http://www.asse-plumbing.org>.

American Water Works Association. Available from URL: <http://www.awwa.org>.

National Sanitation Foundation. Available from URL: <http://www.nsf.org/international>.

Plumbing-Heating-Cooling Contractors Association. Available from URL: <http://www.phccweb.org>.

Underwriters Laboratories Inc. Available from URL: <http://www.ul.com>.

For more water conservation tips and energy saving ideas for businesses, industries, and individuals, visit the EPA's Water-use Efficiency Program Web site (<http://www.epa.gov/owm/water-efficiency/index.htm>).

# Chapter 10: On-site Wastewater Treatment

*“Technology has made large populations possible; large populations now make technology indispensable.”*

Joseph Wood Krutch, Author, 1932

## Introduction

The French are considered the first to use an underground septic tank system in the 1870s. By the mid 1880s, two-chamber, automatic siphoning septic tank systems, similar to those used today, were being installed in the United States. Even now, more than a century later, septic tank systems represent a major household wastewater treatment option. Fully one-fourth to one-third of the homes in the United States use such a system [1].

On-site sewage disposal systems are used in rural areas where houses are spaced so far apart that a sewer system would be too expensive to install, or in areas around cities where the city government has not yet provided sewers to which the homes can connect. In these areas, people install their own private sewage treatment plants. As populations continue to expand beyond the reach of municipal sewer systems, more families are relying on individual on-site wastewater treatment systems and private water supplies. The close proximity of on-site water and wastewater systems in subdivisions and other developed areas, reliance on marginal or poor soils for on-site wastewater disposal, and a general lack of understanding by homeowners about proper septic tank system maintenance pose a significant threat to public health. The expertise on inspecting, maintaining, and installing these systems generally rests with the environmental health staff of the local county or city health departments.

These private disposal systems are typically called septic tank systems. A septic tank is a sewage holding device made of concrete, steel, fiberglass, polyethylene, or other

approved material cistern, buried in a yard, which may hold 1,000 gallons or more of wastewater. Wastewater flows from the home into the tank at one end and leaves the tank at the other (Figure 10.1) [2].

Proper maintenance of septic tanks is a public health necessity. Enteric diseases such as cryptosporidiosis, giardiasis, salmonellosis, hepatitis A, and shigellosis may be transmitted through human excrement. Historically, major epidemics of cholera and typhoid fever were primarily caused by improper disposal of wastewater. The earliest epidemiology lesson learned was through the effort of Dr. John Snow of England (1813–1858) during a devastating cholera epidemic in London [3]. Dr. Snow, known as the father of field epidemiology, discovered that the city's water supply was being contaminated by improper disposal of human waste. He published a brief pamphlet, *On the Mode of Communication of Cholera*, suggesting that cholera is a contagious disease caused by a poison that reproduces in the human body and is found in the vomitus and stools of cholera patients. He believed that the main, although not only, means of transmission was water contaminated with this poison. This differed from the commonly accepted belief at the time that diseases were transmitted by inhaling vapors.

## Treatment of Human Waste

Safe, sanitary, nuisance-free disposal of wastewater is a public health priority in all population groups, small and large, rural or urban. Wastewater should be disposed of in a manner that ensures that

- community or private drinking water supplies are not threatened;
- direct human exposure is not possible;
- waste is inaccessible to vectors, insects, rodents, or other possible carriers;
- all environmental laws and regulations are complied with; and
- odor or aesthetic nuisances are not created.

In Figure 10.2, a straight pipe from a nearby home discharges untreated sewage that flows from a shallow drainage ditch to a roadside mountain creek in which many children and some adults wade and fish. The clear water (Figure 10.3) is quite deceptive in terms of the health hazard presented. A 4-mile walk along the creek

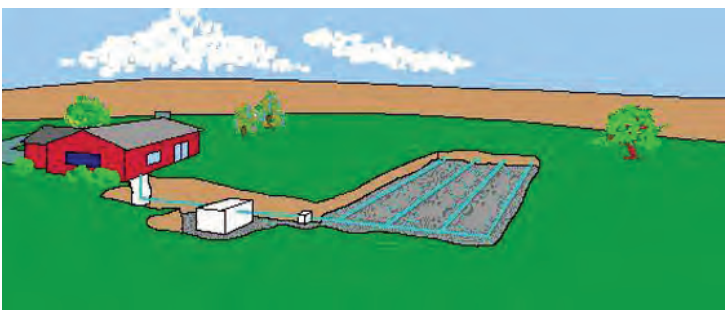

**Figure 10.1.** Conventional On-site Septic System [2]  
Effluent leaves home through a pipe, enters a septic tank, travels through a distribution box to a trench absorption system composed of perforated pipe.



**Figure 10.2.** Straight Pipe Discharge  
**Source:** Donald Johnson; used with permission.



**Figure 10.3.** Clear Creek Water Contaminated With Sewage  
**Source:** Donald Johnson; used with permission.

revealed 12 additional pipes that were also releasing untreated sewage. Some people in the area reportedly regard this creek as a source of drinking water.

Raw or untreated domestic wastewater (sewage) is primarily water, containing only 0.1% of impurities that must be treated and removed. Domestic wastewater contains biodegradable organic materials and, very likely, pathogens. The primary purpose of wastewater treatment is to remove impurities and release the treated effluent into the ground or a stream. There are various processes for accomplishing this:

- **Centralized treatment**—Publicly owned treatment works (POTWs) that use primary (physical) treatment and secondary (biologic) treatment on a large scale to treat flows of up to millions of gallons or liters per day,
- **Treatment on-site**—Septic tanks and absorption fields or variations thereof, and
- **Stabilization ponds (lagoons)**—Centralized treatment for populations of 10,000 or less when soil conditions are marginal and land space is ample.

Not included are pit privies and compost toilets.

## Epidemiology

John Snow, a London physician, was among the first to use anesthesia. It is his work in epidemiology, however, that earned him his reputation as a prototype for epidemiologists. Dr. Snow's brief 1849 pamphlet, *On the Mode of Communication of Cholera*, caused no great stir, and his theory that the city's water supply was contaminated was only one of many proposed during the epidemic.

Snow, however, was able to prove his theory in 1854, when another severe epidemic of cholera occurred in London. Through painstaking documentation of cholera cases and correlation of the comparative incidence of cholera among subscribers to the city's two water companies, he showed that cholera occurred much more frequently in customers of one water company. This company drew its water from the lower Thames, which became contaminated with London sewage, whereas the other company obtained water from the upper Thames. Snow's evidence soon gained many converts.

A striking incident during this epidemic has become legendary. In one neighborhood, the intersection of Cambridge Street and Broad Street, the concentration of cholera cases was so great that the number of deaths reached over 500 in 10 days. Snow investigated the situation and concluded that the cases were clustered around the Broad Street pump. He advised an incredulous but panicked assembly of officials to have the pump handle removed, and when this was done, the epidemic was contained. Snow was a skilled practitioner as well as an epidemiologist, and his creative use of the scientific information of his time is an appropriate example for those interested in disease prevention and control [3].



Historically, wastewater disposal systems are categorized as water-carrying and nonwater-carrying. Nonwater-carried human fecal waste can be contained and decomposed on-site, the primary examples being a pit privy or compost toilet. These systems are not practical for individual residences because they are inconvenient and they expose users to inclement weather, biting insects, and odors. Because of the depth of the disposal pit for privies, they may introduce waste directly into groundwater. It should be noted that these types of systems are often used and may be acceptable in low-water-use conditions such as small campsites or along nature trails [4–6].

## On-site Wastewater Treatment Systems

As urban sprawl continues and the population increases in rural areas, the cost of building additional sewage disposal systems increases. One of the prime reasons for annexation is to increase the tax base without increasing the cost of municipal government. The governments involved often buy into short-term tax gains at massive long-term costs for eventual infrastructure improvements to annexed communities. Installing septic tank systems is common to provide on-site disposal systems, but it is a temporary solution at best. Because property size must be sufficient to allow space for septic system replacement, the cost to the municipality installing a centralized sewer system will be dramatically increased because of the large lot size.

Two microbiologic processes occur in all methods that attempt to decompose domestic wastewater: anaerobic (by bacteria that do not require oxygen) and aerobic (by bacteria that require oxygen) decomposition. Aerobic decomposition is generally preferred because aerobic bacteria decompose organic matter (sewage) at a rate much faster than do anaerobic bacteria and odors are less likely. Centralized wastewater treatment facilities use aerobic processes, as do most types of lagoons. Septic tank systems use both processes.

### Septic Tank Systems

Approximately 21% of American homes are served by on-site sewage disposal systems. Of these, 95% are septic tank field systems. Septic tank systems are used as a means of on-site wastewater treatment in many homes, both in rural and urban areas, in the United States. If maintained and operated within acceptable parameters, they are capable of properly treating wastewater for a limited number of years and will need both routine maintenance and eventually major repairs. Proper placement and installation is a key to the successful operation of any on-

site wastewater treatment system, but septic tank systems have a finite life expectancy and all such systems will eventually fail and need to be replaced. Figure 10.4 shows a typical rural home with a well and a septic system.

Septic tank systems generally are composed of the septic tank, distribution box, absorption field (also known as the soil drain field), and leach field. The septic tank serves three purposes: sedimentation of solids in the wastewater, storage of solids, and anaerobic breakdown of organic materials.

To place the septic tank and absorption field in a way that will not contaminate water wells, groundwater, or streams, the system should be 10 feet from the house and other structures, at least 5 feet from property lines, 50 feet from water wells, and 25 feet from streams. The entire system area should be easily identifiable. There have been occasions when owners have paved or built over the area. The local health code authorities must be consulted on required distances in their area because of soil and groundwater issues.

Aerobic, or aerated, septic systems use a suspended growth wastewater treatment process, and can remove suspended solids that are not removed by simple sedimentation. Under appropriate conditions, aerobic units may also provide for nitrification of ammonia, as well as significant pathogen reduction. Some type of primary treatment usually precedes the aerated tank. The tanks contain an aeration chamber, with either mechanical aerators or blowers, or air diffusers, and an area for final clarification/settling. Aerobic units may be designed as either continuous flow or batch flow systems. The continuous flow type are the most commercially available units.

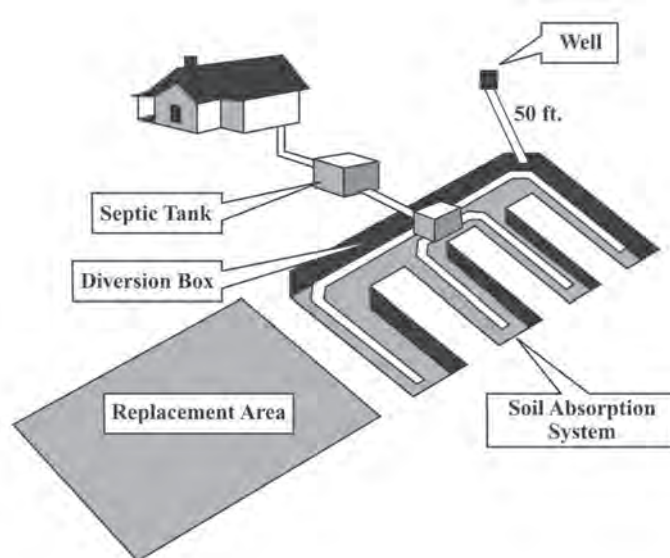

Figure 10.4. Septic Tank System [7]

Effluent from the aerated tank is conveyed either by gravity flow or pumping to either further treatment/ pretreatment processes or to final treatment and disposal in a subsurface soil disposal system. Various types of pretreatment may be used ahead of the aerobic units, including septic tanks and trash traps.

The batch flow system collects and treats wastewater over a period of time, then discharges the settled effluent at the end of the cycle [8].

Aerobic units may be used by individual or clustered residences and establishments for treating wastewater before either further treatment/pretreatment or final on-site subsurface treatment and disposal. These units are particularly applicable where enhanced pretreatment is important, and where there is limited availability of land suitable for final on-site disposal of wastewater effluent. Because of their need for routine maintenance to ensure proper operation and performance, aerobic units may be well-suited for multiple-home or commercial applications, where economies of scale tend to reduce maintenance and/or repair costs per user. The lower organic and suspended solids content of the effluent may allow a reduction of land area requirements for subsurface disposal systems.

A properly functioning septic tank will remove approximately 75% of the suspended solids, oil, and grease from effluent. Because the detention time in the tank is 24 hours or less, there is not a major kill of pathogenic bacteria. The bacteria will be removed in the absorption field (drain field). However, there are soils and soil conditions that prohibit the ability of a drain field to absorb effluent from the septic tank.

Septic tanks are sized to retain the total volume of sewage produced by a household in a 24-hour period. Normally a 1,000-gallon tank is the minimum size to use. State or local codes generally require larger tanks as the potential occupancy of the home increases (e.g., 1,250 gallons for four bedrooms) and may require two tanks in succession when inadequate soils require alternative system installation. Figure 10.5 shows a typical septic tank.

Distribution boxes are not required by most on-site plumbing codes or by the U.S. Environmental Protection Agency. When used, distribution boxes provide a convenient inspection port. In addition, if a split system absorption field is installed (two separate absorption trench systems), the distribution box is a convenient place to install a diversion valve for annually alternating absorption fields.

### Absorption Field Site Evaluation

The absorption field has a variety of names, including leach field, tile field, drain field, disposal field, and nitrification field. The effluent from the septic tank is directed to the absorption field for final treatment. The suitability of the soil, along with other factors noted below, determines the best way to properly treat and dispose of the wastewater.

Most, but unfortunately not all, states require areas not served by publicly owned sewers to be preapproved for on-site wastewater disposal before home construction through a permitting process. This process typically requires a site evaluation by a local environmental health specialist, soil scientist, or, in some cases, a private contractor. To assist in the site evaluation process, soil survey maps from the local soil conservation service office may be used to provide general information about soils in the area.

The form shown in Figure 10.6 is typical of those used in conducting a soil evaluation.

Sites for on-site wastewater disposal are first evaluated for use with a conventional septic tank system. Evaluation factors include site topography, landscape position, soil texture, soil structure, internal drainage, depth to rock or other restrictive horizons, and useable area. If the criteria are met, a permit is issued to allow the installation of a conventional septic tank system. Areas that do not meet the criteria for a conventional system may meet less-restrictive criteria for an alternative type of system.

Many sites are unsuitable for any type of on-site wastewater disposal system because of severe topographic limitations, poor soils, or other evaluation criteria. Such sites

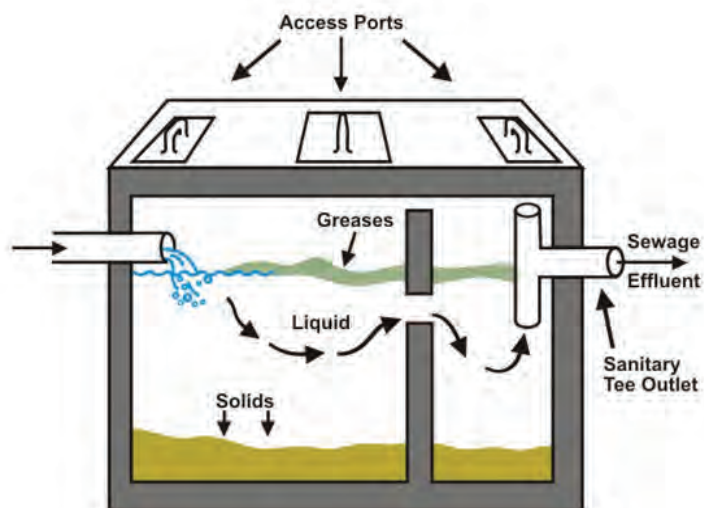

Figure 10.5. Septic Tank [9]

SAMPLE ON-SITE SEWAGE DISPOSAL SYSTEM SITE EVALUATION FORM						
Location _____		Application No. _____				
Owners Name _____		Applicant's Name _____				
Evaluation Factors	Proposed System Area			Alternative Area 1		
1. Topography (slope percent)	S	PS	U	S	PS	U
2. Landscape Position	S	PS	U	S	PS	U
3. Soil Texture and Group	S	PS	U	S	PS	U
4. Soil Structure	S	PS	U	S	PS	U
5. Internal Soil Drainage	S	PS	U	S	PS	U
6. Soil Depth (inches)	S	PS	U	S	PS	U
7. Restrictive Horizons	S	PS	U	S	PS	U
8. Available Space	S	PS	U	S	PS	U
9. Overall Site Classification	S	PS	U	S	PS	U
10. Soil Series (if available)	S	PS	U	S	PS	U

**S = Suitable    PS = Provisionally Suitable    U = Unsuitable**

11. List site and/or system modifications or alternatives required for site approval and the specific area selected for the system. \_\_\_\_\_

12. Percolation test required Yes \_\_\_\_\_ No \_\_\_\_\_

Figure 10.6. On-site Sewage Disposal System Site Evaluation Form

should not be used for on-site wastewater disposal because of the high likelihood of system failure.

Some states and localities may require a percolation test as part of the site evaluation process. As a primary evaluation method, percolation tests are a poor indicator of the ability of a soil to treat and move wastewater throughout the year. However, information obtained by percolation tests may be useful when used in conjunction with a comprehensive soil analysis.

### Absorption Field Trench

A conventional absorption field trench (Figure 10.7), also known as a rock lateral system, is the most common system used on level land or land with moderate slopes with adequate soil depth above the water table or other restrictive horizons. The effluent from the septic tank flows through solid piping to a distribution box or, in many cases, straight to an absorption field. With the conventional system and most alternative systems, the effluent flows through perforated pipes into gravel-filled trenches and subsequently seeps through the gravel into the soil.

The local regulatory agency should be consulted about the acceptable depth of the absorption field trench. Some states require as much as 4 feet of separation beneath the bottom of the trench and the groundwater. The depth of absorption field trenches should be at least 18 inches, and ideally no deeper than 24 inches. The absorption field pipe should be laid flat with no slope. There should be a

minimum of 12 to 18 inches of acceptable soil below the bottom of the trench to any bedrock, water table, or restrictive horizon. The length of the trench should not exceed 100 feet for systems using a distribution box. Serpentine systems may be several hundred feet long and should be filled with crushed or fragmented clean rock or gravel in the bottom 6 inches of the trench. Perforated 4-inch-diameter pipe is laid on top of the gravel then covered with an additional 2 inches of rock and leveled for a total of 12 inches. A geotextile material or a biodegradable material such as straw should be placed over the gravel before backfilling the trench to prevent soil from clogging the spaces between the rocks.

One or more monitoring ports should be installed in the absorption area extending to the bottom of the gravel to allow measurement of the actual liquid depth in the gravel. This is essential for subsequent testing of the adequacy of the system.

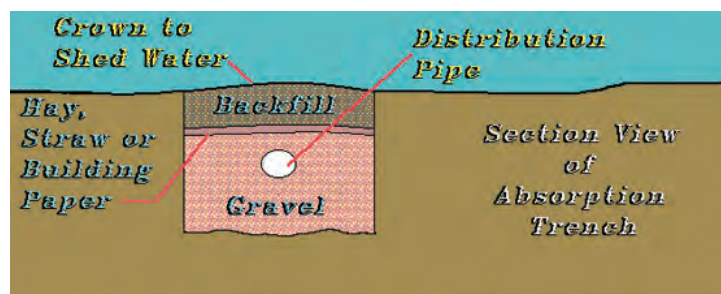

Figure 10.7. Cross-section of an Absorption Field [10]

As a general rule, using longer and narrower trenches to meet square footage requirements produces a better working and longer lasting ground absorption sewage disposal system. Studies have shown that as septic systems age, the majority of effluent absorption by the soil is provided by lateral movement through the trench sidewalls. Longer and narrower trenches (such as 400 feet long by 2 feet wide instead of 200 feet by 4 feet to obtain 800 square feet) greatly increase the sidewall area of the system for lateral movement of wastewater.

### Alternative Septic Tank Systems

As the cost of land for home building increases and the availability of land decreases, land that was once considered unsuitable is being developed. This land often has poor soil and drainage properties. Such sites require a considerable amount of engineering skill to design an acceptable wastewater disposal system. In many cases, sites are not acceptable for seepage systems within a reasonable cost. These systems are primarily regulated by state and local government and, before use, approval must be obtained from the appropriate regulatory agencies. Even if a site is approved in one state or county jurisdiction, a similar site may not be approved in another.

The primary difficulty with septic tank systems is treating effluent in slowly permeable or marginal soils. Low-water-use devices, when installed, may make it possible to use a small percentage of septic tank systems in marginal soil. However, low-water-use devices are usually required as part of a larger effort to develop a usable alternative sewage disposal system. Alternative sewage disposal methods that can be used if regular subsurface disposal is not appropriate are numerous [11]. Some of the more common alternative systems are described below.

### Mound Systems

A mound system (Table 10.1) is elevated above the natural soil surface to achieve the desired vertical separation from a water table or impervious material. The elevation is accomplished by placing sand fill material on top of the best native soil stratum. At least 1 foot of naturally occurring soil is necessary for a mound system to function properly. Minimizing water usage in the home also is critical to prevent effluent from weeping through the sides of the mound (Figure 10.8).

When a mound system is constructed, the septic tank usually receives wastewater from the house by gravity flow. A lift station is located in the second compartment or in a separate tank to pump the effluent up to the distribution piping in the mound. Floats in the lift station control the size of the pumped effluent dose. An alarm should be installed to alert the homeowner of pump failure so that repairs can be made before the pump tank overfills.

### Low-Pressure Pipe Systems

Low-pressure pipe (LPP) systems may also be used where the soil profile is shallow. These systems are similar to mounds except that they use naturally occurring soil as it exists on-site instead of elevating the disposal field with soil fill material. LPP systems are installed with a trenching machine at depths of 12 to 18 inches. The LPP system consists of a septic tank, high-water alarm, pumping tank, supply line, manifold, lateral line, and submersible effluent pump (Figure 10.9).

When septic tank effluent rises to the level of the pump control in the pumping tank, the pump turns on, and effluent moves through the supply line and distribution

Advantages	Disadvantages
May be used in areas with high groundwater, bedrock, or restrictive clay soil near the surface	Must be installed on relatively level lots
Space efficient compared to conventional rock lateral systems	Periodic flushing of the distribution network is required
Allows home building in areas unsuitable for below grade systems	System may be expensive
Water softener wastes, common household chemicals, and detergents are not harmful to this system	System may be difficult to design
	Regular inspection of the pumps and controls necessary to maintain the system in proper working condition

**Table 10.1.** Mound System Advantages and Disadvantages

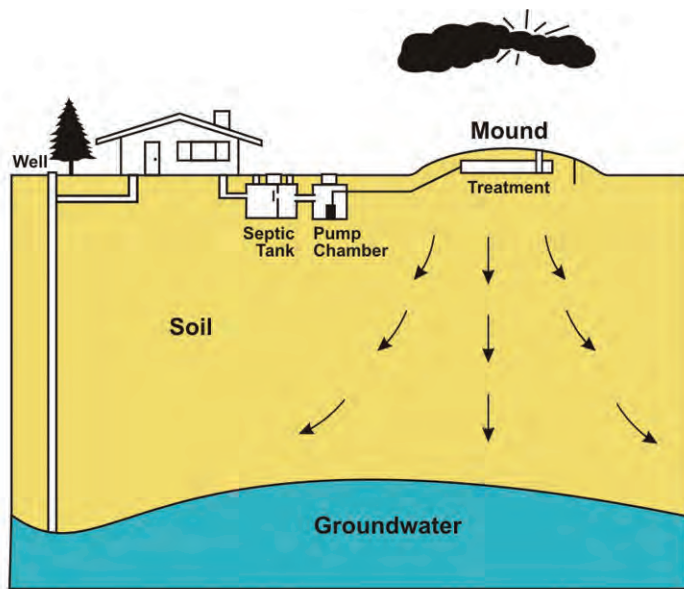

**Figure 10.8.** Mound System Cutaway [3]

laterals. The laterals contain small holes and are typically placed 3 to 8 feet apart. From the trenches, the effluent moves into the soil where it is treated. The pump turns off when the effluent falls to the lower control. Dosing takes place one to two times daily, depending on the amount of effluent generated. Pump malfunctions set off an alarm to alert the homeowner. The time between doses allows the effluent to be absorbed into the soil and also allows oxygen to reenter the soil to break down solids that may be left behind. If the pump malfunctions, an alarm notifies the homeowner to contact a qualified septic system contractor. The pump must be repaired or replaced quickly to prevent the pump tank from overflowing. Table 10.2 shows the advantages and disadvantages of LPP systems.

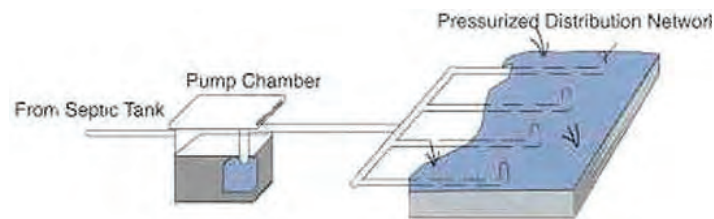

**Figure 10.9.** Low Pressure On-site System [12]

### *Plant-rock Filter Systems (Constructed Wetlands)*

Considered experimental in some states, plant-rock filter systems are being used with great success in Kentucky, Louisiana, and Michigan. Plant-rock filters generally consist of a septic tank (two-compartment), a rock filter, and a small overflow lateral (absorption) field. Overflow from the septic tank is directed into the rock filter. The rock filter is a long narrow trench (3 to 5 feet wide and 60 to 100 feet long) lined with leak-proof polyvinyl chloride or butylplastic to which rock is added. A 2- to 4-inch-diameter rock is used below the effluent flow line and larger rock above (Figure 10.10).

Plant-rock filter systems are typically sized to allow 1.3 cubic feet of rock area per gallon of total daily waste flow. A typical size for a three-bedroom house would be 468 square feet of interior area. Various width-to-length ratios within the parameters listed above could be used to obtain the necessary square footage. The trenches can even be designed in an “L” shape to accommodate small building lots.

Treatment begins in the septic tank. The partially treated wastewater enters the lined plant-rock filter cell through solid piping, where it is distributed across the cell. The plants within the system introduce oxygen into the waste-

Advantages	Disadvantages
Space requirements are nearly half those of a conventional septic tank system	Some low-pressure pipe systems may gradually accumulate solids at the dead-ends of the lateral lines; therefore, maintenance is required
Can be installed on irregular lot shapes and sizes	Electric components are necessary
Can be installed at shallower depths and requires less top-soil cover	Design and installation may be difficult; installers with experience with such systems should be sought
Provides alternating dosing and resting cycles	
Installation sites are left in their natural condition	

**Table 10.2.** Low-pressure Pipe Systems Advantages and Disadvantages

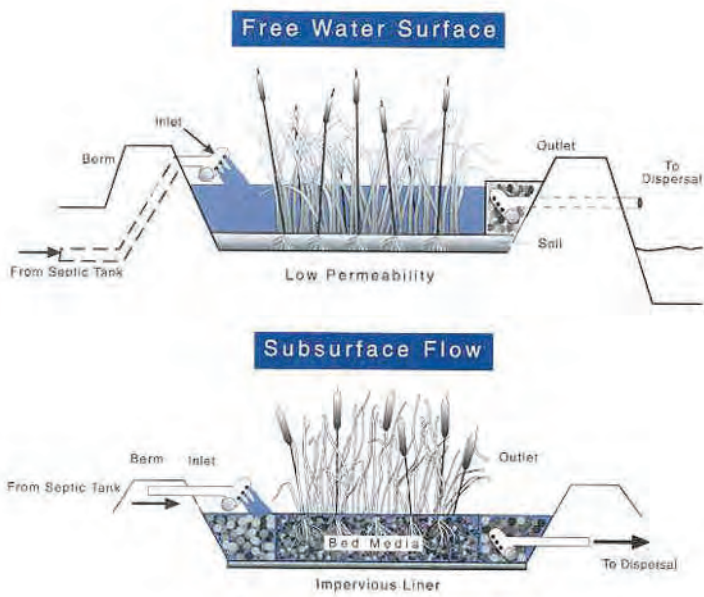

**Figure 10.10.** Plant-rock Filter system [12]

water through their roots. As the wastewater becomes oxygenated, beneficial microorganisms and fungi thrive on and around the roots, which leads to digestion of organic matter. In addition, large amounts of water are lost through evapotranspiration. The kinds of plants most widely used in these systems include cattails, bulrush, water lilies, many varieties of iris, and nutgrass. Winter temperatures have little effect because the roots are doing the work in these systems, and they stay alive during the winter months. Discharge from wetlands systems may require disinfection. The advantages and disadvantages of the plant-rock filter system are shown in Table 10.3.

## Maintaining On-site Wastewater Treatment Systems

Do's and don'ts inside the house:

- Do conserve water. Putting too much water into the septic system can eventually lead to system failure.

(Typical water use is about 60 gallons per day for each person in the family.) The standard drain field is designed for a capacity of 120 gallons per bedroom. If near capacity, systems may not work. Water conservation will extend the life of the system and reduce the chances of system failure.

- Do fix dripping faucets and leaking toilets.
- Do avoid long showers.
- Do use washing machines and dishwashers only for full loads.
- Do not allow the water to run continually when brushing teeth or while shaving.
- Do avoid disposing of the following items down the sink drains or toilets: chemicals, sanitary napkins, tissues, cigarette butts, grease, cooking oil, pesticides, kitty litter, coffee grounds, disposable diapers, stockings, or nylons.
- Do not install garbage disposals.
- Do not use septic tank additives or cleaners. They are unnecessary and some of the chemicals can contaminate the groundwater.

Do's and don'ts for outside maintenance:

- Do maintain adequate vegetative cover over the absorption field.
- Do not allow surface waters to flow over the tank and drain field areas. (Diversion ditches or subsurface tiles may be used to direct water away from system.)
- Do not allow heavy equipment, trucks, or automobiles to drive across any part of the system.
- Do not dig into the absorption field or build additions near the septic system or the repair area.

Advantages	Disadvantages
Approximately one-third the size of conventional septic tank absorption field systems	May be slightly more costly to install Disinfection required for effluent discharge
Can be placed on irregular or segmented lots	May not find installers knowledgeable about the system
May be placed in areas with shallow water tables, high bedrock, or restrictive horizons	Life span of the system is unknown because of its relative newness
Relatively low maintenance	Perception of being unsightly to some

**Table 10.3.** Plant-rock Filter System Advantages and Disadvantages

- Do make sure a concrete riser (or manhole) is installed over the tank if not within 6 inches of the surface, providing easy access for measuring and pumping solids. (Note: All tanks should have two manholes, one positioned over the inlet device and one over the outlet device.)

There is no need to add any commercial substance to “start” or clean a tank to keep it operating properly. They may actually hinder the natural bacterial action that takes place inside a septic tank. The fecal material, cereal grain, salt, baking soda, vegetable oil, detergents, and vitamin supplements that routinely make their way from the house to the tank are far superior to any additive.

### Symptoms of Septic System Problems

These symptoms can mean you have a serious septic system problem:

- Sewage backup in drains or toilets (often a black liquid with a disagreeable odor).
- Slow flushing of toilets. Many of the drains will drain much slower than usual, despite the use of plungers or drain-cleaning products. This also can be the result of a clogged plumbing vent or a nonvented fixture.
- Surface flow of wastewater. Sometimes liquid seeps along the surface of the ground near your septic system. It may or may not have much of an odor and will range from very clear to black in color.
- Lush green grass over the absorption field, even during dry weather. Often, this indicates that an excessive amount of liquid from the system is moving up through the soil, instead of down, as it should. Although some upward movement of liquid from the absorption field is good, too much could indicate major problems.
- The presence of nitrates or bacteria in the drinking water well indicates that liquid from the system may be flowing into the well through the ground or over the surface. Water tests available from the local health department will indicate whether this is a problem.
- Buildup of aquatic weeds or algae in lakes or ponds adjacent to your home. This may indicate that nutrient-rich septic system waste is leaching into the surface water, which may lead to both inconvenience and possible health problems.
- Unpleasant odors around the house. Often, an improperly vented plumbing system or a failing septic system causes a buildup of disagreeable odors.

Table 10.4 is a guide to troubleshooting septic tank problems.

### Septic Tank Inspection

The first priority in the inspection process is the safety of the homeowner, neighbors, workers, and anyone else for which the process could create a hazard.

- Do not enter septic tanks or cesspools.
- Do not work alone on these tanks.
- Do not bend or lean over septic tanks or cesspools.
- Note and take appropriate action regarding unsafe tank covers.
- Note unsanitary conditions or maintenance needs (sewage backups, odor, seepage).
- Do not bring sewage-contaminated clothing into the home.
- Have current tetanus inoculations if working in septic tank inspection.

Methane and hydrogen sulfide gases are produced in a septic tank. They are both toxic and explosive. Hydrogen sulfide gas is quite deceptive. It can have a very strong odor one moment, but after exposure, the odor may not be noticed.

### Inspection Process

As sewage enters a septic tank, the rate of flow is reduced and heavy solids settle, forming sludge. Grease and other light solids rise to the surface, forming a scum. The sludge and scum (Figure 10.11) are retained and break down while the clarified effluent (liquid) is discharged to the absorption field.

Sludge eventually accumulates in the bottom of all septic tanks. The buildup is slower in warm climates than in colder climates. The only way to determine the sludge depth is to measure the sludge with a probe inserted through an inspection port in the tank’s lid. Do not put this job off until the tank fills and the toilet overflows. If this happens, damage to the absorption field could occur and be expensive to repair.

### Scum Measurement

The floating scum thickness can be measured with a probe. The scum thickness and the vertical distance from the bottom of the scum to the bottom of the inlet can also be measured. If the bottom of the scum gets within 3 inches of the outlet, scum and grease can enter the absorption field. If grease gets into the absorption field, percolation is impaired and the field can fail. If the scum

Problem	Possible Cause(s)	Remedies
Wastewater backs up into the building or plumbing fixtures sluggish or do not drain well.	Excess water entering the septic tank system, plumbing installed improperly, roots clogging the system, plumbing lines blocked, pump failure, absorption field damaged or crushed by vehicular traffic.	Fix leaks, stop using garbage disposal, clean septic tank and inspect pumps, replace broken pipes, seal pipe connections, avoid planting willow trees close to system lines. Do not allow vehicles to drive over or park over lines. Contact local health department for guidance.
Wastewater surfaces in the yard.	Excess water entering the septic tank system, system blockage, improper system elevations, undersized soil treatment system, pump failure, absorption field damaged or crushed by vehicular traffic.	Fix leaks, clean septic tank and check pumps, make sure distribution box is free of debris and functioning properly, fence off area until problem is fixed, call in experts. Contact local health department for guidance.
Sewage odors indoors.	Sewage surfacing in yard, improper plumbing, sewage backing up in the building, trap under sink dried out, roof vent pipe frozen shut.	Repair plumbing, clean septic tank and check pumps, replace water in drain pipes, thaw vent pipe. Contact local health department for guidance.
Sewage odors outdoors.	Source other than owner's system, sewage surfacing in yard, manhole or inspection pipes damaged or partially removed, downdraft from vent pipes on roof.	Clean tank and check pumps, replace damaged inspection port covers, replace or repair absorption field. Contact local health department for guidance.
Contaminated drinking water or surface water.	System too close to a well, water table, or fractured bedrock; cesspool or dry well being used; improper well construction; broken water supply or wastewater lines. Improperly located wells must be sealed in strict accordance with state and local codes.	Abandon well and locate a new one far and upslope from the septic system, fix all broken lines, stop using cesspool or drywell. Contact local health department for guidance.
Distribution pipes and soil treatment system freeze in winter.	Improper construction, check valve in lift station not working, heavy equipment traffic compacting soil in area, low flow rate, lack of use.	Examine check valve, keep heavy equipment such as cars off area, increase water usage, have friend run water while away on vacation, operate septic tank as a holding tank, do not use antifreeze. Contact local health department for guidance.

**Table 10.4.** Septic Tank System Troubleshooting

is near the bottom of the tee, the septic tank needs to be cleaned out. The scum thickness can best be measured through the large inspection port. Scum should never be closer than 3 inches to the bottom of the baffle. The scum thickness is observed by breaking through it with a probe, usually a pole.

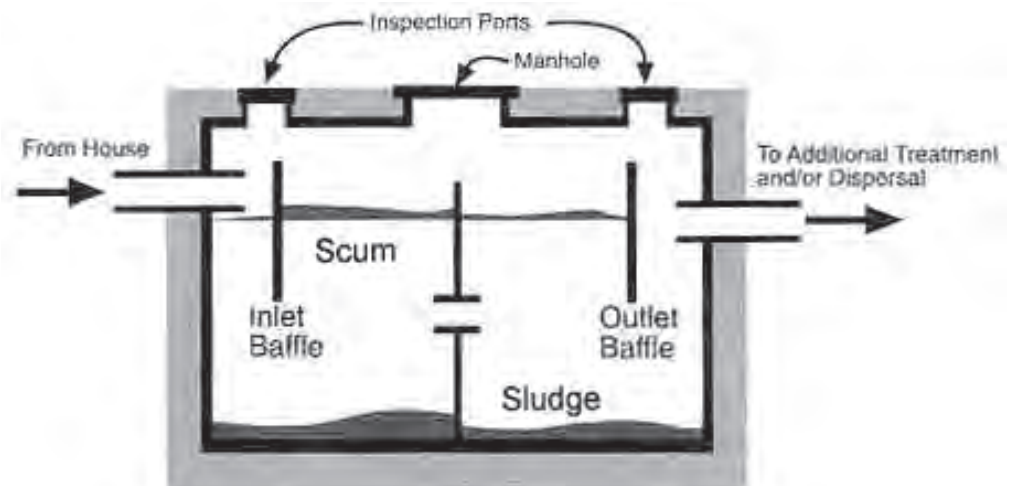

**Figure 10.11.** Sludge and Scum in Multicompartment Septic Tank [13]



## Sludge Measurement

To measure sludge, make a sludge-measuring stick using a long pole with at least 3 feet of white cloth (e.g., an old towel) on the end. Lower the measuring stick into the tank, behind the outlet baffle to avoid scum particles, until it touches the tank bottom. It is best to pump each tank every 2 to 3 years. Annual checking of sludge level is recommended. The sludge level must never be allowed to rise within 6 inches of the bottom of the outlet baffle. In two-compartment tanks, be sure to check both compartments. When a septic tank is pumped, there is no need to deliberately leave any residual solids. Enough will remain after pumping to restart the biologic processes.

## References

1. University of California Cooperative Extension, Calaveras County. Septic tanks: the real poop. San Andreas, CA: University of California Cooperative Extension, Calaveras County; no date. Available from URL: <http://cecalaveras.ucdavis.edu/realp.htm>.
2. University of Nebraska-Lincoln. Residential on-site wastewater treatment: septic system and drain field maintenance. Lincoln, NE: University of Nebraska-Lincoln; 2000. Available from URL: <http://ianrpubs.unl.edu/wastemgt/g1424.htm>.
3. Rosenberg CE. The cholera years. Chicago: The University of Chicago Press; 1962.
4. Salvato J, Nemerow NL, Agardy FJ, editors. Environmental engineering. 5th ed. New York: John Wiley and Sons; 2003.
5. Advanced Composting Systems. Phoenix composting toilet system. Whitefish, MT: Advanced Composting Systems; no date. Available from URL: <http://www.compostingtoilet.com>.
6. BioLet USA, Inc. Composting toilets. Newcomerstown, OH: BioLet USA, Inc.; no date. Available from URL: <http://www.biolet.com>.
7. Mankl K, Slater B. Septic system maintenance. Columbus, OH: The Ohio State University Extension; no date. Available from URL: <http://ohioline.osu.edu/aex-fact/0740.html>.
8. Hutzler NJ, Waldorf LE, Fancy J. Aerated tanks (aerobic units). In: Performance of aerobic treatment units. Madison, WI: University of Wisconsin - Madison; no date. Available from URL: <http://www.ci.austin.tx.us/wri/treat5.htm>.

9. Center for Disease Control. Basic housing inspection. Atlanta: US Department of Health and Human Services; 1976.
10. Purdue Research Foundation. Environmental education software series. West Lafayette, IN: Purdue Research Foundation; 1989. Available from URL: <http://www.inspect-ny.com/septic/trench.gif>.
11. North Carolina Cooperative Extension Service. On-site wastewater treatment websites. Jacksonville, NC: North Carolina Cooperative Extension Service; 2002. Available from URL: <http://www.ces.ncsu.edu/onslow/staff/drashash/enved/sepsites.html>.
12. Clay Township Regional Waste District. Septic systems. Indianapolis: Clay Township Regional Waste District; 2004. Available from URL: <http://www.ctrwd.org/septics.htm>.
13. Jackson Purchase Resource Conservation and Development Foundation, Inc. Septic systems: an overview. Cynthiana, KY: Jackson Purchase Resource Conservation and Development Foundation, Inc.; no date. Available from URL: <http://www.jpfr.org/LRV/septic.htm>.

## Additional Sources of Information

Agency for Toxic Substances and Disease Registry. Science page, Office of the Associate Administrator for Science. Atlanta: US Department of Health and Human Services; no date. Available from URL: <http://www.atsdr.cdc.gov/science/>.

American Society of Civil Engineers. Available from URL: <http://www.asce.org>.

Burks BD, Minnis MM. Onsite wastewater treatment systems. Madison, WI: Hogarth House, Ltd.; 1994. Textbook and reference manual on all aspects of on-site treatment.

International Code Council. International private sewage disposal code, 2000. Falls Church, VA: International Code Council; 2000.

National Onsite Wastewater Recycling Association (NOWRA). Available from URL: <http://www.nowra.org> or 1-800-966-2942.

National Small Flows Clearinghouse. Available from URL: [http://www.nesc.wvu.edu/nsfc/nsfc\\_index.htm](http://www.nesc.wvu.edu/nsfc/nsfc_index.htm) or 1-800-624-8301.

US Army Corps of Engineers. Available from URL: <http://www.usace.army.mil>.



*“To electrize plus or minus, no more needs to be known than this, that the parts of the tube or sphere that are rubbed, do, in the instant of the friction, attract the electrical fire, and therefore take it from the thing rubbing; the same parts immediately, as the friction upon them ceases, are disposed to give the fire they have received to any body.”*

Benjamin Franklin  
*Franklin’s Discovery of the Positive and Negative States of Electricity*, 1747

## Introduction

Two basic codes concerned with residential wiring are important to the housing inspector. The first is the local electrical code. The purpose of this code is to safeguard persons as well as buildings and their contents from hazards arising from the use of electricity for light, heat, and power. The electrical code contains basic minimum provisions considered necessary for safety. Compliance with this code and proper maintenance will result in an installation essentially free from hazards, but not necessarily efficient, convenient, or adequate for good service or future expansion.

Most local electrical codes are modeled after the National Electrical Code, published by the National Fire Protection Association (NFPA). Reference to the “code” in the remainder of this chapter will be to the National Electrical Code, unless specified otherwise [1].

An electrical installation that was safe and adequate under the provisions of the electrical code at the time of installa-

tion is not necessarily safe and adequate today. An example would be the grounding of a home electrical system. In the past, electrical systems could be grounded to the home’s plumbing system. Today, many plumbing systems are no longer constructed of conductive material, but are made of plastic or polyvinyl chloride-based materials. Today, the recommendations for grounding a home electrical system are to use two 8-foot by 5/8-inch copper ground rods. These must be spaced 6 feet apart and be connected by a continuous (unbroken) piece of copper wire (the size of this wire corresponds to the size of the system main). It is also highly recommended that the system be grounded to the incoming water line if it is conductive or to the nearest conductive cold water supply line. Hazards often occur because of overloading wiring systems or usage not in conformity with the code. This occurs because initial wiring did not provide for increases in the use of electricity. For this reason, it is recommended that initial installations be adequate and that reasonable provisions for system changes be made for further increases in the use of electricity.

The other code that contains electrical provisions is the local housing code. It establishes minimum standards for artificial and natural lighting and ventilation, specifies the minimum number of electric outlets and lighting fixtures per room, and prohibits temporary wiring except under certain circumstances. In addition, the housing code usually requires that all components of an electrical system be installed and maintained in a safe condition to prevent fire or electric shock.

## Definitions of Terms Related to Electricity

**Ampere**—The unit for measuring intensity of flow of electricity. Its symbol is “I.”

**Bonding**—Applies inert material to metal surfaces to eliminate electrical potential between metal components and prevent components and piping systems from having an elevated voltage potential.

**Circuit**—The flow of electricity through two or more wires from the supply source to one or more outlets and back to the source.

**Circuit breaker**—A safety device used to break the flow of electricity by opening the circuit automatically in the event of overloading or used to open or close the circuit manually.

**Conductor**—Any substance capable of conveying an electric current. In the home, copper wire is usually used.

- A bare conductor is one with no insulation or covering.
- A covered conductor is one covered with one or more layers of insulation.

## Flow of Electric Current

Electricity is usually created by a generator that converts mechanical energy into electrical energy. The electricity may be the result of water, steam, or wind powering or turning a generator. The electricity is then run through a transformer, where voltage is increased to several hundred thousand volts and, in some instances, to a million or more volts. This high voltage is necessary to increase the efficiency of power transmission over long distances.

This high-transmission voltage is stepped down (reduced) to normal 115/230-volt household current by a transformer located near the point of use (residence). The electricity is then transmitted to the house by a series of wires called a service drop. In areas where the electric wiring is underground, the wires leading to the building are buried in the ground.

For electric current to flow, it must travel from a higher to a lower potential voltage. In an electrical system, the hot wires (black or red) are at a higher potential than are the neutral or ground wire (white or green).

## Definitions of Terms Related to Electricity

**Conductor gauge**—A numeric system used to label electric conductor sizes, given in American Wire Gauge (AWG). The larger the AWG number, the smaller the wire size.

**Current**—The flow of electricity through a circuit.

- Alternating current is an electric current that reverses its direction of flow at regular intervals. For example, it would alternate 60 times every second in a 60-cycle system. This type of power is commonly found in homes.
- Direct current is an electric current flowing in one direction. This type of current is not commonly found in today's homes.

**Electricity**—Energy that can be used to run household appliances; it can produce light and heat, shocks, and numerous other effects.

**Fuse**—A safety device that cuts off the flow of electricity when the current flowing through the fuse exceeds its rated capacity.

**Ground**—To connect with the earth, as to ground an electric wire directly to the earth or indirectly through a water pipe or some other conductor. Usually, a green-colored wire is used for grounding the whole electrical system to the earth. A copper wire is usually used to ground individual electrical components of the whole system. (The home inspector should never assume that insulation color wiring codes have been used appropriately.)

**Ground fault circuit interrupter (GFCI)**—A device intended to protect people from electric shock. It de-energizes a circuit or portion of a circuit within an established very brief period of time when a current to ground exceeds some predetermined value (less than that required to operate the over-current protected device of the supply circuit).

**Hot wires**—Those that carry the electric current or power to the load; they are usually black or red.

**Insulator**—A material that will not permit the passage of electricity.

**Kilowatt-hour (KWH)**—The amount of energy supplied by one kilowatt (1,000 watts) for 1 hour (3,600 seconds), equal to 3,600,000 joule. Electric bills are usually figured by the number of KWHs consumed.

**Neutral wire**—The third wire in a three-wire distribution circuit; it is usually white or light gray and is connected to the ground.

**Resistance**—A measure of the difficulty of electric current to pass through a given material; its unit is the ohm.

**Service**—The conductor and equipment for delivering energy from the electricity supply system to the wiring system of the premises.

**Service drop**—The overhead service connectors from the last pole or other aerial support to and including the splices, if any, connecting to the service entrance conductors at the building or other structure.

**Service panel**—Main panel or cabinet through which electricity is brought to the building and distributed. It contains the main disconnect switch and fuses or circuit breakers.

**Short circuit**—A break in the flow of electricity through a circuit due to the load caused by improper connection between hot and neutral wires.

**Volt**—The unit for measuring electrical pressure of force, which is known as electromotive force. Its symbol is “E.”

**Voltage drop**—A voltage loss when wires carry current. The longer the cord, the greater the voltage drop.

**Watt**—The unit of electric power. Volts times amperes = watts.

Voltage is a measure of the force at which electricity is delivered. It is similar to pressure in a water supply system.

Current is measured in amperes and is the quantity of flow of electricity. It is similar to measuring water in gallons per second. A watt is equal to volts times amperes. It is a measure of how much power is flowing. Electricity is sold in quantities of kilowatt-hours.

The earth, by virtue of moisture contained within the soil, serves as a very effective conductor. Therefore, in power transmission, instead of having both the hot and neutral wires carried by the transmission poles, one lead of the generator is connected to the ground, which serves as a conductor (Figure 11.1). All electrical utility wires are carried by the transmission towers and are considered hot or charged. At the house, or point where the electricity is to be used, the circuit is completed by another connection to ground.

The electric power utility provides a ground somewhere in its local distribution system; therefore, there is a ground wire in addition to the hot wires within the service drop. In Figure 11.1 this ground can be seen at the power pole that contains the step-down transformer.

In addition to the ground connection provided by the electric utility, every building is required to have an independent ground called a system ground. The system ground is a connection to ground from one of the current-carrying conductors of the electrical system. System grounding, applied to limit overvoltages in the event of a fault, provides personnel safety, provides a positive means of detecting and isolating ground faults, and improves service reliability. Therefore, the system ground's main purpose is to protect the electrical system itself and offers limited protection to the user.

The system ground serves the same purpose as the power company's ground; however, it has a lower resistance because it is closer to the building. The equipment ground protects people from potential harm during the

use of certain electrical equipment. The system ground should be a continuous wire of low resistance and of sufficient size to conduct current safely from lightning and overloads.

## Electric Service Entrance

### Service Drop

To prevent accidental contact by people, the entrance head (Figure 11.2) should be attached to the building at least 10 feet above ground. The conductor should clear all roofs by at least 8 feet and residential driveways by 12 feet. For public streets, alleys, roads, and driveways on other than residential property, the clearance must be 18 feet.

The wires or conductor should be of sufficient size to carry the load and not smaller than No. 8 copper wire or equivalent.

For connecting wire from the entrance head to the service drop wires, the code requires that the service entrance conductors be installed either below the level of the service head or below the termination of the service entrance cable sheath. Drip loops must be formed on individual conductors. This will prevent water from entering the electric service system. The wires that form the entrance cable should extend 36 inches from the entrance head to provide a sufficient length to connect service drop wires to the building with insulators. The entrance cable may be a special type of armored outdoor cable, or it may be enclosed in a conduit. The electric power meter may be located either inside or outside the building. In either instance, the meter must be located before the main power disconnect.

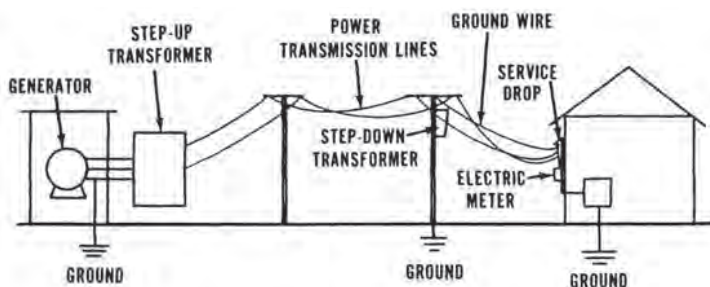

Figure 11.1. Utility Overview [2]

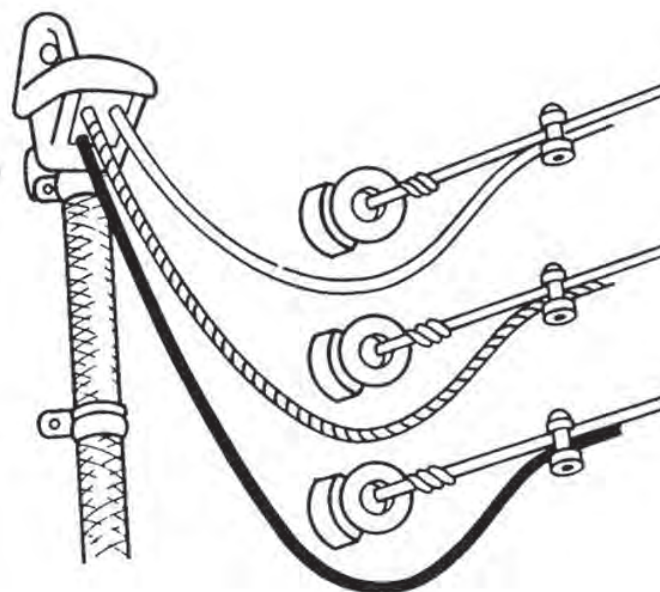

Figure 11.2. Entrance Head

Figure 11.3 shows an armored cable service entrance with a fuse system. Newer construction will have circuit breakers, as shown in Figure 11.4. The armored cable is anchored to the building with metal straps spaced every 4 feet. The cable is run down the wall and through a hole drilled through the building. The cable is then connected to the service panel, which should be located within 1 foot of where the cable enters the building. The ground wire need not be insulated. This ground wire may be either solid or stranded copper, or a material with an equivalent resistance.

Figure 11.5 shows the use of thin-wall conduit in a service entrance.

### Underground Service

When wires are run underground, they must be protected from moisture and physical damage. The opening in the

building foundation where the underground service enters the building must be moisture proof. Refer to local codes for information about allowable materials for this type of service entrance.

### Electric Meter

The electric meter (Figure 11.6) may be located inside or outside the building. The meter itself is weatherproof and is plugged into a weatherproof socket. The electric power company furnishes the meter; the socket may or may not be furnished by the power company.

### Grounding

The system ground consists of grounding the neutral incoming wire and the neutral wire of the branch circuits. The equipment ground consists of grounding the metal parts of the service entrance, such as the service switch, as well as the service entrance conduit, armor or cable.

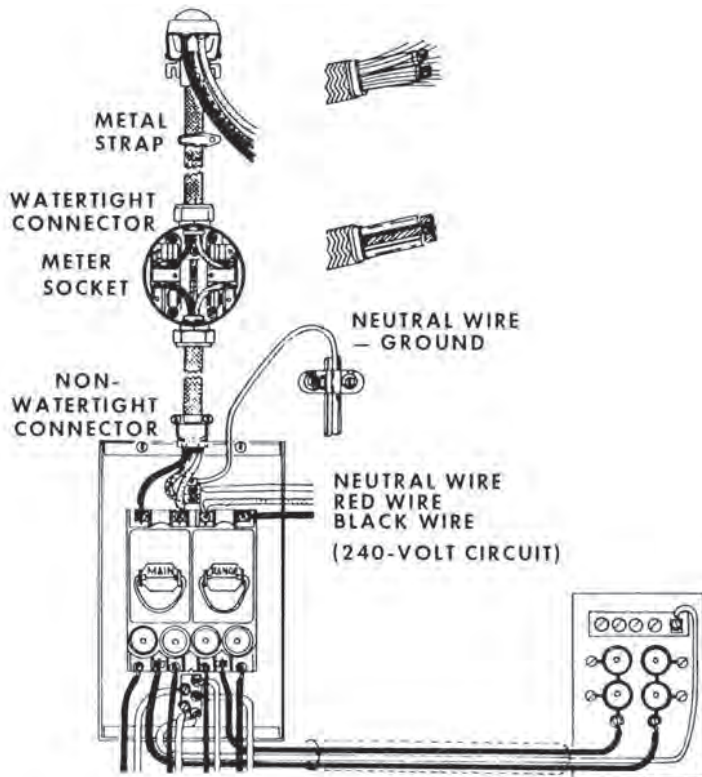

Figure 11.3. Armored Cable Service Entrance [2]

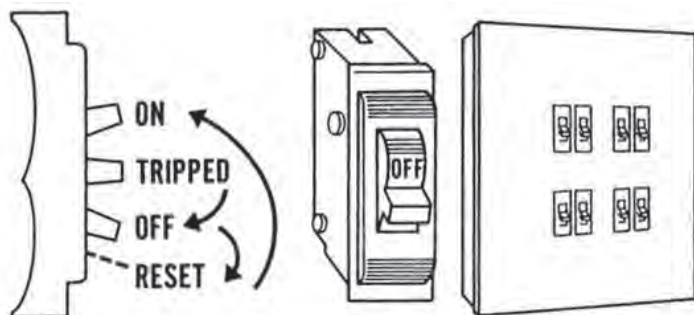

Figure 11.4. Breakers [2]

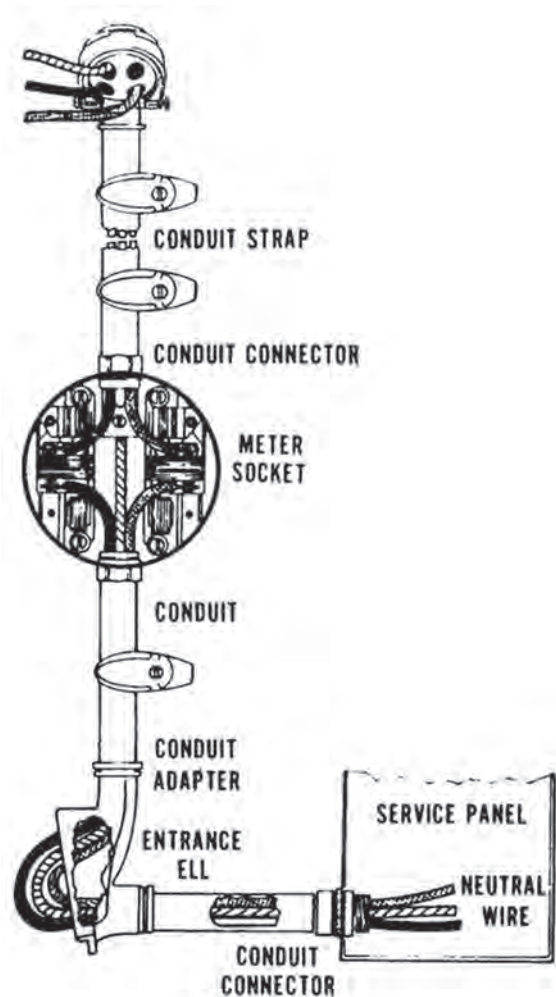

Figure 11.5. Thin-wall Conduit [2]

Poor grounding at any point can result in a person providing a more effective route to ground than the intended ground, resulting in electrocution. This can occur from damaged insulation allowing electricity to flow into the case or cabinet of the appliance.

The system must be grounded by two 8 foot by 5/8-inch copper ground rods of at least 8 feet in length driven into the ground and connected by a continuous (unbroken) piece of copper wire (the size of this wire corresponds to the size of the system main). It is highly recommended that the system also be grounded to the incoming water line or nearest cold water supply line if it is metal.

The usual ground connection is to a conductive water pipe of the city water system. The connection should be made to the street side of the water meter, as shown in Figure 11.7. If the water meter is located near the street curb, then the ground connection should be made to the cold water pipe as close as possible to where it enters the building. It is not unusual for a water meter to be removed from the building for service. If the ground connection is made at a point in the water piping system on the building side of the water meter, the ground circuit will be broken on removal of the meter. This broken ground circuit is a shock hazard if both sides of the water meter connections are touched simultaneously. Local or state codes should be checked to determine compliance with correct grounding protocols.

In increasing instances, the connections between the water meters and pipes are electrically very poor. In this case, if the ground connection is made on the building side of the water meter, there may not be an effective ground. To prevent the two aforementioned situations, the code requires effective bonding by a properly sized jumper-wire around any equipment that is likely to be disconnected for repairs or replacement.

Often, the house ground will be disconnected. Therefore, the housing inspector should always check the house ground to see if it is properly connected.

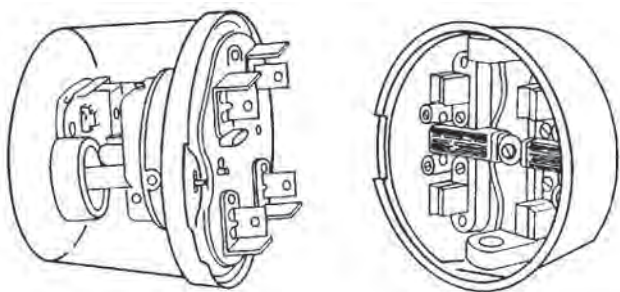

Figure 11.6. Electric Meter

Figure 11.8 shows a typical grounding scheme at the service box of a residence. In this figure, only the grounded neutral wires are shown. The neutral strap is a conductive bare metal strip that is riveted directly to the service box. This conductive strip forms a collective ground that joins the ground wires from the service entrance, branch circuits, and house ground.

Follow these key grounding points:

- Use two metal rods driven 8 feet into the ground.
- Bond around water heaters and filters to assure grounding.
- If water pipes are used, they must be supplemented with a second ground.
- Ground rod must be driven to full depth.
- If ground rod resistance exceeds 25 ohms, install two rods at a minimum of 6 feet apart.
- When properly grounded, the metal frame of a building can be used as a ground point.
- Do not use underground gas lines as a ground.
- Provide external grounds to other systems such as satellite, telephone, and other services to further protect the electrical system from surges.
- If the water service pipes to the home are not metal or if all of the service components in the home are not metal, then the water system cannot play a role in grounding.

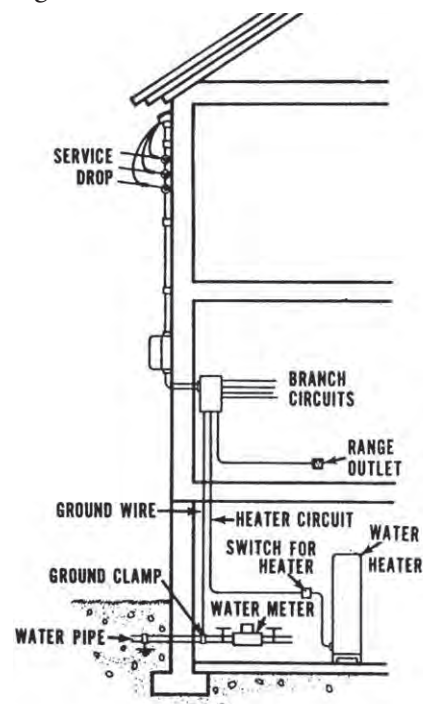

Figure 11.7. Typical Service Entrance [2]

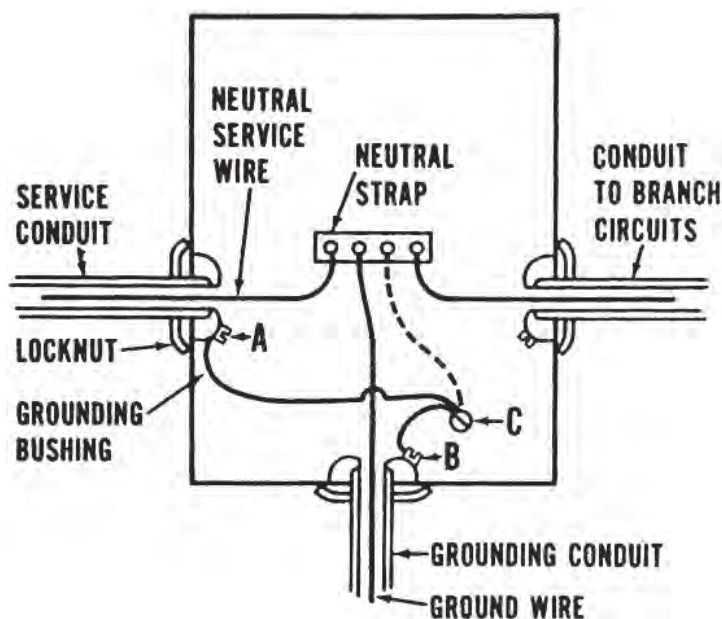

Figure 11.8. Grounding Scheme [2]

Bonding is necessary to provide a route for electricity to flow around isolated elements of a piping system to ensure electrical potential is minimized for both the protection of the system from corrosion and to protect individuals from electrical shock.

## Two- or Three-wire Electric Services

One of the wires in every electrical service installation is supposed to be grounded. This neutral wire should always be white. The hot wires are usually black, red, or some other color, but never white.

The potential difference or voltage between the hot wires and the ground or neutral wire of a normal residential electrical system is 115 volts. Thus, where there is a two-wire installation (one hot and one neutral), only 115 volts are available.

When three wires are installed (two hot and one neutral), either 115 or 230 volts are available. In a three-wire system, the voltage between the neutral and either of the hot wires is 115 volts; between the two hot wires, it is 230 (Figure 11.9). The major advantage of a three-wire system is that it permits the operation of heavy electrical equipment such as clothes dryers, cooking ranges, and air conditioners, the majority of which require 230-volt circuits. In addition, the three-wire system is split at the service panel into two 115-volt systems to supply power for small appliances and electric lights. The result is a doubling of the number of circuits, and, possibly, a corresponding increase in the number of branch circuits, with a reduction in the probability of fire caused by overloading electrical circuits if the electrical demands exceed the capacity.

## Residential Wiring Adequacy

The use of electricity in the home has risen sharply since the 1930s. Many homeowners have failed to repair or improve their wiring to keep it safe and up to date. In the 1970s, the code recommended that the main distribution panel in a home be a minimum of 100 amps. Because the number of appliances that use electricity has continued to grow, so has the size of recommended panels. For a normal house (2,500 to 3,500 square feet), a 200-amp panel is recommended. The panel must be of the breaker type with a main breaker for the entire system (Figure 11.4). Fuse boxes are not recommended for new housing.

This type of service is sufficient in a one-family house or dwelling unit to provide safe and adequate electricity for the lighting, refrigerator, iron, and an 8,000-watt cooking range, plus other appliances requiring a total of up to 10,000 watts.

Some older homes have a 60-ampere, three-wire service (Figure 11.10). It is recommended that these homes be rewired for at least the minimum of 200-amperes recommended in the code. The 60-amp service is safely capable of supplying current for only lighting and portable appliances, such as a cooking range and regular dryer (4,500 watts), or an electric hot water heater (2,500 watts), and cannot handle additional major appliances. Other older homes today have only a 30-ampere, 115-volt, two-wire service (Figure 11.11). This system can safely handle only a limited amount of lighting, a few minor appliances, and no major appliances. Therefore, this size service is substandard in terms of the modern household's needs for electricity. Furthermore, it is a fire hazard and a threat to the safety of the home and the occupants.

## Wire Sizes and Types

Aluminum wiring, used in some homes from the mid 1960s to the early 1970s, is a potential fire hazard [3]. According to the U.S. Consumer Product Safety Commission (CPSC), fires and even deaths have been caused by this hazard. Problems due to expansion can cause overheating at connections between the wire and devices (switches and outlets) or at splices. CPSC research

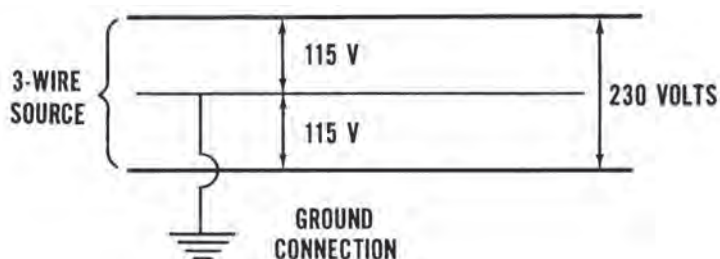

Figure 11.9. Grounding [2]



shows that homes wired with aluminum wire manufactured before 1972 are 55 times more likely to have one or more connections reach fire hazard conditions than are homes wired with copper. Post-1972 aluminum wire is also a concern. Introduction of aluminum wire alloys around 1972 did not solve most of the connection failure problems. Aluminum wiring is still permitted and used for certain applications, including residential service entrance wiring and single-purpose higher amperage circuits such as 240-volt air conditioning or electric range circuits.

### Reducing Risk

Only two remedies for aluminum wiring have been recommended by the CPSC: discontinued use of the aluminum circuit or the less costly option of adding copper connecting “pigtail” wires between the aluminum wire and the wired device (receptacle, switch, or other device). The pigtail connection must be made using only a special connector and special crimping tool licensed by the AMP Corporation. Emergency temporary repairs necessary to

keep an essential circuit in service might be possible following other procedures described by the CPSC, and in accordance with local electrical codes [4,5].

### Wire Sizes

Electric power actually flows along the surface of the wire. It flows with relative ease (little resistance) in some materials, such as copper and aluminum, and with a substantial amount of resistance in iron. If iron wire were used, it would have to be 10 times as large as copper wire to be as effective in conducting electricity. In fine electronics, gold is the preferred conductor because of the resistance to corrosion and the very high conductivity.

Electricity is the movement of electrons from an area of higher potential to one of lower potential. An analogy to how electricity flows would be the flow of water along the path of least resistance or down a hill. All it takes to create the potential for electricity is the collection of electrons and a pathway for them to flow to an area of lesser concentration along a conductor. When a person walks across a nylon carpet in times of low atmospheric humidity, his or her body will often collect electrons and serve as a capacitor (a storage container for electrons). When that person nears a grounding source, the electrons will often jump from a finger to the ground, creating a spark and small shock.

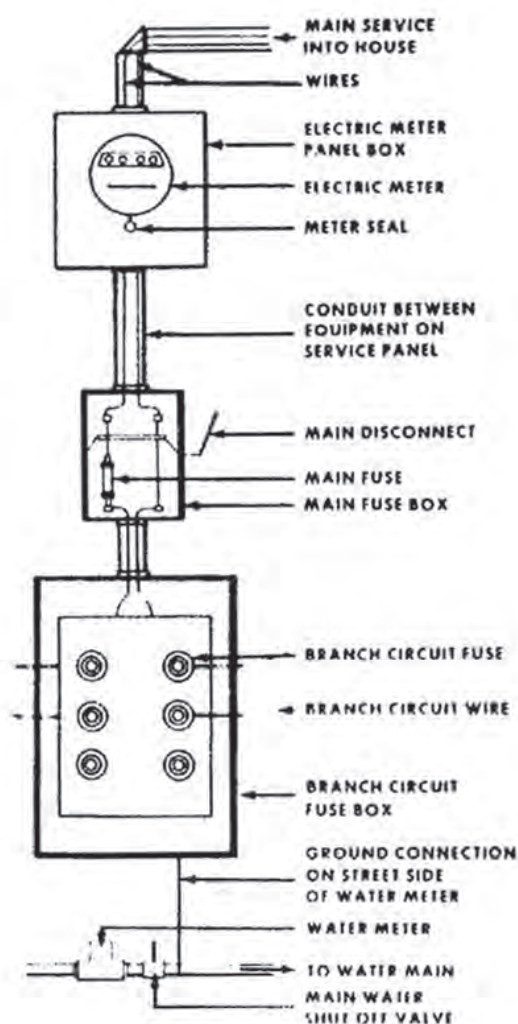

Figure 11.10. Three-wire Service [2]

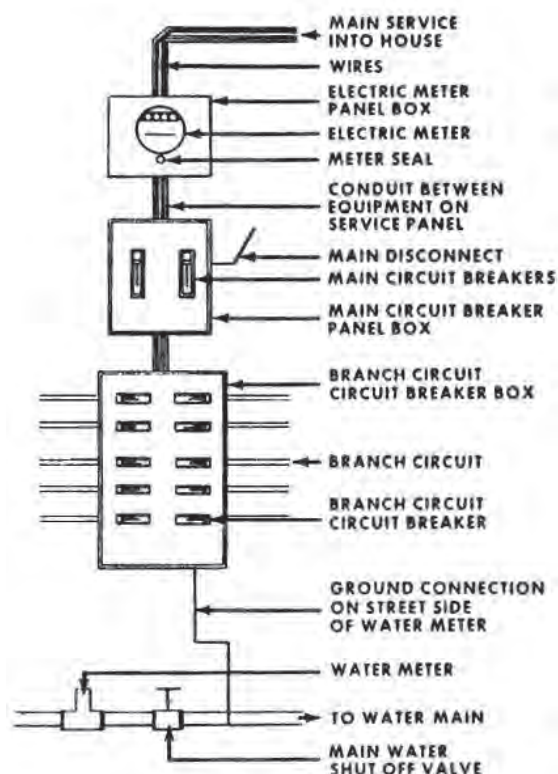

Figure 11.11. Two-wire Service [2]

## Maximum Current Recommended for AWG Wire Size

Size wire (AWG) (larger wire, smaller number)	#14	#12	#10	#8
Maximum capacity in amperes	15	20	30	40

A number preceded by the letters AWG (American Wire Gauge) indicates copper wire sizes [6]. As the AWG number of the wire becomes smaller, the size and current capacity of the wire increases. AWG 14 is most commonly found in older residential branch circuits. AWG 14 wires should be used only in a branch circuit with a 15-ampere capacity or no more than a 1,500-watt demand. Wire sizes AWG 16, 18, and 20 are progressively smaller than AWG 14 and are used for extension wires or low-voltage systems. Wire of the correct size must be used for two reasons: current capacity and voltage drop or loss.

When current flows through a wire, it creates heat. The greater the amount of flow, the greater the amount of heat generated. (Doubling the amperes without changing the wire size increases the amount of heat by four times.) The heat is electric energy (electrons) that has been converted into heat energy by the resistance of the wire. The heat created by the coils in a toaster is an example of designed resistance to create heat. Most heat developed by an electrical conductor is wasted; therefore, the electric energy used to generate it is also wasted.

If the amount of heat generated by the flow of current through a wire becomes excessive, a fire may result. Therefore, the code sets the maximum permissible current that may flow through a certain type and size wire. The blue box provides examples of current capacities for copper wire of various sizes.

In addition to heat generation, there will be a reduction in voltage as a result of attempting to force more current through a wire than it is designed to carry. Certain appliances, such as induction-type electric motors, may be damaged if operated at too low a voltage.

### Wire Types

All wires must be marked to indicate the maximum working voltage, the proper type letter or letters for the type wire specified in the code, the manufacturer's name or trademark, and the AWG size or circular-mil area (Figure 11.12). A variety of wire types can be used for a wide range of temperature and moisture conditions. The code should be consulted to determine the proper wire for specific conditions.

### Types of Cable

Nonmetallic sheathed cable consists of wires wrapped in plastic and then a paper layer, followed by another spiral layer of paper, and enclosed in a fabric braid, which is treated with moisture- and fire-resistant compounds. Figure 11.12 shows this type of cable, which often is marketed under the name Romex. This type of cable can be used only indoors and in permanently dry locations. Romex-type wiring is normally used in residential construction. However, when cost permits, it is recommended that a conduit-based system be used.

Armored cable is commonly known as BX or Flexsteel trade names. Wires are wrapped in a tough paper and covered with a strong spiral flexible steel armor. This type of cable is shown in Figure 11.13 and may be used only in permanently dry indoor locations. Armored cable must be supported by a strap or staple every 6 feet and within 24 inches of every switch or junction box, except for concealed runs in old work where it is impossible to mount straps.

Cables are also available with other outer coatings of metals, such as copper, bronze, and aluminum for use in a variety of conditions.

### Flexible Cords

CPSC estimates that about 4,000 injuries associated with electric extension cords are treated in hospital emergency rooms each year. About half of the injuries involve fractures, lacerations, contusions, or sprains from people tripping over extension cords. Thirteen percent of the injuries involve children younger than 5 years of age; electrical burns to the mouth account for half the injuries to young children [7].

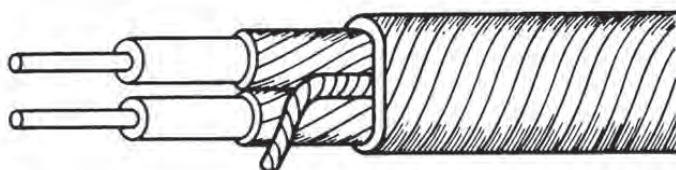

Figure 11.12. Wire Markings [2]



**Figure 11.13.** Armored Cable [2]

CPSC also estimates that about 3,300 residential fires originate in extension cords each year, killing 50 people and injuring about 270 others [7]. The most frequent causes of such fires are short circuits, overloading the system, and damage to or misuse of extension cords.

### The Problem

Following are CPSC investigations of injuries that illustrate the major injury patterns associated with extension cords: children putting extension cords in their mouths, overloaded cords, worn or damaged cords, and tripping over cords:

- A 15-month-old girl put an extension cord in her mouth and suffered an electrical burn. She required surgery.
- Two young children were injured in a fire caused by an overloaded extension cord in their family's home. A lamp, TV set, and electric heater had been plugged into a single, light-duty extension cord.
- A 65-year-old woman was treated for a fractured ankle after tripping over an extension cord.

### The Standards

The code says that many cord-connected appliances should be equipped with polarized grounding plugs. Polarized plugs can only be inserted one way into the outlet because one blade is slightly wider than the other. Polarization and grounding ensure that certain parts of appliances that could have a higher risk of electric shock when they become live are instead connected to the neutral, or grounded, side of the circuit. Such electrical products should only be used with polarized or grounded extension cords.

Voluntary industry safety standards, including those of Underwriter's Laboratory (UL), now require that general-use extension cords have safety closures, warning labels, rating information about the electrical current, and other features for the protection of children and other consumers.

In addition, UL-listed extension cords now must be constructed with 16-gauge or larger wire or be equipped with integral fuses. The 16-gauge wire is rated to carry 13 amperes (up to 1,560 watts), as compared with the for-

merly used 18-gauge cords that were rated for 10 amperes (up to 1,200 watts).

### Safety Suggestions

The following are CPSC recommendations [7] for purchasing and safely using extension cords:

- Use extension cords only when necessary and only on a temporary basis.
- Use polarized extension cords with polarize appliances.
- Make sure cords do not dangle from the counter or tabletops where they can be pulled down or tripped over.
- Replace cracked or worn extension cords with new 16-gauge cords that have the listing of a nationally recognized testing laboratory, safety closures, and other safety features.
- With cords lacking safety closures, cover any unused outlets with electrical tape or with plastic caps to prevent the chance of a child making contact with the live circuit.
- Insert plugs fully so that no part of the prongs is exposed when an extension cord is in use.
- When disconnecting cords, pull the plug rather than the cord itself.
- Teach children not to play with plugs and outlets.
- Use only three-wire extension cords for appliances with three-prong plugs. Never remove the third (round or U-shaped) prong, which is a safety feature designed to reduce the risk for shock and electrocution.
- In locations where furniture or beds may be pushed against an extension cord where the cord joins the plug, use a special angle extension cord specifically designed for use in these instances.
- Check the plug and the body of the extension cord while the cord is in use. Noticeable warming of these plastic parts is expected when cords are being used at their maximum rating. If the cord feels hot or if there is a softening of the plastic, this is a warning that the plug wires or connections are failing and that the extension cord should be discarded and replaced.
- Never use an extension cord while it is coiled or looped. Never cover any part of an extension cord with newspapers, clothing, rugs, or any objects while the cord is in use. Never place an extension cord where it is likely to be damaged by heavy furniture or foot traffic.

- Do not use staples or nails to attach extension cords to a baseboard or to another surface. This could damage the cord and present a shock or fire hazard.
- Do not overload extension cords by plugging in appliances that draw a total of more watts than the rating of the cord.
- Use special heavy-duty extension cords for high-wattage appliances such as air conditioners, portable electric heaters, and freezers.
- When using outdoor tools and appliances, use only extension cords labeled for outdoor use.

## Wiring

### Open Wiring

Open wiring is a wiring method using knobs, nonmetallic tubes, cleats, and flexible tubing for the protection and support of insulated conductors in or on buildings and not concealed by the structure. The term “open wiring” does not mean exposed, bare wiring. In dry locations, when not exposed to severe physical damage, conductors may be separately encased in flexible tubing. Tubing should be in continuous lengths not exceeding 15 feet and secured to the surface by straps not more than 4½ feet apart. Tubing should be separated from other conductors by at least 2½ inches and should have a permanently maintained airspace between them and any and all pipes they cross.

### Concealed Knob and Tube Wiring

Concealed knob and tube wiring is a wiring method using knobs, tubes, and flexible nonmetallic tubing for the protection and support of insulated wires concealed in hollow spaces of walls and ceilings of buildings. This wiring method is similar to open wiring and, like open wiring, is usually found only in older buildings.

## Electric Service Panel

The service switch is a main switch that will disconnect the entire electrical system at one time. The main fuses or circuit breakers are usually located within the service switch box. The branch circuit fuse or circuit breaker may also be located within this box.

According to the code, the switch must be externally operable. This condition is fulfilled if the switch can be operated without the operator being exposed to electrically active parts. Figure 11.14 shows a 200-amp service box. Figure 11.15 shows an external “hinged switch” power shutoff installed on the outside of a home.

Most of today’s older homes do not have hinged switches. Instead, the main fuse is mounted on a small insulated block that can be pulled out of the switch. When this block is removed, the circuit is broken.

In some installations, the service switch is a “solid neutral” switch, meaning that the switch or a fuse does not break the neutral wire in the switch.



Figure 11.14. 200-Amp Service Box

When circuit breakers are used in homes instead of fuses, main circuit breakers may or may not be required. If it takes more than six movements of the hand to open all the branch-circuit breakers, a main breaker, switch, or fuse will be required ahead of the branch-circuit breakers. Thus, a house with seven or more branch circuits requires a separate disconnect means or a main circuit breaker ahead of the branch-circuit breakers.

## Over-current Devices

The amperage (current flow) in any wire is limited to the maximum permitted by using an over-current device of a size specified by the code. Four types of over-current devices are common: circuit breakers, ground fault circuit interrupters (GFCIs), arc fault circuit interrupters (AFCIs), and fuses. The over-current device of a specific size is specified by the code. The over-current device must be rated at equal or lower capacity than the wire of the circuit it protects.



Figure 11.15. External Power Shutoff and Meter

## Circuit Breakers (Fuseless Service Panels)

A circuit breaker looks something like an ordinary electric light switch. Figure 11.14 shows the service box in a 200-amp fuseless system. Figure 11.15 shows a service switch. There is a handle that may be used to turn power on or off. Inside is a simple mechanism that, in case of a circuit overload, trips the switch and breaks the circuit. The circuit breaker may be reset by turning the switch to off and then simply resetting the switch to the on position. A circuit breaker is capable of taking harmless short-period overloads (such as the heavy initial current required in the starting of a washing machine or air conditioner) without tripping, but protects against prolonged overloads. After the cause of trouble has been located and corrected, power is easily restored. Fuseless service panels or breaker boxes are usually broken up into the following circuits:

- A 100-ampere or larger main circuit breaker that shuts off all power.
- A 40-ampere circuit for an appliance such as an electric cooking range.
- A 30-ampere circuit for a clothes dryer, water heater, heat pump, or central air conditioning.
- A 20-ampere circuit for small appliances and power tools.
- A 15-ampere circuit for general-purpose lighting, TVs, VCRs, computers, and vacuum cleaners.
- Space for new circuits to be added if needed for future use.

## Ground Fault Circuit Interrupters

Unlike circuit breakers and fuses, GFCIs are installed to protect the user from electrocution. These devices provide protection against electrical shock and electrocution from ground faults or contact with live parts by a grounded individual. They constantly monitor electrical currents flowing into a product. If the electricity flowing through the product differs even slightly from that returning, the GFCI will quickly shut off the current. GFCIs detect amounts of electricity much smaller than those required for a fuse or circuit breaker to activate and shut off the circuit. UL lists three types of GFCIs designed for home use that are readily available and fairly inexpensive and simple to install:

- **Wall Receptacle GFCI**—This type of GFCI (Figure 11.16) is used in place of a standard receptacle found throughout the house. It fits into a standard outlet box and protects against ground faults whenever an electrical product is plugged into the outlet. If

strategically located, it will also provide protection to downstream receptacles.

- **Circuit Breaker GFCI**—In homes equipped with circuit breakers, this type of GFCI may be installed in a panel box to protect selected circuits. A circuit breaker GFCI serves a dual purpose: it shuts off electricity in the event of a ground fault and will also trip when a short circuit or an overload occurs.
- **Portable GFCI**—A portable GFCI requires no special knowledge or equipment to install. One type contains the GFCI circuitry in a self-contained enclosure with plug blades in the back and receptacle slots in the front. It can be plugged into a receptacle, and the electrical product plugged into the GFCI. Another type of portable GFCI is an extension cord combined with a GFCI. It adds flexibility in using receptacles that are not protected by GFCIs.

Once a GFCI is installed, it must be checked monthly to determine that it is operating properly. Pressing the test button can check units; the GFCI should disconnect the power to that outlet. Pressing the reset button reconnects the power. If the GFCI does not disconnect the power, have it checked by a qualified, certified electrician.

GFCIs should be installed on circuits in the following areas: garages, bathrooms, kitchens, crawl spaces, unfinished basements, hot tubs and spas, pool electronics, and exterior outlets. However, they are not required on single outlets that serve major appliances.

## Arc-fault Circuit Interrupters

Arc-fault circuit interrupters are new devices intended to provide fire protection by opening the circuit if an arcing fault is detected. An arcing fault is an electric spark or hot plasma field that extends from the hot wire to a ground. An arc is a luminous discharge of electricity across an insulating medium or simply a spark across an air gap. Arcs occur every day in homes. For example, an arc occurs inside the switch when a light is turned on. Toy racecars and trains create arcs. The motors inside hair driers and power drills have tiny arcs. All of these are controlled arcs. It is the uncontrolled or nondesigned arc that is a serious fire hazard in the home. The arc-fault circuit interrupter looks like the GFCI unit (Figure 11.17), but it is not designed to protect against electric shock.



Figure 11.16. GFCI



**Figure 11.17.** Arc Interrupter

Because most electrical wiring in a home is hidden from view, many arc faults go undetected and continue arcing indefinitely. If left in this arcing state, the potential for fire increases. It is estimated that about one third of fires are caused by arcing faults. Normal

fuses and circuit breakers are not capable of detecting arc faults and therefore will not open the circuit and stop the flow of electricity.

### Fused Ampere Service Panel (Fuse Box)

Fuse-type panel boxes are generally found in older homes. They are as safe and adequate as a circuit breaker of equivalent capacity, provided fuses of the proper size are used.

A fuse, like a circuit breaker, is designed to protect a circuit against overloading and short circuits and does so in two ways.

When a fuse is blown by a short circuit, the metal strip is instantly heated to an extremely high temperature, and this heat causes it to vaporize. A fuse blown by a short circuit may be easily recognized because the window of the fuse usually becomes discolored.

In a fuse blown by an overload, the metal strip is melted at its weakest point, breaking the flow of current to the load. In this case, the window of the fuse remains clear; therefore, a blown fuse caused by an overload may also be easily recognized.

Sometimes, although a fuse has not been blown, the bottom of the fuse may be severely discolored and pitted. This indicates a loose connection because the fuse was not screwed in properly.

It is critical to check that all fuses are properly rated for the designed amperage. The placing of a fuse with a higher amperage than recommended presents a significant fire hazard.

Generally, all fused panel boxes are wired similarly for two- and three-wire systems. In a two-wire-circuit panel box, the black or red hot wire is connected to a terminal of the main disconnect, and the white or light gray neutral wire is connected to the neutral strip, which is then grounded to the pipe on the street side of the water meter.

In a three-wire system, the black and red hot wires are connected to separate terminals of the main disconnect,

and the neutral wire is grounded the same as for a two-wire system. Below each fuse is a terminal to which a black or red wire is connected. The white or light gray neutral wires are then connected to the neutral strip. Each fuse indicates a separate circuit (Figure 11.18).

- **Nontamperable fuses**—All ordinary plug fuses have the same diameter and physical appearance, regardless of their current capacity, whereas nontamperable fuses are sized by amperage load. Thus, with regular fuses, if a circuit designed for a 15-ampere fuse is overloaded so that the 15-ampere fuse blows out, nothing will prevent a person from replacing the 15-ampere fuse with a 20- or 30-ampere fuse, which may not blow out. If a circuit wired with 14-gauge wire (current capacity 15 amperes) is fused with a 20- or 30-ampere fuse and an overload develops, more current than the 14-gauge wire is safely capable of carrying could pass through the circuit. The result would be a heating of the wire and potential fire.
- **Type-S fuses**—Type-S fuses have different lengths and diameter threads for each amperage capacity. An adapter is first inserted into the ordinary fuse holder, which adapts the fuse holder for only one capacity fuse. Once the adapter is inserted, it cannot be removed.
- **Cartridge fuses**—A cartridge fuse protects an electric circuit in the same manner as an ordinary plug fuse, already described, protects an electric circuit. Cartridge fuses are often used as main fuses.

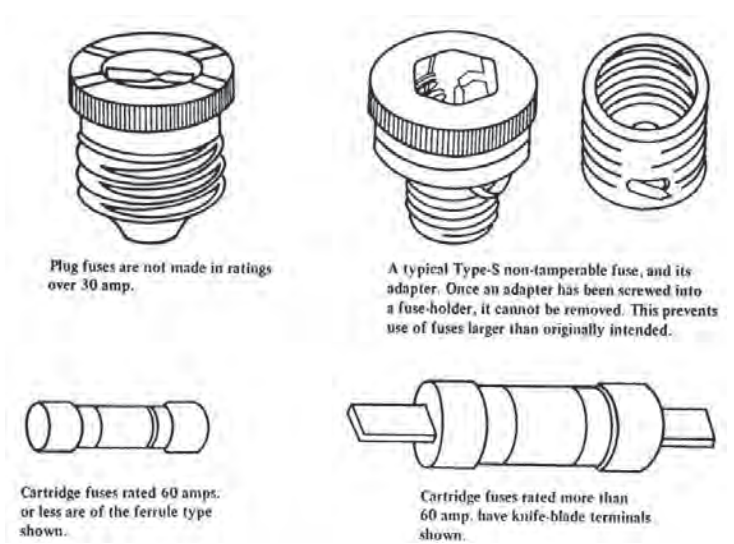

**Figure 11.18.** Types of Fuses

## Electric Circuits

An electric circuit in good repair carries electricity through two or three wires from the source of supply to an outlet and back to the source. A branch circuit is an electric circuit that supplies current to a limited number of outlets and fixtures. A residence generally has many branch circuits. Each is protected against short circuits and overloads by a 15- or 20-ampere fuse or circuit breaker.

The number of outlets per branch circuit varies from building to building. The code requires enough light circuits so that 3 watts of power will be available for each square foot of floor area in a house. A circuit wired with 14-gauge wire and protected by a 15 ampere over-current protection device provides  $15 \times 115$  (1,725 watts); each circuit is enough for 1,725 divided by 3 (575 square feet). Note that 575 is a minimum figure; if future use is considered, 500 or even 400 square feet per branch circuit should be used.

Special appliance circuits will provide electric power for lighting, radio, TV, and small portable appliances. However, the larger electric appliances usually found in the kitchen consume more power and must have their own special circuit.

Section 220-3b of the code requires two special circuits to serve only appliance outlets in the kitchen, laundry, pantry, family room, dining room, and breakfast room. Both circuits must be extended to the kitchen; either one or both of these circuits may serve the other rooms. No lighting outlets may be connected to these circuits, and they must be wired with 12-gauge wire and protected by a 20-ampere over-current device. Each circuit will have a capacity of  $20 \times 115$  (2,300 watts), which is not too much when toasters often require more than 1,600 watts.

It is customary to provide a circuit for each of the following appliances: range, water heater, washing machine, clothes dryer, garbage disposal, dishwasher, furnace, water pump, air conditioner, heat pump, and air compressor. These circuits may be either 115 volts or 230 volts, depending on the particular appliance or motor installed.

## Outlet Switches and Junction Boxes

The code requires that every switch, outlet, and joint in wire or cable be housed in a box. Every fixture must be mounted on a box. Most boxes are made of plastic or metal with a galvanized coating. When a cable of any style is used for wiring, the code requires that it be securely anchored with a connector to each box it enters.

## Grounding Outlets

An electrical appliance may appear to be in good repair, and yet it might be a danger to the user. Older portable electric drills consist of an electric motor inside a metal casing. When the switch is depressed, the current flows to the motor and the drill rotates. As a result of wear, however, the insulation on the wire inside the drill may deteriorate and allow the hot side of the power cord to come in contact with the metal casing. This will not affect the operation of the drill.

A person fully clothed using the drill in the living room, which has a dry floor, will not receive a shock, even though he or she is in contact with the electrified drill case. The operator's body is not grounded because of the dry floor. If standing on a wet basement floor, the operator's body might be grounded; and, when the electrified drill case is touched, current will pass through the operator's body.

To protect people from electrocution, the drill case is usually connected to the system ground by means of a wire called an appliance ground. In this instance, as the drill is plugged in, current will flow between the shorted hot wire and the drill case and cause the over-current device to break the circuit. Thus, the appliance ground has protected the human operator. Newer appliances and tools are equipped with two-prong polarized plugs, as discussed in the standards section of this manual.

The appliance ground (Figure 11.19) is the third wire found on many appliances. The appliance ground will be of no use unless the outlet into which the appliance is plugged is grounded. Being in physical contact with a ground outlet box grounds the outlet. Having a third ground wire, or a grounded conduit, as part of the circuit wiring grounds the outlet box.

All new buildings are required to have grounded outlets. A two-lead circuit tester can be used to test the outlet. The circuit tester lights when both of its leads are plugged into the two elongated parallel openings of the outlet. In addition, the tester lights when one lead is plugged into the round third opening and the other is plugged into the hot side of the outlet. Most problems can be resolved using inexpensive testers resembling a plug with three leads. These can be purchased in many stores and most hardware stores for very reasonable prices.

If the conventional two-opening outlet is used, it may be grounded if the screw that holds the outlet cover plate is electrically connected to the third-wire ground. The tester should light when one lead is in contact with a clean

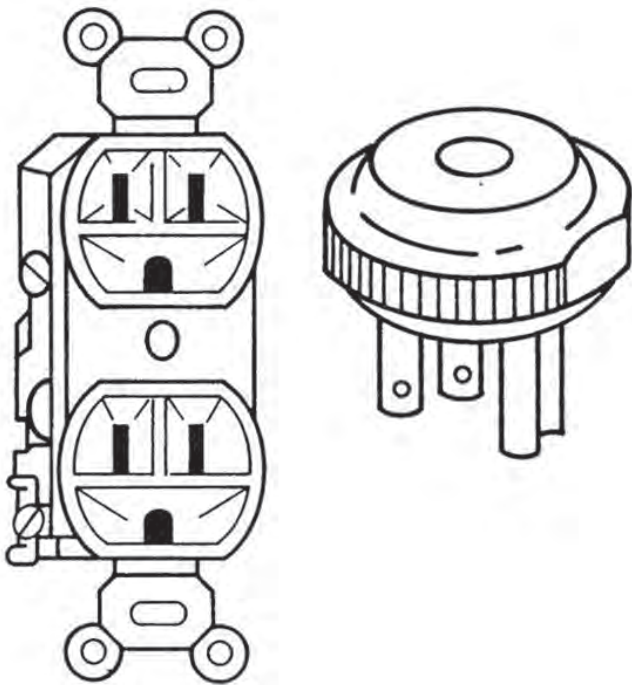

**Figure 11.19.** Appliance Ground and Grounded Plug

paint-free metal outlet cover plate screw and the hot side of the outlet. If the tester does not light, the outlet is not grounded. If a two-opening outlet is grounded, it may be adapted for use by a three-wire appliance by using an adapter. The loose-wire portion or screw tab of the adapter should be secured behind the metal screw of the outlet plate cover. Many appliances, such as electric shavers and some new hand tools, are double insulated and are safe without having a third ground wire.

### Polarized Plugs and Connectors

Plugs are polarized or unpolarized. Polarization helps reduce the potential for shock. Consumers can easily identify polarized plugs; one blade—the ground prong—is wider than the other. Three-conductor plugs are automatically polarized because they can only be inserted one way. Polarized plugs are used to connect the most-exposed part of an appliance to the ground wire so that if you are touching a ground (such as a pipe, bathtub, or faucet) and the exposed part of an appliance (the case, the threaded part of a light bulb socket, etc.), you will not get an electrical shock. Many appliances, such as electric drills, are doubly insulated so the probability of any exposed part of the appliance being connected, by a short or other problem in the appliance, to either wire is very small. Such devices often use unpolarized plugs where the two prongs of the plug are identical.

## Common Electrical Violations

The most obvious things that a housing inspector must check are the power supply; the type, location, and condition of the wiring; and the number and conditions of wall outlets or ceiling fixtures required by the local code. In making an investigation, the following considerations will serve as useful guides.

- **Power supply**—Where is it, is it grounded properly, and is it at least of the minimum capacity required to supply current safely for lighting and the major and minor appliances in the dwelling?
- **Panel box covers or doors**—These should be accessible only from the front and should be sealed in such a way that they can be operated safely without the danger of contact with live or exposed parts of the wiring system.
- **Switch, outlets, and junction boxes**—These also must be covered to protect against danger of electric shock.
- **Frayed or bare wires**—These are usually the result of long use and drying out and cracking of the insulation, which leave the wires exposed, or of constant friction and rough handling of the wire, which cause it to fray or become bare. Wiring in this condition constitutes a safety hazard. Correction of such defects should be ordered immediately.
- **Electric cords under rugs or other floor coverings**—Putting electric cords in locations such as these is prohibited because of the potential fire hazard caused by continuing contact over a period of time between these heat-bearing cords and the flammable floor coverings. Direct the occupant to shift the cords to a safe location, explain why, and make sure it is done before you leave.
- **Ground fault circuit interrupter**—All bathroom, kitchen, and workroom outlets—where shock hazard is great—should have GFCI outlets. Check for lack of or nonuse of GFCI outlets.
- **Bathroom lighting**—Bathrooms should include at least one permanently installed ceiling or wall light fixture with a wall switch and plate located and maintained so that there is no danger of short circuiting from use of other bathroom facilities or splashing water. Fixture or cover plates should be insulated or grounded.



- **Lighting of public hallways, stairways, landings, and foyers**—A common standard is sufficient lighting to illuminate 10 foot-candles on every part of these areas at all times. Sufficient lighting means that people can clearly see their feet on all parts of the stairways and halls. Public halls and stairways in structures containing less than three dwelling units may be supplied with conveniently located light switches controlling an adequate lighting system that may be turned on when needed, instead of full-time lighting.
- **Habitable room lighting**—The standard here may be two floor convenience outlets (although floor outlets are dangerous unless protected by proper dust and water covers) or one convenience outlet and one wall or ceiling electric light fixture. This number is an absolute and often inadequate minimum, given the contemporary widespread use of electricity in the home. The minimum should be the number required to provide adequate lighting and power to accommodate lighting and appliances normally used in each room.
- **Octopus outlets or wiring**—This term is applied to outlets into which plugs have been inserted and are being used to permit more than two lights or portable appliances, such as a TV, lamp, or radio, to be connected to the electrical system. The condition occurs where the number of outlets is insufficient to accommodate the normal use of the room. This practice overloads the circuit and is a potential source of fire.
- **Outlet covers**—Every outlet and receptacle must be covered by a protective plate to prevent contact of its wiring or terminals with the body, combustible objects, or water.

Following are six situations that can cause danger and should also be corrected.

### Excessive or Faulty Fusing

The wire's capacity must not be exceeded by the fuse or circuit breaker capacity or be left unprotected by faulty fusing or circuit breakers. Fuses and circuit breakers are safety devices designed to “blow” to protect against overloading the electrical system or one or more of its circuits. Pennies under fuses are there to bypass the fuse. These are illegal and must be removed. Overfusing is done for the same reason. The latter can be prevented by installing modern fusestats, which prevent use of any fuse of a higher amperage than can be handled by the circuit it serves.

### Cords Run Through Walls or Doorways and Hanging Cords or Wires

This makeshift installation often is the work of an unqualified handyman or do-it-yourself occupant. The inspector should check the local electrical code to determine the policy regarding this type of installation.

### Temporary Wiring

Temporary wiring should not be allowed, with the exception of extension cords that go directly from portable lights and electric fixtures to convenience outlets.

### Excessively Long Extension Cords

City code standards often limit the length of loose cords or extension lines to a maximum of 8 feet. This is necessary because cords that are too long will overheat if overloaded or if a short circuit develops and, thus, create a fire hazard. This requirement does not apply to specially designed extension cords for operating portable tools and trouble lights.

### Dead or Dummy Outlets

These are sometimes installed to deceive the housing inspector. All outlets must be tested or the occupants questioned to see if these are live and functioning properly. A dead outlet cannot be counted to determine compliance with the code.

### Aluminum Wiring Inside the Home

Although aluminum is an excellent conductor, it tends to oxidize on the conducting surface. The nonconductive oxidized face of the conductor will arc from the remaining conductive surfaces, and this arc can result in fire.

### Inspection Steps

The basic tools required by a housing inspector for making an electrical inspection are fuse and circuit testers and a flashlight. The first thing to remember is that you are in a strange house, and the layout is unfamiliar to you. The second thing to remember is that you are dealing with electricity—take no chances. Go to the site of the ground, usually at the water meter, and check the ground. It should connect to the water line on the street side of the water meter or be equipped with a jumper wire. Do not touch any box or wire until you are sure of the ground. Go to the main fuse box or circuit breaker box and check all fuses and breakers for operational integrity (proper amperage range; functional). Note the condition of the wiring and of the box itself and check whether it is overfused. Examine all wiring in the basement. Make sure you are standing in a dry spot (concrete poses a particular

problem because you cannot determine its water content from visual examination) before touching any electrical device. Standing on a dry piece of wood is far safer than standing on concrete. Do not disassemble the fuse box, circuit breaker, or other devices. Decisions must be made on what you see. If in doubt, consult your supervisor.

Note whether any fuse boxes, circuit breakers, or junction boxes are uncovered. Examine all wiring for frayed or bare spots; improper splicing; or rotted, worn, or inadequate insulation. Avoid all careless touching; when in doubt—DON'T! If you see bare wires, have the owner call an electrician. Look for wires or cords in use in the basement. Be certain all switch boxes and outlets are in a tight, sound condition. Make sure that the emergency switch for an oil burner is at the top of the basement stairs, not on top of the unit.

Bathrooms, kitchens, and utility rooms—where electric shock hazard is great—should have GFCI outlets.

While inspecting the bathroom, also check for dangerous items, such as radios that are not made for bathroom use or portable electric heaters. Have inappropriate items removed immediately. Such items have killed thousands of people who touched them after getting out of the bathtub or shower while still wet or because the appliance fell into water the person had contact with.

Electric washer and dryer combinations should have a 240-volt circuit, 30-ampere service connected to a separate fuse or circuit breaker. Washer and dryer combinations and other portable appliances should be served by sufficiently heavy electrical service. If either of these special lines is not available under the above-stated conditions, consult your supervisor.

An electric range needs a 50-ampere, 240-volt circuit. A dishwasher needs a 20-ampere, 120-volt circuit. A separate three-wire circuit must be installed for an electric water heater. Continue your inspection systematically through the house.

To sum up, the housing inspector investigates specified electrical elements in a house to detect any obvious evidence of an insufficient power supply, to ensure the availability of adequate and safe lighting and electrical facilities, and to discover and correct any obvious hazard. Because electricity is a technical, complicated field, the housing inspector, when in doubt, should consult his or her supervisor. The inspector cannot, however, close the case until appropriate corrective action has been taken on all such referrals.

## References

1. National Fire Protection Association. National electrical code handbook 2005. Florence, KY: Thomson Delmar Learning; 2005.
2. Center for Disease Control. Basic housing inspection. Atlanta: US Department of Health and Human Services; 1976.
3. British Columbia Safety Authority. The facts about aluminum wiring in the home. New Westminster, British Columbia, Canada: British Columbia Safety Authority; no date. Available from URL: [http://www.safetyauthority.ca/services/esp/The\\_Facts\\_About\\_Aluminum\\_Wiring\\_In\\_The\\_Home.pdf](http://www.safetyauthority.ca/services/esp/The_Facts_About_Aluminum_Wiring_In_The_Home.pdf).
4. Consumer Product Safety Commission. May is National Electrical Safety Month: good news for homeowners—aluminum wiring fix still available. Washington, DC: Consumer Product Safety Commission; 2003. Available from URL: <http://www.cpsc.gov/CPSCPUB/PREREL/prhtml03/03120.html>.
5. Consumer Product Safety Commission. CPSC safety recommendations for aluminum wiring in homes. Washington, DC: Consumer Product Safety Commission; 1974. Available from URL: <http://www.cpsc.gov/CPSCPUB/PREREL/prhtml74/74040.html>.
6. AWG American wire gauge/diameter/resistance. Cologne, Germany: Bernd Noack; no date. Available from URL: <http://www.bnoack.com/data/wire-resistance.html>.
7. Consumer Product Safety Commission. Extension cords fact sheet. Washington, DC: Consumer Product Safety Commission; no date. CPSC #16. Available from URL: <http://www.cpsc.gov/CPSCPUB/PUBS/16.html>.

## Additional Sources of Information

- Croft T, Summers W. American electricians' handbook. 14th edition, New York: McGraw-Hill Professional; 2002.
- Tuck D, Tuck G, Woodson RD. Electrician's instant answers. New York: McGraw-Hill Professional; 2003.
- Black and Decker. The complete guide to home wiring: a comprehensive manual, from basic repairs to advanced projects (Black & Decker Home Improvement Library; US edition). Chanhassen, MN: Creative Publishing International; 2001.
- Sunset Publishing. Basic wiring. 3rd edition. Menlo Park, CA: Sunset Books, 1995.

Hometime.com. Electrical service panel: panel components, circuit breakers, fuses, electrical glossary. Hometime.com; no date. Available from URL: [http://www.hometime.com/Howto/projects/electric/elec\\_2.htm](http://www.hometime.com/Howto/projects/electric/elec_2.htm).

Vandervort D. How your house works: electric systems. Glendale, CA: Hometips.com; no date. Available from URL: <http://www.hometips.com/hyhw/electrical/electric.html>.

PNM Resources. Residential subdivisions: electric service requirements. In: Electric service guide. Albuquerque, NM: PNM; 2004. Available from URL: <http://www.pnm.com/esg/chapters/56-63.pdf>.

Textor K. Extension cord basics. Fine Homebuilding 2000, 129: 84-9. Available from URL: <http://www.taunton.com/finehomebuilding/pages/h00010.asp>.

Consumer Product Safety Commission. Repairing aluminum wiring. Washington, DC: Consumer Product Safety Commission; 1994. CPSC #516. Available from URL: <http://www.cpsc.gov/CPSCPUB/PUBS/516.pdf>.



# Chapter 12: Heating, Air Conditioning, and Ventilating

“Our climate is warming at a faster rate than ever before recorded.”

D. James Baker  
NOAA Administrator, 1993–2004

## Introduction

The quotes below provide a profound lesson in the need for housing to provide protection from both the heat and cold.

“France heat wave death toll set at 14,802: The death toll in France from August’s blistering heat wave has reached nearly 15,000, according to a government-commissioned report released Thursday, surpassing a prior tally by more than 3,000.” *USA Today*, September 25, 2003.

“In the study of the 1995 Chicago heat wave, those at greatest risk of dying from the heat were people with medical illnesses who were socially isolated and did not have access to air conditioning.” Centers for Disease Control and Prevention, *Morbidity and Mortality Weekly Report*, July 4, 2003.

“3 Deaths tied to cold...The bitter cold that gripped the Northeast through the weekend and iced over roads was blamed for at least three deaths, including that of a Philadelphia man found inside a home without heat.” *Lexington [Kentucky] Herald Leader*, January 12, 2004.

“In many temperate countries, death rates during the winter season are 10%–25% higher than those in the summer.” World Health Organization, Health Evidence Network, November 1, 2004.

This chapter provides a general overview of the heating and cooling of today’s homes. Heating and cooling are not merely a matter of comfort, but of survival. Both very cold and very hot temperatures can threaten health. Excessive exposure to heat is referred to as heat stress and excessive exposure to cold is referred to as cold stress.

In a very hot environment, the most serious health risk is heat stroke. Heat stroke requires immediate medical attention and can be fatal or leave permanent damage. Heat stroke fatalities occur every summer. Heat exhaustion and fainting are less serious types of illnesses. Typically they are not fatal, but they do interfere with a person’s ability to work.

At very cold temperatures, the most serious concern is the risk for hypothermia or dangerous overcooling of the body. Another serious effect of cold exposure is frostbite or freezing of exposed extremities, such as fingers, toes, nose, and ear lobes. Hypothermia can be fatal if immediate medical attention is not received.

Heat and cold are dangerous because the victims of heat stroke and hypothermia often do not notice the symptoms. This means that family, neighbors, and friends are essential for early recognition of the onset of the conditions. The affected individual’s survival depends on others

## Definitions of Terms Related to HVAC Systems

**Air duct**—A formed conduit that carries warm or cold air from the furnace or air-conditioner and back again.

**Antiflooding Control**—A safety control that shuts off fuel and ignition when excessive fuel oil accumulates in the appliance.

### Appliance:

- High heat—A unit that operates with flue entrance temperature of combustion products above 1,500°F (820°C).
- Medium heat—Same as high-heat, except above 600°F (320°C).
- Low heat—same as high-heat, except below 600°F (320°C).

### Boiler:

- High pressure—A boiler furnishing pressure at 15 psi or more.
- Low pressure (hot water or steam)—A boiler furnishing steam at a pressure less than 15 psi or hot water not more than 30 psi.

**Burner**—A device that mixes fuel, air, and ignition in a combustion chamber.

to identify symptoms and to seek medical help. Family, neighbors, and friends must be particularly diligent during heat or cold waves to check on individuals who live alone.

Although symptoms vary from person to person, the warning signs of heat exhaustion include confusion and profuse and prolonged sweating. The person should be removed from the heat, cooled, and heavily hydrated.

Heat stroke signs and symptoms include sudden and severe fatigue, nausea, dizziness, rapid pulse, lightheadedness, confusion, unconsciousness, extremely high temperature, and hot and dry skin surface. An individual who appears disorientated or confused, seems euphoric or unaccountably irritable, or suffers from malaise or flulike symptoms should be moved to a cool location and medical advice should be sought immediately.

## Definitions of Terms Related to HVAC Systems

**Carbon monoxide (CO) detector**—A device used to detect CO (specific gravity of 0.97 vs. 1.00 for oxygen, a colorless odorless gas resulting from combustion of fuel). CO detectors should be placed on each floor of the structure at eye level and should have an audible alarm and, when possible, a digital readout at eye level.

**Chimney**—A vertical shaft containing one or more passageways.

**Factory-built chimney**—A tested and accredited flue for venting gas appliances, incinerators and solid or liquid fuel-burning appliances.

**Masonry chimney**—A field-constructed chimney built of masonry and lined with terra cotta flue or firebrick.

**Metal chimney**—A field-constructed chimney of metal.

**Chimney connector**—A pipe or breeching that connects the heating appliance to the chimney.

**Clearance**—The distance separating the appliance, chimney connector, plenum, and flue from the nearest surface of combustible material.

**Central cooling system**—An electric or gas-powered system containing an outside compressor, cooling coils, and a ducting system inside the structure designed to supply cool air uniformly throughout the structure.

**Central heating system**—A flue connected boiler or furnace installed as an integral part of the structure and designed to supply heat adequately for the structure.

**Collectors**—The key component of active solar systems and are designed to meet the specific temperature requirements and climate conditions for different end uses. Several types of solar collectors exist: flat-plate collectors, evacuated-tube collectors, concentrating collectors, and transpired air collectors.

### Controls:

- **High-low limit control**—An automatic control that responds to liquid level changes and will shut down if they are exceeded.
- **Primary safety control**—The automatic safety control intended to prevent abnormal discharge of fuel at the burner in case of ignition failure or flame failure.

**Combustion safety control**—A primary safety control that responds to flame properties, sensing the presence of flame and causing fuel to be shut off in event of flame failure.

**Convactor**—A radiator that supplies a maximum amount of heat by convection, using many closely spaced metal fins fitted onto pipes that carry hot water or steam and thereby heat the circulating air.

**Conversion**—A boiler or furnace, flue connected, originally designed for solid fuel but converted for liquid or gas fuel.

**Damper**—A valve for regulating draft on coal-fired equipment. Generally located on the exhaust side of the combustion chamber, usually in the chimney connector. Dampers are not allowed on oil- and gas-fired equipment.

**Draft hood**—A device placed in and made a part of the vent connector (chimney connector or smoke pipe) from an appliance, or in the appliance itself. The hood is designed to a) ensure the ready escape of the products of combustion in the event of no draft, back draft, or stoppage beyond the draft hood; b) prevent backdraft from entering the appliance; and c) neutralize the effect of stack action of the chimney flue upon appliance operation.

Warning signs of hypothermia include nausea, fatigue, dizziness, irritability, or euphoria. Individuals also experience pain in their extremities (e.g., hands, feet, ears) and severe shivering. People who exhibit these symptoms, particularly the elderly and young, should be moved to a heated shelter and medical advice should be sought when appropriate.

The function of a heating, ventilation, and air conditioning (HVAC) system is to provide for more than human health and comfort. The HVAC system produces

heat, cool air, and ventilation, and helps control dust and moisture, which can lead to adverse health effects. The variables to be controlled are temperature, air quality, air motion, and relative humidity. Temperature must be maintained uniformly throughout the heated/cooled area. There is a 6°F to 10°F (-14°C to -12°C) variation in room temperature from floor to ceiling. The adequacy of the HVAC system and the air-tightness of the structure or room determine the degree of personal safety and comfort within the dwelling.

## Definitions of Terms Related to HVAC Systems

**Draft regulator**—A device that functions to maintain a desired draft in oil-fired appliances by automatically reducing the chimney draft to the desired value. Sometimes this device is referred to in the field as air-balance, air-stat, or flue velocity control or barometer damper.

**Fuel oil**—A liquid mixture or compound derived from petroleum that does not emit flammable vapor below a temperature of 125°F (52°C).

**Heat**—The warming of a building, apartment, or room by a furnace or electrical stove.

**Heating plant**—The furnace, boiler, or the other heating devices used to generate steam, hot water, or hot air, which then is circulated through a distribution system. It typically uses coal, gas, oil or wood as its source of heat.

**Limit control**—A thermostatic device installed in the duct system to shut off the supply of heat at a predetermined temperature of the circulated air.

**Oil burner**—A device for burning oil in heating appliances such as boilers, furnaces, water heaters, and ranges. A burner of this type may be a pressure-atomizing gun type, a horizontal or vertical rotary type, or a mechanical or natural draft-vaporizing type.

**Oil stove**—A flue-connected, self-contained, self-supporting oil-burning range or room heater equipped with an integral tank not exceeding 10 gallons; it may be designed to be connected to a separate oil tank.

**Plenum chamber**—An air compartment to which one or more distributing air ducts are connected.

**Pump, automatic oil**—A device that automatically pumps oil from the supply tank and delivers it in specific quantities to an oil-burning appliance. The pump or device is designed to stop pumping automatically if the oil supply line breaks.

**Radiant heat**—A method of heating a building by means of electric coils, hot water, or steam pipes installed in the floors, walls, or ceilings.

**Register**—A grille-covered opening in a floor, ceiling, or wall through which hot or cold air can be introduced into a room. It may or may not be arranged to permit closing the grille.

**Room heater**—A self-contained, freestanding heating appliance (space heater) intended for installation in the space being heated and not intended for duct connection.

**Smoke detector**—A device installed in several rooms of the structure to warn of the presence of smoke. It should provide an audible alarm. It can be battery powered or electric, or both. If the unit is battery powered, the batteries should be tested or checked on a routine basis and changed once per year. If the unit is equipped with a 10-year battery, it is not necessary to replace the battery every year.

**Tank**—A separate tank connected, directly or by pump, to an oil-burning appliance.

**Thimble**—A metal or terra cotta lining for a chimney or furnace pipe.

**Valve (main shut-off valve)**—A manually operated valve in an oil line used to turn the oil supply to the burner on or off.

**Vent system**—The gas vent or chimney and vent connector, if used, assembled to form a continuous, unobstructed passageway from the gas appliance to the outside atmosphere to remove vent gases.

Gas, electricity, oil, coal, wood, and solar energy are the main energy sources for home heating and cooling. Heating systems commonly used are steam, hot water and hot air. A housing inspector should have knowledge of the various heating fuels and systems to be able to determine their adequacy and safety in operation. To cover fully all aspects of the heating and cooling system, the entire area and physical components of the system must be considered.

## Heating

Fifty-one percent of the homes in the United States are heated with natural gas, 30% are heated with electricity, and 9% with fuel oil. The remaining 11% are heated with bottled fuel, wood, coal, solar, geothermal, wind, or solar energy [1]. Any home using combustion as a source of heating, cooling, or cooking or that has an attached garage should have appropriately located and maintained carbon monoxide (CO) gas detectors. According to the U.S. Consumer Product Safety Commission (CPSC), from data collected in 2000, CO kills 200 people and sends more than 10,000 to the hospital each year.

The standard fuels for heating are discussed below.

### Standard Fuels

#### *Gas*

More than 50% of American homes use gas fuel. Gas fuels are colorless gases. Some have a characteristic pungent odor; others are odorless and cannot be detected by smell. Although gas fuels are easily handled in heating equipment, their presence in air in appreciable quantities becomes a serious health hazard. Gases diffuse readily in the air, making explosive mixtures possible. A proportion of combustible gas and air that is ignited burns with such a high velocity that an explosive force is created. Because of these characteristics of gas fuels, precautions must be taken to prevent leaks, and care must be exercised when gas-fired equipment is lit.

Gas is broadly classified as natural or manufactured.

- **Natural gas**—This gas is a mixture of several combustible and inert gases. It is one of the richest gases and is obtained from wells ordinarily located in petroleum-producing areas. The heat content may vary from 700 to 1,300 British thermal units (BTUs) per cubic foot, with a generally accepted average figure of 1,000 BTUs per cubic foot. Natural gases are distributed through pipelines to the point of use and are often mixed with manufactured gas to maintain a guaranteed BTU content.

- **Manufactured gas**—This gas, as distributed, is usually a combination of certain proportions of gases produced from coke, coal, and petroleum. Its BTU value per cubic foot is generally closely regulated, and costs are determined on a guaranteed BTU basis, usually 520 to 540 BTUs per cubic foot.
- **Liquefied petroleum gas**—Principal products of liquefied petroleum gas are butane and propane. Butane and propane are derived from natural gas or petroleum refinery gas and are chemically classified as hydrocarbon gases. Specifically, butane and propane are on the borderline between a liquid and a gaseous state. At ordinary atmospheric pressure, butane is a gas above 33°F (0.6°C) and propane a gas at -42°F (-41°C). These gases are mixed to produce commercial gas suitable for various climatic conditions. Butane and propane are heavier than air. The heat content of butane is 3,274 BTUs per cubic foot, whereas that of propane is 2,519 BTUs per cubic foot.

Gas burners should be equipped with an automatic shut-off in case the flame fails. Shutoff valves should be located within 1 foot of the burner connection and on the output side of the meter.

Caution: Liquefied petroleum gas is heavier than air; therefore, the gas will accumulate at the bottom of confined areas. If a leak develops, care should be taken to ventilate the appliance before lighting it.

#### *Electricity*

Electricity has gained popularity for heating in many regions, particularly where costs are competitive with other sources of heat energy, with usage increasing from 2% in 1960 to 30% in 2000. With an electric system, the housing inspector should rely mainly on the electrical inspector to determine proper installation. There are a few items, however, to be concerned with to ensure safe use of the equipment. Check to see that the units are approved by an accredited testing agency and installed according to the manufacturer's specifications. Most convector-type units must be installed at least 2 inches above the floor level, not only to ensure that proper convection currents are established through the unit, but also to allow sufficient air insulation from any combustible flooring material. The housing inspector should check for curtains that extend too close to the unit or loose, long-pile rugs that are too close. A distance of 6 inches on the floor and 12 inches on the walls should separate rugs or curtains from the appliance.



Heat pumps are air conditioners that contain a valve that allows switching between air conditioner and heater. When the valve is switched one way, the heat pump acts like an air conditioner; when it is switched the other way, it reverses the flow of refrigerants and acts like a heater. Cold is the absence of energy or calories of heat. To cool something, the heat must be removed; to warm something, energy or calories of heat must be provided. Heat pumps do both.

A heat pump has a few additions beyond the typical air conditioner: a reversing valve, two thermal expansion valves, and two bypass valves. The reversing valve allows the unit to provide both cooling and heating. Figure 12.1 shows a heat pump in cooling mode. The unit operates as follows:

- The compressor compacts the refrigerant vapor and pumps it to the reversing valve.
- The reversing valve directs the compressed vapor to flow to the outside heat exchanger (condenser), where the refrigerant is cooled and condensed to a liquid.
- The air blowing through the condenser coil removes heat from the refrigerant.
- The liquid refrigerant bypasses the first thermal expansion valve and flows to the second thermal expansion valve at the inside heat exchanger (evaporator) where it expands into the evaporator and becomes vapor.
- The refrigerant picks up heat energy from the air blowing across the evaporator coil and cool air comes out at the other side of the coil. The cool air is ducted to the occupied space as air-conditioned air.
- The refrigerant vapor then goes back to the reversing valve to be directed to the compressor to start the refrigeration cycle all over again.

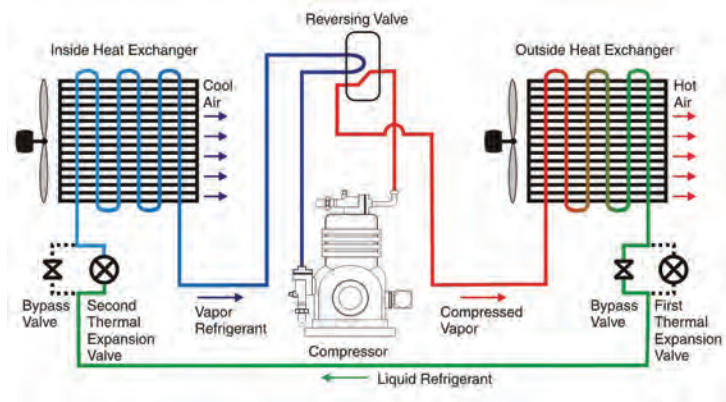

Figure 12.1. Heat Pump in Cooling Mode [2]

Heat pumps [3] are quite efficient in their use of energy. However, heat pumps often freeze up; that is, the coils in the outside air collect ice. The heat pump has to melt this ice periodically, so it switches itself back to air conditioner mode to heat up the coils. To avoid pumping cold air into the house in air conditioner mode, the heat pump also uses electric strip heaters to heat the cold air that the air conditioner is pumping out. Once the ice is melted, the heat pump switches back to heating mode and turns off the burners.

Radiant heat warms objects directly with longwave electromagnetic energy. The heating panels diffuse heating energy rays in a 160° arc, distributing warmth evenly. The goal is to achieve no more than a 4°F (-16°C) difference in temperature between floor level and ceiling level. When properly installed, radiant heat warms a room sooner and at lower temperature settings than do other kinds of heat. Extreme care must be taken to protect against fire hazards from objects in close proximity to the infrared radiation reflectors. Inspectors dealing with this heat source should have specialized training. Radiant heating is plastered into the ceiling or wall in some homes or in the brick or ceramic floors of bathrooms. If wires are bare in the plaster, they should be treated as open and exposed wiring. The inspector should be knowledgeable about these systems, which are technical and relatively new.

### Fuel Oil

Fuel oils are derived from petroleum, which consists primarily of compounds of hydrogen and carbon (hydrocarbons) and smaller amounts of nitrogen and sulfur. Domestic fuel oils are controlled by rigid specifications. Six grades of fuel oil—numbered 1 through 6—are generally used in heating systems; the lighter two grades are used primarily for domestic heating:

- **Grade Number 1**—a volatile, distillate oil for use in burners that prepare fuel for burning solely by vaporization (oil-fired space heaters).
- **Grade Number 2**—a moderate weight, volatile, distillate oil used for burners that prepare oil for burning by a combination of vaporization and atomization. This grade of oil is commonly used in domestic heating furnaces.

Heating values of oil vary from approximately 152,000 BTU per gallon for number 6 oil to 136,000 BTU per gallon for number 1 oil. Oil is more widely used today than coal and provides a more automatic source of heat and comfort. It also requires more complicated systems

and controls. If the oil supply is in the basement or cellar area, certain code regulations must be followed (Figure 12.2) [4–7]. No more than two 275-gallon tanks may be installed above ground in the lowest story of any one building. The IRC recommends a maximum fuel oil storage of 660 gallons. The tank shall not be closer than 7 feet horizontally to any boiler, furnace, stove, or exposed flame(s).

Fuel oil lines should be embedded in a concrete or cement floor or protected against damage if they run across the floor. Each tank must have a shutoff valve that will stop the flow if a leak develops in the line to or in the burner itself. A leak-tight liner or pan should be installed under tanks and lines located above the floor. They contain potential leaks so the oil does not spread over the floor, creating a fire hazard.

The tank or tanks must be vented to the outside, and a gauge showing the quantity of oil in the tank or tanks must be tight and operative. Steel tanks constructed before 1985 had a life expectancy of 12–20 years. Tanks must be off the floor and on a stable base to prevent settlement or movement that may rupture the connections. Figure 12.3 shows a buried outside tank installation. In 1985, federal legislation was passed requiring that the exterior components of underground storage tanks (USTs) installed after 1985 resist the effects of pressure, vibration, and movement. Federal regulations for USTs exclude the following: farm and residential tanks of 1,100 gallons (420 liters) or less capacity; tanks storing heating oil used on the premises; tanks on or above the floor of basements; septic tanks; flow-through process tanks; all tanks with capacity of 110 gallons or less; and emergency spill and overfill tanks [8]. A review of local and state regulations should be completed before installing underground tanks because many jurisdictions do not allow burial of gas or oil tanks.

## Coal

The four types of coal are anthracite, bituminous, sub-bituminous, and lignite. Coal is prepared in many sizes and combinations of sizes. The combustible portions of the coal are fixed carbons, volatile matter (hydrocarbons), and small amounts of sulfur. In combination with these are noncombustible elements composed of moisture and impurities that form ash. The various types differ in heat content. Heat content is determined by analysis and is expressed in British thermal units per pound.

Improper coal furnace operation can result in an extremely hazardous and unhealthy home. Ventilation of the area surrounding the furnace is very important to prevent heat buildup and to supply air for combustion.

## Solar Energy

Solar energy has gained popularity in the last 25 years as the cost of installation of solar panels and battery storage has decreased. Improved technology with panels, installation of panels, piping, and batteries has created a much larger market. Solar energy largely has been used to heat water. Today, there are more than a million solar water-heating systems in the United States. Solar water heaters use direct sun to heat either water or a heat-transfer fluid in collectors [3]. That water is then stored for use as needed, with a conventional system providing any necessary additional heating. A typical system will reduce the need for conventional water heating by about two-thirds, minimizing the cost of electricity or the use of fossil fuel and thus the environmental impact associated with their use. The U.S. Department of Housing and Urban Development and the U.S. Department of Energy (DOE) have instituted initiatives to deploy new solar technologies in the next generation of American housing [3]. For example, DOE

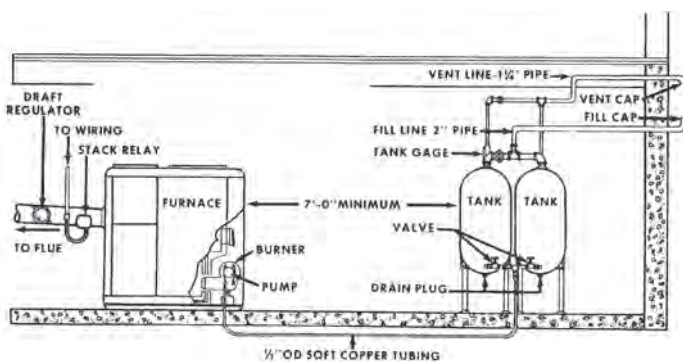

Figure 12.2. Piping Hookup for Inside Tank Installation [4]

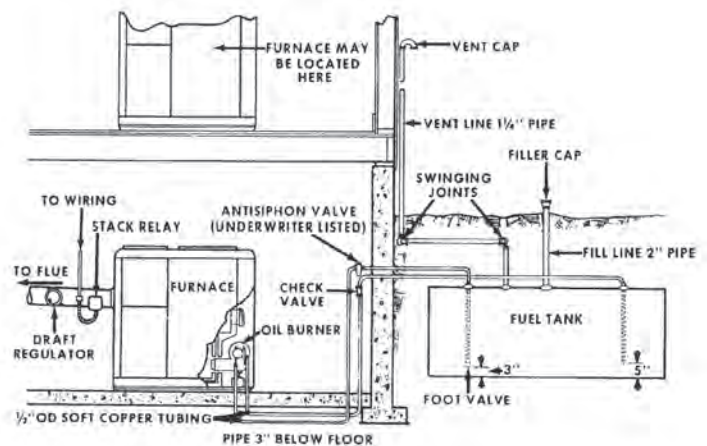

Figure 12.3. Piping Hookup for Buried Outside Tank [4]

has the Million Solar Roofs Initiative begun in 1997 to install solar energy systems in more than 1 million U.S. buildings by 2010.

### Central Heating Units

The boiler should be placed in a separate room whenever possible, which is usually required in new construction. In most housing inspections, however, the inspector is dealing with existing conditions and must adapt the situation as closely as possible to acceptable safety standards. In many old buildings, the furnace is located in the center of the cellar or basement. This location does not lend itself to practical conversion to a boiler room.

Consider the physical requirements for a boiler or furnace.

- Ventilation—More circulating air is required for the boiler room than for a habitable room, to reduce the heat buildup caused by the boiler or furnace and to supply oxygen for combustion.
- Fire protection rating—As specified by various codes (fire code, building code, and insurance underwriters), the fire regulations must be strictly adhered to in areas surrounding the boiler or furnace. This minimum clearance for a boiler or furnace from a wall or ceiling is shown in Figures 12.4 and 12.5.

Asbestos was used in numerous places on furnaces to protect buildings from fire and to prevent lost heat. Figure 12.6 shows asbestos-coated heating ducts, for example. Where asbestos insulation is found, it must be handled with care (breathing protection and protective clothing) and care must be taken to prevent or contain release into the air [10].

The furnace or boiler makes it difficult to supply air and ventilation for the room. Where codes and local authority permit, it may be more practical to place the furnace or boiler in an open area. The ceiling above the furnace should be protected to a distance of 3 feet beyond all

furnace or boiler appurtenances, and this area should be free of all storage material. The furnace or boiler should be on a firm foundation of concrete if located in the cellar or basement. If codes permit furnace installations on the first floor, then they must be consulted for proper setting and location.

### Heating Boilers

The term boiler is applied to the single heat source that can supply either steam or hot water (a boiler is often called a heater).

Boilers may be classified according to several kinds of characteristics. They are typically made from cast iron or steel. Their construction design may be sectional, portable, fire-tube, water-tube, or special. Domestic heating boilers are generally of low-pressure type with a maximum working pressure of 15 pounds per square inch (psi) for steam and 30 psi for hot water. All boilers have a combustion chamber for burning fuel. Automatic fuel-firing devices help supply the fuel and control the combus-

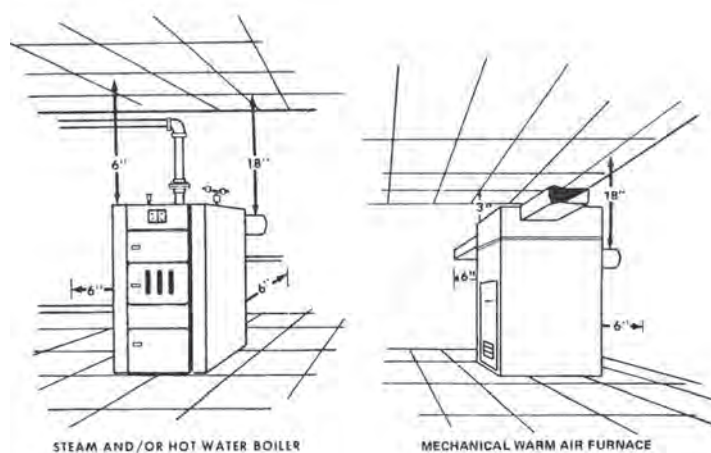

**Figure 12.5.** Minimum Clearance for Steam or Hot Water Boiler and Mechanical Warm-air Furnace [4]

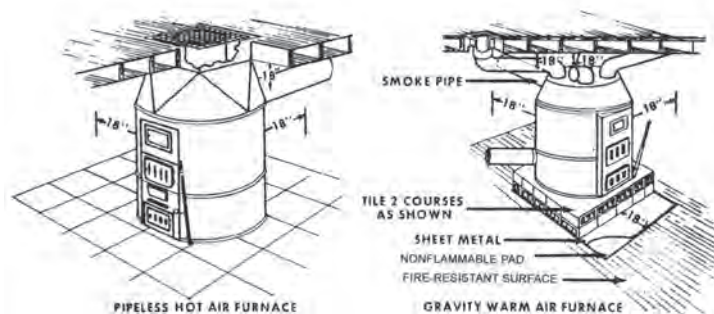

**Figure 12.4.** Minimum Clearance for Pipeless Hot Air and Gravity Warm Air Furnace [4]



**Figure 12.6.** Heating Ducts Covered With Asbestos Insulation

tion. Hand firing is accomplished by the provision of a grate, ash pit, and controllable drafts to admit air under the fuel bed and over it through slots in the firing door. A check draft is required at the smoke pipe connection to control chimney draft. The gas passes from the combustion chamber to the flue passages (smoke pipe) designed for maximum possible transfer of heat from the gas. Provisions must be made for cleaning flue passages.

Cast-iron boilers are usually shipped in sections and assembled at the site. They are generally classified as

- square or rectangular boilers with vertical sections; and
- round, square, or rectangular boilers with horizontal pancake sections.

Most steel boilers are assembled units with welded steel construction and are called portable boilers. Large boilers are installed in refractory brick settings on the site. Above the combustion chamber, a group of tubes is suspended, usually horizontally, between two headers. If flue gases pass through the tubes and water surrounds them, the boiler is designated as the fire-tube type. When water flows through the tubes, it is termed water-tube. Fire-tube is the predominant type.

### Heating Furnaces

Heating furnaces are the heat sources used when air is the heat-carrying medium. When air circulates because of the different densities of the heated and cooled air, the furnace is a gravity type. A fan may be included for the air circulation; this type is called a mechanical warm-air furnace. Furnaces may be of cast iron or steel and burn various types of fuel.

Some new furnaces are as fuel efficient as 95%. Furnaces with an efficiency of 90% or greater use two heat exchangers instead of one. Energy savings come not only from the increased efficiency, but also from improved comfort at lower thermostat settings.

### Fuel-burning Furnaces

Some localities throughout the United States still use coal as a heating fuel, including residences, schools, colleges and universities, small manufacturing facilities, and other facilities located near coal sources.

In many older furnaces, the coal is stoked or fed into the firebox by hand. The single-retort, underfeed-type bituminous coal stoker is the most commonly used domestic automatic-stoking steam or hot-water boiler (Figure 12.7). The stoker consists of a coal hopper, a screw for conveying coal from hopper to retort, a fan that supplies

air for combustion, a transmission for driving coal feed and fan, and an electric motor for supplying power. The air for combustion is admitted to the fuel through tuyeres (air inlets) at the top of the retort. The stoker feeds coal to the furnace intermittently in accordance with temperature or pressure demands.

Oil burners are broadly designated as distillate, domestic, and commercial or industrial. Distillate burners are usually found in oil-fired space heaters. Domestic oil burners are usually power driven and are used in domestic heating plants. Commercial or industrial burners are used in larger central-heating plants for steam or power generation.

Domestic oil burners vaporize and atomize the oil and deliver a predetermined quantity of oil and air to the combustion chambers. Domestic oil burners operate automatically to maintain a desired temperature.

Gun-type burners atomize the oil either by oil pressure or by low-pressure air forced through a nozzle. The oil system pressure-atomizing burner consists of a strainer, pump, pressure-regulating valve, shutoff valve and atomizing nozzle. The air system consists of a power-driven fan and an air tube that surrounds the nozzle and electrode assembly.

The fan and oil pump are generally connected directly to the motor. Oil pressures normally used are about 100 psi, but pressures considerably in excess of this are sometimes used.

The form and parts of low-pressure, air-atomizing burners are similar to high-pressure atomizing (gun) burners (Figure 12.8) except for addition of a small air pump and a different way of delivering air and oil to the nozzle or orifice.

The atomizing type burner, sometimes known as a radiant or suspended flame burner, atomizes oil by throwing

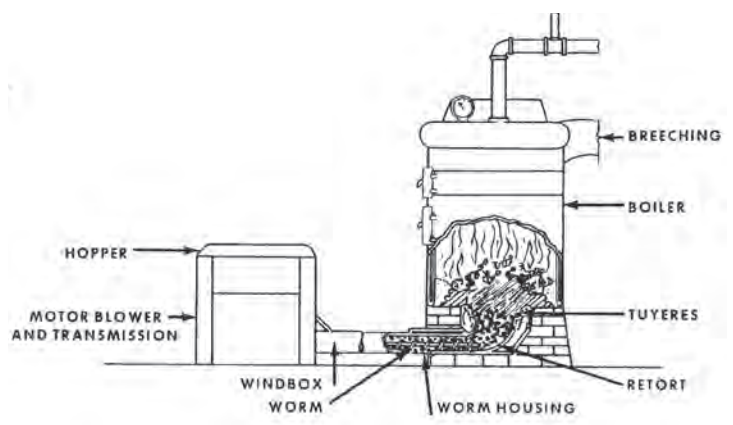

Figure 12.7. Typical Underfeed Coal Stoker Installation in Small Boilers [4]

it from the circumference of a rapidly rotating motor-driven cup. The burner is installed so that the driving parts are protected from the heat of the flame by a hearth of refractory material at about the grate elevation. Oil is fed by pump or gravity; the draft is mechanical or a combination of natural and mechanical.

Horizontal rotary burners were originally designed for commercial and industrial use but are available in sizes suitable for domestic use. In this burner, fuel oil being thrown in a conical spray from a rapidly rotating cup is atomized. Horizontal rotary burners use electric gas or gas-pilot ignition and operate with a wide range of fuels, primarily Numbers 1 and 2 fuel oil. Primary safety controls for burner operation are necessary. An antiflooding device must be a part of the system to stop oil flow if ignition in the burner should fail. Likewise, a stack control is necessary to shut off the burner if the stack temperatures are exceeded, thus cutting off all power to the burner. This button must be reset before starting can be attempted. The newer models now use electric eye-type control on the burner itself.

On the basis of the method used to ignite fuels, burners are divided into five groups:

- **Electric**—A high-voltage electric spark in the path of an oil and air mixture causes ignition. This electric spark may be continuous or may operate only long enough to ignite the oil. Electric ignition is almost universally used. Electrodes are located near the nozzles, but not in the path of the oil spray.
- **Gas pilot**—A small gas pilot light that burns continuously is frequently used. Gas pilots usually have expanded gas valves that automatically increase flame size when a motor circuit starts. After a fixed interval, the flame reverts to normal size (Figure 12.9).

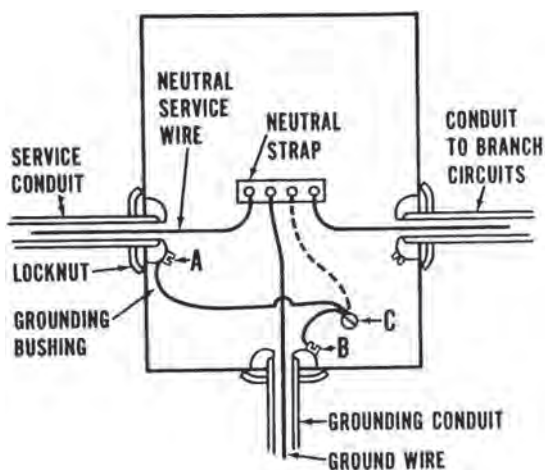

Figure 12.8. Cutaway View of Typical High-pressure Gun Burner [4]

- **Electric gas**—An electric spark ignites a gas jet, which in turn ignites the oil-air mixture.
- **Oil pilot**—A small oil flame is used.
- **Manual**—A burning wick or torch is placed in the combustion space through peepholes and thus ignites the charge. The operator should stand to one side of the fire door to guard against injury from chance explosion.

The refractory lining or material should be an insulating fireproof bricklike substance, never ordinary firebrick. The insulating brick should be set on end to build a 2½-inch-thick wall from furnace to furnace. The size and shape of the refractory pot vary from furnace to furnace. The shape can be either round or square, whichever is more convenient to build. It is more important to use a special cement having properties similar to that of the insulating refractory-type brick.

### Steam Heating Systems

Steam heating systems are classified according to the pipe arrangement, accessories used, method of returning the condensate to the boiler, method of expelling air from the system, or the type of control used. The successful operation of a steam heating system consists of generating steam in sufficient quantity to equalize building heat loss at maximum efficiency, expelling entrapped air, and returning all condensate to the boiler rapidly. Steam



Figure 12.9. Gas-fired Boiler  
Source: HUD

cannot enter a space filled with air or water at pressure equal to the steam pressure. It is important, therefore, to eliminate air and remove water from the distribution system. All hot pipelines exposed to contact by residents must be properly insulated or guarded. Steam heating systems use the following methods to return the condensate to the boiler:

- **Gravity one-pipe air-vent system**—One of the earliest types used, this method returns condensate to the boiler by gravity. This system is generally found in one-building-type heating systems. The steam is supplied by the boiler and carried through a single system or pipe to radiators, as shown in Figure 12.10. Return of the condensate is dependent on hydrostatic head. Therefore, the end of the steam main, where it attaches to the boiler, must be full of water (termed a wet return) for a distance above the boiler line to create a pressure drop balance between the boiler and the steam main.

Radiators are equipped with an inlet valve and an air valve. The air valve permits venting of air from the radiator and its displacement by steam. Condensate is drained from the radiator through the same pipe that supplies steam.

- **Two-pipe steam vapor system with return trap**—The two-pipe vapor system with boiler return trap and air eliminator is an improvement of the one-pipe system. The return connection of the radiator has a thermostatic trap that permits flow of condensate and air only from the radiator and prevents steam from leaving the radiator. Because the return main is at atmospheric pressure or less, a boiler return trap is installed to equalize condensate return pressure with boiler pressure.

### Water Heating Systems

All water heating systems are similar in design and operating principle. The one-pipe gravity water heating system is the most elementary of the gravity systems and is shown in Figure 12.10. Water is heated at the lowest point in the system. It rises through a single main because of a difference in density between hot and cold water. The supply rise or radiator branch takes off from the top of the main to supply water to the radiators. After the water gives up heat in the radiator, it goes back to the same main through return piping from the radiator. This cooler return water mixes with water in the supply main and causes the water to cool a little. As a result, the next radiator on the system has a lower emission rate and must be larger.

Note in Figure 12.11 that the high points of the hot water system are vented and the low points are drained. In this case, the radiators are the high points and the heater is the low point.

- **One-pipe forced-feed system**—If a pump or circulator is introduced in the main near the heater of the one-pipe system, it becomes a forced system that can be used for much larger applications than can the gravity type. This system can operate at higher water temperatures than the gravity system can. When the water is moving faster and at higher temperatures, it makes a more responsive system, with smaller temperature drops and smaller radiators for the same heating load.
- **Two-pipe gravity system**—A one-pipe gravity system may become a two-pipe system if the return radiator branch connects to a second main that returns water to the heater (Figure 12.12). Water temperature is practically the same in the entire radiator.
- **Two-pipe forced-circulation system**—This system is similar to a one-pipe forced-circulation system except that it uses the same piping arrangement found in the two-pipe gravity system.
- **Expansion tanks**—When water is heated, it tends to expand. Therefore, an expansion tank is necessary in a hot water system. The expansion tank, either open or closed, must be of sufficient size to permit a change in water volume within the heating system. If the expansion tank is open, it must be placed at least 3 feet above the highest point of the system. It will require a vent and an overflow. The open tank is usually in an attic, where it needs protection from freezing.

The closed expansion tank is found in modern installations. An air cushion in the tank compresses and

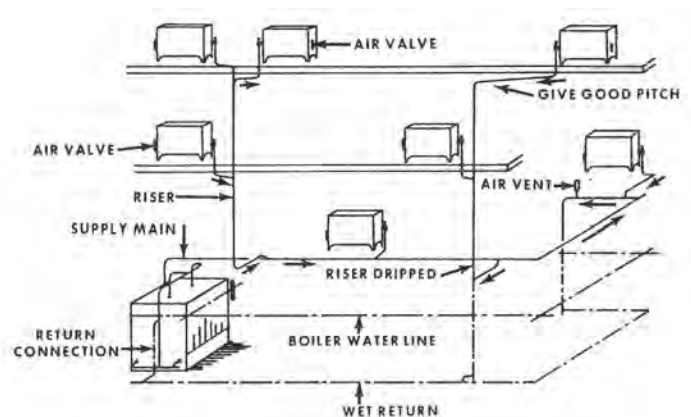

Figure 12.10. Typical Gravity One-pipe Heating System [4]

expands according to the change of volume and pressure in the system. Closed tanks are usually at the low point in the system and close to the heater. They can, however, be placed at almost any location within the heating system.

### Air Heating Systems

**Gravity Warm-air Heating Systems.** These operate because of the difference in specific gravity of warm air and cold air. Warm air is lighter than cold air and rises if cold air is available to replace it (Figure 12.13).

- **Operation**—Satisfactory operation of a gravity warm-air heating system depends on three factors: size of warm air and cold air ducts, heat loss of the building, and heat available from the furnace.
- **Heat distribution**—The most common source of trouble in these systems is insufficient pipe area, usually in the return or cold air duct. The total cross-section area of the cold duct or ducts must be at least equal to the total cross-section area of all warm ducts.
- **Pipeless furnaces**—The pipeless hot-air furnace is the simplest type of hot-air furnace and is suitable for small homes where all rooms can be grouped about a single large register. Other pipeless gravity furnaces are often installed at floor level. These are really oversized jacketed space heaters. The most common difficulty experienced with this type of furnace is supplying a return air opening of sufficient size on the floor.

**Forced Warm-air Heating Systems.** The mechanical warm-air furnace is the most modern type of warm-air equipment (Figures 12.13 and 12.14). It is the safest type because it operates at low temperatures. The principle of

a forced-warm-air heating system is very similar to that of the gravity system, except that a fan or blower is added to increase air movement. Because of the assistance of the fan or blower, the pitch of the ducts or leaders can be disregarded; therefore, it is practical to deliver heated air in the most convenient places.

- **Operation**—In a forced-air system, operation of the fan or blower must be controlled by air temperature in a bonnet or by a blower control furnace stat. The blower control starts the fan or blower when the temperature reaches a certain point and turns the fan or blower off when the temperature drops to a predetermined point.
- **Heat distribution**—Dampers in the various warm-air ducts control distribution of warm air either at the branch takeoff or at the warm-air outlet. Humidifiers are often mounted in the supply bonnet to regulate the humidity within the residence.

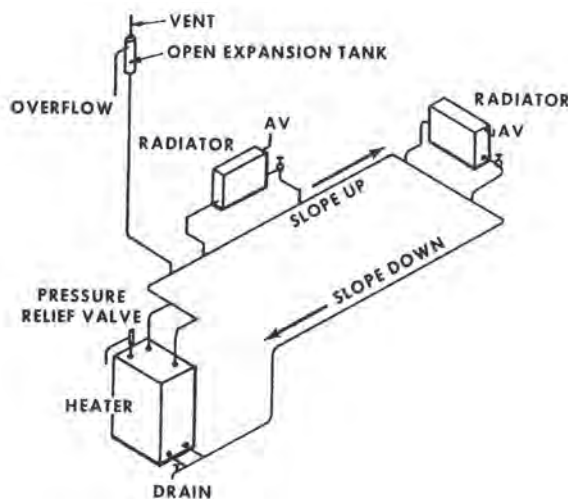

Figure 12.11. One-pipe Gravity Water Heating System [4]

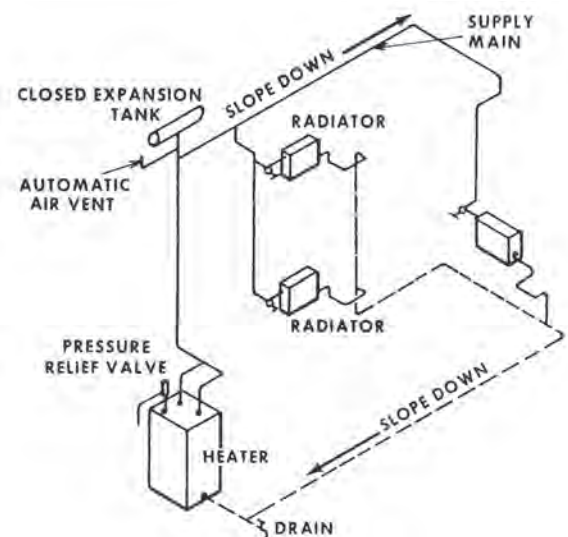

Figure 12.12. Two-pipe Gravity Water Heating System [4]

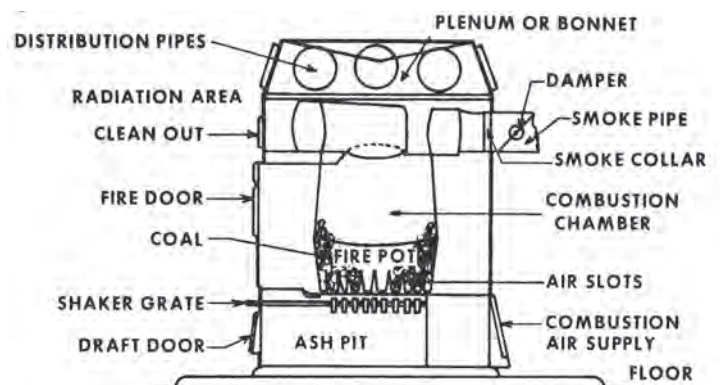

Figure 12.13. Warm-air Convection Furnace [4]

## Space Heaters

Space heaters are the least desirable type of heating from the viewpoint of fire safety and housing inspection. A space heater is a self-contained, free-standing air-heating appliance intended for installation in the space being heated and not intended for duct connection. According to the CPSC, consumers are not using care when purchasing and using space heaters. Approximately 21,800 residential fires are caused by space heaters a year, and 300 people die in these fires. An estimated 6,000 persons receive hospital emergency room care for burn injuries associated with contacting hot surfaces of space heaters, mostly in nonfire situations.

Individuals using space heaters should use the heaters in accordance with the following precautions:

- Read and follow the manufacturer's operating instructions. A good practice is to read aloud the instructions and warning labels to all members of the household to be certain that everyone understands how to operate the heater safely. Keep the owner's manual in a convenient place to refer to when needed.
- Choose a space heater that has been tested and certified by a nationally recognized testing laboratory. These heaters meet specific safety standards.
- Buy a heater that is the correct size for the area you want to heat. The wrong size heater could produce more pollutants and may not be an efficient use of energy.
- Choose models that have automatic safety switches that turn off the unit if it is tipped over accidentally.
- Select a space heater with a guard around the flame area or heating element. Place the heater on a level, hard, nonflammable surface, not on rugs or carpets or near bedding or drapes. Keep the heater at least 3 feet from bedding, drapes, furniture, or other flammable materials.

- Keep doors open to the rest of the house if you are using an unvented fuel-burning space heater. This helps prevent pollutant build-up and promotes proper combustion. Follow the manufacturer's instructions for oil heaters to provide sufficient combustion air to prevent CO production.
- Never leave a space heater on when you go to sleep. Never place a space heater close to any sleeping person.
- Turn the space heater off if you leave the area. Keep children and pets away from space heaters. Children should not be permitted to either adjust the controls or move the heater.
- Keep any portable heater at least 3 feet away from curtains, newspapers, or anything that might burn.
- Have a smoke detector with fresh batteries on each level of the house and a CO detector outside the sleeping area. Install a CO monitor near oil space heaters at the height recommended by the manufacturer.
- Be aware that mobile homes require specially designed heating equipment. Only electric or vented fuel-fired heaters should be used.
- Have gas and kerosene space heaters inspected annually.
- Do not hang items to dry above or on the heater.
- Keep all heaters out of exit and high-traffic areas.
- Keep portable electric heaters away from sinks, tubs, and other wet or damp places to avoid deadly electric shocks.
- Never use or store flammable liquids (such as gasoline) around a space heater. The flammable vapors can flow from one part of the room to another and be ignited by the open flame or by an electrical spark.

### Coal-fired Space Heaters (Cannon Stove)

A coal stove is made entirely of cast iron. Coal on the grates receives primary air for combustion through the grates from the ash-door draft intake. Combustible gases driven from the coal by heat burn in the barrel of the stove, where they receive additional or secondary air through the feed door. The side and top of the stove absorb the heat of combustion and radiate it to the surrounding space. Coal stoves must be vented to the flue.

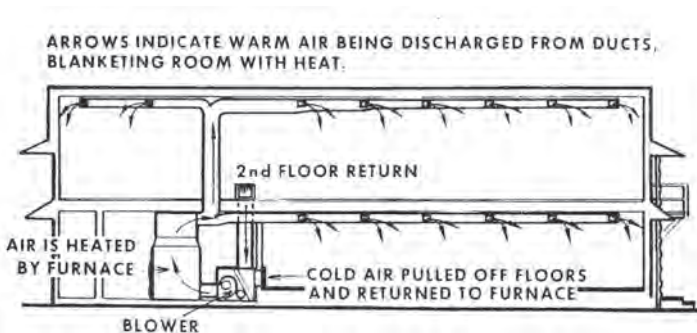

Figure 12.14. Cross-sectional View of Building Showing Forced Warm-air Heating System [4]



## Oil-fired Space Heaters

Oil-fired space heaters have atmospheric vaporizing-type burners. The burners require a light grade of fuel oil that vaporizes easily and in comparatively low temperatures. In addition, the oil must be such that it leaves only a small amount of carbon residue and ash within the heater. Oil stoves must be vented.

The burner of an oil-fired space heater consists essentially of a bowl, 8 to 13 inches in diameter, with perforations in the side that admit air for combustion. The upper part of the bowl has a flame ring or collar. Figure 12.15 shows a perforated-sleeve burner. When several space heaters are installed in a building, an oil supply from an outside tank to all heaters is often desirable. Figure 12.16 shows the condition of a burner flame with different rates of fuel flow and indicates the ideal flame height.

## Electric Space Heaters

Electric space heaters do not need to be vented.

## Gas-fired Space Heaters

The three types of gas-fired space heaters (natural, manufactured, and liquefied petroleum gas) have a similar construction. All gas-fired space heaters must be vented to prevent a dangerous buildup of poisonous gases. Each unit console consists of an enamel steel cabinet with top and bottom circulating grilles or openings, gas burners, heating elements, gas pilot, and a gas valve. The heating element or combustion chamber is usually cast iron.

**Caution:** All gas-fired space heaters and their connections must be approved by the American Gas Association

(AGA). They must be installed in accordance with the recommendations of that organization or the local code.

## Venting

Use of proper venting materials and correct installation of venting for gas-fired space heaters is necessary to minimize harmful effects of condensation and to ensure that combustion products are carried off. (Approximately 12 gallons of water are produced in the burn-

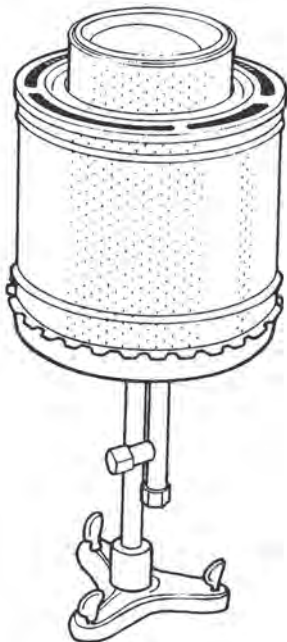

Figure 12.15. Perforated-sleeve Burner

ing of 1,000 cubic feet of natural gas. The inner surface of the vent must therefore be heated above the dew point of the combustion products to prevent water from forming in the flue.) A horizontal vent must be given an upward pitch of at least 1 inch per foot of horizontal distance.

When the smoke pipe extends through floors or walls, the metal pipe must be insulated from the floor or wall system by an air space (Figure 12.17). Sharp bends should be avoided. A 9° vent elbow has a resistance to flow equivalent to that of a straight section of pipe with a length 10 times the elbow diameter. Be sure that vents are of rigid construction and resistant to corrosion by flue gas products. Several types of venting material are available such as B-vent and other ceramic-type materials. A chimney lined with firebrick type of terra cotta must be relined with an acceptable vent material if it is to be used for venting gas-fired appliances.

The same size vent pipe should be used throughout its length. A vent should never be smaller than the heater outlet except when two or more vents converge from separate heaters. To determine the size of vents beyond the point of convergence, one-half the area of each vent should be added to the area of the largest heater's vent. Vents should be installed with male ends of inner liner down to ensure condensate is kept within pipes on a cold start. The vertical length of each vent or stack should be at least 2 feet greater than the length between horizontal connection and stack. Remember that the more conductive the unit, the lower the temperature of combustion and the more byproducts of combustion are likely to be

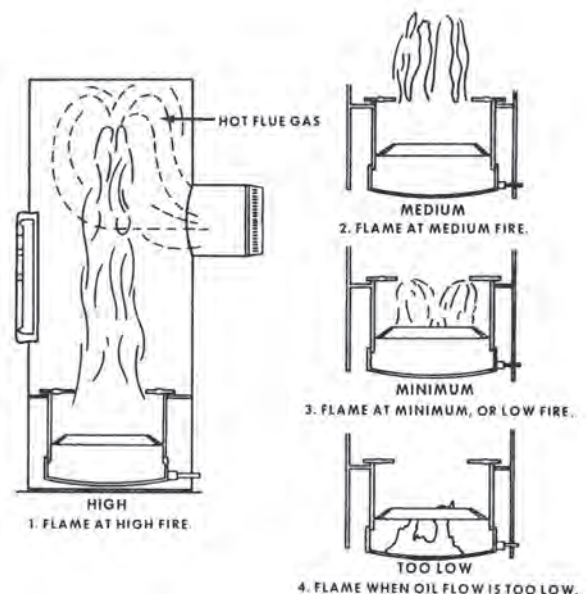

Figure 12.16. Condition of Burner Flame with Different Rates of Fuel Flow [4]

produced. These by-products are sometimes referred to as soot and creosote. These by-products will build up in vents, stacks, and chimneys. They are extremely flammable and can result in fire in these units that is hot enough to penetrate the heat shielding and throw burning material onto the roof of the home.

The vent should be run at least 3 feet above any projection within 20 feet of the building to place it above a possible pressure zone due to wind currents (Figure 12.18). A weather cap should prevent entrance of rain and snow. Gas-fired space heaters, as well as gas furnaces and water heaters, must be equipped with a backdraft diverter (Figure 12.19) to protect heaters against downdrafts and excessive updrafts. Only draft diverters approved by the AGA should be used.

The combustion chamber or firebox must be insulated from the floor, usually with airspace of 15 to 18 inches. The firebox is sometimes insulated within the unit and thus allows for lesser clearance firebox combustibles.

Floors should be protected where coal space heaters are located. The floor protection allows hot coals and ashes to cool off if dropped while being removed from the ash chamber. Noncombustible walls and materials should be used when they are exposed to heated surfaces. For space heaters, a top or ceiling clearance of 36 inches, a wall clearance of 18 inches, and a smoke pipe clearance of 18 inches are recommended.

## Hydronic Systems

Hydronic (circulating water) systems involving traditional baseboards can be single-pipe or two-pipe. Radiant systems are also an option. All hydronic systems require an expansion tank to compensate for the increase in water volume when it is heated (i.e., the volume of 50°F [10°C]

water increases almost 4% when it is heated to 200°F [93°C]). Single-pipe hydronic systems are most commonly used in residences. They use a single pipe with hot water flowing in a series loop from radiator to radiator. Massachusetts has a prototype set of hydronic systems requirements [11].

The drawback to this arrangement is that the temperature of the water decreases as it moves through each radiator. Thus, larger radiators are needed for those locations downstream in the loop. A common solution to this is multiple loops or zones. Each zone has its own temperature control with circulation provided by a small pump or zone valve in each loop. Two-pipe hydronic systems use a pipe for supplying hot water to the radiators and a second pipe for returning the water from the radiators to the boiler.

There are also direct- and reverse-return arrangements. The direct-return system can be difficult to balance because the pressure drop through the nearest radiator piping can be significantly less than for the farthest radiator. Reverse-return systems take care of the balancing problem, but require the expense of additional piping. Orifice plates at radiator inlets or balancing valves at radiator outlets can also be used to balance the pressure drops in a direct-return system.

## Direct Vent Wall Furnaces

Direct vent wall furnaces are specifically designed for areas where flues or chimneys are not available or cannot be used. The furnace is directly vented to the outside and external air is used to support combustion. The air on the inside is warmed as it recirculates around a sealed chamber.

## Cooling

### Air Conditioning

Many old homes relied on passive cooling-opening windows and doors and using shading devices-during the summer months. Homes were designed with windows on opposite walls to encourage cross ventilation and large

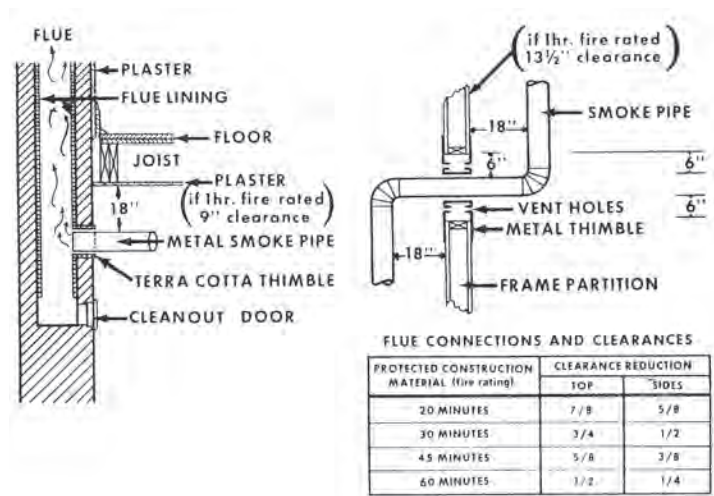

Figure 12.17. Wall and Ceiling Clearance Reduction [4]

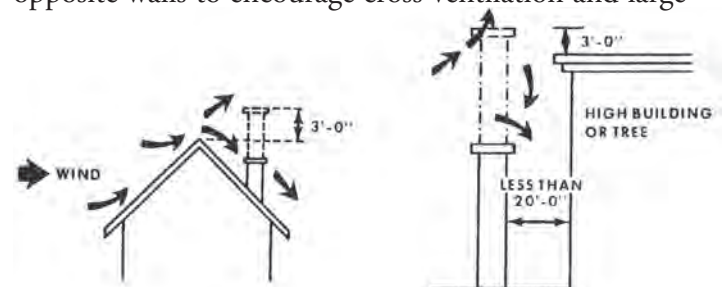

Figure 12.18. Draft Relation to Height of Chimney [4]

shade trees reduced solar heat gains. This approach is still viable, and improved thermal performance (insulating value) windows are available that allow for larger window areas to let in more air in the summer without the heat loss penalty in the winter. However, increased outdoor noise levels, pollution, and security issues make relying on open windows a less attractive option in some locations today.

An air conditioning system of some kind may be installed in the home. It may be a window air conditioner or through-the-wall unit for cooling one or two rooms, or a central split-system air conditioner or heat pump. In any event, the performance of these systems, in terms of providing adequate comfort without excessive energy use, should be investigated. The age of the equipment alone will provide some indication. If the existing system is more than 10 years old, replacement should be considered because it is much less efficient than today's systems and nearing the end of its useful life.

The refrigerant commonly used in today's residential air conditioners is R-22. Because of the suspicion that R-22 depletes the ozone layer, manufacturers will be prohibited from producing units with R-22 in 2010. The leading replacements for R-22 are R-134A and R-410A, and new products are now available with these nonozone-depleting refrigerants.

The performance measure for electric air conditioners with capacities less than 65,000 BTU is the seasonal energy efficiency ratio (SEER). SEER is a rating of cooling performance based on representative residential loads. It is reported in units of BTU of cooling per watt per hour of electric energy consumption. It includes energy used by the unit's compressor, fans, and controls. The higher the SEER, the more efficient the system. However, the highest SEER unit may not provide the most com-

fort. In humid climates, some of the highest SEER units exhibit poor dehumidification capability because they operate at higher evaporator temperatures to attain the higher efficiency. A SEER of at least 10 is required by the National Appliance Energy Conservation Act of 1987 for conventional central split-system air-cooled systems. The Department of Energy announced a SEER of 13 effective January 2006.

Cooling system options vary widely, depending on the level of control and comfort desired by the homeowner. Fans can increase circulation and reduce cooling loads, but they may be unsatisfactory in hot climates because their cooling capability is directly limited by outdoor conditions. Radiant barriers can reduce cooling loads in very hot climates. Evaporative coolers can be a relatively inexpensive and effective method of cooling in dry climates, such as the Southwest. Electric air conditioning maintains a comfortable indoor temperature and humidity even under the most severe outdoor conditions. More than 75% of new homes in the United States are equipped with some form of central air conditioning: 50% of the homes in the Northeast, 75% in the Midwest, 95% in the South, and approximately 60% in the West. Electric air conditioning removes moisture from the air and reduces its temperature. It can be a good investment because, in most parts of the country, the pay-back is significant when the house is sold.

Electric air conditioners that use the vapor-compression, refrigeration cycle are available in a variety of sizes and configurations, ranging from small window units to large central systems. The most common form of central air conditioning is a split-system with a warm air furnace (Figure 12.20). The same ductwork is used for distributing conditioned air during the heating and cooling seasons. Supply air is cooled and dehumidified as it passes over an A-shaped evaporator coil. The liquid refrigerant evaporates inside the coil as it absorbs heat from the air. The refrigerant gas then travels through refrigerant piping to the outdoor unit, where it is pressurized in an electrically driven compressor, raising its temperature and pressure, and returned to a liquid state in the condenser as it releases, or dumps, the heat to the outdoors. A fan draws outdoor air in over the condenser coil. The use of two-speed indoor fans can be advantageous in this type of system because the cooling load often requires higher airflows than the heating load. The lower speed can be used for the heating season and for improved dehumidification performance during the cooling season. The condenser unit for a house air conditioner is shown in Figure 12.21.

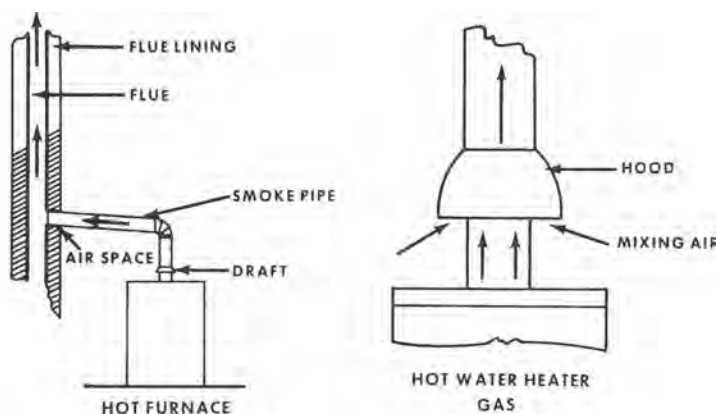

**Figure 12.19.** Location and Operation of Typical Backdraft Diverter [4]

## Circulation Fans

Air movement can make a person feel comfortable even when dry-bulb temperatures are elevated. A circulation fan (ceiling or portable) that creates an airspeed of 150 to 200 feet per minute can compensate for a 4°F (-16°C) increase in temperature.

Ceiling circulation fans also can be beneficial in the heating season by redistributing warm air that collects along the ceiling, but they can be noisy.

## Evaporation Coolers

In dry climates, as in the southwestern United States, an evaporative cooler or “swamp” cooler may provide sufficient cooling. This system cools an airstream by evaporating water into it; the airstream’s relative humidity increases while the dry-bulb temperature decreases. A 95°F (35°C), 15% relative humidity airstream can be conditioned to 75°F (24°C), 50% relative humidity. The simplest direct systems are centrally located and use a pump to supply water to a saturated pad over which the supply air is blown. Indirect systems use a heat exchanger between the airstream that is cooled by evaporating water and the supply airstream. The moisture level of the supply airstream is not affected as it is cooled.

Evaporation coolers have lower installation and operating costs than electric air conditioning. No ozone-depleting refrigerant is involved. They provide high levels of ventilation because they typically condition and supply 100% outside air.

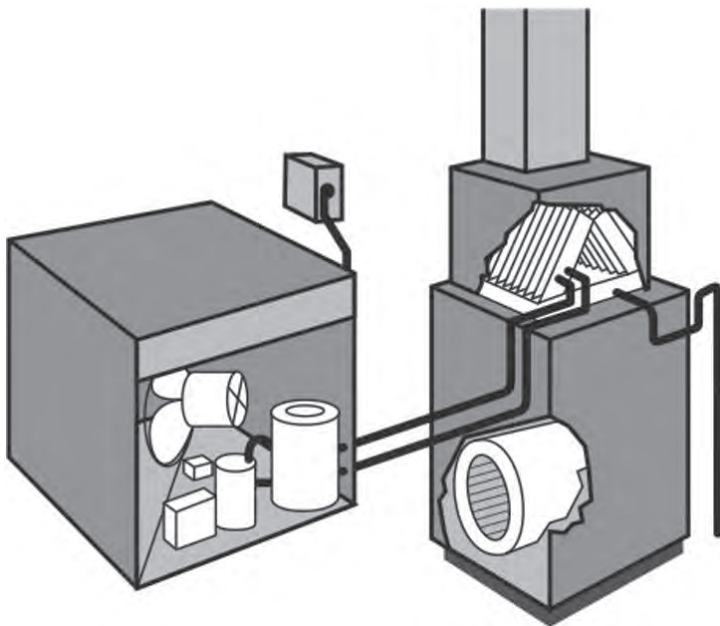

Figure 12.20. Split-system Air Conditioner

The disadvantages are that bacterial contamination can result if not properly maintained and they are only appropriate for dry, hot climates.

## Safety

Cooling homes with window air conditioners requires attention to the maintenance requirements of the unit. The filter must be cleaned or replaced as recommended by the manufacturer, and the drip pan should be checked to ensure that proper drainage from the unit is occurring. The pans should be rinsed and disinfected as recommended by the manufacturer. Both bacteria and fungi can establish themselves in these areas and present serious health hazards.

Condensation forms on the cooling coils of central air units inside and outside the home. These units should have a properly installed drip pan and should be drained according to the manufacturer’s instructions. They also should receive routine maintenance, flushing, and disinfection. In the spring, before starting the air conditioner, the unit should be checked by a professional or someone familiar with the operation of the system. This is a good time to check drip line(s) for conditions such as plugs, cracks, or bacterial contamination because many of these lines are plastic. The drip pan should be cleaned thoroughly and disinfected if necessary or replaced. A plugged drip line can cause water damage by overflow from the drip pan. In the fall, the heat unit also should be checked before starting the system. Care should be taken with both window air conditioning units and central air systems to use quality air filters that are designed for the specific units and meet the specifications required by the system’s manufacturer.



Figure 12.21. External Air-conditioning Condenser Unit

The housing inspector should be on the alert for unvented, open flame heaters. Coil-type, wall-mounted water heaters that do not have safety relief valves are not permitted. Kerosene (portable) units for cooking or heating should be prohibited. Generally, open-flame portable units are not allowed under fire safety regulations.

In oil heating units, other than integral tank units, the oil must be filled and vented outside the building. Filling oil within buildings is prohibited. Cutoff switches should be close to the entry but outside of a boiler room.

## Chimneys

Chimneys (Figure 12.22) are often an integral part of a building. Masonry chimneys must be tight and sound; flues should be terra cotta-lined; and, where no linings are installed, the brick should be tight to permit proper draft and elimination of combustion gases.

Chimneys that act as flues for gas-fired equipment must be lined with either B vent or terra cotta. When a portion of the chimney above the roof either loses insulation or the insulation peels back, it indicates potential poisonous gas release or water leakage problems and a need for rebuilding. Exterior deterioration of the chimney, if neglected too long, will permit erosion from within the flues and eventually block the flue opening.

Rusted flashing at the roof level will also contribute to the chimney's deterioration. Efflorescence on the inside wall of the chimney below the roof and on the outside of the chimney, if exposed, will show salt accumulations—a telltale sign of water penetration and flue gas escape and a sign of chimney deterioration. During rainy seasons, if terra cotta chimneys leak, dark areas show the number of flues inside the masonry chimney so they can actually be counted. When this condition occurs, it usually requires 2 or 3 months to dry out. After drying out, the mortar joints are discolored (brown). After a few years of this type of deterioration, the joints can be distinguished whether the chimney is wet or dry. These conditions usually develop when coal is used and become more pronounced 2 to 5 years after conversion to oil or gas.

An unlined chimney can be checked for deterioration below the roofline by looking for residue deposited at the base of the chimney, usually accessible through a cleanout (door or plug) or breaching. Red granular or fine powder showing through coal or oil soot will generally indicate, if in quantity (a handful), that deterioration is excessive and repairs are needed.

Unlined chimneys with attached gas units will be devoid of soot, but will usually show similar telltale brick powder

and deterioration. Manufactured gas has a greater tendency to dehydrate and decompose brick in chimney flues than does natural gas. For gas installations in older homes, utility companies usually specify chimney requirements before installation; therefore, older chimneys may require the installation of terra cotta liners, nonlead-lined copper liners, stainless steel liners, or transit pipe. Black carbon deposits around the top of the chimney usually indicate an oil burner operation using a low air ratio and high oil consumption. Prolonged operation in this burner setting results in long carbon water deposits down the chimney for 4 to 6 feet or more and should indicate to the inspector a possibility of poor burner maintenance. This will accent the need to be more thorough on the next inspection. This type of condition can result from other causes, such as improper chimney height, or exterior obstructions, such as trees or buildings, that will cause downdrafts or insufficient draft or contribute to a faulty heating operation. Rust spots and soot-mold usually occur on deteriorated galvanized smoke pipe.

## Fireplaces

Careful attention should be given to construction of the fireplace (Figure 12.23). Improperly built fireplaces are a serious safety and fire hazard. The most common causes of fireplace fires are thin walls, combustible materials such as studding or trim against sides and back of the fireplace, wood mantels, and unsafe hearths.

Fireplace walls should be no less than 8 inches thick; if built of stone or hollow masonry units, they should be no less than 12 inches thick. The faces of all walls exposed to fire should be lined with firebrick or other suitable fire-resistant material. When the lining consists of 4 inches of

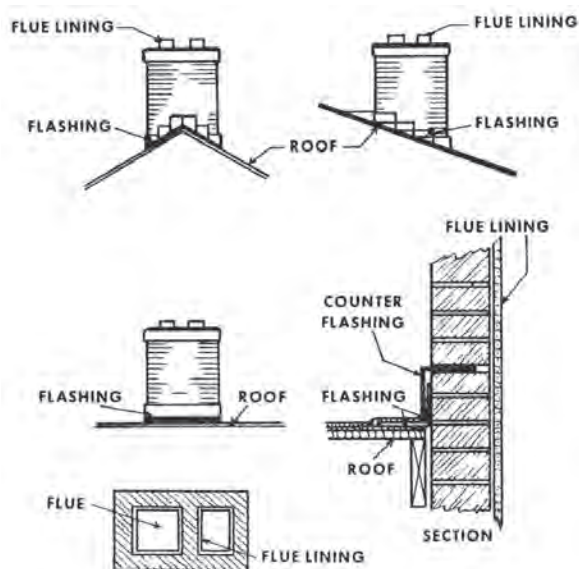

Figure 12.22. Chimney Plan [4]

firebrick, such lining thickness may be included in the required minimum thickness of the wall.

The fireplace hearth should be constructed of brick, stone, tile, or similar incombustible material and should be supported on a fireproof slab or on a brick arch. The hearth should extend at least 20 inches beyond the chimney breast and no less than 12 inches beyond each side of the fireplace opening along the chimney breast. The combined thickness of the hearth and its supporting construction should be no less than 6 inches at any point.

It is important that all wooden beams, joists, and studs are set off from the fireplace and chimney so that there is no less than 2 inches of clearance between the wood members and the sidewalls of the fireplace or chimney and no less than 4 inches of clearance between wood members and the back wall of the fireplace.

A gas-log set is primarily a decorative appliance. It includes a grate holding ceramic logs, simulated embers, a gas burner, and a variable flame controller. These sets can

be installed in most existing fireplaces. There are two principal types: vented and unvented. Vented types require a chimney flue for exhausting the gases. They are only 20% to 30% efficient; and most codes require that the flue be welded open, which results in an easy exit path for heated room air. Unvented types operate like the burner on a gas stove and the combustion products are emitted into the room. They are more efficient because no heat is lost up the flue and most are equipped with oxygen-depletion sensors. However, unvented types are banned in some states, including Massachusetts and California. Gas fireplaces incorporate a gas-log set into a complete firebox unit with a glass door. Some have built-in dampers, smoke shelves, and heat-circulating features that allow them to provide both radiant and convective heat. Units can have push-button ignition, remote control, variable heat controls, and thermostats. Gas fireplaces are more efficient than gas logs, with efficiencies of 60% to 80%. Many draw combustion air in from the outside and are direct vented, eliminating the need for a chimney. Some of these units are wall-furnace rated. There are also electric fireplaces that provide the ambience of a fire and, if desired, a small amount of resistance heat. These units have no venting requirements. The advantages are that there are no ashes or flying sparks that occur with wood-burning fireplaces. They are not affected by wood-burning bans imposed in some areas when air quality standards are not met. Direct-vented gas or electric models eliminate the need for a chimney.

The disadvantages are that the cost for equipment and running the gas line can be high.

## References

1. US Census Bureau. Rooms, number of bedrooms, and house heating fuel: 2000. Census 2000 Summary File 4 (SF4). Washington, DC: US Census Bureau; 2000. Available from URL: <http://factfinder.census.gov> [select Data Sets, then select Census 2000 Summary File 4 (SF 4) - Sample Data].
2. National Energy Efficiency Committee. Building: heat pumps; application of heat pumps in Singapore. Singapore: National Environment Agency; 2003. Available from URL: [http://www.neec.gov.sg/building/heat\\_pump.shtm](http://www.neec.gov.sg/building/heat_pump.shtm).
3. National Energy Efficiency Committee. Renewables: solar energy. Singapore: National Environment Agency; no date. Available from URL: <http://www.neec.gov.sg/renewables/solar.shtm>.

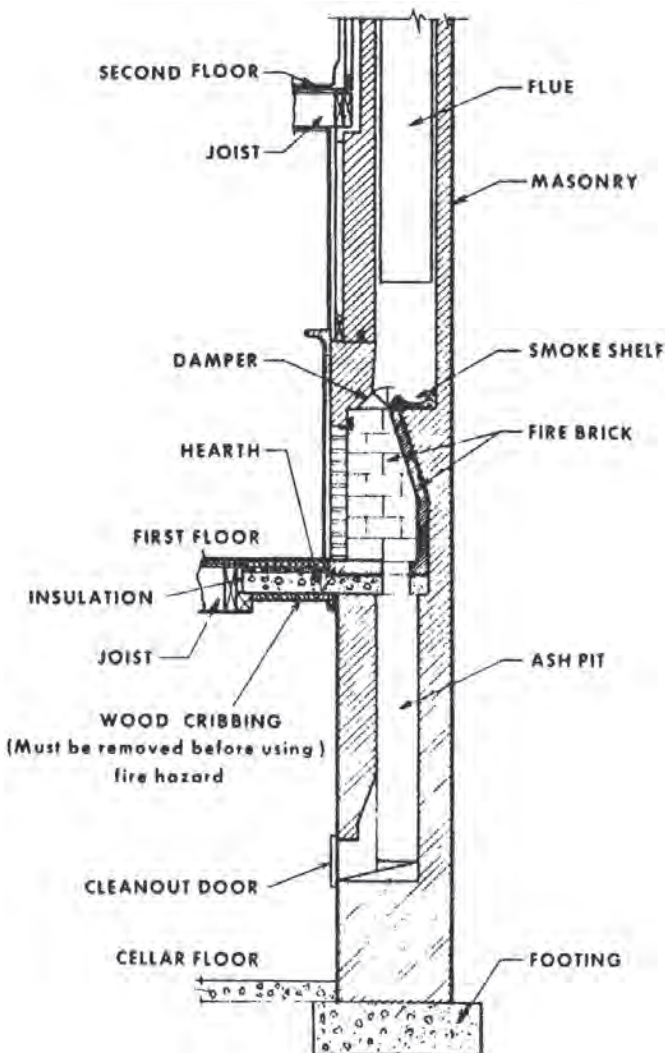

Figure 12.23. Fireplace Construction [4]

4. Center for Disease Control. Basic housing inspection. Atlanta: US Department of Health and Human Services; 1976.
5. Fairfax County. Fuel storage tanks. Fairfax, VA: Fairfax County; 2004. Available from URL: [http://www.co.fairfax.va.us/dpwes/construction/fuel\\_tanks.htm](http://www.co.fairfax.va.us/dpwes/construction/fuel_tanks.htm).
6. Wisconsin Department of Commerce. Environmental services—residential fuel oil and gasoline storage tanks. Madison, WI: Wisconsin Department of Commerce; 2004. Available from URL: <http://www.commerce.state.wi.us/ER/ER-BST-ResTk.html>.
7. Michigan Department of Environmental Quality. FAQ: Home heating oil tanks, Lansing, MI: Michigan Department of Environmental Quality; no date. Available from URL: [http://www.michigan.gov/deq/0,1607,7-135-3311\\_4115\\_4238-9379--,00.html](http://www.michigan.gov/deq/0,1607,7-135-3311_4115_4238-9379--,00.html).
8. US Environmental Protection Agency. Overview of the federal underground storage tank program. Washington, DC: U.S. Environmental Protection Agency; no date. Available from URL: <http://www.epa.gov/swerst1/overview.htm>.
9. US Department of Housing and Urban Development. Initiatives Programs. Washington, DC: US Department of Housing and Urban Development; 2004. Available from URL: <http://www.hud.gov/offices/cpd/energyenviron/energy/initiatives>.
10. US Environmental Protection Agency. Sources of indoor air pollution—asbestos. Washington, DC: U.S. Environmental Protection Agency; no date. Available from URL: <http://www.epa.gov/iaq/asbestos.html>.
11. The Commonwealth of Massachusetts Board of Building Regulations and Standards (BBRS). Hydronic system requirements. Boston: The Commonwealth of Massachusetts Board of Building Regulations and Standards (BBRS); no date. Available from URL: <http://www.mass.gov/bbrs/commntry/cmpxhydr.htm>.

## Additional Sources of Information

McQuiston FC, Parker JD, Spitler JD. Heating, ventilation, and air conditioning: analysis and design. 5th ed. Hoboken, NJ: John Wiley and Sons, Inc.; 2000.

Kittle JL. Home heating and air conditioning systems. New York: McGraw-Hill; 1990.

Pita EG. Air conditioning principles and systems: an energy approach. 4th ed. New York: Prentice Hall; 2001.





*“Engineering is the science of economy, of conserving the energy, kinetic and potential, provided and stored up by nature for the use of man. It is the business of engineering to utilize this energy to the best advantage, so that there may be the least possible waste.”*

William A. Smith  
1908

## Introduction

Using energy efficiently can reduce the cost of heating, ventilating, and air-conditioning, which account for a significant part of the overall cost of housing. Energy costs recur month-to-month and are hard to reduce after a home has been designed and built. The development of an energy-efficient home or building must be thought through using a systems approach. Planning for energy efficiency involves considering where the air is coming from, how it is treated, and where it is desired in the home. Improper use or installation of sealing and insulating materials may lead to moisture saturation or retention, encouraging the growth of mold, bacteria, and viruses. In addition, toxic chemicals may be created or contained within the living environment. These building errors may result in major health hazards. The major issues that must be balanced in using a systems approach to energy efficiency are energy cost and availability, long-term affordability and sustainability, comfort and efficiency, and health and safety.

## Energy Systems

Making sound decisions in designing, constructing, or updating dwellings will ensure not only greater use and enjoyment of the space, but also can significantly lower energy bills and help residents avoid adverse health effects. Systematic planning for energy efficiency also can assist prospective homeowners in qualifying for mortgages because lower fuel bills translate into lower total housing and utility payments. Some banks and credit unions take this into account when qualifying prospective homeowners for mortgages. “Energy-efficient” mortgages provide buyers with special benefits when purchasing an energy-efficient home.

Energy use and efficiency should be addressed in the context of selection of fuel types and appliances, location of the equipment, equipment sizing and backup systems, and programmed use when making decisions on space

heating, water heating, space cooling, window glazing, and lighting. Usage variables, such as taking excessively long showers, turning off lights when leaving rooms, or using appliances at full or near-full capacity, may increase or decrease energy use, depending on occupancy. Many of these demands can be optimized in the design stage of housing for new construction. However, when remodeling dwellings, making modifications to improve energy efficiency is often difficult. Preconstruction consultations with architects and energy specialists can produce trade-offs that retain the aesthetics and special aspects of a dwelling, while making appropriate investments in energy efficiency.

A price is paid for poor design and lack of proper insulation of dwellings, both in dollars for utility bills and in comfort of the occupants. The layout of rooms and overall tightness of a house in terms of air exchange affect energy requirements. In addition, home occupants and owners often are called on to make relatively minor decisions affecting total energy consumption, such as selecting lighting fixtures and bulbs and selecting settings for thermostats. Buying energy-efficient appliances can save energy, but the largest reduction in energy use can be derived from major decisions, such as considering the R-value of roof systems, insulation, and windows.

## R-values

Thermal resistance (a material’s resistance to heat flow) is rated by R-value. Higher R values mean greater insulating power, which means greater household energy savings and commensurate cost savings. Table 13.1 is a guideline for choosing R-values that are right for a particular home based on the climate, household heating system, and area in which it is located.

Another way of understanding R-value is to see it as the resistance to heat losses from a warmer inside temperature to the outside temperature through a material or building envelope (wall, ceiling or roof assembly, or window). Total heat loss is a function of the thermal conductivity of materials, area, time, and construction in a house.

The R-value of thermal insulation depends on the type of material, its thickness, and its density. In calculating the R-value of a multilayered installation, the R-values of the individual layers are added. Installing more insulation increases R-value and the resistance to heat flow.

In a climate that is...	And a heating system that is... [b]	Insulate to these levels in the...				Ducts [e] in unheated/uncooled...	
		Ceiling	Wood-frame wall [c]	Floor	Basement or crawl space walls [d]	Attic	Basement or crawl space
<b>Warm</b> , with cooling and minimal heating requirements [f]	Gas/oil or heat pump	R-22 to R-38	R-11 to R-15	R-11 to R-13	R-11 to R-19	R-4 to R-8	None to R-4
	Electric resistance	R-38 to R-49	R-11 to R-22	R-13 to R-25	R-11 to R-19	R-4 to R-8	None to R-4
	Gas/oil or heat pump	R-38	R-11 to R-22	R-13 to R-25	R-11 to R-19	R-4 to R-8	R-2 to R-8
<b>Mixed</b> , with moderate heating and cooling requirements [g]	Electric resistance	R-49	R-11 to R-28	R-25	R-11 to R-19	R-4 to R-8	R-2 to R-8
<b>Cold</b> , with mainly heating requirements [h]	Gas/oil	R-38 to R-49	R-11 to R-22	R-25	R-11 to R-19	R-6 to R-11	R-2 to R-11
	Heat pump or electric resistance	R-49	R-11 to R-28	R-25	R-13 to R-19	R-6 to R-11	R-2 to R-11

a. Adapted from the U.S. Department of Energy 1997 Insulation Fact Sheet available at (800)-DOE-EREC and Modera et al., *Impact of Residential Duct Insulation on HVAC Energy Use and Life Cycle Cost to Consumers*, *ASHRAE Transactions* 96-13-4.

b. Insulation is also effective at reducing cooling bills. These levels assume your house has electric air conditioning.

c. R-values may be achieved through a combination of cavity insulation and rigid board insulation and are for insulation only (not whole wall).

d. Do not insulate crawl space walls if crawl space is wet or ventilated with outdoor air.

e. Use the lower R-value for return ducts and higher R-value for supply ducts.

f. Florida and Hawaii; coastal California; southeast Texas; southern Alabama, Arkansas, Georgia, Louisiana, and Mississippi.

g. Idaho, Kentucky, Missouri, Nebraska, Oklahoma, Oregon, Virginia, Washington, and West Virginia; southern Indiana, Kansas, New Mexico, and Arizona; northern Alabama, Arkansas, Georgia, Louisiana, and Mississippi; inland California; and western Nevada.

h. Great Lakes area, mountainous areas [e.g., Colorado, Wyoming, Utah, etc.], New England, New York, northern Midwest, and Pennsylvania.

**Table 13.1.** Cost-effective Insulation R-values for Existing Homes [a;1]

The effectiveness of an insulated wall or ceiling also depends on how and where the insulation is installed. For example, insulation that is compressed will not provide its full rated R-value. Also, the overall R-value of a wall or ceiling will be somewhat different from the R-value of the insulation itself because some heat flows around the insulation through the studs and joists. That is, the overall R-value of a wall with insulation between wood studs is less than the R-value of the insulation itself because the wood provides a thermal short-circuit around the insulation. The short-circuiting through metal framing is much greater than that through wood-framed walls; sometimes the metal wall's overall R-value can be as low as half the insulation's R-value. With careful design, this short-circuiting can be reduced.

## Roofs

Roofs are composite structures, with composite R-values. The total R-value for the roof components shown in Figure 13.1 is 14.54 (Table 13.2). In general, a composite structure with a composite R-value of more than R-38

provides a substantial barrier to heat loss. Of course, in the winter the outside air temperature would vary significantly between locations such as Pensacola, Florida, and Fairbanks, Alaska, and would affect the cost-effectiveness of additional insulation and construction using various roofing components (Table 13.2).

The location of a house is usually a fixed variable in calculating R-values once the lot is purchased. However, the homeowner should consider the value of additional insulation by comparing its cost with the savings resulting from the increase in energy efficiency. Roof construction, including components such as ridge vents and insulating materials, is quite important and is often one of the more cost-effective ways to lower energy costs.

## Ridge Vents

Ridge vents are important to roofs for at least three reasons. First, ridge vents help lower the temperature in the roof structure and, consequently, in the attic and in the habitable space below. Second, ridge vents and rotating turbine vents help prolong the life of the roofing materials,

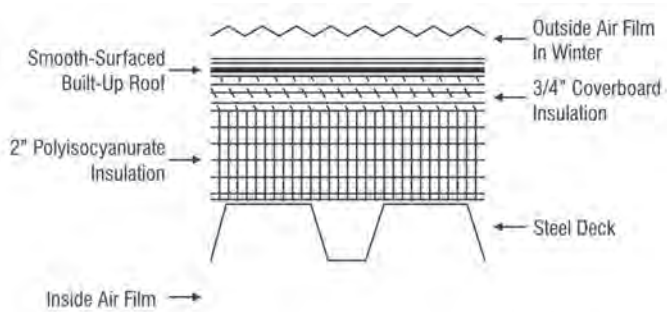

**Figure 13.1.** Roof Components [2]

particularly asphalt shingles and plywood sheathing. Third, ridge vents assist in air circulation and help avoid problems with excessive moisture.

### Fan-powered Attic Ventilation

Attic ventilators are small fans that remove hot air and reduce attic temperature. Adequate inlet vents are important. Typically these vents are located under the eaves of the house. The fan should be located near the peak of the roof for best performance.

### White Roof Surface

White roof surfaces combined with any of the measures listed above will improve their performance significantly. The white surface reflects much of the sun's heat and keeps the roof much cooler than a typical roof.

### Insulation

Insulation forms a barrier to the outside elements. It can help ensure that occupants are comfortable and that the home is energy-efficient. Ceiling insulation improves comfort and cuts electricity or natural gas costs for heating and cooling. For instance, the use of R-19 insulation in houses in Hawaii [3] could have the following results:

- Reduce indoor air temperature by 4°F (-16°C) in the afternoon.

Component	R-value
Inside air film	0.92
Steel deck	0.00
2-inch polyisocyanurate (5.56 x 2)	11.12
¾-inch perlite (2.78 x 0.75)	2.09
Smooth built-up roof	0.24
Outside air film in winter	0.17
<b>Total</b>	<b>14.54</b>

**Table 13.2.** Potential Effects of Radiant Barriers [3]

- Lower the ceiling temperature, perhaps by more than 15°F (-9.4°C). Insulation [radiant barrier] can reduce ceiling temperatures from 101°F (38°C) in bright sun on Oahu to 83°F (28°C). (Figure 13.2).
- Reduce or eliminate the need for an air-conditioner.

Energy savings, of course, will vary depending on energy prices. The payback afforded by additional insulation or investment in energy conservation measures is the average amount of time it will require for the initial capital cost to be recovered as a result of the savings in energy bills. A payback of 3 to 5 years might be economic, because the average homeowner stays in a home that long. However, payback criteria can vary by individual, and renters, for example, often face the dilemma of not wanting to make improvements for which they may not be able to fully realize the benefits. Described below are a few insulation alternatives.

To achieve maximum effect, the method of installation and type of insulation are of considerable importance. The proper placement of moisture barriers is essential. If insulation becomes moisture-saturated, its resistance to energy loss is significantly reduced. Barriers to moisture should be installed toward the living area because significant moisture is generated in the home through respiration, cooking, and the combustion of heating fuels.

**Cellulose or fiberglass** insulation is the most cost-effective insulation. Blown-in cellulose or fiberglass and fiberglass batts are similar in cost and performance. Recycled cellulose insulation may be available. For the best performance, insulation should be 5 to 6 inches thick. It can be installed in attics of new and existing homes. It is typically the best choice for framed ceilings in new homes, but can be costly to install in existing framed ceilings. It is very important that this type of insulation be treated for fire resistance.

**Foamboard** (R-10, 1.5 to 2 inches) provides more insulation per inch than does cellulose or fiberglass, but is also more expensive. It is best where other insulation cannot be used, such as open-beam ceilings. It is applicable for new construction or when roofing is replaced on an existing home. Two common materials are polystyrene and polyisocyanurate. Polystyrene is better in moist conditions, and polyisocyanurate has a higher R-value per inch. However, some of these insulations present serious fire spread hazards. They should be evaluated to ensure that they are covered with fire-retardant materials and meet local fire and building codes.

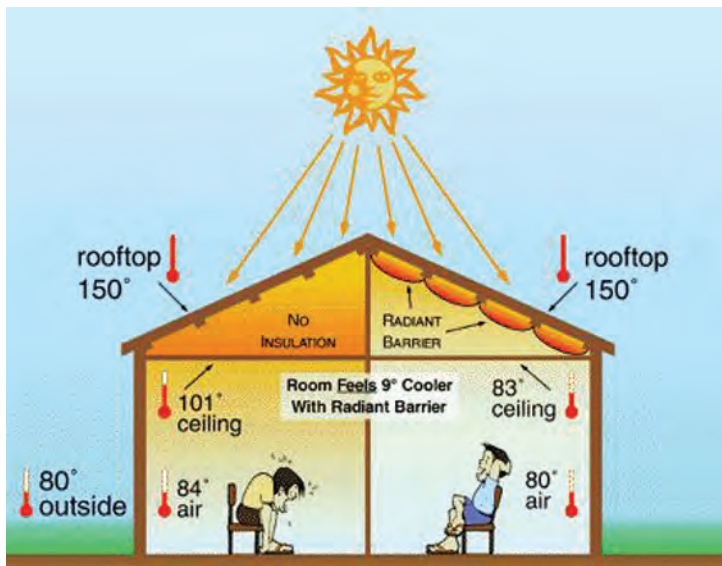

Figure 13.2. Potential Effects of Radiant Barriers [3]

**Radiant barrier** insulation is a reflective foil sheet installed under the roof deck like regular roof sheathing. The effectiveness of a radiant barrier (Figure 13.2) depends on its emissivity (the relative power of the surface to emit heat by radiation). In general, the shinier the foil the better. Radiant barrier insulation cuts the amount of heat radiated from the hot roof to the ceiling below. It may be draped over the rafters before the roof is installed or stapled to the underside of the rafters. The shiny side should face downward for best performance. Some manufacturers claim that the radiant barrier prevents up to 97% of the sun's heat from entering the attic.

### Wall Insulation

As shown in Table 13.1, it makes sense to insulate to high R-values in the ceiling. Insulation in walls should range from R-11 in relatively mild climate zones to R-38 in New England, the northern Midwest, the Great Lakes, and the Rocky Mountain states of Colorado and Wyoming. Insulation requirements vary within climate zones in these states and areas as well (for instance, mountainous areas and areas farther north may have more heating-degree days). The same logic of installing insulation applies to both ceilings and walls: the insulation should provide a barrier for heat and moisture transfer and buildup from inside the dwelling, where temperatures will generally be in the 68°F to 72°F (20°C to 22°C) range, compared with the much colder or hotter temperatures outside. The key to heat loss is the difference in temperatures and the time that the heat transfer takes place over a given area or surface. The choice of heating system, from gas/oil or heat pump, to electric resistance, will also affect the payback of

additional wall insulation due to variation in energy fuel prices. For regions identified as “cold,” careful attention should be made in selecting energy fuel type; in particular, a heat pump may not be a practical option.

A homeowner exploring designs and construction methods should examine the value of using structural insulated panels. The incorporation of high levels of insulation directly from the factory on building wall and ceiling components makes them outstanding barriers to heat and moisture. These integrated systems, if appropriately used, can save substantial amounts of energy when compared with traditional stick-built systems using 2×4 or 2×6 lumber. Also, building energy-efficient features (as well as electrical, plumbing, and other elements) directly into the building envelope at the factory can result in labor cost savings over the more traditional methods of construction.

### Floor Insulation

Warm air expands and rises above surrounding cooler air. This process of heat transfer is called convection. Warm air, which is lighter, rises and, as it cools, falls, creating a convection current of air. The two other processes of heat transfer are conduction (kinetic energy transferred from particle to particle, such as in a water- or electrically heated floor) and radiation (radiant energy emitted in the form of waves or particles such as in a fireplace or hot glowing heating element). Floor insulation limits all three modes of heat loss. A warmer floor reduces the temperature difference that drives convection. Floor insulation also directly impedes conduction and radiation to the colder air below the floor.

### Batt Insulation

The advantage of floor insulation lies in adding extra R-value without a significant increase in cost. It is cheaper to put more insulation under the floor than to add foam sheathing or change the type of wall construction to accommodate greater insulation levels.

Like walls, floor cavities should be completely filled with insulation—without gaps, missing insulation, or cavity voids. Floor insulation must contact the subfloor and both joists. In many cases, it is worth the extra cost to buy enough insulation to fill the entire cavity.

The amount of floor insulation required by some codes can be less than the space available. For example, an R-19 fiberglass batt is 6¼ inches thick. A floor framed with 2×8s is about 7½ inches deep, while a 2×10 floor is 9½ inches deep. A builder following a code's minimum insulation level will leave extra space that will allow for greater

R-value	Batt Thickness, Inches
R-19	6¼
R-22 HD	5½
R-22	7½
R-25	8½
R-30	10
R-30 HD	8½
R-38	12
R-38 HD	10

**Table 13.3.** Floor Insulation [5]

the floor above a crawl space or a basement.

The thickness of typical fiberglass batts can assist the designer and the builder in creating a floor system that works for the occupants. Table 13.3 shows a list of R-values, along with the associated batt thickness. Individual brands can vary by as much as 1 inch.

### Cavity Fill

According to Oikos, a commercial Web site devoted to serving professionals whose work promotes sustainable design and construction, “Buying a thicker batt may be a better option than trying to lift a thinner batt into the proper position. Material costs will climb slightly but labor should be the same. Attaching the insulation support to the bottom of the floor joist will be easier. It could also lead to a higher quality job because there is less chance for compression or gaps” (Figure 13.4) [4].

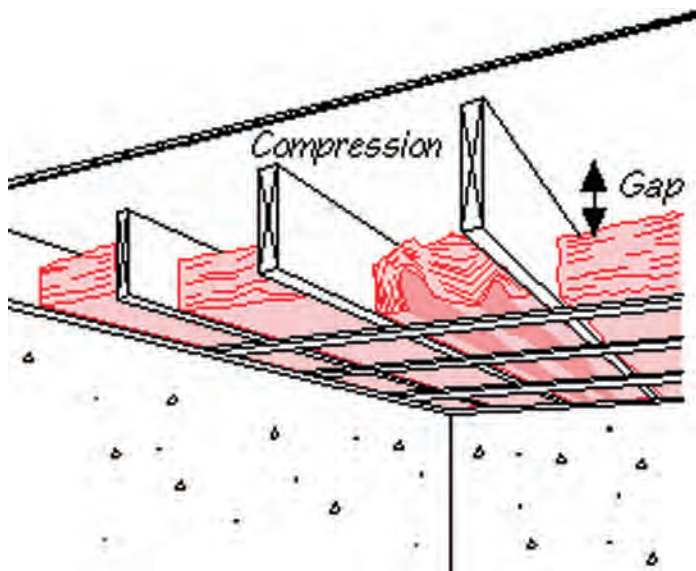

**Figure 13.3.** Common Floor Insulation Flaws [4.] Two common flaws in floor insulation are gaps above the batt and compression of the batt in the cavity.

Source: Reprinted from Energy Source Builder 38 with permission of Iris Communications, Inc., publisher of Oikos.com.

heat loss. To avoid this situation, the batt must be pushed up into the cavity. With the proper support, this can be done. Springy metal rods are commonly used to hold insulation up in the top of the floor cavity. Another viable option is the use of plastic straps. Figure 13.3 shows batt insulation improperly applied to

In some areas, it’s common to hang plastic mesh over floor joists. Installers drop the insulation onto the mesh before the subfloor is installed. However, hanging the mesh creates sagging bellies. Insulation compresses near the framing and sags in the middle. Mesh should be attached to the bottom of the floor framing [4].

Each stage of increased floor insulation, from R-19 to R-30 or R-30 to R-38, can save energy over the life of the house. This energy translates into energy savings that are multiples of the initial installation costs. Floor insulation will generate the greatest savings in colder climates; in moderate climates, the target insulation level should depend on economics.

### Blow-In Insulation

A blown-in insulation system allows the builder or insulator to fill the entire cavity completely, even around pipes, wires and other appurtenances. Using well-trained installers will pay dividends in quality workmanship.

### Doors

Today there is an endless variety of doors, ranging from metal doors with or without insulation to hollow core to solid wood. When properly installed into fitted frames, doors serve as a heat barrier to maintain indoor temperatures. Quality metal doors with insulation are best if they have a thermal break between the interior and exterior metal surfaces; this keeps heat from being transferred from one side to the other.

### Standard Doors

Because doors take up a small percentage of a wall, insulating them is not as high a priority as is insulating walls and ceilings. That said, heat loss follows the path of least resistance; therefore, doors should be selected that are functional and add to the energy-efficiency of the house. Doors usually have lower R-values than the surrounding wall.

Storm doors can add R-1 to R-2 to the existing door’s R-value. They are a valuable addition to doors that are frequently used and those that are exposed to cold winds, snow, and other weather. Screens allow natural breezes to circulate air from outside, rather than totally relying on air-conditioning, which can be energy intensive.

When considering replacement doors, select insulated, metal foam-core doors. Besides insulation, metal doors provide good security, seal more tightly, tend to warp less. Metal doors also are more soundproof than conventional wood doors.

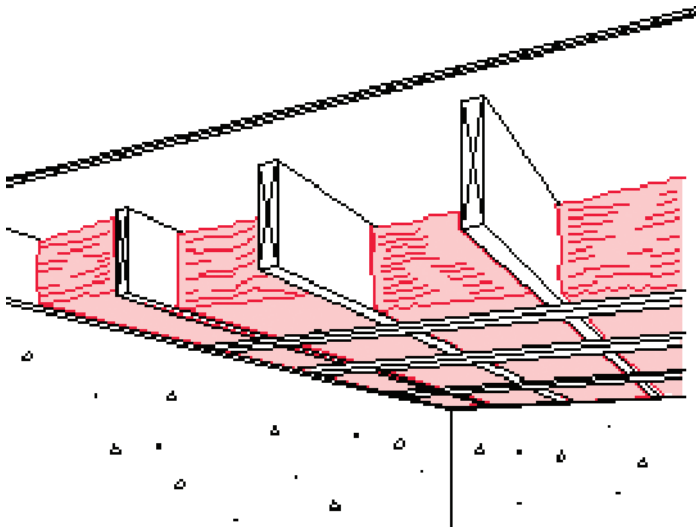

**Figure 13.4a.** Insulation Cavity Fill [4]. Lath provides a sturdy support for insulation.

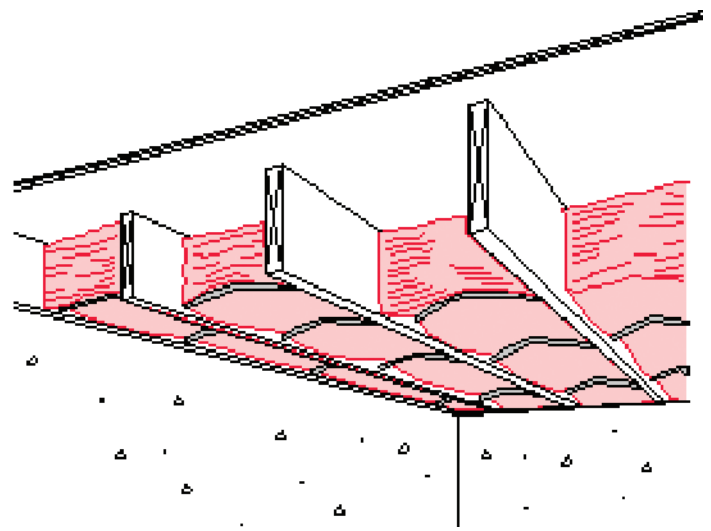

**Figure 13.4b.** Insulation Cavity Fill [4]. Metal rods are available through insulation distributors. They are easy to use, but insulation has to be compressed in the middle.

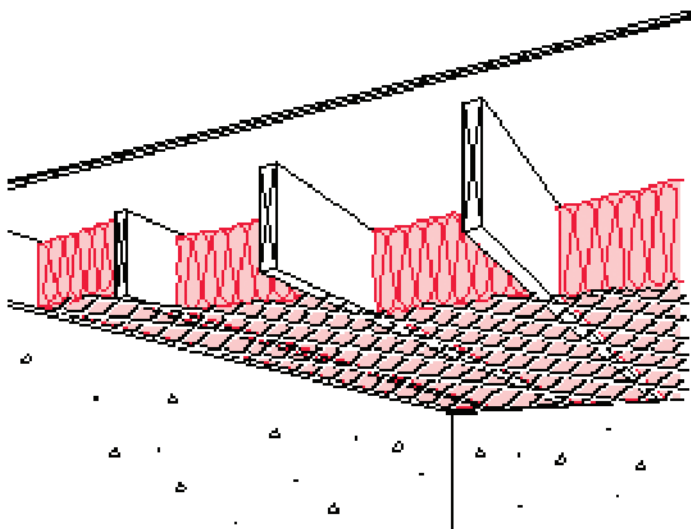

**Figure 13.4c.** Insulation Cavity Fill [4]. Mesh should be attached to the bottom of the framing. Draping the mesh over the joists leads to compression that reduces insulating value.

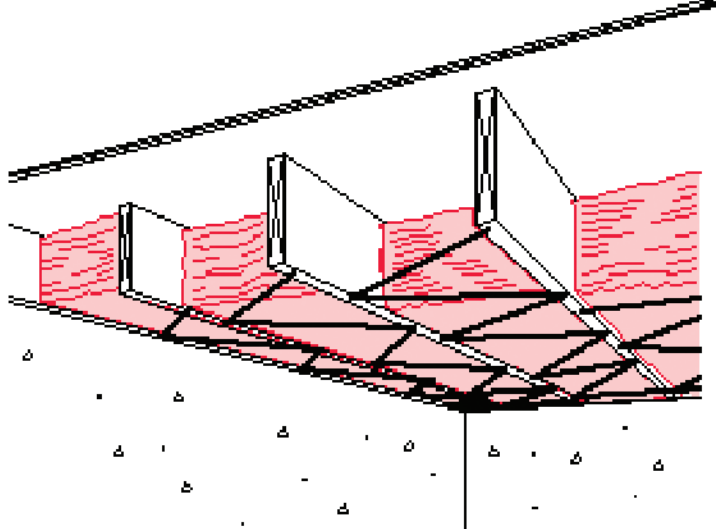

**Figure 13.4d.** Insulation Cavity Fill [4]. Polypropylene twine resists rot, mildew, rodents, and other dangers. It is to be stapled every 12 to 18 inches.

Source: Reprinted from Energy Source Builder 38 with permission of Iris Communications, Inc., publisher of Oikos.com.

### *Sliding Glass Doors*

Although sliding glass doors have aesthetic appeal, they have very low R-values and hence are minimally energy efficient. To improve the energy efficiency of existing sliding glass doors, the homeowner should ensure that they seal tightly and are properly weather-stripped.

Additionally, heavy insulated drapes with weights, which impede the airflow, can cut down on heat loss through sliding glass doors.

### *Door Installation*

Doors must be installed as recommended by the manufacturer. Care must be taken to be sure that doors are

installed in a manner that does not trap moisture or allow unintended introduction of air. Numerous types of sealing materials are available that range from foam to plastic, to metal flanging and magnetic strips.

### *Hot Water Systems*

The hot water tank can be insulated to make it more efficient, unless the heat loss is used within the space where it is located. Special insulation is available for this type of appliance, and insulating it will reduce the energy required to deliver the hot water needed by the occupants of the dwelling. Of course, any pipe that is subject to extreme temperatures also should be insulated to decrease heat loss.

## Windows

Windows by nature are transparent. They allow occupants of a dwelling to see outside and bring in sunlight and heat from the sun. They make space more pleasant and often provide lighting for tasks undertaken in the space. Especially in the winter, these desirable characteristics offset the heat loss. Heat gain in the summer through windows can be undesirable.

Rather than give them up, it is important to use windows prudently and to keep energy considerations in mind in their design and their insulating characteristics (air, glass, plastic, or gas filler). Good design takes advantage of day lighting. Weather-stripping and sealing leaks around windows can enhance comfort and energy savings. Energy Star windows are highly recommended. Housekeeping measures can improve the efficiency of retaining heat. Heat loss follows the path of least resistance: caulking, weather-stripped framing, and films can help. These measures are relatively labor intensive, low to very low in cost, and can be quite satisfying to the homeowner if accomplished correctly. On the other hand, it is not easy finding the perfect materials or even replacement parts for old windows.

When working with older windows, remember that there is the risk for leaded paint and the dispersion of toxic lead dust into the work area. Please refer to the lead section of Chapter 5, Indoor Air Pollutants and Toxic Materials.

### Caulking and Weather-Stripping

According to the U.S. Department of Energy, caulking and weather-stripping have substantial housekeeping benefits in preventing energy loss or unwanted heat gain.

#### *Caulking*

Caulks are airtight compounds (usually latex or silicone) that fill cracks and holes. Before applying new caulk, old caulk or paint residue remaining around a window should be removed using a putty knife, stiff brush, or special solvent. After old caulk is removed, new caulk can then be applied to all joints in the window frame and the joint between the frame and the wall. The best time to apply caulk is during dry weather when the outdoor temperature is above 45°F (7.2°C). Low humidity is important during application to prevent cracks from swelling with moisture. Warm temperatures are also necessary so the caulk will set properly and adhere to the surface [5].

#### *Weather-stripping*

Weather-stripped frames are narrow pieces of metal, vinyl, rubber, felt, or foam that seal the contact area between the fixed and movable sections of a window joint. They should be applied between the sash and the frame, but should not interfere with the operation of the window [6].

### Replacing Window Frames

The heat-loss characteristics and the air tightness of a window vary with the type and quality of the window frame. The types of available window frames are fixed-pane, casement, double- and single-hung, horizontal sliding, hopper, and awning. Each type varies in energy efficiency.

Correctly installed fixed-pane windows are the most airtight and inexpensive choice, but are not suited to places that require ventilation. The air infiltration properties of casement windows (which open sideways with hand cranks), awning windows (which are similar to casement windows but have hinges at the top), and hopper windows (inverted awning windows with hinges at the bottom) are moderate. Double-hung windows, which have top and bottom sashes (the part of the window that can slide), tend to be leaky. The advantage of the single-hung window over the double-hung is that it tends to restrict air leakage because there is only one moving part. Horizontal sliding windows, though suitable for small, narrow spaces, provide minimal ventilation and are the least airtight.

In buildings with large older windows, there are often weight cavity areas that hide counter balances that make it easy to raise and lower heavy windows. These areas should be insulated to reduce energy loss.

### Tinted Windows

Another way to conserve energy is the installation of tinted windows. Window tinting can be installed that will both conserve energy and also prevent damaging ultraviolet light from entering the room and potentially fading wood surfaces, fabrics, and carpeting. Low-emissivity coatings, called low-e coatings, are also available. These coatings are designed for specific geographic regions.

### Reducing Heat Loss and Condensation

The energy efficiency of windows is measured in terms of their U-values (measure of the conductance of heat) or their R-values. Besides a few highly energy-efficient

exceptions, window R-values range from 0.9 to 3.0. When comparing different windows, it is advisable to focus on the following guidance for R- and U-values:

- R- and U-values are based on standards set by the American Society of Heating, Refrigerating, and Air-Conditioning Engineers [7].
- R- and U-values are calculated for the entire window, which includes the frame.
- R- and U-values represent the same style and size of windows.

The R-value of a window in an actual house is affected by the type of glazing material, the number of layers of glass, the amount of space between layers and the nature of the gas filling them, the heat-conducting properties of the frame and spacer materials, and the airtightness associated with manufacturing.

For windows, rating and approval by the National Fenestration Rating Council or equivalent rating and approval is strongly recommended [8].

Please refer to the window section of Chapter 6, Housing Structure.

## Glazing

Glazing refers to cutting and fitting windowpanes into frames. Glass has been traditionally the material of choice for windowpanes, but that is changing. Several new materials are available that can increase the energy efficiency of windows. These include the following:

- **Low-emissivity** (low-e) glass uses a surface coating to minimize transmission of heat through the window by reflecting 40% to 70% of incident heat while letting full light pass through the pane.
- **Heat-absorbing glass** is specially tinted to absorb approximately 45% of the incoming solar energy; some of this energy passes through the pane.
- **Reflective glass** has a reflective film that reduces heat gain by reflecting most of the incident solar radiation.
- **Plastic glazing materials** such as acrylic, polycarbonate, polyester, polyvinyl fluoride, and polyethylene are stronger, lighter, cheaper, and easier to cut than glass. However, they are less durable and tend to be affected by the weather more than glass is.
- **Storm windows** can improve the energy efficiency of single-pane windows. The simplest example of storm windows would be plastic film, available in

prepackaged kits, taped to the inside of the window frame. Because this can affect visibility and be easily damaged, a better choice would be to attach rigid or semirigid plastic sheets such as plexiglass, acrylic, polycarbonate, or fiber-reinforced polyester directly to the window frame or mounting it in channels around the frame on the outside of the building. Care should be taken in installation to avoid ripples or blemishes that will affect visibility.

## Layering

The insulating capacity of single-pane windows is minimal, around R-1. Multiple layers of glass can be used to increase the energy efficiency of windows. Double- or triple-pane windows have air-filled or gas-filled spaces, coupled with multiple panes that resist heat flow. The space between the panes is critical because the air spaces that are too wide (more than  $\frac{3}{8}$  inch) or too narrow (less than  $\frac{1}{2}$  inch) allow excessive heat transfer. Modern windows use inert gases, such as argon and krypton, to fill the spaces between panes because these gases are much more resistant to heat flow than air is. These gas-filled windows are more expensive than regular double-pane windows.

- **Frame and spacer materials** may be aluminum, wood, vinyl, fiberglass, or a combination of these materials, such as vinyl- or aluminum-clad wood.
- **Aluminum frames** are strong and are ideal for customized window design, but they conduct heat and are prone to condensation. The deterioration of these frames can be avoided by anodizing or coating. Their thermal resistance can be boosted using continuous strips of plastic between the interior and exterior of the frame.
- **Wood frames** are superior to aluminum frames in having higher R-values, tolerance to temperature extremes, and resistance to condensation. On the other hand, wood frames require considerable maintenance in the form of painting or staining. Improper maintenance can lead to rot or warping.
- **Vinyl window frames** made from polyvinyl chloride are available in a wide range of styles and shapes, can be easily customized, have moderate R-values, and can be competitively priced. Large windows made of vinyl frames are reinforced using aluminum or steel bars. Vinyl windows should be selected only after consideration of the concerns surrounding the use of vinyl materials and their off-gassing characteristics.



- **Fiberglass frames** have the highest R-values and are not given to warping, shrinking, swelling, rotting, or corroding. Fiberglass is not weather-resistant, so it should also be painted. Some fiberglass frames are hollow; others are filled with fiberglass insulation.
- **Spacers separating multiple windowpanes** in a window use aluminum to separate glass in multipane windows, but it conducts heat. In addition, in cold weather, the thermal resistance around the edge of such a window is lower than that in the center, allowing heat to escape and condensation to occur along the edges.
- **Polyvinyl chloride foam separators** placed along the edges of the frame reduce heat loss and condensation. Window manufacturers use foam separators, nylon spacers, and insulation materials such as polystyrene and rock wool insulation between the glass panes inside windows.

### Other Options

Shades, shutters, and drapes used on windows inside the house reduce heat loss in the winter and heat gain in the summer. The heat gain during summer can also be minimized by the use of awnings, exterior shutters, or screens. These cost-effective window treatments should be considered before deciding on window replacement. By considering orientation, day lighting, storage of or reflection of energy from sunshine, and materials used within the house and on the building envelope, heat loss and gain can be decreased.

### Solar Energy

Solar energy is a form of renewable energy available to homeowners for heating, cooling, and lighting. The more energy-efficient new structures are designed to store solar energy. Remodeled structures may be retrofitted to increase energy efficiency by improving insulation characteristics, improving airflow and airtightness of the structure, and enhancing the ability to use solar energy. Solar energy systems are active and passive. Whereas active solar systems use some type of mechanical power to collect, store, and distribute the sun's energy, passive systems use the materials and design elements in the structure itself.

### Active Solar Systems

Active solar systems use devices to collect, convert, and deliver solar energy. Solar collectors on roofs or other south-facing surfaces can be used to heat water and air and generate electricity. Active solar systems can be installed in new or existing buildings and periodically need to be inspected and maintained. Active solar energy

equipment consists of collectors, a storage tank, piping or ductwork, fans, motors, and other hardware. Flat panel collectors (Figure 13.5) can be placed on the roof or on walls. Typically, the collector will be a sandwich of one or two sheets of glass or plastic and another air space above a metal absorber plate, which is painted black to enhance heat absorption. After collection, when the sun's energy is converted to heat, a transfer is made to a liquid storage tank. The heated liquid travels through coils in the hot water tank, and the heat is transferred to the water and perhaps the heating system. Most hot water systems use a liquid collector system because it is more efficient and less costly than an air-type system.

In the southwest United States, solar roof ponds have become popular for solar cooling. Evaporative cooling systems depend on water vaporization to lower the temperature of the air. These have been shown to be more effective in dry climates than in areas with extremely high relative humidity.

In certain climates, like those in the Hawaiian Islands, using solar energy is cost-effective for providing hot water. Some builders even include it as a standard feature in their homes. The total cost to the homeowner of solar energy systems consists of the capital, operational, and maintenance costs. The real cost of capital may be lowered by the availability of tax credits offered at the federal (to lower federal income taxes) and state levels.

Homeowners and builders can benefit from tax credits because they lower the total upfront investment cost of installing active solar systems. This is the major portion of the total cost of using solar energy, because operation and maintenance costs are small in comparison to initial system costs.

### Passive Solar Systems

Buildings designed to use passive solar energy have features incorporated into their design that absorb and slowly release the sun's heat. In cold climates, the design allows the light and heat of the sun to be stored in the



Figure 13.5. Solar Panels

structure, while insulating against the cold. In warm climates, the best effect is achieved by admitting light while rejecting heat. A building using passive solar systems may have the following features in the floor plan:

- Large south-facing windows
- Small windows in other directions, particularly on the north side of the structure
- Designs that allow daylight and solar heat to permeate the main living areas
- Special glass to block ultraviolet radiation
- Building materials that absorb and slowly reradiate the solar heat
- Structural features such as overhangs, baffles, and summer shading to eliminate summer overheating.

Passive design can be a direct-gain system when the sun shines directly into the building, thereby heating it and storing this heat in the building materials (concrete, stone floor slabs, and masonry partitions). Alternatively, it may be an indirect gain system where the thermal mass is located between the sun and the living space. Isolated gain is yet another type of system that is separated from the main living area (such as a sunroom or a solar greenhouse), with convective loops for space conditioning into the living space.

Energy Star is a program supported and promoted by the U.S. Environmental Protection Agency (EPA) that helps individuals protect the environment through superior energy efficiency. For the individual in his or her home, energy-efficient choices can save families about one third on their energy bill, with similar savings of greenhouse gas emissions, without sacrificing features, style, or comfort. When replacing household products, look for ones that have earned the Energy Star; these products meet strict energy-efficiency guidelines set by EPA and the U.S. Department of Energy. When looking for a new home, look for one that has earned the Energy Star approval. If you are planning to make larger improvements to your home, EPA offers tools and resources to help you plan and undertake projects to reduce your energy bills and improve home comfort [9]. In 2004 alone, Americans, with the help of Energy Star, saved enough energy to power 24 million homes and avoid greenhouse gas emissions equivalent to those from 20 million cars—all while saving \$10 billion.

## Conducting an Energy Audit

Energy audits can help identify areas where energy investments can be made, thereby reducing energy used in lighting, heating, cooling, or meeting other demands of housing occupants. An inspection can evaluate the worthiness or compliance with codes of energy-saving measures, including accepted or written standards. For example, if a new addition requires the equivalent of R-19 insulation in the ceilings, this can be validated in the inspection process. Whereas an audit is generally informational, an inspection should validate that materials and workmanship have yielded a structure that protects the occupants from the elements, such as rain, snow, wind, cold, and heat. Potentially hazardous situations within a structure should be evaluated in an inspection. The overall goal of a housing inspection in the case of energy efficiency is to identify potential hazardous conditions and help to create conditions under which the health and welfare of the occupants can be enhanced, rather than put at risk.

The housing inspector should be aware that there is variation (sometimes quite significant differences) in heating degree days or cooling loads and in relative humidity conditions within given regions. Local and regional topography, as well as site conditions, can affect temperatures and moisture.

Numerous Web sites listed in this chapter's Additional Sources of Information section discuss the procedures for conducting energy audits. Local and regional utilities often offer audit services and assist with selecting cost-effective conservation measures for given areas of the United States.

## References

1. Lawrence Berkeley National Laboratory. Energy star insulation project: R-value guidelines. Berkeley, CA: Lawrence Berkeley National Laboratory; 2004. Available from URL: <http://enduse.lbl.gov/Projects/Rvalue.html>.
2. RoofHelp.com. R-value. Fort Worth, TX: RoofHelp; 1999. Available from URL: <http://www.roofhelp.com/Rvalue.htm>.
3. State of Hawaii, Department of Business, Economic Development, and Tourism, Energy Resources and Technology Division. Ceiling insulation. Honolulu, HI: State of Hawaii, Department of Business, Economic Development, and Tourism; no date. Available from URL: [http://www.hawaii.gov/dbedt/ert/rf\\_insul.html](http://www.hawaii.gov/dbedt/ert/rf_insul.html).

4. Oikos. Filling a floor with batt insulation. Energy Source Builder 1995 [Apr]; 38. Available from URL: <http://oikos.com/esb/38/floorinsulation.html>.
  5. US Department of Energy. Energy savers: fact sheets. Washington, DC: US Department of Energy; no date. Available from URL: <http://www.eere.energy.gov/consumerinfo/factsheets.html>.
  6. US Department of Energy. Advances in glazing materials for windows. Washington, DC: US Department of Energy; 1994.
  7. American Society of Heating, Refrigerating and Air-Conditioning Engineers (ASHRAE). Standards; no date. Atlanta: American Society of Heating, Refrigerating and Air-Conditioning Engineers. Available from URL: <http://www.ashrae.org>.
  8. National Fenestration Rating Council. Search for energy performance ratings. Silver Spring, MD: National Fenestration Rating Council; no date. Available from URL: <http://www.nfrc.org/windowshop/surveybegin.aspx>.
  9. US Environmental Protection Agency. What is Energy Star? Washington, DC: US Environmental Protection Agency; no date. Available from URL: [http://www.energystar.gov/index.cfm?c=about.ab\\_index](http://www.energystar.gov/index.cfm?c=about.ab_index).
- Hawaii Department of Business, Economic Development and Tourism. Ceiling insulation. Available from URL: [http://www.state.hi.us/dbedt/ert/rf\\_insul.html](http://www.state.hi.us/dbedt/ert/rf_insul.html).
- National Association of State Energy Officials. Available from URL: <http://www.naseo.org>.
- Nexus Energyguide. Available from URL: <http://www.energyguide.com/default.asp>.
- Oak Ridge National Laboratory Buildings Technology Center. Available from URL: <http://www.ornl.gov/ORNL/BTC>.
- Oak Ridge National Laboratory. Whole-wall thermal calculator performance. Available from URL: [http://www.ornl.gov/roofs+walls/whole\\_wall/wall-a30.html](http://www.ornl.gov/roofs+walls/whole_wall/wall-a30.html).
- Oikos. Whole wall R-value ratings. Energy Source Builder #47; October 1996. Available from URL: <http://oikos.com/esb/47/wholewall.html>.
- RoofHelp.com. R-value. Available from URL: <http://www.roofhelp.com/Rvalue.htm>.
- Senate Committee on Energy and Natural Resources. Highlights of the Energy Policy Act of 2003 and the Energy Tax Incentives Act of 2003. Available from URL: [http://energy.senate.gov/news/rep\\_release.cfm?id=203374](http://energy.senate.gov/news/rep_release.cfm?id=203374).
- Trandt J. Americans want energy efficiency. Available from URL: [http://healthandenergy.com/energy\\_efficiency.htm](http://healthandenergy.com/energy_efficiency.htm).

## Additional Sources of Information

Alliance to Save Energy. Save energy at home. Available from URL: [http://www.ase.org/section/\\_audience/educators/edsavhome/](http://www.ase.org/section/_audience/educators/edsavhome/).

Christian J, Kosnay J. Home Calculating whole wall R-values on the Net. Energy Magazine Online, November/December 1999.

Energy Information Administration. Available from URL: <http://www.eia.doe.gov>.

Environmental Solar Systems. Available from URL: <http://www.environmentalsolarsystems.com/systems/>.

Enviro\$en\$e: Common sense solutions to environmental problems. Available from URL: <http://es.epa.gov/>.

Florida Power and Light. Building shell: insulation. Available from URL: [http://www.fpl.com/savings/energy\\_advisor/PA\\_45.html](http://www.fpl.com/savings/energy_advisor/PA_45.html).

Florida Power and Light. Online home energy survey. Available from URL: [http://www.fpl.com/home/ohes/contents/online\\_home\\_energy\\_survey.shtml](http://www.fpl.com/home/ohes/contents/online_home_energy_survey.shtml).

US Department of Energy, Energy Efficiency and Renewable Energy. Building envelope. Available from URL: [http://www.eere.energy.gov/EE/buildings\\_envelope.html](http://www.eere.energy.gov/EE/buildings_envelope.html).

US Department of Energy, Energy Information Administration. Available from URL: <http://eia.doe.gov/>.

US Environmental Protection Agency. Available from URL: <http://www.epa.gov>.

US Environmental Protection Agency, Energy Star. Available from URL: <http://www.energystar.gov>.

Wilson A. Thermal mass and R-value: making sense of a confusing issue. EBN 1998 7(4). Available from URL: <http://www.buildinggreen.com/features/tm/thermal.cfm>.

World Energy Efficiency Association. Available from URL: <http://www.weea.org/>.



# Chapter 14: Residential Swimming Pools and Spas

*“Most people assume if their young child falls into the pool, there will be lots of splashing and screaming, and plenty of time to react. In reality, a child slips into the water and often goes under the surface. These drownings can happen quickly and silently—without warning.”*

Hal Stratton, Chair  
U.S. Consumer Product Safety Commission,  
2002–Present

## Introduction

Swimming is one of the best forms of exercise available and having a residential swimming pool also can provide much pleasure. Nevertheless, it takes a great deal of work and expense to make and keep the pool water clean and free of floating debris. Without a doubt, a properly maintained and operated pool is quite rewarding. Home pools, however, are sometimes referred to as attractive nuisances or hazards. It is essential to be able to evaluate the risks associated with a pool. A regulatory agent or consultant must understand the total engineered pool system and be capable of identifying all equipment, valves, and piping systems. The piping system for a pool should be color-coded to assist the pool operator or the owner to determine the correct way to operate the swimming pool. The specific goal is to protect the owners, their families, and others who may be attracted to a residential pool.

Residential pools and spas should provide clean, clear water; water free of disease agents; and a safe recreational environment. In addition, residential pools and spas should have effective, properly operating equipment and effective maintenance and operation.

## Childproofing

Although it seems obvious, close supervision of young children is vital for families with a residential pool. A common scenario is a young child leaving the house without the parent or caregiver realizing it. Children are drawn to water, and they can drown even if they know how to swim. All children should be supervised at all times while in and around a pool.

The key to preventing pool tragedies is to provide layers of protection. These layers include limiting pool access, using pool alarms, closely supervising children, and being prepared in case of an emergency. The U.S. Consumer Product Safety Commission (CPSC) offers these tips to prevent drowning:

- Fences and walls should be at least 4 feet high and installed completely around the pool. The fence should be no more than 2 inches above grade. Openings in the fence should be a maximum of 4 inches. A fence should be difficult to climb over.
- Fence gates should be self-closing and self-latching. The latch should be out of a small child’s reach. The gate should open away from the pool; the latch should face the pool.
- Any doors with direct pool access should have an audible alarm that sounds for 30 seconds. The alarm control must be a minimum of 54 inches high and reset automatically.
- If the house forms one side of the barrier to the pool, then doors leading from the house to the pool should be protected with alarms that produce a sound when a door is opened.
- Young children who have taken swimming lessons should not be considered “drown proof”; young children should always be watched carefully while swimming.
- A power safety cover—a motor-powered barrier that can be placed over the water area—can be used when the pool is not in use.
- Rescue equipment and a telephone should be kept by the pool; emergency numbers should be posted. Knowing cardiopulmonary resuscitation (CPR) can be a lifesaver.
- For aboveground pools, steps and ladders should be secured and locked or removed when the pool is not in use.
- Babysitters should be instructed about potential hazards to young children in and around swimming pools and their need for constant supervision.
- If a child is missing, the pool should always be checked first. Seconds count in preventing death or disability.
- Pool alarms can be used as an added precaution. Underwater pool alarms can be used in conjunction with power safety covers. CPSC advises consumers to use remote alarm receivers so the alarm can be heard inside the house or in other places away from the pool area.

- Toys and flotation devices should be used in pools only under supervision; they should not be used in place of supervision.
- Well-maintained rescue equipment (including a ring buoy with an attached line and/or a shepherd's crook rescue pole) should be kept by the pool.
- Emergency procedures should be clearly written and posted in the pool area.
- All caregivers must know how to swim, know how to get emergency help, and know CPR.
- Children should be taught to swim (swimming classes are not recommended for children under the age of 4 years) and should always swim with a buddy.
- Alcohol should not be consumed during or just before swimming or while supervising children.
- To prevent choking, chewing gum and eating should be avoided while swimming, diving, or playing in water.
- Water depth should be checked before entering a pool. The American Red Cross recommends 9 feet as a minimum depth for diving and jumping.
- Rules should be posted in easily seen areas. Rules should state “no running,” “no pushing,” “no drinking,” and “never swim alone.” Be sure to enforce the rules.
- Tables, chairs, and other objects should be placed well away from the pool fence to prevent children from using them to climb into the pool area.
- When the pool is not in use, all toys should be removed to prevent children from playing with or reaching for them and unintentionally falling into the water.
- A clear view of the pool from the house should be ensured by removing vegetation and other obstacles that block the view.

## Hazards

Numerous issues need to be considered before building residential pools: location of overhead power lines, installation and maintenance of ground fault circuit interruptors, electrical system grounding, electrical wiring sizing, location of the pool, and type of vegetation near the pool. The commonly used solar covers that rest on the surface of the pool and amplify sunlight do an excellent job of increasing the pool temperature, and they also increase the risk for drowning. If children or pets fall in and sink

below the cover, it can be nearly impenetrable if they attempt to surface under it.

Winterizing the pool also can be hazardous. The pool water in most belowground pools is seldom drained because of groundwater pressure that can damage the structure of the pool. Therefore, water in most home pools is only lowered below the frost line for winter protection. In these cases, a pool cover is installed to keep debris and leaves from filling the pool in the winter months. The pool cover becomes an excellent mosquito-breeding area before the pool is reopened in the spring because of the decomposing vegetation that is on the pool cover, the rain that accumulates on the top of the pool cover during the winter, and the eggs laid on the pool cover in early fall and early spring. The cover also provides ideal conditions for mosquitoes to breed: stagnant water, protection from wind that can sink floating eggs, the near absence of predators, and warm water created by the pool cover collecting heat just below the surface (Figure 14.1).

## Public Health Issues

Current epidemiologic evidence indicates that correctly constructed and operated swimming pools are not a major public health problem. They are preferable to bathing beaches because of the engineered controls designed into pools. Poorly designed or operated pools, however, can be major public health hazards. Data from CDC between 1999 and 2000 show that 59 disease outbreaks from 23 states were attributed to recreational water exposure and affected an estimated 2,093 people. Of the 59 recreational outbreaks, 44 (74.6%) were of known infectious etiology. Of the 36 outbreaks involving gastroenteritis, 17 (47.2%) were caused by parasites; 9 (25.0%) by bacteria; 3 (8.3%) by viruses; 1 (2.8%) by a combination of parasites and bacteria, and the remaining 6 (16.7%) were of unknown cause. Of the 23 nongastroenteritis-related recreational outbreaks, seven were attributed to



Figure 14.1. Pool Cover

*Pseudomonas aeruginosa*, four to free-living amoebae, one to *Leptospira* species, one to *Legionella* species, and one to bromide. Sixteen of the 17 parasitic recreational water outbreaks involving gastroenteritis; nine (24.3%) were outbreaks of dermatitis; and six (16.2%) were caused by *Cryptosporidium parvum*. The seventeenth outbreak was caused by *Giardia lamblia* (intestinalis). In 1999, an outbreak of *Campylobacter jejuni* was associated with a private pool that did not have continuous chlorine disinfection and reportedly had ducks swimming in the pool [1].

## Diseases

- **Intestinal diseases:** *Escherichia coli* O157:H7, typhoid fever, paratyphoid fever, amoebic dysentery, leptospirosis, cryptosporidiosis (highly chlorine resistant), and bacillary dysentery can be a problem where water is polluted by domestic or animal sewage or waste. Swimming pools have also been implicated in outbreaks of leptospirosis.
- **Respiratory diseases:** Colds, sinusitis, and septic sore throat can spread more readily in swimming areas as a result of close contact, or improperly treated pool water, coupled with lowered resistance because of exertion.
- **Eye, ear, nose, throat, and skin infections:** The exposure of delicate mucous membranes, the movement of harmful organisms into ear and nasal passages, the excessive use of water-treatment chemicals, and the presence of harmful agents in water can contribute to eye, ear, nose, throat, and skin infections. Close physical contact and the presence of fomites (such as towels) also help to spread athlete's foot, impetigo, and dermatitis.

## Injuries

Injuries and drowning deaths are by far the greatest problem at swimming pools. Lack of bather supervision is a prime cause, as is the improper construction, use, and maintenance of equipment. Injuries include evisceration, electrocution, entrapment, and entanglement. Some particular problem areas include the following:

- loose or poorly located diving board,
- slippery decks or pool bottoms,
- poorly designed or located water slides,
- projecting or ungrated pipes and drains that can catch hair or body parts,
- drain grates of inadequate size,

- improperly installed or maintained electrical equipment, and
- improperly vented chlorinators and mishandled chlorine materials.

## Water Testing Equipment

It is essential that correct equipment be used and maintained for assessing the water quality of both swimming pools and spas. The operators of pool and spas need to monitor a wide range of chemicals that influence pool operations and water quality. Their equipment should test for chlorine, bromine, pH, alkalinity, hardness, and cyanuric acid build up. The chlorine should be measurable at a range of 0 to 10 parts per million (ppm). Water pH levels should be accurately measured with an acid or base test. A kit to check pool chemical levels usually includes N,N-diethyl-p-phenylene-diamine (DPD) tablet tests for free and total chlorine, and other one-step tablet tests for pH, total alkalinity, calcium hardness, and cyanuric acids. The homeowner should determine acid or base demand using an already reacted pH sample in dropper bottles. Paper test strips with multiple tests (including chlorine, bromine, and pH) are also available, but the reliability of these tests varies greatly. If used, they should be kept fresh, protected from heat and moisture, and checked against other test systems periodically if water quality problems persist.

Swimming pools are engineered systems, with demanding safety and sanitary requirements that result in rather sophisticated design standards and water treatment systems. The size, shape, and operating system of the pool is based on the following considerations:

- the intended use of the pool and the maximum expected bather loading;
- the selection of skimmers, scuppers, or gutters, depending on the purpose, size, and shape of the pool;
- the recirculation pump, whose horsepower and impeller configuration are based on the distance, volume, and height of the water to be pumped;
- the filters, which are sized on the volume of water to be treated and the maximum gallons (liters) of water per minute that can be delivered by the pump and the type of filter media selected; and
- the chemical feeder sizes and types, which are based on the chemicals used, total quantity of the water in the system, expected use rates, and external environmental factors, such as quantity of sunlight and wind that affect the system.

## Disinfection

The length of time it takes to disinfect a pool depends, for example, on the type of fecal accident and the chlorine levels chosen to disinfect the pool. If a fecal accident is a formed stool, the following chlorine levels will determine the times needed to inactivate *Giardia*:

Chlorine Levels (ppm)	Disinfection Time
1.0	45 minutes
2.0	25 minutes
3.0	19 minutes

These times are based on a 99.9% inactivation of *Giardia* cysts by chlorine, pH 7.5, and 77°F (25°C). The times were derived from the EPA *LT1ESWTR Disinfection Profiling and Benchmarking Technical Guidance Manual* [2]. These times do not take into account “dead spots” and other areas of poor pool water mixing.

If the fecal accident is diarrhea, the following chlorine levels will determine the times needed to inactivate *Cryptosporidia*:

Chlorine Levels (ppm)	Disinfection Time
1.0	6.7 days
10.0	16 hours
20.0	8 hours

A CT value is the concentration (C) of free available chlorine in parts per million (ppm) multiplied by the time (T) in minutes (CT value = C×T). The CT value for *Giardia* is 45 and the value for *Cryptosporidia* is 9,600. If a different chlorine concentration or inactivation time is used, CT values must remain the same. For example, to determine the length of time needed to disinfect a pool at 15 ppm after a diarrheal accident, the following formula is used: C×T = 9,600. Solve for time: T = 9,600÷15 ppm = 10.7 hours. It would, thus, take 10.7 hours to inactivate *Cryptosporidia* at 15 ppm. You can do the same for *Giardia* by using the CT of 45.

CDC has Web sites that contain excellent information about safe swimming recommendations, recreational water diseases, and disinfection procedures for fecal accidents [3,4].

## Content Turnover Rate

The number of times a pool’s contents can be filtered through its filtration equipment in a 24-hour period is the turnover rate of the pool. Because the filtered water is diluted with the nonfiltered water of the pool, the turbid-

ity continually decreases. Once the pool water has reached equilibrium with the sources of contamination, a 6-hour turnover rate will result in 98% clarification if the pool is properly designed. A typical-use pool should have a pump and filtration system capable of pumping the entire contents of the pool through the filters every 6 hours. To determine compliance with this 6-hour turnover standard, the following formula is used:

$$\text{Turnover rate} = \frac{\text{pool volume (gallons)}}{\text{flow rate} \times 60} \text{ (minutes in hour)}$$

Following is a sample calculation of the pool content turnover rate using the rate of flow reading from the flow meter:

$$\text{Turnover rate} = \frac{90,000 \text{ (gallons in pool)}}{180 \text{ gallons per minute} \times 60 \text{ (minutes in hour)}}$$

$$8.3\text{-hour turnover rate} = \frac{90,000 \text{ (pool volume in gallons)}}{10,800}$$

The above pool would not meet the required turnover rate of 6 hours. The cause could be improperly sized piping or restrictions in the piping, an undersized pump, or undersized or clogged filters. This turnover rate would probably result in cloudy water if the pool is used at the normal bather load. The decreased circulation would also make it difficult for the disinfecting equipment to meet the required levels.

## Filters

Pool filters are not designed to remove bacteria, but to make the water in the pool clear. Normal tap water looks quite dingy if used to fill a pool and, in some cases, the bottom of the pool is not visible. The maximum turbidity level of a pool should be less than 0.5 nephelometric turbidity units. Pool filters should be sized to ensure that the complete contents of the pool pass through the filter once every 6 hours. Home pools typically use one of three types of filters.

### High-rate Sand Filters

High-rate sand filters were introduced more than 30 years ago and reduced the size of the conventional sand filter by 80%. The sand filter is the most popular filter on the market. High-rate sand filters use a silica sand that has been strained to give it a uniform size. It is referred to as pool-grade sand #20 silica. The sand is normally 0.45 millimeters (mm) to 0.55 mm in diameter. As water passes through the filter, the sharp edges of the sand trap the dirt from the pool water. When the backpressure of the filter increases to 3 to 5 psi, the filter needs to be



cleaned. This is usually accomplished by reversing the flow of the water through the filter and flushing the dirt out the waste pipe until the water being discharged appears clear. These filters perform best when used at pressure levels below 15 to 20 gallons per minute, depending on the manufacturer of the filter.

### Cartridge Filters

Cartridge filters have been around for many years, but only recently have gained in popularity in the pool industry. They are similar to the filter on a car engine. The water is passed through the cartridge and returned to the pool. When the pressure of a cartridge filter increases approximately 5 psi, the pump is turned off; and the top of the filter is removed. The cartridge is removed and either discarded and replaced or, in some cases, washed.

### Diatomaceous Earth

Diatomaceous earth (DE) is a porous powder made from the skeletons of billions of microscopic animals that were buried millions of years ago. There are two primary types of DE filters, but they both work the same way. Water comes into the filter, passes through the DE, and is returned to the pool. If properly sized and operated, DE filters are considered by some to provide the highest quality of water. They are capable of filtering the smallest particle size of all the filter types. It is usually adequate to change the DE once every 30 days. However, if your pool water is very dirty, it is not uncommon to change it 3–4 times a day until the water is clear. The frequency of backwashing will depend on many factors, including the size of your filter, flow rate of your plumbing, and the bather load in your pool. When the pressure reading on the filter reaches the level set by the manufacturer's manual, it will be ready for backwashing.

### Filter Loading Rates

The specification plate on the side of approved residential or commercial swimming pool filters contains such information as the manufacturer, type of filter, serial number, surface area, and designed loading rate. Knowing the surface area of the filter permits calculation of the number of gallons flowing through the filter per minute. An excessive flow rate can push the media into the pool or force pool solids and materials through the media, resulting in turbid water. Figure 14.2 shows a typical home pool treatment system. Regulations typically specify how much water can be filtered through the various types of pool filtration systems.

## Disinfectants

Many disinfectants are used in pools and spas around the world, including halogen-based compounds (chlorine, bromine, iodine), ozone, and ultraviolet light with hydrogen peroxide. Those used most often are chlorine, bromine, and iodine, and each has advantages and limitations.

**Chlorine**—Pools can be disinfected with chlorine-releasing compounds, including hypochlorite salt compounds. Calcium hypochlorite is inexpensive and popular for cold-water pools, but not suitable for hot pools and spas because it will promote scaling on heat exchangers and piping. Chlorine levels can be rapidly reduced with high use and regular checks should be made to ensure maintenance of disinfection. Some adjustment of pH is required for most forms of chlorine disinfection. When chlorine gas is used, a fairly high alkalinity needs to be maintained to remove the acid formed during dosing [5]. Sodium hypochlorite is a liquid chlorine, and has a pH of 13, causing a slight increase in the pH of the pool water, which should be adjusted with an acidic mixture. The sun's rays will degrade sodium hypochlorite. Chlorinated isocyanate is available in three forms—granular, tablet, and stick. The granular form contains 55%–62% available chlorine and the stick and tablet form contain 89% available chlorine [6].



Figure 14.2. Typical Home Pool Equipment System

**Bromine**—Bromine needs to be used at levels twice those of chlorine to achieve similar disinfection. Bromine is available as the sodium or potassium salts. In the presence of ammonia, bromine rapidly forms relatively unstable ammonia bromamines that possess disinfection efficiencies comparable to that of free bromine. It is also unnecessary to destroy ammonia bromamines because they do not produce irritating odors [5].

**Iodine**—Potassium iodide is a white, crystal chemical. This chemical needs an oxidizer, such as hypochlorite, to react with organic debris and bacteria. Iodine does not react with ammonia, hair, or bathing suits, or cause eye irritation, but it can react with metals, producing greenish-colored pool water [6].

**Ozone**—Ozone is a very powerful oxidant and is effective against viruses. It can only be generated at the point of use and commercial generation units are safe for use. Ozone dosing is only practical where there is water circulating off-pool because adequate ozone-water mixing is essential for maximum oxidation. Ozone generators may be of the ultraviolet lamp or corona discharge type. The ultraviolet lamp efficiency reduces with time and the lamp and associated activated charcoal filter will need replacement [5].

**Ultraviolet Light**—Ultraviolet light, like ozone, is sometimes used for off-pool water disinfection. Ultraviolet light has no effect on pH or color and has little effect on the chemical composition of the water. However, color, turbidity, and chemical composition of the water can interfere with ultraviolet light transmission. The water must be adequately treated before ultraviolet light exposure. Hydrogen peroxide is often used for this purpose as it is relatively safe in low concentrations, is nonflammable, and produces oxygen and water as end products. For the ultraviolet light plus hydrogen peroxide system to be effective, it must operate 24 hours a day. Ultraviolet light disinfection is not pH dependent, but the addition of hydrogen peroxide results in slightly acidic conditions [5].

**Silver-copper Ionization**—Sanitizing can be accomplished by using an ionizing unit that introduces silver and copper ions into the water by electrolysis, or by passing an electric current through a silver and copper electrode. The limiting factors in using this system in the pool and spa are cost, slow bactericidal action, and potentially high contaminant levels caused by bather loads. Also, black spots can form on pool surfaces if the proper parameters of water chemistry are not maintained. An approved chemical disinfectant must be used with an ionizing unit [6].

The effective use of halogen disinfectants is based on the pH, hardness, and alkalinity of the water. Improper pH, hardness, and alkalinity levels in the pool can render high levels of disinfectant useless in killing disease-causing organisms. Table 14.1 summarizes water-quality problems that affect pools and suggests corrective actions.

### Effect of pH

The ideal pH to avoid eye irritation is 7.3. Bacteria- or algae-killing effectiveness is improved with an even lower pH. National standards typically recommend a range of 7.2 to 7.6, which is cost-effective. Table 14.2 demonstrates the loss of disinfection as pH increases.

### Chlorine Disinfectants

The options for selecting the form of chlorine disinfectant to use in pools are quite varied, and the choices are complex. Table 14.3 gives the properties of each form. Gas chlorine costs the least, and the relative cost of each form of chlorine increases as you move right across the table. The cost of the disinfectant tends to be less the higher the concentration of available chlorine. The safety issues are more complex than they might appear. The hazards of gas chlorine are well known. The solid forms of chlorine, such as calcium hypochlorite, are quite reactive. When exposed to organic compounds, they can generate a great deal of heat and are potentially explosive. Because solid chlorine seems inert to the untrained worker, it is often stored beside motor oil or gasoline or left in where moisture can start a chemical reaction. Even a pencil with a graphite core that drops from a shirt pocket into a container of calcium hypochlorite could result in a chemical reaction leading to a fire that would release free chlorine gas [7].

The following chemical reactions produce chlorine by-products that reduce the effectiveness of chlorine and cause most eye irritation.

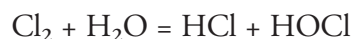

Chlorine + Water = Hydrochloric Acid + Hypochlorous Acid

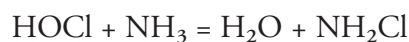

Hypochlorous Acid + Ammonia = Water + Monochloramine

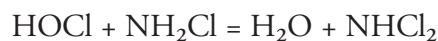

Hypochlorous Acid + Monochloramine = Water + Dichloramine



Hypochlorous Acid + Dichloramine = Water + Nitrogen Trichloride

Tables 14.1–14.4 serve as a quick problem-solving reference for the home pool owner and operator. The CDC Web site ([www.cdc.gov/healthyswimming](http://www.cdc.gov/healthyswimming)) provides a great deal of useful information for both the inspector and the homeowner.

Water Quality Issue (Symptoms)	Potential Problems (Root Causes)	Corrective Approaches (Actions)
Air bubbles coming from inlets	<ol style="list-style-type: none"> <li>1. Air in filter shell (easy fix)</li> <li>2. Leak in hair and lint strainer, pipe, valves, or fittings on suction side of pump (may be difficult to fix)</li> </ol>	<ol style="list-style-type: none"> <li>1. Bleed air off of top of filter shell.</li> <li>2. Check seal around opening of hair and lint strainer. Locate leaking fitting and seal.</li> </ol>
Foam on water, around floating objects, and on sides of pool	<ol style="list-style-type: none"> <li>1. Low hardness of water (easy fix)</li> <li>2. Effect of algaecides (do not need)</li> <li>3. Spillage of detergent into pool</li> </ol>	<ol style="list-style-type: none"> <li>1. Maintain minimum of 200 ppm calcium hardness, but less than 400 ppm.</li> <li>2. Do not use algaecides, but maintain 1 ppm of free chlorine at minimum and a pH of 7.2–7.3. (pH of 7.2 is preferable) for algae-free water.</li> <li>3. Backwash filters for extended time and add makeup water. If foam is still a problem, add defoaming agent.</li> </ol>
Cloudy water	<ol style="list-style-type: none"> <li>1. Inadequate turnover rate</li> <li>2. Filter media corrupted, channeled, or creviced.</li> <li>3. Excessive filter pressure.</li> <li>4. High pH or alkalinity above 150 ppm.</li> </ol>	<ol style="list-style-type: none"> <li>1. Check pump capacity and flow rate.</li> <li>2. If sand, clean filter and replace media, if necessary. If diatomaceous earth (DE) filter, wash filter bags in weak acid solution.</li> <li>3. Backwash filter, bleed air pressure from filter shell, check pump for proper sizing.</li> <li>4. Reduce pH to maximum of 7.6 and alkalinity to less than 150 ppm.</li> </ol>
Milky water (uniform water color with white, opaque appearance)	DE entering pool from DE filter leakage	Check filter bags for tears or holes and the mounting of the bags on the filter septa. Expect 24-hour minimum filtering to clear water.
Dull green color, varying density	Algae growth	Super-chlorinate, then maintain pH at 7.6 (preferably 7.2) and disinfectant level of 1 ppm or higher.
Bright green color	Dissolved iron	Adjust pH to between 7.2 and 7.6, adjust disinfectant level to between 1 and 1.5 ppm. Iron should precipitate to ferrous state (brown); backwash repeatedly to remove. Expect 24 to 46 hours of filtering to clear water.
Bluish green color	Copper damage from low pH	Raise pH to 7.6, increase hardness to 200 ppm and alkalinity to at least 150 ppm. Perform a saturation index calculation. Adjust water to slightly above +0.5 to achieve scale-forming water to isolate before equipment damage.
Reddish brown water, uniform in color and texture	Precipitated iron (ferrous)	Adjust pH and disinfectant level and backwash filter as needed until clear.

**Table 14.1.** Pool Water Quality Problem Solving [7]

HOCl $\longleftrightarrow$	H +	OCl -
Hypochlorous Acid— More Increases Effectiveness [Percent of Chlorine as HOCl]	Hydrogen Ion [pH]	Hypochlorite Ion— More Reduces Effectiveness [Percent of Chlorine as OCl]
90	6.5	10
73	7.0	27
66	7.2—IDEAL	34
45	7.6—IDEAL	55
21	8.0	79
10	8.5	90

**Table 14.2.** pH Effect on Chlorine Disinfection [7]

	Gas Chlorine	Sodium Hypochlorite	Calcium Hypochlorite	Dichloro	Trichloro
<b>Percent Chlorine</b>	100	10–15	65–70	56–62	90
<b>Effect on pH</b>	Lowers pH	Raises pH	Raises pH	Neutral	Lowers pH
<b>Sunlight Effects</b>	Considerable	Yes	Yes	Little loss	Little loss
<b>Physical Form</b>	Gas	Liquid	Granular or tablets	Granular only	Granular or tablets

**Table 14.3.** Chlorine Use in Swimming Pools

## Pool Water Hardness and Alkalinity

The ideal range of water hardness for a plaster pool is 200 to 275 ppm. The ideal range for a vinyl, painted, or fiberglass surface is 175 to 225 ppm. Excess hardness causes scaling, discoloration, and filter inefficiency. Less than recommended hardness results in corrosion of most contact surfaces.

Alkalinity should be 80 to 120 ppm. High alkaline levels cause scale and high chlorine demand. Low levels cause unstable pH. Sodium bicarbonate will raise the alkalinity level. The pool water will be cloudy if alkalinity is over 200 ppm.

## Liquid Chemical Feeders

### Positive Displacement Pump

A positive displacement pump is preferable to erosion disinfectant feeders. Positive displacement pumps can be set to administer varied and specific chemical dosage rates to ensure that a pool does not become contaminated with harmful microorganisms. A positive displacement pump does need routine cleaning, descaling, and servicing. Running a weak muriatic acid or vinegar solution through the pump weekly can minimize most major servicing of the pump. Most service on the pump involves one of four areas:

1. the check valves are scaled, their springs are weak, or valves are no longer flexible;
2. the diaphragm is cracked, leaking, or not flexible;
3. the drive cam needs replacement or requires adjustment; or
4. the motor requires replacement.

### Erosion and Flow-through Disinfectant Feeders

These feeders work by the action of water moving around a solid cake of chlorine and eroding the cake. The feeders work quite well for smaller pools, but require considerable care and maintenance. The variables that affect the effectiveness of erosion feeders are

1. solubility of the chlorine cake or tablet;
2. surface area of the cake or tablet;
3. amount of water flowing around the cake or tablet;
4. concentration of chlorine in the cake or tablet; and
5. number of cakes or tablets in the feeder.

Note: For safety reasons, the disinfectant cake must not be accessible.

	Minimum	Ideal	Maximum	Comments
<b>Water Clarity</b>				
Crystal-clear water at all times is the goal	Main drain visible	Crystal clear, object the size of a dime easily seen from pool deck at main drain, water sparkles	None	Lack of clarity is often due to malfunctioning or undersized filters. Other problems may be improperly sized pump, air collecting in the filter shell, or operator not running filter 24 hours per day.
<b>Disinfectant Levels</b>				
Free chlorine				
Standard pool	4	4	4	Continuous levels at 1 to 1.5 ppm minimum. Super-chlorinate indicators: high chlorine level, eye irritation, or algae growth. Super-chlorinate indicators: High chlorine levels, eye irritation or algae growth. Continuous levels.
Wading or shallow pool for children	3	3	3	
Combined chlorine	None	None	0.5	
Bromine	2	5	10	
Wading or shallow pool for children	4	7	10	
Iodine ppm	Consult product manufacturer	—	—	—
<b>Chemical Values</b>				
Hardness, CaCO <sub>3</sub>	150	200–400	500+	If difficult to control, use a different disinfectant.
Heavy metals	None	None	None	Check algacide for heavy metal presence or by-products of corrosion (partial water replacement may be recommended).
Stabilizer, cyanuric acid	10	30–50	100	If level exceeds 100 ppm, partial water replacement recommended.
Algae, bacteria	None	None	None	Shock treat and maintain required levels of disinfectant and 7.2 to 7.6 pH.

**Table 14.4.** Swimming Pool Operating Parameters [7]

## Spas and Hot Tubs

Hot tubs (large tubs filled with hot water for one or more people) or spas (a tub with aerating or swirling water) are used for pleasure and are increasingly being recommended for therapy. The complexity of these devices increases with each new model manufactured. Newer models often have both ozone and ultraviolet light emitters for enhanced disinfection (see Disinfectants section earlier in this chapter). However, the environment of the spa and hot tub, if not cleaned and operated correctly, can become a culture medium for microorganisms. Because the warm water is at the ideal temperature for growth of microorganisms, good disinfection is critical.

Table 14.5 provides suggested hot tub and spa operating parameters. It is essential that all equipment works properly and that the units are cleaned and disinfected on a routine basis. Monitoring the water temperature is very important and, depending on the health of the user, can be a matter of life and death. Time in the heated water should be limited, and the temperature for pregnant users should be below 103°F (39°C) to protect the unborn baby.

	Minimum (ppm)	Ideal (ppm)	Maximum (ppm)	Comments
<b>Disinfectant Levels</b>				
Free chlorine	3	4	10	Continuous levels. Super-chlorinate when combined level exceeds 0.2.
Combined chlorine	None	None	0.5	Super-chlorinate indicators: High chlorine levels, eye irritation or algae growth.
Bromine	4	5	10	Continuous levels.
Iodine ppm	Consult product manufacturer			
Ozone, ultraviolet light, hydrogen peroxide, and others	Consult product manufacturer			Use also requires a disinfectant in most health jurisdictions.
<b>Chemical Values</b>				
pH	7.2	7.3	7.6	Ideal range: 7.2–7.6.
Total alkalinity, CaCO <sub>3</sub>	60	80–100	180	
Dissolved solids	300	NA	2,000	Excess solids may lead to hazy water and corrosion of fixtures (may need partial water replacement).
Hardness, CaCO <sub>3</sub>	150	200–400	500+	If difficult to control, use a different disinfectant.
Heavy metals	None	None	None	Check algacide for heavy metal presence or by-products of corrosion (partial water replacement may be required).
Stabilizer, cyanuric acid	10	30–50	100	If level exceeds 100 ppm, partial water replacement may be required.
Algae, bacteria	None	None	None	If observed, shock treat and maintain required levels of disinfectant and the appropriate pH.

**Table 14.5.** Spa and Hot Tub Operating Parameters [7]

## References

1. Lee HL, Levy DA, Craun GF, Beach MJ, Calderon RL. Surveillance for waterborne-disease outbreaks—United States, 1999–2000. *MMWR* 2002; 51(SS08):1–28. Available from URL: <http://www.cdc.gov/mmwr/preview/mmwrhtml/ss5108a1.htm>.
2. US Environmental Protection Agency. LT1ESWTR Disinfection profiling and benchmarking: technical guidance manual. Washington, DC: US Environmental Protection Agency; 2003. Available from URL: <http://www.epa.gov/safewater/mdbp/pdf/profile/lt1profiling.pdf>.
3. Centers for Disease Control and Prevention. Healthy swimming. Atlanta: US Department of Health and Human Services; no date. Available from URL: <http://www.cdc.gov/healthyswimming/>.
4. Centers for Disease Control and Prevention. Fecal accidents response recommendations for aquatics staff. Atlanta: US Department of Health and Human Services; no date. Available from URL: <http://www.cdc.gov/healthyswimming/fecalacc.htm>.

5. Broadbent C. Guidance on water quality for heated spas. Rundle Mall, South Australia, Australia: Public Environmental Health Service; 1996. Available from URL: <http://www.dh.sa.gov.au/pehs/publications/monograph-heated-spas.pdf>.
  6. Michigan State University Pesticide Education Program. Swimming pool pest management: category 5A, a training guide for commercial pesticide applicators and swimming pool operators. Chapter 3: pool disinfectants and pH. East Lansing, MI: Michigan State University; no date. Available from URL: <http://www.pested.msu.edu/BullSlideNews/bulletins/pdf/2621/E2621chap3.pdf>.
  7. National Swimming Pool Foundation. Certified pool-spa operator handbook, 2004. Colorado Springs, CO: National Swimming Pool Foundation; 2004. Available from URL: <http://nspf.org>.
- Children's Safety Network. Available from URL: <http://www.childrensafetynetwork.org>.
- Chlorine Institute, Inc. Available from URL: <http://www.cl2.com>.
- National Safe Kids Campaign. Available from URL: <http://www.safekids.org>.
- National Safety Council. Available from URL: <http://www.nsc.org/>.
- National Swimming Pool Foundation. Available from URL: <http://www.nspf.com/>.
- Think First National Injury Foundation. Available from URL: <http://www.thinkfirst.org>.
- US Consumer Product Safety Commission. Available from URL: <http://www.cpsc.gov>.

## Additional Sources of Information

American Academy of Pediatrics. Available from URL: [www.aap.org](http://www.aap.org).

American National Standards Institute. Available from URL: <http://www.ansi.org>.

American Red Cross. Available from URL: [www.redcross.org](http://www.redcross.org).

American Trauma Society. Available from URL: [www.amtrauma.org](http://www.amtrauma.org).

Association of Pool and Spa Professionals. Available from URL: <http://www.nspi.org/>.

Centers for Disease Control and Prevention, National Center for Injury Prevention and Control. Available from URL: [www.cdc.gov/ncipc/factsheets/drown.htm](http://www.cdc.gov/ncipc/factsheets/drown.htm).

For more information about the CDC fecal accident recommendations, go to URL: [http://www.cdc.gov/healthyswimming/fecal\\_response.htm](http://www.cdc.gov/healthyswimming/fecal_response.htm).

For additional information about cryptosporidiosis, go to URL: <http://www.cdc.gov/healthyswimming/cryptofacts.htm>.

See also Web-based Injury Statistics Query and Reporting System (WISQARS) [Online]. (2002). National Center for Injury Prevention and Control, Centers for Disease Control and Prevention. Available from URL: [www.cdc.gov/ncipc/wisqars](http://www.cdc.gov/ncipc/wisqars).