

**New
products
2021**

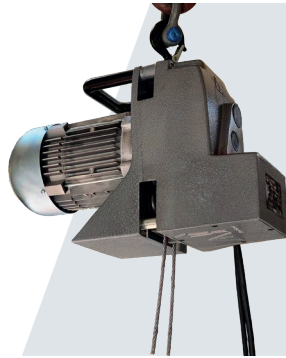

**minifor™
TR55/
TR110**
page 29



**dynafor™
Industrial/Pro/Expert**
page 102



davitrac
page 182



**new
harness range**
page 124

Price list 2021

Valid from July 2021

Table of Contents

1	Lifting and Handling	Page
	Hand operated lifting and pulling equipment	8
	Motorised pulling equipment	22
	Toe jacks and floor handling	47
	Beam clamps and trolleys	48
	Load arresters	52
	Pulleys and sheaves	54
	Lifting beams and clamps	63
2	Measure and Control	Page
	Load link dynamometers	100
	Mechanical & Electronic load monitoring	108
	Tension meters	114
3	Height safety products	Page
	Harnesses	124
	Lanyards and connectors	145
	Fall arresters	159
	Derope	168
	Lifelines and anchor points	170
	Rescue and rope access	176
4	Valbeveiligingssystemen	Page
	Guard trac guardrail	192
	Permanent lifelines	194
	FABA safety ladders	203
5	General conditions of use	Page
	Additional information	208

Traceability is an essential element in assessing the effectiveness of personal protective equipment. These products must be inspected at least once every 12 months. Tractel® has set up a simple traceability system for the tirfor® TU-series hoist and all PPE products so that the user can easily perform these periodic checks.

Below you can see an example where the traceability label can be found on a harness, life line and fall arrest device. In addition to the tirfor® TU series, all other L&H products will follow.

Safety harness

Tractel® harnesses are equipped with a traceability label embedded in the back plate of the harness. It is protected by a polyethylene film which guarantees information will continue to be legible over time.



Lanyard

Tractel® lanyards are equipped with a traceability label that guarantees information will continue to be legible over time.



Automatic fall arrester

Tractel® fall arrestors, **blocfor™**, are equipped with a traceability label on the casing of the **blocfor™**. It is protected by a transparent polyethylene film which guarantees information will continue to be legible over time.



Instructions for using the platform

- 1 Download a free QR code scanner on your smartphone, tablet or computer.



Example :
QR Code Reader for Android

- 2 Open the QR Code Scanner app and scan the code on the packaging or product.



You will be redirected to a special Tractel® website with a webpage dedicated to your product.

- 3 Find all the relevant information of the product you scanned.

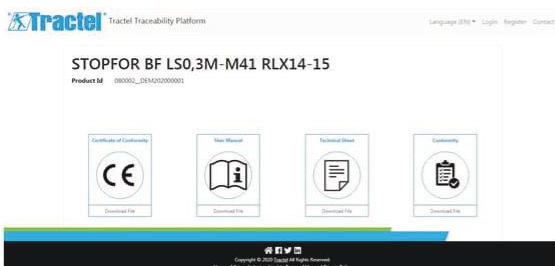

Available downloads in PDF format:

- Identification information of the product: batch & serial number, manufacturing date.
- Certificate of Conformity (Notified body product certificate)
- User manual
- Technical data sheet
- Declaration of conformity

- 4 Register to have immediate access to advanced functionalities.

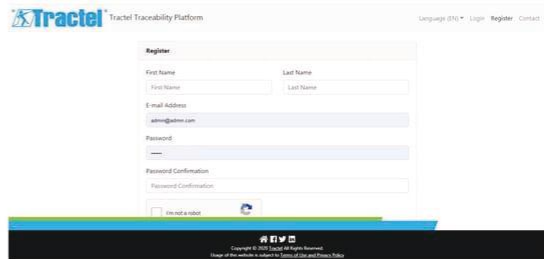

- Details to create an account:
 - Name
 - E-mail address
- Create a password to secure your account.

- 5 Enter and track the key life information of your product.

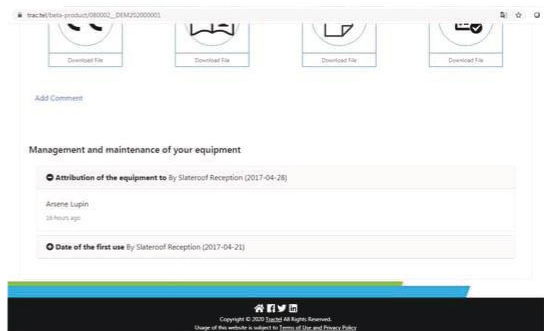

- Date of the first use
- Attribution of the equipment to a user
- Periodic inspection
- Maintenance Operation
- Disposal

Instant access to key product information

Introducing **Tractel**®'s new product information and traceability platform – an exciting new tool giving you instant access to a range of technical information related to your product.

Simply use a QR code reader to scan the identification label on the product or packaging to gain access to the information you need; direct to your phone, tablet or computer.



Packaging product label
(on packaging)



Product label
(on product)



EAN Code label
(on packaging)

Instant access to:

- Product Identification information (batch & serial number, manufacturing date etc).
- Product Data (available to download to your device):
 - Certificate of Conformity (Notified body product certificate)
 - User manual
 - Technical data sheet
 - Declaration of conformity
- Traceability system
 - Possibility to register & trace the key life events of the equipment: date of the first use, attribution of the equipment to a user, periodic inspection, maintenance operation, disposal, etc.



Language (EN) ▾ Login Register Contact

STOPFOR BF LS0,3M-M41 RLX14-15

Product Id 080002_DEM202000001



Copyright © 2020 Tractel All Rights Reserved.
Usage of this website is subject to Terms of Use and Privacy Policy

1.

Lifting & Handling



Hand operated lifting and pulling equipment

Page 8–21

Motorised pulling equipment

Page 22–46

Toe jacks and floor handling

Page 47–47

Beam clamps and trolleys

Page 48–51

Load arresters

Page 52–53

Pulleys and sheaves

Page 54–62

Lifting beams and clamps

Page 63–97

- Available on request. Please ask about the delivery time of these articles.
- Order on day 1, shipment no later than day 3 (maximum quantities apply).
- Order products on day 1, shipment no later than day 2.



tirfor®

The tirfor® principle

- Two jaws alternatively pull the wire rope and the load in the required direction, like pulling a rope with both hands.

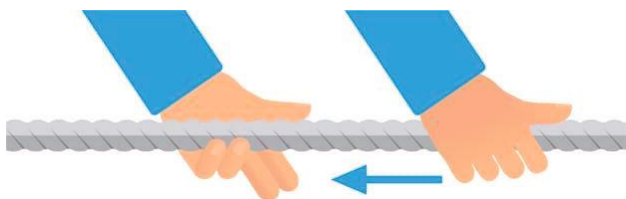

- The jaw is self-gripping for safety reasons.
- The heavier the load, the tighter the jaws will clench.
- By operating the unlocking mechanism, the wire rope can be inserted between the jaws.

Multifunctional

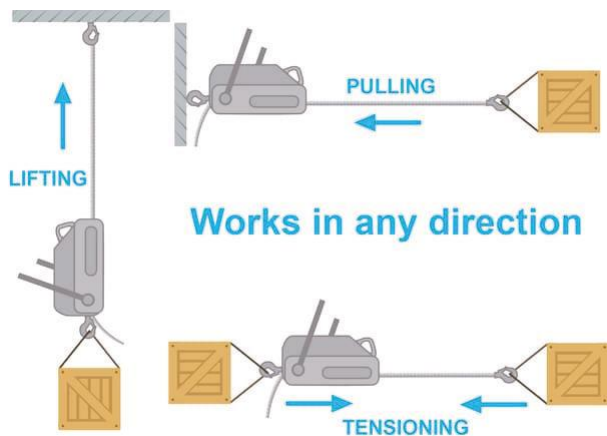

- Work can be carried out in any direction: horizontally, vertically or at an angle.
- No limit to the wire rope length.
- WLL can be increased.

Safe and reliable

- Constant control over loads during lifting and lowering with millimetre accuracy.
- When the hoist is stopped, the load will be automatically distributed over the two jaws.
- Overload protection.

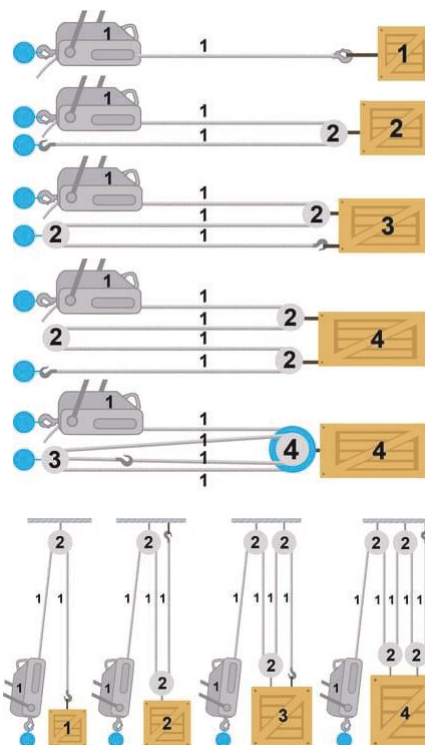

Increasing the WLL

- The tirfor®'s WLL can be increased by a factor of 2, 3, 4 or more by using sheave blocks.
- Specified values must be multiplied by the device's WLL.
- When calculating the load limit, allow for a loss of 4% per sheave block, caused by friction.

tirfor® T500 Series

The tirfor® T500 hoist is a manual lifting and pulling device. It is a versatile and portable multi-purpose device that can be used for lifting and pulling, but also for lowering, tensioning and securing loads in all directions.

One-man operation by using the telescopic control lever supplied as standard. Spare shear pins for overload protection are supplied as standard.

The tirfor® T Series is designed for standard applications.

Specifications:

- Lightweight and easily portable
- Reliable
- Overload protection for safe and secure operation
- Fast and easy to install and use
- Working load can be increased by using sheave blocks
- Positioning loads with millimetre accuracy



T508D



T516D



T532D

Model	WLL (kg)	(Wire/Chain/Reel) Diameter	Movement Left (mm)	Movement Right (mm)	Weight (kg)	Product Code	Price
T508D	800	8.3	46	63	6.6	18109	€572.00
T516D	1600	11.5	42	57	13.5	18119	€724.00
T532D	3200	16.3	18	36	24	18129	€1,121.00

Excluding maxiflex wire rope.

The standard tirfor® is only suitable for material displacement.

For more information about lifting solutions for transporting people and other applications, please contact Tractel® (0031 (0)765435135).

Accessories for the tirfor® T-serie

Model	Description	Product Code	Price
Shear pin T508	For T508D	29506	€2.60
Shear pin T516	For T516D	29516	€2.60
Shear pin T532	For T532D	41206	€3.20
Swivel hook T508	For T508D	21857	€63.50
Swivel hook T516	For T516D	21867	€126.00
Swivel hook T532	For T532D	21877	€203.00
Metal storage box T-508D & TU-8	For T-508D & TU-8	1408	€228.00
Metal storage box T-516D & TU-16	For T-516D & TU-16	1298	€266.00
Metal storage box T-532D & TU-32	For T-532D & TU-32	1228	€330.00
Telescopic lever T508	For T508D	11338	€21.00
Telescopic lever T516/T532	For T-516D & T-532D	11348	€40.00

The shear pins are delivered in packs of 10 pieces.

Order products on day 1, will be shipped no later than day 2

Order products on day 1, will be shipped no later than day 3. Maximum quantities apply for this service.

Available on request. Please enquire about delivery times of these items.

TRIED, TESTED, TRACTEL®

tirfor® TU™ EN13157 Series

The tirfor® TU series is developed for daily heavy-duty applications under the most extreme circumstances.

The tirfor® TU hoist is a versatile and portable multi-purpose manual hoist for lifting, pulling and positioning device. It can be used for lifting and pulling, but also for lowering, tensioning and securing loads in all directions.

One-man operation by using the telescopic control lever supplied as standard. Spare shear pins for overload protection are supplied as standard

Optimal relocation of the wire rope per movement.

Specifications:

- Lightweight and easily portable
- Complies to the EN 13157
- Overload protection for safe and secure operation
- Fast and easy to install and use
- Working load can be increased by using sheave blocks
- Positioning loads with millimetre accuracy
- Secure release system



TU8



TU16



TU32

Model	WLL (kg)	(Wire/Chain/Reel) Diameter	Movement Left (mm)	Movement Right (mm)	Weight (kg)	Product Code	Price
TU-8	800	8.3	70	76	8.4	18009	€315.00
TU16	1600	11.5	56	70	20	18029	€1,023.00
TU32	3200	16.3	30	48	27	18039	€1,727.00

Excluding maxiflex wire rope.

The standard tirfor® is only suitable for material displacement.

For more information about lifting solutions for transporting people and other special applications, please contact Tractel® (0031 (0)765435135).

Accessories for the tirfor® TU-serie

Model	Description	Product Code	Price
Shear pin TU8 & TU16	For TU-8 & TU-16	8836	€2.60
Shear pin TU32	For TU32	6866	€4.30
Metal storage box TU-8	For TU-8	1408	€228.00
Metal storage box TU-16	For TU-16	1298	€266.00
Metal storage box TU-32	For TU-32	1228	€330.00
Telescopic lever TU8	For TU8	508	€23.00
Telescopic lever TU16 & TU32	For TU16 & TU32	18	€48.00

The minimum quantity of shear pins is 10 pieces.



Order products on day 1, will be shipped no later than day 2



Order products on day 1, will be shipped no later than day 3. Maximum quantities apply for this service.



Available on request. Please enquire about delivery times of these items.

maxiflex wire rope

The maxiflex wire rope has been developed especially for optimal use guaranteed by Tractel®, in combination with tirfor® hoists, and can be used under the most extreme circumstances. Supplied on a transport reel. Upon request also available on a drum reel and in different lengths. Including certificate.



- Supplied on a transport reel
- Including certificate
- Standard version with tip and hook
- Hook with safety catch
- Different lengths available

Wire Rope Type	C8 - 5 strands hook		C12 - 4 strands hook		C16 - 4 strands shackle	
Description	ø wire rope - 8.3mm for T-7/TU-8/T-508		ø wire rope - 11.5mm for T-13/TU-16/T-516		ø wire rope - 16.3mm for T-35/TU-32/T-532	
Length	Code	Price	Code	Price	Code	Price
10 m	1939	€116.00	628	€157.00	708	€246.00
15 m	1949	€142.00	638	€185.00	718	€289.00
20 m	1959	€155.00	648	€210.00	728	€337.00
25 m	1969	€179.00	658	€236.00	818	€383.00
30 m	1979	€187.00	668	€267.00	738	€429.00
40 m	1989	€228.00	688	€321.00	748	€522.00
50 m	1999	€275.00	698	€376.00	758	€614.00
60 m	2009	€322.00	808	€434.00	768	€747.00
Extra par m.	4171	€3.90	4181	€6.90	4191	€12.00

drum reel for wire rope

Diameter per wire rope type:

- C8 ø 8,3 (m) - for T7/TU-8/T-508
- C12 ø 11,5 (m) - for T-13/TU-16/T-516
- C16 ø 16,3 (m) - for T-35/TU-32/T-532

Maximum wire rope length (m):

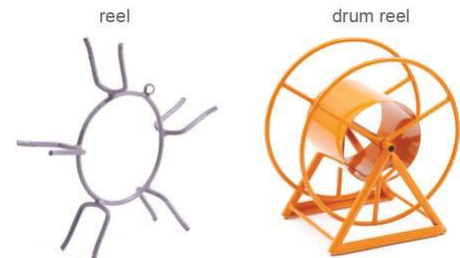

Model	Description			Product Code	Price
Reel No. 0 - small	C8 - 25m max			889	€27.00
Reel No. 1 - standard	C8 - 26-50m	C12 - max 25m		909	€30.50
Reel No. 2 - medium	C8 - 51-75m	C12 - 26-50m	C16 - max 25m	939	€43.00
Reel No. 3 - double	C8 - 75-100m	C12 - 51-75m	C16 - 26-50m	899	€49.00
Drum reel 200	C8 - 75-150m	C12 - 51-75m	C16 - 26-50m	878	€170.00
Drum reel 300	C8 - 151-200m	C12 - 76-150m	C16 - 51-75m	868	€193.00
Drum reel 400	C8 - 201-300m	C12 - max 200m	C16 - max 100m	858	€229.00

Order products on day 1, will be shipped no later than day 2

Order products on day 1, will be shipped no later than day 3. Maximum quantities apply for this service.

Available on request. Please enquire about delivery times of these items.

TRIED, TESTED, TRACTEL®

Ground screw anchor

Model	Description	Weight (kg)	Product Code	Price
HAA	For tirvit™ and jockey™	-	5589	€102.00
HAB	For tirfor® TU-8 / T-508D	1-2	3779	€184.00
HAC	For tirfor® TU 16 / T-516D	2-4	3789	€192.00
HAD	For tirfor® TU 32 / T-532D	4-6	3799	€279.00



Ground screw anchor

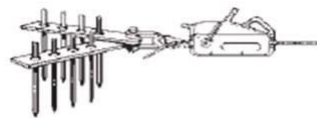

Strap anchor with rods

Strap anchor with rods

Model	Description	Product Code	Price
TU16	2 connecting plates - code 003809 8 pins of 75 cm - ø 25 1 shackle 3 t	13599	€478.00
TU32	3 connecting plates - code 003809 12 pins of 75 cm - ø 25 1 shackle 5 t	13609	€724.00

Coniclamp - wire rope clamp



Model	(Wire/Chain/Reel) Diameter	WLL (kg)	Product Code	Price
EC 10	5 - 10	1000	1269	€329.00
EC 14	10.5 - 14	2000	1289	€472.00
EC 21	15 - 21	3000	1309	€893.00



Order products on day 1, will be shipped no later than day 2



Order products on day 1, will be shipped no later than day 3. Maximum quantities apply for this service.



Available on request. Please enquire about delivery times of these items.

Sheave block

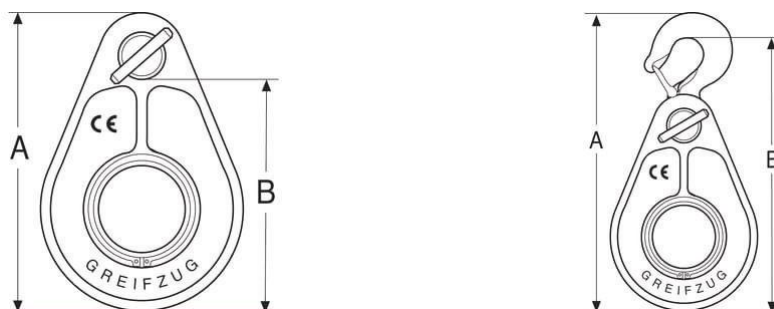

Model	WLL	Sheave Diameter	Height A	Height B	Weight (kg)	Product Code	Price
MC 3.2	3.2	140	250	200	2.4 kg	3329	€748.00
MC 3.2 - with hook	3.2	140	340	310	3.4 kg	292899	€791.00
MC 6.4	6.4	200	310	250	5.5 kg	31629	€1,049.00
MC 6.4 with eye hook	6.4	200	480	430	9.5 kg	292909	€1,259.00
MCW 2,0W with hook	2	160	326	303	2.5	43549	€247.00
MCW 2.0W	2	160	270	228	4.2 kg	87849	€308.00

Eye hook & Swivel hook for tirfor®



Eye hook

Model	Product Code	Price
Eye hook - C27	1157	€11.50
Eye hook - C33	1187	€15.00
Eye hook - C34	1397	€25.00
Swivel hook - CT08 - T508	21857	€63.50
Swivel hook - CT32 - T532 & TU32	21877	€203.00
Swivel hook - CT16 - T516	21867	€126.00



Order products on day 1, will be shipped no later than day 2



Order products on day 1, will be shipped no later than day 3. Maximum quantities apply for this service.



Available on request. Please enquire about delivery times of these items.

jockey™

Versatile wire rope hoist with unlimited wire rope length.

The jockey™ hoist is a manual lifting and pulling device. A versatile and portable multi-purpose device. Can be used for lifting and pulling, but also for lowering, tensioning, securing loads in all directions. Spare shear pins for overload protection are supplied as standard. Includes jockey™ hoist, 2 slings, 10m rope, operating handle.

- Light and compact - Reliable and easy to use
- Equipped with standard accessories
- Unlimited wire rope length
- Working load can be increased by using sheave blocks
- Overload protection



Model	WLL (kg)	Weight (kg)	Product Code	Price
jockey™ J3	300	1.75	5469	€378.00
jockey™ J5	500	3.75	5479	€585.00

maxiflex wire rope for jockey™

The wire rope is equipped with a hook with safety cover on one side and a point on the other side.

Wire Rope Type	ø 4.7mm	ø 6.5mm		
Description	for jockey™ J3	for jockey™ J5		
Length	Code	Price	Code	Price
Extra per meter	5021	€2.30	17361	€6.40
10	5839	€67.50	7429	€101.00
15	4029	€75.00	7419	€132.00
20	4039	€92.00	7439	€158.00
25	4049	€98.00	7449	€173.00
30	4059	€113.00	7489	€196.00
40	4129	€137.00	7509	€248.00
50	4149	€159.00	7529	€295.00
60	4159	€182.00	7539	€332.00

Sheave blocks for jockey™

Model	Description	WLL	Sheave Diameter	Height A	Height B	Weight (kg)	Product Code	Price
MC 1.6 - with eye hook	See above	1.6	130	277	254	1.6	3849 + 1187	On request



Order products on day 1, will be shipped no later than day 2



Order products on day 1, will be shipped no later than day 3. Maximum quantities apply for this service.



Available on request. Please enquire about delivery times of these items.

Wire rope tensioners and clamps

tirvit™ rope tensioner

Fast and easy tensioning of wire ropes such as electric transport cables, telephone cables and fence assembly. Also suitable for pulling loads. Not suitable for lifting.

- WLL: 400 - 800 kg.
- Complete with mounting chain
- Suitable for tensioning wire ropes
- Suitable for pulling loads
- NOT suitable for lifting

Model	WLL (kg)	Wire rope diameter ø (mm)	Productcode	Prijs
F2	400	6-8	1029	€273.00
F3	600	7-15	1039	€280.00
F4	800	14-18	1049	€387.00



Tension clamp for jockey™

Tension clamp with shackle

- Complete with bow shackle
- Spring-loaded wire rope clamping jaws
- Lightweight enclosure

Model	WLL (kg)	Wire rope diameter ø (mm)	Productcode	Prijs
G2	320	3 - 8	1018	€67.50
G3	380	7 - 15	1028	€78.00
G4	400	14 - 18	1038	€117.00



Order products on day 1, will be shipped no later than day 2



Order products on day 1, will be shipped no later than day 3. Maximum quantities apply for this service.



Available on request. Please enquire about delivery times of these items.

bravo™ lever hoist

The bravo™ desync lever hoist has been developed especially for lifting, pulling, securing and tensioning loads under the most extreme circumstances. The hoist has a special system with two independent desynchronised pawls which doubles the accuracy of movement and guarantees safe use, by preventing shock loads.

Manual overloading is virtually impossible, thanks to the handle's unique design and the gear ratio. The hoist complies with the EN 13157 standard. The corolim® load chain, Grade 80 EN 818/7, has an inorganic coating consisting of zinc flakes in a matrix of chromate and provides excellent corrosion protection. Due to the coating process, all parts are free of hydrogen embrittlement. Since the coating contains teflon, the friction between the parts is significantly reduced. The coating works as a dry lubricant. Salt water spray resistance up to 400 hours, without signs of red rust. Heat resistance up to 280 °C, without any visible changes. Lifting height available in any required length.

- Corolim® load chain with coating
- Easy to handle
- Light-weight and compact
- Safety catch
- Nyloc nuts
- ISO grade 80, starting from 500 kg
- EN 13157, starting from 500 kg
- Free-wheel mechanism (unloaded)
- Spare parts are available
- Exclusive Tractel® design

bravo™ lever hoist - desync - 1,5 m



Model	WLL (t)	Number of Falls	Pressure (N)	Load Chain	Weight (kg)	Product Code	Price
bravo™ 0,25t	0.25	1	260	4x12	2	35919	€159.00
bravo™ 0,5t	0.5	1	393	5x15	5	244029	€284.00
bravo™ 0,75t	0.75	1	233	6x18	7	244039	€367.00
bravo™ 1t	1	1	310	6x18	7.3	244049	€399.00
bravo™ 1,5t	1.5	1	400	7x21	11.5	244059	€448.00
bravo™ 3t	3	1	390	10x30	21.4	244069	€646.00
bravo™ 6t	6	2	410	10x30	30.2	244079	€1,126.00
bravo™ 9t	9	3	430	10x30	56.1	244089	€1,594.00

The 1.5 meter model (WLL:250kg) is delivered without desync functionality.

We also have the bravo™ hoist available with load limiter - go the page 20.



Order products on day 1, will be shipped no later than day 2



Order products on day 1, will be shipped no later than day 3. Maximum quantities apply for this service.



Available on request. Please enquire about delivery times of these items.



bravo™ desync lever hoist - 3 m

Model	WLL (t)	Number of Falls	Pressure (N)	Load Chain	Weight (kg)	Product Code	Price
bravo™ 0,5t	0.5	1	393	5x15	5.84	244099	€317.00
bravo™ 0,75t	0.75	1	233	6x18	8.2	244109	€402.00
bravo™ 1t	1	1	310	6x18	8.5	244119	€434.00
bravo™ 1,5t	1.5	1	400	7x21	13.12	244129	€487.00
bravo™ 3t	3	1	390	10x30	24.75	244139	€677.00
bravo™ 6t	6	2	410	10x30	36.9	244149	€1,259.00
bravo™ 9t	9	3	430	10x30	66.1	244159	€1,803.00

bravo™ desync - extra lifting height per m

Model	Description	Weight (kg)	Product Code	Price
0,5t	Extra lifting height per meter - WLL: 0,5t	0.56	353760	€21.00
0,75t	Extra lifting height per meter - WLL: 0,75t	0.8	353770	€24.50
1t	Extra lifting height per meter - WLL: 1t	0.8	353780	€24.50
1,5t	Extra lifting height per meter - WLL: 1,5t	1.08	353790	€28.50
3t	Extra lifting height per meter - WLL: 3t	2.23	353800	€33.00
6t	Extra lifting height per meter - WLL: 6t	4.46	353810	€41.00
9t	Extra lifting height per meter - WLL: 9t	6.69	353820	€98.00

We also have the bravo™ hoist available with load limiter - go the page 20.



Order products on day 1, will be shipped no later than day 2



Order products on day 1, will be shipped no later than day 3. Maximum quantities apply for this service.



Available on request. Please enquire about delivery times of these items.

bravo™ AC aluminium lever hoist

The bravo™ AC series ratchet lever hoist with aluminium enclosure has been developed especially for light weights and manual lifting, pulling, securing and tensioning loads. The hoist is supplied in a carrier bag for easy transport (tool belt) and storage. With free-wheel mechanism (unloaded), double brake discs and chain guide.

- Aluminium casings
- Compact and lightweight
- Robust design equals less down time
- Easily portable for use anywhere
- Swivel hook
- Pull-through feature to quickly adjust the load chain
- Carry bag with belt loop
- Galvanized load chain



Model	WLL (t)	Pressure (N)	Lifting Height (m)	Load Chain	Weight (kg)	Product Code	Price
bravo™ 0,25t	0.25	170	1,5	4 x 12 mm	2.3	251129	€225.00
bravo™ 0,25t	0.25	170	3	4 x 12 mm	2.8	251139	€281.00
bravo™ 0,5t	0.5	190	1,5	5 x 15 mm	3.3	251149	€263.00
bravo™ 0,5t	0.5	190	3	5 x 15 mm	4.1	251159	€328.00

bravo™ CLD - chain locking device

The bravo™ CLD chain locking system serves as an adjustable end stop when lowering a load.

- Can be used in combination with the bravo™ chain hoist for lifting and pulling loads and rope tensioning applications
- Can only be used in combination with the bravo™ chain hoist produced by Tractel®
- Is attached to the end of the chain by using a bolt or self-locking nut
- Automatically slides and locks onto the chain, as close as possible to the chain structure
- Can be mounted on all types of Bravos
- CLD is tested to 2.5 times the WLL, in conformity with EN 13157



bravo™ chain hoist with CLD

Model	Length (mm)	Height (mm)	Chain size (ø x P) in mm	Weight (g)	Product Code	Price
CLD 4/5	70 x 34	34	4x12/5x15	0.14	196438	€9.60
CLD 6	85 x 42	42	6x18	0.24	196448	€12.50
CLD 7/8	110 x 52	52	7x12/8x24	0.48	196458	€18.00
CLD 10	130 x 64	64	10x30	0.76	196468	€24.50

 Order products on day 1, will be shipped no later than day 2

 Order products on day 1, will be shipped no later than day 3. Maximum quantities apply for this service.

 Available on request. Please enquire about delivery times of these items.

tralift™ manual chain hoist

The tralift™ manual hand chain hoist has been developed especially for lifting loads under the most challenging circumstances.

Its unique design makes it one of the lightest and smallest hoists available on the market. Combined with the corolim® load chain, the hoist complies with the EN 13157 standard. The corolim® load chain, Grade 80 EN 818/7, has an inorganic coating consisting of zinc flakes in a matrix of chromate and provides excellent corrosion protection. Due to the coating process, all parts are free of hydrogen embrittlement. Since the coating contains teflon, the friction between the parts is significantly reduced. The coating works as a dry lubricant. Salt water spray resistance up to 400 hours, without signs of red rust. Heat resistance up to 280 °C, without any visible changes. Lifting height available in any required length.

- corolim® load chain with coating
- Easy to handle
- Light-weight and compact
- Safety catch
- Nyloc nuts
- ISO grade 80, starting from 500 kg
- EN 13157, starting from 500 kg
- 180° chain guide
- Spare parts available
- Exclusive Tractel® design
- Also available with load limiter - go to page 20





Model	WLL (t)	Number of Falls	Pressure (N)	Load Chain	Lifting Height (m)	Weight (kg)	Product Code	Price
tralift™ 0,5t	0.5	1	224	5x15	3	9	272269	€301.00
tralift™ 1t	1	1	365	6x18	3	12.4	272279	€332.00
tralift™ 1,5t	1.5	1	403	7x21	3	16.5	272289	€403.00
tralift™ 2t - 1f	2	1	412	8x24	3	19.6	272309	€445.00
tralift™ 2t - 2f	2	2	365	6x18	3	17.2	272299	€520.00
tralift™ 3t	3	2	403	7x21	3	24.2	272319	€623.00
tralift™ 5t	5	2	428	10x30	3	42	272329	€883.00
tralift™ 10t	10	4	428	10x30	3	85.1	272339	€1,848.00
tralift™ 20t	20	8	428	10x30	3	165.1	272349	€3,901.00

tralift™ manual chain hoist - extra lifting height per m

Model	Description	Hand Chain	Product Code	Price
0,5t	Extra lifting height per meter - WLL: 0,5t	5 x 24 mm	353830	€34.00
1t	Extra lifting height per meter - WLL: 1t	5 x 24 mm	353840	€35.50
1,5t	Extra lifting height per meter - WLL: 1,5t	5 x 24 mm	353850	€40.00
2t	Extra lifting height per meter - WLL: 2t	5 x 24 mm	353860	€45.50
2t - 2f	Extra lifting height per meter - WLL: 2t	5 x 24 mm	353870	€59.00
3t	Extra lifting height per meter - WLL: 3t	5 x 24 mm	353880	€67.50
5t	Extra lifting height per meter - WLL: 5t	5 x 24 mm	353890	€76.50
10t	Extra lifting height per meter - WLL: 10t	5 x 24 mm	353900	€143.00
20t	Extra lifting height per meter - WLL: 20t	5 x 24 mm	353910	€272.00

 Order products on day 1, will be shipped no later than day 2

 Order products on day 1, will be shipped no later than day 3. Maximum quantities apply for this service.

 Available on request. Please enquire about delivery times of these items.

TRIED, TESTED, TRACTEL®

bravo™ & tralift™ with load limiter

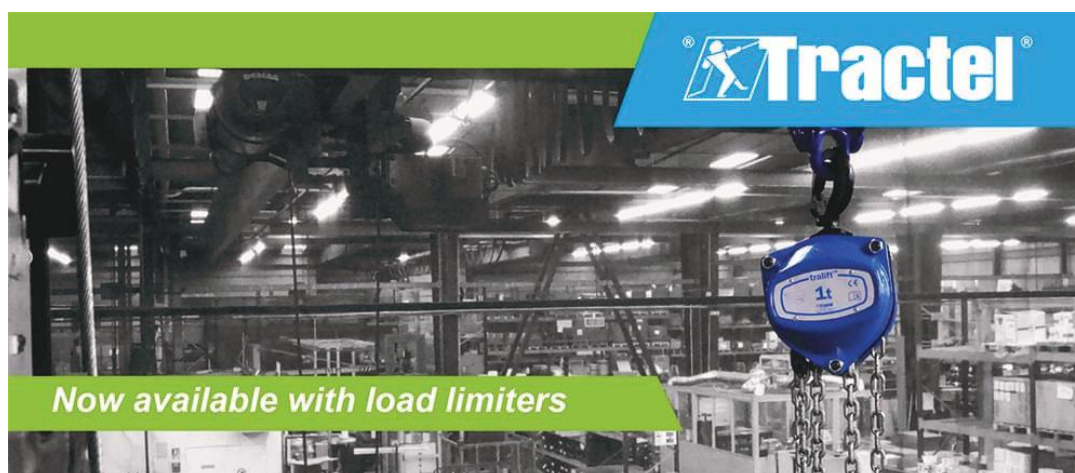

Now available with load limiters

bravo™ hoist with load limiter

Model	WLL (t)	Number of Falls	Pressure (N)	Load Chain	Lifting Height (m)	Weight (kg)	Product Code	Price
bravo™ 0,5t	0.5	1	393	5x15	1,5	5	358720	€426.00
bravo™ 0,75t	0.75	1	233	6x18	1,5	7	358730	€418.00
bravo™ 1t	1	1	310	6x18	1,5	7.3	358740	€550.00
bravo™ 1,5t	1.5	1	400	7x21	1,5	11.5	358750	€626.00
bravo™ 3t	3	1	390	10x30	1,5	21.4	358760	€844.00
bravo™ 6t	6	2	410	10x30	1,5	30.2	358770	€1,287.00
bravo™ 9t	9	3	430	10x30	1,5	56.1	358780	€1,750.00

Model	WLL (t)	Number of Falls	Pressure (N)	Load Chain	Lifting Height (m)	Weight (kg)	Product Code	Price
bravo™ 0,5t	0.5	1	393	5x15	3	5.84	358790	€466.00
bravo™ 0,75t	0.75	1	233	6x18	3	8.2	358800	€562.00
bravo™ 1t	1	1	310	6x18	3	8.5	358810	€593.00
bravo™ 1,5t	1.5	1	400	7x21	3	13.12	358820	€677.00
bravo™ 3t	3	1	390	10x30	3	24.75	358830	€910.00
bravo™ 6t	6	2	410	10x30	3	36.9	358840	€1,418.00
bravo™ 9t	9	3	430	10x30	3	66.1	358850	€1,946.00

tralift™ hoist with load limiter

Model	WLL (t)	Number of Falls	Load Chain	Lifting Height (m)	Weight (kg)	Product Code	Price
tralift™ 0,5t	0.5	1	5x15	3	9	358860	€431.00
tralift™ 1t	1	1	6x18	3	12.4	358870	€476.00
tralift™ 1,5t	1.5	1	7x21	3	16.5	358880	€563.00
tralift™ 2t - 1f	2	1	8x24	3	19.6	358890	€610.00
tralift™ 2t - 2f	2	2	6x18	3	17.2	358900	€635.00
tralift™ 3t	3	2	7x21	3	24.2	358910	€748.00
tralift™ 5t	5	2	10x30	3	42	358920	€1,043.00
tralift™ 10t	10	4	10x30	3	85.1	358930	€1,938.00
tralift™ 20t	20	8	10x30	3	165.1	358940	€4,152.00

carol™ TR serie

The TR gear winch is an extremely robust winch available with a capacity up to 2,000 kg and 40 m wire rope length. Suitable, combined with the non-rotating wire rope, for non-guided loads. Optimal safety devices. Cannot be disconnected while loaded. Delivery excluding wire rope.



- Horizontal or vertical use - Automatic brake
- Strong structure - Crank adjustable and removable

Model	WLL	(Wire/Chain/Reel) Diameter	(Wire/Chain/Reel) Length	Weight (kg)	Product Code	Price
caRol™ TR 300	300	5	38	15	23778	€777.00
caRol™ TR 500	500	7	18	15	23788	€966.00
caRol™ TR 1000	1000	9	30	44	23798	€1,564.00
caRol™ TR 2000	2000	13	25	83	23808	€2,066.00

Supplied without wire rope. Ask our Customer Service for the minimum quantity of 3 or 10 pieces.

carol™ TS serie

The TS worm gear winch is an extremely robust winch available with a capacity up to 3,000 kg and 40 m wire rope length. Suitable, combined with the non-rotating wire rope, for non-guided loads. Optimal safety devices. Delivery excluding wire rope.



- Strong structure with automatic brake function
- Crank adjustable and removable - Cannot be disconnected while loaded

Model	WLL	(Wire/Chain/Reel) Diameter	(Wire/Chain/Reel) Length	Weight (kg)	Product Code	Price
caRol™ TS 250	250	5	15	8	23818	€954.00
caRol™ TS 500	500	7	18	12	23828	€1,374.00
caRol™ TS 1000	1 000	9	30	38	23838	€1,718.00
caRol™ TS 1500	1500	11.5	23	52	23848	€2,771.00
caRol™ TS 2000	2000	13	17	80	23858	€2,926.00
caRol™ TS 3000	3 000	16	18.5	140	23868	€5,478.00

Supplied without wire rope. Ask our Customer Service for the minimum quantity of 3 or 10 pieces.

carol™ non-rotating wire rope

wire rope ¹⁾ ∅ (mm)	wire rope length 10 m		wire rope length 20 m		wire rope length 30 m		additional charge per m	
	code	price	code	price	code	price	code	price
4	026419	105.00	026429	160.00	026439	208.00	016261	5.10
5	026449	108.00	026459	156.00	026469	206.00	016271	5.30
6.8	026479	113.00	026489	167.00	026499	222.00	016281	5.60
8	026509	145.00	026519	207.00	026529	280.00	016291	7.00
9	026539	134.00	026549	218.00	026559	290.00	016301	8.10
11.5	026569	182.00	026579	291.00	026589	412.00	016311	13.00
13	026599	233.00	026609	367.00	026619	492.00	016321	13.00
15.8	026629	335.00	026639	469.00	026649	893.00	016331	30.50

tirfor® TU-P and TU-H series

tirfor® TU-A Series pneumatic wire rope hoist

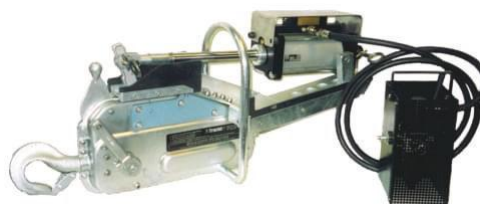
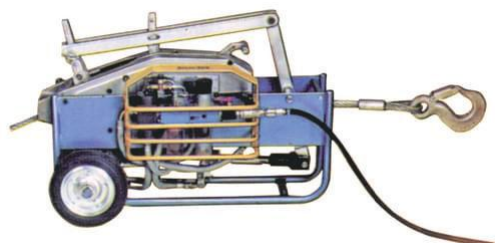

The tirfor® TU-A series is suitable for automatically moving loads over long distances. Many building sites have an air supply by using a compressor. The pneumatic tirfor® can be connected to this compressor and has a standard control unit. If the air pressure is lost, the tirfor® TU-A series can also be operated manually.

- Robust
- Unlimited wire rope length
- Easy to use
- Working load can be increased by using sheave blocks
- Overload protection
- Positioning loads with millimetre accuracy
- Work pressure (atm) TU-16P/TU-32P: 6

Model	WLL	Avg. Consumption (l/min)	Lifting speed (m/min)	Lowering speed (m/min)	(Wire/Chain/Reel) Diameter	Weight (kg)	Product Code	Price
TU-16A	1 600	550	0.5	1.5	11.5	40	77959	€7,845.00
TU-32A	3 200	700	0.8	1.8	16.3	88	5909	€11,009.00

Accessories for tirfor® TU-P

Model	Product Code	Price
Wire rope ø 11.5 mm - standard length 20 m	54759	€331.00
Wire rope ø 16.3 mm - standard length 20 m	54959	€416.00
Other wire rope lengths	-	On request

For more information about lifting solutions for special applications, please contact Tractel® Customer Service and Technical Support (0031 (0)765435135).

 Order products on day 1, will be shipped no later than day 2

 Order products on day 1, will be shipped no later than day 3. Maximum quantities apply for this service.

 Available on request. Please enquire about delivery times of these items.

supertirfor™ TU-16H and TU-32H

supertirfor™ TU-16H

Model	Description	Product Code	Price
TU-16H - 1 way	Standard equipment supertirfor™ TU-16H, electric motor, including: Hydraulic power pack, 1 set of 2 tubes, cylinder support, 1 VA2 self-locking cylinder, 1 can of hydraulic oil	199249	€8,476.00
TU-16H - 2 ways	Standard equipment supertirfor™ TU-16H, electric motor, including: 1 hydraulic unit, 2 sets of 2 tubes, cylinder support, 2 VA2 self-locking cylinders, 1 can of hydraulic oil	199259	€12,824.00
TU-16H - 4 ways	Standard equipment supertirfor™ TU-16H, electric motor, including: 1 hydraulic power pack, 4 sets of 2 hoses, cylinder support, 4 VA2 self-locking cylinders, 1 can of hydraulic oil	199269	€20,592.00



supertirfor™ TU-32H

Model	Description	Product Code	Price
TU-32H - 1 way	Standard equipment supertirfor™ TU-32H, electric motor, including: 1 hydraulic power pack, 1 set of 2 tubes, cylinder support, 1 VA3 self-locking cylinder, 1 can of hydraulic oil	199279	€9,672.00
TU-32H - 2 ways	Standard equipment supertirfor™ TU-32H, electric motor, including: 1 hydraulic power pack, 2 sets of 2 tubes, cylinder support, 2 VA3 self-locking cylinders, 1 can of hydraulic oil	199289	€15,288.00
TU-32H - 4 ways	Standard equipment supertirfor™ TU-32H, electric motor, including: 1 hydraulic power pack, 4 sets of 2 tubes, cylinder support, 4 VA3 self-locking cylinders, 1 can of hydraulic oil	199299	€25,584.00



tirfor® TU-H Series

Model	WLL	Product Code	Price
TU-16H	1600	398	€2,438.00
TU-32H	3200	4748	€3,076.00



Order products on day 1, will be shipped no later than day 2



Order products on day 1, will be shipped no later than day 3. Maximum quantities apply for this service.



Available on request. Please enquire about delivery times of these items.

TRIED, TESTED, TRACTEL®

supertirfor™ TU-16H and TU-32H

Hydraulic Power Pack

Model	Product Code	Price
Hydraulic power pack with electric motor, 13 l/min, 3 phase - 1-way model	8488	€5,293.00
Hydraulic power pack with electric motor, 13 l/min, 3 phase - 2-way model	1548	€6,095.00
Hydraulic power pack with electric motor, 13 l/min, 3 phase - 4-way model	1558	€6,975.00
Hydraulic power unit with petrol engine - 13 l/min - 1-way model	1168	€5,600.00
Hydraulic power pack with petrol engine - 13 l/min - 2-way model	4768	€6,104.00
Hydraulic power pack with petrol engine - 13 l/min - 4-way model	4778	€6,795.00

Hydraulic tubes

Model	Description	Product Code	Price
Set of 2 tubes Ø 10 mm (pressure + return) with quick-release connectors, length 3m	x1 for 1-way model	6158	€277.00
	x2 for 2-way model		
	x4 for 4-way model		

Hydraulic cylinder

Model	Description	Product Code	Price
Self reversing cylinder VA2 suitable for supertirfor™ TU-16H	x1 for 1-way model	1138	€1,459.00
	x2 for 2-way model		
	x4 for 4-way model		
Self reversing cylinder VA3 suitable for supertirfor™ TU-32H	x1 for 1-way model	8678	€1,773.00
	x2 for 2-way model		
	x4 for 4-way model		

Hydraulic Oil, 18 L

Model	Product Code	Price
Hydraulic oil can - 18L	107320	€124.00



Order products on day 1, will be shipped no later than day 2



Order products on day 1, will be shipped no later than day 3. Maximum quantities apply for this service.



Available on request. Please enquire about delivery times of these items.

supertirfor™ TU-16H and TU-32H

tube set Ø 10 mm

Model	Product Code	Price
3 m	6158	€277.00
4 m	56098	€337.00
5 m	84828	€370.00
6 m	84838	€402.00
7 m	56108	€434.00
8 m	56088	€478.00
9 m	84848	€515.00
10 m	84858	€549.00
11 m	84868	€575.00
12 m	84878	€615.00
13 m	56118	€644.00
14 m	56128	€675.00

tube set Ø 13 mm

Model	Product Code	Price
15 m	84888	€949.00
16 m	84898	€993.00
17 m	84908	€1,035.00
18 m	56198	€1,070.00
19 m	84918	€1,115.00
20 m	84928	€1,159.00
25 m	84968	€1,365.00
30 m	84978	€1,571.00
35 m	84988	€1,779.00
40 m	84998	€1,987.00

Wire rope - 20 m

Model	Product Code	Price
Wire rope Ø 11.5 mm - standard length 20 m	54759	€331.00
Wire rope Ø 16.3 mm - standard length 20 m	54959	€416.00
Other wire rope lengths	-	On request

 Order products on day 1, will be shipped no later than day 2

 Order products on day 1, will be shipped no later than day 3. Maximum quantities apply for this service.

 Available on request. Please enquire about delivery times of these items.

The minifor™ principle



A unique concept

- Lifting and pulling loads over large distances.
- The electrically powered Minifor™ is well-known in construction and industry because of its unlimited wire rope length.

Product features

- Unlimited wire rope length and therefore unlimited lifting height
- Compact, manageable and low self-weight.
- Unique lifting capacity/self-weight ratio.
- Handle for easy carrying
- Strong, robust and versatile (IP55).
- Power supply 230 VAC or 400 VAC. Can be used in any working environment.
- Wire rope or kernmantle rope version.
- Quick and easy installation and includes a swivel eye hook
- In conformity with Machinery Directive 98/37/EC and the European EN 292 standard.
- WLL can be increased to a maximum of 950 kg by using an optional sheaving kit.



Possible applications

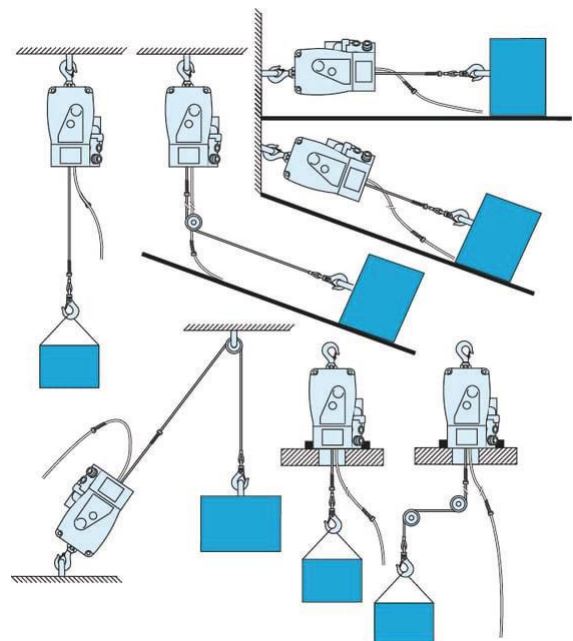

minifor™ TR Serie

minifor™ TR Serie

The minifor™ hoist is compact, light-weight and easy to handle. Unlimited wire rope length and therefore unlimited lifting height. Available in various models. This hoist can also be used for pulling loads in any direction. Operated by a control pendant (2.5 m cable, Up/Down/Emergency Stop), which is supplied as standard. Power supply cable length 1 metre with CEE Form connector.

- Unique lifting capacity/self-weight ratio
- Unlimited wire rope length
- Reliable and easy to use
- Working load can be increased by using sheaving kit
- Up and down limit switches
- Strong, robust and versatile (IP55)
- Available in different lengths
- Wire rope: 6.5 mm



Model	WLL	Lifting speed (m/min)	Volts (V)	Product Code (kg)	Price	Price
TR10	100	15	230	21	42789	€3,228.00
TR30	300	5	230	21	42889	€3,475.00
TR30S	300	13	230	32	42989	€3,807.00
TR30S	300	13	400	28	44779	€4,079.00
TR50	500	7	230	32	44849	€4,259.00
TR50	500	7	400	28	44899	€4,067.00

TR10 and TR30 standard delivered in metal storage box.
TR30S and TR50 standard delivered in cardboard packaging.
Excluding maxiflex wire rope.

Box for minifor™ TR30S/TR50

Model	Product Code	Price
Box for minifor™ TR30S/TR50	102715	€345.00

Sheaving kit for minifor™ serie

The sheaving kit is used to double the lifting capacity of the minifor™.

- The lifting speed is halved
- Including 2 turning springs



Model	Description	WLL	Product Code	Price
sheaving kit TR10/TR30 with safety catch	Bottom hook: Safety hook	200-600	217897	€536.00
sheaving kit TR30/TR50 with safety catch	Bottom hook: Safety hook	600-980	217887	€619.00



Order products on day 1, will be shipped no later than day 2



Order products on day 1, will be shipped no later than day 3. Maximum quantities apply for this service.



Available on request. Please enquire about delivery times of these items.

TRIED, TESTED, TRACTEL®

minifor™ TR serie with radio remote control

The minifor™ is equipped with a simple and robust remote control. Default range 50 m, 433 MHz. With Up/Down/Emergency Stop push buttons.

- Wire rope: 6.5 mm (included)

Model	WLL	Lifting speed (m/min)	Motor (f / VAC / kW)	Weight (kg)	Product Code	Price
TR10	100	15	1 / 230 / 0,32	21	42799	€6,030.00
TR30	300	5	1 / 230 / 0,27	33	42899	€6,126.00
TR30	300	13	1 / 230 / 1,1	32	44759	€6,689.00
TR30S	300	13	3 / 400 / 1,1	28	44789	€6,693.00
TR50	500	7	1 / 230 / 1,1	33	44879	€6,771.00
TR50	500	7	3 / 400 / 1,1	33	44919	€6,783.00

minifor™ TR serie with drum reel

The minifor™ hoist is very compact, light-weight and easy to handle. The lifting cable is wound automatically by using the drum. Operated by a control pendant (2.5 m cable, Up/Down/Emergency Stop), which is supplied as standard. Power supply cable length 1 meter, with CEE Form connector and Mono Duty cycle.



- Unique lifting capacity/self-weight ratio - Reliable and easy to use
- Up and down limit switches - Strong, robust and versatile
- Wire rope: 6.5mm. (included)

Model	WLL	Forward Speed	Volts (V)	Kilowatts (W)	Length wire rope (m)	Dimension (mm)	Weight (kg)	Product code	Price
TR10	100	15	230	0,37	20	562 / 415 / 418	39	279539	€4,649.00
TR30	300	5	230	0,37	20	562 / 415 / 418	39	279569	€4,712.00
TR10	100	15	230	0,37	27	683 / 415 / 418	42	279549	€5,393.00
TR30	300	5	230	0,37	27	683 / 415 / 418	42	279579	€5,408.00
TR10	100	15	230	0,37	40	622 / 415 / 418	42	279559	€5,564.00
TR30 - 40m	300	5	230	0,37	40	622 / 415 / 418	42	279589	€5,648.00

minifor™ TR serie with drum reel and radio remote control

The minifor™ is equipped with a drum reel and a simple and robust remote control. Default range 50 m, 433 MHz. With Up/Down/Emergency Stop push buttons.

- Wire rope: 6.5 mm. (included)

Model	WLL	Forward Speed	Volts (V)	Kilowatts (kW)	Length wire rope (m)	Dimension (mm)	Weight (kg)	Product code	Price
TR10	100	15	230 V / mono	0,37	20	562 / 415 / 418	41	279659	€7,587.00
TR30	300	5	230 V / mono	0,37	20	562 / 415 / 418	41	279689	€7,421.00
TR10	100	15	230 V / mono	0,32	27	583 / 415 / 418	44	279669	€8,279.00
TR30	300	5	230 V / mono	0,27	27	583 / 415 / 418	44	279699	€8,944.00
TR10	100	15	230 V / mono	0,37	40	622 / 415 / 418	42	279679	€8,414.00
TR30	300	5	230 V / mono	0,27	40	622 / 415 / 418	42	279709	€9,230.00

minifor™ TR55 & TR110 push button control

minifor™ TR55 and TR110 are the latest additions to our range of portable endless wire rope electric hoists. Maintaining the same features as all minifor™ hoists the TR55 and TR110 extends the load capacity to the best in market maximum of 1100kg, 15% more than previously available.

TR55 has a load capacity of 550kg offering 10% more from a single fall minifor™ hoist allowing greater scope to lift or pull loads in any direction.

TR110 has a load capacity of 1100kg and is fitted with a load limiting system to be in conformity with EU regulations, providing additional safety during operation.

Operation is by a pendant push button control box, Up/Down/Emergency Stop, with 2.5m control cable supplied as standard, as well as 1m power supply cable or with optional radio remote control with a range up to 500m, providing the best in market solution.



- Unlimited wire rope length and therefore unlimited lifting height
- Compact, manageable and low self-weight
- Unique lifting capacity/self-weight ratio
- Handle for easy carrying
- Quick and easy installation and includes a swivel eye hook
- In conformity with Machinery Directive 2006/42/CE and European EN 292 standard
- Reliable and easy to use
- Upper and lower limit switches
- Optional remote radio control up to a range of 500m
- Strong, robust and versatile (IP55)





Model	WLL	Forward Speed	Volts (V)	Frequency (Hz)	(Wire/Chain/Reel) Diameter	Description	Product Code	Price
TR55	N 550	7	230	50	6.5	with push button control	286869	€4,409.00
TR55	N 550	7	400	50	6.5	with push button control	286889	€4,793.00
TR110	N 1100	3.5	230	50	6.5	with push button control	286909	€5,533.00

minifor™ TR55 & TR110 radio control

Model	WLL	Forward Speed	Volts (V)	Frequency (Hz)	(Wire/Chain/Reel) Diameter	Description	Product Code	Price
TR55	N 550	7	230	50	6.5	with radio control	286879	€7,120.00
TR55	N 550	7	400	50	6.5	with radio control	286899	€7,505.00
TR110	N 1100	3.5	230	50	6.5	with radio control	286919	€8,245.00

 Order products on day 1, will be shipped no later than day 2

 Order products on day 1, will be shipped no later than day 3. Maximum quantities apply for this service.

 Available on request. Please enquire about delivery times of these items.

minifor™ SY Serie

The minifor™ TR125 SY hoist is equipped with a special synthetic rope. It can be used to lift over great heights (standard rope length up to 200 m, longer ropes upon request).

The kernmantle rope is made of polyester and has a 9.4 mm diameter. The maximum length is 200 m. This rope has been developed especially for excellent performance, even if the rope shows signs of wear. The rope can be identified by a blue braided cable. The rope core has a ribbon with a Tractel® marking.

Operated by a control pendant (2.5 m cable, Up/Down/Emergency Stop), which is supplied as standard. Power supply cable (1 m) with CEE Form connector.



- Unique lifting capacity/self-weight ratio
- High speed (30 m/min)
- Rope: kernmantle
- Reliable and easy to use
- Working load can be increased by using a sheaving kit
- Up and down limit switches
- Strong, robust and versatile (IP55)

Model	WLL	Forward Speed	Volts (V)	Duty Cycle	Amps (A)	Weight (kg)	Product Code	Price
TR125 SY	125	30 m/min	690	100%	1.3	22 kg	245199	€4,218.00
TR125 SY	125	30 m/min	400	100%	2.25	20 kg	245189	€3,824.00
TR125 SY	125	30 m/min	230	30%	6.2	20 kg	245169	€3,648.00
TR125 SY	125	15 m/min	230	30%	3.9	20 kg	245179	€3,174.00
TR125 SY	125	15 m/min	115	20%	9	21 kg	245159	€3,490.00

minifor™ with plug-in pendant control box

The control cable length can be flexibly adapted by using the version with connector.

The system must be assembled with a removable plug-in control pendant (to be ordered separately) and an optional extension cable.

Model	WLL	Forward Speed	Volts (V)	Duty Cycle	Amps (A)	Weight (kg)	Product Code	Price
TR125 SY	125	30 m/min	690	100%	1.3	22 kg	245259	€3,996.00
TR125 SY	125	30 m/min	400	100%	2.25	20 kg	245249	€3,340.00
TR125 SY	125	30 m/min	230	30%	6.2	20 kg	245229	€4,118.00
TR125 SY	125	15 m/min	230	30%	3.9	20 kg	245239	€2,982.00
TR125 SY	125	15 m/min	115	20%	9	21 kg	245219	€3,695.00
TR125 SY	125	15 m/min	115	20%	9	21 kg	245209	€4,097.00

 Order products on day 1, will be shipped no later than day 2

 Order products on day 1, will be shipped no later than day 3. Maximum quantities apply for this service.

 Available on request. Please enquire about delivery times of these items.

minifor™ SY with radio remote control

The minifor™ is equipped with radio control (integrated).

- Standard range: 70 metres

Model	WLL	Forward Speed	Volts (V)	Amps (A)	Duty Cycle	Weight (kg)	Product Code	Price
TR125 SY	125	30 m/min	400	2.25	100%	20 kg	245299	€6,066.00
TR125 SY	125	30 m/min	230	6.2	30%	20 kg	245289	€6,461.00
TR125 SY	125	15 m/min	230	3.9	30%	20 kg	245279	€5,683.00
TR125 SY	125	15 m/min	115	9	20%	21 kg	245269	€6,625.00

Relay antenna for remote control

Model	Description	Product Code	Price
Relay antenna	increasing the transmission range to 150m	184756	€92.00

Control cable extension minifor™

Model	Description	Product Code	Price
Plug-in - 1,8 m	Cable length 1.8 metres - with Harting plug	111367	€186.00
10 m	Cable length 10m - with Harting plug	106287	€330.00
15 m	Cable length 15m - with Harting plug	112347	€398.00
20 m	Cable length 20m - with Harting plug	113197	€437.00
25 m	Cable length 25m - with Harting plug	213777	€477.00
30 m	Cable length 30m - with Harting plug	231747	€519.00



Order products on day 1, will be shipped no later than day 2



Order products on day 1, will be shipped no later than day 3. Maximum quantities apply for this service.



Available on request. Please enquire about delivery times of these items.

TRIED, TESTED, TRACTEL®

minifor™ TR-serie - maxiflex wire rope

The maxiflex wire rope has been developed especially for optimal use guaranteed by Tractel®, in combination with the electric minifor™ hoists, and can be used under the most extreme circumstances. Supplied on a transport reel. Upon request, also available on a drum reel and in different lengths. The wire rope (Ø 6.5 mm) has a hook with safety catch on one side and a tip on the other side. Supplies on a transport reel up to 60 metres and for 100 metres on a hand reel.

- Minimum breaking load: 2800 daN.
- Supplied on a transport reel
- Including certificate
- Standard version with tip and hook
- Hook with safety catch
- Different lengths available



Model	Length (cm)	Product Code	Price
10m wire rope	10	108749	€162.00
20m wire rope	20	60999	€213.00
30m wire rope	30	61009	€260.00
40m wire rope	40	61989	€316.00
50m wire rope	50	61019	€369.00
60m wire rope	60	61029	€407.00
100m wire rope	100	61049	€651.00
extra per meter	-	17361	€6.40

maxiflex wire rope can also be ordered per metre. Ask our Customer Service for the possibilities.

Kernmantel rope

The kernmantel rope has been developed especially for use in combination with the electric minifor™ SY hoists, and can be used under the most extreme circumstances. The kernmantel rope is made of durable polyester and has a 9.4 mm diameter.

The rope can be identified by a blue braided cable. The core has a ribbon with a Tractel® marking.

- Sustainable
- Available in different lengths
- Maximum length 200 m.



Model	Description	Product Code	Price
Kernmantel Rope with hook	Ø 9.4mm, length 20m, hook with safety catch	187228	€331.00
Kernmantel Rope with hook	Ø 9.4mm, length 20m, self-locking hook	187268	€337.00
Kernmantel Rope with swivel hook	Ø 9.4mm, length 20m, self-locking swivel hook	187248	€376.00
Kernmantel Rope additional meter	additional Ø 9.4 mm rope, length 1 metre	238587	€3.10

 Order products on day 1, will be shipped no later than day 2

 Order products on day 1, will be shipped no later than day 3. Maximum quantities apply for this service.

 Available on request. Please enquire about delivery times of these items.

Tow bar adapter

The tow bar adapter has been developed especially to create an anchor point for the Minifor™ TR10 and TR125 SY on a vehicle's tow bar. A sheave enables the lifting and pulling of loads, without the hoist hanging above the load. Suitable for tow bars which comply with the 94/20/EC directive, ø 50 mm.

- In conformity with EN 2006/42/CE, compact and light-weight
- Durable, galvanized steel, quick and easy installation



Model	Description	Product Code	Price
MTA Tow bar Adaptor	Towbar adapter for minifor™ TR10 and TR125 SY (125 kg maximum)	251279	€320.00

minifor™ TR-serie - accessories

Model	Description	Product Code	Price
Limit spring	Limit spring - wire rope mounting	22217	€20.50
Storage box	Metal storage box for minifor™ TR10 and TR30	60485	€284.00
Box for minifor™ TR30S/TR50	Metal storage box for minifor™ TR30S en TR50	102715	€345.00
Storage box	Metal storage box for minifor™ TR125 SY with reel	60665	€213.00
Connector kit	Plug set - 6-pole for cable control jack	33570	€117.00
Extension	Power cable 3 x 1.5 mm ² per metre - 230 VAC version	3341	€4.70
Extension	Power cable 4 x 1.5 mm ³ per metre - 400 VAC version	3421	€5.60
Extension	Control cable 5 x 1.5 mm ² per meter for the control spear	9771	€7.30
Strain relief	For cable control jack	15286	€62.50
ELC1-70E7	Pulley - hook with safety lock	252209	€158.00
ELS1-70E7	Pulley - with safety hook (but less compact)	252259	€308.00

minifor™ SY-serie - accessories

Model	Description	Product Code	Price
Drum hasp	Plastic reel for rope - up to 100 m	143865	€31.50
Drum hasp	Plastic reel for rope - up to 200 m	143875	€33.00
Drum hasp	Metal drum reel for rope - up to 200 m	187278	€199.00
Storage box	Metal storage box for minifor™ TR125 SY with reel	60665	€213.00
Combipro - 30L	Combipro - 30 litres - bag for rope up to 100 m	20812	€19.50
Combipro - 60L	Combipro - 60 litres - bag for rope up to 200 m	20822	€34.00
Sheaving kit	WLL 250 kg - swivel hook	217377	€485.00
Sheaving kit	WLL 250 kg - safety catch	217877	€530.00



The tirak™ principle



INFINITE POSSIBILITIES

- For transporting both materials and passengers
- Unlimited lifting height or pulling length
- Unlimited wire rope length
- WLL varying from 300 to 3,000 kg
- No standard version: customized assembly and production
- The working load can be increased by reeving the wire rope

RELIABLE

- Constant speed
- Constant lifting and pulling capacity
- Fixed position of ingoing and outgoing cables
- Integrated mechanical overload protection (≥ 1000 kg)
- Long service life

QUALITY

- Robust, durable and silent
- Areas of application: maritime, building, industry and utility
- Low-maintenance
- Spare parts available

FLEXIBLE

- Different versions for each application
- Various suspension adapters available
- Optionally available with transport reel and frame
- Lifting cable available in any required length
- Non-rotating lifting cable for non-guided loads



The tirak™ principle

ANCHORED TO THE FRAME

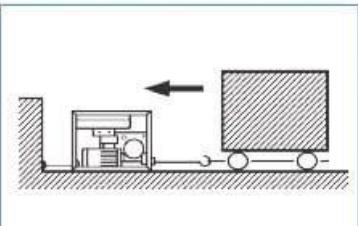

Secure the mobile hoist to a suitable anchor point by using a sling, chain or other securing method and you will be ready to start working.

ORIENTATION

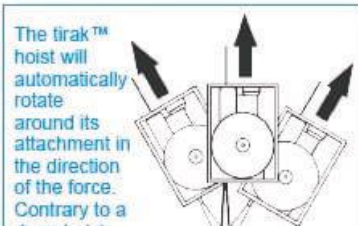

The tirak™ hoist will automatically rotate around its attachment in the direction of the force. Contrary to a drum hoist, the direction of pull is always the same because of the steady wire rope output. In addition, the speed and force are constant.

LIFTING LOADS

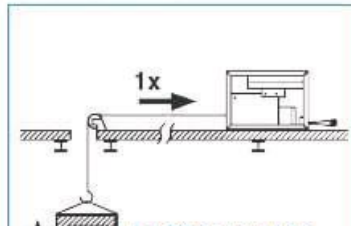

For lifting: secure the mobile hoist to a suitable anchor point and guide the wire rope through 1 or more sheave blocks.

DIRECT LIFTING OR PULLING

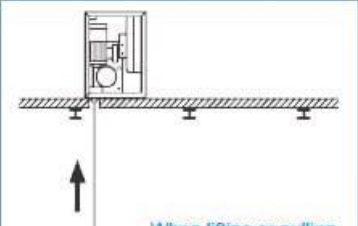

When lifting or pulling through a opening in a ceiling or wall, simply place the hoist in front of the opening.

POSITIONING

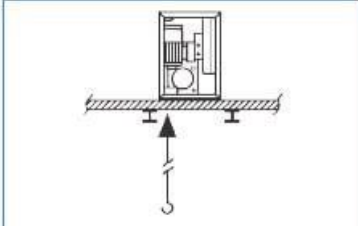

If the opening is not large enough for the hook, first position the hoist and guide the wire rope with the tip through the opening and into the Tirak™.

LIFTING AND REEVING

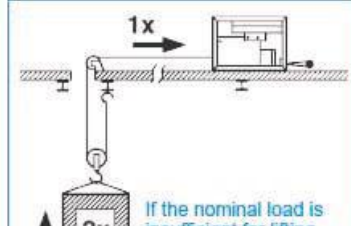

If the nominal load is insufficient for lifting the load, the WLL can be increased by using a number of blocks/sheaves.

Type coding structure, infinite possibilities

Proven technology

- The tirak™ combines proven technology with modern techniques and sophisticated production methods in order to obtain the highest possible quality standards.

Customisation

- Each tirak™ is assembled and produced in accordance with customer requirements. We will be happy to advice and support you while assembling the optimal tirak™ for your application.
- Type coding structure

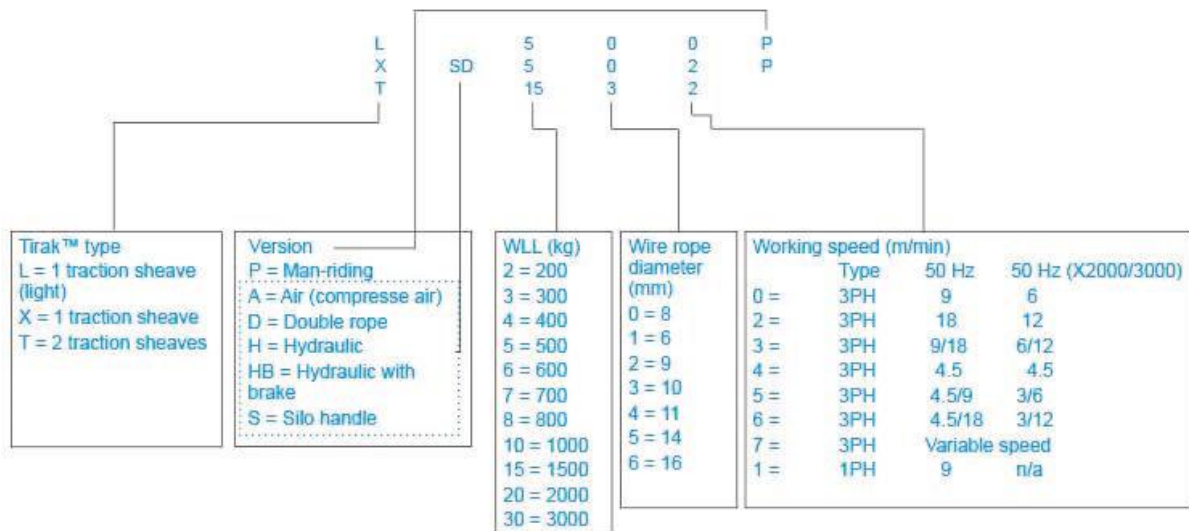

tirak™ electric hoists

tirak™ for material handling

The tirak™ by Tractel® is the number one motorised traction hoist worldwide. With its rope pass-through design, the tirak™ allows for unlimited rope lengths, providing ultimate flexibility.

- Quality: Robust, powerful and easy to transport. Efficient and durable, even in harsh working conditions.
- Reliability: low cost of ownership thanks to a unique design and gentle rope drive which extends rope service life.
- Safety: multiple levels of safety built into the hoist. All relevant standards and safety regulations are considered during the development and design of the tirak™

T-series

When your application calls for moving material back and forth, the T-series is the ideal solution. Equipped with two traction sheaves, the T-series is capable of pulling both forwards and backwards with the same force.

X-series

The X-series is ideal for applications that require lifting in only one direction. Built using a single traction sheave, the X-series allows for easy manoeuvring of heavy loads with a constant lifting speed



tirak™ man riding hoist

Everywhere you have to transport people, the highest safety standards are regulated by law. Certified by an independent notified body according to EN1808, the tirak™ meets all these requirements and is at the heart of many access systems.

- Universal use
- The compact dimensions and low weight enable easy operation and simplify integration of the tirak™ into any application.
- The low weight of the tirak™ increases the payload capacity of the system
- A complete range of tirak™ models offers load capacities from less than 300 kg to 2000 kg for applications involving passenger transport.
- Unlimited wire rope length
- Equipped with an emergency descent system as standard
- Built-in mechanical overload in accordance with EN 1808



tirak™ for central control



tirak™ with control spindle

For information about customized models, please contact Tractel® Customer Service and Technical Support (0031 (0)765435135).

tirak™ with cable reel

tirak™ with cable reel

Because of its unique design, the tirak™ can be used without a cable reel, where the end of the cable will hang freely.

If this situation is undesirable, a cable reel can be used to safely wind and store the wire rope.

Three different cable reels are available::

- Free-running cable reel
 - Driven cable reel (directly by Tirak™ drive shaft)
 - Cable reel driven by a separate electric motor (very long lengths)
-
- WLL varying from 300 to 3.000 kg
 - Storage capacity up to 520 m
 - Choice between material handling or man-riding application
 - Compact size

free-running cable reel

cable reel with electric motor

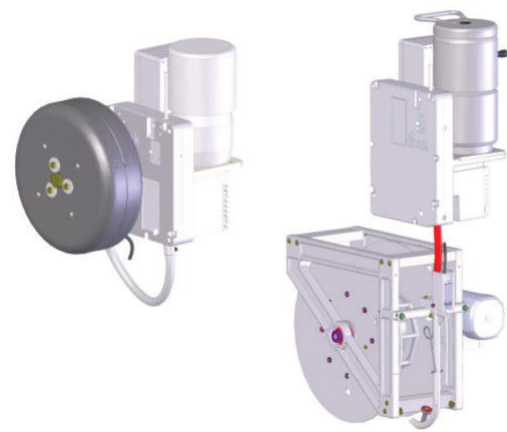

Suspension Adapters for tirak™ Hoists

- Available with hook or eye
- Also available with removable hook and eye
- The circulation discs can be found starting from page 45

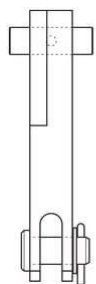

Type A

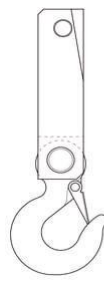

Type B

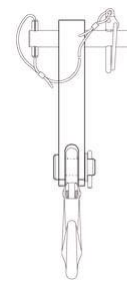

Type C

Model	Description	Product Code	Price
Type A	Suspension adapter for X500-X1530	48657	€90.00
Type B	Suspension adapter with hook. For X500-X1530	48727	€153.00
Type B	Suspension adapter with eye. For X500-X1530	48717	€99.50
Type C	Suspension adapter with removable hook. For X300	180157	€132.00
Type C	Suspension adapter with removable eye. For X300	180167	€126.00
Type C	Suspension adapter with removable hook. For X500-X1530	58527	€132.00
Type C	Suspension adapter with removable eye. For X500-X1530	58537	€126.00

maxiflex wire rope - standard

The maxiflex wire rope has been developed especially for optimal use guaranteed by Tractel®, in combination with tirak™ hoists, and can be used under the most extreme circumstances.

Upon request also available on a drum reel and in any required length.

- Developed especially for tirak™
- Supplied on a transport reel.
- Including certificate
- Standard version with tip and hook
- Hook with safety catch
- Also available on a drum reel (see image below) and available in any required length



Wire Rope Type	wire rope 8.3mm	wire rope 9.5mm	wire rope 10.2mm	wire rope 14.3mm
genCode	46129	17389	352040	34429
productModelName	wire rope 8.3mm	wire rope 9.5mm	wire rope 10.2mm	wire rope 14.3mm

Length	Code	Price	Code	Price	Code	Price	Code	Price
20	46129	€169.00	17389	€195.00	352040	€205.00	34429	€371.00
30	46139	€205.00	17409	€251.00	352050	€262.00	34439	€494.00
40	46149	€226.00	17429	€306.00	352000	€318.00	34449	€606.00
50	46159	€260.00	17449	€358.00	352060	€375.00	34459	€724.00
60	46169	€299.00	17469	€412.00	352070	€434.00	34469	€1,015.00
70	46179	€333.00	17489	€467.00	352080	€494.00	34479	€1,133.00
80	46189	€370.00	17509	€521.00	352090	€553.00	34489	€1,228.00
90	46199	€403.00	17529	€571.00	352100	€612.00	34499	€1,371.00
100	46209	€437.00	17549	€632.00	352110	€673.00	34509	€1,491.00

maxiflex non-rotating wire rope

The maxiflex non-rotating wire rope has been developed especially to prevent non-guided loads from rotating if they are suspended freely in the air. Upon request the non-rotating wire rope will be produced and manufactured especially for you. The maxiflex wire rope is guaranteed by Tractel®, in combination with tirak™ hoists, and can be used under the most extreme circumstances.

- Non-rotating rope for non-guided loads
- Developed especially for tirak™
- Including certificate
- Available in any required length
- Standard version with tip and hook
- Hook with safety catch
- Also available on a drum reel and available in any required length

Model	Length (m)	Description	Product Code	Price
Wire rope 8.3mm	100	Extra per meter: 12301 (code)	39459	On request
Wire rope 9.5mm	100	Extra per meter: 15461 (code)	39499	On request
Wire rope 10.2mm	100	Extra per meter: 16461 (code)	13999	On request
Wire rope 10.2mm	100	Extra per meter: 16631 (code)	33629	On request

Reels for maxiflex wire rope

Model	Description	Product Code	Price
Reel No. 0 - small	C8 - 25m max	889	€27.00
Reel No. 1 - standard	C8 - 26-50m C12 - max 25m	909	€30.50
Reel No. 2 - medium	C8 - 51-75m C12 - 26-50m C16 - max 25m	939	€43.00
Reel No. 3 - double	C8 - 75-100m C12 - 51-75m C16 - 26-50m	899	€49.00
Drum reel 200	C8 - 75-150m C12 - 51-75m C16 - 26-50m	878	€170.00
Drum reel 300	C8 - 151-200m C12 - 76-150m C16 - 51-75m	868	€193.00
Drum reel 400	C8 - 201-300m C12 - max 200m C16 - max 100m	858	€229.00

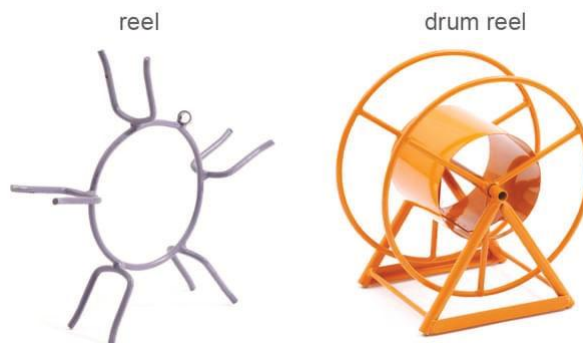

Type:	Wire rope diameter and capacity per metre					Code:
	6mm	8mm	9mm	10mm	14mm	
Reel No. 0	50 m	30 m	25 m	20 m		889
Reel No. 1	120 m	60 m	50 m	40 m		909
Reel No. 2	200 m	130 m	120 m	80 m	30 m	939
Drum reel 200	250 m	150 m	130 m	110 m	60 m	878
Drum reel 300	380 m	240 m	200 m	170 m	90 m	868
Drum reel 400	540 m	340 m	300 m	260 m	130 m	858
Drum reel 500	680 m	430 m	340 m	300 m	160 m	30938
Drum reel 650	850 m	540 m	400 m	360 m	200 m	31788
Wooden reel 1		1000 m	1000 m	1000 m	500 m	10478
Wooden reel 2					1000 m	10488

 Order products on day 1, will be shipped no later than day 2

 Order products on day 1, will be shipped no later than day 3. Maximum quantities apply for this service.

 Available on request. Please enquire about delivery times of these items.

blocstop™ secondary safety device

Fall arrest blocstop™ BSO - manriding applications

An additional safety system in accordance with EN 1808 is mandatory in man riding applications. The system is used to secure the work basket or platform against falling. That is precisely what our blocstop™ does. They are small, light and compact and attached to the working platform where the safety rope runs through it.

BSO – blocstop™ for the detection of overspeed:

If the movement of the safety rope exceeds a specified speed, then the BSO triggers automatically and securely catches the load. The safety rope is held between the clamping jaws, preventing the rope from slipping any further. However, the surface of the clamping jaws is large enough to prevent damage to the rope. The blocstop™ BSO is designed in such a way that the clamping jaws grip tighter, the higher the load on the rope.

Furthermore, the blocstop™ BSO has been tested using many times the nominal load in order to ensure an extremely large safety margin.

The BSO is available in 3 models:

- P version: standard version
- E version: with limit switch and 2m cable - with a plug for the tirak™ connection.
- EFA version: with the option to activate the BSO remotely.

NEW



Model		WLL manriding	WLL	(Wire/Chain/Reel) Diameter	Forward Speed	Product Code	Price
BSO 500P	N	600	600	8	30m/min	291569	€1,265.00
BSO 500E P	N	600	600	8	30m/min	291579	€1,348.00
BSO 520P	N	600	600	9	30m/min	291589	€1,319.00
BSO 520E P	N	600	600	9	30m/min	291599	€1,480.00
BSO 1020P	N	800	800	9	30m/min	291609	€1,766.00
BSO 1020E P	N	800	800	9	30m/min	291619	€1,983.00
BSO 1020EFA P	N	800	800	9	30m/min	291629	€3,869.00
BSO 1030 P	N	1000	1000	10	30m/min	291639	€1,804.00
BSO 1030E P	N	1000	1000	10	30m/min	291649	€2,021.00
BSO 1030EFA P	N	1000	1000	10	30m/min	291659	€3,906.00
BSO 1040P	N	1200	1200	11	30m/min	291669	€2,034.00
BSO 1040E P	N	1200	1200	11	30m/min	291679	€2,248.00
BSO 1040EFA P	N	1200	1200	11	30m/min	291689	€4,134.00
BSO 2050 P	N	2000	2000	14	30m/min	291699	€4,567.00
BSO 2050 P	N	2000	2000	14	30m/min	291709	€4,733.00
BSO 2050EFA P	N	2000	2000	14	30m/min	291719	€6,932.00
BSO 2050 P	N	2400	2400	14	30m/min	291789	€4,567.00
BSO 2050 P	N	2400	2400	14	30m/min	291799	€4,567.00

blocstop™ BSO - material handling

The blocstop™ system, well known from manriding applications, is also used as load arrester to secure loads during material lifting.

Our blocstop™ BSO is small, light and compact and attached to the load where the safety rope runs through it.

If the movement of the safety rope exceeds a specified speed then the BSO triggers automatically and securely catches the load. The safety rope is held between the clamping jaws, preventing the rope from slipping any further. However, the surface of the clamping jaws is large enough to prevent damage to the rope. The blocstop™ is designed in such a way that the clamping jaws grip tighter, the higher the load on the rope. Furthermore, the blocstop™ has been tested using many times the nominal load in order to ensure an extremely large safety margin.

The blocstop™ BSO includes the following models:

- Without marking: standard version
- E version: with limit switch and 2 metre cable equipped with a plug for the tirak™ connection.
- EFA version: with the option to activate the BSO remotely.



Model	WLL	Forward Speed	(Wire/Chain/Reel) Diameter	Product Code	Price
BSO 510	350	30m/min	6	291849	€1,315.00
BSO 510E	350	30m/min	6	291859	€1,785.00
BSO 1004	600	40m/min	8	291889	€1,844.00
BSO 1004E	600	40m/min	8	291899	€2,149.00
BSO 1026	600	60m/min	9	291969	€1,934.00
BSO 1026E	600	60m/min	9	291979	€2,145.00
BSO 1024	800	40m/min	9	291909	€1,801.00
BSO 1024E	800	40m/min	9	291919	€2,111.00
BSO 1022	1000	20m/min	9	291729	€1,924.00
BSO 1022E	1000	20m/min	9	291739	€2,086.00
BSO 1022EFA	1000	20m/min	9	291749	€3,906.00
BSO 1020	1000	30m/min	9	291869	€1,783.00
BSO 1020E	1000	30m/min	9	291879	€2,071.00
BSO 1034	1000	40m/min	10	291929	€1,897.00
BSO 1034E	1000	40m/min	10	291939	€2,126.00
BSO 1032	1200	20m/min	10	291759	€2,199.00
BSO 1032E	1200	20m/min	10	291769	€2,431.00
BSO 1032EFA	1200	20m/min	10	291779	€3,944.00
BSO 1044	1200	40m/min	11	291949	€2,055.00
BSO 1044E	1200	40m/min	11	291959	€2,271.00
BSO 2552	2500	20m/min	14	291819	€4,611.00
BSO 2552E	2500	20m/min	14	291829	€4,830.00
BSO 2552EFA	2500	20m/min	14	291839	€6,999.00
BSO 3060	3000	30m/min	16	291989	€4,740.00
BSO 3060E	3000	30m/min	16	291999	€4,954.00

 Order products on day 1, will be shipped no later than day 2

 Order products on day 1, will be shipped no later than day 3. Maximum quantities apply for this service.

 Available on request. Please enquire about delivery times of these items.

TRIED, TESTED, TRACTEL®

Set of straps blocstop™ BSO

Model	Product Code	Price
Straps for BSO 500 - 1040	42517	€86.00
Straps for BSO 2050 - 2360	198247	€112.00

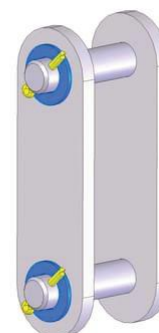
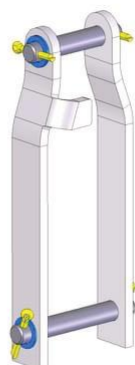

Counterweights blocstop™ BSO

Model	Product Code	Price
Counterweight for BSO 500-1040	21488	€71.20
Counterweight for BSO 2050-2360	199487	€803.20

blocstop™ BS

In contrast to the BSO, the clamping jaws of the BS are not activated by excessive speed, but by the control of the suspension cable. The BS is held open by a lever which is supported on the suspension cable by a coil. If the suspension cable breaks, this support stops and the BS closes.

In exactly the same way as the BSO, the safety wire is held between the clamping jaws preventing the load or the platform from falling. The handle of the Blocstop™ BS is activated manually or mechanically.



Model	WLL manriding (kg)	WLL (kg)	(Wire/Chain/Reel) Diameter	Product Code	Price
BS 15-301	600	800	8.3	3219	€432.00
BS 20-300	600	800	8.3	15929	€464.00
BS 20.303	800	1000	9.5	3239	€467.00
BS 20-304	1000	1600	10.2	6029	€478.00
BS 20-301	1200	1600	11.5	3129	€460.00
BS 35-304	2000	3000	14.3	35319	€841.00
BS 35-300	2400	3200	16.3	3149	€620.00



Order products on day 1, will be shipped no later than day 2



Order products on day 1, will be shipped no later than day 3. Maximum quantities apply for this service.



Available on request. Please enquire about delivery times of these items.

volt trac™ electric chain hoist

volt trac™ hoists are motorised chain hoists. They are used to lift and transfer loads. volt trac™ is designed for permanent installation on a jib crane, underneath an overhead crane, or on motorised or non-motorised trolleys. They are suitable for handling relatively heavy objects while reducing the physical effort of the user. With volt trac™, Tractel® is offering a new generation of electric chain hoists which are robust with FEM/ISO rating of 2m/M5 as well as an economic solution for your lifting needs.

Ergonomic modular construction allows fast disassembly and assembly during maintenance with easy access to all major parts: chain guide, motor and electric components.

This all adds up to low total cost of ownership for you.

In addition, Tractel® is able to provide accessories for volt trac™ which will complete your customised application.

- TuV Rheinland independent certification to all aspects of EN14492
- Modular design allowing ease of maintenance
- Oil bath lubrication for better cooling and low gear wear
- Thermal cut out and phase protection as standard
- Slip clutch overload protection
- Reduced control voltage (24V)
- 50 Hz
- 380 Volt
- **Supplied without electric trolley**



Application picture with trolley (not included)

Standard capacities: 250kg to 2000kg at FEM/ISO rating 2m/M5

Available on request FEM/ISO ratings can be adapted from 1Am/M4 to 5m/M8 expanding the capacity range to: 125kg to 2200kg

Model	Number of Falls	Number of Speeds	Forward Speed	WLL	Product Code	Price
250	1	1	10	250	280209	€1,565.00
500	2	1	5	500	280219	€1,628.00
500	1	1	8	500	280229	€1,785.00
500	1	2	8/2	500	280239	€1,890.00
1000	2	1	4	1000	280249	€1,943.00
1000	2	2	4/1	1000	280259	€2,048.00
1000	1	1	8	1000	280269	€2,258.00
1000	1	2	8/2	1000	280279	€2,415.00
2000	2	1	4	2000	280289	€2,468.00
2000	2	2	4/1	2000	280299	€2,625.00



Order products on day 1, will be shipped no later than day 2



Order products on day 1, will be shipped no later than day 3. Maximum quantities apply for this service.



Available on request. Please enquire about delivery times of these items.

Accessories for volt trac™

Electric trolley 10m/min

Model	Product Code	Price
250 kg 1fall/1speed	276257	€1,440.00
500 kg 2 falls / 1 speed	276267	€1,449.00
500 kg 1 fall/ 1 speed	276277	€1,440.00
1000 kg 2falls/ 1 speed	276287	€1,423.00
1000 kg 1fall/1speed	276297	€1,435.00
2000 kg 2falls/1speed	276307	€1,480.00
500 kg 1fall/ 2 speeds	276417	€1,449.00
1000 kg 2falls/2 speeds	276427	€1,497.00
1000 kg 1 fall/2 speeds	276437	€1,444.00
2000 kg 2falls/2 speeds	276447	€1,487.00

Electric trolley 19/6 m/min

Model	Product Code	Price
250 kg 1fall/1 speed	276317	€1,763.00
500 kg 2falls/1speed	276327	€1,773.00
500 kg 1fall/1 speed	276337	€1,766.00
1000 kg 2falls/1 speed	276347	€1,747.00
1000 kg 1fall/1speed	276457	€1,758.00
2000 kg 2falls/1speed	276467	€1,803.00
500 kg 1fall/2 speeds	276477	€1,775.00
1000 kg 2falls/2speeds	276487	€1,824.00
1000 kg 1fall/2 speeds	276497	€1,771.00
2000 kg 2falls/2 speeds	276507	€1,815.00

Electric trolley 9/3 m/min

Model	Product Code	Price
250 kg 1fall/1 speed	276517	€1,726.00
500 kg 2falls/1 speed	276527	€1,737.00
500 kg 1fall/1 speed	276537	€1,728.00
1000 kg 2falls/1speed	276547	€1,711.00
1000 kg 2 falls/ 1 speed	276557	€1,724.00
2000 kg 2 falls/ 1 speed	276567	€1,768.00
500 kg 1 fall/2 speeds	276577	€1,739.00
1000 kg 2 falls/2 speeds	276587	€1,787.00
1000 kg 1 fall/ 2 speeds	276597	€1,733.00
2000 kg 2 falls/ 2 speeds	276607	€1,777.00

Electric chain hoists volt trac™ are also suitable for use with the manual push and gear trolleys corso and the beam clamp corso.

Chain bags

Model	Description	Product Code	Price
DFA2	250 kg 1 fall 13-25 m & 500 kg 2 falls 7-12 m	276617	€22.50
DFA3	500 kg, 2 falls 13-18 m	276627	€28.50
DTA4	500 kg, 2 falls 19-25 m, steel	276637	€94.50
DFB2	500 kg, 1 fall 13-25 m, 1000 kg 2 strängig 7-12 m	276647	€22.50
DFB3	1000 kg, 2 falls 13-18 m	276657	€25.50
DTB4	1000 kg, 2 falls 19-25 m, steel	276667	€155.00
DFC2	1000 kg 1 fall 7-18 m & 2000 kg 2 falls 4-9 m	276677	€22.50
DTC3	1000 kg, 1 fall 19-25 m	276687	€234.00
DTC3	2000 kg 2 falls 10-15 m	276697	€31.50
DTC4	2000 kg 2 falls 16-25 m	276707	€256.00

Radio remote control

Model	Product Code	Price
250 kg 1 fall	274047	€1,501.00
500 kg 1 fall	274057	€1,501.00
1000 kg 1 fall	274067	€1,365.00
500 kg 2 falls	276717	€1,494.00
1000 kg 2 falls	276727	€1,494.00
250 kg 1 fall & trolley 1 fall	274087	€1,365.00
500 kg 1 fall & trolley 1 fall	274097	€1,365.00
1000 kg 1 fall & trolley 1 fall	274107	€1,365.00
500 kg 2 falls & trolley 1 fall	276737	€1,365.00
1000 kg 2 falls & trolley 1 fall	276747	€1,352.00
250 kg 1 fall & trolley 2 falls	276757	€1,352.00
500 kg 1 fall & trolley 2 falls	276767	€1,352.00
1000 kg 1 fall & trolley 2 falls	276777	€1,352.00
500 kg 2 falls & trolley 2 falls	276787	€1,333.00
1000 kg 2 falls & trolley 2 falls	276797	€1,333.00

Trolley limit switch

Model	Product Code	Price
trolley limit switch	75257	€164.00

Eye suspension for volt trac™

Model	Product Code	Price
250 kg, 1fall	270987	€31.50
500 kg, 2 falls	270997	€31.50
500 kg, 1 fall	274007	€31.50
1000 kg, 2falls	274017	€31.50
1000 kg, 1 fall	274027	€31.50
2000 kg, 2 falls	274037	€31.50

Extended hanger bar for electric trolley

Model	Product Code	Price
250 kg - 1000 kg, 68 - 320 mm	108937	€91.50
2000 kg 76 - 320 mm	108947	€145.00



Order products on day 1, will be shipped no later than day 2



Order products on day 1, will be shipped no later than day 3. Maximum quantities apply for this service.



Available on request. Please enquire about delivery times of these items.

sodenic™ jib crane

The sodenic™ is a complete jib crane with integrated wire rope hoist. Perfect for lifting materials up to and down from a roof.

sodenic™ is made of modular galvanized construction with integrated wire rope winch, making it easy to transport and assemble without specialised tools.

Due to the compact nature of the knocked down crane it can easily fit into a lift and be manipulated and assembled by two people.

- Extremely suitable for construction and industry
- Easy installation, modular construction
- Can be fitted in a lift (disassembled)
- Single-hand operation, tapping and turning



Specifications:

- Galvanized steel construction
- Electric motor FEM class: 1Am/M3
- Petrol engine noise emission: 2000/14/CE
- Duty cycle: 100%
- Safety factor: 4
- Wire rope with swivel safety hook
- Sheave blocks with self-lubricating bearings
- Counterweight 750 kg (30 blocks of 25 kg each)
- Limit switches
- Topping and rotating jib
- Locking pins with safety pin
- Modular configuration
- Fits in elevator, once disassembled
- One-man operation

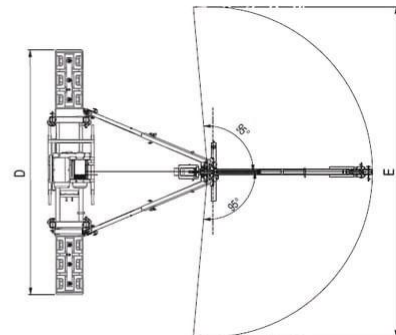
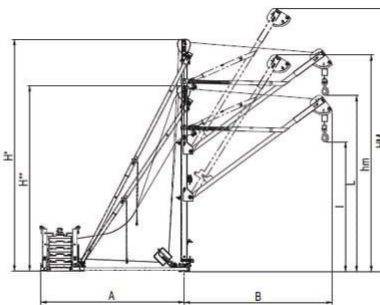
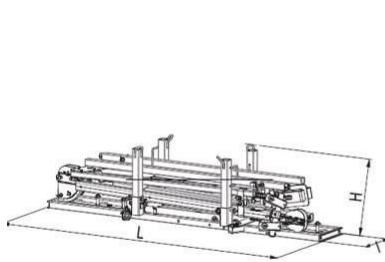



Model	WLL	(Wire/Chain/Reel) Length	Forward Speed	Product Code	Price
sodenic™ petrol	250	45 m	22	251009	€15,046.00
sodenic™ petrol	250	60 m	22	251019	€15,107.00
sodenic™ petrol	200	80 m	22	251029	€13,793.00
sodenic™ electric	250	45 m	28	251039	€13,960.00
sodenic™ electric	250	60 m	28	251049	€14,003.00
sodenic™ electric	200	80 m	28	251059	€15,328.00

Delivery includes: lifting device, wire rope winch with control system and wire rope. Excluding counterweights.

sodenic™ accessories

Model	Description	Product Code	Price
counterweight 25 kg	25kg each	3378	€180.00
manual winch 120 kg 38m	38 metre - WLL: 120kg	38968	€975.00
load bucket 75 l	75 litre	38978	€432.00
wire rope 45m	With hook - 45 metre	38928	€401.00
wire rope 60m	With hook - 60 metre	38938	€440.00
wire rope 80m	With hook - 80 metre	38948	€554.00

 Order products on day 1, will be shipped no later than day 2

 Order products on day 1, will be shipped no later than day 3. Maximum quantities apply for this service.

 Available on request. Please enquire about delivery times of these items.

Toe jacks and trolley skates

TOP toe jack

Specifications:

- Ideal for lifting heavy loads -> workloads up to 10 tons
- Can be used in confined spaces
- Robust frame and equipped with handle and stable footplate
- Force on lever (daN): 30 (BT 1.5), 35 (BT3), 40 (BT5), 58 (BT10)
- With foldable ratchet crank and handle, easy to store and transport



Model	WLL	Lifting Height (mm)	Construction height (mm)	Claw height lowest position (mm)	Weight (kg)	Product Code	Price
BT 1,5	1.5	300	600	70	18	196478	€225.00
BT 3	3	355	735	70	35	196488	€292.00
BT 5	5	345	735	80	40	196498	€339.00
BT 10	10	390	800	100	46	196508	€482.00

pakrol™ trolley skate

The pakrol™ trolley skates are suitable for easy and flexible transport of heavy loads on the ground. This movement is carried out manually by the user on a flat surface. Make sure that the surface is resistant to the total load. Concrete or tiled floors are particularly suitable for safely moving these loads. The trolley skates are fitted with nylon wheels with bearings. Model T 88 is equipped with polyurethane wheels.

- Workload up to 8,000 kg
- Manoeuvrable
- Robust frame with Nylon (P-U) wheels with bearings
- Transport handle, speed max. 5 km/h
- Use -10 to +30 °C

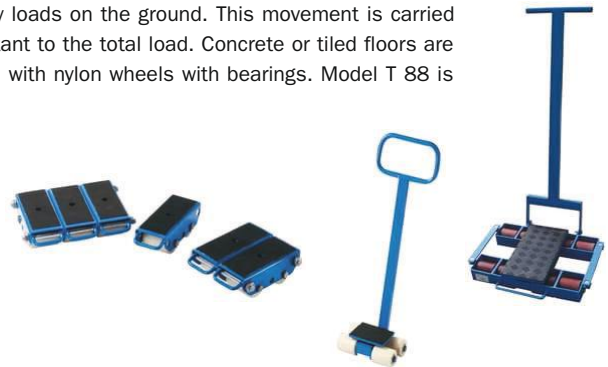

Model	WLL	No. of Wheels	Height (mm)	Weight (kg)	Product Code	Price
Skate 2t	2000	2 / P-U	110	5	50149	€92.50
Skate 4t	4000	4 / P-U	110	11	50159	€191.00
Skate 6t	6000	6 / P-U	110	25	50169	€252.00
Trolley skate 4t	4000	4 / P-U	110	14	50179	€205.00
Trolley skate 6t	6000	8 / P-U	110	50	50189	€561.00
Trolley skate 8t	8000	8 / P-U	110	50	50199	€637.00

Load on trolley skates

Which combination can be used to move the load?

Total load to be moved -> articles needed:

8 tons -> 1 x the T 44 + 2 x the P 22

12 tonnes -> 1 x the T 44 + 2 x the P 44

14 tonnes -> 1 x the T 68 + 2 x the P 44

18 tonnes -> 1 x the T 68 + 2 x the P 66

20 tonnes -> 1 x the T 88 + 2 x the P 66

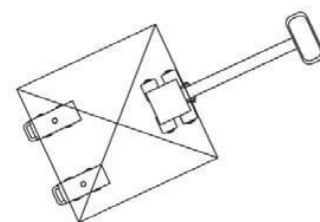

Order products on day 1, will be shipped no later than day 2



Order products on day 1, will be shipped no later than day 3. Maximum quantities apply for this service.



Available on request. Please enquire about delivery times of these items.

corso[®] beam clamps

corso[®] beam clamp for material handling

The corso[®] spindle beam clamp range can be quickly and easily assembled onto a steel beam, creating a reliable anchor point for lifting.

It is possible to manually adjust the opening of the clamping jaws, so it can be easily positioned and adjusted to the most frequently used profiles. A hoisting device such as the tirfor[®], bravo[™], tralift[™] and minifor[™] can be easily placed on the ring. The beam clamp can also be used for lifting steel beams or as a horizontal anchor point for use in combination with the tirfor[®].



- **Suitable for material transport**
- WLL: 1.000 to 10.000 kg
- Robust version
- Perfect stability
- Equipped with suspension eye
- Simple adjustment device
- In accordance with directive 2006/42/EC

Model	WLL (kg)	Flange Width	Weight (kg)	Product Code	Price
LT-1B	1000	75-230	4.8	7009	€161.00
LT-2B	2000	75-230	5.6	7019	€200.00
LT-3B	3000	80-330	11	7029	€244.00
LT-5B	5000	80-330	12.3	7039	€286.00
LT-10B	10000	80-320	21	7049	€506.00

corso[®] beam clamp for manriding

Unique in its kind, suitable for man-riding applications in accordance with the EN1808 standard.

The corso[®] spindle beam clamp range can be quickly and easily assembled onto a steel beam, creating a reliable anchor point. To be used in combination with the tirak[™] or tirfor[®] man-riding applications.



- **Suitable for man-riding transport**
- WLL: 1.000 to 7.000 kg
- In accordance with EN 1808-2006/42/EC
- Perfect stability
- Equipped with suspension eye
- Simple adjusting device

Model	WLL manriding (kg)	Flange Width	Weight (kg)	Product Code	Price
LT-1B	1000	75 - 230	4.8	183209	€201.00
LT-2B	2000	75 - 230	5.6	183219	€242.00
LT-3B	2500	80 - 330	11	183229	€312.00
LT-5B	3000	80 - 330	12.3	183329	€453.00
LT-10B	7000	80 - 320	21	183249	€844.00

 Order products on day 1, will be shipped no later than day 2

 Order products on day 1, will be shipped no later than day 3. Maximum quantities apply for this service.

 Available on request. Please enquire about delivery times of these items.

corso[®] trolleys - material handling

corso[®] push trolley for material handling

The corso[®] push trolley can be quickly and easily assembled onto a steel beam, with both a straight and sloping flange, creating a reliable anchor point for lifting.

It is possible to manually adjust the opening, so the trolley can be easily positioned and adjusted to the most frequently used profiles. A hoisting device such as the tirfor[®], bravo[™], tralift[™] and minifor[™] can be easily placed on the ring.

See the extension spindle table on page 41 to find the correct extension for the push trolley.



- **Material handling**
- WLL: 250 kg to 10.000 kg
- Robust version
- Maintenance-free bearings
- Suspension eye
- Wheel break protection
- Bumper stop
- In accordance with 2006/42/EC directive

Model	WLL (kg)	Flange Width	Min. Radius	Weight (kg)	Product Code	Price
C250	250	45 - 152	650	3.5	69289	€126.00
C500	500	50 - 220	900	8.5	23309	€175.00
C1000	1000	58 - 220	1000	10.5	23319	€208.00
C2000	2000	66 - 220	1200	18	23329	€322.00
C3000	3000	74 - 220	1300	32	23379	€503.00
C5000	5000	90 - 220	1400	48.5	23389	€884.00
C10000	10000	142 - 320	2500	105	56279	€1,371.00

corso[®] manual/geared trolley for material handling

The corso[®] manual/mechanical trolleys can be quickly and easily assembled onto a steel beam, with both a straight and sloping flange, creating a reliable anchor point for lifting equipment such as tirfor[®], bravo[™], tralift[™] and minifor[™].

It is possible to manually adjust the opening, so the trolley can be easily positioned and adjusted to the most frequently used profiles. Equipped with a galvanized manual chain 5x24 mm, operating height 3 m.

See the extension spindle table on page 41 to find the correct extension for the push trolley.



- **Material handling**
- WLL 1.000 kg to 20.000 kg
- Robust version
- Maintenance-free bearings
- Suspension eye
- Wheel break protection
- Bumper stop
- In accordance with 2006/42/EC directive

Model	WLL (kg)	Flange Width	Min. Radius	Weight (kg)	Product Code	Price
1000	1000	58 - 220	1000	19	23339	€363.00
2000	2000	66 - 220	1200	22.5	23349	€489.00
3000	3000	74 - 220	1300	37.5	23359	€638.00
5000	5000	90 - 220	1400	55	23369	€960.00
10000	10000	142 - 320	2500	115	56289	€1,661.00
20000	20000	153 - 320	5000	254	56299	€3,009.00

 Order products on day 1, will be shipped no later than day 2

 Order products on day 1, will be shipped no later than day 3. Maximum quantities apply for this service.

 Available on request. Please enquire about delivery times of these items.

TRIED, TESTED, TRACTEL[®]

corso® push trolleys - manriding

corso® push trolley for manriding

Unique in its kind: Suitable for man-riding applications in accordance with the EN1808 standard.

The Corso® push trolley range can be quickly and easily assembled onto a steel beam, with both a straight and sloping flange, creating a reliable anchor point.

For additional safety, the push trolley has an integrated brake to park the trolley in a fixed position. An extension stick is available as an accessory for remotely tightening the brake.

- **Suitable for man-riding applications**
- EN1808 -2006/42/EC directive
- With integrated brake
- WLL: 500 kg to 3.000 kg
- Perfect stability
- Suspension eye
- Simple adjusting device

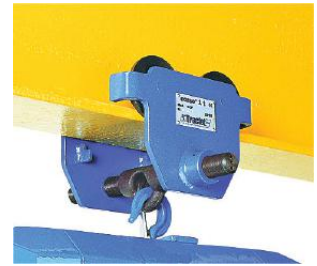

Model	WLL manriding (kg)	Flange Width	Min. Radius	Weight (kg)	Product Code	Price
C500	500	62 - 220	900	8.5	183019	€624.00
C500	500	220 - 300	900	10	183029	€802.00
C1000	1000	58 - 220	1000	10.5	183039	€714.00
C1000	1000	220 - 300	1000	14	183049	€854.00
C2000	2000	68 - 220	1200	18	183059	€757.00
C2000	2000	220 - 300	1200	21.6	183069	€834.00
C3000	3000	74 - 220	1300	32	183079	€990.00
C3000	3000	220 - 300	1300	35	183089	€1,202.00

corso® manual/geared trolley for manriding

Unique in its kind: Suitable for man-riding applications in accordance with the EN1808 standard.

The Corso manual/mechanical trolley can be quickly and easily assembled onto a steel beam, with both a straight and sloping flange, creating a reliable anchor point. For additional safety, the trolley has an integrated brake to park the trolley in a fixed position.

An extension stick is available as an accessory for remotely tightening the brake. Equipped with a galvanized manual chain 5x24 mm, operating height 3m.

- **Suitable for man-riding applications**
- EN1808 -2006/42/EC directive
- With integrated brake
- WLL: 1.000 kg to 3.000 kg
- Perfect stability
- Suspension eye
- Simple adjusting device



Model	WLL manriding (kg)	Flange Width	Min. Radius	Weight (kg)	Product Code	Price
1000	1000	58 - 220	1000	19.8	183099	€861.00
1000	1000	220 - 300	1000	20.5	183109	€1,039.00
2000	2000	66 - 220	1200	22.5	183119	€1,031.00
2000	2000	220 - 300	1200	24	183129	€1,114.00
3000	3000	74 - 220	1300	37.5	183139	€1,293.00
3000	3000	220 - 300	1300	39	183149	€1,611.00



Order products on day 1, will be shipped no later than day 2



Order products on day 1, will be shipped no later than day 3. Maximum quantities apply for this service.



Available on request. Please enquire about delivery times of these items.

corso[®] trolley extension bar - material handling

Model	Flange Width	Description	Product Code	Price
0.5	220-320	to suit 0.5t push trolley 023309	14652	€92.50
1T	220-320	to suit 1t push trolley 023319 and 1t geared trolley 023339	14662	€115.00
2T	220-320	to suit 2t push trolley 023329 and 2t geared trolley 023349	14672	€162.00
3T	220-320	to suit 3t push trolley 023379 and 3t geared trolley 023359	14682	€234.00
5T	220-320	to suit 5t push trolley 023389 and 5t geared trolley 023369	14692	€317.00



Order products on day 1, will be shipped no later than day 2



Order products on day 1, will be shipped no later than day 3. Maximum quantities apply for this service.



Available on request. Please enquire about delivery times of these items.

blocmat™ load arrestors

The blocmat™ is an automatic wire rope load arrestor with an integrated drum reeler. A falling load will be arrested within 10 cm by the blocmat™. It is easy to carry out a functional test and to manually release and reset the load arrestor. After activation, release, and reset the system can immediately be used again.

Available models:

- S - Ceiling assembly
- SI - Floor assembly (to be used with additional sheave)
- BS – attached to a suspended structure
- M and SIP - Upon request: especially for truss systems (entertainment industry).

blocmat™ S, ceiling assembly and SI, floor assembly

- Very limited fall (<100 mm)
- Automatic winding of wire rope
- Very robust and durable
- Easy to use
- Manual test function
- Capacity up to 1,000 kg
- Complies with the 2006/42/EC standard



Model	WLL (kg)	(Wire/Chain/Reel) Length	(Wire/Chain/Reel) Diameter	Product Code	Price
S 500/15	500	15	6.5	47329	€2,832.00
S 500/20	500	20	6.5	47339	€3,551.00
S 500/25	500	25	6.5	47349	€3,558.00
S 800/10	800	10	8.4	47359	€3,872.00
S 800/20	800	20	8.4	47369	€4,229.00
S 1000/8	1000	8	9.5	47379	€4,206.00
S 1000/12	1000	12	9.5	47389	€4,211.00
S 1000/25	1000	25	9.5	75399	€4,721.00
SI 500/15	500	15	6.5	47269	€2,812.00
SI 500/25	500	25	6.5	47279	€3,495.00
SI 800/15	800	15	8.4	47289	€3,900.00
SI 800/25	800	25	8.4	47299	€4,059.00
SI 1000/10	1000	10	9.5	47309	€4,155.00
SI 1000/25	1000	25	9.5	47319	€4,551.00

 Order products on day 1, will be shipped no later than day 2

 Order products on day 1, will be shipped no later than day 3. Maximum quantities apply for this service.

 Available on request. Please enquire about delivery times of these items.

blocmat™ TSD

blocmat™ TSD, self-retracting load srrestor, is equipped with the new TSD system (Top System Dissipator) The TSD system guarantees a fall load of less than 650 daN even if the load drops when the cable is fully unwound.

The main advantages of using the blocmat™ TSD, self-retracting load fall arrester are:

- Integration of TSD system at the top of the device. Eliminates the risk of a violent shock if the load drops when the cable is fully unwound
- A very good grip for transport and installation
- Simplified maintenance due to its optimized design



blocmat™ TSD



blocmat™ TSD

Model	WLL (kg)	Length (cm)	(Wire/Chain/Reel) Diameter	Product Code	Price
blocmat™ 10 TSD	250	10	4.7	279479	€683.00
blocmat™ 20 TSD	250	18	5	279489	€1,029.00



Order products on day 1, will be shipped no later than day 2



Order products on day 1, will be shipped no later than day 3. Maximum quantities apply for this service.



Available on request. Please enquire about delivery times of these items.



CHARLET™ blocks

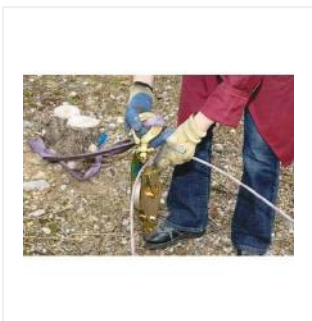

CHARLET™ blocks

- Tractel® blocks, also known as CHARLET™, have been developed for all possible applications and are suitable for the most extreme ambient conditions.
- There is a wide variety of basic versions available. Even models for man-riding applications in conformity with EN 1808 are available from stock.
- The various models are suitable for wire ropes or ropes and can be used for reeving loads. They can be used for pulling, lifting and diverting the wire rope.
- It is important to choose the right block. This choice depends on the type of application, manual or motorized drive and the rope diameter.
- We can design, produce, test and supply all possible cable blocks, crane blocks, rotablocks™, hooks and sheaves (WLL 1 to 500t).
- Through customization and in-house production short delivery times can be realized.
- We are happy to help you make the right choice.

Detail of sheave

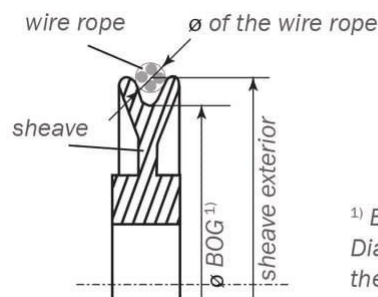

Examples of applications

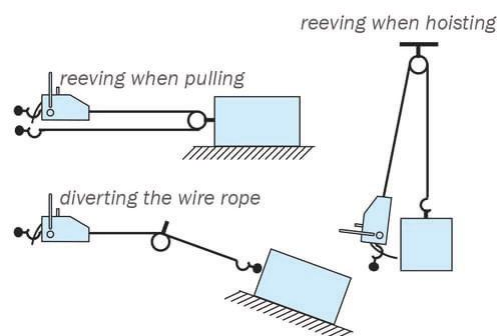

EP block for man-riding applications

The EP blocks are especially designed for man-riding and are in accordance with EN 1808. They can also be used for material transport with identical Working Load Limit (WLL). Very easy installation of the wire rope. Laying the wire rope is very easy by removing the shaft. In this way, the wire rope can be inserted between the opening at the bottom. The housing can be used to activate a limit switch. It also serves as a safety device to prevent fingers and hands from getting stuck.

- Suitable for man-riding - WLL up to 4.8 t
- Easy assembly and wire rope entry
- Housing protects hands and fingers
- Lightweight
- Complies with FEM 87 and EN 1808



EPC block



EPE block



EPF block



EPL block



EPA block

Model	Sheave Diameter	(Wire/Chain/Reel) Diameter	WLL (kg)	Weight (kg)	Product Code	Price
EPA1.6-8/9	172/198	8-9	1600	2.9	192789	€439.00
EPA2.4-10/12	196/219.5	10-12	2400	5	192819	€576.00
EPA4.8-14/16	277.4/310.7	14-16	4800	12.2	192849	€870.00
EPC1.6-8-9	172/198	8-9	1600	3.7	192769	€575.00
EPC2.4-10/12	196/219.5	10-12	2400	6.4	192799	€733.00
EPC4.8-14/16	277.4/310.7	14-16	4800	14.8	192829	€1,083.00
EPE1.6-8/9	172/198	8-9	1600	3.7	192899	€474.00
EPE2.4-10/12	196/219.5	10-12	2400	6.4	192919	€607.00
EPE4.8-14/16	277.4/310.7	14-16	4800	14.8	192939	€897.00
EPF1.6-8/9	172/198	8-9	1600	3.5	192779	€503.00
EPF2.4-10/12	196/219.5	10-12	2400	5.9	192809	€656.00
EPF4.8-14/16	277.4/310.7	14-16	4800	14.1	192839	€987.00
EPL1.6-8/9	172/198	8-9	1600	3.5	192909	€467.00
EPL2.4-10/12	196/219.5	10-12	2400	5.9	192929	€580.00
EPL4.8-14/16	277.4/310.7	14-16	4800	14.1	192949	€867.00

Sheave diameter = \varnothing diameter at the bottom of the groove / \varnothing outer sheave (mm)

Accessories for EP block

Model	Description	Product Code	Price
EP-MCP	Assembly kit for remote installation of EPC/EPL/EPF/EPE block	192969	€392.00
EPBFC	Bracket for assembly on wire rope (operated by external limit switch)	192959	€189.00



Order products on day 1, will be shipped no later than day 2



Order products on day 1, will be shipped no later than day 3. Maximum quantities apply for this service.



Available on request. Please enquire about delivery times of these items.

TRIED, TESTED, TRACTEL®

EH snatch block

Can be opened without the use of any tools, making installation of the cable very quick and easy.



Model	Sheave Diameter	(Wire/Chain/Reel) Diameter	WLL (kg)	Weight (kg)	Product Code	Price
E303H	80/100	8-9	1000	3	80869	€224.00
E460H	132/160	7.5-8.3	1600	7	80969	€319.00
E313H	132/160	10-12	2000	8.5	80889	€318.00
E323H	160/200	13-15	3200	18	80909	€571.00
E470H	160/200	10-11.5	3200	18	80989	€478.00
E490H	160/200	13-15	5000	17	81029	€691.00
E333H	210/250	16-18	5000	22	80929	€714.00
E480H	275/336	14-16.3	6400	34	81009	€995.00
E347H	275/336	21-23	8000	34	80949	€1,374.00

Sheave diameter = diameter sheave at the bottom of the groove / diameter outer sheave (mm)
Specially developed for use in combination with tirfor® wire rope hoist.

ETA off-shore model snatch block

Can be opened without the use of any tools, making installation of the cable very quick and easy.

Equipped with shaft, for intensive use

- Easy to assemble - Lightweight
- Loose parts are protected against loss



Model	Sheave Diameter	(Wire/Chain/Reel) Diameter	WLL (kg)	Weight (kg)	Product Code	Price
ETA 2-79E10	60/79	9-10	2000	1.6	81449	€158.00
ETA5-114E14	90/114	12-14	5000	4.5	81419	€250.00
ETA5-165E14	140/165	12-14	5000	7	81479	€334.00
ETA8-142E19	112/142	17-19	8000	8.5	81509	€375.00
ETA8-209E19	177/209	17-19	8000	13.5	81539	€414.00
ETA8-262E19	221/262	17-19	8000	18	81569	€739.00
ETA8-326E23	275/326	20-23	8000	23	81599	€771.00
ETA12-145E23	112/145	20-23	12500	24	81629	€630.00
ETA12-216E23	174/216	20-23	12500	28	81689	€745.00
ETA12-216E29	174/216	26-29	12500	28	81659	€872.00
ETA15-262E23	221/262	20-23	15000	30	81719	€1,006.00
ETA15-326E23	275/326	20-23	15000	36	81779	€1,070.00
ETA15-420E23	355/420	20-23	15000	52	81839	€1,432.00
ETA20-216E29	174/216	26-29	20000	31	81749	€998.00
ETA20-268E38	224/268	35-38	20000	45	81809	€1,029.00
ETA20-410E38	349/410	35-38	20000	56	81869	€1,533.00
ETA25-262E29	221/262	26-29	25000	48	81899	€1,433.00
ETA25-326E29	270/326	26-29	25000	63	81959	€1,636.00
ETA32-334E46	270/334	42-46	32000	70	81929	€2,862.00
ETA32-518E46	443/518	42-46	32000	100	81989	€3,455.00

ETC off-shore model snatch block

Can be opened without the use of any tools, making installation of the cable very quick and easy.

Equipped with hook, for intensive use.

- Easy to assemble
- Lightweight
- Loose parts are protected against loss



Model	Sheave Diameter	(Wire/Chain/Reel) Diameter	WLL (kg)	Weight (kg)	Product Code	Price
ETC2-79E10	60/79	9-10	2000	2.7	81429	€203.00
ETC5-114E14	90/114	12-14	5000	8	81399	€344.00
ETC5-165E14	140/165	12-14	5000	10.5	81459	€433.00
ETC8-142E19	112/142	17-19	8000	15	81489	€499.00
ETC8-209E19	177/209	17-19	8000	20	81519	€564.00
ETC8-262E19	221/262	17-19	8000	25	81549	€801.00
ETC8-326E23	275/326	20-23	8000	29	81579	€944.00
ETC12-145E23	112/145	20-23	12500	30	81609	€898.00
ETC12-216E23	174/216	20-23	12500	35	81669	€1,056.00
ETC12-216E29	174/216	26-29	12500	35	81639	€1,091.00
ETC15-262E23	221/262	20-23	15000	38	81699	€1,423.00
ETC15-326E23	275/326	20-23	15000	45	81759	€1,530.00
ETC15-420E23	355/420	20-23	15000	65	81819	€1,967.00
ETC20-216E29	174/216	26-29	20000	39	81729	€1,445.00
ETC20-268E38	224/268	35-38	20000	56	81789	€1,523.00
ETC20-410E38	349/410	35-38	20000	70	81849	€2,193.00
ETC25-262E29	221/262	26-29	25000	62	81879	€2,058.00
ETC25-326E29	270/326	26-29	25000	85	81939	€2,344.00
ETC32-334E46	270/334	42-46	32000	95	81909	€2,985.00
ETC32-518E46	443/518	42-46	32000	135	81969	€4,974.00

Sheave diameter = diameter sheave at the bottom of the groove / diameter outer sheave (mm)

Snatch block for tirfor® & tirak™ hoists

- Suitable for motorised hoists
- Equipped with maintenance-free sliding layers
- Number of sheaves: 1
- Diameter wire: max. 10 mm

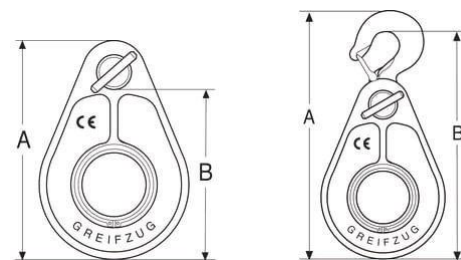

Model	WLL	Sheave Diameter	Height A	Height B	Weight (kg)	Product Code	Price
MC 3.2	3.2	140	250	200	2.4 kg	3329	€748.00
MC 3.2 - with hook	3.2	140	340	310	3.4 kg	292899	€791.00
MC 6.4	6.4	200	310	250	5.5 kg	31629	€1,049.00
MC 6.4 with eye hook	6.4	200	480	430	9.5 kg	292909	€1,259.00
MCW 2,0W with hook	2	160	326	303	2.5	43549	€247.00
MCW 2.0W	2	160	270	228	4.2 kg	87849	€308.00

Order products on day 1, will be shipped no later than day 2

Order products on day 1, will be shipped no later than day 3. Maximum quantities apply for this service.

Available on request. Please enquire about delivery times of these items.

TRIED, TESTED, TRACTEL®

ETM off-shore model snatch block

The ETM block is mainly used for temporary applications for pulling and lifting, when quick assemblies and/or dismantling are required. It can be suspended to a fixed or mobile anchor point with the right strength corresponding to the required load. Thanks to an easy installment, lightweight and attached locking parts, this snatch block is most often used on vessels and off-shore platforms.



- For intense use
- With nut and bolt bow shackle
- Easy to assemble
- Lightweight
- Loose components protected against loss

Model	Sheave Diameter	(Wire/Chain/Reel) Diameter	WLL (kg)	Weight (kg)	Product Code	Price
ETM2-79E10	60/79	9-10	2000	2.7	81439	€218.00
ETM5-114E14	90/114	12-14	5000	8	81409	€380.00
ETM5-165E14	140/165	12-14	5000	10.5	81469	€470.00
ETM8-142E19	112/142	17-19	8000	15	81499	€534.00
ETM8-209E19	177/209	17-19	8000	20	81529	€623.00
ETM8-262E19	221/262	17-19	8000	25	81559	€1,048.00
ETM8-326E23	275/326	20-23	8000	29	81589	€1,033.00
ETM12-145E23	112/145	20-23	12500	30	81619	€933.00
ETM12-216E23	174/216	20-23	12500	35	81679	€1,128.00
ETM12-216E29	174/216	26-29	12500	35	81649	€1,181.00
ETM15-262E23	221/262	20-23	15000	38	81709	€1,622.00
ETM15-326E23	275/326	20-23	15000	45	81769	€1,788.00
ETM15-420E23	355/420	20-23	15000	65	81829	€2,040.00
ETM20-216E29	174/216	26-29	20000	39	81739	€1,518.00
ETM20-268E38	224/268	35-38	20000	56	81799	€1,565.00
ETM20-410E38	349/410	35-38	20000	70	81859	€2,285.00
ETM25-262E29	221/262	26-29	25000	62	81889	€2,281.00
ETM25-326E29	270/326	26-29	25000	85	81949	€2,595.00
ETM32-334E46	270/334	42-46	32000	95	81919	€4,344.00
ETM32-518E46	443/518	42-46	32000	135	81979	€5,244.00

Sheave diameter = diameter sheave at the bottom of the groove / diameter outer sheave (mm)



Order products on day 1, will be shipped no later than day 2



Order products on day 1, will be shipped no later than day 3. Maximum quantities apply for this service.



Available on request. Please enquire about delivery times of these items.

EC snatch block

The EC Snatch Blocks type are mainly used for temporary applications for lifting or pulling. They can be suspended to a fixed or mobile anchor point with the right strength corresponding to the required load. Thanks to the light weight and an easy installment, this is the most current block used for repairing operations. These swing blocks are most often used as winch accessory on 4WD cars.



- Easy to assemble/folding
- Lightweight
- Scissor Type

Model	Sheave Diameter	(Wire/Chain/Reel) Diameter	WLL (kg)	Weight (kg)	Product Code	Price
EC1.6-100E9	80/100	8-9	1600	2.2	80689	€119.00
EC3.2-160E12	132/160	10-12	3200	4.8	80699	€208.00
EC5-200E15	160/200	13-15	5000	9.3	80709	€282.00
EC8-250E18	210/250	16-18	8000	19.4	80719	€467.00

Sheave diameter = diameter sheave at the bottom of the groove / diameter outer sheave (mm)

ES cargo block

ES simple yoke pulleys are return pulleys for wire-rope, dedicated to slow applications. They permit lifting or wire-rope deviation without limit on use height or distance. They can be suspended to a fixed or mobile anchor point with the right strength corresponding to the required load.

ES pulleys are fitted with a swivel hook which ensures good positioning of the pulley regarding the wire-rope.

- Equipped with a swivel eye hook and safety catch
- lightweight
- Cargo block



Model	Sheave Diameter	(Wire/Chain/Reel) Diameter	WLL (kg)	Weight (kg)	Product Code	Price
E110S	60/80	4-5	320	0.9	81329	€77.00
E112S	80/100	8-9	630	1.8	81339	€97.00
E120S	132/160	10-11.5	1200	3.4	81359	€161.00

Sheave diameter = diameter sheave at the bottom of the groove / diameter outer sheave (mm)

ELC - ELS pulley

Light & compact pulley (1t) for use in Offshore applications or together with the minifor™ hoist. The pulley is designed to be as compact as possible for use in elevator cages, to install the elevator motor.

It is designed to be robust and corrosion resistant (coating) and where all elements are waterproof.

Available in two versions:

- ELC - hook with safety clasp
- ELS - with safety hook (but less compact)



Model	Sheave Diameter	(Wire/Chain/Reel) Diameter	WLL (kg)	Weight (kg)	Product Code	Price
ELC1-70E7	55	6.5/7	1000	1.6	252209	€158.00
ELS1-70E7	55	6.5/7	1000	1.8	252259	€308.00

 Order products on day 1, will be shipped no later than day 2

 Order products on day 1, will be shipped no later than day 3. Maximum quantities apply for this service.

 Available on request. Please enquire about delivery times of these items.

TRIED, TESTED, TRACTEL®

DB poulistop 2

The poulistop 2 is a robust and light-weight manual pulley block with automatic brake function, designed for temporary lifting installations on construction sites. It is operated by a braided nylon rope and suitable for lifting loads up to 50 kg (including rope weight) for lifting heights up to 30 meters.

Operation: the poulistop automatic brake mechanism is activated if the rope moves in vertical position along the brake caliper. The brake caliper force depends proportionally on the load. The operator must operate the rope at an angle of 15° in order to release the brake.



- In accordance with CE 2006/42
- Unique automatic brake function
- Safe use for construction and industry
- Easy assembly and rope insertion
- Corrosion protection
- Maintenance-free
- Complies with FEM87 and EN1808

Model	Sheave Diameter	(Wire/Chain/Reel) Diameter	WLL (kg)	Weight (kg)	Product Code	Price
D050B	150/195	18-20	50	4	192319	€207.00
D051B	150/195	18-20	50	4	192329	€193.00

Sheave diameter = diameter sheave at the bottom of the groove / diameter outer sheave (mm)

Accessories for poulistop



Rope



Lifting jib

Model	Description	WLL (kg)	Weight (kg)	Product Code	Price
DC050B	Nylon rope on reel. Length 50m	-	15	192339	€175.00
DPO50B	Lifting jib for assembly to scaffolding pipe	250	9	192359	€119.00



Order products on day 1, will be shipped no later than day 2



Order products on day 1, will be shipped no later than day 3. Maximum quantities apply for this service.



Available on request. Please enquire about delivery times of these items.

Palanmatic

The palanmatic is unique in its kind: a manageable and light-weight manual hoist with $\varnothing 4$ mm nylon rope and automatic brake function. Perfect for lifting and pulling loads and various applications. The 202A, 204A and 206A models are supplied with a control lever to make lifting loads even easier.

- With automatic brake function
- Easy and light operation
- No risk of falling loads
- Manageable
- Swivel eye hook is not rotatable under load

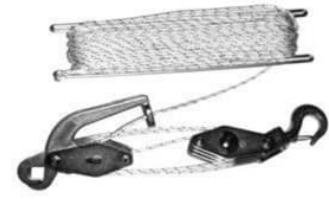

Model	Description	Lifting Height	WLL	Weight (kg)	Product Code	Price
D202A	Scissor eye hook / swivel eye hook*. 3 sheaves.	0.32 - 7 m	250 kg	1.9	80009	€143.00
D212A	Scissor eye hooks. 3 sheaves.	0.28 - 3 m	250 kg	1.6	80039	€128.00
D204A	Scissor hook / swivel eye hook*. 5 sheaves.	0.34 - 7 m	400 kg	2.9	80019	€187.00
D214A	Scissor eye hooks. 5 sheaves.	0.29 - 3 m	400 kg	2.2	80049	€165.00
D206A	Scissor eye hook / swivel eye hook*. 7 sheaves.	0.39 - 3 m	630 kg	3.7	80029	€270.00

* Swivel eye hook is not rotatable under load.





DE Scaffold Block

- Manual return pulley for rope
- The polyamide sheave ($\varnothing = 200$ mm) is rotation-free
- Resistant to corrosion
- The wide top hook can easily be attached to all suspension points
- Perfect for hanging on the tubes of a scaffold
- With a swivel hook for good positioning



Model	Sheave Diameter	(Wire/Chain/Reel) Diameter	WLL	Weight (kg)	Product Code	Price
D039E	200	22-30	40	1.6	80169	€67.50

 Order products on day 1, will be shipped no later than day 2

 Order products on day 1, will be shipped no later than day 3. Maximum quantities apply for this service.

 Available on request. Please enquire about delivery times of these items.

TRIED, TESTED, TRACTEL®

DL Lyons block

The Lyon's rope block permits lifting or deviation, without height or distance limits (these limits depend only on the length of the rope / wire-rope).

The Lyon's blocks are composed in two parts:

- An upper block, equipped with a becket, to be installed on an anchor point (fixed or mobile)
- A lower block on which the load to be lifted or deviated is installed
- Including cord
- In packs of two



Model	Description	Sheave Diameter	(Wire/Chain/Reel) Diameter	WLL (kg)	Weight (kg)	Product Code	Price
D080L	3 polyamide sheaves	25/32	6-8	125	0.7	80339	€120.00
D082L	2 polyamide sheaves	32/40	8-10	160	0.9	80349	€102.00
D083L	2 iron sheaves	34/40	8-10	160	0.9	80359	€142.00
D085L	3 polyamide sheaves	32/40	8-10	250	1.3	80369	€111.00
D086L	3 iron sheaves	34/40	8-10	250	1.3	80379	€201.00
D088L	2 polyamide sheaves	40/50	10-12	320	1.8	80389	€131.00
D089L	2 iron sheaves	42/50	10-12	320	1.8	80399	€168.00
D091L	3 polyamide sheaves	40/50	10-12	500	2.4	80409	€145.00
D092L	3 iron sheaves	42/50	10-12	500	2.4	80419	€189.00

Sheave diameter = diameter sheave at the bottom of the groove / diameter outer sheave (mm)

DD Pulley Block

- Manual return pulley for rope
- Can be suspended from a fixed or mobile anchoring point
- Equipped with rotating hook for good positioning



Model	Sheave Diameter	(Wire/Chain/Reel) Diameter	WLL (kg)	Weight (kg)	Product Code	Price
D040D	63/80	15-17	250	0.8	80139	€94.50
D042D	80/100	17-19	500	1.8	80149	€116.00
D046D	131/160	23-25	1000	3.4	80159	€198.00

 Order products on day 1, will be shipped no later than day 2

 Order products on day 1, will be shipped no later than day 3. Maximum quantities apply for this service.

 Available on request. Please enquire about delivery times of these items.



TOPAL™

TOPAL™

TOPAL™ RANGE

Tractel® offers a complete range of lifting accessories (clamps, beams, etc.) to facilitate safe lifting and movement of materials.

STANDARD PRODUCTS

All standard products exceed the highest safety requirements and are designed from a user's point of view: versatile, robust, simple and suitable for use in building, industry, maritime, on-shore, off-shore, etc. All products are available from stock.

SPECIAL SOLUTIONS

The specialists from the Solutions department design, produce and test a wide variety of special products with a capacity up to 500 t and beyond, in accordance with customer requirements. Special products are: Crane blocks, Rotablocks™, lifting beams, wire rope blocks, C-hooks, directional blocks, sheaves, swivels, etc.



KS clamp - for different positions

Suitable for lifting plates, beams, profiles and steel constructions from any position. The KS clamp has a safety spring and, depending on the weight of the load, will only leave a mark on one side.

- Horizontal and vertical use
- Manual release
- One-sided mark
- Hot epoxy coating
- Hardness up to 300 HB



Model	WLL (kg)	Jaw Opening (mm)	Weight (kg)	Product Code	Price
KS075 0-15	750	0-15	1.55	50238	€282.00
KS1 0-20	1000	0-20	3.5	50248	€356.00
KS2 0-25	2000	0-25	6.26	50258	€464.00
KS3 0-30	3000	0-30	12.1	50268	€721.00

KT clamp

KT clamp, for vertical and horizontal lifting and handling of unit steel loads (plates, sections, welded-plated assemblies, structural steel etc.)

These clamps are fitted with a safety spring mechanism ensuring permanent contact of the cam against the piece to be lifted, even when it is laid down.

- Lifting clamps are not suitable for creating permanent joints.
- Working temperature: -20° to +100°C.
- The plates can also be grasped on their side to be tilted



Model	WLL (kg)	Jaw Opening (mm)	Weight (kg)	Product Code	Price
KT 0.5 0-15	500	0-15	2	189918	€158.00
KT 1 0-20	1000	0-20	4.5	189928	€263.00
KT 2 0-25	2000	0-25	7.3	189938	€326.00
KT 3 0-30	3000	0-30	15	189948	€420.00
KT 5 0-50	5000	0-50	21.6	189958	€504.00
KT 8 45-80	8000	45-80	38.3	189968	€798.00

KF clamp

KF clamps, for vertical lifting and handling of unit steel loads (plates, sections, welded-plated assemblies, structural steel etc.)

These clamps are fitted with a safety spring mechanism ensuring permanent contact of the cam against the piece to be lifted, even when it is laid down.

- Lifting clamps are not suitable for creating permanent joints.
- Working temperature: -20° to +100°C.
- With KF clamps, the lifting load must never be tilted or lifted into a different position



Model	WLL (kg)	Jaw Opening (mm)	Weight (kg)	Product Code	Price
KF 1 0-22	1000	0-22	3.8	189418	€200.00
KF 2 0-30	2000	0-30	6.3	189428	€242.00
KF 3 0-35	3000	0-35	9.6	189438	€273.00
KF 5 0-50	5000	0-50	19	189448	€441.00

NK - automatic lifting clamp

Automatic self-closing lifting clamp suitable for lifting plates, beams, profiles and steel constructions from any position. The clamp is equipped with a safety spring for continuous contact pressure and, depending on the weight of the load, only leaves a print on one side.

- Horizontal and vertical use
- Closes automatically
- Manual release
- Hot epoxy coating
- Hardness up to 330 HB



Model	WLL (kg)	Jaw Opening (mm)	Weight (kg)	Product Code	Price
NK1 0-20	1500	0-20	4	50288	€645.00
NK1 20-40	1500	20-40	6	50298	€921.00
NK1 40-60	1500	40-60	6	50308	€990.00
NK2 0-30	3000	0-30	13	50318	€1,031.00
NK2 30-60	3000	30-60	15	50328	€1,340.00
NK2 60-90	3000	60-90	17	50338	€1,426.00
NK3 0-40	4500	0-40	25	50348	€1,710.00
NK3 40-80	4500	40-80	26	50358	€1,833.00
NK3 80-120	4500	80-120	27	50368	€2,583.00
NK5 0-50	7500	0-50	42	50378	€4,080.00
NK5 50-100	7500	50-100	50	50388	€4,289.00
NK5 100-150	7500	100-150	60	50398	€4,400.00

NX - NXR Automatic Lifting Clamp

Automatic non-marking self-closing lifting clamp, suitable for lifting plain or polished pieces such as steel, stainless steel, aluminium, wood, natural stone, concrete, plastic or glass. Patented design. Clamping jaws are polyurethane coated, leaving no marks on the load. The jaw opening of the NXR model is adjustable and extremely suitable for pressure-sensitive loads.

- Non-marking
- Horizontal and vertical use
- Lifting clamp closes automatically
- Manual unlocking
- Hot Epoxy Coating



Model	WLL (kg)	Jaw Opening (mm)	Weight (kg)	Product Code	Price
NX05 0-20	500	0-20	4.5	50408	€837.00
NX1.5 0-30	1500	0-30	11	50418	€1,085.00
NXR05 0-100	500	0-100	6	50428	€1,134.00
NXR05 20-120	500	20-120	5.8	50438	€1,300.00
NXR05 40-140	500	40-140	6	50448	€1,348.00

 Order products on day 1, will be shipped no later than day 2

 Order products on day 1, will be shipped no later than day 3. Maximum quantities apply for this service.

 Available on request. Please enquire about delivery times of these items.

TLC lifting clamp

Universal lifting clamp for horizontal transport of plates, bundles or construction parts, per 2, 3 or 4 pieces. Opening is easily adjustable with lever for maximum reach from 0 to 150 mm. Lifting chain available on request.

- Adjustable and Hot Epoxy Coating
- Prevents sliding of the load



Model	WLL (kg)	Jaw Opening (mm)	Weight (kg)	Product Code	Price
TLC1	500	0-150	12	50998	€746.00
TLC2.5	1250	0-150	15	51008	€832.00
TLC4	2000	0-150	17	51018	€1,044.00
TLC6	3000	0-150	22	51028	€1,181.00

TLR lifting clamp

Universal lifting clamp for horizontal transport of plates, bundles or construction parts, per 2, 3 or 4 pieces. Clamping pressure proportional to the weight of the load. Lifting chain available on request.

- Very easy to use
- Adjustable per 60 mm
- Non marking and Hot Epoxy Coating



Model	WLL (kg)	Jaw Opening (mm)	Weight (kg)	Product Code	Price
TLR2 0-300	1000	0-300	9	51158	€545.00
TLR3 0-300	1500	0-300	14	51168	€656.00
TLR5 0-300	2500	0-300	22	51178	€809.00
TLR10 0-300	5000	0-300	29	51188	€1,153.00



Order products on day 1, will be shipped no later than day 2



Order products on day 1, will be shipped no later than day 3. Maximum quantities apply for this service.



Available on request. Please enquire about delivery times of these items.

TLH lifting clamp

Universal lifting clamp for horizontal transport of plates, bundles or construction parts, per 2, 3 or 4 pieces. Clamping pressure proportional to the weight of the load. Lifting chain available on request.

- Very easy to use
- Non marking and Hot Epoxy Coating



Use as a pair for lifting horizontal sheets or metal sheets, individually or bundled:

- 1 set with a 2-pole sling.
- Different sets with 2-pole slings and a lifting beam.
- To be used in 3 sets with a 3-pole sling for lifting round plates.



TLH lifting clamp with PU coating

Besides the standard version, the TLH clamp is also available with PU coating. This polyurethane coating will not damage the treated sheets.

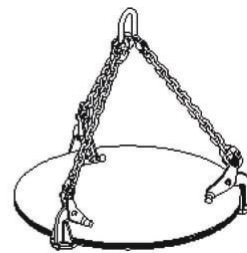
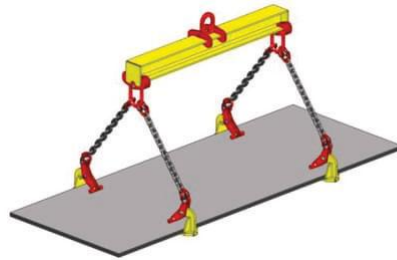

Model		WLL (kg)	Jaw Opening (mm)	Weight (kg)	Product Code	Price
TLH1 0-60		500	0-60	3	51038	€146.00
TLH1 0-120		500	0-120	5	51048	€242.00
TLH2 0-60		1000	0-60	5	51058	€213.00
TLH2 0-120		1000	0-120	8	51068	€292.00
TLH3 0-60		1500	0-60	6	51078	€290.00
TLH3 0-150		1500	0-150	13	51088	€370.00
TLH4 0-60		2000	0-60	8	51098	€348.00
TLH4 0-150		2000	0-150	17	51108	€490.00
TLH5 0-60		2500	0-60	10	51118	€403.00
TLH5 0-150		2500	0-150	21	51128	€579.00
TLH10 0-60		5000	0-60	16	51138	€666.00
TLH10 0-150		5000	0-150	31	51148	€806.00
TLH1 0-40-PU	N	500	0-40	3	189218	€866.00
TLH1 0-100-PU	N	500	0-100	5	189228	€972.00
TLH2 0-40-PU	N	1000	0-40	5	189238	€940.00
TLH2 0-100-PU	N	1000	0-100	8	189248	€1,032.00
TLH3 0-40-PU	N	1500	0-40	6	189258	€981.00
TLH3 0-130-PU	N	1500	0-130	13	189268	€1,094.00
TLH4 0-40-PU	N	2000	0-40	8	189278	€1,039.00
TLH4 0-130-PU	N	2000	0-130	17	189288	€1,174.00
TLH5 0-40-PU	N	2500	0-40	10	189298	€1,091.00
TLH5 0-130-PU	N	2500	0-130	21	189308	€1,348.00
TLH10 0-40-PU	N	5000	0-40	16	189318	€1,239.00
TLH10 0-130-PU	N	10000	0-130	31	189328	€1,634.00

Order products on day 1, will be shipped no later than day 2

Order products on day 1, will be shipped no later than day 3. Maximum quantities apply for this service.

Available on request. Please enquire about delivery times of these items.

TLC sling - 2 falls

	2x TLC 1	2x TLC 2.5	2x TLC 4	2x TLC 6
Plate width maximum	Load to lift			
	≤ 1 000 kg	≤ 2 500 kg	≤ 4 000 kg	≤ 6 000 kg
1 400 mm	191008 E2W01600CO/1000	191108 E2W04000CO/1000	191208 E2W06300CO/1000	191258 E2W06700CO/1000
2 800 mm	191018 E2W01600CO/2000	191118 E2W04000CO/2000	191218 E2W06300CO/2000	191268 E2W06700CO/2000
4 200 mm	191028 E2W01600CO/3000	191128 E2W04000CO/3000	191228 E2W06300CO/3000	191278 E2W06700CO/3000
5 600 mm	191038 E2W01600CO/4000	191138 E2W04000CO/4000	191238 E2W06300CO/4000	191288 E2W06700CO/4000
7 000 mm	191048 E2W01600CO/5000	191148 E2W04000CO/5000	191248 E2W06300CO/5000	191298 E2W06700CO/5000

2x TLC 1 ≤ 1000kg

Model	Product Code	Price
E2W01600CO/1000	191008	€151.00
E2W01600CO/2000	191018	€179.00
E2W01600CO/3000	191028	€213.00
E2W01600CO/4000	191038	€240.00
E2W01600CO/5000	191048	€268.00

2x TLC 4 ≤ 4000kg

Model	Product Code	Price
E2W06300CO/1000	191208	€302.00
E2W06300CO/2000	191218	€333.00
E2W06300CO/3000	191228	€377.00
E2W06300CO/4000	191238	€445.00
E2W06300CO/5000	191248	€494.00

2x TLC 2.5 ≤ 2500kg

Model	Product Code	Price
E2W04000CO/1000	191108	€200.00
E2W04000CO/2000	191118	€233.00
E2W04000CO/3000	191128	€263.00
E2W04000CO/4000	191138	€296.00
E2W04000CO/5000	191148	€331.00

2x TLC 6 ≤ 6000kg

Model	Product Code	Price
E2W06700CO/1000	191258	€365.00
E2W06700CO/2000	191268	€403.00
E2W06700CO/3000	191278	€504.00
E2W06700CO/4000	191288	€585.00
E2W06700CO/5000	191298	€666.00



Order products on day 1, will be shipped no later than day 2



Order products on day 1, will be shipped no later than day 3. Maximum quantities apply for this service.



Available on request. Please enquire about delivery times of these items.

TLC sling - 3 falls

	3x TLC 1	3x TLC 2.5	3x TLC 4	3x TLC 6
Plate width maximum	Load to lift			
	≤ 1 000 kg	≤ 3 750 kg	≤ 6 000 kg	≤ 9 000 kg
1 400 mm	191358 E3W02400CO/1000	191458 E3W06000CO/1000	191558 E3W08500CO/1000	191608 E3W10700CO/1000
2 800 mm	191368 E3W02400CO/2000	191468 E3W06000CO/2000	191568 E3W08500CO/2000	191618 E3W10700CO/2000
4 200 mm	191378 E3W02400CO/3000	191478 E3W06000CO/3000	191578 E3W08500CO/3000	191628 E3W10700CO/3000
5 600 mm	191388 E3W02400CO/4000	191488 E3W06000CO/4000	191588 E3W08500CO/4000	191638 E3W10700CO/4000
7 000 mm	191398 E3W02400CO/5000	191498 E3W06000CO/5000	191598 E3W08500CO/5000	191648 E3W10700CO/5000

3x TLC 1 ≤ 1500 kg

Model	Product Code	Price
E3W02400CO/1000	191358	€267.00
E3W02400CO/2000	191368	€292.00
E3W02400CO/3000	191378	€321.00
E3W02400CO/4000	191388	€369.00
E3W02400CO/5000	191398	€426.00

3x TLC 4 < 6000 kg

Model	Product Code	Price
E3W08500CO/1000	191558	€478.00
E3W08500CO/2000	191568	€549.00
E3W08500CO/3000	191578	€619.00
E3W08500CO/4000	191588	€688.00
E3W08500CO/5000	191598	€759.00

3x TLC 2.5 < 3750 kg

Model	Product Code	Price
E3W06000CO/1000	191458	€334.00
E3W06000CO/2000	191468	€385.00
E3W06000CO/3000	191478	€454.00
E3W06000CO/4000	191488	€506.00
E3W06000CO/5000	191498	€557.00

3x TLC 9 < 9000 kg



Model	Product Code	Price
E3W10700CO/1000	191608	€636.00
E3W10700CO/2000	191618	€728.00
E3W10700CO/3000	191628	€818.00
E3W10700CO/4000	191638	€912.00
E3W10700CO/5000	191648	€1,026.00

 Order products on day 1, will be shipped no later than day 2

 Order products on day 1, will be shipped no later than day 3. Maximum quantities apply for this service.

 Available on request. Please enquire about delivery times of these items.

TLH & TLR sling - 2 falls

	2x TLH 1	2x TLH 2	2x TLH 3	2x TLH 4	2x TLH 5	2x TLH 10
		2x TLR 2	2x TLR 3		2x TLR 5	2x TLR 10
Plate width maximum	Load to lift					
	≤ 1 000 kg	≤ 2 000 kg	≤ 3 000 kg	≤ 4 000 kg	≤ 5 000 kg	≤ 10 000 kg
1 000 mm	191008 E2W01600CO/1000	191108 E2W04000CO/1000	191208 E2W06300CO/1000	191308 E2W11500CO/1000		
2 000 mm	191018 E2W01600CO/2000	191118 E2W04000CO/2000	191218 E2W06300CO/2000	191318 E2W11500CO/2000		
3 000 mm	191028 E2W01600CO/3000	191128 E2W04000CO/3000	191228 E2W06300CO/3000	191328 E2W11500CO/3000		
4 000 mm	191038 E2W01600CO/4000	191138 E2W04000CO/4000	191238 E2W06300CO/4000	191338 E2W11500CO/4000		
5 000 mm	191048 E2W01600CO/5000	191148 E2W04000CO/5000	191248 E2W06300CO/5000	191348 E2W11500CO/5000		

Sling 2x TLH 1 ≤ 1000kg

Model	Product Code	Model Name	Price
E2W01600CO/1000	191008	E2W01600CO/1000	€151.00
E2W01600CO/2000	191018	E2W01600CO/2000	€179.00
E2W01600CO/3000	191028	E2W01600CO/3000	€213.00
E2W01600CO/4000	191038	E2W01600CO/4000	€240.00
E2W01600CO/5000	191048	E2W01600CO/5000	€268.00

Sling 2x TLH-R 10 ≤ 10000kg

Model	Product Code	Model Name	Price
E2W11500CO/1000	191308	E2W11500CO/1000	€602.00
E2W11500CO/2000	191318	E2W11500CO/2000	€718.00
E2W11500CO/3000	191328	E2W11500CO/3000	€910.00
E2W11500CO/4000	191338	E2W11500CO/4000	€1,064.00
E2W11500CO/5000	191348	E2W11500CO/5000	€1,218.00

Sling 2 x TLH-R 2-3 ≤ 2000kg - ≤ 3000 kg

Model	Product Code	Price
E2W04000CO/1000	191108	€200.00
E2W04000CO/2000	191118	€233.00
E2W04000CO/3000	191128	€263.00
E2W06300CO/4000	191138	€296.00
E2W06300CO/5000	191148	€331.00

Sling 2 x TLH-R 4-5 ≤ 4000kg - ≤ 5000kg



Model	Product Code	Model Name	Price
E2W06300CO/1000	191208	E2W06300CO/1000	€302.00
E2W06300CO/2000	191218	E2W06300CO/2000	€333.00
E2W06300CO/3000	191228	E2W06300CO/3000	€377.00
E2W06300CO/4000	191238	E2W06300CO/4000	€445.00
E2W06300CO/5000	191248	E2W06300CO/5000	€494.00

 Order products on day 1, will be shipped no later than day 2

 Order products on day 1, will be shipped no later than day 3. Maximum quantities apply for this service.

 Available on request. Please enquire about delivery times of these items.

TLH & TLR sling - 3 falls

	3x TLH 1	3x TLH 2	3x TLH 3	3x TLH 4	3x TLH 5	3x TLH 10
		3x TLR 2	3x TLR 3		3x TLR 5	3x TLR 10
Plate width maximum	Load to lift					
	≤ 1 500 kg	≤ 3 000 kg	≤ 4 500 kg	≤ 6 000 kg	≤ 7 500 kg	≤ 15 000 kg
1 000 mm	191358 E3W02400CO/1000	191458 E3W06000CO/1000	191558 E3W08500CO/1000	191658 E3W17000CO/1000		
2 000 mm	191368 E3W02400CO/2000	191468 E3W06000CO/2000	191568 E3W08500CO/2000	191668 E3W17000CO/2000		
3 000 mm	191378 E3W02400CO/3000	191478 E3W06000CO/3000	191578 E3W08500CO/3000	191678 E3W17000CO/3000		
4 000 mm	191388 E3W02400CO/4000	191488 E3W06000CO/4000	191588 E3W08500CO/4000	191688 E3W17000CO/4000		
5 000 mm	191398 E3W02400CO/5000	191498 E3W06000CO/5000	191598 E3W08500CO/5000	191698 E3W17000CO/5000		

3 x TLH 1 ≤ 1500kg

Model	Product Code	Price
E3W02400CO/1000	191358	€267.00
E3W02400CO/2000	191368	€292.00
E3W02400CO/3000	191378	€321.00
E3W02400CO/4000	191388	€369.00
E3W02400CO/5000	191398	€426.00

3 x TLH-R 10 ≤ 15000kg

Model	Product Code	Price
E3W17000CO/1000	191658	€1,008.00
E3W17000CO/2000	191668	€1,239.00
E3W17000CO/3000	191678	€1,470.00
E3W17000CO/4000	191688	€1,701.00
E3W17000CO/5000	191698	€1,932.00

3 x TLH-R 2-3 ≤ 3000kg - ≤ 4500kg

Model	Product Code	Price
E3W06000CO/1000	191458	€334.00
E3W06000CO/2000	191468	€385.00
E3W06000CO/3000	191478	€454.00
E3W06000CO/4000	191488	€506.00
E3W06000CO/5000	191498	€557.00

3 x TLH 4-5 ≤ 6000kg - ≤ 7500kg

Model	Product Code	Price
E3W08500CO/1000	191558	€478.00
E3W08500CO/2000	191568	€549.00
E3W08500CO/3000	191578	€619.00
E3W08500CO/4000	191588	€688.00
E3W08500CO/5000	191598	€759.00

 Order products on day 1, will be shipped no later than day 2

 Order products on day 1, will be shipped no later than day 3. Maximum quantities apply for this service.

 Available on request. Please enquire about delivery times of these items.

TRIED, TESTED, TRACTEL®

QS - single lifting hook

Single lifting hook for the horizontal transport of plates, bundles or construction parts. For use in configurations of 4 or more clamps. Lifting chain available upon request. Opening 300mm, suitable for thick plates.

- Fixed model 300 mm
- Easy to use
- Hot epoxy coating



Model	WLL (kg)	Jaw Opening (mm)	Weight (kg)	Product Code	Price
QS1,5 0-300	750	300	7	50678	€475.00
QS3 0-300	1500	300	10	50688	€595.00
QS6 0-300	3000	300	15	50698	€746.00

QR - double lifting hook

Double lifting hook for horizontal transport of plates, bundles or construction parts. Must be used in pairs. Lifting chain available on request. Opening up to 300 mm, ideal for thick plates.

- Fixed model
- Width 800 mm
- Easy to use
- Hot Epoxy Coating



Model	WLL (kg)	Jaw Opening (mm)	Weight (kg)	Product Code	Price
QR3 0-300	1500	300	18	50648	€926.00
QR6 0-300	3000	300	23	50658	€1,237.00
QR12 0-300	6000	300	57.5	50668	€1,738.00

QX - double lifting hook

Double lifting hook for horizontal transport of plates, bundles or construction parts. Must be used in pairs. Lifting chain available on request. Also suitable for separating plates in a bundle. Opening up to 210 mm, ideal for thick plates.

- Fixed model
- Connectable stop point
- Width 390 mm
- Easy to use
- Hot Epoxy Coating



Model	WLL (kg)	Jaw Opening (mm)	Weight (kg)	Product Code	Price
QX10-120	5000	120	30	50708	€1,477.00
QX10-210	5000	210	38	50718	€1,906.00

QX Sling - 2x QX10 ≤ 10000 kg

Model	Product Code	Price
E2W11500HR/1000 (maximum plate width: 1000mm)	192258	€695.00
E2W11500HR/2000 (maximum plate width: 2000mm)	192268	€849.00
E2W11500HR/3000 (maximum plate width: 3000mm)	192278	€834.00
E2W11500HR/4000 (maximum plate width: 4000mm)	192288	€1,157.00
E2W11500HR/5000 (maximum plate width: 2000mm)	192298	€1,311.00

QS - sling

	2x QS1.5-0-300	2x QS3-0-300	2x QS6-0-300
Plate width maximum	Load to lift		
	≤ 1 500 kg	≤ 3 000 kg	≤ 6 000 kg
1 000 mm	191708 E2W01600HR/1000	191808 E2W04000HR/1000	192158 E2W06700HR/1000
2 000 mm	191718 E2W01600HR/2000	191818 E2W04000HR/2000	192168 E2W06700HR/2000
3 000 mm	191728 E2W01600HR/3000	191828 E2W04000HR/3000	192178 E2W06700HR/3000
4 000 mm	191738 E2W01600HR/4000	191838 E2W04000HR/4000	192188 E2W06700HR/4000
5 000 mm	191748 E2W01600HR/5000	191848 E2W04000HR/5000	192198 E2W06700HR/5000

QR - sling

	2x QR3-0-300	2x QR6-0-300	2x QR12-0-300
Plate width maximum	Load to lift		
	≤ 3 000 kg	≤ 6 000 kg	≤ 12 000 kg
1 000 mm	192358 E4W04000HR/10000	192408 E4W6700HR/1000	192458 E4W12900HR/1000
2 000 mm	192368 E4W04000HR/20000	192418 E4W6700HR/2000	192468 E4W12900HR/2000
3 000 mm	192378 E4W04000HR/30000	192428 E4W6700HR/3000	192478 E4W12900HR/3000
4 000 mm	192388 E4W04000HR/40000	192438 E4W6700HR/4000	192488 E4W12900HR/4000
5 000 mm	192398 E4W04000HR/50000	192448 E4W6700HR/5000	192498 E4W12900HR/5000

The maximum plate width depends on the recommended maximum inclination angle of 60°.

Sling 2 x QS1.5 < 1500kg

Model	Product Code	Price
E2W01600HR/1000	191708	€177.00
E2W01600HR/2000	191718	€192.00
E2W01600HR/3000	191728	€234.00
E2W01600HR/4000	191738	€248.00
E2W01600HR/5000	191748	€289.00

Sling 4 x QR3 < 3000kg

Model	Product Code	Price
E4W04000HR/1000	192358	€361.00
E4W04000HR/2000	192368	€426.00
E4W04000HR/3000	192378	€507.00
E4W04000HR/4000	192388	€564.00
E4W04000HR/5000	192398	€624.00

Sling 2 x QS3 < 3000kg

Model	Product Code	Price
E2W04000HR/1000	191808	€233.00
E2W04000HR/2000	191818	€261.00
E2W04000HR/3000	191828	€294.00
E2W04000HR/4000	191838	€344.00
E2W04000HR/5000	191848	€381.00

Sling 4 x QR6 < 6000kg

Model	Product Code	Price
E4W6700HR/1000	192408	€564.00
E4W6700HR/2000	192418	€628.00
E4W6700HR/3000	192428	€763.00
E4W6700HR/4000	192438	€863.00
E4W6700HR/5000	192448	€912.00

Sling 2 x QS6 < 6000kg

Model	Product Code	Price
E2W06700HR/1000	192158	€384.00
E2W06700HR/2000	192168	€465.00
E2W06700HR/3000	192178	€545.00
E2W06700HR/4000	192188	€625.00
E2W06700HR/5000	192198	€670.00

Sling 4 x QR12 < 12000kg

Model	Product Code	Price
E4W12900HR/1000	192458	€805.00
E4W12900HR/2000	192468	€956.00
E4W12900HR/3000	192478	€1,117.00
E4W12900HR/4000	192488	€1,277.00
E4W12900HR/5000	192498	€1,439.00

 Order products on day 1, will be shipped no later than day 2

 Order products on day 1, will be shipped no later than day 3. Maximum quantities apply for this service.

 Available on request. Please enquire about delivery times of these items.

LT - bar for separating plates

Extendable bar (830-1290 mm) with wedge at the end for separating plates in a bundle.



Model	Length (cm)	Weight (kg)	Product Code	Price
LT1-830	830-1.290	7	50278	€892.00

PP - block clamp

Adjustable lifting clamp for lifting loads of steel, concrete, wood, plastic etc., with parallel sides. Clamping jaw, width 200 mm, covered with rubber for optimal grip, non marking.

- Adjustable width (per 100 mm)
- Semi automatic
- Optimal grip
- Easy to use
- Hot Epoxy Coating

Clamping jaws available on request with:

- Polyurethane (PU)
- Spiked (PO)
- Grained (MG)



Model	WLL (kg)	Jaw Opening (mm)	Weight (kg)	Product Code	Price
PP1 200-1000	1000	200-1000	41	50608	€2,158.00
PP1-200-1000 PU	1000	200-1000	42	189738	€2,390.00
PP1-200-1000 PO	1000	200-1000	41	189748	€2,673.00
PP1-200-1000 MG	1000	200-1000	43	189758	€3,135.00

PB - block clamp

Lifting clamp for lifting loads of steel, concrete, wood, plastic etc., with parallel sides. Automatic release and handles for easy operation. Clamping jaw covered with rubber for optimal grip, non marking.

Clamping jaws available on request with:

- Polyurethane
- Steel points
- Centered or with V-shape
- Semi automatic
- Easy to use
- Optimal grip
- Hot Epoxy Coating

Clamping jaws available on request with:

- Polyurethane (PU)
- Spiked (PO)
- Grained (MG)
- Automatic take & release



Order products on day 1, will be shipped no later than day 2



Order products on day 1, will be shipped no later than day 3. Maximum quantities apply for this service.



Available on request. Please enquire about delivery times of these items.

PB - block clamp - codes

Model	WLL (kg)	Jaw Opening (mm)	Weight (kg)	Product Code	Price
PB05 0-100 AMG	500	0-100	10	192068	€1,764.00
PB05 0-100 APO	500	0-100	9	191998	€1,469.00
PB05 0-100 MG	500	0-100	10	189668	€1,330.00
PB05 0-100 PO	500	0-100	9	189598	€1,035.00
PB05 0-100 / PU	500	0-100	9	189528	€863.00
PB05 0-100	500	0-100	10	50458	€595.00
PB05 100-250 AMG	500	100-250	12	192078	€1,845.00
PB05 100-250 APO	500	100-250	11	192008	€1,550.00
PB05 100-250 MG	500	100-250	12	189678	€1,411.00
PB05 100-250 PO	500	100-250	11	189608	€1,117.00
PB05 100-250 / PU	500	100-250	18	189538	€943.00
PB05 100-250	500	100-250	12	50468	€679.00
PB05 200-500 AMG	500	200-500	19	192088	€2,063.00
PB05 200-500 APO	500	200-500	18	192018	€1,768.00
PB05 200-500 MG	500	200-500	19	189688	€1,628.00
PB05 200-500 PO	500	200-500	18	189618	€1,333.00
PB05 200-500 / PU	500	200-500	18	189548	€1,161.00
PB05 200-500	500	200-500	20	50478	€913.00
PB1 0-200 AMG	1000	0-200	25	192098	€2,621.00
PB1 0-200 APO	1000	0-200	23	192028	€2,106.00
PB1 0-200 MG	1000	0-200	25	189698	€2,187.00
PB1 0-200 PO	1000	0-200	23	189628	€1,671.00
PB1 0-200	1000	0-200	25	50488	€1,178.00
PB1 0-200 / PU	1000	0-200	23	189558	€1,355.00
PB1 200-500 AMG	1000	200-500	48	192108	€3,131.00
PB1 200-500 APO	1000	200-500	46	192038	€2,615.00
PB1 200-500 MG	1000	200-500	48	189708	€2,697.00
PB1 200-500 PO	1000	200-500	46	189638	€2,181.00
PB1 200-500	1000	200-500	47	50498	€1,783.00
PB1 200-500PU	1000	200-500	46	189568	€1,865.00
PB1 500-800 AMG	1000	500-800	75	192118	€4,748.00
PB1 500-800 APO	1000	500-800	71	192048	€3,791.00
PB1 500-800 MG	1000	500-800	75	189718	€4,359.00
PB1 500-800 PO	1000	500-800	71	189648	€3,402.00
PB1 500-800	1000	500-800	71	50508	€2,762.00
PB1 500-800 / PU	1000	500-800	71	189578	€3,069.00
PB1 700-1000 AMG	1000	700-1000	99	192128	€5,007.00
PB1 700-1000 APO	1000	700-1000	95	192058	€4,050.00
PB1 700-1000 MG	1000	700-1000	99	189728	€4,618.00
PB1 700-1000 PO	1000	700-1000	95	189658	€3,662.00
PB1 700-1000	1000	700-1,000	78	50518	€2,860.00
PB1 700-1000PU	1000	700-1000	95	189588	€3,327.00
PB3 200-500 / APU	3000	200-500	130	192528	€5,760.00
PB3 200-500 PU	3000	200-500	131	88368	€4,541.00
PB3 500-800 APU	3000	500-800	177	192538	€7,068.00
PB3 500-800 PU	3000	500-800	181	88378	€5,714.00

TRIED, TESTED, TRACTEL®

PL - lifting clamp for beam profiles

Hoisting clamp for hoisting I or H beams. With automatic unlocking. Hoisting clamp is equipped with a handle for easy operation.

*PL3: for each profile > 420 mm, the clamp must be retracted from the end of the beam.

- Semi automatic
- Easy to use
- Hot Epoxy Coating



Model	WLL (kg)	Jaw Opening (mm)	Weight (kg)	Product Code	Price
PL1 95-200	1000	95-200	4	185328	€315.00
PL2 120-300	2000	120-300	8	185338	€465.00
PL3 180-450	3000	180-450*	16	185348	€852.00
PL4 120-300	4000	120-300	14	185358	€844.00

KP - lifting clamp for beam profiles

Lifting clamp for lifting I or H beams or plates in a horizontal position.

Automatic locking with a safety spring.

Depending on the weight of the load, the clamp will only leave a mark on one side.

- Automatically grabs the load
- Hardness 330 HB
- Hot epoxy coating



Model	WLL (kg)	Jaw Opening (mm)	Weight (kg)	Product Code	Price
KP1 0-20	1500	0-20	4	50218	€889.00
KP2 0-30	3000	0-30	10	50228	€1,195.00



Order products on day 1, will be shipped no later than day 2



Order products on day 1, will be shipped no later than day 3. Maximum quantities apply for this service.



Available on request. Please enquire about delivery times of these items.

VDL - drum clamp

Lifting clamp for lifting steel drums with rim, empty or full / open or closed, in horizontal or vertical position. The drum clamp consists of a chain 2-jump and 2 hooks and is equipped with spring for the automatic locking function.

- Horizontal or vertical
- Chain length 516 mm
- Optimal grip by means of spring
- Hot Epoxy Coating



Model	WLL (kg)	Weight (kg)	Product Code	Price
VDL-1	1000	3.5	54398	€279.00

HF - drum clamp

Semi-automatic lifting clamp for lifting steel drums with rim in horizontal position with a length of 440 to 920 mm. Equipped with automatic release and handle for easy operation.

- Horizontal
- Semi-automatic
- Hot Epoxy Coating



Model	WLL (kg)	Jaw Opening (mm)	Weight (kg)	Product Code	Price
HF05 440-920	500	440-920	6	50208	€301.00

VLF - drum clamp

Semi-automatic lifting clamp for lifting steel drums (ø 600 mm / 220 l) with rim in vertical position. Equipped with automatic lock and handle for easy operation.

- Vertical
- Semi-automatic
- Barrels ø 600 mm
- Hot Epoxy Coating



Model	WLL (kg)	Weight (kg)	Product Code	Price
VLF05 600	500	6.7	51268	€334.00
VLF08 600	800	9.6	51278	€514.00

Order products on day 1, will be shipped no later than day 2

Order products on day 1, will be shipped no later than day 3. Maximum quantities apply for this service.

Available on request. Please enquire about delivery times of these items.

TRIED, TESTED, TRACTEL®

VFR - drum clamp

Lifting clamp for lifting closed steel drums (ø 400-600 mm) in vertical position. Clamping jaw is covered with Nitril for an optimal grip.

- Vertical
- Semi-automatic
- With automatic unlocking
- Hot Epoxy Coating



Model	WLL (kg)	Jaw Opening (mm)	Weight (kg)	Product Code	Price
VFR05 5	500	400-500	12	51248	€708.00
VFR05 6	500	500-600	14	51258	€742.00

VFA - drum clamp

Automatic locking and unlocking. Lifting clamp for lifting closed steel drums into vertical position. Clamping jaw is covered with Nitril for an optimal grip.

- Vertical
- Fully automatic
- High stability
- Hot Epoxy Coating



Model	WLL (kg)	Jaw Opening (mm)	Weight (kg)	Product Code	Price
VFA 025	300	600	24	51208	€1,187.00

VFB - drum clamp

Clamping jaw is covered with Nitril for an optimal grip.

Models:

- VFB03-S: semi-automatic unlocking
- VFB03-AR: Reduction gearbox with handwheel for accurate and easy emptying the volume

Specifications:

- Tilting of drums
- Levers for easy operation
- Sustainable
- Nitril finishing of the clamping jaw for optimal grip
- Available in 2 models
- Hot Epoxy Coating



Model	WLL (kg)	Jaw Opening (mm)	Weight (kg)	Product Code	Price
VFB 03 S	300	600	53	51218	€2,499.00
VFB 03 AR	300	600	66	51238	€4,283.00

 Order products on day 1, will be shipped no later than day 2

 Order products on day 1, will be shipped no later than day 3. Maximum quantities apply for this service.

 Available on request. Please enquire about delivery times of these items.

SCX-CX - lifting beam for conical pipe sections

Lifting traverse for lifting conical shaped concrete pipe sections.

Model CX1 is standard equipped with a chain 2-jump and has 2 contact points.

Model SCX1, excluding chain 2-jump, has 3 contact points and is ideal for intensive use.

The contact surfaces are covered with polyurethane to prevent damage to the load.

- CX1 normal use
- SCX1 intensive use
- Non marking
- Hot Epoxy Coating



Model	Description	WLL (kg)	Max. Opening (mm)	Weight (kg)	Product Code	Price
CX1	Lifting beam	1000	650	10	52628	€639.00
SCX1	Lifting beam	1000	650	20	50788	€1,083.00
SCXE	Chain 2-jump for SCX1 - L=490 mm	1000	-	2	52618	€153.00

TB - lifting hook for pipe sections

Lifting clamp has a large opening for lifting pipe sections. Each clamp is easy to position using the integrated handle. To be used in pairs with chain 2-jump. Lifting chain available on request.

Lifting clamp is available as standard model or with polyurethane (PU) protective pads. It is especially recommended for use with rough loads.

- Large opening
- Standard handle
- Hot Epoxy Coating



Model		WLL (kg)	Jaw Opening (mm)	Weight (kg)	Product Code	Price
TB1 0-150		500	0-150	4	50798	€152.00
TB1 0-200		1000	0-200	9	50808	€239.00
TB3 0-250		1500	0-250	15	50818	€382.00
TB1 0-125-PU	N	500	0-125	4	189128	€657.00
TB2 0-175-PU	N	1000	0-175	9	189138	€741.00
TB3 0-225-PU	N	1500	0-225	15	189148	€905.00

Order products on day 1, will be shipped no later than day 2

Order products on day 1, will be shipped no later than day 3. Maximum quantities apply for this service.

Available on request. Please enquire about delivery times of these items.

TRIED, TESTED, TRACTEL®

TB hook - sling

Maximum sling angle	Hook	Sling length (of leg)	1 000 mm	2 000 mm	3 000 mm	4 000 mm	5 000 mm
90°	TB	Maximum tube length	1 400 mm	2 800 mm	4 200 mm	5 600 mm	7 000 mm
		2x TB-1		2x TB-2		2x TB-3	
Maximum tube length		≤ 1 000 kg	≤ 2 000 kg	Load to lift	≤ 3 000 kg		
1 400 mm		191708 E2W01600HR/1000	191808 E2W04000HR/1000	191858 E2W04100HR/1000			
2 800 mm		191718 E2W01600HR/2000	191818 E2W04000HR/2000	191868 E2W04100HR/2000			
4 200 mm		191728 E2W01600HR/3000	191828 E2W04000HR/3000	191878 E2W04100HR/3000			
5 600 mm		192738 E2W01600HR/4000	191838 E2W04000HR/4000	191888 E2W04100HR/4000			
7 000 mm		192748 E2W01600HR/5000	191848 E2W04000HR/5000	191898 E2W04100HR/5000			

Slings 2 x TB1/ < 1000 kg

Model	Product Code	Price
E2W01600HR/1000	191708	€177.00
E2W01600HR/2000	191718	€192.00
E2W01600HR/3000	191728	€234.00
E2W01600HR/4000	191738	€248.00
E2W01600HR/5000	191748	€289.00

Slings 2 x TB2/ < 2000 kg

Model	Product Code	Price
E2W04000HR/1000	191808	€233.00
E2W04000HR/2000	191818	€261.00
E2W04000HR/3000	191828	€294.00
E2W04000HR/4000	191838	€344.00
E2W04000HR/5000	191848	€381.00

Slings 2 x TB3/ < 3000 kg

Model	Product Code	Price
E2W04100HR/1000	191858	€284.00
E2W04100HR/2000	191868	€333.00
E2W04100HR/3000	191878	€383.00
E2W04100HR/4000	191888	€433.00
E2W04100HR/5000	191898	€482.00

 Order products on day 1, will be shipped no later than day 2

 Order products on day 1, will be shipped no later than day 3. Maximum quantities apply for this service.

 Available on request. Please enquire about delivery times of these items.

BX - kerbstone clamps

Lifting clamp for lifting 1 m long kerbstones or concrete edgings, manually with two people or mechanically with a 2-legged chain. Clamping force is proportional to the weight of the load. Non-marking clamping jaws.

- Ergonomic lifting
- Length tolerance ± 10 mm
- Hot epoxy coating

4 models available:

- BX12: single handle on both sides.
- BX01D: double handle for ergonomic lifting.
- BX02: automatic locking. For lifting blocks width-ways.
- BX200: clamp for mechanical lifting. Including 2-legged chain. Zinc bichromated coating.



Model	WLL (kg)	Jaw Opening (mm)	Weight (kg)	Product Code	Price
BX12 1000	120	1000	9	54008	€284.00
BX01D 1000	100	1000	13	50018	€520.00
BX02 120-130	200	120-300	10	50028	€444.00
BX200	200	1000	13	54788	€560.00

BX accessories

Model	Description	WLL (kg)	Weight (kg)	Product Code	Price
BXE1	2-legged chain for BX12, l=700 mm	120	2	54018	€143.00
BXE2	2-legged chain for BX02, l=290 mm	200	1	54038	€131.00

RB - lifting clamp for concrete pipe sections or manholes



Lifting clamp for lifting concrete pipe sections or round/square manholes. For use in 2 (1,000 kg) or 3 (1,500 kg) clamp configurations. Easy positioning of each clamp due to integrated handle. Clamping force is proportional to the weight of the load.

- Vertical lifting
- Ergonomic handle
- Hot epoxy coating

Model	Description	WLL (kg)	Jaw Opening (mm)	Weight (kg)	Product Code	Price
RB1.5 40-110	Lifting clamp	500	40-110	9	50728	€202.00
RBE 1500	Chain 3-hooks, l=1,500 mm for 3 RB clamps	1500	1500	4.9	50738	€154.00



Order products on day 1, will be shipped no later than day 2



Order products on day 1, will be shipped no later than day 3. Maximum quantities apply for this service.



Available on request. Please enquire about delivery times of these items.

F - lifting clamp for pipe sections

Lifting clamp for lifting heavy pipe sections. For use in pairs. Each clamp has a round profile for optimal contact surface with the load. PVC models have a PVC coating for optimal protection of the load. For use in pairs with 2-legged chain. Lifting chain available upon request.

- For loads up to 15.000 kg
- Optional PVC coating or PU pads
- Large opening
- Hot epoxy coating



F clamp with PVC or PU coating

The standard F lifting clamp is also available with PVC coating or with PU (polyurethane) pads for optimal protection. The PVC coating protects against abrasion when used frequently.

Because the PU is more resistant to abrasion than PVC, it is therefore recommended to use it when subjected to abrasive loads.

F hook with PVC coating

F hook with PU pads

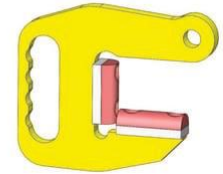

Model		WLL (kg)	Jaw Opening (mm)	Weight (kg)	Product Code	Price
F2 0-60		1000	0-60	2	189028	€102.00
F2-0-60/IIPVC	N	1000	0-60	2	185968	€170.00
F2-0-45/IIPU	N	1000	0-45	2	189078	€620.00
F5 0-75		2500	0-75	5	189038	€179.00
F5-0-75/IIPVC	N	2500	0-75	5	185978	€263.00
F5-0-55/IIPU	N	2500	0-55	5	189088	€700.00
F7.5 0-100		3250	0-100	7.5	185958	€211.00
F7.5-0-100/IIPVC	N	3250	0-100	7.5	185988	€312.00
F7.5-0-90/IIPU	N	3250	0-90	7.5	189098	€753.00
F10 - 0-100		5000	0-100	15	189048	€336.00
F10-0-100/IIPVC	N	5000	0-100	15	185998	€471.00
F10-0-90/IIPU	N	5000	0-90	15	189108	€873.00
F15 0-100		7500	0-100	20	189058	€432.00
F15-0-100/IIPVC	N	7500	0-100	20	189008	€651.00
F15-0-90/IIPU	N	7500	0-90	20	189118	€993.00



Order products on day 1, will be shipped no later than day 2



Order products on day 1, will be shipped no later than day 3. Maximum quantities apply for this service.



Available on request. Please enquire about delivery times of these items.

F hook - sling

Maximum sling angle	Hook	Sling length (of leg)	1 000 mm	2 000 mm	3 000 mm	4 000 mm	5 000 mm
90°	F	Maximum tube length	1 400 mm	2 800 mm	4 200 mm	5 600 mm	7 000 mm

 Maximum tube length	2x F-2	2x F-5	2x F-7.5	2x F-10	2x F-15
	≤ 2 000 kg	≤ 5 000 kg	≤ 7 500 kg	≤ 10 000 kg	≤ 15 000 kg
1 400 mm	191808 E2W04000HR/1000	192258 E2W06700HR/1000	192258 E2W11500HR/1000	192308 E2W17000HR/1000	192308 E2W17000HR/1000
2 800 mm	191818 E2W04000HR/2000	192168 E2W06700HR/2000	192268 E2W11500HR/2000	192318 E2W17000HR/2000	192318 E2W17000HR/2000
4 200 mm	191828 E2W04000HR/3000	192178 E2W06700HR/3000	192278 E2W11500HR/3000	192328 E2W17000HR/3000	192328 E2W17000HR/3000
5 600 mm	191838 E2W04000HR/4000	192188 E2W06700HR/4000	192288 E2W11500HR/4000	192338 E2W17000HR/4000	192338 E2W17000HR/4000
7 000 mm	191848 E2W04000HR/5000	192198 E2W06700HR/5000	192298 E2W11500HR/5000	192348 E2W17000HR/5000	192348 E2W17000HR/5000

Slings 2 x F2 / < 2 000 kg

Model	Product Code	Price
E2W04000HR/1000	191808	€233.00
E2W04000HR/2000	191818	€261.00
E2W04000HR/3000	191828	€294.00
E2W04000HR/4000	191838	€344.00
E2W04000HR/5000	191848	€381.00

Slings 2 x F10 / < 10 000 kg

Model	Product Code	Price
E2W11500HR/1000	192258	€695.00
E2W11500HR/2000	192268	€849.00
E2W11500HR/3000	192278	€834.00
E2W11500HR/4000	192288	€1,157.00
E2W11500HR/5000	192298	€1,311.00

Slings 2 x F5 / < 5 000 kg

Model	Product Code	Price
E2W06700HR/1000	192158	€384.00
E2W06700HR/2000	192168	€465.00
E2W06700HR/3000	192178	€545.00
E2W06700HR/4000	192188	€625.00
E2W06700HR/5000	192198	€670.00

Slings 2 x F15 / < 15 000 kg

Model	Product Code	Price
E2W17000HR/1000	192308	€1,191.00
E2W17000HR/2000	192318	€1,457.00
E2W17000HR/3000	192328	€1,722.00
E2W17000HR/4000	192338	€1,989.00
E2W17000HR/5000	192348	€2,255.00

Slings 2 x F7.5 / < 10 000 kg

Model	Product Code	Price
E2W11500HR/1000	192258	€695.00
E2W11500HR/2000	192268	€849.00
E2W11500HR/3000	192278	€834.00
E2W11500HR/4000	192288	€1,157.00
E2W11500HR/5000	192298	€1,311.00

 Order products on day 1, will be shipped no later than day 2

 Order products on day 1, will be shipped no later than day 3. Maximum quantities apply for this service.

 Available on request. Please enquire about delivery times of these items.

TRIED, TESTED, TRACTEL®

RT - lifting clamp for round materials and pipe sections

Lifting clamp for lifting round material, pipe sections, profiles or bundles. Recommended to use in pairs. Clamping force is proportional to the weight of the load.

- Vertical lifting
- Automatic unlocking
- Ergonomic handle
- Hot Epoxy Coating

The RT clamp is also available as an automatic version (A), with large pads (TC), with (CR) or without chlorophrene coating.

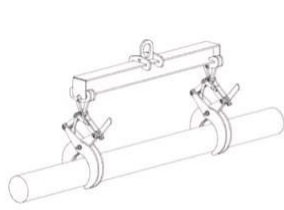

2 RT clamps with lifting beam

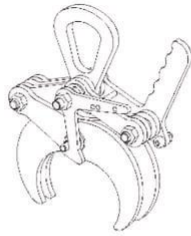

RT



Automatic RT



RT with curved pads



RT with curved pads, chlorophrene coated

Model		WLL (kg)	Jaw Opening (mm)	Weight (kg)	Product Code	Price
RT05 50-100		500	50-100	4	185368	€321.00
RT1 100-200		1000	100-200	9	185378	€391.00
RT2 200-350		2000	200-350	28	185388	€876.00
RT3 250-450		3000	250-450	40	185398	€1,554.00
RTA05 50-100	N	500	50-100	4	189798	€730.00
RTA1 100-200	N	1000	100-200	9	189808	€797.00
RTA2 200-350	N	2000	200-350	28	189818	€1,260.00
RTA3 250-450	N	3000	250-450	40	189828	€1,908.00
RT05 50-100-TC	N	500	50-100	4	189338	€1,157.00
RT1 100-200-TC	N	1000	100-200	9	189348	€1,224.00
RT2 200-350-TC	N	2000	200-350	28	189358	€1,816.00
RT3 250-450-TC	N	3000	250-450	40	189368	€2,590.00
RTA05 50-100-TC	N	500	50-100	4	189838	€1,585.00
RTA1 100-200-TC	N	1000	100-200	9	189848	€1,652.00
RTA2 200-350-TC	N	2000	200-350	28	189858	€2,244.00
RTA3 250-450-TC	N	3000	250-450	40	189868	€3,018.00
RT05 50-100-CR	N	500	50-100	4	189378	€1,475.00
RTA05 50-100-CR	N	500	50-100	4	189878	€1,903.00
RT1 100-200-CR	N	1000	100-200	9	189388	€1,557.00
RTA1 100-200-CR	N	1000	100-200	9	189888	€1,985.00
RT2 200-350-CR	N	2000	200-350	28	189398	€2,195.00
RTA2 200-350-CR	N	2000	200-350	28	189898	€2,623.00
RT3 250-450-CR	N	3000	250-450	40	189408	€2,991.00
RTA3 250-450-CE	N	3000	250-450	40	189908	€3,419.00



Order products on day 1, will be shipped no later than day 2



Order products on day 1, will be shipped no later than day 3. Maximum quantities apply for this service.



Available on request. Please enquire about delivery times of these items.

TI - lifting clamp for round materials and pipe sections

Lifting clamp for lifting round material, pipe sections, profiles or bundles. Recommended to use in pairs for long lengths. Clamping force is proportional to the weight of the load.

2 models available:

- TIS: Automatic unlocking
- TIA: Fully automatic locking and unlocking
- Both models are available with chloroprene (CR) coating
- Vertical lifting
- Semi- and fully automatic version
- Clamping jaw width: 300 mm
- Hot Epoxy Coating



Model		WLL (kg)	Jaw Opening (mm)	Weight (kg)	Product Code	Price
TIA05 230-400		500	230-400	37	50948	€1,578.00
TIS05 230-400		500	230-400	35	50938	€1,422.00
TIA1 450-900		1000	450-900	64	50988	€3,007.00
TIS1 450-900		1000	450-900	64	50978	€2,891.00
TIA05 380-650		500	380-650	39	50968	€2,118.00
TIS05 380-650		500	380-650	39	50958	€1,994.00
TIA 380-650 CR	N	500	380-650	39	189188	€2,625.00
TIS 380-650 CR	N	500	380-650	39	189178	€2,494.00
TIA 230-400 CR	N	500	230-400	37	189168	€1,920.00
TIS 230-400 CR	N	500	230-400	35	189158	€1,794.00
TIA1 450-900 CR	N	1000	450-900	64	189208	€3,453.00
TIS1 450-900 CR	N	1000	450-900	64	189198	€3,213.00

AH - autohook lifting hook

Fully automatic lifting clamp, specially designed for lifting loads that are not or difficult to reach by the user (temperature, height, aggressive conditions, etc.). Equipped with standard handle for easy positioning. When in position, the opening and closing action is automatic and does not require any user intervention.

- Fully automatic operation
- Maximum safety
- Available up to 10.000 kg
- FEM class A5
- Hot Epoxy Coating



Model	WLL (kg)	Jaw Opening (mm)	Weight (kg)	Product Code	Price
AH2-32	2000	0-38	6	185278	€578.00
AH5-40	5000	0-47.5	16	185288	€913.00
AH10-40	10000	0-55	30	185298	€1,265.00

Order products on day 1, will be shipped no later than day 2

Order products on day 1, will be shipped no later than day 3. Maximum quantities apply for this service.

Available on request. Please enquire about delivery times of these items.

TRIED, TESTED, TRACTEL®

PR - lifting clamp for rail profile

Lifting clamp for vertical lifting of rail profiles (vignole). Equipped with automatic release as standard. Recommended to use in pairs.



- Ergonomic lever
- Semi-automatic
- Especially for vertical lifting a rail
- Hot Epoxy Coating

Model	WLL (kg)	Jaw Opening (mm)	Weight (kg)	Product Code	Price
PR1 20-40	1000	20-40	4	185308	€312.00
PR2 40-80	2000	40-80	9	185318	€492.00
PR2A 40-80	2000	40-80	9	185428	€785.00

GP - beam clamp with screw spindle

The GP spindle beam clamp is quick and easy to mount on a steel beam creating a reliable lifting anchor point. Standard equipped with a locknut to fix the spindle. The opening of the clamping jaws can be adjusted manually for easy positioning and adjustment to the most common profiles.

Hoists such as tirfor® , bravo™, tralift™, minifor™ and tralift™ TS can be easily suspended from the ring. It can also be used for lifting steel beams or as a horizontal anchor point for use in combination with the tirfor® .



- Maximum working load (WLL) 1,000 to 10,000 kg
- Robust design
- Perfect stability
- Suspension eye
- Simple adjustment device

Model	WLL (kg)	Jaw Opening (mm)	Weight (kg)	Product Code	Price
GP1 60-180	1000	60-180	3.6	50158	€313.00
GP2 60-200	2000	60-200	5.6	50168	€364.00
GP3 60-300	3000	60-300	8.4	50178	€423.00
GP5 100-390	5000	100-390	10.8	50188	€567.00
GP10 100-390	10000	100-390	20.5	50198	€1,056.00

 Order products on day 1, will be shipped no later than day 2

 Order products on day 1, will be shipped no later than day 3. Maximum quantities apply for this service.

 Available on request. Please enquire about delivery times of these items.

CC - container lug

Lifting lug for lifting containers, to be secured to the (ISO) corner post. For use in 4 lug configurations (max. total load 50.000 kg).

- Easy to install
- For use in 4 lug configurations
- Max. total load 30 t or 50 t
- Hot epoxy coating

2 models:

- CCV: container lifted by the top or bottom, vertical traction.
- CCB: container lifted by the top or bottom, slantwise traction.

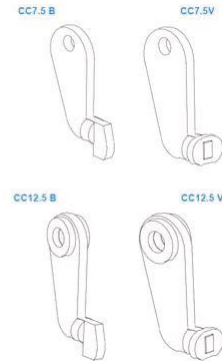
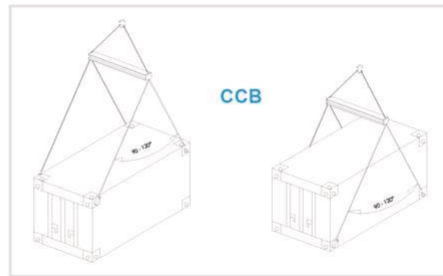
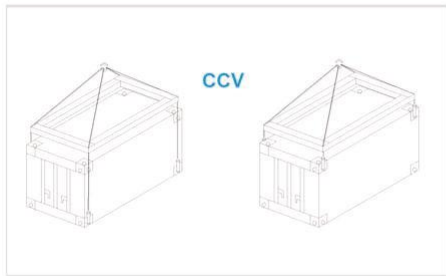

Model	WLL (kg)	Direction	Weight (kg)	Product Code	Price
CC7.5 V	7500	pionowy	4	50038	€239.00
CC12.5 V	12500	pionowy	5	50048	€286.00
CC7.5 B	7500	skośny	4	50058	€228.00
CC12.5 B	12500	skośny	5	50068	€286.00

CR - C-shaped lifting hook for coils

Suitable for lifting and tilting coils from a horizontal to a vertical position and vice versa. The support hook has a movable mechanism which remains in position under load, to ensure safe movement of the load. Equipped with a handle for easy positioning.

- Range 1.000 to 2.000 kg
- Robust version
- Special versions available upon request



Model	WLL (kg)	Coil Width	Weight (kg)	Product Code	Price
CR05 50-120	500	50-120	5.5	50078	€633.00
CR1 70-140	1000	70-140	9	50088	€722.00
CR2 100-200	2000	100-200	16	50098	€1,020.00
CR2 160-330	2000	160-330	31	50108	€1,264.00

Order products on day 1, will be shipped no later than day 2

Order products on day 1, will be shipped no later than day 3. Maximum quantities apply for this service.

Available on request. Please enquire about delivery times of these items.

TRIED, TESTED, TRACTEL®

T0 - lifting hook for cable reels

Suitable for lifting cable reels. For use in pairs. The opening in the reel must be between 55 and 83 mm. With a serrated finish on one side, which clenches the hook (serrated side pointing downwards) during lifting to keep in position.

- Robust version
- Automatically clenches under load
- For use in pairs
- Max. total load 13.000 kg
- Hot epoxy coating



Model	WLL (kg)	Lifting Eye Radius	Weight (kg)	Product Code	Price
To13	6500	27	3	51198	€164.00



Order products on day 1, will be shipped no later than day 2



Order products on day 1, will be shipped no later than day 3. Maximum quantities apply for this service.



Available on request. Please enquire about delivery times of these items.

PC - fork-lift truck lifting beam

The PC lifting beam creates a lifting eye between the 2 forks of a forklift truck. Easy to install without the use of tools. The unique design keeps the lifting beam safely on the fork under all circumstances.

- Lifting eye for forklift truck
- Quick and easy to apply
- Unique design
- Safe to use
- Hot Epoxy Coating



Model	WLL (kg)	Fork Width	Weight (kg)	Product Code	Price
PC1.5 120	1500	120	15	50528	€502.00
PC3 170	3000	170	23	50538	€635.00

PC accessories

Model	Description	WLL (kg)	Product Code	Price
C125E	swivel safety eye hook.	1500	104999	€57.00
C127E	swivel safety eye hook.	3200	105019	€107.00

XBag - cross lifting beam for big-bags

Lifting beam for vertical lifting of big-bags or other loads using 4 lifting chains or lifting straps. Lifting points with rounded corners for optimal protection of the lifting straps. Also provided with 4 load eyelets for lifting loads using a harp clasp.

- Robust design
- 4 x load-bearing point for Big-Bag
- 4 x welding eye for harp closure
- Hot Epoxy Coating



Model	WLL (kg)	Load Width	Weight (kg)	Product Code	Price
XBag 1.5	1500	880 - 990	27	54628	€923.00
XBag 2.5	2500	880 - 990	34	54638	€1,210.00
XBag 3.5	3500	880 - 990	40	54648	€1,543.00

 Order products on day 1, will be shipped no later than day 2

 Order products on day 1, will be shipped no later than day 3. Maximum quantities apply for this service.

 Available on request. Please enquire about delivery times of these items.

TC - load positioning lifting eye

With the TC lifting eye it is possible to lift loads with a single steel wire rope that does not have its centre of gravity in the middle. This makes it possible to balance the load perfectly. Once in position, the clamp, under load, locks the position of the wire rope. Maximum load distribution 30-70% of the total capacity.

- Load positioning
- For single wire rope
- Automatic locking - easy to use
- Large lifting eye



Model	WLL @ 45°	WLL @ 90°	WLL @ 120°	(Wire/Chain/Reel) Diameter	Weight (kg)	Product Code	Price
TC2 11	2000	1400	7000	11	3	50828	€281.00
TC3 13	3000	2100	1500	13	5	50838	€327.00
TC5 18	5000	3500	2500	18	10	50848	€571.00

TF - load positioning lifting eye

With the TF lifting eye it is possible to lift loads with a double steel wire rope of which the centre of gravity is not in the middle. This makes it possible to balance the load perfectly.

Once in position, the clamp locks the position of the wire rope during loading. Maximum load distribution 30%-70% of the total capacity.

- Load positioning
- For double wire rope
- Automatic locking - easy to use
- Large lifting eye



Model	WLL @ 45°	(Wire/Chain/Reel) Diameter	Weight (kg)	Product Code	Price
TF1.5-9	1500	9	4	50888	€1,212.00
TF3-13.2	3000	13	8.5	50898	€1,364.00
TF5-16.8	5000	17	21.5	50908	€2,083.00
TF10-24	10000	24	37.5	50918	€3,520.00
TF20-32	20000	32	76.5	50928	€3,548.00

TE - load positioning lifting eye

With the TE lifting eye it is possible to lift loads with one lifting chain of which the centre of gravity is not in the middle. This makes it possible to balance the load perfectly. Once in position, the clamp locks the position of the chain after loading. The chain is unlocked by using the pulling rope. Maximum distribution 30-70% of the total capacity.

- Load positioning
- For hoisting chain
- Automatic locking - easy to use
- Large lifting eye



Model	WLL (kg)	(Wire/Chain/Reel) Diameter	Weight (kg)	Product Code	Price
TE1.6-7	1600	7	4	50858	€1,131.00
TE3-10	3000	10	11	50868	€1,594.00
TE4.5-13	4500	13	19	50878	€2,504.00



Order products on day 1, will be shipped no later than day 2



Order products on day 1, will be shipped no later than day 3. Maximum quantities apply for this service.



Available on request. Please enquire about delivery times of these items.

PRB - tilt block

The PRB tilt block is suitable for tilting and lifting coils. In combination with a mono palturm™ also suitable for lifting and tilting heavy and bulky loads. If two PRB blocks are used it is also suitable for manual tilting of loads. The PRB block must be provided with a plastic tipping strap which is custom made to length.

- Tilting loads
- Use with tilt strap
- Extended application
- Tilt strap available on request

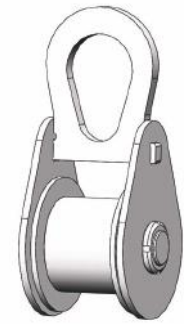

Model	WLL (kg)	Weight (kg)	Product Code	Price
PRB2-90	2000	8.2	189768	On request
PRB3-90	3000	11	189778	On request
PRB5-120	5000	24	189788	On request

palturm™

The palturm™ has been specially developed to create a solution for the controlled turning and lifting of heavy and bulky loads. The tilt straps are rotated by 2 circulation tilt discs which are electrically driven. Suitable for applications in steel and machinery factories, civil engineering, shipyards, manufacturing industry and foundries. The use of palturm™ does not require an anchorage point on the returned load - the load is usually held in the straps. Each device allows the turning of several types of loads as long as its capacity allows it and the straps available are of an appropriate length.

- Tilting loads
- Shockproof
- Tilt disc circulation fixed or adjustable
- Available in single tilt strap version (mono)
- Electric operation
- Capacity up to 100 tons

Important:

The load must keep its shape at all times during the roll-over movement.

Standard configuration:

- Cable remote control, single-speed motorisation
- Protection class IP54
- Design according to FEM A5, lifting speed 30 m/min.

Options:

- Chain pulleys for high temperature loads (> 80°C)
- Stand-alone model (battery operated)
- Radio control with or without infra-red validation
- Two-speed motorisation
- Frequency inverter
- Additional lifting points, retractable lower hook
- Chains or straps - open or open-ended - adjusted to the load, polyurethane protection coated on 1 or 2 sides, impregnated
- Protection class IP55 or higher
- Design according to other FEM class

Customized advice

Each load has unique dimensions (lxwxh), a specific weight and position of the centre of gravity. The palturm™ is produced on the basis of these characteristics and customer requirements.

We will be happy to advise you on the possibilities for a complete customised advice. Please contact our Tractel® Customer Service and Technical Support department via (0031 (0)765435135).

 Order products on day 1, will be shipped no later than day 2

 Order products on day 1, will be shipped no later than day 3. Maximum quantities apply for this service.

 Available on request. Please enquire about delivery times of these items.

TRIED, TESTED, TRACTEL®

magfor™ II - lifting magnet

The latest generation of permanent lifting magnets are suitable for lifting iron-containing round and plate material. The magfor™ lifting magnet combines the extremely powerful 2-pole neodymium iron bore magnet with optimal ease of use. After use, the magnet locks automatically. Safe and controlled disconnection by two-hand operation: the control lever can only be converted if the locking lever is operated at the same time. Almost no residual magnetism after disconnection.

- Capacity up to 5 tons
- Very powerful
- Optimal safety
- Large lifting eye
- Robust design
- Usage: -20 to +80 °C

MAGFOR™ II



MAGFOR™ 3000-5000



detail MAGFOR™ 3000-5000



Model	W.L.L. (Plate/Flat)	W.L.L. (Round)	Weight (kg)	Product Code	Price
magfor™ II 100	100	50	4	185438	€406.00
magfor™ II 300	300	125	9.5	185448	€616.00
magfor™ II 500	500	215	18	185458	€884.00
magfor™ II 1000	1000	450	41.5	185468	€1,536.00
magfor™ II 2000	2000	800	113	185478	€2,799.00
magfor™ II 3000	3000	1200	190	192138	€4,530.00
magfor™ II 5000	5000	2400	400	192148	€7,828.00

The maximum capacity depends on the type of material, shape, surface area and quality of the material to be lifted. We will be happy to advise you in making the best choice.



Order products on day 1, will be shipped no later than day 2



Order products on day 1, will be shipped no later than day 3. Maximum quantities apply for this service.



Available on request. Please enquire about delivery times of these items.

magfor™ II HT - lifting magnet

The HT models are suitable for temperatures up to +250°C, without loss of magnetic properties. The magnet can be used for lifting very warm materials (production after heat treatment, painting, etc.), without cooling them first. This will increase the productivity of your processes.

- High-temperature applications
- Material: ≤ +250 °C



Model	W.L.L. (Plate/Flat)	W.L.L. (Round)	Weight (kg)	Product Code	Price
magfor™ II 200 HT	200	100	9.5	185518	€1,242.00
magfor™ II 400 HT	400	200	18	185548	€1,619.00
magfor™ II 800 HT	800	400	41.5	185578	€2,560.00

magfor™ II TP - lifting magnet

The TP models have been designed especially for separating thin plates in a bundle. Due to the magnetic field's unique design, only the top plate will be lifted.

- Separating thin plates
- Unique magnetic field



Model	W.L.L. (Plate/Flat)	Weight (kg)	Product Code	Price
magfor™ II 180 TP	180	9.5	185528	€953.00
magfor™ II 300 TP	300	18	185558	€1,182.00

magfor™ II HO - lifting magnet

The HO models have 4 thread holes. This facilitates the permanent assembly of the lifting magnet in a customized solution.

- Attachment: 4 threaded holes
- Customized assembly



Model	W.L.L. (Plate/Flat)	W.L.L. (Round)	Weight (kg)	Product Code	Price
magfor™ II 100 HO	100	50	4	185508	€480.00
magfor™ II 300 HO	300	125	9.5	185538	€712.00
magfor™ II 500 HO	500	215	18	185568	€1,027.00
magfor™ II 1000 HO	1000	450	41.5	185588	€1,799.00

The maximum capacity depends on the type of material, shape, surface area and quality of the material to be lifted. We will be happy to advise you in making the best choice.

Order products on day 1, will be shipped no later than day 2

Order products on day 1, will be shipped no later than day 3. Maximum quantities apply for this service.

Available on request. Please enquire about delivery times of these items.

TRIED, TESTED, TRACTEL®

PEF - lifting beam with fixed lifting eyes

Single lifting beam with fixed lifting eyes. **Optimal safety:** all load-carrying connections have been fixated mechanically (non-load carrying welds). Available upon request: higher capacities, different dimensions and finishes.

- Default capacity up to 6 t
- Fixed lifting eyes
- Hot epoxy coating
- Large lifting eye on top
- Safety factor: 3
- Use: -20 to +100 °C



Model	WLL (kg)	Length (cm)	Weight (kg)	Product Code	Price
PEF1-1000	1000	1000	26	82008	€432.00
PEF1-2000	1000	2000	43	82018	€508.00
PEF1-3000	1000	3000	59	82028	€585.00
PEF1-4000	1000	4000	93	82038	€830.00
PEF1-5000	1000	5000	167	82048	€1,125.00
PEF2-1000	2000	1000	26	82058	€474.00
PEF2-2000	2000	2000	53	82068	€567.00
PEF2-3000	2000	3000	106	82078	€802.00
PEF2-4000	2000	4000	137	82088	€975.00
PEF2-5000	2000	5000	198	82098	€1,108.00
PEF3-1000	3000	1000	33	82108	€533.00
PEF3-2000	3000	2000	83	82118	€703.00
PEF3-3000	3000	3000	113	82128	€896.00
PEF3-4000	3000	4000	162	82138	€1,142.00
PEF3-5000	3000	5000	240	82148	€1,515.00
PEF4-1000	4000	1000	52	82158	€593.00
PEF4-2000	4000	2000	83	82168	€817.00
PEF4-3000	4000	3000	140	82178	€1,060.00
PEF4-4000	4000	4000	197	82188	€1,292.00
PEF4-5000	4000	5000	295	82198	€1,825.00
PEF5-1000	5000	1000	68	82208	€626.00
PEF5-2000	5000	2000	104	82218	€977.00
PEF5-3000	5000	3000	165	82228	€1,310.00
PEF5-4000	5000	4000	244	82238	€1,570.00
PEF5-5000	5000	5000	348	82248	€1,979.00
PEF6-1000	6000	1000	69	82258	€681.00
PEF6-2000	6000	2000	123	82268	€950.00
PEF6-3000	6000	3000	194	82278	€1,384.00
PEF6 - 4000	6000	4000	288	82288	€1,741.00
PEF6-5000	6000	5000	392	82298	€2,207.00

The product code is a piece. Accessories such as slings, hooks, chain, etc., are not supplied as standard unless otherwise indicated.

 Order products on day 1, will be shipped no later than day 2

 Order products on day 1, will be shipped no later than day 3. Maximum quantities apply for this service.

 Available on request. Please enquire about delivery times of these items.

PEM - lifting beam with adjustable lifting eyes

Single lifting beam with fixed lifting eye at the top and 2 adjustable lifting eyes at the bottom, which can be adjusted in 100 mm increments without using any tools. **Optimal safety:** all load-carrying connections have been fixated mechanically (non-load carrying welds). Available upon request: higher capacities, different dimensions and finishes.

- Default capacity up to 6 t
- Adjustable
- Large lifting eye on top
- Safety factor: 3
- Use: -20 to +100 °C



Model	WLL (kg)	Length (cm)	Weight (kg)	Product Code	Price
PEM1-1000	1000	400 - 1.000	26	82308	€561.00
PEM1-2000	1000	1.000 - 2.000	43	82318	€738.00
PEM1-3000	1000	1.000 - 3.000	59	82328	€843.00
PEM1-4000	1000	2.000 - 4.000	93	82338	€1,005.00
PEM1-5000	1000	2.000 - 5.000	167	82348	€1,308.00
PEM2-1000	2000	400 - 1.000	26	82358	€658.00
PEM2-2000	2000	1.000 - 2.000	53	82368	€784.00
PEM2-3000	2000	1.000 - 3.000	106	82378	€976.00
PEM2-4000	2000	2.000 - 4.000	137	82388	€1,164.00
PEM2-5000	2000	2.000 - 5.000	198	82398	€1,456.00
PEM3-1000	3000	400 - 1.000	33	82408	€719.00
PEM3-2000	3000	1.000 - 2.000	83	82418	€836.00
PEM3-3000	3000	1.000 - 3.000	113	82428	€1,214.00
PEM3-4000	3000	2.000 - 4.000	162	82438	€1,449.00
PEM3-5000	3000	2.000 - 5.000	240	82448	€1,820.00
PEM4-1000	4000	400 - 1.000	52	82458	€842.00
PEM4-2000	4000	1.000 - 2.000	83	82468	€1,021.00
PEM4-3000	4000	1.000 - 3.000	140	82478	€1,379.00
PEM4-4000	4000	2.000 - 4.000	197	82488	€1,644.00
PEM4-5000	4000	2.000 - 5.000	295	82498	€2,076.00
PEM5-1000	5000	400 - 1.000	68	82508	€934.00
PEM5-2000	5000	1.000 - 2.000	104	82518	€1,184.00
PEM5-3000	5000	1.000 - 3.000	165	82528	€1,661.00
PEM5-4000	5000	2.000 - 4.000	244	82538	€1,790.00
PEM5-5000	5000	2.000 - 5.000	348	82548	€2,375.00
PEM6-1000	6000	400 - 1.000	69	82558	€962.00
PEM6-2000	6000	1.000 - 2.000	123	82568	€1,285.00
PEM6-3000	6000	1.000 - 3.000	194	82578	€1,671.00
PEM6-4000	6000	2.000 - 4.000	288	82588	€2,052.00
PEM6-5000	6000	2.000 - 5.000	392	82598	€2,570.00

The product code is a piece. Accessories such as slings, hooks, chain, etc., are not supplied as standard unless otherwise indicated.

PAL-BEAM - lifting beam

Single lifting beam with fixed lifting eye at the top and 2 fixed lifting points (stud bolts) at the bottom. See accessories for matching swivel safety eye hook.

Optimal safety: all load-carrying connections have been fixated mechanically (non-load carrying welds). Available upon request: higher capacities, different dimensions and finishes.

- Default capacity up to 5 t
- Fixed lifting points (bolt)
- Hot epoxy coating
- Large lifting eye on top
- Safety factor: 3
- Use: -20 to +100 °C



Model	WLL (kg)	Length (cm)	Weight (kg)	Product Code	Price
PBFA1-A	1000	1000	33	51338	€814.00
PBFA1-D	1000	2000	52	51368	€937.00
PBFA1-G	1000	3000	72	51398	€1,016.00
PBFB1-J	1000	4000	141	51428	€1,247.00
PBFA2-A	2000	1000	33	51438	€875.00
PBFB2-D	2000	2000	80	51468	€1,037.00
PBFB2-G	2000	3000	110	51498	€1,216.00
PBFC2-J	2000	4000	167	51528	€1,521.00
PBFB3-A	3000	1000	50	51538	€961.00
PBFB3-D	3000	2000	80	51568	€1,129.00
PBFE5-G	5000	3000	223	51798	€2,012.00
PBFD3-J	3000	4000	202	51628	€1,782.00
PBFC4-A	4000	1000	60	51638	€1,086.00
PBFC4-D	4000	2000	80	51668	€1,263.00
PBFD4-G	4000	3000	160	51698	€1,647.00
PBFE5-J	5000	4000	283	51828	€2,430.00
PBFD5-A	5000	1000	75	51738	€1,250.00
PBFD5-D	5000	2000	117	51768	€1,454.00
PBFC3-G	3000	3000	131	51598	€1,357.00
PBFE4-J	4000	4000	283	51728	€2,276.00

Accessories

Model	Description	WLL (kg)	Product Code	Price
C125E	swivel safety eye hook.	1500	104999	€57.00
C127E	swivel safety eye hook.	3200	105019	€107.00
C126E	swivel safety eye hook.	2500	105009	€68.50

Can be used in packs of 2.

The product code is a piece. Accessories such as slings, hooks, chain, etc., are not supplied as standard unless otherwise indicated.



Order products on day 1, will be shipped no later than day 2



Order products on day 1, will be shipped no later than day 3. Maximum quantities apply for this service.



Available on request. Please enquire about delivery times of these items.

PBM PAL-BEAM lifting beam with adjustable lifting eyes

Single lifting beam with fixed lifting eye at the top and 2 adjustable lifting points (stud bolts) at the bottom, which can be adjusted in 100 mm increments without using any tools. **Optimal safety:** all load-carrying connections have been fixated mechanically (non-load carrying welds). Available upon request: higher capacities, alternative dimensions and finishes.

- Length tolerance $\leq 1,500$ mm: 3 adjustment points per side
- Length tolerance $> 1,500$ mm: 5 adjustment points per side
- Default capacity up to 5 t
- Adjustable lifting points (bolt) - Large lifting eye on top
- Hot epoxy coating
- Safety factor: 3 - Use: -20 to +100 °C

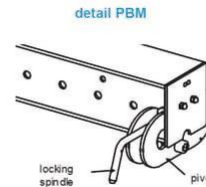

Model	WLL (kg)	Length (mm)	Weight (kg)	Product Code	Price
PBMA1-A	1000	1000	33	51838	€1,010.00
PBMA1-D	1000	2000	52	51868	€1,153.00
PBMA1-G	1000	3000	72	51898	€1,281.00
PBMB1-J	1000	4000	141	51928	€1,552.00
PBMA2-A	2000	1000	33	51938	€1,098.00
PBMB2-D	2000	2000	80	51968	€1,281.00
PBMB2-G	2000	3000	110	51998	€1,545.00
PBMC2-J	2000	4000	167	52028	€1,898.00
PBMB3-A	3000	1000	50	52038	€1,206.00
PBMB3-D	3000	2000	80	52068	€1,422.00
PBMC3-G	3000	3000	131	52098	€1,692.00
PBMD3-J	3000	4000	202	52128	€2,099.00
PBMC4-A	4000	1000	60	52138	€1,373.00
PBMC4-D	4000	2000	80	52168	€1,616.00
PBMD4-G	4000	3000	160	52198	€1,990.00
PBME4-J	4000	4000	283	52228	€2,552.00
PBMD5-A	5000	1000	75	52238	€1,570.00
PBMD5-D	5000	2000	117	52268	€1,812.00
PBME5-G	5000	3000	223	52298	€2,481.00
PBME5-J	5000	4000	283	52328	€3,061.00

PBM accessories

Model	Description	WLL (kg)	Product Code	Price
C125E	swivel safety eye hook.	1500	104999	€57.00
C127E	swivel safety eye hook.	3200	105019	€107.00
C126E	swivel safety eye hook.	2500	105009	€68.50

Can be used in packs of 2. The product code is a piece. Accessories such as slings, hooks, chain, etc., are not supplied as standard unless otherwise indicated.



Order products on day 1, will be shipped no later than day 2



Order products on day 1, will be shipped no later than day 3. Maximum quantities apply for this service.



Available on request. Please enquire about delivery times of these items.

TRIED, TESTED, TRACTEL®

2.

Measure & Control



Load link dynamometers

Page 100–107

Mechanical & Electronic load monitoring

Page 108–113

Tension meters

Page 114–116

- Available on request. Please ask about the delivery time of these articles.
- Order on day 1, shipment no later than day 3 (maximum quantities apply).
- Order products on day 1, shipment no later than day 2.

dynafor™ load indicators



Industrial standard

Years of worldwide experience in Research & Development of lifting & handling equipment have enabled Tractel® to compile a very extensive product range for measuring weights and tensile forces.

The dynafor™ can be used as a stand-alone application, but combined with ZigBee 2.4 GHz technology, it can also be used in very complex projects with up to 8 load cells working simultaneously. Default models ranging from 20 kg to 250t. In addition, Tractel™ can adapt load cells to your specific requirements. We are happy to advise you on the various possibilities.

Features:

- High accuracy
- Extensive product range
- Robust/industrial design
- Very extensive features
- Wireless connection for remote measurements
- Very long battery life
- Full traceability
- PC connection by USB
- Wireless connection
- Bluetooth connection
- Simultaneous reading of multiple load cells
- Specials upon request



Accuracy

The dynafor™ has a very high measuring accuracy of no less than 0.1% of the measuring range. Each dynafor™ is calibrated and adjusted by using testing equipment with full traceability.

- Calibrating means checking whether the dynafor™ complies with the established product features.
- Adjustment means adjusting and setting the dynafor™ to bring it into conformity with the product features.

Monitoring Software:

Real-time displaying, managing, storing and editing the measuring data of up to 8 load cells digitally on your PC? The monitoring software will offer you these possibilities by using a PC USB link with the Dynafor™ ZigBee 2.4GHz technology.

The intuitive operation enables you to easily configure our own dynafor™ network, to assign groups and to set summations and parameters such as measuring frequencies, reading speeds, measuring units, etc.

Wireless connection:

Based on the principle of strain gauge extension measurement, the sensor generates an electrical signal which is processed and analyzed by a built-in microprocessor, which transmits the information to a wireless accessory. Equipped with radio 2.4 GHz (RF) and Bluetooth (BLE) chipsets, the dynafor™ Pro provides a wireless range of:



- 400m to Tractel® dynafor™ HDD, (200m) large displays AL128 and software accessories
- 30 m to any smartdevice equipped with our free dynafor™ Tractel App on iOS or Android

We are happy to advise you on the various possibilities.

handifor™ digital weigher

A convenient electronic load indicator including hooks for measuring small weights, quickly and easily.

- Convenient and light-weight
- Robust
- Easy to use
- Reading on large screen

Specifications:

- 5-digit LCD display, 14 mm
- Safety factor: at least 4 times WLL
- Accuracy: 0.5% of measuring range
- Units: kg, daN, lbs
- Protection class: IP40
- Operating temperature: -10 to +50 °C
- In conformity with: CEM2004/108/C

Functional:

- On/Off
- Taring
- Max. measured value peak mode
- Automatic zeroing
- Automatic shutdown
- Battery life (2 AA): 100 hours
- Overload indication



Delivery includes the handifor™, S-hook and carabiner hook, CE certificate and user manual. Supplied in sturdy cardboard packaging.

Model	W.L.L (kg)	Accuracy (kg)	Min. Value	Weight (kg)	Product Code	Price
handifor™ 20	20	0.1	0.1	0.5	199919	€123.00
handifor™ 50	50	0.25	0.2	0.5	199929	€135.00
handifor™ 100	100	0.5	0.2	0.6	199939	€139.00
handifor™ 200	200	1	0.5	0.9	199949	€153.00



Order products on day 1, will be shipped no later than day 2

Order products on day 1, will be shipped no later than day 3. Maximum quantities apply for this service.

Available on request. Please enquire about delivery times of these items.

TRIED, TESTED, TRACTEL®

dynafor™ ranges

dynafor™ ranges - for accurately measuring loads			
Product	dynafor™ Industrial	dynafor™ Pro	dynafor™ Expert
Accuracy	0.3% FS	0.2% FS	0.1% FS
Capacity	1t to 20t	1t to 250t	0.5t to 10t
Functions	Tare, Peak hold, Units change (kg, t, daN, lbs, ton (US))	As dynafor™ Industrial plus Settable alarm, Single data saving, Sum recording, Multiple readings	As dynafor™ Pro
Display	Display integrated on the load cell with 18mm digits	<p>Multiple display options</p> <p>Multiple reading of loadcells on the HHD, wireless range up to 400m.</p> <p>Free app compatible with Android and iOS devices.</p> <p> Available on the App Store</p> <p> GET IT ON Google Play</p> <p>Robust remote handheld device with unique colour display (LCD)</p> <p>With robust protection case</p> <p>AL 128 giant remote display with 1 to 4 loadcells, wireless range up to 200m.</p>	As dynafor™ Pro
Battery life	Up to 300h	Up to 1000h	Up to 1000h
IP rating	IP64 as standard	IP64 as standard, IP67 available as option	As dynafor™ Pro
Accessories	Compatible with bow shackles	<p>Connection with softwares (real-time monitoring + unloading data saved in the HHD).</p> <p>Compatible with shackles</p> <p>DMU</p>	As dynafor™ Pro
Applications	Overhead Weighing Force measurement testing Towing applications Safety and lifting applications	Overhead Weighing Force measurement testing Towing applications Safety and lifting applications Water Bag Load Testing Heavylift Projects Research & Development Projects Load balancing Load Monitoring on lifting equipments	Overhead Weighing Force measurement testing Towing applications Safety and lifting applications Research & Development Projects Load balancing Load Monitoring on lifting equipments
			

dynafor™ Industrial

Featuring an integrated display, the dynafor™ Industrial load indicator provides great value, with an accuracy of 0.3% of maximum measuring range.

- I.P 64.
- Range from 1 to 20t.
- Accuracy 0.3% measuring range.
- Compatible with standard lifting accessories.
- Accuracy and traceability certified by adjustment certificate (5 points).
- Units: kg, t, daN, kN, Lbs, ton (US)
- Functions: Tare, Peak load
- Automatic stop: 20min without load variation
- Integrated LCD display: 17.8 mm digits
- Autonomy of 350 h (2 x "AAA")
- Indication of battery discharge status



Model	W.L.L. (t)	Weight (kg)	Productcode	Price
dynafor™ Industrial 1T	1	0.75	260889	€1,257.00
dynafor™ Industrial 3.2T	3.2	0.93	260899	€1,417.00
dynafor™ Industrial 6.3T	6.3	1.44	260909	€1,566.00
dynafor™ Industrial 12.5T	12.5	3.22	260919	€1,741.00
dynafor™ Industrial 20T	20	4.95	260929	€1,994.00

Delivered in a plastic case with 1 calibration certificate, instructions for use and CE certificate.

Bow shackle and swivel hook for dynafor™



Bow shackle



Swivel hook

Model	Product Code	Price
Bow shackle 0.5 - 3.2 t	47916	€21.50
Bow shackle 5 - 6.5 t	47926	€48.50
Bow shackle 10 -12.5 t	47936	€107.00
Bow shackle 15T	112427	

Model	Product Code	Price
Swivel hook 1 - 3.2 t	40977	€433.00
Swivel hook 6.3 - 6.5 t	105567	€585.00
Swivel hook 12.5t	113227	€881.00
Swivel hook 20 t	105587	€1,971.00

Option: suppression of the automatic time-off

Model	Product Code	Price
dynafor™ Industrial suppression	281097	€134.00

dynafor™ Pro

The latest addition to the dynafor™ range. Versatile, robust and connected, the dynafor™ Pro integrates perfectly to all your weighing and force measurement applications.

When used in conjunction with our new dynafor™ HHD remote display, our AL128 giant display or our various software packages, the dynafor™ Pro offers a multitude of functions. It is therefore suitable for all your professional requirements.

Equipped with a Bluetooth module, the dynafor™ Pro offers a wireless range of up to 30 m to any smartphone or tablet equipped with our **free dynafor™ App on iOS or Android**.

- I.P 64.
- Wide range from 1 to 250t.
- Accuracy 0.2% measuring range.
- Compatible with standard lifting accessories.
- Wireless range up to 400m using dynafor™ HHD remote displays, 200m AL128 giant displays and software.
- Wireless range 30m with any Android or iOS device equipped with our free dynafor™ App.
- Complies with current standards.
- Precision and traceability certified by calibration certificate (5 points).



Purchase HHD display - Special offer

HHD display is extra cost-effective when purchased directly in combination with the dynafor™ Pro.

Compatible with many accessories.

Delivered in a case with 1 calibration certificate, instructions for use and CE certificate.

Model	W.L.L (t)	Accuracy	Weight (kg)	Product Code	Price
dynafor™ Pro 1t	1	0.2	0.7 kg	293369	€1,638.00
dynafor™ Pro 1t with HHD	1	0.2	0.7 kg	359000	€2,405.00
dynafor™ Pro 3.2t	3.2	0.2	0.86 kg	293379	€1,906.00
dynafor™ Pro 3.2t with HHD	3.2	0.2	0.86 kg	359010	€2,672.00
dynafor™ Pro 6.5t	6.5	0.2	1.6 kg	293389	€2,112.00
dynafor™ Pro 6.5t with HHD	6.5	0.2	1.6 kg	359020	€2,878.00
dynafor™ Pro 15t	15	0.2	3.66 kg	293399	€2,266.00
dynafor™ Pro 15t with HHD	15	0.2	3.66 kg	359030	€3,033.00
dynafor™ Pro 25 t	25	0.2	5.33 kg	293409	€2,678.00
dynafor™ Pro 25 t with HHD	25	0.2	5.33 kg	359040	€3,445.00
dynafor™ Pro 50t	50	0.2	11.45 kg	293419	€4,103.00
dynafor™ Pro 50t with HHD	50	0.2	11.45 kg	359050	€4,869.00
dynafor™ Pro 100t	100	0.2	27.48 kg	293429	€8,797.00
dynafor™ Pro 100t with HHD	100	0.2	27.48 kg	359060	€9,563.00
dynafor™ Pro 250t	250	0.2	97.98 kg	293439	On request
dynafor™ Pro 250t with HHD	250	0.2	97.98 kg	359070	On request

Suitable for use with various accessories.

Delivered in a plastic case with 1 calibration certificate, operating manual and CE-certificate.

NEW! display HHD (optional)

- Universal display, for simultaneous connection of up to 4 sensors.
- Full colour display.
- Protective cover included.
- Intuitive operation.
- 48 hours of autonomy via rechargeable battery.



Model	Product Code	Price
Separate display dynafor™ HHD	293449	€958.00

AL128 Display - dynafor™ AL128

- Range 200m between sensor and display.
- Up to 4 simultaneous sensors.
- Tare, units, peak load functions.



Model	Product Code	Price
AL 128 display kit	293489	€2,936.00
Connection Unit BR	244019	€215.00
Display power supply 110/230VAC -> 24 VDC	199046	€90.00
Bus cable RS485, per metre	25871	€4.00
Adjustment software	199529	€515.00

I.P. 67 | optional

Model	Product Code	Price
dynafor™ Pro I.P. 67 Option	281077	€412.00

Bow shackle and swivel hook for dynafor™



Bow shackle



Swivel hook

Model	Product Code	Price
Bow shackle 0.5 - 3.2 t	47916	€21.50
Bow shackle 5 - 6.5 t	47926	€48.50
Bow shackle 10 -12.5 t	47936	€107.00
Bow shackle 20 - 25 t	47946	€313.00
Swivel hook 1 - 3.2 t	40977	€433.00
Swivel hook 6.3 - 6.5 t	105567	€585.00
Swivel hook 12.5t	113227	€881.00
Swivel hook 20 t	105587	€1,971.00

Software + calibration certificate dynafor™ Pro

- Software - for downloading data stored on the HHD display to a PC.
- Monitoring Software - for a complete real-time monitoring solution.

Model Name	Product Code	Price
dynafor™ Loader Software	293509	€206.00
dynafor™ Monitoring Software	68968	€979.00
Calibration certificate according to ISO 376 - 0.5 to 10 t	109407	€350.00
Calibration certificate according to ISO 376 standard - 25t to 50t	109417	€410.00

 Order products on day 1, will be shipped no later than day 2

 Order products on day 1, will be shipped no later than day 3. Maximum quantities apply for this service.

 Available on request. Please enquire about delivery times of these items.

TRIED, TESTED, TRACTEL®

dynafor™ Expert

The new dynafor™ Expert has brand new electronics. The dynafor™ Expert has an improved reach, and makes it possible to connect to a smartphone or tablet. It furthermore has the same functionality as the dynafor™ Pro. Thanks to its special design, the dynafor™ Expert offers unparalleled precision and applicability.

Equipped with a Bluetooth module, the dynafor™ Expert offers a wireless range of up to 30 m to any smartphone or tablet equipped with our **free dynafor™ App on iOS or Android**.

- I.P 64.
- Wide range from 0.5 to 10t.
- Accuracy 0.1% measuring range.
- Compatible with standard lifting accessories.
- Wireless range 400m on dynafor™ HHD displays, 200m large AL128 displays and Tractel® software.
- Wireless range of 30m with any Android or IOS device equipped with our free dynafor™ app.
- Complies with current standards.
- Precision and traceability certified by an adjustment certificate (5 points).



Purchase HHD display - Special offer

HHD display is extra cost-effective when purchased directly in combination with the dynafor™ Expert.

Model	W.L.L (t)	Accuracy	Weight (kg)	Product Code	Price
dynafor™ Expert 0,5t	0,5	0.1	2.3 kg	293299	€2,208.00
dynafor™ Expert 0,5t with HHD	0,5	0.1	2.3 kg	359080	€2,974.00
dynafor™ Expert 1t	1	0.1	2.3 kg	293309	€2,334.00
dynafor™ Expert 1t with HHD	1	0.1	2.3 kg	359090	€3,101.00
dynafor™ Expert 2t	2	0.1	2.3	293319	€2,479.00
dynafor™ Expert 2t with HHD	2	0.1	2.3	359100	€3,245.00
dynafor™ Expert 3,2t	3,2	0.1	2.3	293329	€2,627.00
dynafor™ Expert 3,2t with HHD	3,2	0.1	2.3	359110	€3,393.00
dynafor™ Expert 5t	5	0.1	3.35 kg	293339	€2,770.00
dynafor™ Expert 5t with HHD	5	0.1	3.35 kg	359120	€3,536.00
dynafor™ Expert 6,3t	6,3	0.1	3.35 kg	293349	€2,908.00
dynafor™ Expert 6,3t with HHD	6,3	0.1	3.35 kg	359130	€3,675.00
dynafor™ Expert 10t	10	0.1	6.45	293359	€3,385.00
dynafor™ Expert 10t with HHD	10	0.1	6.45	359140	€4,151.00

Suitable for use with various accessories.

Delivered in a plastic case with 1 calibration certificate, operating manual and CE-certificate.

NEW! display HHD (optional)

- Universal display, for simultaneous connection of up to 4 sensors.
- Full colour display.
- Protective cover included.
- Intuitive operation.
- 48 hours of autonomy via rechargeable battery.



Model	Product Code	Price
Separate display dynafor™ HHD	293449	€958.00



Order products on day 1, will be shipped no later than day 2



Order products on day 1, will be shipped no later than day 3. Maximum quantities apply for this service.



Available on request. Please enquire about delivery times of these items.

AL128 Display - dynafor™ AL128

- Range 200m between sensor and display.
- Up to 4 simultaneous sensors.
- Tare, units, peak load functions.



Model	Product Code	Price
AL 128 display kit	293489	€2,936.00
Connection Unit BR	244019	€215.00
Display power supply 110/230VAC -> 24 VDC	199046	€90.00
Bus cable RS485, per metre	25871	€4.00
Adjustment software	199529	€515.00

I.P. 67 | optional

Model	Product Code	Price
dynafor™ Expert I.P.67 Option	281067	€412.00

Bow shackle and shackle for dynafor™



Bow shackle



Shackle

Model	Product Code	Price
Bow shackle 0.5 - 3.2 t	47916	€21.50
Bow shackle 5 - 6.5 t	47926	€48.50
Bow shackle 10 -12.5 t	47936	€107.00
Bow shackle 20 - 25 t	47946	€313.00
Shackle 0.5-3.2 t	111407	€68.00
Shackle 5 - 6.3 t	111417	€155.00
Shackle - 10 t	112207	€281.00

Software + calibration certificate dynafor™ Expert

- Software - for downloading data stored on the HHD display to a PC.
- Monitoring Software - for a complete real-time monitoring solution.

Model Name	Product Code	Price
dynafor™ Loader Software	293509	€206.00
dynafor™ Monitoring Software	68968	€979.00
Calibration certificate according to ISO 376 - 0.5 to 10 t	109407	€350.00
Calibration certificate according to ISO 376 standard - 25t to 50t	109417	€410.00



Order products on day 1, will be shipped no later than day 2



Order products on day 1, will be shipped no later than day 3. Maximum quantities apply for this service.



Available on request. Please enquire about delivery times of these items.

dynasafe™ Mecha

The new dynasafe™ Mecha range is a further development of the existing HF31 and HF32 load limiters from Tractel. These dynasafe™ Mecha load limiters offer a cost-effective and robust solution that is quick and easy to install on the fixed lifting cable of a lifting system, making it ideal for use with overhead travelling cranes, wire rope hoists, lifts or other lifting applications. The dynasafe™ Mecha is equipped with two independent switches, each with an adjustable threshold. The threshold value of the switch is set, using fine screws, according to the requested maximum and/or minimum value applicable to the fixed part of the lifting system. Each switch can be connected to various power and control devices (alarm, flash lamp, hoisting relay, etc.).

- Simple and economical solution for load limitation
- Easy installation on the lifting cable
- Capacity 3.2t | 6t | 12t
- Protection class: IP63
- Operating temperature: -30 to +80 °C
- In conformity with 2006/42/CE
- With connector and 2 m cable
- Mechanically adjustable
- Automatic reset if wire rope unloaded



The dynasafe™ Mecha is available in 3 versions:

- Mecha 3.2 - for load capacity from 200 daN to 3200 daN at the wire (5-16 mm)
- Mecha 7 - for load capacity from 500 daN to 7000 daN at the wire (17-26 mm)
- Mecha 12 - for load capacity from 1000 daN to 12000 daN at the wire (27-36 mm)

Model	W.L.L. (kg)	Rope Diameter (mm)	Product Code	Price
dynasafe™ Mecha 3.2	3200	5-16	293599	€649.00
dynasafe™ Mecha 7	7000	17-26	38658	€1,982.00
dynasafe™ Mecha 12	12000	27-36	38668	€2,453.00

Option: default setting

Model	Description	Product Code	Price
Default setting (per threshold)	For dynasafe™ Mecha 3.2	281407	€135.00
Default setting	For dynasafe™ Mecha 7 and dynasafe™ Mecha 12	73887	€144.00



Order products on day 1, will be shipped no later than day 2



Order products on day 1, will be shipped no later than day 3. Maximum quantities apply for this service.



Available on request. Please enquire about delivery times of these items.

Applications

- Cargo receipt control
- Protection against unintentional overloading
- Overload and slack cable control
- Checking the load on the hoist
- Resistance test and control
- Industrial process management
- Management of summation thresholds

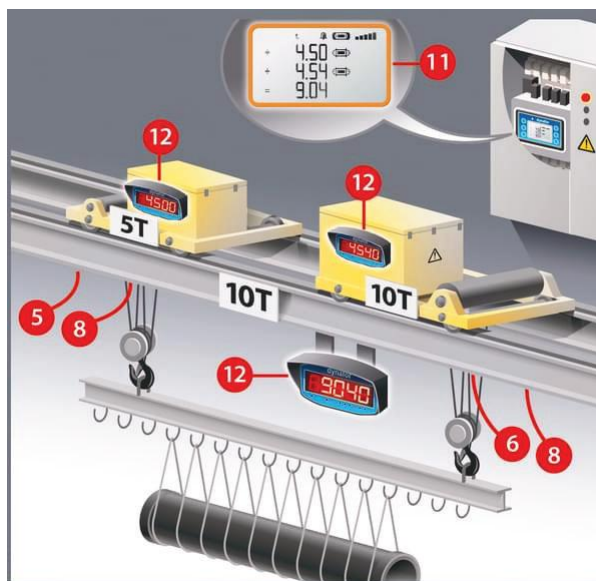

- Inventory management





Fixed point installation

dynasafe™ HF 05

- Mounted on dead strand or integrated in a machine.
- Compact equipment.
- Unit delivered with 2 adjustable thresholds.
- Breaking capacity 230V/5A.
- Allows the user to use an "all or nothing" signal.

Model	W.L.L. (kg)	Trip Points	Product Code	Price
HF05/1/A2/AL	500	2	43508	€1,280.00
HF05/2/A2/AL	1250	2	46188	€1,360.00
HF05/3/A2/AL	2000	2	43528	€1,532.00

Option: default setting

Model	Product Code	Price
Default setting	73887	€144.00



Order products on day 1, will be shipped no later than day 2



Order products on day 1, will be shipped no later than day 3. Maximum quantities apply for this service.



Available on request. Please enquire about delivery times of these items.

dynasafe™ load cells

- The dynasafe™ series have been developed especially for measuring loads.
- All load cells have a measuring cell which generates an output signal, depending on the load.
- The output signal can then be processed by using a Tractel® monitor or display

dynasafe™ HF10 - dead-end installation

Load cell for dead-end installation, based on strain gauge technology. It is used to show loads on a display or to process signals in load protection systems. For use in combination with HF80 monitor or Tractel® accessories.

Specifications:

- WLL: 20kg - 20t
- Output signal options: mV/V, frequency, 0-10V, 4-20 mA,



dynasafe™ HF35 - installation on wire rope

Load cell for installation on wire rope, based on strain gauge technology. It is used to show loads on a display or to process signals in load protection systems. For use in combination with HF80 monitor or Tractel® accessories.

Specifications:

- Cable: 5-45mm
- WLL: 20kg - 20t
- Output signal options: mV/V, frequency, 0-10V, 4-20 mA



dynasafe™ HF50 - load pin

Load pin, based on strain gauge technology. It is used to show loads on a display or to process signals in load protection systems. For use in combination with HF80 monitor or Tractel® accessories

Specifications:

- WLL: 50kg - 1000t
- Output signal options: mV/V, frequency, 0-10V, 4-20 mA

For more information about our measurement and control equipment and other special applications, please contact Tractel® (0031 (0)765435135).



Other types of load cells made to measure: traction, compression, shear, bending, etc. from 20 kg to 1000 t are available on request.

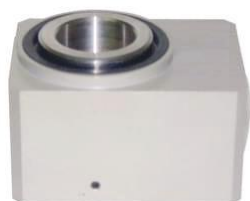

Order products on day 1, will be shipped no later than day 2



Order products on day 1, will be shipped no later than day 3. Maximum quantities apply for this service.



Available on request. Please enquire about delivery times of these items.

dynafor™ D.M.U.

Safety is a major concern for all companies that handle loads using lifting equipment. Accidental overloading can have dramatic consequences on the physical integrity of people and the effective lifespan of lifting equipment. The dynafor™ DMU Monitor combined with the other elements of the dynafor™ and dynasafe™ ranges has been specially developed to meet these requirements.

for:

- Prevent dangerous situations due to overloading
- To guarantee the lifespan of lifting equipment

The dynafor™ DMU monitor is mainly intended to be used as an electronic assistance solution for load or effort management in the industrial field. It is particularly appreciated on overhead cranes, where it ensures the intelligent management of safety thresholds thanks to the integrated relays. Various available options such as: wired high visibility LED display, portable LCD display with radio link, PC connection, etc.

- Safety equipment allowing the management of 5 thresholds for power equipment control.
- Individual and combined sensor management (up to 4 sensors).
- Wireless connection with dynafor™ Pro and Expert sensors.
- Wired connection with sensor equipped with dynafor™ Transmitter RS.
- Use with AL128 possible.



DMU - dynafor™ monitoring unit

Monitor BUS 485 or Zigbee inputs

- Outputs 5 "All Or Nothing" relays.
- Sum function
- Load display
- Filtering of dynamic effects
- Black box

Model	Product Code	Price
dynafor™ Monitoring Unit	293479	€2,055.00
Monitoring power supply 110/230VAC -> 24 VD	199046	€90.00
Bus cable RS485, per metre	25871	€4.00
Connection Unit BR	244019	€215.00
Adjustment software	199529	€515.00

Model	Product Code	Price
Transmitter RS	293469	€567.00
Adjustment software	199529	€515.00

Adjustment software required for initial installation.
Allows calibration of the sensors.



Order products on day 1, will be shipped no later than day 2



Order products on day 1, will be shipped no later than day 3. Maximum quantities apply for this service.



Available on request. Please enquire about delivery times of these items.

AL128 Display - dynafor™ AL128

The AL system has been developed especially to show the current load on a large display. It is possible to include 1 to 4 load cells in the network and to display them with the auto sum feature.

Functional:

- Taring, peak hold and unit display selection by using TLC remote control
- Adjustable dynamic effect filter
- Network communication by BUS RS485
- Addition to the dynafor™ Pro and Expert series

Various configurations are possible using the RS485 network technology.

The AL 128 display has a transmitter, ZigBee 2.4 GHz, which can be combined with the dynafor™ monitor series. This enables reading data on multiple handheld displays and storing measuring data by using monitoring software.

Default installation includes at least:

- 1 dynafor™ AL display
- 1 or 4 load cells (maximum 4)
- 1 dynafor™ transmitter RS or WL module
- 1 RS 485 bus cable
- 1 connecting unit

Separate components and equipment are also available separately.



Model	Product Code	Price
AL 128 display kit	293489	€2,936.00
Connection Unit BR	244019	€215.00
Display power supply 110/230VAC -> 24 VDC	199046	€90.00
Bus cable RS485, per metre	25871	€4.00
Adjustment software	199529	€515.00

AL 128 accessories

Model	Product Code	Price
Transmitter RS	293469	€567.00
Zigbee TLC remote control	293499	€454.00
Connection Unit BR	244019	€215.00
Bus cable RS485, per metre	25871	€4.00
Display power supply 24 VDC	199046	€90.00
Adjustment software	199529	€515.00

Order products on day 1, will be shipped no later than day 2

Order products on day 1, will be shipped no later than day 3. Maximum quantities apply for this service.

Available on request. Please enquire about delivery times of these items.

dynarope™ HF36 tension meter

The dynarope™ tension meter is a precision device for measuring forces in a tensioned cable or rope. The meter can be attached directly to the cable. When the tension meter is placed on a tensioned cable, the load cell will generate a signal which is proportional to the force.

Applications: antenna wires, suspension bridges, electronics, sailing ships, etc.

There is a large variety of cables, each cable having its own characteristics such as composition, diameter, rigidity, density, etc. The database includes several basic wire rope data. We are happy to help you choose the right model and parameter settings in our wire rope database.

The HF36 series have a standard USB link for managing and storing measurement results on a PC. Can also be used as stand-alone.



HF36 delivery (kit) includes:

Plastic case, measuring sensor, handheld display + LPT cable, USB cable, batteries and software loader light

- Can be placed directly on cable or rope
- Stand-alone or PC connection (HF36)
- Extensive wire rope database
- IP 65
- Storing measurement results
- Customized setting
- Accuracy: <1 to 5% full scale



Model	Description	W.L.L (Kn)	Rope Diameter (mm)	Product Code	Price
HF36/1/LPT	complete kit	2-50	5-13	187938	€10,092.00
HF36/2/LPT	complete kit	4-200	9-28	187948	€12,202.00
HF36/3/LPT	complete kit	5-400	20-44	187958	€18,461.00

Options & accessories HF36

Model	Product Code	Price
dynarope™ HF 36/1/LPT, separate sensor	190598	€5,172.00
dynarope™ HF 36/2, separate sensor	190608	€7,042.00
USB cable (display/PC)	230327	€120.00
Case HF 36/1/LPT	230517	€446.00
Case HF 36/2/LPT	230527	€1,132.00

Software HF36

Model	Product Code	Price
Software - Specific calibration in addition to the database	111347	€445.00
Software Loader: Light - transferring data to PC	193008	€188.00
Software Loader: Tech Option - wire rope database online update	193018	€979.00
Software Loader: Full Option - Loader Tech + wire rope database management	187978	€1,672.00
Software Loader: Monitor Option - displaying, managing and storing measuring data on PC.	193028	€1,209.00



Order products on day 1, will be shipped no later than day 2



Order products on day 1, will be shipped no later than day 3. Maximum quantities apply for this service.



Available on request. Please enquire about delivery times of these items.

dynarope™ HF37 tension meter

The dynarope™ tension meter is a precision device for measuring forces in a tensioned cable or rope. The meter can be attached directly to the cable and has a fixed display.

Applications: antenna wires, suspension bridges, electronics, sailing ships, etc.

When the tension meter is placed on a tensioned cable, the load cell will generate a signal which is more or less proportional to the force.

There is a large variety of cables, each cable having its own characteristics such as composition, diameter, rigidity, density, etc. The database includes several basic wire rope data.

The HF 37 series can be connected to a PC for managing and storing measurement results.

Delivery (kit) includes:

Plastic case, measuring sensor with display, batteries, USB cable and software loader light.

Including: CE certificate, calibration report and user and maintenance manual.

A convenient weigher including hooks for measuring small weights quickly and easily.

- Can be placed directly on cable or rope
- Extensive wire rope database
- IP 65
- Customized setting
- Accuracy: <1 to 5% full scale
- Cables 5-18 mm



Model	Description	W.L.L (daN)	Rope Diameter (mm)	Product Code	Price
HF37/1/LPT	complete kit	50 - 1500	5 - 13	190008	€4,999.00
HF37/2/LPT	complete kit	100 - 3000	5 - 16	190018	€7,715.00

Software HF37

Model	Product Code	Price
Software - Specific calibration in addition to the database	111347	€445.00
Software Loader: Light - transferring data to PC	193008	€188.00
Software Loader: Tech Option - wire rope database online update	193018	€979.00
Software Loader: Full Option - Loader Tech + wire rope database management	187978	€1,672.00
Software Loader: Monitor Option - displaying, managing and storing measuring data on PC.	193028	€1,209.00



Order products on day 1, will be shipped no later than day 2



Order products on day 1, will be shipped no later than day 3. Maximum quantities apply for this service.



Available on request. Please enquire about delivery times of these items.

dynaplug™ HF 44

The dynaplug™ anchor tester is an electronic load cell designed to measure anchor strength in construction material. The tool measures traction forces up to 5000 daN. Its shape as a tripod has been especially designed to minimize its influence on the concrete around the fixing. The three legs made in stainless steel can be adapted from 70 mm up to 190 mm high.

Standard content of delivery:

- Anchor tester dynaplug™
- 4 Studs M10, M12, M14, M16 + 1 traction fork
- 3 threaded rods to adjust the height of the legs
- 1 fixing tube with a chain
- CE certificate & calibration certificate
- User manual
- Carrying box



Model	W.L.L (kN)	Product Code	Price
HF44/1/LPT 15kN	15	190028	€4,769.00
HF44/2/LPT 25kN	25	190038	€5,535.00
HF44/3/LPT 50kN	50	190048	€7,652.00

dynaline™ HF 45

Electronic load cell tension meter. Designed to measure the effort applied in a wire rope (lifelines) without having to dismantle the installation. 600daN for wire rope 8-12mm.

Standard content of delivery:

- CE certificate & calibration certificate
- User manual
- Carrying box



Model	Product Code	Price
HF45/1/LPT	187998	€4,961.00
specific wire rope calibration	111347	€445.00

Anchor Tester TA

Anchor testers TA are test specimens endowed with a breaking section calibrated to break under a determined traction force. The anchor tester must be installed between the anchor point to be tested and the loading device by means of shackles or any other adequate mechanical connection.

Tractel offers 6 types of anchor testers calibrated to break respectively at: 600 daN, 1000 daN, 1200 daN, 1500 daN, 2000 daN and 4000 daN, tolerance range of +/- 10%. Anchor testers are made of stainless steel and for single use only.



Model	Breaking load (daN)	Product Code	Price
TA 600 - 20 plates	600	193269	€173.00
TA 1000 - 20 plates	1000	261769	€216.00
TA 1200 - 20 plates	1200	261779	€216.00
TA 1500 - 20 plates	1500	193279	€217.00
TA 2000 - 20 plates	2000	193289	€217.00
TA 4000 - 10 plates	4000	193299	€195.00



Order products on day 1, will be shipped no later than day 2



Order products on day 1, will be shipped no later than day 3. Maximum quantities apply for this service.



Available on request. Please enquire about delivery times of these items.

3.

Height safety products



Harnesses

Page 124–144

Lanyards and connectors

Page 145–158

Fall arresters

Page 159–167

Derope

Page 168–169

Lifelines and anchor points

Page 170–175

Rescue and rope access

Page 176–189

- Available on request. Please ask about the delivery time of these articles.
- Order on day 1, shipment no later than day 3 (maximum quantities apply).
- Order products on day 1, shipment no later than day 2.



Height Safety

Introduction

Tractel offers a comprehensive range of Personal Protective Equipment (PPE) in order to give you the support and assurance needed to guard against the risk from falls when working at height. With over 70 years of industry experience, Tractel has built a culture of safety through its ingenuity in manufacturing high quality, innovative products.

PPE basic requirements

- PPE must be suitable for the intended user.
- PPE must be properly maintained and stored.
- The user must be trained and/or informed in the use, care and maintenance of the equipment.
- Employers must assess the requirements of the PPE.
- Employees must report any loss or damage in the PPE.
- PPE should be compatible with other systems intended for use.

Work restraint

This category describes equipment that has been designed, manufactured and tested to restrain from a fall hazard. It is not intended to arrest a fall.

Work positioning

This type of equipment has been designed, manufactured and tested to enable workers to position themselves properly for working safely at heights. This equipment is incorporated or used in conjunction with a fall arrest system.

Height safety

Height safety equipment is designed to arrest a fall safely, limiting the risk of injury by dissipating the energy produced and holding the person in a suitable position.

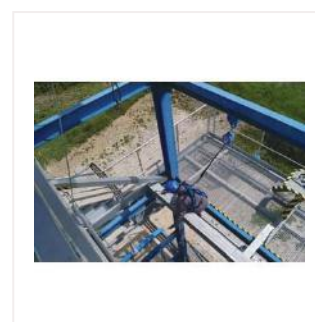
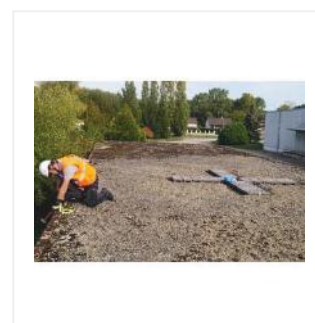

PPE regulation 2016/425

European regulation

On 21 April 2018, the PPE Directive 89/686/EEC was replaced by the PPE Regulation (EU) 2016/425. The transitional period from April 2018 to April 2019 was the period between the publication and implementation of the regulation. From April 2019, all CE marked PPE products must be in compliance with this PPE regulation.

THE PURPOSE OF THIS CHANGE:

- To improve health and safety at work and to ensure high quality of PPE the European Commission has issued a PPE regulation (EU) 2016/425.
- The PPE Regulation 2016/425 sets out stricter rules for placing PPE on the European market.

GLOBAL CHANGES for all products produced after April 21, 2019::

- Marking and information requirements to be provided in the user manuals.
- More precise definitions of the different categories of PPE (I, II and III).
- A more precise definition of the roles and responsibilities of the various stakeholders.
- Type-examination certificates are valid for a maximum of 5 years. Each 5 years a product needs to be re-certified to the most recent norm/standard.

How does the new 2016/425 PPE Regulation affect PPE distributors?

- In order to fulfill the requirements of the new 2016/425 PPE Regulation, you as a distributor of PPE need to ensure that, for all products produced after April 21, 2019:

✓	PPE bears CE marking
✓	PPE is accompanied by instructions for use in the languages needed
✓	PPE is accompanied by a declaration of conformity (print or link)
✓	PPE is labeled correctly (including month/year of manufacture)
✓	PPE comes with the manufacturer's (and importer's) name & address

- It is important for you to know that, as a distributor, you don't need to be in possession of all the documents, but need to be able to identify the manufacturer / importer / distributor in order to ask for the documents in case they are not provided.

Important dates

- **21 April, 2019:** implementation of the new PPE Regulation 2016/425. Tractel® only produces products that meet these new requirements.
- **From 21 April, 2019 to 21 April, 2023:** distributors can continue to sell their remaining stocks of products in accordance with the former PPE Directive 89/686.
- **21 April, 2023:** only products complying with the PPE Regulation 2016/425 can be sold.

TRACTEL® MARKINGS:

a	The trade name
b	The name of the product
c	The applicable standard
d	The product code
e	Notify body : CE number
f	The date of manufacture
g	The serial / batch number
h	User manual icon
w	The maximum capacity

Example :



EN Standards

HARNESSES

EN 361: Personal protective equipment against falls from height. Harness belts for work restraint and fall arrest.

EN 358: Personal protective equipment for work positioning and prevention of falls from a height. Belts for work positioning and restraint and work positioning lanyards. Normally encompassing side 'D' rings on the waist belt, this allows the user to incorporate a work positioning belt.

EN 813: Personal protective equipment against falls from height. Work seats. The seat belt **EN 813** can be incorporated on the harness **EN 361**. These harnesses have a padded seat and are suitable for working in full suspension. This includes rope access and activities such as window cleaning. It allows greater comfort for the user and has an attachment point for attaching a descender.

LANYARDS

EN 354: Personal protective equipment against falls from height. Lanyards. These can be made from webbing or rope and are suitable for work restraint.

EN 355: Personal protective equipment against falls from height. Shock absorbers. These lanyards have a shock absorber and are suitable for fall arrest and work restraint. The maximum length of the lanyard is 2m.

CONNECTORS

EN 362: Personal protective equipment against falls from height. Connectors. These include connectors like karabiners, scaffold hooks and dual action hooks. They are used for connecting to anchor points and structures.

ANCHOR POINTS

EN 795: fall arrest anchorage point permitting connection to the structure. Two types:

1. PPE anchorage: is transportable anchorage not permanently fixed to the structure.

type (B): Temporary anchor points, **type (E):** Dead-weight anchors

2. NOT PPE anchorage: permanently fixed to the structure

type (A): Permanent anchoring, **type (C):** Permanent lanyard systems, **type (D):** Horizontal rail systems

FALL ARRESTERS/CONTROLLED RATE DESCENDERS/ROPE GRABS

EN 360: Personal protective equipment against falls from height. Automatic Fall arresters with retractable lanyards These blocks can be made from webbing or steel wire rope and, depending on the model, can be used in horizontal or vertical applications.

EN 341: Evacuator from height. Descender devices for rescue. These controlled rate descenders can be used to lower a casualty or for self rescue from height. These can be equipped with a rescue winch **EN 1496**

EN 1496: Rescue winch / Rescue lifting devices. These devices can be used to raise a casualty back to the anchor point in the event of an emergency. They are often used as a secondary device

EN 353-1: Personal protective equipment against falls from height. Guided type fall arresters including a rigid anchor line. These are permanently installed systems that can be either wire rope or rail. They include a traveller that will allow the user to ascend and descend. This mechanism will lock off in the event of a fall.

LINE CLEMS

EN 353-2: Personal protective equipment against falls from height. Guided type fall arresters including a flexible anchor line. These are temporary installed systems. Depending on the model, they can be used vertically or horizontally and for work restraint or fall arrest.

HELMETS

EN 397: Industrial safety helmets. Head protection suitable for construction site use.

Additional technical specifications:

CNB/P/11.060 (horizontal use for the blocfor™ range)

CNB/P/11.062 (use with more than 100 kg user weight)

CNB/P/11.074 horizontal use for the range of lanyards)

CNB/P/11.075 (horizontal use for the stopfor™ range)



Harnesses - general

EN 361, EN 358 & EN 813 harnesses

Tractel® offers a wide range of harnesses to meet your requirements, from the bestselling entry level HT22 to the patented technical Easyclimb™ harness. Continuous innovation keeps our harnesses versatile with a variety of attachment points and optional extras:

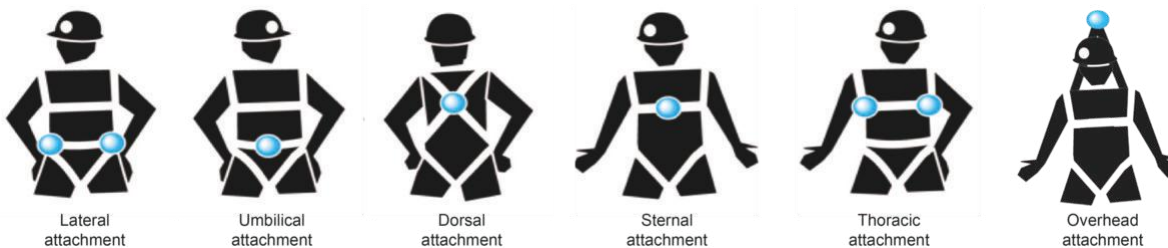

Harness Size Guide

Correct sizing and correct putting on a harness is essential for safety and comfort. It is important that a harness fits properly and that it offers the possibility to adjust it correctly so it is not too tight or too loose. This prevents employees from seeing the harness as a load, because the harness tightens too much or slips continuously.

If the harness is correctly dimensioned and adjusted, the forces on the body are distributed correctly. This enables the body to better withstand the impact of the fall, ensures that the attachment points are in the right place and that the body remains straight in the event of a fall. Incorrect sizing or tightening of the harness increases the risk of the "Harness Suspension Trauma" (hanging trauma).

It is important to choose the right size of harness according to the table below.

	S	M	XL	XXL
A	60 - 100	80 - 120	100 - 160	130 - 170
B	75 - 100	90 - 110	100 - 150	130 - 170
C	45 - 60	45 - 70	45 - 80	45 - 90
D	55 - 65	65 - 80	80 - 90	90 - 100

Options for harnesses



elastrac™ - packs offering 4cm of extra movement.



Quick Release Buckles - available for most harnesses



Accessories



High Capacity Range 150 kg

Is every team member safe?

The average weight of male employees has significantly increased over the last 20 years. This means that a growing number of employees are working outside the certified 100 kg limit of their fall arrest equipment.

To meet the demand for PPE fall arrest equipment for weights of more than 100 kg, Tractel® is the first to offer a complete range of 150 kg fall arrest equipment which complies with European regulations. The products in this range have been tested to arrest falls of weights up to 150 kg (person's weight and equipment) with an impact force of less than 600 daN.

To protect users up to the maximum weight of 150 kg, all system components (anchor point - lanyard/fall arrester - harness) are marked as "HIGH CAPACITY RANGE 150 kg".

Tractel® supplies a complete "HIGH CAPACITY RANGE 150 kg" of PPE, including anchor points and fall arrest/harness solutions which have been tested in accordance with the European CNB/P/11.062 (for weights of more than 100 kg) and CNB/P/11.060 (for horizontal use) standards.

The weight of 150 kg refers to the user's weight plus equipment and tools. The component with the lowest capacity always determines the maximum capacity of the entire fall arrest system.

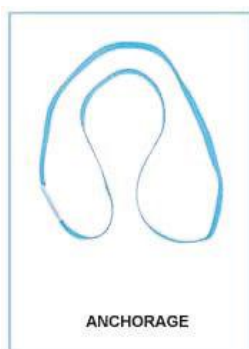
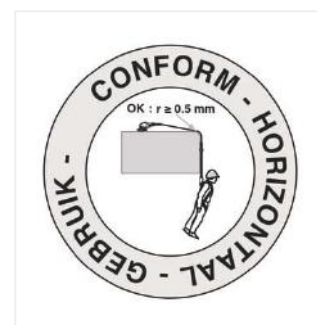

Harness Range Overview

Specialist series

- Designed for specific job requirements
- Daily and extended use in specific positions
- Includes all comfort options (X-pad, mountain type leg straps with a comfort foam layer)
- Multiple attachment points depending on the model
- Standard buckles or automatic buckles
- Big D ring on the back for increased safety
- Elastrac™ to offer more comfort on the shoulder movement included depending the version



Expert series

- Daily and extended use
- 2 piece harness offering increased flexibility in the movement of the harness
- Multiple attachment points depending the version
- Manual or quick release buckles

On the HT55 and HT56:

- Additional safety features
- Big D ring on the back for an increased safety
- Fall indicators embedded in the design of harness
- Fall indicators integrated in the design of the harness
- Additional comfort features
- Elastrac™ to offer more comfort on the shoulder movements
- X-pad included



Pro series

- Regular use
- Multiple attachment points depending the version
- Manual or quick release buckles
- Comfort options available on specific versions



Essential series

- Sporadic use
- Limited application possibilities
- Value range



Specialist serie

Harness HT Secours

- Offers considerable freedom of movement for rope access work.
- Designed for working in suspension
- Complies with the EN 358, EN 361 and EN 813 standards
- Soft, permeable X-Pad back pad
- 1 attachment point dorsal
- 1 attachment point sternal
- 1 attachment point umbilical (EN 813)
- 2 attachment point lateral
- Sliders for strap adjustment. Cannot be removed for security reasons
- Fall indicator on each attachment point
- High-comfort leg straps
- Option: ergonomic work seat (removable)

	S	M	XL	XXL	Price
HT Secours - Standard buckles	66132	66142	66152	-	€199.00
HT Secours - Automatic buckles	65882	65892	65902	80812	€225.00



Harness HT Promast

- For rope access work
- For working in a suspended position for long periods of time.
- Complies with the EN 358, EN 361 and EN 813 standards.
- Soft, permeable X-Pad back pad provides structure and style
- 1 attachment point dorsal
- 1 attachment point sternal
- 1 attachment point umbilical (EN 813)
- 2 attachment point lateral
- Sliders for strap adjustment. Cannot be removed for security reasons
- Fall indicator on each attachment point
- High-comfort leg straps
- Option: elastrac™ units or work seat

	S	M	XL	Price
HT Promast - Automatic buckles	65242	65252	65262	€261.00
HT Promast - Automatic buckles - elastrac™	65712	65722	65732	€281.00





Harness HT Electra

- For working in the utilities industry.
- With freely rotating positioning belt for free rotation while working on masts
- Complies with the EN 358 and EN 361
- Soft, permeable X-Pad back pad
- 1 attachment point dorsal
- 1 attachment point sternal
- 2 attachment point lateral
- Sliders for strap adjustment. Cannot be removed for security reasons
- Fall indicator on each attachment point
- High-comfort leg straps
- Option: elastrac™ units

	S	M	XL	XXL	Price
HT Electra - Automatic buckles	65272	65282	65292	76012	€281.00
HT Electra - Automatic buckles - elastrac™	65912	65922	65932	80722	€301.00



 Order products on day 1, will be shipped no later than day 2

 Order products on day 1, will be shipped no later than day 3. Maximum quantities apply for this service.

 Available on request. Please enquire about delivery times of these items.

Specialist serie



Harness HT Transport

- For working in masts, climbing, staying in position and rope-access work
- For prolonged suspended work
- Great freedom of movement
- Complies with the EN 358, EN 361 and EN 813 standards
- Soft, permeable X-Pad back pad
- 1 attachment point dorsal
- 1 attachment point sternal
- 1 attachment point umbilical (EN 813)
- 2 attachment point lateral
- Sliders for strap adjustment. Cannot be removed for security reasons
- Fall indicator on each attachment point
- High-comfort leg straps
- Option: elastrac™ units or work seat

	S	M	XL	XXL	Price
HT Transport - Automatic buckles	65942	65952	65962	-	€286.00
HT Transport - Automatic buckles - elastrac™	65972	65982	65992	80832	€306.00



Harness HT Greentool

- Equipped with an ergonomic work seat
- Complies with the EN 358, EN 361 and EN 813 standards
- Soft, permeable X-Pad back pad
- 1 attachment point dorsal
- 1 attachment point sternal
- 1 attachment point umbilical (EN 813)
- 2 attachment point lateral
- Sliders for strap adjustment. Cannot be removed for security reasons
- Fall indicator on each attachment point
- High-comfort leg straps
- Option: elastrac™ units

	S	M	XL	XXL	Price
HT Greentool - Automatic buckles	66002	66012	66022	-	€317.00
HT Greentool - Automatic buckles - elastrac™	66032	66042	66052	80772	€337.00





Harness HT Easyclimb

- Climbing up and down ladders with EN 353 fall arrester, rails or cable
- Complies with the EN 358 and EN 361
- Soft, permeable X-Pad back pad
- 1 attachment point dorsal,
- 1 attachment point umbilical (patented) which tears upwards during a fall to prevent the user from falling backwards
- 2 thoracic attachment points
- Sliders for strap adjustment. Cannot be removed for security reasons
- Fall indicator on each attachment point
- High-comfort leg straps
- Option: elastrac™ units

	S	M	XL	XXL	Price
HT Easyclimb - Automatic buckles	66482	66492	66502	-	€337.00
HT Easyclimb - Automatic buckles - elastrac™	66452	66462	66472	80712	€357.00

 Order products on day 1, will be shipped no later than day 2

 Order products on day 1, will be shipped no later than day 3. Maximum quantities apply for this service.

 Available on request. Please enquire about delivery times of these items.

Confined space / rescue series

Harness HT55 Confined Space

The HT55 confined space harness is particularly suited for use with a respiratory system which slides easily onto the belt.

Enhanced comfort is ensured by the back XPad, the mountaineering-type thigh straps and the linkage between the shoulder straps and thigh straps by connecting buckles.

The harness opens fully at the front with the X-Pad preserving the harness' form.

- Universal and very comfortable harness with quick release buckles.
- Ideal for long working wear
- 1 dorsal anchorage with a big "Forged D" anchorage to eliminate the risk of

carabiner disconnection

- 1 sternal anchorage
- 1 special belt for respiratory system
- 1 comfort subpelviene strap
- Sliders for strap adjustment. Cannot be removed for security reasons
- 3 adjustment points
- Independent mountain leg strap High-comfort
- X-pad comfort back pad: Breathable and flexible - it gives the harness shape to make it easier to put on.
- Fall indicator in each anchorage
- Equipped with label holder
- Complies with the EN361 standard



	S	M	XL	Price
HT55 A - confined space	83902	83912	83922	€184.00

Harness HT22R

- Universal harness with automatic buckle and rescue straps
- in accordance with norm EN361 and EN1497
- 1 dorsal anchor point
- 1 sternal anchorage point
- 1 subpelvien strap
- 5 non-detachable adjustment buckles



	S	M	XL	Price
HT22R - Standard buckles	44952	44962	44972	€73.50

HT9 Evacuation triangle

Special harness for evacuation operations, easy to install, even with a person lying on the ground.

Due to its 3 adjustment settings, the HT9 can be used with both children and adults.



Model	Product Code	Price
HT9 Evacuation Harness	17622	€126.00

Expert series



Harness HT120

Harness designed for movement (up or down) on structures equipped with an EN 353 rail or cable fall arrester device.

The HT120 harness is equipped with an approved fall arrest umbilical attachment point. This attachment point, while being fall arrest approved, provides a comfortable support going up or down. HT120 is the only harness on the market that offers this type of attachment point.

The HT120 harness is particularly adapted for climbing on ladders equipped with a rail mounted FABATM type fall arrester.

Its patented design prevents the user from turning over with the serious back injuries which could occur in the event of a fall, unlike the ventral fastening points mounted directly on the traditional safety belts.

The HT 120 harness is equipped with the following equipment:

- 1 dorsal fastening point.
- 2 thoracic fastening points.
- 1 central (patented) fastening point which tears upwards during a fall to prevent the user from falling backwards.
- Complies with the EN361 standard.

	S	M	XL	Price
HT120 - Standard buckles	61702	61712	61722	€169.00





Harness HT ladytrac™

- Specially designed and patented harness for women
- Ergonomics and maximum safety
- The design avoids positioning and therefore friction of the harness straps on the chest. (Tractel® patent)
- Ergonomic jacket made with stretch and poly-cotton fabric to provide maximum safety and comfort
- This elastic, ventilated jacket is equipped with multiple Velcro strips to adapt to any body type.
- Integrated positioning belt (Ladytrac™ B model)



	M	XL	Price
HT ladytrac™ - Automatic buckles	55882	55892	€174.00
HT ladytrac™ B - + positioning belt	55282	55292	€204.00

 Order products on day 1, will be shipped no later than day 2

 Order products on day 1, will be shipped no later than day 3. Maximum quantities apply for this service.

 Available on request. Please enquire about delivery times of these items.

Expert Series

Harness HT44

- Universal harness big confort for a long work
- Complies with Standard EN 361
- 1 dorsal "Forged D clip"
- 2 thoracic ones
- Comfort sub-pelvic straps
- 5 adjustment points
- Independent mountain leg strap High-comfort
- Standard closure buckle

	S	M	XL	Price
HT44 - Standard Buckles	44102	44112	44122	€75.50



Harness HT45

- Universal harness automatic with big confort for a long work
- Complies with Standard EN 361
- 1 Dorsal "Forged D " anchorage
- 1 Sternal anchorage
- Comfort sub-pelvic straps
- Independent mountain leg strap High-comfort
- 5 Adjustment points
- Standard closure buckle

	S	M	XL	XXL	Price
HT45 - Standard Buckles	55012	55022	55032	75532	€82.00
HT45 A - Quick Release Buckles	53072	53082	53092	-	€123.00
HT45 AE - Quick Release Buckles + Elastrac™	54922	54932	54942	-	€143.00





Harness HT46

- Multiple use harness
- Complies with Standard EN 361
- 1 dorsal "Forged D clip", 1 sternal and 2 thoracic ones
- 5 adjustment points
- High-comfort sub-pelvic and leg straps
- Comfort sub-pelvic straps

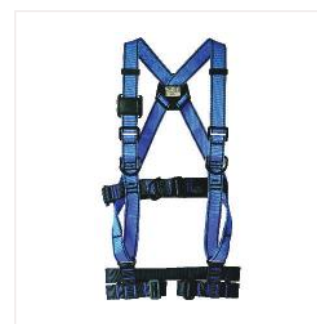
	S	M	XL	XXL	Price
HT46 - Standard Buckles	55042	55052	55062	-	€90.00
HT46 A - Quick Release Buckles	52972	52982	52992	80552	€131.00
HT46 AE - Quick Release Buckles + Elastrac™	54952	54962	54972	-	€151.00



 Order products on day 1, will be shipped no later than day 2

 Order products on day 1, will be shipped no later than day 3. Maximum quantities apply for this service.

 Available on request. Please enquire about delivery times of these items.

TRIED, TESTED, TRACTEL®

Expert Serie



Harness HT45 with orange jacket

- Big comfort for extended work
- 1 dorsal "Forged D" anchorage
- 1 sternal anchorage
- 5 adjustment points
- 1 subpelviene strap
- Orange jacket: comfortable lightweight high-visibility vest
- Already installed on the harness
- Sliders for strap adjustment. Cannot be removed for security reasons
- Equipped with label holder
- Complies with standard EN361

	M	XL	Price
HT45 - Standard buckles - Orange jacket	83822	83832	€184.00





Harness HT45 with yellow jacket

- Big comfort for extended work
- 1 dorsal "Forged D" anchorage
- 1 sternal anchorage
- 5 adjustment points
- 1 subpelviene strap
- Yellow jacket: comfortable lightweight high-visibility vest
- Already installed on the harness
- Sliders for strap adjustment. Cannot be removed for security reasons
- Equipped with label holder
- Complies with standard EN361

	M	XL	Price
HT45 - Standard buckles - Yellow jacket	83802	83812	€184.00



 Order products on day 1, will be shipped no later than day 2

 Order products on day 1, will be shipped no later than day 3. Maximum quantities apply for this service.

 Available on request. Please enquire about delivery times of these items.

Harness HT55

HT55 harness is designed for a wide range of applications. It is particularly suited for construction workers (ladders, scaffolding, roofing, etc.) thanks to its chest anchorage point. Enhanced comfort is ensured by the back X-Pad, horizontal leg straps in combination with the 2-piece harness design which provides greater flexibility in the movement of the harness. Comfort is further enhanced through the use of elastrac™ units available (optional). The harness is very easy to fit because it opens completely at the front and the X-Pad maintains the shape of the harness. Putting on the harness is further facilitated through the use of the quick release buckles available (optional).

- Universal and very comfortable harness automatic with big comfort for a long work
- Complies with Standard EN 361
- 1 Dorsal "big Forged D" anchorage
- 1 sternal anchorage
- 1 Comfort sub-pelvic straps
- 5 Adjustment points
- Independent mountain leg strap High-comfort
- Standards or Automatics closure buckle
- Comfort back X-PAD
- Fall indicator in each anchorage
- Label holder

Optional:

- Elastrac™

	S	M	XL	XXL	Price
HT55 - Standard Buckles	65592	65602	65612	-	€108.00
HT55 A - Quick Release Buckles	65622	65632	65642	80632	€143.00
HT55 AE - Quick Release Buckles - Elastrac	65652	65662	65672	-	€164.00

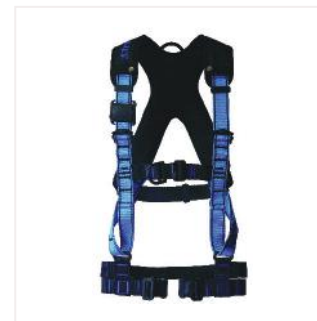



Harness HT56

Universal multiple use comfort harness

- Complies with Standard EN 361
- 1 Dorsal "big Forged D" anchorage
- 2 Thoracic anchorage
- 1 Sternal anchorage
- 5 Adjustment points
- High comfort leg straps
- Sub-pelvic straps
- Standards or Automatics closure buckle
- Comfort back X-PAD
- Fall indicator in each anchorage
- Label holder

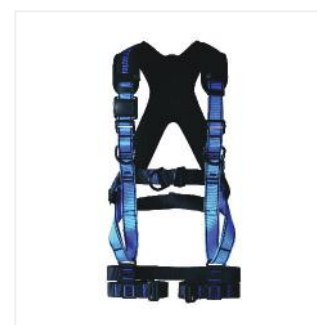
	S	M	XL	XXL	Price
HT56 - Standard Buckles	65302	65312	65322	-	€118.00
HT56 A - Quick Release Buckles	65332	65342	65352	80682	€153.00
HT56 AE - Quick Release Buckles + Elastrac™	65682	65692	65702	80692	€174.00



 Order products on Day 1, will be shipped no later than Day 2

 Order products on Day 1, will be shipped no later than Day 3. Maximum quantities apply for this service.

 Available on request. Please enquire about delivery times of these items.

Professional Series



Harness HT22

- Multiple use harness
- Complies with the EN 361 standard
- 1 dorsal and sternal "Forged D clip"
- 5 adjustment points
- Sub-pelvic strap

	S	M	XL	XXL	Price
HT22 - Standard Buckles	31592	14002	28502	79412	€57.50
HT22 A - Automatic Buckles	31832	31822	31842	-	€97.00
HT22 - Standard Buckles - X-pad	-	69272	69292	80322	€92.00



Harness HT34

- Universal harness with belt
- Complies with Standard EN 361/358
- 1 dorsal "Forged D clip",
- 1 sternal anchorage
- 2 thoracic ones anchorage
- 6 adjustment points
- 2 lateral hitch D rings
- 1 Sub-pelvic strap

	S	M	XL	Price
HT34 - Standard Buckles	35352	35362	35372	€108.00
HT34 A - Automatic Buckles	40782	40792	40802	€158.00

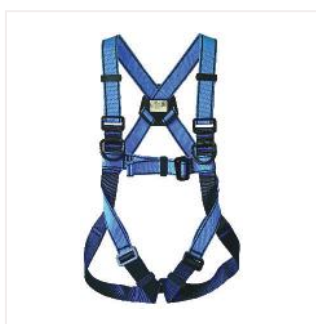



Harness HT42

- Complies with Standard EN 361
- 1 dorsal "Forged D clip"
- 2 thoracic ones
- 5 adjustment points
- Sub-pelvic strap
- Standard closure buckle

	S	M	XL	Price
HT42 - Standard Buckles	31622	10042	31082	€68.50

 Order products on Day 1, will be shipped no later than Day 2

 Order products on Day 1, will be shipped no later than Day 3. Maximum quantities apply for this service.

 Available on request. Please enquire about delivery times of these items.

Harness HT22 with orange jacket

- 1 dorsal "Forged D" anchorage
- 1 sternal "textile loop" anchorage
- 5 adjustment points
- 1 subpelviene strap
- Sliders for strap adjustment. Cannot be removed for security reasons
- Orange jacket: comfortable lightweight high-visibility vest
- Already installed on the harness
- Complies with standard EN361

	M	XL	Price
HT22 - Standard buckles - Orange jacket	83782	83792	€164.00



Harness HT22 with yellow jacket

- 1 dorsal "Forged D" anchorage
- 1 sternal "textile loop" anchorage
- 5 adjustment points
- 1 subpelviene strap
- Sliders for strap adjustment. Cannot be removed for security reasons
- Yellow jacket: comfortable lightweight high-visibility vest
- Already installed on the harness
- Complies with standard EN361

	M	XL	Price
HT22 - Standard buckles - Yellow jacket	83762	83772	€164.00



● Order products on day 1, will be shipped no later than day 2

● Order products on day 1, will be shipped no later than day 3. Maximum quantities apply for this service.

○ Available on request. Please enquire about delivery times of these items.

Professional Series

Harness HT43



- Complies with Standard EN 361
- 1 dorsal "Forged D clip"
- 1 sternal "Forged D clip"
- 2 thoracic ones "Forged D clip"
- 5 adjustment points
- 1 Sub-pelvic strap

	S	M	XL	Price
HT43 - Standard Buckles	33302	33292	33312	€70.50
HT43 A - Automatic Buckles	33332	33322	33342	€122.00



Order products on day 1, will be shipped no later than day 2



Order products on day 1, will be shipped no later than day 3. Maximum quantities apply for this service.



Available on request. Please enquire about delivery times of these items.

Essential Serie

Harness HT10

- The HT10 harness is a simple harness for occasional work at height
- Harness for standard use
- 1 dorsal "Forged D" anchorage
- Chest belt fitted with quick-release buckle
- 2 adjustment points
- Complies with standard EN361

	M	XL	Price
HT10 - Standard buckles	17892	29702	€38.00



Harness HT11

The HT11 harness is a simple harness with a dorsal attachment point for occasional work at height.

- 1 dorsal "Forged D" anchorage
- 3 adjustment points
- 1 subpelviene strap
- Complies with standard EN361

	S	M	XL	Price
HT11 - Standard buckles	31192	10002	31182	€44.00



Harness HT21

- Harness for standard use
- 1 dorsal "Forged D" anchorage
- 1 sternal "textile loop" anchorage
- 2 adjustment points
- 1 subpelviene strap
- Complies with standard EN361

	S	M	XL	Price
HT21 - Standard buckles	31582	10012	29722	€51.00



Order products on day 1, will be shipped no later than day 2

Order products on day 1, will be shipped no later than day 3. Maximum quantities apply for this service.

Available on request. Please enquire about delivery times of these items.

Eco-set

Tractel® Eco-set

- HT10 harness, size M
- LSA 1.5m-10-53 lanyard
- PPE bag



Model	Product Code	Model Name	Price
Eco-set	354060	Eco-set	€140.00

Basic-set

Tractel® basic set

- HT22 harness, size M
- LSA 1.5m-10-51 lanyard
- PPE bag



Model	Product Code	Model Name	Price
Basis set	354070	Basic set	€178.00

Luxury set

Luxury set Tractel® :

- HT 22 Ba harness, size M
- LSAD 1.5 m-10-51-51 lanyard
- AS30S-1 anchor sling
- Combipro, 30 litres



Model	Product Code	Model Name	Price
Luxury set	354100	Luxury set	€281.00



Order products on day 1, will be shipped no later than day 2



Order products on day 1, will be shipped no later than day 3. Maximum quantities apply for this service.



Available on request. Please enquire about delivery times of these items.

Tractel® Aerial platform-set

- HT 22 harness, size M
- AS30S-1 anchor sling
- Combipro, 30 litres

Two types of blocfor:

- blocfor 1.8A ESD-47-51 (version A)
- blocfor 1.8B ESD 47-51 (version B)



Model	Product Code	Price
Aerial platform set - A	354110	€293.00
Aerial platform set - B	356800	€308.00

Tractel® Aerial platform-set

- HT 56A harness, size M
- AS30S-1 anchor sling
- Combipro, 30 litres

Two types of blocfor:

- blocfor 1.8A ESD-47-51 (version A)
- blocfor 1.8B ESD 47-51 (version B)



Model	Product Code	Price
Aerial platform set - A	355560	€407.00
Aerial platform set - B	356810	€423.00

Tractel® Multi-set

- HT 46 harness, size M
- RLXD 11 10
- LDA 12 2 m-10-51 lanyard
- AS30S-1.5 anchor sling
- stopfor KSP 30 M41
- Combipro, 30 litres



Model	Product Code	Price
Multi-set	354090	€455.00

 Order products on day 1, will be shipped no later than day 2

 Order products on day 1, will be shipped no later than day 3. Maximum quantities apply for this service.

 Available on request. Please enquire about delivery times of these items.

Tractel® Pro-set

- HT 22 BA harness, size M
- blocfor 10 ESD M10-47
- AS30S-1,5 anchor sling
- Combipro, 30 litres



Model	Product Code	Price
Pro-set	354080	€652.00

Tractel® Industrial set

- HT 22 BA harness, size M
- blocfor 6ESD M10-47
- AS30S-1.5 anchor sling
- LSA 1.5 m-10-51 lanyard
- Combipro, 30 litres



Model	Product Code	Price
Industrial set	354120	€583.00

Tractel® Vertical set

- HT Promast, size M
- LDAD 11 1.5 m-10-51-51
- AS30S-1,5 anchor sling
- RLXD 11 10, 20 or 30 meters
- stopfor K LS 30 M41
- LCM 05 2 m M41 positioning line
- Combipro, 60 litres



Model	Product Code	Price
Vertical - 10 metres	354130	€775.00
Vertical - 20 metres	354140	€800.00
Vertical - 30 metres	354150	€827.00



Order products on day 1, will be shipped no later than day 2



Order products on day 1, will be shipped no later than day 3. Maximum quantities apply for this service.



Available on request. Please enquire about delivery times of these items.

Accessories for harnesses

Comfort strap

Accessory to reduce the risk of suspension trauma

The comfort strap is a portable, lightweight accessory which fits onto the harness and can be deployed in the event of a fall. This type of strap has a loop for the user to stand in whilst suspended. The straps can be adjusted allowing the user to stand up straight relieving the pressure felt on the inner thighs and legs (suspension syncope).

Suspension syncope occurs when the harness user is left suspended in a hanging positioning following the event of a fall. During this time the harness can cut into the thighs restricting blood flow. If this goes on for prolonged periods of time, it cannot only cause serious discomfort and pain but even fainting. The comfort strap provides a solution to this problem.

Specifications:

- Hard-wearing zipped pouch, 80 mm diameter, 40 mm thickness
- Strap made from polyamide webbing and zinc plated steel adjustment buckles
- Easily adjustable up to 1.2 m to suit the height of the user
- Weight: 100 g
- User manual included within the pouch
- Quick and easy to attach to the harness
- Suitable for any Tractel harness



Model	Product Code	Price
Comfort Strap	66182	€34.00

Easy to Use

Step 1 - Unzip the pouch and deploy the leg hoop

Step 2 - Place both feet in the foot loop

Step 3 - Adjust the strap as required

Step 4 - Stand up straight to relieve pressure on the legs



Ergonomic work seat

Accessory for long-term suspension work

- For long-term suspension work in sit position
- Stiff sides to prevent thigh compression
- Three tool holders
- Is placed on the back of the HT Secours, Promast, Easyclimb, Greentool, Electra and HT Transport



Model	Product Code	Price
Work seat	65762	€135.00



Order products on day 1, will be shipped no later than day 2



Order products on day 1, will be shipped no later than day 3. Maximum quantities apply for this service.



Available on request. Please enquire about delivery times of these items.

Tool holding accessories

Fall protection does not stop when the user falls, falling tools can also cause fatalities. In addition to the fall protection programme for personal protective equipment, Tractel® launches a range of accessories for tool holders to secure tools up to 5 kg.



ETL



ETLS



TL

Model	Product Code	Price
ETL	74782	€12.50
ETLS	74812	€12.50
TL	74842	€11.50
TLS	74872	€10.50
TWB	74902	€10.50
OAS	75572	€12.50



TWB



OAS



Tool holding bag

- Mounting to Tractel® harnesses
- Made of polyamide and has 3 compartments
- A closed bag with Velcro (220 x 20 mm)
- Bag is 180mm high
- Bag has two front pockets (110 x 20 mm)
- Reinforced base with leather to prevent perforation of the tool

Model	Product Code	Price
Belt pouch	75582	€36.50



Order products on day 1, will be shipped no later than day 2



Order products on day 1, will be shipped no later than day 3. Maximum quantities apply for this service.



Available on request. Please enquire about delivery times of these items.

Helmet

- Shell in ABS for optimal protection from impacts and compression
- Short visor for easier upwards vision
- Available in 3 colours: blue, white and red
- Lightweight: 375 g
- Fast knurled wheel adjustment to head size 45 to 62 cm
- Fabric straps for ideal comfort
- Towelling all round sweatband
- 4-point adjustable chinstrap for perfect fit
- Usage temperature -30°C to +40°C
- Service life: 5 years
- Numerous accessories
- EN 397/EN 50365 compliant



Model	Product Code	Price
helmet, blue	60252	€46.00
helmet, red	60432	€46.00
helmet, white	60442	€46.00

High-visibility vest

Comfortable high visibility vest, especially developed for use with Tractel® harnesses.

- 1 size
- Colors: yellow, orange



Model	Product Code	Price
High-visibility vest - Orange	75672	€97.00
High-visibility vest - Yellow	75662	€97.00

Option RL

- Line for extending the anchor point on the back



Model	Product Code	Model Name	Price
Option RL	32872	Option RL	€16.00

Helmet accessories

For optimal safety, the helmet can be equipped with the following accessories:

- Integrated visor, clear
- Integrated visor, tinted
- In-ear defender
- Mounted ear defenders
- Head torch clip

Model	Product Code	Price
integrated visor, clear	60272	€25.50
Integrated visor, tinted	60262	€25.50
in-ear defender	60292	€7.00
mounted ear defenders	60282	€33.50
head torch clip	60302	€7.40



Padded shoulder straps

- Extra comfort
- Set of 2 padded shoulder pads



Model	Product Code	Price
Padded Shoulder Pads	10112	€14.50

Rescue Lanyard Option R

Rescue straps for rescuing a person in a confined space.



Model	Product Code	Price
Option R	83892	€44.00

 Order products on day 1, will be shipped no later than day 2

 Order products on day 1, will be shipped no later than day 3. Maximum quantities apply for this service.

 Available on request. Please enquire about delivery times of these items.

TRIED, TESTED, TRACTEL®

Positioning belts

CE-belts have 2 attachment points on the hip for a positioning line. They are equipped with three eyes for the attachment of the tool bag. Easy and quick size adjustment through only one adjustment buckle. The belt is permanently held in place with positioning straps. They can be combined with any harness in our range, providing a fully integrated harness solution.



Safety belt CE01

- Two lateral pressed steel 'D' clips
- 3 buckles for attaching a tool bag
- Large comfortable padded back support
- The positioning belt can be connected to all standard harnesses
- Positioning straps for permanent attachment to a harness
- Available with standard buckles or automatic buckles
- Available sizes: S, M and XL

	S	M	XL	Price
Safety Belt CE01 - Standard buckles	32882	10052	10062	€50.00
Safety Belt CE01 - Automatic buckles	33202	33212	33222	€68.00



Safety belt CE06

- Two wide, easy-to-handle, forged steel fixing straps 50 mm wide
- 3 buckles for attaching a tool bag
- Large comfortable padded back support
- The CE06 safety belt can be attached to all standard harnesses
- Positioning straps for permanent attachment to a harness
- Available with standard buckles or automatic buckles
- Available sizes: S, M and XL

	S	M	XL	Price
Safety Belt CE06 - Standard buckles	80242	80252	80262	€53.50
Safety Belt CE06 - Automatic buckles	80272	80282	80292	€68.00



Order products on day 1, will be shipped no later than day 2



Order products on day 1, will be shipped no later than day 3. Maximum quantities apply for this service.



Available on request. Please enquire about delivery times of these items.

Accessories

Bag - cloth pocket bag



- Pocket bag
- Zip fastening
- Size : 400 x 290 x 20 mm

Model	Product Code	Price
Small	11942	€5.10

Bag - cloth shoulder bag



- Shoulder bag
- Zip fastening
- Size: 430 x 310 x 150 mm

Model	Product Code	Price
Medium	10542	€13.00

Backpack



- Backpack for height safety products
- Dimensions: 420 x 260 x 120 mm

Model	Product Code	Price
Backpack	67392	€24.50

derope™ drop bag



- Dimensions drop bag: 430 x 310 x 150 mm
- Dimensions bag: 430 x 310 x 150 mm

Model	Product Code	Price
derope™ drop bag	67422	€97.50
derope™ bag	51912	€156.00

Combi Pro bag



- Combi Pro 20L (360 X 320 mm.)
- Combi Pro 30L (570 X 410 mm.)
- Combi Pro 60L (680 X 510 mm.)

Model	Product Code	Price
20L	50992	€21.50
Combi Pro - 30L	20812	€19.50
Combi Pro - 60L	20822	€34.00



Bag for trampoline

- Bag for the trampoline tripod
- l x w x h = 1.900 x 290 x 290 mm.
- Equipped with zip fastening

Model	Product Code	Price
trampoline canvas bag	31572	€75.00



Door anchor bag

- Bag specially designed to transport a door anchor
- Dimensions: 1.550 x 270 x 270 mm

Model	Product Code	Price
Tas voor deurtraverse	68752	€135.00



Order products on day 1, will be shipped no later than day 2



Order products on day 1, will be shipped no later than day 3. Maximum quantities apply for this service.



Available on request. Please enquire about delivery times of these items.

Steel, stainl. steel & aluminium hooks

Steel hooks

Model	Anchorage Hook Gate Opening	Product Code	Price
M10	∅ 15 mm	31652	€7.10
M10T	∅ 15 mm	76312	€10.50
M11	∅ 17 mm	31662	€20.50
M23	∅ 17 mm	59002	€22.00
M41	∅ 18 mm	31722	€12.00
M47	∅ 17 mm	33032	€23.00
M53	∅ 53 mm	31772	€20.50
M60	∅ 47 mm	32482	€64.50
M61	∅ 47 mm	33082	€66.50

Stainless steel hooks

Model	Anchorage Hook Gate Opening	Product Code	Price
M31	∅ 75 mm	10432	€36.50
M32	∅ 100 mm	10442	€40.50
M33	∅ 140 mm	10452	€47.00

Aluminium hooks

Model	Anchorage Hook Gate Opening	Product Code	Price
M12	∅ 23 mm	31672	€18.50
M15	∅ 23 mm	31692	€29.00
M22	∅ 23 mm	56222	€28.00
M42	∅ 18 mm	31732	€23.00
M51	∅ 60 mm	31752	€41.50
M52	∅ 59 mm	31762	€59.00
M54	∅ 110 mm	32462	€110.00

Pole

With the telescopic pole a lifeline can be hung from the ground. Complies with the CE EN 795 class B standard.

- Weight of the pole: 2,685kg
- Weight of the carabiner: 0,765kg.

Model	Description	Product Code	Price
Pole- 6 meter long	6 meter long pole	106697	€263.00
AM53 connector	AM53 connector for pole	106117	€168.00
AM54 Connector	AM54 connector for pole	113427	€168.00

Steel Connectors



M10

- Permanent connection
- Occasional opening
- Manual screw locking
- Opening \varnothing 15 mm
- Bichromatised steel

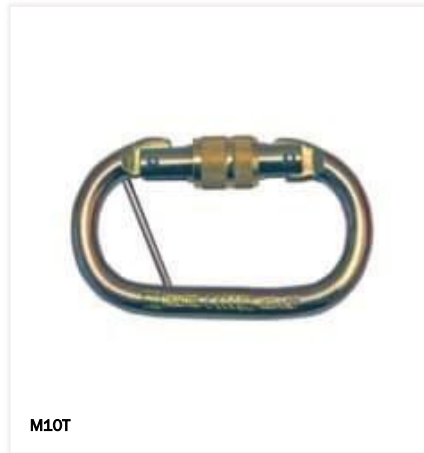

M10T

- Permanent connection
- Occasional opening
- Manual screw locking
- Opening \varnothing 15 mm
- Bichromatised steel

Model with locking pin. Pin supplied separately and must be connected by the user. After assembly, the components cannot be removed.



M11

- Frequent opening/coupling
- Semi-automatic lock
- Opening \varnothing 17 mm
- Bichromatised steel

Semi-automatic lock: no risk of the user forgetting to lock his connector, increased safety.



M23

- Frequent opening/coupling
- Triple automatic safety lock
- Opening \varnothing 17 mm
- Bichromatised steel

Model with locking pin. The pin is supplied separately and must be mounted by the user. After assembly, the parts cannot be removed. Triple automatic safety lock, no risk of the user forgetting to lock his connector, increased safety.



M41

- Frequent opening/coupling
- Double automatic safety lock
- Opening \varnothing 18 mm
- Bichromatised steel

Double automatic safety lock, no risk of the user forgetting to lock his connector, increased safety.

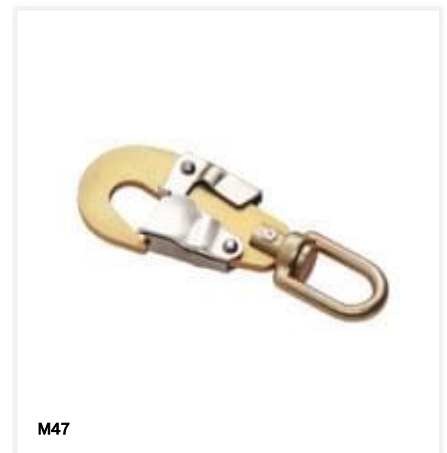

M47

- Frequent opening/coupling
- Double automatic safety lock
- Rotation
- Opening \varnothing 17 mm
- Bichromatised steel

Double automatic safety lock, no risk of the user forgetting to lock his connector, increased safety.

Steel + stainless steel hooks



M61

- Frequent opening/coupling
- Rotation lock
- Bichromatised steel
- Opening \varnothing 47 mm
- EN 362 standard

Model with locking pin. The pin is supplied separately and must be mounted by the user. After assembly, the parts cannot be removed.



M31

- Frequent opening/coupling on tubular structure.
- Double safety lock.
- Stainless steel
- Opening: 75 mm
- EN 362 standard



M32

- Frequent opening/coupling on tubular structure.
- Double safety locking
- Stainless steel
- Opening: 100 mm
- EN 362 standard



M33

- Frequent opening/coupling on tubular structure.
- Double safety locking
- Stainless steel
- Opening: 140 mm
- EN 362 standard

Aluminium hooks



M12

- Permanent connection
- Manual screw locking
- Aluminium
- Opening \varnothing 23 mm
- EN 362 standard

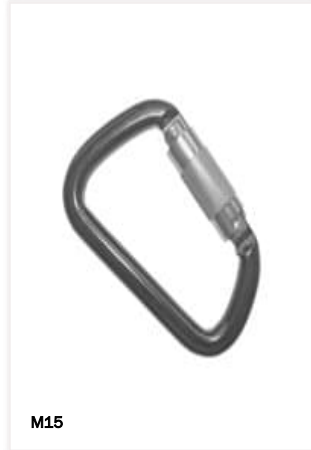

M15

- Frequent opening/coupling
- Triple automatic safety lock
- Aluminium
- Opening \varnothing 23 mm
- EN 362 standard



M22

- Frequent opening/coupling
- Triple automatic safety lock
- Aluminium
- Opening \varnothing 23 mm
- EN 362 standard

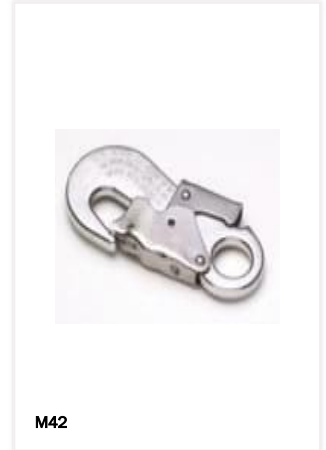

M42

- Frequent opening/coupling
- Double automatic safety lock
- Aluminium
- Opening \varnothing 18 mm
- EN 362 standard

Model with locking pin. The pin is supplied separately and must be mounted by the user. After assembly, the parts cannot be removed.

Triple / double automatic safety lock, no risk of the user forgetting to lock his connector, increased safety.



M51

- Frequent opening/coupling on constructions
- Double automatic safety lock
- Aluminium
- Opening \varnothing 60 mm
- EN 362 standard



M52

- Frequent opening/coupling
- Sliding ring lock
- Aluminium
- Opening \varnothing 59 mm
- EN 362 standard



M54

- Frequent opening/coupling on constructions
- Double automatic safety lock
- Aluminium
- Opening \varnothing 110 mm
- EN 362 standard



Lanyards - blocofor™ - stopfor™

Tractel® fall protection (PPE) is intended for working at height where there is a danger of falling vertically, as well as for work at height on a horizontal surface with risks of falling over a sharp edge (roof terrace use) (with a radius $R \geq 0.5$ mm.)

For this, our range of blocofor™, stopfor™ & lanyards are certified according to the following guidelines:

- CNB/P/11.060 (for the blocofor™ range)
- CNB/P/11.074 (for the lanyards range)
- CNB/P/11.075 (for the stopfor™ range)

Tractel® products are tested to stop the fall of a person, including safety equipment and tools , weighing up to 150 kg.

Tractel® no longer indicates lifespan on fall arrest equipment.

Tractel® Personal Protective Equipment (PPE) can be used without restrictions from their manufacturing date provided that:

- Use is in accordance with the instruction manual.
- The instruction manual procedures for storage and transport are met.
- A periodic inspection is carried out at least every year by a competent person who, after inspection, will authorise in writing that the PPE is fit to be returned to service.
- A full written history is available for the product that you intend to use

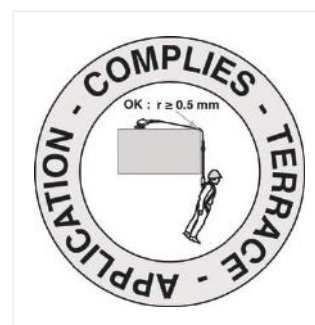

Fall arrest lanyards

LSA - webbing lanyard

Webbing lanyard with shock absorber. Length 1.5 or 2 m.
Complies with:

- EN355, CNB/P/11.074 (horizontal use), CNB/P/11.062 (150kg)

Model	Length (m)	Product Code	Price
LSA 1.5-CC	1.5	75172	€55.50
LSA 1.5-10-10	1.5	75182	€73.00
LSA 1.5-10-51	1.5	75212	€101.00
LSA 1.5-10-53	1.5	75232	€92.00
LSA 2-CC	2	75312	€56.50
LSA 2-10-10	2	75322	€74.00
LSA 2-10-41	2	75342	€83.50
LSA 2-10-51	2	75352	€102.00
LSA 2-10-53	2	75362	€89.50



LDA 12 - braided rope lanyard

Braided rope lanyard with shock absorber, ø12 mm. Length 1, 1.5 or 2 m.
Complies with:

- EN355, CNB/P/11.074 (horizontal use), CNB/P/11.062 (150kg)

Model	Length (m)	Product Code	Price
LDA 1-M10-M10	1	77502	€66.00
LDA 1-M10-M53	1	81962	€87.50
LDA 1-M11-M53	1	84192	€97.00
LDA 1.5-BB	1.5	77512	€49.00
LDA 1.5-M10-M10	1.5	77532	€64.50
LDA 1.5-M10-M51	1.5	77562	€92.00
LDA 1.5-M10-M41	1.5	77552	€72.00
LDA 1.5-M10-M53	1.5	77572	€80.50
LDA 1.5-M12-M51	1.5	77602	€106.00
LDA 1.5-M41-M53	1.5	77652	€96.00
LDA 1.5-M41-M51	1.5	77642	€95.00
LDA 1.5-M11-M53	1.5	84202	€87.50
LDA 2-BB	2	77692	€52.00
LDA 2-M10-M10	2	77712	€67.00
LDA 2-M10-M53	2	77752	€83.50
LDA 2-M10-M51	2	77742	€97.00
LDA 2-M12-M51	2	77782	€107.00
LDA 2-M41-M53	2	77832	€85.50
LDA 2-M41-M51	2	77822	€94.00
LDA 2-M11-M53	2	84212	€94.00



Fall arrest lanyards

LSEA - elastic webbing lanyard

Elastic webbing lanyard with shock absorber. Length 1.5 or 1.8 m.
Complies with:

- EN355, CNB/P/11.074 (horizontal use), CNB/P/11.062 (150kg)

Model	Length (m)	Product Code	Price
LSEA 1.5-10-10	1.5	79202	€94.00
LSEA 1.5-10-53	1.5	79262	€116.00
LSEA 1.5-10-51	1.5	79242	€129.00
LSEA 1.5-41-53	1.5	79302	€139.00
LSEA 1.5-41-51	1.5	79282	€149.00
LSEA 1.8-10-10	1.8	79212	€95.00
LSEA 1.8-10-53	1.8	79272	€117.00
LSEA 1.8-10-51	1.8	79252	€129.00
LSEA 1.8-41-51	1.8	79292	€150.00



LSAD - twin webbing lanyard

Twin webbing lanyard with shock absorber. Length 1.5 or 2 m.
Complies with:

- EN355, CNB/P/11.074 (horizontal use), CNB/P/11.062 (150kg)

Model	Length (m)	Product Code	Price
LSAD 1.5-10-10-10	1.5	74992	€84.50
LSAD 1.5-10-51-51	1.5	75022	€130.00
LSAD 1.5-10-53-53	1.5	75032	€104.00
LSAD 2-10-10-10	2	75102	€81.50
LSAD 2-10-51-51	2	75132	€133.00
LSAD 2-10-53-53	2	75142	€107.00



 Order products on day 1, will be shipped no later than day 2

 Order products on day 1, will be shipped no later than day 3. Maximum quantities apply for this service.

 Available on request. Please enquire about delivery times of these items.

TRIED, TESTED, TRACTEL®

Fall arrest lanyards





LDAD 12 - braided twin rope lanyard

Braided twin rope lanyard with shock absorber Ø 12mm. Length 1, 1.5 or 2 m.
Complies with:

- EN355, CNB/P/11.074 (horizontal use), CNB/P/11.062 (150kg)

Model	Length (m)	Product Code	Price
LDAD 1-M10-M51-M51	1	77862	€127.00
LDAD 1-M11-M53-M53	1	84452	€115.00
LDAD 1-M10-M53-M53	1	77872	€100.00
LDAD 1.5 BBB	1.5	77902	€59.50
LDAD 1.5-M10-M10-M10	1.5	77942	€80.50
LDAD 1.5-M11-M53-M53	1.5	78022	€120.00
LDAD 1.5-M10-M53-M53	1.5	77992	€106.00
LDAD 1.5-M12-M51-M51	1.5	78052	€142.00
LDAD 1.5-M10-M51-M51	1.5	77982	€130.00
LDAD 1.5-M41-M51-M51	1.5	78102	€132.00
LDAD 2 BBB	2	78122	€68.00
LDAD 2-M10-M10-M10	2	78132	€84.50
LDAD 2-M10-M53-M53	2	78172	€110.00
LDAD 2-M11-M53-M53	2	82162	€125.00
LDAD 2-M10-M51-M51	2	78162	€136.00
LDAD 2-M11-M51-M51	2	82152	€141.00

 Order products on day 1, will be shipped no later than day 2

 Order products on day 1, will be shipped no later than day 3. Maximum quantities apply for this service.

 Available on request. Please enquire about delivery times of these items.

Lanyards

LS - webbing Lanyard

Single webbing lanyard. Length 1, 1.5 or 2 m.

- Complies with EN 354 standard
- Without shock absorber



Model	Length (m)	Product Code	Price
LS 1-BB - loops	1	10932	€20.00
LS 1-M10-M10	1	12692	€32.50
LS 1.5-BB - loops	1.5	10952	€21.00
LS 1.5-M10-M10	1.5	12712	€33.50
LS 1.5-M10-M51	1.5	35082	€56.50
LS 2-BB - loops	2	10972	€22.00
LS 2-M10-M10	2	12012	€33.50



Order products on day 1, will be shipped no later than day 2

Order products on day 1, will be shipped no later than day 3. Maximum quantities apply for this service.

Available on request. Please enquire about delivery times of these items.

Lanyards





LD 11 - braided rope lanyard

Braided rope lanyard, Ø 11mm. Length 1 - 1.5 or 2 m.

- Complies with EN354 standard

Model	Length (m)	Product Code	Price
LD 1-BB	1	33692	€17.50
LD 1-10-10	1	37762	€30.50
LD 1-10-51	1	40202	€53.50
LD 1-10-53	1	40422	€42.00
LD 1-M11-M53	1	83952	€52.00
LD 1.5-BB	1.5	37752	€19.00
LD 1.5-10-10	1.5	37772	€31.50
LD 1.5-10-51	1.5	40212	€56.50
LD 1.5-10-53	1.5	40432	€44.00
LD 1.5-M11-M53	1.5	83962	€54.50
LD 2-BB	2	33702	€20.00
LD 2-10-10	2	37782	€33.50
LD 2-10-51	2	40222	€56.50
LD 2-10-53	2	40442	€45.00
LD 2-M11-M53	2	83972	€55.50

 Order products on day 1, will be shipped no later than day 2

 Order products on day 1, will be shipped no later than day 3. Maximum quantities apply for this service.

 Available on request. Please enquire about delivery times of these items.

Lanyards

LSE - elastic webbing lanyard

Elastic webbing lanyard. Length 1.5, 1.75 or 2 m.

- Complies with the EN 354 standard.
- Without shock absorber.

Model	Length (m)	Product Code	Price
LSE 1.5-b-b	1.5	54092	€37.50
LSE 1.5-10-10	1.5	54132	€55.50
LSE 1.5-10-41	1.5	54172	€62.50
LSE 1.5-10-51	1.5	54212	€79.50
LSE 1.5-10-53	1.5	54252	€67.00
LSE 1.75-10-10	1.75	54142	€55.50
LSE 1.75-10-53	1.75	54262	€67.00
LSE 2-b-b	2	54112	€38.50
LSE 2-10-10	2	54152	€57.50
LSE 2-10-51	2	54232	€82.50

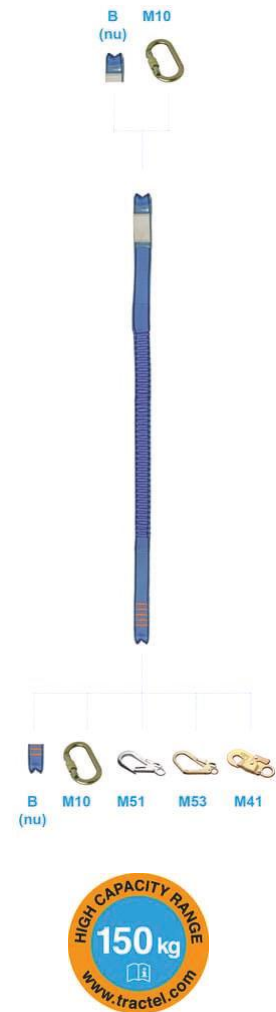



LSE M10-M10



LSE M10-M53

 Order products on day 1, will be shipped no later than day 2

 Order products on day 1, will be shipped no later than day 3. Maximum quantities apply for this service.

 Available on request. Please enquire about delivery times of these items.

Lanyards





LDF 11 - braided rope lanyard

Braided rope lanyard. Length 0.5, 1, 1.5 or 2 m. Ø 11 mm.

- Complies with the EN 354 standard.
- Without shock absorber.

Model	Length (m)	Product Code	Price
LDF 0.5m/1m -B-C-C	0.5	37962	€33.50
LDF 1 - BBB	1	37842	€27.50
LDF 1-10-10-10	1	40232	€45.00
LDF 1-10-53-53	1	40392	€64.50
LDF 1-M11-M53-M53	1	84222	€81.50
LDF 1-10-51-51	1	37932	€93.00
LDF 1.5-BBB	1.5	37852	€29.50
LDF 1.5-10-10-10	1.5	40242	€47.00
LDF 1.5-M11-M53-M53	1.5	84232	€84.50
LDF 1.5-10-53-53	1.5	40402	€69.00
LDF 1.5-10-51-51	1.5	37942	€94.00
LDF 2-BBB	2	37862	€31.50
LDF 2-10-10-10	2	40252	€49.00
LDF 2-10-53-53	2	40412	€70.00
LDF 2-M11-M53-M53	2	84242	€86.50
LDF 2-10-51-51	2	37952	€96.00

 Order products on day 1, will be shipped no later than day 2

 Order products on day 1, will be shipped no later than day 3. Maximum quantities apply for this service.

 Available on request. Please enquire about delivery times of these items.

Positioning lanyards

LDR - positioning lanyard

- Stranded rope with friction tensioning device
- Conforms to EN 358 standard
- Diameter: 11 mm
- Lengths: 1.5 or 2 meters
- Integrated length adjuster (friction)
- Adjustable from 0.75 to 1.5m (1.5m) or from 1 to 2m (2m)

Model	Length (m)	Product Code	Price
LDR 1.5-B-B	1.5	78222	€33.50
LDR 11 / 1.5 / 10-10	1.5	78232	€46.00
LDR 11 / 1.5 / 10-11	1.5	78242	€61.50
LDR 11 / 1.5 / 41-10	1.5	78272	€53.50
LDR 11 / 1.5 / 41-10	1.5	78262	€72.00
LDR 11 / 1.5 / 10-51	1.5	78252	€72.00
LDR 2-B-B	2	78332	€34.50
LDR 11 / 2 / 10-10	2	78362	€47.00
LDR 11 / 2 / 10-11	2	78372	€61.50
LDR 11 / 2 / 10-41	2	78402	€53.50
LDR 11 / 2 / 10-53	2	78432	€60.50
LDR 11 / 2 / 10-51	2	78422	€73.00



Protective sleeve

Model	Product Code	Price
Protective Sleeve	18192	€21.50



Order products on day 1, will be shipped no later than day 2



Order products on day 1, will be shipped no later than day 3. Maximum quantities apply for this service.



Available on request. Please enquire about delivery times of these items.

Positioning lanyards



LCM 03 - adjustable lanyard

- Positioning line reinforced with wire rope that protects against cutting through when using tools such as chainsaws or grinders.
- Line adjuster included
- Easy to use and adjust with one hand
- Complies with the EN 358 standard
- Length 2, 3 or 4 metres

Model	Length (m)	Product Code	Price
LCM 03	2	79092	€219.00
LCM 03	3	79102	€227.00
LCM 03	4	79112	€240.00
Sleeve	-	18192	€21.50



LCM 05 - adjustable lanyard

- Adjustable positioning line
- Braided rope
- Diameter 12.5 mm
- stopfor™ K line adjuster
- Ergonomic
- Efficient positioning thanks to the powerful spring
- Easy to use and adjust with one hand
- Length 2, 3 or 4 metres
- Complies with the EN 358 standard

Model	Length (m)	Product Code	Price
LCM 05	2	79122	€109.00
LCM 05	3	79132	€113.00
LCM 05	4	79142	€119.00
Sleeve	-	18192	€21.50



LCM 06 - adjustable Lanyard

- Adjustable positioning line
- Stranded rope
- Diameter 14 mm
- stopfor™ B line adjuster
- Ergonomic
- Efficient positioning thanks to the powerful spring
- Easy to use and adjust with one hand
- Length 2, 3 or 4 metres
- Complies with the EN 358 standard

Model	Length (m)	Product Code	Price
LCM 06	2	79152	€102.00
LCM 06	3	79162	€103.00
LCM 06	4	79172	€107.00
Sleeve	-	18192	€21.50

blocfor™ 1.8A ESD 150kg

Specifications:

- High Capacity Range 150 kg. Complies with CNB/P/11.062
- Complies with EN 360 and CNB/P/11.060 standards for use on edges with a minimal 0.5 mm curve radius
- Fall arrest device with ESD technology enables the device to arrest a fall even when the webbing is fully unwound. Also suitable for use on terrace roofs
- Can be used vertically or with a standard deviation of 20° in relation to vertical
- Can be used horizontally without the use of a lanyard between the end of the strap and harness
- Flexible unwinding system which doesn't jerk during operator movement
- Responsive system which locks automatically in the event of a fall, reducing the total drop height
- Integrated fall indicator
- Length 1.8 metres, webbing version
- Lightweight
- ABS fibre reinforced polyamide housing
- Standard M47 swivel connector at end of shock absorber

On the blocfor™ 1.8A ESD, the ESD absorber is attached to the retractable belt. The belt of the blocfor™ 1.8A ESD is placed at the anchor point of the harness using the M47 connector. The blocfor™ 1.8A ESD housing is connected to the anchor point on the structure.



Model	Description	Product Code	Price
blocfor™ 1.8A ESD M10 M47	1.8 m – webbing – M10 and M47 connector	70592	€154.00
blocfor™ 1.8A ESD M51 M47	1.8 m – webbing – M51 and M47 connector	70602	€184.00
blocfor™ 1.8A ESD M53 M47	1.8 m – webbing – M53 and M47 connector	70612	€166.00

blocfor™ 1.8B ESD 150kg

In contrast to the blocfor™ 1.8A ESD, the ESD absorber of the blocfor™ 1.8B is attached to the housing of the blocfor™ 1.8B ESD. The blocfor™ 1.8B ESD housing is attached to the harness anchor point using the M47 connector. The belt (with M51 connector) is connected to the anchor point on the structure.



Model	Description	Product Code	Price
blocfor™ 1.8B ESD M51 M47	1.8 m – webbing – M51 and M47 connector	72462	€199.00



Order products on day 1, will be shipped no later than day 2



Order products on day 1, will be shipped no later than day 3. Maximum quantities apply for this service.



Available on request. Please enquire about delivery times of these items.

blocfor™ 1.8A EVO ESD 150KG

Fall arrest device with ESD technology, suitable for use on terrace roofs. 1.8 meter webbing. High Capacity Range 150 kg. Complies with CNB/P/11.062.

- Complies with EN 360 and CNB/P/11.060 standards for use on edges with a minimal 0.5 mm curve radius
- Can be used vertically or with a standard deviation of 20° in relation to vertical
- Can be used horizontally without the use of a lanyard between the end of the strap and harness
- Can be used in the following fall factors: FACTOR 0 (overhead), FACTOR 1 (shoulder level), FACTOR 2 (foot level)
- **Flexible and stronger unwinding system** which doesn't jerk during operator movement
- Responsive system which locks automatically in the event of a fall, reducing the total drop height
- Includes Energy System Dissipater (ESD) technology which enables the device to arrest a fall even when the webbing is fully unwound
- Integrated fall indicator
- Length 1.8 metres, webbing version
- **Strap is wider and stronger**
- Lightweight
- ABS fibre reinforced polyamide housing
- Standard M47 swivel connector at end of shock absorber



On the blocfor™ 1.8A EVO ESD, the ESD absorber is attached to the retractable belt. The belt of the blocfor™ 1.8A EVO ESD is attached to the anchor point of the harness using the M47 connector. The blocfor™ 1/8A EVO ESD housing is connected to the anchor point on the structure.

Model	Product Code	Price
blocfor™ 1.8A EVO ESD 150KG M47-M10	84052	€208.00
blocfor™ 1.8A EVO ESD 150KG M47-M53	84062	€229.00
blocfor™ 1.8A EVO ESD 150KG M47-M51	84072	€240.00

blocfor™ 1.8B EVO ESD 150KG

Fall arrest device with ESD technology, suitable for use on terrace roofs. 1.8 meter webbing. High Capacity Range 150 kg. Complies with CNB/P/11.062.

- Complies with EN 360 and CNB/P/11.060 standards for use on edges with a minimal 0.5 mm curve radius
- Can be used vertically or with a standard deviation of 20° in relation to vertical
- Can be used horizontally without the use of a lanyard between the end of the strap and harness
- Can be used in the following fall factors: FACTOR 0 (overhead), FACTOR 1 (shoulder level), FACTOR 2 (foot level)
- **Flexible and stronger unwinding system** which doesn't jerk during operator movement
- Responsive system which locks automatically in the event of a fall, reducing the total drop height
- Includes Energy System Dissipater (ESD) technology which enables the device to arrest a fall even when the webbing is fully unwound
- Integrated fall indicator
- Length 1.8 metres, webbing version
- **Strap is wider and stronger**
- Lightweight
- ABS fibre reinforced polyamide housing
- Standard M47 swivel connector at end of shock absorber



In contrast to the blocfor™ 1.8A EVO ESD, the ESD absorber of the blocfor™ 1.8B ESD is attached to the housing of the blocfor™ 1.8B EVO ESD. The blocfor™ 1.8B EVO ESD housing is attached to the harness anchor point using the M47 connector. The strap (with M51 connector) is connected to the anchor point on the structure.

Model	Product Code	Price
blocfor™ 1.8A EVO ESD 150KG M51-M47	84082	€240.00

blocfor™ 5ESD and 6 ESD fall arrester

Specifications:

- High Capacity Range 150 kg. Complies with CNB/P/11.062
- Complies with EN 360 and CNB/P/11.060 standards for use on edges with a minimal 0.5 mm curve radius
- Fall arrest device with ESD technology suitable for use on terrace roofs
- Can be used vertically or with a standard deviation of 20° in relation to vertical
- Can be used horizontally without the use of a lanyard between the end of the strap and harness
- Flexible unwinding system which doesn't jerk during operator movement
- Responsive system which locks automatically in the event of a fall, reducing the total drop height
- Includes Energy System Dissipater (ESD) technology which enables the device to arrest a fall even when the webbing is fully unwound
- Integrated fall indicator
- Length: 5 or 6 metres, webbing version
- Lightweight
- ABS fibre reinforced polyamide housing
- Standard M47 swivel connector at end of shock absorber



Model	Description	Product Code	Price
blocfor™ 5 ESD M10 M47	5 m - webbing - M10 and M47 connector	70652	€316.00
blocfor™ 6 ESD M10 M47	6 m - webbing - M10 and M47 connector	70662	€318.00

blocfor™ 10 ESD fall arrester

Specifications:

- High Capacity Range 150 kg. Complies with CNB/P/11.062
- Complies with EN 360 and VG11 CNB/P/11.060 standards for use on edges with a minimal 0.5 mm curve radius
- Fall arrest device with ESD technology suitable for use on terrace roofs
- Can be used vertically or with a standard deviation of 20° in relation to vertical
- Can be used horizontally without the use of a lanyard between the end of the strap and harness
- Flexible unwinding system which doesn't jerk during operator movement
- Responsive system which locks automatically in the event of a fall, reducing the total drop height
- Includes Energy System Dissipater (ESD) technology which enables the device to arrest a fall even when the webbing is fully unwound
- Integrated fall indicator
- Length: 10 metres
- Lightweight
- ABS fibre reinforced polyamide housing
- Standard M47 swivel connector at end of shock absorber (stainless steel versions with a stainless steel M10 hook)



Model	Description	Product Code	Price
blocfor™ 10 ESD M10-M47	10 m - galvanized cable - M10 and M47 connector	70572	€486.00
blocfor™ 10 ESD SR M10-M47	10 m - synthetic cable - M10 and M47 connector	74372	€449.00
blocfor™ 10 ESD I M10 - M10	10 m - stainless steel rope - M10 and M10 connectors	79002	€574.00

 Order products on day 1, will be shipped no later than day 2

 Order products on day 1, will be shipped no later than day 3. Maximum quantities apply for this service.

 Available on request. Please enquire about delivery times of these items.

blocfor™ 20 and 30 ESD

Specifications:

- High Capacity Range 150 kg. Complies with CNB/P/11.062
- Complies with EN 360 and VG11 CNB/P/11.060 standards for use on edges with a minimal 0.5 mm curve radius
- Fall arrest device with ESD technology suitable for use on terrace roofs
- Can be used vertically or with a standard deviation of 20° in relation to vertical
- Can be used horizontally without the use of a lanyard between the end of the strap and harness
- Flexible unwinding system which doesn't jerk during operator movement
- Responsive system which locks automatically in the event of a fall, reducing the total drop height
- Includes Energy System Dissipater (ESD) technology which enables the device to arrest a fall even when the webbing is fully unwound
- Integrated fall indicator
- Length 20 or 30 metres, version with galvanised, stainless steel or synthetic cable
- blocfor™ 20 housing made of polyamide reinforced with ABS fibre, anti-UV and shock resistant
- blocfor™ 30 housing made of coated aluminium: highly resistant to shocks and abrasion
- Lightweight
- M47 swivel connector at end of shock absorber (Stainless steel model with stainless steel M10 hook)
- A blocking mechanism with a double locking pin which reduces the activation time



Model	Description	Product Code	Price
blocfor™ 20 ESD G M10 - M47	20 m – galvanized cable – M10 and M47 connector	74512	€642.00
blocfor™ 20 ESD SR M10 – M47	20 m – synthetic cable – M10 and M47 connector	74392	€773.00
blocfor™ 20 ESD I M10 I - M10 I	20 m – stainless steel cable – M10 and M10 connectors	79012	€876.00
blocfor™ 30 ESD G M10 - M47	30 m - galvanized cable - M10 and M47 connector	74532	€1,230.00
blocfor™ 30 ESD SR M10 - M47	30 m - synthetic cable - M10 and M47 connector	74412	€1,357.00
blocfor™ 30 ESD I M10 I - M10 I	30 m - stainless steel cable - M10 and M10 connector	79032	€1,433.00

 Order products on day 1, will be shipped no later than day 2

 Order products on day 1, will be shipped no later than day 3. Maximum quantities apply for this service.

 Available on request. Please enquire about delivery times of these items.

stopfor™ B fall arrester

stopfor™ B locking system without jaws.

- Vertical & horizontal applications
- Use on 14 mm diameter stranded rope
- Can be installed and removed at any point of the rope
- Aluminium: Lightweight & ergonomic
- Locking system without toothed jaws (less abrasion of the rope)
- Easy to use & to transport
- Available with 30cm strap (LS30)
- Complies with EN353-2, CNB/P/11.075 (horizontal use), CNB/P/11.062 (over 100kg)



Model	Length (cm)	Product Code	Price
stopfor™ B M10 - without lanyard	-	106189	€83.50
stopfor™ B - LS30 + M41	30	106169	€103.00
stopfor™ B - LS30 + M42	30	106179	€109.00

stopfor™ BF fall arrester

Fall arrester suitable for vertical and horizontal use.

- Vertical & horizontal applications
- Use on 14 mm diameter stranded rope
- Product delivered already on the rope
- Aluminium
- Easy to use and transport
- Locking system without toothed jaws (less abrasion of the rope)
- Standard with LS30 strap and M41 connector
- Complies with EN353-2, CNB/P/11.075 (horizontal use), CNB/P/11.062 (over 100kg)



Model	Length (m)	Product Code	Price
stopfor™ BF - rope 10m - strap + M41	10	79992	€146.00
stopfor™ BF - rope 15m - strap + M41	15	80002	€159.00
stopfor™ BF - rope 20m - strap + M41	20	80012	€172.00
stopfor™ BF - rope 30m - strap + M41	30	80072	€188.00
stopfor™ BF - rope 40m - strap + M41	40	80082	€208.00

stopfor™ MSP fall arrester

Fall arrester suitable for vertical and horizontal use.

- Vertical & horizontal applications
- Use on 14 mm diameter stranded rope
- Anti-reversibility system : impossible to assemble upside down, enhanced security
- With park function : locks manually on the rope for a hold at the station
- Easy to use and transport
- Standard with LS30 strap and M41 connector
- Can be installed and removed at any point of the rope
- Material: Galvanised steel
- Complies with EN353-2, CNB/P/11.075 (horizontal use), CNB/P/11.062 (more than 100kg)



Model	Product Code	Price
stopfor™ MSP - LS30 - M41	207018	€128.00



Order products on day 1, will be shipped no later than day 2



Order products on day 1, will be shipped no later than day 3. Maximum quantities apply for this service.



Available on request. Please enquire about delivery times of these items.

TRIED, TESTED, TRACTEL®

stopfor™ SL fall arrester

Fall arrester for vertical use.

- Vertical applications
- Use on 14 mm diameter stranded rope
- Anti-reversibility system: impossible to assemble upside down, enhanced security
- Available with 30cm strap (LS30)
- Locking system with toothed jaws
- Can be placed and removed at any point of the rope
- Material: stainless steel
- Complies with EN353-2, CNB/P/11.062 (over 100kg)



Model	Product Code	Price
stopfor™ SL - M10	276389	€125.00
stopfor™ SL - strap + M10	206918	€134.00
stopfor™ SL - strap + M41	206958	€144.00
stopfor™ SL - strap + M11	206928	€146.00

RLX14 - anchor line

RLX rope anchor line ø 14 mm.

- Complies with EN 353-2 standard
- Type: stitched
- For use with stopfor™ B/BF/MSP/SL
- Equipped with an M10 connector at the top and a plug at the bottom.



Model	Product Code	Price
RLX 14 5-10-B	45372	€47.50
RLX 14 10-10-B	45092	€70.00
RLX 14 15-10-B	45102	€87.00
RLX 14 20-10-B	45112	€109.00
RLX 14 30-10-B	45132	€143.00
RLX 14 40-10-B	45142	€181.00
RLX 14 50-10-B	45152	€220.00



Order products on day 1, will be shipped no later than day 2



Order products on day 1, will be shipped no later than day 3. Maximum quantities apply for this service.



Available on request. Please enquire about delivery times of these items.

stopfor™ K - fall arrester - 100kg

The stopfor™ K fall arrester is easy to use and offers a lot of freedom in vertical and horizontal use.

- Vertical & horizontal applications
- Use on 11 mm diameter braided rope
- Lightweight & ergonomic
- Easy to use & to transport
- Aluminium
- Locking system without toothed jaws. (less abrasion of the rope)
- Available with 30cm strap (LS30)
- Can be installed and removed at any point of the rope
- Complies with EN353-2, CNB/P/11.075 (horizontal use)



Model	Length (cm)	Product Code	Price
stopfor™ K - M10 - without lanyard	-	79922	€90.00
stopfor™ K LS30 M41	30	79932	€114.00
stopfor™ K LS30 M42	30	79942	€114.00

stopfor™ KS - fall arrester - 100kg

The stopfor™ KS fall arrester is easy to use and offers a lot of freedom in vertical and horizontal use. Features additional safety function for increased safety.

- Suitable for 11 mm braided rope
- For vertical, inclined and horizontal applications
- Aluminium
- Lightweight and ergonomic
- Easy to use and transport
- Locking system without toothed jaws. (less abrasion of the rope)
- Anti-reversion system: impossible to mount the fall arrester incorrectly, more safety
- Available with 30cm strap (LS30)
- Can be installed and removed at any point of the rope
- Complies with EN353-2, CNB/P/11.075 (horizontal use)



Model	Length (cm)	Product Code	Price
stopfor™ KS - M10 - without lanyard	-	79952	€102.00
stopfor™ KS - strap + M41	30	79962	€128.00
stopfor™ KS - strap + M42	30	79972	€133.00

stopfor™ KS - fall arrester - 150kg

The stopfor™ KS is now suitable for use up to 150kg, including equipment and tools.

- Suitable for 11 mm braided rope
- For vertical applications
- Aluminium
- Easy to use and transport
- Lightweight and ergonomic
- Locking system without toothed jaws. (less abrasion of the rope)
- Can be installed and removed at any point of the rope
- Complies with EN353-2, CNB/P/11.062 (for more than 100kg)
- Anti-reverse system: improved safety as it is impossible to mount the system upside down



Model	Product Code	Price
stopfor™ KS 150kg	276279	€99.00



Order products on day 1, will be shipped no later than day 2



Order products on day 1, will be shipped no later than day 3. Maximum quantities apply for this service.



Available on request. Please enquire about delivery times of these items.

TRIED, TESTED, TRACTEL®

stopfor™ KSP - fall arrester - 100kg

The stopfor™ KSP can be moved up and down freely, making it ideal for vertical & horizontal applications. Features additional safety and parking function.

- Suitable for 11 mm braided rope
- For vertical, inclined and horizontal applications
- Aluminium
- Lightweight and ergonomic
- With parking function: manual locking on the rope
- Easy to use and transport
- Locking system without toothed jaws (less abrasion of the rope)
- Available with 30cm strap (LS30)
- Can be installed and removed at any point of the rope
- Anti-reverse system: improved safety as it is impossible to mount the system upside down
- Complies with EN353-2, CNB/P/11.075 (horizontal use)



Model	Length (cm)	Product Code	Price
stopfor™ KSP 100kg - M10	-	80022	€135.00
stopfor™ KSP 100kg - strap + M41	30	79072	€155.00
stopfor™ KSP 100kg - strap + M42	30	79082	€172.00

stopfor™ KSP - fall arrester - 150kg

The stopfor™ KSP allows the user to move up and down freely, making it suitable for vertical applications. Features additional safety and parking function.

- Suitable for vertical applications
- Suitable for 11 mm braided rope
- Aluminium
- Lightweight and ergonomic
- With parking function: manual locking on the rope
- Easy to use and transport
- Locking system without toothed jaws. (less abrasion of the rope)
- Can be installed and removed at any point of the rope
- Anti-reverse system: improved safety as it is impossible to mount the system upside down
- Complies: EN353-2, CNB/P/11.062 (for more than 100kg)



Model	Product Code	Price
stopfor™ KSP 150kg	79062	€135.00

Type:	Braided rope 11mm	Stranded rope 11mm	Anti reversibility system	Park function	150kg	Vertical use	Horizontal use	Material
stopfor™ B	-	Yes	-	-	Yes	Yes	Yes	Aluminium
stopfor™ BF	-	Yes	-	-	Yes	Yes	Yes	Aluminium
stopfor™ MSP	-	Yes	Yes	Yes	Yes	Yes	Yes	Steel
stopfor™ SL	-	Yes	Yes	-	Yes	Yes	-	Stainless steel
stopfor™ K	Yes	-	-	-	-	Yes	Yes	Aluminium
stopfor™ KS	Yes	-	Yes	-	-	Yes	Yes	Aluminium
stopfor™ KSP	Yes	-	Yes	Yes	-	Yes	Yes	Aluminium
stopfor™ KS 150kg	Yes	-	Yes	-	Yes	Yes	-	Aluminium
stopfor™ KSP 150kg	Yes	-	Yes	Yes	Yes	Yes	-	Aluminium



Order products on day 1, will be shipped no later than day 2



Order products on day 1, will be shipped no later than day 3. Maximum quantities apply for this service.



Available on request. Please enquire about delivery times of these items.

Anchor lines

RLX D anchor line - M10

RLX D anchor line for the stopfor™ fall arresters

- Complies to EN 353-2 standard
- Equipped with an M10 connector at the top and a stop at the bottom
- Braided rope anchor line \varnothing 11 mm
- For use with stopfor™ K/KS/KSP



Model	Product Code	Price
RLXD 11 5-10-A	37532	€42.50
RLXD 11 10-10-A	37542	€56.50
RLXD 11 15-10-A	37552	€69.00
RLXD 11 20-10-A	35562	€80.00
RLXD 11 30-10-A	37572	€108.00
RLXD 11 40-10-A	37582	€135.00
RLXD 11 50-10-A	37592	€158.00

RLX D anchor line - M41

RLX D anchor line for the stopfor™ fall arresters

- Complies to EN 353-2 standard
- Equipped with an M41 connector at the top and a stop at the bottom
- Braided rope anchor line \varnothing 11 mm
- For use with stopfor™ K/KS/KSP



Model	Product Code	Price
RLXD 11 5-41-A	17002	€45.50
RLXD 11 10-41-A	17012	€60.00
RLXD 11 15-41-A	17022	€71.50
RLXD 11 20-41-A	17032	€84.50
RLXD 11 30-41-A	17052	€112.00
RLXD 11 40-41-A	17062	€138.00
RLXD 11 50-41-A	17072	€160.00



Order products on day 1, will be shipped no later than day 2



Order products on day 1, will be shipped no later than day 3. Maximum quantities apply for this service.



Available on request. Please enquire about delivery times of these items.

derope™

derope™ - to perform an evacuation

The derope™ descent device is a controlled speed descent evacuation system. It can be used to evacuate either one person (up to 150 kg) at heights of up to 400m or 2 people (up to 225 kg) at heights of up to 200m.

Available models:

- STD - is descent only
- UP A - with a recovery winch to raise or lower a casualty
- UP B - with winch and large mounting bracket for ladder
- UP K - with winch and small mounting bracket for ladder

Model UP A, B and K enable an upward and downward evacuation. They include a drill attachment option for use with 14 V 300 W drill.



Derope™ STD



Derope™ UP A



Derope™ UP B



Derope™ UP K

Model	Description	Product Code	Price
derope™ STD	Standard version (with end kit excl. rope)	279499	€971.00
derope™ UPA	With rescue winch (with end kit excl. rope)	279509	€1,372.00
derope™ UPB	With rescue winch and large mounting bracket (with end kit excl. rope)	279519	€1,361.00
derope™ UPK	With rescue winch and small mounting bracket (with end kit excl. rope)	279529	€1,868.00

derope™ std

Additional accessories for the derope™.

Model	Description	Product Code	Price
End Kit	The rope end kit, comprising two M10 connectors and the markings	52962	€6.30
Rope	Rope per meter	50962	€3.10
Bag and reel	combipro 60l + plastic rope reel (max. 70 m)	68792	€217.00
Backpack	Waterproof backpack (max 150 m, 430 x 310 x 150 mm).	67422	€97.50
HT9 harness	For evacuation operations. 3 adjustment settings, suitable for adults and children.	17622	€126.00
HT22R - M	Evacuation harness (shoulder strap attachment) - vertical evacuation. Standard buckles	44962	€73.50

 Order products on day 1, will be shipped no later than day 2

 Order products on day 1, will be shipped no later than day 3. Maximum quantities apply for this service.

 Available on request. Please enquire about delivery times of these items.

derope™ rescue kit

A complete kit for evacuation at heights.

Contents of the rescue kit:

- derope™ UP A for upwards and downwards evacuation
- 10.5 mm braided rope with a length of 85, 120 or 150 m and 3 M48 tri-lock karabiners
- 1 patented Tractel rope reel
- 1 braided rope protector
- 1 lanyard spreader device with connector to keep the rope from the structure
- 1 Stopfor™ K to disconnect the fall arrest lanyard from the user
- 2 strap rings to connect the Derope™ and the pulley onto the structure
- 1 pulley to position the braided rope in the optimal position during descent
- 4 M23 tri-lock connectors
- 1 waterproof box with shock absorbing foam

Advantages:

- Complete with Derope™ UP A for fast and safe evacuation
- Complete equipment ready to use
- Strong and waterproof box
- Overpressure valve to protect against condensation
- Humidity indicator
- Humidity absorption bags
- Storage box seal lets you know if the kit has been opened
- If the seal is unbroken, the kit doesn't require inspection for 5 years

Specifications:

- Dimensions (H x L x D): 225 mm x 200 mm x 165 mm
- Max load recovery: 150 kg (400 m) or 225 kg (150 m)
- EN 341 class A + EN 1496 class A standards
- Descent speed: 0.5 m/s - 2 m/s

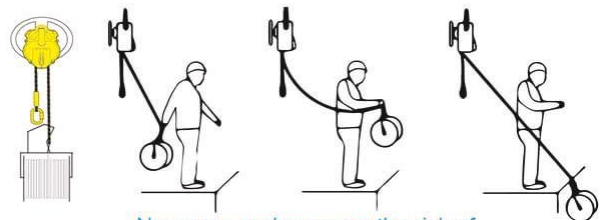

New rope reel removes the risk of tangling when the rope is thrown

Model	Product Code	Price
derope™ rescue kit 85 m	222949	€2,885.00
derope™ rescue kit 120 m	222959	€2,926.00
derope™ rescue kit 150 m	222969	€3,037.00

evak™ 500

The evak™ 500 is a manual rope winch offering unlimited travel, with a 500 kg capacity.

- Designed especially for rescue operations.
- Static rope with a diameter between 10.5 and 12.5 mm.



Model	Product Code	Price
evak™ 500	23498	€1,034.00
evak™ bag	100625	€184.00
Rope 12.5 mm, 20 m	46059	€146.00
Rope 12.5 mm, 40 m	46069	€301.00
Rope 12.5 mm, 60 m	46079	€441.00
Rope 12.5 mm, 80 m	46089	€596.00
Rope 12.5 mm, 100 m	46099	€732.00
Rope 12.5 mm, 200 m	46109	€1,459.00

 Order products on day 1, will be shipped no later than day 2

 Order products on day 1, will be shipped no later than day 3. Maximum quantities apply for this service.

 Available on request. Please enquire about delivery times of these items.

TRIED, TESTED, TRACTEL®

Temporary lifelines



tirsafe™ wire rope temporary lifeline

tirsafe™ T3 is a temporary lifeline that is easy and quick to install when there are two anchoring points offering sufficient support. It allows for total freedom of horizontal movement.

The tirsafe™ T3 temporary lifeline includes:

- 1 anchor point with Tirsafe™ shock absorber which ensures triple function of pre-tension indicator, shock absorber indicator and fall indicator
- 1 tirfor T3 cable winch
- 1x 20 or 30 metre long cable, with a diameter of 8.3 mm
- 2 x 2 metre slings

The tirsafe™ T3 temporary lifeline guarantees the safety of 3 people. Complies with the EN 795 B and EN 795 C standard.

Model	Product Code	Price
tirsafe™ T3 - 20m	280559	€1,144.00
tirsafe™ T3 - 30m	276149	€1,196.00



tempo 2 - temporary lifeline

tempo 2 is a temporary lifeline, easy and quick to install when there are two anchoring points offering sufficient resistance. Lightweight, it allows total freedom of horizontal movement. The tempo 2 lifeline can be installed on the ridge tiling of a roof or onto a metal structure.

- Synthetic fibre webbing straps, adjustable from 0 to 18m
- Can be used by 2 people
- Complies with the EN 795 B standard
- Supplied with 2 AS30S webbing strap rings, 2 MR9 connectors and a shoulder bag

Model	Product Code	Price
Tempo II kit	206018	€306.00



tempo 3 - temporary lifeline

tempo 3 is a compact, temporary lifeline, and is the fastest, most efficient lifeline available on the market.

Using a static rope line, N.G.R reinforced, and a tensioning system, the tempo 3 allows for simultaneous use by 3 users. This lifeline offers the possibility of setting up a temporary lifeline with a maximum length of 18 metres between two anchor points of sufficient strength.

- Static rope line, N.G.R reinforced, adjustable from 0 to 18 m.
- Complies with the EN 795 B standard
- Supplied with 2 AS30S webbing strap rings, 2 M10 connectors and a shoulder bag

Model	Product Code	Price
Tempo III kit	207068	€357.00

 Order products on day 1, will be shipped no later than day 2

 Order products on day 1, will be shipped no later than day 3. Maximum quantities apply for this service.

 Available on request. Please enquire about delivery times of these items.

Temporary anchor points

AS19S - webbing strap ring

Polyester webbing strap (EN 795 B). Ring designed to create an anchor point on a framework onto which a fall arrester can be attached.

- Complies with EN795 B-2012 standard and CENTS16415/2013
- Webbing strap rings available in lengths of 0.6 m, 1 m, 1.5 m and 2 m.
- Optional: sleeve for the anchor strap to prevent abrasion



Model	Product Code	Price
AS19S - 0.6 m	38382	€16.00
AS19S - 0.8 m	38392	€16.00
AS19S - 1.0 m	38402	€21.00
AS19S - 1.5 metre	80852	€25.00
AS19S - 2 metre	72152	€29.00
Sleeve	18192	€21.50

AS19S GA - webbing strap ring with protective sleeve

Polyester webbing strap (EN 795 B). Ring designed to create an anchor point on a framework onto which a fall arrester can be attached.

Version with protective sleeve to prevent wear and protect against sharp or abrasive edges (with kevlar).



Model	Product Code	Price
AS19S GA - 0.6 m	81412	€38.00
AS19S GA - 0.8 m	81422	€39.00
AS19S GA - 1 m	81432	€40.50
AS19S GA - 1.5 m	81452	€48.50
AS19S GA - 2 m	81462	€54.50

Order products on day 1, will be shipped no later than day 2

Order products on day 1, will be shipped no later than day 3. Maximum quantities apply for this service.

Available on request. Please enquire about delivery times of these items.

TRIED, TESTED, TRACTEL®

AS30S - webbing anchor sling

Polyester anchor sling. The sling is used to create an anchor point on a frame.

- Complies with EN795 B-2012 standard and CENTS16415/2013
- Webbing strap rings available lengths: 0.6 m, 1 m, 1.5 m and 2 m.
- Width: 19mm
- Optional: protective sleeve to prevent wear and protect against sharp or abrasive edges.



AS30 S

Model	Product Code	Price
AS30S 0.6m	57272	€19.00
AS30S 0.8m	57282	€20.50
AS30S 1m	57292	€17.00
AS30S 1.2m	59372	€22.00
AS30S 1.5m	59382	€28.50
AS30S 2m	59392	€31.50
Sleeve	18192	€21.50

Door anchor

Door anchor where a door or window can be used as an anchor point.

- Complies with EN 795 B standard
- Fast and easy to install
- Up to 2 users
- Spacing: 1100 mm = 1 user, 800 mm = 2 users



Model	Product Code	Price
Door Anchor	62217	€607.00

Roll clamp

It enables creating a mobile anchor point on an RSJ and working safely while retaining a wide freedom of movement. Thanks to its 4 bearing rollers, the roll clamp follows movements around the framework with a minimum of user intervention.

- Complies with EN 795 B standard
- Medium, adjustable 90 - 400mm (max.)
- Large, adjustable 200 - 615mm (max.)
- Can be installed on the upper or lower flange
- Weight: M 1.48 kg and L 2.04 kg



Model	Product Code	Price
medium	86009	€536.00
large	86019	€728.00

 Order products on day 1, will be shipped no later than day 2

 Order products on day 1, will be shipped no later than day 3. Maximum quantities apply for this service.

 Available on request. Please enquire about delivery times of these items.

corso™ beam clamp

Is only suitable to serve as a fall arrest anchor point for individuals

- Complies with EN 795 B standard
- Beam clamp with adjustable screw rod
- Adjustable between 75 to 235mm
- Compact and strong construction
- Suitable for I, H or T Profiles
- Quick and easy adjustment
- Removable lever



Model	Product Code	Price
corso LT-1B Beam Clamp	97929	€197.00



Corso - beam clamp



Corso rollbeam - push trolley

corso™ roll beam push trolley

- Is suitable to be used as a fall arrest anchor point
- Complies with EN 795 B standard
- Runs over the lower flange of an I, H or T profile



Model	Product Code	Price
rollbeam SB	54369	€260.00
rollbeam LB	88559	€349.00

mobifor™ - dead weight mobile anchor point

The mobifor™ is a deadweight anchoring system, for installation on flat roofs and fall risk areas. The set consists of 24, steel-reinforced, concrete blocks, positioned on four steel arms. The arms are connected at the centre by a joining plate equipped with a rotary anchor point with an energy dissipater. Fast and easy to install. No drilling, no fixings, no penetration of the building structure.

- Can be installed on concrete, bitumen, EPDM or PVC with a maximum slope of 5 degrees.
- Patented anchor concept conforms with the EN 795/2012 class E standard.
- The set consists of dead-weight anchors - 4 arms - 24 concrete blocks of 25 kg.



Model	Product Code	Price
mobifor™ mobile anchor point	279409	€1,716.00

Order products on day 1, will be shipped no later than day 2

Order products on day 1, will be shipped no later than day 3. Maximum quantities apply for this service.

Available on request. Please enquire about delivery times of these items.

TRIED, TESTED, TRACTEL®

Permanent anchor points

Anchor - PAS

The PAS anchor point is suitable for the secure attachment of a fall protection system. The anchor point has been tested to stop a fall of **1 user**, with a maximum weight of 150 kg, including equipment and tools.



- Fixed anchor point
- EN 795 A-2012 standard
- Complies with the CEN TS1641 / 2013 standard for a weight of up to 150 kg.
- Fixed with M12 bolts, chemical or mechanical

Model	Product Code	Price
PAS Anchor	196418	€14.50

Anchor - PO

The PO anchor point is suitable for the attachment of a fall protection system. The anchor point has been tested to stop a fall of **2 users**, both weighing a maximum of 150 kg



- Fixed anchor point made of stainless steel
- Complies with the EN 795 B-2012 standard
- Complies with CEN TS16415 / 2013 standard for a weight of up to 150 kg.
- Fixed with M12 bolts with a thickness of 12 mm.

Model	Product Code	Price
PO Anchor	196428	€28.00

Anchor - ringflex

A stainless steel or galvanized anchor point for fixing to corrugated roofs (steel or aluminum). The Ringflex can be used by **1 to 2 users** at the same time.



- Compliant with the EN795A: 2012 standard for 1 user with a weight of up to 150 kg.
- Complies with TS16415: 2013 standard, 2 users, max. weight 150 kg.
- The ring rotates so that the user can move freely
- Comes with seal, fixing screw for the anchor ring and fixing rivets for the anchor point

Model	Product Code	Price
Ringflex anchor ring single item	193858	€31.50
Anchor plate kit - galva - 125mm.	207788	€68.00
Universal plate - stainless steel 3mm	206888	€141.00
Installation kit universal plate - 4 clamps	232577	€136.00
Installation kit universal plate - 12 rivets	232587	€52.00

Anchor - PA

This aluminum anchor point has been tested to stop a fall of **2 users**, both weighing a maximum of 150 kg. including tools and work clothes.



- Complies with the EN 795 A standard
- Fixed with M12 bolts at 100 mm intervals.
- Available in the following 5 colors: aluminum, gray, black, red and yellow

Model	Product Code	Price
PA Aluminium	64488	€25.00
PA Black	64448	€28.00
PA Grey	64458	€28.00
PA Red	64438	€28.00
PA Yellow	64468	€28.00



Order products on day 1, will be shipped no later than day 2



Order products on day 1, will be shipped no later than day 3. Maximum quantities apply for this service.



Available on request. Please enquire about delivery times of these items.

Permanent anchor points

Anchor - ballsafe

The ballsafe anchor point is made up of a four block plug and a female socket.

- Complies with EN 795 B standard
- It is sealed into concrete or a material of equal density using a chemical compound



Model	Product Code	Price
ballSafe eye	89776	€522.00
ballSafe female socket	89786	€89.00

Anchor - roof anchor point

The roof anchor points are designed to support a ladder and attach fall arresters.

- Complies with EN 795A / EN 517 standards
- Secured directly into wooden roof trusses using annealed crampons or spikes.
- Available in galvanised and stainless steel



Model	Product Code	Price
galvanized, flat	66618	€55.50
galvanized, curved	66628	€55.00
galvanized, twisted	66638	€52.00
stainless steel, flat	66648	€120.00
stainless steel, curved	66658	€126.00
stainless steel, twisted	66668	€118.00
spike 50 mm	66928	€19.00
spike 90 mm	66938	€19.50
spike 130 mm	66948	€22.00
galvanized, annealed tips	66958	€12.50

Anchor - ringsafe

The ringsafe is a fixed anchor point with integrated fall indicator, suitable for attaching a fall protection system.

Tested to stop the fall of one operator weighing 150kg (including the weight of his equipment)

- EN 795 - A : 2012
- Fixed with M12 bolts, chemical or mechanical
- Fixed anchor point made of stainless steel



Model	Product Code	Price
ringsafe Anchor	76299	€19.50

Anchor - roof truss

- Material: steel
- Support: wooden roof trusses
- Complies with CE EN 795 class A standard



Model	Product Code	Price
Roof Truss Anchoring Device	109117	€42.00

Anchor - post

Anchor post fitted with a stainless steel anchor point.

- Complies with EN 795A standard
- Galvanized steel
- square base plate 270 x 270 mm.
- 70x70 mm. cross-section



Model	Product Code	Price
Height: 250mm	72178	€139.00
Height: 500mm	66968	€168.00
Height: 750mm	72338	€192.00

Order products on day 1, will be shipped no later than day 2

Order products on day 1, will be shipped no later than day 3. Maximum quantities apply for this service.

Available on request. Please enquire about delivery times of these items.

TRIED, TESTED, TRACTEL®

Working in Confined Spaces

Every year, people are killed or seriously injured while working in confined spaces. This happens in a wide range of industries and those killed include not just the person working in the confined space, but also those who try to rescue them without proper training and equipment.

Key requirements of the Confined Spaces Regulations 1997 include:

- avoiding entry into a confined space (Regulation 4), eg by doing the work from outside
- where entry into a confined space is unavoidable, following a safe system of work (Regulation 4)
- putting in adequate emergency arrangements before the work commences (Regulation 5).

These regulations define a confined space as:

“any place, including any chamber, tank, vat, silo, pit, trench, pipe, sewer, flue, well or other similar space in which, by virtue of its enclosed nature, there arises a reasonably foreseeable specified risk”.

At Tractel, we specialise in Confined Space Access safety, and this year we have increased our range of products to ensure optimum safety when working in confined spaces, or when mounting a rescue operation.



NEW: davitrac



tracrod 150kg



tracpode 150kg

tracpode tripod

The tracpode is a temporary anchor point tested to stop the fall of two operators weighing 150 kg each; including their equipment and tools. It can also be used as an anchor point for lifting, with the capability to raise a maximum load of 500 kg, provided the strap is fitted to the feet.

Due to its size, the tracpode is extremely suitable as a mobile anchor point for working in confined spaces, handling loads and performing rescue operations. Made from lightweight aluminium, the tracpode can be folded up small enough to be transported easily in most vehicles.

Features tracpode tripod:

- Meets the requirements of the EN 795B standard and the TS16415 (multi-use, 150 kg)
- Compliant with the Machinery Directive 2006/42 / CEE
- Made from aluminum & easy to install
- Tubular legs ensure that the system is strong and rigid
- The extendable legs are attached by narrow cables to hold all parts together
- The legs can be extended at various positions to achieve the required working height
- Adjustable to 1.53 m - 1.72 m - 1.91 m - 2.10 m - 2.29 m - 2.48 m (max. height under head)
- Foldable system for easy transport

The tracpode can receive:

- blocfor™ fall arresters complying with the requirements of EN 363-2008 standard (2 users, max. weight 150 kg)
- Rescue lifting devices per EN 1496:2017
- Devices for working suspended on rope



Model	Description	Product Code	Price
tracpode	Tripod without pulleys	273739	€961.00
tracpode + PPE pulley kit	Tripod with pulleys	273749	€1,049.00
tracpode	tracpode with 2 PPE pulley kits	273769	€1,278.00
PPE pulley kit	PPE pulley kit - 1 piece	196968	€132.00
lifting pulley kit	Lifting pulley kit - 1 piece	196958	€135.00

Delivered without blocfor™ and carol™

tracpode - short model

In addition to the standard size, a short model is also available. This model is adjustable to 1.28 m - 1.47 m - 1.66 m - 1.85 m - 2.04 m - 2.23 m (max height under head).

Model	Product Code	Price
tracpode - short model	278039	€763.00
tracpode + PPE pulley kit	278049	€921.00
tracpode + 2 PPE pulley kits	278059	€1,079.00



DIMENSIONS OF THE TRACPODE

position	height with pulley (A)	height without pulley (B)	height under head (C)	distance between two feet (D)	max. diameter of hole in ground ø
closed	1.88 m	1.76 m	0	0	0
opening no. 1	1.78 m	1.66 m	1.53 m	1.03 m	1.20 m
opening no. 2	1.97 m	1.85 m	1.72 m	1.14 m	1.33 m
opening no. 3	2.16 m	2.04 m	1.91 m	1.25 m	1.46 m
opening no. 4	2.35 m	2.23 m	2.10 m	1.36 m	1.59 m
opening no. 5	2.54 m	2.42 m	2.29 m	1.47 m	1.72 m
opening no. 6	2.73 m	2.61 m	2.48 m	1.58 m	1.85 m

DIMENSIONS OF THE TRACPODE - SHORT MODEL

position	height with pulley (A)	height without pulley (B)	height under head (C)	distance between two feet (D)	max. diameter of hole in ground ø
closed	1.52 m	1.40 m	0	0	0
opening no. 1	1.54 m	1.42 m	1.30 m	0.94 m	1.25 m
opening no. 2	1.73 m	1.61 m	1.49 m	1.07 m	1.38 m
opening no. 3	1.92 m	1.80 m	1.68 m	1.20 m	1.51 m
opening no. 4	2.11 m	1.99 m	1.87 m	1.33 m	1.64 m
opening n. 5	2.29 m	2.17 m	2.05 m	1.46 m	1.77 m

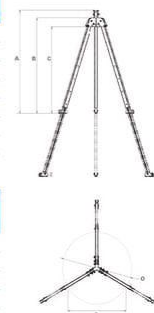

blocfor™ R automatic fall protection device - 150kg/100kg

Automatic fall protection device with integrated winch for raising a casualty in an emergency.

- Complies to EN360 standard for fall arrest and the EN1496B standard for rescue lifting devices.
- Complies to CNB/P/11.060: technical data sheet "use on terrace roof"
- Complies to CNB/P/11.062: Fall arrest with a capacity of more than 100 kg
- Integrated End System Dissipator (ESD) system ensures the user with an impact of less than 600 daN, even with a fall where the cable has been completely unwound.
- Can be fitted to the trapcode 150 kg with a tractel® bracket
- Available cable length 20 m or 30 m.



blocfor™ 20R & 30R ESD I - 100kg

NOTE: The Blocfor™ 20R and 30R (ESD) with stainless steel cable and M10 I hook have a maximum capacity of 100kg.

Model	Description	Product Code	Price
blocfor™ 20R ESD G - 150kg	20 m - galvanised cable - with M46 connector	75492	€1,352.00
blocfor™ 20R ESD I - 100kg	20 m - stainless steel cable - with M10 I connector	28612	€1,612.00
blocfor™ 30R ESD G - 150kg	30 m - galvanised cable - with M46 connector	75502	€1,891.00
blocfor™ 30R ESD I - 100kg	30 m - stainless steel cable - with M10 I connector	42972	€2,028.00
blocfor™ leg bracket	bracket for mounting blocfor™ R onto tripod	200368	€196.00

carol™ + bracket

The carol™ R 150kg winches are rescue winches that have been tested to be attached to one leg of Tractel® trapcode.

- Complies to the EN795B/2012 standard for installation on the tripod
- Complies to EN1496/2017 class B for use up to 150 kg.
- Complies to the Machinery Directive 2006/42/CEE
- Winch has been subjected to all braking and endurance tests according to EN13157:12/2004
- Lifting capacity: 250 kg
- Equipped with support for the tripod, attached to the legs
- Available cable length: 20 and 30 metres



Model	Description	Product Code	Price
caRoI™ 20 + leg bracket + 20m cable	caroI™ winch incl. 20m wire rope and mounting bracket	280589	€942.00
20-m cable for caroI™ R	Galvanized cable - 20 m - for caroI™	51042	€187.00
caRoI™ 30 + leg bracket + 30m cable	caroI™ winch incl. 30m wire rope and mounting bracket	280599	€1,976.00
30-m cable for caroI™ R	Galvanized cable - 30 m - for caroI™	51052	€249.00
Mounting bracket	Mounting bracket for the trapcode 150 kg.	200378	€173.00

 Order products on day 1, will be shipped no later than day 2

 Order products on day 1, will be shipped no later than day 3. Maximum quantities apply for this service.

 Available on request. Please enquire about delivery times of these items.

tracpode for rescue operations

derope™ UPR for tracpode

The derope™ UP R is a descender with rescue winch for upward and downward evacuation (up to 120kg). It can be used for downward evacuation to evacuate 1 person (up to 150 kg.) up to a maximum height of 400 metres or 2 persons (up to 225 kg.) up to a maximum height of 200 metres.

- Complies with the EN341A and EN1496A standards.
- Comes with a bracket for the tripod
- Including new, adapter for a 14 V 300 W drill

Model	Product Code	Price
derope™ UPR + console for tracpode	87498	€1,248.00
derope™ UPR with bracket for tracpode	194199	€2,230.00
Rope (1m)	50962	€3.10



Drill

The UP-series is equipped with an adapter for use with a 14 V, 300 W power drill. This allows the derope™ UP descent unit to be used with a power drill, allowing many more applications to be performed with the product.

- The drill mount allows a person to be lifted quickly over a large height in the event of a rescue operation or vertical displacement. It is recommended for companies working in silos, tankers, drains, etc.
- With the derope™ UP descender, technicians who have access to the rope can easily be raised to a higher height.



scafor™ with bracket for tracpode

Rescue winch that complies with the EN 1496 standard, with a maximum load of 150 kg. scafor™ also complies with the requirements of hoisting winches with a maximum load of 250 kg (directive 2006/42 / EEC).

Model	Product Code	Price
scafor™ R 250kg for tracpode with console - without cable	251079	€2,288.00
Galvanised cable Ø 6.5 / 20m M47 for scafor™ R	245899	€136.00
Galvanised cable Ø 6.5 / 30m M47 for scafor™ R	245909	€167.00
Galvanised cable Ø 6.5 / 40m M47 for scafor™ R	245919	€199.00
Galvanised cable Ø 6.5 / 50m M47 for scafor™ R	245929	€230.00
Galvanised cable Ø 6.5 / 60m M47 for scafor™ R	286929	€262.00
Galvanised cable Ø 6.5 / 70m M47 for scafor™ R	286939	€293.00



Order products on day 1, will be shipped no later than day 2



Order products on day 1, will be shipped no later than day 3. Maximum quantities apply for this service.



Available on request. Please enquire about delivery times of these items.

tracrod 150 kg

The tracrod is a compact, lightweight and movable anchor point for two users of 150 kg each. The tracrod is particularly suitable for confined spaces, manholes, sewers, wells etc.

Before use, the anchor rod is inserted into a stainless steel mounting bracket, which is permanently fixed in a manhole. It can be set up and removed within seconds.

The tracrod is the only 150 kg anchor point of this type on the market to have been certified for use in this configuration.



- Enables two operators, each weighing up to 150 kg (operator + harness +tools), to work in safety.
- Conforms to standard EN 795A and TS16415 (multiple 150-kg users).
- The tubular design ensures that the system offers high levels of stiffness and strength.
- Can be fitted with a bracket to support a blocfor™ 20/30R fall-arresting device.
- Bracket for the blocfor™ can be fitted and removed within seconds.
- Certified for use as an anchor point for fall arrest and rescue systems,
- Small size (1.76 m) and low weight (5.5 kg) makes it easy to transport and quick to set up.
- All components of the tracrod anchor point are made of non-corrosive materials to provide optimal resistance in a humid environment.
- The support mount is fastened using 12 mm chemical anchor fasteners and does not require any special tools.



For more information or a personalised quote, please contact your Area Sales Manager or Tractel on 0114 248 2266

Model	Product Code	Price
tracrod 150 kg anchor rod	207128	€579.00
Support mount	207118	€152.00
Securing plate	207368	€195.00
5 cm thick spacer block	207358	€96.00



blocfor™ with bracket for tracrod

Model	Product Code	Price
Bracket + blocfor™ 20R ESD galva 150 kg	81492	€1,736.00
bracket + blocfor™ 20R ESD inox 100 kg	84412	€1,841.00
bracket + blocfor™ 30R ESD galva 150 kg	81502	€2,363.00
bracket + blocfor™ 30R ESD inox 100 kg	84422	€2,499.00



Order products on day 1, will be shipped no later than day 2

Order products on day 1, will be shipped no later than day 3. Maximum quantities apply for this service.

Available on request. Please enquire about delivery times of these items.

Introducing davitrac, Our first davit arm for manhole and confined space entry: the davitrac arm was designed as a fall protection and rescue system for use in confined spaces and manholes. It offers fall protection and total mobility for two people simultaneously and can be used for lifting materials.



- Transportable anchor point for working in confined spaces (semi-permanent or permanent)
- Tool-free installation (installation by 1 person in less than two minutes without tools)
- Very lightweight (24 kg (without accessories & bases): easy to transport and implement)
- Anchorage for 2 users of 150kg each.
- Can be used for lifting materials (WLL = 400kg).
- Modular: multiple combinations with Tractel® products.
- 360° rotating mast (with locking every 90°)

Technical characteristics:

- Sizes : 1600mm to 1900mm x 400mm to 700mm
- Anchor points for fall arresters (2 users): 150kg each
- Maximum load capacity (materials): WLL 500 kg

Standards:

- EN 795-B : 2012 (transportable anchor point)
- EN 1496
- CEN/TS 16415:2013-B (Fall arrest for 2 users).
- Individual protection of operators against falls (EN 795 A and / or B + EN 360)
- Machine Directive 2006/42/CE (Material lifting).

Compatible applications:

- Rescue
- Confined spaces & manholes
- Rope works
- Pits
- Sewerod access
- Pipes
- Oil and gas
- Civil engineering
- Industry
- Wind and solar installation



1. Clearance mural adapter 2. Wall mounted adapter 3. Flush floor adapter 4. Mounted floor adapter 5. Portable H base self-stabilizing

Model	Product Code	Price
davitrac	286819	€2,205.00
Wall mounted adapter	210118	€473.00
Clearance mural adapter	210128	€525.00
Mounted floor adapter	210108	€473.00
Flush floor adapter	210138	€473.00
Portable H base self-stabilizing	210098	€1,785.00

davitrac accessories

The davitrac is compatible with several other tractel products, allowing a large number of possible configurations. davitrac can be equipped with:

- Manual and motorised winches for rescue operations as well as lifting materials. (caRoI™ TE, caRoI™ MO, scafor®)
- Motorised wire rope hoists for lifting materials (tirak™, minifor™)
- Manual chain hoists for lifting materials (tralift™)
- Controlled speed evacuation device (derope™)
- Fall arresters on a flexible anchor line (stopfor™)
- Automatic fall arrest block with integrated winch (blocfor™ 20r + 30r)

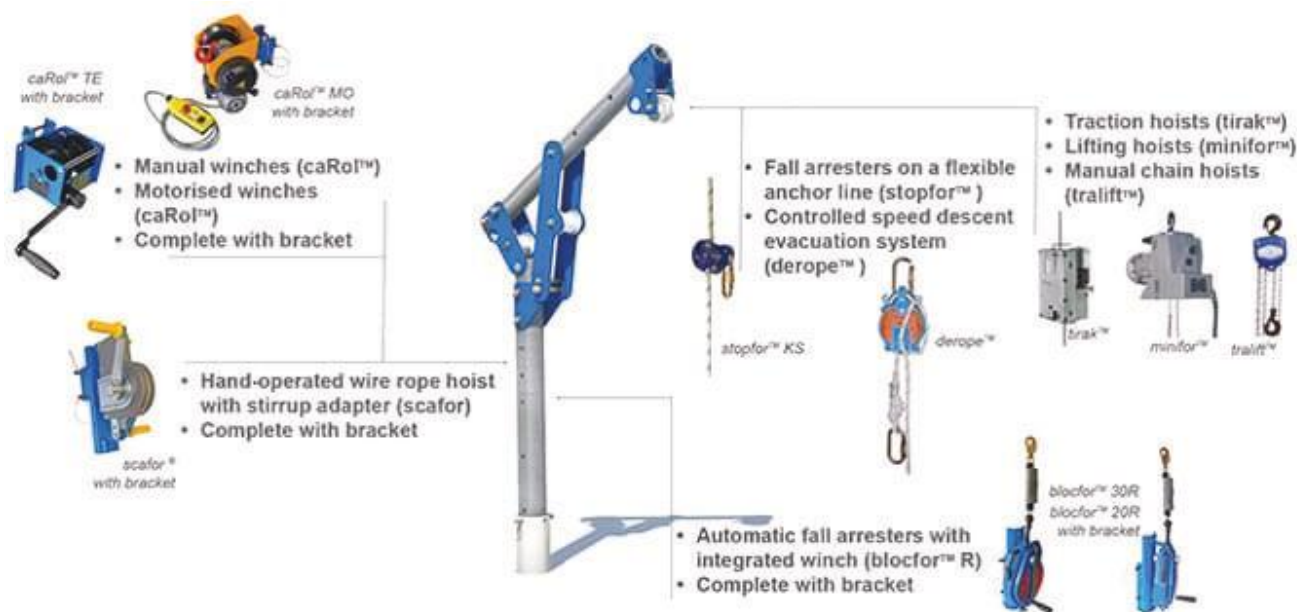

blocfor™ with bracket for davitrac

De blocfor™ 20R ESD en de blocfor™ 30R ESD functioneren als standaard haspels om te voorkomen dat een gebruiker valt. Ze hebben ook een geïntegreerd ophaalsysteem om een persoon snel te evacueren tijdens een redding.

Model	Product Code	Price
blocfor™ 20R galva ESD with bracket for davitrac - 150kg range	84122	€1,838.00
blocfor™ 20R inox ESD with bracket for davitrac - 100kg range	84132	€1,943.00
blocfor™ 30R galva ESD with bracket for davitrac - 150kg range	84142	€2,153.00
blocfor™ 30R inox ESD with bracket for davitrac - 100kg range	84152	€2,310.00

caRoI™ R with bracket for davitrac

- Lifting winch for material
- Rescue winch
- Capacity of 250 kg
- Cable lengths ø 5 mm - 20 m and 30 m
- Makes it possible to work in a suspended position

Model	Product Code	Price
caRoI™ R 250kg with 20m of galvanized cable and bracket for davitrac	286949	€998.00
caRoI™ R 250kg with 30m of galvanized cable and bracket for davitrac	286959	€2,048.00



scafor™ with bracket for davitrac

Manual winch with passing cable.

Model	Product Code	Price
scafor™ R 500kg without cable - with bracket for davitrac	293019	€2,520.00
Galvanised cable Ø 6.5 / 20m M47 for scafor™ R	245899	€136.00
Galvanised cable Ø 6.5 / 30m M47 for scafor™ R	245909	€167.00
Galvanised cable Ø 6.5 / 40m M47 for scafor™ R	245919	€199.00
Galvanised cable Ø 6.5 / 50m M47 for scafor™ R	245929	€230.00
Galvanised cable Ø 6.5 / 60m M47 for scafor™ R	286929	€262.00
Galvanised cable Ø 6.5 / 70m M47 for scafor™ R	286939	€293.00



carol™ TS 500

Manual drum winch.

- Adjustable and removable ergonomic handle.
- Safety: system that makes it impossible to wrap the cable upside down.

Model	Product Code	Price
caRol™ TS 500 - with 18m of galvanized cable and bracket for davitrac	286989	€2,048.00



carol™ MO

Electric winch designed for lifting material and for suspension work.

- Direct transmission (use in a water resistant location).
- Very easy to adjust and very reliable limit switch.
- Lifting and lowering control box with emergency stop (2 m control cable).

Model	Product Code	Price
caRol™ MO 500 - lifting materials - with 13m of galvanized cable and bracket for davitrac	293009	€2,625.00



tralift™

Manual chain hoist.

- Compact and robust
- Safe braking system
- Strong chains and hooks
- Anti-corrosion treated chain

Model	Product Code	Price
tralift™ 500kg for davitrac - 10m lifting chain - 2m manoeuvring chain	286849	€508.00

The davimast is a complete solution for lifting people and loads, especially in confined spaces. It offers a mobile and efficient solution for rescue situations.

It provides protection and total mobility for two people at the same time, in operations where there is a risk of falling. The davimast is installed on the same foot as the davitrac (with the exception of the self-stabilising foot).

It can be used with many Tractel® products and allows a wide range of configurations.

Technical characteristics:

- 2 independent 360° rotatable anchor points
- 2 users: up to 150 kg each
- CMU (lift): 250 kg with carol™ bracket
- Lightweight: easy storage, transport and installation
- No tools required for assembly
- Different types of fixed parts (same parts as davitrac): versatile use
- Can be used as an anchor point for the tempo 3 lifeline

Standard:

- EN 795-B : 2012
- EN 1496
- Machinery Directive 2006/42/EC
- CEN/TS 16415:2013-B
- EN 795 Class A and/or B
- EN 360



davimast: 360° rotatable anchor point

- 2 independent 360° rotatable anchor points
- 2 users: up to 150 kg each

Standards:

- EN 795-B : 2012
- EN 1496
- CEN/TS 16415:2013-B
- EN 795 Class A and/or B
- EN 360

Model	Product Code	Price
davimast mast	210188	£797.00
Bracket with 2 anchor points	210198	€578.00



Order products on day 1, will be shipped no later than day 2



Order products on day 1, will be shipped no later than day 3. Maximum quantities apply for this service.



Available on request. Please enquire about delivery times of these items.



davimast with blocfor™ and bracket

The blocfor™ 20 R ESD and the blocfor™ 30 R ESD function as standard reels to prevent a user from falling.

They also have an integrated rescue system to quickly evacuate a person during a rescue operation.

Model	Product Code	Price
davimast mast	210188	£797.00
blocfor™ 20R galvanised ESD 150 kg with bracket for davimast	84362	€2,048.00
blocfor™ 20R inox ESD 100 kg with bracket for davimast	84372	€2,205.00
blocfor™ 30R galvanised ESD 150 kg with bracket for davimast	84382	€2,520.00
blocfor™ 30R inox ESD 100 kg with bracket for davimast	84392	€2,678.00



davimast with carol™ R and bracket

- Lifting winch for material.
- Capacity of 250 kg.
- Cable lengths ø 5 mm - 20 m and 30 m.
- Complies with EN 1496 150 kg and the Machinery Directive 206/42/EEC 250 kg.

Model	Product Code	Price
davimast mast	210188	£797.00
carol™ R 250kg with 20m galvanised cable and console for davimast	293799	€1,717.00
carol™ R 250kg with 30m galvanised cable and console for davimast	293809	€3,024.00



Spare parts davimast

Model	Product Code	Price
Wall mounted adapter	210118	€473.00
Clearance mural adapter	210128	€525.00
Mounted floor adapter	210108	€473.00
Flush floor adapter	210138	€473.00

 Order products on day 1, will be shipped no later than day 2

 Order products on day 1, will be shipped no later than day 3. Maximum quantities apply for this service.

 Available on request. Please enquire about delivery times of these items.

Rope access accessories

Standard S pulley

Standard S pulley with fixed flanges

- Pulley diameter: 27 mm
- Braided rope, max. Ø 13 mm
- Material: light alloy
- Overall dimensions: 98 mm
- Weight: 75 g



Model	Product Code	Price
Standard S Pulley Fixed Flanges	40162	€16.50

Standard S pulley

Standard S pulley with opening flanges

- Pulley diameter: 27 mm
- Braided rope, max. Ø 13 mm
- Material: steel
- Overall dimensions: 74 mm x 52 mm
- Weight: 165 g



Model	Product Code	Price
Standard S Pulley Opening Flanges	40172	€18.50

Standard M pulley

Standard M pulley with fixed flanges

- Pulley diameter: 29 mm
- Braided rope, max. Ø 16 mm
- Material: light alloy
- Overall dimensions: 110 mm x 82 mm
- Weight: 260 g



Model	Product Code	Price
Standard M Pulley Opening Flanges	40102	€26.00

Double in-line pulley

- Application: tyrolienne (rope bridge) evacuation.
- Pulley diameter: 25 mm
- Braided rope, max. Ø 13 mm
- Overall dimensions: 113 mm x 86 mm
- Weight: 180 g



Model	Product Code	Price
Double In-Line Pulley	40092	€193.00

Double pulley

Double pulley with opening flanges

- Pulley diameter: 29 mm
- Braided rope, max. Ø 16 mm
- Material: light alloy
- Overall dimensions: 110 mm
- Weight: 460 g



Model	Product Code	Price
Double Pulley Opening Flanges	40112	€37.00

Double safety descent device

- Pulley diameter: 29 mm
- Braided rope, max. Ø 16 mm
- Material: light alloy
- Overall dimensions: 110 mm
- Weight: 460 g



Model	Product Code	Price
Double Safety Descent Device	13572	€189.00

 Order products on day 1, will be shipped no later than day 2

 Order products on day 1, will be shipped no later than day 3. Maximum quantities apply for this service.

 Available on request. Please enquire about delivery times of these items.

Mountain eight

- Manual descent device usable with braided rope, \varnothing 9 to 12 mm
- Reliable and lightweight for rescue and quick evacuation
- Weight: 75 g



Model	Product Code	Price
Mountain Eight	20542	€22.50

Sternal ascent rope clamp

- Complies with EN 567 standard
- For rope climbing. Self-locking fall arrester for ropes with a diameter of 8 to 12 mm
- Clamp is used for climbing support



Model	Product Code	Price
Sternal Ascent Rope Clamp	66112	€119.00

Rope protection

- Rope protection against sharp edges. Prevents fraying or cutting the rope
- Material: aluminium



Model	Product Code	Price
Rope Protection	72586	€160.00

Anchor plate

- Braided rope, \varnothing 8 to 12 mm
- Allows to remount on the cord
- in conjunction with right or left ascent handle
- Weight: 106 g



Model	Product Code	Price
Anchor Plate	20512	€49.00

Ascender grip

- Complies with EN 567 standard.
- For rope climbing. Self-locking handle for ropes with a diameter of 8 to 12 mm
- Enables ascension on a rope



Model	Product Code	Price
Ascender Handled Rope Clamp	65742	€110.00

Ascension foot clamp

- Foot-loop with adjustable strap



Model	Product Code	Price
Ascender Foot-Loop	40122	€28.00

Work seat

- For working in a seated position for a long period of time
- Rigid sides to avoid thigh compression
- Three tools holders
- Positioned on back of HT Secours, HT Promast and HT Transport



Model	Product Code	Price
Work Seat	65762	€135.00



Order products on day 1, will be shipped no later than day 2



Order products on day 1, will be shipped no later than day 3. Maximum quantities apply for this service.



Available on request. Please enquire about delivery times of these items.

Tree surgeon accessories

Anchor line for trees

- Mobile anchor point for attaching the lanyard to a tree branch



Model	Product Code	Price
Anchor Line For Trees	40982	€52.00

Arborist braided rope

- Tree pruning cord with a loop on one side
- Length: 20 to 50 meter



Model	Product Code	Price
Rope 20m	59512	€213.00
Rope 30m	59522	€250.00
Rope 40m	59532	€273.00
Rope 50m	69952	€351.00

Saddle bag

- Bag for throwing the arborist rope (51922) over a branch to create an anchor point
- Weight: 250 of 350 g



Model	Product Code	Price
Throw bag 250g	53842	€12.50
Throw bag 350g	59332	€12.50

Arborist rope (for saddle bag)

- Fitted with a buckle at one end
- Length: 50 metre
- Match with throw bag



Model	Product Code	Price
Rope (for saddle bag)	51922	€15.00

Prusik knot®

- Self-locking knot enabling the tree surgeon to move along the arborist rope
- Length 0.6 m



Model	Product Code	Price
Prusik Knot®	40992	€25.00



Order products on day 1, will be shipped no later than day 2



Order products on day 1, will be shipped no later than day 3. Maximum quantities apply for this service.



Available on request. Please enquire about delivery times of these items.

4.

Height safety systems



Guard trac guardrail

Page 192–193

Permanent lifelines

Page 194–202

FABA safety ladders

Page 203–207

- Available on request. Please ask about the delivery time of these articles.
- Order on day 1, shipment no later than day 3 (maximum quantities apply).
- Order products on day 1, shipment no later than day 2.

guard trac™ guardrail



Our guard trac™ guardrail systems have a completely unique design, offering a simple and fast way to secure your roof, without jeopardising your waterproofing. Thanks to the patented design of our bracket and the integrated design, the entire system can be installed without a single tool. The only alternative to common guardrail solutions available on the market.

guard trac™ benefits and features:

- No risk of water penetration as no drilling is required for the installation.
- Thanks to our unique design, the installation is completely tool free.
- **NEW toe board option - when a parapet is not present**
- Fast Installation: 1 minute per meter.
- Compact footprint - ideal for installations with limited space
- Lightweight design
- The guard trac™ system can be installed on flat and inclined surfaces.
- The inclination is limited to 10°.
- The brackets are supplied in red. (other colours are available upon request.)
- The barriers are available in the lengths: 1.5 - 2 - 2.5 and 3 meters.
- The barriers are delivered in a natural aluminium finish (other colours are also available upon request.)
- The guard trac™ conforms and is certified according to **EN 13374-A:2019**.



guard trac™ is perfectly suited and certified for use in a variety of applications:

- Roof replacements / repair
- HVAC replacement and repair
- Rail car platforms
- Ramps
- Construction sites
- Dig sites
- Mezzanines
- Assembly and break areas
- Hoist areas

guard trac™ : a simple and fast way to secure your rooftop:

SAFETY ON JOBSITE:

- Short counter-weight support
- Trip hazard reduced
- Limited number of components
- Lightweight components
- Any angle between 30° - 330°

INSTALLATION:

- Tool free
- Quick (30% faster than comparable solutions)
- Easy installation and customisable on site.

COMPLETE RANGE:

- Range of standard barriers (1.5 - 2 - 2.5 and 3 m)
- Toe-board option
- Adjustable barrier
- Adjustable gate
- Components interchangeable between the 2 versions
- Easy stock management
- No additional components required

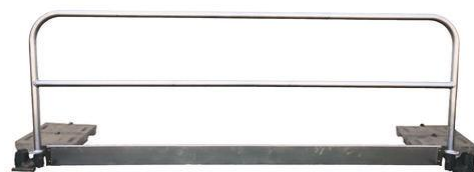

3m guard trac™ barrier with toe board

guard trac™ guardrail



guard trac™

Model	Product Code	Price
Standard barrier - 3m	272047	€147.00
Standard barrier - 2.5m	272317	€124.00
Standard barrier - 2m	272327	€113.00
Standard barrier - 1.5m	272337	€104.00
Standard barrier - 3m - with toe board	272347	€196.00
Standard barrier - 2.5m - with toe board	272357	€190.00
Standard barrier - 2m - with toe board	272367	€166.00
Standard barrier - 1.5m - with toe board	272377	€154.00
Adjustable barrier 1.50 - 2.25m	272027	€319.00
Adjustable barrier 2.25 - 3.00m	272017	€325.00
Latch	227015	€14.00
Counterweight - 25kg	186938	€19.00
Counterweight interface	272077	€3.20

Order products on Day 1, will be shipped no later than Day 2

Order products on Day 1, will be shipped no later than Day 10. Maximum quantities apply for this service.

Available on request. Please enquire about delivery times of these items.

TRIED, TESTED, TRACTEL®

Permanent lifelines



travsafe™ - twin cable lifeline



The travsafe™ lifeline with its two cables is the most efficient and sophisticated lifeline on the market. Thanks to its special design, the slider easily moves past the intermediate cable brackets placed, with no need for any manual intervention.

- Standard travsafe™ (with stainless steel shock absorber rings)
- travsafe™ with two-material shock absorber ring
- travsafe™ with INRS shock absorber

These three travsafe™ lifeline versions can be used by 3 to 5 persons and are designed for installation under ceiling, on wall or ground. The anchors can be installed on any structure or by using post interfaces. Intermediate anchors must be positioned no more than 15 meters apart.

The travsafe™ lifeline is an anchoring system equipped with horizontal, flexible belaying supports which comply with the requirements of the EN 795-C:2012 standard.

For more information please contact Tractel® .





Slider

- Standard: Mobile anchor point sliding on the straight travsafe™ lifeline cable
- Open: Mobile opening anchor point sliding on the travsafe™ lifeline cable
- RollSafe: Mobile anchor point sliding on the straight travsafe™ lifelines on a stainless steel cable installed under ceiling



Model	Product Code	Price
Standard slider	76149	€173.00
Opening slider	76159	€293.00
RollSafe slider	251649	€472.00

 Order products on day 1, will be shipped no later than day 2

 Order products on day 1, will be shipped no later than day 3. Maximum quantities apply for this service.

 Available on request. Please enquire about delivery times of these items.



travflex™ 2 lifeline

travflex™ 2 is a single cable lifeline, enabling automatic passage over anchors. The lifeline is designed for installation on concrete roofs and corrugated metallic tray roofing and complies with the requirements of the EN 795 C:2012 standard. Intermediate anchors must be positioned no more than 15 meters apart. The lifeline is designed for up to three users.

travflex™ 2 may be installed on metallic roofing with a minimum thickness of 0.6 mm or on concrete roofs. It can also be fitted in a straight line on a façade.

- Highly versatile in terms of where it can be installed and how it can be used.
- Easy to pass over intermediary anchors, no need for manual intervention.
- The user can work on either side of the lifeline.
- There is no need to disconnect when changing sides (improved safety).

Meets the installer's needs:

- Exclusive wedge clamp system eliminating risk of loosening over time.
- No special equipment required for assembly. Standard tools are sufficient.
- The wire rope is extremely quick to assemble for enhanced efficiency.
- In the event of a fall, the anchors need to be replaced but this can be done without dismantling the entire lifeline, saving time.

For more information please contact Tractel® .

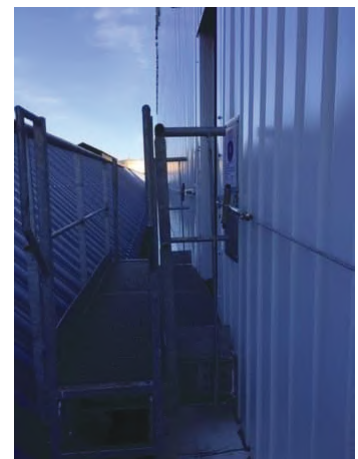

Slider

Mobile, sliding anchor point for travflex™ 2 lifelines, can be connected and disconnected.

- Tractel® patent
- Stainless steel

Model	Product Code	Price
Slider	251349	€305.00



 Order products on day 1, will be shipped no later than day 2

 Order products on day 1, will be shipped no later than day 3. Maximum quantities apply for this service.

 Available on request. Please enquire about delivery times of these items.

TRIED, TESTED, TRACTEL®

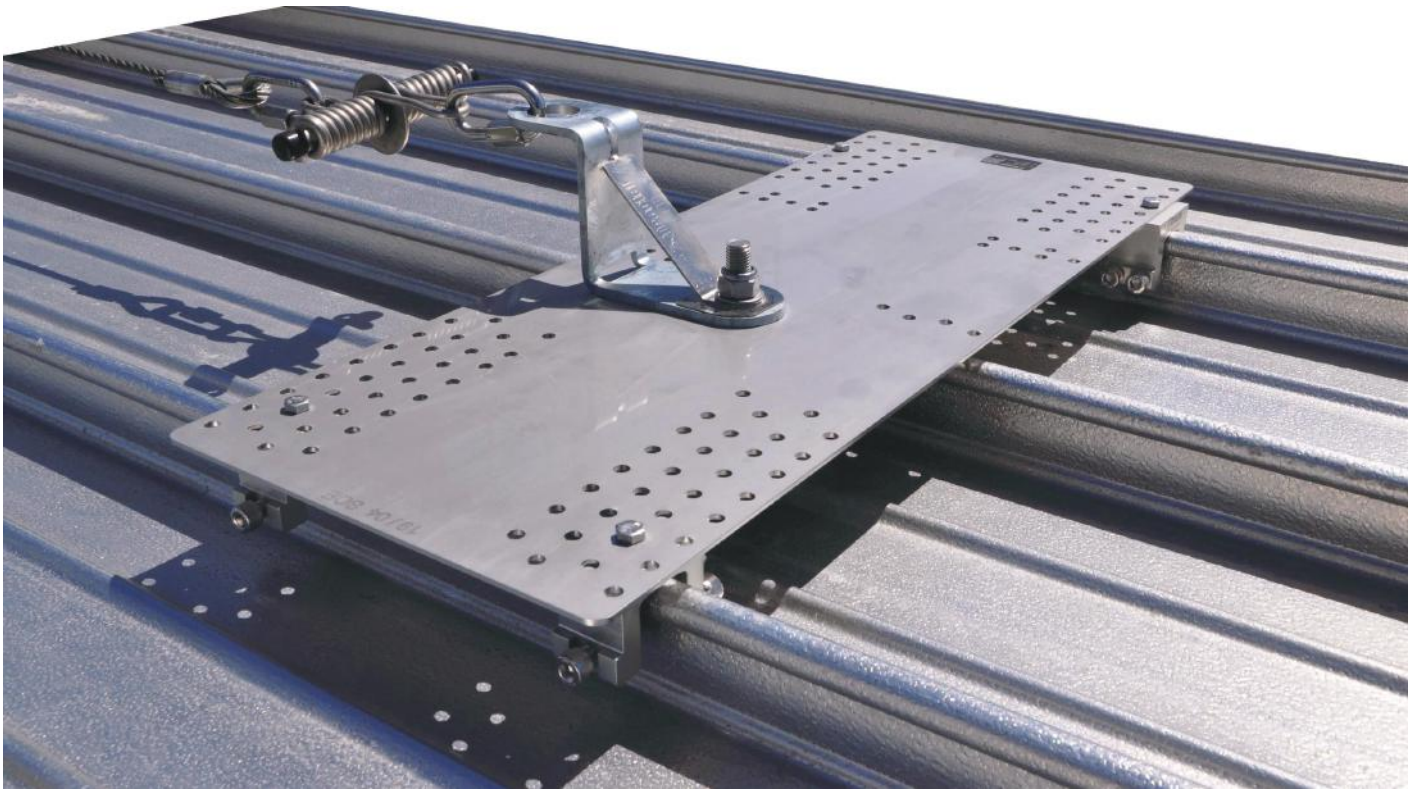

Universal plate

Universal mounting plate for travflex™ 2 on light structures

The universal plate is designed to be installed on light structures for our travflex™ 2 lifeline and ringflex anchor point.

There are two versions available, depending on the intended use:

- Plate for extremity & intermediate bracket or anchor point.
- Plate for curved bracket.

The plate can be mounted on a wide range of roofs:

- Metal sheet roofing.
- Sandwich panel.
- Aluminium standing seam.

Depending on the application, the plate is supplied with a set of 4 clamps or a set of 12 rivets.

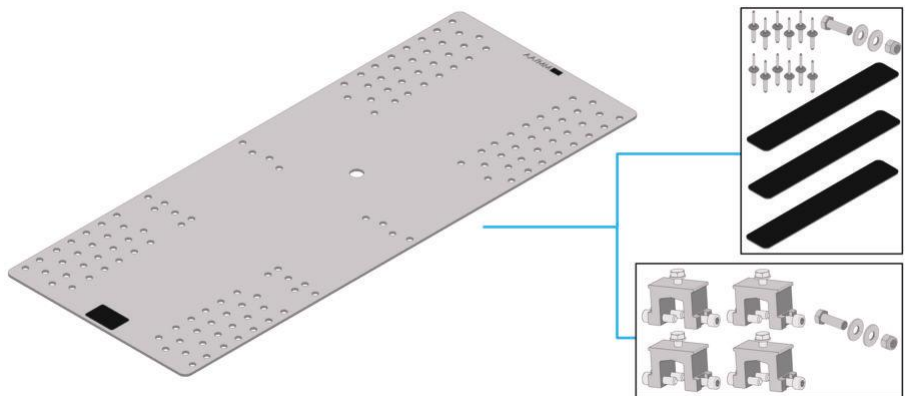

Model	Product Code	Price
Extremity & intermediate universal plate in stainless steel - 3mm*	206888	€141.00
Extremity & intermediate universal plate - in galvanized steel - 3mm*	207788	€68.00
Curve universal plate - in stainless steel - 5mm	206878	€208.00
Kit 4 clamps + 1 bolt M16	232577	€136.00
Kit 12 rivets + rubber sealing bands + 1 bolt M16	232587	€52.00

* Extremity & intermediate universal plate is also suitable for the ring flex.

Delivery

Every universal plate is supplied with the installation manual

Both the 4 clamp kit and the 12 rivet kit are delivered with 1x screw HM16, 2x M16 washers, 1x M16 locknut.





travspring™ 150kg

The new travspring™ lifeline is an evolution of the previous version. The cable clamps of the previous model have been replaced by a wedge clamp. This completely eliminates the risk of disconnecting the cable clamps over time. It complies with the European norm EN795-C:2012 and the CEN/TS16415:2013 for multi-user.

It is designed to be proximity lifeline as the intermediate anchor must be crossed manually.

NEW

150kg High Capacity Range

As an extension of Tractel® High Capacity Range, the travspring™ lifeline is now certified for user weighing up to 150kg including all their equipment. This lifeline is certified for a simultaneous use for a maximum of 5 users 100kg or 3 users 150kg. In order to comply with the 150 kg classification, the harness and connection (lifelines, automatic fall arrest devices or guided fall arresters with flexible anchor line) must all have a 150 kg classification.

Specifications

Intermediate anchors must be positioned no more than 15 meters apart. In single span configuration (without intermediate anchor), Tractel has certified the travspring™ lifeline with a maximum distance between end anchors of 30 meter.

The travspring™ lifeline is certified for the following installation: on a wall, on an inclined surface up to 15°, on the ground or on a post. In addition, in a single span configuration, travspring™ can be installed overhead.

The system is supplied with a visual tension indicator and an in-line energy absorber.

Tractel has certified all of its self retracting fall arrester (EN360) and guided type fall arresters (EN353-2) rated 150kg. All lanyards certified EN 355 can be used with the travspring™ lifeline.

INRS absorbers

The travspring™ lifeline is intended for 5 users of 100kg or 3 users of 150kg. Thanks to the INRS patented fall arrester, the travspring™ lifeline produces a minimal impact in the event of a fall on the end. All parts of the lifeline are made of stainless steel, combined with a galvanised or stainless steel cable of 8 mm. The travspring™ lifeline can be installed on the wall, on a ground support or post.



For more information please contact Tractel®.

 Order products on day 1, will be shipped no later than day 2

 Order products on day 1, will be shipped no later than day 3. Maximum quantities apply for this service.

 Available on request. Please enquire about delivery times of these items.

TRIED, TESTED, TRACTEL®



travspring™ One 150kg

The new travspring™ One lifeline is a derivative of the travspring™ lifeline. It complies with the European norm EN795-C:2012 and the CEN/TS16415:2013 for multi-user.

It is designed as a simple and inexpensive lifeline for occasional use. The system requires a double lifeline to pass the intermediate supports and curves.

NEW

150kg High Capacity Range

As an extension of Tractel® High Capacity Range, the travspring™ lifeline is now certified for user weighing up to 150kg including all their equipment. This lifeline is certified for a simultaneous use for a maximum of 5 users 100kg or 3 users 150kg. In order to comply with the 150 kg classification, the harness and connection (lifelines, automatic fall arrest devices or guided fall arresters with flexible anchor line) must all have a 150 kg classification.

Specifications

Intermediate anchors must be positioned no more than 15 meters apart. In single span configuration (without intermediate anchor), Tractel has certified the travspring™ lifeline with a maximum distance between end anchors of 30 meter.

The travspring™ lifeline is certified for the following installation: on a wall, on an inclined surface up to 15°, on the ground or on a post. In addition, in a single span configuration, travspring™ can be installed overhead.

The system is supplied with a visual tension indicator and an in-line energy absorber.

Tractel® has tested and certified all its automatic fall arrest devices (EN360) and guided fall arresters with flexible anchor line (EN353-2) from the 150kg range together with the travspring™ One. All lifelines certified to EN 355 can be used with the travspring™ One.





Benefits

- Thanks to the wedge socket, the risk of the cable clamp nuts coming loose over time is fully eliminated.
- No special tools are required for the installation of the lifeline.
- Few components to install.

For more information please contact Tractel® .

 Order products on day 1, will be shipped no later than day 2

 Order products on day 1, will be shipped no later than day 3. Maximum quantities apply for this service.

 Available on request. Please enquire about delivery times of these items.



travsmart lifeline 150kg

The travsmart lifeline complies with the requirements of the EN 795 C standard and can be used simultaneously by 5 users of 100kg or 3 users of 150kg. The distance between the intermediate supports is maximum 15m or at a single span of 30m. The travsmart lifeline can be installed under the ceiling, on the wall, on an inclined surface, on the ground or on a post.

MEETS THE USER'S NEEDS:

- Choices of installations and uses (ergonomics).
- The user can work on either side of the lifeline without the need to disconnect (improved safety).
- Wire rope available in galvanized steel or stainless steel.

MEETS THE INSTALLER'S NEEDS:

- No special tools are required for the installation of the lifeline.
- Thanks to the wedge socket, the risk of the cable clamp nuts coming loose over time is fully eliminated.
- Quick and easy installation of the lifeline thanks to the design of the intermediate anchor.
- In the event of a fall, there is no need to fully dismantle the lifeline.

For more information please contact Tractel® .



Slider

Mobile, sliding anchor point for travsmart™ lifelines, which can be connected and disconnected.

- Tractel® patent
- Stainless steel



Model	Product Code	Price
Slider	251349	€305.00

Order products on day 1, will be shipped no later than day 2

Order products on day 1, will be shipped no later than day 3. Maximum quantities apply for this service.

Available on request. Please enquire about delivery times of these items.

TRIED, TESTED, TRACTEL®

Vertical lifelines

stopcable™ 150kg



The use of a ladder to gain access to a high-level workstation can pose an element of risk.

The purpose of the stopcable™ 150 kg system is to ensure the safety of personnel throughout their ascent.

The stopcable™ vertical lifeline is a mobile anchoring device to enable a person to move on a vertical axis in perfect safety and without having to disconnect themselves. It consists of a fixed point and individual mobile equipment.

The stopcable™ vertical lifeline was designed, created and tested to comply with the requirements of the EN353-1 and EN 353-2 standards.



U bolt

The jumpers or stirrups enable the connection of the anchor terminals and the cable guides to the ladder rungs.

- Material: Stainless steel



Model	Product Code	Price
diameter 27 mm	18132	€9.30
diameter 34 mm	18142	€9.20

Cable guide

To be installed approximately every 10 m. The purpose of the cable guide is to restrict cable play.

- Material: stainless steel and rubber.



Model	Product Code	Price
cable guide	108857	€57.50

Cable

- Galvanized or stainless steel cable.
- Start kit: 3 m cable supplied with swage on one side and 3 steel cable clamps.
- Add additional length per meter.



Model	Product Code	Price
galvanized start kit	37422	€87.00
Extra galvanized cable per m.	25101	€5.10
stainless steel start kit cable	18162	€130.00
Extra stainless steel cable per m.	25091	€12.00

Shock absorber

- Material: stainless steel clevis pin,
- PU shock absorber.
- To be used with old fall prevention device without fall arrester (not required with FPDA fall prevention device)



Model	Product Code	Price
Energy shock-absorber	90049	€180.00

Tensioning device

Spring tensioning device.

- Material: stainless steel clevis pin, pre-tension indicator.
- Counterweight (should be used at the bottom end of the installation, if this end is not fixed onto the ladder).



Model	Product Code	Price
counterweight	129445	€107.00
tensioning device	261809	€147.00

 Order products on day 1, will be shipped no later than day 2

 Order products on day 1, will be shipped no later than day 3. Maximum quantities apply for this service.

 Available on request. Please enquire about delivery times of these items.

Fall prevention device

Fall arrester with shock absorber.

- Anti-reversibility system
- Supplied with M10 connector
- Absorber webbing strap
- Material: Stainless steel



Model	Product Code	Model Name	Price
FPDA	72272	FPDA	€175.00



Anchor point

Top or bottom anchor point (per piece).

- Material: Galvanized steel or stainless steel
- 2 models:
 - H - Horizontal support
 - V - Vertical support



Model	Product Code	Price
H, galvanized	17872	€94.50
H, stainless steel	32902	€177.00
V, stainless steel	87378	€112.00

Signpost

Signpost for stopcable™ system.



Model	Product Code	Price
signpost	146465	€15.00

Order products on day 1, will be shipped no later than day 2

Order products on day 1, will be shipped no later than day 3. Maximum quantities apply for this service.

Available on request. Please enquire about delivery times of these items.



NEW

The horizontal fall arrest rail by Tractel®. The travrail is a horizontal rigid anchor rail. It is designed to protect workers in the event of a fall, during tasks such as cleaning or maintenance work, checking an installation or safely entering a construction. It allows the slider to move freely over the intermediate anchors, making it easy for the user to switch from one side of the rail to the other.

The rail makes it possible to secure 3 individuals (each weighing max 100kg incl. equipment and tools) at the same time (1 person per slider).

The rail can also be used as an anchor point for Rope-access work in combination with the special slider for this application.

The maximum distance between the brackets of the aluminium rail is 6m (3m for rope access applications). 90° curves available for wall and floor/ceiling mounting. Can be mounted on the floor, on the wall or overhead.

- Removable end stop for the insertion or retrieval of the slider(s)
- EN 795-D:2012
- CEN/TS 16415:2013 for 3 simultaneous users
- Complies with EN 795-D:2012
- Complies with CEN/TS 16415:2013 for 3 simultaneous users
- To be used with EN 360 Retractable fall arresters
- To be used with EN 353-2 Guided fall arresters with flexible anchor line
- For use with EN 355 energy absorbers and shock absorbers
- To be used with EN 361 Full body harnesses

Model	Product Code	Price
Rail aluminium 3000 mm	232665	€164.00
External corner rail aluminium	232685	€202.00
Internal corner rail aluminium	232695	€202.00
Overhead corner rail aluminium	232705	€202.00
Connection rail aluminium	232715	€38.50
Fix end stop	232745	€38.50
Removable end stop	232655	€77.00
Bracket	232725	€49.00
Expansion bracket	232785	€51.00
Standard slider	232675	€498.00
Rolling slider	233225	€709.00
Slider for wall suspended works	232795	€900.00
Drilling kit	232765	€230.00
-	223326	





Standard slider



Rolling slider

 Order products on day 1, will be shipped no later than day 2

 Order products on day 1, will be shipped no later than day 3. Maximum quantities apply for this service.

 Available on request. Please enquire about delivery times of these items.

Permanent safety ladders

FABA™ system

The FABA™ range is a fall arrest system on a rail for vertical and horizontal movements. The vertical rails are separately available for mounting on an existing ladder or can be supplied with an integrated ladder. The FABA™ systems are designed for accessories such as rest platforms or access blocking systems. They are built to be adapted to all types of supports. These products can be supplied in galvanized steel, stainless steel or aluminium.

FABA™ ladders are complete systems in which all components are aligned with each other. The rigid rail allows the user to better control the movement of the slider. Unlike cable systems, several people can climb up the ladder one after the other (with sufficient spacing). Ideal for use over long distances.

The products of the FABA™ range have been tested to meet the requirements of the European EN 353-1 standard. Areas of application: along towers, chimneys, tanks, bridge piers, masts, antenna supports, access to mines, pits, sludge lagoons, cat walks, dams, tank lorries, cranes, roof terraces, waste water systems, etc.

For more information please contact Tractel® .



Delivery time safety ladders



Order products on day 1, will be shipped no later than day 2.



Order products on day 1, will be shipped no later than day 5. Maximum quantities apply for this service.



Available on request. Please enquire about delivery times of these items.



FABATM Klassik

FABATM A11 system

Introduced in 1965, the FABATM A11 System is the precursor to the vertical access safety devices. Vertical fall arrest system in the form of a rail or ladder, complies with EN 353-1 standard. The slider can be inserted in either direction in the safety rail.

- Version: Ladder with central upright or just a rail.
- Spacing in between stops: 140 mm
- Spacing in between rungs: 280 mm
- Rungs: Inclined forward and welded on the back of the rail.
- Ladder width: 408 mm
- Primary Length: 2800 mm
- Dimension: 68 x 56 x 2.8mm
- Adjustment lengths: 1960, 1680, 1400 and 1120 mm
- Maximum distance between fixings: 1960 mm
- Slider: FABATM Klassik



FABATM EZ

FABATM A12 system

The FABATM A12 System has been on the market since 1995. It is a logical evolution of the FABATM A11 System but a lighter and smaller version. Vertical fall arrest system in the form of a rail or ladder, complies with EN 353-1 standard. The design of the safety rail and carriages is asymmetrical and guarantees that the carriages are always used in the right direction.

- Dimensions rail profile: 48 x 32 x 3 mm
- Design: Ladder with central upright or just rail
- Spacing in between stops: 40 mm
- Spacing in between rungs: 280 mm
- Rungs: Straight and welded on the back of the rail
- Width of the ladder: 380 mm
- Primary lengths: 5600 and 2800 mm
- Maximum distance between fixings: 1400 mm for the ladder and 1960 mm for the rail
- Sliders: FABATM AL-D, FABATM GRIP and FABATM EZ



FABATM Grip

FABATM AL2 system

The FABATM AL2 System is based on the principle of the FABATM A12 System and is suitable for material in anodised aluminum. Vertical fall arrest system in the form of a rail or ladder, complies with EN 353-1 standard. The design of the safety rail and sliders is asymmetrical and guarantees sliders are always used in the right direction.

- Dimensions rail profile (H-shaped): 48 x 65 x 3-6mm
- Material: Anodised aluminum
- Design: Ladder with a central upright or with additional side uprights or just rail
- Spacing in between stops: 70 mm
- Spacing in between rungs: 280 mm
- Ladder width: 414 mm
- Primary lengths: 5600 and 2800 mm
- Distance between fixings: 1680 mm for the ladder with central upright
- Distance between fixings: 2520 mm suitable for ladder with side uprights or the rail.
- Sliders: FABATM AL-D, FABATM grip en FABATM EZ

For more information about our safety ladders and other special applications, please contact Tractel® (0031 (0)765435135).

Sliders

The FABATM system makes it possible to work safely with multiple users. The distance between two users is at least 3 meters and no more than two users may be located within a distance of 10 meters. Each user has his own FABATM slider for the respective rail.

FABATM Klassik 150kg

FABATM Klassik slider is a symmetrical slider suitable for the A11 system. The slider can be placed in both directions in the safety rail, so incorrect positioning is not possible. The user has to climb close to the ladder, so it can also be used if there are obstacles behind the user.

- Complies with standard EN 353-1:2018 and the PPE regulations (EU) (EU) 2016/425
- Suitable for FABATM A11 rail and ladder

Model	Product Code	Price
FABATM Klassik	514208	€695.00



FABATM AL-D 150kg

The AL-D is a slider for universal use that is used to climb close to the ladder if, for example, there is an obstacle behind the user. Can be used when there is free space behind the user.

- Complies with standard EN 353-1:2018 and the PPE regulations (EU) (EU) 2016/425
- Implementation is only possible in one direction due to asymmetric profile
- FABATM AL-D 150 kg is suitable for FABATM A12, AL2, AL2 mobil and the AL2 Mobil-F

Model	Product Code	Price
FABATM AL-D	514008	€540.00



FABATM Grip 150kg

Enables several operators to work in safety (each operator having his own FABATM Klassik slider) if there are no more than two operators within 10m and at least 3m between them.

- Complies with standard EN 353-1:2018 and the PPE regulations (EU) (EU) 2016/425
- Certified for a user up to 150kg
- Suitable for FABATM A12, AL2, AL2 mobil and the AL2 Mobil-F

Model	Product Code	Price
FABATM Grip	514408	€669.00



FABATM EZ 150kg

The FABATM EZ can be inserted and retrieved at any place on the rail or a ladder, thanks to its unique design, you can insert or retrieve it with only one hand.

- Developed and compatible with FABATM A12, AL2, AL2 mobil and AL2 Mobil-F
- Introduction is only possible in the correct direction thanks to asymmetric profile
- Thanks to the design of the slider, entry and exit sections are not necessary
- Conforms with EN 353-1:2018 and the PPE regulation (EU) 2016/425

Model	Product Code	Price
FABATM EZ 150kg M23	513878	€861.00
FABATM EZ 150kg M10	513888	€817.00



 Order products on day 1, will be shipped no later than day 2.

 Order products on day 1, will be shipped no later than day 5. Maximum quantities apply for this service.

 Available on request. Please enquire about delivery times of these items.

TRIED, TESTED, TRACTEL®

Temporary safety ladders



FABA™ AL2 mobil system

The FABA™ AL2 Mobil system

Safety ladder for temporary use on various structure types. The fasteners that accommodate the ladder are permanently fixed. In the standard version, wall and post clamp brackets are supplied for the posts.

Features FABA™ AL2 Mobil:

- Dimensions rail profil (H-shaped): 48 x 65 x 3-6mm
- Material: Anodised aluminum
- Design: Ladder with a central upright or with additional side upright
- Spacing in between stops: 70 mm
- Spacing in between rungs: 280 mm
- Rungs: Straight, inserted and set on the back of the rail
- Ladder width: 414 mm

Delivery Tractel® :

- Supplied in managable lengths of: 2800, 2520, 2240, 1960 and 1680 mm



FABA™ AL2 Mobil-F system

The FABA™ AL2 MOBIL-F system

Designed for access to posts or masts with a circular cross-section. The fasteners are pre-installed on the ladder sections and provided with fastening straps to enable the ladder sections to be tightened and positioned directly on the post or mast.

Features FABA™ AL2 MOBIL-F:

- Dimensions rail profil (H-shaped): 48 x 65 x 3-6mm
- Material: Anodised aluminum
- Design: Ladder with a central upright or with additional side upright
- Spacing in between stops: 70 mm
- Spacing in between rungs: 280 mm
- Rungs: Straight, inserted and set on the back of the rail
- Ladder width: 414 mm

Delivery Tractel® :

- Supplied in managable lengths of: 1960 and 1680 mm
- Maximum distance between fixings: 1680 mm
- Characteristics of connectors: Automatic release of the upper end stops when fitting the next Ladder section.

For more information about our safety ladders and other special applications, please contact Tractel® (0031 (0)765435135).



Order products on day 1, will be shipped no later than day 2.



Order products on day 1, will be shipped no later than day 5. Maximum quantities apply for this service.



Available on request. Please enquire about delivery times of these items.

Global and local presence

Established more than 70 years ago, Tractel® today has significant manufacturing facilities in Europe (France, Germany, Poland, Spain), the USA (Minneapolis and Houston), Canada (Toronto and Montreal), China (Shanghai), Singapore and Turkey.

These facilities are supported by dedicated centres of excellence in R&D, engineering and safety standards. Tractel® has customers in 120 countries, subsidiaries in 19 countries and 10,000 distributors around the world, and employs more than 1,100 people.

This network of people, expertise and experience, shared across multiple locations, allows Tractel® to achieve global reach.

Local service on a global basis

Tractel® works with distributor and rental partners, in addition to direct company sales, to reach customers around the world. These partnerships help us to deliver local sales, marketing and technical support, as well as comprehensive service and maintenance programmes.

In practice, we organise training programmes; supply marketing materials, such as videos, customer testimonials, point-of-sale materials; implement product configurators and decision-support tools for end-users; and accompany our distribution partners to present our solutions to end-customers.

Tractel Benelux is located in Breda
Paardeweide 38, 4824 EH Breda
Tel: 076 543 5135
E-mail: sales.benelux@tractel.nl



General conditions of use

Of Tractel Benelux B.V. (hereafter referred to as "Tractel") in BREDA.

Article 1 Applicability

Para 1 - These General Conditions apply to all offers from Tractel and all agreements with Tractel.

Para 2 - Any deviating arrangements will be effective only insofar as they have been confirmed by Tractel in writing.

Article 2 Offers and Agreement

Para 1 - The offers and quotations from Tractel are without any obligation, unless the opposite has been determined expressly in writing.

Para 2 - Where an order is placed by the customer without a prior offer by Tractel, an agreement will become effective only if Tractel confirms the order in writing within eight days of receipt or actually executes the order. If the agreement is concluded in writing, it will become effective on the day it is signed by Tractel.

Para 3 - Oral promises by and arrangements with employees of Tractel will be binding on Tractel if and insofar as they have been confirmed by a legally authorised representative of Tractel.

Article 3 Prices

Para 1 - Prices are ex VAT. If the cost factors (including the costs of wages and materials) are subject to an increase between the conclusion of the agreement and the date of delivery, Tractel will be entitled to increase the prices accordingly.

Article 4 Payments

Para 1 - Payments must be received by Tractel within 14 days of the invoice date at the latest, unless a different term has been agreed in writing. Payments must be made without any deduction or set-off and without suspension due to an alleged or actual nonconformity on the part of Tractel. The prices stated are in euros and ex VAT.

Para 2 - If payment does not take place within the term defined in paragraph 1, the customer will be in default without further notice of default, and will owe default interest at 1% a month from the invoice's due date, without prejudice to the other rights of Tractel.

Para 3 - Tractel is entitled to demand adequate security prior to delivery, irrespective of the agreed payment conditions. Where such security is not provided, Tractel will be entitled to suspend further performance of the agreement.

Para 4 - Any legal and other costs to be incurred by Tractel in order to ensure compliance with the payment obligation of the customer will be payable by the customer. Those costs are at least 15% of the outstanding amount, with a minimum of € 50, such without prejudice to Tractel's right to claim the higher, actual damages

Article 5 Retention of title

Para 1 - Any goods already delivered will remain the property of Tractel until the customer has complied in full with all its payment obligations arising from any agreement between parties, without prejudice to the customer's obligation to pay in good time. The customer will be liable for any damage done to the delivered goods, which have remained the property of Tractel under this provision.

Para 2 - If the customer fails to comply with its payment obligations or fails to do so in good time, Tractel will be irrevocably authorised to repossess the goods which are its property on the basis of the previous paragraph, without any notice of default or judicial intervention being required.

Para 3 - The customer will not be authorised to permit third parties to use the goods, to rent out, pledge or transfer the ownership of the goods, or to dispose of or encumber the goods in any other manner, until they have been paid for in full. However, the customer is entitled to sell, rent out or deliver the goods, in accordance with their purpose, within the context of its normal business activities.

Para 4 - The customer is not entitled to a right of retention or a right of suspension in respect of the delivered goods.

Article 6 Delivery dates

Para 1 - Delivery dates are stated to the best of Tractel's knowledge, but those dates will never be absolute deadlines. In the event of failure to deliver in time, the customer must demand delivery in writing, whereby Tractel will be given a reasonable extension of the delivery date of at least 14 days.

Para 2 - If the extended term referred to in paragraph 1 is also exceeded, the customer will be entitled to dissolve the agreement without written notice insofar as no delivery has as yet taken place, without Tractel being held to pay any damages in such case. Tractel will then be entitled to invoice that part of the agreement that has already been fulfilled separately, and the customer must pay those invoices as if they concerned a separate agreement.

Article 7 Delivery

Para 1 - The time when the goods leave Tractel's warehouse (ex warehouse) applies as the delivery time and the time when the risk is transferred to the customer.

Para 2 - Unless otherwise has been agreed in writing, dispatch will take place at the expense and risk of the customer. If delivery takes place from the company premises of a third party, dispatch will be at (the expense and) risk of the customer, from the moment when the goods have left the company premises of said third party. The provisions of this paragraph also apply where transport is organised by – whether or not at the expense of – Tractel.

Article 8 Force majeure

Para 1 - Any unforeseen circumstances, such as disruptions and impediments affecting the business operations of Tractel and/or the suppliers of Tractel, for example strike actions, lockouts, export and import bans or restrictions, attachments of any kind and for whatever reason, fire, accidents or new relevant legal provisions, constitute force majeure and entitle Tractel to suspend or cancel its delivery obligations in full or in part.

Article 9 Warranty

Para 1 - The warranty period for the delivered goods is 12 months, beginning at the time of delivery (see Art. 7).

Para 2 - If any defects as a consequence of manufacturing and/or material faults occur within the warranty period defined in paragraph , Tractel will repair those defects or make available the parts necessary for repair, replace the goods in question in full or pay a maximum of the invoice value of the goods, such to be decided by Tractel. Any call-out charges to be incurred by Tractel in that respect or any transport/ dispatch costs are not covered by the warranty.

Para 3 - Any goods returned in connection with a warranty can be accepted only if Tractel has agreed thereto in writing and if the receipt number or invoice number and date of the returned goods are included.

Para 4 - Any claims under a warranty must be reported (in writing) to Tractel within 8 days of the occurrence of the defect. In the absence of a timely claim, any entitlement under a warranty will no longer apply.

Para 5 - Not included in a warranty issued by Tractel are, in any case, any defects occurring in, or fully or partially the consequence of: failure to observe the user manual, operating instructions, etc., and/or any use other than the intended normal use; normal wear and tear; assembly/ installation or repair by third parties, the application of any government regulation concerning the nature or quality of the used materials; and any parts obtained by Tractel from third parties, insofar as those third parties have not issued a warranty to Tractel.

Para 6 - If the customer fails to comply with its contractual obligations, or fails to do so properly or in good time, Tractel will not be held to issue any warranty or pay any damages, of whatever description.

Article 10 Complaints

Para 1 - The customer must, at the risk of forfeiting all its rights, report to Tractel (in writing, stating a receipt or invoice number), any defects/faults that could be discovered or reasonably should have been discovered during a thorough inspection within 8 days of delivery. Where parties have agreed an inspection period and that period has lapsed without any written complaints about any defects/faults that have been identified or reasonably should have been identified, the good will be considered to have been accepted.

Para 2 - Any complaints about invoices must be submitted in writing within eight days of the date on the invoices.

Para 3 - Any deviations and differences in colour, size and weight that are minor and/or common in the sector can never provide a ground for complaints.

Article 11 Liability

Para 1 - Any liability on the part of Tractel for any damage arising from or relating to the execution of an agreement will always be limited to the amount paid in the relevant case under the product and professional indemnity insurance it has effected, increased by the amount of the excess which, according to the policy conditions, is not payable by the insurer.

Para 2 - If, for whatever reason, the provisions of para. 1 of this article do not apply, the liability of Tractel will always be limited to the amount that was charged for the agreement with regard to which the damage was inflicted, or in the event of a continuing performance contract, to an invoice amount over a max. period of six months. The compensation referred to in this para will never exceed € 25,000.

Para 3 - Tractel will never be liable for any consequential damage or for any damage that is the consequence of:

- incorrect and/or incomplete data and/or data not provided in time, originating from the customer;

- failure to observe the user manual / operating instructions and/or improper use.

Para 4 - The limitation of liability stipulated in this article does not apply if the damage is the consequence of intent or wilful recklessness on the part of Tractel and/or its – whether or not subordinate – supervisory staff.

Para 5 - After the lapse of one year after commencement of the day following that on which the customer became aware of the damage, or could reasonably be aware of this, any right of action on the part of the customer will cease.

Para 6 - The Seller shall not be liable for delay or failure to perform one of its obligations under the Agreement should the delay or failure be the direct or indirect result from circumstances which are beyond its reasonable control and independent from its will such as - but not limited to - disease outbreaks or pandemics (covid-19, etc.).

Para 7 - The Seller (Tractel) shall make its best efforts to determine which of its obligations it is being prevented from complying with, and when possible will give an estimate of the period during which it is likely that it shall be prevented from complying with the said obligation or obligations. The Parties undertake to get in contact before the end of such period to jointly determine the consequences on the timetable, the financial aspects and practicalities to resume works. In any case, the Purchaser will not be able to cancel any order, as long as the delays resulting from the said circumstances not exceed 3 months from its date of notice.

Article 12 Dissolution

Para 1 - In the event of the bankruptcy or suspension of payments of the customer, or any petitions to that effect, or an attachment is made of the customer's assets, Tractel will be entitled to dissolve the agreement by means of a written notification, without any notice of default or any judicial intervention being required.

Para 2 - If one or more of the situations mentioned in paragraph 1 occurs or occur, Tractel will be entitled to halt the (further) deliveries under a (partially completed) order, without any right arising from the agreement being invalidated as a result. Neither does continuation of the deliveries imply the relinquishment of any right.

Article 13 General

Para 1 - If it becomes evident that one or more provisions from these General Conditions are invalid, or if, for whatever reason, it is impossible to demand compliance with them, the other provisions of these General Conditions will remain in full force, and parties will consult with one another about the invalid provision or the provision with regard to which it is impossible to demand compliance, and discuss the way in which the purport of the relevant provision can be enforced in the best possible manner.

Article 14 Disputes

Para 1 - Any disputes relating to the offers issued by Tractel and/or agreements concluded with Tractel will be settled exclusively by the competent judge in the judicial district of the Zeeland - West-Brabant District Court in the Netherlands.

Para 2 - All offers and quotations from Tractel and agreements concluded with Tractel and all contracts arising from them are governed exclusively by Dutch law. The applicability of the Vienna International Sales Convention (CISG) and any other international sales conventions is excluded.

Article 15 Deposition

Para 1 - These General Conditions of Sale have been deposited with the Chamber of Commerce and Industry in Breda, the Netherlands, under no. 20086113. 20086113.

**confined space
harnesses**
page 127



tracrod
page 180



blocstop™
page 40



travrail
page 202



Tractel Benelux
Paardeweide 38
4824 EH Breda
Tel: 076-5435135
E-mail: sales.benelux@tractel.nl

