

**Broadcast Supply West
C A T A L O G**

1

9

8

9

America's Full-Time Broadcast Supplier

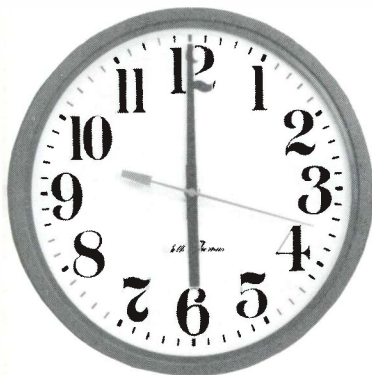

6:00 - 6:00
Pacific

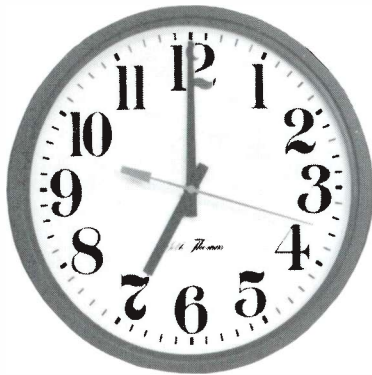

7:00 - 7:00
Mountain

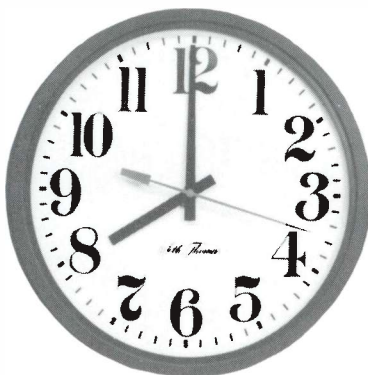

8:00 - 8:00
Central

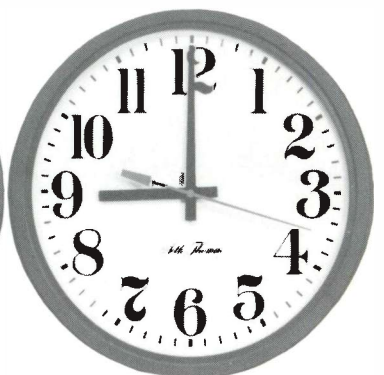

9:00 - 9:00
Eastern

OPEN 12 HOURS DAILY IN YOUR TIME ZONE

When BSW was founded in 1973, our goal was to establish a single-source supply house to serve the needs of America's broadcast professionals. Regional offices solved the problem of time zone but only served to delay delivery of equipment critical to a station's operation. So we decided to work overtime every day of

the week. 12 hours a day, there is a qualified sales engineer on duty who knows your business and your needs. And there's only one number you need to know — toll free across America. BSW's commitment to service is why we're America's full-time broadcast supplier.

LOCAL 206-565-2301
TWX 910-441-2617
FAX 206-565-8114



Terms 2% - 20 Days/
Net 30 Days On Approved
Credit

FOB: Point Of Origin

Sustaining Member



1-800-426-8434





We're As Close As Your Telephone

All prices contained within are subject to change. Please call or write for current pricing.

Copyright 1989 Broadcast Supply West • Personal checks up to \$1,000.00 accepted with Telecheck approval.



Index Products By Type

	Page		Page		Page
AM/FM Receivers	119	Editing Pencils	71	Reel To Reel Machines	88-93
Amplifiers	2-7	Equalizers	13, 16, 17, 20, 22	Reel To Reel Accessories	70, 85
Distribution	4, 5, 7, 8	Erasers	26, 27	Reels & Boxes (Empty)	124
Headphone	2-5	Fire Extinguishers	78	Remote Control	51-53
Line	2-4	FM Exciters	117, 118	Remote Control Systems	99, 101
Microphone	2, 5	Frequency Extenders	105, 110	Remote Pick-Up Systems	102, 104
Monitor/Power	2, 3, 5, 6	Furniture Studio	86	Reverb Units	13, 15, 16, 18, 19
Preamps/Phono	7	Harmonizers	15	Routing Switchers, Audio	94
Antennas & Accessories	8-10	Headphones/Headsets	54, 55	SCA Generator,	
Attenuators	67	Amplifiers	2-5	Receivers	77, 118, 119
Audio Processing	11-24	Splitters	56	Samplers	11
Composite Clipper	18	Heads, Recording	71, 78	Screens	74
Compressors/Limiters	11-14, 17, 19-24	Cleaners	25	Slide Projectors	74
Delay Units	15, 17	Intercom	77	Sound Effects, CD & Records	70
Equalizers	13, 16, 17, 20, 22	Isocouplers	79	Soundproofing	68, 76
Harmonizers	15	Jacks/Panels	94, 95	Speakers	96, 97
Mic processors	13, 17, 22, 23	Light Bulbs	68	Mounting Brackets	98
Noise Gates	19, 21, 23,	Lights	67-69, 78	Powered	96, 97
Noise Reduction	16, 19, 21, 22	Line Surge Protectors	72	Splice Finders	33
Reverbs	13, 15, 16, 18, 19	Live Assist Controllers	73	Splicing Blocks	25
Spatial Enhancers	12, 18	Marking Pencils	71	Splicing/Leader/Tape	71, 124
Stereo Generators	12, 14	Microphones	58-64	Stereo Generators	12, 14
Stereo Synthesizers	13	Accessories	57	Stereo Synthesizers	13
Voice Processors	13, 17, 22, 23	Amplifiers	2, 5	Studio Transmitter Link Equip.	99-104
Batteries	73	Booms	65	Antenna	8
Bulk Erasers	26, 27	Cable Assemblies	57	Remote Pick-Up	99, 101
Cable	57, 128	Mixers	53	Remote Pick-Up	102, 104
Cable Modulators	72	Parabolic	62	TRL Links	102
Cartridges, Phono	123	Preamps	4, 5, 17, 22, 23	Styli, Phono	123
Cartridges, Tape	28, 29	Processor	13, 17, 22, 23	Subcarrier/Generator/Demodulator	100
Cartridge Accessories	25-28	Shock Mounts	57, 58	Surge Protector	72
Alignment Aids	25	Stand Clamps	57	Switchers, Audio	67, 68
Degaussers, Erasers	26, 27	Stands	65	Switchers, RF	128
Labels	25	Windscreens	56, 57	Telephone Equipment	76, 105-111
Racks	82-84	Wireless	63, 64	Couplers	105, 110, 111
Rebuilds	29	Mobile DJ System	48	Temperature Gauges	126
Splice Finders	33	Monitors	80	Test Equipment	67, 72, 79, 114-116
Tape	124	Audio Signal	73	Test Records	71
Winders	25	Modulation	80, 81	Test Tapes	71
Cartridge Machines	30-36	EBS Weather	80	Timers, Clocks	112-113
Cleaning Aids	25	Multimeters	116	Tonearms	122
Timers	36	Noise Reduction		Tone Sensors,	
Cassettes	28	System	16, 19, 21, 22	Generators	73
Cassette Decks	36-39	On Air Lights	69	Tools	76
Cleaners Head/Swabs	25	Overhead Projectors	74	Towers	116
Clocks & Timers	112-113	Patchbays	94, 95	Lights	78
Compact Disc Players	40, 41	Patchcords/Jack Panels	94	Translators	117
Compact Disc Accessories	40, 41, 71	Phono Cartridges, Styli	123	Transmitters	117, 118
Compact Disc Racks	83	Preamplifiers, Turntable	7	FM Exciters	117, 118
Compressor/		R-DAT	87	Tuners	119
Limiters	11-14, 17, 19-24	Racks & Furniture	82-86	Turntables	120-122
Contact Cleaner	70	Cartridge	82-84	Accessories	66, 71, 121-123
Consoles	42-53, 75	Cassette	83	Bases	120, 121
Console Labels	48	Compact Disc	83	Controllers	66
Copy Holders	70	Equipment	85	Two-Way Radio	125
DAT (Digital Audio Tape)	87, 124	Furniture	86	Antennas	9
Dehydrators	128	Reel-Reel	85	Utility Lights	67
Delay Lines	15, 17	Rain Gauge	126	Voice Processor	13, 17, 22, 23
Dummy Loads	79	Rechargeable Batteries	77	Voice Remote Control	99, 101
EBS Monitors Encoder/Decoder	80	Record Cleaners	123	Weather Instruments	126
Editing Blades	71	Record Jackets	123	Wire & Accessories	127, 128
		Recording Tape & Accessories	124	Wiring Duct	127



SHURE



**Headphone
Bridging
Amplifier**
Portable
Battery Powered

Model FP-12

The FP-12 is a 1-input, 2-output headphone bridging amplifier designed to provide headphone feeds from any type of audio input. The FP-12 can be used for a wide variety of applications such as multiple headphone feeds, audio line troubleshooting, extra power for existing headphone circuits. The FP-12 features two XLR in/out connectors and two 1/4 inch in/out jacks. Other features include a Mic/Line input switch, Hi Z/Lo Z headphones switch, headphone level control, and removable belt clip. The FP-12 is powered by one standard 9V battery.

Mfg. list \$245.00 **CALL FOR BSW PRICE**

SHURE



**Portable Mic
To Line
Amplifier**

FP-11

The FP-11 is a portable, 1-input, 1-output microphone-to-line level amplifier designed for field production. It is ideal for use where long lines must be driven at higher than microphone or auxiliary levels. It can also be used to interface between equipment requiring different signal levels.

The balanced, locking XLR input and output provide for excellent rejection of hum and RF interference. A switchable peak limiter prevents output overload distortion. Additional features include a peak/limiter LED indicator, aux level mini-phone jack input, balanced line-level binding post output, and a removable belt clip. The FP-11 is powered by one standard 9V battery.

Mfg. list \$260.00 **CALL FOR BSW PRICE**

RANE



HC 6 Six Channel Headphone Amplifier

- Six stereo headphone amplifiers in a single rack chassis
- Main stereo inputs drive all six amps through individual volume controls
- Each headphone amp also has its own separate input which independently by-passes the main stereo input

Mfg. list \$369.00 **CALL FOR BSW PRICE**

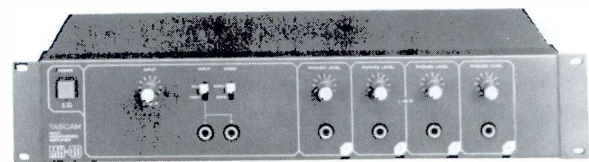

Model MH-40B 4 Channel Headphone Amplifier

The MH-40B accepts low or high line level mono or stereo input, which feed it to four independently adjustable headphone outputs. The MH-40B provides increased monitoring capacity - with practically unlimited freedom of expansion and figure configuration.

Mfg. list \$350.00 **CALL FOR BSW PRICE**

EDCOR



Model HA-400A 4 Channel Headphone Amplifier

Four independent stereo amplifiers, each with its own volume control. Provides high fidelity reproduction, far surpassing all but the most expensive systems.

Mfg. list \$223.00 **CALL FOR BSW PRICE**

Symetrix



20 Watts Per Channel

Model A-220 Stereo Amplifier

High performance, low power stereo amplifier. The A-220 will develop better than 20 watts per channel into 8 ohms with full power distortion of less than .02% @ 1 kHz. Typical application includes the powering of headphone distribution boxes and small monitor speakers.

Mfg. list \$315.00 **CALL FOR BSW PRICE**



MATCHBOX

By Henry Engineering



The Matchbox is the ideal, inexpensive way to correctly interconnect "HI FI" or semi-pro equipment with professional studio gear. The Matchbox is a bidirectional unit with four independent amplifiers providing full stereo input and output interface. Features adjustable output levels.

Mfg. list \$195.00 **CALL FOR BSW PRICE**

GENTNER AUDIO PRODUCTS



The 6X Headset/Speaker Amplifier is a six output stereo amplifier capable of delivering up to 2 watts per channel. The flexible input configuration of the 6X makes set-up and operation fast, simple, and adaptable to each and every application. The 6X has a master stereo input and individual direct inputs for each of six channels. The direct inputs are designed for your flexible applications, providing either mono or stereo input.

Mfg. list \$595.00 **CALL FOR BSW PRICE**



DOAs-1 & 2

Interfacing a compact disc player, FM tuner, audio or video cassette machine to the professional audio environment can be very frustrating. The DOAs-1 & 2 provide the optimum answer to the need for a professional level interface, and at less than half the price of an external device. With variable gain from off to +26 dB and by mounting inside your equipment, they turn your gear "pro".

BSW PRICE 1-5 \$55.00 ea.
BSW PRICE 6+ \$49.50 ea.

RUSSCO

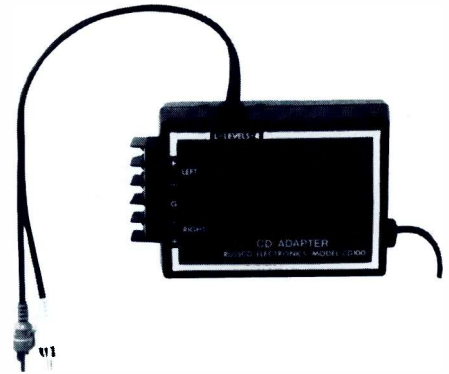

Model CD100 Impedance Matching Amplifier

Don't be fooled by the size or price of this little gem. Despite its small size and inexpensive price tag, the CD100 is an impedance matching amplifier forged from the anvil of craftsmanship.

The CD100 can be used to interface any high impedance output device to a 600 ohm line; balanced or unbalanced.

Frequency response: 15 Hz - 30 kHz

H. distortion: < .1%

Noise: < 75 dB

Mfg. list \$69.95 **CALL FOR BSW PRICE**

APHEX



Model 124

The Model 124 from ApheX will easily interface consumer audio equipment with professional studio and broadcast facilities. Active, servo-balanced circuitry converts +4 dBm (or +8 dBm) line levels to -10 dBm (hi-fi) levels, and back again. XLR and RCA-type connectors enable quick hookup.

Frequency response: 5 Hz to 50 kHz +0. -0.4 dB

THD: 0.005% @ 1 kHz

Crosstalk: -95 dB @ 1 kHz, -78 dB @ 20 kHz

Noise: -95 dBm. 20 Hz - 20 kHz

Mfg. list \$219.00 **CALL FOR BSW PRICE**

TASCAM

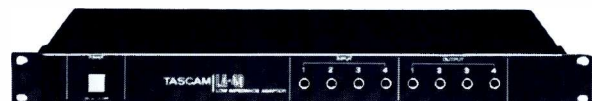

LA-40 Line Amplifier/Impedance Converter

The Tascam LA-40 is the perfect one rack space solution to the problem of mismatched line levels or impedances. The LA-40 is a compact 4 channel unit that establishes instant compatibility between Tascam or similar -10 dbv unbalanced inputs and outputs and almost all other equipment. Compatible levels, compatible impedances and balanced/unbalanced operation.

Mfg. list \$450.00 **CALL FOR BSW PRICE**



Protect against dangerous paralleled feeds, noisy unbalanced loops, poorly isolated splitters and inaccurate attenuators.

Distribution Amplifiers

Isolate, balance and set levels precisely

- 8 or 16 Balanced. +18 dBm outputs
- Individual smooth log taper controls
- LED output overdrive indicators
- Parallel inputs for 1 x 8, 2 x 8, or 1 x 16 use
- Short proof outputs
- Triple RFI protection

DA208 Dual 1 x 4
Mfg. list \$329.00 **CALL FOR BSW PRICE**

DA416 Quad 1 x 4
Mfg. list \$469.00 **CALL FOR BSW PRICE**



Model DA1008-1 (1 in, 8 out)
Distribution Amplifier
Individual level adjustment for each output - hot molded audio taper controls.

- SCAN monitor system readout shows selected channel for monitoring
- Headphone output with front panel level control
- Rack mount brackets supplied

Mfg. list \$850.00 **CALL FOR BSW PRICE**

Model DA2016-1 (Dual-2 in, 16 out)
Mfg. list \$1,195.00 **CALL FOR BSW PRICE**

Model L-1000
Precision Dual Line Amplifier

- High input overload capability: ± 24 dBm bridging
- Low noise: -107 dBm equivalent input noise (20 kHz bandwidth)
- Low distortion: .2% max. transformer output

L-1000-1 Dual, Transformer Outputs Mfg. list \$345.00

Model M-1000
Precision Dual Microphone Amplifier

- Transformer coupled inputs incorporate full electrostatic and magnetic shielding
- XLR type input connectors
- Low noise: -124 dBm equivalent input noise

M-1000-1 Dual, Transformer Outputs . . . Mfg. list \$365.00

Model MA 1000-1
Precision Stereo Headphone Power Amplifier

- Ideal headphone or small loudspeaker driver for low output consoles, newsroom cart machines, etc.
- 25 W switchable mono bridged operation

MA 1000-1 Mfg. list \$385.00

CALL FOR BSW PRICE

Disc-Patcher

Model DP-100
PRO—IHF
The Disc-Patcher™
DP-100

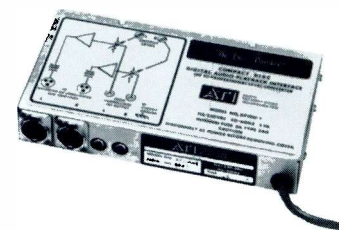

A uni-directional stereo interface for Playback Only applications. It is designed specifically to convert the unbalanced IHF outputs of Digital Compact Disc Players to transformer balanced and isolated 600 ohm line levels with no compromise or degradation of the superb performance available from the digital audio source. The DiscPatcher™ is equally at home on a newsroom desk to interconnect field ENG cassette recorders into broadcast systems for dubbing.

Mfg. list \$209.00 **CALL FOR BSW PRICE**

Rack Mt. Panel Available.



SHURE



Model FP-16 Portable Distribution Amplifier

Shure Model FP-16 is a 1-input, 6-output distribution amplifier specially designed for field production use and offers features and performance rarely found in other distribution amplifiers. Phantom power is available at the input for use with condenser microphones; and all 6 outputs, as well as the input, are individually switchable to mic-or-line level. In addition, The FP-16 features link input and output jacks for interconnecting several FP-16's or adding external signal processing equipment such as equalizers, compressors or limiters.

Other features include: ruggedness and reliable operation over wide temperature and humidity extremes; light weight and compactness for portable/location use or rack-mountable (with accessory rack mount kit) for studio installations; powered by AC or built-in battery pack; recessed, screwdriver-adjustable gain controls; and power, normal, and overload LED indicators.

Mfg. list \$570.00 **CALL FOR BSW PRICE**

Symetrix



1/2 Rack SX200 Series

All SX200 Series products from Symetrix have high headroom balanced inputs, very low noise, wide dynamic range, low distortion studio quality circuitry, and low impedance high current balanced and unbalanced output line drivers. The small physical size of the SX200 Series allows them to be used in stand alone table-top operation, or mounted side by side using the optional rack mounting kit.

Model SX202 Dual Mic Preamp

The SX202 Dual Microphone Preamplifier, features two ultra clean microphone preamplifiers with variable gain, 15 dB pad, + 48 volt phantom powering, left, right, and left + right outputs. Mfg. list \$219.00 **CALL FOR BSW PRICE**

Model SX204 Headphone Amp

The SX204 Headphone Amplifier, 1-in 4-out amplifier utilizing proprietary high voltage converter technology to drive high impedance headphones like a big power amp, while providing more than ample power for low impedance phones. Mfg. list \$269.00 **CALL FOR BSW PRICE**

RADIX

Sterling Performance

So Much More Than An Ordinary Distribution Amplifier



DA 1600 Distribution Amplifier

Sure the specs on the Radix DA-1600 are great, but one of the best things about this DA is on the back...removable, plug-in connectors. Wiring changes can be made quick and effortlessly with the DA still in the rack. Connectors require no soldering and are better than barrier strip.

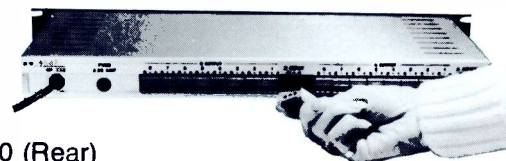

DA 1600 (Rear)

Features and Specifications

- 8 stereo or 16 mono outputs. Each output has front panel level control
- Exceptionally low noise circuitry
- Selectable pads to accommodate a wide range of input levels
- THD: .01% max @ +20 dBm out
- Noise: 90 dB with respect to 0 dBm out
- Output separation: 90 dB

Compact design for easy installation

Mfg. list \$435.00 **CALL FOR BSW PRICE**

RAMSA

Panasonic
Industrial Company



Professional Power Amplifier 50 Watt Stereo

Model WP 9055

Truly great amplifiers are measured by two standards. Sonic quality and reliability. The Ramsa 9055 power amplifier achieves excellence on both counts.

- UL listed
- 5 year limited warranty

Mfg. list \$590.00 **CALL FOR BSW PRICE**

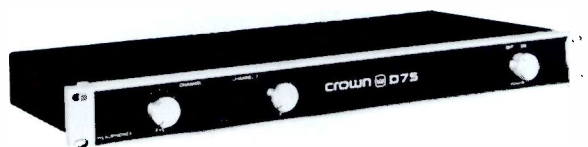

Model D75 Stereo Amplifier

Broadcasting's most popular amplifier. 35 watts per channel RMS with harmonic distortion only .05%. The D75 features active balanced inputs and XLR connectors. 3 year warranty. Mfg. list \$524.00 **CALL FOR BSW PRICE**



Model D150A2 Stereo Amplifier

Broadcasters, recording studios, churches and sports arenas all over the world have recognized Crown's D150A as a standard of audio excellence. 80 watts per channel RMS into 8 ohms. Mfg. list \$749.00 **CALL FOR BSW PRICE**

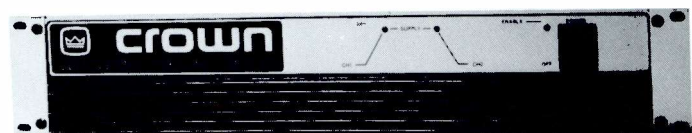

Model MT 1200 Stereo Amplifier

Micro-Tech™ series amplifiers from Crown are packed with Crown Quality and plenty of power. Model 600 delivers 200 watts per channel into 8 ohms and Model 1200 delivers 350 watts per channel into 8 ohms. 3 year warranty.

Model 600

Mfg. list \$949.00 **CALL FOR BSW PRICE**

Model 1200

Mfg. list \$1,199.00 **CALL FOR BSW PRICE**

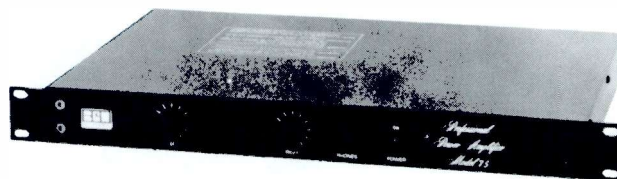

Model 85 Stereo Amplifier

- Front panel mounted magnetic circuit breaker
- Power output 35 watts per channel or 90 watts mono (80 ohms)
- Toroidal mains transformer
- Front panel headphone jacks
- Rear panel stereo/mono switch

Mfg. list \$529.00 **CALL FOR BSW PRICE**



Model 150 Stereo Amplifier

- 50 watts per channel
- .05% THD 8 ohms
- XLR and 1/4 inch input connectors

Mfg. list \$799.00 **CALL FOR BSW PRICE**



Model 1080 Stereo Amplifier

The Model 1080 is a moderate power, single rack space amplifier designed for professional and commercial audio applications requiring both high performance and high reliability. The 1080 is loaded with useful features and benefits.

35 watts per channel at 8 ohms. Mfg. list \$538.00 **CALL FOR BSW PRICE**

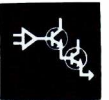

Model 310B Professional Phono Preamp

The Model 310B Stereo Phono Preamp is designed to correctly interface all Stanton and selected magnetic phonograph cartridges for optimum playback of disk records and calibration of audio systems. The 310B Preamp features universal mounting by special brackets, instant selection of flat or NAB postemphasis curves, switchable, effective rumble filter, individual adjustments of gains and high frequency responses, trimming of the capacitive cartridge loading at the input, provision for setting the power transformer for either 117 or 230V operation at 50 or 60 Hz and immunity to external magnetic AC fields. The 310B can be used in balanced as well as in unbalanced modes as well as in-phase and out of phase mix of L and R channels for monophonic reproduction of older records.

Mfg. list \$280.00 **CALL FOR BSW PRICE**

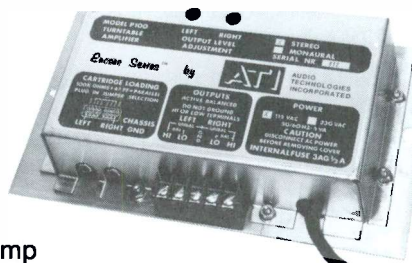

Model P-100S Precision Phono Preamp

When you're on a limited budget, (and aren't we all) you want the very best audio quality without the expensive frills. The P-100S Stereo phono preamp from ATI offers state-of-the-art specs in a cost effective enclosure. Quality components allow the P-100S to achieve a 90 dB signal to noise ratio, channel separation of 60 dB minimum and distortion .1% maximum 20 - 20 kHz.

Mfg. list \$269.00 **CALL FOR BSW PRICE**



M64A Series Stereo Preamp

The M64A is a compact, professional stereo preamp which solves a variety of preamplification and equalization problems. A three-position slide switch selects different equalization depending on the desired application.

In the phono position, the M64A provides standard RIAA equalization.

In the tape position, playback heads on tape recorders are provided with NAB equalization.

In the flat position, The M64A can be used as a microphone preamp or a low-gain buffer amplifier where long cable lengths are necessary.

Mfg. list \$106.00 **CALL FOR BSW PRICE**

RADIX

Turntable Preamp

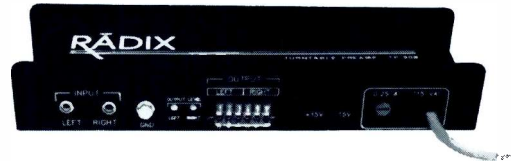

Sterling Performance

Model TP-500

RADIX is everything you would expect from a high performance turntable preamp. Superb specifications make Radix ideal for stereo, or dual preamp for two channel monaural use. And yet, the cost remains competitive with other quality brands. That's sterling performance.

Designed For Exceptional RFI Immunity

- Distortion: Less than .01% at full output
- Noise: Better than 76 dB S/N unweighted
- Channel separation: 90 dB
- Output: +20 dBm single ended .600 ohms
+25 dBm balanced .600 ohms
- Designed for stereo or dual mono operation
- Compact enclosure - easy to install

Mfg. list \$289.95 **CALL FOR BSW PRICE**

BSW

**YOU WANT IT?
WE'VE GOT IT.**

At BSW we pack our warehouse full, so you've always got a great selection of product waiting for you. Check out our million dollar inventory today!

1-800-426-8434



SCALA ELECTRONIC CORPORATION

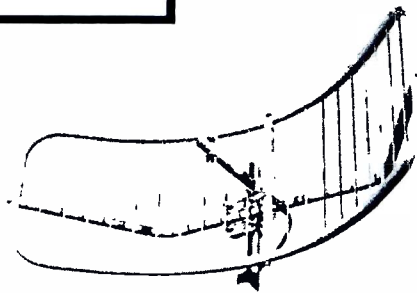

Model MF-960 Miniflector Antenna

- Aural broadcast STL
- Telemetry
- Point to point communications
- Vertical polarization for STL

Mfg. list \$300.00

CALL FOR BSW PRICE

MARK ANTENNA

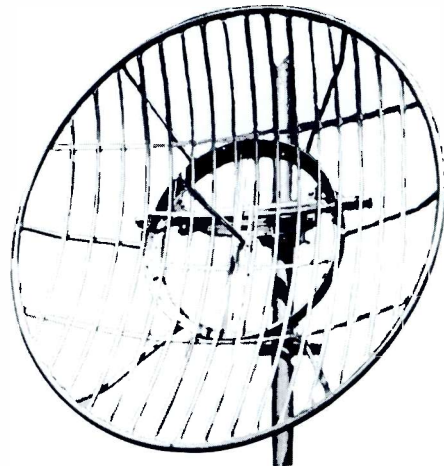

**GRID PARABOLIC RINGBACK ANTENNA
380 - 960 MHz**

- Wind loading characteristics to 25% of comparable size parabolas
- Cross polarization discrimination response exceeds 40 dB
- Survival: 125 MPH with 1 inch ice

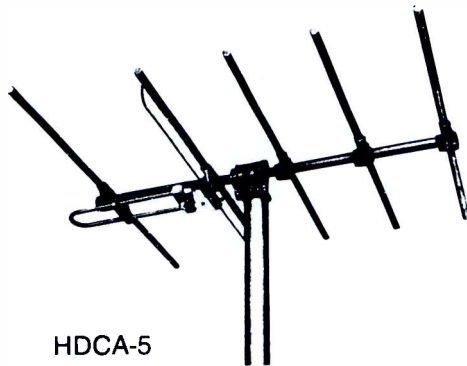

HDCA-5

HDCA-5 Series Ruggedized Yagis

Five and ten element single-channel yagis for VHF-TV and FM channels. Anodized aluminum castings and seamless pipe and tubing, plus stainless steel fastenings and hardware for long life in severe environmental conditions. Heavy brass balun structure for improved performance and reliability. Precision coax stacking harness available for two-bay and four-bay arrays.

PRICES BASED ON CONFIGURATION

CALL BSW 1-800-426-8434

FULL LINE OF ANTENNAS

- Microwave
- Point To Point
- Cellular
- Earth Station
- Two Way

**FOR THE BEST INFORMATION —
SPECIFICATIONS — SERVICE &
PRICING CALL BSW TOLL FREE
1-800-426-8434**

Model PR-450U Antenna

- UHF-TV reception
- UHF-TV translators
- Telemetry
- CATV systems
- Point to point communications
- Aural broadcast STL systems

Mfg. list \$550.00

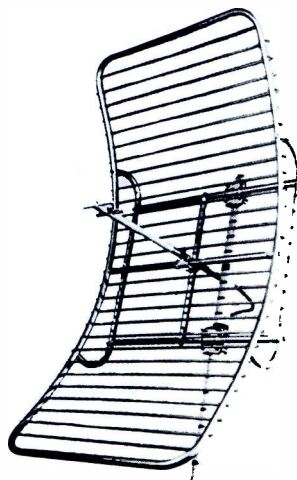

CALL FOR BSW PRICE

BSW

TIME IS MONEY

**SAVE A BUNDLE WITH
BSW'S FAST SERVICE,
CALL US AT
1-800-426-8434**

Larsen

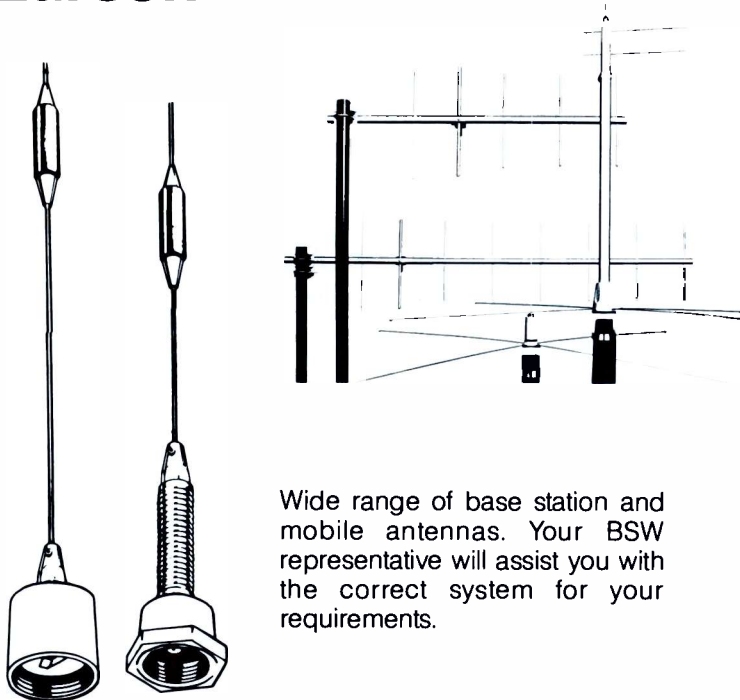

Wide range of base station and mobile antennas. Your BSW representative will assist you with the correct system for your requirements.

CALL FOR BSW PRICES

SCALA ELECTRONIC CORPORATION



Model 8000 STL Preamp
Now, Improved Performance From Your 950 MHZ Radio Link, at a Very Modest Cost.

Scala offers the 8000/STL low-noise preamplifier for use in broadcast STL, TSL and ICR systems. This professional quality preamp is specifically designed to be used by broadcasters where the excellent noise-figure and high gain can provide improved system noise performance, allow the use of smaller receive antennas and coax transmission line than might otherwise be necessary, and help overcome path fades on marginal systems. Gain is 20 dB minimum.

Mfg. list \$380.00 **CALL FOR BSW PRICE**

Shively Labs

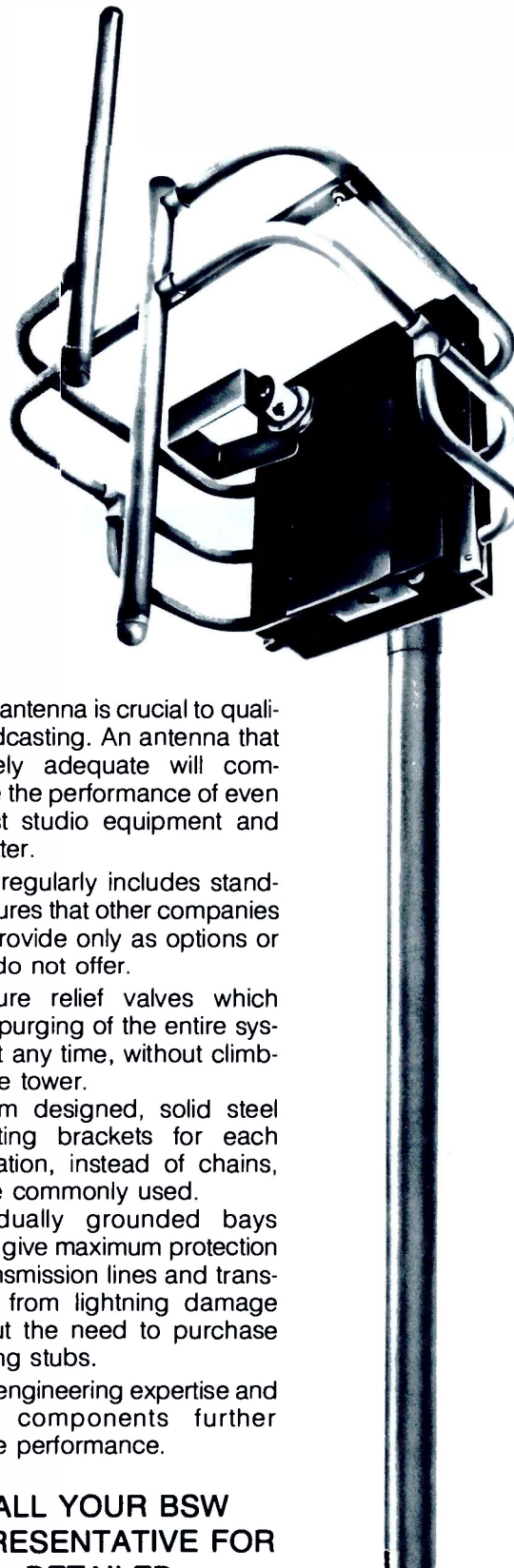

A good antenna is crucial to quality broadcasting. An antenna that is merely adequate will compromise the performance of even the best studio equipment and transmitter.

Shively regularly includes standard features that other companies either provide only as options or simply do not offer.

- Pressure relief valves which allow purging of the entire system at any time, without climbing the tower.
- Custom designed, solid steel mounting brackets for each installation, instead of chains, as are commonly used.
- Individually grounded bays which give maximum protection to transmission lines and transmitter from lightning damage without the need to purchase shorting stubs.

Shively engineering expertise and quality components further enhance performance.

**CALL YOUR BSW
REPRESENTATIVE FOR
DETAILED
INFORMATION,
SPECIFICATIONS
AND PRICING.
1-800-426-8434**



CELWAVE

FM BROADCAST ANTENNAS

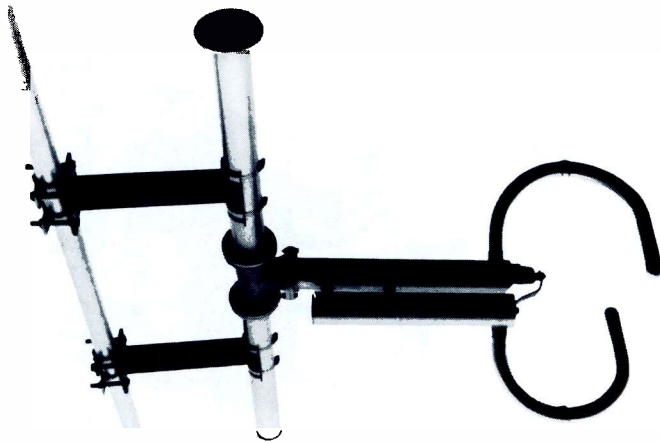

- FM Broadcast Antennas
- Circularly or Horizontally Polarized
- Radomes
- Directional Couplers
- Low Pass Filters
- Base Station Antennas
- Cavity Resonators
- Duplexers

Here is a series of circularly polarized and horizontally polarized commercial and educational antennas for the FM broadcast industry. These antennas are less susceptible to corona. The unique circularly polarized antenna assures phase coincidence of the vertical and horizontal components.

Circularly and horizontally polarized antennas are available with any combination of null fill and beam tilt. The high power and low power antennas utilize identical radiating elements. The low power series employs 1 5/8 inch feedline. The high power units use 3 1/8 inch feedline. Both series of antennas are available in systems which incorporate 1 to 16 elements.

**For Details Call Toll Free 1-800-426-8434
Or FAX 206-565-8114**



Cetec Broadcast Group

FM Broadcast Antenna
True Circular Polarization

FM Broadcast Antenna
Educational & Low Budget

FM Broadcast Antenna
Low Power Broadcast

FM Broadcast Antenna
Medium Power

FM Broadcast Antenna
High Power - Heavy Duty

FM Broadcast Antenna
Extremely High Power
Heavy Duty

Radomes

Electronic & Automatic
Deicer Controls &
Deicer Heating Equipment

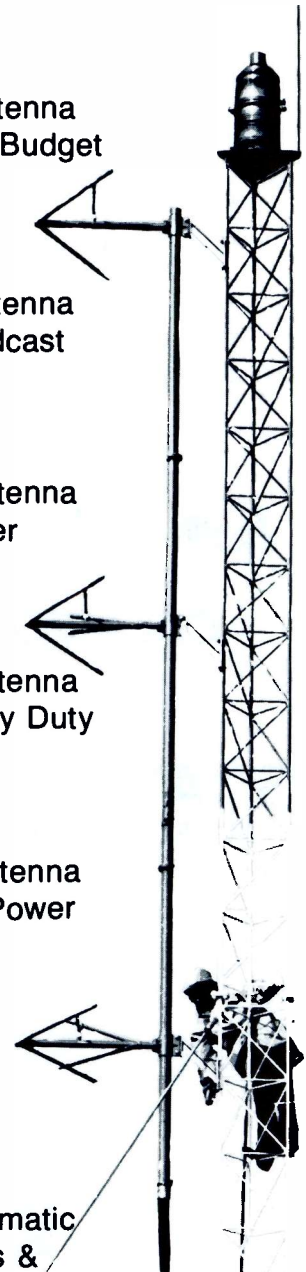

JSCP Series B
Broadcast Antenna

CETEC Antenna (formerly JAMPRO), manufactures a complete line of high quality antennas, components and deicer equipment for all broadcast applications.

**Call BSW Toll Free
For Configuration & Pricing
1-800-426-8434**



AKAI

professional

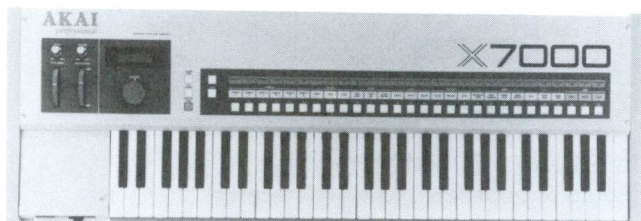

Model X7000
Digital Sampler

Audio Production facilities nationwide are enjoying the benefits of owning a keyboard sampler. Sound effects, creative musical beds, are just two of the many things samplers allow you to do all without tape and razor blades. The Akai X7000 is an extremely versatile unit that even includes a disc drive so you can load factory programs or create your own. Call your BSW sales representative today for information on the benefits of owning the Akai X7000.

SPECIFICATIONS

KEY

- 61 key 5 octave C-C scale/velocity sensitive

VOICE

- 6 voice

SPLIT

- 16 split areas (with memory expansion P.C. board ASK70)

SYSTEM

- 12 bit digital sampling
- Sampling frequency: 4kHz-40kHz (MIN-MAX)
- Sampling time: 8 sec-0.8 sec (MAX-MIN)
- Frequency response: 25 Hz-16kHz

DATA STORAGE

- Built-in 2.8 inch disk drive
- Memory capacity: 128k byte
- Memory medium: 2.8 inch quick disk
- Internal memory: 16 sampled sounds

Mfg. list \$1349.95

CALL FOR BSW PRICE



ORBAN

AM OPTIMOD™

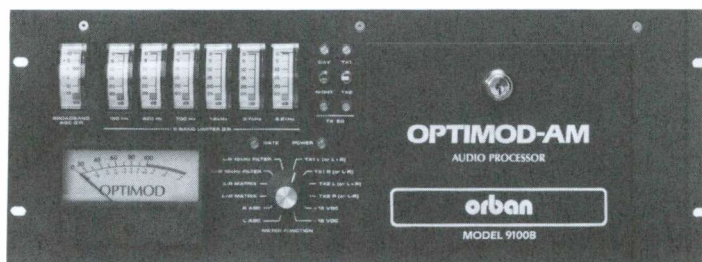

Model 9100B

The new Model 9100B OPTIMOD-AM gives you all the performance and features that have made OPTIMOD-AM the choice of so many stations concerned about competing with FM. In addition, the 9100B provides the high frequency pre-emphasis and 10 kHz low pass filtering recommended by the National Radio Systems Committee (NRSC). The 9100B increases coverage, improves source to source consistency and delivers superb audio quality on both voice and music. And, incorporating the new NRCS standard allows the new OPTIMOD-AM to be even louder.

Model 9100B1 Mono

Mfg. list \$4,395.00 **CALL FOR BSW PRICE**

Model 9100B2 Stereo (For C-QUAM)

Mfg. list \$5,995.00 **CALL FOR BSW PRICE**

ORBAN CO-OPERATOR™

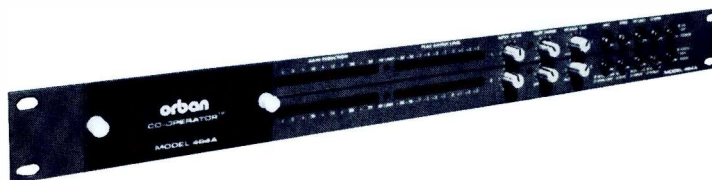

Your Assistant Operator

The Orban Co-Operator is a friendly, automatic "assistant operator" that smoothly and unobtrusively rides gain and limits peaks.

Model 464A
Co-Operator

Features:

- Transparent gain riding—without overshoots
- Release time and release shape are adjustable to optimize processing for music or voice
- A defeatable "silence gate" prevents noise rush-up
- Two channels in a space saving, rugged, all metal, 1 3/4" package

The Orban 464A Co-Operator provides an unprecedented combination of versatility, audio quality and ease of use.

Mfg. list \$1,195.00 **CALL FOR BSW PRICE**



ORBAN

Orban 222A Stereo Spatial Enhancer

An effective and affordable enhancement tool for on air spatial definition.



Why Stereo Spatial Enhancement?

In contemporary broadcast audio processing, high value is placed on the loudness and impact of a station compared to its competition. The industry leading OPTIMOD™ processors already have made a major contribution to competitiveness. Now, the new Orban 222A stereo spatial enhancer can augment your station's spatial image the way your audio processor maximizes loudness and brightness. Your stereo image will become magnified and intensified; your listeners will also hear more loudness, brightness, dynamics and depth.

- Proprietary, patent pending technique detects and enhances psychoacoustic directional cues which are present in all stereo program material.
- Increases brightness, impact and definition of music
- Front panel enhancement and width limit controls allow tailoring of processing to user requirements.
- No increase in FM multipath distortion, no unnatural exaggeration of reverberation, and no increase in sensitivity to vertical tracing distortion in disc playback.
- Full mono compatibility
- Complements any broadcast audio processor without changing the station's "sound".
- Easy to read LED bargraph displays indicate status and degree of enhancement.

MFG. list Only \$995.00

CALL FOR BSW PRICE



Model 8100A/1 OPTIMOD™ FM Audio Processor/Stereo Generator

The standard in FM audio processing.
Performance Highlights

- Multiband compressor/limiter/stereo generator
- Multiband or wideband operation plus versatile setup controls permit precise "tuning" for different formats
- Freedom from processing artifacts and distortion
- Optimum voice/music balances
- Excellent high frequency power handling for brightest sound
- State-of-the-art stereo generator
- Overshoot compensator permits full modulation at all frequencies, yet doesn't increase low frequency IM distortion

Plus

- Dual chassis (studio/transmitter) option
- Excellent stability and unit to unit uniformity
- Plug-in card construction for easy maintenance
- Built-in crosstalk test generator
- Rigorous RFI shielding
- True VCA gain control
- True peak reading gain reduction meter
- Low stereo generator output impedance permits longer baseband cable runs

Mfg. list \$4,995.00 **CALL FOR BSW PRICE**

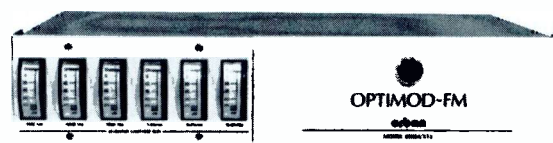

Model 8100A/XT2 Six-Band Limiter Accessory Chassis

The 8100A/XT2 works with any 8100A OPTIMOD™-FM and features two high frequency equalizer controls: Presence and Brilliance. They complement the original 8100A/XT's bass EQ controls, and give you twice the flexibility of the single HF EQ control typical of other add-on multiband processors.

The XT2 also excels in the most difficult of processing tradeoffs—delivering loudness on music while keeping speech free from clipping distortion. Credit this uniquely capable performance to Orban's patented multiband distortion cancelled clipping system—which they were able to implement in the XT2 system because the XT's circuitry is fully integrated into the processing system, not just tacked onto the front.

The XT2 lets you have it all: natural sound, source to source consistency, loudness, clean voice and adjustability that lets you tailor bass and treble to your taste and format requirements. And thanks to its efficient single chassis construction and its use of the main 8100A power supply, it lets you have the next step in OPTIMOD™ processing at an exceptionally reasonable price.

Mfg. list \$2,075.00 **CALL FOR BSW PRICE**



ORBAN

Orban 642B Parametric Equalizer



The Next Generation of Parametric Excellence

- 4 band, dual channel parametric equalizer. Each section offers overlapping tuning with a 25:1 frequency range + 16 dB boost/ - 40 dB cut in each band.
- Bandwidth variable from about 5 to 1/4 octaves: ("Q": 0.29 to 5.0).
- "Constant-Q" design enables use of equalizer as a true infinite depth notch filter; vernier frequency control on each band facilitates precise tuning of notches.
- Tunable 18 dB/octave high pass filter and 12 dB/octave "Automatic Sliding Besselworth"™ low pass filter provide maximum flexibility while preserving musicality.
- Front panel cascade switch permits use as either a two channel 4 band, or one channel 8 band equalizer.
- Noise and distortion specs significantly better than 16 bit digital.
- Active balanced inputs and outputs with optional output transformer.

Mfg. list \$995.00 **CALL FOR BSW PRICE**



Model 412A Compressor/Limiter

The Orban 412A is a basic, cost effective compressor/limiter with remarkably natural sound and extraordinary ease of use. A streamlined, straight forward front panel offers the most demanded user controls, including attack time, release time, ratio and threshold.

This is a no frills unit with all the essentials at a very attractive price.

Model 412A (1 channel)
Mfg. list \$459.00 **CALL FOR BSW PRICE**

Model 414A (2 channel)
Mfg. list \$849.00 **CALL FOR BSW PRICE**



Model 111-B/1 Dual Reverb

The 111-B/1 offers two channels of reverb in a single package that combines both electronics and spring delay lines. It is a reverb that combines full Orban quality and reliability with significant advances in cost effectiveness. It's the only choice for anyone needing two channels of fully professional reverb in an economical package.

Mfg. list \$959.00 **CALL FOR BSW PRICE**

Orban 787A Programmable Mic Processor



Powerful, Programmable Processing for Maximum Impact.

Three band parametric equalizer, compressor, de-esser, noise gate, compressor gate and optional ducker integrated in a compact, powerful system. Stores up to 32 different control setups in memory for instant recall. Designed for DJ mic processing and voice recording, but versatile enough for many other production uses.

Nearly any voice can be made more appealing by the judicious use of mic processing. Each voice at your station or studio can be assigned a permanent setup for each mic/studio combination for instant recall just before the voice airs. The programmable mic processor gives you an important competitive edge by enabling you to get the sound you want quickly and consistently.

Mfg. list \$1,995.00 **CALL FOR BSW PRICE**

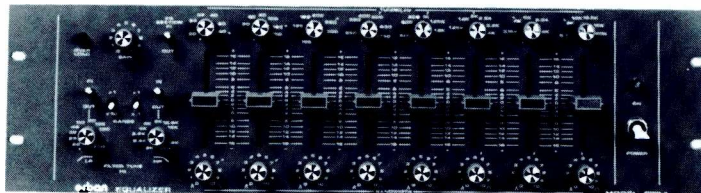

Model 672A Equalizer

A cost effective professional quasi-parametric equalizer with the convenience of graphic type EQ controls. Features very low noise and distortion, high slew rate for minimum TIM (SID), front panel gain control with 12 dB gain available, "peak stretching" overload lamp to warn of clipping, active balanced inputs and unbalanced outputs.

Mfg. list \$689.00 **CALL FOR BSW PRICE**



Model 245F Stereo Synthesizer

The Orban 245F stereo synthesizer has been designed to take any mono signal and create life like pseudostereo. Unlike many other techniques, the patented Orban stereo synthesis technique causes no change in spectral balance, does not blur the transient definition and adds not the slightest audible noise or distortion to the mono original. The stereo output sums back to the original mono for total mono/stereo compatibility. And the simple controls adjust in seconds to create an optimum stereo effect from any mono original.

Mfg. list \$459.00 **CALL FOR BSW PRICE**



THE PROFESSIONAL'S CHOICE



FM STEREO PROCESSING SYSTEM

CRL FM audio processing systems have far more than just a new look. The latest advances in FM broadcast and stereo sound field technology have been incorporated into new products to make the popular CRL processing systems even more flexible and better.

The versatile modular design has been maintained to allow easy interfacing into any transmission environment.

The new CRL FM processing systems are modular and are comprised of either two, three or four of the following basic signal processing concepts:

- Input audio gain control
- Optional multiband compression
- Final peak modulation limiting
- Digital stereo generation

When used together, these units provide complete program audio control to maximize stereophonic modulation while maintaining tonal clarity and integrity of original program sources.

Summary of components:

- SGC-800 stereo gain controller. High quality multiband AGC and is designed for use as the first unit in a CRL system. Exclusive to the unit is Dynafex™ noise reduction.
- SEC-800 spectral energy compressor. Allows four channel EQ. Programmable attack/release times. Switch selectable wideband or multiband limit or compress modes.
- SMP-850 stereo modulation processor. Final peak limiter offering maximum performance and fidelity. Unique stereophonic enhancement system can be used to create dramatic stereo sound fields.
- SG-800A stereo generator. Digitally synthesized providing the ultimate in stereophonic baseband generation.
- CRL FM processing can be purchased either as a system or as separate components.

**FOR DETAILED INFORMATION
BEST PRICE & SERVICE
CALL YOUR BSW
REPRESENTATIVE
1-800-426-8434**

AM AUDIO PROCESSING SYSTEMS

CRL AM audio processing systems have far more than just a new look. The latest advances in AM broadcast processing technology have been incorporated into new products to make the ever popular CRL processing systems even more flexible and better.

The versatile, modular design has been maintained to allow easy interfacing into any transmission system

CRL's commitment to AM is further confirmed by the incorporation of circuits that provide the pre-emphasis and output filtering characteristics which have been defined by the NRSC Voluntary Standard which CRL helped pioneer.

The new CRL AM processing systems are modular and are comprised of either two or three of the following basic signal processing concepts:

- Input audio gain control
- Optional multiband compression
- Final peak modulation limiting

When used together, these units provide complete program audio control to maximize modulation while maintaining tonal clarity and integrity of the original source material.

Summary of components:

- AGC-400 mono SGC-800 stereo gain controller. Designed to be used as the input unit. Offers wideband or multiband processing configuration. In addition, this AGC unit incorporates Dynafex™ noise reduction.
- SEC-400 mono SEC-800 stereo spectral energy compressor. Programmable four channel multiband compressor allows you to tweak your sound. Switchable AGC gating threshold.
- PMC-400A mono SMP-900A stereo peak modulation controller. Incorporates selectable NRSC pre-emphasis and bandwidth filtering standards. Also standard is adjustable, low frequency phase ("tilt") correction and high frequency overshoot correction. Purchase as a system or separate components.

**YOUR BSW REPRESENTATIVE
IS READY TO ANSWER
YOUR QUESTIONS
1-800-426-8434**



Eventide



Shattering Development In Audio Effects

Model H3000B

Special effects that will blow you away. Never before has such a creative opportunity presented itself in one complete package. Clear the rack...here comes the Eventide H3000B. Special software created specifically for broadcasters, will amaze your air staff and delight your listeners.

Air personalities suddenly have all sorts of unusual voices at the push of a button. When they speak through the H3000B, characters that sound like Max Headroom, Cuzzin It, or a variety of others, mysteriously appear. Thundering helicopters, blasting cannons, and tremendous storm-like effects capture the attention of your listeners and are easy to use.

Now look what the H3000B will do for your production department. This unit features built-in stereo audio time compression and expansion, and it's completely automatic. Changing the running time of recorded reel-to-reel and cart tapes has never been this easy. Just use the numeric keypad to input the current running time of the program material and then tell the H3000B how long you want it to be! You get the capabilities of a standalone time compression system which costs five times the price of the H3000B!

Mfg. list \$2,995.00 **CALL FOR BSW PRICE**



SP2016 Effects Processor/Rverb

The most complete, versatile effects unit we sell. The SP2016 is a stereo unit that comes complete with all software that is user programmable.

- Effects include:
- Time scramble
 - Gated reverb
 - Musical combs
 - Chorusing

A whole new world of special effects at your fingertips.
Mfg. list \$6,895.00 **CALL FOR BSW PRICE**



Model H969 ProPitch Harmonizer

Eventide Harmonizers® have always set the world standard in pitch change technology. The H969 ProPitch™ Harmonizer maintains Eventide's leadership with the cleanest, highest quality pitch change ever, for the most demanding applications. This top-of-the-line Eventide Harmonizer features:

- ProPitch™ for unprecedented pitch change quality
- Twelve instant pitch presets at precise musical intervals
- Wide delay range and added delay feature
- Extended reverse and repeat reset modes
- New doppler effect and extended flanging

Mfg. list \$4,500.00 **CALL FOR BSW PRICE**



Model BD980 Broadcast Audio Delay Line

The BD980 features an advanced, deglitched catch-up system, that is based on Eventide's patented Harmonizer® technology. When objectionable program audio is "dumped" with the BD980, delay catch-up is faster and audio quality is cleaner than ever before.

- Features:
- Extended frequency response to 20 kHz
 - Adjustable delay up to 10 seconds
 - Time compression capabilities
 - Stereo operation

Mfg. list \$5,495.00 **CALL FOR BSW PRICE**



Model BD931 Broadcast Audio Delay Line

- 16 kHz frequency response
- Greater than 90 dB dynamic range
- Mono or stereo available

	BD 931 Mono Mfg. list	BD 932 Stereo Mfg. list
3.2 second delay	\$1,795.00	\$2,595.00
6.4 second delay	\$2,295.00	\$4,495.00

CALL FOR BSW PRICE



Lexicon



Model PCM 70

The Lexicon PCM 70 lets you choose from more than 40 imaginative factory programs. Versatile effects programs cover chorus and echo, multiband delays and resonant chords each with six voices. In addition, the PCM 70 offers you Lexicon reverb programs like concert hall, rich chamber and rich plate. Using these factory programs as a basis, you can create 50 of your own individualized programs and store them in separate user registers. That gives you instant access to a total of more than 90 available programs.

Mfg. list \$2,295.00 **CALL FOR BSW PRICE**

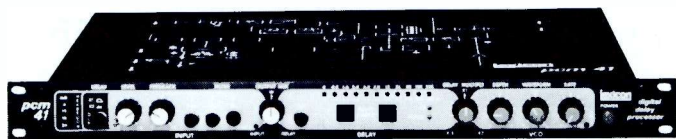

Model PCM 41

The Lexicon PCM 41 digital delay processor is used throughout the performing and recording worlds.

It is designed in the Lexicon tradition—without compromise. The PCM 41 uses pulse code modulation, with its inherent freedom from distortion and its dynamic range. Not a cheaper method with lower fidelity.

With superb VCO capability, the PCM 41 has influenced the sound of a music generation. The Lexicon VCO provides a multi-waveform time sweep for uncommonly dramatic effects, such as extra fat chorusing and doubling.

Live performances, studio recording and broadcast production move fast, so both talent and studio engineers appreciate the simple, functional operation.

Mfg. list \$715.00 **CALL FOR BSW PRICE**

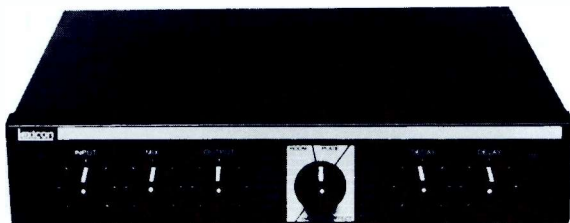

The LXP-1 Multi-Effects Processor...

The right sound, features and price. Lexicon is known throughout the world as the leader in digital reverb effects. Now, you can get that famous Lexicon quality for a very low price. The LXP-1 is simple to operate, yet it will deliver more than 4,000 distinct sounds. Select from effects such as hall, plate, and room reverb in different sizes and brightnesses, delay, chorus, etc... The LXP-1 is space efficient too, only 1/2 rack space required.

Mfg. list \$499.00 **CALL FOR BSW PRICE**

Symetrix



SX201

Parametric EQ-Preamp

The Model SX201 Parametric Equalizer/Preamp is a high performance studio quality parametric equalizer/notch filter designed to handle both low level and line level inputs. Three fully parametric bands of equalization are provided, with +15dB boost and -30dB cut capability, allowing the SX201 to be used for both creative and corrective equalization. Overlapping frequency controls cover the entire audio range, from 16 Hz to 20kHz. Bandwidth is continuously variable from .05 octave (for deep notch filtering), to 3.3 octaves (for smooth tone shaping). Distinguished by its superb sonic integrity, extremely low noise and low distortion performance, the SX201 delivers uncompromising quality in a remarkably compact package. Requires only 1/2 rack space.

Mfg. list \$239.00 **CALL FOR BSW PRICE**



Model 511A

Noise Reduction

The Model 511A is a two channel, single-ended noise reduction system configured for use in professional and commercial audio systems. With its dynamic high frequency filter and downward expander, up to 30 dB overall reduction of both high frequency and broadband noise is attainable. The dynamic filter reduces high frequency sounds like hiss, RF artifacts and dimmer noise, while broadband and low frequency phenomena like hum, turntable rumble and air conditioning noise are reduced by the expander. A high performance 18 dB/octave rumble filter is included for optimal treatment of low frequencies.

Because it's a one way system, the 511A works on any signal without pre-processing. No encoding is required, so the unit can be placed anywhere in the signal chain. Using the 511A noise reduction, existing analog gear can be made quiet enough to work right alongside the latest digital products. Independent two channel or true stereo operation is front panel selectable. In stereo, the left and right control circuits are tied together, assuring a stable stereo image. In mono, the channels operate independently, so each may be used with a separate source.

Mfg. list \$629.00 **CALL FOR BSW PRICE**

FAST FAX

206-565-8114

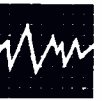

Symetrix



**Model 501
Peak RMS Compressor/Limiter**

Two processor device with variable ratio compressor and an infinity-to-1 peak limiter for the ultimate in compression limiting. Selectable automatic mode significantly reduces overshoot and distortion. Balanced and unbalanced inputs and outputs. Used in broadcasting, music recording, sound reinforcement and tape duplication.

Mfg. list \$279.00 **CALL BSW PRICE**



**Model 525
Dual Gated Compressor/Limiter**

Features:

- A multi-function dynamic range controller designed for exceptional performance and ease of operation
- Two independent channels which may be ganged for stereo operation
- Simultaneous compress/limit and expand/gate action
- Separate compress/limit and expand/gate side-chains each of which respond in a program dependent fashion to make set-up quick and simple
- Balanced inputs and outputs

Mfg. list \$495.00 **CALL FOR BSW PRICE**



**Model 528
Voice Processor**

The 528 is a complete, self contained voice processor that performs five separate functions: mic preamp, de-esser, compressor/limiter, downward expander and parametric equalizer/notch filter. High density packaging allows all five signal processors to fit comfortably in a single rack space.

But, nothing is left out. Each function is served by a full complement of controls, in an easy-to-use layout. As a dedicated single channel voice processor, the 528 delivers the same processing power found in a sophisticated recording studio signal chain. With the 528 Voice Processor you get all the control you need, without the cost or complications of separate units.

Mfg. list \$649 **CALL FOR BSW PRICE**



Model TC-4 Broadcast Digital Delay

A state-of-the-art advancement in broadcast profanity delay. 6.8 seconds delay time, 15 kHz band width, and 85 dB dynamic range. Optional card allows memory dump as well as a catch-up feature.

Mfg. list \$1,521.00 **CALL FOR BSW PRICE**

TEAC



**Model EQA-10II
Stereo 10-Band Graphic Equalizer**

- Ten-band audio frequency spectrum analyzer
- Source and tape input
- Equalizer in/out switch
- Pre/post equalizer switch
- Equalizer boost/cut controls

Mfg. list \$209.00 **CALL FOR BSW PRICE**

BSW

BSW's "after the sale" support is second to no one. Your complete satisfaction is our only goal.

1-800-426-8434
FAX 206-565-8114

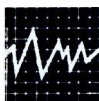

STEREOMAXX™

FROM MODULATION SCIENCES
**Adds Excitement To Every
Music Format.**

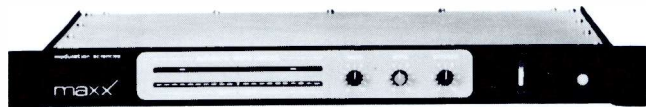

Spatial Image Enlarger

StereoMaxx™ makes your station sound bigger, not just louder. Almost all air chain processors work to increase loudness. But the StereoMaxx™ is different. It enhances and enlarges your station's stereo image. The stereo image becomes wider and deeper — actually extending beyond the speakers. The effect impacts on all kinds of stereo radios — from expensive hi-fi systems to portable boom boxes and head-phone radios. And in the car — wow! No matter what kind of radio your listeners tune, once your station adds the energy and excitement of StereoMaxx™, other stations sound rather tired and dull by comparison.

**StereoMaxx™ Works With All
Loudness Processors.**

Mfg. list \$2,889.00 **CALL FOR BSW PRICE**

MODULATION SCIENCES

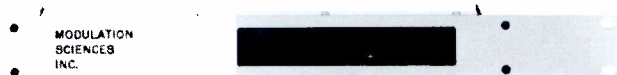

Model CP803RM FM Composite Processor

Sharpen your competitive edge by adding the CP803RM to your compressor/limiter/stereo generator to enhance the stereo composite signal. Increase your signal by 6 dB with greater dynamic range without the breathing, pumping or swishing associated with conventional processing.

Mfg. list \$1,095.00 **CALL FOR BSW PRICE**

BSW

**BSW has an experienced Sales Staff
waiting to answer your audio equipment
questions and to meet all of your
broadcast needs.**

**Call us at
1-800-426-8434**

Digitech

RDS PROFESSIONAL DIGITAL SIGNAL PROCESSING EQUIPMENT



Model RDS 7.6 Digital Delay/Sampler

Digitech's new RDS 7.6 gives you an incredible 7.6 seconds of digital sampling at full bandwidth. Jacks on the rear of the delay unit let you control the functions of the delay and add to the almost endless possibilities this digital delay/sampler opens up to you. The RDS 7.6 also gives you flanging, chorusing, doubling, echoing, infinite repeat, sound-on-sound layering...all from a single rack space high unit. The RDS 7.6 Digital Delay/Sampler is just plain fun.

The RDS Digital Delays give you digital effects in a rack mounted unit. Many of the functions are foot switch controllable. These new generation delay units have soft-touch buttons, a computer designed circuit board and an input level selection switch along with a more precise feedback control scheme. The RDS digital delays are professional effects units, ruggedly built to demanding specifications. Exact control of the delay gives you unlimited creative possibilities putting the power of a digital signal processor into your sound.

Mfg. list \$399.95 **CALL FOR BSW PRICE**



Model DSP-128 Stereo Digital Effects Processor

The DSP-128 is a multi-effect digital signal processor with 128 presets. The digital effects signal processor offers reverberation effects, chorusing, flanging, delays and can do more than one effect at the same time. An LED display on the front panel shows the program number in operation, or displays the operating parameters when programming the effects. A matrix field of 12-LED's on the front panel show which effect or effects are being used making it easy to see what the DSP-128 is doing. 12-bit A-D-A conversion with a 16-bit DSP engine and noise gating give the digital processor wide dynamic range and computing power for smooth sounding effects.

Mfg. list \$499.95 **CALL FOR BSW PRICE**

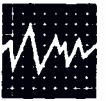

MICROFX

FROM VALLEY INTERNATIONAL

COMPRESSOR

To afford complete control of dynamic range, with an automatic downward expander to remove undesirable noise level recovery.



DE-ESSER

To remove excessive "ess" sounds commonly called sibilance.



NOISE REDUCTION

One-way noise reduction unit to eliminate unwanted noise from audio signals, while improving signal-to-noise ratios.



NOISE GATE

To eliminate unwanted noise in musical program, instrument amplifier hum and buzz.



Before You Pay The Same Price For A Product That Offers Less, Try Micro FX.

Inexpensive signal processors are not new. But, inexpensive processors capable of delivering truly professional sound quality were practically nonexistent prior to the introduction of Micro FX. Each Micro FX product is designed and manufactured to the same exacting standards which have made Valley International an industry leader in the field of analog signal processing. The time-proven proprietary processing circuitry found in our more expensive processing products is also designed into every Micro FX unit. You will find the same high quality components in each Micro FX unit that you find in the rest of the Valley line, so you can be assured of years of trouble-free operation. And, all of the Micro FX products are made in the U.S.A.

The optional FX rack adaptor allows from 1 to 3 units to be mounted in a 1.75" high rack space.

Mfg. list \$165.00 **CALL FOR BSW PRICE**

JBL UREI ELECTRONIC PRODUCTS



The JBL/UREI 7110 Limiter/Compressor is built in the tradition that has made UREI limiter/compressors the audio professional's choice world-wide. Incorporating both peak and average gain reduction detectors in a single rack space size, the Model 7110 is equally at home in the small recording studio, the sound contractor's rack, portable sound systems, broadcasting studios or anywhere audio levels need to be automatically controlled.

Mfg. list \$475.00 **CALL FOR BSW PRICE**

ART



Multiverb Audio Effects Processor

The power of four. ART rockets digital processing into the 21st Century with the best sounding effects processor ever! The Multiverb's new ultra high resolution circuitry yields superior audio performance and unequalled sonic clarity.

The heart of Multiverb is a new fully optimized 20 Bit digital engine which is surrounded by some of the most sophisticated engineering to date. The result is a processor with incredible capabilities.

- Up to 4 Effects At The Same Time
- Pitch Transposing
- 20 Bit Digital Processing
- Fully Utilized 16 Bit A-D-A Conversion
- 32 Character Liquid Crystal Display
- Fully Programmable
- 100 Studio-Crafted Presets
- Ultra-Wide Bandwidth
- Full Parameter Variability
- Rugged Internal Power Supply

Mfg. \$575.00

CALL FOR BSW PRICE



Proverb 200 Audio Effects Processor

200 new software developments. A wide bandwidth and host of new sounds! ART delivers the ultimate creative tool at a price hundreds less than comparable units, packaged in a sleek, rugged steel case.

ART has restructured the best digital algorithms and developed one of the most natural sounding multiple effects processors ever. The Proverb 200 delivers a full range of studio effects without the brittleness or harshness of competitive units and incorporated the finest sounding studio effects combinations and made them available at the touch of a button! Unit is a single space rack mountable. Stereo inputs and outputs.

Mfg. list \$379.00

CALL FOR BSW PRICE

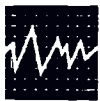

TEXAR GENTNER ELECTRONICS

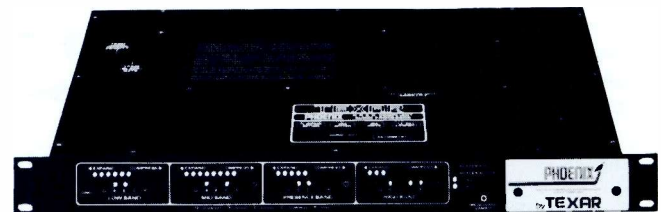
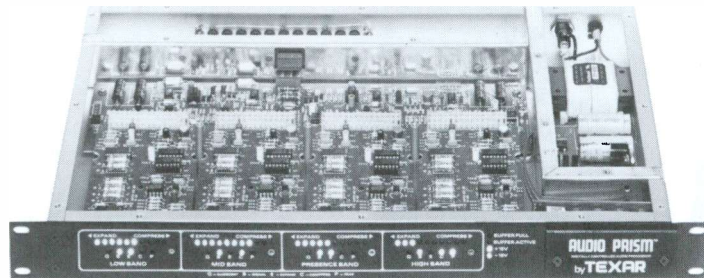

Audio Prism™

The TEXAR AUDIO PRISM delivers world class modulation punch without the grunge factors that can drive listeners away. The secret is digital control. Digital controls allow you to have the best of both worlds: power and clarity. In addition, the AUDIO PRISM can deliver full modulation power without the fatigue factors that appear so often when audio processors are set to maximize modulation.

The AUDIO PRISM uses a four-band parallel layout with opto-attenuators assuring predictable and smooth gain change. Should you experience unusually high input levels, you'll stay in normal operating range because the AUDIO PRISM incorporates a broadband safety buffer. Each band is individually gated. A single density control simultaneously allows for attack and release times to be adjusted.

Set up is quick and painless. A pink noise generator and front panel test points are standard.

The AUDIO PRISM is designed to go before a final peak limiter and stereo generator. Two units are needed for stereo.

Mfg. list \$1,995.00 **CALL FOR BSW PRICE**



IEQ 2/3 Octave Intelligent/Programmable Equalizer

ART offers the IEQ with Smartcurve™. The IEQ family is the next generation in graphic equalizers. They go beyond the latest "constant Q" designs and offer EQs that compensate for the interaction between bands, provide over 128 presets, complete MIDI interface, and a video output that shows you the actual frequency response.

The IEQ Controller EQ is a professional, programmable, mono 2/3 octave graphic equalizer. The addition of Smartcurve™ makes this one of the most advanced equalizers available. All of the presets and operating parameters are battery backed and can be dumped to a computer using MIDI interface. The alphanumeric LCD display prompts the user making this an easy to use yet powerful equalization tool. A composite video output allows you to see the actual frequency response, "slider" positions, and all of the system and MIDI parameter settings.

The Satellite EQ is an IEQ without the video output and front panel controls. It is about 2/3 the cost of the Controller EQ. Up to 15 Satellite EQs can be controlled by an IEQ Controller EQ. The unit is inherently "tamper proof" since it has no front panel controls.

Phoenix™

The PHOENIX is a complete, monaural, AM processing system. Features include:

- Full NRSC compliance
- Advanced digital control produces a clean, powerful signal
- Reduces reflected power from narrowband antenna systems
- All-in-one construction
- Operates in the highest RF environments
- Internal Phase-rotator
- Internal low-frequency tilt corrector with 80Hz square-wave generator

The heart of the PHOENIX is the famous Audio Prism™ multi-band processor used by many FM stations. Digital control insures a clean, bright sound that is sure to please your listeners.

New Life For Old Transmitters

It goes without saying that the better the transmitter, the better the on-air audio. But sometimes a new transmitter just isn't a possibility. In that case, the PHOENIX can do a lot to pump new performance into an old transmitter.

Many AM transmitters, particularly those employing plate-modulation, exhibit low-frequency tilt. Tilt can rob you of up to 20% of the modulation you're entitled to.

The PHOENIX includes a very effective, low-frequency, tilt corrector that "tunes out" this transmitter weakness.

Mfg. list \$2,745.00 **CALL FOR BSW PRICE**

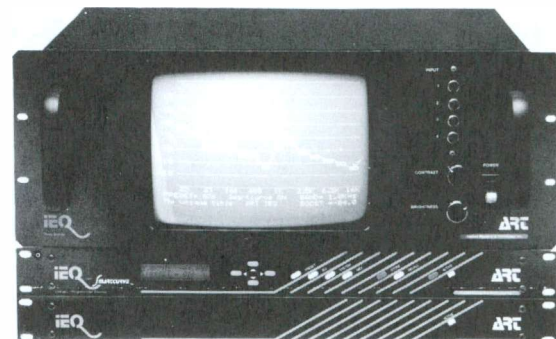

- | | |
|-------------------------------------|--------------------|
| Model 270 IEQ 2/3 Octave Controller | Mfg. list \$595.00 |
| Model 280 IEQ 2/3 Octave Satellite | Mfg. list \$395.00 |
| Model 290 IEQ Video Monitor | Mfg. list \$495.00 |

CALL FOR BSW PRICE



Model 140A
Broadcast Noise Reduction System

The dbx Model 140 simultaneous encode/decode broadcast noise reduction system is a two channel compressor/expander providing a minimum of 30 dB broadband audio noise reduction with a 10 dB increase in system headroom. The two channels feature independent encode and decode circuitry.

In the record mode, the system compresses the input signal by a 2:1 ratio, linear in decibels over a 100 decibel range. Upon playback, the circuitry produces an exact mirror image 1:2 expansion of the encoded signal.

The dbx system eliminates tape hiss in recording, and prevents the noise build-up normally encountered in transferring information from one recorded medium to another; it does not remove noise present in the original signal.

Mfg. list \$569.00 **CALL FOR BSW PRICE**



Model 160X
Mono Compressor/Limiter

In the world of compressor/limiters, the 160X is known as the standard — and with good reason. It delivers outstanding performance and easy to use operational flexibility in a slimline rack mount package. Its metering system provides an instantaneous picture of the gain reduction of the compressed signal compared with either the input or the output level. The 160X is a textbook lesson in compression.

The 160X has all the features a studio operator, broadcast or sound reinforcement engineer, or professional musician would want, as well as outstanding reliability for difficult road and performance conditions. It is the only compressor/limiter that gives you the choice of over-easy or hard-knee operation, irrespective of compression ratio. The unique infinity + compression offers unusual sonic effects, and access to the rms-deflector input offers both frequency and time dependent compression.

Mfg. list \$399.00 **CALL FOR BSW PRICE**

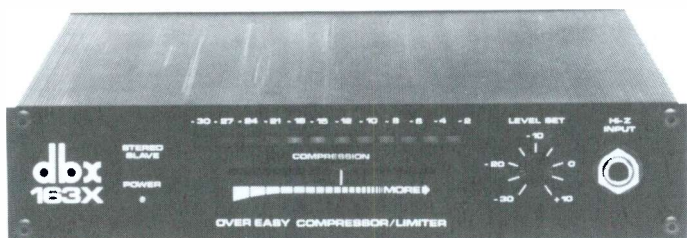

Model 163X
Compressor/Limiter Preamp

The 163X provides traditional dbx sonic quality and performance in a rugged, easy to use package at a very untraditional price. It's designed for the working musician, sound contractor, small studio operator, disco DJ — anyone who needs a low cost, friendly compressor/limiter/preamp.

The 163X was designed for simplicity of use at no sacrifice in sonic quality. A single fader, along with the level-set control, provides the flexible combination of compression and gain at a consistent output level. Rear and front panel inputs allow quick and complete system hookup and operation that can be switched over to instrument or microphone just by "plugging in" to the front panel.

Mfg. list \$149.00 **CALL FOR BSW PRICE**



Model 166
Dual-Channel Gated Compressor/Limiter

- Features:
- Noise gating with switchable release rate
 - Variable over-easy compression
 - Peak stop, for good sounding clipping
 - Sidechain monitoring
 - Rack mountable; low profile
 - Hardwire bypass
 - Stereo or dual-mono operation

Mfg. list \$575.00 **CALL FOR BSW PRICE**

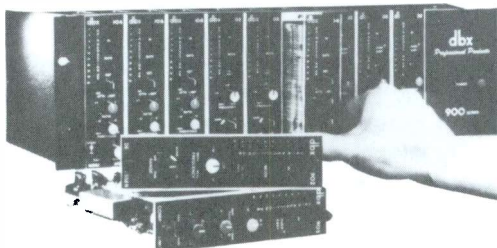

900 Series

The 900 series modular signal processing system from dbx packs up to 9 processing modules in a single 3 space rack. Fill it up with your choice of noise reduction, de-essers, compressor/limiters, noise gates, and parametric equalizers. Get all the details from your BSW sales representative.

Prices based on configuration.

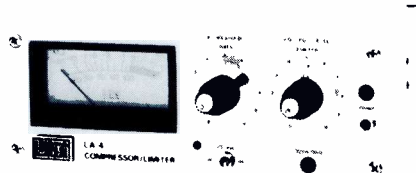

Model LA-4 Compressor/Limiter

Long established in the industry, the Urei LA-4 compressor/limiter gives you smooth, natural sounding compression with selectable compression ratio.

- Long life LED attenuator
- Smooth, natural sounding RMS action
- Input overload indicator
- Simple stereo coupling
- Space saving 8½ inches wide
- Two units needed for stereo

Mfg. list \$590.00 **CALL FOR BSW PRICE**

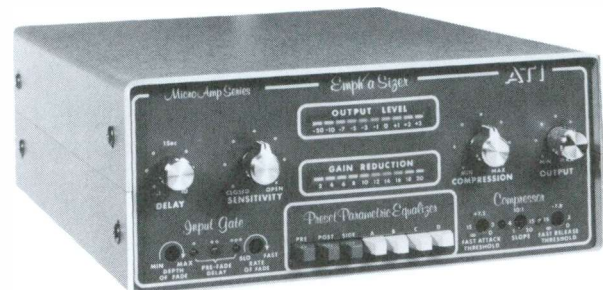

Model EM1000 Audio Processor

The Emph'a Sizer is a complete processing system for Studio use...especially with microphones.

Unit Features:

- Noise gate
- 4 band parametric equalizer with 4 selectable presets
- Compressor/limiter
- Quality mic preamp

The EM1000 is a powerful tool for broadcast.

Mfg. list \$1,395.00 **CALL FOR BSW PRICE**

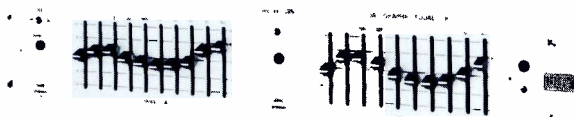

Model 535 Dual Graphic Equalizer

- Two channels in one complete package
- Ten adjustable equalizers on each channel
- Low distortion, low noise
- Standard rack mounting.

Mfg. list \$650.00 **CALL FOR BSW PRICE**

Dynafex™ BY CRL



Model DX2 Noise Reduction System

- Single-ended - no encoding or decoding
- Simple, trouble free operation
- 30 dB of noise reduction
- Brilliance control
- Useful on any audio signal

The Dynafex™ model DX-2 incorporates patent pending noise reduction circuitry that provides up to 30 dB of noise reduction without the encode/decode process.

The Dynafex™ system has gained wide popularity in the professional audio market because of its ability to remove noise from virtually any audio source. Companding type noise reduction systems cannot remove noise from original source material; they only prevent further noise build-up during the recording and playback processes. Being a single-ended system, the Dynafex™ is useful in recording studios, on-line in broadcasting, mixdown recording, video and film production, disc mastering, live sound reinforcement, tape duplication, satellite communications, plus many other applications.

Mfg. list \$749.00 **CALL FOR BSW PRICE**

Model 1176LN Peak Limiter

- True peak limiter
- Excellent noise specs
- Ultra-fast attack time
- Extremely stable.

Model 1176LN.

Mfg. list \$690.00 **CALL FOR BSW PRICE**

Model 1178 - Dual Peak Limiter.

Mfg. list \$1,090.00 **CALL FOR BSW PRICE**



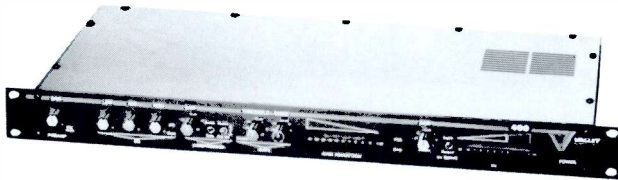

Model 400 Mic Processor

How do you emphasize your on-air personalities' impact? Give them a Model 400 mic processor from Valley International! To begin with, the Model 400 contains a high quality mic preamp, so you can go line level into your console.

Other features include:

- 3 band EQ section
- Compressor/expander
- Noise gate
- De-esser

The Model 400 from Valley International offers the ultimate vocal mic control and dynamics processing capability.

Mfg. list \$649.00 **CALL FOR BSW PRICE**

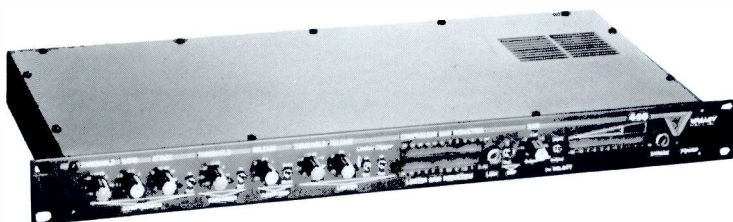

Model 440

Every now and then a truly unique audio signal processor is introduced which evokes the response, "That's just what I've been looking for." The Model 440 limiter/compressor/dynamic sibilance processor is a revolutionary device, sure to put smiles on the faces of broadcasters, recording engineers and sound reinforcement professionals.

The Model 440 limiter/compressor/dynamic sibilance processor offers the convenience of a peak limiter, a high quality compressor/expander package, and a dynamic sibilance processor section, each controlling a common VCA (voltage controlled amplifier). Sophisticated intercoupling of the control circuitry used for each function allows the device to simultaneously limit, compress, expand and eliminate undesirable high frequency components in sibilance.

Mfg. list \$940.00 **CALL FOR BSW PRICE**

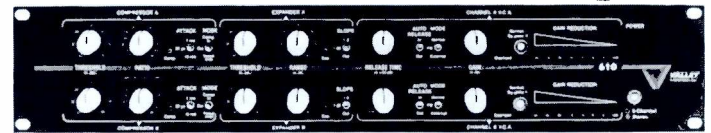

Model 610

The Model 610 dual compressor/expander offers the convenience of two high quality compressors with the flexibility of multi-function dynamics processing in an attractive, rugged 3 1/2" x 9" rack package. Each of the two channels consists of a compressor section and an expander section both controlling a common channel VCA. A special release coupling circuit provides symmetrical release characteristics for both the compressor and expander making interactive processing possible, thus eliminating the problems associated with using separate dedicated function units.

Applications:

- Compressing mixed program material for increased loudness
- Processing noisy cartridge recordings for increased presence and reduced noise
- Pre-emphasis compensated limiting or compression for stereo STL or program feeds
- AGC and limiting for AM stereo

Mfg. list \$1,250.00 **CALL FOR BSW PRICE**

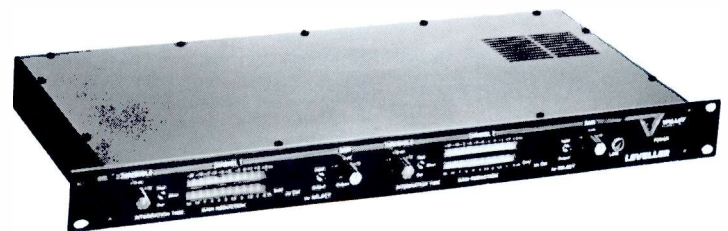

The Leveller

The Leveller from Valley International is a great device for general purpose levelling applications.

While the Leveller uses the latest in state-of-the-art electronic components and complex proprietary circuitry to yield unprecedented level control over your audio signal, you'll find that the sound derived is very warm and natural. In fact, the processed signal is reminiscent of the "tube" sound popular many years ago and recently experiencing revived interest.

A suggested application would be for overall level control for your on air console output.

Mfg. list \$420.00 **CALL FOR BSW PRICE**

Quick ————— Easy ————— Efficient

S E R V I C E

Try BSW's Million Dollar In-House Inventory



Compellor™/Aural Exciter

Model 303

The Model 303 from Aphex Systems, Ltd. provides complete, "invisible" control of audio program dynamics, both long and short term, while also increasing presence, brightness and intelligibility. The 303 accomplishes this by combining two of Aphex's proprietary audio processors, the Compellor and the Aural Exciter to form a single channel, multi-function processor. The 303 is extremely flexible and can be used in any audio application where dynamics control, clarity and intelligibility are important. The 303's unique combination of processes lets your program punch through ambient noise levels without fear of overloading systems or eardrums.

Mfg. list \$949.00 **CALL FOR BSW PRICE**



Compellor Compressor/AGC

The Compellor is a revolutionary audio processor. It delivers invisible compression, leveling and peak limiting simultaneously! The Compellor control circuits are actually analog computers that constantly monitor the input, adapt and control a single VCA per channel for minimal signal path. Operating controls are kept to a minimum, for the Compellor intelligently varies all the parameters for you. All you need do is set input level to control the amount of processing, adjust output level, and set the balance between compression and leveling. That's it. The Compellor will then provide complete dynamic control—smooth, inaudible gain riding for consistent increased loudness—all automatically. Its unique circuitry actually enhances transient qualities, making even heavy processing undetectable.

This smart, versatile, cost effective processor is equally at home in broadcast pre-processing microphone control, audio production, tape duplicating, live sound and film dubbing; producing the "consistent sound" audio engineers have always sought, but seldom found.

Mono

Mfg. list \$795.00 **CALL FOR BSW PRICE**

Stereo

Mfg. list \$1,195.00 **CALL FOR BSW PRICE**

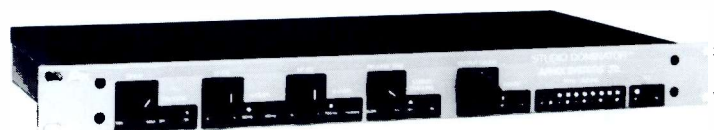

The Studio Dominator™ Stereo Tri-Band Peak Processor/Limiter

The Studio Dominator from Aphex is a stereo multiband peak limiter designed to fit a wide range of audio applications. Through the use of multiband techniques along with new proprietary circuits, the audibility of limiting action has been greatly reduced, especially when compared to conventional limiters. This means that greater limiting depth is possible, resulting in higher loudness with maintained audio quality. At virtually any limiting depth, the Studio Dominator is free of "hole punching," "dullness," and most other sound deterioration normally associated with limiters. As a peak overshoot protection limiter, the Studio Dominator is undetectable in line while it absolutely prevents peak levels from exceeding a user settable output level. In addition, the desired limiting effects of greater audio density, increased "punch," etc., are readily available with the Studio Dominator.

Several options make it the ideal final processor for FM, AM, TV or production.

Mfg. list \$1,195.00 **CALL FOR BSW PRICE**

Affordable Processing for Production



Aural Exciter™ Type C

Aphex Aural Exciters are known for their ability to restore natural brightness, clarity and presence to any audio. They use a patented process involving harmonic restoration rather than some form of equalizer filtering or phase scrambling.

The Type C is the perfect solution to spice up a dull production room. You simply must hear it to believe it.

Output noise is a quiet - 100 dBm.

Mfg. list \$299.95 **CALL FOR BSW PRICE**



FIDELIPAC

Fidelipac
328 Head
Insertion Gauge

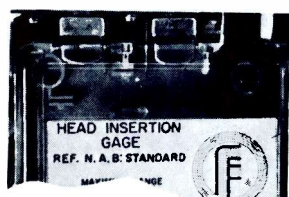

BSW PRICE\$8.00

FIDELIPAC

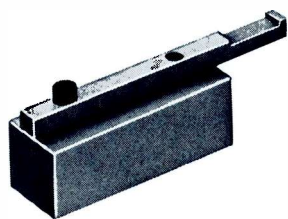

326 Height Gauge
BSW PRICE\$29.00

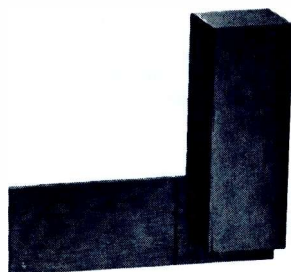

387 Right Angle Zenith
BSW PRICE\$34.50

BSW Cartridge Labels



Six colors to choose from (Black, Red, Orange, Green, Blue, Yellow)
Rolls (1000 Labels)\$19.95 per roll
Sheet (10 Labels) 1-50 sheets 26¢ per sheet
51 + sheets 25¢ per sheet

Tapecaster

Tapecaster X-100 Automatic
Cartridge Loader



Used By Professional
Winders
Full Timing Capability
10½" Tape Capacity
BSW PRICE\$539.00

NORTRONICS



NORTRONICS
Model PF 710
Zenith Height Gauge

- Two Measuring Devices In One
- Easy To Use Package

BSW PRICE\$54.75

NORTRONICS



NORTRONICS
PF-116 Head Cleaning Spray 16 oz.\$8.65
PF-132 Head Cleaning Liquid 32 oz.\$14.80
Non-flammable, non-toxic trichlorotrifluoroethane is completely safe on plastics, rubber, metals, painted surfaces, epoxies and elastomer parts.

NORTRONICS

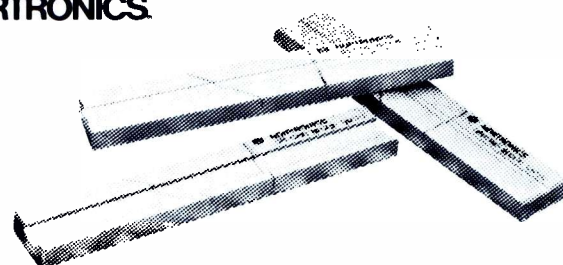

SPLICING TABS

PF-524 50 Metal Sensing **BSW PRICE \$8.75**
QM-526 200 Mylar Reel Tabs ... **BSW PRICE \$22.25**

SPLICING BLOCKS

Nortronics PF-311 **BSW PRICE \$30.70**
Editall S3 **BSW PRICE \$37.75**
Fostex 9930 **BSW PRICE \$18.00**

COTTON SWABS

For Cleaning Heads
Extra Long For Hard To Reach Areas

BCS 100 **\$3.50**
BCS 500 **\$11.50**
BCS 1000 **\$21.00**



TAPE DEGAUSSERS

For Audio, Video, Computer And Cartridge Tape

Erasing Made Easy

AUDIOLAB



Model TD-1B

Table Top Eraser

Erases cartridges and up to 10 1/2" reels. Complete line of audiolab erasers available from BSW.

Mfg. list \$125.00 **CALL FOR BSW PRICE**

SONAR

Mark 1



VideoRaser
VP2001

For audio tape degaussing, the Mark 1 from Sonar offers outstanding value. For all formats from cassettes to carts, the Mark 1 is a wise choice. For video applications, the VP2001 is extremely powerful and will effectively erase up to 1" video tape

Mark 1 Mfg. list \$59.00 **CALL FOR BSW PRICE**
VP2001 Mfg. list \$179.00 .. **CALL FOR BSW PRICE**

FIDELIPAC®

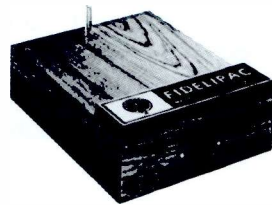

From the company that invented the cartridge, comes two erasers that are broadcast tough. Choose from the durable hand held "blank-it" eraser or the desk top model 400. Expect years of trouble free service and quality.

Model 395 Mfg. list \$70.00
Model 400 Mfg. list \$125.00

CALL FOR BSW PRICES

NORTRONICS



Model PF-211

Hand-Held Professional Bulk Eraser

Mfg. list \$65.00 **CALL FOR BSW PRICE**

garner industries



Taber/AVSC

Model 409

Thoroughly Erases

All Tape Formats

Completely erases all audio, video, instrumentation tapes and magnetic films. Audio and video cartridges as well as tapes on reels or in boxes, can be efficiently degaussed. Reel sizes up to 16 inches can be accommodated.

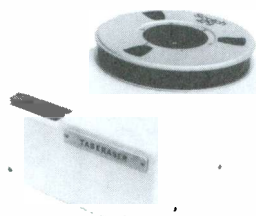

It takes just 4 seconds to erase all sizes and types of audio tape with Garner Degaussers. Just hit the power button and drop any reel or cartridge on the endless belt. You now have a clean, "no whump" erasure. Call for all the Garner models available from BSW, 1-800-426-8434.

**FOUR MODELS TO CHOOSE FROM
STARTING AT \$990.00**

Mfg. list \$1,295.00 **CALL FOR BSW PRICE**

CALL FOR BSW PRICE



Cartridge rebuilding ... the practical, affordable way to lower your cartridge budget.

Your cartridge investment is a substantial one. It's a shame to treat carts like a disposable product when they really aren't. Before you toss them out, send them to BSW.

For over 15 years, BSW has been bringing dead, useless cartridges back to life. Over 200,000 carts have gone through our rebuilding process providing them with many more hours of dependable, quality air time. The end result is new cart performance at 1/3 to 1/2 the price.

What happens when you send your carts to BSW?

First they are inspected for any plastic flaws and parts wear. All carts are disassembled and tape removed.

Your carts are now chemically cleaned in a special solution that removes the labels, graphite, wax, dirt, and other debris.



Once cleaned and dried, new pressure pads, brake pads and washers are inserted in the shell.



BSW loads the carts in lengths specified by you. Tape is of the finest quality and it's your choice. (There is an additional charge for hot tape.) Upon loading with the new tape, all your carts are tested for technical accuracy.

Several stations accumulate failed and worn-out carts and send monthly or quarterly shipments to BSW. You can too. Simply box them up, specify the lengths and tape desired and send to BSW, 7012 27th Street West, Tacoma, WA 98466. Within ten days after receipt of your shipment, your revitalized cartridges will be on their way back to you. BSW rebuild service. Smart cents for your cartridge investment...

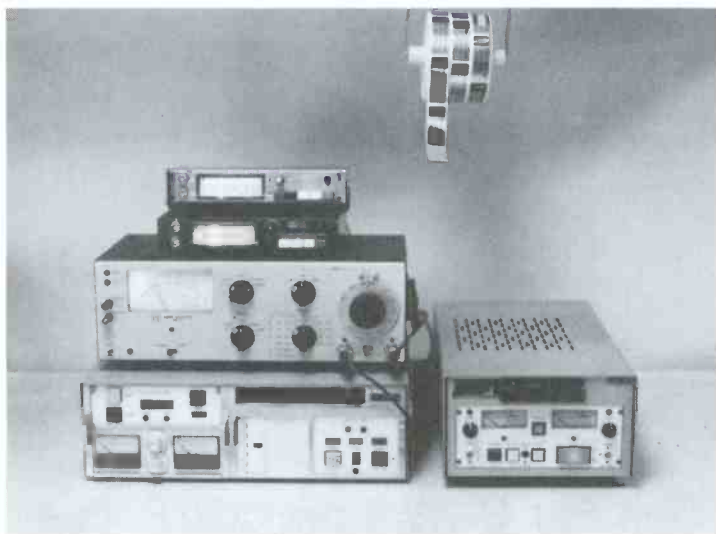

Before

After

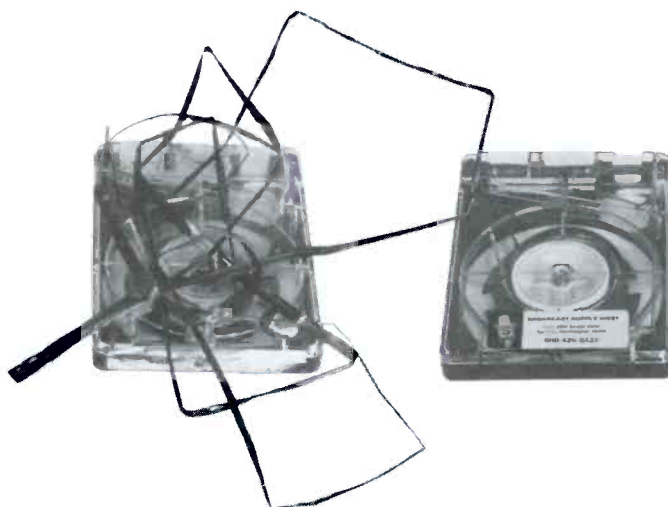



FIDELIPAC

CASSETTES

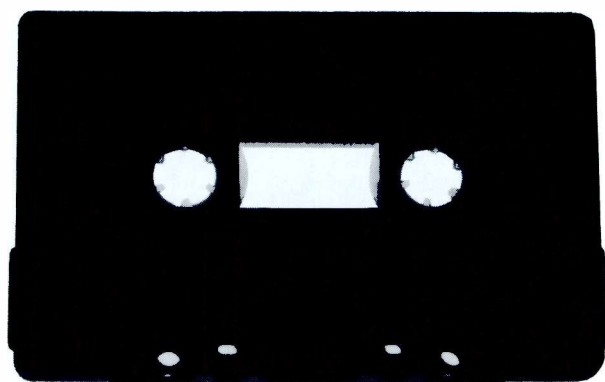

STANDARD VOICE QUALITY

High Output/Low Noise

	25-99	100-499	500-999	1000 +
C-5S	.47	.42	.35	.31
C-10S	.49	.43	.37	.33
C-20S	.52	.48	.40	.35
C-30S	.55	.51	.45	.40
C-45S	.59	.55	.52	.46
C-60S	.64	.60	.57	.51
C-90S	.75	.65	.60	.55

DELUXE MUSIC QUALITY

Super High Output/Low Noise

C-5D	.62	.45	.40	.35
C-10D	.64	.46	.42	.38
C-20D	.67	.48	.44	.40
C-30D	.70	.50	.46	.42
C-45D	.74	.55	.51	.47
C-60D	.79	.59	.55	.51
C-90D	.89	.72	.68	.64

PRIME QUALITY

High Bias Chrome

C-5P	.78	.60	.55	.50
C-10P	.80	.61	.56	.51
C-20P	.82	.66	.61	.56
C-30P	.84	.67	.62	.57
C-45P	.94	.74	.69	.64
C-60P	1.00	.79	.75	.70
C-90P	1.17	.98	.93	.89

BSW cassettes are custom loaded at our facility. You're assured of the finest quality you demand, without having to pay for middle man mark up and fancy packaging. BSW stocks a complete line of cassette accessories. Call us for more details 1-800-426-8434.

Dynamax™ Cobalt Recording Tape

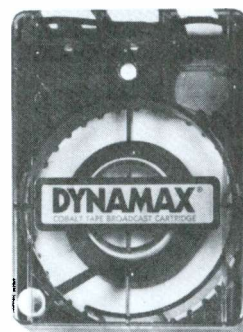

This Dynamax cobalt cartridge is rapidly gaining recognition as something special. A new generation cartridge loaded with broadcastings' first cobalt tape.

The Dynamax shell is constructed of high grade engineering plastic for more strength, greater heat stability and dimensional accuracy.

The new cobalt tape provides extra headroom necessary when carting CD's.

CALL FOR BSW PRICES

FIDELIPAC — MASTERCART



FIDELIPAC 300
The original cartridge for mono broadcast.

The Widely Used Grey Cart At Competitive Prices

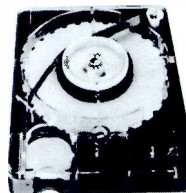

MASTERCART AA
The AA cartridge with standard tape for mono or stereo broadcasting.

Call For BSW Low, Low Prices

For Best Prices And Delivery
Call BSW Toll Free
1-800-426-8434

AUDIOPAK

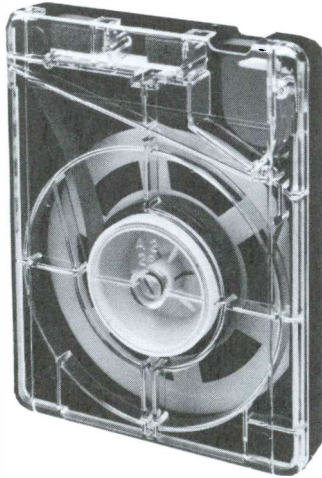

AUDIOPAK A-2
The most popular cartridge on the market for monaural broadcasting.

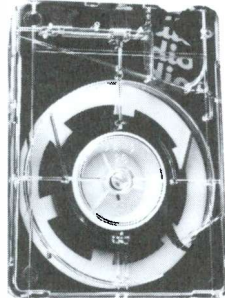

AUDIOPAK AA-3
Precision molding provides highly accurate tape guiding inside the cartridge for excellent stereo phase stability. Tough, reinforced plastics resist warping and damage due to even severe mishandling, thus assuring the phase will not change under any use conditions for the life of the cartridge.



AUDIOPAK AA-4
The key feature of the AA-4 is the SGS-4 broadcast mastering tape. When recorded on a high quality cartridge recorder, the SGS-4 tape can produce virtually identical copies of the best analog or digital master tapes. The SGS-4 tape, available exclusively in AA-4 cartridges offers nearly 5 dB higher saturation headroom at 16 KHz (7½ ips) compared to the HOLN Tape in AA-3 cartridges. No bias adjustment is usually necessary when recording on machines optimized for HOLN or other "hot" tapes.

AUDIOPAK – FOR STATIONS WHO CARE HOW THEY SOUND

ScotchCart

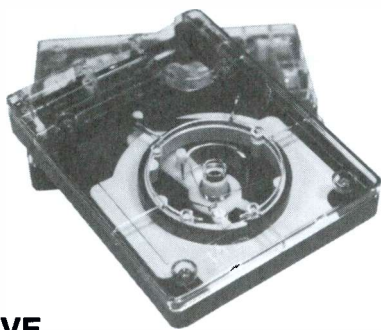

IMPRESSIVE
That's what the Scotchcart broadcast cartridge is. The sales growth and acceptance of this cartridge has been phenomenal to say the least. Together, the innovative design of this cart and the superior mastering tape formulation offer you performance capabilities far beyond what you have come to expect from broadcast cartridges. Not only will you hear unbelievable reel-to-reel sound quality, but Scotch has used the most advanced technologies to eliminate many of the most unwanted cart problems.

**FOR BEST PRICES & DELIVERY
CALL BSW TOLL FREE 1-800-426-8434**

BSW

**YOU WANT IT?
WE'VE GOT IT.**

At BSW we pack our warehouse full, so you've always got a great selection of product waiting for you. Check out our million dollar inventory today!

1-800-426-8434



Model CTM-10 Series Cartridge Recorder/Reproducers



The CTM-10 series NAB audio cartridge players and recorders are designed for broadcast and audio post-production professionals. The microprocessor-controlled CTM-10 cartridge players offer the high performance, outstanding features, and "workhorse" reliability for which Otari products are known.

The series consists of three models: the CTM-10SR stereo record/play deck, and the CTM-10MR mono record/play deck, and the CTM-10 combination mono/stereo playback deck, to which recording capability is a simple conversion. Three CTM-10 series decks may be rack mounted side-by-side in only 5 1/4" of 19" rack space. The record electronics unit, housed in a separate chassis, is the same size as the playback unit.

The tape speed of CTM-10 transports may be user-converted to 15, 7.5 or 3.5 ips by means of internal jumpers.

The CTM-10 record electronics unit uses Dolby HX-Pro™ bias optimization circuitry. HX-Pro increases the CTM-10's high frequency dynamic headroom, to yield high frequency performance at 3.75 ips which is equivalent to non-HX performance at 7.5 ips; and likewise 7.5 ips is equivalent to non-HX performance at 15 ips; HX-Pro is *not* noise reduction so it needs no decoding; thus the benefits of HX-Pro recording will be evident in playback on *all* cart machines.

For audio post-production applications, the CTM-10 includes minutes/seconds display and parallel I/O control port for easy interface to SMPTE/EBU time-code based synchronizers, and 9600 Hz frequency controlled capstan speed control. In addition to conventional cue tones, the cue track on CTM-10 machines may be used for time-code or other automation data.

CTM10 Mono/Stereo Play Mfg. list	\$2195.00
CTM10M Mono/Record/Play Mfg. list	\$2445.00
CTM10S Stereo Record/Play Mfg. list	\$2695.00
CTM10R Record Electronics Mfg. list	\$1350.00

CALL FOR BSW PRICES

* Requires CTM10R For Record Function



PHASE TRAK 90™

The Stereo Solution For Every Cartridge



The Phase Trak 90™ is a completely integrated electronic package specifically designed to meet the changing needs of today's broadcast professional. Features that are optional or unavailable in other cart machines are standard **equipment** in the Phase Trak 90.

Automatic Non-encoding Phase Correction

The phase correction circuit of the Phase Trak 90 continually monitors and corrects the phase relationship between the playback audio of the right and left channels. The output of ANY cartridge will undergo automatic phase correction when it is played through the Phase Trak 90 - **regardless of what machine was used to produce the cartridge originally.**

The phase correction capability of the Phase Trak 90 is essentially invisible to the operator, requiring no user adjustments. (A front panel LED bar-graph indicator is provided to show the amount of relative phase correction taking place during the play cycle.)

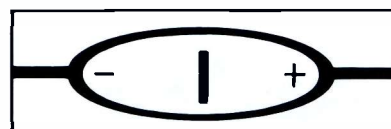

Automatic Tape Analysis

Introducing a new brand of tape is easy with the Phase Trak 90 Record/Play! Through its microprocessor-assisted automatic tape analysis system, the Phase Trak 90 will completely evaluate a new tape and "learn" all of the bias, level and EQ settings necessary to obtain optimum performance. These settings are then stored in memory, ready for selection.

Excellent Audio Performance

The Phase Trak 90 boasts a Signal to Noise Ratio of better than 80 dB (stereo, with Dynafex® noise reduction operational). At ± 2 dB, 40 Hz to 16 kHz, the excellent frequency response of the Phase Trak 90 delivers "audiophile" quality in any application. Wow and Flutter specifications are also outstanding at less than .12%.

Modular Construction

The Phase Trak 90 is completely modular for the ultimate in servicing convenience. All modules are easily removed from the back of the cabinet. Test points and adjustments are reached by removing the top cover.

The list of features goes on and on. Call BSW for complete specifications.

PT90RPS Record/Play Stereo Mfg. list	\$3795.00
PT90PS Play Only Stereo Mfg. list	\$2495.00

CALL FOR BSW PRICE



Fast Forward And All Cue Tones Standard In Every Series 3000A



Model 3100APS

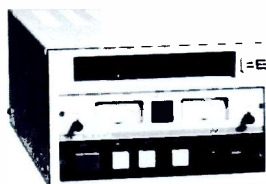

Model 3200ARPS

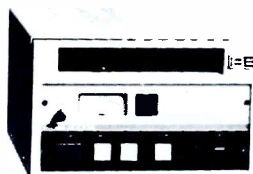

Model 3200ARP

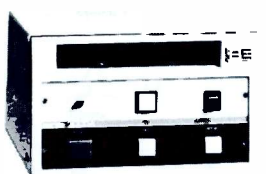

Model 3200APS

Model 3400A Rack Mount (not shown)

The 3400A's come standard as rack mount units with no shelf or filler panels necessary, have all the features of the standard Series 3000A cartridge machines and handle all cart sizes.

Delay Machines - Models 3200A RP/DL and 3400A RP/DL (not shown)

In addition to providing normal playback and record functions, delay units allow the use of the machine whenever a delay might be required. From a six minute delay (for live talk show editing) to a 30 minute network programming delay, these machines can handle any delay length required. The time span of the delay is determined by the length of the tape in the cartridge.

The Series 3000A retains the features that made its predecessor famous and adds new improvements and extra features that all users are sure to appreciate. These new improvements include the addition of the Phase Lok V head block, an innovative cartridge guidance system, a powerful air damped solenoid, and flat response long life heads. In addition, automatic/manual fast forward and three cue tones are now standard in the series 3000A. The styling has changed also to include a new front panel layout.

Features:

- New Phase Lok V Head Block
- Improved Cartridge Guidance System
- More Powerful, Air Damped Solenoid
- Direct Drive Hysteresis Synchronous Motor
- Gold to Gold Contacts
- New Flat Response Long Life Heads
- Automatic/Manual Fast Forward - Standard
- Three Cue Tones - Standard

Model 3100A Slim Line

For use with NAB A and AA cartridges. Available in mono and stereo playback models. Three units can mount side-by-side in a 19 inch rack shelf.

Model 3200A Compact

For use with NAB A, AA and B cartridges. Available in mono or stereo record/playback and playback only models. Two 3200A units can mount side-by-side in a 19 inch rack shelf.

SERIES 2100C

Features:

- Two Cue Tones Standard (1 kHz and 150 Hz)
- Exclusive Mono/Stereo Switching
- New Precision Adjust Phase Lok V Head Block
- New Flat Response, Long Life Heads
- Precision Machined Deck with Improved Cartridge Guidance System
- Direct Drive Transport
- Modular Construction
- Low Voltage Air-Damped Solenoid
- Advanced Electronics - Meets or Exceeds 1975 NAB Standards

The Series 2100C's are the most effective professional tape cartridge machines in the industry today. No other cart machine combines the value and economy of the 2100C's. For example, the Series 2100C's include two cue tones (1 kHz and 150 Hz) as standard features. The construction is modular for easy maintenance. New flat response, long life heads offer superb performance and the direct drive transport ensures maximum reliability. Even the styling has been enhanced for a more attractive appearance.

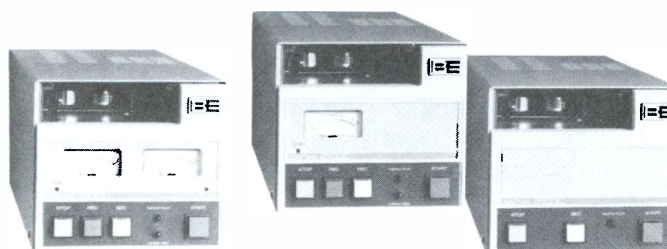

2100CRPS

2100CRP

2100CP

**CALL BSW FOR THE
MOST COMPETITIVE AND
ATTRACTIVE PRICING
1-800-426-8434**



Model 5300C

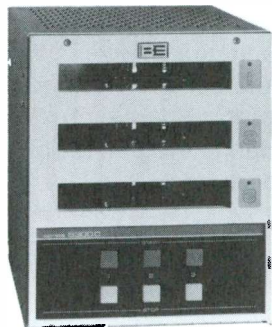

- Non-repeat Lockout
- Phase Lok V Head Block
- Advanced Electronics — (meets 1975 NAB Standards)
- Powerful, Air Damped Solenoids
- Torodial Transformer

Model 5310C



Model 5400C

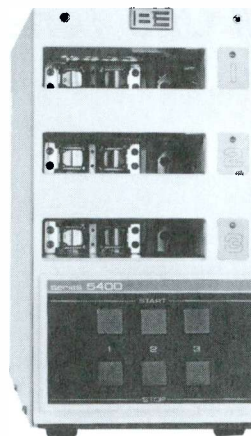

- Non-Repeat Lockout
- Advanced Electronics (meets 1975 NAB Specifications)
- Improved Cartridge Guidance System
- Heavy Duty Solenoid
- Torodial Transformer
- New Phase Lok V Head Block

Model 5410C



series 5300C

series 5400C

The 5300C cart machine from Broadcast Electronics incorporates many of the popular innovations of its companion model 5400C, but adds the capability to handle A, B and AA cartridge sizes. The 5300C is an advanced three deck machine for the serious operator. Its performance specifications are outstanding and its unique features make it a pleasure to use. The 5300C is also one of the easiest machines to install and maintain. It is fully equipped with plug-in decks and PC cards. Table top mounting can be utilized, or a rack mount option is available.

Unique Design Features

Non-repeat Lockout - Non-repeat Lockout prevents any tape cartridge from being played more than once unless the operator resets it from the "lockout" mode by pressing the appropriate STOP button, or by removing and re-inserting the cart. The illuminated STOP switches for each deck will flash on and off to indicate that a cart is in the lockout mode. The non-repeat Lockout feature may be disabled through an internal jumper if desired.

Torodial Transformer - The new 5300C incorporates a torodial transformer in the primary power supply for cool, efficient operation with a significant reduction in stray magnetic fields.

Phase Lok V Head Assembly - The removeable Phase Lok V head assembly provides tight alignment control with a locking azimuth adjustment independent of height or zenith adjustments.

Recording Unit

The optional recording amplifier (mono model 5309C or stereo model 5310C) is available for recording on deck three independent of the other remaining decks. In this manner the 5300C can be utilized as a three deck playback only machine or a two deck playback only with record/play capability on deck three.

Clean sound reproduction and smooth, consistent performance are just two of the reasons why the Broadcast Electronics 5400C is one of the most trusted cart machines in the industry today. The 5400C is designed for the user who requires the utmost in long term reliability and ease of operation. As a three deck cart machine, the 5400C will fit perfectly in any production or on-air studio environment.

Careful attention has been given to the maintenance and installation aspects of this excellent cart machine. The 5400C is fully equipped with plug-in decks and PC cards for quick, easy servicing. The trim line design of the 5400C's makes it easy to rack mount as many as three machines side by side.

Innovative Design Features

Powerful, Air Damped Solenoid - The 5400C utilizes a new air damped solenoid that guarantees reliable cartridge engagement. The solenoid control circuit utilizes solid-state switching and a regulated current source for cool, quiet operation.

Advanced Electronics - The state-of-the-art circuit design of the 5400C is immediately evident in its exceptional dynamic range. (± 2 dB 40 Hz to 16 kHz) Stereo signal to noise ratio is better than 56 dB.

Cool Drive System

The 5400C uses a super-quiet, direct drive hysteresis/synchronous motor for low wow and flutter, long term reliability and cool operation without the use of troublesome fans. Operating speed in the hysteresis/synchronous motor is established and maintained by the stable AC power line frequency.

Recording Unit

The optional recording amplifier (mono model 5409C or stereo model 5410C) is available for recording on deck three independent of the other remaining decks. This allows the 5400C to be utilized as a three deck playback only machine, or as a two deck playback with record/play capability on deck three.

PRICED TO SELL — CALL YOUR BSW REP FOR DETAILS
1-800-426-8434



Dynamax™

by Fidelipac

THE DYNAMAX ESD10 ERASER/ SPLICE DETECTOR



Model ESD10

Reliable splice detection and deep cart eraser for flawless sound reproduction.

Model ESD10

The DYNAMAX ESD10 will consistently — measurably — outperform any other eraser/splice locator on the market. It will, in fact provide erasures that are virtually as clean as those achieved by the best driven erasers.

DYNAMAX engineering staff simply does not believe that the erase function belongs in a cartridge machine. In fact, this configuration compromises both the erasure and machine performance.

Reliable, automatic splice detection.

When program material is recorded over a splice, a severe dropout can occur. Cue track material is also disrupted and that causes false cueing, and/or logging errors.

Splice location, therefore, is very important. But, it is also a time consuming operation when performed manually, an operation busy studios can ill-afford.

'Til now, even automatic splice detection machines have had drawbacks. They are often unreliable and require constant adjustment.

Sensitivity adjustments eliminated.

The DYNAMAX ESD10 uses a patented splice finder system — a system developed for the DYNAMAX CTR100 Series Recorders — and as a result, the ESD10 requires no sensitivity adjustments whatsoever.

The DYNAMAX ESD10 is, quite simply, the most reliable splice detector ever built. It is available in an attractive desk mount cabinet, or may be rack mounted, alone, or in combination with DYNAMAX cartridge machines.

Mfg. list \$1,150.00 **CALL FOR BSW PRICE**

CTR30 SERIES 3 DECK RECORDER/ REPRODUCER

Compare This 3 Deck
With Any Other

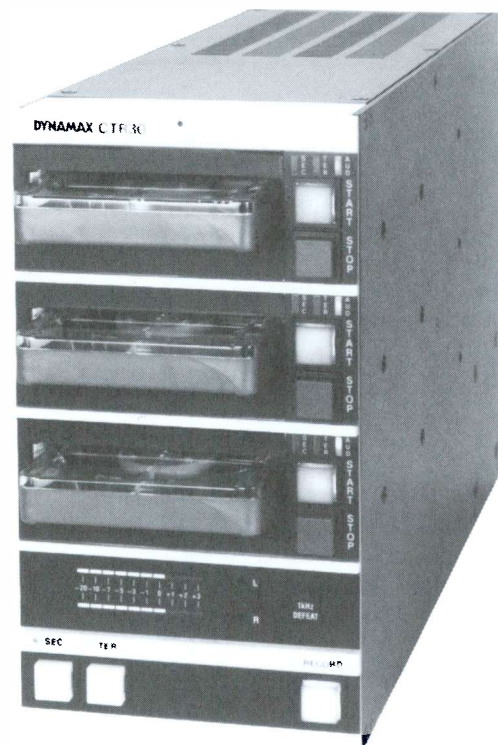

If space is at a premium, then the CTR 30 Triple Stack from Fidelipac is a must consideration. Three decks with the recorder built-in as standard. The bottom deck records as well as plays. Utilizes CTR10 electronics (see page 34). All Plug in boards are interchangeable with those used in CTR10 series machines. All Decks are removable for service without disabling the machine. Audio Switcher and mixer are included to permit connection to single console input.

Flashing Stop lamps warn operators of played cartridges.

CTR33 Mono
Mfg. list \$4,800.00 **CALL FOR BSW PRICE**

CTR34 Stereo
Mfg. list \$5,250.00 **CALL FOR BSW PRICE**



Dynamax[™] by Fidelipac

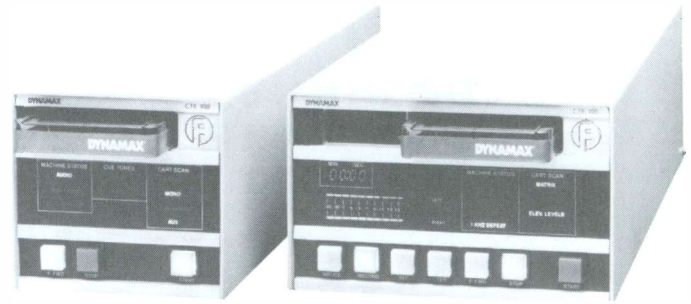
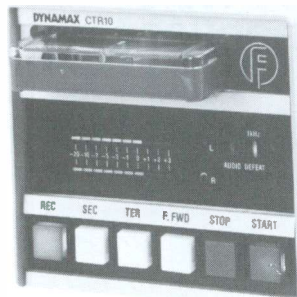

REVOLUTIONARY CARTRIDGE MACHINES

CTR 10 Series

The Dynamax CTR 10 series of cartridge machines provide unsurpassed audio performance and today's most desired operational features. Compact design allows up to 3 recorders, and/or players to be placed side by side in the available rack mount.

- Standard fast forward feature
- All three cue tones standard
- High speed cueing
- Secondary tone allows control of both fast forward & audio muting
- Selectable front panel metering for audio, phase and cue tones on recorders
- Geometrically correct azimuth adjustment, independent of height and zenith
- On board audio switcher & mixer
- Transformerless audio circuitry
- Played indicator with selectable restart disable
- Industry proven AC synchronous motor for reliable operation & ease of maintenance

The CTR 100 Series embodies unique features not available in any other machine on today's market.

- Front panel diagnostics
- DC servo drive motor
- Fast forward
- Secondary and tertiary cue tones
- Low voltage constant current solenoid
- Audio switcher and mixer
- Status display
- Audio transformerless circuitry
- 150 Hz control of audio gate
- Group delay compensation
- Crystal controlled reference for all internal functions
- Front panel 1 kHz add and defeat
- Fully-switchable metering with automatic changeover function
- Two speed *played* flashing indicator
- Played restart disable
- Active bias and signal mixing
- Constant current recording
- Bar graph LED level indicators
- Improved heads for flat low frequency response
- On-board test oscillator
- Splice finder

Model	Description	Mfg. list
CTR11	A Size Mono Play	\$1,575.00
CTR12	A Size Stereo Play	\$1,745.00
CTR13	A Size Mono Rec/Play	\$2,495.00
CTR14	A Size Stereo Rec/Play	\$2,725.00

Model	Description	Mfg. list
CTR111	A Size Mono Play	\$2,235.00
CTR112	A Size Stereo Play	\$2,380.00
CTR123	B Size Mono R/P	\$3,680.00
CTR124	B Size Stereo R/P	\$4,080.00

CALL FOR BSW PRICE

CALL FOR BSW PRICE

For the best service and price Call BSW Toll Free
1-800-426-8434 or FAX Your Orders Direct 206-565-8114



AUDI-CORD

NEW DL SERIES



S Series Record/Play

- Plug-in companion to any similar playback. Easily field exchanged to distribute transport wear if desired.
- All front access operator controls in pull-out drawer.
- Multi-function meter system with automatic switching from record to replay.
- Dual recorder equalization — HI and LO.
- Internal 3 tone response check facility.
- Bias and tone recording indicators.
- Compatible with all known automation encoders.

Mono S21 Record/Play

Mfg. list \$1,839.00 **CALL FOR BSW PRICE**

Stereo S26 Record/Play

Mfg. list \$2,029.00 **CALL FOR BSW PRICE**

Mono S11 Play Only

Mfg. list \$1,119.00 **CALL FOR BSW PRICE**

Stereo S16 Play Only

Mfg. list \$1,209.00 **CALL FOR BSW PRICE**

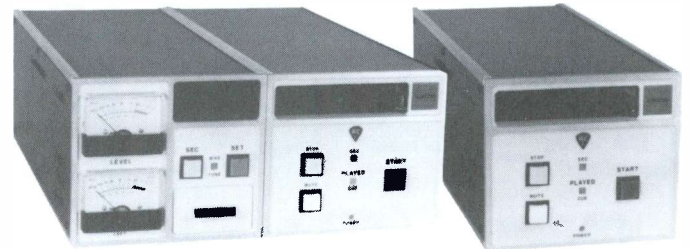

Model DL-RS
Record/Play Stereo

Model DL-PS
Playback Stereo

DURABILITY AT THE LOWEST POSSIBLE COST

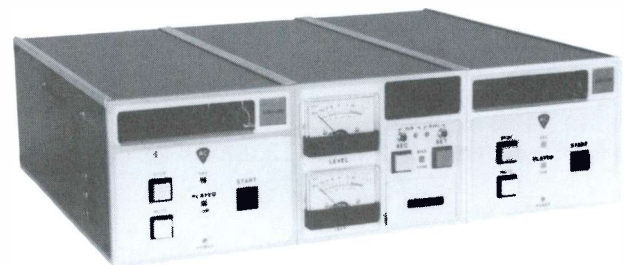

Model DL-DM or DLDS Dual Record/Play
Mono or Stereo



S Series Play Only Twin Deck

- Extensively modular design with plug-in circuit cards throughout.
- SEC, TER and PLAYED signal lights for each deck.
- Replay reminder system with full selectable use options.
- Selectable 600 or 150 ohm balanced transformer audio outputs.
- Full +20dBm clipping point audio amplifier system.
- Complete remote control facilities.
- Automatic motor shut down when both carts have played.

TDS1 Mono

Mfg. list \$1,569.00 **CALL FOR BSW PRICE**

TDS6 Stereo

Mfg. list \$1,779.00 **CALL FOR BSW PRICE**

Optional rack mount shelf available.

Born of the heritage of the Audio-Cord A and E series with thousands in service.

100% solid state design with high noise immunity CMOS logic.

Extensively modular design with plug-in circuit cards.

Audi-Cord's heavy duty deck and head mounts that stay adjusted.

Playbacks:

Replay lock-out and reminder to prevent accidental replay errors. Manual or automatic muting of output audio. (from SEC cue operation) Status indicator lamps show at a glance cue tones presence, both SEC and primary. Latched lamps verify that both have been sensed. Mute lamp to indicate audio on or off status. Automatic motor turn-off if selected conserves power and heat.

Record-Plays:

Full view meters for accurate level monitoring. Bias and tone presence indicators. Automatic meter switching from record to replay. Recording shut-off with the end of SEC tone option is provided. Full +8dBm output ability with 12db of headroom. Cart holding system (over top for stereo) for positive location of the cartridge. Slide back cover design allows for quick and easy access for cleaning. Complete remote control connections. Plugs are furnished.

Ordering Information:

	Mfg. List
Model DL-PM Playback, Mono	\$899.00
Model DL-PS Playback, Stereo	\$979.00
Model DL-RM Record-Play, Mono	\$1,259.00
Model DL-RS Record-Play, Stereo	\$1,449.00
Model DL-DM Dual Transport Record-Play, Mono	\$2,219.00
Model DL-DS Dual Transport Record-Play, Stereo	\$2,579.00

CALL FOR BSW PRICE



Tapecaster

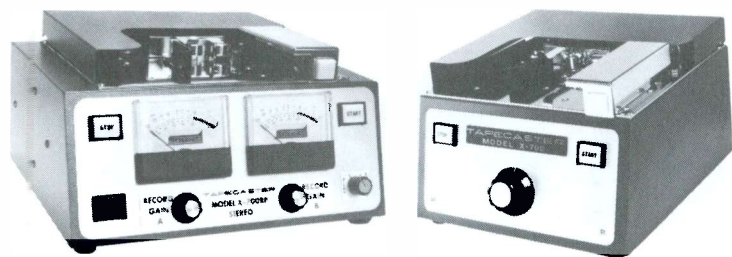

Model X 700P
Play Only

Model X 700RP

Look no further for the best value in cart machines...you have found them. Tapecaster has long been established for great performance at a pleasing price.

Features:

- Precision adjustable head bracket
- Super-torque hysteresis synchronous motor
- Heavy duty air-damped solenoid

SPECIFICATIONS

Equalization: NAB Standard

Frequency Response: $\pm 2\text{db}$ 50-12,000Hz @ 7.5 IPS.
 $\pm 3\text{db}$ 40-15,000Hz @ 7.5 IPS.

Distortion: 2% or less.

Signal to Noise Ratio: 55db or better.

Wow and Flutter: 0.2% or less @ 7.5 IPS.

PLAYBACK

X-700P Mono
Mfg. list \$765.00 **CALL FOR BSW PRICE**

X-700PS Stereo
Mfg. list \$945.00 **CALL FOR BSW PRICE**

RECORD/PLAY

X-700RP Mono
Mfg. list \$1,050.00 **CALL FOR BSW PRICE**

X-700RPS Stereo
Mfg. list \$1,345.00 **CALL FOR BSW PRICE**

X-700RPD Mono Delay
Mfg. list \$1,195.00 **CALL FOR BSW PRICE**

BG ENGINEERING Cartridge Timing Device

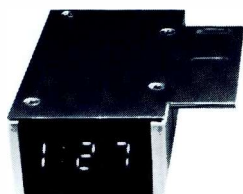

Model BGE T1
Fits Most
Cartridge Machines

BSW PRICE \$139.99

TASCAM

PROFESSIONAL CASSETTE DECKS



Model 122 MKII 4 Track Cassette Deck

The 122 MKII is the leader in TASCAM's line-up of professional 4-track 2-channel stereo cassette machines. To qualify for "professional" status it offers extended durability and reliability so that it can keep up with the tough, relentless pace of professional operation. At the same time it features an extremely high standard of audio reproduction quality with a full 3-head system featuring top performance CA (Cobalt Amorphous) record and playback heads, uncompromised electronics, a precision FG-servo direct-drive capstan motor, and balanced XLR type inputs and outputs (+ 4 dBm) as well as - 10 dBV RCA pin connectors.

Mfg. list \$1,099.00 **CALL FOR BSW PRICE**



Model 112 Stereo Cassette Deck

The 112 is a basic 2-head machine that fully maintains the professional quality performance, stability and reliability of the top line 122 MKII. Special care has been taken in the 112 transport system to ensure unfaltering reliability and stability even under hard non-stop working conditions. The 112 electronics are just as stable and reliable as the rest of the system, while delivering the finest electronic performance possible. The entire electronic system is powered by a precision-regulated bipolar power supply so circuit operation is exceptionally stable, distortion is low and a wide dynamic range is available. Dolby HX Pro is included for significantly increased high frequency MOL, while Dolby B and C type noise reduction aid in making clean, noise free recordings.

Mfg. list \$679.00 **CALL FOR BSW PRICE**

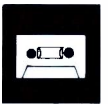

TASCAM



**Model 133B
Stereo Plus Cue
Cassette Recorder/Reproducer**

The TASCAM Plus Stereo Cue Cassette Recorder/Reproducer with extensive auto present features.

- Two position cue select for compatibility with all analog or digital programming units
- +4 dBm balanced/ -10 dBv unbalanced inputs and outputs
- 2-motor, soft-touch logic control transport
- 2-speeds: 1 7/8 and 3 3/4 ips
- Switchable mic/line inputs
- Dolby noise reduction system
- Input and output level controls for each channel
- "Simul-Sync" recording for multitrack recording auto present features
- Cue pulse/generates a 25 Hz tone on the cue channel, does not affect projector operations, but triggers the auto present
- Automatic shutoff or rewind at cue tone

Mfg. list \$1,349.00 **CALL FOR BSW PRICE**



**Model 246 Portastudio
4 Channel Multi-Track Recording System**

If you want the best possible performance available in an integrated 4-channel multitrack recording system, ask about the TASCAM 246 PORTASTUDIO. The 246 PORTASTUDIO is a professional-quality production tool that features a six input/four PGM buss mixer with two-band sweep equalizers on each channel, two-speed tape operation (the high-speed mode offers exceptionally high reproduction quality), an IC logic-controlled transport with remote control and remote punch in/out capability, switchable dbx noise reduction and many other refined features. The 246 PORTASTUDIO offers quality and control that will satisfy even the most demanding professional user. Other features include:

- 4 independent Tape Out jacks.
- Tape memory allows quick search, and creation of continuous playback loops together with zero return function.
- Tape counter shows minutes/seconds or index increments.
- ± 12% pitch control.

Mfg. list \$1,599.00 **CALL FOR BSW PRICE**

marantz



**PMD-430
Stereo Portable Cassette**

- Dolby B noise reduction
- dbx noise reduction
- 3 Heads
- Pitch control
- Bias fine adjustment
- Auto shutoff
- Memory rewind
- Auto replay
- 3 Position mic attenuators (0-5-30db) limiter
- 3 Position tape selector (metal, CrO₂, normal)
- Illuminated VU meters
- 3 Digit tape counter
- 4 Way power supply
- Built-in speaker
- Headphones
- Output jack

Mfg. list \$599.95 **CALL FOR BSW PRICE**



**PMD 221
Mono Portable
Cassette Recorder**

**Deluxe Portable
Three-Head Two-Speed
Cassette Recorder**

- 3-Head design
- Two-speed 1 7/8 and 1 5/16 IPS
- Full auto shutoff
- 3-Way power with low battery indication
- Vu level indication
- Switchable limiter
- 3 Position mic attenuation (0, 10, 20, dB)
- Built-in monitor speaker
- 3-Digit tape counter
- Direct telephone connective jack
- Telephone pickup jack modular
- Line input and output jacks
- External speaker jack
- Anti-roll transport
- Vari-speed
- 3-Position tape selector (normal, CrO₂, Metal)
- Automatic or manual record level
- Built-in electret condenser microphone
- Cue and review
- Volume and tone control
- 3-Position automatic noise cancel switch
- External mic jack
- Headphone jack
- Memory rewind and replay

PMD 221
Mfg. list \$349.95 **CALL FOR BSW PRICE**

PMD 201 (Same as above except 2 head design)
Mfg. list \$279.95 **CALL FOR BSW PRICE**

Accessories: Carry case option available - Rechargeable battery pack available.



TASCAM



Porta 05 4 Track Production System

The TASCAM PORTA 05 has been designed specifically to make multitrack recording as easy and as affordable as possible without compromising on performance or features. It's the most compact and lightweight model of its type, and unquestionably the finest in its class. The mixer section is a 4-channel design that offers plenty of versatility for both recording and playback. All four channels accept line-level input from electronic instruments, while channels 1 and 2 also have trim controls and accept microphones or direct input from electric instruments such as guitars. A 2-channel 2-band equalizer is provided on the stereo buss for tonal adjustment during both recording and mixdown.

Since external signal processing is an important adjunct to creative recording, the PORTA 05 lets you hook up virtually any type of external effect device to its effect send/receive loop — it's the only model in this class that offers this capability.

Mfg. list \$499.00 **CALL FOR BSW PRICE**

Fostex



Model X-30 Multi-track Recorder

Real 4 track recording is so easy and cost effective. The X-30 from Fostex is a powerful tool...not a toy. Whether you are in the studio or on location, the X-30 allows you creative freedom. Features include Dolby C and B noise reduction, equalizer, mic and line inputs, AC/DC power.

Mfg. list \$499.00 **CALL FOR BSW PRICE**

SONY



TC-D5 PROII Portable Stereo Cassette Deck

A lightweight, full-feature stereo deck for professional sound recording in the field.

Sony introduces a true breakthrough in portable recording — a lightweight, compact stereo recorder that delivers professional quality stereo sound in any field situation.

The TC-D5 PROII is ideally suited to a wide range of professional audio applications. With twin VU meters and LED peak level indicator, you're assured of accurate sound recording without distortion. And built-in monitor speaker and earphone jack let you check your recording results immediately.

Mfg. list \$870.00 **CALL FOR BSW PRICE**

Panasonic

HANDY CASSETTE RECORDER

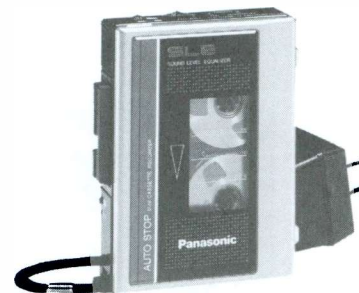

Model RQ 320 Mini monaural cassette recorder

- AC/Battery operation with included AC adaptor
- Sound level equalizer (SLE)
- Auto-stop
- LED indicator (record/battery)
- One touch recording
- Cue and review
- Edit function
- Includes carry strap
- Jacks: DC-in, mic, monitor
- 2 "AA" batteries (not included)
- Silver
- 1 Yr. limited warranty

**GREAT FOR NEWS
AND SALES DEPT.**

Mfg. list \$45.95

BSW PRICE \$37.95



AIWA®

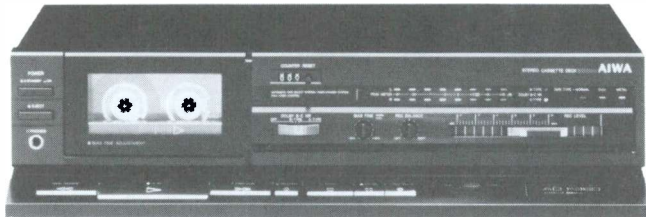

SUPERB MUSIC FIDELITY SIMPLIFIED OPERATION WITH

Model AD-S15 Cassette Deck

Superb fidelity and easy operation in a simply designed 2-head deck are yours with the AD-S15. Its feather-touch controls are mounted on AIWA's flat keyboard operation panel for enhanced convenience, while Dolby B & C noise reduction and the fine bias control enable you to make better recordings. With that extra edge in features and fidelity, the AD-S15 represents a remarkable sound value.

Mfg. list \$150.00 **CALL FOR BSW PRICE**



Double Cassette with Advanced Features

AD-WX707 Double Cassette Deck

The convenience of quick reverse recording and playback in a double deck design is yours with AIWA's AD-WX707. The single-direction Deck I is for playback only, while the recording/playback Deck II features a quick 0.3 sec. auto reverse mechanism for extended tape enjoyment. Also included are Dolby B and C noise reduction and an impressive array of advanced features for performance and convenience.

Normal of High-Speed Tape Dubbing

Synchronized tape dubbing from playback-only Deck I to recording/playback Deck II is as easy as a single touch of a Synchro-dubbing control. Select Normal Speed operation for optimum fidelity, or High Speed dubbing to finish in half the time. Recording levels are set automatically for optimum results in either mode.

Mfg. list \$250.00 **CALL FOR BSW PRICE**

REVOX

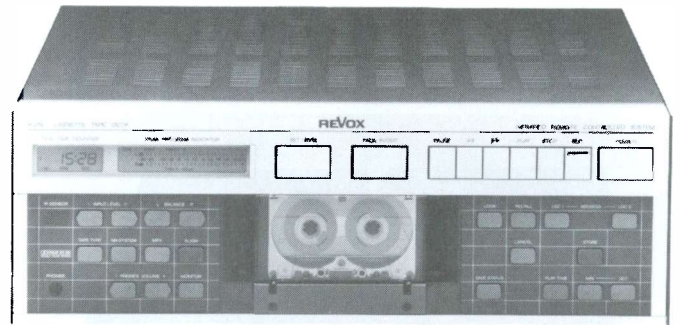

Model B215 Cassette Deck

The Revox B215 is one of the most innovative and sophisticated cassette decks available. Through the use of three on-board microprocessors, the B215 features:

- | | |
|------------------------------|----------------------|
| Auto alignment and level set | Dolby B and C |
| Real time counter | Four separate motors |

Wired remote control and rack mount are available as options.

Mfg. list \$2,300.00 **CALL FOR BSW PRICE**

Technics

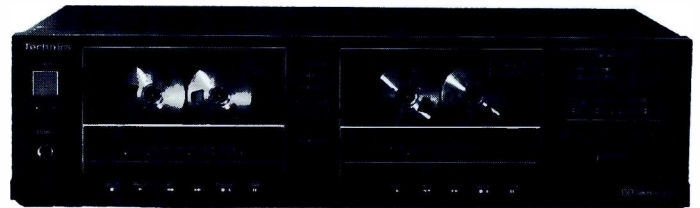

Model RS-T22K Editing and duplicating deck

- Soft touch controls
- Dolby B & C
- High speed duplicating
- Editing
- Cue & review
- Series play
- Auto tape select with LED indicators
- Synchro edit start
- Timer record/play
- Two color peak level meter
- Auto space control
- Headphone jack

Mfg. list \$225.00 **CALL FOR BSW PRICE**

BSW

BSW's "after the sale" support is second to no one. Your complete satisfaction is our only goal.

1-800-426-8434
FAX 206-565-8114

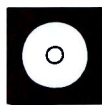

SONY

CDP-3000

CDP-3000

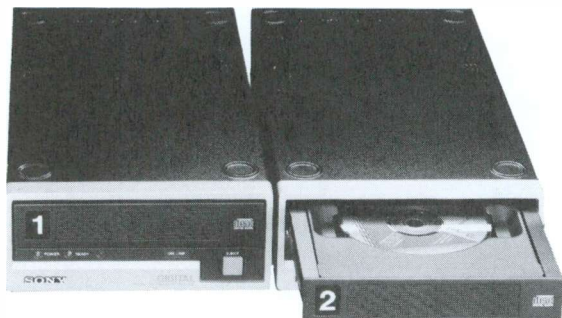

PROFESSIONAL COMPACT DISC PLAYER SYSTEM SERIES 3000



Model CDS-3000

Series 3000

The CDP-3000/CDS-3000 is a modular professional compact disc player system. Compact size? You've got it. Instant access and programmed play? They are yours, with the extra convenience of controlling two CDP-3000 players with one CDS-3000 control unit. How about reliability? Day in and day out under the most demanding situations the system will perform perfectly. Now then, budget? No worry. The system is exceptionally cost-effective despite its high performance. Because Sony doesn't just keep up with technology; it is always a step ahead. Whether you are a radio station or a production house considering the introduction of compact disc digital audio, your requirements will be perfectly met in the new Sony CDP-3000/CDS-3000 system.

Your Production department can now perform tight edits and start the selection with audible cueing...A great feature that most consumer machines simply cannot do.

In the control room, air talent can segue between two discs automatically, as well as seeing remaining time of selection on the air.

The advantages of the Sony 3000 series system go on and on and we would like to talk to you about them. Call us toll free for all the details, 1-800-426-8434.

Series 3000 System

Mfg. list \$5,650.00 **CALL FOR BSW PRICE**
(Units may be purchased individually.)

Technics



SLP1300 similar in appearance to SLP1200 pictured

SL-P1300

- High resolution digital filter
- Double isolated anti resonant cabinets
- Search dial cueing - precision pitch control

Technics developed the SL-P1300 to serve as a reference CD player for broadcast and other situations where the highest possible sound quality is demanded. No other player has all these features unless its twice the price. Look at the advantages of the 1300..8 times oversampling, 4 digital-to-analog converters, XLR connectors with +8dBm output, vari speed, digital output, cue wheel for precise cueing with audio. In addition, the SLP1300 cues to music automatically. Why settle for anything but the best...

Mfg. list \$1,700.00 **CALL FOR BSW PRICE**

AUDIO TEST COMPACT DISC



- 99 audio tests
- Frequency sweeps
- Tone bursts
- Pink noise
- Sample musical selections
- Spot frequency
- IM distortion
- Square wave
- White noise

99 AUDIO TESTS ONLY \$25.00



Technics



CUES TO MUSIC SUPERB SOUND QUALITY

SL-P770
Programmable Compact Disc Player

Technics's SLP770 incorporates several features that the more expensive SLP1200 CD player has, but does not take up valuable counter space. Quadruple oversampling and newly developed 18 bit high resolution system assures the finest audio. The air staff will love the auto cue to music and thumb-wheel cueing giving the SLP770 turntable-like features.

Mfg. list \$660.00

CALL FOR BSW PRICE

Panasonic



Model SL 4300
Compact Disc Player

Introducing the Panasonic SL-4300, a professional compact disc player employing sophisticated digital audio technology. Features include an automatic "series play" function for unattended long-play operation.

Important features

- Quadruple oversampling (176.4 kHz) digital filter and 2-DAC
- Series play function
- Wired remote control unit supplied
- 20-selection random access programming
- Multi-function 2-color FL display
- High Speed Linear Motor Access System
- Rack mount standard

Mfg. list \$500.00

CALL FOR BSW PRICE

TASCAM



- Balanced outputs
- Rack mount
- Hard wired remote control
- Digital oversampling

Model CD-501 CD Player

The Tascam CD-501 compact disc player offers superior CD reproduction performance in a model that has been specifically designed for professional applications. The key words here are durability and compatibility. The CD-501 is built to rugged standards that guarantee consistent, reliable performance even through demanding non-stop use. It also features electronically balanced XLR type line outputs for direct plug-in compatibility with professional equipment. Of course, there are many other features and functions that make the CD-501 perfect for a broad range of applications — especially broadcast. Sound quality is strictly first class, too. Original TEAC ZD circuitry applied to the D/A conversion stage has effectively eliminated one of the last remaining barriers to achieving truly pure, natural CD reproduction: the "harsh edge" of quantization noise. Dual monaural D/A converters and a precision 3-beam laser pickup driven by a unique linear motor also contribute to significantly improved sound quality.

The Tascam CD-501 effectively intergrates CD into the professional environment.

Mfg. list \$1,249.00 **CALL FOR BSW PRICE**

AudioSource®

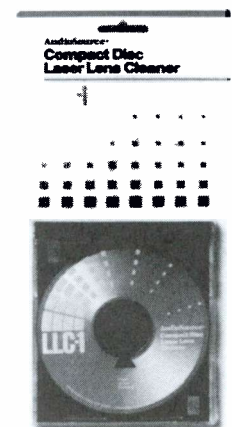

If your C.D. player is experiencing false starts, skipping or distortion, the problem could be a dirty laser lens. The LLC-1 is a digitally encoded compact disc that has a brush to clean the lens automatically. Simple to use with superior results.

BSW PRICE \$29.95



SERIES 5000

Our Best Selling Modular Console

The Arrakis 5000 Series Console is a full featured, modular console for under \$10,000. The mainframe features 16 channels plus a channel for accessory modules and the standard control room monitor module. The meter bridge boasts meters for both program and audition stereo outputs, and clock and timer. The power supply is external, regulated and protected. The entire modular front panel hinges up and back to expose the input/output terminal strip connectors. All wiring is performed from the front of the console. The compact 30" wide by 17" deep mainframe is ideal for efficient studio design.

The standard console preamp module features two balanced stereo inputs, program and audition output assignment switches, stereo cue accessed by detent on the Penny and Giles slide fader and momentary lighted module on and off switches. Remote start/stop, prefader patch points and remote module controls are standard in the 5000.

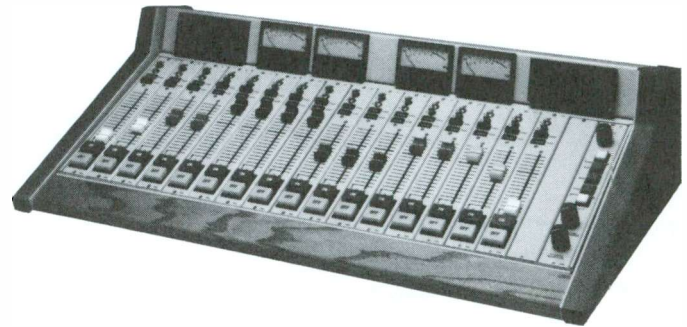

Price based On Configuration For Details Call BSW 1-800-426-8434

10,000 SERIES CONSOLE!



**PRICE BASED ON CONFIGURATION
CALL YOUR BSW PROFESSIONAL
FOR DETAILS 1-800-426-8434**

DELUXE FEATURES

- "On-Air", 4 track and 8 track production are all supported in one mainframe by ten main audio busses, two stereo auxiliary busses, stereo cue buss and stereo solo buss
- Mainframe hinges open on hydraulic lifters for "front of the console" access to all bussing and connectors
- External regulated and protected power supply features independent supplies for audio, logic, monitor and phantom power
- Two stereo auxiliary busses for effects/foldback
- Stereo cue system with autocue switching of earphones
- Stereo solo in place monitoring
- Monitor system provides feeds for console, host, co-host and guest headphones
- Separate control room and studio monitor systems for multiple studios
- Multistation talkback or intercom systems
- Multifrequency test oscillator
- Independent telephone mix-minus module
- Comprehensive remote control logic for each input

Unprecedented Level Of Quality & Flexibility

The ARRAKIS 10,000 series is the most feature laden console of any class. It supports everything from ON AIR to 8-track multitrack recording. The 10,000 series console is a uniquely qualified world class console. It will perform equally well ON AIR in the major market radio station, network TV, or in a live session in a recording studio. Its combination of DC controlled electronics and premium grade components make it ideal for the rigorous professional broadcast environment and yet its appearance would accent the decor of the space shuttle. Timeless grace, classic engineering, and the unfailing commitment of Arrakis Systems to excellence makes the 10,000 series broadcast console the new standard of comparison.



Number One In Consoles

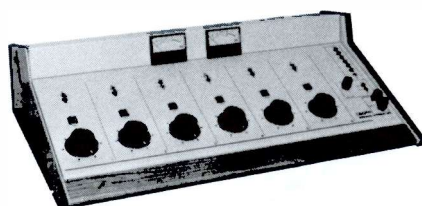

150SC6S

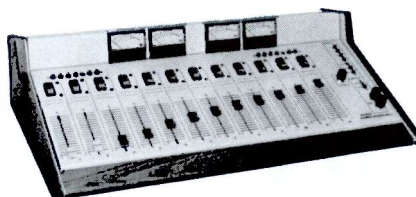

2000SC12S

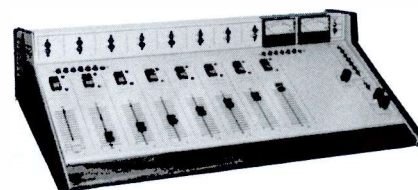

1500SC8S

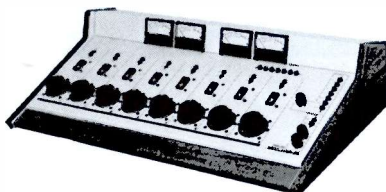

500SC8S

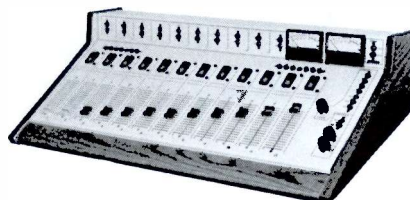

2100SC12S

All Arrakis products are engineered to be reliable first. No expense is spared in the use of quality components. Their use of Penny and Giles slide faders and ITT Shadow switches are examples of this. Any product that they build must do more for the price than any competitive product. Arrakis standard features such as mono mixdowns, remote starting, 4 external monitor inputs, etc. provide features in their consoles that aren't available often at twice the price. Arrakis consoles are exceptionally cost effective while not compromising reliability or product features.

FEATURES:

- VCA level controls
- DC controlled - no audio on pots or switches
- 10 watt per channel monitor amp
- Solid oak end panels and armrest
- NE5532 integrated circuits
- Modular regulated power supply
- Mono mix down standard
- Telephone mix-minus standard
- Remote start standard (except 150SC)

CUE AMP: Selected by detent on the individual volume pot 2 watts RMS at 8 ohms per channel.

EARPHONE AMP: Selectable between Program (Audition), Cue and External, 2 watts RMS at 8 ohms per channel.

REMOTE START: Each of the channels has a ground closure for start. Jumpers determine momentary or sustained action. A & B start individually on 2 input per channel models. The 150SC has no start.

DIMENSIONS: 30"W x 17"D x 7"H

ELECTRICAL — One channel on a fader at -15 dB

FREQUENCY RESPONSE: ±5 dB 20 Hz to 20 kHz

HUM AND NOISE:

MIC CHANNEL - 70 dB below +8 dBm, -50 dBm input, 20 kHz

LINE CHANNEL - 100 dB below +18 dBm, +18 dBm input, 20 kHz

TOTAL HARMONIC DISTORTION: .02% typical at +8 dBm

Backed By A 2 Year Warranty

SPECIFICATIONS FOR ALL CONSOLES

CHANNELS: Five through twelve

INPUTS: 1 or 2 per channel

Remote select switches - 7 inputs each

LO LEVEL - 1000 ohms, -50 dBm typical input level

Trim pot adjustable level from -60 to -30 dBm

HIGH LEVEL - 100,000, 0 dBm typical input level 30 dB trim adjustable A & B inputs

PROGRAM/AUDITION OUTPUTS: Identical 600 ohms balanced +27 dBm maximum output. Mono mix and mix minus busses are the same.

MONITOR AMP: Selectable between Program (Audition) and external inputs. 10 watts at 8 ohms per channel. Line out for external amps.

MODELS AND PRICES

150SC6S Six ChannelsMfg. list \$1,995.00

- 18 inputs to 6 channels
- program output

1500SC8S Eight Channels Mfg. list \$3,999.00

- 28 inputs to 8 channels
- Program and audition outputs

500SC8S Eight ChannelsMfg. list \$2,999.00

- 25 inputs to 8 channels
- Program and audition outputs

2000SC12S Twelve ChannelsMfg. list \$4,695.00

- 24 inputs to 12 channels
- Program and audition outputs

2100SC12S Twelve ChannelsMfg. list \$5,695.00

- 34 inputs to 12 channels
- Program and audition outputs

CALL FOR BSW PRICE



AUTOGRAM

Consoles come and Consoles go.....except Autogram. They have long been established in the broadcast industry as "the" console to own. Why their success? Simple...Autogram consoles are very reliable, easy to install and maintain, but most importantly they are "bullet proof".

The purchase price of a console is quickly forgotten, but the quality and craftsmanship last forever, So, invest in quality.....invest in Autogram.....

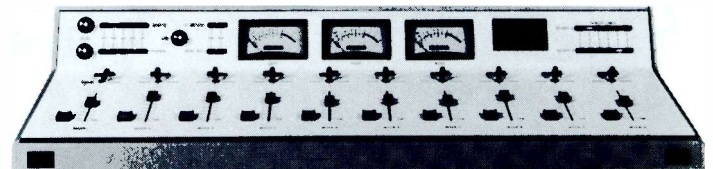
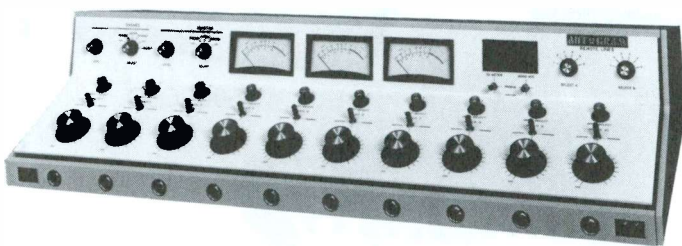

LC-10 (Shown with optional clock/timer)

Model IC-10

Features high quality step attenuators, 2 inputs per channel with 2 six position remote select switches. Remote start switches, headphone monitor and cue amplifiers standard. 2 stereo outputs with mono mix down are standard as well.

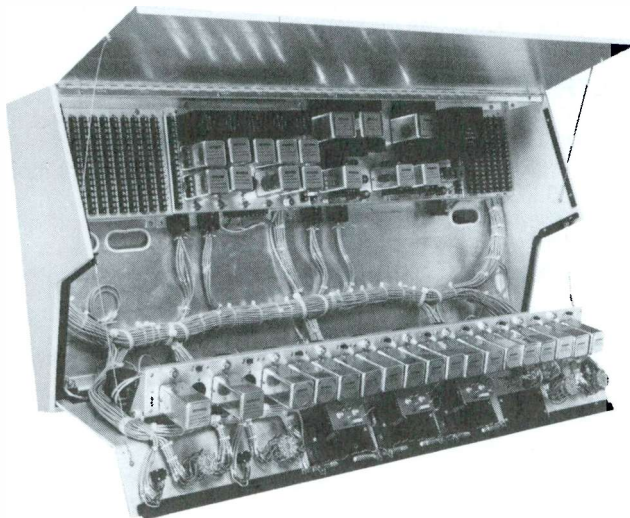

IC-10 (Inside view)

- Model IC-10 10 Channel Stereo 28 Inputs
Mfg. list \$8,986.00 **CALL FOR BSW PRICE**
- Model AC-8 8 Channel Stereo 26 Inputs
Mfg. list \$6,830.00 **CALL FOR BSW PRICE**
- Model AC-6 6 Channel Stereo 23 Inputs
Mfg. list \$5,495.00 **CALL FOR BSW PRICE**
- Mono Versions Available

The LC-10, a complete new look ten-pot audio console. Linear (slide) pots, push button select switches, and the traditional Autogram engraved front panel incorporate to provide a clean and spacious layout.

Using only the highest quality parts, Autogram has selected ITT shadow switches for monitor and phone select, mono mix, VU meter select, remote select and A/B channel select. These switches are color-coded status indicators which change color when pressed. Each channel has a remote start switch which is routed through the A/B channel select switch and is placed on the front panel near the linear attenuator. Large API true VU meters provide visual monitoring in the traditional Autogram fashion.

Sources:

- 28 stereo inputs — customer's option as to use by plug-in modules
- 1 high level cassette

Noise:

Program/audition, - 120 dBm

Frequency Response:

Program/audition, ± 1 dB 30 to 15 kHz

Distortion:

Program/audition, less than 0.5% THB



Try Us
We're As Close As
Your Telephone
Toll Free
1-800-426-8434



AUTOGRAM

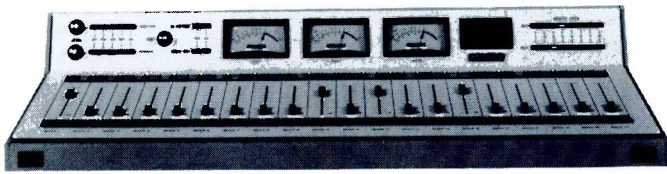

Model R/TV-20 Stereo Console

- 1 cue
- 2 headphones
- 2 line monitors out
- Balanced line outputs
- No audio transformers
- Optional interface card for logging to printer, plus interfacing to live assist or computer
- Penny & Giles faders
- 12 or 20 channels
- Up to 42 inputs
- VCA level control
- Electronic switching
- Each channel remote controllable
- 2 stereo programs
- 1 mono program
- 2 mix minuses

Model RTV-12 12 Channel Mfg. list \$10,775.00
 Model RTV-20 20 Channel Mfg. list \$12,995.00

“Live Assist” Package For R/TV Series Radio & TV Stereo Consoles

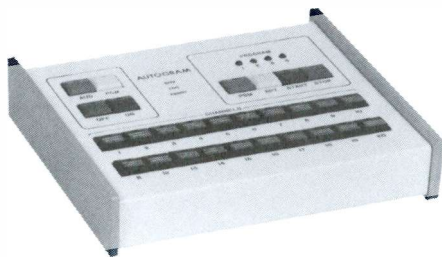

Autogram's Live Assist Package consists of one micro-processor board, one control panel and one interface board with cable.

The Live Assist Package allows automatic operation of one bus while live work is being done on the other bus. It also enables the operator to program up to 32 sequential steps per program on each of four programs: a total of 128 steps.

The system offers complete and random selection of all console channels. It also allows remote control of each channel on the console using a small eight-wire cable.

The Live Assist Panel plugs into the R/TV Series Console and offers full remote control plus four live assist programs. Each program contains up to 32 steps.

With live assist, the operator can:

- Start, stop and select audio bus for each console channel via remote control
- Observe live assist status at all times
- Monitor sources to transfer on EOM or silence sense
- Use multiple live assist panels for tandem remote control
- Override live assist at any time
- Obtain limited real-time up-dates for program format control
- Repeat or chain live assist programs for longer walk-away time.

Mfg. list \$1,395.00

CALL FOR BSW PRICE



Vanguard Series™

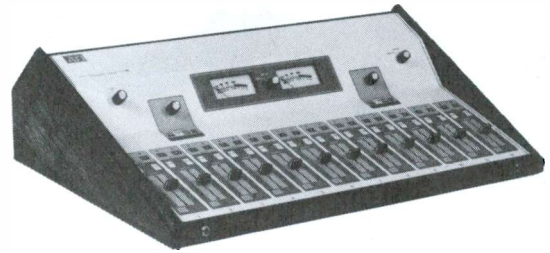

Consoles From ATI

- Dual stereo plus dual mono program outputs.
- Hi-level instrumentation amplifiers accept -20, -10 or +4 dBm inputs with excellent hum and RF rejection.
- Two mono microphone preamps with internal PAN pots standard. Low noise instrumentation amplifiers with DC servo stabilization. Additional preamps optional.
- Programmable muting for every input.
- Two switched analog VU meters standard. Optional four channel, two color vacuum fluorescent bar graphs.
- Three input monitor selector provides muted outputs for external optional power amplifiers.
- Three input headphone selector and amplifier.
- Built-in cue amplifier and speaker.
- Membrane switch locations are raised by embossing to allow easy touch location in the dark. Stainless steel domes above each switch provide silent tactile feedback. Five color graphics are protected by a seamless, rugged polycarbonate overlay. LEDs indicate all operations.
- All faders and level controls drive DC operated VCAs. AB type J pots and smooth acting linear faders.

Model BC8DSR Mfg. list \$3,395.00
 Dual stereo eight rotary faders - 12 inputs

Model BC8DSL Mfg. list \$3,395.00
 Dual stereo eight linear faders - 12 inputs

Model BC12DSL Mfg. list \$4,995.00
 Dual stereo
 12 linear faders
 24 balanced inputs

**For More Details On
 ATI Consoles
 Call Your BSW Representative
 1-800-426-8434**



UREI



**The UREI
1650, 1680 and 1690
Broadcast Consoles**

- Nine models to choose from (12 channel not pictured)
- Choice of 5, 8 or 12 channels
- Choice of Penny & Giles, Shallco or conductive plastic attenuators
- ± 24 dBm output into 600 ohm load
- Better than 90 dB signal to noise
- Built-in monitor, headphone and cue amplifier
- Built-in cueing loudspeaker

The UREI Broadcast Consoles are a fresh answer to the operational requirements of the broadcaster — a top quality, reliable, flexible and affordable line of on-the-air boards which will provide outstanding service for many years.

Excellent specifications and extensive RF shielding make UREI a natural choice in all broadcasting applications. Installation is quick and easy, thanks to barrier strips with clear, easy to read designations. No special tools required.

CALL FOR BSW PRICE

LPB



When quality and durability are your two priorities in selecting a console, look no further than the CITATION Series from LPB. Features include:

- 3 inputs per mixer
- Pre-fader cue
- Remote start

The Citation series offers a wide variety of options so you can customize for your needs. Call us for a complete technical brochure and pricing information.

Signature III consoles offer 3 inputs per mixer, rotary Shallco step or optional P&G stepless faders, plug-in modules, LED peak indicators, switchable mic gain, all transformer inputs and outputs and demonstrated RFI immunity. Mixers 1 through 4 accept either microphone or high level plug-ins (option available for more), others are fixed high level. Monitor speaker muting and tally relays are provided for mixers 1 through 3. Every fader has a cue position, and the consoles include an internal cue amplifier and 5" cue speaker as well as 12 watt/channel monitor amplifiers.

- S10-6 Mixer Dual Stereo Mfg. list \$3,995.00
- S13-8 Mixer Dual Stereo Mfg. list \$4,995.00
- S20-10 Mixer Dual Stereo Mfg. list \$5,895.00
- S24-12 Mixer Dual Stereo Mfg. list \$6,695.00

Call 1-800-426-8434 for BSW Prices



**Broadcast
Electronics Inc.**

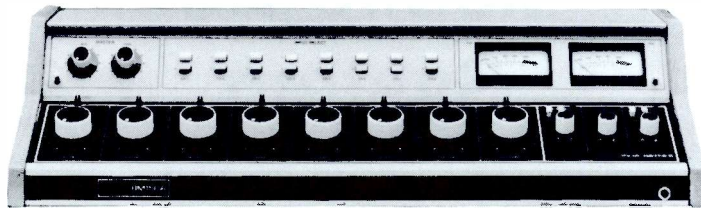

Model 8S150A

**Series 150A
Versatility Plus**

Model 8S150A

The 150A Series consoles offer full featured versatility without straining your budget. Each console features the elegant technical white and gray finish with solid oak end bells. Durable, sealed potentiometers are used in each mixing control with detent cue bus.

Each mixing channel accommodates two pushbutton selectable inputs and may be preset for either microphone or high level service.

Monitor, headphone and cue amplifiers give you full monitoring capability.

- 5S150A 5 Mixer StereoMfg. list \$2,995.00
- 8S150A 8 Mixer StereoMfg. list \$3,695.00
- 10S150A 10 Mixer StereoMfg. list \$5,295.00

CALL FOR BSW PRICE

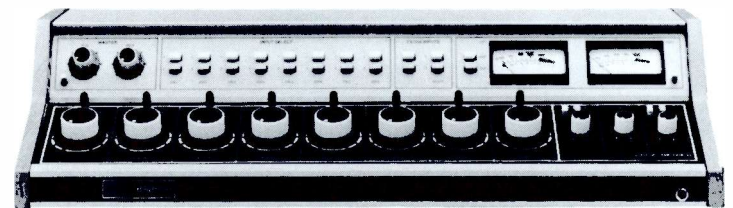

Series 250A

Deluxe Dual-Channel

Model 8S250A

With their two-tone technical white and gray finish and solid oak end bells, the 250A Series consoles are sure to accent any studio. But don't let their stylish exteriors fool you. These consoles are tough performers! Broadcast Electronics has specifically designed the 250A Series for rugged, reliable service in any demanding on-air or production application.

The quality features of the 250A Series consoles include ladder-type step attenuators (with cue detent) for long life and easy maintenance, roller-cam key switches to designate individual channel assignments.

Each mixer preamplifier offers the flexibility of selecting either a microphone or high level input for each channel. Every 250A Series console also features separate monitor, headphone and cue channels. (Mono/stereo mode switching is optional on all stereo consoles) All front panel graphics are protected by a laminated polycarbonate overlay.

- 5S250A 5 Mixer StereoMfg. list \$3,750.00
- 8S250A 8 Mixer StereoMfg. list \$4,850.00
- 10S250A 10 Mixer StereoMfg. list \$5,995.00

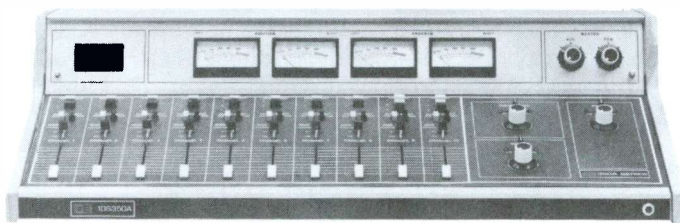

Dual-Channel, Stereo Outputs—Model 10S350A

Series 350A

10-Mixer, Vertical Fader, Dual-Channel Mono/Stereo Models

The 350A Series consoles offer the smooth reliability of Penny & Giles precision faders. Each Penny & Giles fader features convenient dual cue switching through the use of a detent "drop cue" or Cue/Program Audition/Off switch. The 350A's also offer separate audition and program metering. This allows simultaneous monitoring of Audition and Program channel levels. The mono 10M350A console features two meters while the stereo 10S350A console provides four meters (audition right and left plus program right and left). Both models are attired in a two-tone technical white and gray finish with a laminated polycarbonate overlay.

- 10S350A Stereo
Mfg. list \$6,195.00 **CALL FOR BSW PRICE**

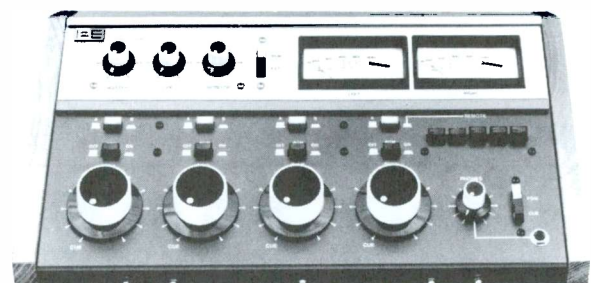

Series 50A

4-MIXER, STEREO • MODEL 4S50A

The 4S50A sets the standard for compact stereo consoles. Featuring excellent stereo performance, the 4S50A lends itself well to either production or on-air use. Each of the first three channels accept two high or low level stereo inputs. Channel four can be pre-selected for a single high or low level stereo input, or for one of five high level remote/utility stereo inputs. Each channel mixer control incorporates sealed dual-potentiometers fitted with detent cue switches.

- 4S50A Mixer StereoMfg. list \$2,150.00

CALL FOR BSW PRICE



STATIONMASTER By Auditronics, Inc.

Model 1008
Dual Stereo Console

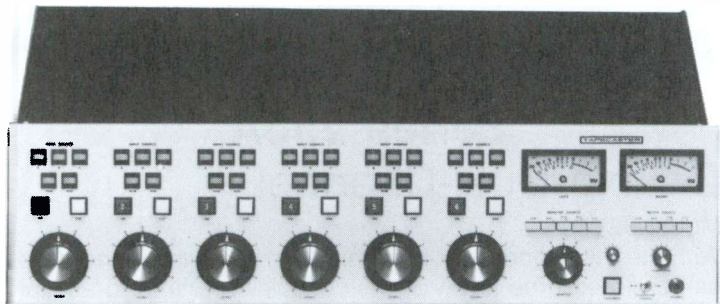

- Any input may be stereo or mono
- Mono inputs may be field upgraded to stereo
- Mono inputs may be line or mic source
- All input switching is DC logic controlled
- Three source selections for each input
- Each input has machine control logic which follows source selection
- Advanced ergonomic design
- Built-in talk back intercommunication to studio
- No internal transformers
- Plus 24 dBm output
- 6, 8, 12 and 16 input mainframes
- plug-in circuit board technology
- All input levels VCA controlled
- Two stereo plus two mono outputs

CALL FOR BSW PRICE

NUMARK Mobile DJ System



Here it is...the most complete mobile DJ system...The Numark includes everything you need...Turntables, amplifier, equalizer, console, microphone, speakers, all housed in road proof cases...Several options and systems available...Call toll free for details...1-800-426-8434.

CALL FOR BSW PRICE

Prices Start as
Low as \$4,769.00

BSW

**OPEN 12 HOURS DAILY
IN YOUR TIME ZONE**

Pacific 6:00 am to 6:00 pm	Central 8:00 am to 8:00 pm
Mountain 7:00 am to 7:00 pm	Eastern 9:00 am to 9:00 pm

Toll Free 1-800-426-8434
Fax 206-565-8114 TWX 910-441-2617

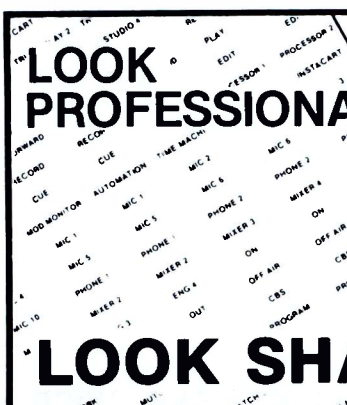

LOOK PROFESSIONAL

CONSOLE LABELS
(Black or White)
296 LABELS PER SHEET
BSW PRICE \$14.95

LOOK SHARP!



RAMSA

PRODUCTION/RECORDING CONSOLES



WR-8210A

Compact-Size Versatile Performance

Recording Console

The Ramsa WR-8210A is a compact, versatile 10x4 mixing console designed for multi-track recording. Although it is designed for compactness, it meets requirements of a wide variety of recording applications.

The WR-8210A is a human-engineered product, incorporating the latest circuit technology. This concept includes access jacks on all inputs and group outputs, a modular approach to internal circuit boards, a built-in sub in tape monitor section, and low-noise, electronically balanced mic inputs.

The WR-8210A provides a level of performance and flexibility usually found only in more expensive mixers. In large studio consoles, one of the most important considerations is to minimize repatching. This same design philosophy is evident in the WR-8210A. It offers direct outs and access points on each input, as well as dual outputs on Groups 1 and 2, for connection of a multi-channel tape deck and a mix down recorder.

Mfg. list \$2,500.00 **CALL FOR BSW PRICE**



Ramsa WR-M10 Multiple Source Stereo Console

22 input connections, 11 output connections, built-in compression, auto-muting and sub-grouping are among the features that make this a most flexible, compact mixer. Rack mountable and remote start standard.

Mfg. list \$900.00 **CALL FOR BSW PRICE**



WR-8616

Highly flexible modular mixing console for post-production-recording & broadcast applications. Production Console

The WR-8616, a mixer specifically designed for recording and broadcast applications, employs a versatile mainframe that can accommodate a variety of modules to meet the user's specific need. Such a design approach facilitates interfacing with a variety of equipment, such as tape cartridge machines, 2 to 16 track tape machines, turntables, or up to 16 microphones.

The WR-8616 offers a choice of two input modules, a mono mic/line module (WU-8101) and a stereo line module (WU-8106). Depending upon which modules are used, The WR-8616 can accommodate up to 16 mic in signals or 32 line in signals, or a combination thereof. For example, 12 mono modules and 4 stereo modules would have the capability of 12 mic in signals and 20 line signals.

Available with remote start switches and equalization, the WR-8616 is one of the most versatile consoles available in its price range. Call us for detailed pricing and specifications toll free, 1-800-426-8434.

CALL FOR BSW PRICE

Price based upon configuration

CLOSE AS YOUR TELEPHONE

- 200 Product Lines For Broadcasters
- Extensive Inventory For Immediate Delivery

TOLL FREE
1-800-426-8434





TASCAM

Model M-106 Production Console

- 6 input channels with selectable inputs, provide:
- 6 Mic in
- 6 line in
- 4 RIAA phono in
- 4 PGM busses
- Aux buss with master level control
- Effect buss with master level control
- Rack mount kit available

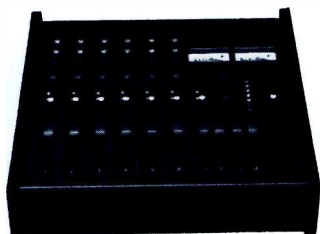

Mfg. list \$699.00 **CALL FOR BSW PRICE**

Model M-208 Production Console

- 8 mic line selectable inputs
- 4 buss
- 2 aux
- Stereo buss
- EQ 3 band sweep
- All channels selectable mic/line or tape input
- All channels balanced mic inputs
- 2 program outputs for buss

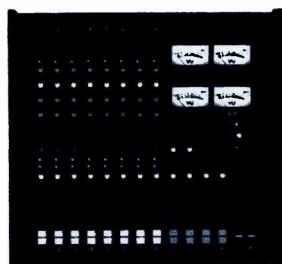

Mfg. list \$1,199.00 **CALL FOR BSW PRICE**

TASCAM'S 500 SERIES



Model M-512 Production Console

The Series 500 console is designed for production professionals. Built to accommodate either +4 dBm or -dBV nominal levels in and out.

The M-512 has 12 input channels, 8 track monitor section, and power supply built into the mainframe. The M-520 (not shown) has 20 inputs, 16 monitor section, and outboard power supply.

With features galore, the 500 Series consoles lend themselves to radio and television production, recording studios, and editing rooms. (Stand shown extra).

Mfg. list \$4,499.00 **CALL FOR BSW PRICE**

STUDIO 8

8 TRACK WORK STATION

ONE NEAT LITTLE PACKAGE



Studio 8

The Tascam Model 388 "Studio 8" is an extremely versatile tool for creative people in a variety of fields. The 388 is a complete recording system incorporating a full-function 8-in/8-buss mixer and a full servo controlled 8-track reel-to-reel recorder.

The mixer section includes 8 input channels, 8 PGM output busses, L/R stereo busses, aux buss, effect buss, 2 effect return systems and monitor section. Each input channel offers; wide range XLR balanced input, 1/4" line input, access send/receive, 3-band parametric EQs, etc.

The recorder section was adapted for compact 1/4" tape, 7" reel, 8-track format. Features include; real time counter, SMPTE compatibility, locator functions, built-in dbx with on/off (1-4 & 5-8), and ch. 8 defeat switches, and tape load mode. The servo system and rec/play amps can be aligned and adjusted easily from the top. Dbx Type 1 noise reduction is included.

Mfg. list \$3,999.00

**CALL FOR BSW
SPECIAL PRICE
1-800-426-8434**



MAX-Z

WORLD CLASS REMOTE

From Zercom

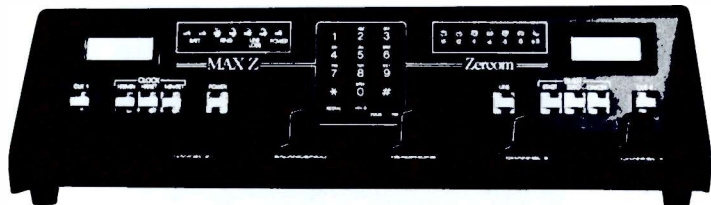

MAX-Z is a remote broadcast console that provides Maximum flexibility, utility, and above all, audio quality.

When it comes to convenience features that help make a remote broadcast run smoothly and sound professional, the MAX-Z has no equal.

A short list of standard features includes...carrying case, built-in rechargeable batteries and charger, clock, stopwatch/timer, V.U. meter, wide range audio inputs (will match almost anything), cue channel, phone line alarms, memory dialing (tone or pulse), etc.

Mfg. list \$1,095.00 **CALL FOR BSW PRICE**

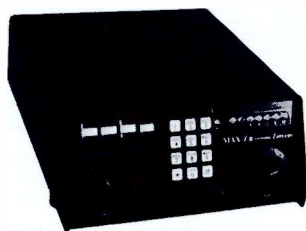

MAX-ZII

The MAX-Z II is an abbreviated version of the MAX-Z. High quality audio handling is maintained in the two channels of audio input. AC/DC powered, two headphone outputs, cue channel.

Mfg. list \$550.00 **CALL FOR BSW PRICE**

BSW

TIME IS MONEY

**SAVE A BUNDLE WITH
BSW'S FAST SERVICE,
CALL US AT
1-800-426-8434**

TELEFAX



Model Ten 32 Remote Console

- Push button dialing with memory redial
- 4 mic inputs - 2 aux. inputs
- Built-in carrying handle
- Superior audio quality

Mfg. list \$795.00 **CALL FOR BSW PRICE**



Model Ten 44 Telephone Remote Console

The Ten 44 has
Ten 32 features plus

- Electronically controlled nicad battery
- Digital up/down timer w/alarm and large LCD display
- 1/4" isolated mono phone jacks
- 4 active balanced mic preamps
- 1 kHz test tone oscillator
- Fused power input
- New mini toggle switches for radio monitor switching, headphone
- Noise cancelling on/off master audio "kill" switch and spotter channel

Mfg. list \$895.00 **CALL FOR BSW PRICE**

MICRO-TRAK

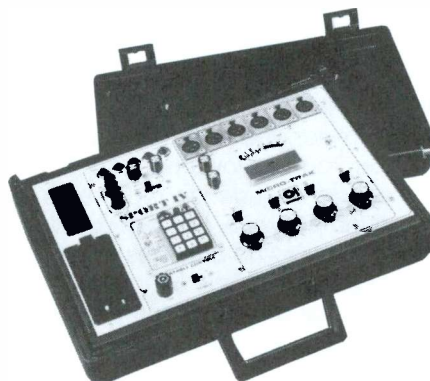

The Sport IV Remote Console

A professional-quality self-contained portable sports console featuring three headphone outputs for announcer and spotter, auxiliary input for commercials, talk-back capability for set-up and a telephone dial option. AC and battery power supplies are built-in, with automatic switchover in case of power loss. Attractively packaged in self-contained carrying case.

Sport IV With 4 Mic Inputs

Mfg. list \$799.50 **CALL FOR BSW PRICE**



GENTNER
ENGINEERING COMPANY, INC.



Combination Remote Mixer

Have you ever had an application where you wished the mic mixer and headset amplifier were all in one box? Gentner's new Combination Remote Mixer just may be your answer. It's the perfect one box solution for easy, quick remotes or similar applications. Four mic inputs, plus four individual headset amps are all built into one convenient package. Each headset output can have its own input and/or input from the "master" audio channel. This means your talent can listen to program audio and independently receive cues.

Mfg. list \$995.00
CALL FOR BSW PRICE

COMREX

THE ULTIMATE IN REMOTE CONSOLES



STLX Sports Console
Mfg. list \$7,750.00



SLX Sports Console
Mfg. list \$3,750.00

RUSSCO

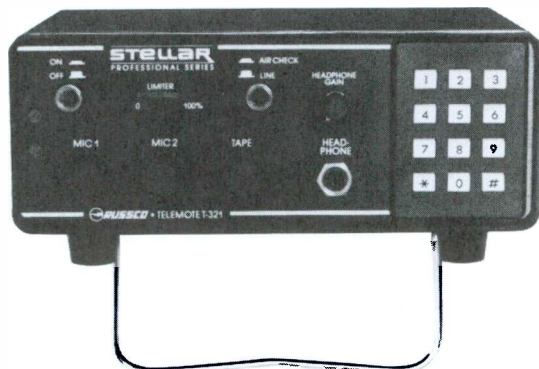

Model 321
Telemote Remote Mixer

Here's the remote mixer you've been waiting for! Russco's Telemote 321 gives you two low impedance microphone inputs and one medium impedance tape recorder input in a handy-dandy 3 pound package. What makes this tiny dynamo so unique is that it requires no batteries or any other external power source except your phone line. That's Right! The 321 works right off your dial or touch-tone phone line feed.

While you're broadcasting that important event, you can supply audio up to 3 headsets at once and control their level by a front panel pot. The audio level feeding the telephone line is controlled by a built-in limiter with the limiting action displayed by a LED bar-graph meter. It also incorporates a signal bell that allows calls originating at your station to be received at your remote location.

The Russco Telemote 321, 3 channel mixer makes life easy for you. No batteries or AC plugs to worry about. Just hook up to your phone line and you're on the air!

Mfg. list \$599.00 **CALL FOR BSW PRICE**

Ideal for sports or news, the STLX and SLX consoles are completely self-contained remote broadcast packages. The STLX incorporates a two line Frequency Extender encoder with noise suppression. The SLX has a built in basic single line Frequency Extender encoder.

Features

- Four mixing channels (2 mic/line)
- Built-in telephone interface
- Custom monitor mix with station talkback available on each headphone
 - (4 headphones/STLX)
 - (3 headphones/SLX)

- AGC
- AUX IN and OUT for external PA feeds, monitors, etc.
- Feeds dial or dedicated circuits

Requires Comrex dual or single line decoder for frequency extension. Call BSW for the complete line of Comrex equipment. 1-800-426-8434 or 206-565-8114.

CALL FOR BSW PRICE



SHURE

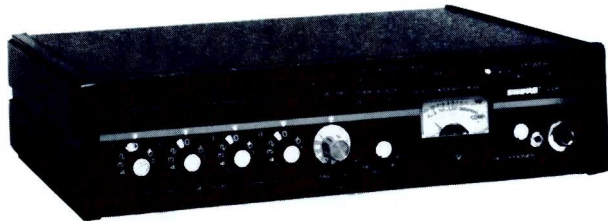

**Model FP51
Gated Compressor/Mixer**

Broadcast and field production professionals will find the Shure FP51 an invaluable time, labor, and space-saving component. By combining a high quality gated-memory compressor with a four-input, one-output professional mixer, the FP51 gives users a lightweight, compact production unit with remarkable versatility and "hands-free" operation. It rides gain automatically, saves on rack space, and eliminates many adjustment problems. It's an ideal component for ENG trucks, remote broadcasts, on-location productions, and sound reinforcement applications. And, like other products in Shure's "FP" Series, the FP51 packs a multitude of useful professional features into an exceptionally space-efficient package.

Mfg. list \$ 940.00 **CALL FOR BSW PRICE**

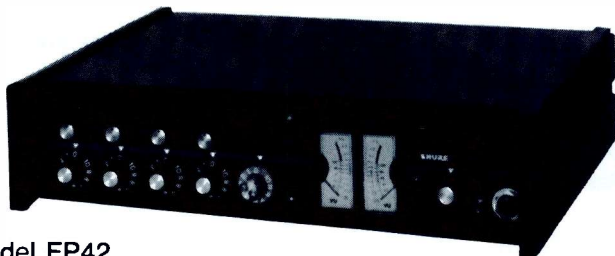

**Model FP42
Stereo Microphone Mixer**

Field production technicians suffering from audio headaches can rejoice. Shure has a cure in the FP42—an extraordinarily reliable, compact, feature-packed stereo audio mixer. The FP42 follows in the illustrious footsteps of Shure's classic, industry standard M267, combining Shure ruggedness with all the convenient features that make the M267 so popular—plus full stereo capability!

Mfg. list \$990.00 **CALL FOR BSW PRICE**



**Model FP32
Stereo Microphone Mixer**

Professional users asked for it, and Shure delivered! Shure's FP32 Stereo Mixer definitely answers the demand for a reliable, rugged compact stereo audio mixer. Electronic news gatherers and field production specialists agree: the FP32 handles their stringent demands with the utmost aplomb.

Mfg. list \$1,350.00 **CALL FOR BSW PRICE**

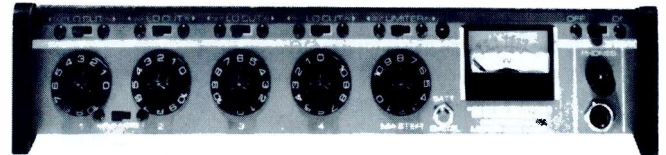

**Model M267
Professional Microphone Mixer with Limiter**

The Shure M267 offers performance and capabilities never before available in a modestly priced mixer. It has all the features that made the Shure M67 the industry standard mixer, plus additional features and performance improvements that promise to make it the industry standard. These features include...peak limiter, phantom power, built-in battery pack, LED peak indicator, headphone level control. The M267 has four mic or line switchable inputs. It also includes transformer balanced inputs and outputs, mix bus, VU meter, low RFI and line noise susceptibility.

Mfg. list \$520.00 **CALL FOR BSW PRICE**



**M268
Professional Microphone Mixer with Phantom Power**

The M268 is a compact, lightweight, five-channel microphone mixer that offers significant improvements in design, performance and versatility over other value-priced mixers including the Shure M68. It is ideal for public address and paging in hotels, schools, community centers, and hospitals, as well as an excellent add-on mixer for expanding current equipment. It is also an excellent mixer for use by the serious tape recording enthusiast.

mfg. list \$290.00 **CALL FOR BSW PRICE**



**Model FP31
Mono Compact Portable Mixer**

A compact, portable microphone mixer specially designed for electronic news gathering (ENG) and electronic field production (EFP) use. Measuring just 6 5/16" x 5 5/16" x 1 7/8", the FP31 incorporates the features most requested by audio engineers, electronic news professionals, sportscasters, and film and video sound engineers. Three XLR connector inputs and two outputs are provided, each switchable for either microphone or line-level operation. Incorporated in the FP31 is a built-in slate microphone for voice announcements and emergency field use.

Mfg. list \$990.00 **CALL FOR BSW PRICE**



SENNHEISER

Digitally Compatible

Successor to the HD 414 series, the single best-selling headphone in the world. Open-Aire design, HD 450 provides higher output and improved accuracy using neodymium-iron magnets. Supplied with 10-ft. stranded-steel cable.

- Frequency Response 20-20,000 Hz
- Impedance 70 OHMS

Mfg. list \$79.00

CALL FOR BSW PRICE

We stock replacement parts for all Sennheiser Headphones.

Model HD410SL

Lightweight open air design. Frequency response 20 HZ to 18,000 Hz. 600 ohm impedance.

Mfg. list \$69.00 **CALL FOR BSW PRICE**

Model HD222

The quality of Sennheiser in a closed ear format. Minimize sound leakage. Frequency response 16 - 20,000 Hz. 600 ohm impedance.

Mfg. list \$122.00 **CALL FOR BSW PRICE**

KOSS®

NEW ALL BLACK FINISH

Pro4AAA Plus

Feedback on the air a problem??? Koss Pro4AAA is a great solution.. Sealed earcups provide comfort and durability. Frequency response 10 to 20,000 Hz. 100 ohms.

Mfg. list \$70.00 **CALL FOR BSW PRICE**

K/6X Plus

This lightweight, stereophone delivers the sound of Koss at a popular price. Frequency response 10 to 20,000 Hz. 100 ohms.

BSW PRICE \$29.05



FOSTEX

Model T 20 Studio Headphone

You say you need a set of phones that can get louder than a 747 jet??? Here they are...guaranteed to please the most discriminating rock 'n' roller...Frequency response 20 Hz to 30,000 Hz. 50 ohms.

Mfg. list \$89.00 **CALL FOR BSW PRICE**



BEYER

Model DT220

Unusually lightweight, closed headphones. Excellent fidelity, sparkling response, and clarity that satisfies even the most discriminating ear. Frequency response 20 - 20,000 Hz. 600 ohm impedance.

Mfg. list \$129.00 **CALL FOR BSW PRICE**



Model K-240M

The K-240M is the first totally sound and comfort engineered headphone incorporating all the features necessary for complete listening enjoyment, accurate stereo imagery, outstanding fidelity of reproduction at all listening levels, extreme comfort with virtually no fatigue under prolonged use. Frequency response 15 Hz - 20,000 Hz. 4 - 600 ohm impedance.

Mfg. list \$120.00 **CALL FOR BSW PRICE**



K-141M

A lightweight, semi-open headphone featuring the resonance-free characteristics of "open air" designs. Frequency response 20 Hz - 20,000 Hz. 4 - 600 ohm impedance.

Mfg. list \$100.00 **CALL FOR BSW PRICE**





SENNHEISER

For easier listening in noisy environments.

Model HMD224X Remote Headset

- Sealed ear cushions guard against ambient noise
- 16 - 20,000 Hz frequency range headphone
- 50 - 12,000 Hz frequency range microphone
- Cardioid pick up pattern.

Mfg. list \$275.00 **CALL FOR BSW PRICE**



Astrolite

Astrolite headsets provide high quality communications for professional applications. The noise-cancelling electret boom microphone is broadcast quality providing 25 dB of noise cancellation and a frequency response of 100 Hz to 10,000 Hz \pm 3 dB. Headphone 50 - 15,000 Hz.

Model 8649 Cardioid

Model 8650 Omnidirectional.

BSW PRICE \$299.00



TELEX

Model PH92 Sportscaster Headset

- Push-to-cough switch
- Omni-dynamic microphone
- 50 - 15,000 Hz response microphone
- 50 - 15,000 Hz response headphone.

Mfg. list \$225.00 **CALL FOR BSW PRICE**



SHURE



Model SM-1
Mfg. list \$175.00



Model SM-2
Mfg. list \$200.00

SM1 and SM2 Headsets

Shure Models SM1 and SM2 are professional quality headsets that provide maximum comfort, durability and sound reproduction—designed for broadcasting applications. The SM1 (one ear cue) and SM2 (two ear cue) are loaded with deluxe features that make them an ideal choice for professional TV and radio broadcasters, film and video production crews and other A/V professionals.

Headset features include: a patent boom mount for total flexibility in microphone positioning—the boom adjusts for left or right side use; an all metal boom that is less subject to damage; a rugged, double-braced all metal headband with leather-like covering; and large "pillow-soft" ear pads for maximum comfort as well as superior external noise isolation. Detachable cables for added convenience.

Frequency response:
Headphone: 100 - 8,000 Hz
Microphone: 50 - 15,000 Hz

CALL FOR BSW PRICE

1-800-426-8434

BEYER

Model DT109K Headset

A headphone/microphone combination for heavy duty use. All parts easily interchangeable. Comfortable to wear over long periods of time. Hyper-cardioid microphone has excellent noise-cancelling qualities. Frequency response:

Microphone 40 - 12,000 Hz
Headphone 30 - 20,000 Hz.

Mfg. list \$214.00 **CALL FOR BSW PRICE**



KOSS CORDLESS HEADPHONE SYSTEM

Introducing the **JCK200 Infrared Headphone System**. Simply get headphone signal to the infrared transmitter, turn on the headphones and you're ready to go. Each guest controls their own volume and has complete freedom of movement. Frequency response is an outstanding 20 Hz to 20 kHz with excellent stereo separation. No extra headphone amplifiers are required and at least 4 pair of phones can be used with one transmitter.

Model JCK200 (xmitter, 1 pr. of headphones)

Mfg. list \$159.95 **CALL FOR BSW PRICE**

Model JCK200S (spare headphones)

Mfg. list \$119.95 **CALL FOR BSW PRICE**





RADIX

HEADPHONE SPLITTER Plug in Up to 6 Headphones



AND ONLY **\$69.95**

Model HS160

Headphone signal distribution has never been as easy or inexpensive.

Introducing the Radix 1 x 6 headphone splitter. Simply provide amplified headphone signal and plug in up to six headphones. The Radix 160 features isolation resistors to keep signal constant regardless of how many headphones are plugged in. Heavy duty chassis, excellent for field use. Locking 1/4" jacks prevent accidental unplugging.

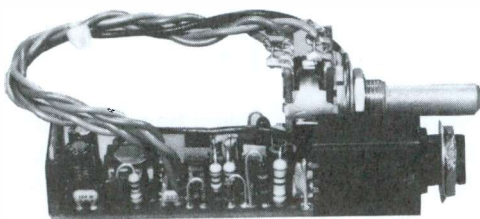

STEREO HEADPHONES ANYWHERE!

The Benchmark jack mounted amplifier series has been called brilliant. We call them practical. They have a recognized commitment to excellence, and the new HPA-1 stereo headphone amplifier follows the tradition

The HPA-1 can be used anywhere. Use them in consoles, at the patch bay, in television talkshow roundtables and in test sets, wherever you need individual level control. Use them in studio monitor boxes, with belt-pack mic preamps, and as unbalanced line drivers. You can even use them to drive speakers to moderate levels.

The HPA-1 features a current boosted NE5532 with a 60 kHz bandwidth at full gain, a gain range of Off to +18 dB and a noise floor of -90 dBu, again at full gain. The HPA-1 is ideal for the "Studio Series" headphones in the 200 to 600 ohm range but will work with 8 ohm devices as well.

Model HPA-1 **BSW PRICE \$58.00**

Call for BSW quantity discounts.

Multi-Color Microphone Windscreen Sets

Blocks out unwanted pop, wind, noise and close talking hiss. Made from special soft cut foam, decorative in design. These multi-color screens add beauty to your microphones. Also identifies each so no mix up will occur when more than one microphone is used.

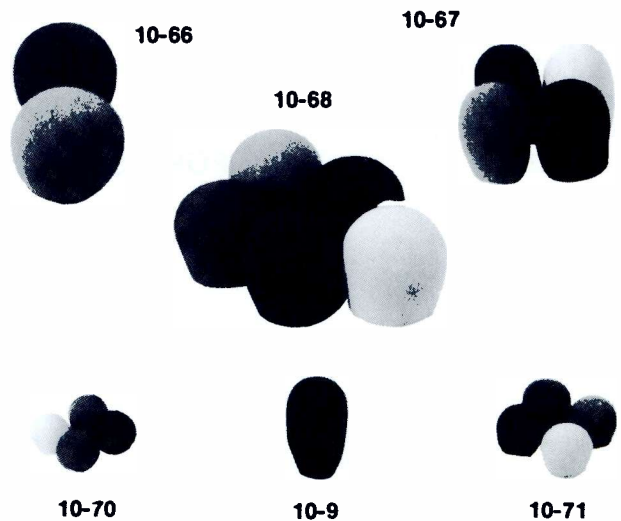

- 10-9 (2 3/4" High screen universal type—Fits slim models from 3/4" to 1 1/8") Color Black. **BSW PRICE \$2.00**
- 10-66 Contains two 2 3/8" High screens to fit 1 3/4" to 2" dia. microphones, 1-Red, 1-Blue. **BSW PRICE \$7.25**
- 10-67 Contains four 2 3/4" High screens to fit 1 3/8" to 1 3/4" dia. microphones, 1 each Red, Blue, Yellow, Black. **BSW PRICE \$8.15**
- 10-68 Contains five screens for spherical head microphone 2 3/8" High to fit over 1 3/4" to 2" microphones. 1 each Red, Blue, Yellow, Green, Black. **BSW PRICE \$19.85**
- 10-69 Contains four 7/8" High screens fit to 1/4" to 1/2" microphone. Designed to fit lavalier type microphones. 1 each Red, Black, Yellow, Green. **BSW PRICE \$4.20**
- 10-70 Contains four 1 1/8" High screens to fit 3/4" to 1" microphones. 1 each Red, Black, Yellow, Green. **BSW PRICE \$4.65**
- 10-71 Contains four 1 1/2" High screens to fit 7/8" to 1 1/8" ball head microphones. 1 each Red, Black, Yellow, Green. **BSW PRICE \$4.65**

BSW

BSW has an experienced Sales Staff waiting to answer your audio equipment questions and to meet all of your broadcast needs.

Call us at

1-800-426-8434



ProCable

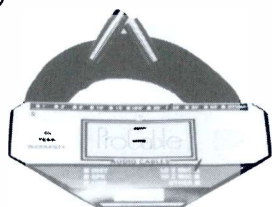

Model Series IIB
25 Ft. XLR to XLR Mic Cable
Excellent quality, outstanding value
BSW PRICE \$15.95 ea. 4 or More \$12.50 ea.



Mic Transformers
Model IMP
Impedance matching transformer XLR type low in to 1/4" high.
BSW PRICE \$29.25



AT8410A
Universal shock mount with clothespin clamp. Fits most sizes and shapes of microphones.
BSW PRICE \$36.50

AT8407
Universal clothespin clamp holds virtually all tubular and tapered body microphones.
BSW PRICE \$14.95

ACCESSORIES FOR MICROPHONES



MZA 421 Stand Clamp
For MD 421U\$35.00
MZA 441 Stand Clamp
For MD 441U\$49.00
MZW 421 Windscreen\$25.00
MZW 40 Windscreen\$31.00
HZL26-3 Mic Cable
XLR to Open End\$19.00



Windscreens
A2WSA for SM57 \$10.85
A58WS for SM58, 78 \$5.00
90A2089 for SM7 \$15.47
Stand Clamps
A25B for SM57, 58 \$4.00
A57D for SM59, 60, 61 \$12.20
A55M Isolation Mount \$35.55



Stand Clamps
301: Stand clamp for 1" to 1 1/8" diameter microphones. Allows snap-out use. Black or Gray.
BSW PRICE \$8.50
311: Stand clamp for 3/4" microphones. Allows slip-out use. Black.
BSW PRICE \$9.75

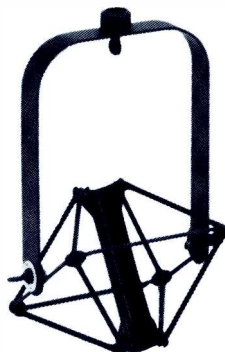

309: Shock mount for RE20 microphones. Provides excellent isolation.
BSW PRICE \$79.95

Windscreens
314: For RE10 and RE15 mics. Zippered for easy installation. Rear portion can be used on RE11 and RE16 for wind protection.
BSW PRICE \$19.55
314E: For 631B and 635A. Can be used for pop protection only on front of 660, 661, RE10 and RE15.
BSW PRICE \$9.75
355A: For DO54, RE55, 654A, 655 mics.
BSW PRICE \$9.75



BSW stocks a variety of microphone accessories. Call 1-800-426-8434 for the accessories you need.



SOUND GRABBER PZM TECHNOLOGY

The hottest microphone concept for conferencing, news gatherings and meetings. Fantastic pick up qualities from all corners of the room. Pressure-zone-microphone technology.

Mfg. list \$99.00 **CALL FOR BSW PRICE**

The Full Line Of PZM™ Microphones Are Available - Call 1-800-426-8434 For Details



Professional Omnidirectional Electret Condenser Microphone With Miniature Design

Model ECM55S/B

One of the most popular lavalier microphones we sell. Available in your choice of black or satin-nickel plating, the ECM-55 from Sony has an omnidirectional pick-up pattern. It can be powered by AA batteries or external power supply. Comes with mesh windscreen and holder clips.

Mfg. list \$281.00 **CALL FOR BSW PRICE**



Model MD421-U

One of the most versatile and popular of Sennheiser's dynamic microphones. For on air or production use, the MD421-U from Sennheiser is the natural choice for many stations. Reknown for its sonic quality, ability to handle high sound pressure levels and durability. Cardioid pattern-Frequency response 30 to 17,000 Hz.

Mfg. list \$399.00 **CALL FOR BSW PRICE**

Model TM3 Shock Mount

(Mic stand clamp not included) **BSW PRICE \$16.95**

Exceptional Quality And Versatility

**Model MD441-U
Unidirectional Dynamic
Studio Microphone**

Sennheiser's top-of-the-line dynamic microphone. designed for professional applications in broadcast, TV and film studios, but also perfect for first class PA installations.



- Frequency range from 30-20,000 Hz
- Super-cardioid pattern
- Shock mounted capsule to prevent handling noise

- Highest SPL without distortion
- Ten different switchable response curves
- Built-in pop filter

Mfg. list \$559.00 **CALL FOR BSW PRICE**



SHURE

SM-89
Shotgun Condenser

Incorporating a truly innovative design, the SM89 was built to fulfill the rigid requirements set down by the professionals. Designed especially for location film and TV production, theatre sound reinforcement and spot news coverage. The SM89's highly directional polar pattern and fine-tuned frequency response will discriminate at a distance in favor of desired dialogue or effects and against ambient noise, and will accurately pickup sound without excessive on-or-off axis coloration. Frequency response 60-20,000 Hz. Output - 52 dB.

Windscreens, carrying case and shock mount optional.

Mfg. list \$900.00
CALL FOR BSW PRICE



Model SM57LC (Less Cable)
Unidirectional Dynamic Cardioid

The SM57 is a slender dynamic microphone built to provide wide range reproduction of music and voice. Ideal for both studio and remote use in broadcasting, recording, motion picture and critical sound reinforcement applications. It is especially suitable for interview type use where "hand-a-bility" of the microphone is important. Frequency response 40-15,000 Hz.

Mfg. list \$137.00
CALL FOR BSW PRICE



SM83CN
Condenser
Lavalier/ Omnidirectional

A miniature marvel. The SM83 lavalier was designed to provide superior quality sound reproduction in professional broadcasting, film and demanding sound reinforcement applications. It features a wide range frequency response, specially tailored to provide natural sound because of an electronically created dip at 730 Hz to overcome the chest resonance phenomenon. Mic is detachable from the high performance, lightweight preamp. Versatile mounting hardware provided. Frequency response 80-20,000 Hz.

Mfg. list \$223.50
CALL FOR BSW PRICE



Model SM58LC (Less Cable)
Self-Windscreened
Unidirectional Dynamic Cardioid

The world standard professional stage microphone, with the distinctive Shure upper mid-range presence peak for an intelligible, lively sound. A tough, handsome microphone that weighs less than 11 oz....the SM58 is often imitated in appearance, but never duplicated in performance, ruggedness or reliability. Frequency response 50-15,000 Hz. Output - 56 dB.

Mfg. list \$176.00
CALL FOR BSW PRICE



Model SM63LLC (Less Cable)
Omnidirectional Dynamic

The SM63 is an elegant, rugged microphone with very high output — up to 6 dB higher than comparable omnidirectional microphones. Frequency response 50-20,000 Hz. Output - 56dB.

Mfg. list \$145.00
CALL FOR BSW PRICE



Model SM99

Shure has combined outstanding acoustical, electrical, and aesthetic design features to produce the most versatile miniature gooseneck condenser microphone available. Its uniform supercardioid polar pattern and extended frequency response deliver exceptional gain-before-feedback and source isolation, making the SM99 the ideal unit for multi-mic sound reinforcement installations.

Mfg. list \$240.00
CALL FOR BSW PRICE



Model SM82LC
Hand-Held Line Level
Condenser Unidirectional

An outstanding choice for on-the-spot broadcasting, sound reinforcement and recording applications where a line level microphone with a built-in limiter is needed. It is also ideal for applications involving long cable runs (up to one mile without equalization) such as sporting events, parades, political rallies and other live remotes. Frequency response 40-15,000 Hz.

Mfg. list \$410.00
CALL FOR BSW PRICE



Model SM7
Unidirectional Dynamic Cardioid

The SM7 is among the finest studio professional dynamic microphones in use today. Its "smooth and silky" sound has made it extremely popular for radio and television work. It features a wide-range, very smooth frequency response with graphic response-tailoring switches to permit the choice of four different microphone response curves. Frequency response 40-16,000 Hz. Output - 57 dB.

Mfg. list \$550.00
CALL FOR BSW PRICE



SM90/SM91
Condenser Surface

Professional, studio-quality, "boundary effect," surface microphones. Ideal for TV settings, news conferences, dramatic productions, choirs or wherever inconspicuous microphone placement is desired. The SM91 is unidirectional and the SM90 is omnidirectional.

Mfg. list \$310.00
CALL FOR BSW PRICE



EV Electro-Voice

For Broadcasting Professionals



Model 635A
Omnidirectional
Our Largest Seller

The 635A is our largest seller and for good reasons. Extreme durability and low cost. Frequency response 80-13,000 Hz. Output - 55 dB.

Mfg. list \$123.60

CALL FOR BSW PRICE



Model RE-50
Dynamic Omnidirectional

- Frequency response 80-13,000 Hz
- Output - 55 dB
- Internal shock and built-in windscreen

Mfg. list \$183.35

CALL FOR BSW PRICE



Model RE-20
Dynamic Cardioid

One of the most popular microphones used in broadcast environments. The RE-20 has a warm sound which will please the most discriminating announcers. Frequency response 45-18,000 Hz. Output - 57 dB.

Mfg. list \$545.00

CALL FOR BSW PRICE



Model RE-18
Shock-Mounted Super Cardioid Dynamic

Combines the best performance features of the famous RE-15 and RE-16 with superb mechanical noise insulation, uniform frequency response at all angles for colored pickup on and off axis. Consistent sound quality at any working distance. Refined, low-profile blast filter. Frequency response 80-15,000 Hz. Output - 57 dB.

Mfg. list \$339.50

CALL FOR BSW PRICE



Model DS35
Dynamic Cardioid

- Frequency response 60-17,000 Hz
- Output - 60 dB
- Built-in blast filter
- Two stage shock mount results in low handling noise

Mfg. list \$193.65

CALL FOR BSW PRICE



Model RE-11
Dynamic Super Cardioid

- Frequency response 90-13,000 Hz
- Output - 56 dB
- Built-in blast filter

Mfg. list \$222.50

CALL FOR BSW PRICE



Model RE45N/D

Specifically designed for hand-held ENG/EPF use, the Model RE 45N/D is a new design concept in shotgun microphones. The exclusive EV N/DYM™ dynamic element has the output level of a condenser microphone (- 50 dB) without need for battery or phantom power.

Truly a unique microphone, the RE45N/D is ideal for field interviews under high ambient noise conditions. Used as an interview microphone the RE45N/D allows added "reach" when needed, something not normally possible with traditional microphones. Frequency response 50-15,000 Hz (close), 150-15,000 Hz (far). Output - 50 dB

Mfg. list \$386.25

CALL FOR BSW PRICE



Model DO56
Shock Mounted
Dynamic Omnidirectional

Virtually impervious to mechanical noise. Isolated capsule design makes it the ideal microphone whenever there is lots of action. Built-in blast filter reduces "P-popping" to keep your audio clean. Frequency response 80-18,000 Hz. Output - 61 dB.

Mfg. list \$154.50

CALL FOR BSW PRICE

Model DO56L (Same as above, but has extended handle.)

Mfg. list \$172.00

CALL FOR BSW PRICE



Model RE-15
Super Cardioid

The RE-15 features wide, flat response for broadcast applications. With its uniform super-cardioid pattern you can extend working distances compared with other cardioid mics. Frequency response 80-15,000 Hz. Output - 57 dB.

Mfg. list \$316.20

CALL FOR BSW PRICE

Model RE-16 (Same as the RE-15 except includes blast filter to reduce "P" pops.)

Mfg. list \$327.55

CALL FOR BSW PRICE



BEYER

STUDIO QUALITY CONDENSER MICROPHONE

Model MC 740 N (C) P 48

Studio quality condenser microphone with frequency-independent, switch-selectable directional pattern: omnidirectional, wide cardioid, cardioid, hypercardioid, bidirectional. Uniform frequency response independent of polar pattern. For 48 V phantom powering. Switch-controlled preattenuation of 10 dB for high sound pressure levels. Available not only in the standard version with 3-pin XLR connector, but also in the special version 5-pin XLR connector for remote control of the directional pattern from the power pack MSG 740.



Mfg. list \$1,325.00
CALL FOR BSW PRICE

DYNAMIC STUDIO MICROPHONE

Model M500

Dynamic directional microphone. Hypercardioid characteristic. High quality ribbon microphone for vocal soloists. Rising frequency response curve for optimum voice reproduction and vocal presence. Extremely low feedback. Built-in popscreen. Widely used announcer's microphone.

Mfg. list \$300.00
CALL FOR BSW PRICE



SHOTGUN CONDENSER MICROPHONE

Model MC 737 N (C) P 48

Long shotgun microphone. Particularly rugged housing design. Exceptionally high sensitivity ensures ready connectability to all common OB tape recorders. Exceptionally large signal-to-noise ratio. Built-in, switch-controlled frequency response filter for lowering bass frequencies. For 48 V phantom powering.

Mfg. list \$950.00
CALL FOR BSW PRICE

AKG[®] ACOUSTICS

Unmarred Sound + Technology For Years To Come.

Model C414B/ULS Condenser Microphone

AKG staff and engineers have concentrated their efforts and know-how to produce a microphone of transmission qualities matching digital technology. The low inherent self-noise and high overload point guarantee a dynamic range in order of 126 dB. Four different polar patterns selectable on mic. All metal housing in black chrome finish.

Mfg. list \$995.00 **CALL FOR BSW PRICE**



Model C 522 ENG Stereo Microphone

Features:

- Two cardioid condenser capsules with 90° opening angle for XY-stereo recording technique.
- Simple to use one-hand operation for quick action often required from reporters on the scene.
- All-metal robust housing to match the requirements of field work.
- Built-in rechargeable battery to be independent from microphone supplies.
- Integrated on/off switch operated by the cable connector.
- The microphone may be operated into all balanced or non-balanced inputs of recording equipment designed to accept low-impedance microphones.
- Suitable for vocal, speech and music recordings.
- Integrated LED for checking battery condition prior to operation of the microphone.

Mfg. list \$995.00
CALL FOR BSW PRICE



Model D-1200E Cardioid Microphone

The D-1200E is an extraordinarily versatile microphone. The key to the D-1200E's versatility is an integral B-M-S switch, an AKG exclusive, which permits the user to create an almost endless variety of tone control possibilities.

Transducer type: Dynamic
Directional characteristic: Cardioid
Frequency range: 40-17,000 Hz
Mfg. list \$250.00 **CALL FOR BSW PRICE**





Model AT815A "Shotgun"

With the acceptance angle of approximately 40° at high frequencies, the AT815A provides a useful tool to overcome problems of noise or distance for radio or TV broadcasting special stage applications and motion picture dialogue recording. Its flat response and high output insures well balanced, natural sounding pickup.

Mfg. list \$270.00

CALL FOR BSW PRICE



Model AT857QM Unipoint™

The AT857QM Unipoint™ is self-contained, with the power module for phantom powering built into the base. Two gooseneck sections offer flexibility of positioning, while the low weight of just 4¾ ounces eliminates the tendency to sag common to heavier cardioid microphones. An AT8102 two-stage windscreens is included to minimize pops and wind noise.

Mfg. list \$237.00

CALL FOR BSW PRICE

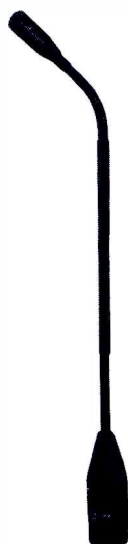

RD SYSTEMS

Model P650 EPM Parabolic Microphone

The EPM Parabolic Microphones are high performance unidirectional microphones perfectly suited to the requirements of the Motion Picture and Broadcast Industries, tape recording, monitoring and other professional or semi-professional applications.

The EPM is one of the most directional microphones ever produced; making it possible to record voices, sounds, practically anything - to professional standards without having the microphone anywhere near the subject being recorded.

Mfg. list \$575.00

CALL FOR BSW PRICE



NEUMANN

U 89 i Condenser Microphone

The U 89 i microphone, is a studio microphone with switchable directional patterns.

Its grille houses a newly developed dual-membrane capsule with a particularly linear frequency response for all polar patterns.

A rotary switch beneath the grille permits selection of one of 5 directional patterns: besides the three usual ones — omni, cardioid, figure-8 — the intermediate positions "wide-angle cardioid" and "hypercardioid" are also available

Mfg. list \$1,700.00

CALL FOR BSW PRICE



TLM 170 i

The TLM 170 i is able to handle sound pressure levels up to 140 dB with minimal distortion. This represents a dynamic range of 126 dB.

Five directional characteristics may be selected: omni, wide cardioid, cardioid, hypercardioid and figure-8.

The TLM 170 i is equipped with a tiltable, elastically suspended mounting bracket, which isolates the microphone effectively against mechanical noise interference.

Mfg. list \$1,750.00

CALL FOR BSW PRICE



RSM 190 i-System

The RSM 190 MS-stereo microphone is the heart of a stereo shotgun system with variable directional characteristics, combined with high directional efficiency.

Two completely separate capsule assemblies - a short shotgun and a system, with its axis at a right angle and operating in a figure-8 characteristic — provide the middle and the side information.

Thus the RSM 190 is the ideal microphone for stereophonic news gathering (ENG) outdoors in environments with high ambient noise levels as well as stereophonic motion picture and TV sound.

Mfg. list \$2,445.00

CALL FOR BSW PRICE



**BSW handles the complete Neumann line.
Call us toll free for all your microphone needs.**



A wireless system worthy of the name **SHURE®**

The Shure Wireless.
A superior system at an affordable price.

No wireless system can give you more sound quality than the mic itself can deliver. A genuine Shure microphone, matched to the Shure Wireless precision electronics, gives you all the performance upon which top quality audio depends. Plus the freedom and convenience of wireless.

Having supplied microphones longer than any other manufacturer, Shure has learned a lot about what it takes to deliver great sound — not to mention the ruggedness and reliability you've come to count on.

This, combined with their new advancements in RF capability, such as the exclusive Diversi-phase™ dual antenna system and individually linear phase filters, puts Shure in the position to offer you the most advanced wireless systems.



CALL FOR BSW PRICE

As close as you can come to the performance of a microphone with a cable. Without the cable.

W25DR
Diversi-phase™ Receiver
Mfg. list \$1,200.00

W2OR
Receiver
Mfg. list \$700.00

W10BT
Body Pack Transmitter
Mfg. list \$400.00

WL83
Electret Condenser Lavalier
Wireless Microphone
Mfg. list \$165.00

**SAMSON
BROADCAST WIRELESS SYSTEMS**

BSW handles the complete line of Samson wireless



BH-3
Hand Held
Transmitter



BT-3
Belt Pack
Transmitter

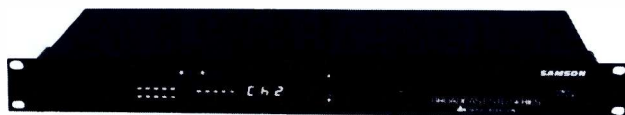

Diversity Receiver BR-3

SYNTHESIZED TRUE DIVERSITY

PRICES BASED ON CONFIGURATION

CALL 1-800-426-8434

**NEW FOR BROADCAST
TEN SELECTABLE
CHANNELS**

The ultimate expression of Samson Wireless Technology, the new Broadcast STD (Synthesized True Diversity) Wireless System features 10 selectable digitally-synthesized channels on both transmitter and receiver, to insure complete RF interference-free performance in any application. By visually scanning all 10 channels on the Broadcast STD, BR-3 receiver, you can select the best channel for operation in your area.

For the first time, you have a visual "window", through the use of the BR-3 level LED ladder, to look at the RF level in any given location. After selecting the best or clearest frequency on the BR-3, you simply dial-up the same frequency on your transmitter to correspond to that of the BR-3. This feature **guarantees** crystal clear wireless performance before ever turning your transmitter on. In the past, a spectrum analyzer was necessary in order to "look at" the RF environment present in any given location.

The Broadcast STD Series also provides improved state-of-the-art RF circuitry and utilizes dbx noise reduction to provide expanded dynamic range and the highest level of audio quality.



TELEX®

Wireless Microphone Systems



Model FMR-2
FM Wireless Mic Receiver
Model WT-200 w/WLM200 Electret Lapel Mic
Belt Pack Transmitter

The Telex wireless microphone system adds significant innovations to the state-of-the-art. Innovations which not only make Telex an outstanding value among wireless systems, but provide performance capability that equals or exceeds that of wired microphone systems for professional applications. Applicable equipment is FCC type accepted. Price shown includes WLM-100 lapel mic.

Mfg. list \$1,720.00 **CALL FOR BSW PRICE**

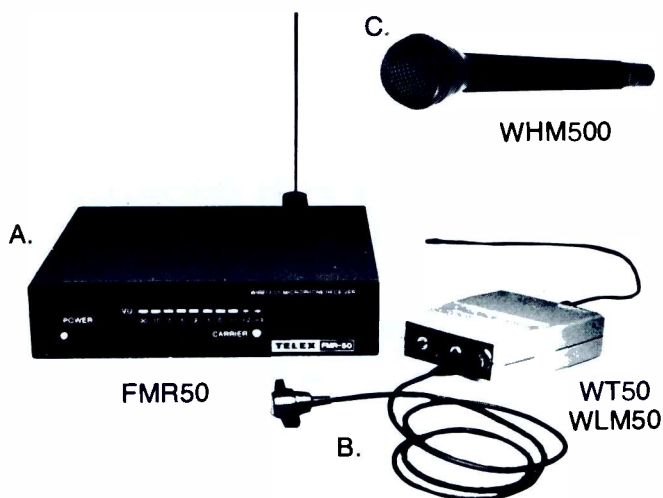

FMR-50 Wireless System

The FMR-50 uses the latest in CMOS electronics with powerful rejection of unwanted signals from TV, FM, CB or Business Radio broadcasts. Selectivity is further enhanced by the exclusive use of a computer designed system of low distortion, linear phase IF filters. This narrow selectivity permits the operation of up to seven systems in a single location, simultaneously, without interference.

Features:

- Peak reading volume indicator
- Carrier indicator
- Adjustable output control

System w/Lapel Microphone A & B

Mfg. list \$975.00 **CALL FOR BSW PRICE**

System w/Hand Held Microphone A & C

Mfg. list \$1,055.00 **CALL FOR BSW PRICE**

Vecta™

By Vega



VS-1 Wireless Microphone System

The Vecta VS-1 is an affordable, high quality wireless microphone system with a clear crisp sound similar to that of a good wired mic. Vecta features a new audio-processing technique to provide a high signal to noise ratio with key low background hiss over a wide dynamic range of input levels.

Mfg. list \$640.00 **CALL FOR BSW PRICE**

VEGA



Model 77/D11 Wireless Mic Transmitter

Compact pocket transmitter equipped with Dynex II® Dynamic Expansion, offering lower noise and wider dynamic range. (Microphone not included.)

Mfg. list \$983.00 **CALL FOR BSW PRICE**



Model R42 Wireless Mic Receiver

Cetec Vega's PRO-PLUS wireless microphone receivers offer a new standard of performance with Dynex II®. Sensitivity, selectivity and stability are exceptional.

Mfg. list \$2,835.00 **CALL FOR BSW PRICE**



ProBoom

CONVENIENT MICROPHONE BOOM

PRICED TO SELL

LM-1 41" reach:

For 1 lb. microphone, oyster or black
 BSW price includes standard bracket **\$34.95**
 BSW price includes 12" pedestal Pro-Bracket..... **\$49.95**

LM-2 26" reach:

For 1 lb. microphone, grey
 BSW price includes standard bracket **\$34.95**
 BSW price includes 12" pedestal Pro-Bracket..... **\$49.95**

LM1-3 41" reach:

Heavy duty model, oyster or black
 BSW price includes standard bracket **\$34.95**
 BSW price includes 12" pedestal Pro-Bracket..... **\$49.95**

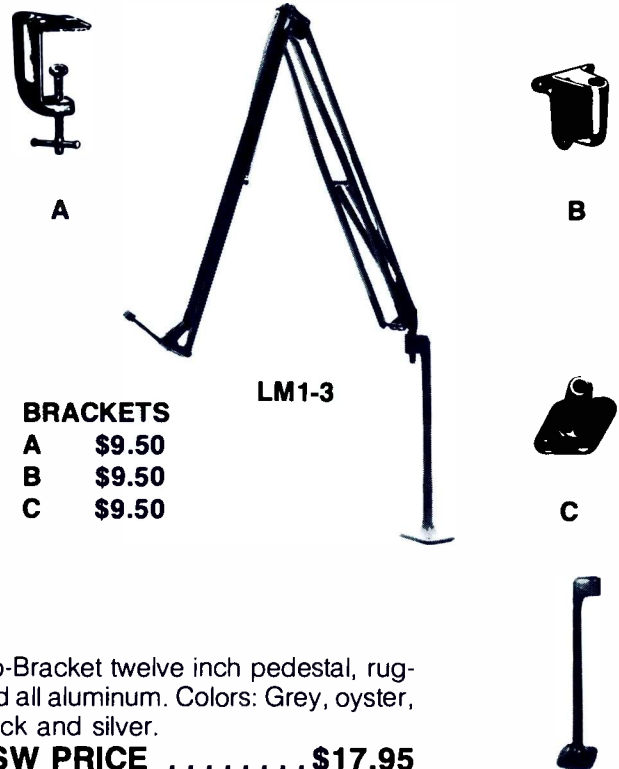

Pro-Bracket twelve inch pedestal, rugged all aluminum. Colors: Grey, oyster, black and silver.

BSW PRICE\$17.95

Atlas Microphone Stands, The World's Standard

AUDIOTEC Mic Stand

Hottest Price Going
 Boomstand with hinged feet. Maximum height: 62" without boom. Boom length 36".

Model S-99
BSW Price \$29.95

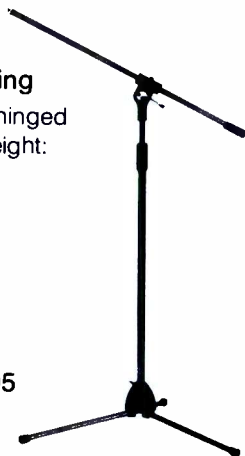

- a. **SB-36w Mobile Boom Stand**
 Grip-action clutch with integral air suspension to counterbalance boom weight. 5/8"-27 thread at microphone end. Boom length 62". Adjustable vertical height from 48" to 72". Rubber casters for mobility. **\$251.70**
- b. **PB-10x Microphone Boom**
 Standard termination for microphone holder. Die-cast swivel, tapered counterweight, coordinated hardware. Attaches to any microphone stand terminating in 5/8" dia. tubing or adapter Grip-action clutch. Expandable from 31" to 50". (Blk. or Silv.) **\$35.25**



- c. **DS-5 General Purpose Stand**
 Non-adjustable 4" high chrome tube. 6" dia. cast iron charcoal base. **\$11.05**
- d. **DS-7 Adjustable Desk Stand**
 Chrome tube assembly, adjustable height 8" to 13". Grip-action clutch. 6" dia. charcoal base. (Blk. or Silv.) **\$16.00**
- e. **DS-4 Lightweight Stand**
 Non-adjustable 4" high chrome tube. 5" dia. phenolic beige base. **\$7.55**
- f. **MS-12c General Purpose Stand**
 Grip-action clutch. Low-profile charcoal base with added weight for extra stability. Our best seller. (Blk. or Silv.) **\$29.80**
- g. **DS-14 Contemporary Stand**
 For professional styled microphones. Non-adjustable 3" high chrome tube. Charcoal base. **\$14.70**
- h. **DS-2 Vibration-isolating Stand**
 Non-adjustable 3" high chrome tube. Non-reflective 4" x 6" charcoal base. **\$21.40**



Henry Engineering



LOGICONVERTER is an interface unit that facilitates remote control of broadcast studio equipment. It eliminates the incompatibility often encountered when a broadcast console is used to provide remote start/stop control of peripheral equipment, e.g., cart machines, CD players, tape recorders, etc. LogiConverter converts TTL/CMOS or 'open collector' console outputs to relay closures for remote interface that is compatible, reliable, and isolated. The unit can be user programmed via internal 'dip switches' to generate either momentary or maintained outputs from various inputs, with 24 input/output combinations possible. LogiConverter will control up to 4 circuits, and can provide start-only or start-stop outputs from a single input signal.

Mfg. list \$195.00 **CALL FOR BSW PRICE**

TURNTABLE REMOTE CONTROL

For Direct Drive Turntables

The Universal Turntable Controller is a control interface device that allows full remote control of popular direct-drive turntables such as Technics SP-10's, SP-15's and the Russco RT-700. The "UTC" easily connects to the turntable with just three wires, and provides CMOS/contact closure compatible outputs for separate start and stop switches, plus run and stop tally lamps. The turntable's own start/stop switch can still be used for cueing records, and the UTC always stays in sync with the turntable. One UTC will control two turntables.

Mfg. list \$195.00 **CALL FOR BSW PRICE**



SUPERELAY is a multi-purpose control interface for use in broadcast station control rooms, A/V systems, or any installation requiring multiple circuit control. SUPERELAY is ideal for controlling the various equipment functions that need to be switched when, for example, a Control Room mic is turned on, e.g. EBS receiver mute, intercom speaker defeat, telephone bell disconnect, skimmer recorder start, "ON THE AIR" warning lights on, etc. SUPERELAY can be controlled by virtually any console's muting output, or by any external switch, either momentary or maintained. It provides two types of outputs: relay and switched AC. Six relays can be used for low-voltage and audio switching; a switched AC output will directly power up to 300 watts of "warning lights" and make them flash. SUPERELAY can also be connected to any dial-up telephone line for control of equipment when the line rings.

Mfg. list \$195.00 **CALL FOR BSW PRICE**

SYNCHROSTART is a unique audio production device that offers two timesaving refinements to the quality conscious broadcast facility. SYNCHROSTART is a turntable-recorder synchronizer with automatic turntable and cartridge recorder. It has two primary functions when used with a turntable and cartridge recorder: (A) It eliminates "cue burn", record surface noise, and accidental turntable "wow-in" and (B) takes the guesswork out of dubbing records to tape cartridge. SYNCHROSTART mutes turntable audio during disc start-up, so that all noise preceding the start of audio is squelched. The audio is "ramped-up" smoothly; a disc may be cued within audio permitting efficient "real time editing" of musical content. SYNCHROSTART also provides a synchronized output to start a cartridge recorder at the exact moment the beginning of disc audio is beneath the playback stylus. Carts are consistently "tight" with one-button ease. The unit is fully automatic needing no user adjustment once installed.

Mfg. list \$395.00 **CALL FOR BSW PRICE**

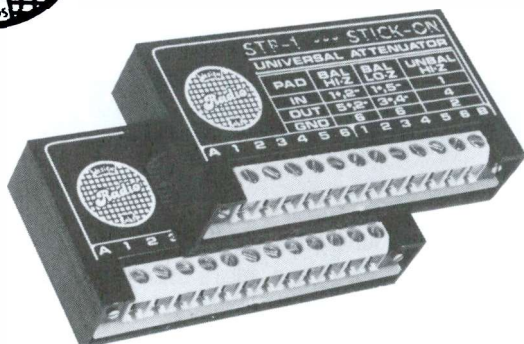

Model STP-1 Attenuator

STICK-ON SERIES ANYWHERE YOU NEED...

- To reduce audio level
- To feed audio into equipment
- To preset audio levels
- To precisely match audio levels
- To prevent input overload
- To increase audio input headroom

You Need STP-1

The STP-1 is a convenient attenuator pad that can be located at the precise location that attenuation is needed without the normal unsightly 'twisted resistor' pads that are all so common. Whether you need to reduce the input level to a machine to improve headroom, feed a line level signal into a mic level input, or simply lower the level of an audio line to match your system's standard levels, the STP-1 is the simple and economic answer.

Available in six-packs only.

Mfg. list \$149.95
BSW PRICE \$139.95



AUTOMATIC STEREO ROUTER



MULTICHANNEL AUDIO CONTROL

Corrects: Loss of Channel, Polarity, Silence
 Automatic/Manual Six by Two Stereo Router
 Audio Monitor — Error Alarms — Level Matching

For years broadcasters and production facilities have had the problem of what to do if a stereo channel or the program audio is lost from a broadcast, satellite feed, or stereo production mistake or the problem of matching and switching sources of two different levels. To correct these problems automatically as well as provide valuable ON LINE audio correction and monitoring requires an "intelligent" and sophisticated audio routing device. Such a device is the Titus Technological Laboratories' MLW-1.

The MLW-1 not only detects and corrects problems, its microprocessor based controls make decisions instantly before inaudibly "cross fading" the appropriate MLW-1 functions in or out of the audio chain.

Features:

- Automatic change to alternate channel on loss of channel
 - Automatic change to alternate source on loss of channel or loss of signal
 - Three balanced, bridging inputs
 - Three modes of operation: Automatic, Manual, Forced
- Mfg. list \$1,800.00 **CALL FOR BSW PRICE**



WHIRLWIND

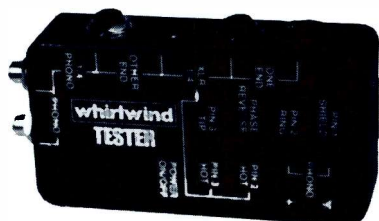

Cable Tester

Check for shorts and bad connections easily with the Whirlwind Cable Tester. Accommodates XLR, 1/4" and phono plugs. 9 volt battery required.

BSW PRICE \$49.30

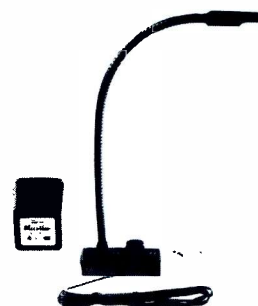

Model L3/12

High Intensity Light

Dimmer with off position, 6' cord, wall plug-in transformer, gooseneck, high intensity hood and quartz halogen bulb. Permanent mounting material included. Perfect for illuminating turntables.

BSW PRICE \$39.95



Profoam

SOUNDPROOFING INSULATION



PURE CLEAR SOUND

Charcoal grey, blends with all decor. One large size for fast installation. 2" x 4 1/2' x 6'. UL listed, UPS shippable. Keeps costs down.

ProFoam Tests As Good Or Better Than The Most Expensive Sound Insulating Material

2 sheets per pkg.

Only \$49.95 Per Sheet (27 sq. ft.) ASK ABOUT QUANTITY DISCOUNTS

Fast Bond Foam Adhesives

Adheres To Wood, Metal or Plastics

- Model 74 Spray Can \$8.15
Model 45 1 Gallon \$29.50
Model 45 5 Gallon \$140.00

NOW AVAILABLE IN 3" x 4 1/2' 6' ONLY \$56.95 PER SHEET

SONEX FOR CLEAN SOUND

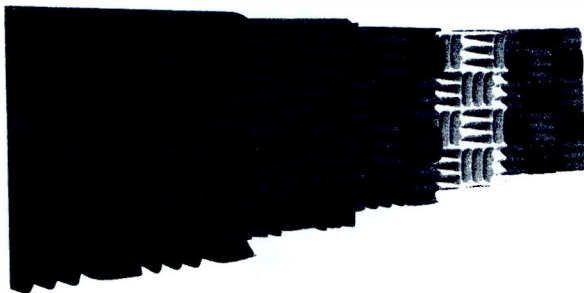

Get the facts today, SONEX is available in five colors, in three thicknesses, and in standard four ft. square panels. Use it in broadcasting, recording, videotaping or performing areas for really pure, clean sound.

CALL BSW ORDER DESK FOR CONFIGURATIONS & PRICING

CONEX

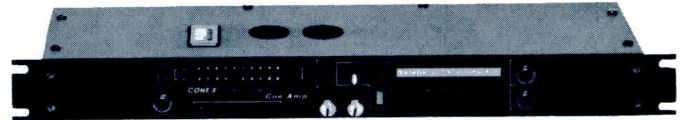

Model UM33 Cue & Monitor Amplifier/Switcher

The CONEX UM33 is a stereo, eight channel in, one channel out, general purpose cue, monitor and line amplifier.

The UM33 provides the easiest, least expensive, and most compact way of handling a variety of common monitoring, cueing, amplifying, and switching situations in any audio installation.

Typical UM33 applications include:

- Network or remote line monitor and buffer amplifier
• Transmitter input selector and monitor
• Automation cue amplifier
• Tape recorder input selector
• Telephone line source selector
• Headphone amplifier
• Intercom, communication system, or multi-media testing
• Console input expander

The UM33 has potential use in every studio in a radio station — newsroom, production room, transmitter, master control, and control room.

Mfg. list \$495.00 CALL FOR BSW PRICE

ProLite

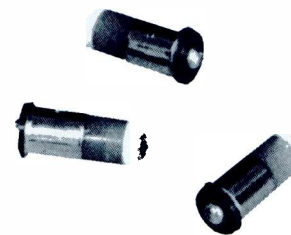

End Lamp Replacement Forever

Relamp your incandescent sockets. Our based multi LED miniature lamps are exact replacements for T 1 3/4 and T 1 1/4 incandescent miniature lamps. Shock and vibration proof, they keep your lighted panel and switches going "on" for 100,000 hours.

CALL FOR BSW PRICE QUANTITY DISCOUNTS



ProLite

ON-AIR LIGHT

Easy To Install

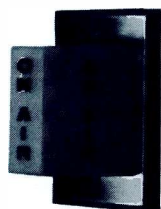

Model L101

12 Volt DC
Fits In A Standard
Duplex Electrical Box
White Or Red — Specify
Good Looking - Easy To Read
BSW PRICE \$19.95



OAL-HG



OAL-VS

Titus Technological Laboratories ON AIR light provides the broadcaster and recording studio with a beautiful and practical means of indicating that a studio is in use. The TTL ON AIR light features a smoked glass window mounted in either a gold or silver frame which is attached to an oak mounting base. The warning "ON AIR" or "RECORDING" only appears when illuminated and is blacked out when not in use.

BSW SPECIAL \$122.50

Features:

- Handsome appearance
- Oak base
- Silver or gold frame
- Horizontal or vertical mounting
- "ON AIR" or "RECORDING" (specify)
- "Blackout" face when not in use
- Low voltage wiring (Class 2)
- Easily serviced

BSW SPECIAL \$122.50

ProLite

ARCHITECTURAL SYSTEMS

33W6142R
Flatwall
On Air Lens
\$87.90

Blank Lens
Without Symbol
\$11.25



33C6242R
Extended
Ceiling
Double Face
\$113.25
or
33E6242R
Wall
On Air Lens
\$113.25

Blank Lens
Without Symbol
11.25

33P6242R
Pendent
On Air Lens
Double Face
\$147.75

Blank Lens
Without Symbol
\$11.25



Dimensions: 7½" square and includes two 20 watt lamps.

FIDELIPAC®



Dimensions: 5"H x 10"L x 2½"D. 120 Volt
Model 65340 On Air **BSW PRICE \$59.50**
Model 340REC Recording **BSW PRICE \$59.50**



VIF NAB HUB ADAPTER

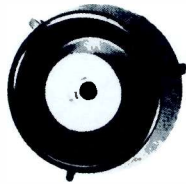

Model VIF1000

Fits Most Professional Reel To Reel Machines

BSW PRICE\$18.00

THINK CRAMOLIN® !



- CLEANS
- PRESERVES
- LUBRICATES

ALL METAL CONTACTS AND CONNECTORS

- Improves Conductivity
- Reduces Wear
- Convenient to Apply
- Economical/ Long Lasting
- Non-Flammable

Liquid Spray Cramolin® Red Liquid

Fast acting anti-oxidizing lubricant that cleans and preserves electrical contacts and connections, effective on all metals including gold.

R5-6 - 6 oz. Spray BSW PRICE \$8.25
R100L2 - 2 oz. 100% Liquid BSW PRICE \$12.50

ACCESSORIES

- AB12 — Pkg. of 12 Audio Brushes \$3.50
- LFCC50 — 50 Lint Free Cotton Cloths \$4.50
- SWP12 — Pkg. of 12 Foam Swabs \$4.50

SOUND EFFECTS CD's OR RECORDS



From A Cat's Meow To A Lion's Roar From A Pistol Shot To A World War

- Ideal for television, radio and film
- Quick cued for easy use
- The professional broadcasters' library
- Recorded the way your ears hear it
- Over 1000 different effects (Records)
- Over 650 different effects (CD's)

Complete Set of 30 LP's — SFXSET
BSW PRICE\$399.00

Complete Set of 10 CD's — SFXCD
BSW PRICE\$499.00

COPY HOLDERS



Copy Holders

- For announcers, newsmen, programmers, secretaries
 - Holds any reading material wherever you need it
- Model 16008 4 lb. BSW PRICE \$77.50
Model 16007 1 lb. BSW PRICE \$49.95
Model LH801 1 lb. BSW PRICE \$26.95



NORTRONICS HEADS

NORTRONICS THE INDUSTRIES' QUALITY HEAD



Large selection in inventory for immediate delivery. All prices dramatically reduced. Check our everyday low prices

STL & MRL

Call...
1-800-426-8434 for all your test tape needs.



ALIGNMENT TAPES, CARTRIDGE TEST TAPES, COMPLETE SELECTION

CBS TEST RECORDS

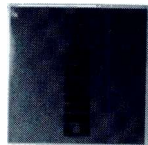

- CTC 300 - Phonograph test record
 - CTC 310 - Distortion test record
 - CTC 330 - Studio test record
 - CTC 340 - Acoustical test record
 - CTC 350 - Turntable & tonearm test record
- YOUR CHOICE

BSW PRICE\$30.00

Scotch Audio Recording Dispenser Kit

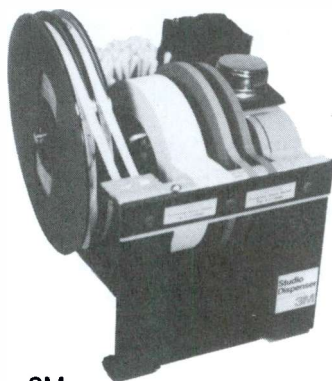

RSD1
Studio Dispenser from 3M

Everything you need at your finger tips for professional editing and splicing.

Mfg. list \$149.12 **BSW PRICE \$143.50**

GEO-DISC™



Geo-Disc™

For tonearm and phono cartridge alignment, we suggest the GeoDisc™. The GeoDisc™ looks like a 12" LP record, but is actually a measuring device that enables you to achieve critical alignment to within .003 of an inch. The GeoDisc™ allows proper phono cartridge off set tracking angle and overhang. A must if you're mounting new tonearms and/or phono cartridges.

BSW PRICE\$24.99

EDITING PENCILS

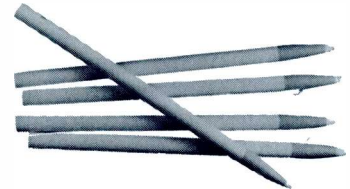

White China Markers

Package of 12 **BSW PRICE \$14.70**

GEM BLADES

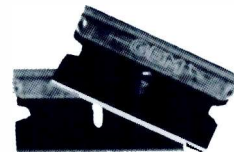

For Splicing And Editing

Box 100..... **\$7.95**

REPLACEMENT CD JEWEL CASES

Best Buy Anywhere IMMEDIATE DELIVERY

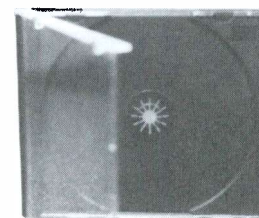

CD BOX

1-25	26-75	76-100	100 +	500 +
79¢ EA	74¢ EA	69¢ EA	59¢ EA	50¢ EA



CATEL FM Modulator



FMX-2100S

The FMX-2100S FM Modulator is a modulator packaged frequency modulation cable transmitter designed specifically for CATV and CCTV applications. When used with the SM-2200 Stereo Generator, it makes possible the origination of stereo programming. With direct audio sources such as AM/FM tuners, tape decks, microphone preamplifiers and short wave receivers, it can add varied FM signals to the cable system. In addition to the re-transmission of audio signals, the wide band (plus or minus 75 kHz) deviation makes the unit ideal for multiplexed voice or data transmission. Specify operating frequency.

Mfg. list \$1,035.00 **CALL FOR BSW PRICE**

WILKINSON By Television Technology

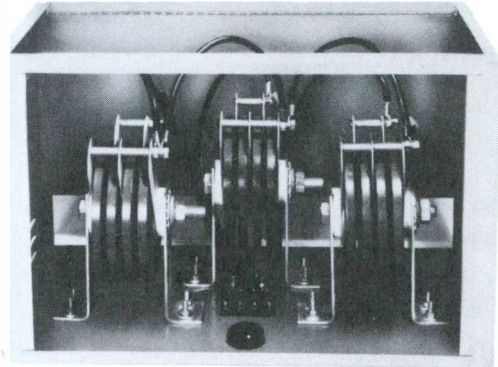

Model S1A Line Surge Protector

The Wilkinson Electronics Line Surge Protector is far superior to standard lightning arresters, surge reactors or other AC line protection devices.

AC line voltage surges, caused by lightning, transformer arcing and induced transients are everyday occurrences that cause heavy damage to equipment incorporating silicon rectifiers, mercury vapor tubes, or other semi-conductor devices. The Wilkinson Electronics Model S1A protects valuable equipment against surges that often exceed many times the normal line voltage.

Single Phase or Three Phase

CALL FOR BSW PRICE

DALE SERIES SPA

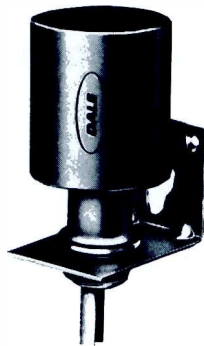

Secondary Power Arresters

Dale SPA secondary power arresters, when connected across an AC power line, limit surge voltages caused by lightning and other transients. They provide excellent protection for wiring, appliances, electrical and electronic equipment of all kinds. These arresters use the Dale rotating arc spark gap which has the capability to withstand multiple lightning strokes. In addition, SPA arresters provide protection from extreme surge amplitudes. Power-follow current is limited and extinguished within one-half cycle. Pre-ionizing of the spark gap yields protection during the fast-rising wavefront of the transient. The arresters are hermetically sealed in a strong steel case and completely contain the surge discharge. High reliability and long life make these arresters especially suitable for isolated or remote installations.

3 Models From 110V to 480V

CALL FOR BSW PRICE



Amplitude Component Monitor



Model ACM-1

What is an AMPLITUDE COMPONENT MONITOR? The ACM-1 is a precise AM noise meter which connects to the RF sample on an FM transmitter. A digital string display with 20 dB of range displays AM noise for precise transmitter tuning. It interfaces with any remote control to sample and then read back a stable indication of AM noise. An adjustable alarm threshold can signal the station operator when AM noise has increased beyond a level you determine will cause reception problems. The nature of AM noise measured can be examined by the engineer with the oscilloscope output. Audio and data outputs are provided.

Mfg. list \$1,495.00 **CALL FOR BSW PRICE**



M.W. PERSONS



Programmer 3A Live Assist Controller

- Use reel to reel tapes in live radio format
- Full logic control including next play memory and auto segue
- Full mono and stereo audio control including cue
- Liquid crystal digital minutes and seconds timer
- Connects directly to up to four channel Otari ARS-1000DC or Revox PR99 reproduce only decks
- Interface with any other reel to reel machine using one of our 25 Hz Tone Processors for each machine

Mfg. list \$990.00 **CALL FOR BSW PRICE**

SENTRY SYSTEMS

AUTOMATION CONTROL UNDER \$5,000.00



Format Sentry FS12C

Remember the days when the price of an automation system was out of sight? Well, Sentry Systems is changing all that. The FS12C Format Sentry starts at less than \$5,000.00. It is the heart of the automation system and will interface with almost any type of audio gear. When you purchase the FS12C you get the controller and software. All you add are the audio sources and a personal computer. Your station can be operated fully automated, Satellite, or live assist. The memory is large enough to offer 50,000 events. 12 sources standard, expandable to 24. The software allows traffic integration and operates with a real time clock. Complete logging is incorporated so record keeping is all automatic. BSW and Sentry Systems are ready to talk to you about your next automation system. 1-800-426-8434.

Mfg. list \$4,900.00 **CALL FOR BSW PRICE**

CONEX



25 Hz TONE SENSORS & GENERATORS

Model CS25B 25 Hz Tone Sensor

The Conex Electro-Systems CS-25A is a compact and reliable bridging-type 25 Hz tone sensor for use in broadcast automation and tape control systems. The unit features two independent sensors, allowing very economical expansion of existing systems.

Mfg. list \$389.00 **CALL FOR BSW PRICE**

With Stereo High Pass Filter

Mfg. list \$466.00 **CALL FOR BSW PRICE**

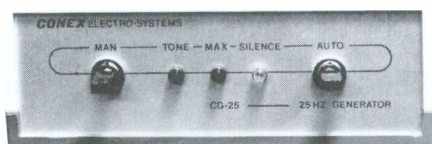

Model CG-25 25 Hz Tone Generator

The CG-25 allows you to put 25 Hz tones on your own tapes. Use with automation systems or live assist operations. Timing intervals, tone levels adjustable.

Mfg. list \$375.00 **CALL FOR BSW PRICE**

Rack Mount Version

Mfg. list \$375.00 **CALL FOR BSW PRICE**

AIR SENTRY II

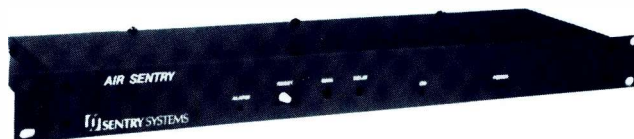

Audio Signal Monitor

The AIR SENTRY is designed to constantly monitor the presence of an audio signal and to energize a relay when the audio is absent. Activation of the relay is front panel adjustable from 4 to 20 seconds. The relay may in turn be used to activate an external audible or visible alarm to notify station personnel of the absence of broadcast signal. AIR SENTRY may be used to monitor any stereo or mono audio source such as audio from AM/FM tuner, TV receiver, or modulation monitor. AIR SENTRY is built to broadcast standards of reliability and is extremely cost-effective.

Mfg. list \$295.00 **CALL FOR BSW PRICE**



DA-LITE® Screens

Model C

Largest available manual pull-down screen. Grooved roller assures permanent fastening of fabric. Mechanical system uses ball bearings for operation and may be locked at any length. Case design minimizes fabric wear. Black borders are standard. Floor stand available.

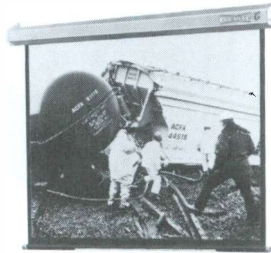

SIZE	LIST
6' x 8'	\$290.00
8' x 8'	\$312.00
9' x 9'	\$336.00
10' x 10'	\$420.00
12' x 12'	\$542.00

CALL FOR BSW PRICE

Challenger

A heavy gauge metal case, sturdy gable legs and push button operation. Locks into all positions, has fabric lock and standard black borders available with Glass Beaded or Matte White surfaces. Optional Keystone Eliminator available.
Glass beaded



SIZE	LIST
50" x 50"	\$120.00
60" x 60"	\$146.00
70" x 70"	\$164.00

CALL FOR BSW PRICE

DA-LITE/BESELER OVERHEAD PROJECTORS Put Your Best Presentation Forward QUALITY AND ECONOMY



Porta-Scribe G-100-LT

An excellent economical projector that is widely used by schools and the government. Precision optics, powerful illumination and rugged, all-steel case for years of dependable, high-quality performance. Energy-efficient 600 watt quartz halogen lamp has an average life of 75 hours. Sealed projection head protects the optical system from dust, fingerprints and casual damage.

Mfg. list \$280.00 **CALL FOR BSW PRICE**

AV PRODUCTS



PROFESSIONAL VIDEO PRODUCTS



The Model 6810 Video Projector is designed to provide stable, dependable performance in a wide range of applications and operating environments. It provides front or rear projection on flat or curved surfaces measuring from five to more than fifteen feet diagonally. The projector may be floor or ceiling mounted. Picture resolution and clarity are ensured through extra-wide bandwidth circuitry, superior optics and 7" diagonal liquid cooled picture tubes.

The projector has a built-in 178 channel stereo tuner, audio amplifier, and computer logic circuitry which displays on-screen graphics and may be programmed to retain specific control settings for any one of the seven possible input sources. The modular construction and hinged convergence assembly make the unit easy to install, simple to maintain and service.

Specify floor or ceiling mount.

Mfg. list \$5,495.00 **CALL FOR BSW PRICE**



KODAK CAROUSEL® 4600 Slide Projector



BC4600Z

- Focus the first slide. All others in same type of mounts will focus automatically.
- Remote control forward and reverse.
- Illuminated control panel and built-in reading light.
- Dark-screen shutter eliminates screen glare.

INCLUDES EKTANER C ZOOM LENS
FOR MORE VERSATILITY TO ROOM
SIZE ADAPTABILITY

Mfg. list \$470.00 **CALL FOR BSW PRICE**

Many Other Models To Choose From



auditronics, inc.

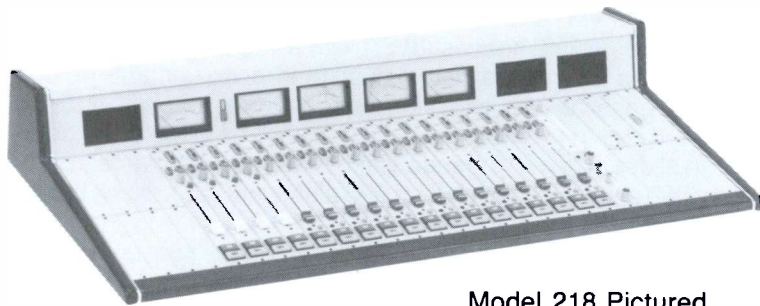

Model 218 Pictured

200 Series

Standard Features

- VCA controlling faders, eliminating noise due to contamination or wear
- Noiseless Hall-effect controlled CMOS muting
- Comprehensive user-oriented logic system
- On-board power regulation on each module
- +30 dBm output capability
- Control Room Monitor with 8 input selections
- Headphone Amplifier with local EQ
- One year warranty

The 200 Series offers a high degree of reliability together with simplicity of use in a compact, operator oriented package. It satisfies the requirements of both engineering and on-air personnel, while offering the station owner a very cost effective investment.

Consoles are available in four mainframe sizes to cover a range of applications from newsrooms to the largest multi-studio installations. The totally modular construction allows initial purchase of only the functions and accessories needed at the time, while allowing for simple future expansion.

Each console includes all mating connectors, installation tools, basic spare parts kit, and service manual at no extra charge. Available with both mono and stereo outputs, and a wide choice of functions and accessories, the 200 Series is the logical choice for those progressive facilities needing to install equipment with provisions for future adaptability and growth.

Prices Based On Configuration.



310 Series

The 310 Series affords the value conscious broadcaster a user defined selection of functional features and a dynamic array of the most important options necessary for uncompromising performance.

Specific attention has been given to not only the audio quality, but to logically located and labeled controls. A comprehensive, built-in, user-programmable logic system simplifies the operation of many internal and external functions. External control ports have been included to provide the possibility of interface to any of several types of external equipment, such as video switchers, editors, etc.

Designed as a modular system, the 310 Series is easily expandable in capabilities, with no sacrifice in performance specifications. All Input Modules include multiple source selections, and each input has dedicated active balanced input circuitry for optimization of level, noise, common mode rejection, and crosstalk. All output bussing assignments are made via CMOS "Load-Lift" switching, thereby ensuring optimum noise specifications throughout the system at all times.

Standard Features

- 4 or 8 Outputs, plus discrete Stereo and Mono Mix
- Output Submastering, with Mix-minus capability
- Mono and/or Stereo Inputs, with or without Equalization
- Hi Cut and Lo Cut Filters on each Input
- VCA Level Control on all Inputs and Stereo Mix Outputs
- VCA Control of Submaster and Mono Outputs, with External Level and Mute Control Capability
- VCA Input Grouping
- 4 Auxiliary Sends
- Auxiliary Returns
- Built-in Monitor Mixer
- Control Room Monitoring

Prices Based On Configuration. Call BSW Toll Free For Complete Specifications.

FAST FAX

206-565-8114



XCELITE Complete Tool Kit



Xcelite
Model TC-150/ ST

A carefully selected assortment of Xcelite hand tools; interchangeable drivers, blades and handles; soldering iron and 1 measuring tape. Removable pallets in lid and base have tool pockets.

Mfg. list \$472.50 **CALL FOR BSW PRICE**

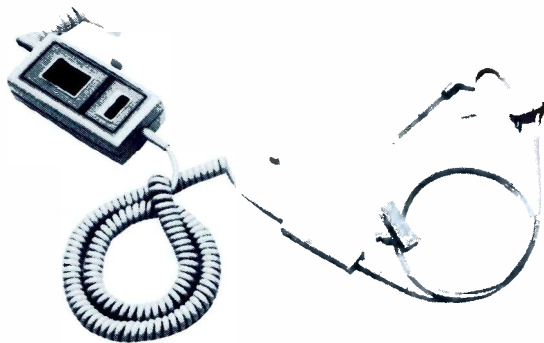

The finest quality telephone headset.

Modular connection attaches in seconds to most telephones with modular connection handsets. Lightweight fit and freedom of head movement lessens "phone fatigue" and increases productivity. Leaves both hands free to take care of other work while talking.

- Quick-Disconnect for user mobility
- Modular connector
- Three position volume control
- Adjustable voice tube
- Adjustable clothing clip
- SoundGuard® system for safe and clear listening levels

Great for the engineering department or receptionist. Specify telephone model for the exact StarMate set that's right for you. Prices vary with model. Call BSW toll free 1-800-426-8434 for more information.

middle atlantic audio products



Model D2
Rack Drawer

Occupies only 2 spaces (3 1/2") with a depth of 14 1/2". A fully enclosed top insures that no dust goes in, no contents go out. Front panel has a flush spring loaded handle that latches upon closing so the drawer stays closed. Full extension ball bearing slides. Top is 16 gauge steel, Black baked enamel. Body is .063 aluminum, welded to .090 aluminum face, Black brushed and anodized.

Mfg. list \$130.00 **CALL FOR BSW PRICE**

SOUNDFORMS

While today's broadcast, film and video industries advance at such an accelerated pace, more emphasis is being placed on the quality of sound recording. Whether you are responsible for music, dialogue or sound effects, it has become extremely important to isolate and control the ambience of your recording and sampling environments. Thus, the concept of SOUNDFORMS was born. SOUNDFORMS are lightweight, portable and modular sound control panels that enable you to effectively control sound in any recording environment. They can be used free-standing, hanging on any wall, or snapped together with Double-Clips to form Sound Booths, Sound Rooms or Sound Walls of any size or shape.



Sound Wall: The SOUNDFORMS Sound Wall includes; three S-22 panels, one pair of T-legs, and six Double-Clips. This system is used as a baffle wall to control the working environment in the home, studio, rehearsal hall, or on stage. The three panels consist of approximately 66 sq. ft. of acoustic foam, weight only 16 lbs., and can be easily collapsed for storage or travel in minutes.

Sound Booth: The SOUNDFORMS Sound Booth package includes; three S-22 panels, one S-15 panel, one pair of T-legs, twelve Double-Clips, and one Cross Bar. This system (measures 3.5' x 3.5' x 6.5') is used as a sound recording booth inside a studio or in any work space, as well as providing a controllable recording environment on-location. These same panels, as with all SOUNDFORMS' packages, can also be disassembled and used to create portable baffle walls or gobos.

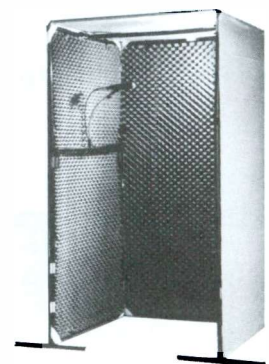

Prices Vary on Application. Call BSW Toll Free 1-800-426-8434 for Price and Detailed Specifications.



INNER STATION COMMUNICATION FROM BROADCAST TOOLS

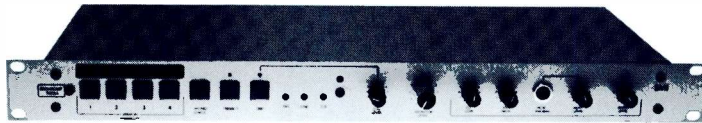

Most broadcast consoles...even very high end consoles...don't have adequate talkback/intercom or monitor capabilities.

The Broadcast Tools SMI (Studio Monitor Intercom) provides an efficient, affordable solution.

We all know that communication between studios is vital. The SMI allows you to talk to up to four other studios. Simply buy as many SMI's as you need. Talk with one studio at a time or on an "all call" basis. Each unit has host and guest headphone jacks with bass and treble eq. The SMI automatically dims studio monitors during talkback. In addition, host headphones split for talkback in the right ear and air signal or program in left ear (defeatable while on air). Other features include:

- Fully remote controllable with tally
- Interconnection via convenient 50 pin telco-type connectors, transformer isolated
- Mono/phase check button
- Front panel talkback mic with adjustable AGC
- Aux input for talkback with level control (for remote feeds, etc.)

Most importantly, the SMI from Broadcast Tools is affordable. Only \$625.00 per station. Call BSW toll free at 1-800-426-8434 for detailed specifications.

BTC



Model 1000 SCA Generator

The Model 1000 SCA Generator from Broadcast Technology of Colorado, sounds almost too good to be true. You get a Dual Channel SCA Generator for only \$485.00. 19" rack mount. 67 kHz and 92 kHz simultaneous carrier frequencies. Distortion 0.1% or less. Crosstalk - 65 dB below program.

Mfg. list \$485.00 **CALL FOR BSW PRICE**

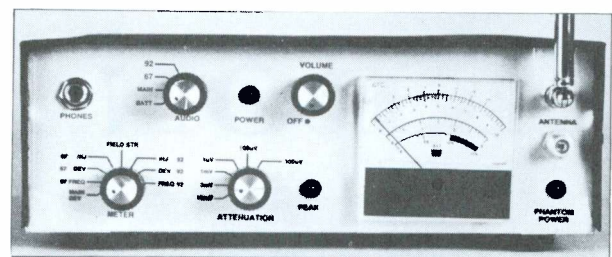

Model 3000 SCA Field Strength Meter

At only six pounds of rugged portability, the Model 3000 tells you everything you need to know about your SCA signal, and it's synthesized.

Versatile audio monitoring is provided with a built-in speaker and head phone jack. You can do an instant check on crosstalk and other problems by monitoring one channel on the meters and the other channel on the audio.

The Fieldstrength Meter can be powered by a plug-in wall transformer, handy battery pack or cigarette lighter jack for convenient use in your vehicle.

Some of the outstanding features are: attenuation is set simply with one rotary switch, phantom antenna power enhances reception where no antenna pre-amp is available, and you can use a built-in telescoping antenna or F-connector.

For the broadcaster who wants bells and whistles, the Fieldstrength Meter features a peak flasher to monitor total modulation and SCA deviation.

Mfg. list \$595.00 **CALL FOR BSW PRICE**

SAFT



Batteries draining your equipment budget? Re-chargeables from Saft pay for themselves almost immediately. We stock the four popular sizes of Nicads and the chargers to go along with them. Look to BSW and Saft for all your battery needs.



MODULATION SCIENCES

COMPOSITE DISTRIBUTION AMPLIFIER

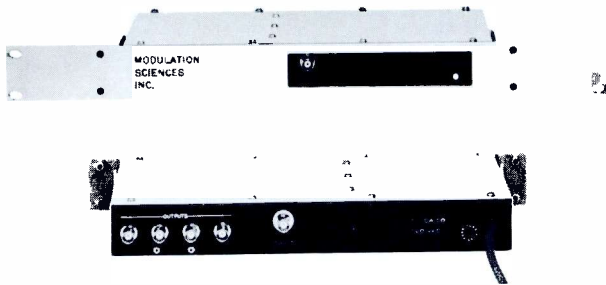

Modulation Sciences' CLD-2504 Composite DA is a problem solver. Its one-in four-out, unity gain configuration makes distribution of the composite baseband signal as easy as distributing audio. The high impedance input avoids circuit loading; the four low impedance outputs drive a wide range of equipment. All connectors are BNC's. The Composite DA provides greater than 50 dB of isolation between outputs.

Drive Multiple Transmitters Without Interaction.

The four isolated outputs of the Composite DA let you continuously and simultaneously drive dual main transmitters, main/aux/back-up transmitters, alternate stereo generators and processor setups, etc. No cable switching, no changeover relays, no level changes and no hassles!

Mfg. list \$950.00 **CALL FOR BSW PRICE**

VIKRON



VIKRON'S FAMILY OF HEADS

There's a Vikron tape head to match your digital or audio application. Our sales engineers will guide you in selecting a "standard" that meets your specifications, an economical modification, or a custom designed head. The result is a head engineered to "fit your mounting holes."

PERFORMANCE ENGINEERED

Critical parameters like crosstalk rejection, wear life and low core losses at high frequency make Vikron heads perform better and more reliably. Ultimate quality is assured by the unique hyperbolic face, laminated poles, precision finish and deposited gaps.

VIKRON is an approved source for all broadcast cart machines including ITC, Fidelipac, Audicord, SMC, IGM, and BE. Prices vary upon application. Call BSW for details. 1-800-426-8434.

TWR Lighting Equipment

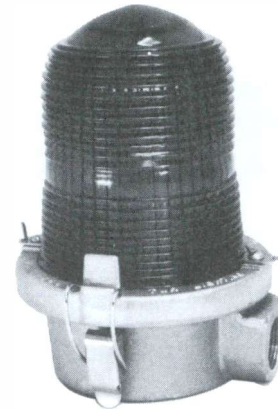

- FAA Approved
- Red Lens (no color screen required)
- Non-Ventilated Construction Insures Clean Interior
- Copper - Free Aluminum Castings
- Neoprene and Teflon Gaskets
- Single Piece Lens Increase Light Output 10%

BSW sells a variety of tower lighting products including controllers, flashers and replacement bulbs. Call us for specifications and prices.

HALONCO™



Here is the best investment you can make for your transmitter site and studios...Halon Fire Extinguishers from HALONCO™. BSW can supply portable hand-helds or automatic systems that you can install and maintain yourself. All HALONCO Extinguishers use a formulated blend of Halon that is expelled as a pure vapor. Safe for use on all classes of fire and will not cause costly damage to sensitive electronic components. The fire kill is 3 times more effective than CO². Each HALONCO Extinguisher is warranted for 5 years against leakage. **Call BSW toll free 1-800-426-8434 for prices. Handhelds start at only \$23.95 and automatic systems only \$89.95.**



bdi

Broadcast Devices, Inc.



Model APC-200

It's a fact that stereo phase error drastically affects your mono sound. The smallest phase error can degrade high frequency performance. Larger phase errors are audible in stereo and can affect your stereo image as well. With Broadcast Devices' RIGHTRACK you no longer have to settle for "dull and muddy" when you can be consistently bright and crisp at an affordable price.

The RIGHTRACK gives you a quick and easy method of making sure that your existing tape equipment consistently provides superior sound — in mono as well as stereo. Both visual and aural indications of phase performance allow you to provide precise phase correction.

The RIGHTRACK is not an encode-decode system. It is designed to work with and improve your existing tape equipment. There is nothing else to add, no special alignment or modifications to perform. With a built-in reference oscillator, the RIGHTRACK doubles as a piece of studio test equipment. Quick and easy alignment and verification of tape head azimuth and frequency response makes the RIGHTRACK even more valuable in any production studio.

Mfg. list \$1,150.00 **CALL FOR BSW PRICE**

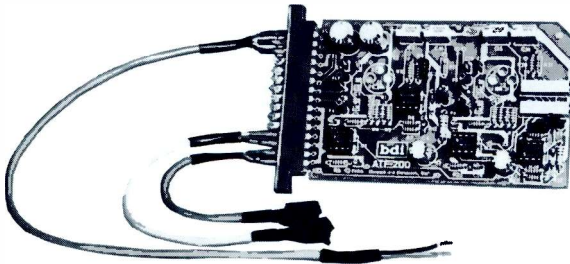

Model ATF 200

Replace the input transformers on your ITC Series 99* recorder and improve its performance. Broadcast Device's ATF-200 Active Transformer Card offers improved headroom, transient response and frequency response over the original transformer balanced inputs.

With an FET differential input, the ATF-200 is a stereo balanced circuit that mounts on the rear of your existing input connectors. It's simple and quick to install — we supply you with all the parts needed, including a step-by-step manual on improving your 99's performance. There are no expensive motherboards to replace, or complicated modifications to perform.

The ATF-200 runs off existing power supply and can be either AC or DC coupled to the audio input. Multiturn controls are provided for gain, offset drift and common mode rejection. These are factory preset and/or field adjustable.

*Series 99 is a product of International Tapetronics Corporation/3M.

With Edge Connector **BSW PRICE \$150.00**

Without Edge Connector **BSW PRICE \$129.00**

ELECTRO Impulse, Inc.



Electro Impulse is a leading supplier of specialized equipment for the communications and broadcast industries. Innovations such as dry, forced air cooled loads for FM broadcasters, termination type power meters, attenuators, high accuracy calorimeters that measure RF power, and other loads up to 1.5 million watts average power, are all representative of products which have emerged from their years of experience in this field.

While many requirements can be met from our standard and/or stock selection, special needs can be filled through either modified stock or custom designed units. In either case, all products are backed by a 12 month warranty.

Prices based on application.

KINTRONIC LABORATORIES, INC.

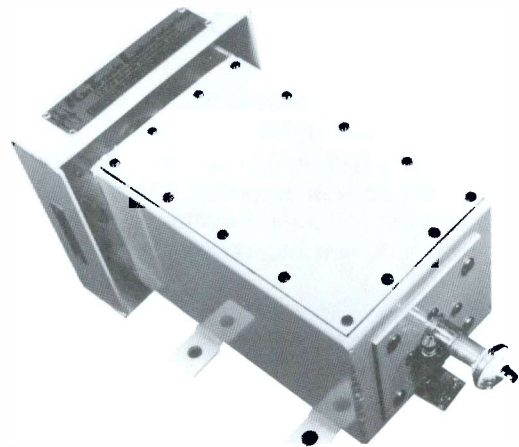

Kintronic Laboratories' Isocouplers provide versatility to existing AM radiating elements by allowing for installation of transmit-receive/FM/TV antennas operating in the frequency range of 30-1000 MHz without disrupting AM antenna characteristics.

Call BSW Toll Free 1-800-426-8434 for prices and specifications.

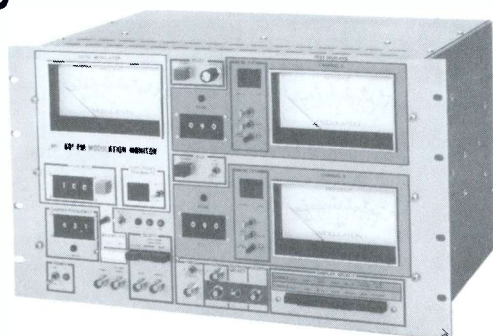

TUNABLE STEREO MODULATION MONITOR AND FM TEST SET

Model 691/01

- A complete proof of performance instrument for mono, stereo and SCA measurements
- Converts x-y oscilloscope into spectrum analyzer

Operator convenience and simplicity of use were primary considerations in the design of the 691.

Mfg. list \$6,675.00 **CALL FOR BSW PRICE**

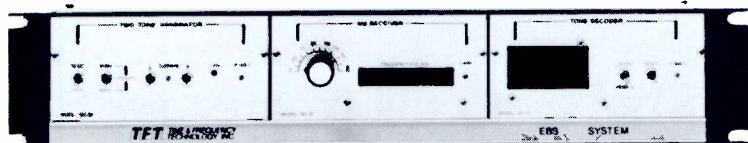

EMERGENCY BROADCAST SYSTEM (EBS) MONITOR

Model 760

EBS system designed for broadcasters for decoding and encoding the two tone alert signal.

Modular construction of the system provides for maximum versatility and consists of a cabinet assembly, AM or FM receiver, two tone decoders and two tone generators. Two or three of the modules can be combined into a cost effective operational EBS system.

Pricing Based Upon Configuration
CALL FOR BSW PRICE



Try Us
We're As Close As
Your Telephone
Toll Free
1-800-426-8434

Gorman-Redlich EBS MONITORS

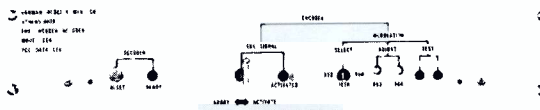

Model CEB Encoder/Decoder EBS Monitor

- Encoder FCC type accepted. Decoder FCC certified. Meets all legal requirements.
- Low cost with uncompromising quality and performance
- Exceeds FCC specifications for EBS requirements
- Provision for remote operation. Programming loop-through standard in encoder. Decoder demutes monitor receiver and/or actuates auxiliary alarm
- Decoder can be self tested
- Requires outboard tuner

Encoder-Decoder (CEB)

Mfg. list \$475.00 **CALL FOR BSW PRICE**



Model CRW Weather, Emergency Alert Monitor

Receive accurate local weather, plus emergency alert messages, weather radar data or marine information. Automatic warning, severe weather or civil defense emergency.

Mfg. list \$475.00 **CALL FOR BSW PRICE**

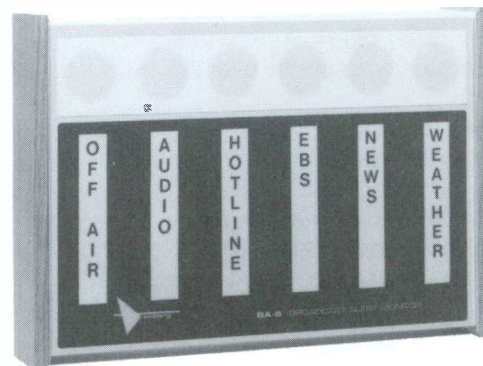

Off the Air...EBS warning...Telephone hotline ringing? Find out in an instant visually with the BA6 from Enberg Electronics. This practical device is attractive as well as functional. Interfaces with a variety of equipment to inform you of status immediately. Stick on letters allow you to customize for your particular requirements.

Mfg. list \$339.00 **CALL FOR BSW PRICE**

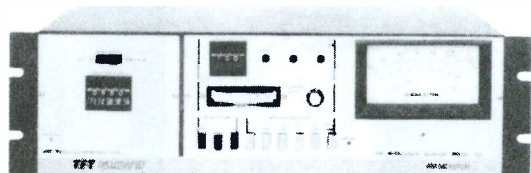

Model 753 AM Modulation Monitor

In today's competitive AM markets, you need to deliver a strong signal to the widest possible area. But, transmitter power alone isn't enough. You also need all the modulation you can legally achieve. That's the basic purpose behind the TFT Model 753 Am Modulation Monitor. Not only does it make extremely accurate proof-of-performance measurements, but more importantly, it allows you to monitor your transmitter so precisely that you can modulate it to the maximum legal limits in absolute confidence.

Mfg. list \$1,600.00 **CALL FOR BSW PRICE**



Model 844 FM/Stereo Modulation Monitor

Based on TFT's years of engineering experience - with over 5,000 modulation monitors operating world wide - these third generation instruments bring you innovations that solve today's advanced technology. You get everything you need for complete proof-of-performance measurements (for distortion, an external analyzer is needed) right on the front panels, plus accuracy, versatility and convenience no other monitors can match.

The Model 844 FM Monitor combines a tunable RF preselector, a baseband monitor and a stereo monitor in one compact instrument. State-of-the-art design, for optimum monitor performance, includes the use of linear phase filters, large scale integrated circuits (LSI) and toroidal power transformers to reduce hum and power line noise. Modular PC cards make service and routine calibrations easy, and high quality, industrial grade electronic components and parts are used throughout.

Mfg. list \$4,425.00 **CALL FOR BSW PRICE**

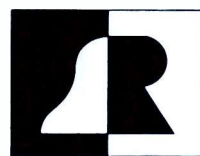
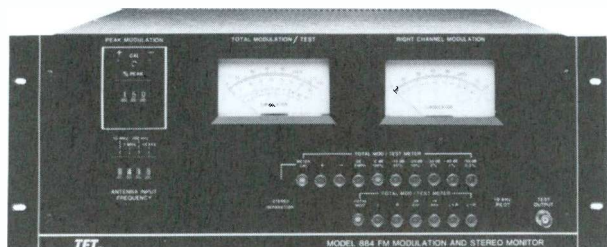

BELAR ELECTRONICS

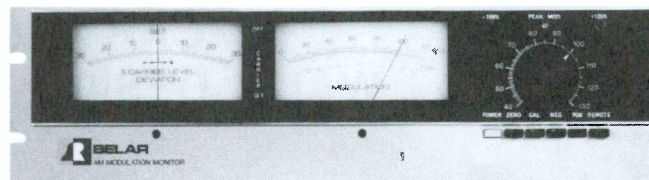

Model AMM-2B AM Modulation Monitor

- Separate 100% negative peak modulation indicator lamp, independent of carrier level
- Separate 125% positive peak modulation indicator lamp, independent of carrier level
- Adjustable peak modulation indicator, 40 to 130% in less than 1% increments, independent of carrier level
- True peak-reading modulation meter responds accurately to the shortest duration program peaks
- Built-in carrier-off alarm
- Built-in modulation calibrator

Mfg. list \$1,195.00 **CALL FOR BSW PRICE**



Model FMM-2 FM Modulation Monitor

The FMM-2 sets new standards in accurate FM monitoring - the first to incorporate a sample hold peak modulation meter circuit independent of modulation polarity to allow the meter to respond to program peaks of the shortest duration. The heart of the FMM-2 is an ultra-linear digital discriminator which provides a distortionless baseband signal for accurate monitoring as well as precise stereophonic, and SCA decoding. FMM-2 required with FMS-2 or SCM-1.

FMM-2 Mono Modulation Monitor
Mfg. list \$1,450.00 **CALL FOR BSW PRICE**

FMS-2 Stereo Modulation Monitor
Mfg. list \$1,650.00 **CALL FOR BSW PRICE**

SCM-1 SCA Carrier Modulation Monitor
Mfg. list \$1,695.00 **CALL FOR BSW PRICE**

Model 884 FM Stereo
The TFT Model 884 FM Stereo Modulation Monitor is a cost-effective alternative to TFT's popular Model 844. The 884 allows you to maximize modulation levels while maintaining the highest signal quality.

The 884 can be used for transmitter* Proof-Of-Performance measurements, or at the studio for off-air monitoring. The frequency-synthesized pre-selector can be used to select your own station's signal or the signal of another station for easy and convenient comparison.

*With a 40 dB attenuator inserted before the antenna input
Mfg. list \$3,200.00 **CALL FOR BSW PRICE**

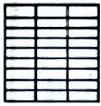

ProRax

YOUR CHOICE OAK OR WALNUT CARTRIDGE RACKS WALL, DESK & FLOOR CAROUSEL

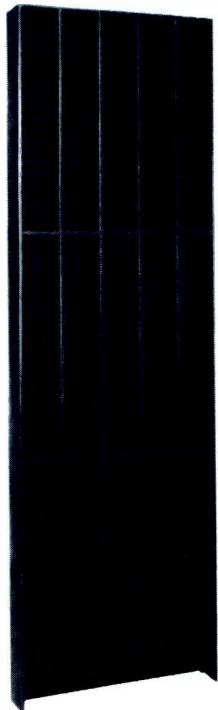

W-300 Wall
Capacity 300
Dimensions
23½" x 75¾" H x 4¾" D

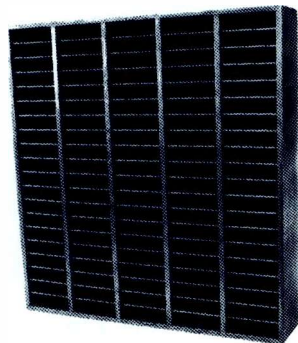

ProRax 100
Wall or Desk
Capacity 100
Dimensions
23½" W x 24½" H x 4¾" D

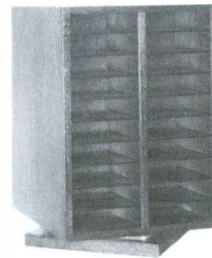

C-40 Carousel
Capacity 40
Dimensions
9⅝" W x 13¾" H x 9½" D
Turning Radius 13⅜"

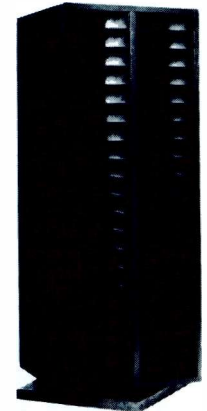

C-80 Carousel
Capacity 80
Dimensions
9⅝" W x 25½" H x 9½" D
Turning Radius 13½"



W-20 Wall
Capacity 20
Dimensions
5¼" W x 24½" H x 4¾" D

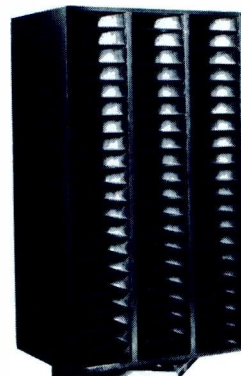

C-120 Carousel
Capacity 120
Dimensions
14" W x 25½" H x 9½" D
Turning Radius 17"



C-200 Carousel
Capacity 200
Dimensions
23½" W x 25½" H x 9⅜" D
Turning Radius 25"

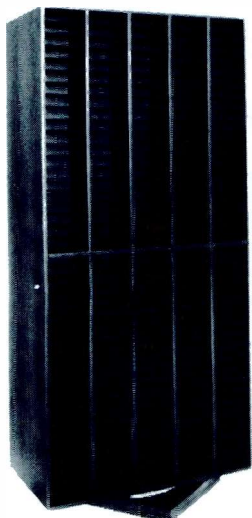

C-400 Carousel
Capacity 400
Dimensions
23½" W x 50¾" H x 12⅜" D
Turning Radius 26⅜"

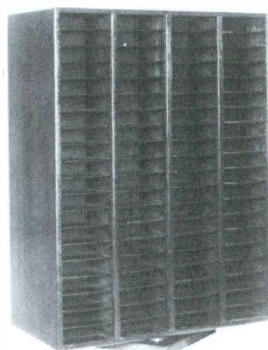

C-160 Carousel
Capacity 160
Dimensions
19" W x 25½" H x 9⅜" D
Turning Radius 21"

PRORAX ARE BETTER AND THEY COST LESS

Solid Mahogany Or Oak Frames & Dividers
Carousel Models — Storage Two Sides Only
Easier To Index & Locate
Carousel Models Have Short Turning Radius
Twenty Seven Models To Choose From
15 Carousels — 12 Wall/Desk Models

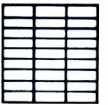

ProRax

YOUR CHOICE OAK OR WALNUT

COMPACT DISC RACKS

CASSETTE RACKS

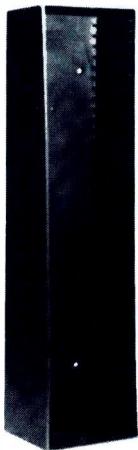

Model AW-40
5 1/4" W x 21 1/4" H x 4 3/4" D
High Impact Plastic
Compact Disc Rack
Holds 40 CD's



CD-20W Wall or Desk
Capacity 20 CD's
Dimensions
6 1/4" W x 16 1/2" H x 4 3/4" D



CS160LS Carousel
Capacity 160
Dimensions
19" W x 25 1/2" H x 9 3/8" D
Turning Radius 21"

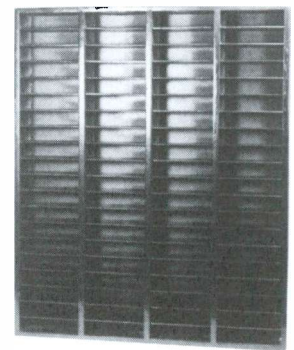

CS80W
Dimensions
20 3/16" W x 24 1/2" H x 3" D
Wall or Desk
Holds 80 Cassettes

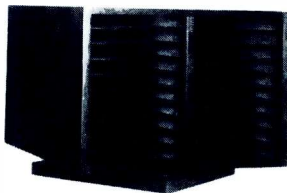

CD-40LS Carousel
Capacity 40 CD's
Dimensions
11 1/2" W x 9 1/4" H x 11 3/8" D
Turning Radius 16"

ProRax

PRICE LIST

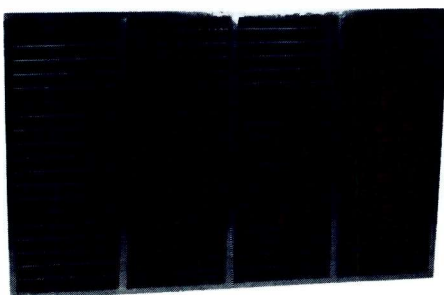

CD-80W
Holds 80 CD's
Dimensions
23 1/4" W x 15 1/8" H x 4 5/8" D

MODEL	DESCRIPTION	WALNUT	OAK
W-20	WALL CARTRIDGE	\$39.95	\$49.95
W-100	WALL CARTRIDGE	\$82.95	\$103.00
W-300	WALL CARTRIDGE	\$295.00	\$425.00
C-40	CAROUSEL CARTRIDGE	\$67.95	\$68.95
C-80	CAROUSEL CARTRIDGE	\$98.00	\$115.00
C-120	CAROUSEL CARTRIDGE	\$138.95	\$165.00
C-160	CAROUSEL CARTRIDGE	\$198.95	\$226.95
C-200	CAROUSEL CARTRIDGE	\$244.95	\$279.95
C-400	CAROUSEL CARTRIDGE	\$489.95	\$575.00
CD-20W	WALL COMPACT DISC	\$37.95	49.95
AW-40	WALL PLASTIC CD	\$24.95	N/A
CD 40LS	CAROUSEL CD	\$69.95	\$89.95
CD 80W	WALL CD	\$72.95	\$93.95
CS-80W	WALL CASSETTE	\$69.95	N/A
CS 160LS	CAROUSEL CASSETTE	\$227.00	N/A

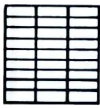

Carousel File

Quality High Impact
Polystyrene
Lasts a Lifetime

- Desk top or floor
- Modular construction for add-on expansion
- High-impact polystyrene

	BSW PRICE
60 Carts	\$105.00
120 Carts	\$154.00
240 Carts	\$252.00
360 Carts	\$346.00
600 Carts with flat base and castors	\$579.00
60EX Cart expansion	\$49.50
Flat base with castors	\$59.00
Metal storage base with castors	\$152.00

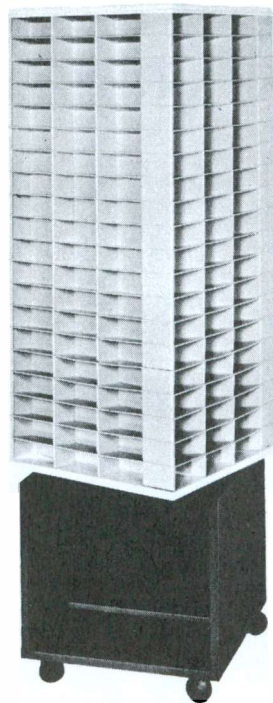

FIDELIPAC

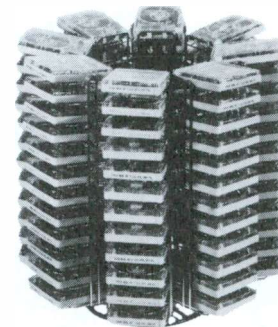

TR-96 Lazy Susan
Holds 96 Carts
BSW PRICE . \$173.25

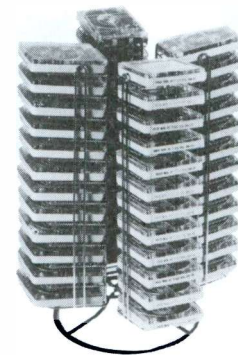

TR — 48 Lazy Susan
Holds 48 Carts
BSW PRICE . . \$97.00

ABCO Wire Cart Racks Wire CD Racks

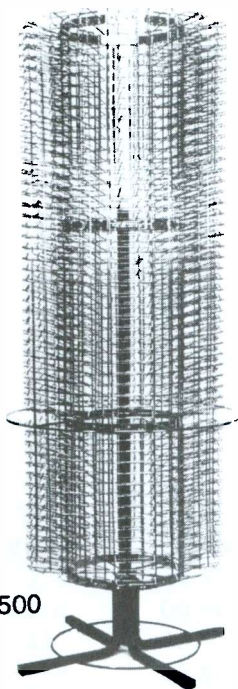

500

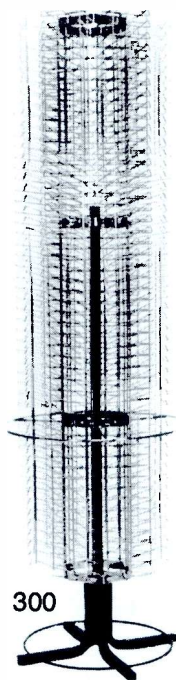

300

Model 300 (Holds 300 Carts)
BSW PRICE **\$372.75**

Model 500 (Holds 500 Carts)
BSW PRICE **\$568.65**

Model 280 (Holds 280 CD's)
BSW PRICE **\$335.00**

Model 560 (Holds 560 CD's)
BSW PRICE **\$600.00**

FIDELIPAC

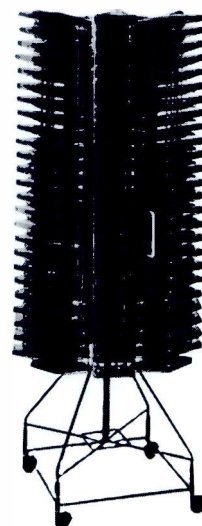

ARISTOCART.

- Aristocart AW-20
- Holds 20 carts
 - High impact polystyrene
 - Will not break, rust or mildew
 - Lowest per-tray cost
 - Great for console or mass wall mounting
 - Includes mounting screws

BSW PRICE . \$11.50 ea.
10 or more . . **\$10.50 ea.**
20 or more . . . **\$9.55 ea.**



MR-200 Lazy Susan Holds 200 Carts
MR-200
BSW PRICE **\$346.50**

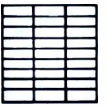

TASCAM

Roll Around Equipment Rack

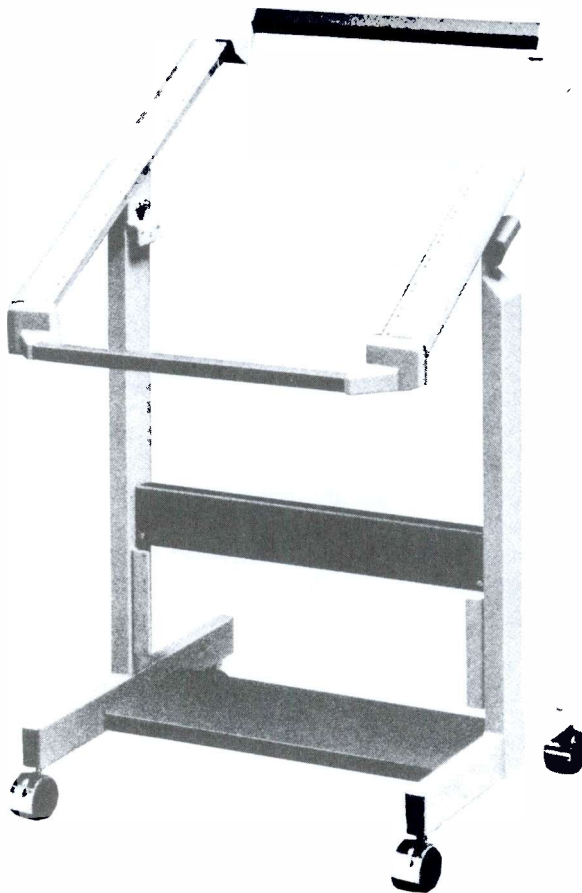

CS-607B
Roll Around Equipment Rack

Rack-n-roll your equipment with the Tascam CS-607B portable rack. Ideal for engineers and audio professionals on the move. The CS-607B is perfect for mounting reel-to-reel machines. Two large knobs and backing pins allow the rack frame to tilt from vertical to horizontal, so equipment can be placed in the most convenient position for your working environment.

BSW PRICE **\$450.00**



Toll Free From All 50 States,
Including Puerto Rico,
Virgin Islands and Canada

1-800-426-8434

soundolier

Equipment Racks

Welded & Completely Assembled

(Specify Color)

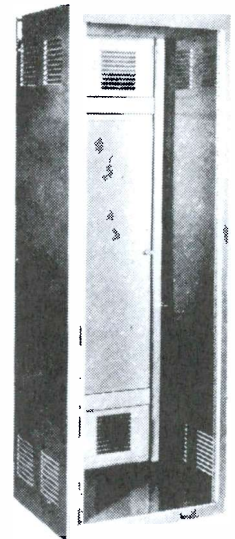

	BSW PRICE
Series 100	
WA 100-36"	\$283.50
WA 100-42"	\$295.60
WA 100-61"	\$338.50
WA 100-70"	\$377.30
WA 100-77"	\$395.50

We know...you've seen one rack, you've seen 'em all. Not true with Soundolier. They make Racks which have bright colors, specialized dimensions, and quality features that will bring out the best in your studio and equipment. Call us for your specialized rack needs.

Oh yea, we do sell the basic racks because we know you need them too. They are priced above and shipped to you welded and completely assembled.

ProRax

for

OTARI



TABLE TOP CONSOLE Designed For Otari 5050 BII

Model PO 100

At last. An attractive, rugged and economical table top console to accommodate your Otari 5050 BII tape transport. Simply remove 8 screws holding the 2 side panels of your 5050 B and attach the two ProRax side panels with the same 8 screws. "Voila" an attractive, versatile table top console at an attractive price.

The ProRax Table top console is decorative laminate closely matching the original side panels. Order yours today for immediate delivery.

LOOK AT THE PRICE

Only **\$79.95**

Sorry - Otari not included. But available from BSW.



The Graphic Express Corporation



The Series 1000 features a solid oak bolster providing a comfortable and elegant touch to the most economic system. This series incorporates the high quality materials and craftsmanship found throughout the entire line, including Birch plywood construction and quarter turn fasteners on all access panels.

In addition to the stylish combination of solid color high-pressure plastic laminate and solid oak trim, the Series 4000 incorporates all the benefits inherent in the Series 3000, including console cutouts, Poplar hardwood structural members, and open cabinet bottoms for sub-floor cable ducting.



The Series 3000 provides enhanced versatility featuring an Interview Table Module and a Turntable Module with dustcover. Like all the cabinets, the Series 3000 includes leveling feet, factory installed rack rails, and a built-in wire pass.

Image-enhancing design and quality craftsmanship have made the Series 5000 the hallmark of broadcast furniture. The hand-rubbed solid hardwood trim, sleek styling and contemporary colors will compliment any studio facility while providing a showcase environment.

YOUR BSW REPRESENTATIVE WILL HELP YOU WITH THE SYSTEM THAT WILL BEST SUIT YOUR REQUIREMENTS

1-800-426-8434



SONY



Model PCM2500

Two hours of digital recording on one compact DAT cassette.

Professional Features:

- Direct digital inputs and outputs
- Analog balanced in & out
- Wired and wireless remote
- Instant cueing with standby for instant start
- Up to two hours recording on one cartridge
- 19" rack shelf available

Mfg. list \$3,200.00 **CALL FOR BSW PRICE**

Panasonic



Model SV-250

Portable Digital Audio Tape Recorder

Introducing the SV-250 Portable Digital Audio Tape Recorder from Panasonic. Ideal for high quality professional or on-the-job recording applications indoors or out, the ultra-compact SV-250 is just 9" wide, 1 3/4" high, and 5 3/8" front to back. And, it weighs only 3.2 lbs.

To pack high performance DAT capability into such a small package required considerable technological innovation including eleven new LSIs.

The rechargeable battery delivers 2.2 hours of continuous recording or playback.

Other valuable features:

- XLR type MIC/LINE inputs.
- 32-step random access programming.
- 2-way power supply accepts AC and rechargeable battery.
- High speed search that is 60 times faster than standard record/playback rate.
- Wide range level meters with peak hold.
- LCD display shows: track number in play, next track number, tape counter/program step, inter-track detection level, battery indication.
- Digital output terminal.
- Direct access and skip search.
- End search.

The last recorded position is automatically detected by pressing the end search key.

Mfg. list \$3,900.00 **CALL FOR BSW PRICE**

TASCAM

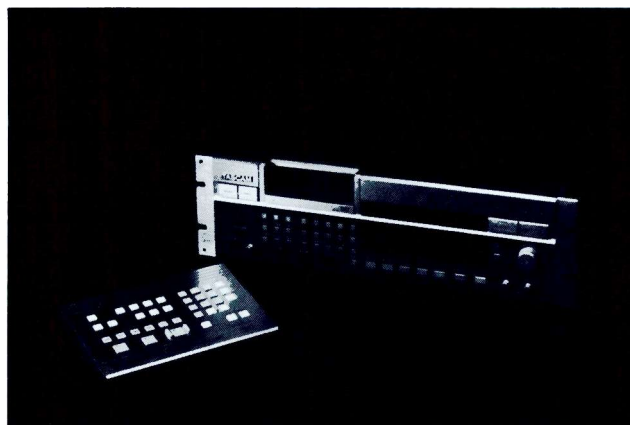

PRO DAT

Model DA 50

Tascam has entered the professional DAT market with the introduction of the Model DA 50. No attempt was made to cut corners in its design. Features include:

- Analog balanced in and out
- Full function wired remote
- Rack mount
- Digital inputs and outputs
- Oversampling digital filter

Mfg. list \$3,999.00

TRULY PROFESSIONAL

CALL FOR BSW PRICE

Panasonic



Model SV-3500

Introducing Panasonic's version of a professional R-Dat recorder...the SV-3500. This tough, rack mounted unit has excellent audio characteristics. By employing two A/D converters with 18 bit resolution, distortion is less than .05% and S/N ratio more than 93 dB.

Other valuable features:

- Multiple sampling frequencies: 48kHz/32kHz recording and playback, 44.1 kHz playback.
- Balanced XLR type analog in/out and coaxial digital in/out terminals.
- Wired remote control unit (supplied) enables stop, play, rec, pause, ff, rew, forward skip, reverse skip.
- Input terminal for serial remote control signal.

Mfg. list \$2,950.00 **CALL FOR BSW PRICE**

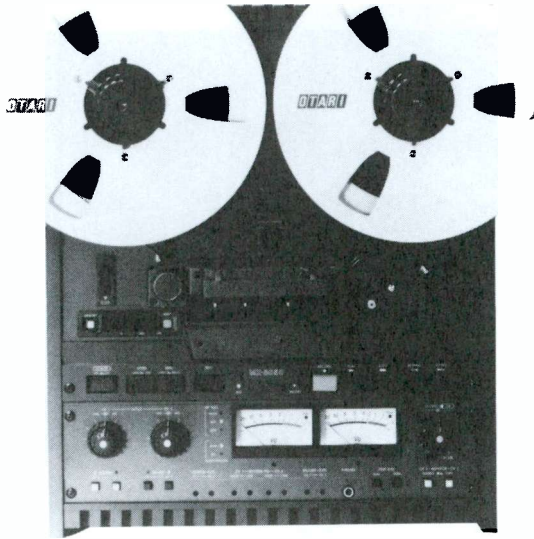

MX-55 A New Concept In 1/4" Compact Recorders



Model MX5050B-II 1/4" Two Channel Recorder

The one integral component found in most radio stations and audio facilities is, of course, the MX5050BII from Otari. For over a decade this machine and it's earlier versions have performed day in and day out without a complaint. From the smallest market areas to the largest cities, the 5050BII is, without a doubt, the most sought after tape machine in the industry.

Clean design, with features broadcasters demand, it offers easy editing, vari speed, real time counter, selectable 1/4 track or 1/2 track playback heads.

Mfg. list \$2,995.00 **CALL FOR BSW PRICE**

New from Otari, the MX-55 1/4" recorder has all the features you've been asking for, at a price you can afford.

Each MX-55 incorporates these standard features:

- D.C capstan, servo-controlled
- Variable speed, $\pm 20\%$
- Speed select in pairs: 15/7.5 or 7.5/3.75 ips
- Reel size compensation control
- Plug-in four head design for easy access
- Integral tape splicing block
- Microprocessor controlled real time counter with search-zero, search-cue, 3-point cue memory and repeat
- Noise free punch in/out
- Built-in test oscillator (100 Hz, 1 kHz and 10 kHz)
- Active balanced in/output
- Cue speaker
- Dump edit mode
- Front panel record set up adjustable
- XLR input/output and microphone connectors
- Lighted VU meter with peak reading indicators
- Rugged die cast deckplate and side panels
- Available 19" rack mount

Mfg. list \$3,895.00

CALL FOR BSW PRICE

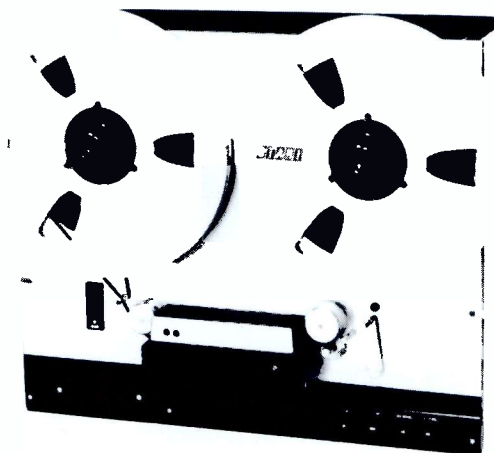

AUTOMATED RADIO STATION REPRODUCER

Model ARS 1000DC

The ARS 1000DC from Otari is the number one choice in playback only or automation environments. 25 Hz sensor is included to stop machine with tones. 7 1/2 & 3 3/4 IPS. Half track, 2 channel stereo. Designed to fit in all standard equipment racks.

Mfg. list \$2,115.00 **CALL FOR BSW PRICE**



OTARI



Otari's Mark III Series. A complete line of professional audio tape recorder/reproducers for broadcast production, audio post-production and recording studio applications.

Mark III/2

Otari's Mark III/2, 4 & 8 recorders, offer the professional a complete range of innovative features and accessories to make any audio recording task easier and more cost effective.

The Mark III/2 1/4" two channel machine is ideal for recording studio mixdown, as well as for broadcast editing applications. In audio for video or film sound production, Otari's optional speed resolver (the EC-401) makes the Mark III/2 the right choice for daily transfer applications using pilot-tone synchronization.

The Mark III/4 provides you with the 1/2" four channel format which has been the world standard for both audio post-production mixdown and broadcast production—at a great price.

The Mark III/8, 1/2" eight-channel machine offers the recording studio many of the features of Otari's legendary MTR-90, plus performance that rivals 1" eight-channel machines.

MK III/2

Mfg. list \$3,925.00 **CALL FOR BSW PRICE**

MK III/4

Mfg. list \$5,935.00 **CALL FOR BSW PRICE**

MK III/8

Mfg. list \$5,495.00 **CALL FOR BSW PRICE**

TASCAM

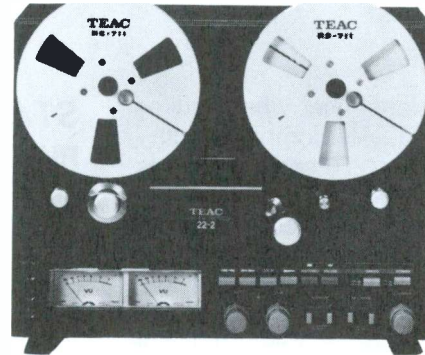

Tascam Model 22-2 Recorder/Reproducer

- 2 track record/playback
- 7 inch reel capacity
- 7 1/2" - 15 IPS
- Remote pause function
- NAB equalization
- Rack mount available

The Tascam 22-2 is a great reel to reel recorder for use where large reels are not needed. Quality electronics and great tape handling.

Mfg. list \$1,099.00 **CALL FOR BSW PRICE**



Model X-300 2 Channel Recorder/Reproducer

3 motor transport. 3 head reproduction system. Light touch locking transport controls. Mic/line mixing. Record mute function. Independent left and right output, and line and mic input level controls. Tape/source monitor selector. Front panel mic and headphone jacks. 1/4 track record/playback.

Frequency response: 30-34 kHz (@ 7 1/2 IPS)

Signal/noise: 65 dB (3% THD)

Wow & flutter: 0.04% (7 1/2 IPS WRMS)

Mfg. list \$1,145.00 **CALL FOR BSW PRICE**



STUDER REVOX PRO

For the professional user who requires superior audio quality combined with overall value, the C270 series presents Studer Revox design and engineering integrity in a variety of recording formats.

The C270 1/4" 2-channel recorder, the C274 1/4" 4-channel recorder, the C278 1/2" 8-channel recorder. Every machine in the C270 line comes with all the standard features and capabilities that professionals need — *standard*.

STANDARD

COMPREHENSIVE PROFESSIONAL TRANSPORT FEATURES.

The 2-channel, 4-channel and 8-channel machines all have 3 tape speeds — 3 3/4 (9.5), 7 1/2 (19) and 15 ips (38 cm/s) — any pair of which can be selected and quickly changed in the field. The 4 and 8-channel recorders also come in low speed versions, especially suited for logging applications, with speeds of 15/32 (1.19), 15/16 (2.38) and 1 7/8 ips (4.75 cm/s). Constant tape tension on both spooling motors, one-hand servo controlled cueing, built-in varispeed (-33% to +50%), an integral scrape-flutter filter in the head assembly and a true AUTOLOCATOR with Zero, Address and Search locate functions allowing for precise search to cue — these are just a few of the features standard in the C270 series of records.

STANDARD

PROFESSIONAL AUDIO ELECTRONICS. Dolby HX Pro® Headroom Extension and proprietary phase compensated audio electronics, seamless and gapless punch-in and punch-out, plug-in EQ cards for easy service and speed conversion, plus superior audio performance are part of the C270 concept of a pro performer, and standard features on every machine.

STANDARD

RUGGED QUALITY, EASY TO MAINTAIN.

The C270 is built with characteristic Studer Revox attention to its service and maintenance throughout a long working life. Fully modular audio electronics — all front-accessible, even in rack-mount configuration — and a rugged die-cast deckplate, head assembly and chassis tell you that this sophisticated series of pro performers shares the same construction values that define all Studer Revox tape recorders.

In addition to the features and capabilities *standard* on every recorder in the C270 series, the 4 and 8-channel machines have these special capabilities:

- Internal logging time and date code generator *and* reader capable of searching and locating to any time directly.
- LED bar graph meters that read both peak and VU program levels simultaneously.
- Auto Reverse Playback mode allowing continuous playback in both directions of pre-recorded 1/4-track stereo tapes (on C274 4-channel machine only).
- SMPTE time code applications.

Model C270
1/4" — Two Channel
Mfg. list \$3,995.00

Model C274
1/4" — Four Channel
Mfg. list \$5,995.00

Model C278
1/2" — Eight Channel
Mfg. list \$7,995.00



C270



C274

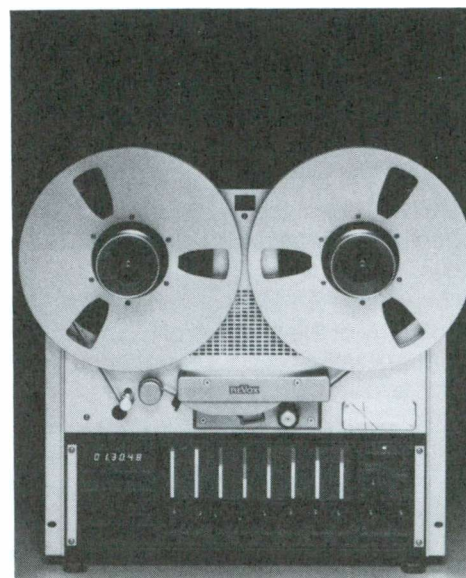

C278

CALL YOUR BSW PROFESSIONAL FOR DETAILED SPECIFICATIONS AND BSW SPECIAL PRICE QUOTATION. 1-800-426-8434.



REVOX PR99 MKIII



True to the Studer Revox tradition, the PR99 has always offered the best combination of features, price and long term service. In other words **OVERALL VALUE.**

The new PR99MKIII is one of the best small professional tape recorders available on the market. The sturdy die cast deck plate offers durability while features such as an autolocator make production or on air work a breeze.

The new front panel is now less cluttered to make overall operation easier. Controls and switches are easy to find making the PR99MKIII a natural performer for your operation.

Reserve yours today. (Shown with optional wood side panels. Unit is rack mounted standard.)

Mfg. list \$2,995.00 **CALL FOR BSW PRICE**

TEAC



X-2000M

Open Reel Mastering Deck With Features Found Only In The Most Expensive Machines **dbx Noise Reduction Included**

With the prices of open reel tape machines soaring, BSW searched for a machine to fill the broadcasters' needs without costing an arm and a leg... Here it is, the TEAC 2000M.

Features: half and quarter track heads, motion sensing logic, NAB eq, dbx type 1 noise reduction, search to zero and search to cue functions. Rack mount and full function remote control available as options.

SPECIFICATIONS

Tape speed: 15 ips & 7½ ips
Motors: 1 FG servo DC capstan
2 DC slotless reel

Wow & flutter (WRMS): 7½ ips: 0.03%
15 ips: 0.02%

Frequency response (overall): 7½ ips: 40 Hz-33 kHz
15 ips: 40 Hz-40 kHz

Signal/noise ratio (overall): dbx out: 66 dB
dbx in: 100 dB

Mfg. list \$2,235.00 **CALL FOR BSW PRICE**

BSW

BSW has an experienced Sales Staff waiting to answer your audio equipment questions and to meet all of your broadcast needs.

**Call us at
1-800-426-8434**



TASCAM



- 1/4" tape
- 10 1/2" reel capacity
- SMPTE interlock capability
- 4 & 8 track revisions available

Model 42B Recorder/Reproducer

The 42B is an exceptionally versatile, high performance, 2 track, 2 channel recorder/reproducer designed especially for demanding production applications. Extra heavy chassis ensures stable tape motion and alignment for long hours of high speed start/stop shuttling.

Mfg. list 2,999.00 **CALL FOR BSW PRICE**



Model 32 Recorder/Reproducer

- 2 track record/playback
- 10 1/2" reel capacity
- Independent record mode L-R
- Full frequency response in sync. mode
- Independent input/output level controls
- 7 1/2 - 15 IPS
- Dump edit
- N.A.B. E.Q.
- Pitch control

Mfg. list \$1,749.00 **CALL FOR BSW PRICE**



Model 48L 8 Channel Logger

- Tape speed 15/32 IPS
- Over 24 hours continuous recording
- 1/4" tape
- 10 1/2" reel capacity

The Tascam 48L is slow speed, logger version of the 48 multi-channel recorder/reproducer. It is designed for long term, multi-channel recording in an industrial, broadcast or government setting. The 48L may be externally controlled for continuous operation by means of a computer, or intermittent operation by means of a voice actuated circuit (VOX) or computer control. Connections for computer or VOX are made at the rear panel 38 pin Accessory Connector.

Mfg. list \$4,995.00 **CALL FOR BSW PRICE**

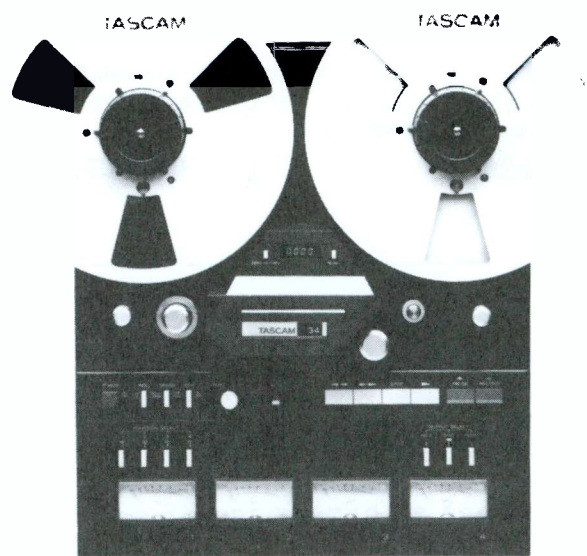

Model 34B

Now there's cost effective 4 track production. The model 34 has all the features of the model 32 plus two extra tracks! Full sync. and modular adjustable electronics.

Mfg. list \$2,199.00 **CALL FOR BSW PRICE**

Model 38 - Eight Track

Mfg. list \$2,999.00 **CALL FOR BSW PRICE**



OTARI

Model MTR-10 and MTR-12 Series II Two Channel and Four Channel Mastering/Production Recorders

The Otari MTR-10 and MTR-12 Series II microprocessor controlled recorders are designed for recording studio, audio post production, and broadcast professionals. The series includes 1/4" two-channel, 1/2" two-channel, 1/2" four-channel, and an optional 1/4" two-channel with IEC standard (SMPTE/EBU) time code center track kit. (A conversion kit with a plug-in head assembly allows you to quickly convert the four-channel version to the 1/4" format.) The MTR-12 allows 12.5" diameter reels for applications requiring extended program lengths. All machine versions are housed in an overbridge, roll-around console.

The Series II machines feature a cast aluminum alloy deck-plate for smooth tape handling and easier format conversion.

The MTR-10 and MTR-12 Series II transport and editing controls are conveniently located on a separate panel. The entire transport assembly swings up for easy access. Audio, transport circuitry, and power supply assemblies are contained on plug-in modules for quick diagnosis and repair.

The MTR machines are designed for easy interface with any SMPTE/EBU time-code-based synchronizer, editor, or machine controller. All transport functions and tallies, 9600 Hz capstan speed over-

ride, and tachometer data are available on one rear panel multipin connector.

There are three choices of optional remote controls available:

- Model CB-109 — A full-function auto-locator which includes ten assignable memories with one stroke keyboard access, vari-speed control and dual LED displays for both tape and locate timing.
- Model CB-111 — A remote transport controller with dual-lit controls, cue, variable speed control, and return to zero.
- Model CB-102 — A remote transport controller

Each MTR-10 and MTR-12 Series II incorporates these standard features:

- Three speeds: 30/15/7.5 or 15/7.5/3.75 ips, (specify)
- Full servo, DC PLL capstan
- 5" to 10.5" reel size capacity (12.5" with MTR-12) Automatic reel size sensing
- Electronically balanced I/O with direct-coupled high current outputs (transformers available if required).
- One hand "reel rocking"



The MTR-12, 1/2 inch, four-channel recorder.

- -20% variable speed control with percentage and ips display
- Cue control with tape lifter defeat and transport shuttle (variable speed in forward or reverse)
- Monitoring with headphones or built-in cue speaker
- Internal multi-frequency square/sine wave generator including convenient external oscillator input
- User-adjustable record phase combination
- Three selectable record flux calibration levels: 185,250 & 320 nWb/m
- NAB/IEC/AES selectable equalization
- Direct access to head assembly and head calibration adjustments
- Proprietary Otari microprocessor for timing functions and transport control
- Master bias switching for two tape types at all speeds
- Controlled wind mode in either direction
- Return-to-zero from positive or negative domain. Machine will accept and store a play command while searching zero
- Back timing mode
- Dump edit mode
- Integral splicing block

MODELS		MFG. LIST
MTR-10-B:	1/4" full-track prewired for two channels in floor console	\$9,295.00
MTR-10-C:	1/4" two-channel in floor console	\$9,495.00
MTR-10-CT:	1/4" center track time code	\$12,095.00
MTR-10-I:	1/2" four-channel	\$12,550.00
MTR-12-C:	1/4" two-channel 12.5" max. reel size in floor console	\$10,455.00
MTR-12-H:	1/2" two-channel 12.5" max. reel size in floor console	\$12,775.00
MTR-12-I:	1/2" four-channel 12.5" max. reel size in floor console	\$13,525.00
MTR-12-I LX:	1/2" four-channel 12.5" max. reel size in floor console optimized for duplication master-making (data sheet available)	\$14,050.00

CALL FOR BSW PRICE

Due to contracted obligations BSW can offer the MTR Series in only the following states: AK, WA, OR, NM, WY, ID, UT, MT, CO, NV, and California North of San Francisco.



Routing Switchers

The RS Audio Routing Switcher is the professional alternative to patch panels, mechanical switches and distribution amps. Ultra-reliable, the power supply is regulated, protected, has a 10 year meantime before failure. LSI integrated circuits reduce parts count to a minimum. All IC's are socketed for ease of replacement. The thumbwheel control switches are 1,000,000 operation. Due to the ultra-reliable design, redundant power supplies are unnecessary. These switchers may be used in most critical sections of the audio chain with total confidence.

Routing switchers perform many applications that are difficult with other technologies. A single audio line with remote control can link a satellite system to a studio. This replaces several DA's and a massive cable bundle. Studios can be linked together and to the transmitters.

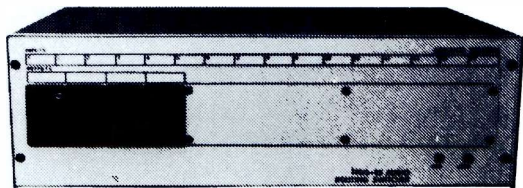

Model 1100ARSS Routing Switcher

- Control by four 16 position binary thumbwheels. One per output
- Remote control - 4 bit binary plus enable
- Size - 5 1/4" x 19" rack mount
- 16 in by 4 outputs stereo
- Expandable - yes, in and out

Mfg. list \$995.00 **CALL FOR BSW PRICE**
Many More Models Available

CONEX ELECTRO SYSTEM

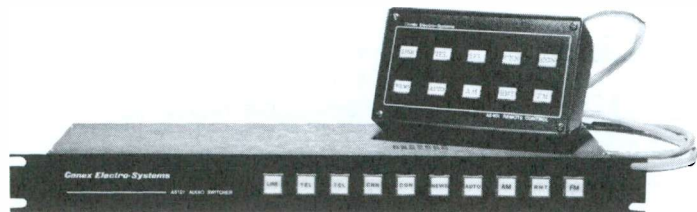

Audio Switching System

Model AS-101

The Conex AS-101 Audio Switcher allows any one of 10 stereo sources to be switched to the stereo output channel. Switching is accomplished by pressing one of the illuminated buttons on the front panel, or remotely, via the remote control connector on the rear panel. Several remote control devices may be connected in parallel, and all will indicate the selected channel.

AS-101

Mfg. list \$895.00 **CALL FOR BSW PRICE**

AS-401 Remote Control (Shown)

Mfg. list \$150.00 **CALL FOR BSW PRICE**

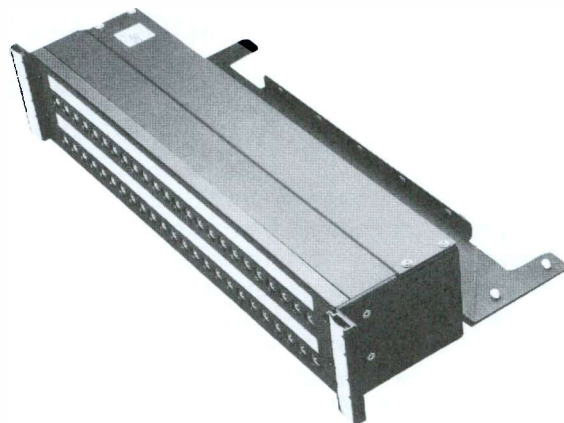

Here's a Great Way to Save Money....Patch Kit from ADC

Patch Kit has many of the features of the pre-assembled patchbays, but in a package designed specifically for the do-it-yourselfer. Simply add your own cable and an Ultra Patch termination panel (see pg. 88) and you'll have it made. and you'll have made it yourself.

Catalog #	Description	Mfg. list
P-KIT-1	1.75" panels with 2 x 24 array of longframe (1/4") jacks	\$180.00
P-KIT-3	3.5" panels with 2 x 24 array of longframe (1/4") jacks	\$180.00
P-KIT-B	1.75" panels with 2 x 48 array of Bantam jacks	\$240.00

CALL FOR BSW PRICE

PATCH CORDS



Long Frame 1/4"



Bantam

LONG FRAME

ADC NO.	Length	BSW Price
PJ-81	1 Foot	\$12.97
PJ-82	2 Foot	\$13.66
PJ-83	3 Foot	\$14.14
BANTAM		
PJ-712	1 Foot	\$7.63
PJ-714	2 Foot	\$7.96
PJ-716	3 Foot	\$8.26

Other ADC Patch Cords In Stock
Call For Details 1-800-426-8434



Pro Patch Mark II

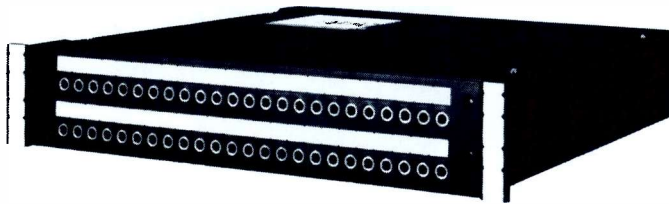

ADC has enhanced the design of Pro Patch front and back to deliver more time and work savings. In front, circuit designations are neat and convenient; and in back, the terminal layout affords faster installation and more flexibility of configuration. The fully enclosed Pro Patch chassis protects all the internal patchbay wiring as well as eliminating the need for routing and dressing conventional patchbay harnessing. Front panel and rear panels remove easily for service without removing the unit from the rack — saving downtime. QCP is featured on Pro Patch. This proven method of cable termination provides numerous benefits. QCP provides a “gas tight” connection. This means your cable connections are impervious to harmful environments, thereby giving you a connection that will not deteriorate over time. Pro Patch includes S.A.I.L.S. (Self Adhesive Identification Label System). No more designation strip hassles.

Call BSW for Price and Configuration

BJF MKII Patchbays

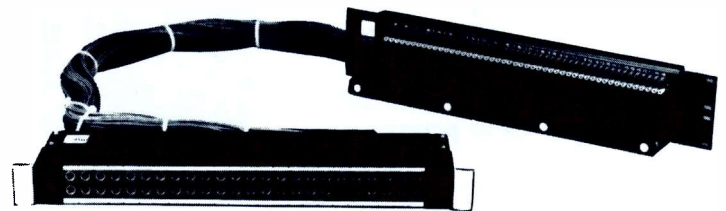

The standard BJF MKII Patchbays include:

- Ultra Patch Termination (See below)
- A four foot cable harness

BJF MKII Patchbays are available in numerous harness length and termination configurations on a special order basis.

Call BSW For Pricing & Configuration

Ultra Patch Panels

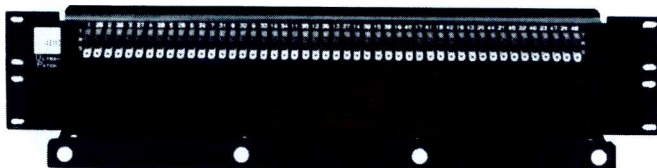

- Utilizes QCP technology
- On Ultra Patch panels with normals, contacts are arrayed to facilitate full and half normaling.
- Four design configurations to interface with 24 circuit (48 jack) and 48 circuit (96 jack) patchbays, with provisions for normals if necessary.
- Cable support system insures that your cabling will dress neatly and stay that way, without stressing your connections.

Call BSW For Pricing & Configuration

Wire Insertion Tools

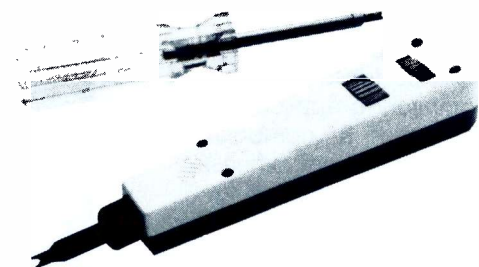

The insertion tools are used for insertion of wire into the QCP split cylinder modules. The impact tool applies the correct force to the wire by a spring loaded mechanism within the tool. Either of 2 impact forces can be applied, as selected by the LO-HI thumbwheel on the side of the tool. The LO position installs 24 or 26 AWG wire, the HI position installs 22 AWG wire. The impact tool includes 1 removable tip which comes stored in the tool's handle.

The manual tool performs identical functions as the impact tool without the aid of a spring loaded tip.

Model Q114 Manual Tool
BSW PRICE \$17.50

Model Q814804 Impact Tool
BSW PRICE \$65.00

Model Q804 Spare Tip
BSW PRICE \$23.50



JBL's NEW Generation of Studio Monitors

4406 Studio Monitor

The 2-way 6 inch Model 4406 monitor is ideal for console or close-in listening. The low distortion 6" woofer is composed of a filled polypropylene material which provides both high internal damping and excellent structural integrity.

Mfg. list\$225.00

CALL FOR BSW PRICE



4410 Studio Monitor

The powerful 3-way 10 inch Model 4410 features a vertical line array that gives maximum spatial detail at greater listening distances. The special laminated high polymer composite 10" woofer has outstanding power handling capabilities, delivering extraordinary punch and fidelity.

Mfg. list\$425.00

CALL FOR BSW PRICE

4408 Studio Monitor

JBL's 2-way 8 inch Model 4408 is an ideal choice for broadcast and general monitoring applications. The low distortion 8" composite woofer gives maximum stiffness, mass and internal damping for superior reproduction of both speech and music.

Mfg. list\$237.00

CALL FOR BSW PRICE



4412 Studio Monitor

The 3-way 12 inch Model 4412 is highlighted by an ultra-large, ultra-precise 12" laminate composite woofer. Its tight cluster arrangement and superior power efficiency make it the ultimate monitor for close-in listening. The mid-range element and larger woofer allow for greater power handling, increased sensitivity and extended bandwidth.

Mfg. list\$650.00

CALL FOR BSW PRICE



Sentry 100A For Tight Spaces

Just because your monitor space is limited, you don't have to compromise on sonic accuracy. The Sentry 100A is a compact, no frills speaker system. It's the oldest member of the Sentry family and has become the industry standard of reliability.

The Sentry 100A delivers a flat 45-18,000 Hz frequency response with wide 120° dispersion at 5,000 HZ. The Super Dome™ tweeter handles a remarkable 25 watts of input power and is matched with an 8" direct radiator woofer in an optimally vented enclosure.

Sentry 100EL With An Integral Power Amplifier

The Sentry 100EL combines the reproduction components of the Sentry 100A with an integral high performance 50 watt power amplifier that's perfectly matched to the requirements of the speaker system.

Sentry 100A

Mfg. list \$278.00 ea **CALL FOR BSW PRICE**

Sentry 100EL

Mfg. list \$572.00 ea **CALL FOR BSW PRICE**



POWERED MONITOR SPEAKER

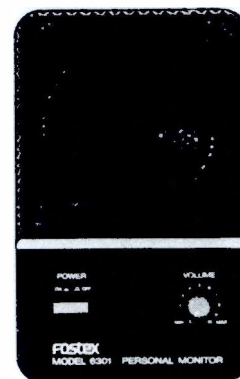

Model 6301B With 20 Watt Amplifier

The 6301B is completely self-contained. The sound is delivered from a full-range speaker that's surprisingly flat and accurate. You get a frequency response of 80 Hz-13 Hz, which makes the 6301B an ideal reference when you're producing music, radio spots or audiovisual sound tracks.

The built-in 10 watt (RMS, into 8 ohms) amplifier will handle anything you feed it. The 6301B's input has been designed to accept any line or instrument-level input, even from an amplifier. There's no confusion. Just one 1/4" phone jack to deal with.

Mfg. list \$350.00 Pr **CALL FOR BSW PRICE**



AURATONE

Recording Monitors For The Real World



Model 5CV
 Super Sound Cube, known the world over for its outstanding reproductive qualities.
 Mfg. list \$99.00 Pair **CALL FOR BSW PRICE**

RACK MOUNTABLE



Model 5MCV
 Three Channel Broadcast Monitor
 Mix down monitors contained in three compartment ultra compact enclosure.
 Mfg. list \$150.00 ea. **CALL FOR BSW PRICE**
 RM525 Rack Mount Kit **BSW PRICE \$9.90**

RAMSA WSA-70 Compact Sound Monitor



Wide Frequency Range for High Quality Sound Reproduction
 The WS-A70's easy listening tonal qualities are complemented by high fidelity sound reproduction of professional studio standard over a wide frequency range. High frequency driver frequency range is 1,250 Hz—18,000 Hz, while the low frequency driver ranges from 50 HZ to 4,000 Hz. Good frequency separation is achieved by using an 18 dB/oct curve in the crossover network at the 2,000 Hz crossover points. This delivers clear and vivid sound, suppressing irritating peaks in the middle and low frequency ranges.
 Recessed ceiling mounting is available, and optional mounting brackets provide a variety of mounting possibilities, such as suspension from the ceiling or walls.
 Mfg. list \$240.00 **CALL FOR BSW PRICE**

ALC

MONITOR SPEAKERS

Dramatic Response in a Small Convenient Size. Ideal for Broadcast Control Rooms, Studios, Remote Recording and Quality Control Areas.

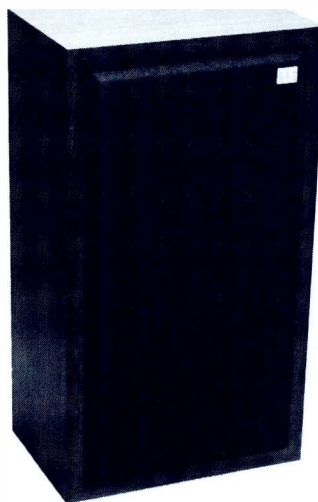

Model 20306
 • Two-way speaker
 • Flat response
 • 50 Hz to 20 kHz
 • 8" woofer
 • Phenolic tweeter
 • Walnut grain vinyl
 • 19½" x 11" x 7¼"

BSW PRICE ONLY
\$196.00 Pair

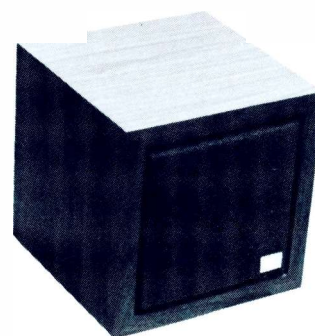

Model 10302
 Sound Cube
 • Full range
 • Compact 7⅞" cube
 • Snap-away grill
 • -60 Hz to 15 kHz

BSW PRICE ONLY
\$98.00 Pair

JACOUSTECH CORPORATION



Model MTR. 4.5
 Compact 2-way speaker system with built-in power amplifier. Same dimensions as most scopes. Perfect addition to your test bench. 2 balanced inputs and outputs. Front panel volume control, Shielded case.
 Mfg. list \$549.00 ea. **CALL FOR BSW PRICE**

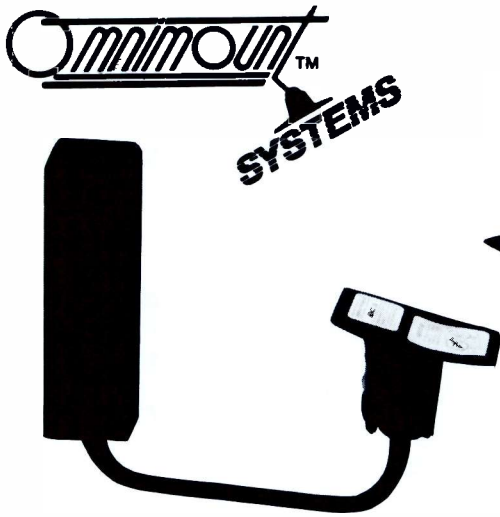

SPEAKER MOUNTING BRACKETS

Installing speakers is no easy task unless you use Omnimount speaker brackets. Only Omnimount offers models that allow you to mount speakers from assorted angles and locations. Weight handling ranges from 1 pound to 255 pounds. Call BSW with your requirements and we will suggest the proper Omnimounts for you.

- Model 100WA Holds up to 75 lbs. Mfg. list \$62.50 **BSW PRICE \$59.95 ea.**
- Model 75WABC Hold up to 40 lbs. Mfg. list \$53.95 **BSW PRICE \$49.95 ea.**

TOUGH TECH.

SUSPENDER System
U.S. Patent Pending

IMMACULATE SUSPENSION

A SIMPLE, EFFECTIVE MEANS OF SUSPENDING LOUDSPEAKERS

- Easy to install
- Multi-directional control
- Safely supports 125 lbs. per loudspeaker
- Improved loudspeaker performance



To find the strap size you need, measure the distance from A to B.

THREE STRAP SIZES TO CHOOSE FROM

- S • Speakers measuring from 41" — 54"
- M • Speakers measuring from 54" — 67"
- L • Speakers measuring from 67" — 80"

BSW PRICE ONLY \$59.95 PAIR
Specify Model S, M or L When Ordering

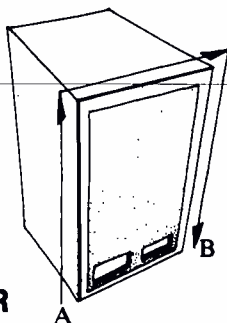

Pivotelli

U * S * A

STRONG ELEGANT SPACE SAVER
Hold up to 110 lbs.

Model PU
Speaker Mounting Brackets

Construction: High grade sobel aluminum
Finish: Durable nylon in matte black
Mounting screws included

BSW PRICE \$69.50 Pr.

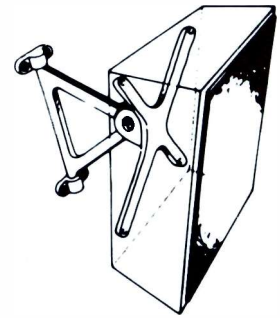

Here is an easy answer to installing speakers without having to drill into the speaker cabinet.

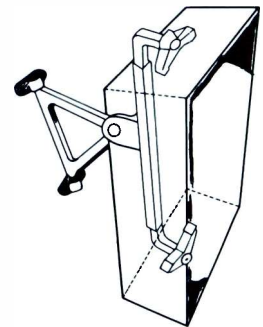

The Limpet Universal Baseplate can be mounted horizontally or vertically, and grips the cabinet from above, below or behind, with rubber covered clamps. Both clamps swivel, so that even equipment with rounded or tapering sides can be securely held.

The bracket is fixed to the wall with four (4) screws, and nylon wall plugs (included).

Construction High grade solid aluminum.
Holds up to 88 lbs.

WITH LIMPET BASEPLATES

- Model PULUP (7" - 11") **BSW PRICE \$89.95 Pair**
- Model PULUM (11" - 17³/₄") **BSW PRICE \$99.95 Pair**
- Model PULUS (17³/₄" - 30") **BSW PRICE \$109.95 Pair**

NEW! FLEXIBILITY PLUS

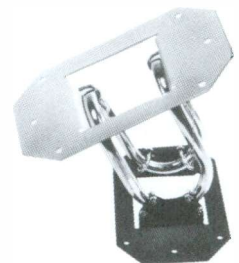

Model No. 040-815-02

The RADIAL CUBE from Peerless offers the ultimate in versatility and simplicity in a loudspeaker mounting bracket. This lightweight mount achieves the muscle to handle hefty size speakers from a unique design based on the strength of tubular steel formed into a "cubic" frame. One model allows wall or ceiling installations. Holds up to 75 lbs.

BSW PRICE \$43.00



GENTNER

Advanced
micro-dynamics inc.

*Remote Control From
Anywhere...*



**VCR-1000
Voice Remote Control**

The VRC-1000 is a single chassis located only at the remote or transmitter site. The studio or control end of the system is any dial telephone connected to the normal (dial) telephone network. No complex array of buttons or controls are needed to operate the VRC-1000, just a standard telephone. Thus, any designated telephone, anywhere in the world, can be the control point for a broadcast transmitter plant—even a cellular or mobile telephone. Interaction with the VRC-1000 System is accomplished with Touch-Tone® (DTMF) signals as the input, and synthesized voice information as the output. An alternate output is available as serial digital data (ASCII) when the VRC-1000 is equipped with the internal modem option.

All synthesized voice outputs are in frameworks stored within the memory of the VRC-1000. At the time of system setup, the words used to label and define each command, metering and status channel are selected from a vocabulary of almost 800 words.

Auto Dial - Auto Answer

The VRC-1000 automatically answers when called, and will automatically dial up to five different numbers to report an alarm.

Absolute Security

Multiple-level security codes (user-defined) prevent unauthorized operation of the VRC-1000.

16 Metering Channels

Each channel has a 4 digit presentation, with four user-defined tolerance limits. Linear, power-to-linear and indirect power presentations are available on each channel.

16 Status Channels

Each channel has two conditions—open and closed.

32 Command Outputs

“Smart” operation. The VRC-1000 can detect a predetermined alarm condition and automatically correct that condition by issuing a command. It also initiates a telephone call to up to five telephone numbers to report the problem (and it keeps calling until it gets an answer).

Pricing Based Upon Configuration

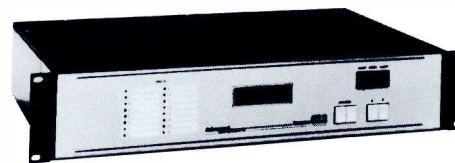

**16-Channel Transmitter Remote Control
ARC 16**

- Full-time studio control, dial-up control, or both
- Studio controller displays clear text prompts for non-technical operators
- Dial-up speech unit features digitally-recorded human voice
- Built-in subcarrier generators at no extra charge
- Built-in alarms
- Optional computer interface
- Control multiple sites with a single unit

Now, you have a choice: full-time studio control, dial-up telephone control — or both. And because of modular design, the ARC-16 offers features never before available in a 16-channel remote control system.

16 Channels

The ARC-16 system includes 16 analog metering channels, 16 status channels and 32 control outputs (16 raise, 16 lower).

Studio Control

With the studio controller you have a constant link to your transmitter, for instant response to any problem. The 32-character LCD display shows out-of-tolerance conditions at a glance, and it's simple to make adjustments, with clear-text prompting to guide you.

Telephone Access

Call the ARC-16 from any tone phone: the Digital Speech Unit (DSU) lets you take control using your telephone keypad. It can be used as the only control — or in addition to the studio controller — and can be installed in the transmitter or the studio unit. **PRICES BASED ON CONFIGURATION**



**Model TC-8
Remote Control**

The TC-8 is a full featured remote control system from Advanced Micro Dynamics.

The TC-8 requires only 1 3/4" of rack space and provides 8 metering channels, 8 status inputs and 8 pair of control outputs. Studio and transmitter units communicate via telco loops or STL/SCA subcarriers. Specify which you prefer at time of ordering.

Status inputs accept 5 to 28 V signals and metering channels accept inputs of either polarity from 0.25 to 4 V, ensuring easy interface with all broadcast equipment. Status LED's and the large dot matrix metering display can be read from across the room.

CRT display, logging and fully automatic operation is possible using the optional RS-232 interface.

Mfg. list \$2,495.00 **CALL FOR BSW PRICE**



Moseley

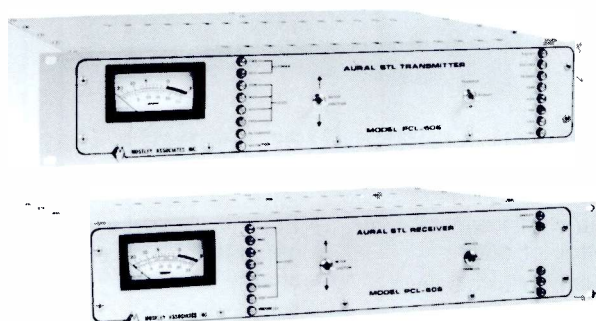

PCL 6000 Series Studio Transmitter Links *It's Synthesized*



PCL-606/C STL Totally Transparent

You're scrupulous about quality. You're running compact discs mastered on digital equipment. You've bought the best console you can afford. Your processing plant is as clean as a whistle. Don't compromise now! Deliver your signal with the only STL that's totally transparent. The composite stereo PCL-606/C or the mono PCL-606. Find out why Moseley STL's outsell all others.

Frequency Response	Composite: ± 0.1 dB or better 30 Hz to 53 kHz, ± 0.3 dB or better 53 kHz to 73 kHz
THD & IMD Distortion: Narrow (Wide) I.F. Filter	0.3% (0.2%) or less 30 Hz to 53 kHz, typically better than 0.1% (0.7%) at 1 kHz
Stereo Separation	48 dB or better, 50 Hz to 15 kHz (typically 50 dB or better)
Nonlinear Crosstalk, Subchannel to Main- channel, Mainchannel to Subchannel: Narrow (Wide) to I.F. Filter	50 dB (54 dB) or better
Signal-to-Noise Ratio	72 dB or better (typically 75 dB) below 100% modulation, demodulated, de-emphasized left or right

PCL606/C Transmitter & Receiver
Mfg. list \$10,490.00 **CALL FOR BSW PRICE**

Moseley Associates and BSW are proud to introduce the PCL 6000 Series Studio-Transmitter Links. Blending technology and innovative engineering, the PCL 6020 and 6030 systems are ready to provide a flexible, high performance alternative to leased telephone lines.

What's unique about the PCL 6000 Series?

As leaders in STL technology for the past 25 years, Moseley has always provided the highest quality program conveyance. Not wanting to design just another STL, Moseley engineered the PCL Series to offer unique and innovative features.

Both the PCL 6010 transmitter and PCL 6020 and 6030 receivers employ a synthesized reference oscillator to eliminate fixed-frequency crystals.

Now, monaural or composite operation is available from a single system. By selecting appropriate jumpers, you can enable wideband composite stereo or 15 kHz monaural basebands. Two PCL 6000 systems can be used in a dual discrete configuration to transmit right and left stereo programs with no measurable crosstalk. Receiver IF bandwidth can be factory or field set for channel spacing of 100 kHz to 500 kHz. Which system is right for you? If you have no adjacent channel interference the PCL6020 will offer superior performance. The PCL6030 is designed for hostile RF environments.

PCL 6020
Mfg. list \$7,200.00
PCL 6030
Mfg. list \$8,800.00

CALL FOR BSW PRICE



Model SCD-8 Multiplex FM Subcarrier Demodulator

Model SCD-8 Multiplex FM Subcarrier Demodulator was developed as a companion to the SCG-8 generator. Front panel peak deviation, automatic muting, self contained power supply, meter, all electronic squelch and audio low-pass filter are standard equipment. Operating frequency easily changed with plug-in filters from 26 kHz to 185 kHz spectrum.

Mfg. list \$995.00 **CALL FOR BSW PRICE**



Model SCG-8 Multiplex FM Subcarrier Generator

SCG-8 Subcarrier Generator, with automatic muting and front panel peak deviation meter, including self contained power supply. Available for operation at any standard frequency in the 26 kHz to 185 kHz spectrum. Specify operating frequency when ordering.

Mfg. list \$995.00 **CALL FOR BSW PRICE**



Moseley

THE LEADERS IN TECHNOLOGY AND INNOVATIVE ENGINEERING

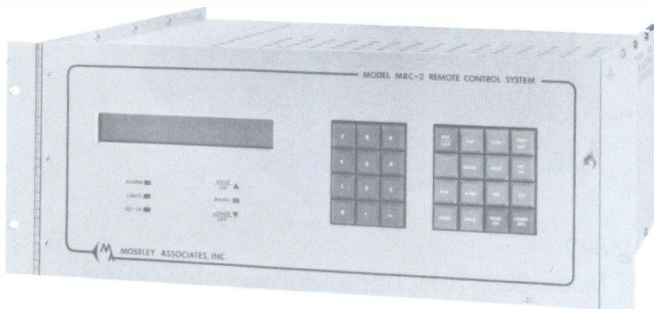

The Moseley MRC-2 Commander in Chief

More and more, broadcasters are issuing executive commands through their MRC-2 microprocessor remote control.

Multi-site, Multi-function

The MRC-2 controls and monitors as many as 99 remote sites, with multiple control terminal capability to let you delegate control from master to master as needed. Up to 255 status, 255 telemetry and 255 command channels supervise your sites. Dual tolerance limits can be set to prevent a telemetry parameter from reaching critical levels. Choose from 6 modes in which to calibrate telemetry inputs, and set status inputs to initiate alarms or events on rising or falling waveforms, or both.

Control Options

Optional automatic loggers provide a printed record of system operation and CRT terminals display your data in plain language. An optional ACU-1 automatic control unit automates your operation by issuing programmable time and feedback-actuated sequences of commands without operator assistance. Add multiple direct command and multiple status display options for streamlined operator interface.

PRICES BASED ON CONFIGURATION

BSW

BSW's "after the sale" support is second to no one. Your complete satisfaction is our only goal.

1-800-426-8434
FAX 206-565-8114

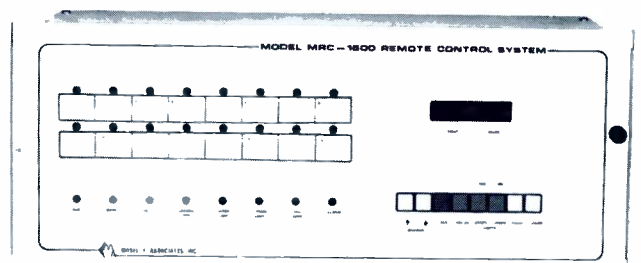

MRC-1600 Microprocessor Remote Control

The MRC-1600 microprocessor remote control system offers microprocessor flexibility and sophistication in an economical and dependable package for general remote control applications. It comes equipped with 16 status inputs, 16 telemetry inputs, 16 raise command outputs and 16 lower command outputs. Each command output is relay-isolated. Adapting the MRC-1600 to current system interconnections is easy. Plug-in modules can be ordered to accommodate almost any communication system, from standard 2 wire to 4 wire telephone lines to FM subcarriers, subaudible telemetry or a combination of any of these.

Mfg. list \$4,595.00

CALL FOR BSW PRICE

MRC-1600 Options:

A Dial Access/Voice Response Option can be added to the Control or Remote Terminal allowing access over the Public Switched Telephone Network via DTMF telephones. An RS-232 port serial interface is provided to connect a terminal or personal computer through a modem.

Mfg. list \$1,080.00 . . \$1,380.00

CALL FOR BSW PRICE

The CRT option for the MRC-1600 gives the user full control of the transmitter from the keyboard at the Control Terminal. All status and telemetry data are displayed simultaneously on an Hazeltine Espirit 6110+ terminal.

Mfg. list \$1,095.00

CALL FOR BSW PRICE

An Automatic Logging option can be added to the CRT option to provide a printed log of station operation. A Texas Instruments Model 850XL printer records status and telemetry data at user-specified intervals from one minute to twenty-four hours.

Mfg. list \$995.00

CALL FOR BSW PRICE



Moseley



Model 4010 Transmitter Shown

Moseley Associates has designed the most advanced Remote Programming Link available today. The RPL 4000 offers the features and specifications you expect from Moseley at a modest cost.

The versatile RPL 4000 handles every remote programming situation with ease.

RPL 4000 System Features:

- Broadcast quality performance
- Audio bandwidths from 5-15 kHz
- 25, 50, and 100 kHz channels
- Encoding and decoding for repeaters
- Noise-reduction companding

A portable RPL 4010 Transmitter is designed to meet stringent demands of quality, ruggedness and flexibility. Fully synthesized and lightweight (weighing less than 8 lbs.), the RPL 4010 is ready to use in conjunction with your existing repeater and portable audio mixers. Extensive front panel metering lets you operate with confidence.

The RPL 4020 Receiver has excellent channel rejection characteristics, which are absolutely essential in crowded UHF bands. An industry-standard connector is provided for audio and control interface with existing equipment.

RPL 4000 System includes transmitter and receiver.

Mfg. list \$3,500.00 **CALL FOR BSW PRICE**



Model 8888

The TFT Model 8888 RPU Transmitter and 8889 RPU Receiver bring new levels of performance and convenience to Remote Pickup equipment for remote broadcast. Frequency agility, selectable deviation, selectable receiver bandwidth and DTMF control are among the advances that TFT has brought to RPU's for high quality audio performance and convenience.

Features:

- Frequency Agile Transmitter and Receiver
- Selectable Transmitter Deviation
- Selectable Receiver Bandwidth
- 25 watts RF Power; switchable to 12 and 6 watts
- DTMF Signaling for System Security and Cueing
- Front Panel Diagnostics Metering
- Transmitter Portable or Rack Mount

Model 8888 Transmitter

Mfg. list \$2,200.00

Model 8889 Receiver

Mfg. list \$1,750.00

CALL FOR BSW PRICE

Communications Link CL-100 System

Moseley

The CL-100 system gives the broadcaster an alternative to sub-carriers and telephone lines for conveying control and telemetry data between the studio and transmitter locations. CL-100 systems provide the broadcaster with independent control and telemetry circuits, while freeing the STL or program subcarrier channels for other uses. CL-100 system data transmission is extremely reliable, even over a path length of 50 miles (line of sight).

Features:

- Telemetry or voice transmission
- Superior adjacent channel rejection
- AC/DC operation
- 1 or 10 watt options
- Data and voice versions

The CL-100 comes in Data and Voice versions. The Data version has increased audio bandwidth and controlled group delay characteristics to allow 9600 baud data rates. In highly congested RF environments, the improved selectivity of the Voice version can be used, providing data rates up to 1200 baud.



Communication Link

Model CL100-10W (10 watt)

Mfg. list \$4,980.00 **CALL FOR BSW PRICE**

Model CL100-1W (1 watt)

Mfg. list \$3,980.00 **CALL FOR BSW PRICE**

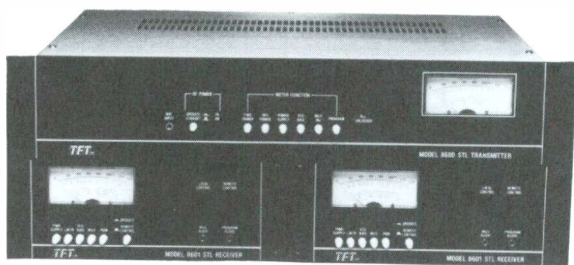

**Model 8600
Aural STL System (950 MHz)**

The Model 8600/8601 is an economical, high quality studio-to-transmitter (STL) system which is specifically designed for either single channel or dual monaural channel radio broadcast applications.

FCC rulings permit 100 kHz "drop-ins" in the 950 MHz STL band. The 8600 system meets the FCC criteria which permits broadcasters to use a monaural link between two composite links. It is an ideal narrowband system which is optimized for operation in congested STL environments. The system is designed to deliver superlative audio quality without signal degradation or adjacent channel interference.

Based upon TFT's 10+ year's experience with STL designs (like the sophisticated 8300 and 7700B series of composite STL's), the 8600 system incorporates the latest microwave components and LSI devices.

System shown above shows dual-link, redundant receivers.
Mfg. list \$3,325.00 **CALL FOR BSW PRICE**

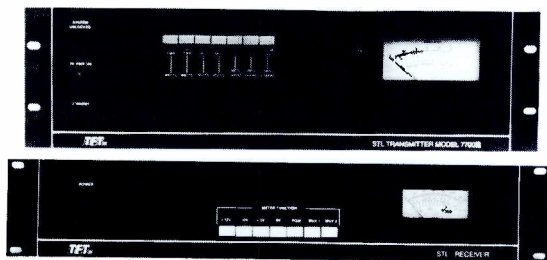

**7700B Series
Transmitter/Receiver**

TFT STL's are designed with broadcast applications in mind using state-of-the-art RF and digital technology. Some of the innovations in the 7700B Series STL include:

IF Modulated Transmitter

Improves signal to noise ratio and stereo performance by providing low distortion and high stereo performance.

Hot Standby

A fully redundant receiver and transmitter are available, both with automatic transfer and alarm, which provides maximum security across the system.

Modular Construction

Modular construction in the transmitter and receiver contribute to low maintenance cost and ease of servicing.

7700B Transmitter
Mfg. list \$3,975.00 **CALL FOR BSW PRICE**

7707 Receiver
Mfg. list \$3,250.00 **CALL FOR BSW PRICE**



**WIDE-BAND COMPOSITE
BROADCAST QUALITY AURAL
STUDIO-TRANSMITTER LINK
AND INTER-CITY RELAY SYSTEM**

**For Major Market's
RF Signal Environment
Model 8300**

The 8300 is specifically designed for the major market's RF signal environment where it becomes increasingly difficult to operate composite STL's with the large number of signals present in the 940-960 MHz band. By using the latest technology and components, such as S.A.W. filters, selectable RF front end gain, variable bandwidth IF amplifiers and cast aluminum RF shielded housings for critical circuits; TFT engineers were able to design one of the best STL systems available to the broadcast industry for aural program transmission.

Model 8300 Mfg. list \$4,675.00
Model 8301 Mfg. list \$4,555.00

CALL FOR BSW PRICE

**8300 Series
IF Repeater**

Today's urban STL and ICR frequency spectrum in the 950 MHz region is saturated to the point of frustration. Outside of major metropolitan areas, there are continuous needs to relay aural programming many miles from source to intermediate sites, and to the final over-the-air transmission site. With the arrival of TFT's advanced STL IF repeater, many problems are dissolved; many solutions are available, to overcome today's STL dilemmas.

Features:

- Unique IF repeating eliminates audio demodulation
- Frequency synthesized carriers
- True composite stereo performance
- 55 dB separation, nominal
- Audio frequency response of ± 0.1 dB, 50 Hz to 53 kHz
- Demodulated baseband available at any relay site

Mfg. list \$1,290.00 **CALL FOR BSW PRICE**



MARTI

STL SYSTEMS

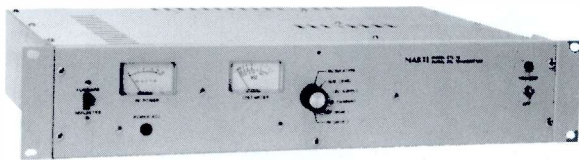

STL-10 TRANSMITTER

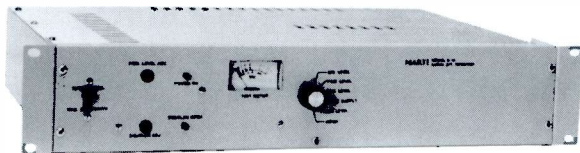

R-10 RECEIVER

The Marti Studio Transmitter Link/Intercity Relay is a line-of-sight FM communication system providing a high quality broadcast audio channel with two optional sub-channels. A dual link for stereo provides two identical broadcast quality channels with better than 60 dB stereo cross talk and four optional sub-channels. This system offers greater rejection of interference, superior noise performance, lower channel cross talk and greater redundancy.

Features:

- Excellent square wave response
- User selectable audio processing provides 0, 25, 50 or 75 microsecond de-emphasis options
- Low pass filters designed to eliminate overshoot on complex audio waveforms
- Helical resonator pre-selector and double balanced mixer
- Two IF bandwidths available to meet domestic and international requirements
- Computer designed bandpass filters for high selectivity with optimum phase and group delay
- Test meter on front panel indicates signal level, main channel audio level, sub-carrier level, supply voltage, L.O. level and mixer level. Additional test points inside receiver
- Sensitivity switch on front panel provides optional 10 dB RF attenuation for interference rejection
- Built-in automatic switching capability

STL-10 Mfg. list\$1,597.50
 R-10 Mfg. list\$1,597.50

CALL FOR BSW PRICE

RPU SYSTEMS

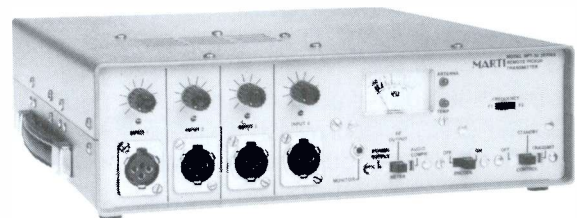

The Model RPT-30 is a light, compact, but powerful transmitter designed for remote pickup broadcast service. It will operate in continuous duty while providing broadcast quality audio when used with the Marti CR-10 or AR-10 receivers. Operating from internal regulated power supply or external 11 to 13.5 V. DC (negative ground) power, the RPT-30 delivers high performance in mobile, portable or fixed station applications. The RPT-30 is designed to operate with other Marti equipment to function in mobile repeaters, fixed automatic repeaters, base stations and transmitter to studio links (TSL). Four balanced inputs with mixing are provided. Input number four may be switched to balanced line level if desired. Other advanced features include a high performance FM compressor/limiter, subaudible encoder, dual frequency operation, illuminated meter, warning lights for antenna VSWR and temperature.

RPT-30 Single Mfg. list\$1,695.00
 RPT-30 Dual Mfg. list\$1,725.00

CALL FOR BSW PRICE

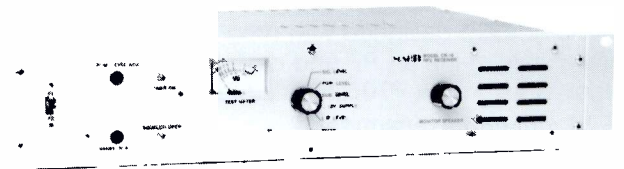

Model CR-10 is a rack mounted VHF or UHF base station receiver designed for broadcast remote pickup service. This receiver has dual frequency capability built in. Marti technology has provided the highest frequency response with the lowest noise and distortion possible for the assigned channel band width. Special attention has been given to solving today's high interference problems. The CR-10 features a built-in test meter, squelch relay, optional DC operation, built-in sub-audible tone decoder, special noise reduction circuit, 90 dB spurious rejection. Includes front panel monitor speaker.

	Single Freq.	Dual Freq.
CR-10	\$1,045.00	\$1,075.00



TWO LINE FREQUENCY EXTENDER SYSTEM

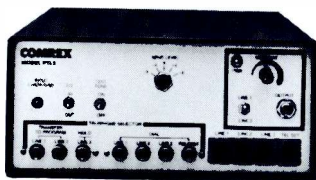

Model PTLX Encoder
Two Line Extender



Model RTLX Decoder
Two Line Extender

Comrex two line systems give you a full 50 to 5 kHz of program audio using two standard telephone lines. On one line, input audio is shifted upward by 250 Hz, so program audio as low as 50 Hz can pass through the 300 Hz telephone cutoff. On the second line, program is shifted down by 2,000 Hz to pass frequencies as high as 5,000 Hz. Since line noises can also detract from program quality, Comrex two line systems incorporate sophisticated multiband noise suppression that can handle even the high noise environment found on many long haul international circuits.

System consists of an encode unit Model PTLX and decode unit Model RTLX.
Mfg. list \$9,250.00 **CALL FOR BSW PRICE**



TH-1 Telephone Hybrid

Comrex TH-1 basic hybrid provides precision multi-frequency hybrid balance allowing you more effective separation between caller and studio. Features include manual operation or auto answer, remote relay for cart start, selectable ring count, de-clicking and A & A1 closure. All controls are remotable. Rack Adapter available.

Mfg. list \$1,750.00 **CALL FOR BSW PRICE**

**THE COMREX BASIC EXTENDER
Single-Line Frequency Extension For Smaller-Market Stations**



Frequency extension has numerous possible applications, from farm reports to religious broadcasts. The only major obstacle to its broader use has, quite frankly, been cost. That's why Comrex developed its basic frequency extender system.

It doesn't offer the extra features that some users find unnecessary. What they do offer is a distinct improvement in pro-

gram quality sent over telephone lines. And an affordable price. This system is ideal for smaller market stations, and is designed to offer optimum quality in short and medium haul use. Both encoder and decoder are completely compatible with other Comrex one line frequency extenders.

Mfg. list \$1,300.00 **CALL FOR BSW PRICE**

THE ENTIRE PACKAGE INCLUDES 1 LXR PLUS & 1 LXT PLUS



Model
TCB-1A
Broadcast Telephone Coupler

The Comrex Model TCB-1A broadcast coupler is designed for use by radio and television broadcasters as a means of sending and receiving program material via the switched telephone network. The unit is connected with modular plugs and requires no external power. The TCB-1A contains an FCC registered, protective voice coupler which provides longitudinal impedance balance, isolation from hazardous voltages and currents and includes an active circuit to hold the telephone line. 1/4 inch jack provides line level input.

Mfg. list \$135.00

CALL FOR BSW PRICE

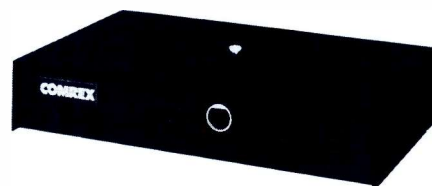

Model TCB-2A
Auto Answer Coupler For Telephones

It's easy to put your audio on the phone with the new TCB-2A auto-answer coupler from Comrex. Built specifically for broadcast use, the TCB-2A is perfect for listen line applications. Just plug in the standard connectors, attach the power supply and you're ready to go. Coupler answers on the first ring and disconnects when calling party hangs up.

Mfg. list \$275.00

CALL FOR BSW PRICE



Symetrix

Broadcast Telephone Systems



Shown w/optional call director

(Telephones pictured not included.)

Broadcast Telephone Systems

Models 108A and 104A

No matter what you do. Radio talk shows, TV, commercial or non-commercial broadcast, legal or corporate teleconferencing, even video classrooms. Any job that calls for listener involvement means telephones.

And as most broadcast engineers will tell you, telephones and audio consoles don't usually mix. At least they didn't until now. Symetrix has developed two products designed especially for today's broadcast and teleconferencing market. The Model 104A multi-line interface and Model 108A broadcast telephone systems can connect your audio console directly to incoming phone lines without going through an outdated and expensive KSU.

These are not add-ons or adaptations of existing telephone equipment. Instead, the 104A and 108A are fully stand alone systems. Each has been designed to bridge the gap between bi-directional telephone lines and uni-directional audio mixing consoles.

The Symetrix 108 interface is the perfect choice for medium to large broadcast stations. This unique telephone system uses a microprocessor to handle up to eight incom-

ing telephone lines at once.

The system is simple enough to be controlled by the on-air personality from one console. Or, with an optional second desk controller, as second person can act as "call director." The call director uses a standard (user provided) desk telephone to answer incoming calls and "pass" them to the host.

The desk consoles allow lines to be seized, routed and released. Control functions for each incoming line include seize, release, transfer to hold, transfer to cue and transfer to air. The Model 108 desk console also contains a caller monitor gain control, caller override control, a caller monitor headphone output jack and an audible ringer (which may be disabled). The Model 108 permits up to six callers on air at one time. The callers hear each other and they hear the host. The callers may be switched to an alternate CUE buss for off-air communications. When callers are on hold, they may be "backfed" program audio or music on hold. The host may transfer an entire group of callers from air to hold or to cue with a single keystroke and bring them back to air again — with a single keystroke. A beep alerts the caller before he goes on-air. A caller may be transferred back to the call director or dropped from the line

instantly.

Not all applications require the capacity of the Model 108.

The Symetrix 104 interface is ideal for the smaller format broadcast stations, corporate user or educational institution. This unique microprocessor-based unit handles up to four incoming telephone lines at once. Calls can be screened with an additional 104 console.

The 104 may be used in conjunction with a standard (user provided) touch-tone phone or in a "hands-free" mode. All lines may be seized, routed and released by buttons on the desk console. The control functions include seize, release, transfer to hold, transfer to cue and transfer to air.

Up to four callers may be conferenced "on-air" at one time. An output jack and gain control on the desk module provide caller monitoring via headphones. The desk module also contains an audible ringer which may be muted by a switch on the module. An additional switch on the desk module enables the "auto answer" mode in which incoming calls may be seized, routed to air and released with single keystrokes for rapid polling of callers.

Model 108A - 8 Lines Full Duplex (1/2 Duplex available)
Mfg. list \$3,450.00 **CALL FOR BSW PRICE**

Model 104A - 4 Lines Full Duplex (1/2 Duplex available)
Mfg. list \$1,695.00 **CALL FOR BSW PRICE**

TELEPHONE INTERFACE

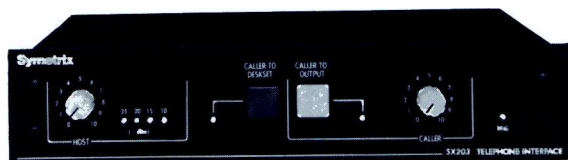

SX203

The Model SX203 Telephone Interface is a single line coupling device that provides high quality audio transfer between telephone lines and professional audio equipment. Very fast hook up and ease of operation make the SX203 ideal for radio and television talk shows and news gathering, recording studios, teleconferencing, and rental systems. Only 1/2 rack space.

Mfg. list \$389.00 **CALL FOR BSW PRICE**



Model TI-101 Telephone Interface

The Symetrix TI-101 telephone interface is the most practical, yet economical device on the market today designed specifically for the connection of professional audio equipment to telephone lines in broadcast and production operations. The TI-101 employs a carefully engineered electronic hybrid circuit which creates a maximum trans-hybrid loss, yielding effective isolation between your studio's send to the telephone line, and your caller return signal. Your net result is clear, intelligible telephone audio which helps you keep pace with today's rapid improvements in AM, FM and TV audio.

Mfg. list \$495.00 **CALL FOR BSW PRICE**

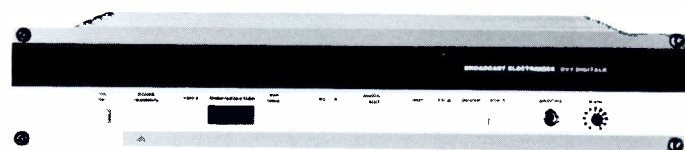

DV-2 Digitalk

The DV-2 "Digitalk" from Broadcast Electronics is the first unit of its kind to offer digital voice recording and reproduction capability in a broadcast quality design.

The reliability of the DV-2 is nothing short of phenomenal. Unlike cart machines, there are no moving parts in the DV-2. All recordings are stored digitally in random access memory. The large memory capacity of the DV-2 allows up to six minutes and twenty-nine seconds of total recording time. One long message or several short messages can be stored and accessed at will.

Advanced Technology: The DV-2 utilizes 256K dynamic RAM chips as the foundation of its versatile digital memory. The latest data compaction techniques are used to make the most efficient use of the available storage. In addition, the playback audio is processed through the innovative Dynafex™ noise reduction system to enhance the broadcast quality of the output signal.

Features

- Completely solid state - no moving parts
- Over six minutes of available recording time
- Extended 20 to 6500 Hz frequency response
- Multiple message recording capability
- Informative Time/Selection display
- Random Message Access capability

Mfg. list \$3,195.00 **CALL FOR BSW PRICE**



Model PS11 AWPW Telephone Strobe Signal

Compact telestrobe signals emit high intensity flashing light when the telephone rings. Ideal for broadcast studios.

Mfg. list \$75.00 **CALL FOR BSW PRICE**

Panasonic

Model KX-T1625 Telephone Answering Machine Beeperless Remote Dual Microcassette

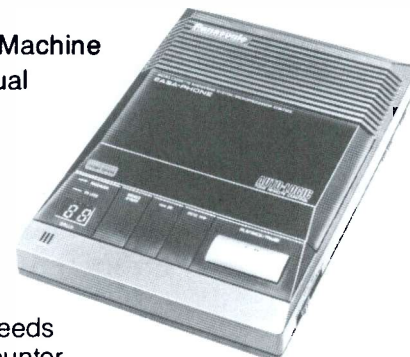

- Quick erase
- Toll saver
- Ring control
- Message memo
- Two way record
- Auto disconnect
- Two variable tape speeds
- Two digit LED call counter
- 12 function beeperless remote (playback, reset, back space, skip, marker message, OGM, re-record, memory playback, remote call counter, room monitor, remote on remote off, OGM skip)
- Variable outgoing message up to 5 minutes
- Variable incoming message up to 60 minutes
- Flashing LED call counter (up to 15)
- FCC registered
- One year limited warranty.

Mfg. list \$149.95 **CALL FOR BSW PRICE**

Model KX-T1020 Speaker Phone

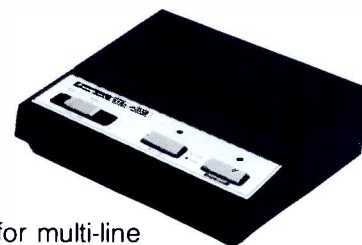

- Compact design for desk or wall mount
- Easy self installation with single line modular plug (included)
- Optional KX-T86 adapter for multi-line
- LED power indicator
- Mute (hold) button and LED indicator
- Electric condenser microphone
- FCC registered
- Optional AC adapter (KX-A01)
- 1 year limited warranty.
- Powered by telephone line cord or AC adapter (optional)

Mfg. list \$64.95 **CALL FOR BSW PRICE**

WHEELOCK Auxiliary Signals For Telephone Systems



Model PR-11A-W Telephone Relays

Wheelock offers a wide variety of relays for most common telephone ringing applications. Designed for insertion in standard AC receptacles, it can actuate any 115 VAC device up to five amps rated current during on-time of the telephone ring cycle.

Mfg. list \$75.00 **CALL FOR BSW PRICE**



THE VOICE

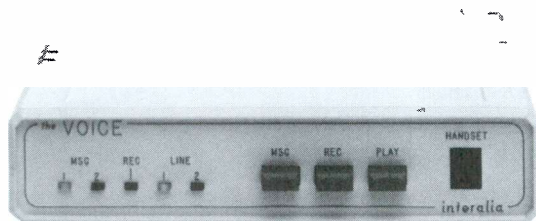

DIGITAL VOICE ANNOUNCER Sports Line Weather Line Concert Line

System 23

- Works with any telephone system
- Replaces cart machines or other tape devices
- Frequency response same as phone line (3 dB band width: 130 Hz to 3.5 kHz)
- Two line
- Two message capability
- 100% solid state - no moving parts (maintenance free)
- Update messages instantaneously (from any telephone)
- Non barge-in, all lines receive message from beginning

The Interalia digital voice announcers are far less expensive than cart machines for telephone services. Extremely high quality and features galore. Use for all telephone answering purposes. With remote control option, you can record messages from anywhere! Perfect for updating messages from home or the field. Call BSW toll free at 1-800-426-8434 for all the exciting details. Prices start as low as \$995.00

CALL FOR BSW PRICES



TELEPROCESSOR Telephone Audio Processor

Gentner's teleprocessor improves the sound of any telephone system. Use in conjunction with telephone hybrids, frequency extenders or other interface equipment to enhance your telephone audio.

- **Compliments any telephone system.** Use with existing hybrid equipment or add to new equipment to further improve phone audio.
- **Use with frequency extenders** to achieve best possible phone line audio.
- **Maintains average send level to caller.** This allows you to reduce the send level of your hybrid equipment, thus improving the hybrid null.
- **Low and high band EQ adjustments.** Maximize sound of each phone line; reduce line hiss and hum.
- **Aphex® processing** re-creates higher frequencies, giving you improved high-end sound.

Aphex® is a registered trademark of Aphex Systems, Ltd.
Mfg. list \$499.00 **CALL FOR BSW PRICE**

Henry Engineering

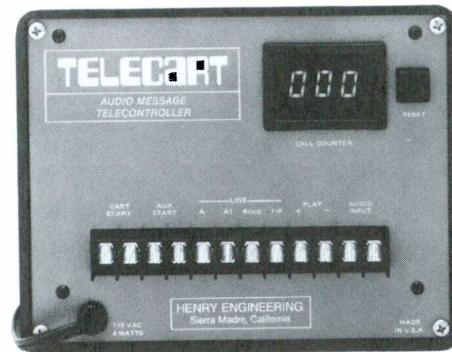

TELECART Audio Message Control

An automatic answering unit that permits a standard NAB type cartridge machine to answer a telephone line and play a recorded message to the caller.

- Digital call counter (records 999 calls)
- Failsafe - permits unattended automatic operation
- Built-in power supply
- Works with virtually any cart machine
- Cart cues for all incoming calls

Mfg. list \$195.00 **CALL FOR BSW PRICE**

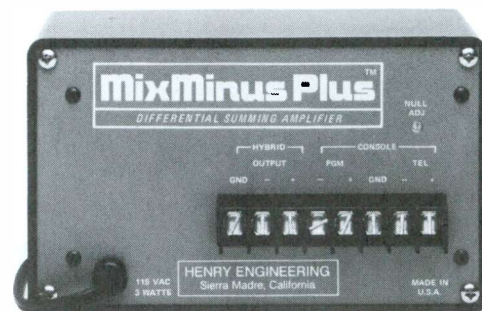

MIX MINUS PLUS Differential Summing Amplifier

MixMinus Plus is a differential summing amplifier designed to add a "Mix-Minus" output to a broadcast audio console. This output is typically used to feed the send input of a telephone hybrid device. MixMinus Plus has two inputs and one output. One input is fed with the program output of the console. The second input is fed with the hybrid receive audio, tapped just after the phone channel fader on the console. MixMinus Plus subtracts the hybrid receive signal from the program output, thus creating a program mix minus the receive audio. The null adjustment will provide 40 dB rejection of the receive audio signal (30 Hz-3 kHz). MixMinus Plus is easily connected to most consoles and needs no adjustment once installed.

Mfg., list \$195.00 **CALL FOR BSW PRICE**



SHURE®

**Shure Model 50AC
telephone Acoustic Coupler**

- Ideal for voice transmission from remote locations where "hard wiring" to telephone lines is impractical or impossible
- Convenient hands-free operation with most cassette tape recorders
- Ruggedly constructed of rubber and high-impact plastic

BSW PRICE\$45.50



from **SOUND AMERICA CORPORATION**

**Better, Faster
Telephone Communications**

- For field or studio phone
- Transmit any electronic source over phone
- Uses no batteries
- Installs in seconds
- Select mic or external or mix both
- Frequency compensated amplifier gives wider response
- May be left permanently on phone
- Maintain instantaneous 2-way contact while feeding

Western Electric

BSW PRICE\$84.90

GTE

BSW PRICE\$90.90

Carrying Case

BSW PRICE\$6.95



**Model RSVP
Record or Send
Verywell Phone**

From Sound America Corporation

- An audio coupler built in the standard U.S. made 2500 series Touch-Tone® phone
- No extra "black boxes"
- Panel on phone base has send jack (8 ohms) for direct connection to cassette recorder or other electronic source and record jack (low imp.) provides clear, balanced signal to record conversation.
- Amplified electret condenser microphone for superior voice quality. Dual mic sensitivity: normal (close talk) and high (for use at 4" to 12"). Mute mic for background noise elimination while sending electronic material.
- Mix voice with tape
- Two year warranty

Model RSVP.....BSW PRICE \$127.50

Model SVP (Without record feature)

BSW PRICE\$109.50

**GENTNER
ENGINEERING COMPANY, INC.**

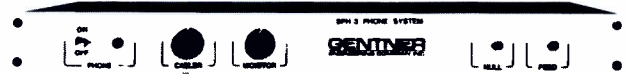

**Model SPH-3A
Telephone Interface**

The SPH-3A telephone system provides an easy, inexpensive method of interfacing your equipment with a telephone system. The SPH-3A permits simultaneous send and receive audio (full duplex operation); in addition, a built-in monitor amplifier eliminates the need for guests or talent to wear headsets. The SPH-3A is simple to install and is fully remotable.

Mfg. list \$599.00 **CALL FOR BSW PRICE**



**Model SPH-4
Telephone Interface**

The Gentner SPH-4 telephone system incorporates a variety of features to give you clean, clear telephone audio for a variety of uses. The unique "caller control" reduces the caller's level when talent is speaking (continuously adjustable); switching transients are suppressed on connection to provide a clean on-air sound. Computer designed equalization assures best hybrid performance.

Mfg. list \$799.00 **CALL FOR BSW PRICE**

Digital Hybrid™

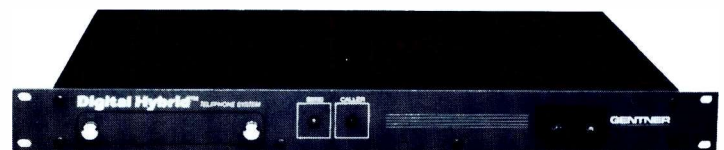

Gentner's Digital Hybrid™ is a digitally processed telephone hybrid that provides a direct interface between a single telephone line and your equipment. It provides the best possible audio quality from the telephone line. The Digital Hybrid™ can be used for all types of telephone interfacing including broadcast talk shows, on-air interviews, teleconferencing, etc. Multiple units may be stacked to provide a teleconference bridge.

Features:

- Superior hybrid performance
- Automatic nulling
- Totally remotable
- Send and receive audio processing
- Telephone system compatibility

Mfg. list \$2,199.00 **CALL FOR BSW PRICE**



GENTNER RF PRODUCTS DIVISION



EFT-1000A With Frequency Extension

Have you ever wished you could send one person out to do a remote and not have to worry if all the right "switches" were in the right position at the studio? Now you can trust the EFT-1000A to get the job done for you. Because the EFT-1000A has an automatic answer and automatic encode-decode, just go to the remote, phone the station, and you're ready to go. The EFT-1000A is capable of using two different telephone lines. You can transmit on one line and use the other for continuous cues from the station. Two needed for complete system.

Mfg. list \$1,295.00

CALL FOR BSW PRICE



EFT-3000A System

A revolutionary advance in technology now allows you to get 7.5 kHz on three standard dial-up telephone lines. Now you can do the whole show, even the music, from the remote. Gentner's exclusive design uses digital signal processing to give you the frequency response you want from your remotes. Set-up is quick and painless because it's automatic. Because you get automatic answer, equalization, phase correction, and group delay realignment, one person can set the remote. The remote location even hears cues from the station. The EFT-3000 is the answer for simple high quality audio remotes over standard dial-up telephone lines.

Mfg. list \$7,999.00

CALL FOR BSW PRICE



Hybrid Coupler

The Hybrid Coupler is a low cost telephone coupler that provides both "Send" and "Caller" capabilities. This unit turns the two wire telephone circuit into a four wire system. It's a perfect match for the EFT-100 or any time you need a connection to a telephone line.

Mfg. list \$129.00

CALL FOR BSW PRICE



EFT-100

Here is your answer for low cost, good quality remotes. The new Gentner EFT-100, for use with your existing hybrid, is a two-frequency extender. This means you get the benefit of hearing the cues back from the station with just one telephone line. If you already have a hybrid, all you need is the EFT-100.

Mfg. list \$495.00

CALL FOR BSW PRICE



Auto Coupler

If you're looking for an automatic answering and disconnect hybrid coupler, our Auto Coupler is just what you need. It gives you both "Send" and "Caller" capabilities. Use this with the EFT-100 or any time you need an automatic answer and disconnect to a telephone line.

Mfg. list \$299.00

CALL FOR BSW PRICE

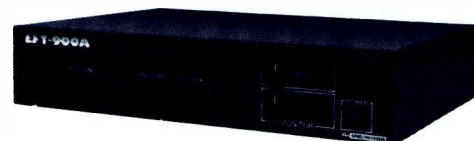

EFT-900A

There's no simpler way to get great audio from your remote over a dial-up telephone line than using our EFT-900A. It's digital circuitry ensures improved audio response. In fact, all you need for the remote site is an EFT-900A. The telephone coupler, microphone or line level input, and headset amplifier are all built right in. No more hassles doing a remote when you rely on our EFT-900A.

Mfg. list \$795.00

CALL FOR BSW PRICE



**Model TC-100
Automatic Telephone Interface**

The TC-100 is the most versatile telephone coupler you'll find. The design not only gives you auto-answer/auto-disconnect and latching or momentary tape starts; it allows you to use the unit as a hybrid for on-air calls...as a remote controller (with the Touch-Tone® board option)...as a private party line telephone intercom and more. The TC-100 is easy to install and operate, and is fully remountable.

- Table, undertable, wall and rack mount configurations
- Direct connection to the phone line (uses USOC RJ11C)
- A-lead control for 1A2 and digital phone systems
- Send and receive level controls are front panel adjustable
- Bi-color LED flashes red on rings and glows green on answer
- Optional Touch-Tone® decoder board with dial tone detector and call progress decoder
- Manual or automatic operation
- Momentary or latching tape starts

Mfg. list \$429.00 **CALL FOR BSW PRICE**



Microtel-1

- Portable mixing
- Studio talkback
- In the field news mixing/telephone feeding
- Sports console/back-up sports console
- Mic to line driver for equalized program loops

Gentner Engineering's Microtel is a portable, battery operated telephone interface that may be used for a wide variety of applications. In its typical application, Microtel replaces the handset of the telephone to permit high quality audio feeding down the phone line while simultaneously monitoring the return audio. Microtel is powered by a single 9V battery.

Mfg. list \$219.00 **CALL FOR BSW PRICE**

Telephone Line Mixer



**Radix TLM-500
Telephone Line Mixer**

The TLM-500 is a highly portable, battery powered mini-console that can turn any modular telephone into a remote broadcast studio link or telephone interview control center. To use with a telephone, simply plug the telephone handset cord into the TLM (telephone line mixer) along with a studio quality microphone and headphones. The telephone is dialed normally and incoming calls can be answered, the difference is the convenience of the microphone/headphones for broadcast operations and the quality of and control over the audio signals.

Features include:

- Mic and line inputs
- Low battery indicator
- Headphone amplifier
- Peak reading LED
- AC adapter available

BSW PRICE \$179.95

For Sterling Performance, Insist on Radix

Miwltronsics, Inc.



Model API/C

Extremely versatile and inexpensive, the Miwltronsics Model API telephone interface does everything but the dishes. In a nutshell, it interfaces your cart machines to the telephone. It will: auto answer, disconnect and allow multi-lines to get the start of message at the same time. We simply do not have the room to tell you all the features, so call us toll free for more details....1-800-426-8434.

Model API

Mfg. list \$265.00 **CALL FOR BSW PRICE**

Model API/C (with call counter)

Mfg. list \$315.00 **CALL FOR BSW PRICE**

AUDIOLAB



Model AT1200 Studio Timer

Event timer provides automatic 3-way operation. Timing starts and stops from any audio source, panel pushbuttons, remote contacts or pulse.

- Interface with any audio source
- Automatic switching from auto to manual operation
- Interface one or more sources for start-stop reset operation
- Minutes/seconds mode displays up to 10 minutes
- Hours/minutes shows elapsed time to 24 hours
- Dimensions 4 1/8" x 3" x 2"
- Rackmountable (4 timers)

Mfg. list \$197.50 **CALL FOR BSW PRICE**



Model ES510ER 60 Minute Timer

- Start/stop reset
- Four digits
- Count up
- Remote capable

Mfg. list \$193.00 **CALL FOR BSW PRICE**



**Model ES562E Studio Timer
Six Digit Clock/Timer with Memory**

Mfg. list \$362.00 **CALL FOR BSW PRICE**

RADIX

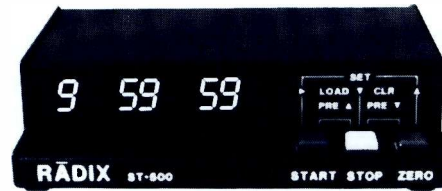

*Counts Up And Down
Sterling Performance*

**Studio Timer
Model ST-500**

Compact studio timer with many applications in the control room, production or news room. Time events to 9 hours 59 minutes 59 seconds. Large—Highly visible red display digits 1/2" high. Rear terminal strip interface connections. Versatile interface allows remote start, stop and reset. Powerful microprocessor allows preset times from memory to count up or down. Outstanding value. That's Sterling Performance.

BSW PRICE \$225.00

**SEIKO
SOUND PRODUCER**

**PERFECT FOR
PRODUCTION AND
NEWS ROOM USE**



4 SEPARATE FUNCTIONS

1. Time Calculator: Allows you to add and subtract time segments in hours, minutes, seconds, without conversion.
2. Timer: Counts down from any pre-set time.
 - A. Keeps track of number of time segments
 - B. Can revert to the prior segment of time, eliminate current segments and recommence counter.
3. Stop Watch: Counts lapped time.
4. Time: Keep regular time of day.

BSW PRICE \$59.00

BSW

**OPEN 12 HOURS DAILY
IN YOUR TIME ZONE**

Pacific	Central
6:00 am to 6:00 pm	8:00 am to 8:00 pm
Mountain	Eastern
7:00 am to 7:00 pm	9:00 am to 9:00 pm

**Toll Free 1-800-426-8434
Fax 206-565-8114 TWX 910-441-2617**



Seth Thomas

CLOCKS GALORE

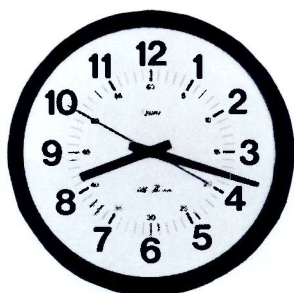

Model 710

- Brown molded case, textured finish
- Red sweep second hand (full length)
- Quartz (one "C" battery)
- Glass lens
- Diameter 14"
- Large, easy to read dial graphics

Mfg. list \$35.00 **BSW PRICE \$26.95**



Model 2636

Quartz accuracy and extra bold dial graphics. Popular 14" case size. Light beige case. Shatter resistant crystal. Red sweep second hand. Uses one AA battery.

Mfg. list \$35.00 **BSW PRICE \$27.95**

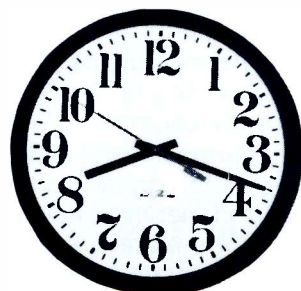

Model 709

- Brown molded case
- White dial
- Arabic numerals
- Sparkling glass lens
- Electric
- Diameter 13³/₈" (not shown)

Mfg. list \$25.00 **BSW PRICE \$18.95**

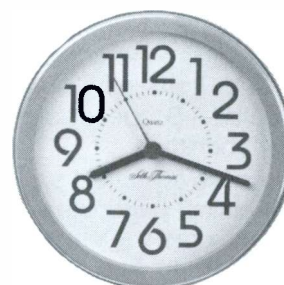

Model 2626

8¹/₂" diameter. Flat, shatter resistant crystal. Bold Arabic numerals. Red second hand. Color: career toast. Quartz movement. Uses one AA battery.

Mfg. list \$18.00 **BSW PRICE \$14.95**

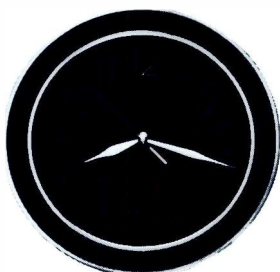

Model 2812

An elegant addition to any studio or office. Gold tone case with contemporary matte black insert. Glass crystal protects gold color Arabic numerals. Quartz movement. Uses one AA battery. Diameter 10".

Mfg. list \$27.00 **BSW PRICE \$21.95**

BSW

**OPEN 12 HOURS DAILY
IN YOUR TIME ZONE**

Pacific	Central
6:00 am to 6:00 pm	8:00 am to 8:00 pm
Mountain	Eastern
7:00 am to 7:00 pm	9:00 am to 9:00 pm

Toll Free 1-800-426-8434
Fax 206-565-8114 TWX 910-441-2617



Potomac Instruments



Model AT-51 Audio Test System Measures

Harmonic distortion, intermodulation distortion, volts, dB, signal + noise/noise ratio, wow and flutter, stereo phasing, differential gain in stereo channels.

Features

Separate generator and analyzer — Transformerless stereo outputs (Balanced or unbalanced; switch selectable) — Source resistance 150 ohms or 600 ohms (switch selectable) — Automatic signal leveling — Precision 10 dB, 1.0 dB and 0.1 dB step attenuators — RFI shielding — Automatic "set level" and "balance" circuits — Scope display of distortion products — Output level monitor.

The AT-51 is an innovative audio test system which facilitates the measurement of critical parameters in monophonic and stereophonic audio equipment. Designed primarily for commercial broadcast proof-of-performance measurements and equipment maintenance, the AT-51 exhibits features which are unique and well suited to laboratory type measurements by design engineers, quality control facilities and professional high fidelity service centers. The AG-51 Audio Generator and AA-51 Audio Analyzer are packaged separately for remote measurements requiring physical separation of signal source and signal analyzer. Both units are RFI shielded to enable accurate measurements in high level radio frequency environments typical to broadcast transmitter facilities. Signal input and output connectors are also RFI shielded.

Mfg. list \$3,975.00 **CALL FOR BSW PRICE**

BSW

BSW has an experienced Sales Staff waiting to answer your audio equipment questions and to meet all of your broadcast needs.

**Call us at
1-800-426-8434**



Just imagine, proof of performance tests anytime you want them. Even when you're on the air.



RTA-1

The dbx RTA-1 lets you perform precise and comprehensive source analysis of signals and noise as well as rooms, equipment, and transmission media—using the music itself as the test signal. You can make measurements during system setup, sound checks, tape recording or broadcasting, all while program material is actually playing.

Analyze response of transmitter and transmission media with continuous updating using normal program. See the effects of signal processing, land lines/microwave/satellite/STL's, noise reduction. Pinpoint problem areas and components during equipment troubleshooting; real time means less down time. Monitors competitor's peak level.

Of course, the RTA-1 has other features too (would you expect any less from the makers of the world's leading signal-processing systems). You can store up to 16 curves in its memory, and recall them for comparisons, inversions, or any other manipulations. You can hold peaks, isolate any one of its 1/3-octave bands, and average performance signals over any period of time. You can even measure the old-fashioned way, using RTA-1's stereo pink-noise generators.

We should also point out the RTA-1's compatibility with equalizers, PC's, color monitors and printers; its flexible micro-computer architecture (complete with user-friendly menus and Help functions); its two microphone inputs, six line inputs, built-in preamps and phantom power supplies.

Mfg. list \$4,500.00 **CALL FOR BSW PRICE**

For a complete analysis of the dbx RTA-1 real time analyzer

**CALL YOUR BSW REPRESENTATIVE TOLL FREE
1-800-426-8434**



Fostex



Model TT-15 Test Tone Oscillator

Battery operated, low distortion sine wave oscillator with five selectable frequencies (40 Hz, 400 Hz, 1 kHz, 10 kHz, and 15 kHz) and three selectable output levels (-30 dB, -10 dB and 0dB). RCA output jack. Useful for spot checking frequency response, calibrating mixers with tape recorders and other level matching jobs. Output is constant and not affected by battery voltage or frequency.

Mfg. list \$48.00 **BSW PRICE \$43.95**

LOFTECH

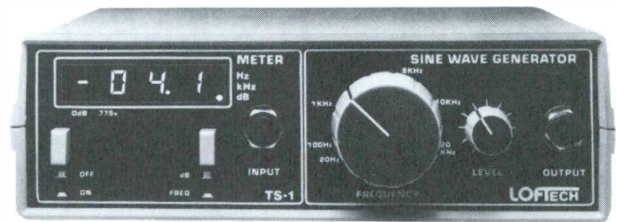

User Friendly Test Equipment

The Loftech TS-1 provides a combination of three precision test instruments that is capable of making audio frequency tests and measurements with a high degree of certainty, accuracy, efficiency, and in less time than conventional test instruments.

The TS-1 is a:

- Low distortion oscillator
- dB meter
- Frequency counter

Mfg. list \$299.95 **CALL FOR BSW PRICE**

GOLD LINE

LL-10 Audio Spectrum Analyzer

The Model LL-10 is a 10-band line level Audio Spectrum Analyzer designed to save time for the audio service technician. A 23 dB LED display allows line level readings from tape machines or turntables to be simultaneously displayed over the entire audio range. By making use of a pink noise cassette, or the built-in noise generator, it is easy to record and see immediately the performance of the heads or if either bias or dolby noise tracking calibration is required.

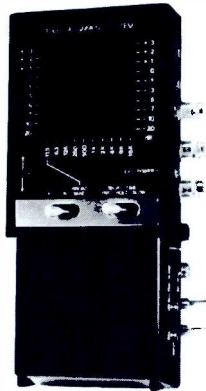

Mfg. list \$339.95 **CALL FOR BSW PRICE**

ASA-10B Audio Spectrum Analyzer

An affordable, professional quality, 10-octave analyzer covering the full range that allows you to balance your audio system; EQ and check out your phono amplifier, tape deck and loud speakers and make sure that your system delivers its optimum performance.

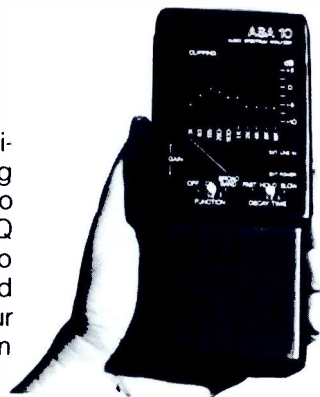

ASA-10B

Mfg. list \$339.95 **CALL FOR BSW PRICE**

PN2 Pink Noise Generator

Mfg. list \$89.95 **CALL FOR BSW PRICE**

BIRD



Now in its fifth decade of serving the broadcast industry, Bird Electronic Corporation has been the pioneer in developing products for measurement, filtering and termination of RF power. The Company's products originally developed in response to specific design requirements of broadcast equipment manufacturers, have since become standards of the industry.

Recognizing that broadcast test equipment must be even more reliable than the transmitter, must be constantly on-call and totally trustworthy, Bird has achieved an enviable record of reliability.

Call today for your Bird equipment needs. 1-800-426-8434 toll free.

BSW

TIME IS MONEY

**SAVE A BUNDLE WITH
BSW'S FAST SERVICE,
CALL US AT
1-800-426-8434**



FLUKE

THE WORLD'S FINEST DIGITAL MULTIMETER



Fluke 75

- Analog bar graph
- 3200 count display
- 0.5% basic accuracy
- Auto-ranging with range hold
- 10 amp & autoranged mA ranges
- Continuity and diode test beeper
- Three year warranty

BSW PRICE
\$117.80

Fluke 73

- Analog bar graph
- 3200 count display
- 0.7% basic accuracy
- 10 amp
- Auto-ranging only
- Three year warranty

BSW PRICE
\$78.00

Fluke 77

- Analog bar graph
- 3200 count display
- 0.3% accuracy
- Auto-ranging with range hold
- 10 amp and autoranged mA ranges
- Continuity and diode test beeper
- Touch hold
- Three year warranty

BSW PRICE
\$147.50

HANDY LOW COST MULTITESTER

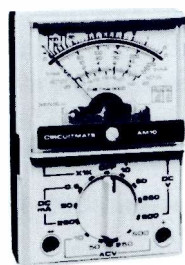

Model AM10

The pocket sized AM10 is built to perform the most frequent quick circuit checks or to be kept in the tool kit as a spare. The jeweled analog meter movement provides an accuracy of 4% of full scale and the unit has 16 measuring ranges in four functions plus decibels on the AC volt scale. With 2000 ohms/volt sensitivity, two times scale overload protection and zero adjust for ohms and meter movement. Buy an extra for your glove compartment.

ONLY \$9.95 2 FOR \$18.50



Model DM78 Pocket Size W/Carrying Case

Ideal for carrying in your shirt pocket, the pocket-sized DM78 is the smallest digital multimeter on the market yet it has an easy-to-read 3/8 inch high LCD readout. The autorange feature automatically sets the optimum measuring range to simplify operation and to avoid overloads. Its five functions check up to 450 volts, AC or DC in four ranges, up to 2000 K ohms in four ranges, plus diodes and circuit continuity with a beeper. Best value around.

ONLY \$29.95

ROHN

TOWERS AND SHELTERS

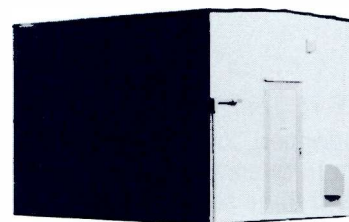

Design

This tower can provide excellent rigidity and strength in heights up to 450 feet when properly guyed. Because of its rugged strength, the No. 65 tower covers a broad range of communication uses particularly where extraordinary windloading and height requirements must be met.

Construction

Constructed on a 26 1/4" equilateral triangle pattern, utilizing 2" x 1/8" high-strength steel tube side rails. Sections 10' or 20' in length. Cross bracing is formed by a continuous 5/8" solid rod fashioned into a "zig-zag" shape, joining side rails every 22" electrically welded throughout.

Finish

All tower sections are completely hot-dip galvanized after fabrication to protect all points of welding and construction against corrosion, and to provide an attractive installation. The quality of Rohn towers is always assured by a complete quality control program that begins with the examination of the raw material to assure that exact specifications are met and follows on through the finished product. You know it's the best when it's a Rohn tower.

Transmission Shelter

Construction of the basic shelter is done to Rohn's high quality standards. A complete environmental control system is available in each Rohn shelter. Security will be no problem with the optional reinforced insulated aluminum doors with three-point locking systems. In short, your shelter will be a complete protection system.

This is just one example of the towers and shelters available from Rohn. Call BSW toll free 1-800-426-8434 for application and pricing.

CALL FOR BSW PRICE

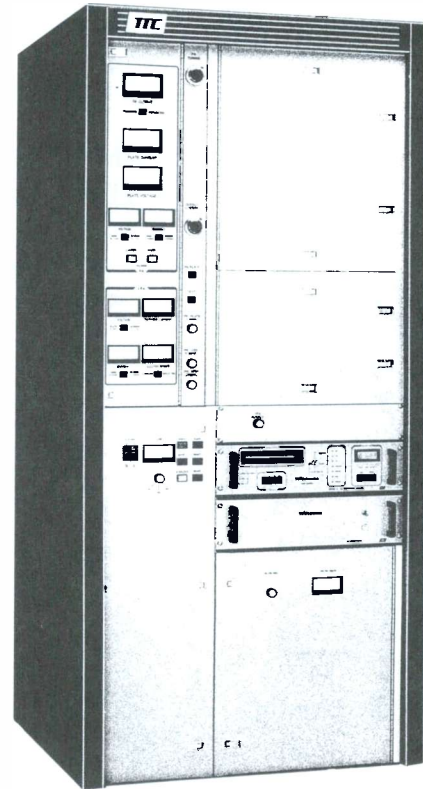

**8090 Series Model X
FM Broadcast Exciter**

- 5 subcarrier inputs standard
- Completely broadband - no tuning adjustments
- Frequency synthesized in 2.5 kHz steps from 76-108 kHz
- Ultra high performance
- 28 volt DC power

Typical THD and IMD less than .005%
 Typical FM signal to noise ratio better than -95 dB
 Typical frequency response within .025 dB, 20 Hz to 100 kHz

The Model X exciter by Television Technology is superior to all others in every way. Your test equipment will prove it, more importantly your ears will actually notice the difference.

Mfg. list \$5,395.00 **CALL FOR BSW PRICE**

**Television Technology
FM Translators**



XL (FM Series)

- 1 and 10 watt models
- Very conservatively rated
- Stable output under any load condition
- Withstands extreme input overload
- Choice of selectivity
- Stereo monitor
- Optional local origination
- Superlative performance
- Competitively priced

Call BSW for Pricing and Configuration

When you buy a new TTC/Wilkinson transmitter, not only do you get a great product, you also get a factory engineer to provide training and turn-on service at your facility and at No Extra Charge. In addition, factory warranty can be extended 1 year simply by adding a Wilkinson surge protector at the time of installation. Call BSW for details on all TTC/Wilkinson AM and FM transmitters.

AM TRANSMITTERS

Models - 250 Watts To 50,000 Watts

- Variable vacuum capacitor tuning eliminates sliding contacts.
- Motorized variable capacitor loading for ease and precision of adjustment.
- Solid state time delay and recycling increases reliability.
- Solid state control circuitry conserves space and reduces complexity.
- Complete metering.

CALL FOR BSW PRICING & APPLICATION

FM TRANSMITTERS

Models - 30 Watts To 50,000 Watts

- Input and output reflectometers
- Self-testing Wilkinson silicon rectifiers provide more than 300% voltage and current protection.
- Printed circuit control ladder conserves space, reduces complexity.
- Solid state time delay and recycling increases reliability
- Conservatively rated, double duty plate transformer and filter reactor
- VSWR overload protection standard

CALL FOR BSW PRICING & APPLICATION

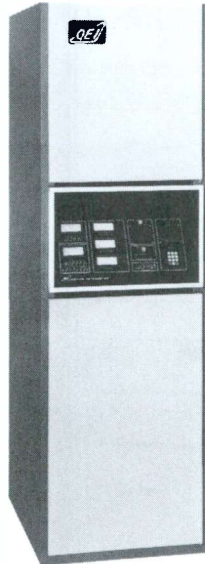

**FM BROADCAST
TRANSMITTERS
10 WATTS
TO
55,000 WATTS**

Model FMQ5000 (Shown)

FMQ Series Transmitters

The FMQ series advanced-technology transmitter offers a myriad of features made possible only by introducing recent technological advances to FM transmitter design. The FMQ series design blends microprocessor technology with QEI's expertise in solid-state transmitters, control systems, and FM modulation monitors. Features here-to-fore not available in FM transmitters are built into the FMQ series. Alarm points on important parameters will warn you before a catastrophic failure occurs. Automatic Power and Modulation control are available at the flick of a switch; ideal for stations with satellite feed or those that are heavily automated. Auto logging standard, optional dial-up password protected remote control available. All solid-state at 1 kW and grounded grid final amplifiers at high power levels.

Call for Prices and Configurations

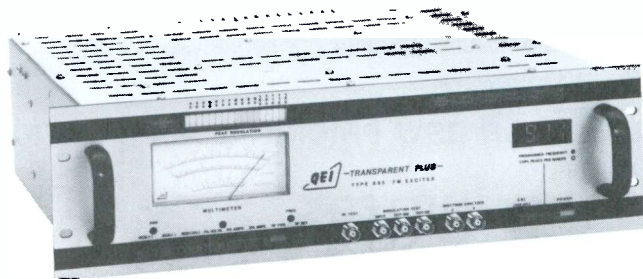

**The 695 Exciter
Transparent Plus**

- Super low distortion (typically less than .025%)
- Convection cooled — no fans
- AUTOMOD automatic modulation control
- Displays modulation peaks over 100% built-in modulation monitor and peak control
- Synthesized phase locked loop

Mfg. list \$5,295.00 **CALL FOR BSW PRICE**

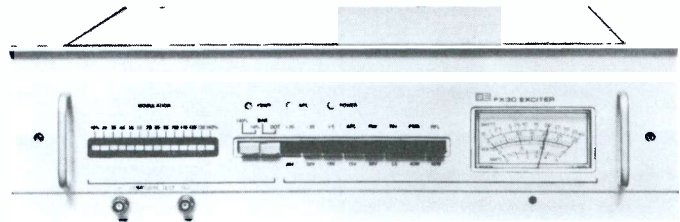

Model FX-30 FM Broadcast Exciter

- Superior performance rivals the best Hi-Fidelity tuners
- Ultra-linear modulated oscillator for unexcelled stereo and SCA performance
- Composite inputs compatible with all stereo and SCA generators
- Extremely low distortion - THD and IMD less than 0.08%
- First exciter to specify transient intermodulation distortion (TIM) at less than 0.1%
- Advanced dual-speed phase locked loop greatly improves low frequency response
- Quiet operation - typical S/N ratio of 78 dB
- Completely broadband - requires no tuning

Mfg. list \$5,795.00 **CALL FOR BSW PRICE**



Model FC30 FM SCA Generator

- Very low FM noise, highly-stable, ultra-linear 67 kHz modulated oscillator ensures minimum distortion
- Memory logic retains mode of operation during power interruption up to one hour, with automatic restart
- Advanced dual-mode, controlled-decay subcarrier attenuator ensures noise-free receiver muting
- Unique, optically-isolated remote control operation

Mfg. list \$1,495.00 **CALL FOR BSW PRICE**



**Model SCA 186
SCA Generator**

Sidekick combines the four elements needed for successful SCA operation into the one package: subcarrier generator, modulation monitor, audio processor and transmitter tuning aid. Engineered to work together, these components form an integrated system which provides a level of performance previously unattainable. Crosstalk is dramatically reduced, signal quality is significantly improved and operation is greatly simplified.

Mfg. list \$2,875.00 **CALL FOR BSW PRICE**

Soundcraftsmen



Pro Tuner Four AM-FM Stereo Digital Tuner

Soundcraftsmen's advanced technology incorporates sophisticated Frequency Synthesized Tuning with a highly stable Quartz Crystal Oscillator that locks onto the broadcast signal and makes station selections precise and drift-free. A 16-station Microcomputer Memory System, coupled with two-way Automatic Scanning, provides incredibly simple pre-programming and station selection.

Rack Mountable

Mfg. list \$349.00 **CALL FOR BSW PRICE**



PFM-Three Tuner

Incorporates the most recent achievements in radio frequency design and has been judged to provide better sound than any competitor's model in a wide range of operating environments.

True digital quartz accuracy for tuning AM & FM signals.

Mfg. list \$795.00 **CALL FOR BSW PRICE**

NIKKO



Gamma-30 Quartz-Lock Digital-Synthesized AM/FM Stereo Tuner

The Gamma-30 features 14 station presets (7 AM and 7 FM) with illuminated selector buttons. The front-panel variable muting threshold control eliminates inter-station noise during tuning, and its high-blend filter maximizes FM clarity. IF linear phase ceramic filters are also included for improved group-delay characteristics.

RACK MOUNTABLE

Mfg. list \$339.95

BSW PRICE \$305.00

CARVER

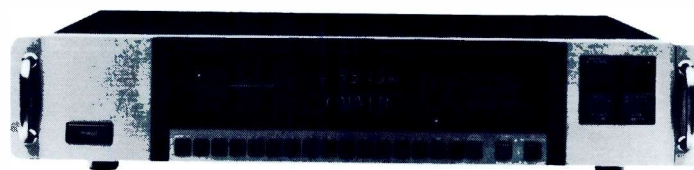

Model TX-11A Stereo AM/FM Tuner

- Ultra-High Fidelity Wide-Band AM Stereo
- Asymmetrical Charge-Coupled FM Stereo Detector
- 13 Random AM/FM Station Presets
- Multipath Elimination Circuitry
- Noise Reduction

The Carver TX-11A is a technical tour de force which further distances Bob Carver's unique products from traditional components — and which can vastly enhance your enjoyment of the myriad kinds of music and entertainment available from the airwaves.

It dramatically reduces FM multipath and distant station noise while providing stereo reception with space, depth, ambiance, and full separation. The TX-11A also opens up whole new sonic possibilities through the incorporation of the world's finest AM stereo reception section. AM signals sound as good as FM!

Mfg. list \$720.00 **CALL FOR BSW PRICE**

JOHNSON ELECTRONICS, INC.

Desk Top SCA Receiver



Model DTR

The desk top receiver is housed in a walnut grained wooden case with a high performance four (4) inch speaker. Side mounted volume and tone controls are provided on the DTR for total sound control. A self-contained swivel, retractable antenna is all that is needed for most installations.

A series of auxiliary connectors are included on the rear of the unit for user convenience. At the top on the rear is a private listening, miniature phone jack for the attachment of earpiece or headset. A tape recorder may be attached to the second connector of the DTR for recording a program while listening. Optionally, a main/sub channel switch is available, and 12 VDC connector for automobile or battery operation. This unit is crystal controlled, thereby eliminating confusion of which channel is to be selected.

Specify operating frequencies.

Mfg. list \$144.00 **CALL FOR BSW PRICE**

Technics

Quartz Controlled Direct-Drive



Model SL-1200 MKII
Quartz-Controlled Direct-Drive Turntable
 Two speed. Pitch control. Tonearm, dustcover and base included.
 Mfg. list \$525.00 **CALL FOR BSW PRICE**

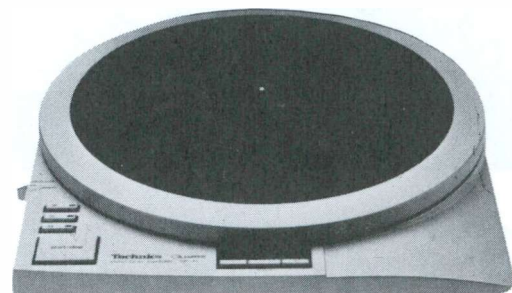

Model SP-15
Quartz-Synthesizer-Controlled Direct-Drive Turntable
 Quartz synthesizer permits up to $\pm 9.9\%$ deviation with digital readout. Enormous torque. Electronic brakes. Three speeds.
 Mfg. list \$980.00 **BSW PRICE \$725.00**

Technics & ProBase Package Deal



(SP-15 Pictured)

SP-15	\$725.00	SP-25	\$449.00
ProBase II	\$129.95	ProBase II	\$129.95
Protec		Protec	
Tone Arm	\$99.95	Tone Arm	\$99.95
Total	\$954.90	Total	\$678.90
BSW PACKAGE PRICE		BSW PACKAGE PRICE	
\$824.95		\$574.95	

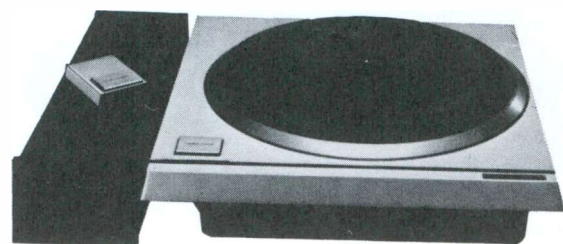

Model SP-10MKIIA
Broadcast Turntable with Quartz-Phase-Locked Direct-Drive Motor
 Quartz control for virtually perfect speed accuracy (max. $\pm 0.002\%$ deviation). Direct-drive for virtually no rumble, wow or flutter. Electronic brakes. Enormous torque. Three speeds.
 Mfg. list \$1,550.00 **BSW PRICE \$1,179.00**



SP10MKIIA	\$1,179.00
ProBase II	\$129.95
Protec Tone Arm	\$99.95
Total	\$1,408.90
BSW PACKAGE PRICE	\$1,259.95

Model SP-25
Quartz-Synthesizer-Controlled Direct-Drive Turntable
 Quartz-controlled. Pitch control of $\pm 6\%$ of standard speeds. High torque. Electronic brakes. Two speeds.
 Mfg. list \$600.00 **BSW PRICE \$449.00**



ProBase
for Technics

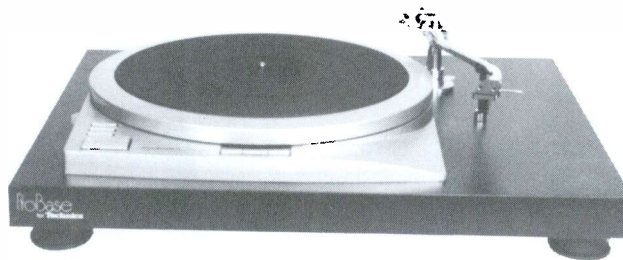

BETTER THAN EVER!

ProBase II

With the addition of the all new, scientifically designed rubber neo gas ProBase pads, broadcasting's most popular turntable base is better than ever. The new pads greatly diminish feedback, rumble and counter top noise.

- Beautiful designed turntable base
- Black overlay on 1 1/2" sound absorbing particle board
- Free floating, low resonance

ProBase II for SP-10, SP-15, SP-25

ONLY \$129.95

Add \$6.00 for drilling — Specify tonearm

ProBase III

ProBase III looks identical to ProBase II, but there is a world of difference. ProBase III is scientifically weighted and harmonically balanced for maximum performance.

This new technology eliminates the need for all the sand, lead, concrete and other bizarre ways of mounting turntables in a shock and feedback-free environment. Simple, effective, cosmetically appealing. ProBase III is absolutely the finest turntable base for Technics available anywhere at any price.

PROBASE III WILL:

**ELIMINATE
TRANSIT NOISE**

**ELIMINATE
SHOCK VIBRATIONS**

**ELIMINATE
FEEDBACK VIBRATIONS**

**ELIMINATE
AIRBORNE VIBRATIONS**
Transmitted through Base and Tonearm

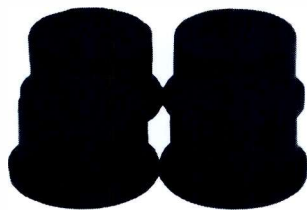

**UPDATE YOUR
PROBASE
WITH PROBASE PADS**

If You Have ProBase With
Audio Technica Pads: Update.

**PROBASE PADS
SET OF 4 \$59.95**

NOTICE A DRAMATIC DIFFERENCE

ProBase III For:

SP-15, SP-25 **\$199.00**

SP-10 **\$249.95**



Protec

**THE BIG
SELLER**

Model S220

Very popular tonearm - thousands in use everywhere. Rugged all metal construction with exceptional tone quality.

BSW PRICE \$99.95



Model ATP12T

A demand tonearm in many engineering and programming circles. Fully adjustable tracking weight.

Mfg. list \$275.00 **BSW PRICE \$209.00**



Laminated mahogany shaft for low resonance and small tracking error.

Long established reputation of quality.

Model 303A 12"

Mfg. list \$149.50 **BSW PRICE \$142.00**

Model 306 16"

Mfg. list \$199.50 **BSW PRICE \$189.50**

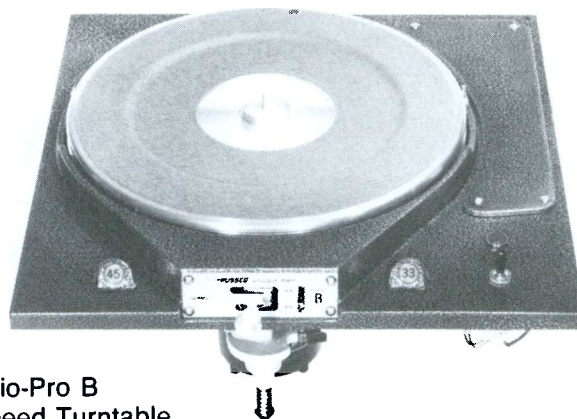

Studio-Pro B
2 Speed Turntable

- Precision engineered for quiet, dependable operation
- Solid cast aluminum chassis and turntable
- Illuminated speed indicators
- Tightest cue potential in the industry
- Detachable tonearm mounting plate

BSW PRICE \$524.00



Model RT700
Direct Drive and Made in the USA

- Direct drive
- Phase locked servo
- Rumble—50 dB
- Quartz controlled
- Wow and flutter .025%
- Enormous torque

BSW PRICE \$930.00



Model QRK-12C
3 Speed Turntable

Shown With
Optional Tonearm

- Instant start, full speed in less than 1/16 revolution
- Rugged construction, only 3 moving parts
- Stereo rumble less than 48 dB (exceeds NAB Standards)

Mfg. list \$415.00 **BSW PRICE \$406.00**
Drilling Fee (Specify Tonearm) **\$15.00**

FAST FAX

206-565-8114



Stanton Cartridges Includes Styli

Model	1-3	4-11	12 PLUS
500A MKII	15.75	13.15	11.30
500AL	17.25	15.65	13.45
500E MKII	19.40	13.50	12.85
500EE MKII	22.25	19.15	16.45
681A	55.00	49.95	46.25
681SE	60.00	54.00	50.00
681EEE MKIIS	72.00	63.75	58.95
881S MKIIS	110.00	96.65	82.85
680AL	51.00	49.00	44.90
680EL	56.00	51.25	47.50

Stanton Replacement Styli

Model	1-3	4-11	12 PLUS
D6800SE	23.40	23.00	22.50
DP6800EL	48.60	47.00	46.85
L500AL	22.00	15.70	13.40
D50A MKII	7.20	7.00	6.90
D50E MKII	11.50	9.00	7.70
D50EE MKII	15.00	11.65	9.99
D5107AL	7.20	7.00	6.90
D5105AA	11.50	10.00	8.60
D6807A	19.40	19.00	18.75
D6800SE	23.40	23.00	22.50
D6800EEEEIIS	27.00	26.00	25.95
D81IIS	45.00	44.00	43.40
D5107A	7.20	7.00	6.90
D6800AL	15.00	14.00	13.00
D6800EE	23.40	23.00	22.50

Shure Phono Cartridges Includes Styli

Model	1-3	4-11	12 PLUS
M44-7	29.00	24.15	20.70
M44-C	29.00	24.15	20.70
M44-E	32.50	27.10	23.20
SC35C	48.50	40.40	34.60
SC39B	68.00	56.70	48.60
SC39EJ	76.00	63.30	54.30
BC70	90.00	75.00	64.30
BC80	126.00	105.00	90.00
BC90	126.00	105.00	90.00

Shure Replacement Styli

Model	1-3	4-11	12 PLUS
N44-7	16.30	13.60	11.60
N44-C	16.30	13.60	11.60
N44-E	19.60	16.30	14.00
SS35C	18.50	15.40	13.25
SS39B	27.80	23.20	19.90
SS39EJ	34.90	29.10	24.90
SS39ED	43.60	36.30	31.10
SS70 4 per pkg	82.00	68.40	58.40
SS80 4 per pkg	114.00	95.00	81.60
SS90 4 per pkg	114.00	95.00	81.60

Audio Technica Cartridges Includes Styli

Model	1-3	4-11	12 PLUS
ATP 1	31.95	25.55	22.40
ATP 2	42.30	33.80	29.60
ATP 3	56.70	45.35	39.70

Audio Technica Replacement Styli

Model	1-3	4-11	12 PLUS
ATPN 1	18.45	14.75	12.90
ATPN 2	26.90	21.50	18.85
ATPN 3	35.90	28.70	25.15

**45 RPM
Record
Jackets
Green
Blue
Red
Gold**

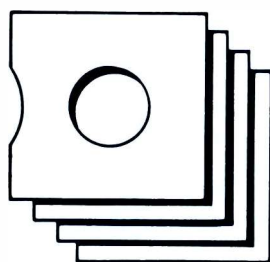

**Mix 'em for
maximum discount**

QUANTITY	1-199	200	300	500	1000
UNIT PRICE	.15	.13	.12	.11	.09

discwasher® D4

**Record
Care
System**



BSW PRICE \$14.30

- Cleans without reduction in record dynamics & fidelity.
- D4 fluid lifts & suspends contaminants in solution on record surface.
- D4 pad mick-fibers are directional, lifting dust rather than lining it up.

Refills

6oz. bottles	\$6.95
16oz. bottles	\$11.95

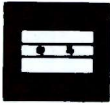

Catalog Number	Mil	Reel Size	Pack	Price Per Reel	
				Single Reel	Case Lots
Ampex Audio Tape					
Standard Output					
631-17611T 1/4 x 2500PH	1.5	Hub	Bulk		6.30
631-151111 1/4 x 1200	1.5	7"	Box	5.40	4.70
631-173111 1/4 x 2500NAB	1.5	10 1/2"	Box		16.70
Low Noise/High Output					
632-131111 1/4 x 600	1.5	5"	Box	3.90	3.40
632-17611T 1/4 x 2500PH	1.5	Hub	Bulk	7.65	6.60
632-151111 1/4 x 1200	1.5	7"	Box	5.90	5.15
632-173111 1/4 x 2500NAB	1.5	10 1/2"	Box		17.00
642-17611T 1/4 x 3600PH	1.0	Hub	Bulk		8.70
642-151111 1/4 x 1800	1.5	7"	Plastic Reel		7.00

Studio Mastering - Low Noise/High Output					
406-17613T 1/4 x 2500PH	1.5	Hub	Bulk	11.10	9.65
406-151131 1/4 x 1200	1.5	7"	Box	8.00	6.95
406-17313J 1/4 x 2500NAB	1.5	10 1/2"	Box		17.90
407-17613T 1/4 x 3600PH	1.0	Hub	Bulk		15.40
407-17313J 1/4 x 3600	1.0	10 1/2"	NAB		24.25
Grand Master					
456-17311J 1/4 x 2500	1.5	10 1/2"	NAB		21.90
456-17611T 1/4 x 2500PH	1.5	Hub	Bulk	13.80	12.00
456-151111 1/4 x 1200	1.5	7"	Box	9.50	8.25

Catalog Number	Mil	Reel Size	Pack	Price Per Reel	
				Single Reel	12 Pack
3M Scotch Audio Tape					
Low Noise/High Output					
806 1/4 x 2500HPB	1.5	Hub	Bulk	11.30	9.20
806 1/4 x 1200	1.5	7"	Box	8.25	6.70
806 1/4 x 2500RN	1.5	10 1/2"	Box	20.70	17.95
Studio Mastering - Low Noise/High Output					
250 1/4 x 2500HPB	1.5	Hub	Bulk	14.20	11.50
250 1/4 x 1200	1.5	7"	Box	9.80	7.95
250 1/4 x 2500RN	1.5	10 1/2"	Box	25.20	21.80

Catalog Number	Pack	Price Each
Scotch Splicing Tape		
41-7/3266	Box	2.60
67-7/32100	Box	5.70
620-7/3266	Box	4.50

Scotch Leader Tape		
20-1/4-1000 Paper	Box	7.15
61-W1/4-1500 White Polyester	Box	17.90
61-Y1/4-1500 Yellow Polyester	Box	17.90
62-1/4-1500	Box	17.90

Scotchcart Tape		
219-1/4-2500HPB	2500'	Hub 19.60

Lubricated Tape For Carts			
Capital Formula 17			
17-918-100	1800'	Box	13.30
17-984-605	8400'	Hub	15.10

Capital Q 17 Hoin			
17-618-613	1800'	Box	15.80

Empty Reels and Boxes			
Plastic Reels			
5464	5" NAB	Bulk	.55
5196	5"	Bulk	.40
5231	7"	Bulk	.70
6284	10 1/2" NAB	Bulk	3.50
5908	10 1/2" EIE	Bulk	5.45

Metal Reels			
6393/600	10 1/2" NAB	Box	10.95
(Includes Box)			

Empty Boxes			
605	5"	Bulk	.40
607	7"	Bulk	.35
630	10 1/2"	Bulk	1.10

BSW handles the complete Ampex and Scotch tape line. 1/2", 1", and 2" available. If you don't see the tape you want above, please call us. 1-800-426-8434.

SONY R-DAT

TWO HOURS OF DIGITAL RECORDING ON A COMPACT DAT CASSETTE

THE WORLD'S MOST PRECISE REPRODUCTION OF SOUND

DAT tape is about half the size of the standard audio cassette. Nevertheless, it can hold up to 2 hours of 2-channel, 16-bit linear digital audio data. A new level of recording density resulting in an easy-to-handle, space-saving cassette tape.



ACTUAL SIZE

Qty.	DT120R - 120 Minute Cassette
1 - 9	\$14.50
10 +	\$13.50
60 - 90 Minute Cassettes Available	



IC-H16 VHF Portable

VHF Synthesized Portable, Broadband (no degradation over the entire sub-band), 16 Channels, 3 Watts/5 Watts Optional, LCD Readout, Separate Tx and Rx CTCSS Tones, Priority and Non-priority Scanning, DTMF, Cloning Capability, High/Low Power Switch, Keyboard Programmable.
Mfg. list \$712.00 **CALL FOR BSW PRICE**



Model IC-125

VHF Synthesized Mobile, Broadband (no degradation over the entire sub-band), 5 Channels, 25 Watts, Diode Matrix Programmable, Compact Size.
Mfg. list \$611.00 **CALL FOR BSW PRICE**



Toll Free From All 50 States,
Including Puerto Rico,
Virgin Islands and Canada

1-800-426-8434



Model FTC-1143

The FTC 1143 is a lightweight hand-held transceiver that provides 3.5 watts RF output on any 10 preprogrammed channels in a 10 MHz range between 460 and 470 MHz. The newest automated design and production techniques have now been applied to business communications, resulting in the lightest and most convenient hand portable transceiver ever. Not one, but two internal microprocessors make the FTC-1143 the ultimate in simplicity of operation - with channel selection or scanning at just the touch of a button. But that's not all; press a few more buttons and the scanner will skip over the very busy or unused channels, so you need only monitor those you choose.

FTC-1143 UHF

Mfg. list \$699.00 **CALL FOR BSW PRICE**



**VHF/UHF
COMMUNICATION
RECEIVER**

FRG-9600

60-905 MHz All Mode VHF/UHF 100 Keypad Programmable Memory Channels

The FRG-9600 is an all mode scanning receiver that provides features never offered before, covering 60 through 905 MHz continuously, with 100 keypad-programmable memory channels.

In addition to FM wide (for FM and TV broadcasts), FM narrow (for two-way police, military, business and amateur communications), and AM wide and narrow (for aeronautical and amateur communications), the FRG-9600 also provides SSB (single sideband) reception up to 460 MHz, allowing monitoring of amateur and military CW and SSB, and the new ACSB mode now used by the military and experimentally as the mode of the future for VHF.

Mfg. list \$735.00 **CALL FOR BSW PRICE**



RainWise® DOES IT ALL

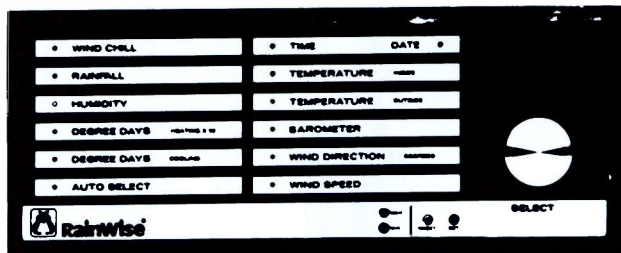

	Windchill Choice of readout in F° or C°		Time 12 hour format Date Month and Day (24 hour format for max min)
	Rainfall Measures in 0.1 of an inch Provides a cumulative recall		Inside Temperature Choice of readout in F° or C°
	Relative Humidity Shown in percent		Outside Temperature Max-min for selected period of time Choice of readout in F° or C°
	Degree Days Heating, X10		Barometric Pressure in inches of mercury Flashing indicates falling. Has max/min recall *
	Degree Days Cooling.		Wind Direction Display in 10° increments of 360° compass rose
	Auto Select Provides 4 second readout of each function in sequence		Windspeed With maximum gust Choice of scales MPH, KPH, Knots

Outside Temperature is shown *Readout in Millibars available by special order

Model WS1000 The Digital WeatherStation™ ...the Ultimate In Weather Information

Engineered for precision and trouble-free operation, this computer age WeatherStation™ monitors nine different weather phenomena. The station provides digital readout for time, indoor and outdoor temperature, barometric pressure, wind direction, wind speed, wind chill, rainfall and accumulates degree day heating and degree day cooling throughout the year. Maximums and minimums are provided for any desired period to the nearest hour, day, and month. The unit is easy to read and operate. A red light indicates the function chosen by the selector knob, and the value is displayed in bright .8" LED numerals. An auto select position displays each function in sequence for four second intervals.

The unit measures 7" high, 17½" long, 1½" deep, and may be mounted without cutting a hole in the wall. The attractive black and brushed aluminum faceplate is complimented by the genuine walnut frame. The unit operates on safe low voltage from a power supply that plugs into a standard AC receptacle. An optional battery pack prevents loss of memory data in the event of a power failure.

Mfg. list \$1,042.00 **CALL FOR BSW PRICE**
Computer Compatible Models Available

COMPUTEMP 5



Computemp 5 The Fascinating Approach To Time & Temperature

- Accurately monitors outdoor and indoor temperatures and time of day
- Temperature alarm alerts to any predetermined setting
- 24-hour memory of daily high and low temperatures, and the exact time of the occurrence
- Continually alternating LED display
- Battery back-up system, to retain memory
- Removable temperature sensors
- Optional rotary switch for monitoring up to nine locations
- 30 feet outdoor cable standard (additional lengths available)

Mfg. list \$110.00 **CALL FOR BSW PRICE**

RainWise®



Raingauge

Industrial quality counter shows rainfall up to 999.9 inches in tenths of an inch.

You can accumulate total inches of rainfall over any period you choose. Pushing the button resets system to zero, starting a new period of counting. There is no need to empty or check the outdoor collector.

Long life 9 volt battery available anywhere, powers entire system for one year or more. Battery may be replaced in seconds...completely safe.

Comes with 30 feet of weather-proof wire to easily connect collector with indicator. Clear plastic insulation makes a handsome, unobtrusive hook-up. Wire is thin enough to allow a window to close over it and unit will operate up to 100 feet away. (additional wire may be purchased)

BSW PRICE \$69.95



RF INDUSTRIES



Our Most Popular Kit!

RFA-4024 (30 PCS)

Unidapt® Universal Adapter Kit

Mix and match any male or female adapter section with any other SMA, N, UHF, BNC, TNC, or mini UHF section. Make any custom adapter you can dream up.

The Universal Adapter Is The Key

Each Unidapt fitting has a common connector end, and a universal adapter end. You simply choose the two common connector ends you need, and screw them together with the universal adapter. It's so easy — that's why technicians love it!

Model RFA-4024 **BSW PRICE \$124.95**

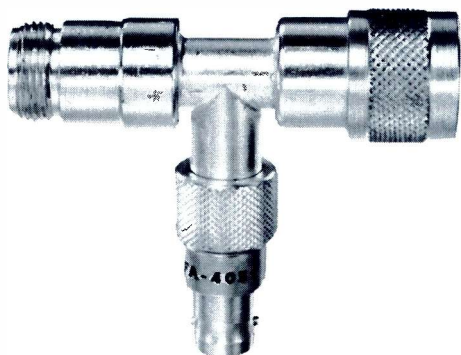

The Sampler

RFA-4059A

Coaxial Signal Sampler

Now you can test for RF power failure or inject signal for noise measurements in transmitter output circuits without dismantling the line! This N male to N female thru-line coax section is inductively coupled to an adjustable BNC female port. This BNC fitting will supply between 20-80 dB of attenuated signal (depending on frequency). Ideal for signal generators, tap offs, modulation meters, or RF millivoltmeters. Male - female connectors can be disconnected - use up to 6 different connectors.

Model RFA-4059A **BSW PRICE \$45.00**

WEST PENN WIRE



Rainbow Of Colors
1000' reels

\$74.00

COLORS: Red • Blue • Grey General all purpose wire for all your studio audio needs.

West Penn 291

Twisted pair - 22 AWG - stranded Tinned Copper - Aluminum foil shield with 24 AWG tinned copper. Drain wire.

Other multipair wire available from BSW. Call us for your wiring solution.

PANDUIT

Wiring Duct

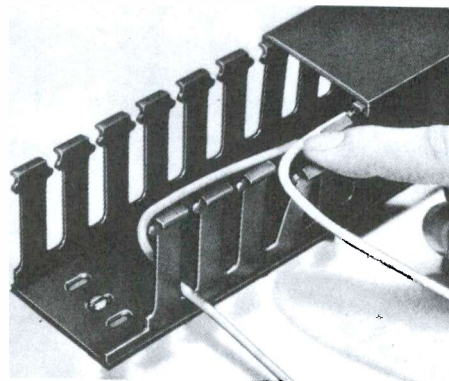

TYPE "E" - PRICE INCLUDES COVER

• Width: 2 inches • Height: 2 inches • Length: 6 feet
BSW PRICE \$21.95



ANDREW

Cablewave Systems



LDF4-50A, 1/2"

HELIAX® Coaxial Cable
1 5/8", 7/8", and 1/2" Foam-Dielectric

These low loss Heliax foam-dielectric cables provide a combination of strength and efficiency not available in other cables. Applications include STL's, RPU and lower power transmitter.

Prices upon application.



L44N



L44W

BSW Stocks a wide variety of Andrew connectors. Call us for a current price.



Model JC3
3 foot RG8U jumper cable. N male to N male connectors.
BSW PRICE\$12.00

Custom Lengths available

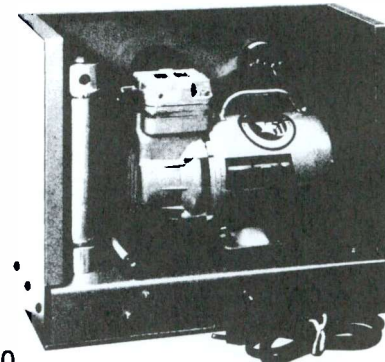

Model APD-20

The APD-20 Automatic Pressurization Dehydrator is designed for reliable pressurization of elliptical waveguide, coaxial cable, waveguide, and rigid line systems. The dehydrator utilizes the pressure swing absorption drying system with completely automatic operation eliminating the need for replacement or manual reactivation of the desiccant.

Model APD-20

Mfg. list \$1,411.00 **CALL FOR BSW PRICE**

BSW handles the complete Cablewave line. Call us toll free for all your Cablewave requirements. 1-800-426-8434

DIELECTRIC

**80 SERIES
HIGH POWERED
MOTORIZED
SWITCHES**

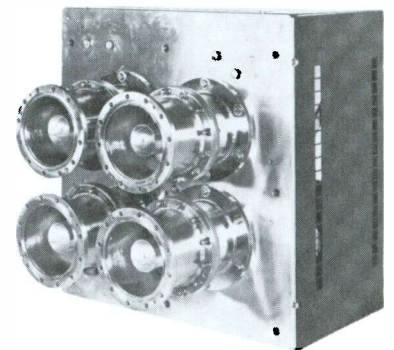

80 Series High Power Motorized Switches - 4 1/16", 6 1/8" and 8 3/16"

The 80 series of motorized 4 port* cold break coaxial switches is a U-link type (with silver plated contacts) capable of high isolation and high power handling.

Switch position is indicated with a rotating arrow and with auxiliary switches. The auxiliary switches are for readout and interlocking circuits. In the closing mode, the interlock switches do not activate and are ready to accept full power. In the opening mode, the interlock switches open prior to the RF contacts to prevent the breaking of the RF contacts while under power. Manual operation is provided for through the use of a hand lever. Terminations are EIA fixed flanges with non-removable inner conductors.

* For SPDT applications, one port is not used.

**BSW Offers The Complete
Dielectric Line. Call Your
BSW Representative For Details.
1-800-426-8434**

Index Products By Brand

Abco	84	Fostex	25, 38, 54, 96, 115	Russco	3, 52, 122
Acoustech	97	Garner	26	Saft	77
ADC	94, 95	Gentner	3, 48, 52, 99, 108-111	Samson	63
Advanced Microdynamics	99	Geodisc	71	Scala	8, 9
Aiwa	39	Goldline	115	Scotch	29, 71, 124
Akai	11	Gorman Redlich	80	Seiko	112
Akg	54, 61	Graphic Express	86	Sennheiser	54, 55, 57, 58
ALC	97	Halonco	78	Sentry Systems	73
Ampex	124	Henry Engineering	3, 66, 108	Seth Thomas	113
Andrew	128	Icom	125	Shively Labs	9
Aphex	3, 24	Information Design	84	Shure	2, 5, 7, 53, 55, 57, 59, 63, 109, 123
Aristocart	84	Interalia	108	Sonar	26
Arrakis	42, 43, 94	JBL	19, 74, 96	Sonex	68
ART	19, 20	Johnson	119	Sony	38, 40, 58, 87, 124
Astrolite	55	Kintronic Labs	79	Sound America	109
ATI	4, 7, 22, 45	Kodak	74	Soundcraftsmen	119
Atlas	65	Koss	54, 55	Soundforms	76
Audi-cord	35	Larsen	9	Soundolier	85
Audiological	17	Lexicon	16	Stanton	7, 123
Audiolab	26, 112	Littlite	67	Starmate	76
Audiopak	29	Loftech	115	STL	71
Audiosource	41	LPB	46	Studer Revox	90, 91
Audiotec	65	Luxo	70	Symetrix	2, 5, 16, 17, 106
Audiotechnica	57, 62, 122, 123	Marantz	37	Taber/AVSC	26
Auditronics	48, 75	Mark Antenna	8	Tapecaster	25, 36
Auratone	97	Marti	104	Tascam	2, 3, 36-38, 41, 50, 85, 87, 89, 92
Autogram	44, 45	Microtrak	51, 122	Teac	17, 91
Belar	81	Middle Atlantic	76	Technics	39, 40, 41, 120
Benchmark	3, 56	Miwltronics	111	Television Technology	72, 117
Beyer	55, 61	Modulation Sciences	18, 78	Telex	55, 64
BG Engineering	36	Moseley	100-102	Telfax	51
BGW	6	MPM	128	Texar	20
Bird	115	MRL	71	TFT	80, 81, 102, 103
Broadcast Devices	79	MW Persons	73	Titus Tech Labs	67, 69
Broadcast Electronics	30-32, 47, 107, 118, 122	Neumann	62	Tough Tech	98
Broadcast Tools	77	Nikko	119	TWR	78
BSW	25, 27, 28, 56, 71	Nortronics	25, 26, 71	Urei	22, 46
BTC	77	Noteworthy	123	Valentino	70
Cablewave	128	Numark	48	Valley International	19, 23
Caig	70	Omnimount	98	Vega	64
Carver	119	Orban	11-13	VIF	70
Catel	72	Otari	30, 88, 89, 93	Vikron	78
CBS	71	Panasonic	38, 41, 87, 107	West Penn	127
Celwave	10	Panduit	127	Wheelock	107
Cetec	10	Peerless	98	Whirlwind	67
Comrex	52, 105	Pivotelli	98	Xcelite	76
Conex	68, 73, 94	Potomac	114	Xedit	25
CRL	14, 22	Probase	121	Yaesu	125
Crown	6, 58	Proboom	65	Zercom	51
Dale	72	Procable	57		
Da-lite	74	Profoam	68		
DBX	21, 114	Prolite	68, 69		
Denon	40	Prorax	82, 83, 85		
Dielectric	128	Protec	122		
Digitech	18	QEI	80, 118		
Discwasher	123	QSC	6		
Dynamax	33, 34	Radio Design Labs	67, 72		
Edcor	2	Radix	5, 7, 56, 111, 112		
Electro Impulse	79	Rainwise	126		
Electro Voice	57, 60, 96	Ramsa	5, 49, 97		
Enberg	80	Rane	2		
ESE	112	Rebuilds	27		
Eventide	15	Revox	39		
Fidelipac	25, 26, 28, 33, 34, 69, 84	RF Industries	127		
Fluke	116	Rodco	126		
		Rohn	116		



BSW • 7012 - 27th St West
Tacoma, WA 98466

DON PERRIGUEY TECH SERV 14976
RT 3 PO BOX 98
ELLINGTON, MO 65638

BULK RATE
U.S. POSTAGE
PAID
TACOMA, WA
PERMIT #275

TIME VALUE

Route To:
General Manager
Program Director
News Director

PRICES SUBJECT TO CHANGE