

QST

DEVOTED ENTIRELY TO

AMATEUR RADIO

PUBLISHED SINCE 1915 BY THE AMERICAN RADIO RELAY LEAGUE INC.



E PODUNK
VS PUT IN A
BEK AT THE LAKE

SEPTEMBER, 1930

25¢

SURE!

There are a lot of
short-wave "Manuals"
—but what of it?

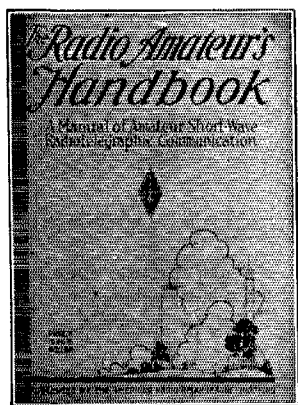

There's only ONE

RADIO AMATEUR'S HANDBOOK

By *HANDY and HULL*

Now in its 82nd thousand

This book is a publication of the American Radio Relay League, the amateur's own organization, written by amateurs for amateurs. It is hailed everywhere as the greatest help that an amateur ever saw. ¶ Because it starts in at the very beginning of the story and tells what amateur radio is, how to become an amateur, how to learn the code, and how to operate a simple station, it is an invaluable and a sympathetic guide for the beginner. ¶ Because it progresses through working descriptions and building instructions for many varieties of receivers, transmitters, power supplies and antennas, and because it goes into all the intricacies of station operation and message handling, it is an indispensable necessity for the proficient amateur.

A world of valuable information, printed in "QST" format and bound in durable paper covers so that the price may be modest.

Blue-and-Gold Paper Cover, \$1.00

Stiff Buckram Binding, \$2.00

◀ We honestly don't see how you can get along
without the Handbook. Order yours today! ▶

AMERICAN RADIO RELAY LEAGUE

HARTFORD, CONN., U. S. A.

"The quality and life of CeCo Radio Tubes compare with any that are manufactured today."

R. C. Hiner, MAY, STERN & COMPANY, PITTSBURGH, PA.

There's new pep for summer transmissions in CeCo Radio Tubes.

Amateur stations use CeCo Radio Tubes types 245, 210 and 250 for oscillators, modulators and power amplifiers.

CeCo Tubes — products of CeCo's experimental station—are built to your special requirements and highest standards."

DO YOU KNOW?

1. The CeCo Engineering Laboratory operates station WIXAC for testing and developing power tubes.

2. The CeCo Power Pentode P6 can be used as a buffer amplifier in transmitters or as an output amplifier in receivers.

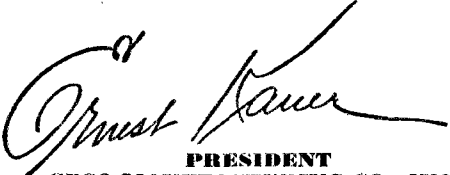

**PRESIDENT
CECO MANUFACTURING CO., INC.
PROVIDENCE, R. I.**

CeCo Radio Tubes are licensed under the patents and applications of the Radio Corporation of America and affiliated companies.

CeCo 1930
Radio Tubes

Say You Saw It in QST — It Identifies You and Helps QST

THE NEW TYPE 334-Z VARIABLE CONDENSER

Maximum Capacitance, 500 $\mu\mu\text{f}$

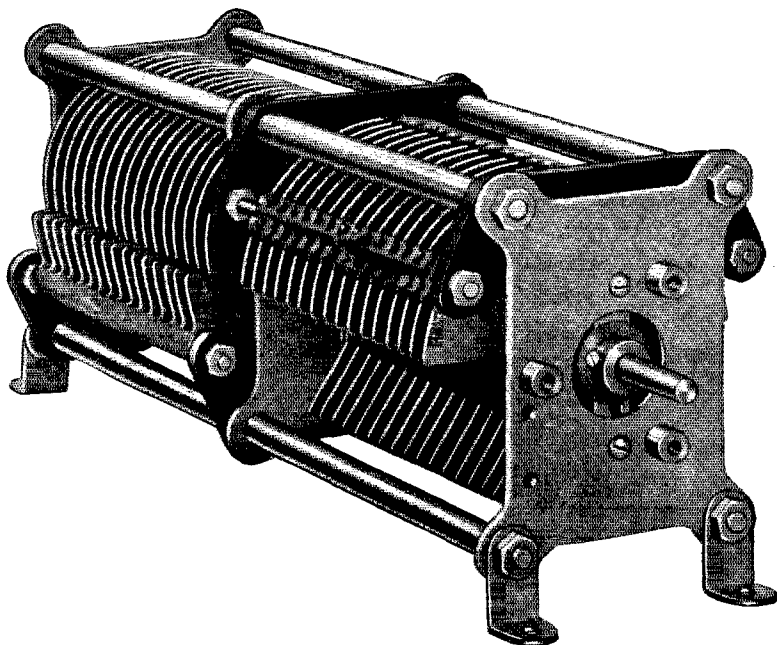

SPECIFICATIONS

THIS condenser is made in two sections so placed that the rotor is balanced without requiring a counterweight. Both rotors are connected, but the stators are isolated from each other.

Breakdown Voltage: 3500 volts, peak. Condensers are built in jigs so that the 0.088 inch spacing between rotor and stator plates is accurately maintained.

Mounting: For panel or table mounting. Four feet supplied with each unit. Drilling template furnished.

Dielectric Suspension: First-quality hard rubber.

Type Number	Capacitance		Overall Dimensions	Weight	Price
	Max.	Min.			
334-Z	500 $\mu\mu\text{f}$	35 $\mu\mu\text{f}$	3 $\frac{1}{2}$ x 3 $\frac{1}{2}$ x 11 in.	3 $\frac{1}{2}$ lb.	\$10.00
*334-R	250 $\mu\mu\text{f}$	30 $\mu\mu\text{f}$	3 $\frac{1}{2}$ x 3 $\frac{1}{2}$ x 6 $\frac{1}{2}$ in.	2 lb.	5.50
*334-T	100 $\mu\mu\text{f}$	15 $\mu\mu\text{f}$	3 $\frac{1}{2}$ x 3 $\frac{1}{2}$ x 4 in.	1 $\frac{1}{8}$ lb.	2.75
*334-V	50 $\mu\mu\text{f}$	10 $\mu\mu\text{f}$	3 $\frac{1}{2}$ x 3 $\frac{1}{2}$ x 3 $\frac{1}{2}$ in.	$\frac{5}{8}$ lb.	2.50

* Single section models, with counterweight.

Order from this ad and if cash accompanies it we will pay the transportation charges anywhere in the United States or Canada. We ship within twenty-four hours after we get your order.

GENERAL RADIO COMPANY

CAMBRIDGE A

MASSACHUSETTS

274 BRANNAN STREET, SAN FRANCISCO

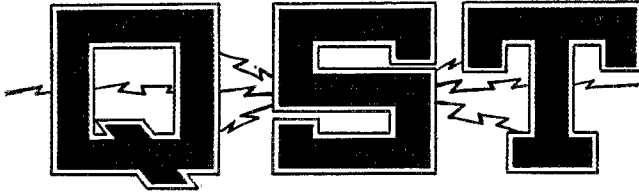

The Official Organ of the A.R.R.L.

VOLUME XIV

SEPTEMBER, 1930

NUMBER 9

Editorials	11
Doings at Headquarters	12
Making Practical Use of the 56-Mc. Band	<i>J. J. Long, Jr., W8ABX</i> 13
With IPH in Mexico	<i>Bertram Sandham, W6EQF</i> 17
Bringing Frequency Measurement Up to Date	<i>George Grammer</i> 21
QST Lab. Capacity Bridge	<i>Beverly Dudley</i> 27
A New Line of Power Transformers and Chokes	30
QSY With Crystal Control	<i>Boyd Phelps, W2BP-W9BP</i> 31
Experiments With Dynatron Oscillators	<i>O. P. Susmeyan, W1BLH</i> 33
Pacific Division Convention (Announcement)	35
Harmonious Harmonics	<i>Uncle Jimmy and the Boys</i> 36
Election Notice	36
Standard Frequency System News	40
Roanoke Division Convention (Announcement)	41
The Operating Characteristics of Vacuum Tube Detectors — Part II	<i>H. A. Robinson, W3LW</i> 42
Experimenters' Section	47
W9BAN	51
I.A.R.U. News	55
Calls Heard	57
Correspondence Department	58
West Gulf Division Convention (Announcement)	88
Remote Control	88
Display Your Licenses	90
Atlantic Division Convention (Report)	90
Book Reviews	91
Ham-ads and QRAs	92
QST Index of Advertisers	94

QST is published monthly by The American Radio Relay League, Inc., at Hartford, Conn., U. S. A.
 Official Organ of the A.R.R.L. and the International Amateur Radio Union

Kenneth B. Warner (Secretary, A.R.R.L.), *Editor-in-Chief and Business Manager*

James J. Lamb
Technical Editor

George Grammer
Assistant Technical Editor

Clark C. Rodimon
Managing Editor

David H. Houghton
Circulation Manager

G. Donald Meserve
Advertising Manager

Advertising Offices.....55 West 42d Street, New York City
 Editorial Offices.....1711 Park Street, Hartford

Subscription rate in United States and Possessions, Canada, and all countries in the American Postal Union, \$2.50 per year, postpaid. Single copies, 25 cents. Foreign countries not in American Postal Union, \$3.00 per year, postpaid. Remittances should be by international postal or express money order or bank draft negotiable in the U. S. and for an equivalent amount in U. S. funds.

Entered as second-class matter May 29, 1919, at the post office at Hartford, Connecticut, under the Act of March 3, 1879. Acceptance for mailing at special rate of postage provided for in section 1103, Act of October 3, 1917, authorized September 9, 1922. Additional entry at Concord, N. H., authorized February 21, 1929, under the Act of February 28, 1925.

Copyright 1930 by the American Radio Relay League, Inc. Title registered at United States Patent Office.

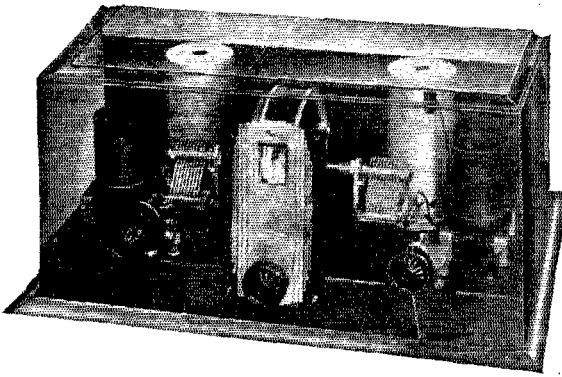

Robert S. Kruse and NATIONAL CO. engineers collaborated in the design of this remarkable, new high-frequency receiver.

No Hum on Phones

with full A. C. Operation

NEW NATIONAL S. W. 5 THRILL-BOX

Easily assembled by anyone with genuine NATIONAL RADIO PRODUCTS

Full A. C. High-Frequency operation. Actual single control. Set and forget the antenna trimmer. Tunes and logs as easily as a broadcast receiver. Absolutely free from hand-capacity. 1080 dial degrees between 21.2 m.c. and 2.61 m.c. Smooth sensitivity control either for C. W. or phone. No grunting or backlash. Easily adapted for wide spread of amateur bands. Double-Screen-Grid, using 224 grid leak detector. Push-Pull audio, with special phone jack after first stage. Made also in new battery model, using the new UX 230, 231 and 232 tubes.

The Condensers

New type SE-100 S. W. Condensers. Insulated bearing, constant impedance pigtail, straight frequency line plates.

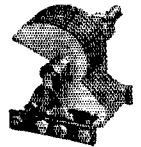

The Coils

The coil-forms used in the new THRILL-BOX are made of R-39, the low-loss coil-form material recently developed by Radio-Frequency Laboratories.

Operates on Special Power-Unit

A special power-unit is made for use with the New A. C. THRILL-BOX. Licensed under R. C. A. patents.

↓ *Send Coupon Today*

NATIONAL
Precision-Built
HIGH-FREQUENCY
APPARATUS



NATIONAL CO. INC.
Sherman, Abbott and Jackson Streets
Malden, Mass.

Gentlemen:

Please send your new Bulletin # 141
describing your new H.F. Receivers.

Name

Address

Section Communications Managers of THE COMMUNICATIONS DEPARTMENT, A. R. R. L.

Eastern Pennsylvania	W3ZF	ATLANTIC DIVISION Don Lusk	116 West Wyoming Ave.	Germantown, Phila.
Maryland-Delaware-District of Columbia	W3BBW	Forrest Cathoun	1036 Thomas Ave.	Baltimore, Md.
Southern New Jersey	W3ATJ	Bayard Allen	416 Mount View Ave.	Mount Holly
Western New York	W8CKC	John R. Blum	44 Seward St.	Dansville
Western Pennsylvania	W8CFR	Robert Lloyd	175 Allegheny Ave.	Emsworth (Pgh) Pa.
		CENTRAL DIVISION		
Illinois	W9APV	Fred J. Hinds	3337 Oak Park Blvd.	Berwyn
Indiana	W9BKJ	George Graue	824 Home Ave.	Fort Wayne
Kentucky	W9BAZ	J. B. Wathen, III	Mockingbird Valley	Louisville
Michigan	W8DYH	Ken Conroy	7553 E. Robinwood Ave.	Detroit
Ohio	W8BAH	Harry A. Tummonds	2073 West 85th St.	Cleveland
Wisconsin	W9VD	C. N. Crapo	443 Newton Ave.	Milwaukee
		DAKOTA DIVISION		
North Dakota	W9BVF	Guy L. Ottinger	326 6th Ave., So.	Jamestown
South Dakota	W9DNS	Howard Cashman	121 N. Spring St.	Sioux Falls
Northern Minnesota	W9BVF	Carl L. Jabs	1822 James St.	St. Paul
Southern Minnesota	W9EFK	J. C. Pehoushek	60 Melbourne Ave., S. E.	Minneapolis
		DELTA DIVISION		
Arkansas	W5ABI	H. E. Vette	315 No. Jackson St.	Little Rock
Louisiana	W5WF	F. M. Watts, Jr.	1716 Park Ave.	Shreveport
Mississippi	W5AKP	J. W. Gullett	1708 23rd Ave.	Meridian
Tennessee	W4SP	James B. Witt-	832 N. Fifth Ave.	Knoxville
		HUDSON DIVISION		
Eastern New York	W2QU	H. J. Rosenthal	Box 740	New Rochelle
N. Y. C. & Long Island	W2BGO	V. T. Kenney	1836 Hone Ave.	Bronx
Northern New Jersey	W2WR	A. G. Wester, Jr.	50 Princeton St.	Maplewood
		MIDWEST DIVISION		
Iowa	W9DZW	H. W. Kerr	915 Lincoln Ave.	Little Sioux
Kansas	W9CET	J. H. Amis	8010 Mercer St.	Topeka
Missouri	W9RR	L. B. Lutz		Kansas City
Nebraska	W9FAM	Samuel C. Wallace		Clarks
		NEW ENGLAND DIVISION		
Connecticut	W1CTT	Frederick Ells, Jr.	7 Union Ave.	Norwalk
Maine	W1AQL	G. C. Brown	269 No. Main St.	Brewer
Eastern Massachusetts	W1WV	M. W. Weeks	40 Norfolk Rd.	Chestnut Hill
Western Massachusetts	W1JV	Leo R. Pelouin	24 Arthur St.	Worcester
New Hampshire	W1ATJ	V. W. Hodge	227 Main St.	Claremont
Rhode Island	W1BCR	C. N. Kraus	92 Keene St.	Providence
Vermont	W1IT	Clayton Paulette		North Troy
		NORTHWESTERN DIVISION		
Alaska	W4VDN	W. B. Wilson	U. S. LHT Fern	Ketchikan
Idaho	W7ACN-JL	James L. Young	303 13th Ave., So.	Nampa
Montana	W7AAT-7QT	O. W. Viers		Red Lodge
Oregon	W7UN	Wilbur S. Claypool	1059 Greenwood Ave.	Portland
Washington	W7ACS	Eugene A. Picty	912 No. Ainsworth St.	Tacoma
		PACIFIC DIVISION		
Hawaii	K6CIB	L. A. Walworth	2737 Ferdinand Ave.	Honolulu
Nevada	W6EAD	Keston L. Ramsay	1151 Buena Vista Ave.	Reno
Los Angeles	W6EQF	B. E. Sandham	4508 8th Ave.	Los Angeles
Santa Clara Valley	W6NX	F. J. Quement	1348 Hanchett Ave.	San Jose
East Bay	W6CZR	J. Walter Frates	439 62nd St.	Oakland
San Francisco	W6WB	C. F. Bane	202 Castro St.	San Francisco
Sacramento Valley	W6LON	Everett Davies	Rt. 5, Box 380	Sacramento
Arizona	W6BWS	Russ Shortman	519 W. Madison St.	Phoenix
Philippines*	KALJR	John R. Schultz		Calauan, Laguna, P.I.
San Diego	W6EOP	Harry A. Aabler	4101 Hamilton St.	San Diego
		ROANOKE DIVISION		
North Carolina	W4DW	H. L. Caveness	State College	Raleigh
Virginia	W3CA	J. F. Wohlford	118 Cambridge St.	Roanoke
West Virginia	W8JM	D. B. Morris	703 Maryland St.	Fairmont
		ROCKY MOUNTAIN DIVISION		
Colorado	W9CAA	C. R. Stedman	1041 Albion St.	Denver
Utah-Wyoming*	W6DPJ	C. R. Miller	134 E. 2nd North St.	Provo, Utah
		SOUTHEASTERN DIVISION		
Alabama	W4AHP	Robt. E. Troy, Jr.	516 Cloverdale Rd.	Montgomery
Florida	W4AII	Harvey Chahin	6002 Swanee Ave.	Tampa
Georgia-So. Carolina-Cuba- Isle-of-Pines	W4RZ	M. S. Alexander	79 Rogers St., S. E.	Atlanta
Porto Rico-Virgin Islands	K4KD	E. W. Mayer	Box 103	Ensenada, P. R.
		WEST GULF DIVISION		
Northern Texas	W5RJ	Roy Lee Taylor	1500 St. Louis St.	Ft. Worth
Oklahoma	W5GF	W. J. Centry	538 N. Fottenger St.	Shawnee
Southern Texas	W5ZG	H. C. Sherrod	4715 Crockett Blvd.	Galveston
New Mexico	W5AHI	Leavenworth Wheeler, Jr.	Box 33	Valmora
		MARITIME DIVISION		
Maritime*	VE1DQ	A. M. Crowell	69 Dublin St.	Halifax, N. S.
		ONTARIO DIVISION		
Ontario	VE3FC	E. C. Thompson	206 Queensdale Ave.	Toronto, 6
		QUEBEC DIVISION		
Quebec	VE2AC	Alphy Blais	Box 221	Thetford Mines
		VANALTA DIVISION		
Alberta	VE4EC	Fred Barron	Warwick Apts., 95th St.	Edmonton
British Columbia	VE5AL	J. K. Cavalsky	4868 Blenheim St.	Vancouver
		PRAIRIE DIVISION		
Manitoba	VE4HR	A. V. Chase	109 Lanark St.	Winnipeg
Saskatchewan	VE4FC	W. J. Pickering	514 19th St. W.	Prince Albert

*Officials appointed to act until the membership of the Section choose permanent SCMs by nomination and election.

Leeds Listening MONITOR

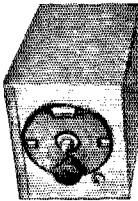

For checking your note, its stability and whether D.C. or not. **THE ONLY SURE CHECK.** Gives you an accurate idea as to what your signal sounds like to the other fellow. The Leeds Monitor is enclosed in an aluminum shield, 5" x 6" x 9" overall. Completely shielded, with batteries self contained. Supplied with A. & B. batteries, but without 1-UX, 199 tube.

Special **\$15.00**

Make your own transmitting and receiving coils. Copper tubing transmitting inductance.

	Size of tubing		
Inside Dia.	3/16"	1/4"	5/16"
2 1/8"	9c	10c	12c
2 3/8"	9c	10c	15c
3 1/8"	10c	12c	17c

Prices per turn

Thordarson B-Eliminator Transformer **\$1.65**

Thordarson 150 watt Transformer. Limited quantity — over 1000 sold at \$3.95, for specifications see previous issues — a few left at **\$3.50**

Leeds 50 watt socket specially priced. See previous issues of QST for details.

LEEDS

The Home of RADIO
45 VESEY STREET
NEW YORK

New York's Headquarters
for
Transmitting Apparatus
When in Town Visit Our Store

EVERYTHING IN
ACME JEWELL PYREX
BRADLEY FLERON
THORDARSON
ELECTRAD NATIONAL
LYNCH SIGNAL
FLECHTHEIM
NATIONAL RECTOBULB
GENERAL RADIO
CARDWELL
IN STOCK

Leeds Microphone STANDS



Beautiful oxidized copper finish. Very sturdy construction. Artistically designed, effective appearance.

Desk Type, \$4.75
Price.....

Floor Type, Adjustable to 7 feet, \$9.75
Price.....



NEON GLOW LAMPS

Super Sensitive. For wave meter and other uses; candelabra base, 1/2 watt, 5/8 inch diameter, 1 3/4 inch long over all. Special..... **\$1.75**

Porcelain base socket for above lamp..... 10c

WIRE

No. 14 Enamel..... 3/4c Foot

No. 12 "..... 1c "

No. 10 "..... 1 1/2c "

Any length up to 1000 feet

DUBILIER HIGH VOLTAGE FILTER CONDENSER



4 MFD. D.C. Working Voltage 600 V

These Filter Condensers are designed for use in filter circuits in Transmitters, and all high Voltage Socket power devices and Power Packs.

TYPE PL 571
List Price \$7.25
Several thousand sold at \$2.25, the balance at..... **\$1.80**

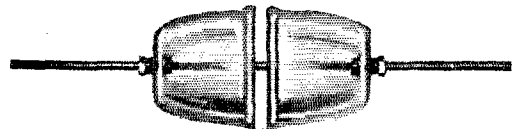

Special LEEDS lead in bowls made of Pyrex. Two cups size 3 1/4" dia. x 2 1/2" high; supplied complete with 18" brass rod and hardware. Price **\$2.25** complete.....

Larger size cups 6" dia. x 4 3/4" high; complete set two cups, hardware and 24" brass rod. **4.25** Price complete.....

LEEDS RADIO LABORATORIES

Precision Custom Built Short Wave Receivers and Transmitters

This department under the supervision of the Short-Wave Specialist Jerome Gross. We design, construct and advise on any material for the "Ham" Broadcasting station or laboratory. Write Jerry Gross for advice on any of your problems

LEEDS Special 75 Watt Master OSCILLATOR—Power Amplifier TRANSMITTER

The ultimate in a real transmitter of medium high power. Finest construction throughout. Angle aluminum framework, oscillator thoroughly shielded with heavy aluminum. Circuit perfectly balanced. Easily adjusted for full output. Size 11" x 19" x 26" overall. Extremely flexible wavelength changes easily effected. Utilizes one UX210 as oscillator, one UX852 as power amplifier.

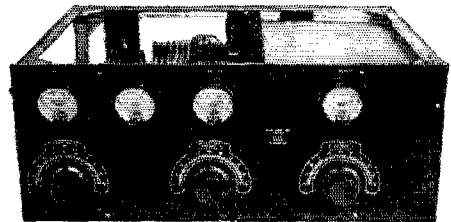

WRITE FOR OUR CIRCULARS ON OUR PRODUCTS. QUOTATIONS ON SPECIAL TRANSMITTERS, ETC., SUPPLIED UPON APPLICATION.

THORDARSON FILTER CHOKE

30 Henry, 150 Mill — special heavy choke, good for filter circuits for transmitters up to and including one UX852, or as a modulation choke on medium power transmitters. Size 6 1/2" high, 3 1/2" wide, 3 1/2" deep. Weight over 6 lbs. Value \$12.00. Specially priced at..... **\$3.25**



AEROVOX

Complete line of nationally advertised AEROVOX Condensers and Resistors

PLEASE PRINT YOUR NAME AND ADDRESS PLAINLY TO AVOID DELAY

WRITE FOR SPECIAL PRICE LIST

MAIL ORDERS FILLED SAME DAY
10% Cash Must Accompany All C. O. D. Orders

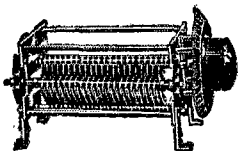

LEEDS

The Home of RADIO
45 VESEY STREET
NEW YORK

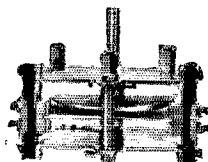

The 201E

We have a complete line of NATIONAL TRANSMITTING and Receiving Condensers.

New York's Headquarters for Transmitting Apparatus
When in Town Visit Our Store

A 2 plate variable condenser having the stator plate readily adjustable to permit changes in maximum capacity ranging from 50 to 10 mmfds, with a constant minimum of 7 mmfds.

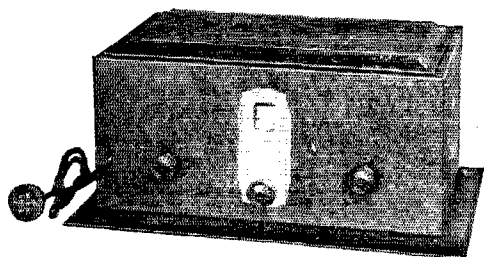

NEW 1930

NATIONAL

DOUBLE SCREEN-GRID
5-TUBE THRILL BOX—Type SW5
AC AND DC MODELS

NATIONAL complete set of parts for 5-tube Battery operated Short Wave Thrill Box.....\$75.00

NATIONAL complete set of parts for 5-tube AC Short Wave Thrill Box... 79.50

AB Power Supply (less tube) for use with above AC Short Wave Thrill Box..... 34.50

Either of the above sets wired for..... 10.00

We are the largest distributors of National Products in the East
Write for Special Discount List

VIBROPLEX

IN COLORS: Blue—Green—Red

10 New features. Easy to operate. Easy on the arm. Fast or slow. Transmits signals unequalled for strength, clarity and beauty. Black or Colored. \$17 and up.

We carry a complete line of Vibroplex instruments at all times.

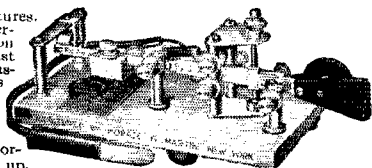

Cardwell TAPERPLATE CONDENSERS

LEEDS always has a complete line of receiving and transmitting CARDWELL products

Write for Cardwell folder



Hardwick, Hindle Bleeder Resistors

We recommend HH Resistors for the following voltages:



500 to 600 volts — 50,000 ohms — 100 watt.....	\$2.75
500 to 600 volts — 50,000 ohms — 200 watt.....	3.25
1000 volts — 60,000 ohms — 100 watt.....	2.95
1000 volts — 100,000 ohms — 100 watt.....	2.95
1000 volts — 60,000 ohms — 200 watt.....	3.45
1500 volts — 80,000 ohms — 200 watt.....	3.60
2000 volts — 100,000 ohms — 200 watt.....	6.50

(Double Unit)

100 watt resistors. Size 6 1/4" x 1 1/4"
200 watt resistors. Size 8 1/4" x 1 1/4"

All Above Complete with mounting brackets

200 Watt Centre Tapped Transmitting GRID LEAK



Size 8 1/4" x 1 1/4" complete with bracket mounting

5,000 ohm. Special.....	\$2.25
10,000 ohm. Special.....	2.70
15,000 ohm. Special.....	2.95
20,000 ohm. Special.....	3.25
30,000 ohm. Special.....	3.75
50,000 ohm. Special.....	4.50

PLEASE PRINT YOUR NAME AND ADDRESS PLAINLY to AVOID DELAY

WRITE FOR SPECIAL PRICE LIST

MAIL ORDERS FILLED SAME DAY
10% Cash Must Accompany All C. O. D. Orders

It's a JEWELL

That's all you need to know about a meter

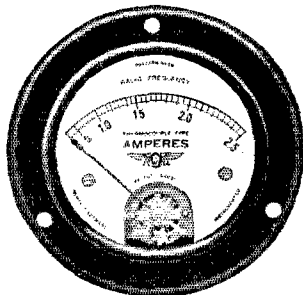

LEEDS

The Home of RADIO
45 VESEY STREET
NEW YORK

New York's Headquarters
for
Transmitting Apparatus
When in Town Visit Our Store

The Jewell Pattern 68 Radio Frequency Ammeter, is the ideal instrument for measuring the radio frequency current in the tank circuit.

LEEDS has the largest stock of Jewell Instruments in the East, covering over 200 ranges in radio frequency, direct and alternating current—bakelite and metal cased instruments are included.

Shipments made the same day orders are received

SPECIAL PRICES TO SET BUILDERS, SERVICE MEN AND AMATEURS

Complete line of direct reading Ohmmeters and continuity testers.

30 YEARS MAKING GOOD INSTRUMENTS

JEWELL Instruments

Write for Literature

Cartridge or Pigtail Type

The moulded end caps insure positive mechanical and electrical contact. The tinned copper pigtails are molded into the caps — not soldered or strapped thereto — proof against noise caused by faulty construction. Heavy duty ceramic casing permits maximum heat dissipation.



Write us for special price list

Easy to use — whether you contemplate building a home or auto radio set, short wave receiver, power pack or television outfit.

Furnished in the following capacities: 1 watt Dynohmic, 500 ohms to 10 meg-ohms, .50 each; 2 watt Dynohmic, 500 ohms to 5 meg-ohms, .75 each.

Also complete line of Lynch precision wire wound resistances in stock. Accuracy to within 1%.

An Ever Increasing
NUMBER of

Broadcast Stations
Amateurs
Experimental Labs
ARE USING

FLECHTHEIM
SUPERIOR CONDENSERS
EXCLUSIVELY

REASON No. 2—

To the conservative rating of our condensers is due their tremendous popularity

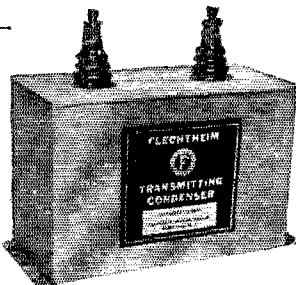

In use by over 50% of the Broadcast Stations!

TYPE VM 200-2 MFD.
5000 V. D.C. - 3300 rms RAC



ELECTRAD

Truvolt All Wire RESISTANCES

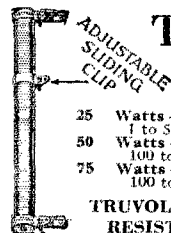

- 25 Watts — 2 inches long
1 to 50,000 ohms
- 50 Watts — 4 inches long
100 to 100,000 ohms
- 75 Watts — 6 inches long
100 to 100,000 ohms

TRUVOLT AIR-COOLED RESISTANCE BANK

Three Truvolt Type C Units mounted on an insulated Bracket for use as voltage divider with any 250 or 210 amplifier or plate supply device. Total Resistance 21,000 ohms divided in 3 sections to give all voltages required by means of Truvolt Sliding Contacts.

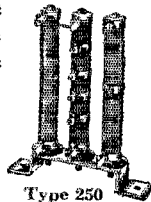

LIST PRICE \$5.00

Two Truvolt Type C Units mounted on an insulated Bracket for use with any receiver or power amplifier using 245 type tubes.

Total Resistance 14,700 ohms divided in 7 sections to give all voltages required by means of Truvolt Sliding Contacts.

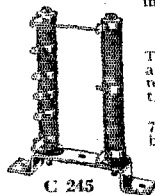

LIST PRICE \$3.50

Write for Booklet and Special Price List

PLEASE PRINT YOUR NAME AND ADDRESS PLAINLY to AVOID DELAY

WRITE FOR SPECIAL PRICE LIST

MAIL ORDERS FILLED SAME DAY
10% Cash Must Accompany All C. O. D. Orders

LEEDS

The Home of RADIO
45 VESEY STREET
NEW YORK

New York's Headquarters for Transmitting Apparatus
When in Town Visit Our Store

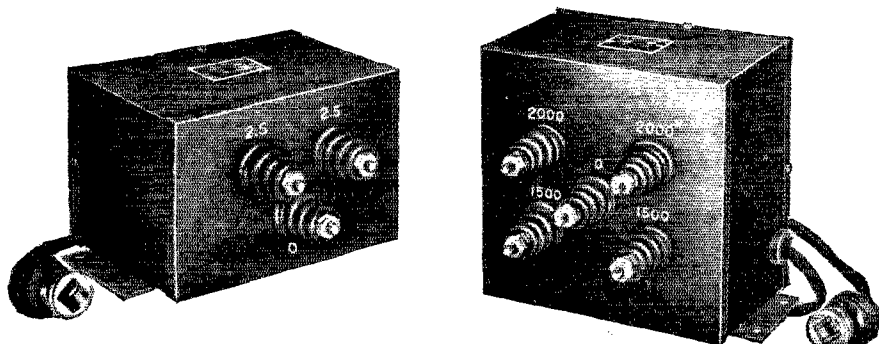

We are the sole distributors of ACME products in the United States. That certainly is accomplishing the unusual — all due to our policy of selling nothing but the best in radio.

PLATE TRANSFORMERS 115 VOLT 60 CYCLE

Type	Capacity	Sec. Volts	Sec. Amps.	Insulation	Price
673	1000 V.A.	2000-0-2000 1500-0-1500	.250	7000	\$28.00
672	500 V.A.	2000-0-2000 1500-0-1500	.125	7000	21.00
671	300 V.A.	1500-0-1500 1000-0-1000	.100	7000	16.00

FILAMENT TRANSFORMERS 115 VOLT 60 CYCLE

669	25 V.A.	1.25-0-1.25	10	7000	\$8.50
670	50 V.A.	1.25-0-1.25	20	7000	10.00
684	50 V.A.	2.50-0-2.50	10	7000	10.00
685	100 V.A.	2.50-0-2.50	20	7000	12.00
667	100 V.A.	6.00-0-6.00	8	7000	12.00
668	175 V.A.	6.00-0-6.00	15	7000	14.00

CHOKE COILS

	Henries	D.C. Current	D.C. Resistance	Insulation	Price
674	30	500 M.A.	130 Ohms	7000	\$20.00
675	30	300 M.A.	155 "	7000	14.00
676	30	150 M.A.	250 "	7000	11.00
686	20	500 M.A.	105 "	7000	18.00
687	20	300 M.A.	140 "	7000	12.00
688	20	150 M.A.	210 "	7000	9.00
677	10	500 M.A.	65 "	7000	14.00
678	10	300 M.A.	80 "	7000	10.00
679	10	150 M.A.	125 "	7000	7.50
680	6	500 M.A.	50 "	7000	11.00
681	6	300 M.A.	60 "	7000	8.00

MICROPHONE TRANSFORMERS

Use	P. Henries	Ratio	Price
712 Single Button	.06	1-60	\$5.00
711 Double Button	.06	1-	
	.06	1-30	7.50

If you require special transformers or chokes to suit your particular need, send us complete details and we will build them for you. Write for Bulletin No. 110 describing these and other Acme products.

ACME ~ for transmission

PLEASE PRINT YOUR NAME AND
ADDRESS PLAINLY to AVOID DELAY

WRITE FOR
SPECIAL PRICE LIST

MAIL ORDERS FILLED SAME DAY
10% Cash Must Accompany All C. O. D. Orders

The American Radio Relay League

The American Radio Relay League, Inc., is a non-commercial association of radio amateurs, bonded for the promotion of interest in amateur radio communication and experimentation, for the relaying of messages by radio, for the advancement of the radio art and of the public welfare, for the representation of the radio amateur in legislative matters, and for the maintenance of fraternalism and a high standard of conduct.

It is an incorporated association without capital stock, chartered under the laws of Connecticut. Its affairs are governed by a Board of Directors, elected every two years by the general membership. The officers are elected or appointed by the Directors. The League is non-commercial and no one commercially engaged in the manufacture, sale or rental of radio apparatus is eligible to membership on its board.

"Of, by and for the amateur," it numbers within its ranks practically every worth-while amateur in the world and has a history of glorious achievement as the standard-bearer in amateur affairs.

Inquiries regarding membership are solicited. A bona fide interest in amateur radio is the only essential qualification; ownership of a transmitting station and knowledge of the code are not prerequisite. Correspondence should be addressed to the Secretary.

DIRECTORS

President
HIRAM PERCY MAXIM
WIAW
Drawer 2102,
Hartford, Conn.

Vice-President
CHARLES H. STEWART
W3ZS
St. David's, Pa.

Canadian General Manager
ALEX. REID
VE2BE
169 Logan Ave.,
St. Lambert, P. Q.

Atlantic Division
EUGENE C. WOODRUFF
W8CMP
234 W. Fairmount Ave.,
State College, Pa.

Central Division
D. J. ANGUS
W9CYQ
P. O. Box 596,
Indianapolis, Ind.

Dakota Division
CY. L. BARKER
W9EGU
Henning, Minn.

Delta Division
M. M. HILL
W5EB
P. O. Box 274,
Natchitoches, La.

Hudson Division
A. LAFAYETTE WALSH
W2BW
220 West 42d St.,
New York City

Midwest Division
LOUIS R. HUBER
W9DOA
517 East 4th St.,
Tipton, Iowa

New England Division
FREDERICK BEST
W1B1G
13 East Crescent St.,
Augusta, Maine

Northwestern Division
K. W. WEINGARTEN
W7BG
3219 No. 24th St.,
Tacoma, Wash.

Pacific Division
ALLEN H. BABCOCK
W6ZD
65 Market St.,
Southern Pacific Co.,
San Francisco

Roa-noke Division
W. TREDWAY GRAVELY
W3BZ
Box 245,
Danville, Va.

Rocky Mountain Division
PAUL M. SEGAL
W9EEA
Box 1771,
Denver, Colo.

Southeastern Division
HARRY F. DOBBS
W4ZA
292 Spring St., N. W.,
Atlanta, Ga.

West Gulf Division
FRANK M. CORLETT
W5ZC
2515 Catherine St.,
Dallas, Tex.

OFFICERS

President HIRAM PERCY MAXIM, Hartford, Conn.
Vice-President CHARLES H. STEWART, St. David's, Pa.
Secretary KENNETH B. WARNER, Hartford, Conn.
Treasurer ARTHUR A. HEBERT, Hartford, Conn.
Communications Manager F. EDWARD HANDY, Hartford, Conn.

GENERAL COUNSEL

PAUL M. SEGAL, 1010 Shoreham Bldg., Washington, D. C.

ADDRESS ALL GENERAL CORRESPONDENCE TO THE EXECUTIVE HEADQUARTERS AT HARTFORD, CONN.

EDITORIALS

IT IS to us a source of great satisfaction that with the passing of some phases of radio pioneering the amateur has not lessened his value to the art but has risen to the position of one of the solid and respected settlers of the communication picture.

We passed through a period in which amateur radio was a game that was little heard of outside its own circle, then through a period of high-frequency pioneering when the widest and most extravagant publicity greeted each amateur discovery. Now we are on a basis where the amateur is an integral part of the radio operation of the nation, not greatly talked about but essential in several ways that many amateurs never suspect and that few in other communication branches realize. Consider, for example, the undeniable facts that the fundamentals of the world's knowledge of high-frequency behavior were derived entirely from amateur observation and that the American high-frequency communication systems, both commercial and governmental, are built upon the results of amateur pioneering. Regard, for instance, the fact that the biggest part of the radio engineering staffs of to-day are being drawn from amateur ranks. Contemplate, if you will, how the amateur is adapting himself to this state of affairs and becomes more and more the experimenter and the operator, less and less the tinker or the publicity seeker. Add to this our vast free message service for the public, the duty our Army entrusts to us in handling organized distress communication, the extent to which we are a training school for executives in the industry and skilled operators for the government services and the commercial operating world — consider these together and you have a total of rich worth, well justifying the traditional American government policy of encouraging amateur radio.

Why this summation? It's because we want to stiffen the backbone of amateurs everywhere by increasing their consciousness of their great value as a class — because the time approaches when a big and hard job must be undertaken. International conferences loom on the radio horizon, the C.C.I.R. at Copenhagen next summer, the new international treaty to be negotiated at Madrid in 1932. Already in the United States preparation has started for the Copenhagen meeting, a technical conference which this time is doubly important because of the effect of its recommendations upon the Madrid situation. League representatives are actively participating in this preparatory work. In this country, as always, we need have no doubt about the attitude of our Government — they will be "for" us. In other countries too, however, study commences for Copenhagen and Madrid, and there the situation is different — yet very important to all of amateur radio because all these countries vote in the international decisions to be reached at those conferences.

The amateur outside of this country and Canada and a very few other places seems to be in mortal fear of his Government. Here is where we hope to inject a little of the old spine by asking our overseas brethren to convince themselves of the merit of the amateur movement and act appropriately. We must not be afraid to crash in where we can be of use and thus demonstrate the national value of amateur radio. In many a European country we in North America must infer that the amateur society is afraid to do anything about unfavorable amateur regulations promulgated by a Government that does not know the amateur — that is, beyond making mild and strictly parliamentary objection in carefully-chosen language. These government radio administrators are people, aren't they? There is some way to get to see them, isn't there? They need to be told,

clearly and succinctly, what amateur radio is and all about its demonstrated great value in the national economy, and what recognition properly ought to be extended to it. When parliamentary objections are inadequate to produce the necessary results, other methods must be invoked. Contact and real representation before the radio administrators are essentials. Honest education about the amateur is the best remedy; a campaign of concerted effort may be necessary; unfortunately improvement generally involves a willingness to engage in a certain amount of scrapping, and that may be in the picture too.

We hold that few Governments of their own volition and wisdom will be found ready to give amateur radio its due — not until the amateurs of that country demonstrate their worth, speak their piece, say what they want, and prove that they're entitled to it. We assert that that policy is the one which has gained recognition for the amateur in lands where he is adequately provided for, and that such action has always shown itself to be in the national interest. The A.R.R.L. therefore urges its sister societies of the world to commence now an aggressive policy of demonstrating the national value of amateur radio and bringing the same to the attention of their Governments; of asking for, and expecting to receive, national amateur regulations commensurate with the provisions and recognitions of amateur radio in the existing Washington Convention; and particularly of preparing, in the official mind, a wholesome understanding and respect for and a sympathetic attitude towards the radio amateur that will exist during the preparation of their Government's views for these international conferences and leaven their delegations' actions there. This is a hard job, but amateur radio is worth it and must have its deserts. The job requires men of vision, intelligence, enterprise and courage. The next two years mean a great deal to amateur radio. It is time now to go to work!

K. B. W.

Doings at Headquarters

SINCE the last "Doings" we have had visitors from all parts of the country, mostly amateurs with and without wives and "sweeties," who are touring around the country during the summer.

After the Byrd ships docked in New York three of the radio personnel, well known to the

Arctic Expedition also) and H. N. Shrimpton (ZLIAO) paid us a visit. We had an informal dinner with President Maxim as toastmaster, and were regaled with tales of the radio work of the party. Mr. Shrimpton joined the Expedition in New Zealand to operate aboard the *Eleanor Bolling* (nicknamed *Evermore Rolling*) between New Zealand and the base, as well as back to U. S. A. Mr. Shrimpton created quite a sensation

with an immense key which had "Kiaora" (meaning, "greetings") inscribed on it. Kiaora was presented to the A.R.R.L. from the New Zealand Amateur Radio Transmitters, of which organization he is vice-president. This is a real key, as may be seen from the photograph, and overall dimensions are 28" x 7" with real good heavy "buggy" bolt contacts. Written on all sides of Kiaora are names of members of N.Z.A.R.T. as well as the operators of the Byrd Antarctic Expedition. This key was originally designed to keep order at a farewell dinner in New Zealand given the Byrd operators and then it was entrusted in care of Nev Shrimpton to suitably present to A.R.R.L.

This token of "hamship" from our

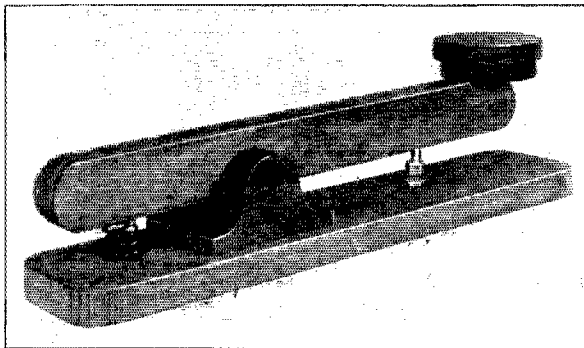

"KIAORA," PRESENTED TO A.R.R.L. FROM NEW ZEALAND AMATEURS

amateur fraternity throughout the world, Malcolm P. Hanson, chief of radio personnel, Lloyd K. Grenlie (both members of the Byrd

brothers in New Zealand has been placed behind portals guarded by nothing less than the Wouff Hong. Our hearty thanks, Zedders! (Cont. on p. 35)

Making Practical Use of the 56-Mc. Band

Successful Phone Work on "Five Meters"

By J. J. Long, Jr., W8ABX*

The opening of the 28-mc. band and the necessity for improving our technic on the lower amateur frequencies have more or less distracted attention from the "five-meter" band during the last few years. The 56-mc. band has not been entirely unattended, however, and a small group of intrepid experimenters have been doing great things with it. This band offers tremendous promise as a useful band for communication between points within "sight-line" of each other and is particularly fine for radiotelephony. Its DX possibilities also offer encouragement. The small antenna systems required make the use of directive transmission especially easy, and tremendous signals are possible with low power. — EDITOR.

ANY development work in radio communication requires the cooperation of several experimenters. Those who assisted very materially in the work described in the following pages are W8PK, Ethelbert and Charles Seiler of East Bloomfield, N. Y., and W8BHM, Wilfred O'Brien of Fishers, N. Y. The

long and then cut into two sections each 49.2" long. A wooden frame was built and the antenna mounted as shown in the photograph. The antenna must be at least $\frac{1}{2}$ wavelength above the ground in order that the dimensions shown will give a true wavelength of 5 meters, because the capacity effects to ground will tend to raise the

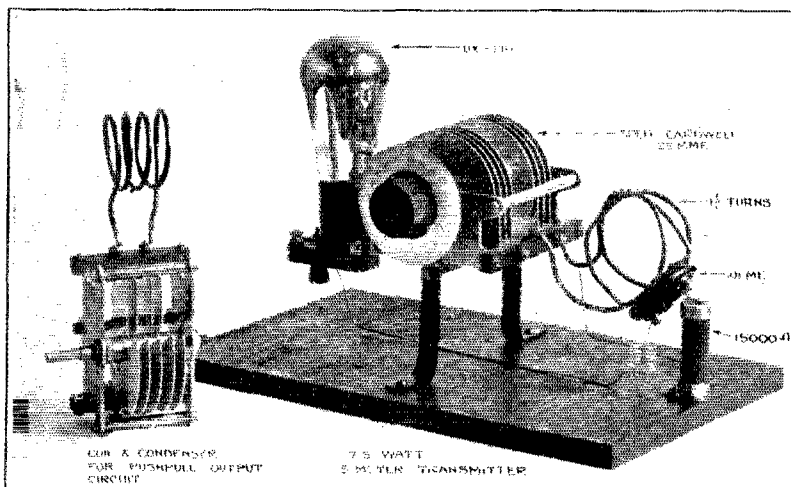

THERE ISN'T MUCH TO THE 56-MC. OSCILLATOR

For telephony the modulator plate is connected to the same positive plate voltage terminal of the 404 power pack as the oscillator. The modulation chokes are in the power pack.

object of these experiments was to see whether it was possible to use the ordinary equipment found in the average amateur's shack to operate with any degree of success on the "five-meter" band.

The first thing done was to cut a five-meter half-wave antenna to the proper length. A piece of $\frac{1}{4}$ " copper tubing was used. It was cut 98.4"

wavelength. This holds true also for any conductor brought near the antenna.

Previous to the time when we started to try communicating on the 56-mc. band, experiments were tried with different types of circuits to determine which was best adapted to use with a '10 tube at such frequencies and which was foolproof in operation. We give Hoffman of W9EK the credit for having the very circuit that we were looking for, all mapped out in *QST*.¹ This circuit is a split-coil Colpitts, allowing us to feed the power for the plate and grid of the tube

* WHAM, Stromberg-Carlson Telephone Mfg. Co., Rochester, N. Y.

¹ The push-pull circuit used in the transmitter described in *QST*, June, 1930, is especially fine for the 56-mc. band. Type '10 or '52 tubes may be used. — EDITOR.

at a point where the r.f. voltage is practically zero. This eliminates the bother of r.f. chokes, which are quite critical at 56-mc. This same cir-

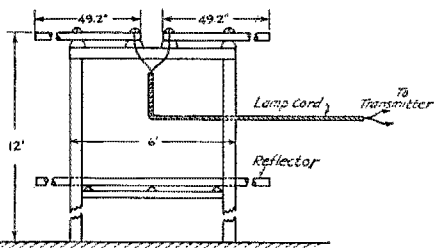
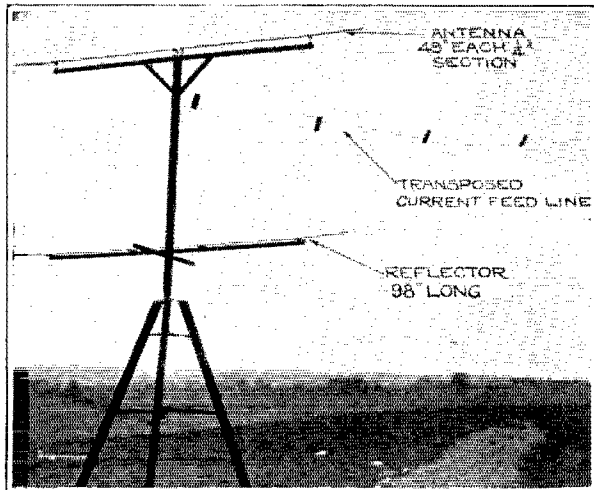

FIG. 1.— THE DIRECTIVE ANTENNA ASSEMBLY

The antenna and reflector are of quarter-inch diameter copper tubing supported on small stand-off insulators. The frame is of wood.

cuit works just as well at the lower frequencies as well. Fig. 2 shows the circuit with constants for 60 mc.

The next step is to couple the transmitter to the antenna. This is done by means of an ordinary twisted lamp cord. In experiments carried on at W8AZL, the amateur station at the Victor transmitter of WHAM, a cord 60 feet long was used to facilitate changing the position of the antenna.



THE DIRECTIVE ANTENNA FOR VERTICAL RADIATION

The two-wire spaced feeder system is usually replaced by a twisted pair.

No unusual loss was noticed by this comparatively long feeder. The antenna is current-fed at the center with the antenna ammeter placed in one section at the point where the feeder is connected. With input to the Type '10 at 15 watts, an antenna current of .3 amp. has been obtained.

With the transmitter feeding the antenna, we were naturally anxious to see what the outfit

sounded like. In the rush to find out, a regular regenerative receiver was tried. The carrier could be tuned in but the results from a receiving standpoint were very unsatisfactory. A special type of receiver had to be designed but we also kept in

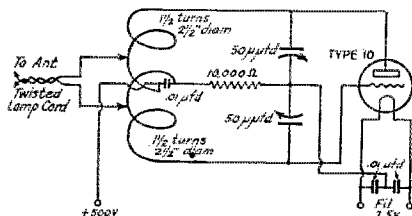

FIG. 2.— THE SPLIT COLPITTS TRANSMITTER CIRCUIT

A fixed blocking condenser is connected in the center of the inductance. No radio-frequency chokes are required in the grid return and d.c. plate supply circuits.

mind the fact that the average amateur does not have parts to make up several receivers. (That was not hard to do since we were just as average as the rest when it came to buying power.) Type '99 tubes had been used in the first receiver and, as anyone who has used these tubes knows, they were very microphonic. When used in a set in an automobile it was some job to get the noise level low enough to hear the signal.

At 56 mc. the voltage across the input of the detector is likely to be very low and it is necessary to get it as high as possible to make the receiver sensitive.² WSBHM designed an arrangement for the coil condenser of the detector so that we were able to put about twice as much inductance in the circuit as with the older method of mounting the parts. The arrangement is shown in the receiver illustration. Among the tubes that we tried were Types '99, '01-A, '12-A, '27, '24, W.E. 239-A, UX-240 and W.E. 102-E. The most satisfactory of the lot from a standpoint of quiet operation and simplicity was the Type '27 operated with d.c. on the heater, although a.c. may be used with good results on the 7- and 3.5-mc. bands. One stage of audio was used for headphone reception at all times, except when a loudspeaker signal was wanted; then another external audio amplifier was used to give the necessary gain and power.

² The input (grid-filament) capacity of the tube becomes appreciable at such high frequencies. Push-pull detector circuits could be used to advantage in reducing the effective tube capacity and a series-tuned grid circuit is also advantageous in giving a high inductance-capacity ratio in the grid circuit. — Editor.

The circuit for the present regenerative set is shown in Fig. 3. The coils are mounted on a tube-base bottom and are self supporting. Five turns of No. 18 enameled wire are used and the coils are wound around an ordinary fountain pen about $\frac{3}{8}$ " in diameter. Fringe howl was encountered and was stopped by loading the secondary of the audio transformer with a $\frac{1}{2}$ meg. leak. This also cuts out considerable a.c. hum from the lighting circuit when using a.c. on the heaters. Bias for the audio stage is obtained from the voltage drop across the heaters. The positive "A" battery lead is connected to the cathodes. The heater leads are twisted so that if a.c. is used the hum will not be objectionable. The antenna is coupled to the receiver by two or three turns of wire (inductive coupling). Capacitive coupling gave quite a bit of hum when the receiver was located in the station near a.c. lines, while inductive coupling showed a decided absence of this trouble. Almost any kind of an antenna can be used for the receiver. If the receiver is used with the batteries at a distance from the ground connection, trouble is encountered with capacity effects when the hand is brought near the tuning dial. This can be eliminated by completely shielding the receiver and running the battery leads in a piece of BX flexible cable, or any other shielded cable.

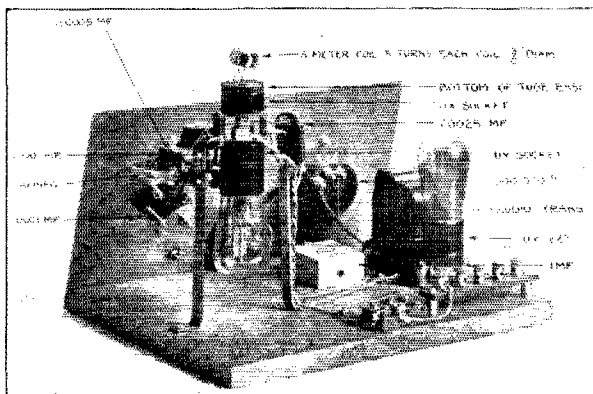

THE 56-MC. AUTODYNE RECEIVER

The 100- μ fd. tuning condenser is mounted on the panel and the 50- μ fd. midget is built into the detector assembly at the left. The plug-in coils are mounted on the bottom of a tube base. Two heater-type tubes are used with their filaments connected in series.

volts of "B" batteries. Music was received clearly in a car at a distance of 20 miles, with an antenna 5 feet long. Addition of an antenna 50 feet long gave such a strong signal that it blocked the second detector. This receiver has not been fully developed and we expect some real DX from it without impairing the quality when we get the thing up to maximum sensitivity.

DUPLIX TELEPHONY

What will probably interest the amateur the most, is the story of a two-way 56-mc. duplex telephone conversation between WSAZL and WSPK. The ordinary regenerative receiver and the 7.5-watt transmitter described (with 350 volts and 50 ma. on the plate of a 'Type '10 and a modulator with the same power input) were used.

One night last summer, WSPK and myself were working on the 3500-ke. band with phone. The 56-mc. transmitter as WSAZL was running also and WSPK was trying to get it. Within two minutes after the 56-mc. transmitter was started, he picked it up and reported a very strong phone signal—much louder and clearer than the 3500-ke. phone—and a total lack of QRN or QRM. The 3500-ke. phone at WSAZL was then turned off and the 56-mc. set was used entirely. We worked that way for about a half hour, and QRM and QRN became so bad on WSPK's

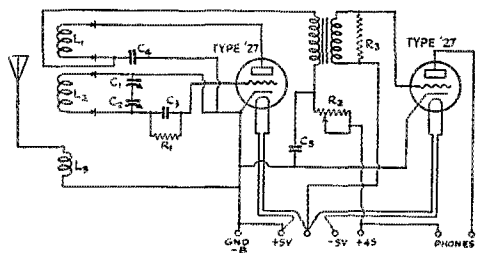

FIG. 3.—CIRCUIT OF THE 56-MC. AUTODYNE RECEIVER

- L1 — Tickler. See text.
- L2 — Grid coil. See text.
- L3 — Antenna coil. See text.
- C1 — 100- μ fd. midget condenser.
- C2 — 50- μ fd. midget condenser.
- C3 — 100- μ fd. grid condenser.
- C4 — 250- μ fd. plate by-pass condenser.
- C5 — 1- μ fd. by-pass condenser.
- R1 — 10-megohm grid leak.
- R2 — 500,000-ohm regeneration control resistor.
- R3 — 0.5-megohm grid-leak type resistor.

During the summer of 1929, the 56-mc. set at WHAM was operated under the call WXSAC. Phone was used and a superheterodyne receiver was built to see how the quality was at this high

3500-kc. phone that he had to resort to telegraph to tell me how the "5-meter" stuff was coming along. Finally he got disgusted with his phone and wanted to quit. Jokingly I said, "Come on over and get a five-meter set. Take it back and

of to balance out the hum but without much success. For ordinary phone work it is not bad enough to be of serious trouble. Using a battery filament supply increases the effective range, because it brings up the intelligibility quite a bit.

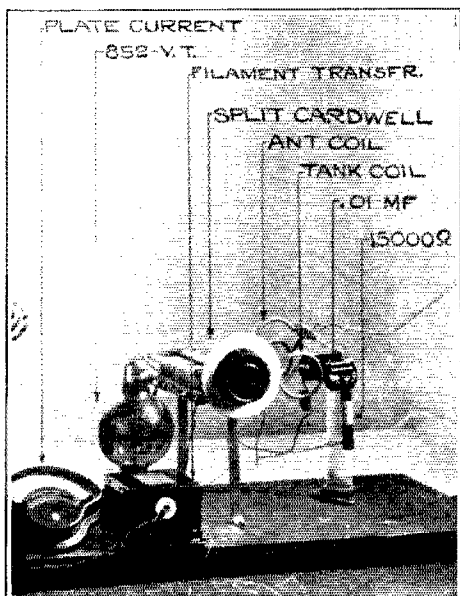

THE NEW 75-WATT TRANSMITTER AT W8AZL
A single-turn antenna coupling coil is used in this arrangement.

"I'll QSO you!" He took me up on it! I didn't like to back down on what I had proposed so I said, "O.K. Come on; I'll be building it while you are on the way over."

A split Cardwell condenser was all cut and ready, and the transmitter was literally thrown together. By the time he arrived, it was perking O.K. on the power supply that we had, which consisted of a Stromberg-Carlson 404 socket-power unit, wired as shown in Fig. 5. He took the transmitter and went back home, and we made a sked to QSO in an hour (it took a half-hour for him to get home).

At the end of the hour, I started tuning on the 56-mc. band and ran across his carrier right away. I got it tuned in good, and gave him a call. He came back, "O.K." Then for two hours we talked back and forth without a break. If you have never held a two-way conversation on phone with no QRM or QRN you still have one more thrill to get from amateur radio.

Later we improved the quality by using a battery on the filament of the oscillator. The filament with the a.c. flowing through it seems to act the same as an absorption loop and modulates the set. We tried everything that we had ever heard

DIRECTIVE TRANSMISSION

Reflectors were used to determine how much better the signal could be received when the energy was all concentrated in one direction. A half-wave rod was placed a quarter-wave behind the antenna, and this helped to some extent. Next we tried the Warner Splatter System by putting a reflector 1/4-wave under the antenna, the object being to project the wave straight up into the air. We got the surprise of our lives when the signal increased about double. We don't know what or where it splattered, but the results are such that we have been using this type of antenna ever since.³

Recently, we have started in to do some more work on this problem and by courtesy of W8ALY

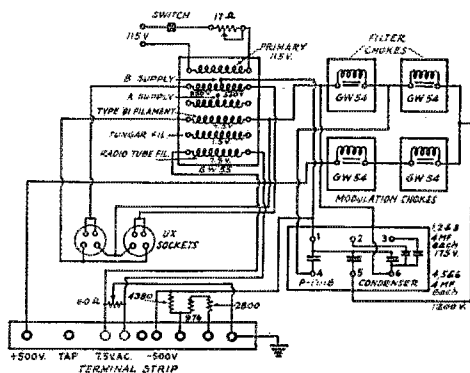

FIG. 4.—CIRCUIT OF THE CONVERTED STROMBERG-CARLSON 404 POWER PACK

The GW-54 chokes are each rated at 22 henries, 300 ma., 20 ohms d.c. resistance. The d.c. output of the unit is 300 volts and the a.c. filament supply available for the transmitter is 7.5 volts.

we now have at our disposal his pet Type '52. It is running at the present time on 60 mc. at W8AZL and is shown in an illustration. We will run the set through the summer and would appreciate schedules from the gang who are interested in this band. At this time it offers only short distance phone communication but as our receivers and transmitters improve with use of the band, we may expect just as much from it in the line of thrills as any other band, and undoubtedly

(Continued on page 76)

³ Present theory would indicate that the maximum electron density in the upper atmosphere is generally insufficient to give such complete reflection—but theory isn't always puncture-proof and sometimes the layer is.—Editor.

With IPH in Mexico

High Adventure With a Portable in an Auto Caravan

By Bertram Sandham, W6EQF*

THE motorist is ever looking for new lands to conquer. The United States has already been thoroughly toured by automobilists who have the time and desire to wheel their cars over thousands of miles before turning homeward. Canada is much the same way. Her statistics on visiting motorists lend themselves well to painting the picture of the American motorist searching for new background, particularly where different customs of living are to be encountered and where romantic history abounds. Where, then, can the motorist now go without retracing his course?

To Mexico, our neighbor to the south of us, to be sure! But today the roads progress into that country but little before they become impassable. Investigation and, in fact, exploration are needed. Therefore, with physical obstructions considered, and with the element of safety and the state of mind of the people in the west coast states of Mexico as questions to be answered, the First International Pacific Highway Exploring Expedition was outfitted by the Automobile Club of Southern California with orders to proceed as far south as was humanly possible, or until the rains set in which would obviously render the ox-cart trails and lowlands impassable. If a highway through Mexico appeared to be feasible as an extension of the present Pacific Highway, reaching from British Columbia to the Mexican border, why should it not continue on into Central America, Panama and the many countries of the southern continent? Thus, the International Pacific Highway was conceived and will some day be completed. It will run a course from Fairbanks, Alaska, on the north, on down to Argentina, ending at Buenos Aires on the Atlantic coast, 12,000 miles in length and the longest highway in the world.

As a member of this expedition I was in charge of a portable high-frequency radio station which operated under the call IPH.

When it was decided to include radio in the equipment of the expedition, but ten days remained before the departure. In that space of time the portable transmitter and receiver, in a single carrying case, had to be designed and built, spare parts accumulated, reliable schedules arranged, a portable mast built, an extra storage battery hung beneath the rear floorboards of the car with suitable switches for throwing both

batteries on charge or in series for the transmitter. Added to this my own personal equipment had to be assembled. It was a busy ten days.

The radio unit was designed and built by W6QF, put in final shape and tested by W6F'E and myself. The transmitter consisted of two Type '10's in parallel in a t.p.t.g. circuit with

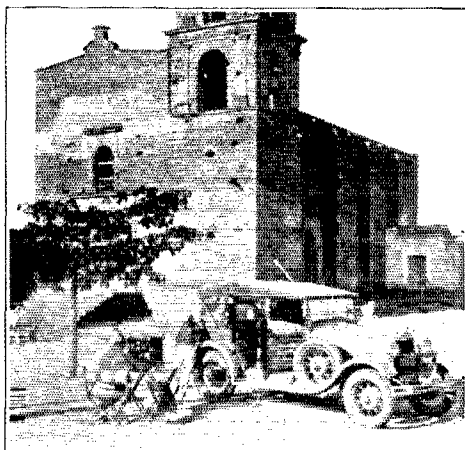

IPH IN OPERATION AT ELOTA

The set-up here is in the public square with the Zepp swung from a balcony in the temple.

high-C, so that the frequency might be shifted from the 7000- to the 14,000-ke. band without changing coils. The receiver was a conventional autodyne with two stages of audio. A reel was provided to carry the two antennas wound over it, one for either band and built particularly for the lower portion of the 7000-ke. band and the upper part of the 14,000-ke. band. A large waterproof box was built and installed between the front and rear seats of the radio car and in this, fourteen 45-volt "B" batteries were packed, two being for the receiver, and the remainder for transmitter plate supply. A long 7-wire cable conducted the various voltages from the box to the transmitter in the tent, or wherever it happened to be set up. A portable table and camping chair completed the radio equipment. Sturdiness was the paramount consideration in the construction of the unit. Every part was solidly anchored and all connections well soldered. How wise the extra effort in this regard, for the radio equipment took a terrific thrashing and was almost a daily

* Section Communications Manager, Los Angeles Section, A.R.R.L.

subject for discussion. We all wondered at the end of a day's pounding how much of the unit remained intact. Despite the well-soldered joints, they were broken loose occasionally.

The expedition, consisting of nine men in five cars, departed from the club building in Los Angeles on March 15th in a heavy downpour of rain. A motorcycle police and aerial convoy had to be dispensed with because of the inclement weather, and we turned toward the Mexican border via San Diego, Imperial Valley, Yuma,

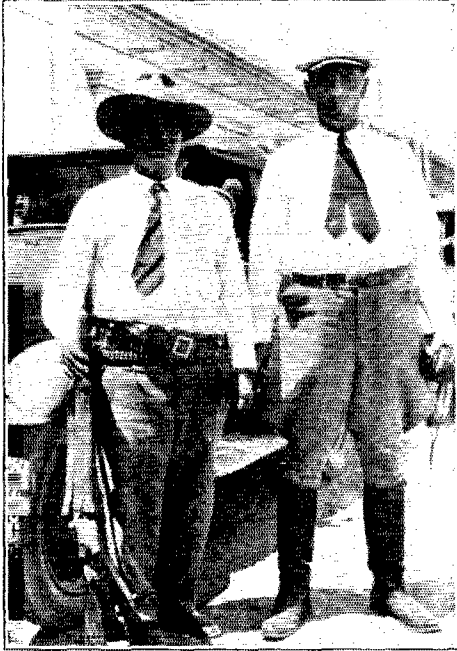

THE AUTHOR WITH MEXICAN BODYGUARD

The bodyguard was necessary through the bad country. The Mex is the walking arsenal at the left.

and Nogales. Heavy rains preceded us the entire distance to Nogales, resulting in our being hours late at official functions along the line.

Three of the cars were light trucks with heavy special bodies built for the purpose. Complete equipment of every nature was included for the well-being of the men and the countless problems that would face the expedition's mechanic and engineers. Compartments back of the driver's seats were both water and fireproof, containing motion picture and "still" equipment, delicate engineering instruments, ammunition for the rifles and automatics, tobacco, and so on. The remaining two cars were of the touring variety, open and heavily loaded. Truck springs had to be substituted in them to bear the heavy load. One of these was the radio car which, in addition to the batteries and all radio equipment, had baggage

jammed in every available space and a long rifle locker fastened along the top of the seat just at the driver's back. The other touring car, in addition to baggage, had mounted in it two compasses, altimeter, gradometer, special mileage recorder and other appurtenances necessary for this branch of the work. A road chartman sat before these instruments and noted every mile of the road below the border in a chartbook, showing bridges when encountered, with the direction of flow of the water, topography of the mountains or adjacent land, isolated churches or structures for identification to the tourist later, all roads branching off or crossing, with mileages between them, per cent of grade, and the altitudes of all cities encountered, with mileages between them also. Notes were made of gasoline stations, etc. In fact a complete record of use to engineer and tourist alike returned with us.

Just across the Mexican border at Nogales, the portable was rigged and IPH went on the air officially for the first time. Conditions were discouraging for our purpose, as all Pacific Coast signals faded after 8 p.m., M.S.T. Central and eastern U. S. signals, however, seemed to boom in constantly. It was soon learned that all of the expedition's traffic would have to be disposed of on a morning schedule only, as long as the 7000-kc. band remained good. As the set was rigged at Nogales, the Mexican mayor, the special representative of the Governor of Sonora and other officials began filing messages in Spanish as rapidly as they could write them — traffic that we heretofore had not anticipated. Had it not



SCORES OF MILES OF THIS TYPE OF COUNTRY HAD TO BE COVERED

The caravan often went over country never travelled before by automobile; mapping the country for a future international highway.

started to rain I believe I should still be sitting in the center of a street in Nogales pounding out their messages.

A correspondent of the North American Newspaper Alliance, representing 51 of the largest dailies in the country, was with us, and consequently his press had to go through. That which he filed with me the first night at Nogales had to be sent to Los Angeles via Honolulu, although

we were but 600 miles distant. All signals along the Pacific had faded for the night, yet K6 signals came in R6. After several days' layover at Nogales to permit the dirt road to dry up somewhat, we started into Mexico in earnest and the battle was on. The many odd experiences encountered along the line of travel would require many pages to recount, so only the high-lights can be included.

A task that became exceedingly tiresome was the locating of a suitable building or flagpole in each city or village to support the antenna. At one time or another we used ice plants, breweries, flour mills, cathedrals, penitentiaries, city halls, weather observatories, governors' palaces and state buildings. The portable mast was used only when the expedition was in camp. What appeared to be a perfectly suitable QRA from the distance, as we entered town, would usually prove worthless as a telephone pole nearby probably supported a bank of heavily overloaded and buzzing transformers. In some cities the electric light wires hung so low that women hung their washings on them!

As a rule great crowds of natives would form a circle about the transmitter during schedules, never having seen a radio set before—in fact many of the children in the more isolated towns had probably never seen an automobile. In

and there are millions of them in Mexico, all of the nondescript breeds—would occasionally snap at my heels as I sat at the transmitter.

At Navajoa a burro lazily made his way up to my side and, flipping his upper lip several times, started to eat the power cable running to the car.

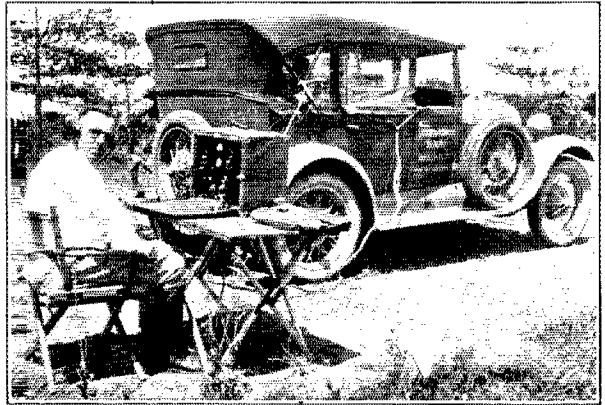

THE AUTHOR, STATION AND RADIO CAR

This shows a typical country set-up. The transmitter and receiver are enclosed within the carrying case atop the portable table.

At Guamachil, I felt a warm draught of air on my neck and turned in my chair to face an immense long-horned bull with his horns encircling my head like a halo. I thought that would be the last schedule. At Santiago several soldiers endeavored to detour a flock of pigs around my QRA, but managed to get them in such a frame of mind that the only way out was beneath my table and chair.

With my limited knowledge of Spanish and the natives' lack of English, the placing of the antenna on a building usually required an hour. A rope was handed one and a definite place decided upon to fasten it, but the native would invariably appear at the wrong window or church spire. In throwing the rope down (to which I would fasten the Zepp) it never failed to become entangled in whatever lay below it. In one instance the native threw the coil of rope down into the street, not knowing that he was to retain one end of it. After the antenna was secured finally, the Mexicans, on several occasions, thought the antenna should be as tight as a guitar E-string, and would give a final jerk that would send me leaping to the set to prevent it being pulled from the table.

At Guadalajara a tall metal pole at the weather observatory was used, in lieu of anything better. Three power leaks from loose electric wires could

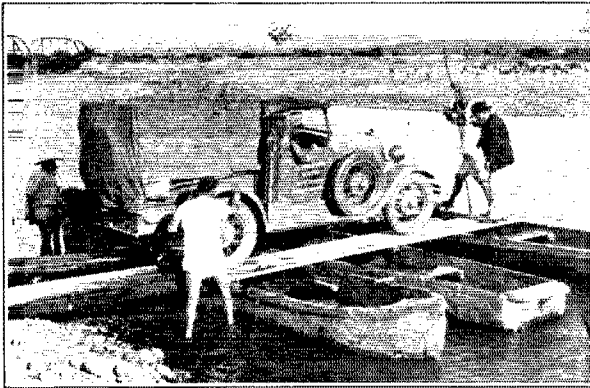

CROSSING THE CULICAN RIVER

The equipment had to be ferried across on extremely crude wooden boats. Crossing rivers this way was a common occurrence. Streams were forded with the water up to the doors of the cars. Quicksand claimed vehicles as victims every so often, whereupon cables and hoists were attached and the trapped vehicle yanked to safety.

larger cities police or soldiers would keep the curious some distance from our set-up, but in the smaller towns difficulty was experienced many times with the natives standing at my elbows and all jabbering furiously. The infuriated dogs—

be seen from this QRA and heard R9. Four other power leaks could be seen from my hotel window in the same city. In the hotel lobby I had quite a conversation with a Mexican general on various subjects. He neglected to inform me, as I later learned, that he himself had executed some 300 priests during the religious difficulties a year or so ago.

At Hermosillo I had the good fortune to meet X29A who, with a friend of his (who owned a brewery), took me in tow during our visit in that city.

In Mexico City, which has a population of more than a million, an entire afternoon was spent



CHALLENGING A STRANGER IN CAMP IN THE BARRANCAS
Through this country the cars occasionally had to be towed by ox-teams.

endeavoring to find a suitable location for the set-up. An oil derrick was finally chosen and the portable rested about fifty feet from a boiler and steam engine. Mechanical QRM, however, was much preferred to the collection of electrical noises that could be heard elsewhere. A drive of about five miles from the hotel to the oil derrick was necessary. There are thousands of automobiles in this city, and the traffic control system was such that when I arrived at my QRA for skeds I didn't care whether school kept or not. It is necessary to proceed along the extreme right-hand side of the street to make a left-hand turn, and *vice-versa*. When the signal is given there is a grand dash of pleasure cars, trucks, buses and street cars into the intersection, where all of them dove-tail and cross each other's bows. I would finally extricate myself from one of these messes to find that I was going the wrong way on a one-way street. Police whistles would fill the air after me, but I wouldn't know how many laws had been broken, so I kept going. I had to choose a different route each day, however, to keep out of jail. Cars pass you on both the right and left sides. When you hear a horn to the rear you just drive straight ahead and pray. You must sound your horn at every intersection, and you are stopped quite frequently and must display your driver's license and car registration certificate.

The rains began again, and it was found that travel from Mexico City into Central America would have to be postponed until a more favorable season next year. IPH went off the air after

a week in Mexico City, and preparations were made for the drive back to Los Angeles over a road paralleling the Atlantic coast and over which no skeds need be kept. This road entered the United States at Laredo, Texas, necessitating a drive across this state, New Mexico, Arizona and California to reach home — where finally ended one of the hardest drives ever attempted by an automobile caravan, and probably the first expedition of such a nature to be equipped with a radio transmitter.

Keeping the expedition in touch with the world by radio was but a part of my duties with the expedition. Piloting one of the cars through the day over roads that could hardly be called roads, and attending functions of various descriptions in cities consumed the balance of the time. We arrived in cities anywhere from 8 p.m. to 4 a.m., in some instances having but one hour of sleep in forty-eight. This night driving also precluded any evening radio schedule unless we laid over several days.

Crossing the barrancas of Jalisco, better described as several Grand Canyons scrambled in all directions, was indeed a task. But two cars were risked through this country, the radio car and the supply cars being loaded on the railroad and sent through on the S. P. Lines. As we camped on the brink of the barrancas for three days to make preliminary surveys by foot, before a decision was reached, I concluded that one car would be lost over the precipice in descending and

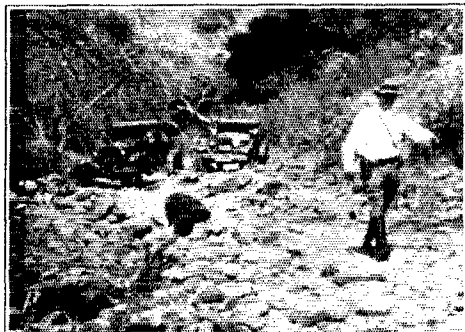

BLAZING TRAIL FOR THE CARAVAN OVER DRIED UP RIVER BEDS AND MOUNTAIN RANGES

The rocky parts were dangerous, as each rock moved held the menace of a deadly alacrana or scorpion, or the even more deadly tarantula.

that an entire day would be consumed in turning the other car around in the road so that it could be dragged out by oxen. The road we were taking was one used five hundred years ago to haul Spanish treasure from San Blas to the Atlantic

(Continued on page 72)

Bringing Frequency Measurement Up to Date

The Development of a New Type Frequency Meter

By George Grammer, Assistant Technical Editor

ONE problem of amateur radio today is that of using our frequency bands to the fullest possible extent, but without exceeding their limits. *QST* has devoted thousands of words and scores of pages to discussions on frequency precision and practical means of obtaining it; nevertheless, there are still numberless amateurs who have not yet grasped the fact that accuracy of frequency measurement is of vital importance to every one operating a transmitter and is certain to become more important as time goes on.

Measurement of frequency "to within 0.1%" (or even $\frac{1}{4}\%$ or 1%) is not something purely arithmetical, to be left to the other fellow to play with if he likes that sort of thing; it is not simply one of those things which the experimenter gets a kick out of doing; it is of most importance to the practical brasspounder, because the amount of frequency "territory" he has available for operation is dependent upon the precision of his frequency-measuring equipment as well as upon the legal limits of the amateur bands.

This does not mean that an amateur is not entitled to use all of a band simply because his frequency measuring equipment is not up to present-day standards. The bands are open to the fellow without a frequency meter as well as to the one who has a primary standard at his elbow. But it does mean that the tuning of the transmitter is restricted to those portions of the band in which the error in frequency measurement cannot result in the transmitter's being off-wave.

The reason for this should be apparent. The actual frequency of a transmitter will lie on either side of that indicated by the frequency meter, and the amount of deviation is directly proportional to the percentage error of measurement. The transmitter, therefore, must be set to an indicated frequency sufficiently removed from either edge of a band so that, allowing for error in measurement, the actual frequency will not be outside the band. A station assigned a spot frequency might legally "wander" within small limits, which limits are becoming narrower and narrower as progress is made in the development of frequency stability of oscillators and precision of measurement. Amateurs, however, are assigned bands of frequencies, and there are no frequency tolerances for services which are assigned bands. Translated into operating practicality, this means that the width of a band is

something less than the number of kilocycles specified by the regulations. It is up to the individual amateur to say how much of each band he loses, because the loss is proportional to the error in his frequency measurements.

Let us see how it works out. Suppose a transmitter is to be set to some frequency within the limits of the 7000-ke. band. A frequency meter is available which permits measurement of frequency with an error of not more than 1% — a fair estimate for an absorption-type meter. (Accuracy of measurement is something entirely different from accuracy of calibration with some meters; but more about that later on.) To be certain that the transmitter is working inside the 7000-ke. band the operating frequency as read by the meter must be between 7070 and 7228 ke. This in effect reduces the size of the band to 158 ke. — a loss of almost 50%. If the percentage error in measurement can be reduced to 0.1%, the useable limits will be widened to 7007 and 7293 ke. (an effective width of 286 ke.), representing a loss of less than 5%. In the former case the transmitter could not be set by the meter to frequencies between 7000 and 7070 ke. or between 7227 and 7300 ke. with any assurance of tuning within the legal assignments. In the second case the portion of the band which cannot be safely used is considerably smaller. The chart, Fig. 1, shows the limits of tuning in each band as set by the accuracy of frequency measurement.

Evidently there is an intensely practical need for accuracy of a high order in frequency measurement if the full width of each of our bands is to be intentionally utilized without danger of overstepping the edges. But just what is the accuracy of measurement which the average amateur can hope to attain, and how can it be accomplished? One thing is certain; we cannot afford to sacrifice any of our precious operating territory simply because we are unable to determine with our frequency-measuring devices just where that territory lies.

LIMITATIONS OF ABSORPTION METERS

The old absorption meter — so called because the energy which actuates its resonance indicator must be absorbed from the source of oscillation whose frequency is being measured — with its calibrated coil and condenser, and flashlight bulb, neon lamp, thermo-galvano meter or rectifier indicating device, has outlived its usefulness in

the amateur field. It is inherently a comparatively low-precision device — not because a coil and condenser cannot hold a calibration if carefully handled, but because the functioning of such an instrument depends upon magnetic or electrostatic coupling to the circuit being measured, and this coupling cannot be secured without affecting the tuning of both the source of oscillations and the meter — to the detriment of accurate measurement. An absorption meter might be calibrated to a high degree of accuracy — yet under any conditions differing from those under which it was calibrated the readings would be "off." The faith which some amateurs have in absorption meters either purchased with an accurate calibration or home-calibrated from standard frequency signals is as pathetic as it is misguided. And this in spite of the fact that everyone who has ever used these meters knows that a small difference in the coupling between the meter and the source of oscillation will make a noticeable difference in the scale reading.¹

Such meters may be successfully used when they are sufficiently sensitive to give an indication several feet away from a transmitter, although even then there is a possible source of error from hand capacity unless the meter is shielded from the operator's body. Unfortunately, such a meter cannot be calibrated or checked easily from standard frequency signals with such loose coupling — at least we

have never seen one which would give a good "click" several feet away from the receiver. The answer to the last problem is to mount the meter permanently near to the receiver with a

fixed degree of coupling and the calibration will hold. However, it can't be moved near the transmitter in that case and so is of no value in measuring transmitter frequency unless used in conjunction with a monitor as suggested previously in QST. This is the best method of using it, but still is not good enough, because it is difficult to accurately calibrate the meter to the required degree of precision — in fact, the monitor itself is likely to be a better frequency meter. Clicks or stoppage of receiver oscillation are not sufficiently positive for real precision of calibration or reading, although much better (when the coupling is the loosest possible) than any form of resonance indicator introduced into the tuned circuit or coupled to it. Unless the resonance indicator is extremely sensitive it will considerably broaden the tuning of a circuit which is already a great deal broader than desired, even though the best of coils and condensers are used.

The absorption meter thus falls short not only of the ideal frequency meter, but far below the working standards necessary for the accuracy of measurement required today. Its calibration is only good under certain fixed conditions which are almost never duplicated by amateurs in practice; readings are never as accurate

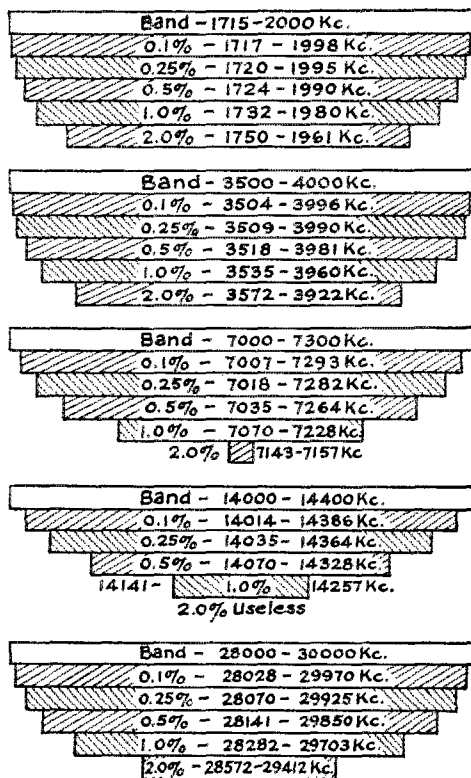

FIG. 1. — THIS CHART SHOWS GRAPHICALLY HOW TRANSMITTER TUNING IN THE DIFFERENT BANDS IS LIMITED BY THE ERROR IN FREQUENCY MEASUREMENT

Readings which cannot be guaranteed to closer than 2% in the 7000-ke. band limit the tuning to frequencies between 7143 and 7157 kc., because a setting on either side of these frequencies is likely to be outside the band. The same meter would be absolutely useless on 14,000 kc.

Absorption meters, with careful handling and a sensitive indicating device, will ordinarily give readings which are in error by two or three times the error in calibration; that is, a meter calibrated to 0.25% can be depended upon to give indications with a transmitter which will be within 0.5% or 0.75% of the actual frequency. Neon-tube and flashlight-bulb indicators are not sufficiently sensitive or sharp to stay within these limits. Readings with such indicators are often "off" as much as four or five times the error in calibration.

The following table is a fair estimate of the accuracy of different types of meters in practice:

- 0.1% — A good, stable heterodyne meter of the dynatron type.
- 0.25% — Heterodyne meter with an ordinary oscillator, or a precision absorption meter calibrated to 0.01%.
- 0.5% — Absorption meter with sensitive indicator, calibrated to 0.25%.
- 1.0% — A good absorption meter with neon-tube or flashlight indicator calibrated to 0.25%.
- 2.0% — Same type of absorption meter calibrated to 0.5%.

¹ QST, October, 1928, page 14.

as the original calibration, and often do not even approach the calibrated precision; it is never sufficiently sensitive to give a satisfactory indication of resonance with "zero" coupling, or coupling so loose as to have no effect on the readings; the resonance indications are far too broad for precision work — flashlight bulbs and neon lamps are hopeless, and even indications from galvanometers and milliammeters are not sharply defined; in fact, its sole recommendations seem to be ease of construction and cheapness — and even on the latter count it is far from being inexpensive if a sensitive resonance indicator is used.

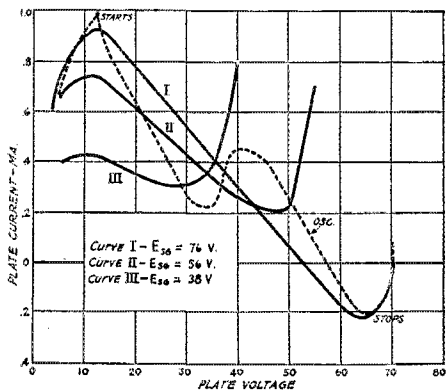

FIG. 2. — TYPICAL DYNATRON CURVES OF A TYPE 22 TUBE

The plate resistance is negative over a portion of each curve, as indicated by the decrease in plate current as the plate voltage is raised. It is equal to the slope of the line in each case. Curve I gives a value of approximately 42,000 ohms, Curve II about 56,800 ohms, and curve III about 11,000 ohms.

The dotted curve was taken with the voltages of Curve I, but with the tube oscillating at about 3600 kc. No explanation has been evolved for the "hump" in the center of the curve, although it is possible that the use of resistance to vary the plate voltage may have had something to do with it. The hump had no noticeable effect on the frequency of oscillation, which varied uniformly as the voltage was increased.

As such meters are ordinarily used, the error in readings is often several times the percentage error in calibration. A meter calibrated to within 1/4% rarely gives readings of that accuracy in the hands of the average amateur; 1/2% would be excellent, and 1% probably would be about representative. Which reminds us of one phone ham who was logged on 3600 kc. and couldn't understand it at all. He had a "good" meter that was guaranteed to be within 1/4% and it showed he was in the middle of the 'phone band. Of course he had to jam the meter right inside the inductance on his modulated Hartley to get a good reading, but what of that? The calibration was guaranteed, wasn't it?

DESIRABLE CHARACTERISTICS FOR A FREQUENCY METER

The meter which meets practical needs must be one which can be calibrated and used with

coupling so loose that its calibration is unaffected; it must be capable of holding that calibration within very small limits over a considerable period of time; and it must give positive and extremely sharp indications. The characteristics of the heterodyne frequency meter most nearly approach these conditions. The sensitivity is great enough to allow the use of coupling so loose that neither receiver nor transmitter can affect the calibration. The zero beat method of reading is so sharp that the frequency can be read to within a few cycles. The vacuum-tube oscillator, when properly designed, will hold calibration to a fairly high degree of constancy — in fact, with an oscillator which is only fair in this respect it is possible to attain a much higher degree of accuracy than with the best of amateur absorption-type meters. Practically any oscillator built with ordinary care is capable of holding calibration — and at the same time capable of being read to within 1/4% of the calibrated accuracy under reasonable conditions of use. A cheap calibrated monitor is better than an absorption meter unless one wishes to pay a few hundred dollars for special meters such as are used with high-power transmitters — which incidentally lose a great deal of their accuracy with low-power sets.

But a simple ordinary oscillator, even though better than an absorption meter, is not good enough. When a fair degree of accuracy is to be attained, minute changes in calibration cannot be lightly ignored. There is a vast difference between attaining an accuracy within 0.5% and within 0.1% — a difference of much more than 5 to 1, as the figures would indicate. Oscillator frequency stability of the order of a few hundred cycles about a mean frequency is much harder to obtain than stability of the order of a few kilocycles (at amateur frequencies) — so much so that such things as tube and room temperature make noticeable differences. The constancy of the plate and filament supplies becomes of increasing importance.

At low radio frequencies it is possible to build a tube oscillator which will maintain its frequency to 1 part in 10,000 or better, but this becomes increasingly difficult at 3000 kilocycles and higher because the effect of tube characteristics — the most variable elements in the circuit — becomes more pronounced. With careful construction and a high-C circuit, however, a satisfactory oscillator can be constructed. A heterodyne frequency meter of this type has already been described in QST.² At frequencies higher than 3500 kc., however, the high capacity required for stability makes oscillation difficult, and at the same time harmonics are weakened by the high-C circuit so that the 3500-ke. oscillator will not always give satisfactory harmonic signal strength on the 7000- and 14,000-ke. bands. In addition, there are

² "A High-C Heterodyne Frequency Meter," QST, November, 1929.

constructional difficulties involved in getting the right values of fixed condenser capacities and grid leak resistance, and adjusting the tickler for smooth oscillation over the entire band without too-weak oscillation at one end and too-strong oscillation at the other.

A BETTER TYPE OF OSCILLATOR

There is another type of oscillator, however, which is free from these objectionable features — the pliodynatron or dynatron. Although not new in principle, since information on it was first published about twelve years ago, it has been largely neglected because of lack of vacuum tubes which had a suitable negative resistance charac-

oscillator circuit consists simply of a coil and condenser — no tickler, grid leak or blocking condensers are required. No juggling of tickler or grid coil turns to secure band-spreading and smooth oscillation simultaneously is necessary. The thing simply oscillates or doesn't — depending on the negative resistance of the tube and the parallel impedance of the tuned circuit. The construction of an oscillator of this type is so easy that even if it had no other advantages over the ordinary tube oscillator this point alone would recommend it.

The screen-grid type tubes have a pronounced negative-resistance characteristic over a portion of their plate characteristics.⁴ Both the Type '22 and Type '24 tubes are good oscillators at frequencies of 3500 kc. and even higher. It is sometimes hard to get dynatron oscillators to function at frequencies higher than 10,000 kc. because of the difficulty of building tuned circuits of sufficiently high impedance, but since good practice in heterodyne frequency meter design dictates the use of the lowest frequency band to be covered as the oscillator frequency, and the use of harmonics for the higher bands, this obstacle is immaterial. The frequency meter may cover the 3500-kc. band and the second and fourth harmonics will take care of the other two most popular bands.

With the dynatron oscillator it is possible to use a lower C/L ratio for good frequency stability than with the ordinary tube oscillator, which removes the objection to loss of harmonics with high- C circuits. A small amount of fixed capacity in the tuned circuit is beneficial, but it need not be so large as to decrease the strength of harmonics.

Summing up, the points of superiority of the dynatron oscillator over the ordinary tube oscillator are these: first, it is more stable; second, harmonic strength can be secured without loss of stability; third, construction is much simpler; fourth, it is possible to have a constant check on the operation of the meter, as will be explained later, which eliminates the effects of aging of batteries and decrease of filament emission during the useful life of the tube; fifth, less apparatus is required than with the tube oscillator, decreasing the number of elements in the meter which can for various reasons change the calibration with time.

SUITABLE TUBES

While the screen-grid tubes exhibit the best dynatron characteristics of tubes available at present, they are by no means the only ones which do so. Some triodes also show a negative-resistance characteristic, although they are less uni-

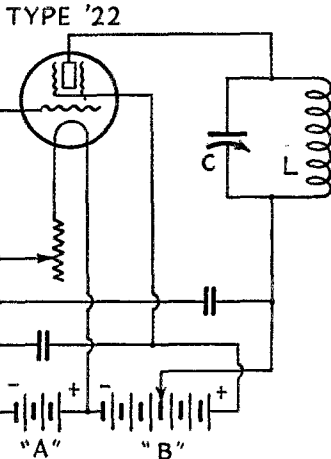

FIG. 5. — THE DYNATRON OSCILLATOR CIRCUIT

The frequency of oscillation is determined chiefly by the inductance L and condenser C . The other two condensers are used to maintain the screen grid and lower end of the tank circuit at the same r.f. potential as the filament, and should be rather large (0.5 to 1.0 $\mu\text{fd.}$) by-pass condensers.

Oscillations will start when the negative resistance of the tube is equal to or less than the parallel impedance of the tuned circuit. In simple language the losses of the tuned circuit are "wiped out" by the negative resistance of the tube, and once the oscillations are set up — as they will be if there is only a very minute change in plate current — they will continue so long as the negative resistance is maintained at the proper value. The amplitude of oscillation will be determined by the value of the negative resistance and the operating limits of the tube.

teristic.⁵ It is a very stable oscillator when lightly loaded, although few of the tubes now available are capable of developing an appreciable amount of power without loss of stability. However, no power is taken from a frequency meter, so the desirability of the dynatron for such a purpose is not lessened on account of low power output.

Aside from the fact that it is comparatively easy to build a dynatron oscillator which will maintain frequency stability better than a good tube oscillator of ordinary type, the whole constructional job is greatly simplified. The

³ "The Dynatron," *QST*, February, 1930.

⁴ The four-element tube more properly should be called a "pliodynatron" when its dynatron characteristic is utilized. However, the distinction is quite academic and the term "dynatron" may be used.

form in this respect than the screen-grid tubes. Several tubes of the '71-A type made by one manufacturer were excellent dynatron oscillators in some tests made in the laboratory, while other '71-A's of different manufacture could not be made to oscillate. Other three-electrode tubes behaved similarly. On the other hand, we have yet to find a screen-grid tube which would not oscillate, although some are better than others.

After a number of tests of both Type '22 and '24 tubes as dynatron oscillators, it was finally decided that the '22 was more suitable for frequency meter use. To those who are familiar with the dynatron characteristics of these two types of tubes this decision may at first glance seem a little odd, since the '24 has a much lower negative resistance than the '22 and therefore is a better oscillator. For frequency stability, however, the negative resistance should be high. This follows from the equation for the frequency of oscillation, which is

$$f = \frac{1}{2\pi} \sqrt{\frac{1}{LC} - \left(\frac{R}{2L} - \frac{1}{2\bar{r}C} \right)^2}$$

where L and C are the inductance and capacity of the tuned circuit, R is the resistance of the tuned circuit, and \bar{r} is the negative resistance of the dynatron.⁵ The values of L , C and R will not change appreciably in a practical circuit if the coil and condenser are of good solid construction and if no extraneous material (not a part of the meter) is introduced into the field of either the coil or condenser. Temperature changes will have some effect on these quantities and so the temperature should be constant for best stability. However, this effect is smaller than some others which cannot be well avoided and is not bothersome unless the change in temperature is greater than that encountered in an ordinary room.

The negative resistance of the dynatron is subject to variation from changes in battery voltage, grid bias and filament emission, and these variations must be kept to a minimum if the oscillator is to be stable. Since \bar{r} appears only in the denominator of the last term of the equation, it is evident that the larger \bar{r} is made the smaller will be that term, and consequently small variations in negative resistance will have less effect on the frequency than if \bar{r} were small. There is a practical limit beyond which \bar{r} cannot be increased, however, because if it is greater than the

parallel impedance of the tuned circuit $\frac{L}{Ck}$ the circuit will not oscillate. The quantity $\frac{L}{Ck}$

must, therefore, be made as large as practicable, which can be done by using a large inductance and small capacity and keeping the resistance

low by the use of a good coil and condenser. The quantity C , however, includes the capacity between the plate and screen grid of the tube, which is quite likely to change somewhat as the tube warms up, giving rise to frequency drift. Therefore a compromise must be made which will allow the use of such values of \bar{r} and C as will give good dynamic stability with a minimum of frequency drift. In practice the quantities can be worked out in such proportions that the frequency will drift less than 1000 cycles at 3500 kc., even starting with the tube cold. The Type '22 is noticeably better than the '24 in this respect; it operates at much lower filament temperature, which greatly reduces the time required for the

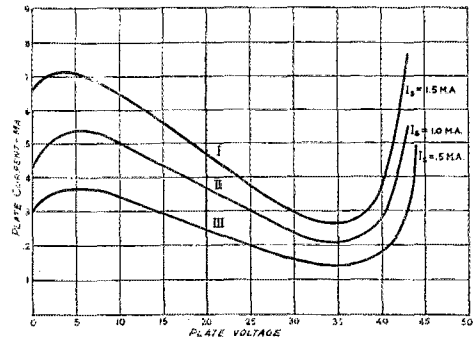

FIG. 4. — VARIATION OF NEGATIVE RESISTANCE WITH CONSTANT SPACE CURRENT

The screen-grid voltage is fixed, and the space current, I_b , changed either by variation of filament emission or grid bias.

tube to reach its operating temperature and thus reduces the time during which the frequency drifts, and at the same time the amount of drift during warming up is less than with the '24 because the smaller amount of heat developed results in less expansion of the tube elements and therefore smaller capacity change.

After the proper constants have been decided upon, there is still the problem of maintaining the negative resistance of the tube at a constant value. One method would be to keep plate voltage, screen-grid voltage, filament emission and control-grid bias constant. The tube is more sensitive to changes in filament emission and bias voltage than to changes in plate or screen-grid voltages, but the latter affect the frequency sufficiently to require a constancy of the order of a few per cent to be within the allowable limits. This would make the use of several voltmeters necessary and increase the expense unduly. Fortunately — and this is yet another point of superiority of the dynatron over the ordinary tube oscillator — a single inexpensive milliammeter provides a visual indication of the operating conditions if connected in the circuit so that it reads the total current furnished by the "B" battery.

A glance at the curves of Fig. 4 (taken from

⁵ A. W. Hull, "The Dynatron," Proc. I.R.E., February, 1918.

July QST⁶⁾ shows that with fixed screen-grid and plate voltage the negative resistance is a function of the total space current. It seemed that this relation also should hold with different screen-grid and plate voltages if the ratio between the two voltages was held constant. Measurements were taken on a number of tubes of differ-

the calibration will hold. Adjustment of the filament rheostat or grid bias to maintain the correct value will compensate for loss of voltage in the batteries with age, and also for loss of emission during the life of the tube. Actual tests by beating the dynatron oscillator against a crystal-controlled oscillator and varying the screen-grid and plate voltages on the dynatron confirmed this. With changes in voltage of the order of 25% (representative of the usual drop in battery voltage during useful life) the frequency never changed more than 250 or 300 cycles — less than 0.01%.

A PRACTICAL STANDARD OF PRECISION

We can now answer with some degree of certainty the question raised at the beginning of this article — what degree of accuracy in frequency measurement the average amateur can hope to reach. With a maximum variation of frequency from all causes in a well-constructed dynatron oscillator of less than 1300 cycles at 3500 kc. it is possible to make a few simple calculations which will indicate the accuracy which can be expected. Oscillator vagaries represent a frequency variation of the order of 0.04%. With a good vernier dial which can be read to a tenth of a scale division (100-division scale) it is possible to return to within 600 cycles of a previous setting if the band is spread over 85% of the scale, representing a possible error of 0.02%. Standard frequency transmissions are within 0.01% of the frequency announced at the time of transmission. The sum of these possible errors — which in some cases may cancel each other instead of being additive — is 0.07%. No allowance has been made for errors in getting zero beat settings either in calibration or taking readings, for with reasonable care these will be so small as to be negligible. Even with a little allowance for errors which may creep in from other causes the useful accuracy with an intelligently operated, well-constructed meter will be within 0.1%, which is a very good standard for amateurs to set for themselves — and better accuracy than this is entirely possible.

An idea of just what such accuracy means can be gained by considering that it is possible to set the receiver by the frequency meter to pick up a signal of known frequency which, when heard, will be within beat-note audibility on the 3500- and 7000-kc. bands, and possibly also on 14,000 kc. Accuracy to within 0.1% is the least which can be tolerated if the edges of our bands are to be as fully utilized as the centers, and at the same time represents a good working standard for the average amateur. Undoubtedly some will be able to better this figure considerably — the standard frequency transmissions are ten times as good and are there for everyone's use. Improvements in oscillator stability and methods of resetting

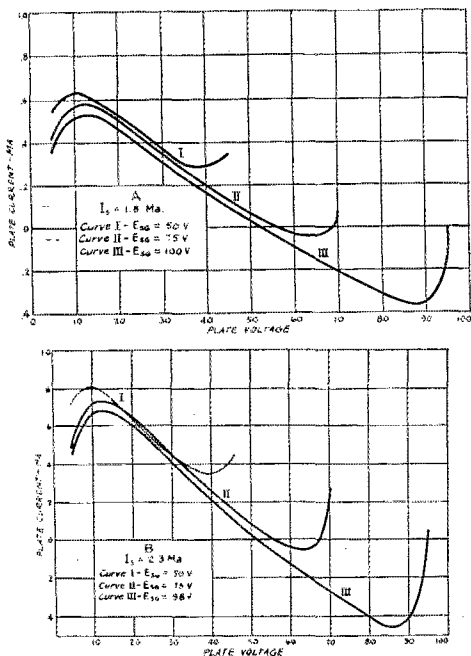

FIG. 5

The curves illustrate the point brought out in the text — that the negative resistance is approximately constant so long as the ratio of screen-grid voltage to plate voltage is unchanged, provided the total space current to the filament is constant.

In Chart A the space current, I_s , is fixed at 1.8 ma. The straight portions of the curves are parallel, indicating that the negative resistance is the same in each case. In Chart B I_s is 2.3 ma. The same relation holds for the higher plate and screen-grid voltages but shows signs of variation at the lowest voltage. For least variation, therefore, the plate and screen-grid voltages should be comparatively high and I_s comparatively low. This relation results in greater amplitude of oscillation and low filament emission, both of which are desirable.

ent manufacture and this was found to be true within rather wide limits of changes in actual voltages so long as the ratio between them was nearly constant. Values of filament voltage and control-grid bias were immaterial so long as the space current was fixed at a convenient value and held there. The curves of Fig. 5 for a typical tube illustrate this. A low-range milliammeter inserted in the negative "B" lead provides a ready indication of the conditions in the tube, and if the space current is always maintained at the value at which the oscillator was calibrated,

⁶ "Impedance Measurement With the Plidynatron," page 39, QST, July, 1930.

(Continued on page 35)

The QST Lab. Capacity Bridge

By Beverly Dudley*

TO the experimentally inclined radio amateur the multitudinous uses of a capacity bridge are at once apparent. A capacity bridge is also a useful adjunct to the equipment of the amateur interested in the less technical side of radio communication. With it he can determine not only the maximum and minimum capacity of the tuning condenser in his receiver, but also the actual total circuit capacity including the capacity of the wiring, socket and associated apparatus. The correct size of the grid and plate blocking condenser to insure best operation in a transmitter may be measured; the useful capacity of the transmitter tuning condenser may be checked to determine whether or not the transmitter is actually high-C or not. Condensers may be aligned and checked in the broadcast receiver when necessary, and by doing a good turn for the BCL the amateur is less likely to be bothered by telephone calls reporting the "peculiar clicks which break up the program from WTIC." But these are only some of the uses of the capacity bridge.

With a capacity bridge available, one can determine (at least to a close approximation) other important factors which should largely take the guess work out of amateur operation, design, and construction.

For instance, knowing the frequency at which a given circuit resonates, and then measuring its capacitance, it is a simple matter to determine quite accurately, the inductance of the circuit. This method can always be relied upon, for the product of inductance and capacity are directly related to the frequency of the circuit, and is especially valuable at high frequencies where mathematical calculations fail because it is impossible to account for stray or distributed inductance or capacitance. This relationship between inductance, capacitance and frequency makes it possible for the amateur to determine the number of turns to use on a given coil form for any frequency band if the capacity used is known.

Then, too, lots and lots of the condensers which are sold nowadays don't have anything like the actual capacity marked on the bakelite case. We recently came across one condenser which was marked as having a capacitance of 250 μfd . We found, upon measurement, that the actual capacity of the condenser was 425 μfd .—an error of 70%. One or two condensers of this sort in the tuned circuit of a transmitter would

certainly put the amateur out of the band if his calculations were made on the assumption that the condenser was a 250- μfd . unit.

But fixed condensers marked with their supposed capacity aren't the only condensers whose actual capacitance is not known. What



THE CAPACITY BRIDGE OPEN FOR USE

about that neutralizing condenser? Has it a capacity of 10 μfd . or 100 μfd .? What capacity is actually used in the circuit when the plates of a variable condenser are not entirely enmeshed? What size should be used to give full dial coverage of the amateur band, and how shall its capacitance be determined? Perhaps the wiring of the set is such that the circuit capacity is high; maybe high circuit capacity causes the tube to go into parasitic oscillation and behave erratically! A simple capacity bridge, such as described in this article, will help solve all these problems.

The accuracy and simplicity of bridge methods have made them almost universally accepted for the measurement of capacity, especially for values smaller than one microfarad. Although there are a number of bridge arrangements, all

* Former Assistant Technical Editor, QST.

of them depend for their operation upon the balancing of potentials in the bridge arms so that the current through the indicating device is zero for the condition of balance.

The bridge described in this article has a range from 10 $\mu\text{fd.}$ to 0.05 $\mu\text{fd.}$, and if carefully calibrated its accuracy will be well within 3%,

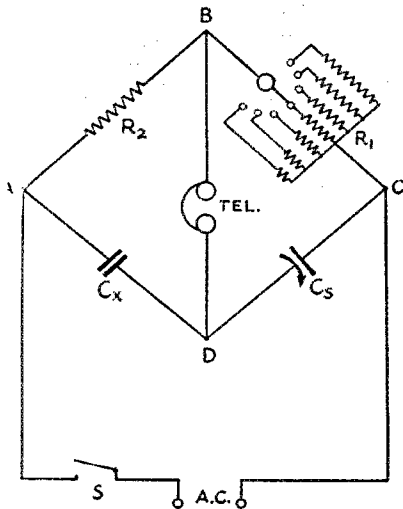

FIG. 1. — SCHEMATIC WIRING DIAGRAM OF THE BRIDGE

which is sufficiently accurate for amateur requirements. A schematic wiring diagram of the bridge is shown in Fig. 1, a layout diagram in Fig. 2, and the two photographs show the constructional details of the bridge. Accurate resistors, R_1 and R_2 , form two arms of the bridge. The third arm contains a calibrated variable air condenser, while the fourth arm is formed by the condenser whose capacitance it is desired to measure. All of the equipment used in the construction of the bridge is readily available to the amateur on the open market at reasonable prices.

The condition of balance in any bridge obtains when the arms of the bridge are adjusted so that the current through the indicating device (in this case a headset is used) is zero. That this condition be fulfilled the voltage drop across AB must equal the drop across AD , and similarly the drop BC must then equal that across DC . When the adjustments of balance are obtained,

$$\frac{C_x}{C_s} = \frac{R_1}{R_2}, \quad (1)$$

where: C_x is the capacitance of the unknown condenser,

C_s is the capacitance of the known or calibrated condenser,

R_1 is the resistance of the bridge arm BC , and

R_2 is the resistance of the bridge arm AB .

By multiplying both sides of the equation by C_s , Eq. (1) may be rewritten to give the capacity of C_x directly. The capacity of the unknown condenser is then given directly by:

$$C_x = C_s \left(\frac{R_1}{R_2} \right) \quad (2)$$

It will be seen from Eq. (2) that the capacitance of the unknown condenser, C_x , may be determined if we know (A) the ratio of the resistance R_1 to R_2 , and (B) the capacity of the standard condenser, C_s , at the setting which gives the null indicative of the point of balance.

The fact that the capacity of C_x depends upon the ratio of R_1/R_2 is a decided advantage in extending the useful range of the bridge, for by making this multiplying ratio less than unity we can measure condensers whose capacitance is less than that of C_s , whereas by making this ratio greater than unity, condensers whose capacitance is greater than that of C_s may be determined. The use of an adjustable ratio R_1/R_2 permits the single calibrated condenser to be used in making a variety of measurements of capacitance either smaller or larger than the capacity range of C_s . It will be seen from Eq. (2) that if the capacity of the standard condenser for a given bridge balance adjustment is 500 $\mu\text{fd.}$ and the ratio R_1/R_2 is 100, the capacitance of the unknown condenser will be 50,000 $\mu\text{fd.}$ or 0.05 $\mu\text{fd.}$ Similarly, if the condenser C_s were to be set at 500 $\mu\text{fd.}$ for the balance point and the multiplier switch set so as to select $R_1/R_2 = 0.1$, the capacity of C_x will be 50 $\mu\text{fd.}$ The limit of capacity measurements with this bridge is from approximately 10 $\mu\text{fd.}$ to about 0.05 $\mu\text{fd.}$, and the bridge is accurate to within 3% over this range.

The construction of the bridge is not difficult — in fact it is much simpler than the construction of a single tube receiver. A list of parts used in the bridge is given at the end of this article. All of the parts should be obtained before the construction of any portion of the bridge is started.

The accuracy of the bridge will depend upon the accuracy of the components going to make up the bridge as well as upon the care with which the bridge is constructed and calibrated. Therefore, it pays to purchase well-made and accurate component parts and to take sufficient time in the construction of the bridge to make a good electrical and a substantial mechanical job of its construction. The standard condenser, C_s , should be a straight-line-capacity condenser (the kind with semi-circular plates) so that its capacity may be easily determined from its calibration chart. If a straight-line-wavelength, a straight-line-frequency, or some other hybrid condenser is used in the bridge it will not be so easy to obtain a balance and correctly interpolate readings because of the manner in which the capacity variation occurs. In general, a condenser having a maximum capacitance of 500 $\mu\text{fd.}$ is quite satisfactory; a condenser smaller than 250 $\mu\text{fd.}$

should not be used because of the lower ratio of maximum to minimum capacity of the smaller condensers.

The resistors for use in the bridge should be non-inductive, should have negligible capacitance, and should be accurate; the more accurate the better. The error in the resistance values of R_1 and R_2 affects the accuracy of the bridge, as may be seen from Eq. (2). The error introduced is approximately equal to the algebraic difference of the errors in R_1 and R_2 . If R_1 and R_2 are each accurate to within 1% of their specified resistance, errors of as much as 2% may be present. Similarly, if R_1 and R_2 are accurate to within $\frac{1}{4}$ of 1% the bridge cannot be depended upon for accuracy greater than $\frac{1}{2}$ of 1% of the correctly calibrated value. The type 6M resistors manufactured by the Shalleross Mfg. Co. used in this bridge, since they fulfill the conditions given above, are accurate to within 1%, and are reasonable in price. Moreover, being small in size, they may be easily and conveniently mounted, as may be

possible short circuits or grounds. No. 14 copper wire, covered with heavy spaghetti, is used in wiring the bridge, and since all wires are heavy

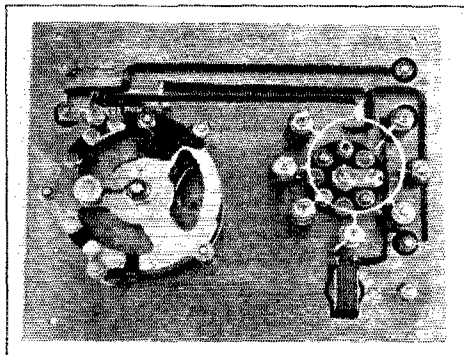

THE SIMPLICITY OF THE BRIDGE CONSTRUCTION IS APPARENT FROM THIS VIEW OF THE INTERIOR

The variable condenser is a Marco with a maximum capacity of 500 μ fd.

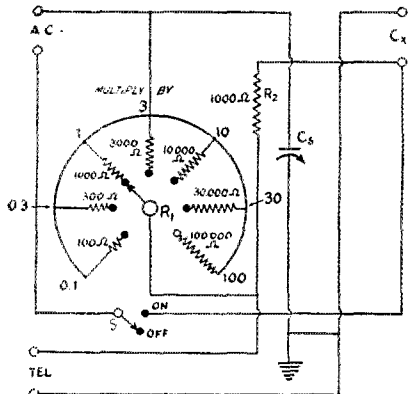

FIG. 2.—DIAGRAMMATICAL WIRING CIRCUIT OF BRIDGE

C_s is the standard 500- μ fd. straight-line capacity condenser. The resistors used in the circuit are plainly marked.

seen from the cut showing the interior of the bridge.

The cuts show the layout and the method of mounting the apparatus. The bakelite panel upon which the apparatus is mounted is backed with heavy copper sheeting. Both the bakelite panel and the copper sheet are drilled at the same time so that all holes will coincide. The copper sheet is later cut away around the binding post, the a.c. switch, and the multiplier switch, to prevent short circuits; as shown in the photograph of the back of the bridge. The cabinet housing the bridge is also lined with copper.

When the panel has been properly drilled, finished, and engraved, the parts are mounted and wired according to the diagram of Fig. 2. The wiring is simple and the only precaution to observe is to provide sufficient clearance to avoid

and short, it is possible to make all connections rigid and solid.

When the bridge is properly wired the condenser C_x should be calibrated. Ordinarily this is a difficult task for the average amateur to accomplish, because variable condensers suitable for calibration purposes are seldom available. There are available to amateurs, however, methods of calibrating C_x sufficiently accurate for all amateur requirements.

The best procedure to follow in calibrating the bridge is to calibrate the condenser C_x against another condenser of known calibration. A source of a.c., preferably of 1000 cycles or of other pleasing high pitch (which may be obtained from a vacuum tube oscillator, tuning fork generator, or buzzer) is connected to the posts marked C_x and the switch S is closed. A hum will be heard in the phones which should be balanced out by adjusting the switch R_1 and by varying C_s until the hum disappears. In the event that it is impossible to obtain a well defined null point, the difficulty may usually be traced to excess pick-up from the generating apparatus. When the null point is obtained, the capacity of the condenser C_x will be equal to the capacity of the standard condenser divided by the multiplying factor of the switch. With this method of calibrating the bridge, a calibrated standard condenser is required.

A laboratory type standard condenser is desirable for this purpose but is not available to the majority of amateurs. However, the General Radio Co. case mounted type 247 condensers may be obtained with a dial calibrated directly in capacity, the error of this dial calibration being approximately 2%. This condenser

may be used as an inexpensive standard, or if used as C_s in the bridge, it will need no calibration other than that afforded by the dial supplied with it.

Another method of calibrating the bridge is to balance the bridge when fixed condensers of known capacity are connected across the posts marked C_s . As before, the capacity of C_s will be equal to the capacity of the fixed condensers divided by the multiplying factor of the switch,

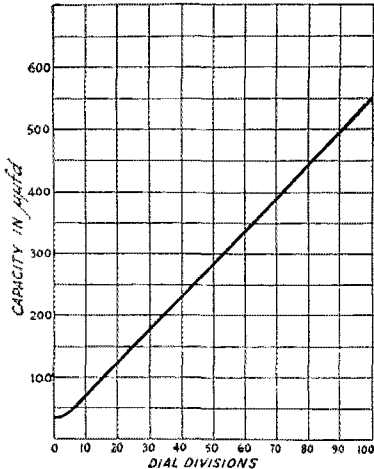

FIG. 3.—CALIBRATION CURVE OF THE STANDARD CONDENSER

This calibration is for C_s , or will apply to C_x if the rotary switch is set at 1. For the rotary switch set at any other value, C_x will be determined by reading the capacity of the standard condenser from the calibration chart and multiplying this by the multiplying factor of the ratio arms. Notice the curve at the low capacity end of the dial representing the minimum capacity of C_s . Needless to say, this calibration curve will not apply to your own meter.

but because the fixed condensers are seldom accurate to greater than 5% of their rated capacity, a number of fixed condensers of the same and of various capacities should be used to provide several good checks on the calibration of C_s . Enough checks should be made so that it will be possible to draw a smooth calibration curve through the points representing the capacity calibration of C_s .

In the event that none of these methods is available to the amateur, a graphical method of calibration may be resorted to if a straight-line capacity condenser is used and if the maximum capacitance of the condenser is quite accurately known. The minimum capacitance of 500- $\mu\mu\text{fd.}$ condenser is about 35 $\mu\mu\text{fd.}$ when mounted in a shielded case, whereas for the 350- $\mu\mu\text{fd.}$ and 250- $\mu\mu\text{fd.}$ condensers, the minimum capacitances are approximately 25 $\mu\mu\text{fd.}$ and 30 $\mu\mu\text{fd.}$, respectively. Assuming these values for the minimum capacitances of the condenser and knowing the maximum capacitance of the

condenser at 100, a straight line curve may be drawn through these two points for the calibration of the condenser. While this method of calibration is not entirely accurate, it will usually suffice for the measurements required in the average amateur station. Even though the absolute error with such calibration may be large, the bridge will still be useful for comparative purposes.

The list of parts used in this bridge is given below:

1 Wooden box with cover, 9 $\frac{1}{2}$ " x 7 $\frac{1}{2}$ " x 6 $\frac{1}{2}$ "	\$3.50
1 Bakelite panel, 9" x 7" x 3/16"	.75
1 500- $\mu\mu\text{fd.}$ straight-line capacity variable condenser	5.00
1 Four-inch dial and marker	1.00
1 Seven-point inductance switch	.50
1 100-ohm resistor	1.50
1 300-ohm resistor	1.50
2 1000-ohm resistors	3.00
1 3000-ohm resistor	1.50
1 10,000-ohm resistor	1.50
1 30,000-ohm resistor	1.50
1 100,000-ohm resistor	2.00
1 Closed circuit switch	.50
6 Binding posts	.60
Copper shielding	1.00
Engraving	1.75
Total	\$27.10

A New Line of Power Transformers and Chokes

THE Acme Apparatus Corp., Cambridge, Mass., has just placed on the market a new series of transformers and filter chokes designed to take care of practically all amateur requirements. They are conveniently divided into two groups; for low-voltage tubes (suitable for receiving power-packs and transmitters which do not require more than 600 volts), and for transmitters of medium and high power.

In the low-voltage group of transformers, both plate and filament windings are included in the same unit. The largest transformer of this classification has a capacity of 250 V.A. The filter chokes to be used with these transformers are rated at 15 and 30 henrys, with current-carrying capacity ranging from 50 to 150 ma.

The transformers and chokes in the high-voltage group are all insulated for 7000 volts. Plate and filament transformers are separate units. The plate transformers are made in sizes ranging from 300 to 1000 V.A., and supply 1000, 1500 or 2000 volts each side of the center-tap. Filament transformers are designed to furnish the standard voltages for transmitting tubes and high-voltage rectifiers. The chokes are manufactured in four values of inductance, with current-carrying capacity ratings from 150 to 500 ma.

In addition to the above, The Acme Apparatus Corp. now manufactures an auto-transformer, 220-110 volts, in 250- and 500-V.A. sizes. Microphone transformers for both single and double-button microphones are also available.

QSY With Crystal Control

By Boyd Phelps, W2BP-W9BP*

CRYSTAL control is generally accepted for commercial and broadcast transmitters where tolerance of only a few cycles deviation from one particular assigned frequency is permitted. For operation in a band, as in the case of the amateur, it has not such a strong argument but the advantages to be realized from stability are not to be overlooked and any good amateur station should take pride in always being found close to the same spot in the band for schedule operation, in not creeping out of tune of the distant receiver, and in not spreading over a hog's share of the band, not to mention being *in* the band — and a few other arguments.

But this rigid inflexible stability sometimes is a hardship and is one of the few reasonable arguments left against crystal control. I have fought through hours of QRM from two other stations on the same frequency as my crystal and being just as stubborn as they, stuck it out until daylight overtook us. (Eastern stations on 3500- kc. 'phone can be practically put out of business by low power 'phones a few hundred miles further west). When spasmodic semi-intelligent communication was established I was told that if I could shift a few kilocycles I would be free of QRM. I have tried grinding crystals for these mythical QRM-less holes, as others have done, with the conclusion that they are "subject to change without notice." The switching in of several crystals seems like a partial solution, though interference is often as bad on the new frequency, capacity losses in the switching arrangement reduce output, and the distant station cannot find you again in a different section of the band, especially since he probably did not get your telling him about where you were shifting to. These conditions can be remedied usually by a moderate shift in frequency, or at least remedied as much as general congestion in the band permits.

It is well known that several factors change crystal frequency. A variable condenser connected across the holder terminals will lower the frequency as this capacity is increased and it is a good method of obtaining final synchronism of two transmitters or final adjustment of a standard. However, when this capacity is a few microfarads the crystal stops oscillating and the range is only about a hundred cycles in a million, with reduced output as the capacity is increased. Temperature variation suggests another way of dodging interference if one wants to keep crushed

ice and a blow torch handy to manipulate the frequency as conditions demand. While water cooled crystals may have suggested themselves to some unfortunate amateurs, variation of frequency by juggling temperature is slow, sluggish and accompanied by the necessity of closely maintaining the finally chosen temperature as against changes due to heat radiation, convection and conduction.

To make a long story short, adjustment of the top plate above the crystal instead of resting on it represents one of the easiest ways of varying the

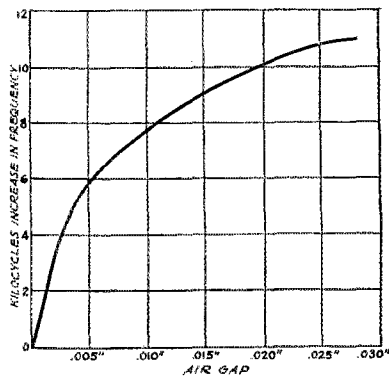

FIG. 1

frequency. A surprisingly large frequency variation can be covered by regulating the air-gap above the crystal and still maintaining the characteristic crystal frequency stability over this range. As the pressure of the top plate on the crystal is reduced and some air gap introduced the power output actually increases, since decrement (mechanical loading) is reduced.

Reference to the curve of Fig. 1 shows a variation of frequency with air gap, with 11 kc. as the maximum. This curve was plotted from data obtained on a random picked ordinary 30-degree cut crystal in the 3500-ke. band using a Type '10 with 6 volts on the filament and 60 on the plate with a quarter megohm grid leak across the crystal in the ordinary conventional circuit. A micrometer opening up to two inches was fitted with a flat-faced plug over the movable side of the jaw and formed the top electrode. Frequency settings could be duplicated to about a hundred cycles without difficulty with this arrangement, which is about the change caused by a change in room temperature of one degree Centigrade. The power did not vary considerably over the lower portion of the curve that is practically a straight line but began to fall off when the frequency

*8505 167th Street, Jamaica, L. I., N. Y.

passed the 7-ke. deviation point and very rapidly between 10 and 11 ke. in this case. It is interesting to note that oscillation continued with an air gap even greater than the thickness of the crystal.

Let us examine for a moment what this possible shift may mean in reducing interference. In the first place it has little use on an amateur receiver having audio response much above 2,000 cycles and it usually is a disadvantage. (The A. T. & T. Co. transatlantic phone passes modulation only up to 2,500 cycles.) Peaked audio for code reception has been admirably covered in *QST* by Hatry, Hull, Bourne and others. Some amateurs

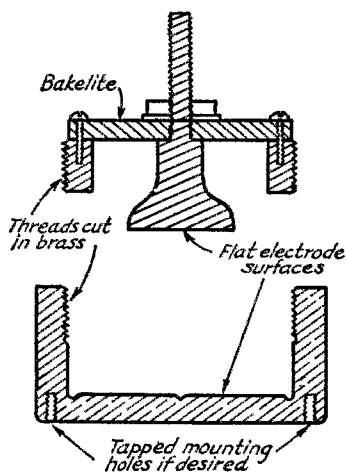

FIG. 2

in receiving do not make use of the fact that the relative beat note of two incoming signals can be transposed by working them on the other side of zero beat. For example, in getting nicely started copying a long message coming in on a beat note of 1500 cycles, an interfering station with a strong 500-cycle heterodyne busts the message. He may have heavy a.c. modulation or be too unsteady to hold at zero beat while the msg is copied on 1000 cycles, so the beat of the desired station is run through zero beat to the other side and up to a high enough pitch so that the interference (now a higher beat note than the desired signal) is relatively inaudible due to cut-off of the audio system. Some hams have been known to fight along with interference of about the same beat pitch but on the opposite side of zero beat. In such a case when the tuning vernier is moved, one note goes up and the other down and the stations separate themselves though in reality their transmitted frequencies are 3 ke. separated. From this discussion it may be seen that a frequency shift of 2 ke. ordinarily will be enough to permit copy even if the interfering station is exactly on top of the desired signals (the worst

condition) for this shift would permit reception at 1 to 2-ke. beat note with the interference at 3 to 4 ke.

From the curve it will be seen that operation with a little over .001" air gap will permit a 2-ke. variation of frequency in either direction by screwing the top electrode up or down. As mentioned previously and noted from the curve, this may be greatly extended to about 8-ke. variation with slight decrease in crystal output which may not necessarily reduce antenna input and even so is justifiable for improved communication. It is also to be noted that these frequency changes are with respect to the fundamental of a crystal in the 3500-ke. band. The effect is doubled in the 7000-ke. band and is four times as much in the 14,000-ke. band. In other words, a 44-ke. frequency shift is possible in the 14,000-ke. band and 20-ke. shift is entirely practicable.

After all the hashing up of the "Q" signals at the last International Convention and supposed modernizing of them, there is no adequate signal to request such a frequency shift. Our old ham-brew QSS signal got written into the new code in several places (QSB, QSC, QSE, etc.) and possibly if we suggest something to handle this situation it may find permanent use although probably with different letter designation. The following is easily remembered and leaves no doubt as to whether the frequency or wavelength is to be raised or lowered:

QIF: If possible please increase your frequency to avoid interference (or to get back in the band —hi).

QDF: Decrease frequency of your transmitter slightly.

NOTE.—The signal may be followed by a number designating the ke. shift requested. In the absence of this it is assumed to be approximately 2 ke. for telegraphy and 4 to 5 ke. if communicating by telephony.

THE HOLDER

The design of an adjustable air gap holder can take a number of forms according to the material and machine equipment at the disposal of the builder. The important and only difficult part of the job is to have the top plate mounted so it is parallel with the crystal or the bottom plate and will remain so as the air gap is varied. One should try and get it flat to .0001" and remain parallel to the same precision but for wide air gaps this is not so important. Of course the top plate must be insulated from the bottom plate and bakelite is far preferable to rubber or fibre.

If access is had to a machine shop the holder may follow Fig. 2 in which is shown a round brass cup with a hole 1½" in diameter, ¾" deep, and with a ¼" thick wall. The last two operations on the cup should be the cutting of the thread and light finishing cut on the bottom face against which the crystal is to lie. These two operations

(Continued on page 74)

Experiments With Dynatron Oscillators

By O. P. Susmeyan, W1BLH*

APPRECIABLE interest has been shown of late in vacuum tubes having negative-resistance characteristics. The primary purpose of this paper is to further stimulate this interest and to emphasize that these devices and their applications constitute extremely interesting material for study and experimentation. Illustrating one application, a heterodyne frequency meter using a negative resistance tube as an oscillator is described.

A number of years ago A. W. Hull produced a special form of three-electrode vacuum tube which made use of the phenomenon of secondary emission. This tube had a peculiar voltage current characteristic: For a certain range of plate potential, the plate current decreased with increased plate voltage. In other words, part of the E_p-I_p curve had a negative slope and the device acted as a negative resistance. Hull called his tube the "dynatron."

The "falling" characteristic of the dynatron is due to the emission by the plate of impact or secondary electrons and has been well explained in an earlier issue of *QST* by W. H. Newbold. It is on this part of the characteristic that the operation of the dynatron is based. The tube, when properly designed, can be used as detector, amplifier or oscillator. The latter case will be reviewed briefly here.

Fig. 1 shows a dynatron connected as an oscillator. Hull has made a mathematical analysis of the circuit and has shown that it can oscillate if $r < \frac{L}{RC}$ where L , C and R are, respectively, the tank circuit inductance, capacitance and resistance at the resonant frequency; and r is the positive numerical value of the dynatron negative resistance. The frequency of oscillation is, in most practical circuits, given to a close approximation by $f = \frac{1}{2\pi\sqrt{LC}}$. It follows that the range of the frequency of oscillations is limited by the negative resistance of the tube and the L/RC ratio of the parallel circuit. This limit can be widened either by increasing the impedance of the tuned circuit or by decreasing the negative resistance

of the dynatron. By doing both, the writer has been able to generate frequencies of the order of 14,000 kc.

The impedance of the parallel circuit can be made a maximum by proper choice of the circuit constants and "low-loss" construction. Great progress has been made along this line during the past few years.

The negative resistance obtainable is, of course, limited by the particular tube used. Of the tubes available on the market today, the one possessing the best dynatron characteristic is the Type '24. Fig. 2 shows this characteristic for a few of the Type '24 tubes tested. The slope

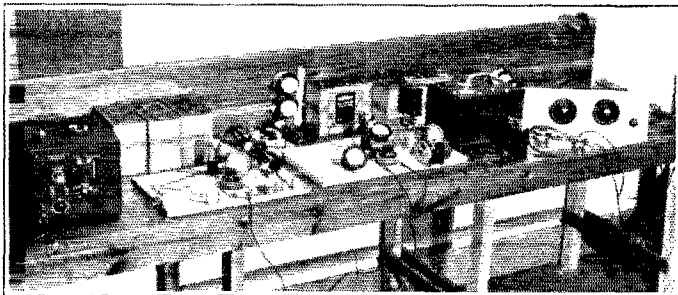

THE EXPERIMENTAL LAYOUT

With this equipment measurements were made on the various tubes to determine their negative-resistance characteristics as well as the oscillator measurements described in the text. From left to right on the bench are the crystal temperature-control box, the bread board layout for measuring static characteristics, the experimental oscillator, and a precision frequency meter.

(voltage divided by current) on the "falling" part of the curve represents the negative resistance of the tube. It will be seen that it varies

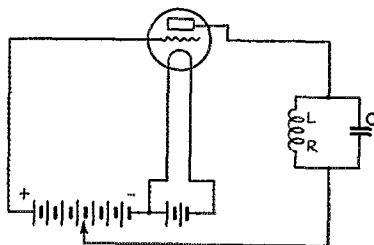

FIG. 1. — THE DYNATRION AS AN OSCILLATOR

A tube with a suitable falling characteristic must be used. With low negative resistance and proper choice of circuit constants a wide range of frequencies may be generated.

greatly from tube to tube, the variation being due to several small discrepancies which occur during the manufacture of the tube, affecting the spacing of the elements, cathode temperature, degree of

* Champion Radio Works, Inc., Danvers, Mass.

activity of cathode coating, condition of impact surface and degree of vacuum. These differences are negligible when the tube is used for the purpose for which it was designed, but they materially affect its negative resistance value as a dynatron and consequently vary the upper limit of frequencies obtainable with a given L/C

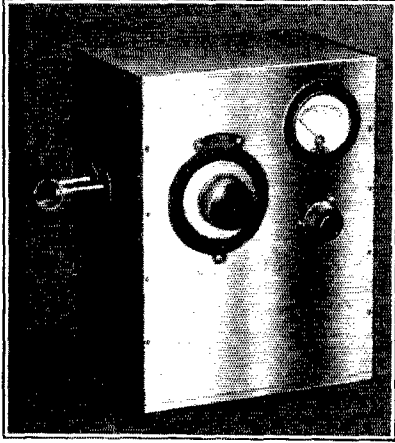

THE FREQUENCY METER

The coil and condenser are from a General Radio amateur frequency meter. The "B" batteries are inside the aluminum case, the "A" supply being furnished by an external battery. The filament voltage is held constant by adjustment of the rheostat.

ratio. Therefore, no set operating conditions can be specified. If maximum frequency is aimed at, the characteristic of each tube should be plotted and the most suitable operating point determined. Fig. 3 shows the simple setup used for obtaining the data. E_b can be varied by means of a suitable potentiometer. The negative resistance of the Type '24 at $E_f=2.5$ v. and $E_d=67$ v. was found to range anywhere from 6500 ohms to 16,000 ohms, the lower limit constituting the exception rather than the rule. With a tube of such low negative resistance it is possible to obtain frequencies of the order of 7000 kc.

The stability of the dynatron oscillator depends mainly upon the filament temperature. In the case of the Type '24 the filament voltage should be kept constant within two or three percent, the allowable variation being even smaller for the Type '22, which has a smaller filament. However, if the filament temperature is kept within reasonable limits, the stability of the dynatron oscillator is extremely good. From all tests made, it was concluded that this stability was fully as good as that of the non-temperature-controlled crystal.

If a pair of phones is connected in series with the plate of the dynatron, it will oscillate at a high audio frequency. This frequency may be lowered to three cycles per second simply by

increasing the inductance of the circuit and inserting capacitance in parallel with the phones. The stability of these audio frequencies also was found to be very good, especially when $\frac{L}{C}$ was made small.

By specially designing tubes for negative resistance operation, smaller resistances may be obtained. The writer has for some time devoted himself to the production of low negative-resistance dynatrons. Fig. 4 shows a comparison between a Type '24 having a fairly good negative slope and a low voltage dynatron. This particular dynatron is one of our first ones. It uses the same heater and cathode elements as the Type '24 and has a negative resistance of about 6200 ohms, a high value. Since then, dynatrons with much lower negative resistances have been produced, one of the larger types having a resistance of 1800 ohms. These dynatrons require from 125 to 150 volts on the grid and they pass a plate current of about 30 milliamperes. From the trend of the work now under progress, it is predicted that even lower resistances will be obtained. The filaments of these dynatrons are made to have a high temperature inertia to insure steady operation.

A DYNATRON FREQUENCY METER

In making a frequency meter for the use of W1BLH, the writer used a dynatron having a resistance of 2600 ohms with 70 volts on the grid. For the tuned circuit, the condenser and coils of a General Radio Type 558-P frequency meter

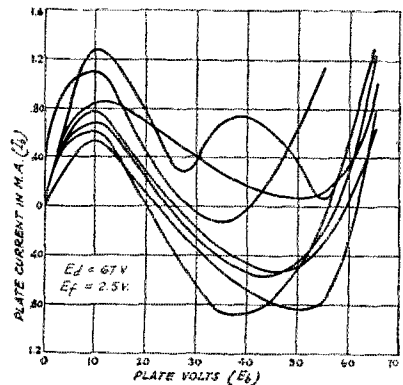

FIG. 3.—DYNATRON CHARACTERISTICS OF A GROUP OF TYPE '24 TUBES

Show the lack of uniformity in negative resistance, which accounts for the failure of some tubes to function as dynatron oscillators at very high frequencies.

were used. The experimental set-up is shown in a photograph. A temperature-controlled quartz crystal oscillator supplied the standard frequency and the frequency of the dynatron oscillator was made to beat against the crystal frequency and its harmonics. The beats between the

two oscillators were picked up and reproduced by a conventional receiver. The resultant beat notes were found to be surprisingly steady.

Another photograph shows the finished meter enclosed in an aluminum casing, which also contains the "B" batteries. A shielded cable is

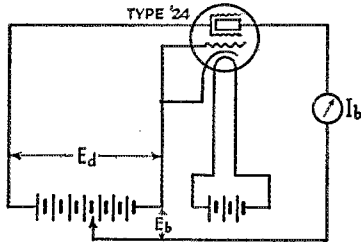

FIG. 3.—SET-UP FOR MEASURING NEGATIVE RESISTANCE OF A TYPE 24 TUBE

The heater voltage is held constant at 3.5 volts, and the screen-grid voltage at about 67 volts. The plate voltage may be varied by means of a potentiometer.

used for the "A" battery connections. A filament rheostat and voltmeter are essential. The National Type N vernier dial permits accurate readings.

The meter was calibrated from the crystal oscillator, while a precision meter was useful for frequencies intermediate to the quartz oscillator

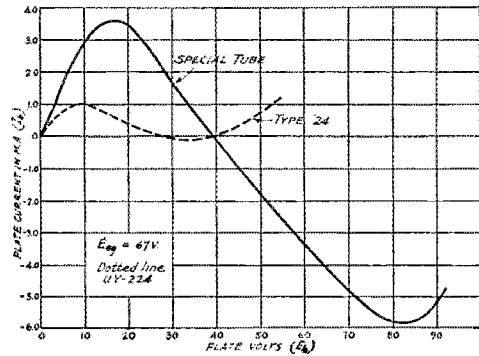

FIG. 4.—THESE CURVES SHOW HOW THE NEGATIVE RESISTANCE MAY BE DECREASED BY PROPER DESIGN OF THE TUBE

The solid curve was taken on a specially-designed dynatron, while the dotted curve represents an average Type 24 tube.

and its harmonics. This calibration could also have been obtained by listening to standard frequency transmissions, as has been explained in QST several times.

The dynatron frequency meter just described has been very satisfactory. Its upper frequency limit was found to be 10,700 kc. As mentioned before, frequencies above 14,000 kc. have been obtained but they necessitated the use of the larger dynatrons, with a tuned circuit consisting of the tube capacity and a few turns of heavy copper wire.

In conclusion, the experimenter and amateur is once more urged to look into the dynatron. For those interested, the following bibliography is given:

W. H. Newbold, QST, Feb., 1930
 A. W. Hull, Proc. I. R. E., Vol. 6 (1918) No. 1.
 A. W. Hull, E. F. Hennelly, F. R. Elder, Proc. I. R. E., Vol. 10 (1922) No. 5.
 A. L. Klein, Phys. Rev., Vol. 26 (1925).
 F. Horton and A. C. Davis, Proc. Roy. Soc., p. 23-43 (1920).

Bringing Frequency Measurement Up to Date

(Continued from page 26)

dials will increase the accuracy which can be expected.

In the October issue of QST complete constructional information on a heterodyne frequency meter of the dynatron type will be given, together with information on how to calibrate the meter from standard frequency transmissions and how best to use it in the station.

Doings at Headquarters

(Continued from page 12)

Don Meserve, QST's Advertising Manager, vacated his New York bailiwick and spent a couple weeks in Chicago on a business survey.

F. E. Handy is spending a vacation in Maine with his family.

K. B. Warner has left Hartford for the seashore, from where he is sandwiching in some vacation along with regular routine work.

J. J. Lamb, Tech. Ed., spent a few days in New York attending preliminary meetings relative to the C.C.I.R.

The rest of the gang here at Hartford have been taking a little snatch of vacation here and there, when duties permit.

W1MK and W1SZ have been on mornings lately keeping in touch with Australian stations. Fine relaying has been done by YS1X (a ship plying between New York and Chile), VK5HG and VK5GR, as well as a regular schedule being kept with VK2EK.

—C. C. R.

Pacific Division Convention

Sacramento, California, October 17th and 18th

JUST a preliminary announcement of our forthcoming convention. See October issue QST for full particulars.

Harmonious Harmonics

By Uncle Jimmy and the Boys

BEAUTIFULLY strained music emerges from the peaked amplifier. The words are dreamily indistinct, yet reach our ears with piercing definition.

"Hi diddle dystal.

A Ham and a crystal.

The sig skipped over the land.

Commissioners laugh to hear such fun
(Provided we stay in the band)."

"You have been listening, dear little hams, to our theme-song as rendered by His Majesty, Old King Cole, and his harmony boys, The Fiddlers Three.

"His Majesty's services are made available through the courtesy of Santa Claus, Incorporated, manufacturers and distributors of transmitting tubes, crystals, and other ham supplies. Mr. Claus, president of the company, is, as you know, the patron saint of the little ham.

"Bitter opposition was presented by the Pied Piper, note specialist, when it was learned that the King was to broadcast from this station. It was argued by the Piper that the a.c. note emitted from His Majesty's pipe (produced by singing through it and allowing it to resonate in his bowl) had no place in modern transmission. The Piper's plea was quite eloquent, but the station management, convinced that Mr. Piper was allowing himself to be swayed by professional jealousy, set aside the objection.

"The new feature, though distressing, is certainly unique -- which, of course, squares matters completely from the management's viewpoint. Personally, and just between hams, I am disappointed to learn that His Majesty's famous merri-ment is of the induced variety.

"You hear the boys for the first time tonight. If you find the sound of the King's pipe discordant, be thankful, at least, that you can't tune in its odor.

"Now, let me see . . . Oh yes, the fairy tale . . . First let me explain how it comes to pass that your old Uncle Jimmy is at the mike tonight.

"In order that he may remain a well-balanced ham instead of becoming a nut, Uncle Jimmy reads a certain amount of popular fiction. He has been complaining about the laziness of his favorite author, who has turned in few stories of late. It didn't occur to Uncle Jimmy that his own house might be not entirely shatter-proof. It didn't, in fact, occur to him that anyone gave a tinker's inspiration whether he wrote or not. Imagine, then, his consternation when he received a letter from a little ham who gently hinted that U. J. was growing lazy. The little ham didn't know that he

was writing to Uncle Jimmy; he thought he was writing to another little ham who has written a few things for QST.

"It was Uncle Jimmy, however, who received the letter and, believe me, he felt as mortified as if his call had appeared among the prehistoric sigs. There was but one grain of consolation in the in-

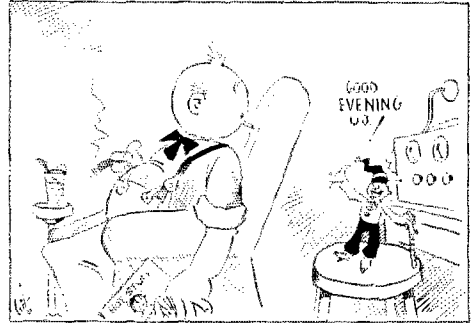

cident. The little ham's letter disclosed the fact that he is full of original ideas and that *he, himself, should be writing for QST*. He, in turn, can console himself with the fact that Hamdom is full of others just like him.

"That's that; now you understand that U. J. is at the mike to prove to you little hams that he's not lazy (which, of course, he is).

"Now I want to tell you about Piper. Piper dropped in one evening in his usual manner, sliding down the lead-in and skipping nimbly over the series condenser.

"'Good evening, U. J.,' he piped in his clear and tinkling tones. 'How is the push-pull perking?'

"'Who in Q-R-M-dom told you I was fooling with push-pull?' I asked, naturally startled at his knowledge of what I thought was a secret. Honestly, I believe I'll never get used to the way these fairies know everything.

"'Don't be silly,' said Piper as he yanked the dust-cover off of the new push-pull job. (The job, by the way, used the circuit of Fig. 1. If your scanning disc has the wrong number of holes, here it is in QST; Mr. Warner agreed to print the diagrams for this tale.)

"'I can't help appearing silly, P. P.,' I retorted, 'with you continually doing your best to make a fool of me. You know the answers to your questions before you ask 'em. You ask 'em just to show me up -- just to tantalize me.'

"'Pooh, pooh, U. J.,' said Piper soothingly. 'I ask questions to stir up discussions --'

“‘To stir up argument, you mean.’
 “‘To stir up discussion and make you think. Thinking is very beneficial; you should foster it. Now, about this push-pull business; did you say you were using the second harmonic?’

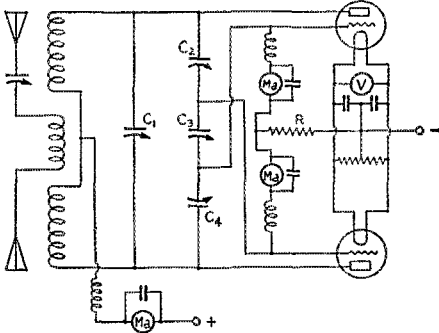

FIG. 1

Tubes are Type '10. C₁ is a two-ying condenser with the two halves paralleled — 750 micromikes. C₂, C₃ and C₄ are 23-plate nudgets. Grid meters, 0 to 25 mils; plate meter, 0 to 500. R can be 10,000 ohms or higher. Coupling may be varied by mounting the antenna coil on a rotor, or by hanging it so that it will swing in and out of the gap in the primary coil. Antenna coil may be wound (spaced a bit) with No. 12 or 14 antenna wire.

Adjustment is simpler than it looks. C₂ and C₄ are left at maximum capacity unless the grid of one tube receives more excitation than the other (as indicated by the grid meters). In this case, the capacity of one condenser (C₂ or C₄) is reduced till the meters balance. C₃ controls the amount of excitation to both tubes (the more capacity, the less excitation). Uncle Jimmy's thump filter will eliminate clicks — if you're good!

The only snag likely to be struck is the matter of grid chokes. They need to be good ones, designed for the band in which you work. Again, you need to be good.

The shunt condensers across the meters protect the meters from r. f.

“‘There isn't any second harmonic,' I sulked. 'It cancels in push-pull.'

“‘There! What did I tell you? You're not thinking. It cancels in the main tank circuit, to be sure, but what about the plate choke?’

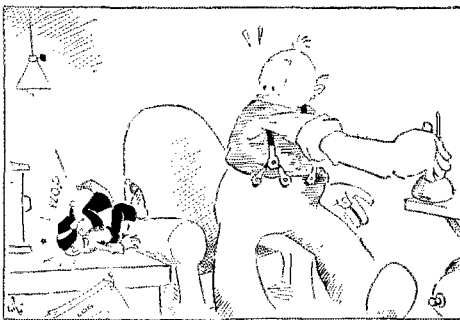

“‘You can't kid me, P. P.; it's the same thing there. The plate current from one tube is increasing while that of the other is decreasing and —

“Piper fainted. I was frightened. What to do

for fainting fairies? Inspirationally, as it were, I recalled seeing King Cole, at the time of his first visit, experimentally and then enthusiastically sample the contents of the m.g. oil can on the shelf. Seizing the can, I forced a few drops of the liquid between Piper's lips. He revived instantly and sat up; then resumed the argument quite as if nothing had happened.

“‘You're much worse than I thought, U. J.,' he said. 'See this.' He reached out and picked up the sheet of cross-lined paper that I was saving for the calibration curve of my new monitor. He rapidly drew the graph of Fig. 2.

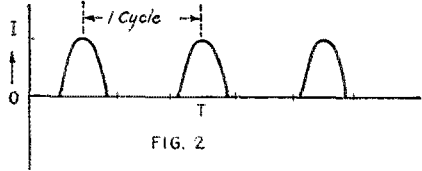

FIG. 2

“‘Here,' he said, 'is a picture of the plate current as fed to the plate tank of a one-tube oscillator, plotted against time. Please note that the current flows during less than half of one cycle. If, now, we add another tube in push-pull, it will work in the same manner on the other half of the cycle. Your dull human intellect is a handicap, but you should be able to perceive that but one tube works at a time.' He drew Fig. 3.

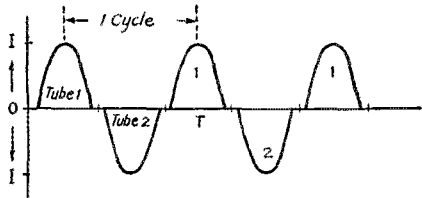

FIG. 3

“‘Hold on, Piper,' I objected. 'You're drawing the curves for the second tube in the wrong direction.'

“Piper cast me a withering glance. 'The current from tube 2 flows through the helix in the opposite direction, therefore I have to draw the curves in that direction. An increase of current from one tube is equivalent to a decrease from the other.'

“Piper had me there, but I carefully extracted what I thought was the joker from my sleeve. 'Have it your way, P. P. Now, if you please, show me something in your figure that remotely resembles a second harmonic!'

“The little fellow set his lips grimly. 'I knew you'd forget what we were talking about. We've been discussing the main helix — where the harmonic cancels. Now we will consider the plate choke. Plate current flows through it in one direction only. If we look upon the plate choke as being the load circuit, we have something like

the equivalent of a circuit in which the input is push-pull and the output of the tubes is paralleled.

"I was beginning to see the light and I watched with enthusiasm while he drew Fig. 4. An idea

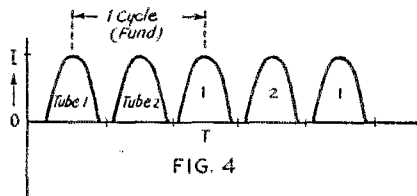

FIG. 4

popped into my head. 'I see it now, Piper. Splendid! Gee! all a fellow needs to do is to clip his antenna feeder onto a tuned choke and —'

"'Whoa! Not so fast, son.' (It always riles me when that type '99 wart calls me 'son.')

'You couldn't get enough second harmonic power into the antenna to make it worth your while.'

"'Why not?'

"'Because, for one thing, of the r.f. voltage-drop across the turns of helix between the choke and the tubes.'

"'I could use plate clips and move them in from the ends of the helix.'

"'Good move; even so, it wouldn't get you far. Most of the power dissipation would be in the tubes instead of the choke, where you need it. I'll try to explain.' He drew Fig. 5.

"'I knew well enough that the little rascal had something up his sleeve, but I couldn't help bursting out: 'Piper, you can't get away with that; you can't compare resistance with a tuned reactance.'

"'He grinned impishly. 'Don't kid yourself, son. A fairy can do whatever he likes. Now, tell me, which dissipates the greater number of watts, R_1 or R_2 ?'

"'He couldn't catch me there. ' R_1 ,' I said. 'The resistance of R_1 is greater, therefore the voltage-drop across it is greater; the current is the same in both resistors — but that's old stuff,' I broke off impatiently. 'The point is that you're trying to make an impossible comparison.'

"'Not at all,' he maintained. 'It's quite possible if you go about it properly. The tube itself, you will admit, is a variable resistor equipped with a fairy knob (the grid potential) which can be twirled back and forth at radio frequency. While in action, the tuned tank cannot be compared with pure resistance. We can, however, take instantaneous snapshots of the thing; get an idea of the voltage-drop across it at a given instant —'

"'I see!'

"'But you don't.'

"'Why can't you figure the instantaneous watts from the instantaneous volts and amperes?'

"Piper reeled and I reached for the m.g. oil. He recovered himself with an effort and waved me back. 'Never mind!' he said sharply. 'I'm all right, now . . . Instantaneous amperes! Watts! Shades of old audions! Surely, U. J., you understand that it takes *time* for current to flow? Amperes are coulombs per *second*. An instant is a dot in time; it has no dimensions. An instantaneous ampere is impossible.'

"'Then how in the name of crackling, double-forked QRN are you going to get anywhere with that crazy figure of yours?' I was really provoked.

"'By using an *extended* instant. By that means we can get a snapshot comparison that will serve nicely for all practical purposes. We will need to take a number of shots at various parts of the cycle to get an idea of the whole. On one side of the cycle we draw blanks as far as applied power is concerned; the grid potential is below cut-off — we are assuming, you understand, that r.f. voltage of the frequency to which the tank is tuned is being applied to the grid. The tank circuit is dissipating energy on both sides of the cycle because of its fly-wheel effect — pendulum

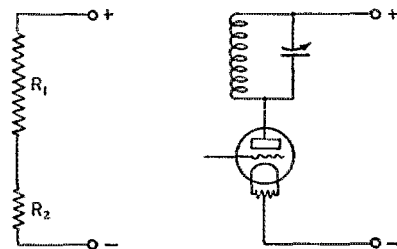
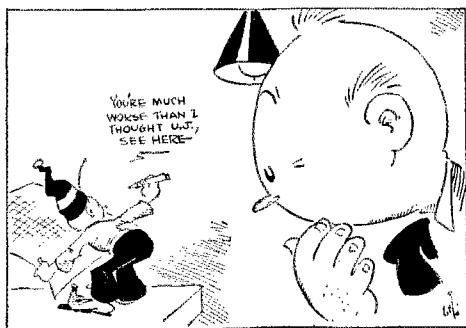

FIG. 5

effect. On one side, however, it is merely dissipating stored energy; we are interested only in noting how the applied voltage is divided between tube and tank at times when power is applied (when plate current is flowing).

"'A few snapshots are revealing. We find that at the peak of the cycle the pendulum voltage is squarely opposed to the applied voltage. If the losses are low, the pendulum voltage is almost equal to the applied voltage. The difference between the two voltages is the voltage across the tube. Since this voltage is very low, the dissipation in the tube is slight compared to that in the tank — even though the grid is so positive as to allow a heavy flow of plate current. At other parts of the half-cycle, we find less reactance voltage (pendulum voltage), but the tube dissipation is still low because the grid isn't allowing much plate current to flow. (Power, you know, is produced by neither current nor voltage, but is the product of the two.) Our snapshotting brings out one fact very clearly. We notice that the grid *never* allows any current to flow while the pendulum voltage is *aiding* the applied voltage.

"It is hardly necessary to tell you the rest. The case of the fundamental input — second harmonic output is sad. The pendulum effect of the output tank causes it to complete nearly a full cycle while plate current is flowing. In other words, there are times when the pendulum volts are added to the power-supply volts and the sum applied to the tube while the grid is allowing



current to flow. The tube dissipation is enormous. High bias will improve the tank-tube dissipation ratio, but will also reduce the plate current so that the output will be low for the tube size and plate voltage used.' Piper sat back and sighed.

"Needless to say, I was disappointed. To have a vision of a transmitter which covered two hands by the simple expedient of shifting the antenna coupling from the plate tank to the plate choke and then to have that vision rudely snatched away — it was heart-breaking. I nearly wept. 'Piper,' I protested, 'why did you wake me up?'

'Piper is really a sympathetic little soul. Tiny tears glistened in his little eyes as he tried to console me. 'Don't grieve, U. J.,' he begged. 'There is at least enough second harmonic power available in the choke to handle the grid losses of an amplifier.'

"I became childishy unreasonable. 'Amplifiers are just a nuisance and, anyway, I have no battery for the bias!'

"Great Reaching Rettysmith! They're in again. (See here, Your Majesty; these interruptions must cease. I'll have it understood—)."

(A door slams and we hear the sound of a new voice.)

"What's the row in here?"

"How do you do, sir? I take it that you are the new R. I.?"

"Are I? Whaddeya mean — 'are I'?"

"Pardon me! I thought, from the federal twang in your voice —"

"You got it right, mister; I'm federal all right. Who are these funny little face-cards? And what's in them bottles over there?"

"Permit me, sir, to present you to His Majesty, Old King Cole — who is really a merry old soul, in spite of his BCL penchant — and his —"

"You're crazy!"

"— Fiddlers Three. The pieces of apparatus which you call bottles are very expensive. They —"

"I bet you!"

"— are filled with r.f."

"So? Say, mister, I've heard it called by lots of names and I'm not so thick —"

"The evidence —"

We've no defence!

(Destroy it, King; be quick!)"

(The swish of His Majesty's pipe and bowl is distinctly audible as they hurtle through the air.)
Click! !

ELECTION NOTICE

To all A.R.R.L. Members residing in the
CENTRAL, HUDSON, NEW ENGLAND,
NORTHWESTERN, ROANOKE, ROCKY
MOUNTAIN and WEST GULF Divisions
of A.R.R.L.:

1. You are hereby notified that an election for an A.R.R.L. Director, for the term 1931-1932, is about to be held in each of the above Divisions, in accordance with the Constitution. Your attention is invited to Sec. 1 of Article IV of the Constitution, providing for the government of A.R.R.L. affairs by a Board of Directors; Sec. 2 of Article IV, defining their eligibility; and By-Laws 10 to 19 providing for their nomination and election. Copy of the Constitution and By-Laws will be mailed any member upon request.

2. The election will take place during the month of November, 1930, on ballots which will be mailed from Headquarters in the first week of that month. The ballots for each Division will list the names of all eligible candidates nominated for the position by A.R.R.L. members residing in that Division.

3. Nominating petitions are hereby solicited. Ten or more A.R.R.L. members residing in any one Division have the privilege of nominating any member of the League in that Division as a candidate for Director therefrom. The following form for nomination is suggested:

(Place and date)

Executive Committee,
American Radio Relay League,
Hartford, Conn.

Gentlemen:

We, the undersigned members of the A.R.R.L. residing in the Division, hereby nominate of as a candidate for Director from this Division for the 1931-1932 term.

(Signatures and addresses)

The signers must be League members in good

(Continued on page 82)

Standard Frequency System News

W9XAM to Start Operation—Special Transmissions Scheduled for Oceania and Far East

THE A.R.R.L. Standard Frequency System has made further advances since the last report and the second transmitting station is almost ready for service at the time of this writing. Regular scheduled transmissions from W9XAM are to begin in September, unless something unforeseen occurs to cause delay. Tentative schedules for W9XAM standard frequency transmissions are a part of this report. Last-minute information will be shot out in an official broadcast from WIMK. In case the authority for W9XAL to transmit these schedules does not come through on time, the call W9SI will be used for the first transmissions. However, it is quite probable that everything will be lined up by the time of the first September schedule.

The schedules have been arranged so that every Friday night will be a standard frequency night. It would be greatly appreciated if everyone but the S.F. stations would QRX during these transmissions and cut down the QRM which has been making them hard to get. Many of the gang have suggested this and it would certainly be worth trying. Incidentally, make use of the transmissions while you are standing by. That's what they are being transmitted for.

SPECIAL SCHEDULES FOR OCEANIA

Headquarters has received a request from the Wireless Institute of Australia, through the society's Hon. Secretary, asking that a 7000-ke. schedule be transmitted for Australian amateurs. This has been provided for by Schedule BX, to be transmitted by W9XAL at 4:00 a.m., C.S.T. (1000 G.C.T.) one Saturday each month. It is probable that an additional early morning schedule will be provided by the Pacific Coast station when it gets going in October. Harold Peery informs us that the frequency standard has been ordered for the Pacific Coast station and that the other equipment is being assembled. The call for this station has not been assigned at this time. We hope to publish its schedules in the October issue of QST, however. Next month should see the whole System in working order.

INTERPRETING THE SCHEDULES

The understanding of the Standard Frequency Schedules is quite simple and follows a few easy rules. The table of dates indicates the date of the month and day of the week on which the transmissions are to take place. The letters designating the schedules are combinations of the letters "A," "B" and "C." The presence of the letter

"A" indicates that the transmission is on the 3500-ke. band; "B" that the transmission is on the 7000-ke. band; and "C" that the transmission is on the 14,000-ke. band. The addition of a second letter to one of these designations indicates that the transmission is at a time other than the usual for that particular frequency. For instance, "BB" indicates a special afternoon transmission on 7000-ke. for European amateurs; "BX" indicates a special early-morning transmission for Oceania and the Far East. Schedules "A" and "B" always begin at 8:00 p.m., local standard time at the transmitter; those designated by the letter "C" always begin at 4:00 p.m., local standard time at the transmitter.

DATES OF TRANSMISSION

Date	Schedule	Station
Sept. 12, Friday	A	W1XP (W1AXV)
	B	W9XAM (W9SI)
Sept. 19, Friday	BB	W1XP
	B	W9XAM
Sept. 21, Sunday	C	W9XAM
Sept. 26, Friday	B	W1XP
	A	W9XAM
Sept. 27, Saturday	BX	W9XAM
	C	W1XP
Sept. 28, Sunday	BB	W9XAM
	A	W1XP
Oct. 3, Friday	B	W9XAM
	BB	W1XP
Oct. 10, Friday	B	W9XAM
	C	W9XAM
Oct. 12, Sunday	B	W1XP
	A	W9XAM
Oct. 17, Friday	BX	W9XAM
	C	W1XP
Oct. 18, Saturday	BB	W9XAM
	A	W1XP
Oct. 19, Sunday	B	W9XAM
	BB	W1XP
Oct. 24, Friday	B	W9XAM
	BB	W1XP
Oct. 31, Friday	B	W9XAM
	B	W9XAM

STANDARD FREQUENCY SCHEDULES

Time (p.m.)	Friday Evenings Schedule and Frequency		Friday and Sunday Afternoons Schedule and Frequency	
	A	B	BB	C
	ke.	ke.	ke.	ke.
8:00	3500	7000	4:00	7000
8:08	3550	7100	4:08	7100
8:16	3660	7200	4:16	7200
8:24	3700	7300	4:24	7300
8:32	3800		4:32	14,300
8:40	3900			
8:48	4000			

Saturday Morning Schedule and Frequency

Time (a.m.)	BX
	ke.
4:00	7000
4:08	7100
4:16	7200
4:24	7300

The time is local standard time at the transmitting station. W1XP-W1AXV uses Eastern Standard Time and W9XAM-W9SI uses Central Standard Time. For conversion from E.S.T. to G.C.T., 4:00 p.m. E.S.T. is 2100 and 8:00 p.m. E.S.T. is 0100, G.C.T. For conversion from C.S.T. to G.C.T., 4:00 p.m. C.S.T. is 2200, 8:00 p.m. C.S.T. is 0200, and 4:00 a.m. C.S.T. is 1000 G.C.T.

The special Friday afternoon 7-mc. schedule transmitted by W1XP-W1AXV is intended particularly for European listeners, although it is useful in Eastern North America also. The special Saturday morning 7-mc. schedule from W9XAM-W9SI is transmitted at the request of the Wireless Institute of Australia. Amateurs in all parts of the world are requested to listen for and report on this transmission. It should be useful not only in Oceania and the Far East but also throughout the Americas.

Although frequencies of the transmitting stations are not guaranteed as to accuracy, every effort is made to keep to within 0.01% of the announced frequencies. The station standards are calibrated from the National Frequency Standard at the Bureau of Standards, Washington, D. C. Frequent checks on the transmissions are made by laboratories equipped with accurate frequency standards. The transmissions are also checked by the U. S. Department of Commerce monitoring stations. A recent check made by the Department of Commerce Monitoring Station at Hingham, Mass., showed that a 7000-kc. schedule transmitted by W1AXV was accurate to within less than 50 cycles. This accuracy is within one thousandth of 1% and over ten times as good as the specified accuracy of the transmission, which is 0.01%.

TRANSMITTING PROCEDURE

The time allotted to each transmission is now 8 minutes, divided as follows:

- 2 minutes — QST QST QST de (station call letters).
- 3 minutes — Characteristic letter of station, interrupted by call letters. Characteristic letter of W1XP-W1AXV is "G." Characteristic letter of W9XAM-W9SI is "D."
- 1 minute — Statement of frequency in kilocycles, to nearest integral figure, and announcement of next frequency.
- 2 minutes — Time allowed to change to next frequency.

W1XP-W1AXV: Communications Department Experiment Station, Massachusetts Institute of Technology, Round Hill, South Dartmouth, Mass. Howard A. Chinn in charge.

W9XAM-W9SI: Elgin Observatory, Elgin National Watch Co., Elgin, Ill. Frank D. Urie in charge.

During the hour preceding each standard frequency schedule, W1AXV offers the individual

QRG service described in the May and July issues of QST. Listen for W1AXV during these periods as well as during the regular S.F. transmissions.

Finally, do not forget to QSL the transmissions. All reports should be sent to the A.R.R.L. Standard Frequency System, 1711 Park St., Hartford, Conn. A record will be made at Headquarters and the report will be then forwarded to the proper station. S.F. blanks can be obtained from Headquarters, free and postpaid, upon request.

— J. J. L.

Roanoke Division Convention At Richmond, Virginia, September 19th and 20th

RICHMOND! Richmond! On to Richmond! The Virginia Section of the Roanoke Division, under the auspices of the Richmond Short Wave Club, will hold their first convention at the Hotel Richmond, Friday and Saturday, September 19th and 20th, respectively, and extend to all amateurs and A.R.R.L. members a cordial invitation to this affair. Worthwhile speakers will be present to talk on interesting subjects, amongst whom are Dr. Woodruff, Director of the Atlantic Division; our own Director, Mr. Gravelly; our S.C.M., J. F. Wohlford; Mr. William Reveley of the A. T. & T., and we are hopeful of having Dr. C. Francis Jenkins, the father of television.

So you see, gang, our program from a "talk-fest" standpoint will leave nothing to be desired. A.R.R.L. Headquarters are sending A. A. Hebert, the Treasurer and Fieldman, as the official representative.

There will be plenty of sightseeing, entertainment, a regular "Ham Booth" at the Radio Show, with short-wave equipment on display, and last, but not least, the biggest Banquet on Saturday evening with distributions of trophies. The cost for the two-day convention is \$4.00.

Of importance — please write R. N. Eubanks, Chairman, 2817 Montrose Ave., Richmond, Va., and signify your intentions.

Strays

Hams should encourage their motorist friends to install broadcast receivers in their cars. The ignition interference suppressors stop one source of noise on the higher frequencies. If we could only induce some of these truck and bus operators to do likewise!

Hum in an a.c. receiver can sometimes be reduced by simply reversing the connections to the 110-volt line.

The Operating Characteristics of Vacuum Tube Detectors

A Graphical Study of Grid and Plate Detection for Triode and Screen-Grid Tubes

In Two Parts—Part II

By H. A. Robinson, W3LW*

LET us now consider the screen-grid tube in the rôle of detector. For plate detection, the Type '24 is connected as shown in the schematic diagram of Fig. 17A.

The series of curves of Fig. 18 show the variation of detector gain with r.f. input for several

over a triode, both employing plate detection, is evident. The effect of shifting the operating point by changing the grid bias is quite pronounced for detector performance at various input signal voltages, as shown by the curves of Fig. 20 as well as those of Figs. 18 and 19. The higher signal voltage levels require an increasingly greater

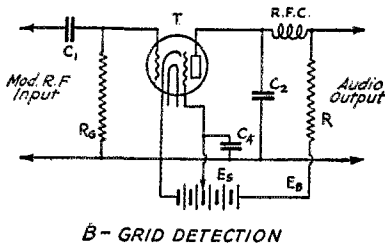
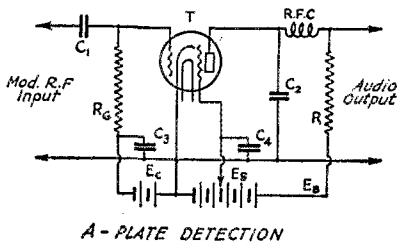
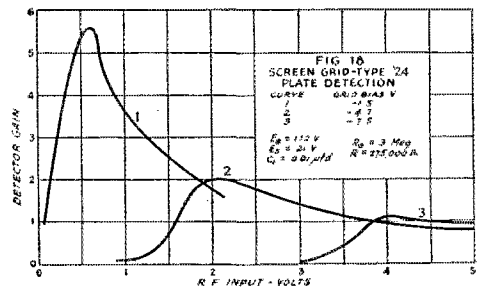

FIG. 17

- C₁ — Grid Condenser.
- R_g — Grid Leak.
- R — Plate Load Resistance.
- C₂ — 100 μfd.
- C₃ — 1 μfd.
- C₄ — 0.1 μfd.
- R.F.C. — Radio Frequency Choke.
- T — Type '24 Tube.

values of negative control grid bias, while the corresponding series of curves of Fig. 19 show the audio output voltage variation under the same condition. Here again the detector gain reaches a decided maximum and the increased gain obtained by the use of a screen-grid detector

* Silver Lake Farm, Willow Grove, Pa.



negative control grid bias for maximum detector output.

Figs. 21, 22 and 23 show similar variation of detector gain and audio output voltage respec-

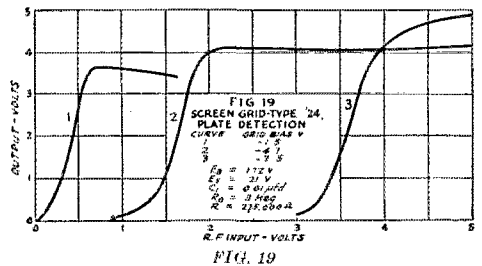

tively for several values of screen-grid voltage, the optimum condition for detector performance depending largely upon the input signal voltage. The operating voltages for the curves of Fig. 23 indicate the necessity for relatively low screen grid and control grid voltages for maximum detector performance at the low signal input (less than 0.5 volts).

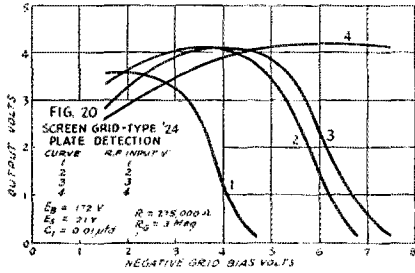

FIG. 20

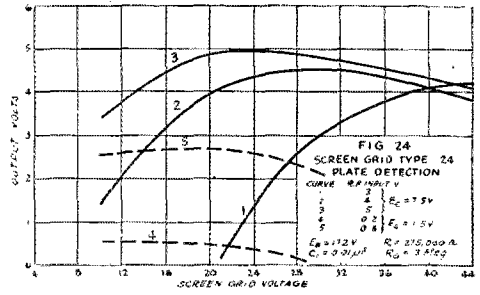

FIG. 24

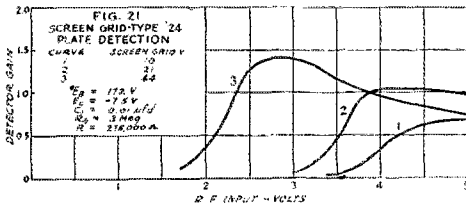

FIG. 21

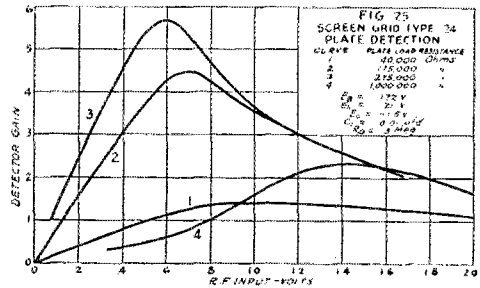

FIG. 25

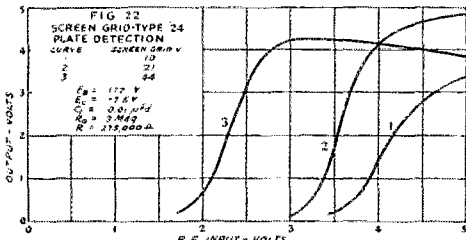

FIG. 22

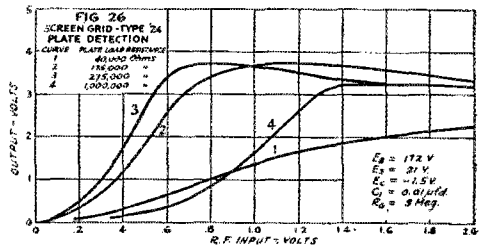

FIG. 26

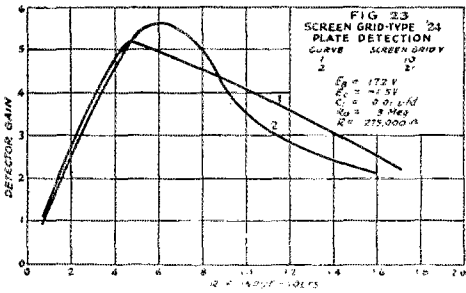

FIG. 23

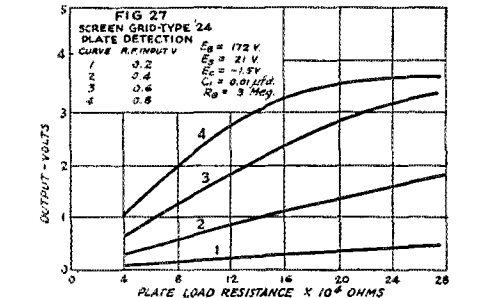

FIG. 27

This same conclusion is reached by analysis of the series of curves of Fig. 21. Here the variation in output voltage with screen-grid voltage is shown for several values of r.f. signal input as well as two values of control grid bias. These curves (4 and 5) indicate that the screen-grid voltage is not particularly critical for plate detection at low signal voltages.

The effect of the external load impedance in the detector plate circuit upon the detection is shown

by the series of curves of Figs. 25 and 26. These curves would indicate that the optimum value of plate load resistance is of the order of 250,000 ohms for the screen-grid and control-grid voltages employed in these measurements. These operating voltages play an important part in determin-

ing the best value of load for detector performance over a considerable range of signal input voltages. However, this value of plate load is not critical. This is particularly true for detection at the lower signal inputs as shown by the curves of Fig. 27.

THE SCREEN-GRID TUBE AS A GRID DETECTOR

The consideration of the performance of the screen-grid tube as a grid detector will perhaps

form of performance as obtained with plate detection, but the greatly increased value of detector gain at low signal voltages is quite apparent. For the particular operating voltages used in these measurements a plate load resistance of the order of 175,000 ohms seems to be most favorable. This value varies considerably with the plate and screen-grid voltages employed.

The curves of Fig. 30 show the variation of detector audio output with plate load resistance for several different signal input levels. These

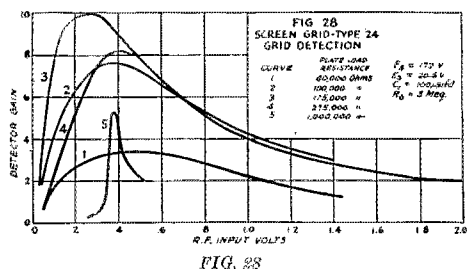

FIG. 28

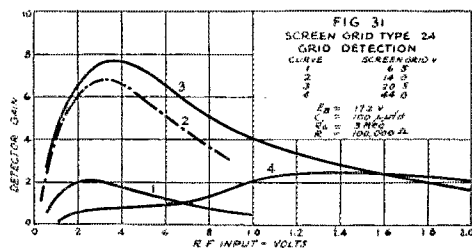

FIG. 31

be of greatest interest, to the average amateur, than all the arrangements considered thus far. The schematic diagram of Fig. 17B shows the circuit arrangement.

The series of curves of Fig. 28 show the variation of detector gain with r.f. signal input for

curves tend to indicate that the value of plate load resistance is far from critical.

The effect of screen-grid potential upon the performance of this type of detector is clearly shown by the series of curves of Figs. 31, 32 and 33. The variation of detector gain with r.f. input is shown for several values of screen grid potential by the curves of Fig. 31 and the corresponding variation of output voltage is shown by Fig. 32.

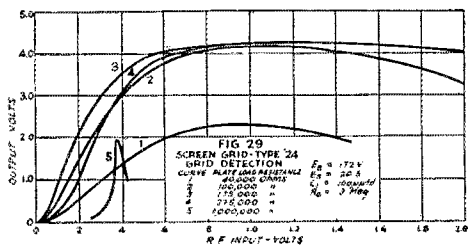

FIG. 29

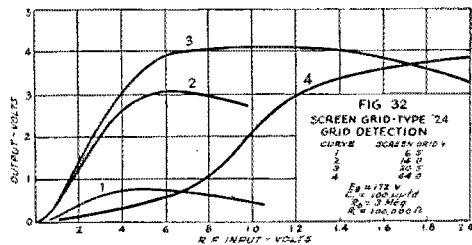

FIG. 32

several values of plate load resistance and the curves of Fig. 29 show the corresponding variation of detector audio output voltage. The variation of detector gain follows the same general

The best value of screen-grid voltage seems to be of the order of 21 volts for these particular operating conditions. This value does not appear to be critical, however, as the curves of Fig. 33 indicate. This series of curves shows the variation of detector output voltage with screen grid potential for several signal input voltage levels. The value of screen grid potential for maximum detector performance will depend considerably upon the plate voltage and plate load resistance as well as upon the input signal level at which detection is to take place.

SUMMARY

The performance of typical triode and screen-grid tubes has been considered for various operat-

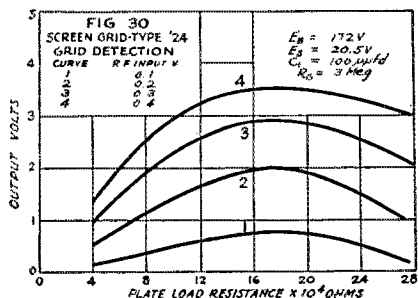

FIG. 30

ing voltages, circuit constants and signal input levels, and the numerous factors influencing the detector operating characteristics have been studied and their effects shown in a more or less complete series of detector performance curves.

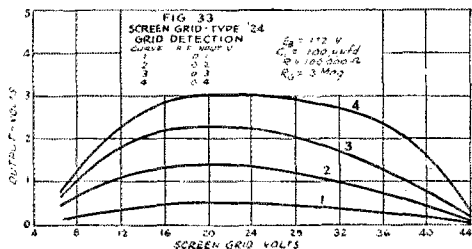

FIG. 33

This experimental data should be of value in determining the proper type of vacuum tube detector and its operating characteristics for most of the usual applications.

The curves of Fig. 34 are plotted on logarithmic scales and show the relation between detector

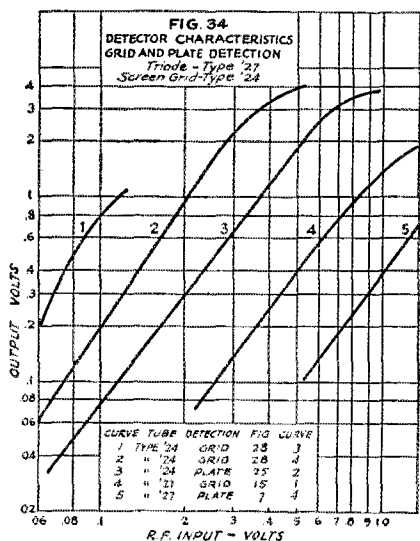

FIG. 34

audio output voltage and r.f. signal input for the various types of detectors. It will be noticed that this comparison is made at relatively low signal input levels. The order of performance of the various types of detectors will be different at higher signal levels.

The slope of these curves gives the power by which the detector output varies with the r.f. input voltage. This slope is of the order of 1.5 and no account of distortion of the output has been taken. The operating voltages and circuit constants for each of these performance curves can be

determined readily by reference to the figure and curve numbers corresponding to the data considered.

A more complete summary and comparison of the operating characteristics of the detectors considered is given in Table 1. The maximum detector gain for the Type '27 and Type '24 tubes as both grid and plate detectors was obtained from the performance curves previously analyzed, and these values of detector gain are compared graphically in the table. The actual operating voltages and circuit constants for each value can be obtained by reference to the curve indicated in the column under that heading, giving the figure and curve numbers.

This comparison of detector performance was made at four different values of r.f. signal input. The relative merits of the several detector ar-

TABLE 1 SUMMARY OF DETECTOR CHARACTERISTICS					
TUBE	DETECTOR	OUTPUT V	CURVE	DET. GAIN	RELATIVE DET. GAIN
R F INPUT = 0.1 V					
TYPE '27	GRID	0.15	12-3	1.5	100%
TYPE '27	PLATE	~	~	~	~
TYPE '24	GRID	0.8	28-3	8.0	533%
TYPE '24	PLATE	0.15	18-1	1.5	100%
R F INPUT = 0.5 V					
TYPE '27	GRID	0.75	13-2	1.5	100%
TYPE '27	PLATE	0.09	7-4	0.2	13%
TYPE '24	GRID	3.9	28-3	7.8	517%
TYPE '24	PLATE	2.75	18-1	5.5	367%
R F INPUT = 1 V					
TYPE '27	GRID	1.57	10-4	1.6	100%
TYPE '27	PLATE	0.37	7-4	0.4	25%
TYPE '24	GRID	4.2	28-3	4.2	263%
TYPE '24	PLATE	3.7	25-2	3.7	231%
R F INPUT = 5 V					
TYPE '27	GRID	3.7	10-4	0.74	48%
TYPE '27	PLATE	3.34	7-3	0.67	42%
TYPE '24	GRID	~	~	~	~
TYPE '24	PLATE	4.85	18-3	0.97	66%

TABLE 1

rangements are dependent to a great extent on the value of signal input at which detection takes place. The results of these arrangements would lead to the following conclusions:

1. At signal inputs of the order of 0.1 volt or less the screen-grid tube as a grid detector is by far the most sensitive of the arrangements measured, the triode as a plate detector being the least sensitive.

2. These same conclusions hold for signal input levels up to 0.5 volt, though the screen-grid tube as a plate detector shows considerable gain at this value of signal voltage.

3. At higher signal levels (of the order of 5 volts) both types of tubes as plate detectors show

the best performance, with the screen-grid type giving maximum gain. The Type '24 as a grid detector at these signal levels is least effective. It should be noted that the screen-grid tube is operating with a high plate load impedance under these conditions and must be worked directly into the grid circuit of the following audio amplifier tube. In the case of the triode, however, for both grid and plate detection the output was across the primary of an audio transformer. With the triode there can be an added gain due to the step-up ratio of a suitable coupling transformer and this must be considered in a rigid comparison of the two types of tubes as detectors.

Again, it should be remembered that all the measurements were made on a 1500-kc. carrier modulated 30 per cent by a 400-cycle audio frequency, unless otherwise specified.

In conclusion, it is hoped that this paper may prove of benefit to the amateur fraternity by promoting a better understanding of the operating characteristics of vacuum-tube detectors and the factors influencing the detector performance, as well as by giving experimental and comparative data on typical vacuum-tube detectors.

APPENDIX

The non-linear relation between current and voltage, such as that shown by the dynamic characteristic of Fig. 1, can be expressed mathematically:

$$i = f(e')$$

where i = current

e' = electrode voltages

f = some function

Expanding this relation in the form of a series:

$$i = a_0 E_0 + a_1 e + a_2 e^2 + \dots \quad (1)$$

where E_0 = steady d.c. operating voltages

e = impressed signal voltage

a_0, a_1, a_2, \dots = constants depending on the operating voltages, plate resistance, curvature of characteristic, etc.

Considering the case of an impressed signal consisting of a plain unmodulated radio-frequency carrier, then

$$e = E \sin \omega t$$

where $\omega = 2\pi f_r$

and f_r = carrier frequency

Substituting this in (1) to obtain the corresponding current variation:

$$i = a_0 E_0 + a_1 E \sin \omega t + a_2 E^2 \sin^2 \omega t + \dots$$

Expanding these terms into components of fundamental or harmonic frequencies:

$$i = a_0 E_0 + a_1 E \sin \omega t + \frac{a_2 E^2}{2} (1 - \cos 2\omega t) + \dots$$

The first term is the steady direct current determined by the operating voltages, E_0 :

$$a_0 E_0 = I_0$$

The second term is the current component of fundamental radio frequency:

$$a_1 E \sin \omega t = I_1 \sin \omega t$$

The third term has two components. One is of double the frequency of the impressed signal:

$$-\frac{a_2 E^2}{2} \cos 2\omega t = I_2 \sin (2\omega t + \phi)$$

The second component is an added d.c. increment:

$$\frac{a_2 E^2}{2} = \Delta I$$

Thus it is seen that the d.c. increment due to the impressed signal comes out of the squared term of the series and is proportional to the square of the radio frequency signal amplitude (E). This is the term which determines the detector performance, neglecting higher powers of the series. This is permissible, without introducing appreciable error, for detection at small signal levels.

For the case of detection of a c.w. signal by the heterodyne method, two radio-frequency signals of slightly different frequency are impressed on the grid. In the autodyne system, one frequency is the incoming frequency (f_r) and the other is the locally generated oscillation frequency (f_l). These can be represented by

$$E_1 \sin \omega t, \text{ where } \omega = 2\pi f_r$$

$$\text{and } E_2 \sin qt, \text{ where } q = 2\pi f_l$$

$$\text{Therefore, } e = E_1 \sin \omega t + E_2 \sin qt$$

Substituting this in (1) and expanding as before, we obtain the relation for current:

$$i = a_0 E_0 + a_1 (E_1 \sin \omega t + E_2 \sin qt) + a_2 (E_1^2 \sin^2 \omega t + E_2^2 \sin^2 qt + 2E_1 E_2 \sin \omega t \sin qt) + \dots$$

Expanding and reducing to components of fundamental or harmonic frequencies:

$$i = a_0 E_0 + a_1 E_1 \sin \omega t + a_1 E_2 \sin qt + \frac{a_2 E_1^2}{2} + \frac{a_2 E_2^2}{2} - \frac{a_2 E_1^2}{2} \cos 2\omega t - \frac{a_2 E_2^2}{2} \cos 2qt + a_2 E_1 E_2 \cos (\omega + q)t + a_2 E_1 E_2 \cos (\omega - q)t$$

Examining these current components, we find first the steady d.c. due to the operating voltages:

$$a_0 E_0 = I_0$$

The second term is of the frequency of the impressed r.f. signal and the third term is of the same frequency as the locally generated carrier, also of radio frequency.

The fourth and fifth terms are the d.c. increments due to the impressed signals while the sixth and seventh are second harmonics of the incoming and locally generated r.f. signals. The eighth term is also a radio frequency component and is of a frequency equal to the sum of the local and carrier frequencies. None of these components produces an audible signal. The last term, however, is the useful term. It represents the audible beat frequency between the incoming r.f. signal and the local oscillator frequencies.

It will be noted that this useful component comes from the squared term of the original series and that the coefficient (a_2) enters both this term and the d.c. increments, thus justifying the relation between the d.c. increment and the detector performance.

Experimenters' Section

A Method of Measuring Capacity and Inductance

By C. A. Briggs, W3CAB*

THE calibration method to be described may be useful to experimenters who desire a variable condenser for measuring capacities or inductances and who have no regular laboratory apparatus for the work. The equipment consists of the variable condenser to be calibrated, a fixed condenser of known value (but with less capacity than the maximum of the variable condenser) and a coil of such inductance that in connection with the variable condenser the broadcast frequencies will be covered.

The variable condenser should be connected to the coil, which should be solidly constructed, and the fixed condenser so arranged that it can be connected in parallel with the variable condenser or taken out of the circuit at will. This, in effect, forms a frequency meter for the broadcast band.

In the experimental observations, the curve of frequency in kilocycles versus the reading of the condenser dial is first determined, the fixed condenser being left out of the circuit. This course is readily obtained by using a suitable radio receiver to tune in and identify broadcasting stations whose frequencies are known, and the receiver is also used to determine when the frequency meter is brought in tune with them. An unshielded receiver will be best for this purpose.

After the frequency meter is calibrated and the curve carefully plotted, a station in the lower frequency range of the broadcast band is tuned in and the fixed condenser connected in the circuit. The variable condenser is then backed off until it is again tuned to the selected station and the reading noted.

The known quantities involved then comprise the frequency of the station chosen, the value of the fixed condenser, the reading of the dial, and, from the frequency calibration curve, the frequency corresponding to the dial reading when the fixed condenser is not in place. From these quantities can be determined the inductance of the coil and the capacity of the condenser corresponding to various readings of the dial.

The relations involved are as follows:

$$LC = \frac{1}{4\pi^2 f^2} \dots \dots \dots (1)$$

where L = inductance in henrys, C = capacity of condenser in farads, and f the frequency in cycles per second.

When the small condenser of known value is placed in the circuit and the frequency meter is tuned to a chosen frequency, the relation can be expressed

$$L(C+K) = \frac{1}{4\pi^2 f_1^2} \dots \dots \dots (2)$$

where K is the value of the fixed condenser and f_1 is the particular frequency selected.

Denoting by f_2 the frequency corresponding to the same reading when the fixed condenser is removed, as shown by the calibration curve, we can write

$$LC = \frac{1}{4\pi^2 f_2^2} \dots \dots \dots (3)$$

By eliminating C between equations (2) and (3) we obtain

$$L = \frac{1}{4\pi^2 K} \left(\frac{1}{f_1^2} - \frac{1}{f_2^2} \right) \dots \dots \dots (4)$$

The value of L may be computed by inserting the proper values for K , f_1 and f_2 as obtained in the experimental work.

Substituting the value of L as given in equation (4) in equation (1) and rearranging terms there results

$$C = \frac{1}{f^2} \left(\frac{K f_1^2 f_2^2}{f_2^2 - f_1^2} \right) \dots \dots \dots (5)$$

The quantity $\frac{K f_1^2 f_2^2}{f_2^2 - f_1^2}$ is a constant for the particular coil used and its numerical value can be computed from the known quantities K , f_1 and

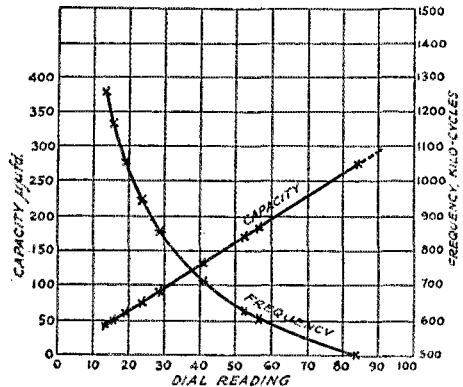

FIG. 1

f_2 . The variables in equation (5) are, therefore, the capacity C and the frequency f .

The capacity for any reading of the variable condenser is then readily obtained; the frequency f corresponding to the reading is taken from the

* 1311 Spring Rd., N.W. Washington, D.C.

frequency calibration curve and inserted in equation (5) and the value of C promptly computed. By selecting a suitable number of points a complete calibration curve can be obtained.

This method was tried out using as a standard a small fixed condenser of 200 $\mu\text{mfd.}$ capacity. The results were very consistent and a typical curve is shown in Fig. 1.

The precision of the observations may exceed the accuracy of the results, because of the varying effects of distributed capacity and the inductance of the leads, which produce effects that change with the frequency. Laboratory equipment employing low frequencies is necessary where great accuracy is needed.

This method can be applied in numerous instances. After the variable condenser is calibrated it is a simple matter to measure the capacity of other fixed condensers by connecting them in the circuit and determining how much the variable condenser has to be backed off to compensate. Inductances can be measured by applying the relations given in equation (3) and solving for L .

TUNED FILTERS

One type of plate-supply filter which has been largely overlooked by amateurs is the tuned filter, in which the inductance and capacity are adjusted to form a rejector circuit for the ripple frequency. The functioning of this type of filter is similar to that of a common "wave-trap." Alfred H. Turner, W3AUX, of Camden, N. J., writes us as follows concerning it:

"While reading over the *résumé* of d.c. plate supply systems in the June, 1930, issue of *QST* as well as the article entitled, 'ABC of Filter Design' in the April, 1930, issue, it occurred to me that we amateurs are overlooking the advantage to be gained by tuning the filter choke to the major ripple frequency — 120 cycles when the rectifier is of the full-wave type operating from a 60-cycle source.

"The tuned filter is becoming increasingly common in broadcast receiver design. In broadcast practice, the filter is usually of two sections in which the speaker field constitutes the second section. The first section is tuned because it is of lower resistance and because all of the rectified current passes through it. If the rectified current contained only the 120-cycle ripple, there would be no objection to tuning the speaker field also. However, since there are objectionable higher harmonic ripple frequencies present, one section is left untuned as a low-pass filter.

"Mr. B. F. Meissner, in *Proceedings of the Institute of Radio Engineers* for January, 1930, described a modification of the straight tuned

choke, in which a tapped choke is used and a small section of it tuned. This arrangement incorporates in a single choke the advantages of a two-section filter one section of which is tuned and the other untuned.

"The tuning of a choke of low resistance is fairly critical and care should be taken that the capacity not exceed the correct value. The inductance of the choke usually varies considerably with the current through it and it is suggested, therefore, that the tuning be done under normal load. As the usual filter choke has an inductance value between 10 and 50 henrys, it requires an approximate capacity of from 0.2 $\mu\text{fd.}$ to 0.04 $\mu\text{fd.}$ for resonance at 120 cycles. If the voltage rating of this tuning condenser, which is usually of the tin-foil and waxed paper type, is made equal to the voltage rating of the input condenser to the section, there is little danger of puncture. The usual input and output condensers of one or two microfarads do not materially alter the tuning of the section.

"It is not too much to expect at least a five-to-one reduction of the major ripple in one section when the small tuning condenser is added. However, this much overall improvement may not be obtained if the tuned section is followed by a good untuned section."

A RECEIVER WITH PUSH-PULL R.F. AND DETECTOR

1930 might be called the "push-pull year" because so much interest is being shown in push-

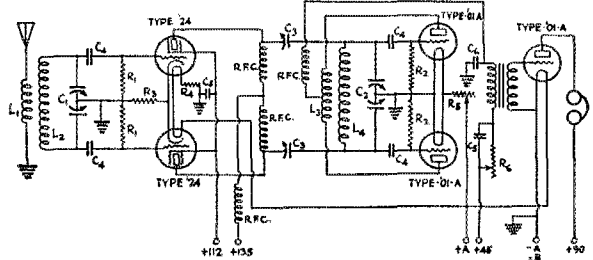

FIG. 2

- C_1 — Two midget condensers cut to $\frac{1}{4}$ plates each with rotors connected. (May be same as C_2 if desired.)
 C_2 — 150- $\mu\text{mfd.}$ condenser cut to $\frac{1}{4}$ plates with two stator plates insulated from each other.
 C_3 — 5-plate midget.
 C_4 — 100 $\mu\text{mfd.}$
 C_5 — 0.5 or 1.0 $\mu\text{mfd.}$
 C_6 — 2000 $\mu\text{mfd.}$

- R_1 — 1-megohm grid leak.
 R_2 — 5-megohm grid leak.
 R_3 — 750 ohms.
 R_4 — 1 ohm.
 R_5 — 10 ohms.
 R_6 — 100,000-ohm variable resistor.
 R.F.C. — Commercial short-wave rejector choke coils.

R_5 — 10 ohms.

R_6 — 100,000-ohm variable resistor.

R.F.C. — Commercial short-wave rejector choke coils.

COIL DATA

Band	L_1	L_2	I_3	L_4
28 mc.	3	4	5	4
1 $\frac{1}{2}$ mc.	4	8	5	10
7 mc.	6	16	7	20

wound with No. 22 d.s.c. on Pilet forms (diameter $1\frac{1}{2}$ "'). Spacing between turns for 28 and $1\frac{1}{2}$ mc. on L_2 and L_4 is adjusted for proper band coverage. No spacing used for 7 mc.

pull transmitters and receivers. In the August Experimenters' Section there appeared a description of a receiver using push-pull screen-grid detectors; this month we have data on a receiver

using a push-pull tuned r.f. amplifier with push-pull triode detectors. The chap responsible for this is R. N. McCord, W9RAY, 300 Nelson Ave., St. Paul, Minn. He writes as follows concerning the circuit:

"By referring to Fig. 2 you will notice that a.c. tubes have been adapted to a d.c. circuit. Type '24 tubes were used in the r.f. amplifier because of their greater amplification. The other tubes are Type '01-A's. Midget variable condensers are used throughout except C_3 , which is a good standard condenser with bakelite strips holding the stator plates. All but two of the stator and two of the rotor plates have been removed, and the stator plates have been separated from each other by cutting the metal tie.

"The most prominent difference noticed when this receiver was compared with other types was the absolute quietness of operation. This was a revelation to me as I live on one of the busiest thoroughfares of the city and with all the racket from passing cars, especially on 14 mc., good reception is at a premium. With other types of receivers it was impossible for me to hear any foreign DX. Now those signals come in almost as good, on the average, as do U. S. stations. On account of the weak background noises, weak signals stand out prominently.

"The next great difference noticed was the comparative r.f. gain on 14 and 28 mc. as compared with other tuned and untuned r.f. receivers. In fact, the percentage of gain on 14 mc. is almost as great as on 3500 kc. This is explained by the utilization of all r.f. energy due to the push-pull arrangement.

"The addition of another tuning control may not appeal to some amateurs, but it does not in any way make the tuning more difficult or complicated. The r.f. tuning condenser, when once set for the different bands, need not be touched except when it is desired to aid in separating signals or to bring in a weak signal. In reality, it is not as hard to tune this type of set as a straight oscillating detector, since it will work over a greater range of frequencies near the oscillating point without adjustment of the regeneration control. Therefore, very rapid tuning is permissible. I have had trouble in getting receivers to oscillate on 28 mc. and higher but this set worked near the 50 mc. region at the first try.

"The coils L_1 , L_2 , L_3 and L_4 are wound on Pilot forms. The windings L_2 and L_4 are spaced in the middle for about $\frac{1}{4}$ " and the primary and tickler windings are wound in the space. It is also best to try spacing the windings L_2 and L_4 to get into the band as the addition of one turn will throw the tuning out of the band. If oscillations do not take place at once try reversing the tickler connections. Even if the set is oscillating it is difficult to tell by the usual method of touching the stator plates of the detector tuning condenser and listening for the 'pluck' when the receiver goes out of

oscillation, or by listening for the 'pluck' when going into oscillation by varying the regeneration control. My experience has shown that the same kind of 'pluck' is heard when the receiver is in a non-oscillating condition when following the above practice. The best method is to use a wave-meter or similar absorption device or by varying the tuning condenser until signals are heard, that is, if the set is working.

"During adjustment the condensers marked C_3 need not be varied for the different bands when the right setting is once found. They should be adjusted to give a maximum energy transfer without causing any reaction on the detector tuning, or by stopping oscillation. The screen-grid voltage is higher than usual but was found to give better signals this way. Aside from the above, no extra precautions are necessary except that complete shielding of the r.f. will be found advantageous."

Exploring the 56 Megacycle Band

By Harry D. Hooton, W8BKV*

Although the 56-mc. band is practically unexplored at the present time it can be the field for some very interesting experiments. Effects that are unnoticed at lower frequencies are greatly exaggerated at these extremely short waves and this is one of many things that make this band interesting to the experimenter. Most of the 56-mc. apparatus is easily constructed and very economical in cost.

Let us consider the 5-meter receiver. It will need special design and construction, and while this sounds like a job there is nothing "freakish" about it. The usual short-wave circuit will work well at 56 mc. The first rule is the cardinal rule for all high frequency apparatus: short leads. The writer used copper tubing coils, mounting them directly on the tuning condenser to avoid any kind of leads. It is important to use heavy material not only because of increased efficiency but also to reduce vibration. The second step is to reduce capacity between the wiring and the various parts of the receiver. Metal end-plate variable condensers are taboo for this frequency as they have too much capacity effect with other receiver parts. Small "midgets" of the soldered plate variety are best and the importance of soldered plate construction can hardly be over-emphasized at this frequency. Very small capacity between parts of the circuit will often cause a receiver to refuse to oscillate. It is advisable to use coils of small diameter as a 56-mc. coil has a large field.

It is best to eliminate the socket for the detector, soldering direct to the terminals of the tube. This not only eliminates all chance of losses at this point but as different tubes change things greatly

*Gallipolis Ferry, W. Va.

on this band nothing is gained by changing tubes. It is the best policy to select a good tube and design the circuit around its individual characteristics. The Type '12 was used by the writer but '99s have been used with success, although it is a little more difficult to make them oscillate. It is desirable to use separate batteries on the audio amplifier as this centers the trouble hunting in the detector circuit.

Almost any antenna will do for reception of 56-mc. signals, but the coupling should be considerably less than that used at lower frequencies. An antenna about 20 feet long was used here with

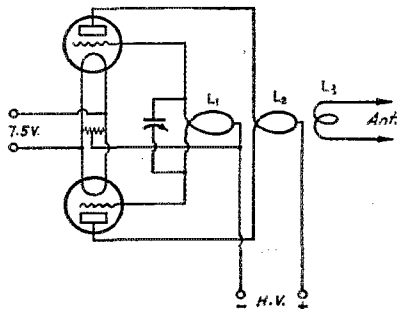

FIG. 3. — THE 5-METER MESNY OSCILLATOR

C1 — Tuning condenser. Should have small capacity. A 2-plate condenser with plates separated about $\frac{1}{8}$ " should serve.
L1 — 1 turn of $\frac{1}{4}$ " copper tubing about 4" in diameter, tapped at center of turn.
L2 — 1 turn same as *L1* but slightly larger in diameter, tapped at center of turn.
L3 — One or two turns, depending on how the antenna is coupled to the oscillator.

These sizes are subject to some modification, as it is difficult to specify exact dimensions at such high frequencies. The values had best be determined experimentally.

success, but a directive antenna identical with the one used for the transmitter gave stronger signals.

Now with regard to the transmitter. The writer used the "Mesny" circuit in all his experiments, and the present transmitter in use at W3BKV is almost identical in design and construction with that used by F8PY at Paris. As shown in Fig. 3 the circuit is of the push-pull type. The transmitter is composed of two tightly coupled coils (grid and plate), the grid coil being connected to the grids of the two tubes and the plate coil similarly connected to the plates. No r.f. choke is used in the plate circuit. Two $7\frac{1}{2}$ -watt tubes are used at this station. The plate coil should have $\frac{1}{2}$ more turns than the grid for proper oscillation. It is advisable to use a low-capacity tuning condenser or the tuning will be extremely critical, making the transmitter hard to adjust.

As the antenna for the transmitter is short, reflectors can be used conveniently. The antenna system in Fig. 4 is quite successful for both transmitting and receiving. It is the single-wire reflector type and considerably increases signal strength.

Some interesting effects were noticed while using the beam antenna described. This is a hilly

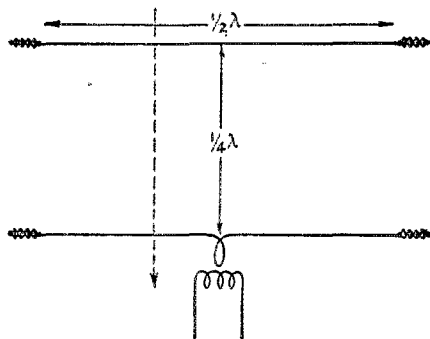

FIG. 4. — THE DIRECTIVE ANTENNA SYSTEM

This is only one of the many forms which can be used. See April QST, page 15. The arrangement above is directive in the plane of the antennas as shown by the arrow. A half-wave 5-meter antenna will be approximately 7' 10" long.

location and when the receiver was on top of the hills signals were strong, but if on a lower level or behind an object such as a tree or house the signals were blotted out entirely.

The writer would be glad to hear from other 56-mc. experimenters, exchange information and make test transmissions.

ELIMINATING HUM

The question of hum elimination in a.c. receivers is still a burning one and Newton Beall, W3ZY, of Washington, D. C., sends us a good list of suggestions for curing it. Here they are:

1. Don't ground the receiver panel or case, if metal is being used. It is better to use the negative "B" connection.
2. Center tap your filament transformer with a 60- to 100-ohm resistor, and be sure that you have the true electrical center. This can best be checked by a good voltmeter and small battery ($4\frac{1}{2}$ -volt) by obtaining the same reading on either half of resistor. Connect center tap to ground.
3. Try placing your receiving antenna lead-in in inductive relation to the filament transformer or primary supply. Be careful in adjusting this, as you will find a point where bringing the lead-in closer or moving it farther away from the transformer will cause hum to become very pronounced.
4. If an antenna coupling condenser is used, it should be variable and have some means of being adjusted with micrometer precision. Careful adjustment of this condenser will not only spread the band properly but also affects the hum.
5. Make sure your tubes are in good condition, especially the Type '24 if one is being used.
6. Make sure that all 110-volt lines in, around or near the set are covered in some manner such as BX cable is covered and all covers properly

(Continued on page 73)

W9BAN

IN October, 1926, the call W9BAN was allotted to George P. Taylor, of 728 Second Street, Henderson, Ky. The station progressed smoothly for nearly two years. Then one Sunday afternoon in September, 1928, while peacefully QSO Chicago, the op was politely but firmly informed that the house was on fire. Practically everything was burned from the transoms up, and

Type '10 tubes with d.c. power supply, a four-tube receiver, and a calibrated monitor, together with the usual control equipment.

The receiver was modeled after a description in *QST*, with a few changes. It has a screen-grid antenna coupling tube, a regenerative triode detector, and two stages of transformer-coupled audio amplification. The circuit diagram is shown

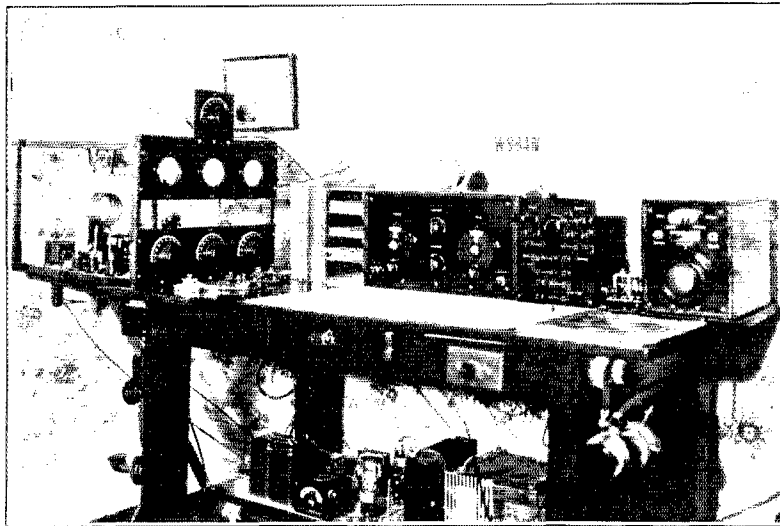

A VIEW OF W9BAN

From left to right are the transmitter, receiver, battery control panel, key and monitor. The batteries for the receiver and the power supply for the transmitter are on the shelf under the table.

the radio table was piled high with debris and fallen timbers. W9BAN was unquestionably *hors de combat*. But it really was a blessing in disguise, as the station was rebuilt to a much higher standard.

One year later, W9BAN was the recipient of a direct hit by lightning. (Lightning switches are fine, but unless they are grounded . . .) And a couple of billion volts of concentrated electricity is positively ruthless. It blew everything but the postman's whistle . . . tubes, meters, chokes, transformers, condensers, lights, telephone, relay, and made crude but nearly permanent welded joints on the key contacts. As before, the station was rebuilt and improved. Such were two incidents of a devastating nature in the short history of W9BAN which, though costly, proved to be of decided benefit to the station in the long run.

The present station, a general view of which is shown in the large photograph, is the result of experience acquired during the two previous rebuildings, and consists of a high-C push-pull tuned-plate tuned-grid transmitter using two

in Fig. 1. Regeneration is controlled by a variable resistor. The 15- μ fd. midget condenser in shunt with the 100- μ fd. tuning condenser spreads the 7-mc. band over 93 degrees on the dial. The main tuning condenser covers a much wider range than this, however, so that territory outside the amateur bands can be covered. Since the receiver was built primarily for c.w. reception, maximum distortion was wanted, and high-ratio transformers are used in both audio stages.

The coils are plug-in type, covering 3.5, 7, and 14 mc. Three-inch factory-wound coils are used on the 7- and 14-mc. bands. Half the top of a tube base was cut off and the four ends of the coil were pulled tightly through the tube prongs and soldered. No bolts or bakelite strips were needed, and the coils are very rigid and self-supporting. The last audio stage is cut in or out for speaker operation by a rotary D.P.S.T. switch mounted on the receiver panel. Phone leads are brought under the table and connected to a Yaxley outlet jack conveniently located on the front of the table.

A top view of the receiver is shown in one of the photographs, while the station photograph shows the appearance of the panel. The two National dials control the tuning and vernier condensers,

and is about 6 inches from the nearest antenna coil. No clips are used on the transmitting inductance — all leads are soldered or bolted.

A receiving-type resistor is used for the grid leak and is rated at 0 to 500,000 ohms. It is a variable wire-wound resistor and about one quarter of its full value is used, or approximately 125,000 ohms. This high-resistance grid leak reduces the plate current to 85 milliamperes and probably is responsible for a few of the reports of "xtal d.c." At any rate, it noticeably improves the quality of the signal with but a small sacrifice in power output.

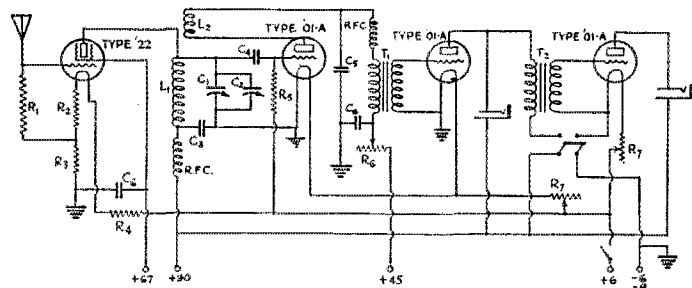

FIG. 1.— THE RECEIVER

- C₁ — 100 μfd.
- C₂ — 25-μfd. midget.
- C₃ — 4,000 μfd.
- C₄ — 100 μfd.
- C₅ — 2000 μfd.
- C₆ — 0.1 μfd.
- R₁ — 10,000 ohms.
- R₂ — 10 ohms.

- R₃ — 5 ohms.
- R₄ — Amperite.
- R₅ — 5-megohm grid leak.
- R₆ — 50,000-ohm variable resistor.
- R₇ — 10-ohm rheostat.
- T₁ — Audio transformer, 10-1 ratio.
- T₂ — " " " 5-1 "
- RFC — Honeycomb-type coil, 1/4" x 3/4"

	L ₁	
3,500 kc.	21 turns	
7,000 kc.	6 "	
14,000 kc.	3 "	

	L ₂	
	14 turns	on old tube base
	4 "	3 in. diameter
	2 "	" "

the filament rheostat and regeneration control resistor being mounted in the center of the panel.

The receiver is in a home-made oak cabinet, 9 x 15 x 7 inches. Body capacity is eliminated by copper shielding. Baldwin headphones are used and are equipped with soft sponge rubber cushions which are very comfortable when the phones are used for any length of time.

The receiving antenna is approximately 80 feet over all and is strung in the attic.

THE TRANSMITTER

The transmitter works in the 7000-ke. band and is usually tuned to a fixed frequency of 7175 kc. In keeping with the "1930" type transmitter it is of high-C design. Two Type '10 tubes are employed in push-pull, using the tuned-grid tuned-plate circuit. An idea of the constructional details of the transmitter can be obtained by inspection of the photograph. Most of the transmitter parts are mounted on the 7/8" baseboard, which is 18" x 18". The white pine uprights and cross members are 3/4" x 1/2". The two main panels are 18" x 5" each and the auxiliary panel at the top is 5" x 5".

The plate coil and two antenna coils are mounted on glass rods just back of the meters. The glass rods run through the coils and are spaced so that the coils will be held rigid at all times and yet permit a change in coupling should it become necessary. The coupling is usually 2 1/2 to 3 inches. The grid inductance is permanently mounted "out-of-field" on stand-off insula-

tors, and is about 6 inches from the nearest antenna coil. No clips are used on the transmitting inductance — all leads are soldered or bolted.

Filament voltage is controlled by an E210 Bradleystat in the primary of the filament transformer. This rheostat is placed within easy reach on the side of the table. An old telegraph sounder equipped with silver contacts serves well as a keying relay.

Christmas tree lamps are used to obtain a center tap on the filament transformer supplying the oscillator tubes. While probably not quite up to date, these lights present one decided advantage over other resistances in tuning. By touching the key very lightly for a short dot, the brilliancy of the bulbs determines the approximate plate current in a fraction of the time required to take a reading on the milliammeter, thus reducing to a minimum the time of excessive loads on the tubes during tuning.

There is a slight knack in tuning the tuned-grid tuned-plate circuit which some amateurs may have overlooked. In tuning the closed circuit the grid condenser is tuned to resonance with the plate circuit, as indicated by the lowest plate — current reading. The grid condenser is then detuned to show an added plate current of approximately 20% or more, by slightly increasing the capacity.

POWER SUPPLY

The power supply is conventional in design. It is visible on the shelf under the operating table in

a six-volt bulb. The meter is panel mounted and enclosed in a thin wooden cabinet.

ANTENNA SYSTEM

The antenna system is a half-wave Zeppelin. The feeders are spaced ten inches and are 34 feet

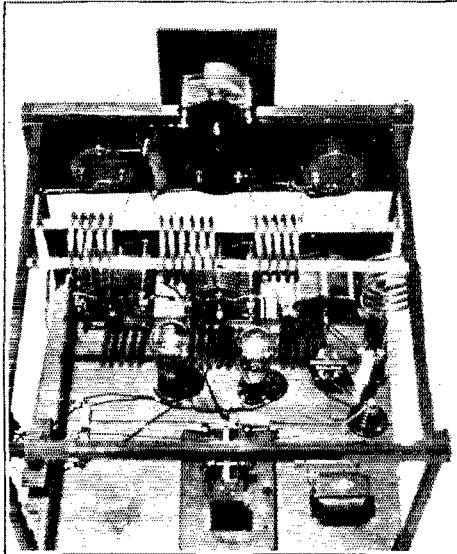

A REAR VIEW OF THE TRANSMITTER

The central coil mounted on the glass rods is the plate tank coil, the ones on either side of it being the antenna coupling inductances. The grid inductance is mounted on stand-off insulators on the baseboard at the extreme right. Behind the tubes are the keying relay and the key-thump filter.

long from the antenna coupling coils. The radiator is 68 feet long and approximately 27 feet high.

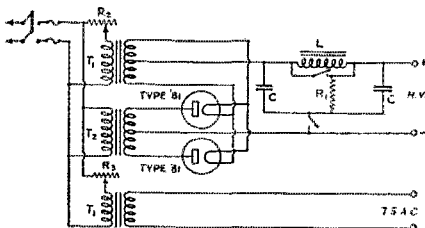

FIG. 3. — THE RECTIFIER-FILTER SYSTEM

- L — 30-henry, 150-mil filter choke.
- C — 4- μ fd. filter condenser.
- R₁ — 30,000-ohm 75-watt wire-wound resistor.
- R₂ — Wire-wound rheostat.
- R₃ — E210 Bradleystat.
- T₁ — 7.5-volt filament transformer.
- T₂ — Power transformer, 550 volts each side center-tap.

It is suspended between a 30-foot mast in the back to a 6-foot pipe mast on top of the house, and is practically horizontal. The feeders connect to the top at an angle of 60 degrees. Lead-ins come through G.R. insulators bolted either side

of a board under the window. Six-inch stand-off insulators are at the window and roof-edge of the house. Between these two pairs of insulators the feeders are pulled taut and need no spacers. Only one is needed above this point. Number 12 soft-drawn enamelled copper wire is used for both antenna and feeders.

OPERATION

The transmitter is turned on from the switch panel seen at the right of the receiver. This panel is 9" x 7", and on it are mounted a battery switch for charge position and receiver operation, a 110-volt switch to the dry-disk charger, charge indicator meter with switch, relay, buzzer and ground switch, and a Century high-frequency buzzer. They are all battery switches removed from the porcelain bases and mounted on the bakelite panel. It is very handy to have them mounted in this manner, as they occupy very little space and are readily accessible.

Two dry cells are used to energize the buzzer and two for the relay. Both are hooked directly across the keys. The buzzer is generally left on during operation, as it is an accurate monitor of the list, and in a psychological way will greatly improve sending. The relay is mounted on a thin rubber sponge, although this precaution against vibration is not wholly necessary, as the push-

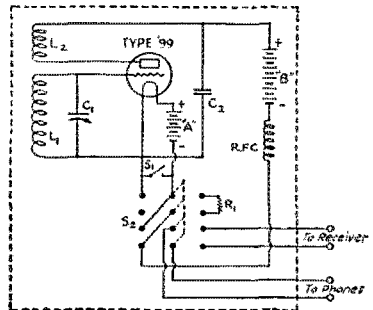

FIG. 4. — THE COMBINED MONITOR AND FREQUENCY-METER

- L₁ — 17 turns of No. 28 d.c.c. on old tube base.
 - L₂ — 12 " " " spaced 3/16" from L₁.
 - C₁ — Double-spaced 3-plate condenser.
 - C₂ — 1000 μ fd.
 - R₁ — 3000 ohms.
 - RPC — 160 turns of No. 28 d.c.c. on 1/2" form.
 - B — Battery switch.
 - S₁ — Battery switch.
 - S₂ — Federal 3-pole double-throw toggle switch.
- Dotted lines represent shielding.

pull circuit is very stable and apparently is entirely free from creeping, chirps, or the dreaded "wobulation." The addition of a small key-click filter was the last touch to banish forever the old nickname the BCL's once gave the station, "Broadcast All Night."

To the left of the receiver are four small "pigeon holes" made from aluminum plates.

(Continued on page 52)

I.A.R.U. NEWS

Devoted to the interests and activities of the

INTERNATIONAL AMATEUR RADIO UNION

President: H. P. MAXIM

Vice-President: C. H. STEWART

Secretary: K. B. WARNER

Headquarters Society:

THE AMERICAN RADIO RELAY LEAGUE, Hartford, Conn.

MEMBER SOCIETIES

American Radio Relay League
 Asociacion E. A. R.
 Associazione Radiotecnica Italiana
 Canadian Section, A.R.R.L.
 Deutscher Amateur-Sende-und Empfangsdienst
 Experimenterende Danske Radioamatører
 Nederlandsche Vereeniging voor Internationaal Radio-amateurisme

New Zealand Association of Radio Transmitters
 Norwegian Radio Relay League
 Radio Society of Great Britain
 Reseau Belge
 Reseau Emetteurs Français
 South African Radio Relay League
 Wireless Institute of Australia

Conducted by Clinton B. DeSoto

THE principal matter under consideration in the June Calendar of the I.A.R.U. as sent to the member-societies, is a discussion of policies in anticipation and preparation for the Copenhagen and Madrid conferences on international radio affairs. We are at present principally concerned with that at Copenhagen, which will be held in the spring of 1931.

The *Rede dos Emissores Portugueses* is proposed for membership with this Calendar, and we hope soon to be able to welcome this active society and its enthusiastic membership into the Union.

We record two additions to the list of QSL Forwarding Bureaus of the world, published in this department of the November, 1929 issue of *QST*.

Cards for Norwegian amateurs can be sent to the Norwegian Radio Relay League, Industriegaten 30, Oslo, Norway.

Cards for amateurs in the Dutch East Indies can be sent to the N. I. V. I. R. A., Traffic Department, Egb. A. Krygsman, c/o Bataafsche Petrol Col, Boela, Ceram, Dutch East Indies.

Cards for Egypt, Iraq, and Roumania can be forwarded via the A.R.R.L.

Further information on QSL-Services is to be found in the national section reports in this issue.

J. W. Jennison, VK2JJ, recently achieved WAC membership with 3 watts input from "B" batteries to a UX-201-A in a t.g.t.p. circuit. His reports were all excellent, pure d.c. QSA 3 being the poorest, and QSA 5 from Africa the best.

The first reaction to the suggestion offered in this department of the July issue of *QST* con-



GENERAL ASSEMBLY OF THE U.S.K.A. (SWITZERLAND) AT BERNE, MARCH 30, 1930

The large fellow in the center of the front row is the President, Degler, 9D. To his left (your right) is Dr. Schoenlank, the Secretary, and on the other side, to his right, Schneeberger, 9G, Traffic Manager. On Dr. Schoenlank's left are respectively Van Burgen, QSL Service, and Wolf, Treasurer.

cerning abbreviation of the names of principal cities, comes from Art Bates, well known for QRA's and W9FO.

He points out that too many messages are "lost, strayed, or stolen" under present conditions because the receiving operator merely guesses at the name of the town, and also enters a plea for the hundreds of cards undelivered because of improper address, "no such post office," etc. The time and effort necessary to send a few more characters and thus insure correct reception of the name seems to him well worth while, especially where operators are of different nationalities.

Will we hear from any defenders?

The South African amateurs are now using the prefix "VP." Although no official intimation that this is in order has been received, it is obviously more correct than the old intermediate "fo." "VP" is also being used in Southern Rhodesia, and will be their prefix in the future.

A surprisingly large number of WAC certificates has been issued recently. At this writing the number issued since the WAC Club was assumed by the Union is well over one hundred,

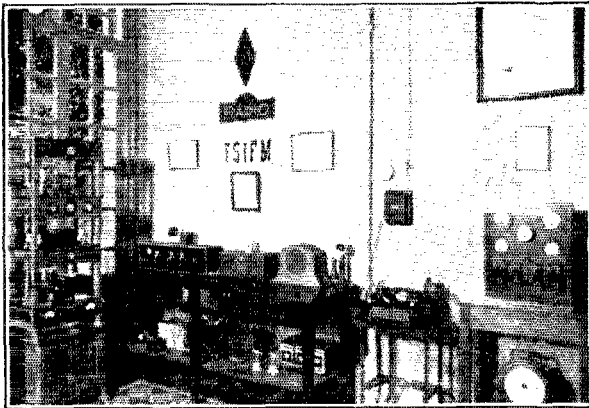

YSI FM, OWNED AND OPERATED BY J. FREDERICO MEJIA, SAN SALVADOR, REPUBLIC OF EL SALVADOR, CENTRAL AMERICA, "WHERE THE BEST COFFEE GROWS!"

This station, which operates in the 7-mc. band, uses one Type '03-A as oscillator, fed by 1000 v. pure d.c. at 100 mls. The receivers are both R.C.A., being, left to right, types AR-1406-D and AR-1145. The loud-speaker is an R.C.A. A-100. The owner is an E.E. and Assoc. A.I.E.E. He is chief of the Radio Division of the Government of Salvador.

and, at the rate they are going now, it will be close to 150 when these lines are read. Remember that's only for 1930 — and in addition we have WAC's for 'phone, and have promised one for 28-mc. contact. International communication is rapidly becoming commonplace.

BELGIAN NOTES

By Paul de Neck, Pres., Reseau Belge

This summer brings us especially bad propagation conditions on all bands.

The June International 28-mc. Tests showed no results from our amateurs. There were four Belgian stations on this band every Saturday and Sunday afternoon, but they were unable to hear or work anyone. Only a few harmonics from 14-mc. stations working locally came through. ON4CK, ON4RO, ON4AU, and ON4UU were the active stations.

The best work on 14 mc. has been done by ON4JB, who worked five continents with only 3 watts input. His set is an m.o.p.a. arrangement with the push-pull stages capacity coupled. Two Dutch A.409 tubes are used as oscillators and two B.406 tubes as amplifiers, with 120 volts

at 30 mls on their plates. A Zeppelin antenna about 60 feet high is used.

ON4FT wishes to point out that the official call just granted him for his sailing yacht *Tenacity* is ON4FX and not XON4FT, as reported in these pages previously.

DANISH REPORT

From the Experimenting Danish Radioamateurs Receiving conditions on 28 mc. have been entirely hopeless, the only stations heard being local Danish amateurs. Several OZ stations were on the air for the June tests on this band.

On 14 mc. conditions have been very unstable, contrary to our experiences with early spring in previous years, when it has regularly been possible to work North and South American stations every evening.

Contact with South Africa will soon be impossible until Autumn comes again. New Zealand has not been heard much, while Australia has come through regularly on Sunday mornings, quite a number of contacts having been effected.

It has been interesting to note the variation in conditions from year to year, but we hope that conditions on 14 mc. will soon become stable so that regular contact with North and South America will again be possible.

Conditions on 7 mc. have also been very peculiar. In the daytime European contacts are always easily possible, but nearly every evening has been quite dead, only faint DX stations being heard.

On a few evenings European contacts have been excellent, but very little DX has been heard or worked, and one has the impression that 7 mc. is no longer used for DX.

On 3.5 mc. everything has been normal; the band is chiefly used by 'phone stations, but seems to be becoming more and more popular for European contacts, many of these being effected every day.

DUTCH NOTES

By H. Pomes, Ass't Traffic Manager N.V.I.R. (We preface this report with an announcement of the election of new officers in the N.V.I.R.)

J. Corver, Burnierstraat 38, The Hague, is the new President.

W. Tappenbeck, Hotel de l'Europe, N. Doelentstraat 2-4, Amsterdam C, is the address of the Secretary-Treasurer.

(QSL cards should be sent to the QSL-Service, Post box 400, at Rotterdam — C.B.D.)

During the latter spring months, reception was rather poor, and the activity of the Dutch amateurs, we are sorry to say, was confined to a

(Continued on page 66)

Calls Heard



ZL1FU, G. D. White, Bridge St., Poltiki, N. Z.

14,000-ke. band

wlajv w1akg w1akv w1apq w1aqs w1aqt w1asf w1awk w1aze w1bft w1bwm w1bux w1dp w1pe w1pi w1zz w2afb w2arb w2avj w2ayj w2biv w2bg w2boz w2bys w2ced w2el w2qn w2rs w2zg w3aaaz w3aqi w3arp w3ced w3jm w3nt w3ym w3yw w4abv w4ack w4aek w4agv w4ahl w4aik w4ll w4ly w4mk w4mr w4pau w4um w4wz w5aak w5aot w5qu w6afi w6aqj w6bax w6btj w6bb w6by w6cuh w6cxw w6dcv w6de w6drb w6dts w6dwi w6egh w6ew w6eje w6jn w6vz w7aj w7ait w7be w7pj w7ty w8adm w8bet w8bf w8bvw w8cag w8cew w8cut w8ddr w8djv w8dyk w8ff w8fz w8uf w8zza w9ces w9ecz w9eqt w9eve w9dgz w9flh w9ghh w9io ac1bd ac1ts ac8hm ac8wb au8at celah ce3ch ce5aa cm8uf cp1aa ct1aa ct1br ct2aa cx1ap d4aaez ear21 ear65 ear96 ear98 ear116 ear136 eu3kao f8axq f8aw f8ef f8ex f8faf f8fk f8gdb f8rko f8sawa im8er g2gm g2lz g5by g5bz g6hr helic he2jm j1dp j2cb kal1km kaldj k6acv k6ecu k6erh kfu5 lu3fg lu4dq lu6aj o4tc o4j o4l o4q o4t o4x o4z oh2nm ok2va on4bc on4tp on4z pa0qf pk1jr pk3bq pk3bm pk4az py2bg py2sb su8rs velar vel1dq ve2be ve2ca ve3ao ve4gk ve4bx ve5aw vs6ag vs7ap vu2dg x9a xu2uu yslap xg2xc wfat wfbt

K6CIB, L. A. Walworth, 11th Signal Co., Schofield Barracks, T. H.

w1bes w2vy w2byp w2xel w2hj w3fq w3hy w4akm w4aiq w4lj w4ly w4is w4agd w5ty w5bek w5axx w5bdz w5bcb w5uf w5aqe w5bny w5ana w5axs w5adp w5any w5cyp w8efd w8of w8pr w8hh w9cgk w9dvc w9dvy w9ke w9qf w9qgdh w9ebo w9apd w9cxy w9ces w9gka kalaw kalhr k7ch k7pb ve4bq ve4bv ve4go vedj vk2jt vk3rg zl2gy j1dq helic

W. A. W. Stevens, 75 Wilson St., Hawera, New Zealand

3500-ke. band

ve3gn vkg vkgy vk2yb vk2kg vk3za w1ajt w1ayi w1bdc w1by w1dx w1gs w1pi w1ps w2aae w2acel w2vy w3aay w3nu w4ax w4ll w4ut w5ags w5ap w5blv w6abe w6abi w6acv w6ak w6ak w6bfi w6bem w6bie w6bj w6bne w6bvr w6cgy w6caz w6cia w6ejm w6dli w6dnl w6dyk w6ef w6et w6fgy w6fp w6fr w6kc w6lx w7aad w7aar w7aqp w7aup w7dp w8cif w8cmw w8cny w8cuy w8dra w8ej w8ey w8hd w9agb w9awe w9baz w9bes w9bnr w9elb w9cgh w9cio w9dex w9dtk w9dxy w9ebx w9emb w9evd w9fi w9fkm w9fqg w9fsc w9fvy w9gdt w9ks

7000-ke. band

ac1bx ac1ts ac3bd ac8ls ac8jt aurt2a aulbo au8er au8er bam bbal cm8lc cn8eis ear1 ear116 ei9ai ei9l eu2kx eutk f8af f8auj f8fb f8gdb f8xz f8gz f30cn fil fmsfs fnih g2sa hai9af j1dn j2uc j3cq j3er j3ct j6ta j9zll ohan ok1na om1tb rx1aa sslaz saf9 ve3kp ve4bv ve4cu ve4gd ve4gi ve4j ve5al ve5dd ve5fs vp9as vp9v vs3ab vs6ae waf wfbt x29a xam xim ylxca z2c z2z z2v kalaf kalce kalcm kaljd kaldp kael kalgo kalhr kaljr kalre kalrh kfu5 kiah k6avl k6acr k6boe k6bxw k6bbe k6bzx k6bic k6dv k6dyc k6eym k6eyw k6ewb k6erh k6ba k6bt k7ans vk2ak vk2aw vk2by vk2cj vk2cz vk2dy vk2dw vk2dh vk2dz vk2j vk2ek vk2fp vk2xz vk2gz vk2gy vk2hk vk2hu vk2hw vk2hb vk2hm vk2hc vk2hl vk2jh vk2je vk2jv vk2jo vk2jj vk2jz vk2jt vk2ks vk2ku vk2kg vk2kh vk2ki vk2ka vk2kl vk2kx vk2le vk2lf vk2mr vk2ns vk2nw vk2ow vk2ra vk2rb vk2rf vk2ru vk2rw vk2sk vk2wd vk2wp vk2wu vk2xw vk2yk vk2zh vk2zn vk2zr vk3aj vk3ab vk3ag vk3bv vk3cj vk3cm vk3cw vk3dc vk3es vk3ew vk3gt vk3gu vk3hk vk3hm vk3hr vk3hw vk3jk vk3ju vk3kv vk3lu vk3lj vk3lv vk3mr vk3ot vk3pa vk3pm vk3pp vk3rb vk3ru vk3rj vk3vp vk3w vk3wj vk3xi vk3za vk4af vk4am vk4br vk4bs vk4cm vk4eg vk4do vk4gh vk4gj vk4jb vk4jo vk4ju vk4kz vk4kg vk4kn vk4mi vk4pn vk4pr vk4rp vk4rk vk4wk vk4xn vk4z vk5bj vk5dc vk5dr vk5dv vk5hg vk5it vk5kj vk5lk vk5mb vk5rx vk5wa vk5vi vk6fl vk6fm vk6wp vk6wr vk7ch vk7dx vk7lj vk7lv vk7wi vk7wm wlaek w1afa w1axx w1by w1bxm w1bes w1biz w1caa w1cek w1cei w1de w1dn w1er w1mo w1mg w2af0 w2ajp w2ayb w2bpx w2bta w2bne w2bnx w2bda w2bno w2bxj w2bds w2beq w2eg w2dw w2gz w2mb w3ag w3awm w3ba w3hd w3w w3ut w4aij w4akg w4al w4aeq w4cq w4ew w4gx w4hd w4hu w4iv w4jd w4ll w4mh w4mm w4vw w5ajj w5alf w5aea w5afm w5af w5af w5bek w5fb w5fm w5gi w5lj w5ly w5mw w5p w5ru w5x w5xf w5fm w6ama 26auj w6auu w6ahp w6aga w6ac w6akp w6af w6af w6amz w6ake w6acf w6ael w6aoc w6azd w6anal w6az w6akf w6axe w6axm w6aos w6bz w6bpx w6byq, w6by w6bpm w6buk w6bi w6byz w6bc w6bvs w6br w6bhg w6bpo w6bf w6bdn w6bfb w6bftm w6bwi w6byb w6bpf w6bjd w6bip w6bco w6bkx

AU1AO, Viktor Solomin, Sennaia St. 57, Brijks, Siberia, U. S. S. R.

aaidh ac1sn ac1tb ac1bd ac2ek ac2aj ac2al ac2pw ac2ff ac2aa ac3gbc ac3ma ac6ag ac7xot ac8rv ac8zw ac8umf ct1aa d4aar d4ahg d4um d4dbd d4gq ear1 ear110 f8kco f8pbo f8lkm f8wrg f8acj f8rot f8l f8gca f8xh f8gdb f8xz f8rs g5vl g6up ha3bk ifu ilgc ij1ll j3ek j2nk kalcz kalrs kalbd kalaf kalanw oh1co oh2os oh2dsa oh5nz ok1ro ok1ve ok1br ok1rf ok2va on4tp on4fm on4ns on4rv on4uu ok4we ok4og on4gm pa0gt patgw ry1f sp3ce sp3bm sp3ao sp3yl sp3ar sp3dl sp1sl t5au vs1bc vu2dg vu2by vy2kx vu2zx wlz w2boa yi2dg yi2as ymzso zl2go zllac zl3aj z8bl

VK5GR, G. B. Ragless, South Rd., St. Mary's, South Australia

7000-ke. band

wlkn w1fx w1vp w1asf w1bes w1sz w2ayj w2bak w2cxl w2uk w3ahp w3ajd w4aaq w4ahl w4ft w4oc w4qv w5zav w5ww w6aaaz w6dpl w6car w6bbd w6bfb w6epz w6bax w6bz d w6g w6cnx w6ehi w7be w7ev w7kt w7iv w7dc w7aff w7gp w7pr w7sl w7ry w7w w7mo w8adg w8bfc w8gz w9ap w9um w9cph w9gdh w9ve ve2ca ve3cz ve4bl ve5aw vs1ab vs8mc oh2gp ac1bd ac8cw ear1 ear94 f8ex g5tz k4cf

14,000-ke. band

w1bwa w1aep w1wz w1cow w1bds w1aqt w1asf w1bux w2fl w2bcx w2czg w2amm w2el w2qn w2bda w2amr w2bxx w3cnuq w2bv w2ary w2hq w2afz w2bwc w2auu w2bak w2ai w2vd w2aef w2sn w2abu w2oa w2byr w3auo w3la w3agj w4ir w4ft w4lj w4agr w4kh w5ben w6aoc w6dvc w6chy w6bax w8dgp w8tbo w8ddk w8app w8cum w8afm w8caq w8bc w8bb1 w8ayw w8cut w8ef w9ka w9dra w9gtz w9cps w9tce w9cou w9bba w9dbj w9mt w9ams w9fz w9ghh w9tee w9aja w9cum w1jr w1cmx w1pe ac1bd ac8ik ac8ag ac8ls acx1hn au8at cm8uf ct1aa ear59 f8cs f8bx f8fem f8whz f8sawa ear59 eu5x g5by g5bz g5sz g5ml g5pi g6rb g6xb oa4j oa4r oa4l on4af ok2sl kaljr pk4az p3bkm pa0qf pk4na ve6ab vs8ag vs8ab vo2zx vt4yz vq4tna ve9si sp1ae sp3yl sp3pb su8rs x9a y1llm oh2nm un1cc z56k z5qg wfat

(Continued on page 54)

Correspondence

The Publishers of QST assume no responsibility for statements made herein by correspondents.



Looking Across at You

1 Boulevard Haussmann,
Paris, France.

Editor, QST:

Bobbie Burns once said, "Oh wad some power the giftie gie us — to see oursel's as ithers see us." No one, particularly if engaged in any kind of technical work, should ever resent a square and honest opinion of himself, if that opinion comes from a source capable of competent judgment.

I have been collecting the opinions of some of my European "ham" friends. They should at least amuse and also give food for thought.

The European ham looks at you chaps with a sort of wistful envy. He reads the advertisements (particularly the "bargain" ones) in QST and moans. The average OM here lives on a salary that would make the poorest of you blink. His choice of equipment is limited and stupidly expensive.

He has the real ham spirit and that keeps a good head of steam in his boilers. Instead of whining at his difficulties he rolls up his sleeves and smashes into them. When you hear a Continental European signal you may be utterly sure that it is the result of labor, mental and manual, the like of which you have never experienced.

I visited an "F" station yesterday. He had two, thirty-watters in push-pull, and the construction work looked as if it had come out of a jeweller's shop. Fixed and variable condensers, all meters, all transformers and chokes — in fact everything except the tubes — were home made — and a lot better job than a good many professional ones I have seen. This man is a very low-salaried office-worker with no formal technical training, but, from his own study and pains, he had full data, curves, all dope on inductance ratios, condenser factors, coefficients of coupling and impedance matchings worked out to three decimals of perfection.

The fellows over here always hand you a whale of a big bouquet, but they feel that your results are in most cases due to lots of available information, lots of inexpensive and varied sources of equipment and — lots of money. They feel that they have you stopped on the pure engineering side.

This is a day of technical precision, and one hopes that the little band of men who cannot only make the old works mote, but who can also tell you exactly why it does, will grow.

— Jack Paddon

Kc. or kHz.?

Caen Van Necklaan 227,
Rijswijk, Z. H.

Editor, QST:

Unnecessary to say, I'm as full of admiration for your fine paper as everybody else, but just this fact urges me the stronger to protest against one inaccuracy. Some time ago you pointed out to all hams that it is much better to speak about frequencies than wavelengths, and the whole world has followed your example. But when speaking about frequencies, we mean the number of cycles per second, in any case the number of cycles in a certain time, and therefore it is wrong to speak about a frequency of, for instance, 14,300 kilocycles; one should speak about kilocycles per second, abbreviated kc/s. Nobody would speak about coulombs instead of amperes, but neither should we speak of kilocycles when we mean kilocycles per second.

Now we have a new name for this unit, the Hertz, abbreviated Hz, which was internationally adopted by some congress. As Heinrich Hertz was without doubt an eminent and leading figure in physics, and as it is easier to type and print kHz than kc/s, I think you had better adopt it, too, before you lead all hams in the world astray by the wrong unit, the kilocycle, which you are using to-day.

— W. Kccman, P.10ZK.

While agreeing with the author of this letter on the merits of the term "kiloHertz" as a unit of frequency, QST is inclined in this respect to follow the recommendations of the Committee on Standardization of the Institute of Radio Engineers, which is still at work in collaboration with other agencies in the standardization of radio definitions, nomenclature, measuring practice, etc. The current recommendation of that committee gives the meaning "kilocycles per second" to the abbreviation "kc.", exactly as attaches to the abbreviation "kHz." The "kiloHertz" is not yet a recognized unit of frequency either in this country or in the international literature, and for that reason QST does not use it.

— EDITOR.

This Business of Power Supply

West Lafayette, Ind.

Editor, QST:

It has been my pleasure, during the several years that I have been interested in amateur

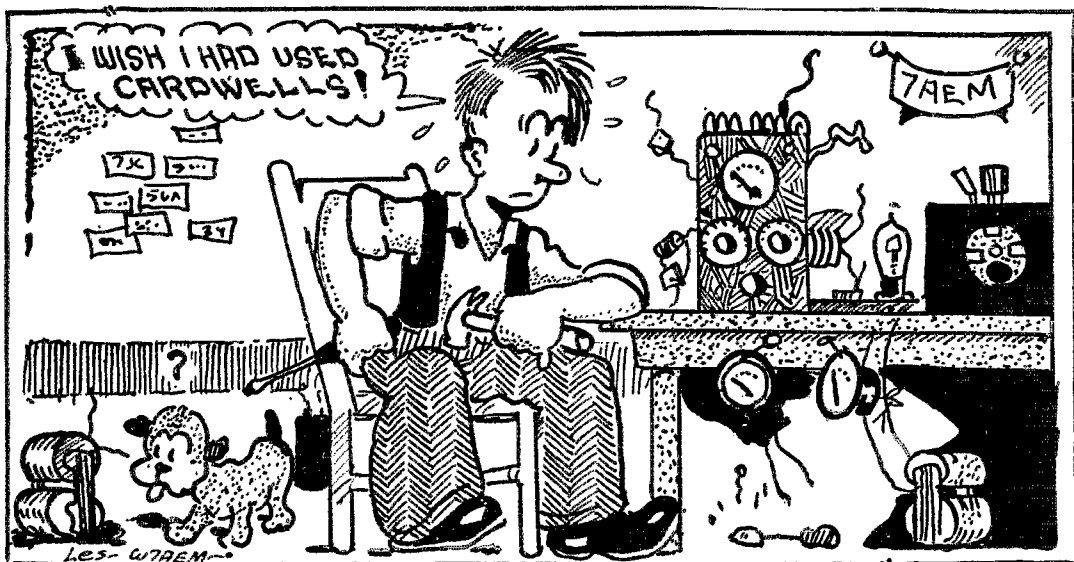

"THE PROOF OF THE PUDDING"

"A few days ago a young man brought to me one of your model .0005 condensers that has seen about 7 years of service and is still good for that many more. It has been rebuilt, cut down to 3 plates and remodeled so many times that there is practically nothing left of the original stator assembly of 10 plates. Please advise if you can furnish the complete stator assembly of ten plates, and the cost. It has previously served in countless numbers of receiving sets and is now going to be used in a low power amateur short-wave transmitter."

—From a letter received by us, now on file.

IT PAYS TO USE CARDWELLS

CARDWELL CONDENSERS

TRANSMITTING—RECEIVING
SEND FOR LITERATURE

THE ALLEN D. CARDWELL MFG. CORP.

81 Prospect St., Brooklyn, New York

Since Broadcasting Began

"THE STANDARD OF COMPARISON"

Say You Saw It in QST — It Identifies You and Helps QST

Cunningham RADIO TUBES



Tested and Proved True

There must be some GOOD reason why Cunningham Radio Tubes continue, year after year, to maintain their high standing with amateur engineers and the public alike.

They stand the "acid test" for in-built quality.

E. T. CUNNINGHAM, INC.

New York Chicago San Francisco
Dallas Atlanta

radio, to visit a large number of amateur stations throughout the country. I do this with one purpose in mind, namely, to get ideas that might be of benefit to me and consequently make my station better.

All kinds of layouts may be found. Some are neat and efficient, while others are not; some are permanently built and some are in the experimental stage. A large percentage of amateur stations are laid out well with fine ideas incorporated, but many are constructed about a lot of queer and radical ideas.

One point that strikes me as worthy of more attention is the power supply for the transmitter. A large majority of us are not rich and consequently want to have just as good a station as can be afforded and with as much power as possible. But do we all know how to select our equipment with good reasoning and common sense?

If we put a given amount of power into our antenna it does not make a bit of difference whether this power is supplied by a lot of 210's, an 852, or a 204-A. Of course all of us like to have a big tube—it looks nice, for one thing. But what is the sense of having a high-powered tube in a transmitter if the power supply is unable to load it up to its rating? The power supply is more likely to be slighted than any other one thing in an amateur transmitter.

For instance, a friend of mine has recently installed an 852. Prior to this time he was using two 210's in parallel. His set now works to his complete satisfaction although he gets out very little better than formerly. The reason for this is that his present plate supply equipment is so light that when the 852 is drawing normal plate current, the tube is actually getting 1100 volts. However, he adjusts his circuit so that the tube draws 75 milliamperes, and is happy because he has a 75-watt tube working in his set. He knows, or should know, that he is getting little more output than formerly, but his set is more "showy."

How many of us are doing this same thing? There are many, because I have visited a lot of typical stations. I would venture to say that half the fellows operating radio transmitters are unaware of the actual voltage on their tubes.

In order to get the most from any tube it is necessary to work it at its rating. A tube operating at half rated voltage will deliver less than one-fourth rated output, under ordinary conditions. There is no reason for spending a lot of money on a big tube unless you are able to go ahead and get a suitable power supply. Adequate power at the proper voltage for the transmitting tube with good regulation are the things that count, and they can be obtained only by the use of a husky and well-designed power supply. A 210 properly loaded is better than an 852 with a poor power supply.

— F. J. Smith, ex-W9FOO

The Board's Phone Policy

Detroit, Mich

Editor, *QST*:

Just read your editorial in July *QST* and think the Board's recommendations were wise ones. I

AMERTRAN

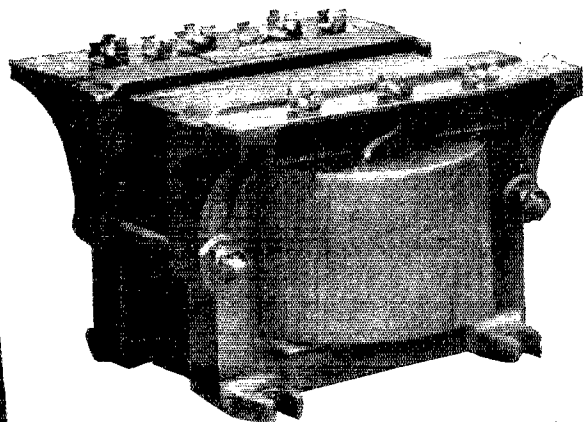
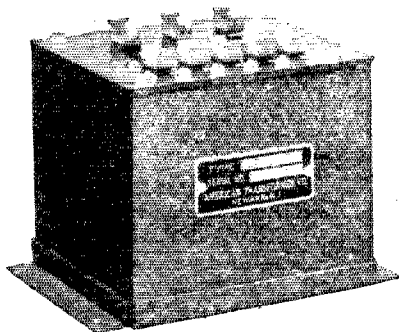

Equipment

Designed to meet the new amateur requirements of an adequately filtered D. C. current supply.

Filament Heating Transformers

Voltage regulation within 5%. Note insulation test voltage.

Type	V. A.	Cycles	Line Volts	Sec. Volts	Sec. Amps.	Test Voltage	Type Tube
H-4648	12½	50/60	200/230	2.5/1.25	5	12,000	—66
H-66A	25	50/60	100/115	2.5/1.25	10	12,000	—66
H-4649	37½	50/60	200/230	2.5/1.25	15	12,000	—66
H-4650	50	50/60	100/115	5/2.5	10	12,000	—72
H-4651	50	50/60	200/230	5/2.5	10	12,000	—72
H-4652	100	50/60	100/115	5/2.5	20	12,000	—72
H-4653	150	50/60	200/230	5/2.5	30	12,000	—72

Plate Transformers

P-4656	290/415	50/60	100/108 115/125	2360 1180	O.175	6,000	two 211 two 845
--------	---------	-------	--------------------	--------------	-------	-------	--------------------

The above Plate Transformer is designed to deliver 1000 volts D. C. with the average filter. Other Plate Transformers can be furnished upon receipt of specifications giving your requirements.

Choke Coils

Many standard size Choke Coils available for transmitting circuits.

Amertran Radio Parts have long been recognized as the highest quality. Amateurs obtaining the best results realize their value.

Write for Bulletin No. 1066.



**AMERICAN
TRANSFORMER COMPANY**

172 Emmet Street

Newark, N. J.

THIS COMPLETE TREATISE

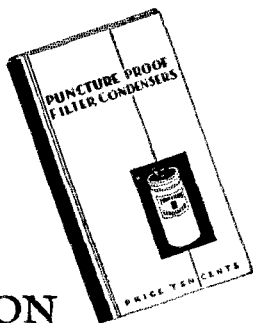

ON THE ELECTROLYTIC FILTER CONDENSER

Perhaps the first ever published, contains live up-to-date information that should be in the hands of every transmitter operator, for it shows how most effective transmitter filters can be built.

In successive chapters it deals with the various filter condenser problems and their solutions. Voltage surge effects, condenser life limits, moisture, safety-valve action, cost and size, are carefully and completely analyzed.

It is replete with diagrams and photographs illustrating the important points, and contains a complete description of the latest developments of Mershon Electrolytic Condensers, showing in detail their construction and characteristics.

Although regularly priced at 10 cents, we offer this booklet **FREE** to *QST* readers. Send for your copy today.

USE THE COUPON
BELOW AND GET THE

NEW MERSHON BOOKLET

The Amrad Corporation
320 College Avenue
Medford Hillside, Mass.

Gentlemen:

Please send me a copy of your new booklet, "Puncture Proof Filter Condensers" without charge.

Name

Address

particularly endorse the decision not to ask for definite specifications as to apparatus.

Experience certainly teaches that circuits and specifications mean very little as compared with construction, adjustment and operation.

During the past six months I have practically given up phone work except on 14 mc., and certainly hope that the recommendations of the Board are put into effect so QRM on 3500 kc. will be reduced to a point where some effective work can be accomplished.

— C. H. Vincent, W8RD

Off-Frequency Operation

Glendale, Calif.

Editor, *QST*:

After reading numerous letters in your columns concerning off-frequency amateurs, I have spent considerable time checking some of them. I find a few off-frequency amateurs and, when possible, I have called them and helped them rectify their deviation. I also find the majority if not the entirety of the offenders are beginners who, not being skilled in the tuning of a transmitter, unknowingly slide off. The only way to become 100% is to pull together and help the off-frequency fellow ham.

While these so-called commercials are gnashing their teeth over a little QRM, let's reverse the situation. In the past month I have copied seven of the supposedly "on frequency" commercials wandering around our bands, to say nothing of the dozen or more commercial J's, X's, etc., who operate daily schedules in the center of our 7000-ke. band.

The mush and parasitic harmonics of the rip-saw alternators used by some of these commercials don't add a great deal to the pleasures of amateur radio. The majority of the commercials who run twenty-four hours a day in order to hold the frequency assigned them should give the poor over-worked V-wheels a vacation at least long enough to give themselves time to look up the act concerning unnecessary or superfluous signals.

— Maurice E. Kennedy, W6BG

A.R.R.L. Headquarters solicits reports from amateurs who log non-amateur stations operating in our bands. Several such stations have been moved as a result of protests to the stations or governments concerned, and we are just as insistent that non-amateur stations shall stay out of our bands as that amateurs shall stay in them. The fact that a commercial station does not stay on its assigned frequency, however, is no excuse, legal or otherwise, for amateur off-frequency operation, nor does it make an amateur who wilfully or carelessly operates outside the bands a bit less culpable. — EDITOR.

Rotten Plate Supplies

Iota, La.

Editor, *QST*:

I wish to voice a protest against the use of raw a.c. on any kind of self-excited ham rig.

It seems to me that instead of getting better

RELIABLE POWER SUPPLY FOR AMATEUR TRANSMITTERS

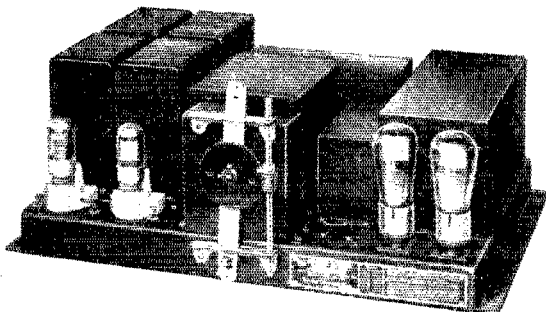

SPECIAL

No. 404
STROMBERG-CARLSON
POWER PLANT

Price, F. O. B. Rochester,

\$35.00

Less Tubes

FOR all amateur operators, who wish to secure a very economical, and a very reliable power supply, we have on hand a limited number of our No. 404 Socket Power Plants. This power plant was used in conjunction with our best radio receiver before the advent of the new AC heater type tubes, and was designed for continuous operation with a good margin of safety. It consists of the following components:

One 250 watt transformer, with the following windings: 115 volt primary, 1100 volt secondary with center tap, two 7.5 volt filament windings, one 120 volt winding with center tap, and one 1.5 volt winding; four 22 henry chokes with a DC resistance of 20 ohms, 300 M. A. current capacity; two 25 henry chokes with a DC resistance of 700 ohms and 100 M. A. current capacity; one condenser block containing three sections of 4MFD each 1200 volt working voltage, and two sections of 4MFD each 175 volt working voltage; one primary rheostat 17 ohms; 25 watt resistors of the following sizes: 976 ohms, 4182 ohms, 137 ohms, 1400 ohms, 1220 ohms, and a 60 ohm potentiometer to be used on the filament winding of the radio tubes to give an exact adjustment of the center tap; two UX sockets for the rectifier tubes. A primary switch is included, and two line receptacles, both being controlled by the switch. All of the equipment is mounted on a steel base with neat covers on the parts, and sub-base wiring which is readily accessible. A wiring diagram of the unit is sent with each plant, showing the proper components to use for a 500-volt plate supply when using 216-B rectifiers. Any of the parts can be used, however, for any type of work for which they are adapted.

The unit with its present hookup makes a splendid power supply for 5, 10, 20, 40, 80 and 150 meter transmitters.

(Mail the Coupon)

STROMBERG-CARLSON TELEPHONE MFG. CO.,
ROCHESTER, N. Y.

COUPON

Stromberg-Carlson
Telephone Mfg. Co.,
Rochester, N. Y.

Send me the No. 404
Socket Power Plant in ac-
cordance with this special
offer. Enclosed find remittance
for \$35.

Stromberg-Carlson

MAKERS OF VOICE TRANSMISSION AND VOICE RECEPTION APPARATUS FOR MORE THAN THIRTY-FIVE YEARS

Your A. R. R. L. EMBLEM



The League Emblem comes in four different forms. Its use by Members is endorsed and encouraged by the League. Every Member should be proud to display the insignia of his organization in every possible way.

THE PERSONAL EMBLEM. A handsome creation in extra-heavy rolled gold and black enamel, $\frac{1}{2}$ " high, supplied in lapel button or pin-back style. The personal emblem has come to be known as the sign of a good amateur. It identifies you — in the radio store, at the radio club, on the street, traveling — you can spot an amateur by it. Wear your emblem, OM, and take your proper place in the radio fraternity. Either style emblem, \$1.00, postpaid.

THE AUTOMOBILE EMBLEM. $5 \times 2\frac{1}{2}$ ", heavily enameled in yellow and black on sheet metal, holes top and bottom, 50c each, postpaid.

THE EMBLEM CUT. A mounted printing electrotype, the same size as the personal emblem, for use by Members on amateur printed matter, letterheads, cards, etc. \$1.00 each, postpaid.

THE "JUMBO" EMBLEM. How about the shack wall or that 100-footer? Think of the attention this big yellow-and-black enamel metal emblem will get! $19 \times 8\frac{1}{4}$ ", same style as Automobile Emblem. \$1.25 each, postpaid.

**The American Radio
Relay League
Hartford, Conn.**

notes as times go on we hear worse notes than ever. The latest regulations of the Federal Radio Commission seem to leave the impression with some hams that an a.c. plate supply is the latest thing. QRM on the 7-mc. band is becoming unbearable on account of the pollution from raspy and buzz-saw notes spreading over several degrees on any ham receiver. I logged one station recently with a bizz-saw note which blotted out several 1930 notes.

Fellows, let's get together on this proposition and make a thorough clean up. Those who have no d.c. plate supply for a $7\frac{1}{2}$ - or 250-wattter should sell those tubes and construct a rig using a 201-A with 200 volts "B" batteries to get a pure 1930 d.c. note. I have worked several hams using 201-A tubes with 135 volts on the plate and certainly must say they sound like crystal control. Every one I worked had a beautiful note — and the first cost and upkeep are low.

Let's get going and clean out the rotten notes.
— R. L. Tomps, W5MH

A Suggestion for Handling Traffic

Ventura, Calif.

Editor, *QST*:

I am not a traffic man because my operating hours are not always reliable and I, therefore, cannot keep any skeds. Naturally I am mostly a rag chewer, but even so I QSP quite a few messages each month. There are many of us in the same boat, and at times it is rather hard to give QSP quickly when time is limited, especially when no schedules are kept.

I have tried directional CQ's without much luck, and yet I am sure there are lots of fellows who would be glad to exchange messages. Overcrowding of the bands is one reason, and a lot of needlessly long CQ's trying to get rid of traffic without the other fellow's knowing what's wanted make an awful lot of useless QRM.

To overcome this allow me to offer the following suggestions:

For rag chewers:

CQ CQ CQ de W . . . etc.

For traffic:

CQ CQ TFC de W . . . etc.

Will QSP and have outgoing traffic:

CQ CQ XTFC de W . . .

I believe this system would do away with a lot of needless QRM by letting the other fellow know just what is wanted.

Criticism is always welcome — let's have some.
— Roy R. Wallace, W6ERU

Another View of the DX Question

St. Louis, Mo.

Editor, *QST*:

Upon going through some old issues of *QST*, I happened upon an article, "Don'ts for DX" which appeared in *QST* for June, 1929.

(Continued on page 66)

BYRD'S Antarctic Radio Equipment

The advanced types of receivers, transmitters, and navigation aids that triumphed on this epochal flight now fully described in this book.

TELEVISION

Mr. C. F. Jenkins, father of television and radio movies, gives you in his own words complete directions for building practical television equipment.

INTERFERENCE ELIMINATION

Tracking down troublesome interference and eliminating it, systematically outlined by W. F. Fleming, radio engineer.

RADIO AUTO-ALARM

New automatic device on ships to keep the SOS watch while operator is off duty—fully described in this book.

Latest BROADCASTING Equipment

Temperature-controlled Piezo crystal oscillator, 100% modulation panel, and other new apparatus, completely described, with instructions for operation.

SHORT-WAVE Apparatus

Latest types of commercial and amateur short-wave apparatus; directions for securing operator's and station license.

MARINE and AERIAL Radio Equipment

Radio beacons; arc radio transmitter for ships; Reed course indicator; latest developments in high frequency transmitters.

New RADIO LAWS and REGULATIONS

New regulations governing all classes of operators' licenses, U. S. Laws, and I. R. T. C. laws.

New Developments!

Complete Instructions and Data on All Recent Radio Inventions Now Yours for Ready Reference in This One Big Guide Book of Radio

THE RADIO MANUAL

A Handbook for Students, Amateurs, Operators and Inspectors

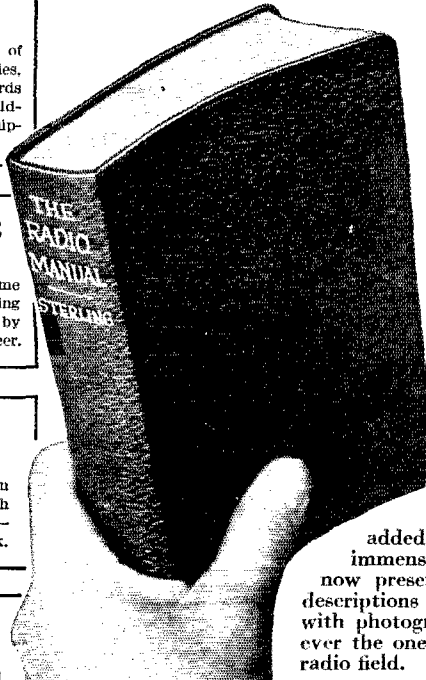

Here's the answer to every question about the principles, operation and maintenance of apparatus for radio transmitting and receiving. No detail has been omitted, from elementary electricity and magnetism for the beginner to television and radio movies. Important new chapters have been

added to bring it right up-to-the-minute, and an immense volume of facts never before available is now presented in the book. Included are detailed descriptions of standard equipment, fully illustrated with photographs and diagrams. It is now more than ever the one complete handbook covering the entire radio field.

A Complete Course in Radio Operation IN ONE VOLUME

Enables You to Qualify for Gov't. License as Operator or Inspector
20 Big Chapters Cover:

Elementary Electricity and Magnetism; Motors and Generators; Storage Batteries and Charging Circuits; The Vacuum Tube; Circuits Employed in Vacuum Tube Transmitters; Modulating Systems and 100% Modulation; Wave-meters; Piezo-Electric Oscillators; Wave Traps; Marine Vacuum Tube Transmitters; Radio Broadcasting Equipment; Arc Transmitters; Spark Transmitters; Commercial Radio Receivers; Marconi Auto-Alarm; Radio Beacons and Direction Finders; Aircraft Radio Equipment; Practical Television and Radio-movies; Eliminating Radio Interference; Radio Laws and Regulations; Handling and Abstracting Traffic.

Prepared by Official Examining Officer

The author, *G. E. Sterling*, is Radio Inspector and Examining Officer, Radio Division, U. S. Dept. of Commerce. The book has been edited in detail by *Robert S. Kruse*, for five years Technical Editor of *QST*, the Magazine of the American Radio Relay League, now Radio Consultant. Many other experts assisted them.

Mail This Coupon Today

Examine it FREE!

The 1930 edition of "The Radio Manual" has just been published. Nearly 800 pages, 350 illustrations. Bound in Flexible Fabrikoid. The coupon brings the volume for free examination. If you do not agree that it is the best Radio book you have seen, return it and owe nothing. If you keep it, send the price of \$6.00 within ten days.

D. Van Nostrand Co., Inc.
250 Fourth Avenue, New York

Send me the Revised edition of THE RADIO MANUAL for examination. Within ten days after receipt I will either return the volume or send you \$6.00, the price in full. (*QST* 9-30)

Name.....

St. and No.....

City and State.....

Business Connection.....

» FOR PRACTICAL JOBS

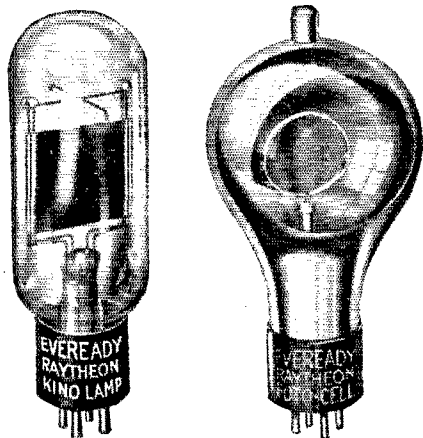

EVEREADY RAYTHEON TUBES FOR TALKING PICTURES, TELEVISION AND ALL INDUSTRIAL PURPOSES

These wonderful tubes are finding a new place in many industries, in some cases revolutionizing production methods.

The Eveready Raytheon Foto-Cell is a long-life transmitting tube for talking pictures and television. It is being used more extensively every day for such industrial purposes as color matching, paper testing, automatic counting, control of illumination and many others. It comes in standard types or can be made to specification.

The Eveready Raytheon Kino-Lamp is the first television receiving tube developed commercially that will work with all systems. Each tube is thoroughly tested in our laboratories.

Write, if you are interested in talking pictures, television or Foto-Cell applications of any kind. Free — Eveready Raytheon Technical Bulletin No. 1, dealing with the Kino-Lamp, and No. 2, covering the Foto-Cell.

* * *

The Eveready Hour, radio's oldest commercial feature is broadcast every Tuesday evening at nine (New York time) from WEAJ over a nation-wide N. B. C. network of 31 stations.

NATIONAL CARBON COMPANY, INC.
General Offices: New York, N. Y.

Branches: Chicago Kansas City New York San Francisco
Unit of Union Carbide and Carbon Corporation



Trade-marks

Being pretty much a "DX Hound" myself, naturally I became very interested, but have different views from the author's. In the first place, he mentions that it should be a punishable offense to call "CQ" from this country after one hour before sunset and for at least one hour after sunrise in the morning. Quoting from the article, "Why clutter the air with such trash and make international QSO impossible? There can be plenty of inter-U. S. A. QSO's during daylight hours if 40 and 20 meters are to be used, and the traffic handler still has the 80 meter band for this work after dark."

Very true, but myself with thousands of others get home from our daily work at sundown and go to work about sun-up or shortly after. Possibly the author does not have to work and can have his inter-U. S. A. QSO's during the day. All the interference that shows itself up is from raw a.c. and terrible r.a.c. signals, and if these can be harnessed and made d.c. or xtal-controlled the "DX" will come through just the same, and also be workable.

The fact is appreciated if no one CQ'd more foreigners would possibly be heard, but we OM's that work for a living all day and come home in the evening have to CQ once in a while. And then not every Amateur has BPL ambitions. Any number of us fellows are eligible to become members of the RCC.

— Elmer F. Koehler, W9BEU-BAX

I.A.R.U. News

(Continued from page 56)

few dozen stations. Summertime has other attractions than the ham shack!

On the 3.5-mc. band both receiving and transmitting conditions were very bad, much worse than two or three years ago. No DX work has been reported, the best contacts being those made with South Russian stations — in spite of their using the old intermediates. We are glad to see that our German amateur friends do not like to work those "old-timers" any more either.

On 14 mc. only PA0DW and PA0ZK reported DX contact. Both worked several North and South American stations, while PA0DW worked one VK and two PK's in addition. On May 25th to 29th conditions for communication in Western directions (W1, 2, 3 and 8) were fair. It is a curious thing that every twenty-six days a relatively short period comes with good possibilities for working American stations. The next period will be September 9th, and so on. We beg those hams who are interested in this subject to write PA0ZK; reports on reception from the European West coast and the U. S. East coast stations are very welcome.

No 28-mc. reports have been received.

Amateurs of The Hague are preparing enthusiastically for a radio fox hunt. A portable transmitter will be hidden somewhere, and the gang will try to locate it by means of direction-finding receivers. Several elections have been held at the club meetings, and many portables have

A SAFE GUIDE

in the selection of insulation for Radio Transmitting and Receiving Sets



OVER 300 broadcasting stations, leading radio telegraph systems, the United States Army, Navy, Air Mail, Coast Guard and Ice Patrol Services, explorers like Commander Byrd, and exacting amateurs everywhere have utilized PYREX Insulators in many spectacular achievements.

Regardless of whether you are sending or receiving — on land, sea or airplane — you should be thoroughly familiar with the PYREX Antenna, Strain, Entering, Stand-off and Bus-bar Insulators that are helping these leaders to make radio history.

The new PYREX Radio Insulator booklet lists all types and sizes with data that you will want for ready reference.

Return the coupon for your copy, and if you want further advice on any insulation problem, our Technical Staff will answer your questions promptly.

Send the coupon for your copy

CORNING GLASS WORKS
Corning, N. Y.

Gentlemen:

Please send me copy of your new bulletin on Radio Insulators.

Name

Address

.....

QST 9-30

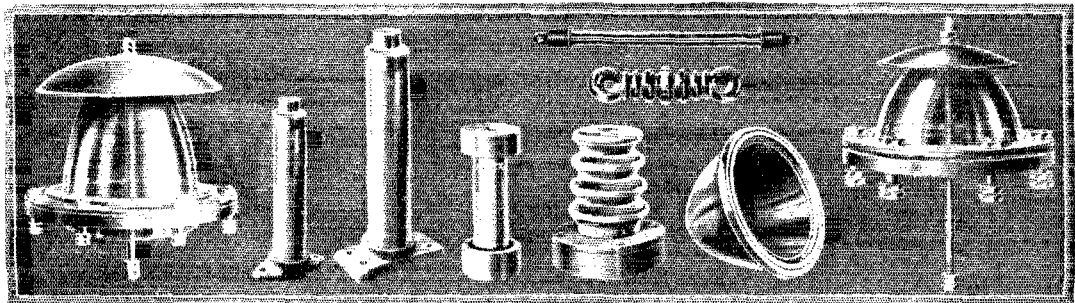

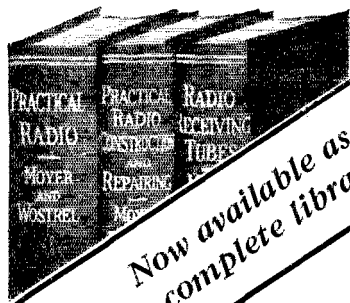

Now available as a complete library

993 pages
12x8 inches
fully
illustrated

Three books covering the entire field of building, repairing, and "trouble-shooting" on modern broadcast receiving sets.

This Library serves alike the needs of the commercial radio dealer, installer and serviceman, and the amateur who keeps abreast with the latest trend in radio by building his own sets.

Radio Construction Library

By JAMES A. MOYER

Director of University Extension, Massachusetts Department of Education

and JOHN F. WOSTREL

Instructor in Radio Division of University Extension, Massachusetts Department of Education

THESE three books embody not only a thorough home-study course, but a ready means of reference for the experienced radiotician. Step-by-step information is given on wiring, "trouble-shooting" installation and servicing to get the best tone quality, distance and selectivity in broadcast reception in all types of sets.

Practical data is given on radio equipment such as antenna systems, battery eliminators, loud speakers, chargers, vacuum tubes, etc., etc.

A section is devoted to the identification of common faults in receivers and methods of making workmanlike repairs.

The three books are profusely illustrated with understandable diagrams of hookups, connections, loud speaker units, installation work and antenna erection — as well as numerous photographs, tables and charts which clarify the text.

See this Library for 10 Days Free

No Money Down — Small Monthly Payments

It is your privilege to examine this Library for 10 days without cost. If they prove satisfactory, send an initial payment of only \$1.50 and \$2.00 a month until \$7.50 has been paid. Otherwise return the books.

McGraw-Hill FREE EXAMINATION COUPON

McGraw-Hill Book Company, Inc.
370 Seventh Avenue, New York

You may send me the Radio Construction Library, three volumes, for 10 days' free examination. I agree to return an initial payment of \$1.50 at the end of 10 days and \$2.00 a month until the price of \$7.50 is paid — or — I will return the books.

Name

Home Address

City and State

Position

Name of Company..... QST-9-30

been built. It is an ideal job for summer work. We understand that our Southern District gang are likewise planning a hunt. We hope to have some reports on this for next month.

GERMAN NOTES

By Dr. Curt Lamm, D4AFA

The outstanding event of the period covered by this report was our Fifth Annual Convention, held at Halle a/S. on June 7-9, 1930. About 80 amateurs from all over the country gathered at what may be called a very successful and enjoyable meeting.

The convention opened with an address by our President, Colonel Fulda, and letters and wires of congratulation from many foreign sections of the Union, as well as from special foreign friends of ours, were read amid frantic applause. May we once more express our heartfelt thanks to all fellow-societies and amateurs who so kindly thought of us during this festival occasion?

On Sunday, June 8th, the business meeting took place, with results to be detailed below. On Monday, June 9th, two exceedingly interesting lectures were given. Professor Wigge of the institute of technology of high frequency currents at Koethen spoke on infra-red rays and their possibilities in regard to telephone communication over short distances, especially through dense fog, with a view to improving safety on ships and aeroplanes. A very excellent demonstration was given that showed clearly the behaviour of these frequencies, and very fine telephony was produced.

The second lecture, also with demonstrations and experiments, was given by Rolf Wigand of Berlin on the subject of modern circuits. It was shown that a small crystal-controlled valve is capable of controlling directly the final stage in a high-power amateur transmitter, at a power ratio as great as 1 to 50. Experiments showed that it was easily possible to control a 500-watt tube by a small c.c. 10-watt oscillator, not only with telegraphy but also when using telephony (with 100% modulation obtained by using the Ross A. Hull modification of the Heising circuit). It is hoped that some informative data on these circuits will soon be available for publication.

The Constitution of the D. A. S. D. has been changed to some extent, and a new council elected, as follows: President, Colonel Fulda; Treasury and Home Office, Wolfgang Rach (D4ADF); Foreign Office, Dr. Curt Lamm (D4AFA); Editor of CQ, Joseph Brey (D4KZA); Manager QSL*-Section, Kurt Schlupp (D4ADC); Technical Information Bureau, Julius Kron (D4SAR), Rolf Wigand, Ernst Reiffen; Representative of D.F.T.V., Dr. Paul Gehne.

In addition, all district managers in this country and in Austria and Jugo-Slavia now belong to the general council.

We are pleased to state that our Jugo-Slavian fellow-amateurs have as a whole become affiliated with the D.A.S.D., and will in the future be represented in Union matters by this section, as

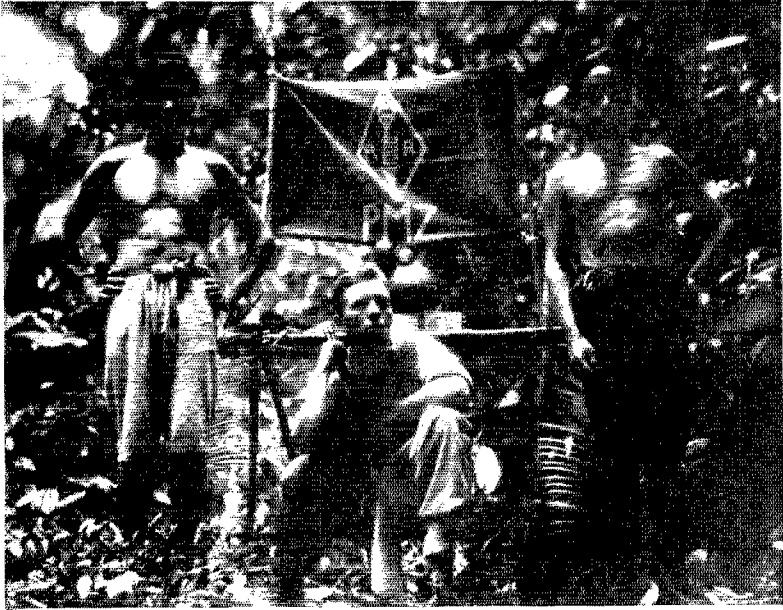

H. W. Wells, radio operator, and the two Punan Dyaks who made the trip to the head waters of the Murung River with the All-American Lyric Malaysian Expedition.

In Borneo too...

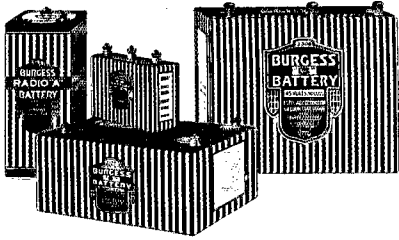

Take notice, Hams, of the A. R. R. L. banner—and the Burgess Battery over in the wilds of Borneo, with the All-American Lyric Malaysian Expedition. The only comment was, “If my next expedition is radio equipped I plan on calling on Burgess Batteries.

“Ask *any* Radio Engineer”

BURGESS BATTERY COMPANY

MADISON,

WISCONSIN

UNCLE DAVE

115 No Pearl Street Albany New York
 We buy, sell and trade Ham stuff!
 24 HOUR SERVICE. • SHIP ANY PLACE.
 If we have not got it, we will get it for you.



Special for This Month

- General Radio Stand off insulators \$1.10 each, \$1.00 a dozen.
 Calibrated Monitors, built for three uses: Oscillator, Monitor
 and frequency meter. These are individually calibrated
 and are checked against Provo oscillators, net \$9.35
 with batteries and three coils for 20, 40, 80 meters.
 Wave meters for 20, 40 and 80 meter band with
 individual charts, complete with external loop,
 indicator and coils. \$6.25
 Splittorf 30 Henry 150 mill chokes. 1.35
 Dongan power transformers, 300 watt 1000 volt
 each side of center and with following voltages:
 34, 40, 50, 60 and 70 volt not C.T. Fully
 mounted. Weight 14 pounds. 5.95
 Ward Leonard 10,000 ohm 50 watt trans. leaks.50
 5000 ohm leaks.39
 New Universal double button microphones, model
 BB, net. 16.50
 Model KK. 32.50
 Microphone cases, special. 2.25
 New Sprague 8 mid 430 volt Electrolytic condensers
 New Mershon 18 mid Electrolytic condensers. 2.00
 Aluminum cabinets 5" x 9" x 6" all assembled. 2.65
 All size cabinets and panels upon request
 Flechtheim 1 mid 1500 volt porc. ins. Cond. 2.49
 Flechtheim 2 mid 1500 volt porc. ins. Cond. 4.50
 Flechtheim 4 mid 1500 volt porc. ins. Cond. 7.00
 Rectobulbs mercury vapor R-81 type. Just out, new
 list \$7.00. Special. 4.50
 Rectobulbs mercury vapor R-3 type, net post-paid. 10.00
 Signal Corps 3-16" silver contact keys.95
 Slightly used Western Electric 212D tubes, guar.
 R.E.L. Sockets for above, guaranteed. 9.00
 Slightly used R.C.A. U.V. 211 or 203A's, guar. 17.00
 Slightly used Western Electric 50 watters, guar. 15.00
 Slightly used R.C.A. U.X. 851 1000 wattor, guar. 175.00
 New and in sealed cartons R.C.A. U.X. 852 tubes
 R.C.A. U.X. 240 Hi Mu tubes. 1.00
 R.C.A. U.X. 874 voltage regulators. 2.00
 G.E. 3 1/2 mid 1000 volt unimtd. sealed paraffin. 1.85
 G.E. 10 mid 3500 volt oil immersed condensers. 20.00
 New Allen-Bradley 500 watt radiostat. 5.50
 National Var. condensers .00045-3000 volt with
 velvet vernier dials. 9.50
 New CeCo guaranteed mercury vapor 866 tubes,
 immediate delivery. Special. 7.00
 New CeCo 230 2 volt 199 type. Non microphonic. 1.25
 New CeCo 232 2 volt 120 type. Non microphonic. 1.25
 New CeCo 232 2 volt screen grid U.C. 1.90
 U. S. Navy 5 watters CG 1102, new.65
 Thordarson double button microphone trans-
 formers. 5.70
 Peerless 12" dynamic auditorium speakers, latest
 type, low impedance 110 volt D.C. 11.95
 Two transformers for changing above to A.C. extra
 Sangamo .00325, .0005, .001, .002, 5000 volt con-
 densers. 1.20
 Pyrex 7 1/2 inch insulators. 1.05
 R.E.L. 40 and 80 meter inductances with rods, pair
 Thordarson 150 watt 400 volt C.T. 5 volt C.L. 3.00
 silver-Marshall round the world four with coils. 20.00
 Used U.X. 852 tube, guaranteed. 20.00
 Anrad S. tubes (slightly used). 3.50
 Two Mercury are outfits. Each. \$25.00 and \$28.00
 Three wire shielded cable. Per ft.20
 Three wire pig and receptacle for above cable, pair
 Standard clarostat 0-5 megohm.85
 R.F. chokes for receiver and transmitter.50
 50 watt sockets. 1.40
 Kenotron type KM 1. Filament 10 volts 100 watts
 rectify 10,000 volts at 2 ampere. One pair only. 40.00
 Power crystals, anywhere in the 3500 k.c. band. 5.25
 Dustproof bakelite holders. 1.50
 Crystal blanks, unfinished. 1.75
 Finished oscillating crystal blanks. 2.75
 Enamelled No. 12 aerial wire. One hundred feet.90
 Two hundred feet. Coils. 1.65
 Magnet wire, all sizes in stock. Write.

Include postage with all orders and 20% deposit against
 C.O.D. shipments

Moved to larger quarters. Visit our radio shack when in town.
 Good time assured

What have you for sale or trade?

We carry everything for the Ham
MORE FOREIGN TRADE SOLICITED

Write for free Ham sheet

UNCLE DAVE'S RADIO SHACK
 115 No. Pearl Street, Albany, New York

has been done during the past year for our
 Austrian brothers.

All QSL cards for Jugo-Slavian (Jugoslavian)
 amateurs should now be sent to the D.A.S.D.,
 Berlin. Foreign QSL-managers please note.

Foreign amateurs visiting Germany are re-
 quested to get in touch with the D.A.S.D.,
 Berlin W. 57, Blumenthalstrasse 19 (Tel. Kur-
 fuerst 5773) or, when coming from overseas via
 Hamburg, please advise the Hamburg District
 Manager: Dr. R. Wohlstadt, Hamburg 5, Lü-
 becker Tor 22 (Tel. Alster 1385). We hope to see
 many of our foreign friends during their vacations,
 and are only too pleased to be able to show them
 around.

POLISH REPORT

From the Lwowski Klub Krótkofalowców

The increased activity shown by the L.K.K.
 during the years 1928-29 was followed by a pause
 due to a long series of holidays. In spite of the
 unfavorable circumstances, the Polish hams did
 not remain idle, and a remarkable amount of DX
 work was done.

During October, 1929, the annual assembly of
 the L.K.K. convened, and the following amateurs
 were placed upon the managing committee for
 the year 1930: Eng. A. Abenberger, SP3DX,
 President; Ltn. S. Komarnicki, SP3CG, and Dr.
 T. Vrabetz, SP3DR. Vice Presidents; J. Ziem-
 bicki, SP3AR, Secretary; K. Kulawik, SP3LV,
 Treasurer; A. Ligeza, SP3FY, Press Corres-
 pondent; Z. Bartz, SP3FS, Editor of "Krotko-
 falowiec Polski."

The general assembly, besides taking care of
 many routine affairs, decided to arrange the first
 high-frequency radio exposition in Poland.
 Extensive preparations were made for the exhibi-
 tion, which opened on February 9, 1930, in the
 rooms of Industry Museum, in Lwow. Splendidly
 prepared with the cooperation of the most emi-
 nent Polish amateurs and radio firms, together
 with the army and the police, the exposition
 formed the finest enterprise of that sort and scope
 held in Europe, and enjoyed a great success.

Another event in February was a ball arranged
 by our Club and held in a special high-frequency
 frame and humour.

In April, 1930, an extraordinary general
 assembly dedicated to the activity according to
 this year's program, was called together. A con-
 siderable development in our membership has
 taken place, and we now number more than 200
 amateurs as members.

The activity of our amateurs is on a parallel
 with that of the Club. A great deal of DX work
 is done, especially in the vicinity of Lwow. In this
 town there are thirty-five stations who reach
 into all parts of Europe; eight of them have
 communicated with New Zealand. Special atten-
 tion is given by the amateurs of Lwow and
 Poznan to the 14-mc band. SP3AR, SP3KX,
 SP3AV and others work on 28-mc. SP3AR has
 worked both Africa and Europe on this band.

A great number of new WAC members in our

RCA RADIOTRON

UV-845

A modulator tube available for amateur phone transmission. Also an excellent Audio Frequency Power Amplifier.



Designed with characteristics especially suited for modulator service, Radiotron UV-845 is capable of effectively modulating a far greater amount of oscillator input power than any other Radiotron widely used by amateurs.

The high modulating ability of the UV-845, with its freedom from distortion, will greatly assist the amateur in establishing high quality phone transmission, and will be a source of keen satisfaction to him.

Filament Volts	10	Plate Current (m.a.)	75
Filament Amperes	3.25	Plate Resistance (ohms)	2100
Normal Plate Volts	1000	Amplification Factor	5
Normal Grid Bias Volts	-150	Max. Plate Dissipation (watts)	75
Oscillator Input Watts for each UV-845 (Mod. Factor 0.6)			120

PRICE, \$33.70

We invite the amateur to write us for prices and characteristics of other types in which he is interested.

RCA VICTOR COMPANY, INC.

ENGINEERING PRODUCTS DIVISION

233 BROADWAY

NEW YORK, N. Y.

STANDARD

Quartz Plate Holders

Plug-in, dust proof crystal mounting. Fits UX tube socket. Bakelite and nickered brass. Takes square plates up to 1 1/8 inch; discs to 1 1/2 inch in diameter. Made in single and twin models, accommodating one and two crystals, respectively.

MODEL S-1. Single
 Price, **\$6.50** postpaid
COMPLETE
 (illustrated)

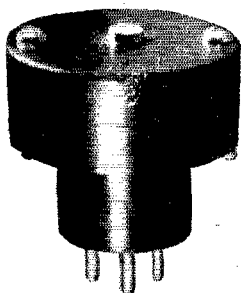

MODEL S-a. Twin
 Double mounting on UX base. For quick change of crystals by means of panel mounting switch.
 Price **\$11.00** postpaid

STANDARD QUARTZ PLATES

Frequency stated to within one tenth of one per cent. Maximum power.

1715-2000 KC.....	\$12.50
3500-4000 KC.....	\$16.50
7000-7300 KC.....	\$35.00

Literature on request

STANDARD RADIO LABORATORIES

602 Slaughter Building
 DALLAS, TEXAS

AEROVOX

BUILT BETTER

CONDENSERS AND RESISTORS

**THE MOST COMPLETE LINE OF
 CONDENSERS AND RESISTORS**

[Write for the Research Worker]
 A free monthly publication

AEROVOX WIRELESS CORP.

78 1/2 Washington St., Bklyn., N. Y.

PRODUCTS THAT ENDURE

Club resulted during the winter season. Among these is the first Polish YL, SPIYL of Poznan (formerly SP3YL).

Contact has been established between China, Ceylon, British colonies in Africa, Equator a.s.o. and Polish stations. Communication with the United States and New Zealand is carried on in the 7-mc. band.

SWISS REPORT

(By W. Niederer, HBR96, Member U.S.K.A.)

High-frequency amateur radio is enjoying good progress in Switzerland. There are ten licensed amateurs actively on the air, using the following official calls: HB9B, 9C, 9D, 9E, 9F, 9G, 9H, 9K, 9L, and 9M. In a short time more amateurs will get their Radiotelegraphy Patents and their station licenses, both issued by the Swiss Telegraph Director at Berne.

Some unlicensed amateurs are now looking forward to being licensed and becoming members of the U.S.K.A. We note that during one year's activity of our organization more progress has been made than in the many years before. The number of licensed amateurs has been raised from five to ten, and the number of official receiving stations from 50 to 100. Conferences on the reduction of taxes on transmitting licenses are now in progress. The U.S.K.A. is also endeavouring to broaden its influence concerning the preparation of new amateurs for their examinations.

HB9G, our Traffic Manager in Lausanne, has worked all continents with a maximum input of 15 watts. He has been issued the first WAC certificate in Switzerland. HB9K is a newcomer on 14 mc. and is on the lookout for good DX, having been QSO with a W1.

The U.S.K.A. is planning to organize tests on 3.5 mc., as that band is little used here, but is probably the solution for many problems in our little territory with high mountains and deep valleys. 3.5 mc. is expected to be the best band for local Swiss traffic. Perhaps our 50-watt stations HB9D and HB9H will also work DX on 3.5 mc. Please look out for them.

With IPH in Mexico

(Continued from page 20)

coast for shipment in galleons to Spain. Its condition today could be well imagined. The storms over the succeeding centuries have left but a vestige of a road. Even in those days their great high-wheeled wagons were hauled by scores of oxen.

The two cars that undertook the passage progressed but three miles from sunup to sundown the first day. The grade out of the first canyon was 43 per cent, and block and tackle were used for 400 yards, with oxen holding the car on the road so that it would not disappear with its driver into oblivion in the abyss beneath. Three

BARGAINS ARMY AND NAVY RADIO SURPLUS

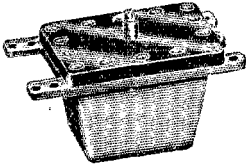

Condensers, Mica, operate volts 12,500 cap., .004 Mfd. Wire- \$12.50 less Specialty - New.....

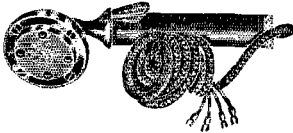

AT LAST—Genuine Western Electric Hand Microphone Home Broadcaster, \$3.50 used, \$5.00 new.

Condensers, Dubilier, mica, ap. volts 8500, .004 Mfd. \$10.00

Air compressors, Kellogg, Model T, 1 1/4 cu. ft. per min., weight 6 lbs., 600 R.P.M., 125-lb. Requires 1/4 h.p. \$3.00

SPECIAL — U. S. Army instruction book on telephony or telegraphy. Hundreds of pictures and diagrams. \$1.00

NAVY Dynamotors General Electric 24/1500 volt, 233 mils. (Extended shaft — \$3.00 extra).... \$37.50

New spare armatures, G.E. 24/1500 volts..... \$12.50

Generator, airplane, Signal corps, with shaft, can be used as motor, 12 volt, 33.6 amps, 5000 R.P.M. \$10.00

Generators, 12 volt, 60 amp. has automatic controls..... \$20.00

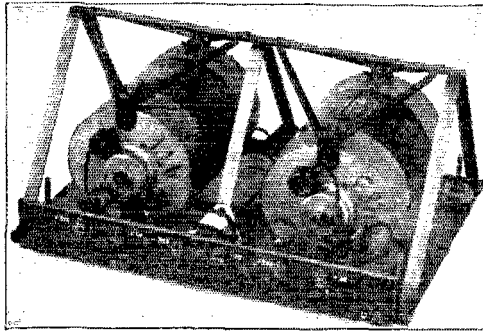

Western Electric Dynamotor System No. C.W. 927, Two 27/350 volt dynamotors in shock-proof hanger. May be used in parallel to give 160 mils at 350 volts, or in series, giving 80 mils at 700 volts. Can be used to operate transmitters up to 30 watts power from 32 volt D.C. mains. Ideal for Delco systems.

TWO dynamotors in hanger \$15

Single Dynamotor \$9 without hanger

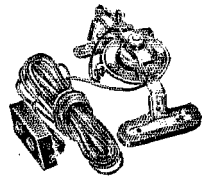

Magnavox anti-noise microphone, good for home \$1.50 broadcasting.....

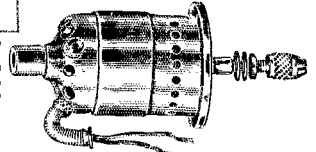

Portable Hi-speed Universal Hamilton-Beach Drill, takes up to 1/2 in. Complete with Chuck, Buff and Grind Attachment..... \$7.50

Condensers, transmitting, Murdock, .0017 Mfd, 12,000 volts. Ideal for plate blocking..... \$2.50

Ampere hour meter, Sankamo, battery charge and discharge, type MS 11-500 scale, capacity 15 amp. \$10.00

Milliammeter, Westinghouse, 0-150, surface mig., b. con..... \$5.00

Relay West, Elec. low voltage, 2 upper and 3 lower platinum point screws, 3 contact arms..... \$5.00

Ammeter, Weston No. 425 thermocouple 0-2 amp., mtd. on large bakelite base with D.P. hi-voltage switch..... \$7.50

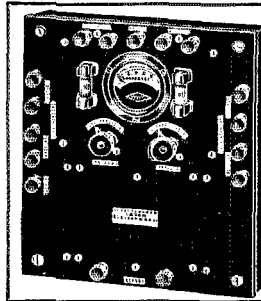

Western Electric Switch board C.W. 928, Control board for Dynamotor System C.W. 927. Consists of starting switches, fuses, 0-50-500 volt voltmeter with switches for testing main lines and output. Also contains complete filter system. Very special

\$8.00

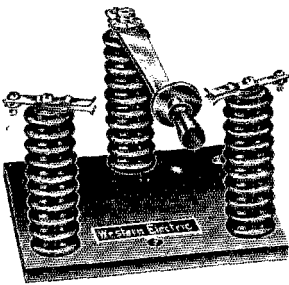

Lightning Switch, High Grade W.E. Heavy Copper Blade and Contacts. Size 7 x 8 x 6 high. While \$2.50 they last,.....

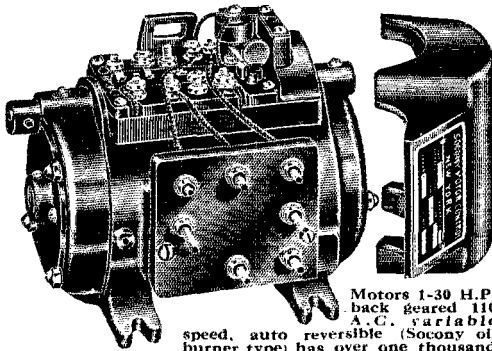

Motors 1-30 H.P. back geared 110 A.C. variable speed, auto reversible (Sesony oil burner type) has over one thousand uses, a very good buy. Regular price \$35.00..... \$7.50



EDISON Storage Battery Cells

Type M-8 1.2 volts, 11 amp. never used, per cell..... \$1.50
Type A-4 1.2 volts, 175 amp. first class, nickel alkali..... \$3.50
Type A-6 1.2 volts, 225 amp. nickel alkali..... \$4.00

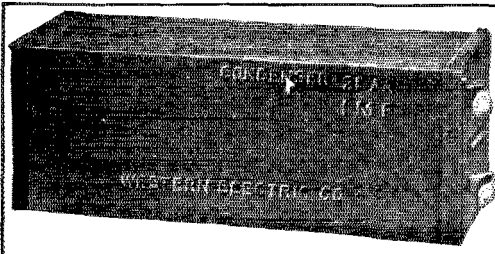

Western Electric Fixed Condenser 21AA, 1 microfarad, 1,000 volt A.C. test. Ideal filter condenser for low power transmitters. Fully guaranteed. Excellent value.

\$1.00

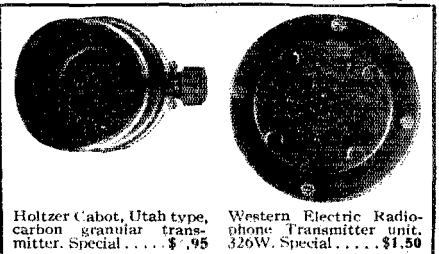

Holtzer Cabot, Utah type, Western Electric Radio-carbon granular transmitters. Special..... \$1.50

Largest Radio and Electric Supply House in U. S. Specializing on Army and Navy Surplus. Write us your particular requirements. Sufficient postage and deposit of 20% required on C.O.D. orders.

NO. C.O.D. ON CANADIAN ORDERS. DUE TO LIMITED GOV'T SURPLUS WE DO NOT ISSUE CATALOGS.

MANHATTAN ELECTRIC BARGAIN HOUSE, Dept. Q, 105-7 Fulton St., New York City

Say You Saw It in QST — It Identifies You and Helps QST

BROADCASTERS!! PUBLIC ADDRESS SYSTEM OPERATORS!!

Brand new WESTERN ELECTRIC Microphone Cables. Heavy, waterproof, live-rubber insulation. Very flexible. Can also be used for power wiring. Here is a chance to stock up on these cables at a fraction of their value:
Three wire, Shielded, 100 feet long. WE No. M4C. Complete with three-prong armored plug and laced end. Weighs 12 lbs. List Price — \$45.00. SPECIAL \$8.75 each. Four for \$31.00. Cable alone 15c per foot. Minimum 15 feet.
Two wire, Shielded. (Three conductor) 12 feet long. Three leads with spade lugs one end. Other end tinned. List Price \$6.00. Our Special Price — \$2.20 each. Ten for \$17.50. Limited Quantities!

MORE BARGAINS!!

QUALITY MERCHANDISE AT LOWEST PRICES
MONEY RETURNED IF NOT SATISFIED

PARSON HIGH VOLTAGE FILTER CONDENSERS

Neat Metal Cases. Novel Bakelite stand-off insulators. New.
DC Working Voltage 1 Mid. 2 Mid. 4 Mid.
1000 Volts \$1.50 \$2.40 \$3.95
1500 Volts 3.00 4.50 7.95
2000 Volts 3.95 6.95

RCA OR STROMBERG-CARLSON CONDENSERS

Designed for use in low-power transmitters and all high voltage socket power devices and power packs. Black metal cases. Lug terminals.

7 Mid., 650 Volt DC Working, \$2.50 each. Four for . . . \$9.20
4 Mid., 650 Volt DC Working, 2.05 each. Four for . . . 7.50
2 Mid., 450 Volt DC Working, .60 each. Six for . . . 3.10

THORDARSON

Power Transformers: Type T-3202, 250 Watt, 1200 7 1/2, 7 1/4, and 3 Volts. All center-tapped. — \$5.95. T-3321, 17 Watt, 1100, 7 1/2, 7 1/4, and 3 Volts. All CT. — \$4.50. T-2430-A, 150 Watt, 800 and 5 Volts. Both CT. — \$3.50. Double Choke, T-2458. Each section 18H, 250 MA. — \$6.25.
RCA Double Filter Chokes, No. 8336. Metal Case containing two 30H, 30 MA chokes. SPECIAL — \$2.50. VICTOR 30H, 125 MA chokes — \$1.75.

GUARANTEED TUBES

Unconditional 60-Day Free Replacement. A guarantee that really means something! UX-250 — \$4.15, UX-210 — \$3.75, UX-281 — \$2.75, UX-222 — \$3.25, UX-224 — \$2.05, UX-245 — \$1.75, UX-280 — \$1.55. Good Tubes at Lowest Prices. (5 Day Replacement) UX-250 — \$2.20, UX-210 — \$2.10, UX-281 — \$1.50. Other Types in Catalog. All tubes meter-tested before shipping.
WARD-LEONARD 10,000 ohm wire-wound grid leaks for 50 Watters — \$6.65. RCA 5000 ohm, 50 watt grid leaks with mounting rod — \$4.48. Two for \$8.99.

2% discount for full remittance (plus postage) with order
A 20c charge is made on orders under \$2
10% deposit required.

"QUICK SERVICE" SEND FOR CATALOG

HARRISON RADIO CO.

35 Ft. Washington Ave. Dept. T New York City

ACME TRANSFORMERS

Acme Apparatus Corp., Cambridge, Mass.

days were required for the passage of 16 miles. The party ran out of water and food and, when Magdalena was reached, were unable to talk.

On other stretches of road, when the five cars were together, we had to traverse solid masses of boulders for scores of miles. The frames of the cars were twisted into such shapes that the tip of a front fender would become imbedded so deep in the tire that progress was halted until the car could be lifted from its predicament. My car at one time was three feet off the ground with all four wheels. Occasionally a tie rod would bend double and the front wheels turn out in opposite directions. A rope fastened to the car ahead would pull the rod out straight again. Many of the shock absorbers had to be removed, as the abnormal twisting would pull the arm down and throw it back on the other side, thus reversing the action. It was inconceivable to any of us that a piece of machinery could hold together under such treatment. The average speed for the expedition from Los Angeles to Mexico City, a distance of 2280 miles, was 11.4 m.p.h.

The electrical equipment and installations in Mexico, for the most part, are far from modern. The nation's telephone and telegraph wires that paralleled our course for many miles were supported by old tree trunks; then the mode would change and old railroad rails would serve the purpose. One span of wires I noted is indeed primitive. A native had stolen the copper wires between these poles, and the repairmen later had completed the circuits with barbed wire from the nearest ranch fence.

Apparently no underground cables are used in Mexico City. Telephone poles are mounted on the roofs of buildings, with twelve or fifteen cross-arms and wires but a few inches apart. A shotgun fired into this mess would ruin the communication system for years.

QSY with Crystal Control

(Continued from page 32)

should be performed without taking the piece out of the chuck. Getting the bottom inside face as near optically flat as possible is aided by making a small depression in the middle. This does not affect the operation materially. A moat is cut around the edge of this surface to keep the crystal corners from climbing up the otherwise curved fillet and to prevent breakage of the crystal when the top plate is screwed down tight on it in such position. A threaded plug is made from a brass ring with a hole in it and covered with a piece of bakelite in the middle of which the top electrode is mounted. The face of this electrode is finished when the thread is cut so as to insure both faces of the electrodes being parallel when screwed together. This holder may be dressed up with a big knurled top of bakelite or polished and lacquered metal and a pointer bent around from under one of the cover screws to read exact frequency on a scale attached to the side of the holder; or the edge of the cover (brass or bakelite

All You Need to Learn TELEGRAPHY

Morse or Continental
with Teleplex

Learn Telegraphy—the world's most fascinating profession—by hearing real messages—sending them. Interesting—simple—you learn quickly—at HOME.
Teleplex is the Master Teacher. Used by U. S. Army, Navy and leading radio and telegraph schools. Write for Folder Q-9.

TELEPLEX COMPANY

76 Cortlandt Street, New York



World-Wide Reception

with the NEW

Norden-Hauck - Short Wave

SUPER DX-5

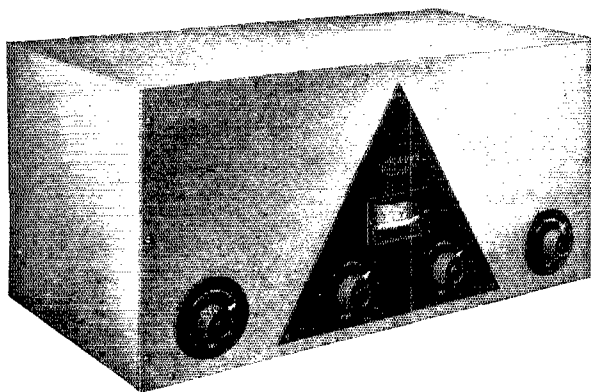

Size: 9 x 19 x 10 inches. Weight 30 pounds

Ideal for Amateur Reception

Entirely New Advanced Design New Pentode Tube

Sensational Distance Range 20-200 Meters Reliable Performance

Adaptable for Long Waves and down to about 10 meters for
Experimental Reception

A-C and D-C Models

NORDEN-HAUCK, Inc.

5-7 South Street

Engineers

Philadelphia, Pa., U. S. A.

Write, telephone or cable TODAY for Complete Information

A millionaire asked this question—

"If money were no consideration, could you build a set that would better the performance of the HY-7?"

Suppose we consider these the components of performance.

1. *Ease of tuning*
 2. *Uniform high selectivity*
 3. *Tone, quality, and volume*
 4. *Sensitivity or range*
1. Cannot be improved without loss of flexibility. It now consists of single control tuning plus a volume control.
 2. Is adequate for normal demands but it can be increased with some sacrifice of tone and considerable expense.
 3. Can be changed. We can alter the tone but it needs no improvement. Of course we also can increase volume tremendously by added audio and its attendant expense.
 4. The sensitivity is high and meets better than normal requirements. It can be increased, but not with large advantage, and an increase comes with large expense.

The HY-7 is supremely fitted to present CW and tone requirements from all viewpoints including that of price. Kit complete, \$58.50. Set, \$95.00.

Complete theoretical and constructional article 506.
Write for it

Hatry & Young

119
Ann St.



Phone
5-2755

HARTFORD - CONNECTICUT - U. S. A.

**and now the
ENAMELED
SLIDE RESISTOR**

..to fill a long-
felt need

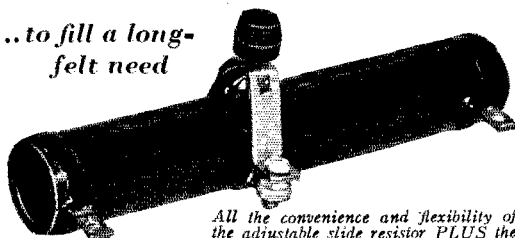

PAT. APP. FOR

All the convenience and flexibility of the adjustable slide resistor PLUS the ruggedness and high wattage of the vitreous enameled resistor!

We offer you a radically new device "for what it is worth" — and enthusiastic expressions from engineers declare it is worth a very great deal! HH Enameled Slide Resistors are made with a straight narrow track left exposed on one side — then fitted with a sliding contact for the desired adjustment. Check off these points: The wire, evenly wound, is embedded and protected in a hard, highly insulating and heat resistant vitreous enamel. The shoe cannot bend the wire, and in sliding it makes contact with the second turn before leaving the first. And HH Slide Resistors are available in three types with a full range of capacities. Your request will bring detailed information immediately.

**ENAMELED
H SLIDE RESISTORS**

HARDWICK, HINDLE, INC.
218 EMMET ST. NEWARK, N. J.

part) may extend through a slot in a vertical panel or be remotely turned.

Another holder easier to make from odds and ends around a ham shop and with common tools is shown in Fig. 3. The bottom plate is flat brass lapped on a piece of plate glass as a crystal would

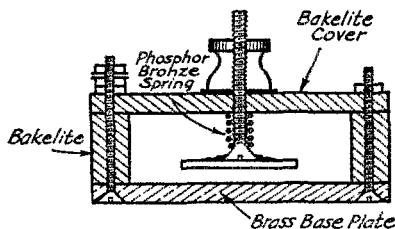

FIG. 3

be ground, preferably after all other work on the plate is finished. A 2" square piece of 1/2" thick bakelite (or thinner pieces stacked in a pile at least 1/8" high) forms the sides of the holder and another piece of 2" square bakelite forms the cover and the whole assembly is screwed together. Some patience may be needed in soldering the top electrode to the flat head brass machine screw so it will be parallel to the crystal when assembled but from the way screws are made a new screw lightly rubbed on emery paper spread flat to just take off burrs will probably have a head that is very close to perpendicular to the axis of the thread. A thumb nut on the thread extending through the cover gives the adjustment and pulls against a small coiled spring between the upper electrode and cover. A pointer may be soldered to the knurled adjusting nut to read on a circle scratched on the bakelite cover. If the cover has been sanded to remove its gloss it will show pencil marked calibrations nicely.

It is believed the general description and the two figures illustrate the idea with considerable leeway left for individual ingenuity and improvement. This gadget is the best answer to the criticism of not being able to QSY on account of crystal control and gives the effect of having a "rubber crystal." Practically no valid arguments now remain for everybody not using crystal control.

**Making Practical Use of the 56-Mc.
Band**

(Continued from page 16)

greatly different thrills. Our pet ambition, at present, is to QSO on phone with W2EB on Long Island, and if we do we will need another band down around one meter again, because every phone on "80" at the present time will be down on "5" within a year. (We can see the code gang on 80 getting a medal or something ready for us if we do.)

All questions will be answered if a self-addressed stamped envelope is enclosed. "C U on five — and 73."

Just Off Press—*Bigger, Better Than Ever*

5TH REVISED EDITION

“Radio Theory and Operating”

By Mary Texanna Loomis

America's best known and most successful radio instructor; President, Loomis Radio College; Member, Institute of Radio Engineers. This text has been enlarged to 1,000 pages and over 800 illustrations, and is made up of the same high class paper with red kraft leather stamped in gold. The book is written in a systematic style and is right up to date, thoroughly covering the very latest material and data on circuits required for obtaining Government licenses of different grades, amateur short waves, broadcast transmitters and receivers, aircraft radio, television, talking pictures, together with the very latest data on every branch of radio theory and operating. No other radio book is so comprehensive. In use by all Government radio schools, leading radio schools in U. S. and Canada and over 400 universities, technical colleges and high schools.

Price \$4.25

Postage paid this and foreign countries

This book is written in such a clear manner that the principle of radio can be easily grasped by anybody reading at home. While this is the standard text book in a great many educational institutions, it is not necessary to attend a radio school in order to gain a practical knowledge of radio from its contents. The users of this book are found at the top in every branch of radio work — some as designing and constructing engineers, many in research laboratories and talking movies, a great many on the ships, a large number in broadcasting stations and in the government service, and a great many in other branches of the radio field. Recognized by radio experts and its many thousands of readers as the book of outstanding merit in the radio world. The reputation of this book is so well established that each edition has sold out before the next edition was ready to deliver.

The 5th edition will be for sale by leading bookdealers
in this and foreign countries

Enclosed find \$4.25, price in full, for which please send me one copy of *Radio Theory and Operating*.

Name.....

Street and Number.....

City and State.....

LOOMIS PUBLISHING CO.

405 Ninth St. N. W.

Washington, D. C.

Dept. 3

FROST-RADIO engineers have banished noise from wire-wound volume controls!

THE necessary use of wire-wound Volume Controls in high gain Radio Receivers has presented fresh problems to the manufacturer of potentiometers and rheostats. Previous standards and methods of manufacture having proved to be wholly inadequate, radically new and different materials and processes were required, and it remained for FROST-RADIO Engineers to develop these.

They have perfected an automatic device for rounding and polishing the contacting edge of the wire. This process so perfectly forms the wire edges that there is not one ten-thousandth of an inch difference in height between any adjacent wires. A velvet smooth contacting surface is thus provided.

They have proven that the new FROST-RADIO Volume Controls will withstand a fatigue test of two hundred thousand half-cycles, at a speed of thirty per minute, without evidence of wear on wire edge or contact arm, and that they are as perfectly noiseless at the completion of test, as before being subjected to fatigue.

A complete treatise on the subject of volume controls has been prepared by our research laboratory. We will be glad to send a copy to any interested engineer.

HERBERT H. FROST, INC.
Main Offices and Factory: ELKHART, IND.

PROCRASTINATION is a 75c word

But you'll lose more than that if you don't get your Handbook soon. You KNOW Handbook must be had. It's EASY to get. Don't procrastinate. Proceed as follows:

- (1) Fill out below, tear off.
- (2) Tap pocketbook for U. S. A. \$1 bill.
- (3) Clip together, mail us.

A. R. R. L.
1711 Park, Hartford
Send Handbook Immediately

(Name)

(Street or P. O. Box)

(City and State)

Experimenters' Section

(Continued from page 50)

grounded. Check the house wiring and see that all 110-volt lines are properly covered and grounded as required by the Fire Underwriter's code. The filament transformer should be encased and the case grounded. Lack of such shielding is probably the cause of more a.c. hum in receivers than any other.

7. The a.c. switch mounted near the receiver can cause plenty of hum. See that it is an enclosed type with the cover grounded to the line covering.

8. Try disconnecting any appliances that may be in use, such as your Frigidaire, iron, etc.

9. There are very few "B" eliminators on the market that can be worked successfully with a.c. short-wave receivers. One of the best is an old Philco with the cover grounded. If you are in doubt, check the set with "B" batteries.

10. Filaments of the tubes should be connected in series, and should have no electrical connection to any part of the receiver, excepting the center-tapped resistor, which in turn is connected to ground.

11. Make sure that all ground connections are common to the same ground.

12. By the proper combinations of the above suggestions you can get rid of all hum that may be present in your receiver, provided of course the trouble is not in the receiver itself.

A Potential Divider for Use at Radio Frequencies

By Don Hale*

In testing r.f. amplifiers or in research work with tubes or circuits it is often necessary that a source of small, high-frequency voltages be available. The ordinary potentiometer devices will not serve. As an example, suppose an amplifier capable of giving a voltage amplification of one million at a frequency of 500 kc. is being tested. Suppose also that a detector tube is being used in the output circuit that cannot have a grid swing or more than twenty volts without giving serious distortion. Under conditions such as these it would be necessary that the input voltage be kept below twenty micro-volts.

It is easy to construct a device that will give these small voltages at high frequencies.¹ Fig. 5

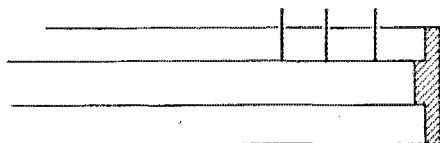

FIG. 5.

shows the appearance of this piece of apparatus, which can be constructed by any machinist. It consists of two concentric brass tubes joined at one end by a brass plug. The plug is carefully sweated into place, making a strong mechanical

* University of Nebraska, Lincoln, Nebr.

¹ Hull, Physical Review, Vol. 25, Series 2.

Two Way Radio Link Never Interrupted — Capt. Yancey's Radio Makes New Records —

Here's the Story behind These Headlines

The Yancey plane (ESCO equipped) in its non-stop flight to Bermuda maintained direct two way communication with New York. Darkness forced the plane down a little short of its goal. The plane floating on the sea remained in communication with New York.

Later, on its "Good Will" flight to South America the Yancey plane, on the ground at the Canal Zone, maintained two way communication with New York. Zeh Bouck, Radio Operator, said—"I believe this is without doubt a record for Airplane transmission, and it shows very clearly what we could have done had we been forced down in some of the jungle over which we have flown during the last few weeks."

And on July 1, this last record was broken — the Yancey plane, on the ground at Buenos Aires, communicated uninterruptedly for more than an hour with the New York Times Station, 5838 miles away.

The Yancey plane was equipped with an "ESCO" wind driven generator to supply radio power while flying, and a battery operated "ESCO" dynamotor for ground work.

"ESCO" has a very complete line of wind driven generators, and dynamotors for airplane service. Let "ESCO" Engineers help you with your power supply for communications.

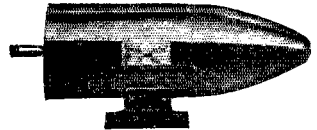

Type NA Airplane Generator

ELECTRIC SPECIALTY COMPANY

225 SOUTH ST.

STAMFORD, CONN.

Manufacturers of motors, generators, dynamotors and rotary converters

TRANSFORMERS

Guaranteed — Mounted — Complete

2 kw 2000—2500 each side \$40.00
700 watt 1000—1500 each side 14.50
250 watt 500—750—1000 each side
unmounted \$10.00; mounted \$11.50

Auto-Transformers, Chokes, Polyphase and 25-cycle Transformers. Add \$2.00 for fil. winding

WGES FRANK GREBEN

1927 So. Peoria Street, Pilsen Sta. Chicago, Ill.

ELLIS MICROPHONES



Models 28N and 30N, \$75.00 list. Approved by every high grade Amplifier Manufacturer in the country. Used by Broadcast Stations and Public Address Systems everywhere. Complete line of stands, cords, etc. Write for descriptive literature and name of nearest jobber.

ELLIS ELECTRICAL LABORATORY

MODEL 28N
\$45.00
List Price

347 W. Jackson St. Chicago, Illinois

BECOME A RADIO OPERATOR

See the World, Earn a Good Income,
Duties Light and Fascinating

LEARN IN THE SECOND PORT U.S.A.

Radio Inspector located here. New Orleans supplies operators for the various Gulf ports. Most logical location in the U. S. A. to come to for training.

Our students qualify for the various branches of radio. Runs to all parts of the world. Positions Ashore and Afloat. Special courses. Day and Night classes. Enrollment time. Oldest and Largest Radio School South.

Literature on request.

GULF RADIO SCHOOL

844 Howard Ave. New Orleans, La.

STANDARD QRH CRYSTALS

Power Type
Crystals
\$10.00

Power Type
Crystals
\$10.00

Power Type
Crystals
\$15.00

1700-Kc. band

3500-Kc. band

7000-Kc. band

Guaranteed — easy oscillators, carefully selected for maximum output, and ground to your approximate frequency. Accurately calibrated within one-tenth of one per cent of frequency delivered. Crystal Holders \$3.00.

Precision Piezo Crystals for

BROADCAST BAND; AIRCRAFT AND COMMERCIAL RADIO CORPORATIONS: from 14000-Kc. to 15-Kc. With temperature ranging from 23 degrees centigrade to 50 degrees centigrade. Temperature control units. Prices on request. (Precision crystals checked against a 30-Kc. standard.)

Standard QRH Crystal Laboratories

37-64 83rd Street

Jackson Heights, New York, N. Y.

TRANSMITTERS and SPECIAL RECEIVERS

for Ship, Shore or Plane

Portable Transmitters and Receivers
Built to Your Specifications

Write for an Estimate

**WIRELESS EGERT
ENGINEERING, INC.**

179 Greenwich Street New York City

Ramsey's RADIO BOOKS

By R. R. RAMSEY,
Prof. of Physics, Ind. Univ.

Radio practice of 1930 is different from that of 1920 or 1925. Radio will change in the future. Basic experiments and fundamental theory do not change. If you keep up to date you must know these principles. Ramsey's books are based on fundamental conceptions and experiments.

The Fundamentals of Radio

(372 pages, 402 figures)

"An excellent text-book of radio written so that a minimum of mathematics is required for its comprehension. — it will be of value to the amateur who wants to know how the radio works." "The book throughout contains that fine blending of theory and practice which makes the theory vital and the applications understandable. — the author has replaced the dead wood found in many books with up-to-date discoveries and inventions." "If such a bureau (government) could recommend a list of hit-the-point books Ramsey's Fundamentals of Radio would surely be included."



Experimental Radio

(255 pages, 168 figures, 128 experiments)

"All experimenters — here is your book at last." "Truly the finest book on radio which has come to this desk in many a month. — A royal road to knowledge." "The book is actually a group of some 128 experiments covering most every imaginable phase of radio within the range of the average experimenter. The book commends itself to service men, custom set builders, testers, and experimenters." "Ramsey manages to provide that missing fact which is hidden in other books."

Description and enthusiastic endorsement sent on request.

Price Fundamentals, \$3.50, Experimental \$2.75, post paid.

RAMSEY PUBLISHING CO.
BLOOMINGTON, INDIANA

Oscillating Quartz Crystals



For Commercial Stations
For Dealers
For Amateurs

POWERTYPE CRYSTALS ARE RECOGNIZED
AS THE BEST

No off frequency operation with a POWERTYPE crystal

Guaranteed — easy oscillators, carefully selected for maximum output, and ground to your approximate frequency which is stated accurately to within one-tenth of one percent.

1715-2000 Kilocycle band.....	\$10.00
3500-4000 Kilocycle band.....	15.00
One-inch oscillating blanks.....	4.00
Dust-proof, plug-in Crystal Holders as illustrated below.....	6.00

We also supply "POWERTYPE" crystals to broadcast and commercial stations.

With all crystal blanks we furnish grinding instructions.

This is the Powertype, plug-in, dust-proof crystal mounting now being used in hundreds of amateur and commercial stations throughout the world.



FREE Simply send name, no obligation, for full information on crystals, holders, blanks, heater ovens, etc.

"CLEAR AS A CRYSTAL"

American Piezo Supply Company
1101 Huron Building Kansas City, Kansas
Specialists in frequency precision

joint as well as good electrical contact. The inner tube is drilled and tapped at regular intervals from the plug. There is a small hole in the outer tube corresponding to each tapped hole in the inner tube. Small wires are threaded and screwed into the inner tube and project through the outer one.

Fig. 6 shows the method of connecting this device to the input circuit. The brass plug closing the tubes is soldered to the shield of the first stage, and the grid of the first tube connected to one of the projecting wires. In use with a circuit having antenna and ground connections the

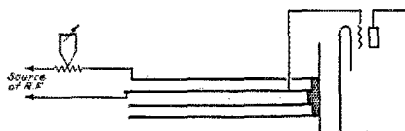

FIG. 6.

ground connection can be joined to the brass plug and the antenna connection to the projecting wire. The alternating current is led through a thermo-connection and connection made to the inner and the outer tube at the open end. A galvanometer is connected across the thermo junction. The thermo-junction-galvanometer combination is calibrated and a curve drawn up showing the deflection given by a chosen number of milliamperes d.c.

At Brace Laboratory, University of Nebraska, one of these dividers is in use in connection with a Western Electric type 20K thermo-junction and a Leeds and Northrup wall galvanometer. A direct current of 0.2 milliamperes gives a deflection of 45 millimeters with this combination. The outer tube in the divider is 5 cm. in inside diameter and the inner tube 2.5 cm. in outside diameter. Each tube is 30 cm. long, and the taps are brought out over 3 cm. The walls of both tubes are 0.4 cm. thick.

The self-inductance of the inner tube is

$$L = 2 \log_e R/r \text{ per centimeter length.}$$

R is the inner radius of the larger tube and r is the outer radius of the inner tube. This value of L is measured in the electromagnetic system. Converting this value to henrys

$$L = 2 \log_{10} R/r \times .0045 \times 10^{-6} \text{ per cm.}$$

The voltage impressed upon the grid of the first tube is

$$E = 2 \log_{10} R/r \times .0045 \times 10^{-6} \times \text{vol.}$$

In the derivation of these equations the current is assumed to flow only on the surfaces of the tubes. This is not quite true, but at radio frequencies the error caused by this assumption is less than one per cent.

Considering the case mentioned above, that is when the current is 0.2 milliamperes and the frequency is 500,000,

$$E = 2 \log_{10} \frac{5}{2.5} \times .0045 \times .0002 \times 2\pi 500000 \times 10^{-6}.$$

This gives a value for E of 1.7 micro-volts per centimeter measured along the inner tube from

ATTENTION BEGINNERS!!!

Now that the "transmitter bug" has bitten, your next step is to get "on the air." Do it the real way with the new Cat. 175 Transmitter

A typical amateur station is shown—The Cat. No. 175 unit is in the middle—economy, simplicity with guaranteed results. Complies with the latest Federal Radio Commission regulations. Ask for Bulletin 35A describing this complete station.

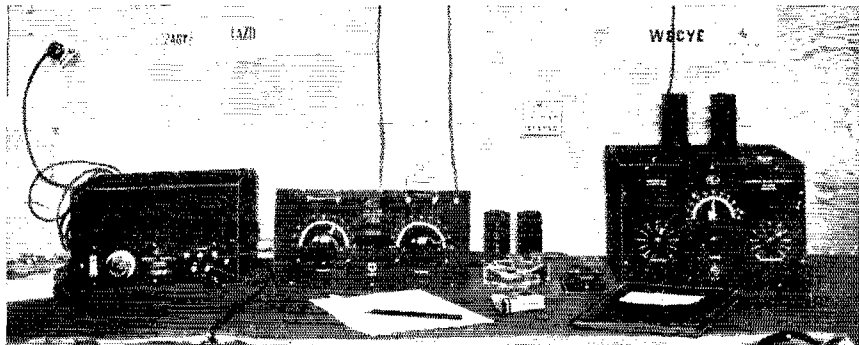

The more advanced amateurs will find valuable data on multi-stage transmitters and 100% modulation systems explained in Booklet No. 50—Yours for the asking.

RADIO ENGINEERING LABORATORIES, INC.
100 WILBUR AVENUE LONG ISLAND CITY, N. Y.

TRANSMISSION CONDENSERS



Send for interesting data and price sheet on Transmission Condensers with working voltages up to 3000 D.C. for use with the following tubes: 203A, 204A, 210, 500W, 851, 852, 860, 865.

CORNELL ELECTRIC MFG. CO.
Long Island City New York

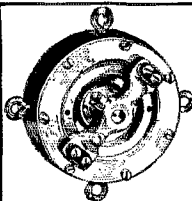

MICROPHONES

EVERY SIZE AND PRICE FOR EVERY POSSIBLE USE

Also Accessories and Repairs

Dealers everywhere

Universal Microphone Co., Ltd.
Inglewood, Calif.

It's probably lost!

Would you believe it? Nearly 4,000 new type QST Binders have been distributed within a comparatively short period of time. They must be good. They are good — and good-looking too.

A splendid tribute to the reference value of QST, and an indication, we believe, that you should resolve to keep past and future issues in a

QST BINDER

\$1.50 each postpaid

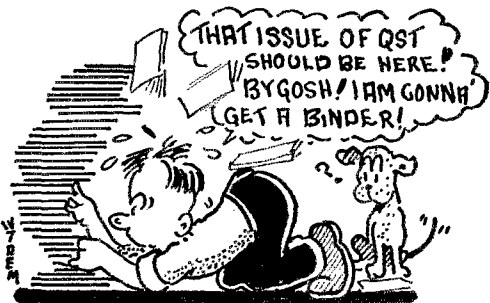

1711 PARK STREET

QST

HARTFORD, CONN.

Qualify for that Land Station Job in a few weeks!

Send 35 wpm or more with less effort than you now send 10. Increase receiving speed from 10 wpm to 30 or 35. Double your typing speed. *It's easy!*

The Candler System of High-Speed Telegraphing Shows How

The Candler System is a system of Physical and Mental Co-ordinative Training for Radio and Morse Operators who want to acquire skill and speed in sending, receiving and writing with pen and typewriter. It relieves and prevents cramps and paralysis and makes the arm strong and fast for both hand and machine sending. Develops the power of Concentration. Gives you confidence by making you sure of yourself at all times. Qualifies you to work any Morse or Wireless job.

What Operators Say

These letters are typical of thousands in our files praising The Candler System. "I owe my speed 55 wpm to your System." (Theo. McElroy, World's Champion Radio Operator, Boston.) "Improved 100% in two weeks after beginning The Candler System." (Frederic Giesler, U. S. Airdrome, Dryden, Texas.)

Write for FREE particulars

If you really want to increase your speed and qualify for that land station job in the shortest possible time and with the least effort to yourself, write at once, for FREE particulars of The Candler System of High-Speed Telegraphing. Give present speed (Morse and Continental.) No obligation. Write NOW!

THE CANDLER SYSTEM CO.

Dept. R. L.

6343 South Kedzie Avenue CHICAGO, ILLINOIS



Walter H. Candler
Former World's
Champion Operator
and Originator and
Director of The Cand-
ler System will in-
struct you personally
throughout the Course.

the closed end. Since the thermo-junction-galvanometer combination is calibrated with d.c. this is an r.m.s. value of voltage.

W9BAN

(Continued from page 54)

Messages, QSL's, correspondence, etc., are filed here. Further left is the station's book shelf with the ever-present *Handbook*, atlas, call book, radio manual and the latest issues of *QST*. To the right of the switch panel is the Vibroplex.

A special lead weight was made for the "bug" so that it could be used at slow speeds, and gives a range of from 13 to 28 words per minute, which seems to be satisfactory for all amateur contacts. The molded lead weight is cylindrical in shape, one inch long and $\frac{3}{8}$ inches in diameter. By having the hole bored accurately no set screw was needed. This facilitated matters greatly, in that it is only necessary to push the weight up or back to vary the speed, the operation taking only a second. The rubber feet of the Vibroplex are moistened and the instrument pressed firmly in place on the table. This prevents any slipping of the "bug" during operation. Two hand manipulated keys are mounted on the table at the left in front of the transmitter, though they are seldom used.

The motto of W9BAN was "See America First," and with that in mind every state in the Union was worked. And one might say that the first forty-five are the easiest. The best DX is New Zealand, with Hawaii, Europe, South America and others in the string. A log is kept of all transmissions, and incidentally, the headings in the log books were disregarded and information was recorded in the same order as the printed headings of the station call card, to facilitate filling out a QSL. A simple four-tube broadcast receiver, with headphones, is occasionally used to fill in the "off" nights. The entire station is home-constructed.

W9BAN holds appointments as Official Broadcast Station and Official Relay Station. Although the monthly total is not high, message traffic is always welcome and is handled as speedily as possible. And next to "traffic" . . . well, the station is a full-fledged member of Ye Rag Chewer's Club

Election Notices

(Continued from page 39)

standing. The nominee must be a League member in good standing and must be without commercial radio connections. His complete name and address should be given. All such petitions must be filed at the headquarters office of the League in Hartford, Conn., by noon of the first day of November, 1930. There is no limit on the number of petitions that may be filed, but no member shall append his signature to more than one such petition.

4. Present Directors from these Divisions are as follows: Central, Mr. D. J. Angus, W9CYQ,

RECTOBULBS

Type R3 for the transmitter: Mercury Vapor Hot Cathode, indirectly heated; standard filament voltage of 10 volts; durable and trouble free when used within specified limits:

Plate voltage	3000
Filament volts	10
Maximum Plate load (Mils)	250
Inverse peak maximum	7000
Drop per tube 15 volts at full load	

Type R81 to replace standard UX281 Rectifier tubes: a wonder for the heavy duty amplifier and small transmitter.

Plate volts	750
Filament volts	7.5
Plate mils	150
Drop per tube 10 volts full load.	

Specialists on Tube Reconditioning. We invite you to use our Service.

Try our N65 Screen Grid Buffer and Amplifier tube.

Priced low for the Ham \$12.50

All products and reconditioning fully guaranteed against defects

NATIONAL RADIO TUBE CO.

3420 18th Street San Francisco, Calif.

QST Oscillating Crystals

"THE STANDARD OF COMPARISON"

AMATEUR BANDS:

Winter is coming, and no doubt you are going over your transmitter removing those weak links so as to get the most possible efficiency from your set.

One item of great importance is the *frequency stability* of your set. Does it *stay on one frequency*? If not, our *power crystals* will solve that problem. SCIENTIFIC RADIO SERVICE crystals are *known* to be the best obtainable, having ONE single frequency and highest output. With each crystal is furnished an accurate calibration guaranteed to *better than a tenth of 1%*. *New prices* for grinding *power crystals* in the *amateur bands* are as follows:

1715 to 2000 Kc band. \$15.00 (unmounted)
3500 to 4000 Kc band. \$20.00 (unmounted)
7000 to 7300 Kc band. \$40.00 (unmounted)

BROADCAST BAND:

Power crystals ground in the 550-1500 Kc band accurate to plus or minus 500 cycles of your specified frequency fully mounted for \$55.00. In ordering please specify type tube, plate voltage and operating

temperature. All crystals absolutely guaranteed regards to output and frequency and delivery can be made within two days after receipt of your order.

CONSTANT TEMPERATURE HEATER UNITS:

We can supply heater units guaranteed to keep the temperature of the crystals constant to *better* than a tenth of 1 degree centigrade for \$300.00. Two matched crystals, ground to your assigned frequency in the 550-1500 Kc band with the heater unit complete \$410.00. More detailed description of this unit sent upon request.

ATTENTION AIRCRAFT AND COMMERCIAL RADIO CORPORATIONS:

We invite your inquiries regards your crystal needs for Radio use. We will be glad to quote special prices for POWER crystals in quantity lots. We have been grinding *power crystals* for over *seven years*, being *pioneers* in this specialized field, we feel we can be of real service to you. We can grind *power crystals* to your specified frequency accurate to plus or minus .03%. All crystals guaranteed and prompt deliveries can be made. *A trial will convince you.*

SCIENTIFIC RADIO SERVICE

"THE CRYSTAL SPECIALISTS"

P. O. Box 86

Dept. P-12

Mount Rainier, Maryland

TRANSMITTERS

7½ watt T.P.T.G. Single Control, \$20. Husky filtered 281 type power, \$18. 15 to 30 watt Tuned Grid, Tuned Plate, uses two 10 tubes in parallel, \$24. Oversize 281 power, filtered, \$20. Both sets absolutely give steady, pure DC notes, neatly built. Preference given to buyers of set and power.

Write for complete description

HAL S. JUSTICE, W4TS, Box 552, Canton, N. C.

Did you send for a copy of our latest
RADIO BARGAIN BULLETIN No. 31?

Full of "Ham" Buys

AMERICAN SALES COMPANY

19-21 Warren Street

New York City

ATTENTION!

Special Sale

PHOTOPHONE



12" DYNAMIC SPEAKERS

Regular List Price \$110.00

OUR PRICE \$15.00 WHILE THEY LAST

BRAND NEW IN ORIGINAL CASES. RUSH YOUR ORDERS!

Field Supply
110 V.D.C.

Field Supply for adaptation to A. C.
operation \$6.50 additional

Terms:—25% with order—Balance C.O.D. or Sight Draft. Specify Express or Freight

RAYMOND ROSEN & CO., INC.

117 North 7th Street

Sound Amplification Division

Philadelphia, Pa.

Model B

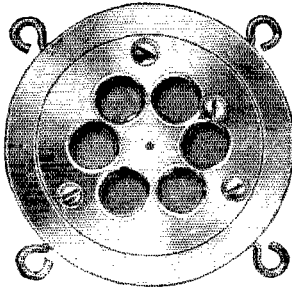

Make your phone set sound like a professional

Remember our old Mike with the three arms? Model B is even better. List — \$55.00

With Filter attachment. List — \$75.00

Condenser Mike complete ready to hook up like a carbon mike. List — \$375.00

Condenser units, for replacement, or use with your own amplifier. List — \$135.00

Write for Our Catalogue on Amplifiers and Microphones

GENERAL INDUSTRIES CORP.
WALTHAM, MASS.

The BETTER Wire-Wound Transmitter Grid Leak —Because QUALITY-BUILT

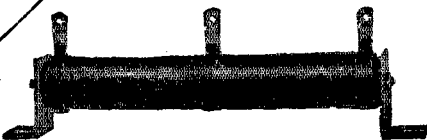

Superior performance — because it is built to quality standards — not to meet any special price level.

Unique construction allows for winding more wire of a larger diameter in a small space. Liberally insulated. Soldering lugs and contact bands of Monel metal — providing equal expansion and positive connections. Covered with moisture-proof enamel. Guaranteed not to develop noise or open circuits. Three sizes (100, 40, 15 watts) and ten resistance values, tapped for all usual needs. \$1.50 to \$5.50.

Write Dept. Q-9 for complete details

175 Varick Street, New York, N. Y.

ELECTRAD
INC.

Indianapolis, elected in April, 1930, to fill unexpired remainder of term of late Clyde E. Darr; Hudson, Dr. A. Lafayette Walsh, W2BW, New York City; New England, Mr. Frederick Best, W1B1G, Augusta, Me.; Northwestern, Mr. K. W. Weingarten, W7BG, Tacoma; Roanoke, Mr. W. Tredway Gravely, W3BZ, Danville, Va.; Rocky Mountain, Mr. Paul M. Segal, W9EEA, Denver; West Gulf, Mr. Frank M. Corlett, W5ZC, Dallas.

5. These elections are the constitutional opportunity for members to put the man of their choice in office as the representative of their Division. Members are urged to take the initiative and file nominating petitions immediately.

For the Board of Directors:

K. B. WARNER, Secretary.
Hartford, Conn., 1 August 1930.

To all A.R.R.L. Members residing in the MIDWEST DIVISION:

1. Mr. Louis R. Huber, W9DOA, A.R.R.L. Director from the Midwest Division, has resigned as Director because of removal from the Midwest Division, the resignation to take effect upon the election of a successor.

2. You are hereby notified that a special election is about to be held in your Division, in accordance with the Constitution, to elect a successor to Mr. Huber for the unexpired remainder of his 1930-1931 term. This special election will be held in the month of November, 1930, concurrently with the regular elections above notified to occur in certain other Divisions. All of the governing details above notified as applying in other Divisions apply to the special election in the Midwest Division except that the term of office is the remainder of the 1930-1931 term.

3. Nominating petitions, complying with the governing details above referred to, are hereby solicited. The following form for nomination is suggested:

(Place and date)

Executive Committee,
American Radio Relay League,
Hartford, Conn.

Gentlemen:

We, the undersigned members of the A.R.R.L. residing in the Midwest Division, hereby nominate of as a candidate for Director from this Division for the unexpired remainder of the 1930-1931 term of L. R. Huber.

(Signatures and addresses)

Members are urged to take the initiative and file nominating petitions immediately.

For the Board of Directors:

K. B. WARNER, Secretary
Hartford, Conn., 6 August 1930.

Calls Heard

(Continued from page 57)

w6cf w6cwh w6cxp w6cum w6cjp w6cwj w6cqs w6cgy
w6cxk w6cbp w6car w6ctz w6cgv w6cqx w6czk w6czn
w6cqq w6cxy w6cej w6cfn w6cgv w6ctk w6cqx w6cug
w6czx w6czr w6cr w6dji w6dzu w6dix w6djp w6dgz w6dpl
w6dnw w6dep w6djj w6dio w6dui w6dtd w6dwi w6dep

IF YOU WANT TO BE
SITTIN' PRETTY.
THEN ~ USE THE
COMPLETE
THORDARSON
ELECTRIC POWER
SUPPLY. ES YOU'LL
HV A 1930
SIGNAL OM

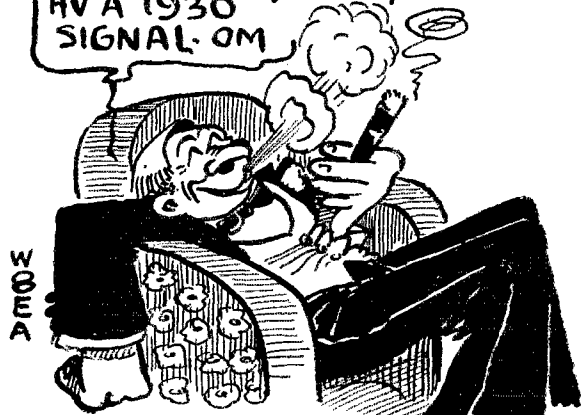

THE BEST IS NONE TOO
GOOD FOR YOUR TRANS-
MITTER —
USE THE BEST!
JUST A REMINDER —
WE STILL HAVE AN
AMATEUR LOG BOOK FOR
THE HAM WHO DID NOT
GET ONE OR THE
BEGINNER WHO WANTS
TO KNOW, WHATS IT
ALL ABOUT, SO SEND
IN YOUR OSL CARD OR
LETTER.
IT HAS A LOT OF GOOD
HAM DOPE IN IT
THAT YOU CAN USE.

THORDARSON ELECTRIC MANUFACTURING CO.

Transformer specialists since 1895

Huron, Kingsbury and Larrabee Sts.

Chicago, U. S. A.



SIEMENS-ZWIETUSCH
High Voltage CONDENSERS

Exceptionally well built—Compact
Very Conservatively Rated
Safe to Use

DC Working Voltage	Mfd	Size	Price
1000	1	2 1/4 - 1 3/4 - 2 1/4	\$ 3.75
	2	6 - 1 3/4 - 2 1/4	6.50
	4	4 1/4 - 2 - 6	11.00
1500	1	6 - 1 3/4 - 2 1/4	4.50
	2	4 3/4 - 2 - 6	8.50
	4	4 3/4 - 4 - 6	14.50
2000	1	4 1/4 - 1 - 6	8.75
	2	4 1/4 - 2 - 6	13.50
	4	4 3/4 - 4 - 6	26.00
3000	1	4 1/4 - 4 - 6	20.00

**The
BIGGEST
VALUE
for
Your
MONEY**

Sold by

J. H. BUNNELL & CO.
215 Fulton Street, New York City

LEEDS RADIO CO.
45 Vesey Street, New York City

WIRELESS EGERT
179 Greenwich Street, New York City

and other reliable dealers throughout the country

MORRILL & MORRILL

30 Church Street, New York City

U. S. A. Distributors

If you cannot get SIEMENS-ZWIETUSCH con-
densers from your dealer, write us sending your
dealer's name and address.

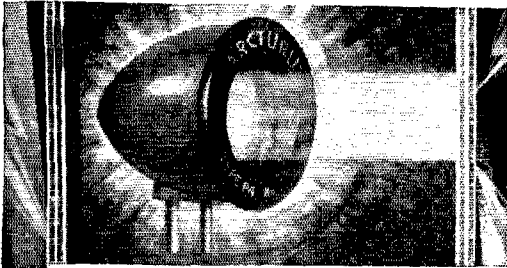

Get Started in Photo-Electricity — a Fascinating Field!

The exceptional performance of the Arcturus Photolytic Cell has already been proved on Sound Picture Equipment; Sorting, Checking and Matching Equipment; Railway Signal Systems; and many other devices.

Other applications are sure to be worked out. Perhaps you will be the one to discover a new use for this improved cell. Send today for complete information, and start working in a fascinating new field of research. *Photo-Electric Division, Arcturus Radio Tube Co., Newark, N. J.*



ARCTURUS

PHOTOLYTIC CELL

The Electric Eye for Every Industry

MADE BY THE MAKERS OF ARCTURUS BLUE TUBES

w6dm w6dm w6dfr w6di A6dpf w6ew w6emk w6eou
w6eoz w6eje w6ebg w6edg w6eak w6epf w6edg w6eab
w6ewb w6ea w6hw w6hy w6im w6io w6qb w6en w6vo w6wa
w6zn w6zzg w7adg w7aat w7amp w7anj w7ajw w7ac w7ahx
w7abj w7acy w7an w7afo w7bd w7be w7dc w7dl w7fh
w7nr w7rl w7ts w7yg w7auc w7axz w7baz w7cyu w7ecp
w7edc w7dyc w7dnx w7dnn w7dgb w7dgm w7dsw w7damv w7ae
w7atv w7aak w7asq w7aab w7akz w7bpb w7bgl w7bcs
w7bhw w7bgz w7bqv w7bex w7efa w7cef w7eaw w7eub
w7epm w7evg w7emv w7ees w7eph w7ef w7dr w7dgg
w7dhj w7dgz w7dts w7ecz w7egu w7eap w7fqm w7fsw
w7fuv w7ghw w7gdv 29la w9oo w9so.

14,000-ke. band

ae1ts au7at au8at ce3cf cm8uf f8ax f8oma g2gm g6vp
hclfb hc1fg hc2jm j1dp kaidj kalaw kaljr k6acw k6erh
k6ewb lu5ae lu8dy lu9dt oa4j oa4q oa4t oa4z oh2nm on4vu
pk3bm pk3bq pk4pa vk2av vk2cd vk2cs vk2ek vk2hb
vk2hu vk2jp vk2jq vk2lv vk2ns, vk2pa vk2ra vk2rf vk2rx
vk3ag, vk3cx vk3es vk3go vk3gu vk3ip vk3pa vk3pp
vk3pr vk3wk vk3wo vk3yr vk3zx vk4bj vk4jr vk4rb
vk4rg vk5gr vk5it vk5wr vk6da, vs6ag w1er, w2adp w2ap
w2cix w6brt w6bab w6chy w6cuh w6dta w7anj w7y w9fvw
w9gdh xu2uu

VE5AW, W. L. Geary, Whitehorse, Yukon,
Canada

ae1ts ae8hm cm8uf d4aar d4aez d4lj d4xn ear21 ear96 f8aw
f8esf f8ct f8da f8eo f8ex f8fem f8fr f8gdb f8ha f8hr f8ja
f8yy f8pac g2ao g2gm g2lz g2sa g2ma g5bd g5by g5bz g5yg
g5yk g6dh g6fg g6nh g6nt g6pr g6vp g6wo g6wt g6wy
g6xn g6qa hc1fg itccc i2cb kalaf kaidj kalhe kalhr
kalpw k6acw k6alm k6bhl k6boe k6ceu k6dv k6dud k6eqm
k6erh k6ef k6cb k7abm k7abs k7ann k7ans k7anj k7aoa
lu2ea lu3dh lu6fc lu8dy lu9dt un1nic oh2nm oh2ob oh2op
oh2nb oh5nl pa0dw pa0qf pa0tw pa0mm pa0mk pk1jr
pk3bm pylaw py2bk py2bz on4fe on4fm on4ft on4fp on4hc
on4jj on4ro on4rs on4uu on4bc oz2u oz5a oz7g oz7im oz7j
oz7t oz7y sm6ua sm6wl su8rs ti2rs un7ww un8mm ve5ao
ve5fs vk2hu vk3hl vk4bh vk5gr vk6mo vk7ch vk7dx vq2bh
x9a y1llm y1lan z1lar z1lbb z1lfc z1lfw z12bx z12cp z13as
z12ac z1sp z2n z4m z5u z6w zu6r e18b haf3b ok1au
ce2ab ce3ab ce3bf la1w rklkad rkrao3 rkrpr rkra97 ac7xot
bal lfeh kfzt zinq bw sslaz ix7 wfat wftb wia ct1aa ct1bx

W1BOD, F. M. Dukar, 57 James St., Hamden,
Conn.

14,000-ke. band

ce2ab ce3ag ce3bf cm2sh cm8uf ct1bx ct2aa cr4ad cxlap
cx2ak d4cc d4jl ear21 ear96 ear116 ei2d ei8b f8aly f8axq
f8cs f8da f8ex f8fem f8fk f8fr f8gg f8hr f8wa f8wis
f8wrg f8zic g2bm g2kf g5bj g5by g5bz g5ml g5ms g6gs
g6hp g6qb g6vp g6wt g6wy g6za hc1fg hc2jc hc2jm k6boe
k6ef kfu5 lu2aa lu3dh lu4bi oa4c oa4j oa4q on4raa on4di
on4fp on4jb on4je on4jj pa0zk pylaa pylc pylcr py2ay
py2bz py2ih py2qb xl1aa sm6wl ys1ap z1as z1lfc z12bg
z13as z13cm zia wfat

W1CPH, Thomas I. Siglin Jr., 16 Sylvan Ave.,
Edgewood, R. I.

w5awp w5bit w5zoo w5aom w5adp w5aea w5abi w5uk
w5brd w5se w5ja w5eja w5dmo w5ezk w5cuh w5egh w5dww
w6eep w6ajm w6bxc w6bck w6dep w6bam w6cxw ve1co
xvela ve2bb ve2be ve2ap ve2ca ve3bk ve3af ve3wk ve3bm
ve3fq ve4bb ve4hc ve4ae ve4al ve4az ve6me voqh ct1aa
ct1bx ct2ac celah cx2bt cm8uf cm8yb cklaf ear39 ei8b
f8dr f8mrc f9w g2vq g5ml gr6b hc1fg itccc k6bcd k4kd
kdv5 lalanz n2pa on4gm pylaw pylcr pylah pylbt pylcl
py2ab py2bk py8ia pxmg x2bc ys1z zp2ab wbt wyp wbn

WK2RX, H. C. St. John, 82 Gibbs St., Rockdale,
N. S. W., Australia

14,000-ke. band

w1asf w2rs w2ay w4aei w4kh w4ly w6abp w6clo w6akf
w8dy1 w8ud w9bmu w9dwn au8at ce5aa ce7aa cm8uf ct1aa
ear96 f8at f8cs f8da f8ex f8fr f8fem f8gdb f8hr f8lgb fa8bak
g2bm g2dz g2lz g2nh g2od g5by g5is g6ia g6nf g6nt g6qb
g6vp g6wl k6acw k6bhl k6boe k6cpo kaljr lu3de lu3pa
lu6af oa4j oa4q oa4r oa4t oa4z oh2nm on4jj oz7y pa0qf
su8rs su8wy vs2af vs3ab vs6ae vs6af vs6ag vs6ah vs7ap
vu2ae vu2dg vu2zx zu2uu

The NEW Easy-Working GENUINE MARTIN

VIBROPLEX No. 6

Reg. Trade Marks: Vibroplex; Bug! Lightning Bug

IN COLORS: Blue — Green — Red

10 New features.
Easy to operate. Easy on the arm. Fast or slow. Transmits signals unequalled for strength, clarity and beauty.

Black or Colored, \$17 Nickel-Plated, \$19

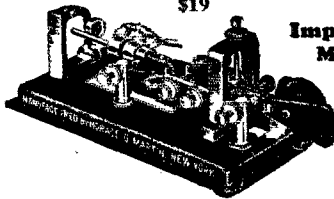
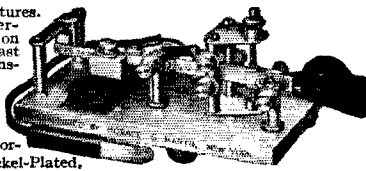

Improved
MARTIN
Vibroplex

Black or Colored, \$17
Nickel-Plated, \$19

Special Martin Radio Bug — Extra large. Specially Constructed Contact Points for direct use without relay. Black or Colored, \$25

Your old Vibroplex accepted as part payment
Remit by Money Order or Registered Mail

THE VIBROPLEX COMPANY, Inc.
825 Broadway, New York City
Cable Address: "VIBROPLEX" New York

Guard Your Reputation

Metallized resistors are used by the best service men,—conservatively and accurately rated,—will not exceed original tolerance,—notably quiet,—remarkably rugged,—all types,—values from 50 ohms to 10 meg ohms,—prompt deliveries.

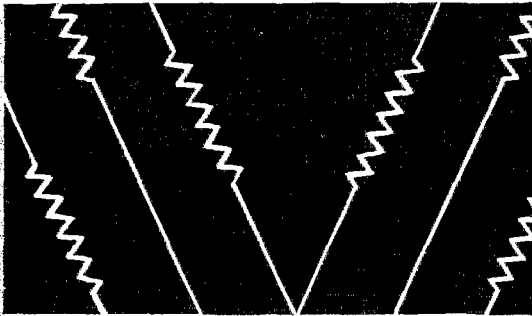

DURHAM

Metallized

RESISTORS

METALLIZED RESISTORS



Definite proof of the quality of Metallized resistors lies in the fact that the largest manufacturers use Durham Resistors.

With the purchase of 10 Durham Resistors (until October 15th) you receive our complete *Resistor Replacement Guide* free; or you may buy it for 50c.

This remarkable booklet shows service men clearly and concisely: (1) How to locate cause of trouble in radio sets. (2) Proper types and values of resistors to use in all popular types of radio receivers for last 3 years.

Send your order today.

INTERNATIONAL RESISTANCE COMPANY

2006 Chestnut St. Phila., Pa.

"No other Resistor has all of Metallized's Advantages."

QUARTZ OSCILLATING CRYSTALS

Scientifically Prepared for Maximum Power and Unconditionally Guaranteed 1 in. square sections, (close to your specified frequency), supplied promptly at the following prices:

75-100 meters	\$12.50
100-200 meters	9.00
200-600 meters	15.00
1 in. Tested blanks, 200-400, 400-600 meters	4.00
Dustproof Bakelite mounts	3.00

(A Calibration furnished with each crystal)

Sections of any practicable dimensions made to order

(Charges for grinding to exact frequencies given on request)

J. T. Rooney, B. Sc., 4 Calumet Bldg., Buffalo, New York
"A pioneer crystal grinder"

Massachusetts Radio and Telegraph School

18 Boylston Street, Boston

Send for Catalogue

Tel. Hancock 8184 Established 1905

ALCOA ALUMINUM SILVER FINISH PANELS

72c per square foot

Maximum width 12", maximum length 48"
Moulding for corners 12c foot

We carry complete lines of the following — Aero, National, Thordarson, Fiechthelm, Pilot, Frost, Signal, DeForest, Hammarlund, R.E.L., Pyrex, Sanyamo, Ellis, Universal, Fleron, Munzig, Magnet wire, Fahnestock clips, Ohmite, Readrite, Cardwell, Bradley, Yaxley, Handbooks, Call books, Bakelite panels and tubing, Jewell.

Everything for the Ham

CATALOG FREE

We pay the postage

218 CHESTNUT ST. **HALL'S** HARRISBURG, PA.

U. S. NAVY SURPLUS

General Electric 24/750-volt 150-watt Dynamotors . . .	\$27.50
General Electric 24/1500-volt 350-watt Dynamotors . . .	37.50
500-watt 500-cycle generators with exciters	7.50
Westinghouse 6-15 volt 500-watt	15.00
Westinghouse 27.5/350-volt 80 mills	12.50
Twins for double voltage or current	20.00

Shafts for external drive \$3.00 additional
HENRY KIENZLE, 501 E. 84th Street, New York
Pioneer Distributor of Government Surplus
Complete list on request

DON'T BANKRUPT Your station using skimpy or salvage stock power equipment. Engineer it with apparatus specifically designed for xmtr rectifier service. Ask for latest engineering data describing power transformers built to QST ratings — double and triple normal load; filter reactors that block the AC, let the DC slip thru, and a brand new reactor 500% more effective than brute force. All insulated for 10 times working voltage. Single and polyphase power equipment for every type of station. Your rectifier problems solved.

Rectifier Engineering Service, 4837 Rockwood Rd., Cleveland, Ohio

H I L E T

Bulletins are complete with regulation curves and engineering data to help in selecting the proper material. **WHEN YOU GET A 30 H-160 MA, CHOKE AT-6 lb, someone is being fooled. IT JUST CAN'T BE DONE.** Adjustable Gap, Chokes: — 100 H-80 MA, 22 lb, \$12.00. 50 H, 160 MA, 22 lb., \$12.00. 30 H-320 MA, 25 lb., \$14.00. 15 H, 500 MA, 32 lb., \$18.00. 3 H-400 MA, 22 lb., \$12.00. Transformers 750 watt 150V-185V each side, \$19.50. 500 watt, 100V-150V each side, \$15.00. 250 watt 50V-75V-100V each side, \$10.50. 150 watt 32V-37V each side, \$9.00. Filament any voltage. Tapped primary \$6.50. Specials to order. Prices are mounted with leads. For Deluxe model with fuse and terminals add \$3.50. Name Plates for transmitter panels engraved to order, \$2.00.

One Day delivery

HILET ENGINEERING CO., Orange, N. J.

RADIO BARGAINS FULLY GUARANTEED

Tubes UX type, 30 day replacement guarantee, No. 210, \$2.25; No. 250, \$2.35; No. 281, \$1.85; No. 280, 95c; No. 245, \$1.25; No. 224, \$1.25; No. 227, 75c; No. 226, 65c; No. 171, 75c.

Low Power Transmitter, adaptable for phone or code. With plug-in Coils \$14.75

Short Wave Sets, one tube complete with 5 coils, 14 to 550 meters \$6.45

Auto Radio—Uses 3-224 and 3-227 tubes, single dial, tremendous volume. Compact. Fits any car. \$20.00

Stromberg Carlson telephone transmitter on desk stand \$2.75

B Eliminator, Dry, 180 volts, will operate up to 10 tube set, with 280 tube, fully guaranteed \$6.75

250 or 245 Power Condenser Blocks, 12 Mfd., 1000 volt A. C. test, tapped 2,2,2,4,1 and 1 mid. \$4.75

2 Mfd. Condenser Packs, 2000 volt A. C. test \$7.90
1500 volt \$3.80

Double Chokes, 30 henry each, 160 mils., 1500 vt. test, shielded \$4.95
130 mils. \$3.75

Power and Filament Transformers for 226, 227 and 171 tubes, with double choke \$4.00

No. 1003 Power Transformers, shielded, Sec. 600 V. for one 281, one 250, one 227, four 226 tubes and 2 chokes \$5.00

AG-A, B, C, Power Packs, completely assembled, \$8.75, 250 V. B. also has A. C. filament for up to 9-tube set.

Can be used as B eliminator. Make your battery set all electric, or build your A. C. set around this pack, 280 tube for this pack, 95c extra.

Thordarson Transformers, 1 to 1 \$1.00

CHAS. HOODWIN CO.

4240 Lincoln Ave., Dept. J-8, Chicago, Ill.

DEALERS IN BANKRUPT RADIO STOCKS

Remote Control!

WE control the newsstand distribution of *QST* separately, of course.

The technical level and purpose of *QST* in the radio field makes it necessary to limit its newsstand output — though we do our best to make it easily obtainable. A dealer tells you he hasn't a copy of *QST*: as a layman, think a moment and try to estimate the number of newsstands in the United States and Canada. It would be financial suicide to try to furnish *QST* to each.

What are we driving at? Simply this — *QST* is the ideal type of magazine to which you should subscribe. You will find it neatly wrapped in your mail basket each month, and you will eliminate the "monthly tour" because its distribution is obviously limited and many dealers quickly sell their quota.

What we have just said has much to do with the regular monthly appearance of the blank on page 94 of *QST*. You'll be glad you used it!

West Gulf Division Convention

Houston, Texas, October 10th
and 11th

WATCH for the October issue of *QST*
for full particulars.

ACME WIRE PRODUCTS

Coils — Magnet Wire Wound

Magnet Wire All Insulations

Varnished Insulations

Parvoit Filter and By Pass Condensers

All products made to Recognized Commercial Standards including those of:

National Electric Mfrs. Assn.

Radio Manufacturers Assn.

American Society for Testing Materials

For more than 25 years manufacturers and suppliers to the largest and most discriminating users.

THE ACME WIRE CO.

NEW HAVEN, CONN.

Branch Offices:

New York Cleveland
52 Vanderbilt Ave. Guardian Bldg.

Chicago
842 N. Michigan Ave.

Strays

W4AFL has a push-pull transmitter with only one tube, according to W4JO. The grid is pushing against the plate and the plate is trying to pull the power-house in!

One of the mail order houses is selling chokes designed especially for amateur use. The secret of their efficiency is in the winding, which is triple-covered *paraffin*. No details are given as to the material used to cover the *paraffin*, but we imagine any conductive material will do.

The filament rating on the Type 231 output tube, described in July *QST*, has been changed from 0.15 to 0.13 ampere, the terminal voltage remaining the same.

A simple code practice outfit can be made from the short-wave receiver by increasing regeneration until the detector howls, and then putting a key in series with the 'phones. Buzzer troubles and noise are eliminated. — W7MM.

SEND TODAY for valuable information on the new Non-Inductive Vitrohm Resistors in plaque form. Lower prices, more efficient operation in transmitters and Vitrohm quality are factors you can't overlook. Get the dope now.

WARD LEONARD ELECTRIC CO.
Mount Vernon, New York

*Have you received your call cards yet? The new design is attractive and easily read.
A supply is yours for the asking.*

EVERY LICENSED AMATEUR
NEEDS THE NEW

A. R. R. L.

LOG BOOK

SEE INSIDE BACK COVER
THIS ISSUE

P A C E N T

Duo Lateral
COILS

Radio engineers and laboratories with real records of accomplishment use Pacent Duo Lateral Coils. They come in all standard turn ratios.

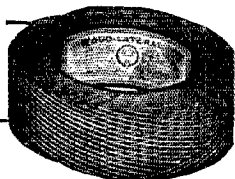

*Write for information
and prices*

PACENT ELECTRIC CO., INC.
91 Seventh Avenue New York City

CONTROL
Counts Most!

BABE RUTH recently wrote that "Control makes a pitcher and lack of it breaks him." Simple . . . easily understood.

In radio it's also a case of CONTROL. That's where CENTRALAB comes to bat with a Volume Control that is as smooth as Dazzy Vance's pitching—yet as powerful as Babe Ruth's slugging.

CENTRALAB volume controls in millions of radio receivers are making this a nation of red hot radio fans.

Write Dept. 320-F for Free Booklet, "Volume Control, Volume Control and Their Uses"

Centralab

CENTRAL RADIO LABORATORIES
Dept. 320-F. Keefe Avenue & Humboldt
MILWAUKEE :: WISCONSIN

followed by Prof. J. A. Martin, who gave one of the finest practical demonstrations on ultra-short-wave work it has ever been the writer's pleasure to witness.

Following the contests, the gang assembled for the banquet where, after plenty of food, music and entertainment Dr. Woodruff assumed the position of toastmaster and introduced Messrs. Handy and Budlong, of Headquarters, and Assistant Radio Supervisor Grinnell. The latter's remarks, in particular, will probably be remembered for some time to come. Prizes, donated in quantity by friendly manufacturers, were distributed at the last; we are sure everybody must have had at least one, and such people as "Lindy" walked off with practically entire station lay-outs!

In closing, we must again extend hearty congratulations to Messrs. Brotherson and Wagner, and their associates of the Erie Club, for putting across a top-notch convention; we suggest that other clubs planning conventions might study this particular program with profit. The combination of a real outing with just the right amount of good technical sessions is an ideal one. After all, the purpose of a convention is to learn a little, but also to meet the other fellow and have a good time. The Erie convention was ideal in all three respects.

— A. L. B.

Book Reviews

Radio and Its Future, by Martin Codel. Published by Harper & Brothers, New York. 349 pages; illustrated. Price, \$4.00.

To exploit the layman's interest in the romantic side of radio communication, a number of books have been thrown together and presented. Many of these have had little if any merit. Only a few have been worth writing. The serious amateur who thumbs through some of these works of imaginative enthusiasm is affected with the weary cynicism typical of those who know too much about the limitations of radio.

It refreshes one to pick up *Radio and Its Future*. This book represents the collaboration of the best minds affiliated with the several branches of radio with Martin Codel, Washington newspaper correspondent, whose signed articles on radio in the daily press are well-known throughout North America.

In eighteen pages of his delightful writing, Mr. Maxim presents a picture of the radio amateur, who "has never yet been given a problem he could not solve." To the amateur, this presentation exemplifies the spirit of accuracy and impartiality with which the entire book is impressed. A. Y. Tuel, Vice-President and General Manager, Mackay Radio and Telegraph Company, tells the absorbing story of maritime radio. The development and possibilities of international broadcasting are presented by C. W. Horn, General Engineer of National Broadcasting Company. M. H. Aylesworth, President of that Company, outlines the special functions of broadcasting which are making for its permanency and influence the social scheme. Most of the great names in contemporary radio are represented: the field is covered, from television to aircraft radio, from advertising to law. Technically, sociologically, economically, the whole view is authoritatively presented. *Radio and Its Future* is an excellent book.

— Paul M. Seegal.



P. R. 872

Fil. Volts - - 5
 Fil. Amps. - - 10
 Peak Inverse
 Volts - - 5,000
 Peak Plate
 Amps. - - 2.5
 Voltage Drop - 15
 Overall
 Length - 8 1/2"
 Overall
 Diam. 2-5/16"
 Price - - \$18.00

FOR PURE D.C. POWER SUPPLY



P. R. 866

Fil. Volts - 2.5
 Fil. Amps. - 5
 Peak Inverse
 Volts - 5,000
 Peak Plate
 Amps. - 0.6
 Voltage
 Drop - - 15
 Overall
 Length 6 1/2"
 Overall
 Diam. 2 3/8"
 Price - - \$8.00

UNDER the new regulations all amateurs must use an adequately filtered D. C. current supply.

P. R. 866 and P. R. 872, both mercury vapor rectifiers, besides emitting a wave form easy to filter, furnish a stable source of plate voltage—full load or no load, because both tubes possess a low and practically constant voltage drop. The unusually long life of the P. R. 866 and P. R. 872 is due to the low operating temperature of the oxide coated filament combined with the extremely low voltage drop resulting from their mercury content.

Use these Perryman rectifiers, famous for their rugged strength, in bringing your station in line with the new regulations.

Attractive prices for licensed amateurs

PERRYMAN ELECTRIC CO., INC.,
4901 Hudson Blvd., North Bergen, N. J.

Enclosed please find money order for \$.....for
check

..... P. R. 872 at \$18.00. P. R. 866 at \$8.00.

Name.....Station.....

Street.....

City.....State.....

HAM-ADS

(1) Advertising shall pertain to radio and shall be of nature of interest to radio amateurs or experimenters in their pursuit of the art.

(2) No display of any character will be accepted, nor can any special typographical arrangement, such as all or part capital letters be used which would tend to make one advertisement stand out from the others.

(3) The Ham-Ad rate is 15c per word, except as noted in paragraph (6) below.

(4) Remittance in full must accompany copy. No cash or contract discount or agency commission will be allowed.

(5) Closing date for Ham-Ads is the 25th of the second month preceding publication date.

(6) A special rate of 7c per word will apply to advertising which, in our judgment, is obviously non-commercial in nature and is placed and signed by a member of the American Radio Relay League. Thus, advertising of bona fide surplus equipment owned, used and for sale by an individual or apparatus offered for exchange or advertising inquiring for special equipment, if by a member of the American Radio Relay League takes the 7c rate. An attempt to deal in apparatus in quantity for profit, even if by an individual, is commercial and takes the 15c rate. Provisions of paragraphs (1), (2), (4) and (5) apply to all advertising in this column regardless of which rate may apply.

PLATE power for your set, the very heart of its performance. For quietness, DX ability, life-long permanence, absolute dependability, lowest ultimate cost, no other plate source even approaches the achievement of an Edison steel alkaline storage B battery. Built painstakingly; every joint pure nickel, upset electrically welded. Genuine Edison Electrolyte. Our list describes complete batteries, construction parts, enameled aerial wire, silicon steel. Available immediately, filament and plate transformers for the new 872 rectifier, complete plate power units. Rectifier Engineering Service, radio W8ML, 4837 Rockwood Road, Cleveland, Ohio.

THE finest in radio for amateur, broadcast and marine. The most modern short-wave receivers. Four to ten tube designs. Radiophone CW transmitters of any power or type. We make a complete line of apparatus, including speech amplifiers, filter coils, inductances, power units, etc. Any special apparatus, designs, built to order, using your parts if desired. Prices on request. New bulletin lists complete line of apparatus. Write for copy. Ensell Radio Laboratory, 1527 Grandview St., S. E., Warren, Ohio.

AMATEURS — experimenters, builders. We serve over 4000 I.R.E., A.R.R.L., etc., experimenters and "nuts." Full discounts. \$50,000 stock approved parts — no sets. Over four pounds catalog, circuits, data, prepaid, 50c. Weekly bulletins (new items, results of experiments, etc.), 20 weeks \$1. Sample experimenters' "Over the Soldering Iron" magazine, 25c. Transmitting data, price list, etc., 25c. Kladag Radio Laboratories, established 1920, Kent, Ohio.

SPECIAL rectifier aluminum, \$1.25. Lead, \$1 square foot. Elements 1 x 4 1/2 cents, 1 x 6 1/2 cents pair. All prepaid. Best silicon transformer steel cut to order, 25-35 cents pound. Postage extra. George Schulz, Calumet, Mich.

TELEGRAPHY — Learn Morse and wireless telegraphy. Big salaries. Tremendous demand. Expenses low, can earn part. Catalog free. Dodge's Institute, Wood St., Valparaiso, Ind.

SILVER-Marshall 737 Bearcat short wave receiver, wired, \$83.50. All S-M parts in stock. 40% and 2% to hams. Write for best prices on 737 kit and for our special price list on standard parts. Radio Inspection Service Co., 193 Trumbull St., Hartford, Conn.

G.E. 1000-watt transformers, 1100-2200-4400 each side center tap. Used by Cornell, Navy, and 300 hams. Guaranteed unconditionally, \$12. F.O.B. Some 500 watters, no center tap (bridge circuit), \$5.00. Detroit, Fred G. Dawson, 5740 Woodrow, Detroit, Mich.

LOCATING buried treasure by radio offers hams profitable diversion. Accurate. Fascinating. Details for red stamp. Exchange, Box 607, El Monte, Calif.

QSLs \$1 per hundred. W9BEU, 9032 Windom Ave., St. Louis, Mo.

CRYSTALS for sale or trade. W9CVT, Dr. S. J. Blum, 702 Shukert Bldg., Kansas City, Mo.

WILL trade receiver and loudspeaker for good typewriter. Orville Alexander, Cairo, Mo.

SELL REL 209 o.w. and phone transmitter. Any reasonable offer accepted. W8DCY, Nicktown, Pa.

TRADE or sell set of drums. Value, \$185. What have you in the transmitting line? Long wave receiver? etc. H. P. Brewer, Y. M. C. A., Ottumwa, Iowa.

SELL — Three used W.E. 211Ds at \$12 each. Two used W.E. 211As at \$10 each. Money back if not satisfied. H. J. Moran, 1776 Castlehill Ave., Bronx, N. Y.

VIBROPLEXES — new and parts. Rebuilds, \$10. Lyceard, 28 Circuit, Roxbury, Mass.

JEWELL meters No. 54, 0-1000 v. with external resistor, 1000 ohms per volt, \$13. Same 0-2000 volts, \$14. Edison 6-volt battery, \$12. Edison 6-volt battery box with 5-ampere Tungar charger, \$8. General Radio 247W wavemeter with 3 coils, \$10. Write for lists. M. Leitch, 34 S. Park Drive, West Orange, N. J. \$35 takes Silver Marshall Round the World Four Receiver with coils, new tubes and three Layerbilt batteries. Chas. Piccone, Manco, Colo.

SELL — New G.E. 24750-volt dynamotor, \$22.50. New S-M Round the World Four, \$20. Trade 12-inch, 230-volt fan for parts. Henry W. Ray, Indianola, Miss.

CRYSTALS with a guarantee of complete satisfaction. 7000 kc., \$15; 3500 kc., \$12; blanks, \$4. W9DRD, Herbert Hollister, Edwardsville, Kans.

SELL — 1930 Hartley transmitter and receiver, \$30. Write Don McKinley, 215 4th Ave., E., Oskaloosa, Iowa.

CLOSING OUT — Sell everything, including S-M, 630 amplifier, Jewell Pat. 74 R. F. Meter O-0.5, Four Jewell Pat. 54 0-1 mill. milliammeters, three double button microphones. Floor and deck stand, Four Racon trumpets, and other articles. List upon request. Glade Brett, Spirit Lake, Iowa.

QSLs, two colors, 90c per hundred. W9DGH, 1816 Fifth Ave., N., Minneapolis, Minn.

CODE: Learn the code with our improved learner's device, which has a beautiful, steady tone like a commercial station. Equipped with good telegraph key and headset. Ready for use. \$17.50 postpaid. Summit Electric Co., 561 Brussels St., San Francisco, Calif.

THROUGH hamming! Buy my equipment cheap. Send for Bargain-List. Curtis, 1109 Eighth Ave., Fort Worth, Texas.

TRADE transmitting apparatus, receiver. Want typewriter, teleplex, parts. W2BG.

BEST offer takes one marble base key; 1925, 1926, 1927, 1928, 1929 issues QST with three binders and Handbook, 15 Raytheon BHs, \$2 each; 0 Bs, \$1 each; 4 Bs, \$3 each; 2 870's, \$2 each; 4 281s \$3 each; one I.R.E. binder, \$1. J. G. O'Shea, Darlington, Pa.

1930 transmitter 10 watts, complete with tubes. Full wave rectifier. Best offer takes it. Branko Marohnic, Route No. 1, Gladstone, Mich.

SALE — Pilot spare wasp d.c., good condition, \$25. F. E. Latham, W8CVG, Penn Yan, N. Y.

SHORTCUT to Code Reading Speed. These results produced in few hours. With Radio Shortcut 25; High Speed 35; Morse Shortcut 20. Users surprised. Reports all districts on request. Methods, \$5 each, money order. C.O.D. if deposit \$2. Dodge Radio Shortcut, Box 100, Mamaronck, N. Y.

LEARN code at home with our famous code machine. Only \$9.85 c.o.d. Formerly sold for \$25. Codegraph Co., Box 107, Winchendon, Mass.

TUBES — 210, \$1.85, 2 for \$3.50; 281 \$1.50. 5-day replacement. Postage extra. W9BOR, 4544 Pierce St., Gary, Ind.

W8CUX for QSLs. Nuff sed.

TWO photo-cells. Eveready Raytheon, slightly used, one hour each — guaranteed — \$14.50 each. C. Weant, 4213 Springwood Ave., Baltimore, Md.

SELL — dynamotor — G.E. 24/1500 v. with extension shaft. Best offer. W. Hamburg, 3996 Lovell Ave., Cheviot, Ohio.

QSLs 100 two-color, \$1. Stationery. Samples. W9CKA, Corwith, Iowa.

RECTOBULBS, Type R3, new and guaranteed, \$9. Selling extra equipment. W9AXH, 4130 N. Meridian St., Indianapolis, Ind.

TRANSFORMERS — made to your order. Amateurs, Custom Builders, Servicemen: We build power transformers and chokes to your specifications. For power amplifiers, radio receivers, transmitters, etc. Quality products, quick service, moderate prices. Write for quotations, stating voltages, current, approximate physical dimensions, and number desired (if more than one). Baker Engineering Labs., 2131 Curdes Ave., Ft. Wayne, Ind.

DURALUMINUM. Specially treated for microphone diaphragms. .002" x 4" x 4", \$2. Gold spot for carbons, \$3. W9BWI, Ft. Wayne.

TRADE new 16MM. moving picture camera for large transmitting tubes. Sell screen-grid receiver and CW transmitter cheap. Send for list. W2CIT, Seaford, N. Y.

QSL cards, logs, message blanks, etc. Seldens, Cranesville, Pa.

POWER CRYSTALS: Guaranteed excellent oscillators. One inch square sections of your approximate specified frequency. Special prices: 7000 kc. band, \$11.50; 3500 kc., \$7.50; frequency precision, 1%. Precision Piezo Supply, 427 Asia St., Baton Rouge, La.

TRANSFORMERS? Here is what you have been looking for and at the lowest prices ever. Dongan 250-watt transformers with Areturus line ballast tubes. Primary: 110-120 v. a.c. Secondary: 1500 v. center-tapped at 750 v. Filaments: 7 1/2, 7 1/2 ct, 2 1/2 ct, 1 1/2 v. There is a limited quantity, so rush your order. Priced to sell fast at \$6.50. 150-watt transformer with outputs of 600 v, 7 1/2 ct, 7 1/2 ct, 2 1/2 1 1/2. Reduced to \$2.75. Cash or C.O.D. Columbia Specialty Co., 1038 Longwood Ave., New York City.

6000 v. 12000 v. 3-phase drive motor-generator, \$1500; 3000v. 6000 v. 3-phase drive motor-generator, \$750; 2000 v. 500 v. 1-phase drive, \$195; 1500 v. 400 v. 3-phase drive, \$125; 1000 v. 300 v., \$95; 1000 v. 250 v., \$85. 1/2 hp. 3450 r.p.m. motors, \$10.50; 1/2 hp., \$16.50. Converters, 32 v. d.c. to 110 v. a.c., \$35. Queen City Electric, 1734 Grand Ave., Chicago.

CRYSTALS: Highest quality, \$5 up. Oscillating blanks, \$2.50 up. W6BCX.

CRYSTALS: 1.7, 2 m.c., \$6; 3.5, 4 m.c., \$9; 100 k.c., \$6; 1% calibration and guaranteed by Collman & Biley, 34 West 8th St., Erie, Pa.

QSL cards, two colors, \$1 per hundred. Free samples. W8DTY, 257 Parker Ave., Buffalo.

CRYSTALS for sale or trade. 80 meter, \$8; 160 meter, \$6. One-inch tested blanks, \$2.50. W10CVT, 702 Shukert Bldg., Kansas City, Mo.

CRYSTALS — Guaranteed power type: 3500 kilocycles, \$7.50; 1750 kilocycles, \$5. Will trade. W9DLL, 222 W. 73rd Terrace, Kansas City, Mo.

\$300 will buy complete 250-watt panel transmitter. R.C.A. tube, Jewell meters, Cardwell condensers, etc. W7BS, 1069 Division St., Portland, Oregon.

C.Q., C.Q., C.Q., Look at these prices. Columbia transmitting tube condensers, working voltage 1000 d.c., mfd., \$1.40; 2 mfd., \$2.30; 4 mfd., \$3.80. Working voltage 1500 d.c., 1 mfd., \$3; 2 mfd., \$4.50; 4 mfd., \$8.95. Working voltage 2000 d.c., 1 mfd., \$3.95; 2 mfd., \$6.95. R.C.A.-Victor 30 h, 125 ma. chokes, \$1.75; 30 h, 200 ma. chokes, \$2.50. First-class tubes with a 30-day free replacement guarantee. Type X 250, \$2.75; X 210, \$3.95; X 281, \$2.25; X 800, \$9. Write for free list. Cash or C.O.D. All merchandise guaranteed. Columbia Specialty Co., 1038 Longwood Ave., New York City.

FOR sale — 500-watt composite transmitter. Will sell complete or in parts. Write for information. Stanley F. Northcott, Radio Station WSDAT.

TRADE 900-cycle alternator and transformer for receiver or what have you? W1QK.

GENERAL Electric CG1182 Navy five-watters, 750 volts on plate, 7.5 volts on filament, standard bases. Special spiral platinum filament, stands heavy overload. Thousands in use. Special, only \$1.25 each. Our surprise package is the fastest selling item we have had in years. Contains 4 to 6 lbs. of radio equipment, only \$1 per package. Please include postage. Nuff sold! General Radio 00025 and 00035 variable condensers, 800 each, 281 type tubes, \$1.50 each. R.C.A. 201A tubes, 85c each. Antenna wire, 25c per 100 ft. Rubber-covered wire, 50 ft. only 25c. Neop tubes for wavemeters, 50c each. 0-100 milliamperes, flush panel mounting, \$1.25. Audio transformers, 500 ohm, 65c each. Odd lots variable condensers, 65c. All merchandise guaranteed. Sent C.O.D. E. P. Hufnagel, 879 S. 18th St., Newark, N. J.

TRANSFORMER specials. Mounted and fully guaranteed. 150 watt, 650 each side, 7 1/2 ct, \$7. Same 550 each side, \$6. 250 watt, 550, 750 each side, 7 1/2 ct, \$10.50. 700 watt, 1000, 1500 each side, \$14.50. 75 watt, 7 1/2 ct, \$3.50. 10 volt, \$3.50. 12 volt, \$3.50. 2 1/2 volt, 10A, \$3. 350-0-350, 5, 2 1/2, 2 1/2, \$4.50. 500-0-500, 7 1/2 ct, \$4.50. Specials to order. Send for new bargain list. Electrone Labs., 834 N. Randolph St., Philadelphia, Pa.

TYPE 886 mercury tubes—firsts, \$8 each. Seconds (slight imperfections), \$5 each. Seconds guaranteed to work perfectly. E. Ewing, Jr., 29 S. LaSalle St., Chicago, Ill.

SELL or trade xtals, 24 1500-volt dynamotor, list. Want Edison A-6, B-6 batts, 206, 208, 861 tube. W9GFZ, Wheaton, Ill.

VIBROPLEXES, Teleplexes, Omnigraphs, Codeographs, wasps, 50, 75, 100 watters, transformers, receivers, bought, sold, traded. Ryan Radio Co., Hannibal, Mo.

204A used 500 hours, \$25, if taken at once. W8BPI, 79 Eiseman, Kenmore, N. Y.

BULLETIN available, standard amateur apparatus. Special modulation chokes, transformers and filter chokes. Push-pull and multi-stage transmitters. Pontiac Engineering Co., 1100 Ave. I, Brooklyn, N. Y.

\$20 C.O.D. takes all-aluminum, shield-grid, Super Wasp style short-wave set. V. F. Jones, 815 Loma Ave., Long Beach, Calif.

BRAND-NEW WE211E 50-watters of the latest type with bakelite bases and in original cartons shipped prepaid with safe delivery and satisfactory operation guaranteed for \$18 each. W9ARA, Butler, Mo.

SELL or trade: R.C.A. 203-A, 211, 860, 845, 204-A; WE211D, 121D; Power Xtal; 210 Xmitter; G.E. 24-1500 V. dynamotor; 500 V. MG; mercury arc outfit; Jewell set tester; Omnigraph; Teleplex; other apparatus. W9ARA, Butler, Mo.

RECTOBULBS, hi-power, \$10; 281 type, \$5.25; Power Xtals, \$12; Jewell meters volt or MA, \$5.50, RF, \$9.90; Leach relays, \$6.75 and \$9; 2 mfd. 2000 wkg. V. Flechthman, \$8.75, Tobes, \$11.70; Sangamo .002 5000 V. conds., \$1.40; REL kits list, sockets 50-watt, \$1.50, 204-A, \$4; heavy 99.6% Alcoa aluminum, 70 c sq. ft.; 30% off on Thordarson. Any other apparatus, 50c. Henry's Radio Shop, Butler, Mo.

FOR sale — complete 50-watt master oscillator power amplifier radiophone, using three 50-watt tubes, ready to operate. Plate supply, mercury arc full-wave rectifier, 1000 watts, 1100 volts pure direct current. Everything good as new and works perfectly. Net wholesale price of parts alone over \$525. First \$200 takes it. Write for description. W9EJZ, Herman Hansen, Beloit, Kans.

TUBES — Oscillators and power amplifiers. Tested in transmitter. Replacement guarantee. 250's, 210's and 281's, \$1.95. Postage extra. R. V. Howard, 5508 Fulton St., Chicago.

SPREADERS — for antenna feeders. Pyrex glass. Eliminate QSK and leakage, 22 cents. W9DWA. (Q.R.A.R.)

TUNGARS — Full-wave (Westinghouse) 2 amperes, for "Keep-alive" and chargers. \$2. W9DWA, 5508 Fulton St., Chicago.

POWER crystals 3500 k.c., \$5.25. Dustproof bakelite holders, \$1.50. Crystal blanks, unfinished, \$1.75. Finished oscillating crystal blanks, \$2.75. 18 mfd. Mershon condensers, \$2.00, New Sprague 8 mfd. electrolytic condensers, \$1.40. Dongan 1000 volt each side of center, 300 watt, 10 and 20 not center tapped windings, three volt c.t. 10 c.t. Weight 14 pounds, \$5.95. Dongan 500 volt each side center with two 20 volt windings, one three volt c.t., one five volt winding 150 watt, \$2.95. All size variable condensers, \$.75. Odd microphones, \$2.00. Eby sockets, all types, \$.20. 100 ohm relays, \$2.30. Look at display ad on page 70. Free Ham Sheet. Uncle Dave's Radio Shack, 115 N. Pearl St., Albany, N. Y.

Q R A SECTION

50 c. straight with copy in following address form only:

W2BNL-W2ZZH — Edwin C. Wilbur, 108 Park Terrace East, New York City.

W2CHF — Percy R. Mead, 39-64 51st St., Woodside, Long Island, N. Y.

W2CID — Robert McGirr, 534 S. 16th St., Flushing, Long Island, N. Y.

W2CJV — Steven Garcia, 1528 Amsterdam Ave., New York City.

W3ZY — Newt Beall, 5 Spa St., Brentwood, Md.

W4AHS — H. G. Johnson and R. B. Webb, 1415 Dickinson Ave., Greenville, N. C.

W4SK — John V. Fill, 135 14th Ave., N., St. Petersburg, Fla.

W6AM-W6ZZA — Don C. Wallace, 4214 Country Club Drive, Long Beach, Calif.

W7KG — Lloyd Colvin, 1620 North 6th St., Boise, Idaho.

W8BUC — Merle Cross, Washington St., Bruin, Pa.

W8CO 32-1000 volt d.c. generator, \$25. R. Wood, 46-20 102nd St., Corona, N. Y.

EXCHANGE — New 500-watt tube, never used, for used-outboard motor, 10 to 16 h.p. H. F. Southwick, County St., Somerset, Mass.

ALUMINUM call letters for auto radiator or station, 55c set, prepaid. Send cash. W2BMB, Bellmore, N. Y.

WIMK

A.R.R.L. Headquarters

R. B. Parmenter, Chief Op. "rp"

The following calls and personal sines belong to members of the A.R.R.L. Headquarters gang:

W1AKW-W1KP Clyde J. Houldson "ch."

W1BAW R. B. Beaudin.

W1BDI-W1XL F. E. Handy "fh."

W1CBD-W9KL Clinton B. DeSoto "do."

W1CEI J. J. Lamb. "jim."

W1DF Geo. Grammer "hg."

W1EH K. B. Warner "kb."

W1ES A. A. Hebert "ah."

W1FL-W2JR G. Donald Meserve "dm."

W1SZ-W1BIZ C. C. Rodimon "rod."

W1UE E. L. Battey "ev."

ALUMINUM

SHIELDS

GENUINE ALCOA STOCK
ANY SIZE TO ORDER

MONITOR SIZE 6" x 10" x 7" \$3.25
BLAN, The Radio Man, Inc. 89 U Cortlandt Street
New York City

To Our Readers who are not A.R.R.L. members

WOULDN'T you like to become a member of the American Radio Relay League? We need you in this big organization of radio amateurs, the only amateur association that does things. From your reading of *QST* you have gained a knowledge of the nature of the League and what it does, and you have read its purposes as set forth on page 6 of this issue. We should like to have you become a full-fledged member and add your strength to ours in the things we are undertaking for Amateur Radio. You will have the membership edition of *QST* delivered at your door each month. A convenient application form is printed below — clip it out and mail it today.

A bona fide interest in amateur radio is the only essential qualification for membership

AMERICAN RADIO RELAY LEAGUE
Hartford, Conn., U. S. A.

I hereby apply for membership in the American Radio Relay League, and enclose \$2.50 (\$3 in foreign countries) in payment of one year's dues, \$1.25 of which is for a subscription to *QST* for the same period. Please begin my subscription with the issue. Mail my Certificate of Membership and send *QST* to the following name and address.

.....

.....

.....

.....

Do you know a friend who is also interested in Amateur Radio, whose name you might give us so we may send him a sample copy of *QST*?

.....

.....

Thanks

For Your Convenience

QST'S INDEX OF ADVERTISERS IN THIS ISSUE

Aeae Apparatus Corporation	74
Aeae Wire Company	88
Aerovox Wireless Corporation	72
American Piezo Supply Co.	80
American Sales Company	83
American Transformer Company ..	61
Amrad Corporation	62
Arcturus Radio Tube Corporation ..	86
Aurisma, Inc., Ad.	90
A.R.R.L. Application Blank	94
A.R.R.L. Emblem	64
A.R.R.L. Handbook	78, Cover II
A.R.R.L. Log Book	89, Cover III
Blan, The Radio Man, Inc.	93
Burgess Battery Company	69
Candler System Co.	82
Curdwell Mfg. Corp., Allen D.	59
CeCo Mfg. Company, Inc.	1
Central Radio Laboratories	89
Cornell Electric Mfg. Co.	81
Corning Glass Works	67
Cunningham, Inc., E. T.	60
DeForest Radio Company	Cover IV
Electrad, Inc.	84
Electric Specialty Co.	79
Ellis Electrical Laboratory	79
Frost, Inc., Herbert H.	78
General Industries Corporation ..	84
General Radio Company	2
Greben, F.	79
Gulf Radio School	79
Hall's	87
Hardwick Hindle, Inc.	76
Harrison Radio Company	74
Hatry & Young	76
Hillet Engineering Co.	87
Hoedwin & Co., Chas.	88
International Resistance Co.	87
Justice, Dal S.	83
Kienle, Henry A.	87
Leeds Radio Company	6, 7, 8, 9
Loomis Publishing Co.	77
Manhattan Electric Bargain House ..	73
Massachusetts Radio & Telegraph School	87
McGraw-Hill Book Co.	68
Morrill & Morrill	85
National Carbon Company	66
National Company	8
National Radio Tube Co.	82
Norden-Hauck, Inc.	75
Pacent Electric Company	89
Perryman Electric Company	91
QST Binder	81
Radio Engineering Laboratories ..	81
Ramsay Publishing Co.	50
RCA Victor Company	72
Rectifier Engineering Service	87
Rooney, John T.	87
Rosen & Co., Raymond	83
Saugamo Electric Company	Insert
Scientific Radio Service	83
Shalleross Mfg. Company	90
Silver-Marshall, Inc.	96
Sprague Specialties Company	95
Standard QRH Crystal Laboratories ..	79
Standard Radio Laboratories	72
Stromberg-Carlson Telephone Mfg. Co.	63
Teleplex Company	74
Thordarson Electric Mfg. Co.	85
Uncle Dave's Radio Shack	70
Universal Microphone Co.	81
Van Nostrand Company, D.	65
Vibrox Company	86
Ward Leonard Electric Co.	89
Wireless Egert Engineering	79

It
Packs
The
Punch

Capacity
8 MFD
Peak Voltage
430 DC
Can Negative



HERE'S a heavy-weight wallop in fly-weight form—the new Sprague electrolytic condenser. Packing 8 MFD capacity and a rating of 430 volts DC into a space of only 1 3/8" diameter x 4 1/2" high over-all.

And what advanced construction you'll find inside the can! A one-piece rolled edged anode of pure aluminum without welded joint or soldering. Absolute prevention of liquid leakage thru practically a one-piece rubber top with integral vent. Unequaled flexibility in mounting, due to standardized size and form. And individual screw socket mounting that makes attachment or adjustment almost instantaneous.

The Sprague Condenser is engineered and constructed for maximum efficiency in practical use. Let us send you illustrated folder showing in detail how the Sprague exceeds all other types.

SPRAGUE SPECIALTIES COMPANY
Offices and Factory: North Adams, Mass.

RADIO SET designers, builders and service men are invited to get in touch with our engineering department, and learn more about successful tested circuits embodying Sprague Condensers in their design.

SPRAGUE
Electrolytic **CONDENSER**

SM

Silver-Marshall Is Again Making—

SUPERHETS

Man! Talk about news—that is something. The super has always been called the Rolls Royce of radio design—and what McMurdo Silver doesn't know about 'em you could write on three inches of No. 41 wire! Absolute 10 kc. selectivity, sensitivity that drags 'em in, and not a trace of harmonics, "repeat spots" or hum—try these receivers and see for yourself.

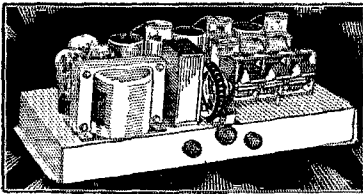

S-M 724 (AC and DC) Superhet

There are nine tuned circuits in the 724—six (three dual-selector) in the i.f. amplifier, preceded by two tuned r.f. circuits, plus the oscillator circuit. Uniform selectivity and hot sensitivity over the entire broadcast band and not a repeat point. Tubes required in the AC model: 5—'24, 1—'27, 2—'45, 1—'80. The 724DC (for batteries) uses: 5—'32, 1—'30, 2—'31.

724AC lists at \$99.50, less tubes. Parts total \$87.50.
724DC lists at \$82.50, less tubes. Parts total \$68.50.

The S-M 714 Dual Pre-Selector Superhet Tuner

The 714 is the successor to the Sargent-Rayment 710 and the 712, and has a tuner design never before attempted: a dual pre-selector t.r.f. circuit built into a single-dial superheterodyne! And you can imagine what tuning control you get with *eleven tuned circuits!*

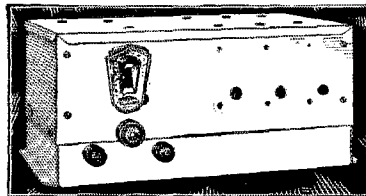

The 714 is ideal for use with the finest amplifiers and in locations where interference is worst.

Tubes required: 4—'24, 2—'27.

S-M 714 Superhet Tuner (only), completely factory wired and tested, RCA licensed, \$87.50 List. Component parts total only \$76.50 List.

S-M 738 S. W. Superhet Converter

Here is one of the newest and most interesting of all sensations—a self-contained all a.c.-operated converter which makes a powerful short-wave superheterodyne out of any broadcast receiver. Tuning control is by a single dial. Will give, in addition to short-wave broadcasting, phone and i. c. w. where there's any carrier modulation at all. Included in the list price are eight coils (four pairs) which cover the wave length range from 18 to 206 meters.

S-M 738 Converter, wired, \$69.50 List. Parts total \$59.50.

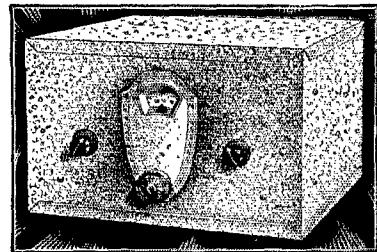

The new S-M 1931 Catalog is off the presses. Write for your copy. The Radiobuilder, Silver-Marshall's official publication, telling the latest developments of the laboratories, gives full inside information of great value to the radio world. See the coupon—or enclose 50c for the next twelve issues.

4,000 Authorized S-M Service Stations are being operated. Write for complete information on the franchise arrangement.

SILVER-MARSHALL, Inc., 6409 WEST 65TH ST.
CHICAGO, U. S. A.

Silver-Marshall, Inc.
6409 West 65th St., Chicago, U. S. A.

... Send your new General Parts Catalog with sample copy of the Radiobuilder.

... 6c enclosed; send Data Sheets giving complete information on the 724, 714 and 738 Superhets.

Name.....

Address.....

TYPE

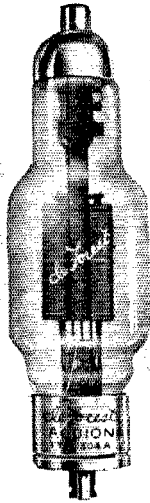

504A

the ideal high power tube for general use

Delivers 250 watts normal output as an oscillator or radio frequency amplifier. The standard "250-watt", de Forest Audion 504A, has a thoriated tungsten filament, making for low filament current. Where filament consumption is no object Audion 504 may be used with good results. Audion 504 has a robust tungsten filament and is preferred for heavy service. A radical departure from the usual plate construction is employed in these Audions, making for greater rigidity and greater heat dissipation. These Audions are recommended by well-posted engineers.

Net price: \$105.00

*Characteristics of
Type 504A and 504 de Forest Tubes*

Fil. Voltage.....	11.0
Fil. Current.....	504-A—3.85
Fil. Current.....	504—14.75
Plate Voltage.....	(Max.) 2000
Plate Current.....	(Max.) 250
Max. plate dissipation.....	250 watts
Amplification factor.....	25
Average plate resistance.....	5000
Average mutual conductance.....	5000



*For further technical information
address our Engineering Department*

DE FOREST RADIO COMPANY
PASSAIC, NEW JERSEY

Export Department:

304 E. 45th St., New York City, N. Y., U. S. A.

These are *net* prices on de Forest Transmitting Tubes

510	—15 Watt Oscillator.....	\$ 9.00
503-A	—50 Watt Oscillator and R. F. Power Amplifier.....	30.00
511	—50 Watt Oscillator, R. F. Ampli- fier, Modulator or R. F. Power Amplifier.....	30.00
545	—50 Watt A. F. Amplifier and Modulator.....	33.75
552	—75 Watt Oscillator and R. F. Amplifier.....	24.25
504-A	—250 Watt Oscillator, Modulator or R. F. Power Amplifier.....	105.00
504	—A heavy duty 250 watt oscillator or R. F. Power Amplifier, tung- sten filament.....	105.00
500	—500 Watt Special Oscillator.....	97.50
520-B	—5000 Watt Oscillator, R. F. Ampli- fier and modulator, water cooled	187.50
565	—7½ Watt Screen Grid R. F. Amplifier.....	16.50
560	—75 Watt Screen Grid R. F. Amplifier.....	37.50
561	—500 Watt Screen Grid R. F. Amplifier.....	292.50
566	—Half-wave hot cathode, mercury vapor rectifier.....	9.00
572	—Half-wave hot cathode, mercury vapor rectifier.....	22.50

Key to the market



TONE QUALITY

*is the magic key that finally
opens the purse and closes the sale*

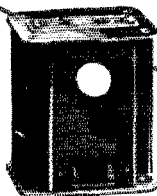

Today, Mr. Everyman and his brother who make up the radio market are *tone-conscious*. Critical ears now pass judgment on your set and if you would win popular approval you must look to the "audio end." Tone quality is the key to the radio market.

There is no such thing as "saving money" on transformers. You only place another hurdle in the path of your sales force. The buying public judges the price of your set by its tone quality.

Transformer building is an exact science—best left to an organization like Sangamo, whose research experience and precision manufacturing facilities guarantee results. Sangamo "A" Line Transformers are for custom set makers or manufacturers who want a "tone" advantage over competition. They cost a little more but the cost of selling your set is reduced.

SANGAMO ELECTRIC CO.

SPRINGFIELD, ILLINOIS, U. S. A.

Manufacturers of Precision Electrical Apparatus for 30 years

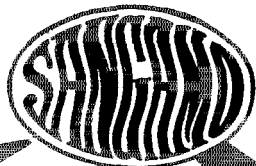

See Reverse
Side

"A" Line Transformers

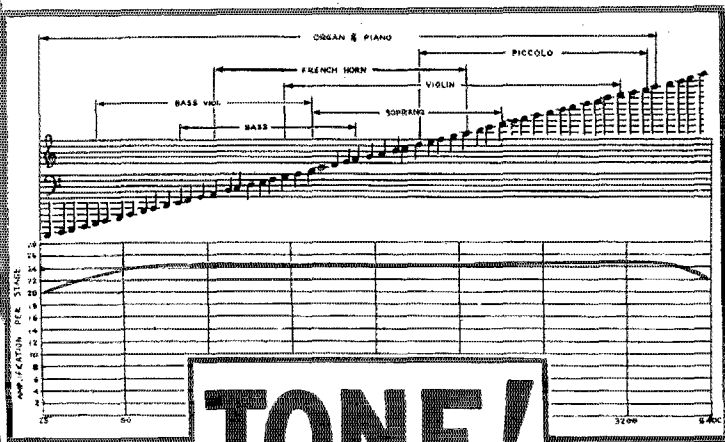

TONE!

Curve of Type "A" Sangamo Straight Audio Transformer showing uniformity of amplification at all audible frequencies.

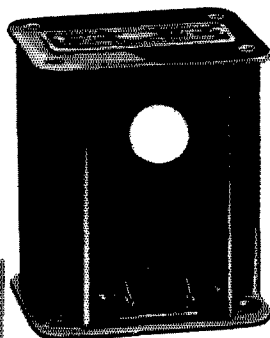

Type "A" straight audio amplification. List price.....\$10.00

Type "B" Push-pull Input Transformer for all tubes. List price \$12.00

Type C-171 Push-pull Output, for 171, 245 or 250 type power tubes with cone speaker. List price \$12.00

Type D-210, same as C, except for 210 and 112 power tubes. List price.....\$12.00

Type H-171, Push-pull Output for 171, 245, or 250 power tubes for Dynamic Speaker. List price \$12.00

Type G-210, same as type H, except for 210 and 112 power tubes. List price.....\$12.00

Type F Plate Impedance for use as a choke to prevent oscillation and for impedance coupled amplifiers. List price.....\$5.00

Unusual facilities for furnishing transformers with or without cases ready for mounting and quick assembly with the receiver. Prices on application.

PIN THIS TO YOUR LETTERHEAD AND MAIL

SANGAMO ELECTRIC CO.
Springfield, Illinois, U. S. A., Dept. U-94

(For manufacturers) I am interested in engineering data regarding your transformers and condensers.

(For set builders) Please send circulars describing your apparatus and latest audio hook-ups. I enclose 10c to cover cost of mailing.

Name.....

Address.....

The Sangamo Type "A" Condenser

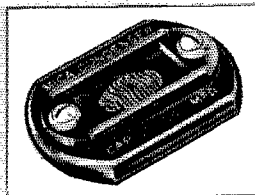

Every sound characteristic is affected by the quality of the fixed condensers in a set. Sangamo builds accurate mica condensers, molded within an overall enclosure of genuine bakelite with only the terminals brought outside. Moisture, heat, shocks or jars will not alter their characteristics nor affect operation after the set leaves the factory.

Sangamo "Illini" Condensers

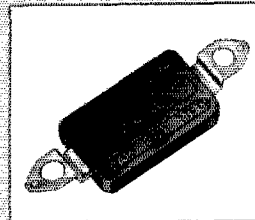

"Illini" Condensers are standard with those manufacturers who insist on ratings being actually what the specifications call for. Manufactured by exclusively designed equipment, held to the tolerances your engineering department demands, Sangamo Condensers will reduce to a negligible quantity inspection department rejects and "reassembly" losses in profit.

Sangamo High Voltage Condensers

Tested at 5000 volts D. C. and 3500 A. C. and built to Sangamo standards, known throughout the radio world, amateurs, commercial men and manufacturers have learned to depend on Sangamo High Voltage Condensers. Accurately rated and adequately tested—these condensers offer the maximum protection in high voltage, high frequency circuits.

Prices on request