

Only
£2.00

Hi-Fi WORLD

JULY 1994 £2.00

**LINN
MAJIK- I AMPLIFIER**

**MISSION
DISCMASTER TRANSPORT
DACMASTER CONVERTOR**

**DPA'S PDM 1024 -
THE FINEST CD CONVERTOR?**

**HI-FI SHOWS
CHESTERFIELD AND MIAMI**

**GROUP TEST
5 WALL STANDING
SPEAKERS**

**NEW
ORTOFON
SUPREME MC
CARTRIDGES**

**NEW AIWA
AD-F850
CASSETTE DECK**

**COMPETITION - WIN ORTOFON'S £2000
MC7500 CARTRIDGE & CHESKY RECORDS**



The most complex DAC in the World



The PDM ten twenty-four - packed full of dpa innovations that redefine CD performance.

is also the simplest.

It has long been held as a tenet of audiophile wisdom that the simpler the analogue circuitry, the better the sound quality. We have spent many years developing our own DAC technology that results in an order of magnitude improvement in analogue simplicity. This is achieved by the use of our patent pending DX processor DAC that employs up to 128 times digital filtering. This gives a very simple analogue topology - just our op-amp and four passive components in the direct signal path.

This is some ten times simpler than conventional DAC's - and the sonic result it gives is extraordinary. Words cannot convey the sense of excitement when listening to music through it. Instruments sound much more tangible with better focus and separation. Sound stage and detail resolution are remarkable. Indeed, we are convinced our DX DAC technology completely redefines the capability of digital music.

However, this performance comes at a price - one being the complexity of the digital domain. An amazing one billion single bit additions are performed each second. The PDM ten twenty-four also features nearly 2,000 discrete components, 4,000 gates, 8 noiseshapers, 8 digital filters, 8 programmable dither sources and gold plated solid copper construction throughout - to name but some of the features. It is modular in construction, thus allowing future upgrades.

Moreover, the DX processor technology can be applied to more affordable DAC's. The PDM two fifty six (our replacement for the highly regarded PDM two) is available. We are currently developing the PDM sixty-four that features a scaled down version of this technology for only £1250. For more information please telephone or write to:

dpa Digital Ltd.,
7&8 Willowbrook Lab Units,
Crickhowell Rd., St Mellons,
Cardiff, Wales CF3 0EF
Tel: (0222) 795621
Fax: (0222) 794267

The logo for dpa Digital Ltd., consisting of the lowercase letters 'dpa' in a stylized, white, sans-serif font.

A logo for the 'dx 128 processor' featuring the text 'dx 128 processor' in white, with 'dx 128' on the top line and 'processor' on the bottom line, all enclosed within a white oval border.



EXPERIENCE MUSICAL TRUTH



45 High Street, Hounslow, Middx.
TW3 1RH
Tel: 081 569 5802
(Also at Edgware, Middx,
Tel. 081 952 5535)



34, Buckingham palace
Road, London SW1W ORE
Tel: 071 - 233 0774
Fax: 071 - 233 7226

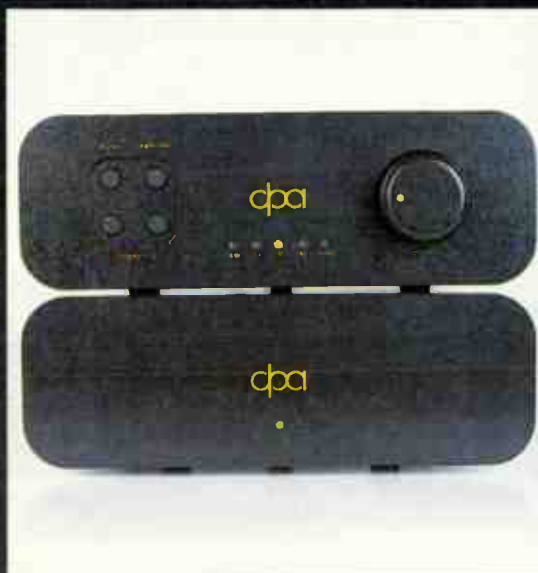

**NEW 200S PRE POWER
£1250**



93 Hobs Moat Road,
Solihull,
W. Midlands
Tel: 021 742 0254

audible difference

Scale, Diss, Norfolk.
IP21 4DX.
Tel : 0379 740227

Doug Brady Hi-Fi

Kingsway Studios,
Kingsway North,
Warrington.
Tel: 0925 828009
(Also at Liverpool, London
and Otley, Nr Leeds)



Tel/Fax. 0252 377952

Oxford Audio Consultants

Cantay House,
Park End Street,
Oxford OX1 1JE
Tel: 0865 790879
Fax: 0865 791665



Chantry Walk,
16/18A Eldon Street,
Tuxford, Nr Newark,
Notts NG22 OLH.
Tel: 0777 870372

Audio Suite

42 St. Andrews Street,
Aberdeen AB1 1JA.
Tel: 0224 625 635

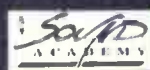

152A High Street,
Bloxwich,
West Midlands.
Tel: 0922 493499



3 Bridge Street,
Guildford,
Surrey.
Tel: 0483 504801

SHROPSHIRE HI-FI

St Michael's Street
Shrewsbury
Shropshire SY1 2ES.
Tel: 0743 232317



41 Victoria Road,
Cambridge.
CB4 3BW.
Tel: 0223 68305

ZEUS AUDIO

2/4 Great Victoria Street
Belfast BT2 7BA.
Northern Ireland.
Tel: 0232 332522



KJ WEST ONE

26 New Cavendish
Street,
London W1M 7LH.
Tel: 071 486 8262

AT OUR KEY DEALERS

dpa digital ltd

**Unit 7, Willowbrook Technical Units,
Crickhowell Road, St. Mellons, Cardiff CF3 0EF, Wales,
UK**

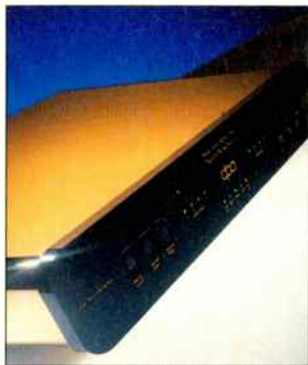

Cover Photograph by
Paul Hartley Studio 071-482 3768

THIS MONTH'S REVIEWS

AMPLIFIERS

LINN MAJIK-I 42

Noel Keywood looks for magic in Linn's new Majik-I integrated amplifier.

CREEK CAS4240 66

Creek bring out a new, slimline budget amplifier. Does it revive the sound they were once regarded for? Dominic Todd investigates.

RECEIVERS

NAD702 26

NAD's new 702 receiver is a real power house - with remote control. Dominic Todd, well acquainted with their products, listens carefully.



COMPACT DISC

DPA Ten Twenty-Four 14

Is this the ultimate in CD converters? Dominic Baker listens to a gold-plated, copper chassis £6000 technological wonder from Wales based DPA.

CYRUS DISCMASTER & DACMASTER 24

Cleverly designed and beautifully made, Eric Braithwaite checks out Mission's new Cyrus CD transport and DAC, complete with special outboard PSX power supplies.



LOUDSPEAKERS

PMC TBI 19

Made for broadcast use, do these loudspeakers from the Professional Monitor Company bring higher standards into the home? Dominic Baker measures and listens.



FIVE WALL STANDING 'SPEAKERS 31

Pushed for room in the lounge? Perhaps wall standing loudspeakers are the solution. We carefully select five pairs suitable for this role by measurement, then describe their sound.

TURNTABLES

ORTOFON SUPREMES 50

No fewer than three new moving coil cartridges from Ortofon, thoroughly tested by Noel Keywood and Eric Braithwaite.

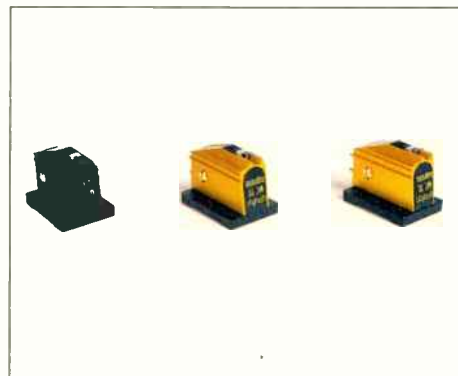

CASSETTE

AIWA AD-F850 28

Aiwa's new budget dual-capstan cassette deck comes under close scrutiny. Does it offer the same sort of value as its predecessor? Noel Keywood investigates.

Editor
Noel Keywood

Assistant Editor
Dominic Baker

Production Editor
Ferewini T. Michael

General Manager
Mark Winfield

Marketing Manager
Richard Johnson

Advertising Director
Caroline Knott
Advertising Tel: 071-266 0969

Advertising Executive
Amanda Sweeney

Design Engineer
Andy Grove

Technical Assistant
Nick Lucas

Contributors
Eric Braithwaite
Richard Brice
Giovanni Dadomo
Peter Herring
Simon Hopkins
Dominic Todd

Cartoonist
Freddy Ahmet

Distributed by:
COMAG, Tavistock Road, West
Drayton, Middlesex, UB7 7QE
Tel: 0895 444055

Origination by:
Ashford Scanning
2 Norfolk Drive,
Fairwood Industrial Park,
Asford, Kent TN23 2FB
Tel: 0233 622042

Printed by:
Southernprint, Poole, Dorset.
Tel: 0202 622226

AUDIO PUBLISHING LTD.,
64 Castellain Road, Maida Vale,
London W9 1EX.
Tel: 071-289 3533
Fax: 071-289 5620
Queries cannot be answered
by telephone.

MAIL ORDER
Tel: 071-266 0461 (24 hours)

Subscription Rates:
UK: £22,
Overseas Surface: £29, Airmail:
£42 (Europe) £52 (USA, Middle
East), £62 (Australia, Japan).

No material may be reproduced
from this magazine without
the publisher's written
permission.
© Audio Publishing Ltd



**AMERICAN
and
CANADIAN
SUBSCRIPTIONS**
- see page 68

REGULARS

- NEWS** 7
All the latest interesting products and events from Britain and around the world.
- LETTERS** 44
A wonderful cross section of views from our ever enthusiastic readers, as always from around the world.
- Q&A** 103
A broad range of in-depth answers to your problems, from our own in-house team, as well as outside experts.
- COLUMNS** 61, 63, 69, 71
Opinions on a wide variety of hi-fi topics, both from us and from others involved in audio.
- NEXT ISSUE** 84
Our August issue will turn the heat up - in the middle of summer! Find out what's in store for the future.
- SUBSCRIPTIONS** 68
Make sure you receive your copy of Hi-Fi World regularly every month, even before it appears on the bookstand.
- ACCESSORIES** 97
Hi-fi tweaks that'll make your ears happy.
- HI-FI WORLD LIBRARY** 101
Books for bedtime reading.
- DIAL-A-DEALER** 89
Want to find out where you can listen to a piece of kit and buy it? All the info is here.

- HI-FI WORLD KITS** 81
Unique kit valve amps and more from our own in-house expert design team.
- MEET YOUR MAKER** 65
A listing of manufacturers so you can find out more about their products and availability.
- WORLD FAVOURITES** 128
A selection of the finest products we have reviewed in the magazine.
- CLASSIFIEDS** 139
A superb selection of second-hand bargains. Buy a wonderful system on a shoestring.
- ADVERTISER'S INDEX** 146

FEATURES

- VALVE MANUFACTURING PLANTS** 39
Sited in distant parts of the globe, valve factories are a rare and endangered species. Noel Keyword explains why events in Siberia and Saratov may affect you.
- MIAMI SHOW** 59
We take a trip to Miami to see how the Americans organise a hi-fi show. Dominic Baker gets wowed.
- CHESTERFIELD SHOW** 57
And, by way of contrast, we also take a trip North to a beautifully tweaky, enthusiastic British hi-fi show. Eric Braithwaite enjoys his weekend.

MUSIC

Our guide to some of the best new releases.

ROCK RECORD OF THE MONTH:

Nick Cave & The Bad Seeds: Let Love In

CLASSICAL RECORD OF THE MONTH:

Dmitri Shostakovich
Modest Mussorgsky

ROCK AND POP 74

CLASSICAL 85

JAZZ 93

COMPETITION

COMPETITION 72

Here's one for all dyed-in-the-wool lovers of black vinyl - win a fabulous, top of the range Ortofon MC7500 moving coil cartridge worth no less than £2000. And, to go with it, we've added five Chesky 180gm audiophile albums



CONTENTS

analogue replay

Project

Michell

Townsend

Wilson Benesch

Basis

Pink Triangle

SME

Sumiko

Lyra

Transfiguration

digital replay

TEAC

Pierre Lurine

Micromega

Counterpoint

Mark Levinson

Audio Alchemy

Pink Triangle

valve amplification

Audio Innovation

Trilogy

Audionote

Lectron

Conrad Johnson

Lumley Reference

C.A.T

Copland

Sonic Frontiers

solid state amplification

Rotel

Aura

Jeff Rowland

D I V A

a u d i o f i d e l i t y



Experience just how good your LPs and CDs really can sound by listening to them through one of our hifi systems. from £50,000 to £500 we put together the finest hifi to suit every budget.

Our demonstration room is available for booking anytime day or evening from Monday through to Saturday; alternatively, we will demonstrate systems in your own home if you wish. We install both single and multi-room remote control systems, and can put together the finest in audio-visual home cinema. Call us or pop in to arrange a musical experience you'll never forget.

**Workshop 30, Royal Victoria
Patriotic Building, Fitzhugh
Grove, Wandsworth
Common, London SW18**

0 8 1 8 7 5 9 5 9 3

Counterpoint

Audiogram

Primare

Mark Levinson

loudspeakers

Charios

Monitor Audio

Proac

B & W

Martin Logan

Triangle

Audionote

SD Acoustics

Impulse

REL

Audiostatic

Thiel

Klipschorn

Sonus Faber

cables & accessories

XLO

Audioquest

Audionote

Cogan Hall

Silver Sounds

Seismic Sink

Tripod

Framworks

Leider

audio-visual

Harman

Lexicon

JBL

GARRARD SPARES

Loricraft have been hard at work producing a whole range of spares for Garrard turntables. The most recent introduction is a new self adhesive replacement panel which replaces the often worn plate around the control knobs. The price for this scratch resistant screen printed panel is expected to be around £14.95.

Other parts include specially punched and ground rubber washers for the 301 and 401, re-built bearing assemblies, re-built switch suppressors for the 301, precision turned eddy current discs for 301 and 401, platter damping rings etc, etc.

For further information on the range of spares and services offered by Loricraft contact -

Loricraft Audio, 4 Big Lane, Goose Green, Lambourn, Berks, RG16 7XQ.
Tel: 0488 72267

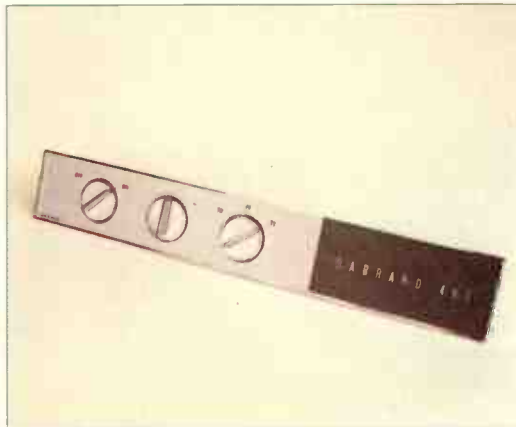

NEW AUDIOLAB PHONO STAGE

Audiolab's forthcoming 8000PPA phono stage is the first product to use their new Zq technology. The circuit within the 8000PPA is direct coupled and can extend downwards to 100mHz, but highly sensitive detectors and a digitally controlled muting system ensure that subsonic signals never reach the main amplifier.

The 8000PPA will retail for £799 and promises very low noise and distortion. The two inputs will accept either MM or MC cartridges and each have three gain settings and automatic impedance switching. Knowing Audiolab's dependable but imaginative engineering, this sounds like one very advanced phono stage. It's nice to see Audiolab are oblivious to the AV/Home Cinema fad, preferring to produce real hi-fi irrespective of fashion.

Audiolab, Spitfire Close, Ermine Business Park, Huntingdon, Cambs, PE18 6XY.
Tel: 0480 52521

WORLDWIDE MUSIC SALES GO UP

The International Federation of Phonogram and Videogram Producers, or IFPI, recently released world music sales figures based on audits from 64 countries. They showed that, worldwide, the value of sales increased by 5.9% to \$US30.5billion (£20.6billion).

The cassette continues to dominate the market, selling no fewer than 1.44 billion (billion=1000 million) units in

trade winds

trade winds

trade winds

trade winds

trade winds

trade winds

trade winds

trade winds

trade winds

trade winds

trade winds

trade winds

SONIC INTEGRITY



Creek Audio Limited
2 Bellevue Road, Friern Barnet,
London N11 3ES

Telephone: 081 - 361 4133 Fax: 081 - 361 4136

WORLD GROWTH BY FORMAT 1991-1993

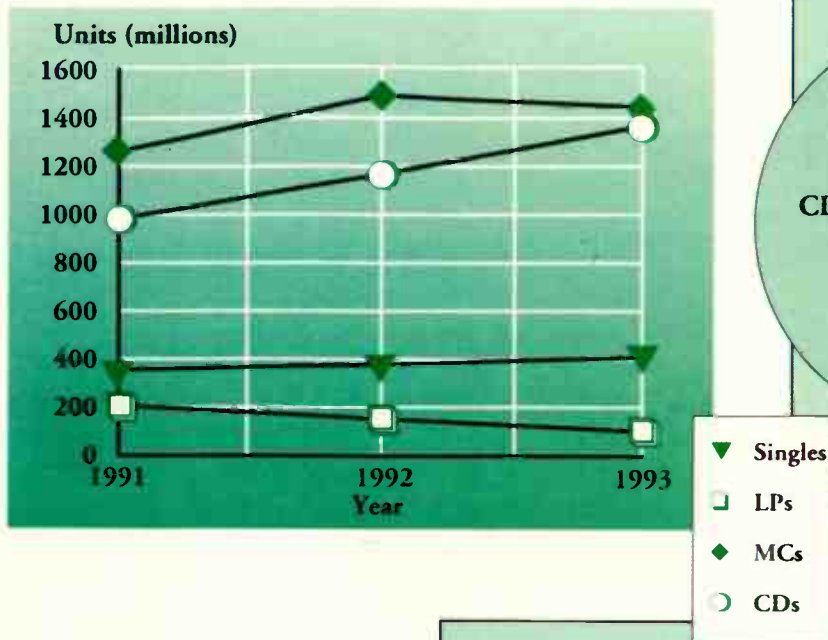

1993 FORMAT SPLIT

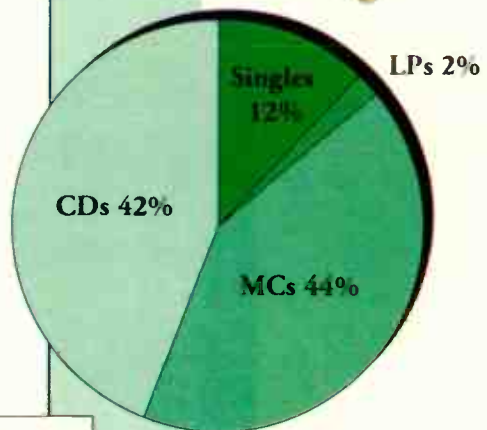

Source: IFPI

1993, but CD was fast overhauling it. Cassette sales are in slow decline (-2%) - hence the launch of DCC and MD - but CD sales are rapidly rising (+19.4%), now totalling 1.39 billion.

Lovers of black vinyl will be disappointed to hear that worldwide LP sales dropped 30% in 1993, now representing just 2% of the total music market. Although the IFPI say "the format has all but disappeared from almost every developed market", this is something of an overstatement. In the UK alone 5 million were sold in 1993, against 55.7 million cassettes and 92.9 million CDs. It is likely that specialist vinyl outlets do not contribute to national sales figures compiled by the BPI, so real LP sales may well be higher. Interestingly, the IFPI note that LP sales in China (15m), Brazil (16.4m), Greece (3.2m) and South Korea (20.5m) contribute most to world LP sales, whilst ignoring the UK (5m) and Colombia (4.5m). However, with total worldwide sales of just 80.4m in 1993 it looks like LP sales will shrink to a trickle by the turn of the century. However, it must be remembered that thousands of millions of LPs have been sold during the format's life-span (1958-2000?) many of which remain in collections, so a demand for vinyl replay equipment is likely to remain.

From the IFPI figures for 1993 we have derived the following chart to show you which countries are most into music. It has some interesting features. Americans (U.S.A.) play more music than anyone, by a good margin, but Canadians and Australians are well up too, as we suspected from our reader's letters. Germany, the UK and the Netherlands have strong indigenous recording industries, so their high sales per head are perhaps to be expected. Japan has a surprisingly low sale/head, considering the size and strength of its audio hardware business and the wealth of its populace - it is beaten by South Korea! But we haven't included singles and the Japanese are singles crazy - they bought no fewer than 145m in 1993, pushing the U.S.A. into second place with 108m.

Italy - amazingly - puts up an even worse performance than Japan; for Italians audio gear must be decorative, which seems strange for a country associated with the arts. Otherwise, the figures reflect as much the national average standard of living as anything else, since music is a leisure activity related to free time, disposable income and relative software/hardware costs.

Country	Unit sales (millions)	Population (millions)	Sales per Head
USA	835	241	3.5
China	240	1072	0.22
India	237	766	0.31
Japan	206	121	1.7
Germany	202	77	2.6
UK	154	57	2.7
France	118	55	2.1
South Korea	78	41	1.9
Canada	67	26	2.6
Mexico	62	80	0.8
Spain	50	39	1.3
Indonesia	48	167	0.3
Italy	39	57	0.7
Netherlands	37	14	2.6
Australia	37	16	2.3

DCC STAYS IN MAJOR STORES

Newspaper reports that Our Price was to discontinue stocking DCC were apparently untrue. Our Price said that it "continues to stock DCC" and that it has "no plans to withdraw stock in the foreseeable future. Space limitations in certain stores have meant that DCC has been moved to stores with more space". It seems that the removal of DCC from some stores gave rise to reports claiming it is to be dropped altogether.

HMV also confirmed to us that they would continue to stock DCC in their major stores. A spokesman said that both DCC and MD sales "were very marginal, they haven't taken off", for a variety of reasons he felt, including the fact that the technologies were, apparently, "not very ground breaking". All the same, he confirmed that HMV "would continue to support the efforts of the industry".

THE NAIM OF SUCCESS

Naim Audio have recently won the Solent Exporter of the Year award, which is awarded to businesses with a turnover of less than £2m in Export sales. Still beaming with success and preparing for celebration, they were further honoured when

SCALING NEW HEIGHTS.

There's a new tower on the block – the Studio 200.

And it's going to make you think again about how much loudspeaker you should get for your money.

Innovative cabinet construction, critical driver offset placement and state-of-the-art componentry combine to bring you a new sophistication in high-end listening experience.

The Studio 200 can now be auditioned at selected dealers. Contact us for details.

 **ProAc**
Perfectly Natural

130-132 THIRSK ROAD
BOREHAMWOOD
HERTS WD6 5BA
TEL: 081-207-1150
FAX: 081-953-8933

judged Outstanding Winner of the nine finalists and also received the coveted Touche Ross Trophy.

Delighted with this success, Naim has a £1m+ factory extension and refurbishment programme under way to help them meet demand for their products. We congratulate Naim and wish them well for the future.

Naim Audio, Southampton Rd, Salisbury, SP1 2LN.
Tel: 0722 332266

CHINA STEPS UP CD PRODUCTION

The Recording Industry Association of America (RIAA) estimates that China now has no fewer than 26 CD manufacturing plants, but that indigenous sales amount to less than 5 million units in 1993. Their assumption, from these figures, is that "these plants are producing far in excess of the republic's legitimate product" and that "several million pirated CDs are being sold in China, while many millions more are being exported throughout the world". As a result, "the U.S. trade representative has already upgraded China to a priority watch list".

In a separate newsletter the RIAA claims that worldwide CD piracy doubled in 1993 to reach 75 million units, saying that "the main source of our problem, but by no means the only source, is China". According to their researches many of these CDs are smuggled over the border into Hong Kong, where they have, in one year, captured 20% of the market.

Both the IFPI and America's RIAA are worried that the music industry is losing a lot of revenue from these pirated CDs, making the observation that, nowadays, CD pressing plants are run as general commercial operations not, as in the past, being run by the music industry to press its own product. Independent plants are out of the control of the music business and more likely to produce pirate CDs, the RIAA says, in order to turn a profit. Worldwide CD pressing capacity is now roughly double that of demand.

ACOUSTIC ROCK

No, not a new kind of music, but a new kind of 'speaker stand. Cast in concrete and weighing in at around 18kgs they should certainly provide a firm support for your 'speaker. Available in either textured black or an authentic rock finish retail price is expected to be around £100. For further details contact,

Acoustic Rock, 37 Grummock Avenue, Neithercourt, Ramsgate, Kent, CT11 0RP.

NEW STYLE WBTs

Path group are amongst the first to be using the new style WBT phono plugs with their range of IXOS interconnects. The new style WBT plugs use a matt black anodise over copper body and have more slits cut in the barrel to make better contact. The new style WBTs are available for £19.95 a pair.



Path Group PLC, Unit 2, Desborough Industrial Park Road, High Wycombe, Bucks, HP12 3BG.
Tel: 0494 441736

VALVES IN IRELAND

Arion Acoustics, based in N. Ireland, have just announced two new valve amplifiers, the Elektra and Eos. Both use the 5881 military spec output tetrode with an ECC83 input stage and 6SN7 phase splitter and driver valve. The £999 Elektra is a five-input line-level integrated version of the £899 Eos power amplifier.

Arion also have a special mains filter called Titan and silver interconnects 'speaker cable.

Arion Acoustics, Unit 1, 35 Furlough Rd, Newmills, Dungannon, Co. Tyrone, N. Ireland, BT71 4DU.
Tel: 0868 748632



BRITISH VINTAGE WIRELESS SOCIETY SWAPMEET - SUNDAY JUNE 5th.

If you've bought Hi-Fi World early, like most people, then there might still be time to go Sunday walkies to a BVWS Swapmeet at Harpenden Herts. O.K., so the reality is you'll probably spend more time on the M25 trying to avoid heavy lories charging down the centre lane, right on the speed limit and apparently intent on generating more business for local scrapyards.

But Harpenden on a summer's Sunday is a sweet enough contrast - always assuming you make it of course. Early birds get the worms, which can turn out to be an old valve amp or two. Anyone capable of driving in a straight line down the M25 whilst the dawn choristers are tucking into their Ready Brek should contact Robert Hawes on 081-808-2838, since you must be a member, but you can join at the door. Highly recommended.

PHILIPS MAKES A PROFIT ON AUDIO

After a lot of changes under the tough but realistic outlook of managing director Jan Timmer (ex-Polygram), Philips Consumer Electronics (C.E.) sector finally turned a profit of £15m. Last year it produced a £10m loss, so business is looking up - sort of. Profits were helped by cost cutting and sell offs, including the company's stake in Matsushita, brand names Technics and Panasonic. Philips said that reduced C.E. sales in Europe were compensated for by increased sales elsewhere and that, under competitive pressure, prices had fallen -3%. "A slightly lower loss at Grundig also contributed to the improvement", they said. Obviously, things are tough in Europe for Philips, for which they blame the recession.

CORRECTION

In last month's group amplifier test we quoted the Aura VA-50 price as £349.95. In fact this is the VA-100 price. Even though the VA-50 came top of the group, it costs a lot less than we said, being available in black chrome for just £249.95, or bright chrome for £299.95.

Announcing our 4th DEMONSTRATION ROOM



MAIN AUTHORISED DEALERS FOR:

ACOUSTIC ENERGY
ADCOM
AIWA
AKAI
AKG
ALCHEMIST (KRAKEN)
ALPHASON
ARCAM
AUDIO ALCHEMY
AUDIO INNOVATIONS
AUDIOQUEST
AUDIO TECHNICA
AURA
B & W
BANDRIDGE ACCESSORIES
BANG & OLUFSEN
BEYER DYNAMIC
BOSE
BOSTON
CABLE TALK
CANON
CASTLE
CDI SOFTWARE
CELESTION
CERWIN VEGA
CHORD
CREEK
CYRUS
DENON
DPA
DUAL
FOSGATE
GEMINI/KAM
GOLDRING
HARMON KARDON
HECO
HEYBROOK
INFINITY
IXOS
JAMO
JBL
JPW
JVC
KEF
KENWOOD
LASER DISCS
MARANTZ



MAIN AUTHORISED DEALERS FOR:

MAXELL
MICHELL
MICROMEGA
MISSION
MITSUBISHI
MONITOR AUDIO
MONSTOR
MORDAUNT-SHORT
NAD
NAKAMICHI
ORELLE
ORTOFON
PANASONIC
PHILIPS
PINK TRIANGLE
PIONEER
PROJECT TURNTABLES
QED
QUAD
REL
ROGERS
ROKSAN
ROTEL
ROYD
RUARK
SCOTCH/3M
SENNHEISER
SHURE
SME
SONY
SOUND STYLE
SPENDOR
STAX
SYSTEMDEK
TANNOY PRESTIGE
TARGET
TDK
TEAC
TECHNICS
THORENS
TOSHIBA
VAN DEN HUL
WHARFEDALE
YAMAHA
E & OE
AND MANY MORE

Nth/NW London

173 Station Road
Edgware, Middx
HA8 7JX
Tel: 081-952 5535
Fax: 081-951 5864

West/South London

45 High Street
Hounslow, Middx.
TW3 1RH
TEL: 081-569 5802
Fax: 081-569 6353

Home Cinema demo evenings at
Hounslow – Thursday 30th June 6pm - 8.30pm.

We are open
SUNDAYS

REPAIR
SERVICE

PART
EXCHANGE



WHY WAIT, BUY NOW WITH MUSICAL IMAGES SPECIAL

- 1) Decide what you want to buy
- 2) Decide what you want to pay each month
- 3) Ask if it can be done on

0% APR INTEREST FREE CREDIT

ANYWHERE IN THE UK

Ask for
Details

The



Club

HOTLINE
081-952 5535

► Membership of the **MUSICAL IMAGES CLUB** gives you access to all the leading developments in the world of Hi-Fi and Home Entertainment:

First 1,000 people to join the Musical Images Club after 1/5/94 will get

Vouchers worth

£100 FREE

Usable against **BEST BUY & AWARD WINNING PRODUCTS**

*** STOP PRESS *** Vouchers can be used with other offers until 30/8/94 and have no equivalent cash value

**MAIL ORDER
WORLDWIDE**
☎ 081 952 5535

- Exclusive invitations to special manufacturers demonstration evenings – your opportunity to sample the very latest products.
- Exclusive and priority offers on both new and ex-demonstration equipment, accessories and all kinds of up-grades and add-ons.
- Competitions, special deals and added value purchasing exclusive to club members

CLUB SPECIAL – SPEND

£100	▶	{ CLAIM GOODS WORTH }	▶	£15	▶	F R E E
£300	▶		▶	£50	▶	
£500	▶		▶	£85	▶	
£1000	▶		▶	£200	▶	

Not with any other offer & until 15/8/94 E & OE

OR

BUY AUDIO VISUAL EQUIPMENT AND COLLECT AIR MILES VOUCHERS



FOR EVERY £1 SPENT GET ▶ 1 AIR MILE AWARD

Not with any other offer & until 15/8/94

MAIN AUTHORISED DEALERS FOR OVER 100 MANUFACTURERS

Join Today – only 1000 Free voucher packs available

Yes, please commence my subscription to the MUSICAL IMAGES CLUB FOR £10

I enclose a cheque for £10 payable to Musical Images

Please charge my credit card VISA/Access

I will claim free goods I will collect Air Miles Awards

Please send complete coupon to: MUSICAL IMAGES, 173 Station Road, Edgware, Middx HA8 7JX

Name _____
Address _____
Postcode _____
Exp: _____ Signed _____

HFW 7/94



It gave a richly detailed and sweet balance to each and every CD I pushed into the transport draw. I'd started to fear that CD technology was at its limit - even Pink Triangles' Da Capo, itself ahead of the competition by quite a margin, wasn't so obviously superior. DPA's new PDM Ten Twenty-Four CD convertor is so different in its sound to what I have become used to, so just right it seemed to me, it came as a bit of a

shock. I was expecting to hear subtle improvements from this convertor, in spite of its radical circuitry and healthy £6000 price tag, but they turned out to be blatant.

The PDM Ten Twenty-Four is incredibly complex for one main reason - to make the analogue signal path as simple as possible. Their own dx128 processor was designed

components and 4000 logic gates.

But it isn't the number of components, nor the unusual circuits, that you see first. They're all tucked away inside a striking gold-plated solid copper chassis. The choice of gold, however, is not purely a matter of style. Thick gold plate on top of solid

DISCRETELY BETTER

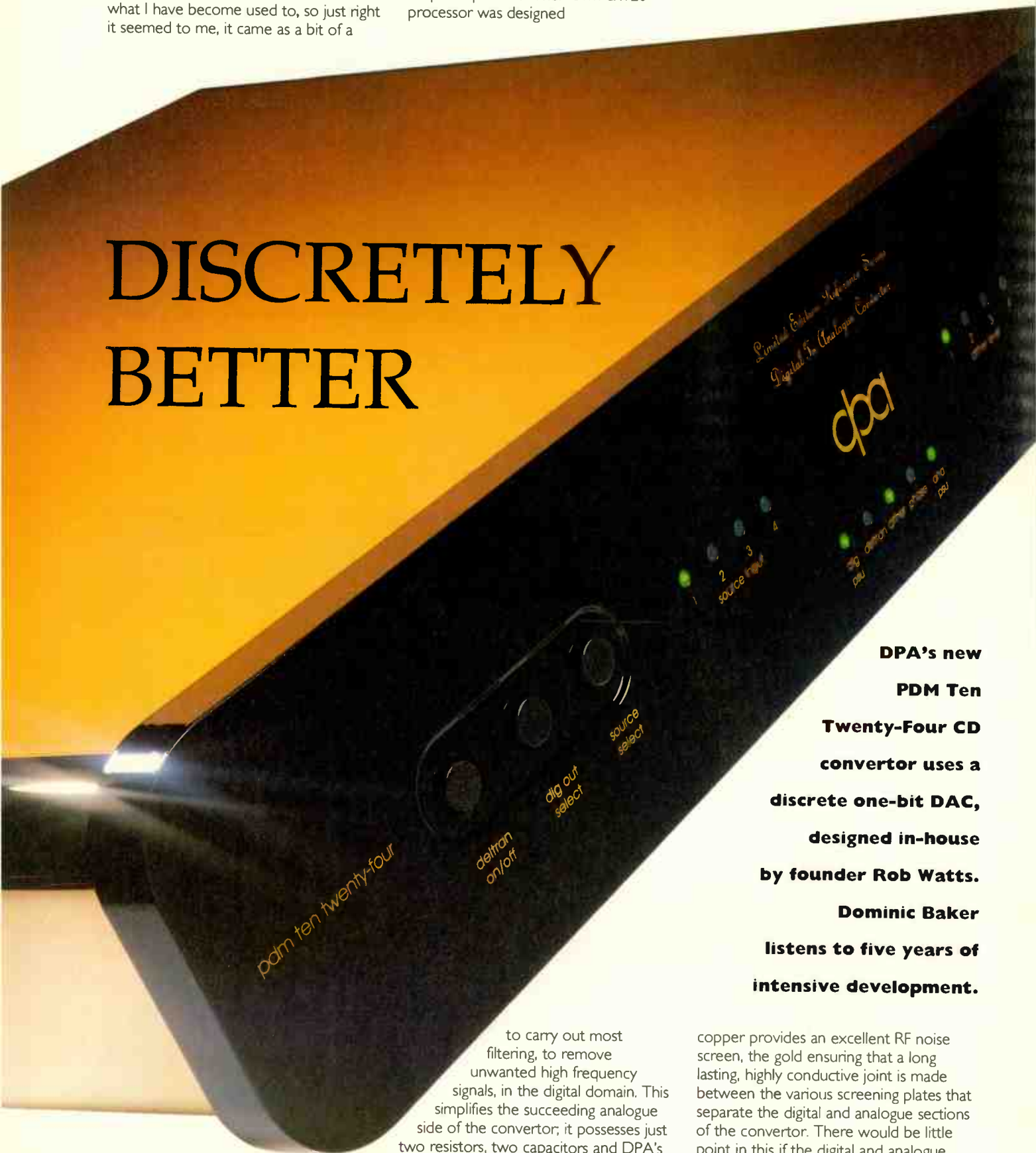

*Limited Edition Reference Series
Designed For Analogue Converters*

DPA's new PDM Ten Twenty-Four CD convertor uses a discrete one-bit DAC, designed in-house by founder Rob Watts. Dominic Baker listens to five years of intensive development.

to carry out most filtering, to remove unwanted high frequency signals, in the digital domain. This simplifies the succeeding analogue side of the convertor; it possesses just two resistors, two capacitors and DPA's own discrete op-amp. However, such simplicity has its price; the digital stage is highly sophisticated, using nearly 2000

copper provides an excellent RF noise screen, the gold ensuring that a long lasting, highly conductive joint is made between the various screening plates that separate the digital and analogue sections of the convertor. There would be little point in this if the digital and analogue sides of the DAC were electrically connected with wires, allowing uncorrelated digital signals to pollute the

one-bit convertor and analogue stages, so DPA use 36 ultra high speed opto isolators to prevent this.

DPA have also paid careful attention to the vibration sensitivity of digital circuits. The copper chassis is in itself very dense, but to further resist and damp vibration a 10mm glass plate has been bonded to the bottom of the convertor and a set of compliant springs are supplied for it to sit on. The heavy chassis, glass plate and thick front panel make the Ten Twenty-Four feel solid and heavy, in fact heavier than most similarly sized power amplifiers. This weight, and the rich contrast of black front panel against bright gold will give some welcome reassurance to anyone who has just parted with the £6000 it takes to buy the unit.

The convertor was delivered to me with DPA's own T1 transport, to allow sync-locking between the two. The master clock in the convertor is fed to the transport through an external optical 'sync lock' link in order to provide the necessary internal clock signal. Having both items work from one clock in this fashion reduces the effects of jitter, giving a sound with razor edged timing. The convertor itself takes its power from two separate, outboard power supplies in DPA's more familiar casework, one for digital and one for the analogue domain. This makes it quite a bulky system, filling a complete three tier equipment rack, but it's a small price to pay for this level of technology.

DPA have given this convertor versatility. It can accept up to four digital sources, via coaxial or optical connectors, one with the facility for AT&T optical. It also has a digital output monitor, so a digital recording can be made from any one of the four sources to a digital recorder whilst you listen to a different source.

Another unique feature of the Ten Twenty-Four, apart from its proprietary dx128 processors, is the provision of user selectable dither noise. Dither is a concept unique to digital processing and it is not easy to explain in lay terms. It is used (or should be) during recording to lessen distortions that arise in the digital-to-analogue conversion process by randomising conversion errors. Dither noise is, quite simply, hiss, albeit in special form. Dither isn't commonly used in digital convertors, because its addition isn't straightforward. DPA use a special form of dither noise (triangular) fed into the multiple filters and noise shapers to randomise and reduce errors.

One of four levels of dither can be selected on the Ten Twenty-Four. In practice I found that I could set the DAC for the highest dither level and best sound quality without the hiss from the speakers being audible at the listening position. The differences this dither makes was small, but I noticed a slight warmth appear in the midband as dither level was increased.

SOUND QUALITY

I normally try to steer clear of drawing comparisons between CD and vinyl, but this is the first convertor that I've heard that has a similar richness of texture and sweetness in the treble to that of a top flight turntable. It also has the fantastic central image presence and body that, until now, only a turntable could produce. I've long been of the opinion that the reason for vinyl being so much better in this area was because of its reduced stereo separation compared to CD, pulling more of the stereo stage into the centre, but the Ten Twenty-Four tries its best to disprove this hypothesis.

Performers are given such a strong position between the speakers that they could be there in the room with you, six feet tall and singing with an amazing clarity and focus that I'd never imagined the Quads (ESL63s) could produce. In this respect CD has finally equalled and bettered what a good turntable can do in one go. The sound of the Ten Twenty-Four is so complete, so natural and musically rewarding, that any other convertor I tried next to it sounded processed and compressed.

"It has the fantastic central image presence and body that, until now, only a turntable could produce."

Every CD I played, and I played most of my collection over the time I had the Ten Twenty-Four, was subject to renewed appraisal. It was like going into a demonstration for, say, a new pair of 'speakers, with some favourite recordings. You sit down to listen and become aware of something, perhaps quite major like the actual number of backing vocalists, on an album that you thought you knew so well, it's a shock, so much more revealing are the 'speakers being auditioned than those you have been used to. They open up a whole new layer within the performance. That is the kind of effect the Ten Twenty-Four had - and I've hardly led a sheltered life when it comes to auditioning top flight convertors.

For dynamics, this convertor was

awesome. It has real power, depth and slam in the bass, but it doesn't present it in a hard or contrived manner. It has plenty of impact, but behind the initial punch there is a subtle decay and echo that gives it a more realistic character than the more overdamped and sterile presentation normally commonly found with CD. Resolution of detail was so great, it turned bass lines into a series of musical notes, rather than a poorly differentiated sequence of low noises.

This incredible detail resolution continued through the midband and treble, giving vocalists real character and emotion and cymbals the space, air and upper harmonic structure that properly characterises their sound. The twisted nervousness of Tanya Donnelly's voice was enough to make my spine tingle; the technical brilliance of The The's Mind Bomb had me listening deep into the recording, hearing more and more layers; Primal Scream's rocks just made me want to party. The Ten Twenty-Four elevated music to new levels of impact and involvement.

Suzanne Vega's voice had such projection and clarity it was breathtaking, lightly plucked acoustic guitars had a wonderful reverberant character, their echo fading outwards into a seemingly unlimited stage. Lou Reed's fantastically recorded Transformer was fuller in body that I'd ever heard before, even on vinyl. This album has a stunning richness to it, helped in places by the string bass of Herbie Flowers. There is an amazing line up on this album, including David Bowie, Mick Ronson and the Thunder Thighs as backing vocalists, the latter moving from a distant echo at the back of the stage to a full blown chorus a few feet in front of you, and followed by a saxophone solo that made me jump out of my skin, even though I knew it was coming on Walk on the Wild Side.

Forget the Wadias, Krells and what have you - the best DAC in the world, in my opinion, is made in Cardiff, Wales. There is nothing that comes close to the incredible level of complexity on one side, and the simplicity of sound on the other, of this convertor.

Five years of research and development have paid off for DPA. The Ten Twenty-Four is truly outstanding in every area. What you must bear in mind though is that this convertor hasn't been built to a price point. It represents the very best that Rob Watts, its designer, can do with current technology. It really is something special, something for everyone else to aspire to ●

DPA dx128 £6,000
DPA Digital Ltd.,
Unit 7, Willowbrook
Technical Units,
Crickhowell Road,
St.Mellons,
Cardiff CF3 0E1
Tel: 0222 795621

MEASURED PERFORMANCE

The digital filters of this new convertor play a more significant role than those in earlier DPA convertors, simplifying the analogue filters. It was the latter that used to roll off upper treble in products like the Little and Bigger Bit. The 1024, with its new

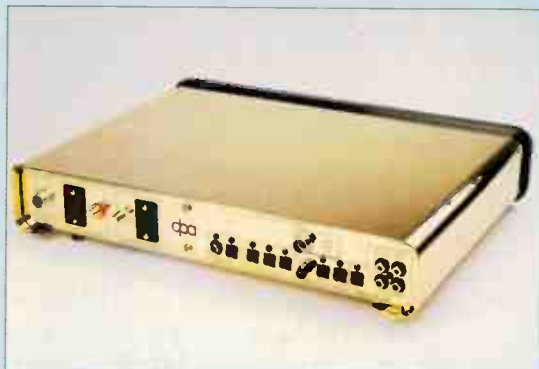

The rear panel houses a mass of input and output sockets, including XLRs for balanced analogue output.

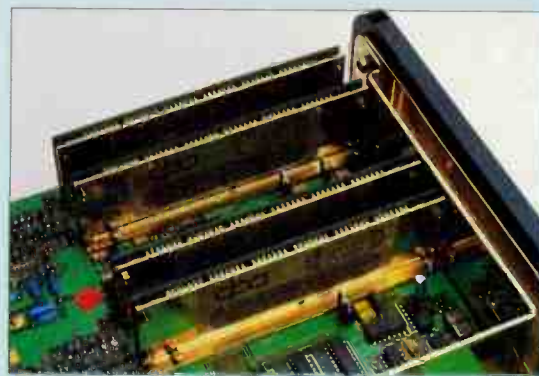

The four dx128 processors designed in-house by DPA.



Surface mount components make it possible to get the thousands of components into one case.

architecture, does not exhibit upper treble roll off, as its ruler flat frequency response shows. However, for me this is a little academic, because neither I, nor most users I believe, ever found DPA convertors dull sounding; quite the reverse in fact, they have always had especially clear and open treble. Naturally, I would also expect the 1024 to sound tonally balanced as a result of its response characteristic.

The 1024 reminded me of Philips' insistence that any new digital technology they introduced had to measure well, since it would be under scrutiny around the world and was seen to be directly comparable to rival products from Japan and (now) the States. Small, specialist companies like DPA do not feel so constrained, being prepared to pursue a purist design approach often at the expense of measurement. The low feedback amplifier with measurable distortion is one good example of this. The new 1024 is another. Being a custom designed convertor, it has its own foibles and Rob Watts warned us - correctly - that it does have higher distortion than is common. We found in fact that its distortion varied during operation and did not stabilise, so our figures are approximate.

The -60dB result was worst, a signal at this level exhibiting 5% distortion, against a common figure of 0.5%-0.8%. Music typically hovers around -30dB up to 0dB nowadays though, engineers having learnt that distortion and noise do exist on CD and will become a problem if levels are allowed to fall. At these higher music levels the 1024 is satisfactorily linear, producing 0.03% distortion at -30dB on one channel for example and 0.08% on the other. That puts it up with Bitstream from Philips, if not alongside the best players and convertors, which produce just 0.02% distortion.

These figures are too marginal and differences too small for me to be able to say much about their affect upon sound quality with any certainty. Above about 0.1% distortion at -30dB I do expect a slight coarseness in the sound to become just audible. The 1024 judiciously stays within this distortion limit, allowing its strengths not to be audibly challenged to any significant degree by potential weaknesses.

I was surprised to find that whilst a signal recorded with dither becomes measurably less distorted, adding dither in the convertor doesn't have the same measured effect. There was no change in our measured distortion levels when dither was introduced; only noise increased.

In all other areas of performance the

1024 measured well, but since dynamic range by the EIAJ method relies on assessing both distortion and noise at -60dB it is especially poor in this case, measuring 85dB against a typical result of 105dB or better.

Possessing a significantly different topology to other convertors, the 1024 doesn't measure quite as well in terms of distortion. However, levels are low enough at normal music levels I believe not to swamp other benefits. Otherwise, it measures normally. I'm reminded of the dilemma posed by low feedback amplifiers: they have more distortion, but they also have a better sound. The 1024 was, similarly, designed for a better sound and ultimately must be judged by listening tests.

NK

TEST RESULTS

Frequency response	3Hz-21.5kHz	
Distortion	L	R
-6dB	0.016	0.014
-30dB	0.03	0.08
-60dB	3.6	6.6
-90	32	30
-90dB dithered	17	17
Separation	left	right
1kHz	93	105
20kHz	91	99
Noise	-97dB	
with emphasis	-98dB	
Dynamic range	85dB	
Output	2V	

Distortion

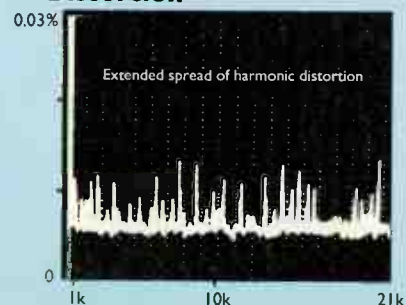

Frequency Response

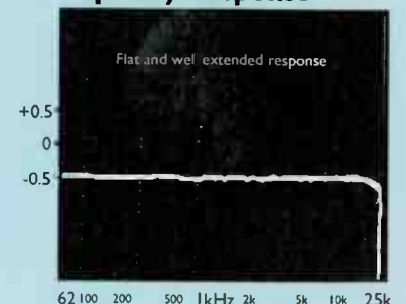

DPA INTERVIEW

Noel Keywood talks to Rob Watts, founder and MD of DPA.

So what is dither and why is it so important in your new 1024 digital processor?

Dither is a form of noise that makes digital sound sweeter and smoother up to the point where you start to hear audible hiss creeping in. Part of the interesting thing about this phenomenon is that its effect depends on the type of recording. If you use a DDD recording there is a bigger effect when dither is added than when you use an ADD recording, as analog noise effectively dithers everything anyway. Analogue generally sounds smoother and warmer than digital CDs. If you get a pop digital CD it can sound incredibly bright and upfront and putting the dither on makes it sound more like an analogue recording.

The problem I was getting in early stages of development is that if you run up to 70dB signal-to-noise ratio it sounds better, but it is unacceptable from the hiss point of view. It was because of this problem that I had the idea of using multiple noise shapers with multiple dither sources. By using eight of them you get a 12dB improvement of signal-to-noise ratio and a resultant noise ratio of 83dB A weighted. When S weighted it is 90dB so from a hearing point of view it is more like a -90dB hiss level, which is all but inaudible.

That's a trade off you are prepared to make?

Yes, but the user can adjust the dither level, as desired, in four levels between the 15th and 11th bit. If the hiss is too strong, the dither level can be reduced until it is inaudible.

Am I right in saying that each of the eight parallel noise shapers is a Philips SAA7350 chip? Why do you need eight rather than one?

You need multiples for two reasons.

It allows you to have much higher settings on the dither level (by 12dB) which is quite a big change.

The second reason is that each individual noise shaper and digital filter when decimating generates small errors and if you put in a random signal the errors are all different so they tend to cancel out on recombination.

Also, they are alternatively positive/negative so any asymmetric

errors that are within the digital filters and noise shapers are converted into symmetrical errors which are far less audible by quite a big margin.

So in an ordinary digital converter you would use one SAA7350 and you're using eight, in order to be able to use a higher level of dither, but with less apparent noise.

You have had to produce your own dither generator too.



Yes. That's on an FPGA (Field Programmable Gate Array) chip and basically I designed the discrete logic circuit and someone makes the chip for us. So we can do, say, a couple of hundred pieces, but it does not cost a small fortune.

In the 1024 we are keeping split analogue and digital domains because that is very important from a sound quality and measurement point of view. But we couldn't use fibre optic cables because

with the 1024 you would need thirty six of them between boxes. Instead we have thirty-six 50megabit high speed optical isolators inside one box, connecting the analogue and digital domains together.

Normally, DAC7 uses the bit clock from the output of the 7350s, but we are using a direct feed into the DX processors from the main master clock so you eliminate the jitter the 7350 itself causes, cleaning the sound up usefully.

Why did you decide to replace Philips' dedicated DAC7 one-bit convertor with your own version?

One was the need to use paralleled up noise shapers and filters and subsequently paralleled up DACs so you can reduce the noise level because of dither requirements. The second thing was I knew getting rid of the passive output filter would improve the sound quality because the performance of the passive filter does detract from the sound quality. These things always do.

Another problem with DAC 7 is that when you use more than a signal above 10 dB you find the noise modulates by quite a large amount. Part of the problem with noise modulation is due to analog-digital crosstalk, best removed by optically isolating the two domains.

Within our DX processor the distortion harmonics are worse than those of Philips DAC7 by quite a large amount; it is not as linear as a DAC7, but it doesn't suffer any noise modulation effects at all.

Now, even-harmonic distortions you can accept in quite large amounts, but noise modulation the ears are extremely sensitive to, so subjectively this convertor system sounds much more linear than the DAC 7 even though it measures worse.

What other processors will you be bringing out?

We have the new £3500 PDM256 which is a slimmed down version of 1024. Also, currently in development is the PDM64 with two noise shapers and filters, it will cost between £1250 and £1500.

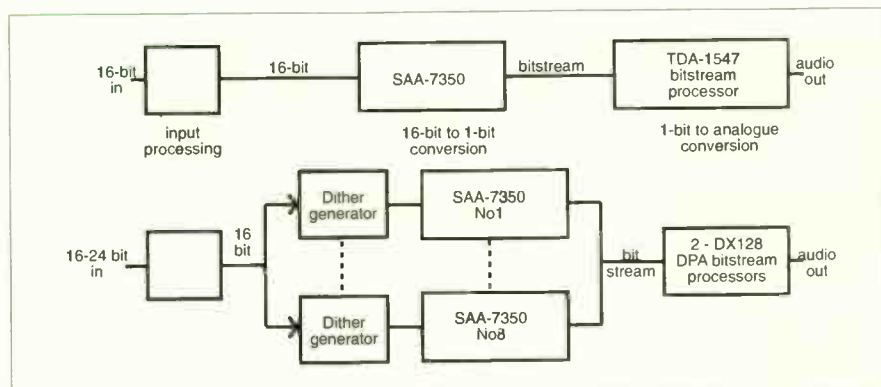

Configuration of a conventional DAC and, below, the DPA 1024

Connections



Tel: 081 348 5676 (2.00-7.00pm)
Fax: 081 341 9368

Esoteric High Fidelity CABLES

Dealers in: Absolute, Audio Note, Audioquest, Deltec, Harmonix, Kimber, Mandrake, MIT, Siltech, Symo, Van den Hul, WBT, and others

...the RIGHT cable
...in YOUR system
...for YOUR ears
...in YOUR home

Contact us by phone, fax, or letter and we'll do our best to help you achieve your goal.

(Auditions may be subject to a handling charge)

CONNECTIONS 13 John Prince's St, London W1M 9AH (A division of Connection 90' Travel Ltd.)

“REAL WOOD HELPS CALLAS HIT ALL THE RIGHT NOTES”

What Hi-Fi? July, 1993



CALLAS from UKD

- ★ Unsurpassed sound at £750 the pair
- ★ Phone or write for review reprints and details of the full range of superb Opera loudspeakers

UK DISTRIBUTION
23 RICHINGS WAY
IVER, BUCKS SL0 9DA

TEL 0753 652669 FAX 0753 654531

UKD distributes: METAXAS - OPERA - BEARD

AUDIO EQUIPMENT FROM LEADING AND SPECIALIST BRANDS ON TWO FLOORS FOR YOU TO LISTEN AND CHOOSE FROM

- 3 Demonstration Rooms
- Home Trials
- Home Cinema – Instore Demonstration Theatre
- Audio Visual Equipment
- Evening Demonstrations by appointment
- Inhouse Service Department
- Mail Order Available
- Interest Free Credit on Selected Items (Apr. 0% – Written details on request)

SOUND ACADEMY

CINEMA
DANCE

Quality, Clarity, Expertise...
and that's just the service!



Sharing the ASDA Carpark with ample free parking. Off High Street, Bloxwich, Nr. Walsall, West Midlands Near M6 Jnc. 10 & 11
Open 6 Days, 9am – 6pm
Late night Friday

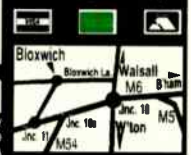

Hi-Fi for the Beginner, the Enthusiast and the Audiophile Telephone (0922) 493499/473499

ACOUSTIC ENERGY • ARCAM • ALEM • AUDIO LAB • APOLLO • A.T. • AUDIO ALCHEMY • AUDIO QUEST • B&W • BOSE • BEYER • CABLE TALK • CHORD COMPANY • CHORD • CYRUS • CELESTION • DPA • EPOS • EXPOSURE • INFINITY
JPW • REFERENCE • KENWOOD • MARANTZ • MICHELL • MONITOR AUDIO • MONSTER • MORDAUNT SHORT • MERIDIAN • MICROMEGA • MISSION • MOTH • MUSICAL FIDELITY • NAKAMICHI • ORTOFON • PROJECT • QUAD
ROKSAN • ROGERS • ROTEL • SENNHEISER • SONY • SPENDOR • SUMIKO • SYSTEMDEK • TARGET • TDL • THORENS • TRIANGLE • TUBE TECHNOLOGY • VAN DEN HUL • VANDERSTEEN • YAMAHA • YBA

PROGRESSIVE AUDIO



DIGITAL BY; SUGDEN, MERIDIAN, MARANTZ, MICROMEGA, PROCEED, AUDIO ALCHEMY, ORELLE AND AUDIOMECA

ANALOGUE BY; MICHELL, PINK TRIANGLE, SME, VPI, BASIS, VOYD, PROJECT, SYSTEMDEK

ARMS AND CARTRIDGES BY; LYRA, MICROBENZ, TRANSFIGURATION, KOETSU, SUMIKO, GOLDRING, AUDIO TECHNICA, DECCA, SME, GRAHAM, REGA, EMINENT AND KUZMA

AMPLIFICATION BY; LFD, AUDIO INNOVATIONS, AUDION, SUGDEN, CHORD, MOTH, LEVINSON, CONRAD JOHNSON, CONVERGENT, LUMLEY REFERENCE, MICHELL, TUBE TECHNOLOGY

SPEAKERS BY; PROAC, AUDIONOTE, SNELL, IMPULSE TDL, JPW, DALI, ORIGIN LIVE, AUDIOSTATIC, RUARK, SOUND LAB, DIAMOND ACOUSTICS, TOWNSHEND, MONITOR AUDIO, UKD, ALCON

ACCESSORIES CABLES BY; QED, STRAIGHTWIRE, LOGAN HALL, AUDIOQUEST, SILVER SOUNDS, AUDIONOTE, KIMBER, L.F.D., AND VAN DEN HUL, STANDS BY; TARGET, TRIPOD, FOUNDATION, GOLDRING, HEADPHONE BY STAX, SEISMIC SINKS BY TOWNSHEND

**HOME DEMONSTRATIONS A PLEASURE
PHONE DAVE ON MEDWAY 0634 389004**

HOME DEMRECORD CLEANING SERVICE, SECOND HAND EQUIPMENT AND RECORDS. PHONE DANNY ON: 0634 580763
DONSTRATIONS A PLEASURE

PHONE DAVE ON MEDWAY 0634 389004

The Professional Monitor Company specialise in design and manufacture of high quality monitor loudspeakers and their designer, Pete Thomas, is an ex-BBC engineer. Would the TBI's, reviewed here, offer a higher standard of

reproduction as a result, since they are meant to appeal to discriminating broadcast professionals? They come at a domestically affordable price of £399.

The TBIs are a medium-sized stand mounter, designed to be used either as a near-field monitor in a studio, or as a

high quality, low colouration hi-fi speaker. They employ a 170mm cast chassis bass/midrange unit with a doped paper cone to handle frequencies up to 3kHz. Above this a 25mm metal dome tweeter takes over. This bass unit is loaded with a truncated transmission

MASTER MONITOR

The Professional Monitor Company's TBI loudspeakers promise the accuracy of a top class Studio Monitor in the home. Dominic Baker listens closely.



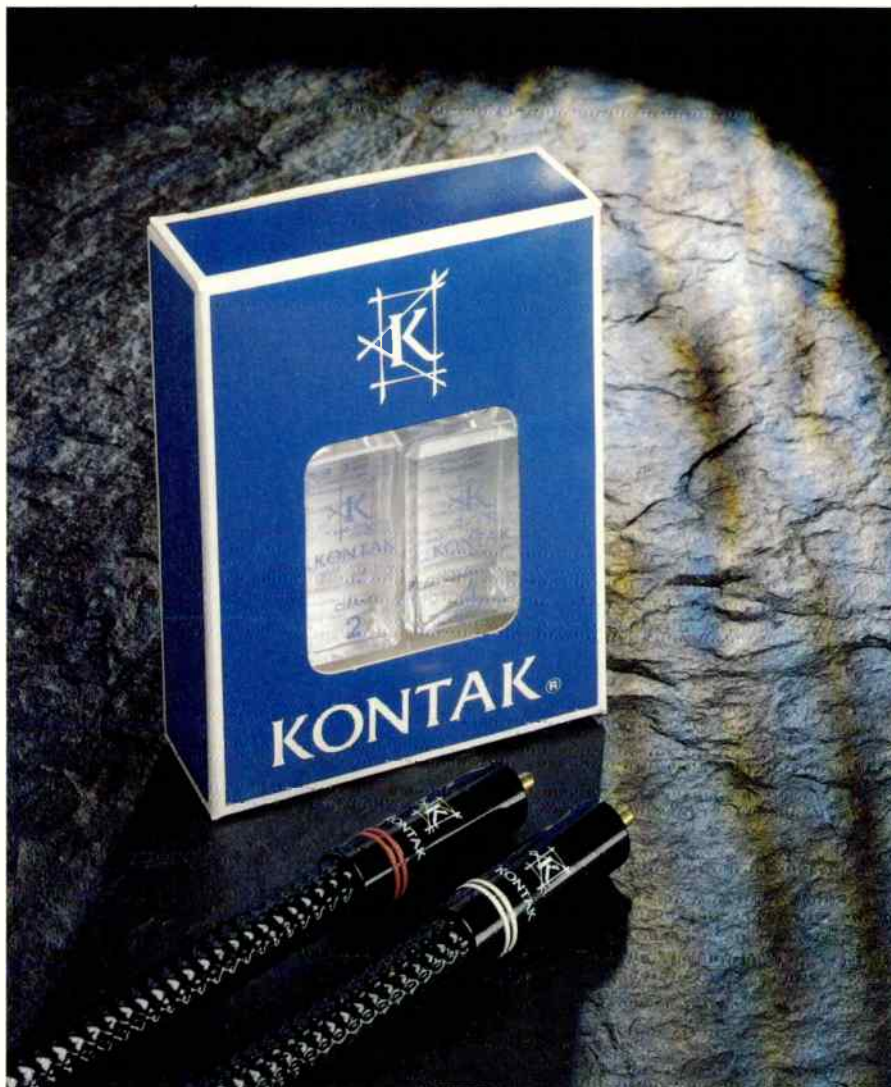
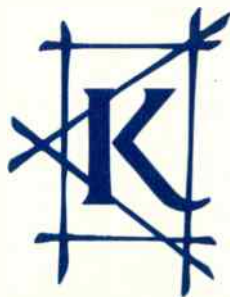

KONTAK®

"For the cost of a couple of CD's, here's an improvement akin to spending a few grand"

KEN KESSLER

HIFI NEWS AND RECORD REVIEW, AUGUST 1990



Kontak is a High Tech Cleaning Solution

Electrical connections are inherently imperfect. The two parts of an electrical connector never fit exactly, which allows contaminants to develop and cause oxidation. This in turn will significantly impair the electron flow and signal integrity. Regular use of Kontak Cleaning Solution will maximise the performance of your equipment by minimising loss of signal and power in electrical connections.

line - PMC call it transflex - tuned to 70Hz. In similar fashion to TDL's RTL loudspeakers, this gives the TBIs deep and powerful bass without compromising sensitivity.

PMC have used a simple first-order crossover to combine the two drive units, just a capacitor on the treble and inductor for bass. High quality components are used along with silver solder and OFC wiring, so I would expect the TBIs to sound clean, assuming good drive units of course.

Our pair came nicely finished in natural walnut (black ash is also available) with a painted grey metallic baffle. The grilles have a soft curve at the bottom which gives them some visual style, but otherwise they are conventional in appearance.

Good chunky bi-wire binding posts are provided which will score points with the audiophile.

Sadly, as I started my listening the most recognisable feature of the TBIs was the metal dome tweeter. It has an obvious sting to it, making them sound sharp at realistic levels. After an hour or so I was already starting to find them fatiguing. I'd hoped that running in for a day or two would soften the treble, but alas no. This wasn't especially helped by the rather cold and hard sounding Bryston 3B power amplifier PMC recommended and supplied. Perhaps a soft valve amplifier would have been a better choice!

I finally settled on a Sugden A21a for my listening, knowing it to provide a detailed and clean sound, free from harshness in the treble that some transistor amplifiers can exhibit. It proved a good partner, enjoying the high sensitivity of the TBIs and pushing forwards the better parts of them, such as the clean and well focused midband and their taut, dry bass quality.

Even so, the bass of the TBIs has a hard, hollow character to it, more so than TDL's RTL series of truncated transmission line designs which have a richer, fuller bloom which is easier on the ear. That's not to say that the TBI's bass was unpleasant though - in fact it was very fast and lean, suiting the crude grunge rock character of Hole's Live Through This extremely well. Courtney Love's hard edged singing (screaming, in fact) on 'Violet' was conveyed with clarity and vigour.

The TBIs are certainly very low

colouration 'speakers; no artificial warmth or bloom was noticeable through their midrange but, at the same time they also came across as slightly cold and unengaging, if strong in intelligibility. Whilst it may appear that I'm criticising clarity or neutrality for producing a characterless presentation, this isn't so. My Quad ESL-63s are acknowledged as arbiters of clarity and neutrality, but they don't sound cold

and limited in conveying the innate character of instruments and singers.

Moving the TBIs back closer towards the rear wall did give their bass a little extra needed richness, but too far back and they became too congested. I found the most acceptable

balance in my room to be with them positioned around 2ft from the rear and side walls. Any further forwards and they became impressively fast, but also thin and lacking body or depth.

Although after an hour or so I decided that the grilles would have to go back on because the treble was so incisive, with the BMX Bandits it actually

gave the steel stringed guitars quite a realistic brashness. They also managed to throw up a precise image, placing performers confidently enough even within what was a scaled down sound stage. Suzanne Vega was given similar treatment. The solid central image placing her centre stage.

Overall, what the TBIs lacked was freedom and spaciousness in their presentation. Their treble was bright, the midband clean and with good projection and the bass taut, but they still sounded compressed and restrained. Their sound never opened out from the two speakers to fill the whole room, seemingly staying within the narrow limits of defining solely the performers, refusing to reveal subtle clues about the atmosphere and acoustic surrounding them.

Subjectively, the TBIs are very precise, but they are also over-concise in their delivery. Coming from a BBC background, perhaps this sort of presentation is deliberate. But it is neither the captivating nor the musically rewarding kind of presentation I think most people will want when they sit down to relax and enjoy a piece of music in the comfort of their home ●

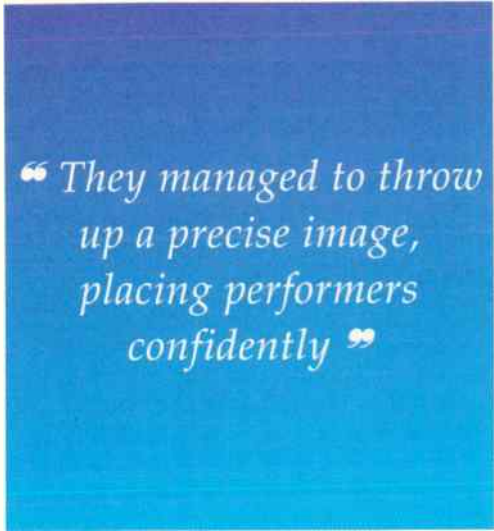

PMC TBI £399
The Professional Monitor Company
Unit 4,
Melinite Industrial Estate,
Brixton Road,
Watford,
Hertfordshire.

MEASURED PERFORMANCE

The output from the truncated transmission line is so strong that it produces a peak in the bass as seen in the response plot below. The TBIs should have powerful bass as a result, but only across a narrow band of frequencies.

A treble lift is also noticeable in our response plot. This may add a sparkle to the treble, or perhaps a sharp sound. Having said that, the metal dome tweeter PMC have selected is known to be a smooth one. The response is well controlled between the raised bass and treble, but the mid-range does droop a little, so I'd expect a fairly distant perspective on vocals as a result.

The truncated transmission line does have its benefits. The TBIs are of above average sensitivity at 88dB for a nominal watt (2.83V) of pink noise measured at 1m and the impedance curve is very smooth in the bass. With an overall impedance of 10.7Ω they won't demand high amplifier currents either and they should go loud with just 20watts or more. **DB**

Frequency Response



Impedance

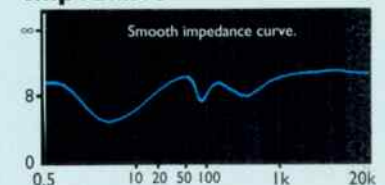

Don't trip up on your speaker cable!

When you invest in good quality hi-fi equipment, why skimp on the cable?

Especially now that Ortofon can offer 3 types of top-quality cable for under £10.

Each cable is made up of very fine core copper strands rated at 6-Nines (that's a copper purity of 99.99999% - it doesn't come much better), is flat and flexible for easy installation and features a 'tack-rack' for panel-pin fixing.

Cable Type	Description
SPK 100	Twin-core white cable, each core with 130 copper strands (total 260 strands).
SPK 200	Triple-core grey cable for bi-wiring with twin-core treble (260 strands) and 3-core bass (390 strands).
SPK 300	7-core blue cable having 13 strands per core (each strand laminated). Requires soldering.

You'd better hound us for the name of your nearest stockist.

ortofon

Ortofon (UK) Limited, Chiltern Hill, Chalfont St Peter, Bucks SL9 9UG. Tel: 0753 889949.



L i s t e n i n n

HI-FI SPECIALISTS

Linn, Naim, Epos, Heybrook, Arcam, Mission, Royd, Audiolab, Creek, Cyrus, Quad, Denon, Rotel, NAD, Marantz, Kef, Chord Company (Naim and Epos Northampton only).

LISTEN INN Northampton
Appointed REGA Agent

32 GOLD STREET, NORTHAMPTON
TEL: 0604 37871
6 HOTEL STREET, LEICESTER
TEL: 0533 623754

Doug Brady Hi-Fi

"You really must hear this"



Also available:

Arcam, Meridian, Naim, Pink Triangle, Exposure, Roksan, Audio Innovations, Tube Technology, Mission, Lyra Cartridges, Michel Engineering etc...

MAKE FRIENDS AT DOUG BRADY HI-FI

Kingsway Studios, Kingsway North, Warrington, Cheshire (0925) 828009 Open six days. Fax: (0925) 825773	401 Smithdown Road, Liverpool L15 3JJ Merseyside (051) 733 6859 Closed on Wednesday.	14/18 Monmouth Street, Covent Garden, London WC2H 9HB (071) 379 4010 (071) 497 1346 Open seven days Fax: (071) 497 9205	The Forge Cottage, 19 Crossgate, Otley, Leeds, West Yorks LS21 1AA (0943) 467689 Closed Sunday & Monday.
--	---	---	---

Great tracking

Ortofon is famed the world over for the tracking capability of its cartridges. Cartridges which will breathe new life into a cherished LP collection, divulging detail as never before.

The cartridge is always the key factor in the reproduction of music from records and Ortofon has dedicated nearly 50 years to the manufacture of the finest pick-ups possible. Enjoying constant critical acclaim along the way. So if you want to bring more out of your records than ever imagined, an Ortofon Cartridge will have you hot on the scent.



500 Series
Moving magnet
cartridges from £30-£100



MC Series
Moving coil cartridges
from £60-£110



Q Series
Moving coil cartridges
from £140-£500



1000 Series
Moving coil cartridges
from £600-£1500

ortofon

Ortofon (UK) Limited, Chiltern Hill, Chalfont St Peter, Bucks SL9 9UG.
Tel: 0753 889949.



Tesseract Audio.

We make them
the way they said
you just can't make
them anymore.

For full details of the Tesseract range of head amplifiers, pre-amplifiers, power amplifiers, turntable power supplies and dealer list contact: Tesseract Research Ltd, Sutton Business Centre, Restmor Way, Hackbridge Road, Wallington, Surrey, SM6 7AH Telephone: 081-669 0011 Fax: 081-773 0406

 **TESSERAC AUDIO**
The Best of British High End

EXPENSIVE TUNER??

THEN HAVE THE
AERIAL IT DESERVES

You spend many hours and quite a lot of money choosing that new tuner, so don't ruin the whole effect by fiddling with bits of wire or old aerials. Have the full benefit of the multipath-free, clean signal which only a well designed and properly installed unit can achieve. If D.X. is your scene, then go for the ultimate in rotating high gain narrow beam systems like our G.23 with 19dB Forward gain, 38dB F. to B. and Acc. Ang. down to 15 Degrees or have a "one off" special built, up to 32 elements.



GALAXIE CIRCULAR 17-ELEMENT STEREO
GAIN 15.9dB F. TO B. 33.7dB. L.74"

WE DESIGN, MANUFACTURE, SUPPLY AND FIT

- ★ FM arrays from 4 to 23 Elements. TV from 10 to 92 Element.
- ★ British-built and designed to withstand our weather.
- ★ Interested D.I.Y. advice freely given, backed by our complete range of masts, brackets, rotors, cables and aerials. Systems available for chimney, loft, wall, or through roof mounting.
- ★ Professional installation service available within a nominal 200-mile radius of LUTON. Full details of this service available on receipt of a large S.A.E. which will bring you our complete "Aerial Guide" which is more than just a list of our products and prices, and carries details of all our services, including MAIL ORDER and site surveys.

CONTACT US ON 0582 36561 or WRITE To:
RON SMITH AERIALS

98, ASH ROAD, LUTON, BEDS, LU4 8AQ

Personal Callers: Shop Hours Mon. Fri. Sat. 9.00 to 6.00. Lunch 12.30-1.00
Tuesday & Thursday 9.00 to 10.30 Wednesday Closed

(On Tue/Wed/Thurs/ we are often available: Phone to check. Mon/Fri/Sat we are always open).

NAIM AUDIO U.K. RECOMMEND OUR FM AERIALS AND THEIR DEALERS
CAN OBTAIN YOUR CHOSEN MODEL WITHIN 48 HOURS, OR SUPPLY EX
STOCK.

Mission's Cyrus brand is moving up-market from the mid-price bracket, feeling for the upper reaches of the hi-fi spectrum. The Cyrus Discmaster and Dacmaster slot in at £1800 (£2400 equipped with an 'intelligent' PSX power supply each), which is in the territory the Mission name, less 'Cyrus', once held for its own.

At least among DACs, this is a land where there are several kings: Conrad-Johnson, Pink Triangle and DPA, to name three. Mission's use of an Analog Devices 1862 bodes well; it may not be the ultimate, but it is a very good all-rounder. Inside the transport is a Philips CDM-9 Pro mechanism, an item I've also come to think well of.

Ignoring the sound for a moment, however, the Discmaster transport has a

fascinating 'Comms' cable connection to the Dacmaster convertor. It routes a remote control instruction to invert phase through to the DAC, and it also switches both transport and DAC to standby together upon command by remote control.

The display needs to be viewed from straight ahead for optimum visibility, but it covers most of the information likely to be needed and can be turned off too, to lessen possible interference. Unlike inverting phase (beneficial on some rock tracks, disadvantageous on Tavener's 'Eternal Memory'), I have to admit I couldn't hear any real difference through the Argo/Chord SPM800 and ESL-63s the new Cyrus set-up was wired into.

Not so comparing the transport and

DAC without, then with, PSX power supply. With both using their internal power supplies, the Discmaster plus Dacmaster was marked by a slightly forward treble compared to the rest of the frequency spectrum, which added a bite that had rhythm or lead guitar sounding hard and justifiably punchy, but was sometimes unwelcome on high strings and female vocals. Kirsty McColl's voice, for example, lost its trace of 'folk-singer adenoids' - you know, the sound of one finger in the ear and the other up her nose - which other DACs have transmitted perfectly well. It was regained, however, with the PSX installed. It was a little more truthful with the PSX applied to the transport; almost entirely truthful with a PSX also plugged into the DAC.

MASTERING THE MUSIC

Eric Braithwaite lends an ear to Mission's Discmaster and Dacmaster CD combination.



Most of the listening was done with an AES/EBU balanced digital connection supplied, a superior and more refined mode to co-axial or optical.

In fact, 'refinement' came to be the word that sprang most to mind over the

neatly pointed and crisp, thanks to the considerable lucidity of the midrange and treble, there were hints of a slight dragging of feet, as though the DAC couldn't quite react to a beat quickly enough to keep a bass line at full speed.

“The Analog Devices breed of chip allows a listener to discount vigour in favour of its marked strengths in portrayal of ambience, precision of focus and mostly spot-on tonal definition.”

hours of listening. Listening to Carl Orff's Der Mond, a superb example of a Walter Legge production from Abbey Road in 1957, a slightly hard violin tone was smoothed and, well, refined, with the PSXs in place, while the focus on singers was delicately precise. In common with other implementations of the Analog Devices chip I've heard, while the full depth of the Abbey Road space wasn't available, the clarity of individual members of the chorus and the soloists made them quite distinctive.

There was, however a mild sense of 'holding back'. Orchestral climaxes gave the sensation of taking a fraction longer to develop than with some DACs. Stephen Isserlis' cello in the Taverner piece was a spot drier and with less resonance than with other DACs. I'm willing, all the same, sometimes to trade finesse, which the Cyrus pair had in plenty, for power in the lower registers. The Dacmaster made this piece ethereal and numinous, which suited the Taverner in any case, though previous exposure suggested Isserlis should have been bowing with a little more force than came across. Inverting phase, on this occasion, undid the focus, by the way, increasing the other-worldliness, but making it harder to follow the notes.

Changing tack, and phase, I resurrected The Special AKA's 'Free Nelson Mandela'. Well, it seemed appropriate to celebrate the new South African President. Here, the percussion sounds were on a par with the very best; the Cyrus transport and DAC could reproduce the subtleties of stick on side-drum and snare. Conversely, the thoroughly artificial drum machine on Kirsty McColl's more commercial and less folksy tracks remained untempered in its boring, muddy, low-resolution sameness. Am I alone in finding these things unimaginative and commonplace?

The Cyrus coupling could be criticised on tracks like these for failing to give the artificial 'lift' that drives the rhythm faster. Alas, that's the way things are in reality. In fact, while rhythm was

Equally, when hard-pressed in the upper frequencies of string instruments, the Discmaster and Dacmaster left the impression of a mild lack of eagerness.

I have to admit that the comparison is made with what I believe are some exceptional DACs, including the Counterpoint DA-10 when equipped

with the same Analog Devices chip, though heaven knows, the Dacmaster comes very close indeed to this machine, even though the Californian is twice the price. I've observed this lack of eagerness before, but there's no doubt that the Analog Devices breed of chip allows a listener to discount vigour in favour of its marked strengths in portrayal of ambience, precision of focus and mostly spot-on tonal definition.

Attractive? Definitely. Value-for-money? Very high marks, especially with the PSX power supplies. Ease-of-use? Apart from the need to use a disc-clamp, practically perfect and way ahead of the competition which mostly requires knob-twiddling instead of lazing about in the armchair. It has been a long wait - a year since the Discmaster and Dacmaster were first seen, but I feel it was definitely worth it ●

Discmaster/Dacmaster £1800
PSX Power supplies £300 each
Mission Electronics,
Stonehill, Huntingdon,
Cambs. PE18 6ED
Tel: 0480 451777

MEASURED PERFORMANCE

Frequency response, seen in our analysis, exhibits a slow roll off in the upper treble (at right), a common enough trait used to avoid any possibility of treble sharpness. It also helps to make a CD player sound smooth and cohesive.

Distortion was very low at all signal levels, from full output down to -90dB. Our analysis of a -30dB signal (average music level) shows the presence of just a few residual harmonics that amounted to just 0.02% - a very low figure. The DACmaster will not possess any sharpness or coarseness in its sound.

Channel separation was very wide at all frequencies and output absolutely standard at exactly 2V. Noise output was satisfactorily low at -102dB and I was pleased to see virtually no signal-related spurious outputs above 21kHz. Largely because of low distortion at -60dB, dynamic range according to the Japanese EIAJ test was a good 107dB.

Mission have engineered the DACmaster very well. It possesses no measurable problems at all. **NK**

Separation	left	right
1kHz	111	110
20kHz	91	93
Noise		-104dB
- with emphasis		-102dB
Dynamic range		107dB
Output		2V

Distortion

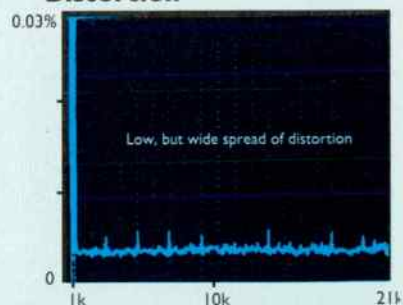

TEST RESULTS

Frequency response 3Hz-21.1kHz

Distortion		
-6dB	0.007	0.007
-30dB	0.02	0.018
-60dB	0.5	0.5
-90	32	32
-90dB dithered	3	4.5

Distortion

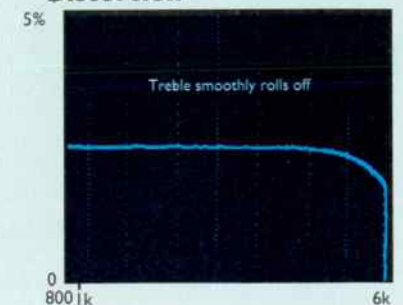

REMOTE RECEIVER

Dominic Todd finds distant reception no problem with NAD's 705 receiver.

amplified speakers in yet another room. Pre and power sections can be separated via linking pins. There's NAD's traditional Soft Clipping switch which

NAD must have known they were on to a sure fire thing when they combined one of their beefy 40 watt amplifier designs with a tuner from the same stable as the revered NAD 402. Although it's not an identical design to the 402, with NAD's expertise in this particular field it would be surprising to find the tuner section in the 705 anything less than class competitive.

In the past, NAD's receivers have been somewhat overshadowed by their legendary amplifier siblings, whilst still enjoying a loyal following due to their excellent value and sound quality. The NAD 705 does initially appear to go against the grain somewhat. At £329.95, it's not exactly low price (although there is a cheaper model, the 701, available at £259.95).

The feature list will also come as quite a shock to a NADophile. Although the 705 retains NAD's usual ergonomic excellence (with the exception of the slightly confusing tuning mechanism) and sparse front panel, it comes with enough toys to amuse those brought up on a diet of Japanese flashing lights and whirling motors. Having said that, there's little that's actually superfluous. A 44 key remote control is included that will not only operate all the main functions on the 705 itself, but also most other NAD equipment, with the exception of the 5425 (why NAD should have used a different infra red receiver for this particular C.D. player, isn't quite clear).

There are two sets of independently switchable speakers. Unfortunately, though, NAD decided to fit cheap spring clips on the second speaker output, which refuse to take speaker cable much

thicker than 42 strand. You'll also find non-defeatable tone controls, loudness and mono buttons and a Record selector independent of the source being listened to.

Around the back of the receiver, there are yet more "essential extras". An up to the minute, multi-room output is included that allows the user to run a set of

allows high speaker levels with reduced risk of damage, and the CD and MM phono inputs are gold plated.

All this is topped off by a very unNAD like back-lit display featuring a graphic finger pointing to the selected source, and visual indication of signal strength and tuning direction. The pocket TV sized display does



MEASURED PERFORMANCE

The 705 possesses NAD's peak power circuitry that will deliver up to 84watts into 8ohms and 120watts into four ohms. Having a very long time constant, these circuits will handle sustained musical crescendos, so the 84watt figure is a real one, giving this receiver the ability to make any loudspeaker go very loud.

Frequency response proved wide at 21Hz-76kHz and distortion levels low at all levels, right across the audio band - they never rose above 0.01%. As always with NAD this amplifier is a low distortion design.

The phono stage was reasonably sensitive and, although its response reaches down to a low 22Hz (-1dB), it nevertheless rolls off fast below this frequency, in order

to suppress warps. NAD have incorporated a well designed high-order filter for this purpose.

In all areas, the 705's amplifier section measured very well, possessing no blemishes at all. It is powerful and well engineered.

The tuner section had a wide frequency response (see analysis), but some second harmonic distortion which measured around 0.4%. Second harmonic is not especially consequential subjectively; budget tuners commonly measure like this, but a better performance is not uncommon either.

Noise (hiss) was low at -72dB, achieved at 1.2mV signal minimum. Selectivity measured a high 87dB, but sensitivity was a little low at 40µV for stereo and 2.5µV mono. The 705 needs a good aerial as a

result. Its signal strength meter unfortunately indicates maximum with just 80µV of signal, enough for only mediocre results. The tuner is a competent design that will deliver a good sound, but it needs a proper aerial. **NK**

TEST RESULTS

Power	84watts
CD/tuner/aux.	
Frequency response	21Hz-76kHz
Separation	72dB
Noise	-85dB
Distortion	0.004%
Sensitivity	280mV
dc offset	17/14mV
Disc (MM)	
Frequency response	22Hz-60kHz

at least extinguish itself after a few seconds.

The only thing missing is some means of unmanned recording. There's no

Music stations excelled through the NAD too. The depth of sound easily



built in timer, and the electronic power switch mitigates against an out-board device.

With any pukka receiver the tuner is likely to take a high priority. With this in mind I scanned the airwaves for suitable material.

Once tuned in, Radio Four was quiet and pleasingly free from compression. There was a very slight sibilance on female vocals, but not to an annoying extent. Dramas showed good staging and depth, with vocals being given body and character, and subtle differences in the spoken word being clearly perceptible. Not surprisingly, the 705 reminded me of the 402 tuner (see Jan. 94) which also had the ability to transcend its price range. Tuner performance was certainly on a par with many tuners costing as much as the entire receiver.

rivalled my own Revox B760, without quite the same width and transparency. Bass lines were solid and deep; obviously a factor helped by the amplifier stage too and, overall, the sound was well balanced with no deficiencies in any particular area of the frequency range. Even the most compressed pop stations were listenable and free from vocal nasality that often afflicts receivers of this price. With higher quality signals, I'd go as far as to say there was a certain amount of fluidity to the sound, avoiding many rivals processed sound quality.

Transparency and detail did slightly trail the 402 and more exotic tuners, but there was still sufficient to hear, on one local station, the presenter mutter as a CD repeatedly skipped. The 705 doesn't disappoint when switching off the airwaves, and on to CD and vinyl, either.

Compact Disc, using my Cambridge CD3M/DAC3, showed the same tight and well controlled bass that had been evident from the tuner. Vocals were still well focused, and little was lost in terms of spaciousness and separation. More complex passages of music, however,

could just cause a degree of muddle to set in. Once again, the effortless transparency of something like an A400 or Alchemist Kraken was missing, with the resulting balance erring on the warm side. Yet this is hardly a major flaw, and could be tweaked somewhat by using brighter cables and ancillaries.

Switching to vinyl demonstrated the excellent phono stage that NAD include with the 705. Even when fed from a low output cartridge it remained reasonably quiet and undistorted.

The NAD showed a fine level of insight into a Miles Davis recording, rewarding the listener far more than a number of integrated amplifiers at this price range can. My solitary concern was a smoothing off of treble, but other than that the NAD remained pretty much unflappable.

Whatever the type of music, the 705 was even handed, lending itself to the vibrance of jazz whilst still having the ability to deal with the subtleties of vocal quartets, and the dynamics and drive for large scale orchestral pieces and rock.

Although initially the NAD 705 seemed a little expensive in comparison to rivals, its sonic performance puts it into another arena and actually makes it great value for money. What's more, it comes generously equipped, including a system remote control, and is extremely versatile.

Put into context, if the amplifier and tuner sections were put into separate boxes they could each justify the price of the complete 705 package! Here is a receiver free from the usual compromises and constraints associated with mass market receivers, and well worth auditioning even if you've never considered a receiver before. What better praise than that ●

NAD 705 £329.95
NAD Marketing Ltd.,
Adastra House,
401-405 Nether Street,
London N3 1QG.
Tel: 081 343 3240

Separation	67dB
Noise	-80dB
Distortion	0.004%
Sensitivity	3.5mV
Overload	120mV

TUNER

Frequency response	23Hz-16kHz
Stereo separation	46dB
Distortion (50% mod.)	0.4%
Hiss (CCIR)	-72dB
Signal for minimum hiss	1.2mV
Selectivity (at 0.4MHz)	87dB
Sensitivity	
mono	2.5µV
stereo	40µV
signal strength meter	
8 segment	80µV max.

Tuner Distortion

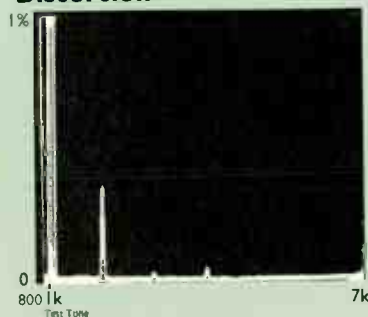

Second harmonic distortion of 0.4%, which is subjectively innocuous.

Tuner Frequency Response

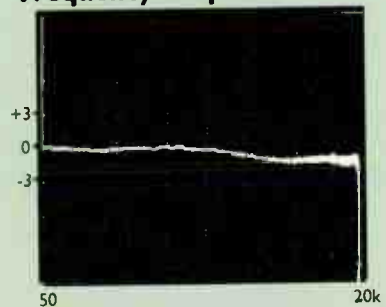

Slight fall in treble level will give a full bodied sound.

Aiwa's new AD-F850 is first through the winning tape for value, finds Noel Keywood.



TAKING THE TAPE

Told you so! Back in the May issue we identified the price cut Aiwa AD-F810 dual-capstan cassette deck as a bin-end. Here's its replacement, the AD-F850 priced at £229.95. Anyone who bought the AD-F810 won't be disappointed - it was the bargain we predicted, for although the new '850 looks different, it has a very similar performance, but the price has increased, albeit by only a small amount.

Let me recap first on what the AD-F850 is and why we are keeping a close eye on its commercial progress. Aiwa have traditionally been good at building cassette decks, offering quite sophisticated units at a reasonable price. This model best demonstrates their ability by combining high level specification with a low selling price, making it something of a bargain for dedicated tape users. There's a dual-capstan transport for good speed stability, three heads for high performance and ease of use, and variable bias and record gain (sensitivity) for tape matching. All reach a good standard of performance in themselves, especially taking price into consideration, making the old AD-F810 a bargain and, potentially, the new 850 a bargain too.

It's only realistic not to expect too much. Audio sales in Japan have been

decimated by various factors and are now 45% down, placing pressure on companies like Aiwa to ensure profitability, so loss leaders are out. Rising production costs forced Aiwa to move production to Singapore long ago, but the transport and head of this deck come from Japan-based specialist suppliers, giving Singapore the benefit of low labour costs only. So don't be surprised that the new AD-F850 costs a little more than its predecessor, even though it has fewer facilities.

What has gone? The pretty green backlight behind the cassette, timer-start and the headphone volume control have all disappeared. The only other changes we can spot are a rather pointless styling revision, the flat fascia extrusion being replaced by a more pneumatic looking curvy affair. I think Aiwa should have made the case smaller to save a little on materials and they should have exchanged dubious benefits like the AMTS cassette shell stabiliser for a simple, but more substantially built door. But, as we all know, Japanese companies are convinced of the need for simply perceived value and performance markers and, no matter what, they don't and won't change their outlook. That's why the AD-F850's case is huge, with an enormous fresh-air-to-hardware

ratio. It's also made of paper thin steel which makes the deck clanky to use.

SOUND QUALITY

I had to listen a little more intently than expected to catch this deck out; it was quite impressive. Modern metals give best results and new (reformulated) Maxell MX worked a treat with bias turned up a little (+2) and music peaking at +6 absolute maximum. The deck was then quiet enough to record with Dolby B alone, hiss being all but inaudible. I noticed a fine sense of clarity across the midband, clean treble with well maintained transients and slightly lightened but clean bass. There's no doubt that the head is a good one, allowing the AD-F850 to work unusually well with good metals.

Sticking with MX, I was surprised at how well the AD-F850 apparently coped with the long, revealing sustains of Chopin's Opus 48 No1. It didn't pitch jerk or momentarily slur, but I did detect some general pitch vagueness and, on the closing chords, heard a slow wavering. Critical listeners beware; many wouldn't notice though.

Ferric tape commonly sounds vague on transients, because of treble overload (saturation). However, with TDK AR and bias backed off a little, the AD-F850 reproduced the cutting steel

guitar strings of Rory Black's Terraplane Blues with surprising ability. However, I did have to pull recording level back to 0dB on peaks and, at this level, hiss became pretty intrusive with Dolby B - Dolby C was needed.

Swapping over to Maxell XL-IIS (chrome bias) I found recording level could be edged up a little without compromising transient definition and hiss was far less obvious - back to Dolby B! The Aiwa gave fine recording quality with this tape, as it did with AR and MX, so it works well with all three tape types - not so common an ability.

The situation with pre-recorded tapes was marginal. Quite obviously,

head azimuth error was causing some dullness, but it wasn't too great. As a result, tapes that were a little bright in

sounded a little dull and leaden, whilst those that sounded a trifle dull (on my Nakamichi ZX-9 reference) became very dull. There's no doubt that this machine would have benefited from better head adjustment, but all the same it gave a fairly clear and stable sound, full in body. Providing you had never heard what a Nakamichi can do to pre-recorded, you'd be satisfied with this result, if not ecstatic ●



The Sankyo Seiki transport is a good one.

themselves - as many are - came out sounding clear and balanced with Dolby engaged. Those properly balanced

CONCLUSION

In spite of its minor weaknesses, I have to say that in the final analysis I was impressed by the AD-F850. It gave fine recording quality with all tape types and managed fairly well with pre-recorded tapes, never becoming unacceptably muffled. At the price, which is almost painfully (for Aiwa that is!) low, this deck remains a real bargain I can recommend.

Aiwa AD-F850 £229.95
Aiwa U.K.
5 Heathrow Summit Centre,
West Drayton,
Middlesex UB7 0LY
Tel: 081 - 564 9446

MEASURED PERFORMANCE

Like its predecessor, the AD-F810 (tested in the May '94 issue), the new AD-F850 has more drift than many dual-capstan recorders. After running in, its Sankyo Seiki transport settled into a reasonably regular slow, cyclic speed variation, of a sort that may make itself known as watery pitch or even occasional slight wow on piano, for example. Otherwise, the 850's dual-capstan transport performed well, possessing little flutter, but some capstan and drift-related wow that measured around 0.08%, but peaked at 0.15%. This phenomenon degrades purity of tone a little, but the amount suffered was reasonably low. The transport Aiwa use is good, but not exceptional and, taking normal variability into account, much the same as that of the outgoing '810.

The head performance figures show, without any doubt, that the head is the same too. It's just as well, because both frequency response and overload values (MOLs and SATs) are all excellent; any change might have been for the worse. Aiwa have done well to keep this head, for it allows relatively high recording levels to be used, up to +6 or so on musical peaks with metals, for example. Variable bias affects metal tape frequency response too, so metals can be tuned in accurately. The deck is good enough to be used with Dolby B only on metal tapes, for best sound quality.

I was a little disappointed at the standard of head azimuth adjustment. Treble rolled off above 12kHz (-2dB point)

when it should have continued up to 20kHz. This will dull pre-recorded tapes, especially when Dolby B is switched in, since Dolby magnifies errors.

The Dolby system was well adjusted, but metal tape sensitivity needed correcting using the front panel Rec. Sensitivity control. Aiwa have yet to take up using the new IEC Type IV standard it seems (manufactured by TDK).

With adjustable bias, sensitivity and an innately flat frequency response that reaches right down to 12Hz, plus a good transport and fine head, the '850 offers a high standard of performance, albeit measurably no better than its predecessor.

NK

TEST RESULTS

REPLAY (pre-recorded tapes)
 Frequency response (-2dB) 30Hz-12kHz
 Speed accuracy +0.8%
 Hiss (70uS, Dolby out) -58dB

RECORDING (blank tapes)
 Frequency response (IEC Primary Refs.)
 ferric (IECI) 12Hz-16kHz
 chrome (IECII) 12Hz-15kHz
 metal (IECIV) 12Hz-19kHz

Separation (1kHz) -55dB
 Distortion (315Hz) 1.3%
 Hiss (70uS, Dolby out) -55dB
 Speed variations (DIN total) 0.08%
 Flutter energy (3-3.13kHz) -26dB

MOL/SAT	(IEC Refs)	315/10k
IEC I	(ferric)	+4.5dB/-5dB
IECII	(chrome)	+3.2dB/-4dB
IECIV	(metal)	+4.5dB/+0.5dB

Frequency Response

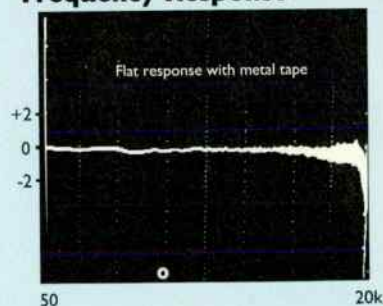

Speed Stability

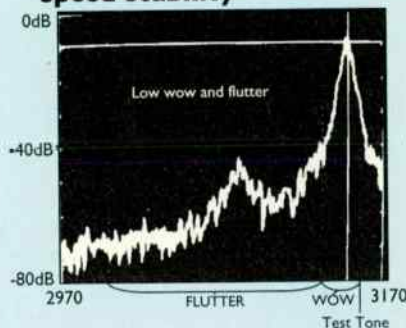



Experience live music

in your home.

Experience a personal service second to none.

At Sound Gallery we will help you tailor a hi-fi system that sounds exactly the way you want it, not the way you've been told it should sound.

Experience the options in the neutral conditions of our demonstration room, and the professional home installation of your desired system.

**FOR A SOUND EXPERIENCE
AND SOUND ADVICE, CALL**

**THE SOUND
GALLERY**

0494 531682

65 CASTLE STREET • HIGH WYCOMBE • BUCKS HP13 6RN

World Radio history



WALL STANDERS

We pick five loudspeakers suitable for near-wall placement. Dominic Baker listens and applies the tests.

Prompted by an increasing number of letters from readers who require loudspeakers that can be used close to, or with their backs against a wall, for this month's group

with an even, or falling bass response. These will have their bass boosted upwards when used as wall mounters, restoring the tonal balance. As you'd expect, the 'speakers best suited to this kind of positioning are small budget designs because of their small drive units/cabinets, both of which limit bass production.

One of the problems with using 'speakers against a wall is the reflex port. Many designers like to mount the port at the rear of the cabinet, out of sight. Unfortunately, at higher levels where the port is working hard and pumping a lot of air, this can cause a chuffing sound as the port blows against the wall. Even 'speakers ported through the front baffle can suffer this. Fortunately, there is a quick and simple remedy for the problem - a foam bung. A piece of foam lightly inserted into the port reduces the boost applied to the bass unit and the bass becomes more controlled. The tighter the bung, the more taut and dry the bass will become.

The five finally selected for this test range from £169 to £770 in the form supplied. The first four fall into a tight group, starting with the £169 Celestion 5 MkIIs and jumping in small steps of £30-£40 through the Richard Allan Minette Golds and Mission 780SEs, up to the £279 Castle Durham 900s. However, the Richard Allans were supplied in a real wood veneer at a price of £199, £50 extra over black, and even further savings can be made if they are purchased direct

from the factory, making them just £109.

At the top end we lined up a pair of Acoustic Energy AEs. These are a high tech. miniature, using a unique metal-coned bass driver and metal dome tweeter. They were regarded as a reference for all other miniatures to be judged against when first launched in the late eighties, possessing superb clarity and power handling for their



test we've chosen to select five pairs that will work best in this position. They were selected using a combination of measurement to assess which ones had the most suitable balance for wall mounting, and then subjectively to make sure that they could actually perform in such a position.

When a loudspeaker is placed in close proximity to a wall, bass is lifted or reinforced both by reflection and the 'speaker setting off the room's natural resonant modes. For more on this, see Noel's column on page 61. Using measurement, I selected loudspeakers

size, and they are still going strong today.

So there we have it, five loudspeakers selected to give their best when wall mounted. The system used for this test comprised an Arcam Delta 250 transport sync-locked to a Black Box 50 convertor and feeding an Audiolab 8000C pre-amplifier and 8000M monoblock power amplifiers ●

The AE I's first appeared on the hi-fi scene at the end of the eighties, when muscular power amplifiers were common and in vogue. They used a metal dome tweeter, essential at the time if you were to be taken seriously. But Acoustic Energy went one step further, using a custom metal-coned bass driver as well. The result was a mini-monitor capable of handling large numbers of watts, which was just as well, 'cause they needed quite a few to get their heavy metal cones going in the first place.

They are still going strong today, and few have tried to follow them. One of the advantages of using a metal coned bass unit is that the metal dome tweeter becomes less obvious, both units having the same tonal character. This helps give them a cohesive sound, where many others trying to combine a metal dome with a plastic cone have failed.

The AE I's we were supplied for this test came in a rich, real wood veneer, looking mean and purposeful, with their twin reflex ports and pointed dust cap on the bass driver. Around the back are chunky gold plated terminals which allow bi-wiring, mounted on sturdy cabinets.

SOUND QUALITY

The AE I's coped very well against a rear wall, bass staying taut and controlled even under the pressure of heavy bass lines. The treble could be a little too bright and sibilant for some tastes and had a tendency to linger on for one note too long, resonating uncontrollably with the crash of cymbals, for instance. But, having said that, it never became harsh,

and the speakers seemed to be more balanced at higher levels when the bass unit was working harder.

Although the bass wasn't especially deep, even hard up against a wall, it was firm and punchy and, with a powerful transistor amplifier, fast enough to steer clear of excessive overhang. The midrange of the AE I's could become overwhelmed by the bright treble and reasonably powerful bass, but was actually very clean and well focused. I felt that it could do with being pushed forwards just a bit further, but as they stand they are easy to listen to and certainly couldn't be accused of being over-intense.

The AE I's aren't a particularly subtle loudspeaker; they are best suited to loud rock and pop than anything requiring more finesse. The Inspiral Carpets' new album Devil Hopping provided just the kind of music that shows the AE I's off: cleanly hit cymbals, melodic bass line and Hammond organ to show how smooth the midband can sound. You do get a feeling though that low level detail is being masked by the heavy metal drive units.

Primal Scream's Give Out But Don't Give Up gave the AE I's something to get their teeth into. They seemed to enjoy themselves more and more as the volume was turned up, opening out and speeding up. Helped by their compact size, the AE I's were quite adept at conjuring up a good, full soundstage with a strong central images. Bobby Gillespie was confidently given centre stage on '(I'm Gonna) Cry Myself Blind', his vocals sounding well focused and free from box

colouration, thanks to the small, rigidly built cabinets.

CONCLUSION

At the end of the day the AE I's are a good little speaker for those who like punchy, loud rock. I enjoyed listening to them, but when you walk away there is a feeling of emptiness. They do their job, and do it well, but there is little emotion to be found in their performance. They're a little bland, the metal cones giving the sound a cold and clean character that was uninvolved ●

MEASURED PERFORMANCE

The AE I has a frequency response that should suit wall mounting. On our tall measurement stands they had falling bass and a raised midband and treble, so once against a wall where bass is reinforced these speakers should balance out well. Front firing ports allow their backs to be put against a wall. They can be filled with foam to give a suitable bass balance.

The strong response lift through the upper midband and treble regions will give the AE I's a bright balance and should help to push vocals out of the box, so they are unlikely to sound closed in on a bookshelf. There are no sharp peaks in the response, but the raised treble may be audible, especially as a metal dome tweeter is used.

Where the AE I's suffer though, is in sensitivity. At 82.5dB they'll need a powerful (70watts) amplifier for high levels. This low sensitivity is the price you pay for heavy metal cones. But they have a high overall impedance of 13.5Ω, so although the amplifier will have to supply a lot of volts, relatively little current is required, easing its load.

The impedance curve is also very flat, suggesting that the AE I's are a mainly resistive load suitable for low or zero feedback amplifiers. **DB**

**ACOUSTIC ENERGY
AE1 £770.00**



Frequency Response

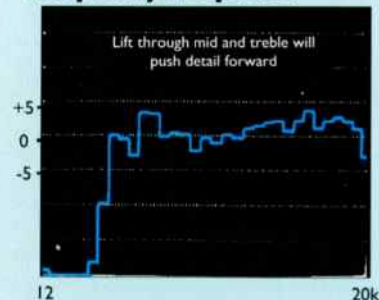

Impedance

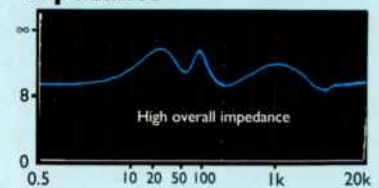

The new Celestion 5 MkIIs fall into the middle of the company's budget range of loudspeakers. Priced at £169 they also fall into the middle of this group test, so they should provide a good bench-mark for the others.

They are a compact, two-way design using a 25mm metal dome tweeter and a soft paper cone. The tweeter has only a three-spoked plastic guard which leaves a lot of the bare metal dome exposed, so beware if you have inquisitive children or pets. The bass unit has a soft, fibrous texture to it around the dust cap in the centre, the paper getting harder to the feel towards the outer edge. Presumably this is to give a smoother sound to the midrange which radiates from the centre of the cone whilst retaining the stiffness needed for lower frequencies.

The bass unit is reflex loaded with a small port on the rear baffle, so a light foam bung will have to be used for back-to-the-wall placement. The 5s aren't bi-wired, but a chunky set of binding posts can accept either 4mm plugs or heavy gauge bare wire.

SOUND QUALITY

I was very impressed by the new 5 MkIIs, especially considering their competitive price tag. The treble had a lovely open, detailed and delicate character to it. Primal Scream's '(I'm Gonna) Cry Myself Blind' brought out the best in them, with its crisp steel strung guitars and vocal harmonies.

The 5s have a bright and lively

presentation, one that suits acoustic music down to the ground. But although they are bright, and Celestion have chosen to use a metal dome tweeter, they managed to avoid sharpness, even when driven hard with our solid state power amplifiers. In fact, they gave cymbals and other high frequency information a sweet and gentle balance.

Moving downwards, the midrange was also surprisingly good. Vocals lost just a little body and depth, but were clear and well focused. They were also smooth and detailed, and not too hard or forward so as to put you on the edge of the seat.

Bass also had good qualities, being firm and rhythmic. The rear firing ports did need to be lightly stuffed, to avoid boom, but otherwise they gave a fuss free performance. The bass wasn't that deep at all, but the upper bass punch, clarity through the mid band and sweetness in the treble made up for it.

The soundstage conjured up by the 5 MkIIs was also reasonable, having a spacious and open atmosphere. Enough in fact to give The Blue Aeroplanes' new album *Life Model* the scale and gusto it needed, even if the bass was somewhat scaled down in comparison to the rest of the performance.

Although the 5s didn't image particularly well, at least Gerard Langley was given a strong, central stage image. Again there wasn't much depth to the stage, but this is a result of the compromise of positioning the 'speakers against a rear wall.

CONCLUSION

I was impressed, no, surprised by the new 5 MkIIs. They had one of the most enjoyable and well balanced sounds in the group: not too bright, not too dull. They had a lovely spaciousness to them which helped to open music outwards to fill the room. Treble was detailed, mid smooth and bass firm. They could have done with a little more power in the lower registers, but then again, they're only £169, and a bargain at that ●

MEASURED PERFORMANCE

Celestion's new 5 MkIIs have a well engineered frequency response. Although it is quite obvious where the tweeter comes in, at least the treble has a downward trend; rising treble from a metal dome tweeter is often subjectively unpleasant. There is a shallow dip in the mid which will give the speakers a soft character, but the dip doesn't appear strong enough to prevent midrange detail projecting well. Bass doesn't go especially deep, but wall reinforcement should rectify this.

The new 5s are of above average sensitivity: I measured 88dB at 1m for a 2.83volt (nominal watt) pink noise signal. This means that the 5s will go louder than most speakers at any particular volume setting. The impedance curve is quite a lumpy one, showing the 5s to be a strongly reactive load. But the curve sits high up, giving a high overall impedance of 11Ω. The 5 MkIIs will not draw much current from an amplifier, which is a good thing, because they will doubtless be used with low power budget integrations.

Overall the new 5 MkIIs measure very well, combining high sensitivity and impedance with a smooth and well tailored response. **DB**

CELESTION 5 MKII £169.00



Frequency Response

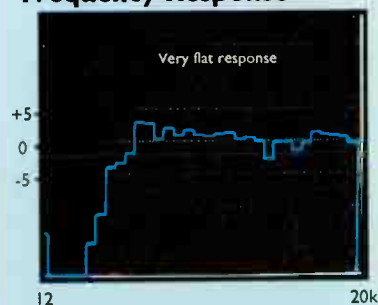

Impedance

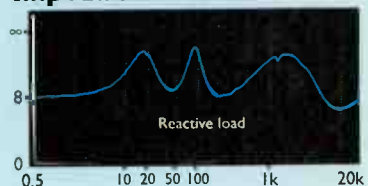

New life has been injected into Castle recently - hardly a month goes past without another new loudspeaker being announced; the latest is the Durham 900. Their excuse for this one? The 900th Anniversary of Durham Cathedral.

Anyway, who could complain? You get a two-way 'speaker sold in mirror image pairs, good sensitivity, stylish looks and all for £279. They're well finished too, our pair sporting a well polished, real wood, mahogany veneer. The 900s are quite large for a bookshelf 'speaker, but small enough to go on stands with their backs to the wall.

The bass unit is a 5inch polypropylene affair, loaded by a small diameter, short, front-firing reflex port. This small, sensitive bass unit should be fast enough to give good, clean bass, free from overhang. The tweeter diaphragm is made from a soft plastic, so I'd expect smooth treble and good integration with the similar material of the bass unit. They're bi-wireable too, via a chunky set of gold plated binding posts.

SOUND QUALITY

The Durham 900s have a lovely rich and deep bass when used against a rear wall. Bass went down deep enough but was solid enough to play fundamentals in a tuneful yet powerful manner. The 900s have real slam to their bass when it's needed, and there's plenty of upper bass, punch to convey speed and tempo in a performance.

The deep bass line, spiraling Hammond organ and short, damped punctuation of

cymbals on Inspiral Carpets' 'The Way the Light Falls' gelled together to form a lively, energetic and thoroughly enjoyable performance.

Castle's Durham 900s have a detailed and clearly focused midrange too, I found. Vocals emerge with a natural character and have a tonal neutrality to them that few speakers in the test could match. Lead singers were reproduced in a solid and believable manner, with plenty of body and depth to them.

The military-march tempo of the snare drum and the sharply plucked guitar strings of REM's 'King of Birds' had good atmosphere and space around it. The Castles are coherent and well focused in this respect, allowing instruments to play in their own space without becoming confused. This allows the listener to follow individual instruments through the track with ease, making the whole performance seem more realistic.

Treble of the 900s was bright and open and the midband quite forward. This emphasis in the upper mid/lower treble does tend to push detail at you, making the Durham 900s possibly a little intense for some peoples' taste. However, although their balance was bright and detailed, they sounded clean and tuneful in the treble which gives them a fast and lively nature.

Although the Durham 900s come as a handed pair, with mirror-image offset tweeters, the soundstage and solidity of stereo images within it wasn't as good as that of the AEs. Although the soundstage wasn't as expansive as the best in the class, it was reasonable in view of the fact that I was using them hard up against a wall,

which does tend to compromise matters in this area.

CONCLUSION

Overall, I found Castle's Durham 900s highly enjoyable and involving to listen to. Although quite forward in their delivery, I was comfortable sitting in front of them for many hours, and the bass was especially solid and deep for their size. They may be a little too lively for some tastes, but I enjoyed the extra energy and effort they seem to put into the music they were reproducing ●

MEASURED PERFORMANCE

Castle's Durham 900s have one of the flattest frequency responses in the group, so I'd expect them to sound tonally neutral and smooth as a result. There's a slightly raised peak in the treble, but only by 1dB or so, so it shouldn't do much other than add a little sparkle, especially as a good soft dome tweeter is used.

On our tall measurement stand, bass rolled off smoothly, so the Durhams should suit near wall placement well, the bass being reinforced upwards towards flatness in such a position. The port is also front firing, so they can go back-to-the-wall, and the front port plugged with foam should one bass become too heavy.

The Durham 900s are quite sensitive considering their small size. I measured 87dB at 1m using a nominal watt (2.83V) of pink noise. This means that they will go loud with relatively few watts.

Overall impedance is high at 9.5Ω so the '900s will not demand much current either. The impedance curve suggests that these speakers are a reactive load, but it doesn't dip below 5Ω, so most transistor amplifiers of around 30watts or so should drive the '900s with ease. **DB**

CASTLE DURHAM 900
£279.00



Frequency Response

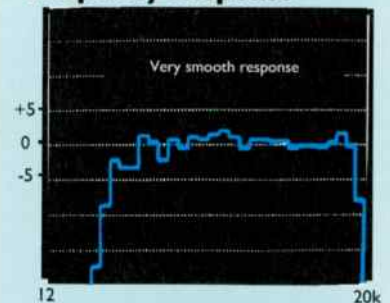

Impedance

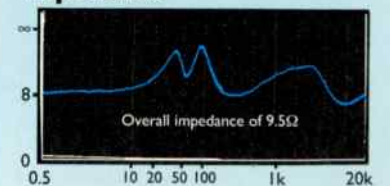

Mission's 780SE is a tweaked up version of the standard 780. Extras include chunky 4mm gold knurled bi-wire terminals and improved internal wiring and crossover. Mission loudspeakers always work well against a wall, only the bigger floorstanders coming into their own in free space.

The 780SEs come in Mission's attractive and high-tech styled black ash cabinets, with moulded front baffle and grille. Many manufacturers could learn a lot from the way Mission style their products. The 780s look neat and business-like, but also mean and powerful. You can certainly see why they are so popular with such a wide audience.

These speakers are a ported design, the port firing forwards, allowing the back to be pushed firmly against a rear wall. The bass unit is a small doped paper cone and the tweeter Mission's 18mm fabric dome. These should give a natural tonal balance and the sturdy cabinet will help to keep the sound free from box colourations.

SOUND QUALITY

As I found when I first listened to the 780SEs, back in February, they have a heavy, almost veiled colouration. Placed with their backs against the rear wall, they became sluggish and unexciting to listen to. Fortunately a light foam bung cured this, limiting the boost applied by the reflex port. In this form they coped admirably even with the strong bass line of John Lee Hooker's 'Same Old Blues Again', managing to reproduce much of the power without becoming overblown in the bass.

They have plenty of upper bass speed and punch which helps to give good subjective speed and attack to tracks like this. The Missions don't go especially deep though; I noticed a lack of really deep fundamentals, but this is not surprising considering the size of the bass unit and box.

The midrange had good focus and depth to it; there was a little colouration which took some of the sharpness and attack away from lead electric guitar, but otherwise I found it clean sounding and tonally balanced. The twisted expression in Bjork's voice, and nervous character of Belly's Tanya Donnelly were conveyed well, the 780s projecting vocals forward enough to convey such information.

The treble of these speakers - unlike most others in this test - wasn't forward or emphasised in any way. Direct comparison to their rivals made them sound less open and spacious, but on the other hand they had a more laid back and relaxing presentation, maybe even smoother. Although not as precise as, say, the Durham 900s in this respect, the Missions still managed to produce a detailed and enjoyable sound. Hard hit cymbals on Magnapop's Hot Boxing album naturally sprang out, but the violence behind their portrayal lay in the performance, not in its conveyance - a problem with lesser drive units.

Good upper bass punch added much to this kind of vibrant rock, maintaining tempo and enhancing slam. The weighty nature of the 780s sound helped this recording in particular, which could sound thin and compressed with 'speakers of a

lighter balance like the AE1s.

CONCLUSION

The Missions needed a little tweaking to get the best from them up against a rear wall, but the effort was worth it. They are a very inoffensive sounding 'speaker and will find many friends because of it. However, for me their treble was just a little too soft. A touch more sparkle could usefully be introduced to give the 780SEs a more exciting and lively balance. They could be a very good partner for a bright sounding system though ●

MEASURED PERFORMANCE

The frequency response of the Mission 780SEs explains their subjective qualities. Treble level is slightly low and there is a dip through the mid range, which gives them a soft and inoffensive sound, but can also lead to dullness. Otherwise the response is smooth, with no lumps visible in the response of each of the individual drive units. Bass, again, doesn't go especially deep, but it is flat and will be bolstered nicely by wall reinforcement.

The 780SEs are of just above average sensitivity, measuring 87dB at 1m with a 2.83V pink noise signal. Overall impedance measured 7.8Ω which, although seeming right, is actually low by current standards, as comparison with others in this report shows. The impedance curve itself starts off very low down, around 4Ω through the bass, so for good solid bass partnering amplifiers must be able to deliver current into a 4Ω load. Most modern transistor amps can; I'd recommend a minimum of 30 watts for good results from the 780s.

Overall the 780SEs are reasonably well engineered. They will sound softer than those that measure flat, but that's not always a bad thing. **DB**

MISSION 780SE

£239.90



Frequency Response



Impedance

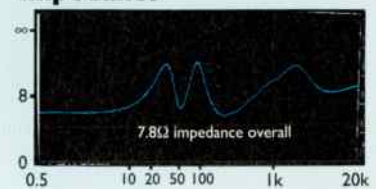

The Minettes were Richard Allan's answer to Mission's 760is, and these, the Minette Golds, are their reply to the popular 760iSE. Like the 760iSEs, the Minette Golds are identical to the standard Minettes, but with better internal wiring and bi-wireable terminals.

A number of finishes are available, ours coming in a Mahogany veneer at £199, but standard black ash costs £50 less. There is also an authracite "Magnatex" finish, which basically translated is grey, to match your TV set should you wish to use these for AV.

The bass unit has a small paper cone, with a supple foam surround. The small size should give it good midrange detail and speed in the bass. This unit is reflex loaded by a small port in the rear baffle, so a foam bung may be necessary when used hard up against a wall. The tweeter is a polymer cell unit, these usually combining high sensitivity with clean treble.

SOUND QUALITY

The polymer cell tweeter instantly made itself known with the Minette Golds. They have a very clean and undistorted sound, which is surprising because these tweeters are not expensive to make. Cymbals leapt from the Minettes with real verve, whilst remaining sweet and tolerable, even at high levels. The treble of these speakers was amongst the most articulate and extended in the group, which considering price is quite a surprise.

The bass was also very good in many ways, staying taut and dry with all but the heaviest of bass tracks. It wasn't especially

deep, as you'd expect from such a small cabinet and driver, but there was enough of it to give the sound good apparent balance. The rear firing reflex port does need to be lightly stuffed with foam if you intend to use them hard up against a wall, but 5-10cms away it can be left unfilled. In this position only the strongest bass, such as the fully blown bass guitar behind John Lee Hooker played at high levels will provoke a chuff from the ports.

In the midrange the Minettes were detailed and had a natural tone that suited acoustic music well, but the sound was also box-bound, lacking the sort of projection I'd have liked. Sadly, this detracted from the performance somewhat. With the new Inspiral Carpets album, the Hammond organ and Tom Hingley's vocals failed to reach me in quite the same way as they did with, say, the Durham 900s or AE1s.

They did cope well with the deep, funky bass lines of Primal Scream, giving them the kick needed. Again, the midrange was reserved, highlighting the bass-thud/treble-sparkle character. The Minettes could become messy at times as well, especially with frantic and energetic rock such as this.

Interestingly, female vocals managed to project far better than I'd have imagined. Denise Johnson sounded just right, silky smooth and forward enough to get away from the box, but without pinning me to the far wall. The Minettes managed to produce a good soundstage as well, not especially deep or tall, but wide enough to give scale to a recording. Instruments were vaguely placed within this

soundstage, but imaging isn't helped by close wall proximity.

CONCLUSION

If you're looking for a good wall mounter on a budget, one that'll give you clean treble and taut and dry bass, then the Minette Golds are certainly worth listening to. They don't throw detail at you in the same way as many of the other speakers in this test can, but they do have a clear and precise sound. Possibly better suited to light acoustic music rather than heavy rock, they have a nice blend of qualities ●

MEASURED PERFORMANCE

At first I thought the Minette Golds were wired with their tweeter out of phase, so bad was the suck-out between midband and treble. But after reversing the tweeter phase and seeing things get worse I can only assume that it's the crossover to blame. Treble output is 3-4dB higher than the midband and this, along with the crossover suck-out, will make it rather obvious as a separate sonic entity.

However, as a wall mounter, the response is at least heading in the right direction. With the reinforcement of a wall to lift bass level, the result should more closely resemble a flat response. The Minettes do have a rear firing port though, so if they are to be used very close to a rear wall it'd be wise to use a foam bung to limit the port's output.

Considering that the Minettes use lightweight paper bass units and sensitive polymer dome tweeters they aren't very sensitive. I measured a low 84dB SPL for 1watt (2.8V). So even though they're a budget 'speaker at heart, they'll need a reasonably powerful amplifier to drive them. Impedance is high overall at 10Ω so they shouldn't need much current. I recommend a 40-50watt transistor amplifier. **DB**

Richard Allan Minette Gold £199.00



Frequency Response

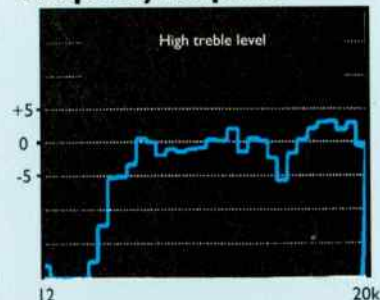

Impedance

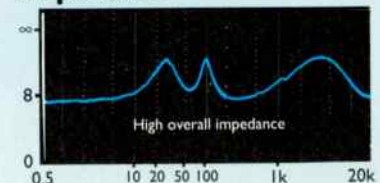

GROUP TEST CONCLUSION

Very few speakers are designed for near-wall placement, for good reasons. Although it is probably the situation that most loudspeakers in a domestic environment end up in, it is possibly the worst



position for quality sound. Against a wall a loudspeaker is positioned where it can drive the room most efficiently. In this position you are hearing more of the room's effects and less of what the 'speaker is actually doing. Additionally, sound stage depth and the ability to image precisely are also compromised as high frequency sound is radiated off the hard surface close to, and between the loudspeakers.

So don't expect a neutral or dry bass and terrific stage depth, but, as with all things in life, there's another side to the equation. Because the room is being used to reinforce bass, smaller, lighter and faster drive units can be used for the same level or depth of bass. This gives them a punchy and lively presentation, even though you must expect the bass to be a bit uneven sounding.

The five speakers we

finally picked, out of a group of eleven, all did well when positioned against the wall of our listening room. One tip to remember though if you are using your 'speakers against a wall, is that plugging the ports of bass reflex designs will make the bass drier, more controlled and less boomy.

Of the five, Celestion's new 5 MkII's were the biggest shock. For £169 these

'speakers really are a bargain, having a sweet and open sound that made most of the others in the test sound slow and muggy in comparison. Their bass had a lovely quality to it too, not very deep, but tuneful and firm in the upper bass, which gave them plenty of energy. I rate these top of

the group, and not just for value; they really were an enjoyable listen.

Second place I'd give to Castle's Durham 900s. Good quality drive units and super cabinet work combined with competent engineering give these speakers a real quality feel. They sounded good too, having a rich and full-bodied sound with plenty of impact in the bass. Although characterful in their presentation they managed to remain clean and open in the mid-range, with good projection.



Of the three left, the Mission 780SEs scored highest as far as I was concerned. They had good upper bass attack and the treble was detailed without being bright, which many will find a little more relaxing. A little thickness in the midband could be heard, but moving them out from the walls by just a couple of inches makes this only a minor gripe.

Out of the remaining two models, it is hard to say which I preferred most. The AEs are undoubtedly better in terms of providing a balanced sound and absolute fidelity, but they're seven times the price of the Minette Golds' factory direct price. Neither really impressed me though. The AEs were clean, but bland and the Minettes sounded like what they are - a small box 'speaker. They had a precise and detailed treble, but mid-range detail failed to project and their bass was dry even against a wall ●

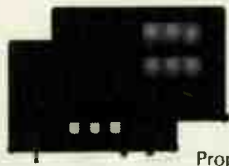

Prophet



Genesis



Unisis

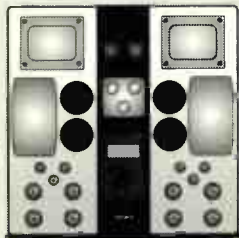

Synergy

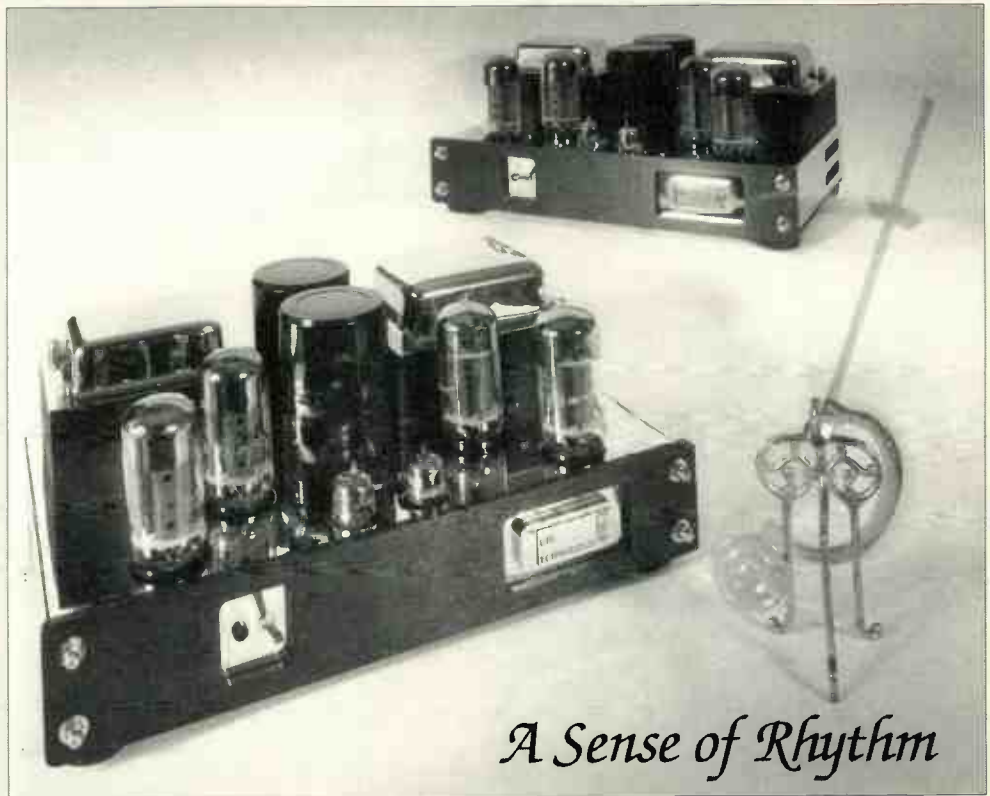

A Sense of Rhythm

Tube Technology & Manufacturers of High Quality Tube Amplification & Distributors of Gold Aero Vacuum Tubes. Please enquire for further information on our range of amplifiers and Vacuum Tubes. ~ Foxhills Farm, Longcross Road, Ottershore, Surrey. KT16 0DN, England. Tel: 0932 87444 Fax: 0932 87 012 ~ Pictured; *The Genesis 100 watt All Tube monoblocs.*

SYSTEM LOUDSPEAKERS

"EVEN A SHORT LISTEN TO THESE WELL BUILT SPEAKERS FROM
THE SCOTTISH COMPANY BEST KNOWN FOR TURNTABLES
WILL TELL YOU THEY'RE SPECIAL"

WHAT HI-FI? February 1994

SYSTEMEK LTD. IRVINE HA12 8LD SCOTLAND U.K. TEL 0294 271251 FAX 0294 277095



GEORGY N. GLAZKOV (left) from the Novosibirsk Electrovacuum Plant, Russia, proudly holds a modern Sovtek valve. This factory alone employs 3,000 people, making a wide variety of electrical items in addition to valves. Russia's largest plant is at Saratov, where they make 5881s, but the St. Petersburg factory also supplies the West. In all, Russia has seven factories producing valves, say P.M. Components.

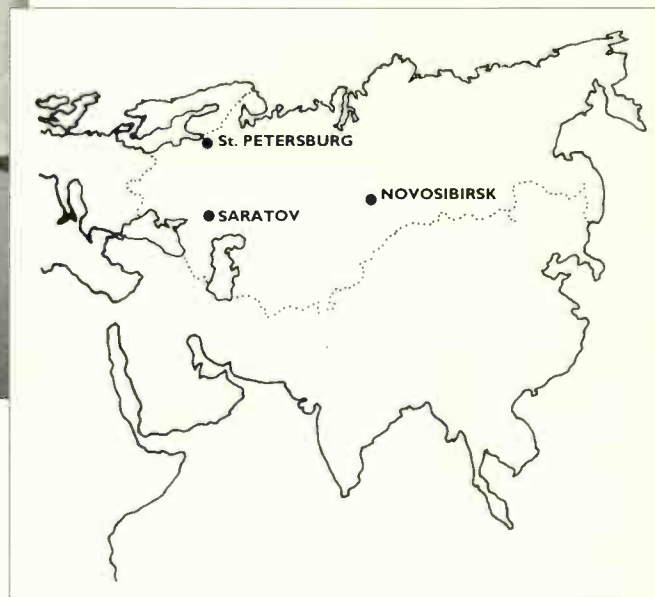

NEW WINE FROM OLD BOTTLES

Recently, two valve manufacturers shut up shop for good. Could valve amplifiers disappear through lack of valves? Noel Keywood talks about the travails of a little known industry.

Andy and I looked glumly at the blue sparks jumping around inside. "That means a re-design. These new valves just can't match the new old ones," I said,

watching the firework display going on inside a GZ34 rectifier sitting in front of us. This was a new valve, collapsing in front of us after a few weeks' hard running; there had previously been no

problem with 'old' valves. Today's valve manufacturers have difficulty producing new valves that match the performance of old ones. With factories closing down, will the situation get worse?

"Please," said the voice from Hong Kong, "can you find me an original EL34? Please fax price." He was nearest to the Chinese factory still making them; we were nearest to the company that made the original and one of the best: Philips. This well illustrates the dilemma faced by enthusiasts around the world, including us as we stared at the collapsing GZ34 and the prospect of a re-design: do you rely on inexpensive, but possibly unreliable new valves, or do you search worldwide for high quality originals? And why can't today's plants match the quality standards of yesterday's?

TURNTABLES tonearms & cartridges FOR THE LOVE of music

To hear the dynamics and explosive power of Tchaikovsky's 1812 Overture, your HI-FI system comes from Audiofreaks. For your final choice of analogue front end components we have selected a few of the very best.

VPI turntables and record cleaning machines, the unsurpassed WHEATON Tri-Planar IV tonearm, BENZ-MICRO state-of-the-art moving-coil cartridges and the latest wonder - EXPRESSIVE TECHNOLOGIES SU-1 step-up transformer with matching interconnect cables IC-1 and IC-2. The first and only MC transformer that works.

AUDIOFREAKS

15, Link Way, Ham, Surrey TW10 7QT.
Tel: 081. 948 4153 Fax: 081. 948 4250.



? Do you seriously listen to music.
? Can you remember what a real piano sounds like.
? Having problems getting the orchestra into the living room.
If the answer to the above is "yes" then the sheer transparency and performance of the Kinshaw perception and overture ranges are for you.

A range of pre-amplifiers, phono centres, DAC's and amplifiers for those who listen with their ears and then buy the best that they have heard.

Ask your specialist retailer for an audition - it will save you the cost of making the wrong choice.

From the 'school' of British audio design but in a 'class' of its own.

Contact your nearest retailer for an audition or for more information ...

Overseas agent:
Kronos Distribution
35 Furlough Road
Newmills, Dungannon
N. Ireland BT71 4DU
Tel: +44 (0)8687 48632
Fax: +44 (0)8687 48281

U.K. agent:
Ortofon (UK) Ltd.
Chiltern Hill
Chalfont St. Peter
Bucks. SL9 9UG
Tel: 0753 889949
Fax: 0753 889636

KINSHAW

Conceptual Design - Sound Engineering

Kinshaw Electronics Ltd. 84 Pendarves Street, Tuckingmill, Carrborne, Cornwall TR14 8RE Fax: +44 (0)208 711939

LOOKS LIKE
NO OTHER...
SOUNDS LIKE
NO OTHER...
SOUNDS LIKE
NOTHING
AT ALL.
THE BEST IN
THE WORLD.

XLO
ELECTRIC

Interconnects and
Speaker Cables.
Made in USA

Available exclusively
from Wollaton Audio and
selected dealers.

WOLLATON
A.U.D.I.O.
tel/fax: 0602 284147
Dealer enquiries welcome.

Neil Ramsden 0535 606086



Open Mon-Sat 9am - 5.30pm. Closed Sun.
COMPLETE RECORD SERVICE
Ground 35 Cavendish Street, Knightley, SO21 2DQ

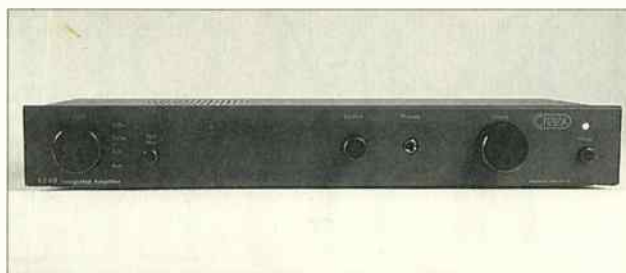

First record store to carry the superb
Creek 4240

"Don't be up the paddle without a Creek"

Neil Ramsden

Also
VINYL, LASERDISC, (NTSC/PAL), CD's, CASSETTES,
NTSC VIDEO, IMPORT SERVICE, INTERNATIONAL
MAIL ORDER, LP CLEANING, SEPARATE MAINS
SUPPLY INSTALLATIONS, SOUNDSTYLE FURNITURE.

There is a fairly solid revival in interest and demand for audio valves, most notably in the East, especially in Taiwan, Hong Kong and Japan. These markets have a generally keener appreciation of audio history and technology than those in Europe, and there's a large body of interest in the States too. Put them all together and you get enough demand to support four valve warehouses in Britain alone, not to mention a network of lesser dealers who scour the country looking for forgotten hoards that may be held by private individuals, the Ministry of Defence or some company making a stock clearance.



Whilst private dealers generally specialise in rooting out 'new' old valves or, in other words, valves manufactured perhaps over thirty years ago by major manufacturers like Mullard and held in stock, unused ever since, the larger warehouses need a less erratic and more dependable source of supply to supplement the 'old' stocks they all hold. For this they turn to the few valve manufacturing plants left in the world.

Current valve manufacturing plants lie mainly in the Eastern Bloc: in Russia (7), in Hungary (Tungsram), Czechoslovakia (Tesla), Yugoslavia (EI), China (Shuguang, etc) and in the U.S.A. Their output reaches the world's markets by various means and routes. The quality of their products varies which, to a fastidious market short of reliable information, gives rise to a trade in which both fear and fashion play a part. Are Chinese valves unreliable? Are Russian valves better? Can either match original valves from manufacturers like Mullard? And where do the Americans figure? Here are our experiences to date.

The Chinese factories, we are told, use valve manufacturing equipment imported from Russia. Some of the difficulties of valve manufacture continue, it appears, to cause problems, through lack of appreciation of quality control, poor raw materials and ageing or inadequate production equipment. For

example, valves need a high vacuum which has to be achieved during manufacture and maintained during their service life (typically 2000-10,000 hours). Even if a satisfactory vacuum is achieved initially, through pumping and ignition of the getter, occluded gases in the metal electrodes and glass enter the vacuum over time, especially if heat treatment to drive them out before the valve is sealed is perfunctory, or the metal-to-glass seal around the pins leaks, due to unmatched co-efficients of expansion between the glass and pin materials.

Valves are a triumph of materials technology and carefully controlled production processes. Their manufacture is difficult and not especially suited to factories facing difficulties of materials and machinery supply. U.S. manufacturer MPD (ex-Kentucky Radio, owned by GE) crystallised this need for specialised knowledge, saying "We maintain a unique capacity to fabricate devices comprised many small parts where careful, precise spacing is

required and where chemical control of confined gases and coated substrates is crucial."

Sadly, MPD admitted defeat in 1993, manufacturing their last 6550A power tube before closing down production for good. Charles Mattingly of MPD believes conditions could never again support the opening of a new valve factory: "the small remaining market would make it impossible to justify the expense of building the furnaces, vacuum machinery and other specialised equipment to produce tubes. Similarly, it would be prohibitively expensive to order the special metal alloys for cathodes and other internal parts."

Is this the case? Or did MPD simply fail to understand the market and sell into it? Valves continue to be popular in guitar and music PA amplifiers (e.g. Marshall amps), which accounts for much of the market. Their re-emergence in hi-fi is slow but, at present, steady. It is helped by a universal desire for distinctive, often 'branded' goods to replace bland,

mass produced items. Rolex watches, Gucci bags and Porsche cars are joined by Japanese Audionote valve amplifiers, ranging in price from £600-£137,000. Although sensitive to economic conditions and disposable income, it's unlikely that demand for such items will wane.

The Russians understand current demand for their valves, but volumes are apparently still insufficient to justify expansion. This may slowly change as other traditional manufacturers close down, however. In addition to MPD, Tungsram, Tesla and EI have all recently either ceased full time production or have left the market for other reasons, removing large amounts of manufacturing capacity.

We, like others, have found that some of today's valves are hampered by reliability problems. The GZ34 is a relatively modern, high performance rectifier designed in the fifties. Running original Mullard GZ34 rectifier valves flat out at their maximum rating of 550V to test for durability, we'd experienced no problems. But there are very few original Mullard GZ34s left, forcing us to use modern production versions. The blue sparks told us they lasted just a few weeks if run hard like this, and that we couldn't rely on either Russian or Chinese GZ34s to meet the 550V rating originally quoted by Mullard. This sort of problem has undermined the reputation of today's valves amongst enthusiasts, even though less critical designs like the 5881 and 300B in our experience work well and are durable.

Will valve manufacture eventually cease worldwide? Peter Qvortrup of Audionote told us "In Russia, valve manufacture will definitely continue - they need the currency and they produce a very good product. The Chinese have not mastered the art; they need to sort out their problems. Otherwise, there are small operations, like Cetron in the United States and Vaic in Czechoslovakia that are specialist low volume

manufacturers who may well represent the future for the specialist audio valve. But don't forget that anyone who makes a cathode ray tube for TVs or test equipment has the capability to manufacture valves and they are still needed by the military. As demand increases I believe we may well see low volume manufacture of high quality audio valves like 300Bs restart, possibly even in Britain" ●





surface mount components. Deltec (now DPA) were amongst the first to turn to surface mount technology (SMT) for improved sound quality, since it reduces path lengths, cuts out component leads and improves solder joint consistency and quality. Again though, the appearance of SMT doesn't guarantee anything, because it also offers reduced build times and much smaller circuit boards, meaning it holds attractions to the big boys too, but for entirely different reasons. There are good SMT products, from DPA and Pink Triangle for example, and budget ones, from Philips and Sony, for example. Quite how these plus points and minus points balance out in the final product can only be determined by listening tests.

Being meant primarily for remote control use, the Majik-I must be operated by front panel keys if the handset goes walkies. Volume is

controlled by Up/Down buttons and covers a 60dB range. A green LED display shows level in dBs and, I noticed, the amplifier switches on at a 30dB setting, so even with CD playing, which gives relatively high output as sources go, and high sensitivity speakers connected (90dB for 2.8V), the amplifier won't blow your head off. If it does sound too loud though, it can be reconfigured to switch on at 15.

Also remotely controllable are balance, input selection, mono, record selection and muting. All these functions can be accessed by the front panel buttons too, but the display - like so many - gives various abbreviations that are not transparently obvious, but the handbook lists them clearly.

The Majik-I is available with or without a phono module; ours came with one fitted. The module offers moving coil and moving magnet options as standard, but Linn recommend the dealer swops the single internal bridging link. With it fitted there are five line inputs, two sets of loudspeaker outputs and a pre/power amplifier split for bi-amping, future upgrading, or the use of a Kaber active crossover. It will also take 'Sneaky' add-on modules, examples being a tuner or line driver for driving amplifiers in a multi-room system. Linn, like Meridian, currently believe there's a good future in multi-room systems because, of course, much more product is required. I would have thought the Majik's low power output would limit it in this role, however.

Linn have built the Majik-I well, using relatively thick mild steel to give it a heavy, solid feel. Its styling can only be described as black-box perfection, though, and whether this constitutes styling or its complete absence must lie in the eye of the beholder.

Ivor's I

Ivor Tiefenbrun, founder of Linn products, sends us his pun-layden Majik-I amplifier for review.

Noel Keyword sees the joke.

Older readers will see the pun immediately, but this surely is as close as Linn will ever get to valves! A 'magic eye' is a special valve that acts as an indicator, giving an attractive blue glow - something every Troughline owner is well acquainted with. How I wished Linn had fitted a real EM84 to the Majik-I - then the joke would have been complete.

Instead, the major feature of Linn's new integrated amplifier is remote control. "Nothing new in that" I hear you say, and you'd be right. But it is something of a departure for Linn, who've traditionally been apparently too purist to use the sort of electronic volume control chips that remote control operation demands. The only alternative, adopted commonly by the Japanese, is the use of a motorised volume control.

Any truly transparent amplifier will reveal the subtle colourations that individual components possess, including electronic gain control chips and attenuators. However, the question is always one of degree: how much will the sound be degraded? A handful of cheap capacitors, especially electrolytics can do

just as much, or more damage, which is why some apparently dedicated hi-fi amplifiers sound muggy and ill-defined. This was brought home to me forcefully some time ago when developing an amplifier. A 'weekend' prototype, knocked up quickly to check basic circuit behaviour, was built from parts bought early one Saturday morning in a shop. Later prototypes, using the same circuit but proper high grade parts, sounded considerably clearer and more defined. It struck me that in their desperate scramble to cut the cost of every component, many mass manufacturers may be throwing the baby out with the bathwater.

From all this you'd rightly assume that I am sceptical about using remote control of volume when it means more silicon chips in the signal path, and there's no way a top amp could sustain such a design approach. But the Majik-I is meant to strike a balance between price, convenience and sound quality and it could just be that by using good quality components, Linn have successfully wrought an acceptable balance between these conflicting parameters.

An encouraging sign in this area is a circuit board populated by miniature

SOUND QUALITY

Linn insist their products should be reviewed in the context of a Linn system - and with some justification in my view. Linn, like Naim, do have a particular sound they pursue and, by definition it comes through best in an all-Linn system. However, the real world just isn't, universally going to acquiesce to this imposition; people also want to know how Linn products fare generally, against others like Arcam, Mission, Audiolab, et al. This review looks at the Majik-I as a product in its own right; I paired it with Heybrook Quartet loudspeakers, an Arcam Black Box 50 CD convertor and Arcam Delta transport. The Heybrook's were needed for their sensitivity (89dB SPL/watt), as well as their sound, for the

Majik-I produces just 30watts. It's important to bear in mind that an amp like this, which is a bit of a rocker, can easily be overloaded if played enthusiastically into normal loudspeakers (i.e. circa 85dB sensitivity), making it sound hard, strained and coarse. The Majik-I needs to be treated with a little circumspection if the best is to be had from it.

After a few hours warming and settling, which made quite a lot of difference, the best became apparent. I started to notice the sharp smack of hand drums and the quick, punctuating drum beats on Tracey Chapman's Bridges; they came over with remarkable power and clarity. Here, I thought to myself, is an amplifier with gutsy dynamics. Tracy Chapman was well defined to the point of

sounding hard etched, but her image was projected out of the speakers and the detailing in her voice and within the accompanying instruments was vivid.

The Majik-I is not an especially neutral amplifier, nor is it especially dimensional in its stereo staging. It has a lot of character, and also supreme ability in certain directions. I was intrigued by the way it projected strongly out of the speakers, always sounding vivid and forward in its presentation. There was what appeared to be upper midrange emphasis that threw vocalists forward, making for superb intelligibility. London Beat's Falling in Love Again streamed past me like a high definition, digital master tape, all control and detail; it was impressive. The amplifier also has explosive bass dynamics, giving drums in particular power, impact and control. Modern dance/rap/techno albums punched their way out of the speakers; 7669 sounded as scuzzy as they should; Sly and Robby nearly made the Quartets explode. The Majik-I is a cone kicker of an amplifier. What it doesn't offer is sonority or an easy neutrality; it's challenging to listen to, forceful and punchy. It isn't sweet, lithe and open, nor is it dimensional in the way of the valve amps I normally use, but it is exciting in a visceral manner.

The disc stages reflected the properties of the amplifier on CD, sounding tight and controlled with both MM cartridges (Goldring 1042) and MC cartridges (Ortofon MC20). I noticed, inevitably, that the bass lacked seismic depth, due to warp filtering, but it was fast, clean and punchy. Offering superb insight and a strongly projected upper midrange with glaring detail projection, plus very low hiss levels, the Majik-I just has to be rated highly for its vinyl replay abilities. Linn have preserved and deployed all their traditional ability in this area, giving the Majik-I another strong plus point.

In spite of its name, the Majik-I couldn't be further removed in character from thermionic devices, or the amplifiers that use them. For that matter, it's quite a long way removed from most solid state amps too. It's has a strong character which, generally, means that you'll love it or hate it. I was impressed, recognising some great properties, as well as distinct character traits. If you want a super tight, fast and punchy sound, one that handles the rhythm in rock with supreme ability, give the Majik-I a listen. If you want vividly projected detail, give it a listen (the Heybrook Quartet loudspeakers I used are a symbiotic match, by the way). I'll guarantee you'll be impressed, even though there isn't a glowing tube anywhere ●

MEASURED PERFORMANCE

Well equipped with a substantial toroidal mains transformer and unusually solid casework, the Majik feels sturdy. However, it delivers a fairly modest 32watts, enough to go loud with most speakers, if not very loud. It is best partnered with sensitive speakers of greater than 86dB SPL (for 1watt). Low loads are handled with ease; power nearly doubles into 4ohms, reaching 56watts.

The CD/tuner/tape inputs were reasonably sensitive at 270mV and noise was low at -91dB. The electronic attenuator had a strange effect upon the noise floor, which jumped up and down suddenly between 30 and 40 on the display, but hiss was low enough not to be audible, all the same. Linn have rolled down high frequency output as soon as possible, band limiting the Majik's response, like most British manufacturers. The idea is to lessen transient distortions, but I have to say that wideband amps don't sound any worse than band-limited ones, so this theory may be misleading. All the same, limiting can, in itself, alter sound quality in other ways, often giving it a warmth and, in the case of the Aura VA-50 for example, even a sense of atmosphere. Ultimately, only listening tests can tell how this factor interacts with many others to determine overall sound quality.

Distortion levels were very low, even at high frequencies, reaching just 0.01% maximum and comprising second harmonic - a good sign, since low-level second is effectively inaudible. However, the Majik almost certainly employs a goodly amount of feedback to achieve this result.

The disc stage can be switched internally to suit moving coil (MC) or moving magnet (MM) cartridges. It offers a 150Ω load to MCs and 47k/180pF for MMs. To suit low output Linn moving coils it is very sensitive and also very quiet, having an equivalent input noise of just 0.04μV, around the lowest I have ever measured. The MM stage was equally quiet. Linn fit a warp filter that rolls off lower bass fast below 50Hz on both MC

and MM. As you might expect from a cartridge manufacturer, the disc stages were very well engineered.

The Majik is relatively low powered for the price, offering remote control as compensation. It measures well, offering low distortion and carefully controlled response parameters, with LP as well as all other sources. **NK**

TEST RESULTS

Power	30watts
CD/tuner/aux.	
Frequency response	15Hz-31kHz
Separation	65dB
Noise	-91dB
Distortion	0.003%
Sensitivity	270mV
dc offset	-37/-35mV
Disc (MM)	
Frequency response	50Hz-27kHz
Separation	63dB
Noise	-80dB
Distortion	0.003%
Sensitivity	2.6mV
Overload	55mV
Disc (MC)	
Frequency response	50Hz-27kHz
Separation	60dB
Noise	-73dB
Distortion	0.005%
Sensitivity	0.2mV
Overload	4.5mV

Distortion

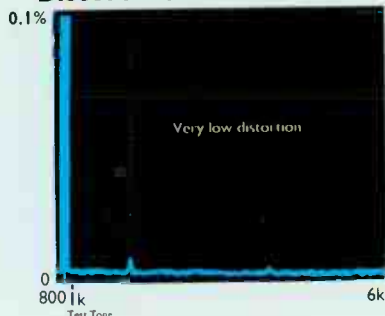

Majik-I £593
Linn Products Ltd.,
Floors Road,
Waterfoot, Eaglesham,
Glasgow G76 0EP
Tel: 041 - 644 5111



World

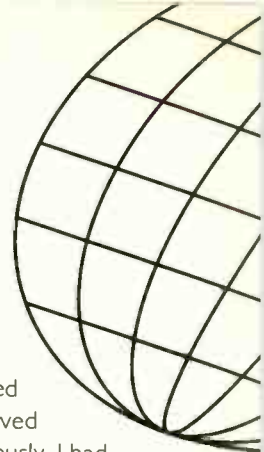

CASSETTE ALIVE

A friend recently brought to me a cassette tape containing a recording he had made of himself playing his grand piano and asked me to replay it through my equipment (Nakamichi CR-7, Quad 34-306 and KEF loudspeakers). The tape was a BASF LH EI 90 ferric, with which Dolby B had been used.

Apart from a few wobbly treble notes at the beginning of the tape, which I assumed had been due to the tape being slack, the natural and realistic quality knocked me

sideways. In particular, the piano bass notes had a lovely rich, vibrant and resonant sound which seemed to come from the heart of the piano and perfect definition.

I have a large collection of piano recordings made on high quality chrome tape, without Dolby, from Radio 3 via my Nakamichi, Quad FM4, 34-306 system, being either live performances, studio recordings (presumably DAT) or CD, and I have heard many CD recordings when auditioning equipment, including Naim Mission, Linn and Quad, but I

have never heard one which presented such a convincingly natural and realistic impression of 'presence'. My wife and I were enthralled by our friend's artistry, and especially by the impression that the piano was actually in the room.

To my astonishment, I was told that the recording had been made on a Kenwood 'stack' and my friend had come to seek my advice on the purchase of equipment which would improve the sound quality.

Frankly, this experience

has worried and unnerved me. Previously, I had been entirely satisfied, even proud, of what I had believed was 'realistic' reproduction through my equipment, but I have not since used it for fear that it will disappoint.

Can you offer an explanation for the superiority of this recording? Is it due to the 'direct' recording, ie. instead of having lost something in radio transmission or manufacturing process; or is it possible that the Kenwood tape recorder and amplifier

Letter of

Your review of the Gyrodec prompted me to send you a photo or two of my creation. All the working parts - motor, platter, weights, bearing, belts and perspex cover were supplied by Michell Engineering. The base is 3" thick black granite, supplied, cut to size and jig bored to specification by an obliging local monumental mason. The arm (where the whole project really started) is a 23.5 carat, gold plated S.M.E. 3012-RG Special Edition fitted with a Goldring 1042 cartridge.

The arm plinth,



Send your letters to Hi-Fi World Letter Page,

writes

are better respectively than the Nakamichi and Quad?

If no other good comes out of this experience, it has confirmed what I have long believed, namely, that cassette analogue tape is capable of a much higher standard of sound quality than that for which it has always been given credit by know-all professional writers who have condemned it as suitable only for in-car use and portable players. I have never heard comparable CD reproduction, even from some very expensive

equipment.
**Peter Williams
Rayleigh,
Essex.**

There's nothing to compare with direct live recordings and this is the reason your friend's tape sounds so wonderful. Remember that nearly all radio transmissions come from a tape or CD source and are subject to compression before transmission. Richard Brice explained recently how much processing lies behind modern recordings too. I tried to record a

speech tape on DAT recently and found it didn't have enough dynamic range without a peak limiter. I swapped to Nakamichi ZX-9 with Maxell Vertex tape and got superb results. No stack system works especially well and their cassette recorders in particular are subject to a lot of cost cutting. I suggest you try to get him to record direct onto your Nakamichi CR-7 and then see what you get (but you'll need mic preamps of course). **NK**

BITTEN BY THE BUG

Having read four issues of your magazine, I realised just how naff the sound of my system must be. Imagine an orchestra addicted to vallium and dipped in glue, and you've pretty much got the idea. There's nothing wrong with the Technics CD player, while the NAD 3120 is old yet venerable, but my Kenwood speakers were rather a sad case.

Inspired by Dominic Todd's article on speaker-tweakery (March), I decided to have a go myself. Mine have no external connectors, so I had to perform invasive surgery to fit some 129-strand cable. A Tandy interconnect had made no difference, so my expectations were low. Oh me of little faith. Tweak and ye shall find! Music acquired a bass-line, sounded louder and was generally less weedy.

I studied 'Fair Views' again, making hmmm-type noises all the while. Following Mr Todd's example, I replaced the internal wiring, even though I'm as handy as a thing with no hands. Now, after much effort and some rather pointless expletives, I can confirm that Mahler did in fact write for the piccolo. A great improvement then, which cost me only a tenner and the loss of some personal dignity. I realise I've utterly failed to amaze you,

continued on page 47...

the Month

motor casing and bearing platform were machined from solid brass, polished and gold plated for colour matching to the arm. Ditto the platter weights. The total weight of the whole assembly is not far short of 55kgs. Its final move onto the customised shelf was almost a feat of engineering in itself.

The final finishing touch was to have our family coat of arms made in enamelled, hall-marked, heavy silver plate and permanently mounted in front of the arm.

Do I need to tell you that I am very happy with this deck? I've been toying with the idea of getting a Michell Iso and fitting a Stilton AT-F5/OCC that I have. Perhaps you may care

to comment on this or maybe I should put a QC power supply on my shopping list.

**Dick Bullimore
Earlsfield,
London.**

We always like to see such dedicated efforts - it just shows how much people put into their hi-fi and how amenable it is to being customised to taste.

The SME 3009 Series lightweight arms were not ideally suited to moving coil cartridges; they were designed for compliant moving magnet designs, so the AT OC5 is not especially suitable. We suggest you consider the power supply. **NK**

64, Castellain Road, Maida Vale, London W9 1EX.

WIN HI-FI WORLD INTERCONNECT CABLES

OR PERFECT PITCH'S FRANCINSTIEN CD

ENHANCER

The writer of the most interesting or funniest letter will receive a choice of either: a free set of Hi-Fi World's silver plated copper interconnect cables, worth £69.95, or a Francinstien CD convertor enhancer worth £150.



THE RECORD SHOP

66 FIFE ROAD
KINGSTON
UPON THAMES
SURREY
KT1 1SP
TEL: 081-546 3880
FAX: 0372 360996

SPECIALIST IN NEW VINYL RECORDS

MAJOR STOCKIST OF ECM, LINN, ORIGINAL JAZZ CLASSICS, BLUE NOTE & ACID JAZZ. WE ARE NOT TIED TO ANY PARTICULAR TYPE OF MUSIC. WE JUST LIKE EVERYTHING ON VINYL. HEAVY TO AMBIENT!

SO PICK UP THE PHONE AND ASK FOR TIM OR MARTIN
(SECOND HAND VINYL ALSO AVAILABLE)

POSTAGE AND PACKING £2.00 + 50P PER ALBUM THERE AFTER.
WE DON'T SKIMP ON THE PACKING AND ALL LPS POSTED WITH
POLY-LINED INNER SLEEVES.

TOM ROBINSON	LOVE OVER RAGE (BRAND NEW ALBUM)	£7.99
TED HAWKINS	THE NEXT 100 YEARS <i>JUST OUT - A REAL GEM</i>	£8.95
RY COODER AND ALI TARKA TOURES	TALKING TIMBUKTU	£9.49
	- <i>THE ONE WE HAVE ALL BEEN WAITING FOR</i>	
VARIOUS	STONE FREE	£12.95
	- <i>TRIBUTE TO HENDRIX - AT LAST SOME VINYL</i>	
ENIGMA	CROSS OF CHANGES	£12.95
DOORS & JIM MORRISON	AMERICAN PRAYER	£12.95
ROGERS WATERS	AMUSED TO DEATH	£13.49
	- <i>DOUBLE VINYL</i>	

ALBUM OF THE MONTH!

TEA PARTY - SPLENDOR SOLIS		£8.95
BRAND NEW LP FROM CANADIAN BAND - BLENDING ZEPPELIN THE DOORS AND THE FLOYD. RECORD SHOP FAVE - COULD BE ALBUM OF THE YEAR! A FAIRLY COMPLEX ALBUM, MAY NEED A COUPLE OF LISTENS!		
WOODSTOCK	I	£19.95
	- TRIPLE VINYL	
WOODSTOCK	II	£13.95
	- DOUBLE VINYL	
ELVIS COSTELLO	JULIET LETTERS	£12.95
	- <i>SORRY NO SIGN OF BRUTAL TRUTH ON VINYL!</i>	
BILLY COBHAM	SPECTRUM	£7.95
JACKSON BROWNE	I'M ALIVE	£12.95
COUNTING CROWS	AUGUST AND EVERYTHING	£8.95
JOHNNY CASH	CASH	
	- BRAND NEW SOLO ALBUM AS VINYL	£9.95
MILES DAVIS & QUINCY JONES	LIVE AT MONTREUX	£9.95
YES	TALK	£8.95
	- <i>BEST ALBUM FOR YEARS!</i>	
JENIFER WARNES	THE HUNTER	£11.95
INDIGO GIRLS	SWAMP OPHELIA	£9.49
	- <i>BRAND NEW U.S. LTD VINYL</i>	
CHRIS CACAVAS	PALE BLONDE HELL	£8.49
	- <i>WONDER LP FROM "GREEN ON RED MAN"</i>	
SONYA HUNTER GEOGRAPHY		£8.49
	- <i>ACOUSTIC MASTERACE SIMILAR TO S.VEGA, S.COLVIN & KIMM ROGERS</i>	
NEIL YOUNG LUCKY 13		£13.95
	- <i>DOUBLE VINYL COLLECTION OF GEFEN YEARS</i>	
SOME UNRELEASED TRACKS		
BUFFALO SPRINGFIELD BEST OF		£13.95
	- <i>DOUBLE VINYL EVERY DECK SHOULD HAVE ONE!</i>	
DONNY HATHAWAY LIVE		£7.95
	- <i>CLASSIC LP</i>	
CRANBERRIES EVERY ONE ELSE IS DOING IT		£8.95
	- <i>LP ISLAND NEVER WANTED TO PRESS NOW BEING PRESSED FOR 3RD TIME!</i>	
OTIS RUSH AIN'T ENOUGH COMIN'		£9.49
	- <i>FIRST LP FOR 17 YEARS - WE THINK?</i>	

"ASTOUNDING"

DIGIT THE DAC

QED'S Bitstream Digital to Analogue Converter

"... It really is the most cost effective upgrade ever... For twice its price it would be superb, at what it costs, it's outstanding." (Hi-Fi World May 1992)

Send a 1st Class Stamp for a copy of the full review and our
NEW 32 PAGE AUDIO CATALOGUE.



QED

QED AUDIO PRODUCTS LTD, RIDGEWAY HOUSE, RIDGEWAY CLOSE,
LIGHTWATER, SURREY, GU18 5XU, ENGLAND

...continued from page 45

but I wanted you to know my copy of Hi-Fi World was two quid well-spent.

By the way, my PrinzSound tuner has always sounded better than the CD, even though it came from a charity shop and is fed by a wire dipole aerial. Through my 'new' speakers, it's terrific. Is this down to the quality of the players used by Radio 3 and Classic FM? I'd like to know what they are. As one who has never laid ears on a CD52II SE, I can only guess what the good stuff sounds like.

Anyway, thanks for the advice. I'm off to get a soldering iron in readiness for your next DIY project.

**Michael Cooper
Watford,
Herts.**

I'm glad you've found new qualities in your system revealed by a little affordable tinkering. It just goes to show, any system; whatever the price, can be improved with a little inventive tweekery. It's also good to see that you are enjoying your system, there are plenty of people out there with far more expensive systems than yours that are less satisfied than you; keep up the enthusiasm. **DB**

NEWS FOR VINYL LOVERS

Now that vinyl is hard to obtain I think it would be a good idea if you asked your readers if they know the names and address of any good second hand record dealers, publish them in your magazine and keep them updated as some shops seem to have short lease arrangements.

I buy new records by mail order (Gema records are very good 0635 8677140) as are yourselves. I was told in one shop that the Donald Fagan album Kamakiriad was only available on CD and

cassette, so I bought the CD. When I got home I phoned the Den record shop and I was told that it is on vinyl for £13 inc p&p so I returned the CD and asked for my money back (blank stare "it's only available on CD and cassette sir") "that's not true", said I, relying on the Den's information. Off went a cheque for £13 only to be disappointed a second time when Gema's new list arrived two weeks later, and the price was £2.50 less, that amounts to quite a saving for just one record, great album though, but why did your magazine not review it.

Another album worthy of mention is Roger Waters' Amused to Death. This is a superb double album on limited vinyl so hurry or miss out. You did not review that album either, I didn't know of it until I read it in an American hi-fi magazine and I don't think many people know of it in this country, but luckily Gema records had it on their lists.

Second hand record shops:

**Sounds Familiar
47 North St
Romford**

**Sounds Familiar
95 Wood St
Walthamstow**

(Take in your unwanted LPs, CDs and cassettes for cash, or for a better deal exchange them)

**L. W. Perkins
Loughton,
Essex.**

If readers know of any good record shops that stock a good range of vinyl, new or second hand, please write in and we'll be pleased to print them in our letters pages.

Same for any of you who belong to hi-fi clubs, we'd love to hear from you and what you're up to. **DB**

instead of gradually phasing them out and increasing production of DCC machines?

It doesn't matter how much money poor, misguided souls pay for analogue tape decks, they will all have one thing in common - HISS!

Judging by your comments and by articles and



DCC - has it replaced the analogue cassette?

Unfortunately we only have a limited amount of space for record reviews in the magazine and consequently it is not possible to review all of the albums we would like to. We receive countless CDs for review and from these we have to pick six or seven which we feel represent a broad selection of rock music currently available. **RJ**

THE LOVE OF CASSETTE

I am afraid that I must take issue with you (Noel Keywood) over your Kaleidoscope page in the April issue of Hi-Fi World.

What is this great love that you and so many others seem to have for analogue compact cassettes and the tape decks that play them, and why are manufacturers STILL bringing out new models of these dinosaurs

letters I have read in Hi-Fi World, you and some others seem to have a big dislike of DCC.

DCC is the future for the compact cassette - why bury your head in the sand? I, perhaps, more than anyone, dislike change for change's sake, but change for the better is surely a good thing - and DCC is significantly better in my and many others' opinion. It is devoid of the dreaded analogue tape hiss (as long as the masters themselves are digitally recorded).

If we rejected new innovations and never moved forward we would still be listening to cylinder records played on Edison phonographs and exalting them as great and not necessary for improvement.

And what about the

continued on page 49...

The WIZARD



Hand made Adjustable Shelf Rotary Unit.

Can hold 1536 CDs or 1440 Cassettes or 384 Videotapes or 575 Penguin Books; or any mixture. Books up to 6 1/4" deep.

Revolves on Ball Bearings in 30-4" turning circle
21 1/2 x 21 1/2 x 75" high.

Teak, oak, pine mahogany, ash, £1550 inc. VAT & Delivery.

FOR OUR BROCHURE of CD/Video Drawer Chests CD racks Bookshelves LP, music · Hi-Fi Cabinets & the Budget Line —Specials made to order—

Please send 3 x 2nd class stamps to:

Ian Edwards The Old Chapel
282 Skipton Road, Harrogate
HG1 3HB. Tel: 0423 500442

LEONARD BOOTH

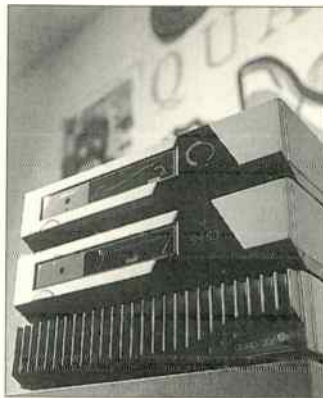

WHY WAIT A LIFETIME BEFORE YOU SEE & HEAR AND BUY YOUR QUAD EQUIPMENT CALL IN NOW FOR YOUR IMMEDIATE DEMONSTRATION
35 SOUTH STREET EASTBOURNE
0323 731755

TABULA RASA LOUDSPEAKERS



"It is a rare experience to play a track that you have known for the better part of, say, twenty years and suddenly, to hear new details and information."

(Hi-Fi World - Dec '93 on CT77 loudspeaker kit)

With the increased popularity of "do it yourself" hi-fi, Tabula Rasa are offering an extensive range of quality loudspeaker kits and car audio kits from top German manufacturer Mainhattan Akustik.

All loudspeakers kits are simple, fun to build, and at prices to suit all pockets. Each kit comprises drivers, filters, connections, terminals, and all the necessary fittings needed to complete your chosen loudspeaker, and every kit is available with or without cabinets. Furthermore, each kit comes with a 10 year warranty as standard and will be delivered within 14 days of confirmation of your order. For a catalogue (including price lists and a brief guide to speaker construction) please send £2.00 (refunded after first kit purchased) and a self addressed A4 envelope to:

Tabula Rasa, 136 Kilnwood, Walters Ash, High Wycombe, Buckinghamshire, HP14 4UR, Tel 0494 565116

Cheques and postal orders should be made payable to Tabula Rasa.

Trade prices available on request.

30 days money back guarantee offered on all drivers & kits.

Hi-End Hi-Fi in the heart of East Anglia.

For the best in Hi-End hi-fi Bury Audio is a must. All the names stocked are individually chosen to complement one another to give the best sound in their class. To get the best from CD there are DAC's like **Pink Triangle - Da Capo or Ordinal**. Great sounds now can mean good looks too thanks to **Michell - Iso, Argo, Alecto**. Now, Gyrodec sounds better still with the **Tesseract - Tags psu**. Valves from **Tube Technology - Unisis**. For fanatics, **Musical Fidelity - F22 and F15**. Open natural sounds from **LFD - PAO, LSO, MMO**. Stunning to look at and to listen to the new **Ruark - Equinox**. These are just a selection of the impressive sounds on demonstration now. Why not come in and have a listen to the best sounds in East Anglia.

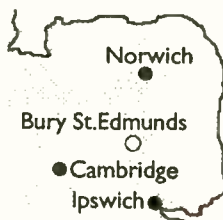

Bury Audio
47 Churchgate Street,
Bury St. Edmunds, Suffolk IP33 1RG
Tel or Fax : 0284 724337

...continued from page 47

various people who are complaining about data compression on digital cassettes? I maintain that if I were to play two tape cassettes to them, one

because there are hissy microphones, preamps and even analogue tape recorders in the original recording chain. Furthermore, hiss is not much of a problem these days with cassette, since it

MD be any different? How many times can we re-invent the wheel, and which version will prove popular enough with the public to stay around for a reasonable period? You have found what you want in DCC, but

I had decided that a NAD tuner fitted my budget and would be the next purchase for my hybrid system, based on your verdict. As a one time owner of a Troughline from the H J Leak stable, I have to say that my long term memory gives the edge to the NAD.

My existing line up is an NAD 402 tuner, Pioneer A400 amplifier and Mission 753 speakers, in a room about 21ft by 14ft. The depth and space of stereo music from Classic FM and Radio 3 is of a higher order than I previously thought possible, without actually being in the studio. The extension of the bass, without being unbalanced is very noticeable, especially as my system has no tone controls. If I close my eyes and open them again, I expect to see the cellist, bass player or pianist sitting in my lounge, just where the stereo imaging places them. I have not experienced this effect so noticeably with any previous tuner.

As a radiophile of more than fifty years, starting with a push-button 'Ekco' radio, circa 1938, the sound has now developed from a noise from the box in the corner, to a room full of music. In a city almost devoid of live classical music, or any other music for that matter, my new NAD tuner has brought the concert hall into my lounge.

Many thanks to those concerned, to NAD for making it possible and to Hi-Fi World for making it happen.

**P. H. Pridmore
Plymstock,
Plymouth.**

We're very glad you like your prize. It's gratifying to learn from many readers that the new NAD402 tuner is proving as obviously superb as we claimed. All we emphasise to anyone is -

continued on page 54...



The NAD 402 brings a new dimension to radio.

analogue and one DCC of the same music track on comparable machines in price and quality, they would notice no difference except for the outstanding clarity and lack of tape hiss on the DCC tape.

I have no affiliation with the manufacturers of DCC, but I think that it's about time that someone spoke out in defence of the format. I actually own two DCC machines and various DCC tapes so I am not basing my opinion on demonstrations or loans of machines for evaluation, or without even listening at all as is obviously the case with some people.

**Kevin Williams
Tredegar,
Gwent.**

As you've noticed, 'silent' digital recordings often hiss,

can be eliminated by Dolby S or reduced to near inaudibility on a Nakamichi DR-2 with metal tape. This closes the gap between the two mediums in this respect.

We have reviewed DCC and, like you, find it works well. We know people with DCC machines and they are happy with it too. But that's not quite all there is to it. The simple truth is that DCC, like MD, has been slow to sell, because people don't like change for change's sake, because of the recession and because of very high tape prices. **NK**

DAT is also free from hiss with digital recordings, is a higher quality medium than cassette and was a new innovation. Where is it now and why should DCC and

many will also have found their favourite with MD. It's not that we dislike DCC or MD, but they haven't exactly taken the industry by storm. It must be nearly a year now since we've had a press release from anyone who's considering manufacturing a DCC or MD player and the software still sits in a distant, dark corner of a few of the larger record shops. **DB**

NEW DIMENSION TO RADIO

Buying my first ever copy of your magazine in January and reading the article in praise of the NAD 402 tuner, was indeed fortunate for me. As one of the winners of a 402 in your February issue competition, the tuner has brought a new dimension to my radio listening.

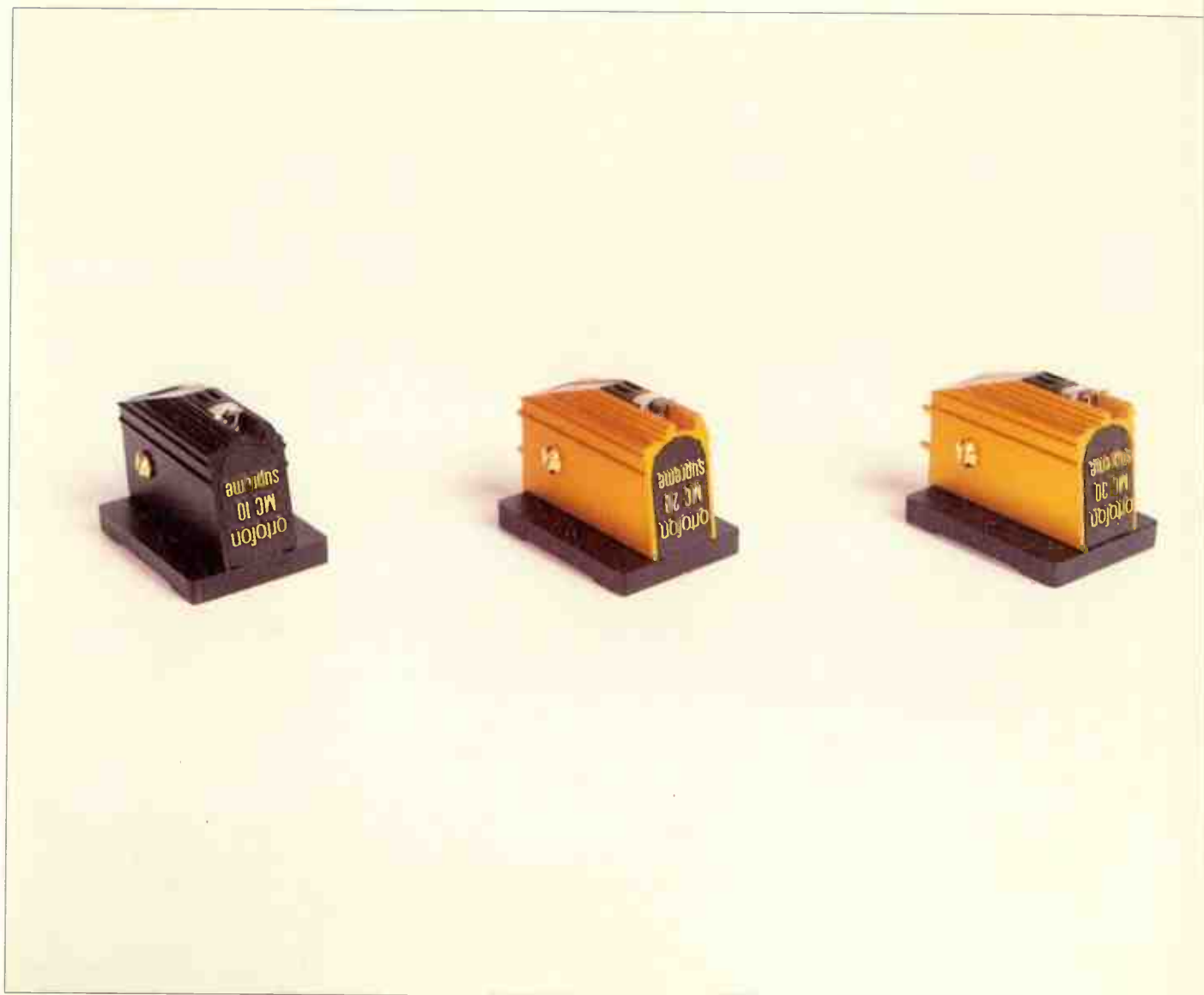

Looking For Supremacy

Eric Braithwaite and Noel Keywood were eager to listen to Ortofon's new Supreme moving coil cartridges. Here's what they found.

Most old turntables just fade away, happily and unquestioningly replaced by a new fangled CD player costing just £149, found on display between the microwaves and the washing machines. I can understand why; budget record

decks never were so good. But their more expensive and refined hi-fi bretheren were - and still are. A good moving coil cartridge mounted in a well engineered turntable still has the ability to cast doubt upon the sound quality of CD in my view.

Ortofon's new range of moving coil cartridges will look both tempting and daunting to anyone considering this upgrade path. And according to our mail, that seems to be many 'World readers who, we know from our surveys, have huge record collections.

The latest revised range now possesses 10 fewer than eleven models, to which can be added various specials.

Ortofon split them into three bands: budget models, mid-price Supremes and top end models.

Let's look at prices and outline specs. The new MC10 Supreme costs £225; break its stylus and an exchange unit will set you back £170. The MC20 Supreme costs £349.95 and an exchange £265. Top of the group is the MC30 Supreme, cost £449.95, an exchange unit £335.

The Supremes all share the same rigid, solid metal body, with a straight-sided slab of a base for easy and accurate alignment in the headshell. The fixing holes are threaded into this thick metal base, eliminating nuts and making fixing a quick and simple task. I found the threads take conventional, specialised cartridge fixing screws, like the stainless steel hex-key types from Goldring, for example.

Drawbacks

These new super-rigid bodies have two drawbacks. One is weight. At 10.6gms they are heavy and some arms will barely balance them. The other was a nightmarishly difficult and dangerous clip-on stylus guard that demanded good eyesight and dextrous fingers to avoid a small, but catastrophic slip upon its replacement. This had me very worried, since reviewing demands cartridges be handled a lot - always with the stylus guard on for safety. But getting the Ortofon guard on seemed almost more perilous than risking leaving it off.

Because all three Supreme models share a body and generator assembly, they look the same (except that the MC10 is black anodised, whilst the 20 and 30 are gold anodised) and provide the same output level. This measured no less than 0.7mV at 5cms/sec rms - high by moving coil standards, meaning amplifier hiss will rarely be audible, through a dedicated MC amplifying stage of course.

Where the Supremes differ is in their stylus and cantilever arrangements. These crucial items have a considerable effect upon performance, but their selection and design involves numerous trade-offs. It's here that science becomes black art.

Broadly, cartridge designers trade ruggedness against performance. As price increases, cantilevers get thinner and diamonds smaller in an attempt to reduce tip mass, making the cartridge progressively more delicate and susceptible to dust, dirt and fluff on the disc. But whilst low tip mass gives better tracking performance, especially under high tip accelerations, thinner cantilevers are less rigid and able to faithfully transmit sudden transient accelerations, due to cantilever flexure. So don't think the less expensive design are automatically worst for it. **NK**



ORTOFON MC10 SUPREME

Eric - Hand on heart and hope to die (actually, I don't, but I haven't given up smoking yet) the MC10 is not so much a lesser breed of the new 20 and 30 as a better MC15. Compared to the '15, it scores a few more Brownie points. It's 'bigger' in the bass and faster in the midband. But by comparison with its more expensive siblings, it also sounds plummier down in the lower reaches.

Conversely, when it comes to sharp, riff-laden serious guitar work like that on Gary Moore's live album, it rips along, though with a trace of hardness and bright edge compared to the MC20 and MC30. Yet it had enough refinement to cope with a contralto and soprano duet without discernible embarrassment. Only some of the sensation of the delicacies of phrasing was missing, some of the subtle in-between shades of tonal colour.

At first listening, too, it could be just as exciting and speedy as the MC20, though inspection revealed that vocals and instrumentals were, again, brought a little more forward and the width constricted compared to the other two. Performers were restricted in a tighter - though no less well defined - space. Rhythm guitars and the upper orchestral string registers had a steelier quality, too, though only enough to add a perkiness to rhythm. It was a matter of degree only: the kind that enhances the subjective impression of speed and liveliness rather than take the wax out of the listener's ears, let alone alters tonal colour. It's extremely well controlled and balanced; if the MC30

had a hundred points for perfect tonal balance, then the MC10 wouldn't go much below ninety-five.

Noel - The MC10 Supreme has an elliptical stylus and a relatively sturdy cantilever. This cartridge comes at a good price and it is reasonably rugged. Tests showed that the stylus suffers a little tracing loss from outer to

inner grooves, so Ortofon have given it a small but useful amount of treble lift. I found the MC10 Supreme had a wonderfully crisp sound, tight as a drum and fast as a greyhound. It's a fine moving coil cartridge, with powerful but superbly controlled bass and a high degree of clarity. The only slight weakness I could detect was a certain brightness and mild tizziness to the treble, even through the gentle fabric dome tweeter of Heybrook Quartets. But this was minor; the MC10 doesn't have the obvious brightness of an Audio Technica OC5 or a Goldring Elite, for example. However, speakers with crude metal dome tweeters may not be ideal partners at the other end of a system.



ORTOFON MC20 SUPREME

Eric - Both the top Supremes - the 20 and 30 - have superb fidelity of tonal colour. I would have loved to fault it, but couldn't. Both passed the tricky test of CPE Bach's Concerti for Two Pianos; both are fortepianos, with highly distinctive tone, which both cartridges reproduced perfectly. Both also reproduced the rather muddled miking and reverberation of this Archiv

recording, correctly identified as such instantly - sight unseen - via the MC30. Both managed that rasping forward-growing blare of horns that few cartridges cope with, even though it is what happens in real life.

The MC20, however, was different to the other two Supremes, in a quality described by said friend as 'richness'. This wasn't any aberration in tonal quality, or of additional warmth. Over extended listening it was discerned more as slightly more forwardness and somewhat less air and space, resulting in a 'larger' and tighter sound than the MC30, with some diminution in subtlety. It made Gary Moore less staged, but a degree faster and punchier; while some of the plethora of textures on Ian McNabb's Truth and Beauty were traded for more rawness and less refinement.

Although it retained very fine bass definition, the sound of drumming was rather cruder, some of the subtlety of drumsticks on parchment (or plastic, or rimshots) less defined. There was no doubt that this would make the MC30 a better rock cartridge for many. Me, I like the microscopic life in the recordings as well, so I preferred the '30 intellectually, but my heart did go out to the '20. It's way different to - and miles better than - the old MC20, which sounded finely detailed, but almost too 'clever' - and restrained - by comparison.

Noel - The MC20 is a compromise between the 10 and the 30 - and an effective one too. It has a slightly finer cantilever than the 10, but not one as fine as that of the 30. It has a 'Fine Line' stylus, reducing treble lift in its frequency response. The MC20 Supreme was crucially more subtle and smooth in its treble delivery than the 10, yet it had more punch and bottom end control than the 30.



ORTOFON MC30 SUPREME

Eric - There's so much of Ortofon's top moving coil, the MC7500, in this it's

startling. At first sounding fairly innocuous, the MC30's ability to put the grooves under a microscope became ever more intriguing. It doesn't have quite the ability to draw the precise shape of instruments in the air between and in front of the speakers that the 7500 can manage, but it's near enough to be spectacular.

Listening to vocals was endlessly delightful. It didn't matter whether it was Gary Moore on Blues Alive or April Cantelo (soprano) and Helen Watts (contralto) in the duet from Berlioz' Beatrice and Benedict. In both cases singers were fully equipped with epiglottis, tonsils and chest expansion. In the Berlioz, the MC30 differentiated precisely between the vocal colour of the duettists, their range, their breathing and phrasing.

If you want this kind of subtlety expressed in terms of rock, that equals sublime and subtle timing information - which went for guitar and drumming as well - and near-perfect dynamic shading of the type that has performers standing starkly on stage, putting all their mobility into their fingers.

All around, front and back, there was space. Not the profound depth and width of the 7500, but enough to put Gary Moore and his band really 'live' in front of the listening seat. Or to place an orchestra in an enveloping acoustic, with every twitch of every player in place. The Ortofon's solidity and firmness in delineating an image was impressive.

As was its ability to drive. Both Moore and Saint-Saens' Organ Symphony had the MC30 pulling me to the edge of my seat in excitement, while displaying some dodgy edits and fluffs, but without forcing them on my attention. It's all a matter of proportion: once the music has taken over (which is the moment you forget you're listening to a cartridge and relax) this cartridge

has a knack of concentrating the attention on what's most important for that particular bar, or melodic line, while not underplaying anything else. Interestingly, what I first thought was excessive analogue tape hiss was merely highlighted because of low vinyl noise - the mark of a very fine stylus.

Noel - The MC30 Supreme was, naturally enough, the model I wanted to hear most. It has a fine cantilever, tapered for rigidity and fitted with a 'Special Fine Line' stylus, to use Ortofon's description. Subtle and delicate, smooth and detailed would be suitable

terms to use with the MC30, but it seemed to me to possess somewhat neutered dynamics. Where was the bass punch? The MC30 was best assigned a role as gentle provider of insight and delicacy with flute, violin and vocals I felt, but it is less at ease reproducing rhythm sections and timpani.

CONCLUSION

Noel - The MC10 Supreme is, in my view, best value. It won't break the bank, but it is a highly developed MC design all the same, capable of revealing all the best attributes of the breed. Tests showed it has no major weaknesses.

The MC20 Supreme is, for me, the model that manages to best balance the various design trade-offs; it has a superb sound, but £350 is a lot of money to anyone. All the same, if you think you can afford it, try and get a demo at an Ortofon dealer.

The MC30 Supreme is for scholars. Sweet and silky smooth, it excels where most others have difficulty.

Eric - Conclusion? How wide does your wallet go? If you want something superior to an MC15, but with its vaunted liveliness and all-round strengths, go for the MC10. If you want a taste of the MC7500, buy the MC30. But the bargain, and a bit of both worlds, is the MC20. Actually, after three weeks with the Ortofon Supremes, I can't help thinking each is worth a good fifty quid - if not a hundred - more than their street price. The only thing better might have been three weeks with the singing Supremes ●

"I can't help thinking each is worth a good fifty quid - if not a hundred - more than their street price."

MEASURED PERFORMANCE

The three Ortofon Supreme moving coil cartridges have much in common mechanically and this is reflected in very similar performances in many areas. All three have a healthy output of 0.7mV at 5cms/sec rms tip velocity. That's high.

All three cartridges tracked very well, both at low frequencies where hinge compliance is important, and in the midband where compliance and tip mass determine results. I'd expect a very confident sound from these Ortofon's, even on the highest vocal crescendos.

All three Supremes produced around 1% second and third harmonic distortion (45µm, 300Hz), with some fifth harmonic evident too, on centre-stage images (i.e. lateral modulation). It may sharpen the sound slightly, adding a little incisiveness, or apparent speed.

Vertical tracking angle measured around 26 degrees, about normal. Although 22 degrees is the standard, few cartridges meet it, since to do so means riding too low, close to the disc surface, or using an excessively long cantilever.

Ortofon quote steady improvement in channel separation from MC10 to 30 and this was verified by measurement, my figures being better than Ortofon's. All three models have adequate separation.

It was in their high frequency response that the Supremes differed most obviously in measured performance. The MC10, with its simple elliptical tip, possessed most treble lift above 10kHz on outer grooves, but also most tracing loss, turning +2dB or so peaking on outer grooves into -3dB or so loss on inner grooves. The published response does not show this, being a 'median' response, as it were, taken one-third the way in.

The MC20 Supreme has some smooth treble lift, as the response analysis shows, but its nude 'Fine-Line' diamond gave very similar results on outer and inner grooves; there was virtually no tracing loss. It was measurably and significantly better than the MC10 in its consistency of treble performance.

The MC30 was also consistent across a disc, but its 'Super Fine-Line' tip gave even less treble lift - in fact, virtually none at all. Here's a cartridge with a really smooth frequency response, one that varies by around 0.5dB maximum from flatness, right across the audio band. It's a fine performance and is likely to give the MC30 Supreme silky treble and a cohesive sound.

All three Supreme cartridges measured well. They have high output as normal moving coil designs go, excellent tracking ability, especially in the midband, and - overall - low distortion. Like all good moving coils, they lack the upper midrange suckout of moving magnet designs, which makes for a clearer, more balanced and detailed sound. **NK**

ORTOFON Supreme MC cartridges

	MC10	MC20	MC30
Tracking force (gms)	2	2	2
Weight (gms)	10.7	10.7	10.7
Vertical tracking angle (degrees)	26	27	25
Frequency response (2dB)	20-20k	20-20k	20-20k
Channel separation (dB)	26	30	36
Tracking ability (300Hz)lateral	80µm	85µm	70µm
vertical	45µm	45µm	45µm
lateral 1kHz (cm/sec)	23	23	20
Distortion, 45µm (%)			
lateral	0.9	1	0.95
vertical	1.4	3.5	3
Output, 5cms/sec rms (mV)	0.7	0.7	0.7
Channel imbalance (dB)	0.5	0.2	0

Frequency Response

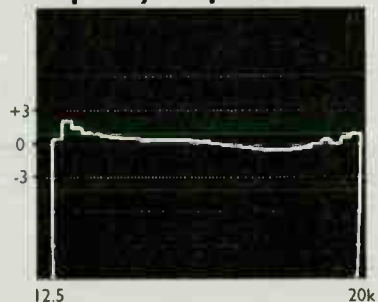

Distortion

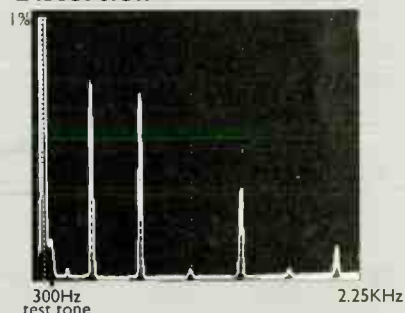

MC10 Supreme

Frequency Response

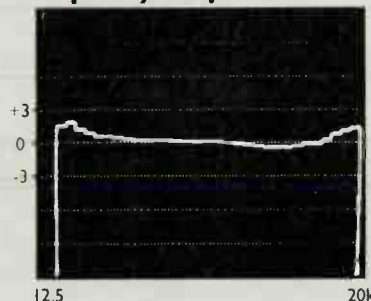

Distortion

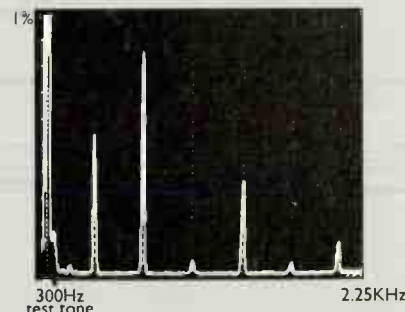

MC20 Supreme

Frequency Response

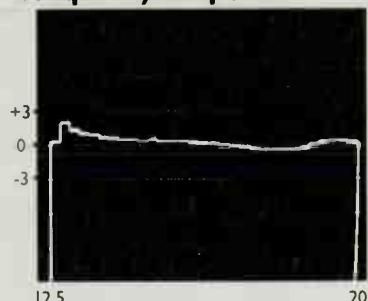

Distortion



MC30 Supreme

...continued from page 49

use a good outdoor aerial to get the best from it. Our Troughlines still have secure homes though! **NK**

IMAGINARY IMAGE

It was interesting to read the correspondence this month on the subject of stereo imaging, whether it in fact exists, and its importance assuming that it does.

If we go to hear a live musical performance, the only type of gig where we can audibly (as opposed to visually) tell where the performers are positioned is

one where only acoustic instruments are being used with no amplification, an acoustic jazz trio playing in a pub or very small club, for instance. Where amplifiers are being used we actually hear where the performers' amplifiers are positioned, not where the performers are positioned themselves. The exception to this is the drummer, and to a lesser extent the saxophone player, because they are so loud.

Once we get to a rock venue we hear the sound through a PA system, which gives no aural clues whatsoever as to positioning

of the performers.

This is the essence of Linn and their dealers' insistence that stereo imaging is of no importance. Unfortunately, it is not quite as simple as that.

Recording engineers and musicians are aware that when listeners are enjoying their music at home their enjoyment will be heightened by a sense of where the performers are actually positioned within the soundstage. At a live concert, the audience get this positioning information visually; this is not possible in the home, and so the

position information is encoded aurally in the recording.

The positioning of the performers in the soundstage is usually roughly that which those performers actually take up in an on-stage situation; singer at stage front, drummer some way behind, guitarist to one side, backing vocalists to the side and to the rear, etc. OK, so this is an illusion, created by the recording engineer's art, but it is there to heighten the listener's enjoyment of the recording and to make the listening experience more realistic.

If a hi-fi system is unable to image properly, or even at all, it is clearly incapable of reproducing what is on the recording accurately enough for anyone who is genuinely knowledgeable about music to stand much chance of actually enjoying it.

I have come to the conclusion that only a truly neutral and totally transparent hi-fi system can give me what I want from the system, which is to hear precisely the information that is on the recording, with nothing added or taken away, "The closest approach to the original sound", as Quad put it.

Why Quad? Test it for yourself. Go and see jazz guitarist Jim Mullen play at The Tulse Hill Tavern one Tuesday night (he is there usually once a month, with superb tenor sax player Dave O'Higgins, drummer Ian Thomas and bass player Lawrence Cottle). Enjoy the gig, and revel in this quartet's brilliant musicianship.

Next morning, first thing, take Jim's excellent CD "Soundbites" on the EFZ label to a dealer

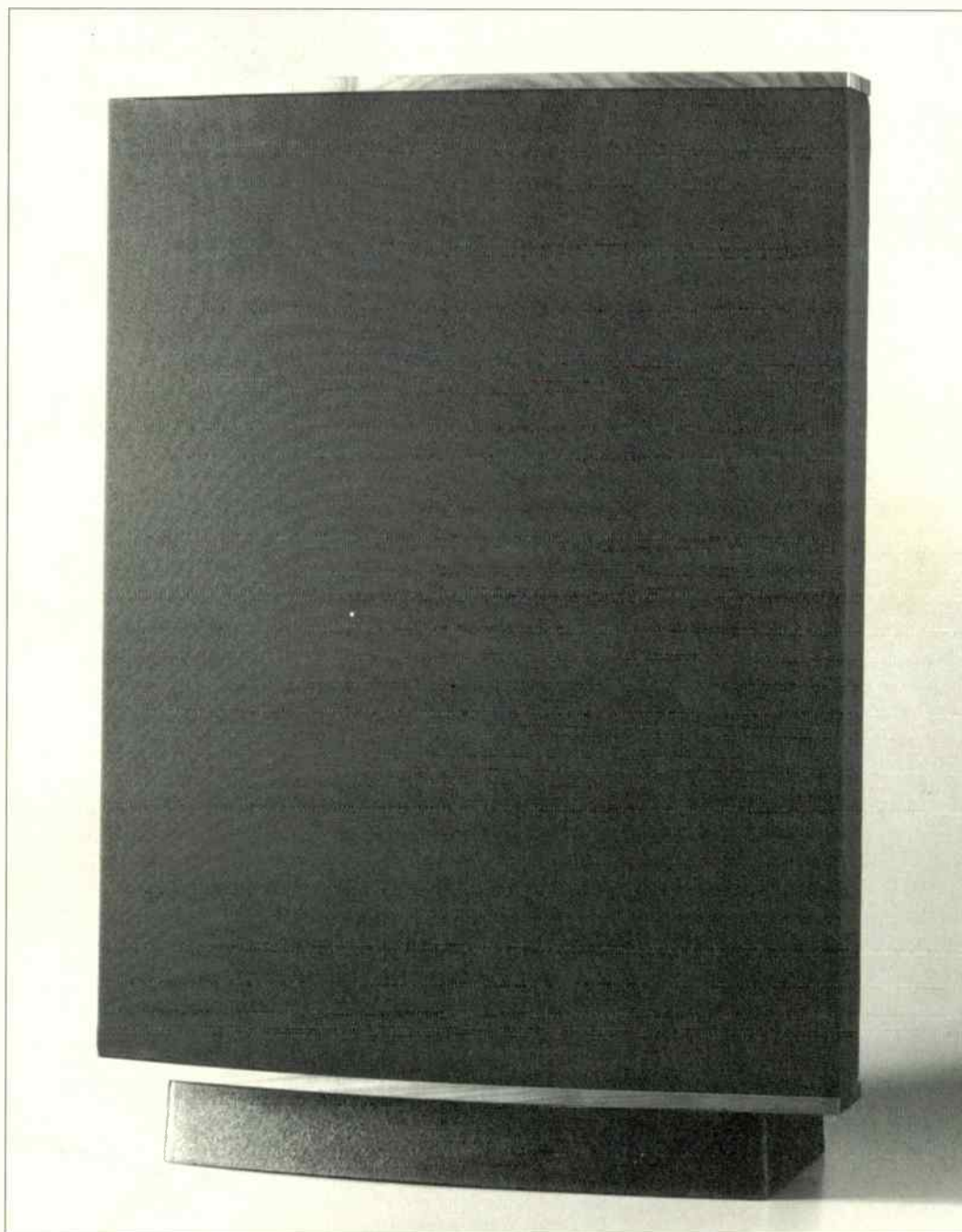

The Quad Electrostatic gained a reputation from being able to produce a believable image.

stocking Linn, Naim and Quad (many do). Go early, when the memory of the previous night's gig is fresh in your mind. See which system sounds most like what you heard the night before. Listen to most of the album, not just one or two tracks.

Take also a completely different type of recording: I would recommend AC/DC's recent live album. Listen to that on all three systems. See which of the systems makes you feel as if you are actually in a field at Castle Donington, with the wind in your hair and with thousands of denim and leather clad rock fans all around you. . .

Order the Quad system. Take it home. Enjoy!

**Anthony Edwards
Chislehurst,
Kent.**

As you say, performer position is commonly determined by the recording engineer, according to convention, but it is important to a performance and, indeed, few if any loudspeaker gives a clearer picture of that position than a Quad electrostatic. It's one reason we love it. But Naim and Linn fans commonly protest that they prefer "grip" or "speed", or even some other factor. There's no doubt that a good Naim or Linn system has something different to offer and, in the end, personal preferences enter into this matter. That's why we say - go to a dealer and listen for yourself. **NK**

CABLE MANIA

Recently I heard that audio separates (such as turntables, compact disc players, amplifiers and loudspeakers), which are normally used in the well-sounding audio systems for connecting cables together, allegedly have audible influence on the final sonic performance of the system. I'll tell the truth: this fact shocked me.

Until today I have always been using the separates packed together with the cables included in their purchase price. I never had to complain about their quality. And believe that my ears are well-educated and refined: I am not one of those good guys who buy a Japanese midi-system in a household appliances shop and, their mouths open and the eyeballs out of their eyelids, enjoy the ecstatic experience of hearing violins get out of the left speaker and double basses of the right!

On the contrary, I am an Italian enthusiast who always opposed the involvement of the Japanese in the true hi-fi, which is and must forever be British. I am not influenced by any ethnical prejudice: I do not hate Japanese, I believe they are the best friends of man. But, unfortunately, Japanese are used to manufacture very versatile audio products, excellently finished, practical to use, working very well and of inexpensive price. Should we admit they sound well too, what will be the destiny of Western competitors?

As mentioned above, I am a very fine expert of cables, I have been using refined, elegant and high class cables only. This is the list of the cables composing my true hi-fi system. Signal cables: Van den Bull The Fourth, Audio Pest Lapsus Hyperquiz, XLO Penitence. Speaker cables: Audio Vote AT-RP, Monster Towerline, Cogan-Tall Turbe 16V, Gold Sounds 12/2, Tara Cab6 Tantum III.

Someone will be certainly wondering how did I manage to insert three pairs of cables between turntable and amplifier and five pairs between amplifier and loudspeakers? It's easy, gentlemen: by means of 14 Y-shaped signal duplicators, which I self-built using Cartier connectors, very practical and ...chic, even if a little bit expensive.

Most of the budget, let's say two thirds, has been reserved to the signal cables, connected to the source, because speaker cables nothing can do to improve the quality of an awfully born signal (garbage in, garbage out). Thus the speaker cables have been chosen among those having the best sound quality to price ratio. The Turbo 16 V, for instance, even costing only £1500 per meter, has the fineness you normally find in cables costing three times more. The Tantum III costs twice as much as the Turbo 16V and, I ensure, you clearly hear the difference. The same way you immediately hear that the Towerline costs 5 % less.

A three-penta-wiring configuration of such a class and sonic fineness, in which eight cables of so strong, defined, remarkable and even different sonic personality are made socially synergic cannot be offhandedly put together in a few months or in a few years. A satisfactory equilibrium has been reached after decades of endless, suffering, intense listening tests during which thousands of signal and power cables have been terminated, tested, coupled and substituted, to build the most complicated and extravagant combinations.

Regarding the quality of the separates to be used for connecting one cable with the other, don't worry: it is sufficient to comply with some basic rules to keep away from any problem. Well, the turntable shall be British, and shall be placed on the indispensable stand, equipped with 4 acuminate spikes.

The amplifier shall not be too much powerful, in order to comply with, as well as put in evidence, the sound limits of home-reproduced music.

The speakers, to be placed on rigid and non-resonant stands, mandatory equipped with 8 spikes each, shall not have more than two

drivers: the larger driver shall not exceed in diameter the thinnest cable of the system, in view not to give too much evidence to the sonic limitations of cables.

Cables shall have all the same length so that no phase differences can take place: keep in mind that refined enthusiast's ear easily detect an asynchronous of less than one microsecond. We hear it.

One day, after changing one of my cables, I immediately heard a slight unbalance of the sound image accompanied by alliterating of sound emission velocity and punctuality. Micro contrast was not more microcontrasted, the detail introspection was not more introspected, the focus was not focused, the concert was disconcerted, double basses and harp suddenly shrank, becoming two feet tall. A curtain materialised in front of the orchestra and the chorus voices started walking around, the acoustic scene becoming oscillating.

After half a minute of such a torture vertigo, nausea, suffocation and tachycardia forced me to switch off my beloved audio system. Gasp! It was horrific! I'd never wish to anybody, even to a Japanese technician, such a terrifying experience! After days of restless investigations I eventually discovered that one of my cables was 5 cm shorter! Of course those sonic disruptions would never have troubled any disco-music maniac (believe me: I don't want to criticise any body's musical taste) convinced that a 200W amplifier working in indecent class AB can sound louder than a 20W amplifier in pure and noble class A - class A really has class - but they nearly killed me.

**Roberto Bruno
Heliopolis,
Cairo.**

Pity they didn't! **NK**

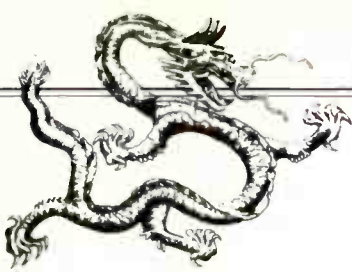

Golden Dragon

Precision Audio Tubes

Please enquire or any tube types not listed. We have an inventory of over 2,500 different types in stock.

RETAIL PRICE LIST

Golden Dragon Pre-Amplifier Tubes	Singles
6A08/ECC85	£6.50
12AT7A/E81CC/ECC81	£6.95
12AU7A/E82CC/ECC82	£6.95
12AX7A/E88CC/ECC83	£6.95
6DJ8/E88CC/ECC88	£10.95
6SL7GT/ECC35	£7.50
6SN7GT/ECC33	£8.95

Special Quality Golden Dragon Pre-Amplifier Tubes

Special Quality Golden Dragon Pre-Amplifier Tubes	Singles
E81CC-01 Gold Pins Low Microphony Low Noise	£10.50
E82CC-01 Gold Pins Low Microphony Low Noise	£10.50
E83CC-01 Gold Pins Low Microphony Low Noise	£9.50
E88CC-01 Gold Pins Low Microphony Low Noise	£14.50

Golden Dragon Triodes

	Singles	Pairs	Quads
2A3 4PIN	£22.50	£50.00	£100.00
2A3 OCTAL	£22.50	£50.00	£100.00
211	£28.50	£60.00	£120.00
811A	£11.50	£25.00	£50.00
845	£36.50	£75.00	£150.00
805	£36.50	£75.00	£150.00

Golden Dragon 300B Range

	Singles	Pairs	Quads
300B Super	£79.00	£160.00	£320.00
4.300B	£84.00	£170.00	£340.00
4.300B Super	£124.00	£250.00	£500.00

Please enquire of any tube types not listed. We have an inventory of over 2,500 different types in stock.

Golden Dragon Power Tubes

	Pairs	Quads	Octets
EL34/6CA7	£25.00	£50.00	£100.00
EL34L (Laminated EL34)	£29.95	£60.00	£120.00
EL84 (Special Quality EL84)	£12.50	£25.00	£50.00
6L6WGB	£25.00	£50.00	£100.00
KT66	£25.00	£52.00	£104.00
KT88 (Wire Design)	£57.95	£116.00	£232.00
KT88 Super (Laminated)	£67.95	£136.00	£272.00

*KT88 Special (Gold Plated)

*KT88 Special (Gold Plated)	£64.95	£136.00	£272.00
6L6GC	£19.95	£40.00	£80.00
6550A	£42.95	£86.00	£172.00
6550A Special (Gold Plated)	£64.95	£130.00	£260.00
50CA10	£84.95	£170.00	£340.00
807	£25.00	£50.00	£100.00

Ceramic Sockets and Hardware

	Standard	Gold Plated
Locking 4 Pin (300B etc.)	£6.95	£15.00
4 Pin UX4 (300B etc.)	£2.5	£3.50
Jumbo (211 etc.)	£14.50	£25.00
Octal Chassis (EL34 etc.)	£1.25	£3.50
Octal PCB (EL34 etc.)	£1.25	£3.50
B9A Chassis (pre amp)		£2.50
B9A PCB (pre amp)	£0.95	£2.50
Screening Can & Skirt (pre amp)		£8.50
Damping Can (pre amp)		£4.50
Power Valve Retainer (EL34 etc.)		£5.50

High Quality Plastic Sockets and Hardware

B9A Chassis (pre amp)	£1.15
B9A PCB (pre amp)	£0.95
Octal Chassis (EL34 etc.)	£1.25
B7G Chassis (85A2 etc.)	£0.95
B9A Skirted Chassis	
Socket & Can (pre amp)	£1.75
Power Valve Retainer (EL34 EC.)	£1.95

Carriage charge £2.50 on any U.K order. Cash with order or Visa - Mastercard accepted. 24 Hour Answerphone Service.

We have a vast range of tubes available from manufacturers all over the world including rare and vintage types. A 50 page booklet of valves available is updated monthly and can be provided at a cost of £2.50 per copy including U.K postage or you may telephone our Sales Desk for prompt a quotation.

A selection from our stock of over 2,500 different audio quality valves. Please enquire for items not listed

ECC81	BRIMAR	4.50	LS9B	COSSOR	6.95	6SL7GT	BRIMAR	4.50
ECH81	MULLARD	3.50	M8136	MULLARD	8.50	6SN7GT	BRIMAR	4.50
EC82	GE	4.50	M8162	MULLARD	8.50	6SN7GT	TEONEX	3.50
ECC82	RFT	4.50	M8137	MULLARD	15.00	6SQ7GT	TEONEX	4.50
ECL82	TEONEX	3.50	MHLD6	MAZDA	5.50	6V6G	RCA	5.50
ECC83	TEONEX	3.50	OA2WA	TEONEX	3.50	6V6GT	TEONEX	4.50
ECC85	TEONEX	3.50	PCC88	SIEMENS	3.50	6X4	TEONEX	2.50
ECL86	TEONEX	3.50	PL36	MAZDA	3.50	6550A	TEONEX	12.50
ECC88	BRIMAR	4.50	PL504	MAZDA	2.50	12AT6	BRIMAR	2.50
ECC88	GE	5.50	PL509	MAZDA	5.50	12AV6	RCA	2.50
ECC88	TEONEX	4.50	PL519	THORN	5.95	12BA6	WESTINGHOUSE	3.50
EF86	TEONEX	4.50	PY32	MULLARD	2.50	12J5GT	RCA	3.95
EF804S	TELEFUNKEN	25.00	TT100	GEC	65.00	12E1	RCA	3.95
EL32	MULLARD	4.50	U19	GEC	8.50	12E1	STC	15.00
EL85	MULLARD	4.50	UCC85	MULLARD	3.50	13E1	STC	140.00
EL86	MULLARD	4.50	UU5	MAZDA	5.50	13D3	BRIMAR	6.50
EL504	TEONEX	3.50	UU6	MAZDA	6.50	85A2	MULLARD	6.50
EL509	TEONEX	5.50	2X2A	RCA	5.00	1625	RCA	6.50
EL519	TEONEX	5.50	3A/167M	ITT	10.00	5687WA	RCA	6.50
EM84	TEONEX	3.50	5Y3WGTA	SYLVANIA	4.50	5751	RCA	6.50
GZ32	MULLARD	8.50	5V4G	BRIMAR	3.50	5814A	GE	5.50
GZ33	MULLARD	5.50	6AG7	RCA	3.50	5881	USSR	4.95
GZ34	MULLARD	12.50	6A7G	RCA	8.50	6146B	TEONEX	8.50
GZ37	MULLARD	4.50	6BH6	BRIMAR	3.50	6158	BRIMAR	6.50
GZ34	TEONEX	5.50	6C8G	RCA	3.50	6189	SYLVANIA	6.50
KT66	TEONEX	6.00	6DQ6B	PHILIPS	3.50	6201	GE	6.50
KT66	GE	16.50	6K7G	RCA	3.50	6463	UNITED	7.50
						6870	BRIMAR	11.50

EXPORT WELCOME CARRIAGE AT COST

P.M. COMPONENTS LTD., Springfield Enterprise Park, Springfield Road, Gravesend, Kent DA11 8HD, England
Sales Desk Tel: 0474 560521. Fax: 0474 333762

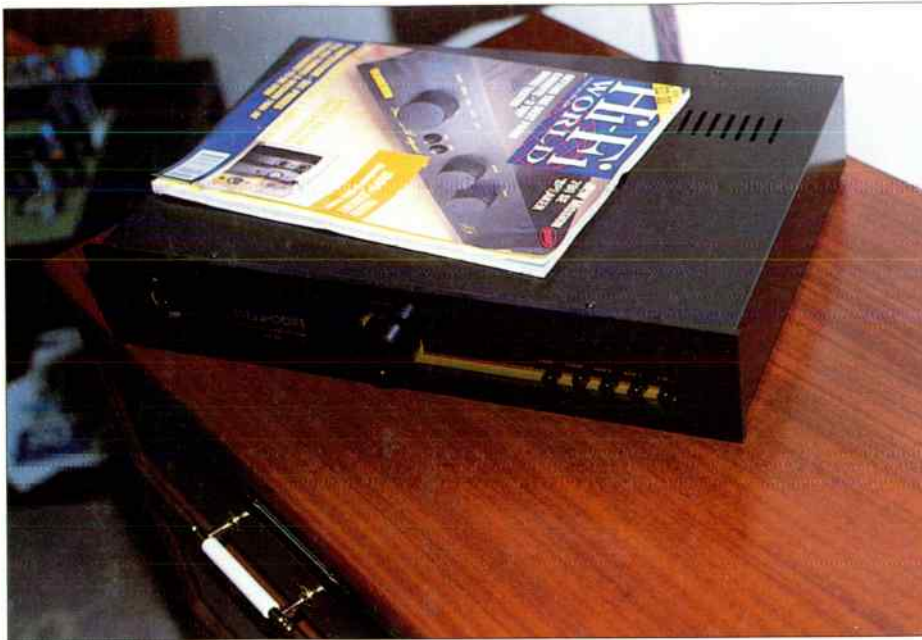

Sugden made a rare appearance, they're normally only seen at shows in Hong-Kong, Frankfurt and Vancouver. Under this Hi-Fi World - mere coincidence, it just happened to be there - lurked the new Sugden-Stemfoort SF60, a 60W power-amplifier with passive volume control and line-level inputs for £499. Also lurking was the A25B, Sugden's new entry-level £275 integrated. Sources were the SDT-1 and SDA-1 transport and DAC; speakers came from Keswick Audio Research. Sugden's associate company, Audio Synergy, has come up with some remarkably flexible flat silver-plated speaker cable at £3.95 per metre. Expect to hear (!) more of that . . .

well as enthusiasm, there was a plenty, Terry O'Sullivan of Loricraft with a Garrard 401 sharing a room with Art Audio, Martin Bastin with a Garrard 301 sharing his with Croft.

Mickey Thien drove up from London with his new heavyweight Silverado speakers and a Silverado pre-amp. Ortofon were showing off Kinshaw electronics and the 7500 cartridge (on a Gyrodec, not one of the Pro-ject turntables Ortofon UK imports and also had on show!). Organiser Les Wolstenholme had his RMS speakers as well as - inevitably - Avondale mains conditioners everywhere. He also has a new pre and power amplifier, currently lodging in smooth cases. Chesterfield has turned from a

Chesterfield Hi-Fi Show

Eric Braithwaite takes a trip north to a real Hi-Fi Show.



Graham Tricker (GT Audio) was playing a real mixture of old and new: Leak TL12 and Pye HF10 valve amplifiers into Posselt Albatross speakers, with - guess what - a Garrard 401 in the equally rare SME plinth standing by. Nearby was a Scott valve tuner 'as mentioned in Hi-Fi World' among other glories from the valve heyday.



Wollaton Audio weren't just dangling XLO cable in front of admiring eyes, but also showing off this glorious shiny black, brass and glass Audio Valve pre-amplifier and power amplifier from Taiwan.

The hotel must have been forewarned. Ringwood Hall turned the heating off for the duration of the Chesterfield Show. There were so many valve amplifiers, central heating would have made the hotel hot enough for some exotic flowering species. And exoticism, as

kind of hi-fi bring-and-buy into a showcase for the small, but highly dedicated and serious British manufacturer.

Not that the dyed-in-the-wool enthusiast was left in the shade. There was still room for Jake Rothman, audio engineer, with his boxes of spares and for the Wavenny Hi-Fi Circle from Lowestoft who get together to conduct blind listening tests, build their own



Richard Lord was busy demonstrating his REL subwoofers, now distributed by Harman UK: hence Harman-Kardon Signature amplification and JBL Ti speakers.

speakers and amplifiers and who will be joined by other similar hi-fi clubs at Chesterfield next year. The kit builder was catered for by Falcon Acoustics and the Speaker Company at one level and



Russ Andrews brought his own wood-encased integrated amplifier (a mere £2500), but also played revitalised Quad II/22 and ESLs. RATA now sells the bits and the instructions for refurbishing both.

Audio Synthesis at the other, who unexpectedly produced a new (but non-kit) power amplifier, which runs in pure Class A up to 50W and looks like a cubic heatsink with a handle. Audio Synthesis are also entering the burgeoning CD-enhancement market, modifying a machine with new circuit boards and jitter-reducing circuitry for between £295 and £395.

And there was vinyl galore. John Michell turned up with Gyrodec electronics and Ruark Equinox loudspeakers, selling a Gyrodec and GyroPower QC to a smiling visitor at the end of the show. Nottingham Analogue came with Mentors and Spacedecks; Sonic Link with the Rivelin

turntable; Doncaster dealers The Hi-Fi Studios with their own Epsilon, a very well-kept secret outside South Yorks. John Turton of The Record Connoisseur had a beam a mile wide; not only were vintage recordings flying out the door, but some of the brand-new Mobile Fidelity vinyl was being scrambled for before it had even been advertised. It seemed everyone had something covetable under their arms, except me - by the time I emerged from the crowded rooms to hit the ground floor stalls, all the best records had gone. There's always next year ●



And a glorious Garrard. This one is by Loricraft, whose Terry O'Sullivan told HFW he had secured a special oil from an oil company for Garrard bearings. The room was shared with Art Audio, who brought in some curious speakers from the USA about which nothing much was known except the name: Brentwood Audio Labs. Given the ambience of the Chesterfield Show it was hardly a surprise to discover they were originally designed by two schoolteachers as a hobby. Look out for some new amplifiers from Art Audio later this year.



The Speaker Company had practically its whole range, including a large horn (with shocking-yellow horn-loaded tweeter) and the floorstanding Tornado, seen here shaking the tulips powered by a Velleman kit valve power amplifier.

The Stereophile High End Hi-Fi Show

at The Doral Country Resort, Miami.

miami hi-fi show

The variety of equipment and the razzmatazz of a big American show is a spectacle to be marvelled at. Also impressive was the extremely high

overall level of sound quality coming from the rooms. There were over 250 exhibitors, so here's just a snippet of what was on display.

SPENDOR were out in force in Miami with their new Master Series loudspeakers. The SP7/1 is a two way floorstander using their 200mm homopolymer bass unit with a soft dome Scanspeak tweeter, and the SP9/1 a three-way with 300mm bass unit and 160mm mid range. The Master Series are extremely heavily engineered and use high grade components in the crossover. Also new in Spendor's Classic Series are the SP3/1s, replacing the S20s. We hope to bring you reviews soon.

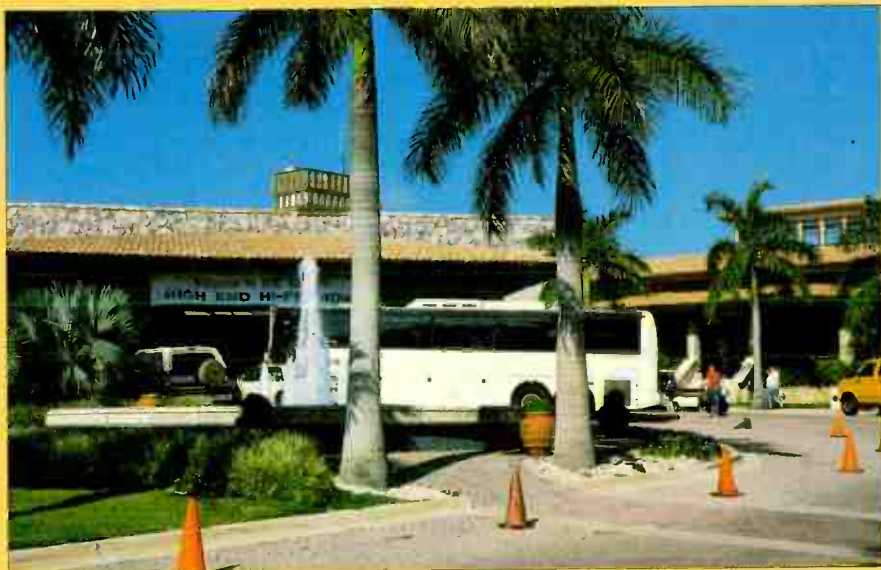

AUDIO ALCHEMY. 'Only in America could you add a £400 tube output stage to a £200 DAC'. It sounded very sweet though. The output stage of a convertor does seem to impart a lot of character. We'll be looking forward to this one, along with Audio Alchemy's first ever amplifier, the Overture OM150 power amp and Digital line pre-amp. The power amplifier boasts 150 watts into 8Ω, has very low feedback and a second power supply can be added for completely dual mono operation. The Digital Line Controller has inputs for four line sources, switched and controlled by microprocessor and it can be upgraded simply by replacing the ROM chip. Look out for these in the UK soon.

TOWNSHEND. Max was there with his massive Sir Galahad 'speakers, using no less than nine ribbon tweeters and six metal cone bass units each. Also on demonstration was the Rock III turntable and, of course, Seismic Sinks. Max was smiling widely, he'd done as much business in the first few hours of the Miami show as he'd done all year in the UK, but then there aren't many homes big enough for the Sir Galahads over here.



SONY were dabbling in loudspeakers. The two-way SS-M3s and three-way SS-M7s certainly looked interesting, being built pyramid-style to reduce standing waves that can form between parallel cabinet walls. The drive units are made from a mineral filled polypropylene and the crossover even uses high quality polypropylene capacitors - shame they won't be available in the UK though.



N.E.W. had on display a 20watt Class A power amplifier which was sounding beautifully sweet and open, but the real interest seemed to be over a massive cubic heatsink sitting on the floor. It was in fact a 75watt single-ended monobloc transistor power amplifier! They promised to play it early in the afternoon, but fearing a mains melt down, I didn't return.



CARY. While we're on the subject of single-ended, two from Cary Audio. The larger of the two is the 805, here using a 300B to drive the 211 output tube for 50watts output. The other is the 300SE, using a single 300B triode for 12watts output. Both are beautifully built, being hand-wired throughout.



MANLEY. 75watts of single-ended valve power from this one. Definitely no user serviceable parts though, with 1500Volts on the anode. It uses a Russian GM70 transmitter valve which has an anode that can dissipate 250watts. The price, not an unreasonable figure, \$15,000 the pair.



UTOPIA, one of the most interesting rooms in the whole show. The Utopia Instrument Co. have a range of over 70 horn enclosures which will take units from Tannoy, JBL, and Altec. A Japanese company,

they believe that the only way to reproduce music

realistically is with horns, and preferably with a Garrard or Thorens front-end and vintage valve amplification. They have a complete range of spare parts for Garrard turntables, some new, but most original. When we were buying LP12s in Britain, they were buying decent 301s and 401s.

Sad, but true.

MBL from Germany brought something unusual. The speakers use what MBL call an isotropic transducer: they radiate all around the balloon-shaped diaphragm driven from a voice coil at the bottom. But the things that caught my eye, were the absolutely massive 9010 monobloc power amps. These are capable of producing a peak power of 5000watts into a 2Ω load, with 50amps on offer. They weigh 70kg each and cost \$38,000 for a pair.



AUDIONOTE/JMlab had on show the new DAC-4 from Audionote, priced at £4950 in the UK, using a specially selected K version of the Burr Brown PCM-63 20bit 8x oversampling chip. It has a silver wired interface transformer and uses 6922 triodes on the output. More single-ended amplification, this time played through \$11,000 JMlab Alcor 'speakers. JMlab are a division of drive unit manufacturer Focal, and the Alcors were certainly a good ambassador for their units, sounding extremely crisp and detailed.



LINN/NAIM/INSTAURO. I'm not sure whether Linn or Naim would have agreed to their equipment being used with copper dustbins, but it certainly sounded OK. All the way from New Zealand, this intriguing 'speaker, described in the literature - "Visually, its design is an obvious assault" - has a metal cabinet designed to improve the sound wave direction from the drive units. Interesting, but I don't think they'd take off over here.



"The decor of this flat is not to everybody's taste, that's why it is offered at a realistic price". Estate agents are masters of euphemism; the spacious Victorian rooms were filled with furniture styled more to suit tastes in Bahrain than Britain. Tatty 'gold' plate (brass) glistened everywhere, the tables had smoked glass tops and tinted mirrors covered the walls. A flimsy drinks cabinets with cheap gold trim shrieked at me. The rooms were filled with cheap copies of Bahrain chic. There was only one word for it: naff.

"I'll take it" I said. It was the rooms I wanted, not the furniture. The acoustics of the lounge seemed superb and luckily, I was right. Finding out how it behaved and how to get the best from it was fascinating.

But firstly, the furniture had to go. Contributor Richard Kelly and I manhandled a table to get it through a doorway. Craaash!! We'd failed to notice that the huge glass table top wasn't fixed. It slid straight off the frame and onto - well, what else? - the glass top of a low coffee table. Both table tops shattered instantly; Kelly and I were struck dumb. Realising I could tackle the

problem in a year's time when the contract expired, we got on dismantling and storing what remained!

At the end of it all I had a lounge 18ft long, 12ft wide and, best of all, an 11ft high ceiling.

A core hi-fi system was installed quickly. I chose Heybrook Sextets, our own K5881 valve power amps in monoblock form, an EMF CD convertor complete with volume control and a Teac transport.

There are a host of different things to consider when speaker positioning. For good stereo staging the



speakers, lessening the influence of reflections.

For me, it's especially important that I listen to the equipment, not the quality of the room reflections, since reflected sound is "dirty". It is of very uneven tonal balance and it's out of phase too, arriving after the main sound.

Having the speakers sitting in the centre of the room like this has given me a beautifully clean sound, with celestial imaging, free from the loudspeakers and seemingly unrelated to them, which is just how it should be. The Sextets have

Reflections from Noel Keywood kaleidoscope

speakers should be kept at least a few feet from a rear wall. What is less appreciated though is that to avoid suckouts and an uneven sound at the listening position, the listener should also sit away from a wall (or heavy sound absorbent should be used behind).

I like a clean sound lacking high frequency confusion, for good clarity and intelligibility. This demands that sound reaching my ears directly from the loudspeakers should be much greater than that reaching my ears from reflections off walls and, especially, the ceiling. This is where a high ceiling is a great benefit.

The system was set up initially as shown (1). The sound was stark, or bare. Stereo imaging was mediocre too. I noticed that the sound livened up and developed a closer perspective with more volume, but then more confusion became apparent and I was very obviously playing the system loud, which neither I nor my new neighbours would appreciate.

I needed a closer perspective on performances, using less amplifier volume. This meant moving the speakers progressively away from the room, keeping them away from the side walls. Currently they sit half way up the length of this room, about 18in from the side walls and toed in slightly (2). This gives more direct sound from the

this property, although it's an area in which Quad Electrostatics reign supreme.

Another interesting feature of this speaker position is the way it lessens lateral and longitudinal room resonances. Floor standing best excites the vertical floor-to-ceiling resonance (it's a pressure anti-node) of a room, so again a high ceiling is a benefit, putting this resonance at a low-ish frequency. I get cracklingly dry bass, every note being reproduced as cleanly as a whistle, without overhang. The drawback, however, is that with the Sextets I don't get much low bass. I can do two things: move the speakers back towards a wall and change my listening position or get bigger loudspeakers with heavier bass.

Since heavy bass doesn't concern me unduly, I'm more than happy at present. I've got plenty of time to think up a few euphemisms of my own before the estate agent comes around to check the furniture. "The table tops collided with each other under the influence of gravity, changing their shape dramatically" I'll tell him ●

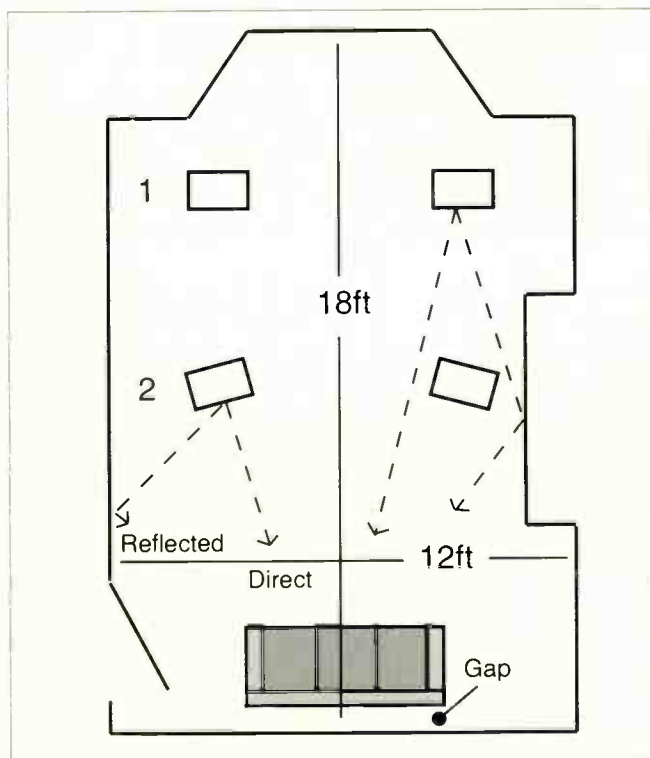

Noel's new listening room



THE HI-FI LAW OF DIMINISHING RETURNS

Ask a Hi-Fi dealer to upgrade your system, and he'll sell you ever more expensive bits of hardware, giving you a constantly changing sound, new solutions producing more problems which can only be solved with more expensive equipment. The harder you try, the more it costs and the less satisfying the results. This is the well known Hi-Fi law of diminishing returns. We have an alternative:

THE RATA LAW OF INCREASING RETURNS

Why buy new equipment when it makes more sense to realise the full potential of your existing equipment. Don't replace it, upgrade it; it's cheaper. Most equipment can be transformed by us for the cost of a dozen CDs. Magic? No - logic! To find out how we do it, ask for our new free Catalogue; it provides discussion, analysis and a definitive resource of audiophile components and advice on the art of recreating music in the home.

Russ Andrews Audiophile Catalogue

Includes :-

- CD Players, Preamplifiers, Disc Preamplifiers, Power Amplifiers,
- Loudspeakers
- Kimber Kable
- Upgrading Services and Guides
- Audiophile Kits and Components
- Accessories
- Reviews

1993 Edition 2 Available Now

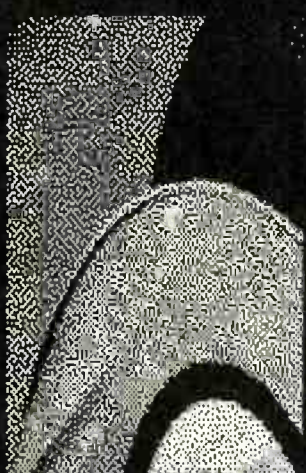

RATA

Edge Bank House,
Skelsmergh,
Kendal,
Westmorland, LA8 9AS

Tel: 0539 823247

Fax: 0539 823317

UK: Post Free,
Europe: 3 International Reply Coupons.
Overseas: Send US \$3 bill or four IRC

There was once a time in hi-fi when all true audio pilgrims sought the chalice of audio perfection with the aid of the mysterious geometry of elliptical styli and tracking protractors. For those of us who were more interested in electronics than in mechanical engineering, this period was dominated by an unending quest for the ultimate RIAA pre-amplifier and equalisation stage.

Looking back, I must have built about twenty or thirty different versions of this front-end circuit, some with op-amps, some with discrete transistors, some with valves. One or two circuits used passive equalisation, most used active feedback arrangements of the so-called 'shunt' or 'series' type. Debates raged in *Wireless World* and *Hi-Fi News* about which type of circuit sounded better with different electronic Merlins claiming better transient performance for this type, or better THD for that type and so on. For my own part, I never really came to any conclusion as to which circuit sounded the absolute best - all seemed to have their advantages and disadvantages.

The last version I built was a hybrid active/passive affair utilising what was then the very state of the art, OP27 operational amplifiers. I was very pleased with it at the time, I still use it and I doubt if I shall ever change it now so much of my listening is

'CD-based'. (Although I must admit that Andy Grove's design in the April 94 *DIY Supplement* got me thinking!) The truth is, there were - and indeed still are - many ways to skin the RIAA cat.

It was sometime during the middle period of my quest for RIAA nirvana that I became involved in sound recording and studio electronics and had, for the first time, the opportunity to compare studio master-tapes with the wax test-cut records and vinyl pressings. I vividly remember the first



they introduce. (I suspect Andy Grove has trodden this path too - hence his very sensible incorporation of a modified IEC time-constant in the *Hi-Fi World* disc pre-amplifier). However, with the widespread adoption of CD, we all now have the opportunity to compare 'control-room bass' with 'vinyl bass' and since the audible effects of rumble filter group-delay distortion can be ameliorated by careful choice of filter alignment, I thought readers might be interested to do

recorded message

Left by Richard Brice

time I made a direct comparison. My initial reaction was, "where has all the bass gone?" The response was due to my unquestioning incorporation, within the RIAA equalisation network, of what is known as the 'IEC amendment' - a further 6dB/octave time constant which reduces output by -3dB at 20.02Hz. Compared with the master tape, this extra bass-cut circuit made the whole 'feel' of vinyl replay bass light.

The idea behind the IEC amendment is cogent enough in that it is intended to provide some discrimination against subsonic rumbles originating from record warps. However from that moment on, there has never been any doubt in my mind that if it's possible to do without the IEC roll-off, in order to provide a more accurate sounding 'bottom end' without the penalty of cone flap due to very low frequency (v.l.f.) rumble and warp information, then this is a very good thing. To that end, my later RIAA amplifier designs all incorporated many forms of high-order, high-pass, 'rumble' filters intended to remove subsonics without removing bass.

With that experience behind me, I now understand why steep-cut rumble filters tend to be disliked by purists! My own experiments revealed that the benefit of steep filters (in terms of warp suppression) is often easily offset by the audible phase and group-delay distortion

some experimentation of their own in this department.

Fig. 1 illustrates the circuit of my most recent RIAA amplifier's subsonic-filter section. Technically, the filter is aligned by means of a switch, either as an over-damped Butterworth with a 10Hz turnover, or as slightly sub-Gaussian with a 20Hz turnover. The switch may therefore be used to select between a response which is essentially that of the IEC recommendation when it is open or one which is flat (-1 dB) to 14 Hz when it is closed. In its Butterworth guise, the circuit offers a 2dB improvement over the straightforward IEC time constant approach in its rejection of warp information. In either case the circuit introduces no further group delay distortion, compared with the simple IEC circuit, within the pass-band. All resistors should be metal-film 1% types. I suggest the 1µF capacitors should be the Wima plastic cased, metallised polyester type ●

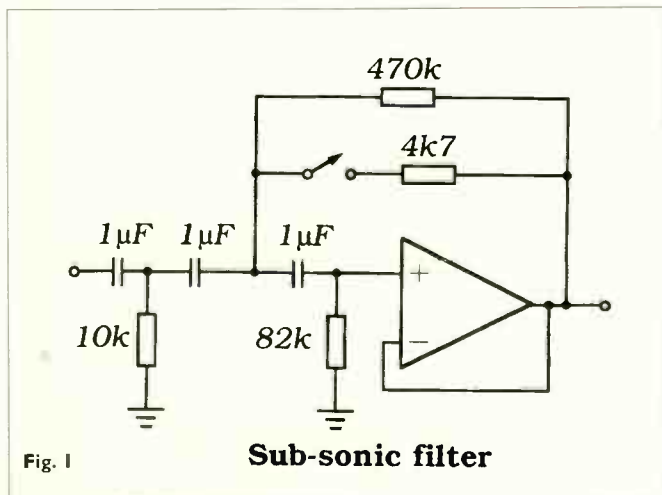

SAVE A FORTUNE
IN DEALER PROFITS
BUY DIRECT

Richard Allan D I R E C T

TOP FIVE STAR
★★★★★
WHAT HI-FI? reviews

Hi-Fi
WORLD AUG 93
"Mighty Miniatures"

CD Review
MAGAZINE JUNE 94
"In short, they're up there with the best of the competition"

WHAT HI-FI? JUNE 94
test speakers under £140
verdict - Sound ★★★★★ Value ★★★★★
"...provide a rewarding hi-fi experience, and they're especially good value"



WHAT HI-FI? MAY 93
"they have a natural and tireless presentation of all sorts of music, with an easy, enjoyable performance. Keenly priced (at £120), cracking little all rounders."

Size 30 x 16 x 20 cm
130mm bass/mid unit on cast chassis

	FINISH	RETAIL	DIRECT
MINETTE 2	Black Ash	£129	£89
	Graphite	£149	£109
	Walnut / Mahogany veneer	£179	£129
MINETTE Gold (Bi-wired)	Black Ash	£149	£109
	Graphite	£169	£129
	Walnut / Mahogany veneer	£199	£149

Add £5 carriage

HAND CRAFTED IN BRITAIN SINCE 1947
ALL SPEAKERS COME WITH A 5 YEAR GUARANTEE
CUTTING OUT THE RETAILER AND SELLING DIRECT MEANS *HUGE SAVINGS* FOR YOU
ASK ABOUT OUR THREE MONTH INTEREST FREE CHEQUE SPREAD PAYMENT SCHEME
TRY THE SPEAKERS IN *YOUR HOME* WITH *YOUR SYSTEM* AT *YOUR LEISURE*
IF NOT DELIGHTED RETURN THEM WITHIN 7 DAYS FOR A FULL REFUND

CUT OUT THE COUPON AND CUT OUT THE MIDDLEMAN HFW0894

NAME _____
ADDRESS _____
POSTCODE _____ TELEPHONE _____

MODEL MINETTE 2 MINETTE 2 GRAPHITE MINETTE 2 WALNUT MINETTE 2 MAHOGANY
MINETTE GOLD MINETTE GOLD GRAPHITE MINETTE GOLD WALNUT MINETTE GOLD MAHOG.

PAYMENT CHEQUE VISA ACCESS OTHER _____ Please tick box

CARD NO. _____ EXPIRY DATE _____

SIGNATURE _____
Richard Allan
D I R E C T

Please allow 14 days for delivery
Cheques payable to:
Richard Allan Audio Ltd., Bradford Road,
Gomersal, Cleckheaton, West Yorkshire,
BD19 4AZ England Fax 0274 86 99 35

Tel. 0274 87 24 42

**PAUL GREEN
HI-FI LIMITED**
at HARPER FURNISHINGS (Customers Car Park)

London Road
Bath, Avon
Tel: Bath 316197
VAT Reg. No. 140 5913 88

MAY DAY SALE BARGAINS WHICH ARE MUSIC TO YOUR EARS

AUDIO RESEARCH LS1 LINE PREAMP	NORMALLY £1797	ONLY	£999.00
SONY CD303ES CD PLAYER	£ 549	ONLY	£349.00
SONY SS125 SPEAKERS (BRITISH)	£119	ONLY	£ 89.00
SONY TCWR DOLBY S DOUBLE CASSETTE DECK	£279	ONLY	£199.00
SONY TCWR 435 DOUBLE CASSETTE DECK	£ 169	ONLY	£129.00
TECHNICS RXB404 CASSETTE DECK	£179	ONLY	£139.00
TECHNICS STG70 TUNER	£249	ONLY	£189.00
AIWA ADF810 CASSETTE DECK 3 HEAD	£ 229	ONLY	£179.00
YAMAHA KX260 CASSETTE DECK	£159	ONLY	£119.00
YAMAHA KX650 CASSETTE DECK 3 HEAD	£259	ONLY	£189.00
YAMAHA KXW 262 DOUBLE CASSETTE DECK	199	ONLY	£149.00
SPENDOR S100 SPEAKERS SECOND HAND	£1965	ONLY	£999.00
SPENDOR SP2/2 SPEAKERS	£699	ONLY	£349.00
AURA V50 AMPLIFIER	£249	ONLY	£199.00
B & W DM610 SPEAKERS	£179	ONLY	£129.00
B & W DM600 SPEAKERS	£239	ONLY	£159.00
APOGEE STAGE SPEAKERS	£3555	ONLY	£1495
KEF 103 LOUDSPEAKERS	£1249	ONLY	£899.00
PANASONIC TX25W3 NICAM/TEXT TV	£699	ONLY	£549.00
TECHNICS SCCH655 SYSTEM	£699	ONLY	£549.00

ONE 5 METRE PAIR GREEN HYPERLITZ SPEAKER CABLES, VERY SPECIAL PRICE
NORMALLY £600.00 ONLY £300.00 (WITH PLUGS)

NEXT DAY DELIVERY ARRANGED
DEMONSTRATIONS BY APP.

CLOSED MONDAY
LARGE SELECTION OF CABLES AND ACCESSORIES AT SALE PRICES. IXOS
AUDIOQUEST FURUKAWA AND OTHERS

NEW DENON MIDI SYSTEMS IN STOCK THE VERY BEST AVAILABLE

ALL ITEMS NEW EXCEPT WHERE STATED
SOME ITEMS DEMONSTRATION MODELS



DYNACO STEREO-70

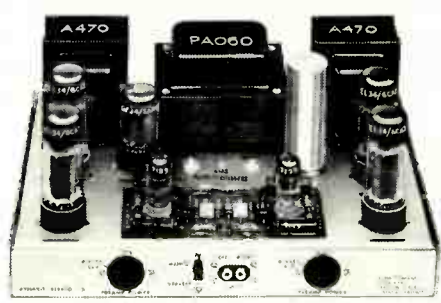

This is one of the most famous American tube amps ever made. Rated at 35 watts per channel, it uses 4-EL34's, 1-GZ34, and two 7199's. This very reliable amp is great for those who wish to modify parts or use it just as it is. Bias is easy to adjust, and the unit can switch between mono and stereo. The output tubes can operate at 65% of their capacity, and the filter caps at less than 85% of their rated voltage. A true classic.

Dynaco, Sherwood, Scott, The Fisher, McIntosh, Eico, Harman-Kardon, Heath, Altec, Stromberg-Carlson

Prompt Insured Delivery. Vintage Parts Available on Request
Looking for a particular piece of vintage equipment?
Send Us Your Requests.

FAX: (604) 876-5876
P.O. BOX 147, STATION A, VANCOUVER, B.C.
CANADA V6C 2M3

Meet-Your-Maker

A reference guide to Britain's Manufacturers and Distributors.

ACOUSTIC ENERGY, 3a Alexandra Road, London W13 ONP. Tel. 081 840 6305. Acoustic Energy manufacture the award winning Reference Series AE1 and AE2 loudspeakers and the new Aegis Series Model 1, all of which feature the unique AE metal cone drive units. The AE distribution division offers superb high end products from WADIA, GRYPHDN, ENSEMBLE and TARA LABS. **ALCHEMIST PRDDUCTS**, 4 Rosebury Mews, London N10 2LG. Call us for a list of our dealers in many areas including:- London, Kent, Hampshire, Wilts, Milton Keynes and N. Ireland and for product information on the Kraken, Freya, Bragi, Odin, Genesis and more Tel: 081 883 3008

ALEMA UK LTD., 25 Montifore Road, Hove, BN3 1RD. Tel. 0273 202637. Audion * Edison * Andersson * (Trade enquiries welcome for our newly extended range).

APPOLLO, The UK based designers and manufacturers of high quality speaker stands and equipment racks have now added to their comprehensive range a modular system ideal for housing audio visual products and CD storage. Please send for our free brochure to Zenith Crown Ltd. Tipton Rd, Dudley, West Midlands, DY14 Tel. 021 520 5070. Fax. 021 522 2055. - All export trade enquiries welcome.

ARCAM, Pembroke Ave, Denny Industrial Centre, Waterbeach, Cambridge, CB5 9PB. Tel. 0223 440964 or Fax. 0223 863384. Manufacturers of the Delta 290 Amplifier and the Delta 280 Digital FM Tuner. The two together produce a sound that has been described as 'subtle and intriguing' and that provide 'real clout' - discover this for yourself. For information on not only these products but also the Arcam CD Players, Speakers, Cassette Decks etc., Phone or write in to request a brochure - The pleasure is all yours!

AUDIOWTE CO, Unit 1, Block C, Hove Business Ctr. Fonthill Road, Hove BN3 6HA. Tel. 0273 220511. Audionote supply a range of very high quality and very expensive audiophile components including valve output transformers.

AUDID SYNTHESIS, 99 Lapwing Lane, Manchester, M20 OUT. Tel. 061 434 0126. Audiophile design, development and distribution. Please contact us for details of: PASSION the passive controller everyone's talking about. SILVERBLUE pure silver interconnect cable and the ultra analog based dac - DSM.

AVONDALE AUDIO, Tel: 0246 200096. Exploit the full potential (and more) of the Linn LP12 Turntable for only £568.00 inc. (Cost much less than a Lingo) with Avondale's very naughty but STUNNING convertor. For a chat...the above number, please.

BANDOR MINIATURE LOUDSPEAKERS, Studio 11, Penfold Cottages, Penfold Lane, Holmer Green, Bucks. HP5 6XR. Tel. 0494 714058. Aluminium anodised cone drivers with only 1.8 gm moving mass giving full detail to sound covering 2/3 of the frequency spectrum.

BANDRIDGE LTD are the premier suppliers of quality audio and video leads, connectors and speaker cables in the UK. In addition to probably the widest range available, including PROFI GOLD, SUPER GOLD and SUPER +, offering a level of quality that meets the needs of the most exacting specification. Bandridge of London Ltd. Premier House, Deer Park Road, Wimbledon SW19 0B1 543 3633.

CABLE TALK PO Box 413, Woking, Surrey, GU22 8YZ. Telephone 0483 750667. Fax 0344 360866. Designers and manufacturers of British made high quality, value for money, interconnect and speaker cables. Phone or fax for a free full colour brochure on our What Hi-Fi? 5 star rated products.

CAMPAIGN AUDIO DESIGN, Llandudno Road, Cardiff CF3 8PG. Tel. 0222 779 401. Supplies / manufactures mailorder, high purity silver interconnects, loudspeaker cables, internal wires and bespoke mains cables. Generous two week trial period.

CHRD ELECTRONICS, 3 Bower Mount Road, Maidstone, Kent. Tel. 0622 764874 Audition the Chord SPM 1200 at any of the following branches: Doug Brady HiFi - Liverpool/Leeds/London/Cheshire, Audio Reflections - Leeds, Music Matters - West Midlands and many others. Please call us for details.

CONCROANT PREMIER TUBE, 14 Glyn Close, Barwell, Leicester, LE9 8GL. Tel. 0455 843752. The Excelsior - Designed for the analogue enthusiast. The Exhilarant - Designed for the line enthusiast. The Exquisite - Designed for the analogue and line enthusiast.

CREEK AUDIO LTD 2 Bellevue Road, Friar Barbet, London N11 3ES. Tel: 081 361 4133, Fax: 081 361 4136. Manufacturers of the 4240 Integrated Amp, P42 and A42 Pre/Power Amps, CD42 CD Player. Please write for further details.

The Exultant Power Amp fitted to Quad II Hardware. **DBS AUDIO**, PO Box 91, Bury St. Edmunds, Suffolk,

IP3 ONF. Tel: 0284 828926. Fax: 0284 828026. The DBS6 loudspeaker kit, as designed by Dave Berriman and featured in Hi-Fi News Feb/Mar 92, is still available - only from DBS Audio. To find out what these comprise, cost and how to order plus any other information on DBS products please telephone, fax or write in to the above address and numbers.

IAN EDWARDS, The Old Chapel, 282 Skipton Road, Harrogate, Yorks. Tel. 0423 500442. Somebody Somewhere must make better storage units for CDs, Music, LPs, HiFi, Books, etc. than Ian Edwards. BUT until he appears, why not send for the brochure showing a selection of HAND MADE units. To do this please send 3 x 2nd class stamps.

E J JORDAN DESIGNS, The Oak, Manor Bier, nr Tenby, S Pembrokeshire, SA70 8QR. Tel. 0834 871 209, or Fax. 0834 871 770. Curvilinear metal cones loud speakers were first developed by Ted Jordan in 1963. EJ Jordan Designs are now World leaders in foil cone technology. First and foremost.

ELECTROMAIL, PO Box 33, Corby, Northants, NN17 9EL. Tel: 0536 204 555. The branch of the well known R.S. Components trade mail-order business that deals with the public. They have a huge range of components - and catalogues to match.

EMF, 2a Bellevue Road, Friar, Barnet, N11 3ES. Tel. 081 361 6734. Manufacturer of Sequel 50w integrated amplifier and the Crystal D2A converter. Amplifier and DAC. Please write in for details.

FALCON ACDUSTICS LTD., Tabor House, Norwich Road, Mulbarton, Norwich, Norfolk, NR14 8JT. Tel. (0508) 78272. U.K. distributors of FOCAL drive units and SOLEN (chateauroux) polypropylene capacitors and the largest inductor manufacturer in the U.K. Comprehensive range of DIY Speaker Parts and Kits, Sub-Bass and Electronic Filters.

"Everything but the wood"
FARADAY SOUND, 248 Hall Road, Norwich, NR1 2PW. Tel: 0603 762967. Loudspeakers in CONCRETE: the ultimate enclosure. Now you can build your own low density concrete cabinet enclosure Faraday FS1, Siren, FS5, FS10 or a design of your own choice. Stunning sound and reviews. Simple DIY skills only. Full instructions including cabinet construction for only £10. Includes reviews, photos etc. and at least £10 discount off any further products purchased from us e.g. ready made cabinets. Also £25-£150 off any complete loudspeakers!!!

FOUNDATION AUDIO, 53 Beecroft Way, Dunstable, Beds. LU6 1EE. Tel. 0582 477550 or Fax. 0582 604001. We have long been acknowledged as the market leader in sonically superior stands and major in 'specials'. Send for our brochure and details of your nearest stockists.

FULLERS AUDIO, 20 Tunbridge Road, Southend on Sea, Essex SS2 6LT. Tel. 0702 612116. Fuller's audio produce a range of innovative products. Amplification - a10 a single ended class A semiconductor power amplifier - £1200, b70 a mosfet power amplifier of high standard - £599, prel and prel + matching pre-amplifiers - £599/£649, geni phone stage for mm and mc cartridges £299. Loudspeakers - Pharoah system, upgradable from 1 pair of cabinets to 3 pairs for truly extended bass, passive/active options £649-£2499, Sphinx a 3 way floor standing unit £849, Sultan 2 way reflex, 91.5dB sensitivity £3099

GRANITE AUDIO STANDS - The ultimate solution to problems of resonance and tonal accuracy. For 'bespoke' designs consult NORLSTONE, West Dean Road, West Tytherley, Salisbury. SP5 1QG. Tel 0980 862253.

J E SUGDEN & CO LTD., Valley Works, Station Lane, Heckmondwike, West Yorkshire, WF16 0NF. Tel. 0924 404088. Manufacturers of hand crafted audio products. 'A world of Music'. Call or write in for information on our SDA-1 Digital to Analogue Converter, SDT-1 CD Player, A21a Class 'A' Amplifier, A25B Integrated Amplifier, A48 Integrated Amplifier, Au51c Pre Amplifier, Au51p Power Amplifier and more.

JORDAN WATTS ACOUSTICS LTD, Cyntra Place, 201 Mare Street, Hackney, London E8 3QE. Tel. 081 985 1646. Jordan Watts Acoustics for Sight AND Sound.

KESWICK AUDIO RESEARCH, 54 Coach Road, Outwood, Wakefield, W Yorks, WF1 3EX. Tel/Fax 0924 870606. 'I'd say that the Figaro is the best miniature speaker I have heard' Audiophile March 1993. Write in or call for details on our full product range and your nearest stockist.

KRONDS DISTRIBUTION, 35 Fallow Road, Dungannon, N. Ireland. BT714 DU. Tel: 0868 748632. Fax: 0868 448281. Kronos is the UK distributor of some of the finest Hi Fi products in Europe. These include Audiomeca digital products and turntables; Lieder silver

speaker and interconnect cables; Pro-Ject turn-tables and amplifiers; Triangle speakers and electronics; and YBA amplifiers. We also handle Frameworks equipment tables; Arion valve amplifiers and mains filters and Essex Audio digital products from the UK. Please telephone or write for product details and dealer lists.

LANGREX SUPPLIES LTD, 1, Mayo Road, Croaydon, Surrey, CR0 2QP. Tel: 081 684 1166. Fax: 081 684 3056. We are one of the largest stockists and distributors of electronic valves, tubes and semiconductor in the UK. Over 6,000 types in stock. We specialise in obsolete types including original UK and USA made audio valves. Telephone or fax for an immediate quotation.

LECSON SYSTEMS LTD., Unit 19, Newfield Rd. Ind. Est. St. Ives, Huntingdon, Cambs, PE17 4LD. Tel: 0480 498211. Call for info on our range of integrated and four channel integrated bi-amplifiers. Stereoplus, Quattra and Quattraplus analogue and digital interconnects and loudspeaker cables. As a compliment to the LFD range of accessories GOLD plated mains 13A plugs and sockets now available.

LOCKWOOD AUDIO, Imperial Studios, Maxwell Road, Borehamwood, Herts, WD6 1WE. Tel. 081 207 4472/ **LORICRAFT AUDIO**, 4 Big Lane, Goose Green, Lambour, Berks. RG16 7SU. Tel. 0488 72267.

Specialist restoration of 301's and 401's using genuine spares and re-manufactured parts to original pristine standards in our newly built work shops designed primarily for these purposes.

LYNWORTH ELECTRONICS, Coley Lane Farm, Lynworth, Rotherham, S62 7SU. Tel. 0709 873667. Lynworth Electronics is famous for manufacturing the only range of audio mains cleaners that really work. A complete range is now available to suit every system and every pocket.

MARANTZ HI FI LTD., Kingsbridge House, Padbury Oaks, S75-583, Bath Road, Longford, Middlesex UB7 0EH. Tel. 0753 680868 or Fax. 0753 680428. Marantz is a manufacturer of Hi-Fi separate components, including CD, DCC, cassette decks, amplifiers, tuners, receivers and speakers. Also now active in Home Cinema with Pro-Logic amplifiers and receivers, plus Nivam VCR and video projector.

MAY AUDIO MARKETING U.K. LTD., 83 Main Street, Burley in Wharfedale, North Yorkshire. LS21 7BU. Tel: 0943 864930. Distributors of High Quality audio products from Duson Electronics, Totem Loudspeakers, Jocklin Float Headphones and quality recordings from Proprius, Prophone, Opus, MAP and Swedish Society. IF ITS MUSIC YDU LOVE, TELEPHONE OR WRITE FOR LITERATURE.

MICHELL, 2 Theobald Street, Boreham Wood, Herts, WD6 4SE. For full information on our full range of excellent products including the Gyrodec, Alecto, Iso, Argo and others please telephone us on 081 953 0771. Michell - Symbol of Precision

PEAR AUDIO, 3 Northumberland Mews, Alnmouth, Northumberland, NE66 2RS. Tel. 0665 830862. A wide range of products including Shahnian Loud Speakers - Super elfs, ARCS, Obelisks, Hawks and Diapasons. Dynaverb amps and cartridges and Bedini amongst others.

PERFECT PITCH MUSIC, Hanworth Trading Estate, Hampton Road West, Feltham, Middlesex, TW13 6DH. Tel: 081 893 8662. Fax: 081 893 4318.

We manufacture the Franciscan CD enhancement system, The Dacula DAC and Perfect Digital and Analogue interconnects. Perfect Pitch also provide freelance design, manufacture, prototyping and test, also valve and solidstate specials. Trade enquiries welcome.

QUANTUM AUDIO LTD, PO Box 26, Kilmarnock, Ayrshire, Scotland, KA3 7JA. Tel. 0563 71122. Audiophile CD's & LP's. The UK's largest specialist: Minstrel ultra linear integrated tube amplifier. Last record and preservation products Write or phone for full listings and prices.

REL ACOUSTICS, Unit 2, New Street, Bridgend Ind Est. Bridgend, Mid Glamorgan, CF31 3UD. UK. Tel. 0656 768 777, international +44 656 768 777. Fax. 0656 766 093. international. +44 656 766 093. The UK's only specialist sub-bass speaker manufacturer. 'The only one that works'. Get your dealer to give you a home demo and find out what the fuss is all about.

REL. HARMAN AUDIO, Unit 2, Borehamwood Ind. Park, Rowley Lane, Borehamwood, Herts. WD6 5PZ. Tel: 081 207 5050, Fax 081 207 4572. Sub Base Systems - Rel Strata. Stadium, Stentor, Studio

RICHARD ALLAN AUDIO, Bradford Road, Gomersal, Cleckheaton, W Yorks. BD19 4AZ. Tel. 0274 872442. Fax 0274 869935. Manufacturers of very high quality loudspeaker enclosures and drive units. Examples

being the £270 RA8 series 2 as supplied to the BBC and the 5" reviewed Minette 2 at £120.

SAMBELL ENGINEERING LTD, Winston Avenue, Croft, Leicestershire, LE9 6GQ. Tel 0455 283251.

ATACAMA AUDIO SUPPORTS from Sambell Engineering Ltd. We are the sole manufacturers of the 'SE' range of speaker stands, consisting of an 8", 12", 16", 20" and the award winning 24" high stand. Also three specialist models for the Tannoy 'sixes' Loudspeakers.

SEQUENCE DESIGN LTD, 24 Brook Street, Mayfair, London W1Y 1AE. Tel. 071 495 0775. Fax 071 495 0281. Slim loudspeakers which stand close to a wall or hang like pictures. 'Likely to cause a glint in the audiophile's eye' (Audiophile); 'the answer to a prayer....a bargain in the extreme' (HiFi News). Available with light or dark grilles and various solid wood finishes. From £199.95 a pair. Call or write in for an information kit and reviews re-prints.

SHEARNE AUDIO, PO Box 22, Stevenage, Herts, SG2 8HF. Tel. 0438740953. Following the success of John Shearn's Phase 1 pre power combination, (reviewed in HW), is the phase2 reviewed earlier in HW and listed as a world favourite. Having many of the design features of the phase 1 R.R.P. £549, 50 wpc and same finish as Phase 1 pre-power. Also, option of phono stage for phase 2 mm £65 mc £75

SLATE AUDIO, makers of 'THE FINEST SPEAKER SUPPORTS IN THE WORLD' have never had a bad review, our reputation is legendary. Contact us now for details on our CUSTOM STANDS, as well as our solid marble GARRARD 301/401 PLINTH SYSTEM (Hi-Fi World Dec 93) THE GLASSMAT platter mat and the very special SME GARRARD 401 CELEBRATION ARMS. 47 Gemini Close, Leighton Buzzard, Bedfordshire, LU7 8UD. Tel: 0525 384174.

THE SPEAKER COMPANY, Unit 9, Waterside Mill, Walsley, Macclesfield, Cheshire, SK11 7HG. Tel. 0625 500507. The Speaker Company are a new company offering a wide range of loud speaker units from Audax, Celestion, KEF, Morel SEAS and many more. Also a wide range of speaker accessories the keen builders.

THE TDI GROUP, Unit 1 Summerlea Court, Alton Road, Herriard, BASINGSTOKE, Hampshire. RG25 2PN. Tel: 0256 381 514. Fax : 0256 381 692. Electronic Components distributors specialising in; Mains Power Connectors, Jack Plugs and Sockets, 4mm Connectors, Din and Mini Din Connectors, Phono Connectors, DC Connectors, XLR Connectors, Rotary Potentiometers, D Type and IDC Type Connectors, Co Axial and BNC Connectors, Switches, LEDs, Diodes, Bridges and Rectifiers, Fuses and Thermal Tips. - Have you got one of our new 1994 General Product Catalogues? **TARGET AUDIO PRODUCTS PLC**, Britannia House, Leagrave Road, Luton, LU3 1RJ. The Audio equipment, rack and speaker stand specialist. For information on our products please telephone or write.

TRICHORD RESEARCH LIMITED Following on from the highly acclaimed CD clock oscillator modifications the Pulsar Series One digital to analogue converter. This unique design is part multibit and part bitstream to give absolute linearity over an extremely wide dynamic range. Switchable between 18 or 20 bit resolution this converter will become the standard for CD replay. For details telephone (0684)573524

WOLLATON AUDIO, 134 Parkside, Wollaton, Notts, NG8 2NP. Tel/Fax. 0602 284147. Trying to bring imported high end down in price with Wollaton is the UK distributor of the following products: XLO interconnects and loudspeaker cables - 'The best in the world'. Clements loudspeakers; ribbons and/or moving coil drive units in outstanding value loudspeaker systems. Monarchy Digital: transports and converters (including the model 33 D to A with built in high quality preamp) to match the best at a fraction of the price.

WILMSLOW AUDIO LTD, Wellington Close, Parkgate Trading Est. Knutsford, Cheshire, WA16 8DX. Tel. 0565 650605. Extensive range of drive units and over 30 different designs of self-assembly kits. Everything required for the loudspeaker builder and four dem rooms to listen to the kits in built-up form.

To Advertise in this section, please contact Caroline Knott on: 071 266 0969

When I was told I'd be reviewing the latest Creek amplifier, memories of the old 4040 and 4140, complete with vinyl wrapped chipboard casing, came flooding back. Definitely a case of Creek by name and creek by nature! However the original Creeks were pretty good little amps. Nothing superlative, but involving none the less. Despite their rather crude build quality they still hold their own against many of today's budget amps. So much so that a AB demonstration often shows little incentive for changing to a newer amplifier of similar cost.

In the late Eighties, Creek were bought out by Mordant-Short, who themselves were part of the TGI group (which also included Tannoy, Goodmans and Epos). It may be coincidence, or the fact that Creek just didn't suit the big corporation approach, but its amplifiers and speakers produced during this stage weren't particularly memorable or innovative, one such CLS10 badged product being little more than a Goodmans Maxim 3 with a green tweeter! Able as the Maxim 3 was, it shows little intuition on the part of Creek.

Recently, however, Creek have pulled out of the TGI group, and are now once again under the management of the original proprietor, Mike Creek. The CAS4240 amplifier is the first product to be launched under the new management and, as such, will come under close scrutiny from the hi-fi trade.

Build quality has certainly improved over the years. The 4240 comes with a bang up-to-date wrap around metal sleeve and fascia. The only flaws that let the side down somewhat were the odd sharp edge on the fascia. Otherwise it's distinctly Creek. Very neat and compact and only the bare essentials on display plus, of course, bright green graphics.

One slight cause for concern is the relative lack of inputs; just four and a single tape loop. Another slight quibble is the lack of a standard phono stage. Modular plug in boards are available, but cost £45 (MM) and £55 (MC) extra. The gold plated outputs for the pre-amp are a nice touch, though. Purists will delight in the fact that there are no tone controls and there's a speaker output (banana plug only) that bypasses the headphone stage.

The 4240's guts are pretty much what you'd expect to find in a British amp of this price.

The components are well chosen and good quality. Alps pots for volume and switches for source selection, for example, combine with



Greener On The Other Side

After several years under the management of TGI group, Creek are once again independent. Dominic Todd finds some of their original character in the new CAS 4240.

Rubycon capacitors and a beefy toroidal transformer fed from a three core IEC type mains cable.

With a modest power output of 40 watts and limited current delivery, the

Creek needs to be matched with a reasonably sensitive speaker. I found that a speaker with a sensitivity of at least 86db was needed for good clean sound at a realistic level.

With Deacon Blue's 'Ooh Las Vegas' there was a strongly identifiable Creek character of a

warm yet punchy bass. The depth to the sound was also surprisingly good for an amp of this price, and the manner in

which the sound poured from the speakers reminded me of more expensive British amps such as the Albany PPI and Kinshaw integrated.

This particular balance suited deep vocalists, with albums such as the Commitments coming across with good presence and excellent projection of vocals. However, the bass could occasionally get caught out with the warmth turning to a slight sluggishness, lacking in articulation. Again, choice of speaker is critical here, as a warm sounding speaker, such as a Castle for example, will exaggerate this. Partnered with lean, fresh sounding ancillaries and there shouldn't be a problem.

Punchy, well produced albums, such as Simply Red's Stars showed the amplifier to soften transients somewhat, taking the edge off the music. The flip side to this, though, is a refinement rare of amps in this price range, and as a result long term listening can be enjoyed without fatigue. There's also a good deal of listener involvement to be had, which

“ imaging and the spaciousness around individual instruments were impressive ”



CAS4240 is flawed, but it is not to a serious degree. In fact, despite its flaws, I enjoyed the way in which the Creek got on with making music without offence. Although giving the impression of damning with faint praise, the 4240 is a pleasant amplifier. One which, if matched carefully with ancillaries, would provide an excellent starter, or second amplifier, providing long term listening pleasure. This must be weighed against the facts that the Creek lacks inputs and the power for high level listening, and complete with a phono stage is somewhat expensive.

However, the Creek has character missing in many amps at this price, has a solid build quality and smart looks that set it apart. Add to this a beguiling sound quality, and it's clear the CAS4240 is worth auditioning. It's not a "superamp" in the mould of the A-400, but deserves to be a big success for the newly independent company ●

Creek 4240 **£249**
Creek Audio Ltd.,
2 Bellevue Road,
Friern Barnet,
London N11 3ES
Tel: 081 - 361 4133

makes a pleasant change from some Far Eastern (and even the odd British) competitors which can sound superficially impressive yet in the long run turn out to sound too clinical and processed.

With female vocalist Tanita Tikaram, the balance was natural and musical. I know that the last term is something of a cliché, but in this case it's adept in describing the Creek's preference for the music rather than impressing in hi-fi terms. For instance, against fierce competitors such as the Rotel RA 960 and Denon PMA 350 (both cheaper when the MC input is taken into consideration), the CAS4240 isn't especially transparent, and loses out on detail in the treble. There also appeared to be a slight dip in the upper-midrange which left some female vocals sounding recessed.

Despite these flaws, the Creek excelled in other areas, imaging and the spaciousness around individual instruments were impressive, and although the bass could occasionally become cloudy, predominantly it was clean and kept well in hand. The double bass on Danny Thompsons, 'Whatever?' was satisfyingly deep and solid. Piano notes too, had a reassuringly realistic timbre, avoiding tinniness.

The Creek's pervasively smooth, mature balance continued with classical music. Although there was a lack of transparency in the strings on the, 'Symphonie Fantastique' the broad sound stage ensured plenty of space around the instruments. Fine scale was afforded by the deep and relatively powerful bass, although some drama was lost in the closing stages when the amp became a tad confused in the mid-range and muted in the very high frequencies. This led to a certain deadness in the

sound typified by the rather blandly portrayed flute in the Third movement. It may sound as though the

MEASURED PERFORMANCE

The 4240 produces a useful 40watts per channel, enough to go loud with most loudspeakers, if not very loud with averagely sensitive (up to 86dB) models. However, these days, with sensitivities beginning to exceed 88dB/watt, amps like the 4240 go plenty loud enough if matched to the right speaker. Regulation was fair, power delivery increasing to 56watts into four ohms. I noticed strong asymmetric clipping, generally considered a bad thing, but hopefully the amplifier would not be run into overload.

To get an extended low frequency response and eliminate all series coupling capacitors Creek use all-direct coupling, but d.c. servo circuits and output protection prevent d.c. output offset occurring. I measured less than 1mV of output offset - a very low figure. CD frequency response extended right down to 4Hz, but due to band limiting, no further upward than 30kHz (-1dB).

The distortion characteristics were interesting. Little extra distortion is produced at high frequencies than in the midband, levels hovering around 0.02% at low and high output levels. The steadiness of the distortion figures with level and frequency were surprising, since most amps get measurably worse at high frequencies, unless they are very high feedback designs, but not the 4240. I would expect a reasonably pure sound, but since third harmonic dominated there may be just some slight enhancement of apparent clarity.

This is a well designed and stable

amplifier, right in the Creek mould. In the past, Creek amplifiers like this have proven to reach a consistently high level of sound quality from a compact package offered at a good price. The 4240 seems to home straight in on this concept. **NK**

TEST RESULTS

Power	40watts
CD/tuner/aux.	
Frequency response	4Hz-30kHz
Separation	77dB
Noise	-97dB
Distortion	0.015%
Sensitivity	330mV
dc offset	0.5/0.8mV
Disc	optional

Distortion

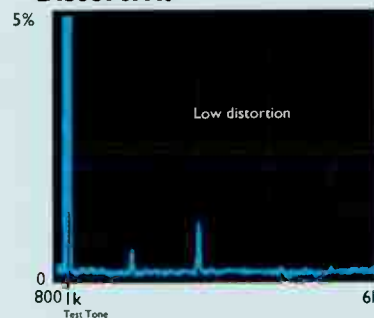

Subscriptions Special Offer

Another exceptional offer from Hi-Fi World!

Using one of the forms below take out or renew a yearly subscription and the first lucky **50 SUBSCRIBERS** out of the Hi-Fi World post bag will be sent a box of **KONTAK** cleaning fluid absolutely free. This effective cleaning solution removes contaminants from electrical connections. After application, a system regains its original life, sparkle and vigour.

KONTAK's normal mail order price is £19.00

12 ISSUES FOR ONLY £22 (UK only)

HI-FI WORLD SUBSCRIPTION FORM

Please send me the next 12 issues of Hi-Fi World, starting with the _____ issue.
I enclose my cheque/postal order for £22 (UK only) made payable to **Audio Publishing Ltd.**

Name _____

Address _____

Daytime Tel No: _____

7/94

Please debit my VISA/ACCESS Card No:

--	--	--	--	--	--	--	--	--	--	--	--	--	--	--	--	--	--	--	--	--

Expiry Date: _____

Tel: 071-266 0461

Send to: **Audio Publishing Ltd.**, 64 Castellain Road, Maida Vale, London W9 1EX.

Overseas subscription rates.

Surface Mail: £29.

Airmail: £42 Europe & Middle East, £52 Middle East, Hong Kong, Singapore & Malaysia, £62 Australia, Japan, Korea & China.

Airmail

Surface Mail (tick as appropriate)



E&OE



Hi-Fi World U.S. & Canadian Subscriptions

P.O. Box 754, Manhasset, N.Y. 11030 - 0754
Telephone: 516 627 3836 Fax: 516 627 1972

I wish to subscribe right now - and receive monthly copies of Hi-Fi World Air Speeded direct from the Publisher in London U.K. to the N.Y. Office

I enclose my payment to :- FRJ/Hi-Fi as checked below
I Year - 12 Issues \$66 (U.S.)

U.S. FUNDS ONLY PLEASE - Add \$10 U.S. for Canada.

OR

Please charge my Credit Card with the amount indicated.
(All major Credit Cards accepted)

No: _____

Expiry Date: _____

Signature: _____ Name: _____

Address: _____

City: _____ State: _____ Zip: _____

Or Telephone:

516 627 3836

Or Fax:

516 627 1972

7/94

HI-FI WORLD BACK ISSUES ORDER FORM

Please tick the box next to the issue(s) you wish to order

<input type="checkbox"/> September 1991	£2.00	<input type="checkbox"/> July 1993	£2.00
<input type="checkbox"/> December 1991	£2.00	<input type="checkbox"/> August 1993	£2.00
<input type="checkbox"/> March 1992	£2.00	<input type="checkbox"/> September 1993	£2.00
<input type="checkbox"/> September 1992	£2.00	<input type="checkbox"/> October 1993	£2.00
<input type="checkbox"/> December 1992	£2.00	<input type="checkbox"/> November 1993	£2.00
<input type="checkbox"/> February 1993	£2.00	<input type="checkbox"/> January 1994	£2.00
<input type="checkbox"/> March 1993	£2.00	<input type="checkbox"/> February 1994	£2.00
<input type="checkbox"/> May 1993	£2.00	<input type="checkbox"/> March 1994	£2.00
<input type="checkbox"/> June 1993	£2.00	<input type="checkbox"/> April 1994	£2.00

Total no of issues ordered.....Total price

Please send completed order form together with your cheque/PO to: **HI-FI WORLD**, 64 Castellain Road, Maida Vale, London W9 1EX.

Please allow 28 days for delivery

7/94

When Noel swung round on his chair at the test bench and asked "Do you want to go to the Stereophile High-End hi-fi show in Miami this weekend?" most of us in the office passed it off as another nutty idea that'd never come to fruition. On Thursday when our Business and Marketing managers were looking pale and trying to persuade Noel that flying me to Miami at such short notice was 'difficult' (i.e. expensive!), especially with a rapidly approaching copy deadline, it started to sink in: I was going to Miami - to an amazing high-end hi-fi show. I couldn't wait.

Saturday morning found me staring at the Boston Belle, a massive Boeing 747, through the glass of the boarding lounge. Little did I know, the worst part of the journey was about to begin. I've flown before, but never for so long, non stop, with about 5 inches of leg room between my seat and the back of the one in front - and I was younger and shorter than the 6'1" I am today.

Ten painful hours later I staggered off the plane to wait for two and a half hours at Miami customs. It seemed that several planes had all arrived at once from Europe, so the queues were huge. By the time I'd got through this the car that was supposed to be waiting to take me to the Hotel had long since departed. I went to ring the Hotel, realising as I picked up the 'phone that I had no American money yet, and would have to find a Bureau de Change. All this in a humid heat that felt like warm bath.

In the end the Hotel sent a "town car". This auto would have had serious trouble negotiating its way through a British town though, complete with chauffeur, deep leather seats, flags on a 9 foot long bonnet and blacked out windows - it was a limousine!

The Doral Country Resort, where the show was to take place and where I was booked to stay, was spectacular. Palm trees, waterfalls, international golf

course, pool with bar - it goes on. And this was just one part of the Doral complex. There's also a spa, beach and various other areas within the Doral empire.

The show was spread between two main buildings. Most of the small guys were in the Executive Lodge, where I stayed. Even though this was for smaller manufacturers, the smallest suites had two generously sized double bedrooms, so there was plenty of space even for the numerous valve amplifiers and panel 'speakers that



result is greater uniformity.

Another thing that surprised me about the Americans was their awareness of how extreme they appear to the outside world, Audio Alchemy professing for example that only in America could you take a £200 convertor, add a £400 valve output stage and get away with it. I went to several demonstrations where "perfect cables" or "zero distortion amplifiers" were being used, much to the joy of the crowds of seemingly appreciative listeners.

Although this attitude

Dominic Baker

dB on the level

were gracing the show.

The most interesting thing about the show for me though, wasn't the masses of esoteric equipment, but the view that the Americans have on hi-fi and the UK industry. I was shocked when many were of the opinion that the UK was where the real enthusiasm came from, where high-end was still strong and the market was doing well. "You're all really much more into the technical side, you like to build and tweak your equipment more than us in the States", I was told. It seems we are very good at convincing the outside world that we are doing better than ever, even if the truth is not so rosy.

Perhaps I met a very narrow crowd, interested only in high-end esoteric equipment, but even so, their view of hi-fi was interestingly different. They are prepared to build

and sell whatever takes their fancy, an approach that produces a wider variety of top-end products than we Brits are used to, but also more bankrupt companies! Those who get, say, seven or eight out of ten ideas to work and sell stay alive, marketing an amazingly interesting and varied range of equipment. By contrast, it seems that British companies will more carefully consider an idea, research it, assess the market and what price it should be, and so on. The

opens up the industry for exploitation, it also makes it an exciting, interesting and enthusiastic one to be a part of. By comparison the staid and safe attitude of UK manufacturers looks dull and unexciting. I still believe we have genuinely innovative, well engineered and competitively priced hi-fi, but we could desperately do with an injection of the sort of razzmatazz I saw at Miami. The High-End show was a Show in the best sense of the word ●



The Virgin 747 Boston Belle.

the

SALE

at..

mike manning
the hi-fi specialists **audio**

starts June 1st...Please phone or call for details.

quads an av
rols an av
at car reg
ate gauran
manning

Together with other fine Hi-Fi from..

**Sugden - Rotel - Pink Triangle - Kinshaw - Mission - B&W
Heybrook - Marantz - Restek - Epos - Shahinian - LYRA - Acoustic
Energy - JPW - Nakamichi - Denon - AURA - NAD - Pioneer - Philips**
NOT ALL MAKES STOCKED AT BOTH BRANCHES PLEASE CHECK FOR AVAILABILITY

*Audition some of the finest Hi-Fi in our purpose built listening lounges where you can,
with our expert guidance, choose an ideal system to suit your ears and your pocket.*

Full Servicing Facilities - 2 Year Guarantees - Mail Order - Instant Credit Facilities - Access - Visa - Switch

BOURNEMOUTH

**128, Poole Road
Westbourne
Bournemouth
0202-751522**

YEOVIL

**110, Middle Street
Yeovil
Somerset
0935-79361**

0% - INTEREST FREE CREDIT- PLEASE PHONE FOR DETAILS - 0%

UNFORUNATELY, 0% FINANCE NOT AVAILABLE ON SALE ITEMS

Picture the scene. It's a dark winters evening in some nondescript market town. The main street is dead except for the transient night life, and one brightly lit shop which bustles with conversation, music and the clink of glasses full of Tesco's plonk. The shop is, of course, a hi-fi shop, and the scene one of the increasingly popular musical evenings.

It seems that despite sluggish to steady business being reported around the country, enthusiasm in hi-fi appears to be flourishing. I must admit to being rather sceptical towards "the musical evening" at first. I had deep seated images of hordes of "anoraks", taking small sips of wine as they poured over input sensitivity and damping factor figures, and just waiting to catch me out with some technical question tough enough to frighten an electronics engineer.

As it turned out, I had nothing to fear. A recently appointed rep. for a British hi-fi specialist company, put my mind at rest by telling me he too had been expecting the worst, on his first product launch musical evening. Yet it turned out that he actually quite enjoyed the evening, and it didn't turn into "the trial by anoraks" as he had expected. Furthermore, the attendance was far from the stereo type, but a mix of literally all ages and even a healthy attendance of women. Now, before you reach for the Basildon Bond in objection to my apparent sweeping sexism, I'm merely reflecting what has previously been fact.

In the past (and even today to a certain degree), hi-fi has always been something of a man's world, rather like the motor industry. Women have always been discerning as far as style and even sound quality (remember the Goodmans advert?) are concerned, but not so interested in the equipment itself. Yet recently I've been taken aback by interest shown in hi-fi, by women. It also

made a refreshing change to witness a reluctant boyfriend being dragged into the shop by a lady keen to have a natter and drool over the Musical Fidelity A1000 amp' and Michell Gyrodec! Still, I digress.

The point is that today's hi-fi enthusiast may not be quite what you'd expect, and as the rep' in question remarked, "they turned out to be a good bunch and quite normal really". Praise indeed!

This reassured me somewhat before my first



whole evening was relaxed, informal, and, yes, I'd even say that the people there were all quite normal! Afterwards we even enjoyed that great tradition in (certain parts) of the hi-fi industry; a tasty vindaloo!

What all this means is that there is a great deal of enthusiasm amongst all types of people out there that should be encouraged by manufacturers and dealers alike. Without such clubs and social events (which also includes the many busy hi-fi shows

Fair Views

- from Dominic Todd, our man in Scarborough

musical evening I'd be helping to host. It's not that I've not had any experience of them, but in the past I have always been at the receiving end, comfortable, ever so slightly merry and pondering whether or not the system I was listening to was really worth the cost of a brand new TVR. One thing they were always good for (apart from the free booze, that is) was that they offer an opportunity to expand your knowledge of music and discover interesting new artists.

And so it came to my first musical evening. This turned out not to be held at the shop, but by a local hi-fi group who simply couldn't get anyone else to demonstrate the differences between a decent valve amp and transistorised equipment. This had me really worried. Musical evenings are one thing, but when the audience is a hi-fi group, all the old pre-conceptions came flooding back. Once again my preconceptions were without foundation. I had desperately swotted up all the relevant technical

specifications, and I had a barrage of "soundbites" as to the many and various advantages of the valve amp'. I was mentally armed and prepared to stand up to the most devious of technical questions. Whether or not I'd be convincing or not would be an entirely different matter.

As it turned out the audience were just as interested in the music as the hi-fi itself and happy to hear the differences for themselves by simply listening to the equipment. In effect the equipment sold itself, leaving us to have an informal chat about the state of the hi-fi separates market, a bit of a winge and the usual discussion as to what on earth has happened to DCC and MiniDisc. There was no mention of total harmonic distortion and peak current figures, in fact the most technical things got was explaining the difference between triode and pentode operation, and even that was in terms of sound quality rather than technical differences. The

around the country) enthusiasm for hi-fi products wanes. Without enthusiasm, individuality and inventiveness suffer. Bright engineers who produce some of the finest analogue and digital equipment on the market today become totally overwhelmed by market forces dictating lifestyle systems which offer neither satisfaction of use nor long term musical enjoyment.

More enthusiasm doesn't necessarily dictate a BSc in electronic engineering. An appreciation of music, fine design both in terms of electronics and aesthetics and simply the satisfaction of matching a separates system together and then possibly tweaking it over time, are all qualities that go to make up the band of hi-fi enthusiasts.

Manufacturers and dealers take note. Neglect those who want more than something to just play music, at your peril. And long live the musical evening and all those who support it, who ever they may be ●

WIN AN ORTOFON CHESKY 180GM

To say that the £2000 Ortofon MC7500 cartridge, launched to celebrate Ortofon's 75th anniversary, is worth every penny of the asking price, is quite a statement. But Eric Braithwaite was so enthralled by the sound of the MC7500, that this was just one of many lines written in its praise.

To quote Eric "Take Mingus live at two different venues in New York. The atmosphere was tangible, the subtle differences of captured ambience quite distinctive, and the playing entrancing. There's something about the way the

Ortofon reproduces acoustic instruments that is exceptional in its stability, shades of tonal colour and convincing accuracy. Listen to an alto or soprano sax and each is absolutely spot-on, so real you can see the shape and size."

This is a top flight cartridge, for those who aspire to the very highest level of reproduction from their record collection. The MC7500 is machined from a solid chunk of titanium, one of the strongest materials available, giving the body tremendous rigidity. The surface is so hard that the name has to be laser engraved!

But it doesn't stop there. The stylus has a new twin-ellipsoid profile which is 25% thinner along its contact face than that of the MC5000, already one of the finest. This allows the MC7500 to reach further into the grooves of a record, retrieving more information. It has the additional benefit of reducing effective tip mass, which improves high frequency tracking.

Other special features include 99.999999% purity copper wire coils, carbon fibre armature and three point mounting which improves the interface between cartridge body and headshell.

What do you need to go with the best cartridge in the world? Obviously, the best vinyl. So that the lucky winner can hear the very best from their prize, we've also selected five superb audiophile 180gm pressings from Chesky records. These comprise two classical pieces, two jazz and one vocal, all recorded to the highest standards.

To enter this fabulous competition for an Ortofon MC7500 anniversary moving coil cartridge and five superb Chesky 180gm audiophile pressings, simply complete the questions opposite.

Please send your entry on a POSTCARD, or the back of a SEALED ENVELOPE, and completed in block capitals, to arrive no later than Tuesday 6th July 1994 to:

**Ortofon/Chesky Competition
Hi-Fi World Magazine,
64 Castellain Road,
Maida Vale,
London. W9 1EX.**

Don't forget to include your name, address and a telephone number so we can contact the winner promptly.

In the event of more than one entrant submitting all the correct answers, the winner will be picked by the Editor from the tiebreaker. We will endeavour to publish the results in the September 1994 issue. Purchase of the magazine is not a precondition to entry.

No correspondence about this competition will be entered into and the Editor's decision is final.

No employees of Audio Publishing Ltd. or any of the companies associated with production or distribution of the prizes may enter ●

COMPETITION ENTRY QUESTIONS

1) Which Anniversary are Ortofon celebrating with the MC7500?

- | | |
|---------|----------|
| A. 25th | B. 50th |
| C. 75th | D. 100th |

2) What is the body of the MC7500 machined from?

- | | |
|--------------|-------------|
| A. Aluminium | B. Steel |
| C. Magnesium | D. Titanium |

3) The coils in the MC7500 use very pure copper, how pure?

- | | |
|---------------|--------------|
| A. 99.999999% | B. 99.99999% |
| C. 99.9999% | D. 99.999% |

4) Chesky use only the best vinyl for their records, what weight is the vinyl used for the five audiophile recordings we selected for the prize?

- | | |
|----------|----------|
| A. 180kg | B. 180gm |
| C. 180lb | D. 180oz |

THE TIE BREAKER (OBLIGATORY)

Ortofon are looking for a SLOGAN to characterise their commitment to vinyl. In no more than ten words, suggest something appropriate.

.....

We will endeavour to publish the results in the September 1994 issue. Purchase of the magazine is not a precondition to entry.

No correspondence about this competition will be entered into and the Editor's decision is final.

No employees of Audio Publishing Ltd. or any of the companies associated with production or distribution of the prizes may enter.

MC7500 AND FIVE RECORDINGS



MAY ISSUE COMPETITION: TUBE ENCOUNTERS, SLAVE AMPLIFIER AND CASTLE HUNGARIAN SPEAKERS

After one month's absence (in this case, writing) in the
 world's premiere forum at World Radio, the subject should
 Tube Encounters (page 10) be considered some smaller and
 original 118 new listed Castle Hungary on the 10th of
 Edward of Massachusetts. Congratulations, I hope hope
 you've got a large room to put the flowers in.

CESKY RECORDS

For more information on the competition,
 please contact the publisher of the magazine.
 The magazine is published by World Radio, 118
 Castle Hungary, 10th of Edward of Massachusetts.
 The magazine is published by World Radio, 118
 Castle Hungary, 10th of Edward of Massachusetts.
 The magazine is published by World Radio, 118
 Castle Hungary, 10th of Edward of Massachusetts.

The Music Pages

Giovanni Dadomo



INDEX

RECORD REVIEWS

ROCK & POP	74
Giovanni Dadomo	
CLASSICAL	85
Peter Herring	
JAZZ	93
Simon Hopkins	

HOLE
Live Through This
 GEFFEN/CITY SLANG EFA 04935-2

● It's almost crass to say it, but there's a terrible irony in the fact that the second LP from Courtney Love's group Hole should coincide with the tragically untimely death of her husband, Nirvana's Kurt Cobain, not least because Hole's music carries so many echoes of the so-called Godfather of Grunge. It's patently obvious from the opening 'Violet', where the lady's primal scream vocal utterances are so often a dead ringer for those of her late spouse. Similarly, the recurrent obsession with mortality now carries an unnervingly unpleasant ring, viz. lines like "I'll make my bed and I'll lie in it/ I'll make my bed and I'll die in it..." and so on and so forth. Not to say that Hole don't make one or two worthwhile post-feminist

points. On 'Plump', for example, a scathing attack on the pressures which lead to anorexia, or the patently hypocritical values that fire 'Miss World'.

But it's the recurring references to death which are most disturbing in the light of recent events. Far better to concentrate on the aptly gentle sentiments of items such as 'Softer, Softer', or liberating low-brow metal/punk collisions like 'She Walks On Me'. If at times Hole do sound like a female Nirvana (actually there is one geezer in the group) at least they have more right than most to the title. And their scope is even broader, witness the sporadic touches of Sonic Youth-style experiment on 'Gutless'. On this evidence Courtney Love's likely be around for a while, and she patently doesn't need to exist simply in her (late) husband's shadow.



NICK CAVE AND THE BAD SEEDS
Let Love In
 MUTE CD STUMM 123

● A funeral of drums and bass, spine-chilling organ flashes, low-life guitars, all heralding a voice from beyond the grave which intones: "My lady of a thousand sorrows / some begged, some stolen, some borrowed, some kept safe for tomorrow". It could only be Nick Cave, the Antipodean poet of dark sins and guilty secrets.

Or could it? It suddenly occurs to me, upon hearing this latest Cave opus, just how much he has in common with that other poète maudit, Canada's Leonard Cohen – the same tormented trouble coping with the torments of love and life, a similar sense of lugubrious drama - and one that can be equally taken seriously or as a somewhat camp, even operatic exaggeration of sentiment and delivery - and so on. The real point of course is

that both chaps strike several and more often deep chords with a vast cross-section of the pop-population. And

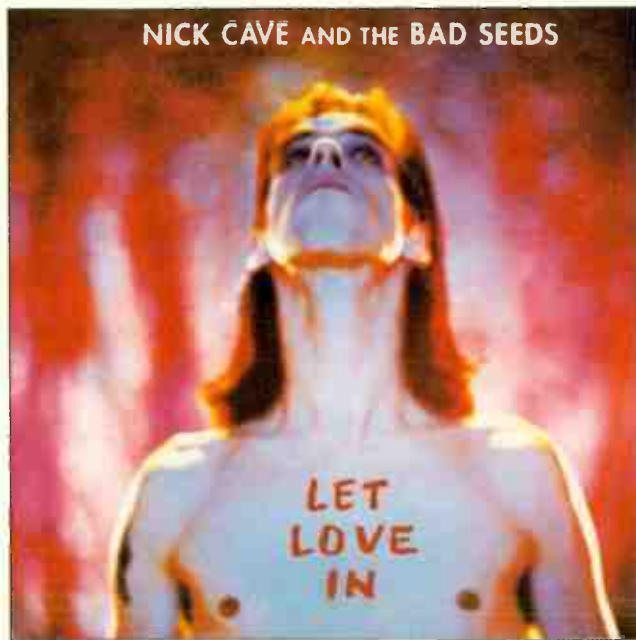

anyway, if Nick's a trifle more liable to pretension, he's a hell of a lot younger than Len and he is, after all, getting better and better with every disc.

I came to Cave late, via what I still believe to be his strongest, most cohesive recording yet, his fifth solo album, 'Tender Prey'. Until, quite possibly, this newest opus. Along with his Bad Seeds – Blixa Bargeld (guitar), Martyn P. Casey (bass), Mick Harvey (guitar, string arrangements etc.), Thomas Wydler (drums) and Conway Savage (piano), not to mention sundry guests too numerous to mention – Cave's fashioned what's most likely his most overwhelming and impassioned collection yet. From the opening 'Do You Love Me', with its volcanic choruses, via the likes of the demented fireworks of 'Jangling Jack', the agonised 'Thirsty Dog' (a drinking song to rival Brecht/Weil's whisky Bar' for sheer existential anguish) up to the closing, even more frenetic reprise of 'Do You Love Me?', this sounds – even on a sparse dozen or so listens – like it could well be Cave and the Seeds' masterpiece.



RIDE
Carnival of Light
 CREATION CRE CD 147

● Oxford's finest are back, and with their third LP, Ride finally justify all the press overkill of the past three or four years. It's a wild, wise, totally eclectic, um, ride, taking in elements of the best of the progressive Sixties – shades of peak-time Beatles, Byrds, Beach Boys (one song even features lyrics from long-vanished Bryan Wilson collaborator Jack Reilly – the subtly sublime 'Only Now') whilst still retaining their distinctly 90's, totally British sound. Items such as 'Natural Grace' are The Byrds filtered through totally modernistic sensibilities, whilst the epic

'Birdman' manages to condense Floyd's 'Dark Side Of The Moon' into an admittedly hefty single A-side.

There is cleverness and subtlety galore – the Stax-souful 'Endless Road', say, an aching ballad which suffers most deliciously, the luscious, hit single-bound 'Magical Spring', whilst experimentation is far from ignored, witness the Indian-flavoured 'Rolling Thunder' with its daring instrumentation including acoustic guitars, bongos, tamboura and upright bass. Then there's the glorious closing shot, 'I Don't Know Where It Comes From', which, with its deft use of a sub-teen boys' choir makes it the perfect 90's answer to the Stones' 'You Can't Always Get What You Want'. Not to mention the oh so subtle inclusion of a vintage Velvet Underground guitar phrase slipped gingerly into a brilliant arrangement. Or the sublime 'Crown Of Creation', just one of several diamantine moments – all of which help make this one the disc most likely to place Ride on the Big Map. A pearl.



HÜSKER DÜ
The Living End
 WEA 9362-45582-2

● With the on-going success of Bob Mould's Sugar, his previous aggregation, the brilliant Hüsker Dü, are finally seeming to get the recognition they deserved all along.

This live selection from the band's final tour of the USA in 1987 covers their entire career, from the thrash punk of their early days – 'Data Control' and

Rock + Pop

others – to such sublimely melodic items as the heart-wrenching 'She Floated Away'. This, somewhat surprisingly, segues perfectly into the proto-thrash of the fretboard-destroying 'From The Gut'. It all goes to prove that Bob Mould was – and is – one of the most important music makers of the past decade.

It also proves once again, Mould's effortless way with heart-stopping guitar madness and an equal facility with melodies and hooks, something barely achieved this side of Pete Townshend at his peak. Check the likes of 'Hardly Getting Over It' or 'Celebrated Summer'. Exemplary lessons in how to combine power and feeling. The fact that it's all so obviously raw and as live as they come makes this selection all the more awesome. A fitting epitaph to a great band, not to mention a moving chapter in a career that still has many, many luminous miles to go. No doubt of that.

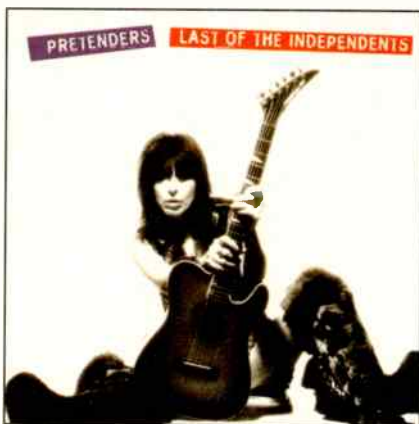

PRETENDERS
Last of the Independents
WEA 4509 95822 2

● It's been four quiet years since we've heard directly from Chrissie Hynde's Pretenders (this is to ignore various collaborations with such disparate outfits as INXS, Moodswings and the frenetic Urge Overkill) and now – re-united with founder member/ace drummer Martin Chambers – Chrissie Hynde's back and with more of a bang than on the somewhat lack-lustiness of the 1990 version of 'Packed!'.

For the most part, this is very much a Back to Basics version of Hynde's original vision, the songs short, sharp, shocking, ditto the ever acerbic lyrics. So there's late-night sexual yearnings as on 'Hollywood Perfume' or the thundering 'Night In My Veins' (a typically great title). New guitarist Adam Seymour is a perfect foil to Chrissie's hard chops, while Chambers melds sturdily with bassman Andy Hobson, and Hynde's cool, calm and acid-tongued deliveries have never been better.

She may have been a committed veggie for more years than your fingers can count, but she can still put meat into your motion. Check the sturdily funky 'Money Talk' or the feisty 'I'm A Mother', a song that could have made a fitting accompaniment to the closing titles of 'Alien 2' (think about it). Back with a boom.

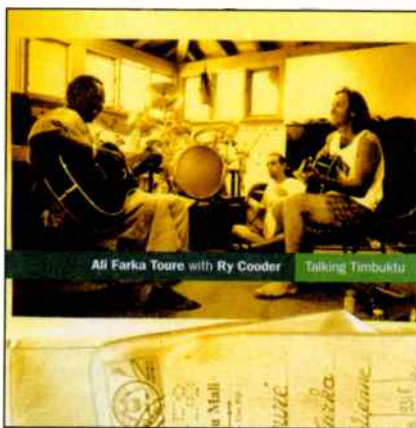

ALI FARKA TOURE WITH RY COODER
Talking Timbuktu
WORLD CIRCUIT WCD 040

● For someone with such a long-standing and widely celebrated reputation, it seems astonishing that Ry Cooder, the unassailable master of modern slide guitar, is without a record deal in his own name. But then Cooder's always been a man of strong principle, and in recent years – with the short-lived Little Village band try-out of the early 90's (alongside long-time pals Nick Lowe, John Hiatt and Jim Keltner) excepted – he's preferred to make his living producing film soundtracks (the most famed being 'Paris Texas', the most recent for Walter Hill's 'Geronimo') through which means he's been able to finance his own musical adventures. Last year he managed to garner an Emmy for his collaboration with Indian musician V. M. Bhatt's on 'A Meeting By The River'.

This time out he's joined forces with Ali Farka Toure – a man virtually unknown in the West, but a major figure in African music for too many years to count – this is Cooder at his humblest, playing side-man for the most part. But nonetheless the results are both moving and illuminating, as Toure gives a new insight into the (African) roots of the Blues, singing songs of simple structure and natural bent but nevertheless



producing music that's evocative and moving in the extreme. With the help of vet bluesman Clarence 'Gatemouth' Brown on guitar and drummer Jim Keltner, this – on paper – odd combination nonetheless produces music that touches the heart and soul. A revelation.

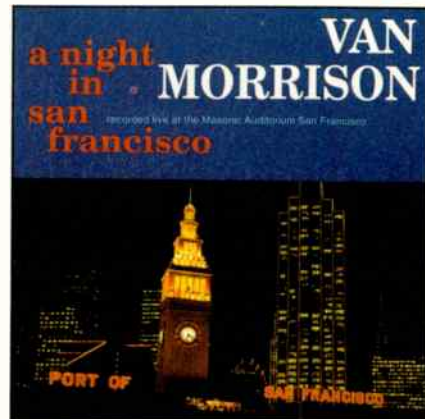

VAN MORRISON
A Night in San Francisco
POLYDOR 521290-2

● Double CD selection from the inimitable Mr Morrison, one that covers everything from 'Moondance', 'Tupelo Honey', even the seminal 'Good Morning Little Schoolgirl'. It's all impeccably played and performed, but at over two and a half hours, you could be forgiven for yearning for the occasional coffee (or Guinness) break.

Still, when he's great, he's great, and even when he's so-so, the man's well hard to beat.



2000 DS
Harder Than Core
2000 DS MUSIK

● For those that like their stage diving serious, their tattoos done with a biro, etc etc, this is the sound of the city, '94-style – fast, frenetic, desperate, filled with fire and righteous anger. And if it lacks polish, so what? These are different, desperate times.

Street sounds as they are here and now – The Clash were never so cred (but they had better production values). The musical equivalent of The Big Issue. Ignore at your peril.

Specialist Hi-Fi Dealers

SOUTH

THE SOUND GALLERY

BUCKINGHAMSHIRE'S PREMIER HI-FI DEALER

Arcam, Denon, Linn Products, Naim Audio, Meridian, Rotel, Yamaha, NAD, Quad, Tripod, Nakamichi, Rega, Creek, Epos, Mordaunt Short, Celestion, Marantz, Mission, Cyrus, etc. ...

65 Castle Street, High Wycombe, Buckinghamshire.
Open Monday - Saturday
0494 531682 / 464670

WORTHING AUDIO

20 Trevill Gate, W Sussex BN11 1UA
(0903) 212133

The friendly shop with the best sound system in the South. Friendly advice

• 3yr guarantees • easy parking

Open Mon-Sat. 10am-6pm Late night Wed. 7.30pm
Agencies include: Arcam, Exposure, Kinshaw, Naim Audio, Marantz, Ruark, Audio Technica, Target, Tripod, IPW, TDL, Orelle, and many more....

the powerplant

BRIGHTON'S LEADING HI-FI SHOP

Cyrus, Roksan, Micromega, Audionote, Audiolab, Rega, Arcam, Exposure, Aura, Epos, Thiel, Ruark, Rotel, Marantz and other fine equipment.

66 Upper North Street, Brighton
Telephone 0273 775978

STATION SOUNDS

W O R T H I N G
FOR A SELECTION OF VALVE AMPLIFIERS AND OTHER OLDER QUALITY EQUIPMENT

Valve amplifiers (combos and hi-fi) overhauled at sensible rates.
Audio Note speakers and used Audio Innovations amplifiers stocked.
Valve and other equipment always wanted.

Mike Pointer 0903 239980 (including Fax)

DOWN PLATFORM WORTHING STATION SUSSEX

Stockists of: ARCAM • CREEK • EPOS
HEYBROOK • MICROMEGA • NAIM AUDIO
NEAT • REGA • ROKSAN • ROTEL • ROYD
TEAC • YAMAHA

Infidelity

indecently good hi-fi

9 High Street, Hampton Wick, Kingston upon Thames, Surrey KT1 4DA. Tel: 081-943 3530
Open Tues - Sat 10.30am - 7.00pm.

CHICHESTER HIGH FIDELITY

7 ST. PANCRAS, CHICHESTER, WEST SUSSEX
CLOSED ALL DAY MONDAY
Tel: (0243) 776402

Appointed stockists of: A+R Cambridge, Castle Acoustic, Creek, Dual, Goldring, Linn Products, Monitor Audio, Naim, Nakamichi, Quad, Rega, Rogers, Royd Audio, Spendor

LONDON & SOUTH EAST

"One of the 5 best hi-fi shops in the world"

GRAHAMS HI-FI

Canonbury Yard, 190a New North Road
London N1 7BS, ☎ 071-226 5500
Ring for a chat, an appointment and a map!

BADA

HI-FI & COMPONENTS

84 Battersea Rise SW11 1EH

WHAT HI-FI? BEST BUYS in stock as well as those hard to find accessories and stylis

Established 29 years

Tel & Fax No
071 - 223 1110

All major Cards accepted

WHAT HI-FI?

DENON - NAD

TANNOY - KEF

ROTEL - BOSE

DUAL - QED

WHARFEDALE

CELESTION

KENWOOD

ORTOFON

INFINITY - SHURE

For the great sound of sound :

The Comflake Shop
37 Windmill Street London W1P 1HH
071 631 0472 Fax. 071 436 7165

We stock ATC, Arcam, Meridian, Naim, Rega, Royde, Roksan, AVI, Monitor Audio, DNM; as well as offering a marvellous mail-order worldwide service • Crunch •

The Hi-Fi Shop

GUILFORD'S SPECIALIST SINCE 1950

We are at
3 BRIDGE STREET, GUILDFORD

(By the traffic lights - just down to Alfred Marks)

0483 304801 • 0483 304756

Access • Visa • Switch

Open Monday-Saturday 9am-6pm (later by appointment)

volume one

Tel: 081 304 4622

Alchemist, Alphason, Arcam, Audioquest, Audio Technica, Beyer, B&W, Cabletalk, Canon, Celestion, Chord Co., Micromega, Michell, Moth, Musical Fidelity, Nakamichi, Neat, Ortofon, Pink Triangle, QED, Rotel, Royd, Ruark, Sennheiser, SME, Sonic Link, Sony

41 UPPER WICKHAM LANE,
WELLING, KENT

AUDIO CONCEPT

27 BOND STREET, EALING
LONDON W5 5AS
TEL. 081 - 567 8703

AMC, Acoustic Energy, Aura, Audiolab, Audio Innovations, B&O, B&W, Cannon, Castle, Cyrus, Denon, Dual, Evolution, JPW, KEF, Marantz, Micromega, Mission, Monitor audio, Musical Fidelity, NAD, Nakamichi, Onix, Onkyo, Quad, REL, Rogers, Rotel, Systemdek, Target, Teac, Thorens, Van den Hul.

10 - 6 pm Mon., Tues., Friday, & Sat.
Late night Thur., closed Wed.

Two demonstration rooms.
Free local delivery and installation
Repairs and Services

World Radio History

studio 99

79/81 Fairfax Road
Swiss Cottage
London NW6 4DY
071 624 8855/6
Mon-Fri 10-7 Sat 10-6

SURREY HIFI

SPECIALIST HI-FI OUTLET
DEMONSTRATION ROOM - PARKING

- QUAD • AUDIOLAB • REL • TUBE TECHNOLOGY •
- TDL • TANNOY • KEF • DENON • NAKAMICHI • THORENS •
- TARGET • MAGNUM • ROTEL • MARANTZ • MICHELL •
- SENNHEISER • BEYER HEADPHONES • JPW •
- SOUND ORGANISATION • SOUNDSTYLE TRIPPODS •
- VAN DEN HUL CABLES • BOSE • MUSICAL FIDELITY •
- SEISMIC SINK •

'HOME CINEMA NOW ON DEMONSTRATION'

Just 2 minutes off Junc. 6 M25, (A25)

GODSTONE 0883 744755
45 High St., Godstone, Surrey RH9 8LS

Spaldings

ESTABLISHED IN SOUND

☎ 081-654 1231/2040
352/4 LOWER ADDISCOMBE RD.,
CROYDON, SURREY

Front End Problems?

contact-

The Cartridge Man

It doesn't have to cost an arm and a leg to get the best - listen to my Koetsu - and Decca - eater.

Also agents for Croft, Sugden, Thorens, Pentachord Speakers & Nottingham Analogue.

plus cartridge re-tipping service

081 - 688 6565

MIDLANDS

W.OWEN EST 1901

Audio/Video Specialists

Pioneer • Reference Point • Kenwood •

Sony • Akai • B&W

Free Installation and Home Delivery

58 Market Street, Oakengates

Leobard, Shropshire

Tel: 0952 615818

21 Stratford Street

Newport, Shropshire

Tel: 0952 6108 06

Specialist Hi-Fi Dealers

MIDLANDS

MUSIC MATTERS

THE AUDIO SPECIALISTS

for the most exciting range of equipment available in the Midlands which includes:

Arcam, Aiwa, Alchemist, Alphason, Apollo, Arcam, Audiolab, Audioquest, Audio Innovations, Audio-Technica, Aura, Beyer, Cambridge Audio, Canon, Celestion, Chord, Cyrus, Deltec, Denon, Dual, Epos, Exposure, Heybrook, Impulse, Infinity, KEF, Luxman, Marantz, Meridian, Michell, Micromega, Mission, B+W, Mordaunt-Short, Michaelson Audio, Monitor Audio, Monster, Musical Fidelity, Nakamichi, NVA, Panasonic, Pink Triangle, Pro-Ac, Revox, Rogers, Roksan, Rotel, Royd, Ruark, Sansui, Sennheiser, Straitwire, Systemdek, Target, Technics, Thorens, Wharfedale, Yamaha etc.

OPENING TIMES:
Tues-Thurs 10.30-6.00
Friday 10.30-8.00
Saturday 10.00-5.00
Demonstration by Appointment

351 HAGLEY ROAD, EDBASTON, BIRMINGHAM B17 8OL
Tel: 021-429-2811

156/7 LOWER HIGH STREET STOURBRIDGE, WEST MIDLANDS DY8 1TS
Tel: 0384 444 184

INTEREST FREE
(for Ltd Period) APR 0%.
Written details on request.
Licensed Credit Broker.
Switch card accepted



THE MOST EXCLUSIVE INDEPENDENT HI-FI STUDIO

The internal atmosphere and easy access make it so much more exciting choosing your hi-fi from the finest audio products available.

Just off the High Street, Bloxwich nr. Walsall, West Midlands.
(Ample free parking)
(OFF M6 JUNCTION 10)
TEL: (0922) 493499 - 473499

Open 6 days a week, Mon - Sat
All major Credit Cards accepted
Part Exchange enquiries welcome

ALBARRY • ACOUSTIC ENERGY • ARCAM • ART AUDIO • AUDIOLAB • AUDIO QUEST • B&W • BOSE • CABLE TALK • CHORD • CYRUS • DPA • DYNAUDIO • ENSEMBLE • EPOS • EXPOSURE • JPW • KEF • REFERENCE • MARANTZ • MERIDIAN • MICROMEGA • MISSION • MOTH • MUSICAL FIDELITY • NAKAMICHI • ORTOFON • PROSPECT • PROJECT • QUAD • ROKSAN • ROGERS • ROTEL • SONICLINK • SYSTEM DEK • TDL • THORENS • TRIANGLE • TOWNSEND • TUBE TECHNOLOGY • VAN DEN HULL • YBA •

Moorgate Acoustics Hi-Fi



Frustrated and confused?
Call in and get some help and advice from a company that cares enough about its customers to put them first.
184 Fitzwilliam St., Sheffield. Tel: (0742) 756048
8 Westgate Chambers, Rotherham. Tel: (0709) 370666

EAST

The Audio File

27 HOCKERILL STREET, BISHOP'S STORTFORD, HERTS.
TEL: 0279 506576
2 FOUNDRY WALK, MARKET HILL, ST. IVES, CAMBS.
TEL: 0480 66123



MUSICAL APPROACH

ARCAM, ROYDE, AUDIOTECH, CELESTION, APOLLO

STAFFORD WOODHEDS YARD 0785 55154

ALDRIDGE 37 HIGH STREET 0922 57926

LINN, ROTEL, MARANTZ, HEYBROOK, TARGET

Surround sound systems available for demonstration

Single speaker demo rooms free expert installation

hifi for grown-ups

Signals

0473 622866

martlesham heath ipswich

MIDLAND STUDIO

PHONE/FAX OR WRITE FOR OUR LATEST LIST OF EXDEMORATION OR SECOND HAND EQUIPMENT FROM LEADING ESOTERIC MANUFACTURERS

MIDLANDS HI-FI STUDIO
WULFRUNA STREET
WOLVERHAMPTON WV1 1LX

TELEPHONE 0902 771774 FAX 0902 380083

CREATIVE AUDIO

9 DOGPOLE, SHREWSBURY, SHROPSHIRE
Tel: (0743) 241924
Closed Mondays

- Comfortable listening rooms
- Home demonstrations available
- Part exchange welcome
- Free home installation
- Interest Free credit

Authorised retailer for:
A & R ARCAM, AUDIOLAB, CELESTION, CYRUS, DENON, DUAL, MERIDIAN, MISSION, MONITOR AUDIO, QUAD, REVOX, ROKSAN, ROTEL, YAMAHA, EPOS, NAIM, KEF, RUARK

EIRE

Acoustic Dimension

AVI • ATC • AUDIO INNOVATIONS • ACOUSTIC ENERGY • MICROMEGA • AUDIO NOTE • LFD • REF 3A • IMPULSE • JPW • TDL PROJECT • PRO AC • TRIANGLE • RUARK • ROTEL • MARANTZ • DPA • APOLLO

Now ex demo equipment.
credit card accepted.

THE STATE OF THE ART....

- EXPERT ADVICE
- CREDIT FACILITIES
- PART EXCHANGE WELCOME
- REPAIRS

Come and hear - NAD • B&W • NAKAMICHI • BOSE • QUAD • BEYER-DYNAMIC • SENNHEISER • AURA - and lots more in our listening room.

Tel. 0743 - 355166

WON Hi-Fi Limited
12 Barker St. Shrewsbury
Plenty of parking - park and ride buses stop outside!

Peter Ellis Audio

A wide range of audio products always in stock including:- Quad, Denon, Stax, Marantz, Arcam, Creek, Sugden, QED, Castle, Rogers, Celestion, Tannoy, Nakamichi, Yamaha

* Home Cinema available *
* Demonstration Room *

29, Kirkgate, Newark,
Nottinghamshire NG24 1AD
0636 704571



Advent, Albarray, AKG, Alphason, AMC, AR, Arcam, Audioquest, Audio Technica, Beyer, Bose, Castle, Chord, Denon, Dual, Goldring, Meridian, Michell, Monitor Audio, Nagaoka, Nakamichi, Ortofon, QED, Quad, Revox, Sennheiser, Sequence Design, Spondor, Target, TDK, TDL, Thorens, Wharfedale, K. Monks Record Cleaning Service.

Five Ways Hi-Fidelity., (Est. 1972)
12 Islington Row
Edgbaston, Birmingham B15 1LD
021-455 0667 (Closed Mondays)

We Never Compromise On Quality

CLONEY Audio

55 Main St Blackrock Co Dublin
Tel 2889449/2888477 Fax 2834887
Open Tue/Sat 10AM-6PM. Thur/Fri 'till 9pm - Closed Monday

FRANK HARVEY

Hi-Fi EXCELLENCE

163 Spon Street. Coventry. CV1 3BB Tel : 0203 525200.
Mon to Sat 9.30 AM 6.30. Closed Thursday

MUCH MORE THAN HI-FI
WE ARE A BADA DEALER

Audiolab - Audio Alchemy - Arcam - Alphason - Bose - Bang & Olufsen - Celestion - Cyrus - Denon - Dual - Foundation - Kef - Marantz - Monitor Audio - Mission - Musical Fidelity - Nakamichi - Nad - Quad - Rega - Rogers - Rotel - Target - Tpod - Tannoy - Thorens - Van Den Hul - Yamaha

MAILORDER - EXPORT - HOME TRIALS

3 Floors. 3 Dem rooms. 3000 sq feet in the pursuit of Hi-Fi Excellence



Peter Dand & Company Ltd
Established 1963

Bang & Olufsen, Quad, KEF, Thorens, TEAC, and many more!
2 Demonstration Rooms
2 Year Guarantee

111 Clonskeagh Road, Dublin 6
Tel. 01035 31 269 4433

Specialist Hi-Fi Dealers

WEST & WALES

ENGLISH

audio

BADA

CYRUS CENTRE

PINK TRIANGLE-AUDION-SYSTEMDEK-HEYBROOK-MICHI-KEF-REFERENCE-MICROMEGA-NAKAMICHI-CHORD-ARCAM-MUSICAL FIDELITY-ROGERS-NAD-ROTEL-DENON-TANNOY-MARANTZ-MISSION-STAX-DUAL-TDL-ALBARRY-JPW-CELESTION-IXOS-SME-RUARK-MOHA-AUDIO TECHNICA-EXPOSURE-AND OTHERS.

Free installations • Credit Facilities • Service Department

Mon - Sat 10 - 6
95 Whitecross Road, Hereford HR4 0DG (0432) 355081

audio excellence

WHERE THE MUSIC MATTERS

Bristol

65 Park Street
Bristol BS1 5PB
(0272) 264975

Cardiff

134/6 crwys Road
Cardiff CF2 4NR
(0222) 228565

Gloucester

58 Bristol Road
Gloucester GL1 5SD
(0452) 300046

Swansea

9 High Street
Swansea SA1 1LE
(0792) 474608

TUESDAY - SATURDAY 9.00 - 5.30
CLOSED MONDAY

NORTH WALES

ACTON GATE AUDIO

THE HI-FI CENTRE IN
WREXHAM

Aiwa, Albarr, Arcam, B&W, Canon, Celestion, Cyrus, Marantz, Michell, Micromega, Mission, Musical Fidelity, NAD, Nakamichi, Quad, Radford, Rega, Rogers, Rotel, Ruark, Spondor, Tannoy, Thorens, Wharfedale, Yamaha.

Yamaha cinema DSP club authorised dealer
4 RUABON ROAD, WREXHAM
TEL. 0978 3645000

NORTH



ASTON AUDIO HI-FI SPECIALISTS

ARCAM • MERIDIAN • MISSION • CYRUS • AUDIOCAB • B & W • NAKAMICHI • AURA • DENON • QUAD • YAMAHA • KEF • MARANTZ •

ROKSAN • NAD • MF • AIWA • DUAL • CELESTION • ROGERS • AUDIOQUEST • TECHNICS •

WEST STREET • ALDERLEY EDGE • PLUS HOME CINEMA • CHESHIRE • TEL 0625 582704 • INTEREST FREE CREDIT • DISCOUNT CD & TAPE • BADA •



THE HI-FI STUDIOS

HEYBROOK, MONITOR AUDIO, ART AUDIO VALVES, DUAL, SUGDEN, ALPHASON, TDL, MICHELL, ACOUSTIC ENERGY, TEAC, A&R, AURA, ORIGIN LIVE, SYSTEMDECK, EPSILON, SHURE, AUDIO TECHNICA, GOLDRING, ALBARRY AND OTHERS FROM THE COMPANY THAT CARES FOR CUSTOMERS.

DEMONSTRATION IN OUR LISTENING ROOMS OR AT HOME

SUNNYFIELD, DONCASTER
Tel: (0302) 781387

AUDIO COUNSEL HI-FI SPECIALISTS

LINN, NAIM, REGA, ARCAM, ROTEL, ROYD, SHAHINIAN, DYNAVECTOR, EPOS, MARANTZ, NAKAMICHI, MICROMEGA and many more....

Time spent with staff may prove to be a particularly wise investment

Audiophile

12/14 Shaw Road, Oldham OL1 3LQ
Tel. 061 633 2602

Cheshire Music

Hi-fi systems for music lovers.

ATC Loudspeakers **AVI** Electronics.
Clearly the best at any price.

For further details or a demonstration contact
Roy Parrish on 061-439 0082

Retailers of Fine Audio Equipment

- ▶▶ EPOS
- ▶▶ ONIX
- ▶▶ DENON
- ▶▶ LINN
- ▶▶ AUDIO ALCHEMY
- ▶▶ ARCAM
- ▶▶ B&W
- ▶▶ NAKAMICHI
- ▶▶ ROYD
- ▶▶ TARGET
- ▶▶ TRIPOD
- ▶▶ LOUSY COFFEE

SUPERB DEMO FACILITIES

FULL INSTALLATION & HOME DEMO SERVICE

OPEN 6 DAYS A WEEK
OTHER TIMES BY APPOINTMENT

0260
297544

1/1A Duke St Congleton Cheshire CW12 1AP



Swift

THE hi-fi SPECIALISTS

ST ANN'S PARADE (ON A34) WILMSLOW CHESHIRE
0(0625) 526213

2 YEAR GUARANTEE • EASY PARKING
DEM ROOM • PART EXCHANGE

Aiwa • Audio Lab • Aura
B & W • Castle • Denon • Cyrus
Celestion • JPW • Kenwood
Marantz • Mission • NAD
Pioneer • Rotel • Systemdek
Tannoy • Technics



Near Norwich
Norfolk
Tel. (0508) 570829

Basically Sound of Norfolk
STOCKISTS OF LEADING HI-FI

Arcam, Naim, Audiolab,
Epos, Denon, Nakamichi,
Acoustic Energy, Heybrook, Micromega, Rotel,
TDL, The Chord Company, Sound Style etc...

ACTION ACOUSTICS

Products Include: Acoustic Energy, Albarr, Croft, Denon, Harman Kardon, Michell, Pink Triangle, Revox, Rogers, TDL, Thorens etc.

Demonstration and Credit Facilities available

155-157 High St., Redcar, Cleveland.
Tel: 0642 480723

REPAIRS/DIY



Chelmer Valve Company for Audio Valves

Buy CVC PREMIUM Hi-Fi valves direct from us. All valves processed for improved performance. We also have Stock of MAJOR BRAND types including MULLARD, GEC, BRIMAR, RCA, GE, etc

130, New London Road, Chelmsford, Essex, CM2 0RG
Tel: 0245 265865 Fax: 0245 490064



RATA

Edge Bank House, Skelmergh, Kendal, Westmorland, LA8 9AS
Telephone: 0539 823247

If you like the Hi-Fi equipment you have but want a better performance, don't change it

UPGRADE IT!

You can build better than you can buy and we offer kits, parts and instructions for anything from simple component upgrades to complete rebuilds, plus kits to build high end equipment from scratch.

New Upgrading Service.

If you are daunted at the prospect of taking the lid off your prized possession, send it to us and we can do the upgrade for you: We will advise on feasibility and cost before starting work and upgrade to the level of performance you require and can afford. We have a secure, low cost collection and delivery service within the UK.

Upgrades to: Audio Research, Celestion, KEF, Krell, Linn, Marantz, Meridian, Naim, Nytech, Pioneer, Quad, Leak, Radford, Rotel etc....

Send now for full details and a copy of our 1993 Audiophile Components Catalogue No. 2
To cover postage Europe 5 x IMCs, World 9 x IMCs, or quote your credit card number (Visa or Mastercard only).
UK - free

LOOKING FOR REAL HI-FI or HOME CINEMA IN SWINDON

Audio Technica, Acoustic Energy, Audio Innovations (valve Amp), Beard (Valve Amp), Cerwin Vega, Impulse, Rod/Acoustics, and many more ...

We also stock quality ex demonstration and secondhand hi-fi Quality car Audio, new, used and secondhand, also available Repair and refurbishment classic equipment

52 Audio Exchange 52

52 Morse St, Swindon Tel. 539008
(Off Commercial Road, Swindon) Open 10am - 6pm, Mon - sat

VINTAGE AND VALVE HI-FI

Haden Boardman buys, sells, modifies & repairs all vintage hi-fi equipment.

Always quality hi-fi available, new and secondhand. Advice is free, phone if just for a chat. Credit cards accepted. New equipment by Croft, E.A.R., Richard Allen + more coming soon!
Quick worldwide delivery, callers by appointment.
Sorry but we are unable to answer queries in writing.

GARRARD 301/401 IN STOCK 7 days a week

Audio Classics
Tel. (0942) 57525
Fax. (0942) 22851

8 Lowe Mill Lane, Hindley, Lancs WN2 3AF

Lockwood Audio

Tel: 081-207 4472 Fax: 081-207 5283

WE BUY AND SELL
NEW, USED AND VINTAGE
SPEAKERS, DRIVERS, CABINETS, PARTS.

SPEAKER REPAIRS
THE
Authorised **TANNOY** Specialist

MAJOR CREDIT CARDS WELCOME
IMPERIAL STUDIOS,
MAXWELL ROAD,
BOREHAMWOOD, HERTS. WD6 1WE



Manufacturers of amplifiers and speaker system with Differential Error Correction, the only amplifiers with virtually zero distortion and no output DC offset. Send for information Installation & Maintenance of Hi-Fi equipment. Acoustic measurement and design of listening environments. Recording studio design and installation. Sole concessionaires of service and spares for 3M professional recording equipment Contact: Clive Kavan.

Phone +44 (0)81 996 8127, (0)860 519 748,
or Fax +44 (0)81 997 0608
9b, Ashbourne Parade, Hanger Lane, Ealing, London, W5 3QS.



BANDOR

MINIATURE LOUSPEAKERS
DESIGNED AND MANUFACTURED BY MINIATURE LOUSPEAKERS AND SYSTEMS.

Drive Units - 2" module with 1.3gms. mms. + 6" 8" & 15" GLUMINIUM CONED DRIVERS. Flat pack TRANSMISSION LINE KIT and NEW BANDORA-MORA semi: active complete loudspeaker system.

Free technical sheets etc.
11 Penfold Cottages, Penfold Lane, Holmer Green, Buck. HP15 6XR
(0494) 714058



Specialist Hi-Fi Dealers

TECHNICAL & GENERAL

THE ORIGINAL TURNTABLE SPECIALISTS
for the Great Classic Turntable, Arms, Cartridges, Styli.

CONNOISSEUR • GARRARD • GOLDRING • Lenco •
ORTOFON • SHURE • S.M.E. • THORENS • WATTS

All available Genuine spares and our own
re-manufacture of obsolete parts
Servicing and Overhauls, to original technical specifications.

NO ILLUSORY 'IMPROVEMENTS', NO DUBIOUS
OR HARMFUL 'MODIFICATIONS'
Remedial Services available

Cartridges and styli, correct radius diamonds, for early
recordings - 78s & LPs

TECHNICAL & GENERAL
P.O.Box 53, Crowborough, East Sussex TN6 2BY.
Tel. 08 32 65 45 34

SOVTEK VALVES

6550WA. 6L6WGC/5881. EL34G.
12AX7WB/7025. EF86/6267
Over 1000 different types of valves stocked S.A.E. for list
DEPT. HFV

Wilson Valves, 28 Banks Ave, Golcar,
Huddersfield, West Yorks, HD7 4LZ
Tel: 0484 654650/420774 Fax: 0484 655699

Mail order only, Visa etc.

SOUNDS AROUND

Professional Service Repairs
and Accessories
Agent for Golden Dragon Valves

146 Clarendon Park Road, Leicester
Telephone : 0533 702442

AERIALS

ANDY'S AERIALS

- TV & FM AERIALS SUPPLIED & INSTALLED
- MULTIPOINT SYSTEMS REPAIRS
- DIV SALES FULLY INSURED COMPETITIVE PRICES
- ALL WORK GUARANTEED FREE SITE SURVEYS
- 7 DAY SERVICE Areas Covered

HARROW, RUSSLIP, NORTHWOOD, EALING, ACTON, HAYES,
SOUTHALL, HEATHROW etc

CALL US FOR A PROFESSIONAL & RELIABLE SERVICE

081864 4990 OR 0850 830283
SHOWROOM AT: 345c NORTHOLT RD. (OPP SAINSBURY'S)
SOUTH HARROW, MIDDX OPEN 9am-5.30 MON-SAT

MUSIC ETC...

QUANTUM AUDIO IMPORTED LPs & CDs

Discover the recording reviewers & manufacturers use for their
standard references.
Listen to high definition compatible digital. Hear awesome & historic
performances, premier recordings, classics, opera, jazz and much more.
on: Athena, DCC, Fone, Klavier, Mark, Origaku, Reference recordings,
Sheffield Lab, VTL & Wilson.
These CDs & LPs are available from good hi-fi & record dealers in the
event of difficulty or for literature & prices call

Quantum Audio Ltd, P.O.Box 26, Kilmarnock KA3 7JA
Tel.: (0563) 71122 Fax: (0563) 71133

CD SELECTIONS

The UK's leading suppliers of bargain CDs and music
for your free catalogue contact

CD SELECTIONS
PO BOX 1011
OORCHESTER OORSET O12 7YG
Tel. 0305 848 725

OVERSEAS

Sum of the parts.

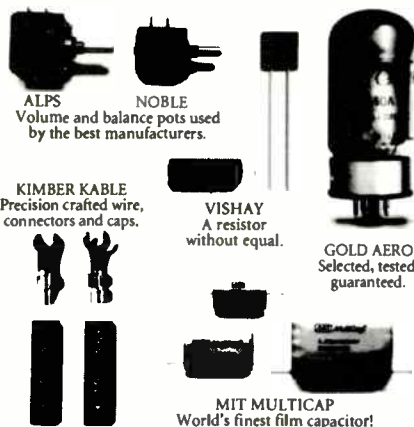

ALPS NOBLE
Volume and balance pots used
by the best manufacturers.

KIMBER KABLE
Precision crafted wire,
connectors and caps.

VISHAY
A resistor
without equal.

GOLD AERO
Selected, tested,
guaranteed.

MIT MULTICAP
World's finest film capacitor!

The very best in audio grade parts,
upgrade/mod kits and complete kit products.
Call, write or fax for our catalogue.

SONIC FRONTIERS
INCORPORATED

2790 Brighton Road, Oakville, Ontario, Canada L6H 5T4
Telephone (905) 847-3245 - Fax (905) 847-5471

MIT MultiCap • Wonder Cap • Kimber Kap • Solen • Siemens
Hovland MusiCap • Wima • Holco • Draloric • Vishay • Caddock
Mills • Matsushita • Noble • Kimber Kable • Cardas • Discovery
Audioquest • Alps • Bourns • Shalco Attenuators • Electroswitch
Elma • CTS • Elna • Nichicon • Gold Aero • RAM • N.O.S. Tubes
Linear Technology • Burr Brown • Analog Devices/PMI • Motorola
Edison Price • Pearl • Tube Sockets • WBT • Neutrik • Kits

SCOTLAND

RIVERSIDE AUDIO

South West Scotland Tel: 0475 631 066
Argyll and Bute Tel: 0700 504845

The mystique of valve amplification demonstrated in the
comfort of your own home. Art Audio, Concordant
Valve Amplification, Atacama Audio Supports, J.P.W.
Speaker Systems, Fullers Audio Loudspeakers.

ANCRUM
ELECTRONICS
YOUR LOCAL HI-FI SHOP
PIONEER, TECHNICS, PROLOGIC AMPS + LASER
DISC FOR HOME ENTERTAINMENT
TEL: (0382) 480030
39 GRAY ST., BROUGHTY FERRY DUNDEE
Dedicated Dolby, Pro-logic listening rooms

STAFFS & DERBY

HOW TO **SAVE £100** ON YOUR **HI-FI**

Choosing the right Hi-fi and saving money is a difficult
task, make it easy on yourself.

To get your copy of "Guide to Buying Hi-fi"
just telephone

FREEPHONE 0800 373039

We will send you one Free of Charge together with our
Fact Pack and see how you can save £100 on
recommended Hi-fi Systems.

Active Audio

12 Osmaston Rd, 29 Market Street, 95 Stafford Street,
The Spot, Tamworth Hanley,
Derby Staffs, Stoke-on-Trent.
Tel. 0332 390385 Worldradio History 0782 214994

SERVICES & CONSULTATIONS

R. J. F. 84 Pendarves Street,
Tuckingmill, Camborne,
Cornwall TR14 8NJ
Tel: (0209) 710777

Dealers for: Albarry, Audio Technica, B&W, Beyer, Cerwin Vega,
Denon, Dynavecator, Exposure, Foundation Audio, Goldring, Harman
Kardon, JBL, Marantz, Michell, Micromega, Musical Fidelity, Nakamichi,
Ortofon, Perception, Pink Triangle, Project, QED, Sansui, SD Acoustics,
Sharp, S.M.E., Tannoy, Target, TDL, Technics, Townshend, plus more!
Much second hand equipment available plus repairs to all brands.



CLEARSOUND

- * HIGH END HIFI EQUIPMENT SERVICED OR REPAIRED *
- * VINTAGE & MODERN VALVE EQUIPMENT A SPECIALITY *
- * QUAD AND LEAK VALVE TUNERS SERVICED & AUGMENTED *
- * KIT BUILDING SERVICE *
- * VERY COMPETITIVE PRICES AND OVER 25 YEARS EXPERIENCE *

ALSO DEALER FOR ATC, AVI, AUDIOLAB, AMESON COOPER,
GROOVE TUBES, SPENDOR AND KLIPSCH

**SPECIAL OFFER. ONE PAIR ONLY ATC SCM100A PIANO
BLACK 3750 NEW BOXED AND 6 YEARS WARRANTY**

PHONE RHYL (0745) 343 060 AFTER 6PM WEEKDAYS OR
AFTER 12 NOON AT WEEKENDS

WANTED URGENTLY
QUAD FM2 8FM3 & QUAD 11 VALVE POWER AMPS ALSO
LEAK TROUGHLINE 3 (STEREO) TUNERS AND STEREO 20
POWER AMPS
EQUIPMENT DOESN'T HAVE TO BE WORKING BUT MUST BE
ORIGINAL AND COMPLETE

L.G.S. AUDIO SERVICES.

Quality Audio Equipment and Hi-Fi Systems
Repaired and Serviced at Reasonable Cost
2nd Floor, Forest Mills, 133 Alfreton Road,
Radford, Nottingham NG7 3JL

Tel: 244443

HI-FI WORLD SPECIALIST DEALER DIRECTORY ORDER

**BOOK 12 MONTHS FOR A 30% DISCOUNT!!
OR 6 MONTHS FOR A 20% DISCOUNT.**

I wish to be included in Hi-Fi World's Specialist Dealer
Directory starting the _____ issue for a total
of _____ insertions.

Please find enclosed my artwork/copy details.
I wish to book _____ column centimetres at £12.50 per
col. Cm.

Name _____

Company _____

Address _____

Postcode _____ Telephone No. _____

Please return to Caroline Knott,
Hi-Fi World,
64 Castellain Road,
London W9 1EX

WORLD DESIGNS

by Mail Order

world audio design mail order

K5881 KIT

£395 ▼



Here's a superb, Class A, 20watt stereo power amplifier that uses the inexpensive Russian 5881 output valve, a military version of the regarded American 6L6, designed for low distortion audio work. It has super-quality output transformers (4/8/16Ω selected internally) to minimise distortion and the input stage uses triode working. A rugged, sixteen-gauge, all-welded steel chassis is provided, together with protective bottom plate for safety.

Designed for long life, low running costs and excellent sound quality, K5881 is sensitive enough to be used with a simple passive pre-amp. or our own line-drive pre-amp, and it matches modern loudspeakers well. There is a choke-regulated power supply and the channels can be paralleled to turn it into a 40W monoblock if desired.

K5881 costs just £395 as a kit of parts and £595 fully built from our own build service. The U.K./Europe version has a 240/220V transformer but 120/110V can be supplied as an alternative - see Overseas details on Order Form.

SPECIFICATION

Power	20watts/ch.
Frequency response	16Hz-40kHz
Distortion	0.02%
Separation	60dB
Noise (CCIR)	-103dB
Sensitivity	240mV
Dimensions (mm)	400w,300d,180h
Supply	110/120V or 220/240V, 220W
Weight	16kgs(34lbs)

VALVE LINE LEVEL PRE-AMPLIFIER

£295 ▶

Constructed from heavy gauge steel with an aluminium anodised and polished front panel. This new chassis comes with the complete kit of parts necessary to build the valve line level pre-amp.

The components are all high quality and include a special screened toroidal transformer, Military Spec. Russian valves, Alps potentiometer, metal film resistors, polypropylene signal capacitors, silver plated copper wire etc.



◀ HIGH DEFINITION LOUDSPEAKER

£295

The High Definition loudspeaker is ideal for low power, high quality amplifiers, transistor or valve. It goes very loud with just 1-5watts, having an enormous sensitivity of 94dB - that's 8dB more than most other speakers. It is also a very easy load for valve amps (8ohms) and it gives a terrifically dynamic and fast sound. This speaker is also unusually suited to low powered vintage amplifiers, such as Quad IIs, Radfords, Pye Mozarts and such like.

The High Definition loudspeaker is available in two forms; as a drive unit pack containing two bass units and two tweeters modified and tested, or complete with all crossover components, gold plated bi-wire terminal dishes, silver plated copper wiring and long haired wool.

KLS2 LOUDSPEAKER

Drive Unit & Crossover kit etc
Drive Unit Pack

£195
£145

See page 83 for order form...

WORLD DESIGNS

by Mail Order

300B VALVE AMP KIT

£750 ▼

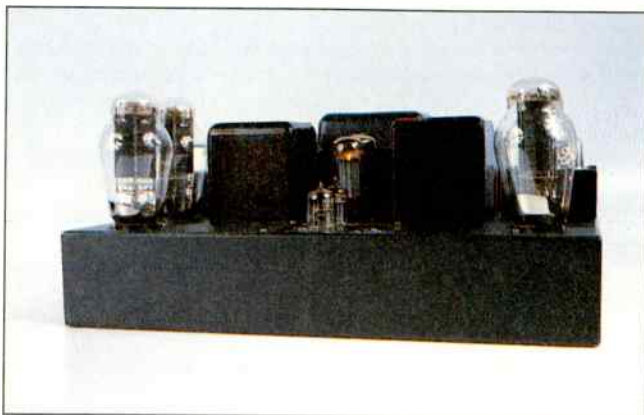

This is a specialised amplifier based on the highly linear 300B triode valve. Our 300B runs in Class A, giving one of the most sweet, open and neutral sounds possible today. Matched with good loudspeakers, it is unsurpassed.

The kit comprises a strong 16-gauge mild steel chassis, fully

punched, welded and ground smooth. Finish is a durable 'powder coat' black. A protective bottom plate is provided for safety. Output terminals (one pair) take 4mm plugs axially and radially for bi-wiring, or heavy gauge bare cable. Output options of 4/8/16Ω are selected internally at the transformer. A small circuit board carries most of the components. 240/220V and 110/120V versions available. Can be monoblocked for 60watts.

All parts are included in the kit, except valves since different 300B makes are available.

A fully built version from an approved build service is also available.

SPECIFICATION

Power	28watts
Frequency response	5Hz-36kHz
Distortion	0.2%
Separation	54dB
Noise (hiss/hum)	-100dB/-72dB
Sensitivity	240mV
Dimensions (mm)	405w,295d,175h
Supply	110/120V or 220/240V, 220W
Weight	20kgs(44lbs)

4W SINGLE-ENDED VALVE AMP KIT

£385 ▼



The 4W Single-Ended amplifier kit is a line level integrated amplifier. It comes with three line level inputs and a tape output. High quality components are used throughout, including polypropylene signal capacitors, Alps volume control, custom C&K gold plated selector switch etc. Valves are included.

SPECIFICATION

Power	4watts	Noise (hiss)	-100dB
Freq. Response	9Hz-64kHz	(hum)	0.7mV
Distortion	1.3%	Sensitivity	180mV
Separation	74dB		

DEMONSTRATIONS!!

By the time you read this we hope to have our K5881 20W valve power amplifier, KLP-1 valve pre-amplifier and 4W single-ended on demonstration at Hi-Fi Confidential, 34 Buckingham Palace Road, Victoria, London. Phone the patient and understanding Luigi on 071-233-0774 to check availability. He's a valve afficianado, knows Tim de Paravicini and is still sane, and stocks plenty of good products - including World Audio Design.

4W SINGLE-ENDED TRANSFORMERS £190

A set of transformers (8kgs) for our single-ended amplifier (December '93. Supplement No 6).

- 1) Mains (1 off) Secondary: 0-210V a.c. at 150mA, 6.3V centre tapped. Primary: 220/240V or 110/120V - please state which on order form. Drop through fixing.
- 2) Output (2 off) High quality transformers with grain orientated silicon steel laminations. Secondary tapped 4/8/16Ω. Drop through fixing.
- 3) Choke (1 off) Compact 1.2H/150mA choke for under-chassis fixing. Frame mount.

6080 valves - double-triode power valve for the single-ended amplifier - **£15.00**

K5881 (20W CLASS A) TRANSFORMERS £220

There are four transformers in all, weighing 12kgs.

- 1) Mains (1 off) Secondary: 0-360, 1 x 6.3V centre tapped. Primary 220/240 or 110/120 - please state which on order form. Drop through fixing.
- 2) Output (2 off) These transformers use high quality materials, laminations of thin and best quality grain orientated silicon steel. Output tapped 4Ω, 8Ω and 16Ω. Drop through fixing.
- 3) Choke For smoothing of the H.T. line to provide best sound quality, a 5H choke that fixes under the chassis. Frame mounting.

300B (28W CLASS A) TRANSFORMERS £430

Seven transformers in all, weighing 16kgs (35lbs)

- 1) Mains (1 off) Secondary: 230V-0-230V, 5 x 5V, 1 x 6.3V. Primary 220/240 or 110/120 - please state which on order form. Drop through fixing.
- 2) Output (2 off) Designed for low distortion and broad load compatibility from the 300B. Cores with centre-hole fixing to avoid corner flux concentrations; laminations of grain orientated silicon steel. Output tapped 4/8/16Ω. Drop through fixing.
- 3) Intervolve/phase splitter (2 off) frame mounting.
- 4) Chokes (2 off) For smoothing of the H.T. lines, two 3H chokes that fix under the chassis. Frame mounting.

WARNING
THESE ARE EXPERT KITS, NOT FOR THE INEXPERIENCED,
THE VALVE KITS CONTAIN LETHAL VOLTAGES. WE CANNOT BE HELD RESPONSIBLE FOR ANY ERRORS ARISING FROM
THE CONSTRUCTION OF THE KITS.

world audio design mail order

ORDER FORM

Please send your completed order form to: **WORLD AUDIO DESIGNS, 64 Castellain Road, Maida Vale, London W9 1EX**
 Tel: 071 266 0461 Fax: 071 289 5620

240/120 option - delete the voltage NOT required.

Valves included except where stated.

'BUILT' - we can supply the amplifiers built up and tested by an approved service, for safety and guaranteed performance to specification.

NOW AVAILABLE - 4W SINGLE-ENDED INTEGRATED AMPLIFIER KIT. INCLUDES CUSTOM CHASSIS, TRANSFORMERS, VALVES AND ALL COMPONENTS - £385

DESCRIPTION	ORDER No.	QTY	PRICES	
			UK (inc VAT & carriage)	OVERSEAS. (net)
4W single ended				
KIT	4WSE-K240/120	<input type="text"/>	£385	£330
transformer set	4WSE-TR240/120	<input type="text"/>	£190	£150
K588I 20W budget valve amplifier				
KIT	K588I-K240/120	<input type="text"/>	£395	£350
BUILT	K588I-B240/120	<input type="text"/>	£595	£550
transformer set	K588I-TR240/120	<input type="text"/>	£220	£180
300B 28W specialised valve amplifier (prices do not include valves)				
KIT	300B-K240/120	<input type="text"/>	£750	£650
BUILT	300B-B240/120	<input type="text"/>	£1050	£950
transformer set	300B-TR240/120	<input type="text"/>	£430	£370
KLPI line level preamplifier				
KIT	KLPI-K240/120	<input type="text"/>	£295	£250
BUILT	KLPI-E240/120	<input type="text"/>	£395	£335
KLSI 3-way floorstanding loudspeaker				
KIT	KLSI-K	<input type="text"/>	£729	£650
Drive units and hardware	KLSI-D	<input type="text"/>	£429	£370
KLS2 2-way, high definition, floorstanding speaker				
Drive Units + Crossover kit etc	KLS2-C	<input type="text"/>	£195	£165
Drive units	KLS2-D	<input type="text"/>	£145	£120
Loudspeaker measurement mic and preamp + test disc	3382B	<input type="text"/>	£440	£390

NAME: _____ I enclose cheque/postal order for £ _____
 made payable to **World Audio design Ltd.**

ADDRESS: _____

 I wish to pay by Access/Visa. Debit my account no:

<input type="text"/>	<input type="text"/>	<input type="text"/>	<input type="text"/>	<input type="text"/>	<input type="text"/>	<input type="text"/>	<input type="text"/>	<input type="text"/>	<input type="text"/>	<input type="text"/>	<input type="text"/>
----------------------	----------------------	----------------------	----------------------	----------------------	----------------------	----------------------	----------------------	----------------------	----------------------	----------------------	----------------------

POST CODE: _____ TEL: _____ Expiry date:

CREDIT CARD ORDERS TELEPHONE 071 - 266 0461 (24 HOURS)  

OVERSEAS PRICES AND DETAILS
 All our kits can be supplied overseas excluding the European Community, free of UK tax (VAT). However, allow for your own local import taxes (customs duties) and for carriage charges, which must be added to our net price.
 Surface mail is slow (1-4 weeks) but inexpensive; airmail is fast (up to 7 days) but more expensive. Couriers like Amtrak we recommend for speed and door-to-door service.
 We package overseas orders strongly.

METHODS OF PAYMENT
 International money order in Sterling, Visa, Mastercard/Access, Local Currency at agreed exchange rate by registered mail.
 Payment in advance. Contact us for details.
CONTACT: RICHARD JOHNSON
 London, England.
PHONE (9.30am-6pm) 071-289-3533
ANSWERPHONE (24hrs) 071-266-0461
FAX (24hrs) 071-289-5620

LIVING VOICE LOUDSPEAKER SYSTEMS

Audio signals can be of infinite complexity.

Their content is prone to corruption during any part of the processes of recording and reproduction.

Given that it is possible to store and recover this information with some degree of accuracy, (a debatable but necessary starting point) audio engineering's prime concerns are with the electronic amplification of that information and its conversion back to mechanical energy in the form of sound.

Both the amplification and the transducer used for the conversion will inevitably distort the signal. The art of good audio design lies in minimising the amount of distortion that occurs.

In each stage of amplification some distortion will be introduced, although most arises as a by-product of the output device's attempts to control an unco-operative loudspeaker. The ease with which the loudspeaker can be controlled varies depending on both frequency and level. It therefore makes good sense to employ the most load tolerant output devices possible in the amplifier, whilst keeping the number of gain stages to an absolute minimum.

Simple low powered amplifiers that fulfil these criteria have become more widely available over the past few years. Until now, the full benefits of this simplicity have not been readily apparent as all commercially available loudspeakers are too difficult to control accurately.

Loudspeaker drive units operate by passing a varying signal through a coil which is suspended in a magnetic field. The coil is usually coupled to a diaphragm and moves backwards and forwards following fluctuations in the input signal. As it is difficult to arrange a magnetic field that remains constant over a large area, the accuracy with which the coil and diaphragm follow the signal deteriorates as the excursions become larger.

If a loudspeaker drive unit can be constructed whereby the coil and diaphragm assembly can move a great deal of air easily for a very small excursion then it will

not be necessary to use as much power to generate the required amount of sound. A technique that achieves this more effectively than any other is "Horn Loading" and involves coupling the diaphragm to the air by using a flared horn. By arranging that the horn opens out at an optimally calculated rate, very effective coupling can be achieved with minimum distortion.

The loudspeaker can then be said to be an efficient transducer and will be easier for our idealised simple amplifier to control.

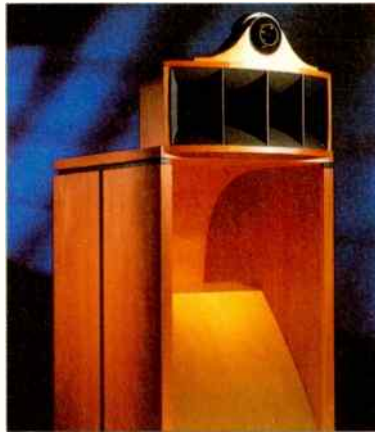

The AIR PARTNER & TONE SCOUT Loudspeaker systems use the principle of full range horn loading to optimise their efficiency. Both are 3-way designs with crossover points at 500 Hz and 10 KHz and sensitivities of 108 & 104 dB/1watt @ 1 metre.

LIVING VOICE has worked closely with SECOMAKVITAVOX and other EC based manufacturers on the development of proprietary Bass and Midrange drive units have.

The Bass drivers are straight-sided, undoped, paper cones mounted in sturdy cast baskets attached to huge magnet assemblies. The decay of the Bass unit's response is very smooth and does not present significant problems in the octave above crossover.

The Bass horn is constructed entirely from High Density Birch Ply and is veneered using only "Crown-Cut" veneers.

The Mid-range units are pressure drivers featuring a rigid dome driven by a 75mm diameter coil operating in an intense magnetic field. The dome and coil former are of one piece of 50 micron thick, chemically stiffened aluminium. With the coil wound directly onto the dome there is direct drive with no intervening adhesive joint. The magnetic field is powered by a heavy ring magnet of Titanium, Nickel and Cobalt alloy.

Once again, the high frequency performance of the driver must decay smoothly and this is achieved by a phase corrector in the centre pole of the magnetic circuit. A complex arrangement of precision machined, tapered plugs form three concentric air channels angled to join each other in the heart of the unit.

These drivers are directly coupled to a genuine, multi-cellular high frequency horn formed as a single piece aluminium casting. The assembly is encased in a matching, veneered cabinet.

The extreme treble response of both designs are handled by smaller horn loaded pressure drivers.

The astonishing efficiency of both the AIR PARTNER & THE TONE SCOUT allows them to reproduce all types of music with an appropriate sense of scale and ease. When used with suitable ancillary equipment they offer a level of resolution and realism that can truly be described as appropriate.

Definitive Audio Import/Export Tel. 0602 813562

IN THE AUGUST ISSUE

Even in high summer we'll be bringing you high quality hi-fi, so wherever you are going to be, lying on the beach or just listening to music in a cool room, make sure you get your August copy of Hi-Fi World packed full of reviews and plenty more. Here's just a small selection -

UKD CALLAS LOUDSPEAKER

They've just been updated and improved and we'll be bringing you the first review of these new solid wood, high quality miniatures from Italy. Using Focal drive units they promise to offer something special for the music lover.

AUDIOLAB 8000 CD TRANSPORT

This long awaited CD transport from Audiolab should be with us in time for the next issue. We'll be expecting great things from the manufacturer of some of the finest audio equipment around.

LEAK 0.1 VALVE POWER AMPLIFIER - PART I

A pair of sought-after Leak 0.1 vintage valve power amplifiers are purchased. We follow their restoration up to mint condition by expert Graham Tricker. Part I - what to look for.

TANNOY D500 LOUDSPEAKER

Following the success of the awesome D700s and the captivating little D100s, Tannoy have launched the D500, a floorstander using a 6.5inch dual concentric driver and a 6.5 inch bass unit.

ROTEL RT930 TUNER

A rival for the superb NAD402 tuner? We've heard good things about this one, so we thought it about time to bring you our official verdict, backed by tests of course.

DIY SUPPLEMENT

We always aim to offer more than the rest, so August sees DIY Supplement No. 9 hit the streets. Plans for this one include a superb low colouration three-way floorstander using latest technology carbon fibre drive units. There will also be Richard Brice's high quality headphone amplifier, DIY letters, Kit News etc. etc.

Hi-Fi World is still only £2, but with more editorial than most rivals. With the most enthusiastic and expert editorial team in hi-fi journalism, can you afford to miss it? Make sure you don't by filling in this order form and handing it to your newsagent. ▶▶

Hi-Fi WORLD

Please reserve/deliver* Hi-Fi World on a regular basis, commencing with the next issue, until further notice.

Name: _____

Address _____

Signed: _____ Date: _____

• Delete as appropriate

Distributed to the news trade by

COMAG
MAGAZINE MARKETING

Classica

Peter Herring

It's about connections this month. Connections between Shostakovich and Mahler; between Shostakovich and the conductor, Rudolf Barshai; between Barshai and Mahler; between Richard Strauss and Ludwig van Beethoven; and between them all, the inevitability of mortality. But it's not all death and despair. There's the invigorating classical music of Mexico, as vibrant and colourful as the country of its birth.



GUSTAV MAHLER
Symphony No 9 in D Major
 Moscow Radio Symphony Orchestra;
 conductor, Rudolf Barshai
 BIS CD632 (DDD/78.30)

● A historic occasion, with a performance to match. In 1977, some two years after the death of his friend and mentor, Dmitri Shostakovich, the Russian conductor, Rudolf Barshai, left the former Soviet Union for exile in Britain. He had been one of his country's foremost musicians: a gifted viola player and the founder of the world-renowned Moscow Chamber Orchestra. In Britain, he enjoyed many successes as the chief conductor of the Boumemouth Symphony Orchestra and became a respected interpreter internationally of several composers including Mahler and - inevitably - Shostakovich.

Last year, Barshai became one of several eminent Russian musicians to have made a triumphant return to their homeland in the wake of the recent reforms. One of the invitations to Barshai came from the Moscow Radio Symphony Orchestra, but its players must have been surprised when he chose to conduct them, not in a Shostakovich symphony, but the epic Ninth Symphony of Gustav Mahler. For a second concert, he chose another work which had long been out of the orchestra's repertoire, Beethoven's *Missa Solemnis*.

The combination of a conductor steeped in a great piece of music and an orchestra coming to it with relative unfamiliarity can sometimes be the catalyst for something special. Such is the case here. Barshai apparently insisted on six full rehearsals for the symphony and the benefit of that can be heard in the end result, not just in the accuracy and detail of the playing, but in its spirit. Some of the phrasing, especially in the first movement, may be a little over-ripe, but what impresses most is Barshai's unerring grasp of this vast score. He illuminates the detail, but never dwells on it; the whole has a potent, compelling momentum. Tempos are well-chosen for all four movements and the Moscow orchestra gives its all, while playing with great assurance. Which is all the more commendable as this CD is a faithful

reproduction of the concert which took place on April 13, 1993, in the great hall of Moscow's Tchaikovsky Conservatory. No post-production 'patching' appears to have been performed on the tape.

The recording is most impressive, strikingly clean and clear in the orchestral tuttis, with convincing perspectives and a satisfying presence. Audience noise is negligible and I commend the production team for keeping the audience there between the movements rather than abruptly descending into clinical, artificial silence as is the case with many 'live' recordings. There is some two minutes of applause at the end but it is treated as a separate track and if, like me, you prefer to just reflect on the moving intensity of that concluding *Adagio*, simply programme it out.

I should add that this recording has extra-musical benefits. In conjunction with the concert, the IPPNW (International Physicians for the Prevention of Nuclear War) organised the distribution of twenty tons of medicines and baby food to children's clinics in Moscow, and all profits from the recording will go to finance further assistance for these clinics. But, even without that, I would be happy to include Barshai's performance among my collection of Mahler Nines; it is up there with Abbado, Walter, Kubelik and Barbirolli.

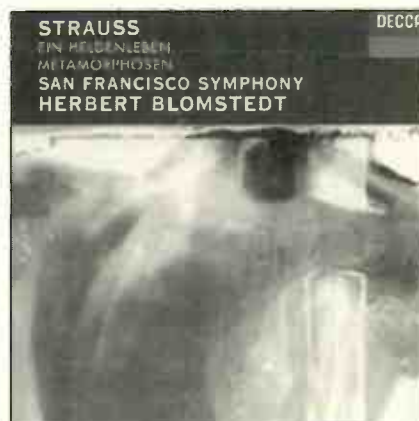

RICHARD STRAUSS
Ein Heldenleben
OP40*/Metamorphosen for
23 solo strings AVI42
 Raymond Kobler, violin*; David Krehbiel, horn*; San Francisco Symphony Orchestra; conductor, Herbert Blomstedt
 DECCA 436 596-2 (DDD 73.28)

● Some thought has gone into this recording. Ostensibly, it's an ill-judged combination: *Ein Heldenleben* (A Hero's Life) should be partnered, from among Richard Strauss's orchestral compositions, by *Tod und Verklarung*

The Twelfth and Thirteenth Symphonies of Dmitri Shostakovich have consecutive opus numbers. And that is the only link between them; in terms of content and expression, they are worlds apart. Or is there a link, on an extra-musical and bitterly ironic level? The Twelfth Symphony, the most hollow and unconvincing of Shostakovich's 'propaganda' symphonies, is sub-titled 'The Year 1917' and the final movement of this hymn of praise for the Bolshevik revolution has the heading 'Dawn of Humanity'. In the light of events, something of a sick joke, and one you suspect may not have escaped its composer, for in the opening movement of the Thirteenth Symphony he recalls, through the poetry of Yevtushenko, one of the most inhuman acts ever perpetrated by so-called humanity: the massacre of Soviet Jews by the Nazis at Babi Yar in the Ukraine.

The Thirteenth was the first of a trilogy of extraordinary works which marked the culmination of Shostakovich's symphonic output. Musically he treats symphonic form very freely, on the basis

that the structure is the servant, not the master, of its subject matter. After the Yevtushenko settings of Noli, he again turned to the 'song symphony' for Noli. In his Fifteenth and final symphony, however, he elected to use the orchestra alone, in a work which mixes wit, enigmatic allusions and even child-like high spirits in a very personal epitaph. It is as though Shostakovich is reflecting on the diverse and often contradictory facets of his own character, and perhaps becoming reconciled to his own mortality.

But there is no hint of reconciliation in the Fourteenth Symphony, the work which concerns us here, it having become the subject of an outstanding and valuable new recording by Neeme Jarvi for DG. The underlying theme of the symphony is death, its inevitability and finality. If its format resembles Mahler's valedictory 'song symphony' *Das Lied von der Erde* (The Song of the Earth), there is nothing of the transcendence or transfiguration implied by Mahler's final setting, *Der Abschied* (Farewell). Shostakovich's Fourteenth bears a greater kinship with Britten's *Nocturne* and the *Serenade* for

Tenor, Horn and Strings. Indeed, there was a strong bond between Shostakovich and the English composer, Britten conducted the British premiere of the Fourteenth Symphony, which is dedicated to him, at Aldeburgh.

The first performance of the work took place in Leningrad under the baton of Rudolf Barshai in September 1969. Surprisingly, for music so far removed from the Soviet 'ideal', both in content and form, there was no officially prompted criticism of the work. Perhaps, by then, Shostakovich was too important a figure to be criticised; perhaps the authorities saw it as a convenient way to demonstrate the new artistic tolerance prevailing in the former Soviet Union; or was it that the intensity and integrity of the music even penetrated the souls of the party apparatchiks?

It would be misleading to give the impression of a symphony of bleak fatality. Its refusal to offer the balm of consolation is also a way of saying that the human spirit can come to terms with the oblivion that awaits us all; that the best protest against death is to make the most of life.

DMITRI SHOSTAKOVICH Symphony No14 Op135*

MODEST MUSSORGSKY Songs and Dances of Death

Brigitte Fassbaender, mezzo-soprano;
Ljuba Kazarnovskaya, soprano*; Sergei
Leiferkus, bass*; Gothenburg Symphony
Orchestra; conductor, Neeme Jarvi
DG 437 785-2 (DD/72.45)

● In May 1966, Dmitri Shostakovich suffered the first of a series of heart attacks and, like many suddenly thrust into that position, he became all too aware of his own vulnerability. Six years later, he produced a wonderfully sympathetic orchestration of Mussorgsky's *Songs and Dances of Death*, four settings of poems by Mussorgsky's friend, Count Arseni-Golenischev-Kutuzov. Here, death is portrayed as a knight claiming his bride, as the dancing partner of a drunken peasant, as the final embracer of a sick child, and as a commander calculating his successes on the battlefield. In Mussorgsky's hands, the words make a telling and lasting impression and it is easy to see how the *Songs and Dances of Death* became the model for Shostakovich's own, equally successful, attempt to face the subject in the Fourteenth Symphony. All credit to DG for confirming the link by including both works in this recording. Brigitte Fassbaender's performance in the Mussorgsky is idiomatic and utterly compelling and Jarvi - with the aid of vivid recording - brings out the full detail of Shostakovich's orchestral scoring. It

provides a memorable prelude to the symphony.

It was during one of his stays in hospital that Shostakovich began selecting the texts for the Fourteenth Symphony. He chose poems by Lorca, Apollinaire, Kuchelbecker and, perhaps courageously, the German, Rainer Maria Rilke. (In 1969, memories of the Russians' treatment at the hands of the Germans were still painfully vivid in the Soviet Union). The soprano and bass soloists are supported by an orchestra of just strings and percussion. As in the Thirteenth

makes very effective use of the tam-tams while - for the only time in his symphonies - omitting the timpani. While the subject may be darkly sombre, the symphony is not short of colour, or of variety in its tempos. The musical language is wholly individual, with a directness and evident heartfelt integrity that makes it immediately accessible, arresting and touching. Shostakovich invites the listener to confront death with him, in a way that we can all understand. Yet you emerge more determined than depressed; in conjuring images of death, the Fourteenth Symphony also puts the case for life.

Neeme Jarvi has been selective in his recordings of the Shostakovich symphonies, avoiding the more bombastic works, as might be expected of a native Estonian. But in each of those he has tackled, a firm grasp of the score and all it implies has seldom been in doubt. This powerfully-driven, highly dramatic performance of the Fourteenth is no exception and he obtains thrilling results from the string players and percussionists of the Gothenburg orchestra. It is a stronger, more sympathetic and more deeply-felt performance than Turovsky on Chandos and - in comparison - Haitink's otherwise first-rate Decca recording occasionally seems to pull back from the emotional edge. The Decca recording, however, is marginally finer; the DG has plenty of range and immediacy but is a little one-dimensional, but given the performances of both works, nothing to preclude an enthusiastic recommendation.

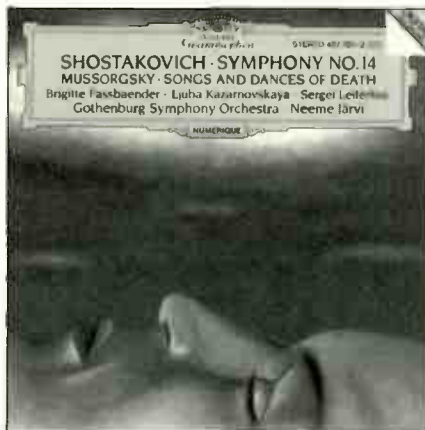

Symphony, the darkness of the texture is emphasised by the employment of five double basses while the array of percussion includes castanets, woodblock, whip, celesta and vibraphone, as well as the tolling of the chimes and the skeletal rattle of the xylophone. Shostakovich also

(Death and Transfiguration), or by Also sprach Zarathustra; the notion of man the hero figures strongly in both. But the inclusion of the valedictory *Metamorphosen* acknowledges a more subtle and more telling link.

In the quasi-autobiographical *Heldenleben*, Strauss unashamedly quotes the exuberant opening theme of Beethoven's *Eroica* Symphony (which, you may recall, was originally dedicated to the latter's 'hero', Napoleon Bonaparte). *Ein Heldenleben* dates from 1898 when Strauss was thirty-four. He was already hugely successful as both composer and conductor and his star was continuing to rise. He was blissfully married and would soon become the world's first millionaire composer, but he also had his critics and in *Ein Heldenleben* he reflected all these aspects of his (the hero's) life in music of graphic brilliance and with a self-indulgence only to be matched by his *Sinfonia Domestica*. Like it or not, *Ein Heldenleben* is one of the great orchestral showpieces.

Forty-six years later, Strauss was again quoting from Beethoven, this time with greater subtlety and, one suspects, greater conviction. In *Metamorphosen*, it is not the confident vision of the *Allegro con brio* that we hear, but the sobering sonorities of the granite-hewn *Funeral March*.

In those four decades, Strauss's world had been reduced to rubble, along with his country. He described the bombing of his beloved Munich opera house as the greatest catastrophe of his life, which - in the circumstances - was, to say the least, parochial. Other opera houses where he had been feted as Germany's greatest living composer had also been destroyed: Dresden, Berlin, Vienna.

He responded with *Metamorphosen*, a composition whose abstract title masks a deeply-felt cry from the heart. It ranks alongside his *Four Last Songs* in its ability to touch both heart and mind but is also a beautifully-wrought work, with its organic development and interweaving of themes. It began with a 24-bar sketch which Strauss headed *Trauer un Munchen* (Mourning to Munich). As we listen, the 'Trauer' motif constantly eludes to something familiar but it is not until the music subsides from its anguished climax that the telling

quotation from Beethoven reveals itself. At that point in the score, Strauss wrote above the notes 'In Memoriam'.

In *Ein Heldenleben*, this new Decca recording faces stiff competition but nonetheless emerges pretty near the top of the list. But it is the performance of *Metamorphosen* which gives this production its edge. There are surprisingly few recordings of the work in the catalogue, and even less which can match this one technically. Reflecting the impact that Herbert Blomstedt has had during his relatively brief spell in charge of the San Francisco Symphony, both performances are first-rate. They join others of Sibelius, Hindemith and Nielsen which have enhanced the catalogue. Moreover, the Decca engineers are now getting the very best from the Davies Hall acoustic. I could live without another version of *Heldenleben*, but Blomstedt's *Metamorphosen* makes this disc essential.



RODOLFO HALFFTER
Violin Concerto Op11 (revised Szeryng)*

JOSE PABLO MONCAYO
Huapango

SILVESTRE REVUELTAS
Cuauhnahuac

MANUEL PONCE
Concierto del Sur (Concerto of the South)#

Henryk Szeryng, violin*; Alfonso Moreno, guitar#; Royal Philharmonic Orchestra*; Orquesta Filarmonica de la Ciudad de Mexico; Orquesta Sinfonica del Estado de Mexico; conductor, Enrique Batiz

ASV DIGITAL CD DCA871 (DDD/63.58)

- This is the third volume in a series from ASV entitled 'Musica Mexicana' which, I should emphasise straight away, does not mean a mix of

tortillas, tequila and Pancho Villa. But that's not to say these orchestral works do not have more than a flavour of their country of origin; it would be disappointing if they did not reflect the rich tradition of Mexican folk music. Indeed, much of the music here is as vivid and vibrant as the Aztec image which graces the cover of the CD insert. For a taster, try Moncayo's *Huapango*: as bright and cheering a piece of music as I've heard for a long time. As an orchestral debut - it was composed in 1941 when Moncayo was twenty-nine - it's remarkably accomplished in its assimilation of Mexican dance themes. Sadly, Moncayo's composing career was short: he died just seventeen years later. The flame of Silvestre Revueltas also burned only relatively briefly before being extinguished when he was fifty-one by a combination of exhaustion and alcoholism. The vitality and colour of his music is evident in the dazzling *Cuauhnahuac* of 1930, the title coming from the Aztec name for the resort of Cuernavaca. Tender lyricism contrasts starkly with the ferocity of other sections of the score, the whole erupting in a concluding blaze of brass.

The programme opens and closes with two concertos, that for violin by Rodolfo Halffter, and one for guitar by Manuel Ponce, entitled *Concierto of the South*. Ponce, who along with the Carlos Chavez, was the key figure of modern Mexican music, began as a teacher of music rather than a composer until his imagination was fired by the genius of the guitarist, Andres Segovia. The delightful *Concierto del Sur*, scored for strings, single woodwind, tympani and tambourine and completed in 1941, was dedicated to Segovia, and it offers the soloist many opportunities to display his skill. The guitarist here, Alfonso Moreno, doesn't disappoint.

In contrast to the relaxed, festive rhythms of the *Concierto del Sur*, Halffter's *Violin Concerto* is an altogether tougher piece, with contrapuntal variations, a substantial cadenza and a dashing coda to tax the soloist. Szeryng, who helped the composer to revise the work in 1953, some eleven years after its first performance, relishes each challenge.

It makes for compelling music-making.

As the list of performers suggests, this is a compilation of recordings made in both London and Mexico City, but all four have come together quite seamlessly and the balances are first-rate.

The sound is as full-blooded and vivid as the music. A taste of Mexico that whets the appetite for more.

Classical

THIS DAC HAS NO UPGRADE PATH!

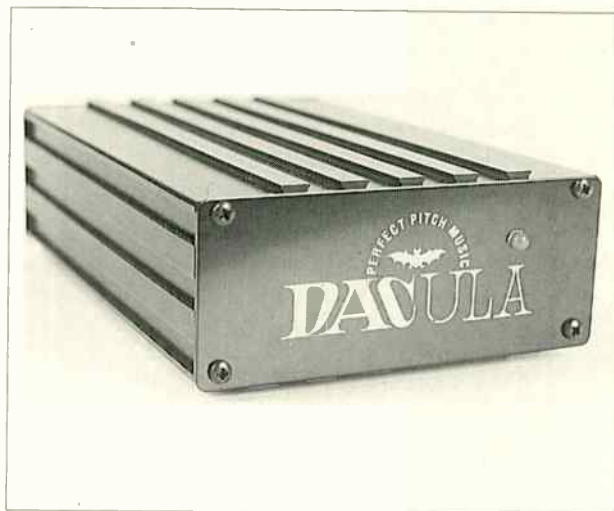

That's because Dacula, the new outboard Delta-Sigma DAC from Perfect Pitch Music, incorporates an array of no compromise audiophile design features as standard. An outboard power-supply provides 5 constant, precision-regulated power rails to keep the unit in a stable "powered up" condition at all times. Distortionless digital-domain muting is incorporated, and the analogue signal electronics utilise a unique combination of precision matched high-speed transistors and selected low-noise servo amplifiers. De-emphasis is performed in a zero- feedback passive network, switched by a relay with gold overlaid silver alloy contacts backfilled with nitrogen. The digital signal from the CD transport is handled no less carefully - the cable impedance being matched to within 0.1% to reduce digital-signal reflection to the minimum amount possible.

All these features ensure tht the highly regarded Crystal Semiconductor Delta-Sigma chip set at the heart of the Dacula performs to its theoretical best. With distortion on a -90dB dithered tone being less than 5%, Dacula equals DACs many times its price in low level detail recovery.

So why have we included all these features in a DAC costing less that £400? Because next time you consider upgrading, we hope you will consider one of our other products!

Perfect Pitch Music is a trademark of Select Systems TM



For further information please complete the coupon below and send it to:
 Select Systems Ltd. Hanworth Trading Estate, Hampton Road West, Feltham, Middx. TW13 6DH Tel: 081 893 8662 Fax: 081 893 4318

Please send me further information on (please tick boxes):

- | | | | |
|--------------------------|-----------------------------------|---------------------------------|--|
| <i>Dacula DAC</i> | <i>Francinstien + CD enhancer</i> | <i>Light Metal Loudspeakers</i> | <i>isolat/lsolat pre-amp combination</i> |
| <input type="checkbox"/> | <input type="checkbox"/> | <input type="checkbox"/> | <input type="checkbox"/> |

Title: First Name: Surname:

Address: Postcode:

Hi-Fi World Dial-a-Dealer

AUDIO EXCELLENCE Where the music matters 65 Park Street, Bristol BS1 5PB Tel: 0272 264975 Fax: 0272 251327. Great Hi Fi carefully selected and demonstrated by friendly enthusiastic staff. Home installations and check-ups. Two year warranty from our own service department. Open 9.00-5.30 Tuesday - Saturday closed Monday

PAUL GREEN HI-FI LTD. Kensington Showrooms, London Road Bath Tel: (0225) 316197 Musical Fidelity, Krell, Creek Rogers, Quad, Cust. car park. Best selection in the West.

V AUDIO, 36 Druid Hill, Stoke Bishop, Bristol, BS9 1EJ. Tel: 0272 686005. ATC Acoustic Energy Ruark, AVI, Exposure, Pink Triangle, Wadia Audio Innovations, SME (incl 20A), Chord Amps, Michell, AMC, Analogue Electronics, Cadence Valve, Jamo, LFD, REL, Sansui, Somic Link, Stax, Townsend Audio Technica, Goldring, Ltra, Drltofon, Sumiko. Demos by appt only, home trial facilities, free install, service facilities

WENTWORTH AUDIO, 83 High Street North, Dunstable, Beds. NU6 1JJ. Tel: 0582 6633 83. Marantz, Pioneer, Rotel, Audioblab, Mission Cyrus, Moth, Sony, HK, NAD, Pink Triangle, Yamaha, Systemdek, Albury, etc. Free installation & delivery. Home dems. Part exchange. Interest free credit - 6, 9, 12, 18 & 24 months terms. Free car parking at rear of shop. Free refreshments (alcoholic or otherwise!) Open 10-6pm Tues-Sat

BERKSHIRE

NEWBURY AUDIO, 2 Weavers Walk, Northbrook Street, Newbury, Berks, RG13 1A1. Tel: 0635 33929. Linn, Creek, Epos, Denon, Nakamichi, Shahinian, Marantz, Micromega, JPW, Ruark. Single speaker dem room. Appt. necessary. Home trial facilities, free install, service dept, late appts. Access/Visa, interest free credit subject to status. 6 days 9.30am - 6.00pm.

ARC AUDIO, 9 Dukers Ride, Crowthorne, Berks, RG1 16L2. (0344) 762201. Denon, Harman Kardon, JPW, Marantz, Monitor Audio, Onyx, Rogers, Tannoy, Thorens, Yamaha. Demonstration facilities, no appointments necessary, home trial facilities, free installation. Access, Visa, Diners. Open Mon-Sat 9-6pm (closed Wed at 1pm)

READING HI-FI CENTRE, 4 Queen's Walk, Reading RG1 7QF. Tel: 0734 585463. "The best equipment, advice and service from Berkshire's premier HiFi emporium". Products include: Arcam, exposure, Audioblab, Meridian, Rotel, Sony, sennheiser, Top Tape Centre, and many more.

ASTLEY AUDIO, Wallingford, 0491 839305. See our entry under OXFORDSHIRE

BUCKS

D. L. CHITTENDEN LIMITED 59-61 The Broadway, Chesham, Bucks, HP5 1BX. (Opposite Boots). Tel: 0494 784441. Philips, Denon, Kenwood, Canon Audio, Koss, Wharfedale, Mitsubishi, Target, Grundig, QED, Mordaunt-Short, Toshiba, Dolby Pro-logic Systems, Nicam TV and Video, Surround Sound, AV Systems. Showroom Demonstrations from expert and friendly staff. No appointments necessary. Service Department. Credit facilities available. Open 8.30 to 5.30 Mon-Sat.

DEJAC HI-FI Consultants, 21 The Broadway, Old Amersham, Bucks, HP7 0HL. Tel: (0494) 433173. AMC, Arcam, Bose, Meridian, Quad, Denon, NAD, Tannoy, Mission, TDL. 2 dem rooms, Appts necessary, Free installation, Tricity finance, instant credit, open 9.30-5.30 pm, including Saturdays.

NORTHWOOD AUDIO II, 98 Cambridge St. Aylesbury, Bucks HP20 1BA. Tel: 0296 28790 (A/P). Selected sounds from Alchemist, Aura, Boston, B & W, Cabellart, Castle, Celestion, Denon, Exposure, Gyrodec, Harman Kardon, Heybrook, Marantz, Micromega, Monitor Audio, Moth, NAD, Nakamichi, Rose, Rotel, Royd, Ruark, Systemdek, Tannoy, TDL, Thorens etc ect. Export orders welcome. 2 Dem rooms. Credit facilities available.

CAMBRIDGE

CAMBRIDGE HI-FI, 1-3 Hawthorne Way, Chesterton, Cambs. CB4 1AT. Tel: 0223 67773. Kenwood, Pioneer, Ariston, Kef, Technics, Yamaha, Marantz, B&W, AR, Mordaunt-Short, Bose. Single speaker dem room. Tues-Sat 9.30-5.30pm. Closed Monday. Free install, service dept. VIs/Access credit facilities.

STEVE BOXSHALL AUDIO, 41 Victoria Road, Cambs CB4 3BW Tel: 0223 68305 10.00-6.00pm 6 days 3 dem rooms Denon Rotel Yamaha Misson Nakamichi Tannoy Audioblab Marantz Krell, Martin Logan, Magneplanar. Wadia. Home trial facilities. Appointments preferred. Free instal. and service dept. Access/Visa

SWIFT HI-FI, St. Annes Parade, Wimmslow, 0625 526213. Aura B&W Denon, Kenwood, Marantz NAD Pioneer, Rotel Systemdek, Tannoy, Revolver, J.P.W. M. Short, Mission, Celestion Technics, Audioblab Castle. Open 9.30-6. Dem room. No pressure. BADA member.

THE HI-FI SHOWROOMS.12A West Str. Congleton, Cheshire (0260)280017, 1 Stanley St, Leek(0533)383780. Celestion, Creek, Exposure, Marantz, Musical Fidelity, Pink Triangle, Project, Rotel, Ruark, Systemdek, Tannoy, Technics. 5 Dem Rooms, Noappts nec, Home trial, Free install, Servicedept Access,Visa, Lombard Tricity. Open 9-5.30, Closed Wed.

HALE HI-FI, 2 Bold St, Hale Road, Atringham, Cheshire WA14 2ER. Tel:061 929 0834. Open Mon - Sat 10am-6pm & later by appointment. Specialising in equipment by: Naim, Quad, Royd, NAD, Denon plus selected others. Large range of quality accessories. On site service department. Installation & delivery. Home demonstrations a pleasure

ASTON AUDIO, 4 West Street, Alderley Edge, Cheshire. Tel: 0625 582704. Products include: Celestion, Creek, Yamaha, Monitor Audio, B&W, Aiwa, Aura, AKG, Musical Fidelity, Tannoy, Sennheiser, Marantz, Dual, Denon, Quad, Sansui, Technics, Sendor, Mission, SME, Nakamichi, Audioblab, Rogers, Audioquest, Mordaunt-short, Meridian, Deltec, Roksan, Arcam, Kef, NAD, Cyrus and others. Discount CD and tape. Extended guarantee, interest free credit and written details on request.

CHRIS BROOKS AUDIO, 29 Gaskell Street, Stockton Heath, Warrington, Cheshire, WA4 2UN. Tel: (0925) 261212. Tues-Sat 10.00-6.00. 2 dem-rooms credit facilities. All credit cards. Established 1978. Total absence of bulls**t.

CONGLETON HI-FI, 1/1a Duke St. Congleton, Cheshire, CW12 1AP. (0260) 297544 Acoustic Energy, Arcam, B&W, Denon, Epos, Linn, NAD, Nakamichi, Onix, Royd, Target, etc. Superbly appointed single speaker demo facilities. No appointments necessary, home trial facilities, free installation. 2 year guarantee on all equipment. Access, Visa. Open Mon-Sat, closed Weds.

DOUG BRADY HI-FI, Kingsway Studios, Kingsway North, Warrington, Cheshire, WA1 3NV. (0925) 828009. "Largest choice of specialist hi-fi in NW. All credit cards 3 dem rooms. Fair demonstrations and home trial facilities. Open 6 days.

CLEVELAND

GILSON AUDIO LTD, 172 Borough Rd., Middlesbrough. (0642) 248793. Linn, Exposure, Arcam, Mission, Cyrus, Denon, Marantz, Rotel, Pioneer, Audioblab, Tannoy. Demonstration facilities in main shop and one demonstration room. Appointments necessary. Home trial facilities. Free installation on request. Service department. Access, Visa, H.P. 10.5-6 days.

ACTION ACOUSTICS, 155-157 High Street, Redcar, Cleveland. TS10 3AN. 0642 480723. Audio Innovations, Denon, Harman Kardon, JBL, Michell, Musical Fidelity, Pink Triangle, Revox, Rogers, Thorens, etc. Dem room. Appointments nec. Home trial facilities, free installation, service dept. Access, Visa & HP. Open 9.15-5.30.

CORNWALL

RJF AUDIO VISUAL, 84 Pendarves Street, Tucking Mill, Camborne, Cornwall. TR14 8NJ. 0209 710777/612260. TDL, Michell, Musical Fidelity, NAD, Nakamichi, B&W, SME, Micromega, Pink Triangle, Pro-ject, Perception, Harman Kardon, Triangle. Integral dem/showroom and special home dems. Appts nec, home trial, free install, service dept. All cards Switch and Transax. Open Mon-Sat 9.30-5.30.

CUMBRIA

MISONS SOUND & VISION, 11 Warwick Road, Carlisle CA1 1DH Tel: (0228) 22620. Bang & Olufson, B & W, Castle, Somic Link, Quad, NAD, Yamaha, Sony. Demo Suite. No appts nec. Home trial facilities. Free installation. Service Department 9 - 5.30 Mon - Frid, Thurs 9-1, Sat 9 - 5.

THE HI-FI ATTIC, 58 New George St. Plymouth, Devon. PL1 1RR. 0752 669511. We stock most leading brands including Linn, Arcam, Denon, Pioneer, Musical Fidelity amongst others and have an expert enthusiastic staff. Premises include attractive hi-fi and home cinema demonstration rooms. We offer free installation and credit facilities (written details on request) also a fully equipped service department. We can also provide a mail order service for all your LaserDisc requirements. We accept Visa, Access, Amex.

CHELSTON HI-FI, 38 Walnut Road, Chelston, Torquay, Devon TQ2 6HS Tel: (0803) 606863. Denon, Marantz, Rotel, Musical Fidelity, Acoustic Energy, NAD, Castle, Heybrook, Celestion, JPW, etc. Two dem rooms. Home trial. Free installation. Access, Visa, Amex, Diners, HiFi Markets Chargecard. Credit facilities. 9.30-7.30 Mon-Frid, 9.30-6.00 Sat.

DERBY

STRAO TRADITIONAL AUDIO, 29 Meadowfield, Whaleybridge, nr Buxton, Derbyshire. SK12 7AX. Tel: 0663 733383. We construct custom made reproductions of classic 1950's loudspeaker enclosure designs using authentic blueprints. These have never been bettered for valve amplification. Requests for specific designs considered and researched. Superb new speaker units from Richard Allan and Lowther are used.

ACTIVE AUDIO, 12 Dsmaston Street, The Spot, Derby. Tel: 0332 380385. Fax: 0332 385185. We have three studios including a dedicated Audio Visual studio for the demonstration of quality equipment from the largest range in the Midlands. Open six days per week. Own service department. Free local delivery, home trial facility. Current special offers and buyers fact pack and quotation on request.

DORSET

DAWSONS, 23 Seamoor Road, Westbourne, Bournemouth, Dorset. 0202 764965. B&O, Castle, Canon, Jamo, JBL, Pioneer, Sony, Target, TDL, Technics. No appts necessary. Free installation. Service dept. Various credit facilities available. Open 9-5.30 6 days a week.

SUTTONS HI-FI, 18 Westover Road, Bournemouth, Hants. Tel: 0202555512. Linn, Arcam, Mission, Quad, Audioblab, Rotel, Yamaha, Denon, etc. 2 single speaker listening rooms. Home demonstrations and free installation. Mon-Sat 9.00-5.30. Call for details.

ENGLAND

BRENTWOOD HI FIDELITY, 2 Ingrave Road, Brentwood, Essex. CM15 8AT. Tel: 0277 221210. Audio Innovations, Aura, AVI, Castle, Chord Electronics, Denon, DNM, EAR, Impulse, John Shearne, Kenwood, Marantz, Micromega, Mission, NAD, Nakamichi, Pink Triangle, Pioneer, Project, Quad, Rotel, Ruark, SME, Systemdek, Tannoy, TDL, Townshend Audio, Yamaha plus many more. Single speaker dem rooms, home trials, dems and installations. Mon-Sat 9.30-5.30. Access, Visa, service facilities. Simply THE place to visit if you're serious about music.

PRO MUSICA, 6 Vineyard Street, Colchester, Essex. Naim, Roksan, Rega, Arcam, Audioblab, Creek, Systemdek, Rotel, Marantz, Denon, Shahinian, Micromega, Neat, Aura, Heybrook, EPDS, RUarc, Monitor Audio, Tripod, Sound Organisation, Lots of records, 2 dem rooms. No appts necessary, Service dept. Part exchange, Finance available. 10-6 Mon-Sat.

TWENTY 20 AUDIO VISUAL LTD. Unit 205 Lakeside Shopping Centre, West Thurrock, Grays, Essex OMI6. Tel: 0708 891818. Fax: 0708891300. For your total home entertainment requirements. From a 2" Casio to a 50" Pioneer screen. Dolby surround specialists with three dem rooms dedicated to pro-logic, laser disc software in stock, from Harman Kardon. Pro logic from Yamaha, Marantz, Pioneer, Technics, Kenwood and B&O.

RAYLEIGH HI-FI, Chelmsford, 216 Moulsham St. 0245 265245. RAYLEIGH HI-FI, Rayleigh 44a High Street. 0268 779762. RAYLEIGH HI-FI, Southend, 132/4 London Rd. 0702 435255.

Over 21 years experience of supplying the best. "The best dealer, the best Hi-Fi equipment, the best service" Carefully selected Hi-Fi from: Arcam, Audioblab, Cyrus, Oenon, Epos, Linn, Meridian, Mission, Naim, Nakamichi, Quad, Rega, Roksan, etc. etc. 3 years guarantee on Hi-Fi systems. 0% credit facilities.

AUDIO T, 442-444 Cranbrook Road, Gants Hill, Ilford, Essex. IG2 6LL. (081) 518 0915. Fax: (081) 554 8463. Great Hi-Fi from Arcam, Audioblab, B&O, Bose, Cyrus, Denon, Kef, Marantz, Yamaha, Mission, Micromega, Nakamichi, Quad, Rega, Roksan, etc. etc. 3 years guarantee on Hi-Fi. Free delivery & installation. 30 day free upgrade scheme. Home demonstrations. Part exchange. 2 listening rooms. Home Cinema specialists. BADA Bonded.

AUDIO EXCELLENCE WHERE THE MUSIC MATTERS. 58 Bristol Road, Gloucester GL1 5SD Tel: 0452 300046 Fax: 0452 310680. Great Hi Fi carefully selected and demonstrated by friendly enthusiastic staff. Home installations and check-ups. Two year warranty from our own service department. Open 9.00-5.30 Tuesday - Saturday closed Monday.

AUDIO T, 40-42 Albion Street, Cheltenham, Gloucestershire, GL52 2RQ. (0242) 583960. Fax: (0242) 226435. Great Hi-Fi from Arcam, Audioblab, Denon, Epos Linn, Marantz, Meridian, Mission, Quad, Rogers, Rotel, Yamaha & many more. Mon-Fri 10-8 Sat 9.30-5.30 3 year guarantee on Hi-Fi. Free delivery & installation 30 day free upgrade scheme. Home demonstrations. Part exchange. Single speaker listening room. BADA Bonded.

HAMPSHIRE

AUDIO GALLERY, Near Petersfield, Hampshire. Mana, Castle, Alchemist, Albany, Audio Innovations, Wadia, Deltec, Tube Technology, Denon, Pioneer, Alphason, Tripod, NAD, Teac, Audio Alchemy, Klipsch, AMC, Proac, JPW, Moth, Pink Triangle. Mail order cabinets supplied to order in any size, wood & hand painted finishes, stone-granite-marble shelving. For a demonstration with home comforts call us for an appointment on: 0730 895194.

HOPKINS HI FI, "FOR THE BEST SEAT IN THE HOUSE" experience home cinema sound with Technics, Denon and Kenwood. Award winning products. Now on demo at HDPKINS HI-FI. 38-40 Fratton Road, Portsmouth, Hants, PO1 5BX. Tel: 0705 822 155 Fax: 0705 830 753

HAMPSHIRE AUDIO LTD., 2-12 Hursley Road, Chandlers Ford, Hants SO5 2FU. Tel: (0703) 252827/265232. 3 hi-fi and 2 home cinema/surround sound dem studio's. Thurs late evening, closed Mondays (except in December) Service dept on site (2 yr guarantee). Large free car park - junctions 4 (M27/M3), 5 (M27), 12 (M3) and 13 (M3) all within 3 miles. est. 1969.

AUDIO T, 4 Feathers Lane, Basingstoke, Hampshire, RG21 1AS. (0256) 24311 Fax: (0256) 24430. Great Hi-Fi from Arcam, Audioblab, Denon, Linn, Meridian, Mission, Naim, Rotel, Sony, Yamaha & many more. Mon-Sat 9.30-5.30. 3 year guarantee on Hi-Fi. Free delivery & installation 30 day free upgrade scheme. Home demonstrations. Part exchange. Single speaker listening room. BADA Bonded.

HAMPSHIRE

ENGLISH AUDIO, 95 Whitecross Road, Hereford HR4 0DG. (0432) 355081. Musical Fidelity, Arcam, Castle, Ruark, Rogers, JPW, Micromega, Chord, Audio, Systemdek, Heybrook, Kef, Stax, Pink Triangle, Denon, Marantz, Mission-Cyrus, A.I., Rotel, NAD, Nakamichi, TDL and others. Single speaker dem room, home trial facilities, free installation, service dept. Access/Visa, Credit arranged. Open Mon-Sat, 10-6pm. BADA members.

GOSPEL MUSIC AUDIO, 32a High Street, Kington, Herefordshire, HR5 3BJ. (0544) 230254. Alphason, Allison, Revolver, Luxman, Yamaha, QED Audio, Systemline.

ACOUSTIC ARTS LTD, 101, St. Albans Rd., Watford, Herts. 0923 245250. Fax 0923 230798. Absolute Sounds, Adcom, Acoustic Energy, Audioblab, Chord, Denon, Marantz, Meridian, Orelle, S.M.E., T.D.L. 3 dem rooms, multi-room & home theatre. Expert installation. Credit facilities available. Tues-Sat 10-6.

STUDIO 82, 82 High Street, Harpenden, Herts AL5 2SP. 0582 764246. Fax 0582 467022. ATC/AVI, Arcam, Aura, Audioblab, B&O, Denon, Epos, Mission, Cyrus, Naim Audio, Nacamichi, Quad, NAD etc. Quiet single speaker dem room. Appts nec. Home trial, free installation. Service dept. Visa, Access and finance terms. 9-5.30 (Mon-Sat) Closed Weds.

THE AUDIO FILE, 27 Hockerill St., Bishop's Stortford, Herts, CM23 2DH. Tel: 0279 506576. Fax: 0279 506638. Linn, Naim, Roksan, Quad, Rega, Mission, Arcam, Proac, Marantz, Sony etc. 4 dem rooms, installation service. Min 3 year warranty, 0%, BADA.

HERTFORD MUSIC. We want you to feel good when choosing your system in our 3 demonstration rooms (and bar!). Systems from budget to £15,000. Products include: CR Developments, Micromega, REL Acoustics, Acoustic Energy, Michell, Magnum, Diamond Acoustics, Beard, Lumley, Renaissance, etc. AAccess, Visa. Mail Order. Please telephone: 0992 442425.

RAOLETT AUDIO, 141 Walling Street, Radlett, Herts, WD7 7NQ. Tel: 0923 856497. Mark Levinson, Proceed, Proac, Magneplan, Martin Logan, Tube Technology, Teac, Roksan, Audioblab, Stax, Systemdek, Jardis,

Hi-Fi World Dial-a-Dealer

CHANDLER AIC Audio Alchemy, 491 EAR Sunrise, Quad, Sonus Faber, Home Trial facilities, free installation. Service Dept. Visa Access 9-5.30 Mon-Fri 10-5.30 Sat.

REVOX Service & Repairs, Suite 10 Smogook Business Centre, Lye Lane, Bricketwood, Herts AL2 3UG. Tel: 0923 893711. Seventeen years experience, ex-Bauch. Authorised agents for Revox products, sales and spares. All repairs carried out are guaranteed. Fast turnaround. Any enquiries telephone: 0923 893711

WEST

ELECTRICAL DISCOUNT CENTRE, EDC, 138 Peilham Road, Gravesend, Kent DA11 0JH. Tel: 0474 563601. Pioneer, Marantz, Technics, Akai, JVC, Jamo

ELECTRICAL DISCOUNT CENTRE, EDC, 109 The Broadway, Bewley Heath, Kent DA6 7JH. Tel: 081 298 7880. Pioneer, Marantz, Technics, Akai, JVC, Jamo

PROGRESSIVE AUDIO, 2 Maryland Court, Rainham, Nr Gillingham, Kent ME8 8QY. Tel: 0634 389004. Agencies include: Audio Innovations, Audion, Audiomote, Audiostatic, Audiotechnica Chord amps, Cogan Hall, Conrad Johnson, Convergent, DALI, Decca, Eminent Technology, Goldring, Impulse, Koetsu, Levinson, L.F.D. Lyra, Lumley Reference, Meridian, Michell, Micromega, Moth, Origin Live, Pink Triangle, Proac, Procead, Ruark, Silversounds, SME, Sugden, Sumiko, Systemdek, Snell, Target, T.D.L. Transfiguration, Townshend, Tube Technology, Voyd, V.P.I. etc., etc., etc. Demonstrations by appointment please

JOHN MARLEY HI-FI CENTRES, 2 Station Road., West Canterbury. (0227)769329. Also at Dover - 0304 207562. Arcam, Aura, B&W, Heybrook, JPW, Proac, Pioneer, Rotel, Ruark, Tannoy, Technics. Dem rooms and home trial facilities. Mon-Sat, 9-5.30 clos. Thurs. Free install. Credit to £1,000. Access. Visa and credit card. Service Dept.

VOLUME ONE, 41 Upper Wickham Lane, Welling, Kent DA16 3AD. 081 304 4622. Arcam, Dual, Epos, Exposure, JPW, Marantz, Micromega, Nakamichi, Pink Triangle, Rotel, Ruark, Royd, Sony, Systemdek, Alchemist, Celestion, B&W. Large dem room, no appts necessary. Evening dems in shop by appt. Home trial facilities, free delivery and installation. Access/Visa 10.00-6.00pm Mon-Sat

KIMBERLEY HIFI, 193 Broadway, Bexleyheath, Kent. Tel: 081 3043272. Pioneer, Technics, Kenwood, Marantz, Denon, NAD, Aiwa, Tannoy, Mission, Rotel, Wharfedale, Castle. Separate dem room no appt necessary. Free installation, service dept, instant credit facilities. No early closing.

V.J. HIFI, 29 Guildhall Street, Folkestone, Tel: 0303 256860. Mon-Sat 9-6. NAD, Yamaha, Marantz, Sony, Tannoy, Denon, Kenwood, Rogers, Musical Fidelity, Quad, Aiwa, Aura, Heybrook, Castle, Mission, Yamaha, REL, JBL, Polk. Dem rooms in both stores. Free install. Credit facilities available, specialists in home theatre. Amex Diners, Visa, Access, Service Dept. We are BADA dealers.

THE WESTGATE HI-FI, 2 Station Road West, Canterbury, Kent. 0227 769329. Suppliers of quality hi-fi equipment including: Arcam, Akai, Aura, B&W, Denon, Jamo, JPW, Mordaunt Short, NAD, Panasonic, ProAc, Quad, Rotel, Ruark, TDL, Technics, Tannoy. Part exchange, Listening room. Service and repairs. Credit facilities. Access/Visa. Open 6 days 9-5.30.

DOVER HI-FI, 43 High Street, Dover. Tel: Dover 207562. Suppliers of quality hi-fi equipment including: Arcam, Akai, Aura, B&W, Denon, Jamo, JPW, Mordaunt Short, NAD, Panasonic, ProAc, Quad, Rotel, RuArc, TDL, Technics, Tannoy. Part exchange, Listening room. Service and repairs. Credit facilities. Access/Visa. Open 6 days 9-5.30.

LANCASHIRE

AUDIO CLASSICS, 8 Lowe Mill Lane, Hindley, Wigan, Lancs. WN2 3AF. Sorry but we are unable to answer queries in writing. I buy, sell, modify and repair all vintage and valve hi-fi equipment. Advice is free. New equipment by EAR, Croft, Ortofon and more soon. Phone if just for a chat. Credit cards accepted. Quick worldwide delivery, callers by appointment. Tel: 0942 57525 or Fax: 0942 525861. 7 days a week.

ROMERS HIFI CENTRE, 94-96 High Street, Rishton, Blackburn, Lancs. Tel: 0254 887799. Stockists of: Sony Esprit HIFI, Technics, Marantz, Musical Fidelity, Pioneer, Kenwood, Rotel, Tannoy, Mission, Ruark, B&W and many others. Dem room, service dept, free delivery and installation (local area) Access/Visa and Switch.

LEICESTER HIFI COMPANY, 6 Silver Walk, St Martin's Square, Leics LE1 5EW. Tel: (0533) 539753. Fax: (0533) 626097. Acoustic Energy, Arcam, Marantz, Micromega, Mission, Cyrus, Musical Fidelity, Nakamichi, Meridian, Rogers, Roksan and over 200 more name home hi-fi ranges for sale. service dept. Credit facilities. Access/Visa Diners Amex 6 days 9.30-5.30

THE LISTENING ROOMS, 6 Hotel Street, Leicester. Tel: 0533 623754. Fax: 0533 623758. Linn, Audiobab, Arcam, Tannoy, Definition, Denon, Rotel, Nad, Heybrook, TDL etc. Open 10.00-5.30 (Six days)

STERED SHACK, 1-3 Guildhall Lane, Leicester, Tel: 0533 530330. Aiwa, A.R. Denon, Kenwood, Jamo, Mission, NAD, Philips, Pioneer, Home Cinema specialists. Free installation. Open 9.30-5.30 6 days. Credit available

BOSTON HI-FI CENTRE, 65a Wide Bargate, John Adams Way, Boston, Lincs PE21 6SG. Tel: 0205 365477. Quad, Nakamichi, Arcam, Marantz, NAD, Castle, Tannoy, Rogers etc. Separate demonstration studio inc. home cinema. Free installation. Access. Visa. Tues-Sat 9-5 pm

COTTAGE AUDIO, 17 Bridge Street, Saxilby, Nr Lincoln LN1 2PZ. Tel: (0522) 702834. Evenings: (0522) 696708. ATC, AVI, Chord amplifiers, Harbeth, LFD, Michell, Origin Live, QED, Royd, Sansui Sequence. Something solid. Sonic Link etc. Demonstration rooms. Home trial facilities. Free installations and above all a personal, friendly service.

LONDON

ANALOG AUDIO, 849 High Road, Finchley, N12. (081) 445 3262. For friendly service and advice. AR, AKG, Allison, AT, Cerwin, Vega, Denon, Dual Harmon Kardon, Jamo, Infinity, Marantz, NAD, Pioneer, Rotel, Revolver, Sonab, Teac, Thorens, Tannoy, Wharfedale, Yamaha. Speaker cables and accessories. Free installation service

AUDIO CONCEPT, 27 Bond Street, Ealing, W5 5AS. Tel: (081) 567 8703. Acoustic Energy, Audiobab, Aura, B&D, B&W, Boston Acoustics, Canon, Castle, Denon, Dual, Evolution, Infinity, JPW, KEF, Marantz, Mission, Monitor Audio, Musical Fidelity, NAD, Nakamichi, Onix, Quad, Revox, Rogers, Rotel, Systemdek, Target, Teac, Thorens, Van den Hul. Two dem rooms. Interest free credit, free local delivery & installation, service department.

'Hi-Fi Specialists without the attitude'

BABBER ELECTRONICS, 158 Uxbridge Road, West Ealing, London, W13 8SB. (081) 579 6315. Akai, Aiwa, A&R, Celestion, Dual, Goodmans, Harman Kardon, JBL, JVC, Kenwood, Marantz, Panasonic, Sennheiser, Sony ES range, Tannoy, Technics, Wharfedale, Yamaha.

THE CARTRIDGE MAN - Front end problems? It doesn't have to cost an arm and a leg to get the best listen to my Koetsu - and - Decca - Eater. Also agents for Croft, Sugden, Thorens, Pentachord Speakers and Notts Analogue. (Plus a cartridge re-tipping service. Tel: 081 688 6565.

QIVA AUDIO FIDELITY: For the finest in real HiFi, AV and Multiroom systems. Accuphase, Audio Innovations, Audio Note, Audiostatic, Aura, Chord, Conrad Johnson, Impulse, Klipschorn, Levinson, Lumley, Lyra, Michell, Micromega, Monitor Audio, Primare, Rel, Rotel, SME, Triangle, Trilogy, XLD. Call us or pop in for a musical experience you'll never forget. Open 10-6. Mon-Sat at Workshop 30, Royal Victoria Patriotic Building, Fitzhugh Grove, Wandsworth Common, London SW18. Tel/Fax: (081) 875 9593. Also see our full page advertisement on page 18 of this issue.

DOUG BRADY HIFI, 18 Monmouth Road, London WC2H 9HB. Tel: (071) 379 4010 or (071) 479 1346. Fair demonstrations and home trial facilities. Wide range of top specialist hi-fi from Britain, America and Japan. Open 6 days.

GOLF ELECTRONICS, 311 Kentish Town Road, NW5 2TJ. Tel: 071 482 2518. Fax: 071 284 3381. Authorised dealers for: Sony, Panasonic, Aiwa, Akai, Mitsubishi, Philips, Grundig, Bose. We carry an extensive range of hardware from Walkmans to camcorders, including a wide range of TV and video equipment. Free local delivery & installation on selected items. Open 10-6 Mon-Sat. We regularly have special offers on different products. A visit to GOLF ELECTRONICS could save you £££.

HIFI & COMPONENTS, 84 Battersea Rise, London SW11 1EH. (071) 225 1110. Denon, Tannoy, NAD, Rotel, Bose, Dual, QED, Wharfedale, Jamo, Occupation, Kenwood, Ortofon, Infinity, Shure to name but a few! Established over 20 yrs. Appts necessary. Service dept 10-6 (closed Weds)

HIFI EXPERIENCE, 227 Tottenham Court Road, London W11. 071 586 35535. Arcam, Audiobab, Mission, Cyrus, Quad, Celestion, Kef, Meridian, Rogers, Tannoy, Yamaha, TDL, Thorens, Marantz, Nakamichi, Musical Fidelity and many more. Open 10.00-7.00 Mon-Fri 9-6 on Sat. Service dept. Credit facilities, delivery and free installation

THE HIFI SURPLUS STORE, 62 White, mouth Street, W1 Tel: 071 486 9981/071 935 7582. Stock a full range of goods including: Aiwa, Akai, B&W, Bose, Dual, JVC, Jamo, Kenwood, Marantz, Mordaunt-Short, Mission, NAD, Pioneer, Rotel, Sony, Technics, Teac, Thorens, Tannoy, Wharfedale. Full range of 'Target' speaker stands always on stock. All goods are brand new in sealed cartons with full 1 yr guarantee. We guarantee you can not buy cheaper elsewhere. Give us your genuine quote and we will beat that price by £10 (goods must be in stock) Access/Visa welcome. Open Mon-Sat 9.30-6pm. Late night 'till 6.30 Thurs.

KAMLA ELECTRONICS, 251 Tottenham Court Road, London W1P 9AD. Telephone: 071 323 2747. Fax: 071 637 2690. Acoustic Research, Aiwa, Akai, Albarry, Alchemist, Aphoson, Audio Alchemy, Audio Innovations, Audio Technica, Audioquest, Aura, Audiostatic, B&W, Cerwin Vega, Conrad Johnson, CopenHagen, Furukawa, Goldring, Infinity, IXOS, JPW, JVC, KEF, Kenwood, Kuzma, Lynwood, Maxell, Micromega, Mitsubishi, Monster, Mordaunt Short, Moth, Nakamichi, Ortofon, Panasonic, Pioneer, Project QED, Rotel, Ruark, Sansui, Stax, TOK, and many more!!!!

K J WEST ONE, 26 New Cavendish St., London W1M 7LH. 071 486 8262/63. Fax: 071 487 3452. Two hi-fi & dedicated home cinema dem studios. Appts pref. Home trial installation by arrangement. Service dept. Major credit cards. Interest free credit on selected items. Major brands stocked: Acoustic Energy, Arcam, Audio Innovations, Audion, Aura, Audiobab, Audio Research, B&W, Chord, DPA, Epos, Impulse, Krell, Martin Logan, Meridian, Michell, Musical Fidelity, Nacamichi, Nitty Gritty, Orrel, Pink, ProAc, Quad, Roksan, Sonus Faber, Stax, Tannoy, Theta. Open 6 days

BILLY VEE SOUND SYSTEMS, 248 Lee High Road, London SE13. (081) 318 5755. Arcam, Linn, Naim, Quad, Creek, Cyrus, Marantz, Nad, Rotel, Rega, Denon, Yamaha, Tannoy, Mission, Micromega, Heybrook, etc., 2 dem rooms, instant free credit, Access/Visa. Closed Thursdays

CONNECTIONS, 13 John Prince's Street, London W1M 9AH. Tel: 081 348 5676. Dealers in: Absolute, Audio Note, Audioquest, Deltec, Harmonix, Kimber, Mandrake, MIT, Siltech, Symo, Van den Hul, WBT and others.

THE LISTENING ROOMS, 161 Old Brompton Road, London SW5 6LJ. (071) 244 7750/59. Fax: (071) 370 0192. Linn, Quad, Meridian, Nakamichi, Arcam, Audiobab, Acoustic Energy, SME, Audio Research, Axi, Wadia, Tannoy, Audio Note, Linn, Mission, Tannoy, Kusterlich, Stax, Pink Triangle, Michell, Monitor Audio, Yamaha, Marantz, Kef, Bose, Celestion, Epos, Mission, Denon, Neat, Petite. Mon-Sat 10-6pm.

STUDIO 99, 79-81 Fairfax Road, Swiss Cottage, London NW6. Tel: 071 624 8855 or Fax: 071 624 5315. Linn, Naim, Meridian, Rega, Quad, Nakamichi, Mission, Cyrus, Kef, B&D, Yamaha, Creek, etc. 2 single speaker dem rooms. Appts necessary. Home trials, free installation. Visa/Access. 10-7pm Mon-Fri 10-6pm Saturday

THE CORNFLEAK SHOP, 37 Windmill Street, London W1 (071) 631 0472 (domestic). (071) 323 4554 (multiroom). Fax: (071) 436 7165. Tues-Sat 10-7. Rega, Roksan, Naim, Monitor Audio, Arcam, Nakamichi, Rotel, Epos, etc. 3 dem rooms (incl. home cinema). Friendly professional service. Home trial facilities, appts preferred. Full delivery and repair service. Multiroom specialists. Access & Visa.

MUSICAL IMAGES, 173 Station Road, Edgeware, Middlesex. Tel: (081) 952 5535. See advert under Middlesex for more information

MUSICAL IMAGES, 45 High Street, Hounslow, Middlesex. Tel: (081) 569 5802. See advert under Middlesex for more information

AUDIO T, 190 West End Lane, West Hampstead, London NW3 1SQ. (071) 794 7848. Fax: (071) 431 3570. Great Hi-Fi from Adcom, Arcam, Audiobab, B&W, Denon, Epos, Marantz, Meridian, Michell, Mission, Philips, Rotel, Proac, Micromega, Nakamichi, Yamaha, & many more. Mon-Sat 10-6. 3 year guarantee on Hi-Fi. Free delivery & installation. 30 day free upgrade scheme. Home demonstrations. Part exchange. 2 listening rooms. BADA Bonded

ALPHABEC, 392 Finchley Rd, London NW2 2HR. Tel: 071 431 9133. Denon, Yamaha, Naim, Heco, Aphoson, JVC, Nakamichi, B&W, Quad, Soundstyle, Stand Design, Boston Acoustics, Thorens, AMC, Grundig, Musical Fidelity and many more. Home Cinema Products. Free installation & delivery. Open Mon-Sat 10-6pm Thurs 10-1pm

GREATER MANCHESTER

THE AUDIO COUNSEL, 12 Shaw Road, Oldham, Manchester OL1 3LQ. Tel: 061 633 2602. Linn, Arcam, Naim, Yamaha, Creek, Nakamichi, Denon, JPW, Marantz, Royd, Lexicon, 3 dem rooms, free install, Visa/Access, Licensed credit brokers up to £1,000 instant credit. Full multi-room & A.V. installation 10.00-5.30pm Mon. Tues. Wed. Sat. 10.00-7.00pm Thurs & Fri.

HALE HI-FI, Tel: 061 929 0834. See our main entry under Cheshire.

**TO FIND YOUR AREA
Use our
COLOUR REFERENCE**



To Advertise in this section, please contact **Caroline Knott** on:

071 266 0969

Hi-Fi World Dial-a-Dealer

BILL HUTCHINSON HI-FI, 50-52 Deansgate, Manchester M3 2FE (061) 8321600. For the largest selection of Hi-Fi and audio visual equipment in the North West. Specialist A.V. demonstrations of the highest quality. Best prices guaranteed. Minimum 2 year warranty and an optional 5 yr guarantee available. Instant credit and mail order service on offer throughout the UK. Pioneer, Denon, Kenwood, Yamaha, Technics, Marantz, Mission, Tannoy plus many more.

MERSEYSIDE

DOUG BRADY HI-FI, 401, Smithdown Road, Liverpool L13 3JJ (051) 733 6859. Fair demonstrations and home trial facilities. All credit cards. Largest choice of specialist hi-fi in NW. Closed Wednesdays and lunch 1.2-1.5pm.

P & A AUDIO (BIRKDALE) LTD., 31 Liverpool Road, Birkdale, Southport (0704) 68373. Arcam, Cambridge, Creek, Denon, Michell, Mission/Cyrus, Mordaunt-Short, NAD, Pink Triangle, QED, Revolver, Rogers, Rotel, Royd, Tannoy, 3 Single speaker dem rooms and Nicam surround sound dem room. Free delivery, installation (Merseyside) service dept. Mon-Sat 9-5.30. Half day Tues. Access, Visa, Lombard.

HARROW AUDIO, 27, Springfield Rd., Harrow, Middlesex. Tel: 081 863 0938. Open Mon-Sat 9.30-5.30. Most brands available - see our regular advert for full range including Audioblab, Arcam, Audioquest, Apogee, Aura, B&W, Cyrus, Denon, Epos, Krell, Marantz, Mission, Nakamichi, Tannoy, Target, Yamaha etc. AV Specialist including installation. Interest Free Credit - ask for details. The largest range of accessories for miles around. 2 dem rooms. Plus Carriage Free Mail Order.

AUDIOCRAFT, 18 Hillingdon Road, Uxbridge, Middlesex, UB10 0AD. (0895) 253340. Unbelievable but true you can audition these brands here. Audion, Proac, Michell, Erelle, LFD, Lumley, Levinson, Lurne, Triangle, Sentez, Mag Audio, Teac, VHD, Silversounds, YBA, Stax, Theta, Monitor Audio, Fuller Audio, Trilogy, Lyra, Sumiko, Ortofon, Decca, Target, Project, Moth, Kelvin, Townshend, Edison, Audio Alchemy, Kesiki, Musical Fidelity.

MUSICAL IMAGES, 45 High Street, Hounslow, Middlesex. Tel: (081) 569 5802. Fax: (081) 569 6353.

MUSICAL IMAGES, 173 Station Road, Edgware, Middlesex. Tel: (081) 952 5535. Fax: (081) 952 5535. Most brands available - see full page advert. Interest free credit, ask for details. Demo rooms. Repairs & Service. Sunday opening - Open all week. A Home Cinema Specialist. Mail order. Part exchange.

AUDIO T, 159a Chase Side, Enfield, Middlesex, EN2 0PW. (081) 367 3132. Fax: (081) 367 1638. Great Hi-Fi from Adcom, Arcam, Audioblab, Celestion, Denon, Marantz, Meridian, Micromega, Mission, Philips, Rotel, Yamaha, & many more. Mon-Fri 10-6. Sat 9.30-5.30. 3 year guarantee on Hi-Fi. Free delivery & installation. 30 day free upgrade scheme. Home demonstrations. Part exchange. 2 listening rooms. Home Cinema specialists. BADA Bonded.

NORFOLK

BASICALLY SOUND, The Old School, School Road, Bracon Ash, Norwich, Norfolk, NR14 8HG. Tel: (0508) 5 70829. Arcam, Heybrook, Chord Co. Rotel, Sound Style, TDL, Royd, Denon, Naim, Spondor, Sound Organisation, Audio Technica, Creek, Epos etc. 2 comprehensive dem rooms, home trial facilities, free installations, Visa/Access, HP facilities. Tues-Fri 9.30-1.00pm, 2.00-5.30pm. Saturday 9.30-5.30pm.

PROTECT-A-OISEC, Unit 4, Elvin Way, Sweetbriar Industrial Estate, Norwich, NR3 2BB. Tel: 0603 482193. Producers and suppliers of finest quality card record and CD sleeves with taped edges, poly-lined or unlined, mailers and cruciforms etc. Please send SAE for full current price list. Trade enquiries welcomed. Tel: 0603 482193.

NORTHAMPTON

LISTEN INN, 32 Gold Street, Northants NN1 1RS. Tel: 0604 37871. Fax: 0604 601430. Naim, Linn, Rega, Audolab, Arcam, Cyrus, Royd, Nakamichi, Mission, Onon, Rotel, Nad, Heybrook, Marantz, Chord Co. etc. etc. Open 10.00 - 5.30 (Closed Thurs).

DEFINITIVE AUDIO, Tel: (0602) 813562. For a carefully considered approach to building a true high fidelity audio system with components derived from the following manufacturers: Audio innovations!, Wadia, Micromega, Deltac, E.M.T, Horming, Voyd, Systemdek, SME, Revex, Impulse, Ortofon, Pioneer. Also the remarkable Living Voice Air Partner loud speaker system. Demos by appt. Please phone for further details. Install free of charge. Mon-Sat 10.00-7pm. Closed Wed a.m.

PETER ELLIS AUDIO, 29 Kirkgate, Newark, Notts NG24 1AD. Tel: 0603 704571. QUAD, Castle, Arcam, QED, Sugden, Tannoy, Thera, Marantz, Denon, Teac. Demo room, free install. Service dept. Access, Visa. Mon-Sat 9-5.30. Closed Thursdays.

CHANTRY AUDIO, 18-18a Eidon Street, Tuxford, Nr Newark, Notts, NG22 0LH. Tel: 0777 870372. Pink Triangle, DPA, Rotel/Michell, Micromega, NVA, Alchemit, Michell, Monitor Audio, Lumley, SME, Audion, and much more! Three dem rooms, home trial, free installation, service department. Access & Visa. credit facilities. Mail order, Mon-Sat 9.30-6.00, Sun and evenings home dem by appointment.

AUDIO T, 19 Old High Street, Headington, Oxford, OX3 9HS (0865) 65961. Fax: (0865) 60415. Great Hi-Fi from Arcam, Audioblab, Cyrus, Denon, Epos, KEF, Marantz, Meridian, Mission, Musical Fidelity, Rotel, Sony, Yamalia & many more. Mon-Fri 10-6. Sat 9.30-5.30. 3 year guarantee on Hi-Fi. Free delivery & installation. 30 day upgrade scheme. Home demonstrations. Part exchange 2 listening rooms. Home Cinema specialists. BADA Bonded.

WESTWOOD & MASON, 46 George Street, Oxford. Tel: 0865 247783. Creek, Marantz, Naim, Arcam, Rotel, Rega, Epos, Tannoy, Mission, Nakamichi, Denon, Awa, Quad, Yamaha, Monitor Audio. Open 9.30-5.00pm. Dem room. Closed Thursdays.

ASTLEY AUDIO LTD, 3 Marketplace, Wallingford (3 miles from Berkshire border). 0491 839305. Aura, B&W, Technics, Panasonic, Pioneer, Kenwood, Sony, Yamaha, Denon, Dual, Marantz, Mission, Tannoy, 1 listening room. Home trial, free installation. Service department. Access, Visa, Amex, Diners. Instant credit. Tues-Fri 9-5.30. Sat 9-5. Records & CDs stocked.

AVON HI-FI, 12 Barker Street, Shrewsbury, Shropshire, SY1 1QJ. Tel: 0743 355166. Aiwa, Beyer-Dynamic, NAD, Quad, B&W, Mordaunt-Short, Kenwood Bose, Nakamichi, Onkyo, Teac, Sennheiser Dem room. Home trial. Free install. Service dept. Access/Visa. £1,000 instant credit. Mon, Tues, Wed, Fri, Sat 9-5.30.

SHROPSHIRE HI-FI, St Michael Street, Shrewsbury, Shrops SY1 2ES. Tel: 0743 232065. Stockists of Musical Fidelity, Mordaunt Short, Sony, Kenwood, Pioneer, Rotel, Denon, B&W, Proac. Audio Visual. Products available. Open 9.30 - 5.30pm Mon-Sat.

SOMERSET

MIKE MANNING AUDIO, 110 Middle Street, Yeovil, Somerset, BA20 1NE. Tel: 0935 79361. Fax: 0935 32923. Mobile 0850 325965. Naim, Roksan, Pink Triangle, A&R (Arcam), ION, NAD, Pioneer, Rotel, Denon etc. Dedicated listening lounge, for relaxed and unpressured demos. Appts not necessary but best to telephone first. Home trial facilities on request, free installation and service dept. Instant credit, Access/Visa etc. 9-5.30, closed Mondays.

STAFFORDSHIRE

ACTIVE AUDIO, 95, Stafford Street, Hanley, Stoke-on-Trent, Staffs. Tel: 0782 214994. Fax: 0782 283346. We have four studios including a dedicated Audio Visual studio for the demonstration of quality equipment from the largest range in the Midlands. Open six days per week. Own service department. Free local delivery, home trial facility. Current special offers and buyers fact pack and quotation service on request.

MUSICAL APPROACH, Unit 7, Woodings Yard, Bailey Street, Stafford, Tel: 0785 55154. Also branch at 37 High Street, Aldridge, nr Walsall. Tel: 0922 57926. Linn, Rega, Arcam, Rotel, Royd, Heybrook, Marantz, Teac, Celestion, Apollo, Target. Mon-Sat 9.30-5.30. Home cinema equipment stocked. 2 single speaker dem rooms. Service dept and free install. Credit facilities. We are now agents for Rega products. Stafford branch only.

ACTIVE AUDIO, 29, Market Street, Tamworth, Staffs. Tel: 0827 53355. Fax: 0827 59513. We have two studios including a dedicated Audio Visual studio for the demonstration of quality equipment from the largest range in the Midlands. Open six days per week. Own service department. Free local delivery home trial facility. Current special offers and buyers fact pack and quotation service on request.

AUDIO IMAGES, 7 All Saints Road, Pakefield, South Lowestoft Suffolk, NR33 6JL. Tel: Fax: 0502 582853. Quad, Triangle, Arcam, Castle, Rotel, Moth, JPW, Finlux, Audio Innovations, plus the amazing ROTHWELL range. Separate dem room, no appts nec. 10-3.30 Tues-Thurs, 7pm-Fri 6pm Sat.

SIGNALS, Martlesham Heath, Ipswich, Tel: (0473) 622866. Audio innovations, Fuller's Audio, Goldring, Heybrook, Impulse, JPW, Micromega, QED, SoniClmk, Sumiko, Alphason, Apollo, Audioquest, Ixos, Project, Soundstyle, Storing, Townshend, Tricord, Sugden and more!

Monday to Saturday 10 till 6

BURY AUDIO, 47 Churchgate Street, Bury St Edmunds, Suffolk, IP33 1RG. Tel: 0284 724337. Arcam, Audio Alchemy, Heybrook, Marantz, Michell, Meridian, Nakamichi, Pink Triangle, Quad, Rotel, Sonus Faber, Stax, Tube Technology. Single speaker dem room. Free install. Credit facilities. Mon-Sat 9.30-6.00, closed Wed.

Evening dems by appointment.

EASTERN AUDIO, 41 Bramford Road, Ipswich, Tel: 0473 217 217. Fax: 0473 215705. Quad, Arcam, Audioblab, Meridian, Mission, Denon, Rotel, Marantz, NAD, Sony, Rogers, Nakamichi, Systemdek, Technics, Celestion, B&W, Tannoy, Morel Thorens and Top Tape. Also stock a wide range of accessories. usual credit facilities. A BADA dealer.

SURREY

SPALJOINS HI-FI, 352-4 Lower Addiscombe Rd., Croydon, Surrey. 081 654 1231/2040. 3 dem rooms and home dem. Free installation/credit. Linn, Naim, Quad, Arcam, Audioblab, Cyrus, Marantz, Denon, Ruark. Mon-Sat 9-6, Tues 9-8, Closed Wed. Service dept.

PJ HI-FI, The HI-FI Shop, 3 Bridge Street, Guildford, Surrey GU1 4RY. Tel: (0483) 504801. 9-6 Mon-Sat. Linn, Meridian, Rega, Arcam, Quad, Revox Musical Fidelity, Rotel, NAD, Nakamichi, Marantz, KEF, Reference etc.

ROGERS HI-FI, 13 Bridge Street, Guildford, Surrey, (0483) 61049. Aiwa, Creek, Denon, Dual, JPW, Marantz, Onix, Pioneer, Systemdek, Ruark, Tannoy, Teac. Dem facilities available, no appts necessary, free installation, service dept. Access/Visa. Instant credit upto £1,000 subject to status. Monday-Saturday, 9.30-6pm, later by appt.

SURBITON PARK RADIO, 48 Surbiton Road, Kingston-upon-Thames, Surrey. (081) 546 5549. QUAD, Castle, Denon, Dual, Kenwood, Mordaunt-Short, JBL, Rotel, Pioneer, QED, B&W and Tannoy. Demo facil. Access, Visa and Switch. 9.30-5pm.

SURREY HI-FI, 45 High Street, Godstone, Surrey, RH9 8LS. (0883) 744755. Specialist HiFi outlet, demonstration room and parking available. Quad, Audioblab, TDL, Tube Technology, Rel Acoustics, Nakamichi, Kel, Thorens, Magnum, Rotel, Marantz, Denon, Michell, Furukawa, Van den Hul, Musical Fidelity, Tannoy, Target, JPW, Lumley Reference in stock. Single speaker dem rooms. Free installation service dept, Access/Visa/Mastercard. Open 9-6pm. Closed all day Wednesday.

SUSSEX (EAST)

THE POWERPLANT "Brighton's Leading HiFi Shop". 66 North Street, Brighton, Tel: 0273 775978. Comfortable listening rooms. Knowledgeable and approachable staff. Roksan, Micromega, Exposure, Audioblab, Epos, Rotel, Marantz, Cyrus, Regal, Arcam, Mission and more.

WORTHING AUDIO, 20 Treville Gate, W Sussex, BN11 1VA. Tel: 0903 212133. "The friendly shop with the best sound systems in the South". Friendly advice, 3 yr guarantees, easy parking, open Mon-Sat 9-6pm. Late night Wed. Arcam, Exposure, Naim Audio, Marantz, Ruark, Restek, Clear Audio, Audio Technica, Target, Tnpod, Sennheiser, AR and many more.

CHURCHERS HI-FI, 154 Montague St, Worthing, Sussex, BN11 3HH. Tel: 0903 821595. All major well known brands of Hi-Fi stocked. Please call for details.

SUSSEX (WEST)

AUDIO DESIGNS, 26 High Street, East Grinstead, West Sussex, RH19 3AS. Tel: 0342 314569. Friendly understanding Hi-Fi specialists. Audioblab, Arcam, Cyrus, Epos, Linn, Marantz, Mission, NAIM, NAD, Neat, Quad, Rotel, Sony, Stax, Tannoy, Target, Thorens, Yamaha. Dem rooms, free installation service dept. credit facilities, mail order, credit cards. 9.30-6.00 6 days a week.

BOWERS & WILKINS Ltd. (est. 1945), 1 Becket Buildings, Little Hampton Road, Worthing, Tel: (0903) 2 64141. Top names in Hi-Fi and audio visual including B&W, Nakamichi, Castle, Denon, Philips, Quad, Technics, Aura, Teac, Sugden, Mission, Thorens and many more. 4 dem rooms (budget - high end.) expert friendly advice service dept. local installations free one minute from A24 & A27, free local parking. Access/Visa. Instant Credit up to £1,000 subject to status. Open 6 days.

CHICHESTER HI-FI, 7 St Panchras, Chichester, W Sussex, PO19 1SJ. Tel: 0243 776402. Linn, Naim, Rega, Creek, Nakamichi, A&R, Denon, Roksa, Epos, JPW, Ruark, Rotel, Quad, Spondor. Evening appts available.

JAYSOUND AUDIO, 5 Waterloo Square, Bognor Regis, Tel: 0243 826355. Aiwa, B&W, Beyer, Denon, Dual, Goodmans, Heco, Jamo, JVC, Marantz, Mitsubishi, Pioneer, QED, Samsung, Sennheiser, Sharp, Shure, Teac, Wharfedale. Free local delivery and install. Part exchange welcome, licensed credit broker, Repairs on all makes of HiFi & TV/Video. Open 9am-6pm. Cl. Weds.

TAYSIDE

J.O. BROWN, 28-36 Castle Street, Dundee DD1 9NZ. Tel: (0382) 26591. Rotel, Denon, Pioneer, Technics, Aiwa, Mission, Castle, Mordaunt-Short, Monitor Audio, Bose, Infinity. All equipment ready for demonstration. No appt. nec, free installation, service dept. Open 9.30-6pm six days a week. (close 5pm Sat).

TYNE & WEAR

BILL HUTCHINSON HI-FI, 87a, Castle Street, Newcastle-Upon-Tyne, (091) 230 3600. For the largest selection of Hi-Fi and audio visual equipment in the North East. Specialist A.V. demonstrations of the highest quality. Best prices guaranteed. Minimum 2 year warranty and an optional 5 yr guarantee available. Instant credit and mail order service on offer throughout the UK. Pioneer, Denon, Kenwood, Yamaha, Technics, Marantz, Mission, Tannoy plus many more.

WILTSHIRE

STRATFORD HI-FI, 25 Henley Street, Stratford-upon-Avon, CV3 0W. Tel: 0789 414533. Pioneer, Technics, Denon, Marantz, NAD, Rotel, Musical Fidelity, Monitor Audio, Mission, Tannoy, Quad, TDL, Sennheiser. 0% finance is available on selected products and all major credit cards accepted. Dem Rooms, Service facilities, open 9.30-5.30pm. Late night Thursday until 8.00pm.

WEST MIDLANDS

FRANK HARVEY HI-FI EXCELLENCE, 163, Spon Street, Coventry, CV1 3BB. Tel: 0203 525200. The Midlands first choice for specialist Hi-Fi. Audioblab, Audio Alchemy, Arcam, Audio Quest, Alphason, Bose, Bang & Olufsen, Celestion, Cyrus, Denon, Dual, Foundation, Kel, Reference, Marantz, Monitor, Audio Mission, Musical Fidelity, Nakamichi, Nad, Rega, Rogers, Rotel, Quad, Systemdek, Target, Tripod, Tannoy, Thorens, Van den Hul, Yamaha, 3 floors, 3 demonstration rooms. Open 9.30 till 5.30. Closed Thursdays. All credit cards incl. Amex & Diners. Instant credit and interest free facilities. Home trials. Free installation, home cinema A/V floor. We are a BADA dealer.

MILANO VALVE HI-FI, Specialising in true fidelity systems built around valve amplification: Audion 300B Silver Nights, Audio Innovations, Impulse, Audio Note, KAL, Townsend Audio, Ortofon, Voyd, Micromega, Edison, Stax, Apollo, Dynavector, Seismic Sink, Valves. Home demonstrations and part exchange. Also vintage: Leak, Quad, Croft, Radford, etc. Flexible opening 7 days. phone Gary 021 722 2317.

MUSIC MATTERS, 351 Hagley Road, Edgbaston, Birmingham, B17 8DL. Tel: 021 429 2811. Roksan, Nakamichi, Arcam, Audioblab, Kenwood, DPA, Tannoy, Royd, Heybrook, Michell, Pansonic, Aura, Celestion,

Hi-Fi World Dial-a-Dealer

Musical Priority, Mission/Cyrus, Meridian, KEF, Monitor Audio, Pink Triangle, Ruarik, Epos, Pioneer, ProAc and many many more! 2 single speaker demo rooms, Acoustic treatment, home trial facilities and free install. Service Dept. Acoustic treatment and wall to wall interest free credit available. Tel: 021 359 4100. Mon-Fri 10.30-6.00pm, Saturday 10.00-3.00pm. Check out the new batch of records. Big stock there so it can't be beat! 01742 0194

COVENTRY HI-FI, 126 Church Lane (off Watling Road), Coventry, CV9 9LJ. Tel: 0203 440823. Good sales & service agent. Pioneer Reference Point. Specialist sales: TDA, B&W, Technics, Fractal, Tannoy and more. 2 year guarantee on all new hi-fi. Open 9.30-5.30 Mon-Sat. Closed Thursday

ELECTRO CENTRE, 244 Salford Road, Huddersfield, Birmingham. Tel: 021 554 15 18. Full range of HiFi. Pioneer, Technics, Kenwood etc. Sony, Anwa Akai. "Guaranteed the lowest price in the UK". 24 hour mail order facility available.

ELMDON AUDIO, Tel: 021 784 8765. Reference imports Ludwig, Aon etc. Esoteric Audio Research 834 integrated on demonstration. Home demonstration can be arranged. Top part exchange prices, lots of used bargains. Quad, Leak etc. Valves and valve testers, new GEC KT66s available.

FIVEWAYS HI-FIDELITY LTD, 12 Islington Row, Edgbaston, Birmingham. B15 1LD. 021 4550667. Advent, Albarry, AKG, Alphason, AMC, ARC, Arcam, Audioquest, Auditechnica, Beyer, Bose, Castle, Chord, Denon, Dual, Gold Ring, Meridian, Michell, Monitor Audio, Nugaoka, Nakamichi, Ortofon, QED, Quad, Revox, Sennheiser, Spendor, Target, TDK, TDL, Thorens, Wharfedale. K Monks Record Cleaning Service. Closed Mondays.

MUSICAL APPROACH, 37 High Street Airdridge, nr Walsail. Tel: 0922 57926. Linn, Arcam, Rotel, Royd, Heybrook, Marantz, Teac, Celestion, Apollon, Target, and others. Mon-Sat 9.30-5.30. Closed Thursdays. Home Cinema equipment stocked. Dem rooms, service dept. Free installation and credit facilities. Free parking at rear of shop.

SOUND ACADEMY, Just off the high Street, Bloxwich, Walsail, W. Midlands. (Ample free parking). Tel: 0922 493499. Albarry, Art Audio, Acoustic Energy Arcam, Audiobab, Audioquest, B&W, Bose, Chord, Cyrus, Cable Talk, DPA, Ensemble, Epos, JPW, Kef Reference, Marantz, Meridian, Mission, Moth, Musical Fidelity, Nakamichi, Ortofon, Project, Quad, Roksan, Tube Technology, Triangle and many more. Open 6 days a week. Mon-Sat. All major credit cards taken. Part exchange, enquiries welcome.

AMADEUS SOUND & VISION, 10 Boldmere Road, Sulton Coldfield, West Midlands. Tel: 021 354 2311. Audio Innovations, B&O, Castle, QED, Wharfedale. Single speaker demo, appts preferred service available, installations, B&O link install, home trials, Access/Visa, interest free credit available subject to status. 9.30-6.00pm 6 days.

GRIFFIN AUDIO, 94 Bristol St., Birmingham. Tel: 021 622 2230/021 692 1359. Tues-Sat 10 a.m.-6 p.m. Enjoy music at home with a system from Griffin Audio. We demonstrate and install the very best hi-fi, with systems from £500 to £25,000. Ask for Bob, Tim or Alex. Linn, Naim, Shinanin, Quad, Arcam, Rega, Denon, Marantz, Rotel.

WILTSHIRE

THE AUDIO EXCHANGE, 52 Morse Street, Swindon, Wiltshire SN1 5QP. (0793) 539008. Acoustic Energy, Audio Innovations, Beard, Cerwin Vega, C.R. Developments, Impulse, Magnum, Micromega, Michell, REL, Sequence, AV and single speaker demo room. Home trial facilities, free installation, service dept. Mon-Sat 10-6.

AUDIO T, 60 Fleet Street, Swindon, Wiltshire, SN1 1RA. (0793) 538222. Fax: (0793) 487260. Great Hi-Fi from Arcam, Audiobab, Denon, Linn, Marantz, Meridian, Mission, Rotel, Sony, Yamaha & many more. Mon-Sat 9.30-5.30. 3 year guarantee on Hi-Fi. Free delivery & installation. 30 day free upgrade scheme. Home demonstrations. Part exchange. 2 listening rooms. Home Cinema specialists. BADA Bonded.

WORCESTERSHIRE

SPAINS HI-FI, 2 +2a New Rd., Bromsgrove, Worcs. Tel: 0527 872460. Aura, B&W, Beyer, Denon, Heco, JVC, Kenwood, Marantz, Mission, Monitor Audio, NAD, Nakamichi, Pioneer, Rotel, Sennheiser, Soundstyle, Sony, Systemdeck, Tannoy, Target, Thorens. Integral demo room/showroom for instant comparisons on Hi-Fi & AV equipment. Free

Installation, Part exchange, wireless. Service department. Access/Visa. 0% finance on selected products. Mon-Sat 9.00-5.30pm. Closed Thursdays.

WEST MIDLANDS

WEST MIDLANDS AUDIO, 158 Ombury Road, Birmingham B10 7HA. Tel: 0202 429446. Tel: 0202 427595. Naim, Rega, Pono, Marantz, Mission, NAD, Audiobab, Roksan, Meriva, B&W, Audio Research, KEF, Monitor Audio, Arcam, 9.30-5.30 Mon-Sat. Always by appointment. Free.

YORKSHIRE SOUTH

HIFI STUDIO'S, Shipley, Wetherby, Wakefield, Tel: 01937 76135. TDL, Sirogdon, ProAc, Ruarik, Teac, Yamaha, Sennheiser, Harmon, Target, Albarry, JVC, Quad, Monitor Audio, JPW, Tannoy, Harbeth, Kinetics Audio Research, Michell Engineering, AMC, CD and Valves. 24 hour service, specialist Hi-Fi, Art Audio, Wharfedale, Ref. Acoustic, Project, Origin, Line, Dual, Yamaha plus home Cinema pro-logic demo. Listening room, demo's, Home trial, free install, licensed credit broker. 2 yr guarantee on all equipment, service available. Access/Visa 10-8pm 6 days a week. Home for further information and free part exchange.

TRC HIFI, 3 Kings Cross Street, Halifax, HX1 0Q22. 366832. Agents for Kenwood, Denon, Castle, Rotel. Demonstrations and advice a pleasure. Call at any time to audition some of the best HiFi and pro-logic systems. Delivering and installation free within 20 miles. "The family firm where the customer matters most."

YORKSHIRE (NORTH)

AUDIO CLINIC, 22 Lord Mayors Walk, Yorks, YO3 7HA. Tel: (0904) 646309. Revox-Qed-Audio Innovation-Alison-Celestion-Yamaha-Teac-Revolver-JPW-Kenwood-Bose-Thorens-Mission-Snell-B&W-Heco-Cannon-NAD-JVC-Musical Fidelity-Wharfedale-Micromega-Ruarik-Heybrook Surround sound and demo rooms, free installation. Service Dept. Credit facilities on request. Access/Visa. Open 10am-5pm 6 days a week.

SCARBOROUGH HIFI, 14 Northway, Scarborough, North Yorkshire YO11 1JL. Tel: 0723 374547. Albarry, Aura, B&W Matrix, Cyrus, Pioneer, Philips, Marantz, Cabasse, Bose, Tannoy, DCC wide screen and lazer vision. Home trial facilities and free installation, service dept. Access/Visa, Credit charge. £1,000 instant credit. Amex/Diners.

THE SOUND ORGANISATION (YORK) 2b Gillygate, York, YO3 Tel: (0904) 627108. Linn, Meridian, Micromega, Naim, Rega, Arcam, Creek, Nakamichi, Mission, Denon, Epos, Royd, Rotel 3 single speaker dem rooms, appts. preferred, home trial facilities, free install, service dept. Credit facilities on request. Access/Visa. 10.00am-5.30pm. Tues-Sat. Sony dealer award nominated '86-'87 and '88.

VICKERS HIFI, 24 Gillygate, York (0904) 629659. Audiobab, Harmon Kardon, Marantz, Musical Fidelity, Pink Triangle, Quad, Systemdek, Tannoy, Technics, and lots more. 3 dem studio's (2 by appointment). Superb showrooms. 2 yr guarantee on all hi-fi products. Appts. as above. Home trial facilities, free install, service dept. Qualified and experienced staff, over 25 yrs experience. 12 mths interest free credit. 10.30-5.30 Mon-Sat.

YORKSHIRE (WEST)

AUDIOVISION (YORKSHIRE) LTD, 5 Bethel Street, Brighouse, W. Yorks. HD6 1JR. Tel: (0484) 713996. 1 mile from junction 25, M 62. THE NORTH'S LARGEST RANGE OF TECHNICHS HIFI SEPARATES AND SYSTEMS. Yamaha Cinema DSP - Hi-Fi dealer for West Yorkshire. Panasonic Nikam TV, VCRs and camcorders. Philips widescreen TV, CD-I and laserdisc players. Sky satellite, Bose, Castle, Cerwin-Vega, Mordaunt-Short, TDL, Awa, & Pioneer. A/V and LD player. Six home Cinema/Dolby Pro-logic systems on continuous demonstration. Access/Visa and Credit charge.

BILL HUTCHINSON HIFI, 26-28 Woodhouse Lane, Leeds (0532) 427777. For the largest selection of HiFi and audio visual equipment in the Yorkshire. Specialist A.V. demonstrations of the highest quality. Best prices guaranteed. Minimum 2 year warranty and an optional 5 yr guarantee available. Instant credit and mail order service on offer throughout the U.K. Pioneer, Denon, Kenwood, Yamaha, Technics, Marantz, Mission, Tannoy plus many more.

DOUG BRADY HIFI, The Forge Cottage, 18 Cross Gate, Otley, West Yorks. LS21 1AA. Tel: (043) 47609. Naim, Arcam, Rotel, Pink Triangle, Meridian, Epos, Castle, Teac, JVC, Philips, JVC Systems/Matrix and home trial facilities. Access/Visa. Home 9.00-6.00pm. Tues-Sat.

SCOTLAND

EDINBURGH

BILL HUTCHINSON HIFI, 43 South Clark Street, Edinburgh, 031 667 2877. For the largest selection of Hi-Fi and audio visual equipment in Leith and South East AV demonstrations of the highest quality. Best prices guaranteed. Minimum 2 year warranty and an optional 5 yr guarantee available. Instant credit and mail order service on offer throughout the U.K. Pioneer, Denon, Kenwood, Yamaha, Technics, Marantz, Mission, Tannoy plus many more.

ABERDEEN

HOLBURN HI-FI, 441 Holburn Street, Aberdeen. Tel: 0224 585713. Arcam, Audiobab, B&W Celestion, Denon, Dual, Epos, Heybrook, ION, Kenwood, Creek, Marantz, Meridian, Mission, Cyrus, M.S., NAD, Nakamichi, Pioneer, QED, Quad, Revox, Rotel, Ruarik, Tannoy, Technics, Wharfedale, Yamaha. 9.30-5.30 Mon-Sat.

HI-FI EXCELLENCE, HI-FI innovators & product designers with 15 years experience. Very much in the business for the music. Musical Fidelity key dealer. Largest Rotel retailer in the area. Particularly keen to make the buying of Hi-Fi a fun experience. Situated in the West End away from the bustle of the City centre - the perfect environment to enjoy quality Hi-Fi. Full time service engineer. Open Mon-Tues 10-6, Wed 10-1, Thurs 10-7, Sat 10-5 or later by appointment. Hi-Fi Excellence, 293 Union Grove, Aberdeen. Tel: 0224 322520

AYRSHIRE

LASER AUDIO, Now at new premises: 1 St Marnock Place, Kilmarnock KA1 1DT. Tel: 0563 40292. Audiobab, Alfa, Celestion, Cyrus, Denon, Dual, Marantz, Mission, Philips, Pioneer, Systemdek and Tannoy. 2 demonstration rooms, AV dem room. Appointments preferred. Home trial facilities. Free installation, service facilities. Access/Visa and written credit. Open Tues-Fri 10.5-3.00 Sat 9.30-5.30

GLASGOW

STEREO STEREO, 278 St Vincent Street, Glasgow, Scotland. Tel: 041 248 4079. Closed Tuesday. Installations throughout Scotland. Credit facilities available.

BILL HUTCHINSON HIFI, 43 Hope Street, Glasgow, (041) 248 2857. For the largest selection of HiFi and audio visual equipment in South West Scotland Specialist A.V. demonstrations of the highest quality. Best prices guaranteed. Minimum 2 year warranty and an optional 5 year guarantee available. Instant credit and mail order service on offer throughout the U.K. Pioneer, Denon, Kenwood, Yamaha, Technics, Marantz, Mission, Tannoy plus many more.

INVERNESS

THE MUSIC STATION, 49 Church Street, Inverness, IV 1DR. Tel: 0463 225523. Beyer Dynamic, Celestion, Denon, Jamo, Kef, Kenwood, Mission, Pioneer, Rotel, Sony. Listening room, service department, free local delivery, part exchange, full range of credit facilities.

IRELAND

DUBLIN

ACOUSTIC DIMENSION, 67 Mountjoy Street, Dublin 7. Tel: 305633, Fax: 305839. (from UK + 0103531). Stockists for speakers: ATC, Acoustic Energy, JPW, Triangle, ProAC, Ref 3A, RuArk, Heybrook, Polk Audio, TDL, Impulse, Chario, Audio Static. Access by: Albarry, AVI, LFD, NVA, Alchemist, Marantz, Audio Innovations, Rotel, CR Developments, EAR, Kinshaw, CD Players and DACs by: AVI, Pierre Lurne, Micromega, Kinshaw. Turntables by: Product, Tables/Stands: Apollo. Cables: Straightwire, Ixos, VLS, Eagle. Credit cards and mail order.

CLONEY AUDIO, 55 Main Street, Blackrock, Co. Dublin. Tel: 2899449 2899477. Fax: 2834357. Products include Arcam, Classe, Philips, Nugaoka, Epos, B&W, Naim, Awa, Worldat and others. Open Tues-Sat 10am-6pm, Thursdays to 5pm. Closed Mondays.

PETER OANO & CO LTD, 111 Cornhill Road, Dublin 6. Tel: 0101531 2694433. Products include B&O, Quad, KEF, Thorens, TEAC & many more! 2 demo rooms, part exchange and 7 year guarantee.

IRELAND

LYRIC HIFI, 163 Stanmuir Road, Belfast (0232) 381296. Linn, Naim, Rega, Arcam, Denon, Rotel and more. Mon-Sat 10.00-6.00pm. Late night Thurs.

ZEUS AUDIO, 6 Hope Street, Belfast, (0232) 332522. Audio Innovations, Pink Triangle, Roksan, Marantz, Celestion, Meridian and more. Mon-Sat 10.00-5.30pm. Late night Thursday.

COUNTY DOWN

ASTON AUDIO, Unit 8, Kings Road Shopping Centre, Kings Road, Belfast. (0232) 402220. Akai, Technics, JVC, Samsung, Toshiba, Panasonic and many more. Demos. Open Mon-Fri 10-8pm Sat 10-5pm.

LONDONDERRY

ZEUS AUDIO, 23a Kingsgate Street, Coirane BT52 4LB. Tel: (0265) 56634. Marantz, Mission, Cyrus, Anwa, Akai, Alphason, Sony, Pink Triangle, Celestion, Rotel. Mon-Sat 10-5.30pm. Closed Thurs.

WALES

ACTION GATE AUDIO, 4 Ruabon Road, Wrexham, North Wales. Tel: 0978 364 500. Arcam, B&W, Marantz, Mission, NAD, Quad, Rega, Rotel, Tannoy, Yamaha, etc. Dem facilities, A.V. on dem. Mail order. No appts. nec. home trial fac. Free install, Service Dept. Access/Visa. 9.30-5.30 closed Weds pm.

ELECTRO TRADER, 19 Colwyn Crescent, Rhos on Sea, Colwyn Bay, Clwyd, Wales, LL28 4RN. (0492) 548932. NOW APPOINTED SUGDEN DEALER FOR THE NORTH WEST. Rotel, Yamaha, NAD, Harman, Kardon, Teac, Alphason, Heco, Infinity, KEF, JBL, Sugden, Tannoy, Rotel, Michell, Heybrook, Acoustic Research, Ruarc and Soundstyle tri-pod racks etc. Dem room appts preferred. Home trial Free install. Access/Visa. Open 9.30 - 1.00, 2.00 - 5.30 Mon-Sat.

AUDIO EXCELLENCE 'WHERE THE MUSIC MATTERS', 134-6 Cnwys Road, Cardiff CF2 4NR. Tel: 0222 228565. Fax: 0222398201. Great Hi-Fi carefully selected and demonstrated by friendly enthusiastic staff. Home installations and check-ups. Two year warranty from our own service department. Open 9.00-5.30 Tuesday - Saturday closed Monday.

WELSH MOUNTAINS

AUDIO EXCELLENCE 'WHERE THE MUSIC MATTERS', 9 High Street, Swansea, SA1 1LE. Tel: 0792 474608. Fax: 0792 645087. Great Hi-Fi carefully selected and demonstrated by friendly enthusiastic staff. Home installations and check-ups. Two year warranty from our own service department. Open 9.00-5.30 Tuesday - Saturday closed Monday.

WELSH VALLEY

I&H GRIFFITHS & SONS, 313 High Street, Bangor LL57 1YA. 0248 370655. Yamaha, Tannoy, Teac, Sony, B&W, Wharfedale, Rotel, JVC. Home trial facilities, free installation, service dept. After hours dems by appointment. Access/Visa, Lombard credit charge. Mon-Sat 9-5.30, Wed 9-1. Audio Visual Specialists.

TOP TAPE, 1 Crystal Way, Elm Grove Road, Harrow, Middlesex, HA1 2RJ. Tel: 081 427 1404. The UK's oldest and largest Tape Mail Order Service. TDK, Maxell, Sony, Ampex audio cassettes plus Fuji, JVC, Konica, Memorex, Scotch & TDK video tapes. Send for complete list of latest prices and offers including Video 8, VHS-C, S-VHS, DAT, MiniDisc and Open Reel and tape accessories including Allsorts. Local Dealer Listing available. Telephone orders on 081 427 1404. Mastercard, Visa & Switch accepted.

God as jazz

Simon Hopkins

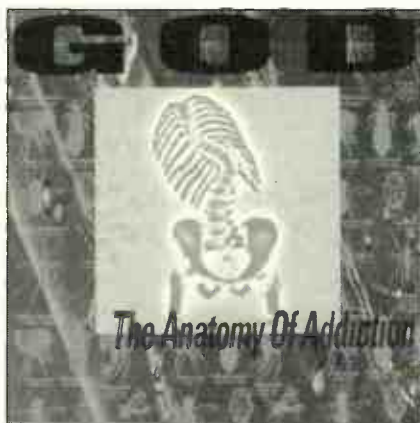

GOD
The Anatomy Of Addiction
BIG CAT ABB62CD

● Given the trajectory from their late 80s debut through their major label debut/swansong *Possession* to last year's live album and finally to this, their second studio album and debut for fine London label Big Cat, *The Anatomy of Addiction* will almost certainly be the final slice of head-copulation that is London-based industrial dub jazz collective God that even this reviewer could squeeze into these pages. For this is without a doubt the furthest the group have thus far travelled from jazz, always a genre which was at best just skirted by them.

Gone are the massed swirling saxophones of *Possession* and its improvised rubato and urgently swinging

passages, not to mention that album's lush, reverberant production. Enter a stripped down sound with massive emphasis on pummeling HM riffing and a production that's a twisted mix of in-you-face dryness and totally flipped dub.

The God line-up for *Addiction* - leader Kevin Martin on tenor sax, vocals and samples, Tim Hodgkinson on alto, Justin Broadrick and Russell Smith on guitars, Tom Prentice on viola, Dave Cochrane and Gary Jeff on electric bass, John Edwards on double bass, Scott Kiehl on percussion, Lou Ciccotelli on drums and guest Alex Buess (of Swiss improv-thrashers 16/17) on bass clarinet - resembles that of *Possession*, but careful scrutiny and listening reveals crucial differences.

The loss of two saxophones and the constant presence of two guitarists (albeit vastly different ones - Broadrick's slashing riffs are million miles from the psychedelic sprawl of Smith) strip the attack of this band down mightily, with the almost tribal emphasis on rhythm that the three-bass/double drum rhythm section maintain almost constantly throughout the nigh-on eighty minutes of this CD. And where the natural riff-inclination of this group has til now - both live and on their previous studio work - been overlaid with layers of improvised, squalling sax and guitar, the sound of *Addiction* is often all-riff, or, if augmented then by the huge swathes of almost ambient sound from Martin and Prentice's heavily FXed sax and viola and Christ-knows-what samples.

Yet the fact of God-as-jazz still rings irresistably true to me. Aside from Tim Hodgkinson's psychotically squalling alto, and Buess' cool bass clarinet, the presence of later Coltrane, and American 60s urban Free Jazz, and, perhaps above all other influences, the great, lacerating early - and mid - 70s recordings of Miles Davis, all haunt this music like some malevolent poltergeist. Where other groups clean up their

sound when they strip out so much of the excess - and move inexorably closer to an accessible sound in the process - only God could at once simplify proceedings and yet make them even more twisted. As to whether God's time will ever come commercially I can't say. But, the fact remains the same: now, more than ever, God are the finest - as in most innovative, most awesome, most frightening, most searching, most involving - group working in this country, and perhaps throughout Europe. That their work is still so widely unknown is a crime; don't you be on the outside.

No doubt about it, album of the year so far, and we're already half way through it.

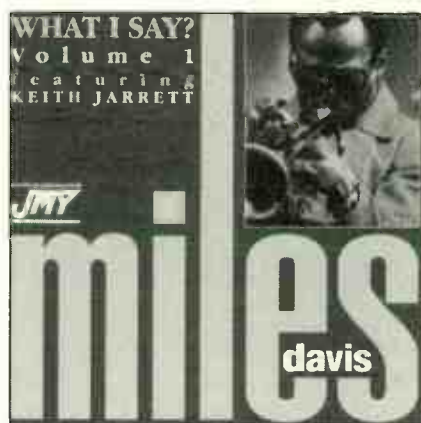

MILES DAVIS
What I Say? Volume 1
JAZZ MUSIC YESTERDAY JMY1015-2
What I Say? Volume 2
JAZZ MUSIC YESTERDAY JMY1016-2

● And the rather glib reference to Davis' late 60s and 70s work leads pretty naturally to these two CDs of the great trumpeter and even greater leader made in 1970 and 1971. Now if you're not already familiar with the music Miles made throughout this period than you've got many records to check out before this: from the 1968 studio records *In A Silent Way* and *Bitches Brew* to *Agharta* and *Pangaea*, the final, monumetal albums recorded on tour in Japan almost a decade later. Davis led successive bands through a musical enchanted garden that cross-bred funk, har-bop, free jazz, musique concrete and psychedelic rock that would, almost unnoticed, change music - all contemporary music, not just jazz - forever.

So then, lucky newcomer, check out all that stuff first; those already hooked will want these, however. The two CDs bring together two concerts: Vienna Konzerthaus, November 5th, 1971 and San Francisco's Fillmore West, October 1970. Both gigs featured a fantastically freely grooving septet: Davis himself, Gary Bartz on alto and soprano, Kieth Jarrett on electric piano (a very

THE SPECIALIST'S SPECIALIST

PETER TYSON



OF
CARLISLE

WE GIVE YOU

KNOWLEDGE IN DEPTH

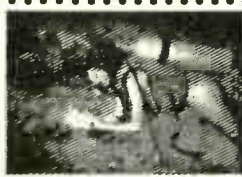

OUR STAFF ARE ALL HI-FI ENTHUSIASTS THEY ALL KNOW THE DIFFERENCE BETWEEN A PUSH PULL ELECTROSTATIC DIAPHRAGM AND A SOFT DOMED TWEETER - AND THEY'RE HERE TO HELP YOU.

WE GIVE YOU



1 SCORE YEARS AND SEVEN
IN THE HI-FI BUSINESS STEADILY BUILDING A REPUTATION AS A REGIONAL CENTRE OF EXCELLENCE IN PRODUCT KNOWLEDGE, SERVICE AND COMMITMENT TO QUALITY.

THE BIGGEST
INDEPENDENT
HI-FI
SPECIALIST
IN CUMBRIA
AND
THE BORDERS

WE GIVE YOU



SPACE

YOU CAN COME AND TEST DRIVE THE VERY LATEST KIT IN OUR DEMO LOUNGE - RELAX IN COMFORT AND ENJOY THE FINEST HI-FI SYSTEMS AND EQUIPMENT WELL AWAY FROM THE SHOP FLOOR AND ALL THE USUAL DISTRACTIONS

WE GIVE YOU



DISTANT PARTS

OUR MAIL ORDER DEPARTMENT OFFERS A UK WIDE DELIVERY SERVICE ON SPECIALIST COMPONENTS AND ACCESSORIES - YOU CAN PHONE OR FAX YOUR REQUIREMENTS WITH COMPLETE CONFIDENCE BECAUSE YOUR ORDER WILL BE PROCESSED BY EXPERTS.

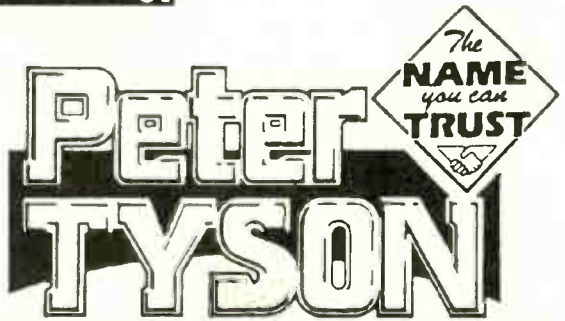

ABBEY STREET CARLISLE CUMBRIA CA3 8TX TEL. (0228) 46756 FAX. (0228) 49253

Wilmslow Audio

THE ULTIMATE HI-FI EXPERIENCE

Arcam Aiwa Audiolab B&W Castle
Denon Dual Heybrook Kef Marantz
Monitor Audio Mordaunt-Short
Nakamichi Qed Revolver Rogers
Tannoy Target Teac . . .

*Britain's leading loudspeaker kit
and drive unit suppliers*

Catalogue of our full range £2.00

Four demonstration rooms

Wellington Close, Parkgate Trading
Estate, Knutsford, Cheshire WA16 8DX
(Dpt HFW)

No appointment necessary Closed
Monday

Telephone (0565) 650605

Fax (0565) 650080

To make the most of your projects,
start with the right tool.

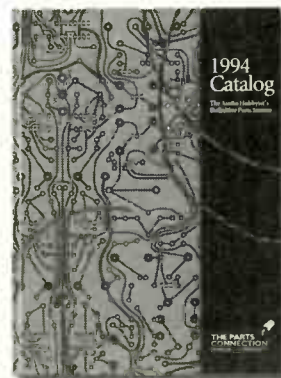

Get connected with the widest selection of audiophile grade parts. Send £3* along with your mailing address and you will receive our 1994 parts catalogue and a \$10 discount** coupon good on your first order over \$100.

**THE PARTS
CONNECTION**

A DIVISION OF SONIC FRONTIERS INC

2790 Brighton Road, Oakville, Ontario, Canada L6H 5T4 Tel: (905) 829-5858
Toll Free Order Line 1-800-769-0747 (U.S. & Canada only) Fax: (905) 829-5388

MIT MultiCap • Wonder Cap • Kimber Kap • Solo • Solen • Siemens
Hovland MusiCap • Wima • Holco • Rel-Cap • Draloric • Vishay • Caddock • Mills
Matsushita • TKD • Noble • Cardas • Kimber Kable • Discovery • Audioquest • MIT
ClearAudio • Alps • Bourns • Shalco Attenuators • Elma • Electros witch • Nichicon
Gold Aero • RAM • Mallory • Ruby Tubes • Edison Price • Linear Technology
Motorola • Analog Devices/PMI • International Rectifier • MagneQuest • Pearl
Sonic Frontiers • Tube Sockets • WBT • Neutrik • Curcio Audio Engineering • Kits

*or \$5.00 US, or credit card information
**catalogue pricing and discounts are in US Dollars



different Keith Jarrett from the acoustic-only performer whose massive reputation has earned him the horrendously cheesy tag "featuring Keith Jarrett" on the CD artwork), funk bassist Mike Henderson, drummers Leon Chandler in Vienna and Jack De Johnette at the Fillmore West, conga players Don Alias (Vienna) and Jim Riley (Fillmore), and percussionists Mtume AKA James Foreman (Vienna) and Airtio Moreira (Fillmore). That funk - by definition, perhaps, a music of intrinsic human warmth, a music of soul and dance - could be warped into something as minimal and blasted as this - pre-empting the transformation of soul music into the industrial, machine-driven maelstrom of techno by a good decade and a half - is still shocking.

And despite their dire covers, these aren't dodgy audience-recorded bootlegs, both recordings being taken from radio broadcasts: this is as close as you're going to get to new Miles live albums. Which is as about as close to saying "essential" as I'm going to get.



STEVE TIBBETTS
The Fall Of Us All
ECM 521 144-2

● A new record from another fine ECM guitarist. Steve Tibbetts is a sadly overlooked talent in the overly hyper-conscious world of contemporary jazz. His music easily and seamlessly melds searing rock guitar, driving and clattering percussion parts and lyrically pastoral acoustic guitar passages. The Fall of Us All features a bigger band than previously - Tibbetts on guitar, constant sidekick Marc Anderson on percussion, tabla player Marcus Wise, bassists Jim Anton and Eric Andersen, singers Claudia Schmidt and Rhea Valentine and keyboardist Mike Olson - and is Tibbetts' finest and most assured record to date. Always rubbing shoulders with the melancholy introspection of New Age music, Tibbetts eschews its predictable limpness with a persistently aggressive undercurrent. Highly enjoyable stuff, and highly recommended.



ZENI GEVA
Desire For Agony
ALTERNATIVE TENTACLES VIRUS
135CD

● Zeni Geva, whose sledgehammer melding of Black Sabbath, Red-period King Crimson and - for its temperament and spirit if not its actual techniques and sounds - Free Jazz, is really to far beyond this column's already stretched brief to warrant much space here. Nonetheless, ZG are certainly one of current hard rock's most exciting propositions, and Null is one of its most wildly experimenting guitar players. The flip side of the coin (or, indeed, of the flippin universe) from Aurora (reviewed previously), but again, highly recommended. For further listening (and I strongly advise it) check out the group's UK debut CD Maximum Money Monster, on Pathological Records.



HANS REICHEL
The Dawn Of Dachsman...
Plus
FMP FMPCD60

● Another German record label, Free music Production or FMP, have been turning out rather different sounds over much the same period as ECM. Whilst the latter turned out some fine experimental and free jazz from the likes of Dewey Redman or, say, Don Cherry, its output is nonetheless characterised by (and often criticised for) its quality of introspection and lyricism. Berlin's FMP, by contrast, from their typographically blunt sleeve design to their bludgeoning

Free Jazz sounds (this is, after all, the label that gave the world Machine Gun, possibly the most brutal, nasty and loudest record of the entire 60s) is a steadfastly urban proposition.

Nonetheless, the label has championed the music of guitarist-luthier-inventor Hans Reichel, a sadly underrated innovator on the world's most played instrument. Reichel's solo records largely feature one-take, overdubless pieces performed on acoustic and electric instruments he builds himself, often with that piece in mind, and use a bewildering number of instrumental techniques. What's always startling is that such awesomely virtuosic playing is yet consantly fresh and often quite shocking.

This set (which also features pieces written for the Dacsophone, a series of hollow wooden sound chambers played with a violin bow) came out originally in 1988. The CD version has welcome extra material and, with its mixture of introspection and willfully extrovert experimentation, forms the perfect road from the ECM releases to the noisier, more frenetic sounds reviewed here this and most other months.

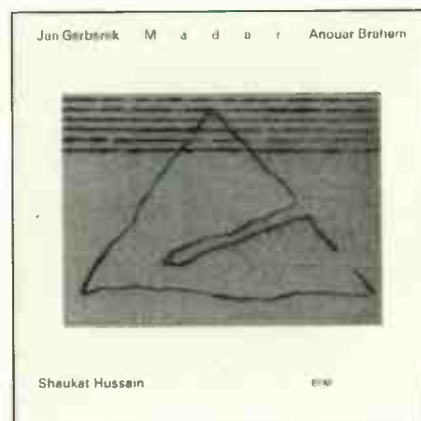

JAN GARBAREK/ANOUAR BRAHEM
Madar
ECM 519 075-2

● The Norwegian tenor and soprano saxophonist Garbarek remains one of the world's most thoughtful and inspired jazz improvisers, but lately I've found his cross-ethnic collaborations - from an album of Mediaeval Norwegian songs with singer Agnes Buen Garnas to dates with Indian percussion virtuoso Zakir Hussain - rather more satisfying than the increasingly lush, layered, and fairly unspontaneous music of his own electric group.

Madar, a trio recording with Anouar Brahem, master of lute-derivative the oud, and tabla player Ustad Shaukat Hussain, firmly falls into the former group. In such stripped-down circumstances Garbarek's stirring flights are unfettered. Proof that cross-cultural collaborations needn't be anodyne guff.

Hi-fi for as little as £50,000.

[And more. Or less.]

If you take your hi-fi seriously – and we do mean seriously – this should sound familiar.

One, you'd like totally unbiased advice on all the available options.

Two, you're not prepared to settle for less than the best your money will buy.

Three, you feel you deserve a professional to tailor a one-off system to your personal requirements.

Four, you expect to test drive equipment – at length – before you decide.

And last, but not least, you'd love to have your own expert on permanent call.

In short, you want Serious Kit.

Simply ring 061-707 4823 for access to all the above.

Plus, most of the world's finest names in top-end equipment. And all the experience of the UK's top talent in hi-fi system design.

Serious sound. Serious sense. Serious service.

Serious Kit.

Music to your ears.

SERIOUS KIT

SERIOUS KIT · 21 ALGERNON STREET · MONTON · ECCLES · MANCHESTER M30 9QA · TELEPHONE 061-707 4823.
THE TOP NAMES. THE TOP EQUIPMENT. ACCUPHASE · ALCHEMIST · APOGÉE · AUDIO INNOVATIONS · AUDIOLAB
AUDIO RESEARCH · COPLAND · COUNTERPOINT · EPOS ACOUSTICS · GROOVE TUBES · HEYBROOK LOUDSPEAKERS
IMPULSE LOUDSPEAKERS · JADIS · KRELL · LYRA · MAGNEPAN · MARTIN LOGAN · MICHEL · MICRO-MEGA
PINK TRIANGLE · P.S.AUDIO · ROKSAN · SONUS FABER · SUGDEN · SYSTEMDEK · TEAC · THETA · THIEL · WILSON AUDIO

AUDIO ACCESSORIES

HI-FI WORLD SOLID SILVER INTERCONNECTS.

Constructed from solid strands of pure silver wire, and with a thick outer casing and screening braid, these interconnects offer the ultimate in transparency, openness and detail. Superb Neutrik Profi phono plugs are silver soldered to the cables in pseudo-balanced configuration for lowest noise/ interference and

extensive use of adhesive heat-shrink is used to strengthen the join between cable and plug for long life. Available exclusively through Hi-Fi World Mail Order.

HIFI WORLD SOLID SILVER CABLE.....£139.95/1M PAIR.
HI-FI WORLD SILVER PLATED COPPER INTERCONNECTS.

A similar construction to our solid silver cables, but using silver plated copper and standard Gold Phono plugs. Because the majority of the audio signal passes through the skin of a cable these can approach the quality of silver, but at the cost of normal high quality copper cable.

HIFI WORLD SILVER PLATED COPPER INTERCONNECTS
£69.95/1M PAIR.



HIGH QUALITY MAINS CABLES.

Supplied to Hi-Fi World by Campaign Audio Design these mains cables are screened to reduce Radio Frequency and Electromagnetic Noise. They also come with a VDR fitted which protects equipment from mains spikes. The MK plugs have a silver plated fuse and holder for the cleanest supply. Available with IEC or Figure eight (Marantz/Philips CD players) equipment plugs or with a hard wired, soldered 4-way mains block.

1M WITH IEC PLUG£19.20
1M FIGURE 8 PLUG£15.75
1M 4-WAY BLOCK.....£31.95



RECORD STORAGE CUBE

Designed to hold about a hundred LPs, with an internal width of 37cm, height of 32.5cm and depth of 32cm. The cubes can be stacked or placed alongside each other - and are even strong enough to be used as seats! Made from 15mm MDF (Medium Density Fibreboard) with a smart durable black paint finish, the

cube is supplied in flat-pack form ready for home assembly.

RECORD STORAGE CUBE
.....£45 EACH

SIX CUBES FOR THE PRICE OF FIVE£225.00
EIGHT CUBES FOR THE PRICE OF SEVEN!.....£315.00



MICHELL ENGINEERING PLUGS

Craftsmanship marks out Michell Engineering's range of gold and rhodium plated plugs from the competition.

GOLD-PLATED SIDE ENTRY BANANA PLUGS (4)£10.00
GOLD-PLATED SURE-LOC BANANA PLUGS (4)£14.95
RHODIUM-PLATED SURE-LOC BANANA PLUGS£18.95
GOLD-PLATED SPEAKER CABLE CONNECTORS...£10.00

GOLD PLATED 4MM BANANA PLUGS

Heavy-duty, gold-plated banana plug with a unique type of axial solderless connection for loudspeaker cables. The cable is stripped back and pushed into a clamping collar which is then screwed down tight, accepting cable up to 6mm external diameter and 4mm core diameter. Supplied in sets of four.

BANANA PLUGS (4)£8.00

AUDIO ACCESSORIES

SME Garrard Celebration Arm



GARRARD 401 CELEBRATION SME IV TONEARM

A special version of the SME IV cast magnesium alloy tonearm, dedicated to the Garrard 401. The SME IV is precision engineered to be fully adjustable, making set-up easy and precise. If you want to get the best from your Garrard 401, this is a fantastic tonearm, sympathetically styled to form a perfect combination.

GARRARD 401 CELEBRATION SME IV TONEARM£847.15



BUG AUDIO

A fascinating little device no larger than a hand-held remote which allows the user to adjust bias on any cassette deck perfectly for any tape. You can check the state of your cables and connections with it, too! Supplied with a cassette test tape and full instructions. (See review, Nov. 1992 issue.)

BUG AUDIO£59.99

SOUND SWIVEL

A rotating, upright, double-sided, storage cabinet with space for up to 160 Compact Discs, including 8 double jewel-cases. Mounted on an all-steel turntable, it swivels smoothly through 360 degrees giving easy access to the storage compartments either side. Manufactured in durable MDF with a Black Ash effect finish, the Sound swivel comes packed for self assembly with full instructions.

SOUND SWIVEL£49.95



Hi-Fi World

AUDIO ACCESSORIES

AUDIO-TECHNICA RECORD CLEANING SYSTEM

Removes both dirt and static; a tiny amount of cleaning agent in the handle removes fingerprints, oil and film, while a pad lifts off dust. Pad brush and fluid are supplied.

AUDIO-TECHNICA RECORD CLEANING SYSTEM £10.50



AUDIO-TECHNICA COMPACT DISC LENS CLEANER

A disc the size of a CD, with fine brushes - one of which is dampened with cleaning fluid. As the disc spins in the player, the brushes clean the laser lens. It may not suit all machines.

CD LENS CLEANER£16.25



KONTAK

An effective cleaning solution that removes contaminants from electrical connections. After application, a system regains its original life, sparkle and vigour.

KONTAK£19.00

HI-FI WORLD DRY STYLUS CLEANER

Keep your stylus sharp and bright for perfect tracking without using fluid. Cut a strip about the size of a matchbox striker off this sheet of card and draw it gently under the stylus from back to front. One sheet of this card, with its aluminium-oxide micro-abrasive coating, should be enough to clean your stylus at least forty times.

DRY STYLUS CLEANER ..£1.95

GOLDRING EXSTATIC MAT

For vinyl users, the Goldring Exstatic is a felt mat made with fine carbon fibre strands. This helps to reduce positively charged static electricity that builds up on the surface of records.

GOLDRING EXSTATIC MAT £7.50



SUPER EXSTATIC CARBON FIBRE DISC CLEANER

Effectively removes dust and grime from record grooves, this cleaner is a combination of one million carbon fibre filaments and a soft velvet cleaning pad.

EXSTATIC CARBON FIBRE CLEANER £9.95

EQUIPMENT SUPPORTS

FrameWorks is an innovative range of versatile hi-fi supports whose high standard of strength and rigidity results from their 'triangulate' design. The shelves are supported on struts of thin cross-section and four sturdy corner columns, to reduce resonances.

Versatility is guaranteed by two or three shelf options, an additional isolation shelf and a stacking unit to expand the system as the hi-fi grows. All you need to do is add components as and

when you feel the need.

FrameWorks stands come with attractive 10mm thick toughened smoked glass shelves, supported on rubber-damped spikes to reduce vibration and lessen the tendency for the glass to slide. Metal parts are finished in a hardwearing satin black powder coat.

FrameWorks stands will extract the best out of any equipment.

FrameWorks' excellent hi-fi equipment stands are now available through our Mail Order Department.



PRICES FOR FRAMEWORKS EQUIPMENT STANDS ARE AS FOLLOWS;

CODE	HEIGHT	PRICE
H100	100MM	£109
H175	175MM	£119
H500	500MM	£205
H700	700MM	£275
H900	900MM	£305

ALL FRAMEWORKS SHELVES ARE 550MM WIDE BY 450MM DEEP. All prices include VAT & p+p for UK only.



H100 ISOLATION TABLE

AUDIO ACCESSORIES

LASAWAY GREEN PEN

When red laser light hits the reflective surface of a CD, some of it can be scattered off the edges of the disc, causing optical interference. Applying this green coating, formulated by Japanese company Mitsubishi, to the inner and outer edges of the CD reduces this interference, improving sound quality.

LASAWAY GREEN PEN£8.50



ANTI-STATIC RECORD SLEEVES

Translucent sleeves, treated to reduce static and dust attraction, supplied in packs of fifty.

They will fit inside ordinary printed inners.

LP SLEEVES (50) PRICE £8.15

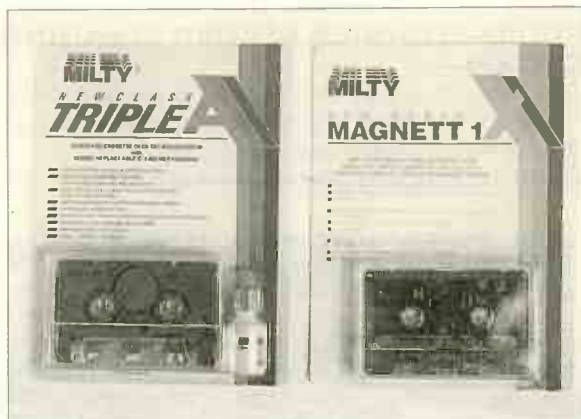

MILTY TRIPLE A

Suitable for all types of cassette players including auto-reverse, the Milty Triple A wipes clean single/dual capstans and pinch rollers with a non-abrasive cleaning action.

MILTY TRIPLE A £6.50

MILTY MAGNET IX

The Milty Magnet IX comes complete with battery. It requires approx one second to de-magnetise the heads removing magnetic charge build up. Recommended after every 30 hours of playing time.

MILTY MAGNET IX £10.50

HI-FI WORLD SPECIAL AUDIO ACCESSORIES ORDER FORM

Please send me:

- Audio Technica CD Lens cleaner.....£16.25 each
- Audio Technica Green CD Ring Stabilizers.....£6.50 (Pack of 5)
- Audio Technica Record Cleaning System.....£10.50
- Automatic CD Cleaner.....£21.95
- Bug Audio Biasbug.....£59.99
- CD sound swivel.....£49.95
- Garrard 401 Celebration SME IV Tonearm.....£847.15
- Gold plated 4mm plugs.....£8.00 (4)
- Goldring Exstatic Mat.....£7.50
- Goldring Super Exstatic Carbon Fibre Disc Cleaner.....£9.95
- Hi-Fi World Silver Plated Copper Interconnects (1m pair).....£69.95
- Hi-Fi World Dry Stylus Cleaner.....£1.95 per sheet
- Hi-Fi World Solid Silver Interconnects (1m pair).....£139.95
- Kontak cleaning fluid.....£19.00each
- Lasaway Green Pen.....£8.50 each
- Laserguide.....£14.95
- Michell Gold-Plated Side Entry Banana Plugs (4).....£10.00
- Michell Gold-Plated Speaker Cable Connectors.....£10.00
- Michell Gold-Plated Sure-Loc Banana Plugs (4).....£14.95
- Michell Rhodium-Plated Sure-Loc Banana Plugs (4).....£18.95
- Milty Magnet IX.....£10.50
- Milty Triple A.....£6.50
- Nagaoka Anti-static record sleeves.....£8.15 (50)
- ON Stylus Cleaning Kit.....£2.50
- Pixall MkII Record Cleaner.....£10.75 each
- Pixall refill roller.....£2.75each
- Record storage cube.....£45.00 each
- Screened Mains Cable With 4-Way Block (1m).....£31.95
- Screened Mains Cable With Fig 8 Plug (1m).....£15.75
- Screened Mains Cable With IEC Plug (1m).....£19.20

Prices are exclusive of postage & packing, please add £1.00 for postage in the UK and £2.00 for postage overseas.

7/94

Please allow 28 days for delivery

Books

- Electrostatic Loudspeaker Design & Construction.....£19.95
- The Williamson Amplifier.....£9.95
- Mullard Circuits for Audio Amplifiers.....£13.95
- The Loudspeaker Design Cookbook.....£23.75
- The Art of Electronics.....£35.00
- The Art of Linear Electronics.....£16.95
- Audio & Hi-Fi Handbook.....£40.00All
- Loudspeakers: The Why & How of Good Reproduction.....£10.95

All prices are exclusive of postage & packing. For U.K. please add £4.00 if ordering 1 book and £7.00 for 2 to 9 books. For 10 or more books p&p is free. Overseas please contact us for rates.

I enclose cheque/PO for £.....made payable to

World Audio Publishing Ltd.

I wish to pay by Visa/Access, please debit my account no:

--	--	--	--	--	--	--	--	--	--	--	--	--	--	--	--	--	--	--	--

Expiry date:

--	--	--	--

Name.....

Delivery Address.....

N.B. If delivery address is different to the credit card holder's address please supply both.

Tel:.....

Please send completed order form together with your cheque/PO to:

HI-FI WORLD,
64 Castellain Road,
Maida Vale,
London W9 1EX.



Credit Card Orders
Telephone 071 - 266 0461
24 hour Mail Order Answerphone

AUDIO ACCESSORIES

ELECTROSTATIC LOUDSPEAKER DESIGN AND CONSTRUCTION, by Ronald Wagner. £19.95

This book takes you step by step through the design and construction of a full range electrostatic loudspeaker, including the basic operating principles behind electrostatics. Whether you intend to build your own electrostatic, repair and restore a vintage electrostatic or are just interested in the principles behind electrostatics, this book is a must.

The author takes you deep into his design decisions and offers practical advice on how to build the amplifier and set it up for best performance.

principles through to full design exercises and practical circuits.

LOUDSPEAKERS: THE WHY AND HOW OF GOOD REPRODUCTION, by G. A. Briggs. £10.95

A popular and easy to understand book on building loudspeakers, using empirical techniques that pre-date computer analysis. A fine grounding, written by a manufacturer with first hand experience - recommended for beginners.

THE LOUDSPEAKER DESIGN COOKBOOK, by Vance Dickason. £23.75

This best selling book in the field of loudspeakers offers good, up-to-date practical design information for the home constructor. Like today's manufacturers it uses modern Thiele Small theory and parameters.

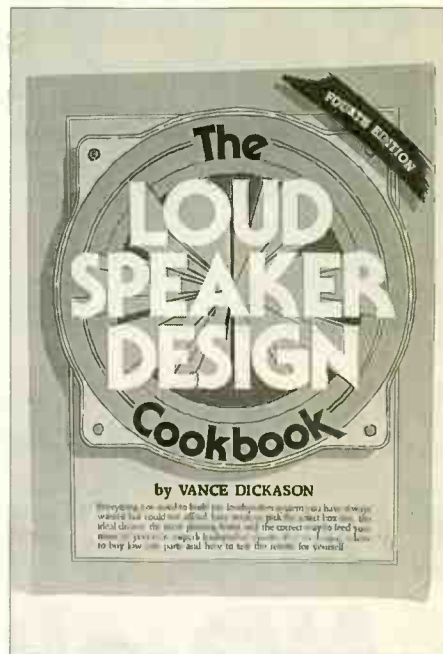

MULLARD TUBE CIRCUITS FOR AUDIO AMPLIFIERS. £13.95

First published in 1959 by Mullard, this book includes full designs for eleven power and control amplifiers, including the 5-20, using valves. This book begins with a four-chapter tutorial on getting the best sound from valve amplifiers.

THE ART OF LINEAR ELECTRONICS, by J. Linsley-Hood. £16.95

Concentrates specifically on analogue electronics for audio and goes into detail on obscure topics like the drawbacks of feedback, as well as its advantages. Covers mainly solid state but also includes valves. A must for serious enthusiasts and budding designers.

THE WILLIAMSON AMPLIFIER, by D. T. N. Williamson. £9.95

In April 1947, Williamson's valve power amplifier became an overnight success.

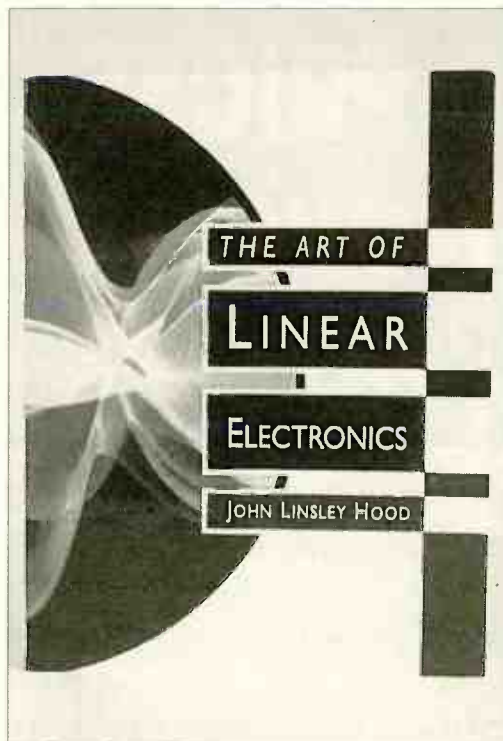

THE ART OF ELECTRONICS, by P. Horowitz and W. Hill. £35

The definitive electronics book. The Art of Electronics is an ideal book for the beginner through to the engineer. Written in easy to understand English, each chapter takes you from basic first

AUDIO AND HI-FI HANDBOOK, edited by I. R. Sinclair. £40.00

The Audio and Hi-Fi Handbook is written by some of the best known designers and spokespeople of the audio industry. It offers an insight into every area of audio, from sound waves and acoustics, through to car hi-fi.

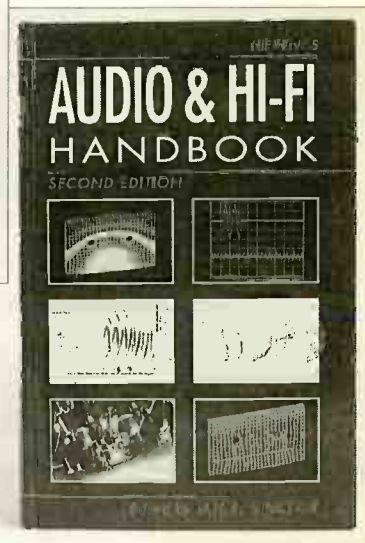

Try me & see **For the very best** **DEALS for 1994!**

**on any current Hi-Fi, A/V,
Home Cinema unit or VCR-
AND all Award Winners**

AMAZING PRICES GUARANTEED

PHONE NOW—*you'll get first-class
service, savings and support.*

- ✔ Budget, Regular and Esoteric Equipment.
- ✔ Insured Overnight Delivery, anywhere in the U.K.
- ✔ Major Credit Cards, Switch/Connect accepted.
- ✔ All goods carry full Manufacturers' Warranty.
- ✔ TMS Warranty covering collection and delivery provided FREE.
- ✔ Extended Warranties up to 5 years available.

*You can always buy from TMS with the complete confidence that we will never let you down.
We ever put our customers first and constantly upgrade and update our systems in order to improve our service.*

081-563 0003
Fax 081-563 0300

Try Me & See Ltd,
5 Rocks Lane, Barnes,
London SW13 0DB



readers' queries

DRY AND COMPRESSED

I want some advice. The system as it stands is Linn LP12 Valhalla, Grace arm, Supex 900 cartridge, sitting on a stand with spikes, Quad 33/303 pre/power amplifier and a pair of Quad electrostatic speakers - the old ones. They rest on home made speaker stands with spikes raised 14 inches above the floor and Linn K20 speaker cable single wired. My room size is 10 x 8 with wooden floor boards.

I've had the speakers and amplifier for twenty years. I love the speakers and the turntable, but I feel the amp and preamp is way overdue. The sound seems very dry and compressed, lacking openness and transparency,

Write in with your problems to Hi-Fi World, 64 Castellain Road, Maida Vale London W9 1EX.

Our panel of experts will endeavour to solve them or at least offer some practical advice

with not much tightness to the sound.

Would the Pioneer A-400 amplifier solve my problem? Would it be a good match for my speakers, or is there another amplifier in the £500

price bracket? I would be very grateful for your advice.

**Michael Smith
Sale Moor,
Cheshire.**

Ah! The old 33/303 - I remember it well. I bought one in the early seventies after three impressive sounding Cambridge P50s had blown up on me, then a reputedly reliable Lux. The Quads were wonderfully solid and reassuring in construction and they soldiered on for years. But I did realise, especially after the tight-as-drum, fast-as-a-bullet Cambridge P50 that the dear old Quad was perhaps a little over warm and a little too insulative with respect to front-end performance.

However, whilst the 33/303 can be accused of most of the properties you list, "dry and compressed" are open to question. Are you sure your cartridge hasn't slowly worn out, as they do? I used to go through a Linn Asaka every 18 months or so. Unless your system often lies fallow, the Supex must surely by now be ready to quit. Cartridges generally tend to lose their sparkle and dynamism as they age, but it is such a slow decline that it passes unnoticed.

I'd suggest you consider a Goldring 1042. It is fulsome and dynamic in its sound, with superbly defined treble from an advanced stylus shape. A brighter and more precise tonal balance



The Quad 33/303 was built to last, many are still in use today.

Continued on page 105...



Announcing . . . the
Elektra Integrated &
Eos Power Amplifiers

ELEKTRA INTEGRATED £999
EOS POWER AMP £899
TITAN MAINS FILTER £125
SILVER INTERCONNECT AND DIGITAL
CABLES FROM £75
SILVER SPEAKER CABLES FROM £25 per m

Arion
ACOUSTICS

MAKE THE LEAP
FROM AUDIO TO
REALITY

Worldwide sales agents

KRONOS DISTRIBUTION

35 Farlough Road • Newmills

Dungannon • N. Ireland

Tel. 0868 748632

Fax. 0868 748281

HAD A BETTER QUOTE?
THEN PHONE US AND SEE
WHAT WE CAN OFFER YOU!!

R.S. AUDIO
MAIL ORDER CENTRE

☎ 071 255 1403 / 071 255 1503

10-12 HANWAY STREET
LONDON W1P 9DD
1st left from Tottenham Court
Road Tube Station

KENWOOD
DP7050
£279

CD PLAYERS
AIWA XC-300 £129
KENWOOD DP2050 £138
DP3050 £199
DP5050 £218
DP7050 £279
DPM6660 £NEW
CD5211 £199
CD5215SE £285
CD63 £215
NAD 505 £185
505 £249
PIONEER PD102 £122
PD202 £139
PDS502 £189
PDS602 £220
PDS702 £246
PDS802 £285
PDS901 £409
PDS902 £440
SONY CDP311 £140
CDP411 £176
CDPC335 £200
CDP711E £200
CDP911E £280
TECHNICS CDPX303ES £480
SLPG340 £180
SLPG440 £149
SLPG520 £187
SLPS620 £163
SLPS740 £205
SLPS900 £285
SLPS840 £340
SLPS2000 £810

AMPLIFIERS

KENWOOD KA1030 £110
KA3020 £136
KA3020SE £NEW
KA3050R £165
KA4050R £220
KA5050R £280
KRA4050DR £185
MARANTZ PM44SE £169
NAD 302 £142
304 £190
306 £278
PIONEER A-102 £105
A-202 £139
A-300X £175
A-602 £285
SONY TAF211B £130
TAF242B £178
TAF442B £210
TAF542E £280
TECHNICS SUVZ220 £110
SUVZ230 £186
SUA600K £186
SUA700K £206
SUA800K £270
SUA900K £385

CASSETTE DECKS

AIWA ADF410 £105
ADF810 £199
ADWX828 £175
ADWX929 £199
KENWOOD KX-3050 £135
KX-5050 £170
KX-5050S £185
KX-7050-S £285
PIONEER KX-9050 S £435
CTS-220 £139
CTS-320 £185
CTS-420 £205
CTS-520 £230
CTS-620 £289
CTS-920 £315
SONY TCFX211B £87
TCK311B £130
TCK411B £175
TCK511B £240
TCK611S £279
TCW435B £180
TCWR535B £175
TCWR635S £280
TECHNICS RSBX404 £155
RSB646 £187
RSB747 £245
RSTR232 £165
RSTR333 £189
RSTR515 £210
RSTR777 £245
RSTR979 £309

MINI SYSTEMS

AIWA NSX270 £249
NSX340 £285
NSX500 £310
NSXD707 £405
JVC UXA3 £280
UXA5 £310
ADAGIO S2 £310
ADAGIO S3 £335
ADAGIO S4 £385
ADAGIO S6 £305
ADAGIO G7 £370
ADAGIO G9 £340
KENWOOD UD-301 £365
UD-351M £369
UD-501 £469
UD-551M £329
UD-701 £309
UD-751M £349
UD-901 £310
UD-951M £360
PIONEER N-33 £320
N-33M £365
N-53 £425
N-53M £465
SONY MHC-510CD £339
MHC-710CD £399
MHC-2800CD £485
MHC-C50CD £440
MHC-C70CD £330
SC-CH404 £419
SC-CH550 £489
SC-CH655 £539
SC-CH655 £379
SC-CH750 £729
SC-CH950 £539

MISSION
760i
£109

MISSION
760iSE
£129

BOSE
AMS-II
£585

SONY
STS311B
£175

NAD
402
£135

AIWA
ADF810
£199

SONY
TCK611S
£279

MARANTZ
CD-5211
£199

MARANTZ
CD-5211 SE
£255

KENWOOD
KA3020
£135

NAD
302
£142

PIONEER
A-400X
£229

KENWOOD
KRV6060
£295

RECEIVERS / AV AMPS

KENWOOD KRV6060 £295
KRV7050 £339
KRV8500 £369
KAV770 £NEW
MARANTZ PM700V £379
PIONEER VSA7015 £379
VSD802S £455
SONY STRD390 £185
STRD590 £205
STRD790 £315
TAAV570 £349
TECHNICS SAGX130 £185

DAT

SONY TCDD7 £480
DTC690 £510

LOUDSPEAKERS

BOSE AM-3-11 £389
AM-5-11 £585
AM-7 £849
XL1000 £95
XL2000 £129
XL4000 £179
CENTRE 100 £115
CENTRE 200 £285
MISSION 760i £109
760iSE £129

M/DI SYSTEMS

AIWA Z-720 £345
Z-D3000M £320
KENWOOD M-27 £440
M-47 £448
M-56AG £548

TUNERS

NAD 402 £135
SONY STS211 £115
STS311 £175
ST610 £110
TECHNICS

10-12 HANWAY STREET, LONDON W1 9DD
1st left from Tottenham Court Road Tube Station

PRICES SUBJECT TO CHANGE WITHOUT NOTICE

... Continued from page 103

will be given by a moving coil cartridge (no generator losses and, therefore, falling midband output). Try an Ortofon MC15 Super. This is more expensive than the 1042, but I have reservations about budget MCs.

Also, the Grace arm is substantially bettered these days by one-piece cast arms, the Rega RB300 being best for the LP12. This arm, you'll find, improves bottom end dynamics in particular.

Now to the painful bit - waving bye, bye to a good servant. The Pioneer A-400X has a very distinctive sound and it may well suit your tastes - or it may not. It has rather fulsome and warm bass, which gives its sound some weight. It also has peculiarly sweet treble that is quite unlike that from 99.9% of solid state amplifiers

So do, by all means, consider the A-400X as a possible upgrade, but don't accept it is the super-amp it is, in some circles, made out to be. Even the inexpensive Denon PMA-350II is a valid alternative, having a more neutral and controlled presentation, yet with enough bottom-end muscle to inject a little welcome drive into the Quads.

Another amplifier you should always use as a yardstick of quality in this area is the Audiolab 8000A; do try to listen to it first. I suggest that you find dealers for these products and get demos if possible. Or give Quad a buzz on 0480-52561 and see if they can suggest a dealer with original electrostatics who can help (Quad are always very helpful to Quad owners - even if they are considering Pioneer!). **NK**

FRESH INTO HI-FI

Having listened to my brother's hi-fi, Rotel CD and amp, plus Mission speakers, I

have decided it is time to get serious about hi-fi. Having a large vinyl collection I also need a turntable. After auditioning, I bought a Linn Basik. Is the K5 cartridge O.K. or should I look at something better?

I also auditioned various amplifiers and the Aura VA-100 sounds right to me. What speakers would you recommend in the £200 bracket? I enjoyed the Mission 760is, 760i SEs and 780s. Which would be the best with the Aura amp and sources I have chosen? Is it worth paying extra for the 780s over the 760i SEs or should I save myself £70.00 and go for the 760is? Please advise.

At a later date I intend to add a CD player and a tuner. Would the Rotel RCD 965BX be a good choice and what tuner (£250.00) would you recommend?

Please also advise me on speaker cables (bi-wired if possible) and quality budget interconnects.

Andre Plant Sunnydale, Fish Hoek, South Afrlca.

The K5 is a bright and lively sounding cartridge that will certainly add energy and enthusiasm to the sound, but if you think you'd prefer something a little more smooth and subtle, especially as you are considering the up-front sounding Missions, then the Goldring 1000 series offers

excellent sound and value. The 1012GX at £60 has a warm, full bass and good clean midband, with the £20 more expensive 1022GX offering a little more speed and dynamics. Have a listen and see what you think.

The 760i SEs are certainly worth the extra over the standard 760is. They have a very similar sound balance to the 780s, but the 780s will go louder and drive a bigger room with more ease. I'd get a pair home to audition. Also worth listening to are the Harman Kardon LS 0300s.

slightly more neutral balance and the Denon players which have a lively and enjoyable presentation.

As far as tuners go there is only one choice at the moment: the NAD402. It's £100 cheaper than your budget, but spend this on a really good FM aerial and decent interconnects and you'll have a tuner capable of taking on the best. It really is a superb tuner, unbeaten in my opinion below £500 when treated well, i.e. good aerial etc.

Good speaker cable to use for bi-wiring is Ortofon's



Mission's 760i SEs and NAD's 402 tuner, two outstanding budget products.

These have a very clean and punchy bass, with a crisp overall balance. We all liked them a lot.

The RCD965BX is a very competent player, but also have a listen to similarly priced Yamaha machines which seem to offer a

SPK300. This sells for around £5/m and is extremely transparent. Recommending interconnects is not so easy, we have a large cottage cable industry in England so there

Continued on page 107...





AUSTRALIA 613 429 2199
661 8 346 6444



SOUTH AFRICA 333 9735



CANADA 416-691-2584



GERMANY 0208/35977
2961/51640



GREECE 01 8064802



MALAYSIA SINGAPORE



SOUTH AMERICA



U.S.A. 602-831-3433
415-669-7181

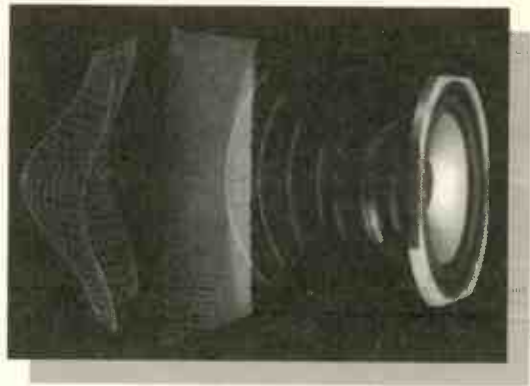

U.K. DISTRIBUTOR (0625) 500507

DEFLEX® acoustic PANELS

"...A marked improvement was obvious from the first few bars of REM's *Automatic for the People* album ..."
"...Vocals took on an air of presence that was stunning compared to what had gone before ..."
"...Rhythm was more definite and seemed to 'glue' the musical experience together ..."

Hi Fi News & Record Review - March 1994

"...The special surface pattern reduces standing waves to cure boxiness and resonance without killing the vitality of the sound ..."
"...expect tighter cleaner bass, crisper articulation, and an increase in liveliness without loss of control ..."
"...The result was sharper imaging, wider dynamics and a more natural sound ..."

Hi-Fi Choice - January 1994

"...Deflex panels seemed to give greater tightness and control, improved internal clarity, and better pitch definition - all without deadening the sound in any way ..."

Audiophile - January 1994

interested?

For further details and a comprehensive information pack - contact:

Spectra Dynamics
(0745) 571600

.... Continued from page 105

is a wealth of stuff to choose from. One that you should be able to get in South Africa is Monster (from the States). They do a good range of interconnects; the Interlink 200 at £20 offers a good quality and affordable upgrade over the patch chords supplied with equipment and Interlink 400 at £40 could be used on sources you use most. **DB**

ITTOK VANISHES

I am writing for advice on my next step. My system is as

11s, or perhaps the Spendor SP20s Noel was so taken with in the Jan '94 issue. Suggestions please!

Finally I see from Linn's latest brochure, that the Ittok has vanished, thus removing a possible future upgrade (couldn't afford an Ekos). Could an SME 309 be mounted on the LP12?

Keep up the good work, the magazine is excellent - well ahead of the competition.

**Mr S.U.C. Chapman
Ilkeston,
Derby.**

The Audio Technica OC5 is a

dynamics. All Goldring moving magnet cartridges are designed for low capacitive loading (circa 200pF) and you are right that the sound gets brighter as capacitive loading increases, contrary to popular belief about this phenomenon with MM cartridges. Out of interest, I measured a 1042 at 80pF loading (arm leads) and 380pF loading - the two frequency responses can be seen in the oscillogram. The treble peak moves from 16kHz (seen at right, upper trace) down to 10kHz (lower trace), at least on outer grooves. Tracing losses further in on a disc, as the mechanical wavelength of the groove decreases, lessens this peaking, giving overall a warm sound, but not one lacking in treble (i.e. not dull). There is some leeway in this area before the sound becomes blatantly incorrect and the A48 and Akito will not cause a problem here; Sugden confirmed that the A48's input capacitance was low at around 120pF.

As usual, I suggest you try and listen to both cartridges if possible. The Ortofon will sound brighter than the Goldring, but not as bright as the OC5.

All SME arms are heavy (700-720gms), because of their strongly engineered pillar/base assembly. They did rather weigh down the floating suspension of early LP12s, but later springs better cope with this, SME told me. So although it's a tight fit, a 309 will go into an LP12. I've heard many good reports of the performance such a combination provides. It is, however, more common to fit the simpler, lighter and less expensive Rega RB300 into the Linn, mainly for convenience's sake.

Your shortlist of domestically acceptable small speakers is a good one. Both

the Spendor SP20s and Heybrook Quartets are superb, small-ish stand mounting speakers that will work with a Sugden A48B (nice amp, that). You should be able to get SP20s closer to the rear wall (12in or less) without upsetting the tonal balance, but the Quartets are easier to drive, they are so sensitive. Both have fabric dome tweeters that are easy on the ear. Try to get a demo of each to make up your mind before buying. The respective manufacturers will be able to help with dealers; give them a buzz. The ESI 1s are less expensive but commensurately less capable too, I feel. **NK**

COMPELLED TO WRITE

Having just read an issue of your magazine - incidentally the first issue of yours I've seen, having previously read other publications - I have been moved to put pen to paper.

My main system is basically a budget one, comprising of Systemdek IIx, Linn Basic Plus, MAG Audio X20, Rotel RC850, RB850 with vdH CS102 interconnect, Denon DCD600, Audioquest Topaz interconnect, Yamaha K340, Rotel RT850 and Monitor Audio R700 with Linn K600 cable. All stands/wall shelves are Target Audio.

I have been quite happy with the sound of this system for several years, but recently acquired a pair of IMF transmission line speakers. The drive units appear to be KEF-sourced and I believe the speakers to be of pre TDL vintage. Just out of curiosity I linked them up to an old Sony TC-121 cassette deck and Harman Kardon PM635 that I had lying about, with Linn K20 cable. Although the driver of one speaker needs a rebuild (about £70 including

Continued on page 109....

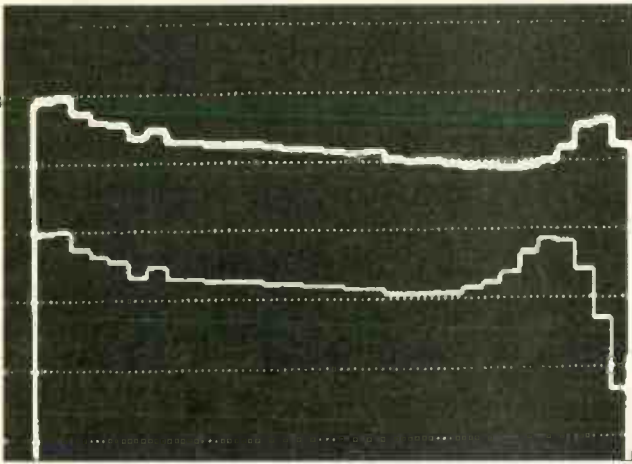

Goldring 1042 cartridge with 80pF loading (above) and 380pF loading (below).

follows:
LP12/Lingo/Akito/OC5,
Sugden A48B, home built
speakers (Linn Cable).

The OC5 is nearly two years old and ready for replacement. I'm looking for something a little less bright, the Goldring 1042 or the Ortofon MC15S among those I've considered.

I remember reading in a previous issue that the 1042 needs to see input conditions near 150pF. I have no idea what the figure for the Sugden - Akito would be, the last thing I need is more rising treble. If the 1042 is not suitable would the MC15 suit?

Later this year I hope to look at some new speakers. I was thinking of auditioning Heybrook Quartets, Epos

moving coil cartridge with a rising high frequency output which I always found to be clearly audible and not to my taste, so I sympathise, but others have enthused; I suspect choice of loudspeaker can influence matters. The new Ortofon MC15 Super moving coil comes highly recommended by Eric Braithwaite and costs just £110. I hope to be both measuring and listening to it soon.

The Goldring 1042 has a warm balance, due to falling mid-range output, which is quite the opposite to what you are used to. However, its stylus gives it keen treble definition and insight, which I find delightful, and it also possesses powerful



THE PAST & THE PRESENT

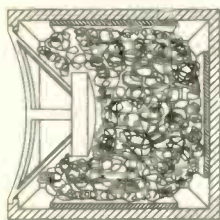

Inside a Typical Cabinet

LISTEN TO THE FUTURE

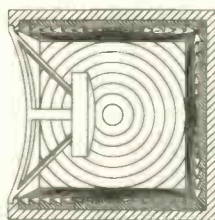

Deflex Panels Fitted

GET THE MUSIC OUT OF YOUR SYSTEM, AND LET YOUR SPEAKERS BREATHE!

Replaces the existing damping material inside your loudspeakers – quick and easy to fit. Available for any loudspeaker.

Deflex acoustic panels have excellent performance characteristics. The polymer is specially formulated to absorb shock and vibration, thus minimising cabinet resonances.

The surface emulsion has been carefully designed to eliminate standing waves

The energy inside the enclosure is controlled – **NOT ABSORBED**, as in other cabinets.

Independent tests on MLSSA show energy gains over 50%.

DEFLEX® A.P.T. ACOUSTIC PANEL TECHNOLOGY

PURPOSELY DESIGNED HI-TECH SPEAKER LININGS NOT BY-PRODUCTS FROM ANY OTHER INDUSTRY

"NEW APPROACH STUNS THE EXPERTS"

"BIGGEST BREAK-THROUGH IN 20 YEARS"

"RESULTS NEVER ACHIEVED BEFORE"

"THE MUSIC IS FASTER, BRIGHTER, CLEANER, WITH DEEP, CONTROLLED BASS"

U.K. DISTRIBUTOR

The SPEAKER Company

UNIT 9,
WATERSIDE MILL,
WATERSIDE,
MACCLESFIELD, CHESHIRE
SK11 7HG
Phone 0625 500507

CURRENT PRICES

Standard Panels
@ £7.95 each

Sub-woofer Panels
@ £11.95 each

Adhesive from
£3.50 (200ml)



Are you tired of getting **ONLY** what you pay for?

Call me and see how different it can be.

For the Best of British...

DPA Digital, LFD, Michell, Orelle, Pink Triangle

And the Best of the Rest...

**Classé, Copland, Linnaeum, Magnepan,
Sonus Faber, Van den Hul**

'Phone or fax me anytime, 9am - 10pm, any day including weekends on:

0252 - 377952

0385 - 317952

Part Exchange/Ex Demo equipment:

Acoustat Model 3 electrostatics £1500, Musical Fidelity A370 £1000, Sonus Faber Electa £1350

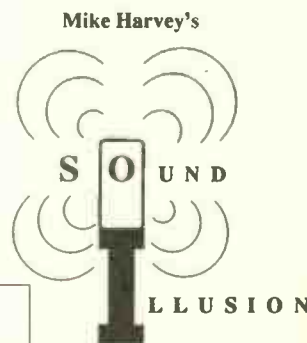

Major credit cards accepted

.... Continued from page 107

p&p direct from KEF) I was surprised at the extra information from various recordings.

Do you know anything about these speakers, and if with new/re-built driver and dedicated stands rather than the wheels they came with, would they integrate with my main system?

I did have the idea of building a 'seventies' vintage system around them - but when a friend heard them he suggested a Marshall Stack would be just as appropriate in my bedroom (14ft by 13ft). The main system is in a room 16ft x 15ft on a suspended floor in a 250 yr old building, i.e. first floor flat over a shop!

I look forward to your comments, and any sensible suggestions as to what to do with the I.M.F.s.

**David Ison
Godmanchester,
Cams.**

Mr Ison does not provide much information from which to establish what IMF speaker model he may have, but he does state that they are on wheels. This could place them as being IMF Monitors up to twenty five years old. The bass and midrange units were KEF, as also were the tweeters - unless there is also a super-tweeter, in which case the tweeters were both Celestion. It is encouraging to learn that these speakers are still performing.

As with such designs, the drive units were selected to work with the associated crossover in that particular enclosure. Modifications made now would have to take into account all of those parameters - just changing drive units would certainly

have a deleterious effect. However, there would certainly be an advantage in having stands made to lift them away from the floor - about 4inches high would be optimum. Later IMF speakers incorporated such dedicated stands.

There is something timeless about transmission line designs, and the bass performance of such speakers has improved little over the years. Later models incorporate higher power handling bass units, but that does little at normal listening levels.

stack with my first separates system in April 1993; so your "opinion" column of January 1994 struck a chord with me.

A complete novice, with no points of reference, I auditioned systems trying to select/compare/criticise sources amplifiers and speakers. Absurd - and no wonder I remain the only person I know with separates.

Dealers recommended equipment which sounded too bright, or seemed similar to my (vague) recollection of the old system.

Eventually I took a leap in the dark and bought an entry

Griffith, China Crisis etc. Atmosphere, stereo imaging and detail are more important than bass.

1. Can you say what limitation(s) this room size places on source (LP), amplification and speakers?
2. In which order should I upgrade the three elements?
3. Should I consider buying any of the three elements second hand. If so, which involves the least risk?

4. Is there a timetable of events at which I could listen to different higher end systems? For instance, I have no idea if my present soundstage is good, bad or indifferent, or what I could hope for in that respect.

My current system comprises:
Systemdek
IIXE900 (acrylic platter) on Target wall stand, Roksan Tabriz arm, Goldring 1042, Audiolab 8000A, Epos ES1 I's with stands, Nakamichi 1.5 and Arcam Alpha Plus tuner.

The loudspeaker cable is Ortofon SPK300 bi-wire.

I would be grateful for any advice you could give. I attach a room plan and system details.

**John Holden
Prestwich,
Manchester.**

If the Epos ES1 I's are working well in your room, and you enjoy the sound, I'd stick with them. They're known to be very room fussy and can sound overblown in the bass and over-bright in the treble if

Continued on page 111....

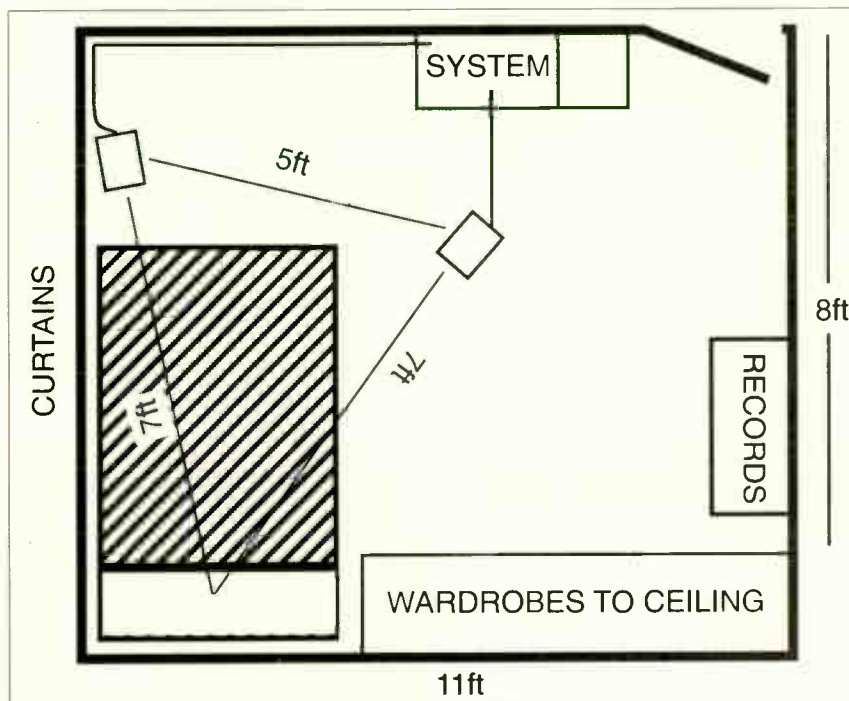

John Holden is looking to upgrade his system for this room.

Of course, midrange and tweeter technology has improved, with consequent improvement in transient response and linearity, but to replace these old loudspeakers with a modern equivalent would cost nearly £2000. We wonder what Mr Ison paid for his IMFs - we suspect he has a bargain!

**John Wright
TDL Electronics.
(ex Managing Director of IMF).**

MIDI OUT - HI-FI IN

I replaced an ancient Oriental

system based on your "World Favourites" list of March 1993. I enjoyed it from the beginning, but did not appreciate it fully until weeks later (this time lag makes buying very difficult).

I have decided on an improvement budget of £2,000+ per annum and I am wondering how/whether to proceed to a high end (L.P.) system in the smallest number of steps.

I listen from the corner of a bedroom which is 11 feet by 8 feet - disastrous, but unavoidable. I like the Cocteau Twins, Nancy

HALE HI FI



We stock:-

**ROYD, NAD, NAIM, LINN, CREEK,
ARCAM, QUAD, YAMAHA.**

A wide range of accessories always
available.

Full demonstration facilities - no
appointment necessary - full service
department.

Free delivery and installation

2 Bold Street, Hale Road Altrincham, Cheshire

WA14 2ER

Telephone: (061) 929 0834

Inaccessible accessories by post.

If you can't get to us, we'll get our accessories to you.

CARTRIDGES: Arcam, A.T., Denon, Dynavector, Goldring, Lyra, Ortofon, Sumiko. **CABLES:** Audioquest, Cable Talk, Ixos, Kimber, Ortofon, Sonic Link, Van den Hul. (including the new carbon cables.) **STANDS:** Alphason, Sound Organisation, Stands Unique, Target. **HEADPHONES:** Beyer, Sennheiser, Stax. **ACCESSORIES:** Allsop, BIB, Discwasher, Hunt, Kontak Last, Michell, Milty, Nagoaka, Pixall, QED. **LP's/CD's:** Audioquest, DCC, Fone, Klavier, Naxos, Opus, Proprius, Reference Recordings, Sheffield Labs. **PLUS** a full range of quality equipment available.

Bury Audio

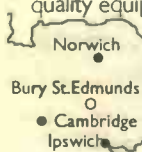

47 Churchgate Street, Bury St. Edmunds, Suffolk IP33 1RG.
**For a full catalogue or to order telephone or
Fax. 0284 724337 or telephone 0850 565693.**
Access, Visa, Diners Club, American Express.

Relatively Speaking,

GOLD AERO TUBES

give Music
more Sense of
Space and Time.

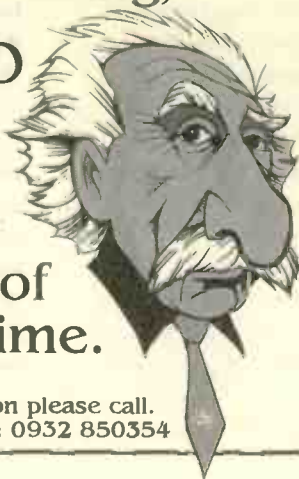

For further information please call.
Tel: 0932 850361 Fax: 0932 850354

Music Mill

At the Music Mill, we believe that buying hi-fi should be a pleasurable experience. We offer friendly professional service and advice in comfortable 'no rush' surroundings with the emphasis on your specific requirements. Excellence in hi-fi includes Nakamichi.

hear

Harman Kardon, DNM, Rehdeko, Audio Innovations, Nottingham Analogue, Pro-Ac, Systemdek, H.W. Cerwin Vega, Dal and Micra-teca

The Music Mill - a fresh approach to hi-fi selection.

Access for people with special needs

Specialist hi-fi technical advice and service

here

The Music Mill (Scotland) Ltd
Bonnington Mill Business Centre
72 Newhaven Road
Edinburgh
EH6 5QG
Tel & Fax: 031-555 3963

.... Continued from page 109

things aren't working well, but are superb loudspeakers when performing at their best. Ultimately, bass depth is going to be limited by the size of your room. I don't think you'd get away with anything much bigger than the Epos, but that doesn't mean that the sound can't be upgraded.

You've selected a very fine system. The front-end is well balanced and should be giving a very neutral and enjoyable sound. The only area here that you could look at is the cartridge. The Goldring is just about the best at its price, but a good Moving Coil will bring a faster, more dynamic and precise sound to your vinyl. The Audiolab has a very good MC stage, so it'd be worth taking advantage of this. Try listening to the £200 Denon DL-304 which has a lovely, sweet and refined sound.

By picking such a well balanced system you have made it difficult to suggest an easy upgrade path. There is no weak link which is in obvious need of replacement. Your best bet would be to audition a complete new system at a good hi-fi dealers so that you can form an idea of what to aim for. I'd suggest listening to the new Townshend Rock III, upon which you could use your existing arm and the Denon cartridge, with an EAR 834P valve phono head amplifier, Michell Argo pre-amp with Alecto Stereo power-amp and either Tannoy D100 or ProAc Studio 100 loudspeakers. This system will give you loads of detail, dynamics, a good soundstage with precise imaging and, above all, a very musical presentation.

The other option, of course, is to stick with what is already an excellent system, and spend the money on records. The only

problem you may encounter, is where to put them all! **DB**

ULTRA GOOD

I subscribed to your magazine in Nov. 1992 and I found it most interesting.

I like your musicality oriented approach for reviewing hi-fi (I used to buy Hi-Fi Review 'till it was stopped, to my sorrow). I'm interested in upgrading my system and would like to know your opinion on the following:

- a) The Audio Synthesis D.S.M. (U.A. version) working in conjunction with Arcam 170.3 transport (which I hear can be sync-locked).
- b) I think it would be interesting to read a full review of the above equipment compared to closely priced DPA T1 + PDMI.
- c) Your recommendation for speakers to work with valve amps. (Quad II) in the £500-£1,000 price range - i.e. a speaker with very good sensitivity and an easy load for the amp. (what do you think of the ProAc Response I and Alphason Orpheus).

My system comprises Linn LP12, Kenwood CD7010 + B.B.3, Croft super micro + QUAD II valve amps, Tannoy DEI- speakers.

Thank you for kind advice and help.

**Arnon Ben-Yacov
Tel-Aviv,
Israel.**

The Audio Synthesis DSM with Ultra Analogue chip is a fine performer, dry in its sound but also clean and punchy; we were impressed. Arcam's chief engineer told

me that Audio Synthesis developed a sync lock version in conjunction with them, for use with Arcam transports having this facility. For those of you who are

(12watts). We designed our own loudspeaker, KLS-2, specifically to work with low powered valve amplifiers. It has a massive 94dB sensitivity (from 2.8V/1 watt)

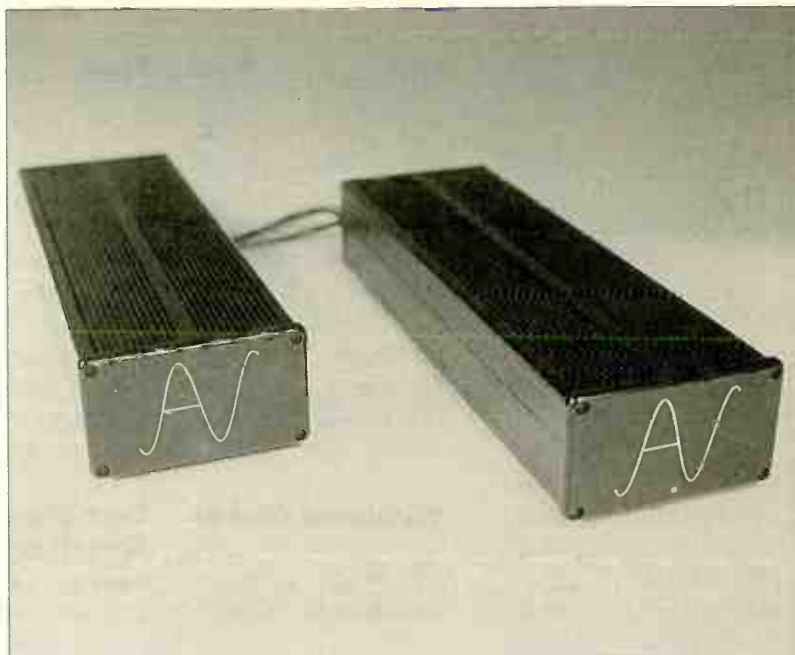

The Audio Synthesis DSM can be modified for sync-locking to Arcam Transports.

wondering what this is about, it is a way of locking a transport to the master clock signal generated in the DAC, rather than using the SPDIF (Sony Philips Digital InterFace) code. The system lessens jitter and timing errors. I've used both the DPA and Arcam sync-lock systems (incompatible) and find they do offer a valuable improvement in performance, generally tightening tempo, sharpening transients and cleaning a signal, so I recommend them.

Although I haven't directly compared the Audio Synthesis DSM with the DPA PDM I/III, the latter is considerably more complex, being a two-box affair with the one-bit convertor sitting in its own enclosure. It is one of my favourite convertors, but I have to say that the T1 is not my favourite transport.

It is very difficult to recommend a speaker truly suitable for Quad IIs, since they produce so little power

and a near-flat load impedance characteristic centred on 8ohms, making it ideal in terms of matching. It also has a flat frequency response, but is available only as a drive-unit + crossover kit. So few people wanted custom built cabinets that, at present, we do not offer a flatpack, so you have to DIY. This speaker is simple, low priced and works with all amplifiers from 1 watt upwards. There's nothing else like it on the market at present. If there was, I wouldn't be so shamelessly plugging one of our own products!

At a lower 90dB sensitivity, which is still sensitive (86dB is typical), choice widens. I favour Heybrook's Quartets, because they are easy on the ear over long periods, dynamically lively and will reveal the properties of the Quads. You could also try Harman Kardon 0500s (bassy) or Triangle Normas

Continued on page 113....

Sussex Surplus

13 STATION ROAD, HORSHAM, WEST SUSSEX RH13 5EZ

Telephone: (0403) 251302 Fax: (0403) 270339

Test Equipment • Components • Accessories
Electromechanical • Mechanical • Engineering

Valves Mostly UK.

Oil Filled Chokes

Type	Price	Type	Price
GZ34 MULL	£9.00	10H 25MA	£8.00
KT66 G.E.C.	£65.00	2.5H 220MA	£10.00
EF86 G.E.C.	£9.00	5H 250MA	£12.00
EF86 MULLARD	£6.00	5H 350MA	£18.00
ECC81 MULLARD	£5.00	5H 400MA	£20.00
ECC82 MULLARD	£5.00	20H 120MA	£15.00
ECC83 MULLARD	£10.00	1.5H 120MA	£15.00
12Ax7 MULLARD	£6.00	2H 150MA	£10.00
E88CC G.E.C.	£8.00	1H 300MA	£10.00
5R4GY	£4.00	10H 250MA	£20.00
6080	£10.00	4.5H 220MA	£10.00
E810F MULLARD	£10.00		
E180F MULLARD	£6.00		
GZ37	£3.00		
EL84 MAZDA	£4.00	10H 75MA	£10.00
6SN7GT	£4.00	3H 40MA	£10.00
DA42 G.E.C.	£15.00		
U19 RECT	£10.00		
6x4 RECT	£3.00		
4212E S.T.C.	£100.00		

Varnished Chokes

Oil Filled Paper Capacitors

Type	Price
2MFD 600V	£6.00
4MFD 600V	£6.00
8MFD 600V	£8.00
8MFD 800V	£10.00
8MFD 1000V	£12.00
1MFD 600V	£5.00
.5MFD 1000V	£5.00
.5MFD 5000V	£15.00
12MFD 350V	£8.00
1MFD 2500V	£15.00
.25MFD 1000V	£5.00

Varnished H.T Transformers

Primary	Secondary
230/240V	612-0-612V
	430 MA £25.00
230V	275-0-275V
	6-3V 2-5A
	6-3V 1A £18.00
	5V 2-5A

P.T.F.E. silver plated wire various colours and sizes 50p per mtr.

A.V.O CT160 Valve Tester EX M.O.D

tested and supplied with data book £99 + £20p+p Solartron verifiable H.T power supplies with meter 0-500V+DC 100MA/3-15-0-3-15 3A tested very good condition £75 + £20p+p P+P odd £5.00 +VAT per order UK only unless otherwise stated.

Overseas postage at cost

VAT at 17.5% to be added to all UK orders.

All items in this advert are made to mill spec

Oil Filled H.T Transformers

Primary	Secondary
115/230V	1250-0-1250V 230V
	310MA £35.00 725/700-0-725/700
	4.6V 100MA 385MA
	180-0-180 55MA
	6.3V 6A
115/230V	400-0-4-00 5V 6A £50.00
	250MA £18.00 6.3V1A
	30V 100MA
115/230V	350-0-350 150MA 115/230V
	6.3V 1A 300/250-0-250/300
	6.3V 2A £37.00 125MA
	6.3V 6A £20.00

Oil Filled Heater Transformers

Primary	Secondary
115/230V	6.4V 3A x2
	2.5-5V-6.4x2 £15.00
115/230V	6.4V 10A
	10V 650MA
	26V 650MA £15.00
115/230V	2-5V-5V-6.4V
	2A x 4 £15.00

All items in this advert are made to mill spec.

THE AUDIO GALLERY

For a Fine Selection of High Quality Audio Equipment

Tube Technology - Audio Innovations - Audio Note - Wadia
Audio Alchemy - DPA - TEAC - Micromega - Alchemist
Martin Logan - ProAc - Klipsch - Acoustic Energy - TDL
Heybrook - JPW - Impulse - Pink Triangle - SME - Denon
Moth - Audio Synthesis - NAD - Pioneer - Alphason - Tripod
Replacement Valves by Gold Aero

Demonstrations by Appointment Only.

Please call 0730 895194 - Hampshire, Nr. Petersfield

campaign audio design

LOVE HERTZ

"You pays your money and you takes your choice"
but our pure silver cables and quality mains interconnects will improve your Hi-Fi system or we will give you your money back.

- ★High Purity Silver interconnects with PTFE
- ★Silver tone arm wires & digital interconnects
- ★Silver speaker cables & mains leads

"We will improve your Hi Fi or give you your money back!"

Campaign Audio Design
Llandudno Road (HW) Cardiff CF3 8PG

Tel: 0222 779401

TRADE & INTERNATIONAL ENQUIRIES WELCOME

RING FOR DETAILS



UXBRIDGE, MIDDLESEX
(0895) 253340

Unbelievable but true you can audition all these brands here.
Audion, Proac, Michell, Lumley, Levison, Lurne, Triangle, Teac, VHD, Silversounds, Stax, Monitor Audio, Trilogy, Lyra, Sumiko, Ortofon, Decca, Target, Project Moth, Townshend, Edison, Sudgen, Trichord Research, Cadence, Kinshaw, SD Acoustics, Totem.

7 days a week 10am - 7pm
RING FOR DETAILS
UXBRIDGE, MIDDLESEX
(0895) 253340

.... Continued from page 111

(a little hard and sharp at high volumes), both of which also give 90dB from 1watt. I think we will have to

is Sonic Link Grey and the interconnects between pre and power amp is Isoda. I also have a Yamaha CD870 to service a small, but growing CD collection and a

amplifier.

2. Find a power amp(s) that will work well with the Ion, which would save cash whilst giving an option for a complete change at a future date.

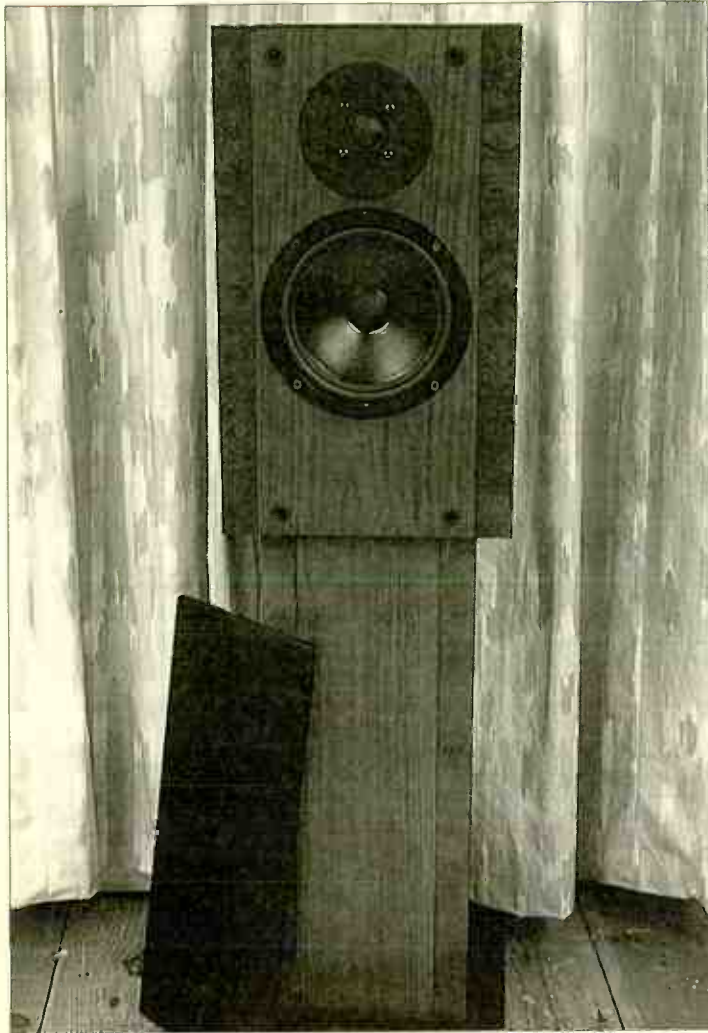

Heybrook's Quartets are sensitive enough to work well with Quad II valve amplifiers.

develop a range of valve-amp compatible speakers soon, because British manufacturers seem intent on ignoring this important and growing niche, in spite of a strengthening clamour from readers. I'd recommend ProAc Response I's only if you don't mind keeping volume down. **NK**

POWER PROBLEMS

My system consists of the following components. Turntable: Pink Triangle Export Improved, Alphason HR1000s MCS, Ortofon Quasar, Ion Nexus SAM 40 amplifier system and Epos ES11 speakers. Speaker cable

Yamaha KX-260 to tape albums for the car. However, at heart, I remain a vinyl junkie.

I am, or was, more than happy with my system and had no immediate upgrade path. I dreamt of a £10,000 vinyl system built around an Anniversary deck, but had no serious plans until the power amp gave up on me. As you know, Ion are no more, and the power amp is beyond repair. My dealer checked the Xpack power supply and Nexus pre amp and pronounced them to be healthy, so I find myself with the following choice:

1. Ditch Ion and buy a new

I believe I'm right in saying that the X-PAK 2 power supply was used to power both the pre and power amplifier of the Sam 40 system. An upgrade for this system was to power the pre-amplifier by its own X-PAK 2, so I'd suggest keeping the SPI pre-amplifier and using the X-PAK 2 power supply with it which then effectively upgrades the pre-amplifier to a higher level of performance.

A suitable power amplifier to go with the Ion Nexus pre-amplifier should be easy to find. Two that spring instantly to mind, both reasonably priced and well suited to driving

Epos ES11s, are the Sugden A41P and the DPA 200S. The DPA in particular would retain some of the flexibility of the original Ion system; it can be bridged into a 200w monoblock, allowing a second power amplifier to be added later if desired.

If at a later date you wanted to complete the system by adding a matching DPA or Sugden pre-amplifier, don't worry. Sugden make very good phono stages for their amplifiers and DPA are about to launch a new head-amp to go with their line level pre-amp, so your vinyl will still be well cared for. **DB**

GENERAL GET TECHNICAL

I have for some time been trying to locate a replacement cartridge for a "Connoisseur" arm manufactured some years ago by A.R. Sugden and Co. (Engineers) Ltd of Brighouse, Yorkshire, now no longer in business. The cartridge was a type SCU1.

After much searching and many enquiries I have been advised to try a firm called Technical & General whom, I have been led to understand, carry spares for products manufactured by the now defunct company.

Unfortunately the name Technical & General is all I have to go on, no address can I find.

I would much appreciate any information you may have as to the whereabouts of Messrs. T and G.

**J. S. Irving
Maryport,
Cumbria.**

Technical and General are in Crowborough, East Sussex. To contact them you must 'phone 0892-654534. This little known about company actually manufacture Garrard idler wheels and various other parts and handle all Connoisseur business since taking over the name when it closed. They also handle Goldring-Lenco (the original Swiss company - not UK Goldring) and Thorens parts. They don't seem very prone to publicise exactly what they do, but Dennis Burke, their M.D. tends to make up for this when he spots me rooting around under the tables for rare items at British Vintage Wireless society meets - I get told all about how specialised T&G are! They do MOD work for a proper living, so I presume idler wheels make a welcome change from the odd Polaris submarine. That's why you can only contact them by dog-and-bone. **NK**



Chelmer Valve Company for Audio Valves

Audio valves with famous Brand Names of yesteryear such as MULLARD, MOV, GEC, RCA etc., are in very limited supply and their scarcity also makes them very expensive.

We at Chelmer Valve Company however provide high quality alternatives to these old makes. We have over 30 years experience in the supply of electronic valves of all types and during this time have established close ties with factories and sources worldwide.

For high fidelity use we further process valves from these sources using our specially developed facilities. After rigorous testing - including noise, hum, microphony, post burn-in selection and matching as needed - we offer this product as CVC PREMIUM valves.

A selection of the more popular types is listed here.

Price list & Order Form for CVC PREMIUM Audio Valves

	UNIT PRICE	QTY.	TOTAL PRICE		UNIT PRICE	QTY.	TOTAL PRICE
PRE-AMP VALVES				CARRIED FORWARD....			
ECC81/12AST7	5.00			RECTIFIERS			
ECC82/12AU7	4.00			GZ33	4.50		
ECC83/12AX7	5.00			GZ34/5AR4	4.50		
ECC85	4.00			5U4G	5.00		
ECC88	5.00			5Y3GT	3.20		
EF86	4.00			5Z4GT	3.50		
E81CC (GOLD PIN)	6.00			SOCKETS			
E82CC (GOLD PIN)	6.00			B9A (PCB)	1.60		
E83CC (GOLD PIN)	6.00			B9A (CHASSIS)	1.60		
E88CC (GOLD PIN)	7.00			OCTAL (CHASSIS)	1.75		
E80F	9.00			4 PIN (UX4)	3.00		
E83F	5.50			4 PIN (FOR 211 & 845)	11.00		
6SL7GT	4.00			MATCHING CHARGES * POST & PACKING 3.00 (UK) TOTAL EXC. VAT VAT @ 17 1/2% (ECC) TOTAL TO PAY £			
6SN7GT	4.20						
6922	5.00						
POWER VALVES				* MATCHING, if required; state valve types & if PAIRS, QUADS or OCTETS - Allow £1.00 per valve for this service.			
2A3 (4PIN)	14.00			Make CHEQUES payable to:			
2A3 (OCTAL)	14.00			'CHELMER VALVE COMPANY or pay by			
211	22.00			ACCESS/MASTERCARD/VISA, give details:			
300B	50.50			<input type="text"/> <input type="text"/> <input type="text"/> <input type="text"/> <input type="text"/> <input type="text"/> <input type="text"/> <input type="text"/> <input type="text"/> <input type="text"/> <input type="text"/> <input type="text"/> <input type="text"/> <input type="text"/> <input type="text"/> <input type="text"/> <input type="text"/> <input type="text"/> <input type="text"/> <input type="text"/>			
811A	9.50			Signature			
845	29.90			Expiry			
EL34/6CA7	7.50			Name			
EL84/6BQ5	4.00			Address			
E84L/7189A	5.10					
KT66	9.20					
KT88	12.50					
KT88 (GOLDQ)	18.50					
6L6GC	6.50					
6L6WGC/5881	8.00					
6V6GT	5.00					
6146B	10.20					
6336A	30.00					
6550A	11.00					
6550-A	13.50					
7581A	11.00					
TOTAL CARRIED FORWARD.....			 Post Code			

Valves amplifiers sound better still with CVC PREMIUM valves!

130 New London Road. Chelmsford. Essex CM2 0RG, England. Telephone: (0245) 355296/265865 Fax: (0245) 490064

**No one was
ever sorry that
they bought
the best!**



As audiophiles you demand the best.

Groove Tubes Performance tested valves certainly measure up every time to those demanding standards. Whatever kind of music you prefer, you'll appreciate it better with Groove Tubes. Simply changing to Groove Tubes will create a whole different set of tonal characteristics to your amplifier, and they are used or approved as the ultimate upgrade to any preamplifier or any power amplifier, by many manufacturers.

Hundreds of professional musicians like Bryan Adams, ZZ Top, Tina Turner, Genesis and Chris Rea use Groove Tubes and G.T. Electronics in their stage and recording amplification.

Now we are introducing the Groove Tubes D.75s power amplifier which is a professional 75 watts per channel stereo amplifier currently in use in top recording studios around the world and of course it comes complete with Groove Tubes as standard. *Retail price £1950.00*

and now...

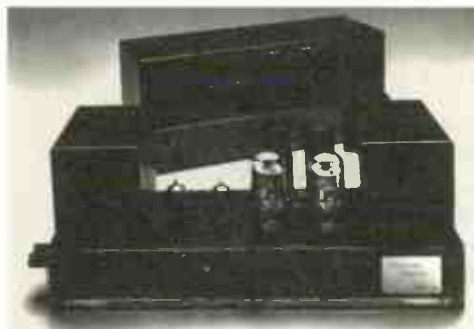

We are pleased to announce an exciting new range of British made valve pre and power amplifiers. Models currently available include:

AMESON-COOPER TWIN 44 MONOBLOCKS
44 watts per channel based on Groove tubes 6L6 valves.
Retail price £1300.00 per pair.

For further information and your nearest stockist contact the Groove Tubes Hotline now.

Telephone: 0902.620156
Fax: 0902.620207

The Groove Tube Centre, Groove Tubes UK, 8 Barn Green, Bradmore, Wolverhampton WV3 7AY England.

SLATE AUDIO

Hi-Fi Design & Cable Services



THE SPEAKERSTAND Custom made to suit any loudspeaker. Solid slate, supremely rigid & totally stable. P.O.A.
"Immaculately finished, sublimely rigid, on a par with the best stands I've used."

Ken Kessler, Hi-Fi News/RR March '89
An astonishing degree of instrumental separation, stable and holographic, with great precision and remarkable poise. The ultimate in high fidelity supports." David Praker, Hi-Fi Answers Sept. '89
Superbly finished, the sound quality was considered to be first rate."

Martin Colloms, Hi-Fi News/RR May '90
"The sound quality when using the Slate Audio stands proved to be a revelation, something special." Paul Messenger, Hi-Fi Choice, May '91
"The finish is excellent, the sound quality magnificent and breathtaking." Tom Bryant, The Telegraph, June '92

The Finest Speaker Supports In The World

GARRARD 401/301 PLINTH SYSTEM With 20 years of experience, we are the leading experts on the 401/301. Our solid marble plinths transform these decks into world class beaters.

(Free servicing and fitting) £349 + £25 p/p

THE GLASSMAT A dedicated platter mat for the Garrard 301/401 that also works with all other turntables. Sensational, unbelievable, brilliant! £49.95 + £2 p/p

SME 309/3 12/IV/V With special graphics "Garrard 401 Celebration"
£568.39 £660.93 £827.20 £1232.49

THE TURNTABLESLAB Solid slate spiked turntable platform, can be placed anywhere with remarkable results. Size 17" x 14" £175.00

THE TABLESLAB Solid slate shelf which replaces any other shelf normally fitted to equipment racks, dramatically improving your turntable's performance. State size £125.00

THE SPIKEKIT Specially developed to fit directly to floor standing loudspeakers or any wooden support. Adjustable and very simple to fit. £20.00

THE STONESET Spike kit for use with stone, slate or marble only. Fully adjustable. £20.00

ALL PRICES INCLUDE PACKING AND FREIGHT UNLESS OTHERWISE STATED.

(U.K. MAINLAND)

I ENCLOSE A CHEQUE/P.O. for £ _____ made payable to SLATE AUDIO

Name: _____

Address: _____

Tel: _____

47 GEMINI CLOSE, LEIGHTON BUZZARD, BEDFORDSHIRE, LU7 8UD. TEL 0525 384174

The SPEAKER Company

For all your needs in DIY speaker and crossover construction

We offer a large range of speaker chassis and crossover components for hi-fi, car audio, public address & studio uses.

The Speaker Company also offers a range of specialist services.

Hi-Fi Chassis speakers, crossover's, cabinet kits, cable, cabinet damping materials, spike kits etc.

Car Audio chassis speakers, crossover's, sub boss cabinets and amplifiers.

Public Address chassis speakers, crossover's mixers, amplifiers, cabinets, microphones and stands.

Plus a comprehensive range of accessories

Chassis is speakers by

Audax, Seas, Morel, Rcf, Kef, Rcl, Richard Allan, Celestion, Eminence, Volt, Altai, Soundlab.

Precision devices, Macrom, Altec Lansing

Please phone or post for a copy of our comprehensive catalogue and price list which includes hints and tips on DIY loudspeaker constructions.

(only £1.00 Export £2.00 refundable upon purchase)

Unit 9, Waterside Mill, Waterside
Macclesfield, Cheshire SK11 7HG

Tel: 0625 - 500507

Fax: 0625 - 500508

All goods dispatched within 24 hours subject to availability
Open 9 am to 5.30 pm Monday to Friday & 10.00 to 4 pm Saturday

Aria. A new way to look at hi-fi support.

Introducing the Aria Modular Hi-Fi Support System. It can change the way you look at your components.

Build up separate vertical shelves. Or link units side by side. Either way, Aria lets you vary shelf heights to suit your components. Start with a Base Pack and go from there.

There's no limit to the number of ways you can build it up.

Not only does Aria give you more flexibility than any other hi-fi support system, it also provides positive sound deadening and decoupling benefits. With black tubular steel legs. Grey tinted glass or black MDF shelves.

And adjustable carpet-piercing spikes.

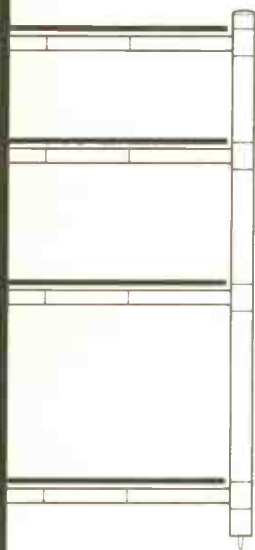

The Aria Support System. Hi-Fi will never look the same again.

I want a good look at the Aria system. Please send me a brochure.

Name

Address

Post code

APOLL
HI-FI FURNITURE

Our components improve yours

Zenith Crown Ltd., Tipton road, Dudley, West Midlands, DY1 4SQ Tel: 021 520 5070/1432

AN EXCLUSIVE

HI-FI DEALER

CAMBRIDGE HI-FI

FOR THE TOTAL EXPERIENCE IN HI-FI

B & W, BOSE, KEF, KENWOOD, MARANTZ,
MERIDIAN, ROTEL, TECHNICS, YAMAHA

AND MANY OTHER QUALITY BRITISH &
JAPANESE HI-FI PRODUCTS INC. TAPES
AND ACCESSORIES

VISIT OUR SHOWROOM FOR ADVICE & A DEMONSTRATION IN OUR DEMO ROOM

OPEN 9.30 - 5.30 6 DAYS A WEEK

1-3 HAWTHORN WAY, CAMBRIDGE

AMPLE CAR PARKING

CAMBRIDGE (0223) 67773



FAX NO. (0223) 353741



SEQUOIA DESIGN

Does your CD player sound dull, lifeless, fatiguing? Are you tired of the sound of your amplification system? If so, then you need a musicality injection!

Sequoia Design can provide an upgrading service for your whole system or individual separates.

CD upgrades from £161, amp upgrades from £149 pre-power combinations, cassette decks, loudspeakers all catered for.

All work is carried out by a highly qualified electronics design engineer with a passion for high quality music reproduction. All modifications are fully guaranteed and all money refunded if you are not satisfied.

**WRITE FOR DETAILS TO : JOHN CHEADLE
SEQUOIA DESIGN, CEFN-YDFA,
NEWBRIDGE-ON-WYE POWYS, LD1 6HT**

"WHERE SERIOUS MUSIC BEGINS"

V' audio

Hi-Fi Consultants

SYSTEM SYNERGY

As I constantly keep mentioning, the vital aspect of getting a system to sound superb is matching the various components. We spend hours checking what works with what, and sometimes the results surprise even us. An interesting case occurred this week while trying out the ISO and perception phono stages for a customer who used an Ortofon MC3000 II + AVI pre-amp + ATC 50's in active form. As it happened my 50's were in passive mode and my trusty old Denon 103D was in the arm, so I carried out a test and the perception won. Having then mounted an Ortofon MC3000 and put the ATC's into AC/VE and repeated the test - the ISO won - it was close, but it is so important to evaluate the right system.

Talking about passive ATC 50's, these really do sound superb; it's strange that in general everyone only seems to consider them as active speakers. I know there are some ATC dealers who have never even listened to a pair of passive 50's, but they should. They are more tolerant than the actives and if you've got good amplification well worth considering, but anyway work well with AVI or Heybrook amplification, at a similar cost to actives.

The AUDIO MECA MEPHISTO transport and TRICHORD RESEARCH PULSAR are now on PERMANENT DEMONSTRATION

36 Druid Hill, Stock Bishop,
Bristol BS9 1EJ.
Tel. Bristol 686005

fuller's audio

combining innovation with classic design

Truly musical amplifiers are few and far between, and whilst some believe that only valve amplifiers can offer this, it is the mode that the amplifier works in that has the greatest influence on the resulting sound.

For the ultimate in sound quality, true single ended class A operation is the only option. With only four active gain stages our a1 power amplifier also meets the requirement of the fewer components in the audio path the better the resulting sound will be. The total absence

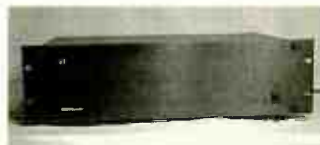

of the dry clinical sound and the racing ahead impression given by many semiconductor amplifiers convinced

some who have auditioned the a1 that they were hearing a valve amplifier, such is the sheer musical quality. To partner this excellent unit we have the pre1+. A hard wired line level pre amplifier with two



tape buffers, and the geni phono stage, a very low noise high gain unit which can be set to match any cartridge.

fuller's audio

20 Tunbridge Road, Southend-on-Sea, Essex SS2 6LT
Tel:- 0702 612116

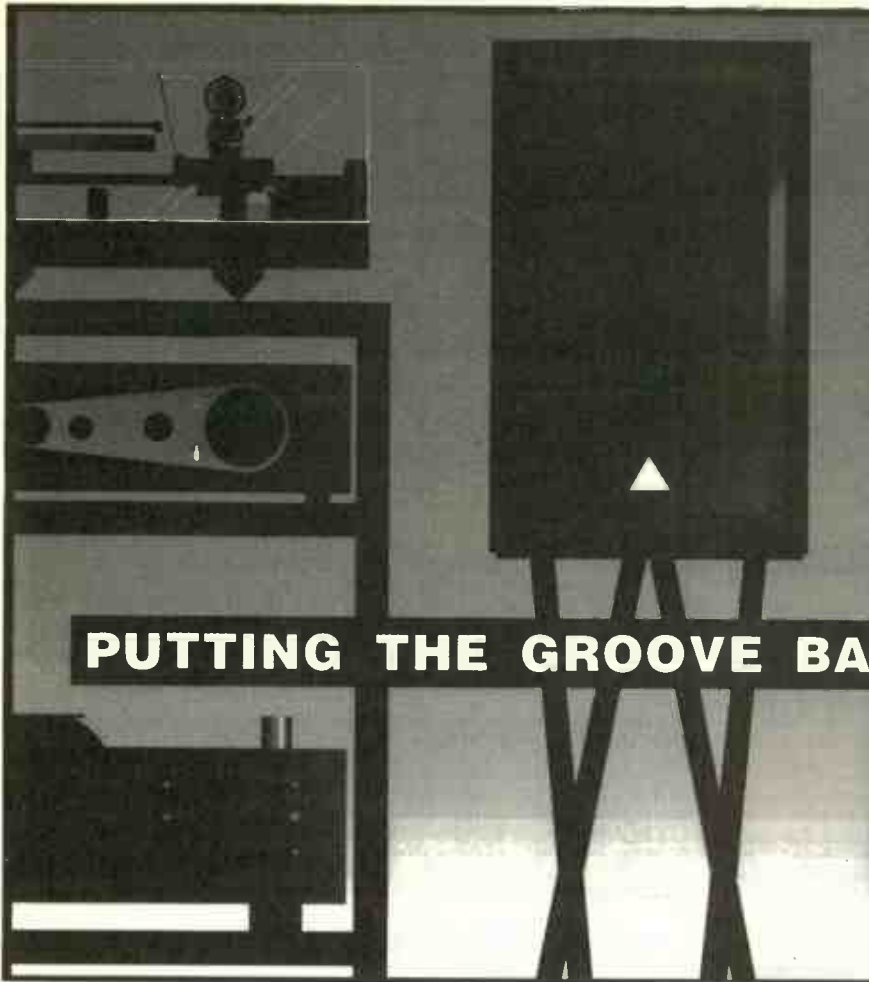

KRONOS

Extraordinary hi-fi for ordinary people.

That would sum up our approach to how we choose the products that we import and distribute.

Pro-ject turntables, *Audiomeca* analogue and digital disc players, *Triangle* amps and speakers, *Lieder* cables, *YBA* and *Arion* amplifiers.

Style, character, top class performance and value for money: another way to sum

PUTTING THE GROOVE BACK INTO MUSIC

For more information, contact

Kronos on: **08687-48632**

LORICRAFT AUDIO

Turntable Repair and Record Cleaning Service

Sale and Repair of Classic Hi-Fi Specialising in Garrard and Thorens

Manufacturers of high quality plinth systems. Review (copy available)

Electronic low distortion power supply and active power supply for Garrard 301/401 Thorens TD124

Re-manufactured spindle bearing and correct lubrication kit. Specifically designed for this type of bearing

Loricraft specialist services start at £5.00 for platter damper rings

**New Catalogue
now
available**

4 Big Lane, Goose Green,
Lambourn, Berks. RG16
&XQ. Tel. 0488 72267

**See us with Art
Audio at
Chesterfield**

Art Audio MAESTRO

"They are just so stunningly gorgeous and open to listen to, I can barely imagine anything more alluring"

NK Hi-Fi World, June '91

Valve amplifiers from £750 to £4150 Cables from £27 to £1700

Select Audio
Glasgow (041) 226 4268

Doncaster Hi-Fi Studios
Sunnyfields (0302) 731387

Paul Green Hi-Fi
Bath, Avon
(0225) 316197

Hazelmere Audio
High Wycombe, Bucks
(0494) 437892

Audio Venture
Banbury, Oxon (0295) 261863

The Hi-Fi Consultants
London (071) 380 0866
Evenings (071) 482 0003

Audible Difference
Diss, Norfolk
(0850) 983233 or
(0379) 740227

K.A.L. (UK) Ltd
Folkstone (0303) 245005

The Hi-Fi Consultants
Nottingham (0602) 232450

Impulse Audio Consultants
Westcliff-on-sea, Essex
(0831) 616426 or 0374 277736

Sound Academy
Bloxwich, West Midlands
(0922) 473499

New A4 brochure containing full details of our amplifier

and silver cable range contact

Art Audio (UK) Ltd., 130 Main Street, Calverton,
Nottingham, NG14 6LU

England UK
Tel. 0602 - 653604
Fax 0602 - 637795

the
neat
PETITE
A Little Giant

neat hi-fi

62 HIGH NORTHGATE,
DARLINGTON, CO. DURHAM DL1 1UW
(0325) 460812

AMADEUS SOUND & VISION

Aura, Audio Innovations,
Bang & Olufsen, Castle
Acoustics, Micromega,
Musical Fidelity, Nakamichi,
NAD, Pioneer, Quad, Royd,
Spendor, Technics.

10 BOLDMERE ROAD
SUTTON COLDFIELD
WEST MIDLANDS
Tel: 021 - 354 2311



Interest Free Credit Facilities



Demo room with A/V system set-up.

Are you making the right connections?

Send for Britain's biggest catalogue of
specialist cable and connections.

All available by mail order.

Phone 081-942124 or clip
the coupon for your Free copy.

CUSTOM CABLE SERVICE

PO Box 4007, London SW17 8XG

Please send me your FREE Custom Cable Catalogue

Name _____

Address _____

Postcode _____

NO FURTHER INFORMATION REQUIRED

Send to : Custom Cable Service
PO Box 4007
London SW17 8XG

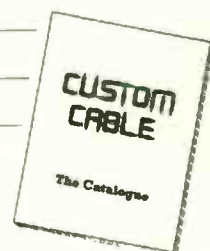

HFW/7/94

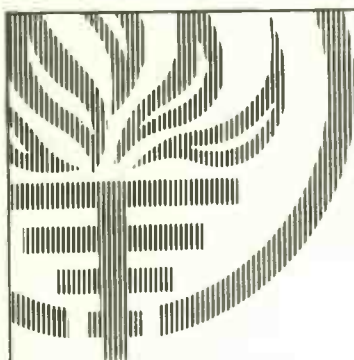

REFRESHINGLY DIFFERENT

the powerplant

CYRUS, REGA and ARCAM products now on demonstration

Roksan, Micromega, Audiolab, Rega, Arcam, Aura, Exposure, Marantz, ruark,
Epos, Thiel and other fine equipment

66 Upper North Street Brighton 0273 775978
Comfortable listening room, knowledgeable and approachable staff

DAN DULEY HI-FI

15 St. Georges Square,
Forest Gate,
London E7 8HN
Tel: 081 470 9795
(after 2pm.)

THE NEGUS is a complete studio quality monitor
system, with loudspeakers customised to suit your
room. LONG demonstration sessions possible.

NEGUS
Electronics:-

COMBINED
PRE-AMP AND
CROSSOVER

THREE
MATCHED
50W_{RMS} PER
CHANNEL
AMPLIFIERS

POWER PAK:-
SUPPLIES ALL
UNITS

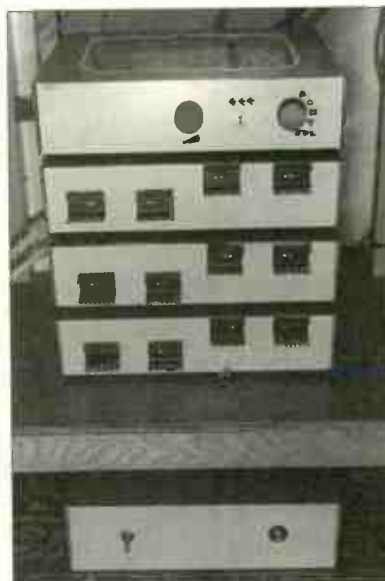

Lumley Reference

"FOR REAL MUSIC LOVERS"



'ST70 STEREO'



'M120 MONOBLOCKS'

FOR DETAILS OF WHY 'LUMLEY STANDS ALONE FOR TRUE

MUSICAL REPRODUCTION

HEATHFIELD

TEL: 0435 868004

CALL REFERENCE IMPORTS

SUSSEX

FAX: 0435 864481

THE MIDLANDS FIRST CHOICE FOR SPECIALIST HI-FI FRANK HARVEY HI-FI EXCELLENCE

THREE FLOORS - THREE DEMONSTRATION ROOMS
3000 SQ FEET IN THE PURSUIT OF HI-FI



For people who like Quad

THE FIRST CHOICE FOR THE BEST HI-FI SET AMIDST THE ELEGANCE OF OUR 14TH CENTURY SHOWROOMS

ON OUR FIRST FLOOR WE ARE NOW SHOWING THE LATEST DOLBY PRO-LOGIC AND SOUND PROCESSING PRODUCTS AVAILABLE FOR AUDIO-VISUAL SYSTEMS

MAKE FRIENDS AT FRANK HARVEY OUR KNOWLEDGABLE AND ENTHUSIASTIC STAFF ARE ALWAYS AVAILABLE TO ADVISE ON YOUR HI-FI REQUIREMENTS. AS MEMBERS OF THE BRITISH AUDIO DEALERS ASSOCIATION WE REALLY DO CARE. WE BELIEVE IN THE PRODUCTS WE STOCK AND THE AFTER SALES SUPPORT WE GIVE. WE BELIEVE THAT YOU OUR CUSTOMER ARE OUR MOST VALUABLE ASSET.

CAREFULLY SELECTED PRODUCTS

AUDIOLAB - AUDIO ALCHEMY - AUDIO - TECHNICA - ARCAM CAMBRIDGE - AUDIO QUEST ALPHASON - APOLLO - BEARD - BOSE - BANG AND OLUFSEN - CELESTION - CREEK - CYRUS - DENON - DUAL - FOUNDATION - GOLDRING - HEYBROOK - KEF - MARANTZ - MERIDIAN - MONITOR AUDIO - MISSION - MORDAUNT SHORT - MUSICAL FIDELITY - NAKAMICHI - NAD - PHILIPS - PIONEER - QUAD - REGA - ROGERS - ROTEL - SENNHEISER - SYSTEMDEK - TARGET - TRIPOD - TANNOY - THORENS - VAN DEN HUL - YAMAHA HOME THEATRE ETC

FROM CAREFULLY SELECTED AGENCIES

OUR PRICE PROMISE GARANTEE ENSURES THE BEST DEAL AT THE LOWEST POSSIBLE PRICE

FREE CARRIAGE UK MAIL ORDER
EXPORT SERVICE AVAILABLE

PART EXCHANGE SERVICE 2 YEAR
FULL GUARANTEES FULLY EQUIPPED
SERVICE FACILITIES 5 YEAR
EXTENDED GUARANTEES AVAILABLE

FRANK HARVEY HI-FI EXCELLENCE

163 MEDIEVAL SPON STREET TEL 0203 525200
FAX 0203 631403 COVENTRY CV1 3BB
ALL MAJOR CREDIT AND BANK
CHARGE CARDS ACCEPTED

INTEREST FREE CREDIT ON
SELECTED PRODUCTS
(WRITTEN DETAILS ON REQUEST)

APR 0%

FREE INSTALLATION AND DELIVERY SERVICE OPEN
MONDAY TO SATURDAY 9.30. FRI. 5.30 CLOSED ALL
DAY THURSDAY

HART

Hart Audio Kits - Your Value for Money Route to Ultimate Hi-Fi

2 Penylan Mill, Uswestry, Shropshire, England SY 1U 9AF
phone Uswestry (0691) 652894

Hart Audio Kits and factory assembled units use the very best audiophile components in circuit designs by the renowned John Linsley Hood to give you unbeatable performance and unbelievable value for money. We have always led the field for easy home construction to professional standards, even in the sixties we were using easily assembled printed circuits when Heathkit in America were still using tagboards. Many years of experience and innovation, going back to the early Dinsdale and Bailey classics gives us incomparable design expertise in the needs of the home constructor. The current range of Hart kits is designed to give you the important core components of a system as a matching ensemble of audio excellence

1100 Series. LH80W "Audio Design" Mosfet Power Amplifier.



Another masterpiece from the drawing board of John Linsley Hood and another opportunity to give a system mega sound performance for only a few hundred pounds cost. A host of advanced features, in the hands of the skilled designer, give this amplifier a performance that really is only equalled, not exceeded, by the 4 or 5 figure price tagged exotica.

As always with a HART kit you have the pleasure of building selected, state of the art equipment, allied to the knowledge that your money has all been spent on quality components, you save all the costs of building and testing, plus the dealers margin on top of these by doing it yourself.

To give an idea of the measures taken to achieve ultimate quality and linearity in this amplifier each of the four output devices is only called upon to work at one NINETY-SIXTH part of its ultimate power rating.

We are proud to offer this latest John Linsley Hood masterpiece, the flagship of our range, which we believe is truly the ultimate design for the perfectionist, combining as it does the best circuit design, the best engineering and the best components, surely the only recipe for REAL sound fidelity. The HART KIT concept also makes it possible to build an amplifier with the facilities YOU want and we offer no less than three variations with options on the basic theme to suit your needs. One of these versions will, we feel sure, cater for your requirements. Should your requirements change at a later date then upgrades or alteration to a different version are no problem, try doing that to your High St store amplifier.

The Standard version has a passive input selector circuit with Alps Precision Low-noise volume and balance controls, switchable CD, Tuner and Pre-amp inputs and an optional stereo bargraph output level display. The 'Slave' version has stereo power amplifiers and standard power supply. The 'Monobloc' version again has the standard power supply but since it is only driving one power amplifier higher than normal output power is achieved with total channel separation. The slave and monobloc versions enable very sophisticated bi-amping and active crossover systems to be constructed.

K1100 Complete STANDARD Amplifier Kit, two power amplifier channels and one power supply module, direct input passive signal selector stage, Construction Manual and RLH11 Reprint.
SPECIAL DISCOUNT PRICE FOR COMPLETE KIT IS ONLY **£395.21**
A1100 Factory Assembled **£499.21**

K1100S Complete SLAVE Amplifier Kit, as above but without passive input stage.
SPECIAL DISCOUNT PRICE FOR COMPLETE KIT IS ONLY **£333.62**
A1100SC Factory Assembled **£422.62**

K1100M Complete MONOBLOC Amplifier Kit, consists of all parts for one power amplifier channel and one power supply module and all chassis parts.
SPECIAL DISCOUNT PRICE FOR COMPLETE KIT IS ONLY **£261.20**
A1100M Factory Assembled **£329.20**

All HART kits are designed for easy home construction to the very highest standards, and can be built by anyone of average manual ability. If you are still not convinced how easy it is to build it yourself with a HART kit you can order the Instruction Manual to read for yourself and we will refund the cost when you buy your kit.

PROBABLY THE LAST VINYL PREAMP YOU EVER BUY.

For those who love the vinyl medium the listening pleasure can only be enhanced by using the very best phono preamplifier available. The Hart range of phono preamps feature a special shunt feedback circuit topology and are designed by John Linsley Hood. This circuit format gives audibly superior sound to the standard series feedback system normally used and gives a performance that will exceed or equal that given by the best of the mega priced offerings. Our range includes units to suit everyone from the occasional user to

the serious audiophile. All can be changed to suit moving coil or moving magnet cartridges at the flick of a switch.



K1500 Series. This is an integrated circuit version of the shunt feedback concept, using so little power that it may be run from batteries. An ideal "first kit" project as it is very simple to put together and no mains voltages are involved.

K1500 Complete Kit With Full Instructions (Battery Powered) **£73.76**
A1500 Factory Assembled **£118.76**

K1450 Features a totally discrete component implementation of the Shunt Feedback concept. Audiophile grade components fitting to an advanced double sided printed circuit board make this a product at the leading edge of technology that you will be proud to own. Nevertheless with our step by step instructions it is very easy and satisfying to assemble. Due to the higher current consumption this unit is powered by our mains driven K1565 Audio Power Supply, itself an advanced piece of technology in a matching case. This supplies the superbly smoothed and stabilised supply lines needed by the preamplifier and features a fully potted Hi-grade toroidal transformer along with a special limited shift earth for hum free operation. Suitable for all moving coil and moving magnet transducers this unit is especially recommended for, and will extract the very best from the modern generation of low output high quality transducers.

K1450/1565X. Complete RIAA Phono preamplifier, Power Supply and power connect cable **Kit form £196.29.**

1450/1565X Factory assembled & tested. **£285.29.**

ALPS PRECISION LOW-NOISE STEREO POTS

Now you can throw out those noisy ill-matched carbon pots and replace with the real hi-fi components only used selectively in the very top flight of World class amplifiers. The improvement in track accuracy and matching really is incredible giving better tonal balance between channels and rock solid image stability.

On the motorised versions the 5v DC drive motor is coupled to the normal control shaft with a friction clutch so that the control can be operated manually or electrically.

Our prices represent such super value for pots of this quality due to large purchases for our own kits.



MANUAL POTENTIOMETERS

2-Gang 100K Lin **£15.67**
2-Gang 10K, 50K or 100K Log **£16.40**
2-Gang 10K Special Balance, zero crosstalk and zero centre loss **£17.48**

MOTORISED POTENTIOMETERS

2-Gang 20K Log Volume Control **£26.20**
2-Gang 10K RD Special Balance, zero crosstalk and less than 10% loss in centre position **£26.98**

HC80 Replacement Cassette Head.



The excellent performance of modern cassette recorders depends totally on the quality of the R/P head. Even the slightest amount of wear can impair the frequency response and distortion levels. Our HC80 is a top quality head from one of the foremost manufacturers in Japan. It is easily fitted to most standard stereo recorders (except Sony) and will transform the performance over a worn head. Only the fact that we buy these in vast quantities enables us to offer them at the amazing price of **only £11.70** each or **2 for £17.60.**

SPECIAL OFFER

PRECISION Triple Purpose TEST CASSETTE TC1DD.

Are you sure your tape recorder is set up to give its best? Our latest triple purpose test cassette checks the three most important tape parameters without test equipment. Ideal when fitting new heads.

A professional quality, digitally mastered test tape at a price anyone can afford.
Test Cassette TC1DD

Our price only **£10.99.**

DISK-COUNT Classical CD's.

Top quality, Full Digital (DDD) Compact Disks of the great classical favourites. Like everyone else we didn't like the idea of paying silly prices for CD's. After a long search we have now located a source of top quality classical recordings at prices that make you suspect the quality - until you try them! Send for our list of titles.

TECHNICAL BOOKSHELF

Modern Books. Selected to represent the state of the art today.

"THE ART OF LINEAR ELECTRONICS."

J.L. Linsley Hood.
Just Out! Hot Off the Press, the definitive electronics and audio book by the renowned John Linsley Hood. This 300+ page book will give you an unparalleled insight into the workings of all types of valve and solid state audio circuits. Learn how to read circuit diagrams and understand amplifiers and how they are designed to give the best sound. The virtues and vices of passive and active components are examined and there are separate sections covering power supplies and the sources of noise and hum. As one would expect from this writer the history and derivation of audio amplifier circuitry have an entire chapter, as does test and measurement equipment. Copiously illustrated this book is incredible value for the amount of information it contains on the much neglected field of linear, as opposed to digital, electronics. Indeed it must be destined to become the standard reference for all who work, or are interested in, this field.

SPECIAL OFFER. With each book purchased you may request a **FREE** extended index, written by the Author, exclusively from HART.

0-7806-0868-4.

£16.95

Don't forget most of our kits have reprints of articles by John Linsley Hood that you can purchase separately.

"THE LOUDSPEAKER DESIGN COOKBOOK" Vance Dickason. (4th Edn.)

All the information you need to build the loudspeaker system you have always wanted but could not afford. Easy ways to pick the exact box size, the ideal drivers, and the correct way to feed the music to your new super loudspeaker system. Over 140 pages packed with important design data.

1991. 152 Pages.

0-9624-191-7-6

£19.97

"THE ART OF SOLDERING"

R. Brewster.
Absolutely essential reading for anyone who ever picks up a soldering iron. Written from knowledge gained in a lifetime in the field, this is the first book ever solely devoted to this essential and neglected skill for all electronic enthusiasts. Covers everything from the correct choice of soldering iron and solder to the correct procedures to follow with many illustrations and practical exercises.

£3.95

Classics from the "Golden Age"

"THE WILLIAMSON AMPLIFIER."

D.T.N. Williamson.

In April 1947, Williamson's power amplifier, using excellent quality push/pull output valves, a special output transformer, and a highly filtered power supply, become an overnight success. The author takes the reader deep into his design considerations, offering practical advice on how to build the units plus concise instructions on setting up the new amp. A cult classic.

1947, Reprinted 1990. 40 Pages.

0-9624-1918-4

£4.95

LOUDSPEAKERS; THE WHY AND HOW OF GOOD REPRODUCTION.

G.A. Briggs This easy-to-read classic, last revised in 1949, introduces the reader to concepts such as impedance, phons and decibels, frequency response, reponse curves, volume and watts, resonance and vibration, cabinets and baffles, horns, room acoustics, transients, crossovers, negative feedback, Doppler and phase effects, and much more. A provocative survey of the right questions about sound reproduction.

1949 Reprinted 1990. 88 Pages.

0-9624-1913-3

£6.95

Send or phone for your copy of our FREE list of these and many other Kits & Components. Enquiries from Overseas customers are equally welcome, but PLEASE send 2 IRCs if you want a list sent surface post, or 5 for Airmail. Ordering is easy. Just write or telephone your requirements to sample the friendly and efficient HART services. Payment by cheque, cash or credit card. A telephoned order with your credit card number will get your order on its way to you THAT DAY. Please add part cost of carriage and insurance as follows: **INLAND Orders up to £20 - £1.50, Order over £20 - £3.50. Express Courier, next working day £10. OVERSEAS - Please see the ordering information with our lists.**

QUALITY
AUDIO KITS

24hrs. SALES LINE
(0691) 652894

ALL PRICES
INCLUDE
UK/EC VAT

HART

The North West's
Big New

 naim
audio

Dealer

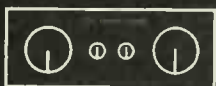

NAIM, RUARK, ROGERS, EXPOSURE, MF,
TANNOY DEFINITION, CREEK, MARANTZ, ROTEL,
TECHNICS, CASTLE, PRO-JECT, TEAC, PINK TRIANGLE.
5 Demonstration rooms.

Open: Mon-Sat 9.00am - 5.30pm
Closed: Wed.

The
Hi-Fi
Showrooms

12a West Street, Congleton,
Cheshire, CW12 1JR.
Tel (0260) 280017

Audio Physics

CleanLine • Modification for the **NAIM HICAP**

Would you believe that the already excellent sound of your NAIM equipment could be further improved?

If you use a HICAP to power your NAIM pre-amp we believe it can. By replacing the IC regulator in the HICAP with our special low noise CleanLine discrete regulator module.

By doing this our customers have found substantially improved clarity and transparency.

The CleanLine is £125 inc p&p, with a guarantee for 12 months and a full 30 day refund if not completely satisfied.

Phone Geoff Mead on 0895 637846 for full details

CLFARAUDIO, S.M.F. AUDIO RESEARCH, KRELL CHORD

HEATHERDALE AUDIO LTD.

Tel. 0903-261218 or 0860-660001

we are pleased to take your calls from 9am to 9pm
7 days a week.

CLEARAUDIO

PREMIUM ALPHONDEAR BRIDGES FOR SUPERIOR MUSIC REPRODUCTION.

"Right from the start the Gamma S was impressive, giving a strong 'solid' musical presentation that sounded very stable and secure".....
Jimmy Hughes, Audiophile April 1994.

EX. demo and used Hi-Fi on offer this month:

Krell KSA 50 S	£2795	Theta Basic CD	£1595
Krell KSA 100 S	£4295	Audio Innovations 300 amp	£295
Jadis Dely 7	£3495	Audio Innovations 200 amp	£295
Lumley Reference 120s	£2895	Audionote ANJs	£650
Martin Logan Quest	£3995	Audionote ANEs	£950
Martin Logan Aeries	£1795	Sonus Faber Minuetto's	£750
Sonus Faber Minima Amator	£995	Voyd/S.M.F. IV	£1995
PS Audio 200 Power amp	£895		

MAGNEPLAN, R, MARTIN LOGAN, SONUS FABER, AUDIONOTE

VOYD, GRAHAM, LUMLEY REFERENCE

THETA, KLIPSCH, APOGEE, COPLAND

Transfiguration, Wilson Benesche,
Magnum, Dynalab, Graham,

M.J.S. HI-FI

We at M.J.S. Hi-Fi are dedicated in the quest for excellence in the reproduction of recorded music.

You can be assured that we are not influenced by reviews and all the hype in Hi-Fi magazines. We devote time and patience when auditioning before we recommend and stock the product.

We feel very sad about the way in which most Hi-Fi equipment is chosen and sold. We offer a refreshing alternative to the norm:-

- * EXTENDED AUDITION TIMES
- * HOME AUDITIONS
- * HOME VISITS
- * OPEN DISCUSSIONS
- * TUNING SUGGESTIONS
- * EVENING AUDITIONS

AND ABOVE ALL COMMITMENT TO YOU AND YOUR MUSIC.
For More Details, Please Phone:

M.J.S. HI-FI
80 Stapleton Lane, Barwell, Leicestershire
LE9 8HE

Telephone: (0455) 846977
BY APPOINTMENT ONLY

Ortofon, CAT, Unistar, Sonic Link,
Pearl, Gamma, Moth

Lumley Reference, Nottingham Analogue, Townshend,
L.F.D., Helius, Silver Sounds, Cogan Hall

John Shearne, Concordant, S.D. Acoustics,
Diamond Acoustics, Origin Live, Basis, S.M.F.

KIMBERLEY HI-FI

A Sound Investment

• SEPARATE DEMONSTRATION ROOM •

BRANDS STOCKED: DENON • TECHNICS • KENWOOD • AIWA
• NAD • DUAL • CASTLE • GOODMAN'S • MARANTZ • MONITOR
AUDIO • HECO • ROTEL • PIONEER • REFERENCE POINT •
SOUTH LONDON'S & NORTH KENT'S ONLY



WE STOCK "NAD 702"
SEE REVIEW THIS ISSUE

193 BROADWAY, BEXLEYHEATH, KENT

081 - 304 3272

triode valve amplifiers

preamplifiers, single ended power amplifiers

designs, components, transformers

For further information and a catalogue send an SSAE to:
sjs electroacoustics

Ben-Dor, Lumb Carr Rd, Holcombe, Bury, BL8 4NN.

JORDAN WATTS ACOUSTICS LTD
201 MARE STREET LONDON E.5
PHONE 081 985 1646
FAX 081 986 0112



**A DESIGN NOT COPIED
 BUT A DESIGN COPIED
 PROBABLY THE BEST SOUND AROUND
 TO ARRANGE FOR A DEMONSTRATION
 SUPPLY DEALER'S NAME AND ADDRESS**

Transformers

Input and Output Transformers designed and manufactured to your requirements, at our OEM prices...

KT66 Single ended valve mono block power amps... **£250.00 pair**

Valve phone stages **MM.. £100.00**
MC.. £135.00

Valve phono stage design sheet, parts and price list.
 UK - £3.00 cheque or PO.
 Overseas - US \$5.00 in \$ bills only

The Garrard 301/401 power supply 100/130 volt setting.... £64.45

All units are fully assembled and tested.
 Prices include delivery and VAT
 2 week money back guarantee

SAE for data sheets

F&S Trading
31 Brooks Road
Sutton Coldfield
West Midlands B72 1HP
Tel/Fax: 021 - 321 3357

Credit Cards



Welcome
 24 hrs. delivery service



071 - 233 0774

Open: 10 - 6pm Mon-Sat
 10 - 9pm Thursday
 World wide tax free export

ENJOY THE MAGIC OF VALVES

Pure Natural Sound

0%
**INTEREST FREE CREDIT
 ON SELECTED ITEMS**



**Audio Innovation, E.A.R,
 Lumley Reference, Tube
 Technology, Conrad Johnson,
 D.D. Audio, Hi-Fi World Kit**

We Offer

- 24hrs. delivery services
- Part x-change
- Free three years warranty on selected product
- Home load
- Home installation
- Interest free credit
- We are located very new to Victoria main line underground station. One minute walk & open late 9pm (Thursday)

*We have in stock:
 Spendor • Quad • Royd • Triangle • KEF •
 Tannoy • Proac • Castle Speakers
 Please ASK for our special offer list*

CD Player From:- Quad • Micromega • Teac • Marantz • Rotel • AMC •
 Pioneer • Orelle Musical Fidelity
 Cassette Decks from:- Aiwa • Denon • Sony • Nackamichi • Harman • Marantz
 Amps From:- DPA • Orelle • Quad • Alberry • Musical Fidelity • Alchemist
 • John Shearn • Aiwa • Pioneer
 Turntables From:- Pink Triangle, Thoren, Alphason, Townsend Rock

*DACS from
 Pink Triangle • DPA • Kinshaw
 Orell • Musical Identity • Teac*

HI-FI CONFIDENTIAL LTD

34 Buckingham Palace Road, London SW1W 0RE (Victoria Station) Phone 071 - 233 0774 Fax. 071 - 233 7226

PIONEER

BEST PRICES GUARANTEED

KENWOOD

TANNOY

LICENSED CREDIT BROKERS ASK FOR DETAILS

LICENSED CREDIT BROKERS ASK FOR DETAILS

DENON

MISSION

ALL BILL HUTCHINSON HI-FI SHOPS ARE DEDICATED AUDIO VISUAL CENTRES

ALL BRANCHES ARE MAJOR LASER DISC STOCKISTS

YAMAHA



PIONEER

REFERENCE POINT

Bill Hutchinson

Hi-Fi • CD • Audio Visual Centre

THE PROFESSIONALS

When you purchase from Bill Hutchinson you're buying the best names in Hi-Fi from the best name for Hi-Fi.

Our Product Guarantee and Pricing Policy ensure you obtain an excellent deal.

My staff and I look forward to being of service to you.

Bill

YAMAHA DSP-A2070



- MARANTZ CD52 MK11SE - CD PLAYER - AWARD WINNER '93
- MARANTZ PM44SE - AMPLIFIER - AWARD WINNER '93
- MISSION 751 - SPEAKERS - AWARD WINNER '93
- SONY TCK-611S - CASSETTE DECK - AWARD WINNER '93
- SONY STS 311 - TUNER - AWARD WINNER '93
- AIWA NSX-360 - MINI SYSTEM - AWARD WINNER '93
- TECHNICS SC-CH950 - PRO-LOGIC SYSTEM - AWARD WINNER '93

PRICE PLEDGE

Should you find any local dealer offering a better price for goods currently in stock at Bill Hutchinson and the alternative quoting retailer, we will better that deal.

THE LARGEST SELECTION OF QUALITY HI-FI AND AUDIO VISUAL SYSTEMS

LEEDS

THE HEADROW

MANCHESTER

MARKET ST.

NEWCASTLE

WESTGATE ROAD

GLASGOW

BROOMBLAIR

EDINBURGH

OPEN 7 DAYS

26-28 WOODHOUSE LANE
0532-427777
OPEN MONDAY - SATURDAY
9.30AM - 6.00PM
THURSDAY LATE OPENING

50-52 DEANS GATE
061-832 1600
OPEN MONDAY - SATURDAY
9.30AM - 6.00PM
THURSDAY LATE OPENING

87A CLAYTON STREET
091-230 3600
OPEN MONDAY - SATURDAY
9.30AM - 5.30PM
THURSDAY LATE OPENING

43 HOPE STREET
041-248 2857
OPEN MONDAY - SATURDAY
9.30AM - 6.00PM
THURSDAY LATE OPENING

43 SOUTH CLERK STREET
031-667 2877
MON - SAT 9.30AM - 6.00PM
SUNDAY 11.00AM - 5.00PM
THURSDAY LATE OPENING

AKAI

PHILIPS

JVC

SONY

TECHNICS

ROTEL

ALL WITH 2 YEAR GUARANTEE

AIWA

“ We stock only
one hi-fi that
will suit you. ”



COLIN WELFORD

At Son et Lumière, we hold what we believe is the best audio solution at every price level from £800 to over £25,000.

So, you won't find us trying to confuse you with numerous hi-fi solutions. As far as we're concerned, we've only got one answer to your requirements.

And with our purpose built listening rooms, we make a point of inspiring you with a musical solution that will give unbridled listening pleasure.

Whatever your aspirations.

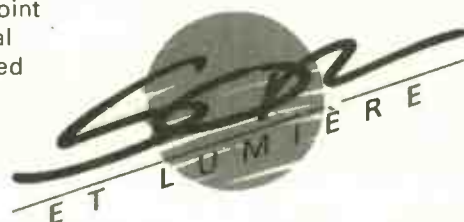

SON ET LUMIÈRE, 67 TOTTENHAM COURT ROAD, LONDON W1P 9PA. TEL 071 580 9059.

COURT & SPARK

**RHODIUM PLATED MK
MAINS PLUG FOR A
LONGER LASTING
CLEAN CONTACT.
SUPERIOR TO GOLD
RHODIUM WILL LAST
TEN TIMES LONGER!!**

13 Amp	£12.95
15 Amp	£14.95

Wall Socket	
Single	£20.95
Double	£30.95
I.E.C. Plug	9.95

(p+p included)

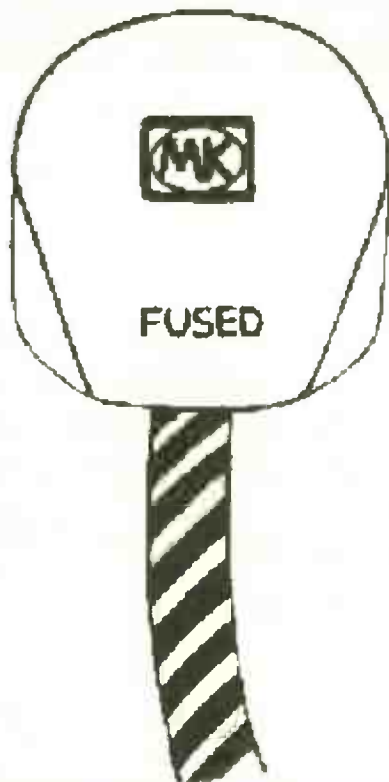

**TO ORDER SEND
CHEQUE/POSTAL
ORDER WITH NAME
AND ADDRESS MADE
PAYABLE TO:**

**T. WESTERMAN
41 GREVILLE STREET
HATTON GARDEN
LONDON EC1**

TEL. 071 - 242 2329

SOCKET 'n' SEE!

WANTED

We wish to buy all kinds of secondhand Hi-Fi equipment from budget to exotic, old or new, working or not, odd items or complete systems.

- TURNABLES -** Japanese, Linn, Rega, Thorens, Lenco, Garrard, Dual, Mitchel etc.
 Belt Drive, Direct Drive, Idler Drive, plus Tonerarms and Cartridges.
AMPLIFIERS - Small ones, Large ones, Good ones, Bad ones, Valve ones, Transistor ones.
 Japanese, Armstrong, Rogers, Leak, Quad, Meridian, Pre-Amps, Power-Amps etc.
RECEIVERS - Japanese, Goodmans, Leak, Armstrong etc.
TUNERS - Analogue ones, Digital ones etc.
CASSETTE DECKS - Single, Twins, Old Top Loaders etc.
REEL - REEL - Revox, Aiwa, Philips, Ferrograph etc. Reels of Tape
CD PLAYERS - Geriatric ones, Modern ones, Multibit ones, Singlebit ones.
SPEAKERS - Big ones, Little ones, Famous ones, Forgotten ones, Brown ones, Black ones, inc. Diamonds,
 Goodmans, Maxims, Celestion, Dittons etc.
 Bookshelf ones, Floorstanding ones, Drive Units, Crossover's.

JOB LOTS OF ACCESSORIES, DEALERS TRADE INS., CLEAR-OUTS, DISCONTINUED MOBELS, EQUIPMENT RACKS, CABLES, PLUGS, RECORD, TAPE, CD COLLECTIONS, GOOD, BAD, OLD, UGLY, BULKY, TINY, WORKING OR NOT.

LOUGHBOROUGH

HI-FI

38 BAXTER GATE, LOUGHBOROUGH, LEICS. LE11 1TQ
TEL. 0509 - 239521/236113
OPEN 9 - 5.30 6 DAYS.

LANGREX SUPPLIES LTD

DISTRIBUTORS OF ELECTRONIC VALVES, TUBES AND SEMI-CONDUCTORS AND I.C.S.

PHONE
081 684 1166

1 MAYO ROAD • CROYDON • SURREY CR0 2QP
24 HOURS EXPRESS MAIL ORDER SERVICE ON STOCK ITEMS

FAX
081 684 3056

A selection of our stocks of New Original Mullard - Brimar audio types made in UK.

STANDARD TYPES			SPECIAL QUALITY TYPES			
ECC88	MULLARD	6.00	E88CC - GOLD PIN MULLARD		8.50	
ECH81	MULLARD	3.00	ECC81 - M8162 / CV4024 MULLARD		6.00	
ECL86	MULLARD	3.50	ECC81 - 6201 / GOLD PIN MULLARD		8.50	
EF86	MULLARD	7.50	ECC82 - M8136 / CV4003 MULLARD		6.50	
EL84	MULLARD	6.00	ECC83 - M8137 / CV4004 BRIMAR		6.50	
GZ32	MULLARD	8.50	EF86 - M8195 / CV4085 G.E.C		10.00	
GZ34	MULLARD	12.50	AMERICAN TYPES GE.			
6SL7GT	BRIMAR	4.50	6146B.G.E	15.00	6L6GC G.E	12.50
6SN7GT	BRIMAR	4.50	6550A.G.E	17.50	12AX7A G.E	7.00
6V6GT	BRIMAR	4.25	7581A.G.E	12.00	12BH7A G.E	6.50
					12BY7A G.E	7.00

OPEN TO CALLERS MON.-FRI. 9AM - 4PM. CLOSED SATURDAY

QUOTATIONS FOR ANY TYPES NOT LISTED.

OVER 6000 TYPES AVAILABLE FROM STOCK

OBSOLETE ITEMS A SPECIALITY

TERMS C W O/VISA/ACCESS ETC...

P&P 1-3 VALVES £1.00, 4-6 VALVES £2.00 ADD 17.5% VAT TO TOTAL INC P+P

VISA



**“ We don't offer
comparisons.
Only absolutes. ”**

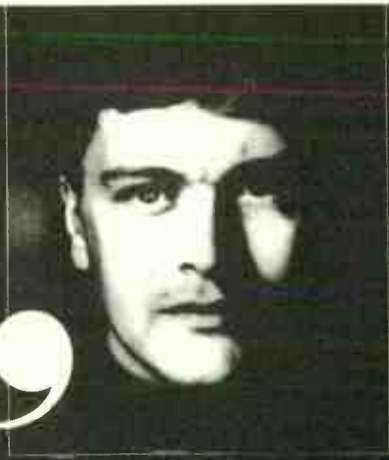

COLIN WELFORD

At Son et Lumière, you won't find us trying to confuse you with numerous hi-fi solutions. As far as we're concerned, we've only got one answer to your requirements.

We hold what we believe is the best audio solution at every price level from £800 to over £25,000.

With our purpose built listening rooms, we make a point of inspiring you with a musical solution that will give unbridled listening pleasure.

Whatever your aspirations.

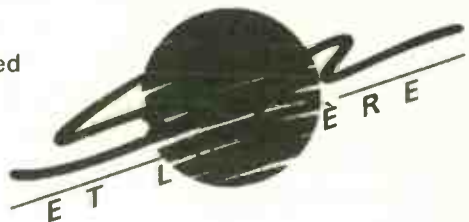

SON ET LUMIÈRE, 67 TOTTENHAM COURT ROAD, LONDON W1P 9PA. TEL 071 580 9059.

FOR THE BEST → **ADVICE**
→ **INSTALLATIONS**
→ **DEMONSTRATIONS**
→ **AFTER SALES SERVICE**

SPALDINGS

The South East's Leading Hi-Fi Specialists

352-354 Lower Addiscombe Road Croydon Surrey CR0 7AF

081 654 1231/2040

World favourites

COMPACT DISC PLAYERS

NAD 501	£180	A break from the MASH tradition, the Philips powered 501 gives excellent results.	Apr'94
DENON DCD 890	£270	Exciting and forceful sounding player, but slightly characterful	Nov'92
ROTEL RCD965 DIS	£350	A smooth and easy sound make this one of the best value players around.	Jan'94
QUAD 67	£790	A new breed of Quad. Lacking nothing in verve or excitement.	May'93
SUGDEN SDT I	£850	Airy and spacious with a rare quality of ambience.	Mar'93
NAIM CDI	£1598	Single box, 16 bit player. Close to the two box CDS, has vital 'tingle factor'.	Apr'92

COMPACT DISC TRANSPORTS

DPA DIGITAL T-1	£795	Superbly detailed sounding transport when sync-locked to DPA's converters.	Jan'93
ORELLE CD10-T	£799	Very involving, unforced and natural when used with Orelle's DA-180 DAC.	Feb'94
M'MEGA DUO CD.2	£1850	Seriously priced, serious CD using Philips' CDM-9 PRO mechanism. Exemplary.	Apr'93

DIGITAL TO ANALOGUE CONVERTERS

QED DIGIT/OPTO	£139/169	Excellent value, with no rough edges. Now with optical input (Opto).	May'92
DACULA	£376	This little devil from Select Systems really gets its fangs into the music.	Dec'93
DPA DACS	£450-2K	The current masters of DAC-7, their DACs offer superb performance at a range of prices.	
ORELLE DA-180	£599	'Analogue' sounding converter, best with matching transport.	Feb'94
P. T. ORDINAL	£695	Pure sound, smooth and free from harshness. One of the best at any price.	Jul'93
M'MEGA DUO PRO	£1050	Spacious and dynamic presentation, with a detailed and informative manner.	Apr'93
P. T. DA CAPO	£1450+	Pink Triangle's own one bit DAC reaches new standards in digital. One of the very best. Even better with DC supply and new filter options.	Mar'94

TURNTABLES

PRO-JECT 6	£350	Great involvement and rhythm. Comes with Ortofon MC15 for £399	Dec'93
MICHELL MYCRO	£397	In between the Syncro/Gyrodec, the Mycro has superb midband clarity and poise.	Apr'92
TOWNSHEND ROCK III	£799	The MkIII has a fabulously stable, solid image and terrific bass.	Feb'94
P. T. ANNIVERSARY	£1200	Very neutral turntable. Excellent imagery and detail.	May'92
SME MODEL 20	£2495	The last great turntable, bettered only by the £11,000 Model 30.	Oct'92

TONEARMS

REGA RB 300	£139	Simple and superb; dynamic with solid bass.	
SME 309	£568	Based on IV and V: Aluminium armtube and detachable headshell.	Jan'93
SME IV	£850	Looses little to the fabulous V, possibly the best value for money SME.	Dec'93
SME SERIES V	£1232	A masterpiece of precision engineering, with a cohesive sound.	May'92

CARTRIDGES

GOLDRING 1012 GX	£60	Rounded bass, slightly forward midband, clean transients. A bargain.	Jul'93
GOLDRING 1022GX	£80	Extra degree of dynamic range and speed over the 1012GX	Jul'93
SUMIKO BLUE POINT	£100	The Blue Point casts a romantic charm over all types of music. Robust too.	Oct'92
ORTOFON MC15	£100	Moving coil cartridge at a moving magnet price. Has a tight grip on rhythm.	Jun'92
GOLDRING 1042	£100	A reference to all other MMs regardless of price	May'92
GOLDRING ELITE	£200	British made moving coil. Good value, smooth and detailed.	Apr'92
ORTOFON MC2000	£650	We came across this one by accident; used on a Garrard 401 with an SMEIV it gave one of the best results we've ever heard.	Dec'93

CASSETTE RECORDERS

SONY TC-K611S	£330	A Dolby S bargain. All the gadgets necessary to produce great recordings.	Feb'94
NAKAMICHI DR2	£500	Worth every penny, pushes recordings to the limit and remains unflustered.	Feb'94
NAKAMICHI DRI	£780	Nakamichi sound quality, and manual head azimuth adjustment.	Jun'93
NAKAMICHI CR-7	£1500	No Dolby 'S', but auto tape tuning and motorised head. The Best!	Aug'92

TUNERS

NAD 402	£160	Stunning budget tuner, with a warm and open sound. Can compete with the best.	Jan'94
AURA TU-50	£230	Superb FM-only tuner. Produces a delightful, three-dimensional sound. A cracker.	May'92
YAMAHA TX-950	£260	Fine all-rounder, with good AM section.	Jul'92
MISSION CYRUS FM7	£299	Clear and lucid sound. One of the best, regardless of price.	Apr'94

World favourites

recommended products

H/K TU9400	£300	Fairly basic facilities, but sound which beats most at the price.	Jul'93
QUAD 66FM	£490	Among the very best in terms of tonal colour and imagery. Remote controllable.	Nov'92
NAIM NAT 03	£500	Warm and easy sound with a good sense of atmosphere. Good value.	Sep'93
NAIM NAT 01	£1377	The best solid state tuner currently available. For better radio, live in the studio!	Mar'92

INTEGRATED AMPLIFIERS

H/K HK6150	£159	Good sounding starter amplifier. Great dynamic range, excellent bass.	Jun 92
NAD 302	£160	Lots of insight and detail, but could sound a little rough in the wrong system.	Jan 93
PIONEER A-300X	£200	Exceptionally sweet mid and treble, plus the superb dynamic range of the A400.	Dec'92
DENON PMA-350II	£220	Powerful and with deep rhythmic bass drive.	Sep'93
H/K HK6550	£349	Thoroughly refreshing, tonally neutral amplifier with a realistic price tag	Nov'92
AUDIOLAB 8000A	£430	Very neutral and superbly built. Good bass, great imagery, but can be sterile.	Apr'92
J.SHEARNE. Phase2	£495	Gorgeous looks, even better sound. Tight, quick bass and valve-like mid and treble	Dec'93
MISSION CYRUS III	£499	Superb engineering, a solid cast chassis and a clear and spacious sound.	Apr'94
SUGDEN A21a	£639	Class A transistor amp. Sharp, crisp, deep, tight, and it images well too.	Feb'94
AUDIONOTE OTO	£1250	12w Valve amplifier. More in tune with music than hi-fi. Superb dynamic range.	Jun'92
EAR 834	£1295	Valve integrated amplifier with a sweet, open and detailed sound.	Feb'93

PRE-AMPLIFIERS

EAR.834P	£290	MM/MC phono stage. Uses valves to create a rich sound with tremendous depth.	Jan'94
A. Innovations. LI	£299	Valve line level preamplifier. Outstanding results with vdH carbon interconnect.	Feb'94
A. SYNTH. PASSION	£475	Or £275 for the kit version. Unrivalled transparency from a passive pre-amp.	Aug 93
ROSE RV23-S	£495	Valve/Transistor hybrid. Smooth and clean, rich and spacious.	Nov'93
DPA DSP 200S	£495	Not quite the 50S, but there's still nothing to match it at the price.	Jun'93
MICHELL ISO HR	£850	Impossible not to recommend. What more does your vinyl want?	May'93
NAIM NAC82	£2000	Remote control preamp. The NAC82 thrusts detail forwards in true Naim fashion.	Apr'94

POWER AMPLIFIERS

ROSE RP-190	£495	Used with the Rose pre-amp it gives 70 watts of smooth relaxing sound.	Nov'93
SUGDEN AU41P	£530	100 Watts of smooth, detailed, full bodied sound. And at a bargain price.	Apr'93
QUAD 606	£675	140W powerhouse. Smooth and civilized, with the legendary Quad back-up.	Aug'93
DPA DPA 200S	£750	Not as cold as the 50S. Better than anything else at the price.	July'93
MICHELL ALECTO (S)	£1300	Valve like transparency, big warm easy going sound.	Sep'93.
MICHELL ALECTOS	£1800	The Alectos have a lucidity and three dimensional realism that is rarely attained.	Dec'92
NAIM NAPI80	£898	Partner to NAC82. Has real drive and grip on loudspeakers.	Apr'94
CHORD SPM 1200	£2995	Massively powerful, dynamic and detailed sound. Among the best of solid state.	Mar'93
E.A.R. YOSHINO	£25,000	Single-ended valve design. Noel is still suffering withdrawal from this product.	Jul'93

LOUDSPEAKERS

R' ALLAN MINETTEII	£120	Fast and lively sounding, competent bass.	Sep'93
GLL MAXIM	£120	Replacing the Maxim 3; not as tight in the bass but still one of the best at the price.	Aug'93
MISSION 760iSE	£150	One of the best miniatures around, very musically involving.	Jan'94
HARMAN LS 0300	£200	Glass fibre woofer gives a forward and open mid with good bass kick	Nov'93
TDL RTL 2	£250	Bass on a budget. Solid, vibrant and spacious sound.	Dec'93
SYSTEMDEK 931	£300	Poor man's LS3/5a? Coherent and involving, these little gems really sing.	Mar'94
HARBETH HL-P3	£400	There probably isn't a more neutral sounding design anywhere near the price.	Feb'93
ROGERS LS8a/2	£449	Big, enjoyable, room filling sound from this 2-way floorstander.	Feb'94
REL STRATA	£499	REL's Strata offers excellent bass depth and power.	Mar'94
H'BROOK QUARTET	£555	Sensitive enough to work with low power valve amps. Fast and detailed sound.	Jul'93
JPW RUBY I	£500	Metal driver 'speaker with an exciting and lively presentation.	Aug'93
TANNOY D100	£650	Believable 3D images produced by this small dual concentric speaker.	Jan'94
PROAC Studio 100	£699	Excellent monitors with detailed, natural sound and plenty of atmosphere	Feb'94
SPENDOR SP2/3	£769	Smooth sounding speaker with a superb mid-range. Very easy to listen to.	Feb'94
PROAC RES I S	£918	Small box design. Can convey the spirit, drive, and passion of music.	Jul'92
TANNOY D700s	£1970	Dynamic and powerful. Needs a good clean power amplifier for best results.	Sep'93
TANNOY GRFM	£3500	Giant loudspeakers. Capable of awesome sound. Need good valve amplification.	Jul'92

SEVENOAKS SUPERFI

This advertisement is valid until at least 30th June 1994

Display, Demonstrations and After Sales

Unlike many of our competitors, all products (subject to availability) are on display and may be auditioned in dedicated listening rooms in any of our branches. Our helpful staff enjoy and understand the equipment they sell and will be only too happy to assist you through the Hi Fi choices that lie ahead. Our Sevenoaks Superfi service dept is one of the largest and best equipped in the business and will maintain your purchase

SUGGESTED SYSTEMS

The suggested systems priced below all include the popular NAD 5120 turntable but an alternative turntable or CD player is available at extra cost. Please see "OPTIONS" list below for further details.

SPEAKERS	JPW Sonata (V) Celebration I JPW Minim	Celestion 3 MK II JPW Sonata (W) Mission 760I	Tannoy 603 MK II Mission 760I SE Nad 800	Tannoy 605 MK II Celebration 5 MK II B&W DM600 Mission 761II Mon Audio I	Tannoy 607 MK II Celebration 7 MK II Nad 802	Rogers LS2A-2 B&W DM610 Mon Audio 7	Castle Durham II Heybrook HB173	Rogers LS4A-2 Tannoy 609 MK II
AMPS								
Technics SUV2220K	226.95	265.95	280.95	304.95	335.95	351.95	366.95	397.95
Nad 302 Kenwood KA3020 Technics SUV2320K	273.95	312.95	327.95	351.95	382.95	397.95	413.95	444.95
Harman HK6150 Technics SUA600K Marantz PM44SE	296.95	335.95	351.95	374.95	405.95	421.95	436.95	468.95
Nad 304 Pioneer A300X	319.95	358.95	374.95	397.95	429.95	444.95	460.95	491.95
Technics SUA700K	335.95	374.95	390.95	413.95	444.95	460.95	475.95	507.95

FREE
with suggested
Systems

- Cartridge (turntable based systems only)
- Speaker Leads (80 strand cable)

Turntables
Dual CS503.2
Dual CS505.4
Nad 533
Project 0.5
Technics SLBD22K
Thorens TD280 IV

Add £69
Add £99
Add £99
Add £49
Add £49
Add £99

CD Players
Aiwa XC300
Denon DCD595
Denon DCD695
Goodmans GCD360
Goodmans GCD650II

Add £29
Add £79
Add £99
Add £0
Add £9

Kenwood DP7050
Marantz CD52II
Marantz CD53
Marantz CD63

Add £249
Add £79
Add £169
Add £79
Add £139

NAD 501
NAD 502
Teac CDP3500
Technics SLPG440AK

Add £79
Add £99
Add £99
Add £59

Options
The following Compact Disc Player or Turntable may be ordered instead of the NAD 5120 in the above systems.

0% FINANCE - UP TO 12 MONTHS

We offer 0% finance on a wide range of Hi Fi separates. **Option 1:** 10% deposit followed by 6 equal monthly payments. Example: Cost £600. Deposit £60 plus 6 payments of £90. **Option 2:** 25% deposit followed by 9 equal monthly payments. Example: Cost £600. Deposit £150 plus 9 payments of £50. **Option 3:** 50% deposit followed by 12 equal monthly payments. Example: Cost £840. Deposit £420 plus 12 payments of £35. All options: minimum balance £400. Subject to status. 0% APR. Personal shoppers only. Written details on request.

HUGE FINANCIAL YEAR END STOCK CLEARANCE

We'd rather sell them than count them!
We're offering at least 10% and up to 30% off R.R.P. on products that are not already showing a discount. But hurry! This clearance ends 30th June 1994.



HIGH END AUDIO BOUGHT/SOLD EXCHANGED

	SALE		LIST
MARK LEVINSON ML7A PREAMP. MINT	2995	S/HAND	£6800
MARK LEVINSON NO26 PHONO BAL. MINT	495	E/DEMO	£8500
GOLDMUND REFERENCE TURNTABLE T3F ARM LATEST TYPE WITH ORIGINAL PACKAGING FANTASTIC. MINT	£11,995	S/HAND	£31,950
SOTA COSMOS VACUUM FLATTER SME V. MINT	£3,750	S/HAND	£5,300
WELL TEMPERED W/TAT TURNTABLE & ARM. MINT	£1,295	EX/DEMO	£1,995
GRAHAM MODEL 1 ARM SPARE ARMTUBE. MINT	£395	S/HAND	£2,350
MERIDIAN 602 TRANSPORT 606 DAC 7 LATEST. MINT	£2250	EX/DEMO	£3,100
CAMBRIDGE CD1 CD PLAYER HEAVILY MODIFIED WITH MASSIVE POWER SUPPLY SUPERB	£1,295	S/HAND	PHONE
METAXIUS ICARUS INTEGRATED AMPLIFIER CHROME. MINT	£595	EX/DEMO	£895
AUDIO RESEARCH SP15 REVISION A PREAMP BLACK	£3,495	S/HAND	£7,000
AUDIONOTE M7 SILVER PREAMP V.G.C.	£3,350	S/HAND	£8,000
PINK TRIANGLE PIP 2 MK2 VISHAY MODIFIED PREAMP. MINT	£1,795	S/HAND	£4,500
CONRAD JOHNSON MOTIF MC8 PREAMP V.G.C.	£895	S/HAND	£2,495
CARY CAD 5500S PREAMP PHONO & PROCESSOR. MINT	£995	EX/DEMO	£2,250
COUNTERPOINT SAIL LINSTAGE & SA9 PHONO GO BLOW YOUR MIND & WALLS! MEGA. V.G.C.	£6,995	S/HAND	£12,600
BURMESTER 808 MK3 PREAMP BALANCED. MINT	£3,995	S/HAND	£8,000
AUDIO RESEARCH D70 MK2 POWER AMP. MINT	£895	S/HAND	£1,929
AUDIO RESEARCH CLASSIC 150 MONO POWER POWER AMPS. MINT	£4,995	S/HAND	£12,000
COUNTERPOINT SA4 OTL MONO AMPS V.G.C.	£2,995	S/HAND	£8,000
MERIDIAN 605 MONO POWER AMPS BALANCED MINT	£1,550	EX/DEMO	£1,850
MARK LEVINSON ML2 REFERENCE MONO POWER AMPS. BALANCED SUPERB V.G.C.	£3,995	S/HAND	£15,000
MARK LEVINSON ML3 POWER AMP. MINT	£3,995	S/HAND	£8,250
MCINTOSH MC2500 POWER AMP. BLACK V.G.C.	£1,995	S/HAND	£4,500
NRG A201S POWER AMP BALANCED LATEST SPEC. MINT	£3,495	S/HAND	£6,600
NRG A 401 400 WATT CLASS A MONO POWER HOUSES BALANCED HIGH POWER WITH SEDUCTION V.G.C.	£5,500	S/HAND	£13,000
CONRAD JOHNSON MV75 VALVE POWER AMP. MINT	£1,295	S/HAND	£2,500
OCTAVE RESEARCH ORI POWER AMP. V.G.C.	£1,795	S/HAND	£4,500
MERIDIAN D6000 DIGITAL ACTIVE SPEAKERS STUNNING LOOKS AND SOUND TO MATCH. MINT	£5,750	EX/DEMO	£7,630
ACOUSTIC ENERGY AE3 SPEAKERS & STANDS. MINT	£995	EX/DEMO	£2,000
BATH TUB & SPONGES SIMILAR WATTS & PUPPIES WALNUT VERY INTERESTING V.G.C.	£2,995	EX/DEMO	PHONE
CELLO AMATI SPEAKERS TWIN MOUNTED PAIR IN OAK ON GRANITE STANDS SUPERB V.G.C.	£5,500	S/HAND	£20,000
CANON ESO SPEAKERS & STANDS BLACK MINT	£250	S/HAND	£400
APOGEE SCINTILLA 10 HM SPEAKERS ANTHRACITE GOOD	£1,250	S/HAND	£5,000
DYNAUDIO FACETTE SPEAKERS BLACK OR CHERRYWOOD MINT	£1,595	EX/DEMO	£2,619
DYNAUDIO CONSEQUENCE SPEAKERS FLAGSHIP MODEL IN CHERRYWOOD DYNAMIC DRAMA. STUNNING MINT	£10,250	EX/DEMO	£15,275
GALE 401 SPEAKERS & CHROME STANDS. BLACK GOOD	£395	S/HAND	£1,000
GENESIS 8300 SPEAKERS & STANDS PIANO BLACK. MINT	£1,395	EX/DEMO	£1,895
CABASSE BISQUINE SPEAKERS WALNUT MINT	£425	EX/DEMO	£580
MERIDIAN ARGENT 1 SPEAKERS PIANO BLACK MINT	£695	NEW	£995
MERIDIAN ARGENT 3 SPEAKERS ROSEWOOD MINT	£575	NEW	£875
MERIDIAN ARGENT 3 SPEAKERS ROSEWOOD MINT	£995	NEW	£1,495
PROAC PROSTATIC ELECTROSTATIC SPEAKERS RARE V.G.C.	£1,995	S/HAND	PHONE
SNELL A3 SPEAKERS WALNUT V.G.C.	£4,495	S/HAND	£8,995
STAX ELS F81 ELECTROSTATIC SPEAKERS OAK V.G.C.	£1,195	S/HAND	£3,890
EQUATION 2 SPEAKERS ROSEWOOD MINT	£1,395	EX/DEMO	£2,700
ART AUDIO VPL PREAMP GOLD MINT	£395	S/HAND	£730
BEARD BB100 MK2 VALVE INTEGRATED AMP MINT	£895	NEW	£1,300
ART AUDIO CONCERTO KT99 VALVE AMP. MINT	£895	S/HAND	£1,619
KRELL KSA-250 POWER AMP BALANCED MINT	£3,995	S/HAND	£6,899
SONUS FABER AMATOR SPEAKERS & STANDS WALNUT MINT	£2,250	S/HAND	£3,450
KRELL SA 100 MK2 POWER AMPS. MINT	£1,695	S/HAND	£3,500
APOGEE DNA & DAX VALVE SPEAKERS MINT	£6,995	S/HAND	£15,000
MARTIN LOGAN HCL25 CLUTH SPEAKERS OAK MINT	£3,995	S/HAND	£8,123
CARVER THE AMAZING LOUDSPEAKER PIANO BLACK V.G.C.	£1,395	S/HAND	£2,299
CAL TEMPEST CD PLAYER VALVE MINT	£995	S/HAND	£2,750
AUDIO RESEARCH SP9 MK2 PREAMP. MINT	£1,150	S/HAND	£1,850
MUSICAL FIDELITY MVT 2 PREAMP. MINT	£495	S/HAND	£1,100
METAXIUS IRAKLIS MK2 POWER AMP CHROME MINT	£995	EX/DEMO	£1,500
AUDIO RESEARCH D125 KT90 VALVES AMP. MINT	£2,250	S/HAND	£4,650
MUSICAL FIDELITY P270 MK2 POWER AMP. MINT	£695	S/HAND	£1,900
DNM 2A PREAMP PRIDUS POWER SUPPLY MINT	£295	S/HAND	£650
APOGEE CALIPER SIGNATURE SPEAKERS GREY MINT	£1,895	S/HAND	£3,998
SYNTHESIS REFERENCE SPEAKER SYSTEM ASH MINT	£3,995	S/HAND	£8,000
TDL MONITOR SPEAKERS TEAK MINT	£995	S/HAND	£1,995
AUDIOPLAN KOWTRAST 2 SPEAKERS ROSEWOOD MINT	£1,595	S/HAND	£2,800
AUDIO RESEARCH SP9 PREAMP SILVER V.G.C.	£995	S/HAND	£1,850
METAXIUS CHARISMA PREAMP CHROME MINT	£895	EX/DEMO	£1,400
MARK LEVINSON ML7 PREAMP MINT	£2,495	S/HAND	£5,800
PI HW19 TURNTABLE TRI PLANAR MK3 ARM	£1,995	S/HAND	£4,000
SME IV & V ARMS MINT FROM	£495 TO £800		
SONOGRAPHIE ATM AMPLIFIER MINT	£1295	S/HAND	£2,400
ARACON 204 POWER AMP MINT	£795	S/HAND	£1,300
DUNTECH CROWN PRINCE SPEAKERS PIANO BLACK MINT	£3,995	S/HAND	£8,500
EQUATION ZERO SPEAKERS PIANO BLACK MINT	£695	S/HAND	£1,300
MERIDIAN 208 CD PLAYER PREAMP 209 MINT	£995	EX/DEMO	£1,550
MERIDIAN 200 TRANSPORT 263 DELTA SIGMA MINT	£995	EX/DEMO	£1,290
MERIDIAN 206 DELTA SIGMA CD PLAYER MINT	£795	EX/DEMO	£995
CRYSTAL REFERENCE MK2 WITH ARTANGENT MINT	£3,495	S/HAND	£8,500
MARSANTZ LEZ CD PLAYER LTD EDITION BALANCED	£1,5495	S/HAND	£3,000
MARK LEVINSON ML12A PREAMP SUPPLY MINT	£995	S/HAND	£2,400
APOGEE DAX CROSSOVER MINT	£195	S/HAND	£4,500
SETA STAR SAPPHIRE 3 ETZ ARM MINT	£1,795	EX/DEMO	£4,000
QUICKSILVER PREAMP MINT	£1,250	NEW	£1,750
MERIDIAN 601 DSP PREAMP BALANCED MINT	£1,995	EX/DEMO	£2,750
MERIDIAN 208 MONO POWER AVA MINT	£795	EX/DEMO	£8,600
NESTROVIC NAI VALVE MONO POWER AMPS BALANCED	£2,995	S/HAND	£6,600
CARY 2A3 VALVE POWER AMP 15 WATT TRIODE MINT	£895	EX/DEMO	£1,400
CARY 300B VALVE MONO POWER AMPS 40 WATT TRIODE	£2,995	EX/DEMO	£4,800
THRESHOLD SA51 CLASS A MONO AMPS MINT	£4,495	S/HAND	£14,400
APOGEE SCINTILLA SPEAKERS GREY 10TH V.G.C.	£895	S/HAND	£1,345
SUMO ARIAS SPEAKERS OAK V.G.C.	£1,495	S/HAND	£2,995
SNELL A2 SPEAKERS WALNUT V.G.C.	£2,495	S/HAND	£4,995
NEW IN THIS MONTH			
OXFORD CRYSTAL REFERENCE TURNTABLE BLACK	£1,495	S/HAND	£2,495
AUDIO RESEARCH SP14 PREAMP BLACK MINT	£1,995	S/HAND	£3,300
AUDIO RESEARCH SP5 MK2 PREAMP SILVER WIRED MINT	£995	S/HAND	£2000+
MUSICAL FIDELITY 3A PREAMP MINT	£225	S/HAND	£400
RESTEK CHALLENGER INTEGRATED AMP. MINT NEW	£799		
RESTEK EXPONENT REFERENCE MONO BALANCED MINT	£7,495	EX/DEMO	£12,000
ROWLAND MODEL 3 MONO POWER AMPS. BALANCED MINT	£2,495	S/HAND	£4,000
DIAMOND ACOUSTIC REF 2 SPEAKERS & STANDS OAK MINT	£995	S/HAND	£2,250
MAGNEPLANAR 4.5 SPEAKERS OAK & BLACK MINT	£895	S/HAND	£1,900
B3 & ACTIVE 1 SPEAKERS OAK & STANDS VGC	£1,395	S/HAND	£1,400
BURMESTER 846 LINE PREAMP CHROME BALANCED MINT	£795	S/HAND	£1,650
MELOS 111 VALVE PREAMP. BLACK MINT	£895	EX/DEMO	£1,695
AUDIO RESEARCH LSI PREAMP SILVER MINT	£995	S/HAND	£1,797
MUSICAL FIDELITY 3B PREAMP MINT	£225	S/HAND	£425
TEAC P1 TRANSPORT D1 DAC BALANCED MINT	£2,495	S/HAND	£4,500
DENON DRM 30 MK3 HEAD CASSETTE DECK MINT	£1,65	S/HAND	£330
AUDIO RESEARCH CLASSIC 30 POWER AMP MINT	£1,595	S/HAND	£2,600
KEF 104.2 SPEAKERS WALNUT MINT	£795	S/HAND	£1,495
MARTIN LOGAN CLS 2 Z SPEAKERS. BLACK MINT	£2,495	S/HAND	£4,333
MIRAGE MI SPEAKERS PIANO BLACK BWIRE MINT	£2,995	S/HAND	£5,000
SOUNDLAB DYNASTAT HYBRID SPEAKERS WALNUT MINT	£1,995	S/HAND	£4,000
KENWOOD KAV 8500 AV AMP. MINT	£399	S/HAND	£700

"OODLES OF HIGH END CARTRIDGES AVAILABLE RING FOR DETAILS" MANY MORE ITEMS IN STOCK. EFFICIENT SERVICING DEPARTMENT. WE ARE LOCATED IN WELWYN, HERTS

ALL ITEMS GUARANTEED - ALL MAJOR CREDIT CARDS ACCEPTED RING FOR DETAILS AND DEMONSTRATION 0438 714038

Oxford Audio Consultants

HI-FI SPECIALISTS



Our superb service is the name, regardless of price.

THETA GENERATION VD/A CONVERTER

This is a revelation! State of the art performance at a new price point; perfect for both analogue and digital lovers!

NOW DEMONSTRATING

DENON DF10 - at last mini sized separates available separately
 AUDIO INNOVATIONA ALTO AMPLIFIER
 AUDIO RESEARCH D200/LS5/LS3 and their CD TRANSPORT
 THETA DATA BASIC and GENERATION V - redefines the state of the art at this price point; what's more it's just brilliant for both digital and analogue lovers!
 TEAC VRDS 710/20 AND 700 2 BOX SYSTEM - class transport systems with excellent sound
 ORELLE PRE/POWER AMP COMBO -
 DPA 200 SERIES PRE/POWER AMPS - A very nice small package.
 MICROMEGA STAGE - the new concept in upgradeable CD players
 AUDIO RESEARCH D200 POWER AMPLIFIER -
 BOSE LIFESTYLE SYSTEM
 RUARK EQUINOX LOUDSPEAKERS - Superb British craftsmanship.
 TDL RTL SPEAKER RANGE
 SME 20 TURNTABLE - top notch analogue built to last.
 MUSICAL FIDELITY F SERIES including the fabulous new CD PLAYER
 HEYBROOK SEXTETS AND QUARTETS on dem!
 COPLAND CTS14 - a bargain at £999
 AUDIO VISUAL SYSTEMS including PIONEER, LASERDISC, DENON, NAD, ROTEL
 AUDIO RESEARCH LSS - earth shattering!
 AUDIO RESEARCH CDT TRANSPORT - Simply brilliant.
 MICHELL GYRODEC - Try the latest power supply
 KRELL KSA 100S & KRC 2 (remote control) - Fabulous
 AUDIO RESEARCH LS2B & LS3 PREAMPS & V70 POWER AMP
 SONUS FABER - THE COMPLETE RANGE; WE LOVE THEM ALL!
 MARTIN LOGAN AERIUS - Stunning looks and sound
 REL STADIUM STRATA SUBWOOFERS AND STRATA SUBWOOFERS - at last no compromises
 VAN DEN HUL CABLES -including The First, Second and Revelation

EX DEM & P/EX BARGAINS

MERIDIAN 602/606 CD COMBO MINT £1750
 AUDIO RESEARCH LS2B EX DEM £2495
 AUDIO RESEARCH SP15 £2495
 MICRO SEIKI CDM 2 CD PLAYER £1295
 SONY 55SD/DAC702ES £350
 MUSICAL FIDELITY PRE3A PREAMP £195
 QUAD 303 POWER AMP £150
 HEYBROOK HB2 SPEAKERS £150
 STAX QUATTRO CD PLAYER £1595
 SEQUERRA MET 7 SPEAKERS NEW £495
 ORELLE CD 160 CD PLAYER £495
 RUARK TEMPLAR EX DEM £375
 AUDIO RESEARCH V70 EX DEM £3495
 ACOUSTIC ENERGY AE 1s EX DEM £550
 KRELL CD DSP CD PLAYER EX DEM £3495
 KRELL STUDIO DAC £3495
 THETA DS PRO PRIME £995
 NEAT PETITE SPEAKERS £395

Please ask for details or our current list

Agencies include: Accuphase, Acoustic Energy, Air Tangent, Apogee, Audio Alchemy, Audio Research, Audio Technica, Basis, B&W, Castle, Copland, Denon, Denon Cartridges, DPA, Dual, Goldring, Harmonix, Heybrook, HPW, Kimber, Koetsu, Krell, Lyra, Magnephanar, Magnum, Mandrake, Marantz, Martin Logan, Michell, Microomega, Music Fidelity, NAD, Nakamichi, Onix, Orelle, Ortofon, Pioneer, Proceed, PS Audio, QED, REL Subwoofer, Revox, Rogers, Roksan, Rotel, Ruark, SD Acoustics, Selsmic Sink, Sennheiser, Sequence, Sequerra, Slate Audio, SME, Sonus Faber, Stax, Target, TDL, Teac, Theta, Thorens, Van den Hul, Wadia, Wharfedale

TAX-FREE EXPORT SERVICE
 MAIL-ORDER AVAILABLE ON MANY ITEMS
 Open Mon-Sat 10am-6pm

Oxford Audio Consultants

Oxford Audio Consultants, Cantay House, Park End Street OX1 1JE
 Telephone: Oxford (0865) 790879 Facsimile: Oxford (0865) 791665

TREAT YOURSELF!

**DEM ROOMS AT BOTH BRANCHES
INSTANT CREDIT AVAILABLE**

Selected sounds from Alchemist, Aura, Boston, B&W, Cabletalk, Castle, Celestion, Denon, Exposure, Gyrodek, Harman Kardon, Heybrook, Marantz, Monitor Audio, Moth, NAD, Nakamichi, Rose, Rotel, Royd, Ruark, Systemdeck, Tannoy, TDL, Thorens, etc...

Export speciality
all major credit cards accepted



NORTHWOOD AUDIO HI-FI SPECIALISTS

126 Pinner Road
Northwood
Middx HA6 1BP
Tel: (0923) 820877

98 Cambridge Street
Aylesbury
Bucks HP20 1BA
Tel: (0296) 28790

VINYL & CDs

FROM THE RECORD CONNOISSEUR

WE CARRY THE FOLLOWING GREAT LABELS:

ALTARUS.....LP	KING SUPER ANALOGUE.....LP
ALTO.....LP	KAMEI.....CD
ANALOGUE	MAPLESHADE.....CD
PRODUCTIONS.....LP/GOLD CD	MOBILE FIDELITY...LP/GOLD CD
ATHENA.....LP	ORIG. JAZZ CLASSICS.....LP
AUDIOQUEST.....LP/CD	POP/ROCK.....LP/CD
BLUE NOTE (JAPAN).....LP	PROPRIUS.....LP/CD
CHESKY.....LP/CD	REFERENCE.....LP/CD
CBS MASTERSOUND..GOLD CD	RYKO.....LP
CONCORD AUDIOPHILE.....LP	SHEFFIELD LAB.....LP/CD
DCC.....GOLD CD	VITAL.....LP/CD
DECCA (180 GM HQ).....LP	WATER LILLY.....LP/CD
ENJA (180 GM HQ).....LP	WILSON.....LP/GOLD CD
GRP JAZZ.....LP	
JAPANESE PRESSINGS.....LP	SUMIKO & LYRA CARTRIDGES
JAZZ IMPORTS.....CD/LP	NAGAOKA SLEEVES

For a Free 50-page Catalogue send a £2.00 stamp to
PO Box 132, Wokingham, Berks, RG11 4NG.

Free to overseas customers

Tel/Fax 0344 780262



RECORDS WANTED

Paying up to £100 each for Classical LPs on Decca SXL, EMI ASD Columbia Sax, Mercury SR, RCA SB. **Top prices paid for** Mobile Fidelity, Nimbus Supercuts, Nautilus, 1/2 Speed Master, Japanese Pressings, Rock, Pop, Jazz, Folk, Blues & more.



The
Audio Room
Pure Sound



For High End Hi-Fi

0784 458176/ 081 893 4485

You can audition any of these products in your own home or in any of our three permanent demonstration rooms.

Audio Note Oto SE	Micromega T/Dac, T/Drive
Audio Note Soro SE	Ortofon cartridges
Audio Note DACs	Project Turntable
Audio Note speakers	Townsend Rock III
Arion valve amps	Transfiguration Cartridge
Audio Innovations Alto	Triangle T60 amp
Audio Innovations valve range	Triangle Alcante, Icare, Scalene
Audiomeca Mephisto/Kreatura	Trilogy 958 monos, /stereo/ pre
Basis turntable	Wilson/Benesch turntable/arm
Graham Tonearm	YBA amps, CD players
Impule H2, H5, H6, H7 speakers	Apollo stands
Kinshaw amps, phono, DAC	Base stands/platforms
Lumley Reference 120s /ST70	Frameworks stands
Lumley Monitor speakers	Seismic Sink
Magnum Dynalab FT101 Etude	Cables: Audio Note, Cogan Hall,
Micromega Stages	Silver Sounds, Lieder, XLO

Ex-dem & p/ex bargains:

Item	Sale
Jadis JP80 MM	3200
Audio Innovations L2 preamp	499
Audio Innovations 2nd Audios	1999
Manley 350 monoblocs	2999
Pink Triangle PIP2 c/w battery pack	1599
YBA 3 Power/2 pre	1999
Trilogy 858 100w monoblocs	1799
Trilogy 901 preamp	599
Trilogy 902 preamp	1099
Lumley 120s	2499
Apogee Scintillas (4/1 ohm)	999
Kef 107/2 as new	1799
Kef 105/3 as new	1499
Ensemble PA1 ref. (Piano Black)	2199
Snell Type E's	599
Impulse H1	1699
Triangle Icare	1199
Triangle Alcante	850
Triangle Scalene	550
YBA CD2 player	2150
T/Dac T/Drive	1999
Audiomeca Kreatura player	999
Proceed PIP PDT2	2200
Theta DS pro-prime (as new)	850
Gyrodec Zeta arm	625

AUDIO NOTE ACIO & CLORIDE FREE SILVER SOLDER

The best solder we have been able to find, does not contaminate the junction, which over time increases junction resistance. Used in all our amplifiers from OT0 to the GAUKU-0N.

Weight/Measure	Price Ex. UK Vat
50 grammes or about 8 meter 1 mm diameter	19.95
1 kilo roll of 1 mm diameter	210.65

AUDIO NOTE CABLES & WIRES

We are proud to offer the **AUDIO NOTE** range of high quality copper and silver coax, speaker and wiring cables, which, depending on the overall price of the project, will do justice to any HiFi system, regardless of price.

Solid 99.99% Pure AUDIO NOTE Silver Wire	Insulation Material	Price per Meter Ex. UK Vat
Gauge		
1.0mm	Polyurethane	16.75
0.6mm	Polyurethane	22.75
0.35mm	ML	24.95
0.6mm	ML	27.85
0.8mm	ML	31.75
1.1mm	ML	36.75

The above solid silver wires are suitable for inductors for speaker crossovers, both active and passive or for internal wiring in tonearms, amplifiers etc.

AUDIO NOTE Coax Interconnected Cables

Type/Colour code	Construction	Price per Stereo Meter Ex. UK Vat
AN-A yellow	symmetrical 6N copper litz coax	15.32
AN-C red	symmetrical 6N copper litz coax	29.79
AN-S dark grey with yellow stripe	symmetrical 99.99% silver litz coax	84.25
AN-V silver grey with yellow stripe	symmetrical 99.99% silver litz coax	152.35
AN-Vx silver grey	symmetrical 99.99% silver litz coax	382.98

It is recommended to use the internal twin silver wires in the **AUDIO NOTE** coax cables as internal wiring cable, this is what we do in amplifiers like the OMSAUKU, M7TUBE etc.

AUDIO NOTE Speaker & Wiring Cables

Type/Colour code	Construction	Price per 100m Meter Ex. UK Vat
AN-O green	single core 6N copper speaker wiring	6.85
AN-B blue	double strand, screened 6N speaker wire	12.34
AN-L blue	double strand, screened 6N litz copper speaker wire	25.11
AN-SP silver	single core 15 strand 99.99% litz silver speaker wire	106.38
AN-SPx silver	single core 20 strand 99.99% litz silver speaker wire	382.98

PTFE Insulated Silver Plated Copper Wires
We can also provide less expensive wiring wires for hard wiring circuits, these PTFE insulated silver plated copper wires are 19 strand of 0.15 mm wire and come in brown, black, blue, pink, red, green, violet, white and red/white, they cost £1.60 per meter in any colour.

AUDIO NOTE HIGH QUALITY STEPPED ATTENUATORS & SWITCHES

These handmade attenuators and switches are manufactured by a friend of Mr. Kondo of **AUDIO NOTE**, and represent the best available volume controls and switches you can use in your pre-amplifier, the attenuator is 48 steps and with silver/niobium plated contacts/bushes made with an array of tantalum film resistors. The switches feature silver plated contacts and self cleaning action.

Type	Value	Price Ex. UK Vat
Stereo Potentiometer /Attenuator	50K Ohms	198.75
Stereo Potentiometer /Attenuator	100K Ohms	207.75
2 Channel switch	6-way adjustable	78.75
4 Channel switch	6-way adjustable	101.75

AUDIO NOTE SELECTED AUDIO VALVES

Our valves are selected from the best available sources and are tested to the same stringent standards that we apply in the production of our own amplifiers, they fall into two categories, standard production items and rare, mostly NOS (New Old Stock) valves which are no longer in production. We have compiled a special list of the NOS items, which is available on request, beware the valves on this list are NOT cheap Standard Stock items.

Type No.	Type	Price Ex. UK Vat
ECC83/12AX7	double triode	2.95
6X4	double triode	3.95
6BE6/6Z5/7Z79	pentode	2.45
ECC82/12AU7/581 4a	double triode, mil spec	1.75
6SN7GT	double triode, URX base	2.85
65L7GT	double triode, URX base	1.75
65J7	pentode	4.55
5687WA	double triode very powerful	4.75
6350VA	double triode	1.55
EL84/6BQ5	small power pentode	4.75
EL84M/6BQ5WA	small power pentode, mil spec version	4.75
6V6GT	small power pentode	2.45
6L6G	medium power pentode	2.75
5881/KT66/6L6WG	medium power tetrode	4.95
EL34G	power pentode	7.45
6550/KT88	large power tetrode	12.45
6C33	powerful regulator, indirectly heated triode	24.65
6AS7/6080	strong regulator, indirectly heated triode	6.45

Type No.	Type	Price Ex. UK Vat
2A3 4-pin	directly heated small power triode	17.95
300B	directly heated power triode	57.95
5U4G	HT-rectifier	3.25
5Y3GT	HT-rectifier	2.25
5Y4GT	HT-rectifier	2.25
GZ34/SAR4	HT-rectifier	8.75
6X4	HT-rectifier, very good for pre-amplifiers	2.65

RESISTORS
Beyschlag
We offer three quality levels of resistor quality, all are 1%, starting with the Beyschlag metallfilm, which are usually 1% (as are the vast majority of other makes of metal film resistors), but nonetheless very good sounding as used in all our UK-made amplifiers, up to quality level 3 (the MEISHU/P3) no-feedback triode amplifiers

HOLCO
Better sound quality can be achieved with the H2, 1 watt, 1% non-magnetic resistors, which we regard as the best "industrial grade" metallfilm resistors available. They have one small drawback, as they are quite fragile, and require careful handling, do not bend the legs too close to the body, they may become noisy.

HOLCO resistor type H2 50PPM cost £0.36 each from 1000hm to 500Khm, higher and lower values are all £0.63 each.

AUDIO NOTE HIGH QUALITY CERAMIC VALVE BASES.

All of our valve bases are of the highest possible quality, made from stainless steel and using the best metal parts from alloys which retain their spring tension around the valve pin for longer. They are recommended as upgrades to most old valve amplifiers and should be an essential part of any OIY project.

Type	Mounting	Plating	Price Ex. UK Vat
4-pin UXX for 300B/2A3/801A	Chassis	Gold	8.25
4-pin UXX for 300B/2A3/801A	Chassis	Nickel	7.25
4-pin UXX WE-type for 300B/2A3/801 A	Chassis	Silver	14.75
4-pin jumbo 4 for 21 UV4C/845	Chassis with bayonet	Silver/chrome	159.95
5-pin UY5 for 80U	Chassis	Gold	8.75
7-pin B7 for 6X4, DA2	PCB	Silver	6.16
7-pin B7 for 6X4, DA2	PCB	Gold	6.16
7-pin B7 for 6X4, DA2	Chassis from above	Silver	7.95
7-pin B7 for 6X4, DA2	Chassis from above	Gold	7.95
8-pin UXX for EL34, 6550, 5U4G			
GZ34, 6L6G, etc.	Chassis	Silver	5.65
8-pin UXX for EL34, 6550, 5U4G			
GZ34, 6L6G, etc.	Chassis	Gold	8.65
9-pin B9 for ECC83, ECC88, 5687, 6350, etc.	PCB	Silver	3.85
9-pin B9 for ECC83, ECC88, 5687, 6350, etc.	PCB	Gold	5.75
9-pin B9A for ECC83, ECC88, 5687, 6350, etc.			
9-pin B9A for ECC83, ECC88, 5687, 6350, etc.	Chassis from above	Silver	4.45
9-pin B9A for ECC83, ECC88, 5687, 6350, etc.	Chassis from above	Gold	6.75
9-pin B9A for ECC83, ECC88, 5687, 6350, etc.	Chassis from below	Silver	4.95
9-pin B9A for ECC83, ECC88, 5687, 6350, etc.	Chassis from below	Gold	7.15

TOPCAPS

Topcap For 80U pentode etc. Nickel 9.75 You may want to start your project with less overall cost, and for this purpose we can offer the following "industrial grade" ceramic valve bases

Type	Mounting	Price Ex. UK Vat
8-pin for EL34, 6550, KT66, 6L6G	Chassis with bracket	1.45
9-pin for ECC83, ECC88, 5687, 6350	Chassis with shroud	1.85

AUDIO NOTE CERAMIC STAND-OFFS

In most hi-fi audio valve power amplifiers it is frequently difficult to get the HT and heater rails properly suspended and separated, safely and neatly from the chassis, this especially applies when building amplifiers using the really high voltage directly heated triodes like 211, VT4C, 845, 849, 304TL, 0A100 etc. When planning design like this, it is important to incorporate suitable layout from the start and the **AUDIO NOTE** stand-offs should be more or less mandatory in that context. They are screw-in type with stainless insulator and either a wrap-round turned "head" on the single way version or separated solder slots on the multi-way versions

Type No.	Number of Tags	Height/Length	Solder Connection	Chassis Fixing	Price Ex. UK Vat
AN-421	1	25.5 mm	Wrap-round	Screw-in bolt	1.41
AN-422	1	17.4 mm	Wrap-round	Screw-in bolt	1.41
AN-423	1	22.6 mm	Solder slot	Screw-in	1.41
AN-452	2	Adjustable, 17mm	Solder slots	Dual bolt screw-in	2.42
AN-453	3	Adjustable, 24mm	Solder slots	Dual bolt screw-in	3.05
AN-455	5	Adjustable, 32mm	Solder slots	Dual bolt screw-in	4.04
AN-458	8	Adjustable, 58mm	Solder slots	Dual bolt screw-in	5.79
AN-460	10	Adjustable, 72mm	Solder slots	Dual bolt screw-in	7.31
AN-476	6	25mm/45mm	Solder slots	Screw-in bolts	5.35
AN-479	9	25mm/60mm	Solder slots	Screw-in bolts	7.53

BLACK GATE ELECTRON TRANSFER, High Performance, Graphite Electrolytic capacitors

These are very low audio parts that provide a guaranteed improvement when replacing practically any other part, but this is what the **BLACK GATE** capacitors actually do. Exchanging any electrolytic capacitor anywhere in the circuit of an amplifier or in the crossover of a speaker will greatly improve sound quality. We are working on some guidelines also where, how and which type of Black Gates to use in different circuits, the first such technical guideline is available now and is called "improving your CD-Player" and can be obtained by sending a stamped addressed envelope to us requesting this leaflet. All **AUDIO NOTE** Level 2 Signature products use **Black G-1-Electro Transfer** in critical signal/power junctions.

It is very important to note that all **BLACK GATE** capacitors take time to charge-up or stabilize when first put in circuit, depending on type and application this "maturing" time can be between 100 and 300 hours

Value	Voltage	BG-Type	Suggested Use	Price Ex. UK Vat
47mF	25volt	PK	Anywhere	1.55
33mF	35volt	PK	Anywhere	1.75
47mF	50volt	PK	Anywhere	1.05
1mF	50volt	PK	Anywhere	1.12
2.2mF	50volt	PK	Anywhere	1.23
3.3mF	50volt	PK	Anywhere	1.38
4.7mF	50volt	PK	Anywhere	1.68
10mF	50volt	PK	Anywhere	1.87
22mF	50volt	PK	Anywhere	2.68
100mF	50volt	Standard	Anywhere	5.47
1000mF	100volt	Standard	Anywhere	7.75
1000mF	160volt	Standard	Anywhere	8.22
2200mF	50volt	Standard	Anywhere	24.55
4700mF	160volt	Standard	Anywhere	4.35
4700mF	160volt	Standard	Anywhere	6.35
2200mF	50volt	Standard	Anywhere	13.45
10000mF	80volt	Standard	PSU smoothing	234.65
4700mF	160volt	Standard	Anywhere	92.65
47mF + 47mF	500volt - 550v surge	SK-Type	PSU filter capacitor	85.95
1000mF + 1000mF	500volt - 550v surge	SK-Type	PSU filter capacitor	72.75
100mF	350volt - 400v surge	SK-Type	PSU filter capacitor	92.65
220mF + 220mF	100mF-350volt - 400v surge	SK-Type	PSU filter capacitor	75.35
100mF + 22mF	350volt	VR-Type	Decoupling or filter capacitor	18.95
22mF	160volt	F-Type	Low ESR version	6.75
220mF	160volt	FK-Type	Ultra low ESR version, comparable to film caps	9.95
1000mF	50volt	FK-Type	As above use anywhere	49.95
220mF	50volt	FK-Type	As above use anywhere	98.85
2.2mF	50volt	C-Type	For circuits with DC potential difference	2.07
4.7mF	50volt	C-Type	For circuits with DC potential difference	3.35
50volt	N-Series		Bipolar for use in negative feedback circuits etc.	4.95
50volt	N-Series		as above	5.75
50volt	N-Series		as above	6.56
50volt	N-Series		as above	13.75
50volt	Bipolar		For loudspeaker crossover networks	18.95
50volt	Bipolar		as above	8.95
50volt	Bipolar		as above	10.85
50volt	Bipolar		as above	17.45
50 volt	Bipolar		as above	27.95
6.3volt	BG-N-Type		For super low noise PSUs	11.85
160volt	BG-N-Type		For super low noise PSU's	24.65
160volt	BG-N-Type		as above	28.95
35volt	BG-N-Type		as above	210.45
50volt	BG-N-Type		as above	6.55
50volt	BG-N-Type		as above	89.95
2200mF	BG-N-Type		as above	423.35

In our component list you will find a listing of all available Black Gate valves, together their sizes, best usage etc. Lastly, we can supply a range of more modestly priced components, still good quality, but more industrial grade, if you like.

SHINKOH Tantalum Film Resistors.

This is definitely the best sounding resistors available, forget the VISHAY, which may be ok in high feedback transistor amplifiers, but in our opinion quite uncompromisingly to the qualities of real Audio Amplification (i.e. directly heated triode amplifiers running feedback free in single-ended Class A), this is where you will need the tantalum film resistor for the best results.

The 1/2 watt Shinkoh tantalum resistors are non-magnetic and cost £0.05 each

AUDIO NOTE 1 WATT TANTALUM RESISTORS

Up to now the tantalum film resistors have been extremely difficult to get, however, after much persuasion and against a minimum quantity guarantee from **Audio Note UK** the manufacturers have agreed to widen the range of 1/2 watt and reintroduce the 1 watt range which becomes an exclusive range for **AUDIO NOTE**, we consider this to be a major breakthrough, since without a reasonable range of values at the 1 watt mark it is pretty difficult to get the very best out of the best circuits. As with most handmade specialist items, which covers most on this list, delivery can be quite long on some values, so be prepared to wait if the value is not in stock.

The **AUDIO NOTE** 1 watt 1% tantalum resistor values are £3.70 each

We shall now be working on getting the 2-watt tantalum resistors made available as well, and who know perhaps we will be able to build amplifiers in a year's time that have all tantalum resistors in all parts of the circuit.

220mF	385volt	52x30 mm radial can	4.45
220mF	450volt	40x30 mm radial can	5.85
220mF	550volt	112x35 mm radial screw terminals	27.65

RCA, BNC, BANANA, PLUGS, RCA SOCKETS, SPEAKER & GROUND TERMINALS & LOUDSPEAKER SPACES

PC/A Plug	Price Ex. UK Vat
Standard Gold plug	1.55
AN-C Gold plug	3.65
AN-CP AUDIO NOTE gold plug	8.51
AN-P AUDIO NOTE Silver plug, teflon insulated, non-magnetic	25.53

RCA Sockets.

Type	Mounting	Price Ex. UK Vat
RCA socket nickel plated	Chassis mounted	0.41
RCA socket gold plated	Chassis mounted	0.65
AN-CS AUDIO NOTE non-magnetic, teflon insulated	Chassis mounted	3.65
socket, gold plated		

Type	Price Ex. UK Vat
Standard BNC plug	3.45
BNC Silver plated socket chassis mounted	2.05

Banana Plugs, Loudspeaker Cable Spades, Chassis Loudspeaker Terminals

Type	Price Ex. UK Vat
Banana plug, gold plated, spring loaded tabson	2.45
AUDIO NOTE Loudspeaker Cable spade, silver plated, non-magnetic	4.65
AUDIO NOTE AN-ST/Speaker Terminal, chassis mounts, nickel plated, red or black	1.85
AUDIO NOTE AN-ST/G Speaker Terminal, chassis mounts, gold plated, red or black	2.75
AUDIO NOTE AN-STR Speaker Terminal, chassis mounts, tully gold plated, non-magnetic, red or black	75
Ground Terminal, chassis mounted and nickel plated	1.45

Our range of components is constantly expanding, as we find new or better suppliers, so stay in touch by reading our adverts in HiFi World and HiFi News

FERRITE RINGS.

In many systems, especially ones using transistor based amplification, there is often a problem of incoming RF mixing into the feedback loop, especially from connected CD-players, clamping a ferrite rings onto the cable between the CD-transport and the DAC, or the output of the DAC or CD-player and the pre-amplifier input yields surprising results.

A set of two Ferrite rings costs £8.50

AUDIO NOTE COMPLETE KITS.

We are developing a range of complete kits, to give those of you who have the ability, but do not have the time to develop a project from the ground, so to speak. In order to be able to offer the best possible quality - price relationship the kits we offer will be good basic circuits, with no Hi-Fi power supplies and components, all kits have Input volume control to allow use of a single source, like CD-player direct in.

KIT ONE.

Based around the justly famous 300B directly heated triode, we see this kit as the introduction to real Audio Amplification, as it covers all the important aspects of design necessary, Single-Ended, No-Feedback, Class A, Directly Heated Triode, to become a member of this exclusive club of amplifiers

Kit One has one 300B per channel running at 420 volts with 75mA current giving 9/10 watts of the cleanest power you will ever hear, the input stage consists of a 65N7GT with a 5687 double triode driver stage running in SRPP. The power supply is a capacitor-choke-capacitor with a 5U4G HT rectifier, the heaters are AC heated. Component quality is similar to our Level 2 limited products. **AUDIO NOTE** paper in OJ signal capacitors, Beyschlag 1 watt 1% metallfilm resistors, good quality electrolytics (sorry NO Black Gates!) and a simple, attractive stereo chassis in grey paintwork. Protecting cover is extra

Price £750.00 incl. Vat, which includes all valves (yes, also the 2 x 300B needed) but not postage/packing, which to UK customers is £12.00, topcover is 199.00 extra. The Kit One is available now

KIT TWO.

Kit Two features a single 6550VA Sovtek tetrode running in Single-Ended mode, yielding some 17 watts of pure Class A, valve rectified



FOR STATE OF THE ART HI-FI

STUDIO ONE

Our dedicated 'Absolute Sounds' Studio. We have on permanent demonstration the following equipment:
APOGEE – from Centaur Minor to Diva
AUDIO RESEARCH – including the LS2b, LS3b & D200
CLASSE – 30, 70, DR4, DR5, DR6, DR10, DR15
KRELL – amplification and digital, now on dem the new KSA50s
MAGNEPLANAR – from SMGa to MG3.3
P S AUDIO – complete range including the Lambda transport
SONUS FABER – Minima Amator, Minuetto, Electa
THETA – Data Basic, Pro basic, Pro prime
WILSON AUDIO speakers

STUDIO TWO

Our new purpose built audio visual room
ADCOM processors
CELESTION shield speakers
CELESTION HT3 package
DENON av amplifiers
LEXICON processors

STUDIO THREE

ACOUSTIC ENERGY
ADCOM
AUDIOLAB
CHORD ELECTRONICS
KEF REFERENCE
MICHELL
MICROMEGA
ORELLE
PROFESSIONAL MONITOR COMPANY
ROKSAN
SME
TANNOY
TDL

Call us or drop in for a chat or to arrange a demonstration. We stock a complete range of speakers from £109 including B&W, CELESTION, HEYBROOK, KEF, SEQUENCE & TANNOY and separate components from £119 from DENON, MARANTZ, SONIC LINK and THORENS all available for audition in **STUDIO FOUR**

A wide range of accessories, headphones and equipment supports available.

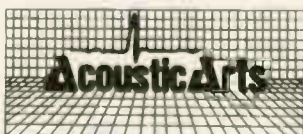

Tel: 0923 233011 Tel: 0923 245250 Fax: 0923 230798

Acoustic Arts Ltd

101 St Albans Rd, Watford WD1 1RD
 Opening hours: 10am – 6pm Tues to Sat
 100 yards from Watford Junction Station



Chord Electronics Ltd

3 Bower Mount Road
 Maidstone ME16 8AX

Tel. 0622 764874/692000 Fax. 0622 764506

Chord UK Dealers

Cottage Audio	0522 702834
KJ Leisuresound, London W1	071 486 8262
Acoustic Arts, Watford, Herts.	0923 245250
Brentwood Music Centre, Brentwood, Essex	0277 221210
Progressive Audio, Gillingham, Kent	0634 389004
Doug Brady Hi-Fi, London WC2	071 379 4010
Doug Brady Hi-Fi, Warrington, Cheshire	0925 828009
Doug Brady Hi-Fi, Liverpool, Merseyside	051 733 6859
Doug Brady Hi-Fi, Leeds, Yorkshire	094 346 7689
Photocraft Hi-Fi, Ashford, Kent	0233 624441
West Midlands Audio, Worcester, West Midlands	0905 58046
The Reference Studio, Heathfield, Sussex	0435 868004
Paul Green Hi-Fi, Bath, Avon	0225 316197
Eastbourne Audio, Eastbourne, Sussex	0323 25828
Surrey Hi-Fi, Godstone, Surrey	0883 744755
Sound Academy, Wallsall, West Midlands	0922 493499
English Audio, Hereford, HR4	0432 355081
Hi-Fi Experience, London W1	071 580 3535
London Hi-Fi Services, London	071 263 1015
Divia Audio Fidelity, London SW11	071 924 5286
Music Matters, Birmingham, West Midlands	021 429 2811
Music Matters, Dourbridge	0384 444184
Vaudio, Stoke Bishop, Bristol	0272 686005
In Hi-Fi	031 225 8854
Audio Reflections	0532 528850
Audible Difference	0379 740227

QUALITY, SOLID TIMBER

CD STORAGE



At last an alternative to cheap plastic or chipboard storage furniture for your Cd collection. Send now for our full colour information leaflet showing the range of craftsman built furniture, featuring our unique swivelling action system. Telephone 0462 670505 or 0438 720102 (eve) or write to Unit 10, Shaftesbury Ind. Est., Letchworth, Herts. SG6 1HE.

IAN HARRISON DISCOUNT HIFI

* BRAND NEW GOODS WITH FULL UK GUARANTEES * NO EX-DEM GOODS * NO GREY IMPORTS * REVIEWS & DETAILS ON REQUEST (0283) 702875

DENON	TECHNICA	AUDIO TECHNICA	SENNHEISER	AUDIOQUEST	MICHELL		
DL304	£170	MC7500	HD 1000	£179	DIAMOND FPS	DT911	£179
DL103D	EP0A	MC2000	HD580	£159	LAPIS FPS	DT901	£180
DL100	£75	MC200H	HD980H	£106	EMERALD FPC	DT988P	£140
DL160	£70	MC200H	HD250H	£100	QUARTZ FPC-9	DT980	£105
DL110	£55	QUASAR	HD540H	£95	RUBY FPC	IR8700	£115
		QUATTRO	AT-OC5	£75	TOPAZ OFHC	IR5890	£180
		QUARTZ	AT-OC3	£69	TURQUOISE OFHC	DT811	£145
		MC155H	ATH900	£50	PHONE FOR PRICES	DT801	£120
V15VMR	£199	MC105	ATH911	£415		DT431	£75
VN25MR	£56	T3000	ATH910	£415		DT430	£70
TEST DISC 117	£15	T201	ATH988/2				
DAT	QED	HI-FI FURNITURE	DENON AUDIO				
AIWA XDS1100	£750	DAC PACK	£169	APOLLO	TECHNICAL TEST CD	£12.99 POST FREE	
GOLDRING		DIGIT	£109	SOUND ORGANISATION	HARRISON MULTI-PURPOSE TEST	£12.99	
EROICA		DIGIFLEX	£18	SOUND FACTORY TRIPOD	FREE		
EXCEL GS		POSITRON	£89	SOUNDSTYLE TRIPOD	FREE		
EXCEL		RODOLINK	£99	GOLDRING - BLACK SATIN	FREE		
EXCEL		AMPS	£124	(Brochure available)	FREE		
ELITE		OPT DIGIT			FREE		

ARCADIA POA TO OPERATE A MOVING COIL EXCHANGE SYSTEM PLEASE TELEPHONE FOR DETAILS AND PRICE. NO OLD MOVING COILS DON'T WORRY, JUST PHONE. ALL GOODS ARE BRAND NEW WITH FULL UK GUARANTEES. NO EX-DEM EQUIPMENT. PLEASE PHONE OR WRITE FOR DISCOUNT PRICES. CD'S: TDK, MAXELL, SONY, AMPEX, BASF. DISCOUNT AUDIO & VIDEO TAPE, AUDIOQUEST, SONIC LINK, REVOX, QUAD, DISCWASHER, TELARC, BIS, ATC, SPENDOR, DELIVERY CHARGE IS £5.

IAN HARRISON DISCOUNT HIFI (MAIL ORDER ONLY), 7 MILL HILL, REPTON, DERBY, DE65 6GQ. 9am - 9pm

CREATIVE AUDIO

9 DOGPOLE, SHIREWSBURY, SHROPSHIRE Fax (0743)271010 Tel (0743)241924 (Closed Mondays)



Fresh tuner sandwich

Complete range of new Cyrus Electronics now on demonstration –
ring us for a free information pack

Authorised retailer for

ARCAM • AUDIOLAB • CELESTION • CYRUS • DENON • EPOS • KEF • MERIDIAN
MISSION • NAIM • QUAD • REGA • ROKSAN • ROTEL • RUARK • SOUND ORGANISATION
TRIPODS

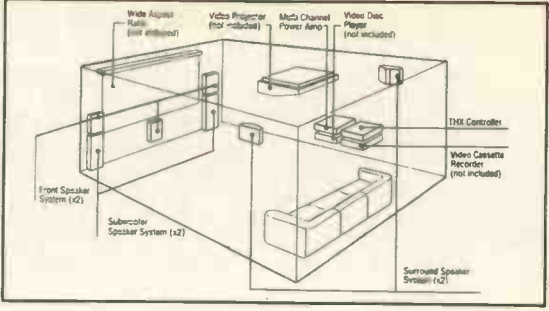

AV ROOM 1 = BANG & OLUFSEN AV9000
 AV ROOM 2 = YAMAHA DSPA2070
 AV ROOM 3 = THX, PROJECTOR & LASERDISCS



SONY MDP-850

Editor's Choice

WHAT BEST BUY VIDEO

DUAL STANDARD (PAL/NTSC)
LASER DISC PLAYER

YAMAHA DSPA 2070 PRO LOGIC AMPLIFIER

UPMARKET AV CONTROL AMP
 7 CHANNEL AMPLIFICATION
 DOLBY PRO LOGIC DECODER
 DIGITAL SOUNDFIELD PROCESSOR
 24 DSP SETTINGS

MAIL ORDER ACCEPTED ON ALL DISCS
 ALL DISCS SUBJECT TO BBFC CERTIFICATION



ALSO LASER DISCS IN STOCK
 PAL & NTSC - Over 7,000 Titles available



TWENTY 20 AUDIO VISUAL LTD
 UNIT 205,
 LAKESIDE SHOPPING CENTRE,
 WEST THURROCK, GRAYS RM16 1ZQ
 Tel: 0708 891818 ● Fax: 0708 891300

CATALOGUE AVAILABLE
£7.99
 CHEQUES ONLY

WANTED: Cambridge Audio AM/FM Tuner (T50?) and amplifier A75/C75/P55 and CD2? W.H.Y. Phone Bob 0939 270 312.

AUDIO RESEARCH Pre and Power Amps. Last of the many tubed type. SP-8 (£750) and D-70II (£800). Both look like new; boxes and instructions. Tel: Brighton 0273-684424.

1960's HI-FI. MAIN UNIT: Tandberg 64 tape deck, Quad FM and AM tuners, Quad 22 amp, Garrard 301 turntable, teak cabinet. Also two speakers, own teak cabinets. Offers. 0734-476167.

LINN AXIS TURNTABLE + K9 Cartridge, excellent condition, £225. Or exchange for Nakamichi deck. Tel 081 852 8155

ARCAM ALPHA CD player £180 ono. Target CD/turntable stand (single, low shelf) £20. AudioQuest Sorbothane feet (large) £25. Or all 3 items for £200. A formidable combination. 081-686 3850.

AT OC7 CARTRIDGE £125 (£260) never used. OC7 replacement but up-graded instead. Meridian component amp (MM, MC, CD, Aux, Tape) can use as pre-amp only £150 (£630). Stoke: 0782-839807.

AUDIO INNOVATIONS S800 valve power amplifier, triode coupled, boxed, £395. Magnaplanar MG1.4 panel speakers, superb sound, bargain £475 (new £1,100). Ortofon T-5 step-up transformers £35. Will post/deliver. 0449-676335.

AUDIO-PRO TA150 tuner-amp 120watt DIN, good working order. Clean (selector L.E.D. faulty). Offers phone: 0539-721995, 9.30 - 5.00pm Wednesday-Saturday.

CASTLE CLYDE SPEAKERS £80. Micromega Logic CD player, £175. Bang & Olufson 4400 receiver 15w/ch. £50. Musical Fidelity B1 amplifier, £50. All in mint condition. Phone 0252 870861 after 6.00 pm.

EPOS ES11 Speakers with stands, still top of the class. £290. Martin Ronaldson. Telephone: 0837-840438.

GARRARD 401 turntable with SME 3009 arm on plinth. Offers: 081-646 6793.

CHORD SPM 1200 250 x 250 watt amplifier, hardly used. Cost £3,000, bargain £1,500; Snell Type 'C' speakers, Audio Note silver wired, 91 dB efficient, pirate stands, stunning sound £1,250; stereo metre Mandrake Ultimate Interconnect. W.B.T. phonos: retail £600, nearly new £420. Torlyte stand £60; Seismic Sink, new £95; 'Mana' style 1-off heavy duty precision made equipment stand, 3 granite shelves. Cost £350 - £190, suit 'Ongaku', LP12 etc; 2 G.E. VT211 valves original 1942. Telephone: 0932-349314.

CONCORDANT EXCELSIOR valve pre-amp (separate power supply), wooden sleeve, one year old, barely used £850. Worcester (0905) 21464.

DIY BARGAIN. IAS Beaulieu 811 Loudspeakers, excellent review in Hi-Fi Answers, cost new £1,000+, need re-covering, spiked stands included, £195 ono. Telephone: 05035-679 (Looe).

DPA BIGGER BIT (DAC 7) DAC: £375.00. 0.5m DPA White Slink interconnect £45.00. Excellent condition. Offers considered. 0670-590395 after 6.00 pm.

DYNAVECTOR 23RS Ruby Karat £55. Lentek Moving Coil amplifier (with separate power supply) £25. Offers for both. Telephone: 0953-717546 (Norfolk).

FOR SALE VINTAGE HI-FI. Quad 22 Control Unit, pair Quad II's amps, 10 spare valves, Garrard 301, Tandberg reel-to-reel, Wharfedale speakers, Wharfedale crossover, all very good condition. £500. Telephone: 0446-700875, after 6.30pm.

FOR SALE: Sonus Faber Minima Amator £1,000. AVI S2000A Power Amp 250wpc £850. Trilogy 948 stereo power amp 50WPC £800. Phone any time: 081-531 5979.

GYRODEC with PSU £495. Celestion 700SE £675. 4 x Magnum A50 monoblocks P200 pre-amp and PSU £1,950. Everything must go, no reasonable offer refused. Fidelity Research FRX. Wanted: 64 tone-arm. Telephone: 0272-257048.

LEAK TROUGHLINE stereo tuner, Varislope 2 stereo pre-amplifier and Stereo 20 power amplifier. System serviced by Haden Boardman, requires further attention. Manuals and additional valves £350. Telephone: 061-430 3749.

LEAK: Troughline III FM mono £125, Stereofetic £115, ST-30MK1 £35, ST-30+ £45, Delta-30 £40, 2030 AM-LW-FM £40. EMI Stereoscope integrated valve amp, faulty £50. Garrard TPA-12 amp + Goldring 600 Mono £40. 071-372 3724.

LINN KAN II speakers and stands. Bi-wireable. Immaculate condition £275. Naim Snaps power supply £50. Telephone: 0444 -248424.

LINN LK1 Pre-amp plus Dirak and Remote £325. Telephone: 0344-484 038 evenings.

LINN LP12 Basik+/K9 £385, Axis Basik+ £265, SME 3009/3s + extra tube £130, Shure V15II + extra stylus £45, Lenco GL-72 £45. WANTED: SME 3012, SME parts, Goldring Eroica, ADC Phase IV. 071-625 8966.

LINN LP12 black, Ittok, Karma, Lingo, Trampolin, £995. Albary PDM1, dual mono pre-amplifier and power supply £400. Telephone: 0992-464320.

LINN LP12 with Ittok arm and Troika. Perfect condition £600. Telephone: 081-802 1736.

LOUDSPEAKERS: pair of transmission lines, professionally made to HFN/McDonald specifications in 1991. Authentic bass without boom, detailed mid-band, (civilised) treble. Sensitivity 89dB/watt. Haggle starts at £350. Further details: 0495-221110.

MERIDIAN 203 DAC £175, Celestion SL6i speakers £145, Celestion SL600si speakers £600 (up-grading to 700's). All very good condition. Telephone: Shrewsbury (0743) 364369 (evenings).

MICHELL MYCRO Moth arm, Goldring 1012. Two years old. Mint condition, original packaging, receipts etc. £350 ono. Telephone: 061-707 7007 daytime, ask for Barrie.

NAIM WANTED. CDS, CDI, 135, 250, 82, 02, Hi-Cap, new style only. Private buyer, cash waiting. Telephone Dave on 0803-555401 South Devon.

ORACLE DELPHI turntable £180. Meridian 103 + 105 power amps. Not in cases. Ring for details. Blyth 0670 354726.

MINT GARRARD 301, African Mahogany plinth, SME Arm, Shure V15, £495 Harman-Kardon Pro turntable, pivoted tangential arm, mint £120. Hitachi FT5500 MK2 tuner (Awards Winner 1988) £95. Telephone: Coventry 0203-679165.

MUSICAL FIDELITY MC-4 loudspeakers complete with Target stands, mint condition. £325.00. Telephone: 0204-365104 (Bolton).

MUSICAL FIDELITY pre-amp 3A and P140X power-amp. Both excellent and little used. £395 (£800+ new). Sony CDP333 ESD CD player, excellent sound and condition, £275 (£600 new). Telephone: 0455-633350.

MUSICAL FIDELITY The Pre-amp 2a, excellent condition £150.00. Perreaux of New Zealand PMF2150B power amp 200wpc mint, boxed £700.00. Acoustic Energy AEI speakers with matching stands, excellent £650.00. Carlisle 0228-21533.

NAIM IBL SPEAKERS, boxed, as new £375. Tannoy M20 Gold MKII speakers, teak veneer, bi-wireable, boxed, V.G.C. £100. Telephone: (0902) 752535 (Midlands).

NAIM NAC 72-Hi Cap (new style) £780. Naim NAP 250 £695. NAC A-5 cable 2 x 6m £20. 2 x 9m £30. Mahogany (52") Hi-Fi cabinet £40. Telephone: 0903-756582.

NAIM NAC42 Pre-amp mm £130 (£350); Naim Nait £179; Pioneer A300X £129; JPVV's £60; Rogers LS7s, stands £250 (£502); TD160B/Grace/Arcam P77 £150. Or exchange IMF TLS/TDL, Audiolab. 0206-861457 Jim.

PAIR BLACK QUAD ESL-63s with open stands, bargain at £950. Must sell due to space problems. Delivery etc. mutually arranged. Peter Brown 0467-643872 (Scotland).

PRIVATE SALE: Naim 42.5 pre-amp, pair 110 amps, power supply, all Avondale improved, £600; Naim IBL speakers, £350. Musical Fidelity PRE3A pre-amp, pair MAS0 amps, £595. All superb - 0872 572397 (Cornwall).

QUAD AM TUNER wanted. AM3 preferred, must be in good condition and in good working order please. Good price paid. Telephone 0208-813613 (Cornwall)

QUAD ESL63 PROS. Latest specification £1,750.00 ono. Gale GS401A + stands £300.00 ono. Meridian CD Player MCD £150.00. Thorens TD160S + SME Series III S Arm £150.00 ono. Telephone: 061-624 3075 (evening).

MAIL ORDER

Tel: 071 436 1053

Fax: 071 637 2690

KAMLA

Coming Soon:
Large range of
NTSC Laserdiscs
will be available
from November

Product List

- AIWA
- AKAI
- AR
- ALCHEMIST
- ALPHASON
- AUDIO ALCHEMY
- AUDIOSTATIC
- AURA
- B&W
- BEYER
- BOSTON
- CERWIN VEGA
- CONRAD JOHNSON
- GOLDRING
- INFINITY
- JAMO
- JVC
- KEF
- KENWOOD
- KINSHAW
- MIRCROMEGA
- MORDAUNT-SHORT
- MOTH
- NAKAMICHI
- ORIGIN LIVE
- PHILIPS
- PIONEER
- PROCEED
- PROJECT
- ROTEL
- RUARK
- SANSUI
- STAX
- SME
- SYSTEMDEK
- TEAC
- TECHNICS
- THORENS
- TOWNSHEND

TEAC
VRDS 7
D700/P700
NOW ON
DEMONSTRATION

We also stock a large
range of TV's/Video's
from
**AKAI, HITACHI, JVC
MITSUBISHI, PANASONIC
PHILIPS, SAMSUNG
SHARP, TOSHIBA**

MIRCROMEGA
T-DAC
T-DRIVE
*the first front loading
transport from Micromega*

*Randall Ave
157 R Watlington
157 157*
**Townshend Rock III
Turntable Now On
Demonstration**
See review in Oct '93
issue of Hi-Fi Choice

**New Rotel AV
Products Now
In Stock**
RSP 960 AX Prologic Processor
RB956 Six Channel Poweramp

*Peter He
7 BRUNLES DRIVE*

SALE ON NEW AND EX-DEM HI-FI

		RRP	NOW
Audio Alchemy DDE V1.0	new	420.00	295.00
Motif (Conrad Johnson) MS2001 200 Watt Power Amp	ex-dem	4000.00	2400.00
Motif (Conrad Johnson) MP111 Phono Stage	ex-dem	2250.00	1125.00
Conrad Johnson MF200 200 Watt Power Amp	ex-dem	2400.00	1800.00
Oracle Alexandria inc. SME345 arm	new	1890.00	945.00
Oracle Delphi III	ex-dem	1595.00	950.00
Alphason Sonata inc. HR100/Atlas	ex-dem	1785.00	1160.00
Teac D500 D/A Converter	ex-dem	330.00	265.00
SD Acoustics SD1	ex-dem	1650.00	825.00
SD Acoustics SD4	ex-dem	700.00	455.00
Nakamichi 1000mbi	new	4500.00	2295.00

UPTO 50% OFF

ACCESSORIES FROM:

AKG, ALPHASON, AUDIOQUEST, AUDIOTECHNICA, BEYER, CABLETALK, FOUNDATION, FURUKAWA, GOLDRING, IXOS, KONTAK, LYRA, LYNWOOD, MONSTER, ORTOFON, QED, SENNHEISER, SONIC LINK, SOUND STYLE, STRAIGHTWIRE, STANDS UNIQUE, SUMIKO, SUPRA, TOWNSHEND, XLO, VAN DEN HUL

ASK Electronics Ltd.
248-250 Tottenham Court Road
London
W1P 9AD
071 637 0353/0590

251 Tottenham Court Road
London W1P 9AD

071 323 2747

Harp Electronics Ltd
237 Tottenham Court Road
London
W1P 9AD
071 636 4611

REVOX A77 MARK III, mint and boxed, Swiss, light amateur use at home, miles of tape £550. Linn Sondek/Ittok/Karma, walnut, Valhalla, glued subchassis, armboard etc. £700. Can demonstrate. Telephone: Derby 0332-763150.

SILVER WIRE with hybrid dielectrics, beats VDH carbon. Fact!! Only £4 mtr, the best for peanuts, enthusiast's surplus, limited supplies. Wanted Naim 250, 135, will buy full amplifier. Paul 0642-532696.

SILVER WIRED loudspeakers: Audio Note K/SP, black with Huygens K4 stands (ideal with valve amps) £625. Telephone 081-572 2504 (Middx).

SINGLE SPEAKERS: Lowther Mini Acousta, Leak Sandwich 600, Tannoy 15" Red chassis, Goodmans Axiom 300, offers or buy your single. WANTED: Single Chatsworth (empty/loaded) or any empty pair Tannoy 12/15" cabinets. 071-372 3724.

SUMO POLARIS AMP. Sumo Athena pre-amp. Sumo Aurora FM/AM Tuner, audiophile American equipment, cost £2,100. Also Michell power supply for GyroDec turntable. All in mint condition. Offers and demo's - 081-651 5711.

TANNOY 611s complete with dedicated plinths, 13 months old £200. Arcam Alpha CD, mint, £175. WANTED: EPOS ES11s. Contact: Mark 0952-619536, evenings.

TASTY TREATS for valve lovers: British Acoustic Films Cinema monoblocks (pair). 1940's: 4 x KT66 Triode connected, oil caps, ultra-reliable, very impressive looks and sound, rare opportunity. Telephone: 0707-328515.

TDL STUDIO I Transmission Line Speakers with TDL Stands, Black Ash veneer, as new condition with boxes. £395. Telephone: 0734 869789 (home), 0635 506620 (work) Berkshire area.

TDL STUDIO I transmission line speakers, walnut finish, complete with stands, excellent condition, boxed. £400. Telephone: 0784-457332.

WANTED: Wadia 3200 transport in mint condition. Also AT&T lead. Sell Meridian 200 transport latest spec £595. Meridian 203 DAC 7 £295. Together £795. Telephone: 0440-714228.

THORENS TD 147 Jubilee (Rosewood) £150. Mayware Arm MKIV £25. Hi-Fi Answers turntable kit £20. Hi-Fi Answers/Audiophile Mags 12/83-4/94 (108 copies) £25. 60 assorted hi-fi mags £6. 2 x Naim calendars 1983/84 £1. Tel: 0934 750361

EXPOSURE 6, 7 and Super 8. Excellent condition, boxed with manual £500. Exposure Speaker Cable 44 metres £70. Evenings 0344 772501 (Bracknell). Day 0734 396393.

LINN LK280 Power Amp with Spark power supply, excellent condition, original boxes etc. cost £1,500, accept £550 o.n.o. Audiolab 8000 DAC updated with latest chip by manufacturer, excellent condition, boxed. £510 o.n.o. Tel: Southampton (0703) 322127.

TOWNSHEND ROCK Reference Turntable with Excalibur Tonearm, complete with Mana Reference Turntable Support - £2,200 o.v.n.o. - marriage forces very reluctant sale! Tel: (0403) 733055 and leave message on answerphone.

LECSON HL-1 Enclosures £150. Revox B780 Receiver £150. Decca Stereo Head MK1 plus SME adaptor. Just re-tipped £55. Decca SC4E re-tipped £55. Tel: 0834 812167 after 7pm.

MUSICAL FIDELITY MA50 Class "A" 50W monoblock power amplifiers, £495 ono, Musical Fidelity Pre-amp Pre3a + MVX PSU, £450 ono. Tel: Worthing (0903) 261931 after 6pm.

PANDORA MAINS Filters (2 off-cost £120 each) £65 each. Lynwood Basic Filter (cost £50) £25. Target TT5 equipment rack - unused £75. Audiophile 'Base' Platform £35. Tel: Malcolm 0483 275389.

B&W 805 Matrix + Stands £690. Meridian 205 Mono Blocks £475. Audio Innovations Passive Pre-amp £100. Tel: 0992 763812.

BEARD P100 Valve Amp recently serviced new Golden Dragon Valves very good condition, excellent sound quality £600. Tel: (0892) 530733) after 6pm or ansaphone.

CREEK 4040 S2 Amplifier £70. Excellent sound, little used. Immaculate. Black. Boxed. Tel: 0734 302868 Reading.

NAIM 72/90 WITH MM Boards (new style) £525 o.n.o. Mission 753 (black) only five months old (mint) £475 - May P/EX. 2 S.M.E. Tonearms, original prototype and 12" £50 (pair) Linn Axis (K9) £185. Tel: 091-4877796 (Tyneside).

WANTED: QED Digit. Good money offered. Tel: 0932 252 567 day, 0932 252 462 eves (6.30 - 7.30). Mr Leckie.

ROKSAN ROK DPI CD Transport with Audiolab 8000 DAC £950 - REL Stadium sub-woofer, black £495. Tel: (0992) 464320.

WANTED ARMAGEDDON psu for LP12, Interconnects Silver Sounds 12/3, Moth Ley Line Black or Chord Solid, Target HJ 12" speaker stands, wall shelf, 4-tier equipment stand or similar. William 071-436 1553 (day) 081-994 0408 (eve. Chiswick).

BARGAIN: PINK TRIANGLE Anniversary, Sumiko MDC 800, V. Den. Hul Koetsu Black, (6 hrs use). All mint. Reluctant sale, £1,300 ono. Tel: Day 051-229 4732 / Eves 051 722-2916.

HI-FI WORLD MAGAZINE. Complete file from Issue 1, March 1991. Excellent condition, includes all supplements, no coupons cut. Offers: Tel: 071-385 0309 (London).

A & R A60 AMPLIFIER fitted with manufacturer's moving coil and cartridge loading modules. Also T21 matching FM Tuner. IBS and original cartons. Excellent. £135 the pair. Tel: 081-866 2959 (Pinner).

NAIM 82 PRE-AMP 15 month £1,200, 2 Hi-Caps (new) £400. Naim CDS 18 months £1,950, Naim CA5 Cable 2x6.5m £25 all excellent or £3,750 the lot. Tel: 0269 591333 evenings.

DYNACO STEREO 70 amp with PAS 2 and 3 pre-amps and FM3 Tuner. All valve and no mods. Plus PAT 4 Pre-amp and FM5 Stereo Tuner. Offers invited. Tel: (0372) 467 264 Esher.

MISSION 753, mint Rosewood 1 year old with cable £450 mint, serviced Garrard 301 with strobe platter, slate plinth, RB250 + Goldring Epic cartridge + Bastin Bearing £200. Tel: Leicester (0533) 553176.

LINN ISOBARIK AKTIV System black Isobarik speakers with stands and panels 3 x LK280/Spark, AKTIV/DIRAK Linn Kaim Pre-amp, cost £12,400 urgent sale £5,000 or offers on Tel: 0904 764089.

FULLY WELDED, twin pillar loudspeaker stands (Target HJ20), damped with lead shot/sand infil. One month old, mint condition, half price bargain at £60.00. I would like to exchange my Linn LP12/Ittok (4 yrs old, mint in black) for a Michell Gyrodec etc. Please phone if interested. Tel: 0803 770006 (evenings).

CROFT MICRO A pre-amp (full size case) + Croft moving coil head amp £150 o.n.o. pair TDL metal dome tweeters (unused) £30 phone Weightman 0782 - 658114 evenings (Stoke-on-Trent).

RUARK TALISMAN II speakers. Finished in black £40. Tel: 081-360 3799.

LEAK 2060 three way floorstanding speaker. Immaculate in real teak. Offers £80. Tel: (0597) 824887 evenings/weekends (Wales).

TANNOY CANTERBURY corner speakers 12" Monitor silver units, mahogany ideal for valve amps £450.00 ono. WANTED: PYE PF91 mono block, single Tannoy corner York, silver Garrard 301. Will P/X Tel: 0225 333735.

NAIM NAP 140, as new, five months old with NAC 42, excellent condition, £575 the pair. Linn Akito arm - six months use £75. Reading (0734) 866616.

ROKSAN XERXES / Tabrizzi / Corus Black, current MK3 spec, Roksan stand £750. Conrad Johnson PFI Pre-amp, Mosfet. "Stereophile" recommended (£1,500) £550. New Proac Supertowers £850. Neat Petites £300. Tel: 021-427-6661 Roy.

LINN SONDEK LP12 with Akito Arm and K9 cartridge plus spare Blask Arm in excellent condition. £550.00 ono. Denon DCD-920 CD player - £150.00. Tel: 0222 869641.

QUAD ELECTROSTATIC SPEAKERS. Very good condition £250.00 or nearest offer. Buyer collects Tel: 0952 596648.

hi Best prices for new, xdem & s/h equipment fi

COUNTERPOINT SA9/SA11	MINT S/H	£6250
MUSICAL FIDELITY F15/F22	MINT S/H	£1995
CONRAD JOHNSON PREM 10/PREM 11	MINT S/H	£5500
TRILOGY 958 MONOBLOCKS	AS NEW	£1795
AUDION 300B MONOBLOCKS	AS NEW	£1695
NAIM 52, 4 X 135, NAXO, SBL'S	MINT S/H	£8000
AUDIO RESEARCH D115	MINT S/H	£995
AUDIO RESEARCH D125	MINT S/H	£1795
MUSICAL FIDELITY MA65	MINT S/H	£550
MUSICAL FIDELITY MA60	MINT S/H	£450
MERIDIAN 205	MINT S/H	£450
KRELL KSA 50/KSA 50 MKII	MINT S/H	£895/995
AUDIOLAB 8000 P/C	VGC	£550
MUSICAL FIDELITY PRE/TYPHOON	MINT S/H	£295
ROKSAN ROK L2/S1	AS NEW	£1495
VTL MANLEY 60 LIMITED EDITION	MINT S/H	£795
CONRAD JOHNSON MV50	MINT S/H	£750
AUDIO RESEARCH LS2	MINT S/H	£1595
AUDIO RESEARCH SP9	MINT S/H	£895
KRELL KRS2/KRSP	MINT S/H	£1795
PINK TRIANGLE PIP II + BATTERY PSU	MINT S/H	£1495
AUDIO RESEARCH SP15	MINT S/H	£2995
AUDIO RESEARCH LS5	MINT S/H	£3600
MERIDIAN 601 DSP	MINT S/H	£1395
MOD SQUAD DE LUXE LINE DRIVE	MINT S/H	£495
COPELAND 301	AS NEW	£850
AUDIO NOTE OTO	AS NEW	£850
QUAD 33/303	MINT S/H	£225
QUAD 405	MINT S/H	£225
BE' YAMAMURA 211	SPECIAL	£4750
TESSERAC RANGE ON PERMANENT DEM.		
INFINITY IRS BETA	MINT S/H £	4995
MONIITOR AUDIO STUDIO 10 + STDS	MINT S/H	£750
M.T.D. TUG + STOS	EX-DEM	£1800
SONUS FABER ELECTA P.BLK.	MINT S/H	£1095
MARTIN LOGAN QUEST	MINT S/H	£2800
APOGEE DIVA + DAX	MINT S/H	£3900
MARTIN LOGAN SEQUEL II	MINT S/H	£1495
ENSEMBLE PA1 REFERENCE P.BLK	AS NEW	£1995
WATT 3 PUPPIE 2	AS NEW	£8000
MAGNEPLANAR 1.4	AS NEW	£800
QUAD ESL 63 + GRAOIENT S/WOOFER	AS NEW	£2850
MERIDIAN ARGENT 1 P.BLK	MINT S/H	£550
FULLERS AUDIO SULTAN	AS NEW	£275
SNELL E'S	MINT S/H £	650
ACOUSTIC ENERGY AEI + STOS ROSEWOOD	MINT S/H	£695
PROCEED PDP2/T2	MINT S/H	£1995
MERIDIAN 602	MINT S/H	£900
WADIA 8	MINT S/H	£2300
EAD T7000 TRAN/DAC	MINT S/H	£1495
MICROMEGA DUO CD3	VGC	£650
ROKSAN DP1/DA1/DS4	MINT S/H	£1195
SONY CDP/DAS R1 REFERENCE	MINT S/H	£1795
KRELL MD1, SPB 64X	MINT S/H	£5995
TEAC P1/D1	MINT S/H	£1995
MARK LEVINSON NO 35	MINT S/H	£5995
MARANTZ CD 12	MINT S/H	£1200
ROKSAN TMS/ARTEM12/SHIRAZ	AS NEW	£2750
ROKSAN XERXES/TABRIZ/XPS3	AS NEW	£950
GOLDMUND STUDIO 4 P.BLK	MINT S/H	£1200
ALPHASON SONATA/HR100S BLK.	MINT S/H	£595
SME SERIES V (GOLD STD)	AS NEW	£895
EMINENT TECHNOLOGY ET II	AS NEW	£750
GOLDMUND T3B	MINT S/H	£995
PIONEER HZ1 HEAD AMP	MINT S/H	£1300
BURMESTER 838 PHOND	MINT S/H	£550
ORTOFON MC 3000/T3000	AS NEW	£795
VAN DEN HUL MC1	MINT S/H	£595

BEST PRICES FOR NEW, X-DEM & SECOND HAND EQUIPMENT
MINT S/H - SECOND HAND AS GOOD AN EXAMPLE AS WE'VE SEEN ANYWHERE
AS NEW - TYPICALLY LESS THAN 4 MONTHS OLD IN NEW CONDITION
X-DEM - TYPICALLY 'AS NEW' BUT MAY BE OLDER
G.C./V.G.C. - IN PERFECT WORKING CONDITION BUT MAY BE MARKED

PLEASE CALL WITH YOUR SPECIFIC REQUIREMENT
(081) 568 8808

hi CHOICE fi

Equipment bought or part exchanged
Full demonstration facility - by appointment
Major credit cards accepted
Open 7 days 9.30am - 8.00pm

CHOICE TOO INTRODUCES

THE HI FI EXCHANGE

WHETHER BUYING OR SELLING AUDIOPHILE EQUIPMENT REGISTER YOUR REQUIREMENTS WITH US NOW. ALL ENQUIRIES ARE ENTERED ON OUR SOPHISTICATED DATABASE WHERE EQUIPMENT MATCHING TAKES PLACE. A COMPLETE CATALOGUE OF EQUIPMENT WANTED AND FOR SALE, AVAILABLE WEEKLY, IS FREE * TO ANYONE BOTH HERE AND ABROAD. THE HI FI EXCHANGE IS CONTINUALLY UPDATED AND IS THE MOST COMPREHENSIVE SOURCE OF SECOND HAND AND X-DEM EQUIPMENT ANYWHERE.

* 1ST ISSUE FREE TO ADVERTISERS, SUBSCRIPTIONS AVAILABLE
TRADE ENQUIRIES WELCOME
CHOICE TOO 081 568 8808 9.30 AM TO 6 PM

definitive audio nottingham

Tel / Fax (0602) 813562

Import/Export

LIVING VOICE AUDIO INNOVATIONS HORNING EMT IMPULSE LOWTHER
VITAVOX SMT TOWNSHEND GOLDRING MIRÓ VOYD

AUDIO INNOVATIONS*	VALDI ASH AND MAHOG680	950
S 200 PRE AMP - MM	220	350
S 200 POWER AMP	250	500
FIRST AUDIO	950	1555
7 1/2 WATT		
SECOND AUDIO		
15 WATT 2A3/82/82	2000	3000
SERIES 1000 MONO -		
NEW BOXED	1400	1500
SERIES 1000 M.C. TRANSFORMER	180	300
HORNING* AGATHON		
SILVER OAK	2800	4000
REVOX* B215 S	1000	1850
AUDIO NOTE		
1 0	950	1500
AN J SP	500	1000
AN E B	650	1400
KESIKI		
PURPLE HEART SAPHIRE	325	800
VOYD* .5 REFERENCE ASH	2500	3600
LINN LP 12 SMT 3009	450	
KABER LS 500	690	1300
LOWTHER ACOUSTA*		
WALNUT/PMBA	390	
PIONEER*		
PD 102 (CD) NEW	120	150
PDS 901 (CD)	400	500
A 102 (AMP) NEW	100	130
CTS 220 (TAPE) NEW	150	170
NAIM 62 PRE	200	
90 POWER	200	
MERIDIAN ARGENT II	400	875
SUGDEN*		
STD 1 (6 MONTHS)	600	960
SNELL* TYPE K II (12 MONTHS)	260	550
TANNOY 603I (inc. STAND.) (1MONTH)	190	280

ALL PRICES EXCLUDE CARRIAGE WARRANTY ON PRODUCTS MARKED *

VITAVOX COMPONENT PRICES	
RH300 MID RANGE 4-CELL DISPERSIVE	253.80
S2 MID RANGE PRESSURE DRIVER	719.10
S5 MID RANGE PRESSURE DRIVER	479.40
AK 157 BASS UNIT 15"	554.60

LOWTHER COMPONENT PRICES	
PM 6A	180.00
PM 7A	220.00
PM 2A	240.00
PM 4	420.00
PM 6C	130.00
PM 2C	160.00

IMPORT/EXPORT / OVERSEAS ENQUIRIES WELCOME
PHONE OR FAX DIRECT (0602) 813562

G T AUDIO

At G T Audio we pride ourselves on selling an excellent range of sound reproduction equipment, backed up by first-class after sales service. From the vast range of quality audio equipment available we have chosen that which we feel offers the best sound at very competitive prices with a high degree of reliability. We have extensive servicing facilities to cater for all types of equipment whether new or old.

CROFT, NOTTINGHAM ANALOGUE, ANALOGUE TRACER, POSSELT, UKD CALLAS, MONARCHY AUDIO, XLO ELECTRONIC, MATISSE, GROOVE TUBES, GOLD AERO, TOWNSEND SEISMIC SINKS, G T AUDIO CABLES, ATACAMA supports, CLEMENTS, METAXUS, ZIKRO AUDRO are available on demonstration.

WE CAN OFFER A COMPLETE RESTORATION SERVICE AS WELL AS SUPPLYING AUDIOPHILE COMPONENT KIT FOR UPGRADING ALL LEAK, QUAD, RADFORD, PYE and QUICKSILVER amplifiers. P.O.A

G T Audio is situated on the outskirts of London, 5 minutes from junction 16 of the M25/M40 Motorways.

FOR DEMONSTRATIONS OR BOOKING IN EQUIPMENT TO OUR SERVICE CENTRE contact Graham Tricker.

TELEPHONE 0895 833099
(DEMONSTRATIONS STRICTLY BY APPOINTMENT ONLY)

LINN ISOBARIKS with stands £680. Creek 3040 Tuner £40. KEF C10 speakers with Apollo stands £30. Tel: 0728 747735.

AUDIOPHILE RECORD collection. Direct cut, half speed masters, dummy head binaural. All originals and pristine. Will split, list available. Realistic Minimus 7 Loudspeakers with Realistic Sub 700 sub-woofer. Boxed £80.00. S. Clifton (0492) 878107.

SUGDEN P51 AMP, C51 Pre-amp £195.00. RS1 Tuner £60. Quad II/22 Amps Pre-amp £250. Dual 505 No lid £25. Linn Kans £185.00, Rogers Export Studio 35's £85. Tel: (0734) 314269 Berks.

AUDIOPHILE SPEAKERS from USA near 50. Rated by the US Audio Magazine, The Absolute Sound, as one of the finest speakers around. Cost new \$3,300, asking £1,150. Tel: 071-281 0821.

EXPOSURE VI power supply, VII pre-amplifier, Super VIII power amplifier, cost £1,100. Excellent condition, will accept £550. Tel: Steve on 0429 867432. Hartlepool, Cleveland.

AUDIO ALCHEMY D.A.C., model DDEV1.0 perfect as new £199 (£419 list). Leak Troughline stereo FM3 tuner, original condition, perfect working order £149 ono. WANTED: Class A Headphone amplifier, preferably Valve design. Tel: 081-340 2240.

LINN BASIK, with Akito and K5 £200. Tel: Ray 071-413 1892 eve 0895 253379.

NAIM NAT 01 FM Tuner and Naim NAPST PST power supply. Naim's top-of-the-range FM Tuner. £775.00 (as new in previous case design). Tel: 071-603 8627 (answerphone).

LINN SONDEK LP12, Rega RB300 am, Rega Elys Cartridge. Just professionally overhauled and set-up. For sale due to upgrade. Can be demonstrated. £400. Tel: 0392 833611 (Devon).

E.A.R. (Pavavicini) 834 integrated valve amp (HFW Feb. 93). As new, mp £1,300 accept £1,000 or make me an offer. Tel: 081-989 6434.

AURA VA100 EVOLUTION Amplifier boxed, as new £200; Sony CDP311 CD Player boxed as new £100. Tel: Soton (0703) 328573.

LEAK TL12 AMPLIFIER. Very rare original model with KT66 output stage, with Varislope III Pre-amp and Troughline II Tuner. Genuine enquiries and offers over £1,100 to Tony on (0702) 351936.

SONY TCD3 Datman, remote control, digital interface unit, digital leads, charger, battery, light use, V.G.C., (£950) £445. Sony CDP911. £195. ATOC9 unused £220. Strathclyde Turntable £50. AT-OC5 £50. Tel: 0273 - 846290.

INCA DESIGN ID25 Class A 25 watt Power Amplifier. Piano black finish, very heavy. Size 19" x 9" x 12" cost over £700. Steal at £175. Buyer collects. (0709) 876354 (South Yorkshire).

AUDIO ALCHEMY DDEV1.0 with QED Digiflex, excellent condition. Boxed. Sell for £250 (£450). Tel: Paul on 051-630 2311.

MICHELL ARGO Pre-amp with Hera power supply £575. Quad 405 Mark 2 Power Amp, £250. Quad II valve monoblocks - Russ Andrews modifications fitted £375. Tel: (0904) 631023 (answer machine).

QUAD 606 Power Amp. Quad 66 pre-amp. Renowned. Excellence. Mint condition. House move forces sale. £950.00. Tel: (0374) 478 781.

WANTED: NAIM Hi Cap. Phone particulars and price to (0745) 826283 (North Wales).

MERIDIAN M60 Active Speakers. Brand new in unopened boxes with full 2 year warranty £1,200 ono. Tel: 021 783 8214.

CELESTION 5 MK2 Speakers. New. Boxed. £99. Mentmore 200 watt mono block valve amps. (Similar to new Papworth). Excellent condition. Boxed. £1,495. Tel: (0242) 523677 (Cheltenham).

ROGERS LS4A/2 Speakers, 6 months old, £150.00. Alexander LS1 Speakers (small, metal cabinets) £50.00. Nakamichi IA3 amp, 4 months old, £145.00. Tel: (0948) 667521 (Shropshire).

AUDIO INNOVATIONS 2nd Audio Triodes (mono blocks) latest spec 2A3/ECC82 L2 Pre-amplifier £2,000 Kenwood DP-X9010, CD, £275, Digilog, £175 Stax SRMT1, SR, Signatures £800. Will demo, all mint. Hampshire (0730) 821 240.

SUGDEN A25B £150 boxed. Tuner. Model SAE 3200 (USA) high specs £100 no offers, ring for details. ENTRE. I. M/C cartridge, plus Lentrex H/Amp. Light use, swap for Decca. John (0268) 745416.

ROYD TOPAZ SPEAKERS one year old £85. Rotel RA 920AX amp 6 months best buy £85. Stax Lambda SR Earspeakers £199. All boxed. Instructions. Will Dem. Steve evenings (0865) 59737

FOR SALE CHORD SPI 200 Power Amp excellent condition, superb sound & boxed. £1,500. Ring (0333) 424642 after 6pm.

IMPULSE H2 HORN Loudspeaker, superb sound, oak finish, mint condition £1,650. Audio Research SPI0 Mark 2 mint, boxed £1,500. Audio Innovations Second Audio Amplifiers 2A3 valves latest finish, boxed, mint £1,550. Tel: 081-450 7384 anytime.

WANTED: TANNOY-AUTOGRAPH, Decca-Decola, Vitavox Drivers, Garrard-301 (V.G.D.), Westrex-Drivers, Lowther-PM-2, PM-3, PM-4, Single TP-1, valves PX4/PP3-250, STC4300, DA30/60, STC4274, Ed/Ad-1, EMT 927/R-80. Tel: (0044) 881184 before 8.00pm.

MERIDIAN 203 Bitstream DAC 7 plus Digilink cable 18 months old, boxed £230 ono (0438) 743807 (Stevenage) after 4.30pm.

VOYD TURNTABLE, latest spec, split-phase P.S.U., Helios Orion arm (Audio Note Silver-wired), Audio Note 10 cartridge, audio Innovations 1000 M.C. Transformer, superb! Must sell, £1,500 or less. Tel: 0364 72153 (anytime).

PAIR BRONZE Quad ELS, serviced, excellent, £350. Pair original Decca Corner Horn Speakers £120? Superb black Radford TT100 100 W.P.C. valve amp (G.E.C. KT88s) £450. WANTED - Leak (or other) valve amps. Tel: 0364 72153.

MAGNEPLANAR MG1c, grey cloth panels, light oak wood, mint condition, boxed, can demonstrate - £550 ono. WANTED: Audiolab 8000T Tuner. Tel: (0734) 843740 (Reading).

NAIM NAP140 Power Amplifier, new style, mint condition, boxed £395. REGA ELA floorstanding Loudspeakers, black finish, excellent condition, boxed £280. Tel: Southampton (0703) 260737.

AUDIO ALCHEMY D.D.E. guaranteed until Jan 1997, excellent up-grade for elderly C.D. player £200. Revolver Turntable (original red) with Linn Basik LVX and Linn K9 £120. Tel: (0324) 638642 (Scotland).

1 PAIR OF MERIDIAN 205 mono blocks. 1 Audio Innovations Passive Pre-amp £625. Phone: (0992) 763812.

THORENS TD150/Basik/K9, attractive, light, oak plinth, superb, £135; Rogers Cadet III valve amp, good condition, £55; Leak Delta 30 amp, nice sound, £15; all ono. Tel: (0565) 634740 (Cheshire).

MUSICAL FIDELITY Tempest Amplifier £100, NAD 502 CD Player £100. Both only 14 months old and very rarely used. Move forces sale. Telephone Chesterfield (0246) 569741.

MULLARD 510 valve monoblocks (homebuilt) £100. Elektor valve pre-amp £120. Beard, 506A, pre-amp £495. Musical Fidelity Synthesis £150. Tel: (0742) 459698.

TANNOY DUAL Concentric Loudspeakers required. 1974 to present day considered. 12 inch or 15 inch drive unit models only please. Cash awaits. Tel: (0886) 888 772.

**CLASSIFIED ADS:
CONTACT
RICHARD
JOHNSON FOR
DEADLINES AND
QUERIES
TEL: 071 289 3533**



MUSIC MATTERS



THE AUDIO SPECIALISTS

THE FINEST HI-FI AND AUDIO VISUAL SYSTEMS

From our comprehensive range we can assemble for the discerning customer carefully selected and matched components from a simple audio system at around £500 to a complete hi-fi and video installation costing many thousands of pounds. Illustrated is a selection from the magnificent Meridian range which includes compact disc players from £995, amplifiers, tuners, loudspeakers and even facilities for multi-room to enable music to be carried to other locations in the home. With the addition of a television, V.C.R. and surround sound processor you can be transported into the concert hall, opera house, cinema, stadium or even join the crowd at major sporting events. Please contact us to arrange a demonstration. We are confident you will not be disappointed!

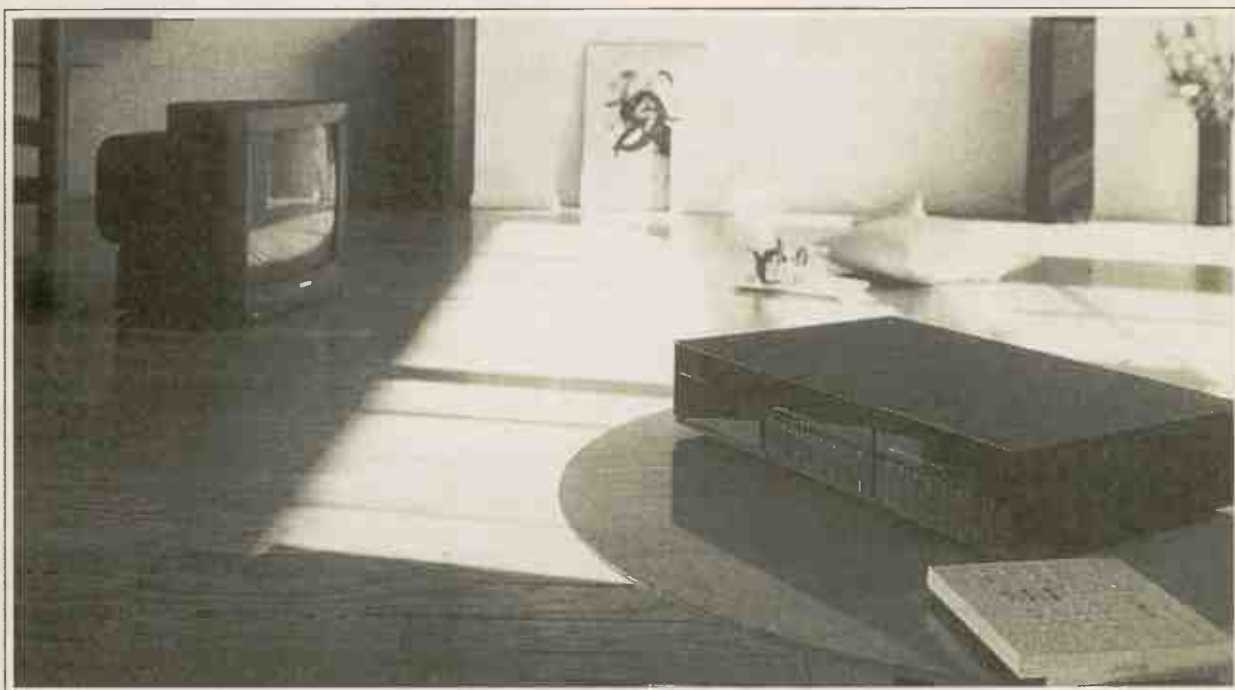

We also stock a wide selection of classical compact discs at competitive prices.

**INTEREST FREE
CREDIT AVAILABLE**

APR - 0% Written details on request.
Licensed Credit Broker



OPENING HOURS

Tuesday - Saturday
10.30 - 6.00

Late night Friday till 8.00
Demonstrations by Appointment

351, Hagley Road, Edgbaston, Birmingham B15 8DL

Tel:- 021 429 2811

156/7, Lower High Street, Stourbridge DY8 1TS

Tel:- 0384 444184

Aiwa, Alphonson, Alchemist, Apollo, Arcam, Audiolab, Audio-Technica, Aura, Beyer, B&W, Canon, Celestion, Chord, Cyrus, Denon, DPA, Duol, Epos, Exposure, Heybrook,

Panasonic, Pioneer, Pink Triangle, Pro-ac, Revox, Rogers, Roksan, Rotel, Ruark, Sennheiser, Systemdek, Tannoy, Target, Teac, Technics, Thorens, Tripod, Wharfedale, Yamaha

JPW, KEF, Lexicon, Marantz, Meridian, Michell, Micromega, Mission, Monitor Audio, Moth, Musical Fidelity, Nakamichi, NVA,

Advertisers Index

ACOUSTIC ARTS	136	HALE HI-FI	110	R.S. AUDIO	104
AMADEUS S & V	119	HART ELECTRONICS	121	REF. IMPORTS	120
APOLLO	116	HEATHERDALE	122	RICHARD ALLAN	64
ARION	104	HI-FI CONFIDENTIAL	123	RON SMITH AERIALS	23
ART AUDIO	118	IAN EDWARDS	48	RUSS ANDREWS	62
AUDIO CRAFT	112	IAN HARRISON	136	SELECT SYSTEMS	88
AUDIO FREAKS	40	J.E. SUGDEN	I.B.C.	SEQUOIA	117
AUDIO GALLERY	112	JORDAN WATTS	123	SERIOUS KITS	96
AUDIO NOTE	135,135	KAMLA	140	SEVENOAKS	130,131
AUDIO PHYSICS	122	KIMBERLEY HI-FI	122	SJS	122
AUDIO ROOM	133	KINSHAW ELECTRONICS	40	SLATE AUDIO	115
BILL HUTCHINSON	124	KRONOS	118	SON ET LUMIERE	125, 127
BURY AUDIO	48, 110	LANGREX SUPPLIES LTD	126	SONIC FRONTIERS	94
CAMBRIDGE HI-FI	117	LEONARD BOOTH	48	SOUND ILLUSION	108
CAMPAIGN AUDIO DESIGN	112	LISTEN INN	22	SPALDINGS	127
CHELMER VALVE CO.	114	LORICRAFT	118	SPEAKER CO.	108
CHOICE HI-FI	142	LOUGHBOROUGH HI-FI		SPEAKER CO.	115
CHORD ELECTRONICS	136	EXCHANGE	126	SPECTRA	106
CMF	136	MAINWAY	18	SUSSEX SURPLUS	112
CONNECTIONS	18	MIKE MANNING AUDIO	70	SYSTEMDEK	38
COURT & SPARK	125	MJS	122	TABULA RASA	48
CREATIVE AUDIO	137	MUSIC MATTERS	144	TESSERAC	23
CREEK AUDIO	8	MUSIC MILL	110	THE DEN	40
CUSTOM CABLE SERVICES	119	MUSICAL IMAGES	12,13	THE HI-FI SHOWROOM	122
DAN DULEY	119	NEAT HI-FI	118	THE RECORD CONNOISSEUR	133
DEFINITIVE AUDIO	84,142	NORTHWOOD AUDIO	133	THE RECORD SHOP	46
DIVA	6	ORTOFON	22,23	THE SOUND GALLERY	36
DOUG BRADY HI-FI	22	OXFORD AUDIO CONS.	132	TRY ME & SEE	102
DPA DIGITAL	IFC, 3	P.M. COMPONENTS	56	TUBE TECHNOLOGY	38,110
DYNAMICS	132	PATH	20	TWENTY 20 AUDIO VISUAL	138
F & S	123	PAUL GREEN HI-FI	64	U.K. DISTRIBUTION	18
FRANK HARVEY HI-FI	120	PETER TYSON	94	V'AUDIO	117
FULLERS AUDIO	117	POWERPLANT	119	VINTAGE VALVES	64
G.T. AUDIO	142	PROGRESSIVE AUDIO	18	WILMSLOW AUDIO	94
GROOVE TUBES	115	Q.E.D.	46	WOLLATON AUDIO	40

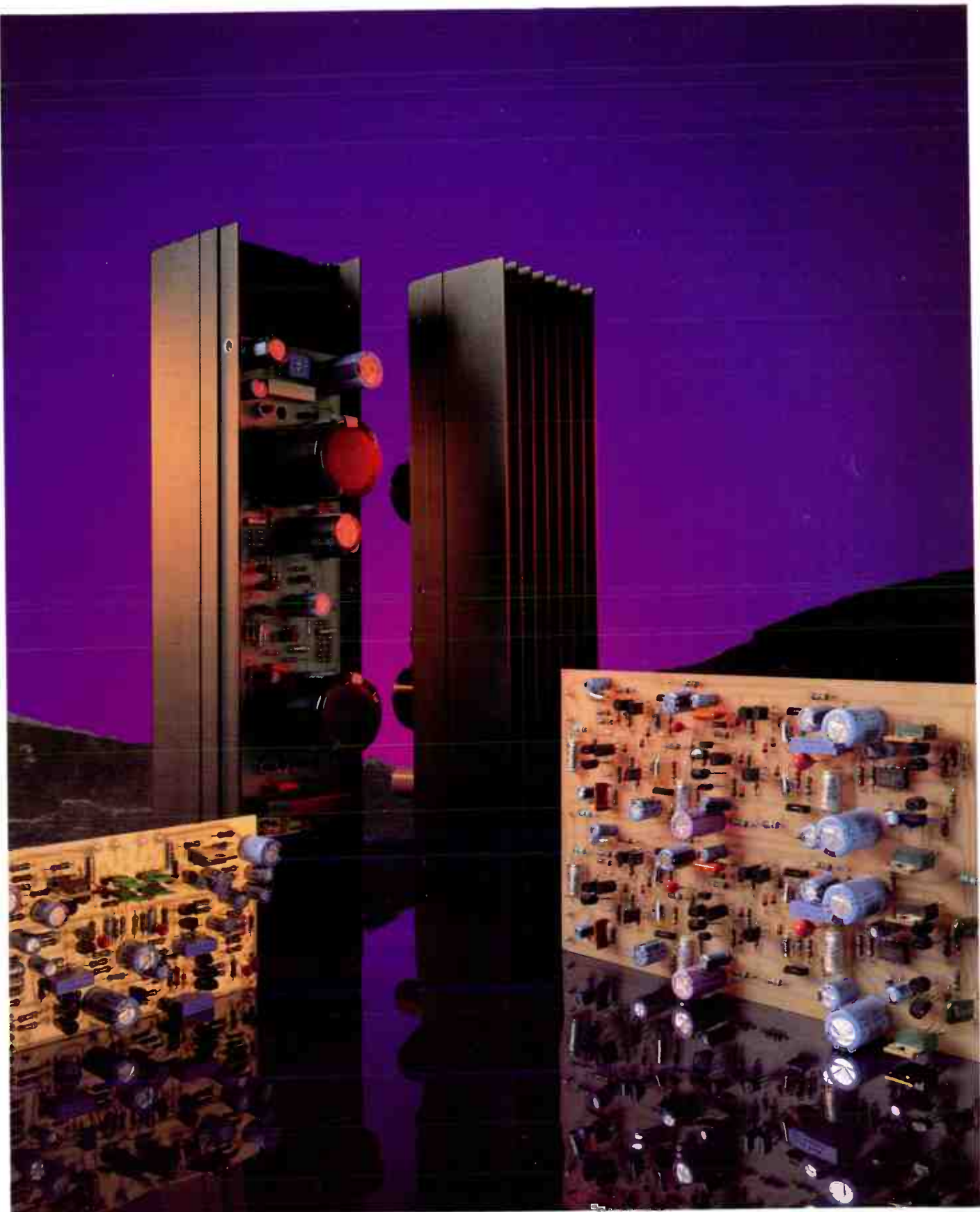

SUGDEN

HAND CRAFTED ■ FAIT À LA MAIN

DESIGNERS & MANUFACTURERS OF HI-FI & AUDIO EQUIPMENT

J. E. SUDGEN & CO. LTD.

Valley Works,

Station Lane, Heckmondwike,

West Yorkshire WF16 0NF

Tel. Heckmondwike 0924 404088/9

Fax No. 0924 410069

World Radio History

MISSION

because...



Mission Group, Huntingdon PE18 6ED England. Tel: 0480-451777 Fax: 0480-432777.

World Radio History