

E+M

BOHRZUBEHÖR
Umfangreiches Bohrzubehör
aus eigener Fertigung

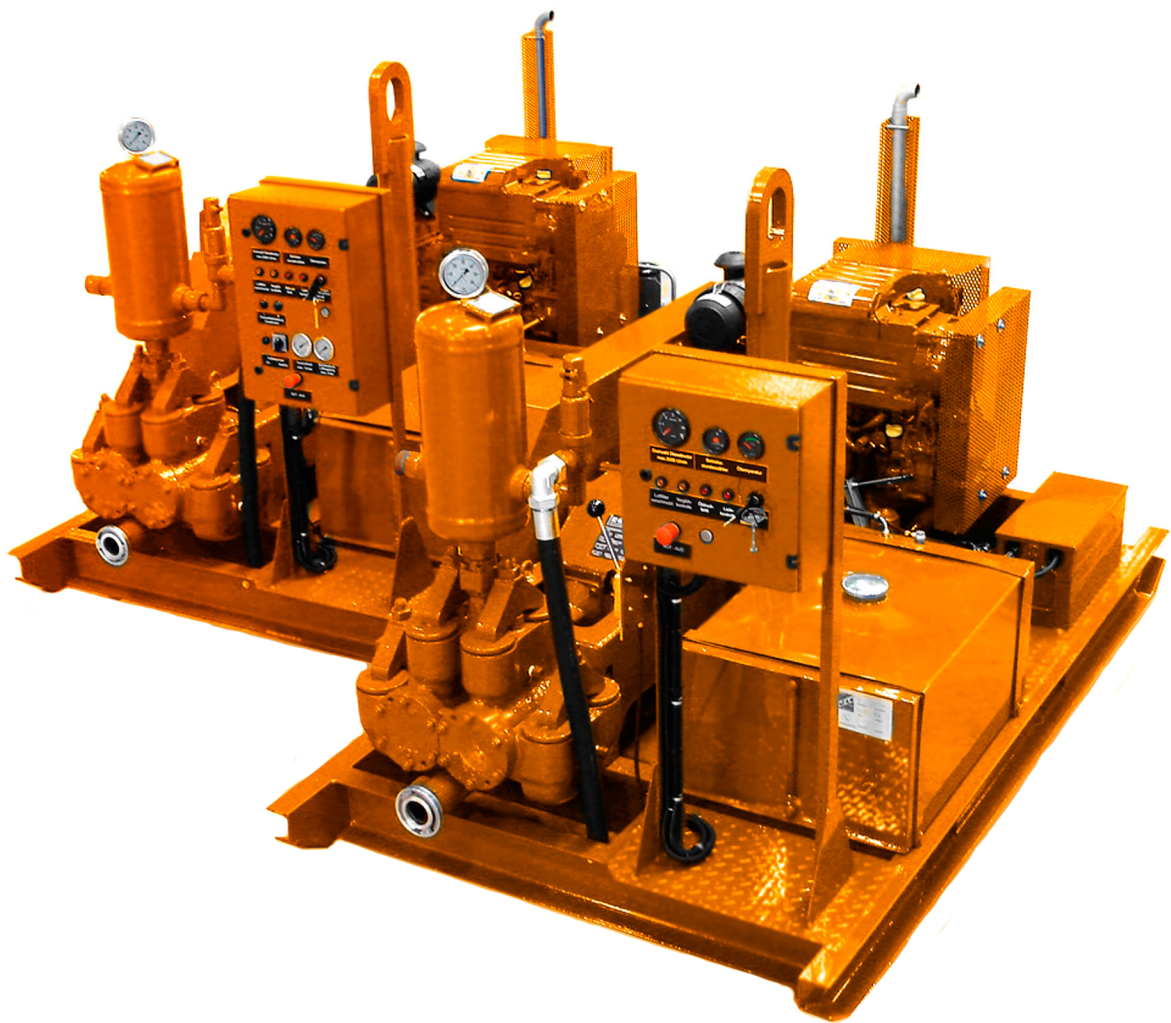

E+M DRILLING TECHNOLOGIES GMBH

Tradition - Qualität - Innovation - Partnerschaft - Weltweit

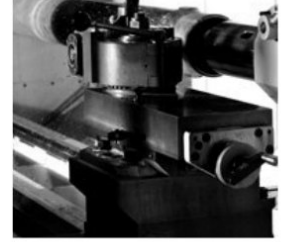
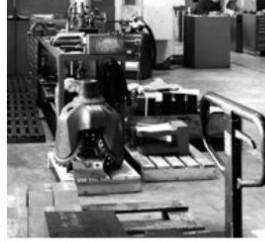

ROLLENMEIßEL

FLÜGELBOHRER

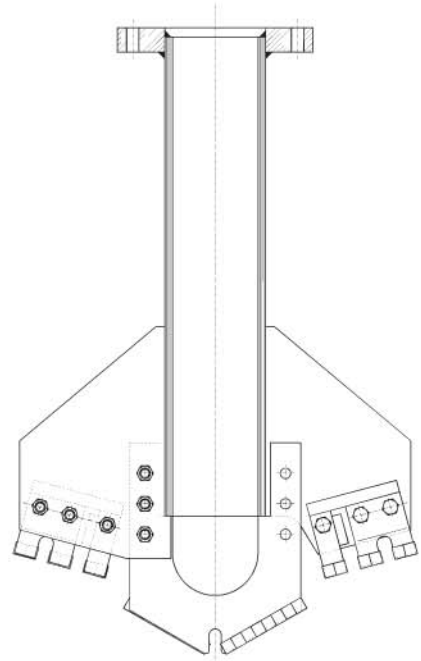
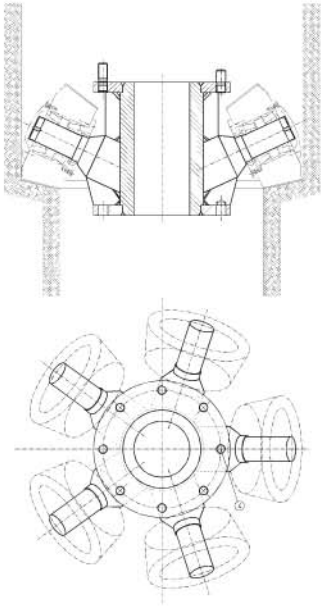

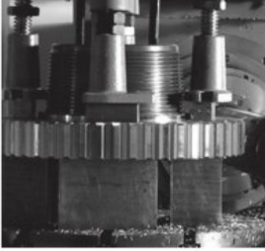

BOHRGREIFER

SCHWERSTANGEN

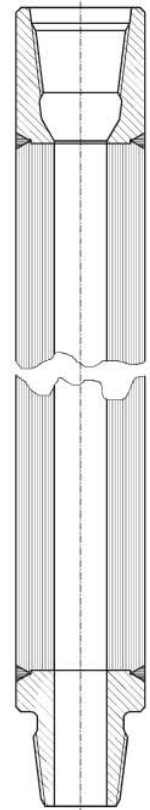
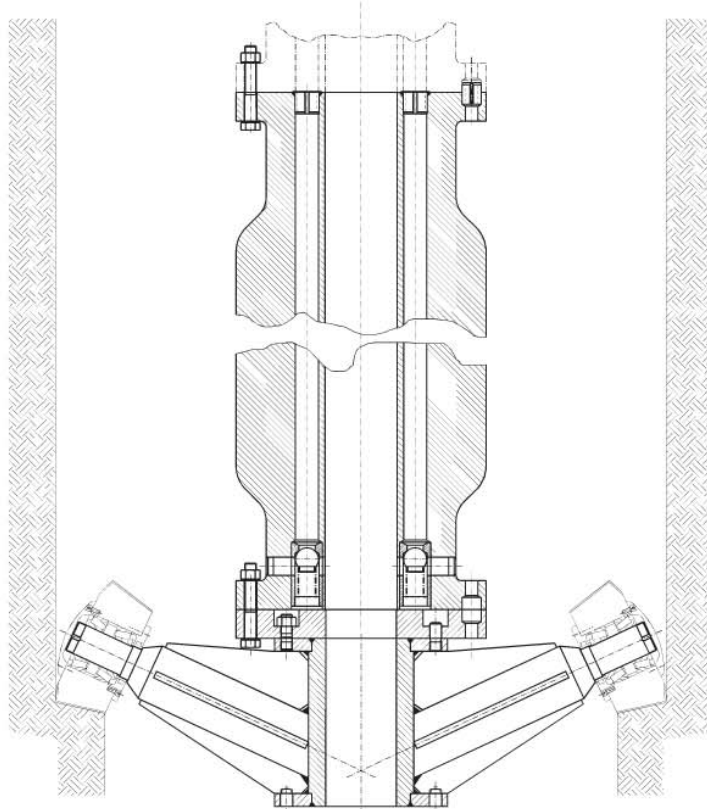
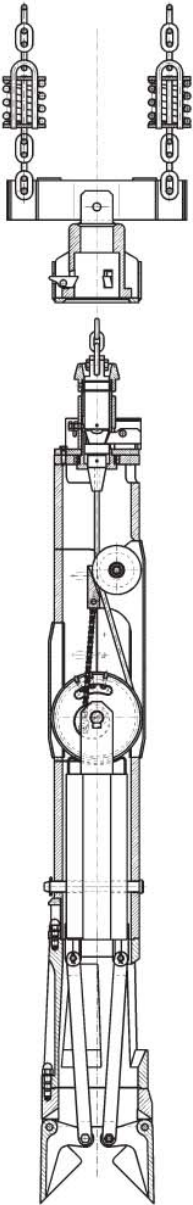



EXZENTERROLLENMEißEL

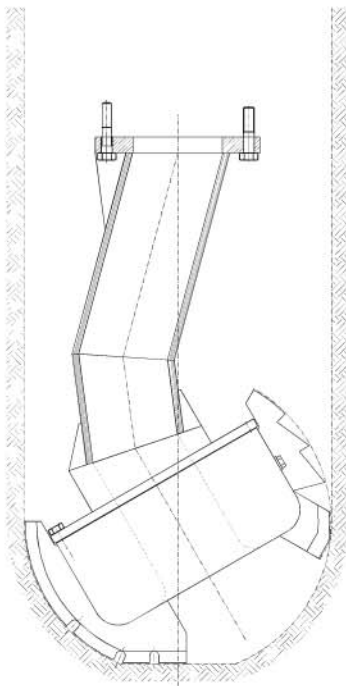

TONSCHNEIDER

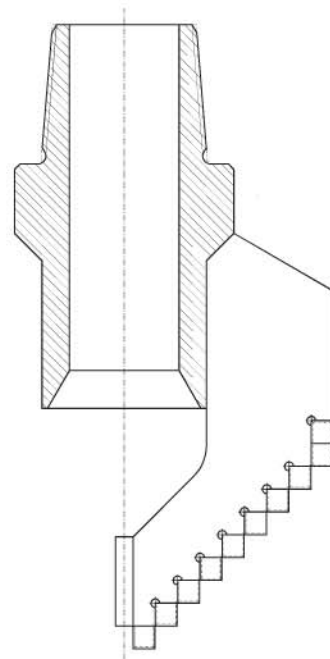



INNENROHRSCNEIDER

INNENROHRSCHLITZER

INNENROHRHEBER

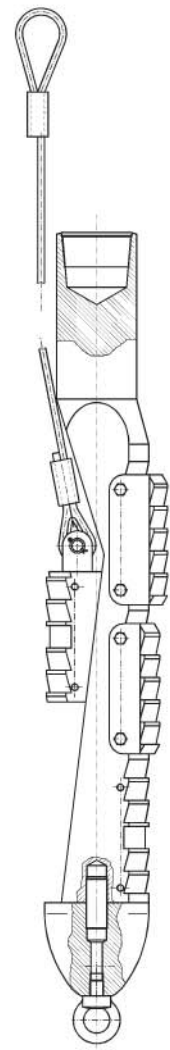
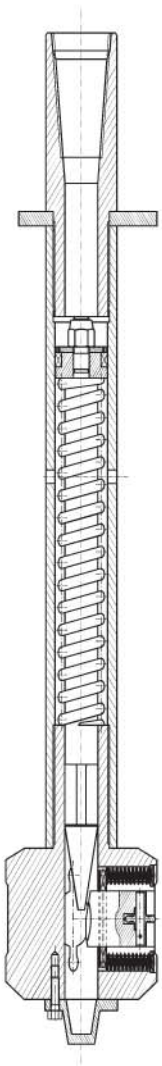

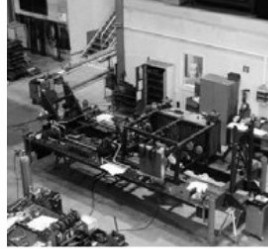

KOLBENPUMPE / KOLBENPUMPENAGGREGATE

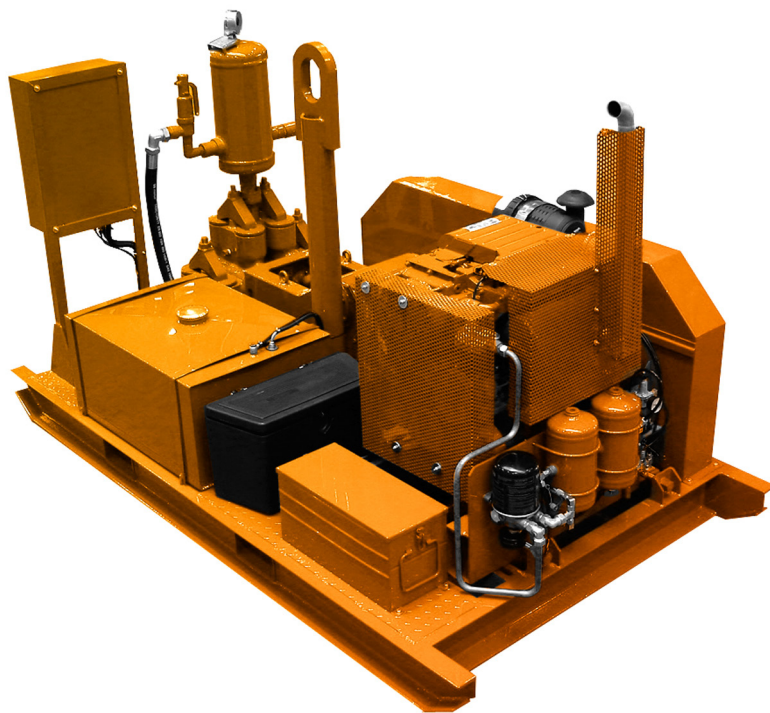
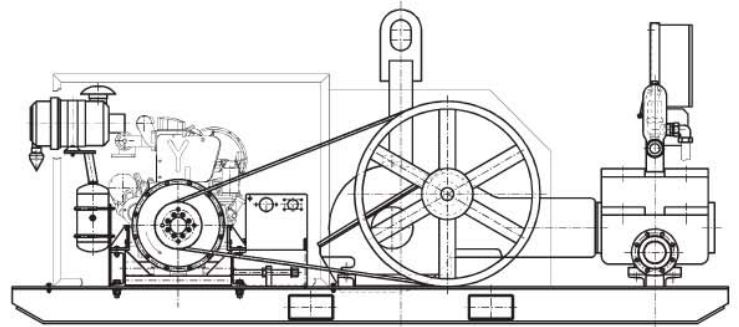
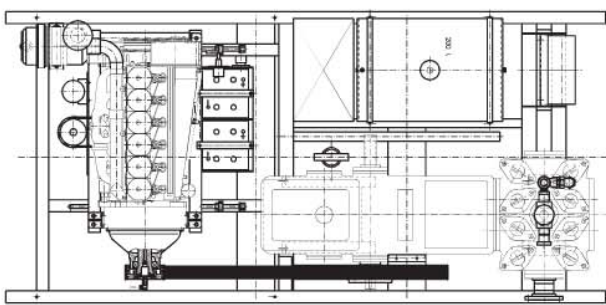

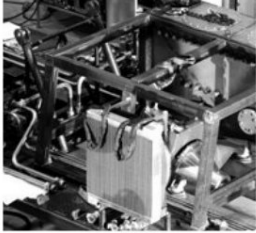
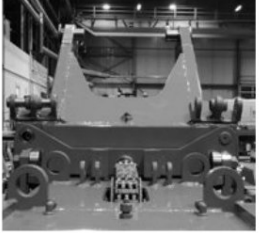

BOHRGESTÄNGE

EINFACH

DOPPELWANDIG

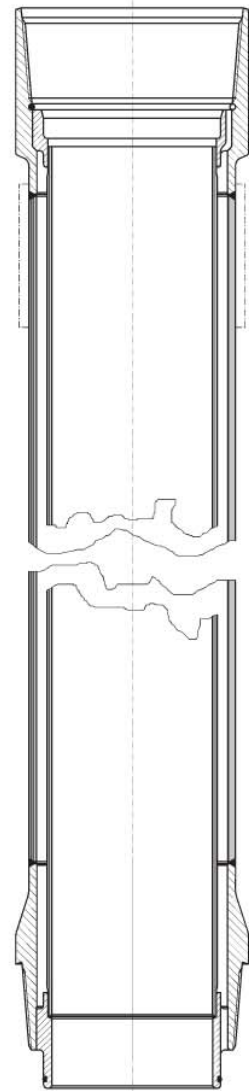
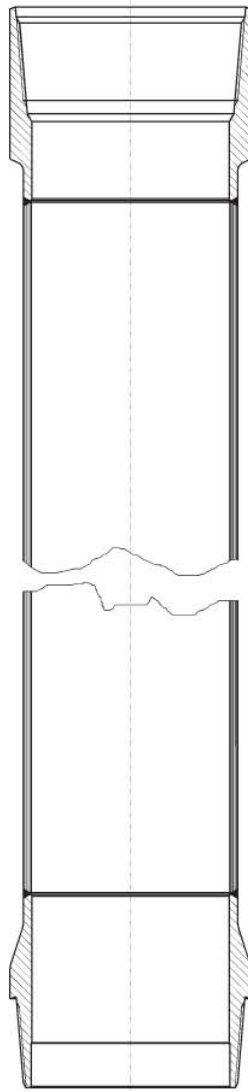

E+M Drilling Technologies GmbH

Köpenicker Allee 123-135 • 10318 Berlin

Tel. +49 (0) 30 - 75 65 44 - 0

Fax: +49 (0) 30 - 75 65 44 - 11

Email: info@em-drilling.com

Homepage: www.em-drilling.com

E+M Drilling Technologies GmbH

Hofer Straße 19 • 95030 Hof

Telefon: + 49 (0) 9281 / 14 45 - 0

Telefax: + 49 (0) 9281 / 14 45 - 518 / 587

Email: info@em-drilling.com

Homepage: www.em-drilling.com