



**SEM VARIO II**

... ist ein doppelwandiges, wärmeisoliertes Rohrsystem für Schornstein und Abgasleitung.

Seine edle Erscheinung wurde gepaart mit hoher Montagefreundlichkeit. Fließende, fast unsichtbare Übergänge an den Rohrkupplungen sind erst durch die neu entwickelte formschlüssige Verbindung der Bauteile möglich geworden.

Es zeichnet sich im Besonderen aus:

Geeignet für alle Brennstoffe im Unterdruckbetrieb bis 400° C bzw. unter Einsatz einer elastomeren Dichtung als druckdichte Abgasleitung 200 Pa und max. 200° C Abgastemperatur.

Einsetzbar an der Außenfassade mit Wandabständen von 50 mm bis 550 mm.

Freier Dachüberstand ab letztem Wandhalter des Abgasrohres ohne Abspannung 3,0 m bis Nennweite 250 mm. Mit dem Statischen Klemmband Set VARIO II 4,0 m.

Optisch sehr ansprechende Ausführung in spiegelblank und beizmatt.

Eine Oberflächenlackierung ist gegen Aufpreis möglich.

Die Blechdicke der Innen- und Außenwandbauteile beträgt 0,6 mm.

Optimale Wärmedämmung mit segmentierten Rohrdämmschalen 29 mm dick.



\*Die Hüllrohrverbindung unterliegt dem Gebrauchsmusterschutz Nr. 20 2007 013 854.7 beim Deutschen Patentamt.

## Leistungserklärung Declaration of Performance DOP

Nr. 250001 DOP 219923

1 **Doppelwandige Edelstahlabgasanlage**  
EN 1856 – 1/ EN 1856 – 2

2 **SEM VARIO II**

### Ausführungen 0.1 bis 0.5

0.1	T400	N1	D	V3- L50060	G65	Mehrschalige Abgasanlage, u. Verbindungsstücke, doppelwandige Ausführung mit 30 mm Wärmedämmung, belüftet über die gesamte Länge, ohne Verkleidung
0.2	T400	N1	W	V2- L50060	O65	Mehrschalige Abgasanlage, u. Verbindungsstücke, doppelwandige Ausführung mit 30 mm Wärmedämmung, belüftet über die gesamte Länge, ohne Verkleidung
0.3	T200	P1	W	V2- L50060	O65	Mehrschalige Abgasanlage, u. Verbindungsstücke, doppelwandige Ausführung mit 30 mm Wärmedämmung, belüftet über die gesamte Länge, ohne Verkleidung
0.4	T400	N1	D	V3- L50060	G80	Mehrschalige Abgasanlage, u. Verbindungsstücke, doppelwandige Ausführung mit 30 mm Wärmedämmung, belüftet über die gesamte Länge, ohne Verkleidung
0.5	T200	P1	W	V2- L50060	O80	Mehrschalige Abgasanlage, u. Verbindungsstücke, doppelwandige Ausführung mit 30 mm Wärmedämmung, belüftet über die gesamte Länge, ohne Verkleidung

**Anwendung:** Schornstein, Abgasleitung, Unterdruck  
Abgasleitung Überdruck  
Anbau im oder am Gebäude  
Für Festbrennstoffe, Öl oder Gas- Feuerstätten,

3 Abführung von Abgasen aus Feuerstätten durch Unter- oder Überdruck in die Atmosphäre mittels doppelwandiger gedämmter Rohre und Formstücke aus Edelstahl nach DIN EN 1856-1: 2009-09 und DIN EN 1856-2: 2009-09. Als Brennstoffe dürfen GAS und ÖL im Überdruck- und Unterdruckbetrieb verfeuert werden. Festbrennstoffe dürfen nur im Unterdruckbetrieb verfeuert werden.

**4 Name und Kontaktanschrift:** SEM Schneider Elementebau GmbH  
Gewerbegebiet 7  
D-06578 Oldisleben  
Tel.034673/754-0  
Fax:034673/75475  
Email:info@sem-online.de  
Web:www.sem-online.de

**Datenerfassungsblatt für Querschnittsberechnungen**

**Bauvorhaben**

\_\_\_\_\_

\_\_\_\_\_

**Absender**

\_\_\_\_\_

\_\_\_\_\_

**Ansprechpartner**

Name: \_\_\_\_\_

Tel.: \_\_\_\_\_

**Wärmeerzeuger**

Hersteller: \_\_\_\_\_

Typ: \_\_\_\_\_  W3G

Durchmesser: \_\_\_\_\_ mm

Brennstoff:  Gas  feste Brennstoffe  
 Öl  \_\_\_\_\_

Brennerbauart:  ohne Gebläse  mit Gebläse

		Volllast	Teillast
Leistung	kW		
CO <sub>2</sub> -Gehalt	%		
Abgasmassenstrom	kg/s		
Abgastemperatur	°C		
Zugbedarf	Pa		
Förderdruck	Pa		
Kesselstutzen-Ø mm			

**Verbindungsleitung**

Durchmesser: \_\_\_\_\_ mm

Werkstoff:  Edelstahl  Stahlblech  
 Aluminium  FAL\*  
 PPS  \_\_\_\_\_

System: \_\_\_\_\_

Umlenkungen:	Winkel	Anzahl
	90°	
	45°	
	30°	
	15°	

**Wichtige Hinweise:**

Eine Querschnittsbemessung ist nur möglich, wenn die o.g. Angaben vollständig und korrekt übermittelt werden. Beachten Sie bitte, dass Veränderungen an Abgasführungen und deren Neubau anmelde- und genehmigungspflichtig sind.\* Die Verwendung nicht geeigneter Werkstoffe (z.B. Abgasrohre aus schwarzem Stahlblech oder FAL-Blech) innerhalb der Abgasführung kann zu Korrosion führen. Mit dem Abgasstrom können Rostpartikel durch den gesamten Abgasweg transportiert werden. Diese führen insbesondere in Verbindung mit Abgaskondensaten an den Edelstahlbauteilen zu nicht reparablen Schäden.

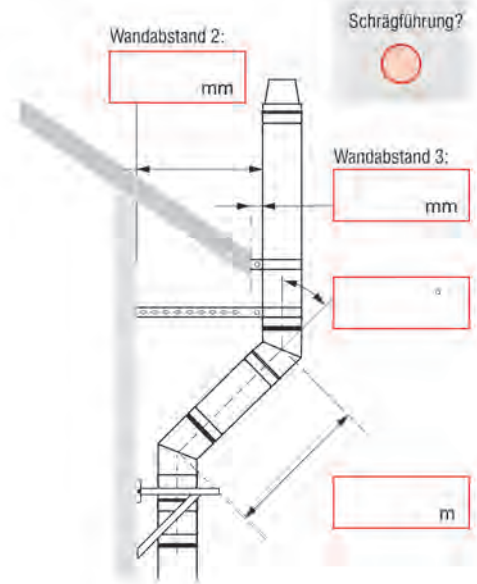
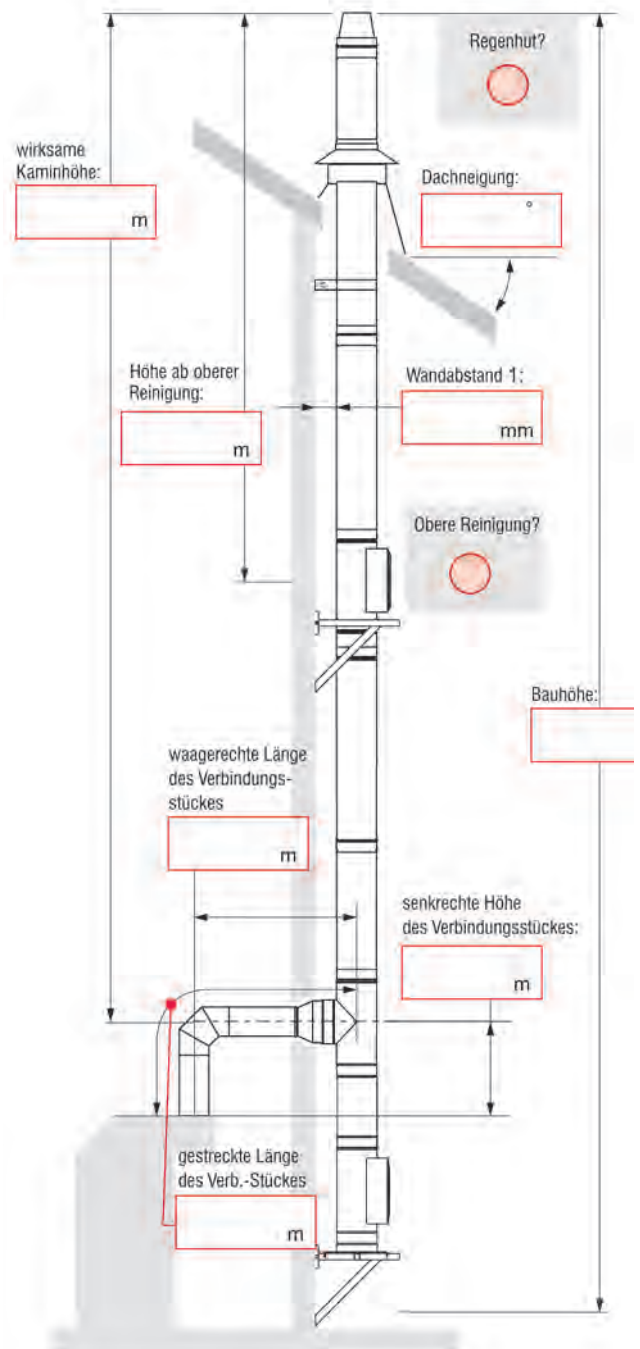

Pos. 4/1:

**Bausatz I mit Übergang auf Rauchrohr**

Bauhöhe: ca. 1,25 lfm.

**Bausatzinhalt:**

Pos.	Bezeichnung	Art.-Nr.	Anzahl (Stück)
1	Konsolplatte mit Ablauf	24 DN 431	1
2	Reinigungselement FU	24 DN 254	1
3	Rohr-Element 253 mm	26 DN 110	1
4	T-Stück 87°, FU	24 DN 303	1
5	Übergang Rauchrohr	24 DN 322	1
6	Mündungsabschluss	26 DN 359	1

Zusätzlich bestellen Sie bitte:

- Wandbefestigungsteile entsprechend Wandabstand und Bauhöhe
- Rohr-Elemente
- gegebenenfalls eine obere Reinigung

Durchmesser des Abgasrohres' DN in mm		130	150	180
Bestell-Nummer		24130P02-130	24150P02-150	24180P02-180
Preis	EUR	721,70	792,60	870,80



Pos. 4/2:

**Bausatz I ohne Übergang** (Übergang nach baulichen Gegebenheiten wählen)

Bauhöhe: ca. 1,25 lfm.

**Bausatzinhalt:**

Pos.	Bezeichnung	Art.-Nr.	Anzahl (Stück)
1	Konsolplatte mit Ablauf	24 DN 431	1
2	Reinigungselement FU	24 DN 254	1
3	Rohr-Element 253 mm	26 DN 110	1
4	T-Stück 87°, FU	24 DN 303	1
6	Mündungsabschluss	26 DN 359	1

Zusätzlich bestellen Sie bitte:

- Wandbefestigungsteile entsprechend Wandabstand und Bauhöhe
- Rohr-Elemente
- Übergang nach baulichen Gegebenheiten
- gegebenenfalls eine obere Reinigung

Durchmesser des Abgasrohres' DN in mm		130	150	180
Bestell-Nummer		24130P02	24150P02	24180P02
Preis	EUR	641,00	697,50	770,80

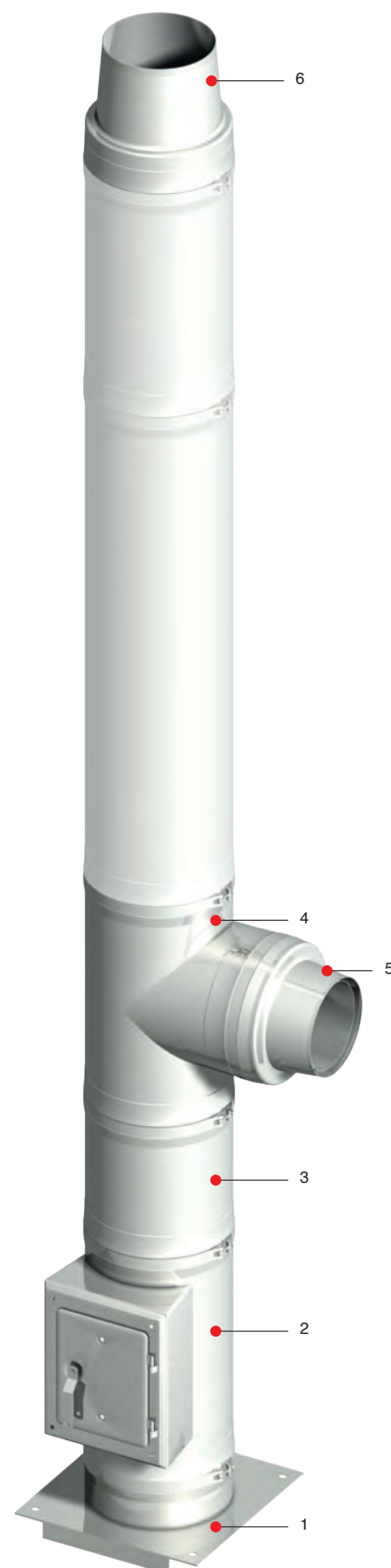



Pos. 4/2:

**Bausatz II - Kaminfußteil, höhenjustierbar**

**Spezifikation:**

- Bauhöhe: 280 bis 1085 mm
- Ausführung : für Brennstoffe Gas und Heizöl EL, feuchteunempfindliche Betriebsweise  
für feste Brennstoffe, trockene Betriebsweise  
Unterdruckbetrieb
- Werkstoff : 1.4404 / 1.4301 0,6 mm
- Leistungserklärung: Nr. 250001DOP219923

**Bausatzinhalt:**

Pos.	Bezeichnung	Anzahl (Stück)
1	Fußplatte	1
2	Hüllrohr	1
3	Kondensatschale mit seitlichem Ablauf	1
4	Klemmband	2

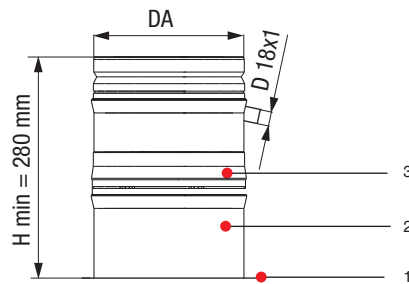
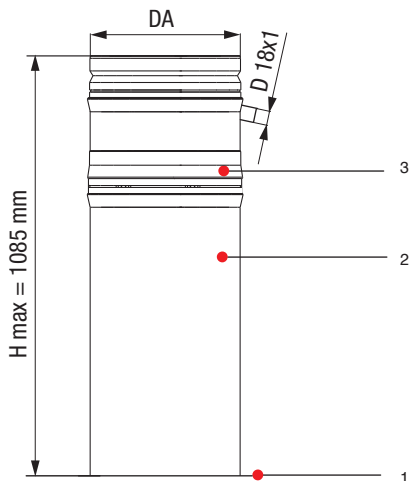

Durchmesser des Abgasrohres <sup>1)</sup> DN in mm		113	130	150	160	180	200	250
Bestell-Nummer		26 113 P90	26 130 P90	26 150 P90	26 160 P90	26 180 P90	26 200 P90	26 250 P90
Preis	EUR	258,10	275,90	287,40	316,20	323,30	356,30	423,90

<sup>1)</sup> Außendurchmesser = Innendurchmesser + 60 mm

Durchmesser des Abgasrohres DN in mm	80	100	113	130	150	
Durchmesser Hüllrohr DH in mm	140	160	173	190	210	

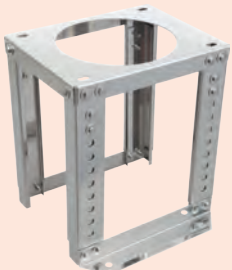
	Pos. 4/3: Schornsteintragegestütze, höhenverstellbar, 340 – 540 mm					
	Art.-Nr.:	26 080 417	26 100 417	26 113 417	26 130 417	26 150 417
	Preis (EUR)	281,60	284,00	286,00	246,40	262,30

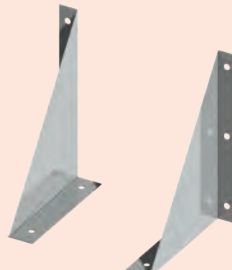
	Pos. 4/4: Wandkonsole, Wandabstand: 50 mm (paarweise), inkl. Schraubenset					
	Art.-Nr.:	26 080 410	26 100 410	26 113 410	26 130 410	26 150 410
	Preis (EUR)	86,70	85,80	67,70	65,80	74,00
	A in mm	245	260	270	290	315
	B in mm	138	148	150	168	186
	C in mm	185	200	210	230	255
	D in mm	52	52	52	52	52
L in mm	325	345	350	385	422	

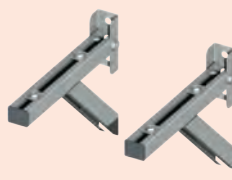
	Pos. 4/5: Wandkonsole, Wandabstand: 80 - 100 mm (paarweise)					
	Art.-Nr.:	26 080 720	26 100 720	26 113 720	26 130 720	26 150 720
	Preis (EUR)	154,00	156,40	121,40	122,20	124,10
	Länge (L) in mm	300	325	325	350	375
	Höhe (H) in mm	253	253	253	293	293
	E in mm	148	148	148	188	188

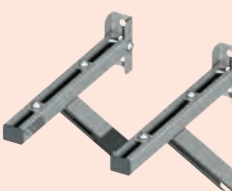
	Pos. 4/6: Wandkonsole, Wandabstand: 100 - 200 mm (paarweise)					
	Art.-Nr.:	26 080 721	26 100 721	26 113 721	26 130 721	26 150 721
	Preis (EUR)	165,50	167,40	142,50	132,40	141,30
	Länge (L) in mm	400	425	425	450	475
	Höhe (H) in mm	293	293	293	333	333
	E in mm	188	188	188	228	228

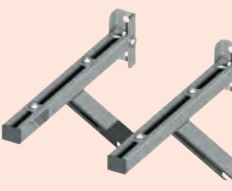
	Pos. 4/7: Wandkonsole, Wandabstand: 100 - 250 mm (paarweise)					
	Art.-Nr.:	26 080 722	26 100 722	26 113 722	26 130 722	26 150 722
	Preis (EUR)	173,10	175,00	153,30	146,60	148,50
	Länge (L) in mm	450	475	475	500	525
	Höhe (H) in mm	333	333	333	373	373
	E in mm	228	228	228	268	268

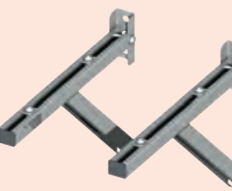
	Pos. 4/8: Wandkonsole, Wandabstand: 100 - 300 mm (paarweise)					
	Art.-Nr.:	26 080 723	26 100 723	26 113 723	26 130 723	26 150 723
	Preis (EUR)	180,80	182,70	182,70	150,10	155,90
	Länge (L) in mm	500	525	525	550	575
	Höhe (H) in mm	373	373	373	373	413
	E in mm	268	268	268	268	308

	160	180	200	250	300	Hinweise	
	220	240	260	310	360		

	26 160 417	26 180 417	26 200 417	26 250 417	26 300 417		
	318,10	273,00	296,60	333,00	438,40		

	26 160 410	26 180 410	26 200 410	26 250 410	26 300 410		
	85,00	89,80	97,30	137,70	233,40		
	325	340	370	415	465		
	190	200	225	261	280		
	265	280	310	355	405		
	52	52	52	52	53		
	430	450	500	572	610		

	26 160 720	26 180 720	26 200 720	26 250 720	26 300 720		
	163,60	125,50	127,60	141,30	148,50		
	375	400	425	475	525		
	293	293	293	333	373		
	188	188	188	228	268		

	26 160 721	26 180 721	26 200 721	26 250 721	26 300 721		
	141,30	146,60	148,50	169,10	172,20		
	475	500	525	575	625		
	333	373	373	413	413		
	228	268	268	308	308		

	26 160 722	26 180 722	26 200 722	26 250 722	26 300 722		
	161,20	150,10	169,10	203,20	212,30		
	525	550	575	625	675		
	373	373	413	413	453		
	268	268	308	308	348		

	26 160 723	26 180 723	26 200 723	26 250 723	26 300 723		
	190,80	170,00	186,90	212,30	221,40		
	575	600	625	675	725		
	413	413	413	453	493		
	308	308	308	348	388		

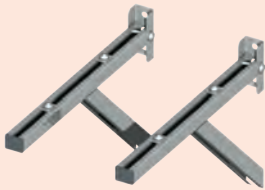

Durchmesser des Abgasrohres DN in mm	80	100	113	130	150	
Durchmesser Hüllrohr DH in mm	140	160	173	190	210	

	Pos. 4/9: Wandkonsole, Wandabstand: 150 - 350 mm (paarweise)					
	Art.-Nr.:	26 080 724	26 100 724	26 113 724	26 130 724	26 150 724
	Preis (EUR)	184,60	190,80	169,10	170,00	172,30
	Länge (L) in mm	550	575	575	600	625
	Höhe (H) in mm	373	413	413	413	413
	E in mm	268	308	308	308	308

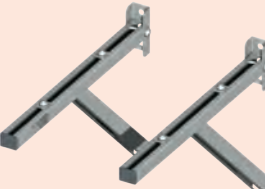
	Pos. 4/10: Wandkonsole, Wandabstand: 150 - 400 mm (paarweise)					
	Art.-Nr.:	26 080 725	26 100 725	26 113 725	26 130 725	26 150 725
	Preis (EUR)	192,20	184,50	203,20	173,80	180,00
	Länge (L) in mm	600	625	625	650	675
	Höhe (H) in mm	413	413	413	413	453
	E in mm	308	308	308	308	348

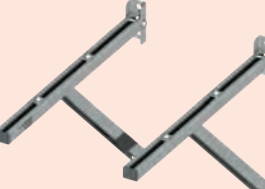
	Pos. 4/11: Wandkonsole, Wandabstand: 250 - 550 mm (paarweise)					
	Art.-Nr.:	26 080 726	26 100 726	26 113 726	26 130 726	26 150 726
	Preis (EUR)	212,30	214,10	221,40	189,50	191,60
	Länge (L) in mm	750	775	775	800	825
	Höhe (H) in mm	493	493	493	533	533
	E in mm	388	388	388	428	428

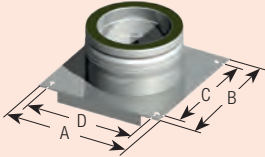
	Pos. 4/12: Konsolplatte FU mit Ablauf Für Unterdruck!					
	Art.-Nr.:	-	-	24 113 431	24 130 431	24 150 431
	Preis (EUR)			73,80	78,30	77,40
	A in mm			273	290	310
	B in mm			223	240	250
	C in mm			180	197	207
	D in mm			225	242	262
	Ablauf			3/4"	1/2"	1/2"

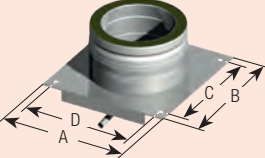
	Pos. 4/13: Konsolplatte AL mit Ablauf Für Über- und Unterdruck!					
	Art.-Nr.:	25 080 431	25 100 431	25 113 431	25 130 431	25 150 431
	Preis (EUR)	142,20	148,50	153,70	158,90	171,80
	A in mm	273	290	273	290	310
	B in mm	223	240	223	240	250
	C in mm	180	197	180	197	207
	D in mm	225	242	225	242	262
	Ablauf	3/4"	3/4"	3/4"	1/2"	1/2"

	Pos. 4/14 Grundplatte mit seitlichem Ablauf D 18x1, inkl. Klemmband					
	Art.-Nr.:	26 080 700	26 100 700	26 113 700	26 130 700	26 150 700
	Preis (EUR)	123,60	129,20	112,80	119,80	100,60
	A in mm	240	260	275	290	311
	B in mm	180	200	215	230	251
	F in mm	18	18	18	18	18



	160	180	200	250	300	Hinweise
	220	240	260	310	360	

	26 160 724	26 180 724	26 200 724	26 250 724	26 300 724	
	203,20	205,00	212,30	221,40	226,00	
	625	650	675	725	775	
	413	413	453	493	493	
	308	308	348	388	388	

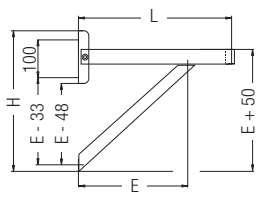

	26 160 725	26 180 725	26 200 725	26 250 725	26 300 725	
	212,30	197,00	221,40	226,00	235,10	
	675	700	725	775	825	
	453	453	493	493	533	
	348	348	388	388	428	

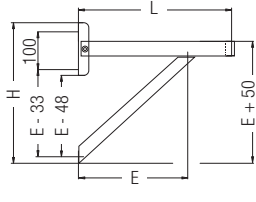

	26 160 726	26 180 726	26 200 726	26 250 726	26 300 726	
	207,90	197,10	235,10	229,10	237,60	
	825	850	875	925	975	
	533	573	613	653	693	
	428	468	508	548	588	

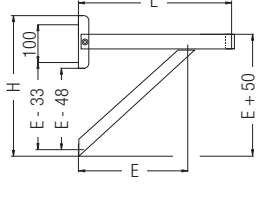

	24 160 431	24 180 431	24 200 431	24 250 431	24 300 431	
	91,30	93,50	101,10	111,90	220,30	
	320	340	360	413	465	
	270	290	310	363	415	
	227	247	267	320	372	
	272	292	312	365	417	
	1/2"	3/4"	3/4"	3/4"	3/4"	

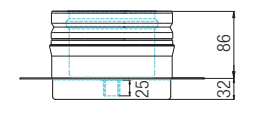

	25 160 431	25 180 431	25 200 431	25 250 431	25 300 431	
	180,40	184,60	193,80	211,80	238,90	
	320	340	360	413	465	
	270	290	310	363	415	
	227	247	267	320	372	
	272	292	312	365	417	
	1/2"	3/4"	3/4"	3/4"	3/4"	

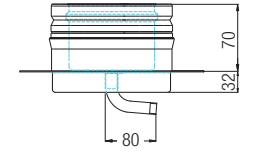

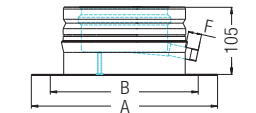

	26 160 700	26 180 700	26 200 700	26 250 700	26 300 700	
	106,80	109,50	154,60	166,20	203,40	
	320	340	360	415	465	Nur für Montage auf feuerfestem Untergrund (z.B. Betonsockel)
	260	280	300	355	405	
	18	18	18	45	45	



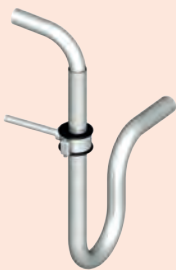

Durchmesser des Abgasrohres DN in mm	80	100	113	130	150	
Durchmesser Hüllrohr DH in mm	140	160	173	190	210	

	Pos. 4/15: Edelstahlsiphon, zweiteilig 18 x 1					
	Art.-Nr.:	26 000 281	26 000 281	26 000 281	26 000 281	26 000 281
	Preis (EUR)	24,80	24,80	24,80	24,80	24,80

	Pos. 4/16: Reinigungs-Element FU Für Unterdruck! , inkl. Klemmband					
	Art.-Nr.:	-	-	24 113 254	24 130 254	24 150 254
	Preis (EUR)			279,00	270,60	291,20
	LH in mm			474	474	474
	LR in mm			488	488	488
	L in mm			429	429	429

	Pos. 4/17: Reinigungs-Element FU, oben Für Unterdruck! , inkl. Klemmband					
	Art.-Nr.:	-	-	24 113 253	24 130 253	24 150 253
	Preis (EUR)			249,40	244,30	251,50
	LH in mm			474	474	474
	LR in mm			488	488	488
	L in mm			429	429	429

	Pos. 4/18: T-Stück 90° FU Für Unterdruck! , inkl. 2 Klemmbänder					
	Art.-Nr.:	-	-	24 113 303	24 130 303	24 150 303
	Preis (EUR)			184,10	183,60	201,40
	L in mm			426	426	426
	L 1 in mm			188	188	188

	Pos. 4/19: Reinigungs-Element AL Für Über- und Unterdruck! T max = 200°C, inkl. Klemmband					
	Art.-Nr.:	25 080 254	25 100 254	25 113 254	25 130 254	25 150 254
	Preis (EUR)	220,40	235,10	440,50	454,90	379,50
	LH in mm	328	328	474	474	474
	LR in mm	343	343	488	488	488
	L in mm	280	280	429	429	429

DN 80 bis 100      DN 113 bis 300

	Pos. 4/20: T-Stück 90° mit Reinigungsöffnung Für Unterdruckbetrieb! inkl. Klemmband					
	Art.-Nr.:	-	-	24 113 309	24 130 309	24 150 309
	Preis (EUR)			386,50	402,30	431,10
	LH in mm			475	475	475
	LR in mm			490	490	490
	L in mm			426	426	426
	L 1 in mm			188	188	188
	E in mm			105	113	123

	160	180	200	250	300	Hinweise
	220	240	260	310	360	

	26 000 281	26 000 281	26 000 281	26 000 281	26 000 281	
	24,80	24,80	24,80	24,80	24,80	

	24 160 254	24 180 254	24 200 254	24 250 254	24 300 254	
	298,00	315,20	337,80	406,80	445,60	
	474	474	474	474	474	
	488	488	488	488	488	
	429	429	429	429	429	

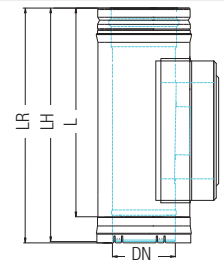

	24 160 253	24 180 253	24 200 253	24 250 253	–	
	273,00	281,70	298,90	333,40		
	474	474	474	474		Maximale Aufbauhöhe oberhalb: • ohne weitere Halterung 1,5 m • mit zusätzlicher Halterung 3 m Nicht für Seilabspannung geeignet!
	488	488	488	488		
	429	429	429	429		

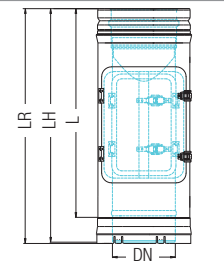

	24 160 303	24 180 303	24 200 303	24 250 303	24 300 303	
	221,10	229,50	272,00	364,30	438,70	
	426	426	426	432	491	
	188	188	188	191	221	

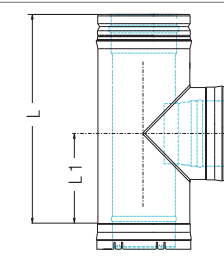

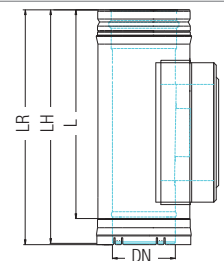

	25 160 254	25 180 254	25 200 254	25 250 254	25 300 254	
	465,30	433,10	419,00	438,70	577,40	
	474	474	474	474	474	
	488	488	488	488	488	
	429	429	429	429	429	



	24 160 309	24 180 309	24 200 309	24 250 309	–	
	445,40	467,00	537,80	600,20		
	475	475	475	475		
	490	490	490	490		
	426	426	426	426		
	188	188	188	188		
	128	138	148	175		

Durchmesser des Abgasrohres DN in mm	80	100	113	130	150	
Durchmesser Hüllrohr DH in mm	140	160	173	190	210	

	<b>Pos. 4/21: T-Stück 87° AL Für Über- und Unterdruck! , inkl. Klemmband</b>					
	<b>Art.-Nr.:</b>	25 080 300	25 100 300	25 113 300	25 130 300	25 150 300
	Preis (EUR)	207,60	215,20	288,10	291,80	251,00
	L in mm	426	426	426	426	426
	L 1 in mm	188	188	188	188	188

	<b>Pos. 4/22: Wanddurchführung 87°-90°</b>					
	<b>Art.-Nr.:</b>	26 080 320	26 100 320	26 113 320	26 130 320	26 150 320
	Preis (EUR)	...	30,40	31,60	33,90	45,10
	Di in mm	180	200	213	230	250

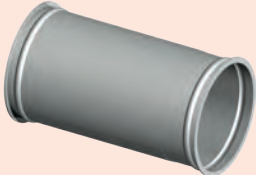
	<b>Pos. 4/23: Wanddurchführung, für Wanddicke: 180 - 300 mm</b>					
	<b>Art.-Nr.:</b>	26 080 325	26 100 325	26 113 325	26 130 325	26 150 325
	Preis (EUR)	53,90	57,10	39,90	41,10	42,20
	Di in mm	180	200	213	230	250
	L 1 in mm	186	186	186	186	186

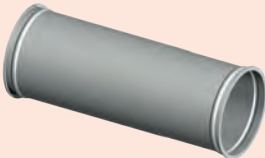
	<b>Pos. 4/24: Wanddurchführung, für Wanddicke: 280 - 500 mm</b>					
	<b>Art.-Nr.:</b>	26 080 326	26 100 326	26 113 326	26 130 326	26 150 326
	Preis (EUR)	64,70	68,20	69,20	47,10	49,60
	Di in mm	180	200	213	230	250
	L 1 in mm	286	289	286	286	286

	<b>Pos. 4/25: T-Stück 45° Für Über- und Unterdruck! , inkl. Klemmband</b>					
	<b>Art.-Nr.:</b>	-	-	25 113 304	25 130 304	25 150 304
	Preis (EUR)			465,40	370,40	405,30
	LH in mm			446	489	489
	LR in mm			459	502	502
	L in mm			400	443	443
	L 2 in mm			40	55	48

	<b>Pos. 4/26: Wanddurchführung 45°</b>					
	<b>Art.-Nr.:</b>	26 080 324	26 100 324	26 113 324	26 130 324	26 150 324
	Preis (EUR)	auf Anfrage	auf Anfrage	auf Anfrage	auf Anfrage	auf Anfrage
	A in mm	165	185	198	215	235

	160	180	200	250	300	Hinweise	
	220	240	260	310	360		

	25 160 300	25 180 300	25 200 300	25 250 300	25 300 300	
	320,50	342,60	369,60	507,50	590,90	
	426	426	426	432	491	
	188	188	188	191	221	

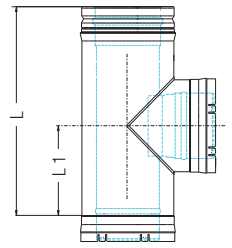

	26 160 320	26 180 320	26 200 320	26 250 320	26 300 320	
	53,00	56,40	79,00	90,20	112,70	
	260	280	300	353	405	

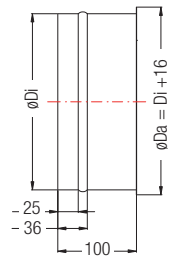

	26 160 325	26 180 325	26 200 325	26 250 325	26 300 325	
	43,20	45,40	48,50	73,90	99,30	
	260	280	300	353	405	
	186	186	186	186	186	
	166	166	166	166	166	

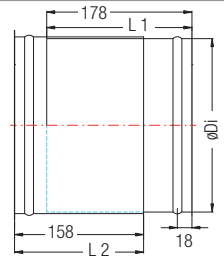

	26 160 326	26 180 326	26 200 326	26 250 326	26 300 326	
	52,70	54,30	55,90	94,50	103,50	
	260	280	300	353	405	
	286	286	286	286	286	
	266	266	266	266	266	

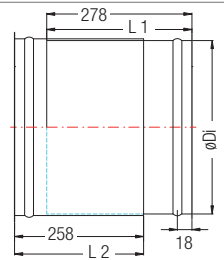

	25 160 304	25 180 304	25 200 304	25 250 304	25 300 304	
	476,30	455,90	622,90	664,20	915,90	
	489	560	560	663	736	
	502	573	573	676	749	
	443	514	514	617	690	
	44	72	65	98	117	
	314	338	362	426	489	

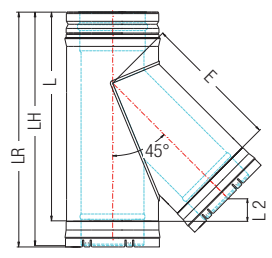

	26 160 324	26 180 324	26 200 324	26 250 324	26 300 324	
	auf Anfrage	auf Anfrage	auf Anfrage	auf Anfrage	auf Anfrage	
	245	265	285	338	390	
	346	375	403	478	552	

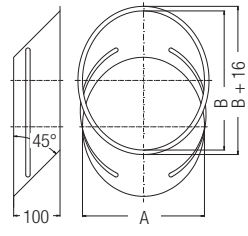

Durchmesser des Abgasrohres DN in mm	80	100	113	130	150	
Durchmesser Hüllrohr DH in mm	140	160	173	190	210	



Pos. 4/27

## Pos. 4/27: Rohr-Element 935 mm, inkl. Klemmband

Art.-Nr.:	26 080 112	26 100 112	26 113 112	26 130 112	26 150 112	
Preis (EUR)	113,20	118,70	122,40	126,00	139,70	
L in mm	935	935	935	935	935	



Pos. 4/28



Pos. 4/29

## Pos. 4/28: Rohr-Element 435 mm, inkl. Klemmband

Art.-Nr.:	26 080 111	26 100 111	26 113 111	26 130 111	26 150 111	
Preis (EUR)	69,20	70,80	73,10	77,60	83,60	
L in mm	435	435	435	435	435	

## Pos. 4/29: Rohr-Element 270 mm, inkl. Klemmband

Art.-Nr.:	26 080 110	26 100 110	26 113 110	26 130 110	26 150 110	
Preis (EUR)	60,10	60,70	60,80	59,50	63,00	
L in mm	270	270	270	270	270	



Pos. 4/30

NEU!

## Pos. 4/30: Rohr-Element 135 mm, inkl. Klemmband

Art.-Nr.:	26 080 109	26 100 109	26 113 109	26 130 109	26 150 109	
Preis (EUR)	53,90	55,40	55,80	59,50	62,90	
L in mm	135	135	135	135	135	

NEU!



Pos. 4/31

## Pos. 4/31: Rohr-Element 140–275 mm, Achtung! Nur für senkrechte Einbaulage!

Art.-Nr.:	24 080 108	24 100 108	24 113 108	24 130 108	24 150 108	
Preis (EUR)	104,10	106,90	108,10	81,30	85,40	
L in mm	275	275	275	275	275	



## Pos. 4/32: Bogen 15° FU Für Unterdruck!, inkl. Klemmband

Art.-Nr.:	–	–	24 113 200	24 130 200	24 150 200	
Preis (EUR)			126,20	82,90	85,20	
A in mm			55	56	57	
B in mm			102	103	105	
E in mm			26	27	27	
L in mm			148	151	152	

	160	180	200	250	300	Hinweise	
	220	240	260	310	360		

	26 160 112	26 180 112	26 200 112	26 250 112	26 300 112		
	164,30	174,60	193,90	285,90	352,10		
	935	935	935	935	935		

	26 160 111	26 180 111	26 200 111	26 250 111	26 300 111		
	97,00	102,80	112,30	163,40	203,00		
	435	435	435	435	435		

	26 160 110	26 180 110	26 200 110	26 250 110	26 300 110		
	70,70	74,00	84,30	129,30	160,40		
	270	270	270	270	270		

	26 160 109	26 180 109	26 200 109	26 250 109	26 300 109		
	70,60	73,90	84,20	164,90	170,20		
	135	135	135	135	135		

	24 160 108	24 180 108	24 200 108	24 250 108	24 300 108		
	93,60	96,20	111,30	164,00	199,50		
	275	275	275	275	275		

	24 160 200	24 180 200	24 200 200	24 250 200	24 300 200		
	116,30	110,40	121,80	212,50	238,70		
	58	59	60	64	67		
	105	106	107	111	114		
	27	27	28	28	30		
	155	157	159	161	164		





Durchmesser des Abgasrohres DN in mm	80	100	113	130	150	
Durchmesser Hüllrohr DH in mm	140	160	173	190	210	

	Pos. 4/33: Bogen 15° AL Für Über- und Unterdruck!, inkl. Klemmband					
	Art.-Nr.:	25 080 200	25 100 200	25 113 200	25 130 200	25 150 200
	Preis (EUR)	198,40	210,60	211,90	227,70	245,20
	A in mm	53	54	55	56	57
	B in mm	99	101	102	103	105
	E in mm	26	26	26	27	27
	L in mm	148	151	148	151	152

	Pos. 4/34: Bogen 30° FU Für Unterdruck!, inkl. Klemmband					
	Art.-Nr.:	-	-	24 113 201	24 130 201	24 150 201
	Preis (EUR)			80,00	85,20	101,10
	A in mm			66	69	71
	B in mm			113	116	118
	E in mm			57	58	59
	L in mm			164	168	173

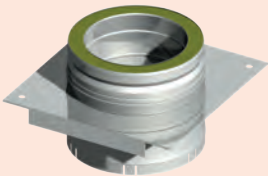
	Pos. 4/35: Bogen 30° AL Für Über- und Unterdruck!, inkl. Klemmband					
	Art.-Nr.:	25 080 201	25 100 201	25 113 201	25 130 201	25 150 201
	Preis (EUR)	174,00	182,20	185,00	187,60	201,30
	A in mm	62	64	66	69	71
	B in mm	109	111	113	116	118
	E in mm	54	56	57	58	59
	L in mm	156	161	164	168	173

	Pos. 4/36: Zwischenstütze, inkl. Klemmband					
	Art.-Nr.:	26 080 420	26 100 420	26 113 420	26 130 420	26 150 420
	Preis (EUR)	103,20	106,30	108,80	95,10	98,10
	A in mm	265	283	273	290	310
	B in mm	197	210	223	240	250
	C in mm	160	193	180	197	207
	D in mm	220	233	225	242	262

	Pos. 4/37: Zwischenstütze inkl. Rohrverschluss mit Kondensatablauf Für Unterdruck!					
	Art.-Nr.:	-	-	26 113 421	26 130 421	26 150 421
	Preis (EUR)			337,00	207,50	180,00

	Pos. 4/38: Wandrosette klappbar, Randbreite 50 mm					
	Art.-Nr.:	26 080 349 01	26 100 349 01	26 113 349 01	26 130 349 01	26 150 349 01
	Preis (EUR)	42,20	31,50	32,60	33,80	34,90
	DR in mm	~ 235	~ 255	~ 268	~ 285	~ 305

	160	180	200	250	300	Hinweise	
	220	240	260	310	360		

	25 160 200	25 180 200	25 200 200	25 250 200	25 300 200	
	248,70	250,60	259,20	307,10	321,40	
	58	59	60	64	67	
	105	106	107	111	114	
	27	27	28	28	30	
	155	157	159	161	164	

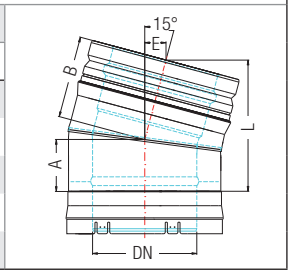

	24 160 201	24 180 201	24 200 201	24 250 201	24 300 201	
	109,10	112,60	121,60	129,30	210,60	
	73	75	78	85	92	
	120	122	125	132	139	
	60	61	62	66	70	
	176	181	186	199	212	

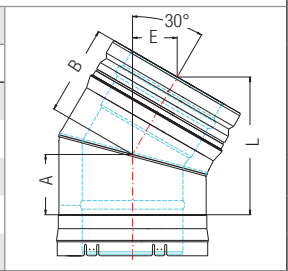

	25 160 201	25 180 201	25 200 201	25 250 201	25 300 201	
	207,10	224,40	258,40	296,40	383,40	
	73	75	78	85	92	
	120	122	125	132	139	
	60	61	62	66	70	
	176	181	186	199	212	

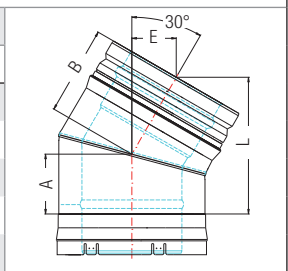

	26 160 420	26 180 420	26 200 420	26 250 420	26 300 420	
	117,90	113,20	121,00	161,70	220,20	
	320	340	360	413	465	
	270	290	310	363	415	
	227	247	267	320	372	
	272	292	312	365	417	

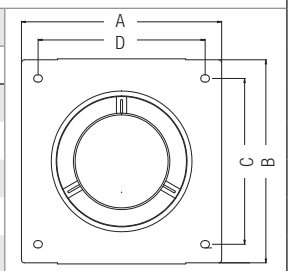

	26 160 421	26 180 421	26 200 421	26 250 421	26 300 421	
	365,80	268,80	381,00	405,30	499,50	

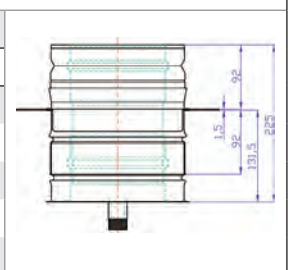

	26 160 349 01	26 180 349 01	26 200 349 01	26 250 349 01	26 300 349 01	
	36,00	37,10	40,50	43,90	61,00	
	220	240	260	313	365	
	~ 315	~ 335	~ 355	~ 408	~ 460	

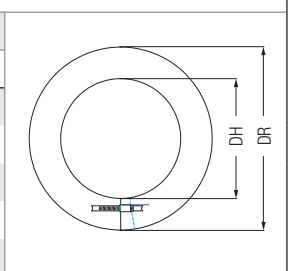

Durchmesser des Abgasrohres DN in mm	80	100	113	130	150	
Durchmesser Hüllrohr DH in mm	140	160	173	190	210	

	<b>Pos. 4/39: Wandrossette klappbar, Randbreite 75 mm</b>					
	<b>Art.-Nr.:</b>	26 080 349 02	26 100 349 02	26 113 349 02	26 130 349 02	26 150 349 02
	Preis (EUR)	38,10	46,70	34,90	36,00	37,10
	DH in mm	140	160	173	190	210
	DR in mm	~ 285	~ 305	~ 318	~ 335	~ 355

	<b>Pos. 4/40: Wandrossette klappbar, Randbreite 100 mm</b>					
	<b>Art.-Nr.:</b>	26 080 349 03	26 100 349 03	26 113 349 03	26 130 349 03	26 150 349 03
	Preis (EUR)	57,50	41,60	40,00	38,30	39,40
	DH in mm	140	160	173	190	210
	DR in mm	~ 335	~ 355	~ 368	~ 385	~ 405

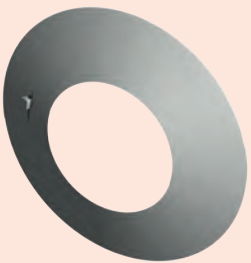
	<b>Pos. 4/41: Wandrossette klappbar, Randbreite 125 mm</b>					
	<b>Art.-Nr.:</b>	26 080 349 04	26 100 349 04	26 113 349 04	26 130 349 04	26 150 349 04
	Preis (EUR)	56,40	58,00	59,70	45,30	42,70
	DH in mm	140	160	173	190	210
	DR in mm	~ 385	~ 405	~ 418	~ 435	~ 455

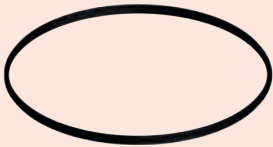
	<b>Pos. 4/42: Dichtung, innenliegend, T max = 200°C</b>					
	<b>Art.-Nr.:</b>	25 080 905	25 100 905	25 113 905	25 130 905	25 150 905
	Preis (EUR)	9,10	9,10	10,10	10,10	11,20

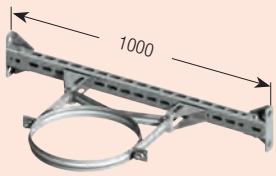
	<b>Pos. 4/43: Sparrenhalter, Sparrenabstand max. 1000 mm, andere Sparrenabstände durch Kürzen des</b>					
	<b>Art.-Nr.:</b>	26 080 990	26 100 990	26 113 990	26 130 990	26 150 990
	Preis (EUR)	189,80	196,40	198,10	187,20	195,90

	<b>Pos. 4/44: Wandhalterung, Wandabstand: 50 mm System II</b>					
	<b>Art.-Nr.:</b>	26 080 760	26 100 760	26 113 760	26 130 760	26 150 760
	Preis (EUR)	44,00	45,80	43,10	43,90	45,60

	160	180	200	250	300	Hinweise	
	220	240	260	310	360		

	26 160 349 02	26 180 349 02	26 200 349 02	26 250 349 02	26 300 349 02		
	38,30	39,40	41,70	46,20	54,00		
	220	240	260	313	365		
	~ 365	~ 385	~ 405	~ 458	~ 510		

	26 160 349 03	26 180 349 03	26 200 349 03	26 250 349 03	26 300 349 03		
	40,50	41,70	43,90	63,40	87,70		
	220	240	260	313	365		
	~ 415	~ 435	~ 455	~ 508	~ 560		

	26 160 349 04	26 180 349 04	26 200 349 04	26 250 349 04	26 300 349 04		
	64,70	46,10	69,60	76,30	87,90		
	220	240	260	313	365		
	~ 465	~ 485	~ 505	~ 558	~ 610		

	25 160 905	25 180 905	25 200 905	25 250 905	25 300 905	
	12,50	13,50	14,60	16,80	20,20	

**C-Profiles einstellbar**

	26 160 990	26 180 990	26 200 990	26 250 990	26 300 990	
	198,60	199,30	201,20	207,80	226,80	

	26 160 760	26 180 760	26 200 760	26 250 760	26 300 760		
	47,10	48,70	56,10	59,40	61,80		

Durchmesser des Abgasrohres DN in mm	80	100	113	130	150	
Durchmesser Hüllrohr DH in mm	140	160	173	190	210	

	<i>Pos. 4/45: Wandhalterung, Wandabstand: 50 - 100 mm System II</i>					
	<b>Art.-Nr.:</b>	26 080 761	26 100 761	26 113 761	26 130 761	26 150 761
	Preis (EUR)	53,50	60,50	57,90	60,60	61,90

	<i>Pos. 4/46: Wandhalterung, Wandabstand: 50 - 100 mm System I</i>					
	<b>Art.-Nr.:</b>	-	-	-	-	-
	Preis (EUR)					

	<i>Pos. 4/47: Wandhalterung, Wandabstand: 100 mm System II</i>					
	<b>Art.-Nr.:</b>	26 080 762	26 100 762	26 113 762	26 130 762	26 150 762
	Preis (EUR)	50,70	52,30	49,00	54,10	50,70

	<i>Pos. 4/48: Wandhalterung, Wandabstand: 100 - 150 mm System II</i>					
	<b>Art.-Nr.:</b>	26 080 763	26 100 763	26 113 763	26 130 763	26 150 763
	Preis (EUR)	71,50	75,50	70,80	72,30	74,30

	<i>Pos. 4/49: Wandhalterung, Wandabstand: 100 - 150 mm System I</i>					
	<b>Art.-Nr.:</b>	-	-	-	-	-
	Preis (EUR)					

	<i>Pos. 4/50: Wandhalterung, Wandabstand: 150 - 200 mm System II</i>					
	<b>Art.-Nr.:</b>	26 080 764	26 100 764	26 113 764	26 130 764	26 150 764
	Preis (EUR)	73,10	78,80	74,20	77,80	80,20

	160	180	200	250	300	Hinweise	
	220	240	260	310	360		

	26 160 761	26 180 761	26 200 761	-	-		
	64,20	67,00	69,80				

	-	-	-	26 250 742	26 300 742		
				94,30	112,80		

	26 160 762	26 180 762	26 200 762	26 250 762	26 300 762		
	53,60	54,50	66,00	63,00	73,30		

	26 160 763	26 180 763	26 200 763	-	-		
	76,40	78,00	80,70				

	-	-	-	26 250 744	26 300 744		
				114,80	133,30		

	26 160 764	26 180 764	26 200 764	-	-		
	82,20	84,40	86,70				

Durchmesser des Abgasrohres DN in mm	80	100	113	130	150	
Durchmesser Hüllrohr DH in mm	140	160	173	190	210	

	<i>Pos. 4/51: Wandhalterung, Wandabstand: 150 - 200 mm System I</i>					
	<b>Art.-Nr.:</b>	–	–	–	–	–
	Preis (EUR)					

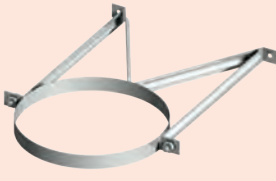
	<i>Pos. 4/52: Wandhalterung, Wandabstand: 200 mm System II</i>					
	<b>Art.-Nr.:</b>	26 080 765	26 100 765	26 113 765	26 130 765	26 150 765
	Preis (EUR)	54,80	56,00	57,10	53,80	55,80

	<i>Pos. 4/53: Wandhalterung, Wandabstand: 200 - 250 mm System I</i>					
	<b>Art.-Nr.:</b>	26 080 750	26 100 750	26 113 750	26 130 750	26 150 750
	Preis (EUR)	118,20	121,60	124,40	117,40	121,00

	<i>Pos. 4/54: Wandhalterung, Wandabstand: 250 - 300 mm System I</i>					
	<b>Art.-Nr.:</b>	26 080 753	26 100 753	26 113 753	26 130 753	26 150 753
	Preis (EUR)	140,60	133,40	148,30	140,00	143,90

	<i>Pos. 4/55: Wandhalterung, Wandabstand: 265 - 340 mm System I</i>					
	<b>Art.-Nr.:</b>	26 080 755	26 100 755	26 113 755	26 130 755	26 150 755
	Preis (EUR)	214,90	217,10	189,90	180,50	204,50

	<i>Pos. 4/56: Wandhalterung, Wandabstand: 305 - 380 mm System I</i>					
	<b>Art.-Nr.:</b>	26 080 756	26 100 756	26 113 756	26 130 756	26 150 756
	Preis (EUR)	219,20	221,40	199,60	190,10	206,60



	160	180	200	250	300	Hinweise	
	220	240	260	310	360		

	-	-	-	26 250 748	26 300 748		
				136,10	156,40		

	26 160 765	26 180 765	26 200 765	26 250 765	26 300 765		
	56,60	58,30	70,90	74,40	80,60		

	26 160 750	26 180 750	26 200 750	26 250 750	26 300 750		
	132,90	125,00	127,80	134,50	153,80		

	26 160 753	26 180 753	26 200 753	26 250 753	26 300 753		
	145,70	148,70	152,00	173,70	198,90		

	26 160 755	26 180 755	26 200 755	26 250 755	26 300 755		
	223,50	210,50	253,60	266,00	284,20		



	26 160 756	26 180 756	26 200 756	26 250 756	26 300 756		
	225,70	212,50	256,10	268,50	281,60		

Durchmesser des Abgasrohres DN in mm	80	100	113	130	150	
Durchmesser Hüllrohr DH in mm	140	160	173	190	210	

	Pos. 4/57: Wandhalterung, Wandabstand: 345 - 420 mm System I					
	Art.-Nr.:	26 080 757	26 100 757	26 113 757	26 130 757	26 150 757
	Preis (EUR)	223,10	225,20	225,20	202,40	215,10

	Pos. 4/58: Wandhalterung, Wandabstand: 418 - 476 mm System I <b>Achtung: C-Profile mit...</b>					
	Art.-Nr.:	26 080 758	26 100 758	26 113 758	26 130 758	26 150 758
	Preis (EUR)	232,10	234,30	234,30	246,00	221,90

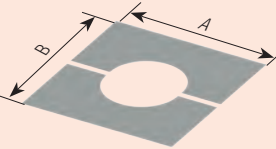
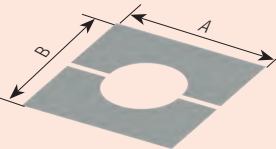
	Pos. 4/59: Wandhalterung, Wandabstand: 492 - 550 mm System I <b>Achtung: C-Profile mit...</b>					
	Art.-Nr.:	26 080 759	26 100 759	26 113 759	26 130 759	26 150 759
	Preis (EUR)	239,80	241,90	222,50	214,50	227,70

	Pos. 4/60: Abdeckblende, 0°, zweiteilig					
	Art.-Nr.:	26 080 351	26 100 351	26 113 351	26 130 351	26 150 351
	Preis (EUR)	34,60	34,60	34,60	34,60	34,90
	A / B	405/415	425/435	440/450	455/465	475/490
	Pos. 4/61: Abdeckblende, Neigung 0 – 25°, zweiteilig					
	Art.-Nr.:	26 080 352	26 100 352	26 113 352	26 130 352	26 150 352
	Preis (EUR)	35,20	35,20	35,20	35,20	35,60
	A / B	405/420	425/440	440/455	455/470	475/490
	Pos. 4/62: Abdeckblende, Neigung 26 – 35°, zweiteilig					
	Art.-Nr.:	26 080 353	26 100 353	26 113 353	26 130 353	26 150 353
	Preis (EUR)	42,40	54,00	42,40	42,40	36,30
	A / B	405/435	425/465	440/480	455/500	475/525
	Pos. 4/63: Abdeckblende, Neigung 36 – 45°, zweiteilig					
	Art.-Nr.:	26 080 354	26 100 354	26 113 354	26 130 354	26 150 354
	Preis (EUR)	52,10	51,80	58,80	36,70	37,90
	A / B	405/470	425/495	440/515	455/535	475/565

	160	180	200	250	300	Hinweise
	220	240	260	310	360	

	26 160 757	26 180 757	26 200 757	26 250 757	26 300 757	
	255,70	240,10	226,10	280,10	247,70	

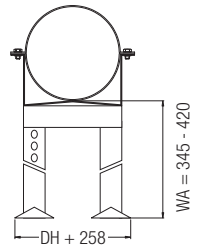

**max. 45° Neigung zur Wand montieren!**

	26 160 758	26 180 758	26 200 758	26 250 758	26 300 758	
	243,00	247,80	274,00	289,20	255,20	

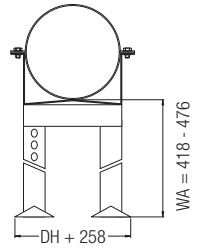

**max. 45° Neigung zur Wand montieren!**

	26 160 759	26 180 759	26 200 759	26 250 759	26 300 759	
	271,10	234,40	259,50	251,90	283,90	

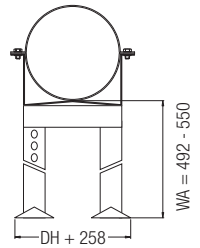

	26 160 351	26 180 351	26 200 351	26 250 351	26 300 351	
	35,20	35,20	35,20	46,80	52,90	
	485/495	505/515	525/535	580/590	630/640	

	26 160 352	26 180 352	26 200 352	26 250 352	26 300 352	
	36,00	36,00	36,00	48,50	55,50	
	485/500	505/520	525/540	580/595	630/650	

	26 160 353	26 180 353	26 200 353	26 250 353	26 300 353	
	43,20	39,80	43,20	50,25	57,40	
	485/535	505/560	525/585	580/645	630/695	

	26 160 354	26 180 354	26 200 354	26 250 354	26 300 354	
	41,40	41,40	47,90	57,20	64,30	
	485/555	505/600	525/630	580/680	630/745	

Durchmesser des Abgasrohres DN in mm	80	100	113	130	150	
Durchmesser Hüllrohr DH in mm	140	160	173	190	210	

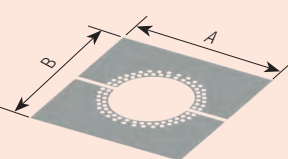
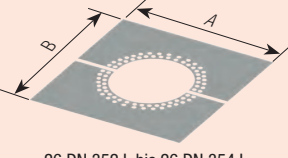
 <p>26 DN 351 L</p>  <p>26 DN 352 L bis 26 DN 354 L</p>	<b>Pos. 4/64: Abdeckblende mit Hinterlüftung, 0°, zweiteilig</b>						
	<b>Art.-Nr.:</b>	26 080 351 L	26 100 351 L	26 113 351 L	26 130 351 L	26 150 351 L	
	Preis (EUR)	67,10	71,60	80,40	34,60	34,90	
	A / B	405/415	425/435	440/450	455/465	475/490	
	<b>Pos. 4/65: Abdeckblende mit Hinterlüftung, Neigung 0 – 25°, zweiteilig</b>						
	<b>Art.-Nr.:</b>	26 080 352 L	26 100 352 L	26 113 352 L	26 130 352 L	26 150 352 L	
	Preis (EUR)	53,60	58,50	61,20	44,60	45,10	
	A / B	405/420	425/440	440/455	455/470	475/490	
	<b>Pos. 4/66: Abdeckblende mit Hinterlüftung, Neigung 26 – 35°, zweiteilig</b>						
	<b>Art.-Nr.:</b>	26 080 353 L	26 100 353 L	26 113 353 L	26 130 353 L	26 150 353 L	
	Preis (EUR)	60,10	65,00	69,80	36,00	36,40	
	A / B	405/435	425/465	440/480	455/500	475/525	
<b>Pos. 4/67: Abdeckblende mit Hinterlüftung, Neigung 36 – 45°, zweiteilig</b>							
<b>Art.-Nr.:</b>	26 080 354 L	26 100 354 L	26 113 354 L	26 130 354 L	26 150 354 L		
Preis (EUR)	61,00	63,10	79,40	36,70	37,90		
A / B	405/470	425/495	440/515	455/535	475/565		

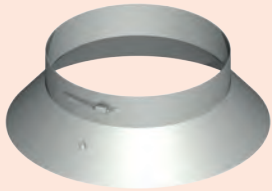
	<b>Pos. 4/68: Regenabweiser für Dachdurchführung</b>						
	<b>Art.-Nr.:</b>	26 080 379	26 100 379	26 113 379	26 130 379	26 150 379	
	Preis (EUR)	34,70	31,70	25,10	22,90	24,40	
	DH in mm	140	160	173	190	210	
	DR in mm	235	235	265	265	295	

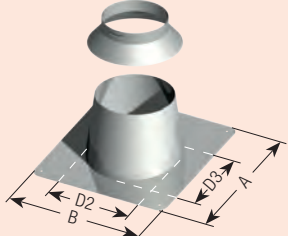
	<b>Pos. 4/69: Dachdurchführung 0 – 15°, inkl. Regenabweiser</b>						
	<b>Art.-Nr.:</b>	26 080 370	26 100 370	26 113 370	26 130 370	26 150 370	
	Preis (EUR)	94,10	106,40	118,00	80,40	82,20	
	A / B in mm	437 / 437	437 / 437	468 / 468	468 / 468	485 / 485	
	H in mm	165	165	167	167	169	
	D 1 in mm	185	185	215	215	245	
	D 2 in mm	237	237	268	268	305	

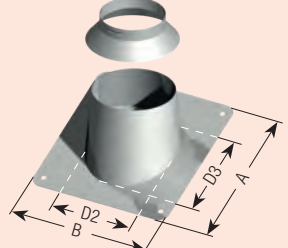
	<b>Pos. 4/70: Dachdurchführung 15 – 30°, inkl. Regenabweiser</b>						
	<b>Art.-Nr.:</b>	26 080 371	26 100 371	26 113 371	26 130 371	26 150 371	
	Preis (EUR)	138,10	139,30	124,10	118,50	95,50	
	A / B in mm	458 / 455	458 / 455	492 / 484	492 / 484	522 / 522	
	H in mm	199	199	205	205	211	
	D 1 in mm	185	185	215	215	245	
	D 2 in mm	255	255	284	284	322	

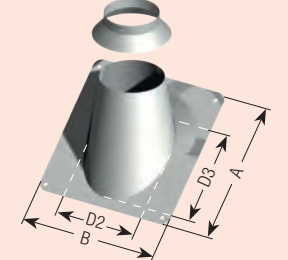
	<b>Pos. 4/71: Dachdurchführung 30 – 45°, inkl. Regenabweiser</b>						
	<b>Art.-Nr.:</b>	26 080 372	26 100 372	26 113 372	26 130 372	26 150 372	
	Preis (EUR)	152,00	155,00	158,60	113,20	115,30	
	A / B in mm	520 / 500	520 / 500	543 / 525	543 / 525	598 / 580	
	H in mm	240	240	252	252	264	
	D 1 in mm	185	185	215	215	245	
	D 2 in mm	302	302	325	325	380	

	160	180	200	250	300	Hinweise	
	220	240	260	310	360		

	26 160 351 L	26 180 351 L	26 200 351 L	26 250 351 L	26 300 351 L		
	51,00	68,80	89,40	92,90	97,70		
	485/495	505/515	525/535	580/590	630/640		

	26 160 352 L	26 180 352 L	26 200 352 L	26 250 352 L	26 300 352 L		
	45,60	45,50	45,60	52,00	98,30		
	485/500	505/520	525/540	580/595	630/650		

	26 160 353 L	26 180 353 L	26 200 353 L	26 250 353 L	26 300 353 L		
	36,70	36,70	45,10	68,70	97,40		
	485/535	505/560	525/585	580/645	630/695		

	26 160 354 L	26 180 354 L	26 200 354 L	26 250 354 L	26 300 354 L		
	38,30	40,10	45,80	91,90	107,40		
	485/555	505/600	525/630	580/680	630/745		

	26 160 379	26 180 379	26 200 379	26 250 379	26 300 379		
	27,60	28,90	29,10	41,40	75,00		
	220	240	260	313	365		
	295	335	335	440	440		

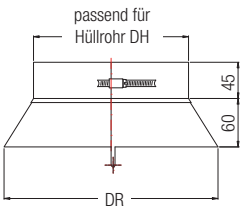

	26 160 370	26 180 370	26 200 370	26 250 370	26 300 370		
	87,30	96,80	100,20	116,30	179,60		
	485 / 485	542 / 542	542 / 542	642 / 642	642 / 642		
	169	172	172	179	179		
	245	285	285	390	390		
	305	342	342	442	442		
	305	342	342	442	442		

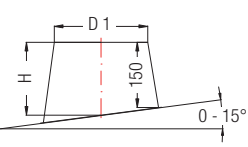

	26 160 371	26 180 371	26 200 371	26 250 371	26 300 371		
	100,60	119,90	135,90	209,40	222,30		
	522 / 522	562 / 562	562 / 562	681 / 681	681 / 681		
	211	220	220	241	241		
	245	285	285	390	390		
	322	362	362	481	481		
	322	363	363	481	481		

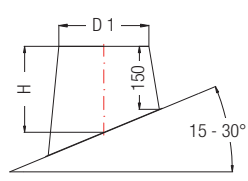

	26 160 372	26 180 372	26 200 372	26 250 372	26 300 372		
	136,10	145,40	148,90	209,40	222,30		
	598 / 580	640 / 640	640 / 640	785 / 765	785 / 765		
	264	279	279	319	319		
	245	285	285	390	390		
	380	437	437	565	565		
	398	442	442	585	585		

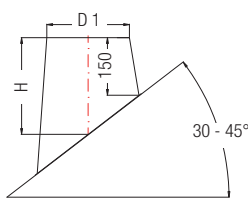

Durchmesser des Abgasrohres DN in mm	80	100	113	130	150
Durchmesser Hüllrohr DH in mm	140	160	173	190	210

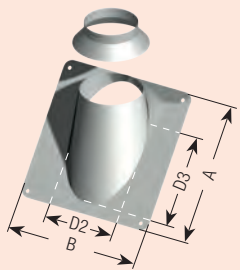
	Pos. 4/72: Dachdurchführung 45 – 55°, inkl. Regenabweiser						
	Art.-Nr.:	26 080 373	26 100 373	26 113 373	26 130 373	26 150 373	
	Preis (EUR)	172,70	174,10	176,00	178,90	188,60	
	A / B in mm	578 / 500	578 / 500	626 / 525	626 / 525	673 / 580	
	H in mm	290	290	308	308	327	
	D 1 in mm	185	185	215	215	245	
	D 2 in mm	302	302	325	325	380	
	D 3 in mm	378	378	426	426	473	

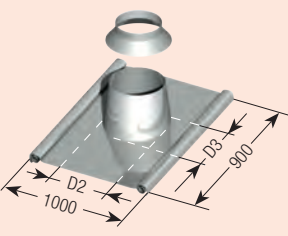
	Pos. 4/73: Dachdurchführung 0 – 15° mit Bleischürze ca. 1000 mm x 900 mm, inkl. Regenabweiser						
	Art.-Nr.:	26 080 374	26 100 374	26 113 374	26 130 374	26 150 374	
	Preis (EUR)	239,80	247,90	219,50	196,80	194,20	
	H in mm	165	165	167	167	169	
	D 1 in mm	185	185	215	215	245	
	D 2 in mm	237	237	268	268	305	

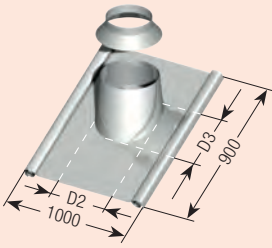
	Pos. 4/74: Dachdurchführung 15 – 30° mit Bleischürze ca. 1000 mm x 900 mm, inkl. Regenabweiser						
	Art.-Nr.:	26 080 375	26 100 375	26 113 375	26 130 375	26 150 375	
	Preis (EUR)	241,10	249,20	216,40	190,40	201,50	
	H in mm	199	199	205	205	211	
	D 1 in mm	185	185	215	215	245	
	D 2 in mm	255	255	284	284	322	

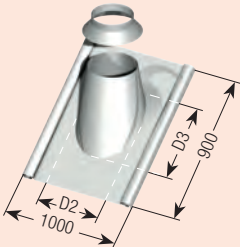
	Pos. 4/75: Dachdurchführung 30 – 45° mit Bleischürze ca. 1000 mm x 900 mm, inkl. Regenabweiser						
	Art.-Nr.:	26 080 376	26 100 376	26 113 376	26 130 376	26 150 376	
	Preis (EUR)	195,70	259,80	203,50	201,50	222,60	
	H in mm	240	240	252	252	264	
	D 1 in mm	185	185	215	215	245	
	D 2 in mm	302	302	325	325	380	

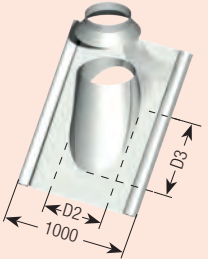
	Pos. 4/76: Dachdurchführung 45 – 55° mit Bleischürze ca. 1000 mm x 900 mm, inkl. Regenabweiser						
	Art.-Nr.:	26 080 377	26 100 377	26 113 377	26 130 377	26 150 377	
	Preis (EUR)	295,40	303,70	209,10	210,60	229,00	
	H in mm	290	290	308	308	327	
	D 1 in mm	185	185	215	215	245	
	D 2 in mm	302	302	325	325	380	

	Pos. 4/77: Mündungsabschluss inkl. Klemmband						
	Art.-Nr.:	26 080 359	26 100 359	26 113 359	26 130 359	26 150 359	
	Preis (EUR)	54,10	56,30	57,90	55,10	63,00	

	160	180	200	250	300	Hinweise	
	220	240	260	310	360		

	26 160 373	26 180 373	26 200 373	26 250 373	26 300 373		
	201,80	207,50	226,90	261,80	277,80		
	673 / 580	736 / 640	736 / 640	900 / 765	900 / 765		
	327	351	351	412	412		
	245	285	285	390	390		
	380	437	437	565	565		
	473	536	536	700	700		

	26 160 374	26 180 374	26 200 374	26 250 374	26 300 374		
	257,90	201,40	215,30	267,50	327,50		
	169	172	172	179	179		
	245	285	285	390	390		
	305	342	342	442	442		
	305	342	342	442	442		

	26 160 375	26 180 375	26 200 375	26 250 375	26 300 375		
	204,80	212,00	215,30	267,60	364,90		
	211	220	220	241	241		
	245	285	285	390	390		
	322	362	362	481	481		
	322	363	363	481	481		

	26 160 376	26 180 376	26 200 376	26 250 376	26 300 376		
	225,80	229,00	232,30	289,10	386,00		
	264	279	279	319	319		
	245	285	285	390	390		
	380	437	437	565	565		
	398	442	442	585	585		

	26 160 377	26 180 377	26 200 377	26 250 377	26 300 377		
	242,90	279,40	320,10	357,50	425,30		
	327	351	351	412	412		
	245	285	285	390	390		
	380	437	437	565	565		
	473	536	536	700	700		

	26 160 359	26 180 359	26 200 359	26 250 359	26 300 359		
	65,10	73,80	76,80	92,80	117,10		



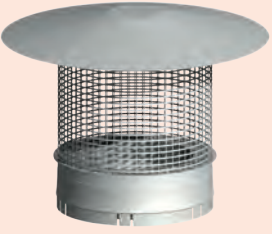

Durchmesser des Abgasrohres DN in mm	80	100	113	130	150	
Durchmesser Hüllrohr DH in mm	140	160	173	190	210	

	Pos. 4/78: <b>Regenhut universal, passend zu Mündungsabschluss 26 DN 359</b> (siehe Seite 4.28 Pos. 4/77)					
	Art.-Nr.:	26 080 364	26 100 364	26 113 364	26 130 364	26 150 364
	Preis (EUR)	58,80	50,40	51,10	53,80	59,80
	Regenhaut in mm	265	265	265	265	325

	Pos. 4/79: <b>Mündungsabschluss mit Vogelschutz- und Funkenfluggitter</b>					
	Art.-Nr.:	26 080 399	26 100 399	26 113 399	26 130 399	26 150 399
	Preis (EUR)	152,40	156,60	187,00	138,80	156,50
	D in mm	325	325	325	325	400

	Pos. 4/80: <b>Mündungsabschluss mit Windringen</b>					
	Art.-Nr.:	–	–	26 113 362	26 130 362	26 150 362
	Preis (EUR)			382,40	391,40	238,10
	D 1 in mm			213	230	250
	D 2 in mm			263	280	300

	Pos. 4/81: <b>Mündung mit Windkat</b>					
	Art.-Nr.:	–	–	26 113 361	26 130 361	26 150 361
	Preis (EUR)			401,50	402,10	380,50

	Pos. 4/82: <b>Ring für Seilabspannung</b>					
	Art.-Nr.:	26 080 424	26 100 424	26 113 424	26 130 424	26 150 424
	Preis (EUR)	46,40	47,80	48,90	29,70	30,40

	Pos. 4/82: <b>Klemmband, als Ersatzteil</b>					
	Art.-Nr.:	26 080 426	26 100 426	26 113 426	26 130 426	26 150 426
	Preis (EUR)	35,90	30,30	30,70	19,80	21,30

	160	180	200	250	300	Hinweise	
	220	240	260	310	360		

	26 160 364	26 180 364	26 200 364	26 250 364	26 300 364		
	68,40	74,40	89,60	111,30	131,90		
	325	325	400	400	470		

	26 160 399	26 180 399	26 200 399	26 250 399	26 300 399		
	173,70	163,80	172,60	292,70	359,20		
	400	400	470	470	575		

	26 160 362	26 180 362	26 200 362	26 250 362	26 300 362		
	434,80	458,80	494,20	524,40	562,70		
	260	280	300	350	400		
	310	330	350	400	450		

	26 160 361	26 180 361	26 200 361	26 250 361	26 300 361		
	513,70	451,10	582,40	704,20	819,10		

	26 160 424	26 180 424	26 200 424	26 250 424	26 300 424		
	53,80	31,20	32,00	53,80	62,30		

	26 160 426	26 180 426	26 200 426	26 250 426	26 300 426		
	22,30	22,90	30,50	26,60	32,70		

Durchmesser des Abgasrohres DN in mm	80	100	113	130	150	
Durchmesser Hüllrohr DH in mm	140	160	173	190	210	

**Ergänzungsbauteile für Verbindungsleitungen:**

	Pos. 4/83: Inspektionselement AL, T max = 200°C, inkl. Klemmband					
	Art.-Nr.:	25 080 313	25 100 313	25 113 313	25 130 313	25 150 313
	Preis (EUR)	270,50	266,80	282,50	301,30	329,00
	L in mm	253	253	253	253	253
	L 3 in mm	150	150	150	150	150
	DS in mm	80	80	100	100	100

	Pos. 4/84: Inspektionselement FU, inkl. Klemmband					
	Art.-Nr.:	24 080 313	24 100 313	24 113 313	24 130 313	24 150 313
	Preis (EUR)	270,50	266,90	282,50	301,30	329,00
	L in mm	253	253	253	253	253
	L 3 in mm	150	150	150	150	150
	DS in mm	80	80	100	100	100

	Pos. 4/85: Rohr-Element 253 mm mit Messöffnung, inkl. Klemmband					
	Art.-Nr.:	26 080 126	26 100 126	26 113 126	26 130 126	26 150 126
	Preis (EUR)	208,20	206,60	210,50	165,00	150,90

	Pos. 4/86: Rohr-Element 253 mm mit Kondensatablauf für waagerechten und senkrechten Einbau, inkl.					
	Art.-Nr.:	26 080 129	26 100 129	26 113 129	26 130 129	26 150 129
	Preis (EUR)	178,90	187,60	195,70	211,00	227,00

	Pos. 4/87: Längenausgleich, L = 280 bis 380 mm Für Unterdruck! , inkl. Klemmband, Für druckdichte Aus-					
	Art.-Nr.:	26 080 151	26 100 151	26 113 151	26 130 151	26 150 151
	Preis (EUR)	240,00	242,30	245,70	209,80	214,10
	L min in mm	280	280	280	280	280
	L max in mm	380	380	380	380	380

	Pos. 4/88: Dichtsatz für Längenausgleich T max. = 200°C					
	Art.-Nr.:	25 080 916	25 100 916	25 113 916	25 130 916	25 150 916
	Preis (EUR)	auf Anfrage	auf Anfrage	auf Anfrage	auf Anfrage	auf Anfrage

	160	180	200	250	300	Hinweise	
	220	240	260	310	360		

	25 160 313	25 180 313	25 200 313	25 250 313	25 300 313		
	356,10	367,70	409,00	433,90	534,50		
	253	253	253	253	253		
	150	150	150	150	150		
	100	100	100	100	100		

	24 160 313	24 180 313	24 200 313	24 250 313	24 300 313		
	356,10	338,30	409,00	471,70	534,50		
	253	253	253	253	253		
	150	150	150	150	150		
	100	100	100	100	100		

	26 160 126	26 180 126	26 200 126	26 250 126	26 300 126		
	216,20	182,80	203,50	210,30	263,70		

**Klemmband**

	26 160 129	26 180 129	26 200 129	26 250 129	26 300 129		
	244,90	198,70	194,70	253,20	383,80		

**führung bitte zusätzlich Pos. 4/88 bestellen**

	26 160 151	26 180 151	26 200 151	26 250 151	26 300 151		
	218,40	219,90	225,60	282,70	259,00		
	280	280	280	280	280		
	380	380	380	380	380		

	25 160 916	25 180 916	25 200 916	25 250 916	25 300 916		
	auf Anfrage	auf Anfrage	auf Anfrage	auf Anfrage	auf Anfrage		

Durchmesser des Abgasrohres DN in mm	80	100	113	130	150	
Durchmesser Hüllrohr DH in mm	140	160	173	190	210	

	Pos. 4/89: Bogen 45° FU Für Unterdruck! , inkl. Klemmband					
	Art.-Nr.:	–	–	24 113 202	24 130 202	24 150 202
	Preis (EUR)			118,60	89,70	105,70
	A in mm			79	82	87
	B in mm			126	130	134
	E in mm			89	92	94
	L in mm			168	174	181

	Pos. 4/90: Bogen 45° AL Für Über- und Unterdruck! , inkl. Klemmband					
	Art.-Nr.:	25 080 202	25 100 202	25 113 202	25 130 202	25 150 202
	Preis (EUR)	158,60	163,40	165,70	168,00	117,10
	A in mm	72	76	79	82	87
	B in mm	119	123	126	130	134
	E in mm	84	87	89	92	94
	L in mm	156	163	168	174	181

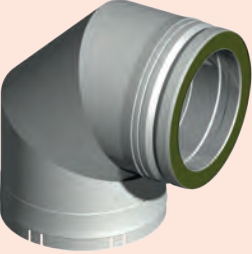
	Pos. 4/91: Bogen 90° FU Für Unterdruck! , inkl. Klemmband					
	Art.-Nr.:	–	–	24 113 204	24 130 204	24 150 204
	Preis (EUR)			283,00	269,90	285,90
	A in mm			79	82	87
	B in mm			126	130	134
	C in mm			107	114	122
	L in mm			154	163	173

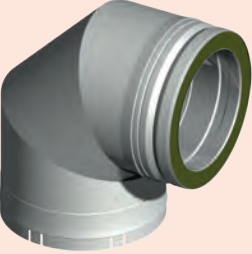
	Pos. 4/92: Bogen 87° AL Für Über- und Unterdruck! , inkl. Klemmband					
	Art.-Nr.:	25 080 204	25 100 204	25 113 204	25 130 204	25 150 204
	Preis (EUR)	317,40	302,60	338,10	346,10	335,70
	A in mm	72	76	79	82	87
	B in mm	119	123	126	130	134
	C in mm	93	101	107	114	122
	L in mm	138	148	154	163	172

	Pos. 4/93: Bogen 90° FU mit Reinigungsöffnung Für Unterdruck! , inkl. Klemmband					
	Art.-Nr.:	–	–	24 113 209	24 130 209	24 150 209
	Preis (EUR)			274,50	285,90	301,90
	A in mm			79	82	87
	B in mm			126	130	134
	C in mm			107	114	122
	L in mm			154	163	173

	Pos. 4/94: Bogen 87° AL mit Reinigungsöffnung Für Über- und Unterdruck! , T max = 200° C, inkl. Klemmband					
	Art.-Nr.:	25 080 209	25 100 209	25 113 209	25 130 209	25 150 209
	Preis (EUR)	349,70	359,50	376,60	394,50	375,30
	A in mm	72	76	79	82	87
	B in mm	119	123	126	130	134
	C in mm	93	101	107	114	122
	L in mm	138	148	154	163	173

	160	180	200	250	300	Hinweise
	220	240	260	310	360	

	24 160 202	24 180 202	24 200 202	24 250 202	24 300 202
	113,60	117,10	129,30	181,90	271,40
	89	93	97	108	119
	136	140	144	155	166
	96	99	102	110	117
	185	192	199	217	236

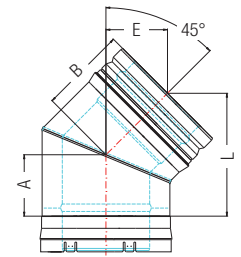

	25 160 202	25 180 202	25 200 202	25 250 202	25 300 202
	190,40	147,20	161,70	264,50	360,70
	89	93	97	108	119
	136	140	144	155	166
	96	99	102	110	117
	184	192	199	217	236

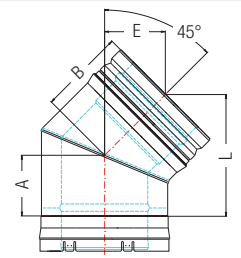

	24 160 204	24 180 204	24 200 204	24 250 204	24 300 204
	315,20	327,80	421,40	456,30	480,10
	89	93	97	108	119
	136	140	144	155	166
	136	134	144	165	189
	225	235	245	271	297
	178	188	198	224	250

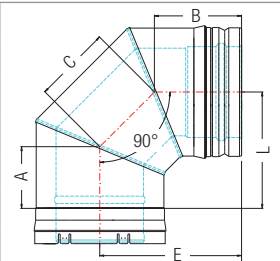

	25 160 204	25 180 204	25 200 204	25 250 204	25 300 204
	404,20	416,00	457,30	508,40	577,40
	89	93	97	108	119
	136	140	144	155	166
	136	135	144	165	189
	225	235	245	271	297
	178	188	198	224	250

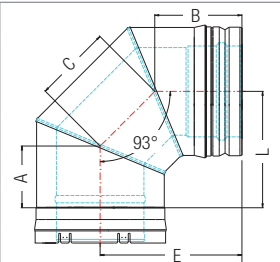

	24 160 209	24 180 209	24 200 209	24 250 209	24 300 209
	331,70	344,50	375,70	407,60	549,70
	89	93	97	108	119
	136	140	144	155	166
	136	134	143	165	190
	225	235	245	271	297
	178	188	198	224	250

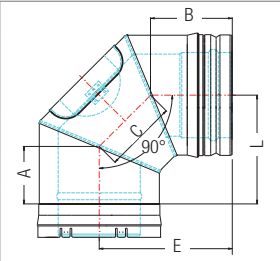

	25 160 209	25 180 209	25 200 209	25 250 209	25 300 209
	430,90	442,10	508,40	581,00	691,40
	89	93	97	108	119
	136	140	144	155	166
	136	134	144	165	189
	225	235	245	271	297
	178	188	198	224	250

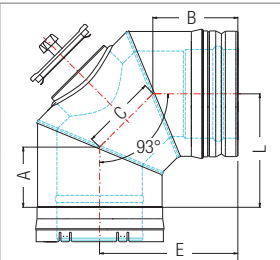

Durchmesser des Abgasrohres DN in mm	80	100	113	130	150	
Durchmesser Hüllrohr DH in mm	140	160	173	190	210	

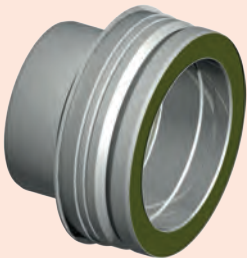
	Pos. 4/95: Übergang SEM AQUA® Sickenende auf SEM VARIO®II, mit Wärmedämmung, Durchmesser gleich					
	Art.-Nr.:	26 080 500	26 100 500	26 113 500	26 130 500	26 150 500
	Preis (EUR)	147,60	73,10	84,30	76,80	78,40
	AD 2 in mm	140	160	173	190	210

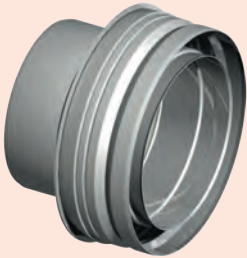
	Pos. 4/95: Übergang SEM AQUA® Sickenende auf SEM VARIO®II, ungedämmt, Durchmesser gleich, ink					
	Art.-Nr.:	26 080 502	26 100 502	26 113 502	26 130 502	26 150 502
	Preis (EUR)	82,90	84,50	85,90	46,50	47,80
	AD 2 in mm	140	160	173	190	210

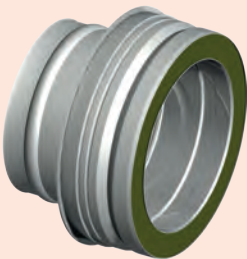
	Pos. 4/97: Übergang SEM AQUA® Muffenende auf SEM VARIO®II, mit Wärmedämmung, Durchmesser gleich					
	Art.-Nr.:	26 080 501	26 100 501	26 113 501	26 130 501	26 150 501
	Preis (EUR)	147,30	145,20	92,70	76,80	78,40
	AD 2 in mm	140	160	173	190	210

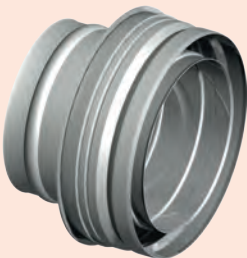
	Pos. 4/97: Übergang SEM AQUA® Muffenende auf SEM VARIO®II, ungedämmt, Durchmesser gleich					
	Art.-Nr.:	26 080 503	26 100 503	26 113 503	26 130 503	26 150 503
	Preis (EUR)	82,90	84,50	85,90	86,70	53,00
	AD 2 in mm	140	160	173	190	210

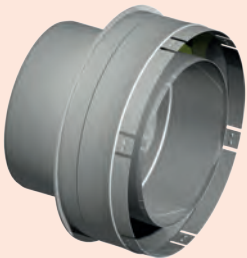
	Pos. 4/99: Übergang SEM VARIO®II DN - SEM AQUA® FU DN Muffe					
	Art.-Nr.:	26 080 505	26 100 505	26 113 505	26 130 505	26 150 505
	Preis (EUR)	82,60	84,10	85,90	46,40	47,90
	AD 2 in mm	140	160	173	190	210

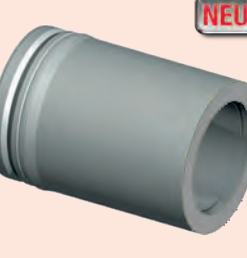
	Pos. 4/100: Doppelfutterrohr mit Abschlussblende, kürzbar Baulänge von 150 bis 435 mm					
	Art.-Nr.:	-	-	24 113 324	24 130 324	24 150 324
	Preis (EUR)			174,80	152,30	161,70
	Di in mm				123	143
				137	157	



	160	180	200	250	300	Hinweise
	220	240	260	310	360	

	26 160 500	26 180 500	26 200 500	26 250 500	26 300 500	
	97,90	85,20	92,80	117,90	116,40	
	220	240	260	310	360	

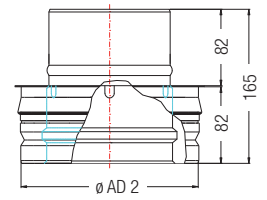

	26 160 502	26 180 502	26 200 502	26 250 502	26 300 502	
	104,40	108,40	123,60	155,30	170,30	
	220	240	260	310	360	

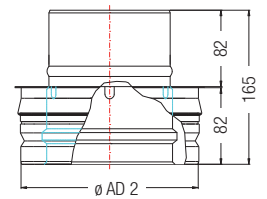

	26 160 501	26 180 501	26 200 501	26 250 501	26 300 501	
	90,10	85,20	92,80	108,70	137,20	
	220	240	260	310	360	

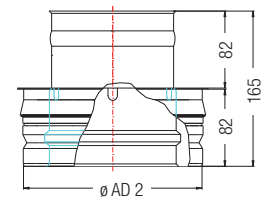

	26 160 503	26 180 503	26 200 503	26 250 503	26 300 503	
	87,90	88,70	70,20	78,30	101,30	
	220	240	260	310	360	

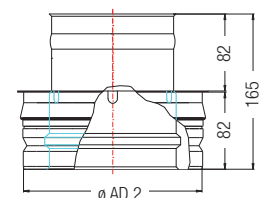

	26 160 505	26 180 505	26 200 505	26 250 505	26 300 505	
	52,70	55,70	63,60	85,00	131,90	
	220	240	260	310	360	

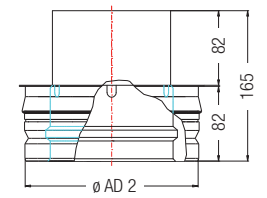

	24 160 324	24 180 324	24 200 324	-	-	
	173,40	188,20	194,70			
	153	173	193			
	167	187	207			

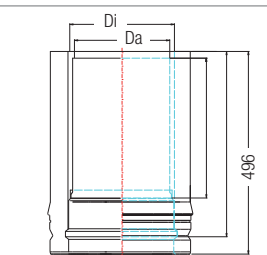

Durchmesser des Abgasrohres DN in mm	80	100	113	130	150	
Durchmesser Hüllrohr DH in mm	140	160	173	190	210	

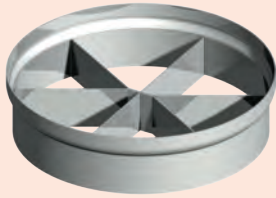
	<i>Pos. 4/101: Kugelfang</i>					
	<b>Art.-Nr.:</b>	–	–	–	26 130 258	26 150 258
	Preis (EUR)				41,30	38,80

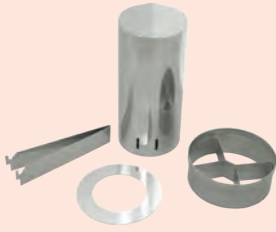
	<i>Pos. 4/102: Rußtopf mit Griff, Ring und Kugelfang</i>					
	<b>Art.-Nr.:</b>	–	–	–	26 130 257	26 150 257
	Preis (EUR)				140,80	131,70

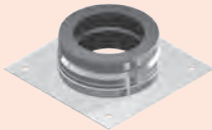
	<i>Pos. 4/103: Schornsteinverlängerung Grundplatte DW II</i>					
	<b>Art.-Nr.:</b>	–	–	24 113 391	24 130 391	24 150 391
	Preis (EUR)			134,30	135,50	83,30

	<i>Pos. 4/104: Schornsteinverlängerung rund</i>					
	<b>Art.-Nr.:</b>	–	–	24 113 392	24 130 392	24 150 392
	Preis (EUR)			107,50	115,40	117,10
	Da Einsteckende (in mm)			111	128	148
	Platte (in mm)			280 x 280	280 x 280	280 x 280
	L Einsteckende (in mm)			200	200	200
	<i>Pos. 4/105: Schornsteinverlängerung rund 2</i>					
	<b>Art.-Nr.:</b>				24 130 392 01	24 150 392 01
	Preis (EUR)				176,50	117,10
	Platte (in mm)				118	138
	L Einsteckende (in mm)				280 x 280	280 x 280
				200	200	

	160	180	200	250	300	Hinweise
	220	240	260	310	360	

	26 160 258	26 180 258	26 200 258	26 250 258	26 300 258	
	59,40	52,70	68,00	92,40	126,60	





	26 160 257	26 180 257	26 200 257	26 250 257	26 300 257	
	164,60	171,20	157,60	234,90	269,40	

	24 160 391	24 180 391	24 200 391	24 250 391	24 300 391	
	90,60	95,40	106,20	107,60	183,70	
	330 x 330	330 x 330	330 x 330	400 x 400	500 x 500	

	24 160 392	24 180 392	24 200 392	24 250 392	24 300 392	
	122,10	128,90	135,10	153,70	243,40	
	156	176	196	246	296	
	330 x 330	330 x 330	330 x 330	400 x 400	500 x 500	
	200	250	250	250	250	

				24 250 392 01		
				153,70		
				216		
				400 x 400		
				250		

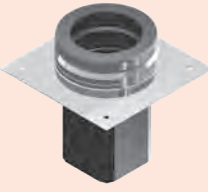
Durchmesser des Abgasrohres DN in mm	80	100	113	130	150	
Durchmesser Hüllrohr DH in mm	140	160	173	190	210	

	<i>Pos. 4/106: Schornsteinverlängerung eckig</i>						
	<b>Art.-Nr.:</b>	-	-	24 113 393	24 130 393	24 150 393	
	Preis (EUR)			187,50	125,00	128,30	
	DA Einsteckende (in mm)			100 100	120 x 120	140 x 140	
	Platte (in mm)			280 x 280	280 x 280	280 x 280	
	L Einsteckende (in mm)			200	200	200	
	<i>Pos. 4/107: Schornsteinverlängerung eckig 2</i>						
	<b>Art.-Nr.:</b>				24 130 393 01	24 150 393 01	
	Preis (EUR)				165,60	128,30	
	DA Einsteckende (in mm)				118 x 118	138 x 138	
	Platte (in mm)				280 x 280	280 x 280	
	L Einsteckende (in mm)				200	200	

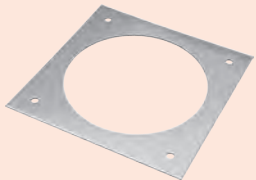
	<i>Pos. 4/108: Schornsteinverlängerung Verstärkungsplatte, 3 mm dick</i>						
	<b>Art.-Nr.:</b>	-	-	24 113 395	24 130 395	24 150 395	
	Preis (EUR)	-	-	64,00	58,50	54,20	
	Platte (in mm)			280 x 280	280 x 280	280 x 280	

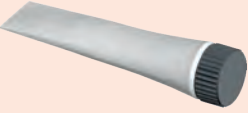
	<i>Pos. 4/109: Gleitmittel, ausreichend für mehrere Montagen</i>						
	<b>Art.-Nr.:</b>	26 000 913	26 000 913	26 000 913	26 000 913	26 000 913	
	Preis (EUR)	18,00	18,00	18,00	18,00	18,00	

	160	180	200	250	300	Hinweise	
	220	240	260	310	360		

	24 160 393	24 180 393	24 200 393	24 250 393	24 300 393		
	132,80	139,60	146,90	167,20	286,30		
	150 x 150	170 x 170	190 x 190	240 x 240	290 x 290		
	330 x 330	330 x 330	330 x 330	400 x 400	500 x 500		
	200	250	250	250	250		

				24 250 393 01			
				167,20			
				216 x 216			
				400 x 400			
				250			

	24 160 395	24 180 395	24 200 395	-	-		
	60,70	61,25	62,00	-	-		
	330 x 330	330 x 330	330 x 330				

	26 000 913	26 000 913	26 000 913	26 000 913	26 000 913		
	18,00	18,00	18,00	18,00	18,00		

## Übergang Rauchrohr Wanddicke max. 2,0 mm auf SEM VARIO II

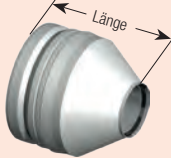
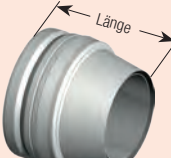
	Pos.	Art.-Nr.	Preis in EUR	ø Rauchrohr in mm max. Wanddicke 2,0 mm	SEM VARIO II DN in mm	Länge in mm
 24 113 322-80	4/110	24 113 322-080	126,10	80	113	175
	4/111	24 130 322-080	163,20	80	130	175
	4/112	24 113 322-100	123,80	100	113	175
	4/113	24 130 322-100	168,90	100	130	175
	4/114	24 113 322-110	87,20	110	113	175
	4/115	24 130 322-110	115,30	110	130	175
	4/116	24 113 322-120	133,40	120	113	175
	4/117	24 130 322-120	90,20	120	130	175
	4/118	24 150 322-120	140,70	120	150	175
	4/119	24 160 322-120	182,50	120	160	175
	4/120	24 113 322-130	121,80	130	113	175
	4/121	24 130 322-130	81,90	130	130	175
 24 150 322-150	4/122	24 150 322-130	115,20	130	150	175
	4/123	24 160 322-130	130,80	130	160	175
	4/124	24 130 322-150	135,90	150	130	175
	4/125	24 150 322-150	96,60	150	150	175
	4/126	24 160 322-150	118,30	150	160	175
	4/127	24 180 322-150	121,70	150	180	175
	4/128	24 200 322-150	152,60	150	200	175

## Übergang Rauchrohr Wanddicke max. 2,0 mm auf SEM VARIO II

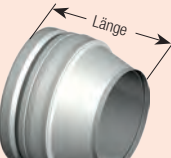
	Pos.	Art.-Nr.	Preis in EUR	ø Rauchrohr in mm max. Wanddicke 2,0 mm	SEM VARIO II DN in mm	Länge in mm
 24 180 322-180	4/129	24 150 322-160	201,40	160	150	175
	4/130	24 160 322-160	103,10	160	160	175
	4/131	24 180 322-160	122,30	160	180	175
	4/132	24 200 322-160	213,50	160	200	175
	4/133	24 150 322-180	206,40	180	150	175
	4/134	24 160 322-180	219,30	180	160	175
	4/135	24 180 322-180	101,50	180	180	175
	4/136	24 200 322-180	124,90	180	200	175
	4/137	24 250 322-180	233,40	180	250	175
	4/138	24 300 322-180	271,50	180	300	175
	4/139	24 180 322-200	129,20	200	180	175
	4/140	24 200 322-200	128,00	200	200	175
	4/141	24 250 322-200	auf Anfrage	200	250	175
	4/142	24 300 322-200	auf Anfrage	200	300	175
	4/143	24 200 322-225	auf Anfrage	225	200	175
	4/144	24 250 322-225	auf Anfrage	225	250	175
	4/145	24 300 322-225	auf Anfrage	225	300	175
	4/146	24 300 322-250	auf Anfrage	250	300	175
	4/147	24 250 322-300	auf Anfrage	300	250	175
	4/148	24 300 322-300	auf Anfrage	300	300	175